

Plot file version 1 created 26-APR-2010 13:25:10

3C273 EA043.UVDATA.1

Freq = 1.6015 GHz, Bw = 16.000 MH No calibration applied and no bandpass applied

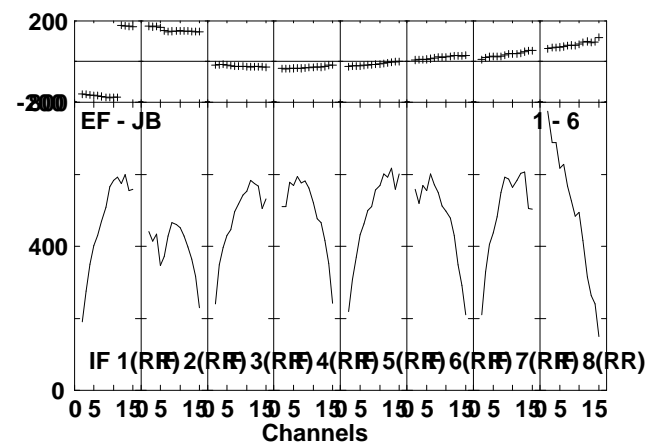
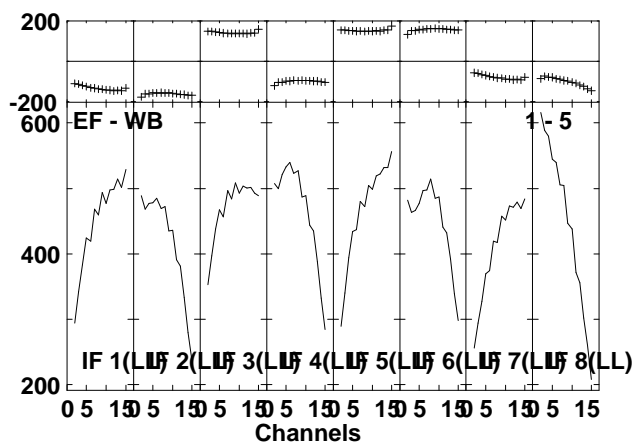
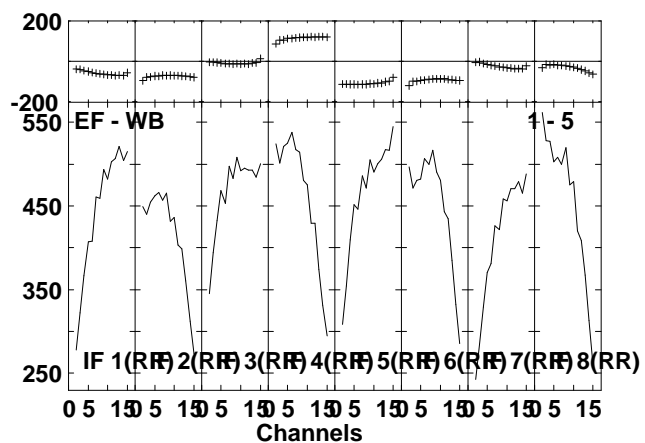
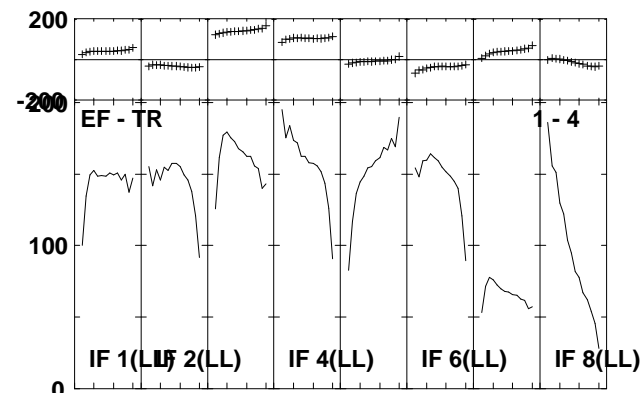
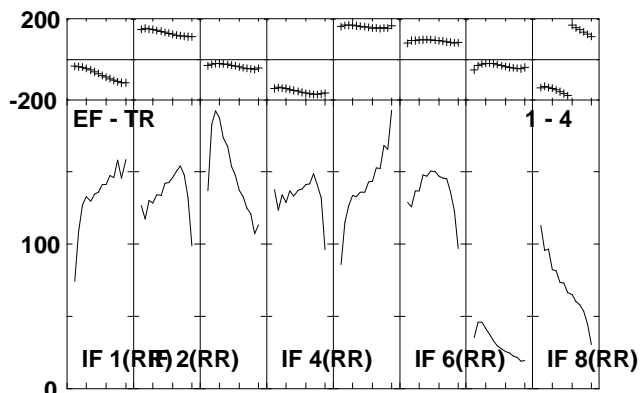
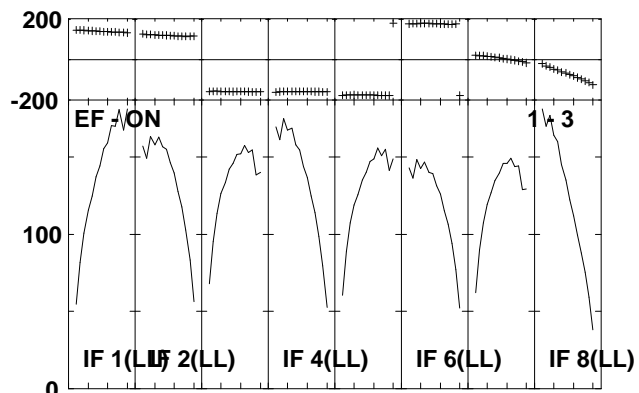
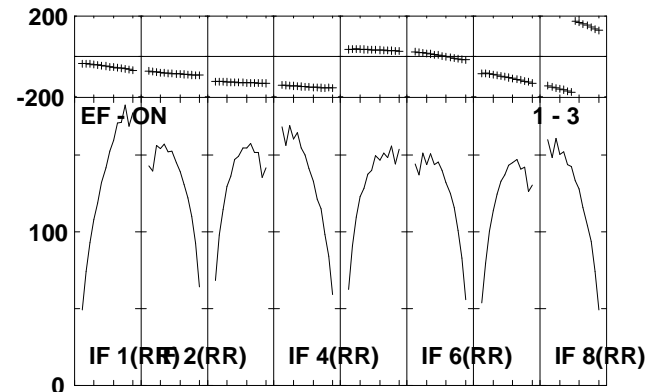
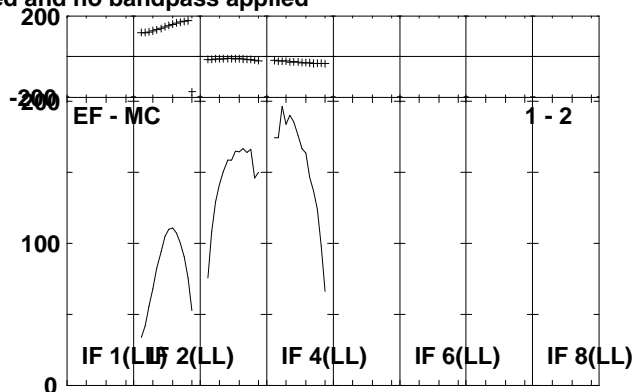
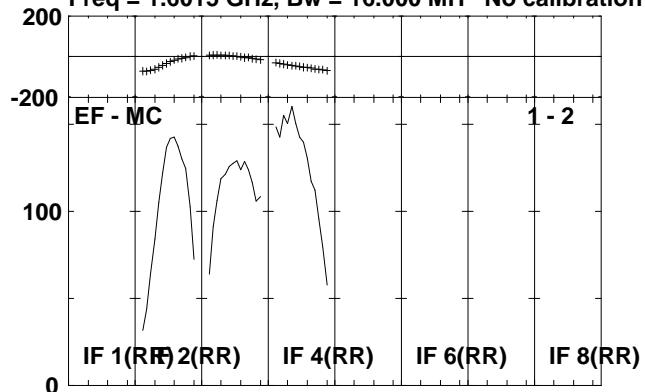

Lower frame: Milli Ampl Jy Top frame: Phas deg
Scalar averaged cross-power spectrum Several baselines displayed
Timerange: 00/18:10:22 to 00/18:19:18

Plot file version 2 created 26-APR-2010 13:25:11
 3C273 EA043.UVDATA.1

Freq = 1.6015 GHz, Bw = 16.000 MH No calibration applied and no bandpass applied

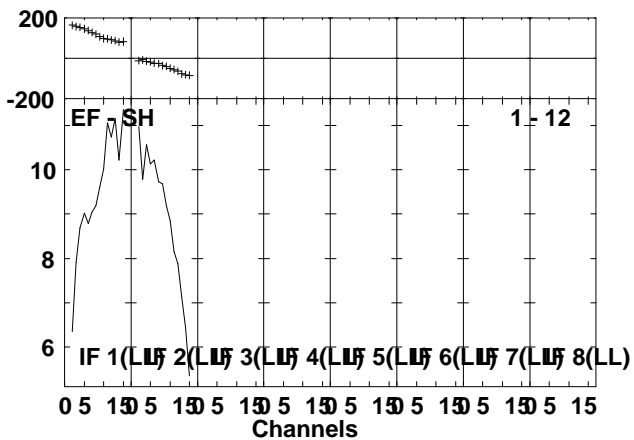
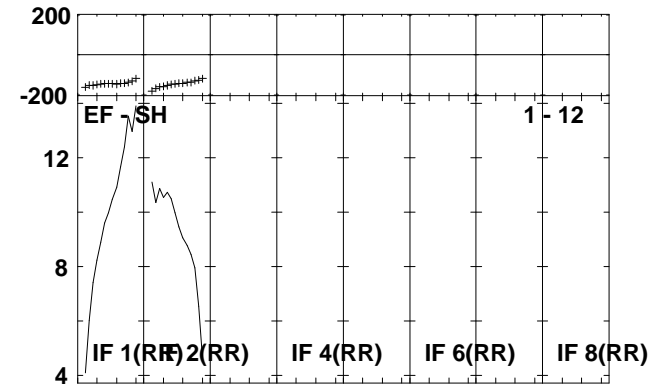
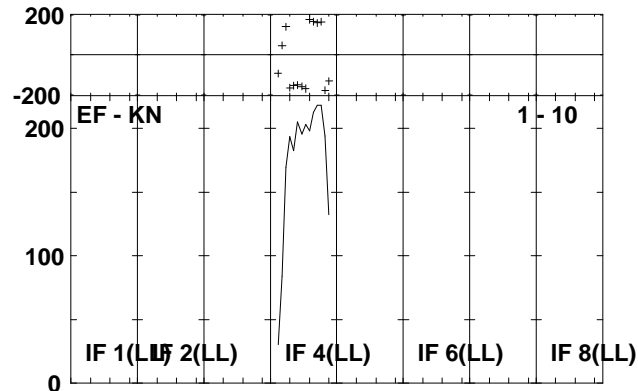
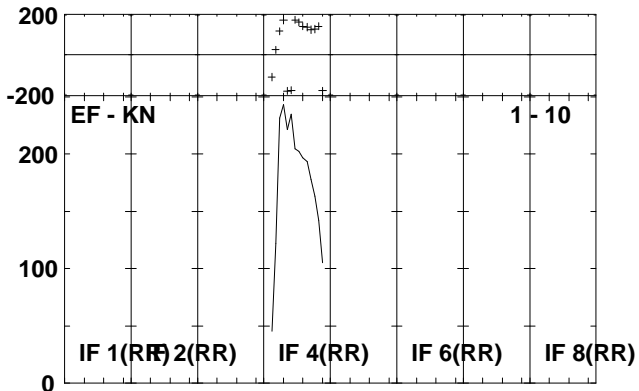
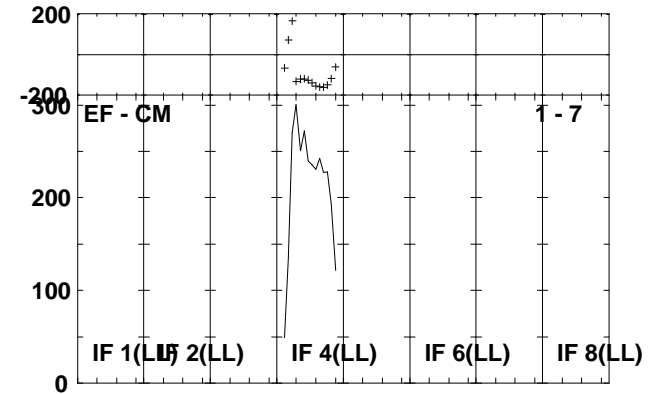
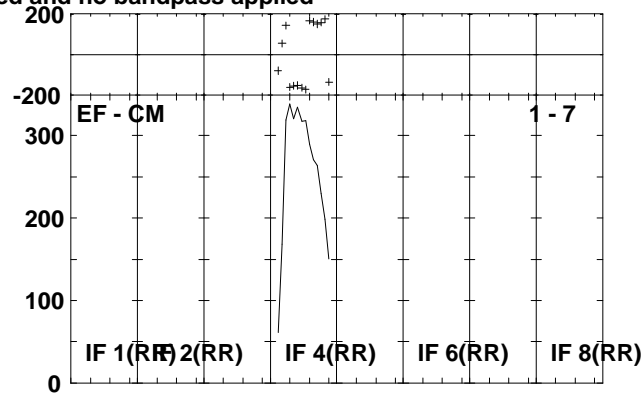
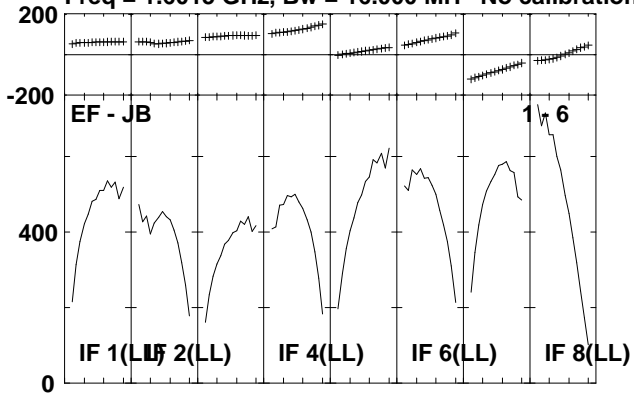

Lower frame: Milli Ampl Jy Top frame: Phas deg
 Scalar averaged cross-power spectrum Several baselines displayed
 Timerange: 00/18:10:22 to 00/18:19:18

Plot file version 3 created 26-APR-2010 13:25:15

J1246-07 EA043.UVDATA.1

Freq = 1.6015 GHz, Bw = 16.000 MH No calibration applied and no bandpass applied

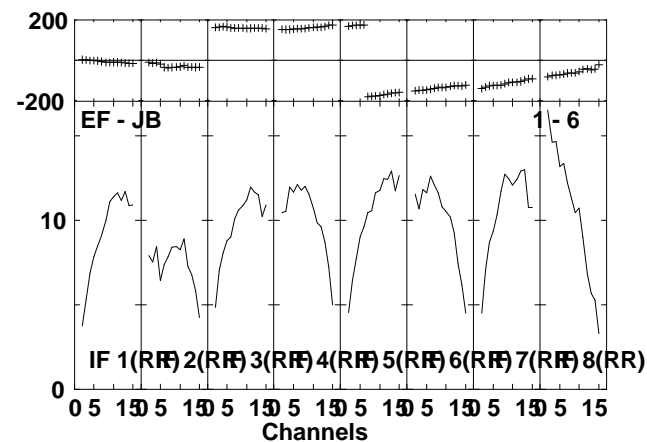
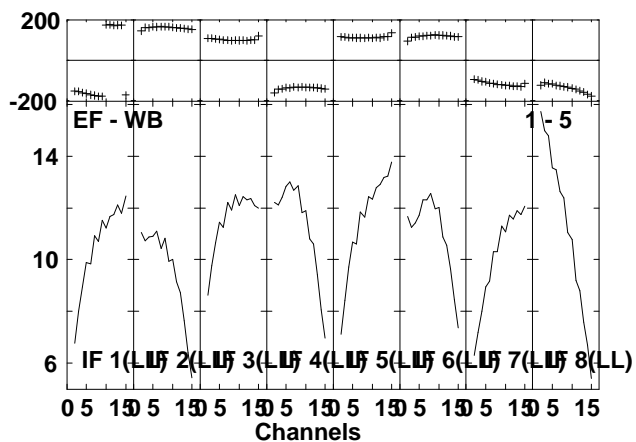
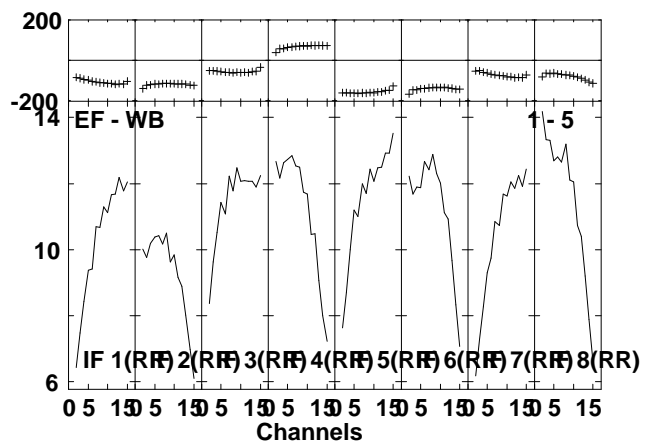
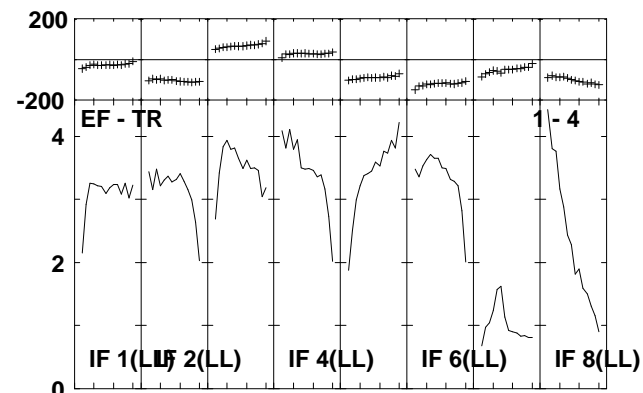
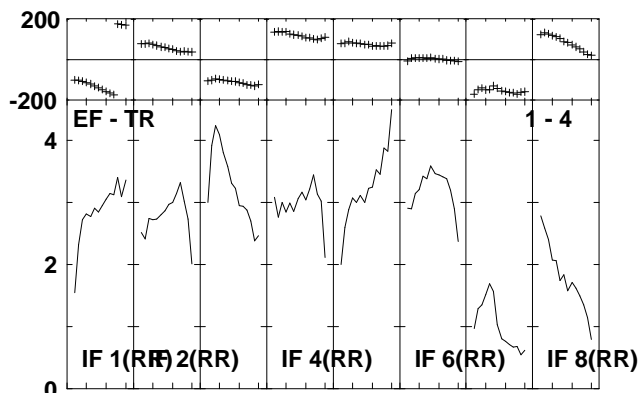
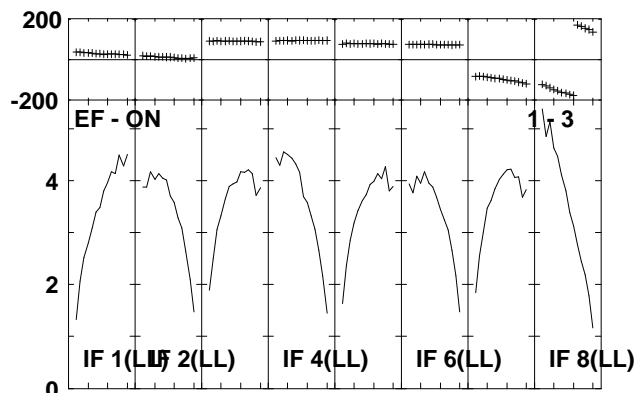
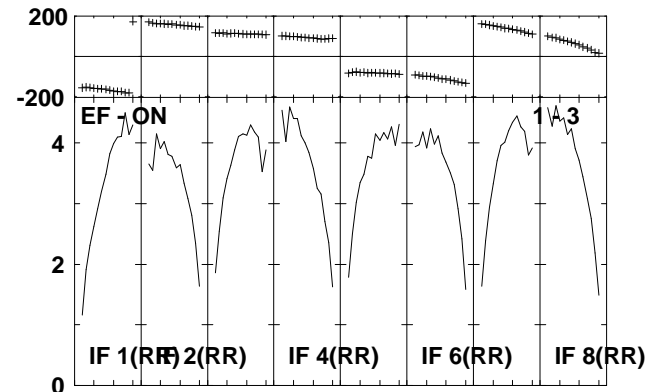
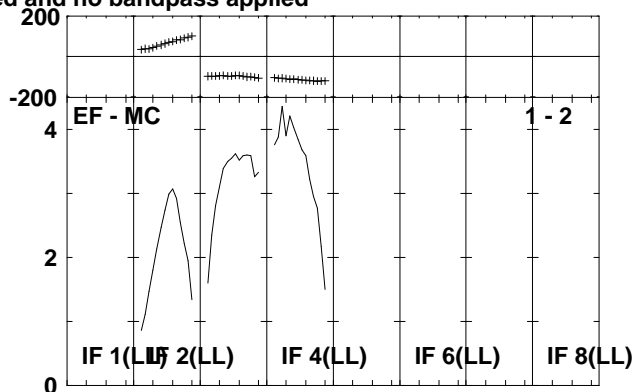
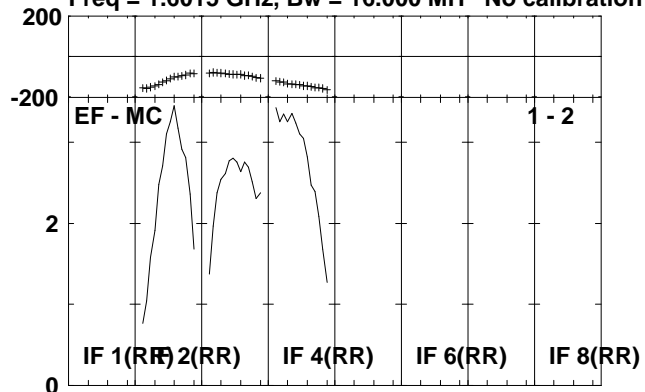

Lower frame: Milli Ampl Jy Top frame: Phas deg
Scalar averaged cross-power spectrum Several baselines displayed
Timerange: 00/18:21:22 to 00/18:27:18

Plot file version 4 created 26-APR-2010 13:25:16
 J1246-07 EA043.UVDATA.1

Freq = 1.6015 GHz, Bw = 16.000 MH No calibration applied and no bandpass applied

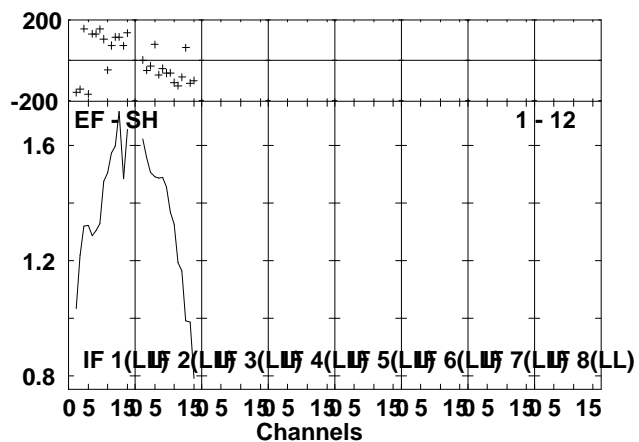
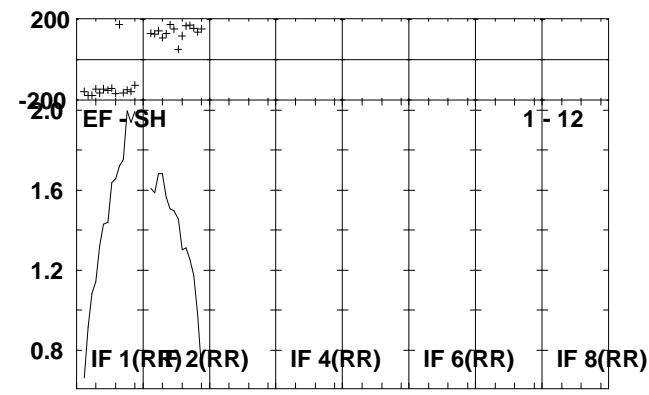
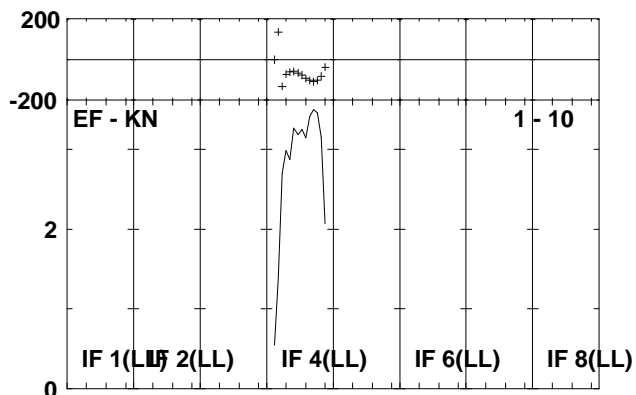
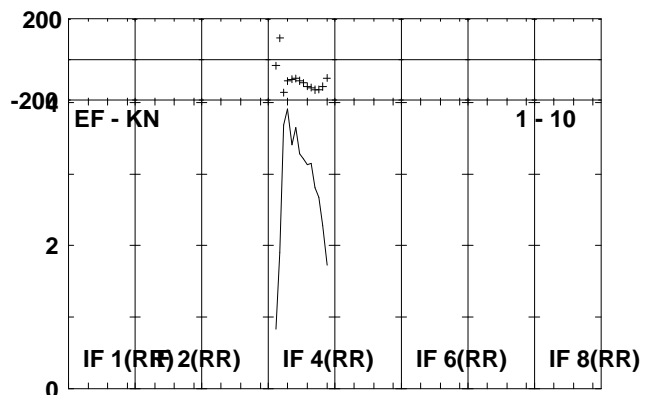
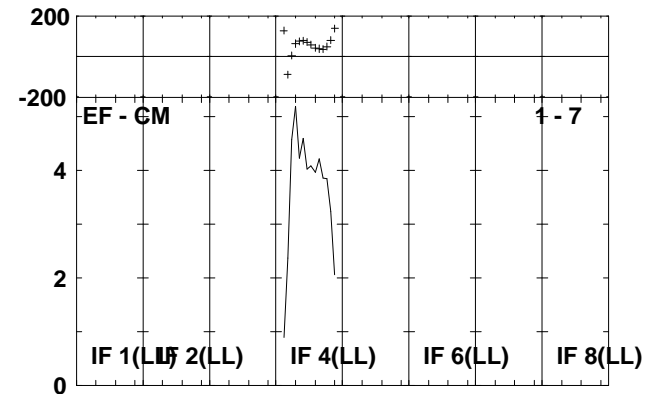
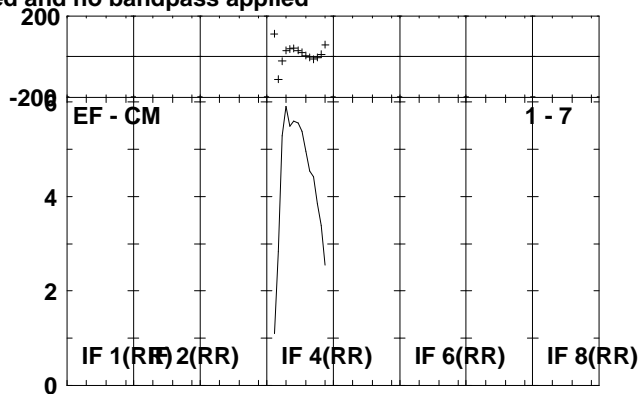
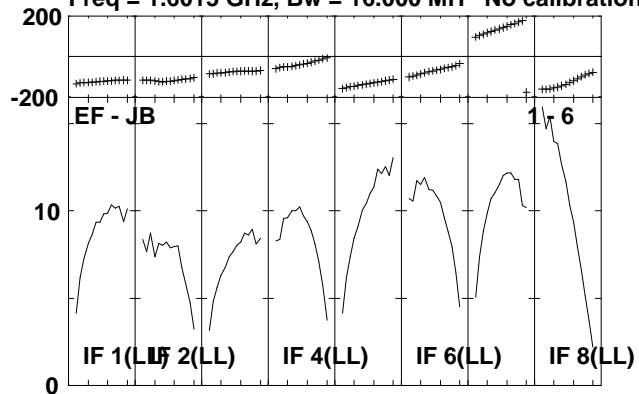

Lower frame: Milli Ampl Jy Top frame: Phas deg
 Scalar averaged cross-power spectrum Several baselines displayed
 Timerange: 00/18:21:22 to 00/18:27:18

Plot file version 5 created 26-APR-2010 13:25:18

HCG62 EA043.UVDATA.1

Freq = 1.6015 GHz, Bw = 16.000 MH No calibration applied and no bandpass applied

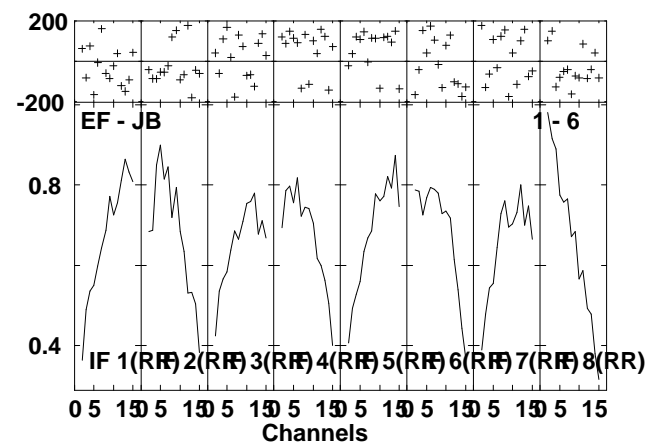
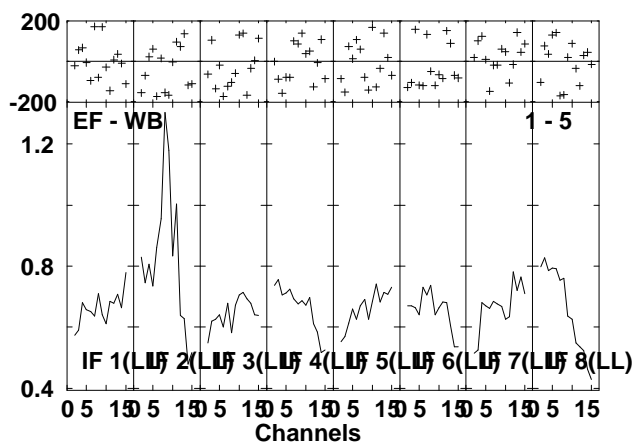
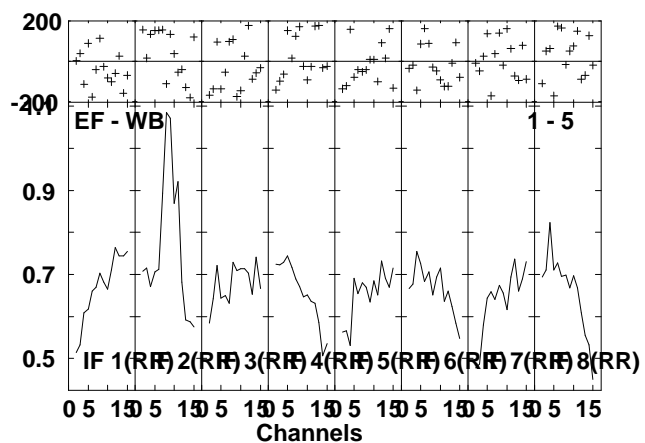
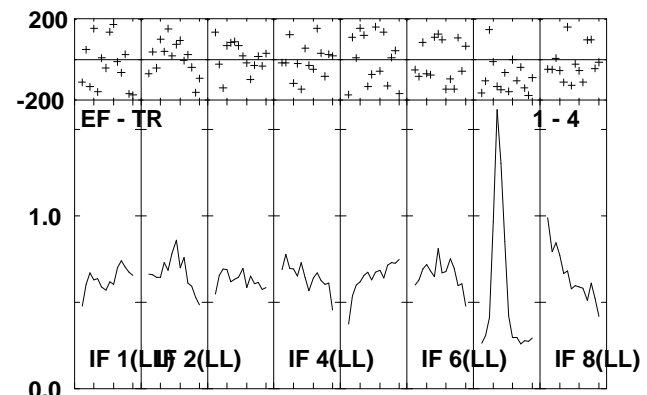
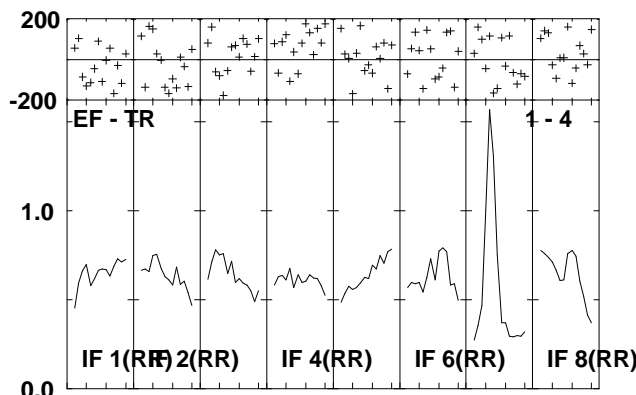
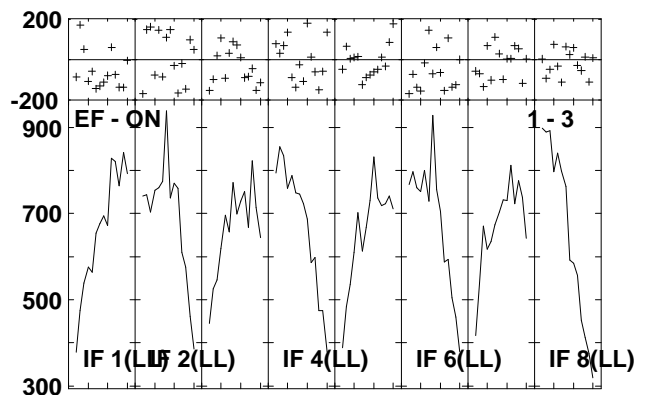
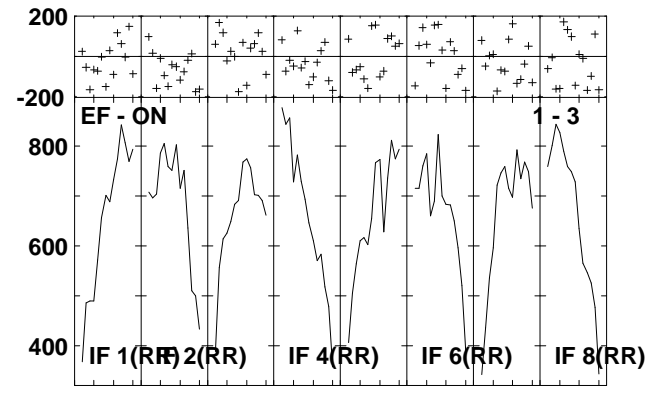
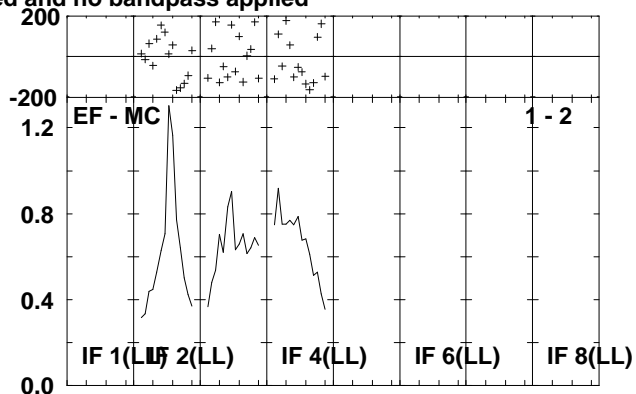
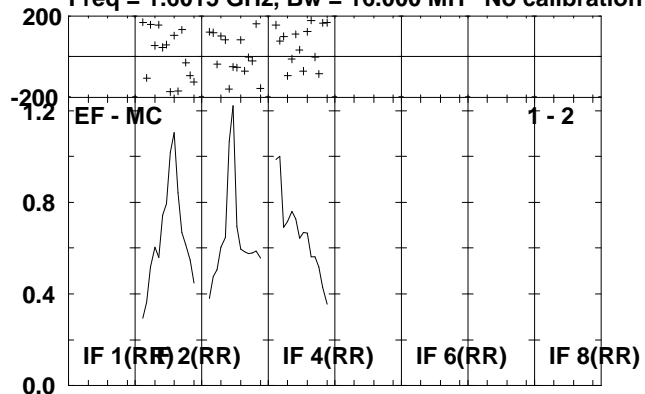

Lower frame: Milli Ampl Jy Top frame: Phas deg
Scalar averaged cross-power spectrum Several baselines displayed
Timerange: 00/18:28:22 to 00/18:35:18

Plot file version 6 created 26-APR-2010 13:25:20

HCG62 EA043.UVDATA.1

Freq = 1.6015 GHz, Bw = 16.000 MH No calibration applied and no bandpass applied

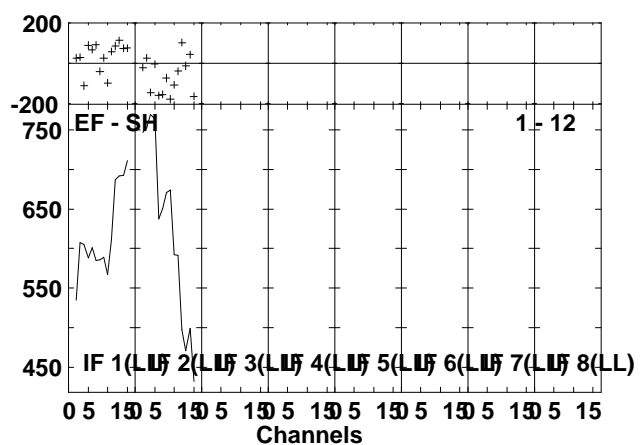
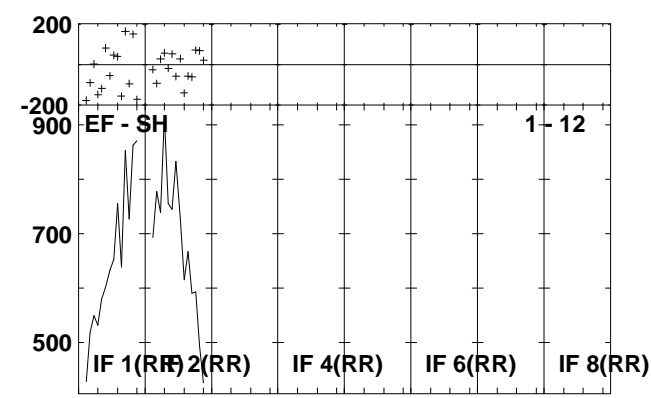
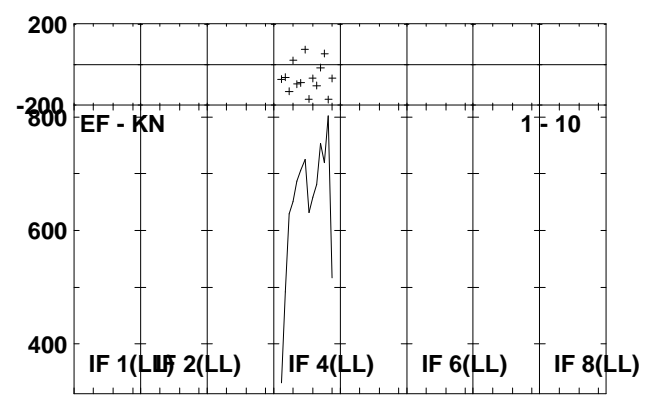
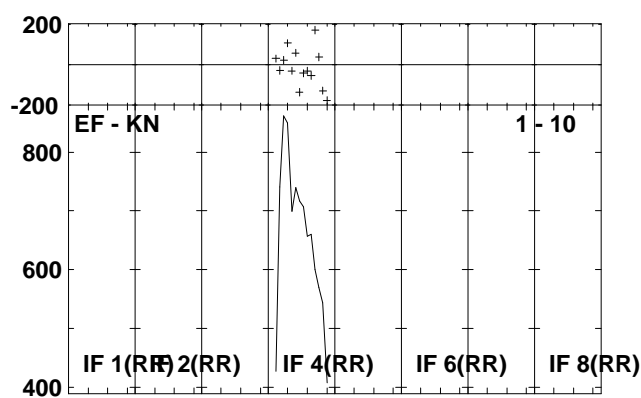
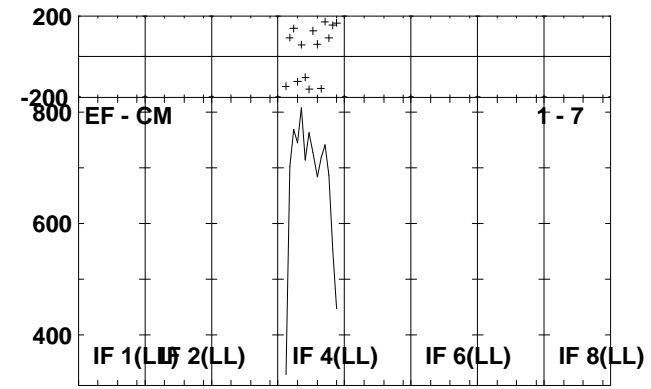
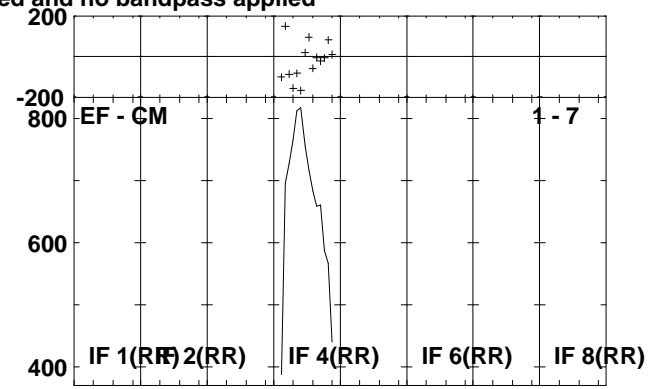
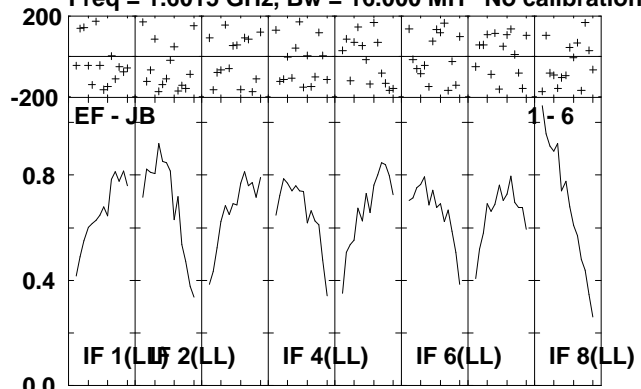

Lower frame: Milli Ampl Jy Top frame: Phas deg
Scalar averaged cross-power spectrum Several baselines displayed
Timerange: 00/18:28:22 to 00/18:35:18

Plot file version 7 created 26-APR-2010 13:25:22

J1246-07 EA043.UVDATA.1

Freq = 1.6015 GHz, Bw = 16.000 MH No calibration applied and no bandpass applied

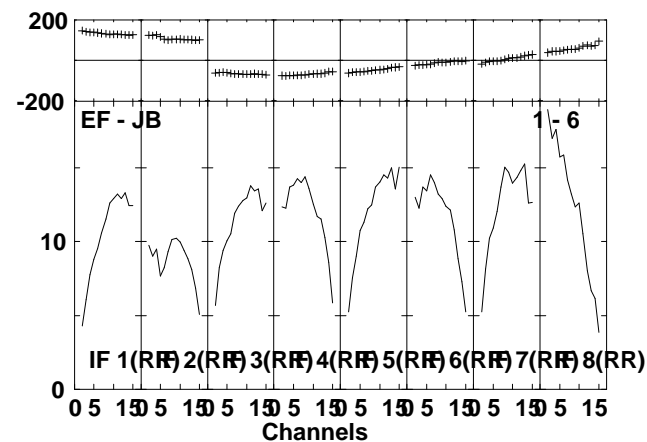
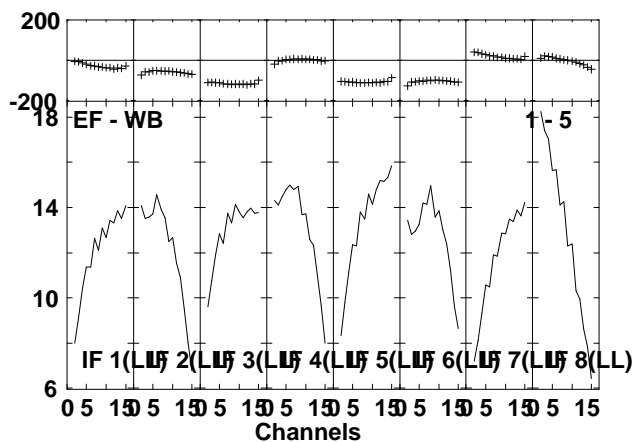
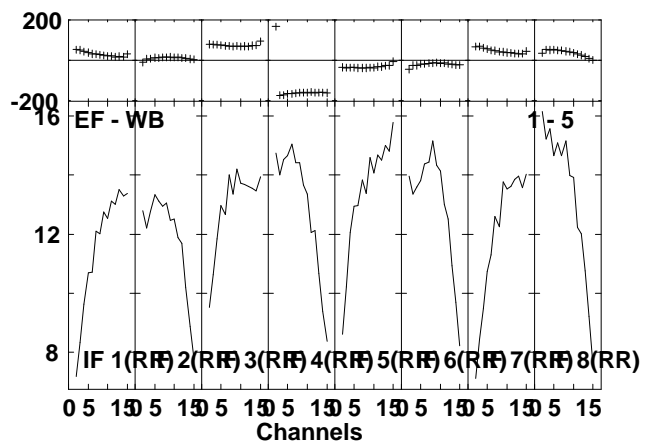
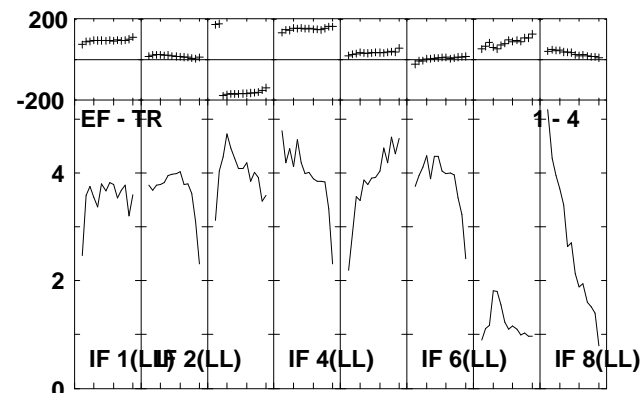
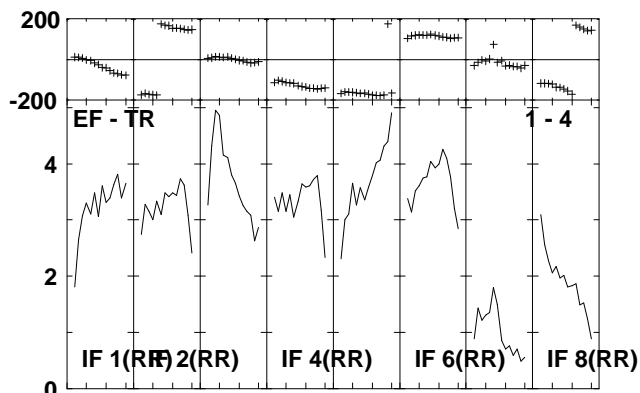
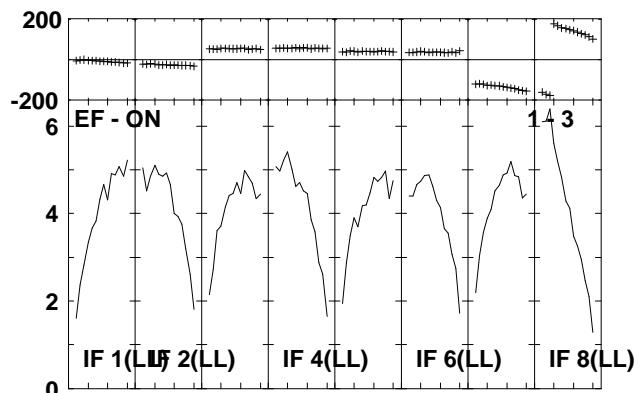
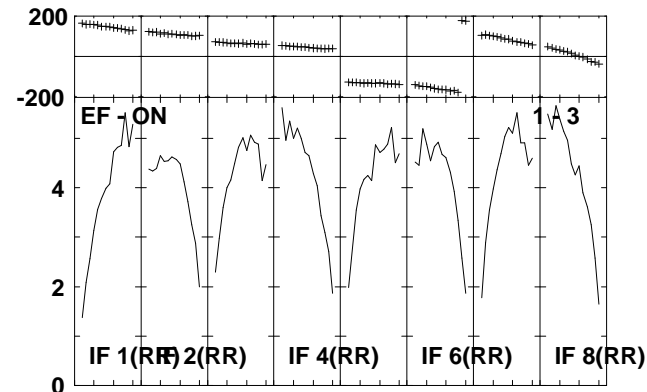
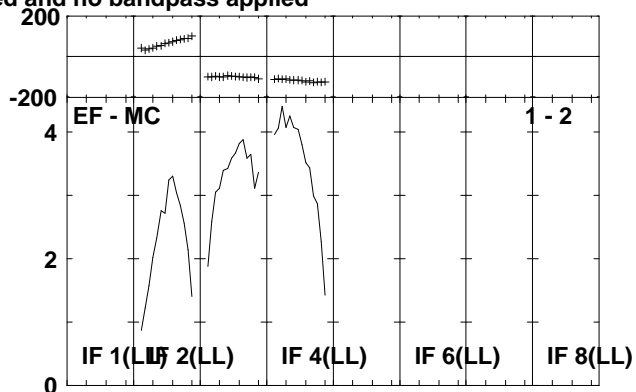
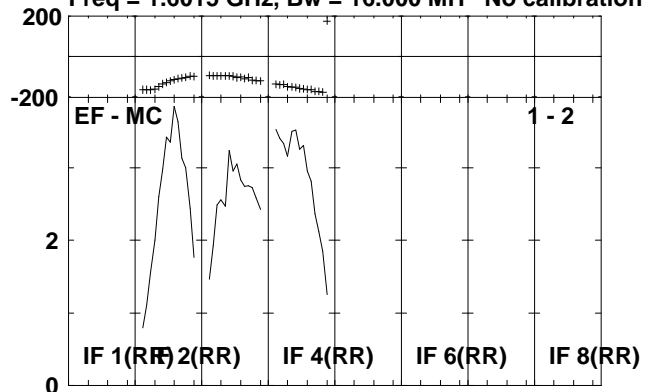

Lower frame: Milli Ampl Jy Top frame: Phas deg
Scalar averaged cross-power spectrum Several baselines displayed
Timerange: 00/18:35:22 to 00/18:37:18

Plot file version 8 created 26-APR-2010 13:25:23

J1246-07 EA043.UVDATA.1

Freq = 1.6015 GHz, Bw = 16.000 MH No calibration applied and no bandpass applied

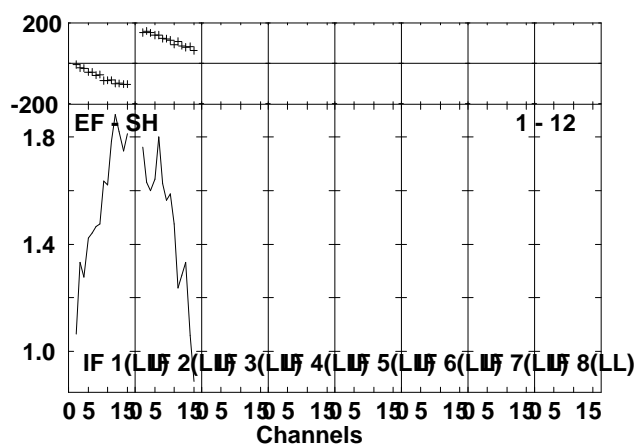
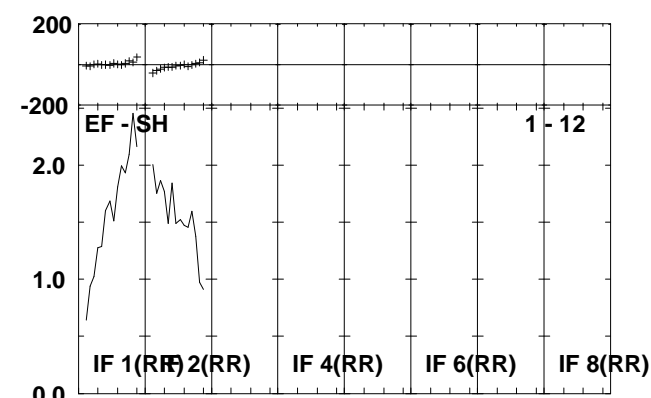
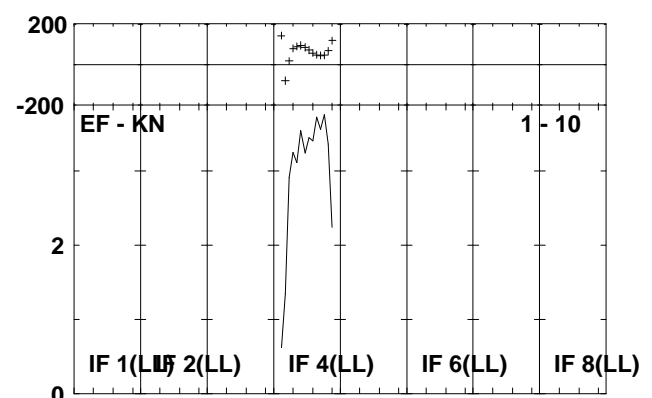
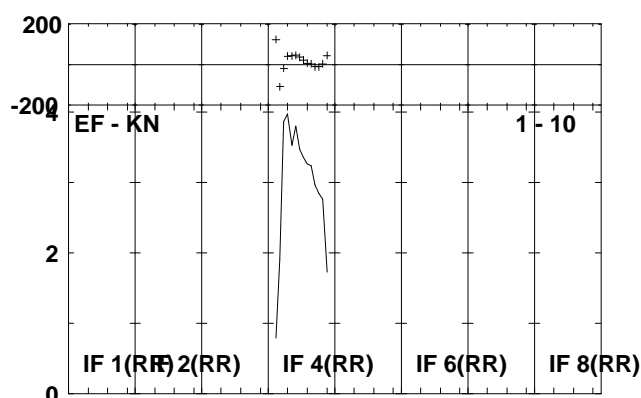
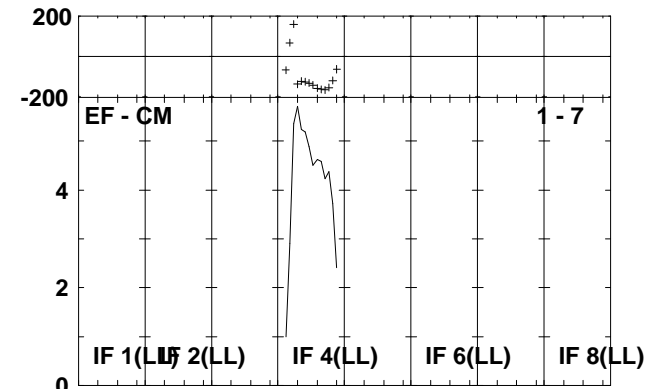
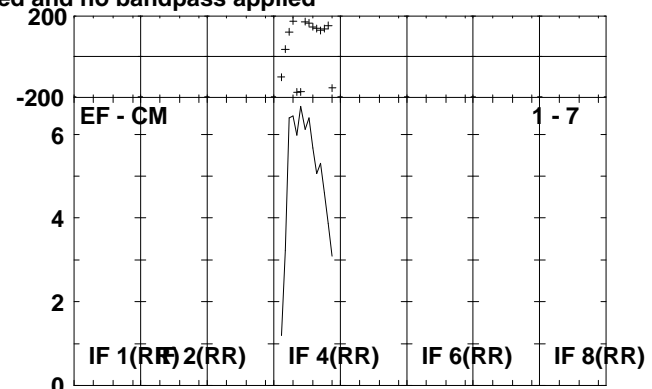
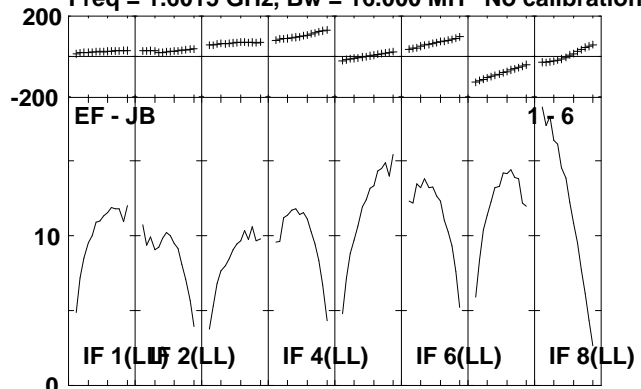

Lower frame: Milli Ampl Jy Top frame: Phas deg
Scalar averaged cross-power spectrum Several baselines displayed
Timerange: 00/18:35:22 to 00/18:37:18

Plot file version 9 created 26-APR-2010 13:25:24

HCG62 EA043.UVDATA.1

Freq = 1.6015 GHz, Bw = 16.000 MH No calibration applied and no bandpass applied

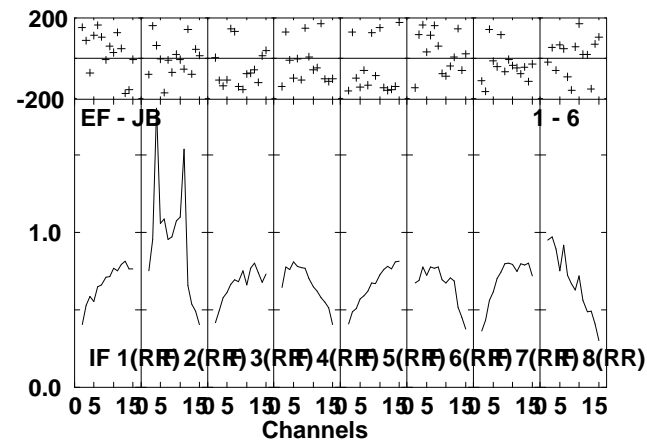
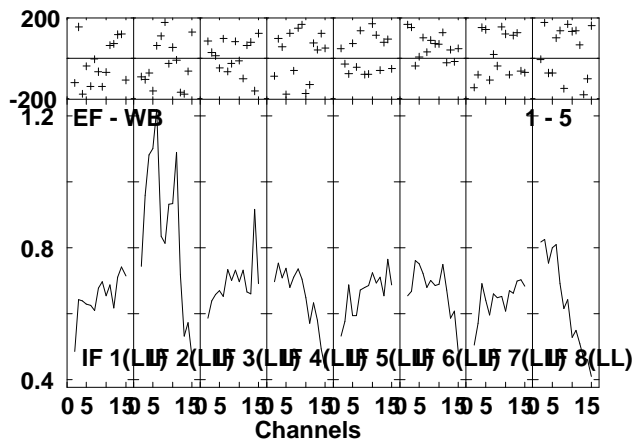
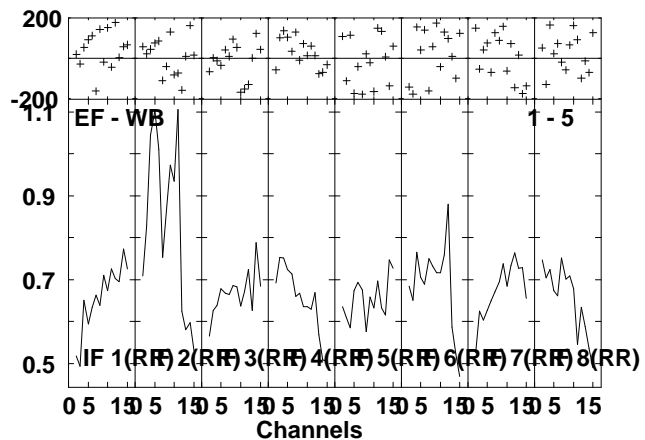
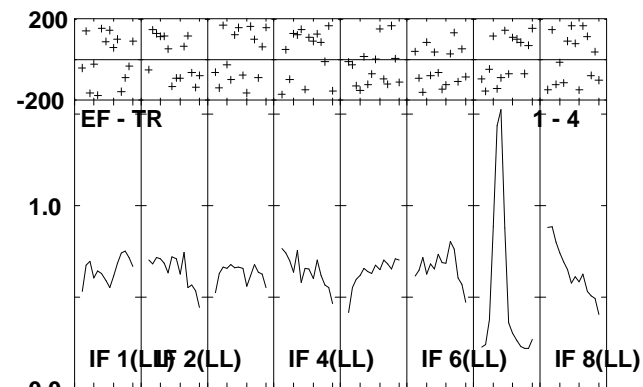
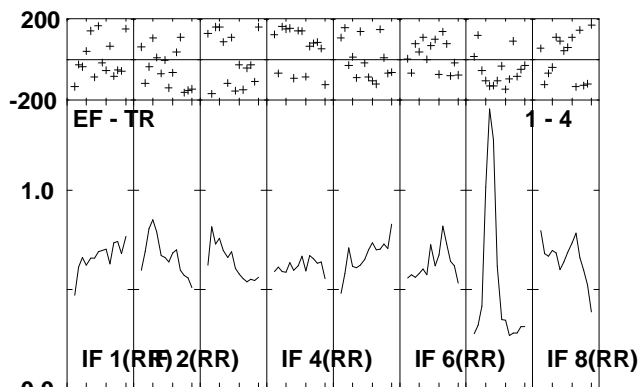
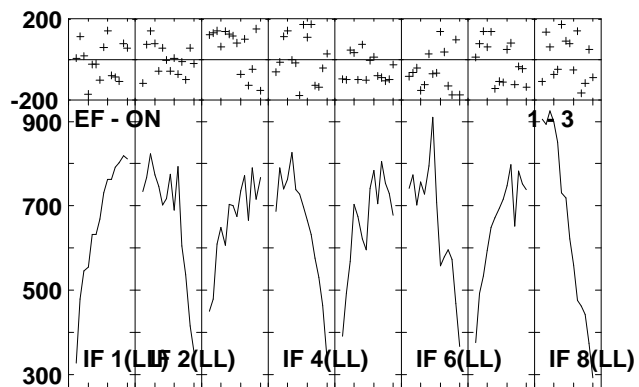
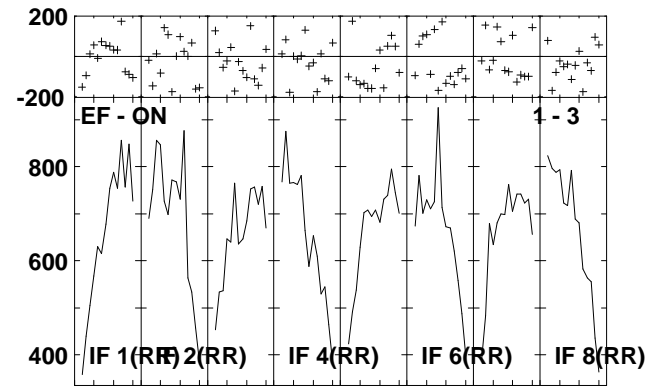
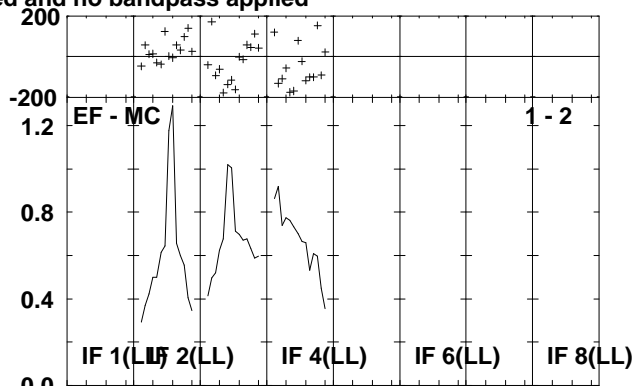
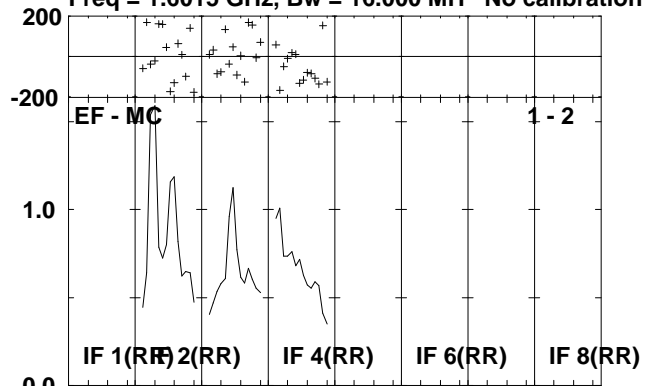

Lower frame: Milli Ampl Jy Top frame: Phas deg
Scalar averaged cross-power spectrum Several baselines displayed
Timerange: 00/18:38:22 to 00/18:45:18

Plot file version 10 created 26-APR-2010 13:25:25

HCG62 EA043.UVDATA.1

Freq = 1.6015 GHz, Bw = 16.000 MH No calibration applied and no bandpass applied

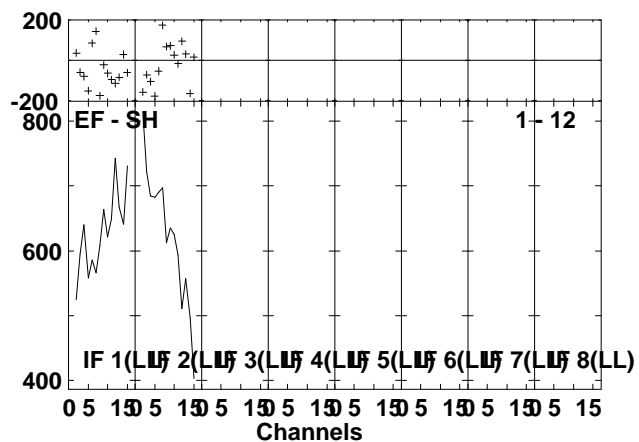
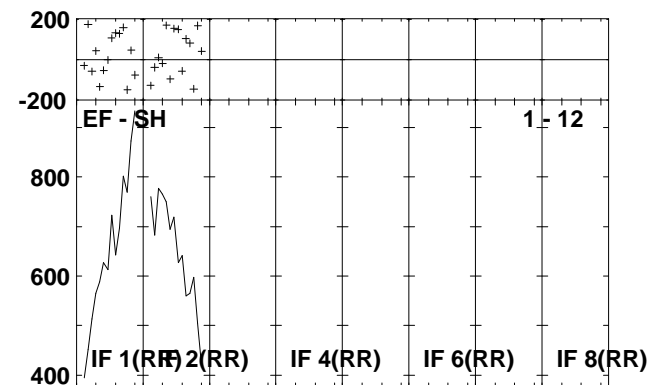
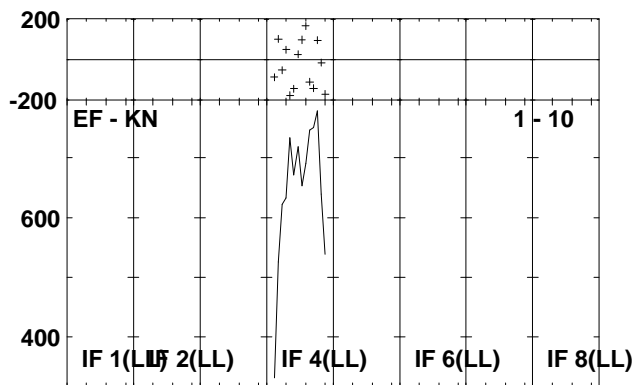
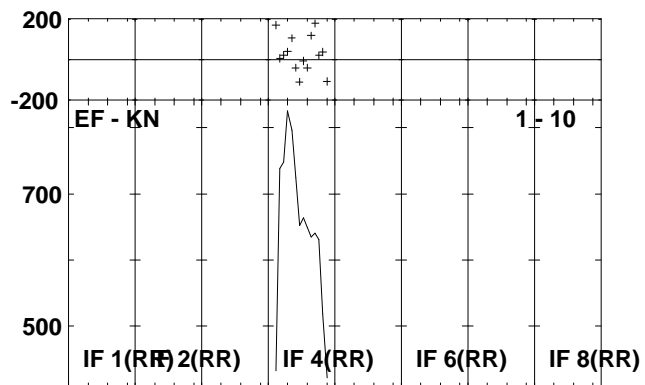
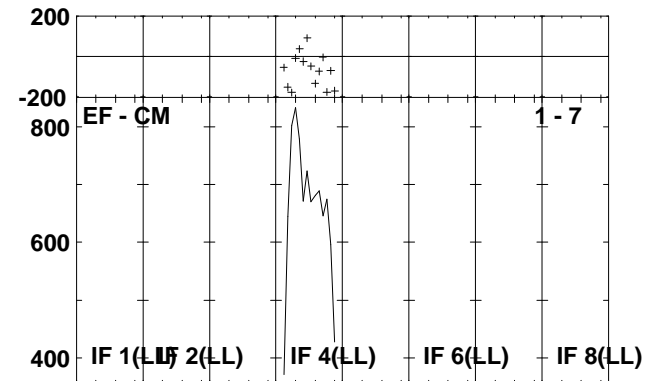
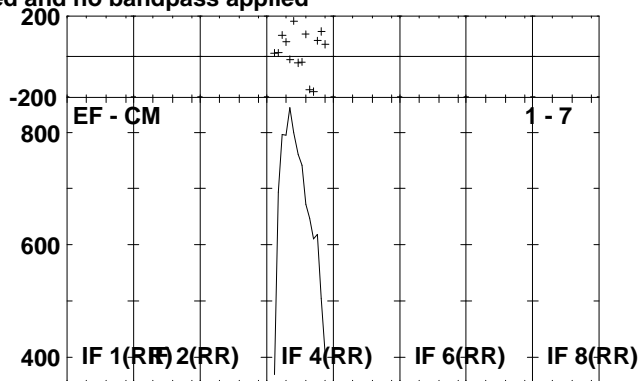
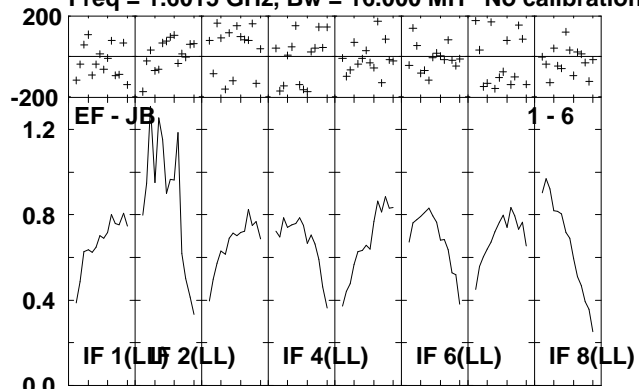

Lower frame: Milli Ampl Jy Top frame: Phas deg
Scalar averaged cross-power spectrum Several baselines displayed
Timerange: 00/18:38:22 to 00/18:45:18

Plot file version 11 created 26-APR-2010 13:25:27

J1246-07 EA043.UVDATA.1

Freq = 1.6015 GHz, Bw = 16.000 MH No calibration applied and no bandpass applied

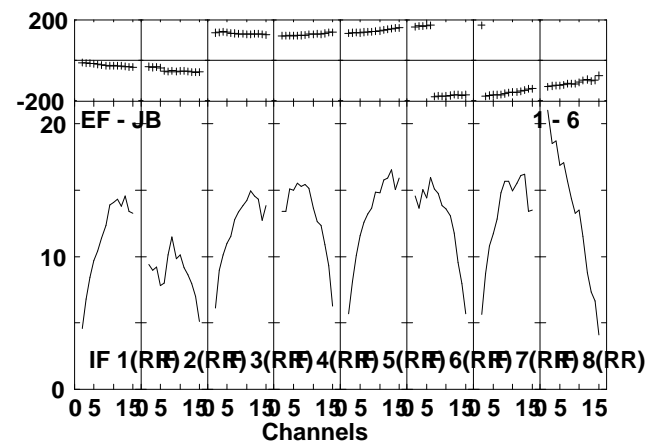
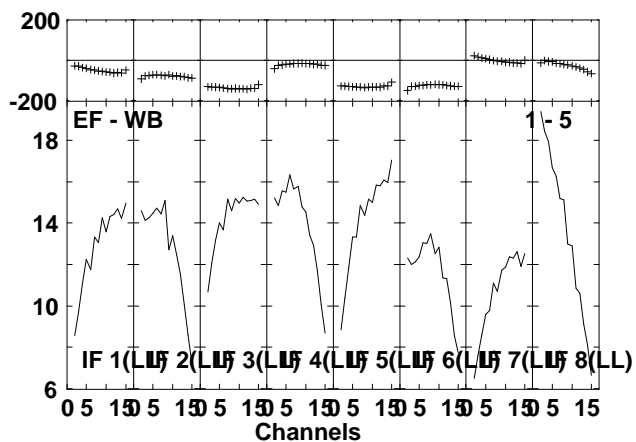
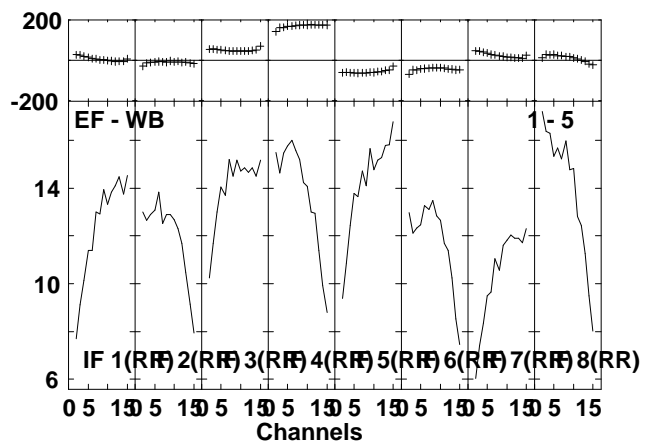
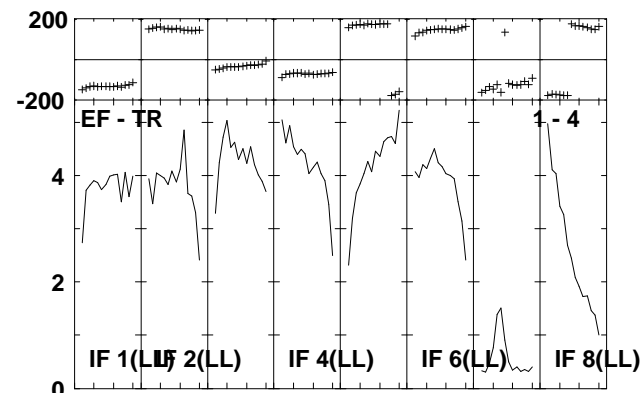
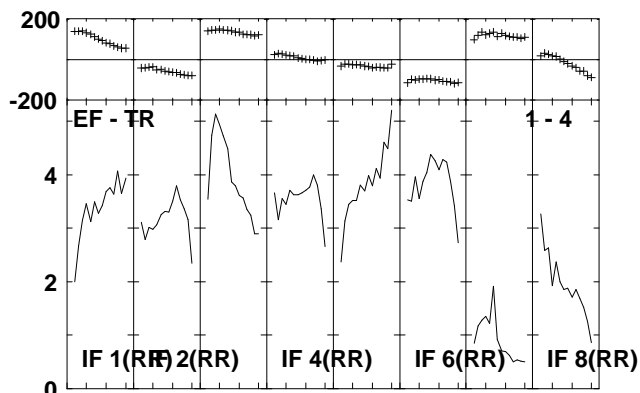
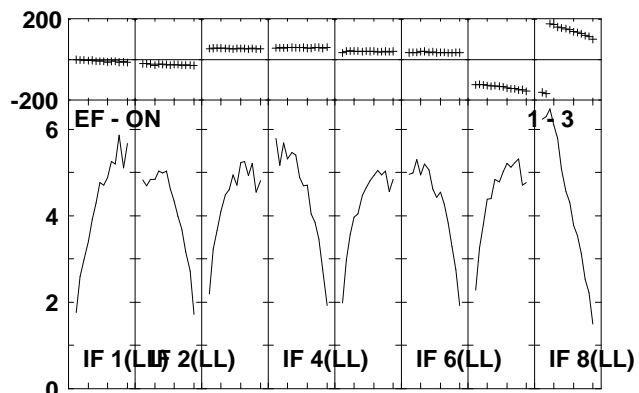
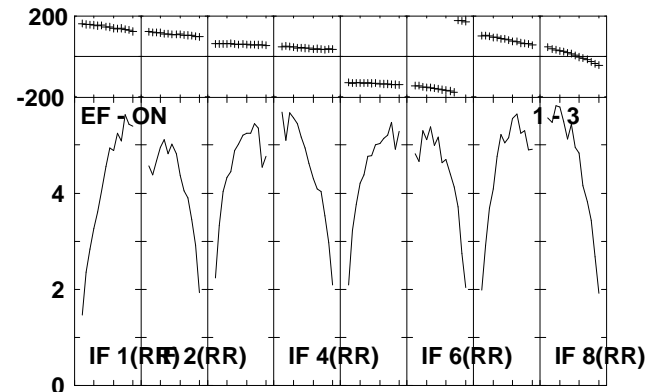
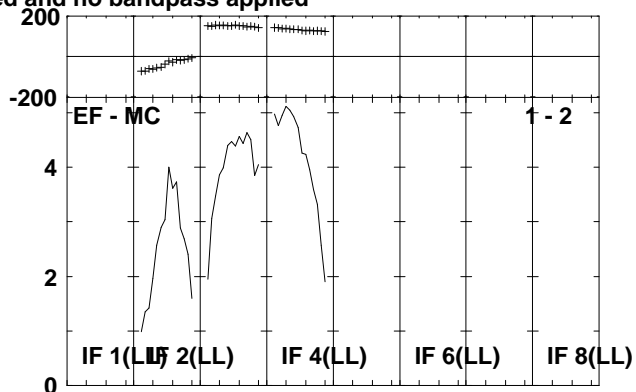
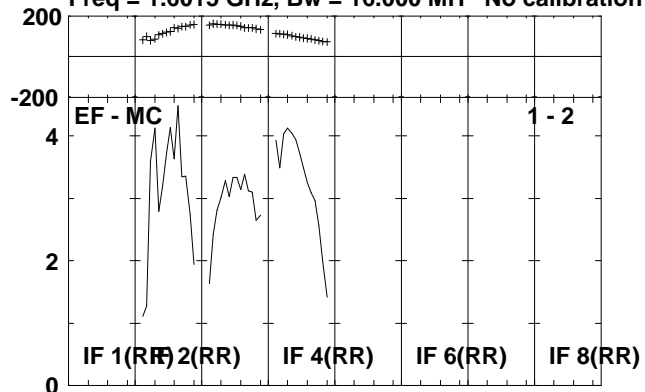

Lower frame: Milli Ampl Jy Top frame: Phas deg
Scalar averaged cross-power spectrum Several baselines displayed
Timerange: 00/18:45:22 to 00/18:47:18

Plot file version 12 created 26-APR-2010 13:25:28

J1246-07 EA043.UVDATA.1

Freq = 1.6015 GHz, Bw = 16.000 MH No calibration applied and no bandpass applied

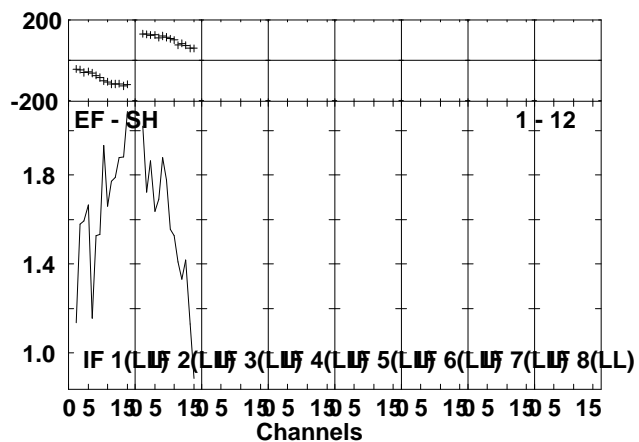
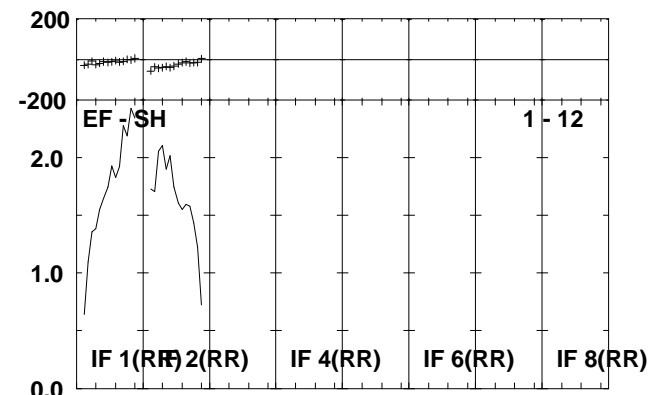
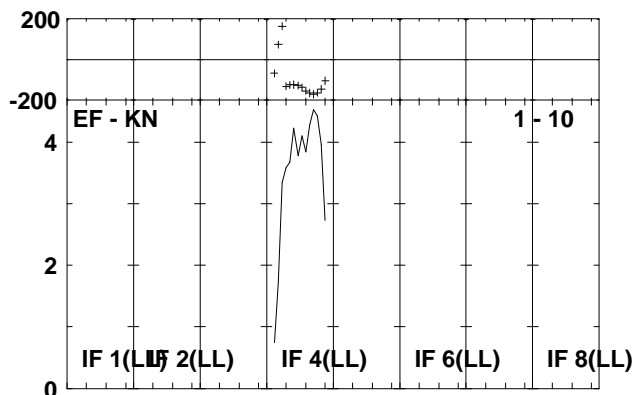
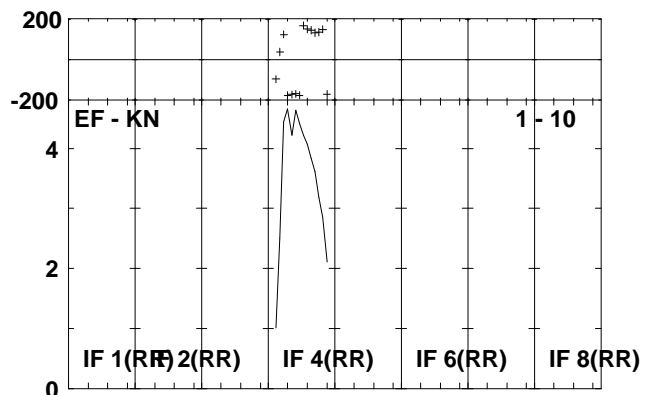
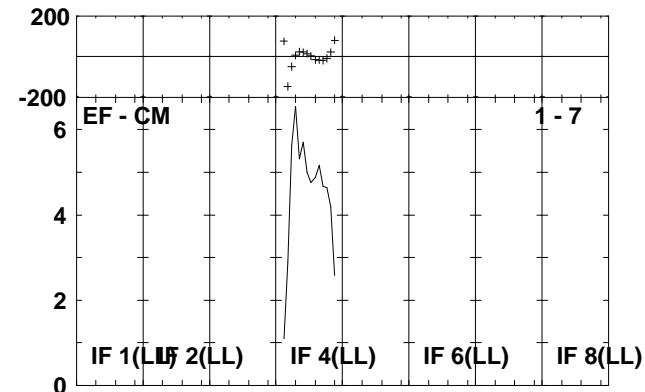
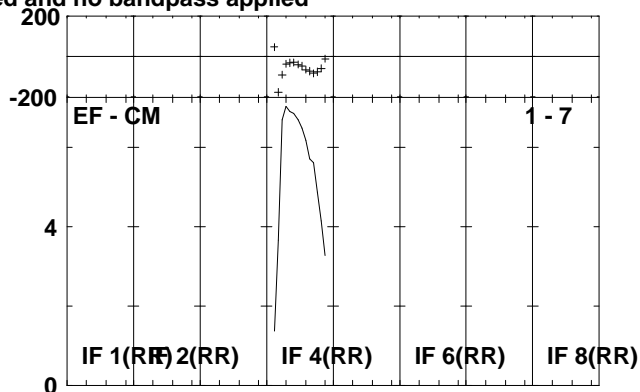
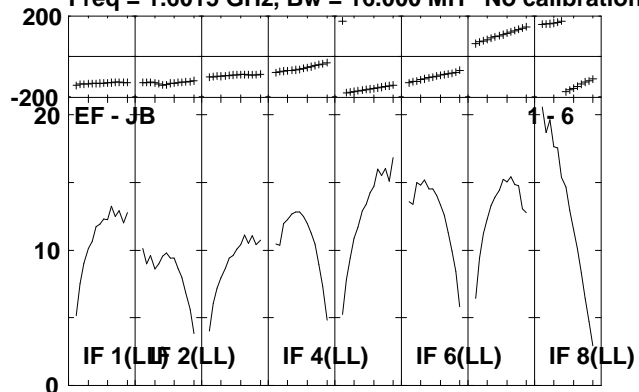

Lower frame: Milli Ampl Jy Top frame: Phas deg
Scalar averaged cross-power spectrum Several baselines displayed
Timerange: 00/18:45:22 to 00/18:47:18

Plot file version 13 created 26-APR-2010 13:25:29

HCG62 EA043.UVDATA.1

Freq = 1.6015 GHz, Bw = 16.000 MH No calibration applied and no bandpass applied

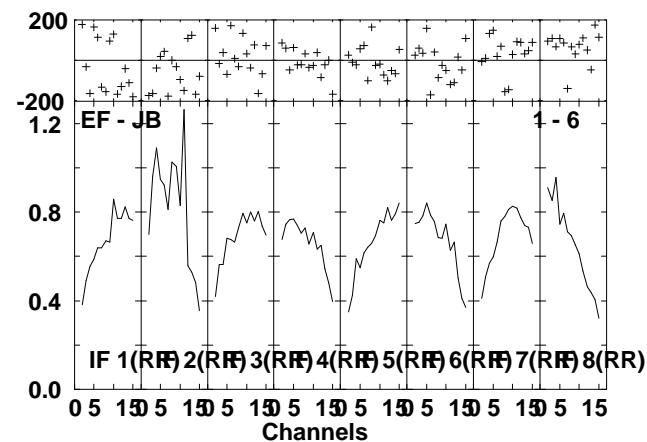
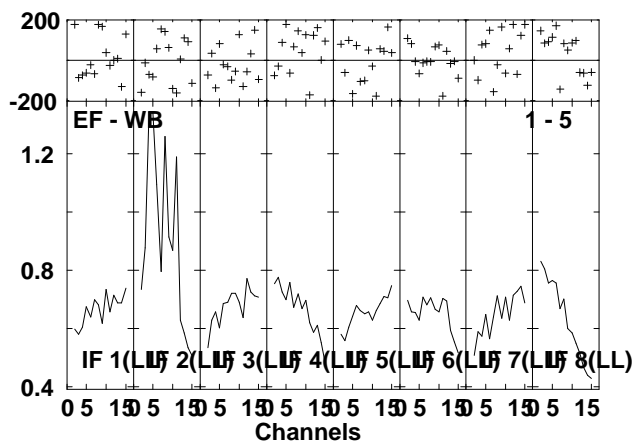
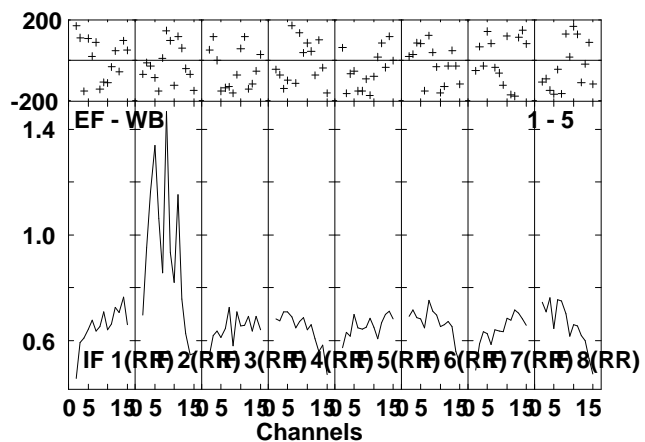
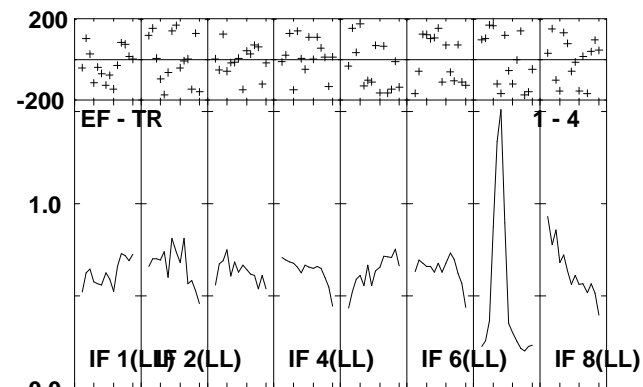
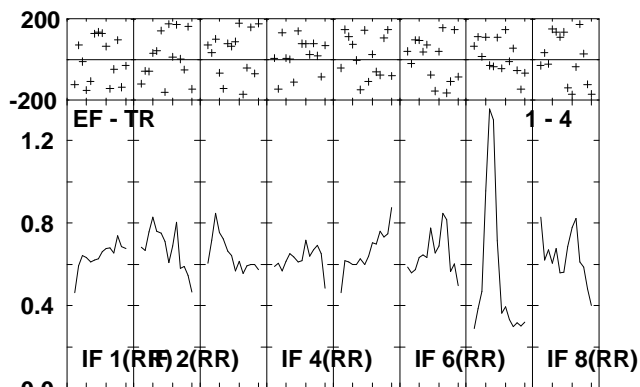
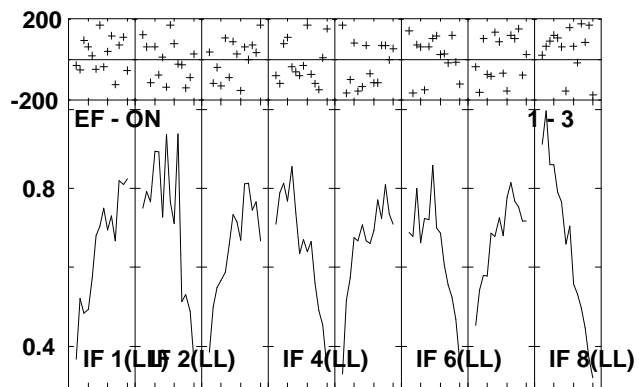
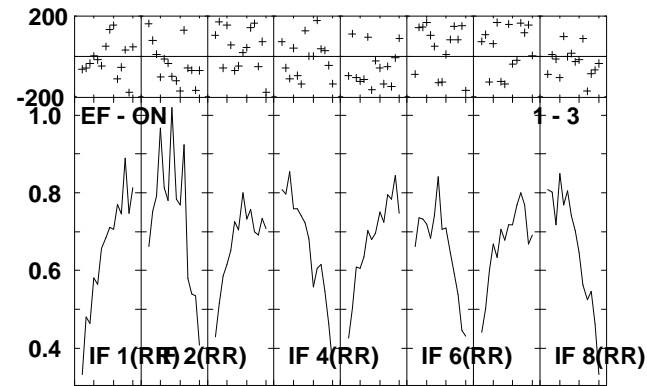
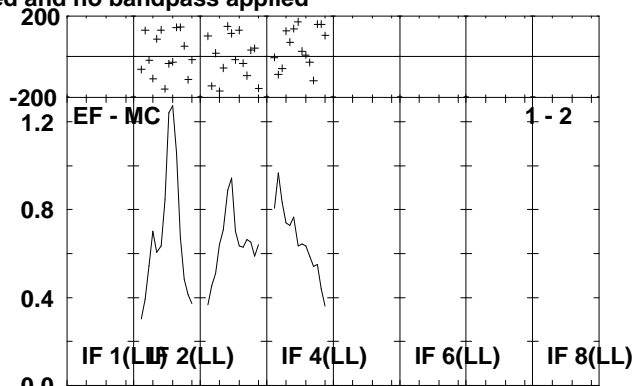
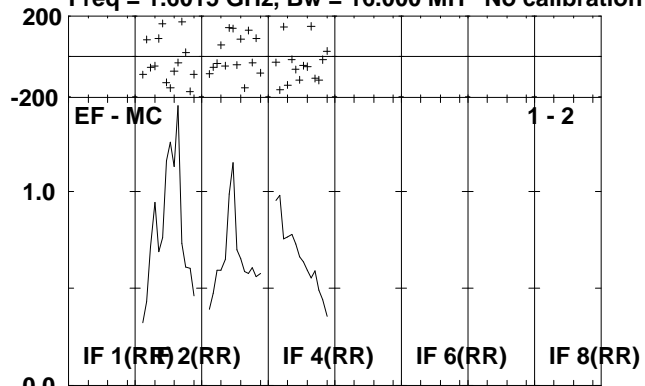

Lower frame: Milli Ampl Jy Top frame: Phas deg
Scalar averaged cross-power spectrum Several baselines displayed
Timerange: 00/18:48:22 to 00/18:55:18

Plot file version 14 created 26-APR-2010 13:25:30

HCG62 EA043.UVDATA.1

Freq = 1.6015 GHz, Bw = 16.000 MH No calibration applied and no bandpass applied

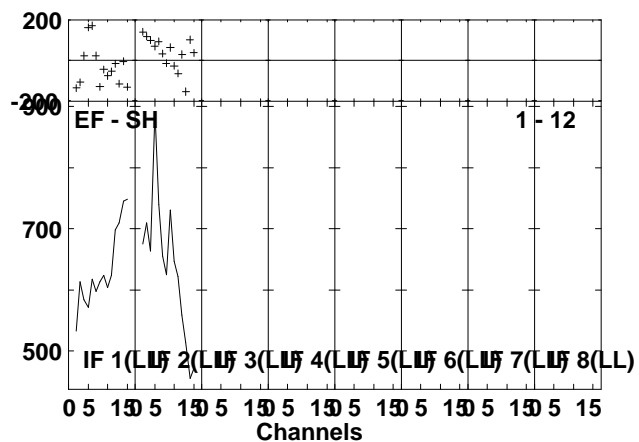
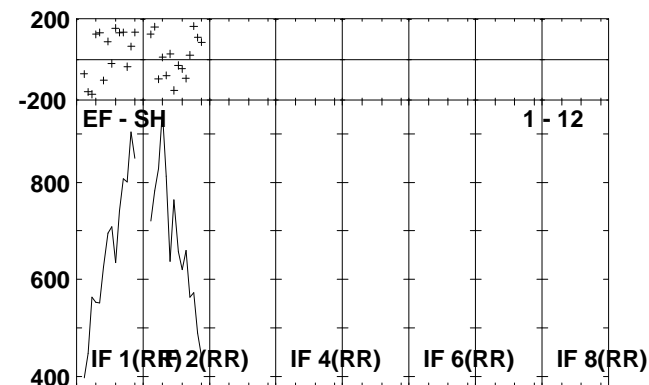
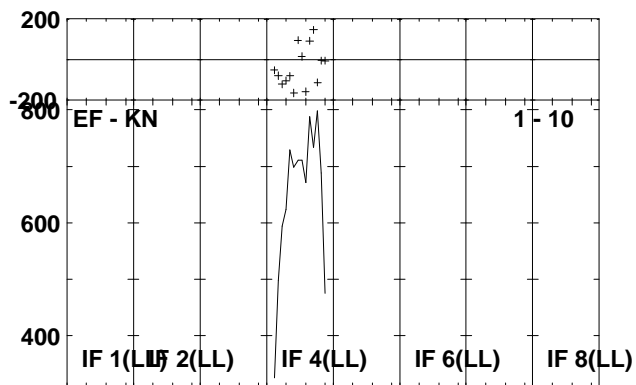
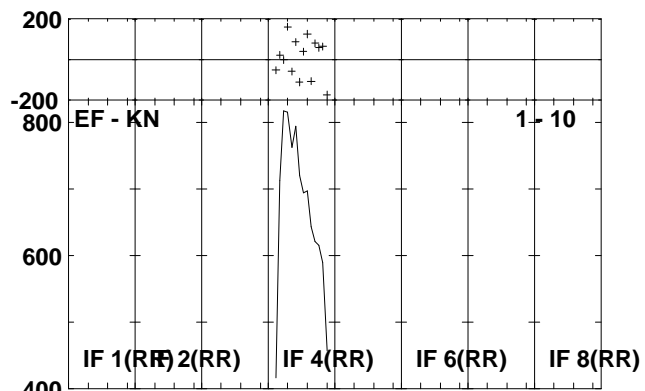
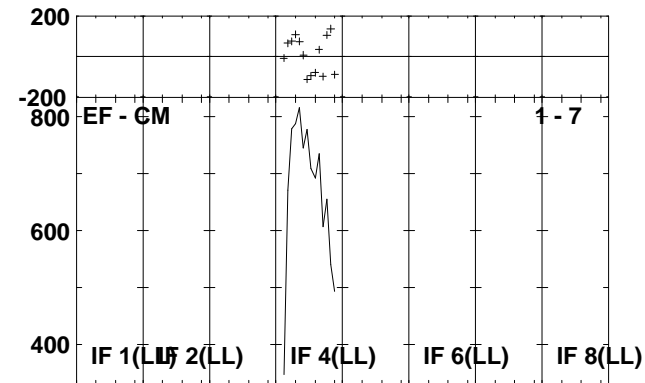
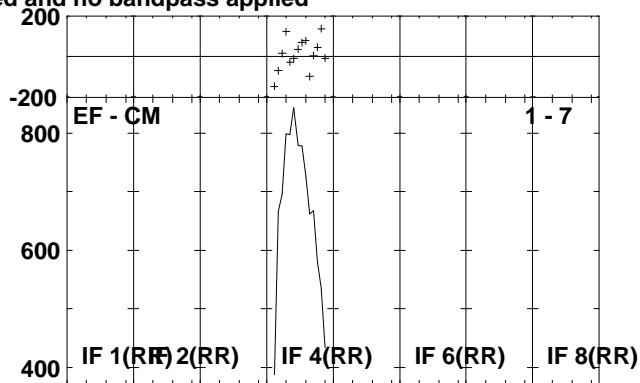
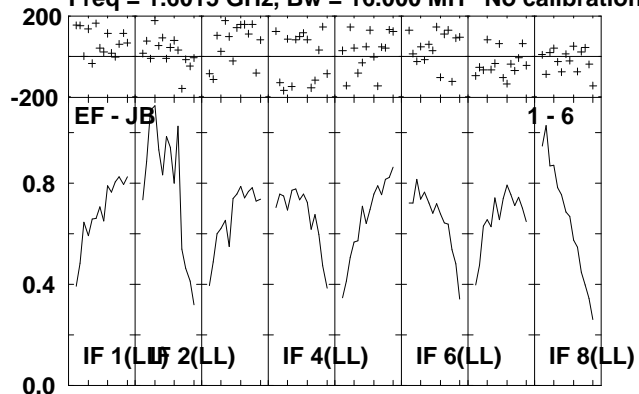

Lower frame: Milli Ampl Jy Top frame: Phas deg
Scalar averaged cross-power spectrum Several baselines displayed
Timerange: 00/18:48:22 to 00/18:55:18

Plot file version 15 created 26-APR-2010 13:25:33

J1246-07 EA043.UVDATA.1

Freq = 1.6015 GHz, Bw = 16.000 MH No calibration applied and no bandpass applied

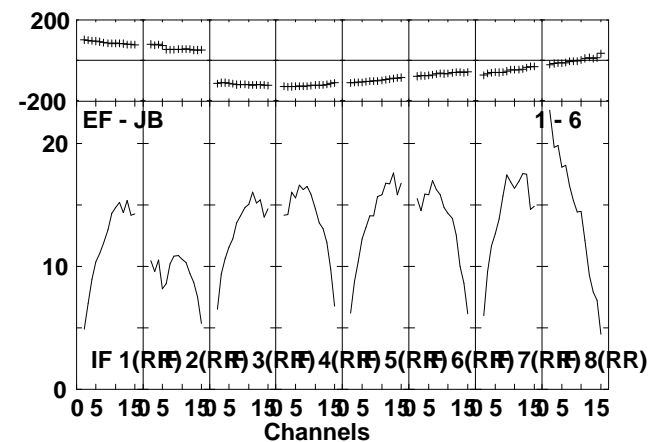
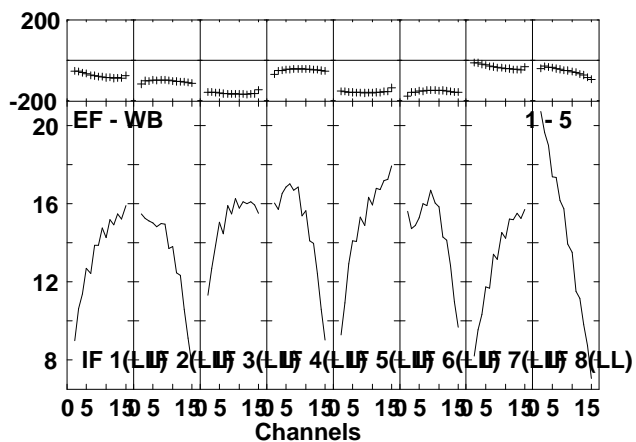
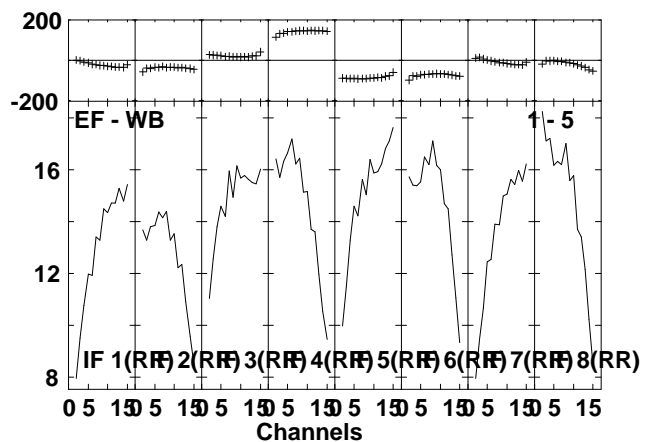
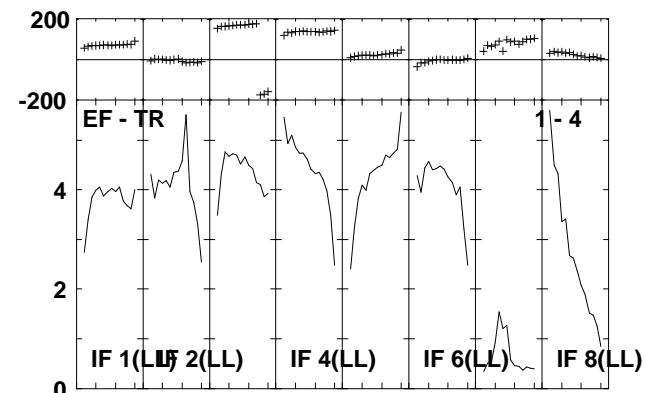
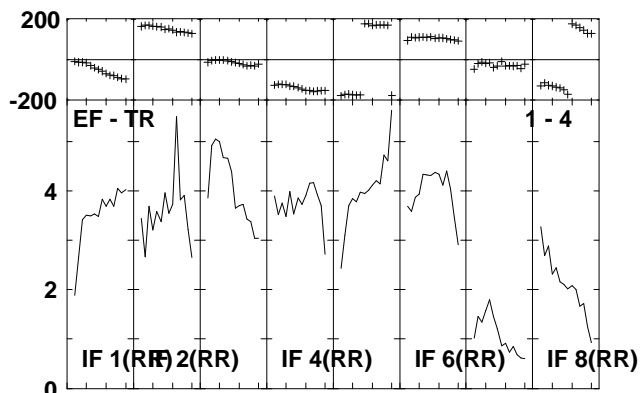
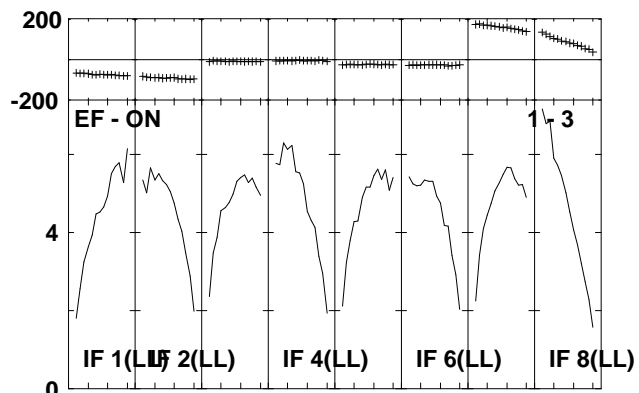
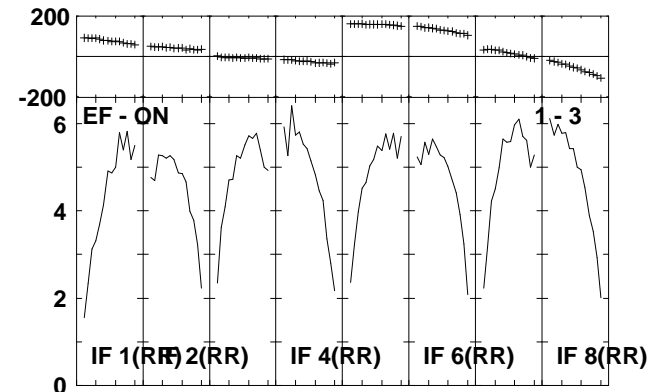
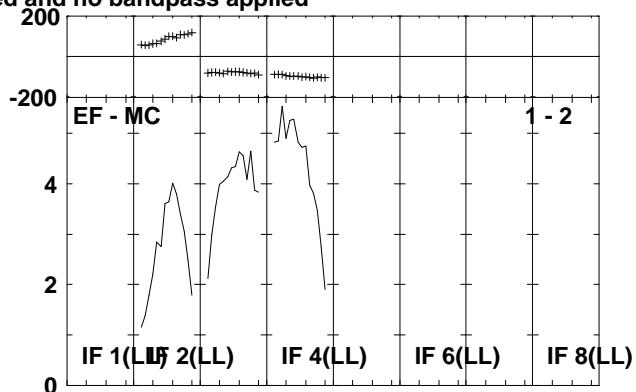
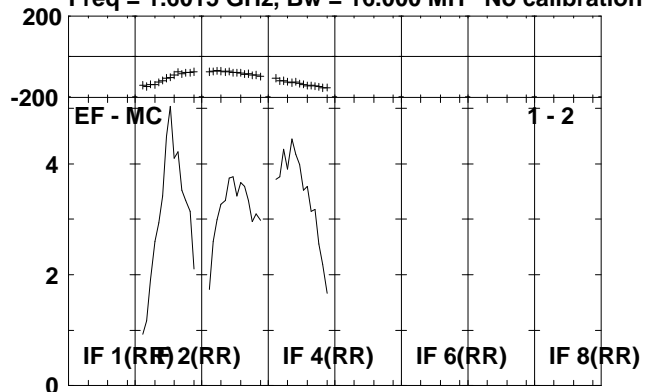

Lower frame: Milli Ampl Jy Top frame: Phas deg
Scalar averaged cross-power spectrum Several baselines displayed
Timerange: 00/18:55:22 to 00/18:57:18

Plot file version 16 created 26-APR-2010 13:25:33

J1246-07 EA043.UVDATA.1

Freq = 1.6015 GHz, Bw = 16.000 MH No calibration applied and no bandpass applied

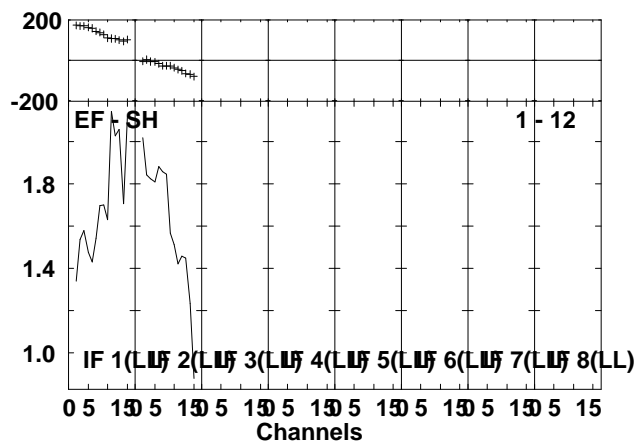
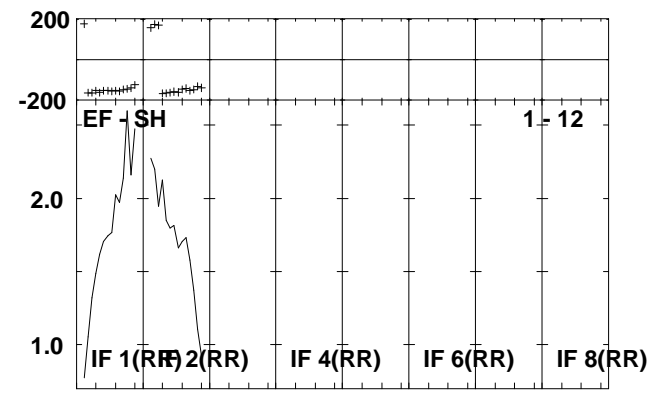
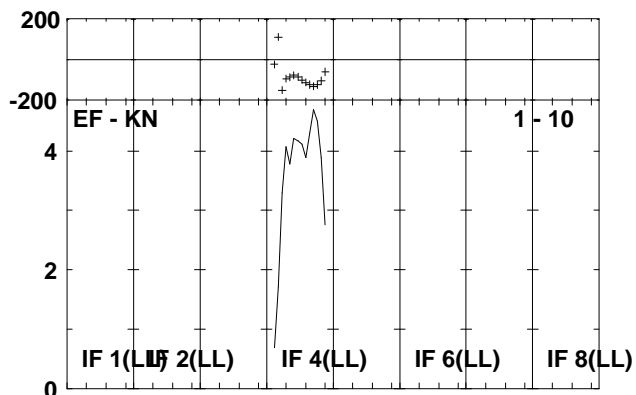
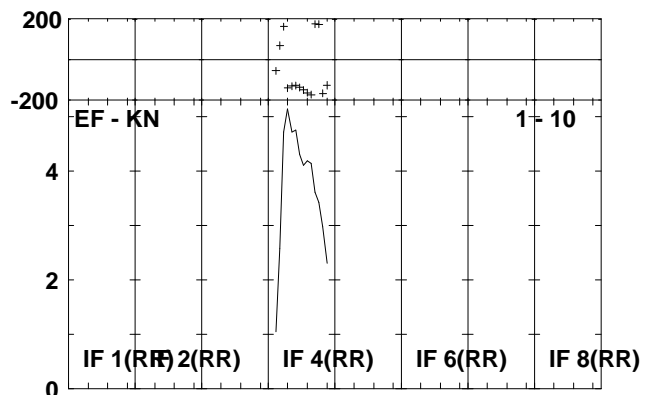
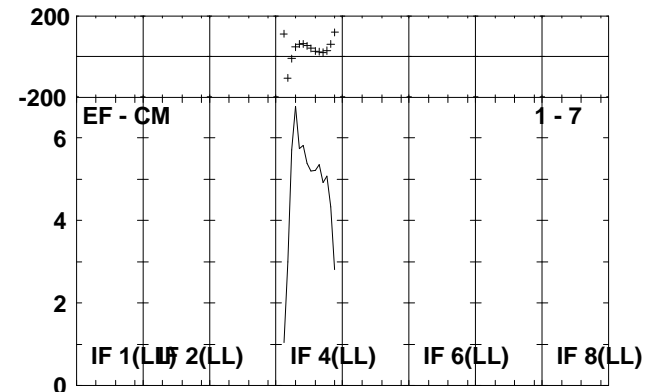
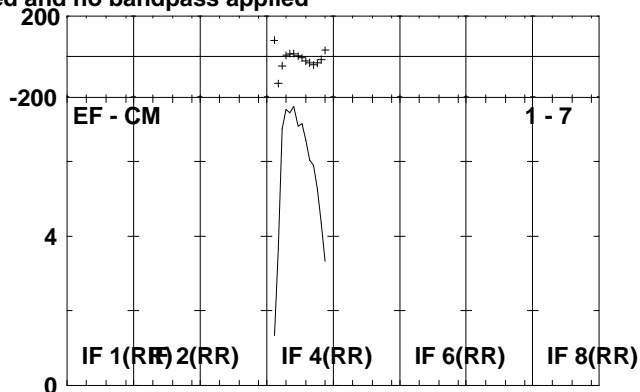
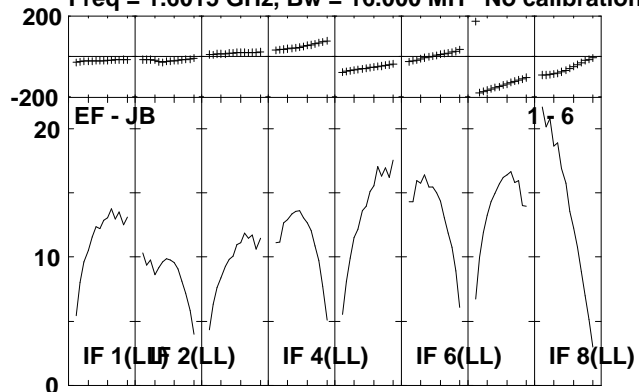

Lower frame: Milli Ampl Jy Top frame: Phas deg
Scalar averaged cross-power spectrum Several baselines displayed
Timerange: 00/18:55:22 to 00/18:57:18

Plot file version 17 created 26-APR-2010 13:25:34

HCG62 EA043.UVDATA.1

Freq = 1.6015 GHz, Bw = 16.000 MH No calibration applied and no bandpass applied

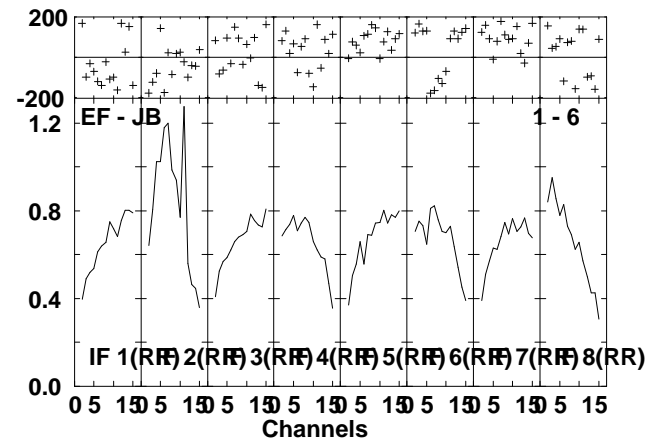
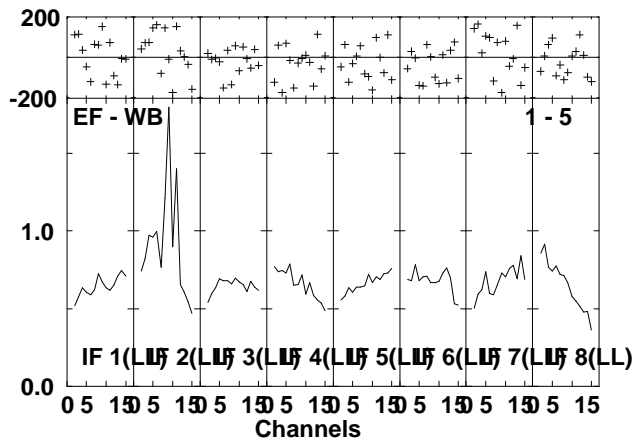
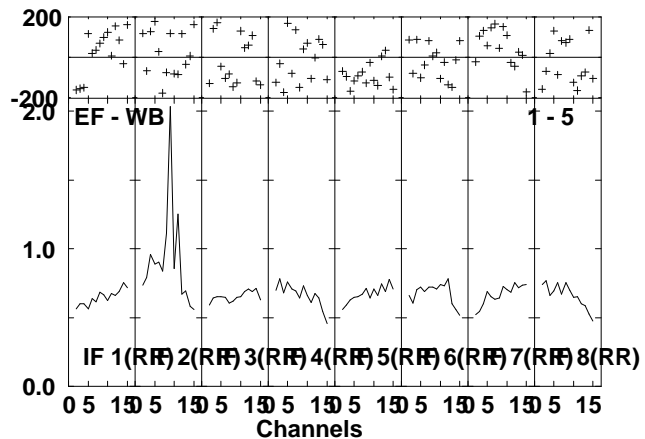
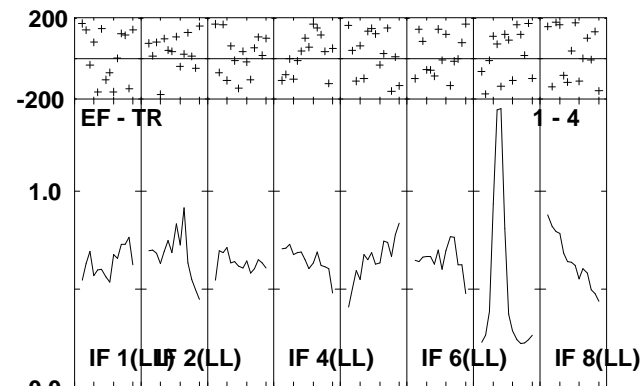
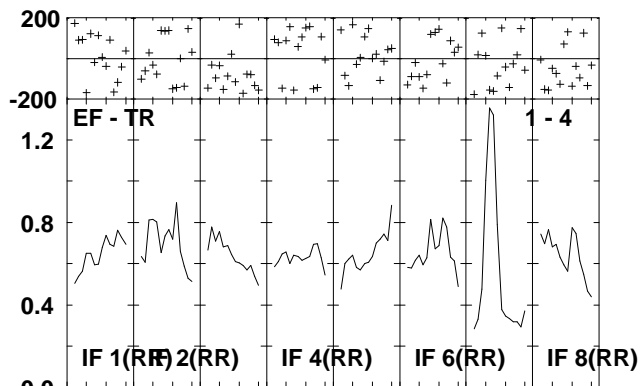
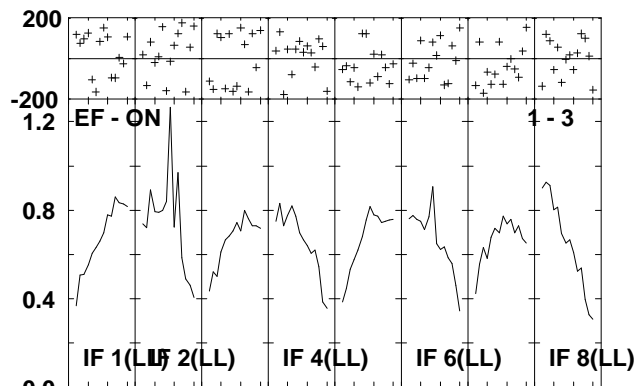
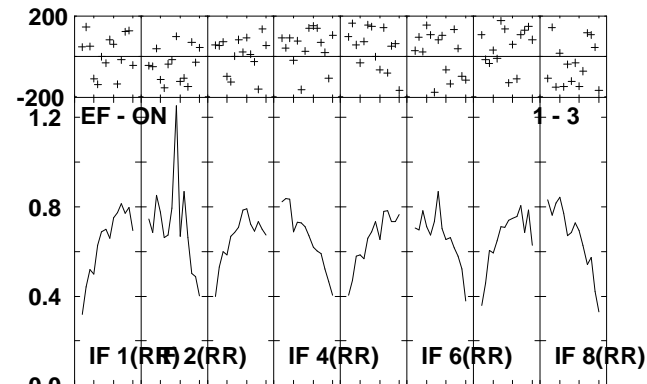
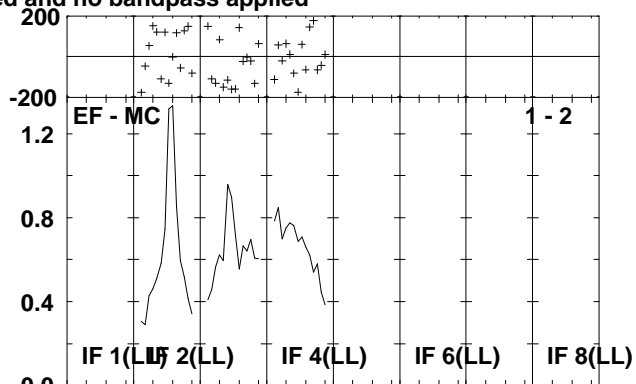
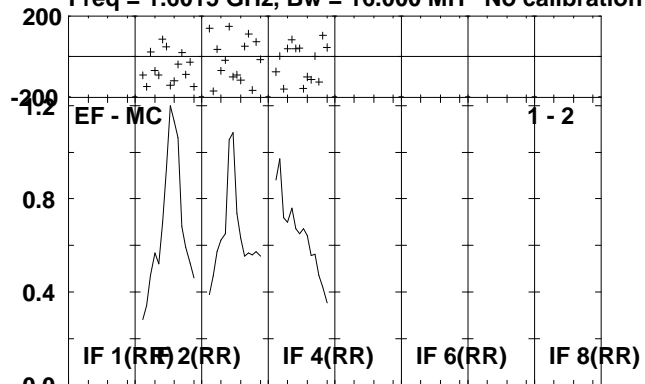

Lower frame: Milli Ampl Jy Top frame: Phas deg
Scalar averaged cross-power spectrum Several baselines displayed
Timerange: 00/18:58:22 to 00/19:05:18

Plot file version 18 created 26-APR-2010 13:25:36

HCG62 EA043.UVDATA.1

Freq = 1.6015 GHz, Bw = 16.000 MH No calibration applied and no bandpass applied

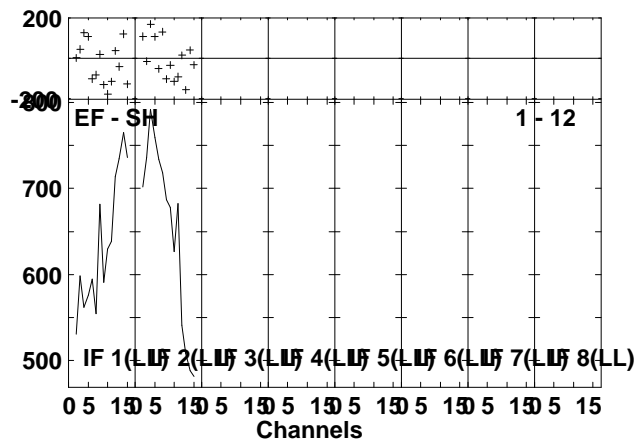
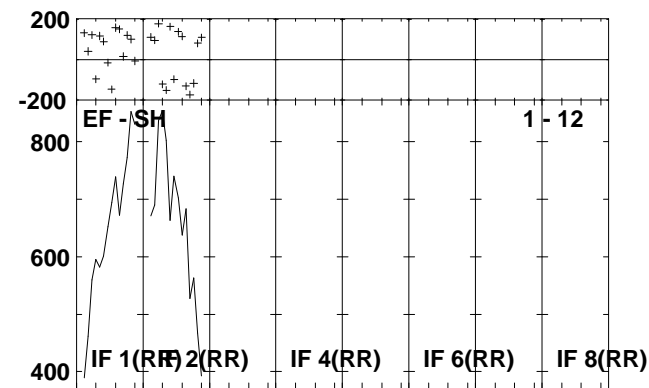
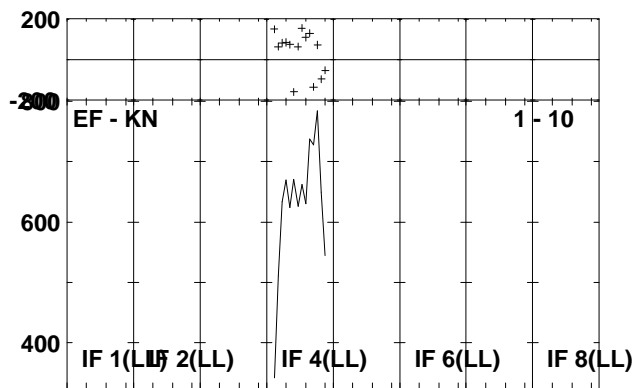
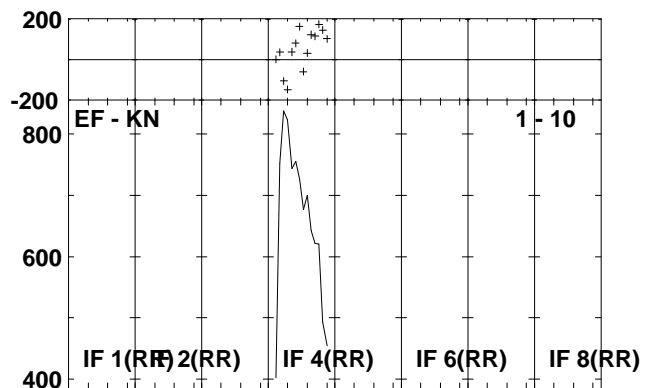
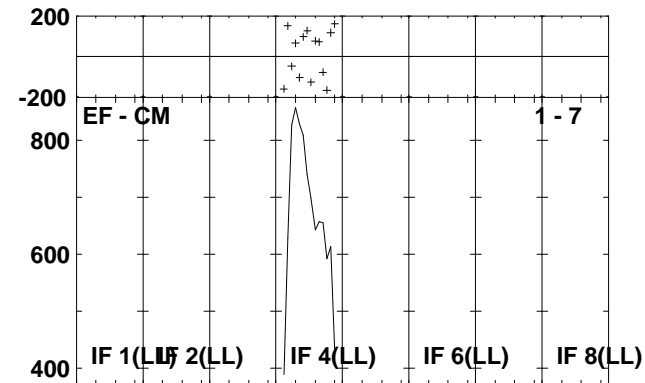
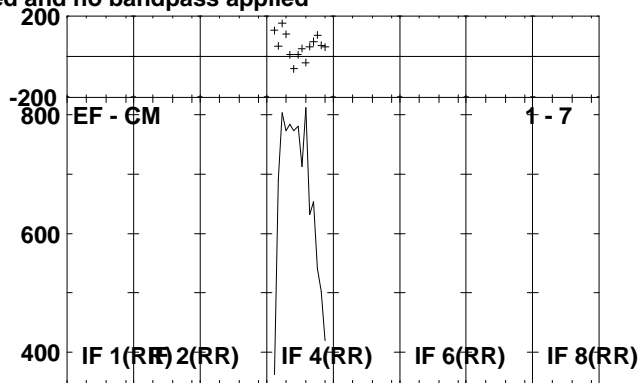
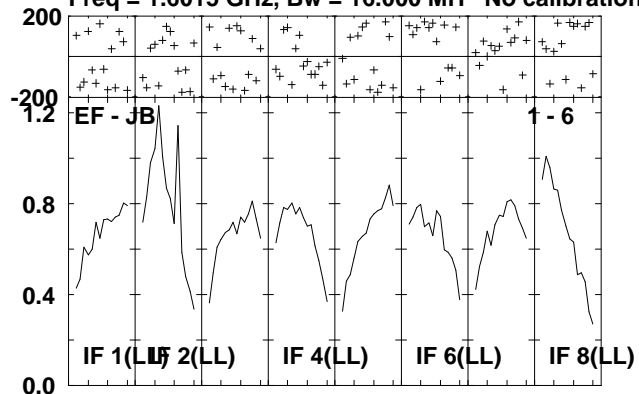

Lower frame: Milli Ampl Jy Top frame: Phas deg
Scalar averaged cross-power spectrum Several baselines displayed
Timerange: 00/18:58:22 to 00/19:05:18

Plot file version 19 created 26-APR-2010 13:25:38

J1246-07 EA043.UVDATA.1

Freq = 1.6015 GHz, Bw = 16.000 MH No calibration applied and no bandpass applied

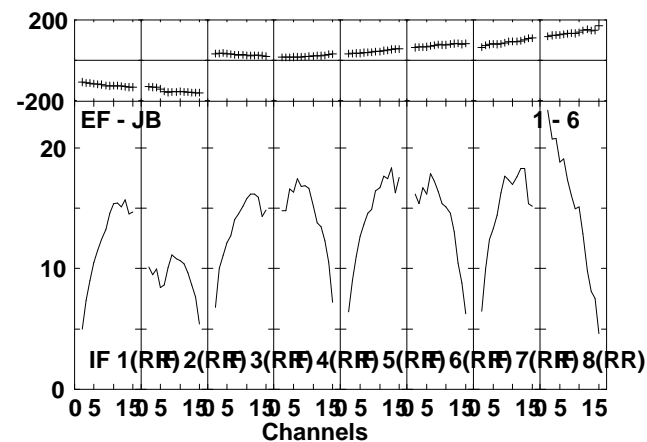
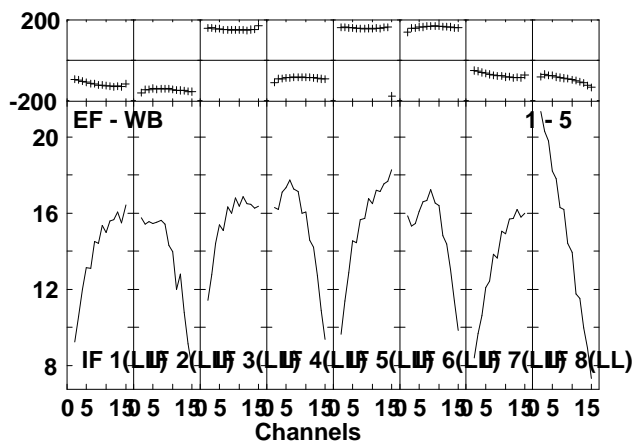
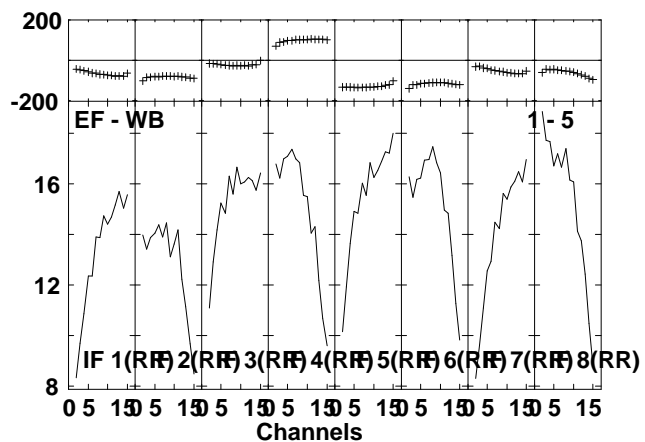
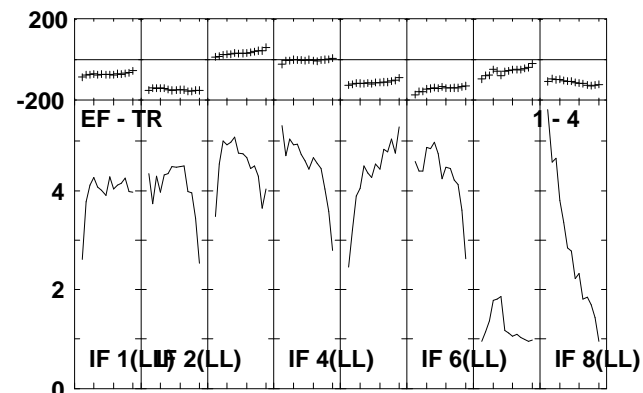
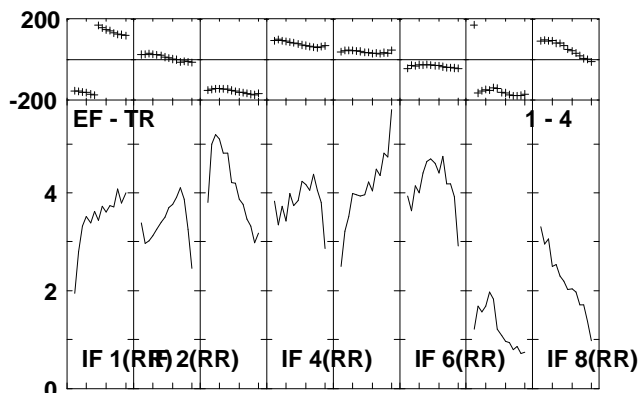
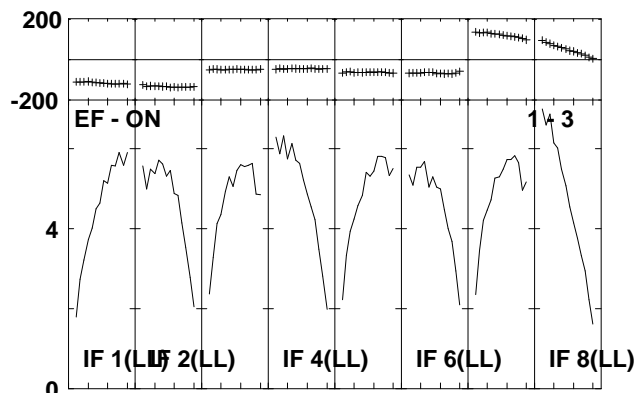
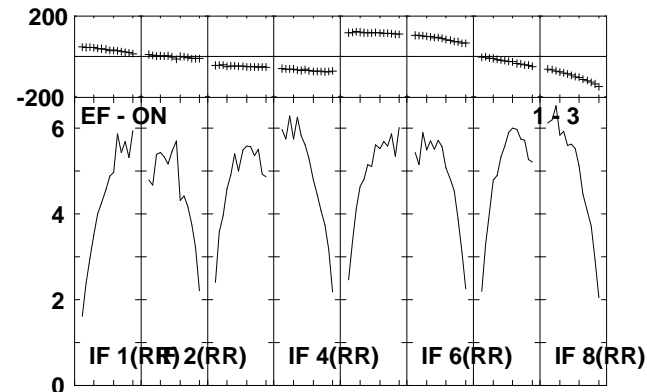
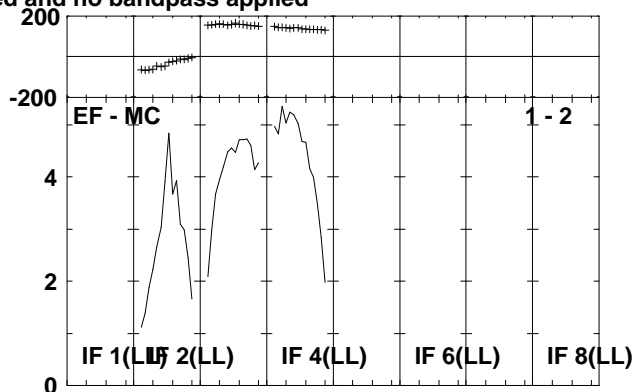
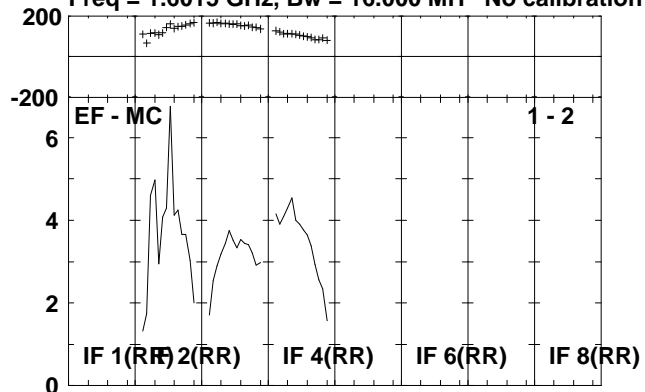

Lower frame: Milli Ampl Jy Top frame: Phas deg
Scalar averaged cross-power spectrum Several baselines displayed
Timerange: 00/19:05:22 to 00/19:07:18

Plot file version 20 created 26-APR-2010 13:25:38

J1246-07 EA043.UVDATA.1

Freq = 1.6015 GHz, Bw = 16.000 MH No calibration applied and no bandpass applied

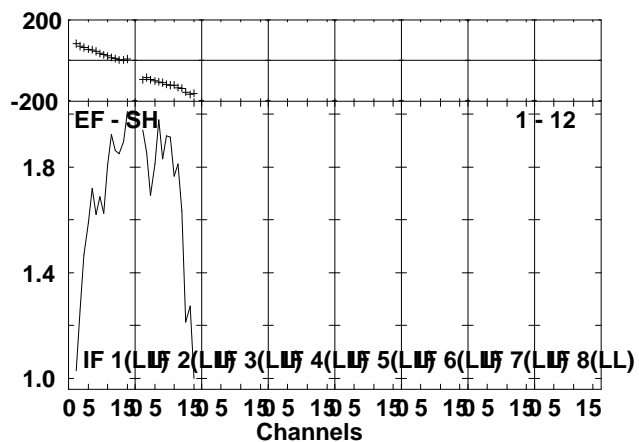
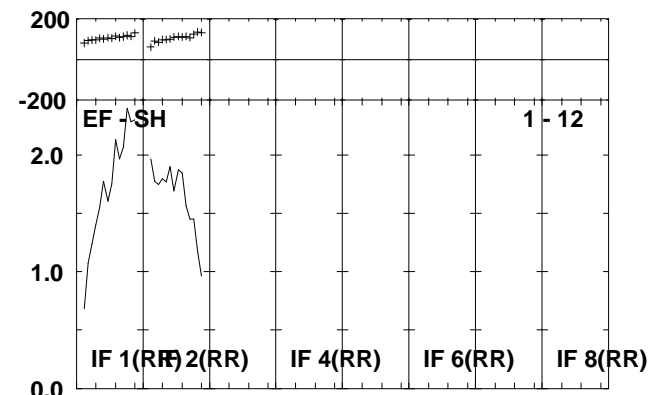
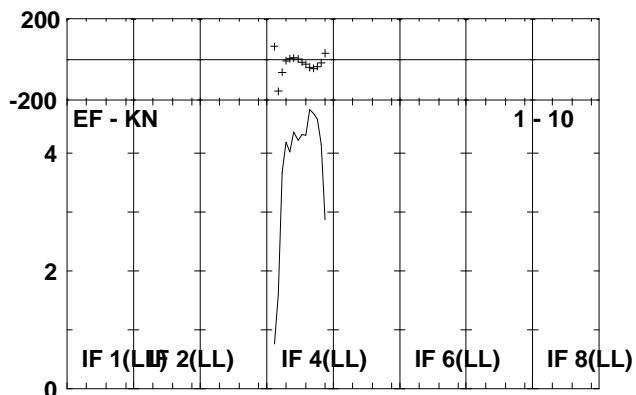
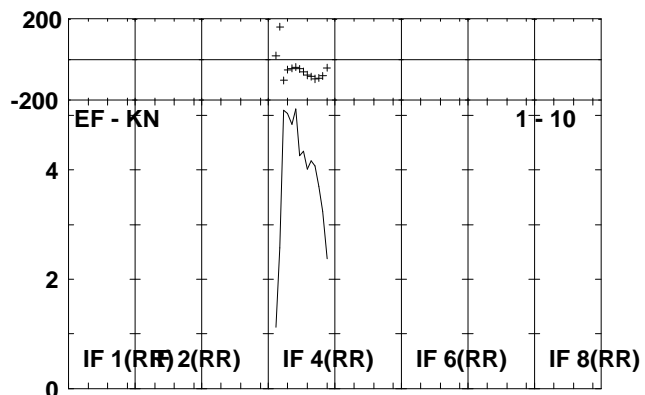
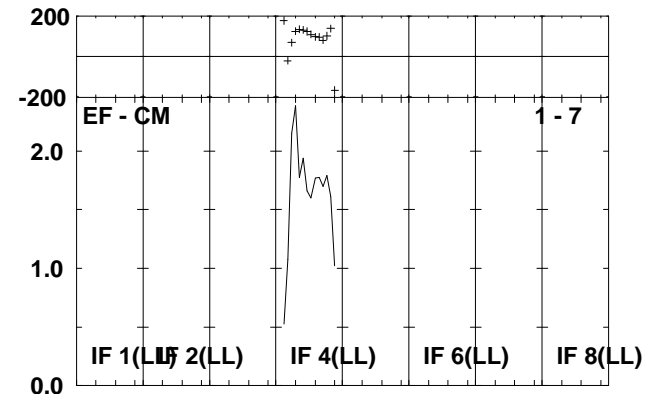
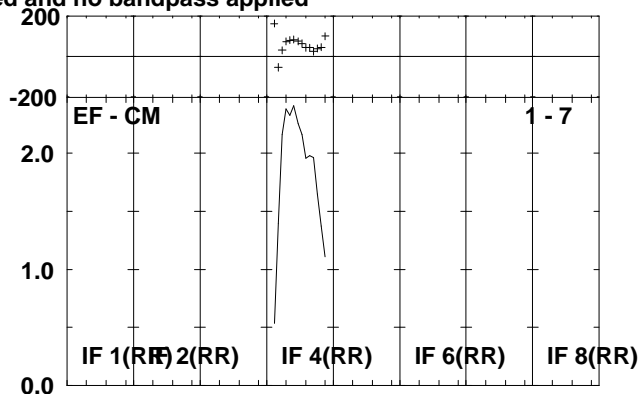
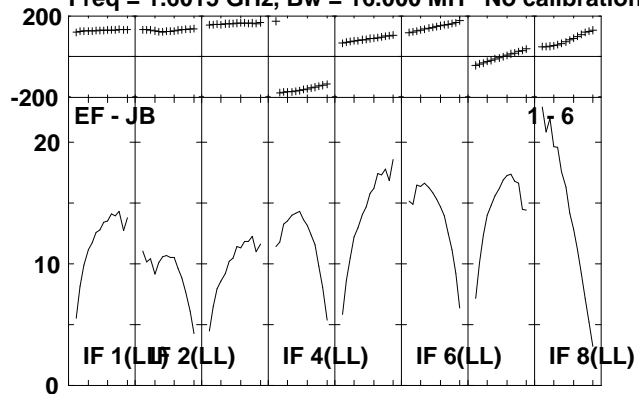

Lower frame: Milli Ampl Jy Top frame: Phas deg
Scalar averaged cross-power spectrum Several baselines displayed
Timerange: 00/19:05:22 to 00/19:07:18

Plot file version 21 created 26-APR-2010 13:25:39

HCG62 EA043.UVDATA.1

Freq = 1.6015 GHz, Bw = 16.000 MH No calibration applied and no bandpass applied

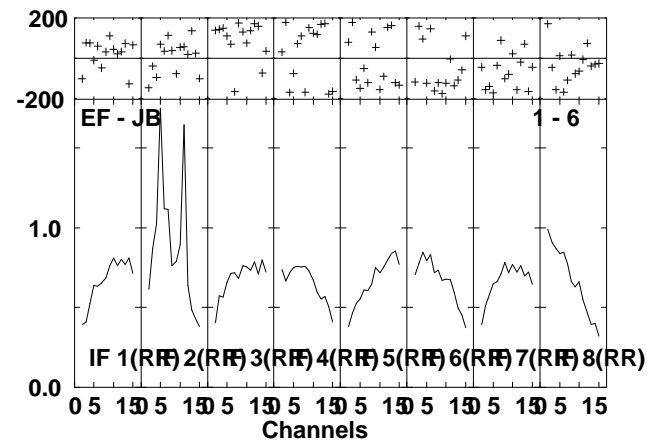
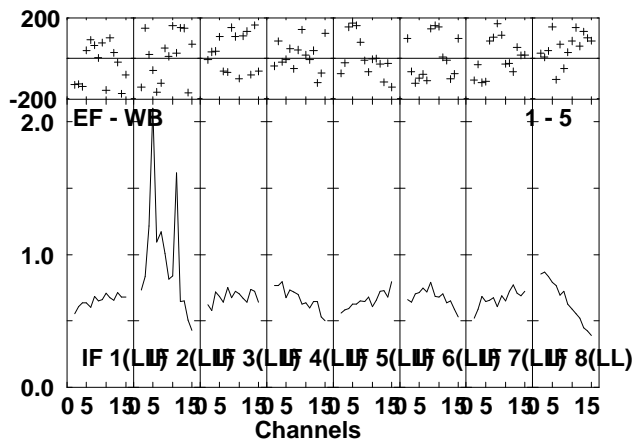
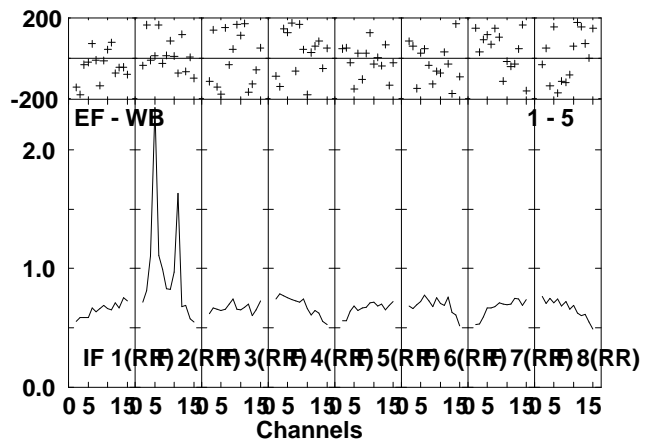
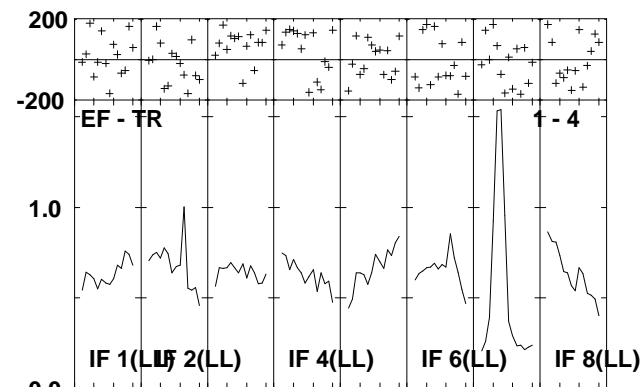
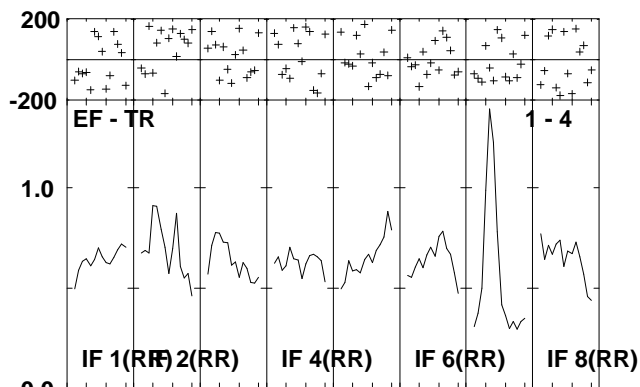
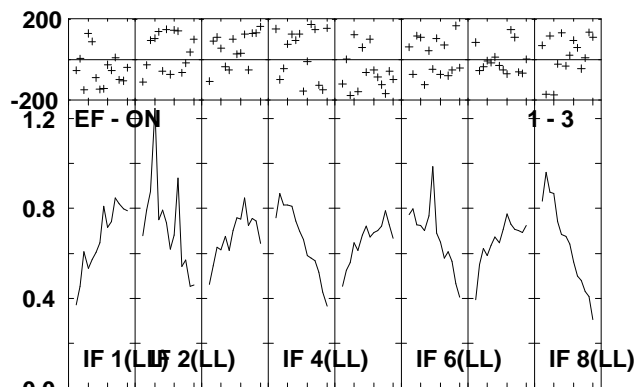
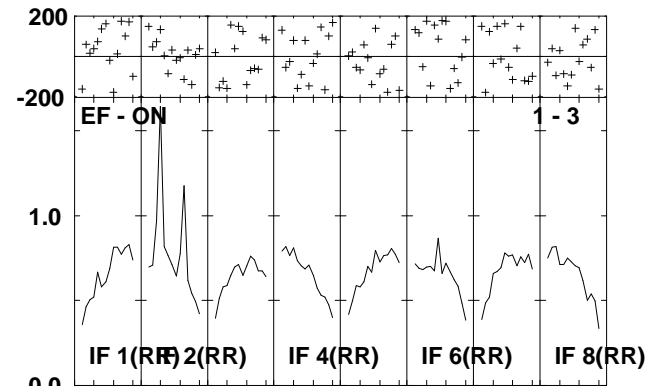
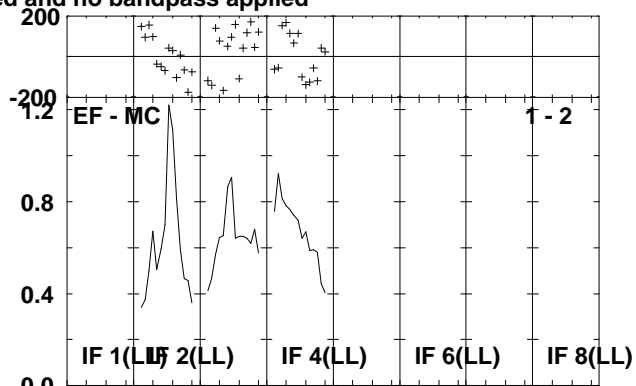
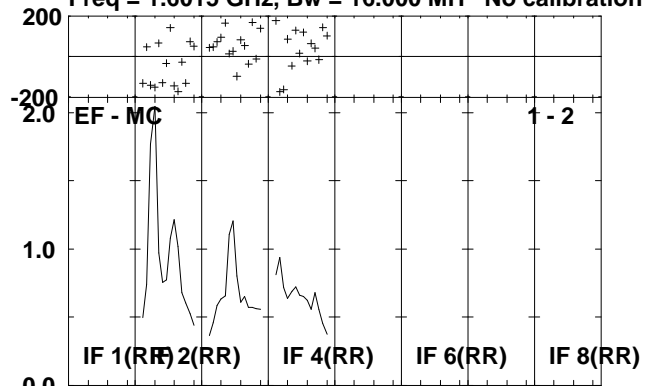

Lower frame: Milli Ampl Jy Top frame: Phas deg
Scalar averaged cross-power spectrum Several baselines displayed
Timerange: 00/19:08:22 to 00/19:15:18

Plot file version 22 created 26-APR-2010 13:25:41

HCG62 EA043.UVDATA.1

Freq = 1.6015 GHz, Bw = 16.000 MH No calibration applied and no bandpass applied

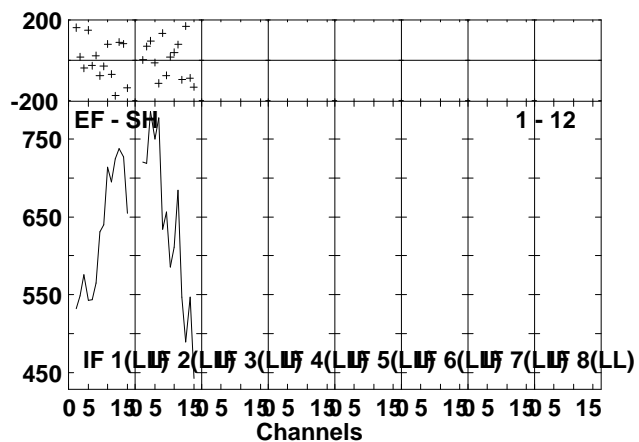
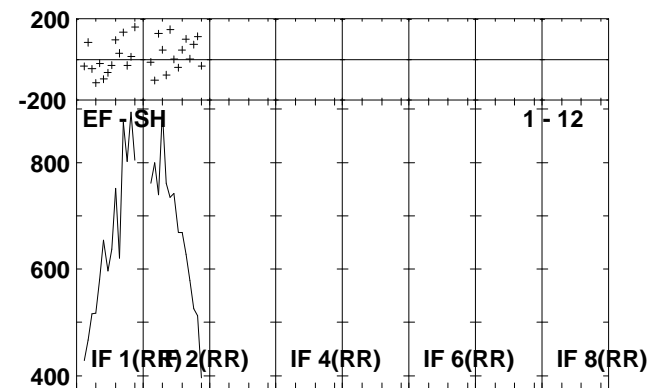
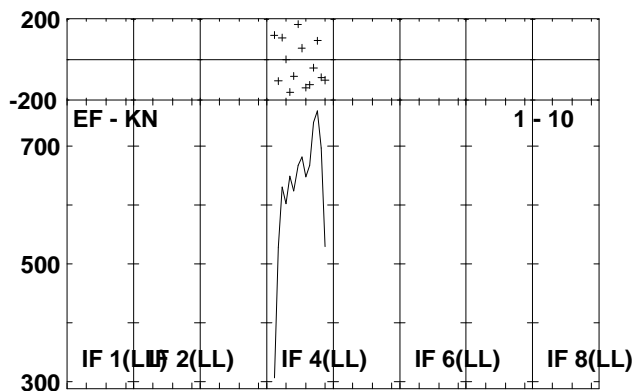
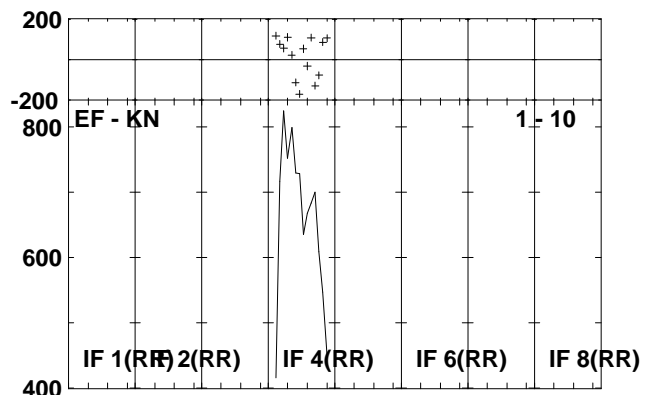
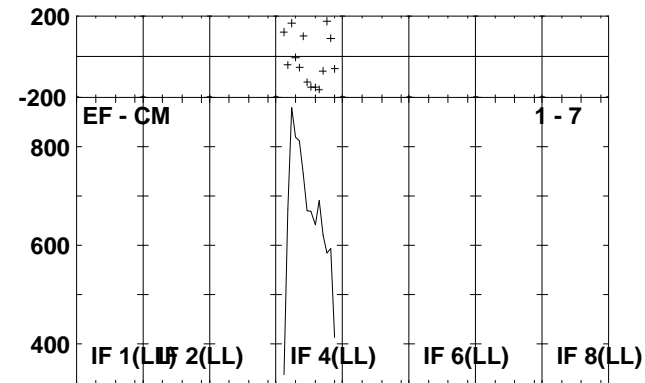
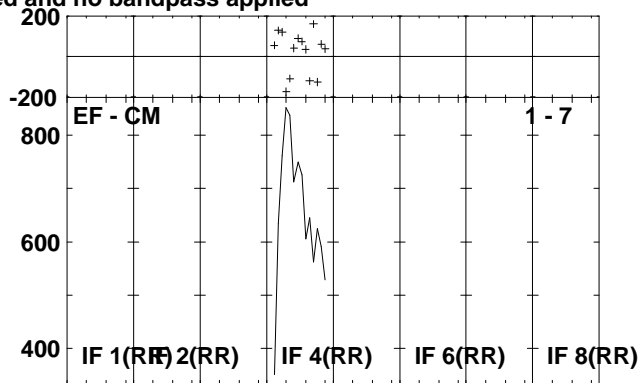
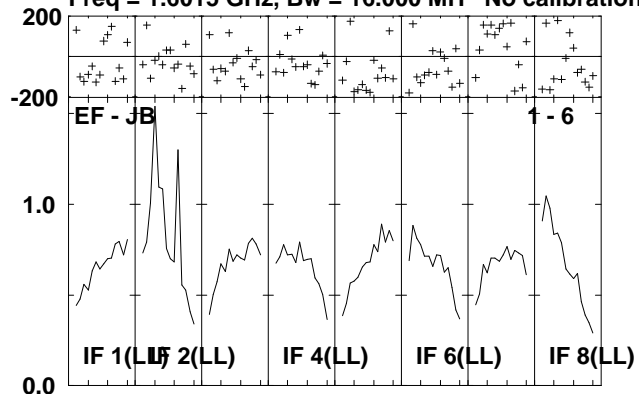

Lower frame: Milli Ampl Jy Top frame: Phas deg
Scalar averaged cross-power spectrum Several baselines displayed
Timerange: 00/19:08:22 to 00/19:15:18

Plot file version 23 created 26-APR-2010 13:25:43

J1246-07 EA043.UVDATA.1

Freq = 1.6015 GHz, Bw = 16.000 MH No calibration applied and no bandpass applied

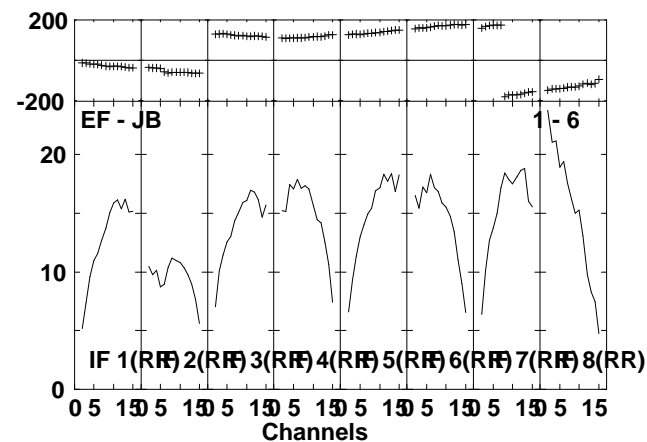
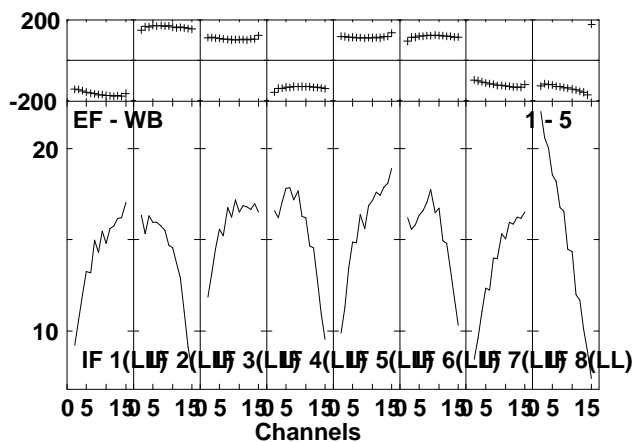
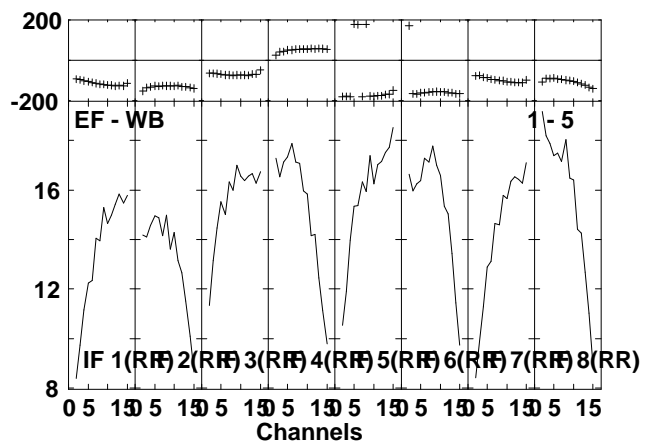
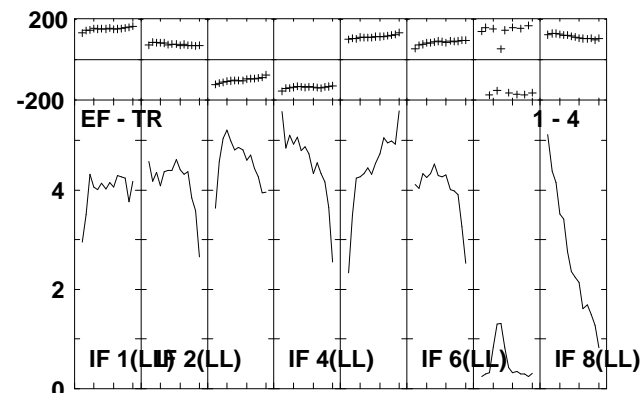
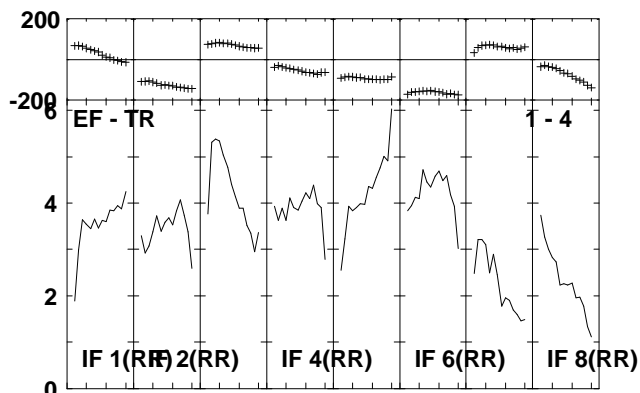
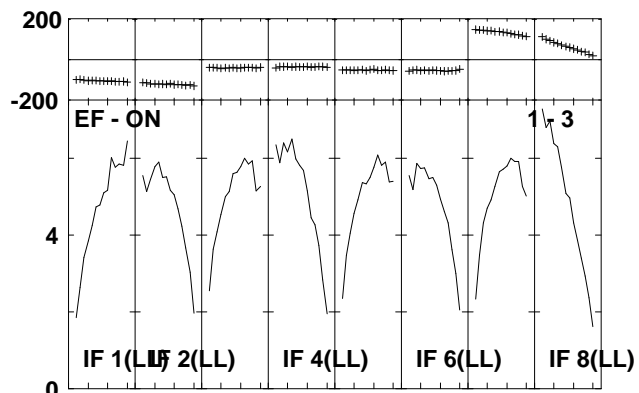
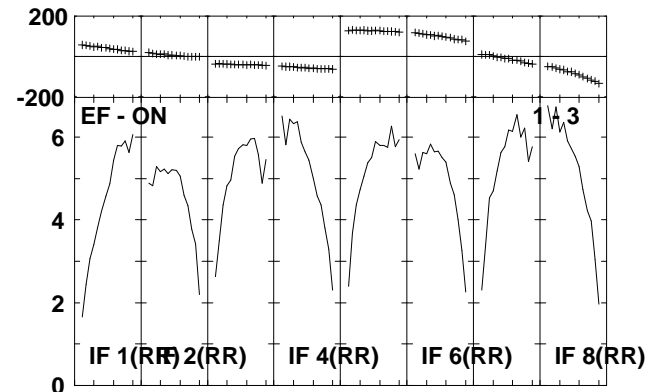
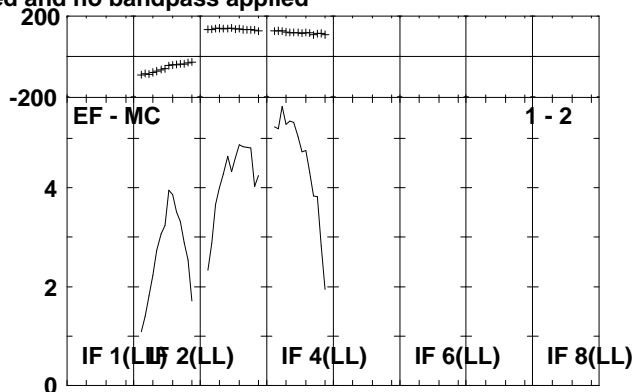
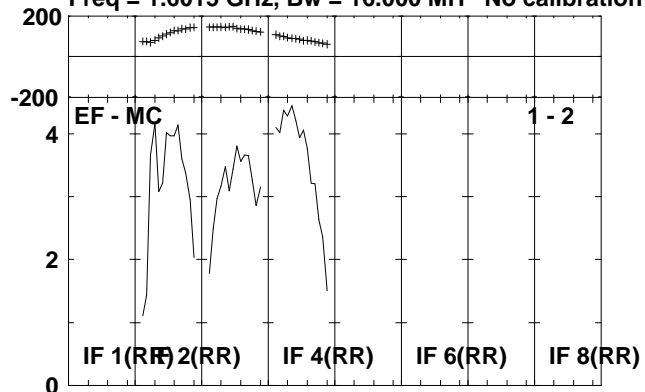

Lower frame: Milli Ampl Jy Top frame: Phas deg
Scalar averaged cross-power spectrum Several baselines displayed
Timerange: 00/19:15:22 to 00/19:17:18

Plot file version 24 created 26-APR-2010 13:25:43

J1246-07 EA043.UVDATA.1

Freq = 1.6015 GHz, Bw = 16.000 MH No calibration applied and no bandpass applied

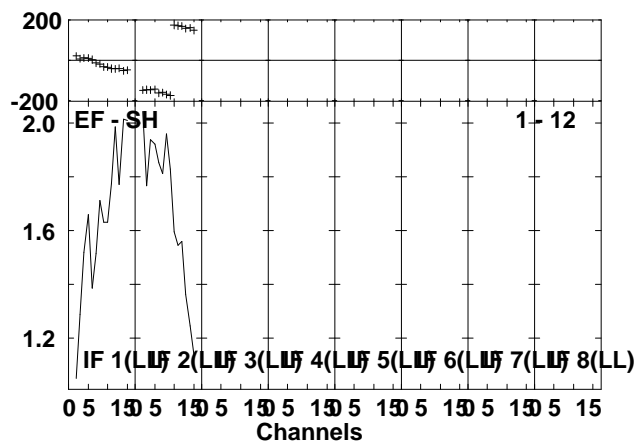
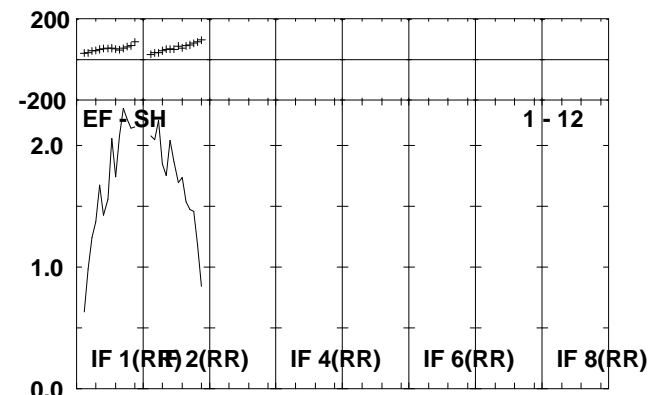
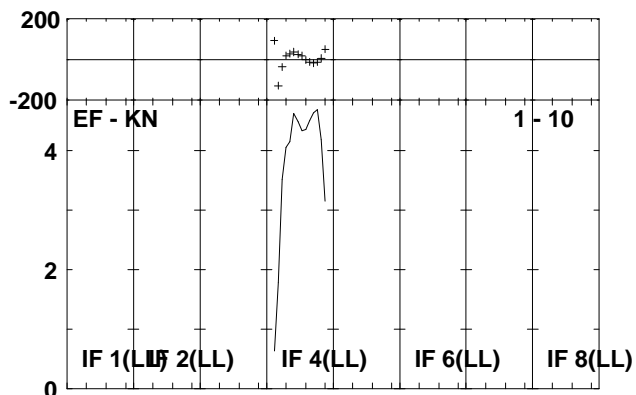
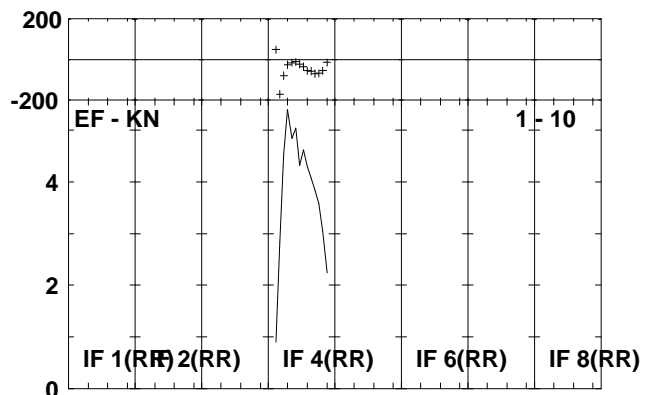
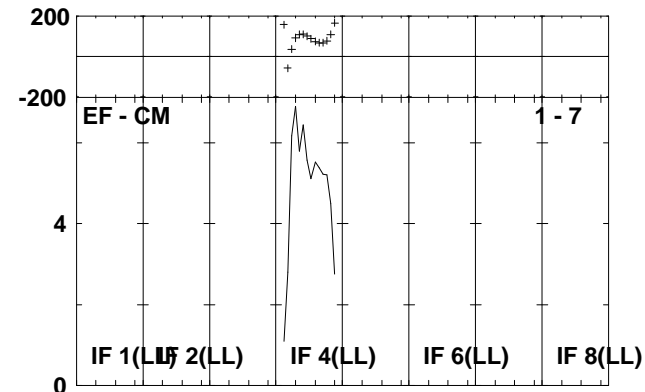
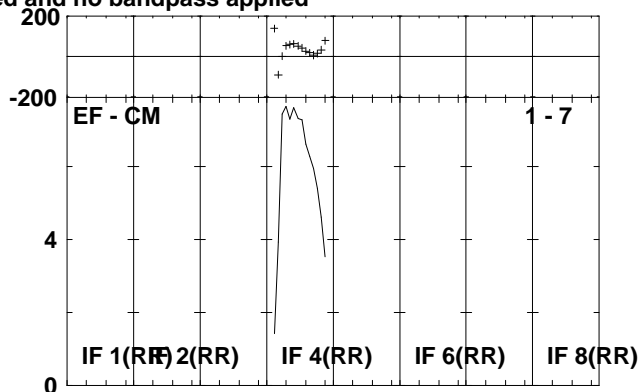
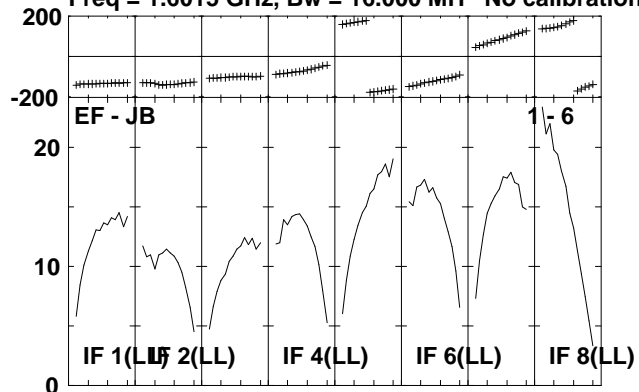

Lower frame: Milli Ampl Jy Top frame: Phas deg
Scalar averaged cross-power spectrum Several baselines displayed
Timerange: 00/19:15:22 to 00/19:17:18

Plot file version 25 created 26-APR-2010 13:25:44

HCG62 EA043.UVDATA.1

Freq = 1.6015 GHz, Bw = 16.000 MH No calibration applied and no bandpass applied

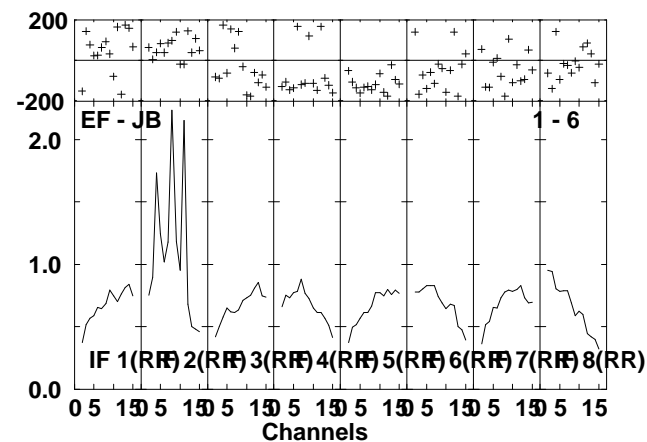
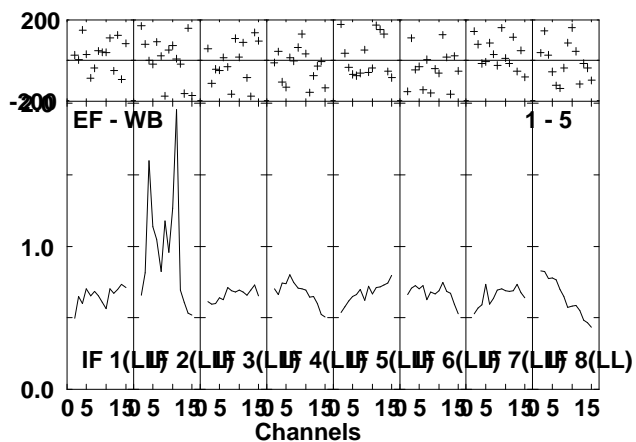
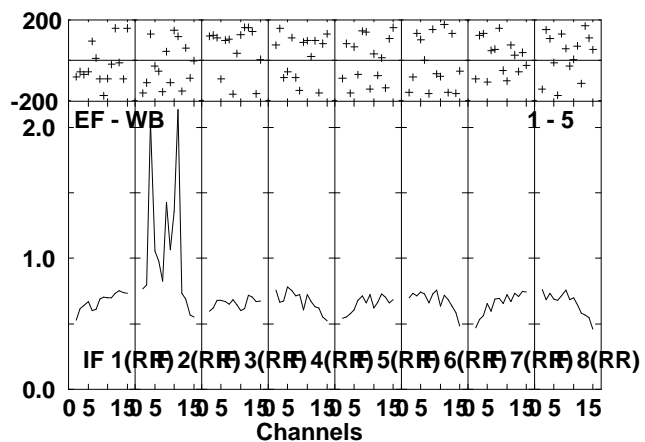
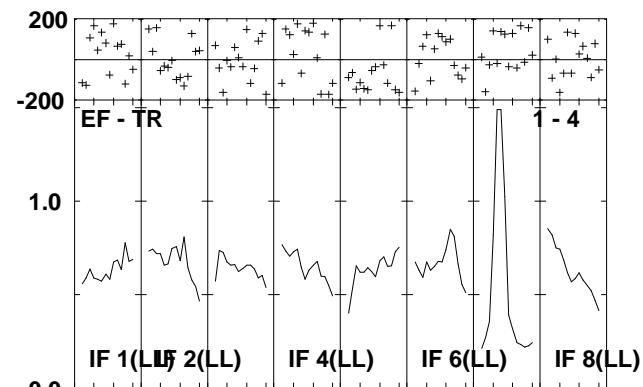
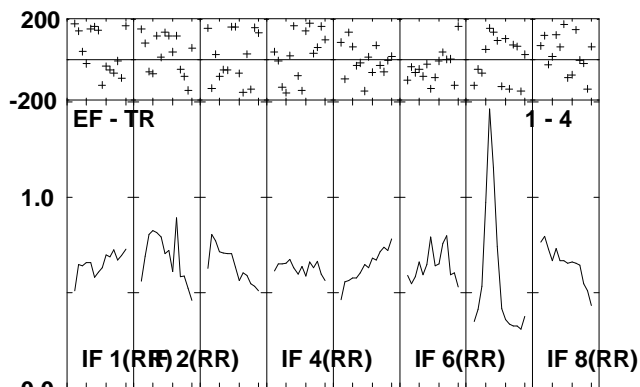
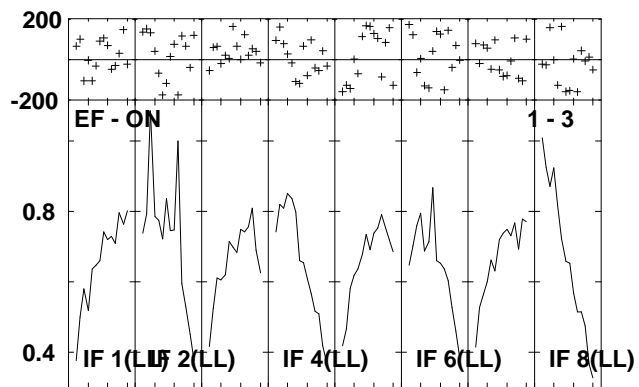
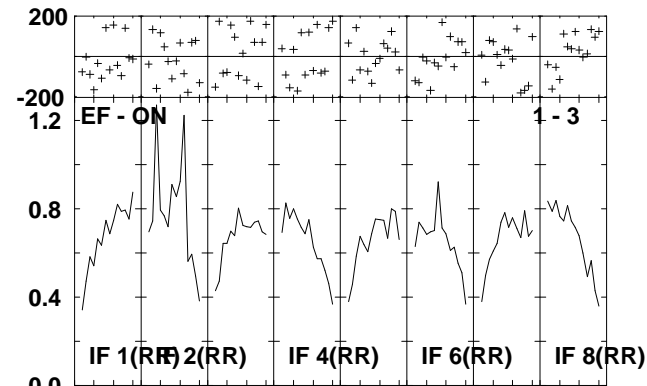
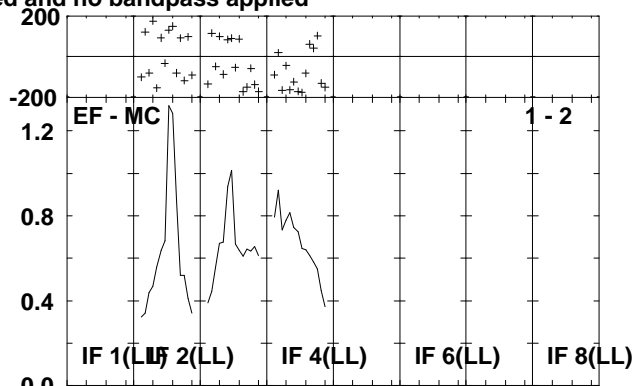
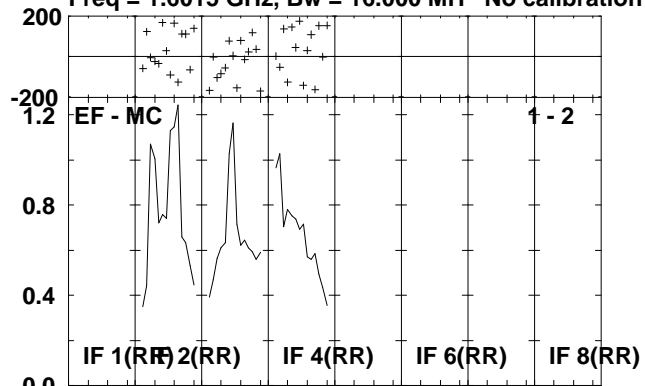

Lower frame: Milli Ampl Jy Top frame: Phas deg
Scalar averaged cross-power spectrum Several baselines displayed
Timerange: 00/19:18:22 to 00/19:25:18

Plot file version 26 created 26-APR-2010 13:25:46

HCG62 EA043.UVDATA.1

Freq = 1.6015 GHz, Bw = 16.000 MH No calibration applied and no bandpass applied

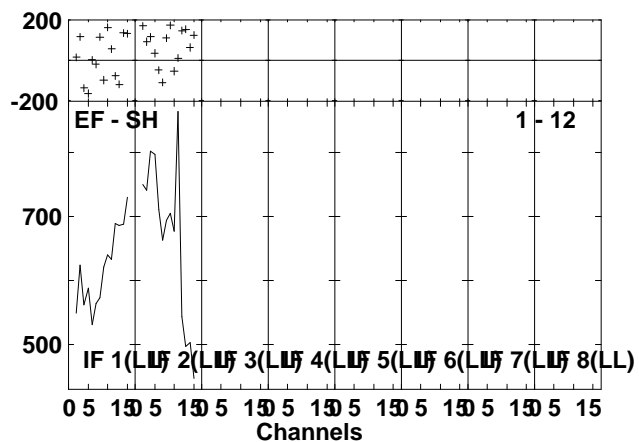
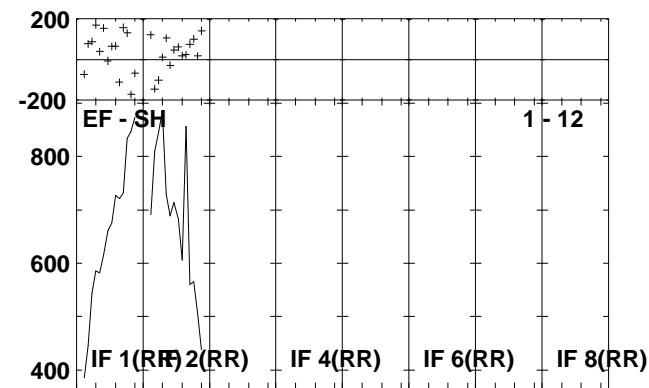
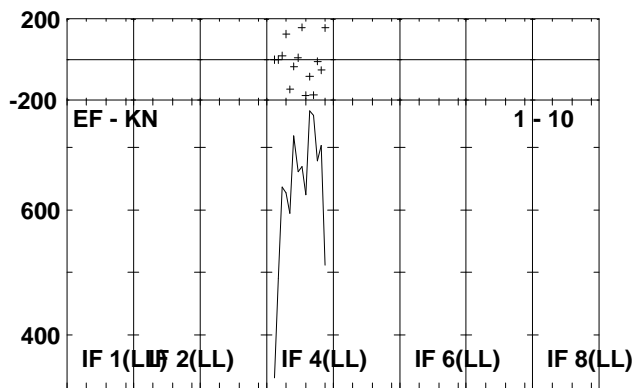
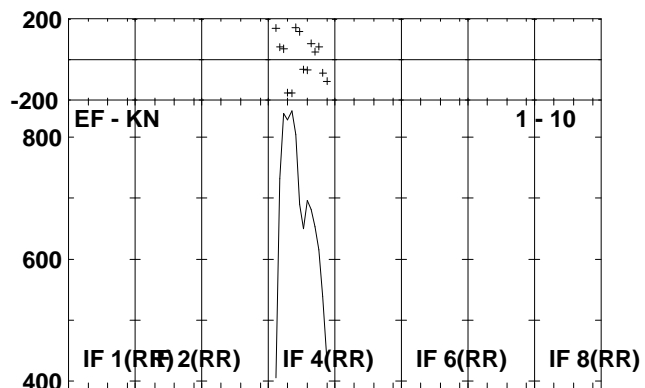
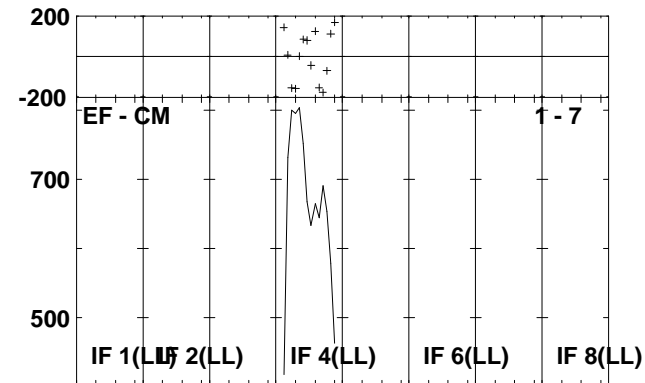
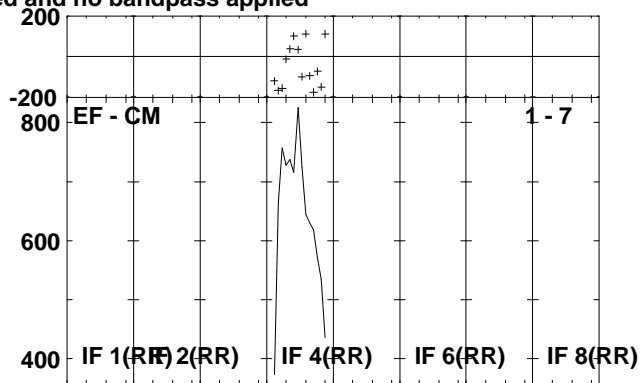
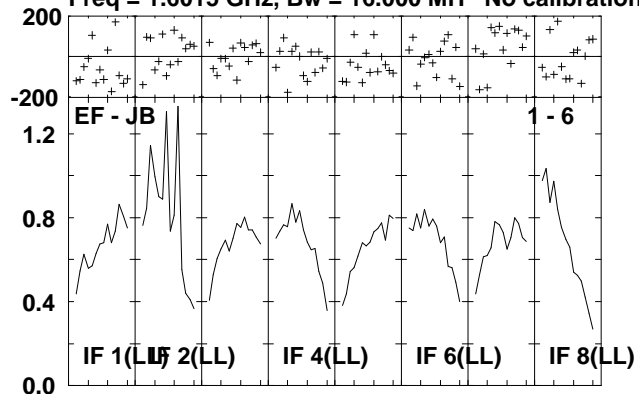

Lower frame: Milli Ampl Jy Top frame: Phas deg
Scalar averaged cross-power spectrum Several baselines displayed
Timerange: 00/19:18:22 to 00/19:25:18

Plot file version 27 created 26-APR-2010 13:25:48

J1246-07 EA043.UVDATA.1

Freq = 1.6015 GHz, Bw = 16.000 MH No calibration applied and no bandpass applied

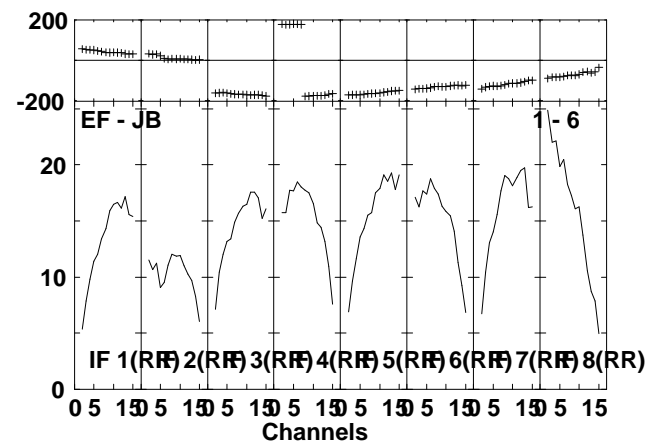
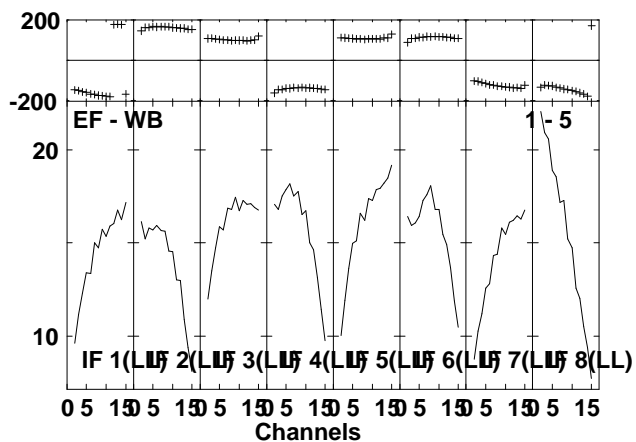
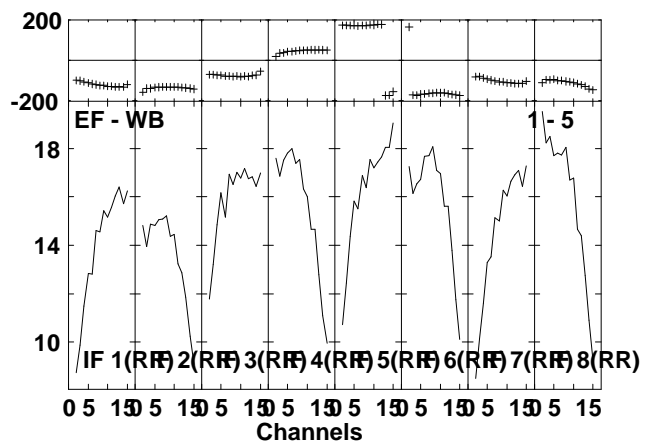
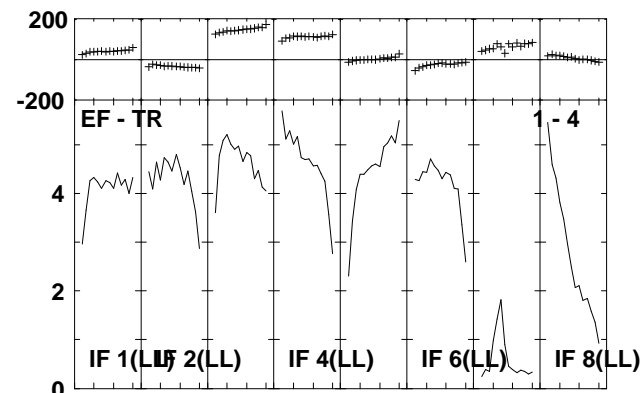
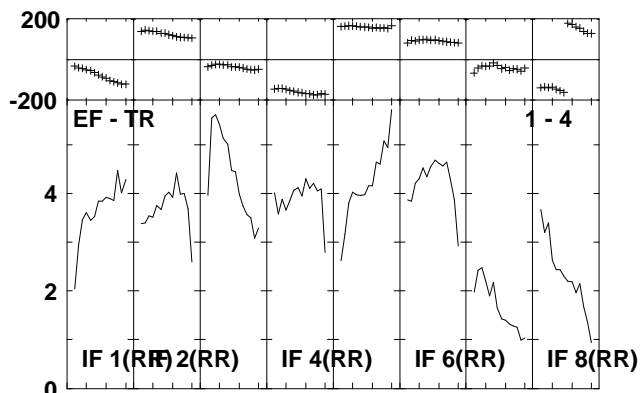
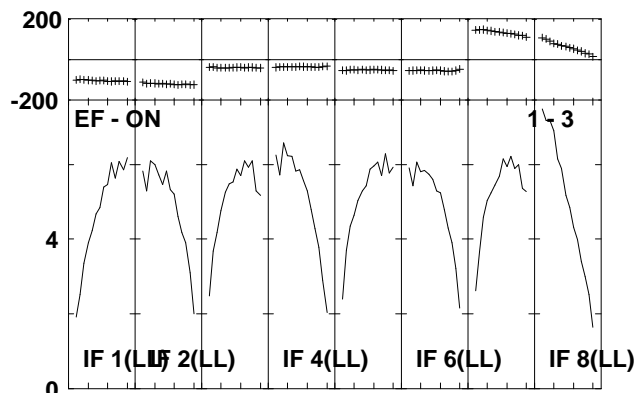
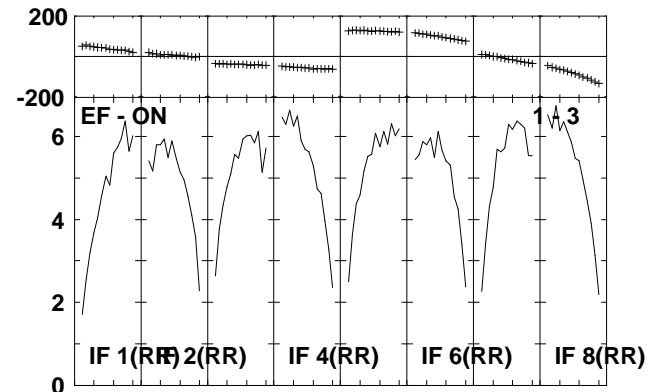
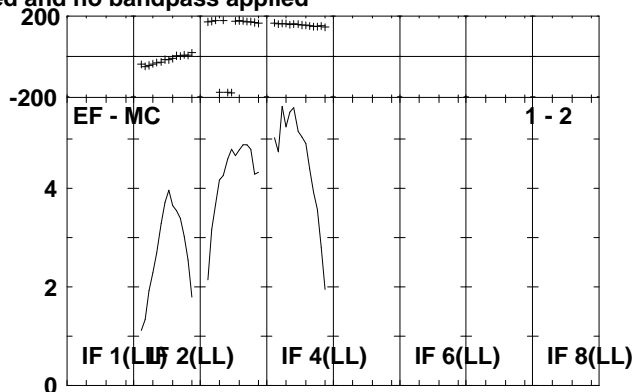
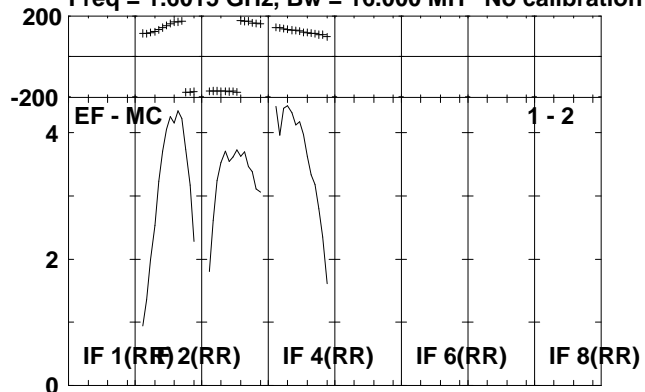

Lower frame: Milli Ampl Jy Top frame: Phas deg
Scalar averaged cross-power spectrum Several baselines displayed
Timerange: 00/19:25:22 to 00/19:27:18

Plot file version 28 created 26-APR-2010 13:25:48

J1246-07 EA043.UVDATA.1

Freq = 1.6015 GHz, Bw = 16.000 MH No calibration applied and no bandpass applied

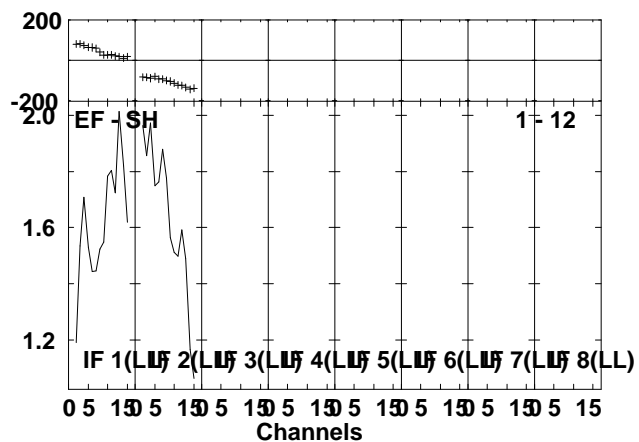
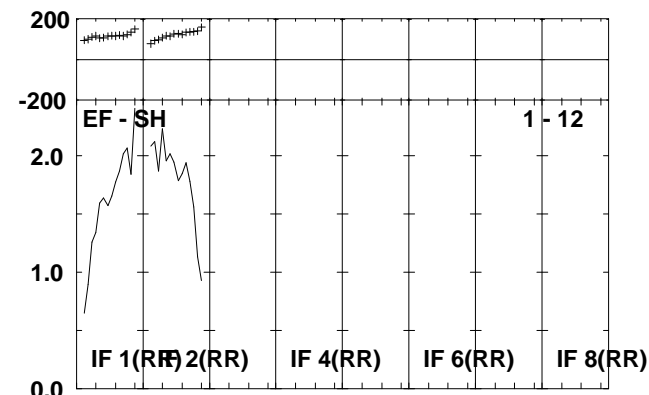
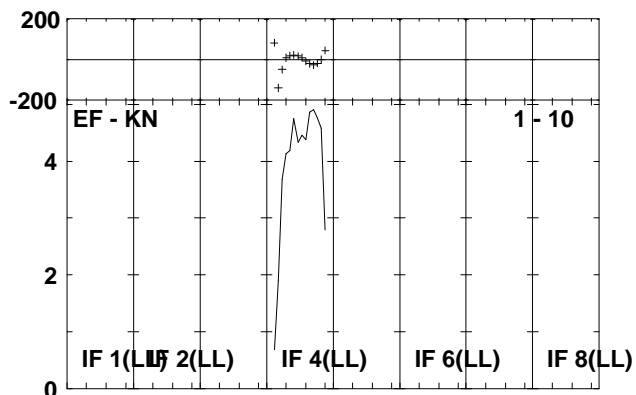
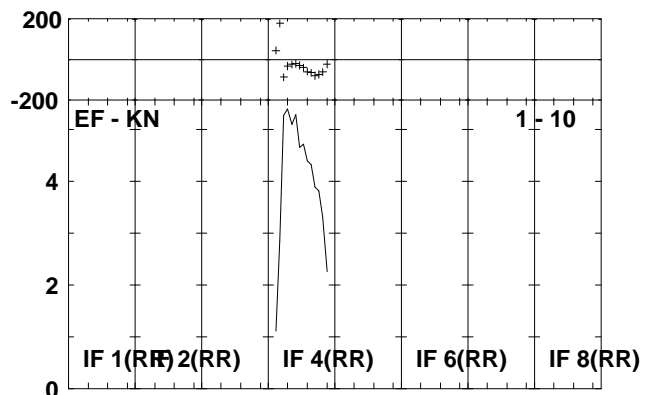
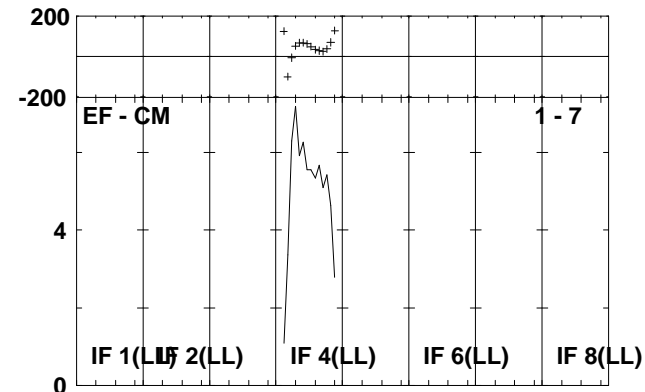
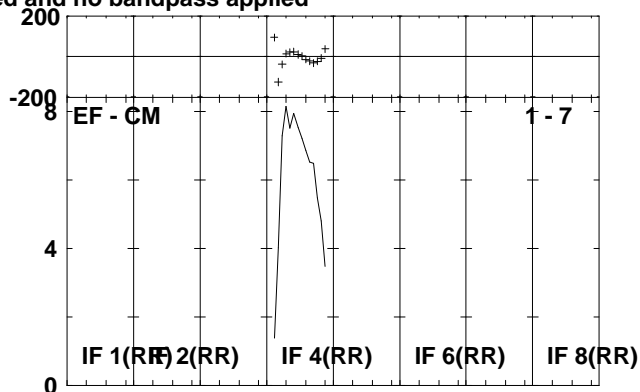
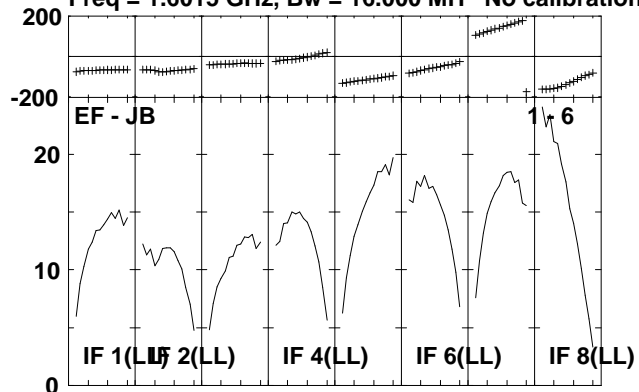

Lower frame: Milli Ampl Jy Top frame: Phas deg
Scalar averaged cross-power spectrum Several baselines displayed
Timerange: 00/19:25:22 to 00/19:27:18

Plot file version 29 created 26-APR-2010 13:25:49

HCG62 EA043.UVDATA.1

Freq = 1.6015 GHz, Bw = 16.000 MH No calibration applied and no bandpass applied

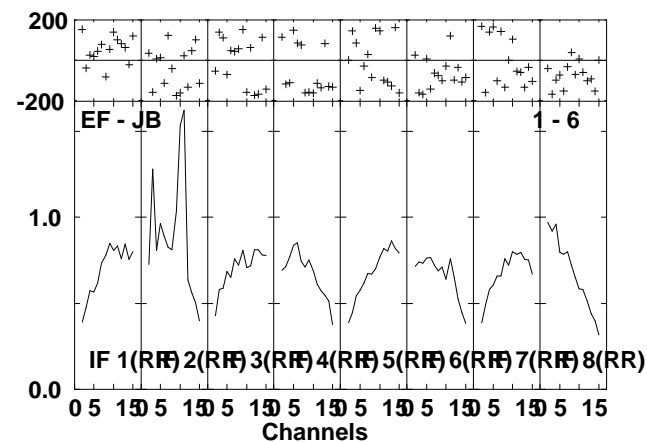
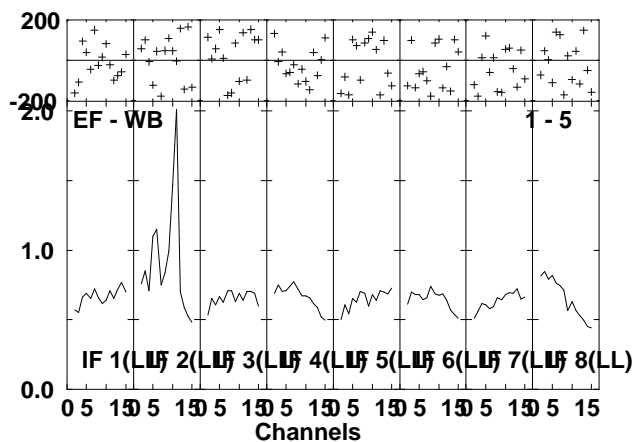
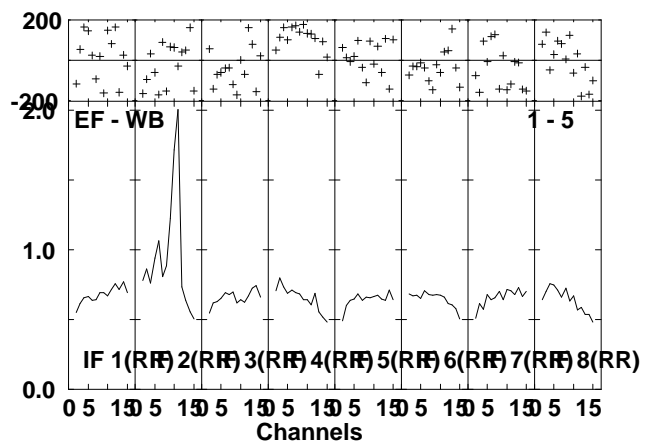
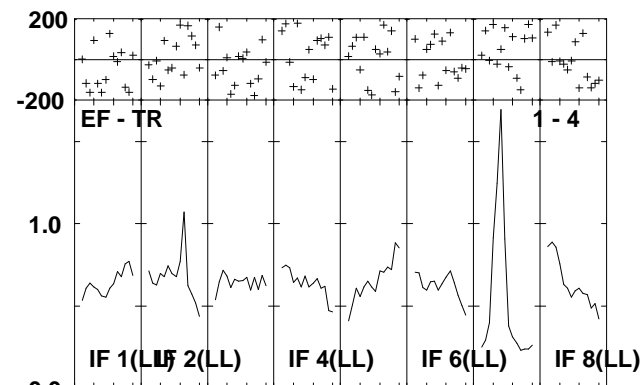
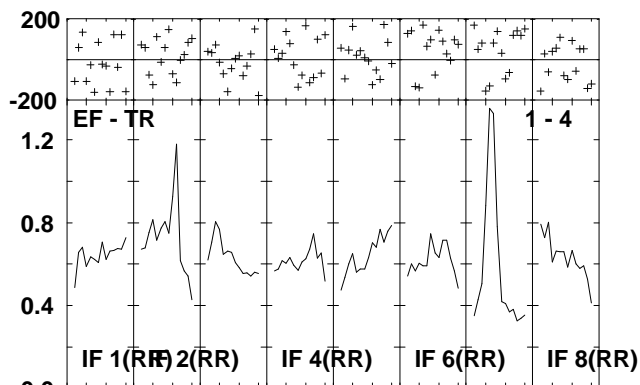
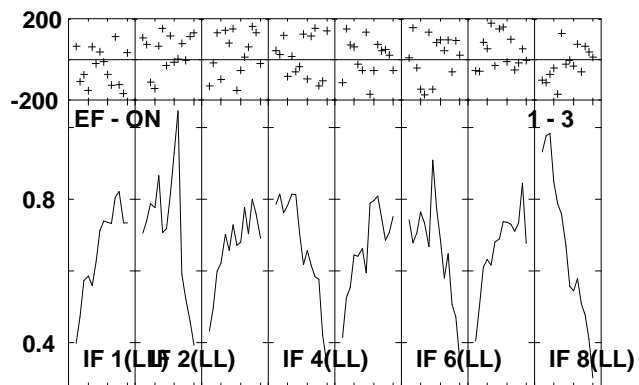
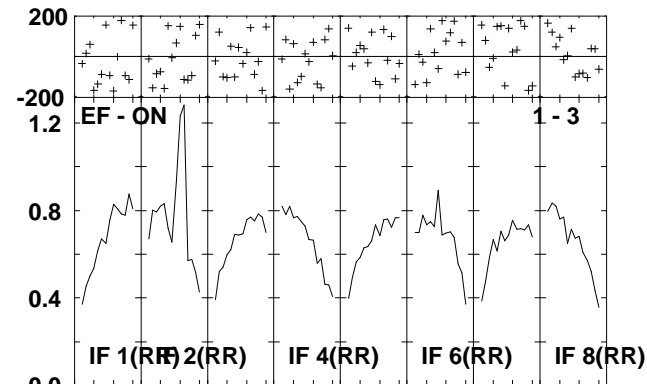
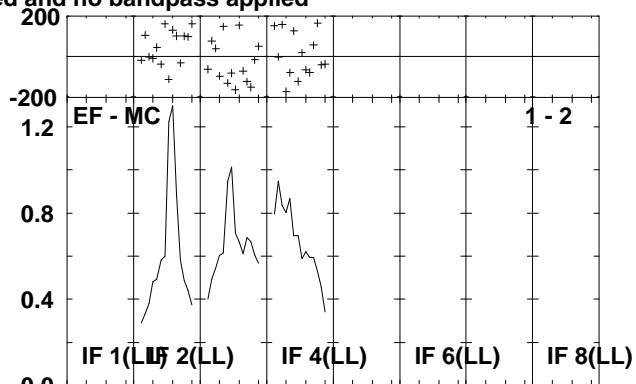
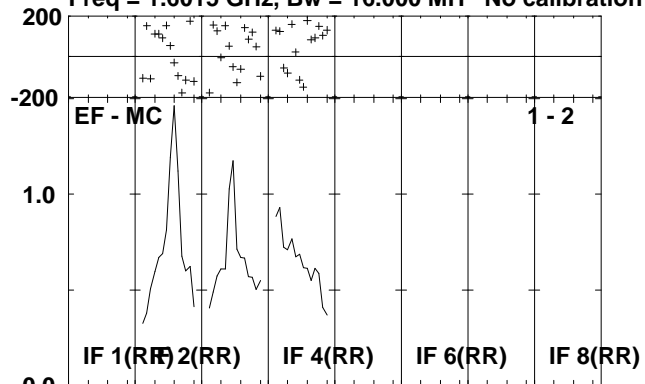

Lower frame: Milli Ampl Jy Top frame: Phas deg
Scalar averaged cross-power spectrum Several baselines displayed
Timerange: 00/19:28:22 to 00/19:35:18

Plot file version 30 created 26-APR-2010 13:25:51

HCG62 EA043.UVDATA.1

Freq = 1.6015 GHz, Bw = 16.000 MH No calibration applied and no bandpass applied

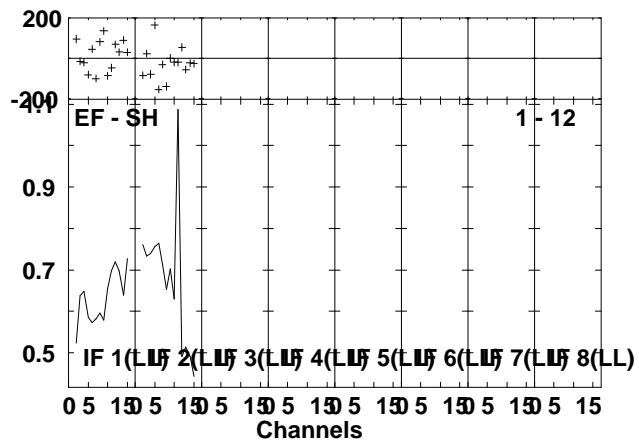
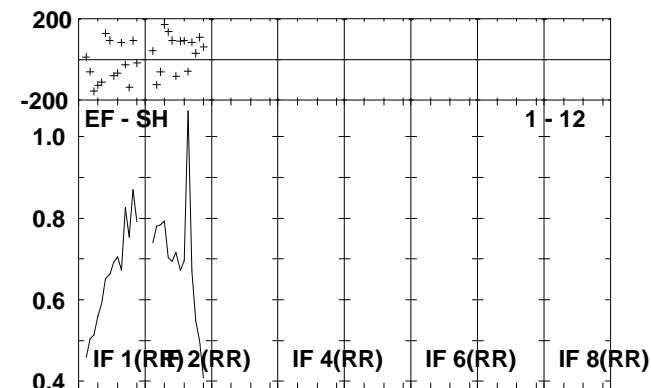
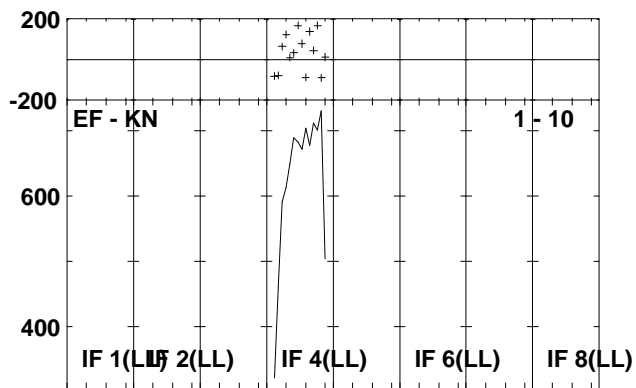
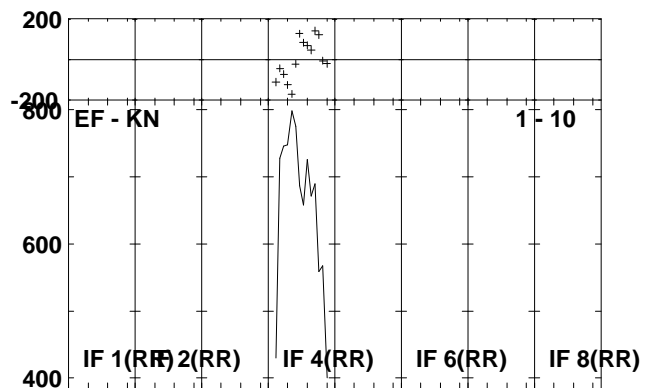
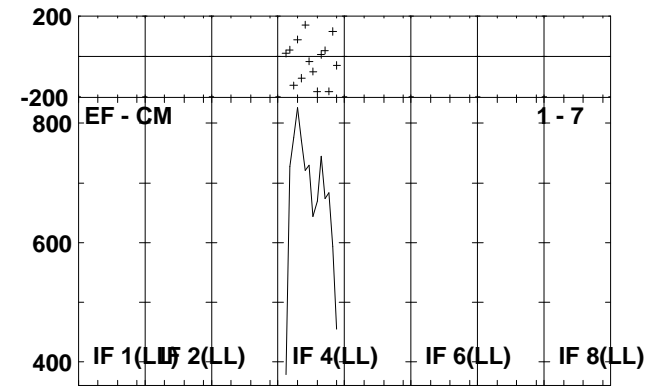
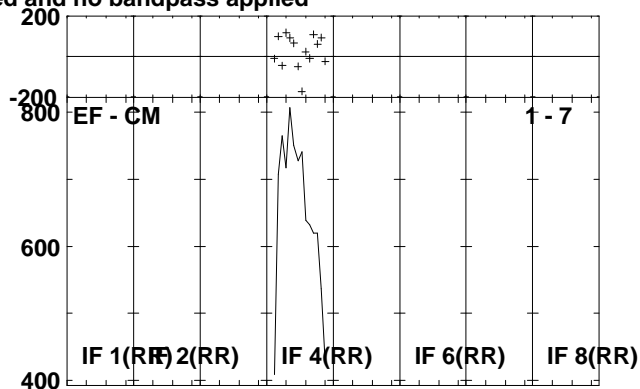
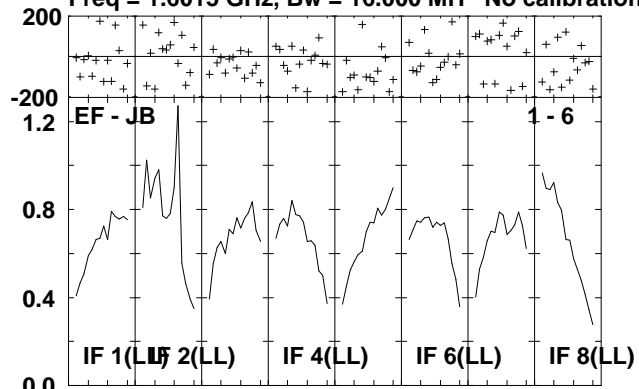

Lower frame: Milli Ampl Jy Top frame: Phas deg
Scalar averaged cross-power spectrum Several baselines displayed
Timerange: 00/19:28:22 to 00/19:35:18

Plot file version 31 created 26-APR-2010 13:25:53

J1246-07 EA043.UVDATA.1

Freq = 1.6015 GHz, Bw = 16.000 MH No calibration applied and no bandpass applied

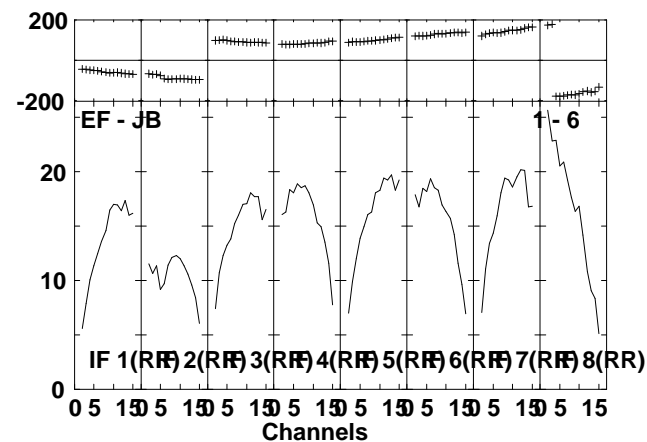
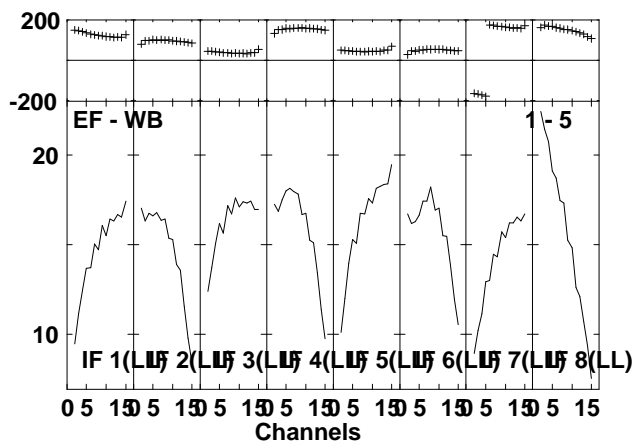
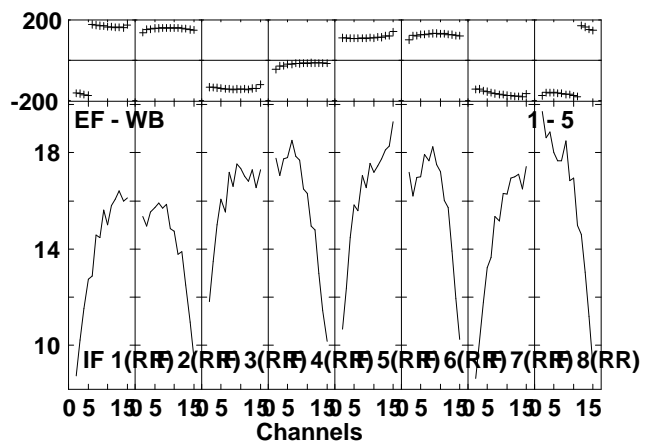
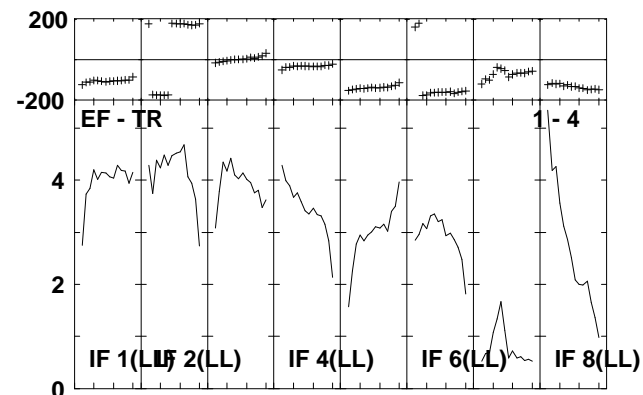
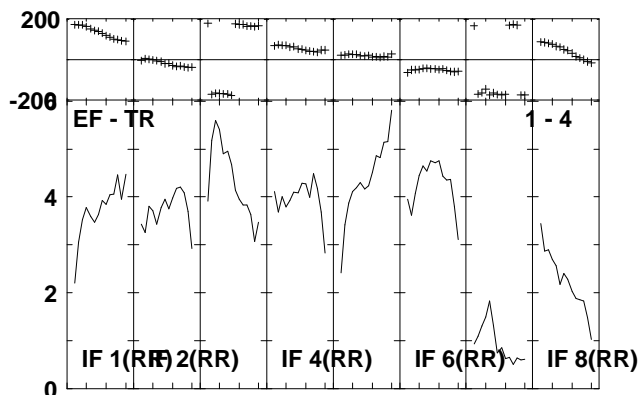
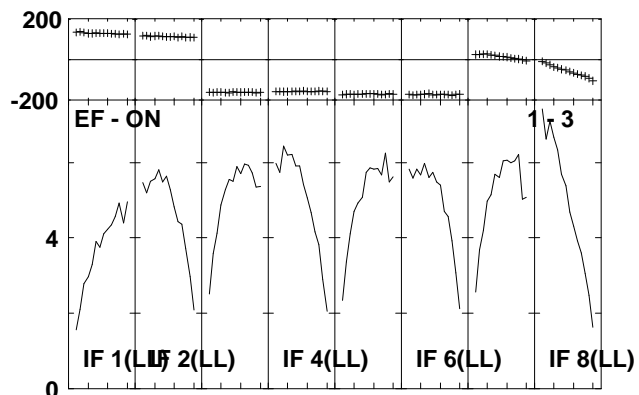
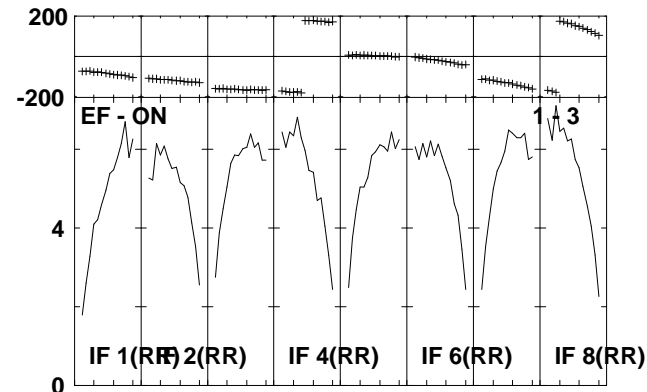
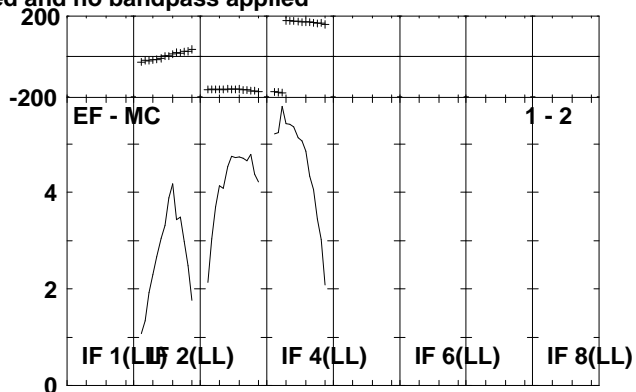
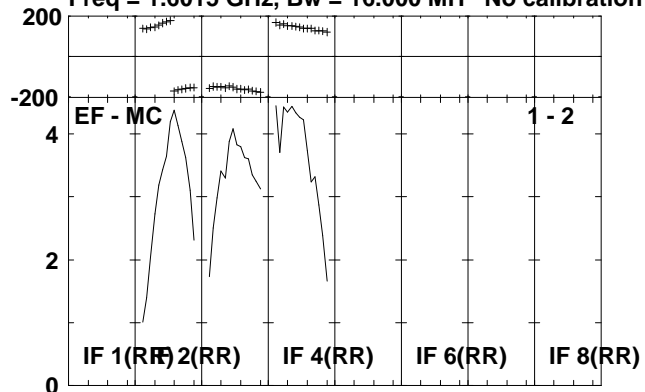

Lower frame: Milli Ampl Jy Top frame: Phas deg
Scalar averaged cross-power spectrum Several baselines displayed
Timerange: 00/19:35:22 to 00/19:37:18

Plot file version 32 created 26-APR-2010 13:25:54

J1246-07 EA043.UVDATA.1

Freq = 1.6015 GHz, Bw = 16.000 MH No calibration applied and no bandpass applied

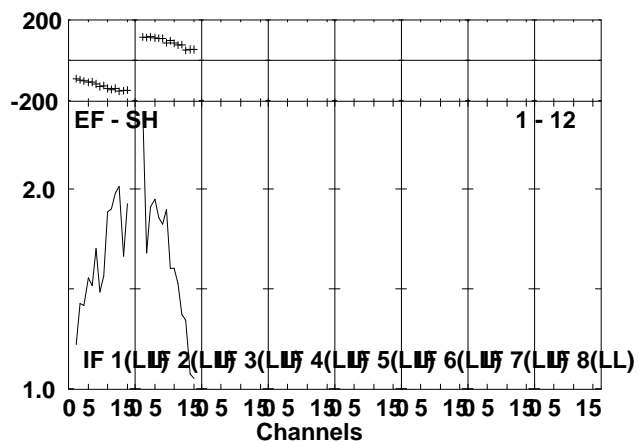
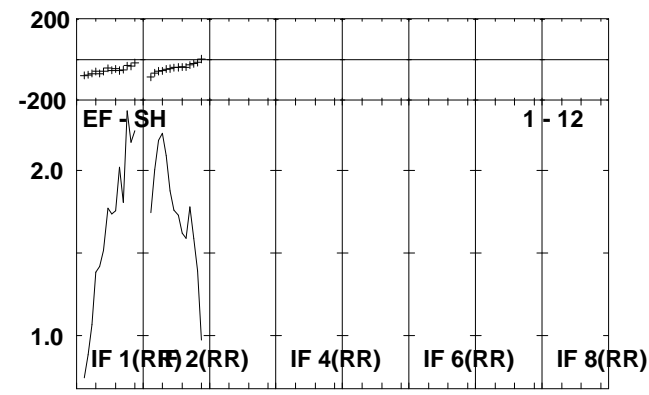
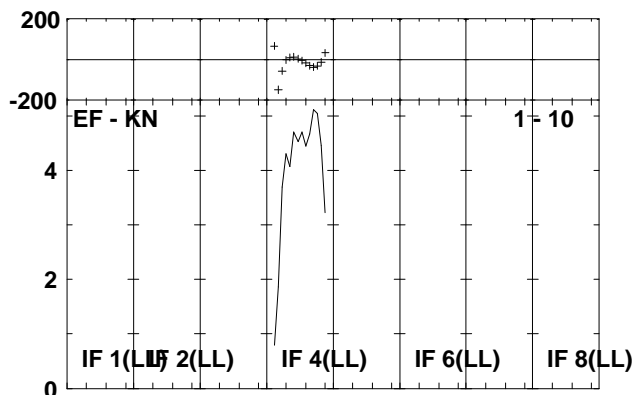
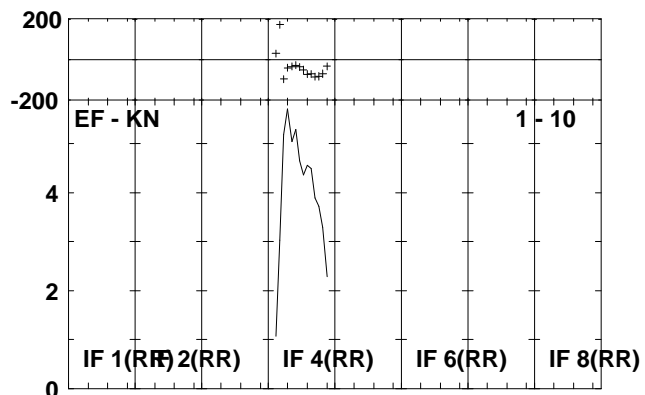
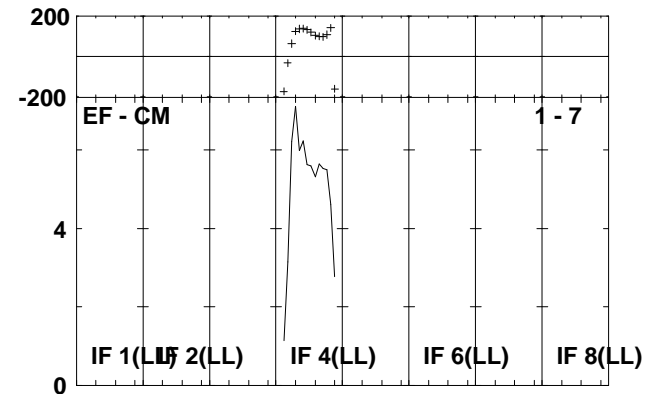
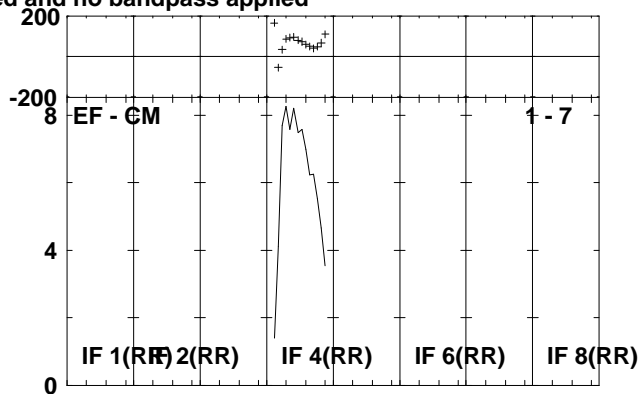
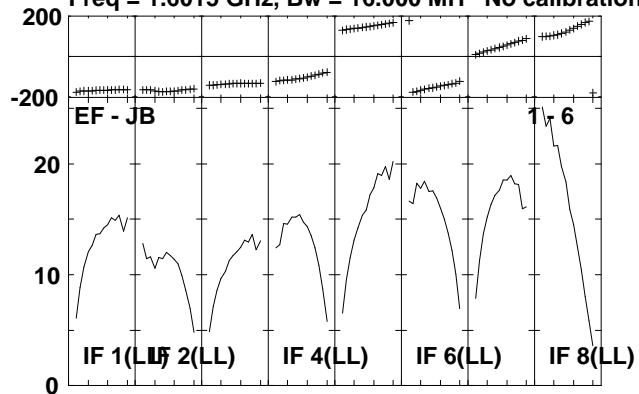

Lower frame: Milli Ampl Jy Top frame: Phas deg
Scalar averaged cross-power spectrum Several baselines displayed
Timerange: 00/19:35:22 to 00/19:37:18

Plot file version 33 created 26-APR-2010 13:25:55

HCG62 EA043.UVDATA.1

Freq = 1.6015 GHz, Bw = 16.000 MH No calibration applied and no bandpass applied

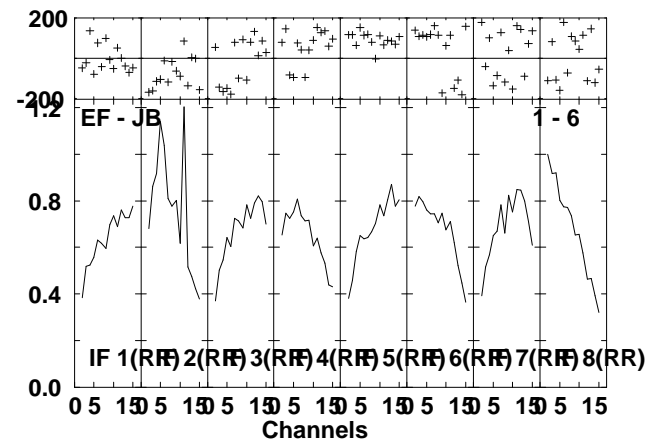
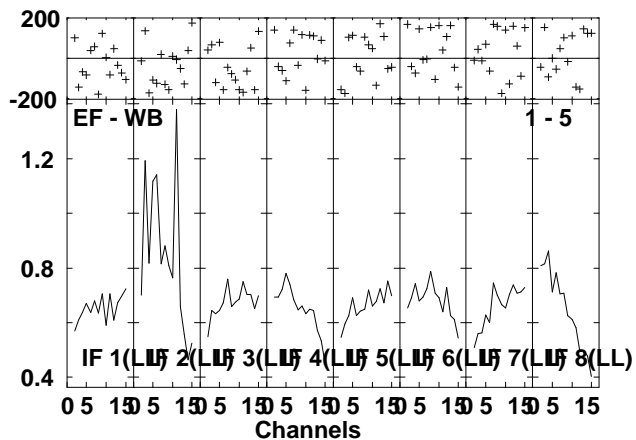
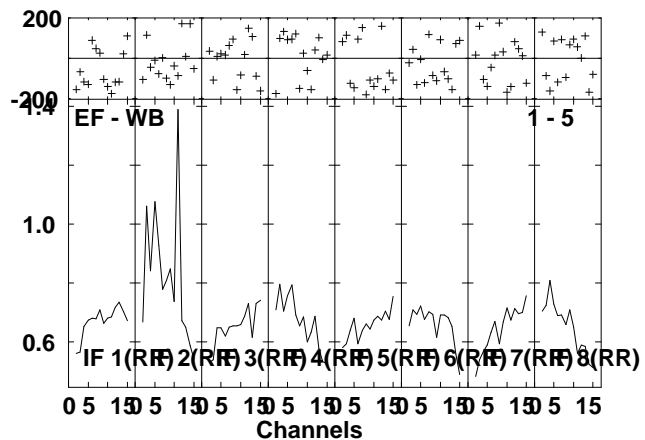
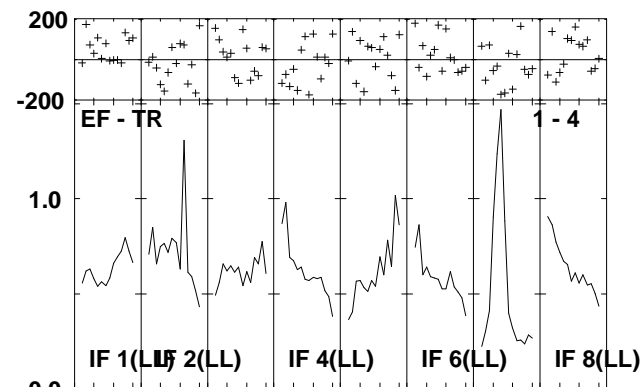
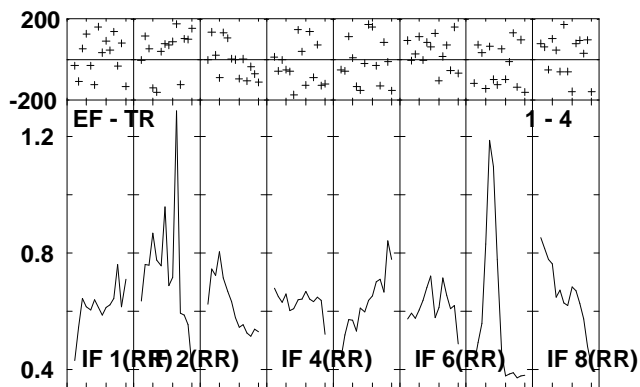
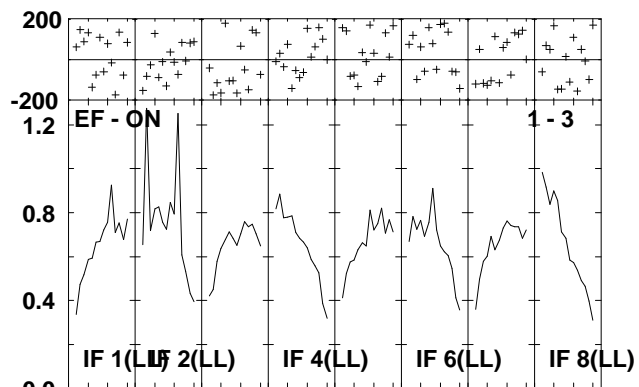
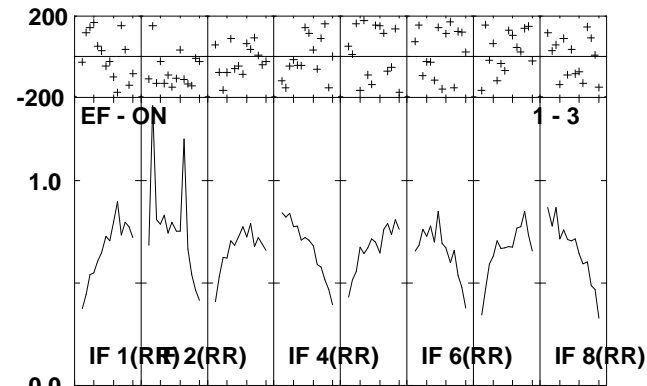
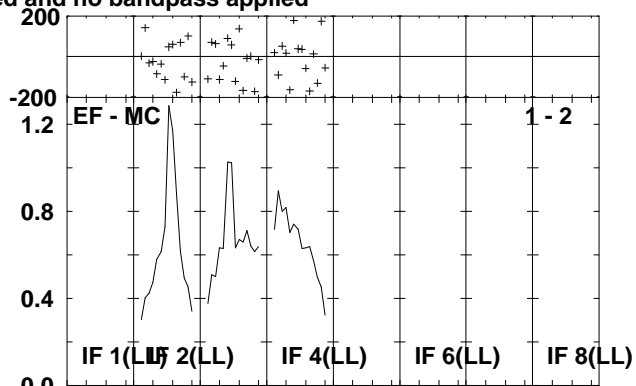
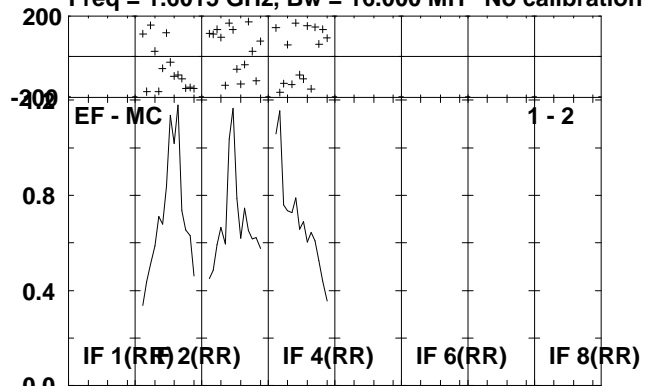

Lower frame: Milli Ampl Jy Top frame: Phas deg
Scalar averaged cross-power spectrum Several baselines displayed
Timerange: 00/19:38:22 to 00/19:45:18

Plot file version 34 created 26-APR-2010 13:25:56

HCG62 EA043.UVDATA.1

Freq = 1.6015 GHz, Bw = 16.000 MH No calibration applied and no bandpass applied

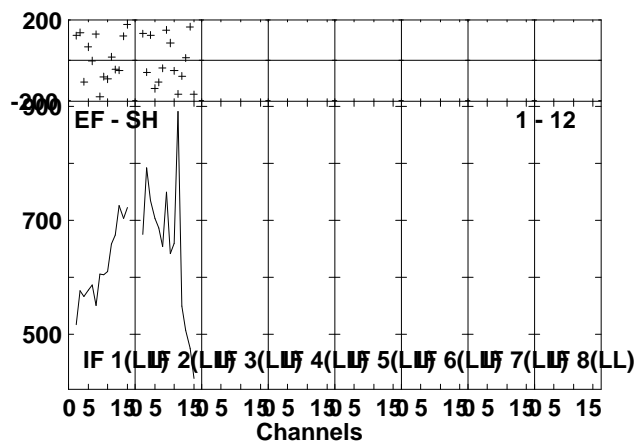
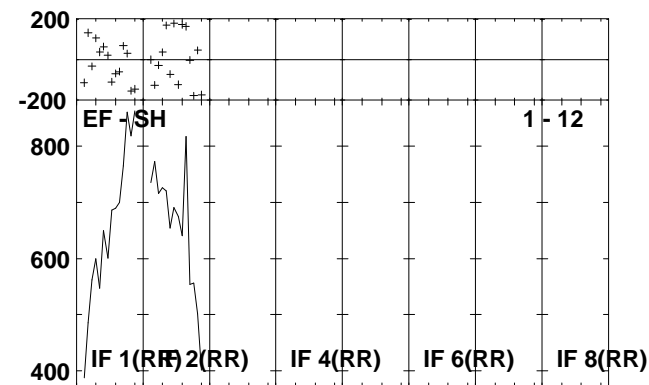
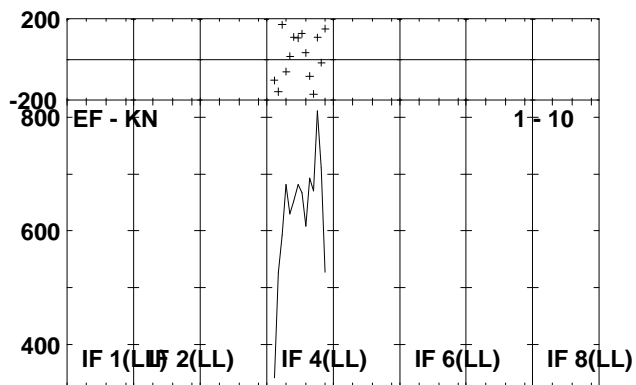
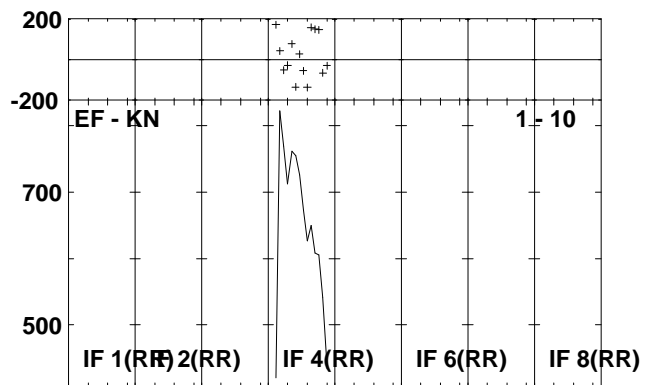
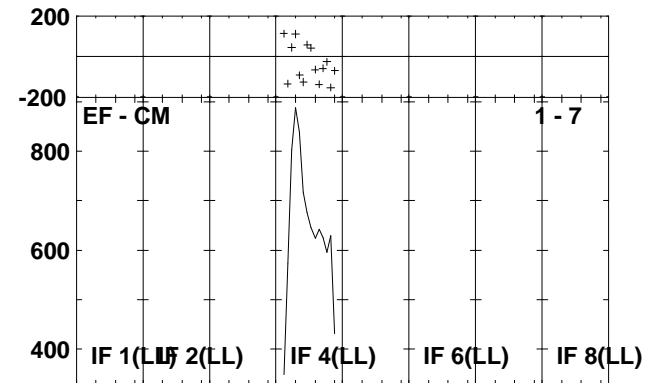
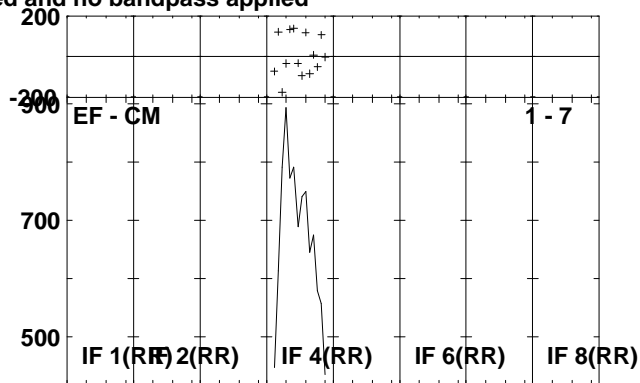
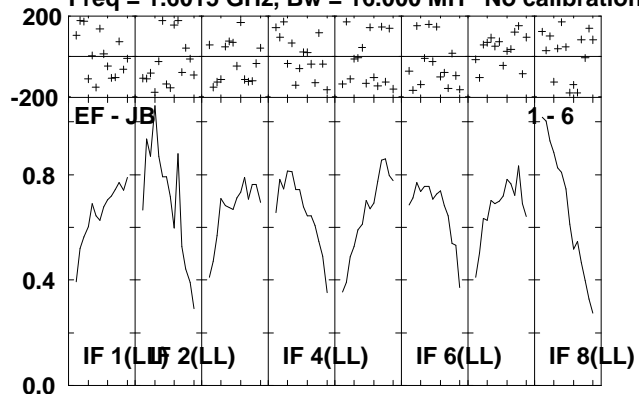

Lower frame: Milli Ampl Jy Top frame: Phas deg
Scalar averaged cross-power spectrum Several baselines displayed
Timerange: 00/19:38:22 to 00/19:45:18

Plot file version 35 created 26-APR-2010 13:25:59

J1246-07 EA043.UVDATA.1

Freq = 1.6015 GHz, Bw = 16.000 MH No calibration applied and no bandpass applied

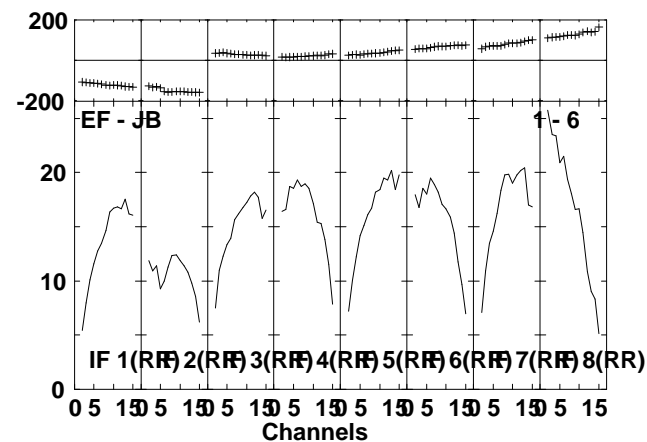
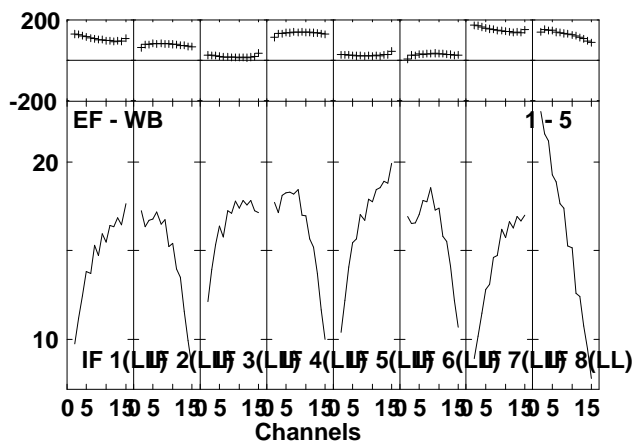
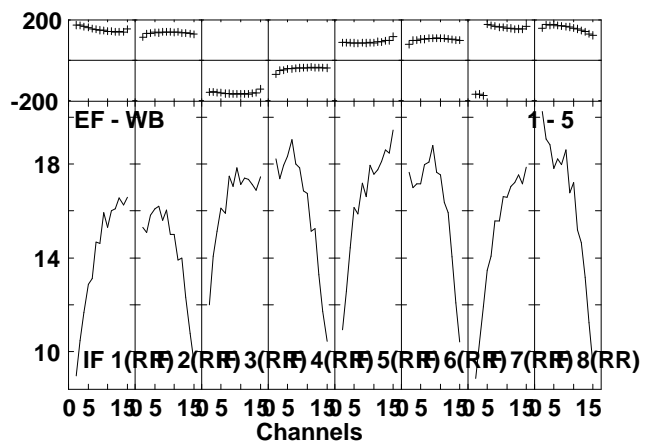
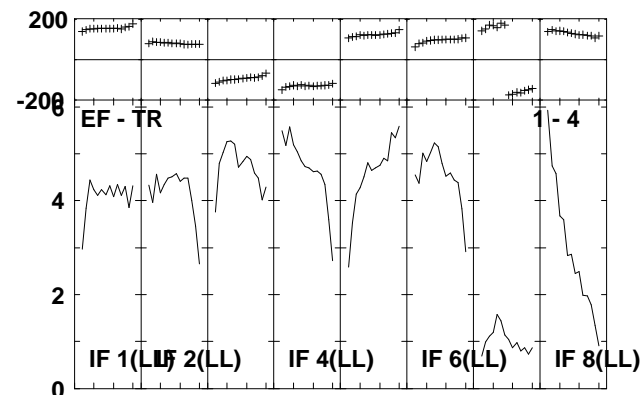
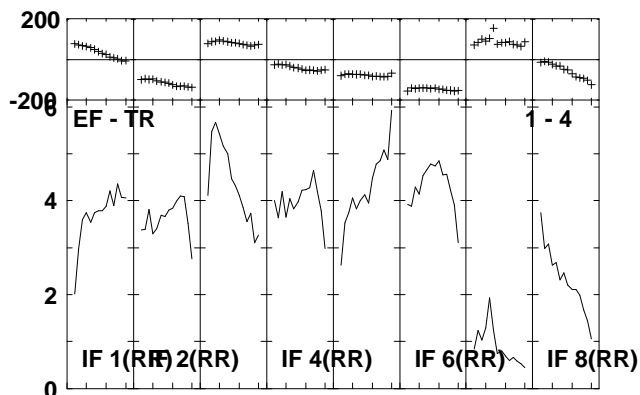
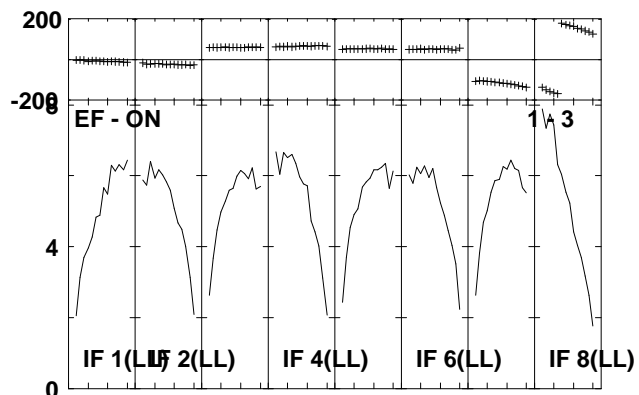
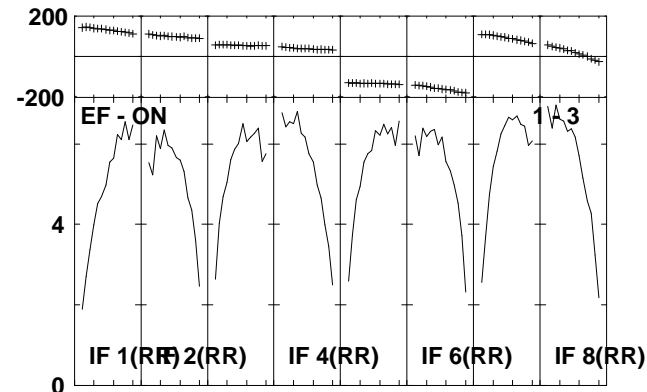
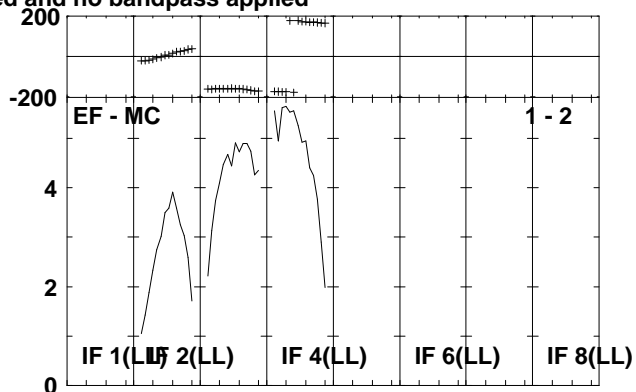
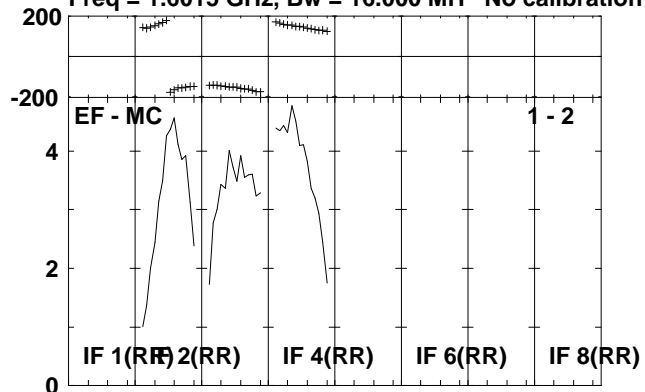

Lower frame: Milli Ampl Jy Top frame: Phas deg
Scalar averaged cross-power spectrum Several baselines displayed
Timerange: 00/19:45:22 to 00/19:47:18

Plot file version 36 created 26-APR-2010 13:25:59

J1246-07 EA043.UVDATA.1

Freq = 1.6015 GHz, Bw = 16.000 MH No calibration applied and no bandpass applied

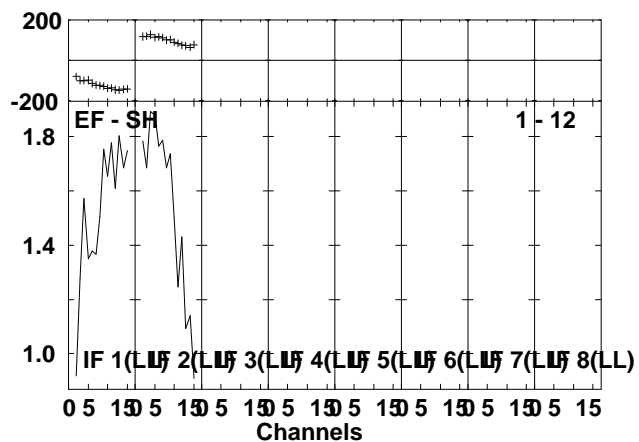
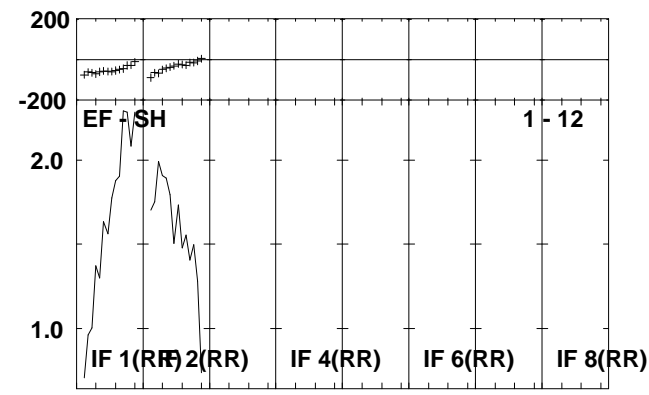
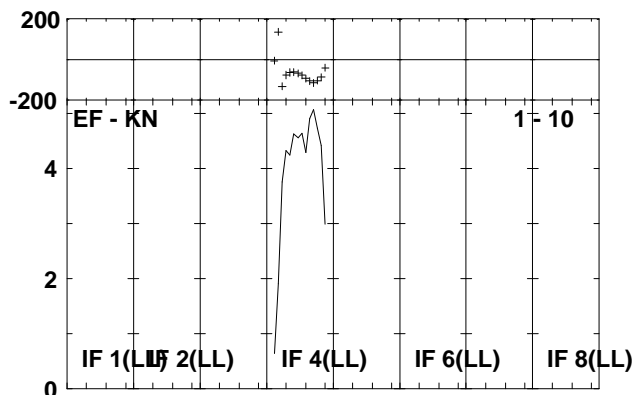
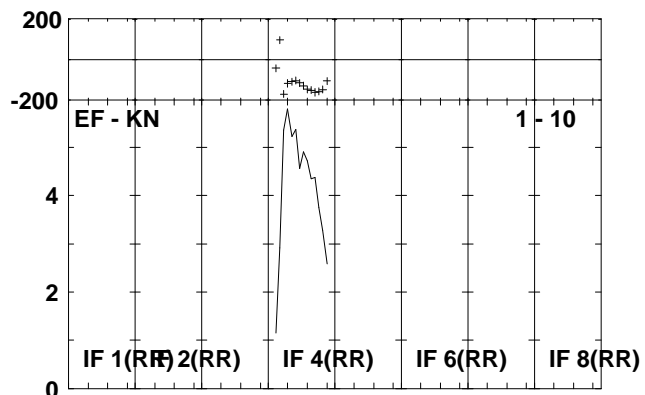
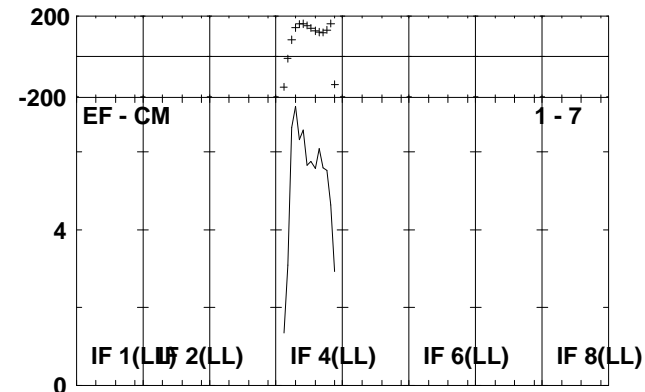
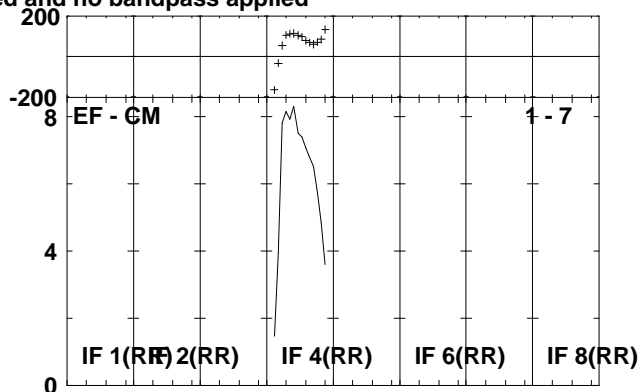
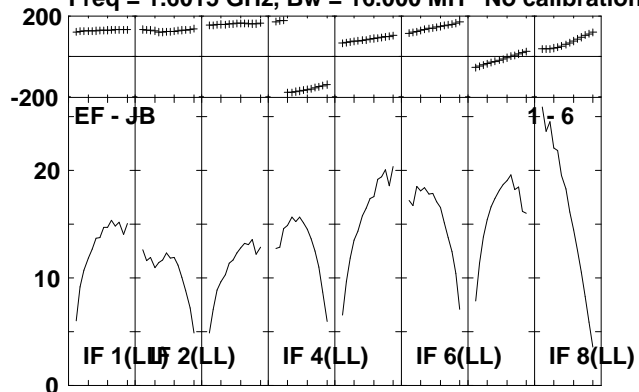

Lower frame: Milli Ampl Jy Top frame: Phas deg
Scalar averaged cross-power spectrum Several baselines displayed
Timerange: 00/19:45:22 to 00/19:47:18

Plot file version 37 created 26-APR-2010 13:26:00

HCG62 EA043.UVDATA.1

Freq = 1.6015 GHz, Bw = 16.000 MH No calibration applied and no bandpass applied

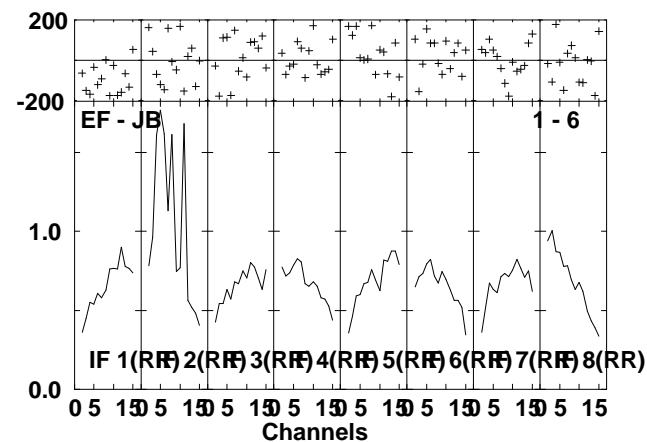
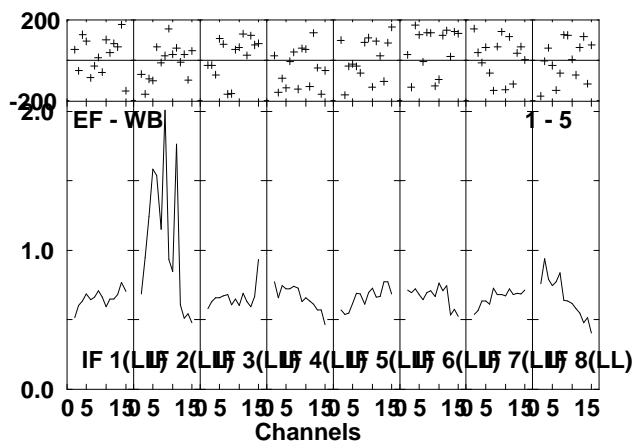
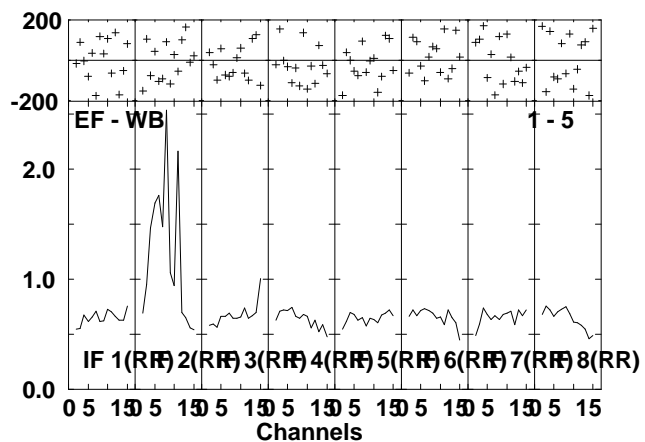
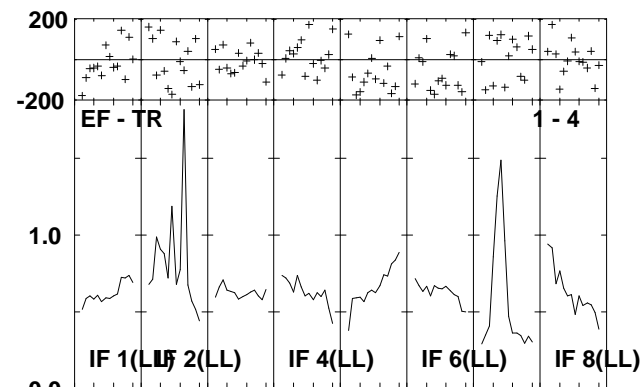
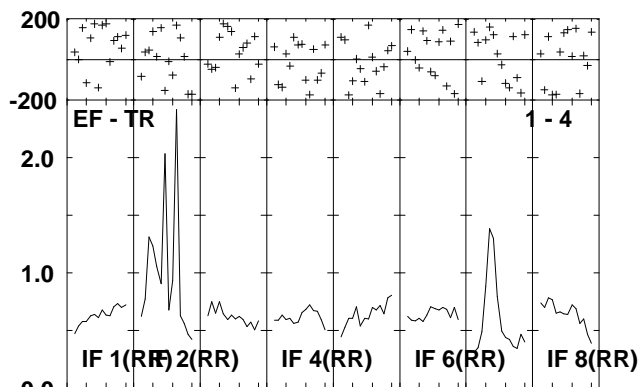
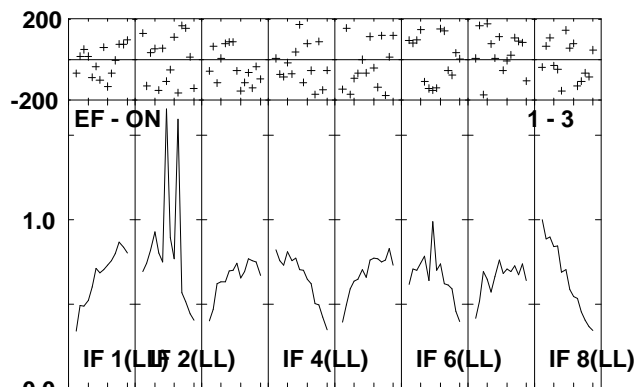
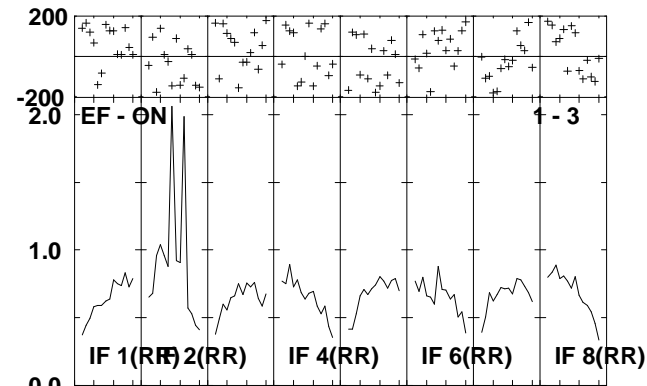
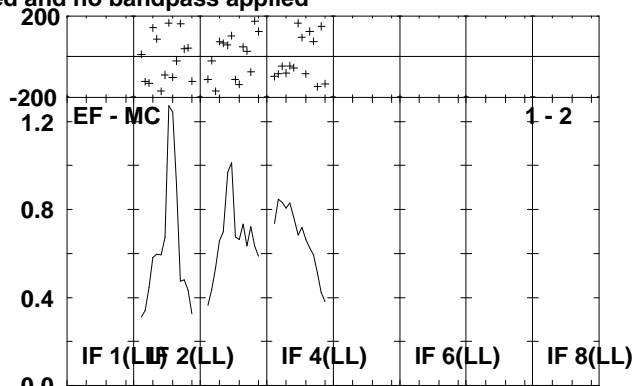
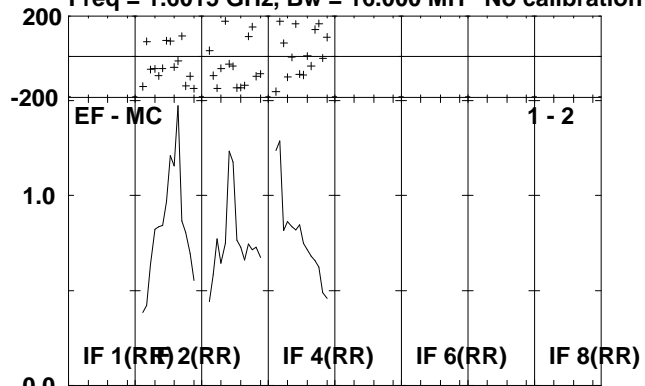

Lower frame: Milli Ampl Jy Top frame: Phas deg
Scalar averaged cross-power spectrum Several baselines displayed
Timerange: 00/19:51:00 to 00/19:55:16

Plot file version 38 created 26-APR-2010 13:26:01

HCG62 EA043.UVDATA.1

Freq = 1.6015 GHz, Bw = 16.000 MH No calibration applied and no bandpass applied

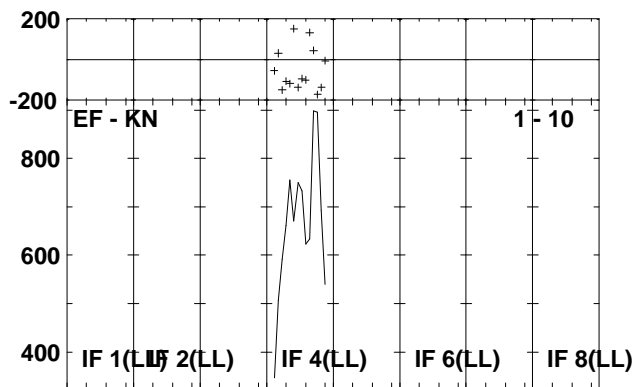
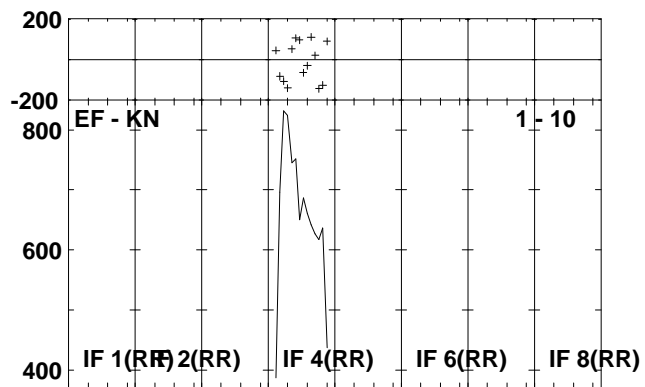
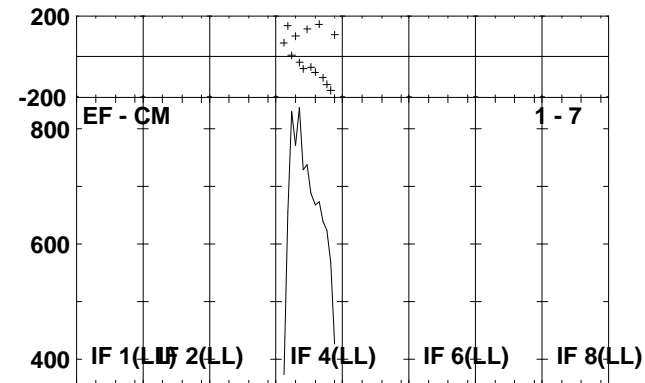
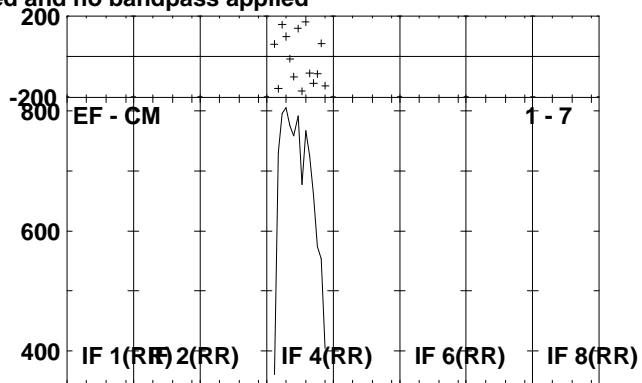
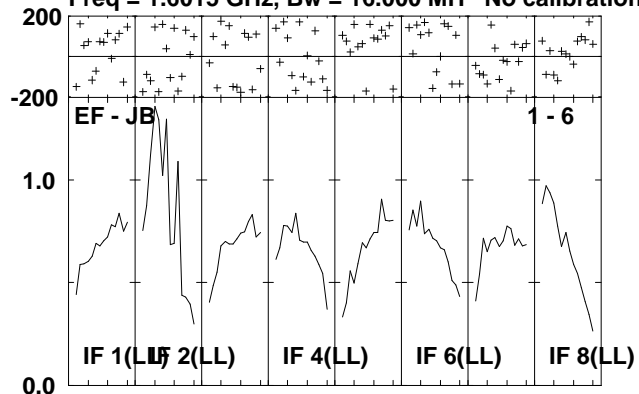

Lower frame: Milli Ampl Jy Top frame: Phas deg
Scalar averaged cross-power spectrum Several baselines displayed
Timerange: 00/19:51:00 to 00/19:55:16

Plot file version 39 created 26-APR-2010 13:26:02

J1246-07 EA043.UVDATA.1

Freq = 1.6015 GHz, Bw = 16.000 MH No calibration applied and no bandpass applied

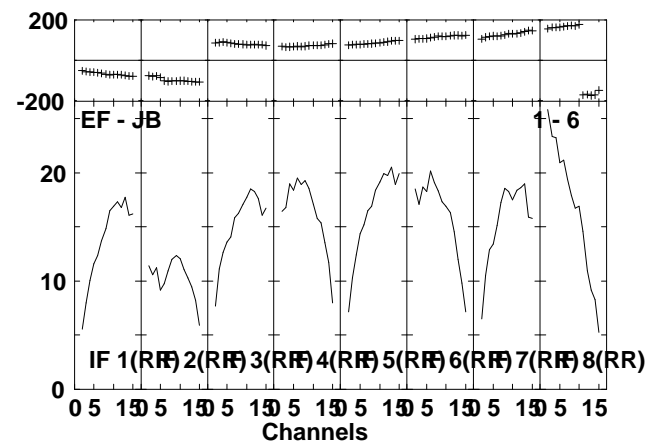
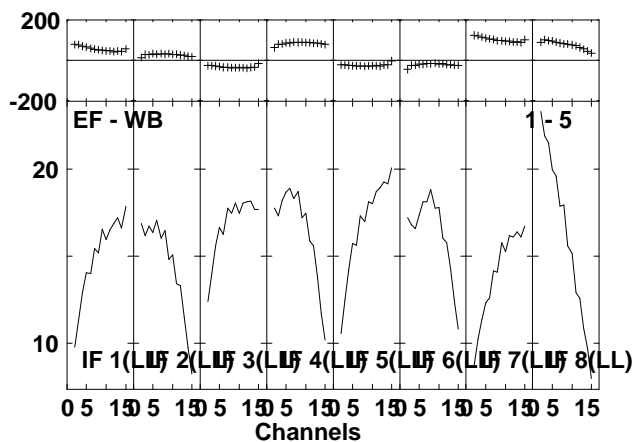
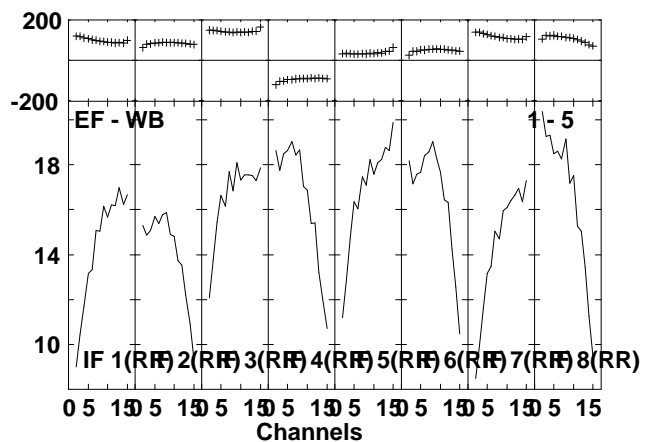
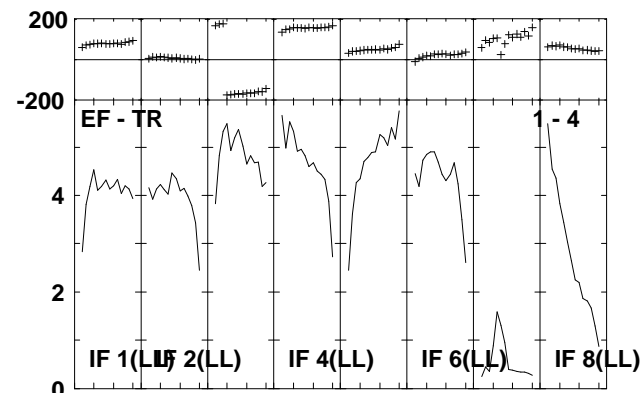
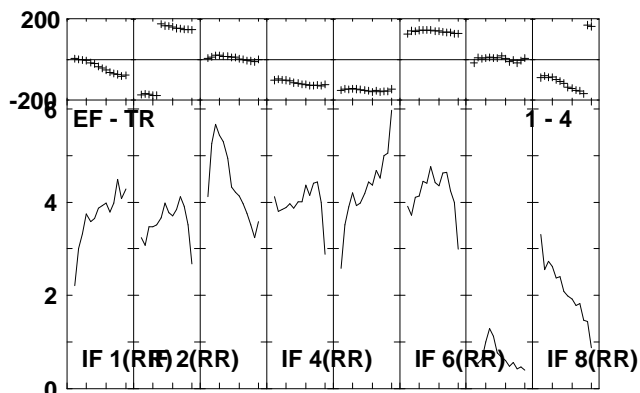
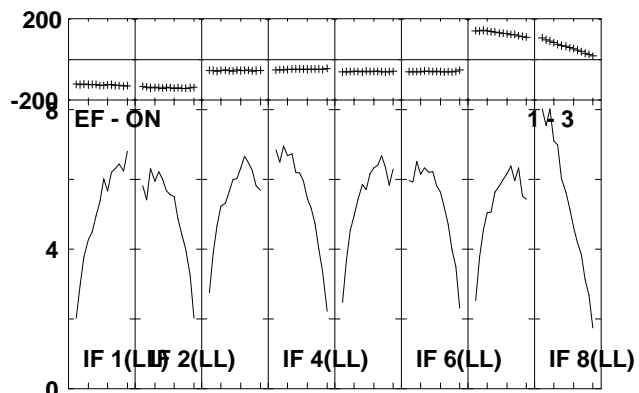
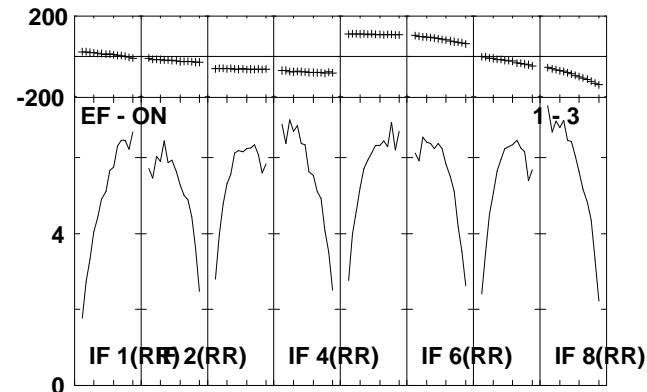
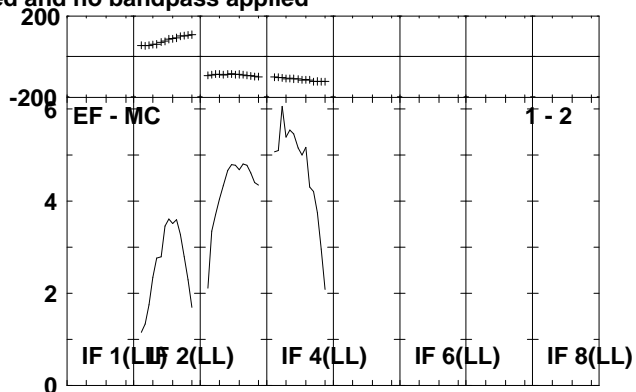
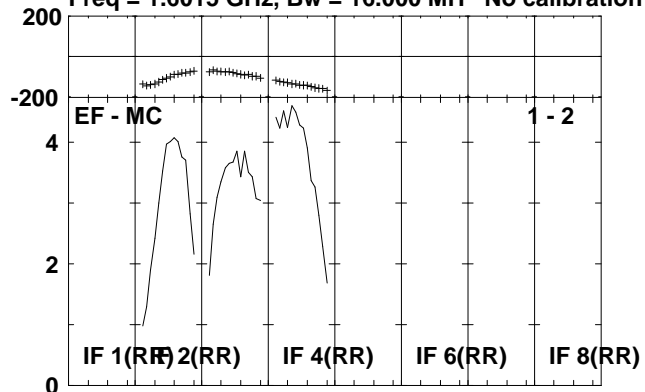

Lower frame: Milli Ampl Jy Top frame: Phas deg
Scalar averaged cross-power spectrum Several baselines displayed
Timerange: 00/19:55:20 to 00/19:57:16

Plot file version 40 created 26-APR-2010 13:26:02

J1246-07 EA043.UVDATA.1

Freq = 1.6015 GHz, Bw = 16.000 MH No calibration applied and no bandpass applied

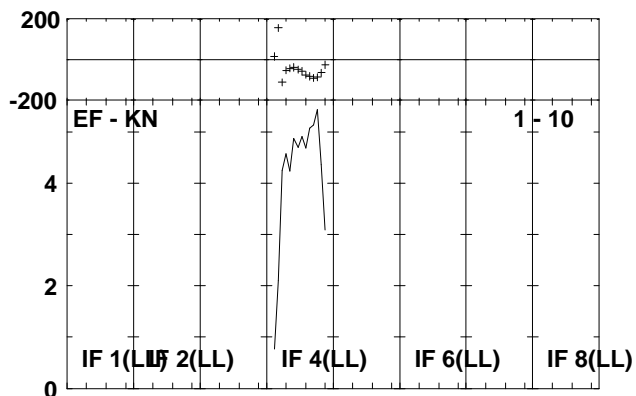
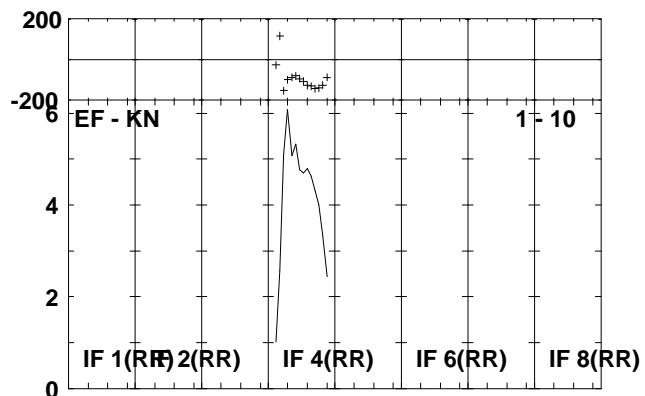
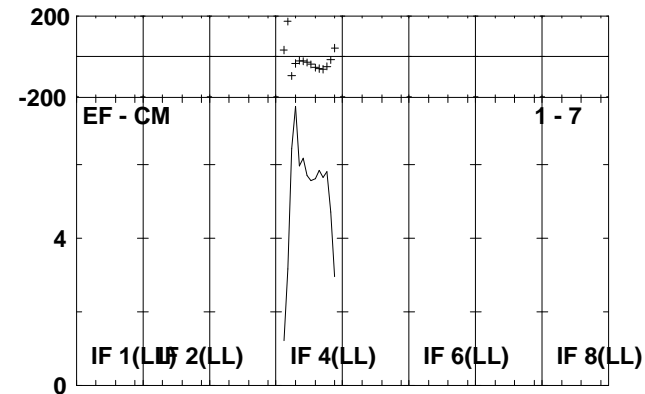
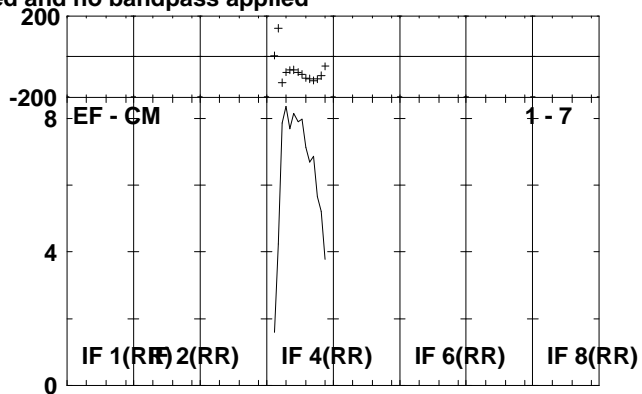
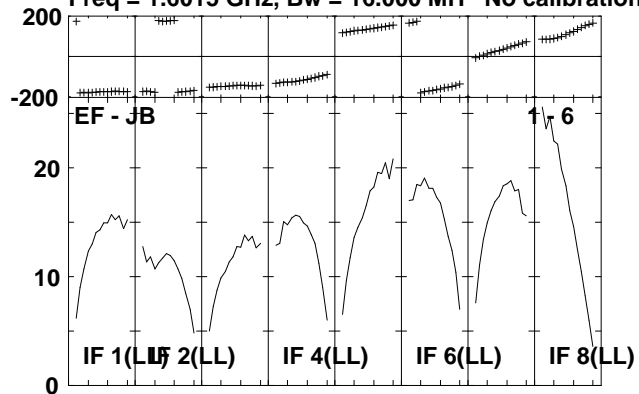

Lower frame: Milli Ampl Jy Top frame: Phas deg
Scalar averaged cross-power spectrum Several baselines displayed
Timerange: 00/19:55:20 to 00/19:57:16

Plot file version 41 created 26-APR-2010 13:26:03

HCG62 EA043.UVDATA.1

Freq = 1.6015 GHz, Bw = 16.000 MH No calibration applied and no bandpass applied

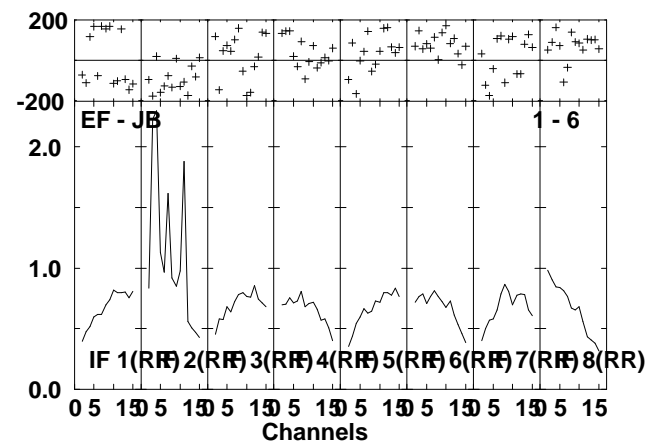
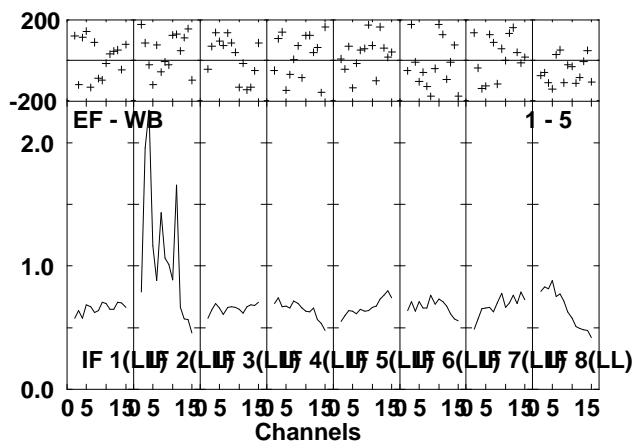
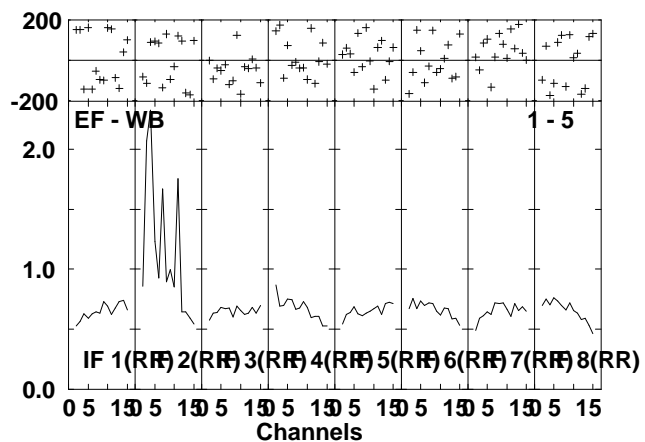
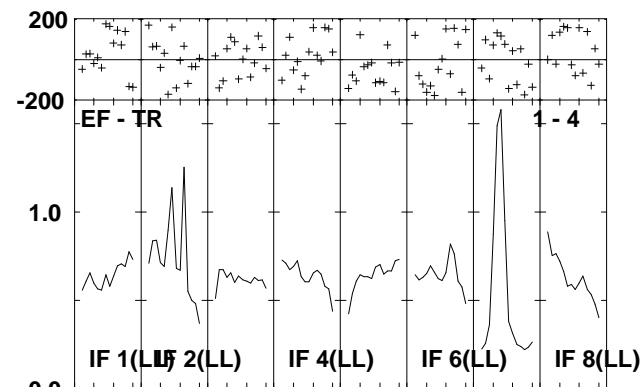
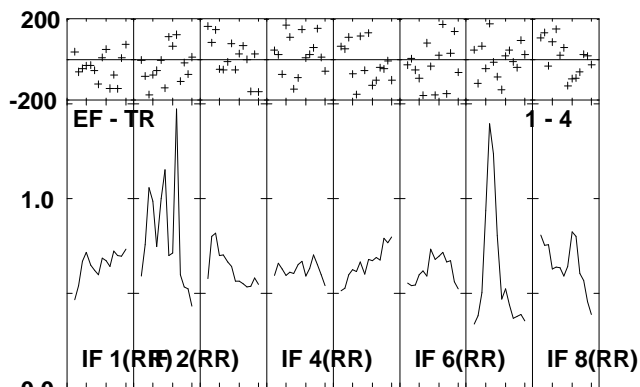
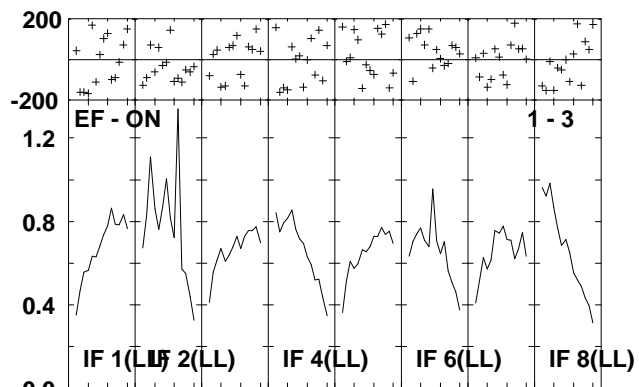
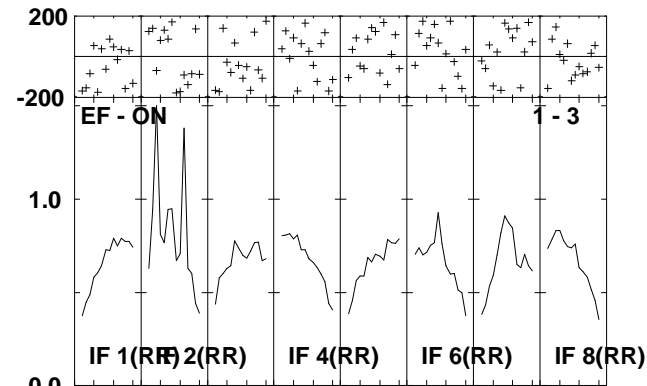
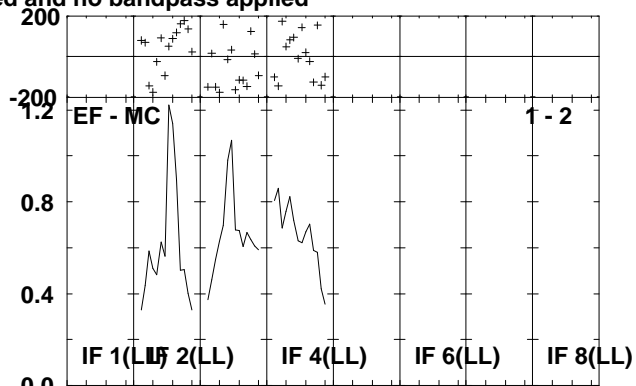
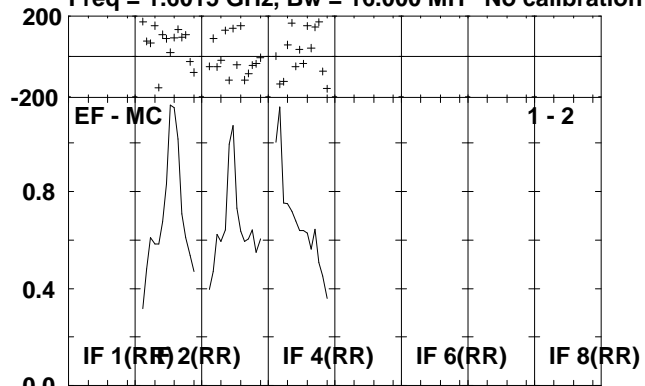

Lower frame: Milli Ampl Jy Top frame: Phas deg
Scalar averaged cross-power spectrum Several baselines displayed
Timerange: 00/19:58:20 to 00/20:05:16

Plot file version 42 created 26-APR-2010 13:26:04

HCG62 EA043.UVDATA.1

Freq = 1.6015 GHz, Bw = 16.000 MH No calibration applied and no bandpass applied

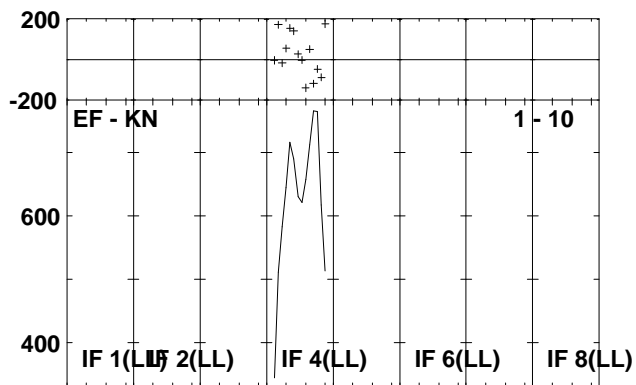
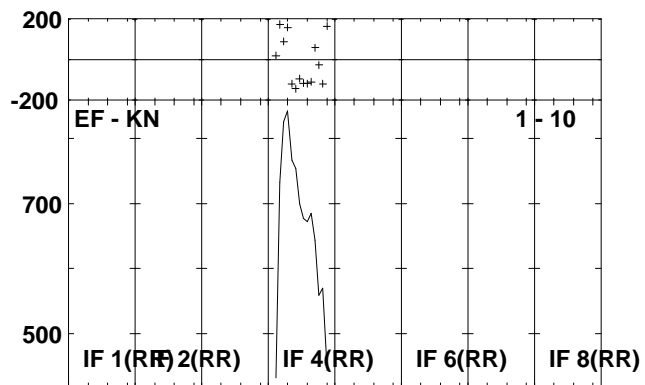
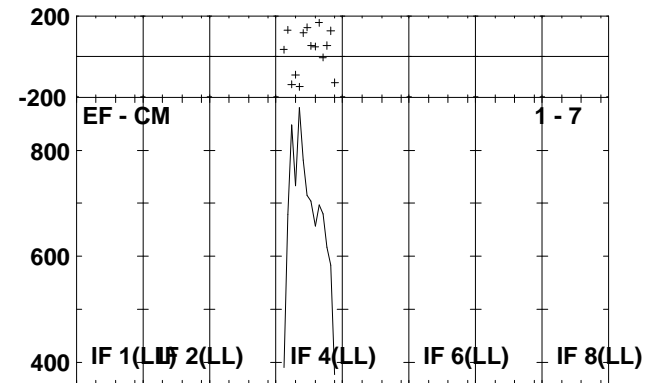
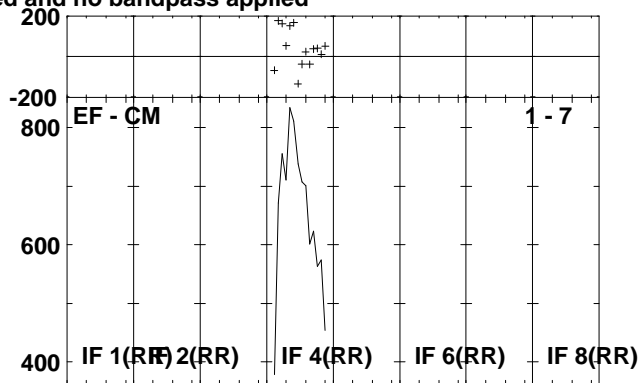
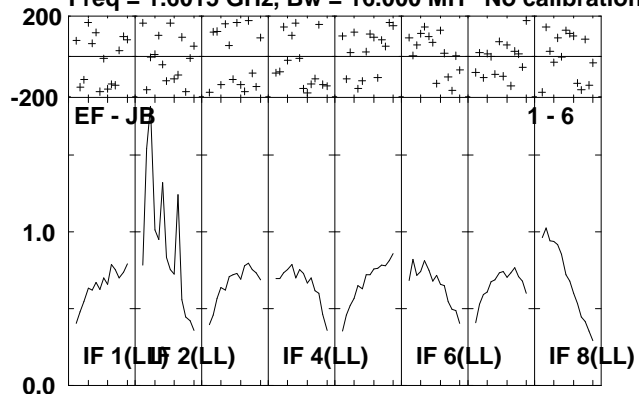

Lower frame: Milli Ampl Jy Top frame: Phas deg
Scalar averaged cross-power spectrum Several baselines displayed
Timerange: 00/19:58:20 to 00/20:05:16

Plot file version 43 created 26-APR-2010 13:26:06

J1246-07 EA043.UVDATA.1

Freq = 1.6015 GHz, Bw = 16.000 MH No calibration applied and no bandpass applied

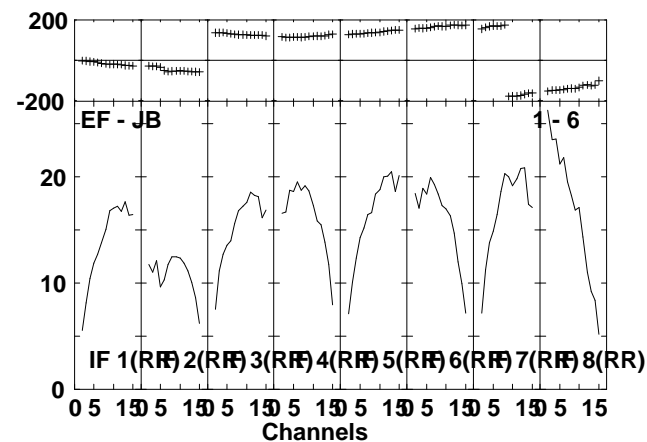
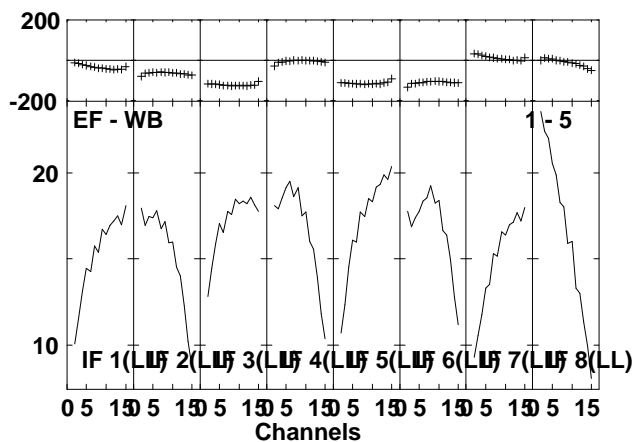
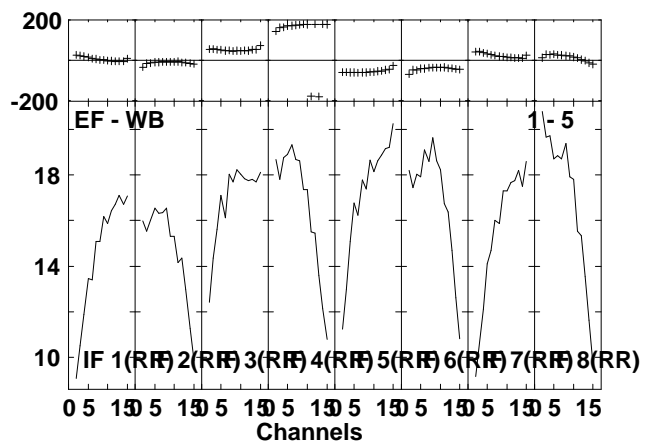
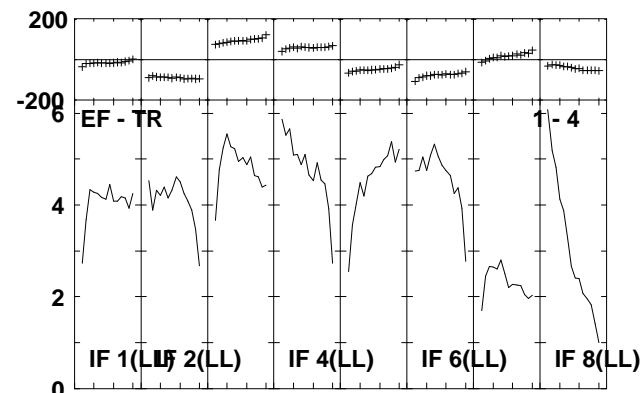
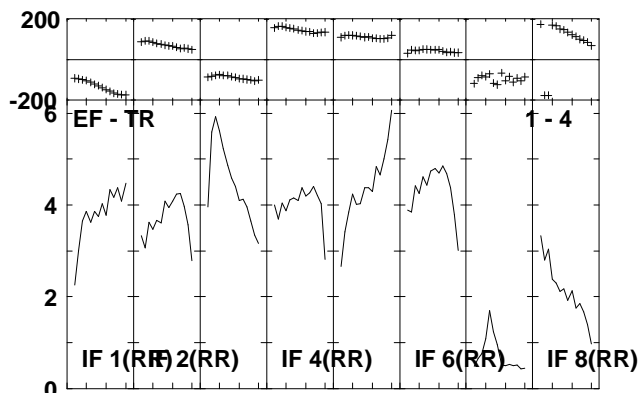
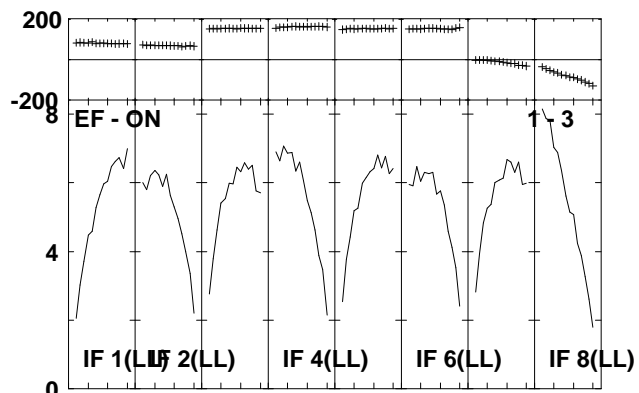
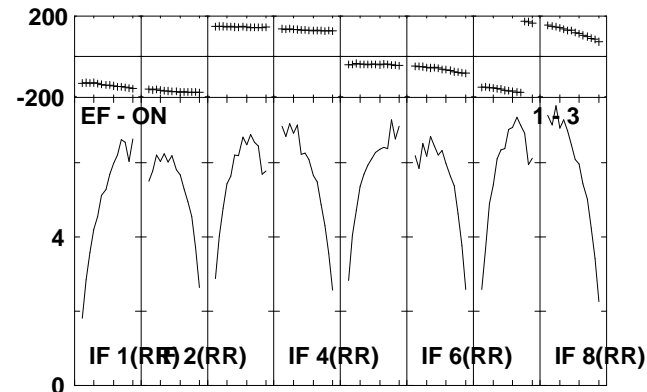
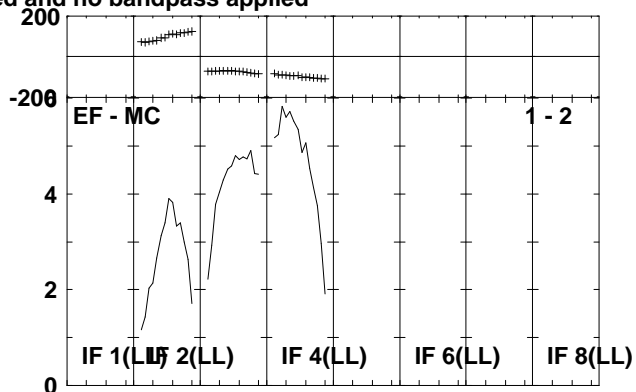
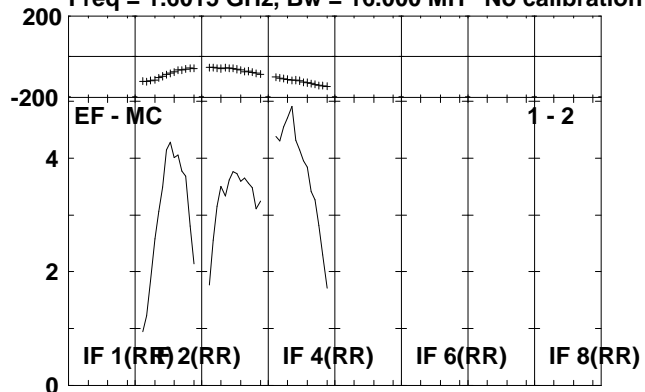

Lower frame: Milli Ampl Jy Top frame: Phas deg
Scalar averaged cross-power spectrum Several baselines displayed
Timerange: 00/20:05:20 to 00/20:07:16

Plot file version 44 created 26-APR-2010 13:26:06

J1246-07 EA043.UVDATA.1

Freq = 1.6015 GHz, Bw = 16.000 MH No calibration applied and no bandpass applied

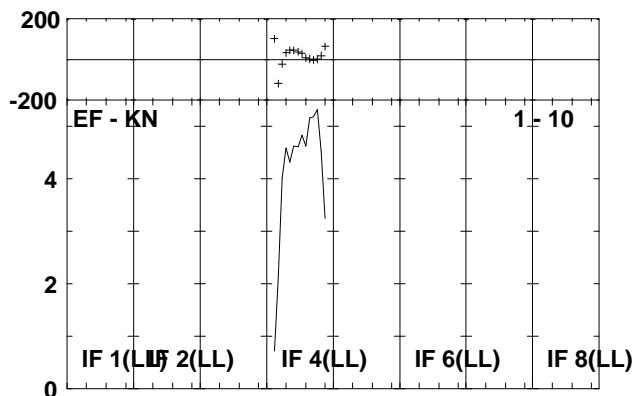
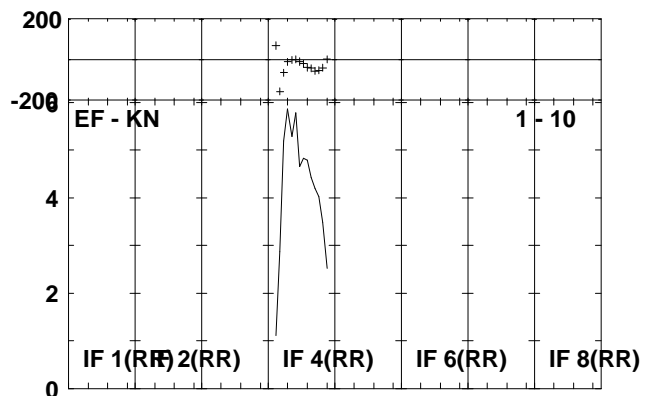
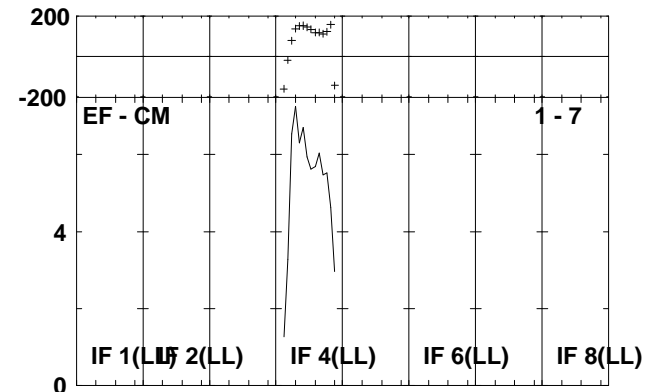
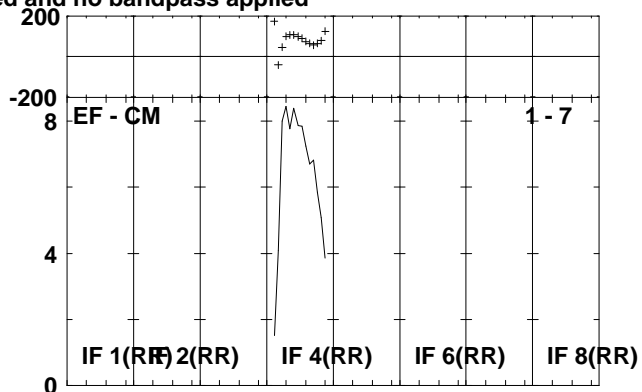
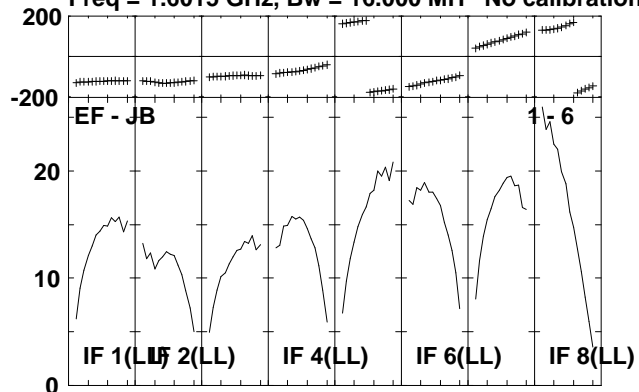

Lower frame: Milli Ampl Jy Top frame: Phas deg
Scalar averaged cross-power spectrum Several baselines displayed
Timerange: 00/20:05:20 to 00/20:07:16

Plot file version 45 created 26-APR-2010 13:26:07

HCG62 EA043.UVDATA.1

Freq = 1.6015 GHz, Bw = 16.000 MH No calibration applied and no bandpass applied

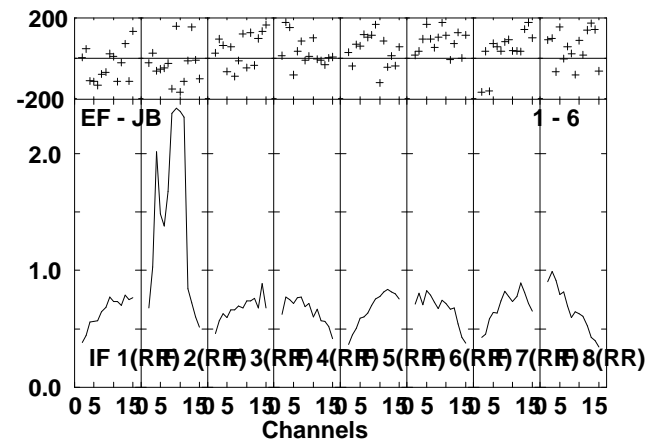
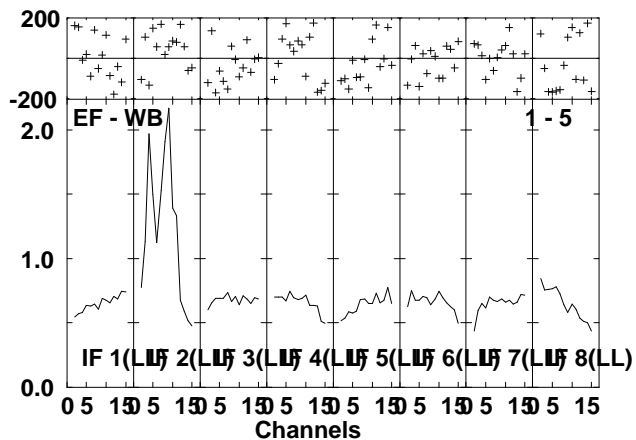
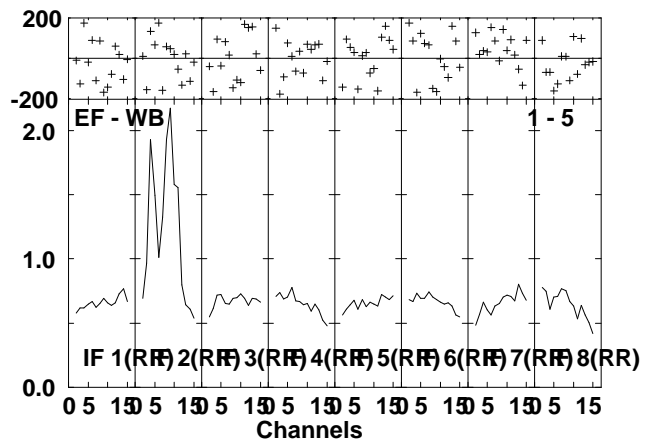
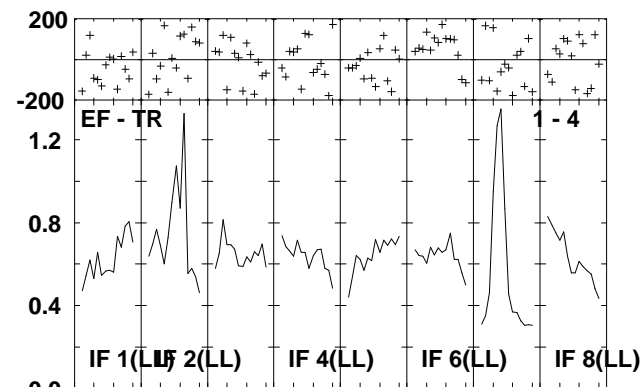
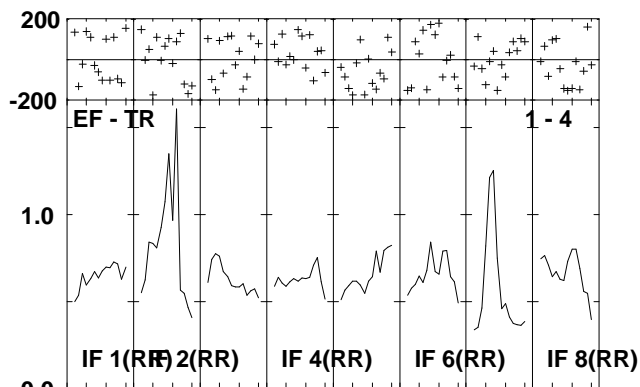
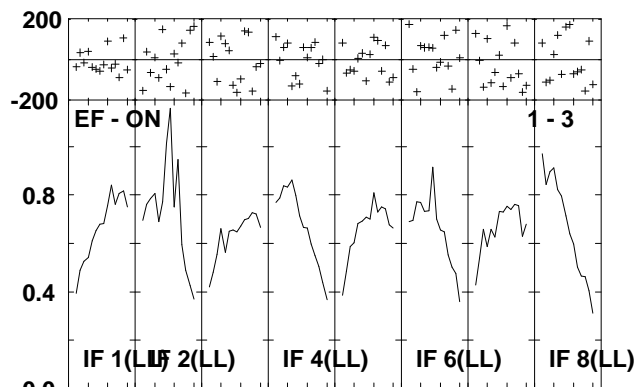
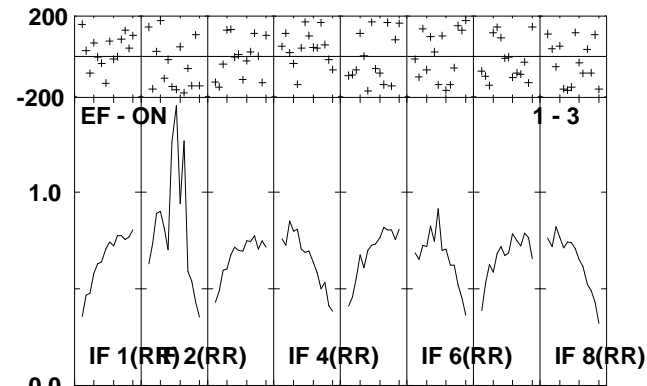
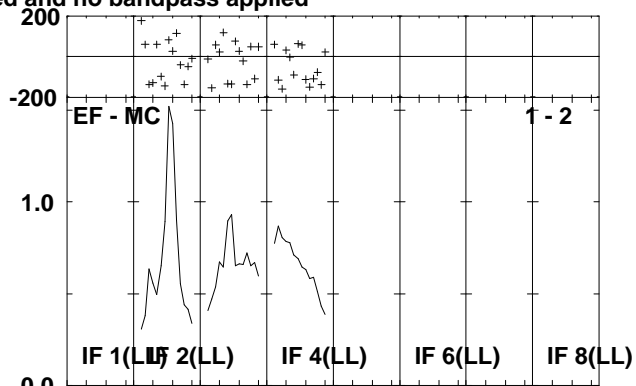
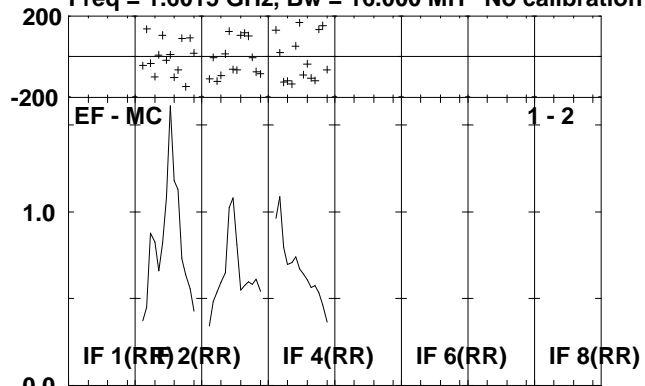

Lower frame: Milli Ampl Jy Top frame: Phas deg
Scalar averaged cross-power spectrum Several baselines displayed
Timerange: 00/20:08:20 to 00/20:15:16

Plot file version 46 created 26-APR-2010 13:26:08

HCG62 EA043.UVDATA.1

Freq = 1.6015 GHz, Bw = 16.000 MH No calibration applied and no bandpass applied

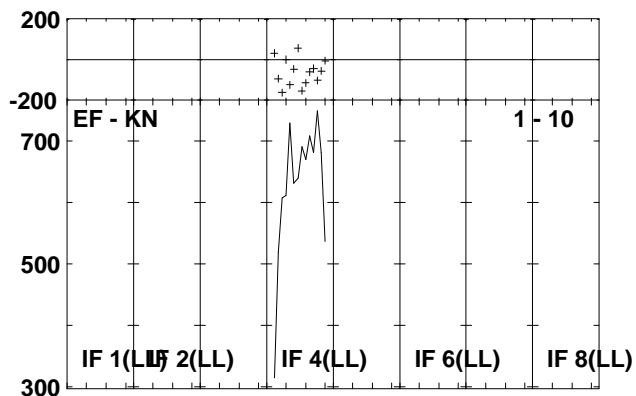
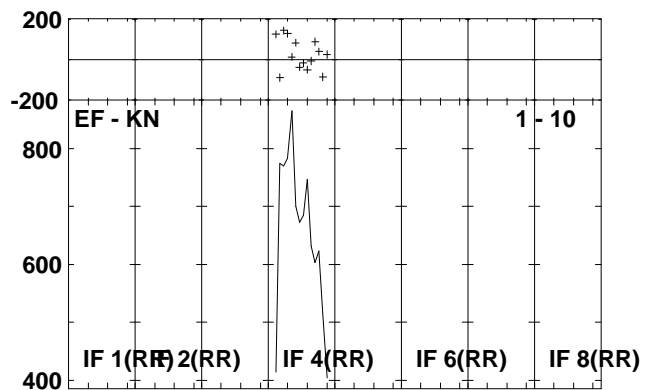
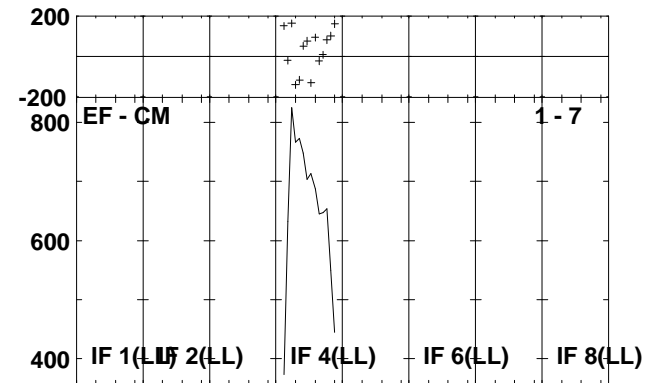
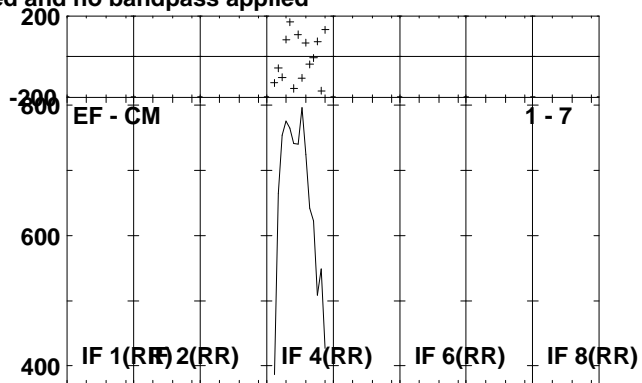
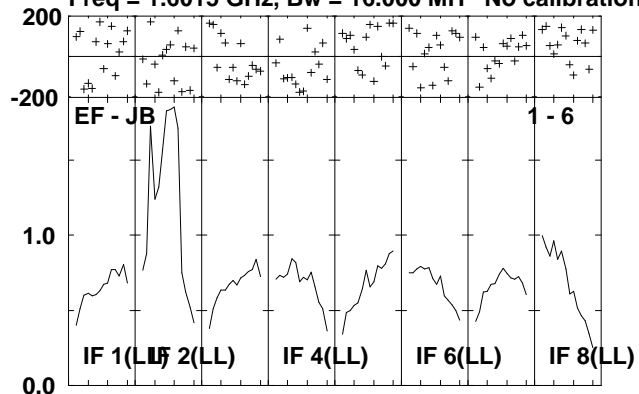

Lower frame: Milli Ampl Jy Top frame: Phas deg
Scalar averaged cross-power spectrum Several baselines displayed
Timerange: 00/20:08:20 to 00/20:15:16

Plot file version 47 created 26-APR-2010 13:26:10

J1246-07 EA043.UVDATA.1

Freq = 1.6015 GHz, Bw = 16.000 MH No calibration applied and no bandpass applied

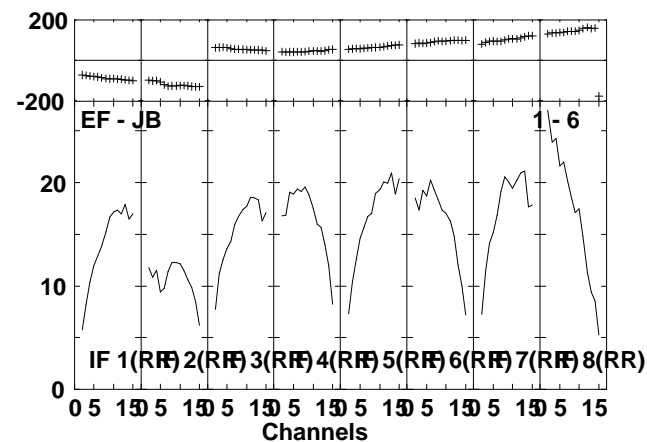
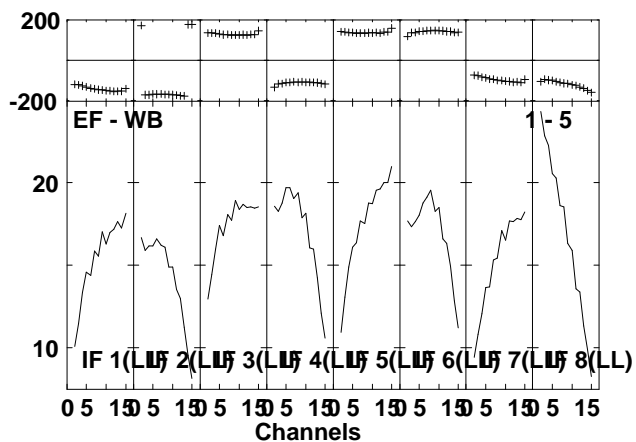
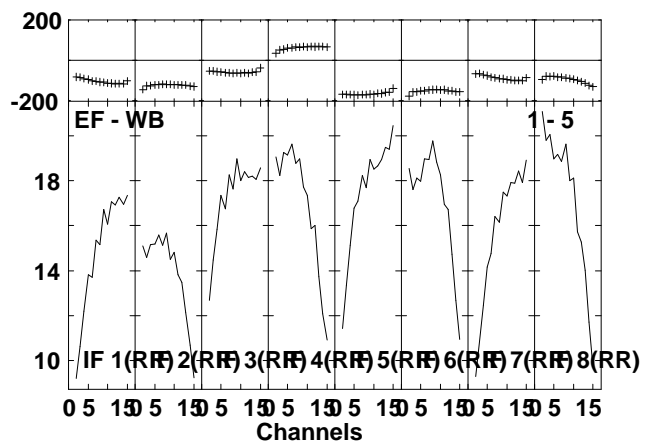
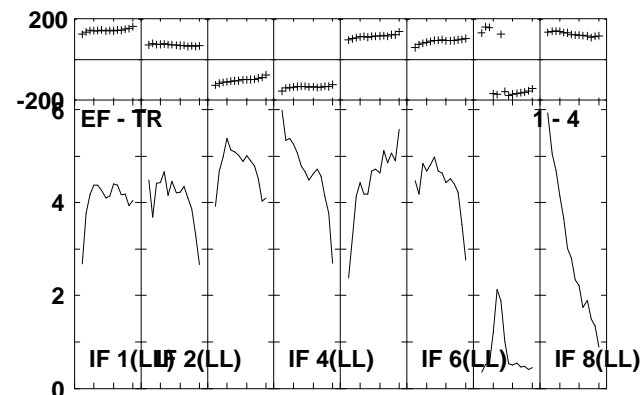
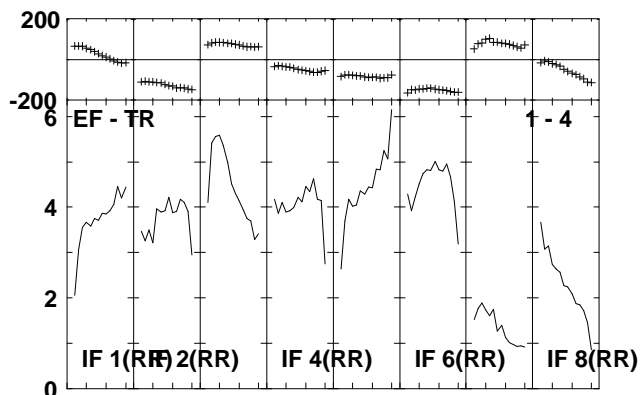
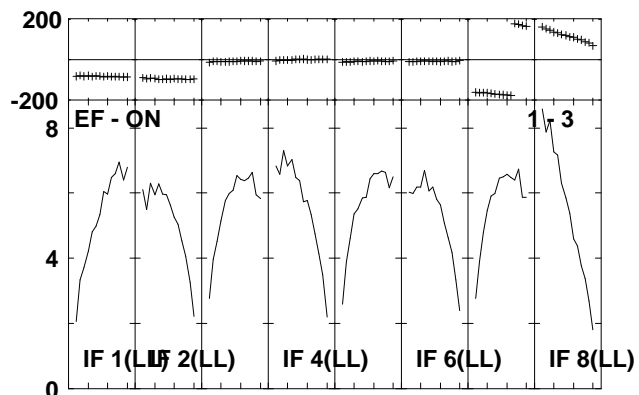
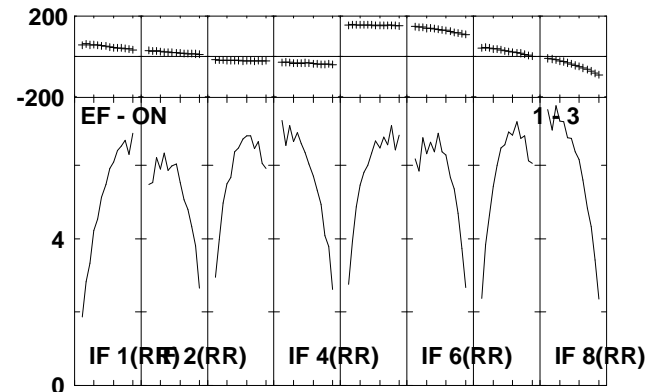
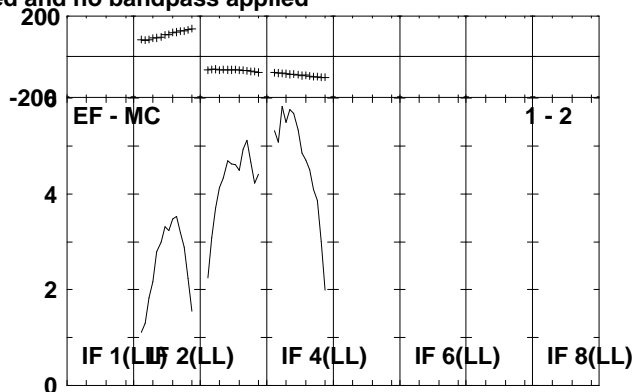
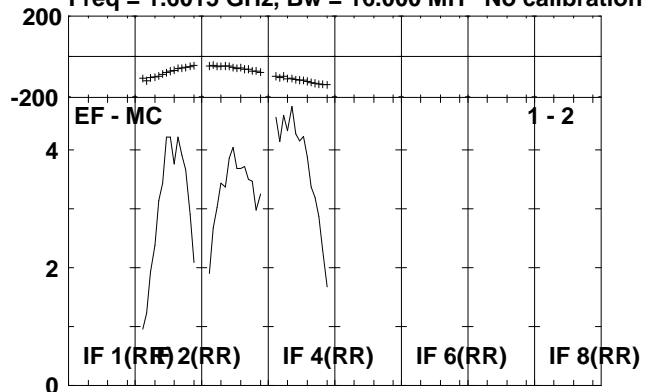

Lower frame: Milli Ampl Jy Top frame: Phas deg
Scalar averaged cross-power spectrum Several baselines displayed
Timerange: 00/20:15:20 to 00/20:17:16

Plot file version 48 created 26-APR-2010 13:26:11

J1246-07 EA043.UVDATA.1

Freq = 1.6015 GHz, Bw = 16.000 MH No calibration applied and no bandpass applied

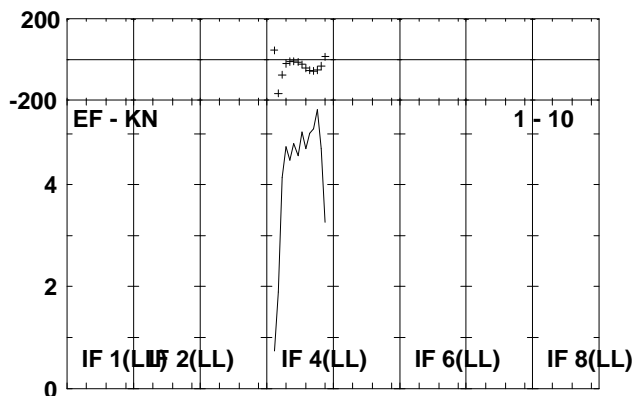
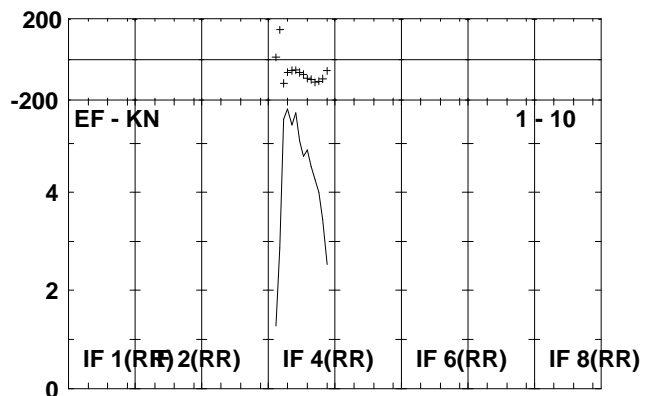
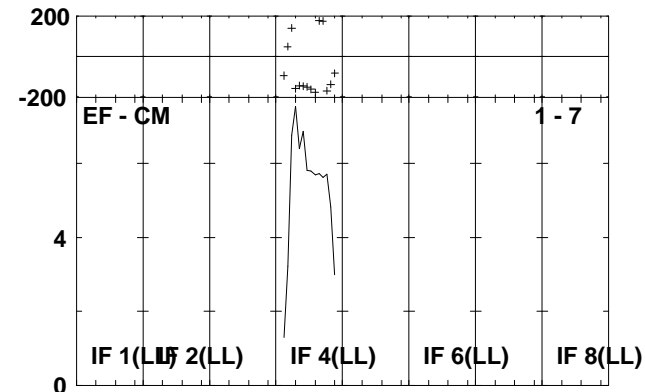
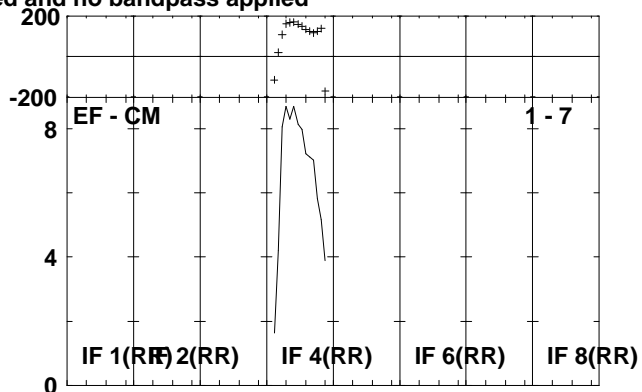
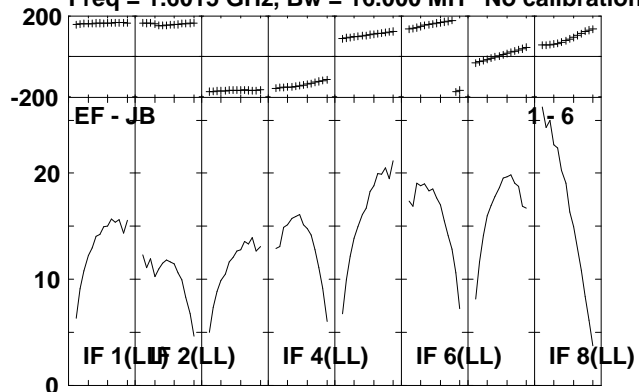

Lower frame: Milli Ampl Jy Top frame: Phas deg
Scalar averaged cross-power spectrum Several baselines displayed
Timerange: 00/20:15:20 to 00/20:17:16

Plot file version 49 created 26-APR-2010 13:26:11

HCG62 EA043.UVDATA.1

Freq = 1.6015 GHz, Bw = 16.000 MH No calibration applied and no bandpass applied

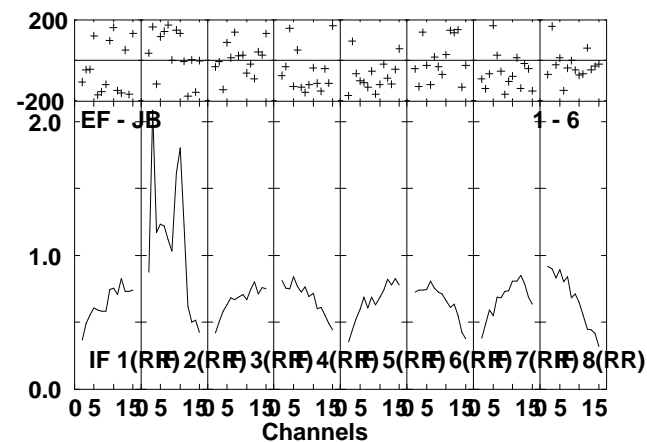
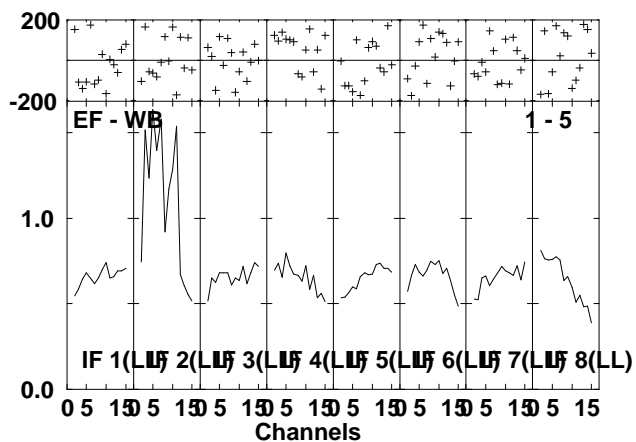
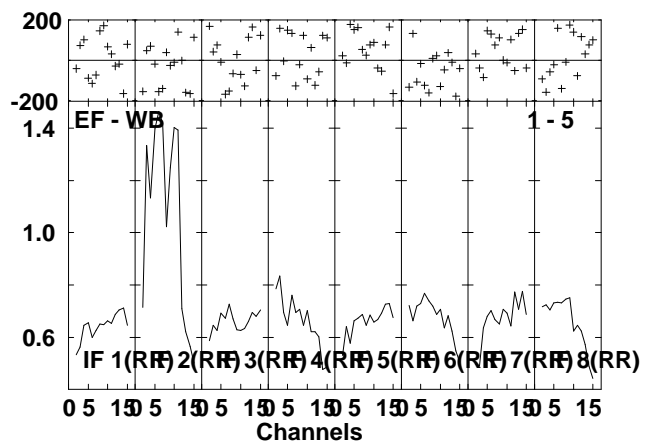
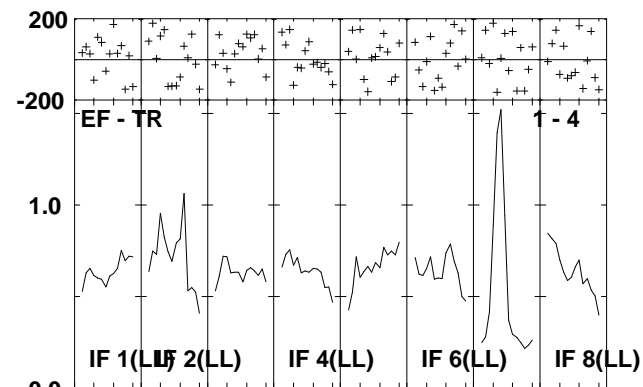
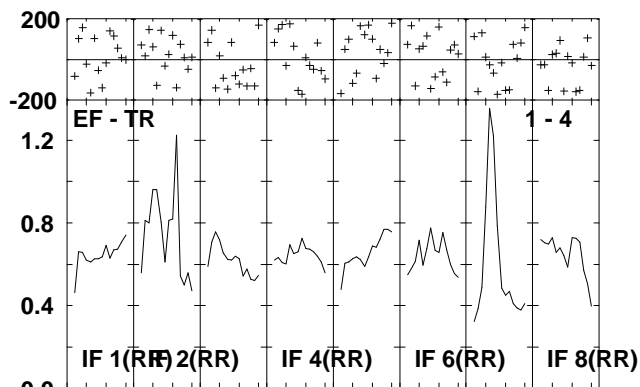
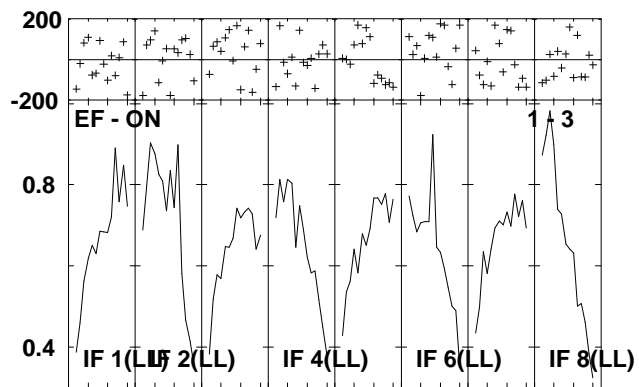
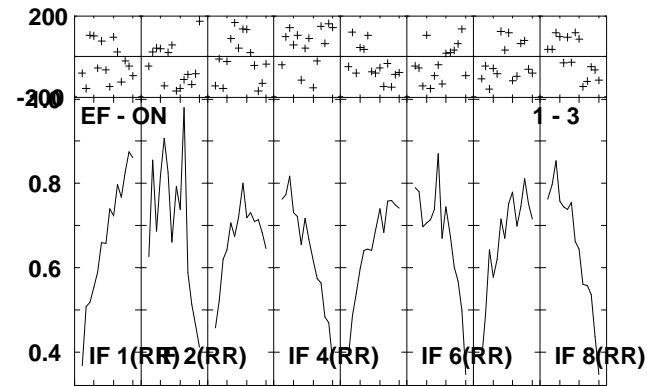
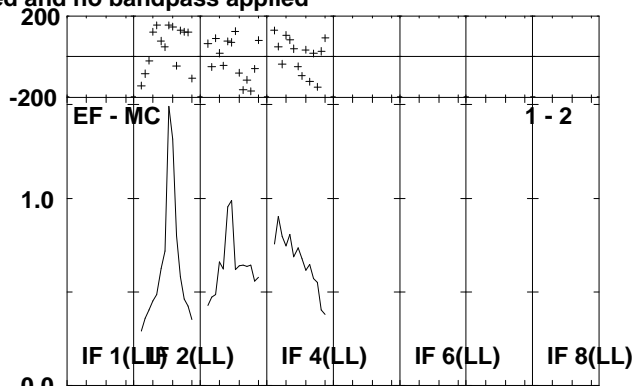
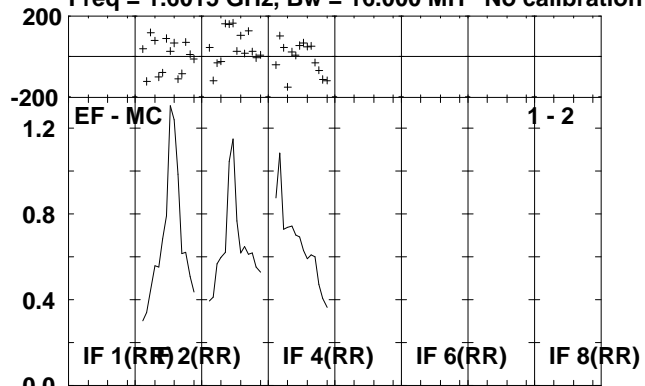

Lower frame: Milli Ampl Jy Top frame: Phas deg
Scalar averaged cross-power spectrum Several baselines displayed
Timerange: 00/20:18:20 to 00/20:25:16

Plot file version 50 created 26-APR-2010 13:26:13

HCG62 EA043.UVDATA.1

Freq = 1.6015 GHz, Bw = 16.000 MH No calibration applied and no bandpass applied

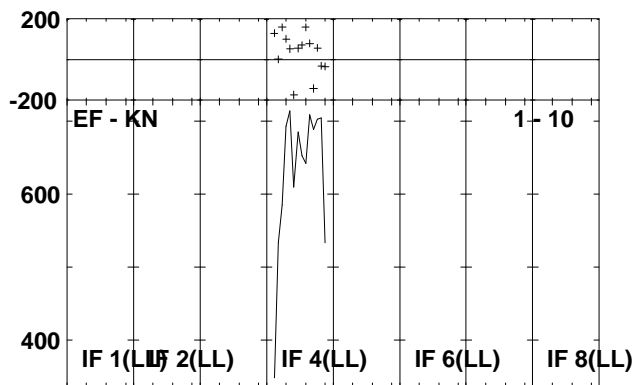
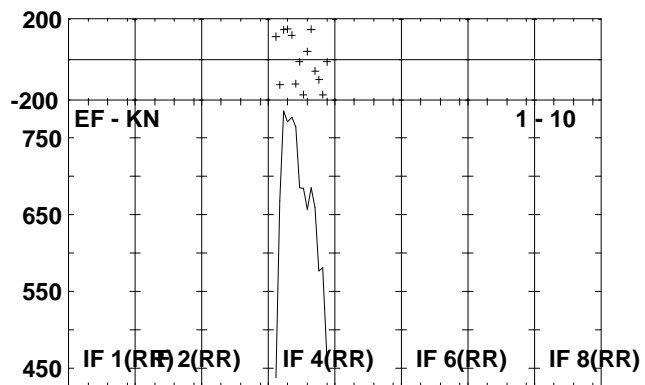
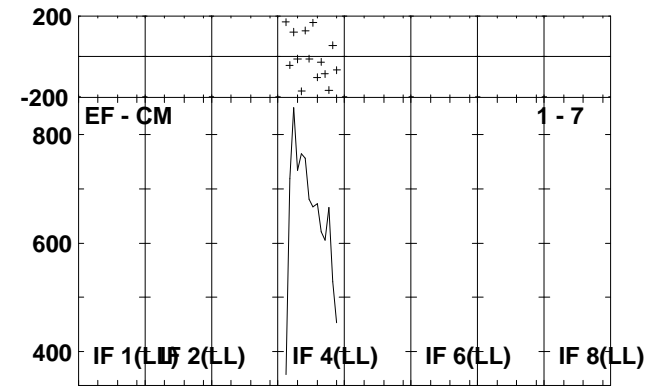
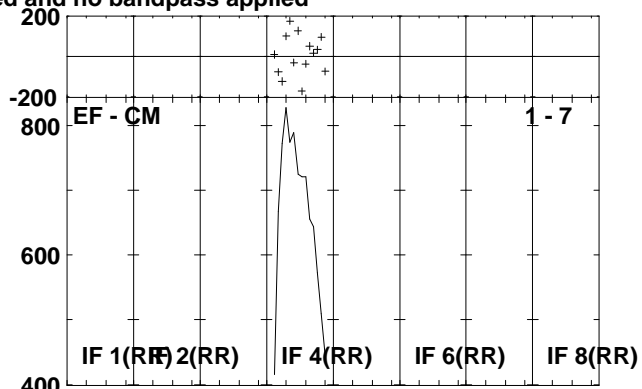
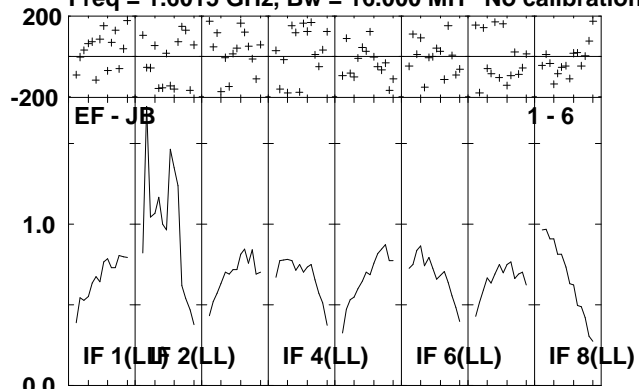

Lower frame: Milli Ampl Jy Top frame: Phas deg
Scalar averaged cross-power spectrum Several baselines displayed
Timerange: 00/20:18:20 to 00/20:25:16

Plot file version 51 created 26-APR-2010 13:26:14

J1246-07 EA043.UVDATA.1

Freq = 1.6015 GHz, Bw = 16.000 MH No calibration applied and no bandpass applied

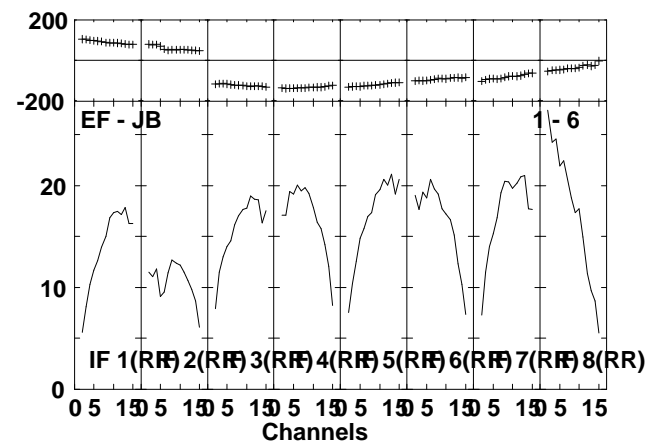
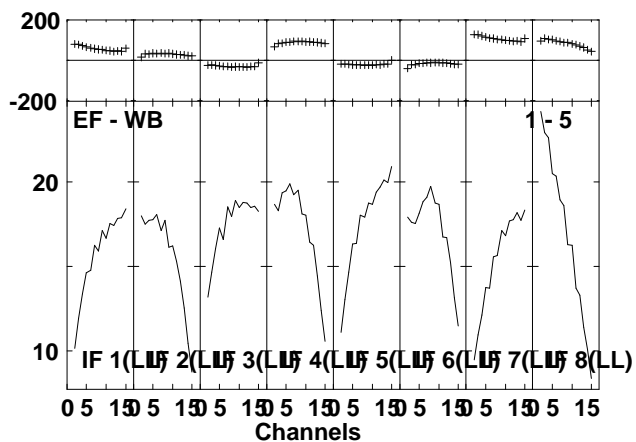
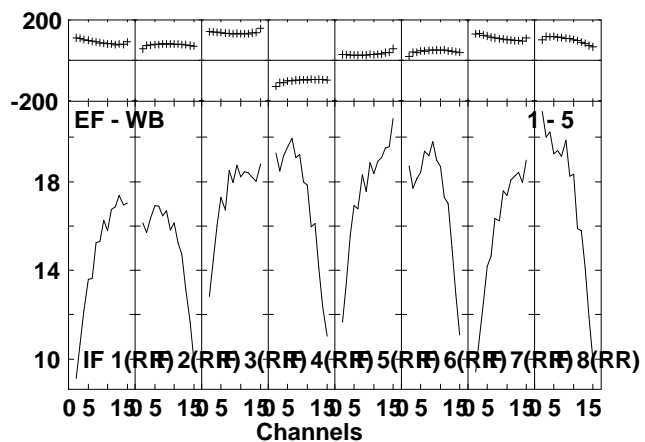
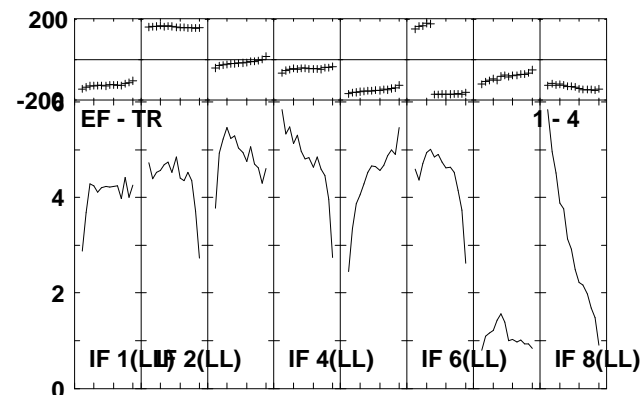
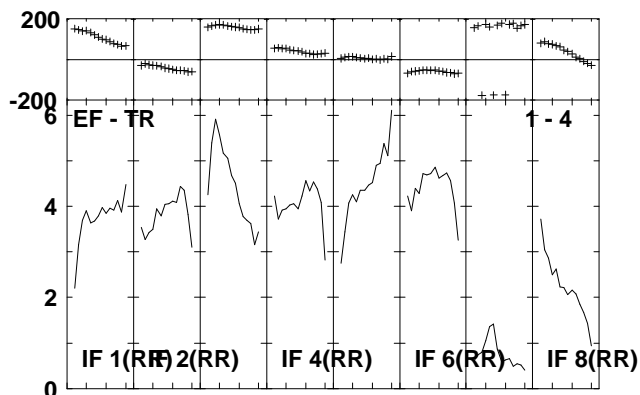
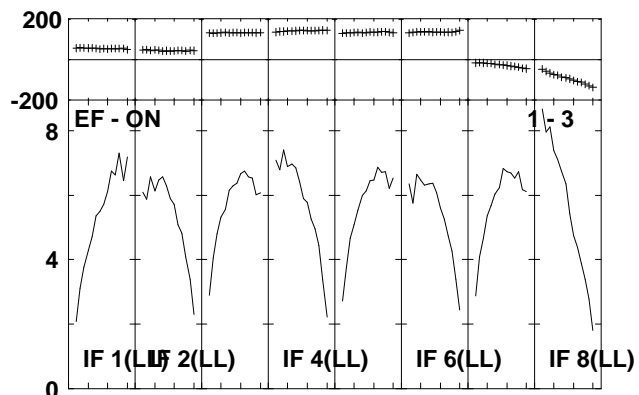
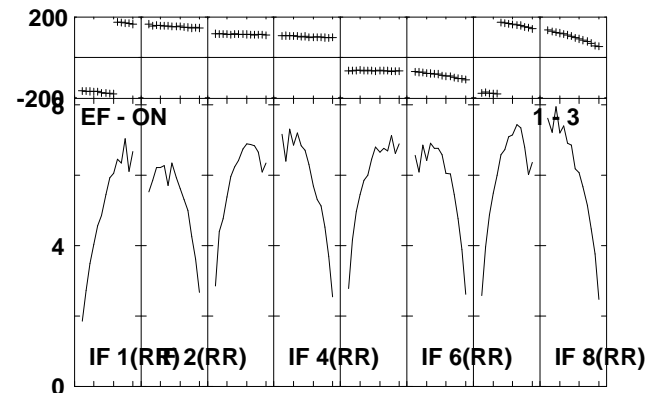
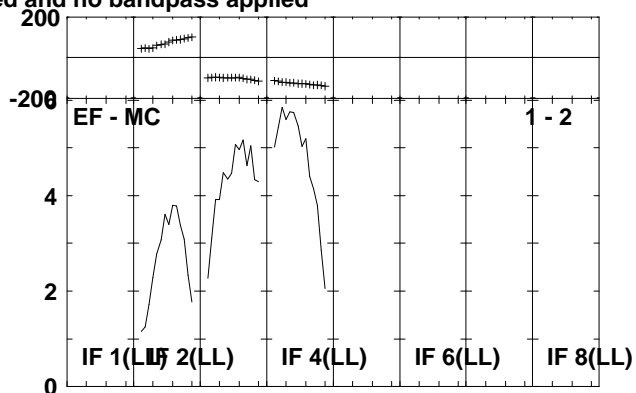
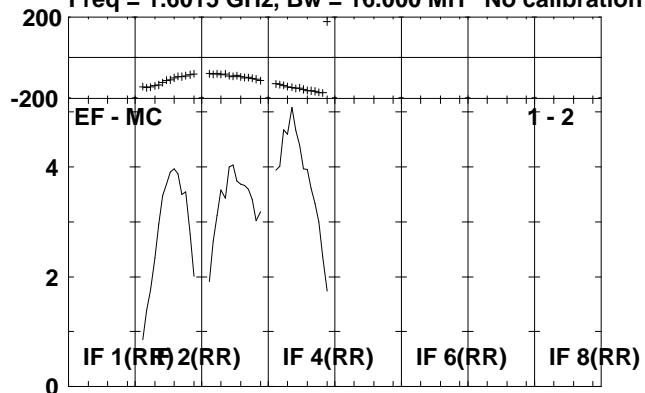

Lower frame: Milli Ampl Jy Top frame: Phas deg
Scalar averaged cross-power spectrum Several baselines displayed
Timerange: 00/20:25:20 to 00/20:27:16

Plot file version 52 created 26-APR-2010 13:26:15

J1246-07 EA043.UVDATA.1

Freq = 1.6015 GHz, Bw = 16.000 MH No calibration applied and no bandpass applied

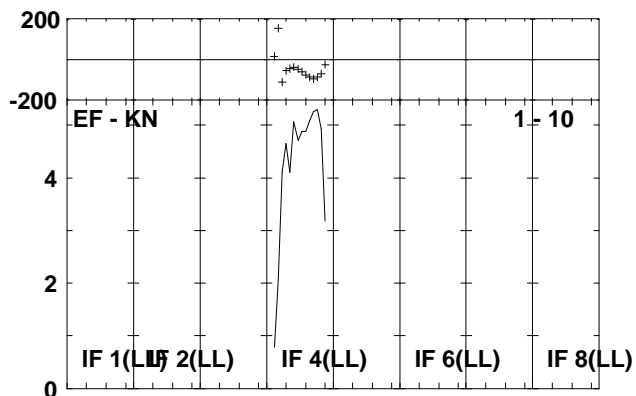
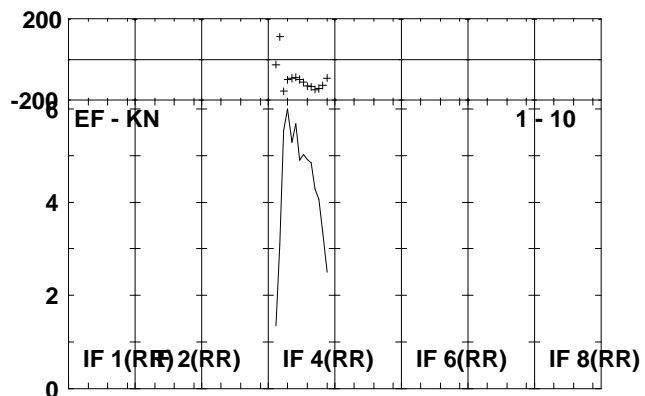
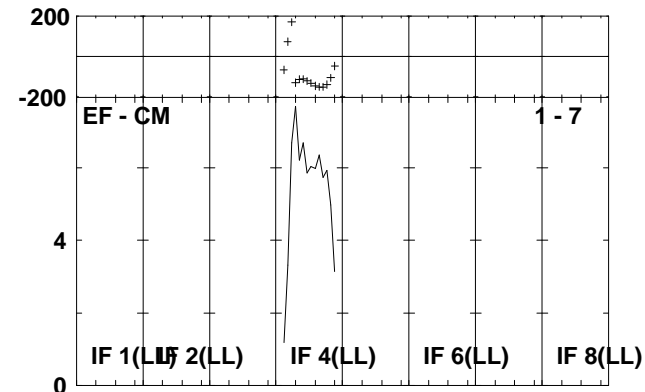
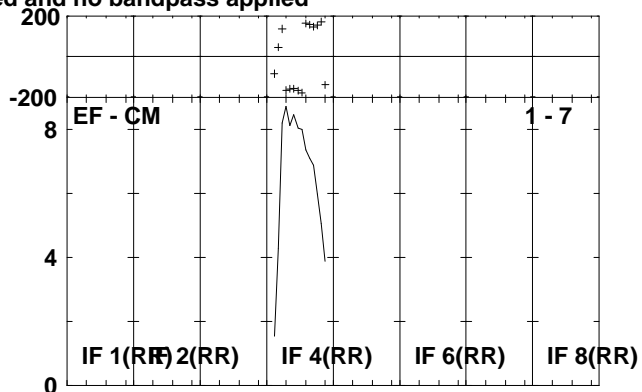
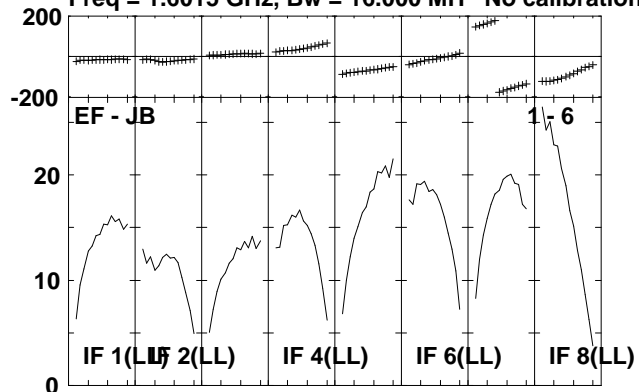

Lower frame: Milli Ampl Jy Top frame: Phas deg
Scalar averaged cross-power spectrum Several baselines displayed
Timerange: 00/20:25:20 to 00/20:27:16

Plot file version 53 created 26-APR-2010 13:26:16

HCG62 EA043.UVDATA.1

Freq = 1.6015 GHz, Bw = 16.000 MH No calibration applied and no bandpass applied

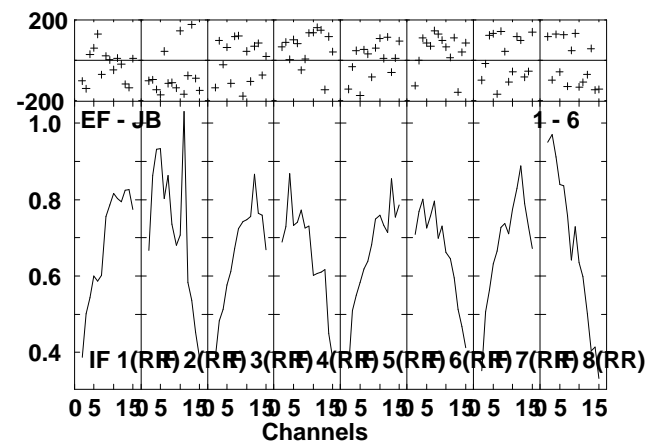
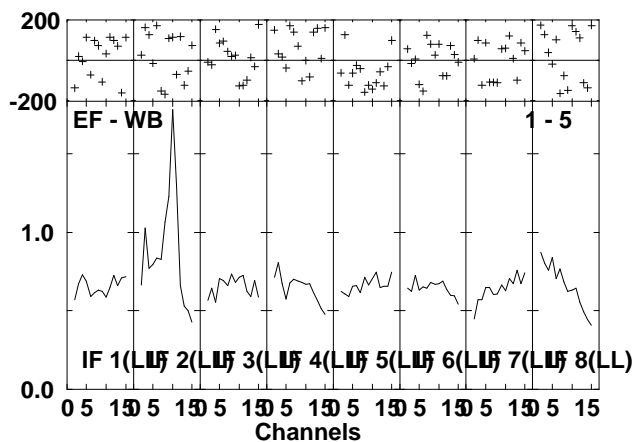
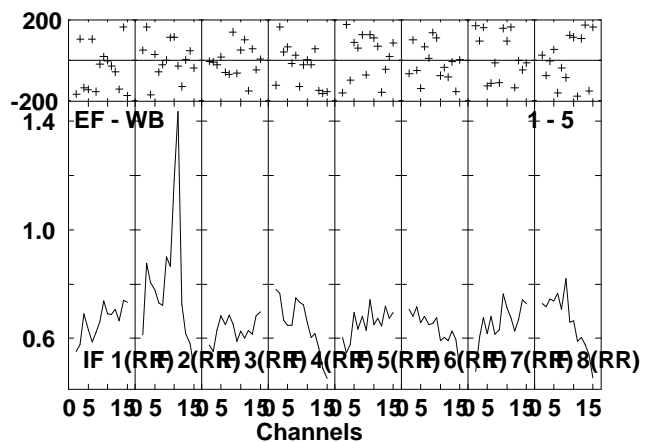
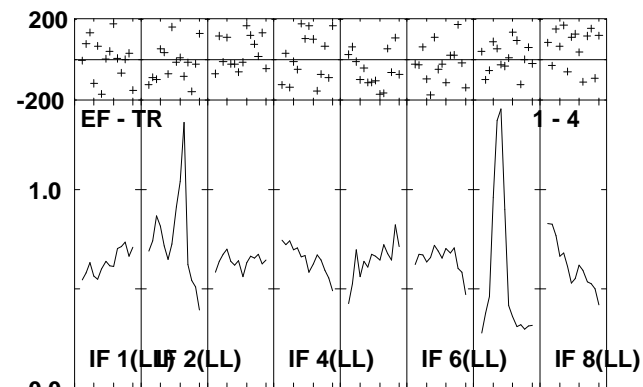
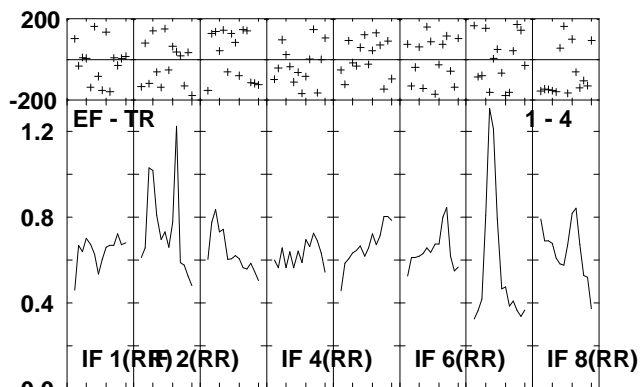
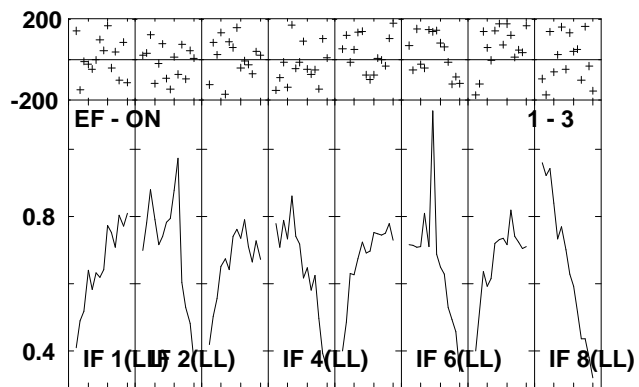
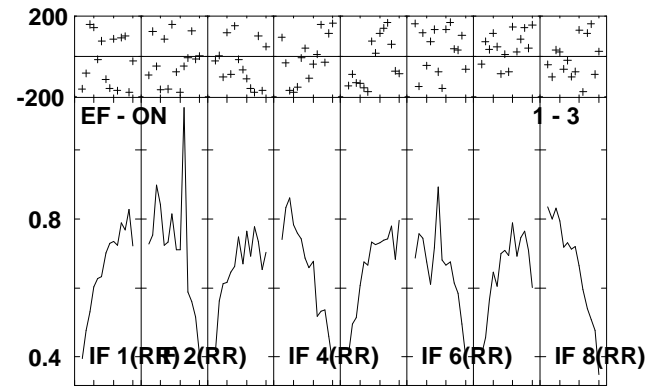
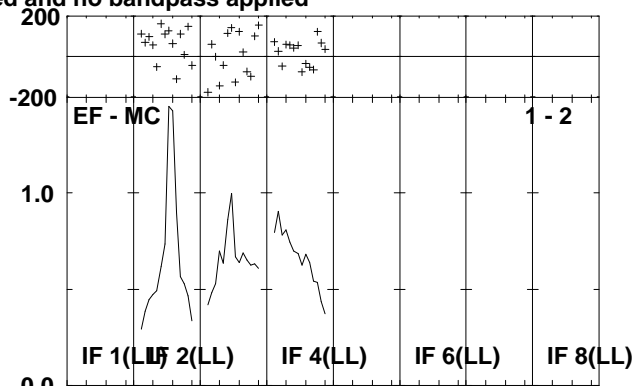
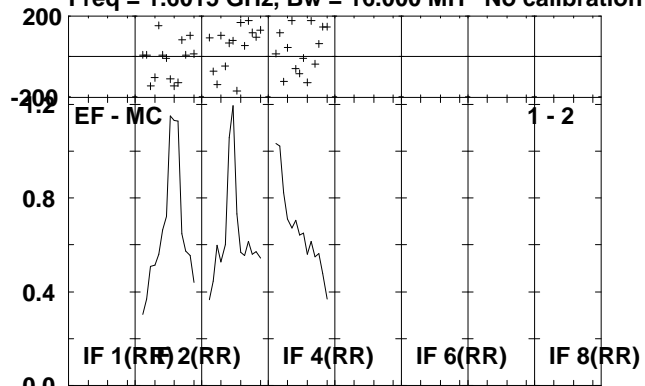

Lower frame: Milli Ampl Jy Top frame: Phas deg
Scalar averaged cross-power spectrum Several baselines displayed
Timerange: 00/20:28:20 to 00/20:35:16

Plot file version 54 created 26-APR-2010 13:26:17

HCG62 EA043.UVDATA.1

Freq = 1.6015 GHz, Bw = 16.000 MH No calibration applied and no bandpass applied

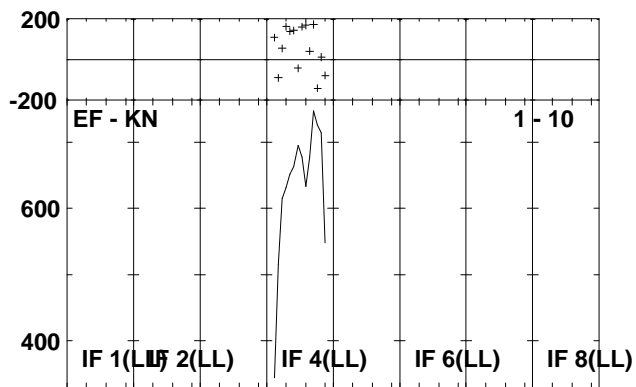
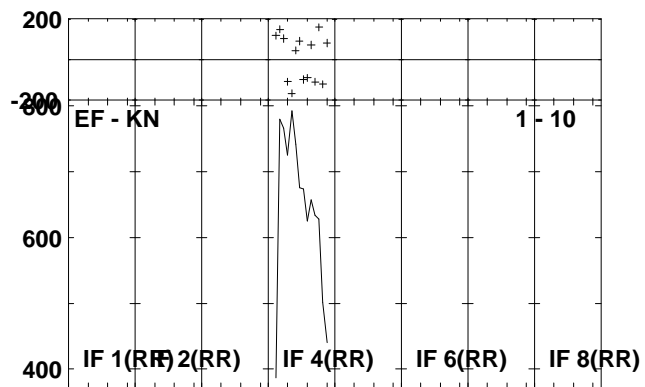
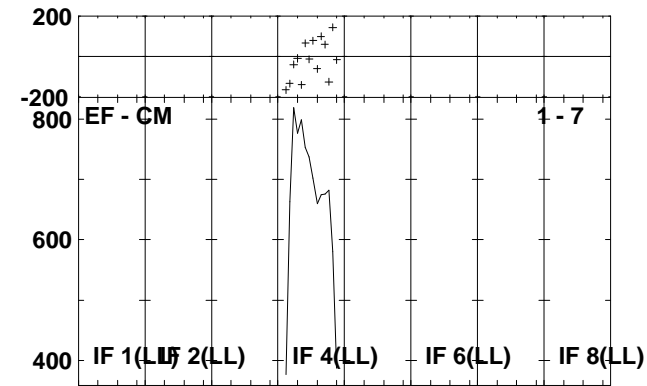
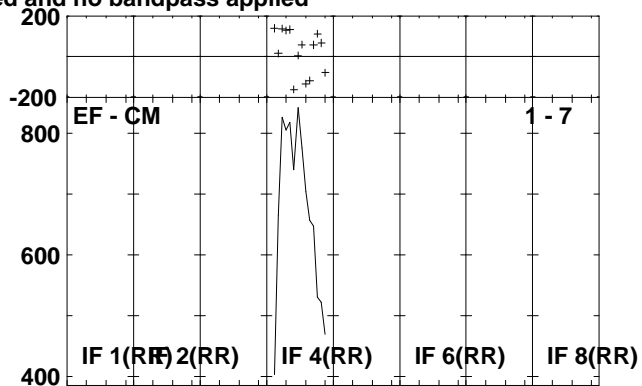
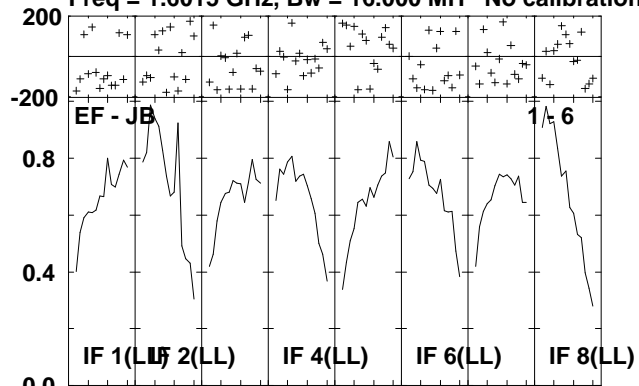

Lower frame: Milli Ampl Jy Top frame: Phas deg
Scalar averaged cross-power spectrum Several baselines displayed
Timerange: 00/20:28:20 to 00/20:35:16

Plot file version 55 created 26-APR-2010 13:26:18

J1246-07 EA043.UVDATA.1

Freq = 1.6015 GHz, Bw = 16.000 MH No calibration applied and no bandpass applied

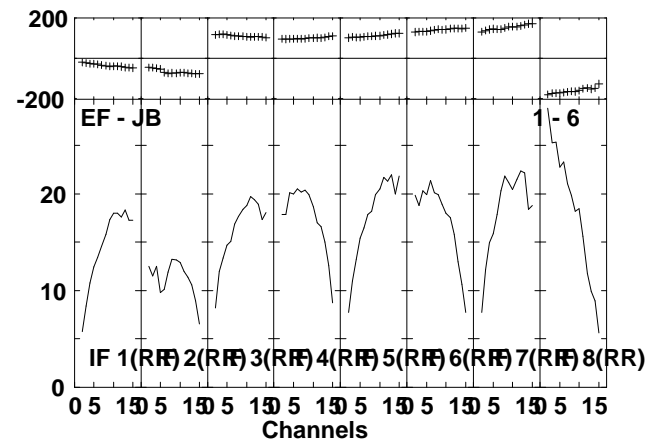
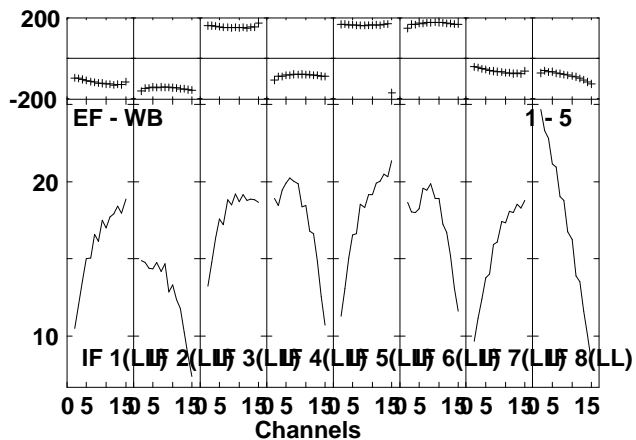
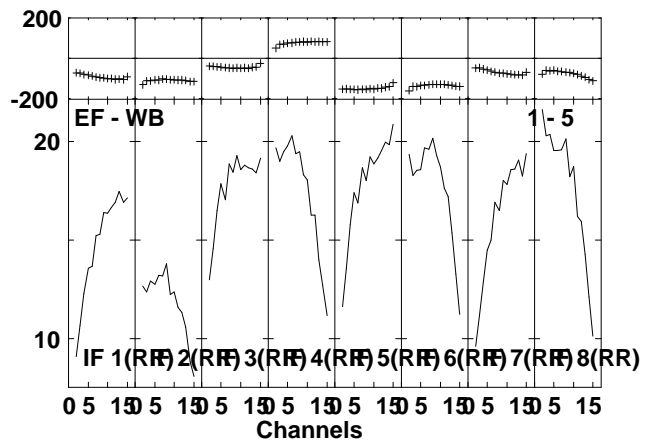
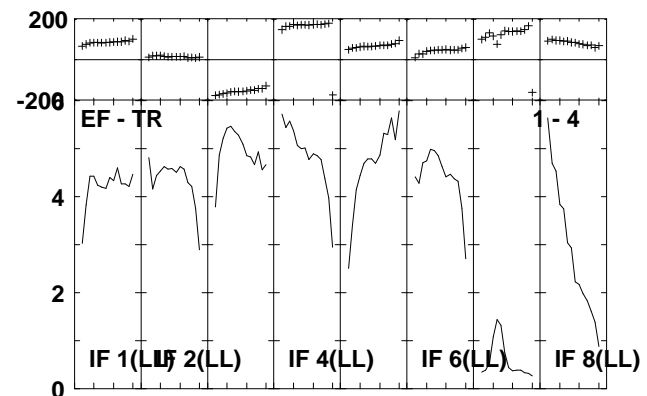
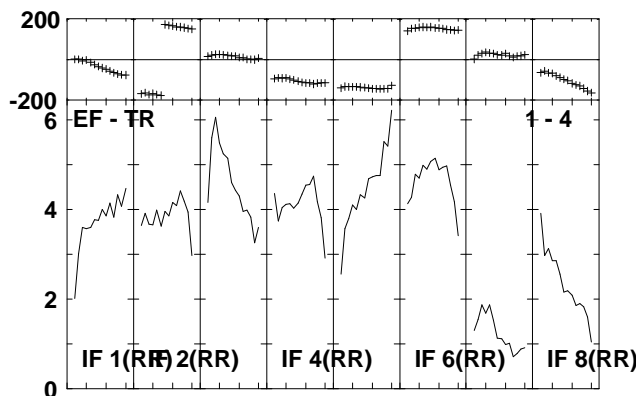
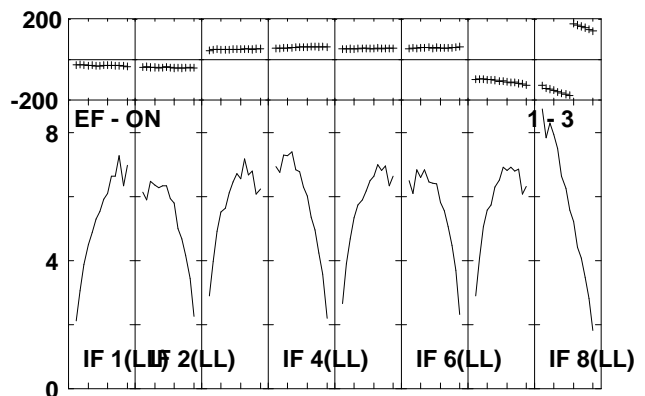
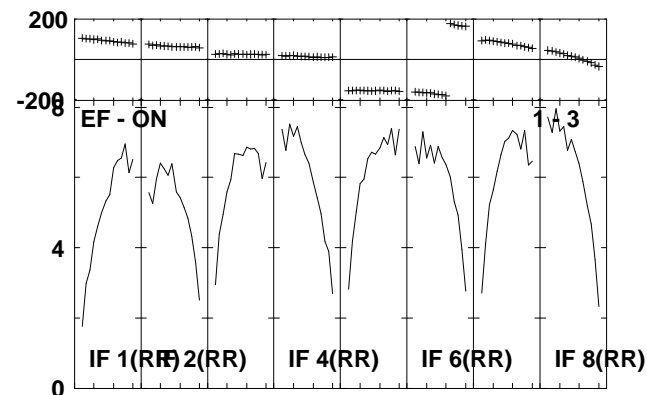
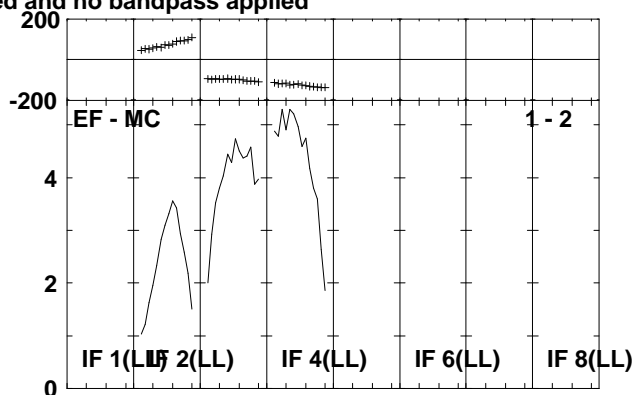
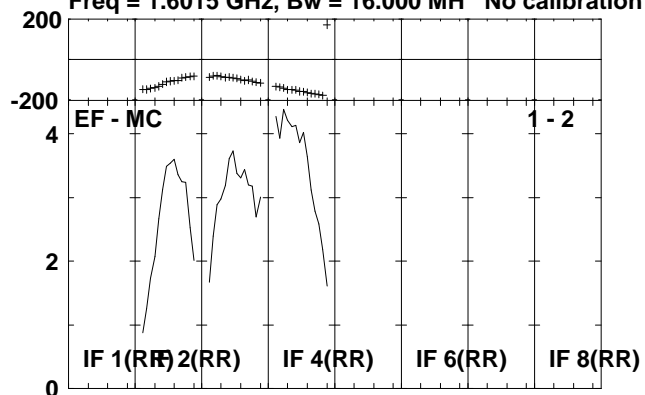

Lower frame: Milli Ampl Jy Top frame: Phas deg
Scalar averaged cross-power spectrum Several baselines displayed
Timerange: 00/20:35:20 to 00/20:37:16

Plot file version 56 created 26-APR-2010 13:26:19

J1246-07 EA043.UVDATA.1

Freq = 1.6015 GHz, Bw = 16.000 MH No calibration applied and no bandpass applied

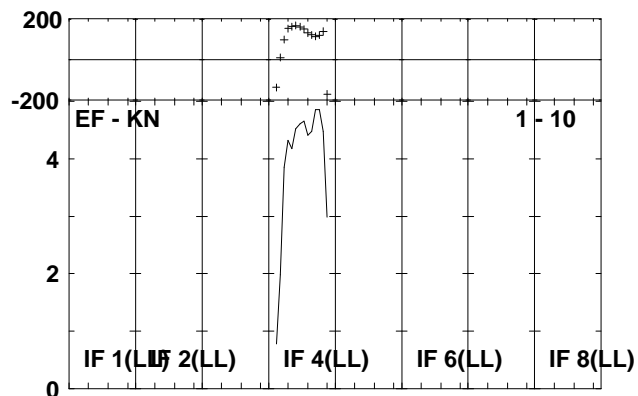
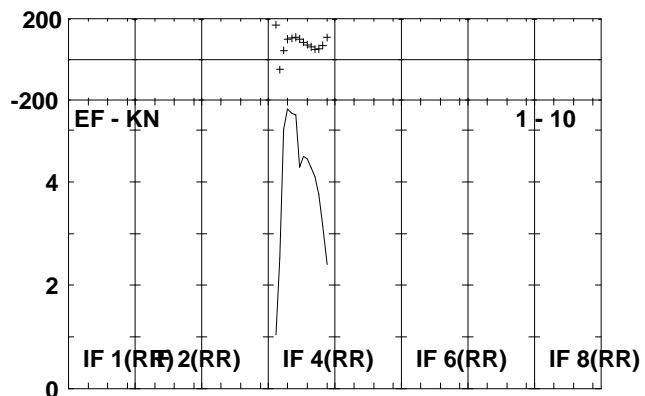
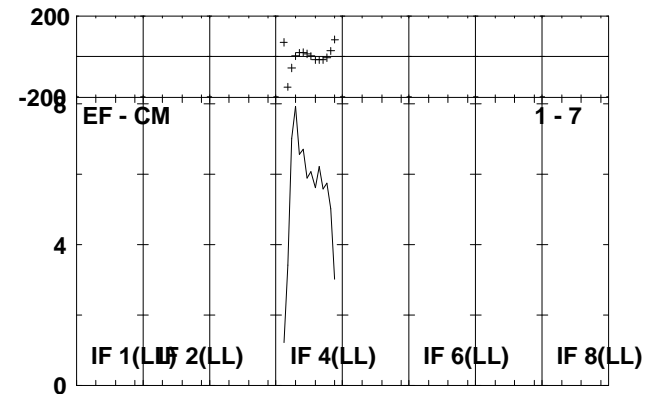
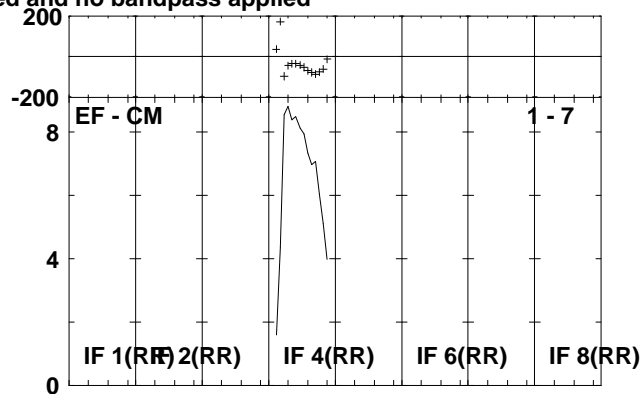
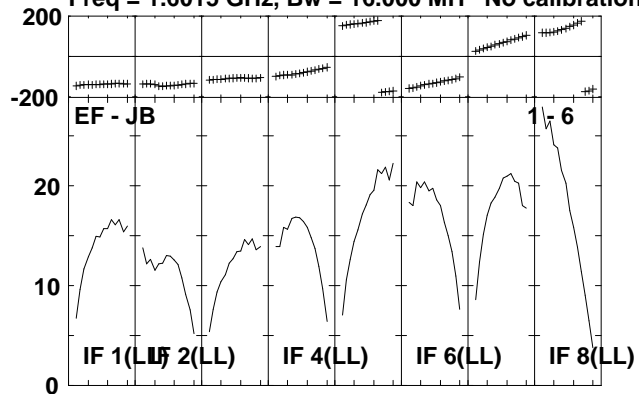

Lower frame: Milli Ampl Jy Top frame: Phas deg
Scalar averaged cross-power spectrum Several baselines displayed
Timerange: 00:20:35:20 to 00:20:37:16

Plot file version 57 created 26-APR-2010 13:26:19

HCG62 EA043.UVDATA.1

Freq = 1.6015 GHz, Bw = 16.000 MH No calibration applied and no bandpass applied

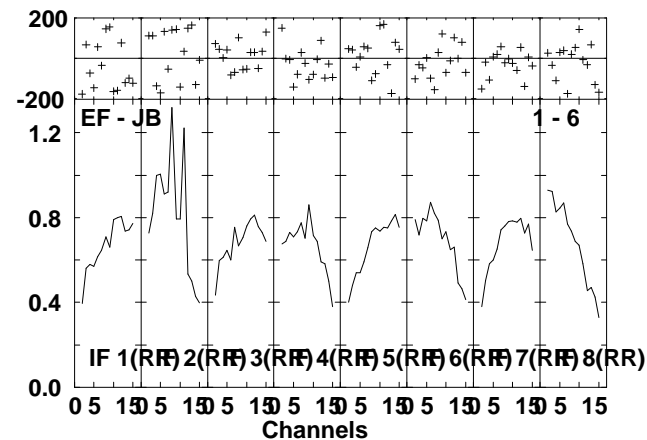
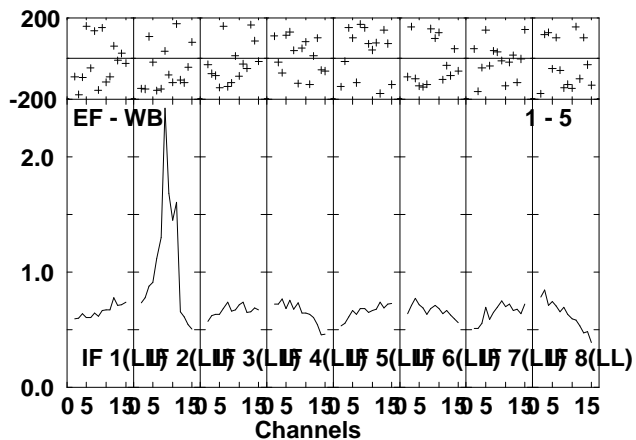
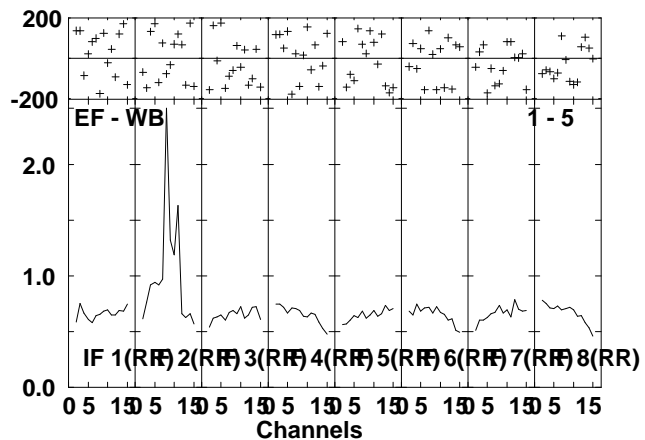
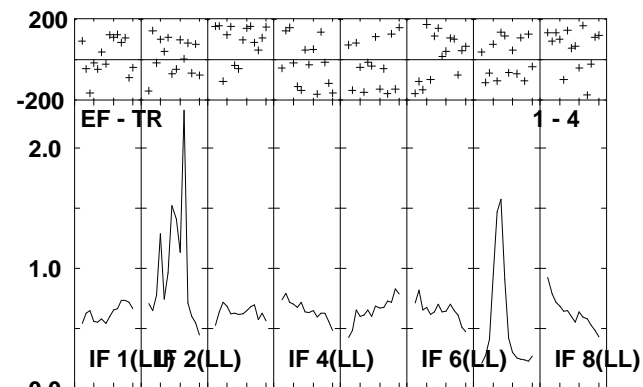
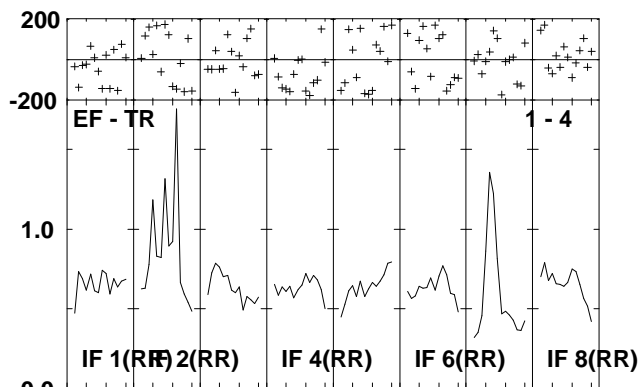
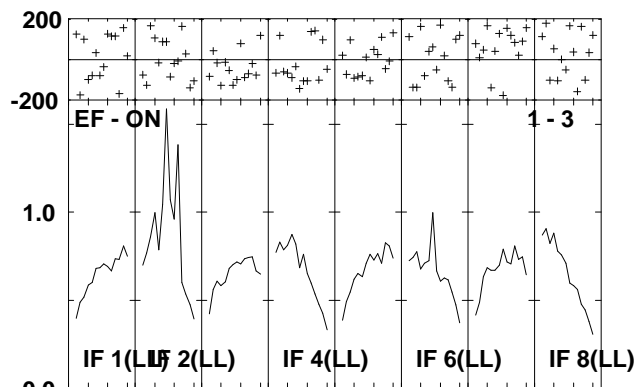
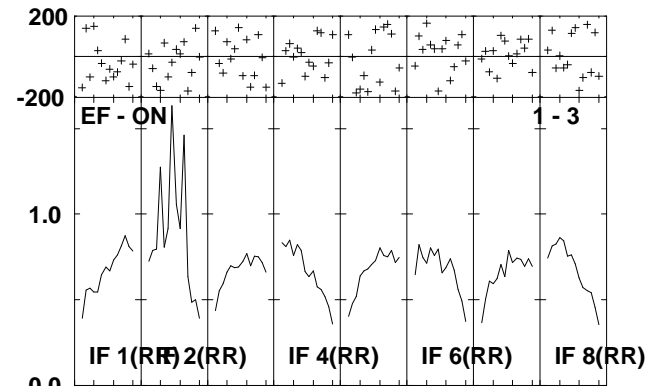
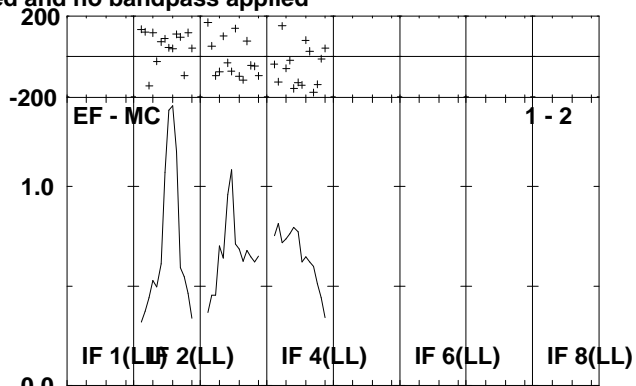
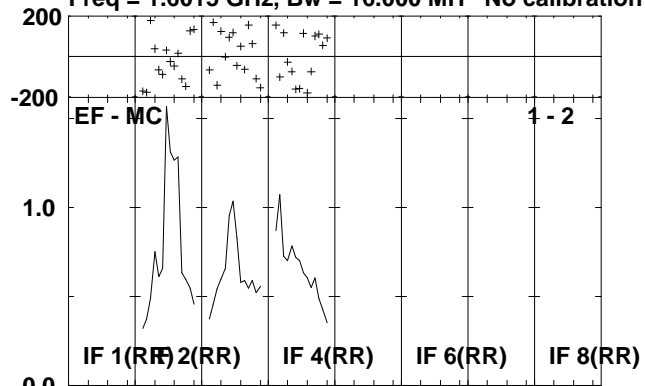

Lower frame: Milli Ampl Jy Top frame: Phas deg
Scalar averaged cross-power spectrum Several baselines displayed
Timerange: 00/20:38:20 to 00/20:45:16

Plot file version 58 created 26-APR-2010 13:26:20

HCG62 EA043.UVDATA.1

Freq = 1.6015 GHz, Bw = 16.000 MH No calibration applied and no bandpass applied

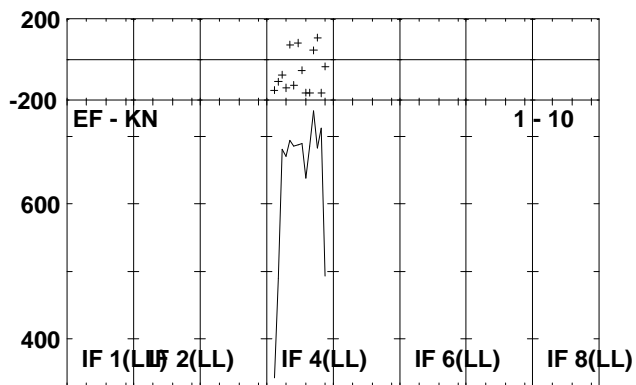
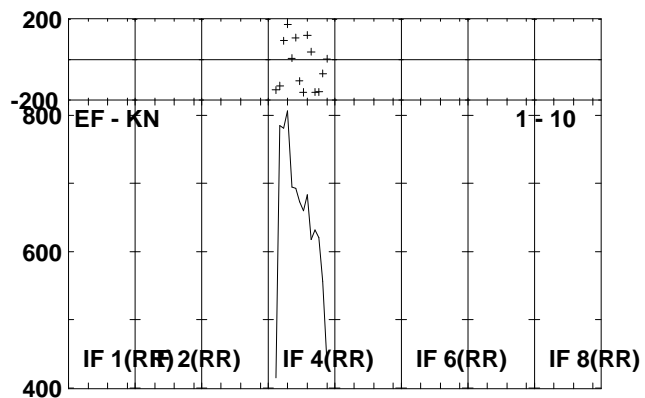
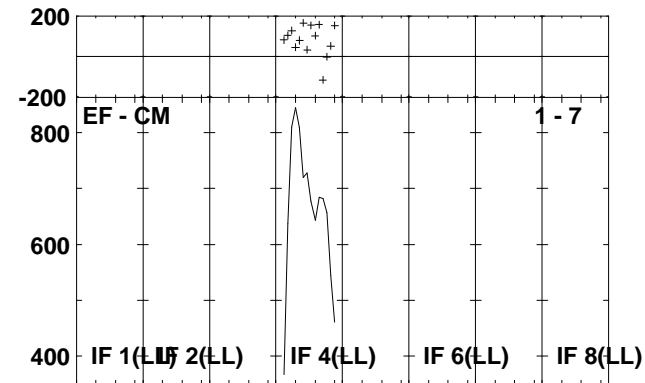
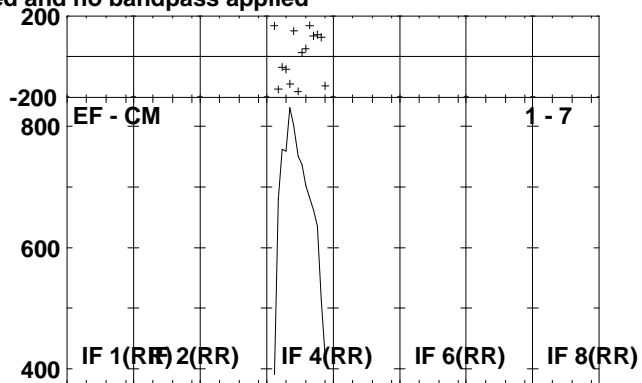
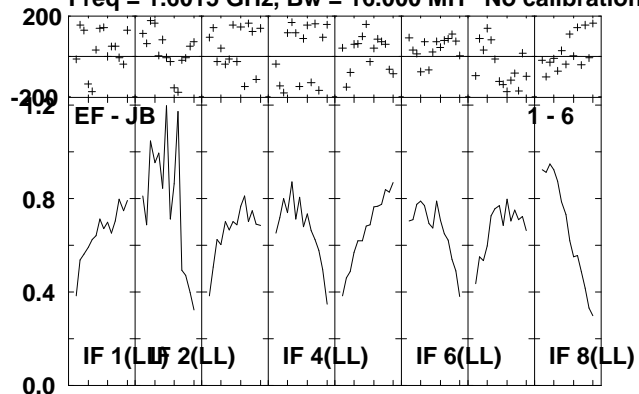

Lower frame: Milli Ampl Jy Top frame: Phas deg
Scalar averaged cross-power spectrum Several baselines displayed
Timerange: 00/20:38:20 to 00/20:45:16

Plot file version 59 created 26-APR-2010 13:26:22

J1246-07 EA043.UVDATA.1

Freq = 1.6015 GHz, Bw = 16.000 MH No calibration applied and no bandpass applied

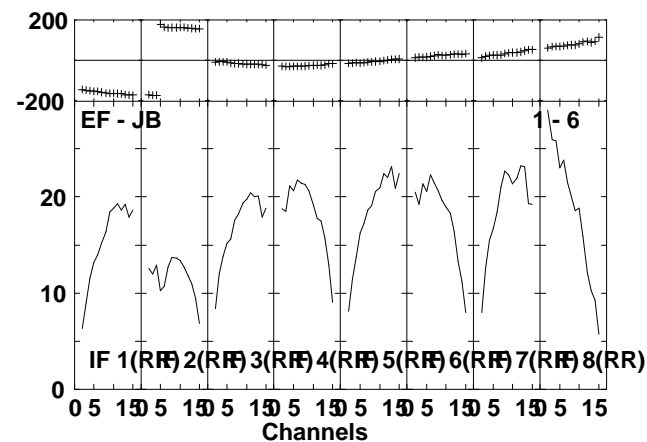
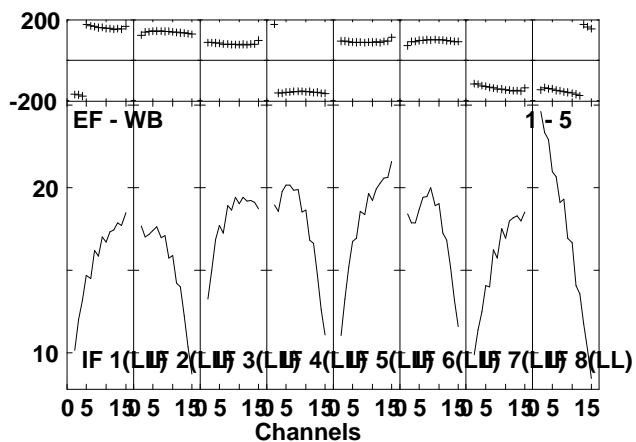
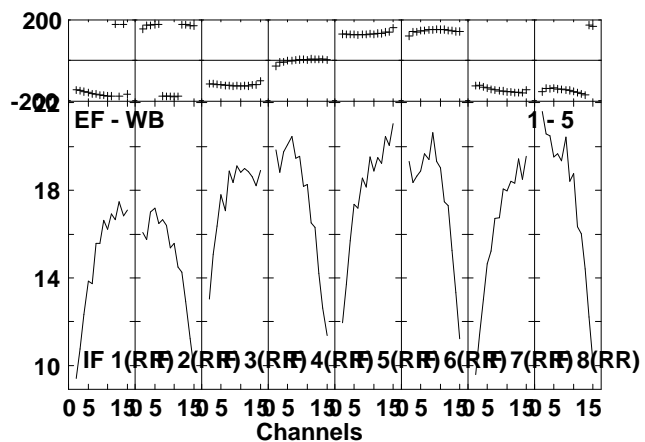
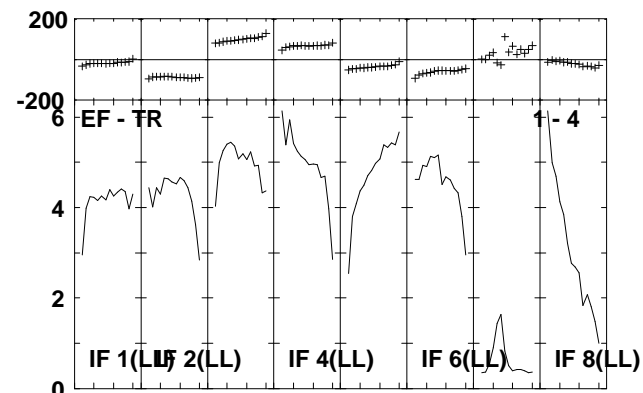
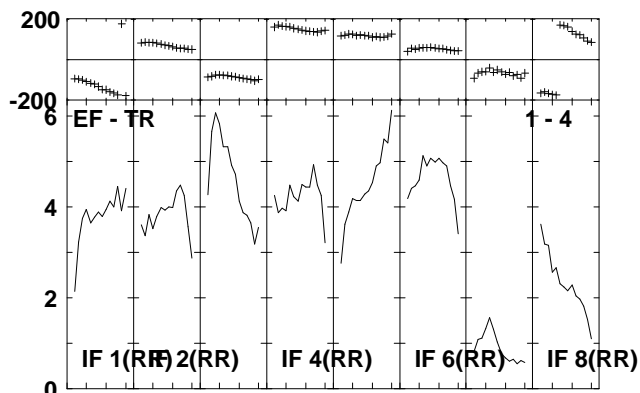
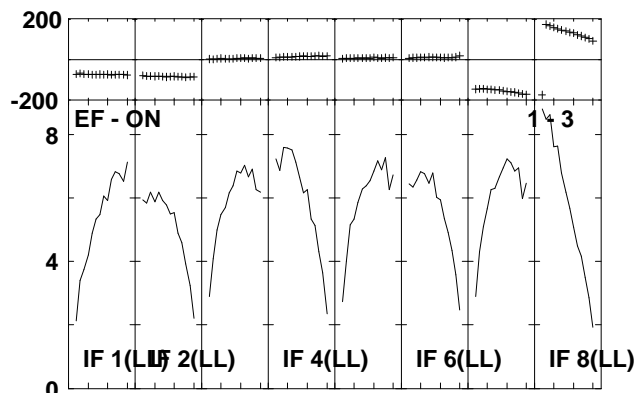
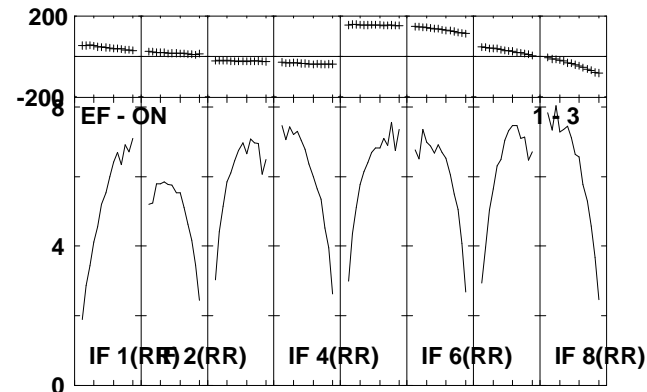
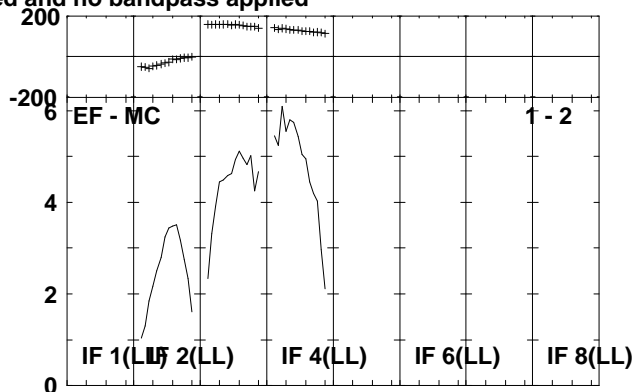
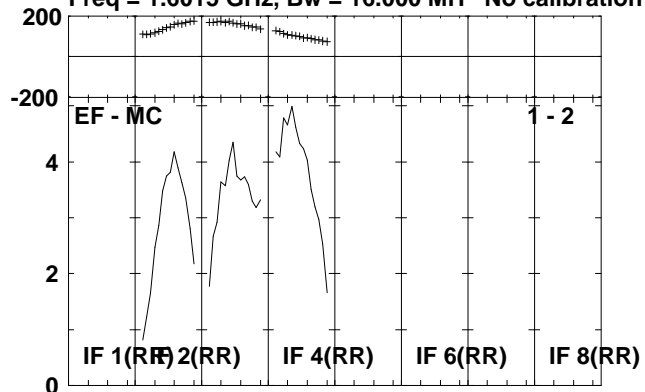

Lower frame: Milli Ampl Jy Top frame: Phas deg
Scalar averaged cross-power spectrum Several baselines displayed
Timerange: 00/20:45:20 to 00/20:47:16

Plot file version 60 created 26-APR-2010 13:26:23

J1246-07 EA043.UVDATA.1

Freq = 1.6015 GHz, Bw = 16.000 MH No calibration applied and no bandpass applied

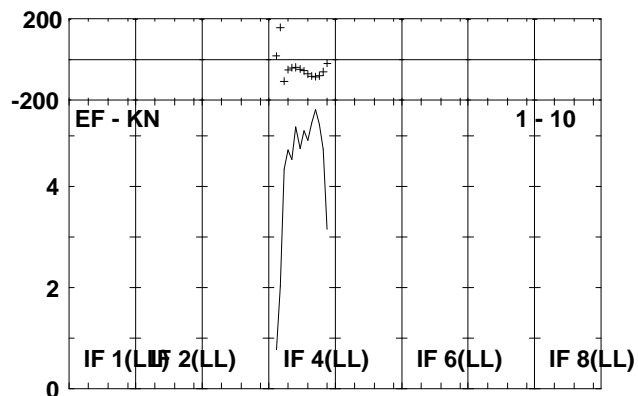
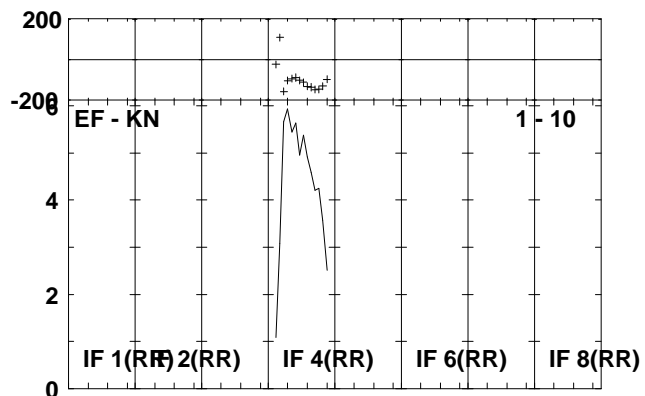
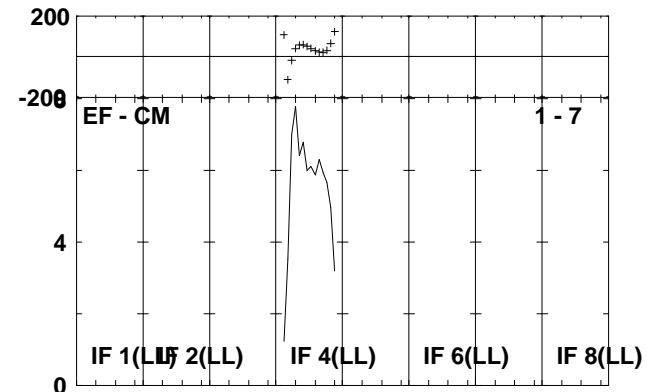
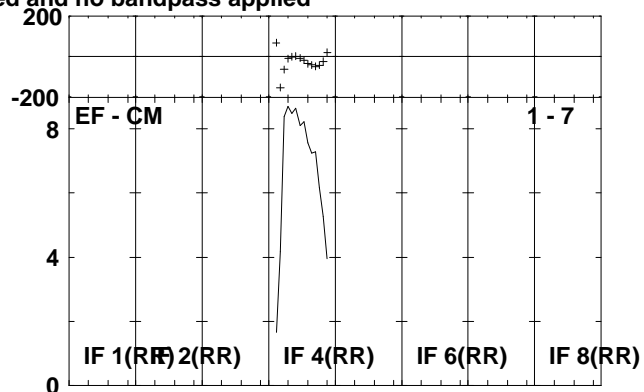
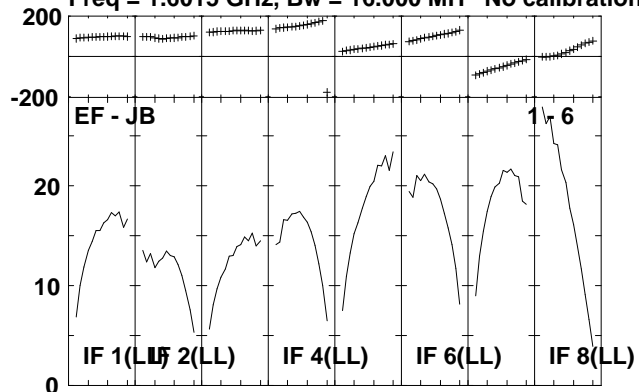

Lower frame: Milli Ampl Jy Top frame: Phas deg
Scalar averaged cross-power spectrum Several baselines displayed
Timerange: 00/20:45:20 to 00/20:47:16

Plot file version 61 created 26-APR-2010 13:26:23

HCG62 EA043.UVDATA.1

Freq = 1.6015 GHz, Bw = 16.000 MH No calibration applied and no bandpass applied

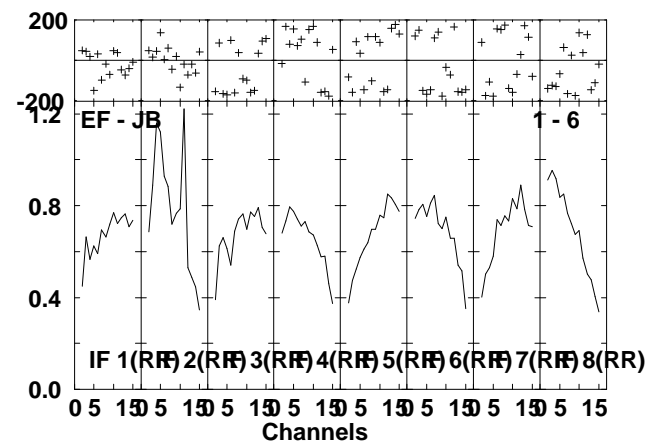
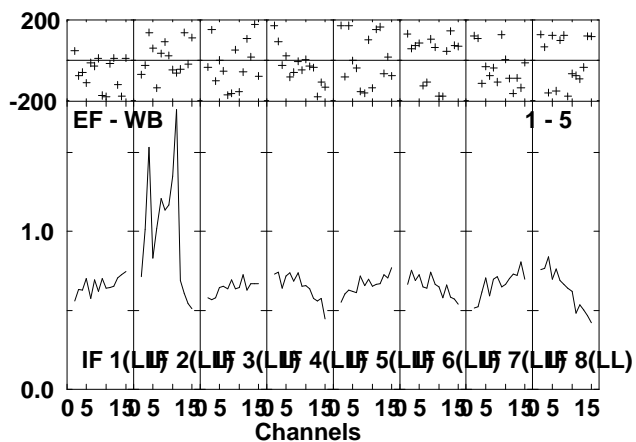
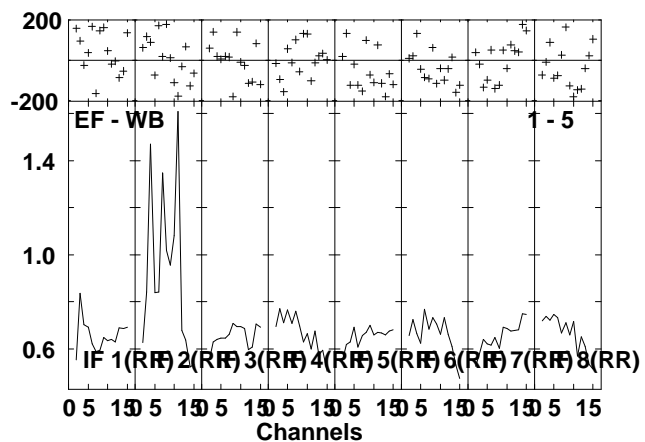
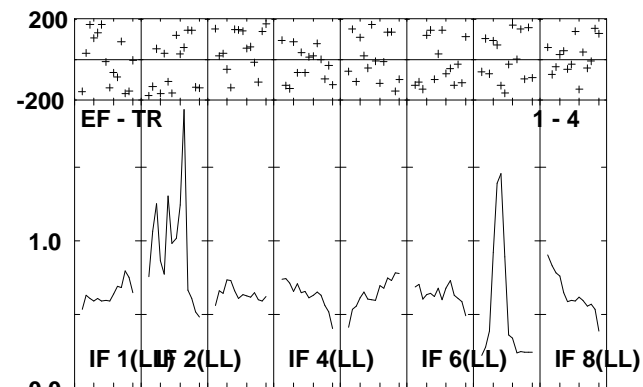
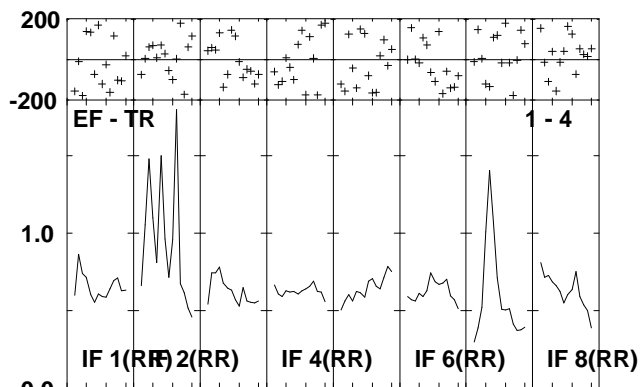
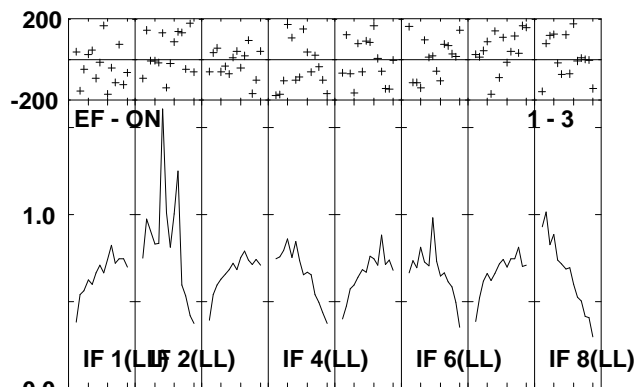
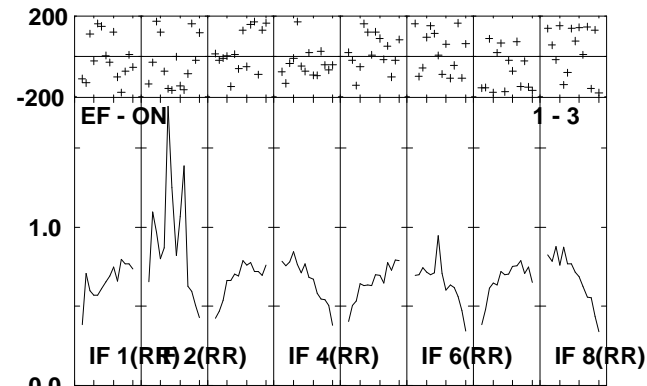
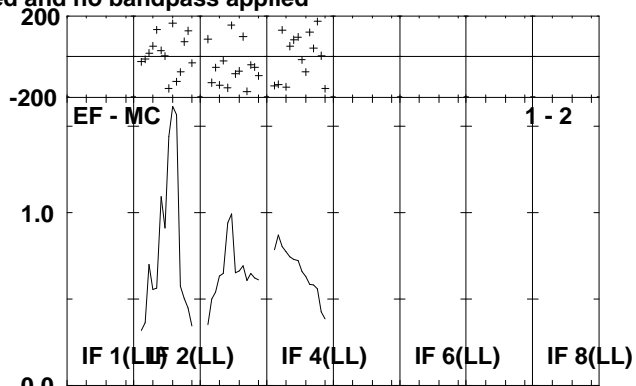
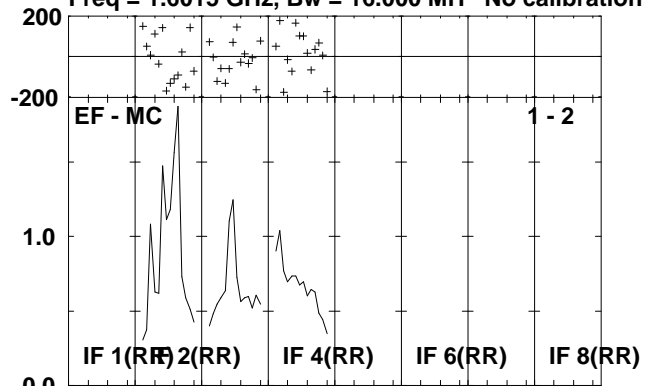

Lower frame: Milli Ampl Jy Top frame: Phas deg
Scalar averaged cross-power spectrum Several baselines displayed
Timerange: 00/20:48:20 to 00/20:55:16

Plot file version 62 created 26-APR-2010 13:26:25

HCG62 EA043.UVDATA.1

Freq = 1.6015 GHz, Bw = 16.000 MH No calibration applied and no bandpass applied

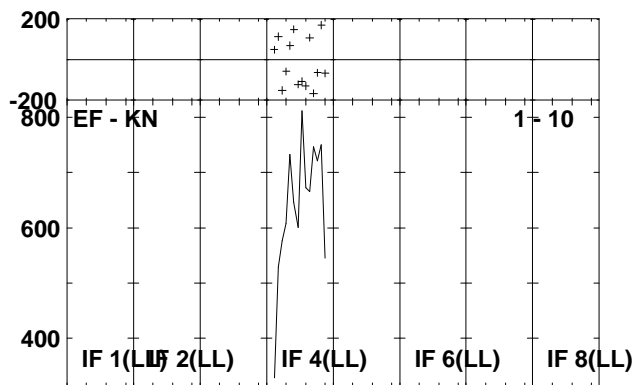
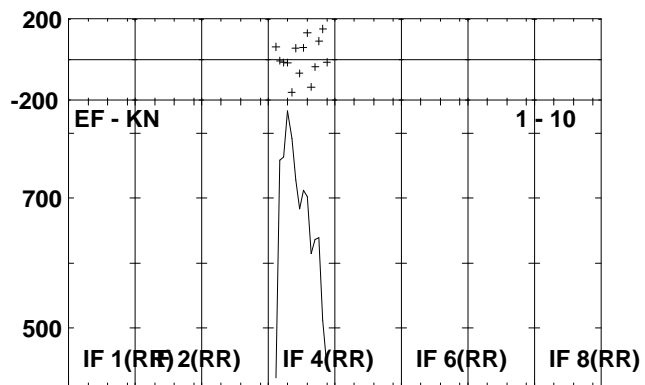
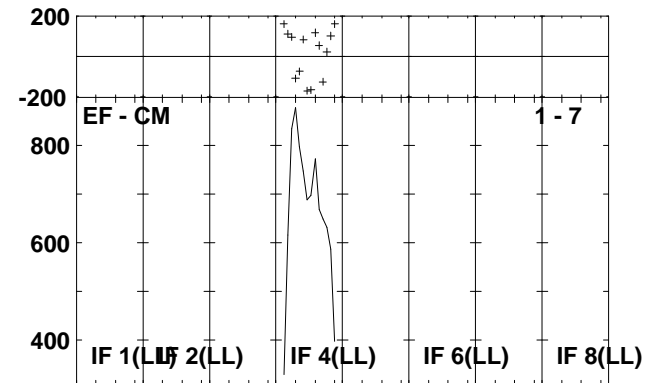
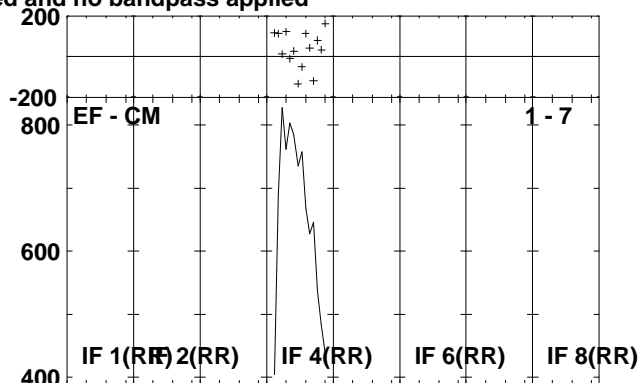
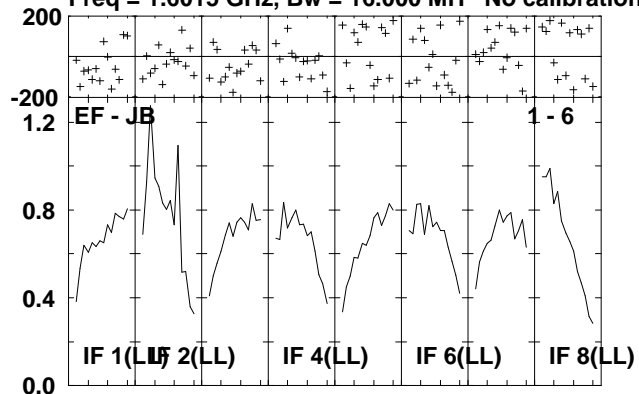

Lower frame: Milli Ampl Jy Top frame: Phas deg
Scalar averaged cross-power spectrum Several baselines displayed
Timerange: 00/20:48:20 to 00/20:55:16

Plot file version 63 created 26-APR-2010 13:26:27

J1246-07 EA043.UVDATA.1

Freq = 1.6015 GHz, Bw = 16.000 MH No calibration applied and no bandpass applied

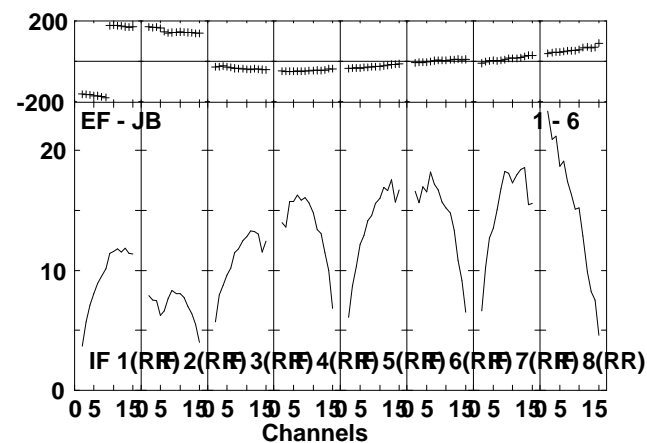
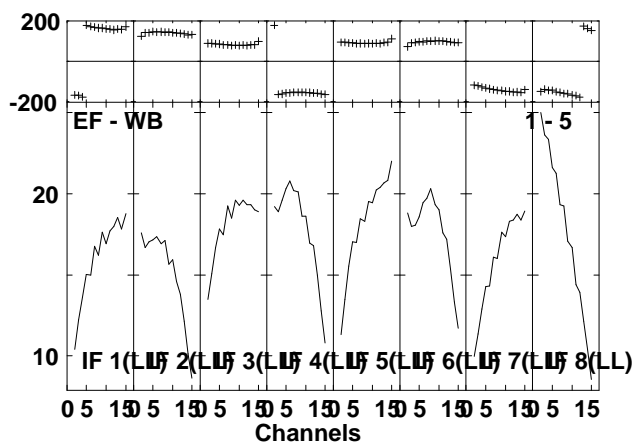
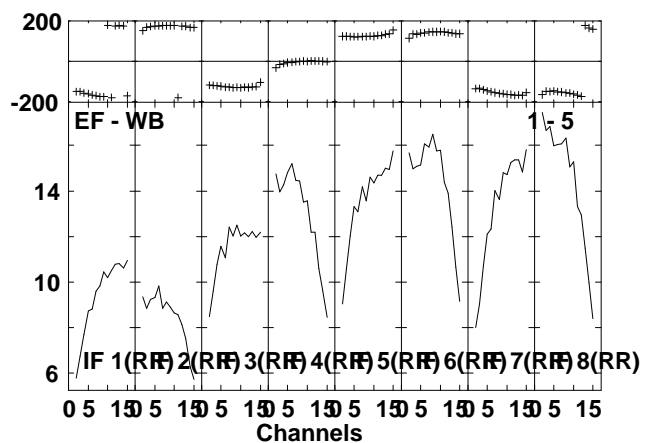
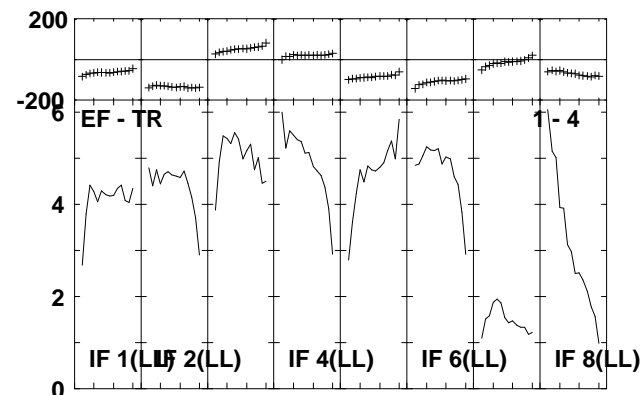
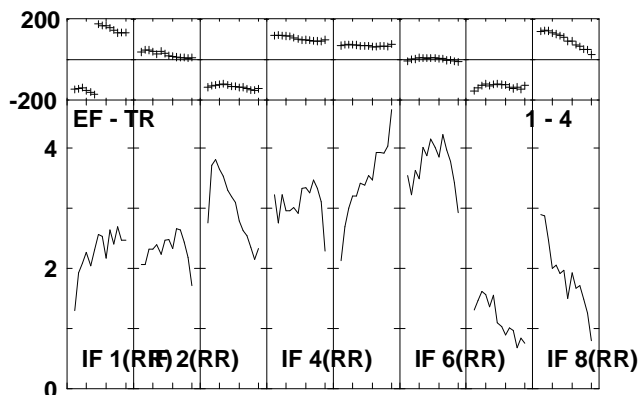
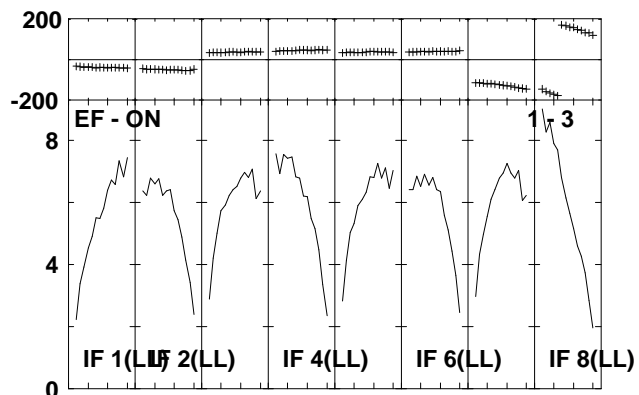
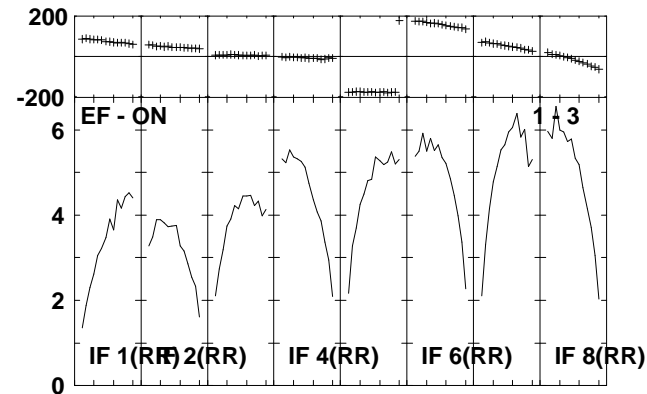
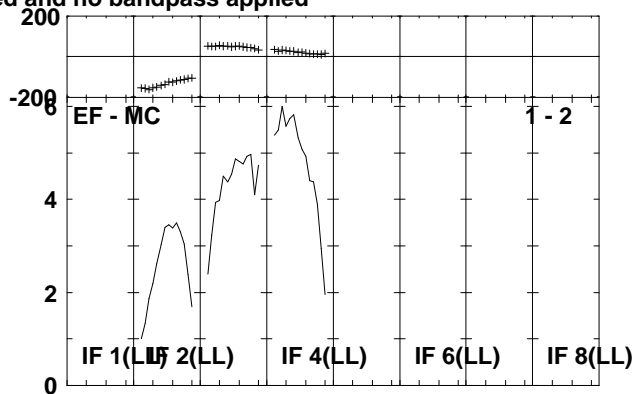
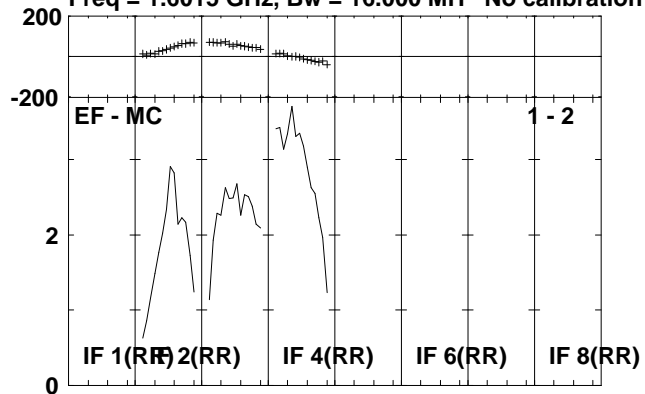

Lower frame: Milli Ampl Jy Top frame: Phas deg
Scalar averaged cross-power spectrum Several baselines displayed
Timerange: 00/20:55:20 to 00/20:57:16

Plot file version 64 created 26-APR-2010 13:26:27

J1246-07 EA043.UVDATA.1

Freq = 1.6015 GHz, Bw = 16.000 MH No calibration applied and no bandpass applied

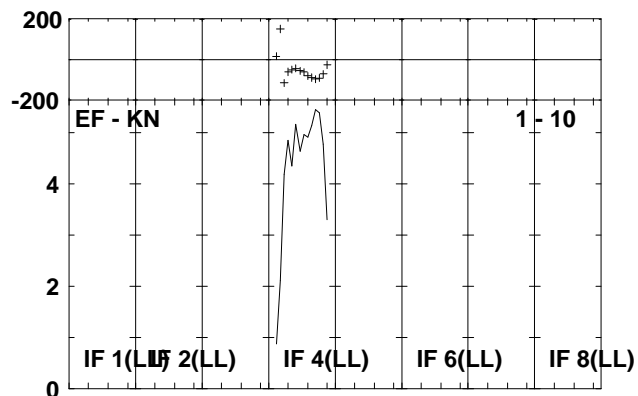
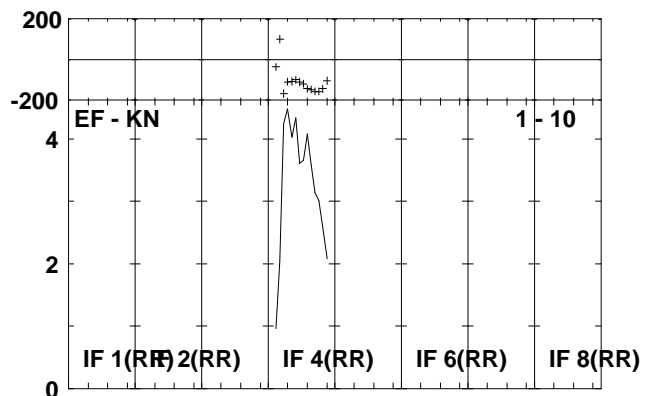
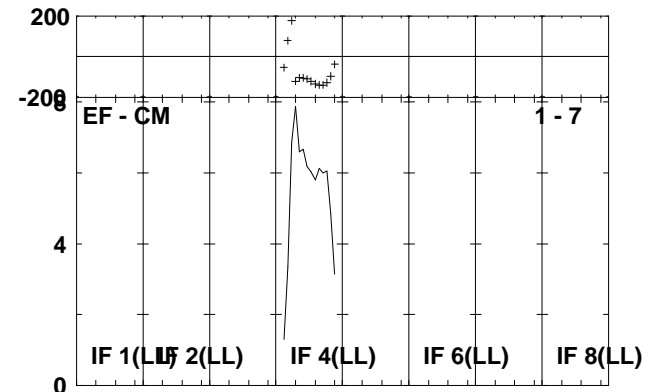
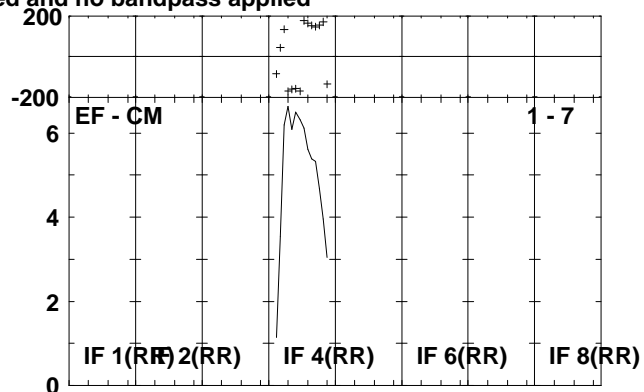
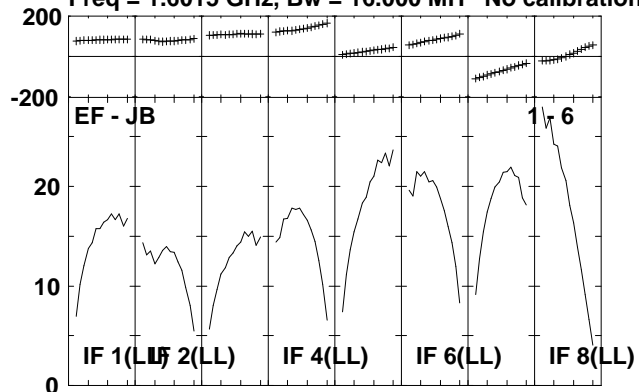

Lower frame: Milli Ampl Jy Top frame: Phas deg
Scalar averaged cross-power spectrum Several baselines displayed
Timerange: 00/20:55:20 to 00/20:57:16

Plot file version 65 created 26-APR-2010 13:26:28

HCG62 EA043.UVDATA.1

Freq = 1.6015 GHz, Bw = 16.000 MH No calibration applied and no bandpass applied

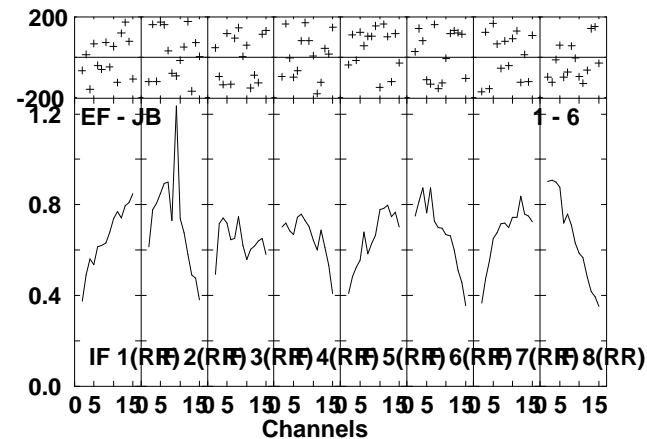
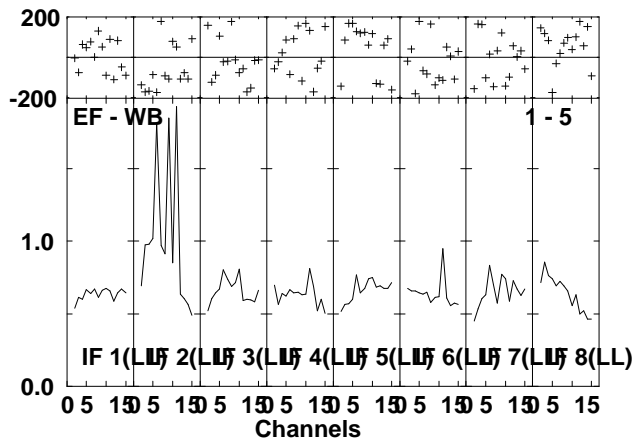
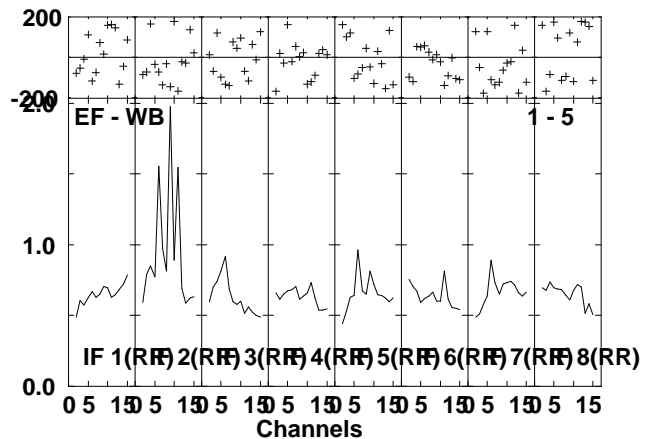
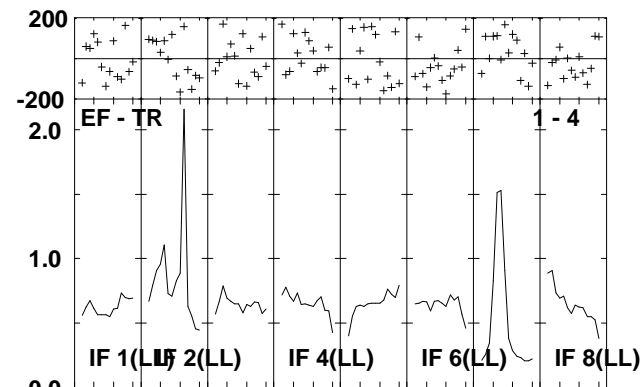
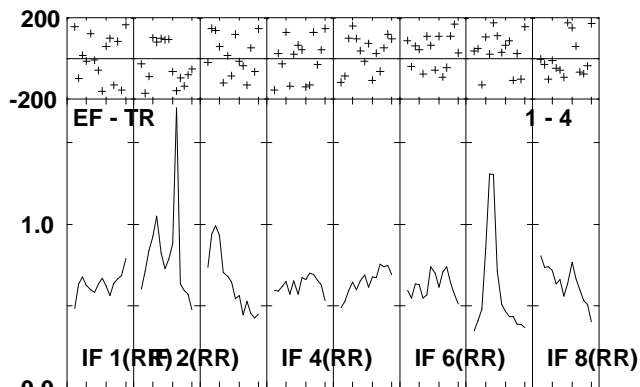
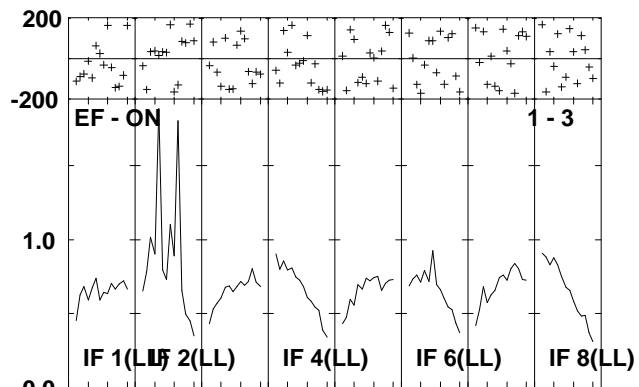
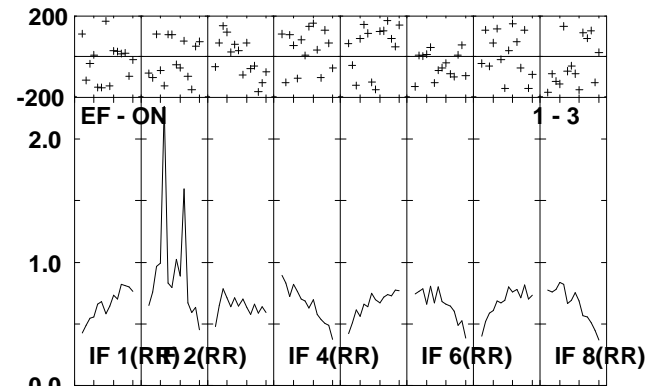
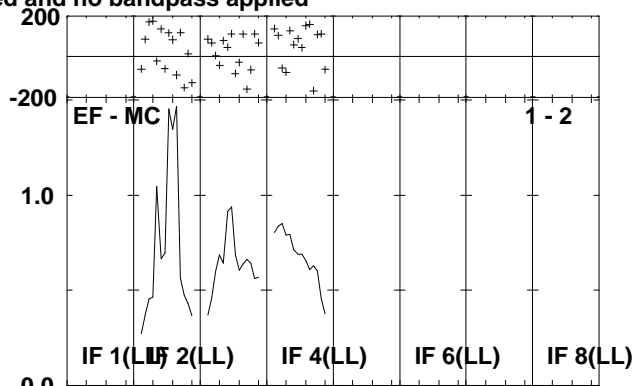
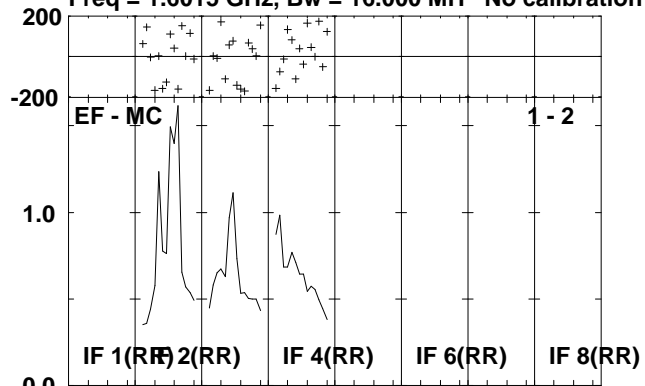

Lower frame: Milli Ampl Jy Top frame: Phas deg
Scalar averaged cross-power spectrum Several baselines displayed
Timerange: 00/20:58:20 to 00/21:05:16

Plot file version 66 created 26-APR-2010 13:26:29

HCG62 EA043.UVDATA.1

Freq = 1.6015 GHz, Bw = 16.000 MH No calibration applied and no bandpass applied

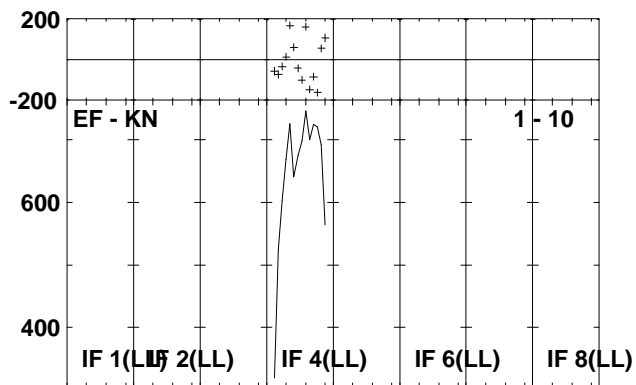
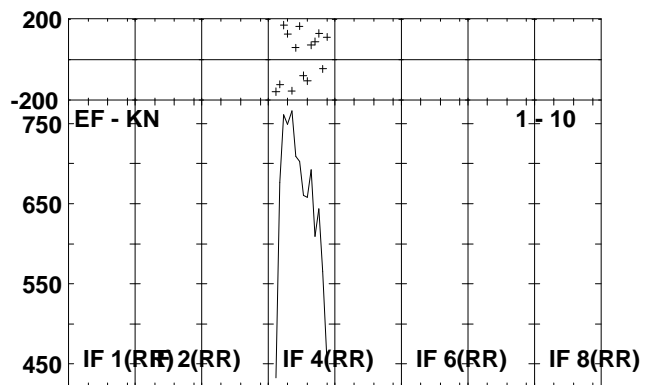
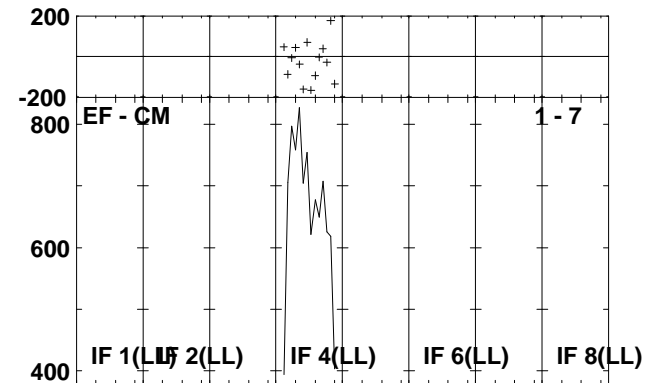
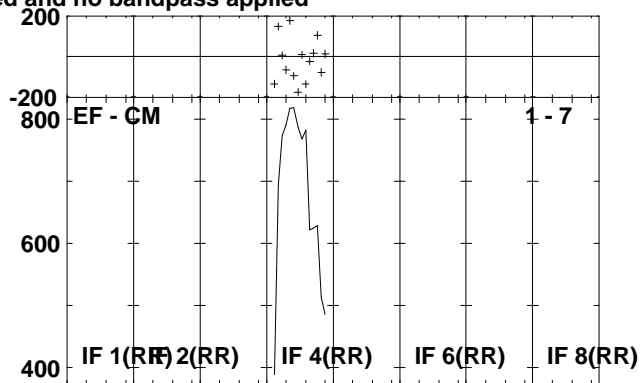
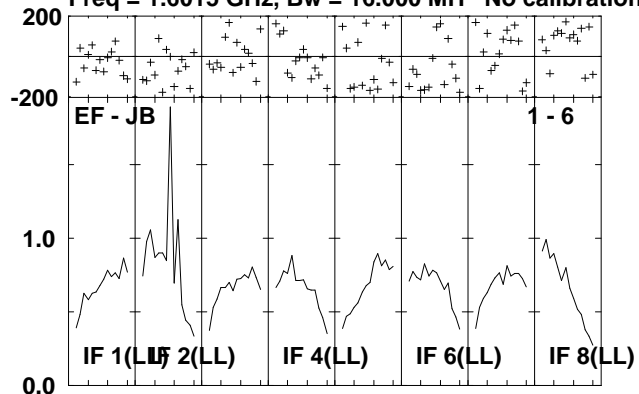

Lower frame: Milli Ampl Jy Top frame: Phas deg
Scalar averaged cross-power spectrum Several baselines displayed
Timerange: 00/20:58:20 to 00/21:05:16

Plot file version 67 created 26-APR-2010 13:26:31

J1246-07 EA043.UVDATA.1

Freq = 1.6015 GHz, Bw = 16.000 MH No calibration applied and no bandpass applied

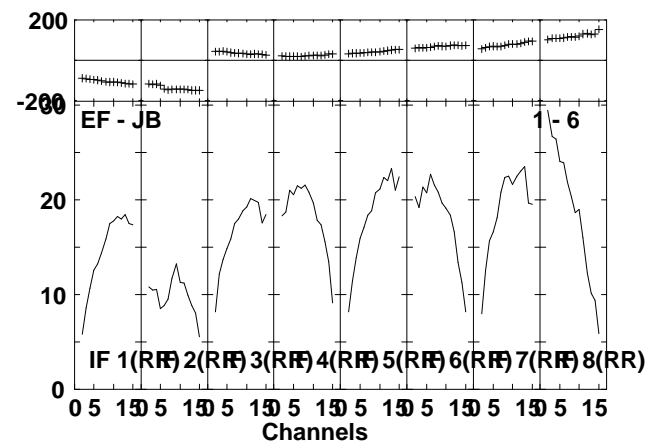
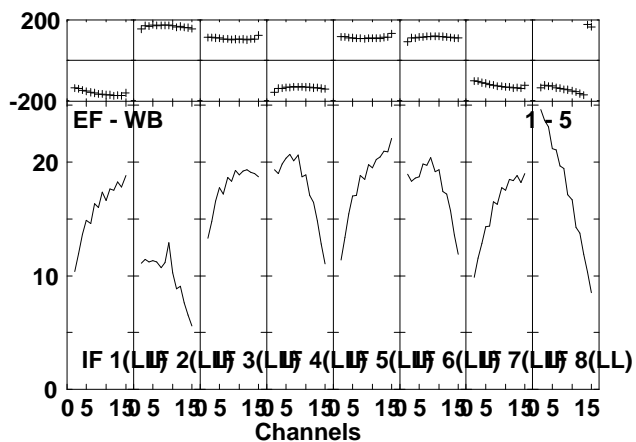
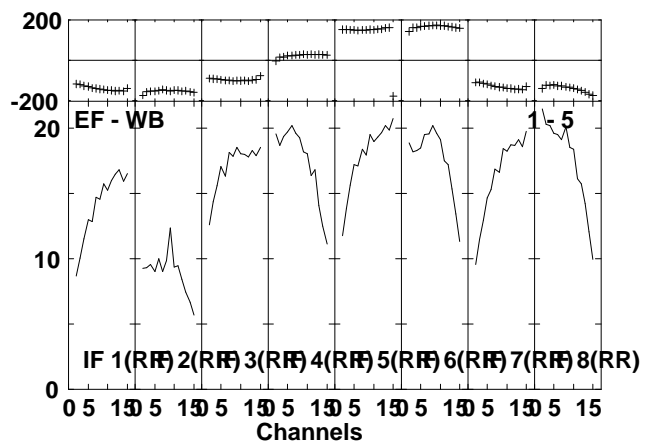
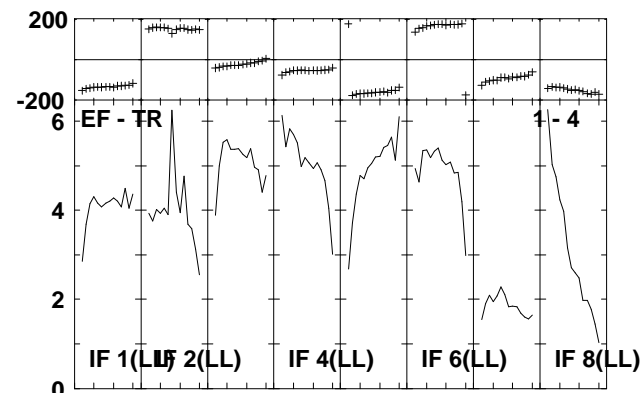
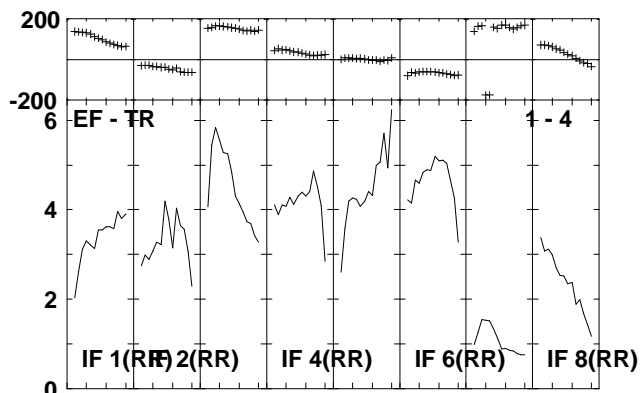
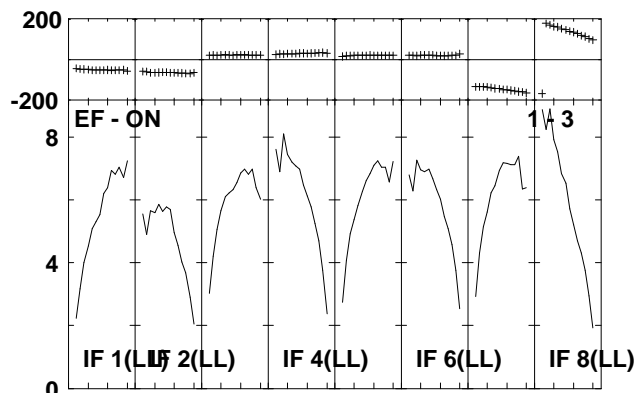
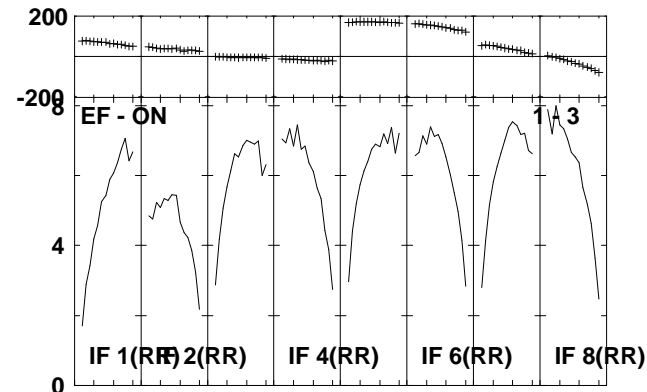
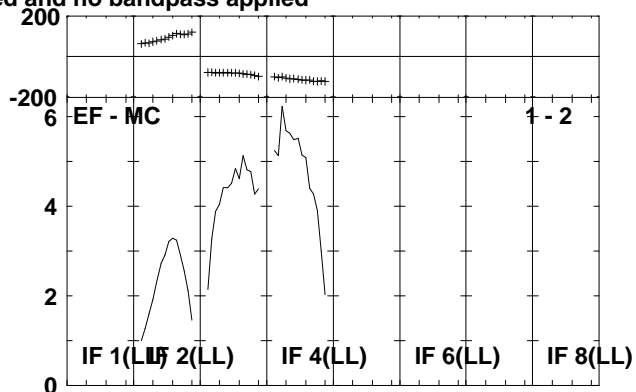
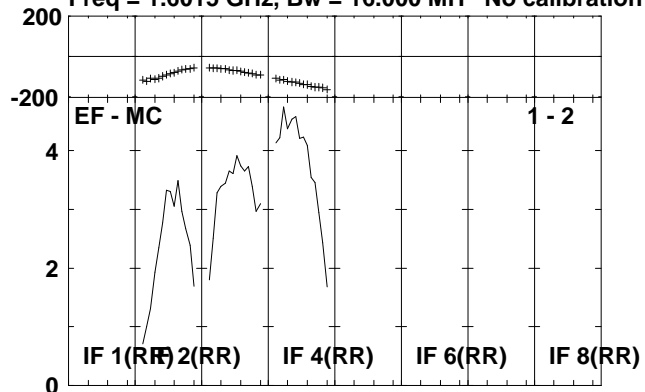

Lower frame: Milli Ampl Jy Top frame: Phas deg
Scalar averaged cross-power spectrum Several baselines displayed
Timerange: 00/21:05:20 to 00/21:07:16

Plot file version 68 created 26-APR-2010 13:26:31
J1246-07 EA043.UVDATA.1

Freq = 1.6015 GHz, Bw = 16.000 MH No calibration applied and no bandpass applied

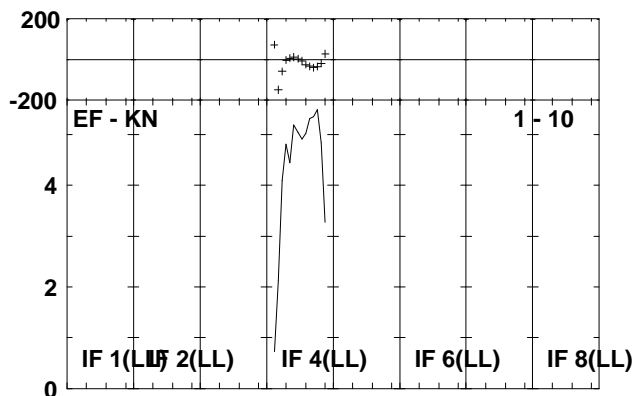
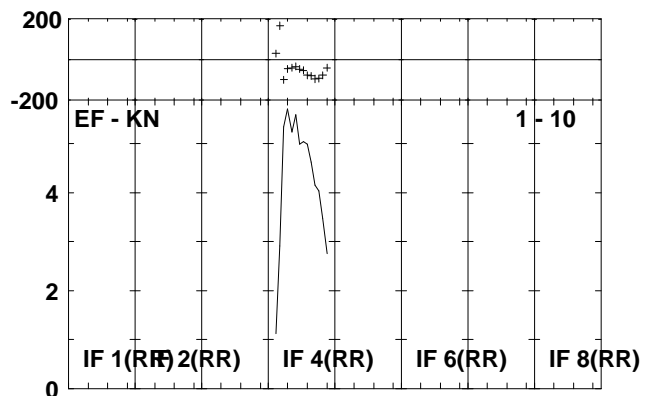
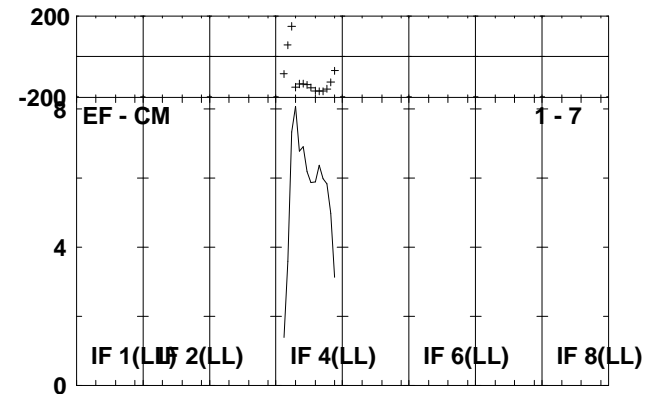
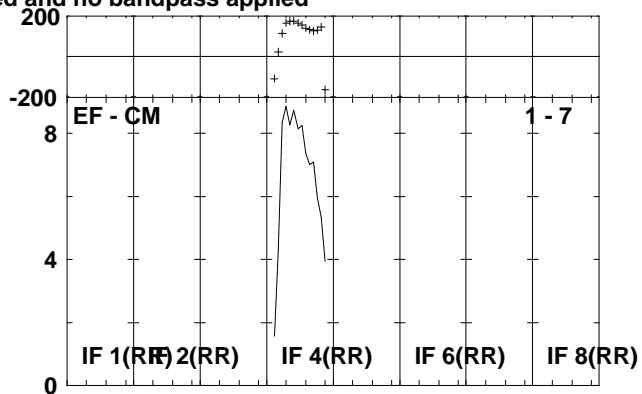
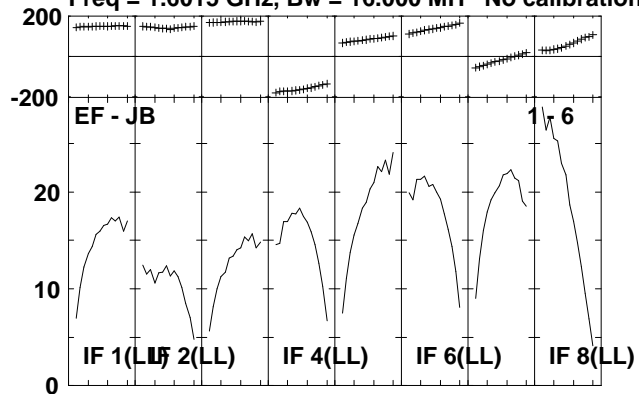

Lower frame: Milli Ampl Jy Top frame: Phas deg
Scalar averaged cross-power spectrum Several baselines displayed
Timerange: 00/21:05:20 to 00/21:07:16

Plot file version 69 created 26-APR-2010 13:26:32

HCG62 EA043.UVDATA.1

Freq = 1.6015 GHz, Bw = 16.000 MH No calibration applied and no bandpass applied

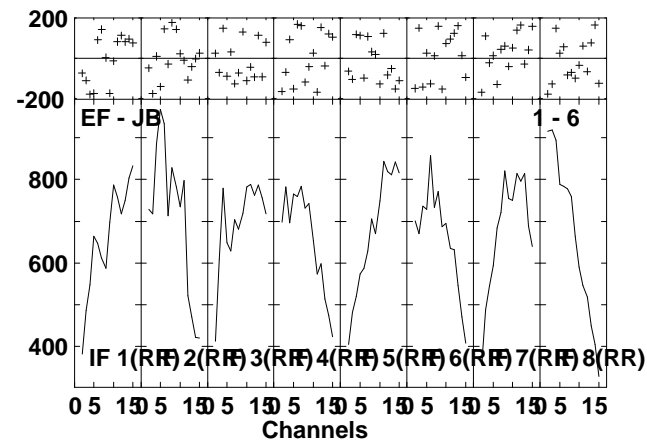
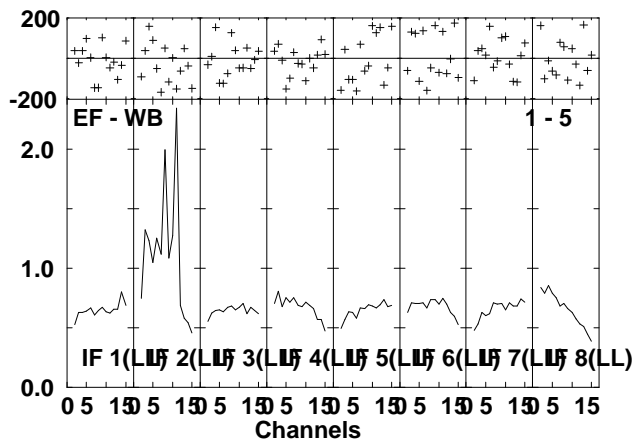
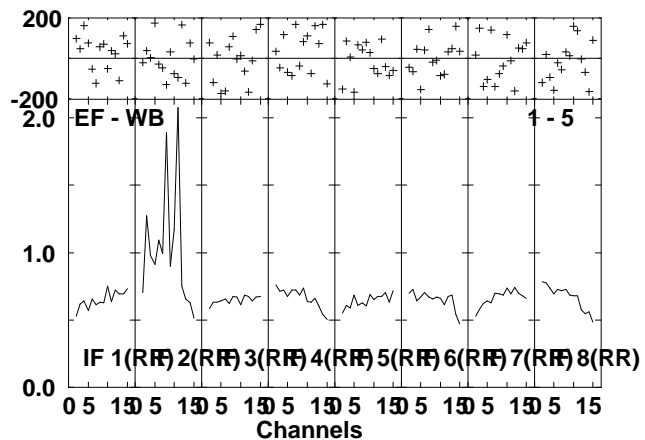
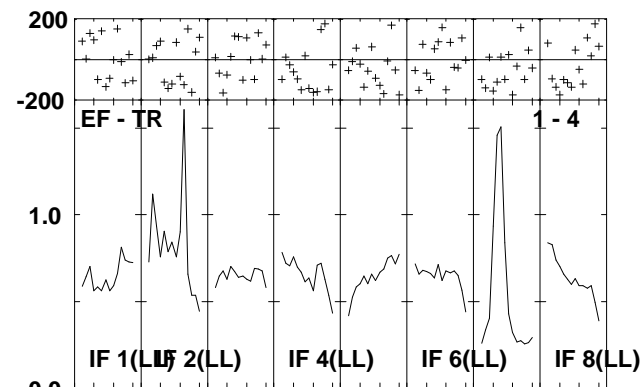
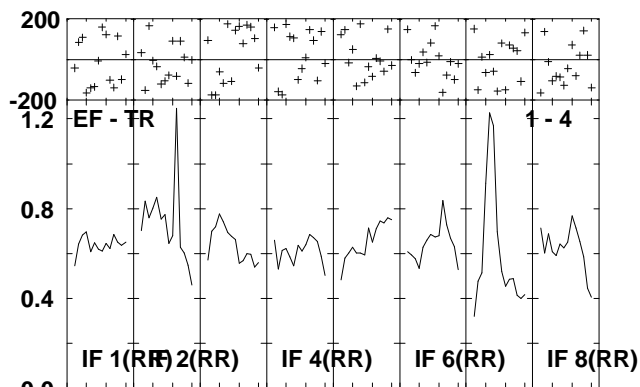
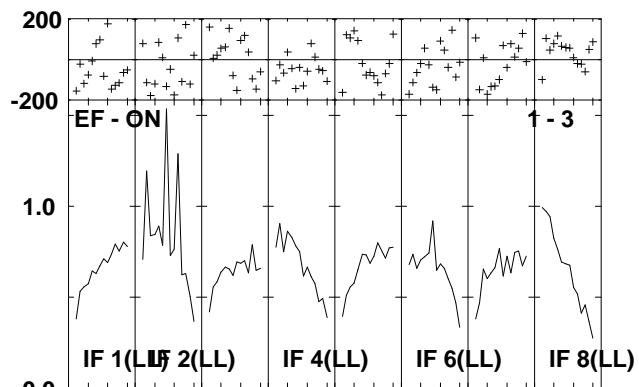
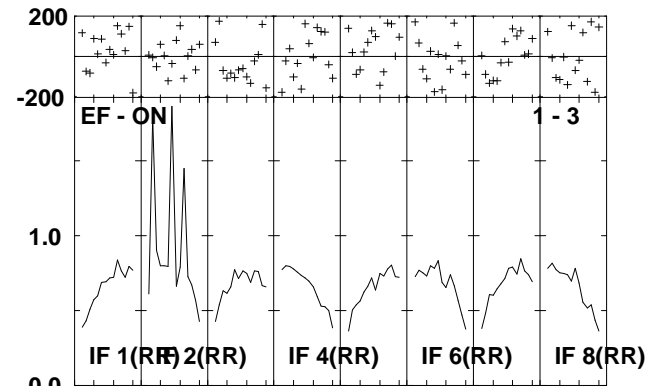
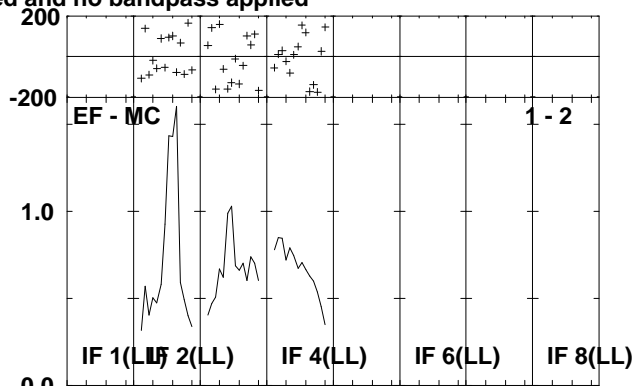
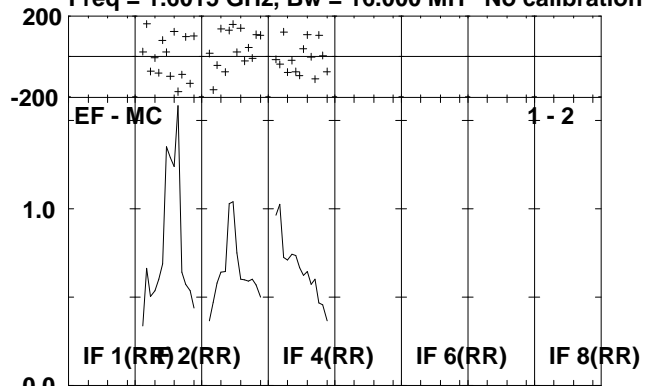

Lower frame: Milli Ampl Jy Top frame: Phas deg
Scalar averaged cross-power spectrum Several baselines displayed
Timerange: 00/21:08:20 to 00/21:15:16

Plot file version 70 created 26-APR-2010 13:26:33

HCG62 EA043.UVDATA.1

Freq = 1.6015 GHz, Bw = 16.000 MH No calibration applied and no bandpass applied

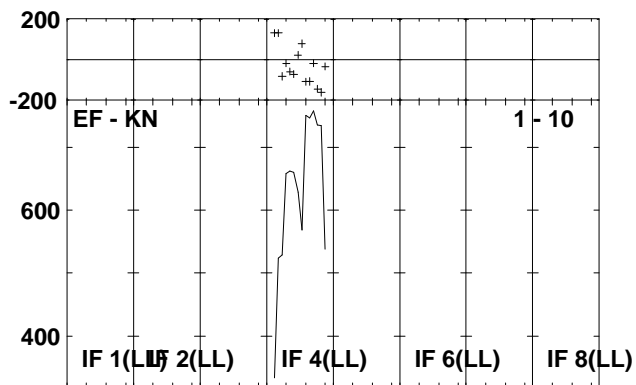
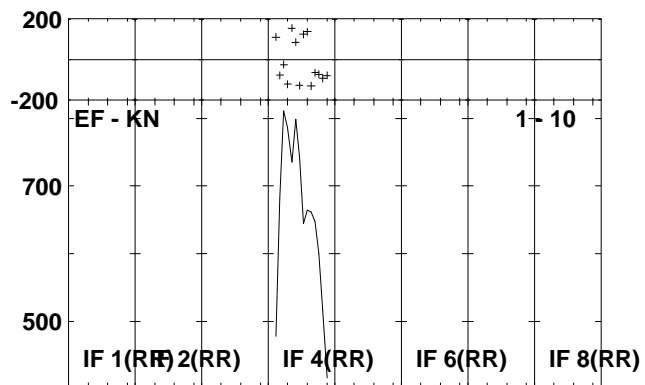
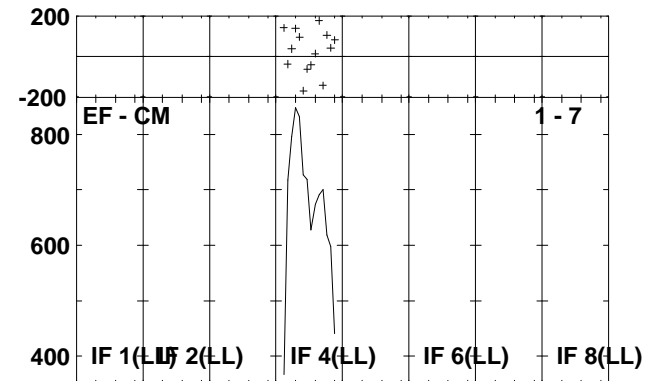
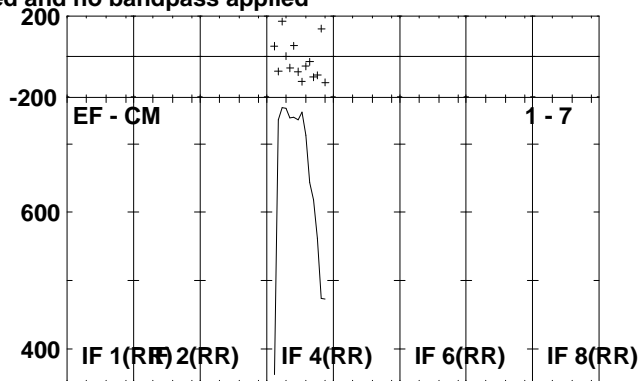
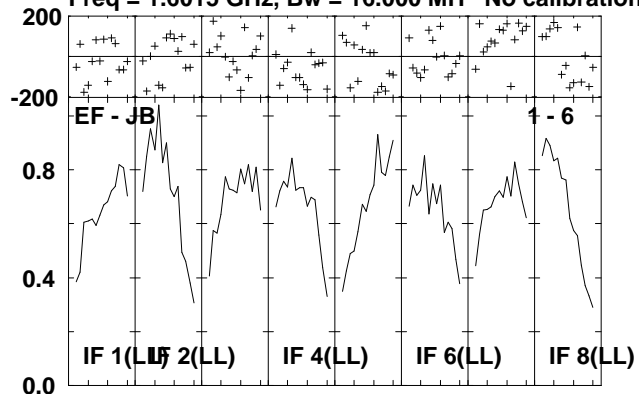

Lower frame: Milli Ampl Jy Top frame: Phas deg
Scalar averaged cross-power spectrum Several baselines displayed
Timerange: 00/21:08:20 to 00/21:15:16

Plot file version 71 created 26-APR-2010 13:26:35

J1246-07 EA043.UVDATA.1

Freq = 1.6015 GHz, Bw = 16.000 MH No calibration applied and no bandpass applied

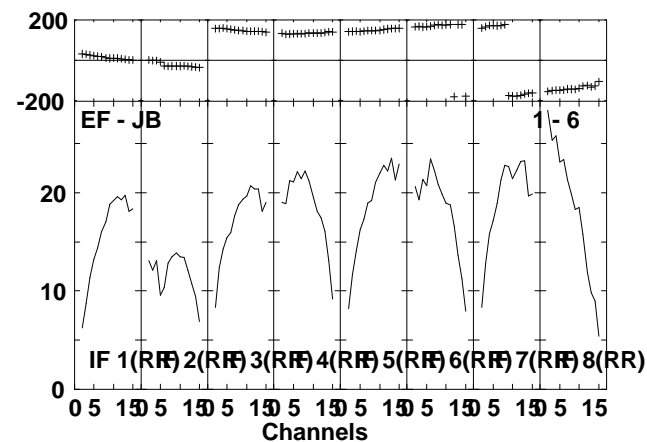
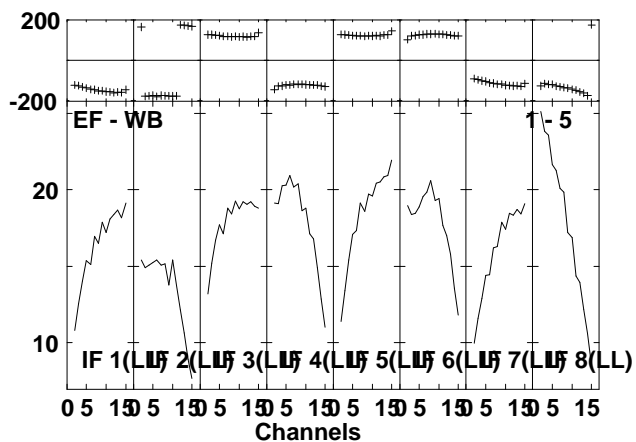
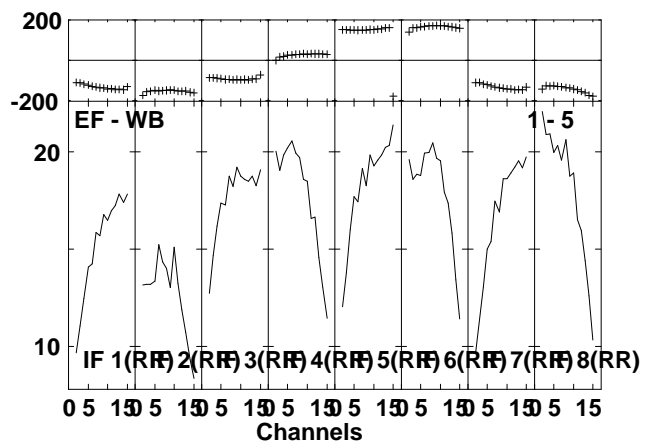
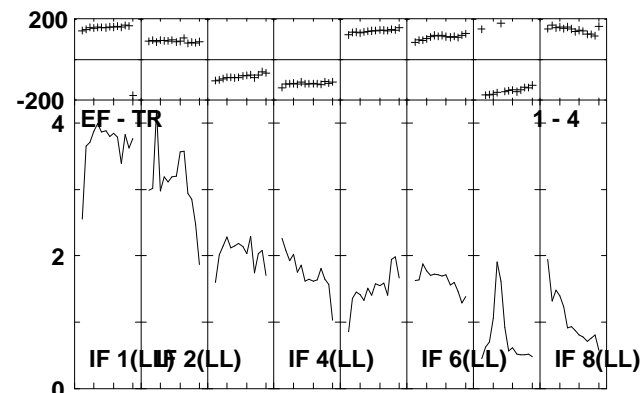
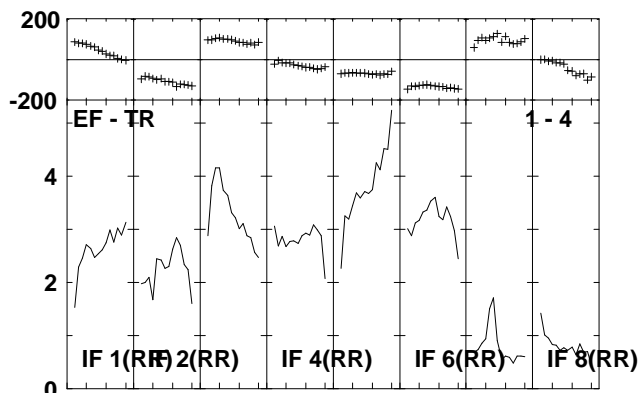
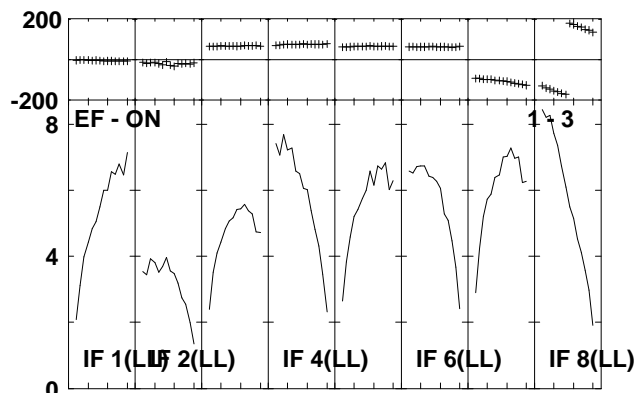
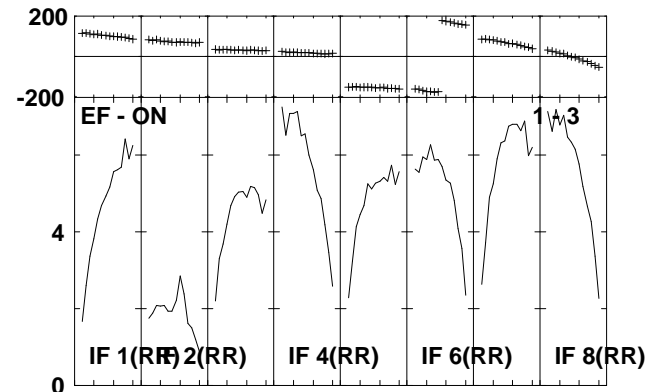
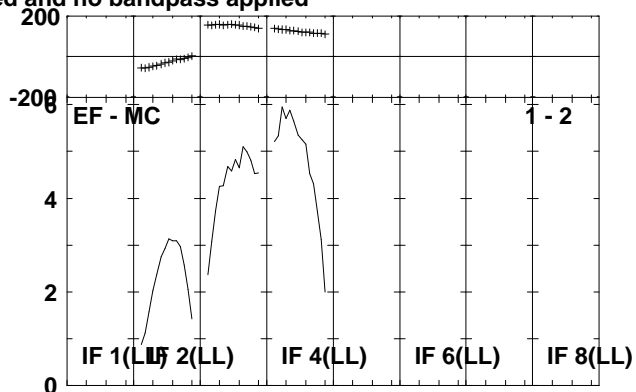
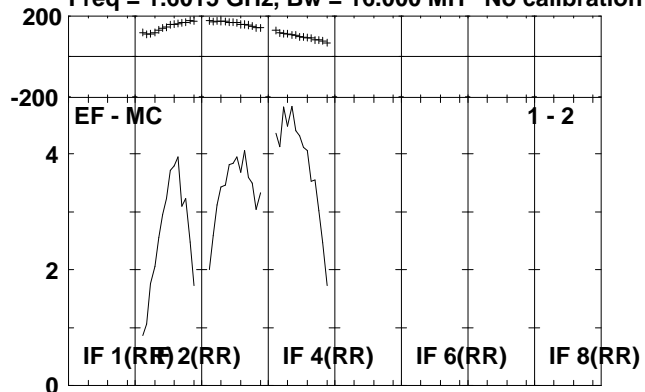

Lower frame: Milli Ampl Jy Top frame: Phas deg
Scalar averaged cross-power spectrum Several baselines displayed
Timerange: 00/21:15:20 to 00/21:17:16

Plot file version 72 created 26-APR-2010 13:26:35

J1246-07 EA043.UVDATA.1

Freq = 1.6015 GHz, Bw = 16.000 MH No calibration applied and no bandpass applied

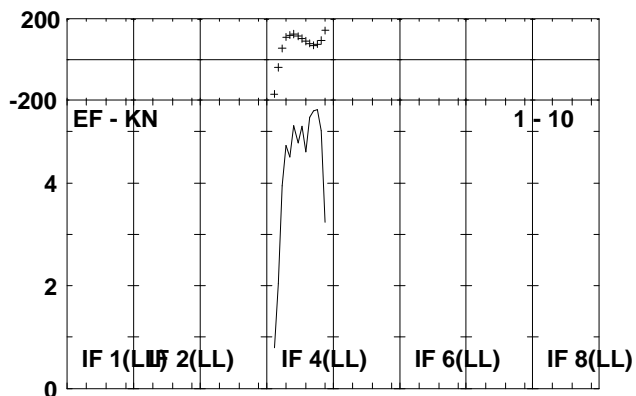
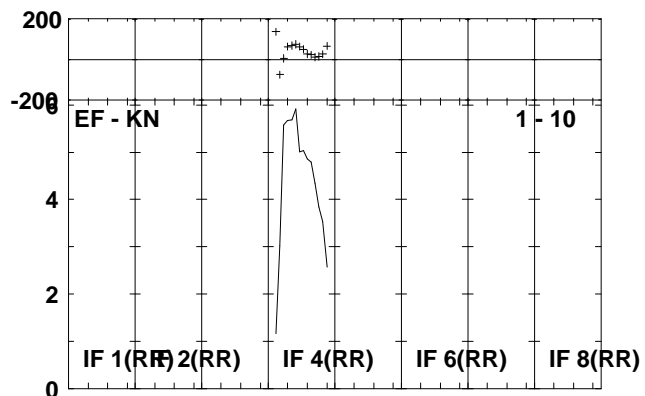
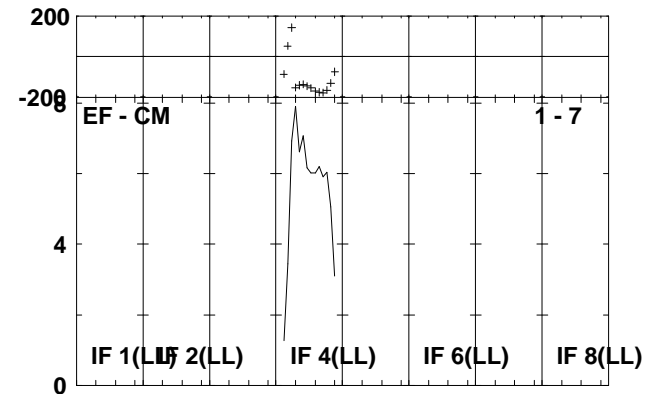
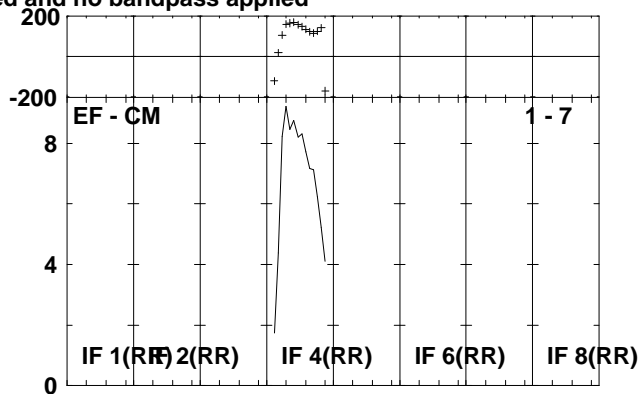
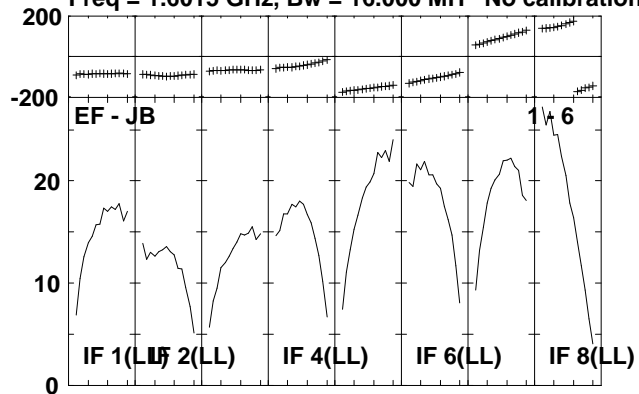

Lower frame: Milli Ampl Jy Top frame: Phas deg
Scalar averaged cross-power spectrum Several baselines displayed
Timerange: 00/21:15:20 to 00/21:17:16

Plot file version 73 created 26-APR-2010 13:26:36

HCG62 EA043.UVDATA.1

Freq = 1.6015 GHz, Bw = 16.000 MH No calibration applied and no bandpass applied

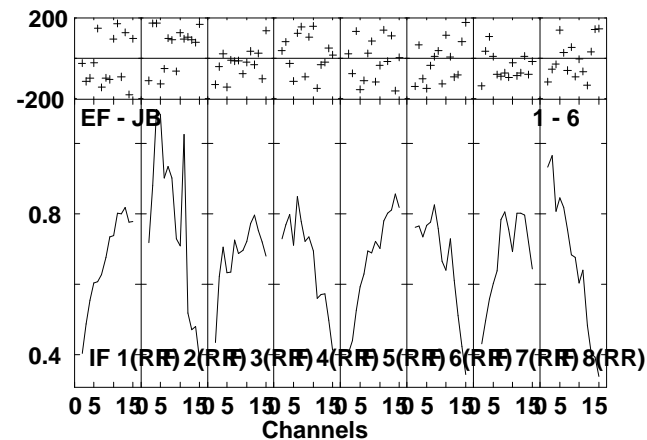
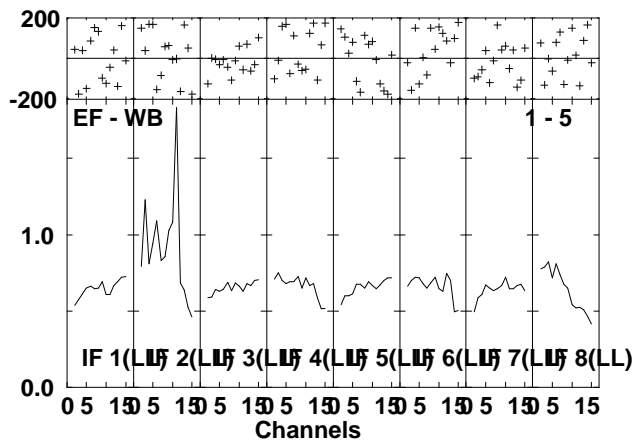
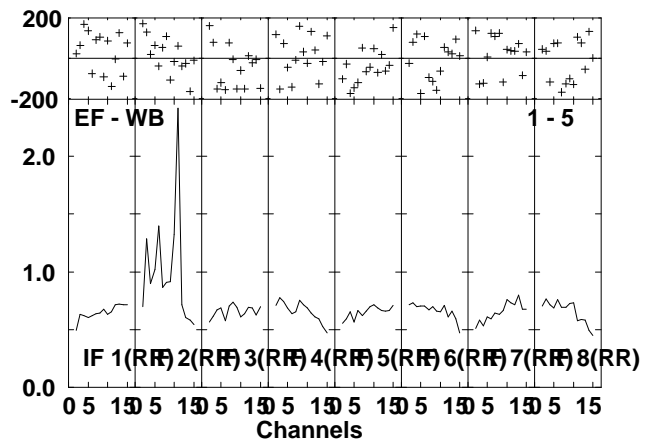
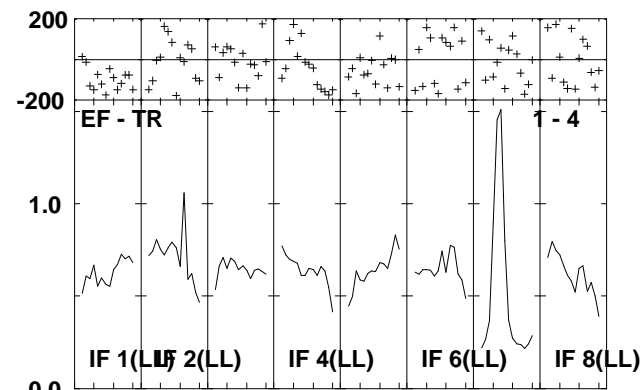
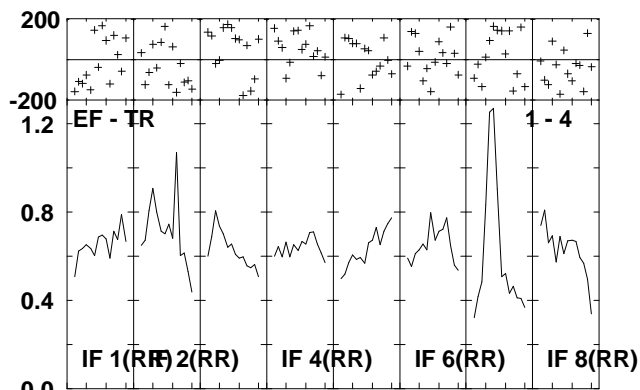
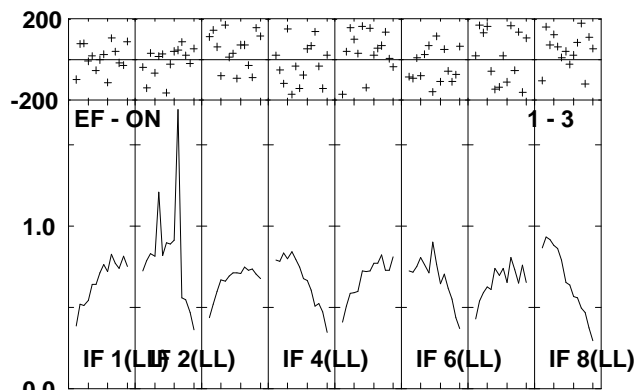
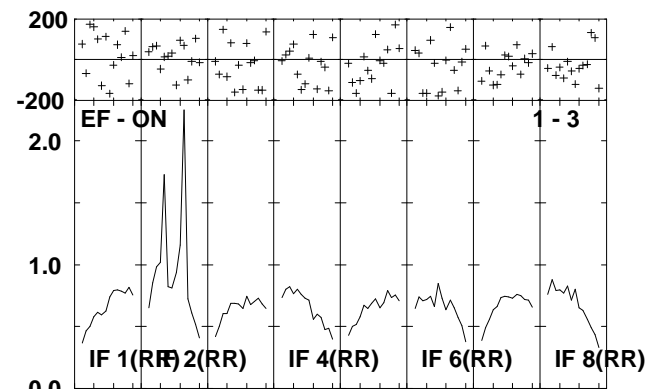
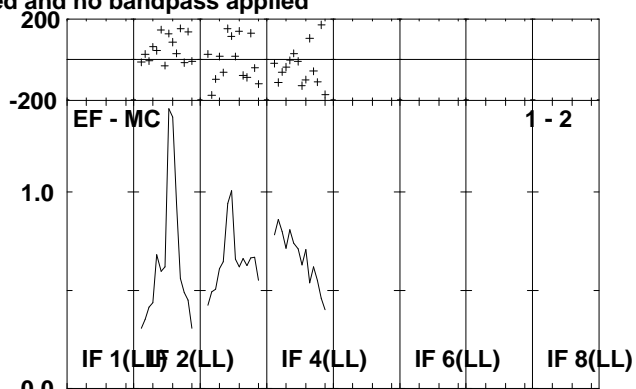
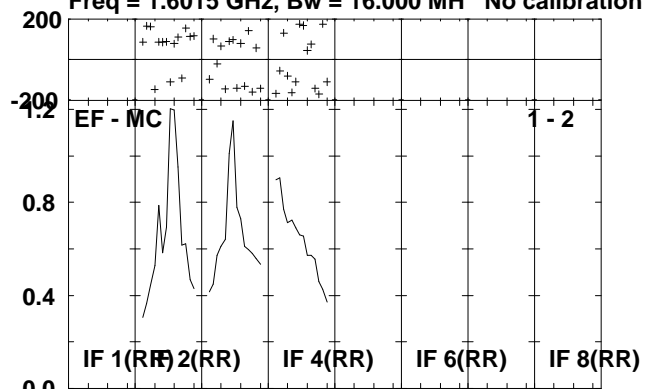

Lower frame: Milli Ampl Jy Top frame: Phas deg
Scalar averaged cross-power spectrum Several baselines displayed
Timerange: 00/21:18:20 to 00/21:25:16

Plot file version 74 created 26-APR-2010 13:26:37

HCG62 EA043.UVDATA.1

Freq = 1.6015 GHz, Bw = 16.000 MH No calibration applied and no bandpass applied

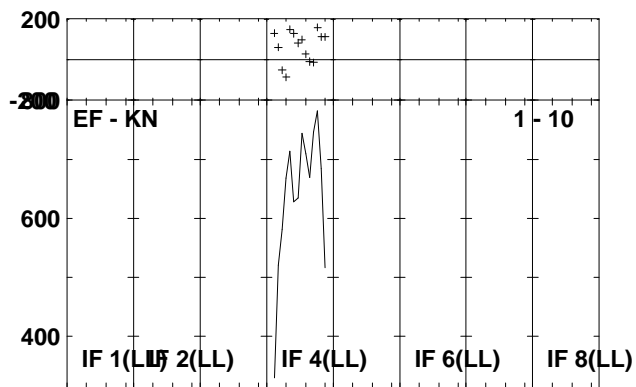
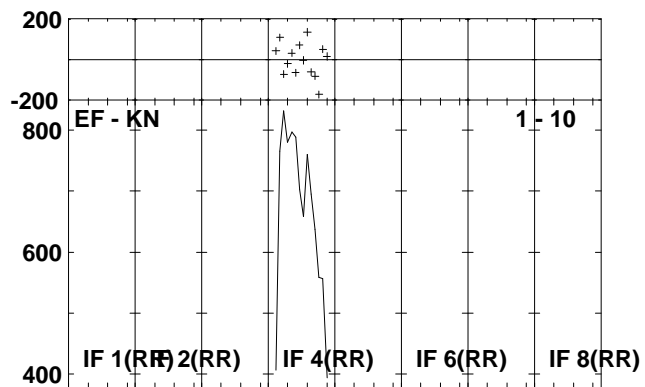
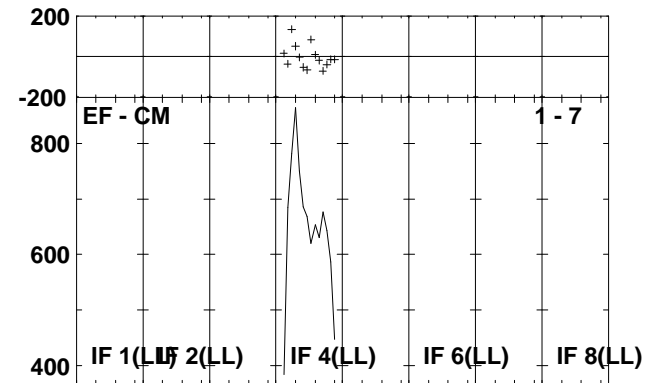
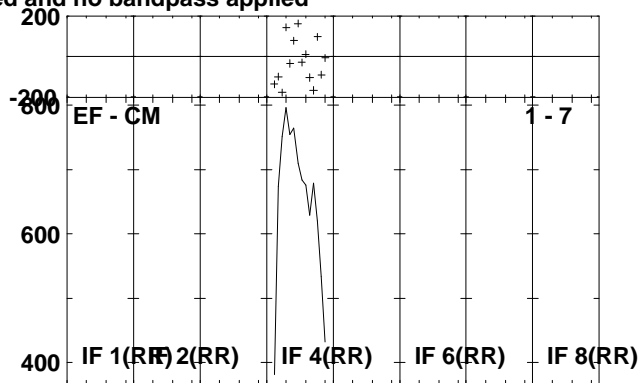
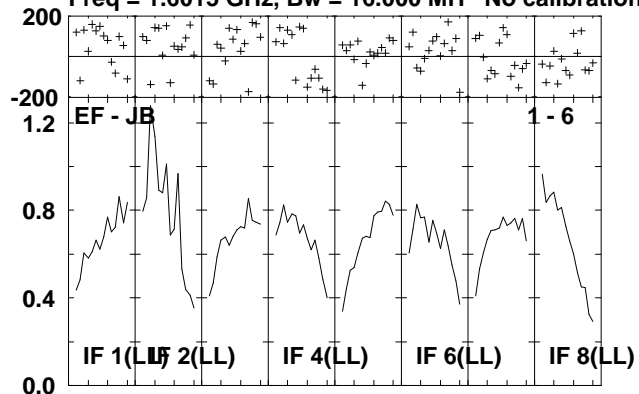

Lower frame: Milli Ampl Jy Top frame: Phas deg
Scalar averaged cross-power spectrum Several baselines displayed
Timerange: 00/21:18:20 to 00/21:25:16

Plot file version 75 created 26-APR-2010 13:26:39

J1246-07 EA043.UVDATA.1

Freq = 1.6015 GHz, Bw = 16.000 MH No calibration applied and no bandpass applied

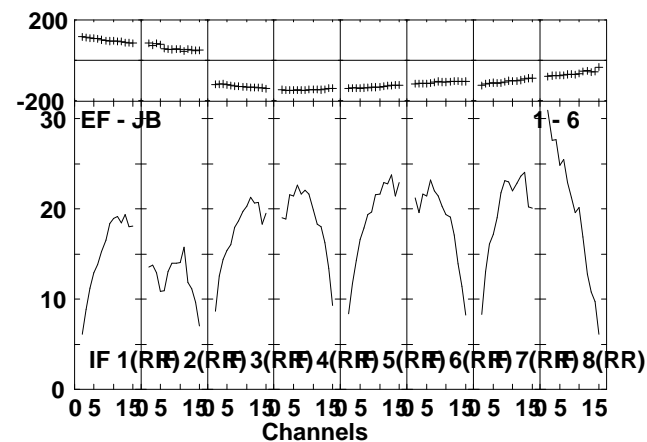
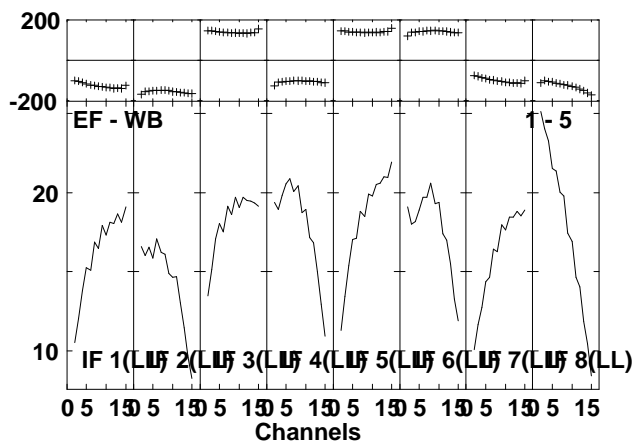
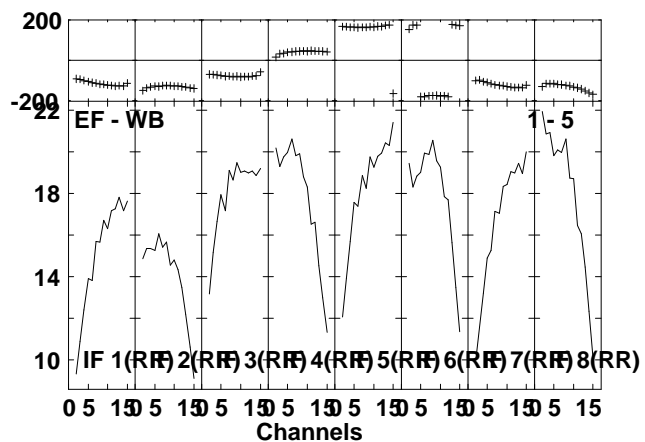
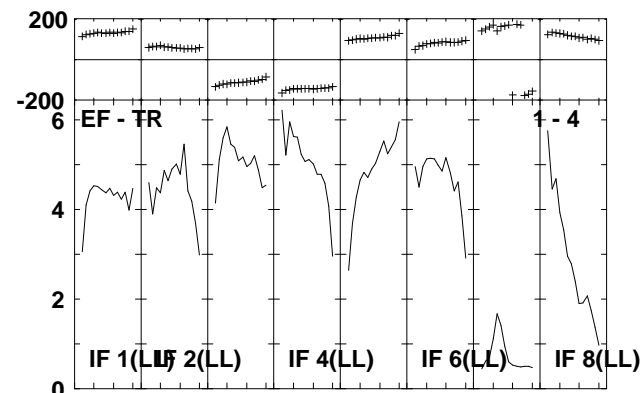
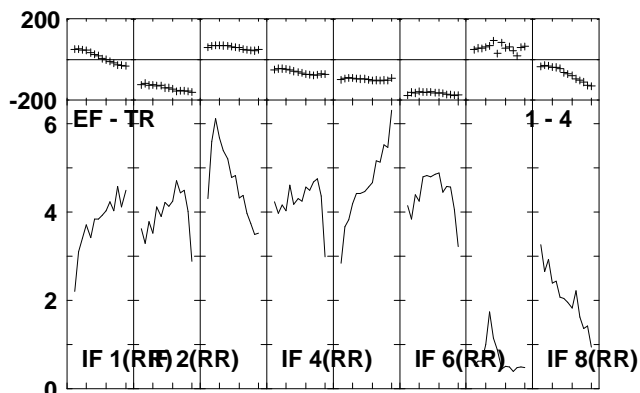
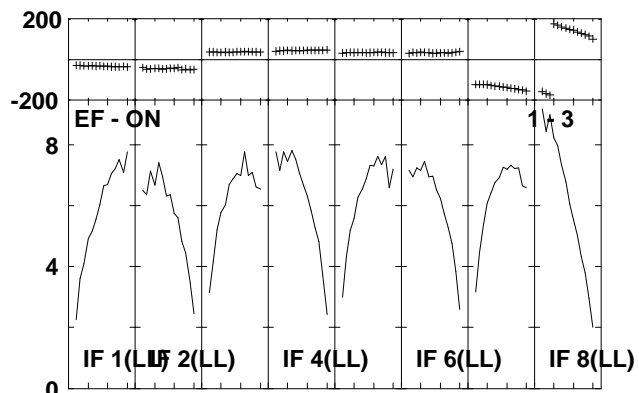
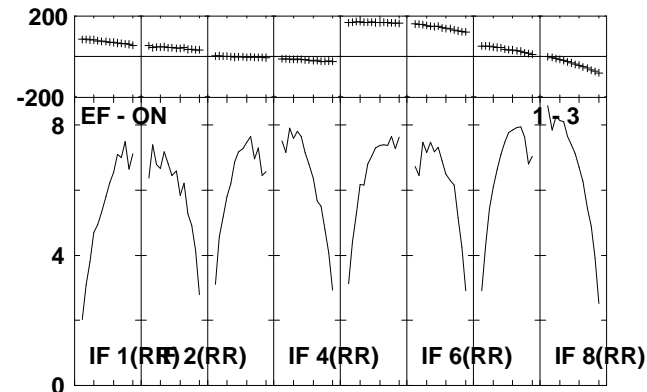
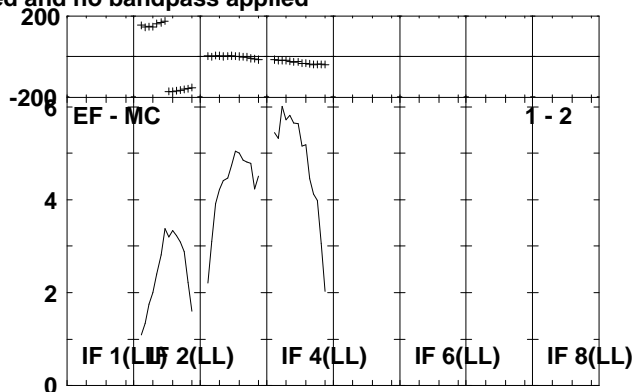
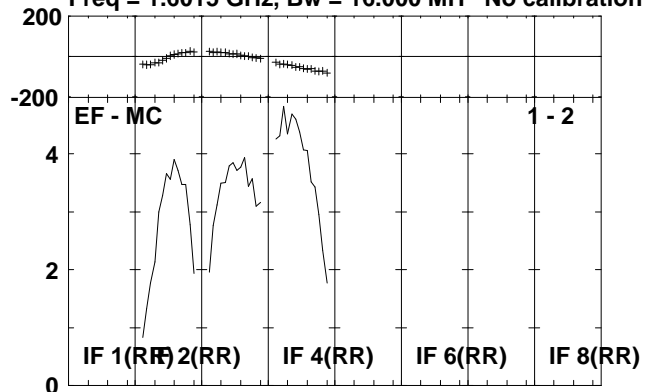

Lower frame: Milli Ampl Jy Top frame: Phas deg
Scalar averaged cross-power spectrum Several baselines displayed
Timerange: 00/21:25:20 to 00/21:27:16

Plot file version 76 created 26-APR-2010 13:26:39

J1246-07 EA043.UVDATA.1

Freq = 1.6015 GHz, Bw = 16.000 MH No calibration applied and no bandpass applied

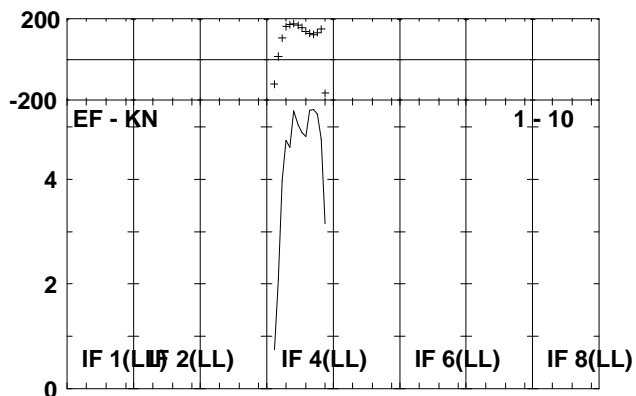
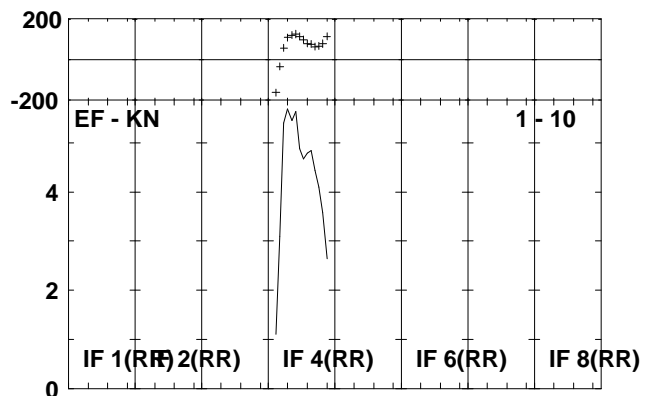
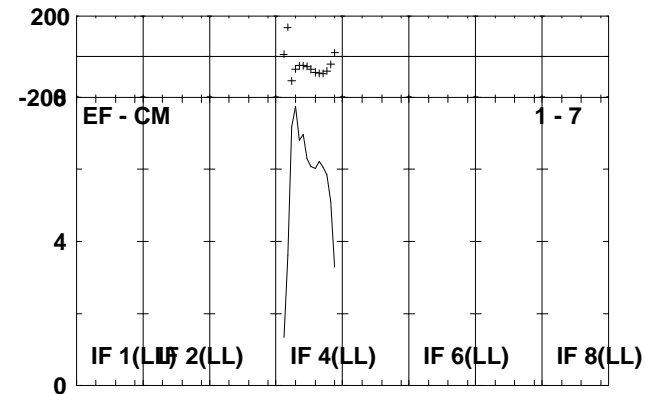
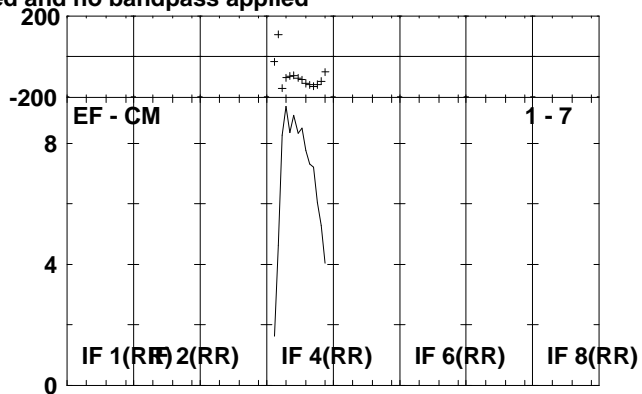
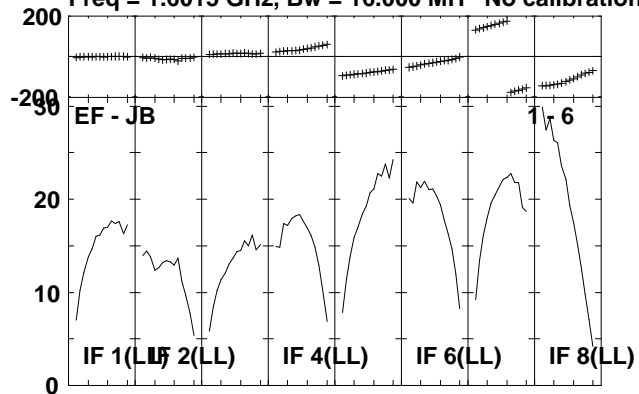

Lower frame: Milli Ampl Jy Top frame: Phas deg
Scalar averaged cross-power spectrum Several baselines displayed
Timerange: 00/21:25:20 to 00/21:27:16

Plot file version 77 created 26-APR-2010 13:26:40

HCG62 EA043.UVDATA.1

Freq = 1.6015 GHz, Bw = 16.000 MH No calibration applied and no bandpass applied

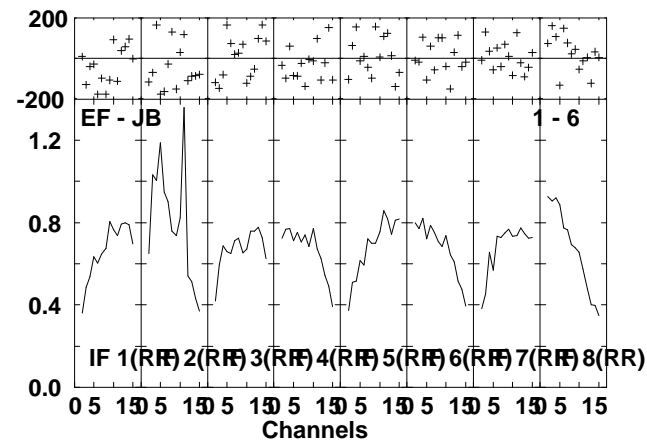
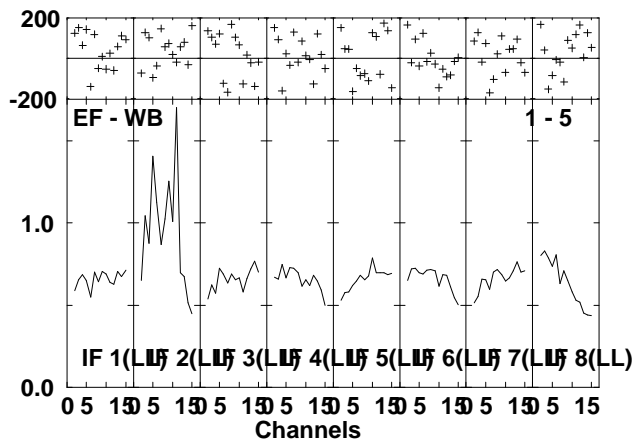
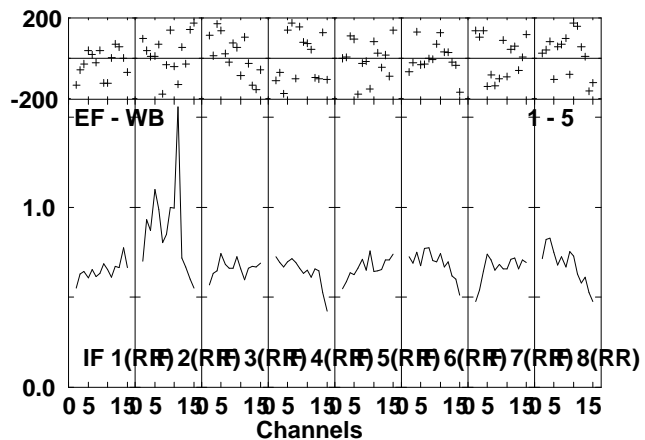
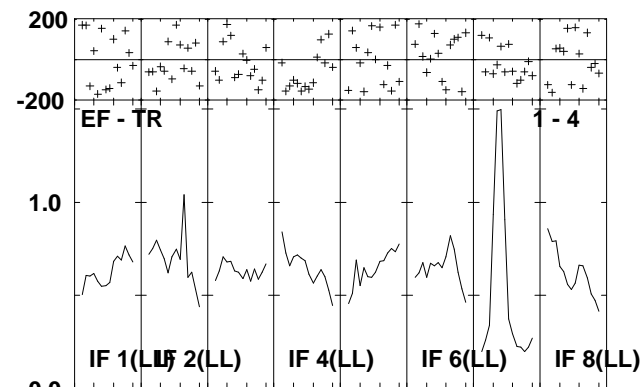
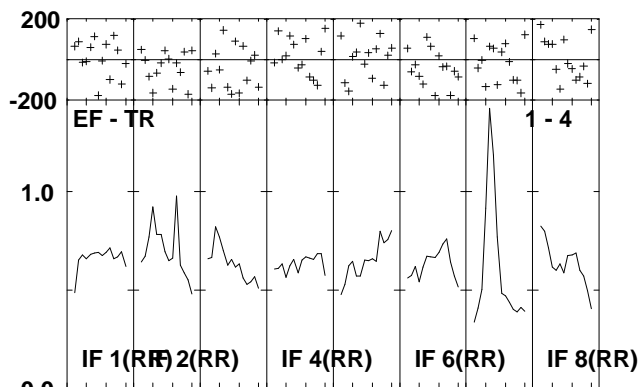
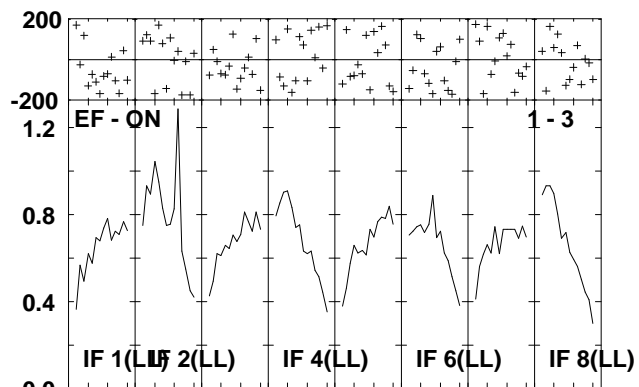
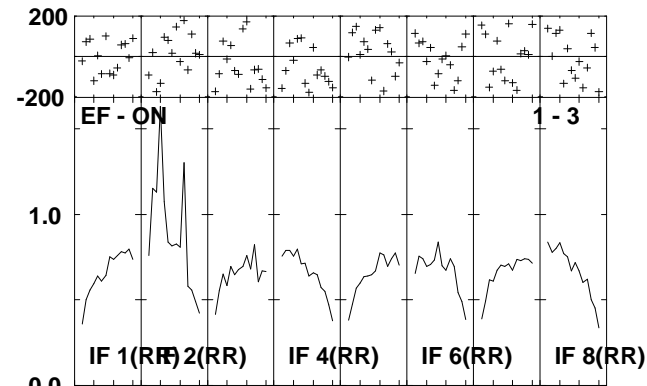
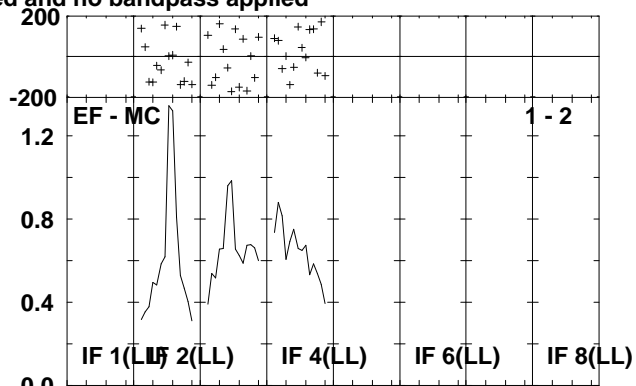
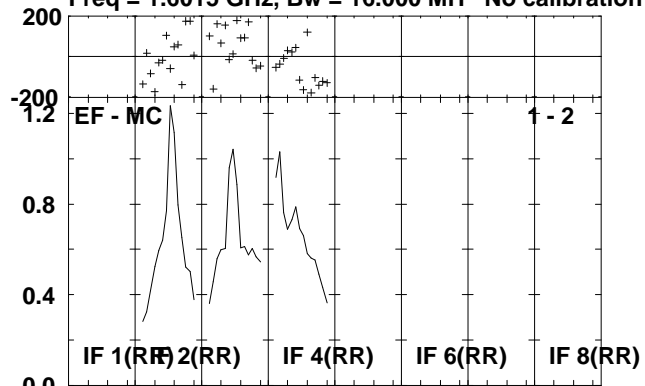

Lower frame: Milli Ampl Jy Top frame: Phas deg
Scalar averaged cross-power spectrum Several baselines displayed
Timerange: 00/21:28:20 to 00/21:35:16

Plot file version 78 created 26-APR-2010 13:26:41

HCG62 EA043.UVDATA.1

Freq = 1.6015 GHz, Bw = 16.000 MH No calibration applied and no bandpass applied

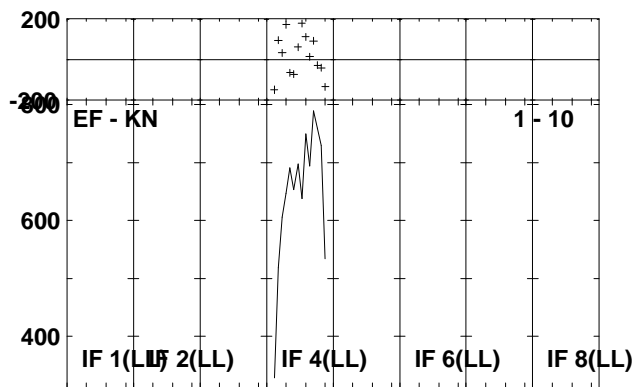
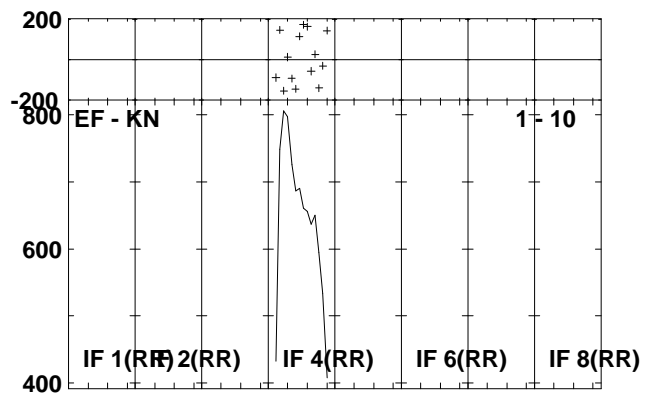
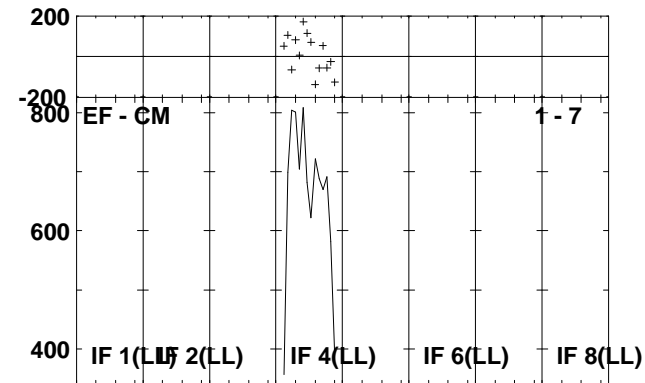
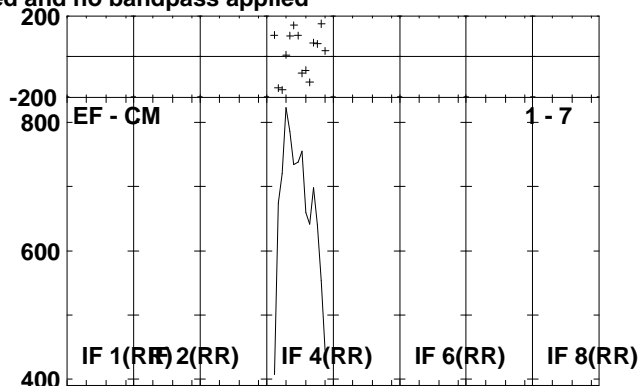
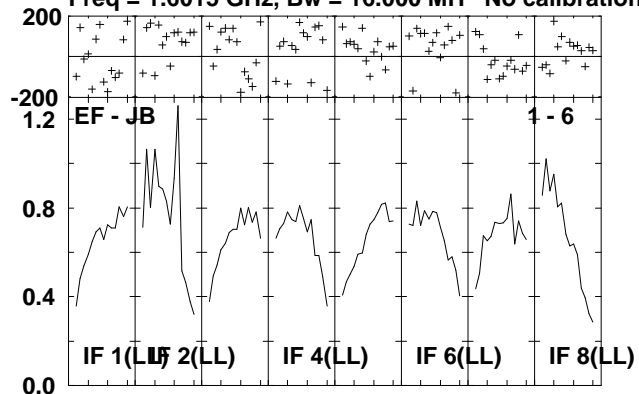

Lower frame: Milli Ampl Jy Top frame: Phas deg
Scalar averaged cross-power spectrum Several baselines displayed
Timerange: 00/21:28:20 to 00/21:35:16

Plot file version 79 created 26-APR-2010 13:26:43

J1246-07 EA043.UVDATA.1

Freq = 1.6015 GHz, Bw = 16.000 MH No calibration applied and no bandpass applied

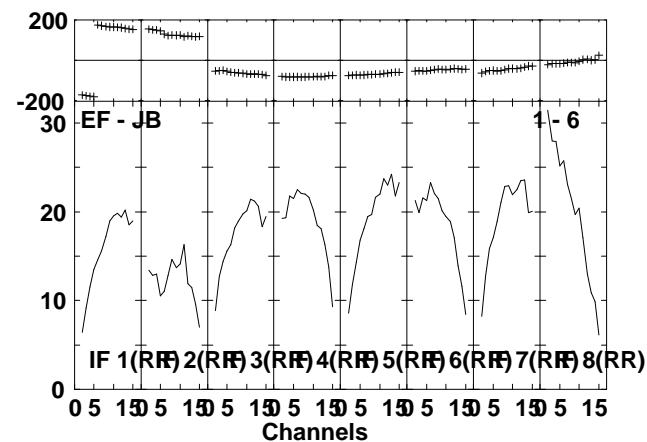
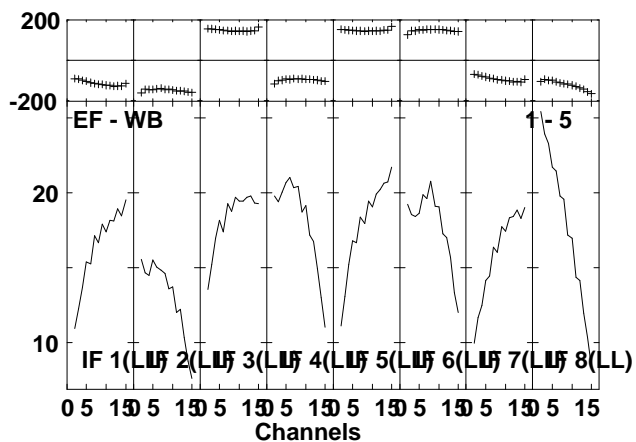
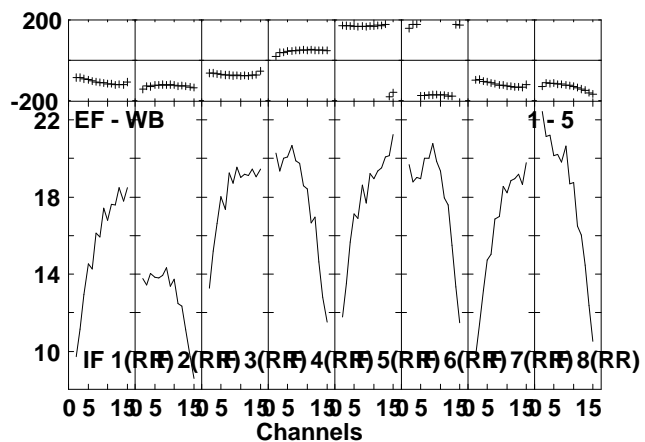
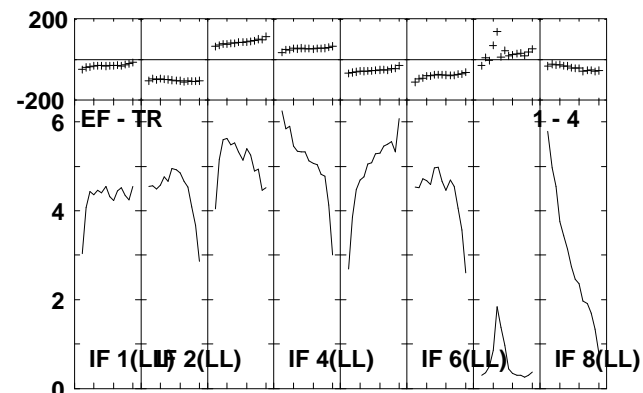
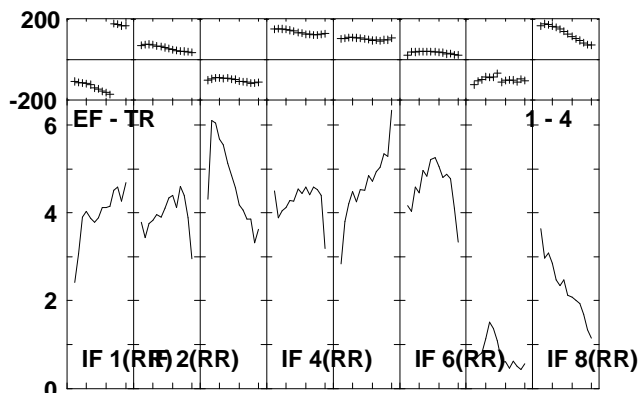
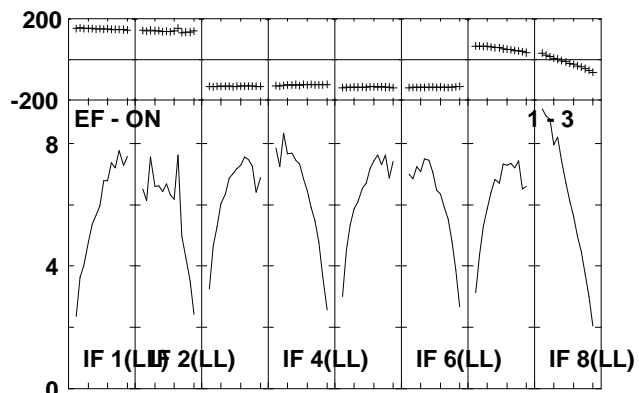
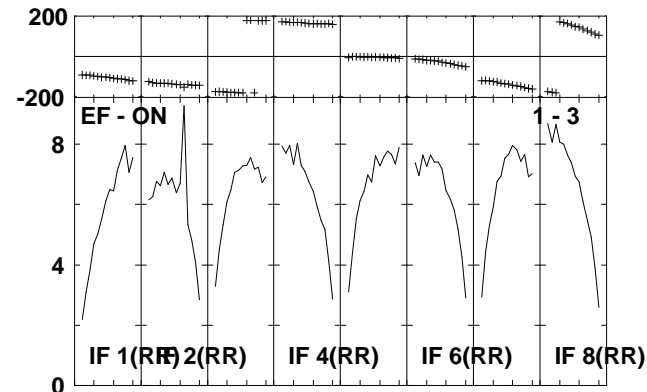
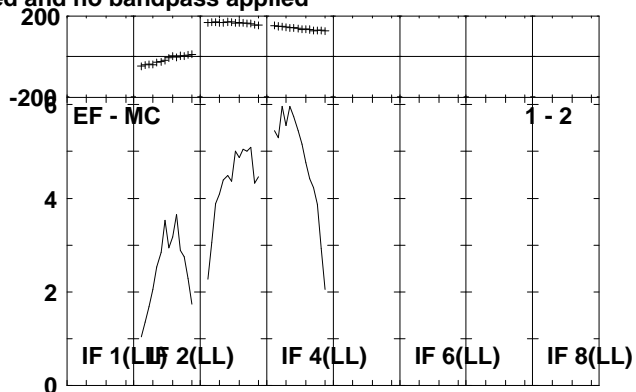
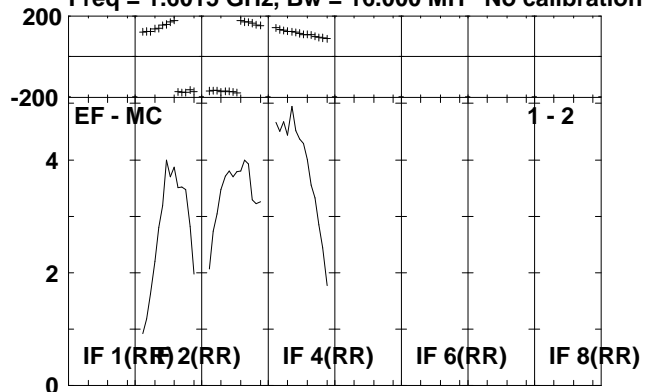

Lower frame: Milli Ampl Jy Top frame: Phas deg
Scalar averaged cross-power spectrum Several baselines displayed
Timerange: 00/21:35:20 to 00/21:37:16

Plot file version 80 created 26-APR-2010 13:26:43

J1246-07 EA043.UVDATA.1

Freq = 1.6015 GHz, Bw = 16.000 MH No calibration applied and no bandpass applied

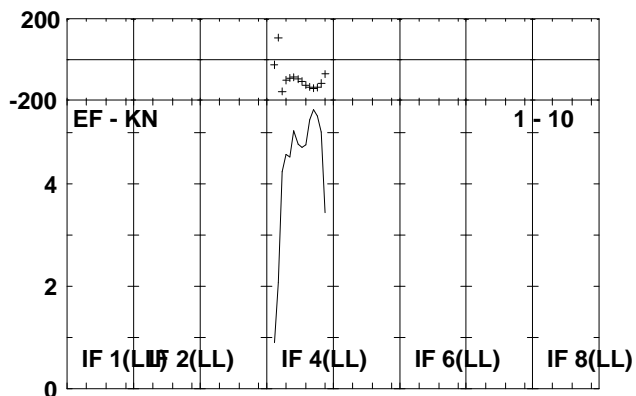
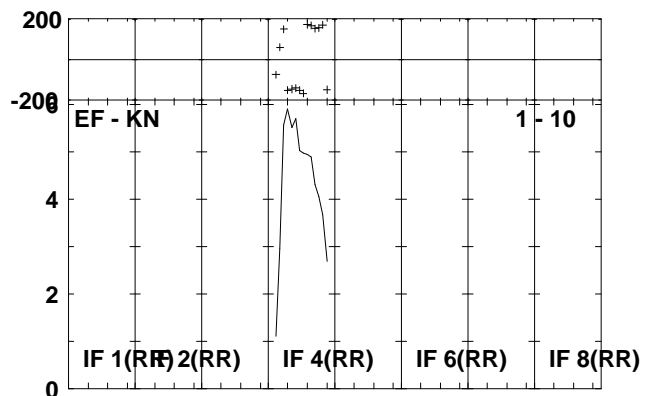
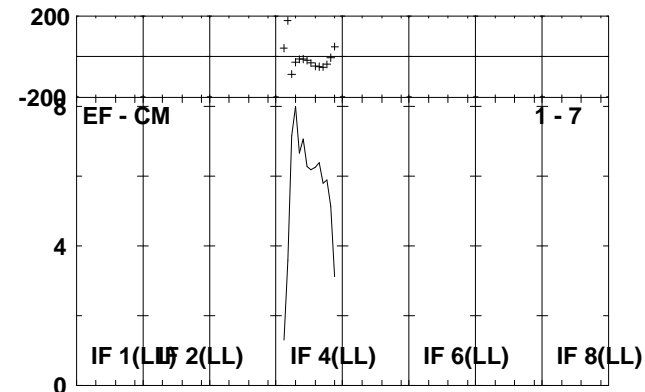
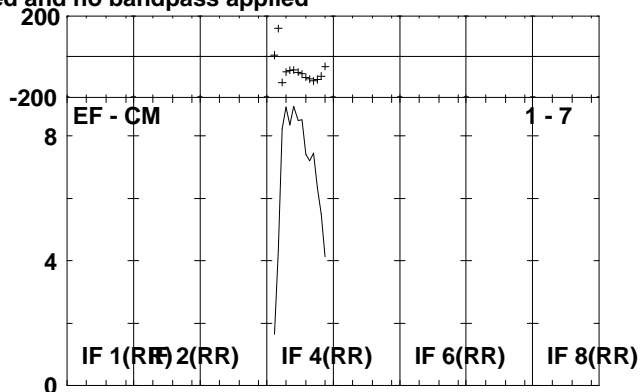
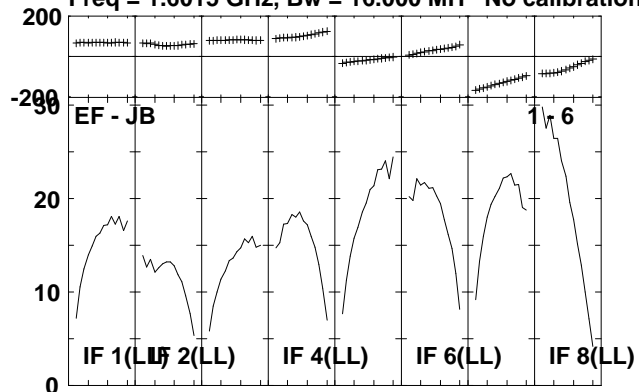

Lower frame: Milli Ampl Jy Top frame: Phas deg
Scalar averaged cross-power spectrum Several baselines displayed
Timerange: 00/21:35:20 to 00/21:37:16

Plot file version 81 created 26-APR-2010 13:26:44

HCG62 EA043.UVDATA.1

Freq = 1.6015 GHz, Bw = 16.000 MH No calibration applied and no bandpass applied

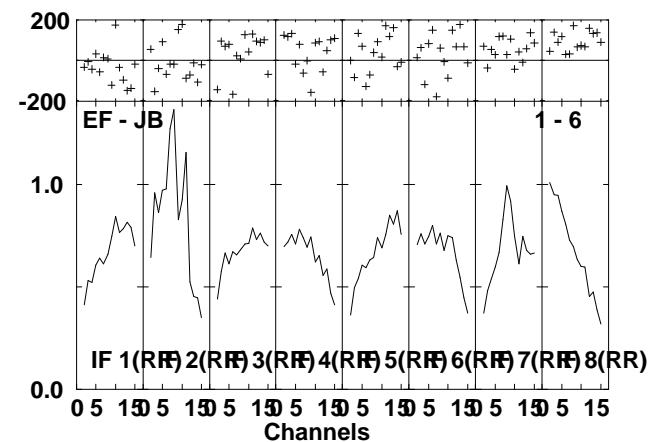
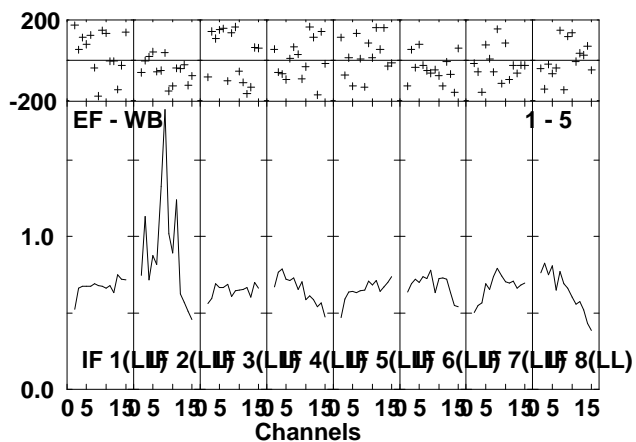
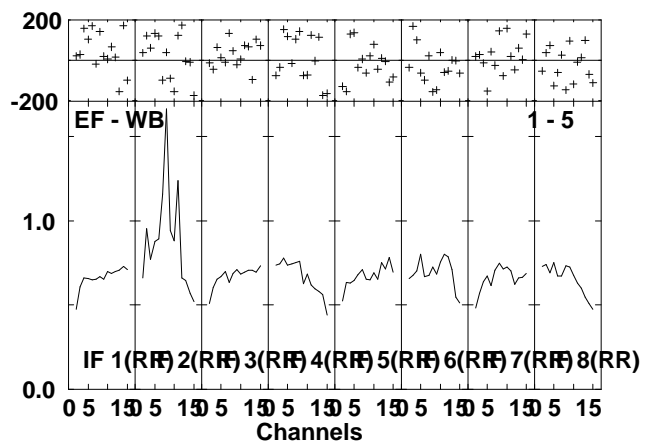
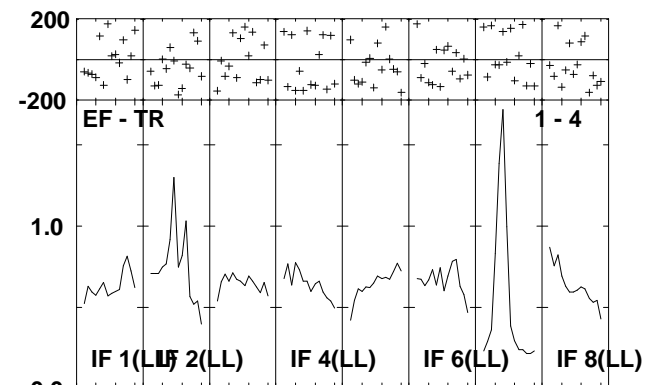
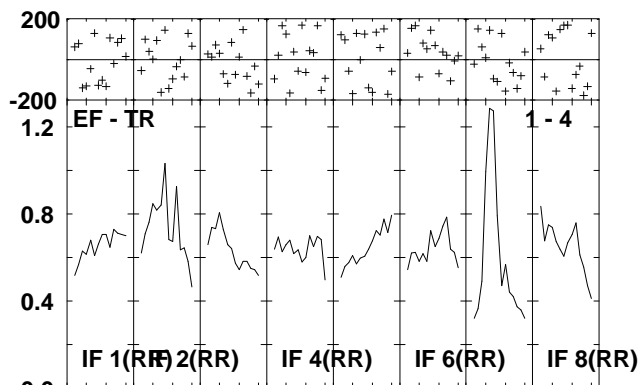
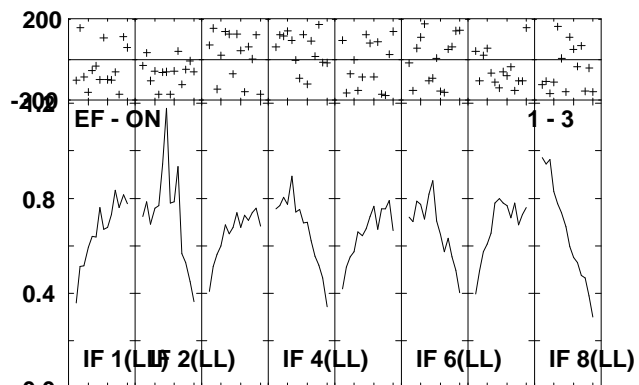
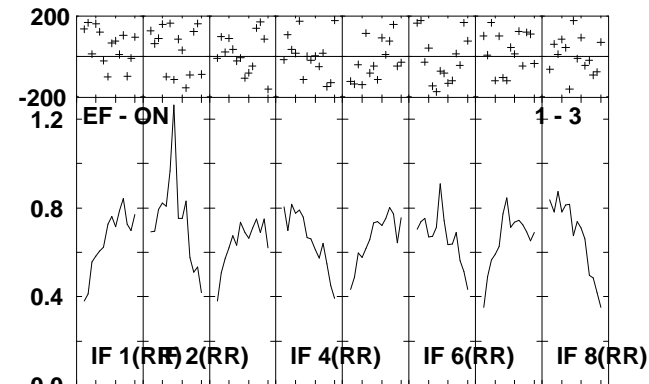
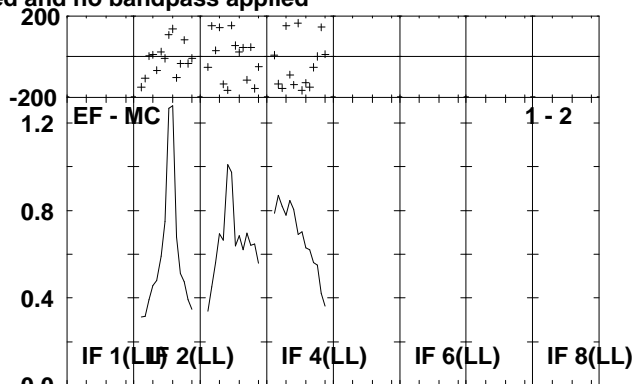
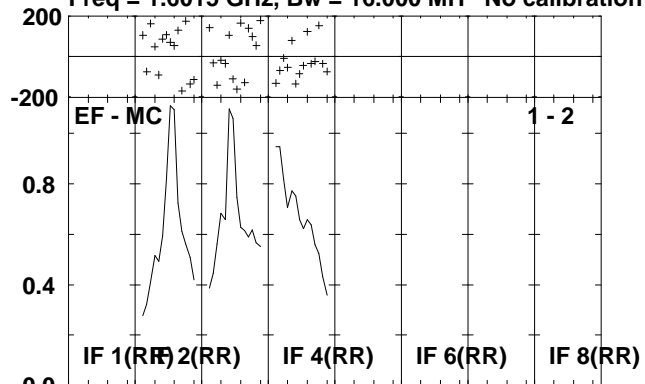

Lower frame: Milli Ampl Jy Top frame: Phas deg
Scalar averaged cross-power spectrum Several baselines displayed
Timerange: 00/21:38:20 to 00/21:45:16

Plot file version 82 created 26-APR-2010 13:26:45

HCG62 EA043.UVDATA.1

Freq = 1.6015 GHz, Bw = 16.000 MH No calibration applied and no bandpass applied

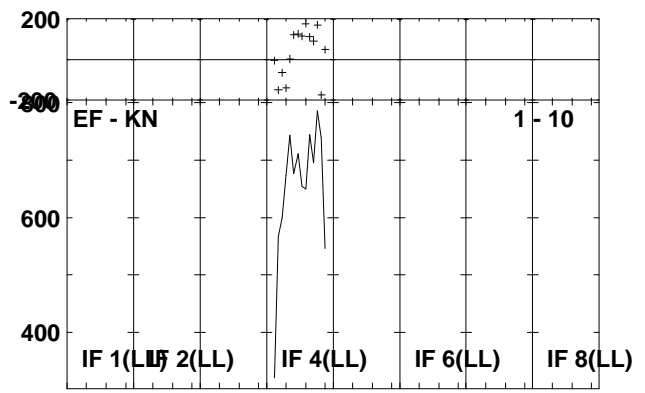
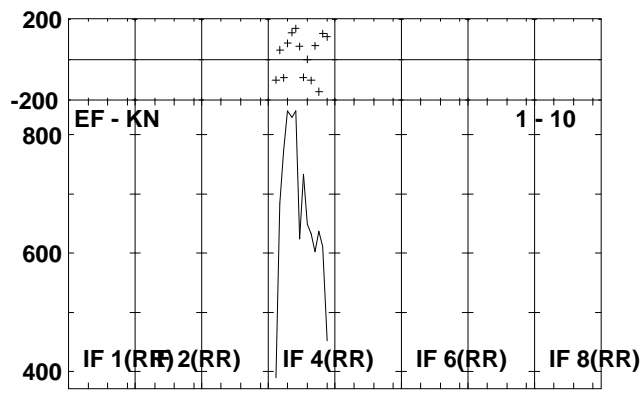
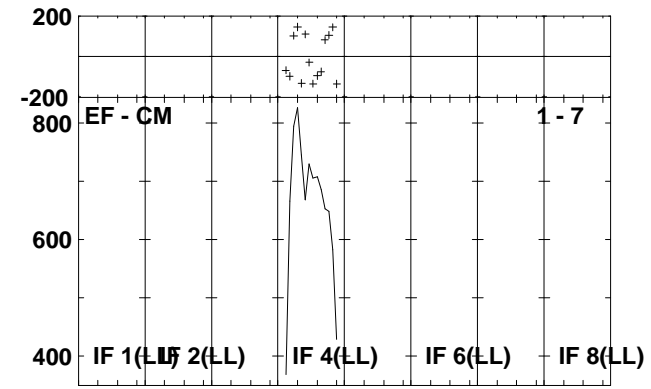
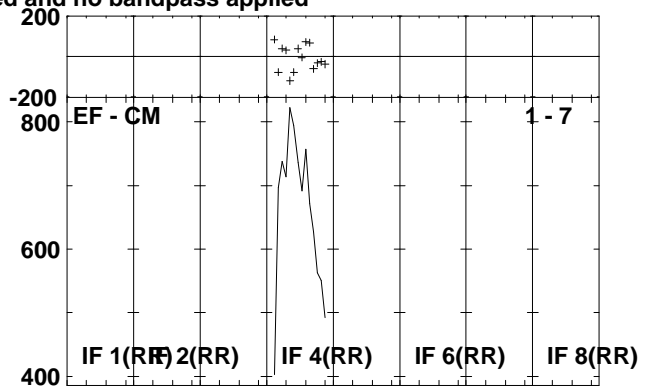
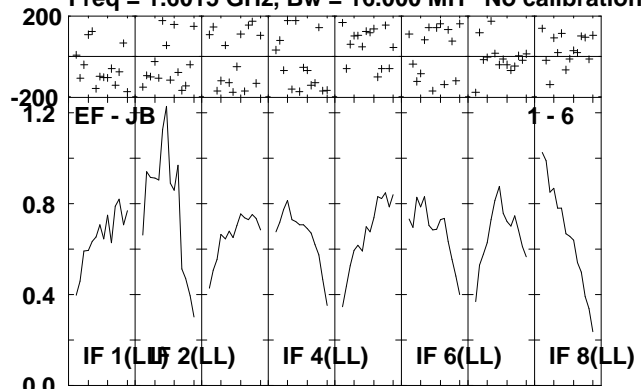

Lower frame: Milli Ampl Jy Top frame: Phas deg
Scalar averaged cross-power spectrum Several baselines displayed
Timerange: 00/21:38:20 to 00/21:45:16

Plot file version 83 created 26-APR-2010 13:26:47

J1246-07 EA043.UVDATA.1

Freq = 1.6015 GHz, Bw = 16.000 MH No calibration applied and no bandpass applied

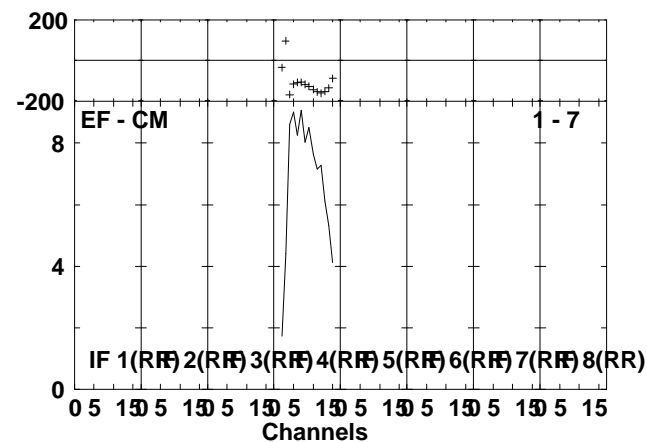
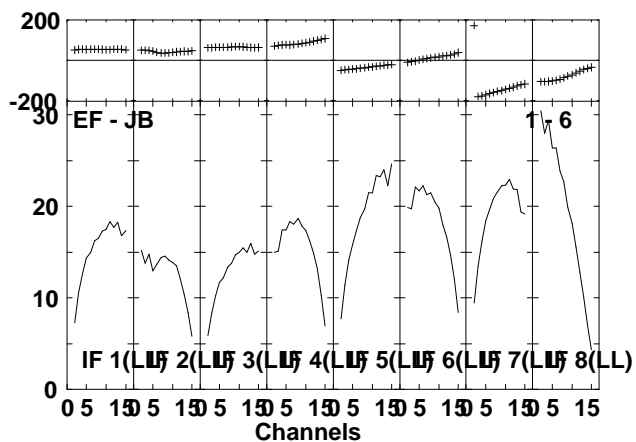
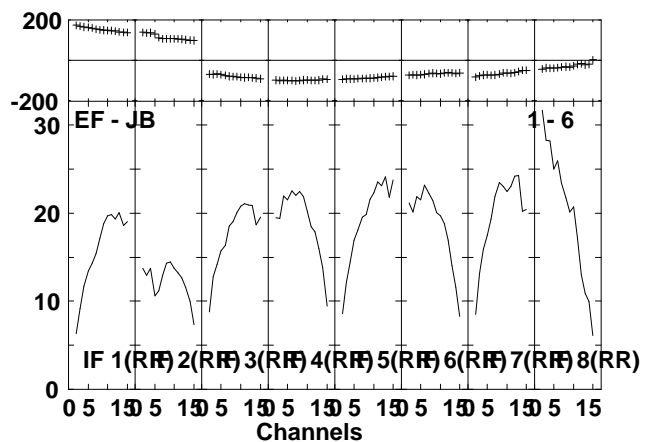
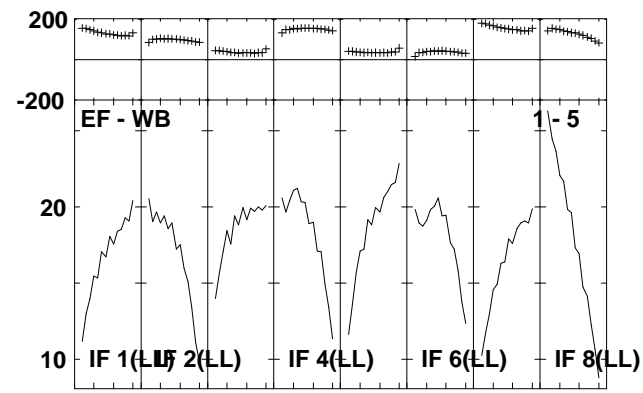
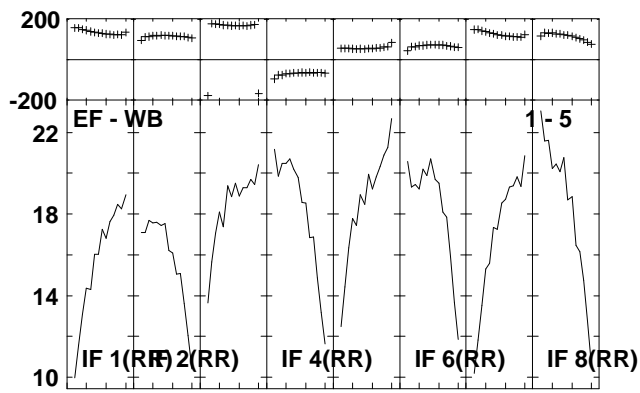
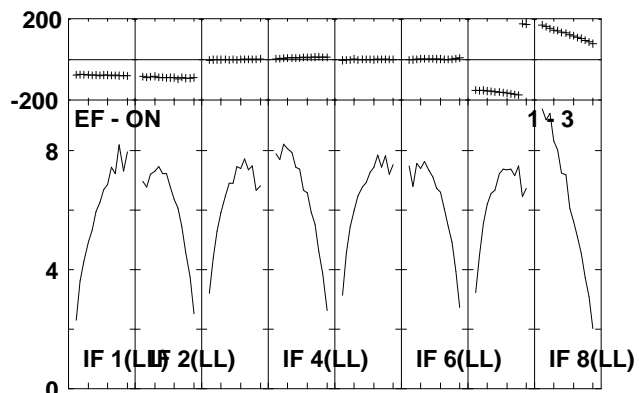
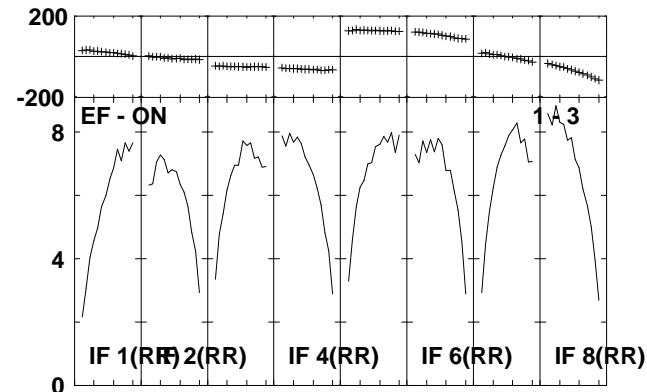
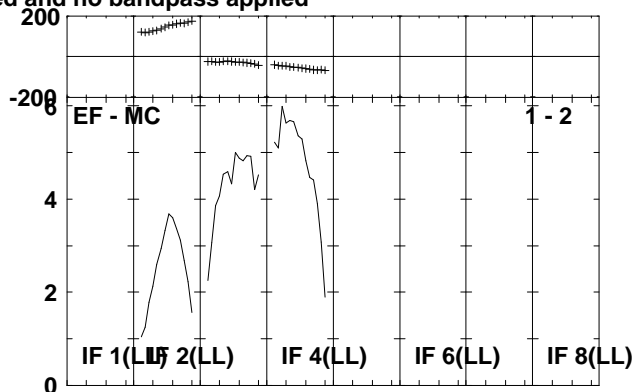
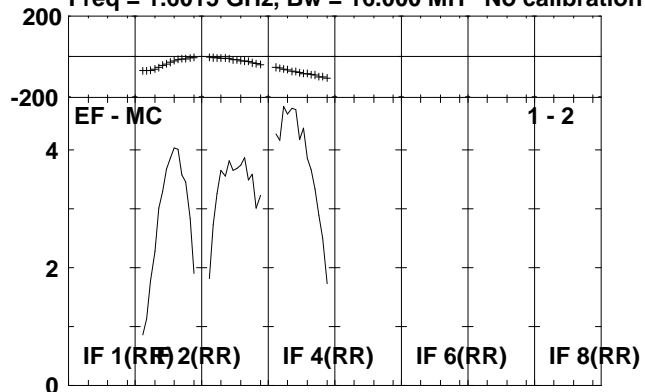

Lower frame: Milli Ampl Jy Top frame: Phas deg
Scalar averaged cross-power spectrum Several baselines displayed
Timerange: 00/21:45:20 to 00/21:47:16

Plot file version 84 created 26-APR-2010 13:26:47

J1246-07 EA043.UVDATA.1

Freq = 1.6015 GHz, Bw = 16.000 MH No calibration applied and no bandpass applied

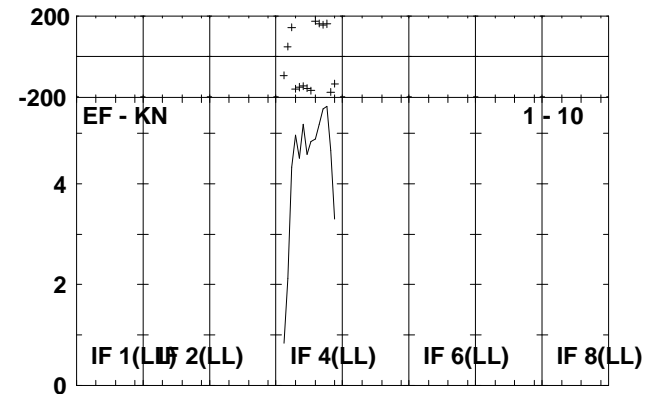
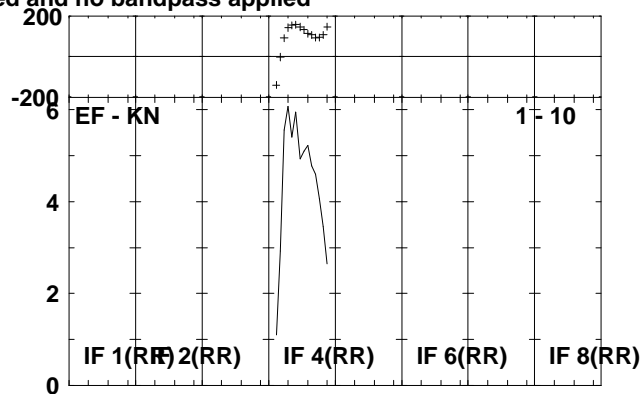
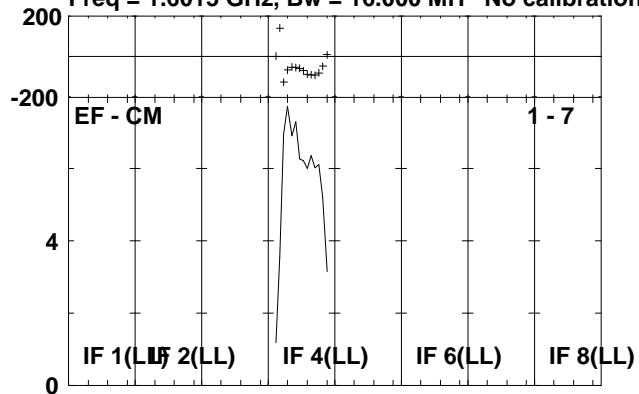

Lower frame: Milli Ampl Jy Top frame: Phas deg
Scalar averaged cross-power spectrum Several baselines displayed
Timerange: 00/21:45:20 to 00/21:47:16

Plot file version 85 created 26-APR-2010 13:26:48

HCG62 EA043.UVDATA.1

Freq = 1.6015 GHz, Bw = 16.000 MH No calibration applied and no bandpass applied

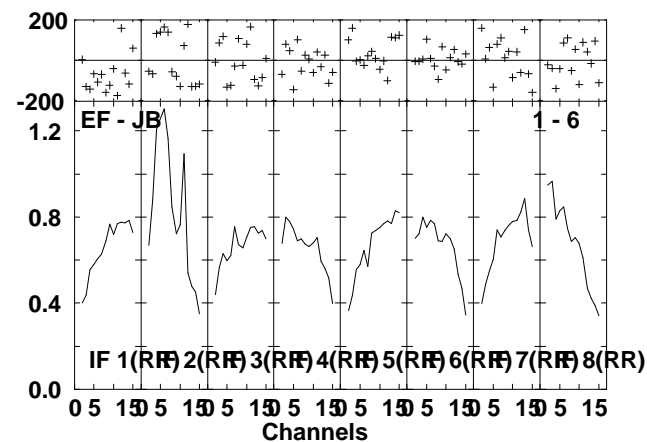
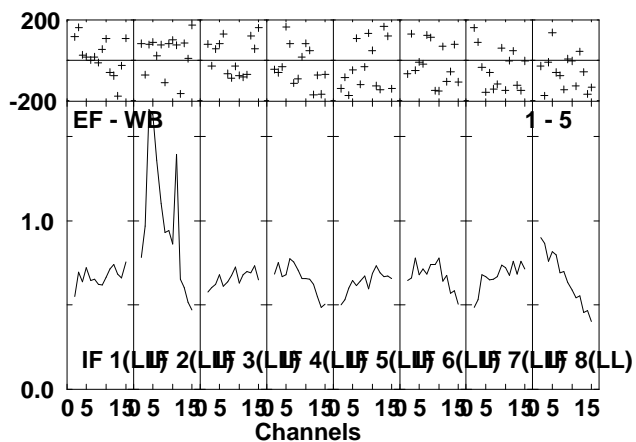
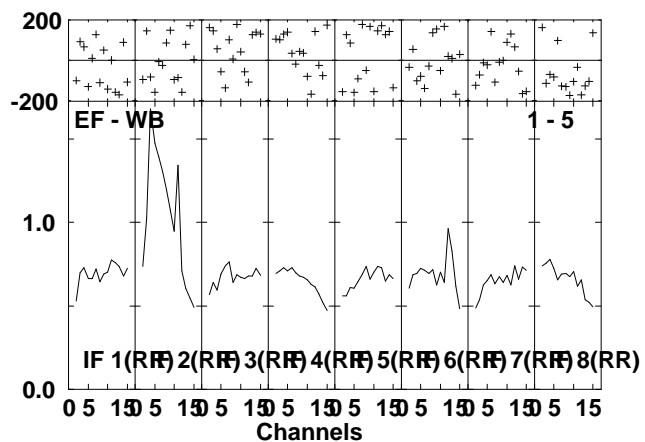
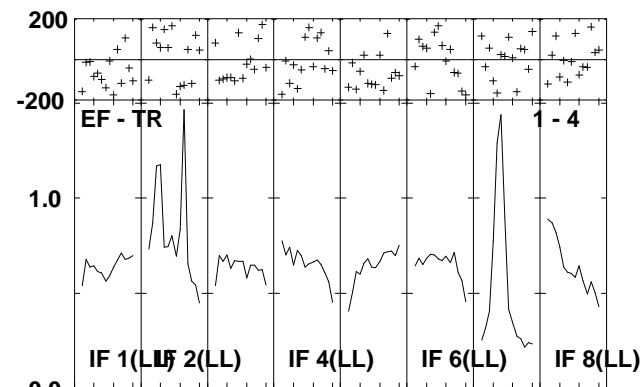
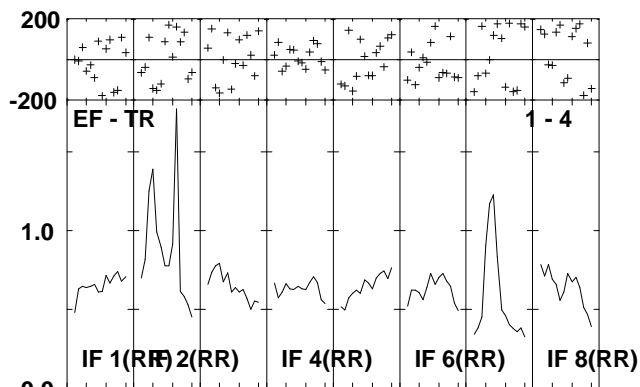
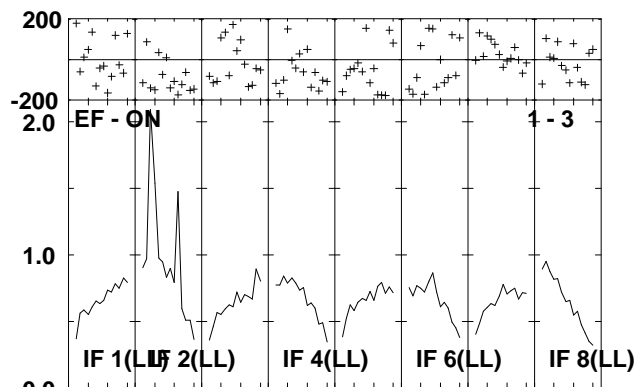
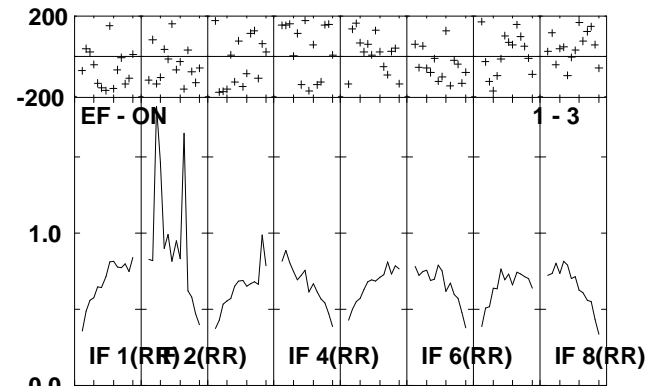
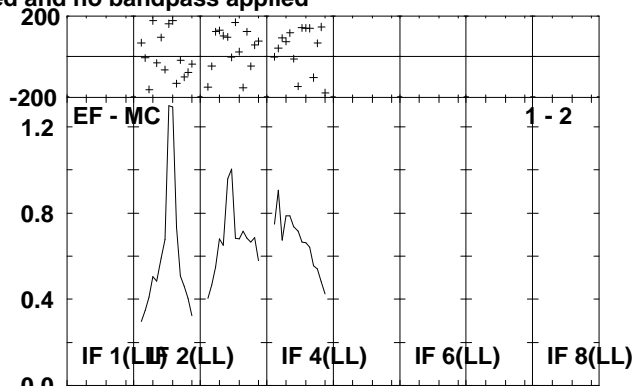
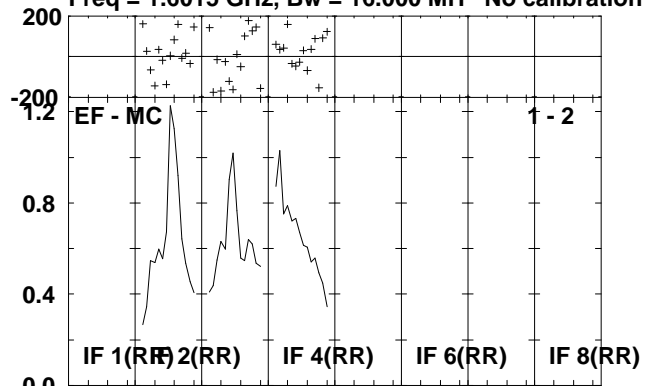

Lower frame: Milli Ampl Jy Top frame: Phas deg
Scalar averaged cross-power spectrum Several baselines displayed
Timerange: 00/21:48:20 to 00/21:55:16

Plot file version 86 created 26-APR-2010 13:26:49

HCG62 EA043.UVDATA.1

Freq = 1.6015 GHz, Bw = 16.000 MH No calibration applied and no bandpass applied

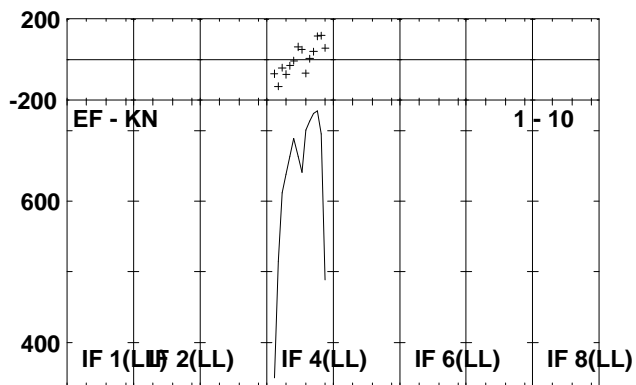
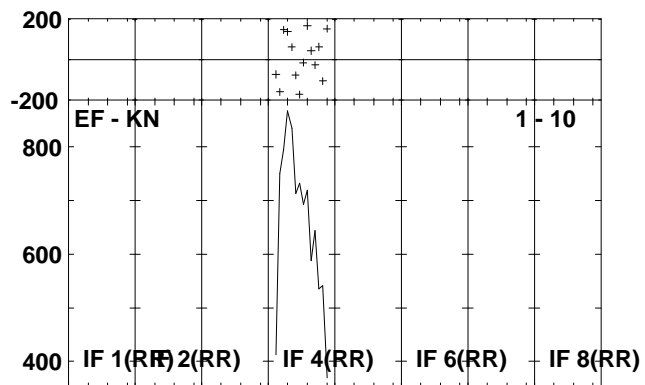
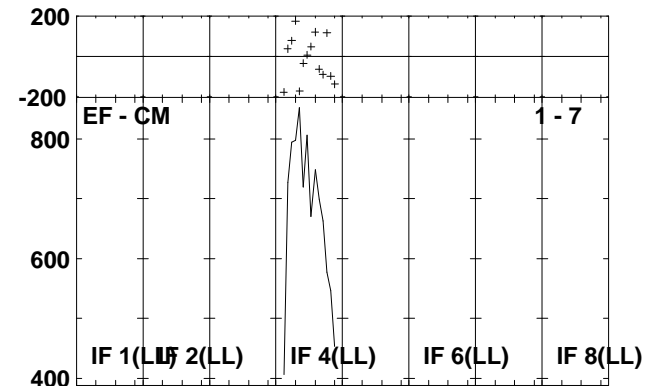
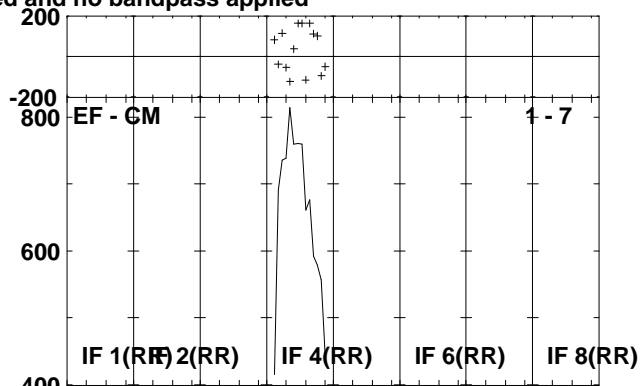
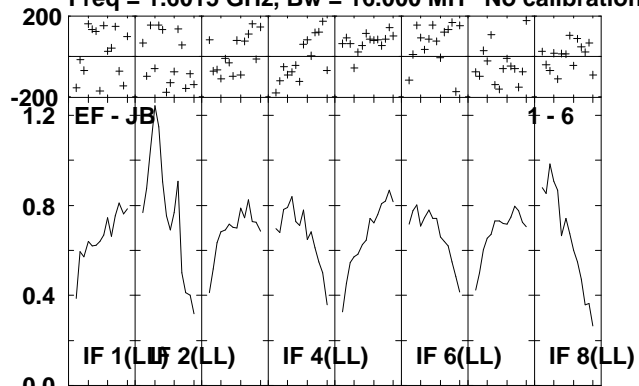

Lower frame: Milli Ampl Jy Top frame: Phas deg
Scalar averaged cross-power spectrum Several baselines displayed
Timerange: 00/21:48:20 to 00/21:55:16

Plot file version 87 created 26-APR-2010 13:26:51

J1246-07 EA043.UVDATA.1

Freq = 1.6015 GHz, Bw = 16.000 MH No calibration applied and no bandpass applied

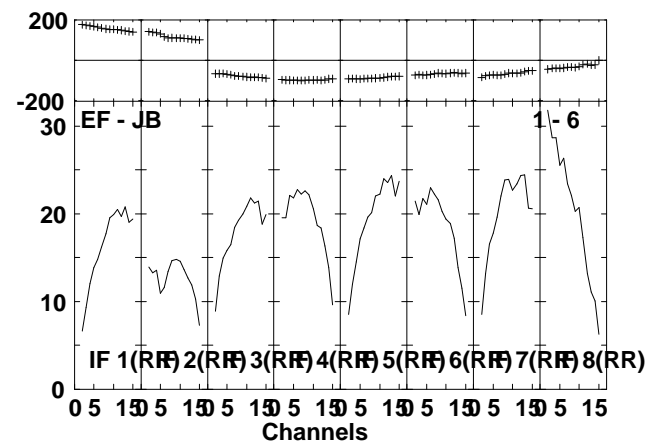
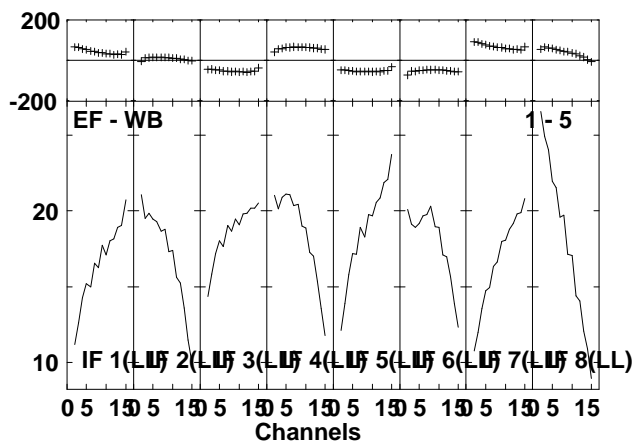
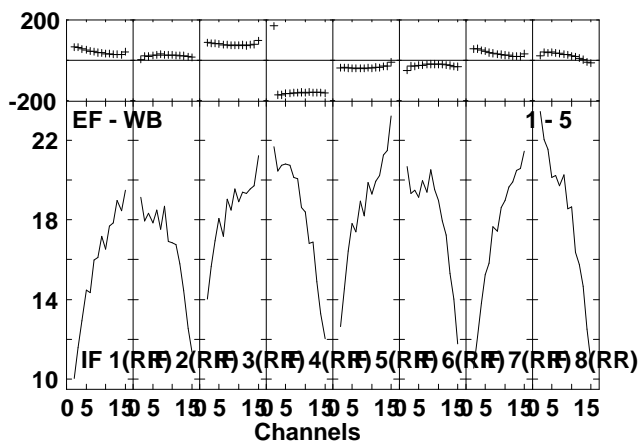
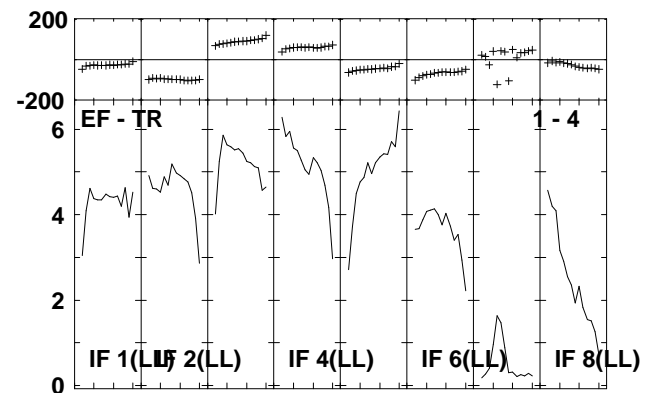
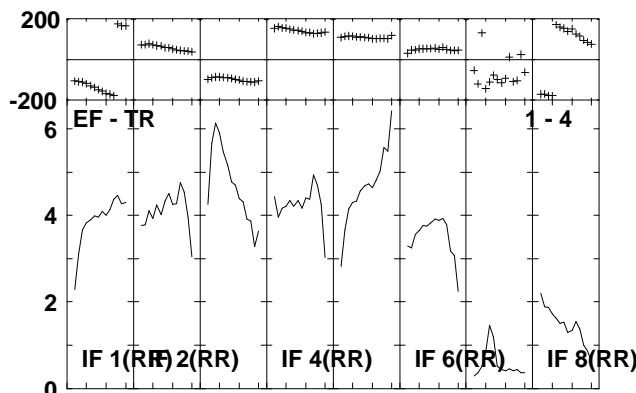
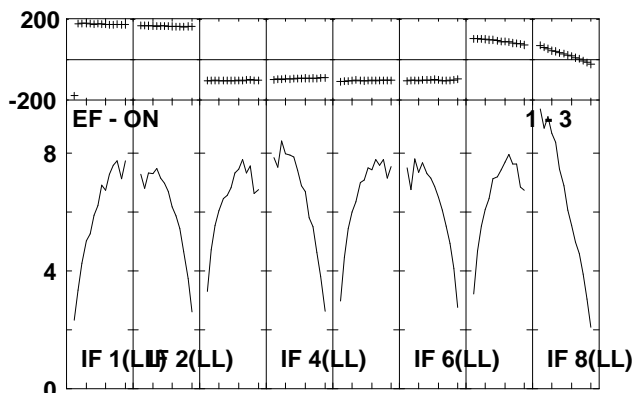
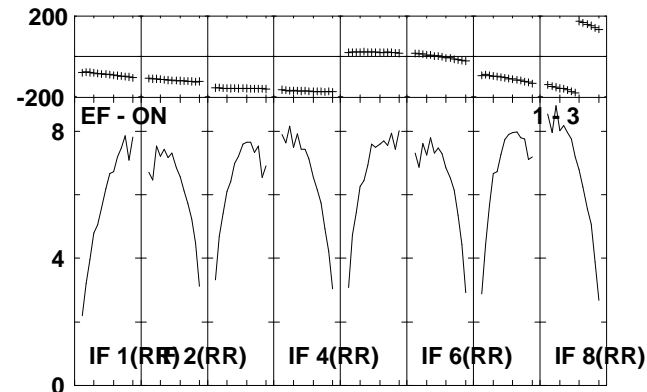
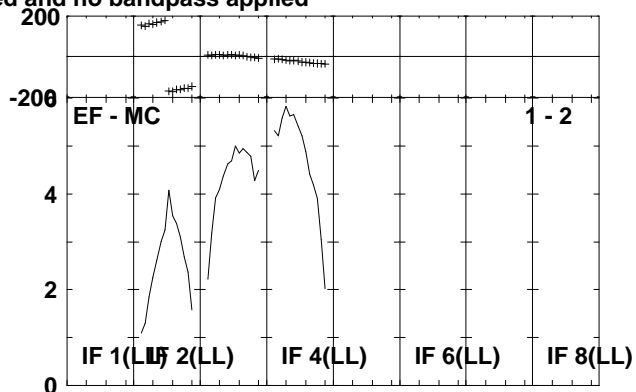
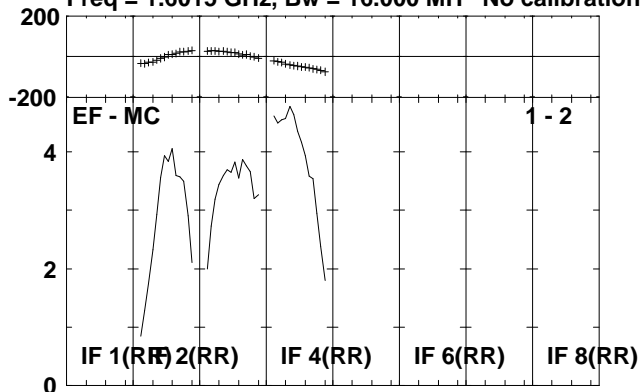

Lower frame: Milli Ampl Jy Top frame: Phas deg
Scalar averaged cross-power spectrum Several baselines displayed
Timerange: 00/21:55:20 to 00/21:57:16

Plot file version 88 created 26-APR-2010 13:26:51

J1246-07 EA043.UVDATA.1

Freq = 1.6015 GHz, Bw = 16.000 MH No calibration applied and no bandpass applied

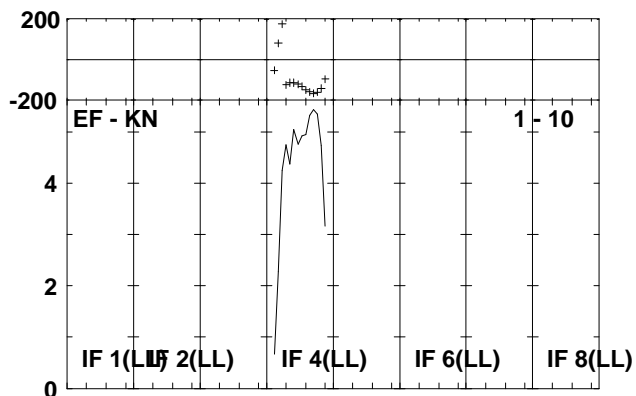
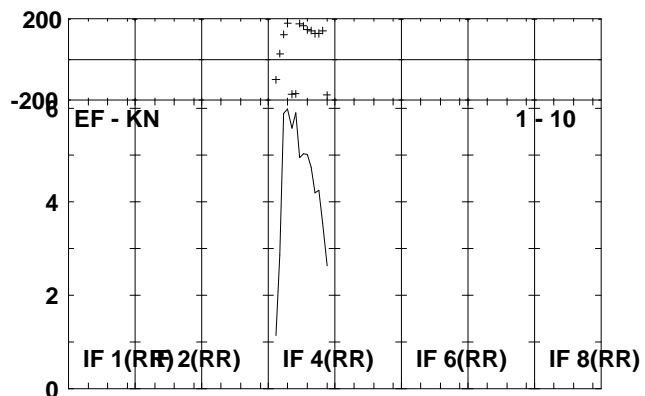
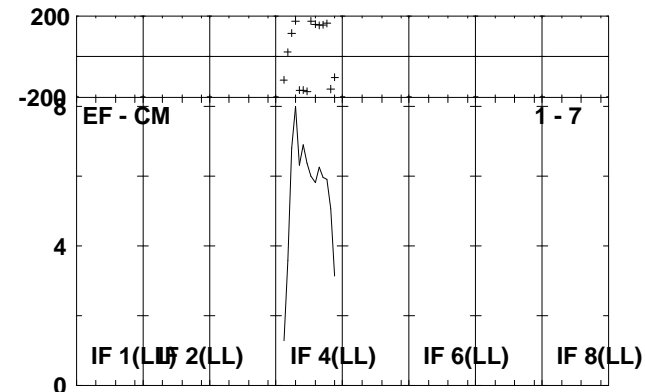
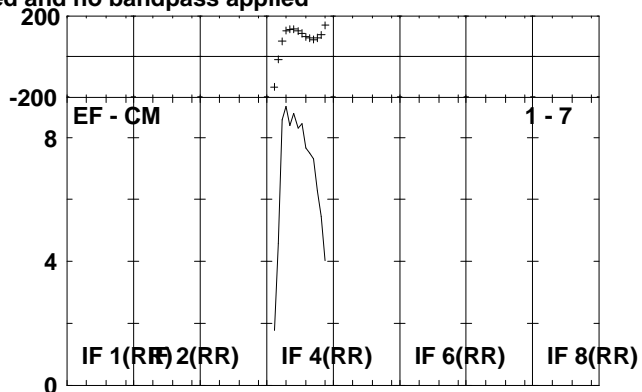
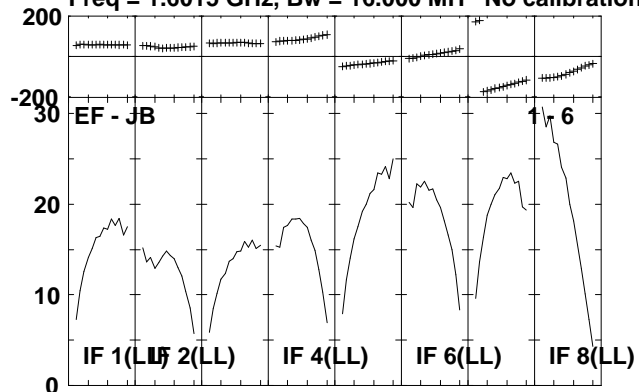

Lower frame: Milli Ampl Jy Top frame: Phas deg
Scalar averaged cross-power spectrum Several baselines displayed
Timerange: 00/21:55:20 to 00/21:57:16

Plot file version 89 created 26-APR-2010 13:26:52

HCG62 EA043.UVDATA.1

Freq = 1.6015 GHz, Bw = 16.000 MH No calibration applied and no bandpass applied

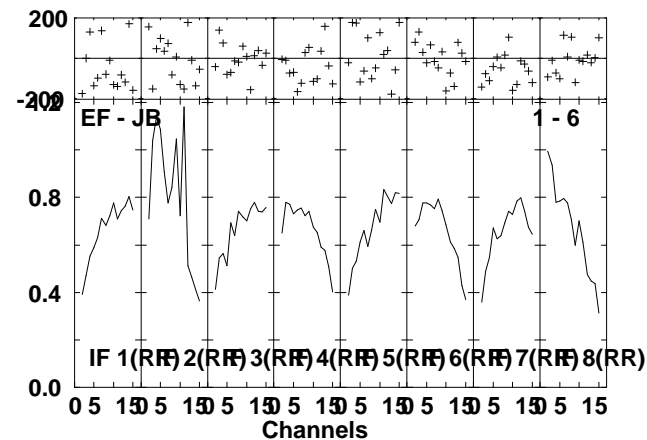
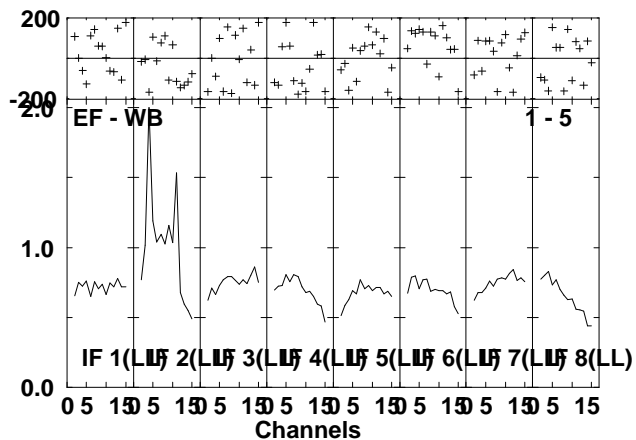
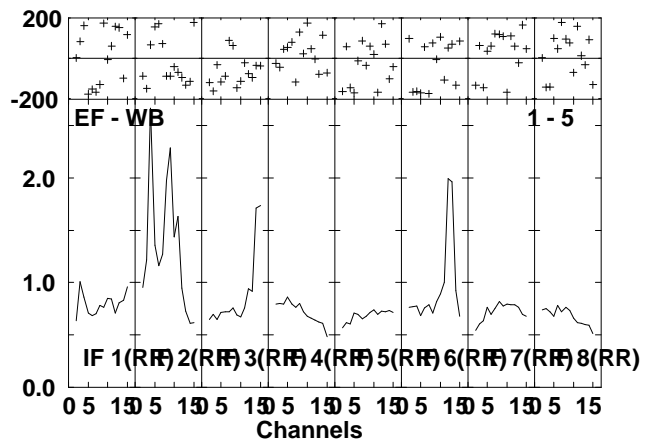
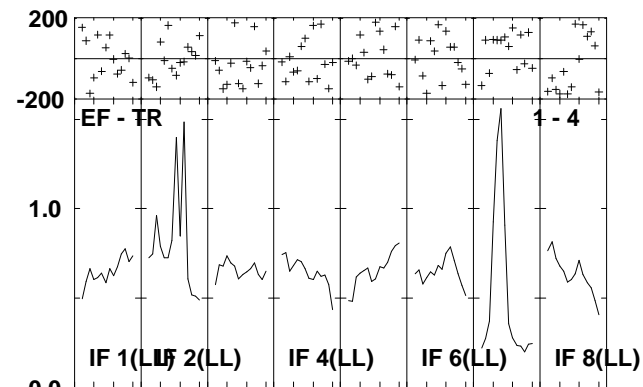
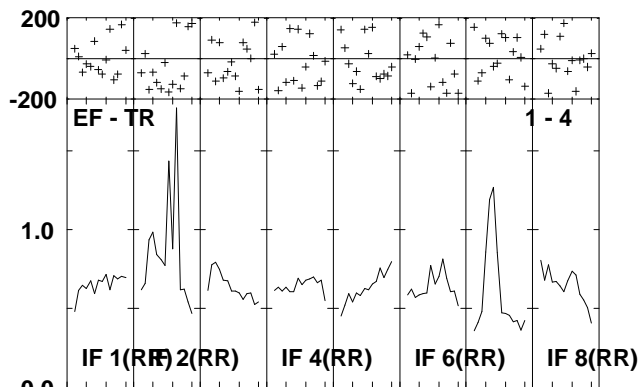
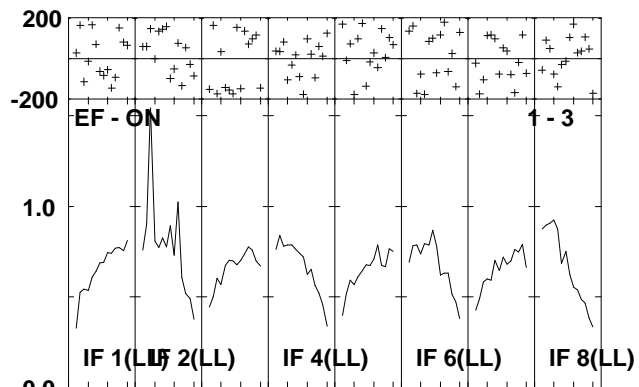
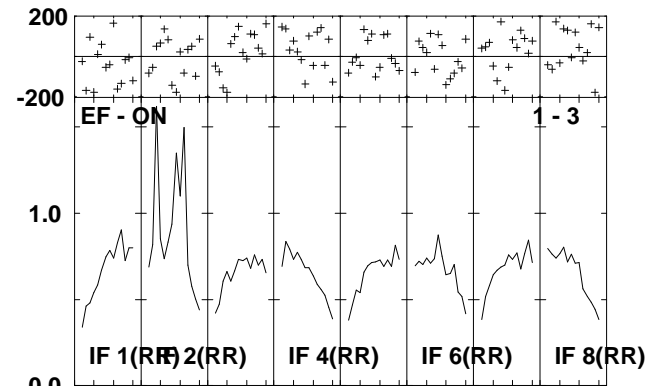
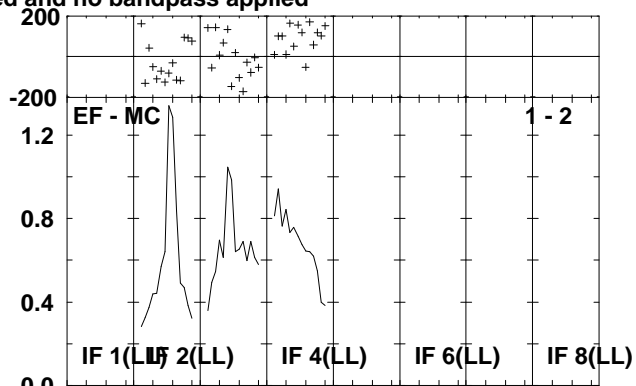
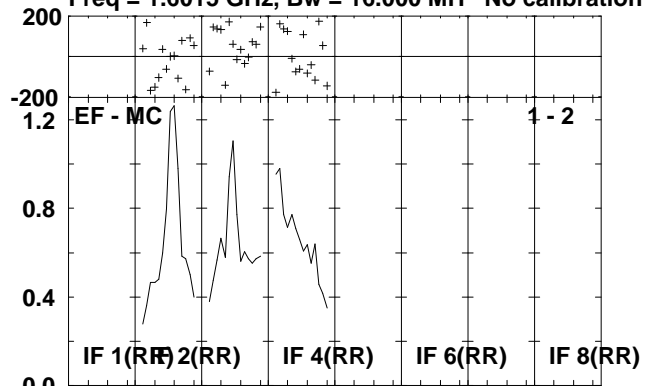

Lower frame: Milli Ampl Jy Top frame: Phas deg
Scalar averaged cross-power spectrum Several baselines displayed
Timerange: 00/21:58:20 to 00/22:05:16

Plot file version 90 created 26-APR-2010 13:26:53

HCG62 EA043.UVDATA.1

Freq = 1.6015 GHz, Bw = 16.000 MH No calibration applied and no bandpass applied

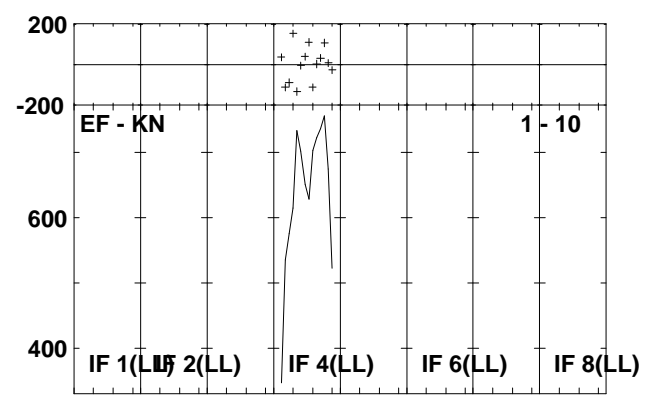
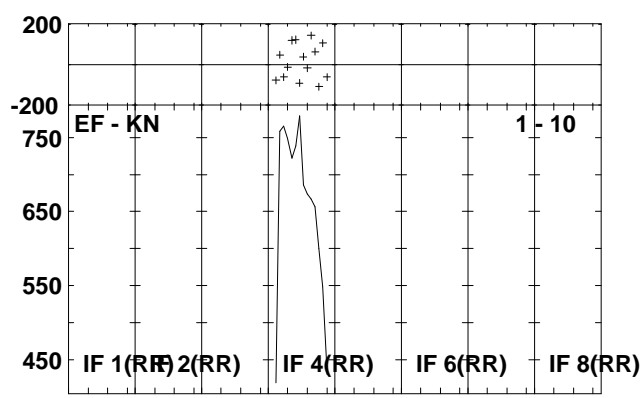
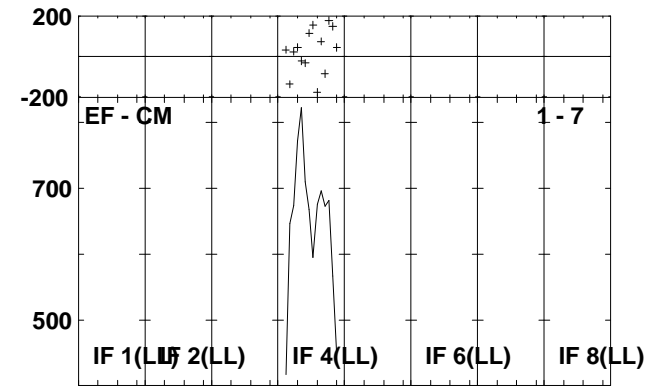
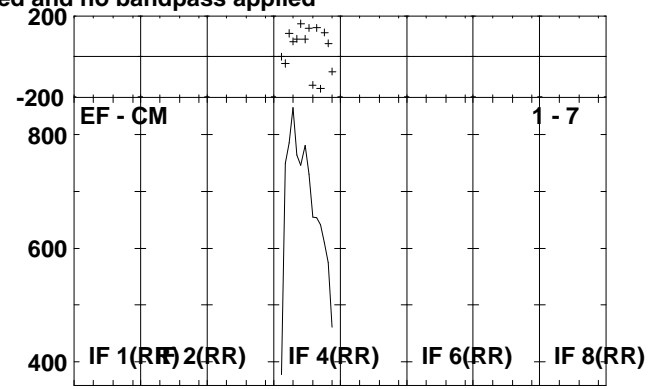
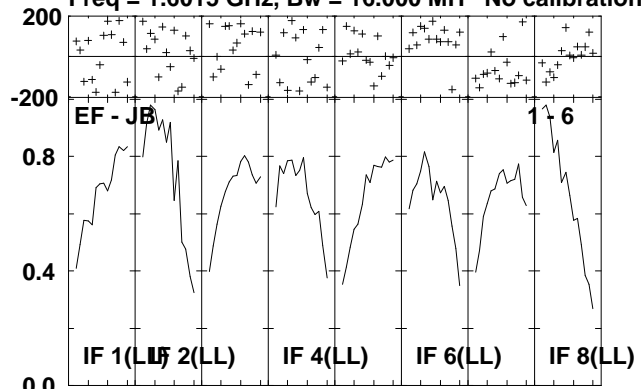

Lower frame: Milli Ampl Jy Top frame: Phas deg
Scalar averaged cross-power spectrum Several baselines displayed
Timerange: 00/21:58:20 to 00/22:05:16

Plot file version 91 created 26-APR-2010 13:26:55

J1246-07 EA043.UVDATA.1

Freq = 1.6015 GHz, Bw = 16.000 MH No calibration applied and no bandpass applied

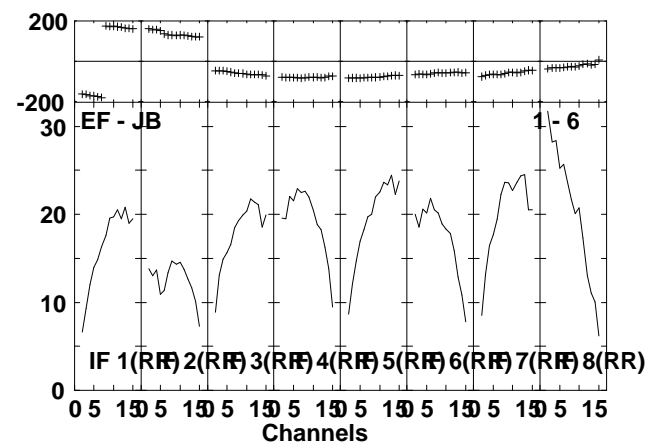
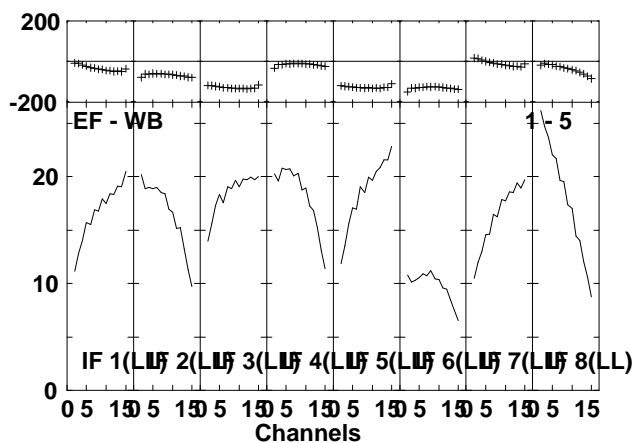
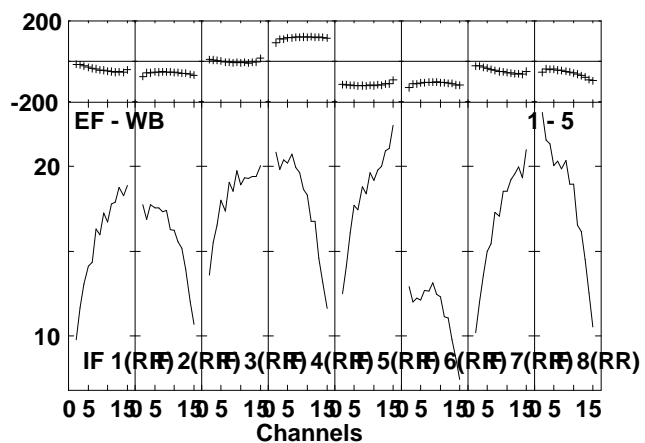
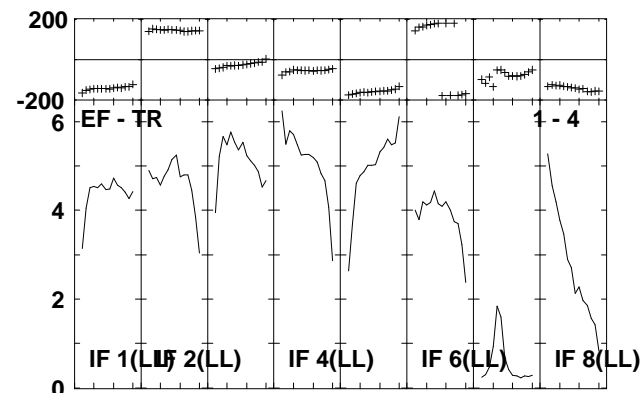
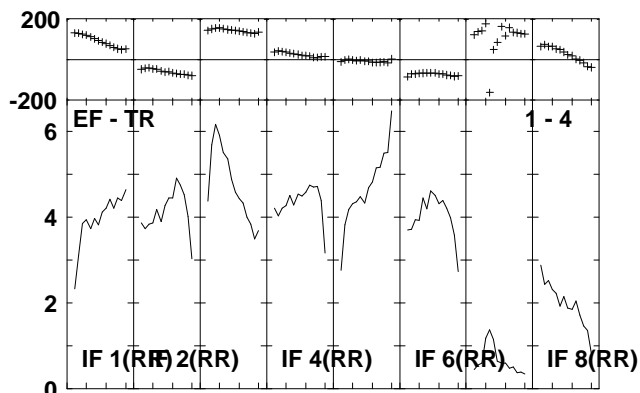
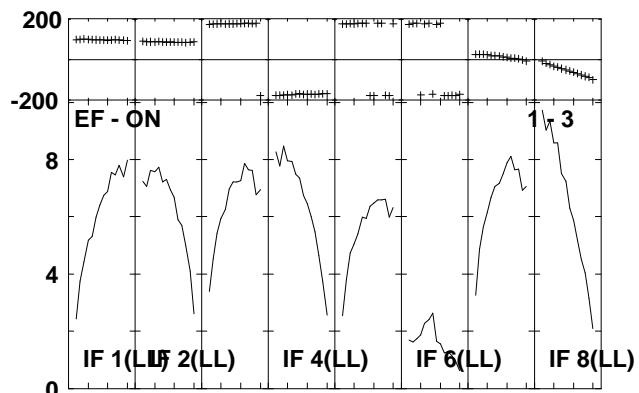
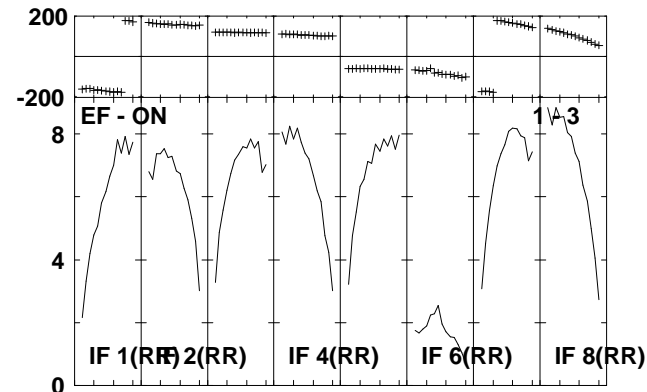
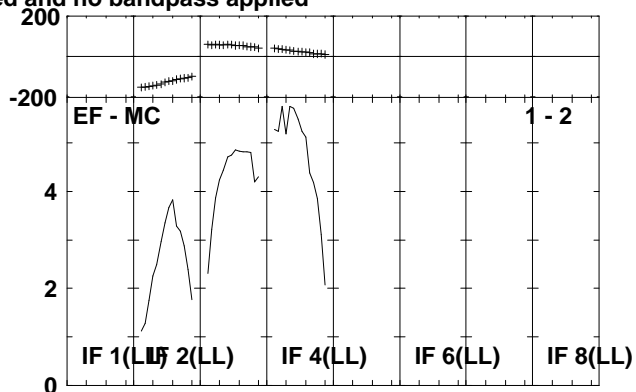
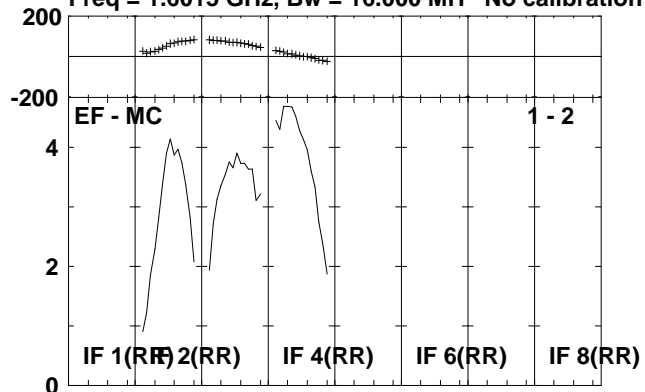

Lower frame: Milli Ampl Jy Top frame: Phas deg
Scalar averaged cross-power spectrum Several baselines displayed
Timerange: 00/22:05:20 to 00/22:07:16

Plot file version 92 created 26-APR-2010 13:26:56

J1246-07 EA043.UVDATA.1

Freq = 1.6015 GHz, Bw = 16.000 MH No calibration applied and no bandpass applied

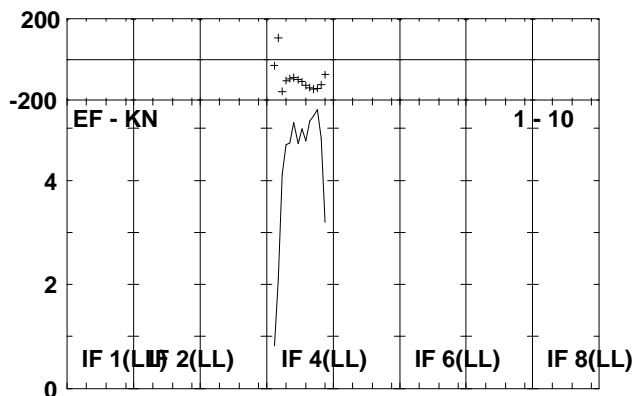
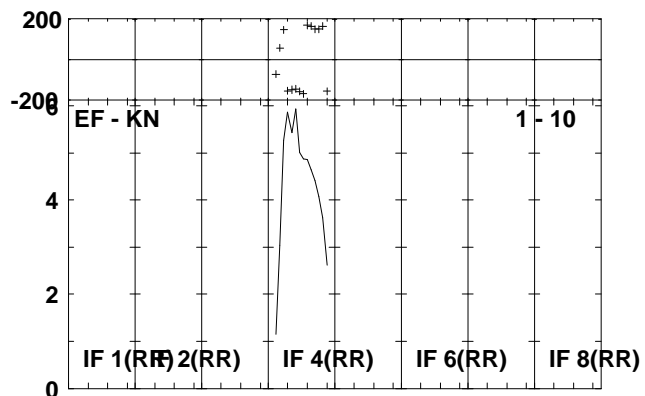
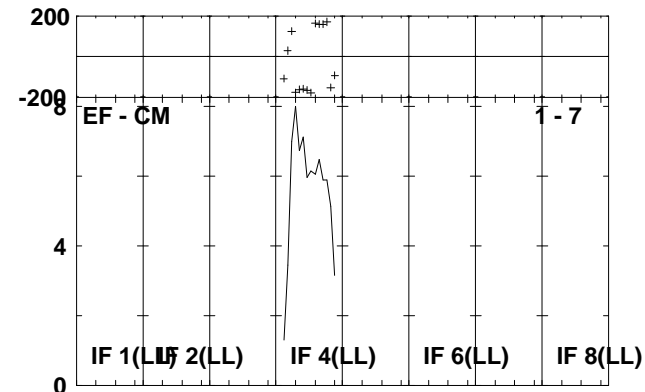
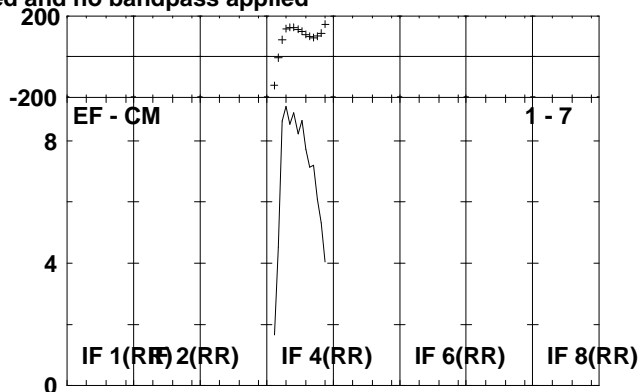
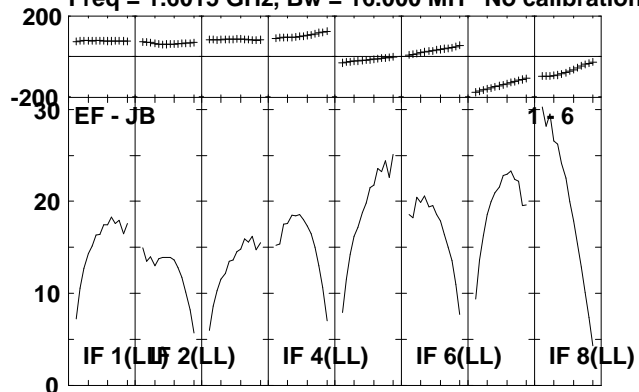

Lower frame: Milli Ampl Jy Top frame: Phas deg
Scalar averaged cross-power spectrum Several baselines displayed
Timerange: 00/22:05:20 to 00/22:07:16

Plot file version 93 created 26-APR-2010 13:26:56

HCG62 EA043.UVDATA.1

Freq = 1.6015 GHz, Bw = 16.000 MH No calibration applied and no bandpass applied

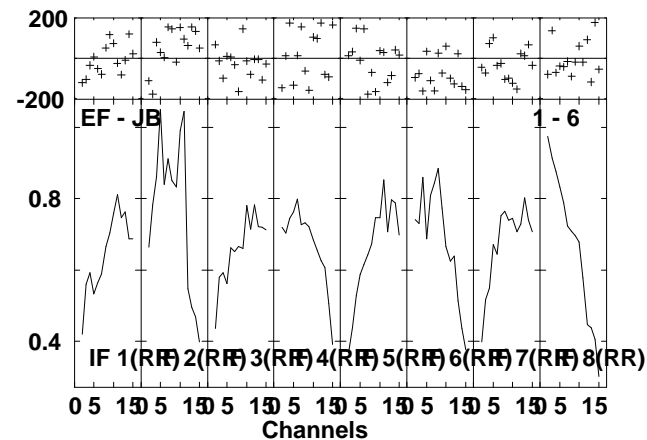
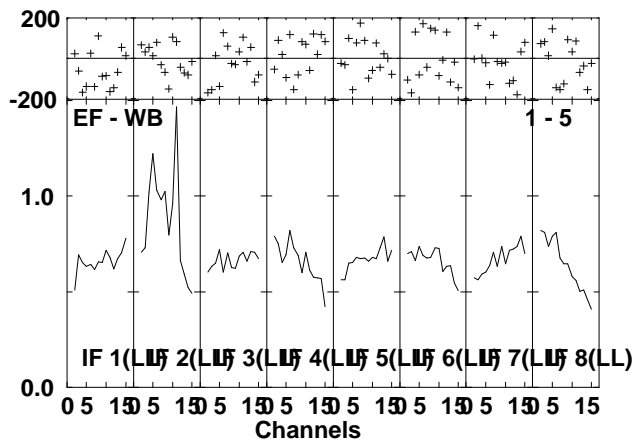
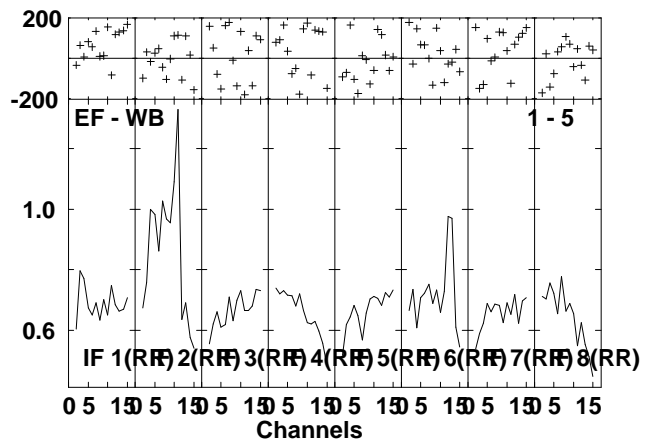
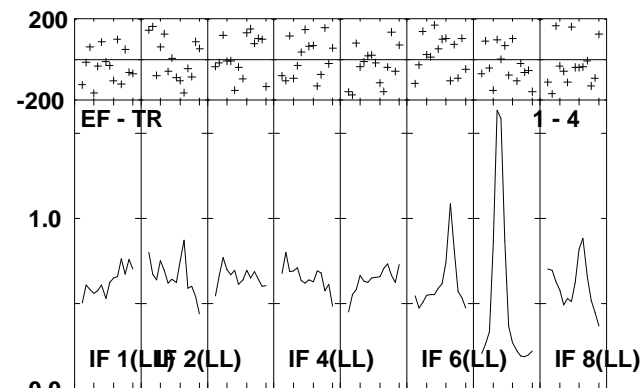
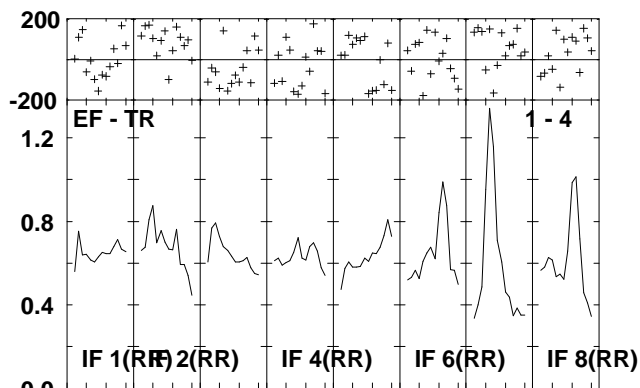
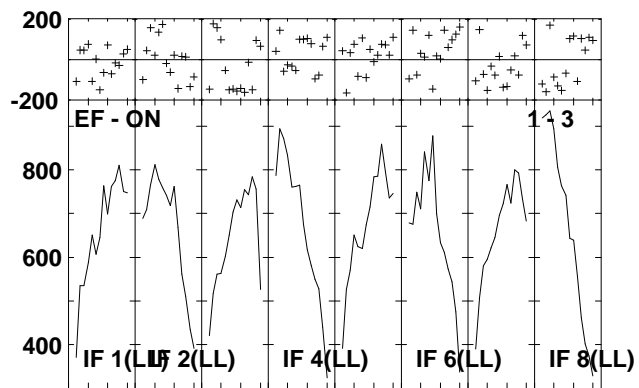
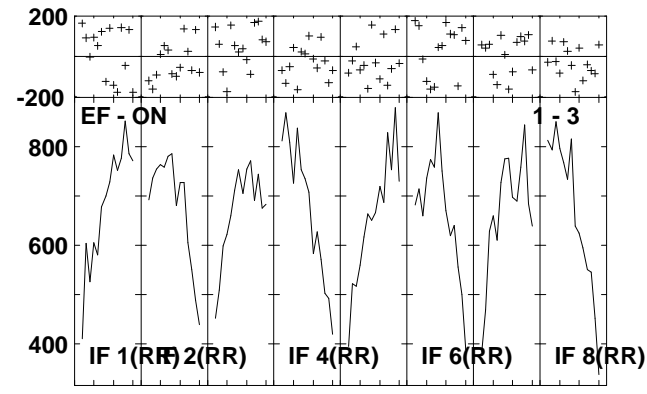
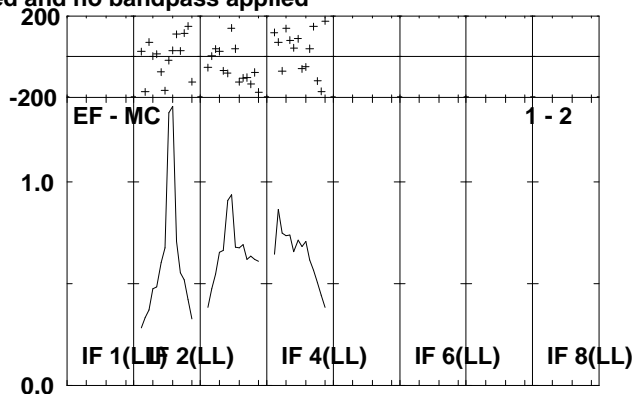
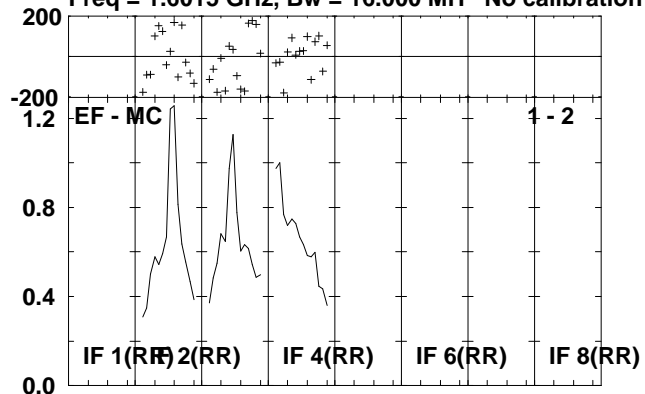

Lower frame: Milli Ampl Jy Top frame: Phas deg
Scalar averaged cross-power spectrum Several baselines displayed
Timerange: 00/22:08:20 to 00/22:15:16

Plot file version 94 created 26-APR-2010 13:26:58

HCG62 EA043.UVDATA.1

Freq = 1.6015 GHz, Bw = 16.000 MH No calibration applied and no bandpass applied

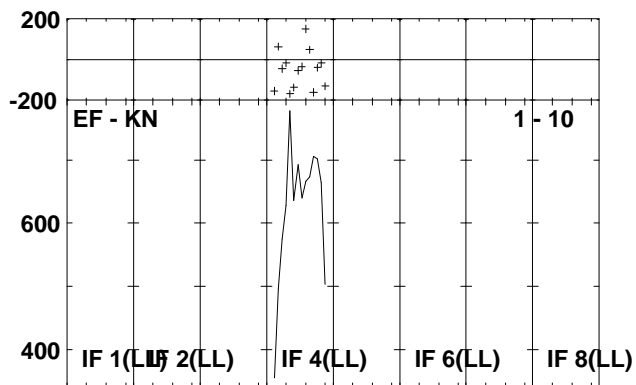
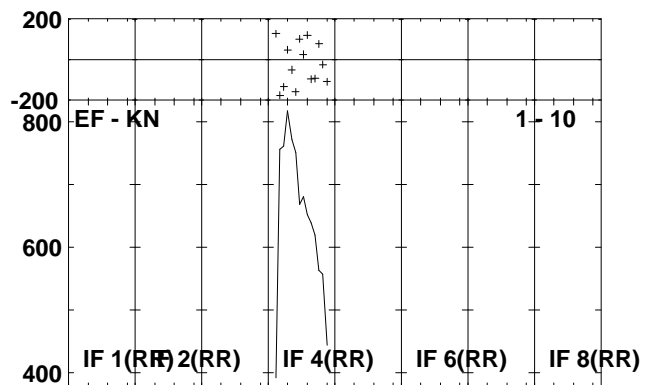
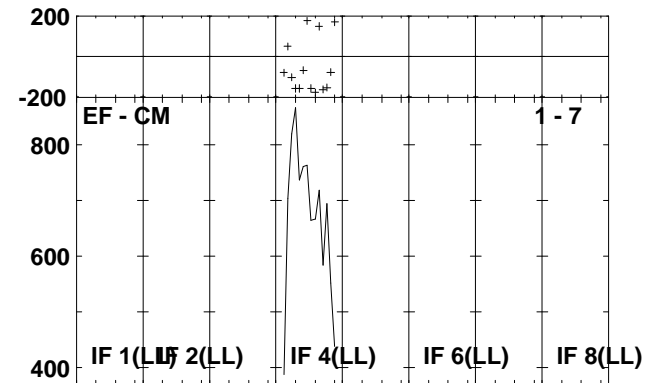
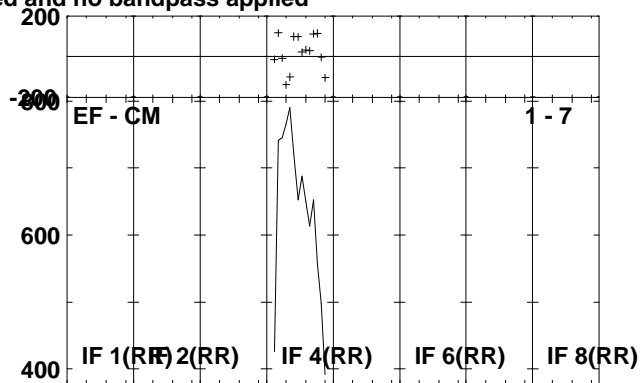
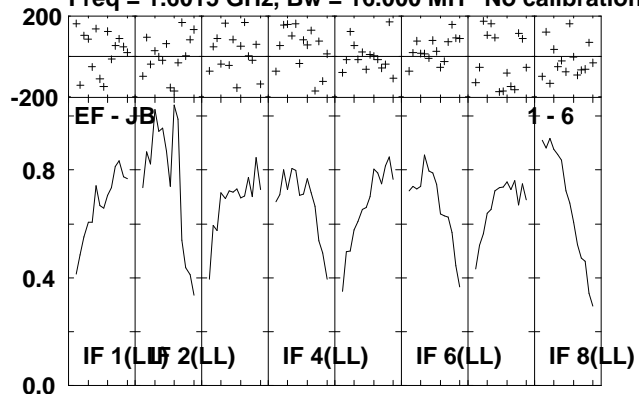

Lower frame: Milli Ampl Jy Top frame: Phas deg
Scalar averaged cross-power spectrum Several baselines displayed
Timerange: 00/22:08:20 to 00/22:15:16

Plot file version 95 created 26-APR-2010 13:27:00

J1246-07 EA043.UVDATA.1

Freq = 1.6015 GHz, Bw = 16.000 MH No calibration applied and no bandpass applied

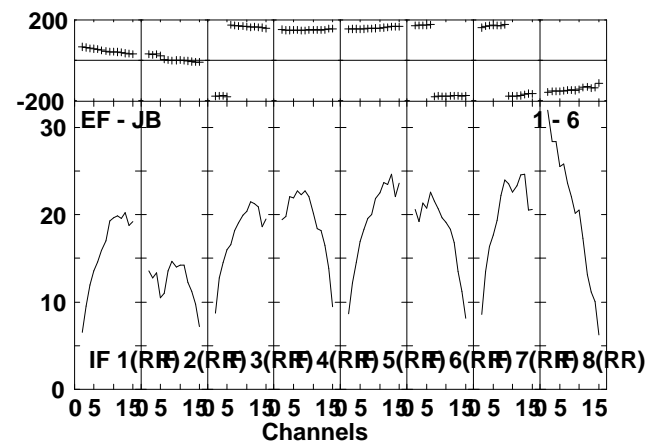
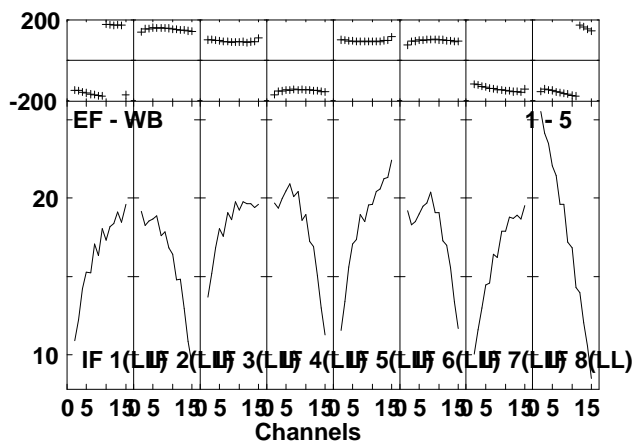
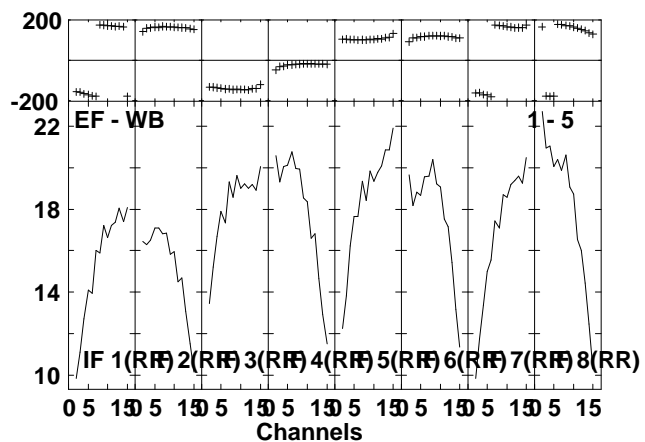
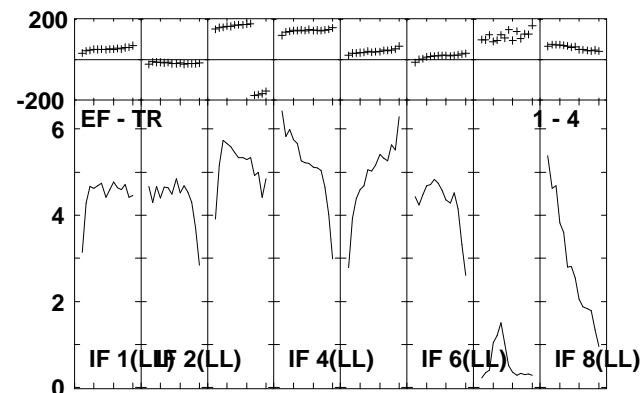
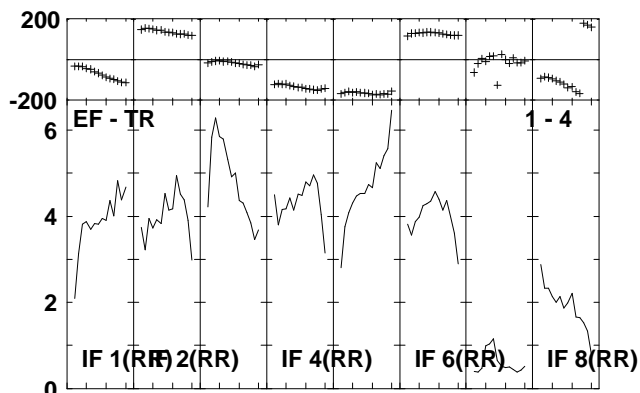
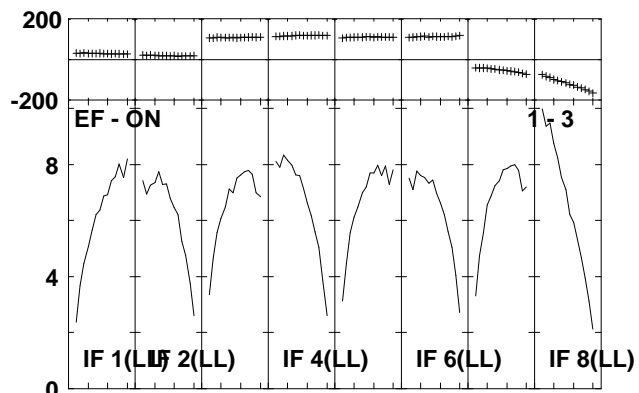
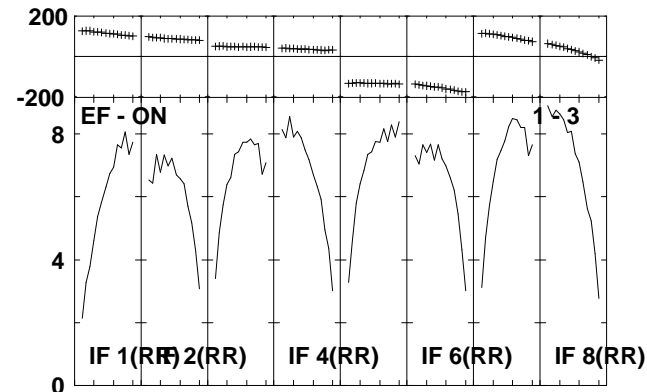
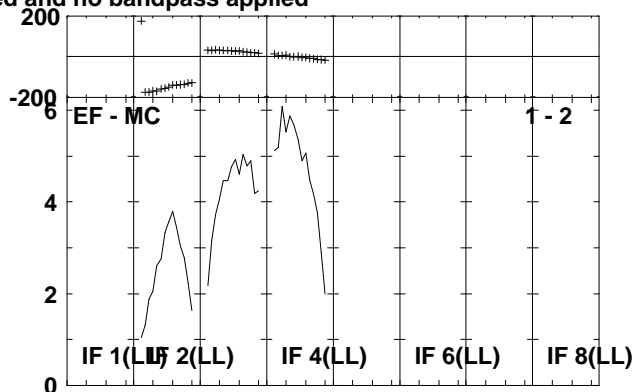
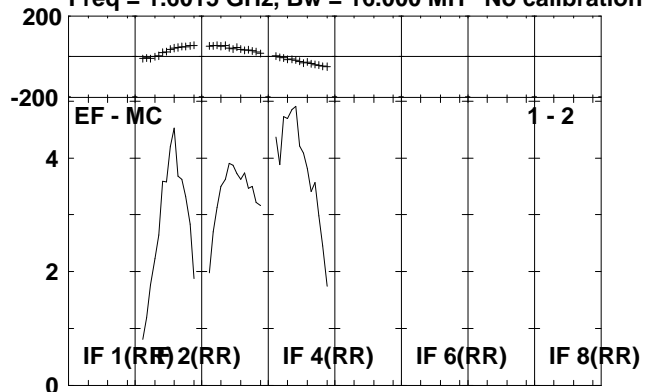

Lower frame: Milli Ampl Jy Top frame: Phas deg
Scalar averaged cross-power spectrum Several baselines displayed
Timerange: 00/22:15:20 to 00/22:17:16

Plot file version 96 created 26-APR-2010 13:27:00
J1246-07 EA043.UVDATA.1

Freq = 1.6015 GHz, Bw = 16.000 MH No calibration applied and no bandpass applied

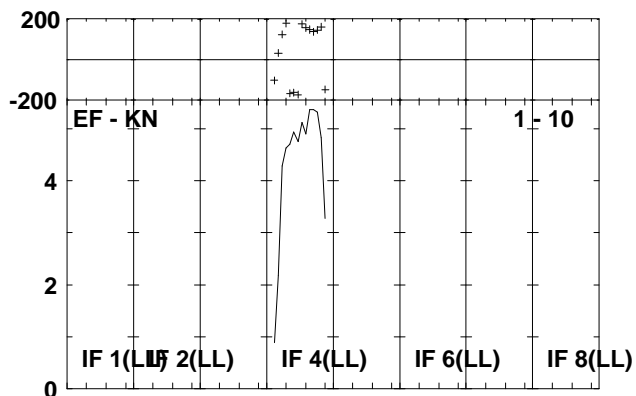
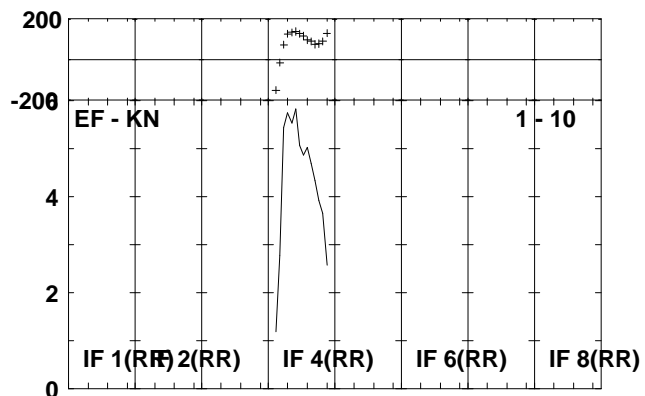
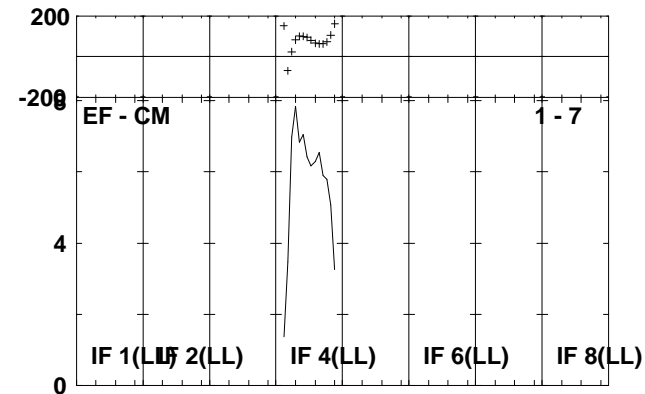
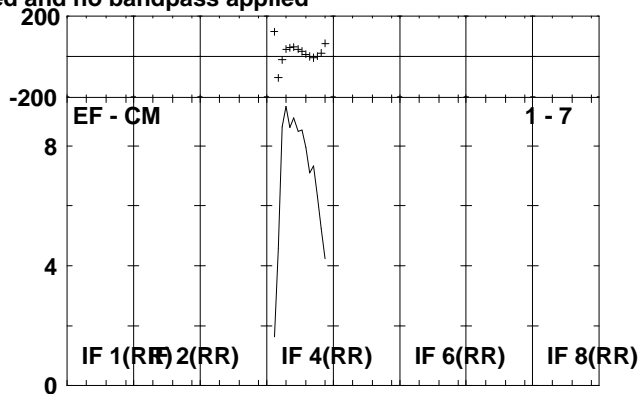
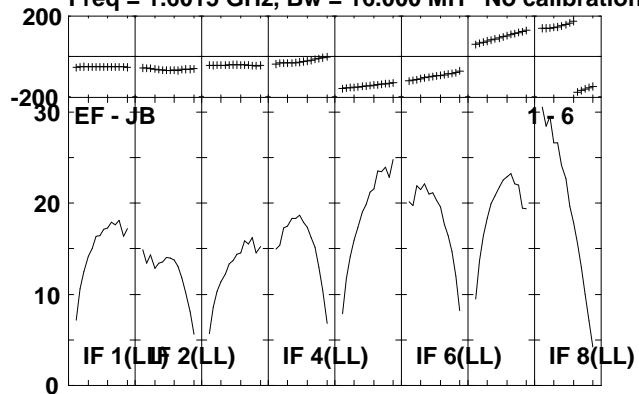

Lower frame: Milli Ampl Jy Top frame: Phas deg
Scalar averaged cross-power spectrum Several baselines displayed
Timerange: 00/22:15:20 to 00/22:17:16

Plot file version 97 created 26-APR-2010 13:27:01

HCG62 EA043.UVDATA.1

Freq = 1.6015 GHz, Bw = 16.000 MH No calibration applied and no bandpass applied

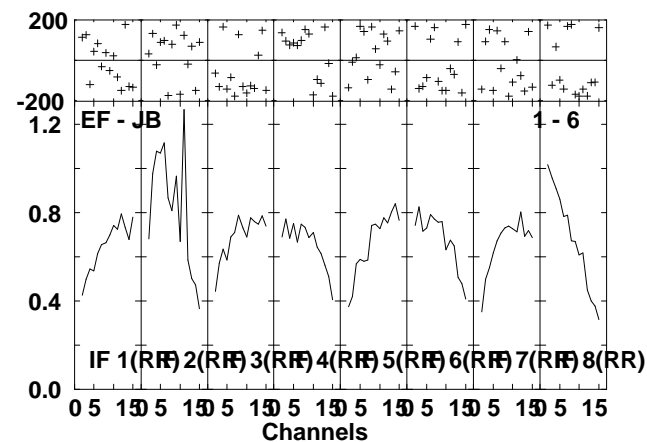
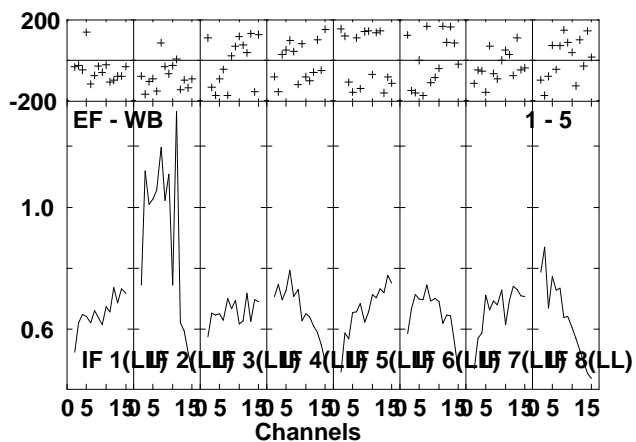
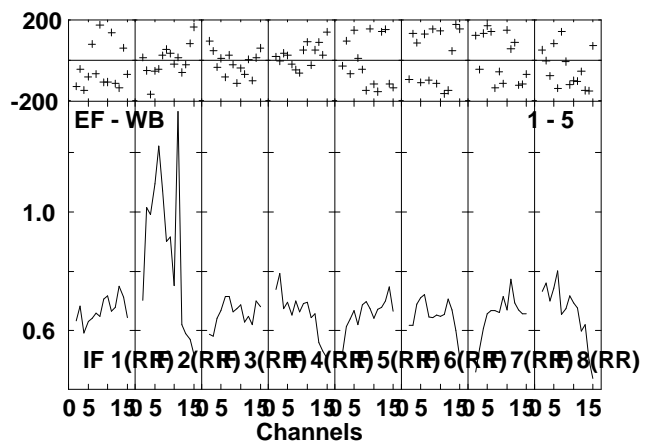
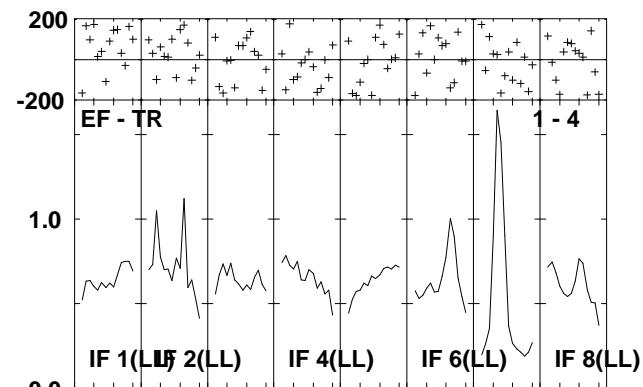
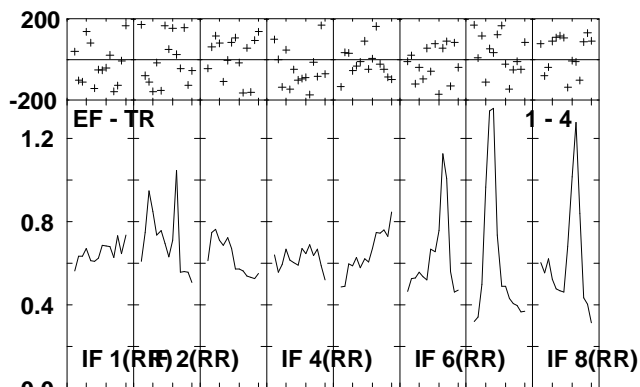
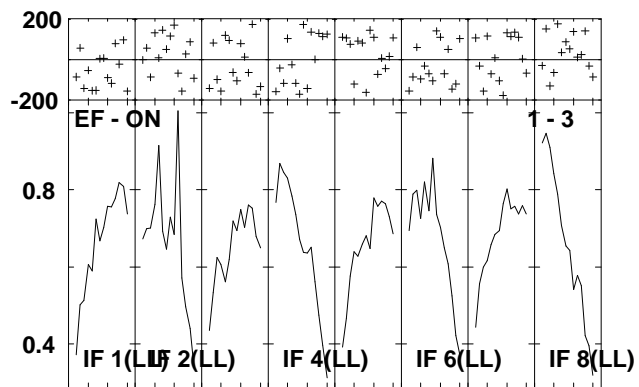
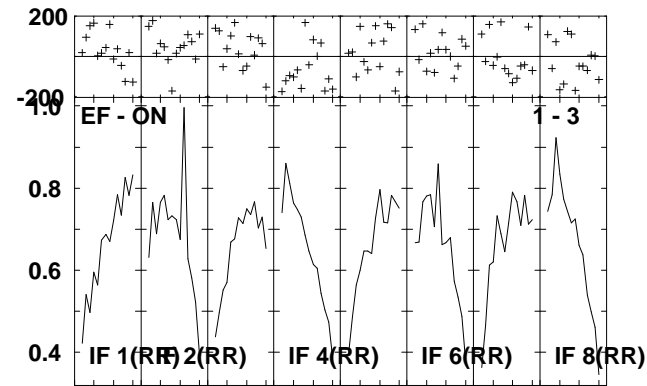
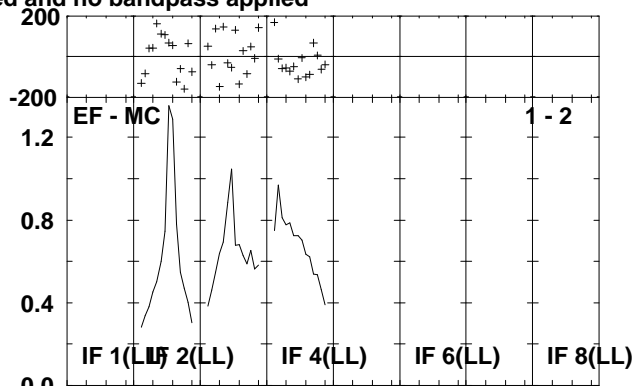
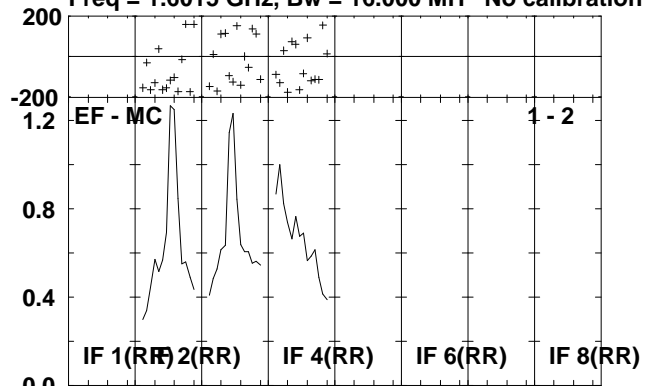

Lower frame: Milli Ampl Jy Top frame: Phas deg
Scalar averaged cross-power spectrum Several baselines displayed
Timerange: 00/22:18:20 to 00/22:25:16

Plot file version 98 created 26-APR-2010 13:27:02

HCG62 EA043.UVDATA.1

Freq = 1.6015 GHz, Bw = 16.000 MH No calibration applied and no bandpass applied

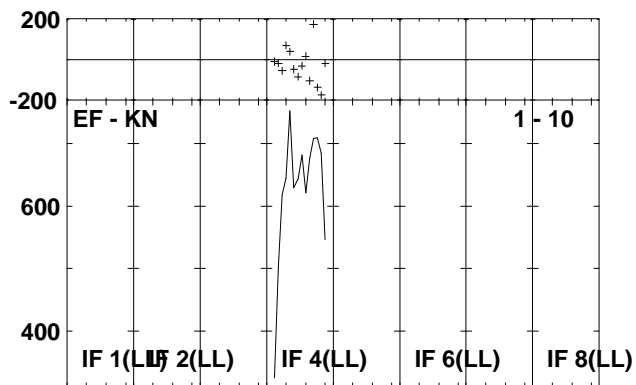
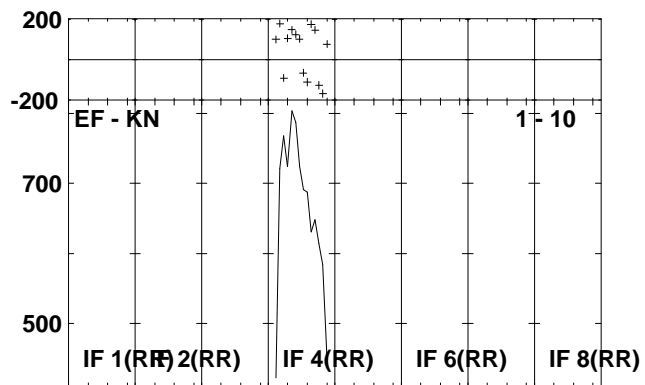
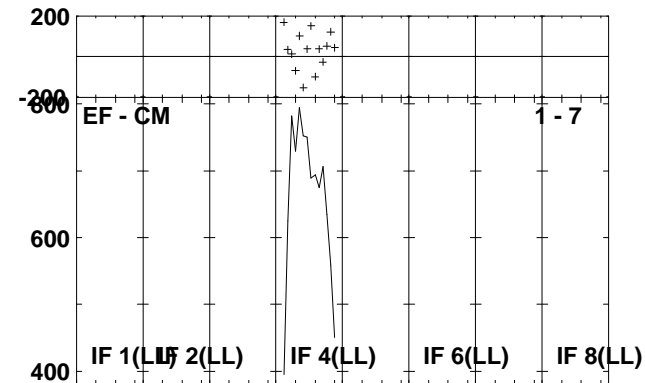
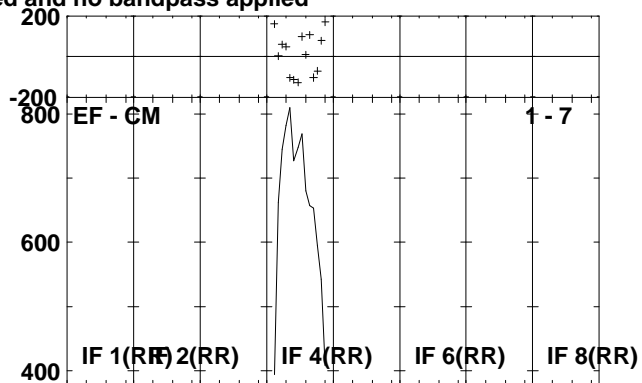
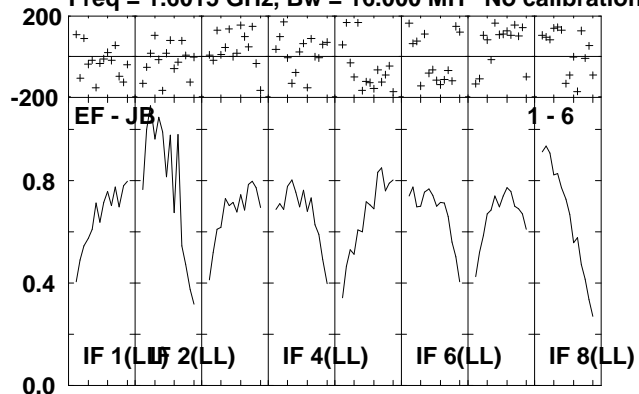

Lower frame: Milli Ampl Jy Top frame: Phas deg
Scalar averaged cross-power spectrum Several baselines displayed
Timerange: 00/22:18:20 to 00/22:25:16

Plot file version 99 created 26-APR-2010 13:27:04

J1246-07 EA043.UVDATA.1

Freq = 1.6015 GHz, Bw = 16.000 MH No calibration applied and no bandpass applied

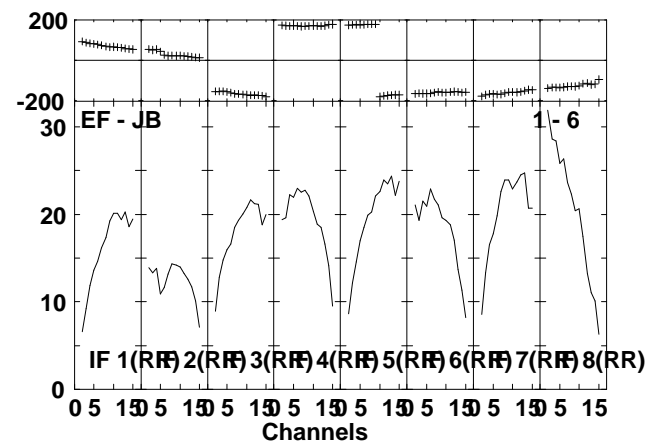
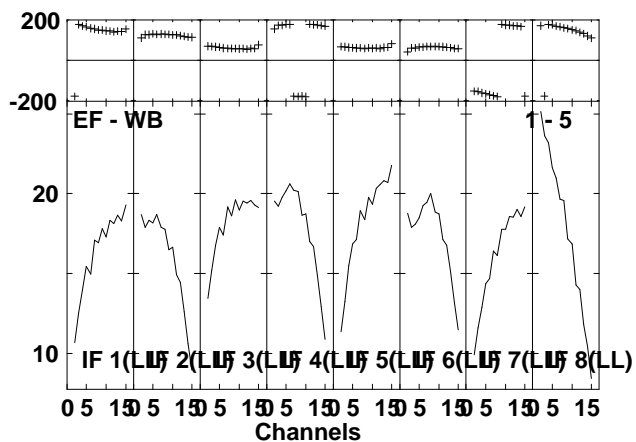
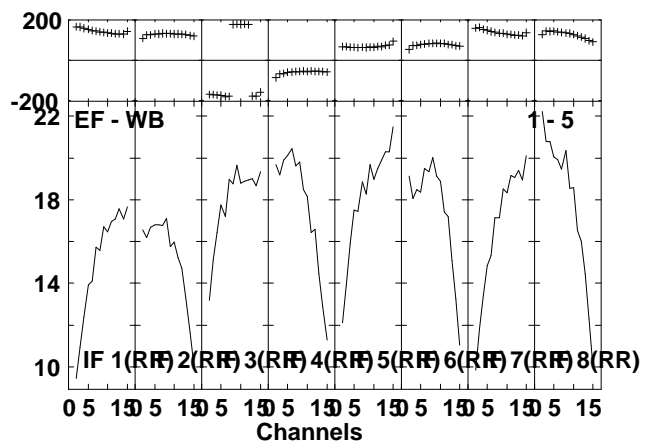
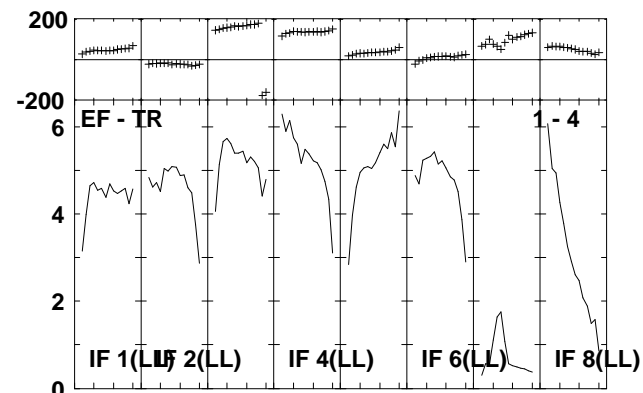
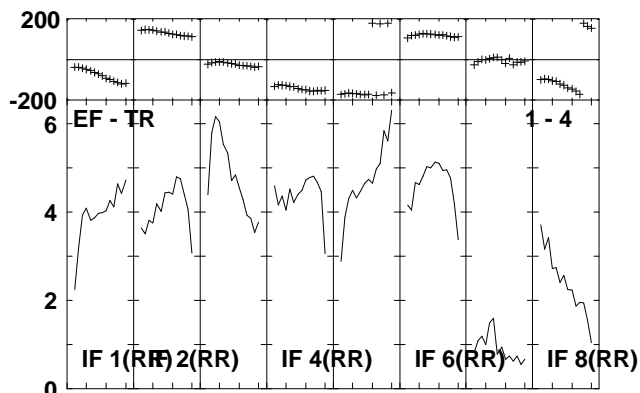
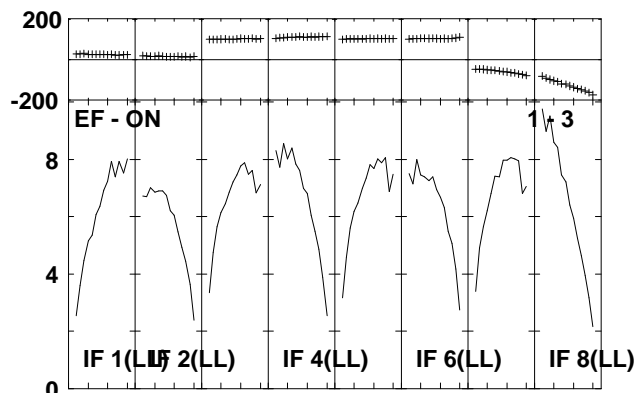
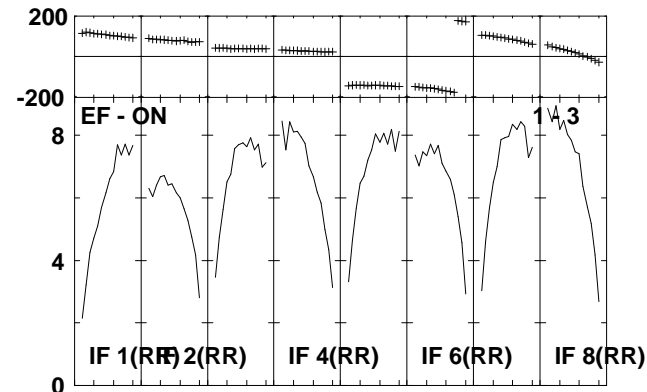
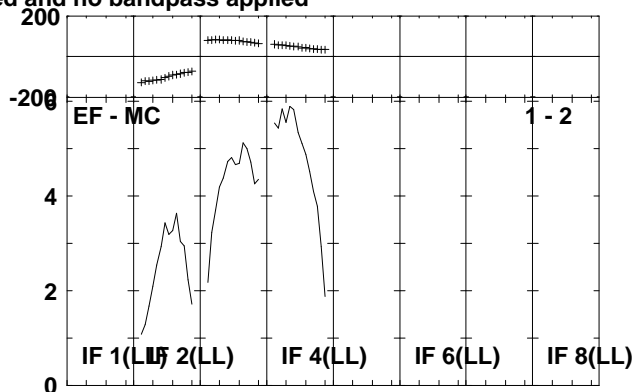
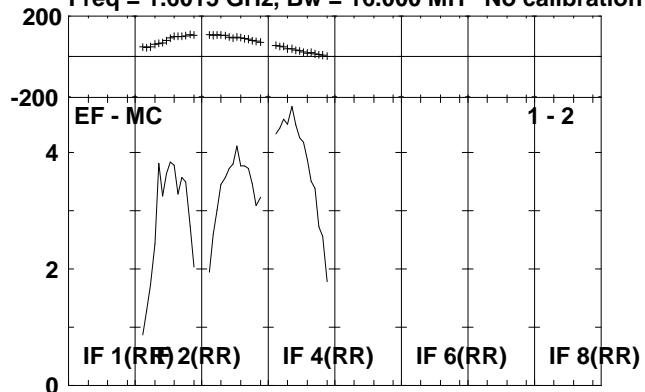

Lower frame: Milli Ampl Jy Top frame: Phas deg
Scalar averaged cross-power spectrum Several baselines displayed
Timerange: 00/22:25:20 to 00/22:27:16

Plot file version 100 created 26-APR-2010 13:27:04

J1246-07 EA043.UVDATA.1

Freq = 1.6015 GHz, Bw = 16.000 MH No calibration applied and no bandpass applied

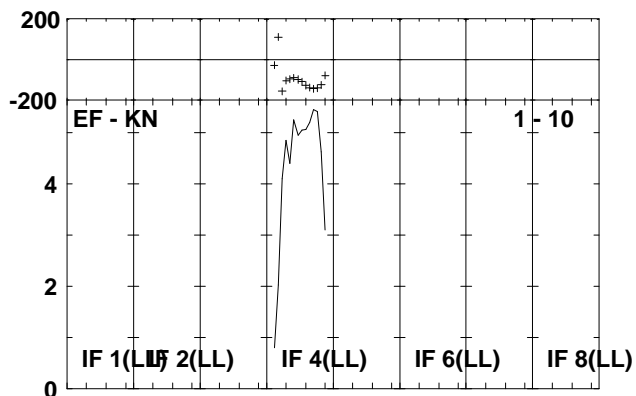
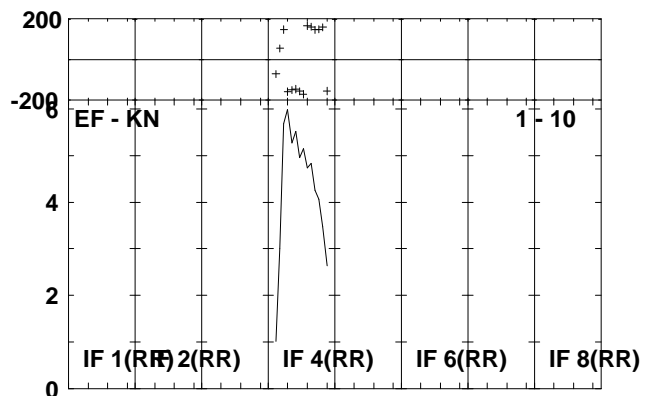
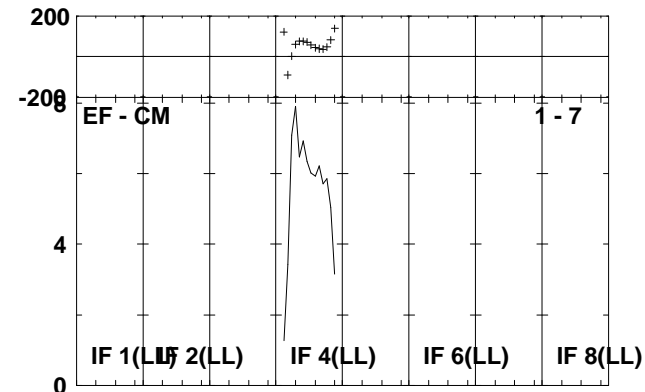
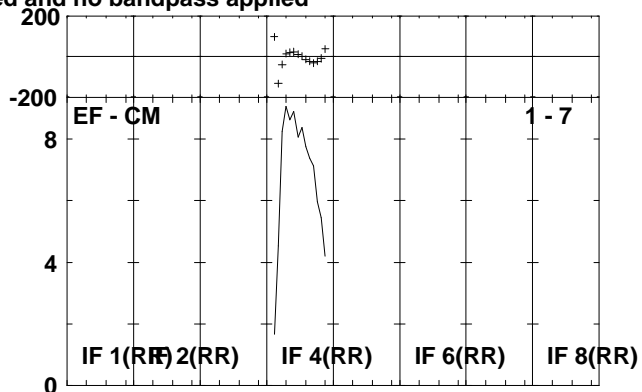
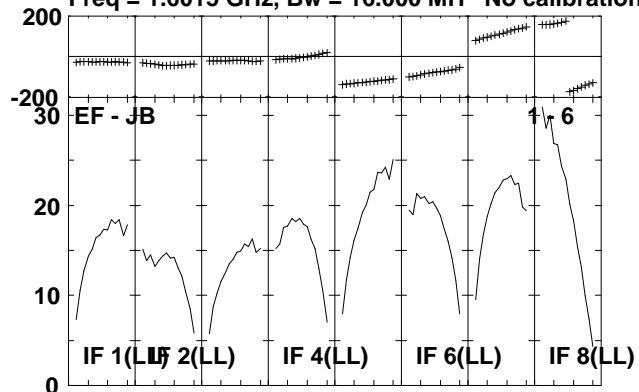

Lower frame: Milli Ampl Jy Top frame: Phas deg
Scalar averaged cross-power spectrum Several baselines displayed
Timerange: 00:22:25:20 to 00:22:27:16

Plot file version 101 created 26-APR-2010 13:27:05

HCG62 EA043.UVDATA.1

Freq = 1.6015 GHz, Bw = 16.000 MH No calibration applied and no bandpass applied

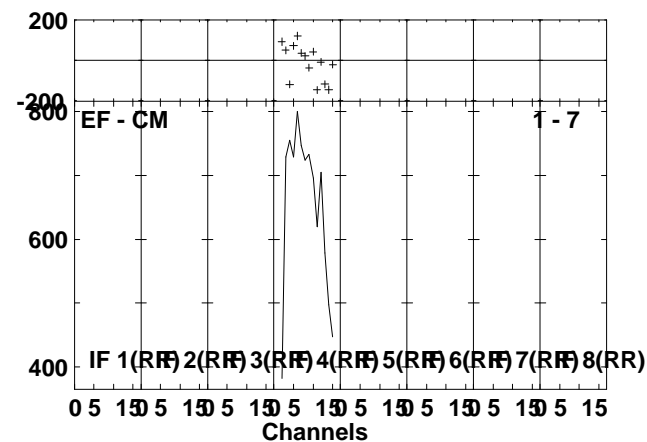
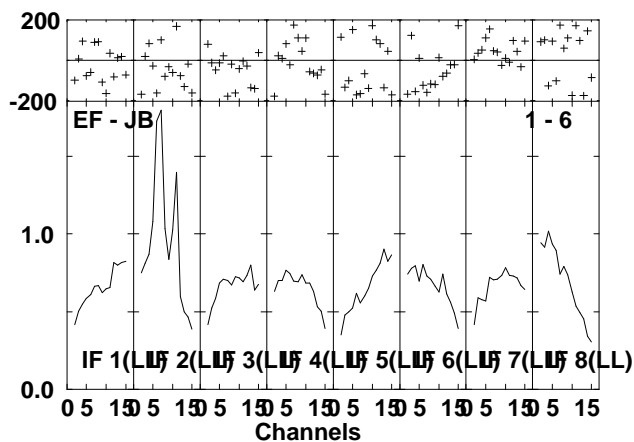
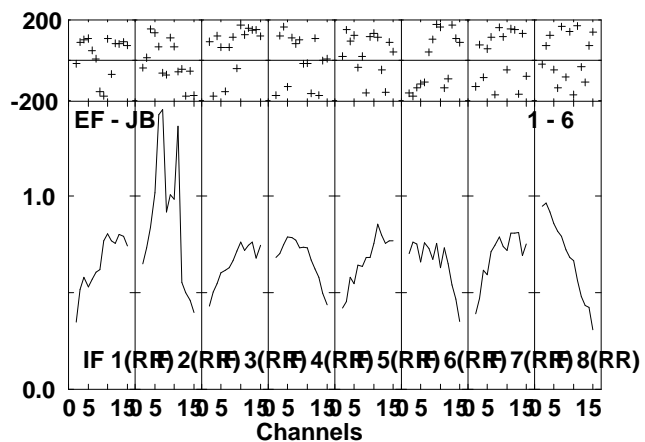
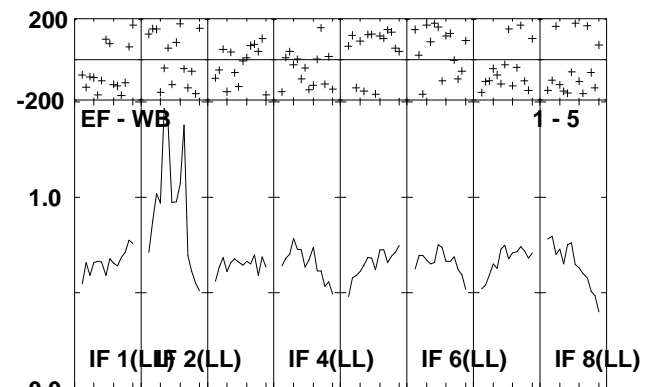
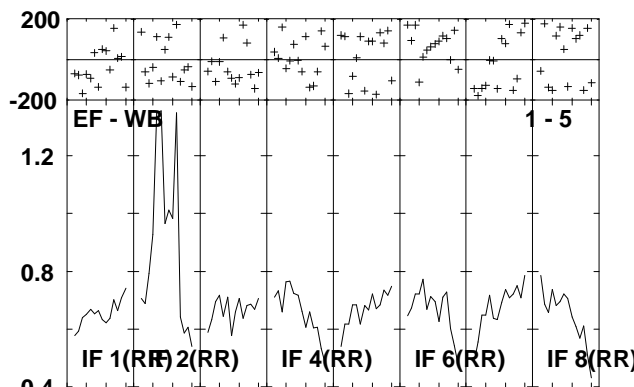
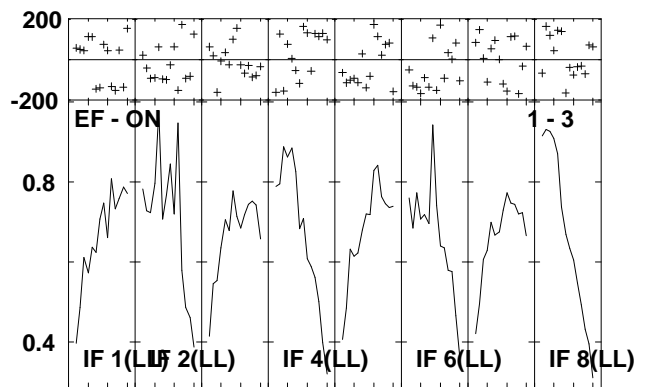
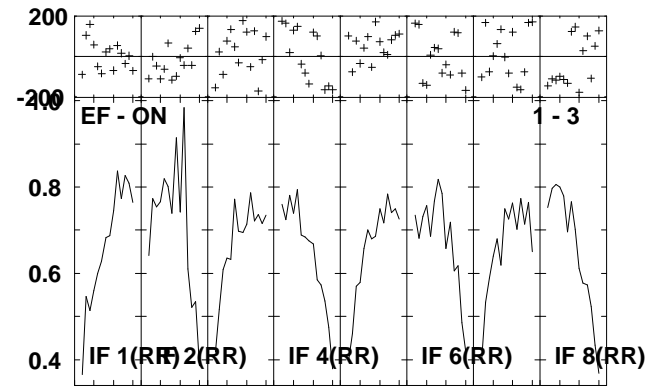
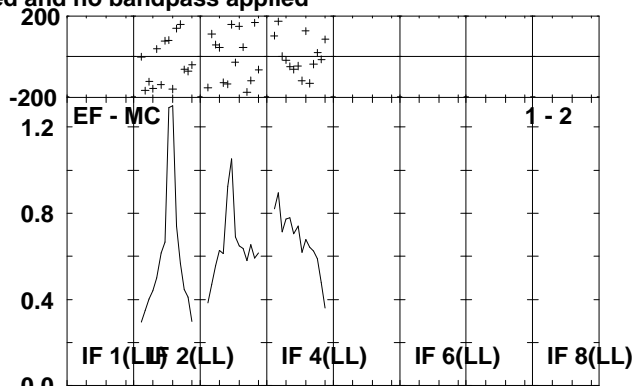
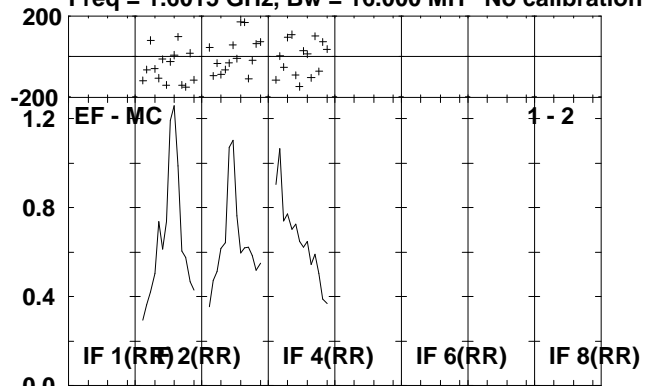

Lower frame: Milli Ampl Jy Top frame: Phas deg
Scalar averaged cross-power spectrum Several baselines displayed
Timerange: 00/22:28:20 to 00/22:35:16

Plot file version 102 created 26-APR-2010 13:27:06

HCG62 EA043.UVDATA.1

Freq = 1.6015 GHz, Bw = 16.000 MH No calibration applied and no bandpass applied

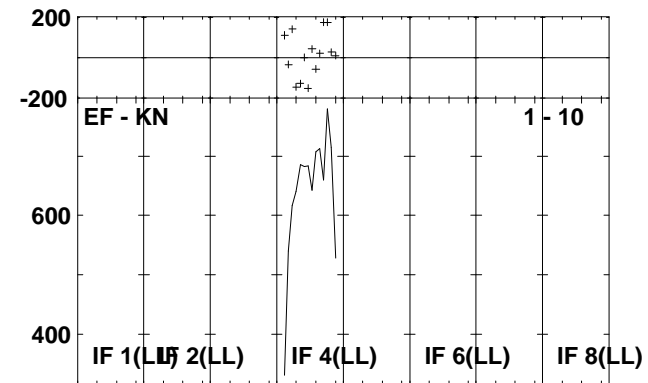
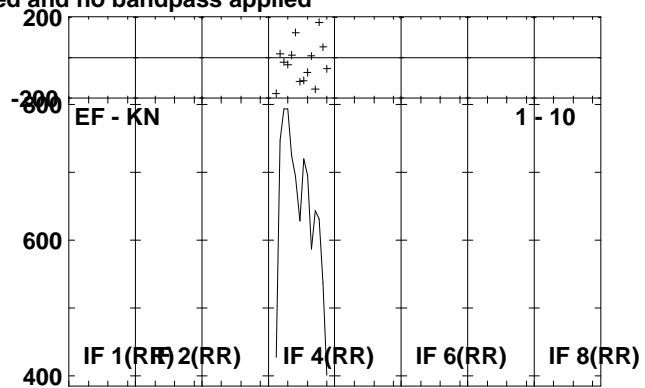
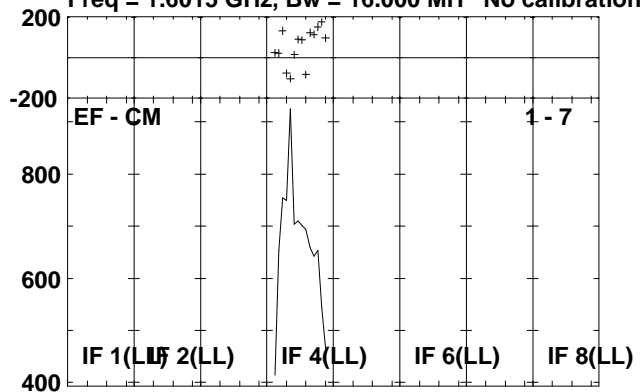

Lower frame: Micro Ampl Jy Top frame: Phas deg
Scalar averaged cross-power spectrum Several baselines displayed
Timerange: 00/22:28:20 to 00/22:35:16

Plot file version 103 created 26-APR-2010 13:27:07

J1246-07 EA043.UVDATA.1

Freq = 1.6015 GHz, Bw = 16.000 MH No calibration applied and no bandpass applied

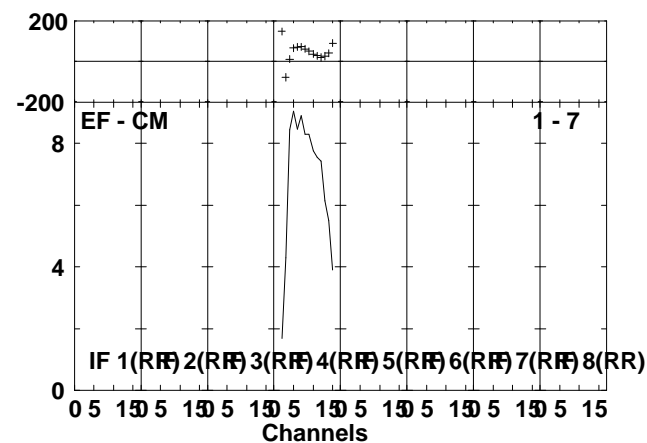
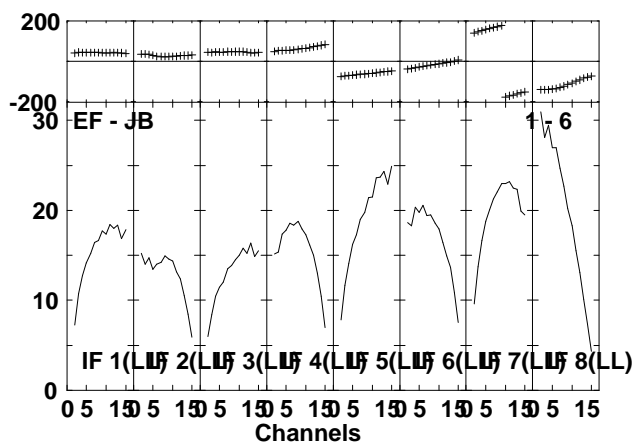
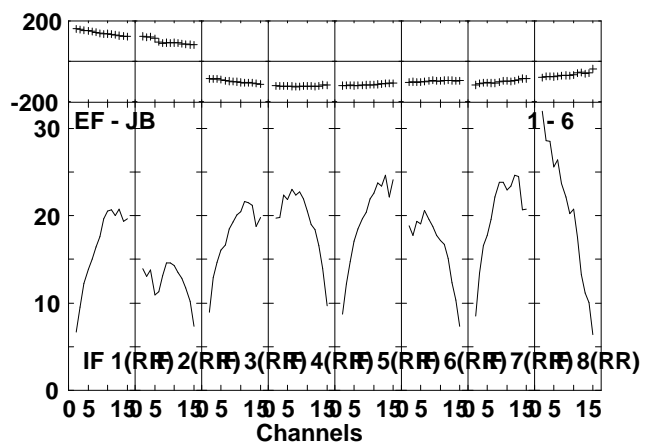
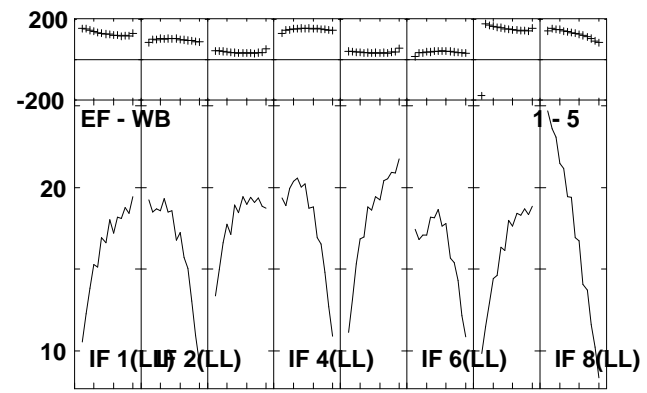
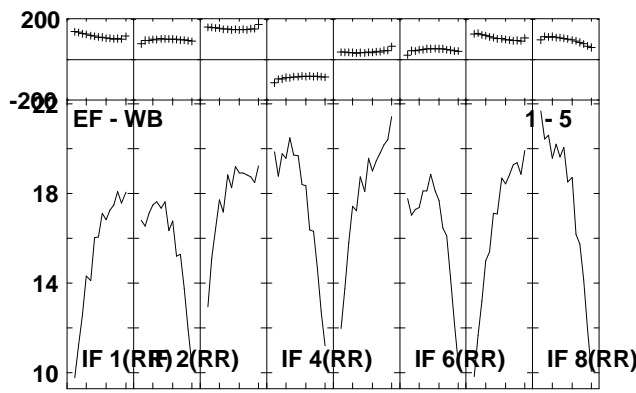
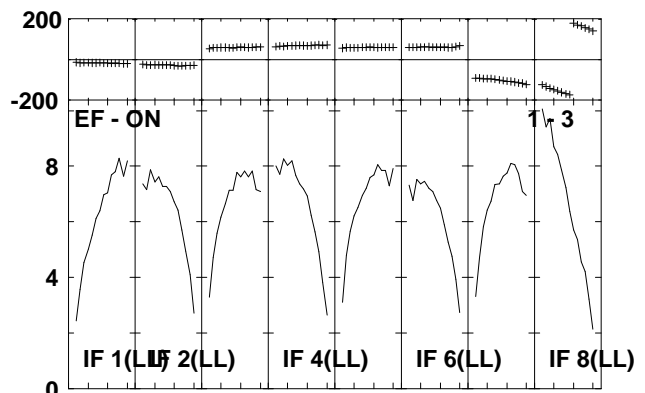
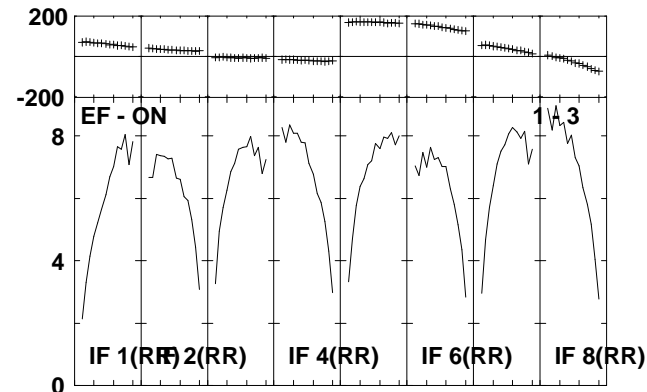
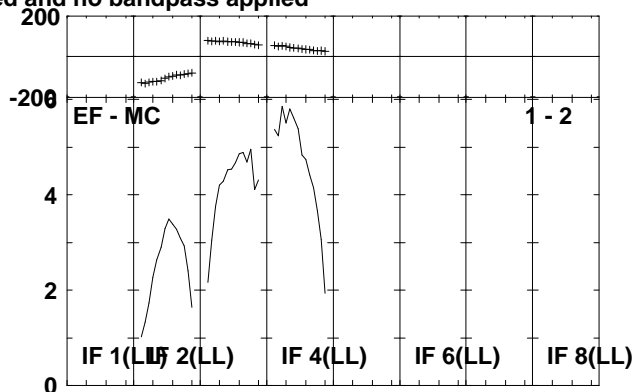
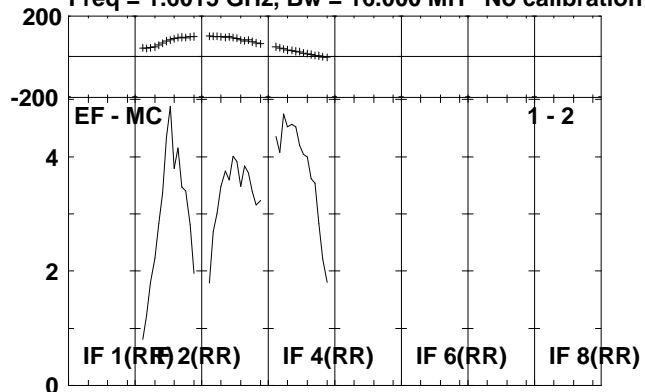

Lower frame: Milli Ampl Jy Top frame: Phas deg
Scalar averaged cross-power spectrum Several baselines displayed
Timerange: 00/22:35:20 to 00/22:37:16

Plot file version 104 created 26-APR-2010 13:27:07

J1246-07 EA043.UVDATA.1

Freq = 1.6015 GHz, Bw = 16.000 MH No calibration applied and no bandpass applied

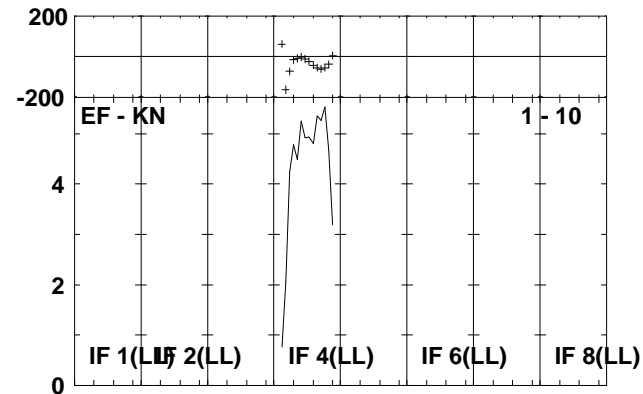
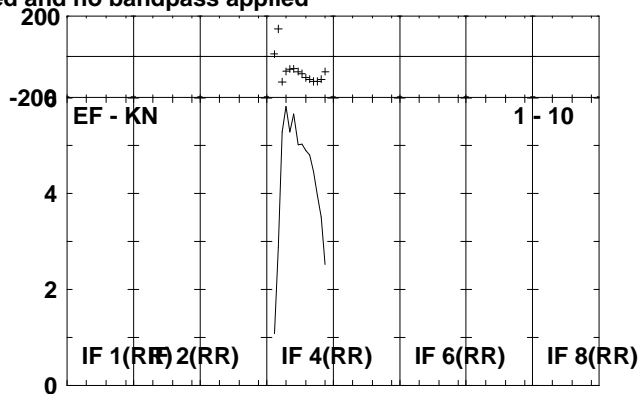
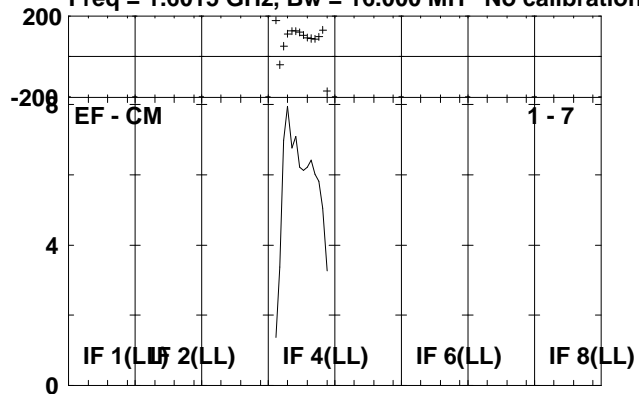

Lower frame: Milli Ampl Jy Top frame: Phas deg
Scalar averaged cross-power spectrum Several baselines displayed
Timerange: 00/22:35:20 to 00/22:37:16

Plot file version 105 created 26-APR-2010 13:27:08

HCG62 EA043.UVDATA.1

Freq = 1.6015 GHz, Bw = 16.000 MH No calibration applied and no bandpass applied

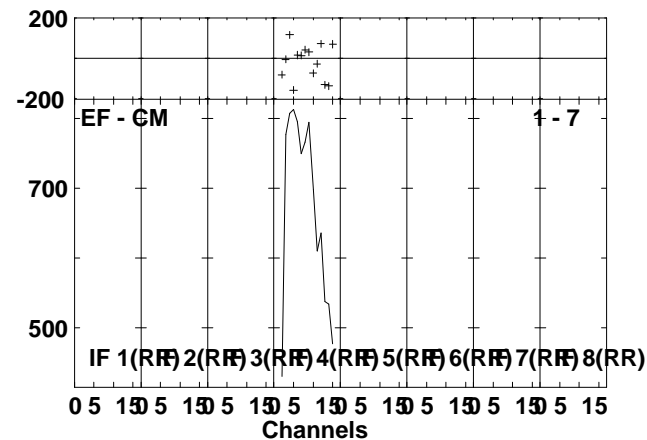
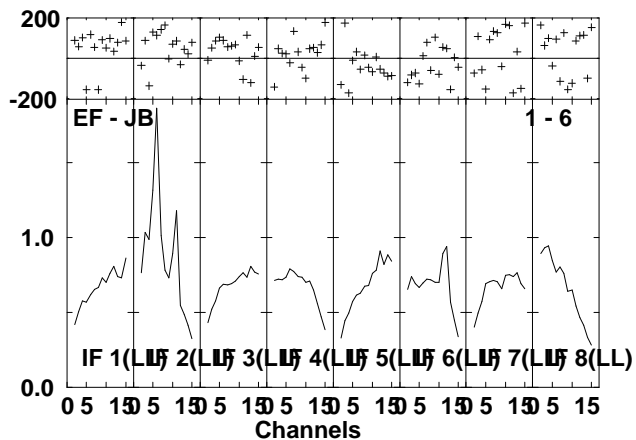
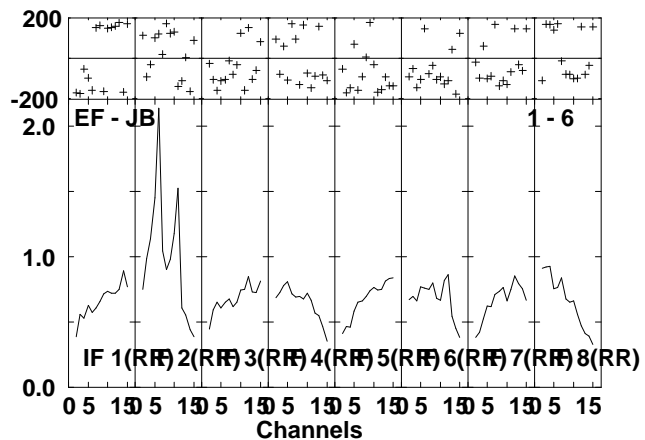
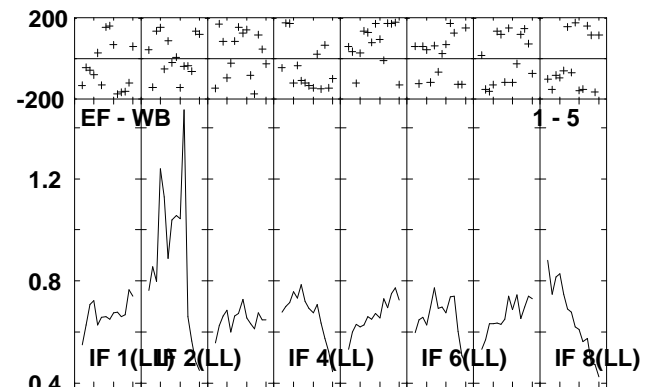
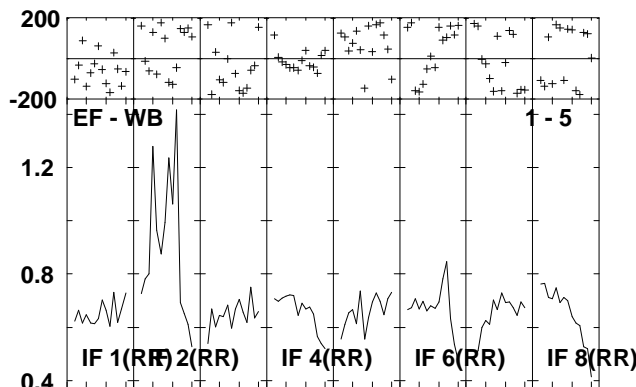
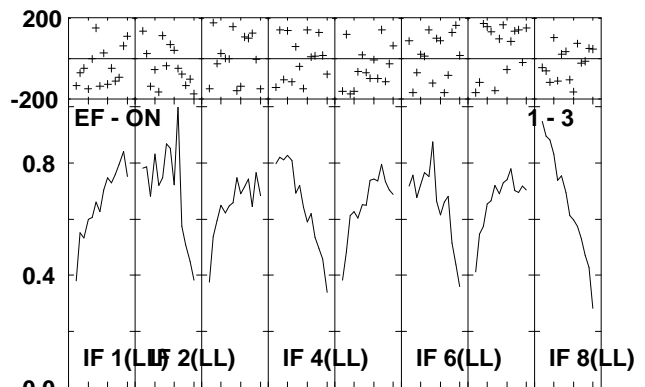
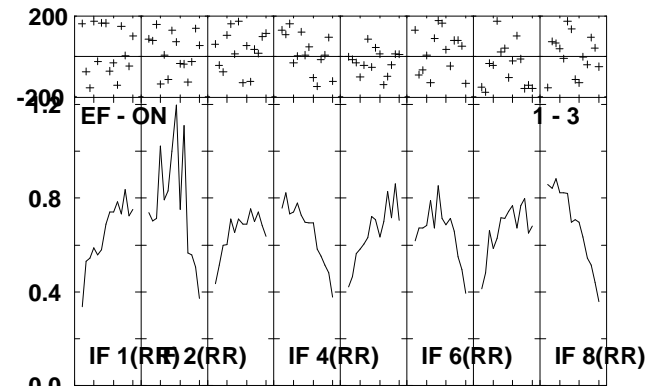
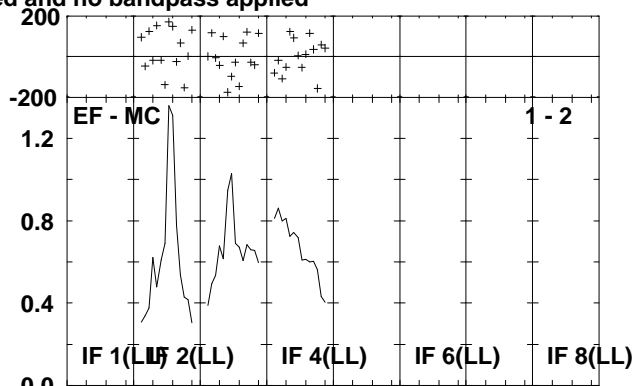
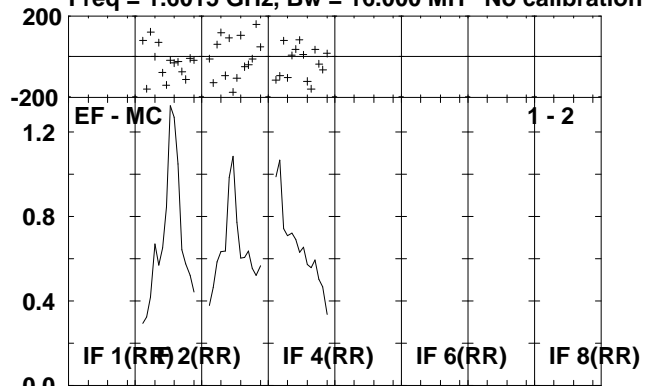

Lower frame: Milli Ampl Jy Top frame: Phas deg
Scalar averaged cross-power spectrum Several baselines displayed
Timerange: 00/22:38:20 to 00/22:45:16

Plot file version 106 created 26-APR-2010 13:27:09

HCG62 EA043.UVDATA.1

Freq = 1.6015 GHz, Bw = 16.000 MH No calibration applied and no bandpass applied

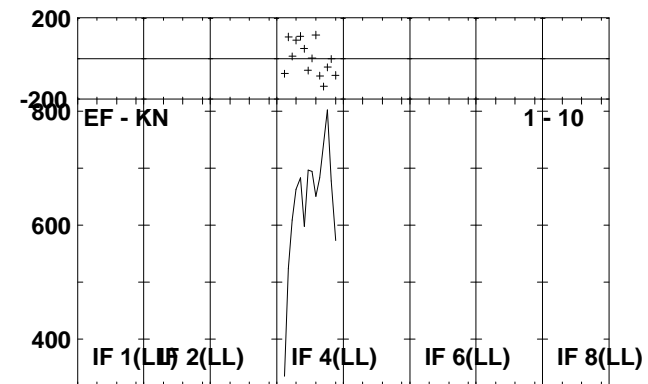
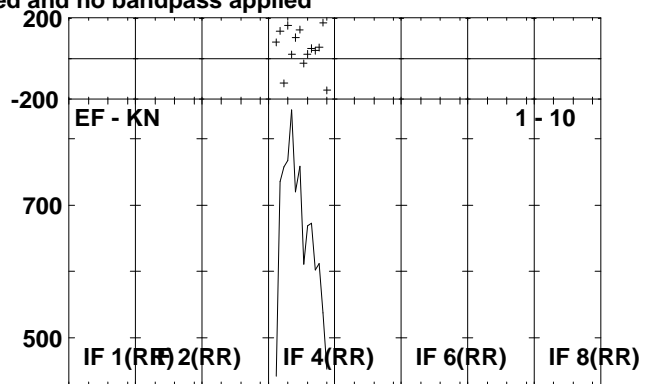
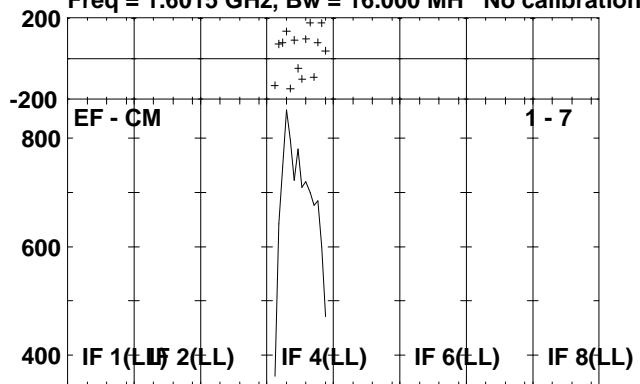

Lower frame: Micro Ampl Jy Top frame: Phas deg
Scalar averaged cross-power spectrum Several baselines displayed
Timerange: 00/22:38:20 to 00/22:45:16

Plot file version 107 created 26-APR-2010 13:27:10

J1246-07 EA043.UVDATA.1

Freq = 1.6015 GHz, Bw = 16.000 MH No calibration applied and no bandpass applied

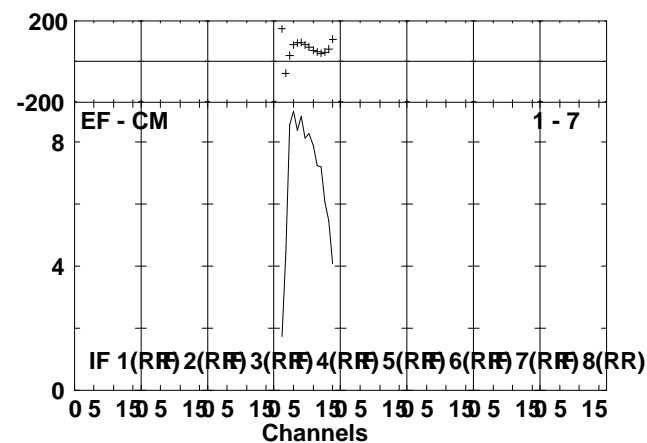
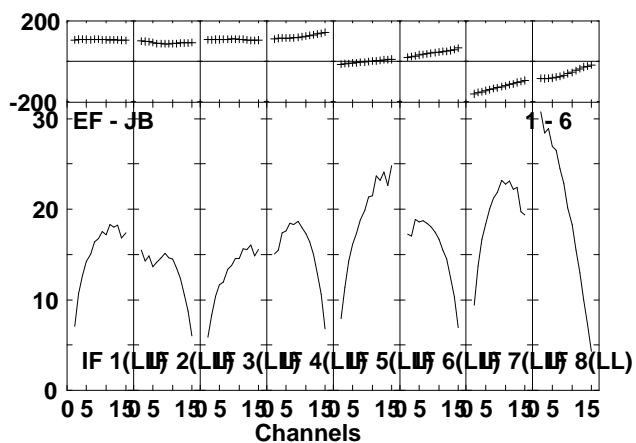
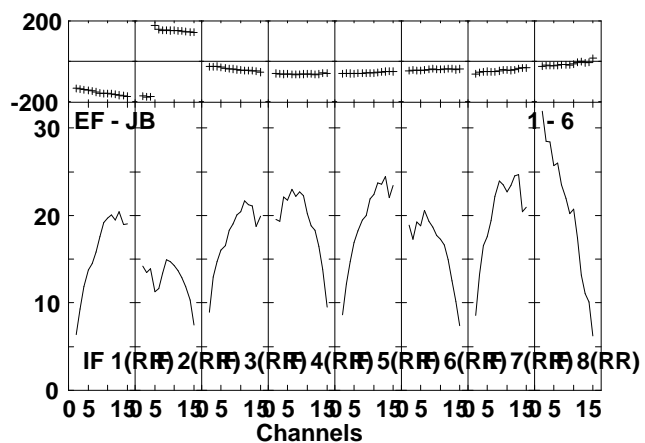
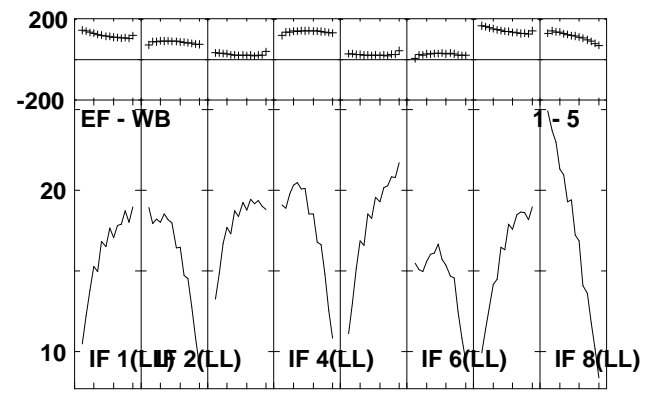
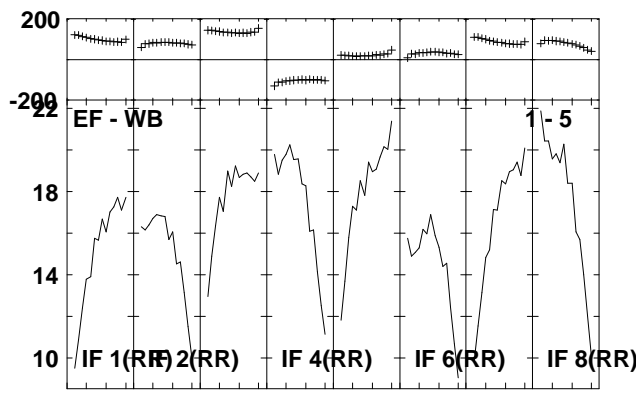
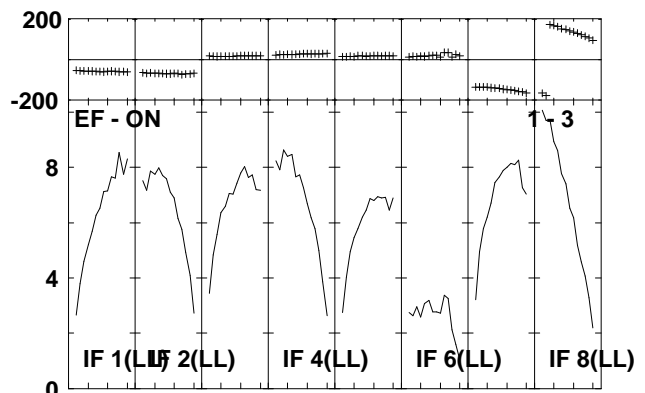
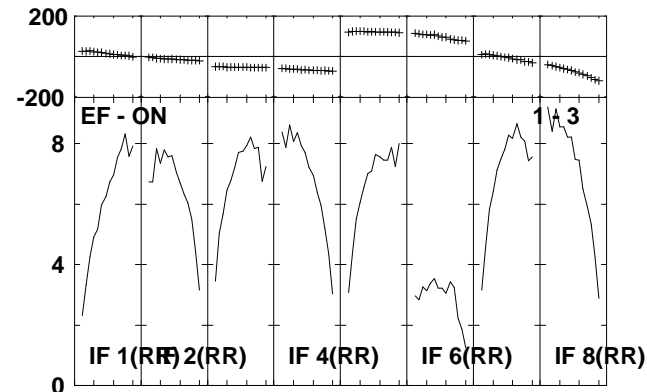
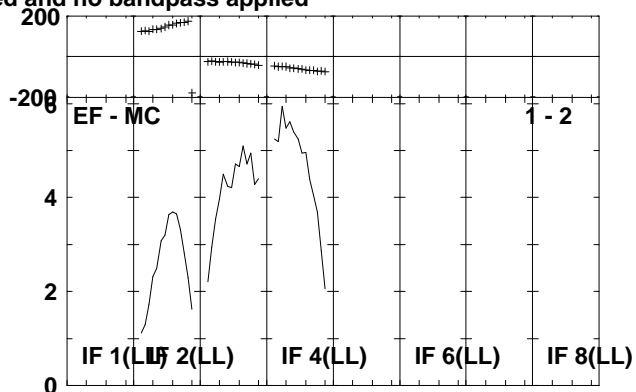
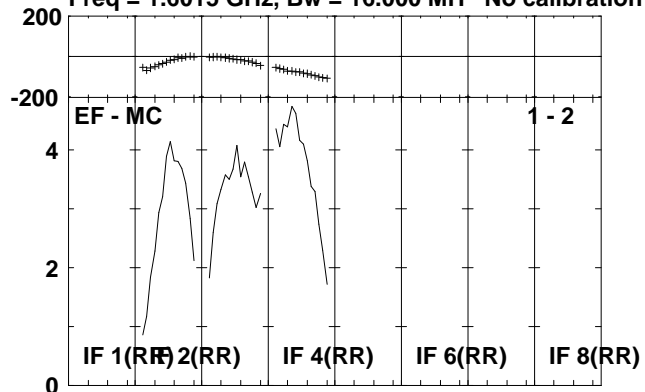

Lower frame: Milli Ampl Jy Top frame: Phas deg
Scalar averaged cross-power spectrum Several baselines displayed
Timerange: 00/22:45:20 to 00/22:47:16

Plot file version 108 created 26-APR-2010 13:27:11

J1246-07 EA043.UVDATA.1

Freq = 1.6015 GHz, Bw = 16.000 MH No calibration applied and no bandpass applied

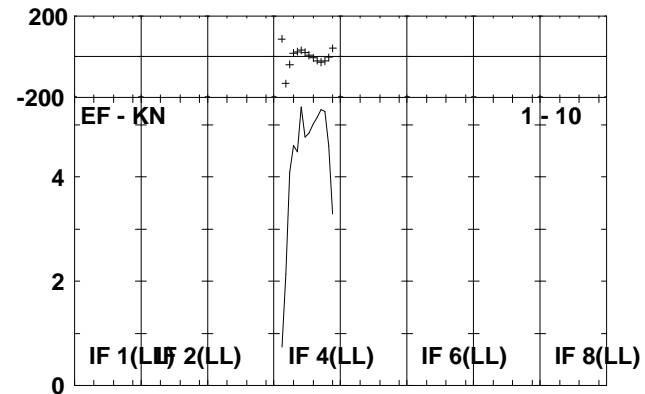
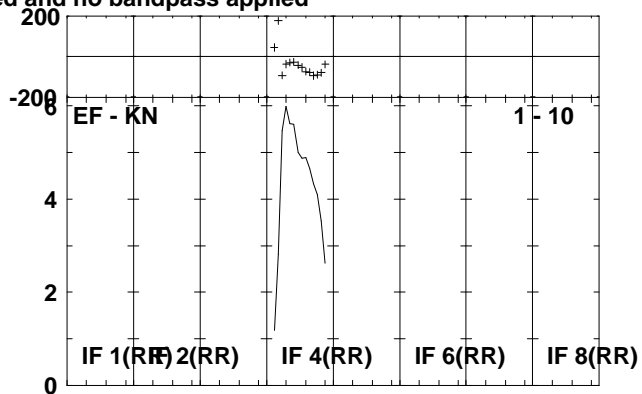
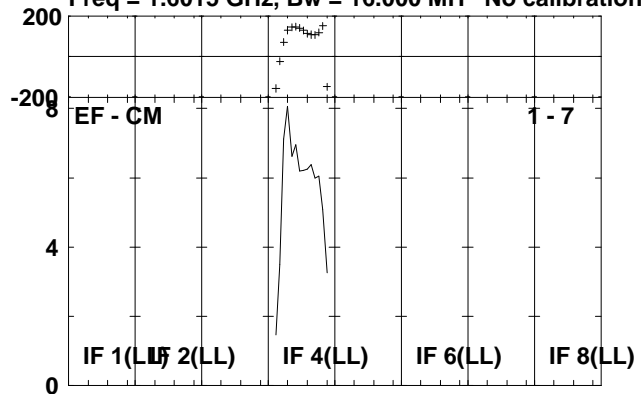

Lower frame: Milli Ampl Jy Top frame: Phas deg
Scalar averaged cross-power spectrum Several baselines displayed
Timerange: 00:22:45:20 to 00:22:47:16

Plot file version 109 created 26-APR-2010 13:27:11

HCG62 EA043.UVDATA.1

Freq = 1.6015 GHz, Bw = 16.000 MH No calibration applied and no bandpass applied

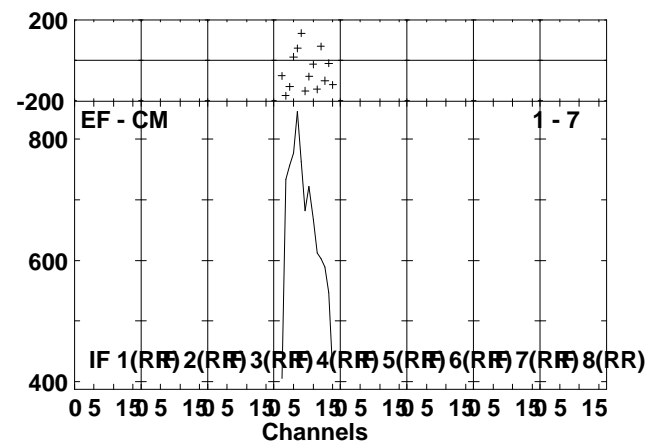
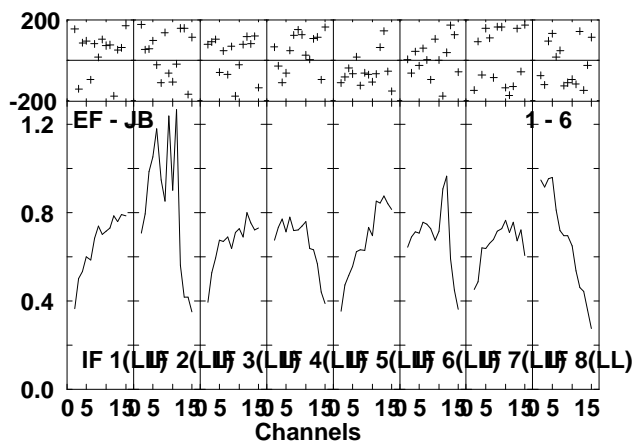
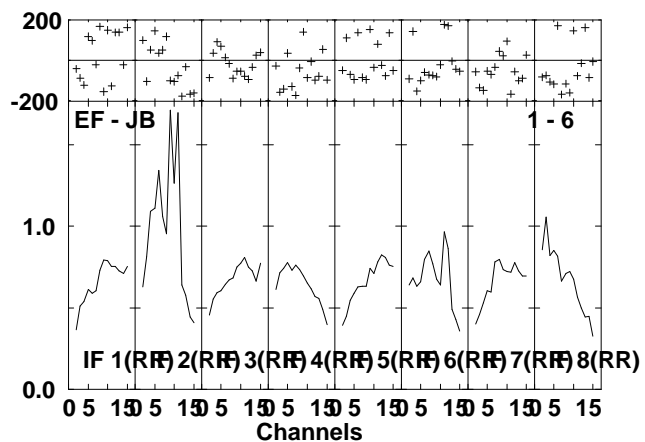
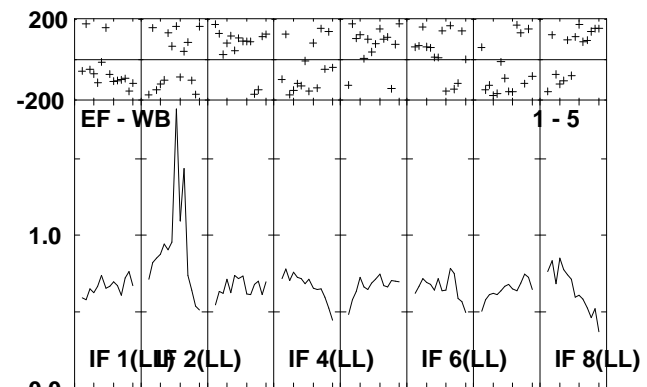
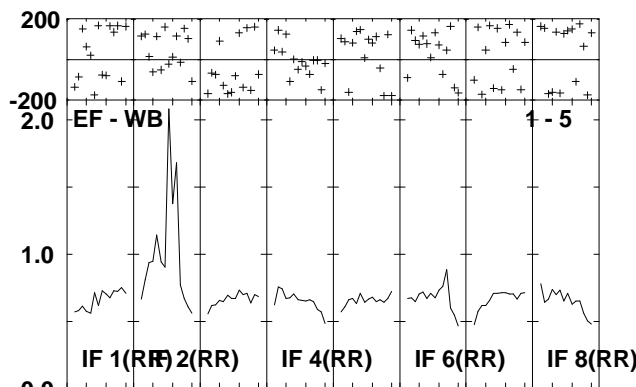
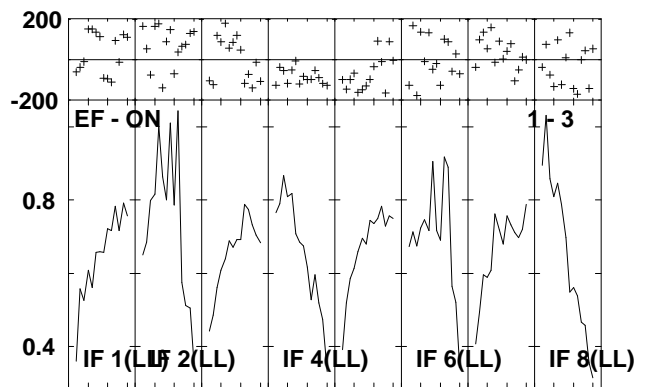
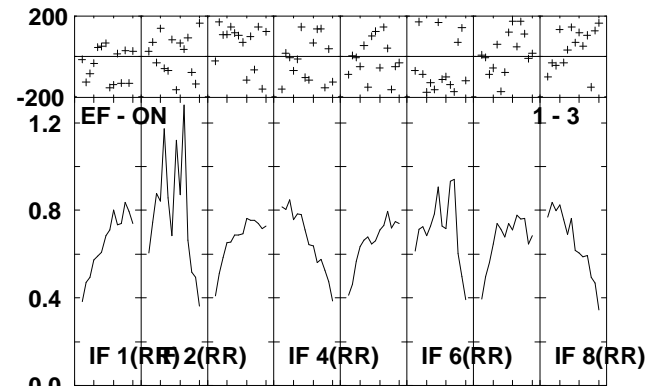
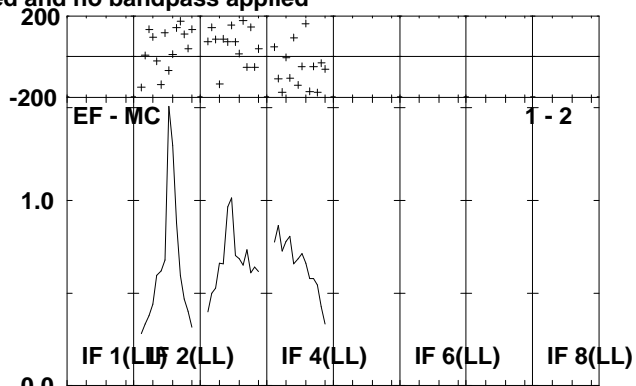
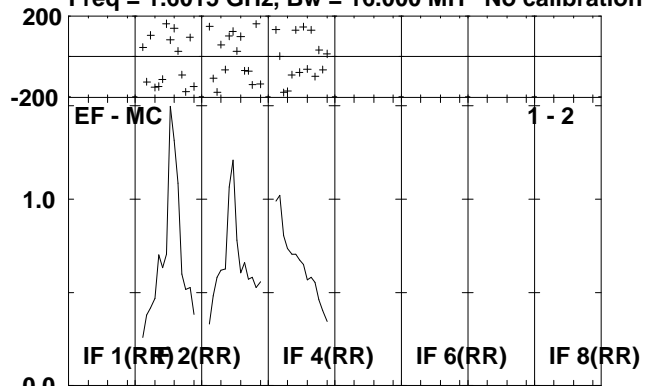

Lower frame: Milli Ampl Jy Top frame: Phas deg
Scalar averaged cross-power spectrum Several baselines displayed
Timerange: 00/22:48:20 to 00/22:55:16

Plot file version 110 created 26-APR-2010 13:27:12

HCG62 EA043.UVDATA.1

Freq = 1.6015 GHz, Bw = 16.000 MH No calibration applied and no bandpass applied

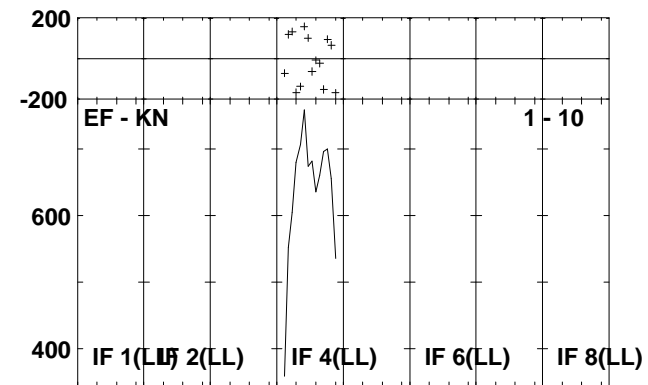
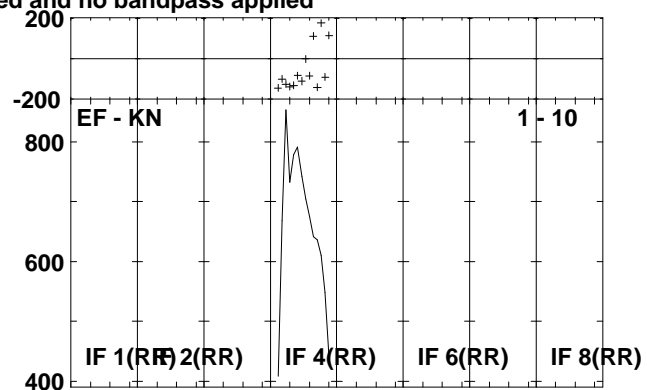
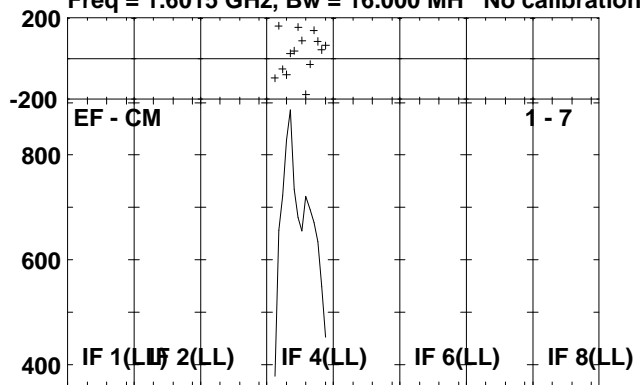

Lower frame: Micro Ampl Jy Top frame: Phas deg
Scalar averaged cross-power spectrum Several baselines displayed
Timerange: 00/22:48:20 to 00/22:55:16

Plot file version 111 created 26-APR-2010 13:27:13

J1246-07 EA043.UVDATA.1

Freq = 1.6015 GHz, Bw = 16.000 MH No calibration applied and no bandpass applied

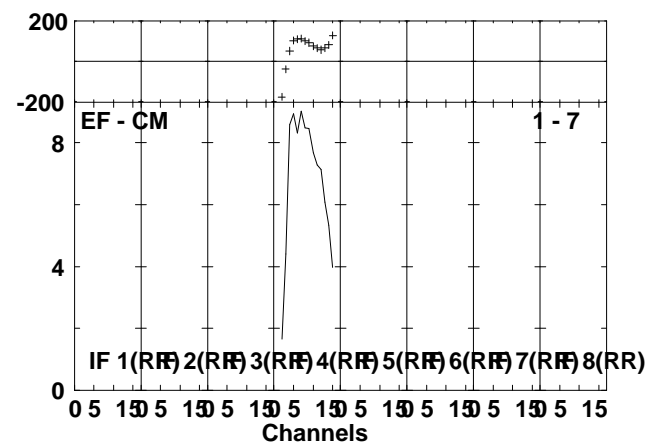
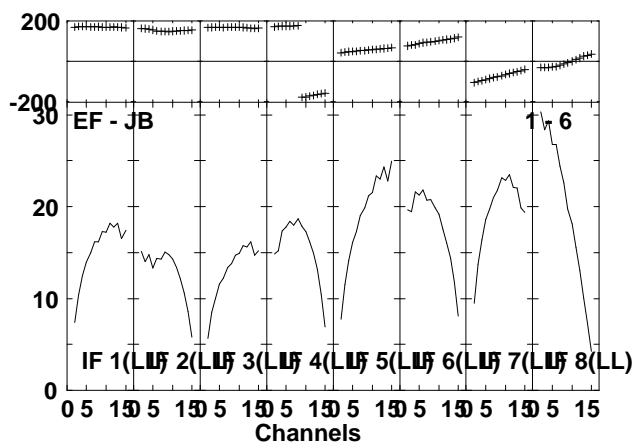
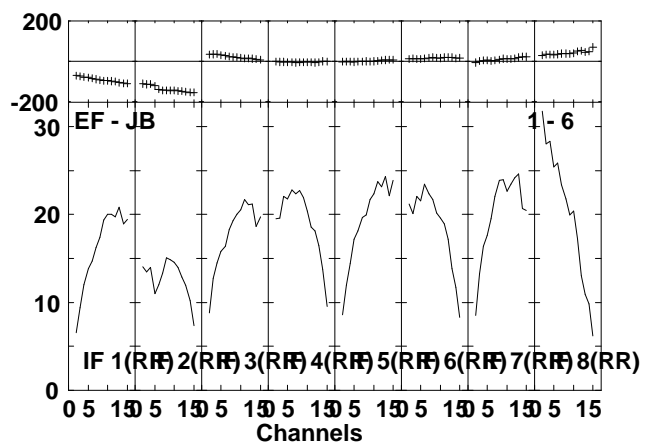
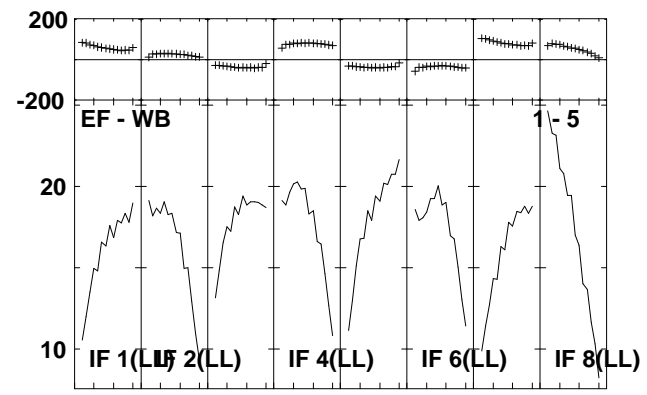
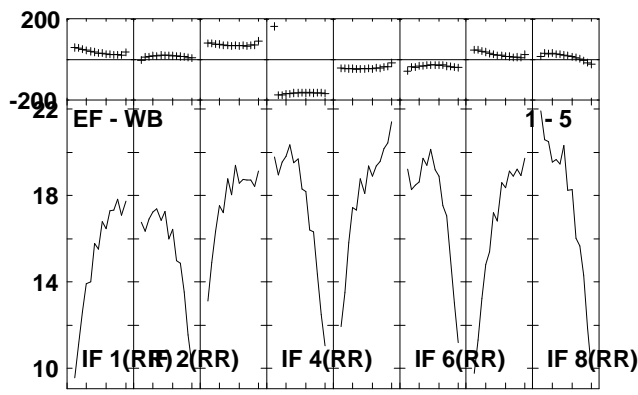
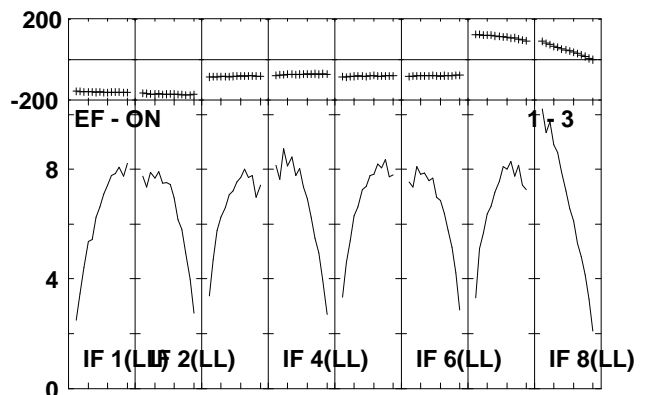
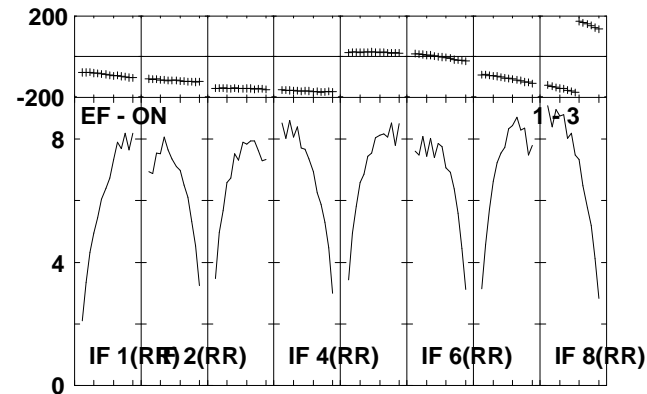
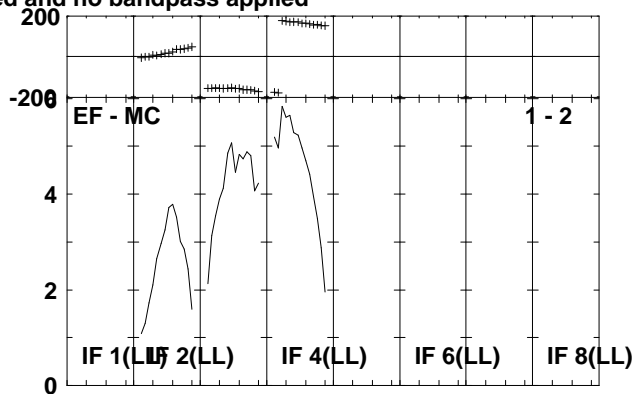
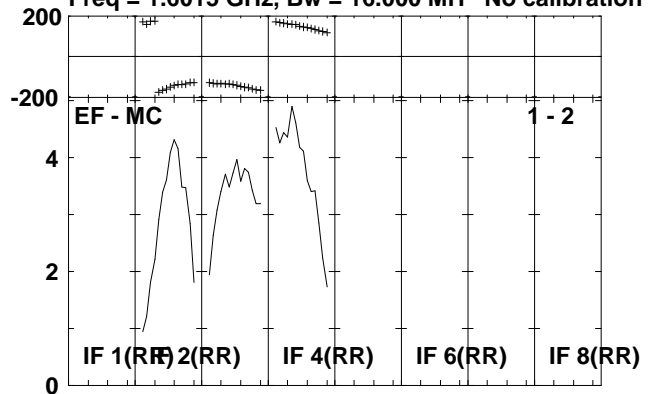

Lower frame: Milli Ampl Jy Top frame: Phas deg
Scalar averaged cross-power spectrum Several baselines displayed
Timerange: 00/22:55:20 to 00/22:57:16

Plot file version 112 created 26-APR-2010 13:27:14

J1246-07 EA043.UVDATA.1

Freq = 1.6015 GHz, Bw = 16.000 MH No calibration applied and no bandpass applied

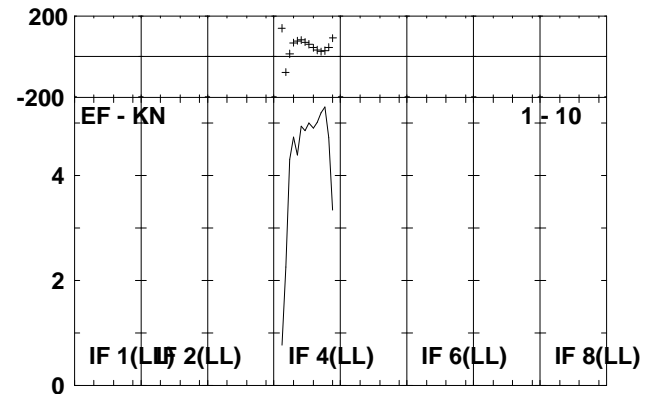
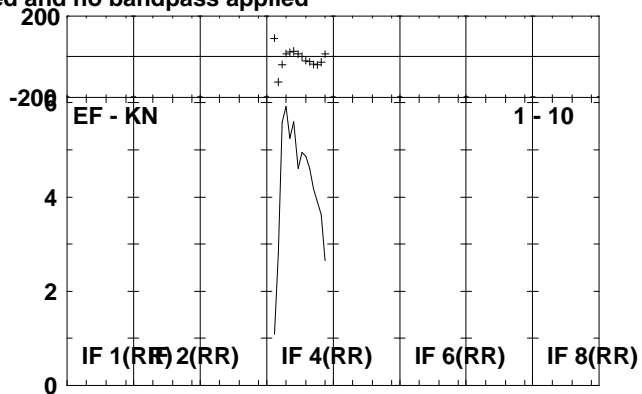
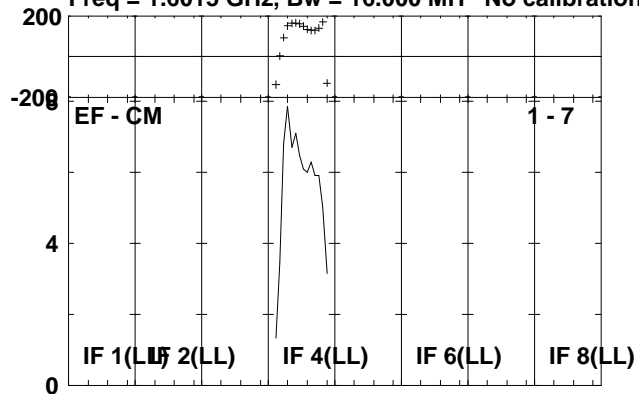

Lower frame: Milli Ampl Jy Top frame: Phas deg
Scalar averaged cross-power spectrum Several baselines displayed
Timerange: 00/22:55:20 to 00/22:57:16

Plot file version 113 created 26-APR-2010 13:27:14

HCG62 EA043.UVDATA.1

Freq = 1.6015 GHz, Bw = 16.000 MH No calibration applied and no bandpass applied

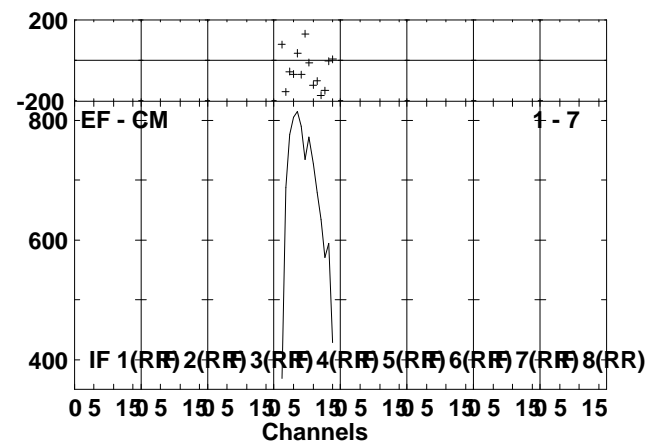
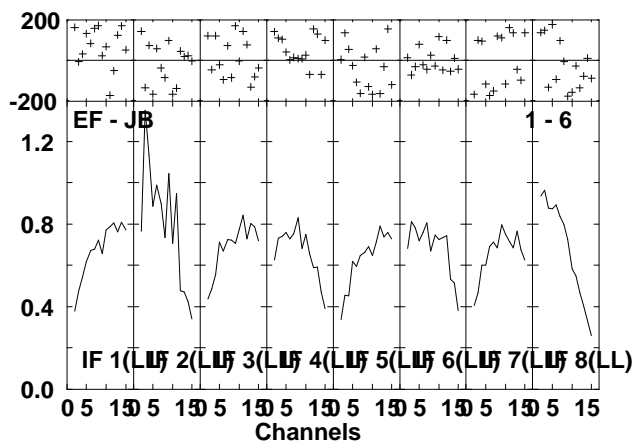
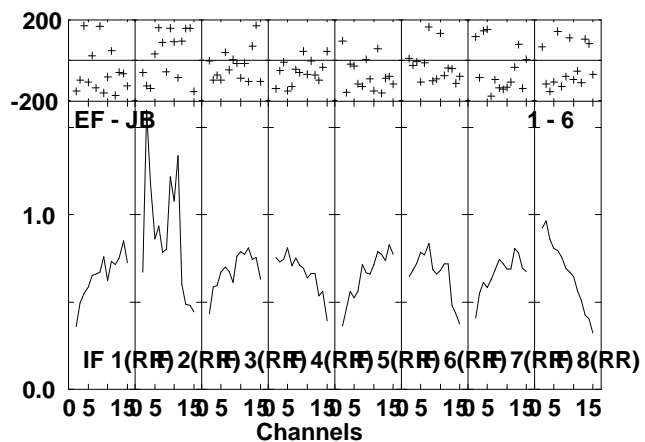
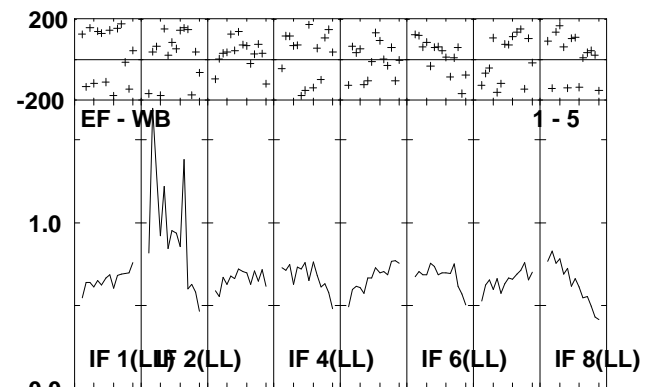
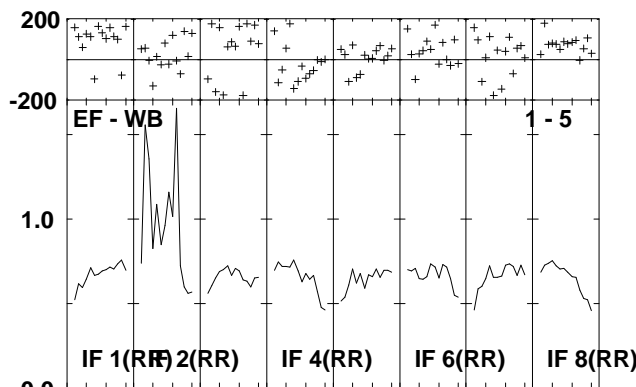
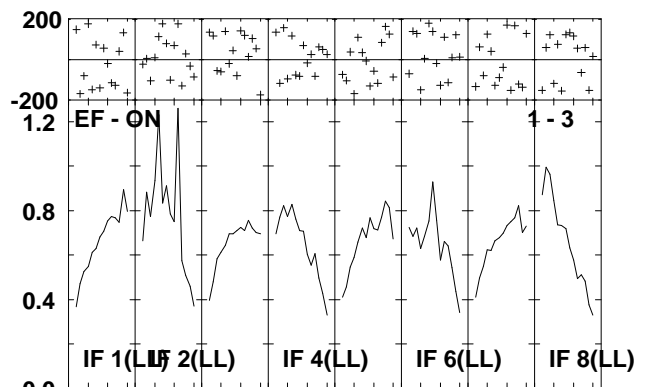
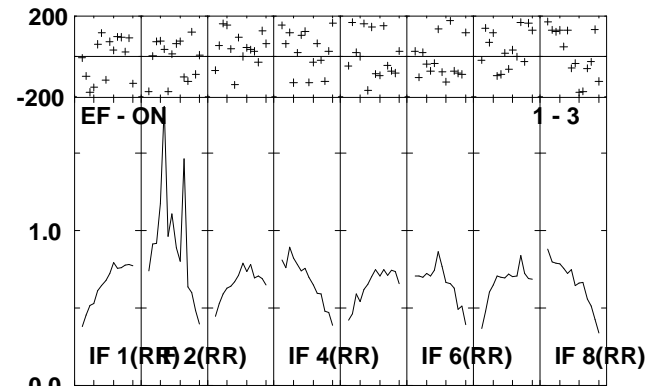
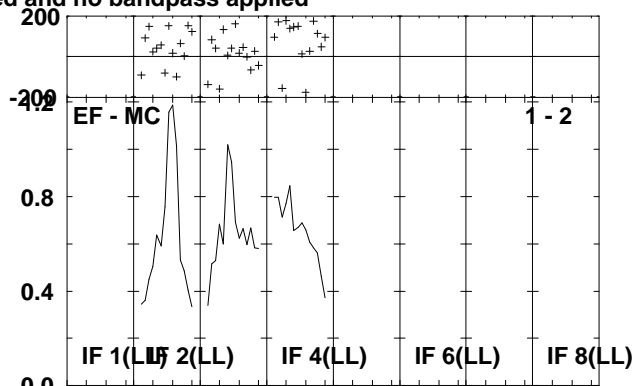
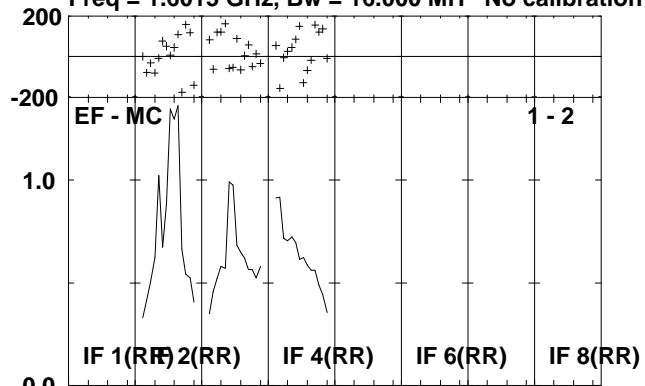

Lower frame: Milli Ampl Jy Top frame: Phas deg
Scalar averaged cross-power spectrum Several baselines displayed
Timerange: 00/22:58:20 to 00/23:05:16

Plot file version 114 created 26-APR-2010 13:27:15

HCG62 EA043.UVDATA.1

Freq = 1.6015 GHz, Bw = 16.000 MH No calibration applied and no bandpass applied

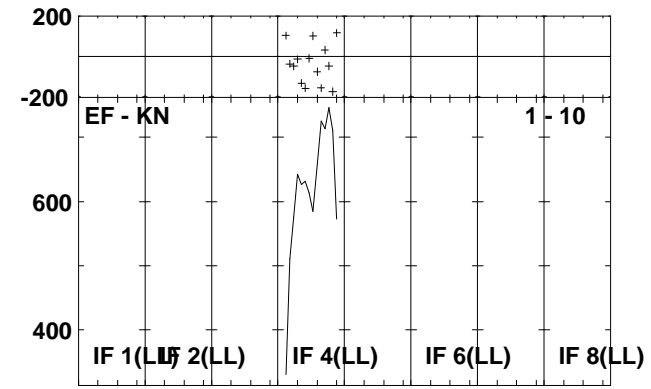
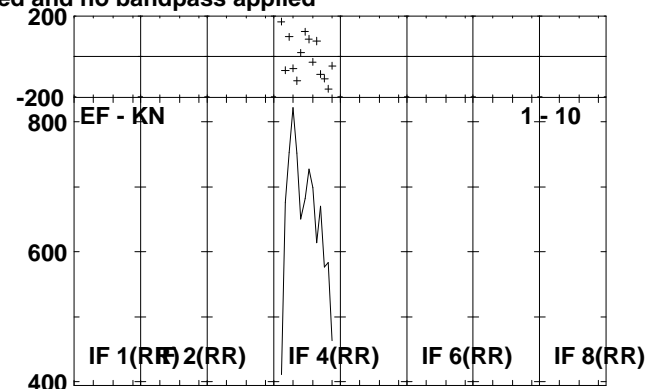
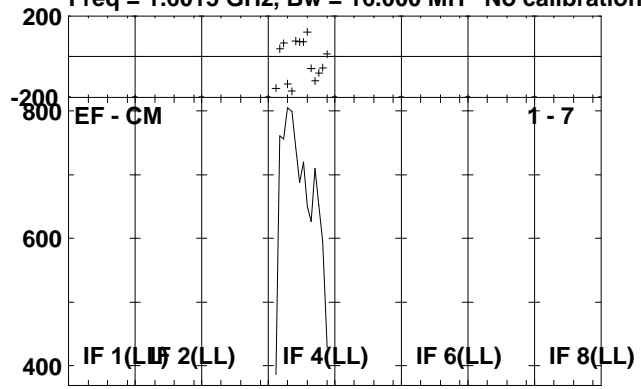

Lower frame: Micro Ampl Jy Top frame: Phas deg
Scalar averaged cross-power spectrum Several baselines displayed
Timerange: 00/22:58:20 to 00/23:05:16

Plot file version 115 created 26-APR-2010 13:27:16

J1246-07 EA043.UVDATA.1

Freq = 1.6015 GHz, Bw = 16.000 MH No calibration applied and no bandpass applied

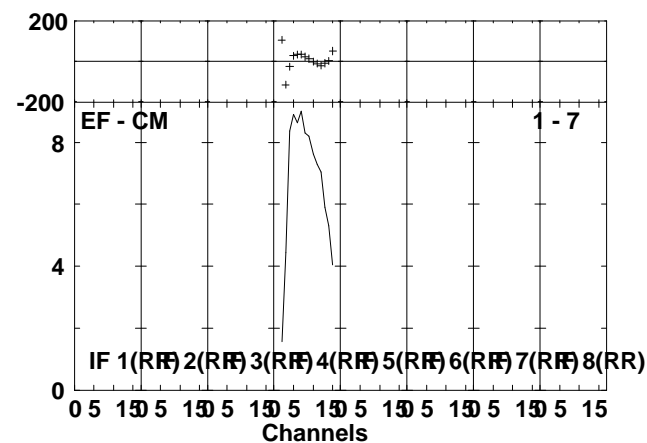
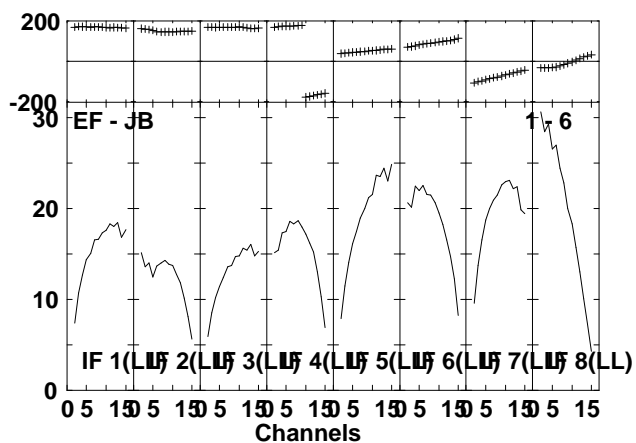
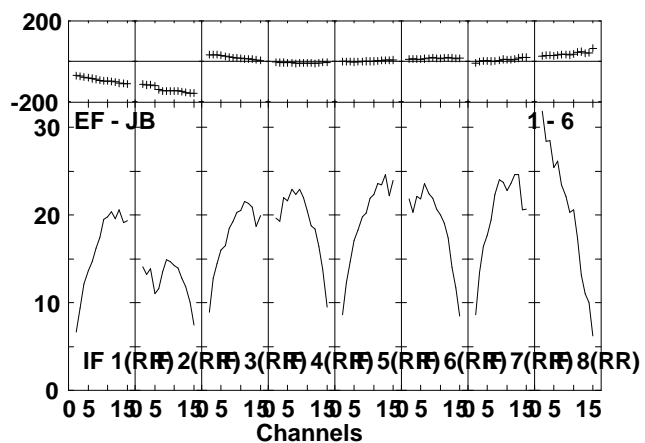
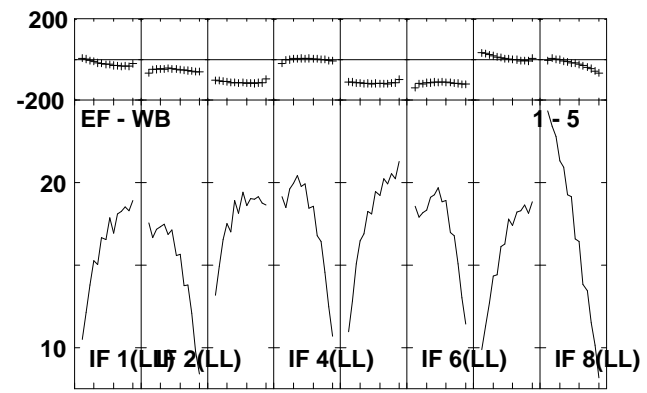
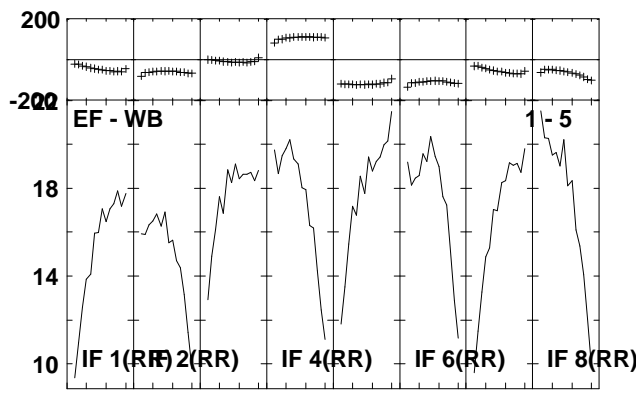
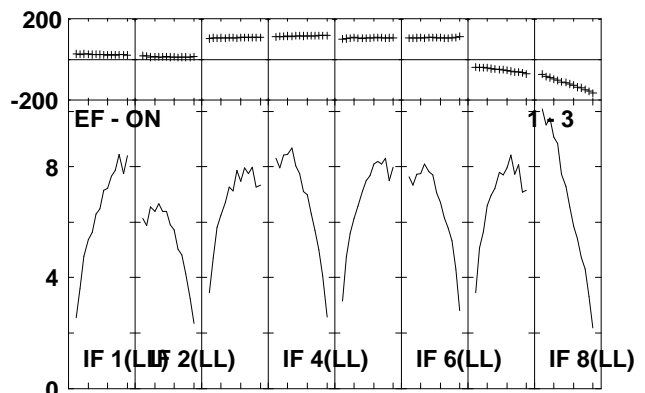
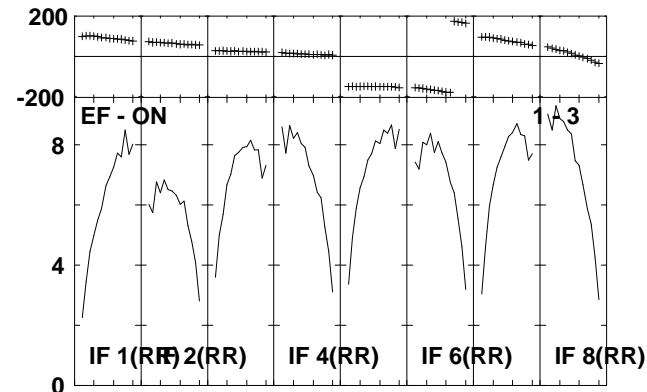
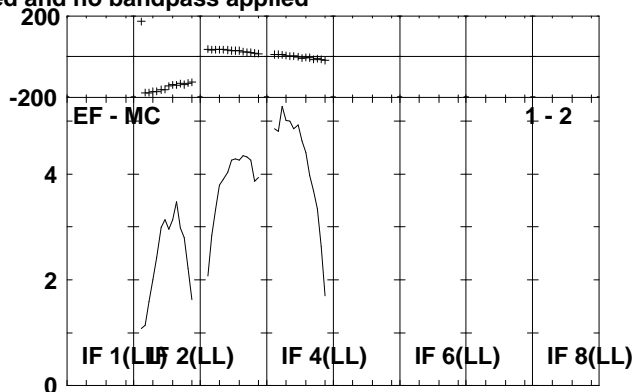
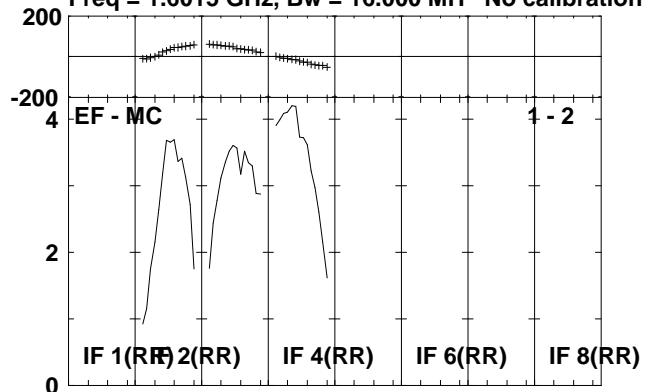

Lower frame: Milli Ampl Jy Top frame: Phas deg
Scalar averaged cross-power spectrum Several baselines displayed
Timerange: 00/23:05:20 to 00/23:07:16

Plot file version 116 created 26-APR-2010 13:27:17

J1246-07 EA043.UVDATA.1

Freq = 1.6015 GHz, Bw = 16.000 MH No calibration applied and no bandpass applied

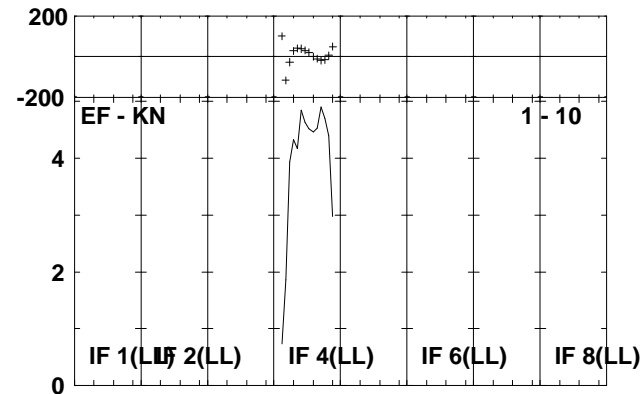
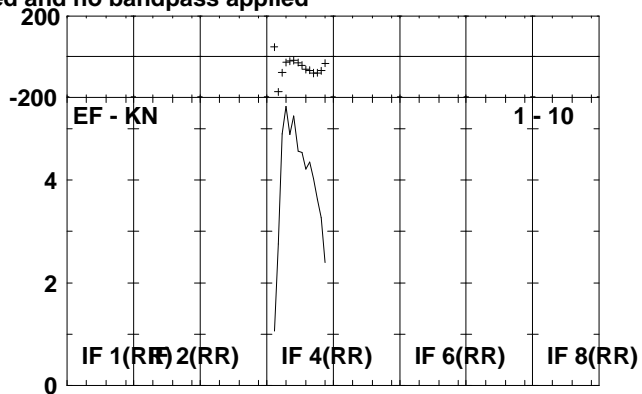
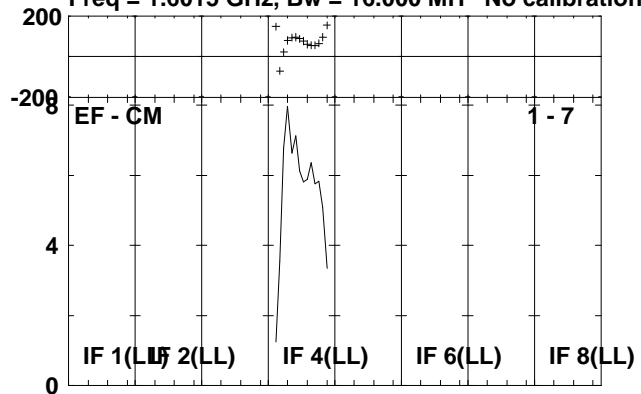

Lower frame: Milli Ampl Jy Top frame: Phas deg
Scalar averaged cross-power spectrum Several baselines displayed
Timerange: 00/23:05:20 to 00/23:07:16

Plot file version 117 created 26-APR-2010 13:27:17

HCG62 EA043.UVDATA.1

Freq = 1.6015 GHz, Bw = 16.000 MH No calibration applied and no bandpass applied

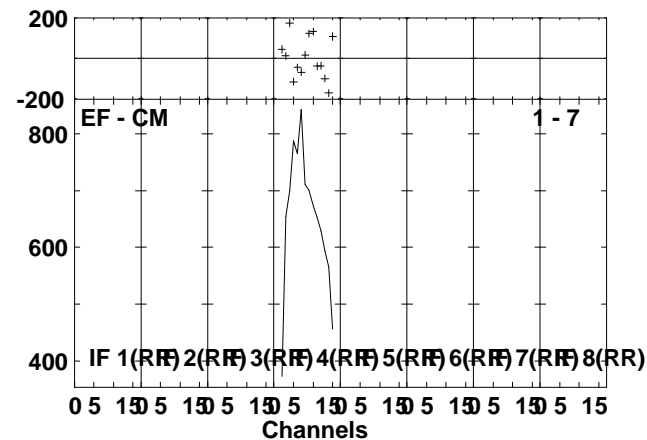
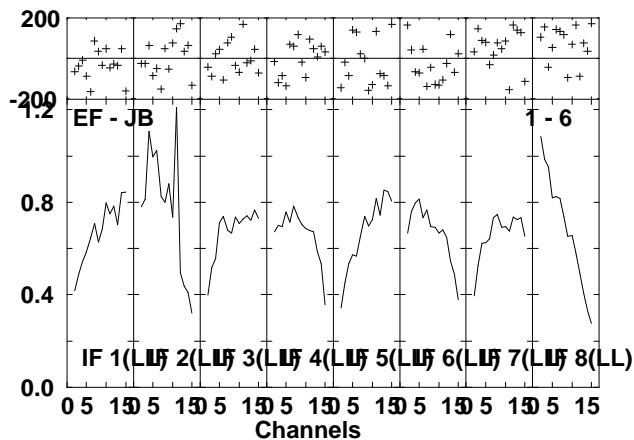
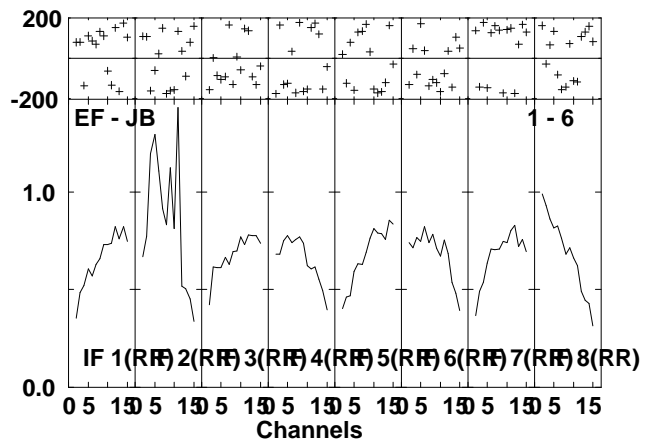
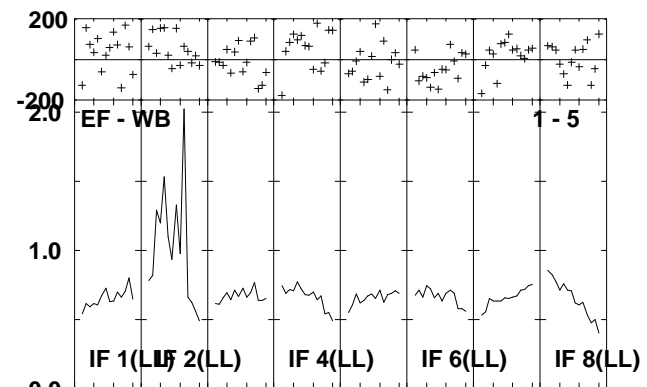
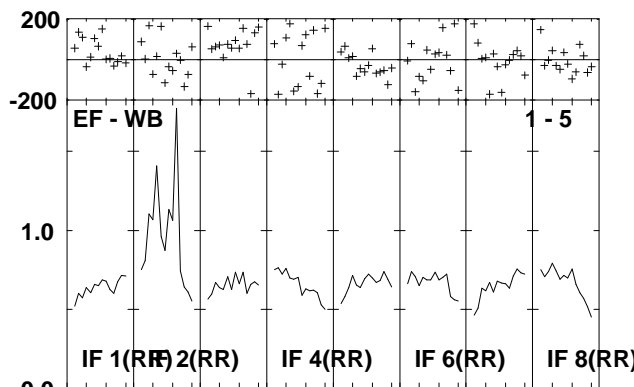
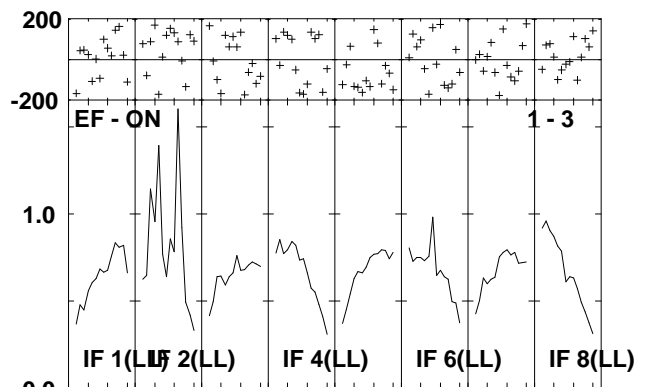
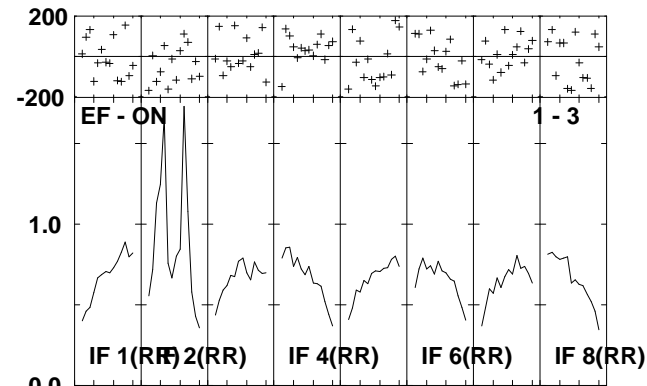
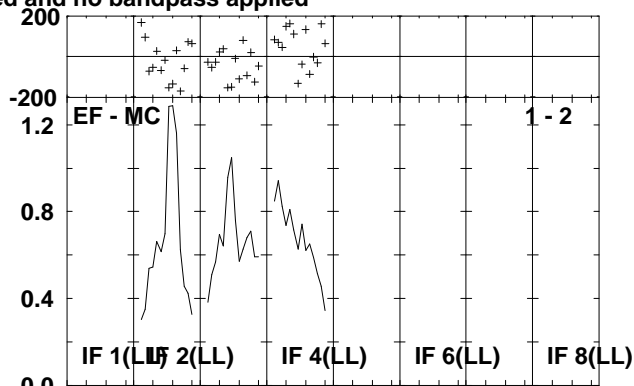
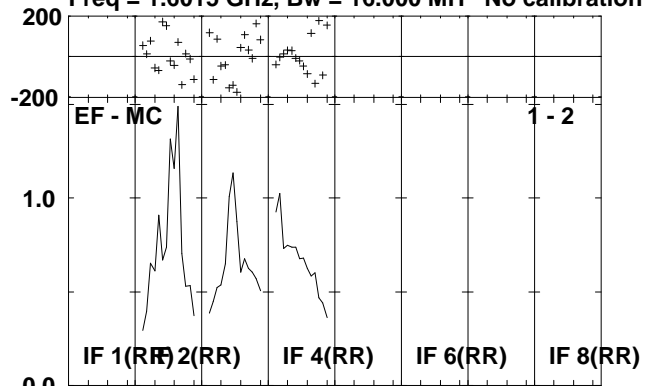

Lower frame: Milli Ampl Jy Top frame: Phas deg
Scalar averaged cross-power spectrum Several baselines displayed
Timerange: 00/23:08:20 to 00/23:15:16

Plot file version 118 created 26-APR-2010 13:27:19

HCG62 EA043.UVDATA.1

Freq = 1.6015 GHz, Bw = 16.000 MH No calibration applied and no bandpass applied

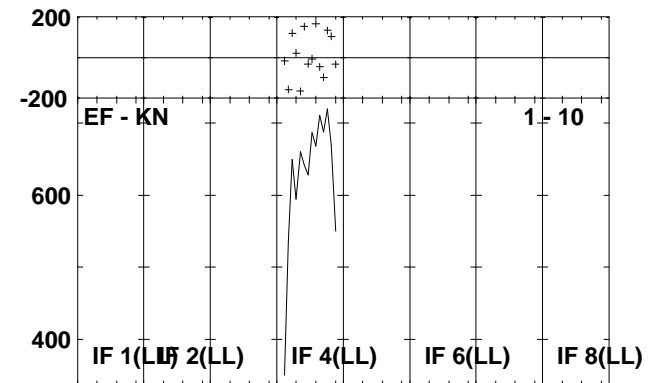
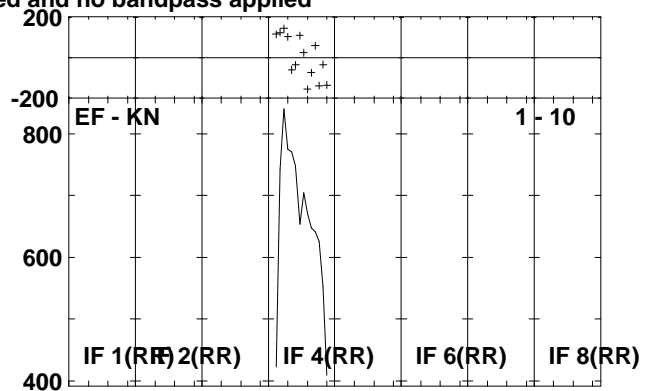
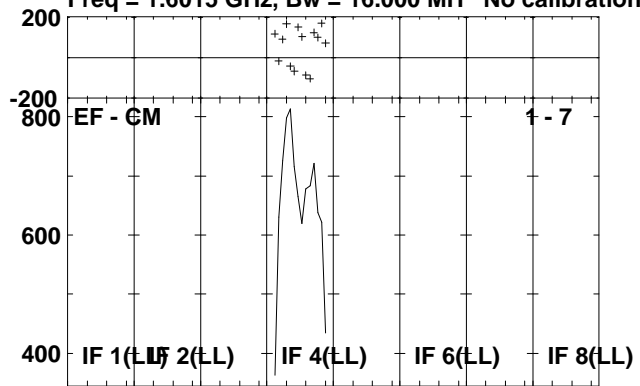

Lower frame: Micro Ampl Jy Top frame: Phas deg
Scalar averaged cross-power spectrum Several baselines displayed
Timerange: 00/23:08:20 to 00/23:15:16

Plot file version 119 created 26-APR-2010 13:27:20

J1246-07 EA043.UVDATA.1

Freq = 1.6015 GHz, Bw = 16.000 MH No calibration applied and no bandpass applied

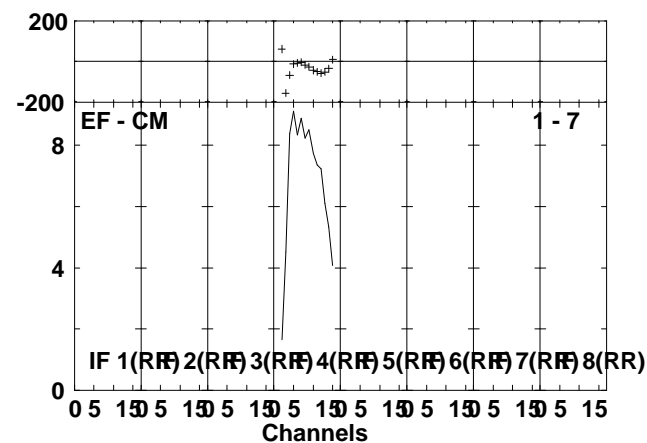
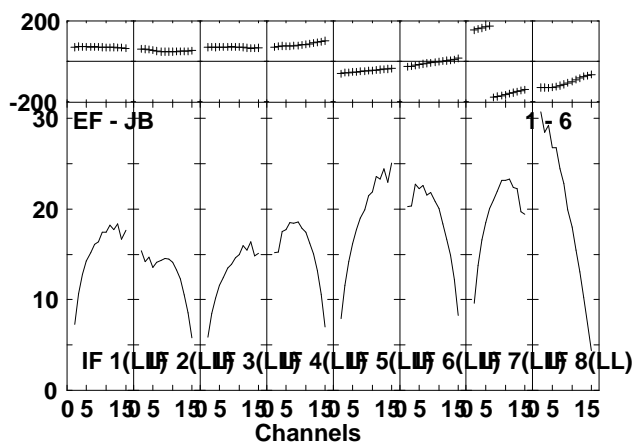
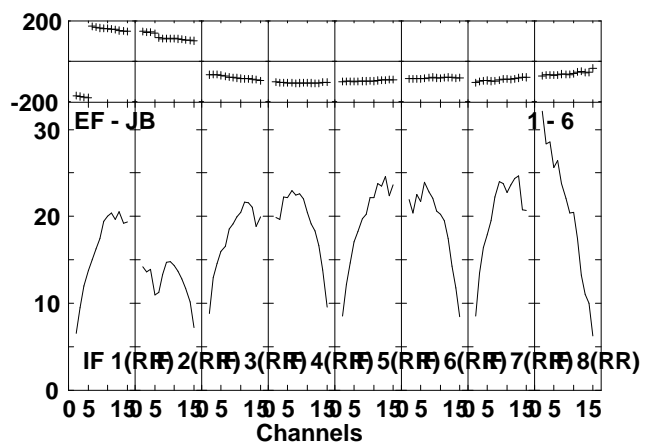
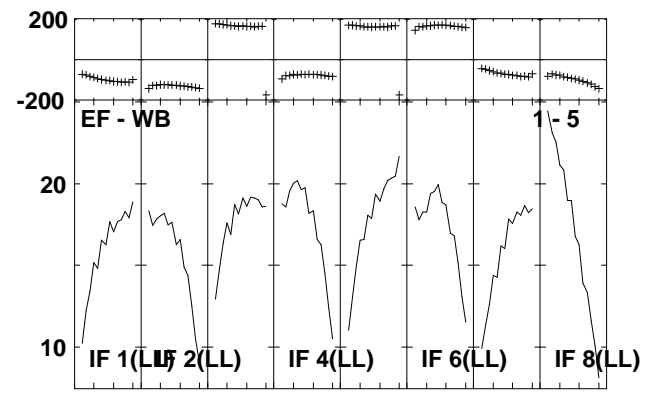
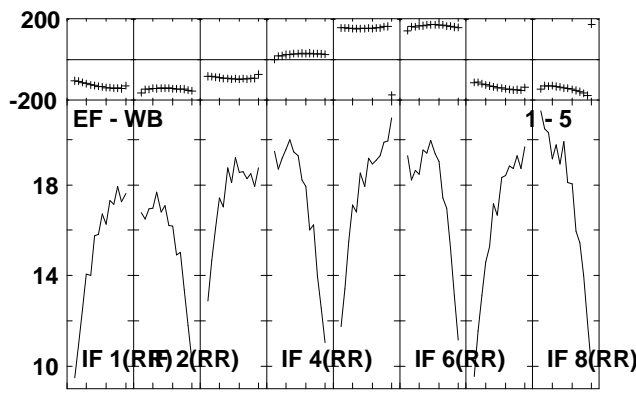
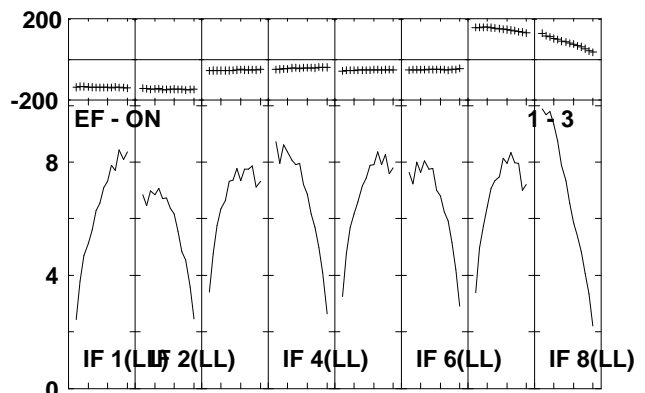
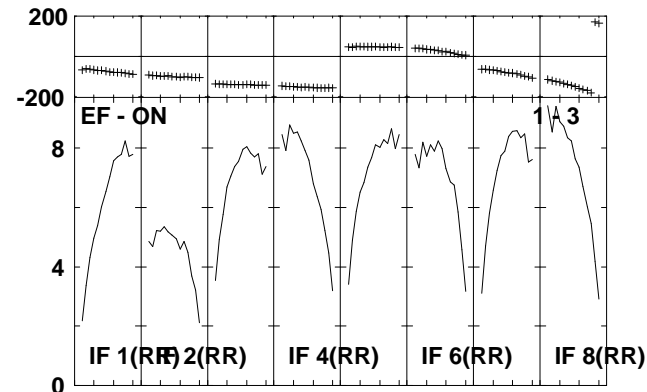
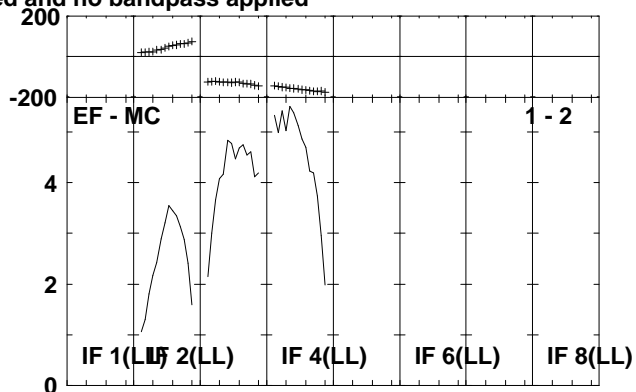
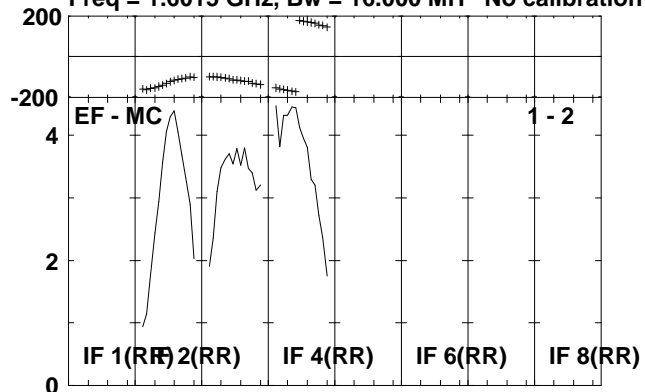

Lower frame: Milli Ampl Jy Top frame: Phas deg
Scalar averaged cross-power spectrum Several baselines displayed
Timerange: 00/23:15:20 to 00/23:17:16

Plot file version 120 created 26-APR-2010 13:27:20

J1246-07 EA043.UVDATA.1

Freq = 1.6015 GHz, Bw = 16.000 MH No calibration applied and no bandpass applied

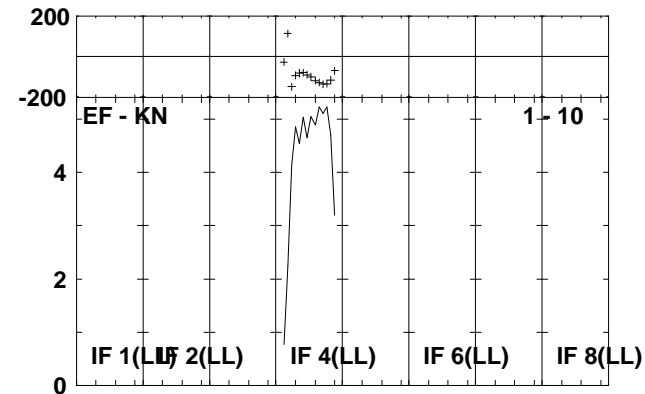
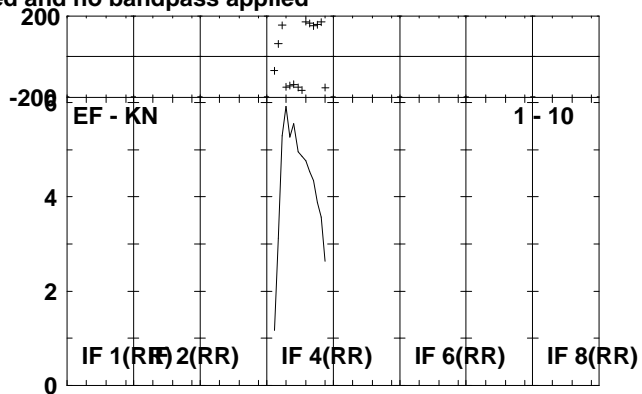
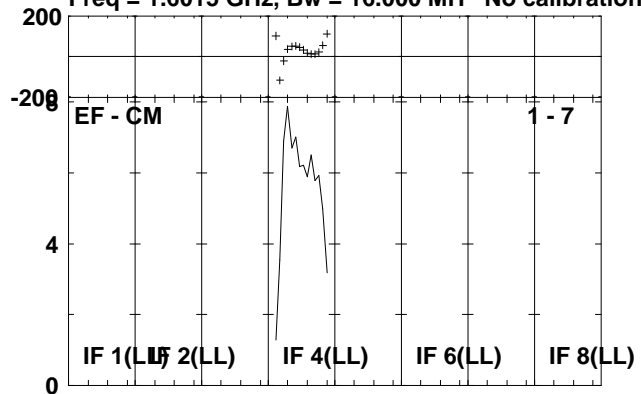

Lower frame: Milli Ampl Jy Top frame: Phas deg
Scalar averaged cross-power spectrum Several baselines displayed
Timerange: 00/23:15:20 to 00/23:17:16

Plot file version 121 created 26-APR-2010 13:27:21

HCG62 EA043.UVDATA.1

Freq = 1.6015 GHz, Bw = 16.000 MH No calibration applied and no bandpass applied

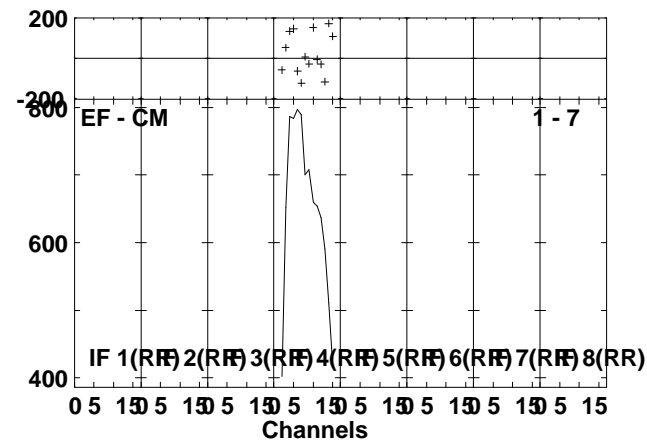
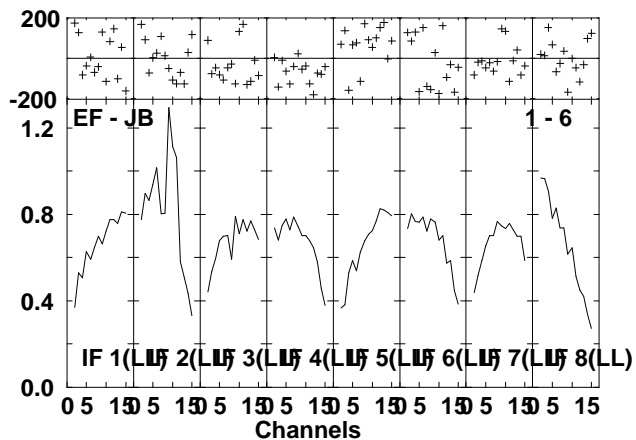
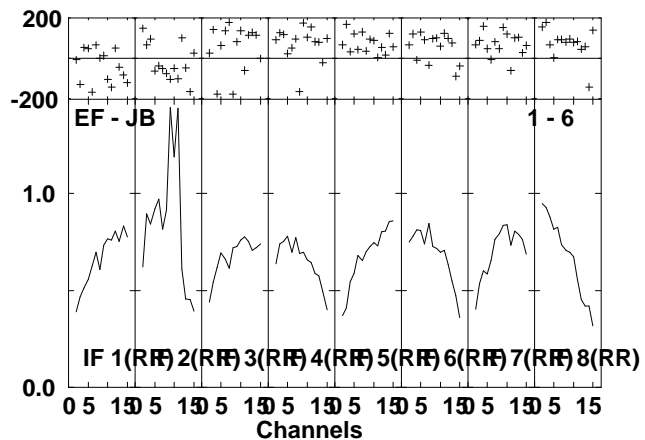
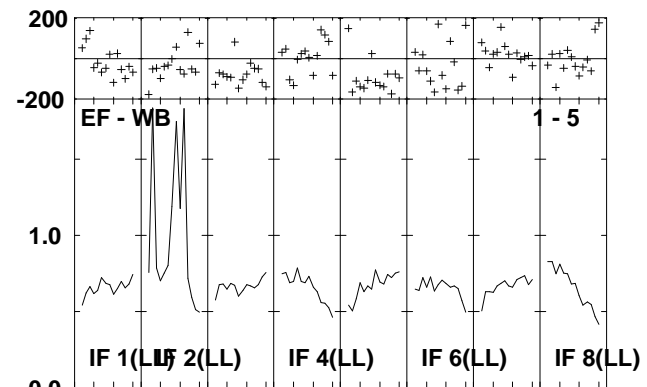
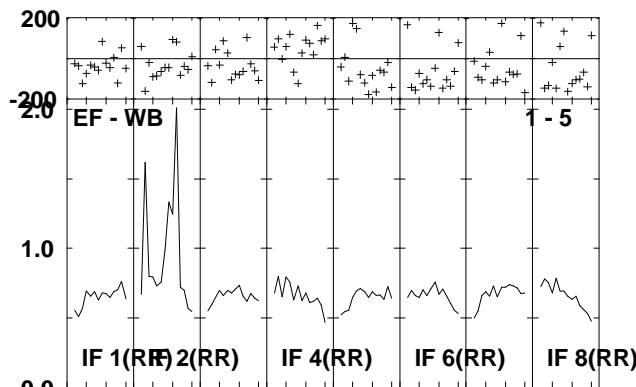
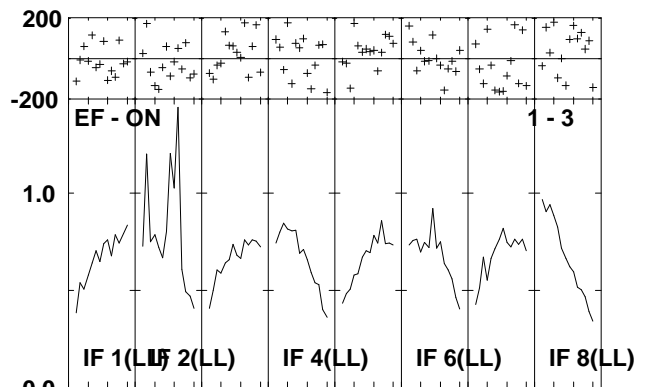
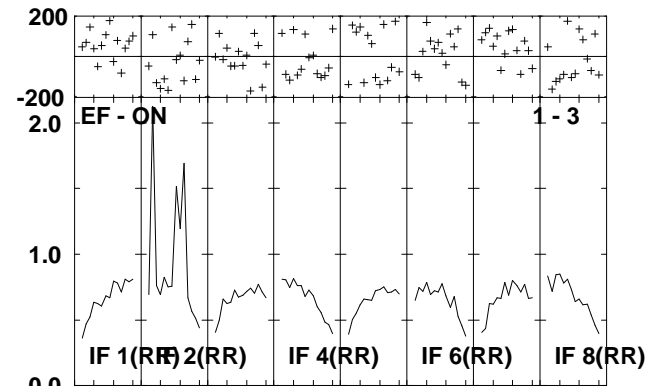
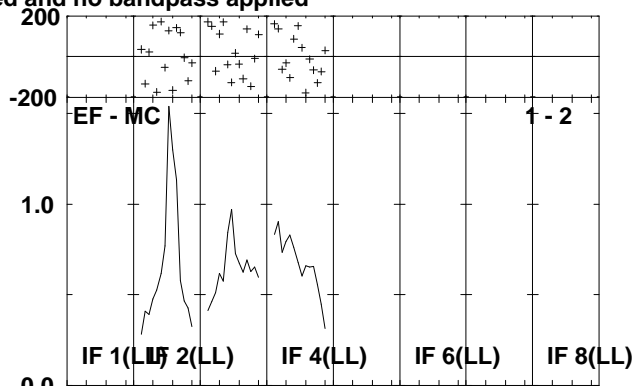
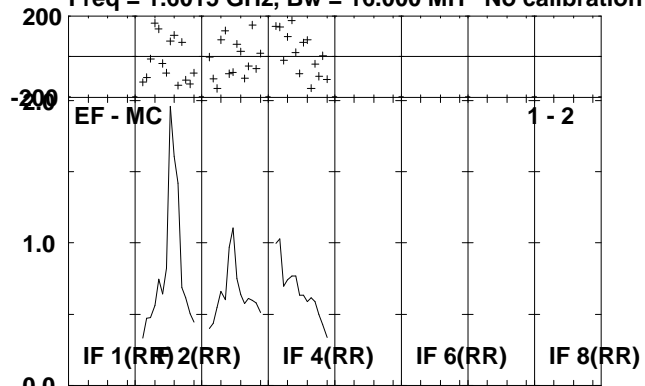

Lower frame: Milli Ampl Jy Top frame: Phas deg
Scalar averaged cross-power spectrum Several baselines displayed
Timerange: 00/23:18:20 to 00/23:25:16

Plot file version 122 created 26-APR-2010 13:27:22

HCG62 EA043.UVDATA.1

Freq = 1.6015 GHz, Bw = 16.000 MH No calibration applied and no bandpass applied

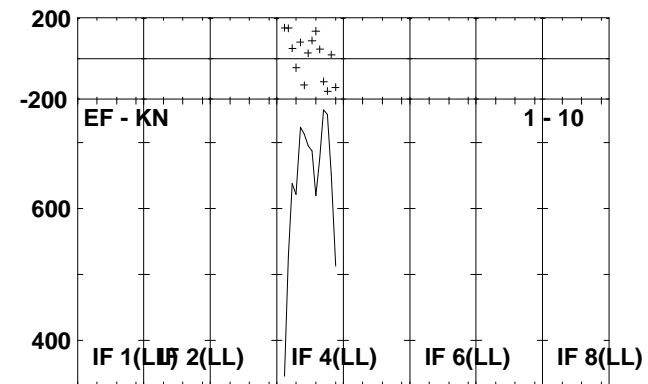
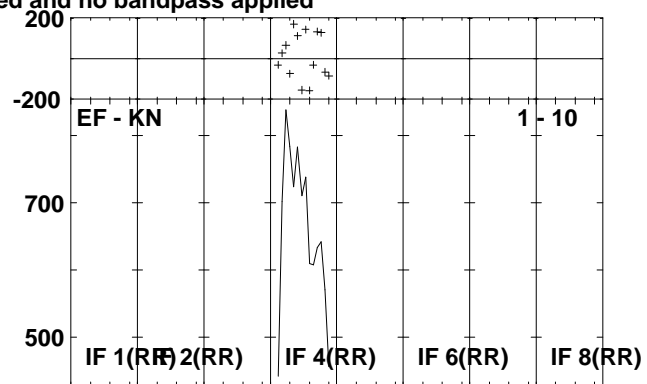
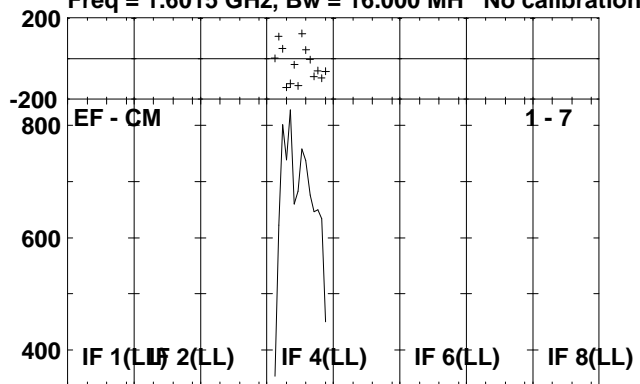

Lower frame: Micro Ampl Jy Top frame: Phas deg
Scalar averaged cross-power spectrum Several baselines displayed
Timerange: 00/23:18:20 to 00/23:25:16

Plot file version 123 created 26-APR-2010 13:27:23

J1246-07 EA043.UVDATA.1

Freq = 1.6015 GHz, Bw = 16.000 MH No calibration applied and no bandpass applied

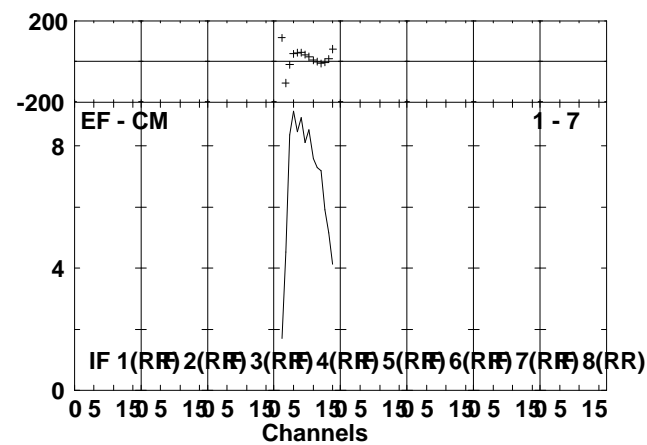
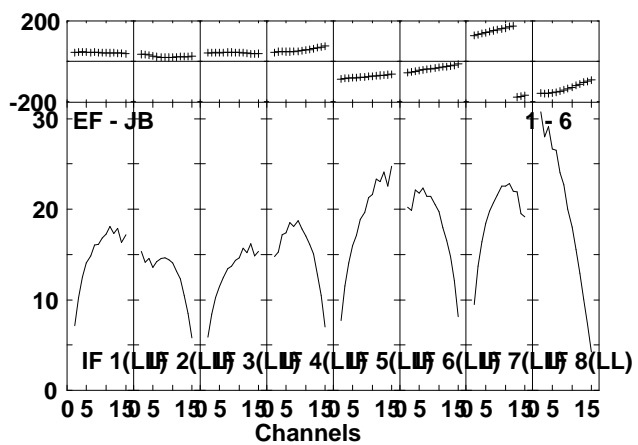
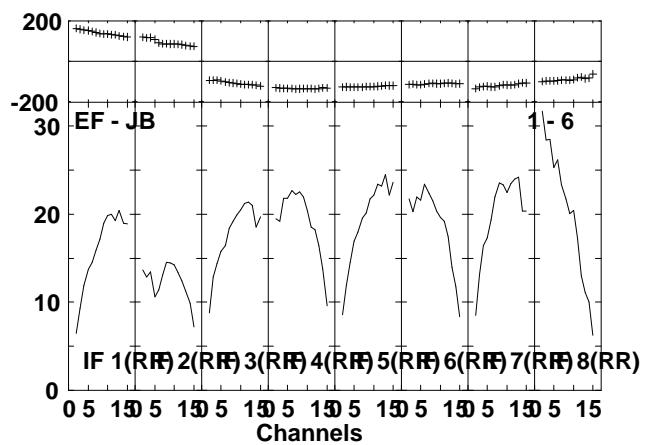
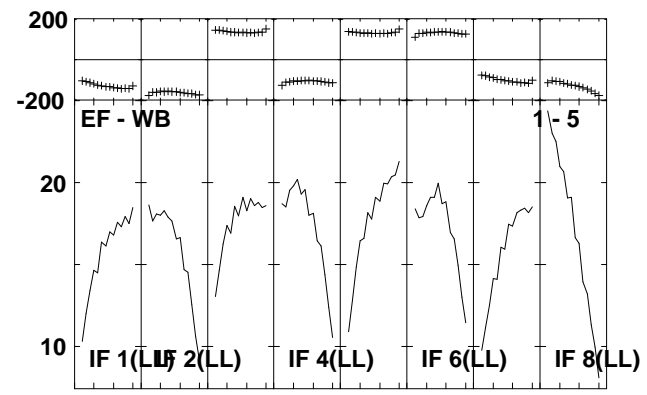
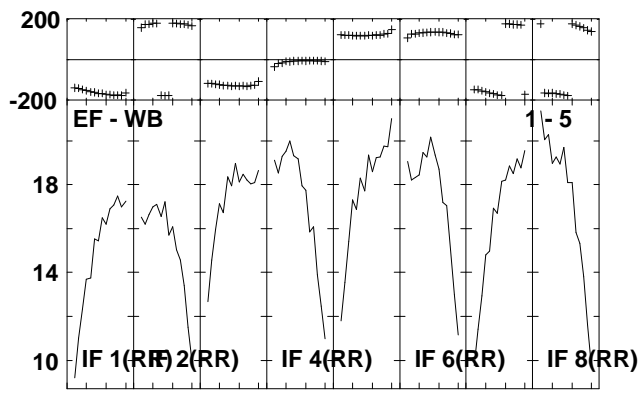
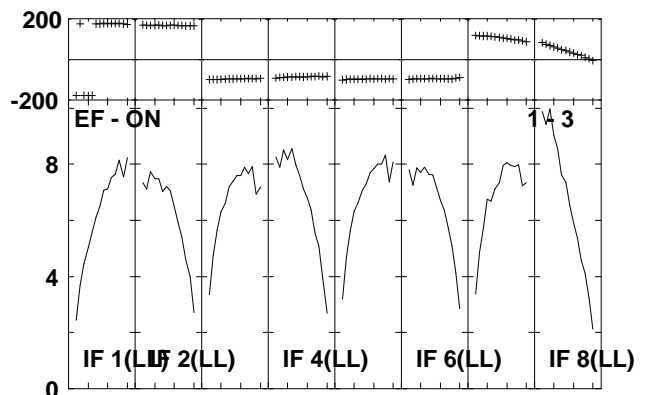
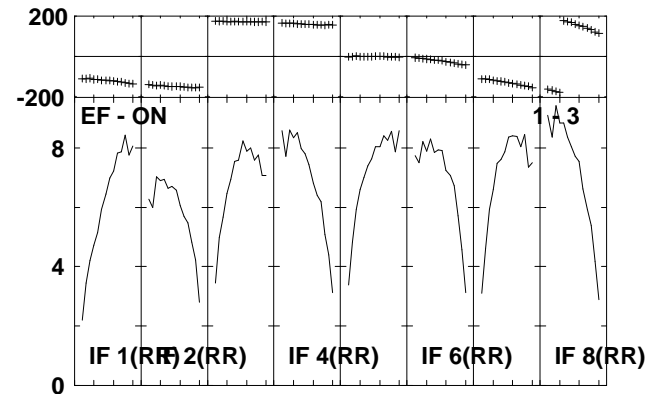
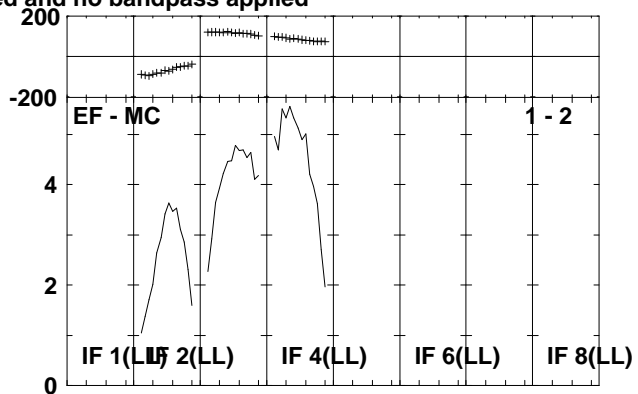
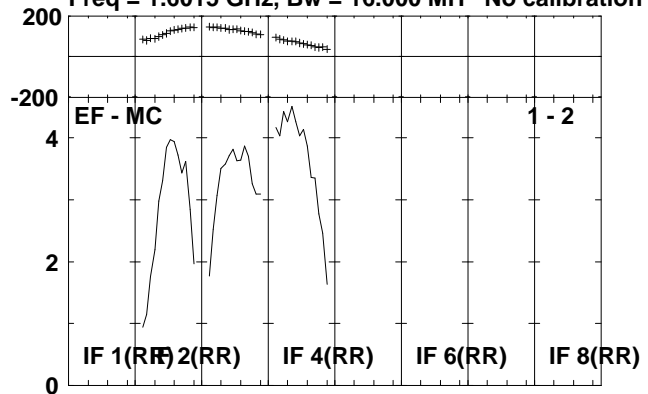

Lower frame: Milli Ampl Jy Top frame: Phas deg
Scalar averaged cross-power spectrum Several baselines displayed
Timerange: 00/23:25:20 to 00/23:27:16

Plot file version 124 created 26-APR-2010 13:27:23

J1246-07 EA043.UVDATA.1

Freq = 1.6015 GHz, Bw = 16.000 MH No calibration applied and no bandpass applied

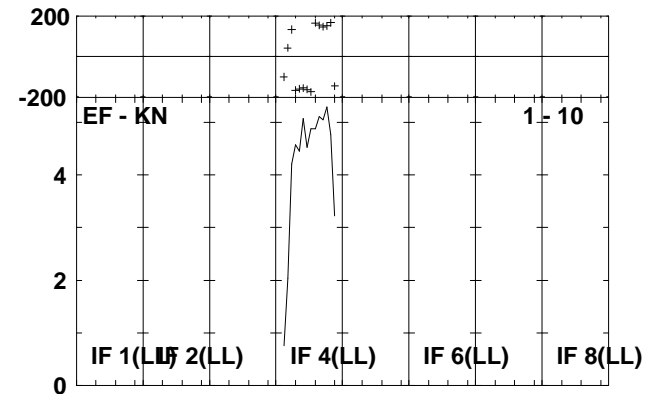
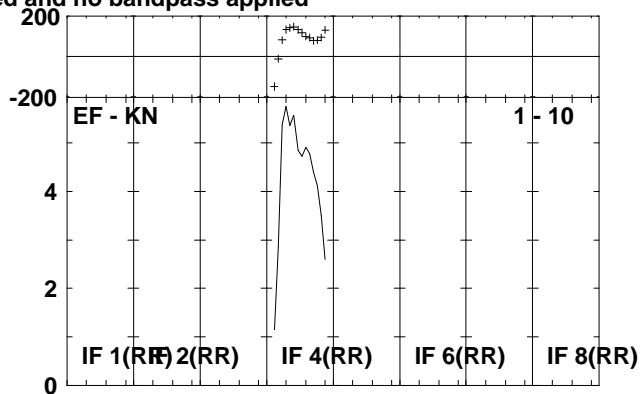
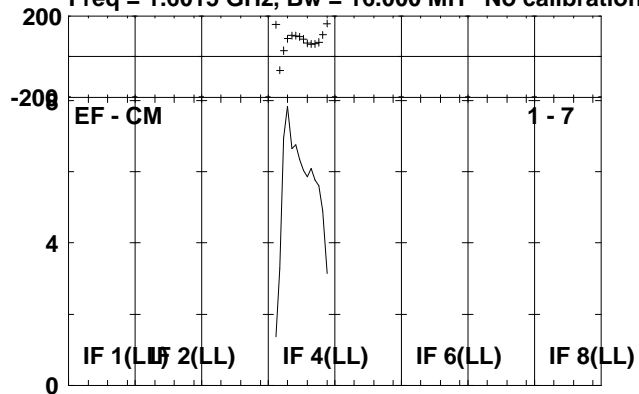

Lower frame: Milli Ampl Jy Top frame: Phas deg
Scalar averaged cross-power spectrum Several baselines displayed
Timerange: 00/23:25:20 to 00/23:27:16

Plot file version 125 created 26-APR-2010 13:27:24

HCG62 EA043.UVDATA.1

Freq = 1.6015 GHz, Bw = 16.000 MH No calibration applied and no bandpass applied

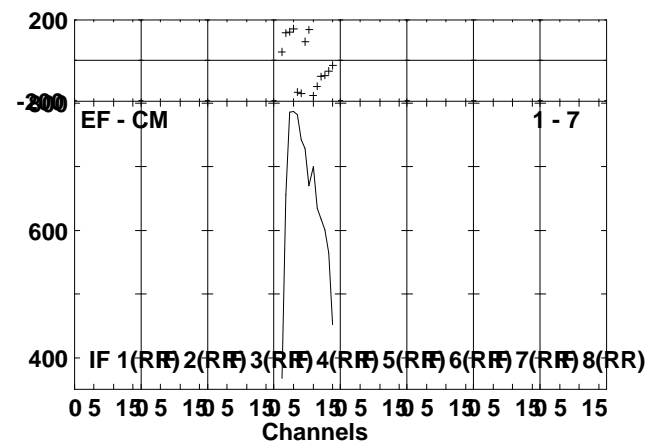
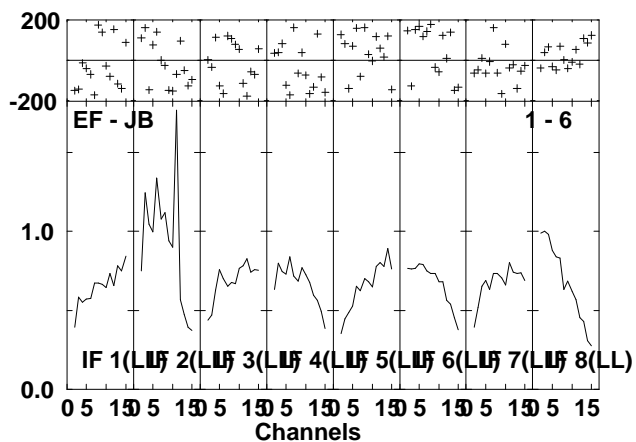
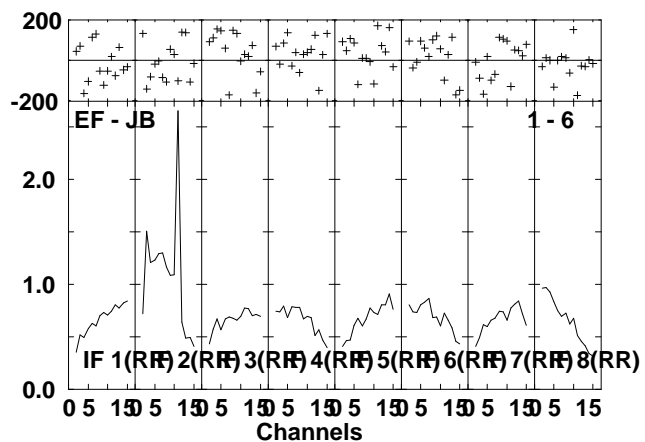
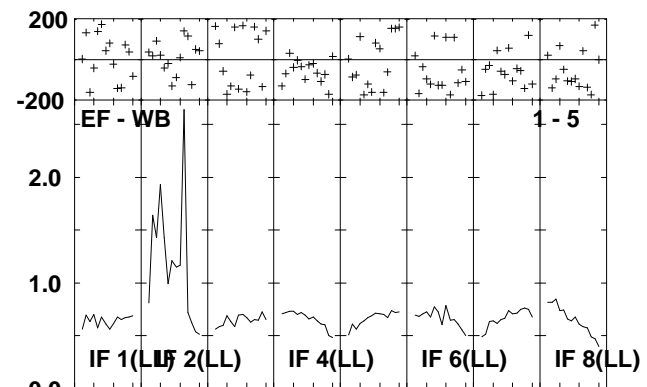
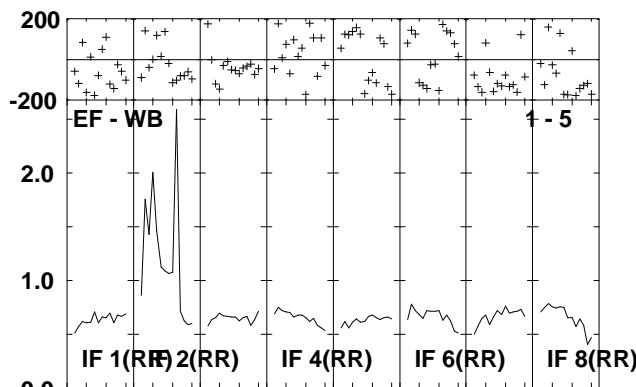
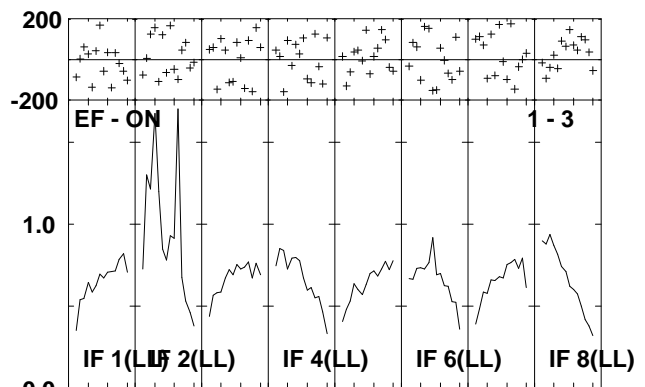
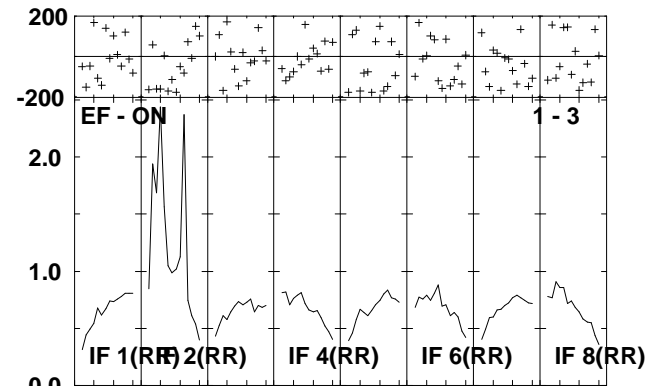
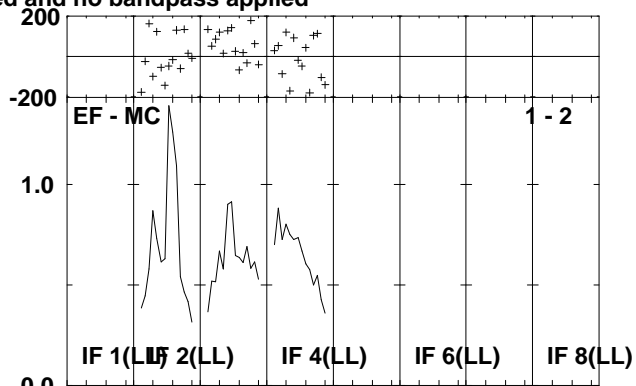
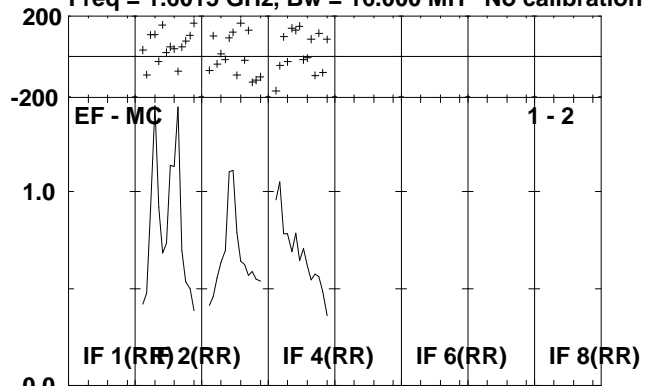

Lower frame: Milli Ampl Jy Top frame: Phas deg
Scalar averaged cross-power spectrum Several baselines displayed
Timerange: 00/23:28:20 to 00/23:35:16

Plot file version 126 created 26-APR-2010 13:27:25

HCG62 EA043.UVDATA.1

Freq = 1.6015 GHz, Bw = 16.000 MH No calibration applied and no bandpass applied

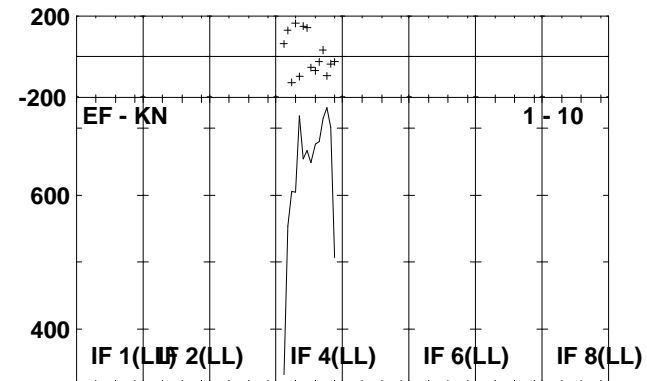
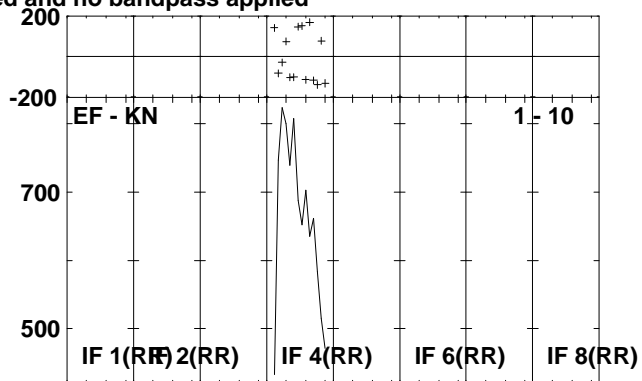
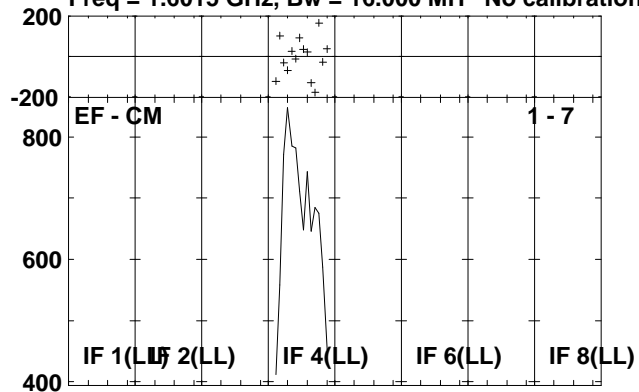

Lower frame: Micro Ampl Jy Top frame: Phas deg
Scalar averaged cross-power spectrum Several baselines displayed
Timerange: 00/23:28:20 to 00/23:35:16

Plot file version 127 created 26-APR-2010 13:27:26

J1246-07 EA043.UVDATA.1

Freq = 1.6015 GHz, Bw = 16.000 MH No calibration applied and no bandpass applied

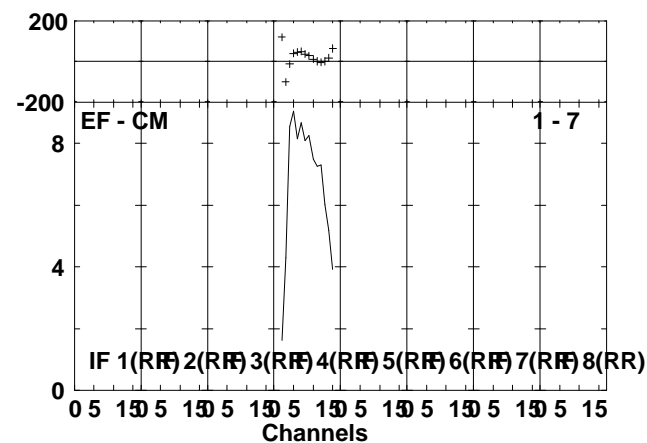
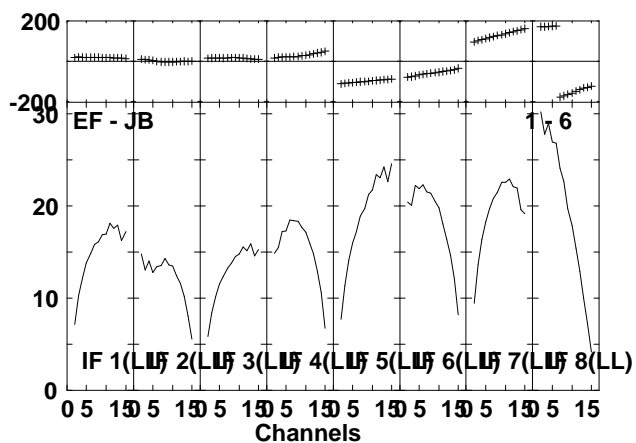
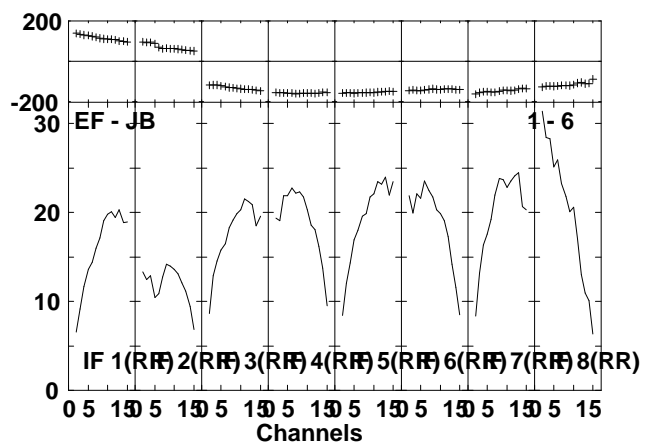
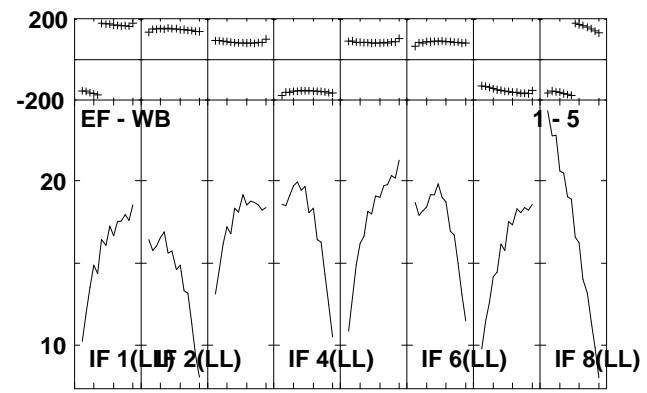
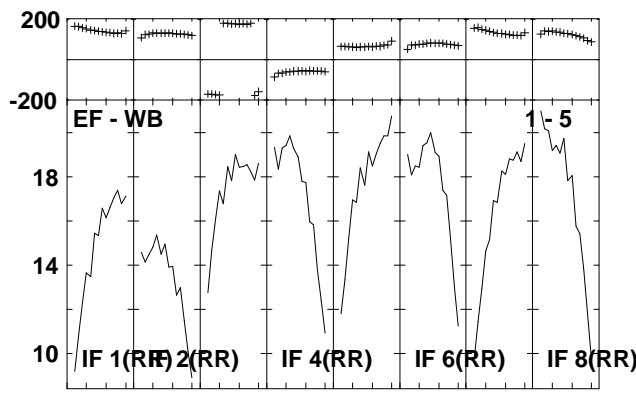
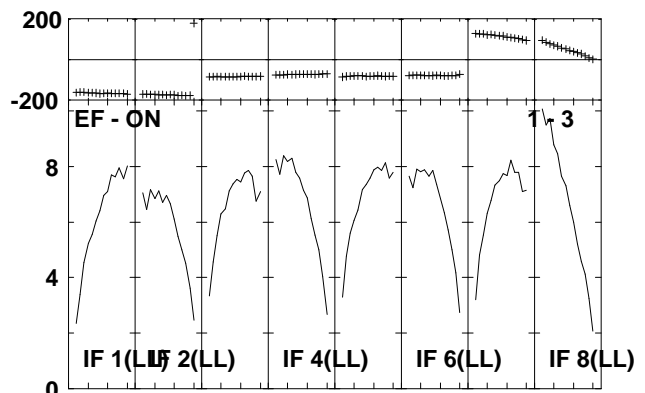
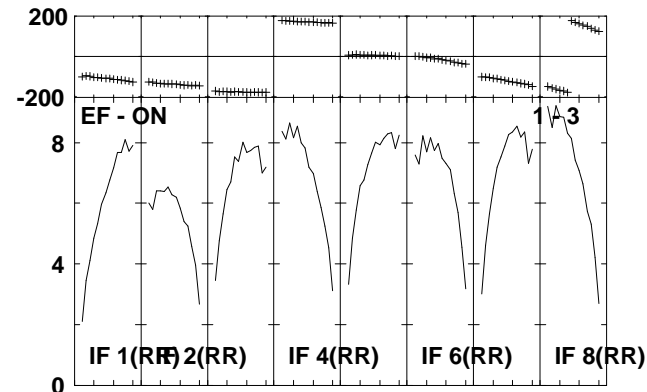
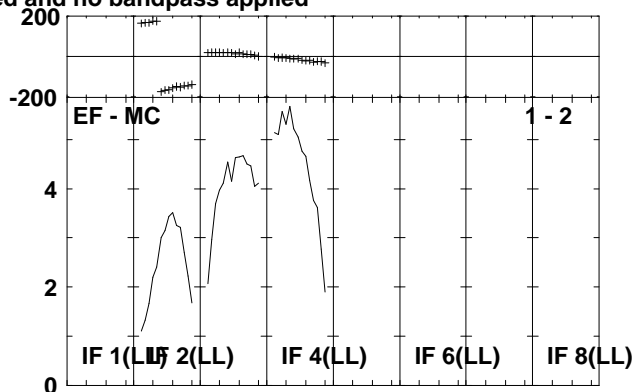
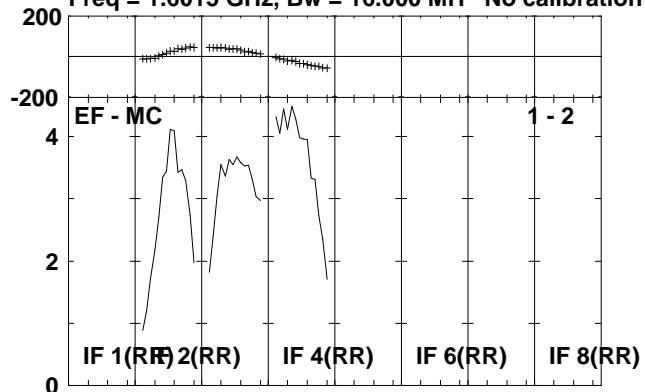

Lower frame: Milli Ampl Jy Top frame: Phas deg
Scalar averaged cross-power spectrum Several baselines displayed
Timerange: 00/23:35:20 to 00/23:37:16

Plot file version 128 created 26-APR-2010 13:27:26

J1246-07 EA043.UVDATA.1

Freq = 1.6015 GHz, Bw = 16.000 MH No calibration applied and no bandpass applied

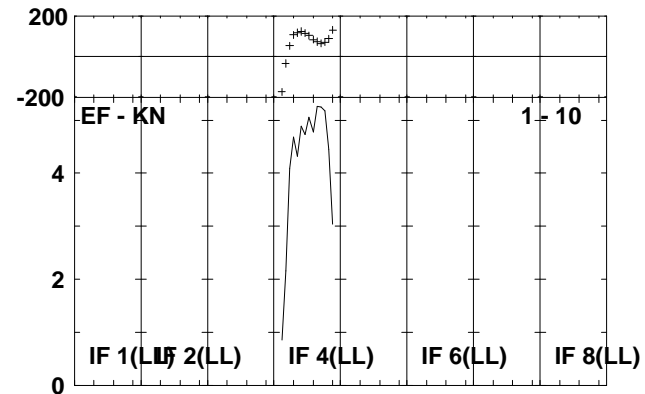
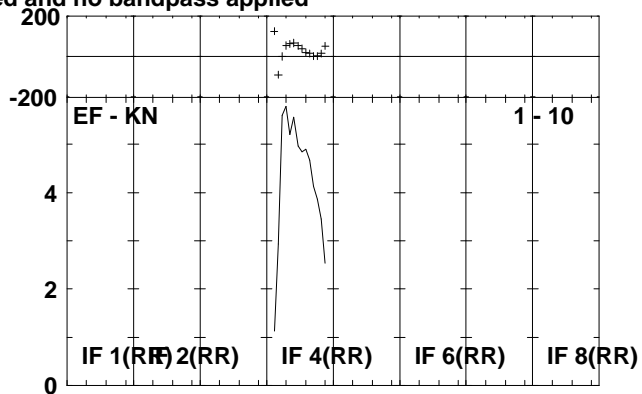
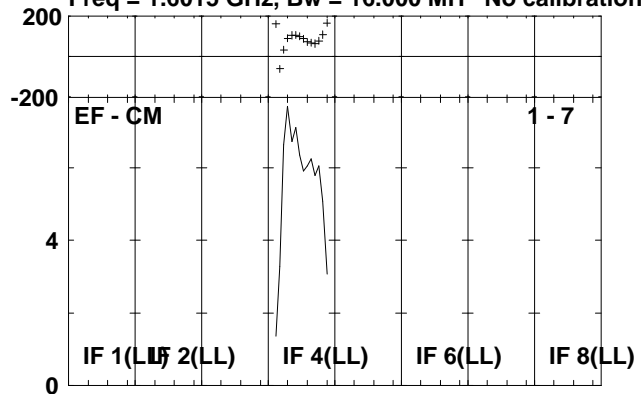

Lower frame: Milli Ampl Jy Top frame: Phas deg
Scalar averaged cross-power spectrum Several baselines displayed
Timerange: 00/23:35:20 to 00/23:37:16

Plot file version 129 created 26-APR-2010 13:27:27

HCG62 EA043.UVDATA.1

Freq = 1.6015 GHz, Bw = 16.000 MH No calibration applied and no bandpass applied

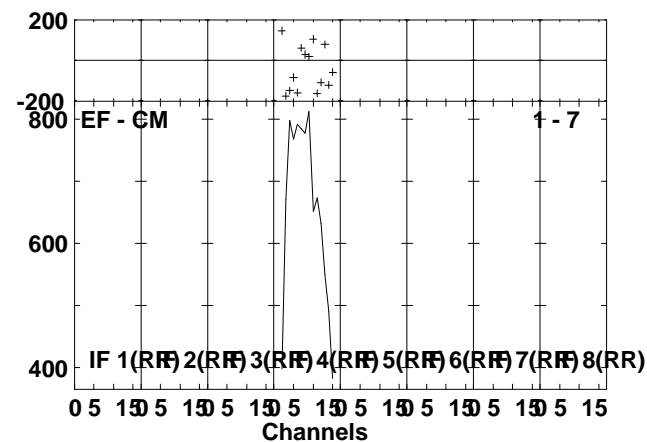
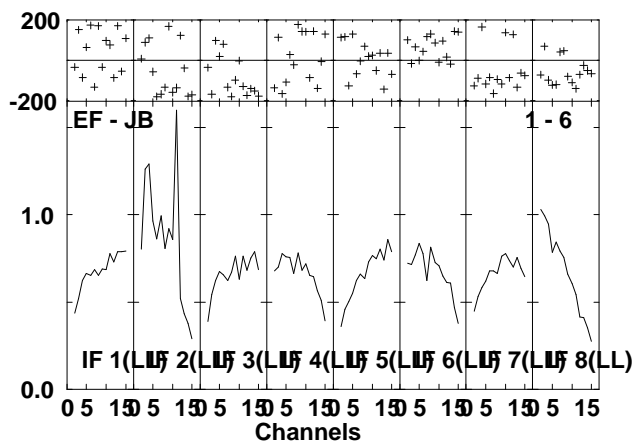
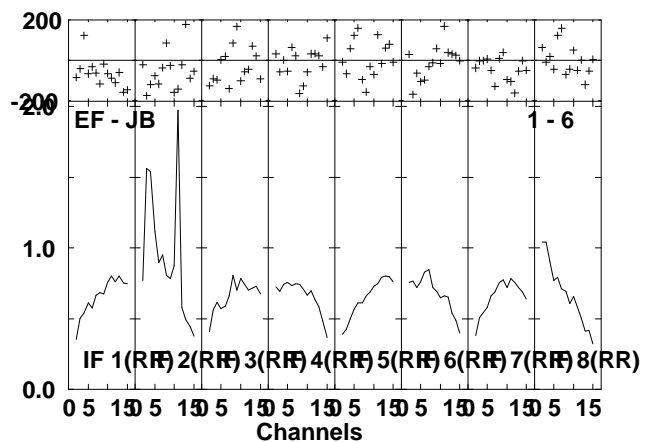
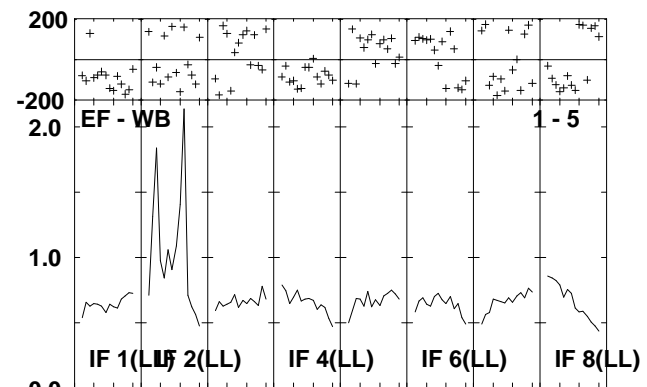
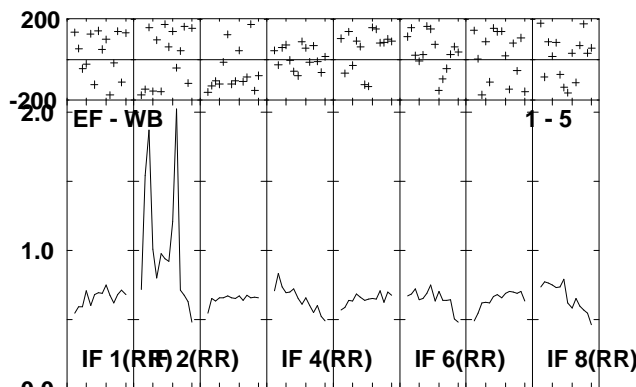
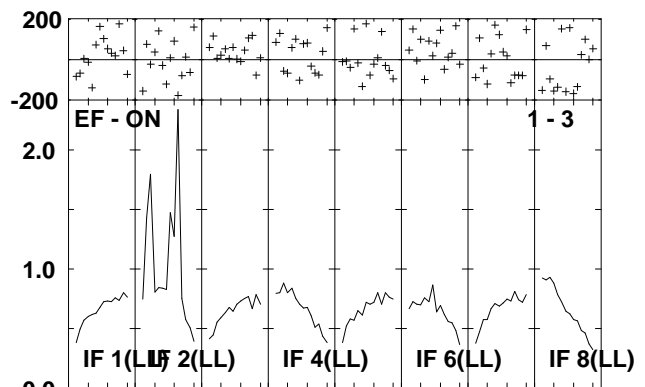
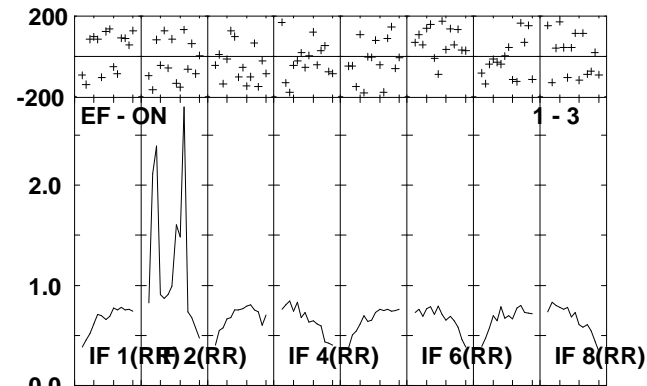
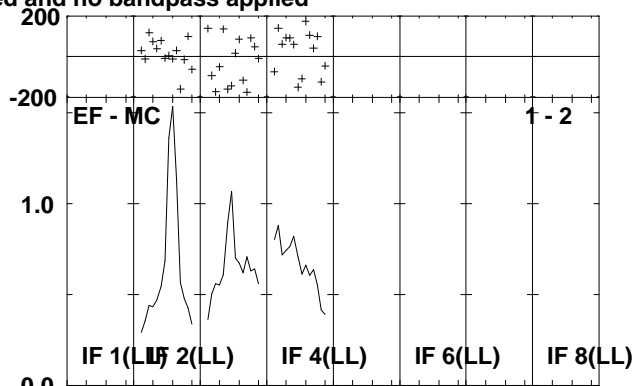
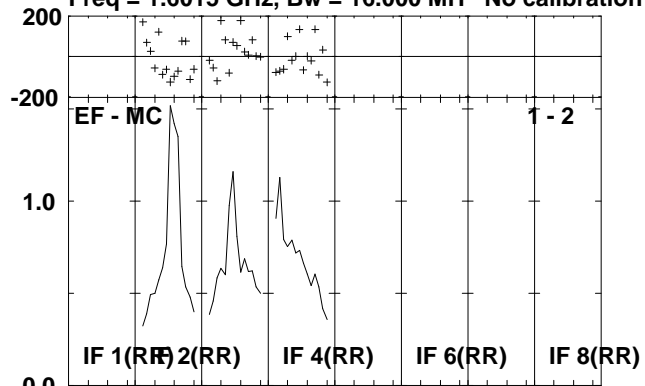

Lower frame: Milli Ampl Jy Top frame: Phas deg
Scalar averaged cross-power spectrum Several baselines displayed
Timerange: 00/23:38:20 to 00/23:45:16

Plot file version 130 created 26-APR-2010 13:27:28

HCG62 EA043.UVDATA.1

Freq = 1.6015 GHz, Bw = 16.000 MH No calibration applied and no bandpass applied

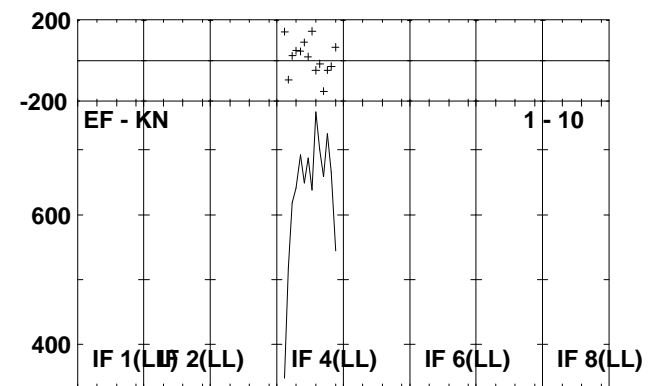
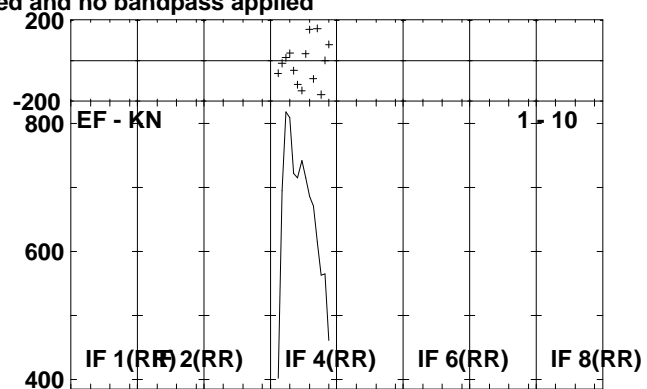
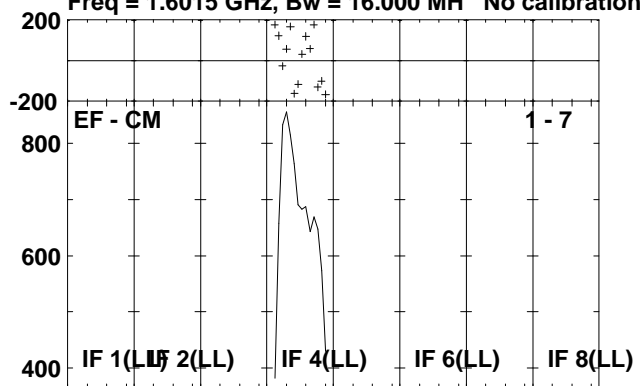

Lower frame: Micro Ampl Jy Top frame: Phas deg
Scalar averaged cross-power spectrum Several baselines displayed
Timerange: 00/23:38:20 to 00/23:45:16

Plot file version 131 created 26-APR-2010 13:27:29

J1246-07 EA043.UVDATA.1

Freq = 1.6015 GHz, Bw = 16.000 MH No calibration applied and no bandpass applied

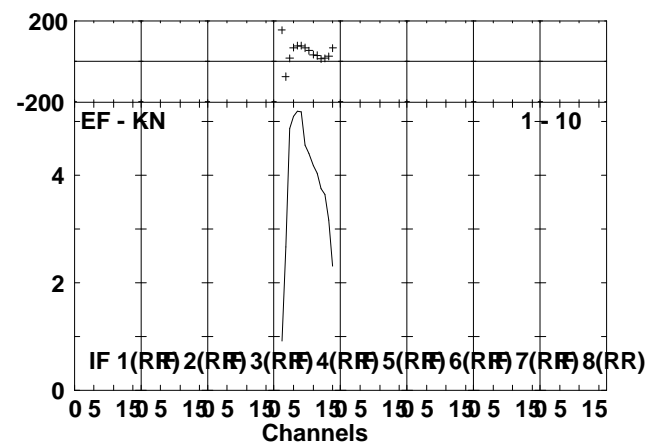
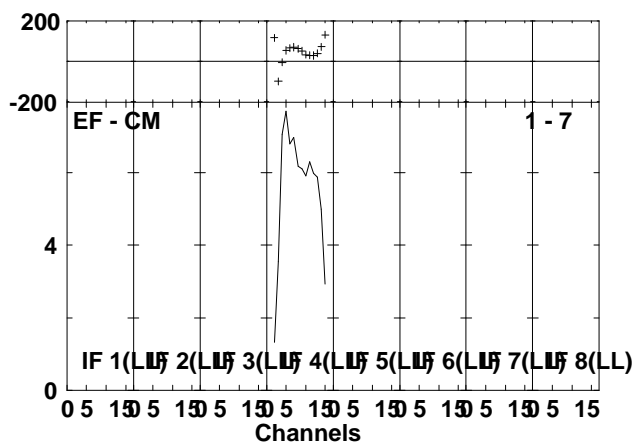
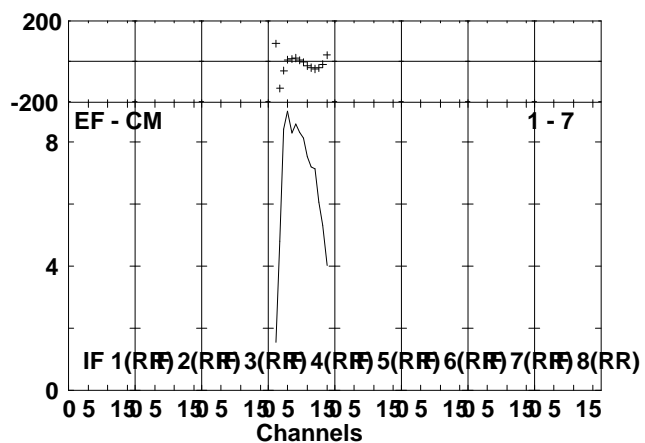
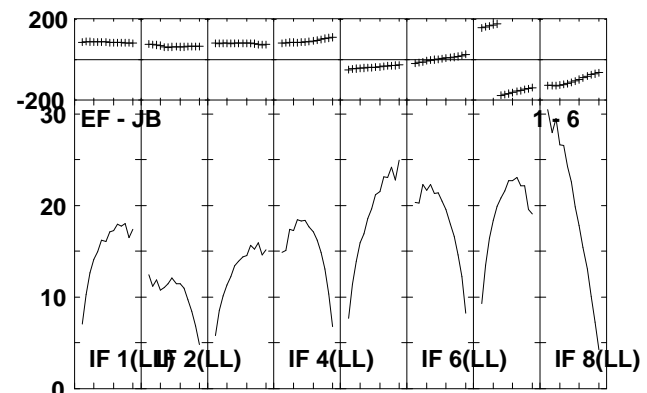
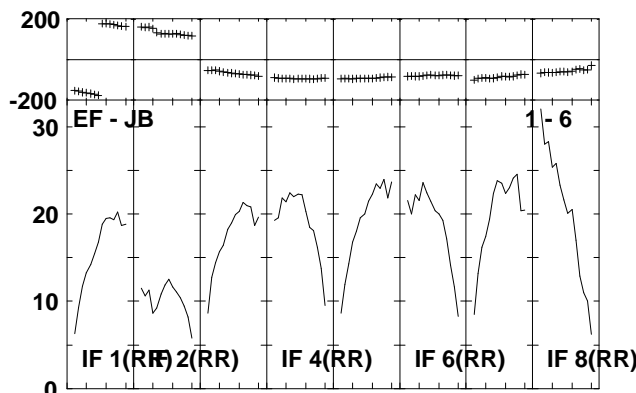
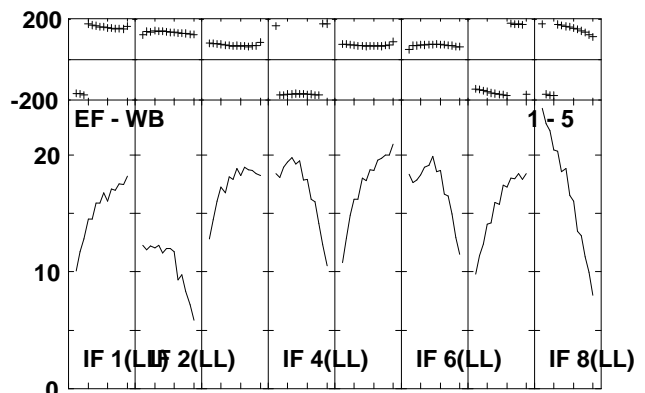
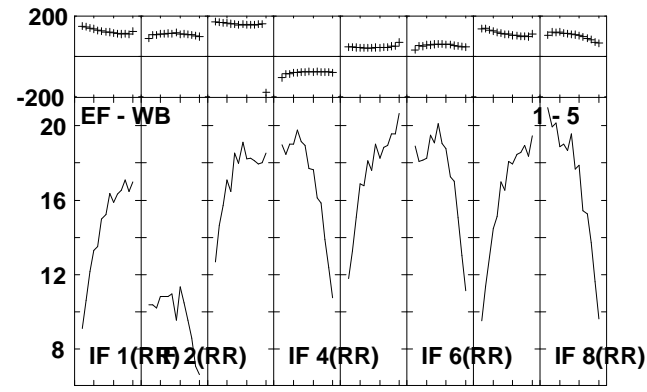
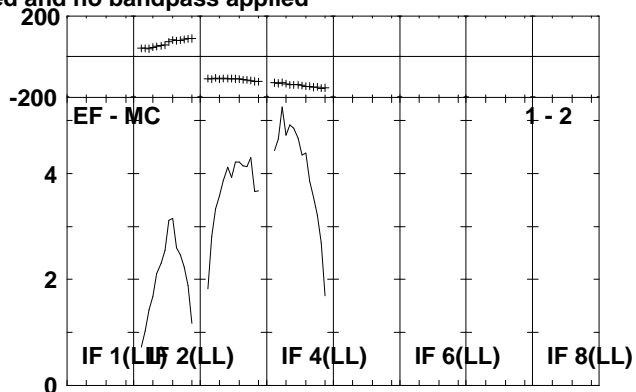
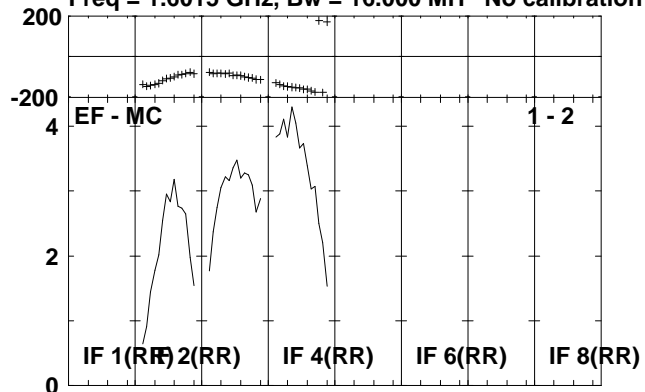

Lower frame: Milli Ampl Jy Top frame: Phas deg
Scalar averaged cross-power spectrum Several baselines displayed
Timerange: 00/23:45:20 to 00/23:47:08

Plot file version 132 created 26-APR-2010 13:27:29
J1246-07 EA043.UVDATA.1
Freq = 1.6015 GHz, Bw = 16.000 MH No calibration applied and no bandpass applied

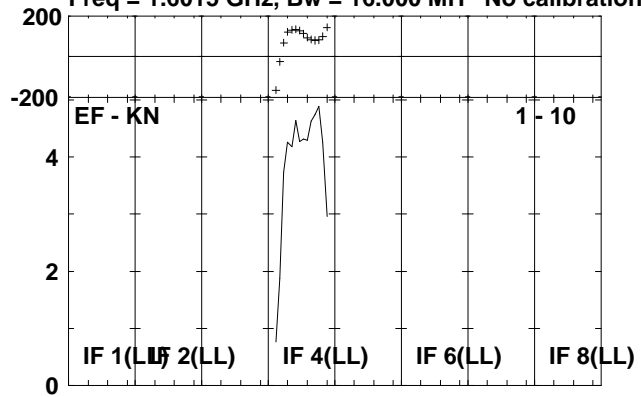

Lower frame: Milli Ampl Jy Top frame: Phas deg
Scalar averaged cross-power spectrum Several baselines displayed
Timerange: 00/23:45:20 to 00/23:47:08

Plot file version 133 created 26-APR-2010 13:27:30

HCG62 EA043.UVDATA.1

Freq = 1.6015 GHz, Bw = 16.000 MH No calibration applied and no bandpass applied

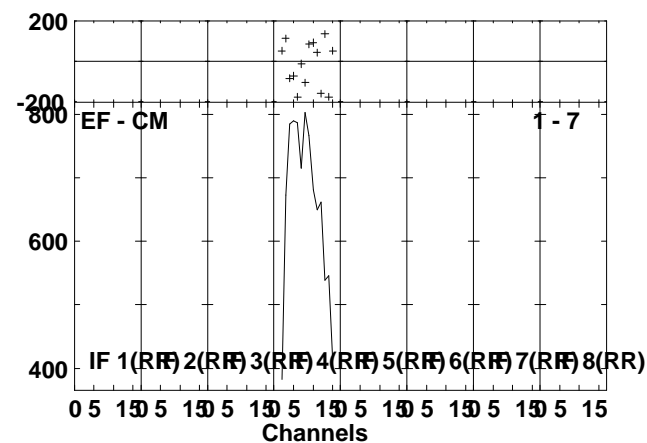
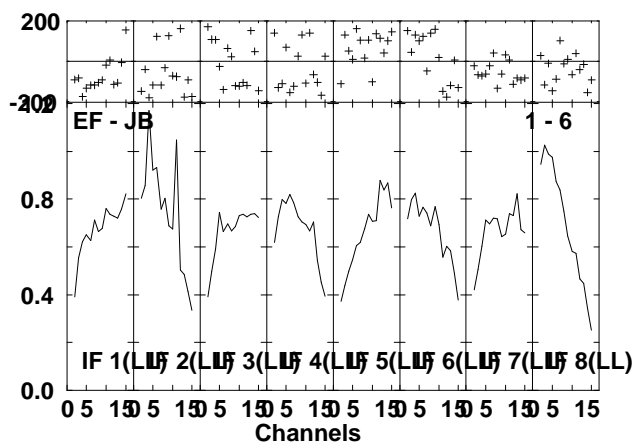
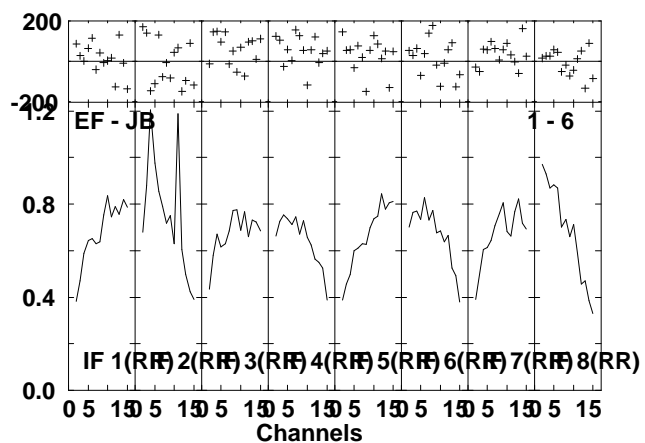
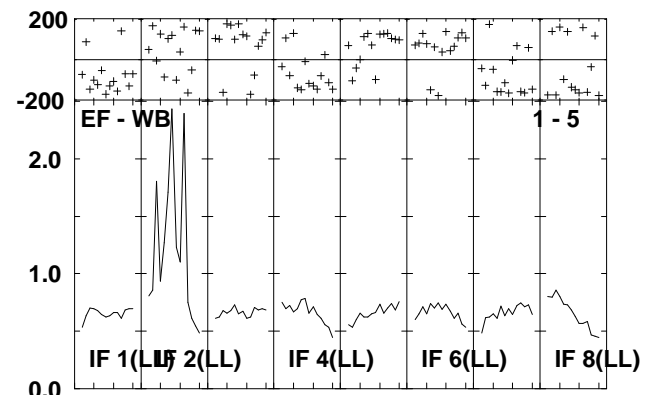
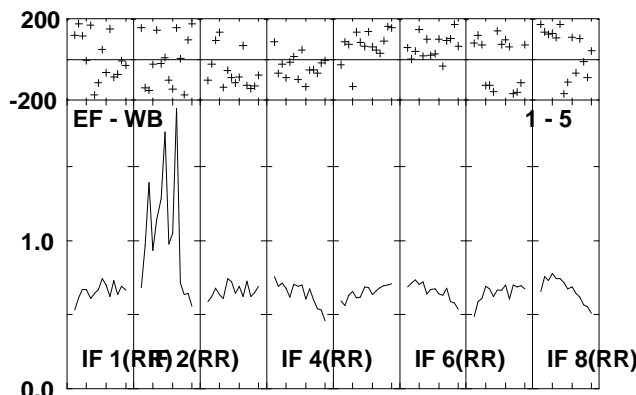
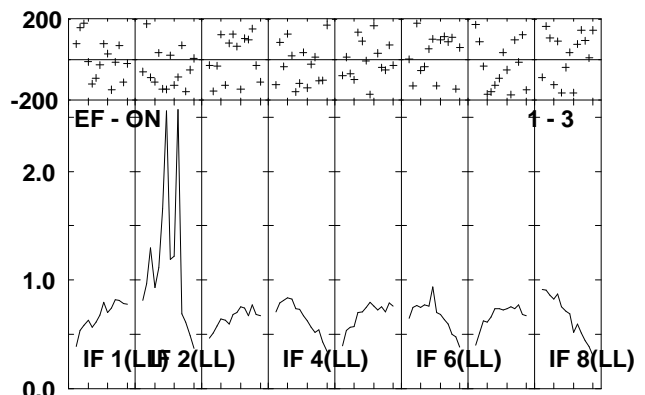
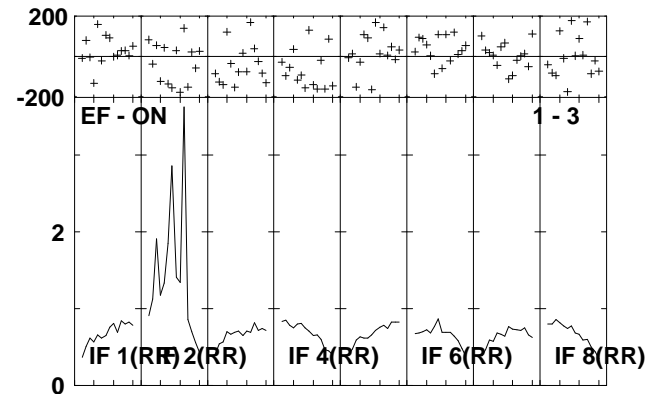
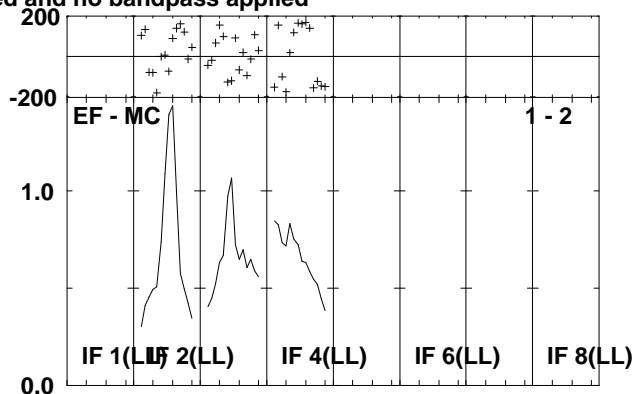
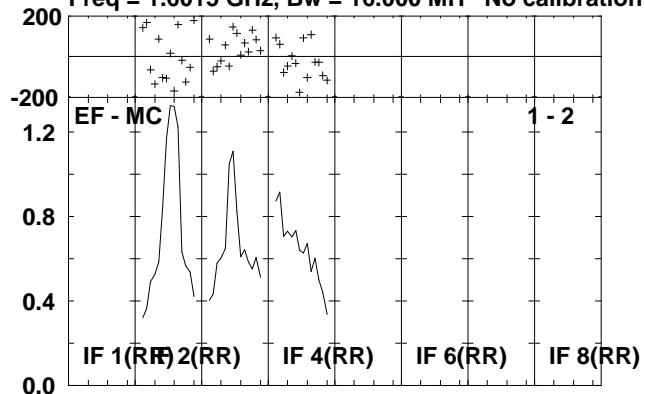

Lower frame: Milli Ampl Jy Top frame: Phas deg
Scalar averaged cross-power spectrum Several baselines displayed
Timerange: 00/23:48:20 to 00/23:55:16

Plot file version 134 created 26-APR-2010 13:27:31

HCG62 EA043.UVDATA.1

Freq = 1.6015 GHz, Bw = 16.000 MH No calibration applied and no bandpass applied

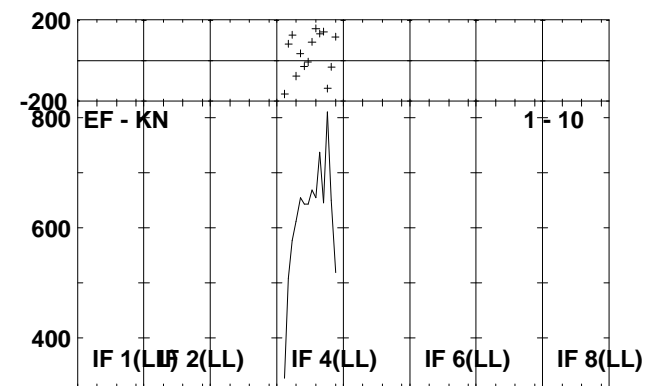
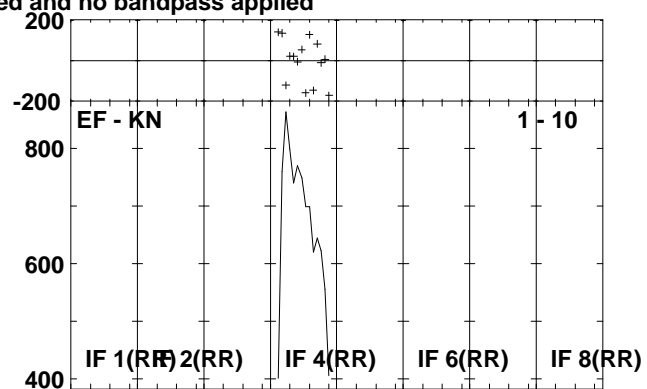
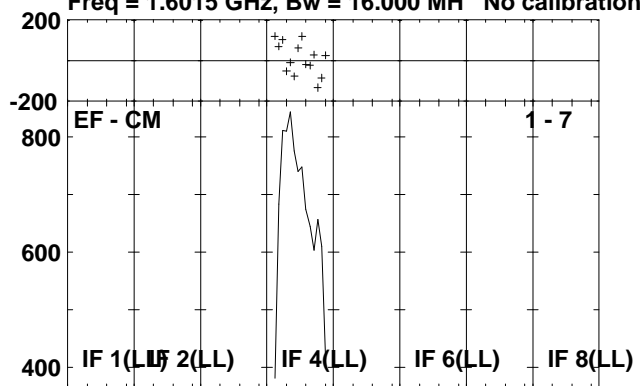

Lower frame: Micro Ampl Jy Top frame: Phas deg
Scalar averaged cross-power spectrum Several baselines displayed
Timerange: 00/23:48:20 to 00/23:55:16

Plot file version 135 created 26-APR-2010 13:27:32

J1246-07 EA043.UVDATA.1

Freq = 1.6015 GHz, Bw = 16.000 MH No calibration applied and no bandpass applied

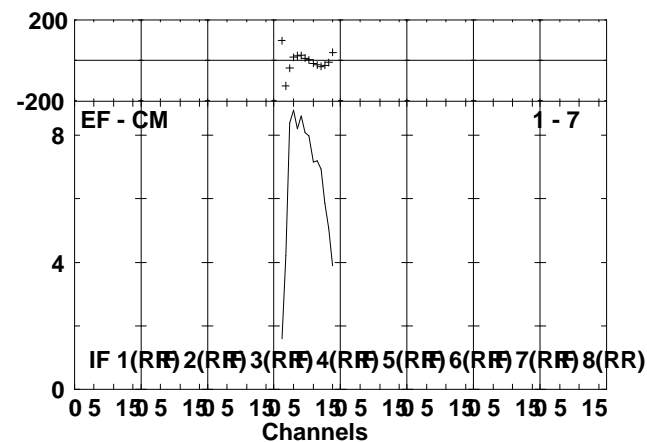
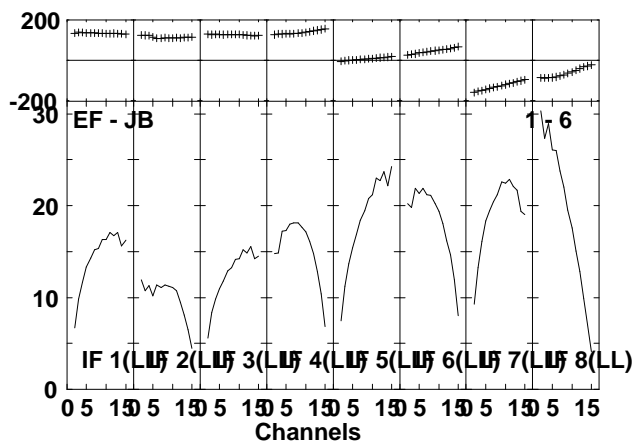
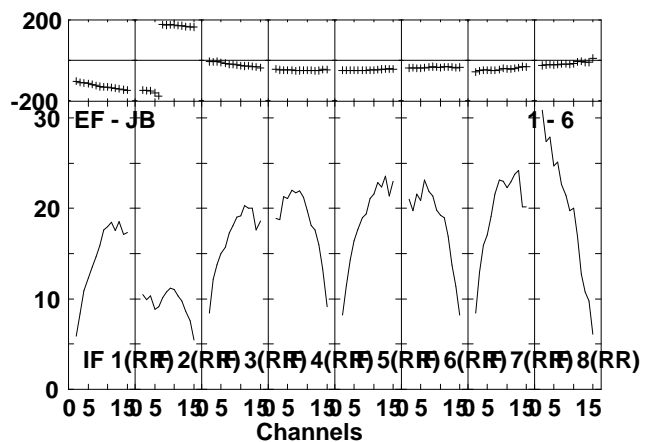
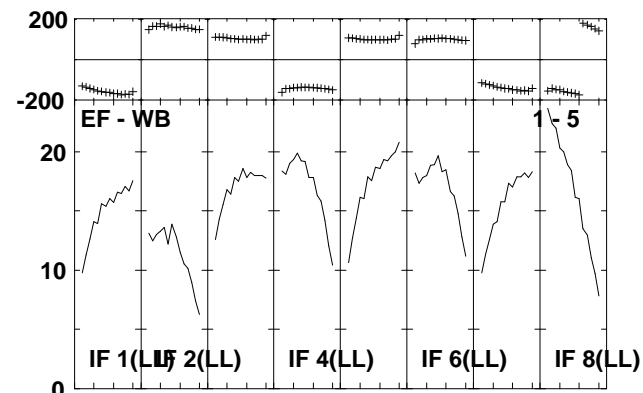
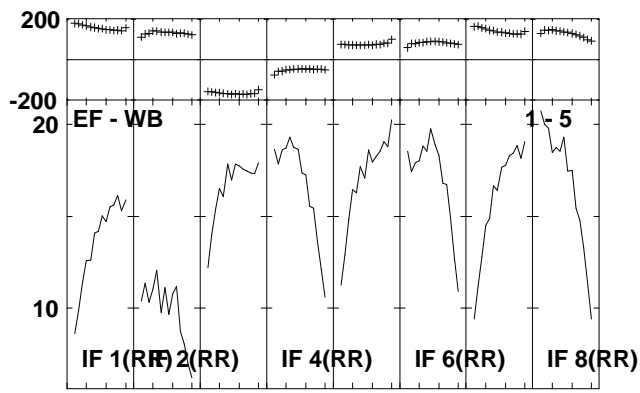
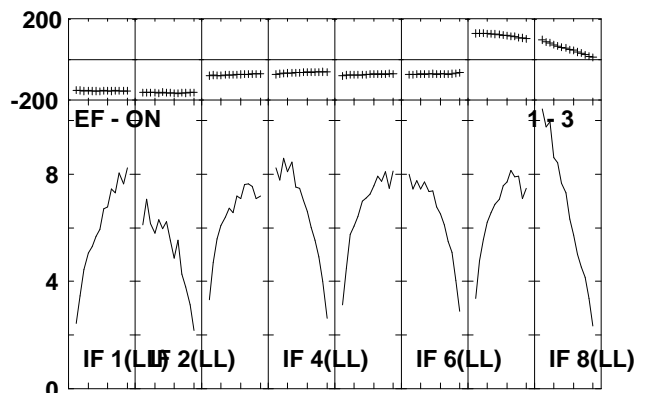
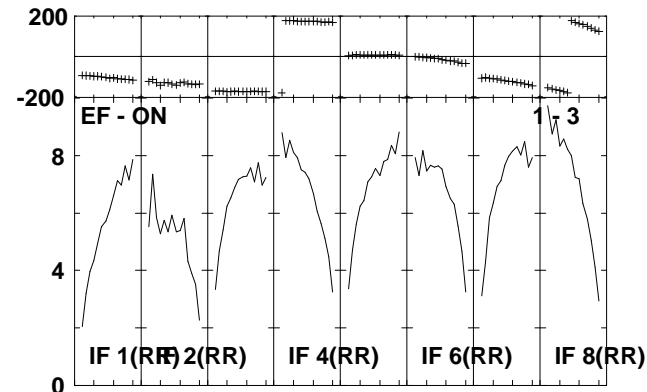
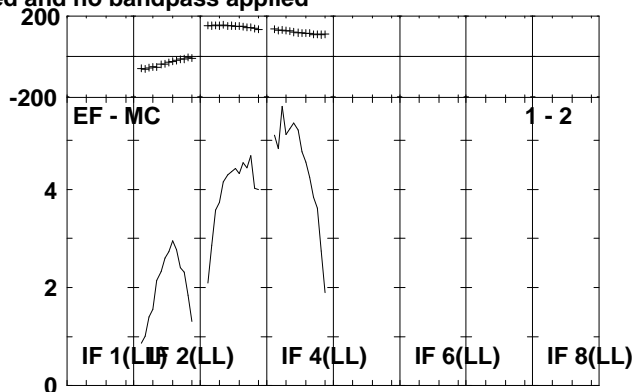
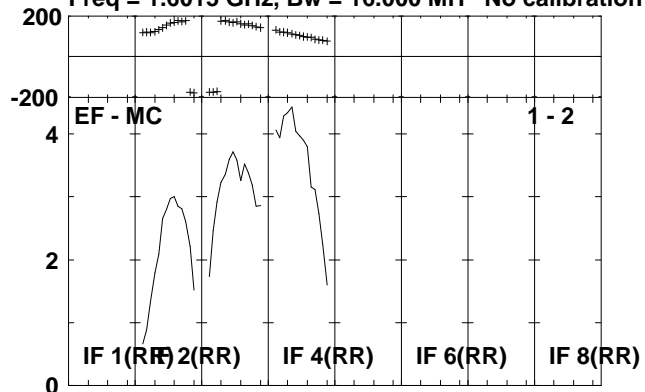

Lower frame: Milli Ampl Jy Top frame: Phas deg
Scalar averaged cross-power spectrum Several baselines displayed
Timerange: 00/23:55:20 to 00/23:57:16

Plot file version 136 created 26-APR-2010 13:27:32

J1246-07 EA043.UVDATA.1

Freq = 1.6015 GHz, Bw = 16.000 MH No calibration applied and no bandpass applied

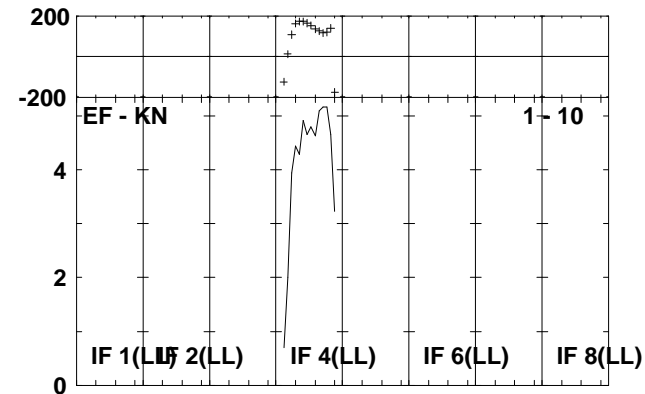
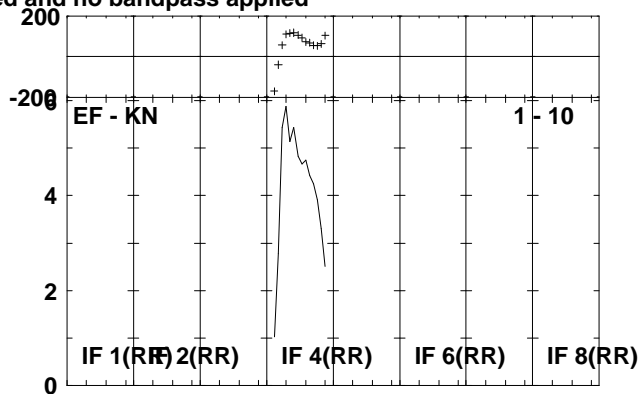
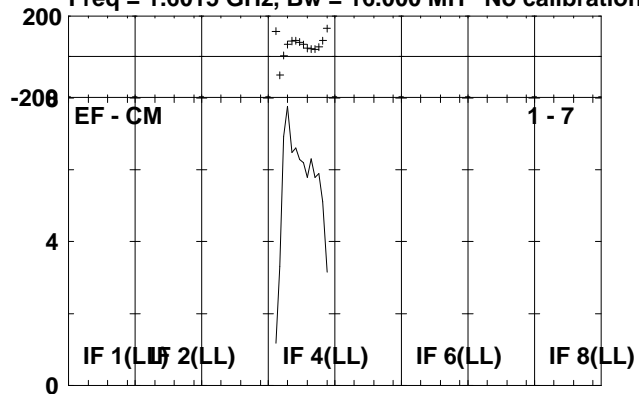

Lower frame: Milli Ampl Jy Top frame: Phas deg
Scalar averaged cross-power spectrum Several baselines displayed
Timerange: 00/23:55:20 to 00/23:57:16

Plot file version 137 created 26-APR-2010 13:27:33

3C273 EA043.UVDATA.1

Freq = 1.6015 GHz, Bw = 16.000 MH No calibration applied and no bandpass applied

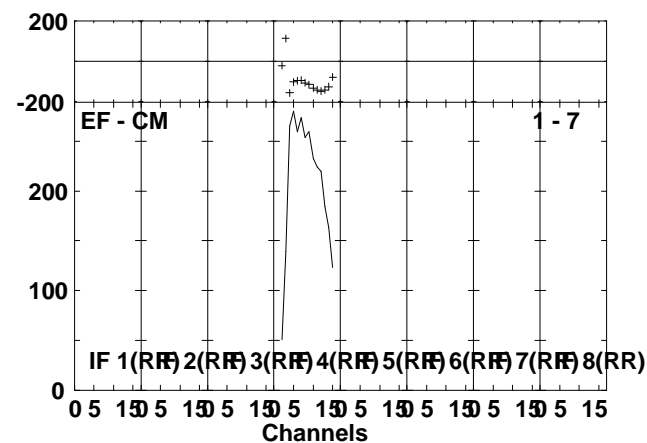
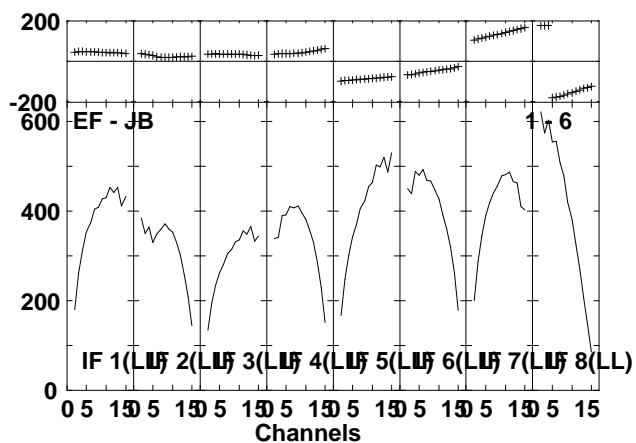
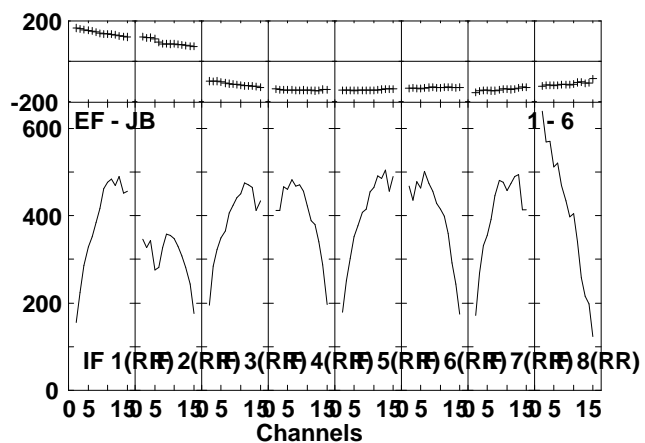
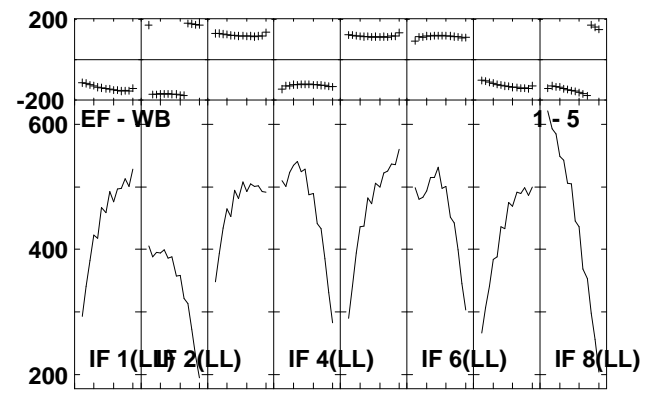
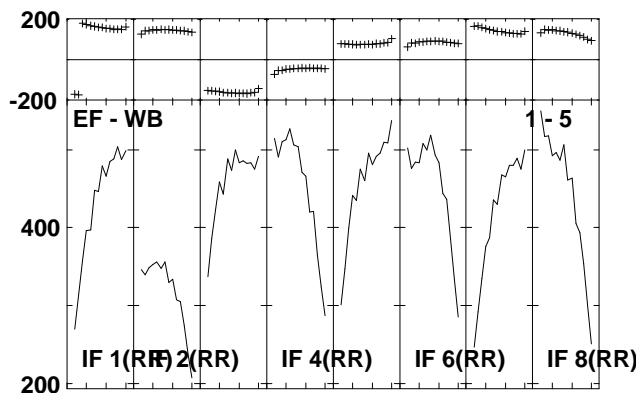
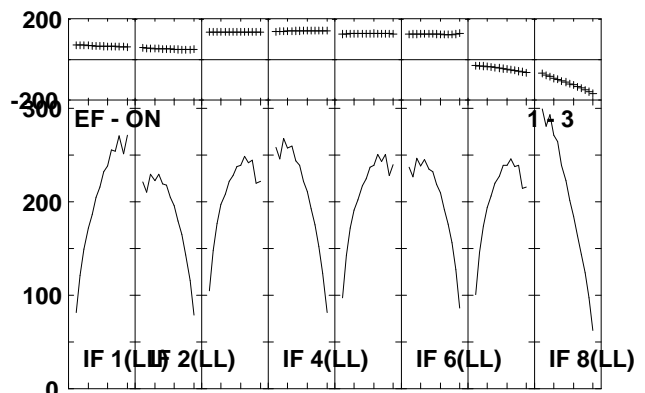
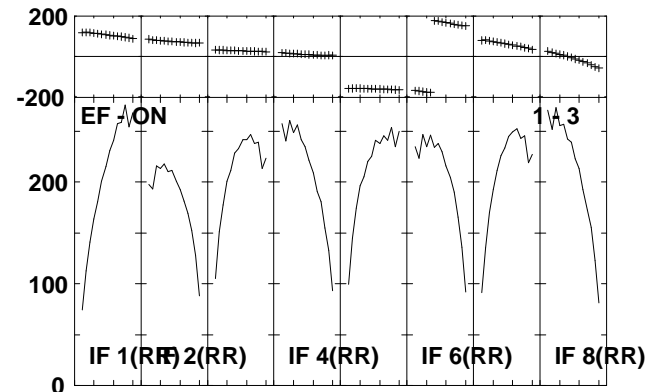
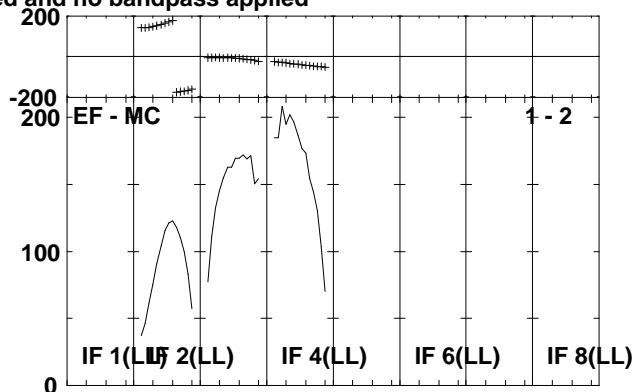
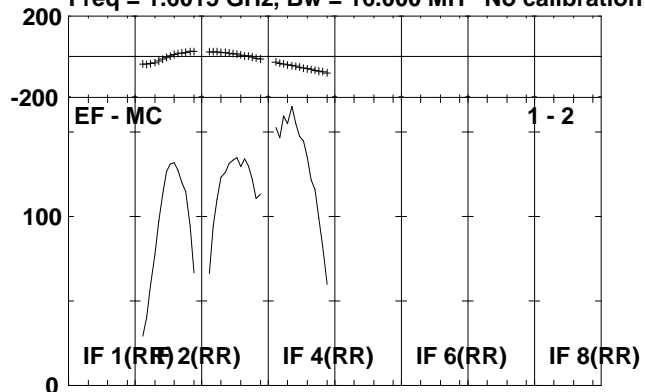

Lower frame: Milli Ampl Jy Top frame: Phas deg
Scalar averaged cross-power spectrum Several baselines displayed
Timerange: 00/23:59:20 to 01/00:05:16

Plot file version 138 created 26-APR-2010 13:27:34

3C273 EA043.UVDATA.1

Freq = 1.6015 GHz, Bw = 16.000 MH No calibration applied and no bandpass applied

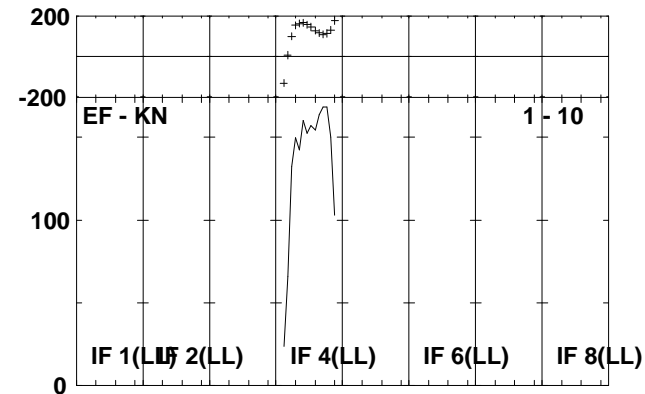
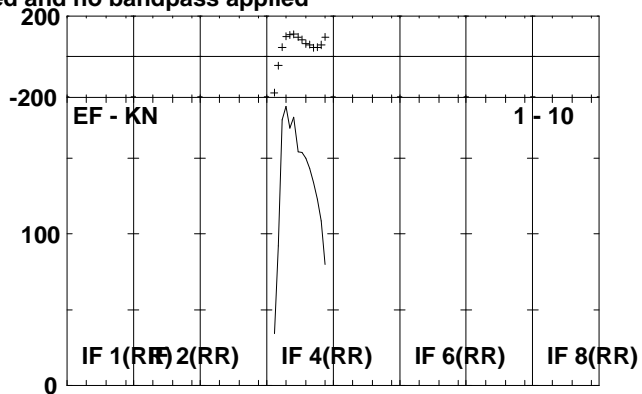
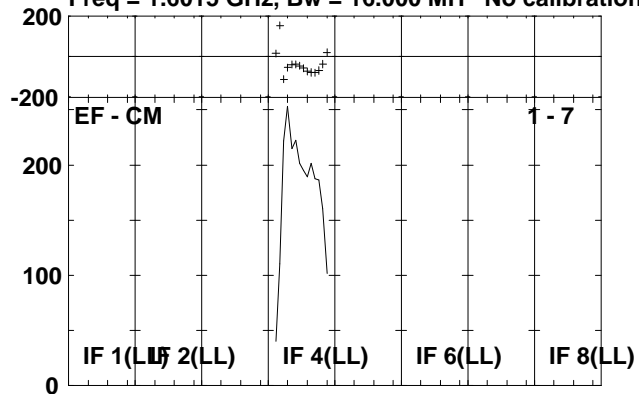

Lower frame: Milli Ampl Jy Top frame: Phas deg
Scalar averaged cross-power spectrum Several baselines displayed
Timerange: 00/23:59:20 to 01/00:05:16

Plot file version 139 created 26-APR-2010 13:27:35

3C286 EA043.UVDATA.1

Freq = 1.6015 GHz, Bw = 16.000 MH No calibration applied and no bandpass applied

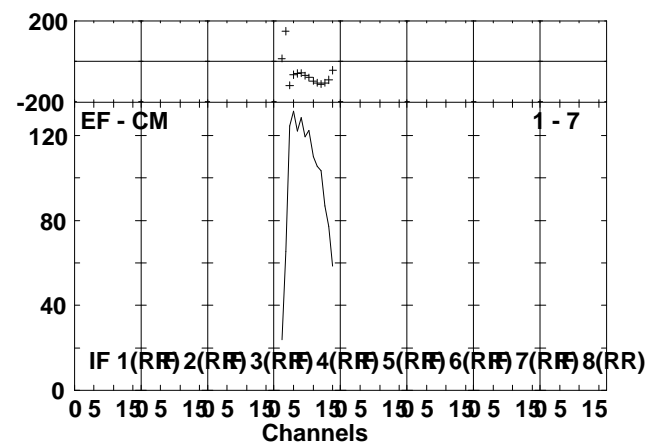
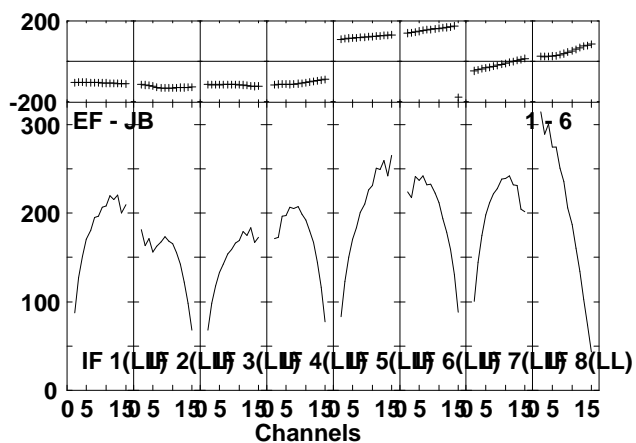
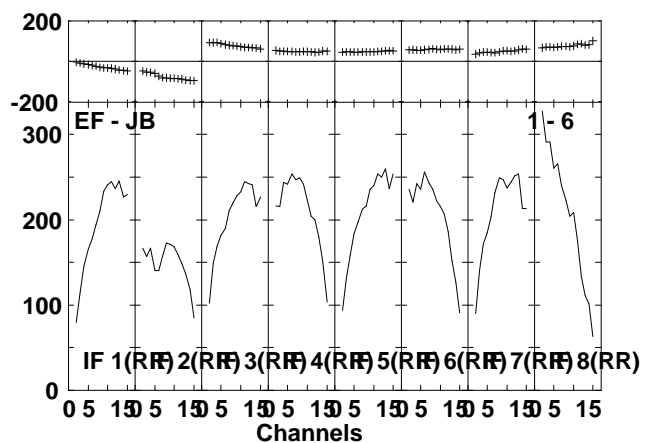
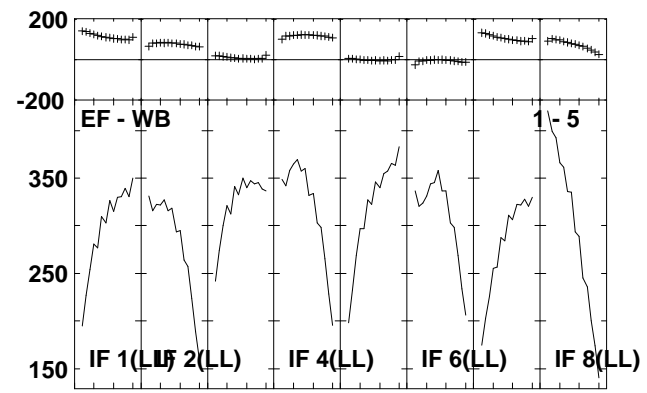
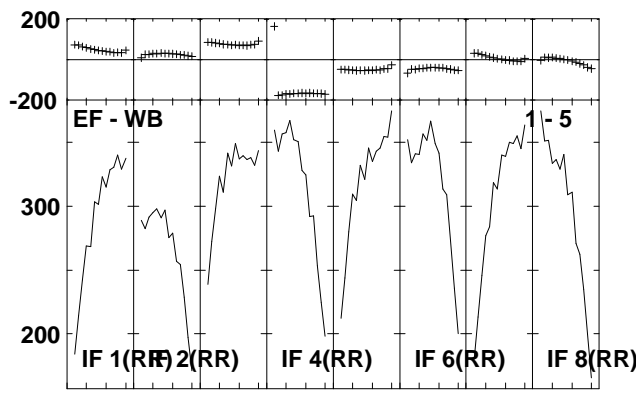
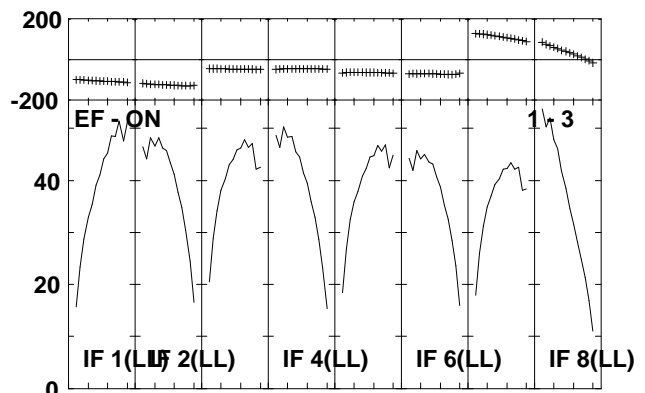
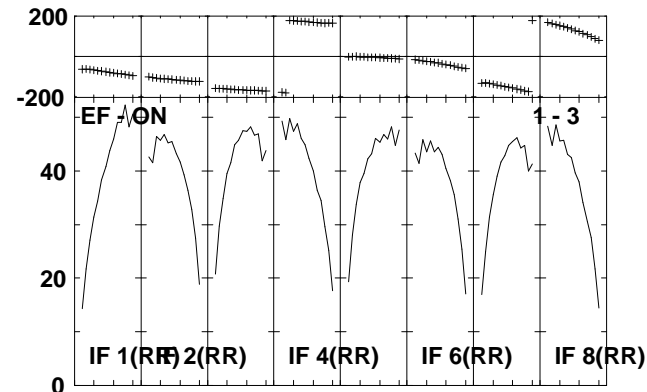
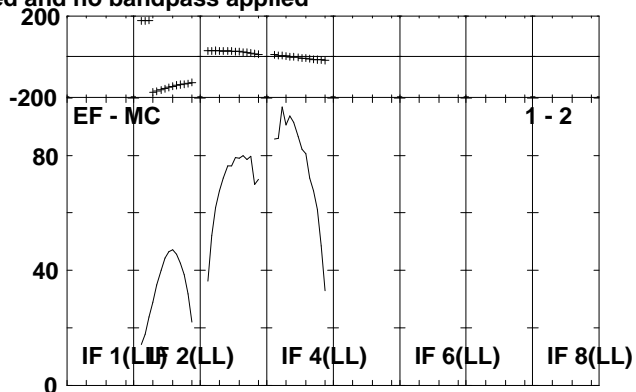
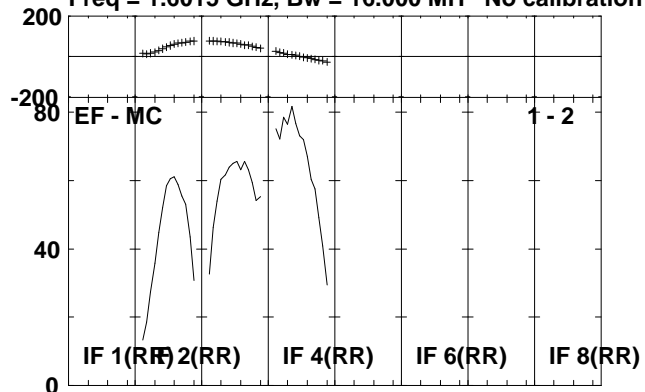

Lower frame: Milli Ampl Jy Top frame: Phas deg
Scalar averaged cross-power spectrum Several baselines displayed
Timerange: 01/00:07:20 to 01/00:17:16

Plot file version 140 created 26-APR-2010 13:27:37

3C286 EA043.UVDATA.1

Freq = 1.6015 GHz, Bw = 16.000 MH No calibration applied and no bandpass applied

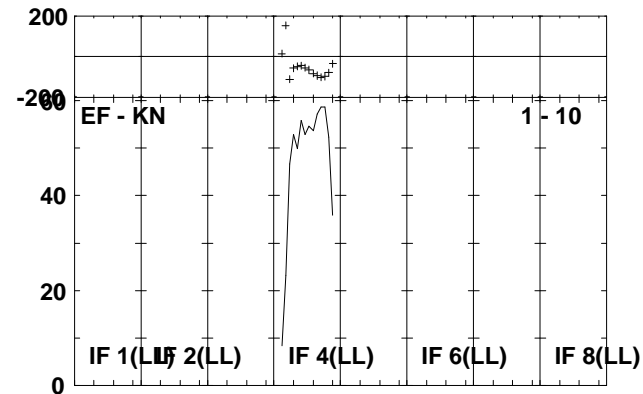
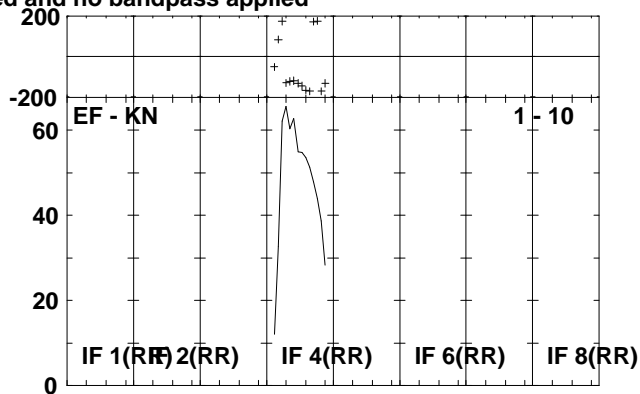
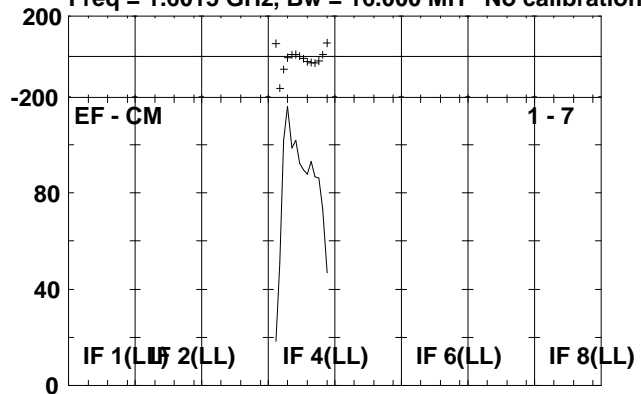

Lower frame: Milli Ampl Jy Top frame: Phas deg
Scalar averaged cross-power spectrum Several baselines displayed
Timerange: 01/00:07:20 to 01/00:17:16

Plot file version 141 created 26-APR-2010 13:27:38

OQ208 EA043.UVDATA.1

Freq = 1.6015 GHz, Bw = 16.000 MH No calibration applied and no bandpass applied

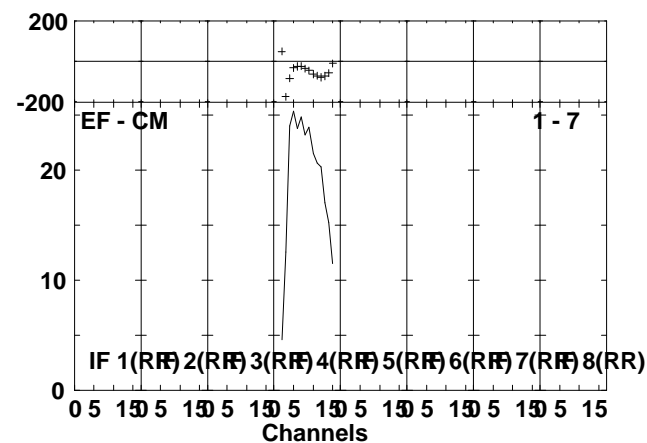
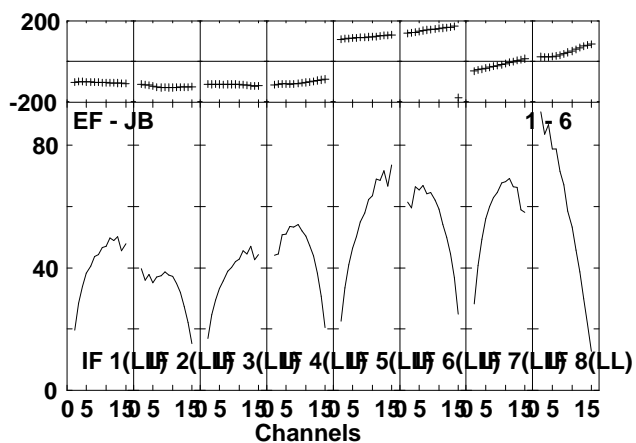
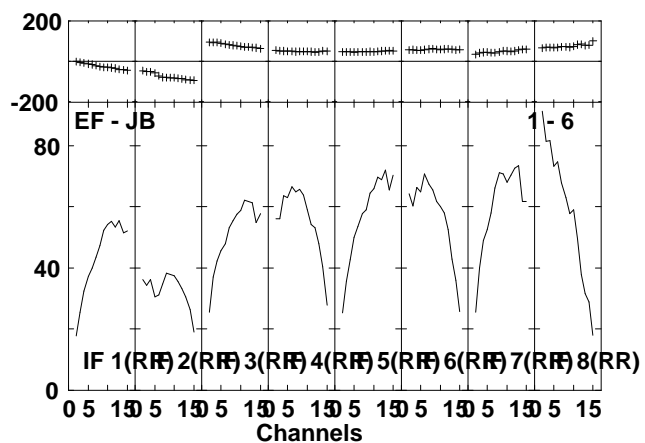
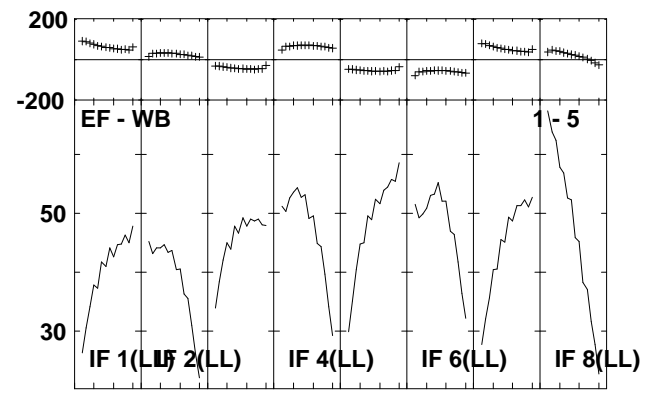
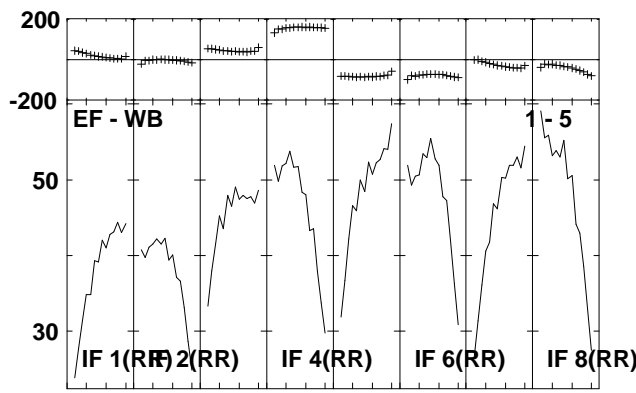
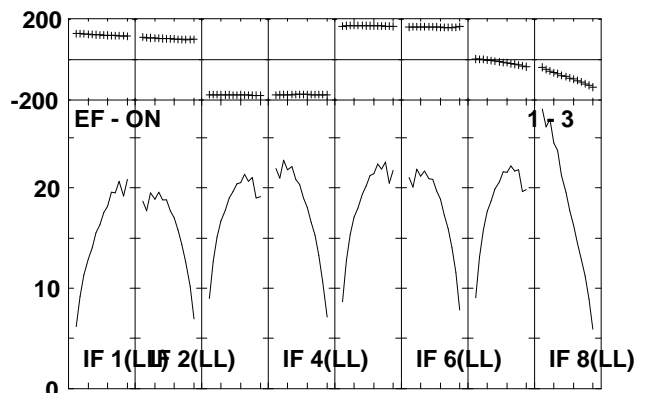
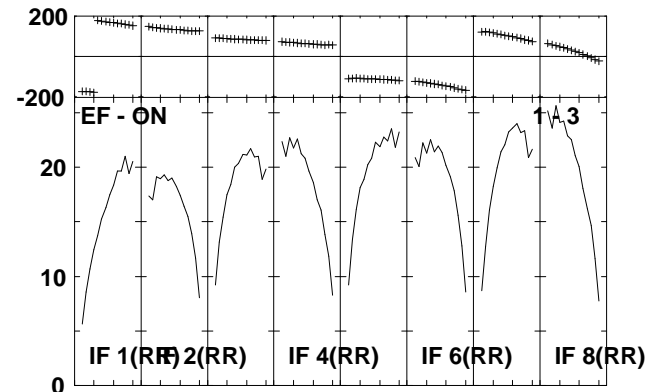
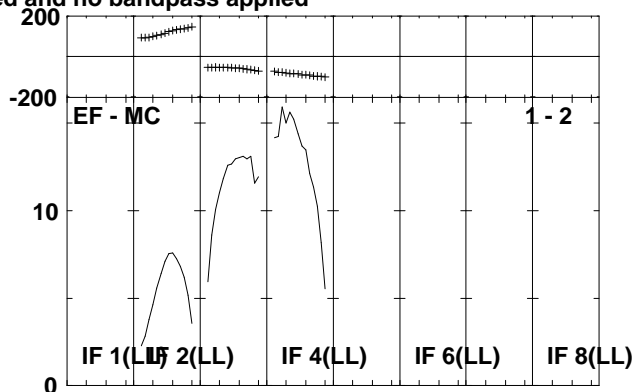
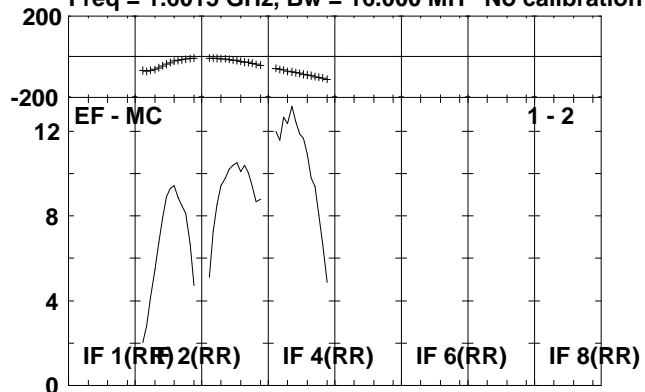

Lower frame: Milli Ampl Jy Top frame: Phas deg
Scalar averaged cross-power spectrum Several baselines displayed
Timerange: 01/00:19:20 to 01/00:29:16

Plot file version 142 created 26-APR-2010 13:27:40

OQ208 EA043.UVDATA.1

Freq = 1.6015 GHz, Bw = 16.000 MH No calibration applied and no bandpass applied

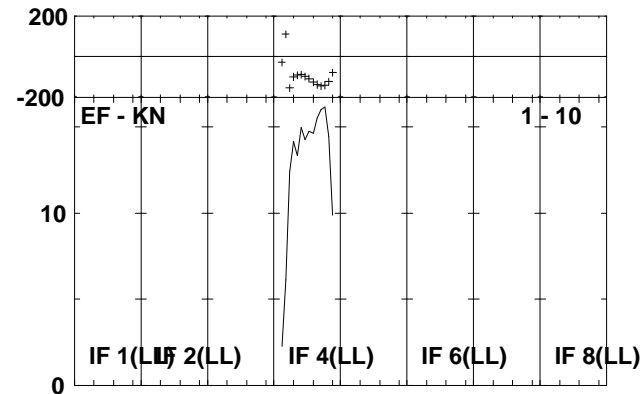
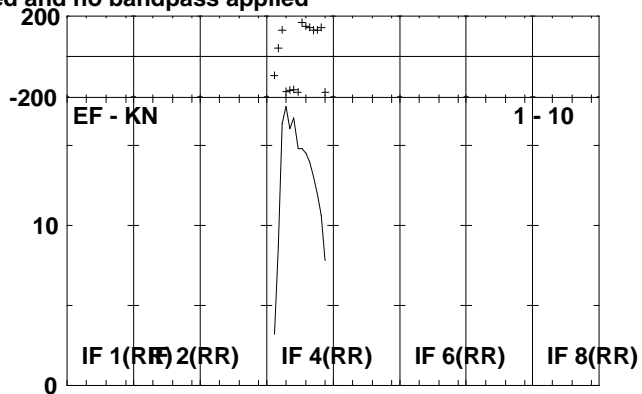
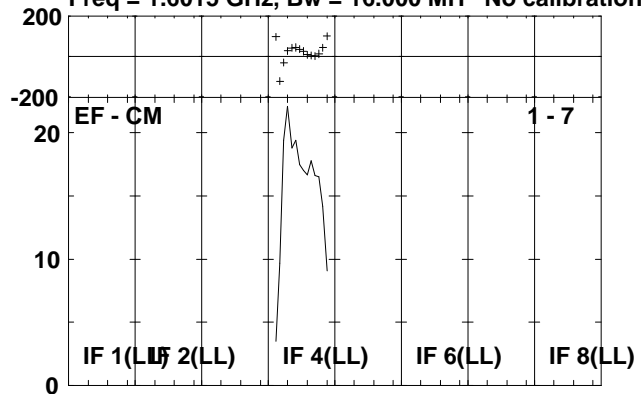

Lower frame: Milli Ampl Jy Top frame: Phas deg
Scalar averaged cross-power spectrum Several baselines displayed
Timerange: 01/00:19:20 to 01/00:29:16