

Plot file version 1 created 19-AUG-2009 15:45:54
 3C345 EB039B 2.UVDATA.1
 Freq = 6.6328 GHz, Bw = 8.000 MH Calibrated with CL # 3 and BP # 1 (BP mode 1)

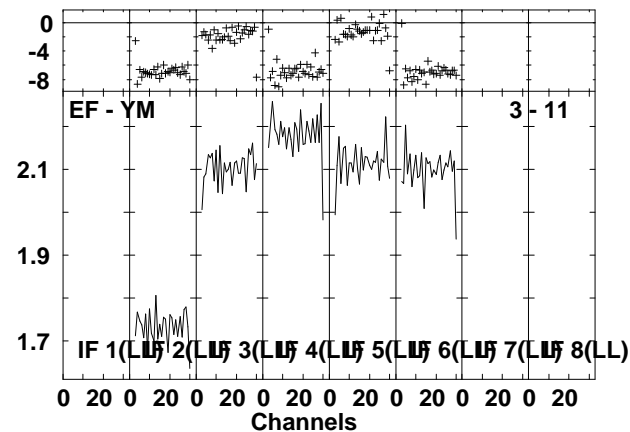

Lower frame: Ampl Jy Top frame: Phas deg
 Vector averaged cross-power spectrum Several baselines displayed
 Timerange: 00/01:29:49 to 00/01:32:47

Plot file version 3 created 19-AUG-2009 15:46:02
 J2029+46 EB039B 2.UVDATA.1
 Freq = 6.6328 GHz, Bw = 8.000 MH Calibrated with CL # 3 and BP # 1 (BP mode 1)

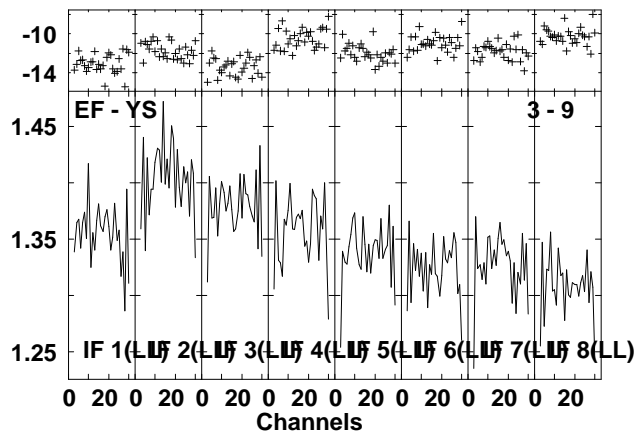
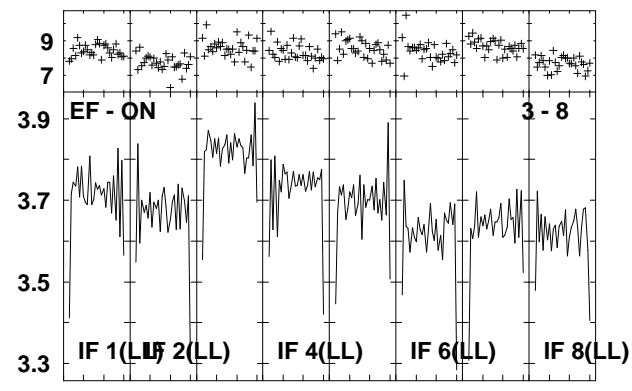
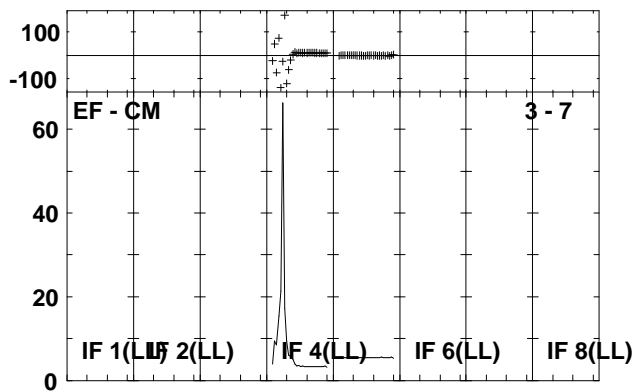
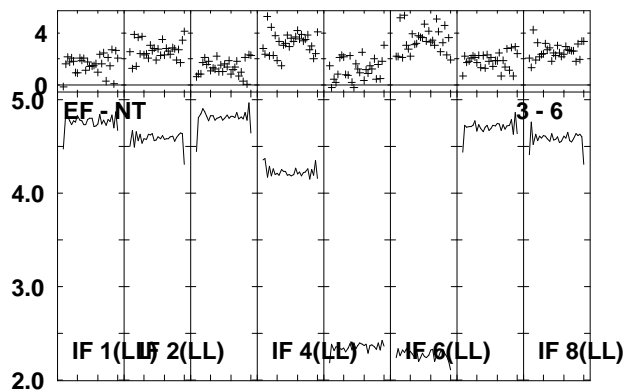
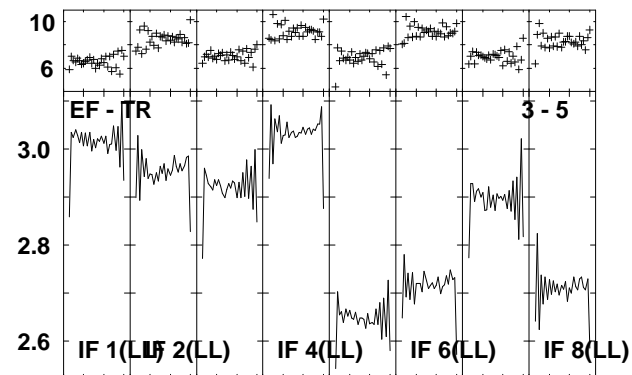
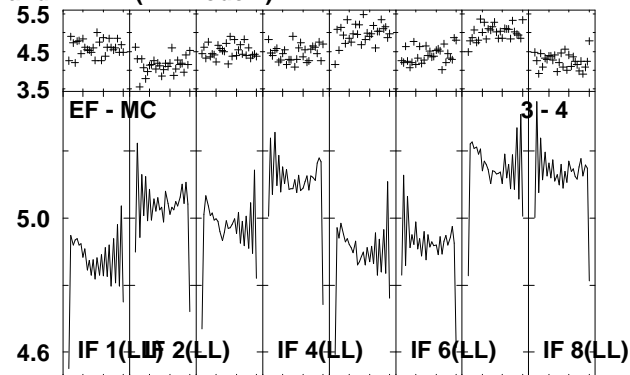
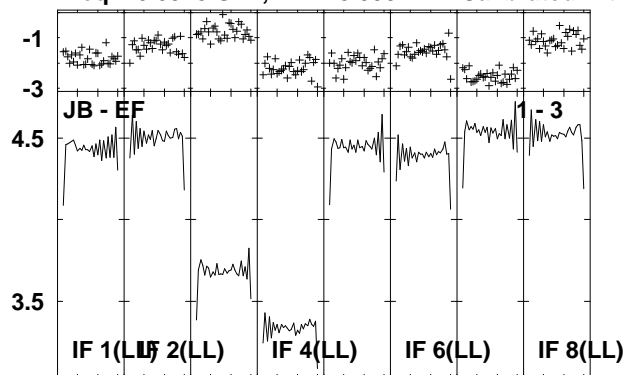
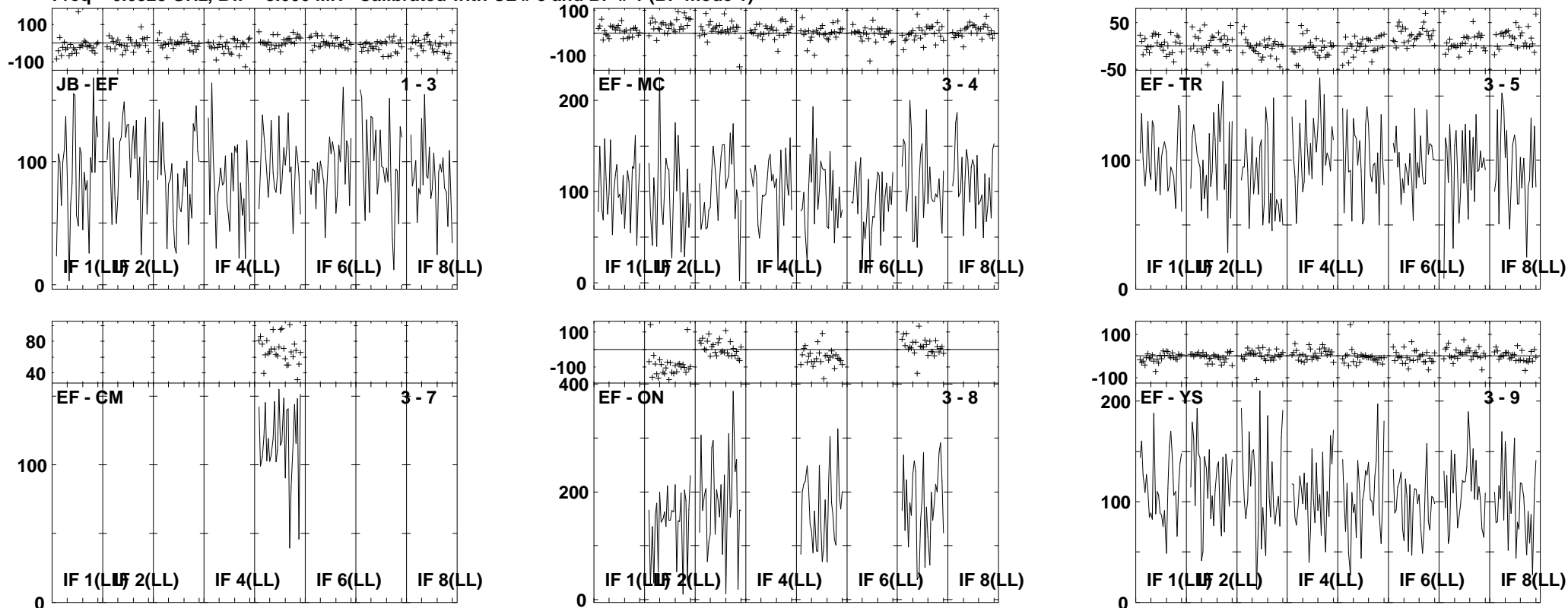

Lower frame: Milli Ampl Jy Top frame: Phas deg
 Vector averaged cross-power spectrum Several baselines displayed
 Timerange: 00/01:37:03 to 00/01:38:32

Plot file version 4 created 19-AUG-2009 15:46:04
 W75 EB039B 2.UVDATA.1
 Freq = 6.6328 GHz, Bw = 8.000 MH Calibrated with CL # 3 and BP # 1 (BP mode 1)

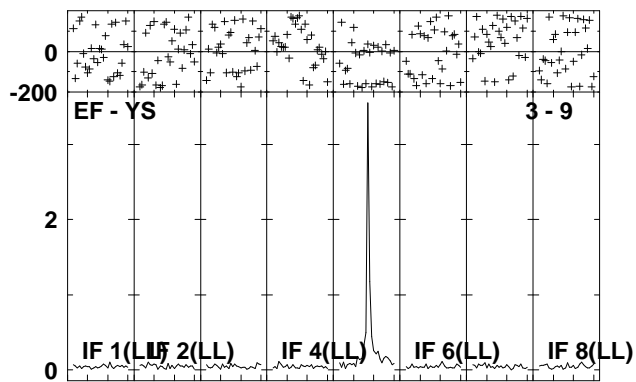
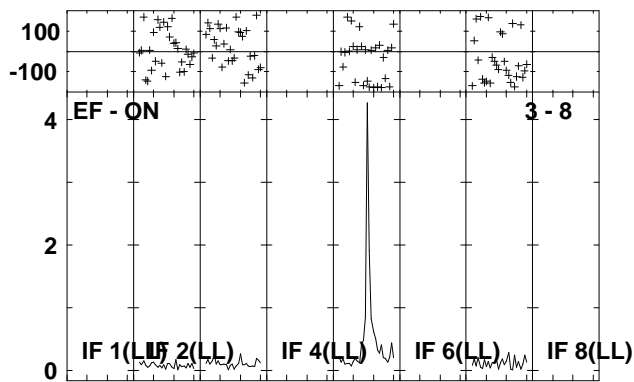
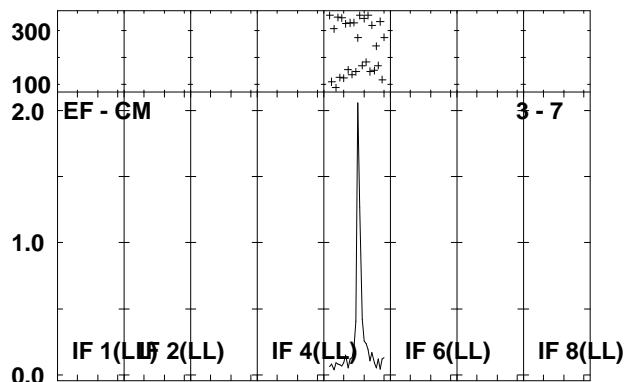
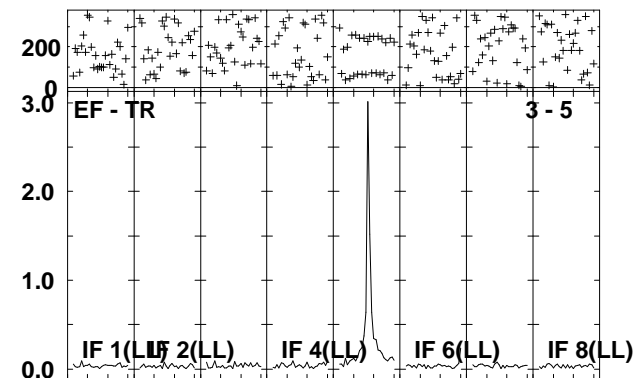
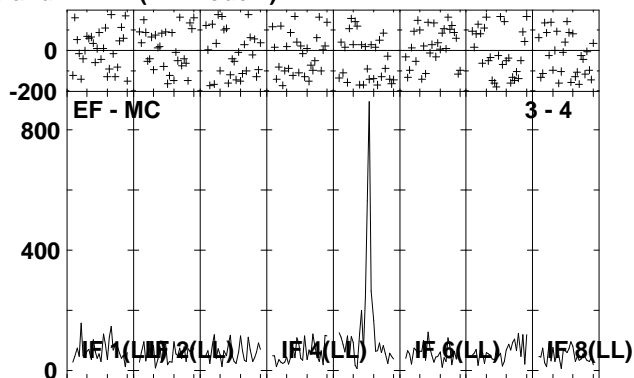
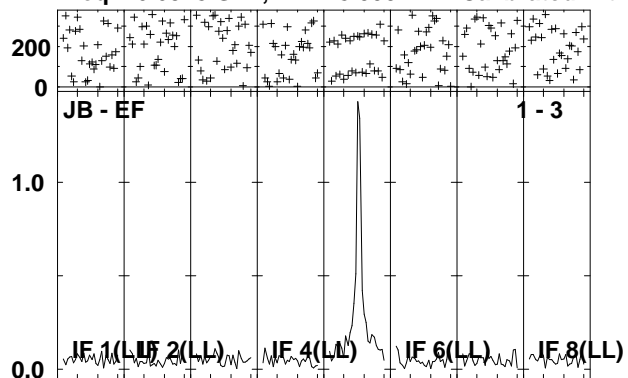

Lower frame: Ampl Jy Top frame: Phas deg
 Vector averaged cross-power spectrum Several baselines displayed
 Timerange: 00/01:38:33 to 00/01:40:02

Plot file version 5 created 19-AUG-2009 15:46:08

W75 EB039B 2.UVDATA.1

Freq = 6.6328 GHz, Bw = 8.000 MH Calibrated with CL # 3 and BP # 1 (BP mode 1)

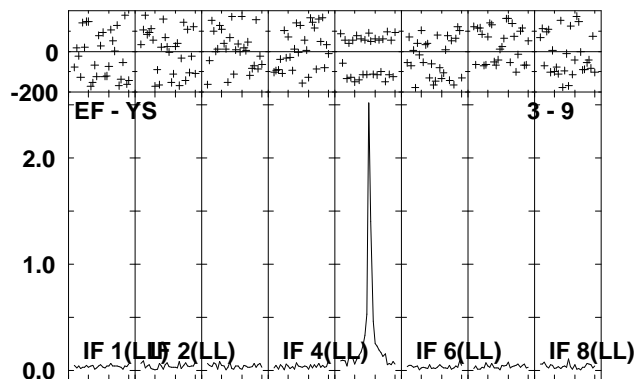
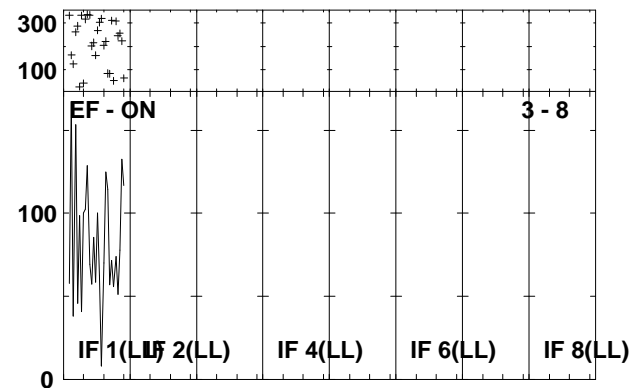
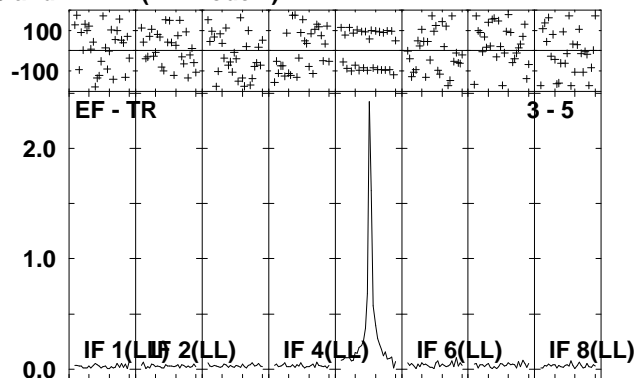
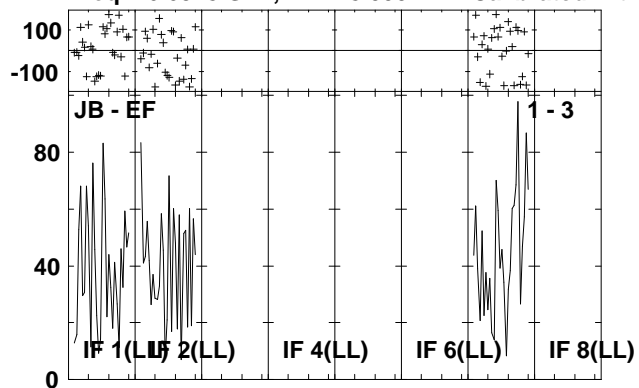

Lower frame: Milli Ampl Jy Top frame: Phas deg
Vector averaged cross-power spectrum Several baselines displayed
Timerange: 00/01:41:34 to 00/01:43:02

Plot file version 6 created 19-AUG-2009 15:46:10
 2048+431 EB039B 2.UVDATA.1
 Freq = 6.6328 GHz, Bw = 8.000 MH Calibrated with CL # 3 and BP # 1 (BP mode 1)

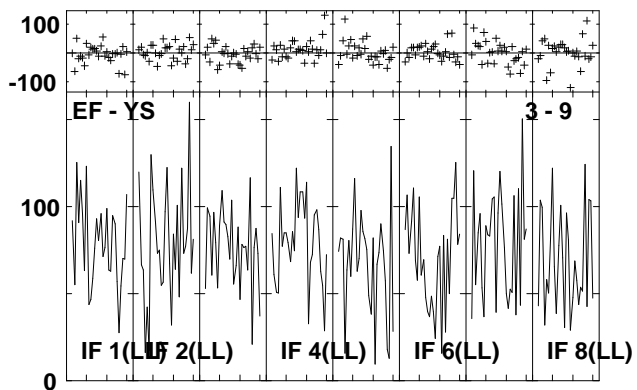
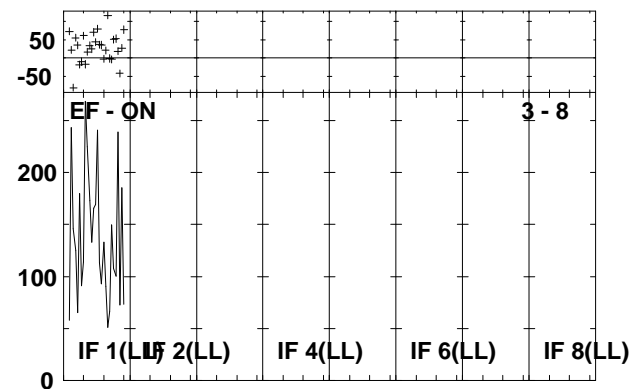
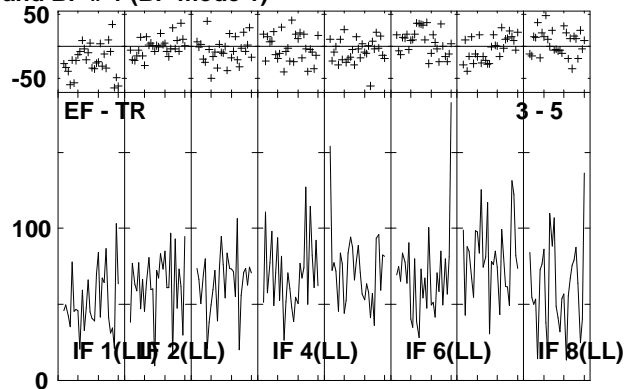
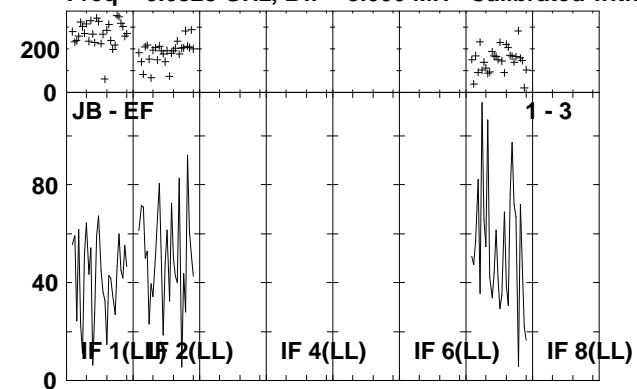

Lower frame: Milli Ampl Jy Top frame: Phas deg
 Vector averaged cross-power spectrum Several baselines displayed
 Timerange: 00/01:43:04 to 00/01:44:33

Plot file version 7 created 19-AUG-2009 15:46:12
 W75 EB039B 2.UVDATA.1
 Freq = 6.6328 GHz, Bw = 8.000 MH Calibrated with CL # 3 and BP # 1 (BP mode 1)

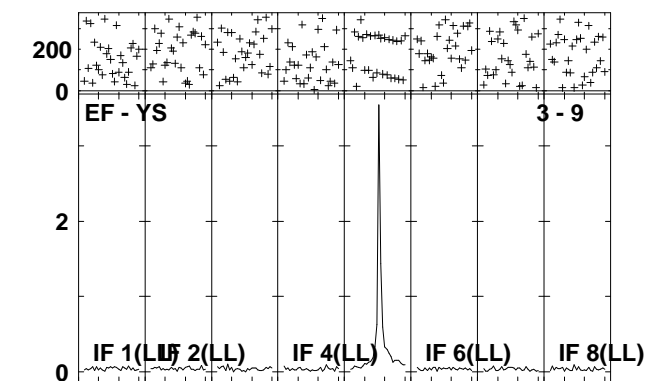
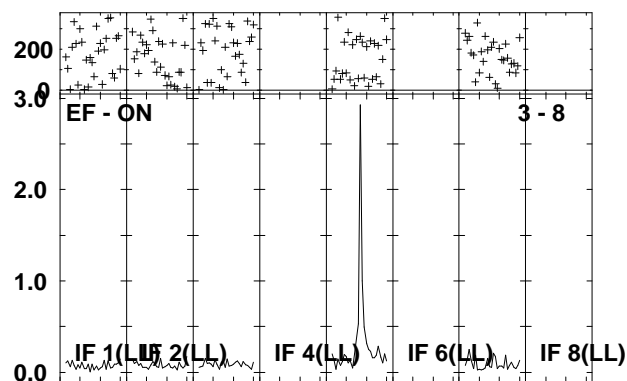
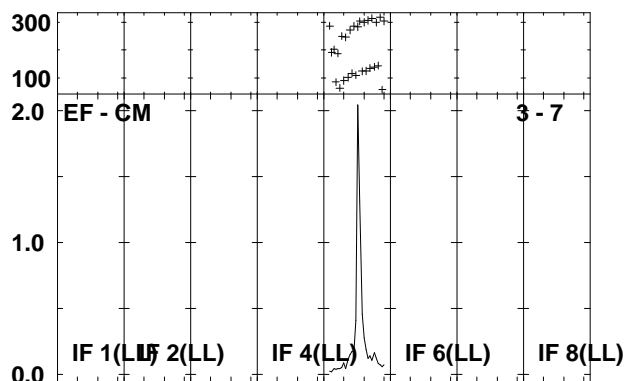
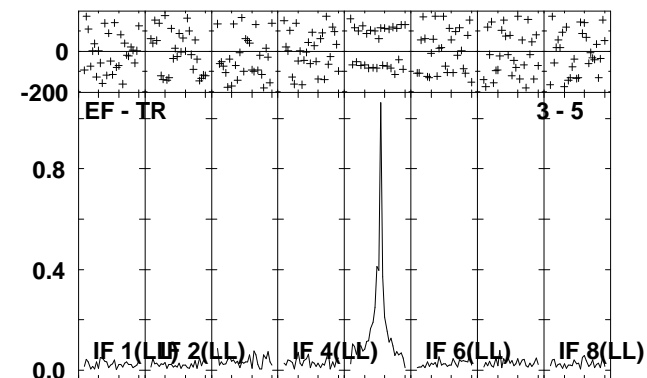
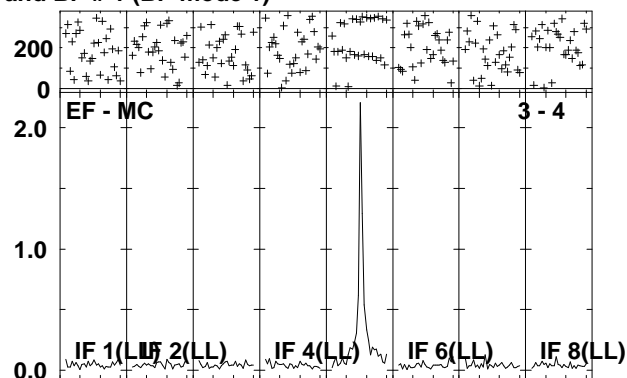
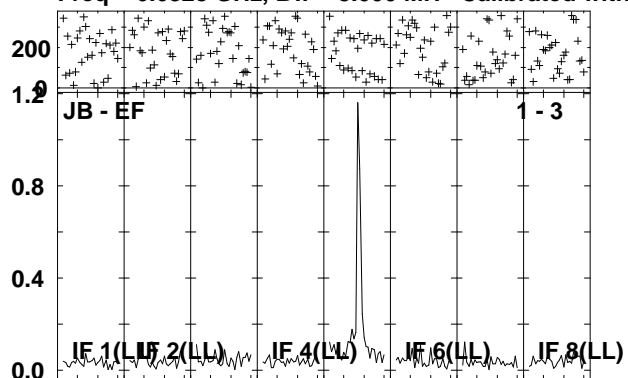

Lower frame: Ampl Jy Top frame: Phas deg
 Vector averaged cross-power spectrum Several baselines displayed
 Timerange: 00/01:44:34 to 00/01:46:03

Plot file version 8 created 19-AUG-2009 15:46:14
 OB2 EB039B 2.UVDATA.1
 Freq = 6.6328 GHz, Bw = 8.000 MH Calibrated with CL # 3 and BP # 1 (BP mode 1)

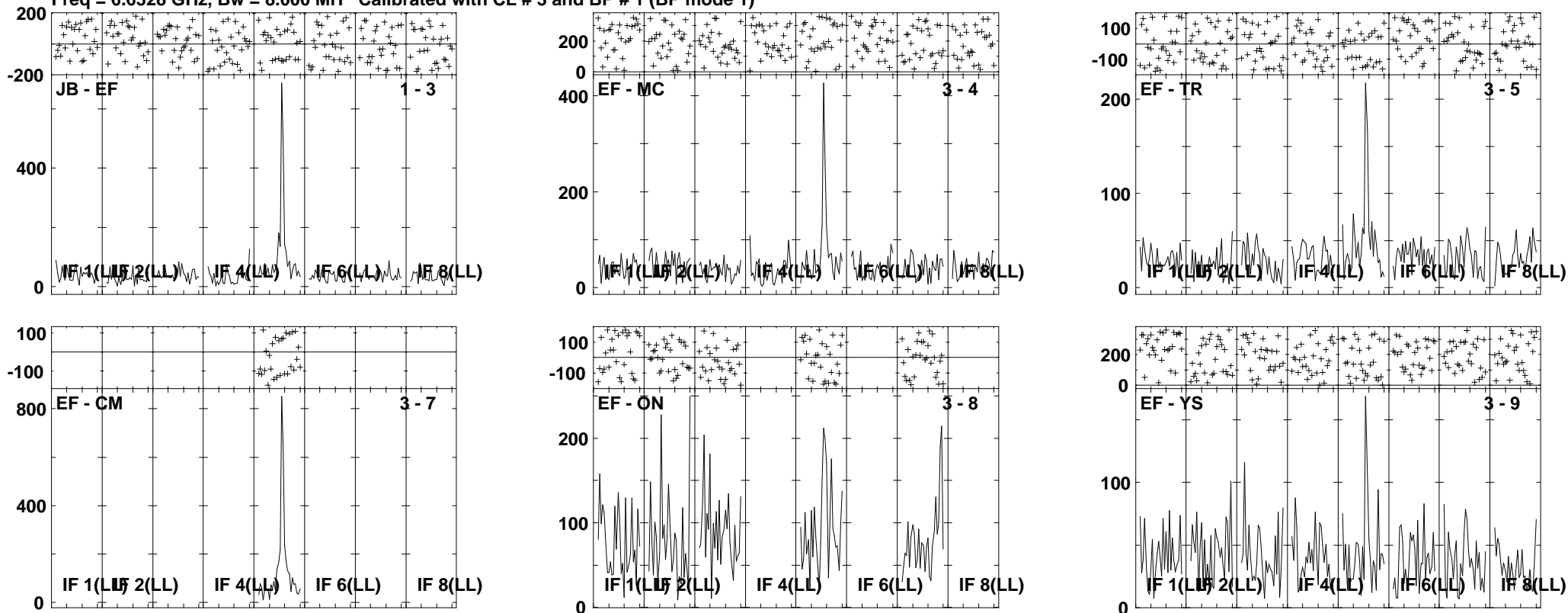

Lower frame: Milli Ampl Jy Top frame: Phas deg
 Vector averaged cross-power spectrum Several baselines displayed
 Timerange: 00/01:46:04 to 00/01:47:33

Plot file version 9 created 19-AUG-2009 15:46:16
 W75 EB039B 2.UVDATA.1
 Freq = 6.6328 GHz, Bw = 8.000 MH Calibrated with CL # 3 and BP # 1 (BP mode 1)

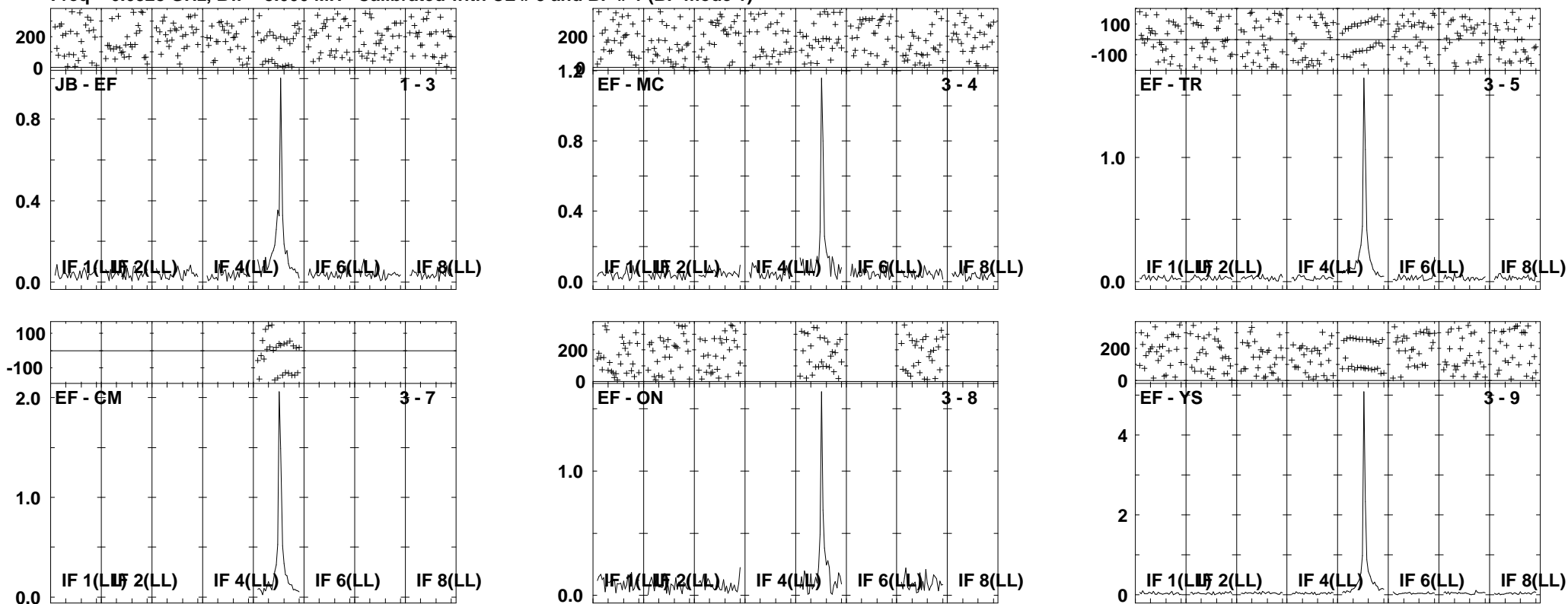

Lower frame: Ampl Jy Top frame: Phas deg
 Vector averaged cross-power spectrum Several baselines displayed
 Timerange: 00/01:48:07 to 00/01:49:05

Plot file version 10 created 19-AUG-2009 15:46:17
 DR21A EB039B 2.UVDATA.1
 Freq = 6.6328 GHz, Bw = 8.000 MH Calibrated with CL # 3 and BP # 1 (BP mode 1)

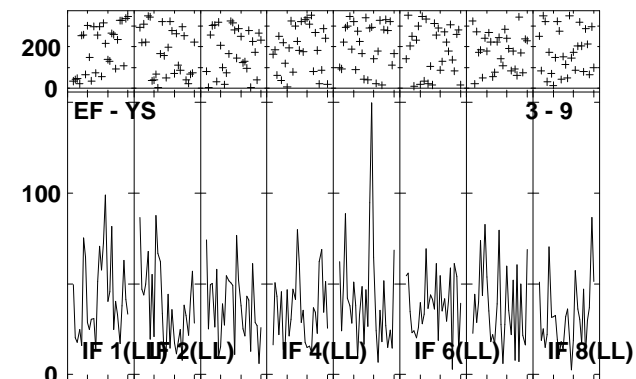
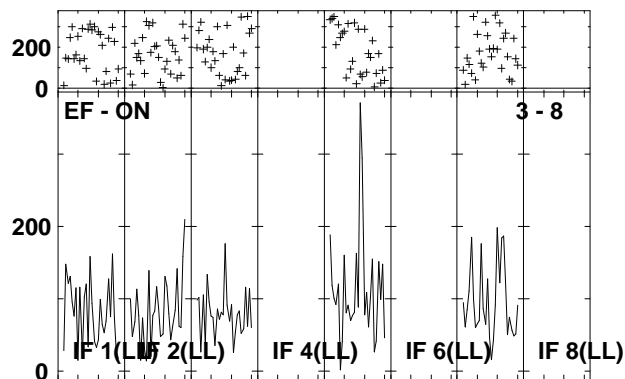
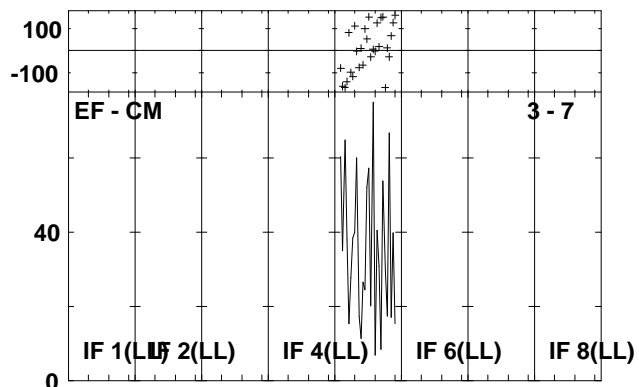
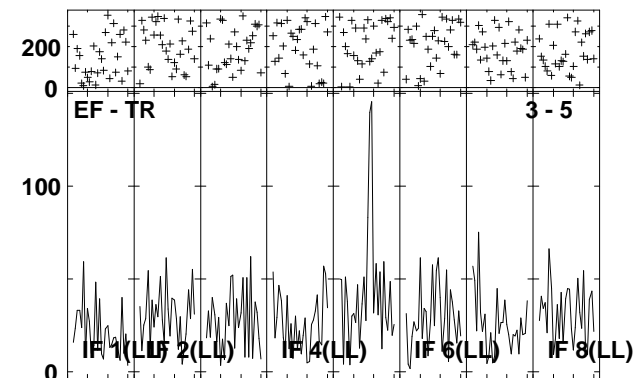
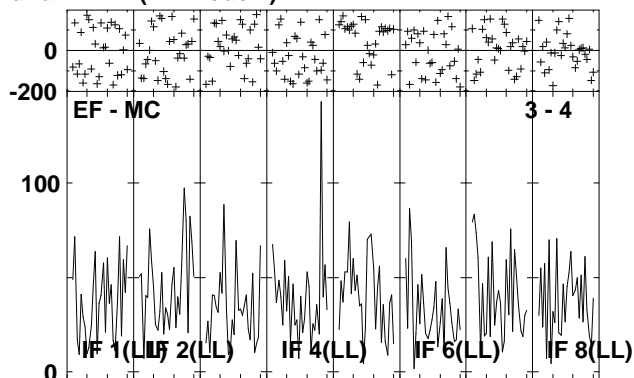
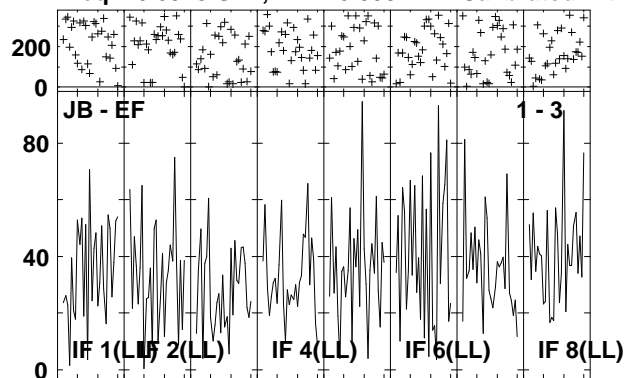

Lower frame: Milli Ampl Jy Top frame: Phas deg
 Vector averaged cross-power spectrum Several baselines displayed
 Timerange: 00/01:49:07 to 00/01:50:35

Plot file version 11 created 19-AUG-2009 15:46:20

W75 EB039B 2.UVDATA.1

Freq = 6.6328 GHz, Bw = 8.000 MH Calibrated with CL # 3 and BP # 1 (BP mode 1)

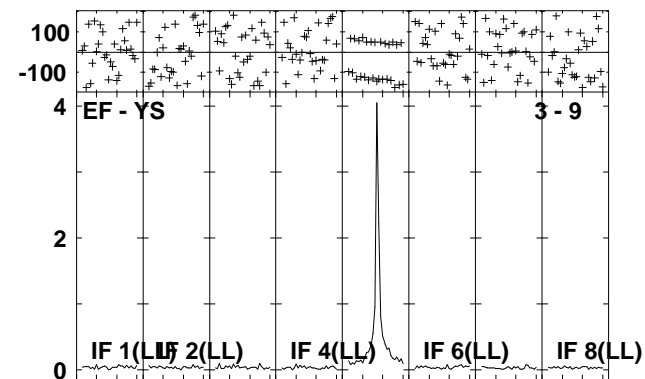
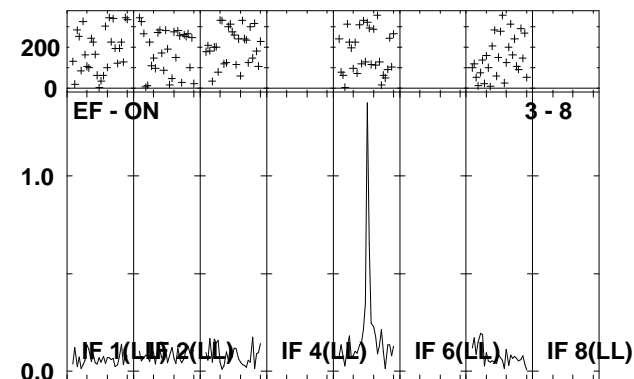
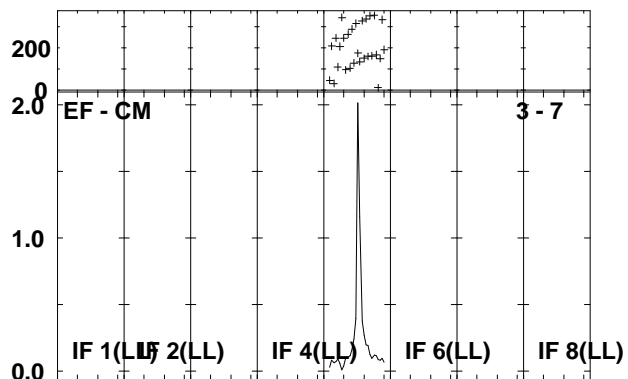
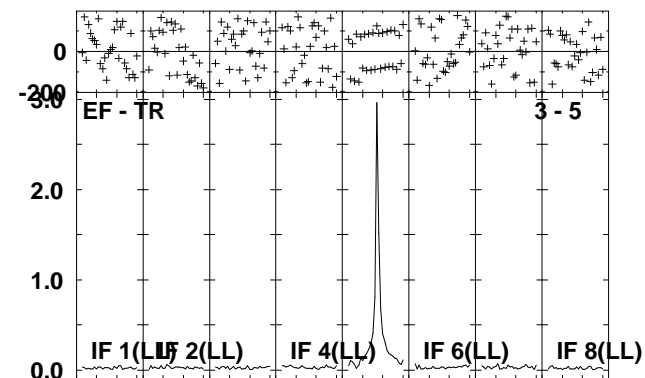
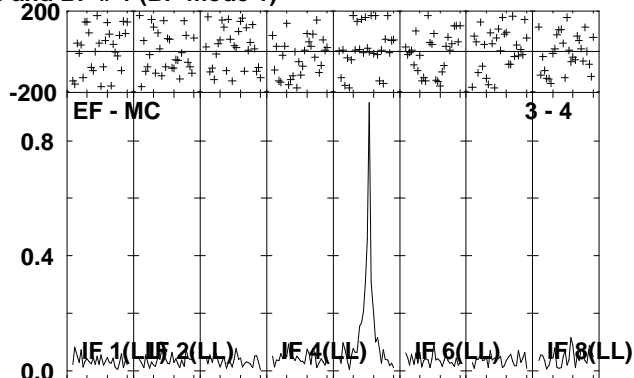
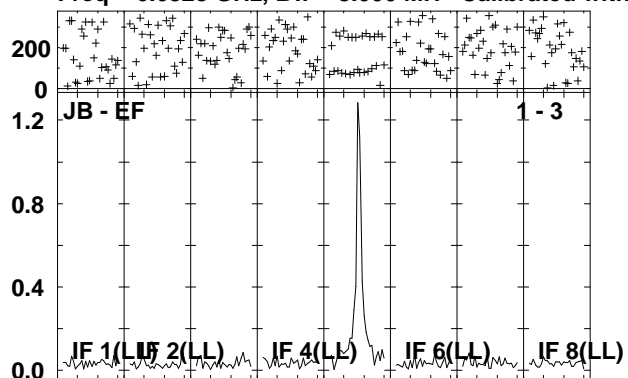

Lower frame: Ampl Jy Top frame: Phas deg
Vector averaged cross-power spectrum Several baselines displayed
Timerange: 00/01:50:37 to 00/01:52:05

Plot file version 12 created 19-AUG-2009 15:46:22
 DR21B EB039B 2.UVDATA.1
 Freq = 6.6328 GHz, Bw = 8.000 MH Calibrated with CL # 3 and BP # 1 (BP mode 1)

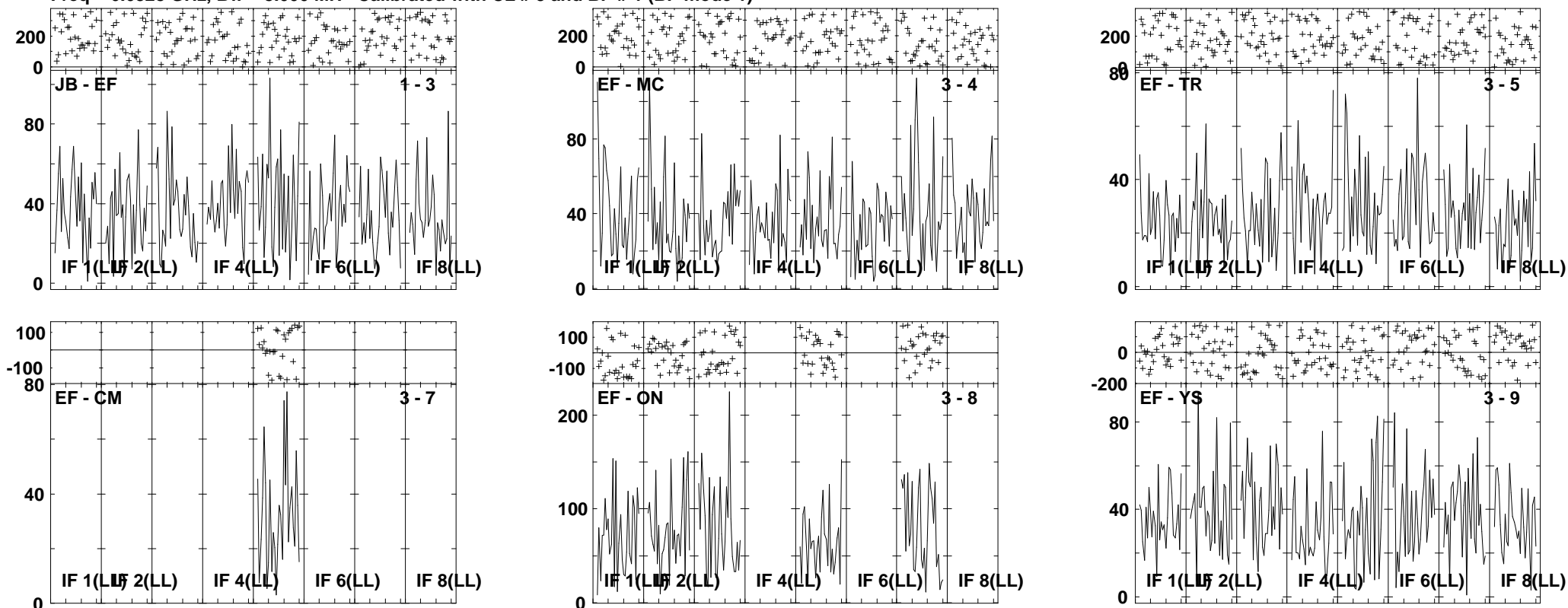

Lower frame: Milli Ampl Jy Top frame: Phas deg
 Vector averaged cross-power spectrum Several baselines displayed
 Timerange: 00/01:52:06 to 00/01:53:35

Plot file version 13 created 19-AUG-2009 15:46:24
 W75 EB039B 2.UVDATA.1
 Freq = 6.6328 GHz, Bw = 8.000 MH Calibrated with CL # 3 and BP # 1 (BP mode 1)

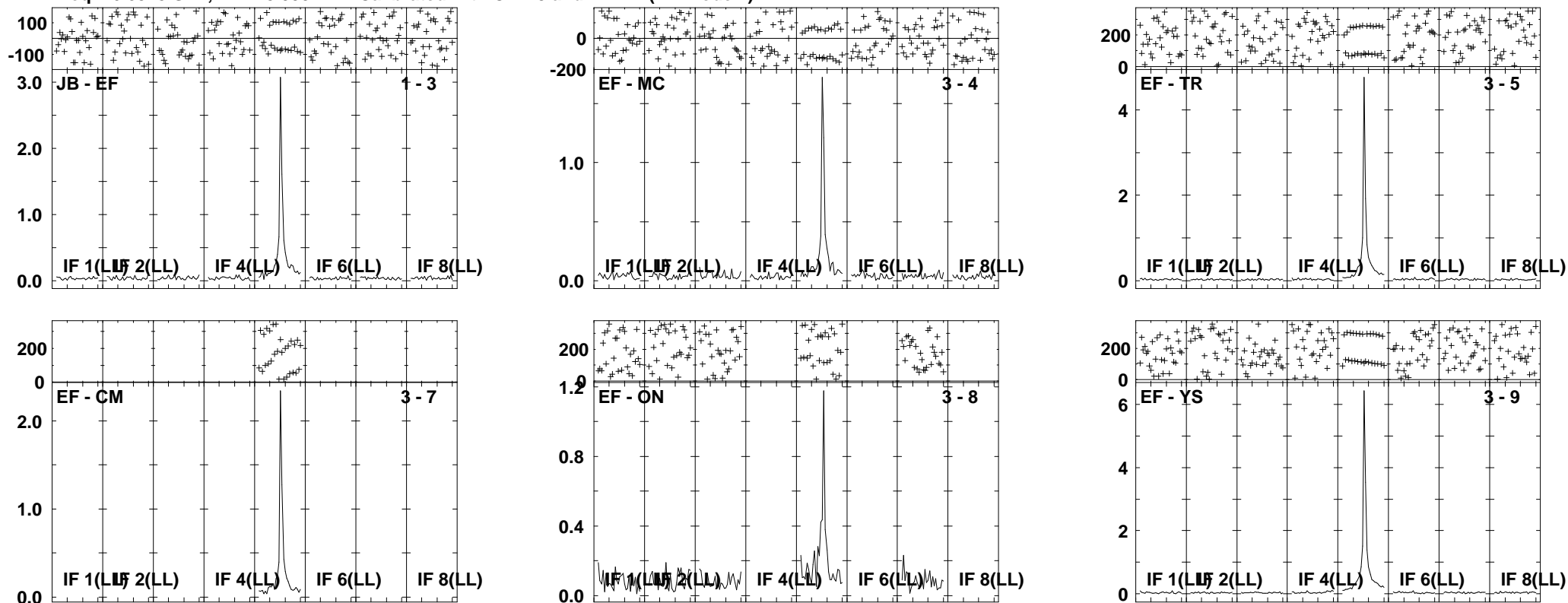

Lower frame: Ampl Jy Top frame: Phas deg
 Vector averaged cross-power spectrum Several baselines displayed
 Timerange: 00/01:53:36 to 00/01:55:05

Plot file version 14 created 19-AUG-2009 15:46:26
 DR21B2 EB039B 2.UVDATA.1
 Freq = 6.6328 GHz, Bw = 8.000 MH Calibrated with CL # 3 and BP # 1 (BP mode 1)

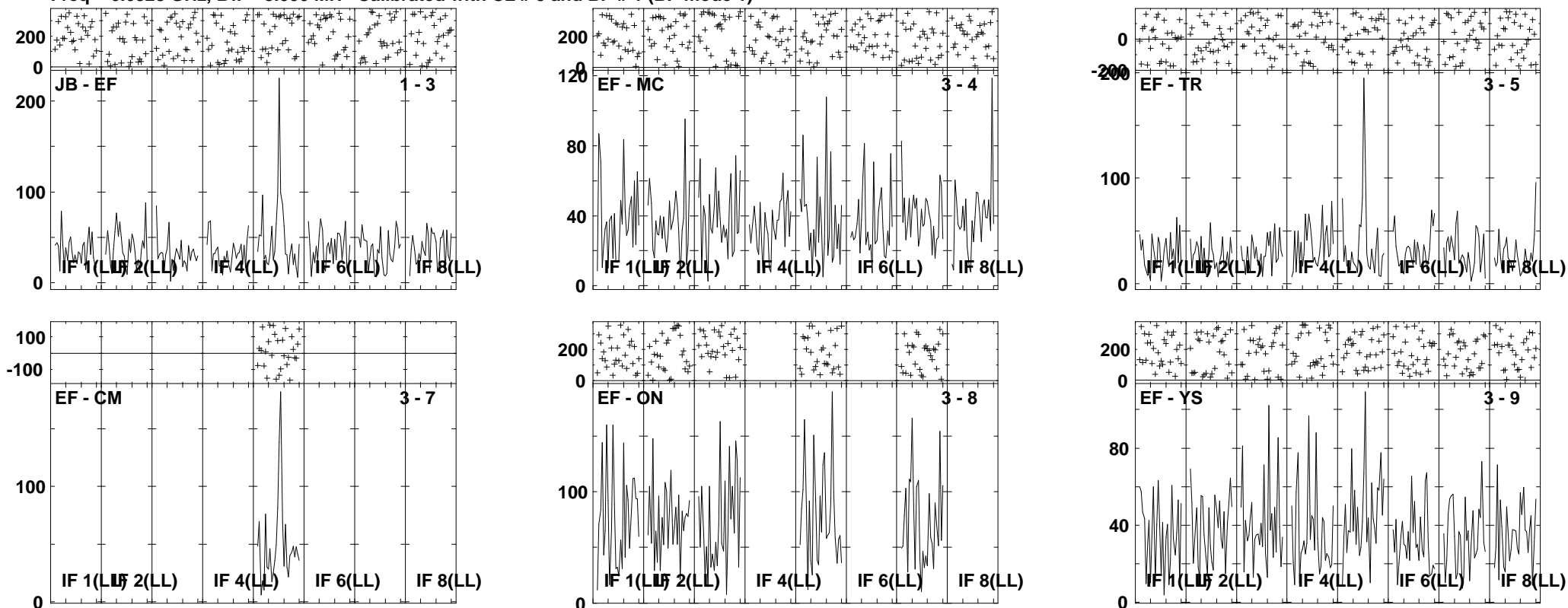

Lower frame: Milli Ampl Jy Top frame: Phas deg
 Vector averaged cross-power spectrum Several baselines displayed
 Timerange: 00/01:55:06 to 00/01:56:35

Plot file version 15 created 19-AUG-2009 15:46:29

W75 EB039B 2.UVDATA.1

Freq = 6.6328 GHz, Bw = 8.000 MH Calibrated with CL # 3 and BP # 1 (BP mode 1)

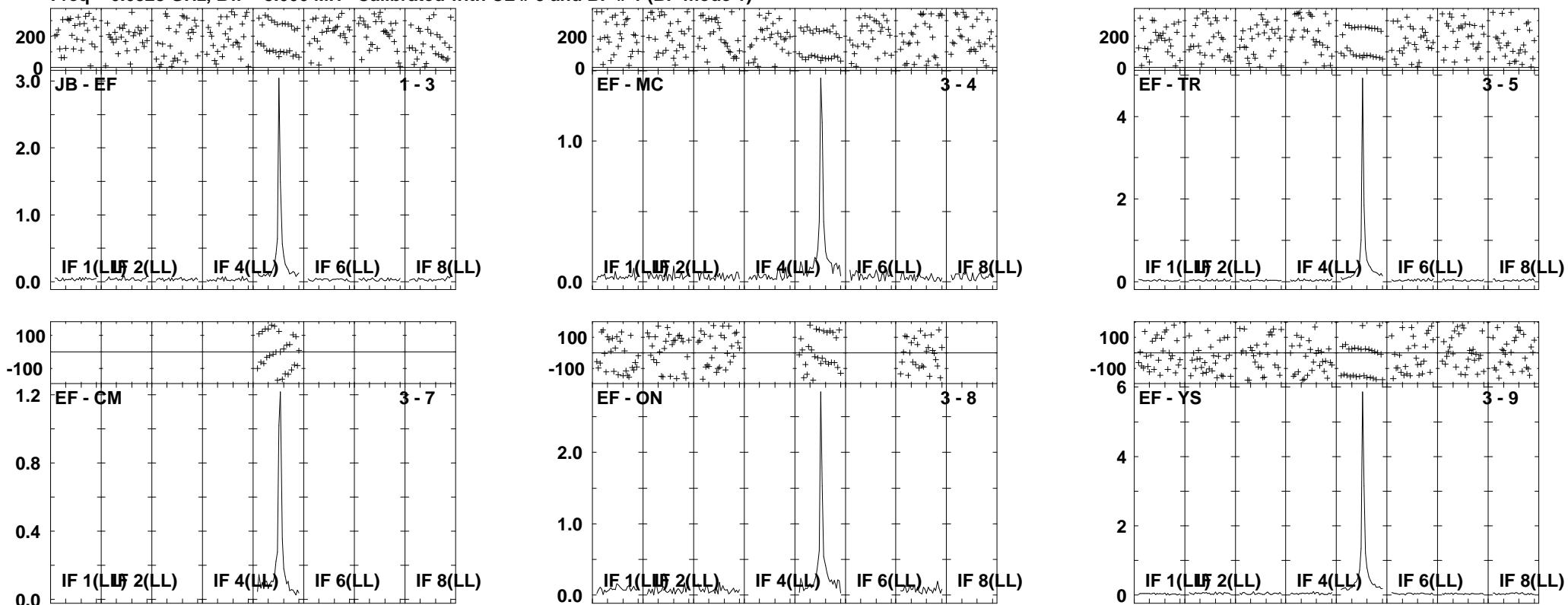

Lower frame: Ampl Jy Top frame: Phas deg
Vector averaged cross-power spectrum Several baselines displayed
Timerange: 00/01:56:36 to 00/01:58:05

Plot file version 16 created 19-AUG-2009 15:46:31
 DR20 EB039B 2.UVDATA.1
 Freq = 6.6328 GHz, Bw = 8.000 MH Calibrated with CL # 3 and BP # 1 (BP mode 1)

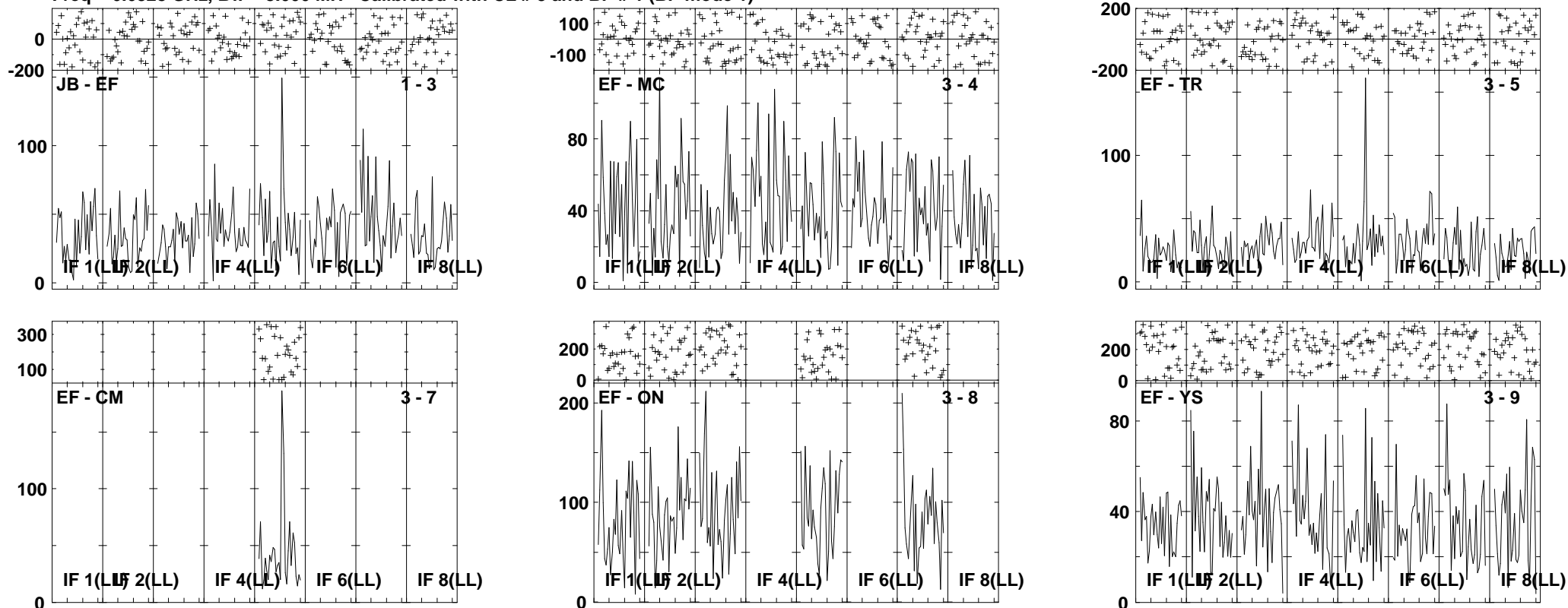

Lower frame: Milli Ampl Jy Top frame: Phas deg
 Vector averaged cross-power spectrum Several baselines displayed
 Timerange: 00/01:58:07 to 00/01:59:35

Plot file version 17 created 19-AUG-2009 15:46:33

W75 EB039B 2.UVDATA.1

Freq = 6.6328 GHz, Bw = 8.000 MH Calibrated with CL # 3 and BP # 1 (BP mode 1)

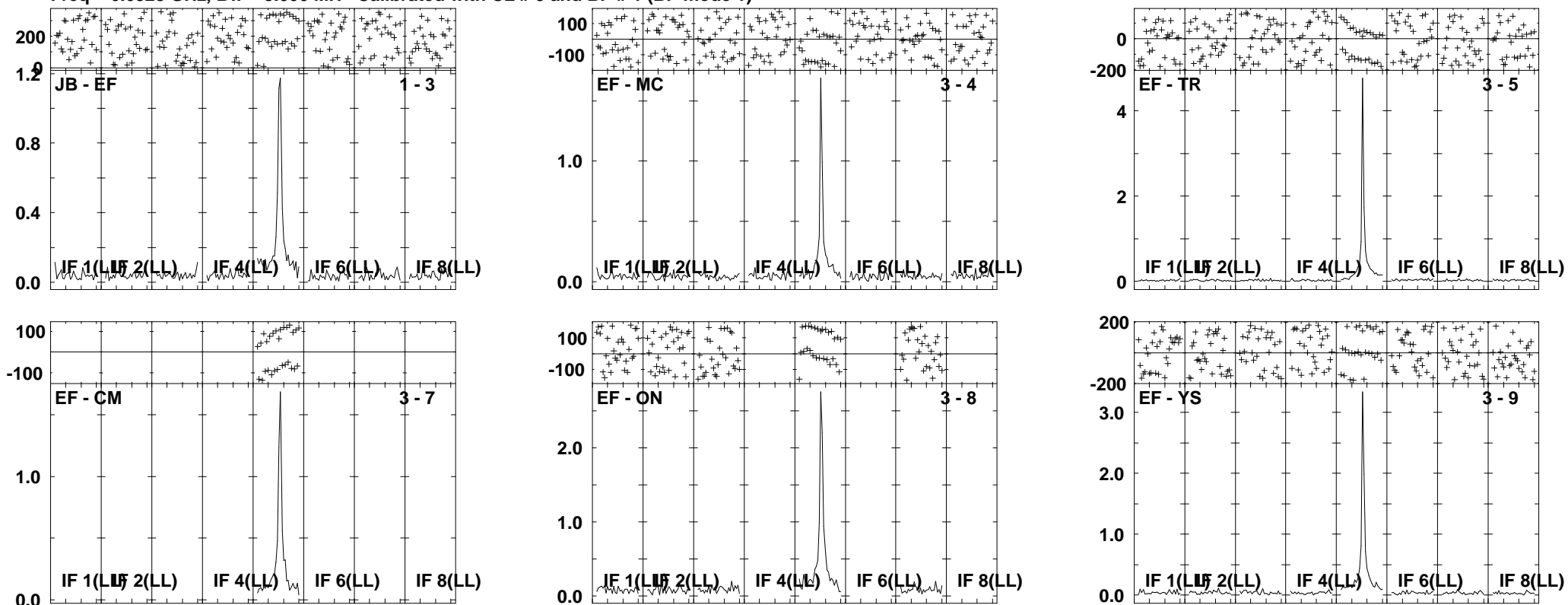

Lower frame: Ampl Jy Top frame: Phas deg
Vector averaged cross-power spectrum Several baselines displayed
Timerange: 00/02:00:00 to 00/02:00:58

Plot file version 18 created 19-AUG-2009 15:46:35
 J2029+46 EB039B 2.UVDATA.1
 Freq = 6.6328 GHz, Bw = 8.000 MH Calibrated with CL # 3 and BP # 1 (BP mode 1)

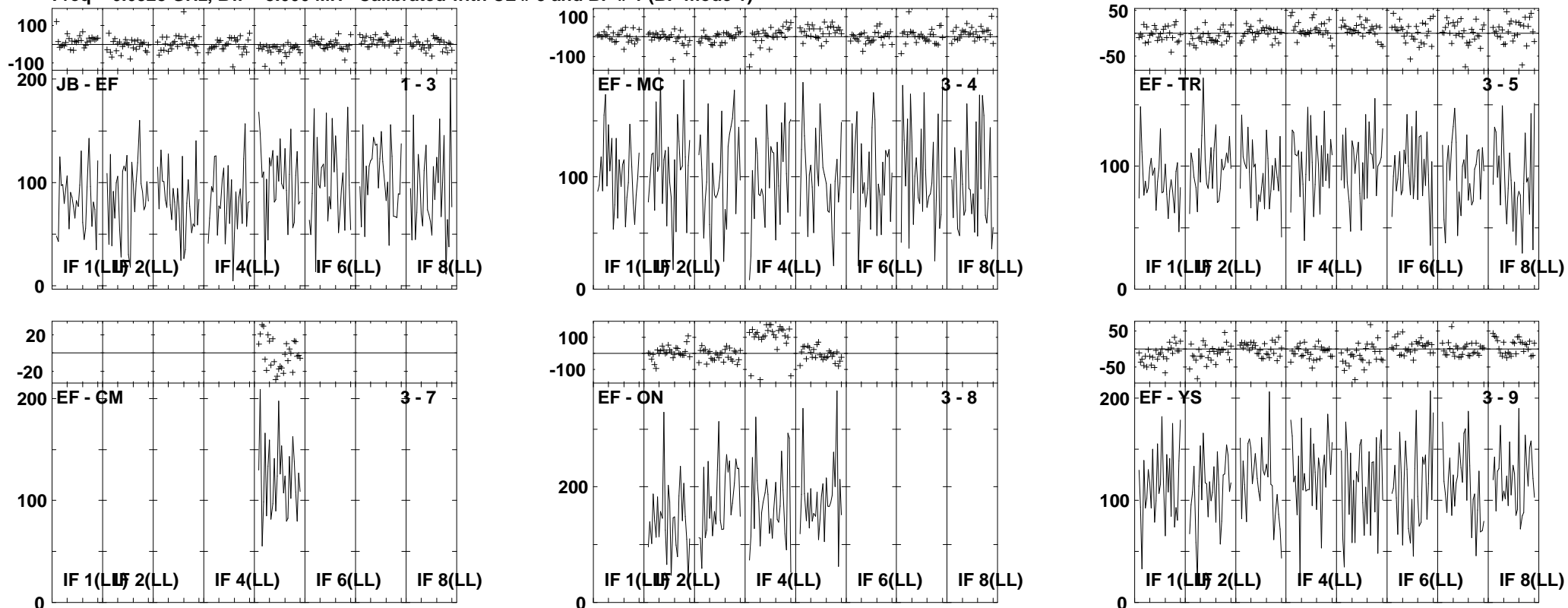

Lower frame: Milli Ampl Jy Top frame: Phas deg
 Vector averaged cross-power spectrum Several baselines displayed
 Timerange: 00/02:01:00 to 00/02:02:28

Plot file version 19 created 19-AUG-2009 15:46:37

W75 EB039B 2.UVDATA.1

Freq = 6.6328 GHz, Bw = 8.000 MH Calibrated with CL # 3 and BP # 1 (BP mode 1)

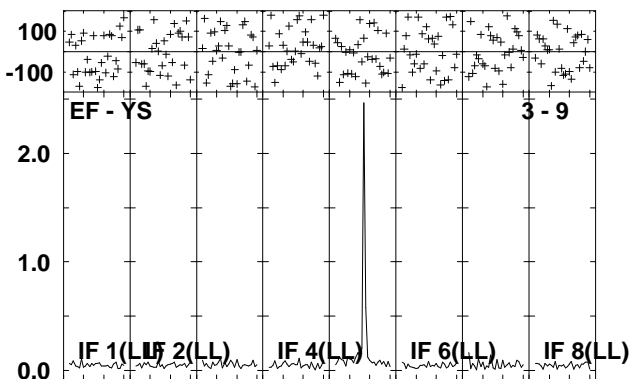
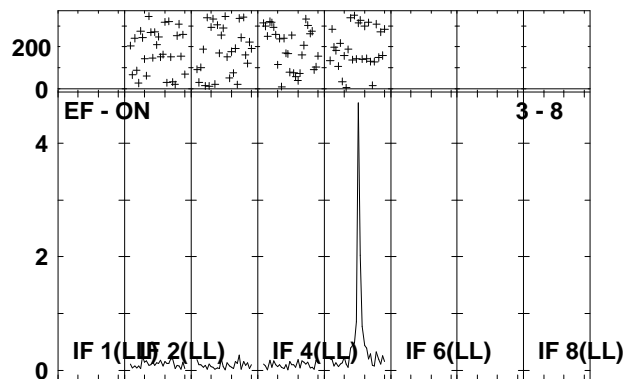
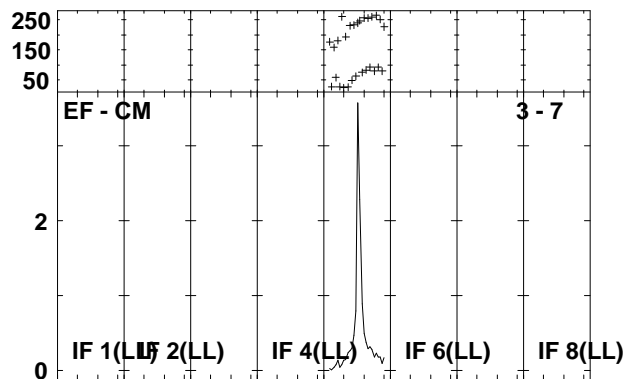
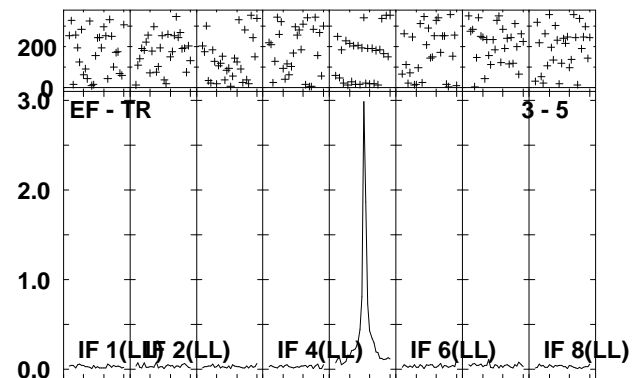
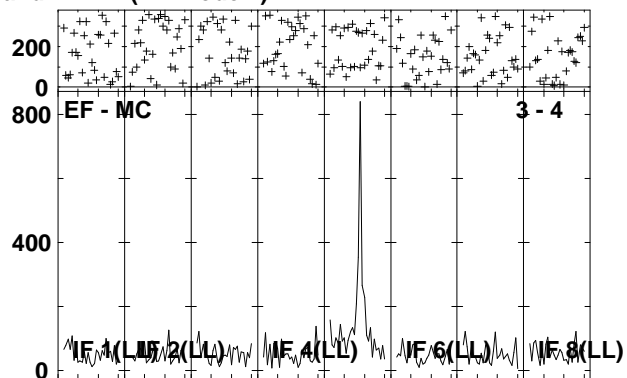
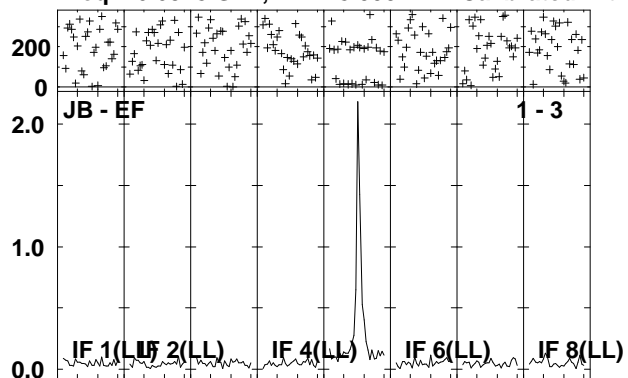

Lower frame: Ampl Jy Top frame: Phas deg
Vector averaged cross-power spectrum Several baselines displayed
Timerange: 00/02:02:30 to 00/02:03:59

Plot file version 20 created 19-AUG-2009 15:46:41

W75 EB039B 2.UVDATA.1

Freq = 6.6328 GHz, Bw = 8.000 MH Calibrated with CL # 3 and BP # 1 (BP mode 1)

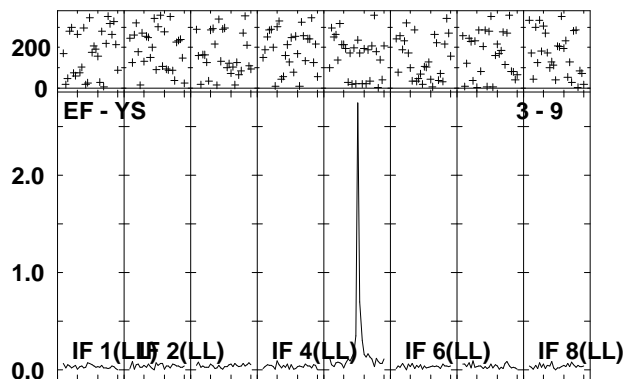
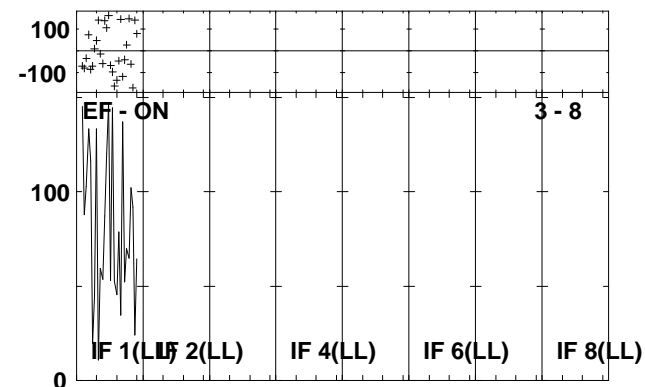
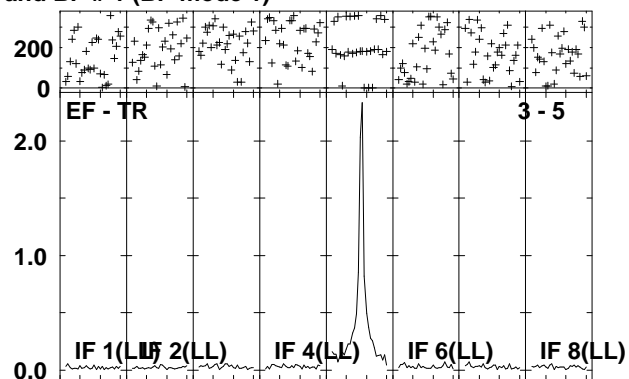
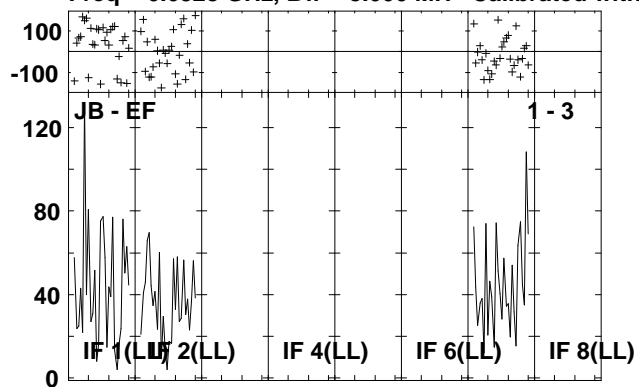

Lower frame: Milli Ampl Jy Top frame: Phas deg
Vector averaged cross-power spectrum Several baselines displayed
Timerange: 00/02:05:30 to 00/02:06:59

Plot file version 21 created 19-AUG-2009 15:46:43
 2048+431 EB039B 2.UVDATA.1
 Freq = 6.6328 GHz, Bw = 8.000 MH Calibrated with CL # 3 and BP # 1 (BP mode 1)

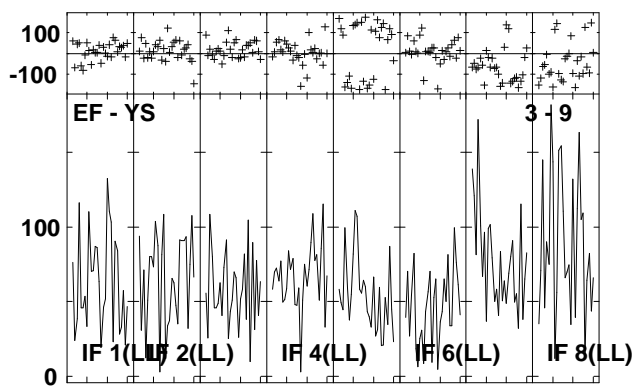
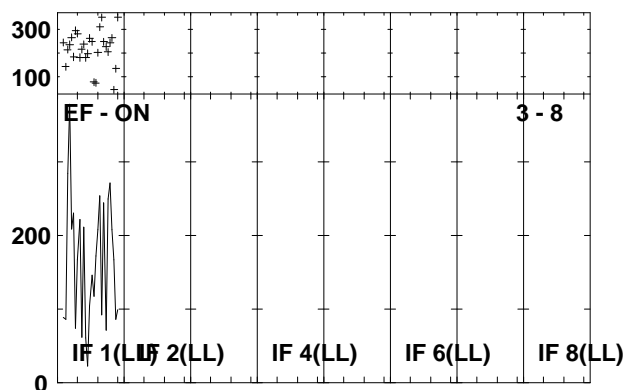
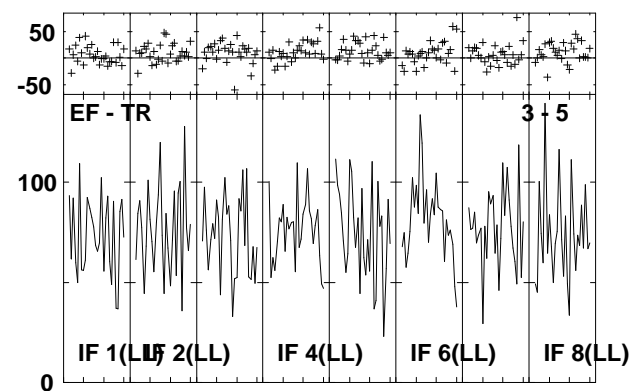
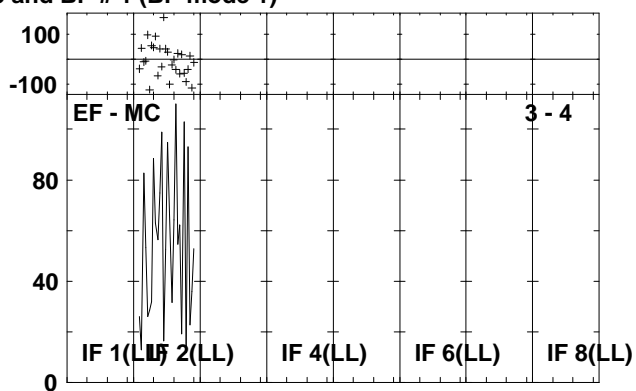
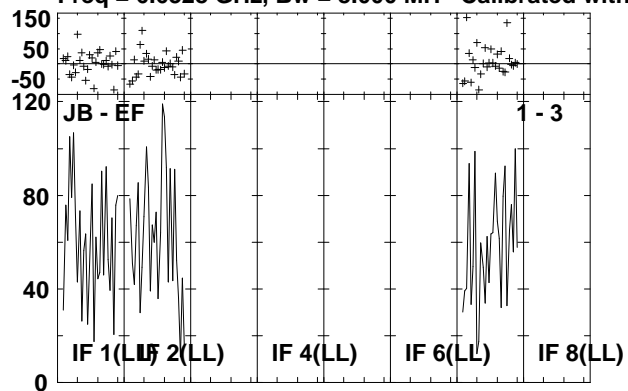

Lower frame: Milli Ampl Jy Top frame: Phas deg
 Vector averaged cross-power spectrum Several baselines displayed
 Timerange: 00/02:07:00 to 00/02:08:29

Plot file version 22 created 19-AUG-2009 15:46:45

W75 EB039B 2.UVDATA.1

Freq = 6.6328 GHz, Bw = 8.000 MH Calibrated with CL # 3 and BP # 1 (BP mode 1)

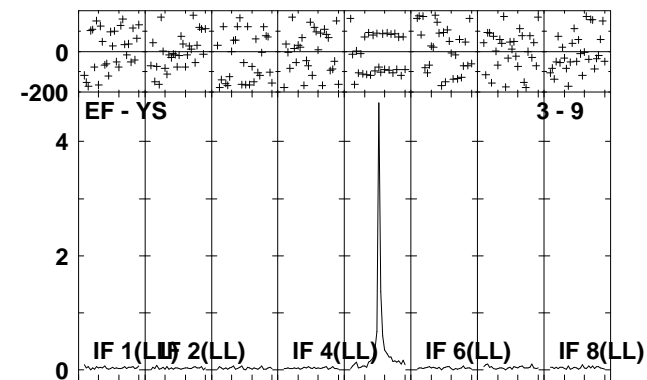
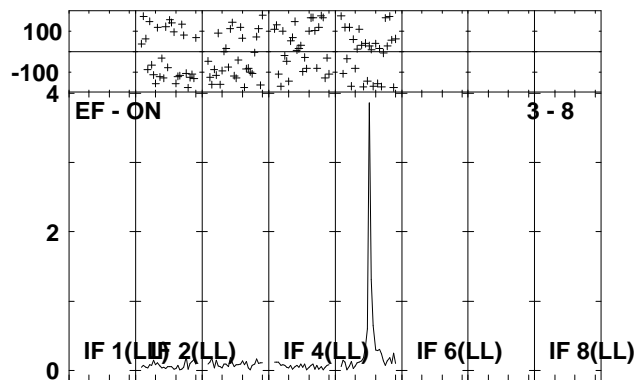
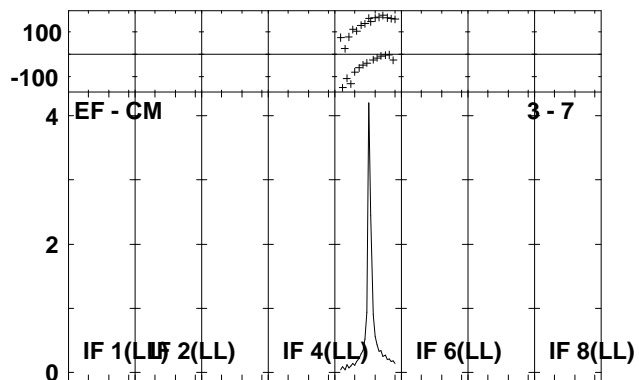
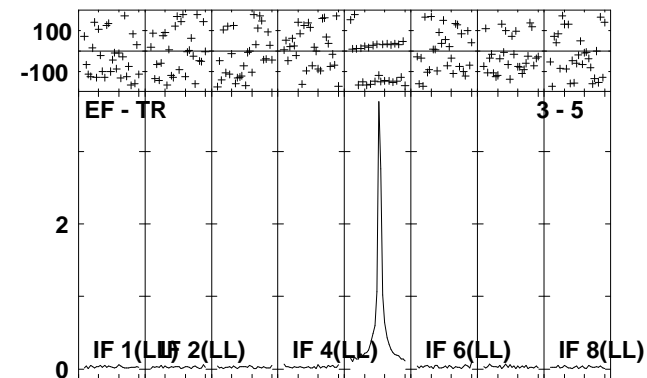
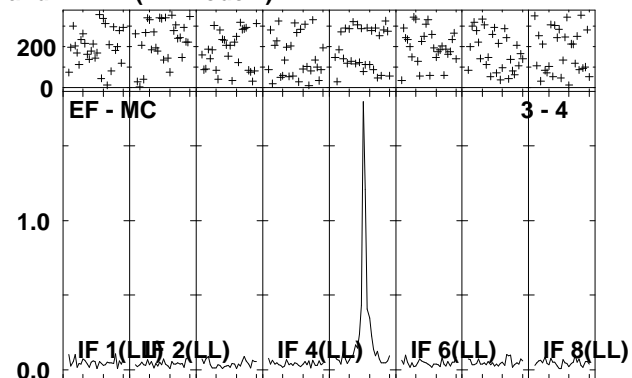
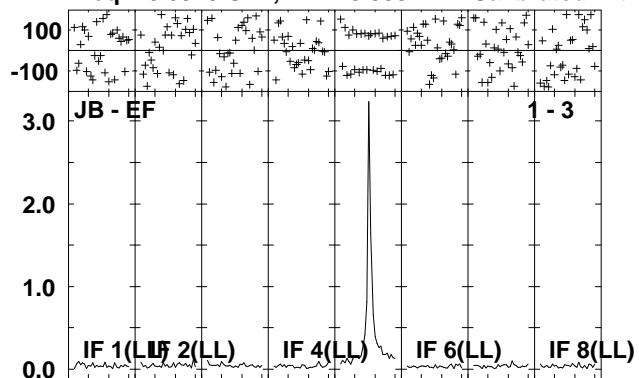

Lower frame: Ampl Jy Top frame: Phas deg
Vector averaged cross-power spectrum Several baselines displayed
Timerange: 00/02:08:30 to 00/02:09:58

Plot file version 23 created 19-AUG-2009 15:46:47
 OB2 EB039B 2.UVDATA.1
 Freq = 6.6328 GHz, Bw = 8.000 MH Calibrated with CL # 3 and BP # 1 (BP mode 1)

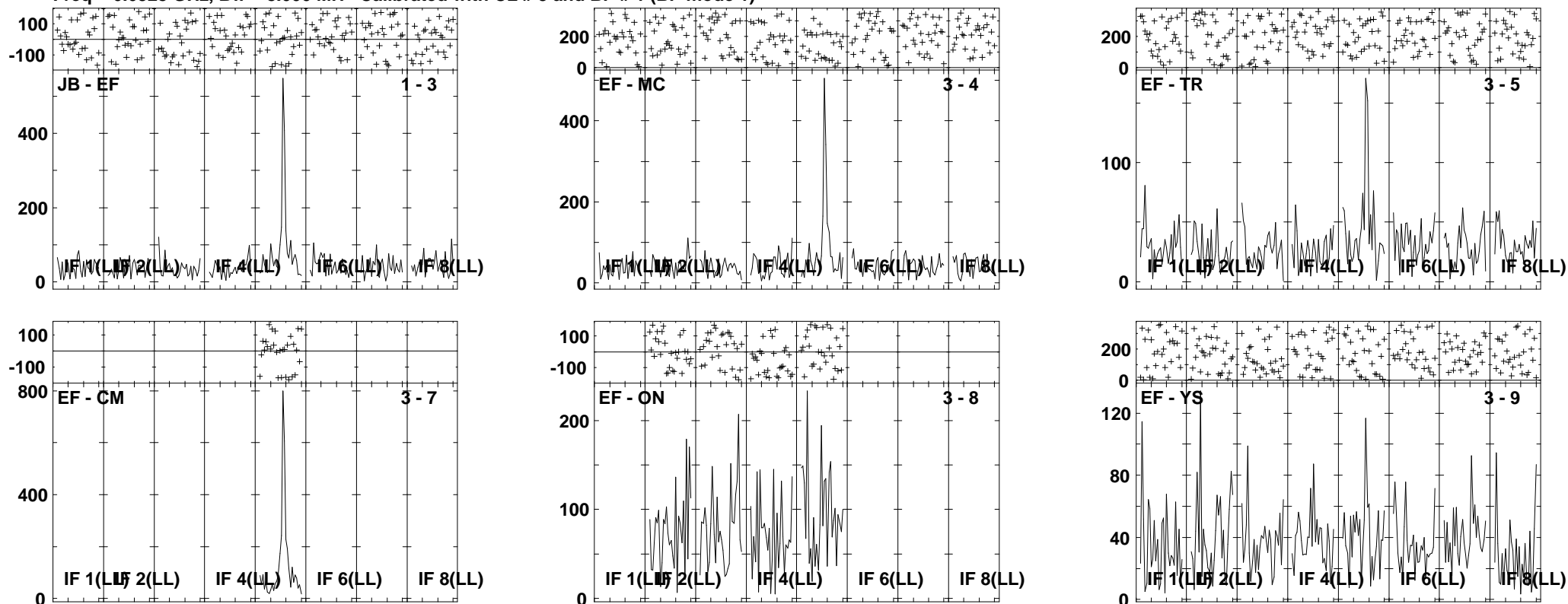

Lower frame: Milli Ampl Jy Top frame: Phas deg
 Vector averaged cross-power spectrum Several baselines displayed
 Timerange: 00/02:10:00 to 00/02:11:28

Plot file version 24 created 19-AUG-2009 15:46:49

W75 EB039B 2.UVDATA.1

Freq = 6.6328 GHz, Bw = 8.000 MH Calibrated with CL # 3 and BP # 1 (BP mode 1)

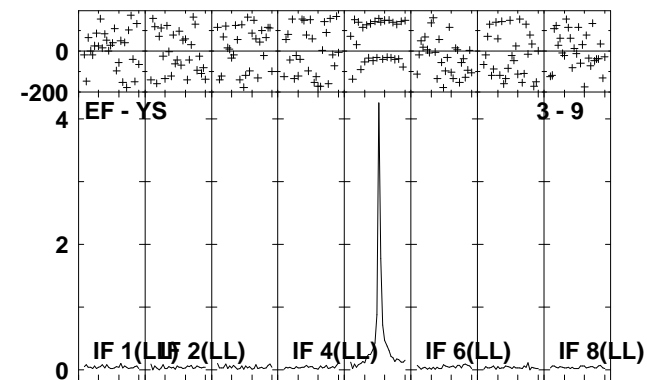
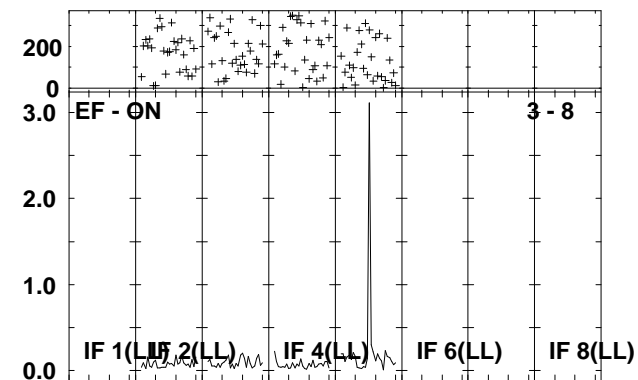
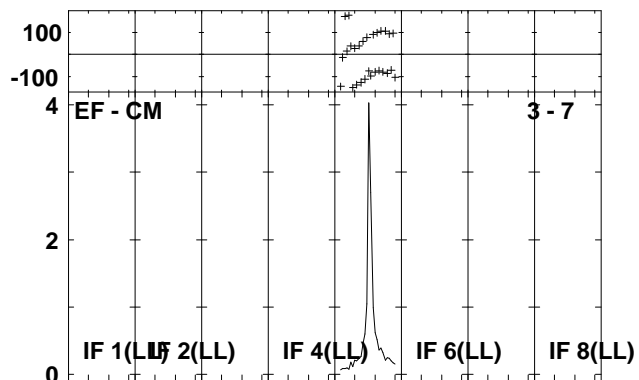
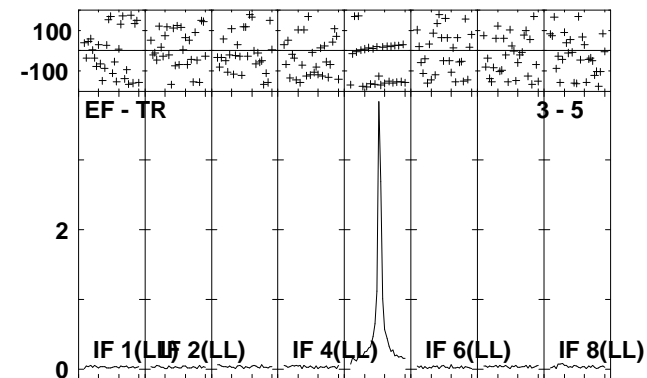
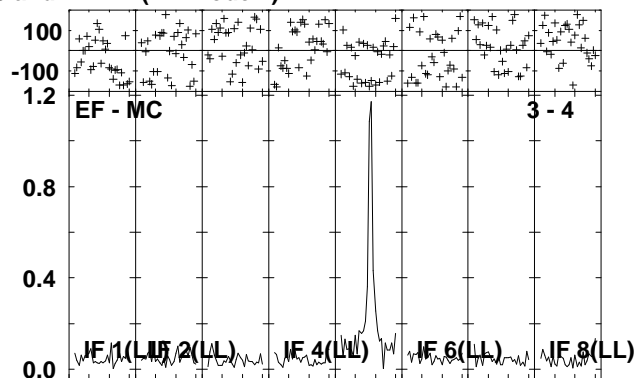
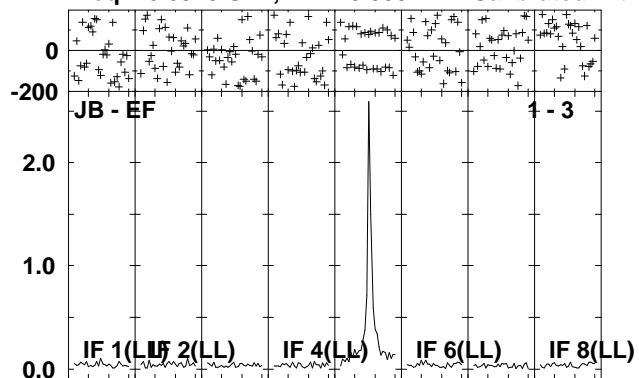

Lower frame: Ampl Jy Top frame: Phas deg
Vector averaged cross-power spectrum Several baselines displayed
Timerange: 00/02:12:00 to 00/02:13:00

Plot file version 25 created 19-AUG-2009 15:46:51
 DR21A EB039B 2.UVDATA.1
 Freq = 6.6328 GHz, Bw = 8.000 MH Calibrated with CL # 3 and BP # 1 (BP mode 1)

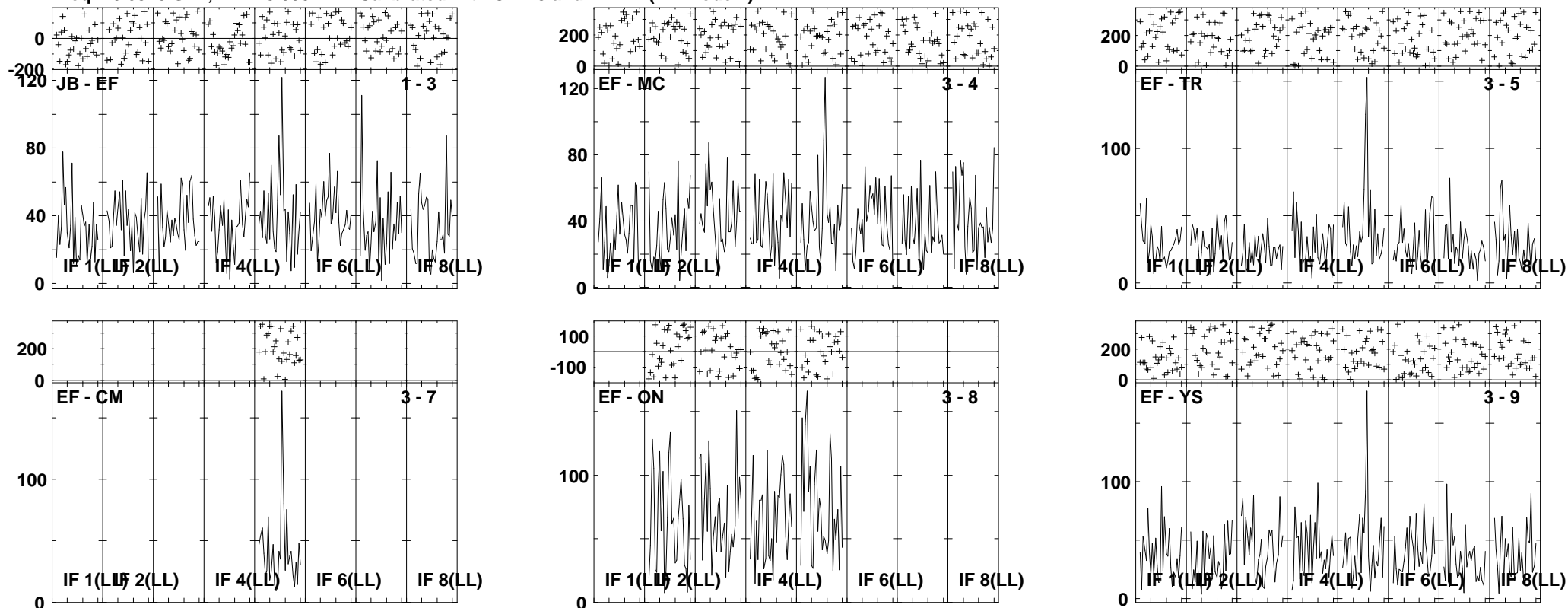

Lower frame: Milli Ampl Jy Top frame: Phas deg
 Vector averaged cross-power spectrum Several baselines displayed
 Timerange: 00/02:13:01 to 00/02:14:30

Plot file version 26 created 19-AUG-2009 15:46:53

W75 EB039B 2.UVDATA.1

Freq = 6.6328 GHz, Bw = 8.000 MH Calibrated with CL # 3 and BP # 1 (BP mode 1)

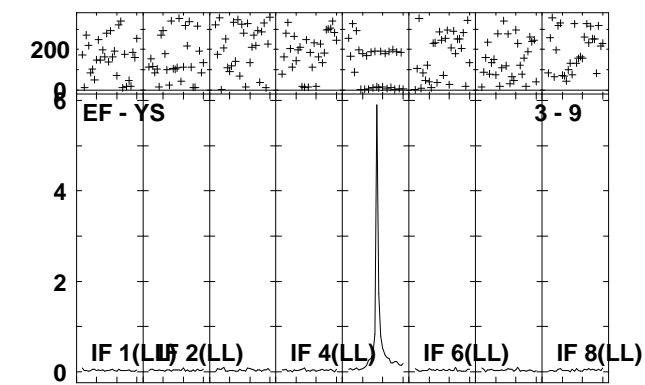
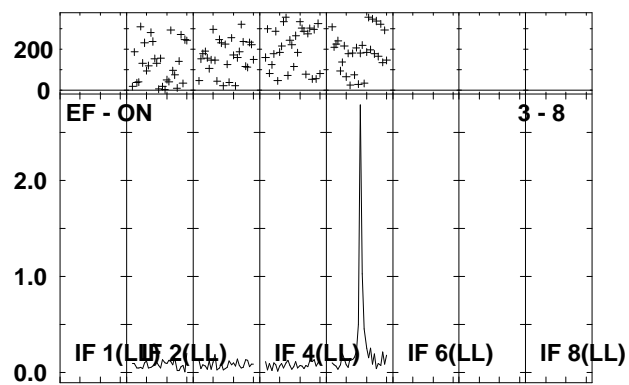
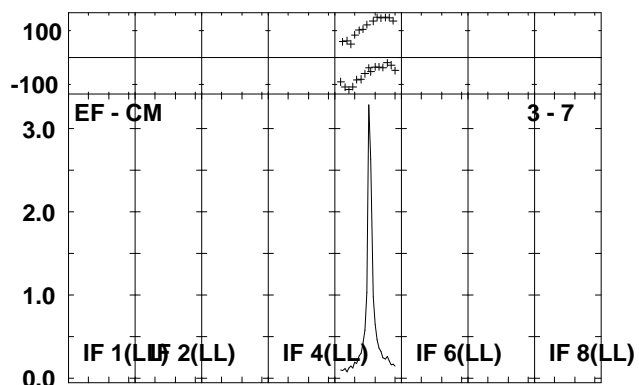
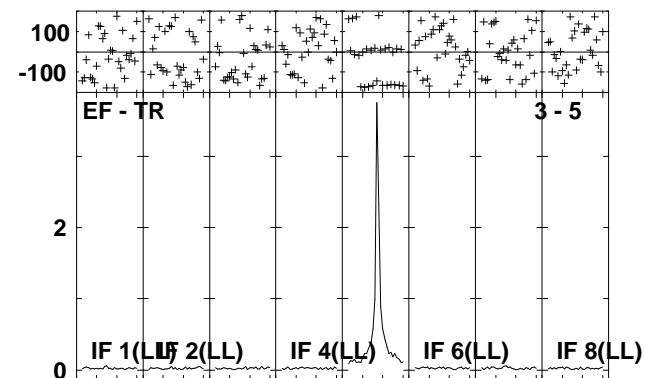
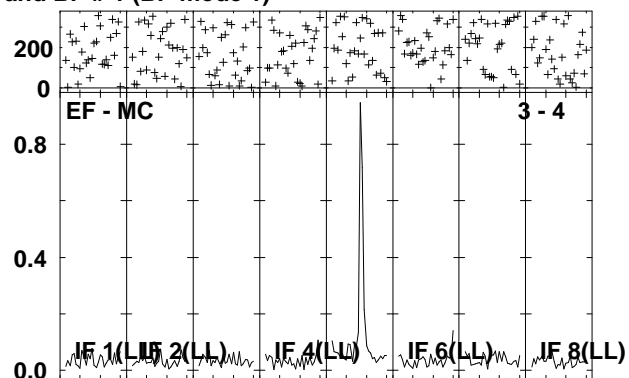
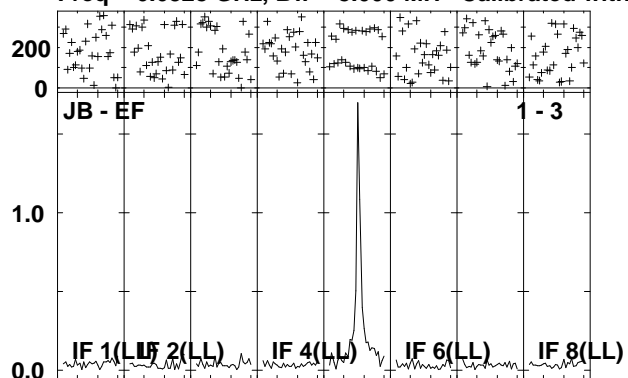

Lower frame: Ampl Jy Top frame: Phas deg
Vector averaged cross-power spectrum Several baselines displayed
Timerange: 00/02:14:31 to 00/02:15:59

Plot file version 27 created 19-AUG-2009 15:46:55
 DR21B EB039B 2.UVDATA.1
 Freq = 6.6328 GHz, Bw = 8.000 MH Calibrated with CL # 3 and BP # 1 (BP mode 1)

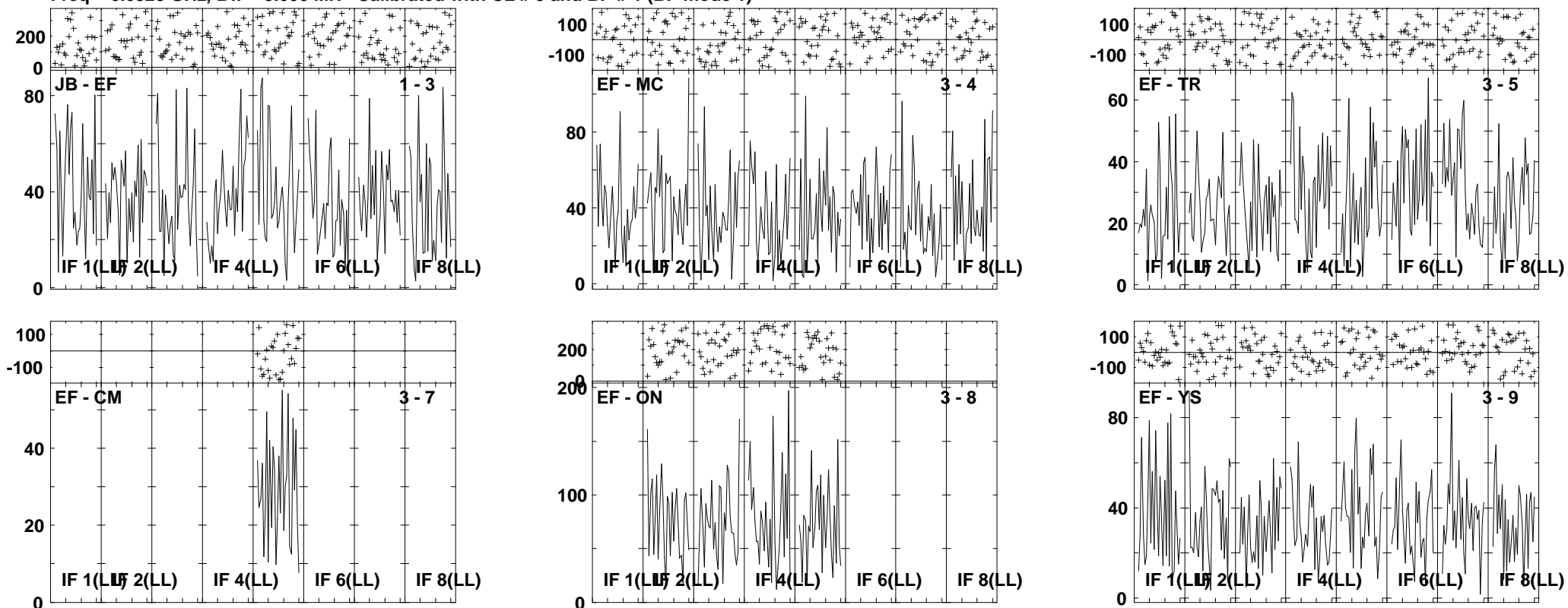

Lower frame: Milli Ampl Jy Top frame: Phas deg
 Vector averaged cross-power spectrum Several baselines displayed
 Timerange: 00/02:16:01 to 00/02:17:29

Plot file version 28 created 19-AUG-2009 15:46:58

W75 EB039B 2.UVDATA.1

Freq = 6.6328 GHz, Bw = 8.000 MH Calibrated with CL # 3 and BP # 1 (BP mode 1)

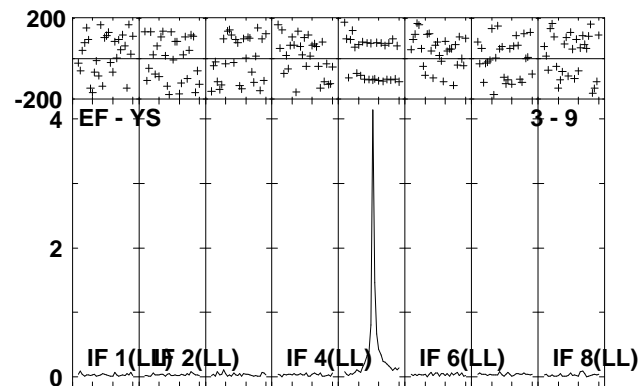
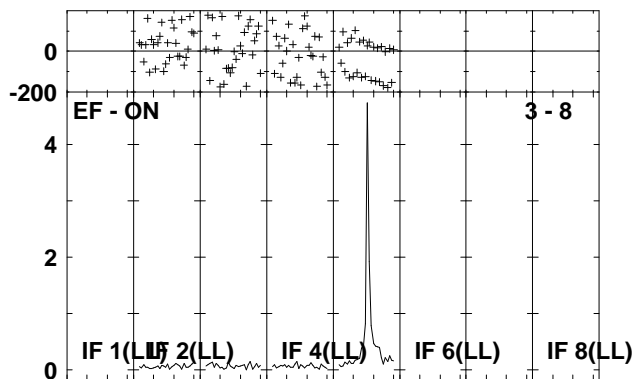
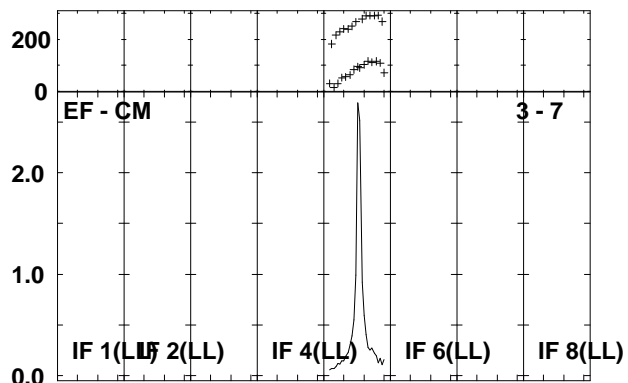
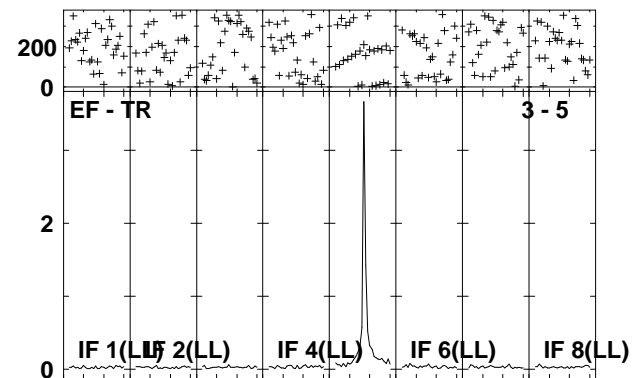
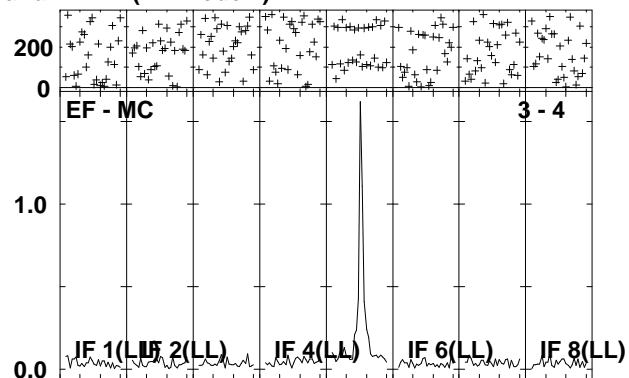
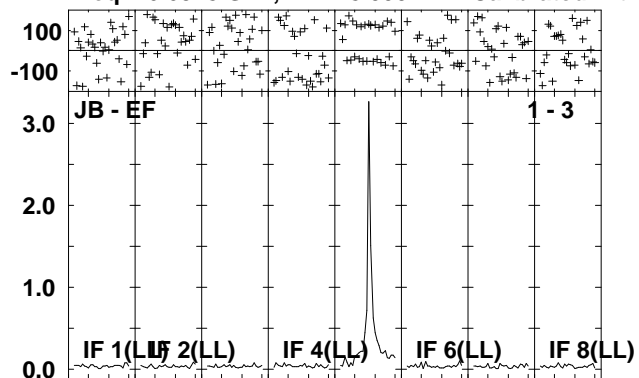

Lower frame: Ampl Jy Top frame: Phas deg
Vector averaged cross-power spectrum Several baselines displayed
Timerange: 00/02:17:31 to 00/02:18:59

Plot file version 29 created 19-AUG-2009 15:47:00
 DR21B2 EB039B 2.UVDATA.1
 Freq = 6.6328 GHz, Bw = 8.000 MH Calibrated with CL # 3 and BP # 1 (BP mode 1)

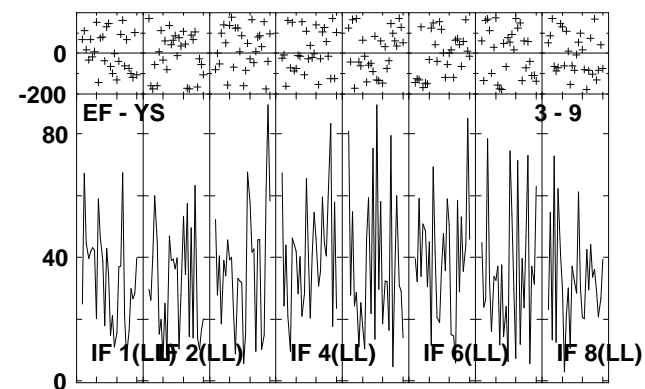
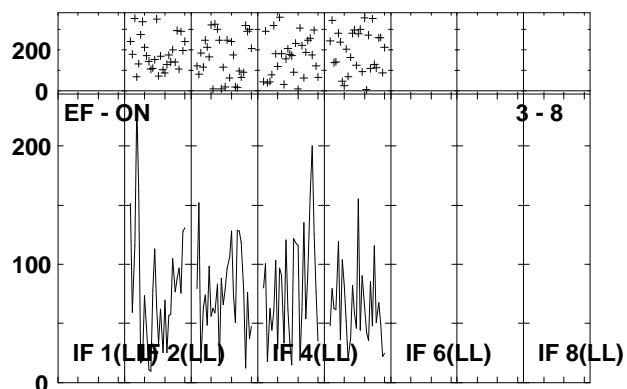
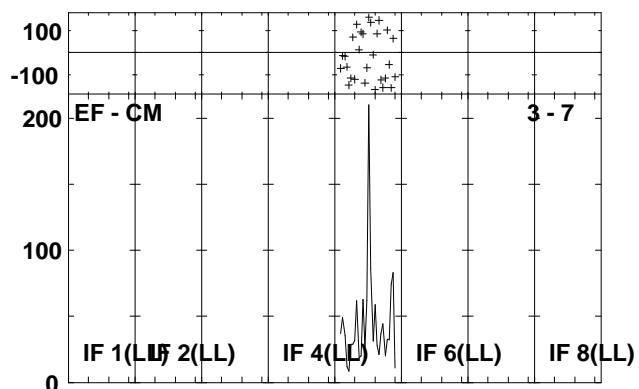
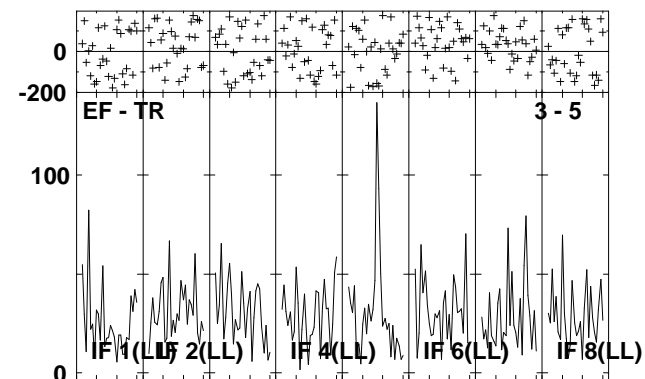
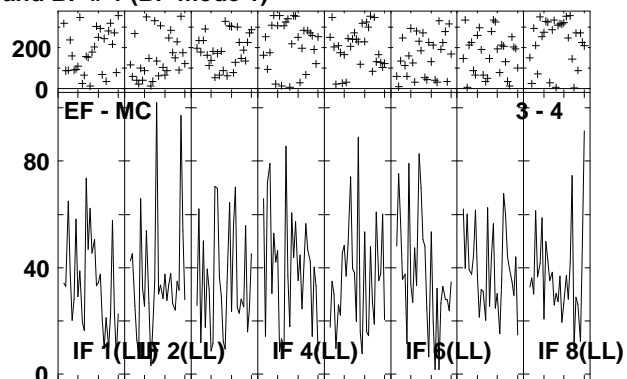
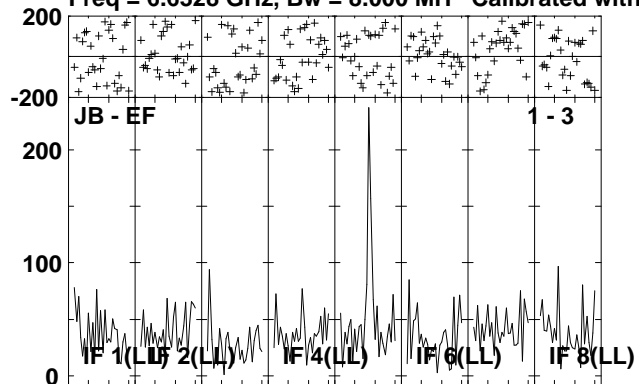

Lower frame: Milli Ampl Jy Top frame: Phas deg
 Vector averaged cross-power spectrum Several baselines displayed
 Timerange: 00/02:19:01 to 00/02:20:29

Plot file version 30 created 19-AUG-2009 15:47:02
 W75 EB039B 2.UVDATA.1
 Freq = 6.6328 GHz, Bw = 8.000 MH Calibrated with CL # 3 and BP # 1 (BP mode 1)

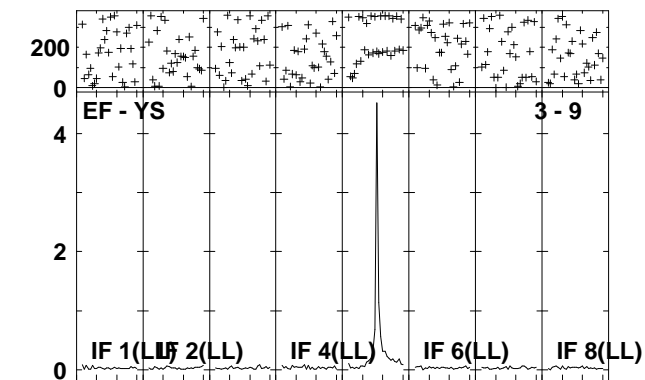
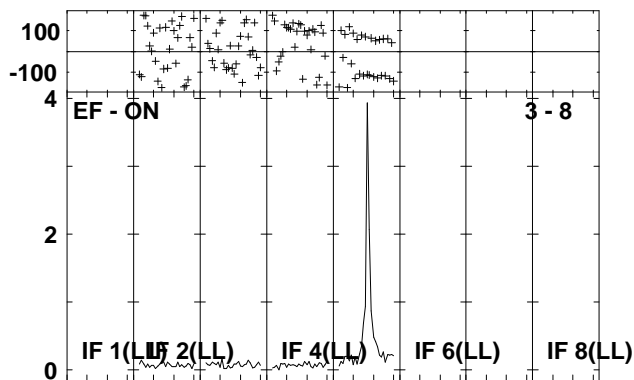
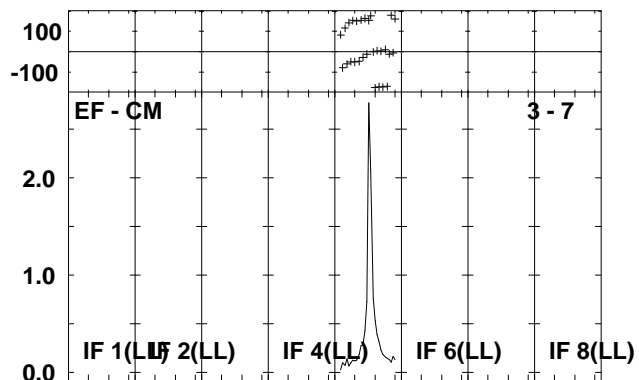
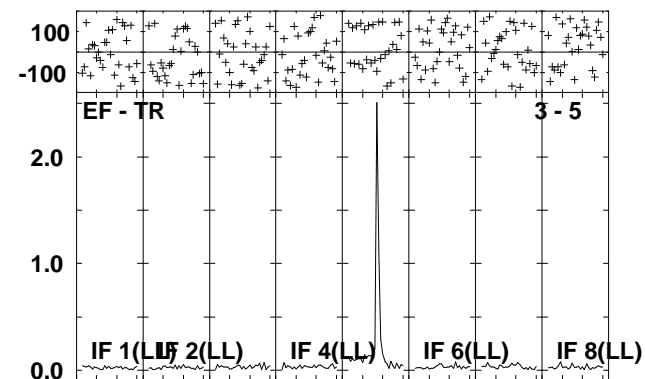
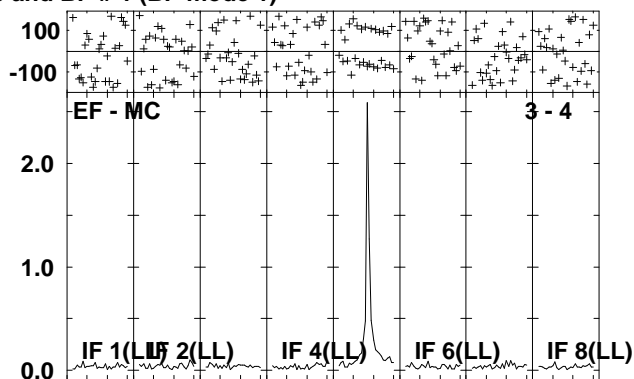
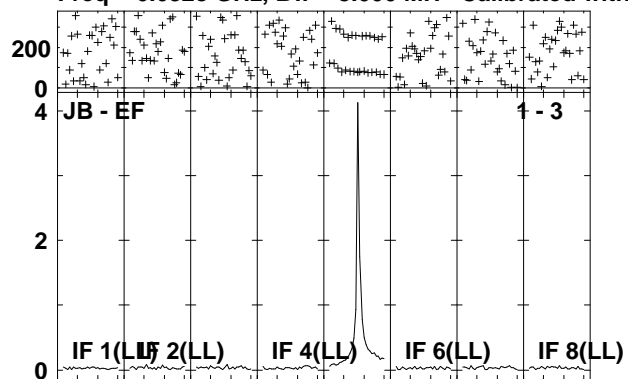

Lower frame: Ampl Jy Top frame: Phas deg
 Vector averaged cross-power spectrum Several baselines displayed
 Timerange: 00/02:20:31 to 00/02:21:59

Plot file version 31 created 19-AUG-2009 15:47:04
 DR20 EB039B 2.UVDATA.1
 Freq = 6.6328 GHz, Bw = 8.000 MH Calibrated with CL # 3 and BP # 1 (BP mode 1)

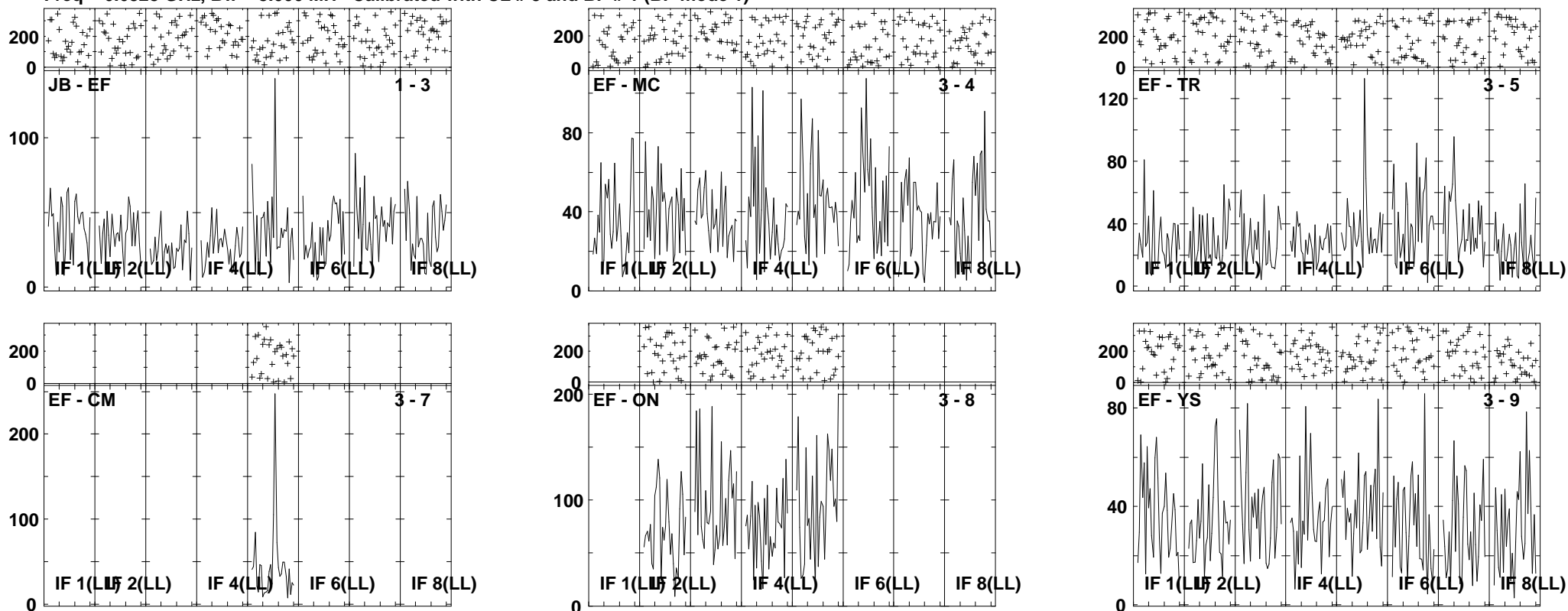

Lower frame: Milli Ampl Jy Top frame: Phas deg
 Vector averaged cross-power spectrum Several baselines displayed
 Timerange: 00/02:22:00 to 00/02:23:29

Plot file version 32 created 19-AUG-2009 15:47:06

W75 EB039B 2.UVDATA.1

Freq = 6.6328 GHz, Bw = 8.000 MH Calibrated with CL # 3 and BP # 1 (BP mode 1)

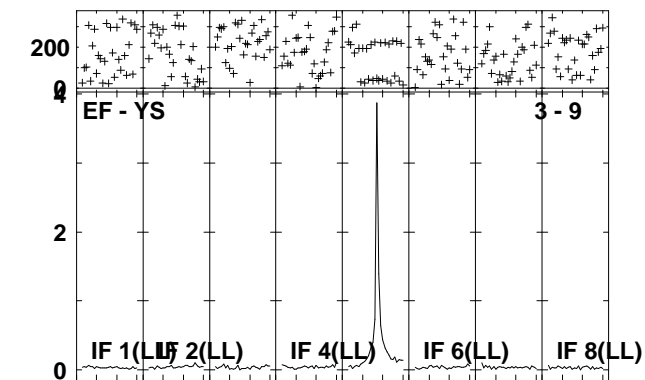
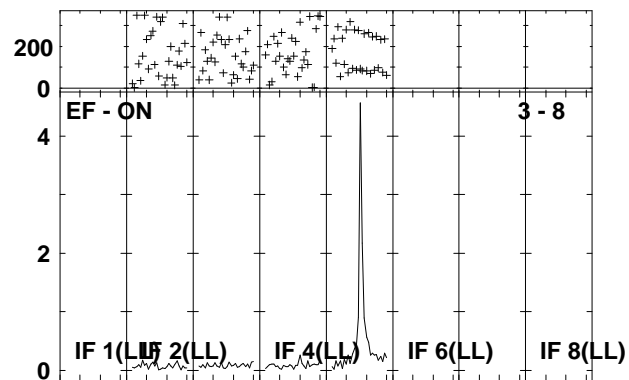
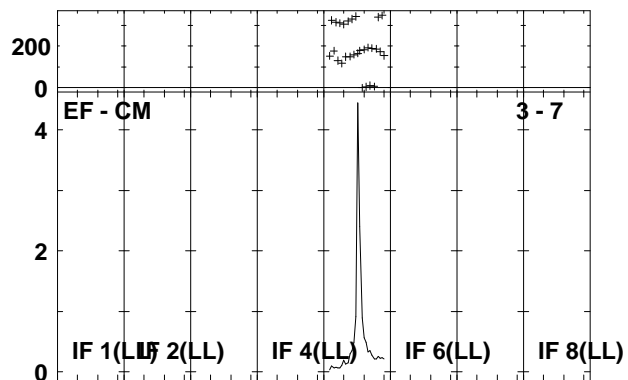
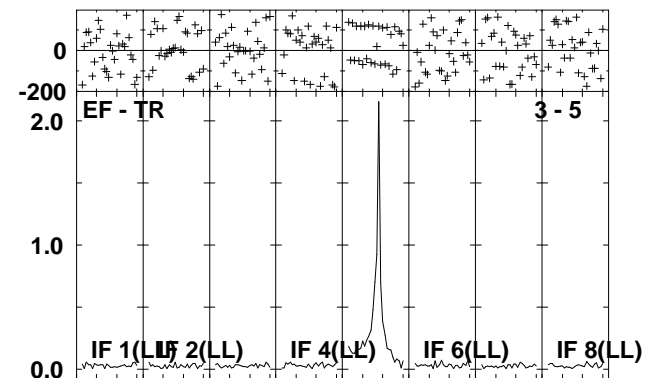
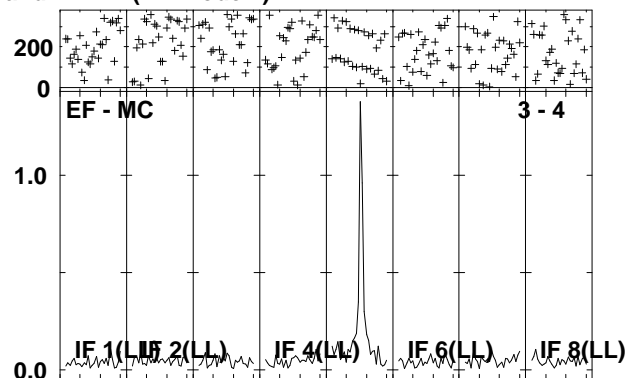
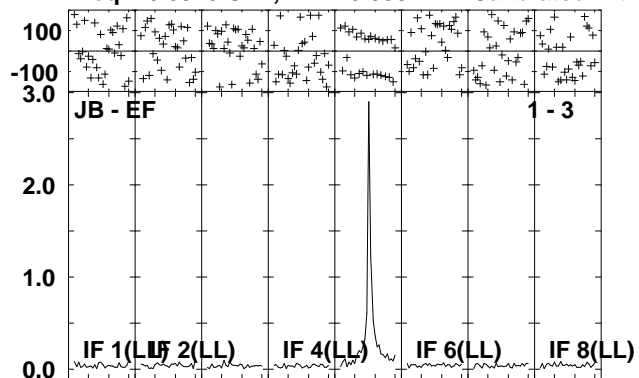

Lower frame: Ampl Jy Top frame: Phas deg
Vector averaged cross-power spectrum Several baselines displayed
Timerange: 00/02:23:55 to 00/02:24:53

Plot file version 33 created 19-AUG-2009 15:47:08
 J2029+46 EB039B 2.UVDATA.1
 Freq = 6.6328 GHz, Bw = 8.000 MH Calibrated with CL # 3 and BP # 1 (BP mode 1)

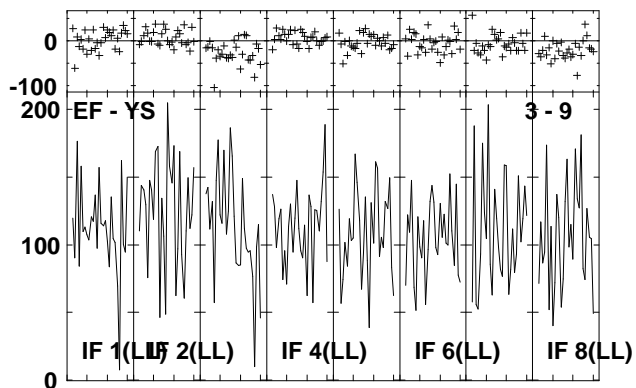
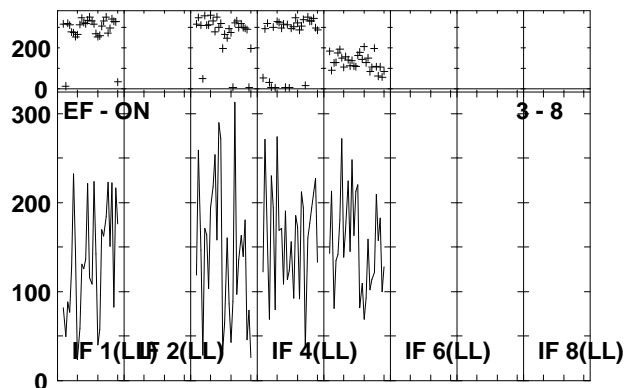
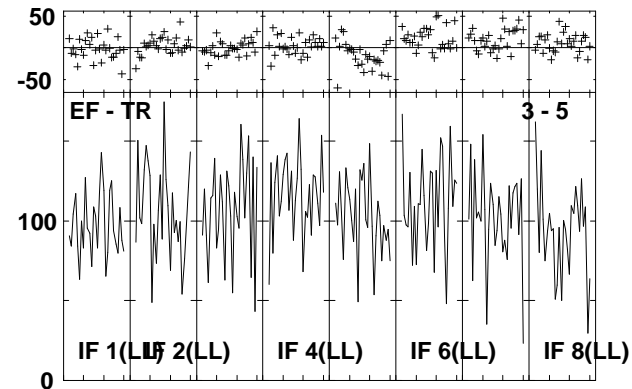
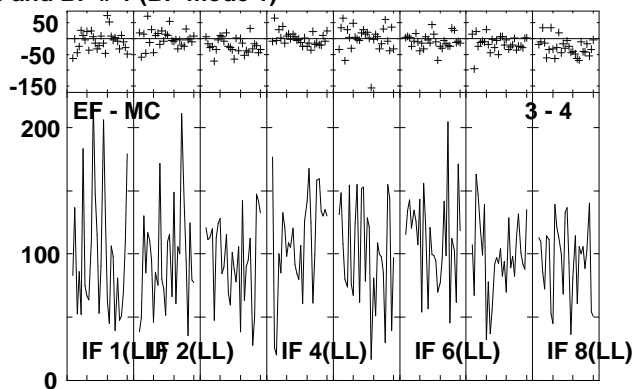
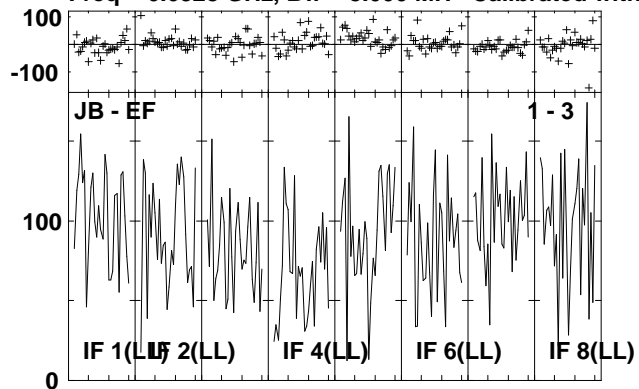

Lower frame: Milli Ampl Jy Top frame: Phas deg
 Vector averaged cross-power spectrum Several baselines displayed
 Timerange: 00/02:24:55 to 00/02:26:23

Plot file version 34 created 19-AUG-2009 15:47:10

W75 EB039B 2.UVDATA.1

Freq = 6.6328 GHz, Bw = 8.000 MH Calibrated with CL # 3 and BP # 1 (BP mode 1)

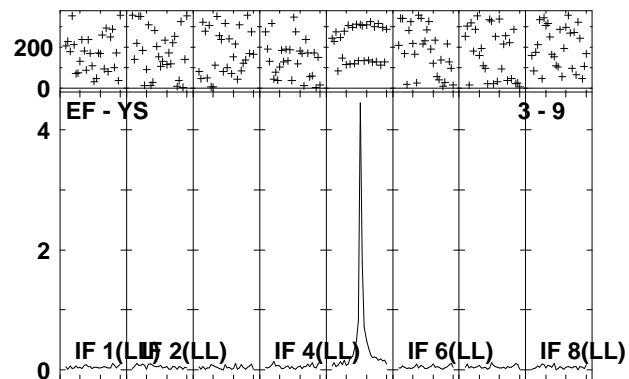
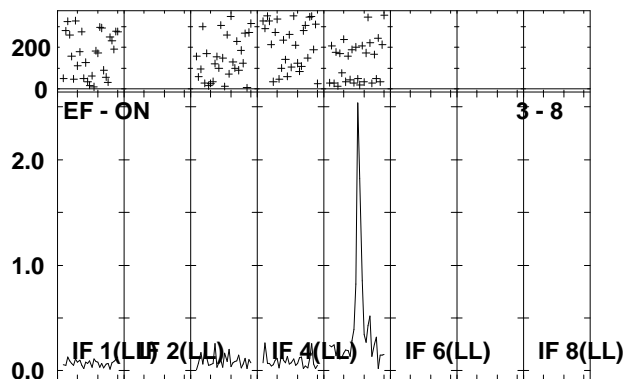
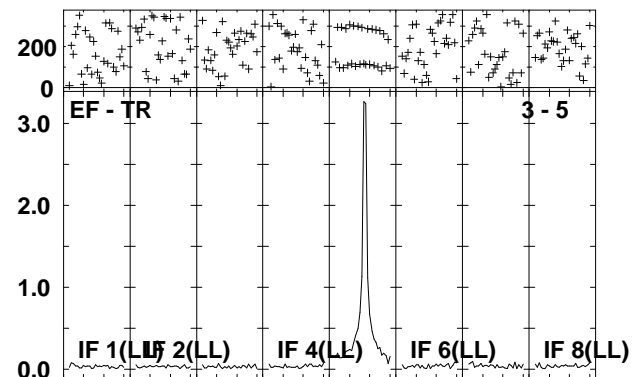
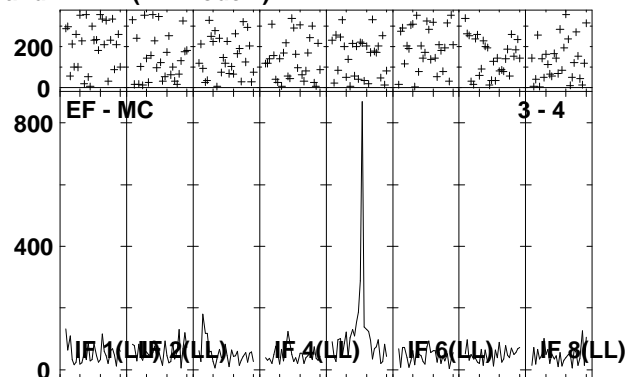
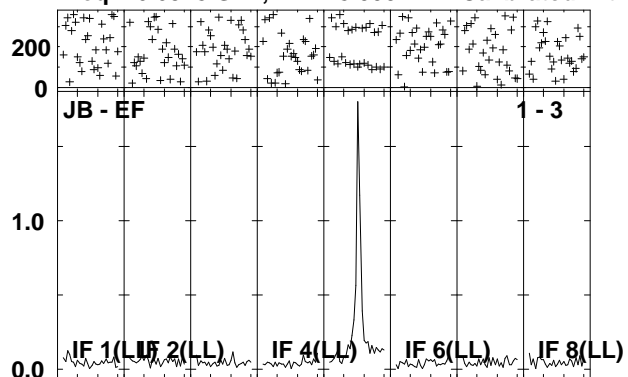

Lower frame: Ampl Jy Top frame: Phas deg
Vector averaged cross-power spectrum Several baselines displayed
Timerange: 00/02:26:25 to 00/02:27:53

Plot file version 35 created 19-AUG-2009 15:47:14

W75 EB039B 2.UVDATA.1

Freq = 6.6328 GHz, Bw = 8.000 MH Calibrated with CL # 3 and BP # 1 (BP mode 1)

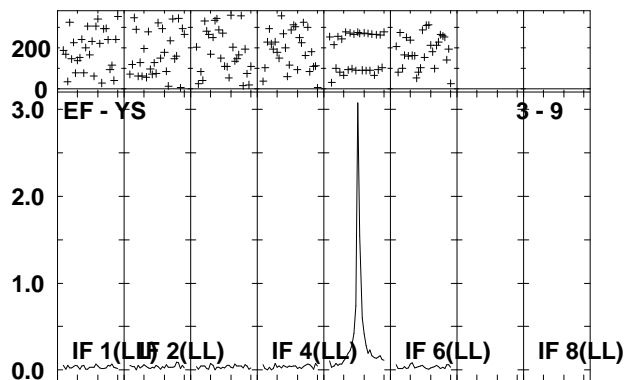
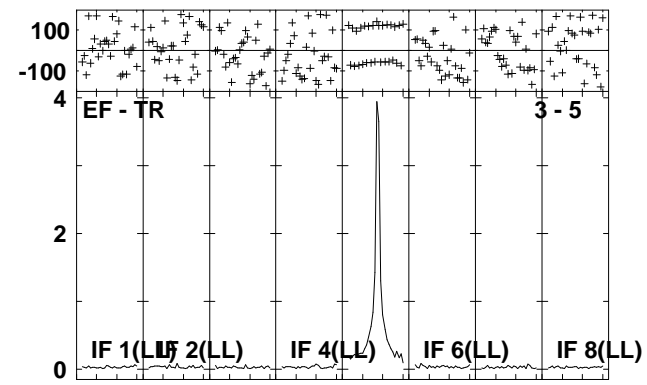
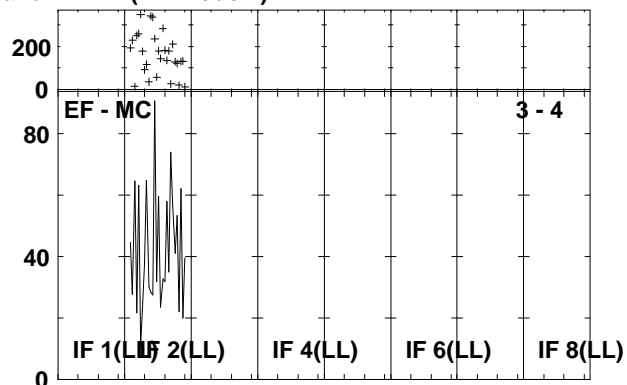
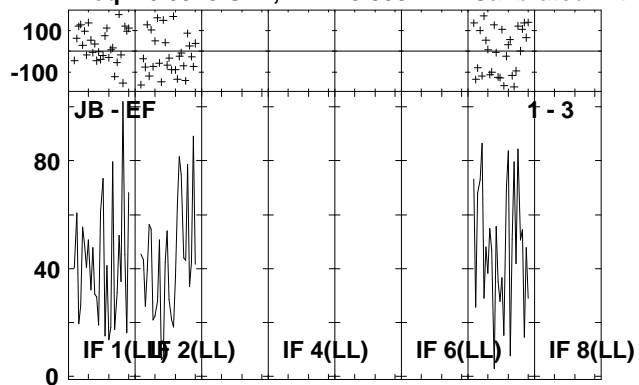

Lower frame: Milli Ampl Jy Top frame: Phas deg
Vector averaged cross-power spectrum Several baselines displayed
Timerange: 00/02:29:24 to 00/02:30:53

Plot file version 36 created 19-AUG-2009 15:47:16
 2048+431 EB039B 2.UVDATA.1
 Freq = 6.6328 GHz, Bw = 8.000 MH Calibrated with CL # 3 and BP # 1 (BP mode 1)

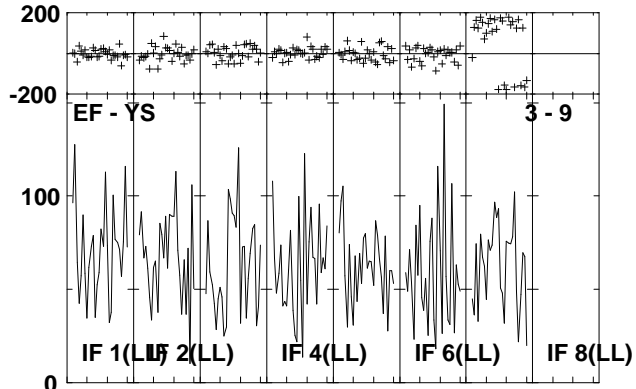
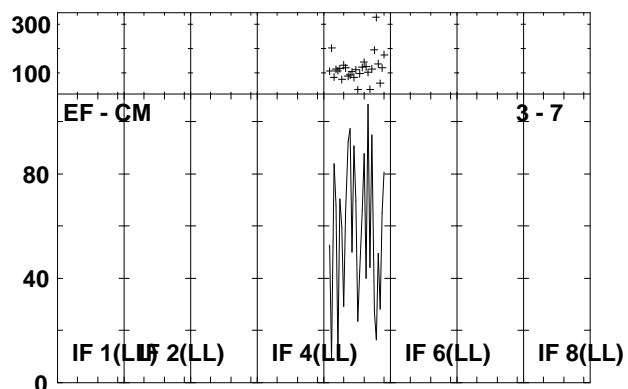
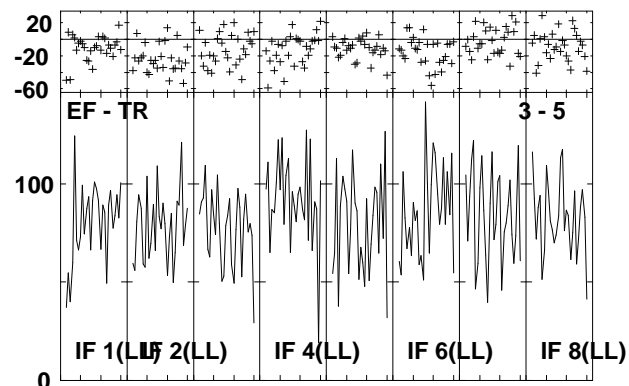
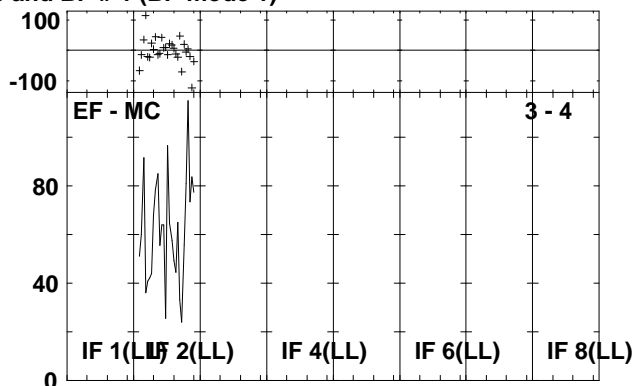
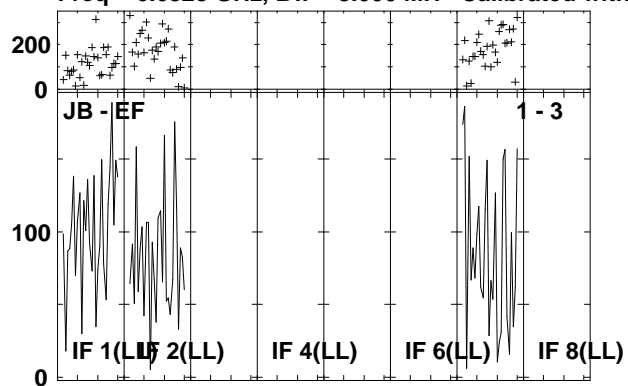

Lower frame: Milli Ampl Jy Top frame: Phas deg
 Vector averaged cross-power spectrum Several baselines displayed
 Timerange: 00/02:30:54 to 00/02:32:23

Plot file version 37 created 19-AUG-2009 15:47:18

W75 EB039B 2.UVDATA.1

Freq = 6.6328 GHz, Bw = 8.000 MH Calibrated with CL # 3 and BP # 1 (BP mode 1)

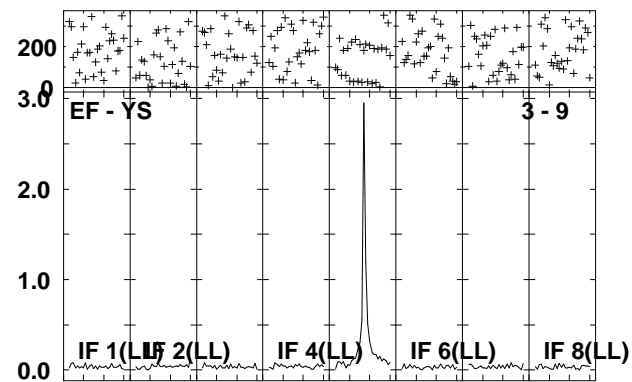
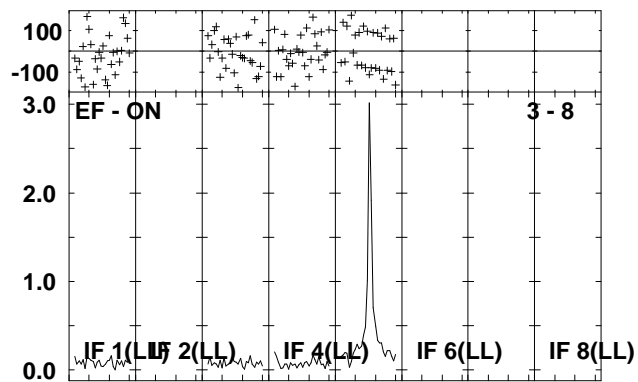
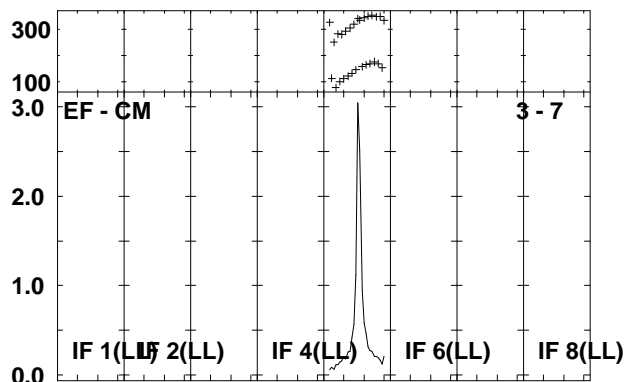
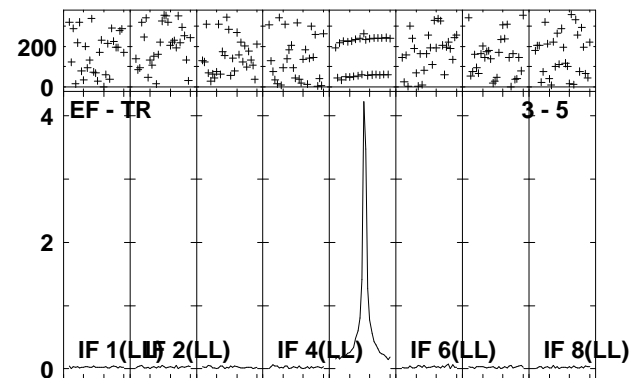
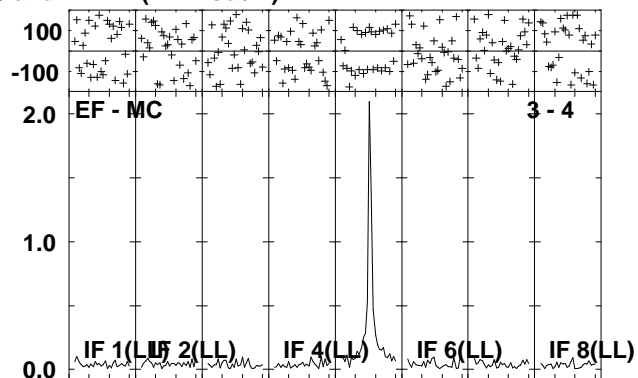
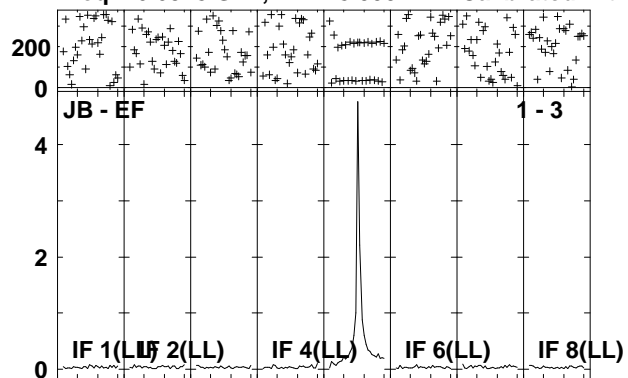

Lower frame: Ampl Jy Top frame: Phas deg
Vector averaged cross-power spectrum Several baselines displayed
Timerange: 00/02:32:24 to 00/02:33:53

Plot file version 38 created 19-AUG-2009 15:47:20
 OB2 EB039B 2.UVDATA.1
 Freq = 6.6328 GHz, Bw = 8.000 MH Calibrated with CL # 3 and BP # 1 (BP mode 1)

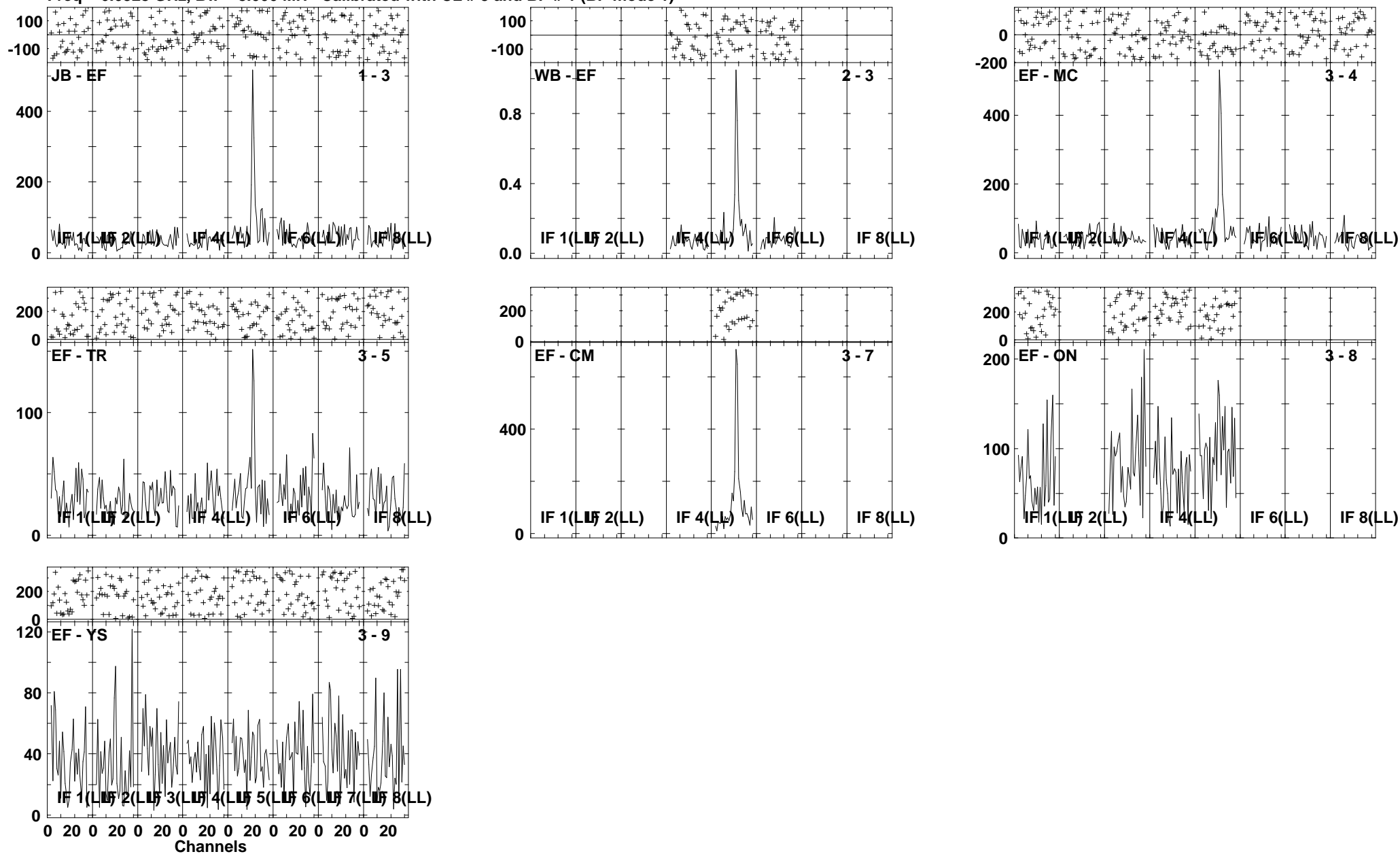

Lower frame: Milli Ampl Jy Top frame: Phas deg
 Vector averaged cross-power spectrum Several baselines displayed
 Timerange: 00:02:33:54 to 00:02:35:23

Plot file version 39 created 19-AUG-2009 15:47:23

W75 EB039B 2.UVDATA.1

Freq = 6.6328 GHz, Bw = 8.000 MH Calibrated with CL # 3 and BP # 1 (BP mode 1)

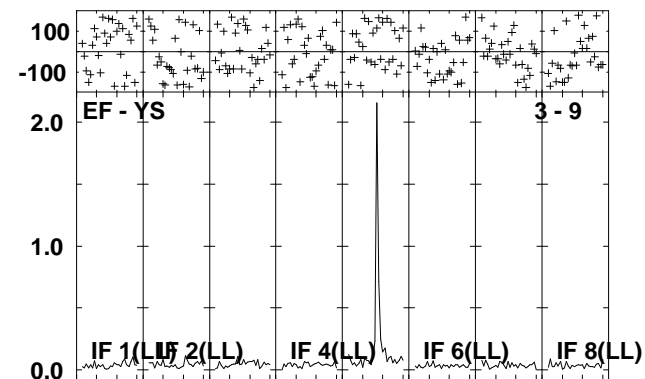
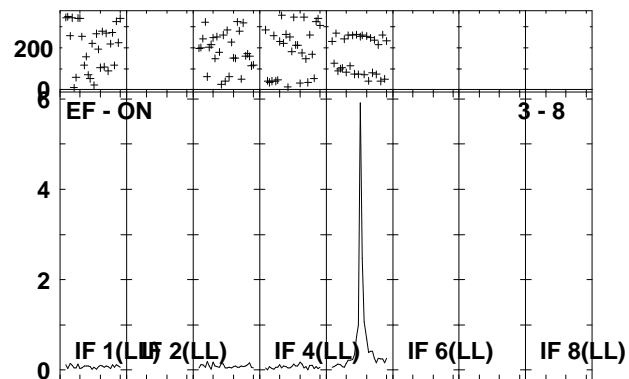
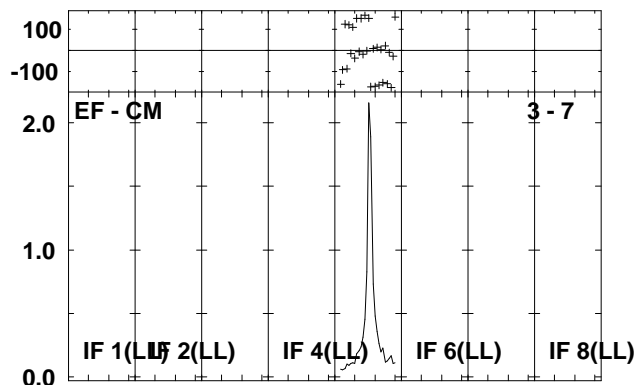
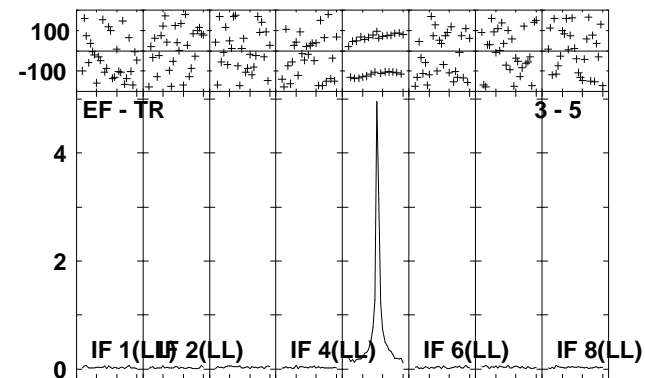
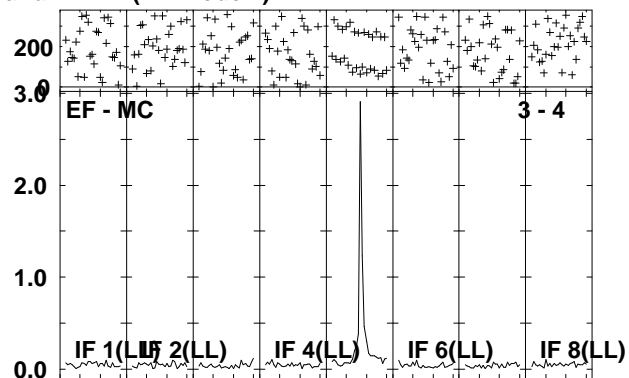
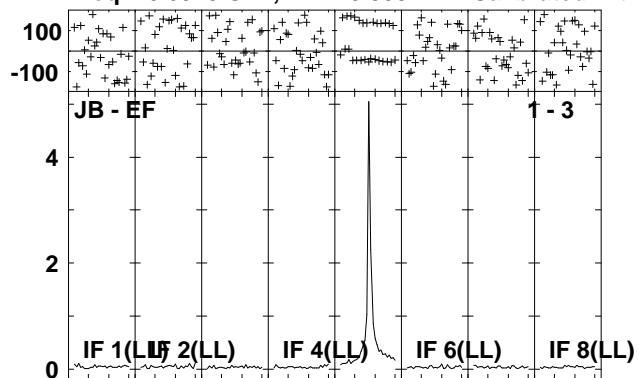

Lower frame: Ampl Jy Top frame: Phas deg
Vector averaged cross-power spectrum Several baselines displayed
Timerange: 00/02:35:55 to 00/02:36:55

Plot file version 40 created 19-AUG-2009 15:47:24
 DR21A EB039B 2.UVDATA.1
 Freq = 6.6328 GHz, Bw = 8.000 MH Calibrated with CL # 3 and BP # 1 (BP mode 1)

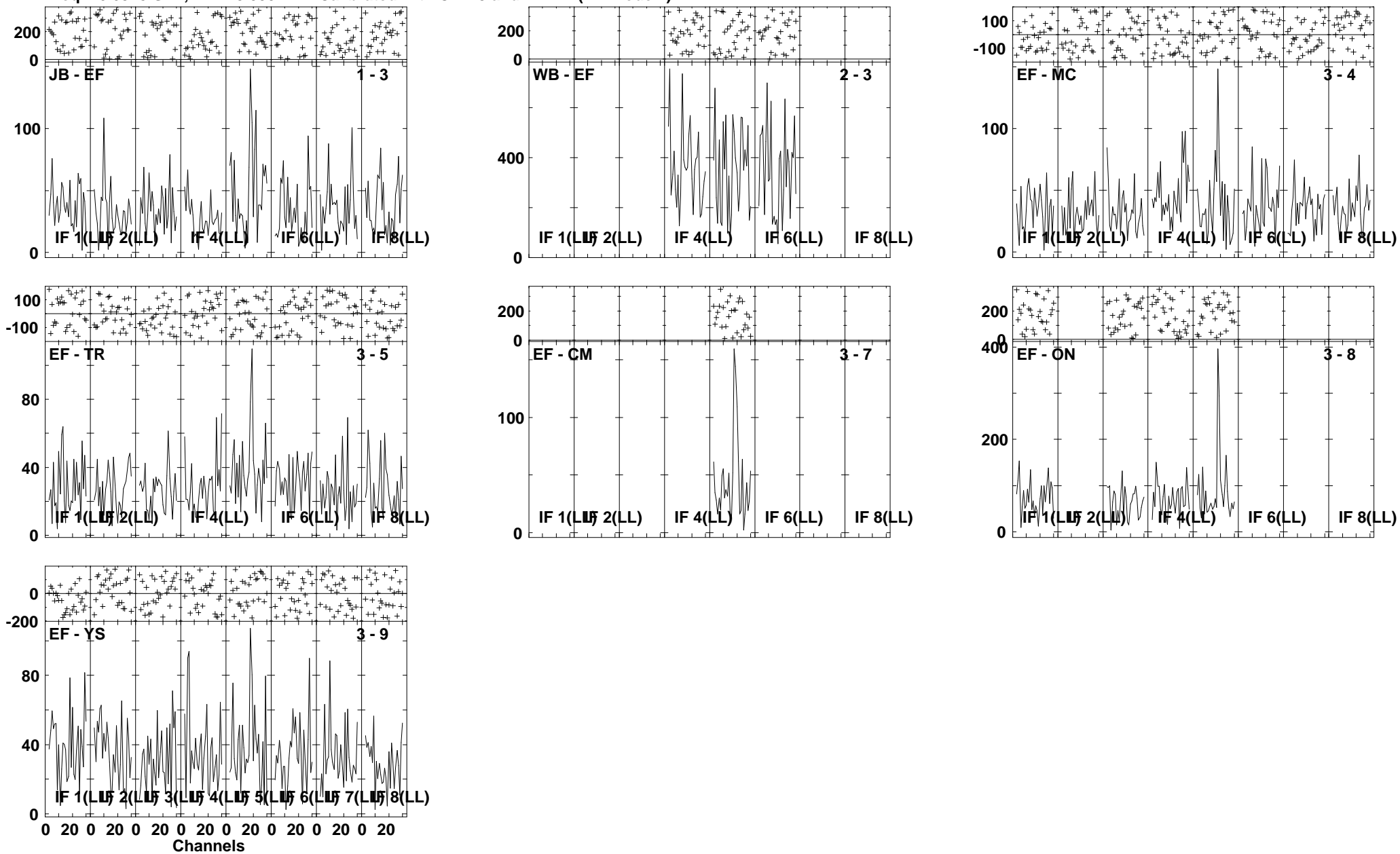

Lower frame: Milli Ampl Jy Top frame: Phas deg
 Vector averaged cross-power spectrum Several baselines displayed
 Timerange: 00/02:36:55 to 00/02:38:24

Plot file version 41 created 19-AUG-2009 15:47:27

W75 EB039B 2.UVDATA.1

Freq = 6.6328 GHz, Bw = 8.000 MH Calibrated with CL # 3 and BP # 1 (BP mode 1)

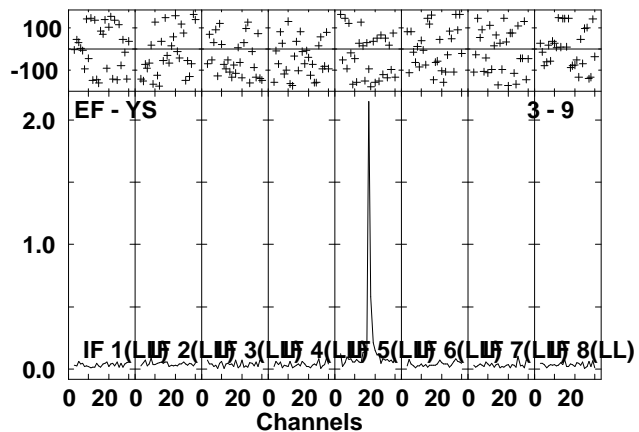
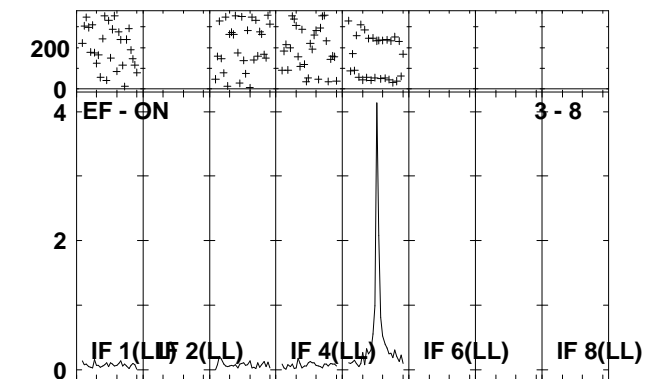
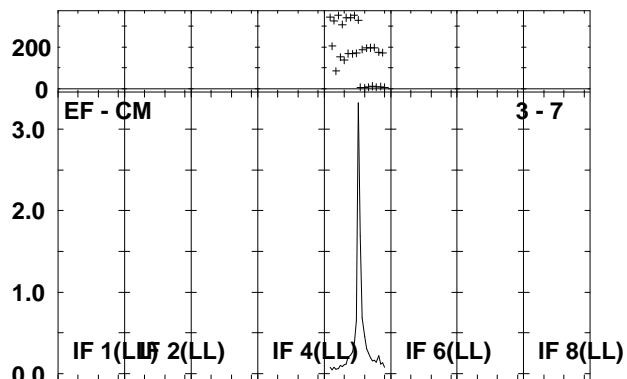
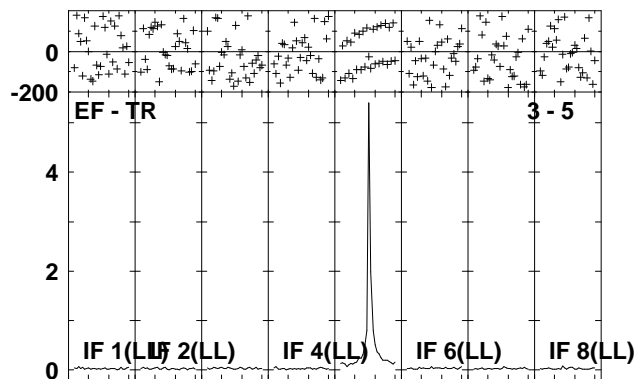
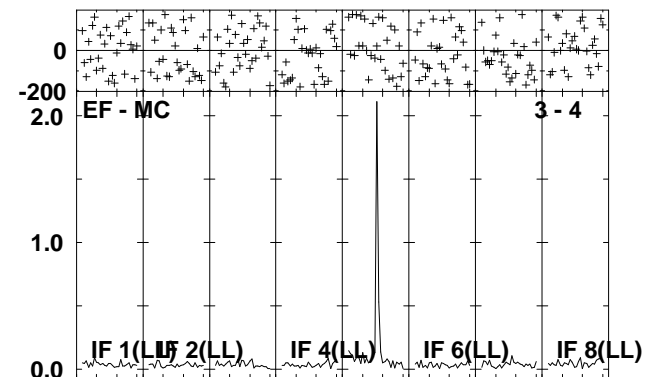
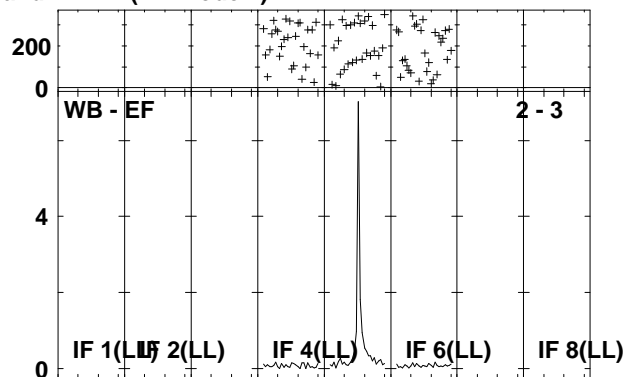
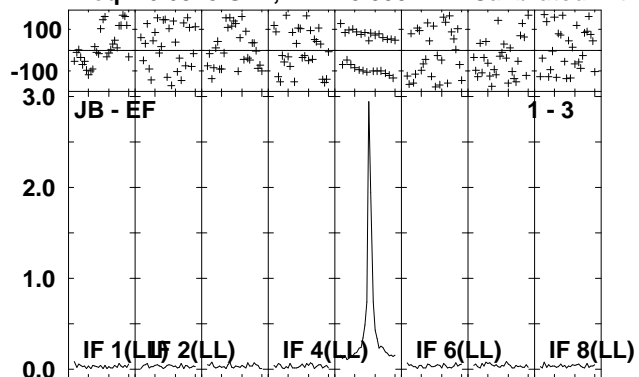

Lower frame: Ampl Jy Top frame: Phas deg
Vector averaged cross-power spectrum Several baselines displayed
Timerange: 00/02:38:25 to 00/02:39:54

Plot file version 42 created 19-AUG-2009 15:47:29
 DR21B EB039B 2.UVDATA.1
 Freq = 6.6328 GHz, Bw = 8.000 MH Calibrated with CL # 3 and BP # 1 (BP mode 1)

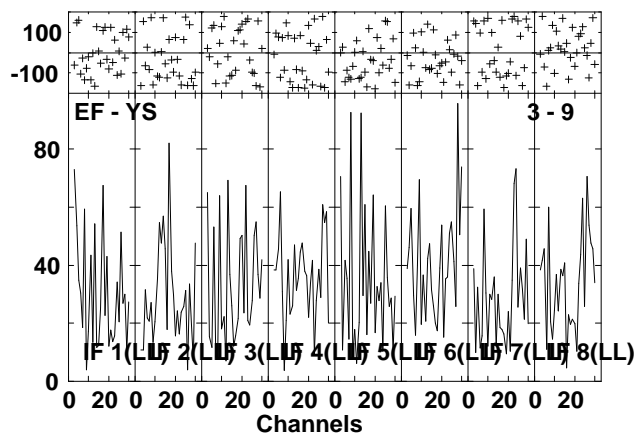
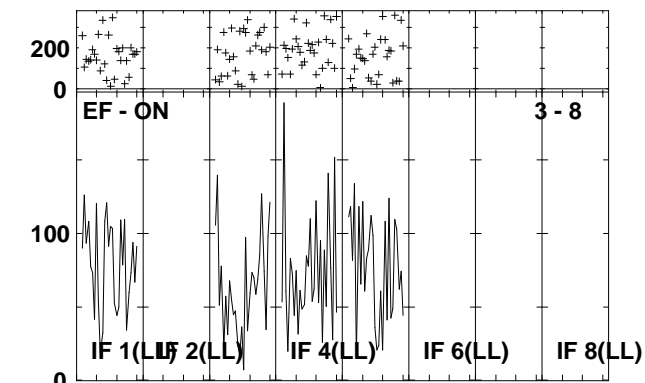
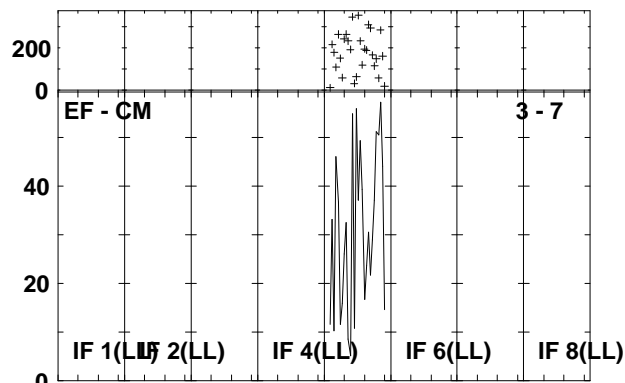
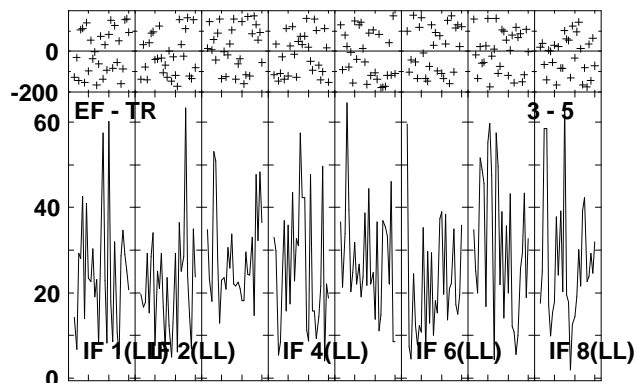
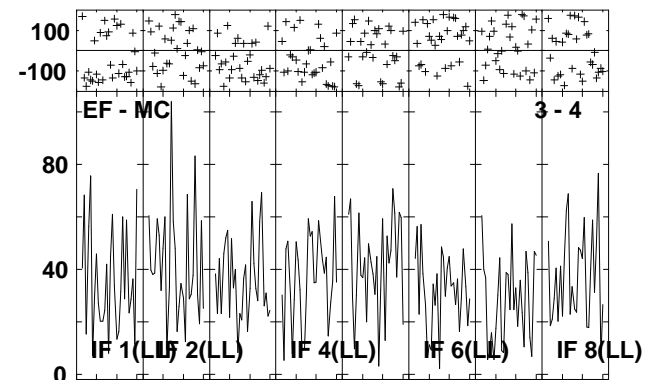
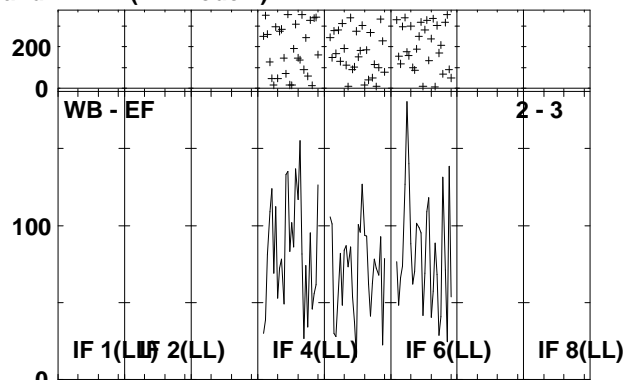
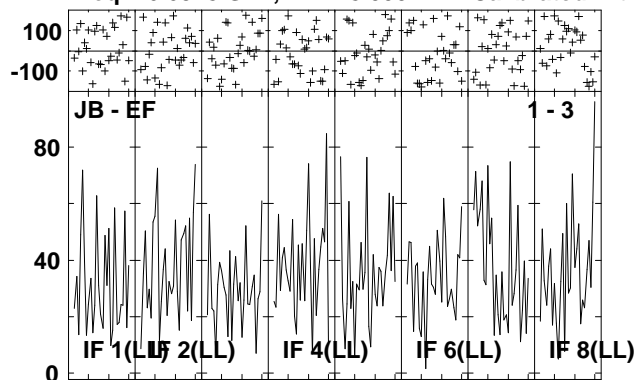

Lower frame: Milli Ampl Jy Top frame: Phas deg
 Vector averaged cross-power spectrum Several baselines displayed
 Timerange: 00/02:39:55 to 00/02:41:24

Plot file version 44 created 19-AUG-2009 15:47:35
 DR21B2 EB039B 2.UVDATA.1
 Freq = 6.6328 GHz, Bw = 8.000 MH Calibrated with CL # 3 and BP # 1 (BP mode 1)

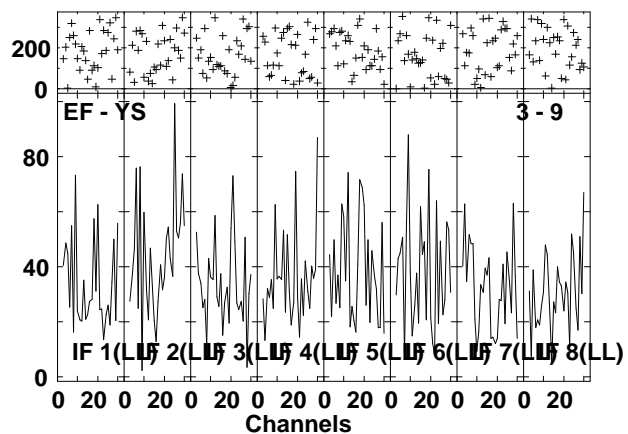
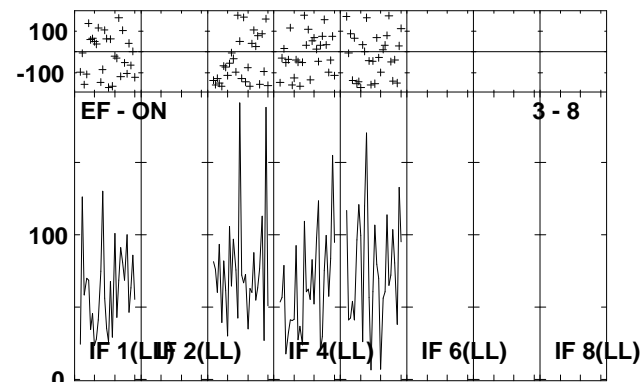
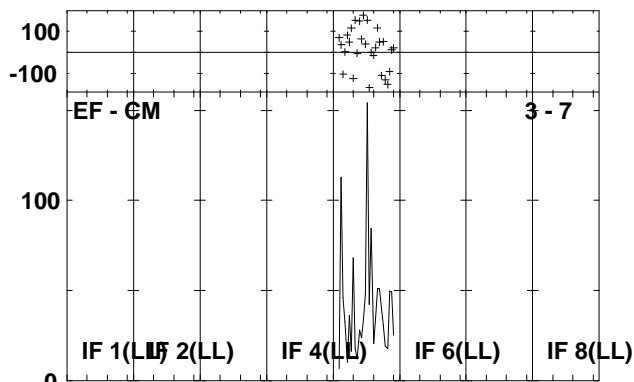
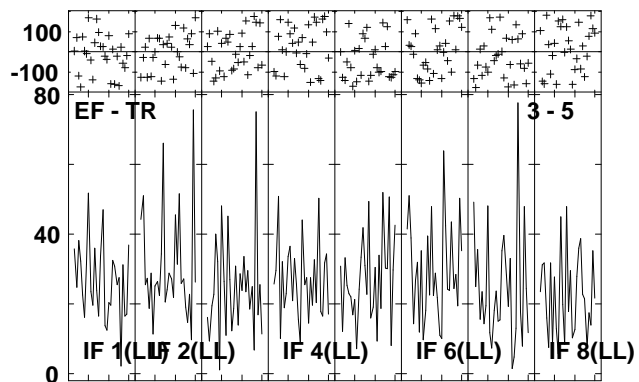
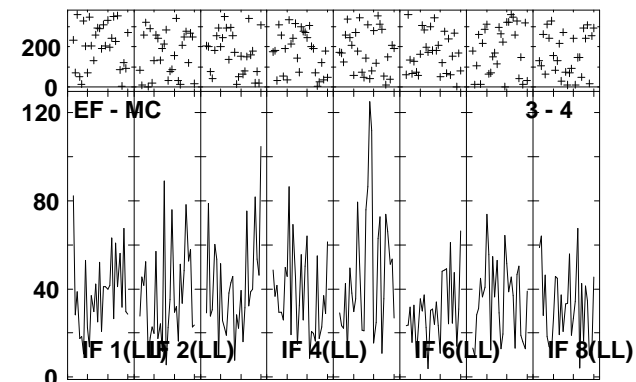
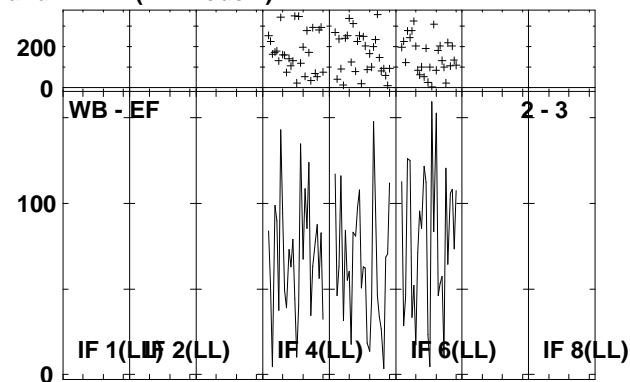
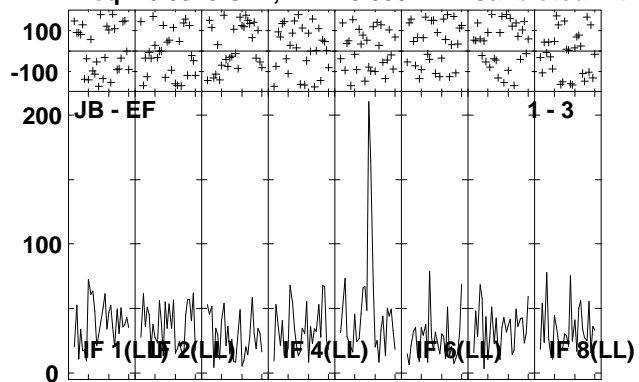

Lower frame: Milli Ampl Jy Top frame: Phas deg
 Vector averaged cross-power spectrum Several baselines displayed
 Timerange: 00/02:42:56 to 00/02:44:24

Plot file version 45 created 19-AUG-2009 15:47:38

W75 EB039B 2.UVDATA.1

Freq = 6.6328 GHz, Bw = 8.000 MH Calibrated with CL # 3 and BP # 1 (BP mode 1)

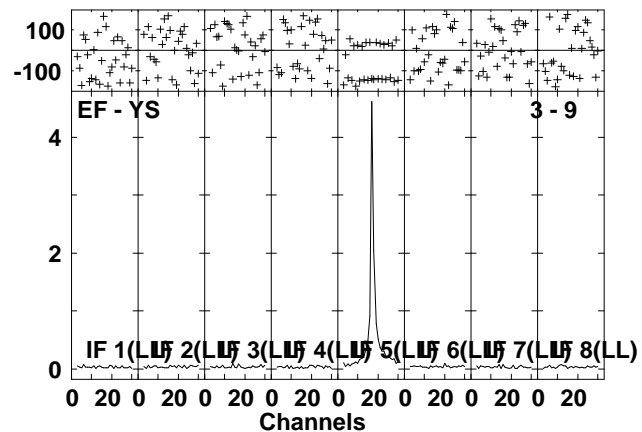
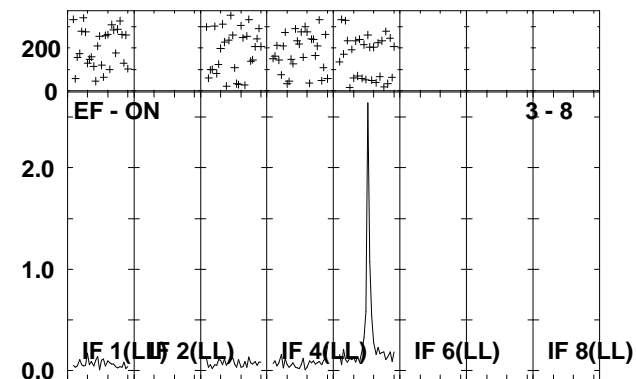
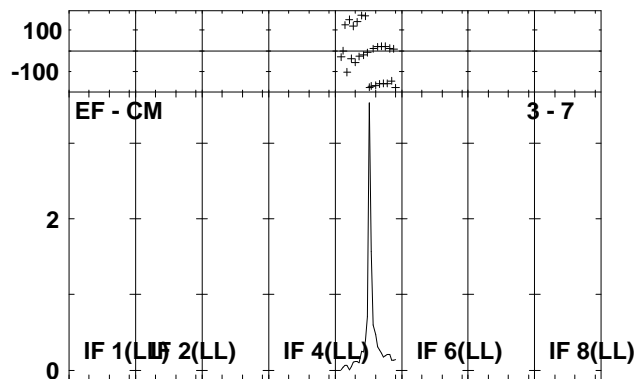
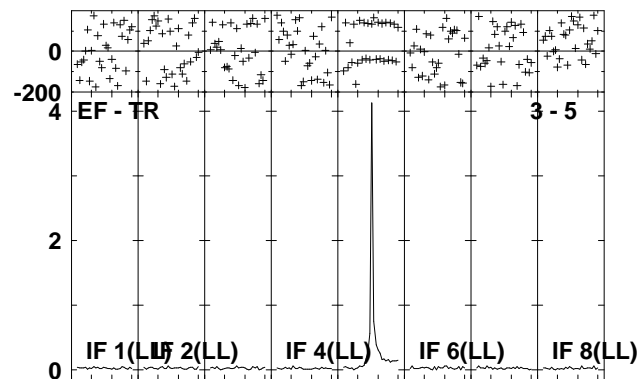
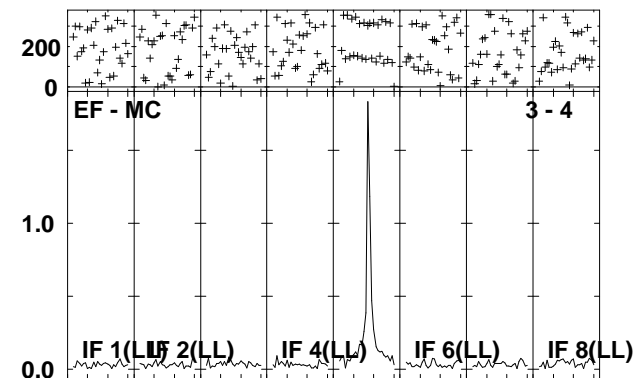
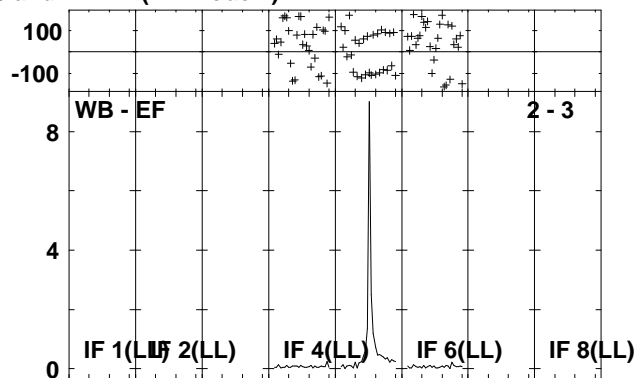
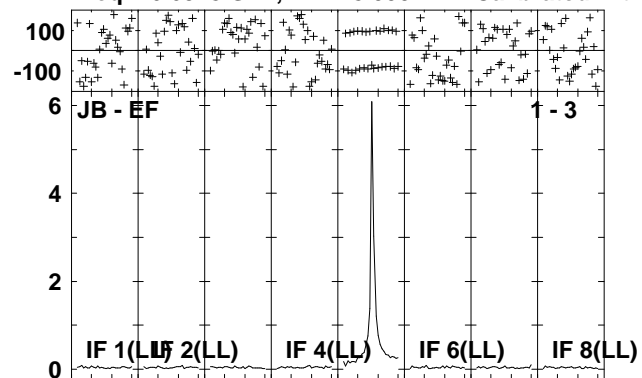

Lower frame: Ampl Jy Top frame: Phas deg
Vector averaged cross-power spectrum Several baselines displayed
Timerange: 00/02:44:26 to 00/02:45:54

Plot file version 46 created 19-AUG-2009 15:47:41
 DR20 EB039B 2.UVDATA.1
 Freq = 6.6328 GHz, Bw = 8.000 MH Calibrated with CL # 3 and BP # 1 (BP mode 1)

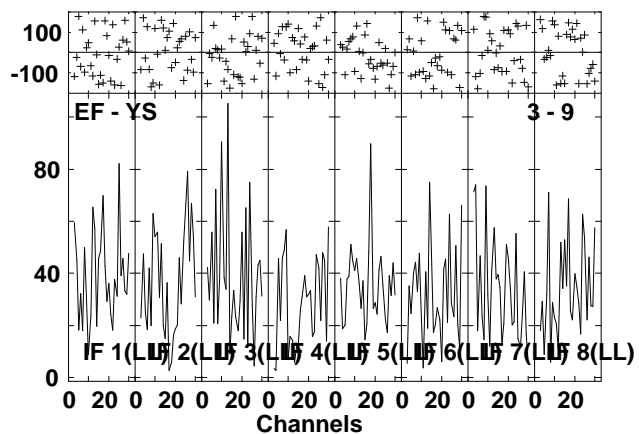
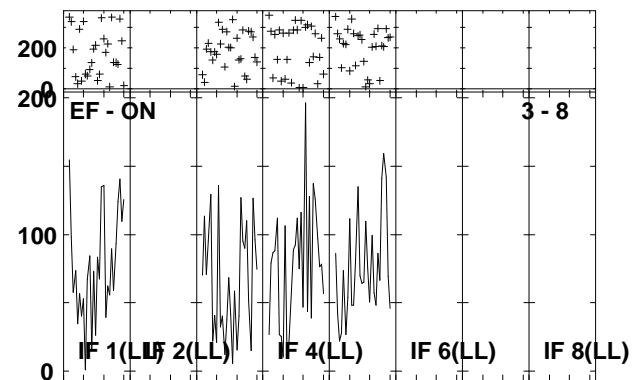
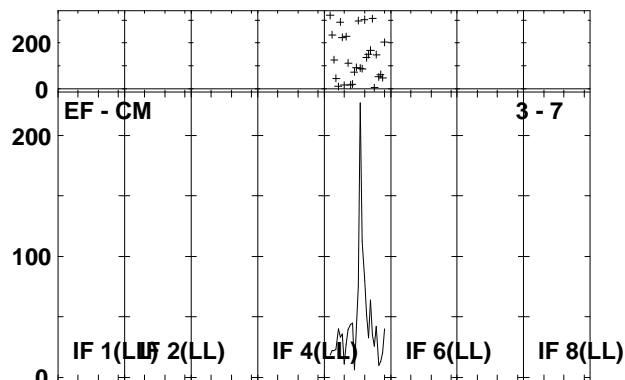
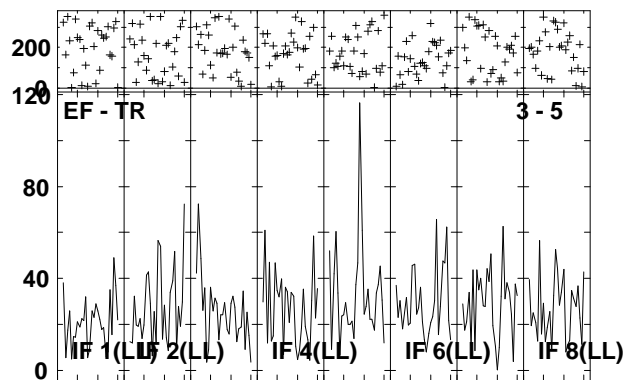
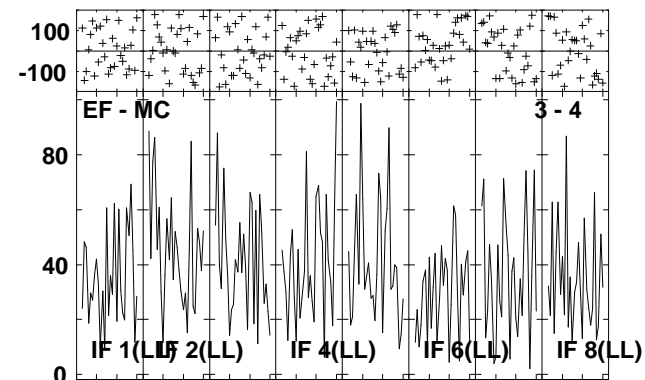
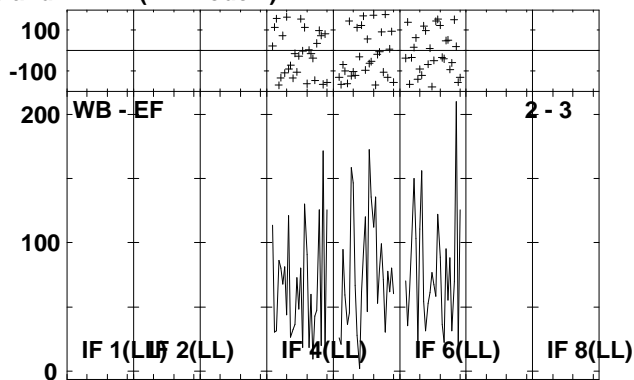
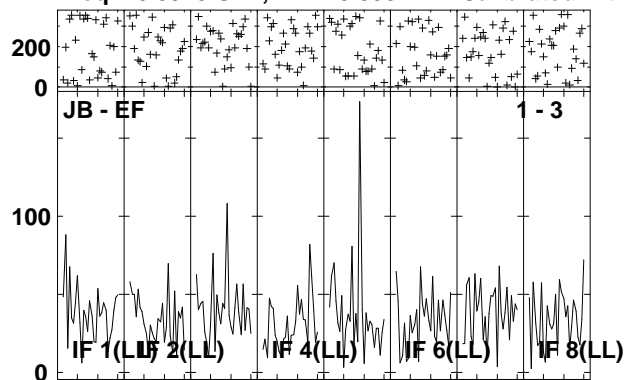

Lower frame: Milli Ampl Jy Top frame: Phas deg
 Vector averaged cross-power spectrum Several baselines displayed
 Timerange: 00/02:45:56 to 00/02:47:25

Plot file version 47 created 19-AUG-2009 15:47:43
 W75 EB039B 2.UVDATA.1
 Freq = 6.6328 GHz, Bw = 8.000 MH Calibrated with CL # 3 and BP # 1 (BP mode 1)

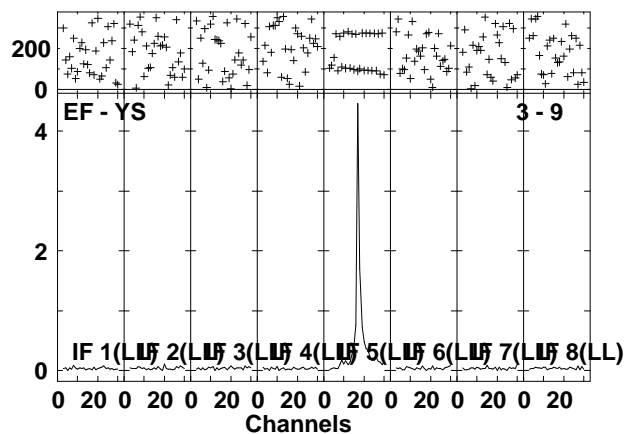
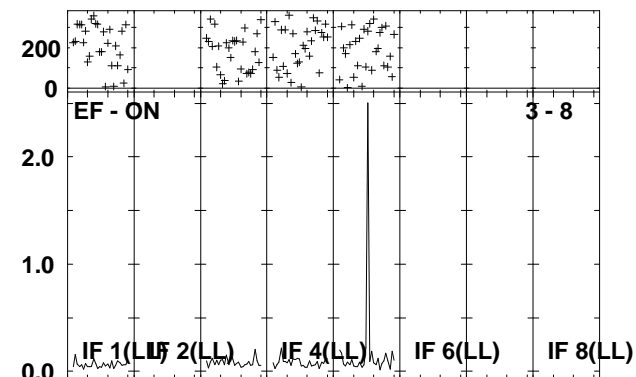
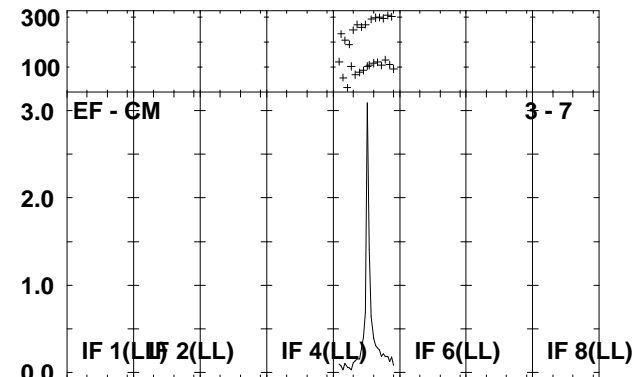
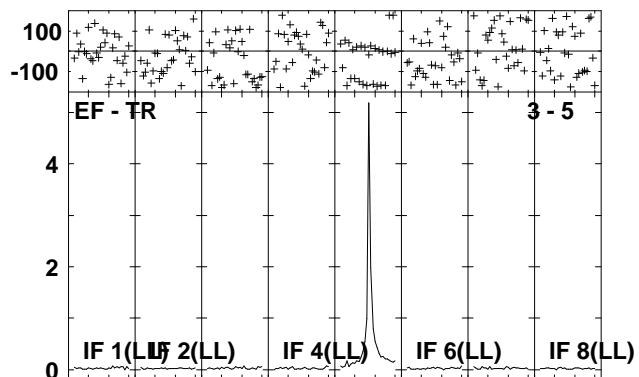
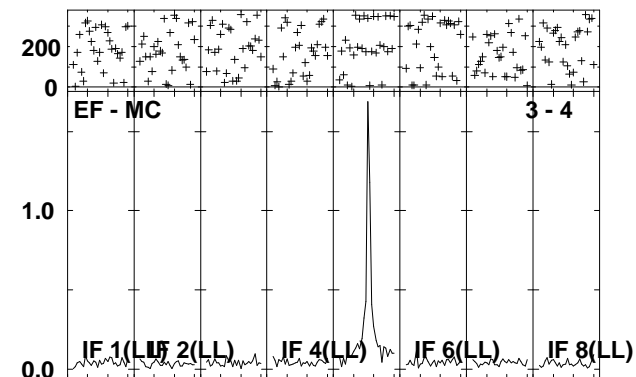
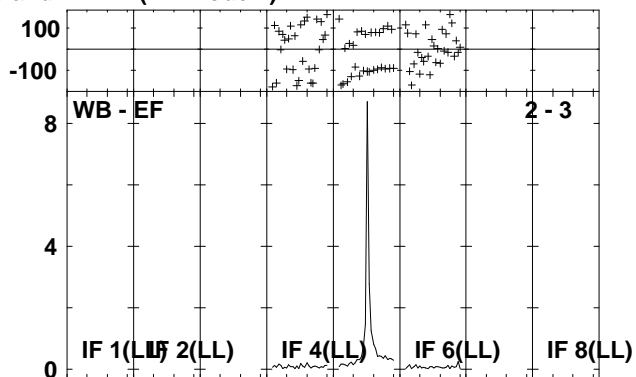
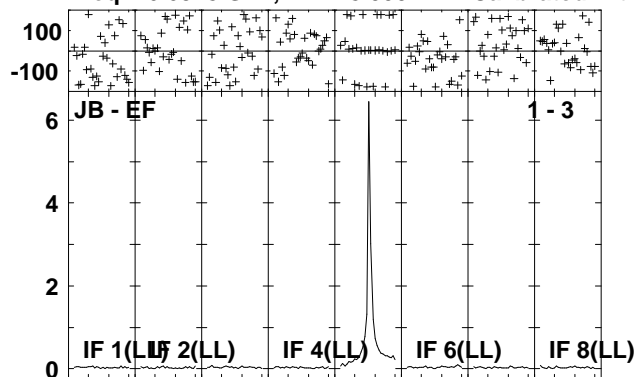

Lower frame: Ampl Jy Top frame: Phas deg
 Vector averaged cross-power spectrum Several baselines displayed
 Timerange: 00/02:47:50 to 00/02:48:48

Plot file version 48 created 19-AUG-2009 15:47:45
 J2029+46 EB039B 2.UVDATA.1
 Freq = 6.6328 GHz, Bw = 8.000 MH Calibrated with CL # 3 and BP # 1 (BP mode 1)

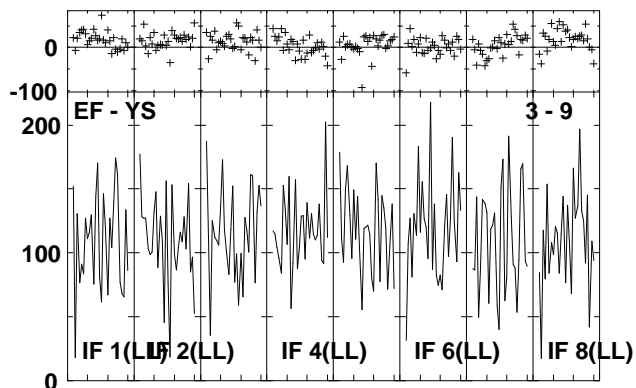
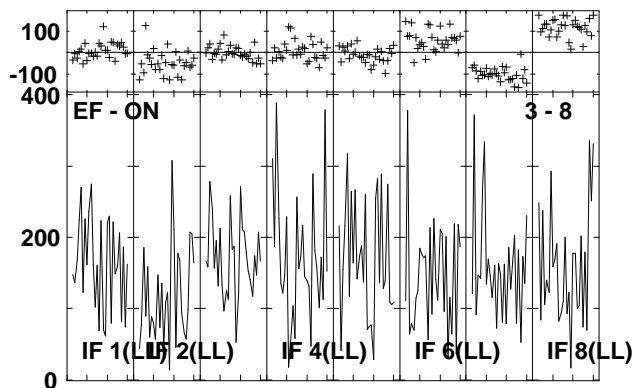
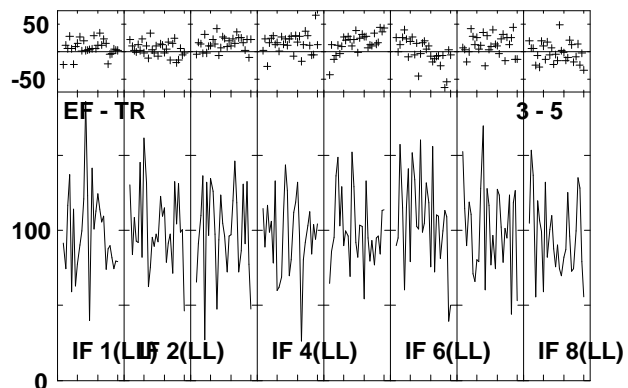
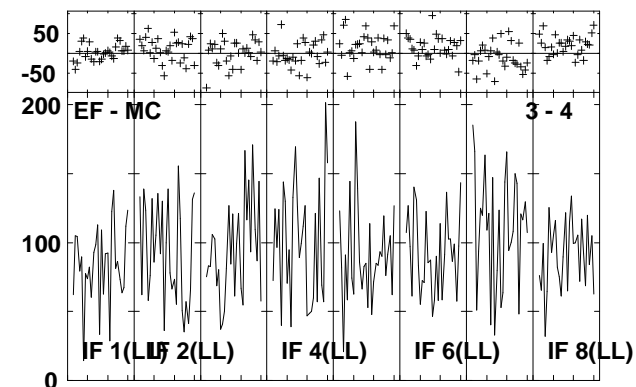
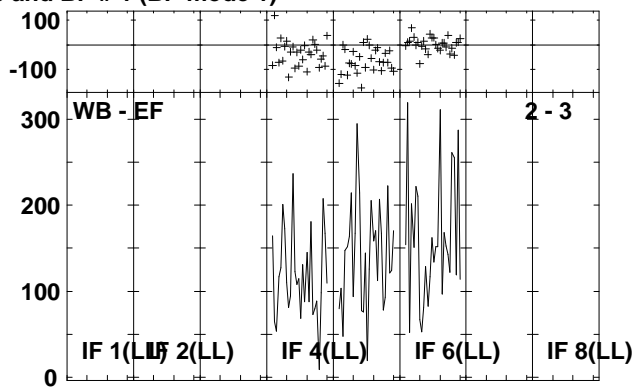
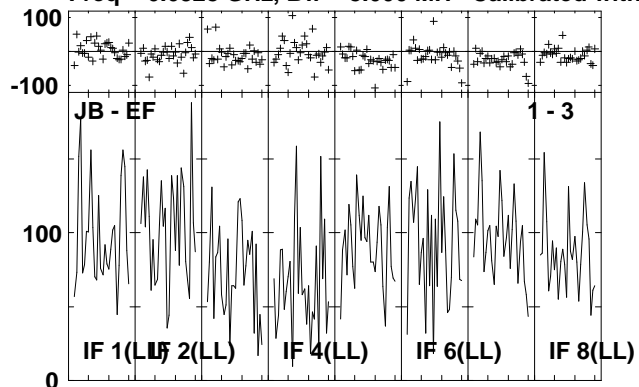

Lower frame: Milli Ampl Jy Top frame: Phas deg
 Vector averaged cross-power spectrum Several baselines displayed
 Timerange: 00/02:48:50 to 00/02:50:18

Plot file version 49 created 19-AUG-2009 15:47:48

W75 EB039B 2.UVDATA.1

Freq = 6.6328 GHz, Bw = 8.000 MH Calibrated with CL # 3 and BP # 1 (BP mode 1)

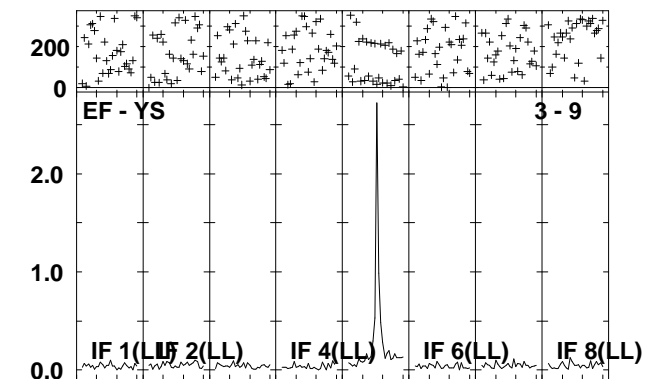
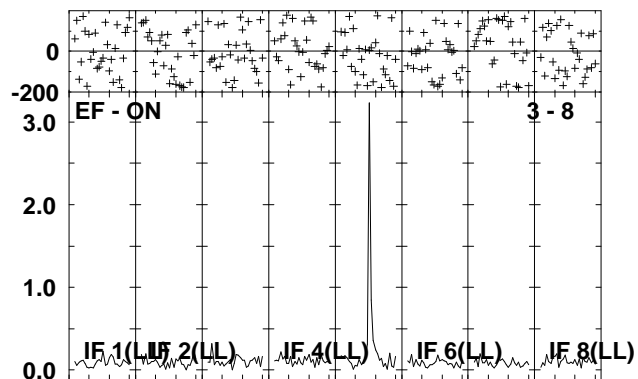
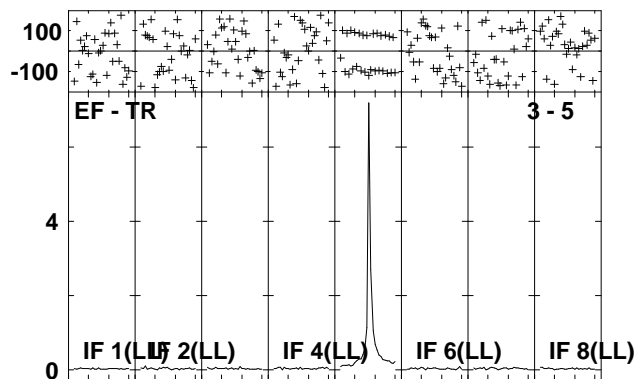
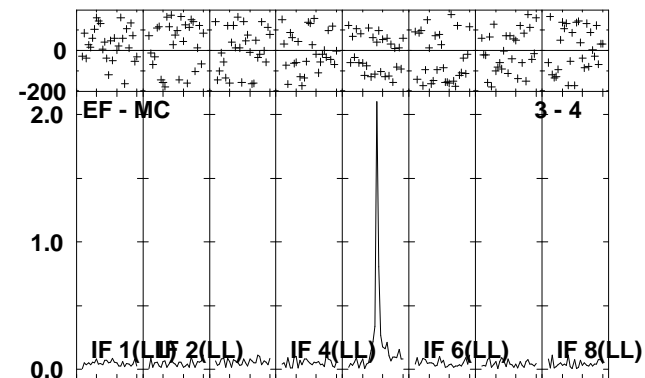
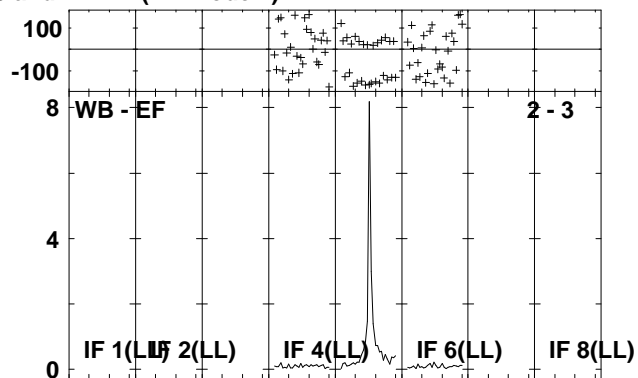
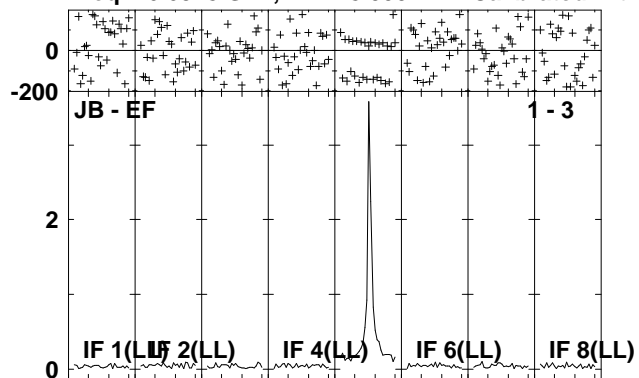

Lower frame: Ampl Jy Top frame: Phas deg
Vector averaged cross-power spectrum Several baselines displayed
Timerange: 00/02:50:20 to 00/02:51:48

Plot file version 50 created 19-AUG-2009 15:47:53

W75 EB039B 2.UVDATA.1

Freq = 6.6328 GHz, Bw = 8.000 MH Calibrated with CL # 3 and BP # 1 (BP mode 1)

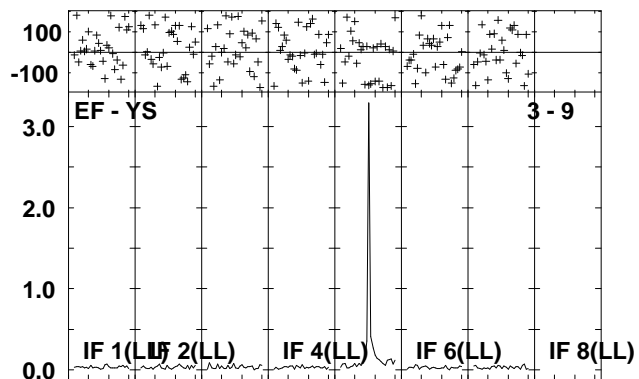
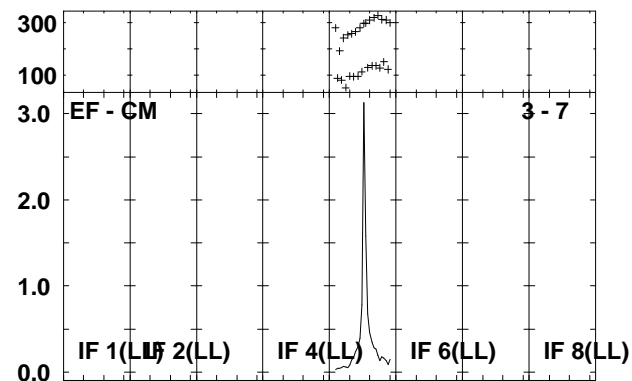
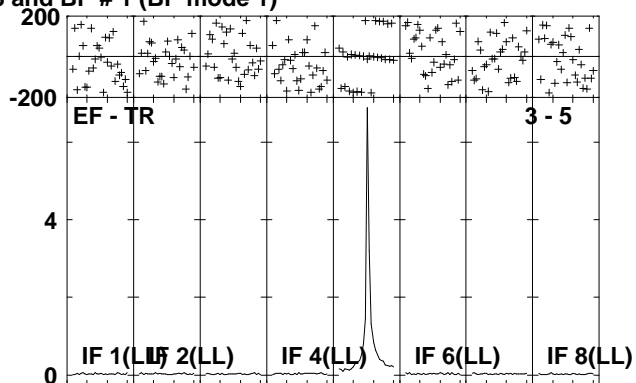
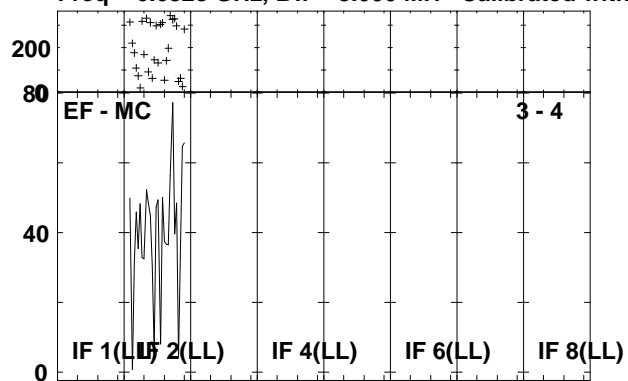

Lower frame: Milli Ampl Jy Top frame: Phas deg
Vector averaged cross-power spectrum Several baselines displayed
Timerange: 00/02:53:20 to 00/02:54:49

Plot file version 51 created 19-AUG-2009 15:47:55
 2048+431 EB039B 2.UVDATA.1
 Freq = 6.6328 GHz, Bw = 8.000 MH Calibrated with CL # 3 and BP # 1 (BP mode 1)

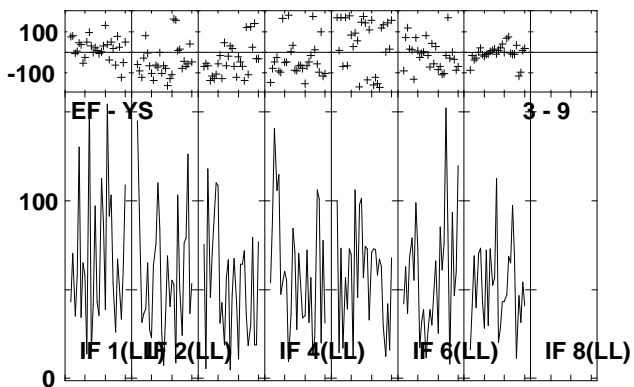
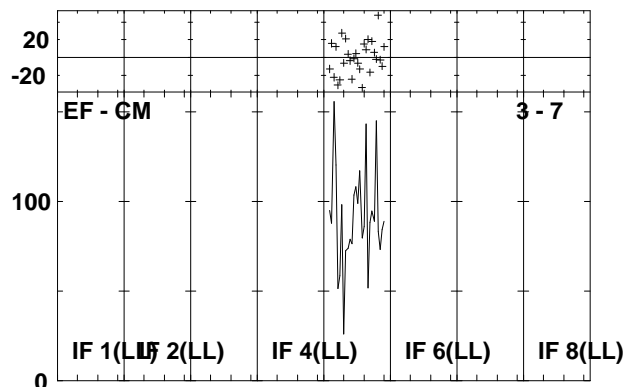
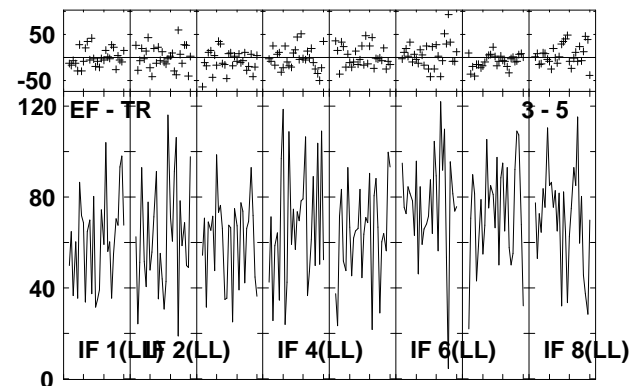
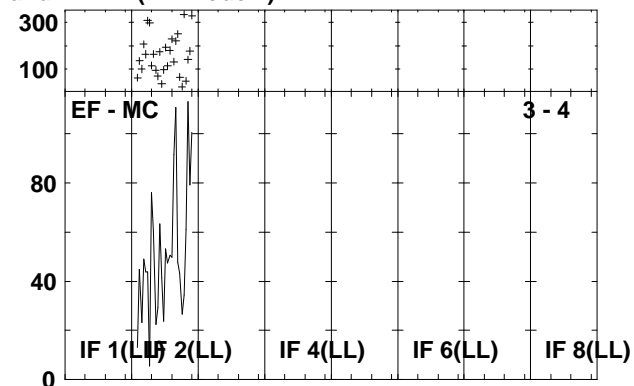
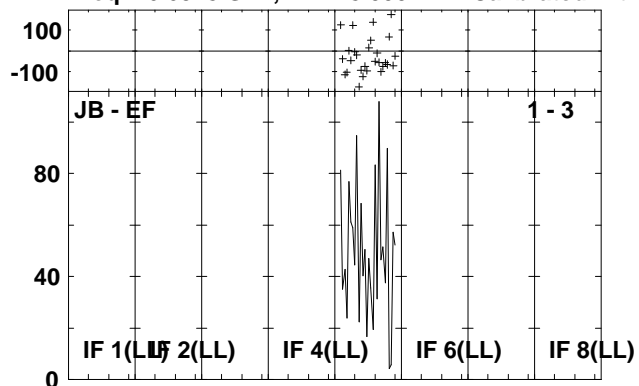

Lower frame: Milli Ampl Jy Top frame: Phas deg
 Vector averaged cross-power spectrum Several baselines displayed
 Timerange: 00/02:54:50 to 00/02:56:19

Plot file version 52 created 19-AUG-2009 15:47:57
 W75 EB039B 2.UVDATA.1
 Freq = 6.6328 GHz, Bw = 8.000 MH Calibrated with CL # 3 and BP # 1 (BP mode 1)

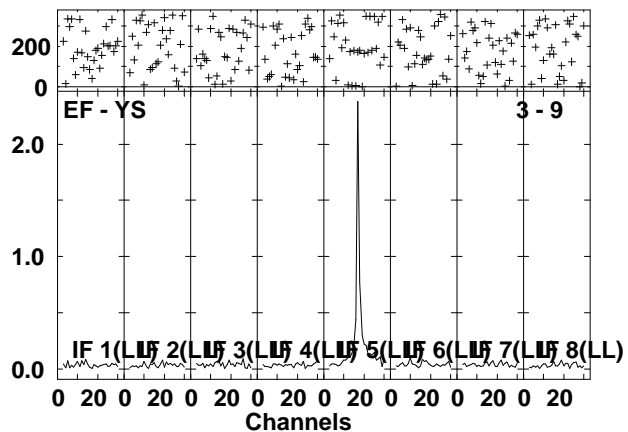
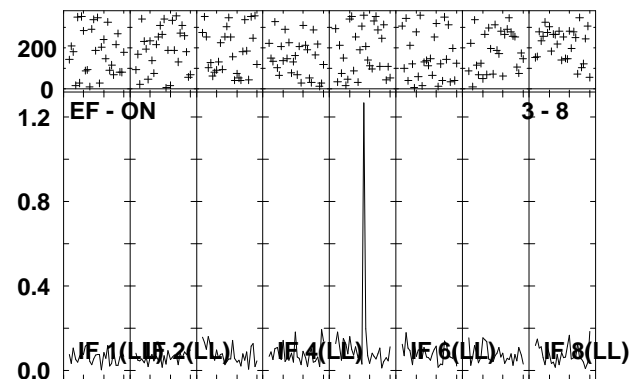
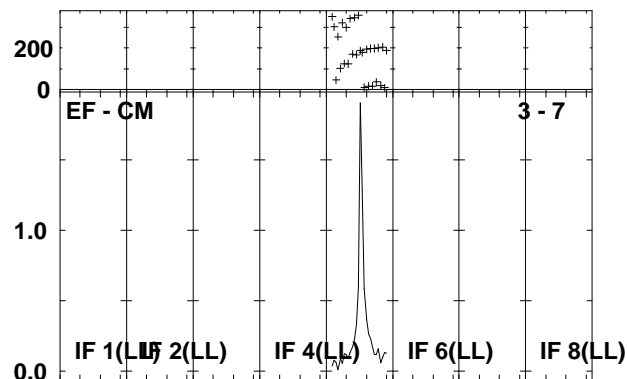
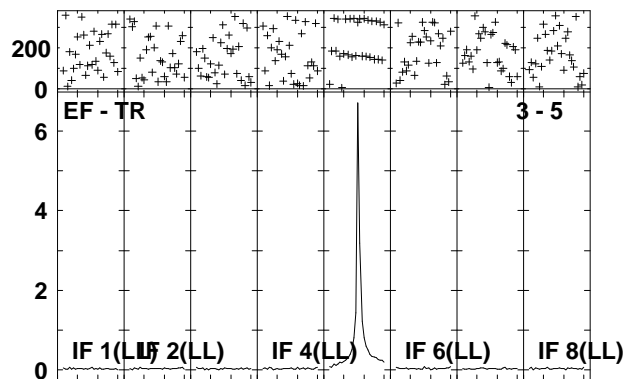
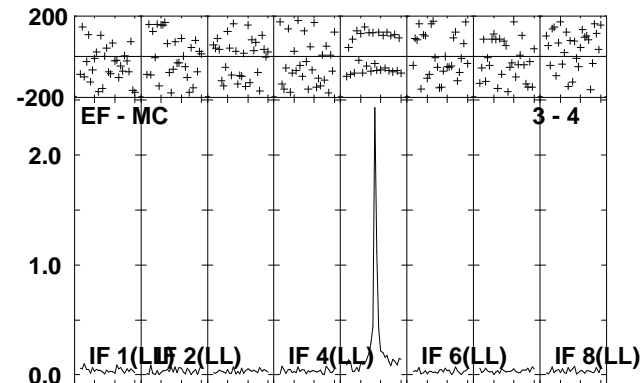
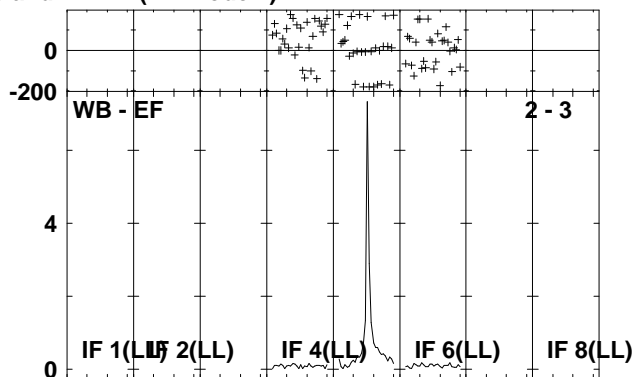
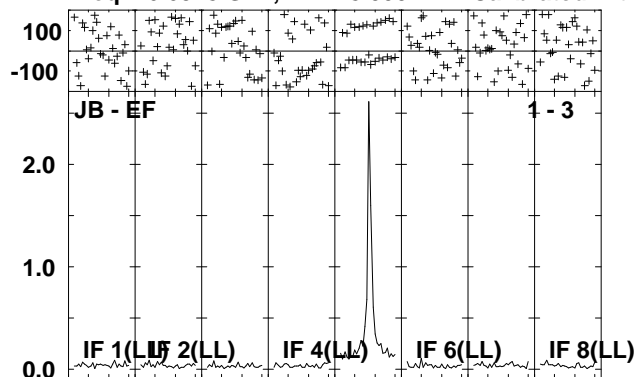

0 20 0 20 0 20 0 20 0 20 0 20 0 20 0 20 0 20 0 20
 Channels
 Lower frame: Ampl Jy Top frame: Phas deg
 Vector averaged cross-power spectrum Several baselines displayed
 Timerange: 00/02:56:20 to 00/02:57:49

Plot file version 53 created 19-AUG-2009 15:48:00
 OB2 EB039B 2.UVDATA.1
 Freq = 6.6328 GHz, Bw = 8.000 MH Calibrated with CL # 3 and BP # 1 (BP mode 1)

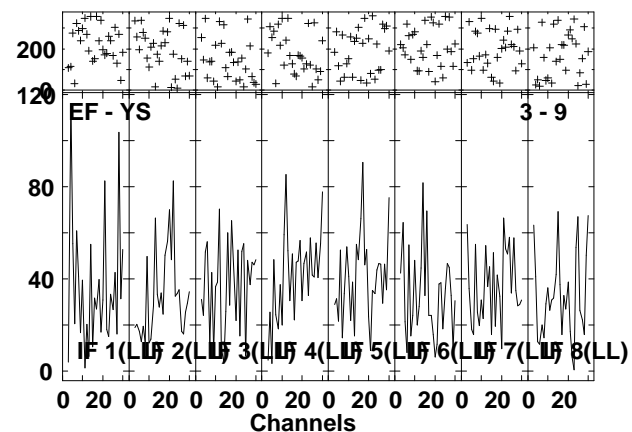
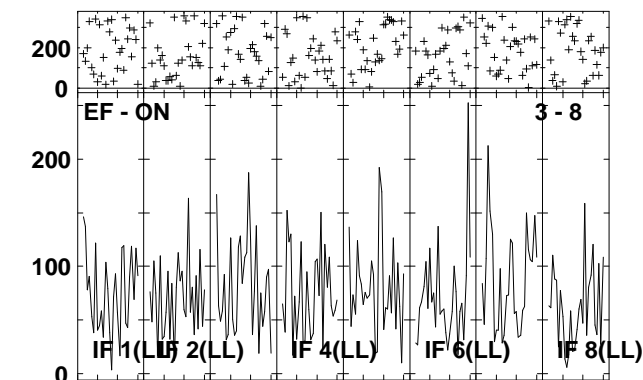
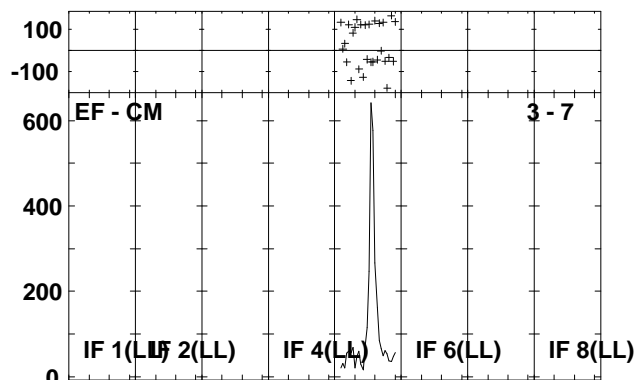
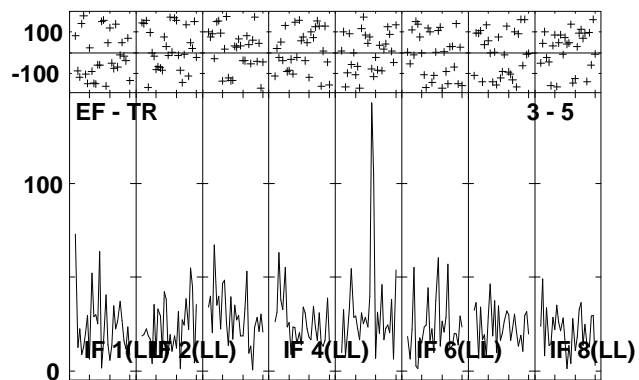
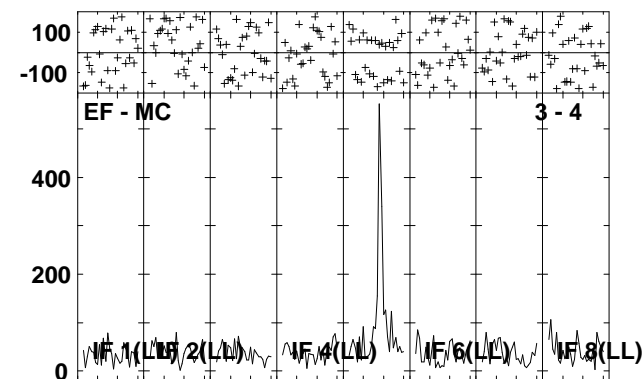
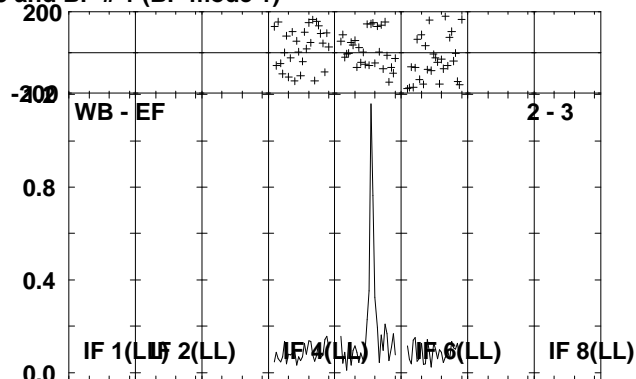
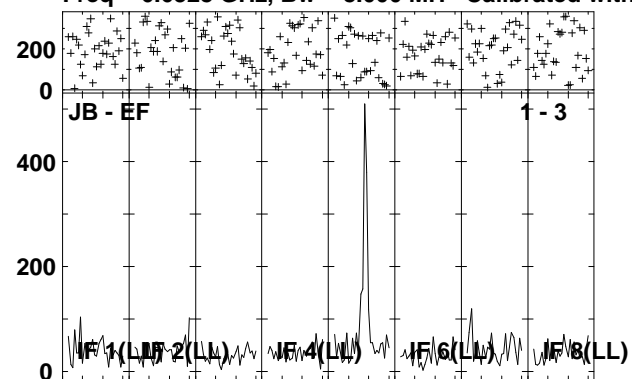

Lower frame: Milli Ampl Jy Top frame: Phas deg
 Vector averaged cross-power spectrum Several baselines displayed
 Timerange: 00:02:57:50 to 00:02:59:19

Plot file version 54 created 19-AUG-2009 15:48:03
 W75 EB039B 2.UVDATA.1
 Freq = 6.6328 GHz, Bw = 8.000 MH Calibrated with CL # 3 and BP # 1 (BP mode 1)

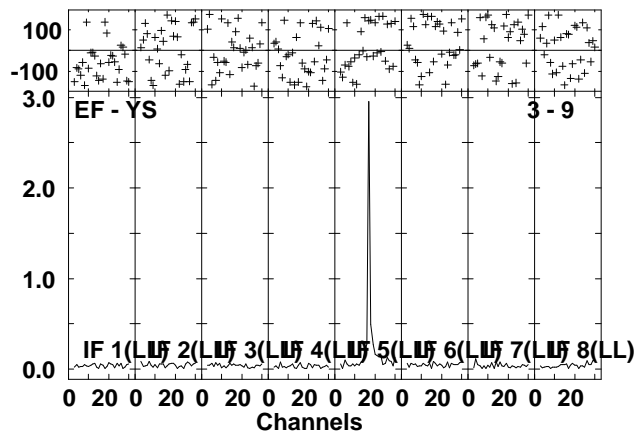
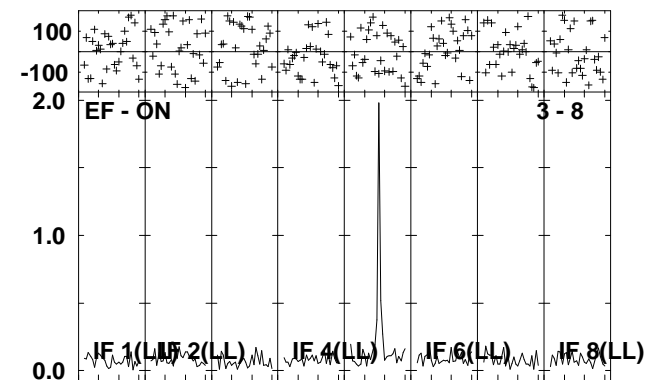
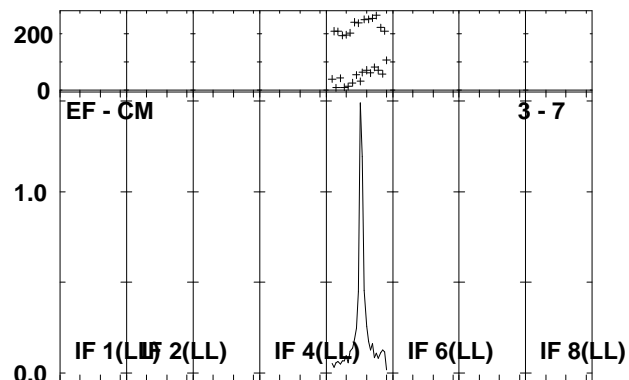
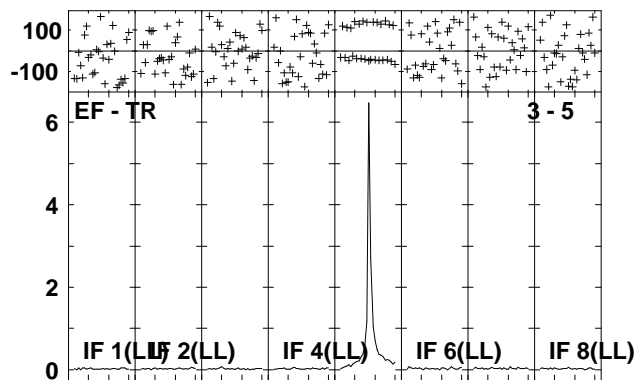
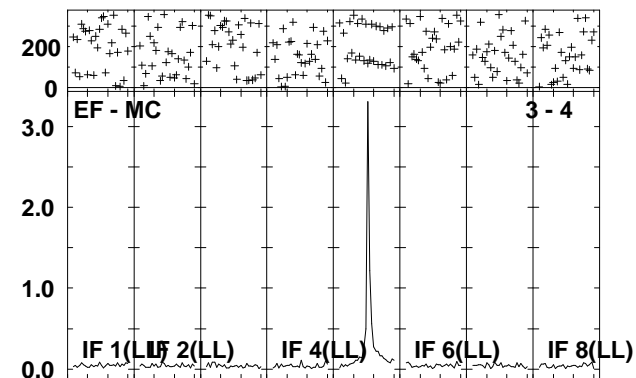
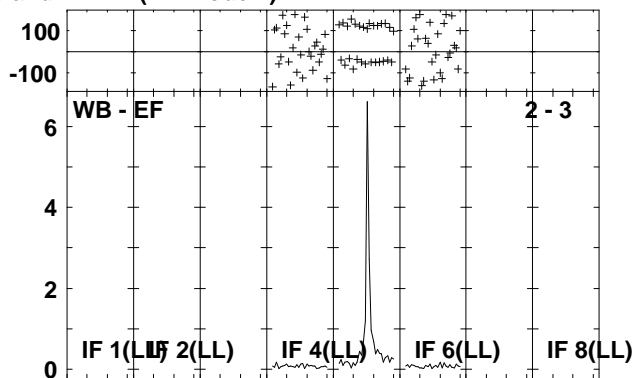
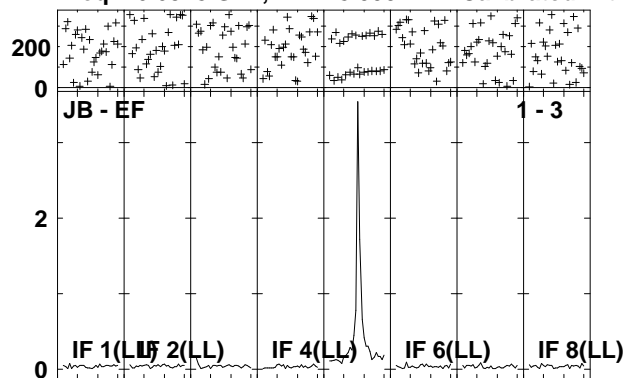

Lower frame: Ampl Jy Top frame: Phas deg
 Vector averaged cross-power spectrum Several baselines displayed
 Timerange: 00/02:59:50 to 00/03:00:50

Plot file version 55 created 19-AUG-2009 15:48:05
 DR21A EB039B 2.UVDATA.1
 Freq = 6.6328 GHz, Bw = 8.000 MH Calibrated with CL # 3 and BP # 1 (BP mode 1)

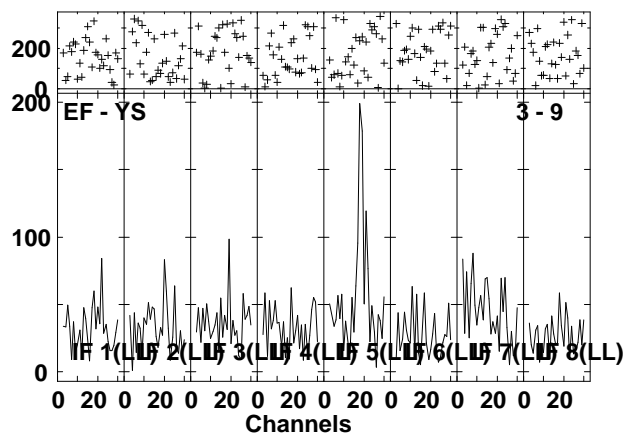
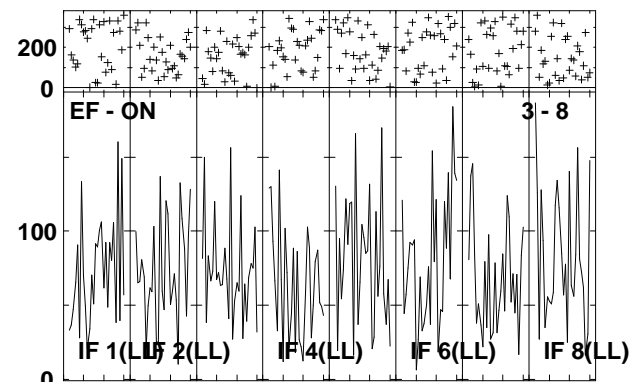
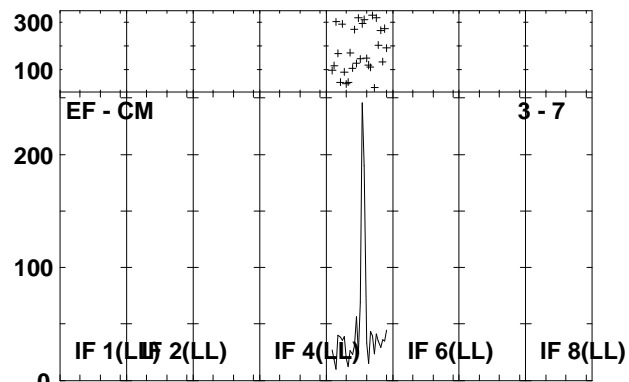
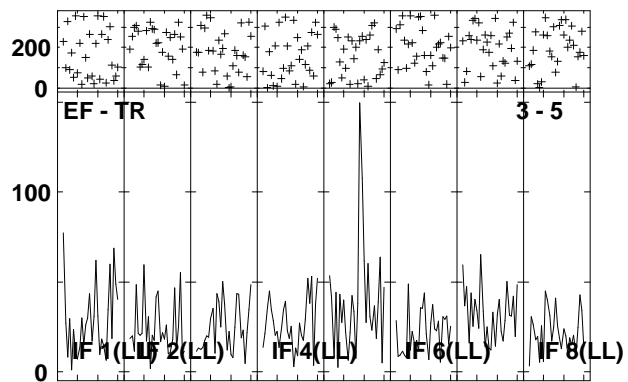
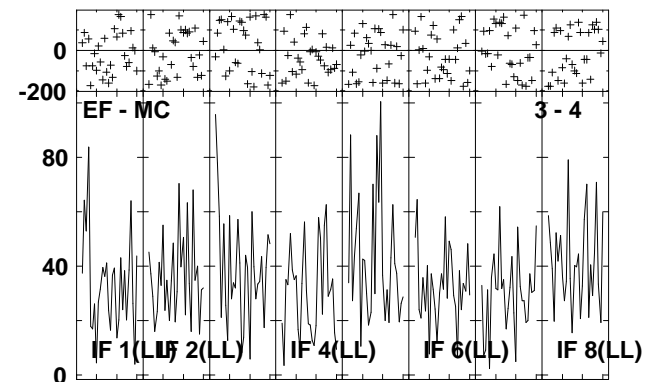
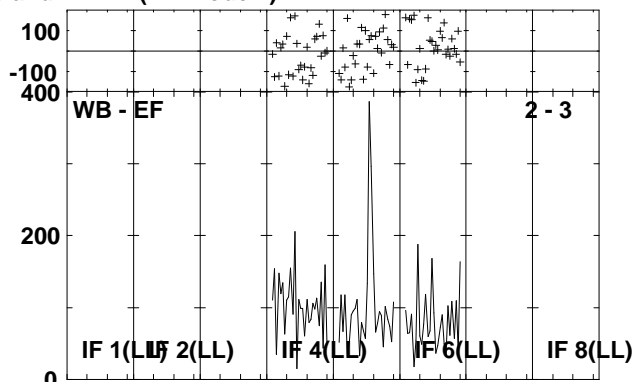
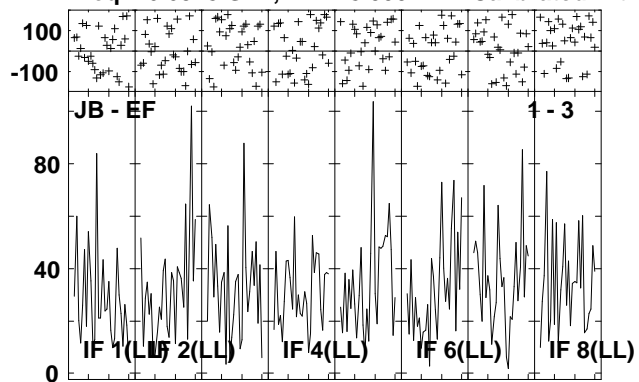

Lower frame: Milli Ampl Jy Top frame: Phas deg
 Vector averaged cross-power spectrum Several baselines displayed
 Timerange: 00/03:00:51 to 00/03:02:20

Plot file version 56 created 19-AUG-2009 15:48:08
 W75 EB039B 2.UVDATA.1
 Freq = 6.6328 GHz, Bw = 8.000 MH Calibrated with CL # 3 and BP # 1 (BP mode 1)

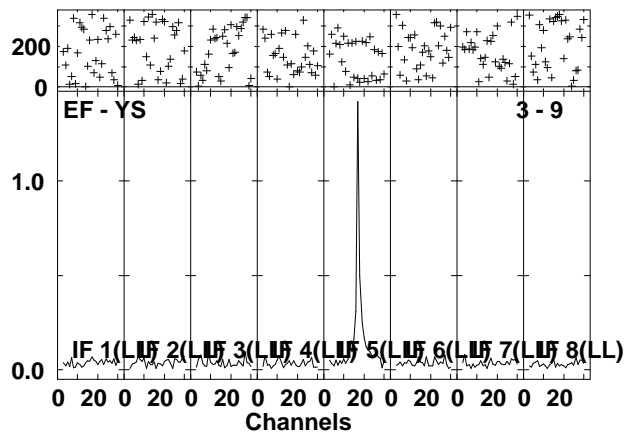
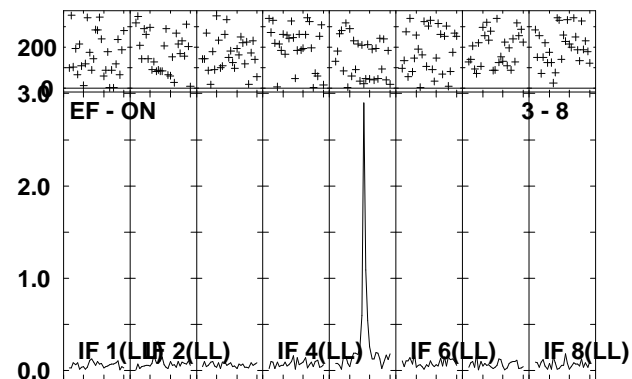
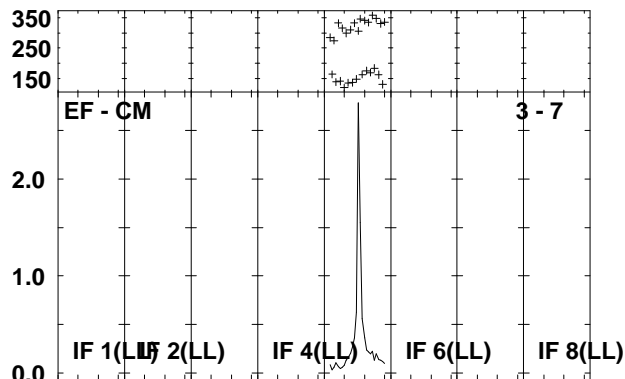
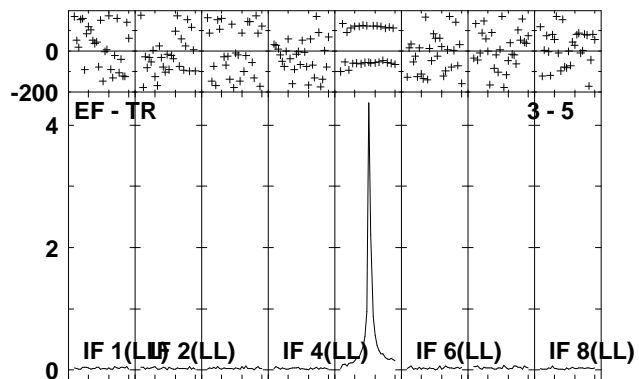
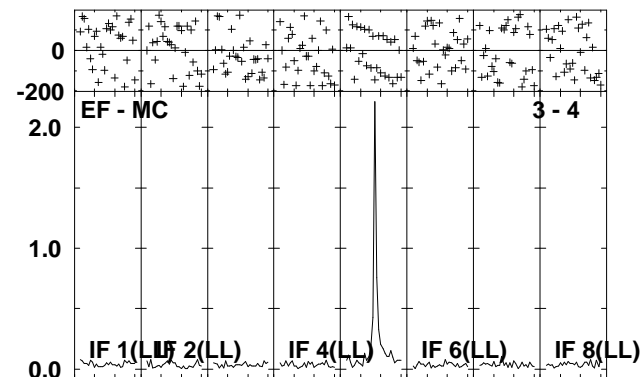
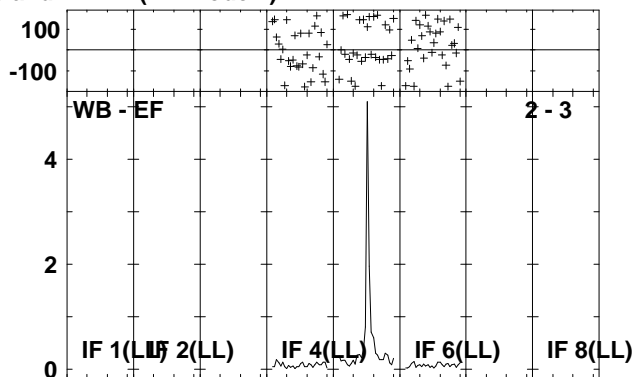
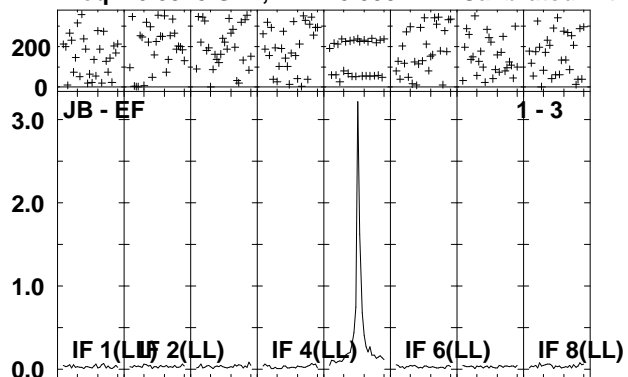

Lower frame: Ampl Jy Top frame: Phas deg
 Vector averaged cross-power spectrum Several baselines displayed
 Timerange: 00/03:02:21 to 00/03:03:50

Plot file version 58 created 19-AUG-2009 15:48:14
 W75 EB039B 2.UVDATA.1
 Freq = 6.6328 GHz, Bw = 8.000 MH Calibrated with CL # 3 and BP # 1 (BP mode 1)

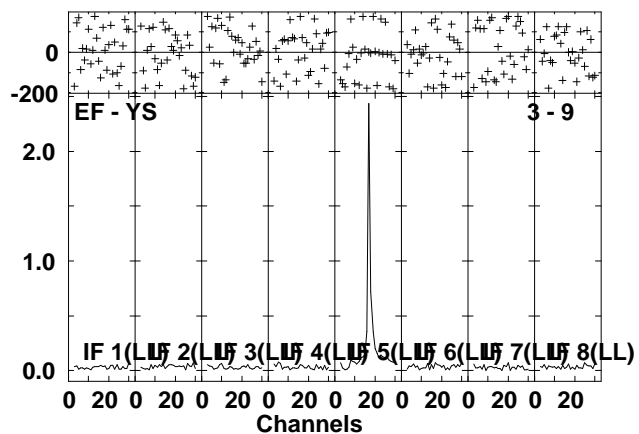
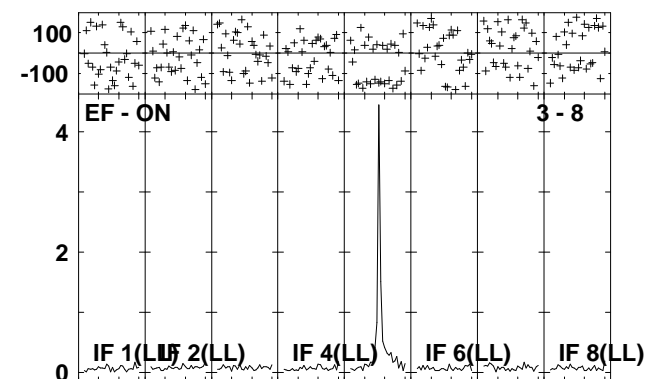
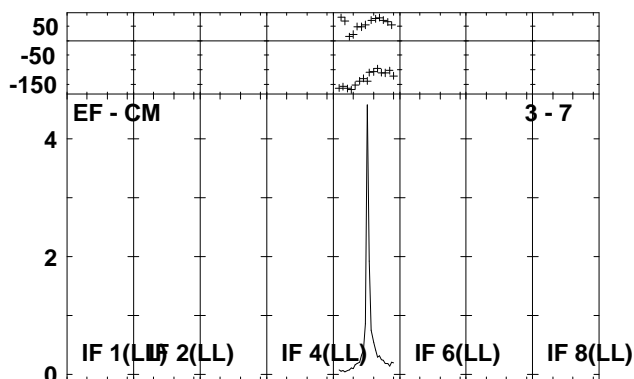
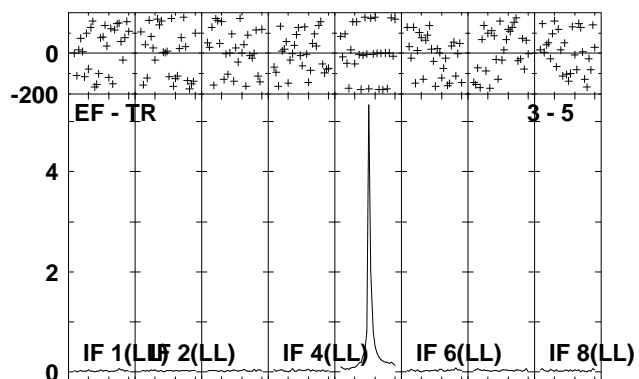
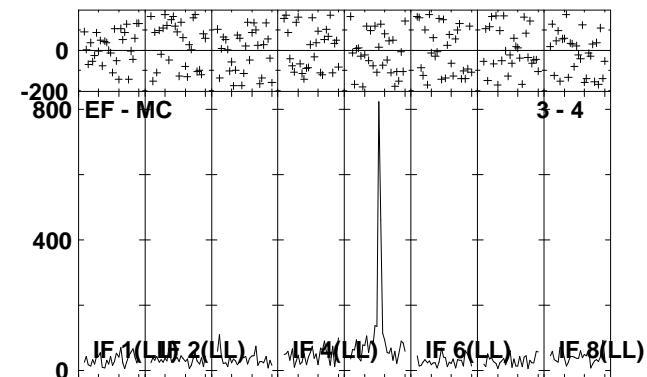
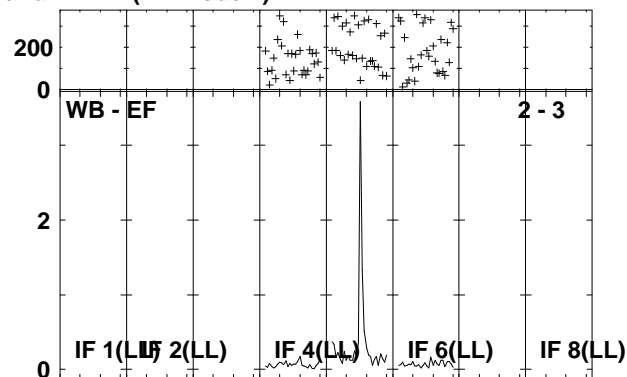
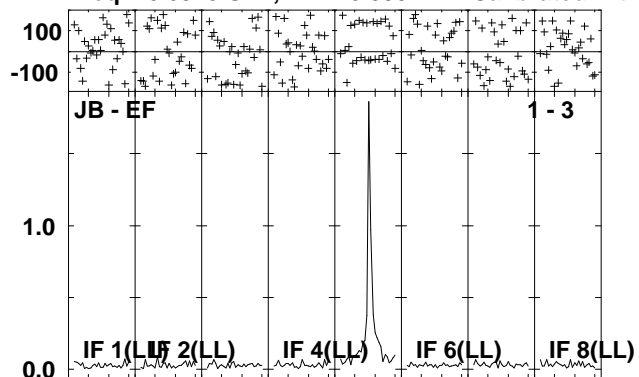

Lower frame: Ampl Jy Top frame: Phas deg
 Vector averaged cross-power spectrum Several baselines displayed
 Timerange: 00/03:05:21 to 00/03:06:49

Plot file version 59 created 19-AUG-2009 15:48:17
 DR21B2 EB039B 2.UVDATA.1
 Freq = 6.6328 GHz, Bw = 8.000 MH Calibrated with CL # 3 and BP # 1 (BP mode 1)

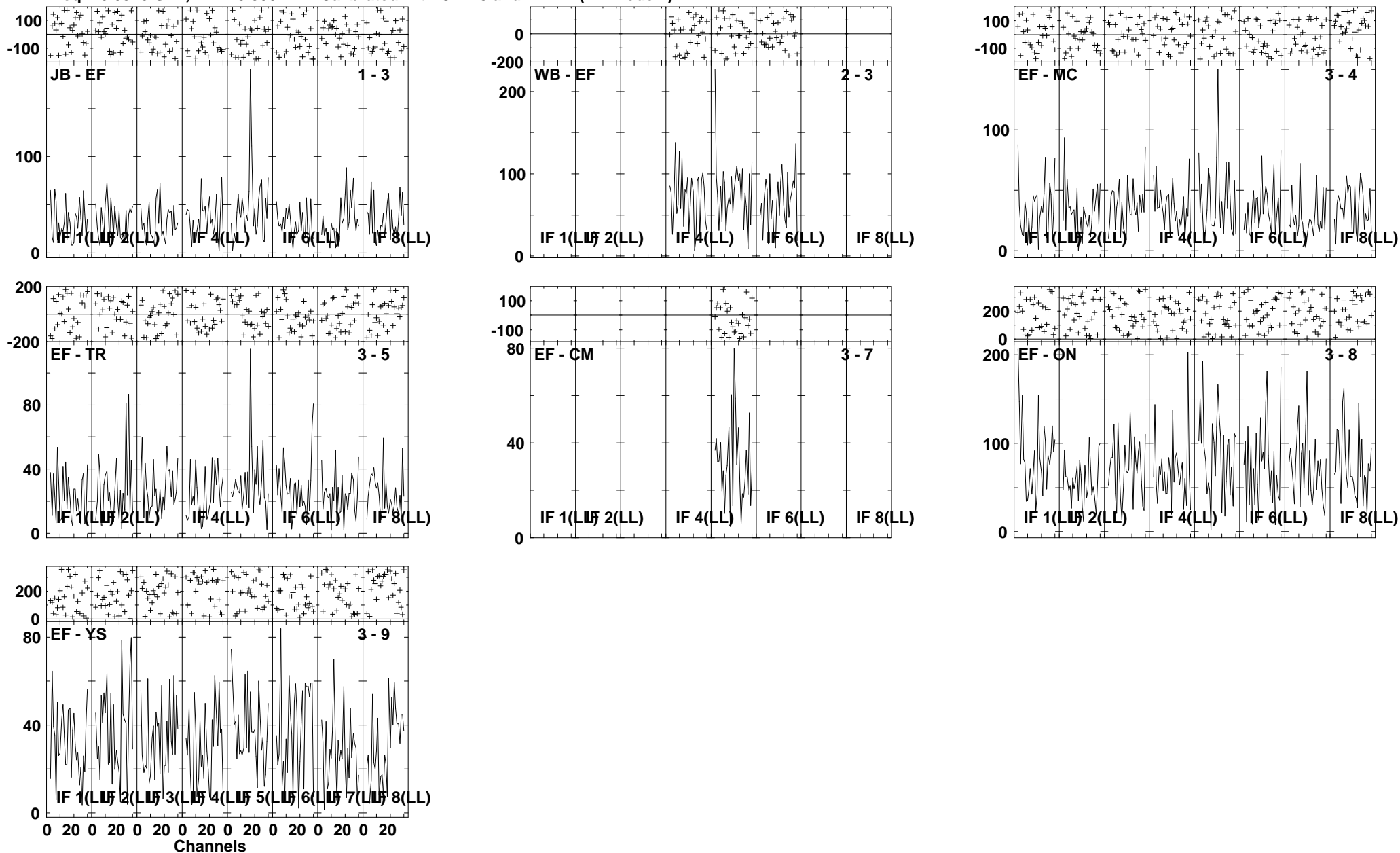

Lower frame: Milli Ampl Jy Top frame: Phas deg
 Vector averaged cross-power spectrum Several baselines displayed
 Timerange: 00/03:06:51 to 00/03:08:19

Plot file version 60 created 19-AUG-2009 15:48:20
 W75 EB039B 2.UVDATA.1
 Freq = 6.6328 GHz, Bw = 8.000 MH Calibrated with CL # 3 and BP # 1 (BP mode 1)

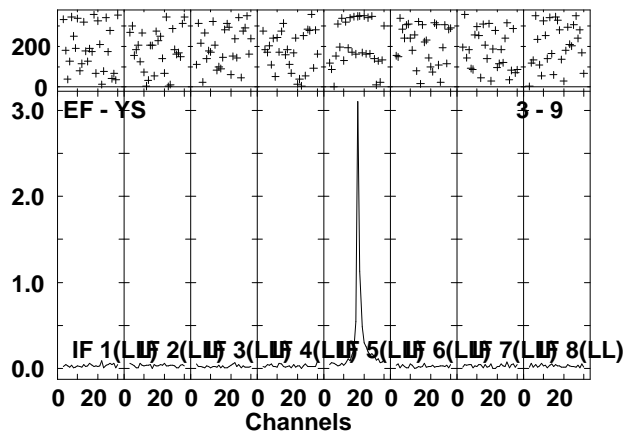
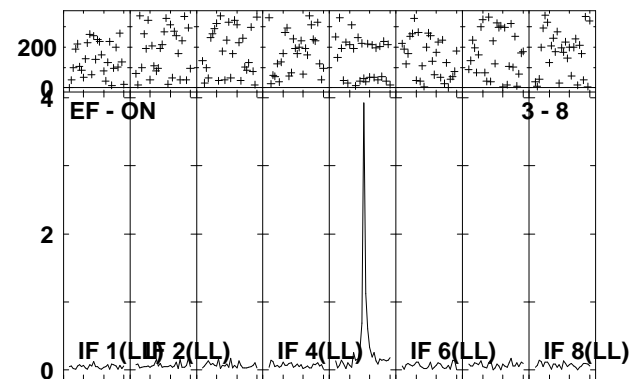
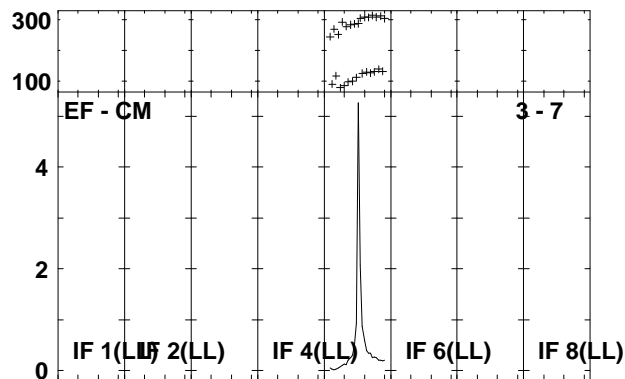
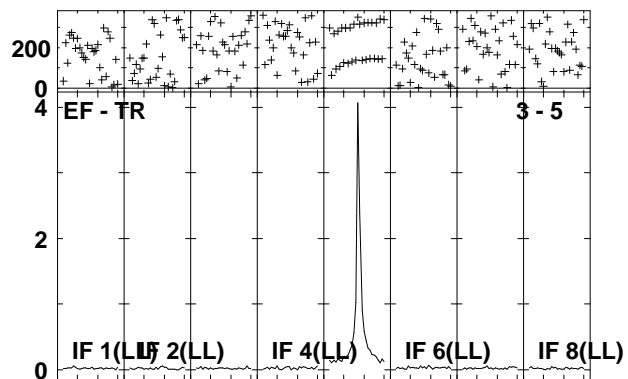
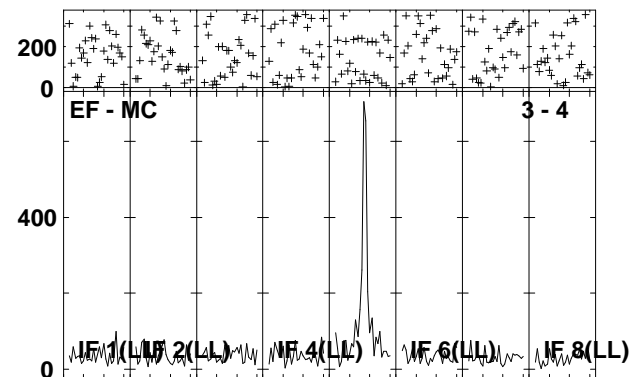
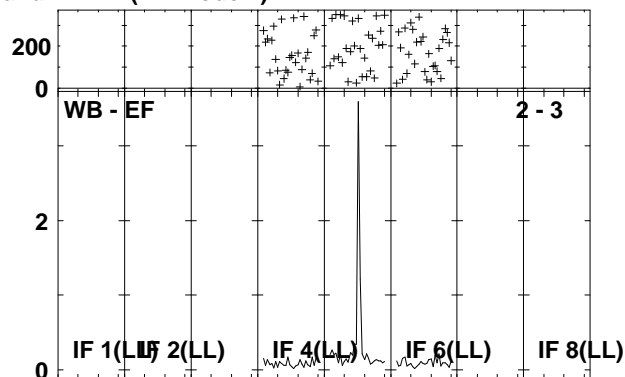
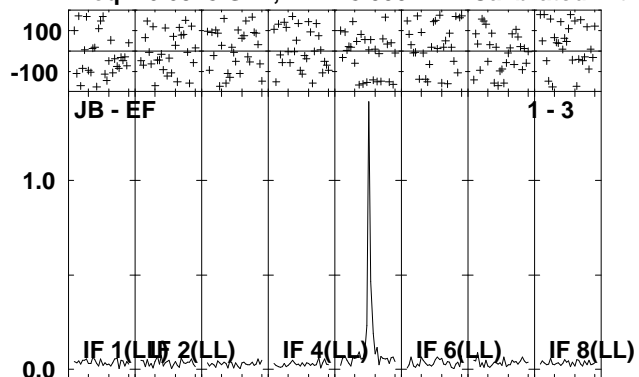

Lower frame: Ampl Jy Top frame: Phas deg
 Vector averaged cross-power spectrum Several baselines displayed
 Timerange: 00/03:08:21 to 00/03:09:49

Plot file version 61 created 19-AUG-2009 15:48:22
 DR20 EB039B 2.UVDATA.1
 Freq = 6.6328 GHz, Bw = 8.000 MH Calibrated with CL # 3 and BP # 1 (BP mode 1)

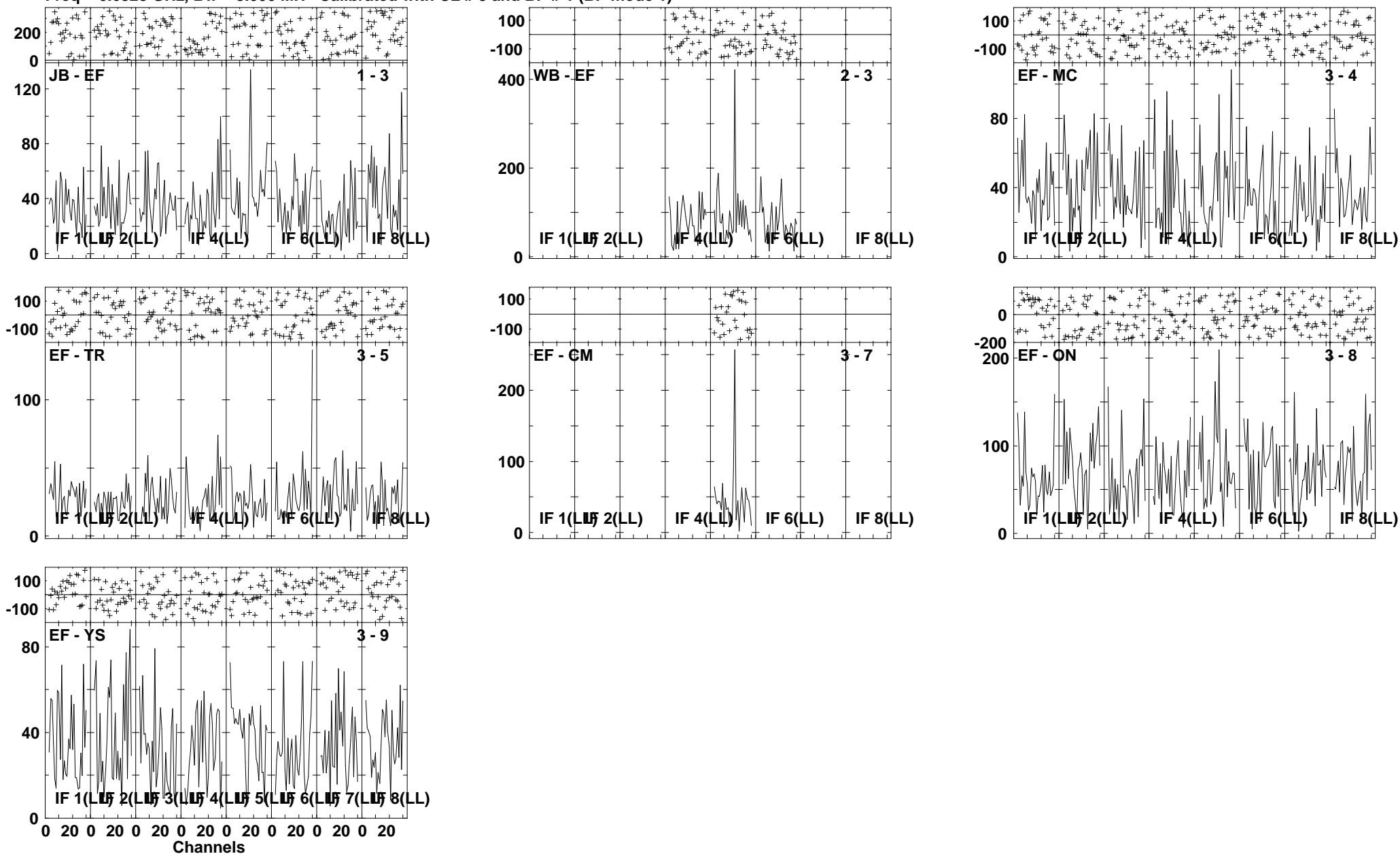

Lower frame: Milli Ampl Jy Top frame: Phas deg
 Vector averaged cross-power spectrum Several baselines displayed
 Timerange: 00/03:09:51 to 00/03:11:19

Plot file version 62 created 19-AUG-2009 15:48:25
 W75 EB039B 2.UVDATA.1
 Freq = 6.6328 GHz, Bw = 8.000 MH Calibrated with CL # 3 and BP # 1 (BP mode 1)

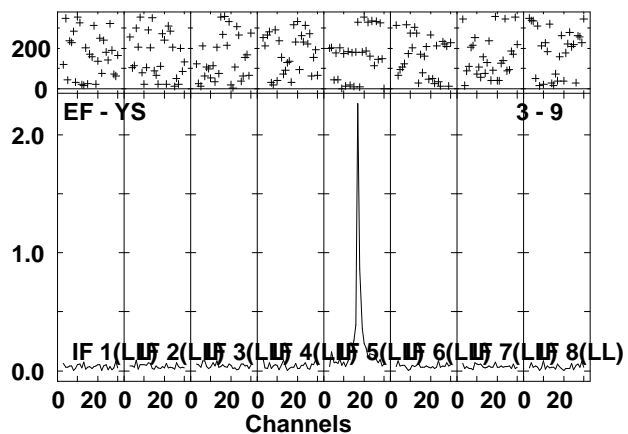
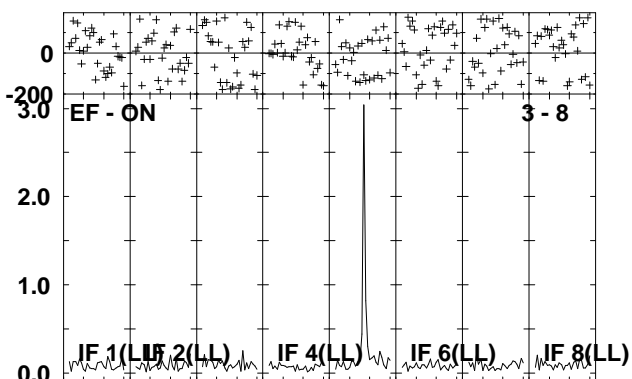
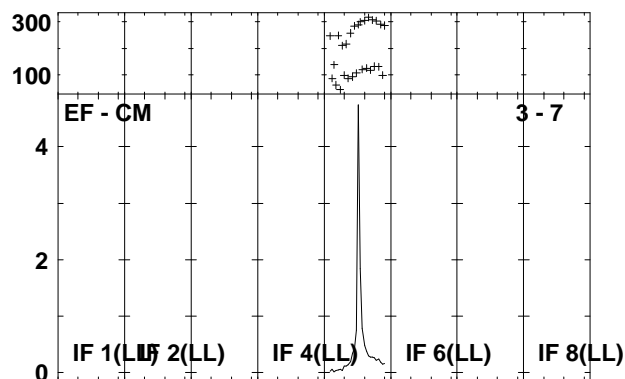
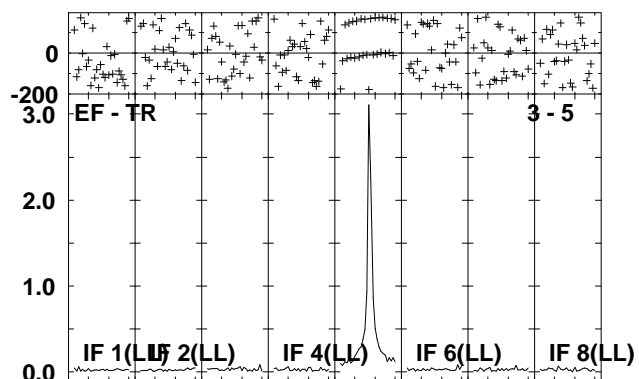
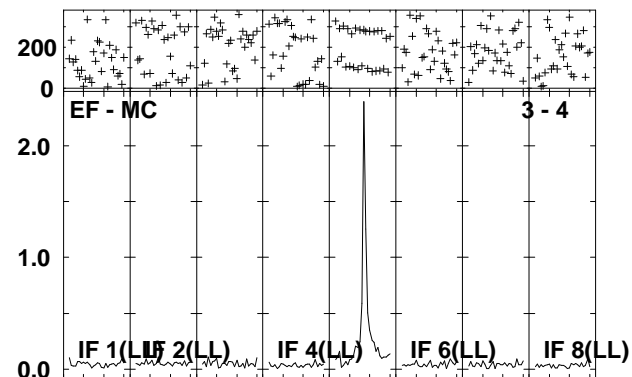
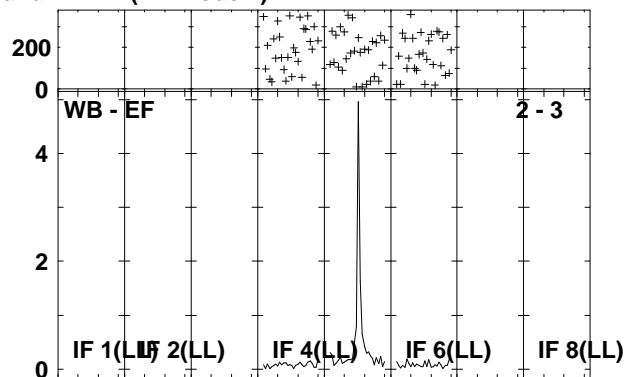
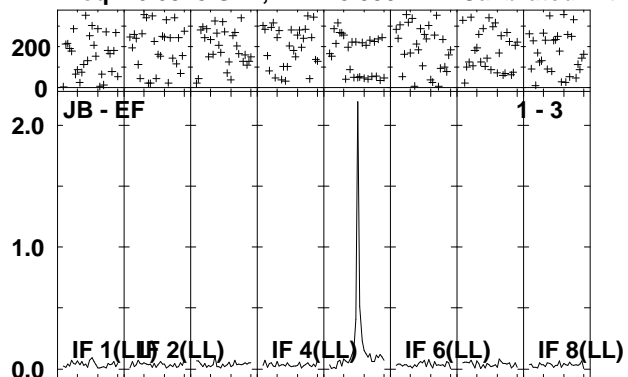

0 20 0 20 0 20 0 20 0 20 0 20 0 20 0 20 0 20 0 20
 Channels
 Lower frame: Ampl Jy Top frame: Phas deg
 Vector averaged cross-power spectrum Several baselines displayed
 Timerange: 00/03:11:44 to 00/03:12:44

Plot file version 63 created 19-AUG-2009 15:48:27

J2029+46 EB039B 2.UVDATA.1

Freq = 6.6328 GHz, Bw = 8.000 MH Calibrated with CL # 3 and BP # 1 (BP mode 1)

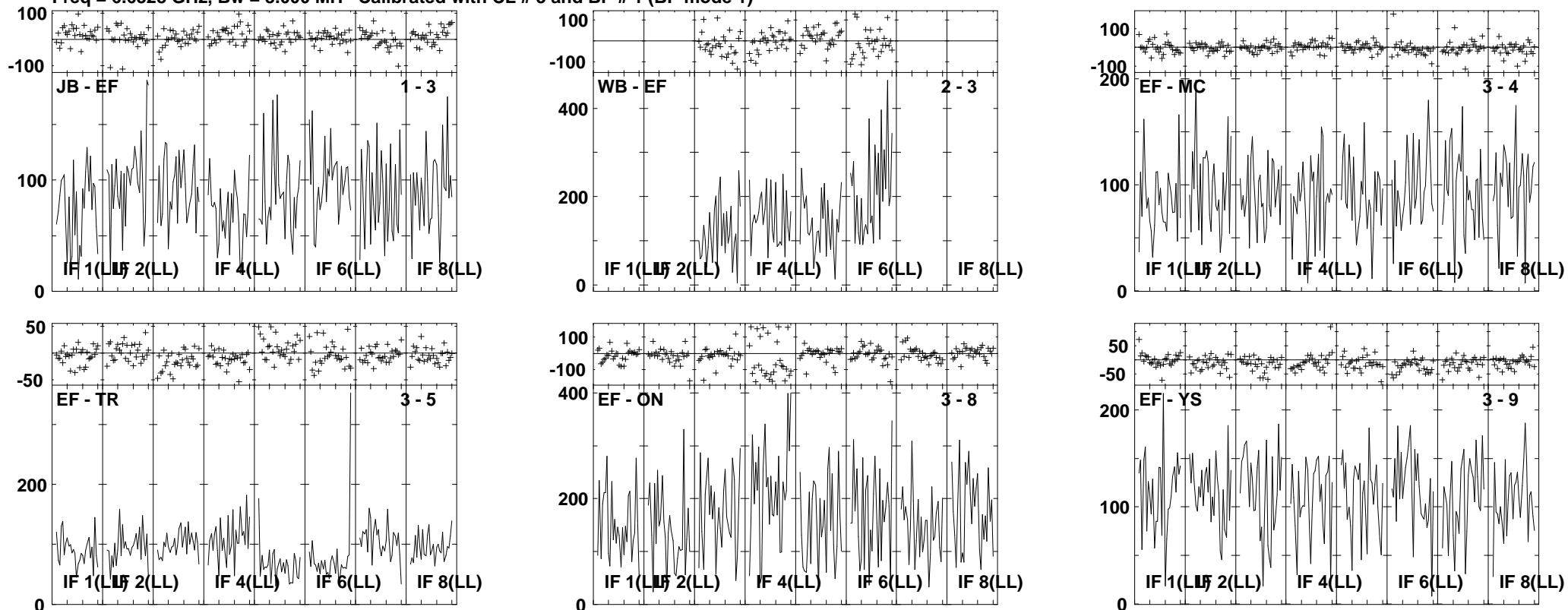

Lower frame: Milli Ampl Jy Top frame: Phas deg
Vector averaged cross-power spectrum Several baselines displayed
Timerange: 00/03:12:45 to 00/03:14:13

Plot file version 64 created 19-AUG-2009 15:48:30
 W75 EB039B 2.UVDATA.1
 Freq = 6.6328 GHz, Bw = 8.000 MH Calibrated with CL # 3 and BP # 1 (BP mode 1)

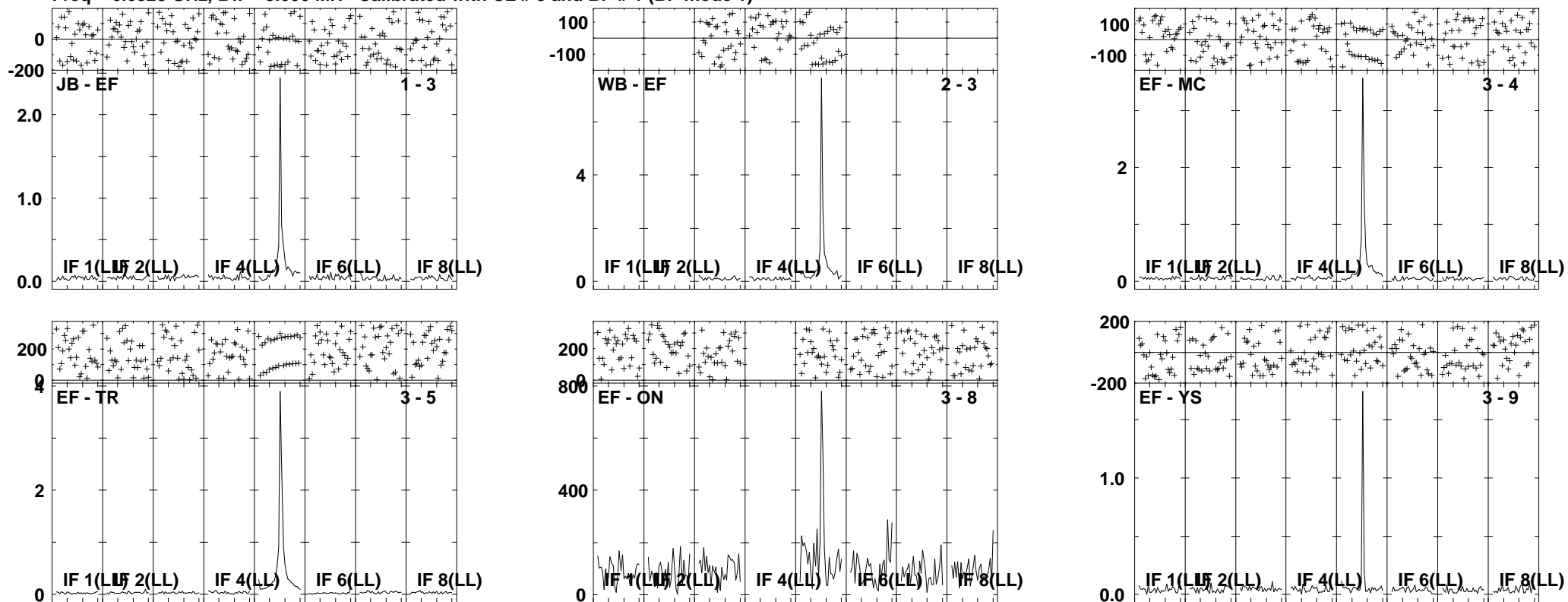

Lower frame: Ampl Jy Top frame: Phas deg
 Vector averaged cross-power spectrum Several baselines displayed
 Timerange: 00/03:14:15 to 00/03:15:43

Plot file version 65 created 19-AUG-2009 15:48:35

W75 EB039B 2.UVDATA.1

Freq = 6.6328 GHz, Bw = 8.000 MH Calibrated with CL # 3 and BP # 1 (BP mode 1)

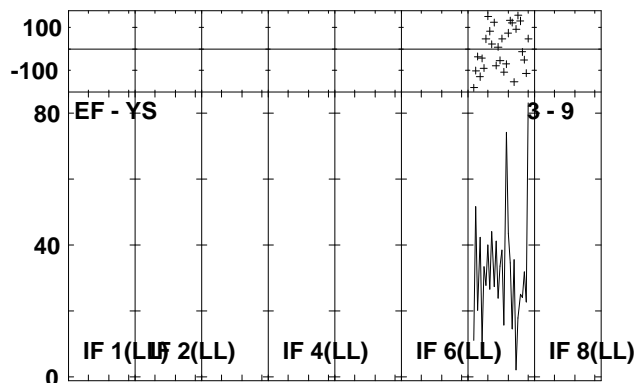
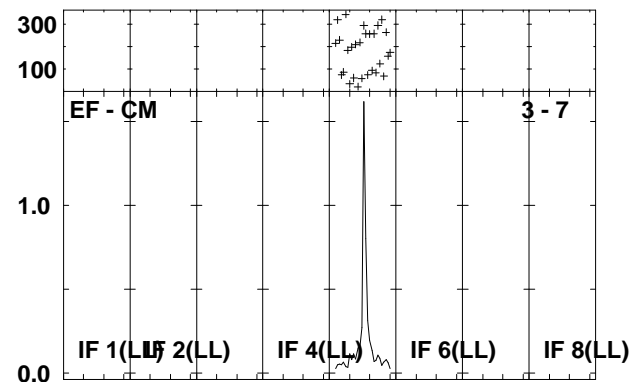
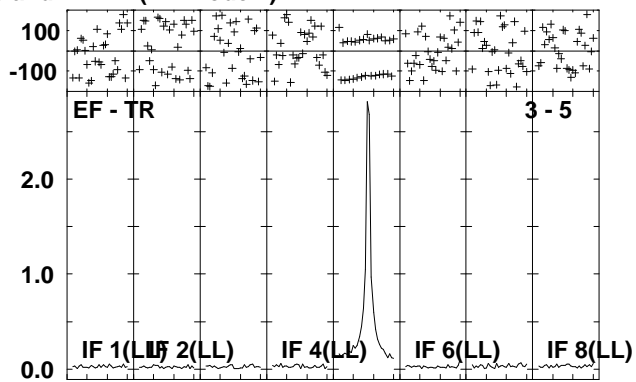
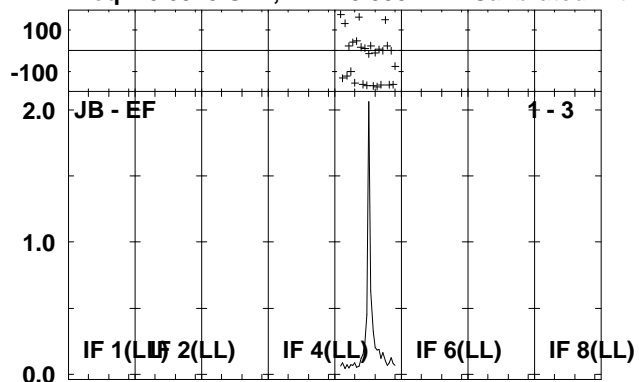

Lower frame: Ampl Jy Top frame: Phas deg
Vector averaged cross-power spectrum Several baselines displayed
Timerange: 00/03:17:15 to 00/03:18:43

Plot file version 66 created 19-AUG-2009 15:48:37

2048+431 EB039B 2.UVDATA.1

Freq = 6.6328 GHz, Bw = 8.000 MH Calibrated with CL # 3 and BP # 1 (BP mode 1)

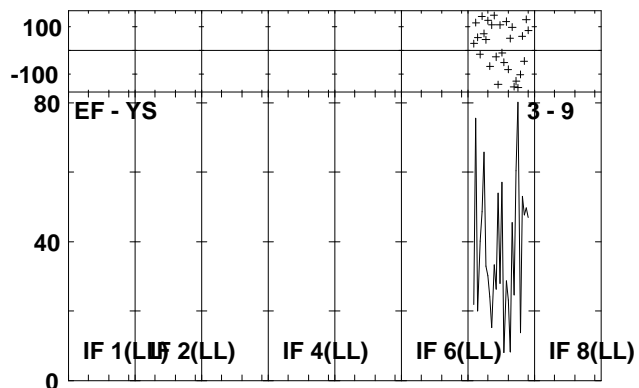
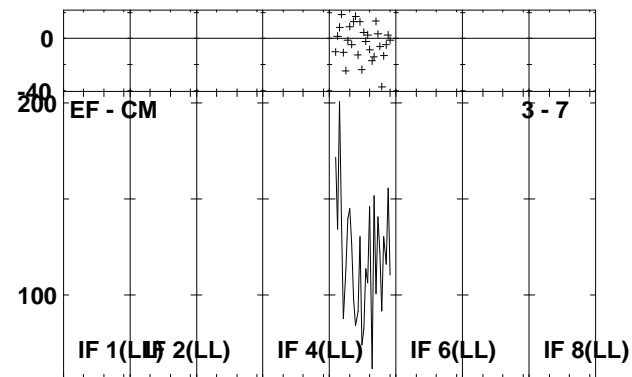
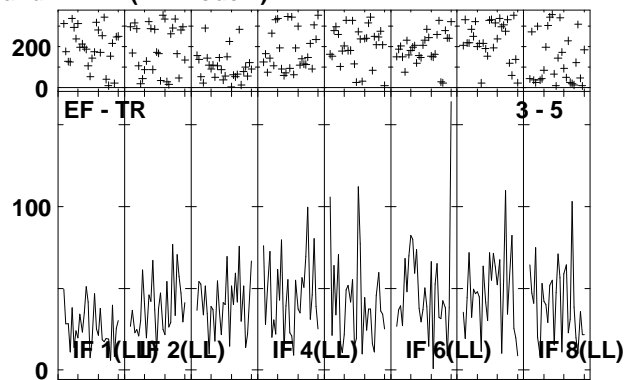
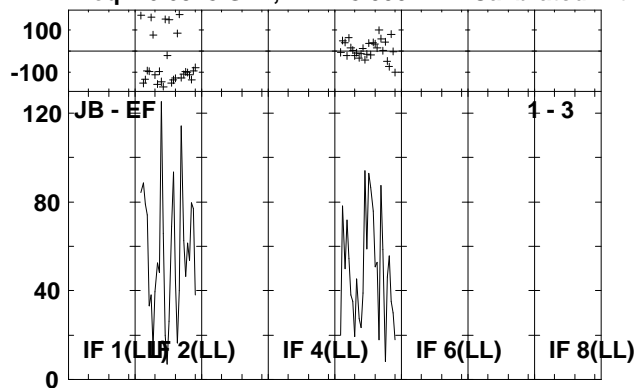

Lower frame: Milli Ampl Jy Top frame: Phas deg
Vector averaged cross-power spectrum Several baselines displayed
Timerange: 00/03:18:45 to 00/03:20:13

Plot file version 67 created 19-AUG-2009 15:48:40
 W75 EB039B 2.UVDATA.1
 Freq = 6.6328 GHz, Bw = 8.000 MH Calibrated with CL # 3 and BP # 1 (BP mode 1)

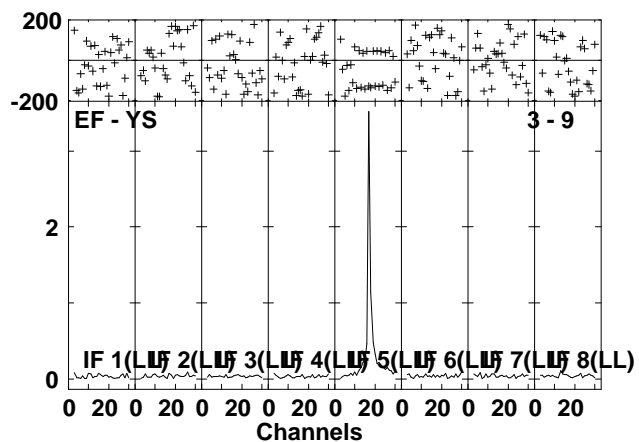
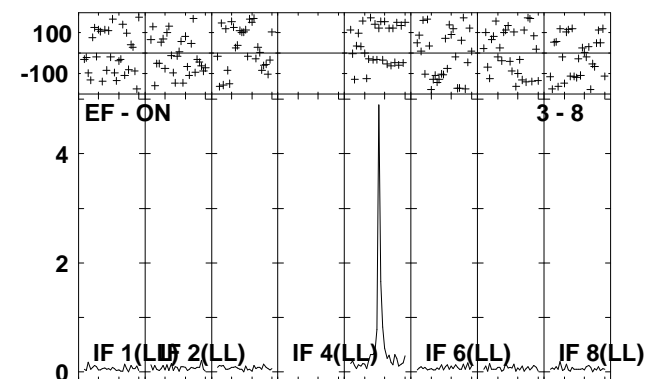
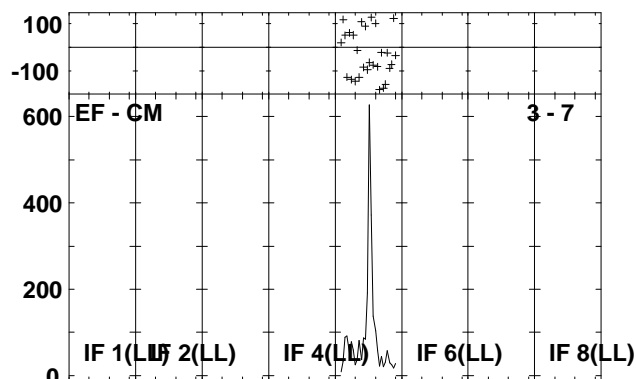
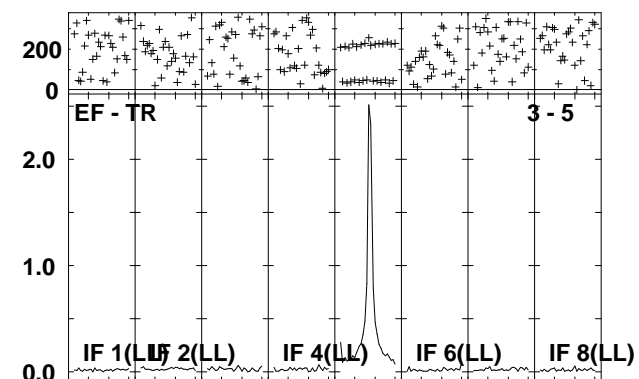
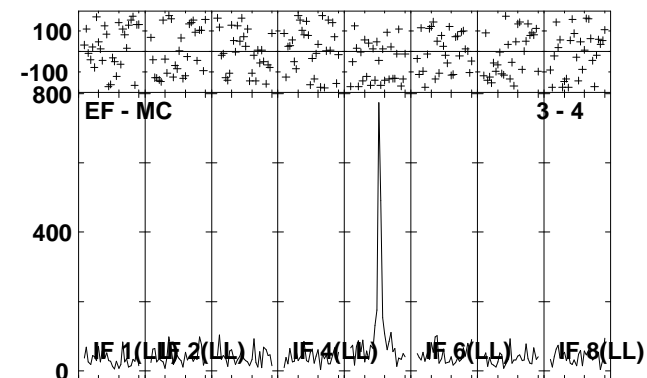
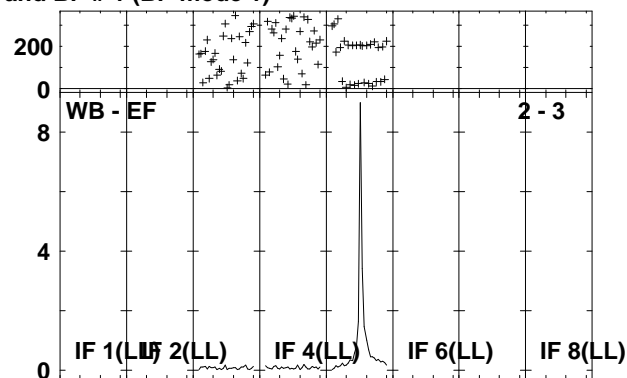
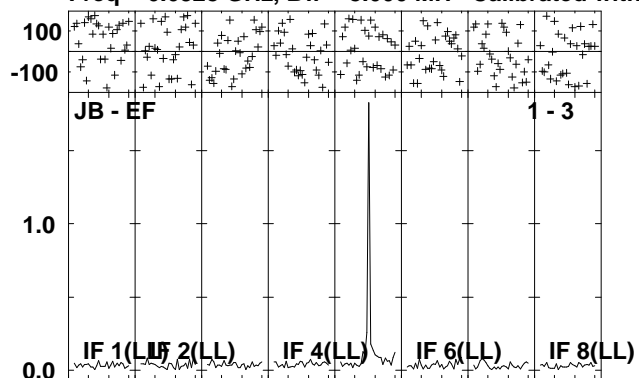

Lower frame: Ampl Jy Top frame: Phas deg
 Vector averaged cross-power spectrum Several baselines displayed
 Timerange: 00/03:20:14 to 00/03:21:43

Plot file version 68 created 19-AUG-2009 15:48:42

OB2 EB039B 2.UVDATA.1

Freq = 6.6328 GHz, Bw = 8.000 MH Calibrated with CL # 3 and BP # 1 (BP mode 1)

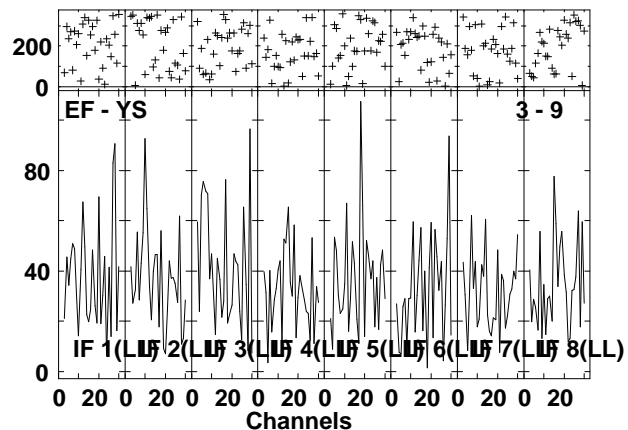
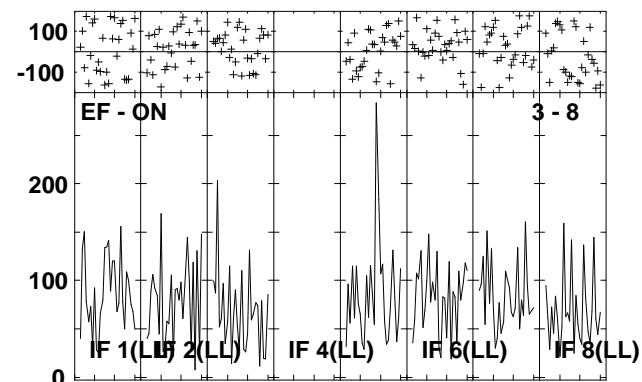
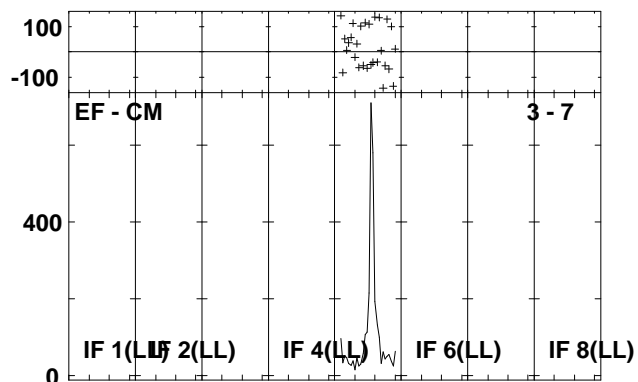
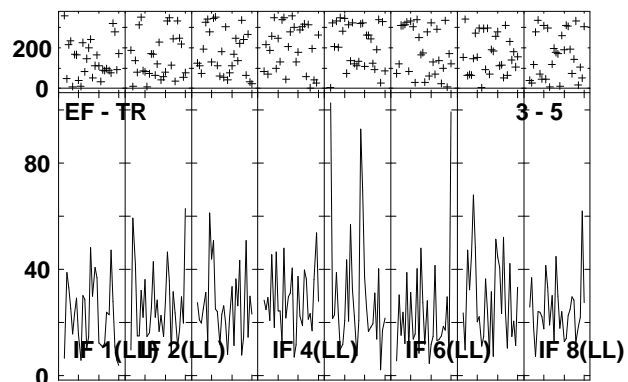
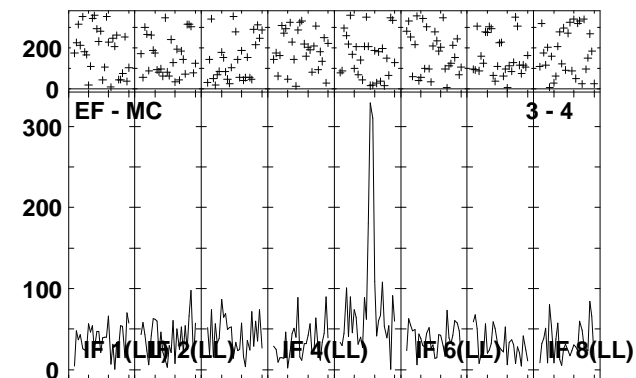
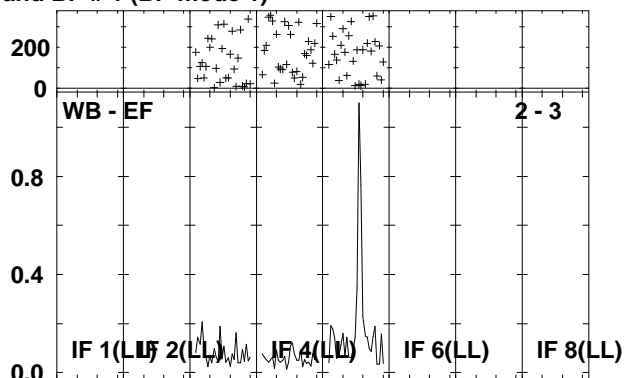
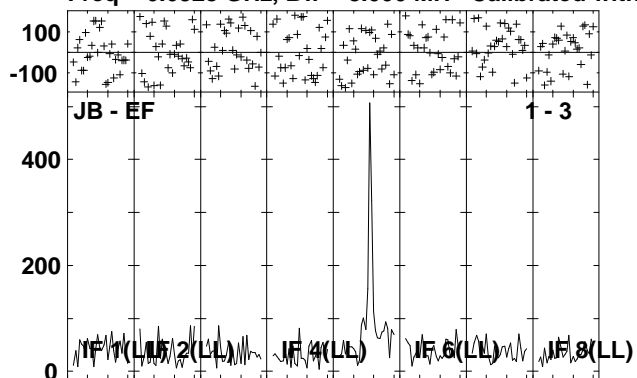

Lower frame: Milli Ampl Jy Top frame: Phas deg
Vector averaged cross-power spectrum Several baselines displayed
Timerange: 00/03:21:44 to 00/03:23:13

Plot file version 69 created 19-AUG-2009 15:48:45
 W75 EB039B 2.UVDATA.1
 Freq = 6.6328 GHz, Bw = 8.000 MH Calibrated with CL # 3 and BP # 1 (BP mode 1)

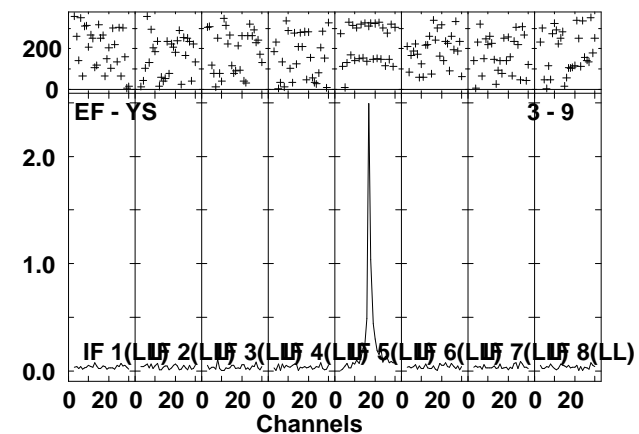
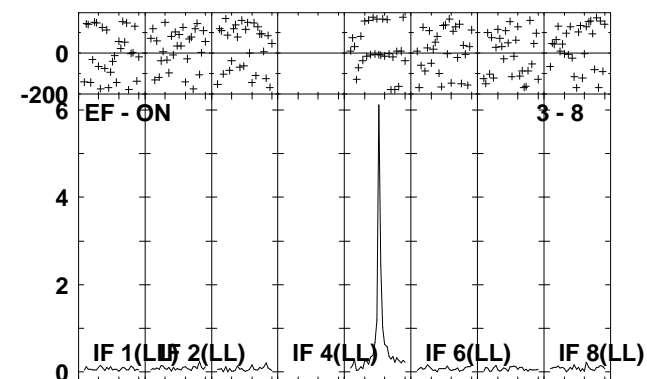
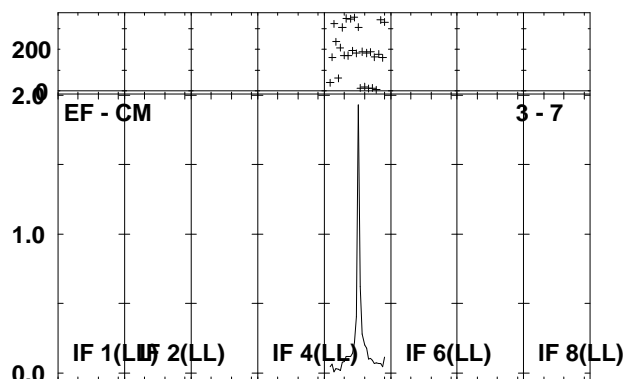
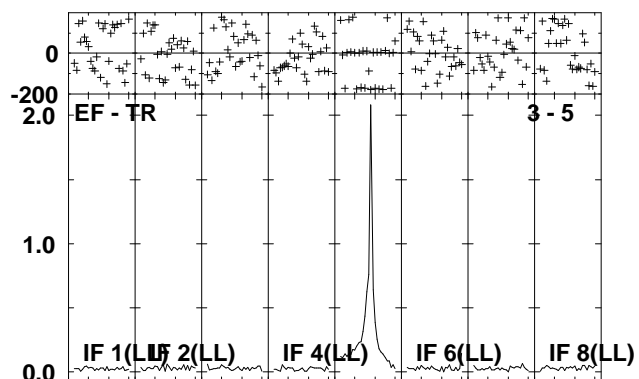
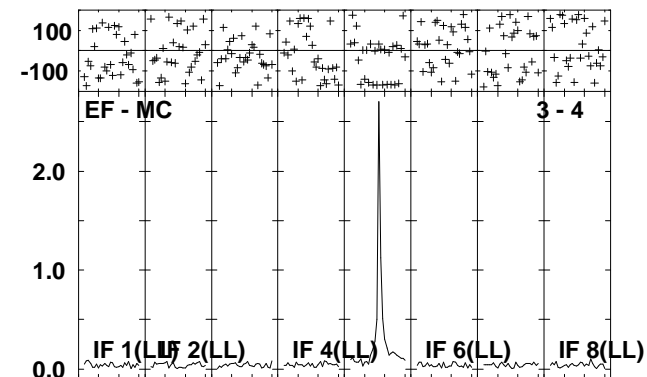
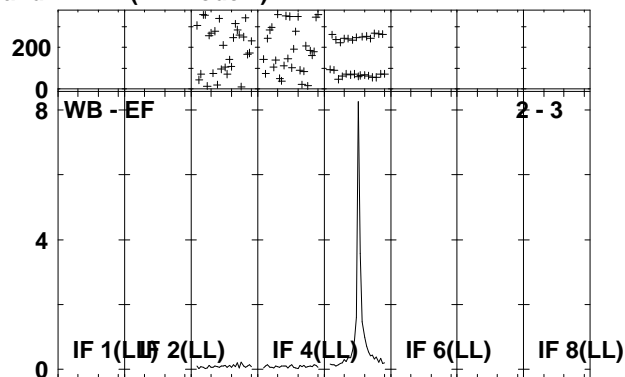
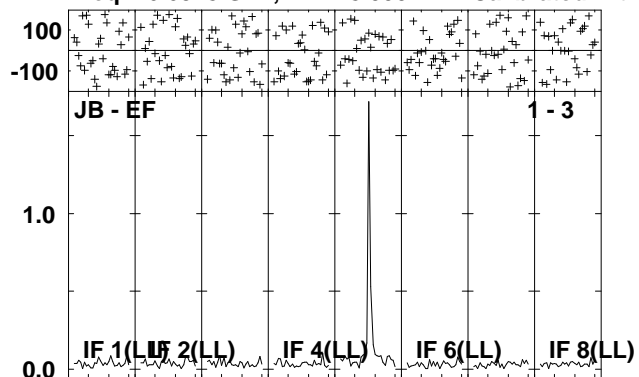

0 20 0 20 0 20 0 20 0 20 0 20 0 20 0 20 0 20 0 20
 Channels
 Lower frame: Ampl Jy Top frame: Phas deg
 Vector averaged cross-power spectrum Several baselines displayed
 Timerange: 00/03:23:47 to 00/03:24:47

Plot file version 70 created 19-AUG-2009 15:48:47
 DR21A EB039B 2.UVDATA.1
 Freq = 6.6328 GHz, Bw = 8.000 MH Calibrated with CL # 3 and BP # 1 (BP mode 1)

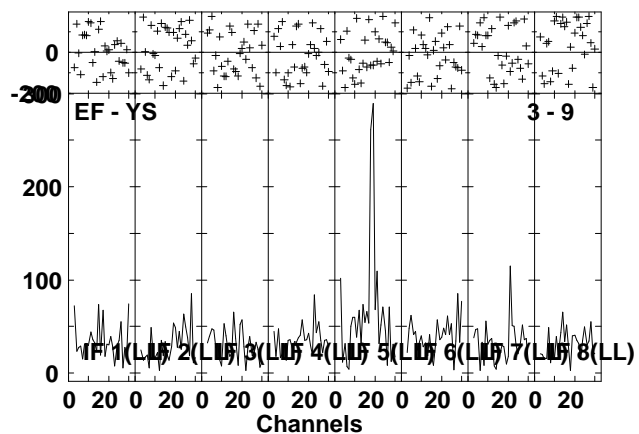
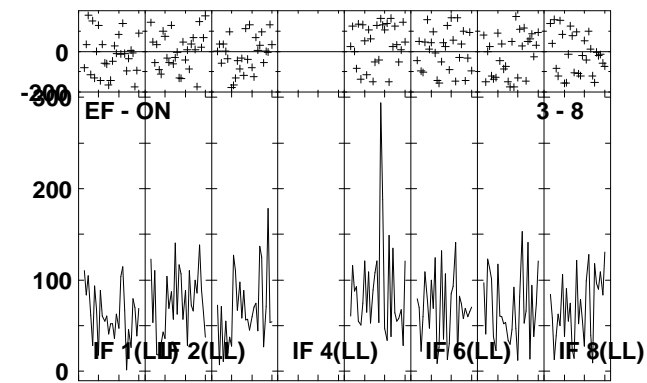
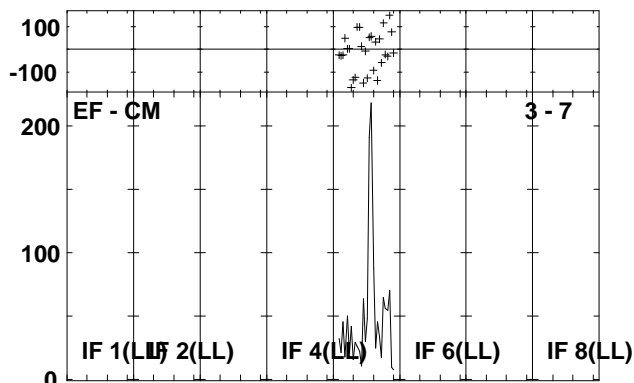
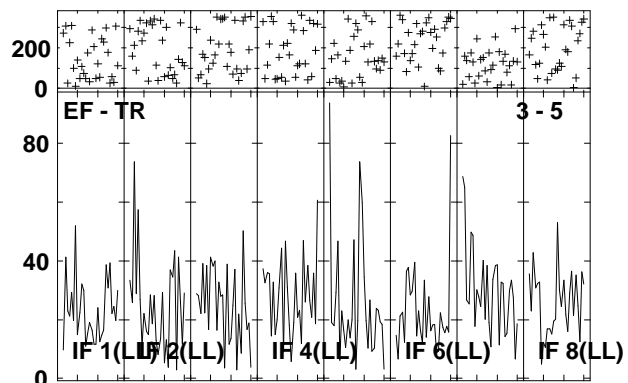
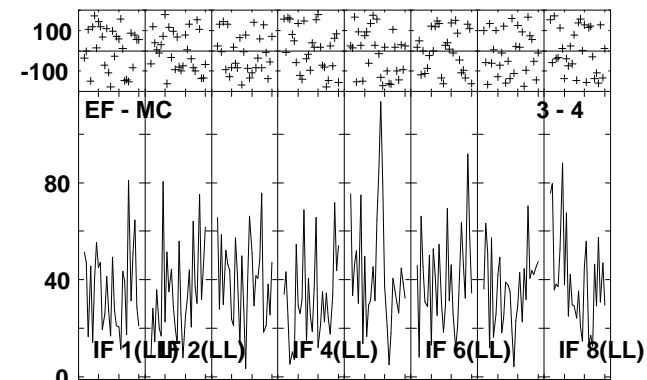
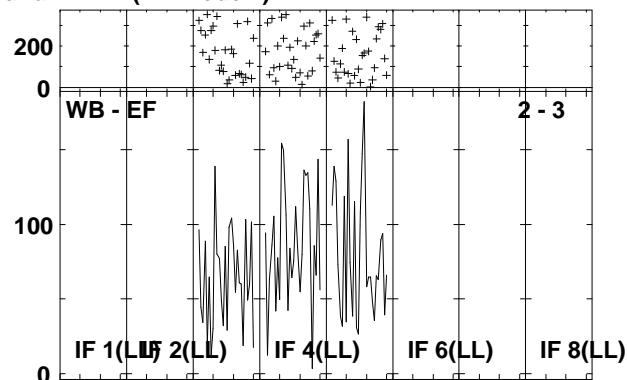
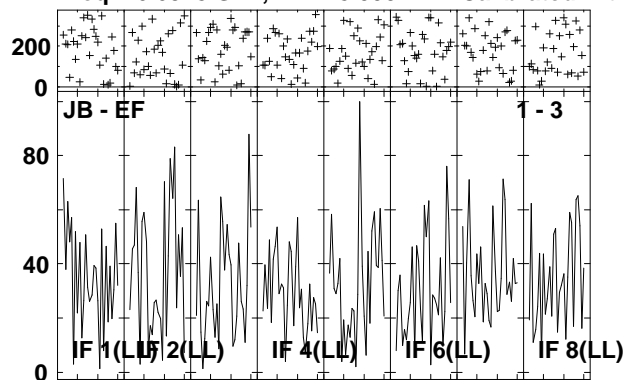

Lower frame: Milli Ampl Jy Top frame: Phas deg
 Vector averaged cross-power spectrum Several baselines displayed
 Timerange: 00/03:24:48 to 00/03:26:17

Plot file version 71 created 19-AUG-2009 15:48:50
 W75 EB039B 2.UVDATA.1
 Freq = 6.6328 GHz, Bw = 8.000 MH Calibrated with CL # 3 and BP # 1 (BP mode 1)

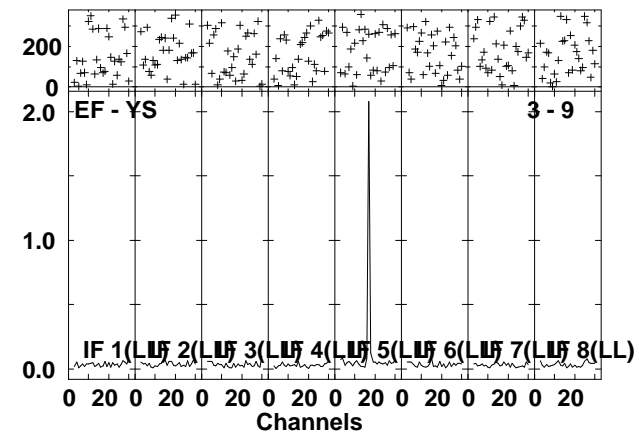
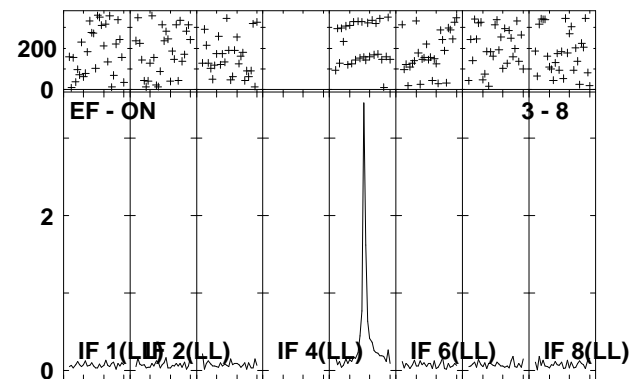
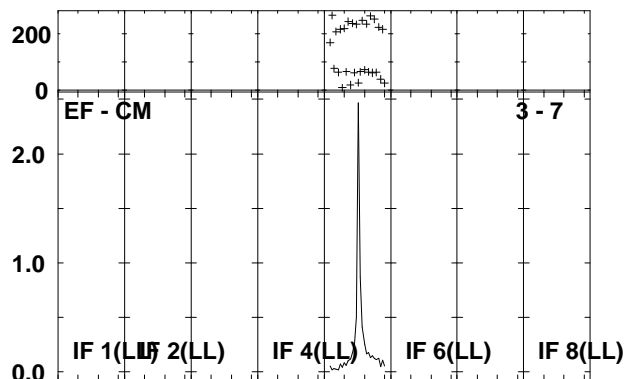
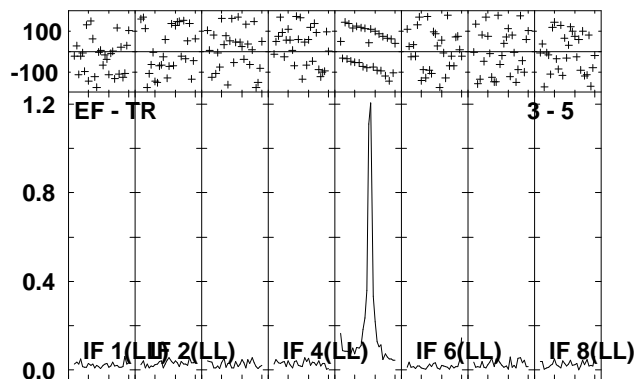
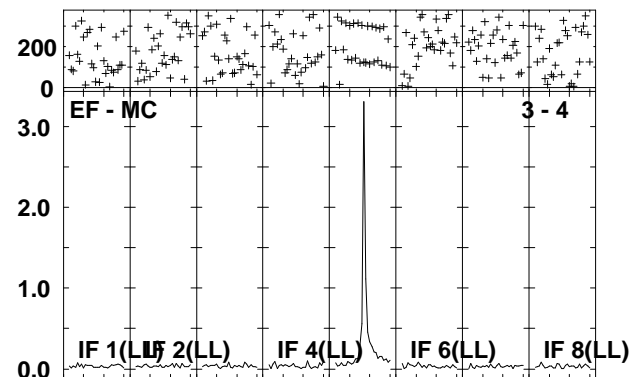
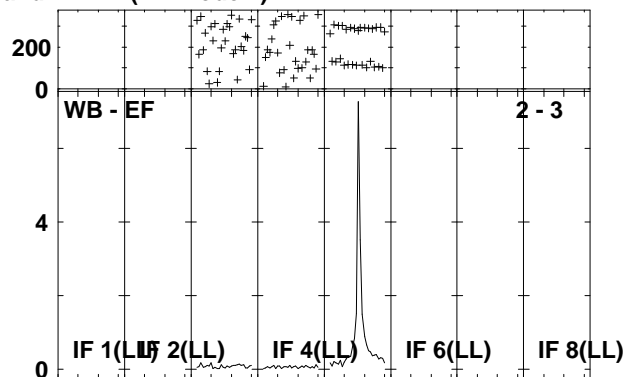
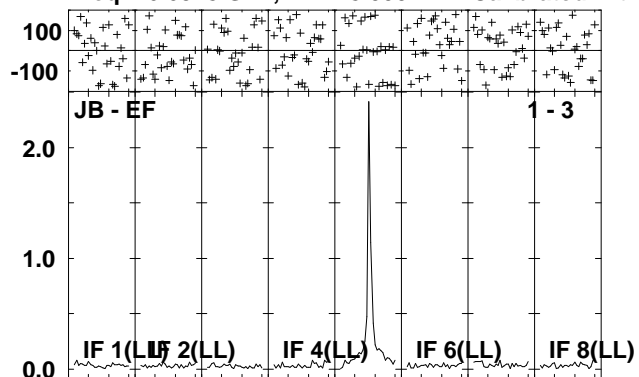

Lower frame: Ampl Jy Top frame: Phas deg
 Vector averaged cross-power spectrum Several baselines displayed
 Timerange: 00/03:26:17 to 00/03:27:46

Plot file version 73 created 19-AUG-2009 15:48:56
 W75 EB039B 2.UVDATA.1
 Freq = 6.6328 GHz, Bw = 8.000 MH Calibrated with CL # 3 and BP # 1 (BP mode 1)

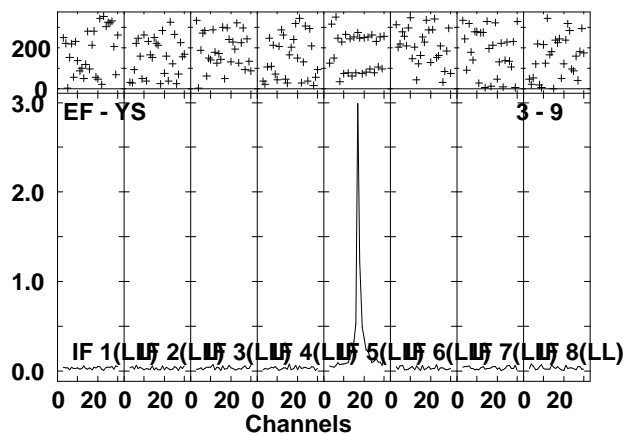
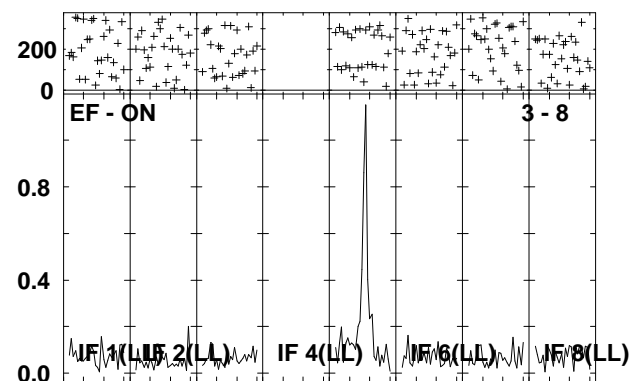
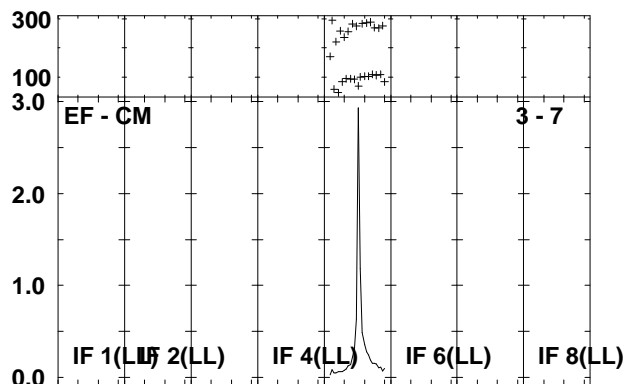
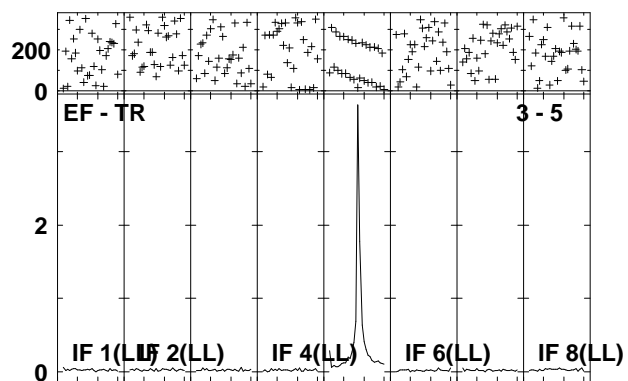
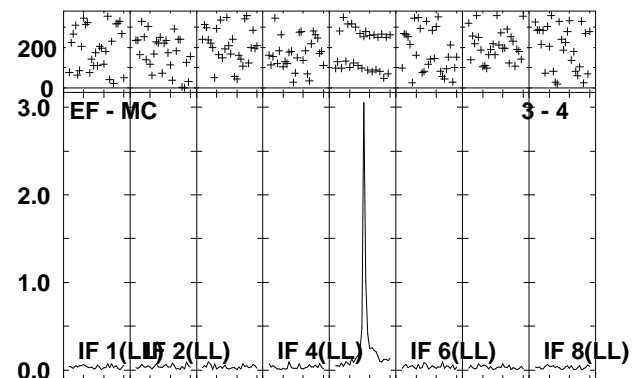
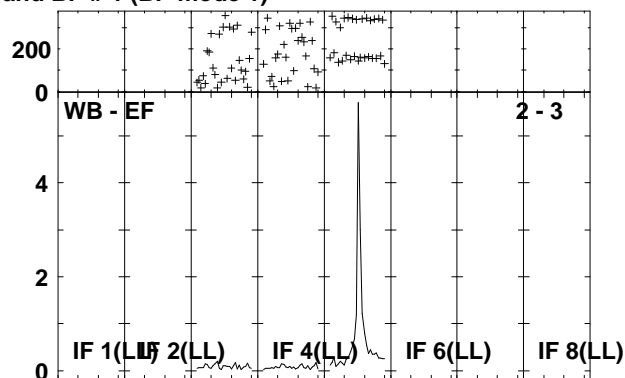
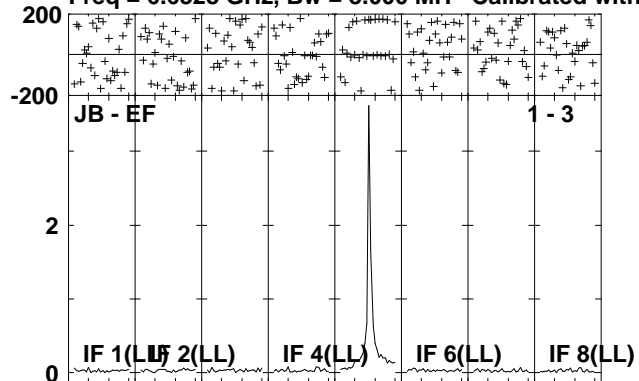

0 20 0 20 0 20 0 20 0 20 0 20 0 20 0 20 0 20
 Channels
 Lower frame: Ampl Jy Top frame: Phas deg
 Vector averaged cross-power spectrum Several baselines displayed
 Timerange: 00/03:29:18 to 00/03:30:47

Plot file version 74 created 19-AUG-2009 15:48:59
 DR21B2 EB039B 2.UVDATA.1
 Freq = 6.6328 GHz, Bw = 8.000 MH Calibrated with CL # 3 and BP # 1 (BP mode 1)

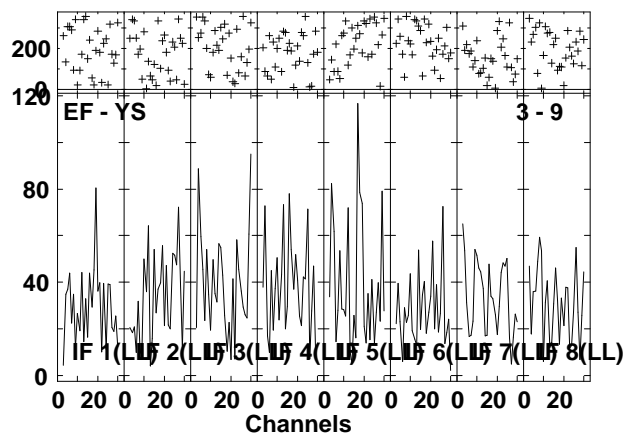
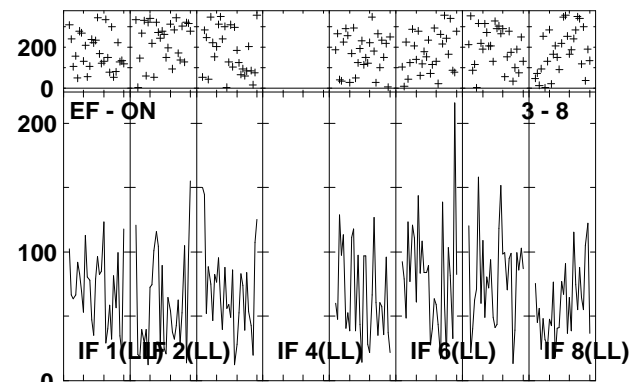
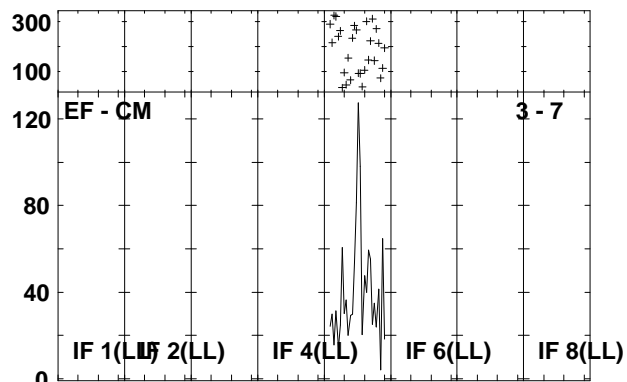
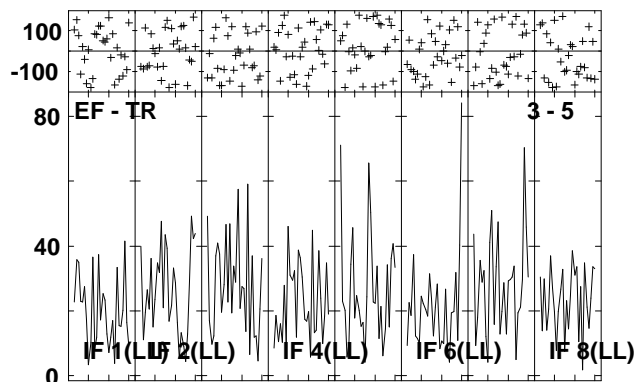
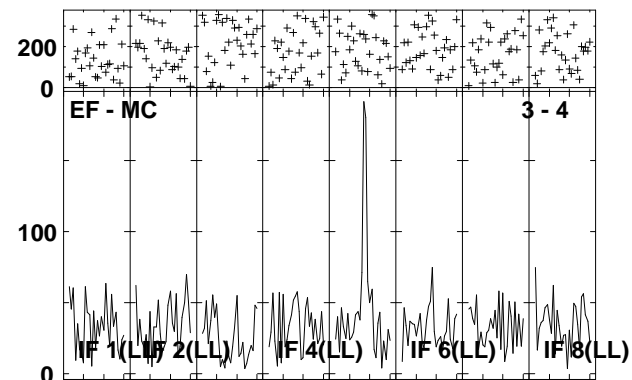
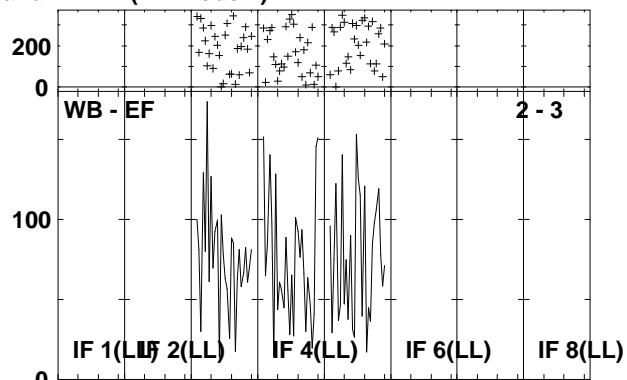
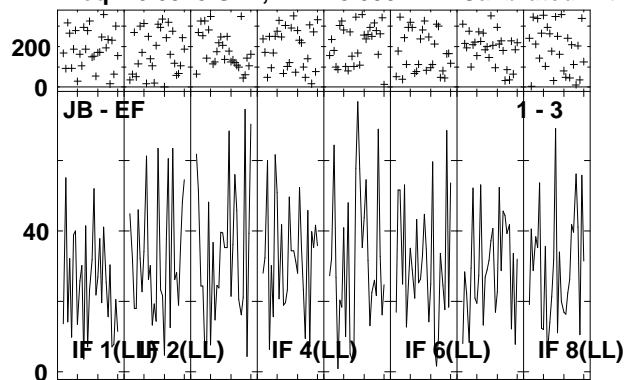

Lower frame: Milli Ampl Jy Top frame: Phas deg
 Vector averaged cross-power spectrum Several baselines displayed
 Timerange: 00/03:30:48 to 00/03:32:16

Plot file version 75 created 19-AUG-2009 15:49:02
 W75 EB039B 2.UVDATA.1
 Freq = 6.6328 GHz, Bw = 8.000 MH Calibrated with CL # 3 and BP # 1 (BP mode 1)

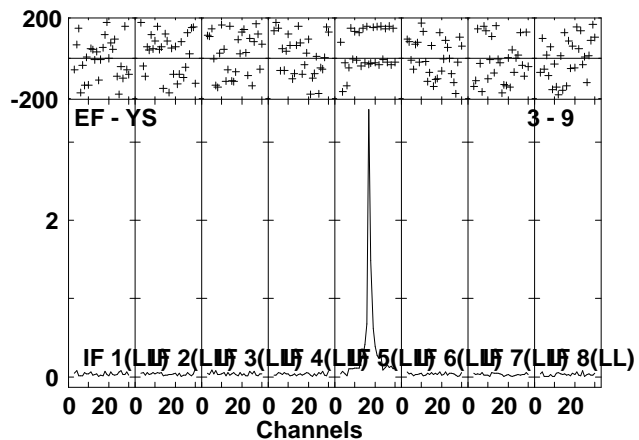
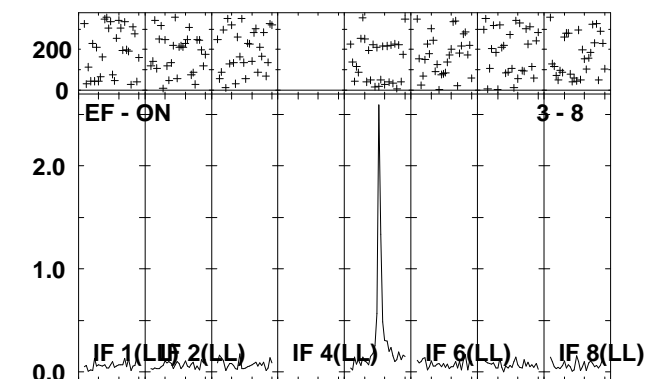
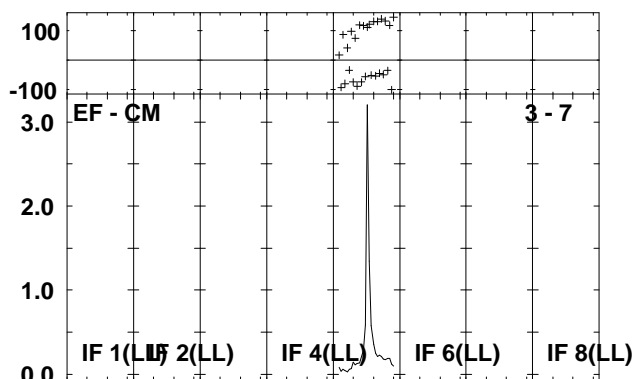
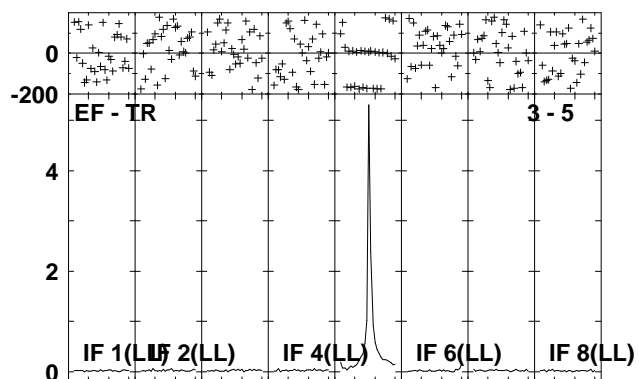
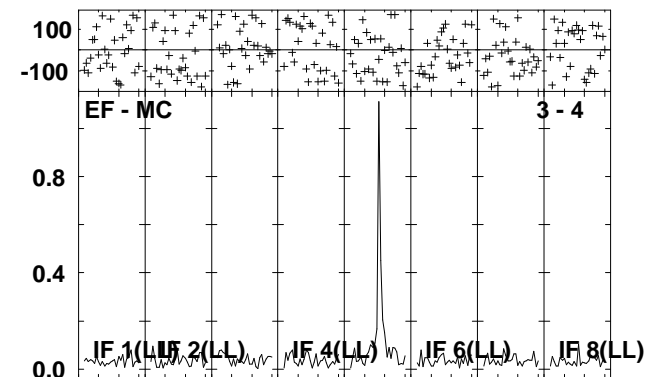
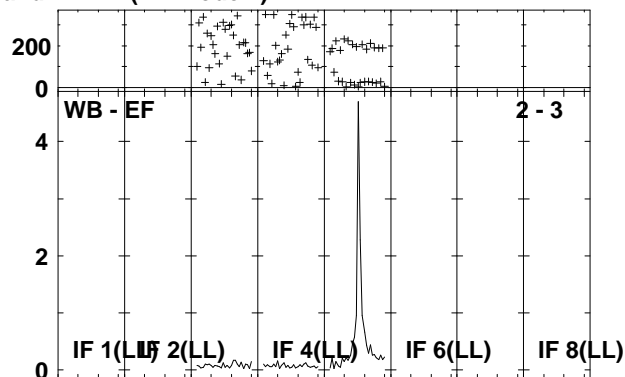
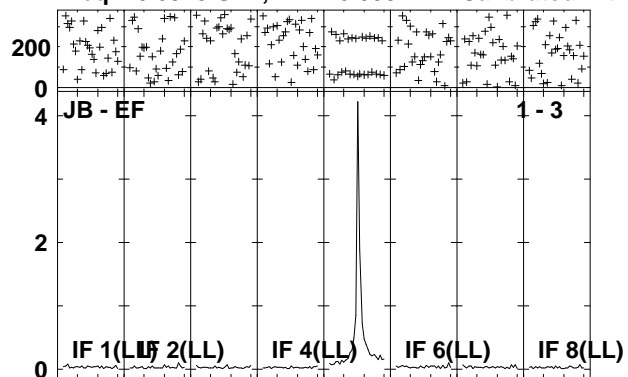

Lower frame: Ampl Jy Top frame: Phas deg
 Vector averaged cross-power spectrum Several baselines displayed
 Timerange: 00/03:32:18 to 00/03:33:46

Plot file version 76 created 19-AUG-2009 15:49:04

DR20 EB039B 2.UVDATA.1

Freq = 6.6328 GHz, Bw = 8.000 MH Calibrated with CL # 3 and BP # 1 (BP mode 1)

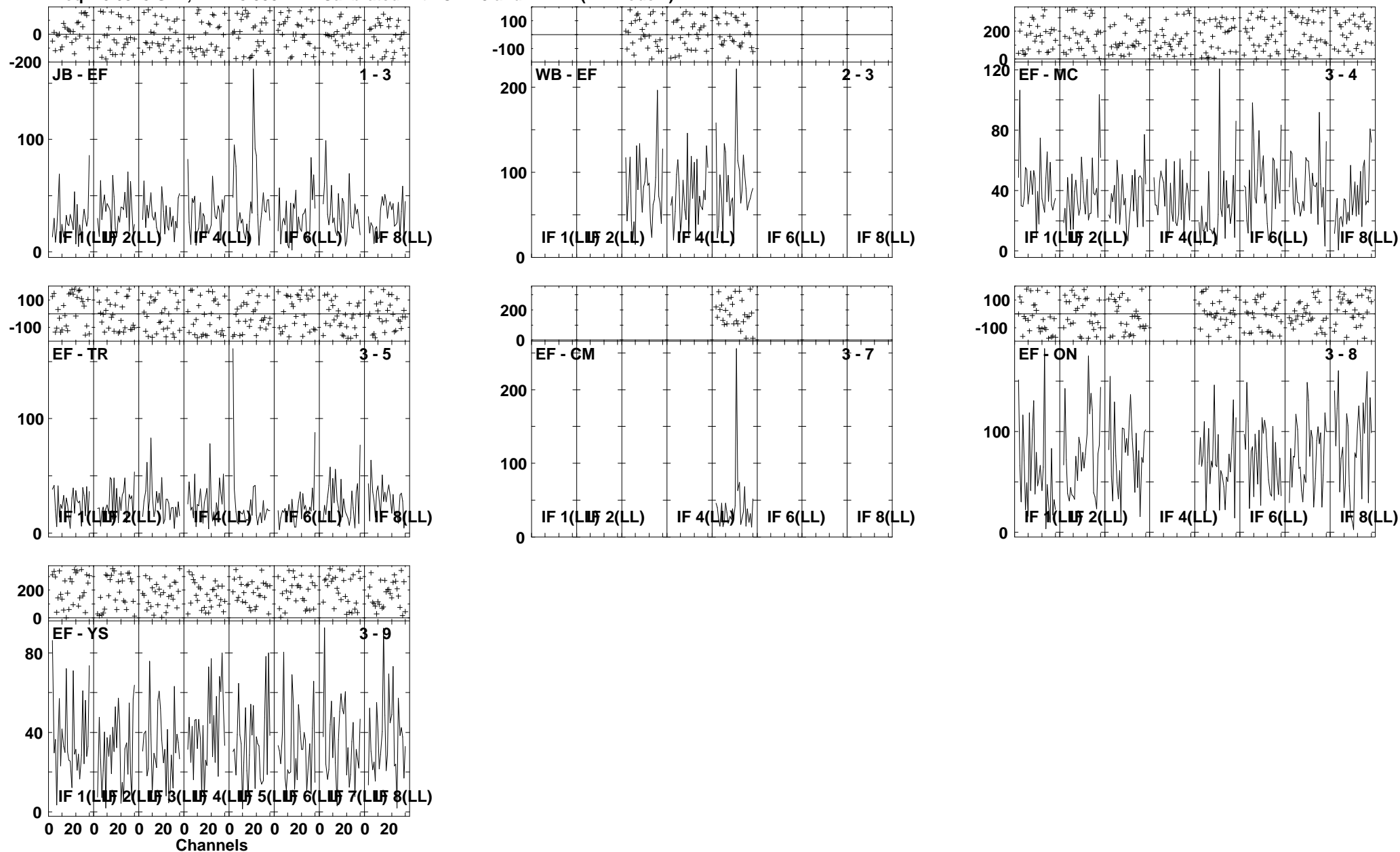

Lower frame: Milli Ampl Jy Top frame: Phas deg
Vector averaged cross-power spectrum Several baselines displayed
Timerange: 00/03:33:48 to 00/03:35:16

Plot file version 77 created 19-AUG-2009 15:49:07

W75 EB039B 2.UVDATA.1

Freq = 6.6328 GHz, Bw = 8.000 MH Calibrated with CL # 3 and BP # 1 (BP mode 1)

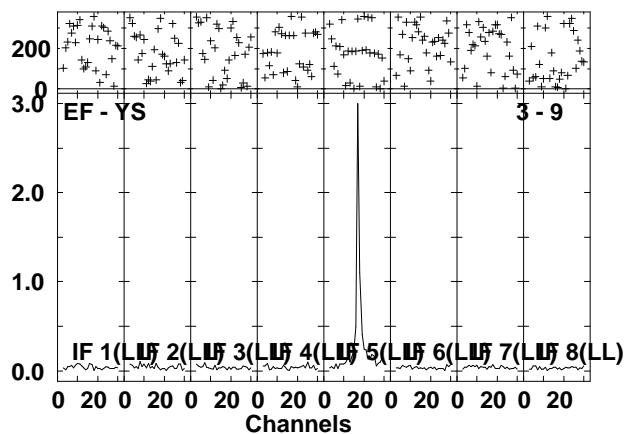
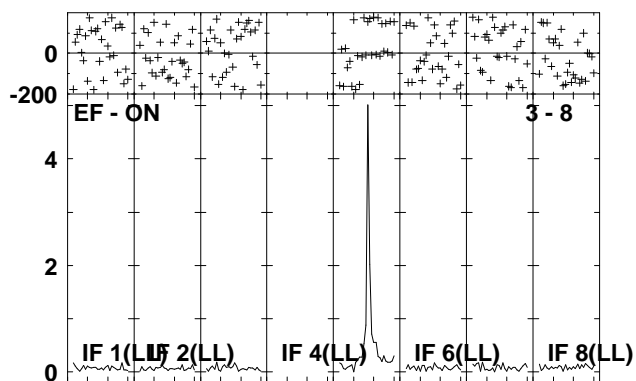
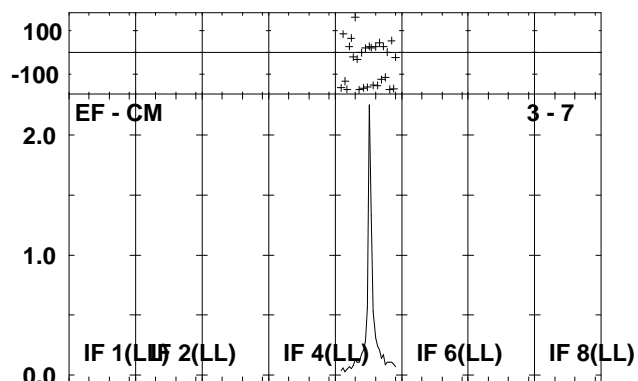
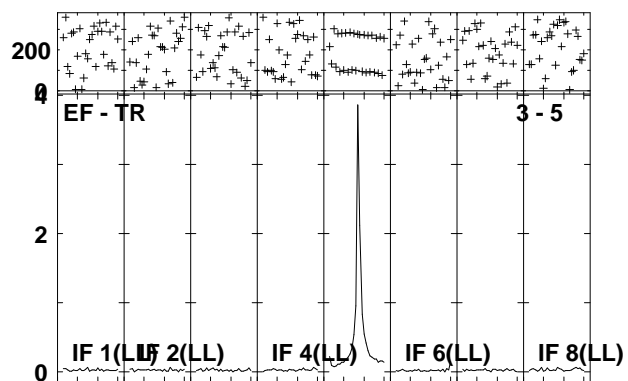
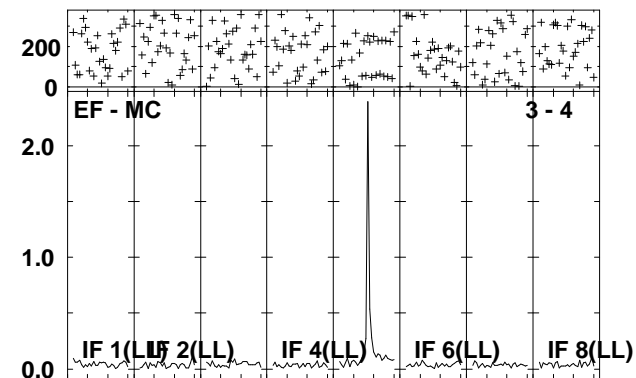
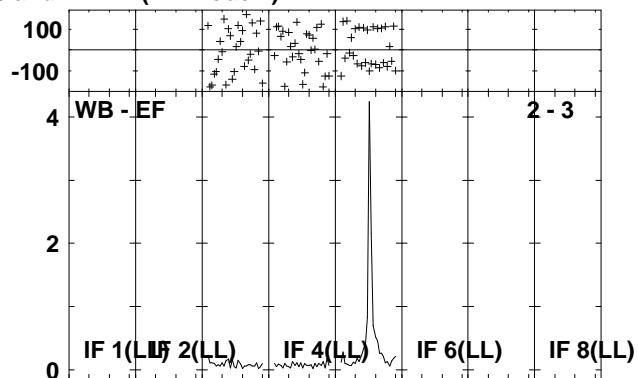
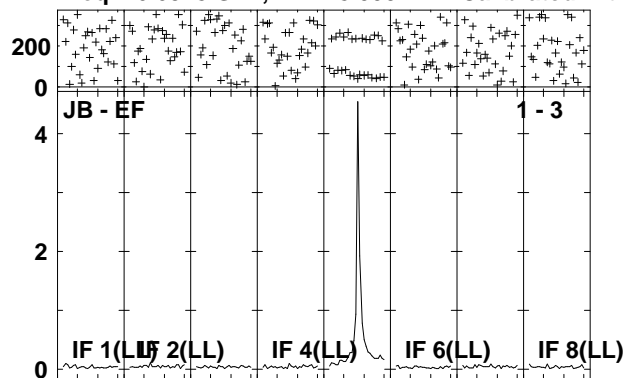

Lower frame: Ampl Jy Top frame: Phas deg
Vector averaged cross-power spectrum Several baselines displayed
Timerange: 00/03:35:41 to 00/03:36:41

Plot file version 78 created 19-AUG-2009 15:49:09

J2029+46 EB039B 2.UVDATA.1

Freq = 6.6328 GHz, Bw = 8.000 MH Calibrated with CL # 3 and BP # 1 (BP mode 1)

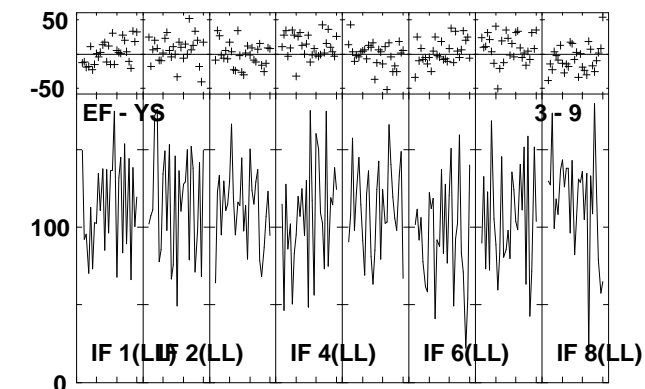
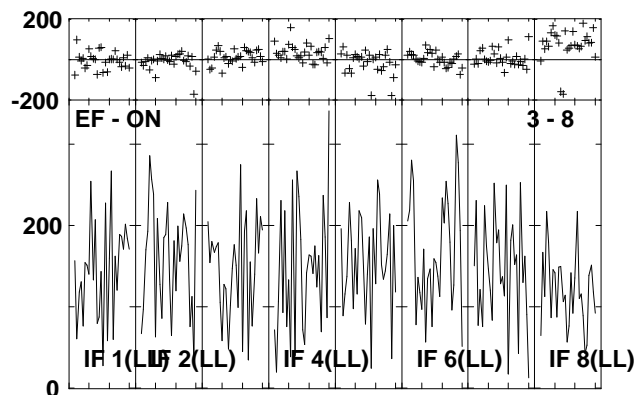
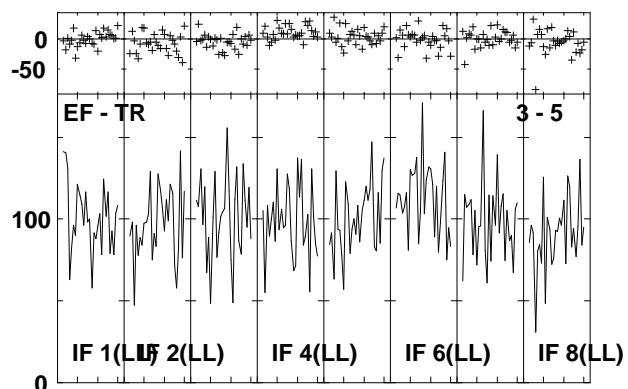
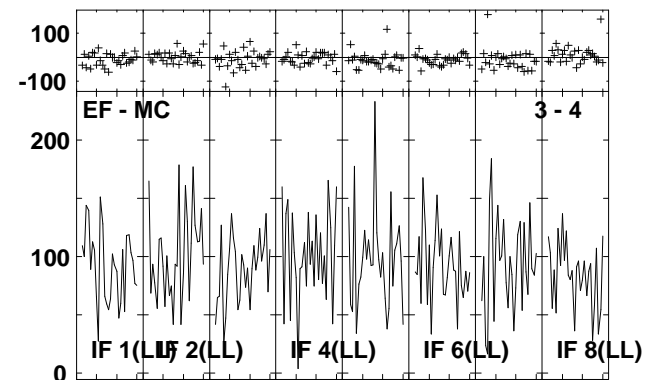
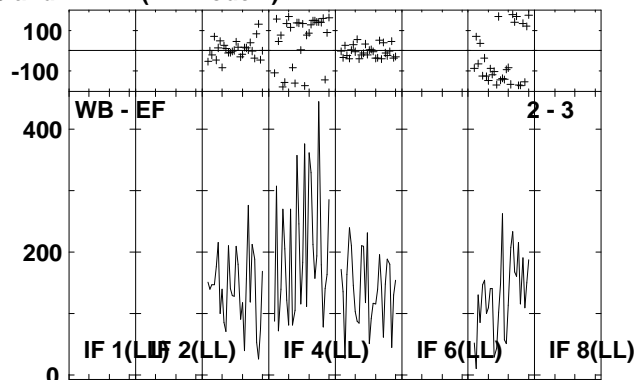
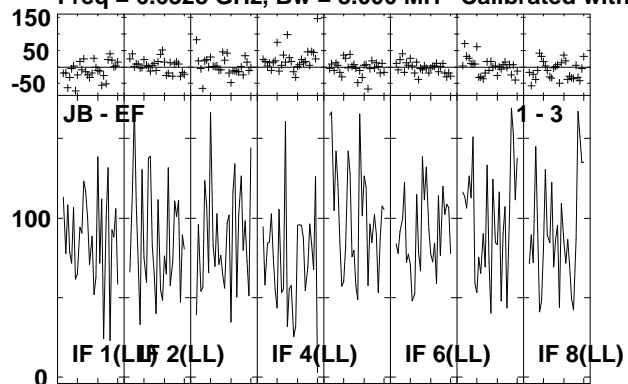

Lower frame: Milli Ampl Jy Top frame: Phas deg
Vector averaged cross-power spectrum Several baselines displayed
Timerange: 00/03:36:42 to 00/03:38:11

Plot file version 79 created 19-AUG-2009 15:49:12
 W75 EB039B 2.UVDATA.1
 Freq = 6.6328 GHz, Bw = 8.000 MH Calibrated with CL # 3 and BP # 1 (BP mode 1)

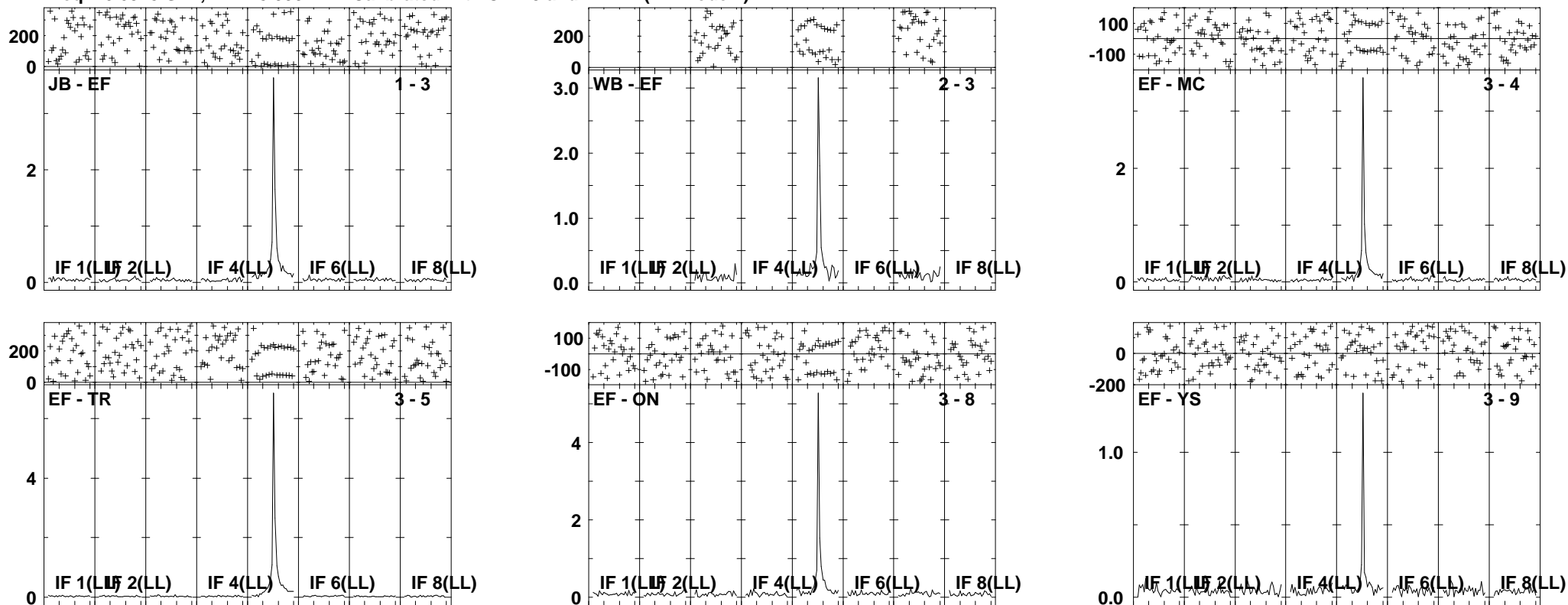

Lower frame: Ampl Jy Top frame: Phas deg
 Vector averaged cross-power spectrum Several baselines displayed
 Timerange: 00/03:38:12 to 00/03:39:40

Plot file version 80 created 19-AUG-2009 15:49:17

W75 EB039B 2.UVDATA.1

Freq = 6.6328 GHz, Bw = 8.000 MH Calibrated with CL # 3 and BP # 1 (BP mode 1)

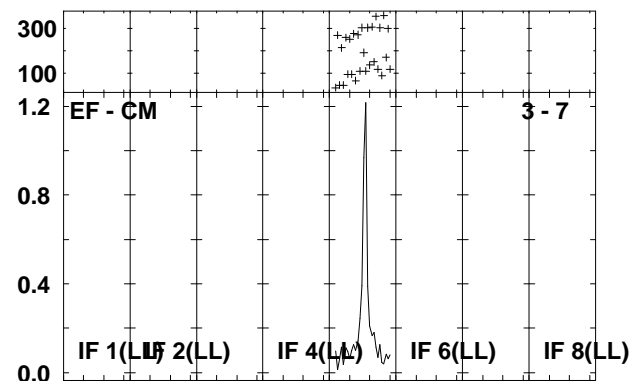
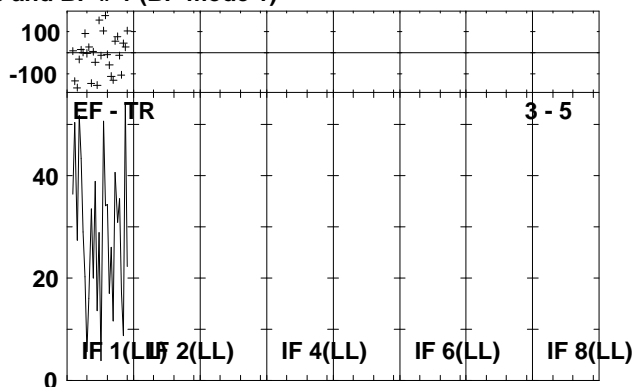
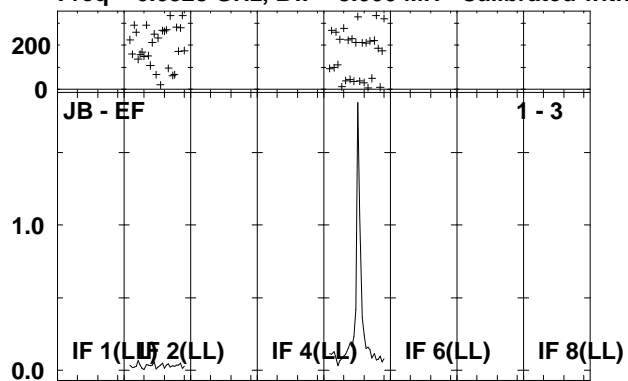

Lower frame: Ampl Jy Top frame: Phas deg
Vector averaged cross-power spectrum Several baselines displayed
Timerange: 00/03:41:12 to 00/03:42:40

Plot file version 81 created 19-AUG-2009 15:49:19

2048+431 EB039B 2.UVDATA.1

Freq = 6.6328 GHz, Bw = 8.000 MH Calibrated with CL # 3 and BP # 1 (BP mode 1)

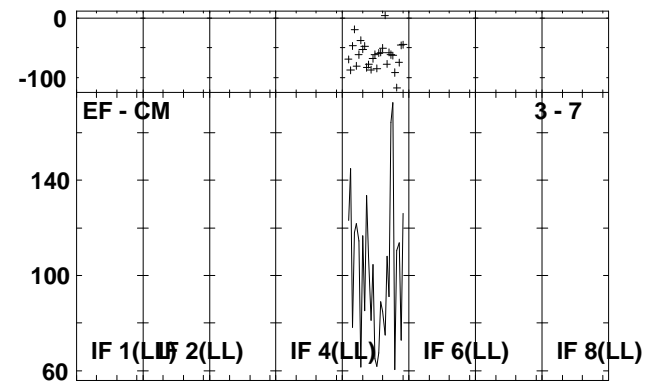
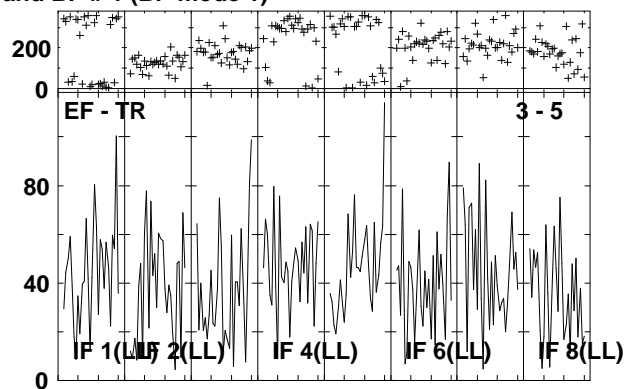
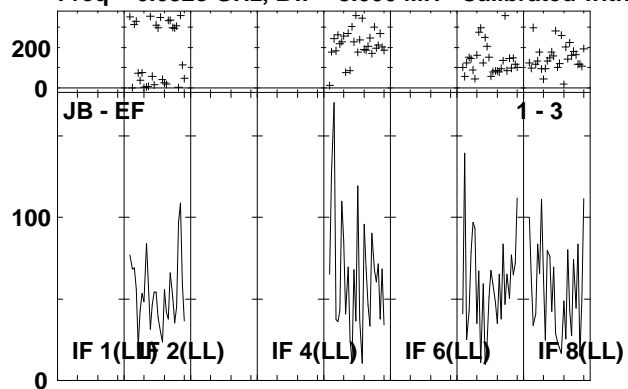

Lower frame: Milli Ampl Jy Top frame: Phas deg
Vector averaged cross-power spectrum Several baselines displayed
Timerange: 00/03:42:42 to 00/03:44:10

Plot file version 82 created 19-AUG-2009 15:49:21
 W75 EB039B 2.UVDATA.1
 Freq = 6.6328 GHz, Bw = 8.000 MH Calibrated with CL # 3 and BP # 1 (BP mode 1)

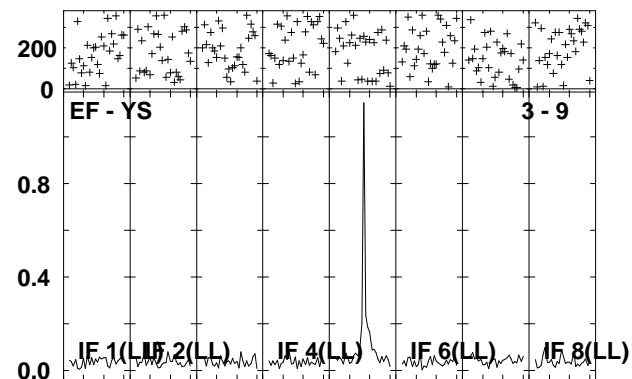
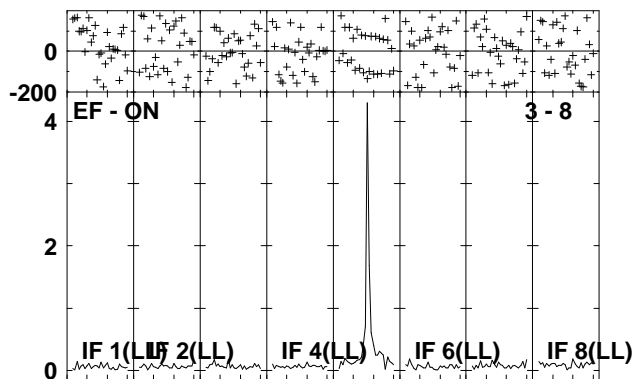
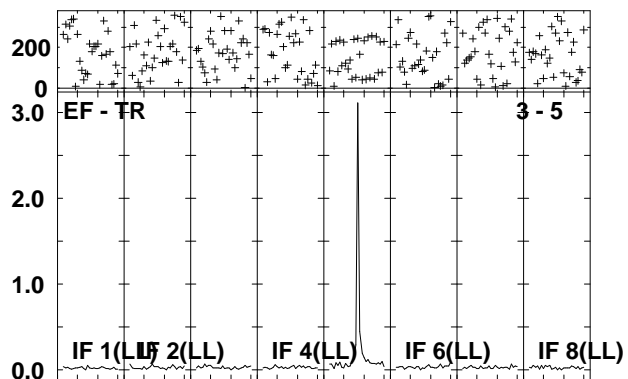
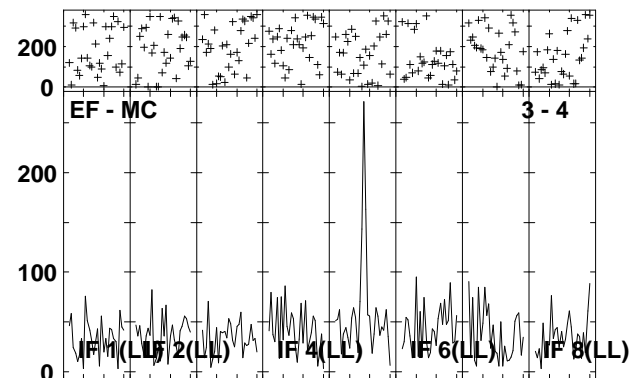
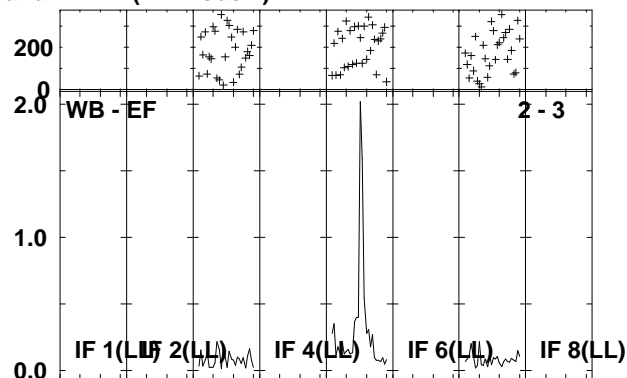
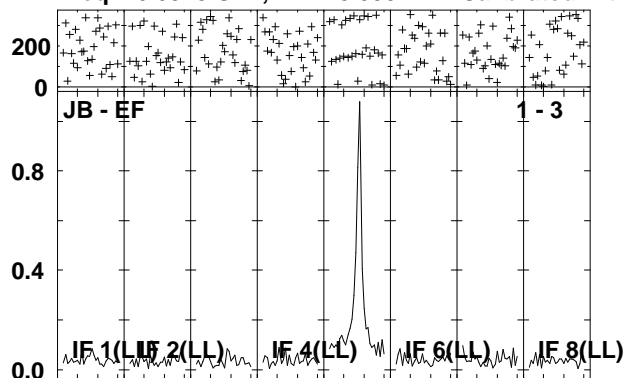

Lower frame: Ampl Jy Top frame: Phas deg
 Vector averaged cross-power spectrum Several baselines displayed
 Timerange: 00/03:44:12 to 00/03:45:40

Plot file version 83 created 19-AUG-2009 15:49:24
 OB2 EB039B 2.UVDATA.1
 Freq = 6.6328 GHz, Bw = 8.000 MH Calibrated with CL # 3 and BP # 1 (BP mode 1)

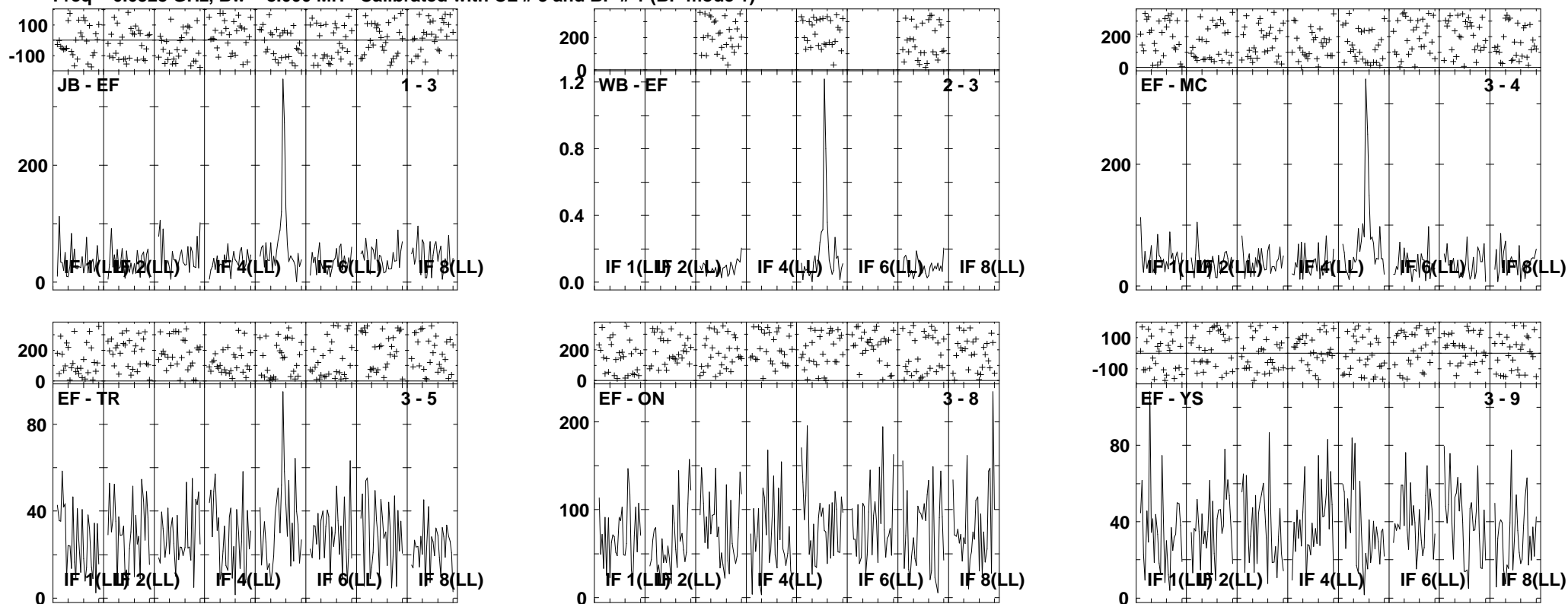

Lower frame: Milli Ampl Jy Top frame: Phas deg
 Vector averaged cross-power spectrum Several baselines displayed
 Timerange: 00/03:45:41 to 00/03:47:10

Plot file version 84 created 19-AUG-2009 15:49:27

W75 EB039B 2.UVDATA.1

Freq = 6.6328 GHz, Bw = 8.000 MH Calibrated with CL # 3 and BP # 1 (BP mode 1)

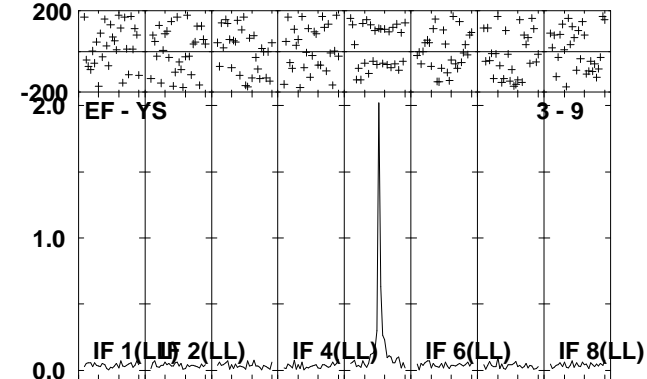
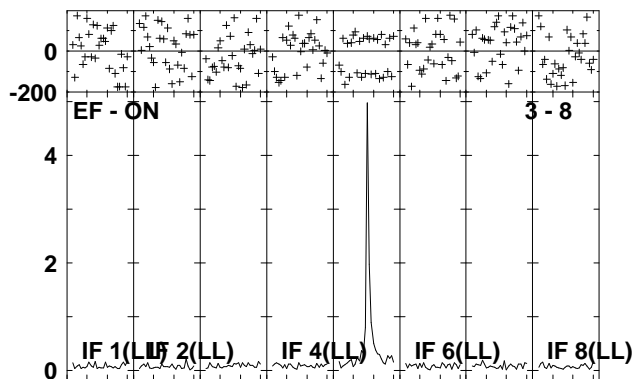
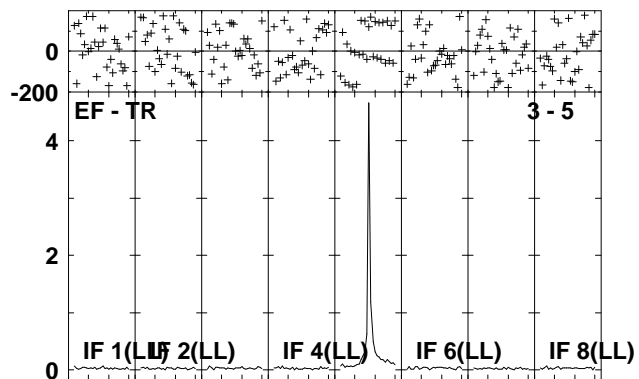
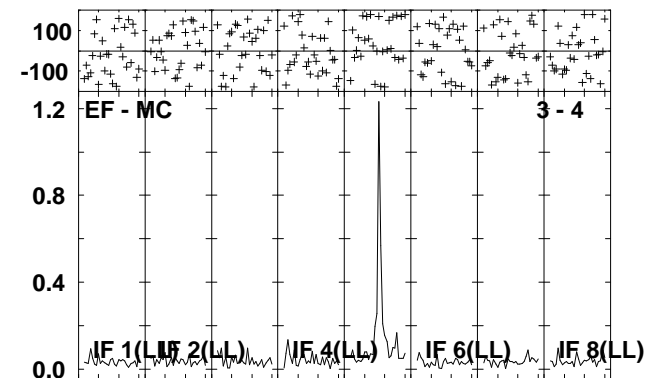
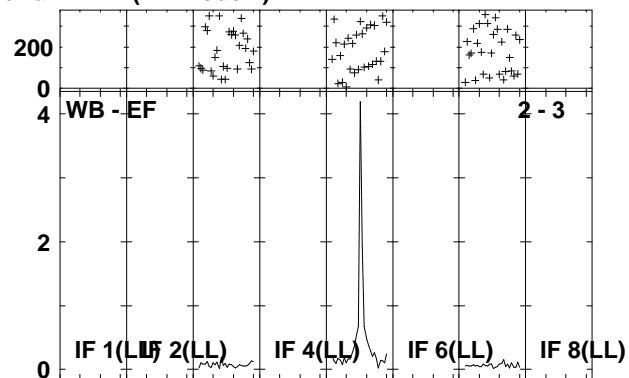
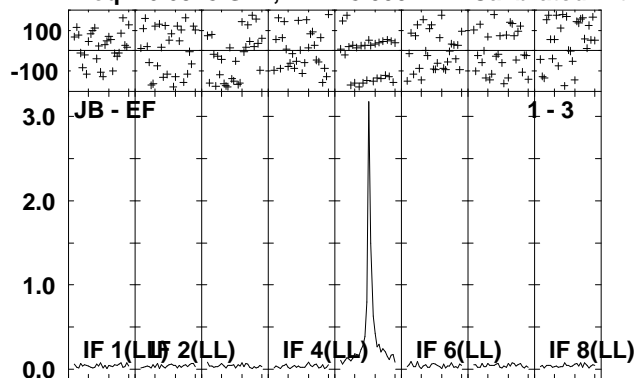

Lower frame: Ampl Jy Top frame: Phas deg
Vector averaged cross-power spectrum Several baselines displayed
Timerange: 00/03:47:44 to 00/03:48:44

Plot file version 85 created 19-AUG-2009 15:49:28
 DR21A EB039B 2.UVDATA.1
 Freq = 6.6328 GHz, Bw = 8.000 MH Calibrated with CL # 3 and BP # 1 (BP mode 1)

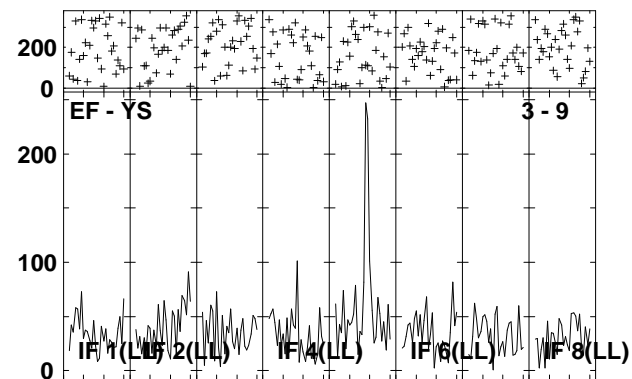
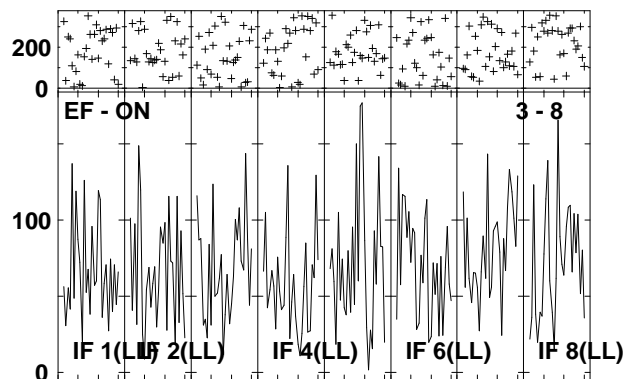
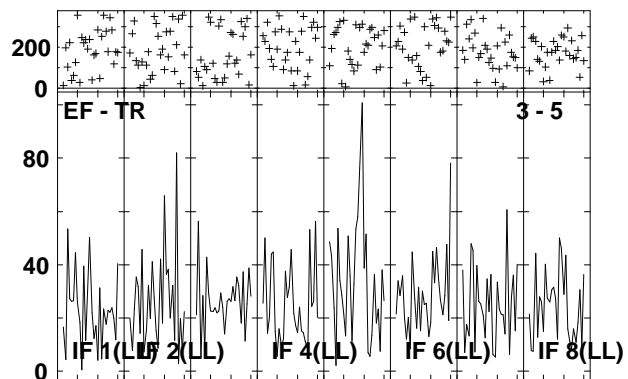
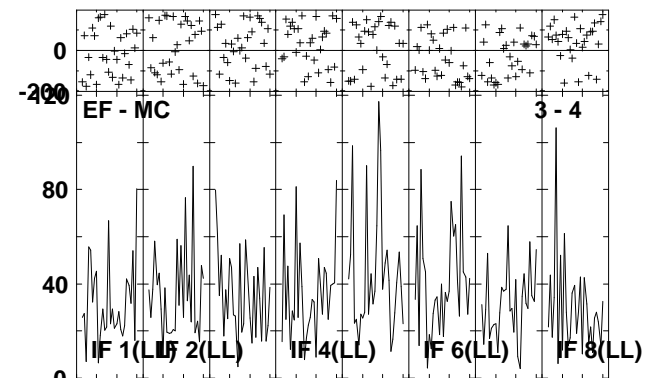
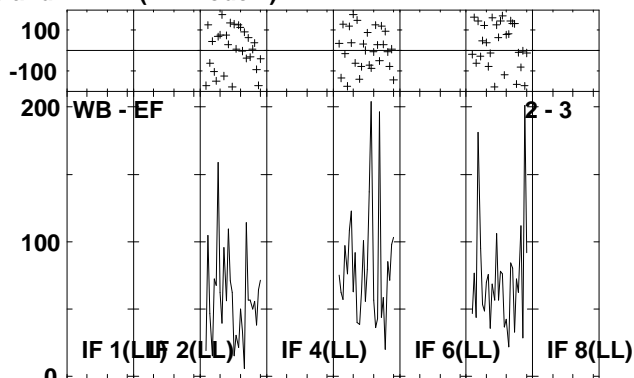
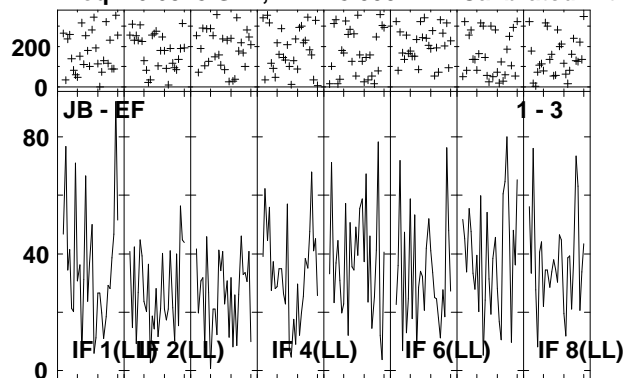

Lower frame: Milli Ampl Jy Top frame: Phas deg
 Vector averaged cross-power spectrum Several baselines displayed
 Timerange: 00/03:48:44 to 00/03:50:13

Plot file version 86 created 19-AUG-2009 15:49:31
 W75 EB039B 2.UVDATA.1
 Freq = 6.6328 GHz, Bw = 8.000 MH Calibrated with CL # 3 and BP # 1 (BP mode 1)

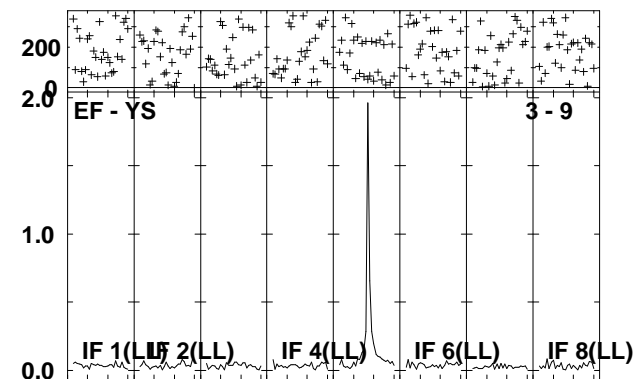
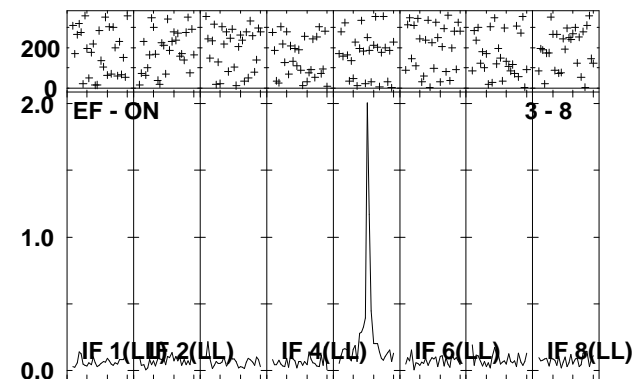
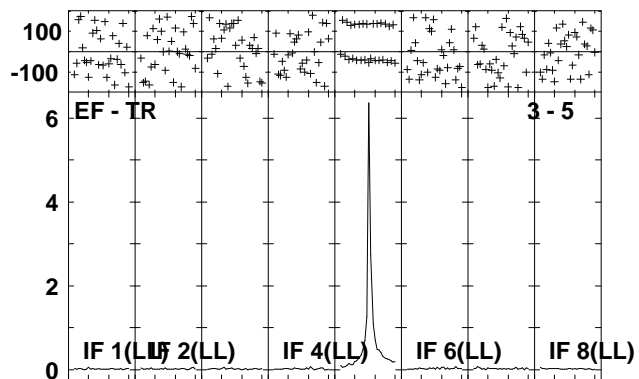
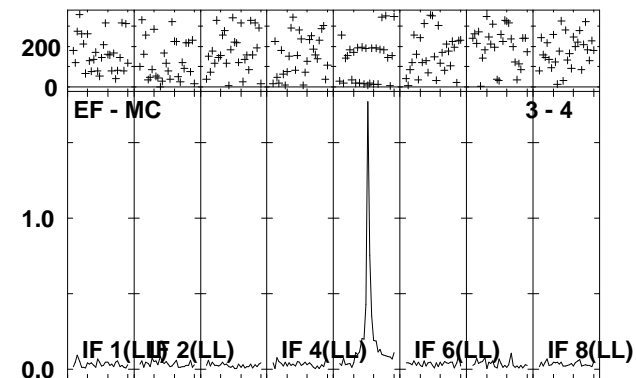
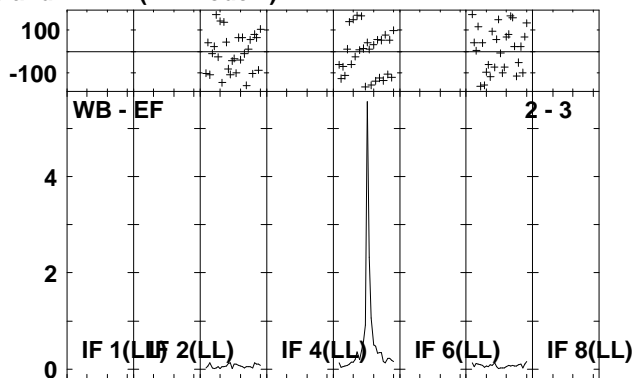
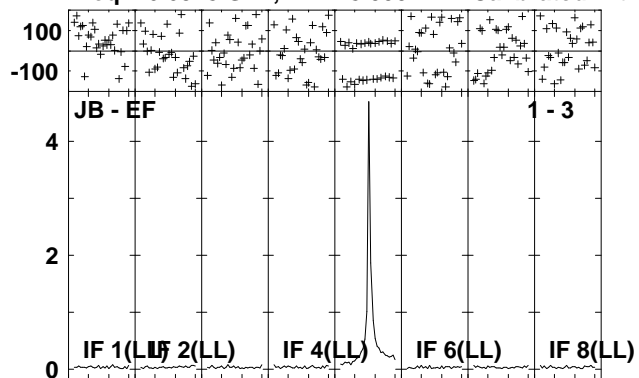

Lower frame: Ampl Jy Top frame: Phas deg
 Vector averaged cross-power spectrum Several baselines displayed
 Timerange: 00/03:50:15 to 00/03:51:44

Plot file version 87 created 19-AUG-2009 15:49:34
 DR21B EB039B 2.UVDATA.1
 Freq = 6.6328 GHz, Bw = 8.000 MH Calibrated with CL # 3 and BP # 1 (BP mode 1)

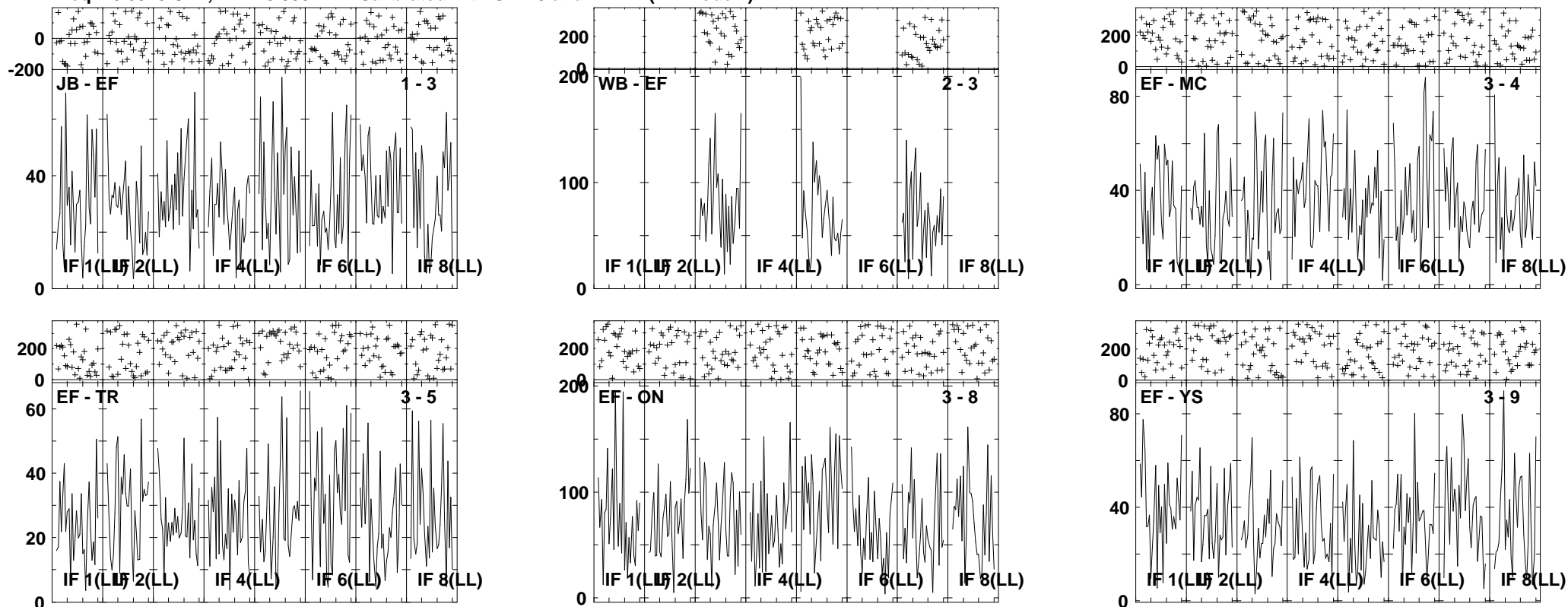

Lower frame: Milli Ampl Jy Top frame: Phas deg
 Vector averaged cross-power spectrum Several baselines displayed
 Timerange: 00/03:51:44 to 00/03:53:13

Plot file version 88 created 19-AUG-2009 15:49:37
 W75 EB039B 2.UVDATA.1
 Freq = 6.6328 GHz, Bw = 8.000 MH Calibrated with CL # 3 and BP # 1 (BP mode 1)

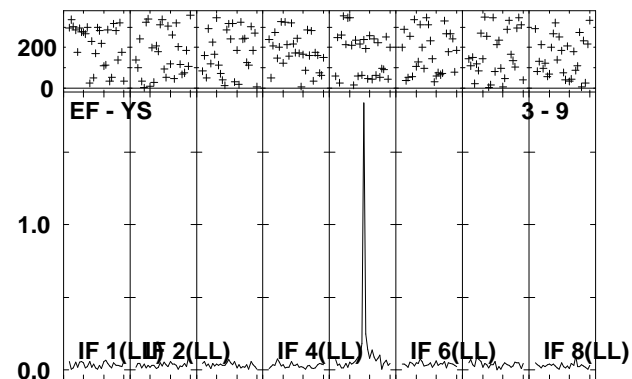
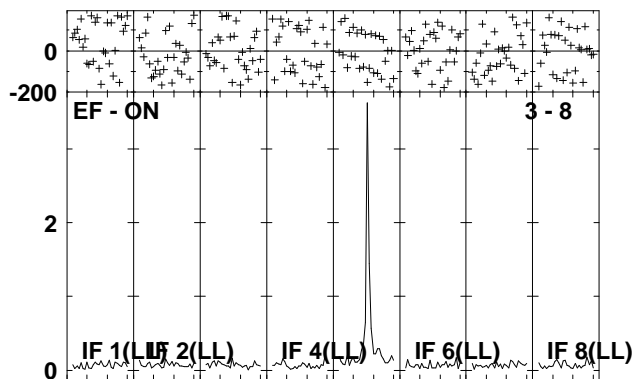
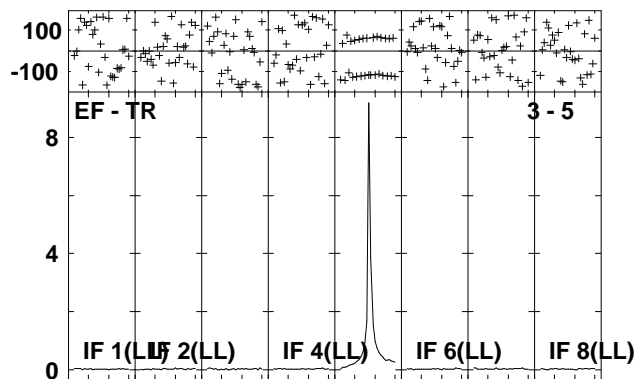
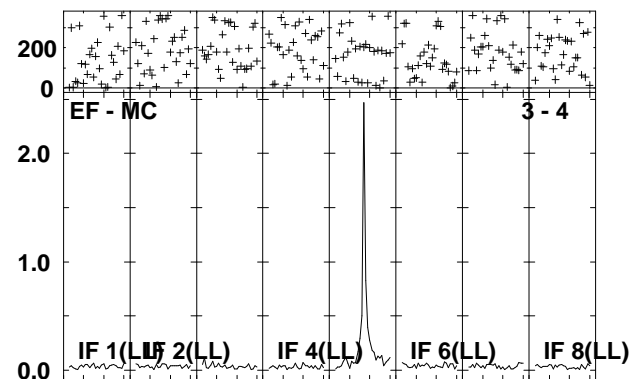
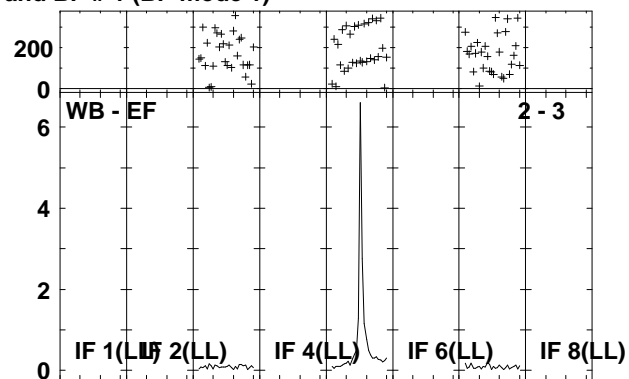
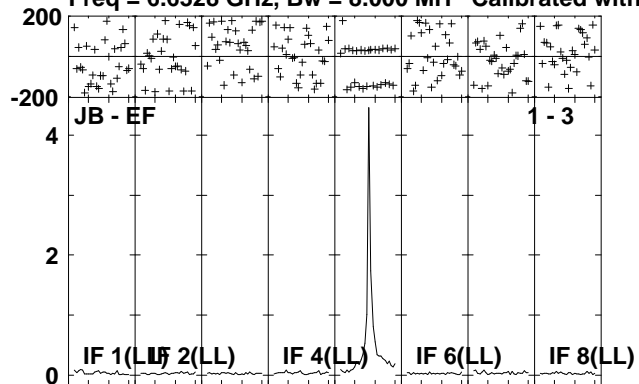

Lower frame: Ampl Jy Top frame: Phas deg
 Vector averaged cross-power spectrum Several baselines displayed
 Timerange: 00/03:53:15 to 00/03:54:44

Plot file version 89 created 19-AUG-2009 15:49:39
 DR21B2 EB039B 2.UVDATA.1
 Freq = 6.6328 GHz, Bw = 8.000 MH Calibrated with CL # 3 and BP # 1 (BP mode 1)

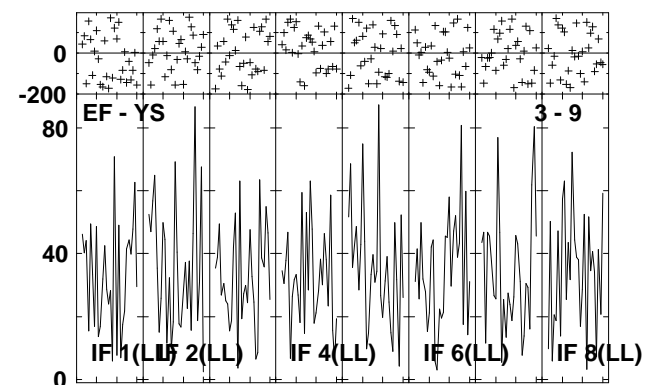
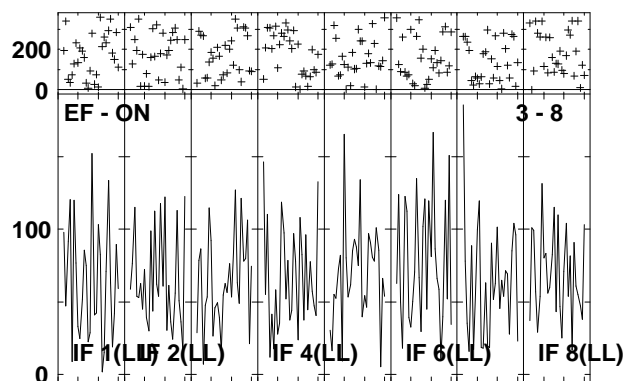
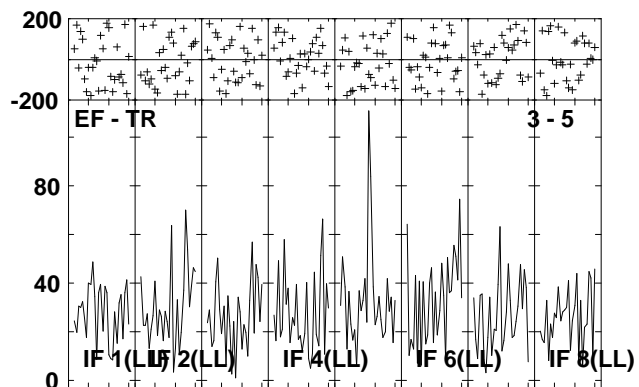
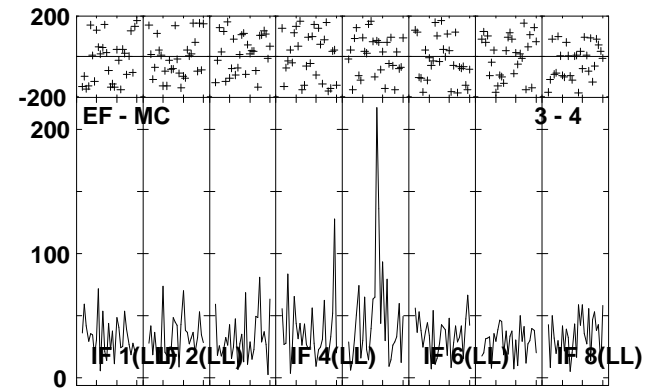
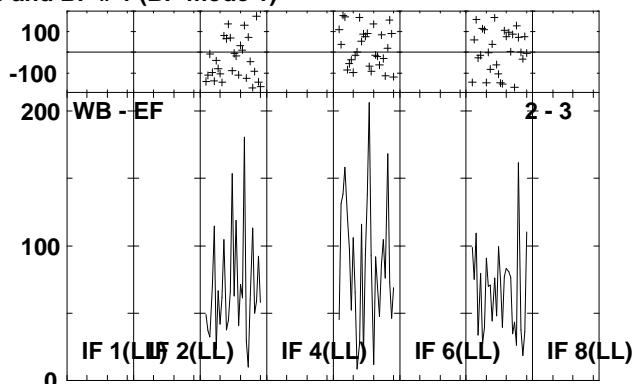
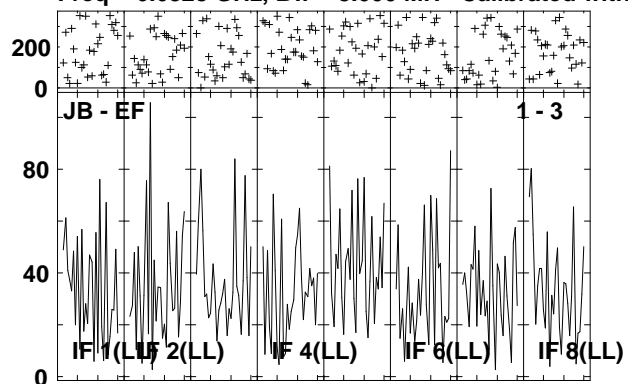

Lower frame: Milli Ampl Jy Top frame: Phas deg
 Vector averaged cross-power spectrum Several baselines displayed
 Timerange: 00/03:54:45 to 00/03:56:14

Plot file version 90 created 19-AUG-2009 15:49:42
 W75 EB039B 2.UVDATA.1
 Freq = 6.6328 GHz, Bw = 8.000 MH Calibrated with CL # 3 and BP # 1 (BP mode 1)

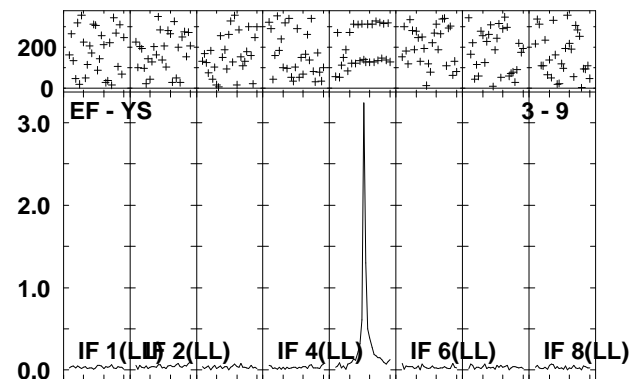
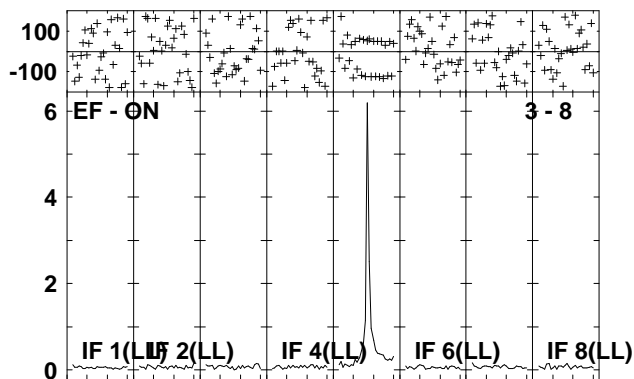
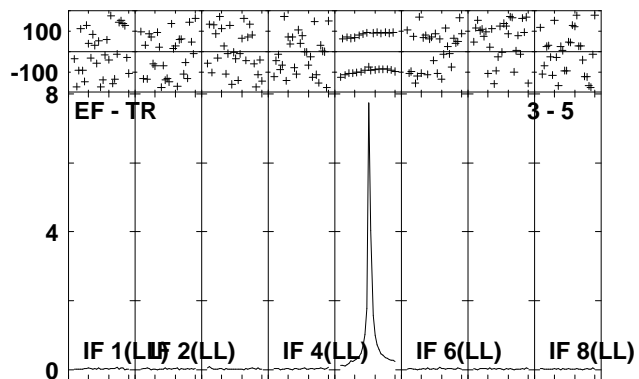
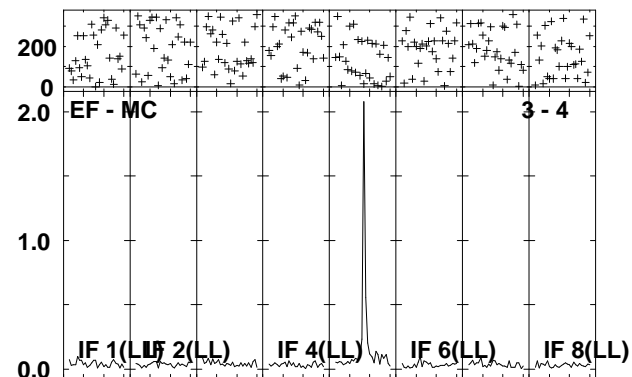
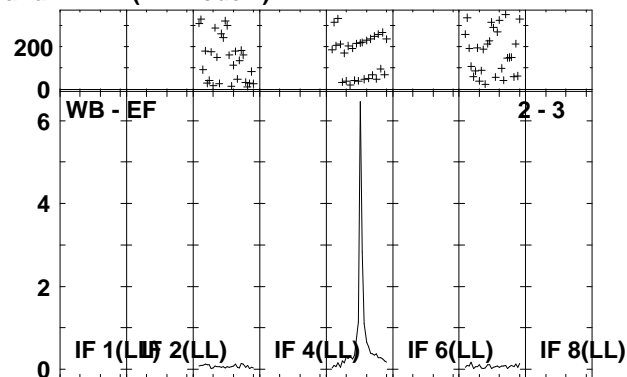
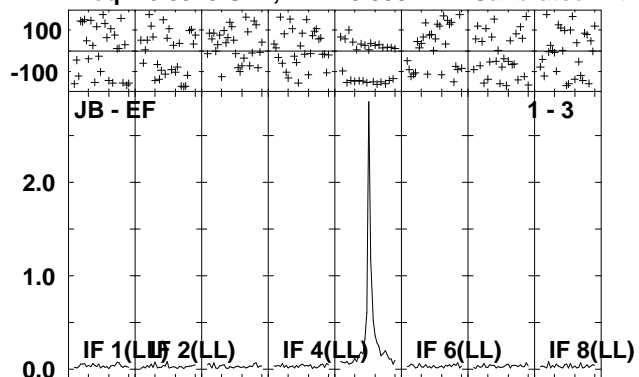

Lower frame: Ampl Jy Top frame: Phas deg
 Vector averaged cross-power spectrum Several baselines displayed
 Timerange: 00/03:56:15 to 00/03:57:44

Plot file version 91 created 19-AUG-2009 15:49:45
 DR20 EB039B 2.UVDATA.1
 Freq = 6.6328 GHz, Bw = 8.000 MH Calibrated with CL # 3 and BP # 1 (BP mode 1)

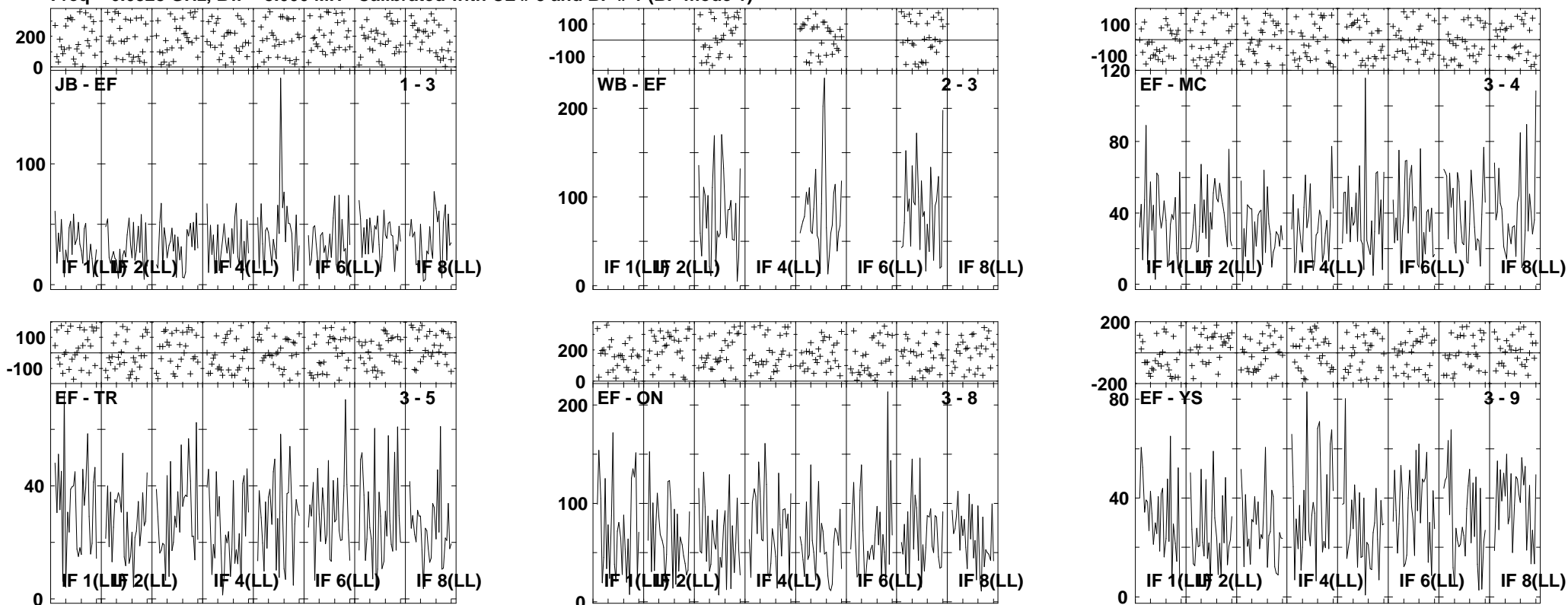

Lower frame: Milli Ampl Jy Top frame: Phas deg
 Vector averaged cross-power spectrum Several baselines displayed
 Timerange: 00/03:57:45 to 00/03:59:13

Plot file version 92 created 19-AUG-2009 15:49:47
 W75 EB039B 2.UVDATA.1
 Freq = 6.6328 GHz, Bw = 8.000 MH Calibrated with CL # 3 and BP # 1 (BP mode 1)

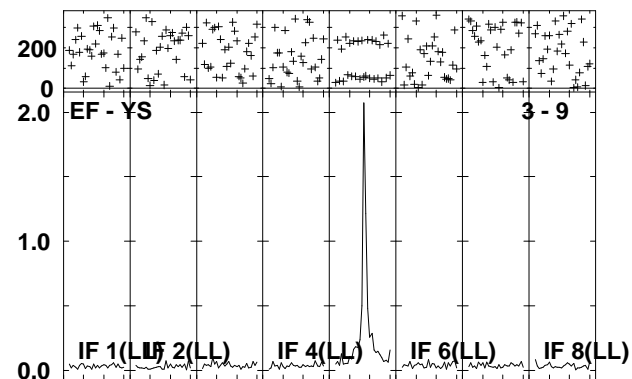
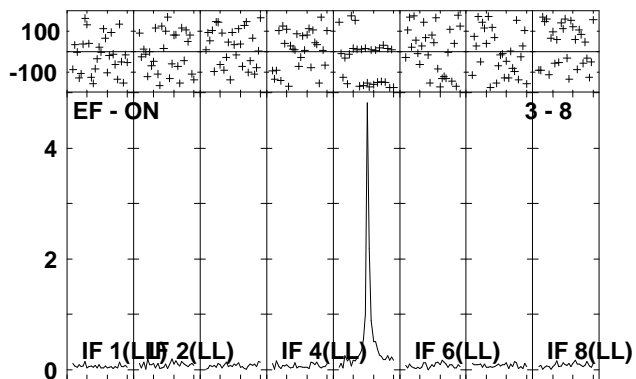
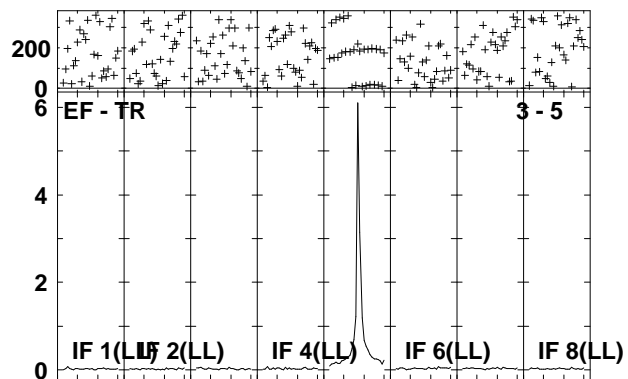
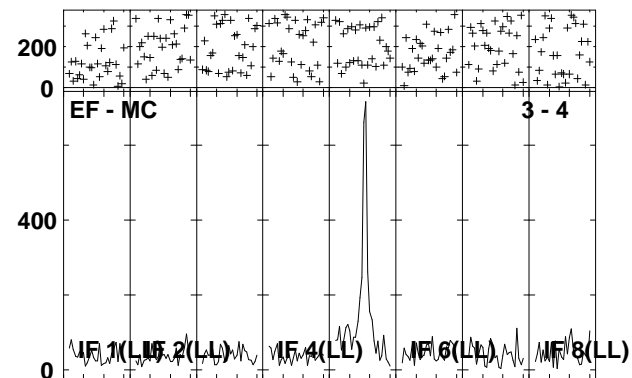
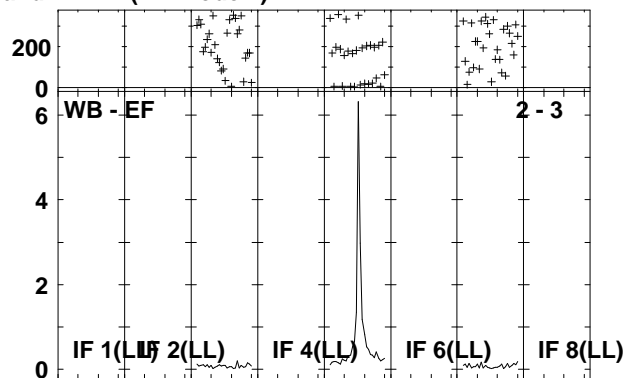
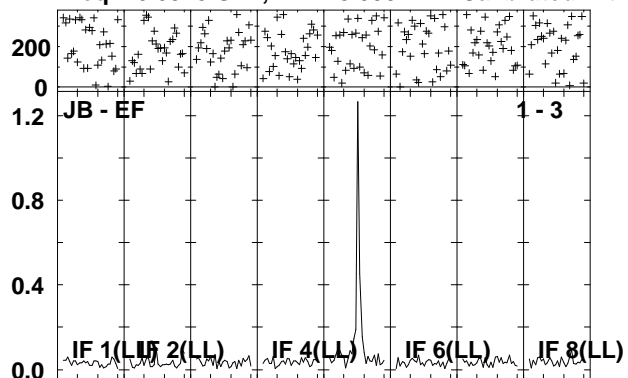

Lower frame: Ampl Jy Top frame: Phas deg
 Vector averaged cross-power spectrum Several baselines displayed
 Timerange: 00/03:59:40 to 00/04:00:39

Plot file version 93 created 19-AUG-2009 15:49:49
 J2029+46 EB039B 2.UVDATA.1
 Freq = 6.6328 GHz, Bw = 8.000 MH Calibrated with CL # 3 and BP # 1 (BP mode 1)

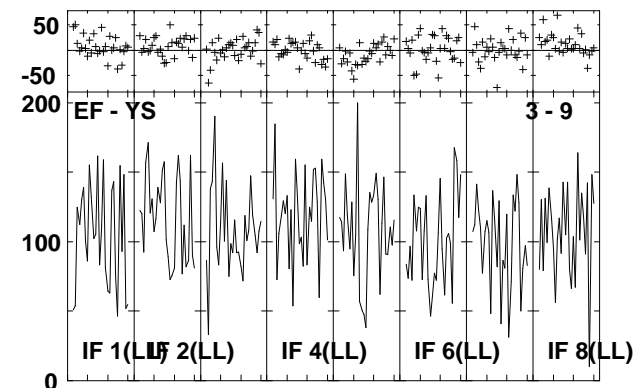
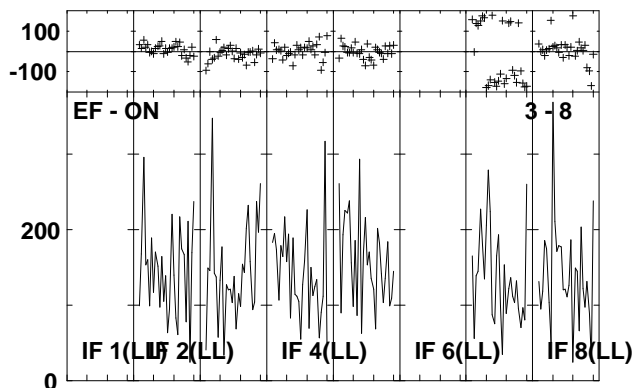
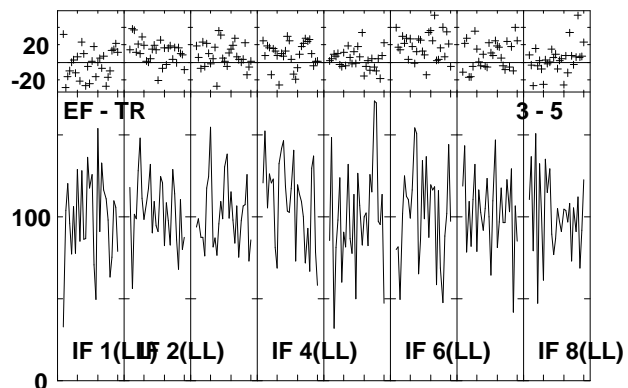
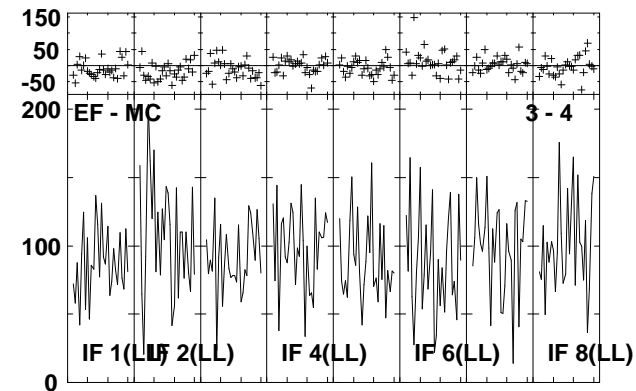
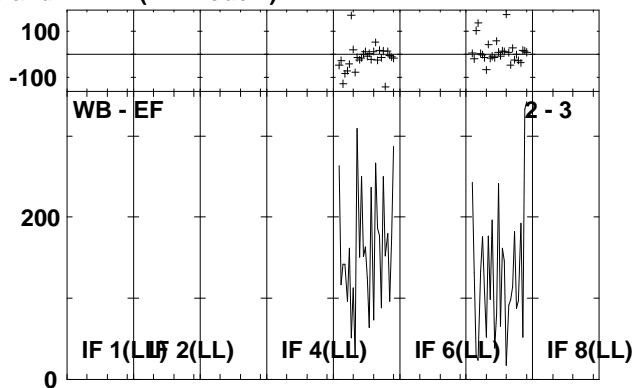
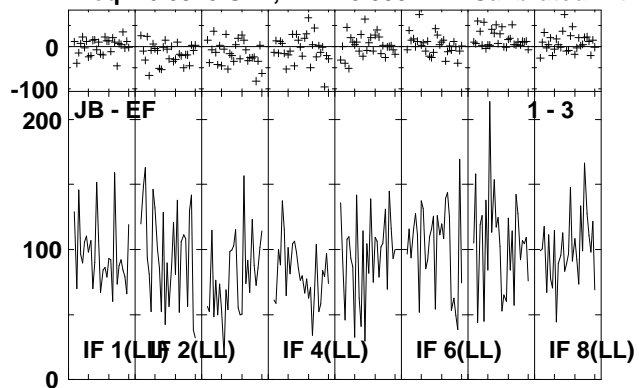

Lower frame: Milli Ampl Jy Top frame: Phas deg
 Vector averaged cross-power spectrum Several baselines displayed
 Timerange: 00/04:00:40 to 00/04:02:09

Plot file version 94 created 19-AUG-2009 15:49:52
 W75 EB039B 2.UVDATA.1
 Freq = 6.6328 GHz, Bw = 8.000 MH Calibrated with CL # 3 and BP # 1 (BP mode 1)

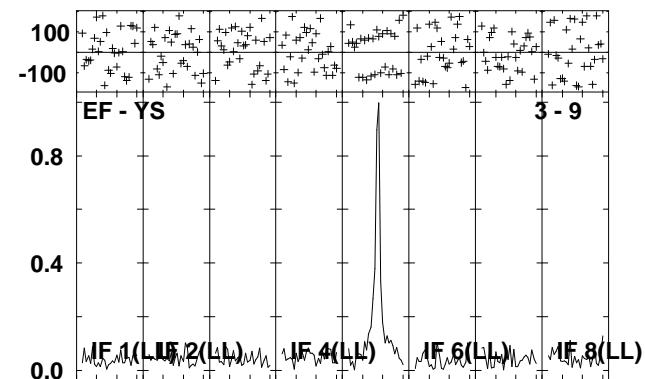
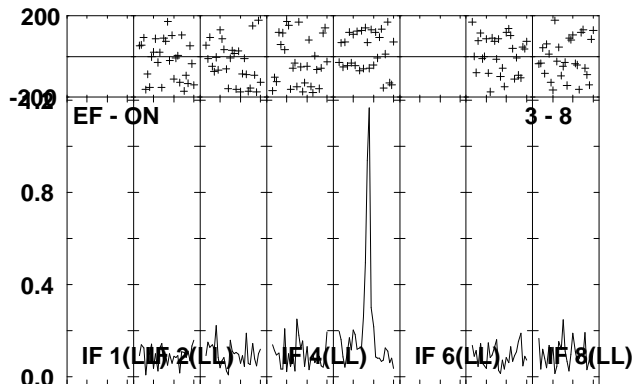
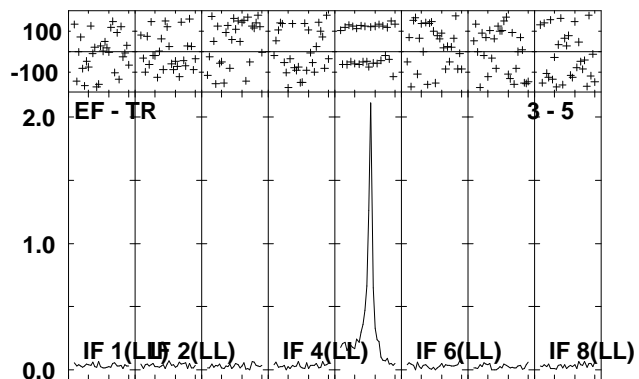
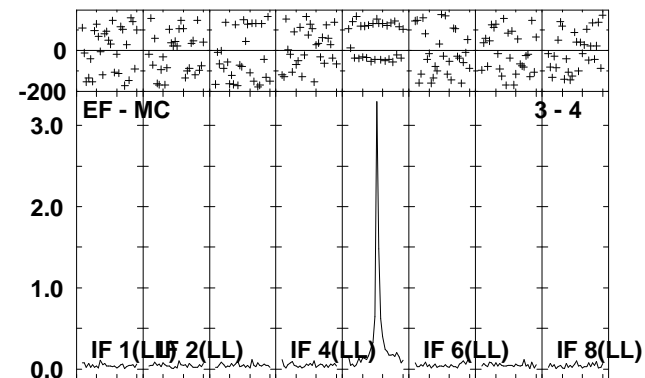
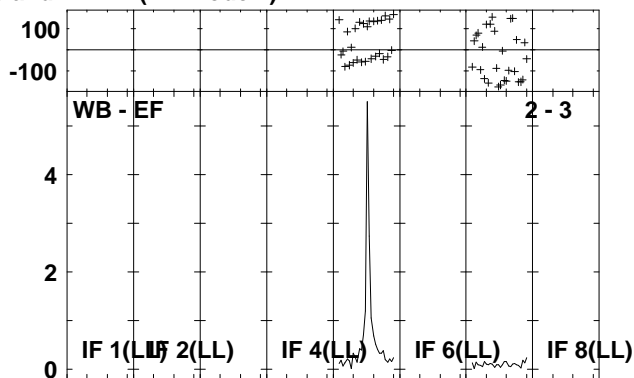
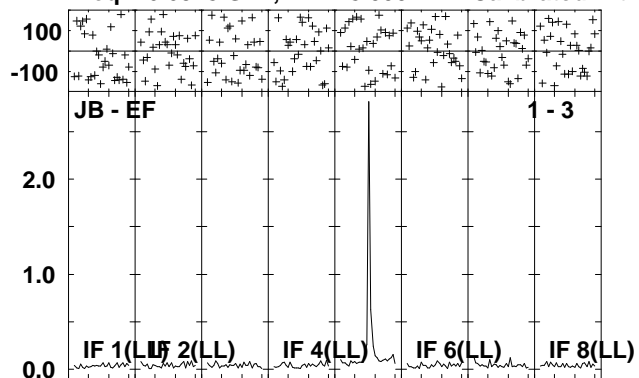

Lower frame: Ampl Jy Top frame: Phas deg
 Vector averaged cross-power spectrum Several baselines displayed
 Timerange: 00/04:02:09 to 00/04:03:38

Plot file version 95 created 19-AUG-2009 15:49:56

W75 EB039B 2.UVDATA.1

Freq = 6.6328 GHz, Bw = 8.000 MH Calibrated with CL # 3 and BP # 1 (BP mode 1)

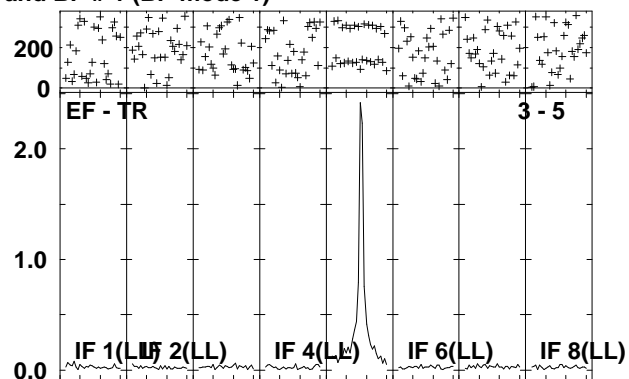
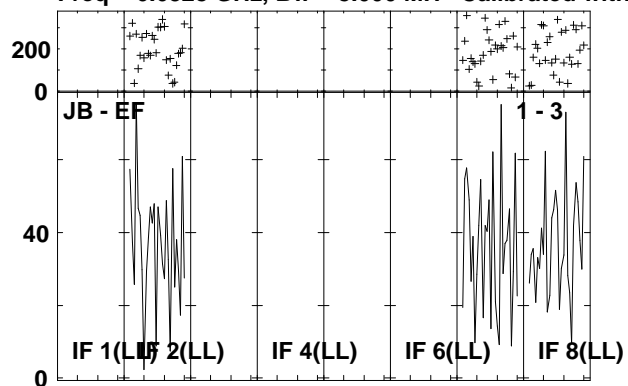

Lower frame: Milli Ampl Jy Top frame: Phase deg
Vector averaged cross-power spectrum Several baselines displayed
Timerange: 00/04:05:09 to 00/04:06:38

Plot file version 96 created 19-AUG-2009 15:49:59

2048+431 EB039B 2.UVDATA.1

Freq = 6.6328 GHz, Bw = 8.000 MH Calibrated with CL # 3 and BP # 1 (BP mode 1)

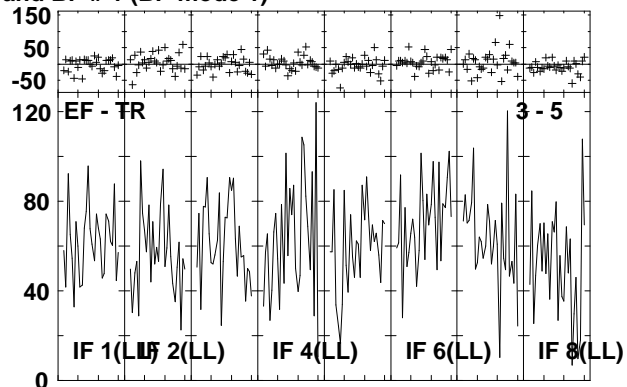
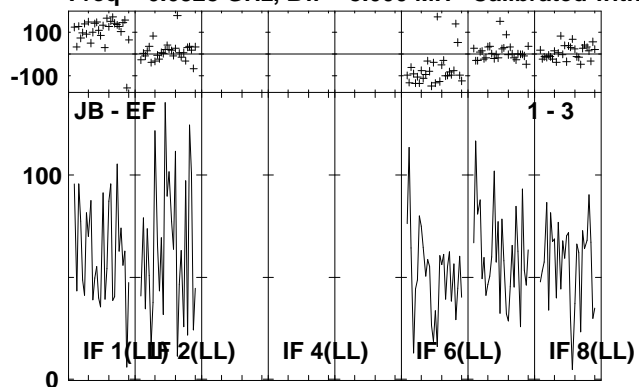

Lower frame: Milli Ampl Jy Top frame: Phas deg
Vector averaged cross-power spectrum Several baselines displayed
Timerange: 00/04:06:40 to 00/04:08:09

Plot file version 97 created 19-AUG-2009 15:50:01
 W75 EB039B 2.UVDATA.1
 Freq = 6.6328 GHz, Bw = 8.000 MH Calibrated with CL # 3 and BP # 1 (BP mode 1)

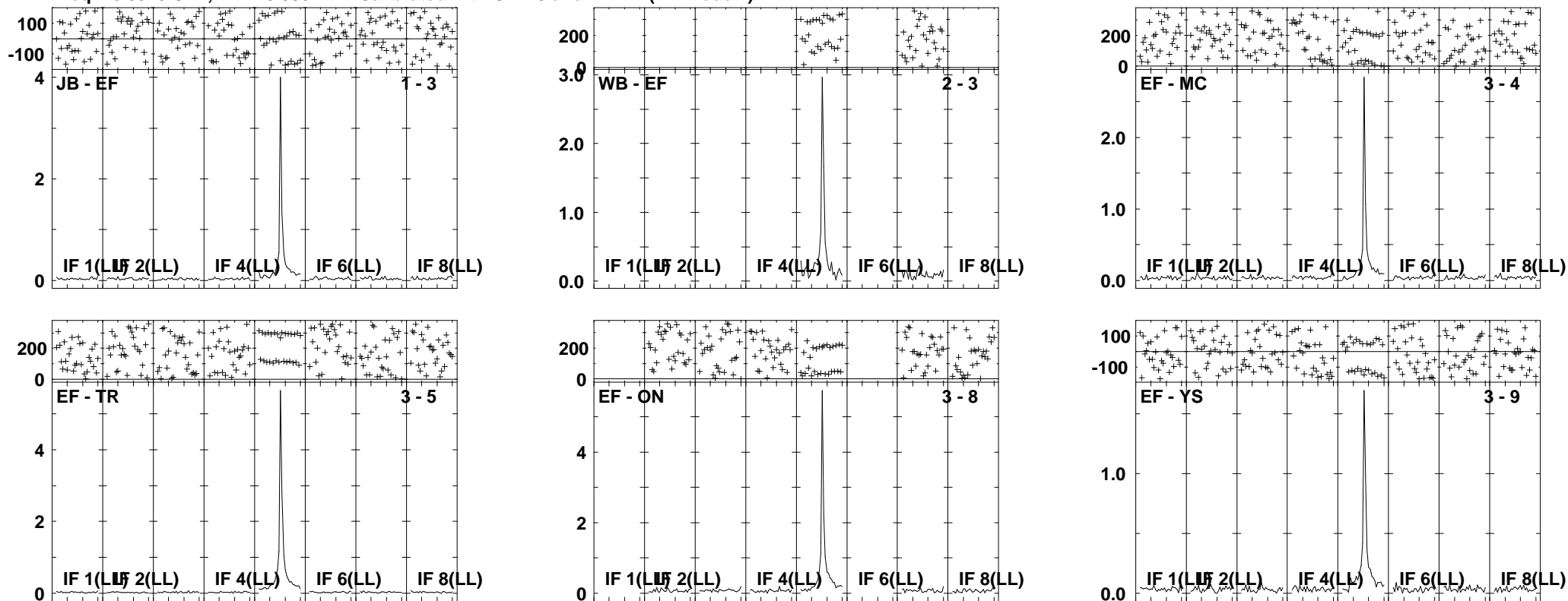

Lower frame: Ampl Jy Top frame: Phas deg
 Vector averaged cross-power spectrum Several baselines displayed
 Timerange: 00/04:08:10 to 00/04:09:39

Plot file version 98 created 19-AUG-2009 15:50:03
 OB2 EB039B 2.UVDATA.1
 Freq = 6.6328 GHz, Bw = 8.000 MH Calibrated with CL # 3 and BP # 1 (BP mode 1)

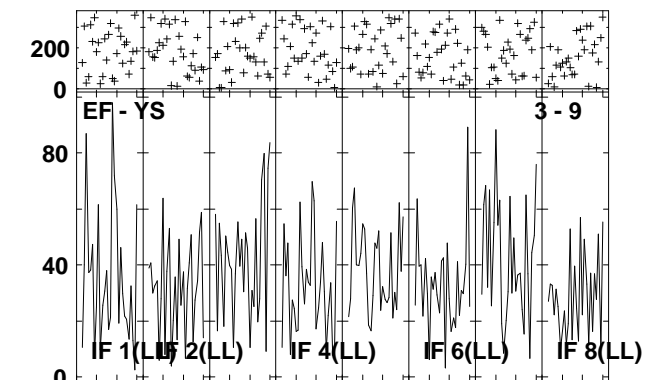
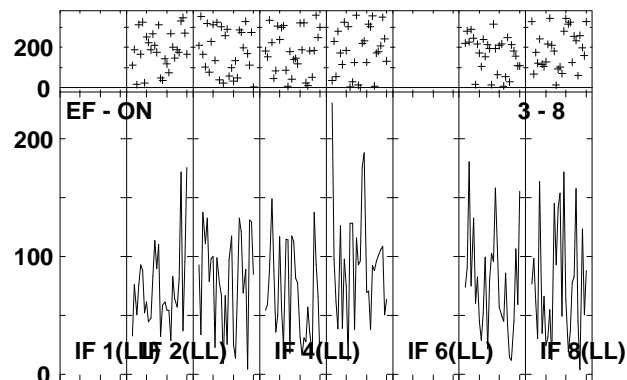
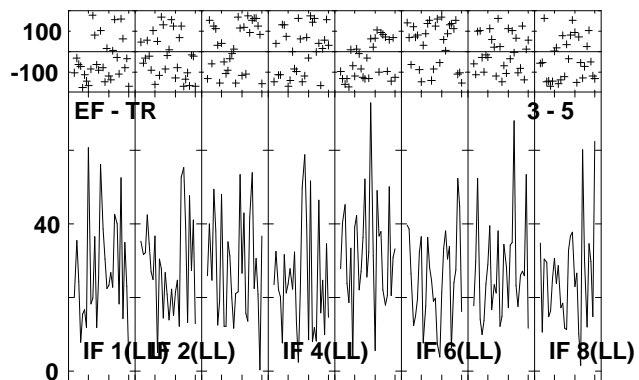
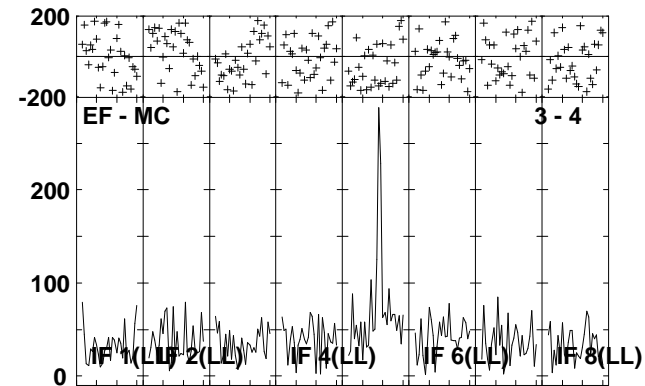
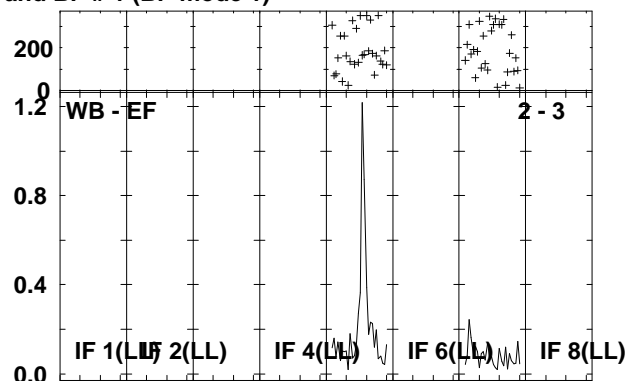
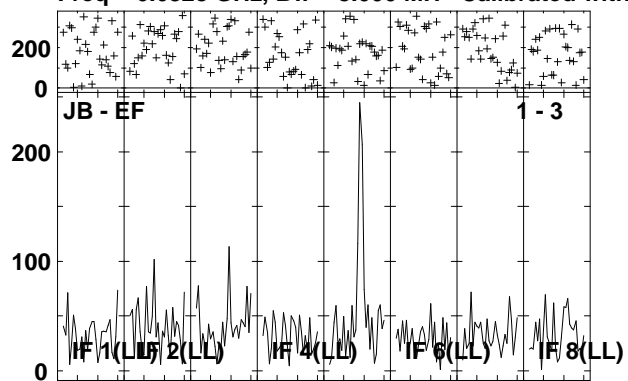

Lower frame: Milli Ampl Jy Top frame: Phas deg
 Vector averaged cross-power spectrum Several baselines displayed
 Timerange: 00/04:09:40 to 00/04:11:09

Plot file version 99 created 19-AUG-2009 15:50:06
 W75 EB039B 2.UVDATA.1
 Freq = 6.6328 GHz, Bw = 8.000 MH Calibrated with CL # 3 and BP # 1 (BP mode 1)

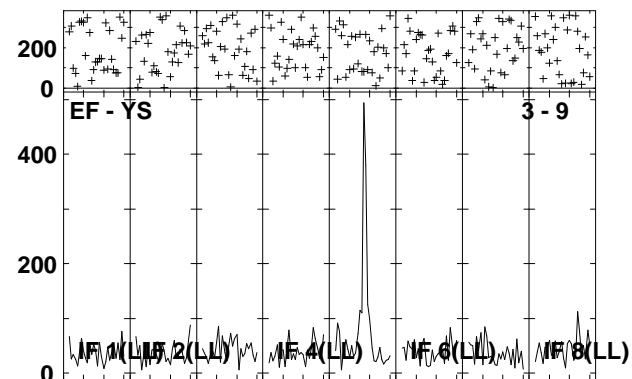
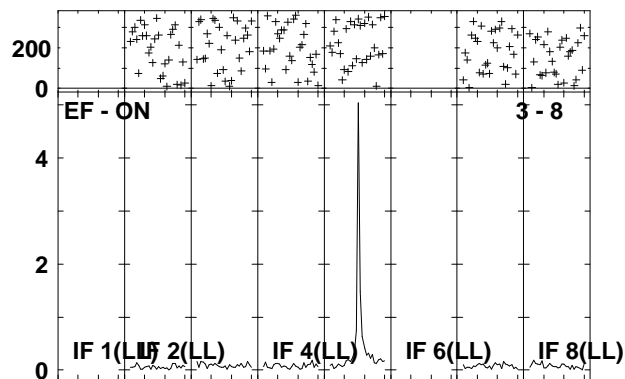
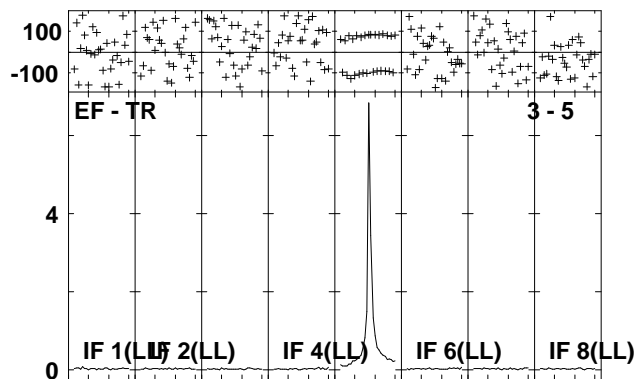
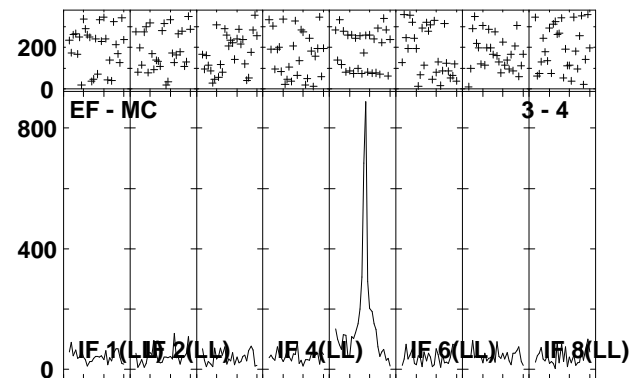
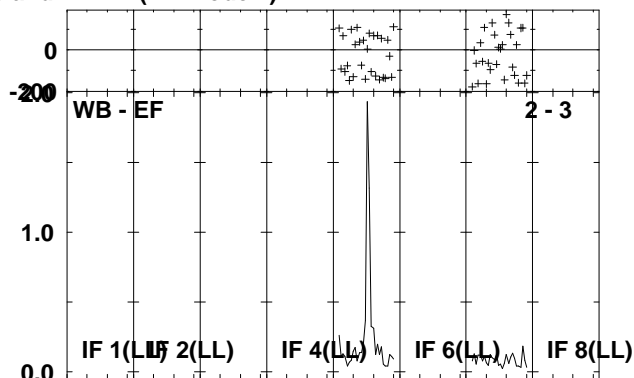
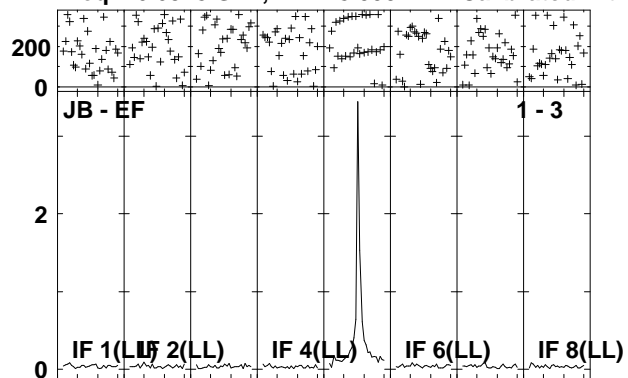

Lower frame: Ampl Jy Top frame: Phas deg
 Vector averaged cross-power spectrum Several baselines displayed
 Timerange: 00/04:11:46 to 00/04:12:43

Plot file version 100 created 19-AUG-2009 15:50:08
 DR21A EB039B 2.UVDATA.1
 Freq = 6.6328 GHz, Bw = 8.000 MH Calibrated with CL # 3 and BP # 1 (BP mode 1)

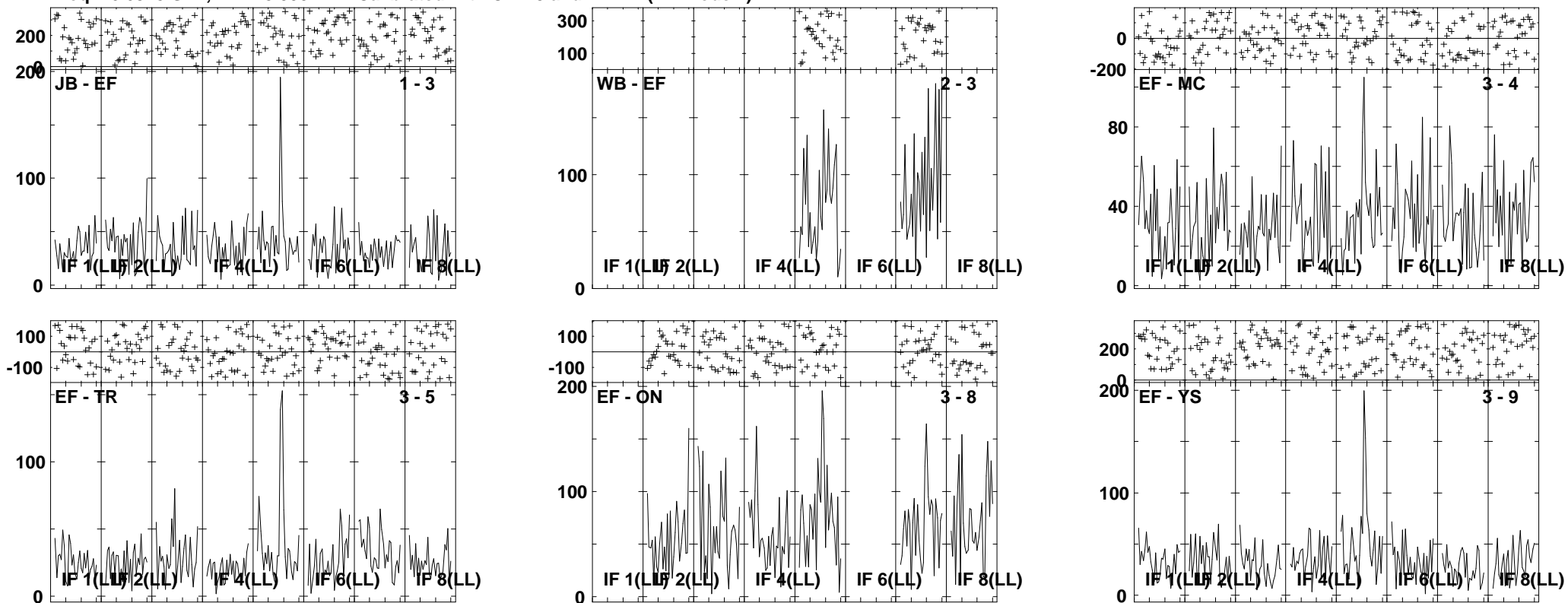

Lower frame: Milli Ampl Jy Top frame: Phas deg
 Vector averaged cross-power spectrum Several baselines displayed
 Timerange: 00/04:12:44 to 00/04:14:13

Plot file version 101 created 19-AUG-2009 15:50:11
 W75 EB039B 2.UVDATA.1
 Freq = 6.6328 GHz, Bw = 8.000 MH Calibrated with CL # 3 and BP # 1 (BP mode 1)

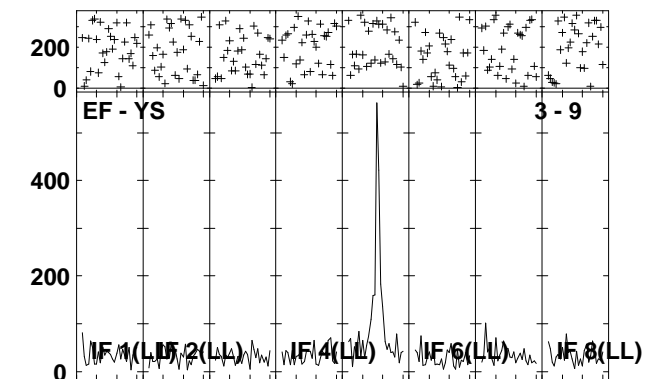
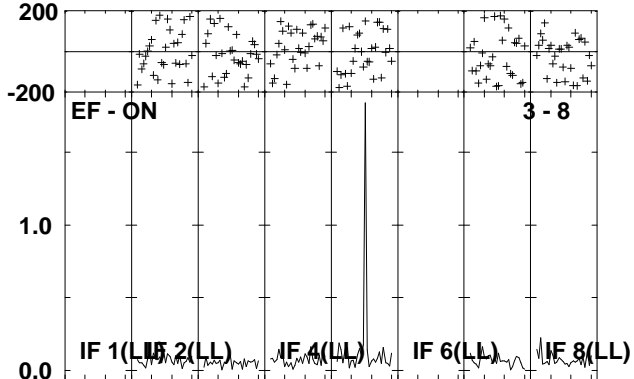
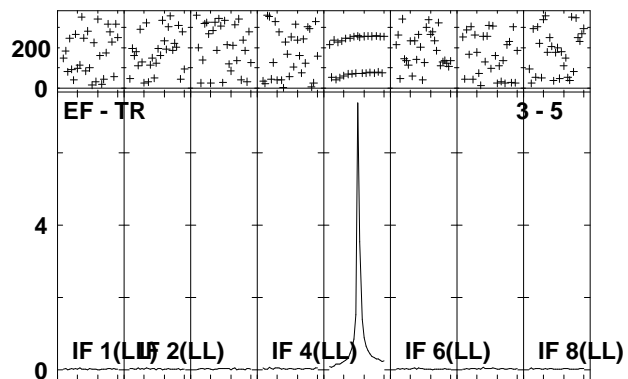
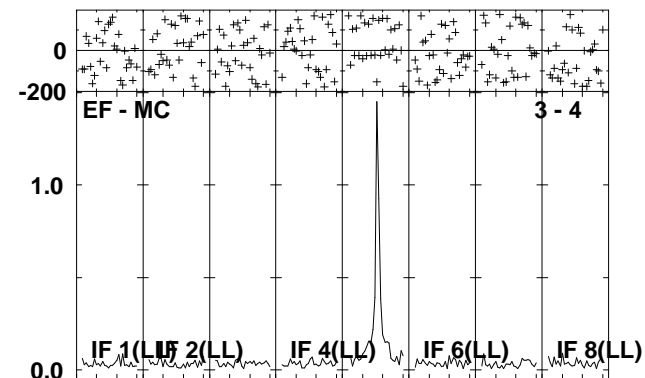
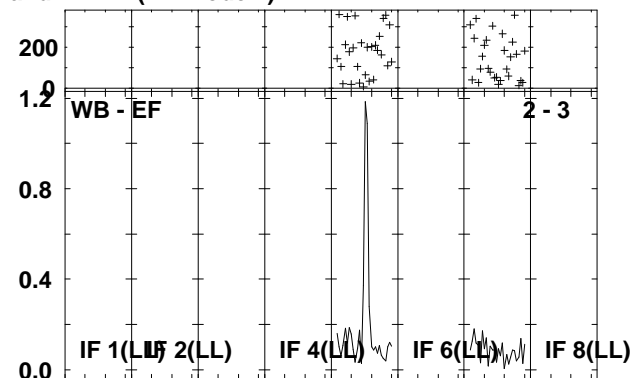
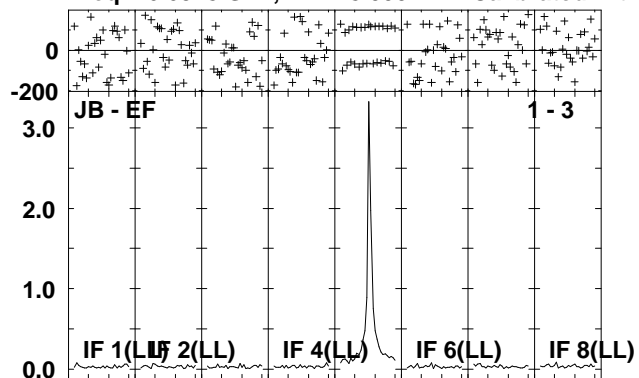

Lower frame: Ampl Jy Top frame: Phas deg
 Vector averaged cross-power spectrum Several baselines displayed
 Timerange: 00/04:14:14 to 00/04:15:42

Plot file version 102 created 19-AUG-2009 15:50:13
 DR21B EB039B 2.UVDATA.1
 Freq = 6.6328 GHz, Bw = 8.000 MH Calibrated with CL # 3 and BP # 1 (BP mode 1)

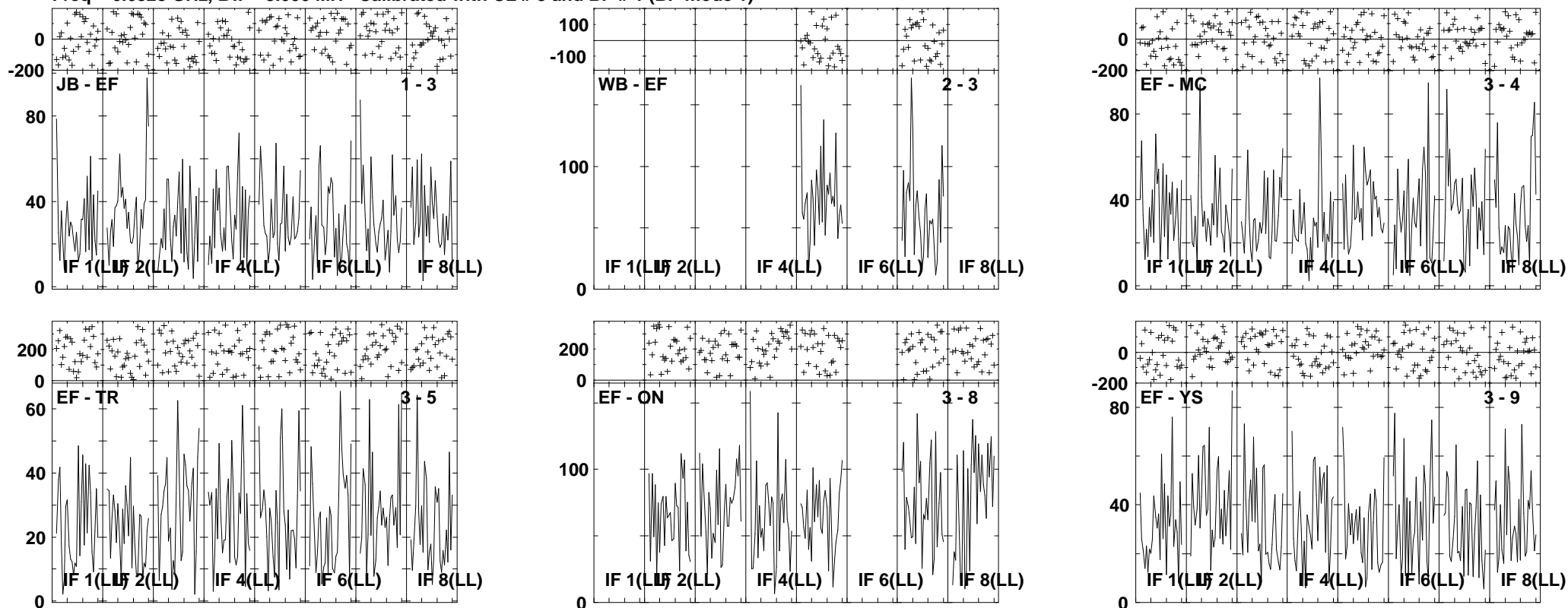

Lower frame: Milli Ampl Jy Top frame: Phas deg
 Vector averaged cross-power spectrum Several baselines displayed
 Timerange: 00/04:15:44 to 00/04:17:12

Plot file version 103 created 19-AUG-2009 15:50:16

W75 EB039B 2.UVDATA.1

Freq = 6.6328 GHz, Bw = 8.000 MH Calibrated with CL # 3 and BP # 1 (BP mode 1)

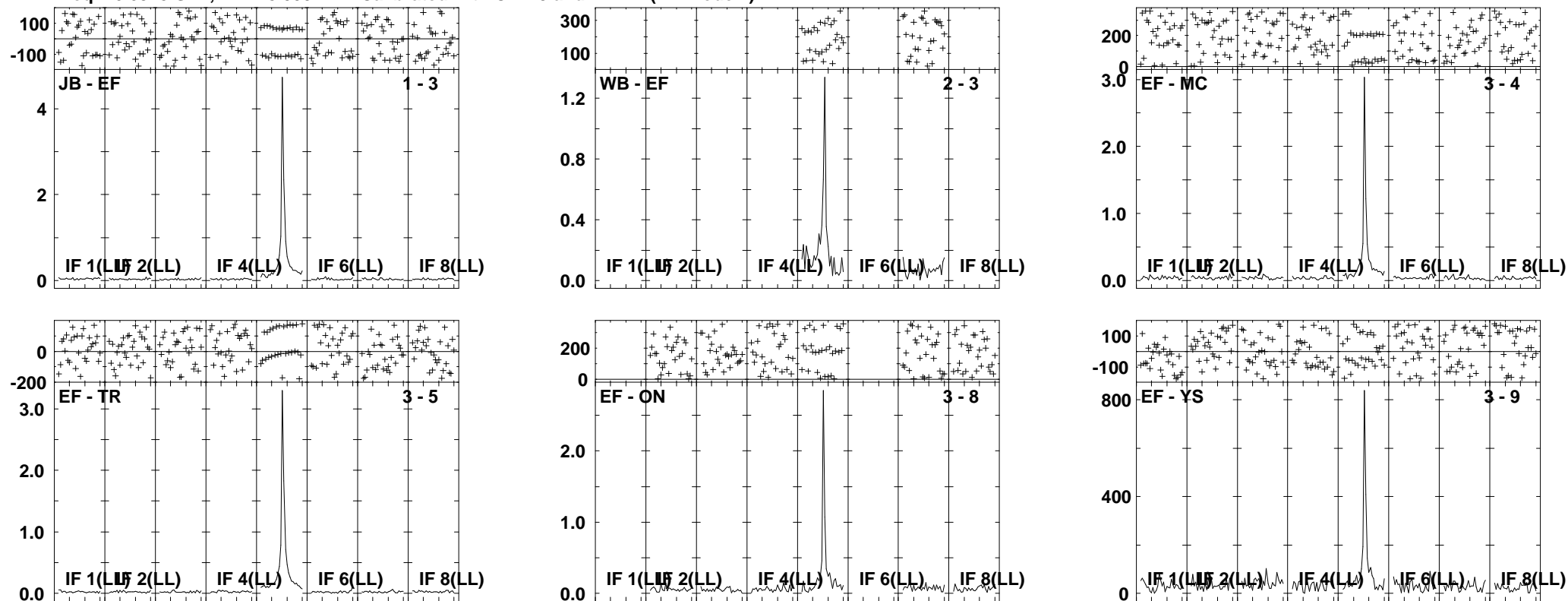

Lower frame: Ampl Jy Top frame: Phas deg
Vector averaged cross-power spectrum Several baselines displayed
Timerange: 00/04:17:14 to 00/04:18:42

Plot file version 104 created 19-AUG-2009 15:50:19
 DR21B2 EB039B 2.UVDATA.1
 Freq = 6.6328 GHz, Bw = 8.000 MH Calibrated with CL # 3 and BP # 1 (BP mode 1)

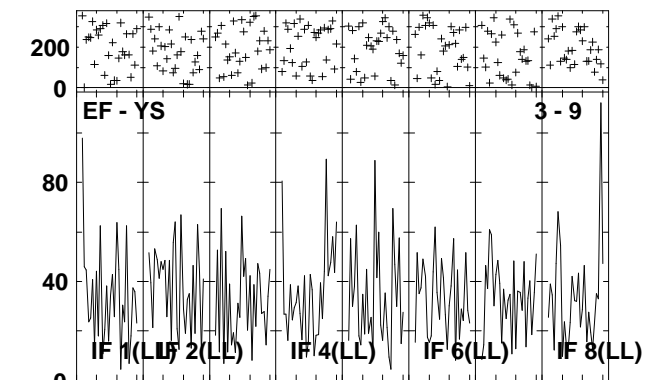
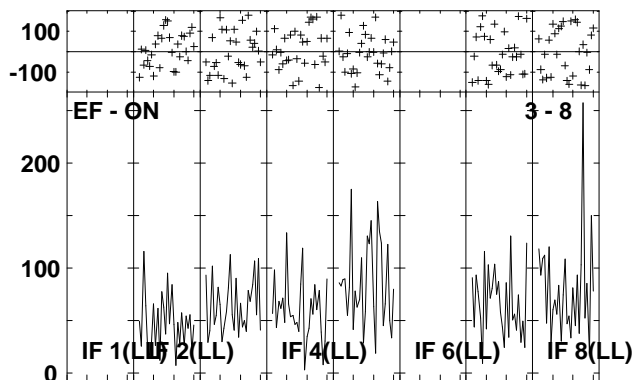
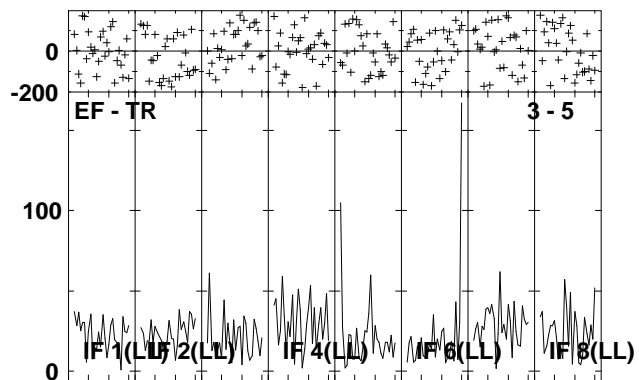
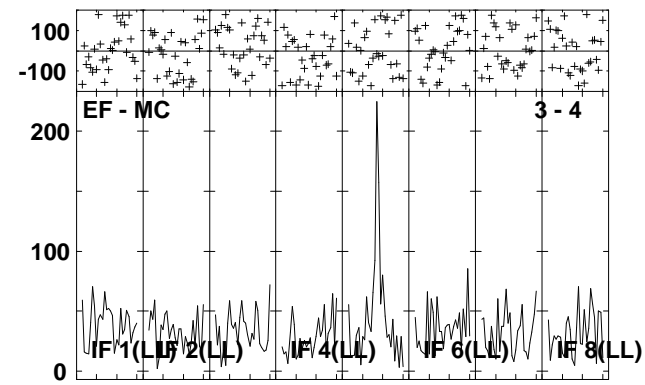
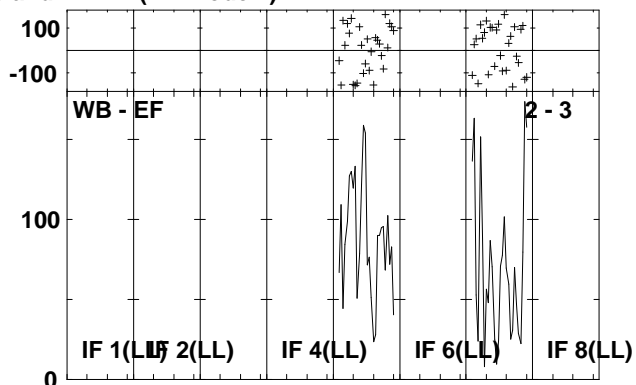
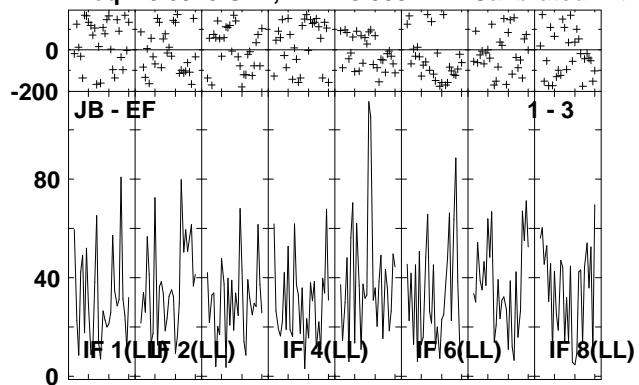

Lower frame: Milli Ampl Jy Top frame: Phas deg
 Vector averaged cross-power spectrum Several baselines displayed
 Timerange: 00/04:18:44 to 00/04:20:12

Plot file version 105 created 19-AUG-2009 15:50:21
 W75 EB039B 2.UVDATA.1
 Freq = 6.6328 GHz, Bw = 8.000 MH Calibrated with CL # 3 and BP # 1 (BP mode 1)

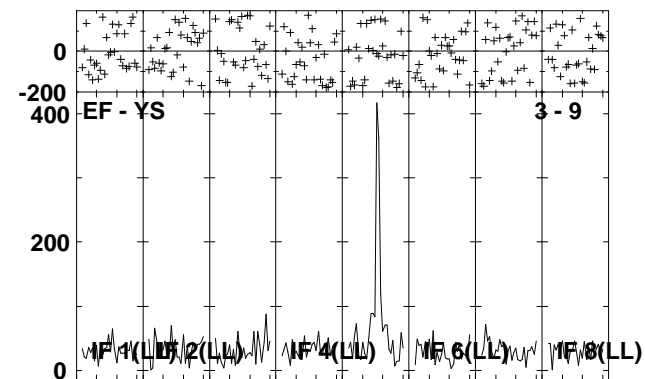
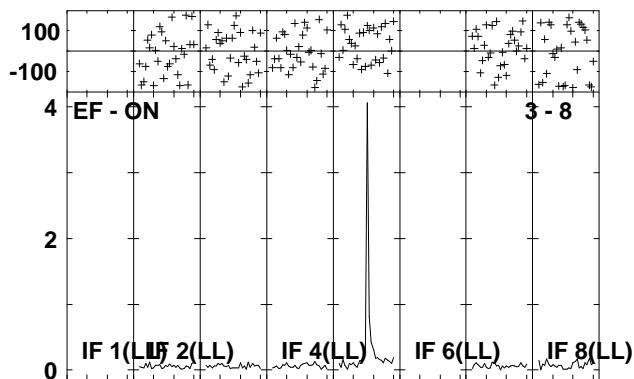
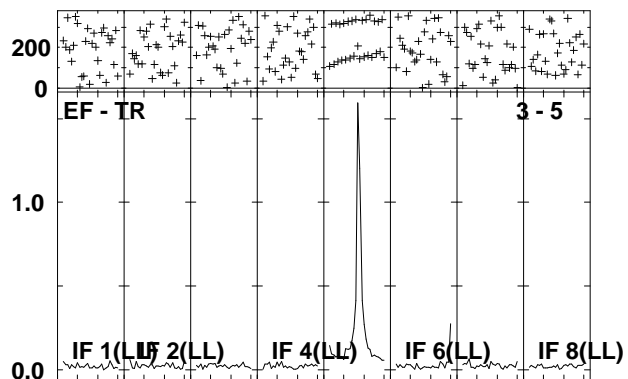
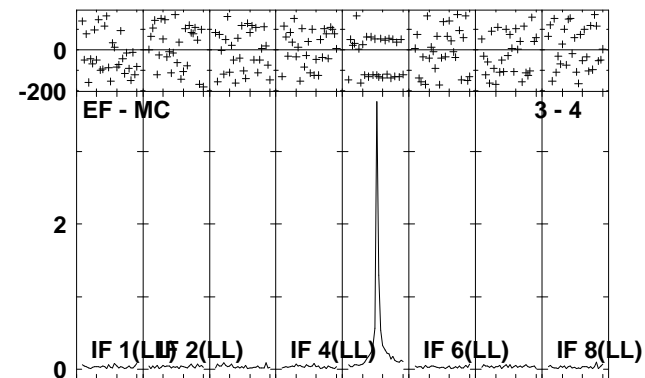
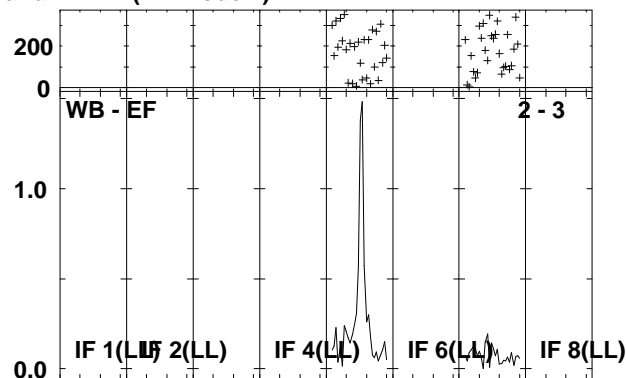
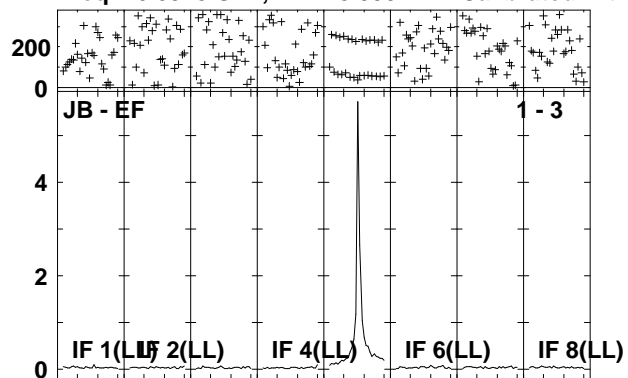

Lower frame: Ampl Jy Top frame: Phas deg
 Vector averaged cross-power spectrum Several baselines displayed
 Timerange: 00/04:20:14 to 00/04:21:42

Plot file version 106 created 19-AUG-2009 15:50:24
 DR20 EB039B 2.UVDATA.1
 Freq = 6.6328 GHz, Bw = 8.000 MH Calibrated with CL # 3 and BP # 1 (BP mode 1)

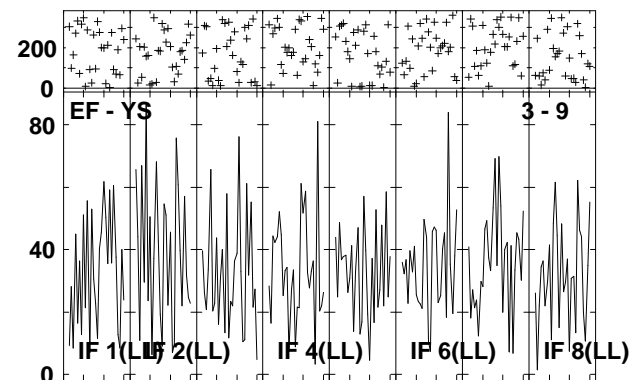
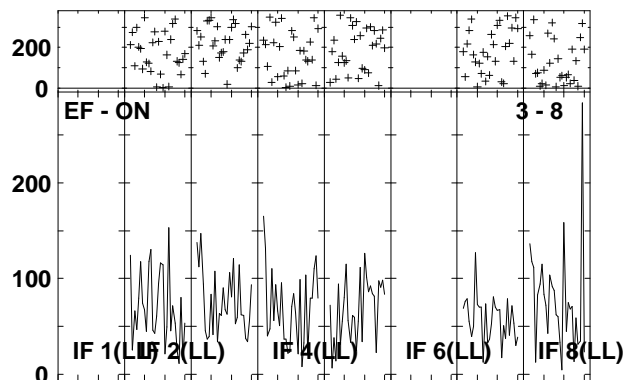
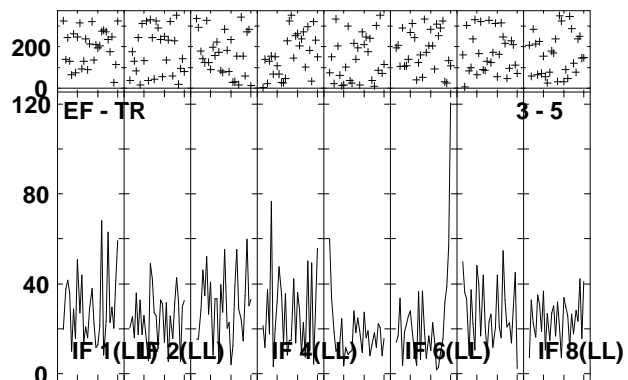
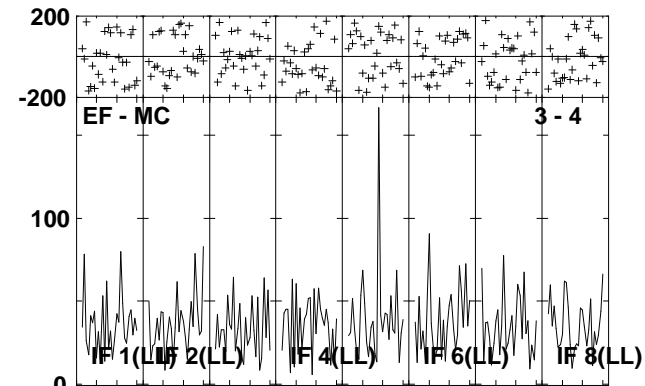
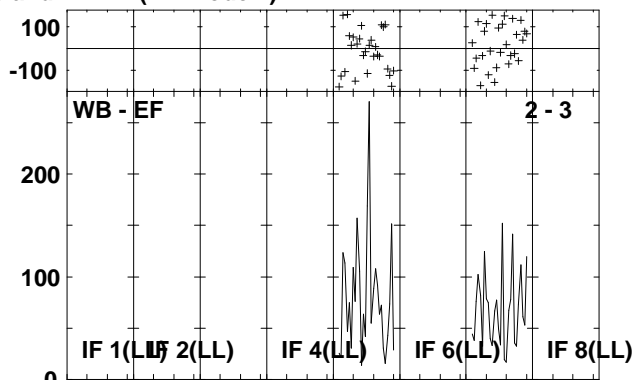
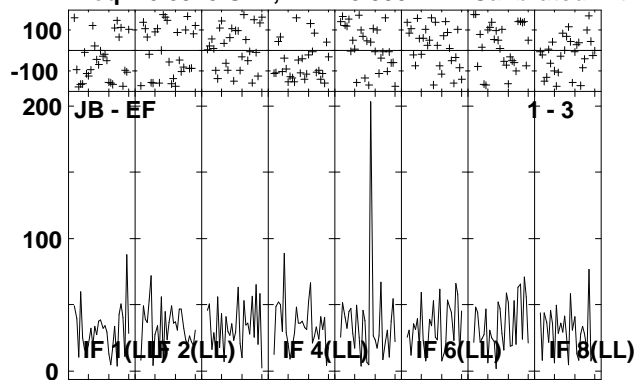

Lower frame: Milli Ampl Jy Top frame: Phas deg
 Vector averaged cross-power spectrum Several baselines displayed
 Timerange: 00/04:21:43 to 00/04:23:12

Plot file version 107 created 19-AUG-2009 15:50:27
 W75 EB039B 2.UVDATA.1
 Freq = 6.6328 GHz, Bw = 8.000 MH Calibrated with CL # 3 and BP # 1 (BP mode 1)

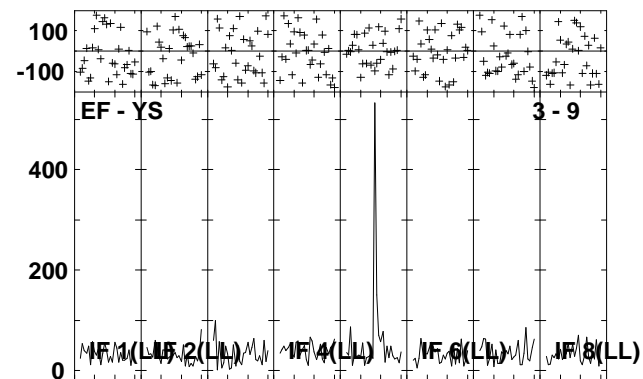
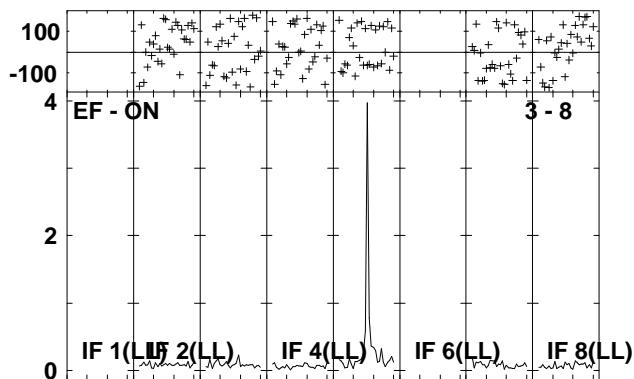
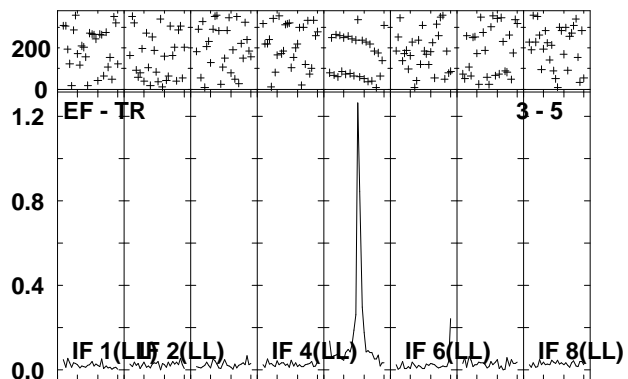
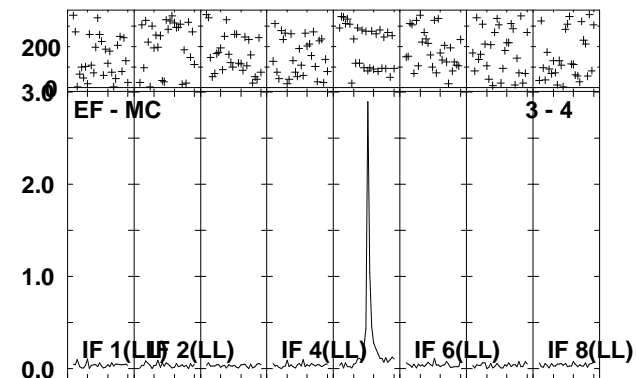
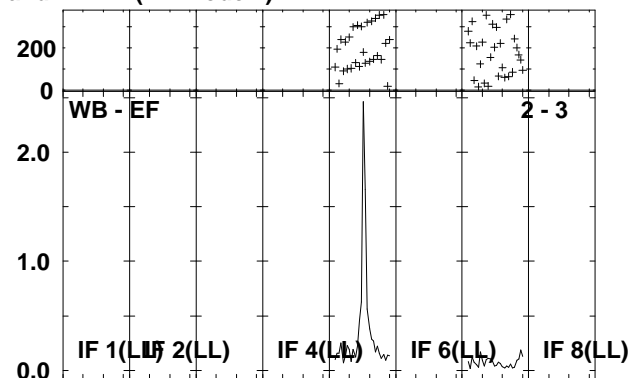
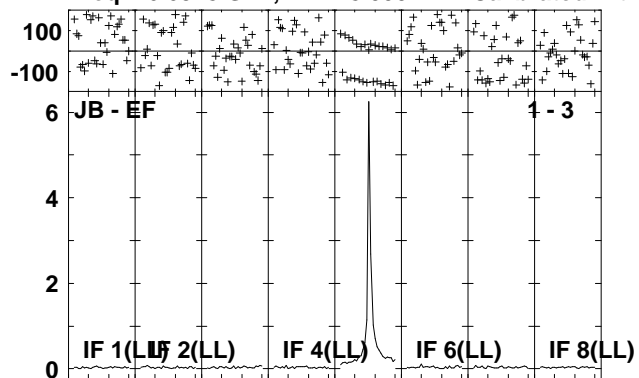

Lower frame: Ampl Jy Top frame: Phas deg
 Vector averaged cross-power spectrum Several baselines displayed
 Timerange: 00/04:23:39 to 00/04:24:39

Plot file version 108 created 19-AUG-2009 15:50:29

J2029+46 EB039B 2.UVDATA.1

Freq = 6.6328 GHz, Bw = 8.000 MH Calibrated with CL # 3 and BP # 1 (BP mode 1)

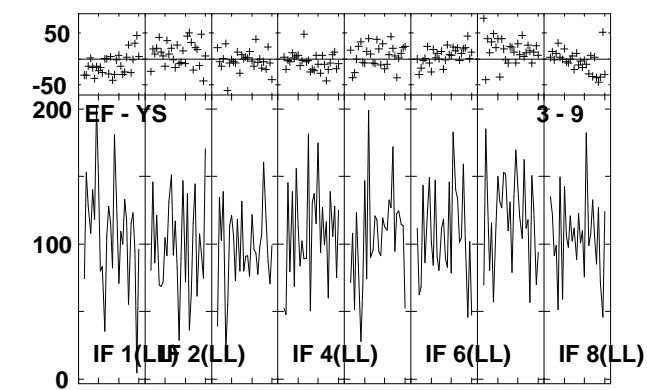
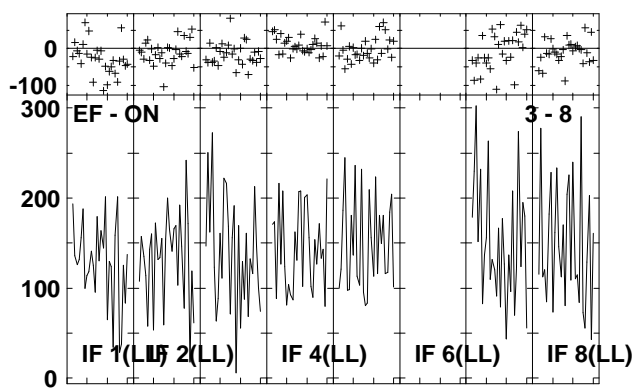
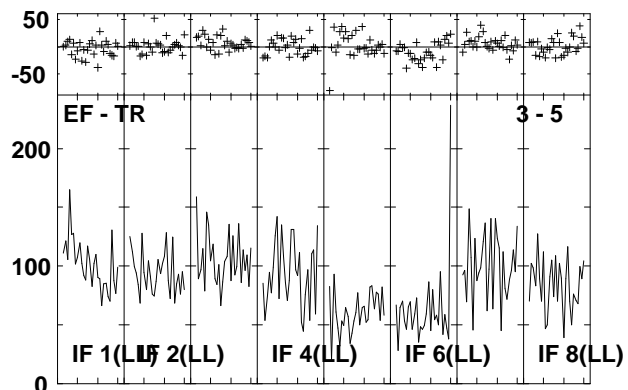
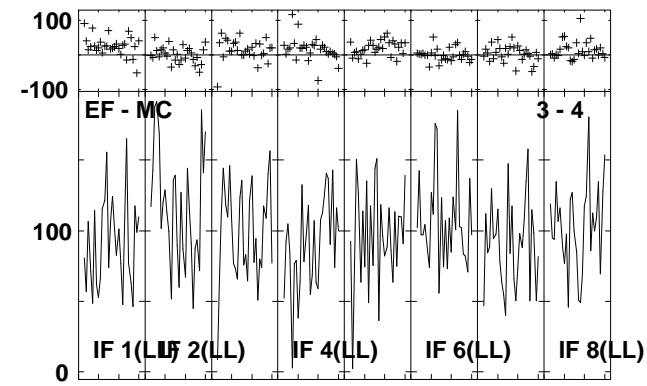
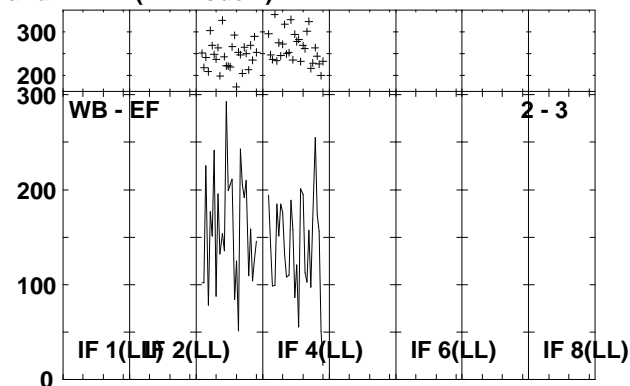
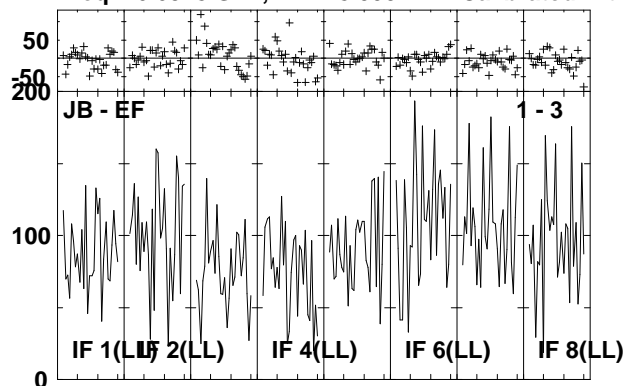

Lower frame: Milli Ampl Jy Top frame: Phas deg
Vector averaged cross-power spectrum Several baselines displayed
Timerange: 00/04:24:39 to 00/04:26:08

Plot file version 109 created 19-AUG-2009 15:50:31

W75 EB039B 2.UVDATA.1

Freq = 6.6328 GHz, Bw = 8.000 MH Calibrated with CL # 3 and BP # 1 (BP mode 1)

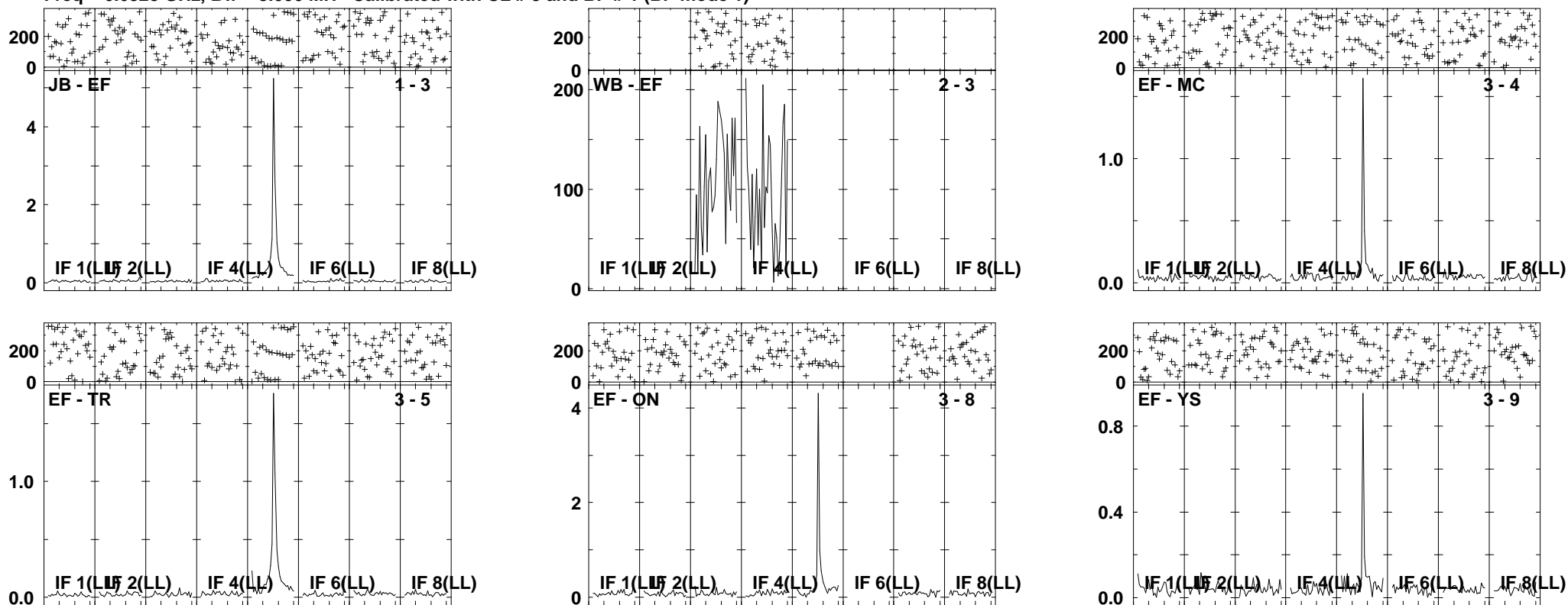

Lower frame: Ampl Jy Top frame: Phas deg
Vector averaged cross-power spectrum Several baselines displayed
Timerange: 00/04:26:10 to 00/04:27:39

Plot file version 110 created 19-AUG-2009 15:50:36

W75 EB039B 2.UVDATA.1

Freq = 6.6328 GHz, Bw = 8.000 MH Calibrated with CL # 3 and BP # 1 (BP mode 1)

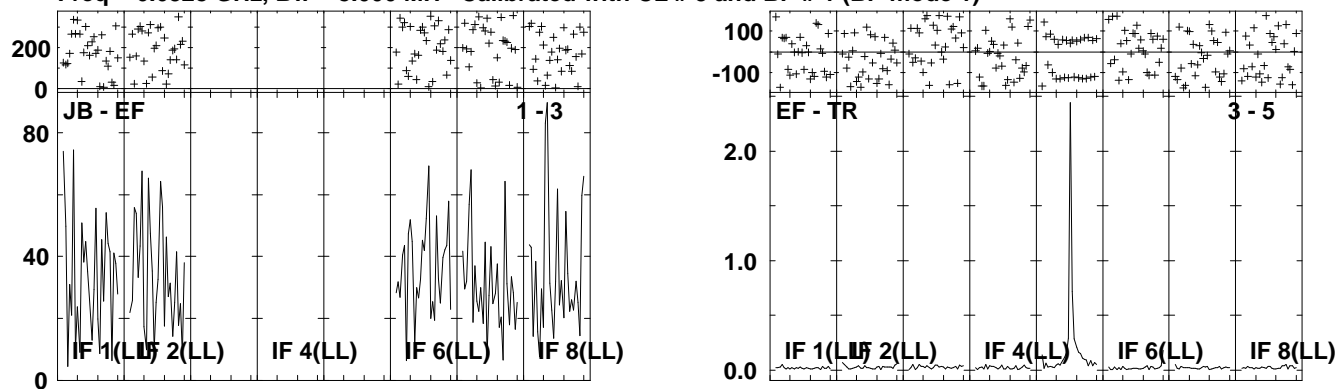

Lower frame: Milli Ampl Jy Top frame: Phas deg
Vector averaged cross-power spectrum Several baselines displayed
Timerange: 00/04:29:10 to 00/04:30:39

Plot file version 111 created 19-AUG-2009 15:50:38

2048+431 EB039B 2.UVDATA.1

Freq = 6.6328 GHz, Bw = 8.000 MH Calibrated with CL # 3 and BP # 1 (BP mode 1)

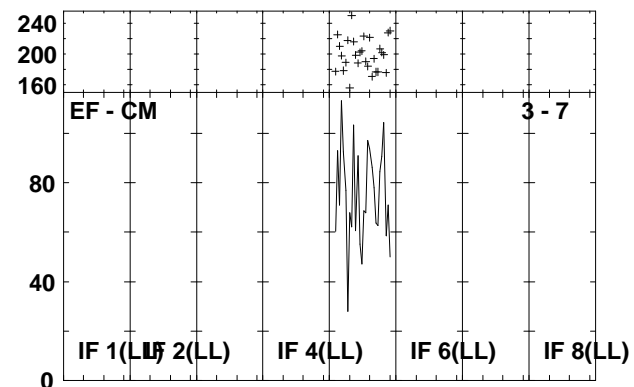
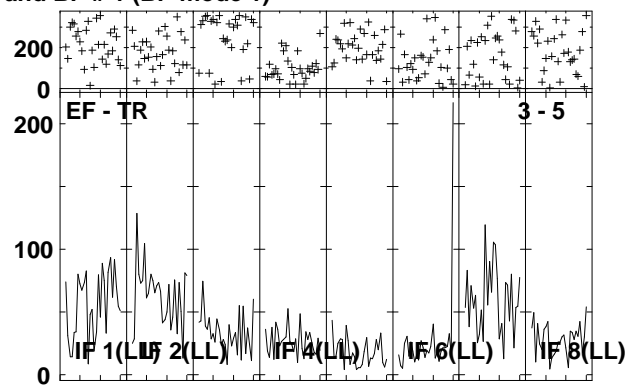
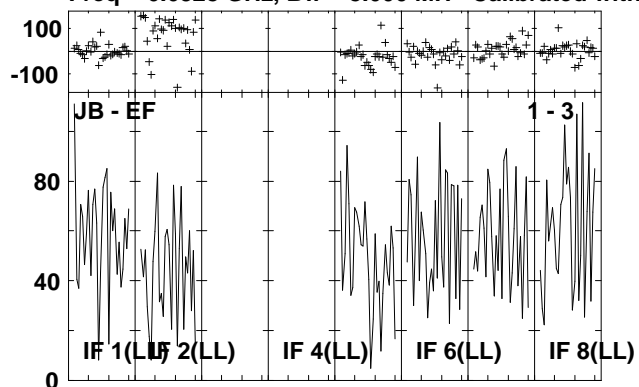

Lower frame: Milli Ampl Jy Top frame: Phas deg
Vector averaged cross-power spectrum Several baselines displayed
Timerange: 00/04:30:40 to 00/04:32:09

Plot file version 112 created 19-AUG-2009 15:50:41
 W75 EB039B 2.UVDATA.1
 Freq = 6.6328 GHz, Bw = 8.000 MH Calibrated with CL # 3 and BP # 1 (BP mode 1)

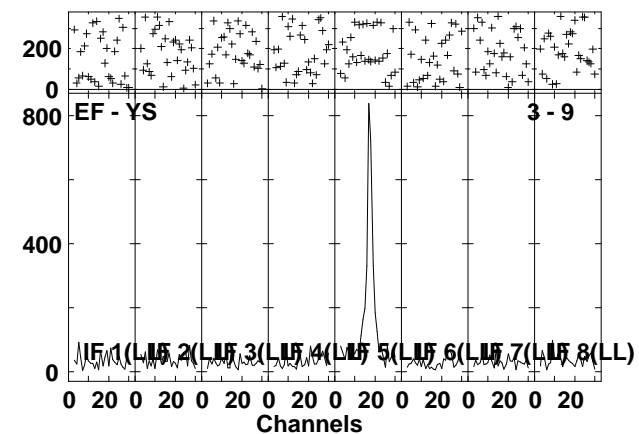
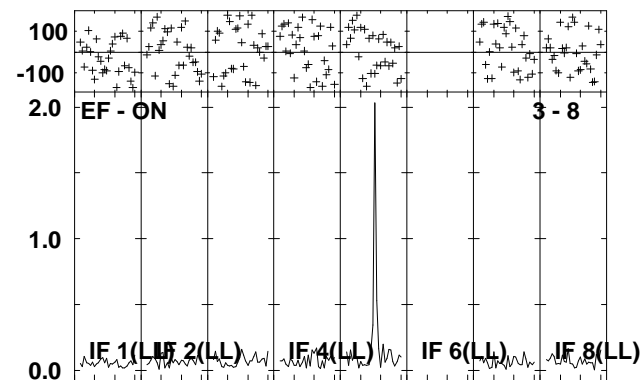
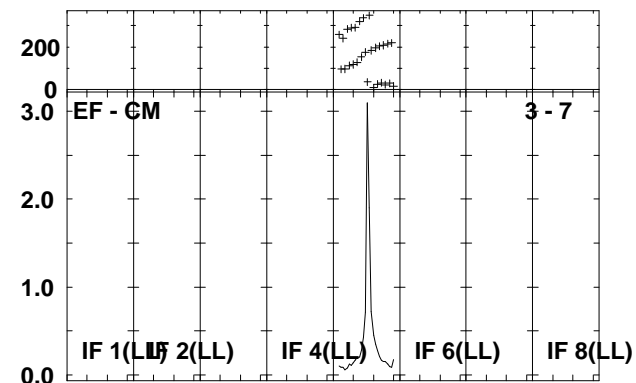
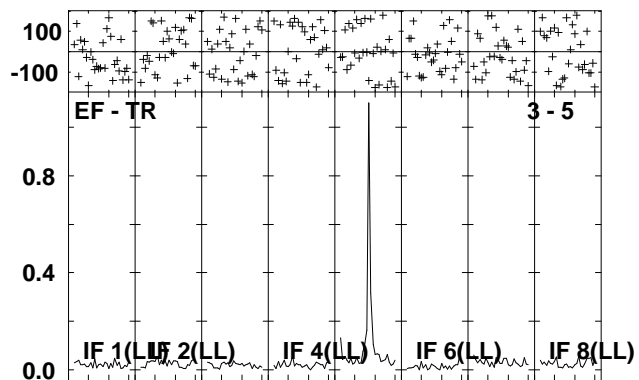
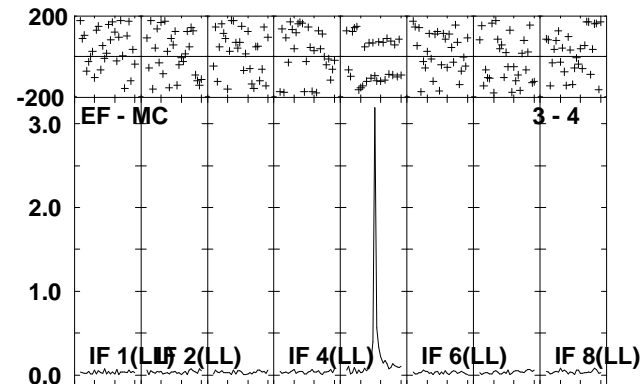
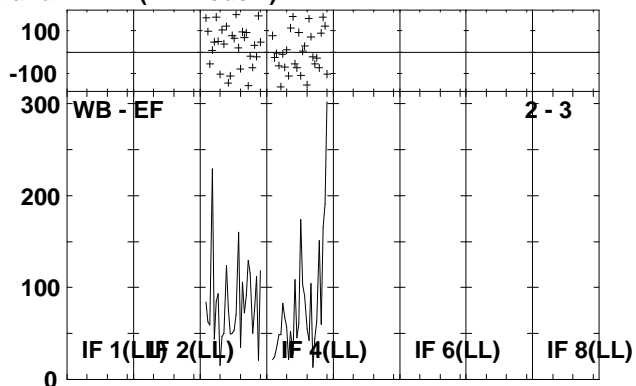
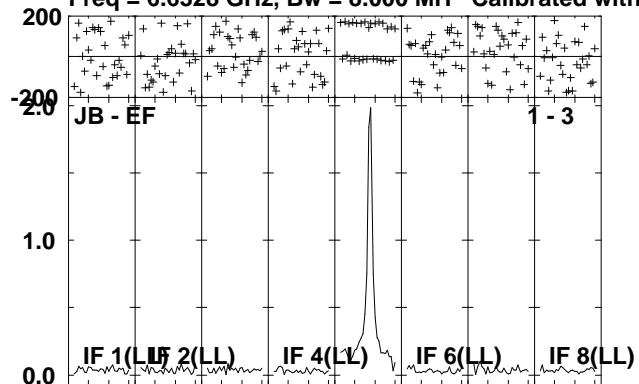

Lower frame: Ampl Jy Top frame: Phas deg
 Vector averaged cross-power spectrum Several baselines displayed
 Timerange: 00/04:32:10 to 00/04:33:39

Plot file version 113 created 19-AUG-2009 15:50:43
 OB2 EB039B 2.UVDATA.1
 Freq = 6.6328 GHz, Bw = 8.000 MH Calibrated with CL # 3 and BP # 1 (BP mode 1)

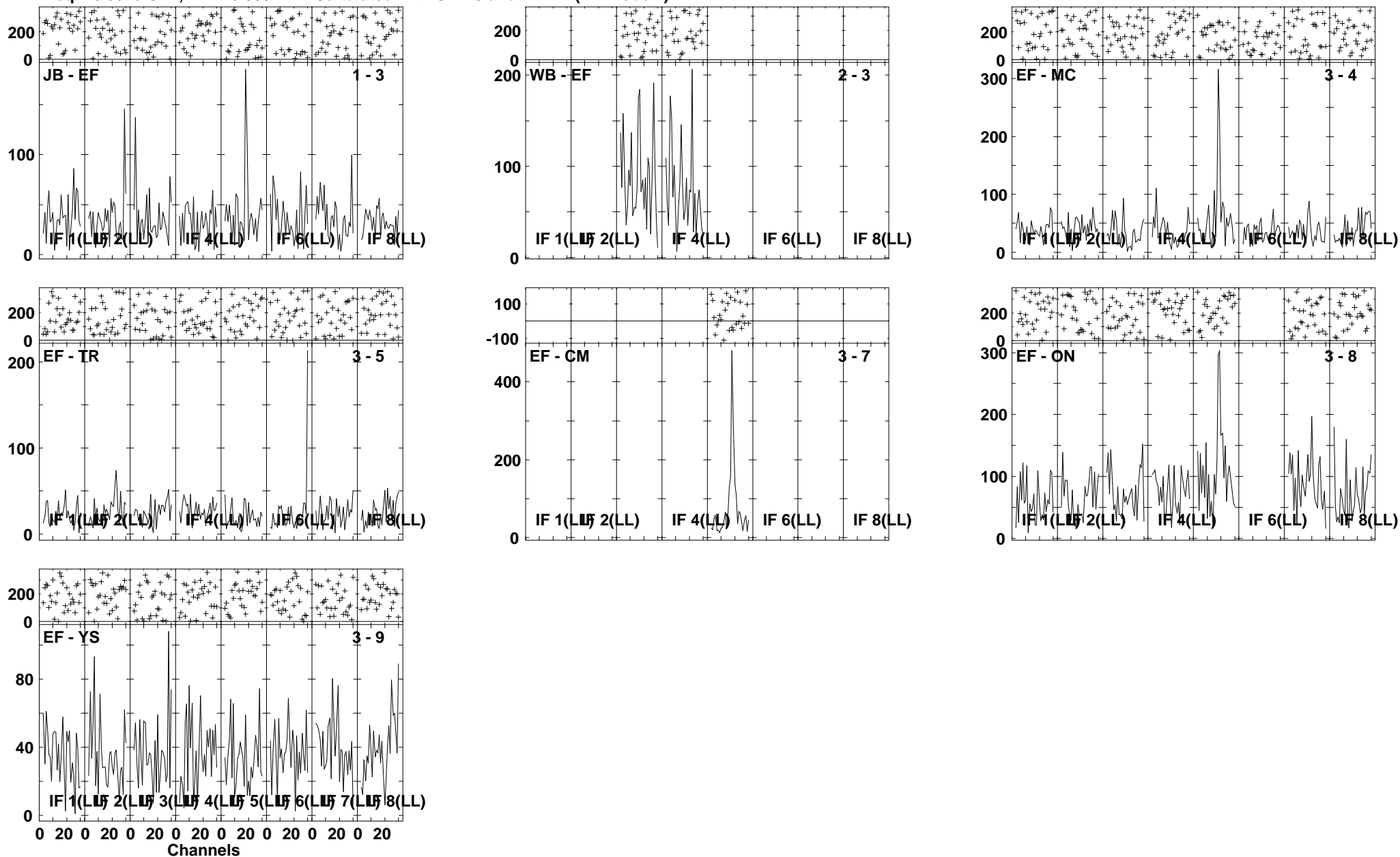

Lower frame: Milli Ampl Jy Top frame: Phas deg
 Vector averaged cross-power spectrum Several baselines displayed
 Timerange: 00/04:33:40 to 00/04:35:08

Plot file version 114 created 19-AUG-2009 15:50:46
 W75 EB039B 2.UVDATA.1
 Freq = 6.6328 GHz, Bw = 8.000 MH Calibrated with CL # 3 and BP # 1 (BP mode 1)

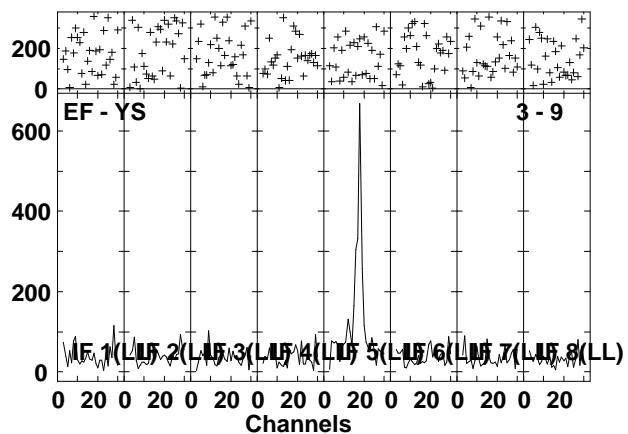
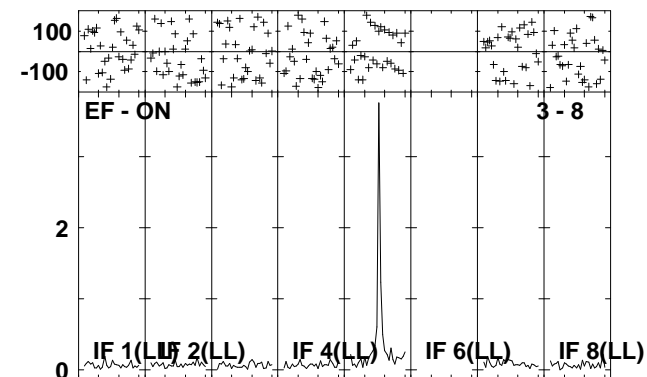
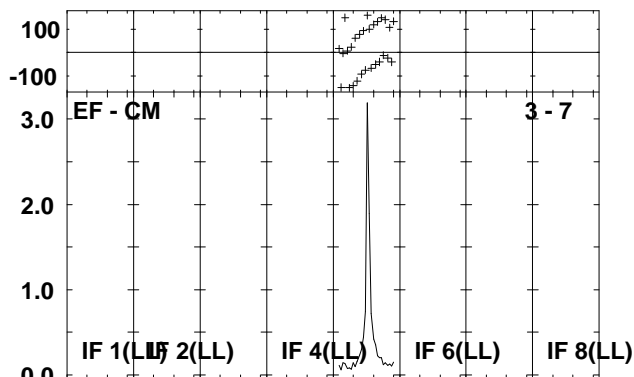
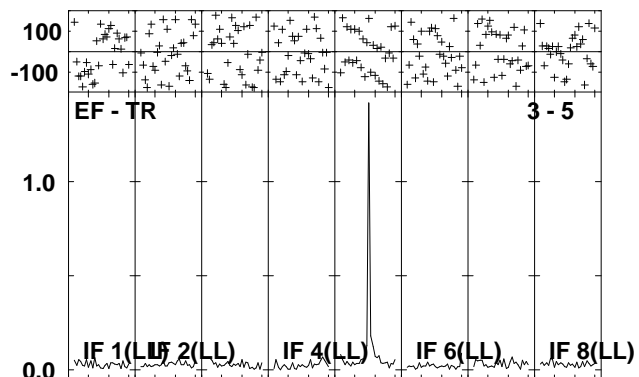
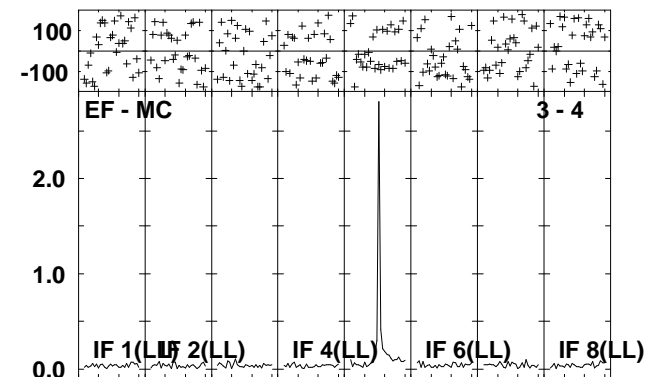
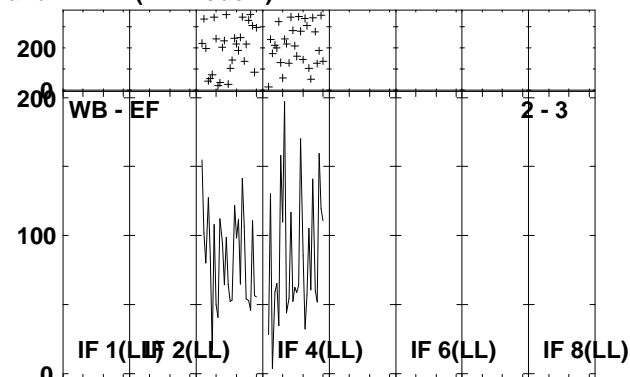
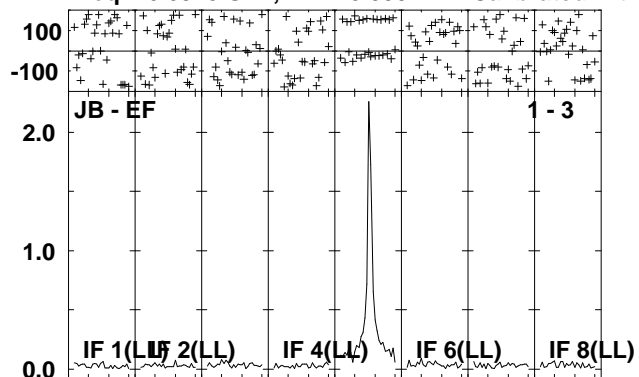

Lower frame: Ampl Jy Top frame: Phas deg
 Vector averaged cross-power spectrum Several baselines displayed
 Timerange: 00/04:35:43 to 00/04:36:43

Plot file version 115 created 19-AUG-2009 15:50:48
 DR21A EB039B 2.UVDATA.1
 Freq = 6.6328 GHz, Bw = 8.000 MH Calibrated with CL # 3 and BP # 1 (BP mode 1)

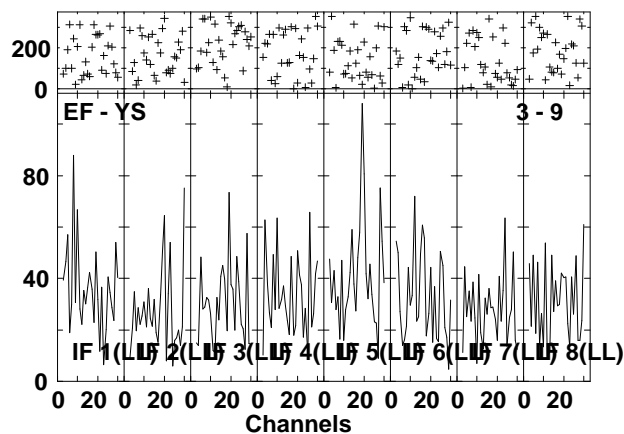
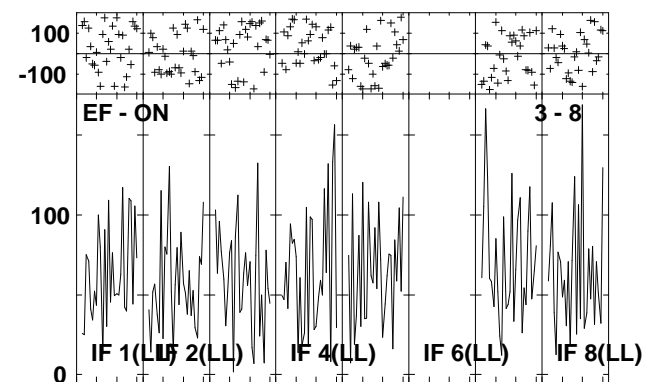
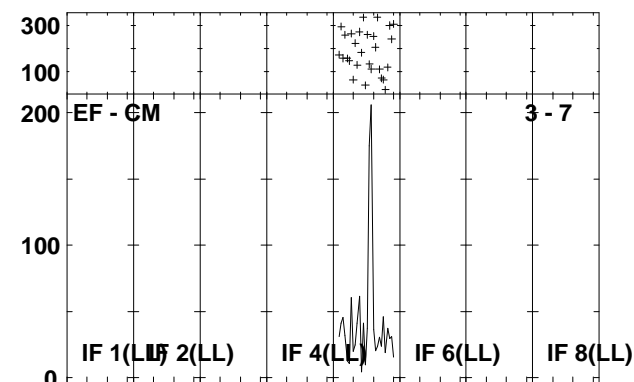
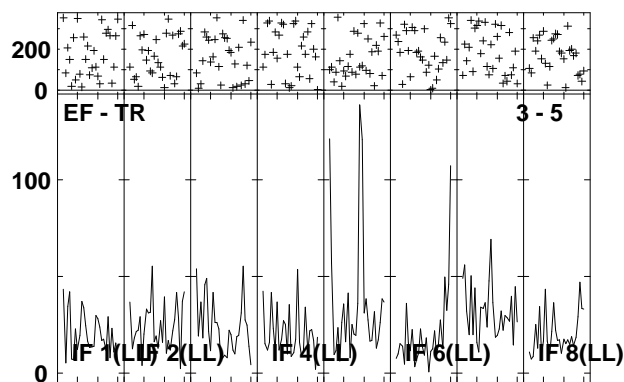
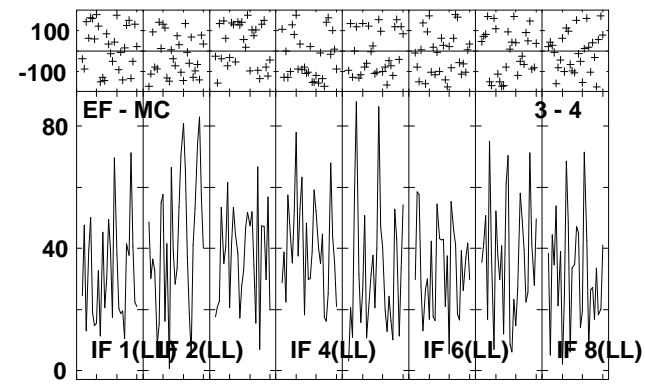
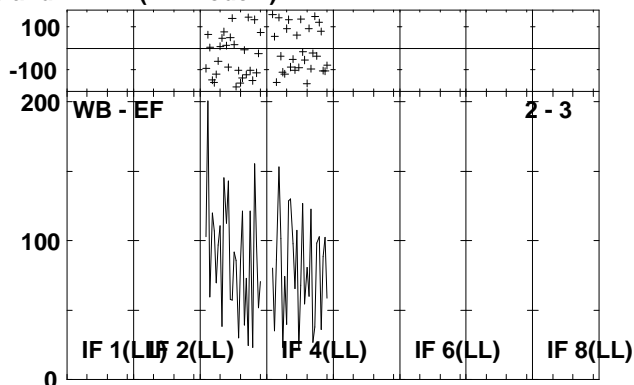
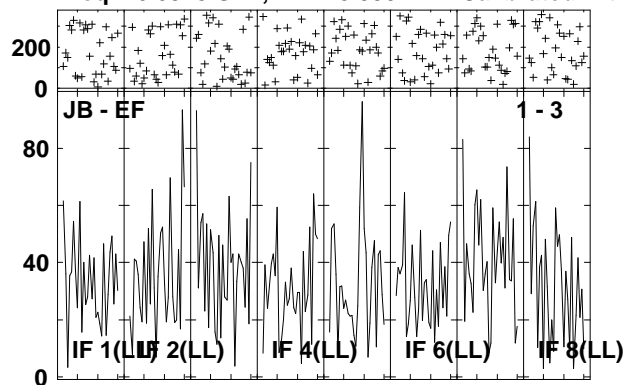

Lower frame: Milli Ampl Jy Top frame: Phas deg
 Vector averaged cross-power spectrum Several baselines displayed
 Timerange: 00/04:36:44 to 00/04:38:12

Plot file version 116 created 19-AUG-2009 15:50:51
 W75 EB039B 2.UVDATA.1
 Freq = 6.6328 GHz, Bw = 8.000 MH Calibrated with CL # 3 and BP # 1 (BP mode 1)

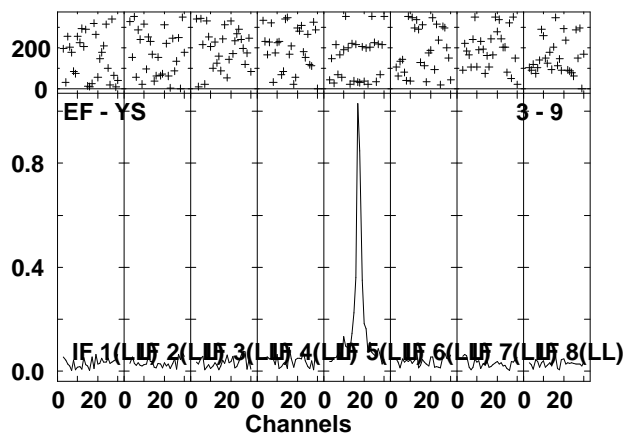
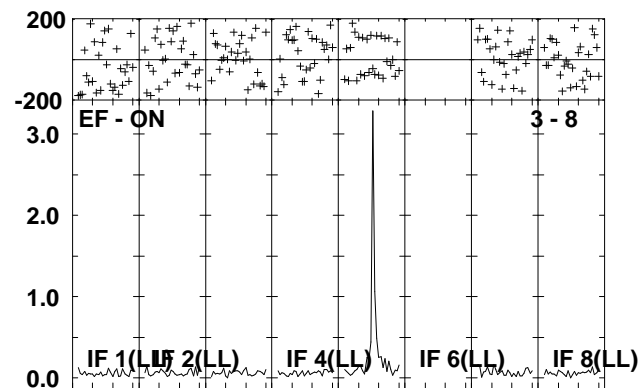
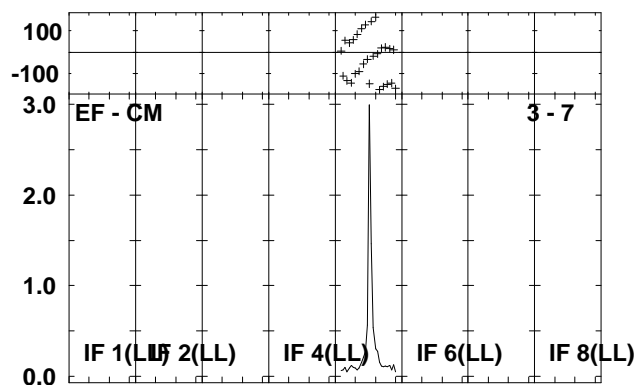
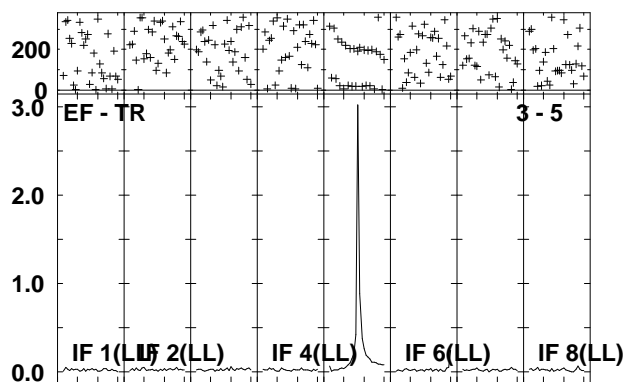
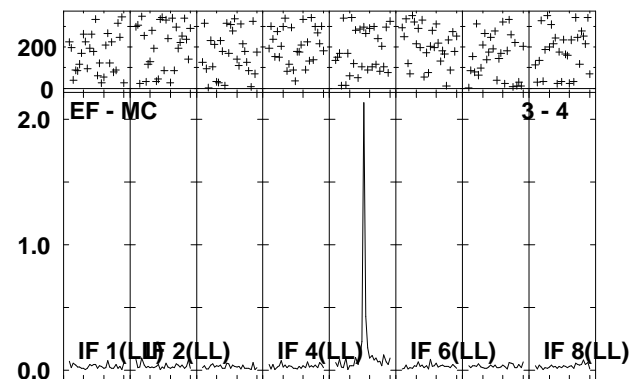
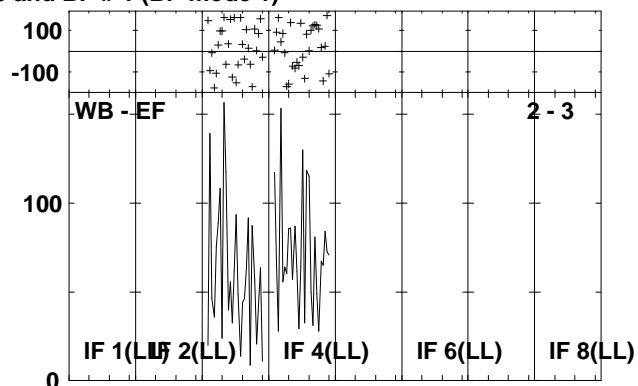
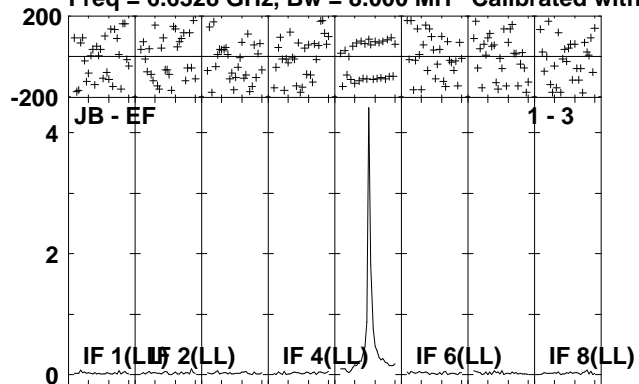

Lower frame: Ampl Jy Top frame: Phas deg
 Vector averaged cross-power spectrum Several baselines displayed
 Timerange: 00/04:38:14 to 00/04:39:42

Plot file version 117 created 19-AUG-2009 15:50:54
 DR21B EB039B 2.UVDATA.1
 Freq = 6.6328 GHz, Bw = 8.000 MH Calibrated with CL # 3 and BP # 1 (BP mode 1)

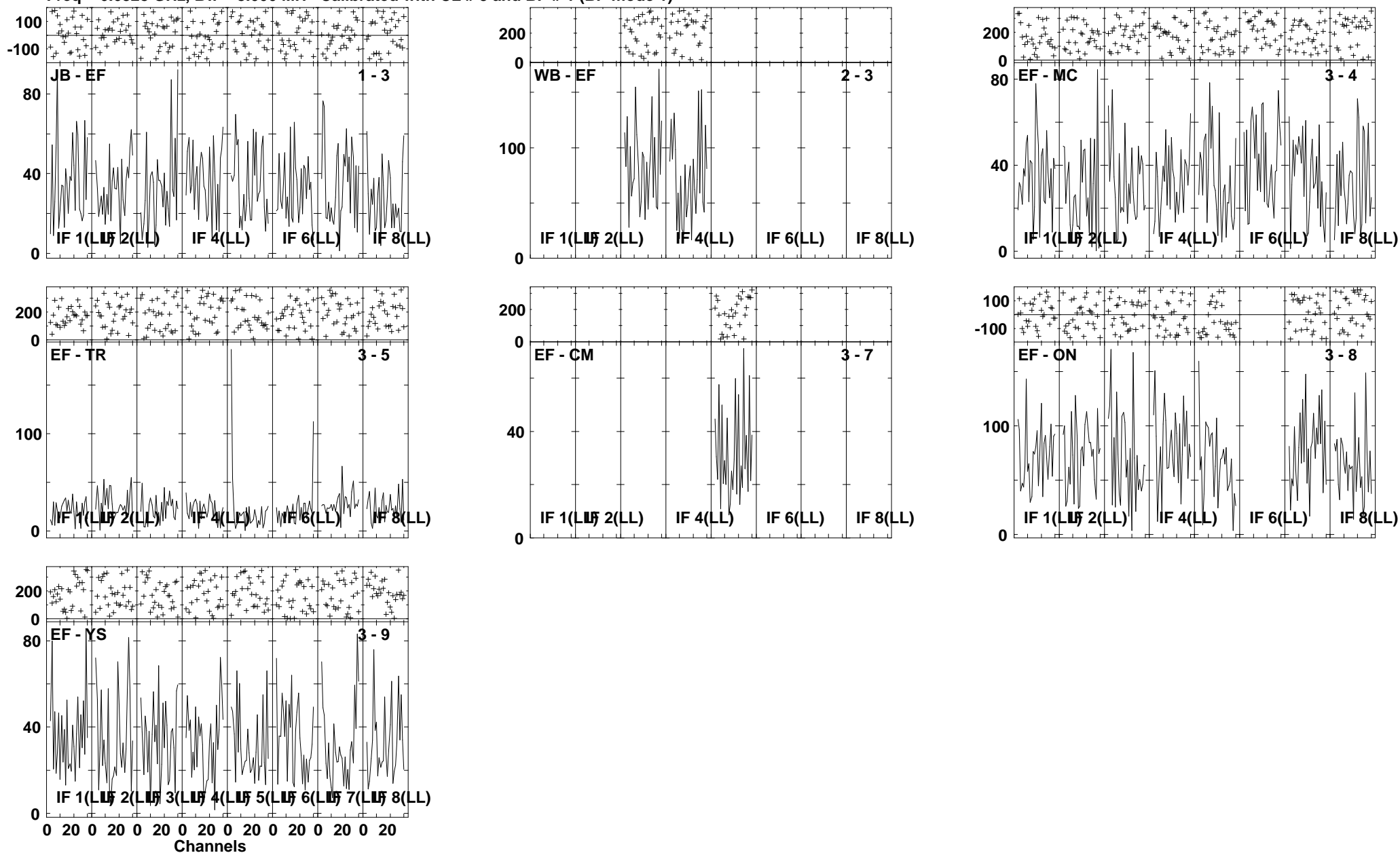

Lower frame: Milli Ampl Jy Top frame: Phas deg
 Vector averaged cross-power spectrum Several baselines displayed
 Timerange: 00/04:39:44 to 00/04:41:12

Plot file version 118 created 19-AUG-2009 15:50:57

W75 EB039B 2.UVDATA.1

Freq = 6.6328 GHz, Bw = 8.000 MH Calibrated with CL # 3 and BP # 1 (BP mode 1)

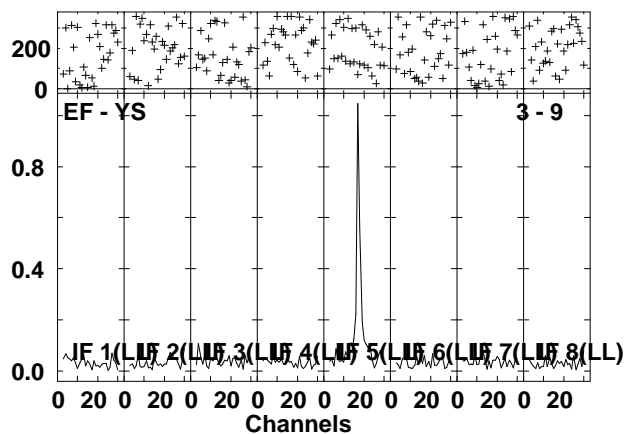
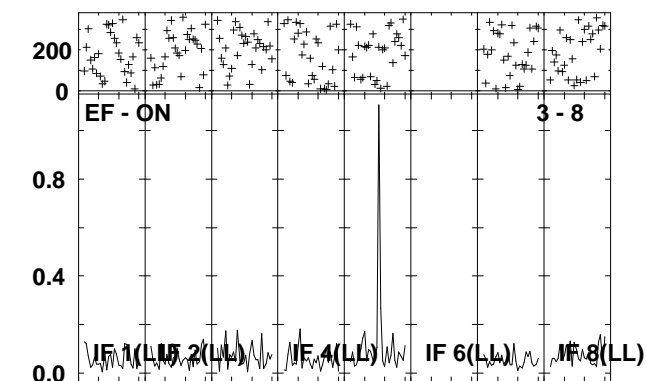
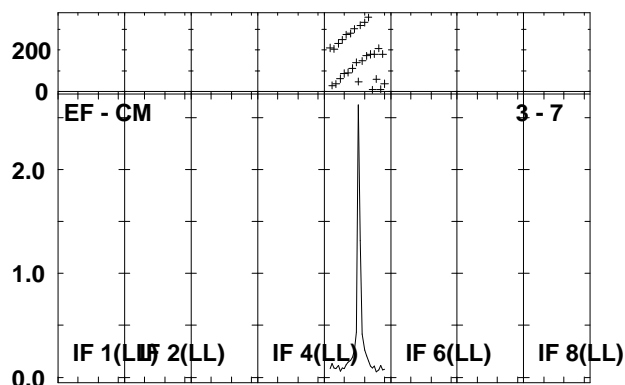
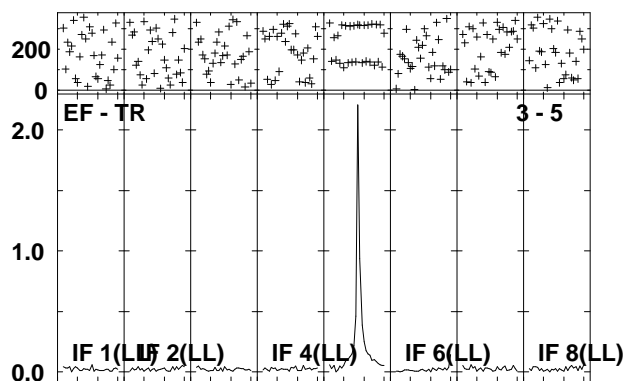
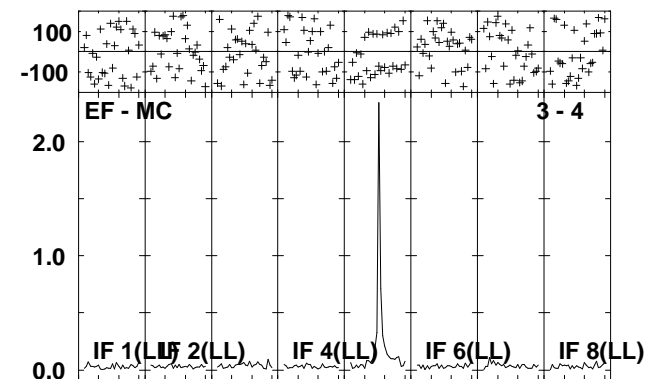
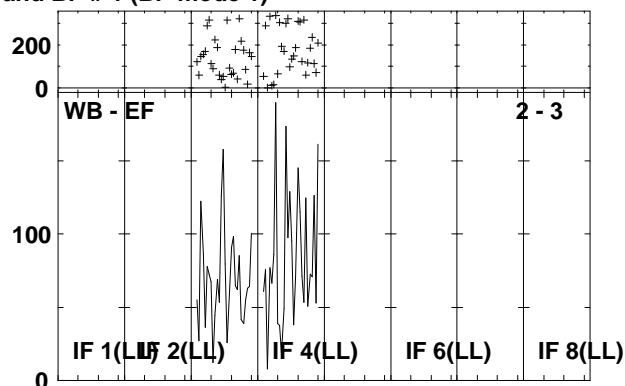
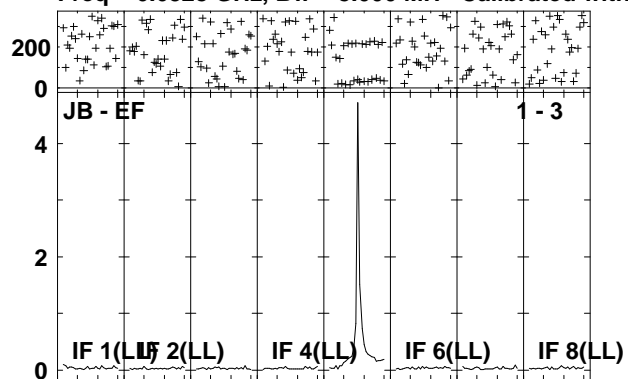

Lower frame: Ampl Jy Top frame: Phas deg
Vector averaged cross-power spectrum Several baselines displayed
Timerange: 00/04:41:14 to 00/04:42:42

Plot file version 119 created 19-AUG-2009 15:51:00
 DR21B2 EB039B 2.UVDATA.1
 Freq = 6.6328 GHz, Bw = 8.000 MH Calibrated with CL # 3 and BP # 1 (BP mode 1)

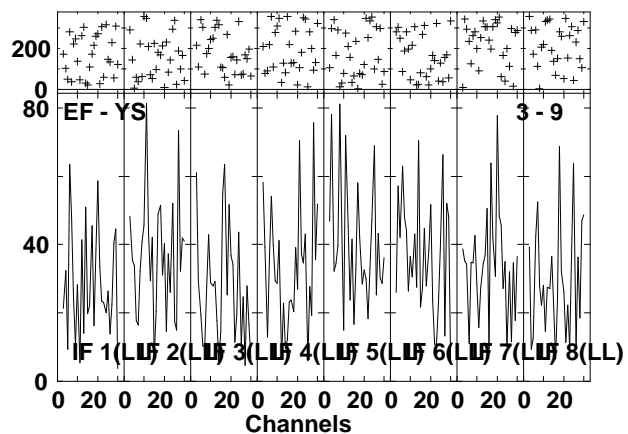
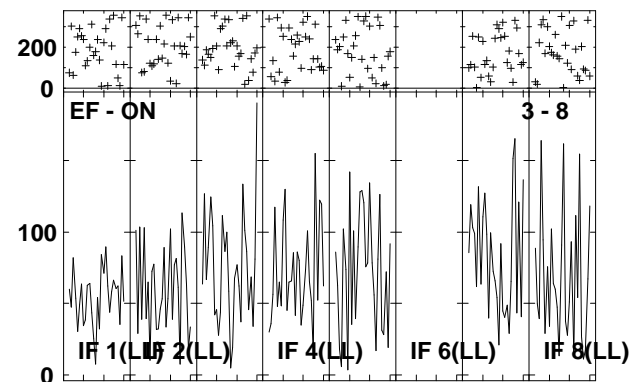
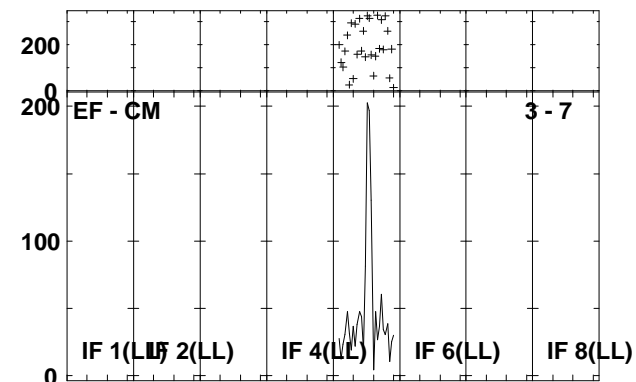
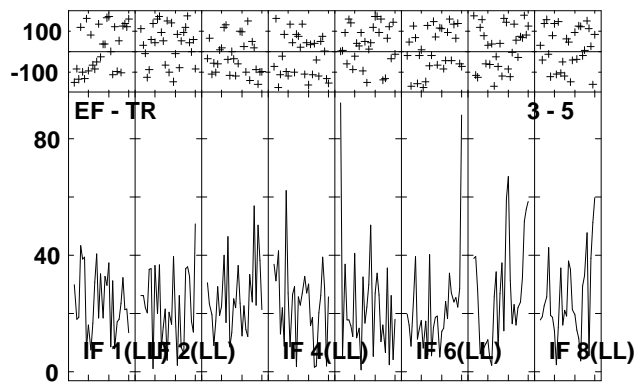
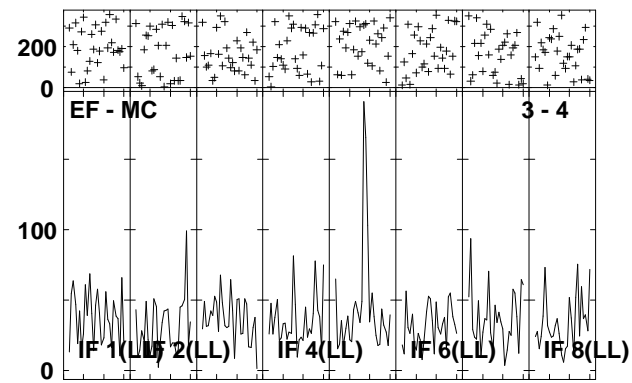
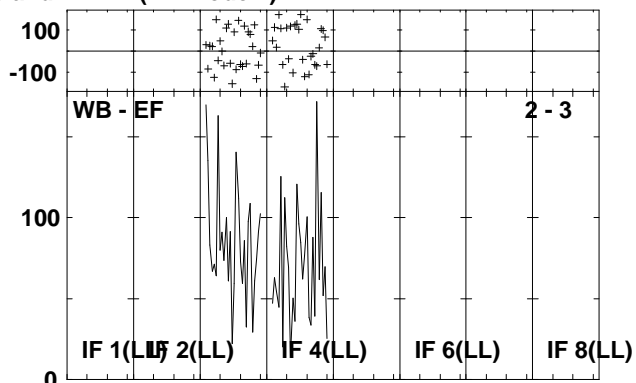
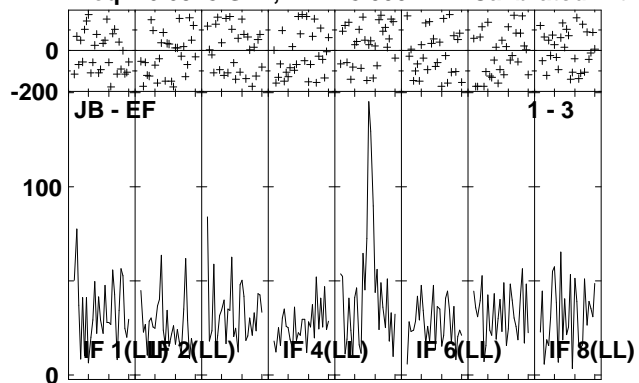

Lower frame: Milli Ampl Jy Top frame: Phas deg
 Vector averaged cross-power spectrum Several baselines displayed
 Timerange: 00/04:42:44 to 00/04:44:12

Plot file version 120 created 19-AUG-2009 15:51:02
 W75 EB039B 2.UVDATA.1
 Freq = 6.6328 GHz, Bw = 8.000 MH Calibrated with CL # 3 and BP # 1 (BP mode 1)

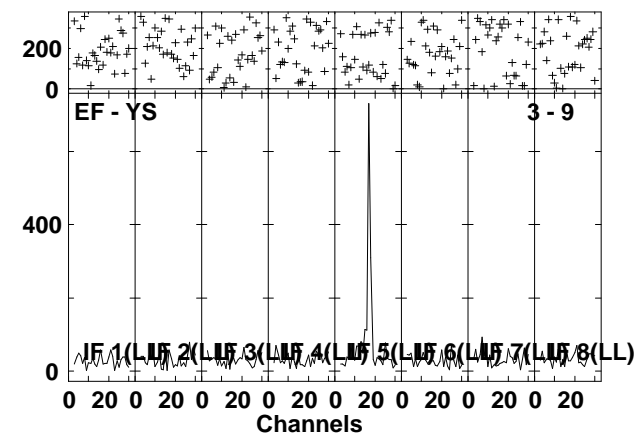
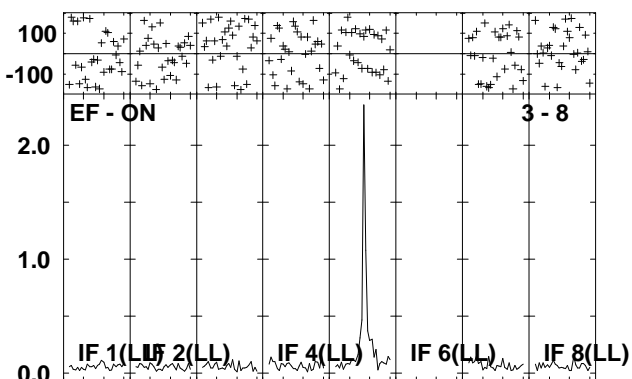
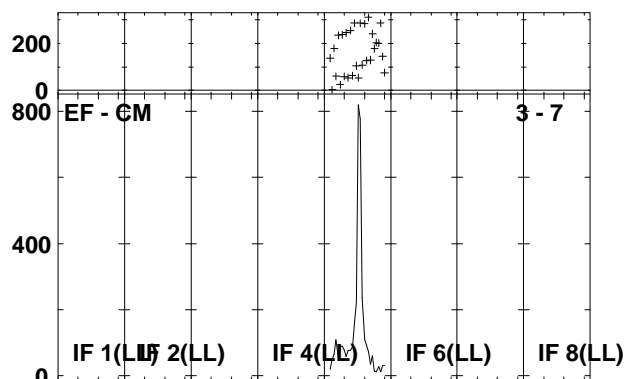
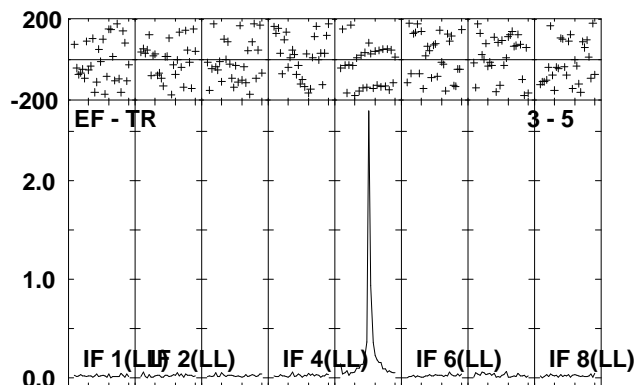
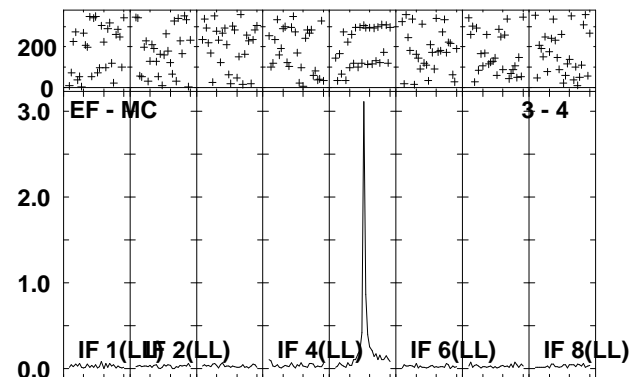
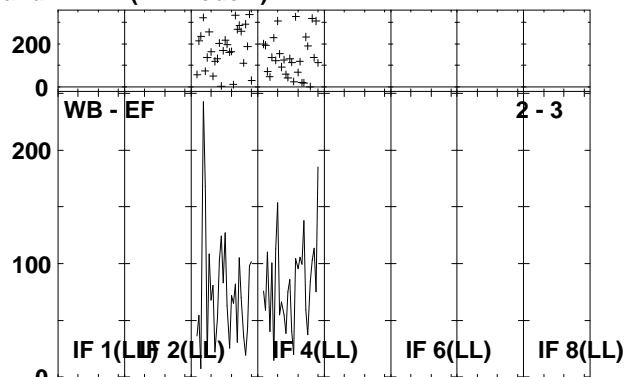
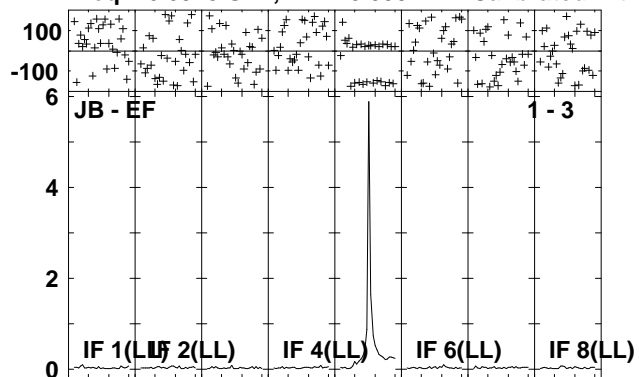

Lower frame: Ampl Jy Top frame: Phas deg
 Vector averaged cross-power spectrum Several baselines displayed
 Timerange: 00/04:44:13 to 00/04:45:42

Plot file version 121 created 19-AUG-2009 15:51:05
 DR20 EB039B 2.UVDATA.1
 Freq = 6.6328 GHz, Bw = 8.000 MH Calibrated with CL # 3 and BP # 1 (BP mode 1)

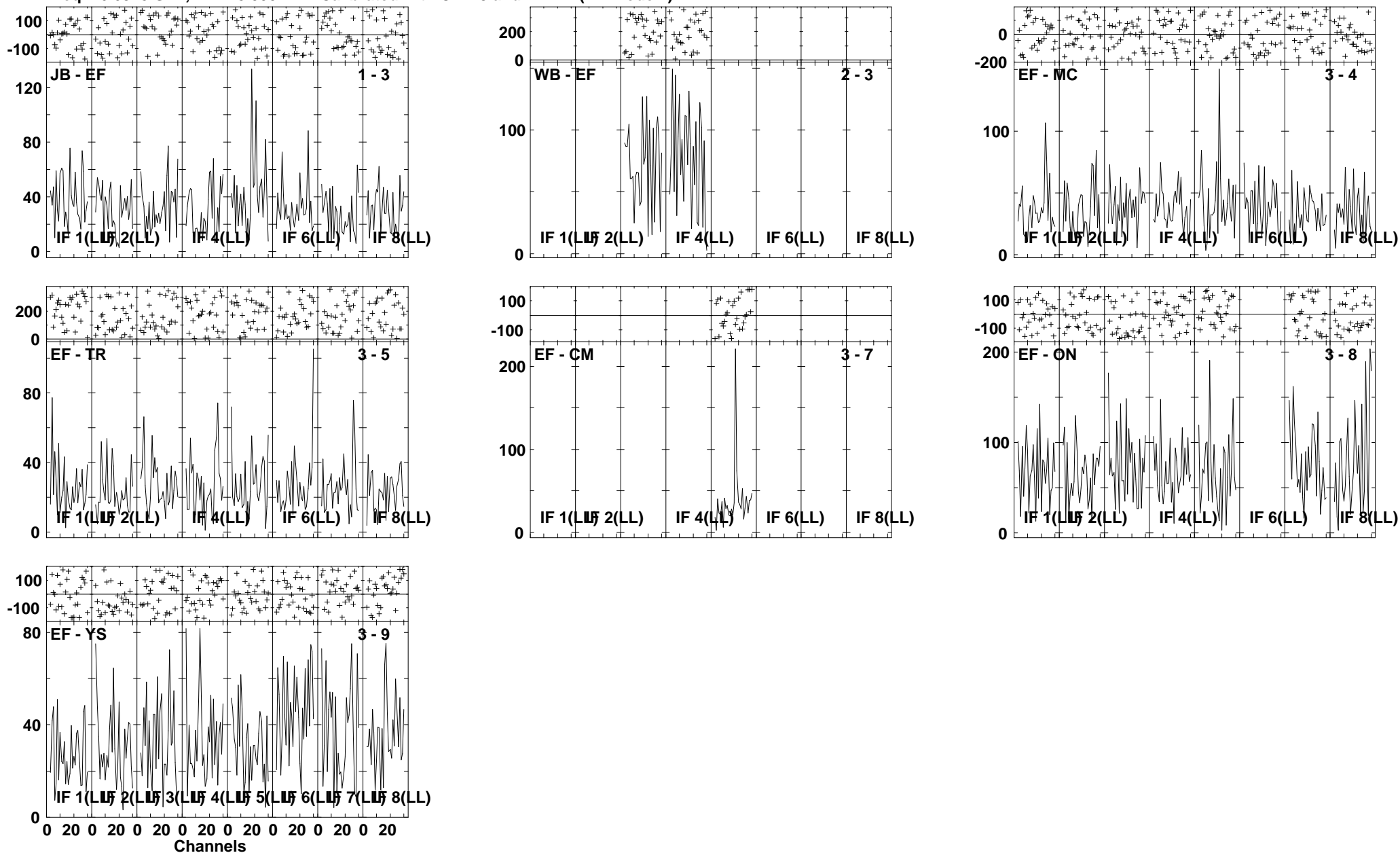

Lower frame: Milli Ampl Jy Top frame: Phas deg
 Vector averaged cross-power spectrum Several baselines displayed
 Timerange: 00/04:45:43 to 00/04:47:12

Plot file version 122 created 19-AUG-2009 15:51:08
 W75 EB039B 2.UVDATA.1
 Freq = 6.6328 GHz, Bw = 8.000 MH Calibrated with CL # 3 and BP # 1 (BP mode 1)

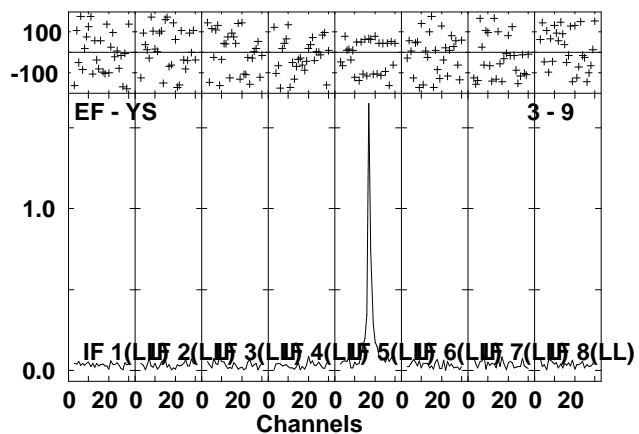
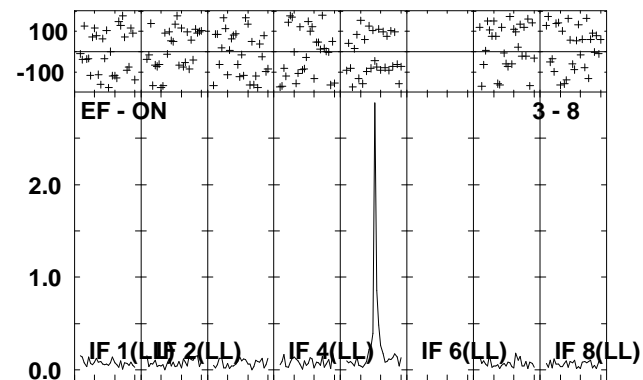
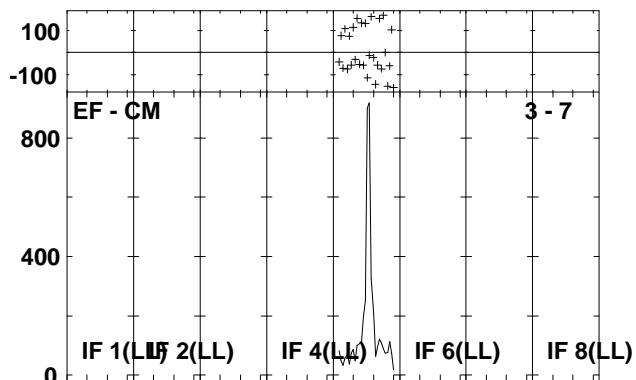
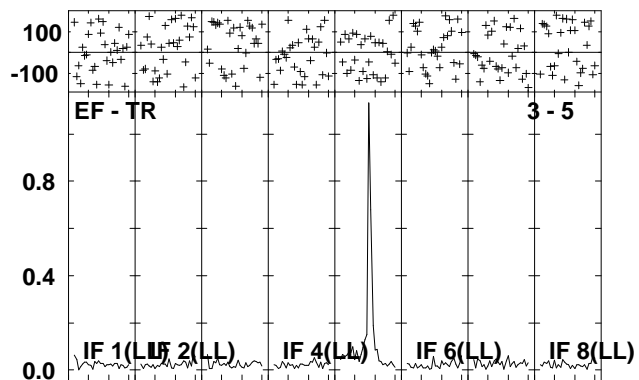
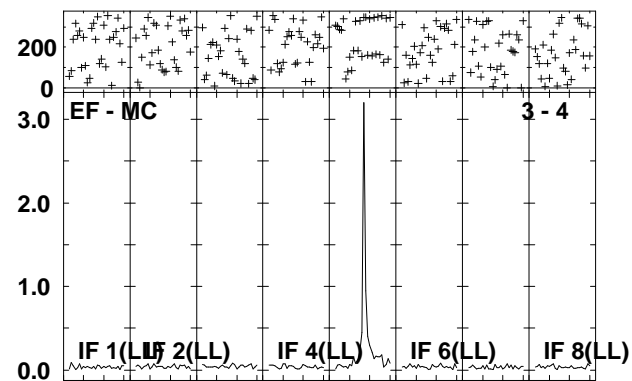
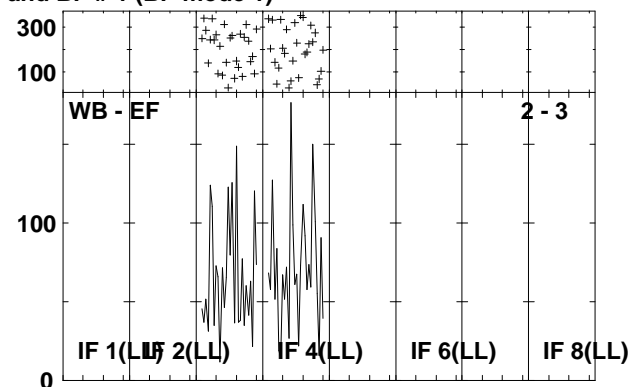
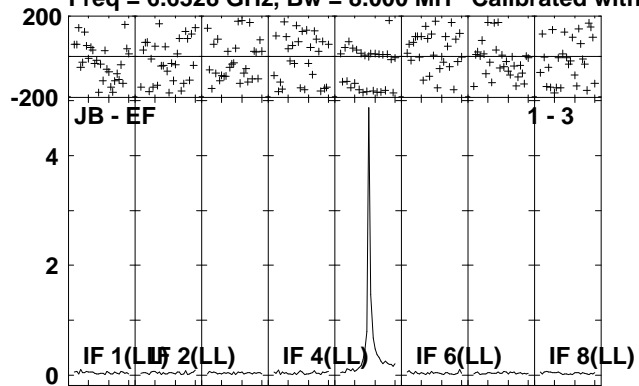

Lower frame: Ampl Jy Top frame: Phas deg
 Vector averaged cross-power spectrum Several baselines displayed
 Timerange: 00/04:47:41 to 00/04:48:39

Plot file version 123 created 19-AUG-2009 15:51:10

J2029+46 EB039B 2.UVDATA.1

Freq = 6.6328 GHz, Bw = 8.000 MH Calibrated with CL # 3 and BP # 1 (BP mode 1)

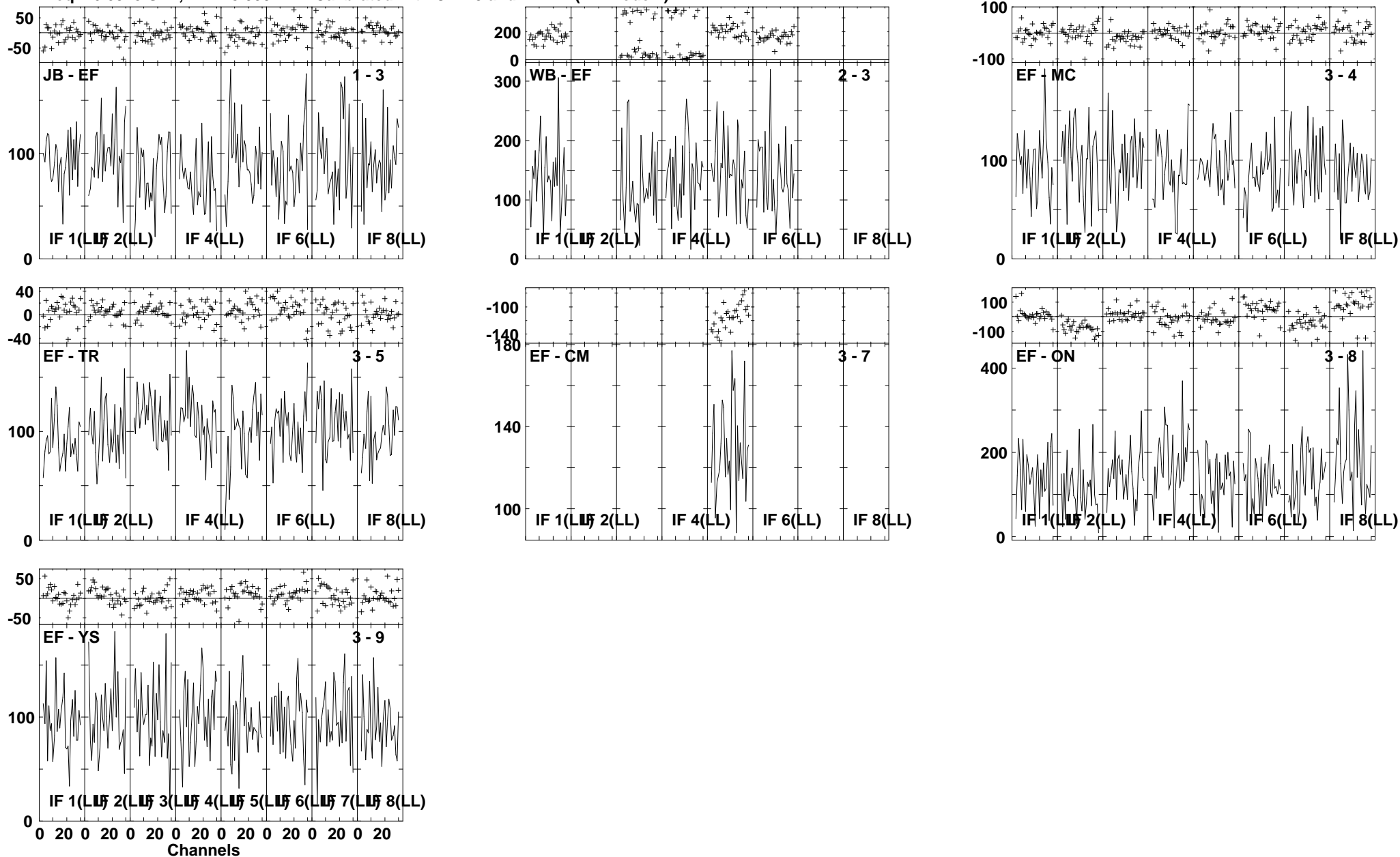

Lower frame: Milli Ampl Jy Top frame: Phas deg
Vector averaged cross-power spectrum Several baselines displayed
Timerange: 00/04:48:40 to 00/04:50:09

Plot file version 124 created 19-AUG-2009 15:51:13
 W75 EB039B 2.UVDATA.1
 Freq = 6.6328 GHz, Bw = 8.000 MH Calibrated with CL # 3 and BP # 1 (BP mode 1)

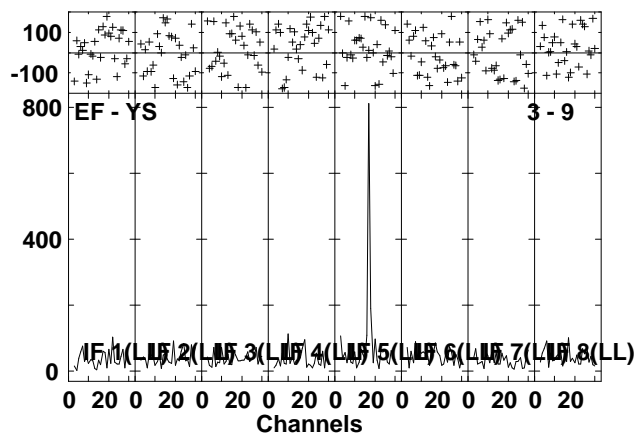
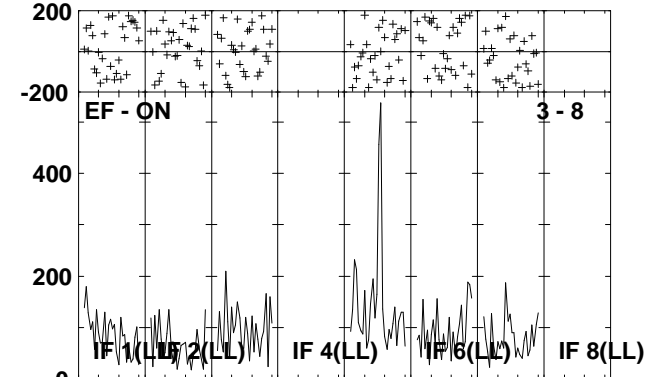
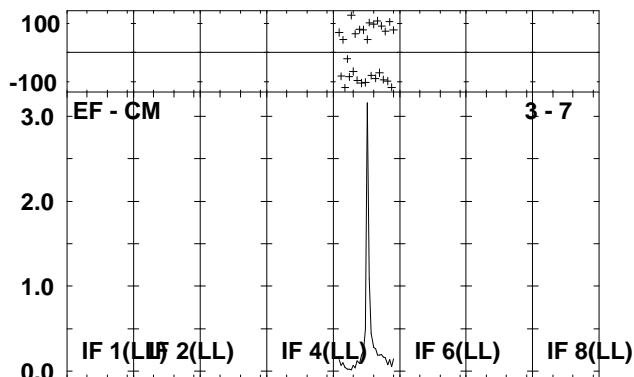
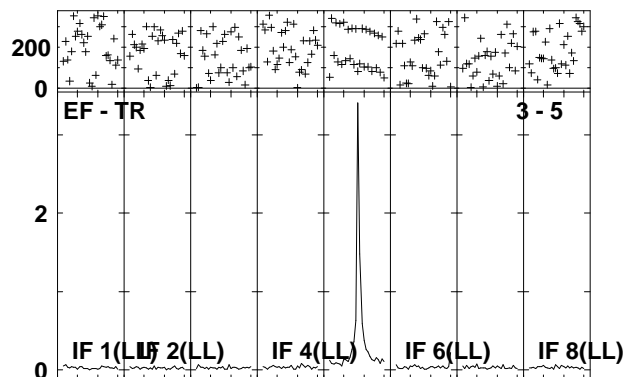
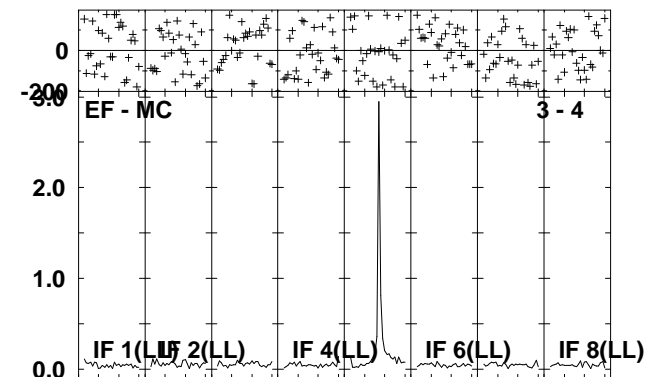
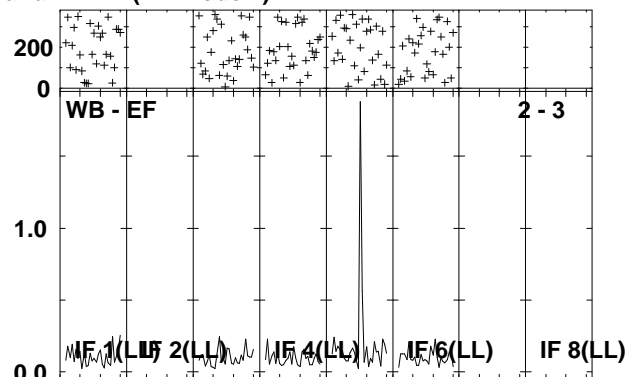
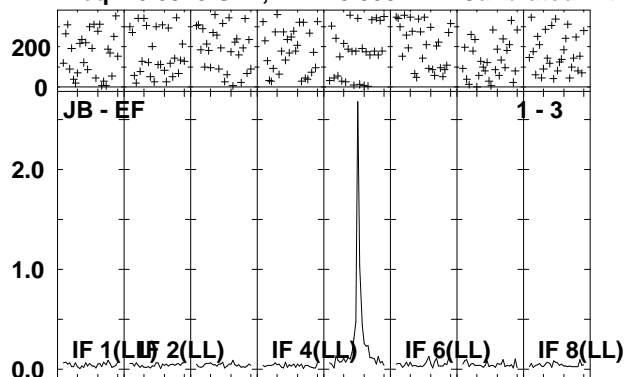

Lower frame: Ampl Jy Top frame: Phas deg
 Vector averaged cross-power spectrum Several baselines displayed
 Timerange: 00/04:50:10 to 00/04:51:39

Plot file version 125 created 19-AUG-2009 15:51:17
W75 EB039B 2.UVDATA.1
Freq = 6.6328 GHz, Bw = 8.000 MH Calibrated with CL # 3 and BP # 1 (BP mode 1)

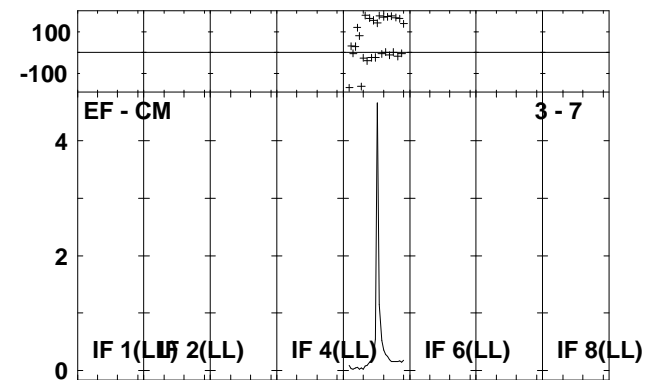
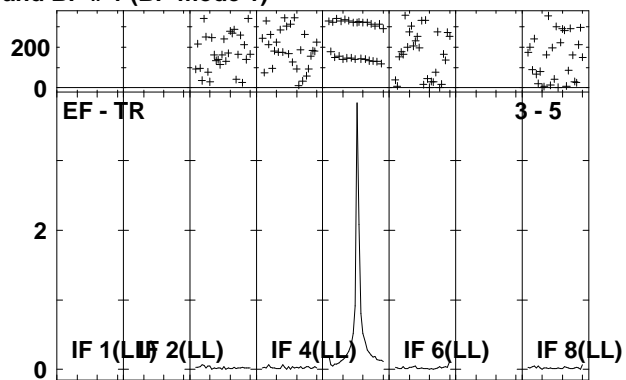
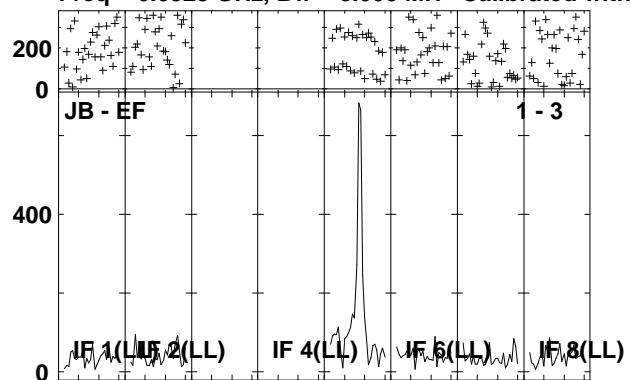

Lower frame: Milli Ampl Jy Top frame: Phas deg
Vector averaged cross-power spectrum Several baselines displayed
Timerange: 00/04:53:11 to 00/04:54:40

Plot file version 126 created 19-AUG-2009 15:51:20

2048+431 EB039B 2.UVDATA.1

Freq = 6.6328 GHz, Bw = 8.000 MH Calibrated with CL # 3 and BP # 1 (BP mode 1)

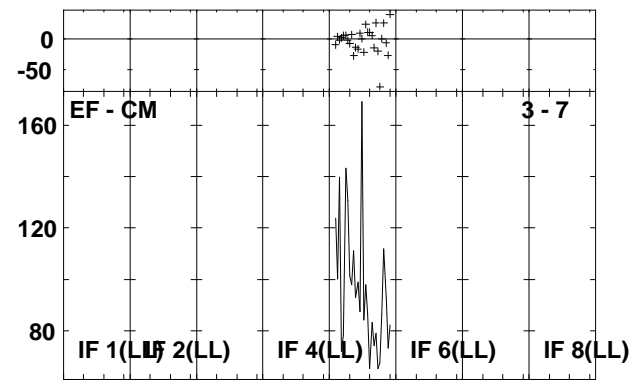
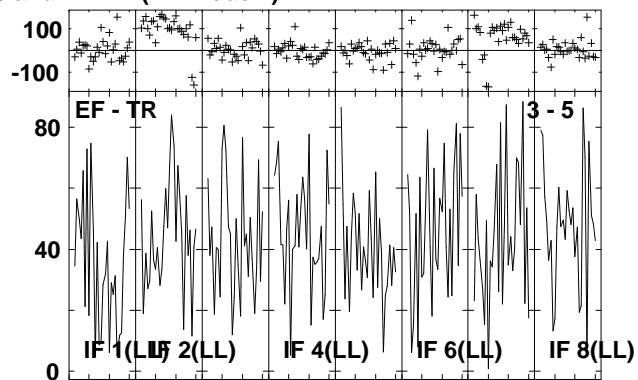
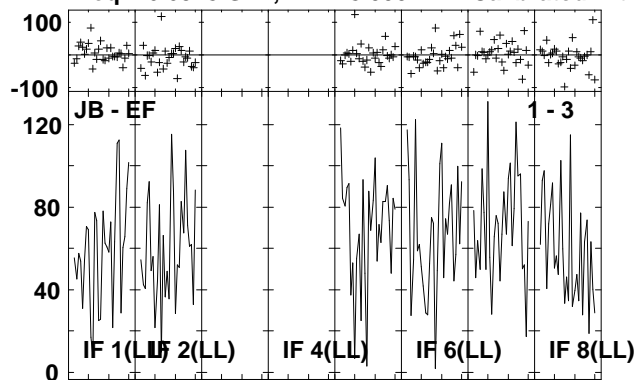

Lower frame: Milli Ampl Jy Top frame: Phas deg
Vector averaged cross-power spectrum Several baselines displayed
Timerange: 00/04:54:40 to 00/04:56:09

Plot file version 127 created 19-AUG-2009 15:51:22
 W75 EB039B 2.UVDATA.1
 Freq = 6.6328 GHz, Bw = 8.000 MH Calibrated with CL # 3 and BP # 1 (BP mode 1)

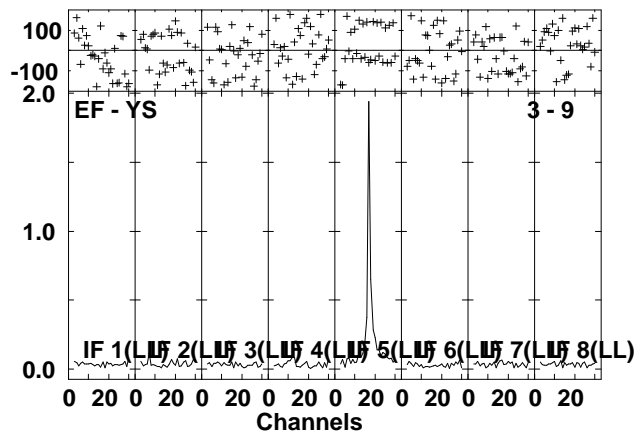
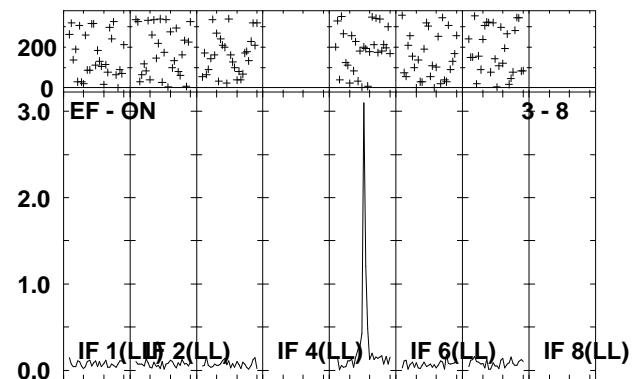
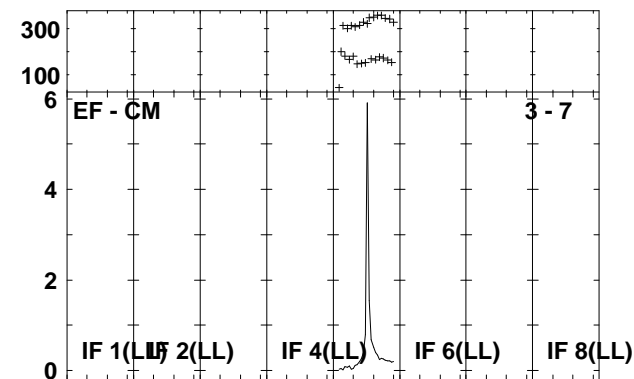
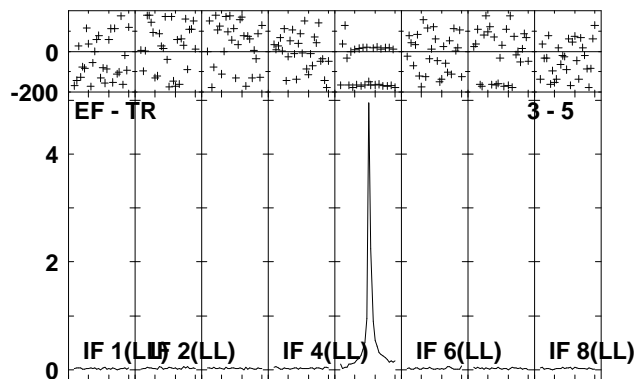
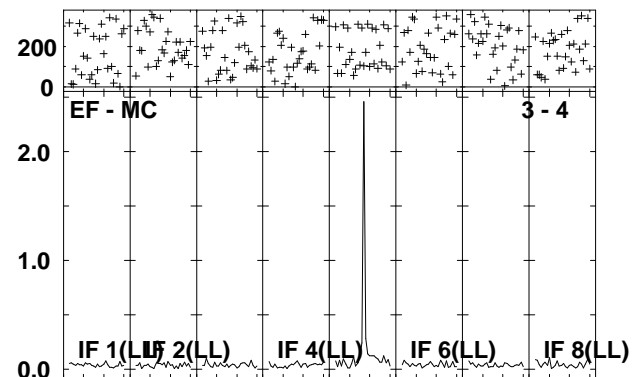
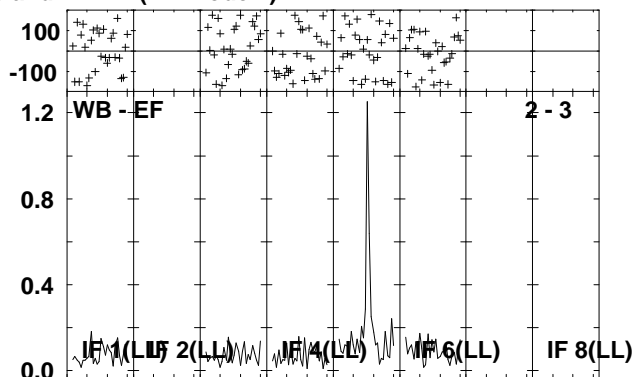
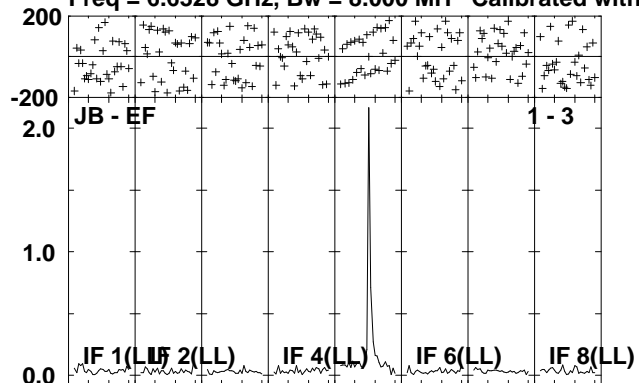

0 20 0 20 0 20 0 20 0 20 0 20 0 20 0 20 0 20 0 20 0 20
 Channels
 Lower frame: Ampl Jy Top frame: Phas deg
 Vector averaged cross-power spectrum Several baselines displayed
 Timerange: 00/04:56:11 to 00/04:57:40

Plot file version 128 created 19-AUG-2009 15:51:25

OB2 EB039B 2.UVDATA.1

Freq = 6.6328 GHz, Bw = 8.000 MH Calibrated with CL # 3 and BP # 1 (BP mode 1)

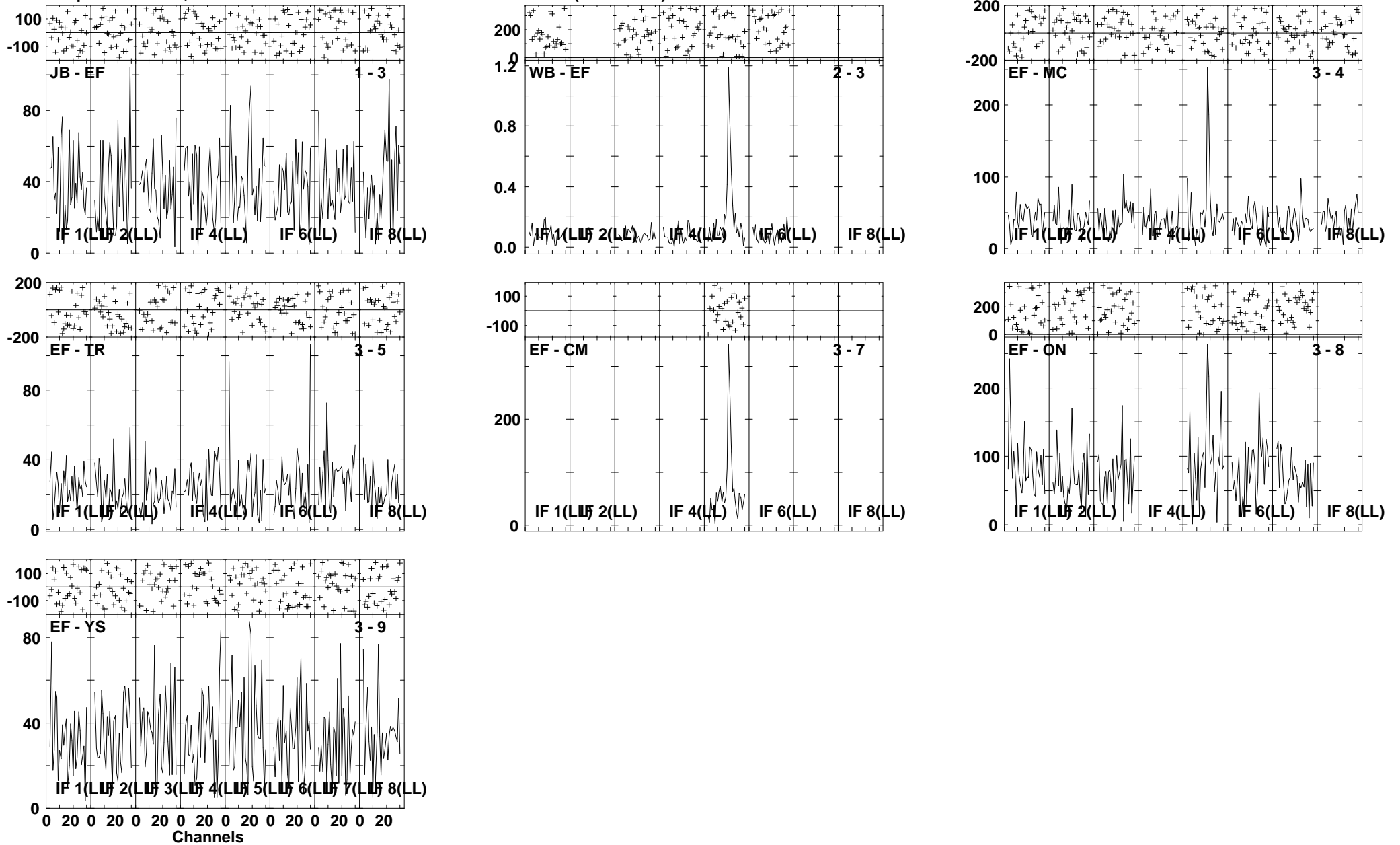

Lower frame: Milli Ampl Jy Top frame: Phas deg
Vector averaged cross-power spectrum Several baselines displayed
Timerange: 00/04:57:40 to 00/04:59:09

Plot file version 129 created 19-AUG-2009 15:51:28

W75 EB039B 2.UVDATA.1

Freq = 6.6328 GHz, Bw = 8.000 MH Calibrated with CL # 3 and BP # 1 (BP mode 1)

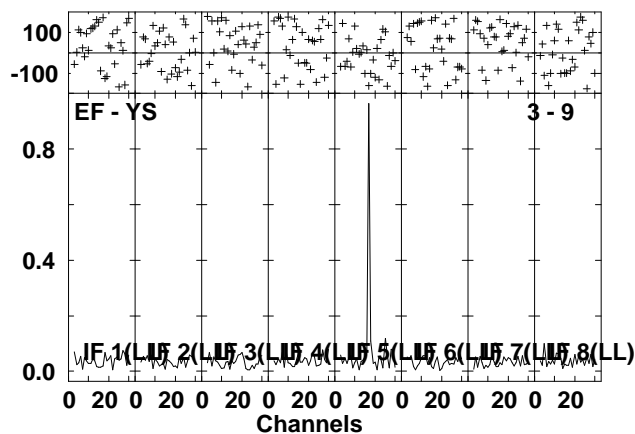
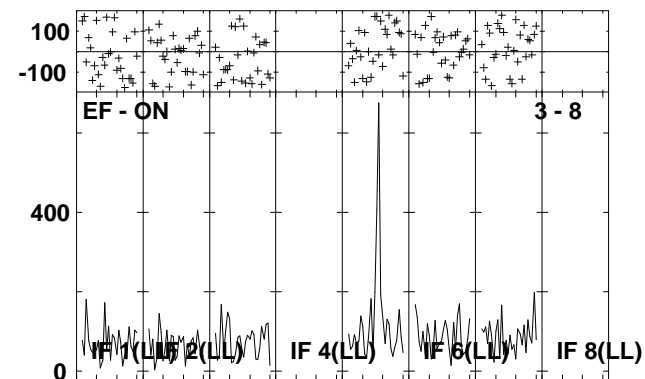
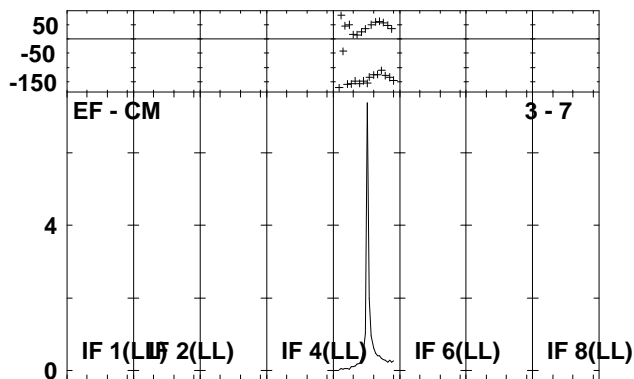
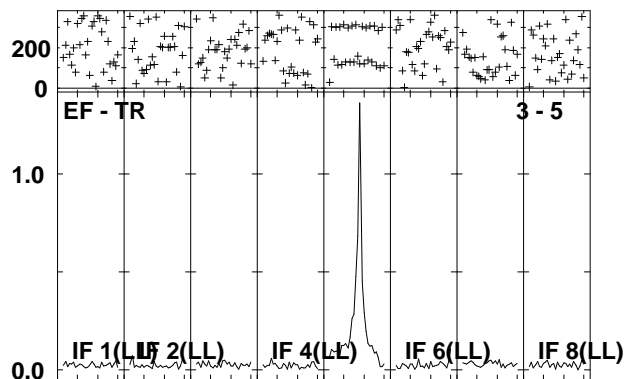
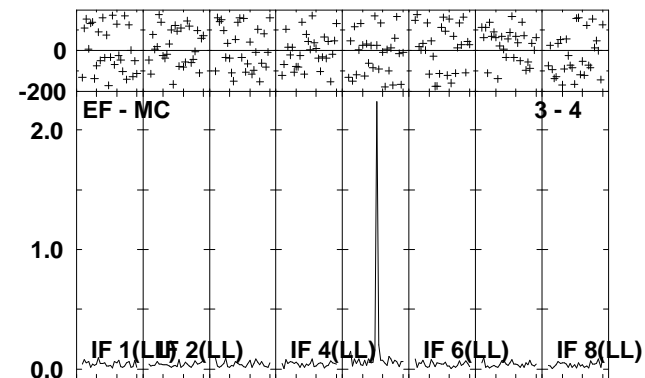
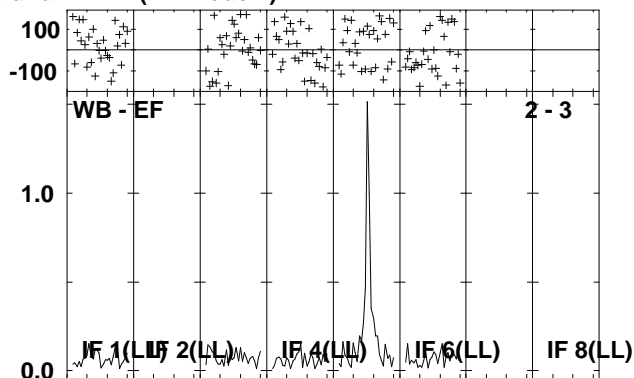
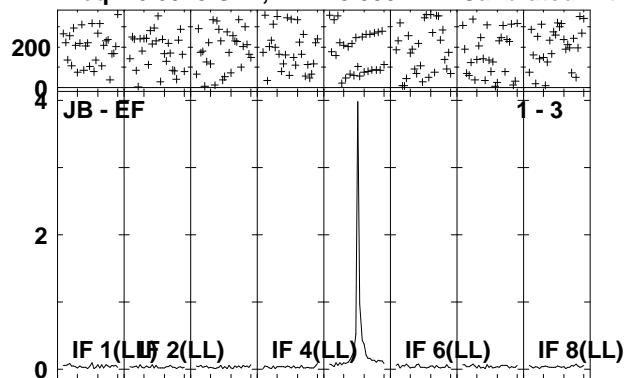

Lower frame: Ampl Jy Top frame: Phas deg
Vector averaged cross-power spectrum Several baselines displayed
Timerange: 00/04:59:45 to 00/05:00:45

Plot file version 130 created 19-AUG-2009 15:51:30
 DR21A EB039B 2.UVDATA.1
 Freq = 6.6328 GHz, Bw = 8.000 MH Calibrated with CL # 3 and BP # 1 (BP mode 1)

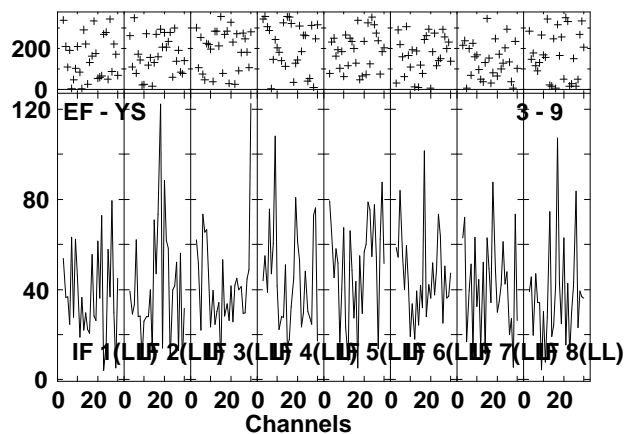
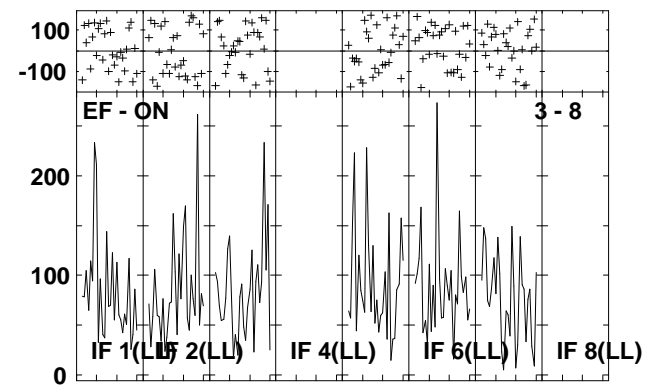
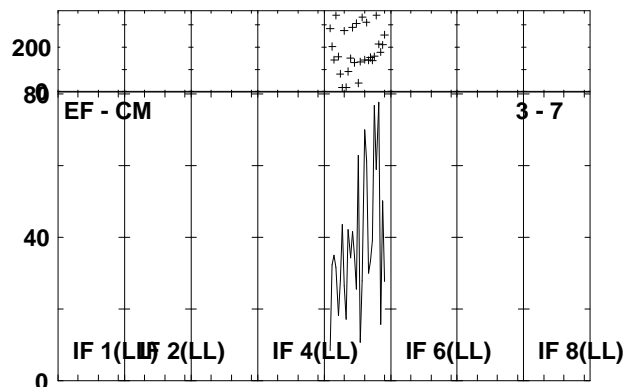
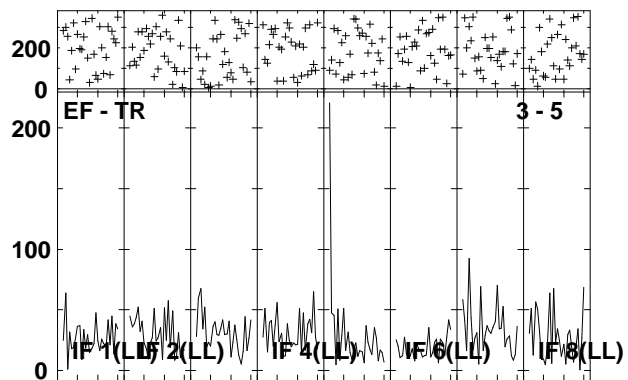
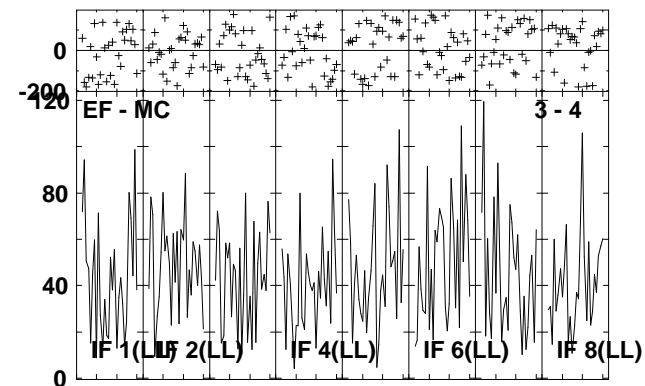
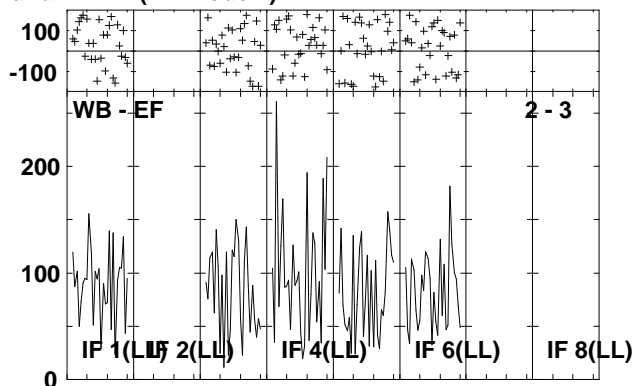
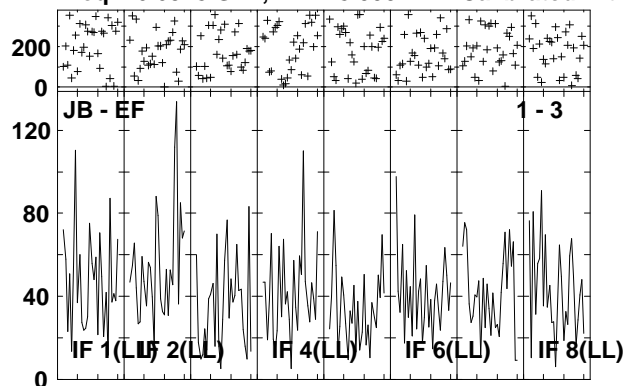

Lower frame: Milli Ampl Jy Top frame: Phas deg
 Vector averaged cross-power spectrum Several baselines displayed
 Timerange: 00/05:00:45 to 00/05:02:14

Plot file version 131 created 19-AUG-2009 15:51:33
 W75 EB039B 2.UVDATA.1
 Freq = 6.6328 GHz, Bw = 8.000 MH Calibrated with CL # 3 and BP # 1 (BP mode 1)

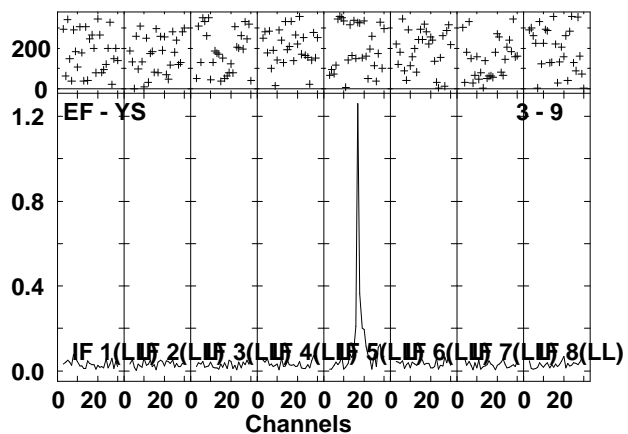
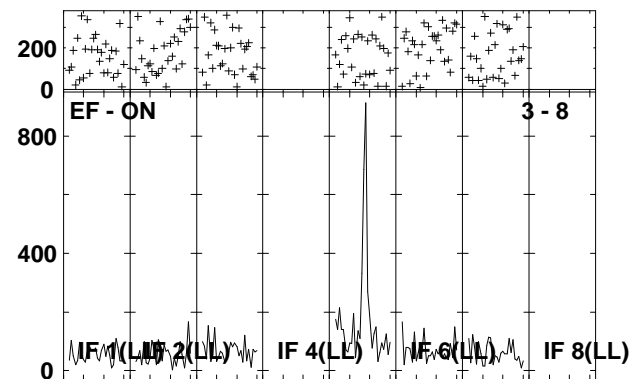
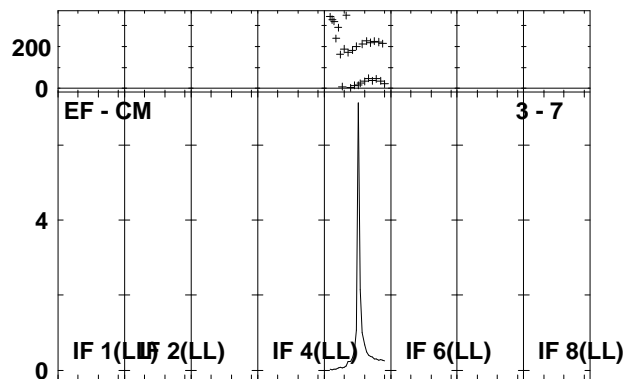
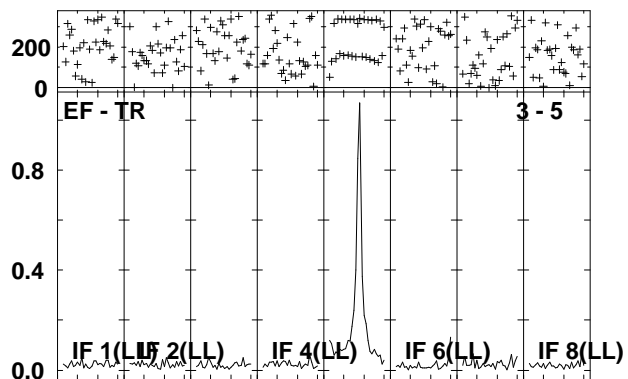
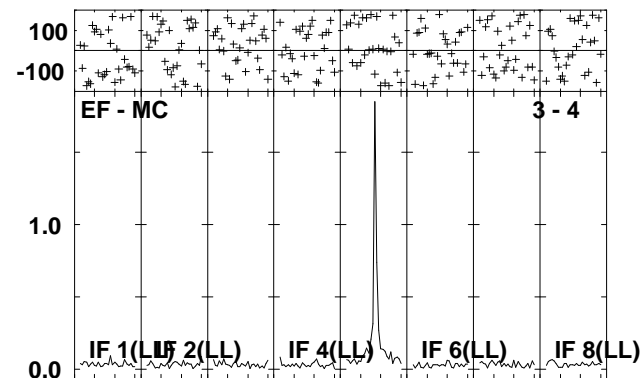
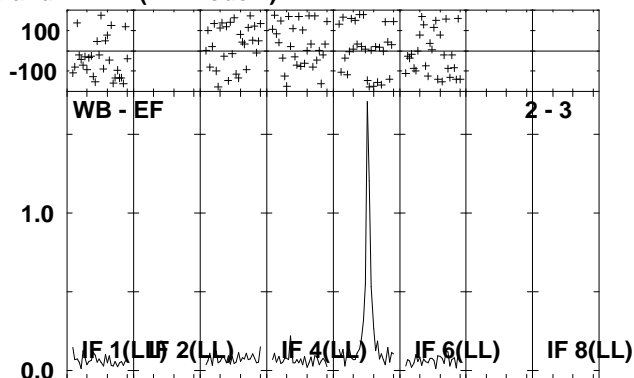
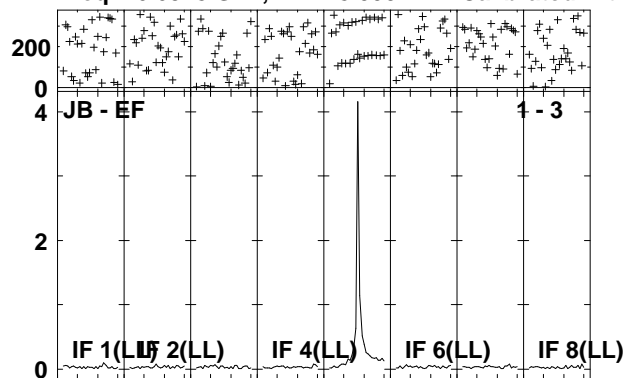

0 20 0 20 0 20 0 20 0 20 0 20 0 20 0 20 0 20
 Channels
 Lower frame: Ampl Jy Top frame: Phas deg
 Vector averaged cross-power spectrum Several baselines displayed
 Timerange: 00/05:02:16 to 00/05:03:45

Plot file version 132 created 19-AUG-2009 15:51:35
 DR21B EB039B 2.UVDATA.1
 Freq = 6.6328 GHz, Bw = 8.000 MH Calibrated with CL # 3 and BP # 1 (BP mode 1)

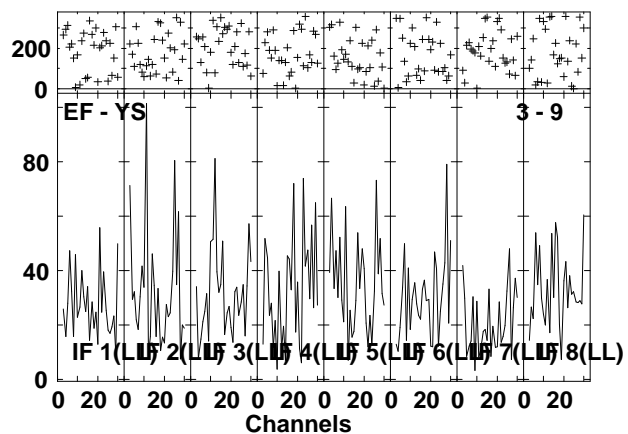
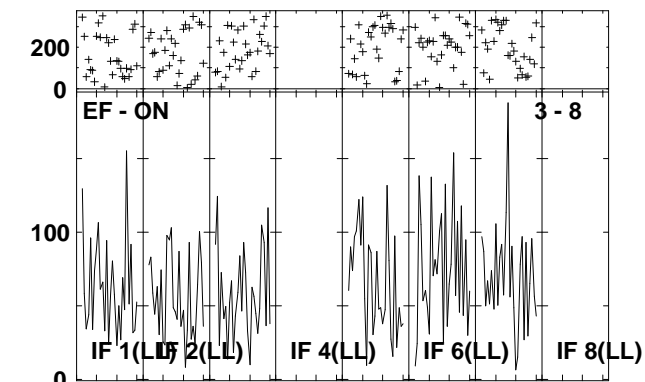
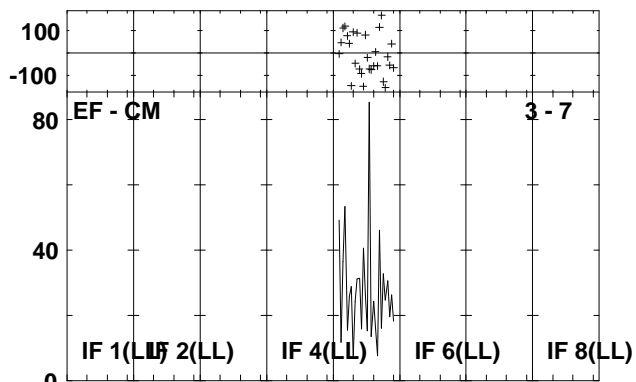
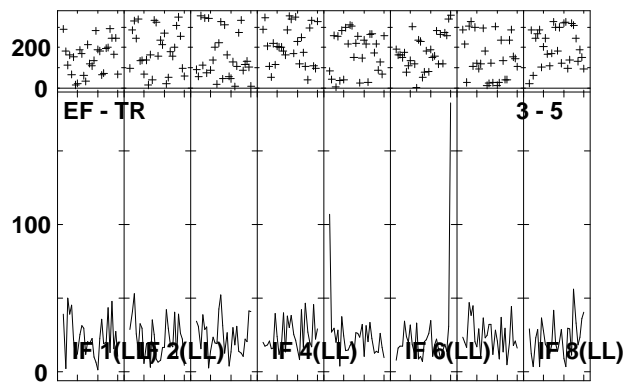
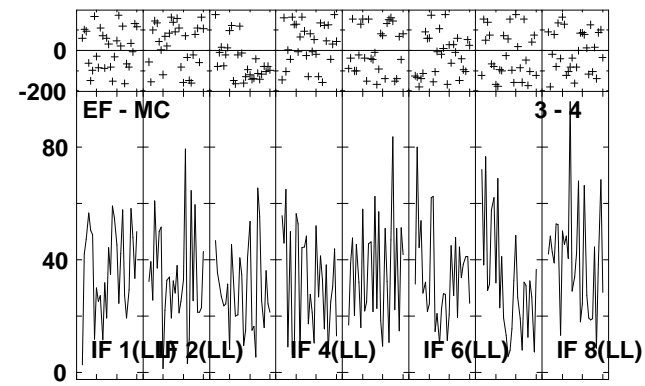
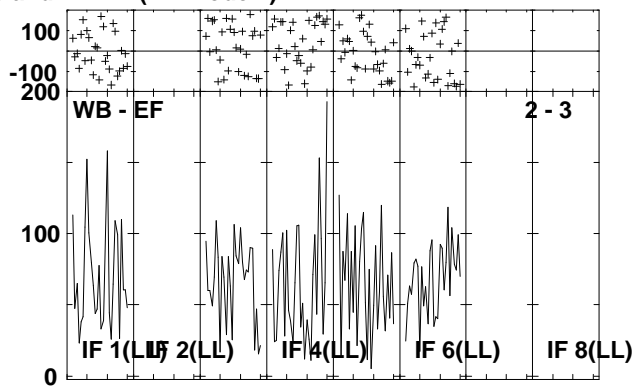
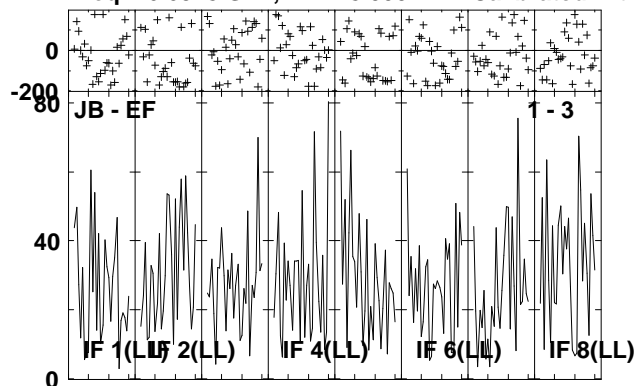

Lower frame: Milli Ampl Jy Top frame: Phas deg
 Vector averaged cross-power spectrum Several baselines displayed
 Timerange: 00/05:03:45 to 00/05:05:14

Plot file version 133 created 19-AUG-2009 15:51:38
 W75 EB039B 2.UVDATA.1
 Freq = 6.6328 GHz, Bw = 8.000 MH Calibrated with CL # 3 and BP # 1 (BP mode 1)

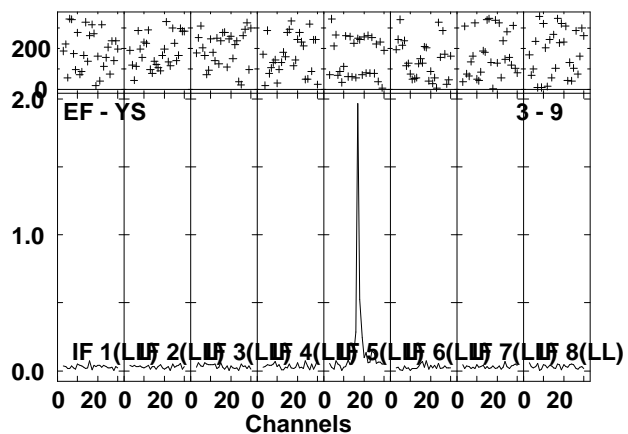
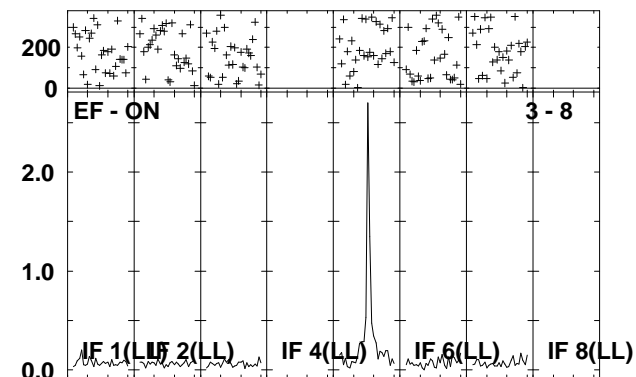
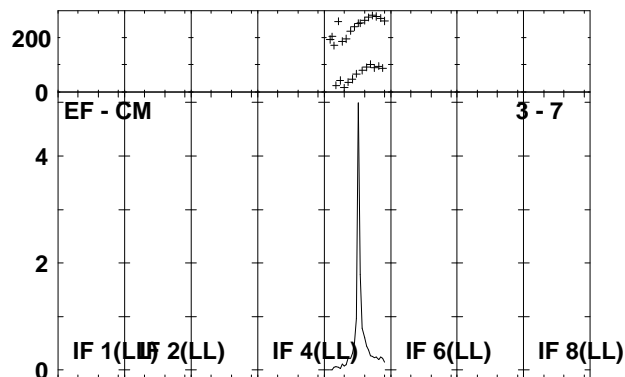
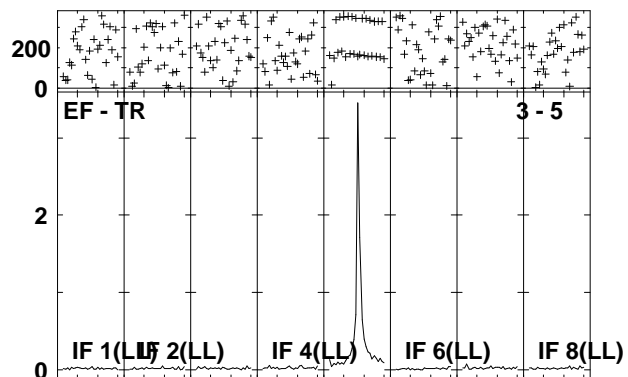
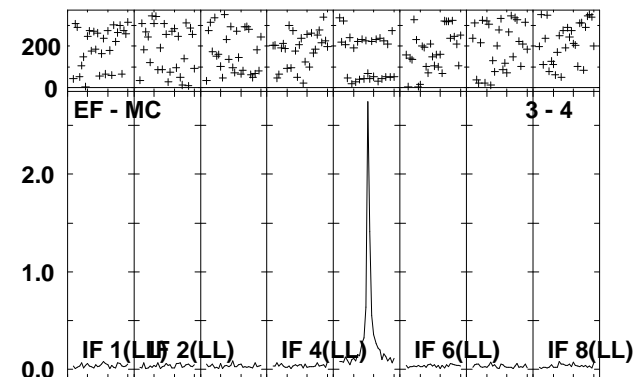
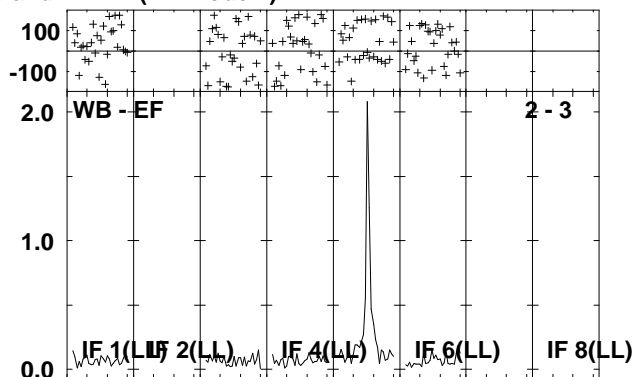
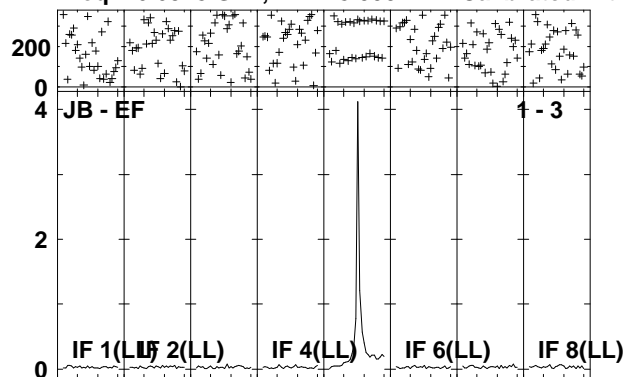

Lower frame: Ampl Jy Top frame: Phas deg
 Vector averaged cross-power spectrum Several baselines displayed
 Timerange: 00/05:05:16 to 00/05:06:45

Plot file version 134 created 19-AUG-2009 15:51:41
 DR21B2 EB039B 2.UVDATA.1
 Freq = 6.6328 GHz, Bw = 8.000 MH Calibrated with CL # 3 and BP # 1 (BP mode 1)

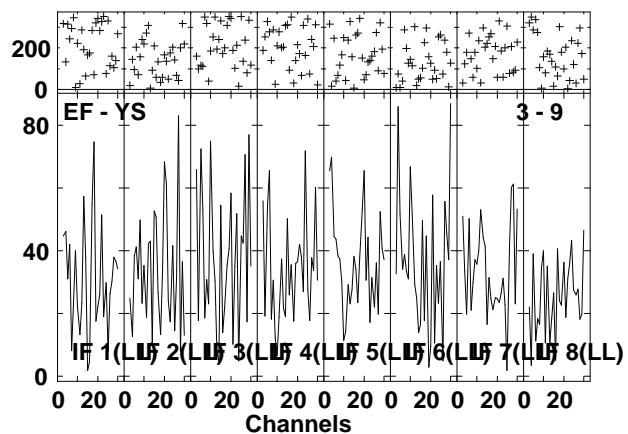
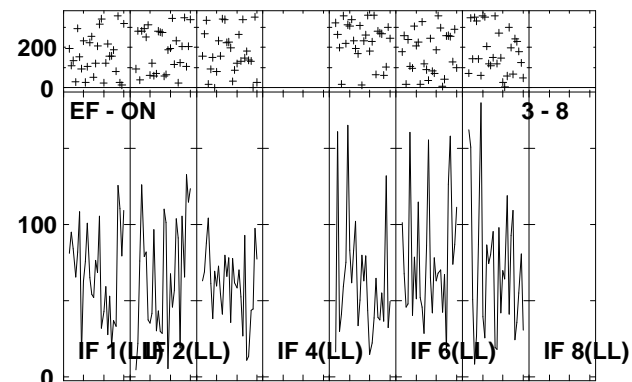
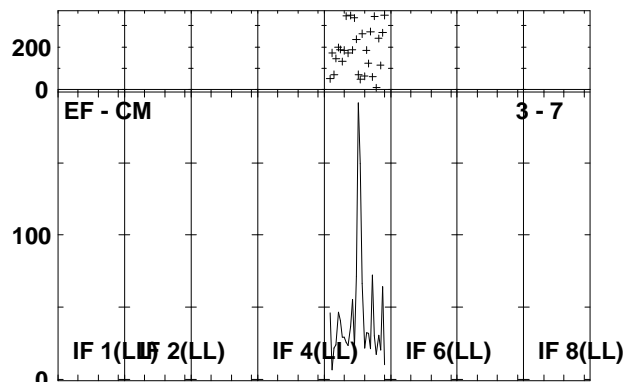
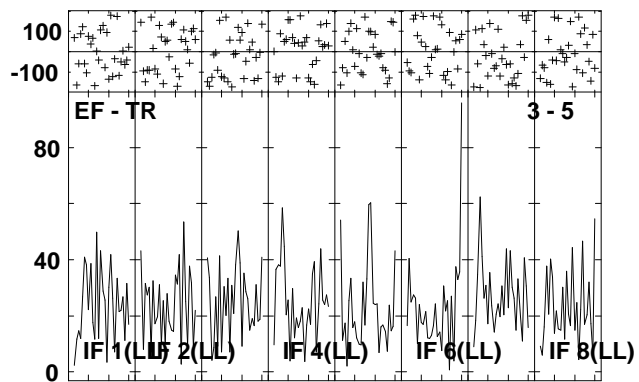
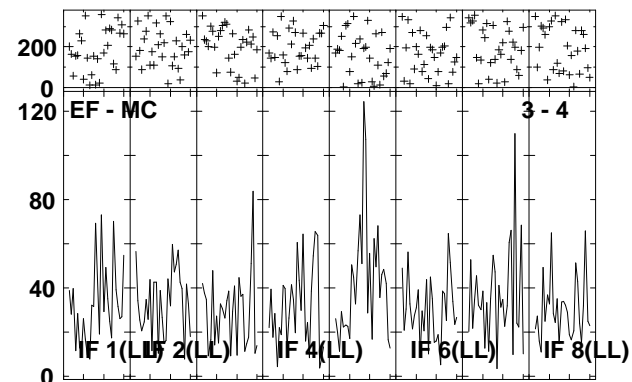
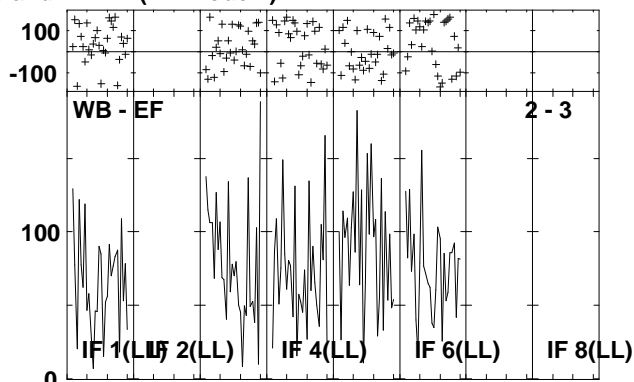
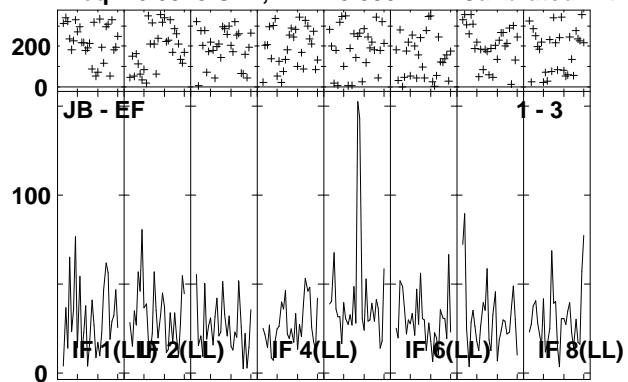

Lower frame: Milli Ampl Jy Top frame: Phas deg
 Vector averaged cross-power spectrum Several baselines displayed
 Timerange: 00/05:06:45 to 00/05:08:14

Plot file version 135 created 19-AUG-2009 15:51:44
 W75 EB039B 2.UVDATA.1
 Freq = 6.6328 GHz, Bw = 8.000 MH Calibrated with CL # 3 and BP # 1 (BP mode 1)

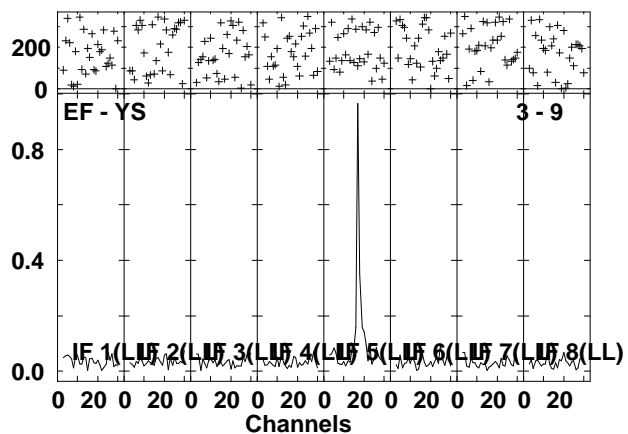
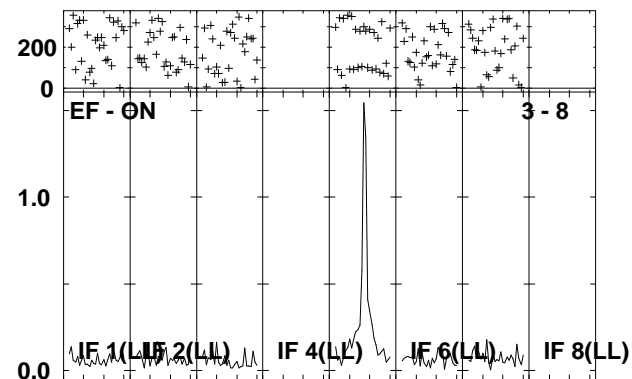
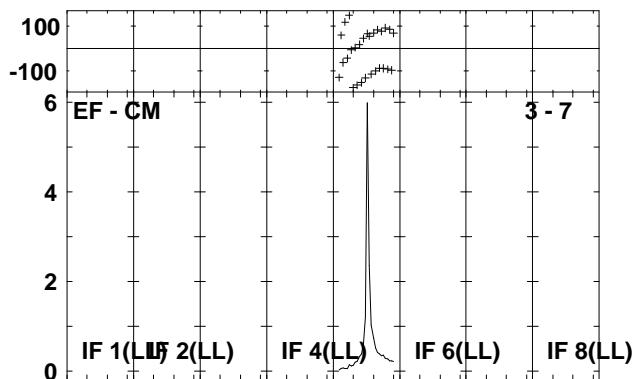
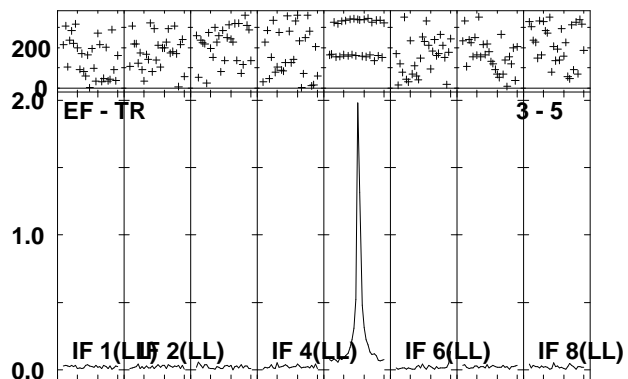
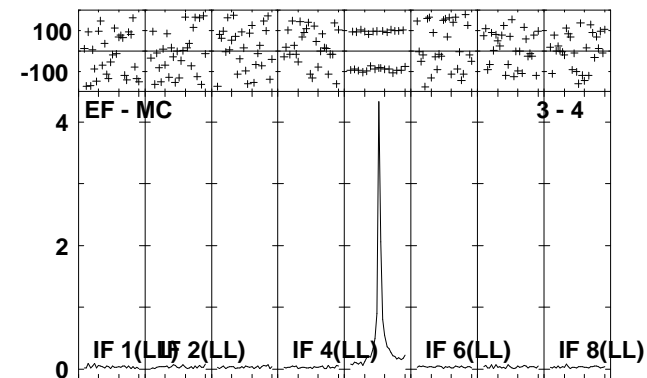
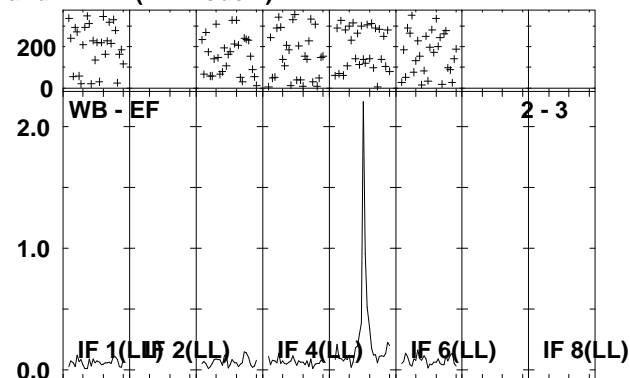
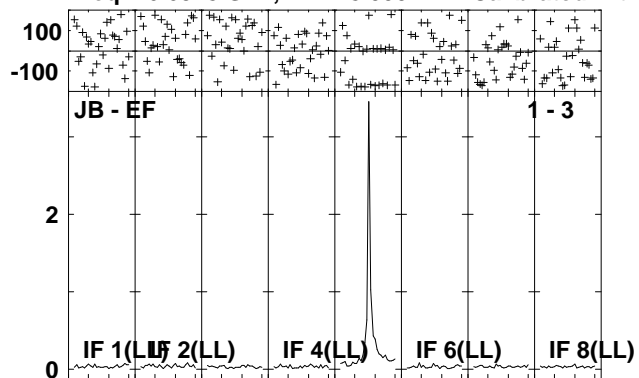

Lower frame: Ampl Jy Top frame: Phas deg
 Vector averaged cross-power spectrum Several baselines displayed
 Timerange: 00/05:08:16 to 00/05:09:45

Plot file version 136 created 19-AUG-2009 15:51:47
 DR20 EB039B 2.UVDATA.1
 Freq = 6.6328 GHz, Bw = 8.000 MH Calibrated with CL # 3 and BP # 1 (BP mode 1)

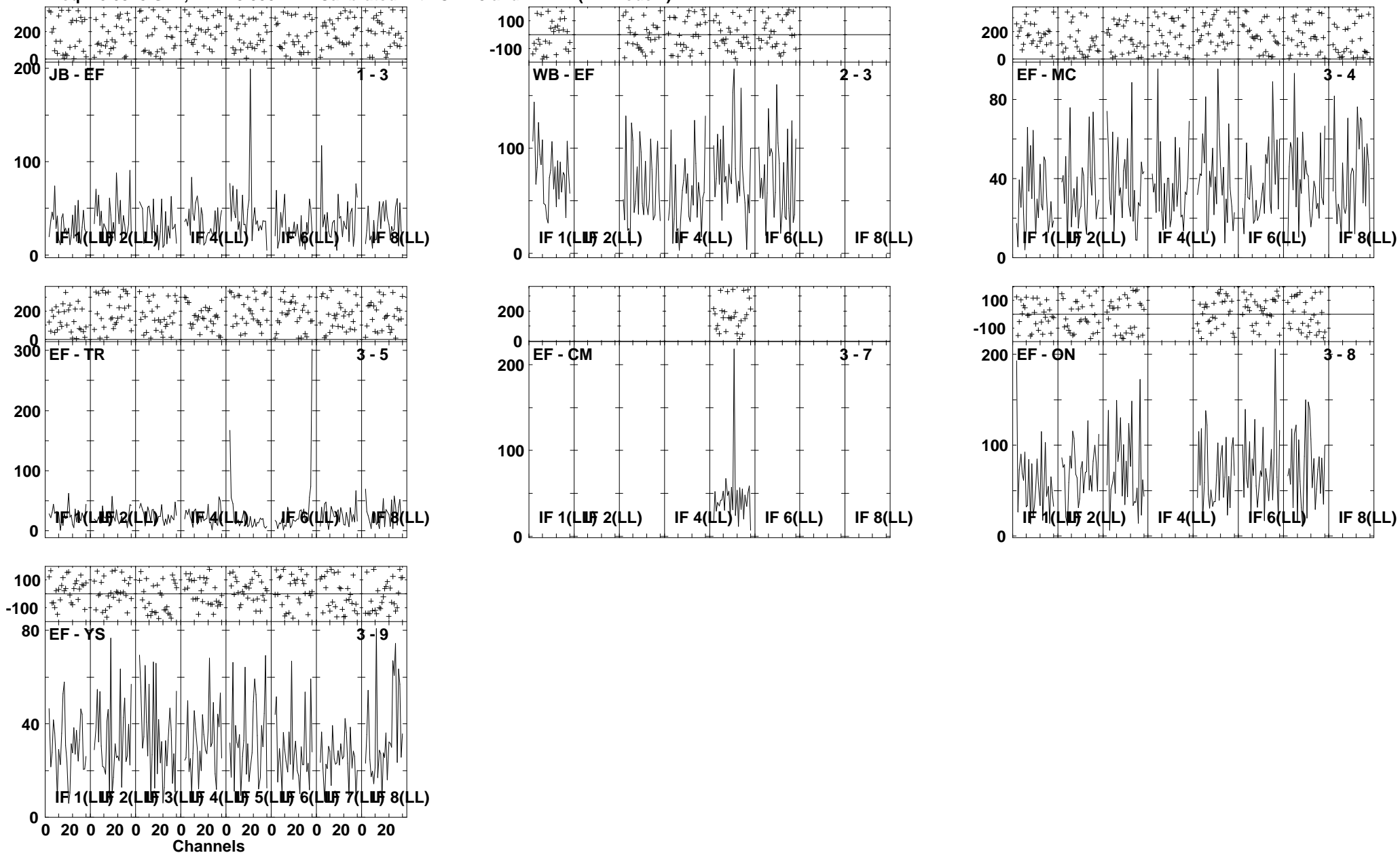

Lower frame: Milli Ampl Jy Top frame: Phas deg
 Vector averaged cross-power spectrum Several baselines displayed
 Timerange: 00/05:09:45 to 00/05:11:13

Plot file version 137 created 19-AUG-2009 15:51:50
 W75 EB039B 2.UVDATA.1
 Freq = 6.6328 GHz, Bw = 8.000 MH Calibrated with CL # 3 and BP # 1 (BP mode 1)

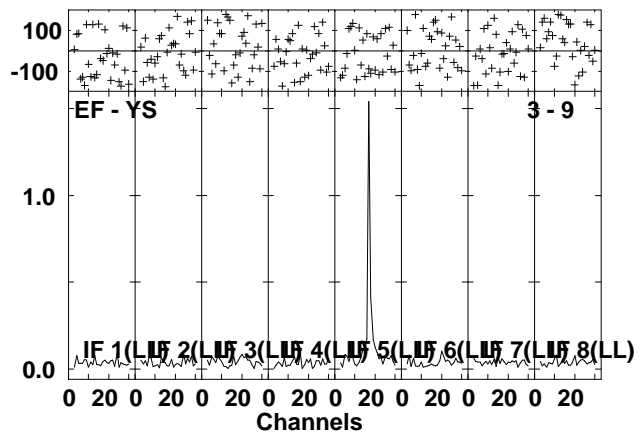
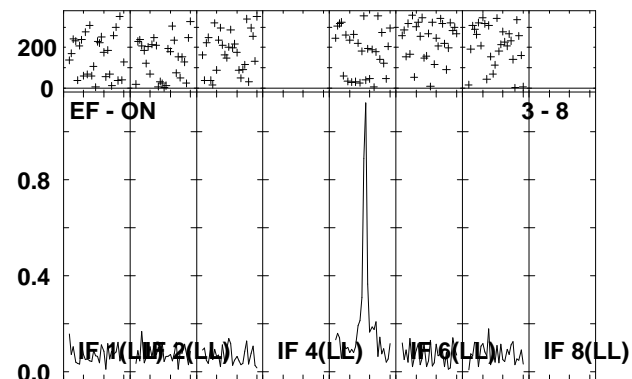
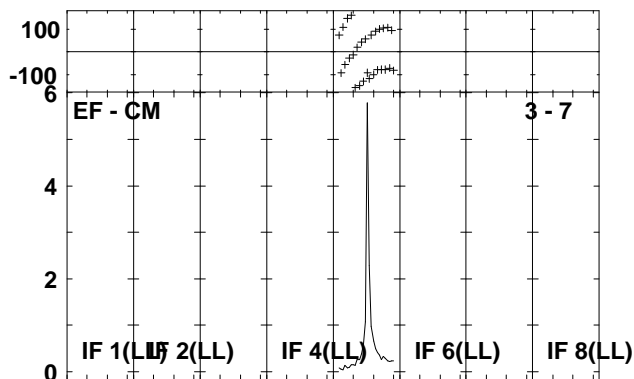
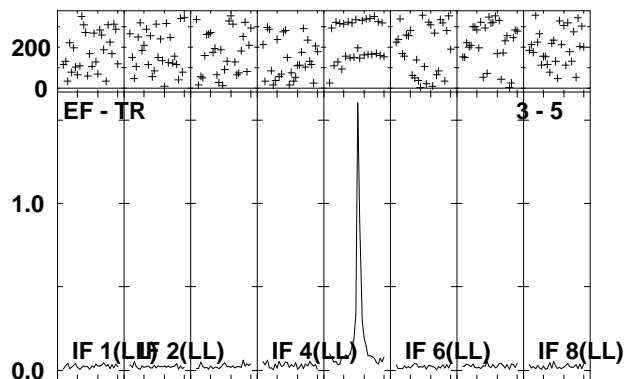
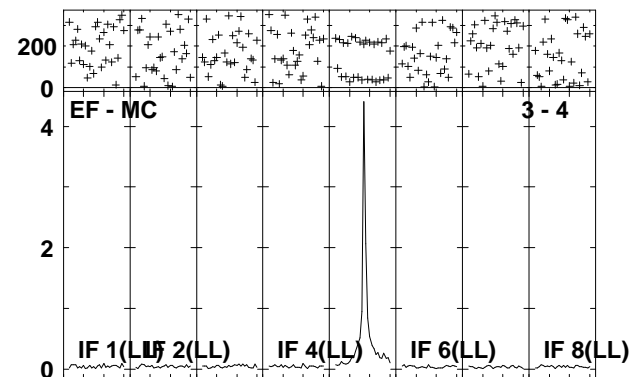
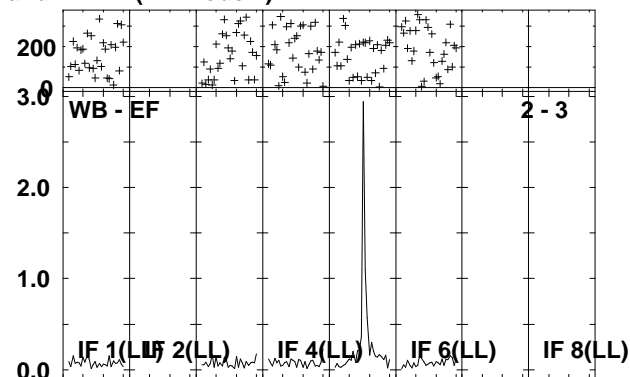
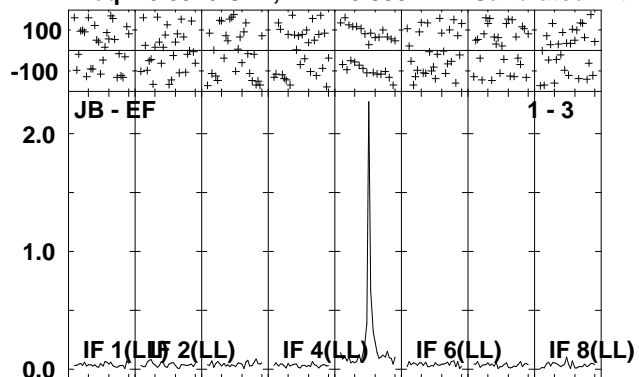

0 20 0 20 0 20 0 20 0 20 0 20 0 20 0 20 0 20 0 20
 Channels
 Lower frame: Ampl Jy Top frame: Phas deg
 Vector averaged cross-power spectrum Several baselines displayed
 Timerange: 00/05:11:42 to 00/05:12:40

Plot file version 138 created 19-AUG-2009 15:51:52

J2029+46 EB039B 2.UVDATA.1

Freq = 6.6328 GHz, Bw = 8.000 MH Calibrated with CL # 3 and BP # 1 (BP mode 1)

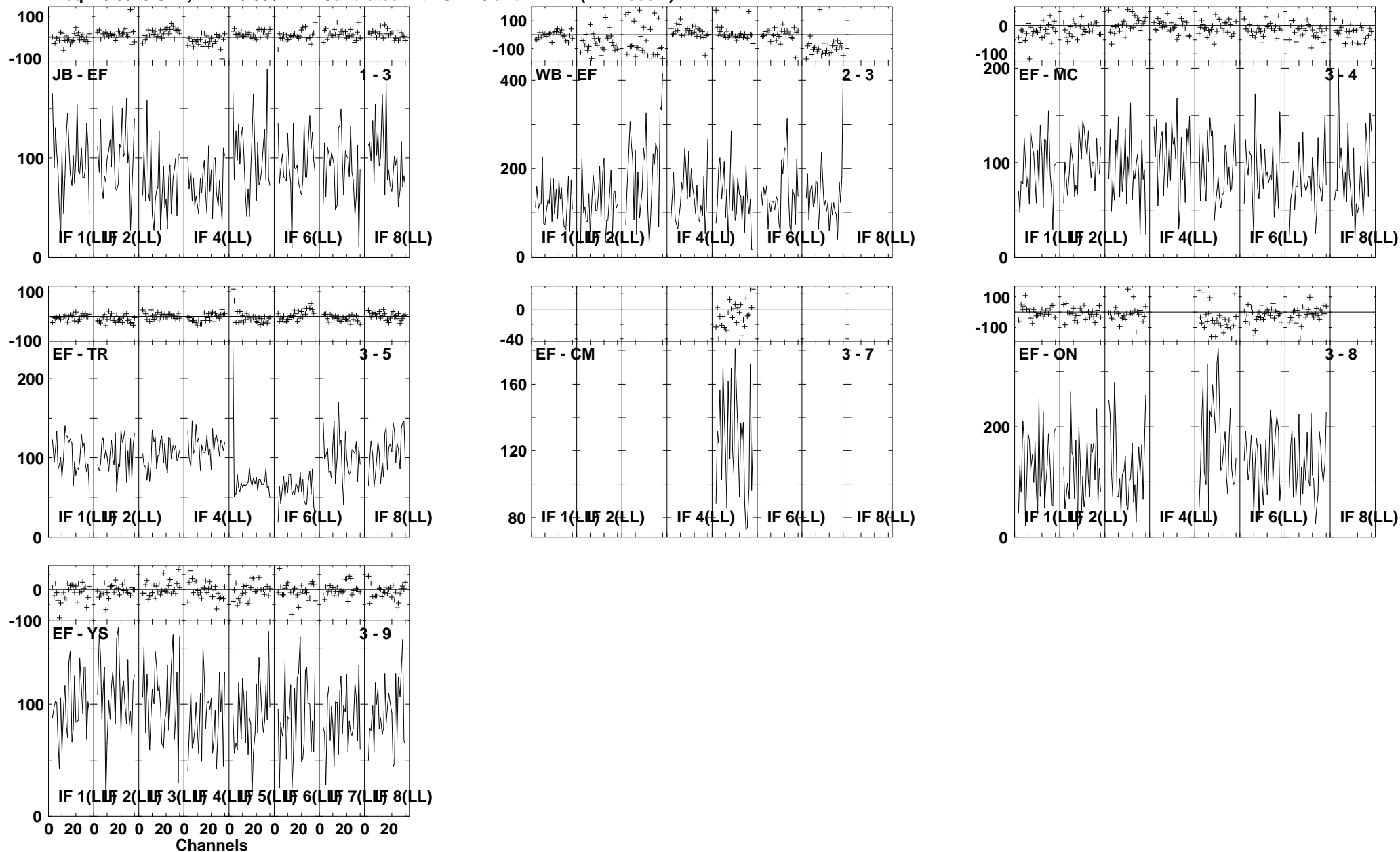

Lower frame: Milli Ampl Jy Top frame: Phas deg
Vector averaged cross-power spectrum Several baselines displayed
Timerange: 00/05:12:42 to 00/05:14:10

Plot file version 139 created 19-AUG-2009 15:51:54

W75 EB039B 2.UVDATA.1

Freq = 6.6328 GHz, Bw = 8.000 MH Calibrated with CL # 3 and BP # 1 (BP mode 1)

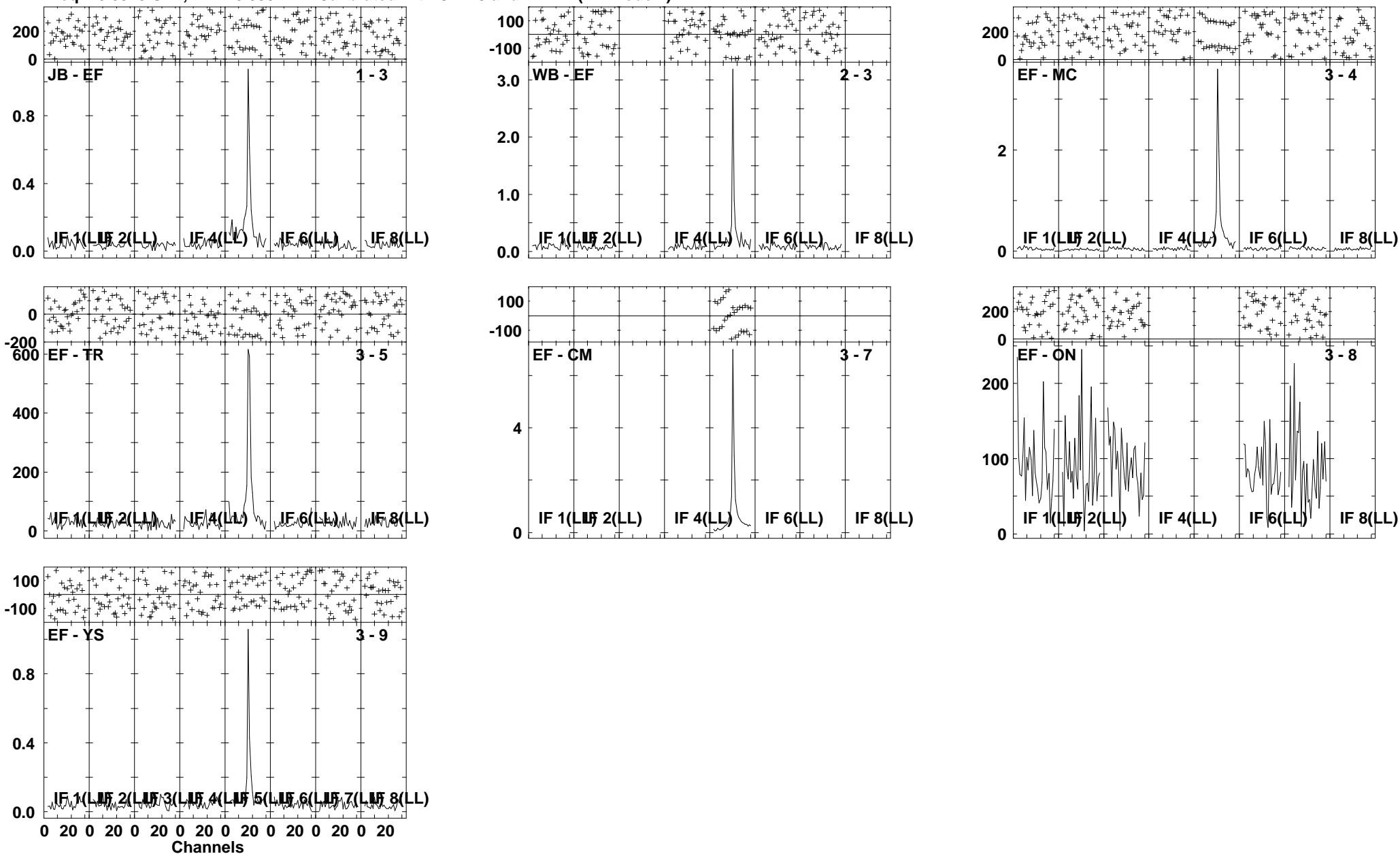

Lower frame: Ampl Jy Top frame: Phas deg
Vector averaged cross-power spectrum Several baselines displayed
Timerange: 00/05:14:13 to 00/05:15:41

Plot file version 140 created 19-AUG-2009 15:51:59

W75 EB039B 2.UVDATA.1

Freq = 6.6328 GHz, Bw = 8.000 MH Calibrated with CL # 3 and BP # 1 (BP mode 1)

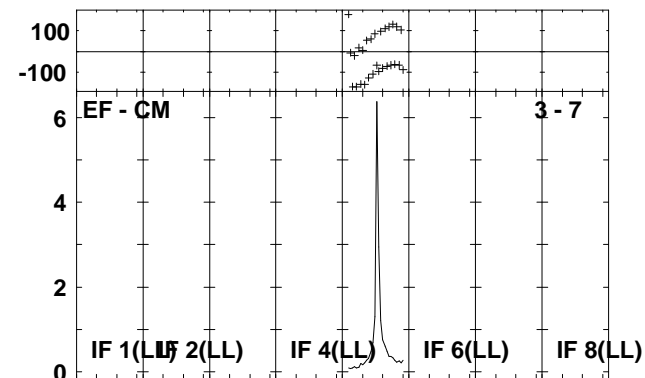
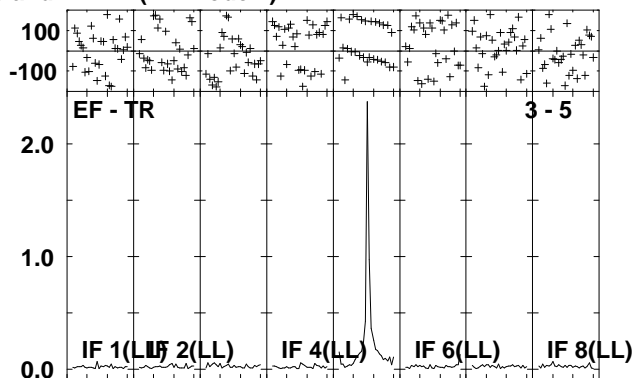
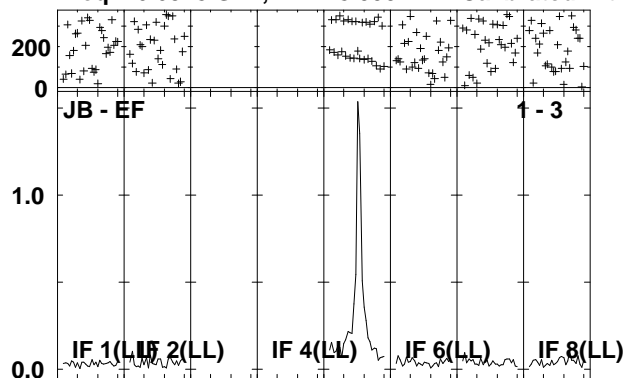

Lower frame: Ampl Jy Top frame: Phas deg
Vector averaged cross-power spectrum Several baselines displayed
Timerange: 00/05:17:13 to 00/05:18:41

Plot file version 141 created 19-AUG-2009 15:52:01
2048+431 EB039B 2.UVDATA.1
Freq = 6.6328 GHz, Bw = 8.000 MH Calibrated with CL # 3 and BP # 1 (BP mode 1)

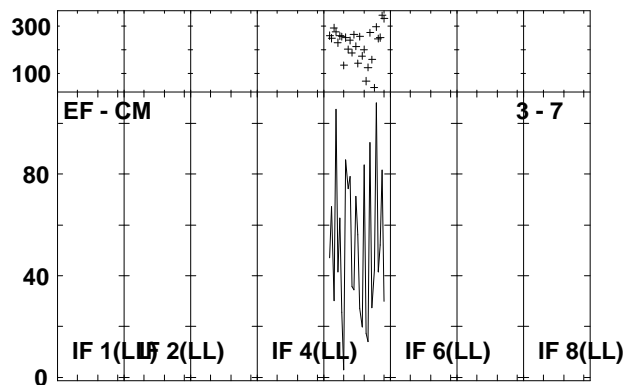
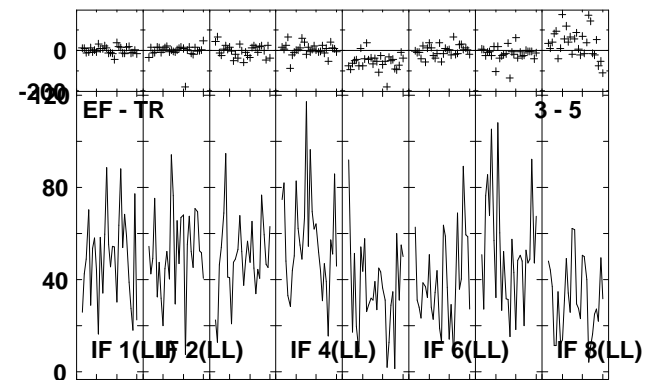
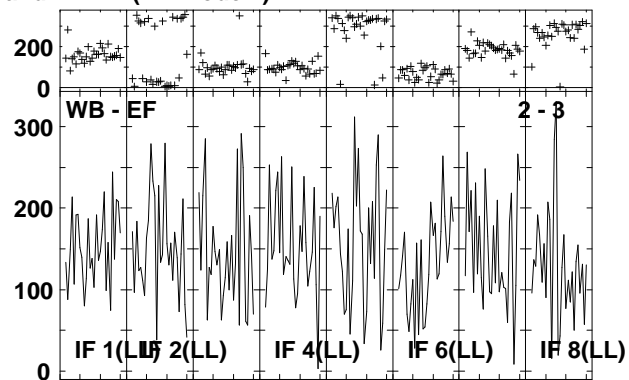
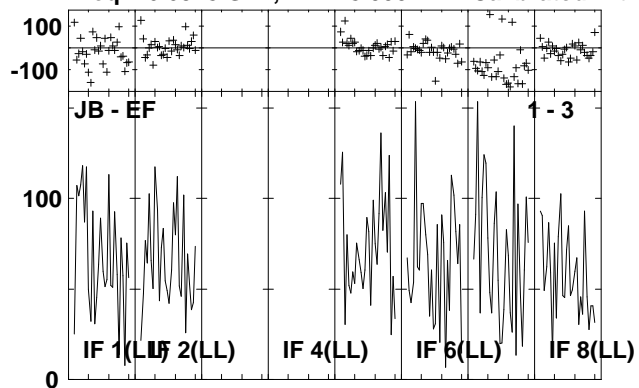

Lower frame: Milli Ampl Jy Top frame: Phas deg
Vector averaged cross-power spectrum Several baselines displayed
Timerange: 00/05:18:43 to 00/05:20:11

Plot file version 142 created 19-AUG-2009 15:52:03

W75 EB039B 2.UVDATA.1

Freq = 6.6328 GHz, Bw = 8.000 MH Calibrated with CL # 3 and BP # 1 (BP mode 1)

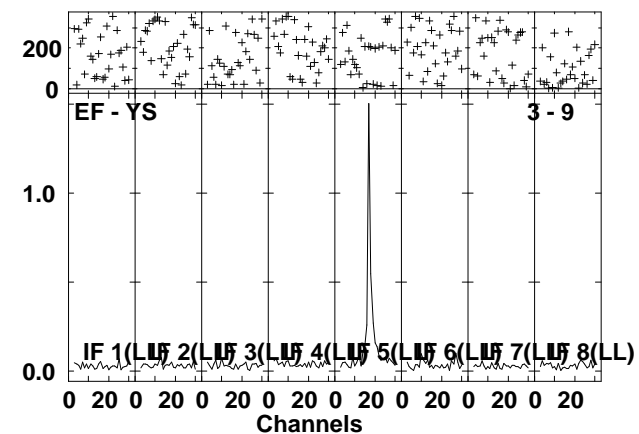
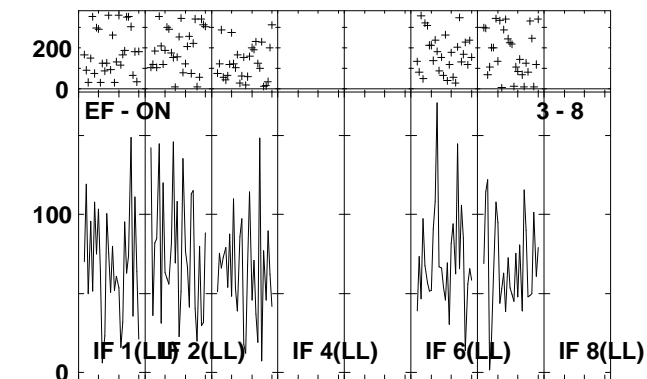
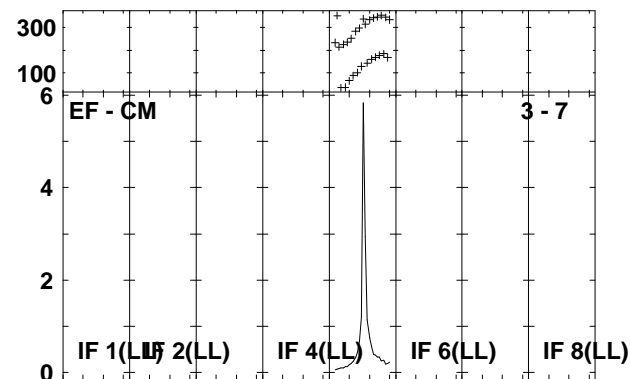
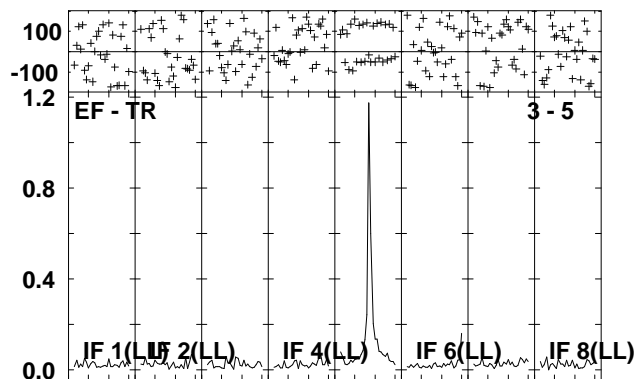
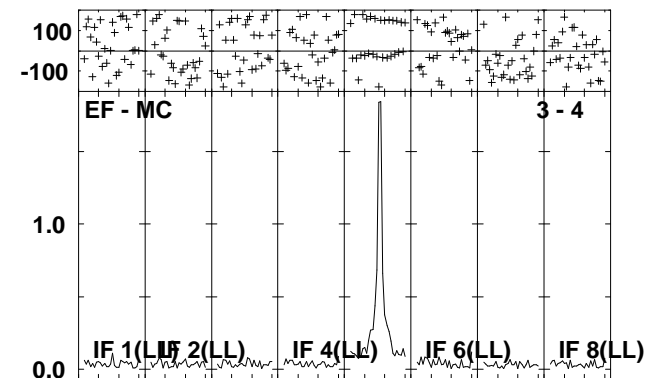
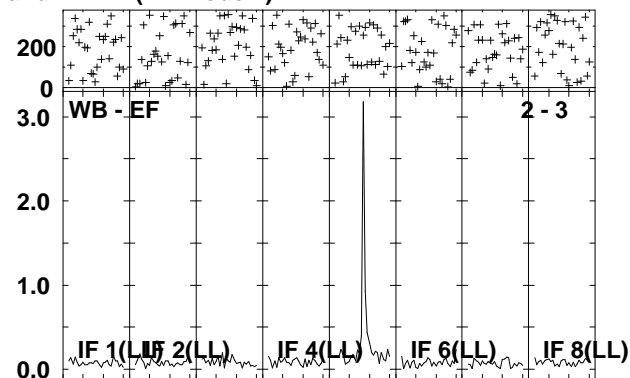
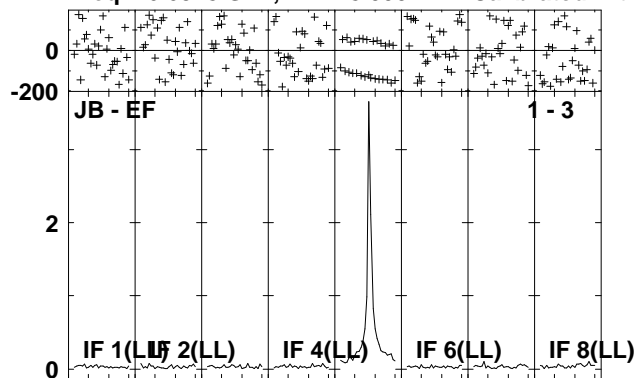

Lower frame: Ampl Jy Top frame: Phas deg
Vector averaged cross-power spectrum Several baselines displayed
Timerange: 00/05:20:13 to 00/05:21:41

Plot file version 143 created 19-AUG-2009 15:52:06

OB2 EB039B 2.UVDATA.1

Freq = 6.6328 GHz, Bw = 8.000 MH Calibrated with CL # 3 and BP # 1 (BP mode 1)

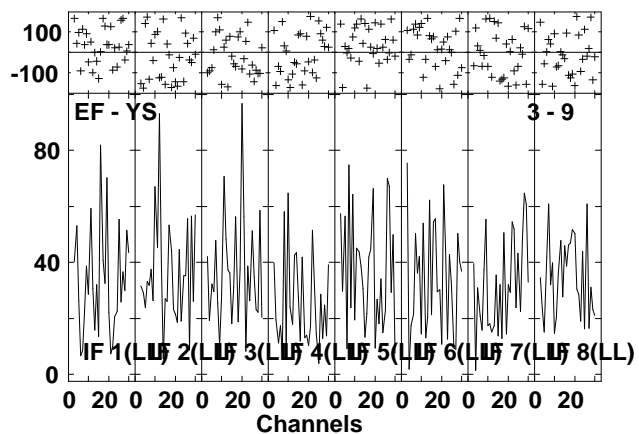
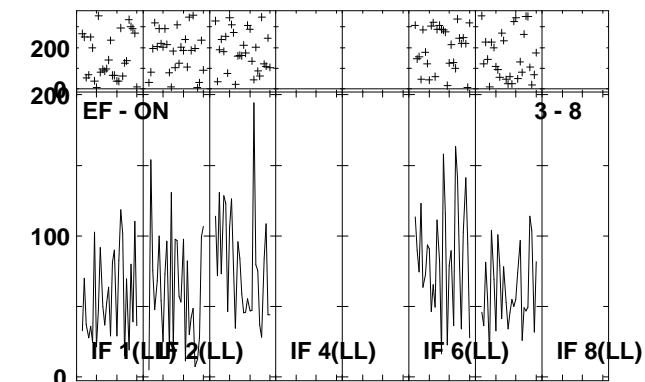
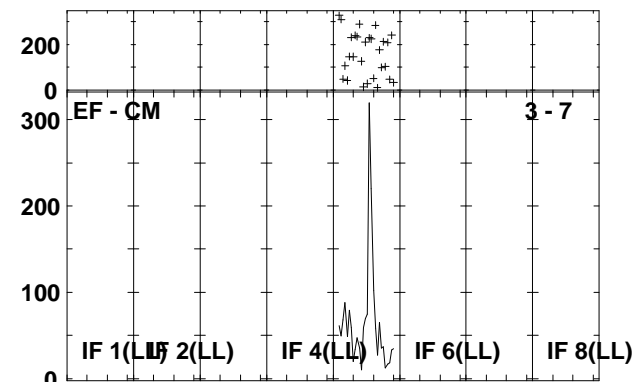
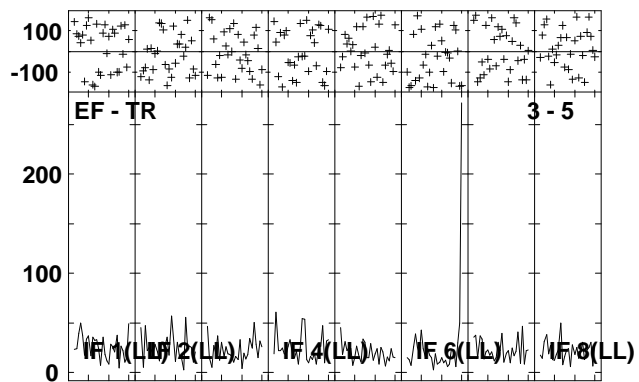
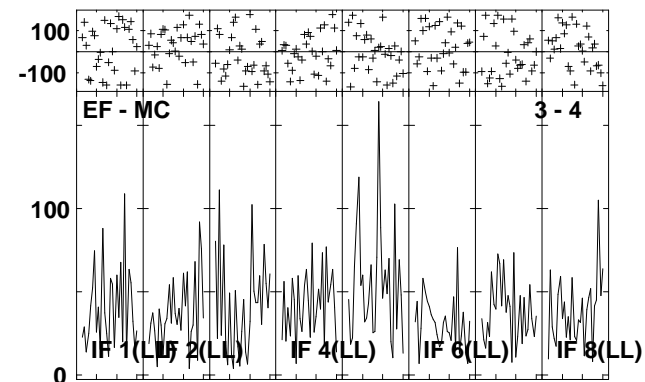
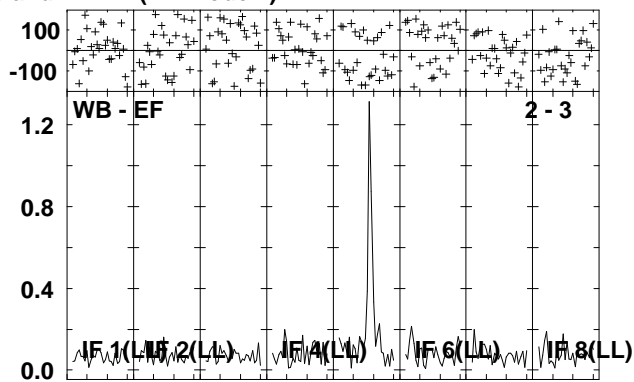
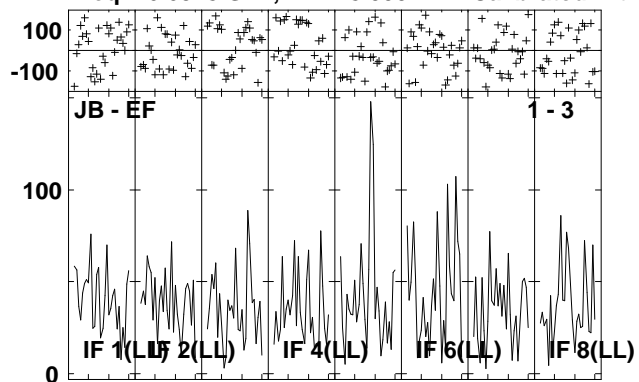

Lower frame: Milli Ampl Jy Top frame: Phas deg
Vector averaged cross-power spectrum Several baselines displayed
Timerange: 00/05:21:43 to 00/05:23:11

Plot file version 144 created 19-AUG-2009 15:52:09

W75 EB039B 2.UVDATA.1

Freq = 6.6328 GHz, Bw = 8.000 MH Calibrated with CL # 3 and BP # 1 (BP mode 1)

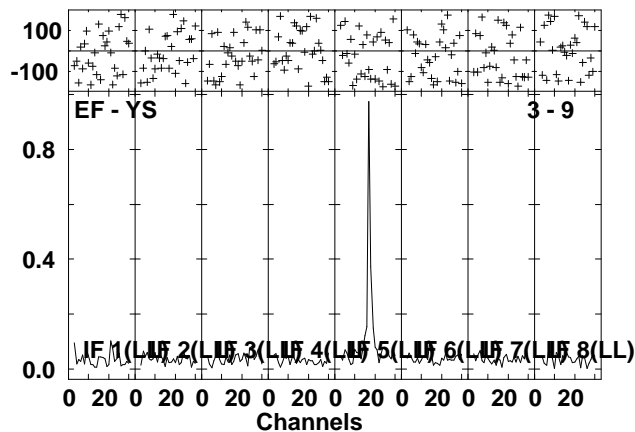
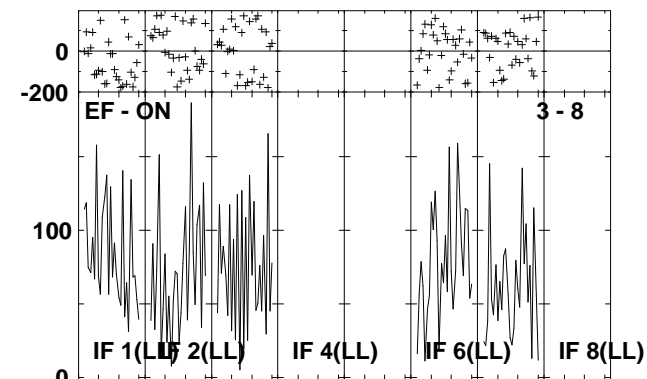
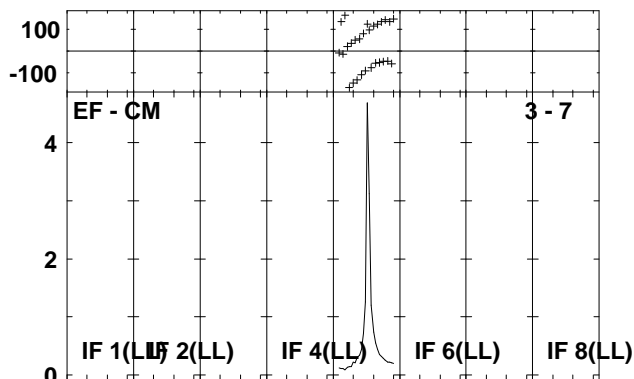
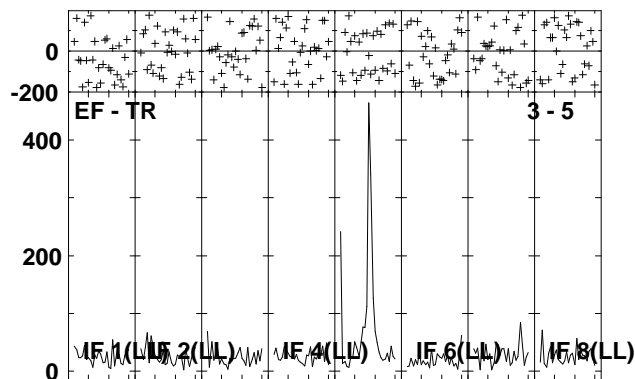
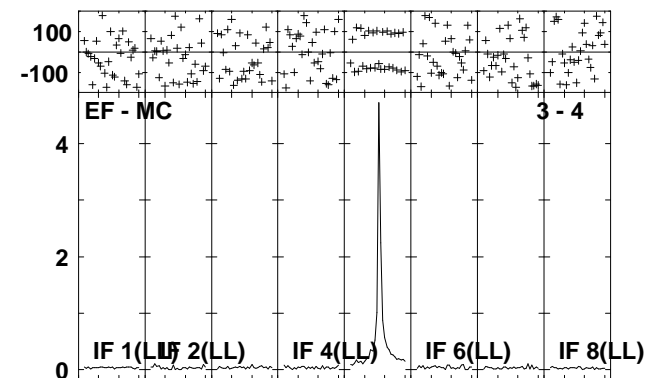
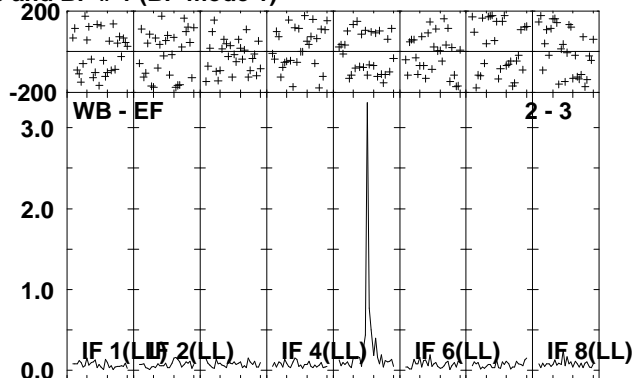
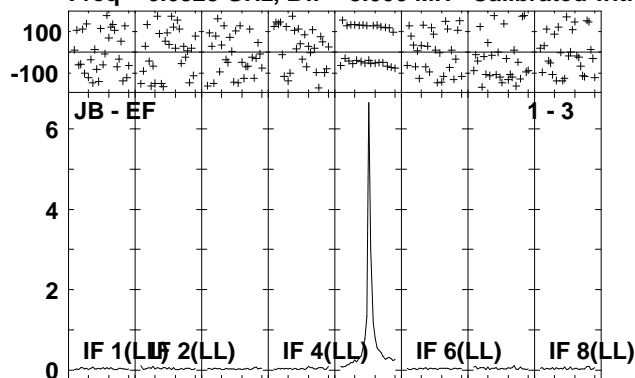

Lower frame: Ampl Jy Top frame: Phas deg
Vector averaged cross-power spectrum Several baselines displayed
Timerange: 00/05:23:50 to 00/05:24:48

Plot file version 145 created 19-AUG-2009 15:52:11
 DR21A EB039B 2.UVDATA.1
 Freq = 6.6328 GHz, Bw = 8.000 MH Calibrated with CL # 3 and BP # 1 (BP mode 1)

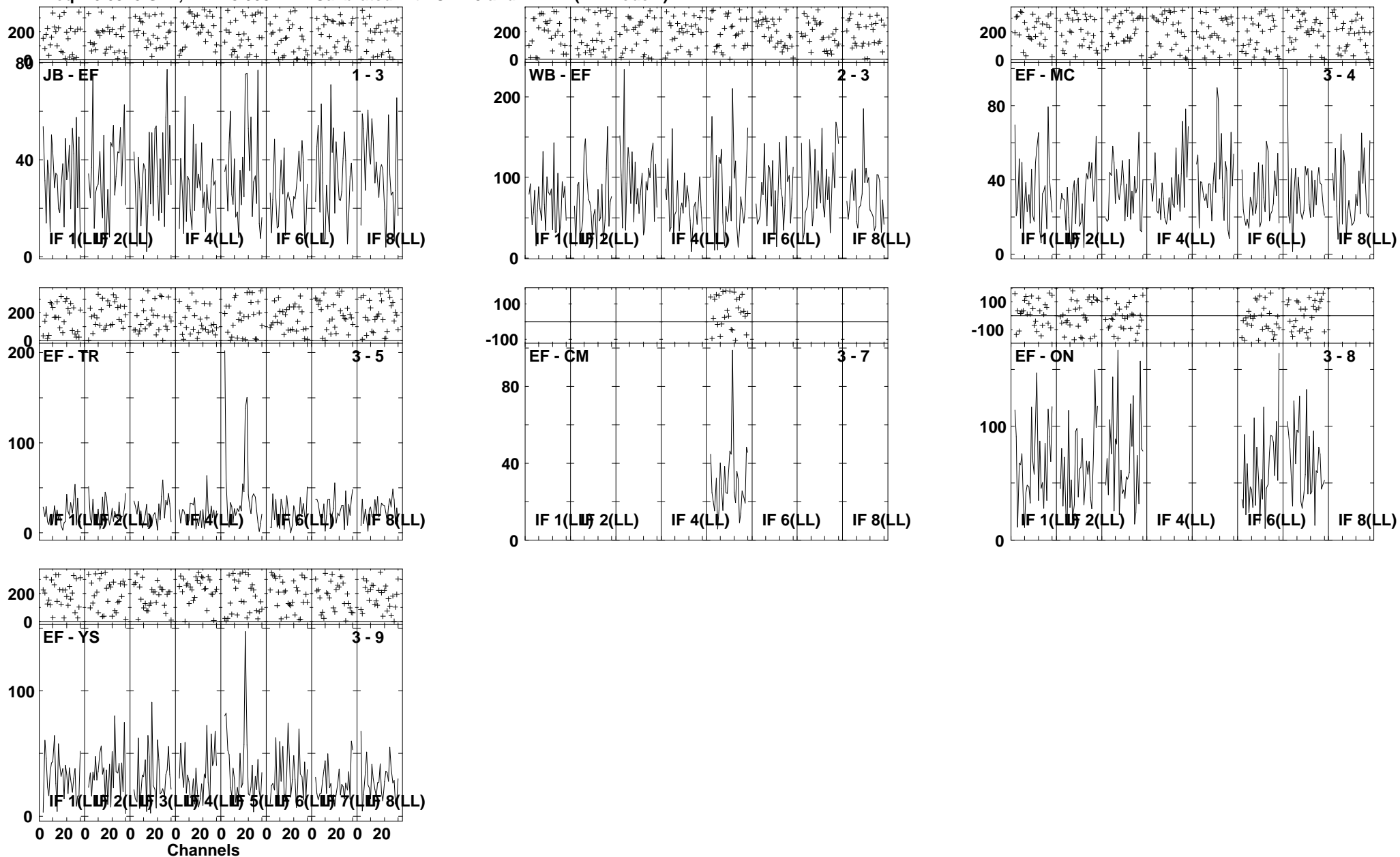

Lower frame: Milli Ampl Jy Top frame: Phas deg
 Vector averaged cross-power spectrum Several baselines displayed
 Timerange: 00/05:24:49 to 00/05:26:18

Plot file version 146 created 19-AUG-2009 15:52:14
 W75 EB039B 2.UVDATA.1
 Freq = 6.6328 GHz, Bw = 8.000 MH Calibrated with CL # 3 and BP # 1 (BP mode 1)

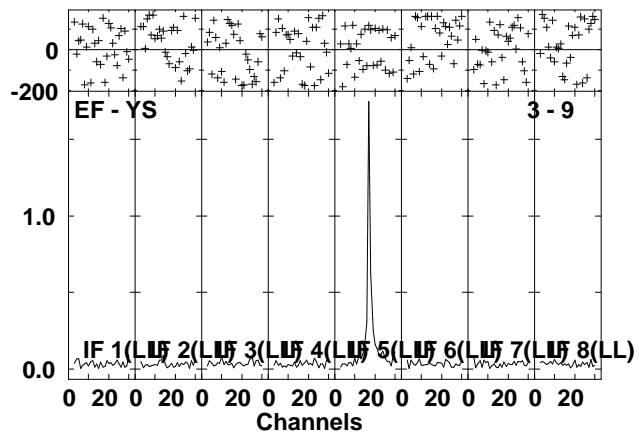
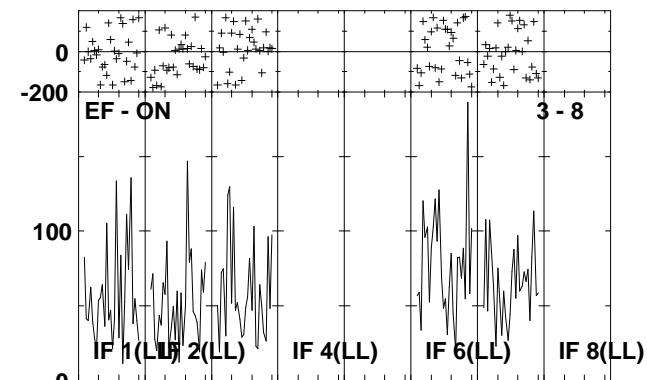
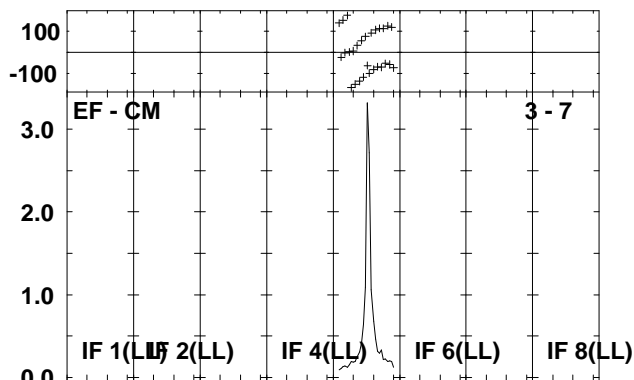
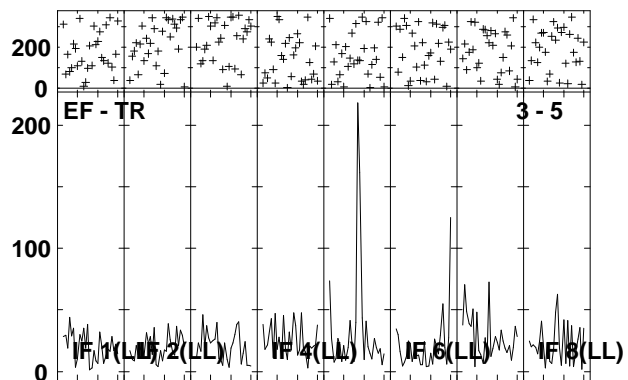
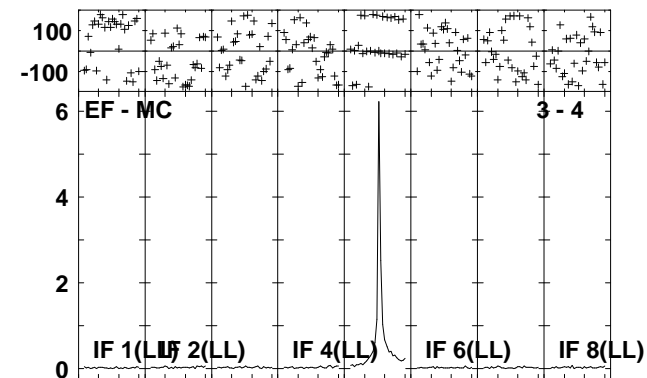
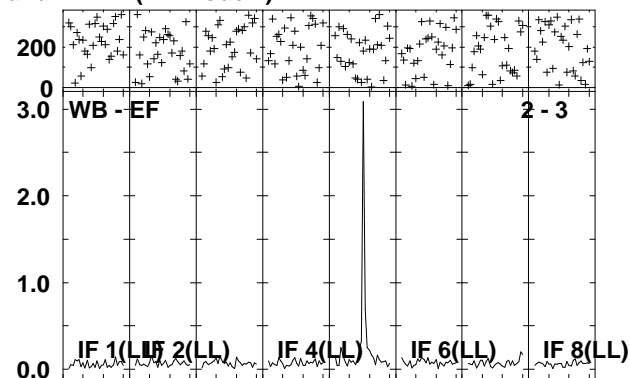
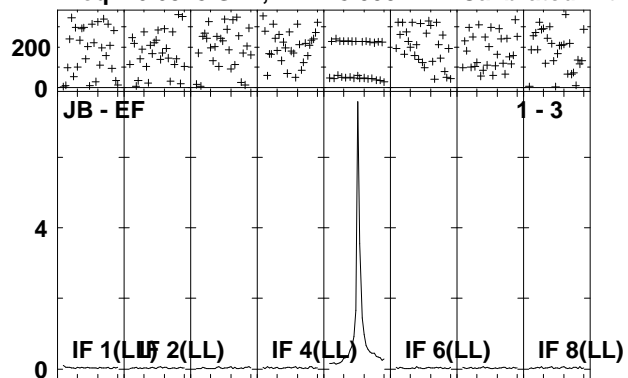

0 20 0 20 0 20 0 20 0 20 0 20 0 20 0 20 0 20 0 20
 Channels
 Lower frame: Ampl Jy Top frame: Phas deg
 Vector averaged cross-power spectrum Several baselines displayed
 Timerange: 00/05:26:20 to 00/05:27:49

Plot file version 147 created 19-AUG-2009 15:52:17

DR21B EB039B 2.UVDATA.1

Freq = 6.6328 GHz, Bw = 8.000 MH Calibrated with CL # 3 and BP # 1 (BP mode 1)

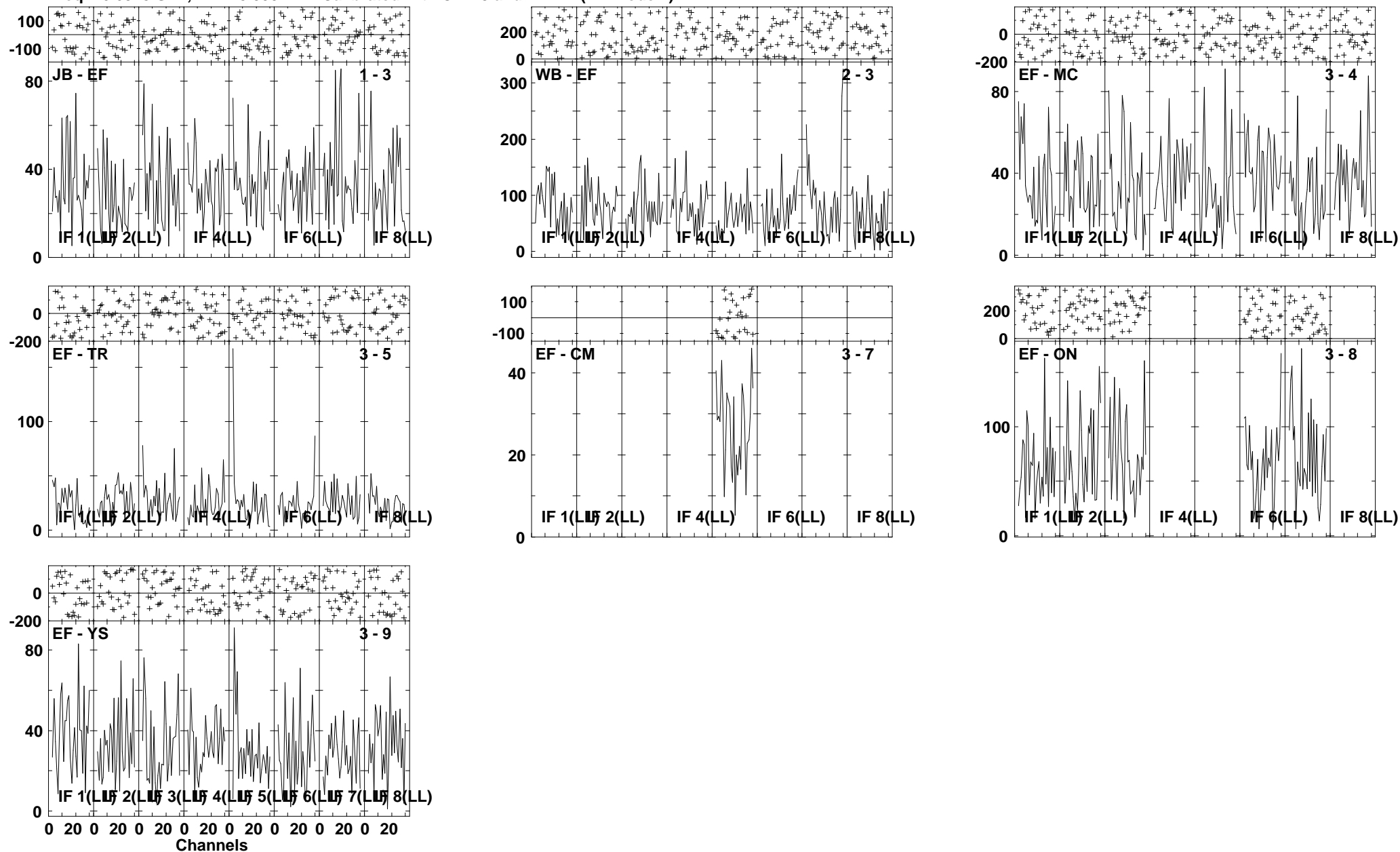

Lower frame: Milli Ampl Jy Top frame: Phas deg
Vector averaged cross-power spectrum Several baselines displayed
Timerange: 00/05:27:49 to 00/05:29:18

Plot file version 148 created 19-AUG-2009 15:52:19
 W75 EB039B 2.UVDATA.1
 Freq = 6.6328 GHz, Bw = 8.000 MH Calibrated with CL # 3 and BP # 1 (BP mode 1)

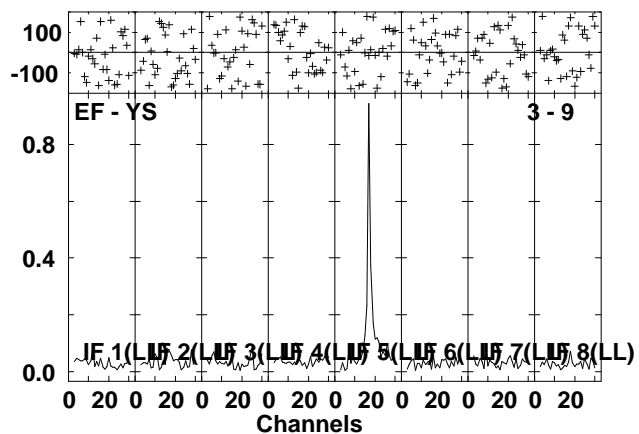
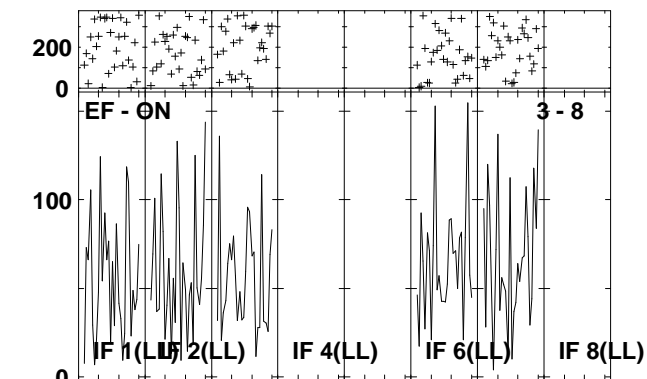
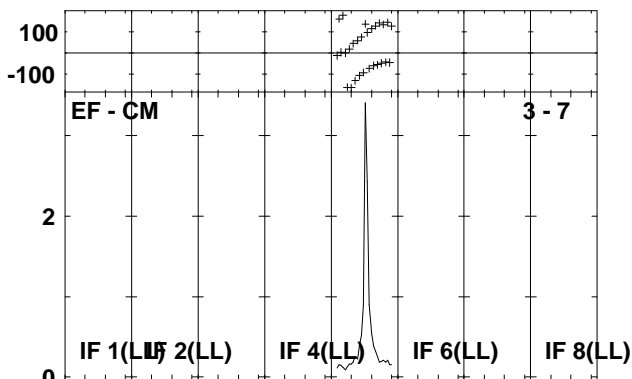
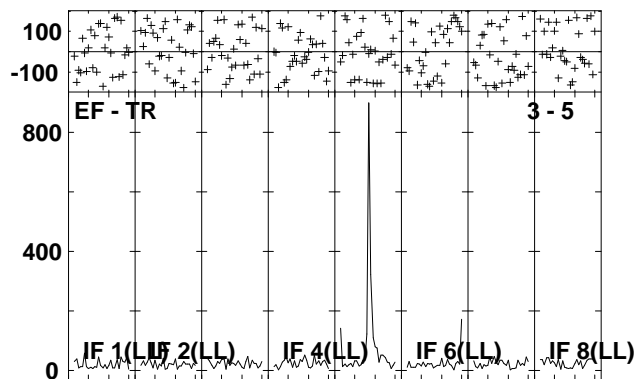
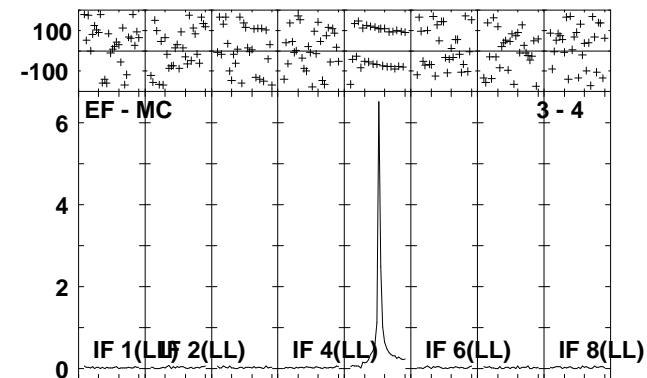
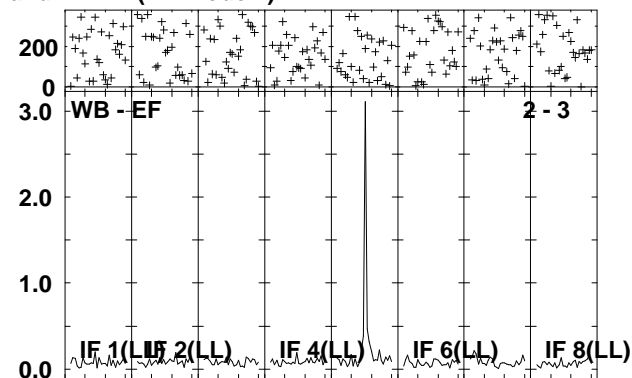
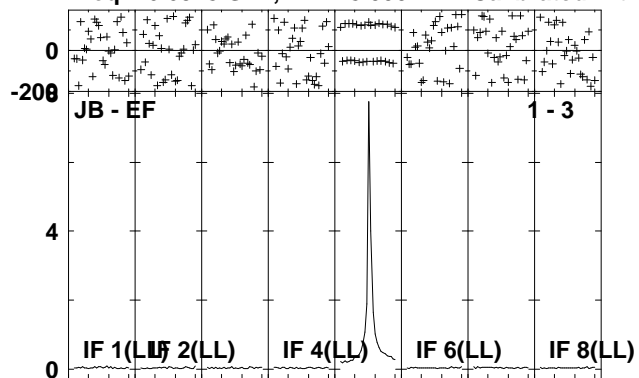

Lower frame: Ampl Jy Top frame: Phas deg
 Vector averaged cross-power spectrum Several baselines displayed
 Timerange: 00/05:29:20 to 00/05:30:49

Plot file version 149 created 19-AUG-2009 15:52:22
 DR21B2 EB039B 2.UVDATA.1
 Freq = 6.6328 GHz, Bw = 8.000 MH Calibrated with CL # 3 and BP # 1 (BP mode 1)

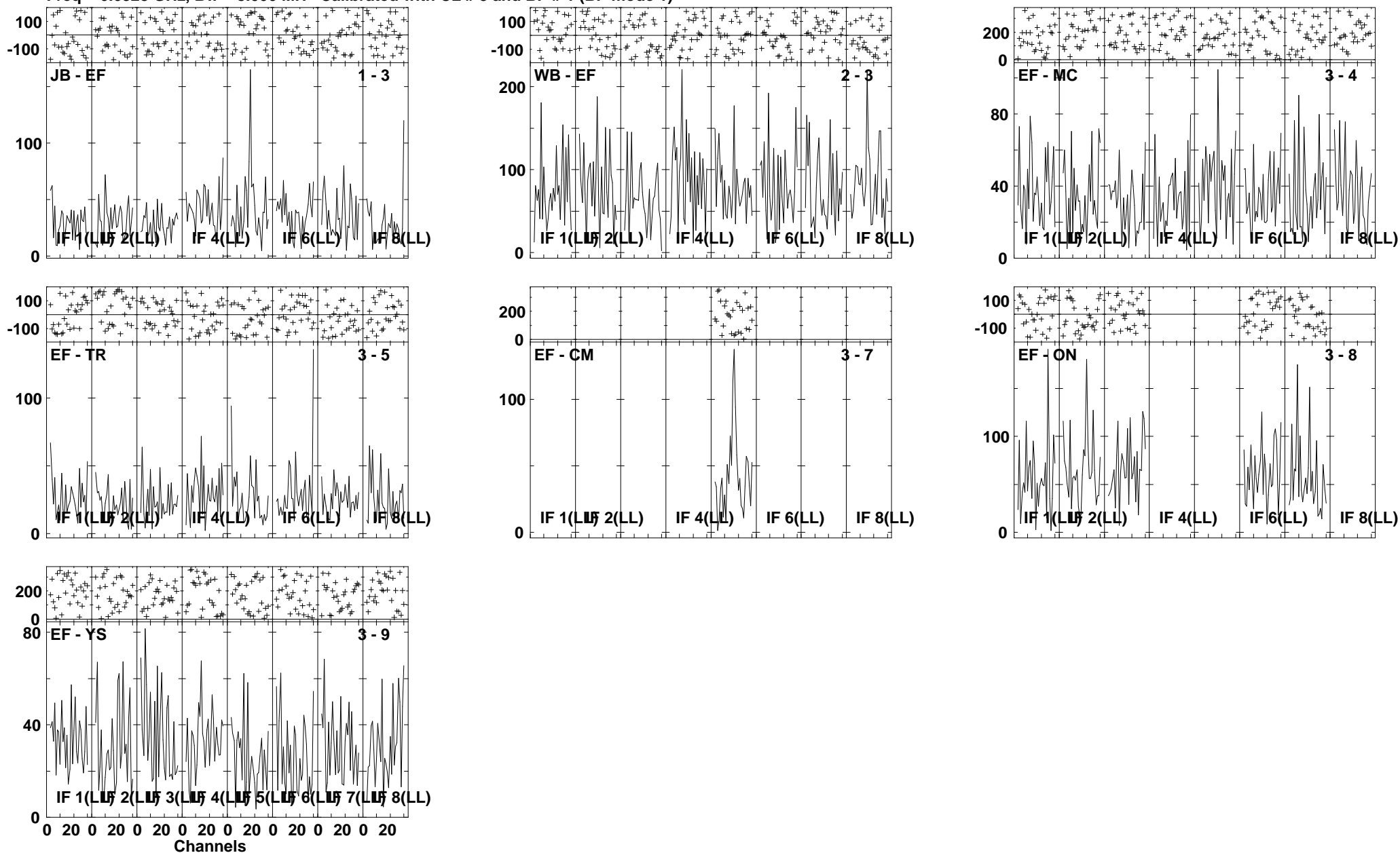

Lower frame: Milli Ampl Jy Top frame: Phas deg
 Vector averaged cross-power spectrum Several baselines displayed
 Timerange: 00/05:30:49 to 00/05:32:18

Plot file version 150 created 19-AUG-2009 15:52:25
 W75 EB039B 2.UVDATA.1
 Freq = 6.6328 GHz, Bw = 8.000 MH Calibrated with CL # 3 and BP # 1 (BP mode 1)

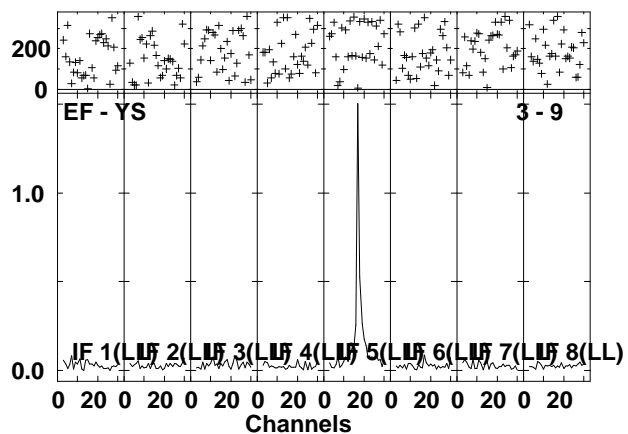
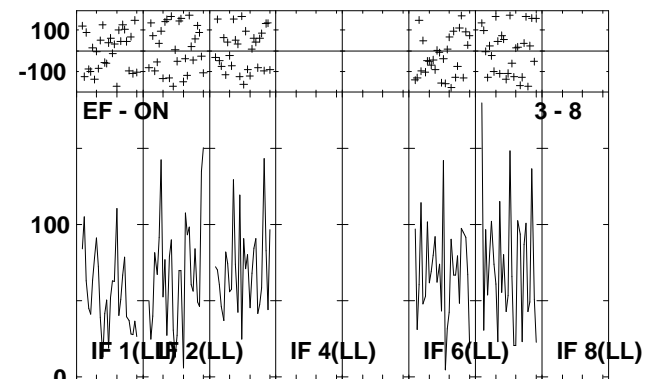
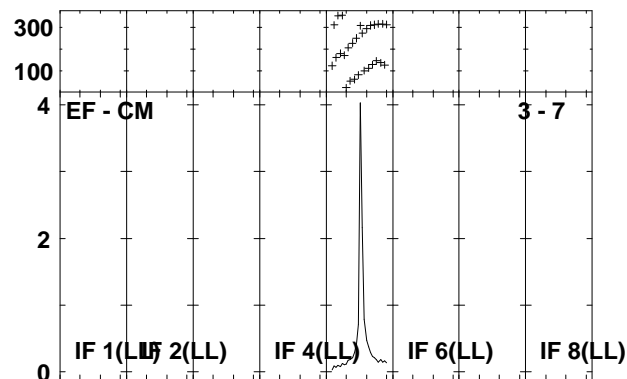
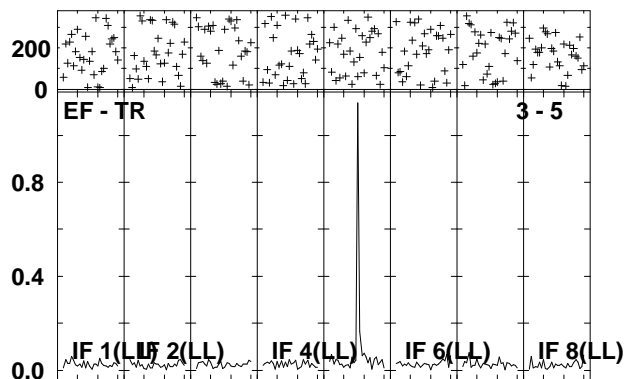
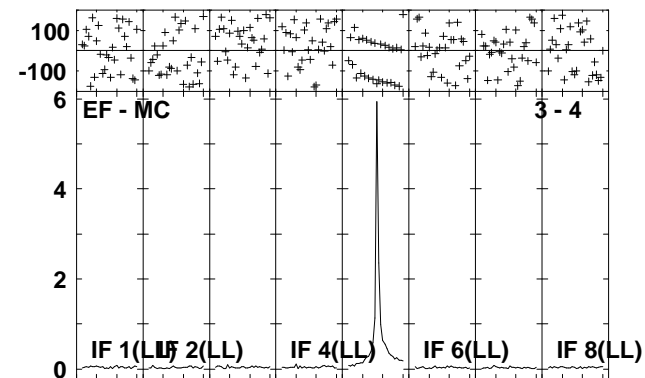
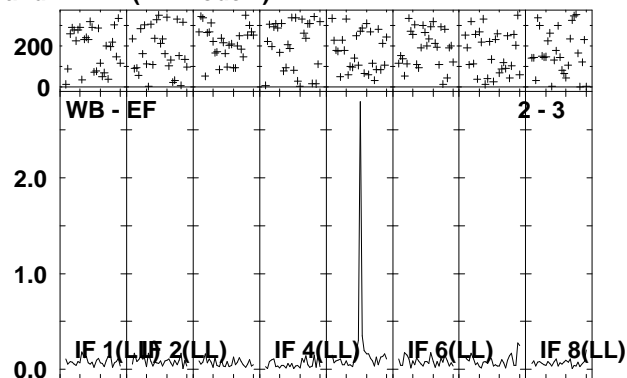
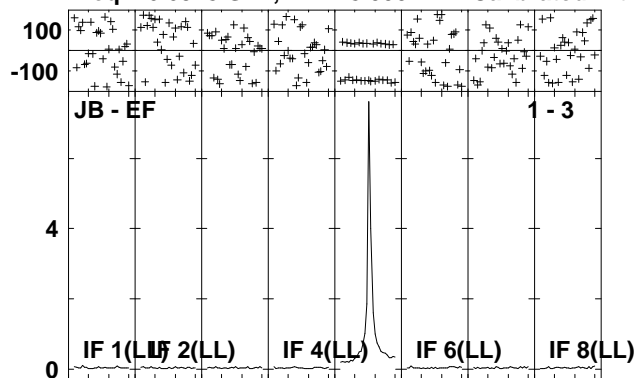

0 20 0 20 0 20 0 20 0 20 0 20 0 20 0 20 0 20 0 20
 Channels
 Lower frame: Ampl Jy Top frame: Phas deg
 Vector averaged cross-power spectrum Several baselines displayed
 Timerange: 00/05:32:20 to 00/05:33:49

Plot file version 151 created 19-AUG-2009 15:52:28
 DR20 EB039B 2.UVDATA.1
 Freq = 6.6328 GHz, Bw = 8.000 MH Calibrated with CL # 3 and BP # 1 (BP mode 1)

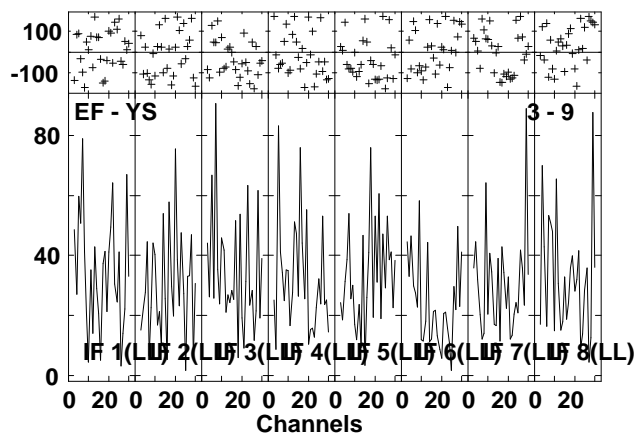
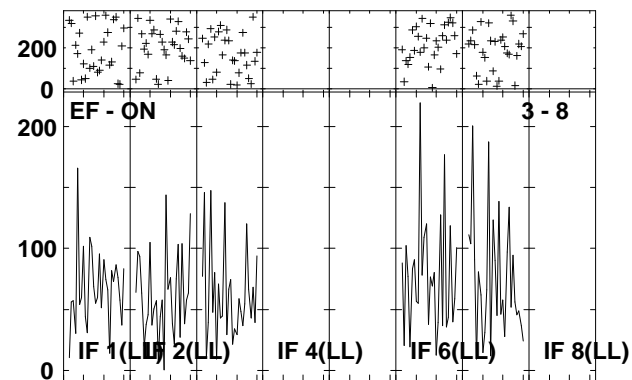
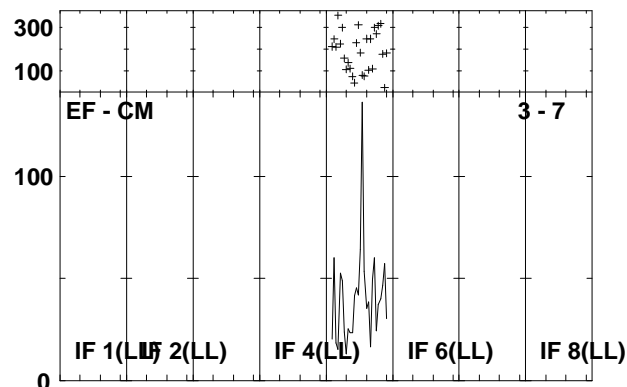
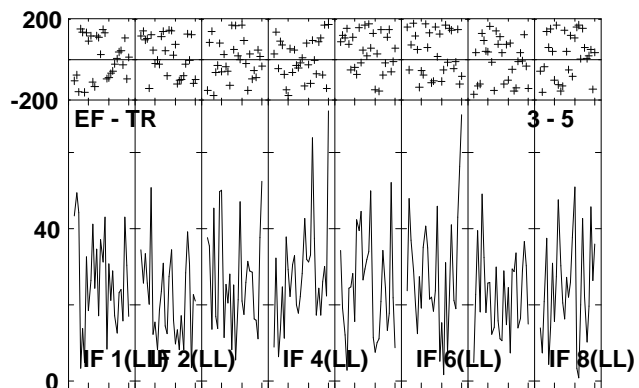
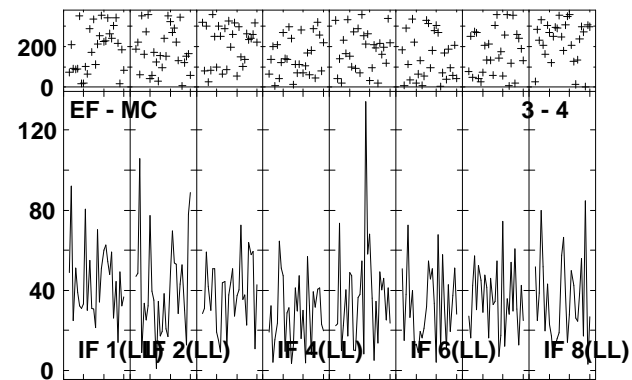
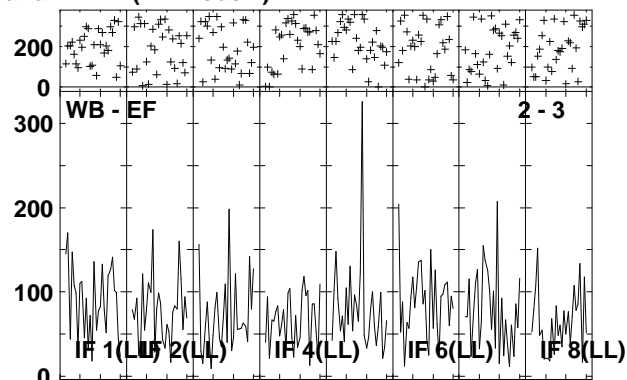
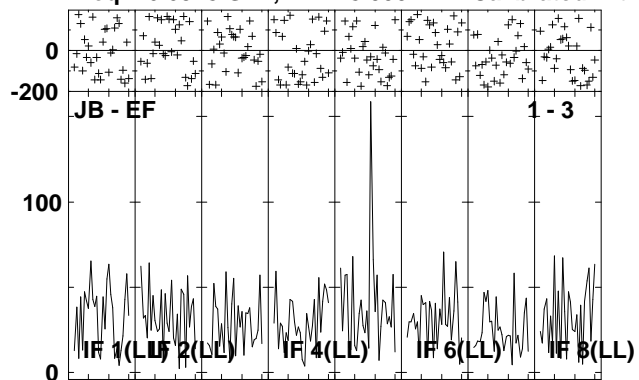

Lower frame: Milli Ampl Jy Top frame: Phas deg
 Vector averaged cross-power spectrum Several baselines displayed
 Timerange: 00/05:33:50 to 00/05:35:19

Plot file version 152 created 19-AUG-2009 15:52:31
 W75 EB039B 2.UVDATA.1
 Freq = 6.6328 GHz, Bw = 8.000 MH Calibrated with CL # 3 and BP # 1 (BP mode 1)

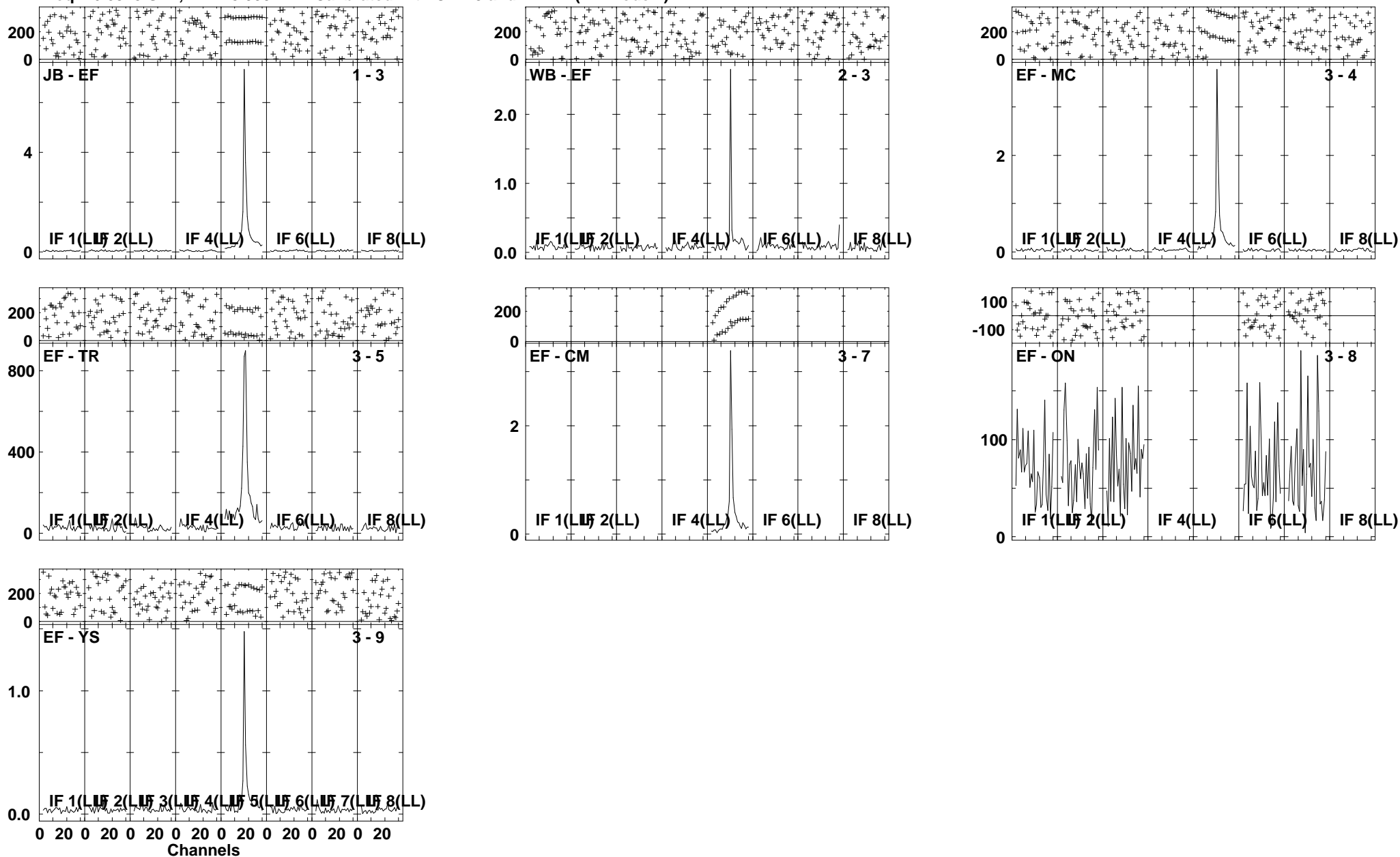

Lower frame: Ampl Jy Top frame: Phas deg
 Vector averaged cross-power spectrum Several baselines displayed
 Timerange: 00/05:35:48 to 00/05:36:47

Plot file version 153 created 19-AUG-2009 15:52:33
 J2029+46 EB039B 2.UVDATA.1
 Freq = 6.6328 GHz, Bw = 8.000 MH Calibrated with CL # 3 and BP # 1 (BP mode 1)

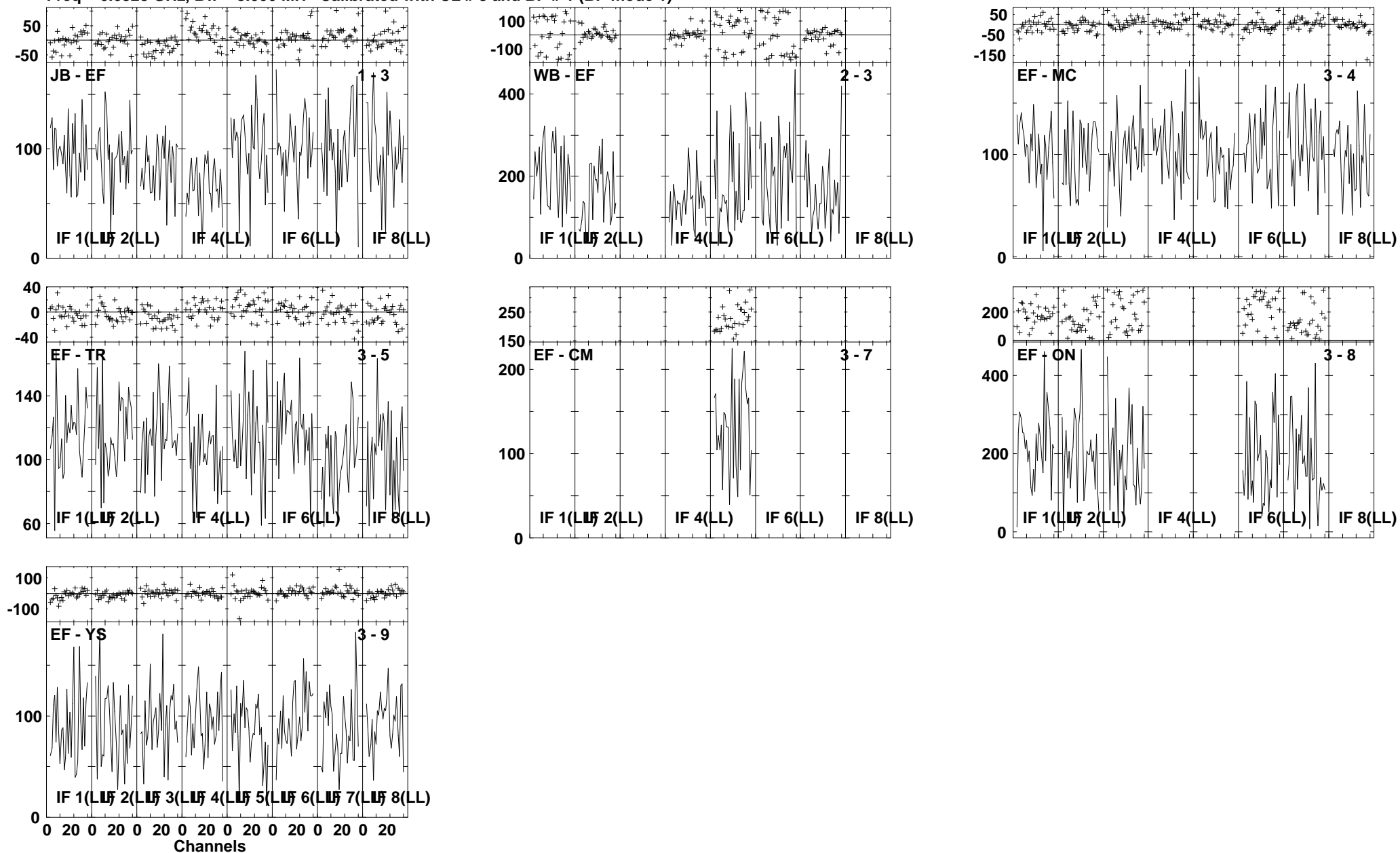

Lower frame: Milli Ampl Jy Top frame: Phas deg
 Vector averaged cross-power spectrum Several baselines displayed
 Timerange: 00/05:36:48 to 00/05:38:17

Plot file version 154 created 19-AUG-2009 15:52:35
 W75 EB039B 2.UVDATA.1
 Freq = 6.6328 GHz, Bw = 8.000 MH Calibrated with CL # 3 and BP # 1 (BP mode 1)

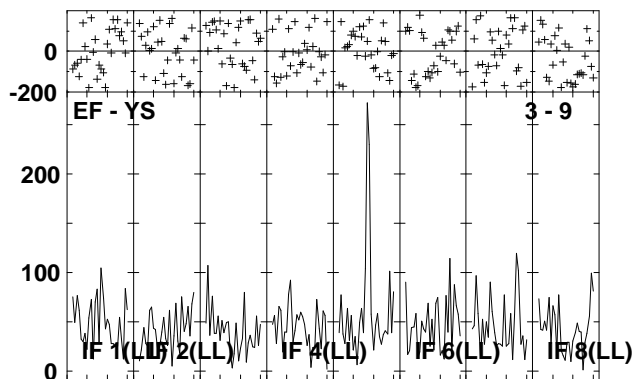
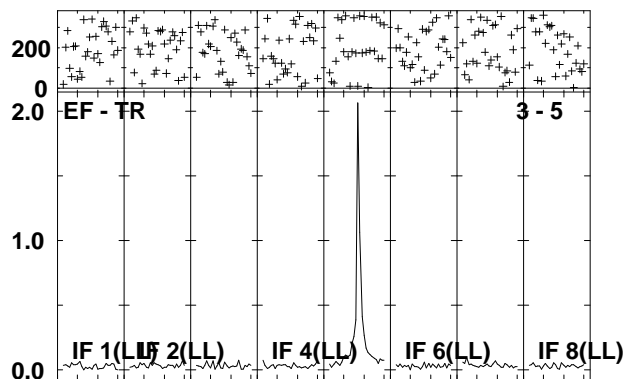
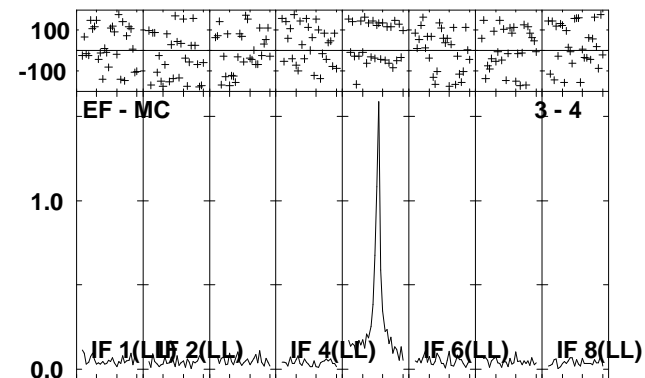
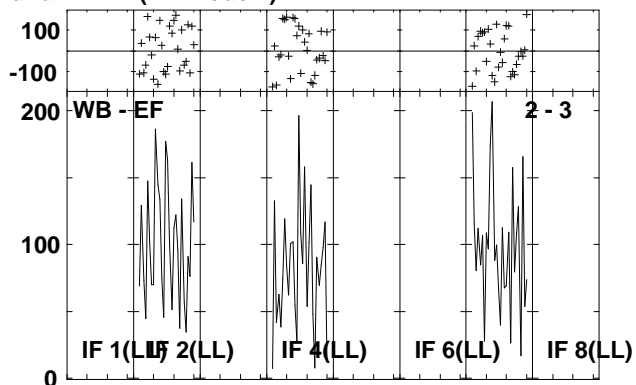
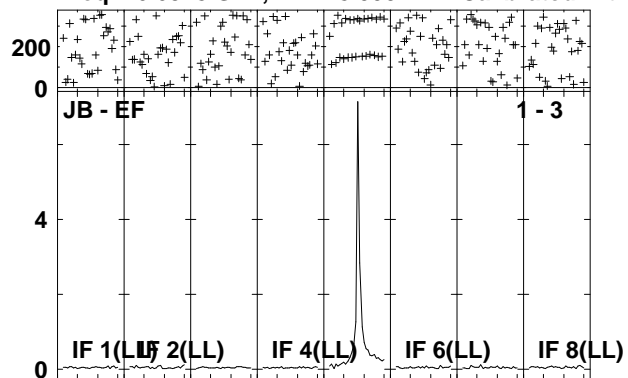

Lower frame: Ampl Jy Top frame: Phas deg
 Vector averaged cross-power spectrum Several baselines displayed
 Timerange: 00/05:38:17 to 00/05:39:46

Plot file version 155 created 19-AUG-2009 15:52:40

W75 EB039B 2.UVDATA.1

Freq = 6.6328 GHz, Bw = 8.000 MH Calibrated with CL # 3 and BP # 1 (BP mode 1)

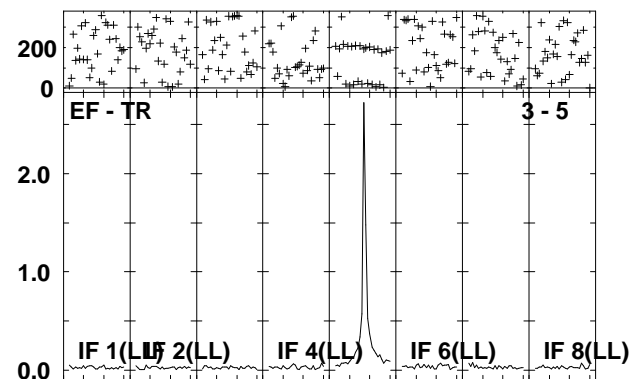
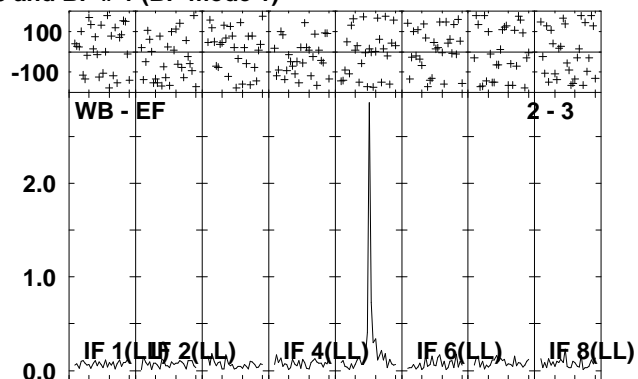
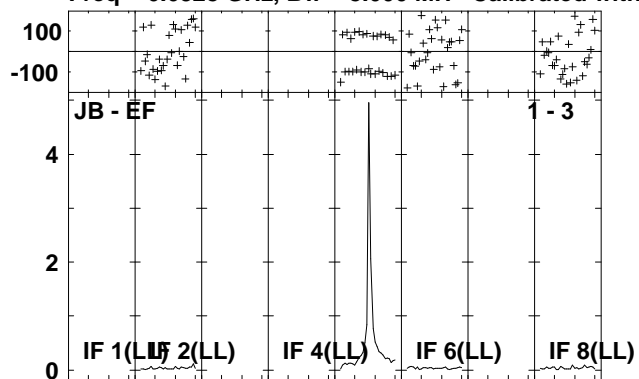

Lower frame: Ampl Jy Top frame: Phas deg
Vector averaged cross-power spectrum Several baselines displayed
Timerange: 00/05:41:17 to 00/05:42:46

Plot file version 156 created 19-AUG-2009 15:52:42

2048+431 EB039B 2.UVDATA.1

Freq = 6.6328 GHz, Bw = 8.000 MH Calibrated with CL # 3 and BP # 1 (BP mode 1)

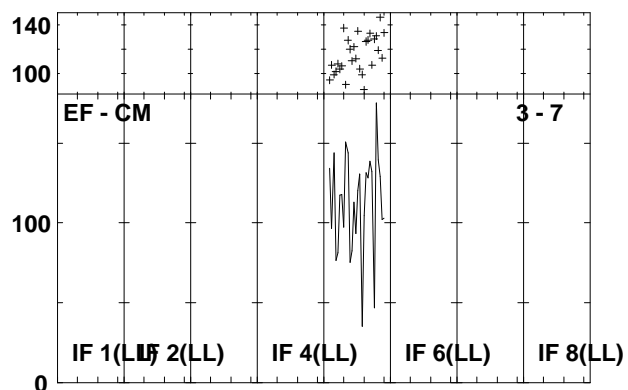
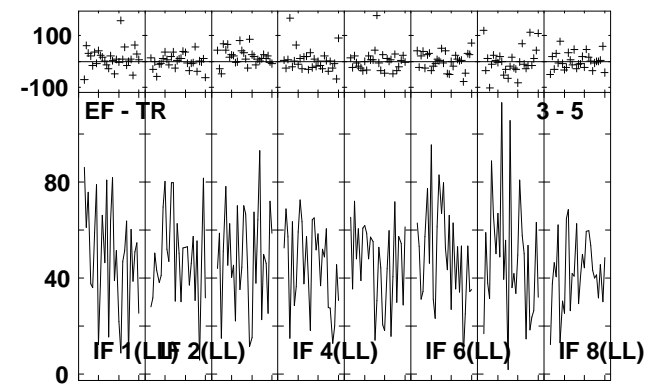
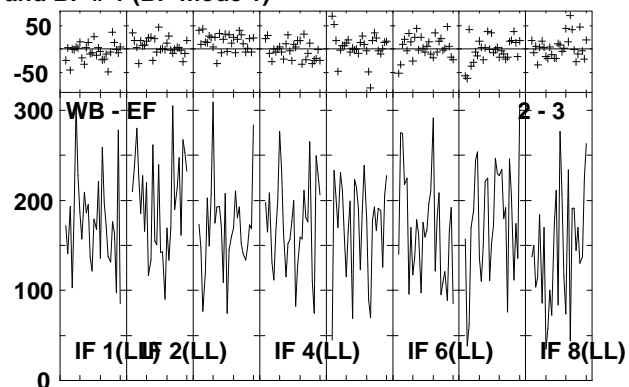
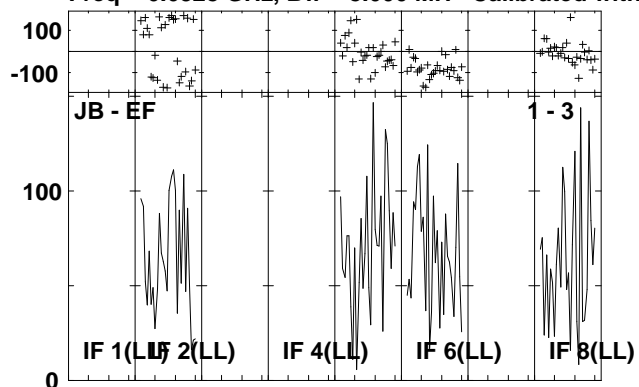

Lower frame: Milli Ampl Jy Top frame: Phas deg
Vector averaged cross-power spectrum Several baselines displayed
Timerange: 00/05:42:48 to 00/05:44:17

Plot file version 157 created 19-AUG-2009 15:52:45
 W75 EB039B 2.UVDATA.1
 Freq = 6.6328 GHz, Bw = 8.000 MH Calibrated with CL # 3 and BP # 1 (BP mode 1)

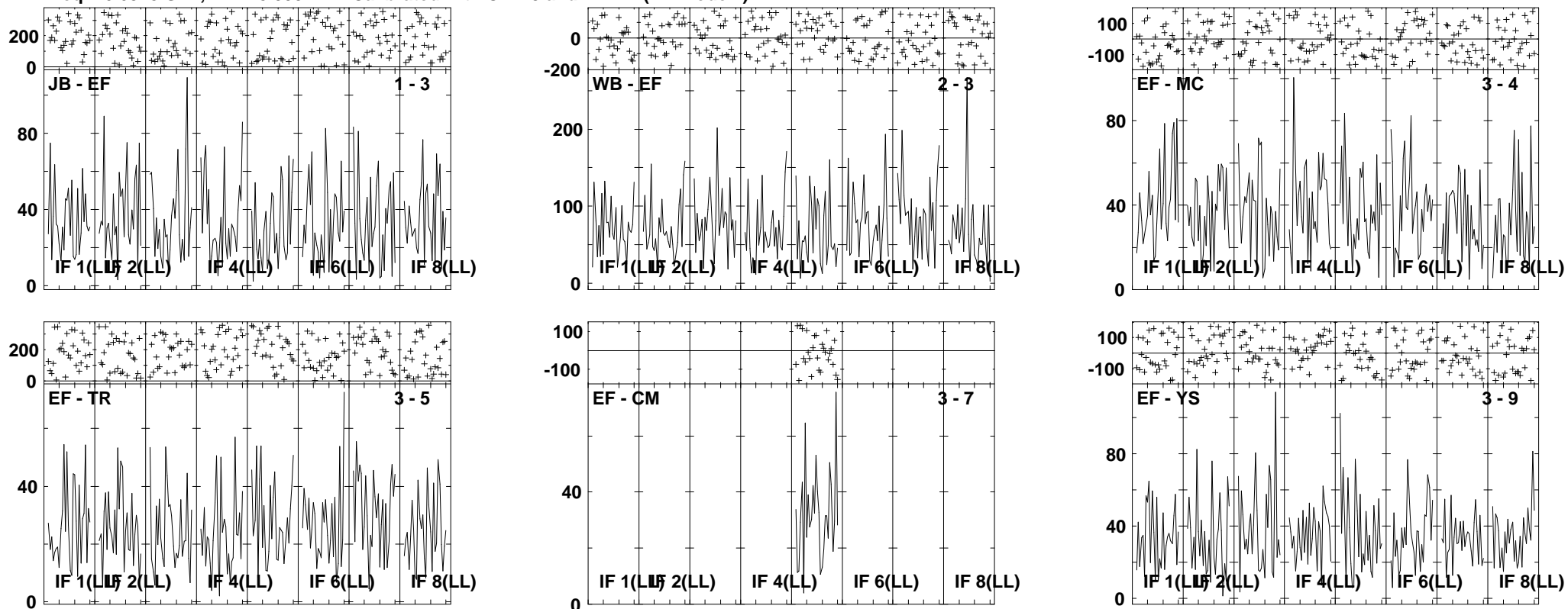

Lower frame: Milli Ampl Jy Top frame: Phas deg
 Vector averaged cross-power spectrum Several baselines displayed
 Timerange: 00/05:44:18 to 00/05:45:47

Plot file version 158 created 19-AUG-2009 15:52:47
 OB2 EB039B 2.UVDATA.1
 Freq = 6.6328 GHz, Bw = 8.000 MH Calibrated with CL # 3 and BP # 1 (BP mode 1)

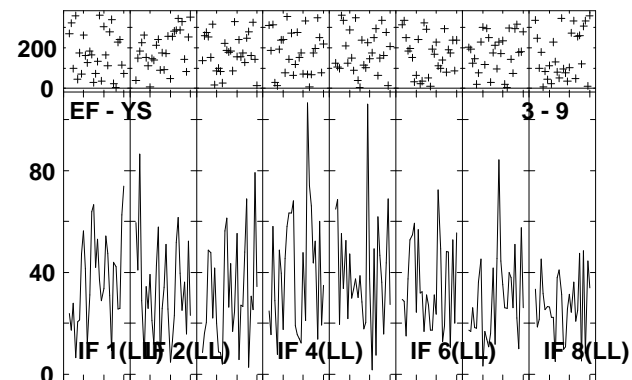
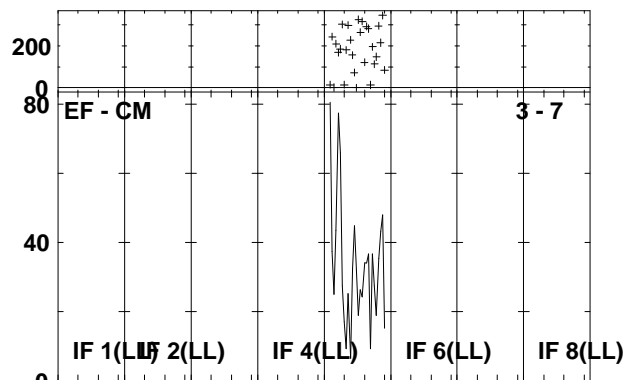
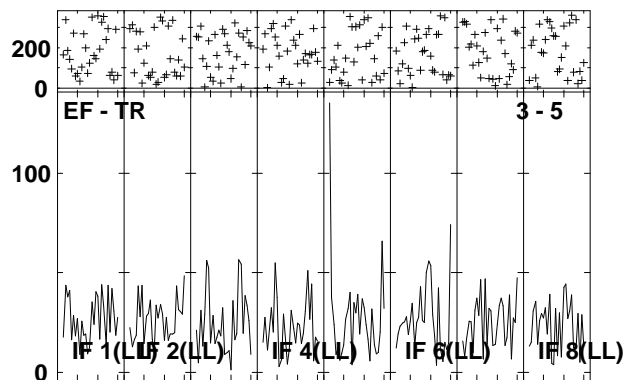
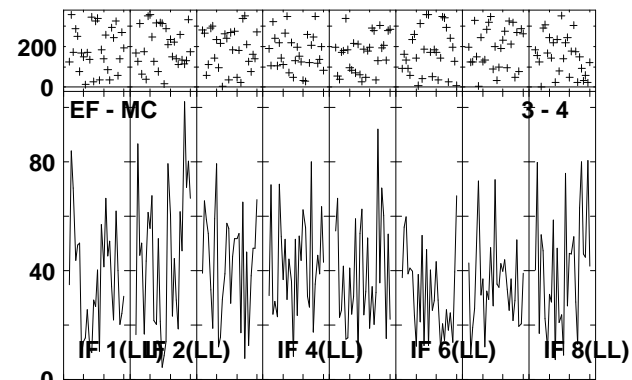
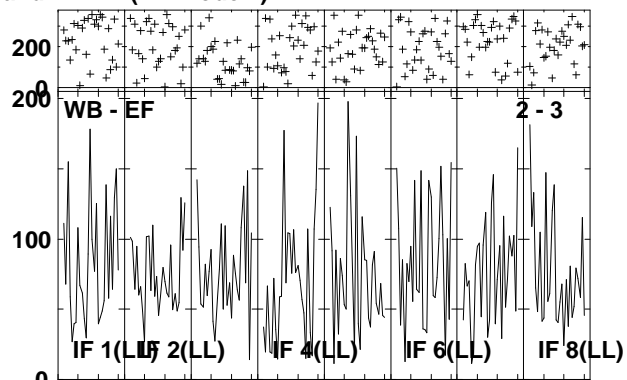
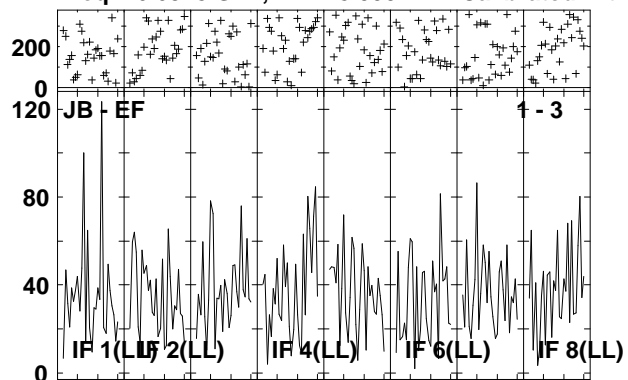

Lower frame: Milli Ampl Jy Top frame: Phas deg
 Vector averaged cross-power spectrum Several baselines displayed
 Timerange: 00/05:45:48 to 00/05:47:16

Plot file version 159 created 19-AUG-2009 15:52:50
 W75 EB039B 2.UVDATA.1
 Freq = 6.6328 GHz, Bw = 8.000 MH Calibrated with CL # 3 and BP # 1 (BP mode 1)

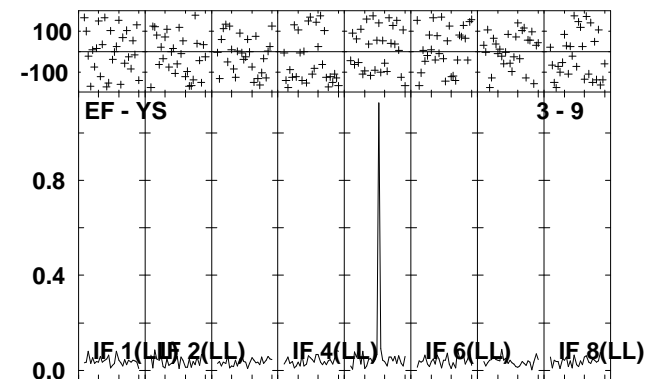
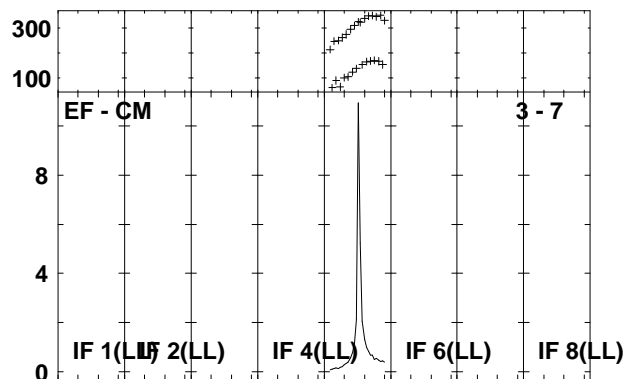
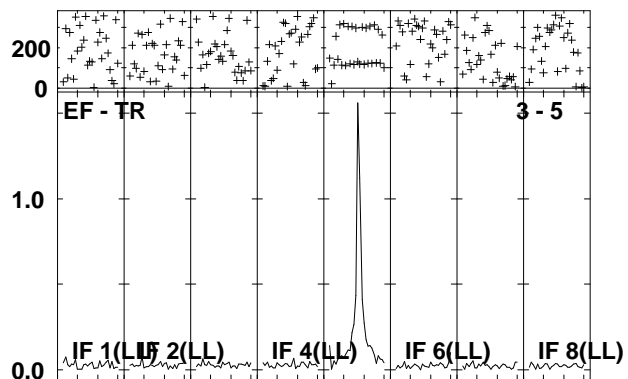
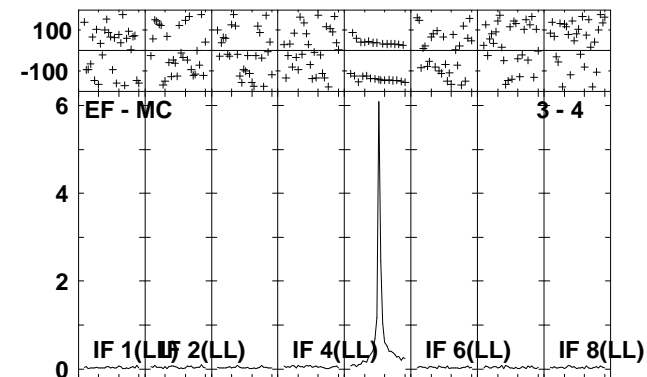
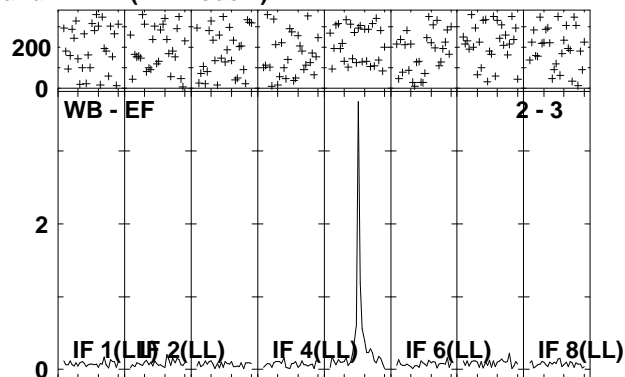
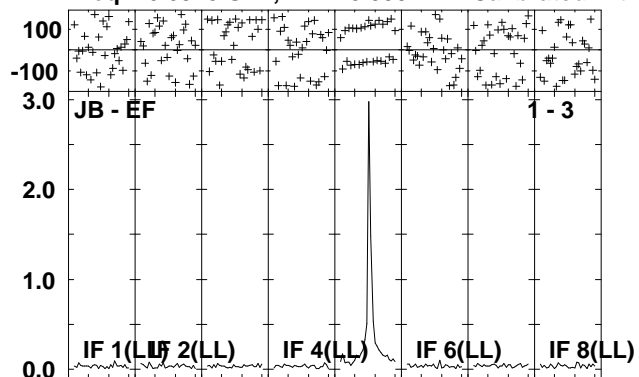

Lower frame: Ampl Jy Top frame: Phas deg
 Vector averaged cross-power spectrum Several baselines displayed
 Timerange: 00/05:47:55 to 00/05:48:55

Plot file version 160 created 19-AUG-2009 15:52:52
 DR21A EB039B 2.UVDATA.1
 Freq = 6.6328 GHz, Bw = 8.000 MH Calibrated with CL # 3 and BP # 1 (BP mode 1)

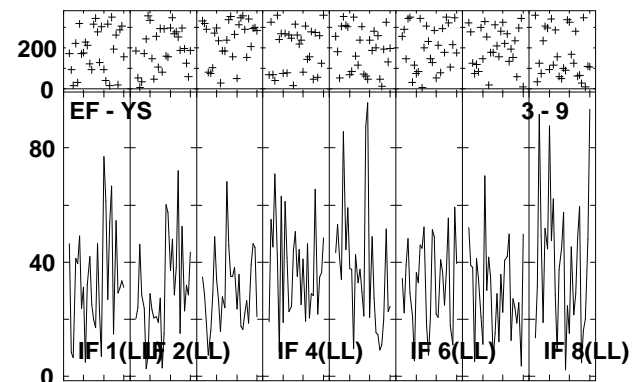
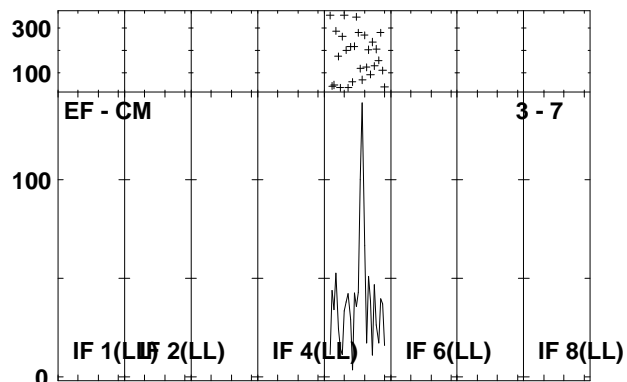
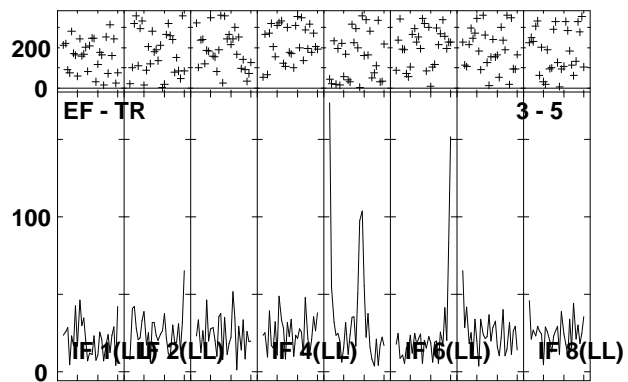
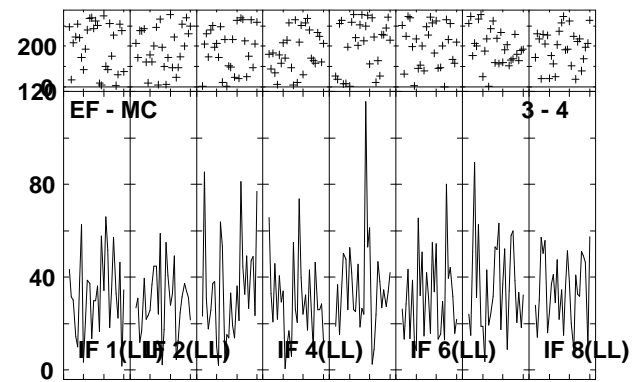
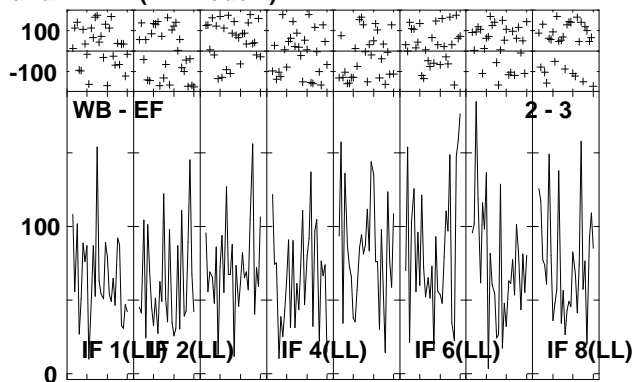
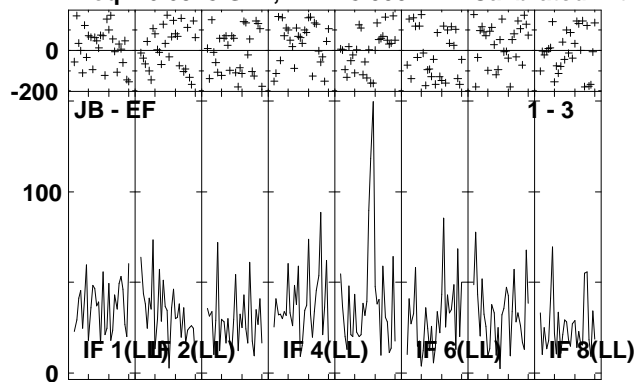

Lower frame: Milli Ampl Jy Top frame: Phas deg
 Vector averaged cross-power spectrum Several baselines displayed
 Timerange: 00/05:48:56 to 00/05:50:25

Plot file version 161 created 19-AUG-2009 15:52:55

W75 EB039B 2.UVDATA.1

Freq = 6.6328 GHz, Bw = 8.000 MH Calibrated with CL # 3 and BP # 1 (BP mode 1)

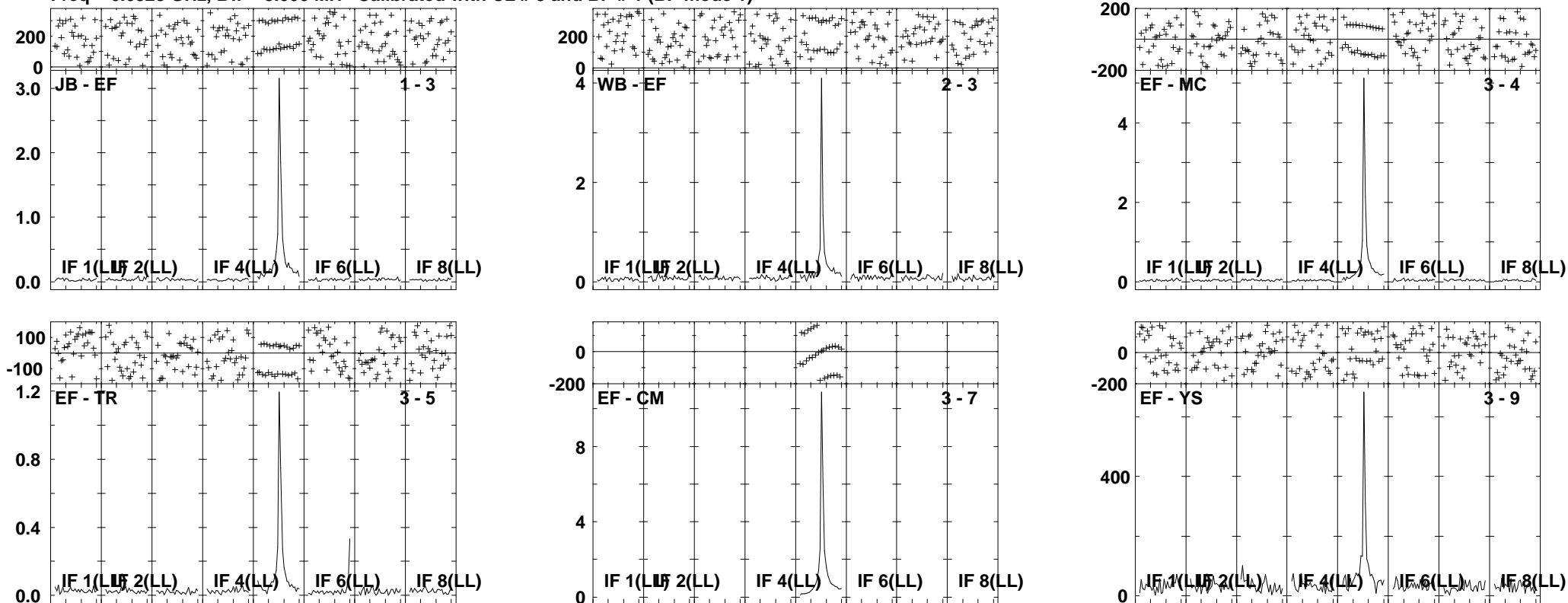

Lower frame: Ampl Jy Top frame: Phas deg
Vector averaged cross-power spectrum Several baselines displayed
Timerange: 00/05:50:26 to 00/05:51:54

Plot file version 162 created 19-AUG-2009 15:52:57
 DR21B EB039B 2.UVDATA.1
 Freq = 6.6328 GHz, Bw = 8.000 MH Calibrated with CL # 3 and BP # 1 (BP mode 1)

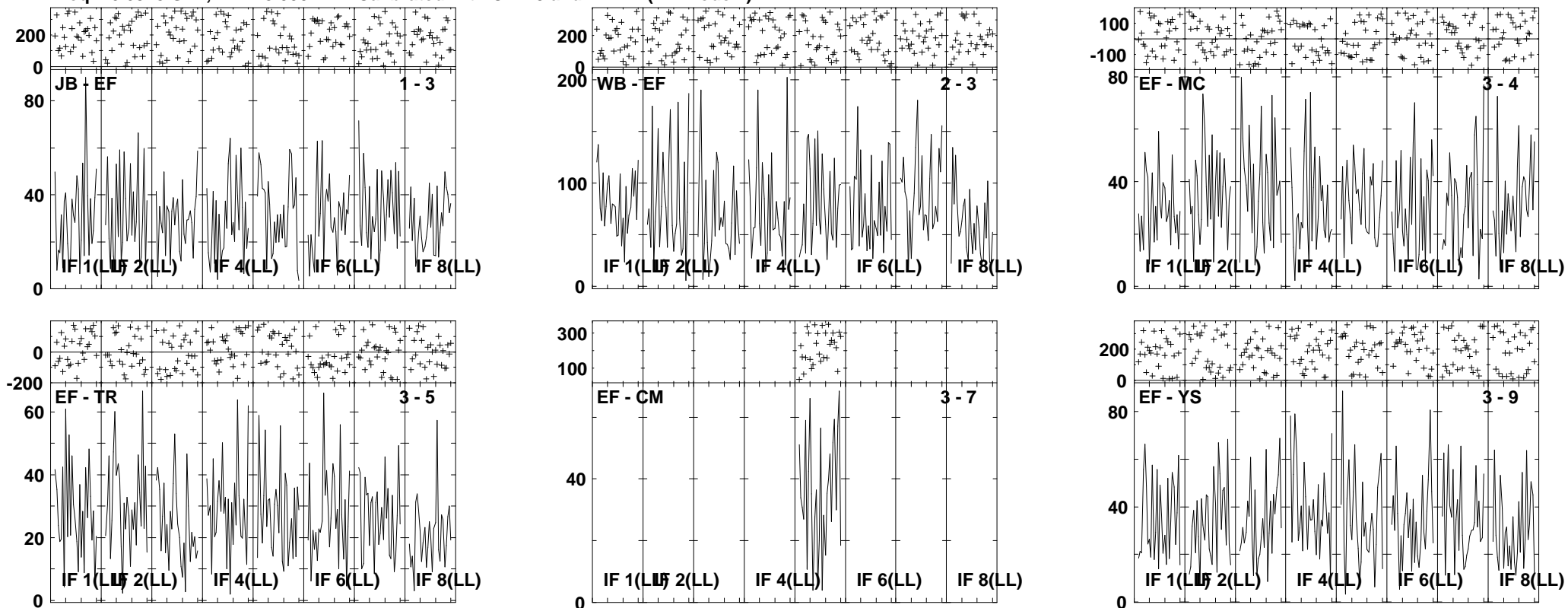

Lower frame: Milli Ampl Jy Top frame: Phas deg
 Vector averaged cross-power spectrum Several baselines displayed
 Timerange: 00/05:51:56 to 00/05:53:24

Plot file version 163 created 19-AUG-2009 15:53:00
 W75 EB039B 2.UVDATA.1
 Freq = 6.6328 GHz, Bw = 8.000 MH Calibrated with CL # 3 and BP # 1 (BP mode 1)

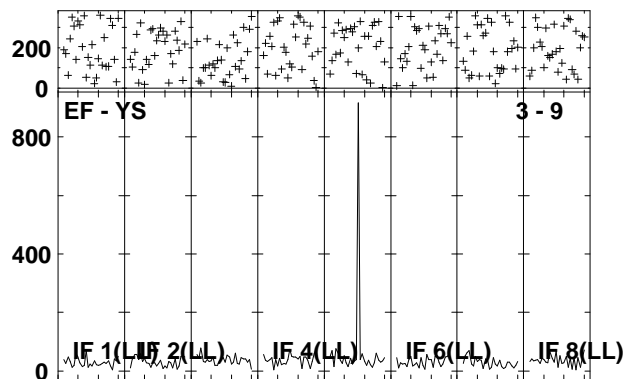
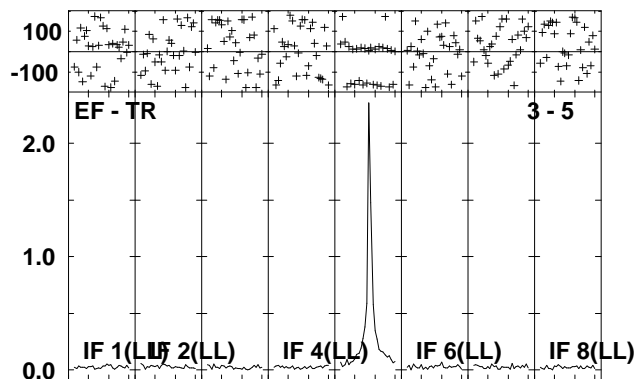
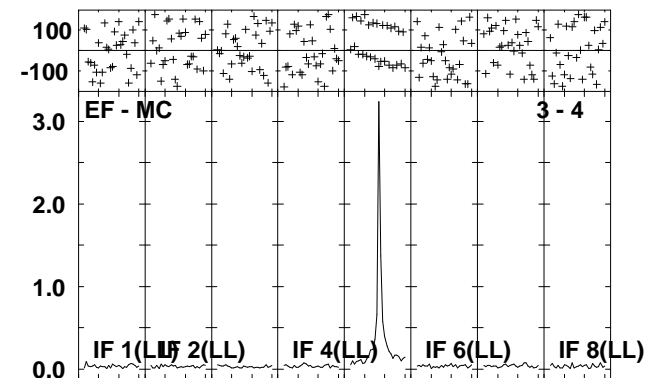
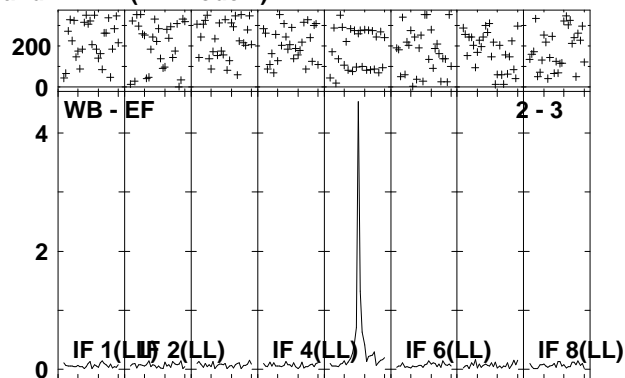
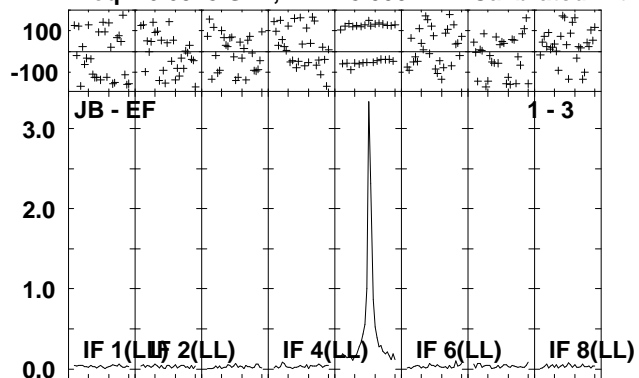

Lower frame: Ampl Jy Top frame: Phas deg
 Vector averaged cross-power spectrum Several baselines displayed
 Timerange: 00/05:53:25 to 00/05:54:53

Plot file version 164 created 19-AUG-2009 15:53:02
 DR21B2 EB039B 2.UVDATA.1
 Freq = 6.6328 GHz, Bw = 8.000 MH Calibrated with CL # 3 and BP # 1 (BP mode 1)

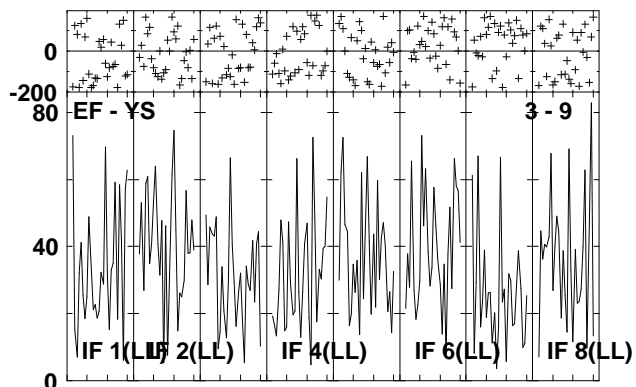
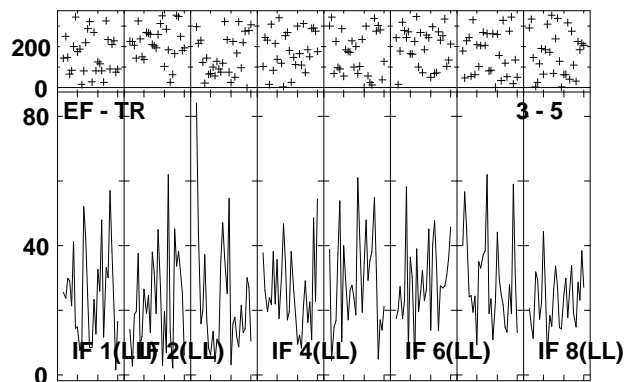
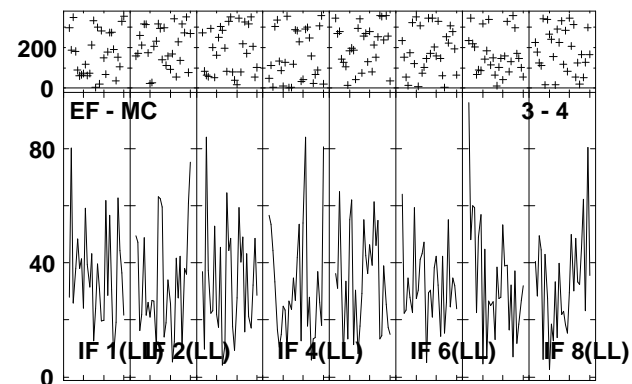
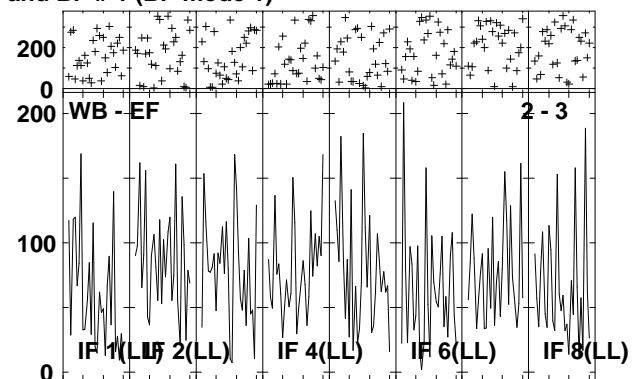
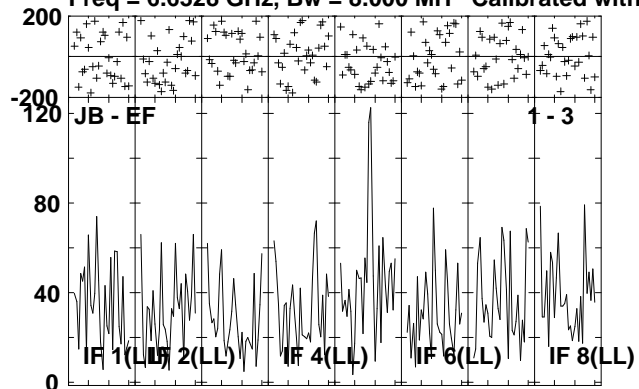

Lower frame: Milli Ampl Jy Top frame: Phas deg
 Vector averaged cross-power spectrum Several baselines displayed
 Timerange: 00/05:54:56 to 00/05:56:24

Plot file version 165 created 19-AUG-2009 15:53:04
 W75 EB039B 2.UVDATA.1
 Freq = 6.6328 GHz, Bw = 8.000 MH Calibrated with CL # 3 and BP # 1 (BP mode 1)

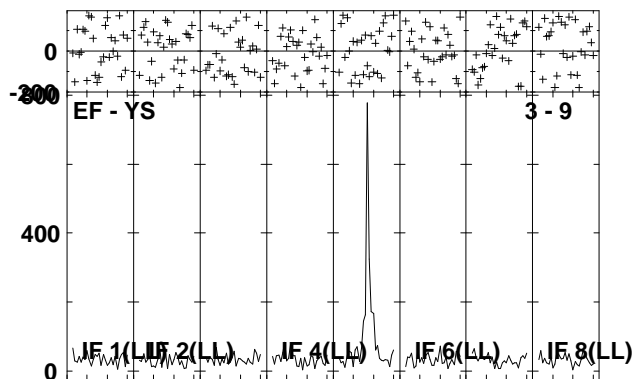
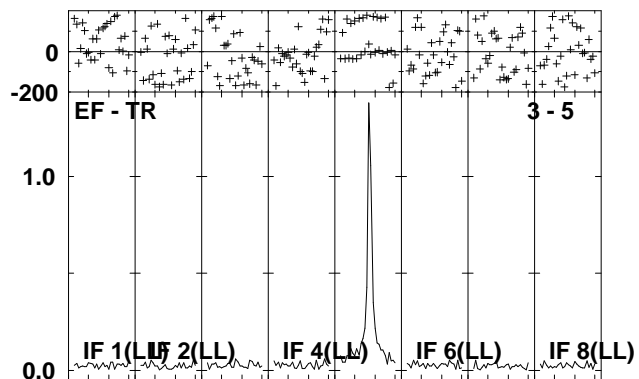
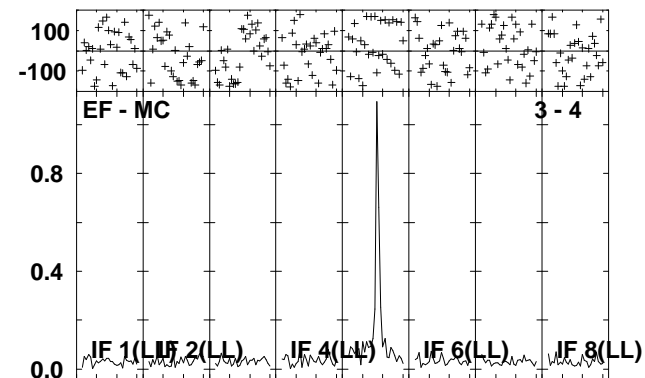
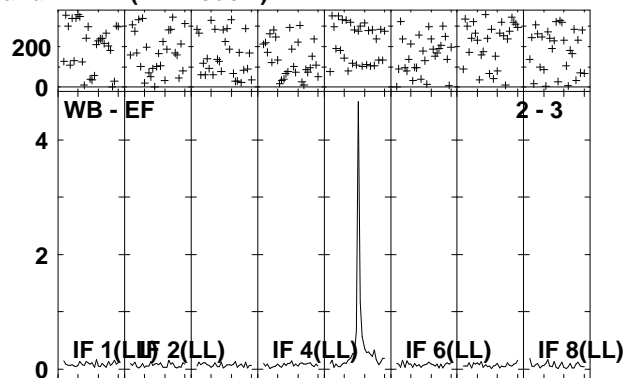
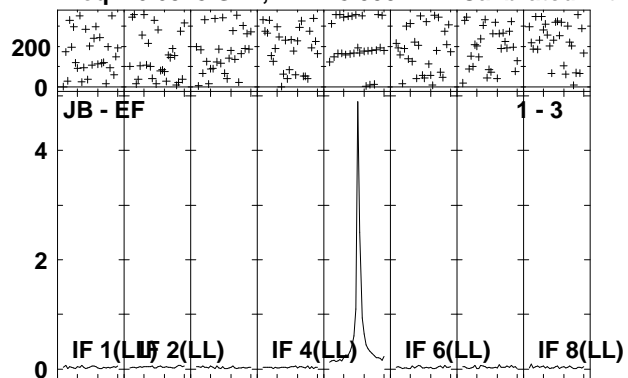

Lower frame: Ampl Jy Top frame: Phas deg
 Vector averaged cross-power spectrum Several baselines displayed
 Timerange: 00/05:56:26 to 00/05:57:54

Plot file version 166 created 19-AUG-2009 15:53:06
 DR20 EB039B 2.UVDATA.1
 Freq = 6.6328 GHz, Bw = 8.000 MH Calibrated with CL # 3 and BP # 1 (BP mode 1)

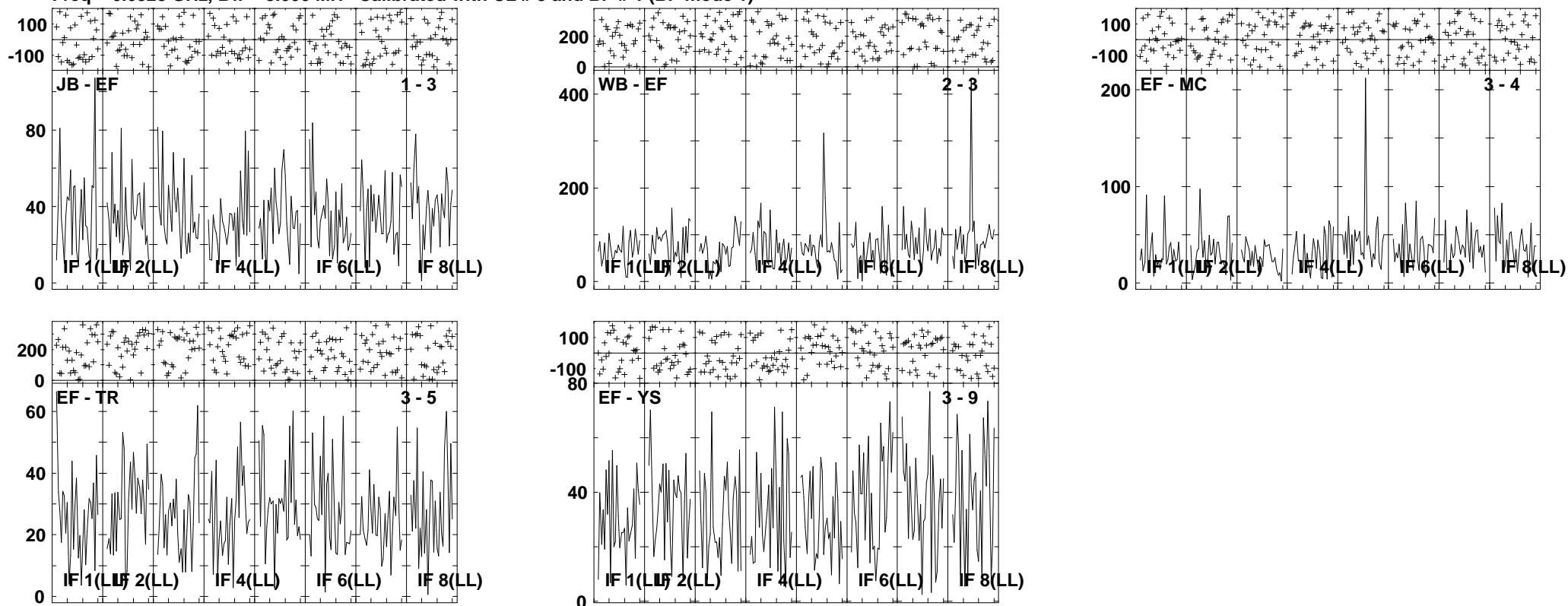

Lower frame: Milli Ampl Jy Top frame: Phas deg
 Vector averaged cross-power spectrum Several baselines displayed
 Timerange: 00/05:57:56 to 00/05:59:24

Plot file version 167 created 19-AUG-2009 15:53:08
 W75 EB039B 2.UVDATA.1
 Freq = 6.6328 GHz, Bw = 8.000 MH Calibrated with CL # 3 and BP # 1 (BP mode 1)

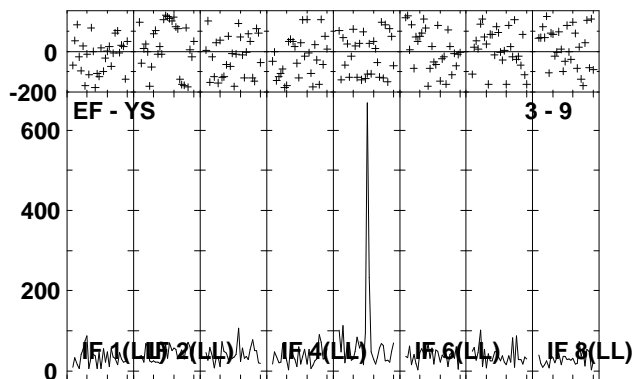
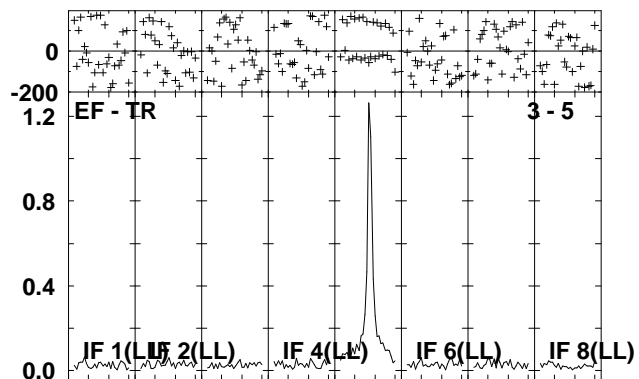
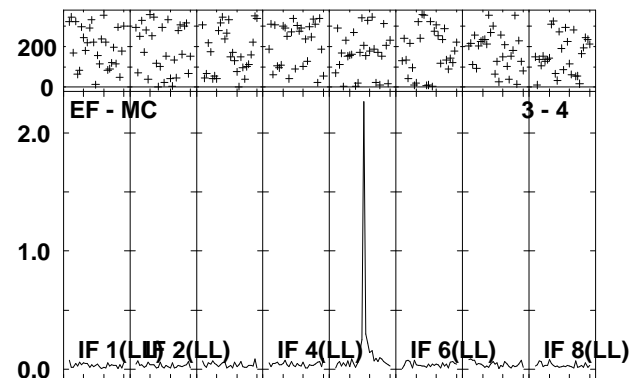
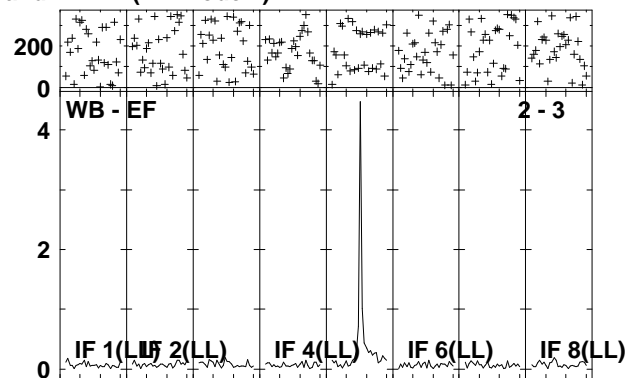
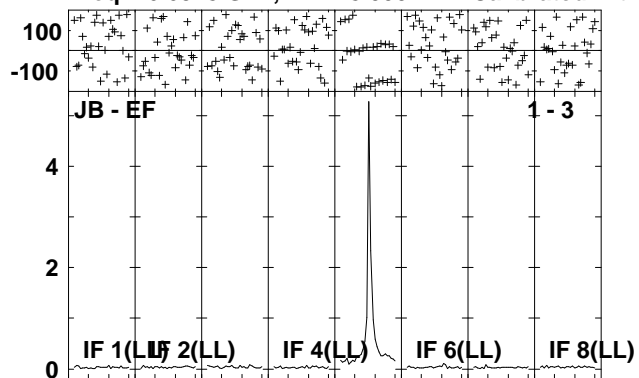

Lower frame: Ampl Jy Top frame: Phas deg
 Vector averaged cross-power spectrum Several baselines displayed
 Timerange: 00/05:59:55 to 00/06:00:55

Plot file version 168 created 19-AUG-2009 15:53:10
 J2029+46 EB039B 2.UVDATA.1
 Freq = 6.6328 GHz, Bw = 8.000 MH Calibrated with CL # 3 and BP # 1 (BP mode 1)

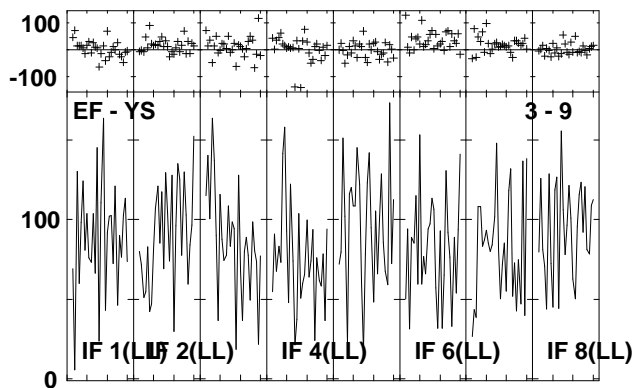
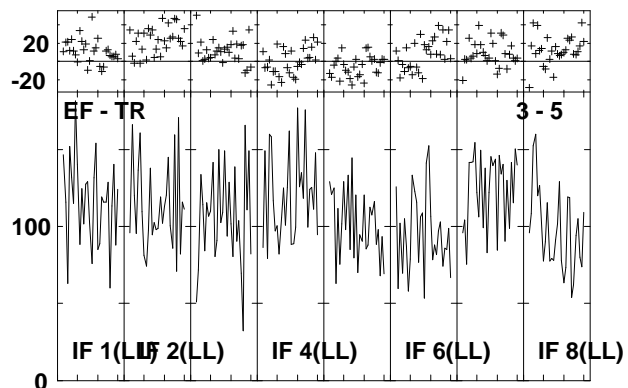
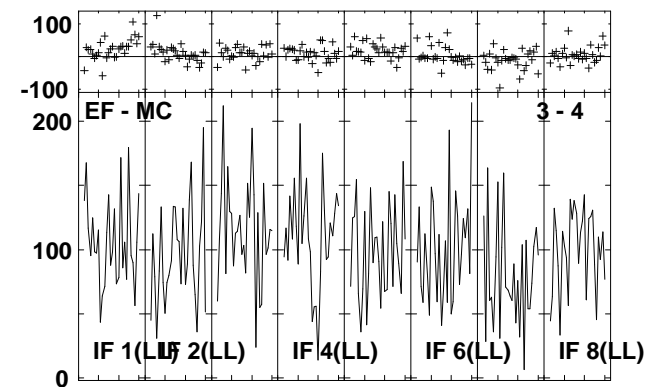
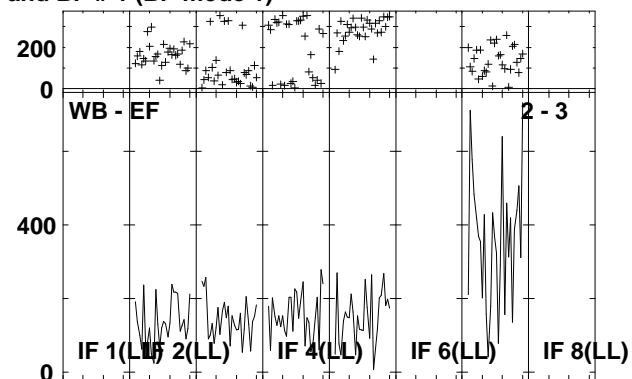
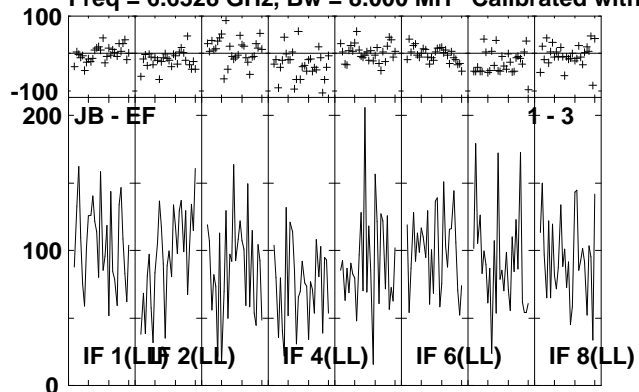

Lower frame: Milli Ampl Jy Top frame: Phas deg
 Vector averaged cross-power spectrum Several baselines displayed
 Timerange: 00/06:00:55 to 00/06:02:24

Plot file version 169 created 19-AUG-2009 15:53:12
 W75 EB039B 2.UVDATA.1
 Freq = 6.6328 GHz, Bw = 8.000 MH Calibrated with CL # 3 and BP # 1 (BP mode 1)

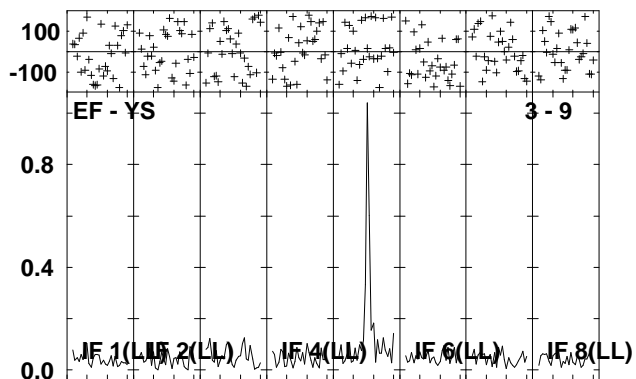
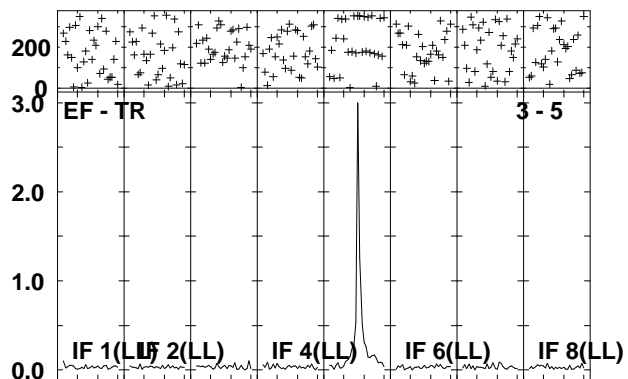
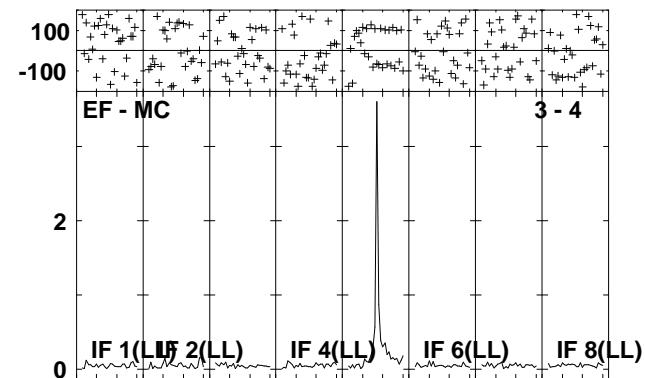
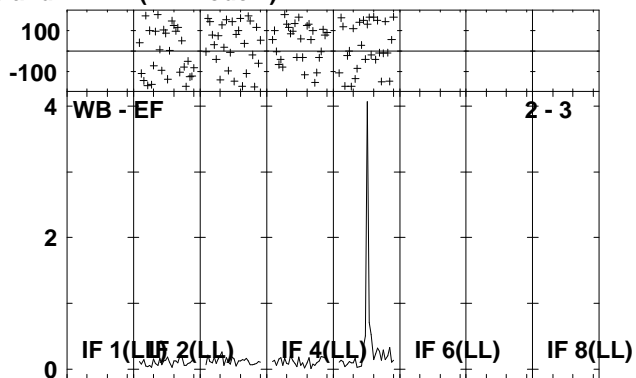
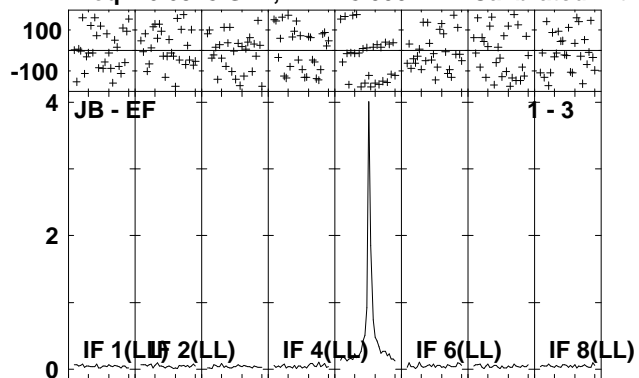

Lower frame: Ampl Jy Top frame: Phas deg
 Vector averaged cross-power spectrum Several baselines displayed
 Timerange: 00/06:02:26 to 00/06:03:55

Plot file version 170 created 19-AUG-2009 15:53:15

W75 EB039B 2.UVDATA.1

Freq = 6.6328 GHz, Bw = 8.000 MH Calibrated with CL # 3 and BP # 1 (BP mode 1)

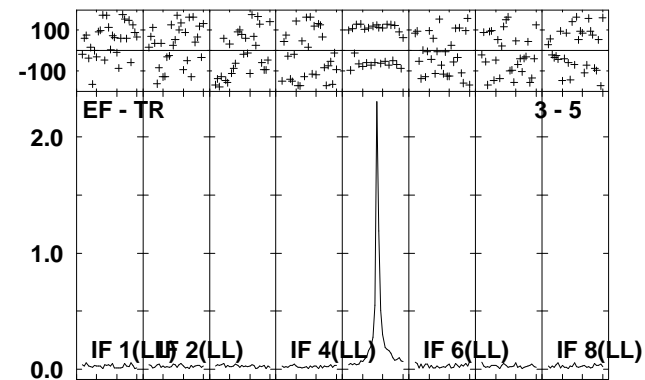
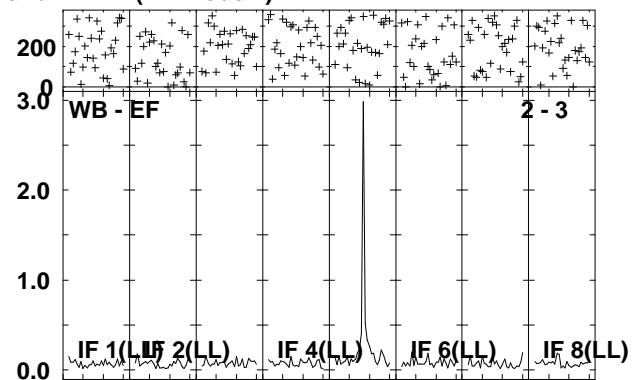
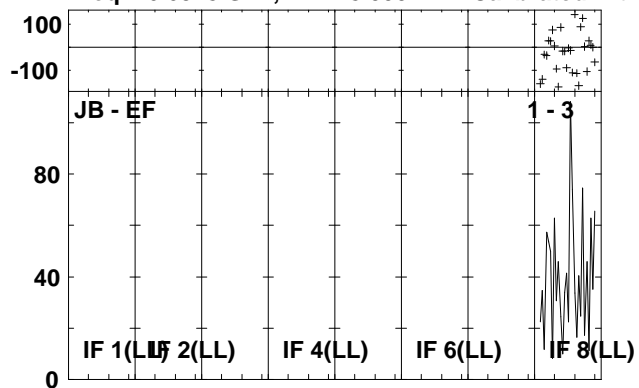

Lower frame: Milli Ampl Jy Top frame: Phas deg
Vector averaged cross-power spectrum Several baselines displayed
Timerange: 00/06:05:26 to 00/06:06:55

Plot file version 171 created 19-AUG-2009 15:53:16

2048+431 EB039B 2.UVDATA.1

Freq = 6.6328 GHz, Bw = 8.000 MH Calibrated with CL # 3 and BP # 1 (BP mode 1)

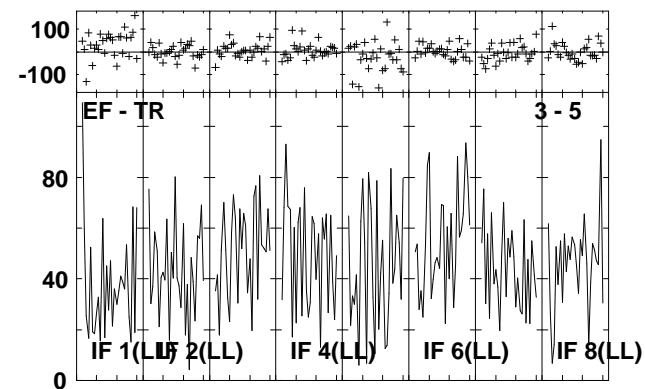
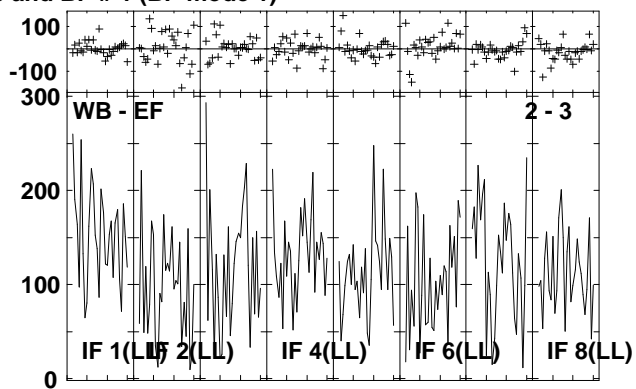
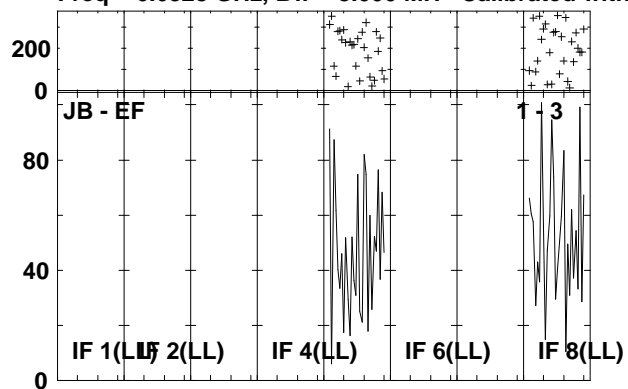

Lower frame: Milli Ampl Jy Top frame: Phas deg
Vector averaged cross-power spectrum Several baselines displayed
Timerange: 00/06:06:55 to 00/06:08:24

Plot file version 172 created 19-AUG-2009 15:53:18

W75 EB039B 2.UVDATA.1

Freq = 6.6328 GHz, Bw = 8.000 MH Calibrated with CL # 3 and BP # 1 (BP mode 1)

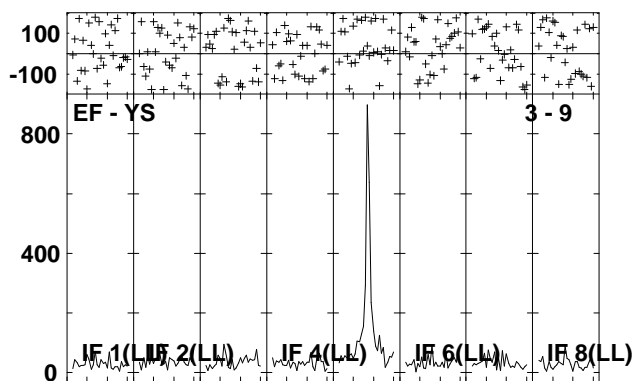
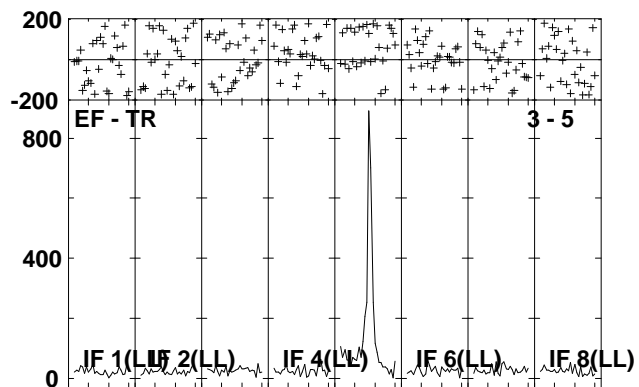
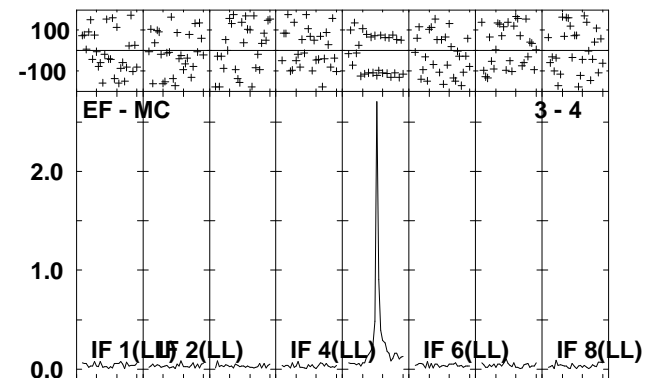
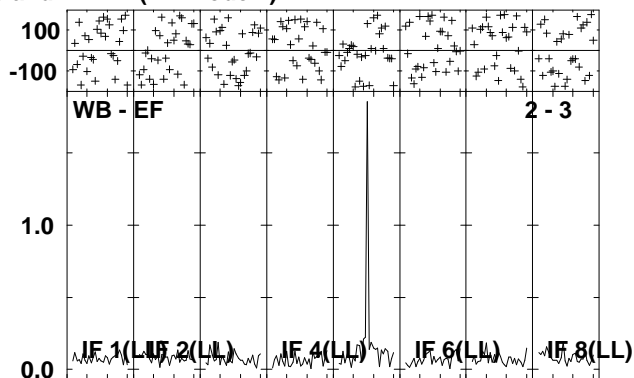
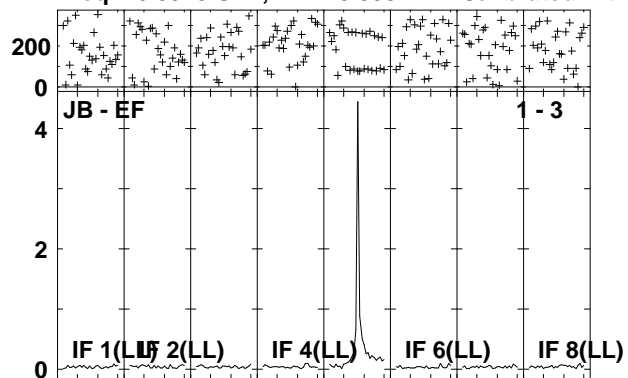

Lower frame: Ampl Jy Top frame: Phas deg
Vector averaged cross-power spectrum Several baselines displayed
Timerange: 00/06:08:26 to 00/06:09:55

Plot file version 173 created 19-AUG-2009 15:53:20

OB2 EB039B 2.UVDATA.1

Freq = 6.6328 GHz, Bw = 8.000 MH Calibrated with CL # 3 and BP # 1 (BP mode 1)

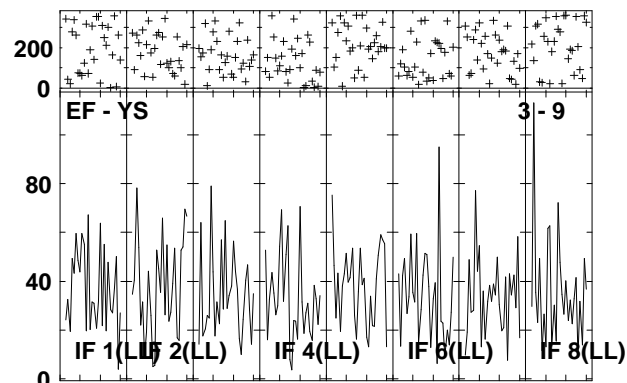
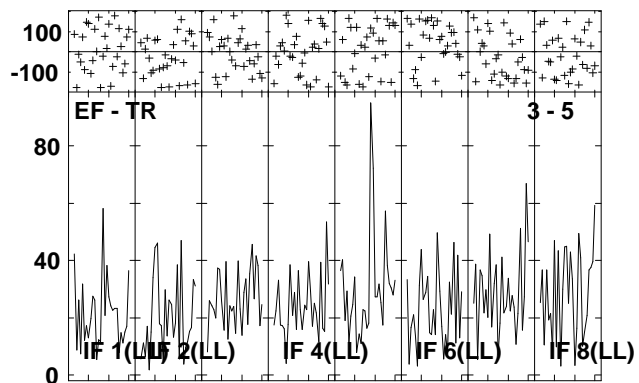
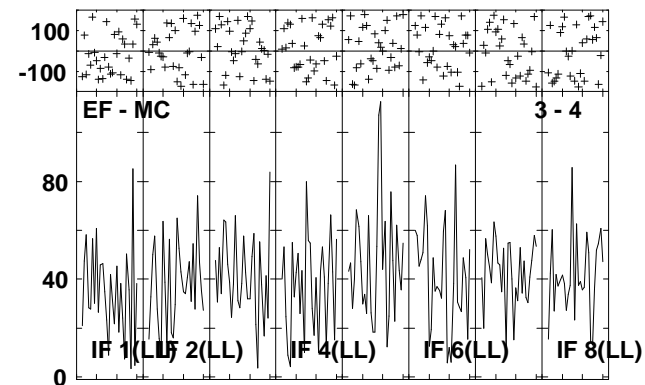
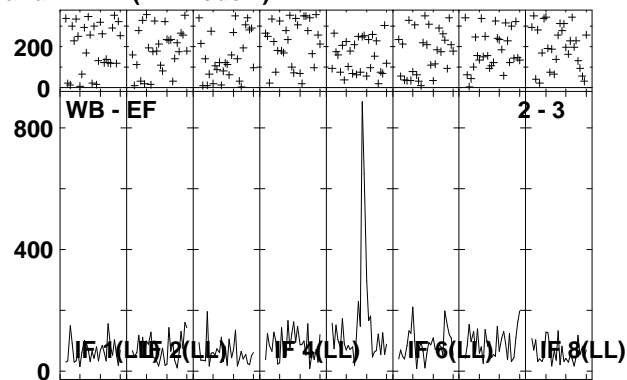
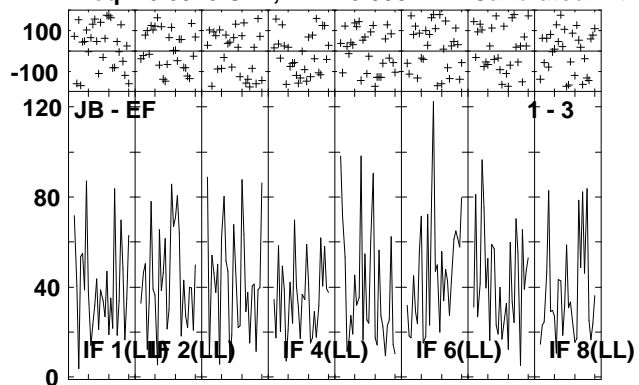

Lower frame: Milli Ampl Jy Top frame: Phas deg
Vector averaged cross-power spectrum Several baselines displayed
Timerange: 00/06:09:55 to 00/06:11:24

Plot file version 174 created 19-AUG-2009 15:53:21
 W75 EB039B 2.UVDATA.1
 Freq = 6.6328 GHz, Bw = 8.000 MH Calibrated with CL # 3 and BP # 1 (BP mode 1)

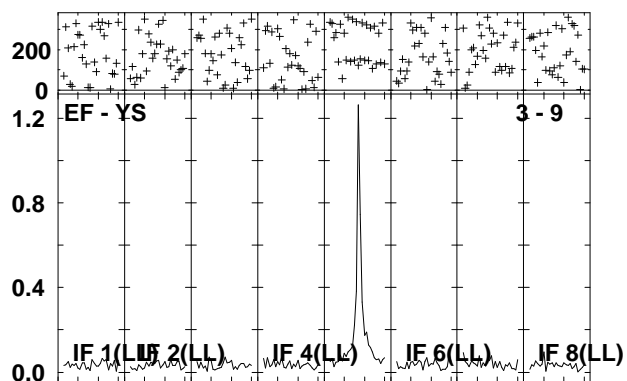
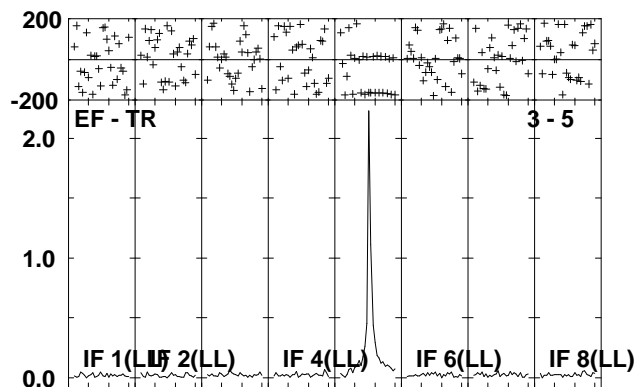
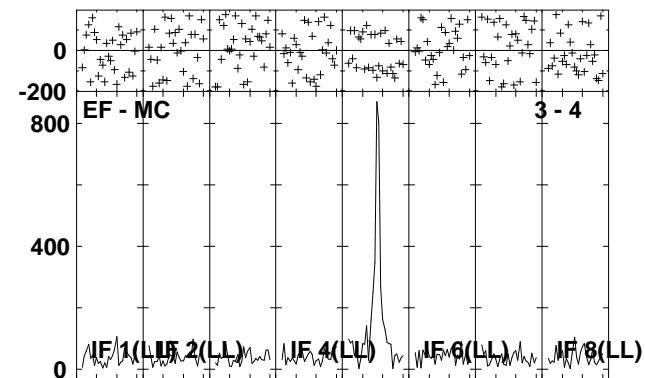
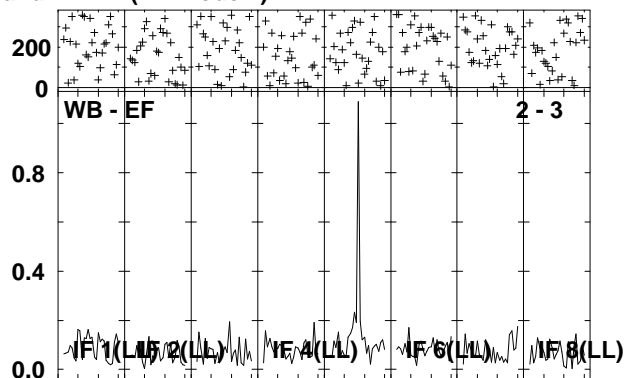
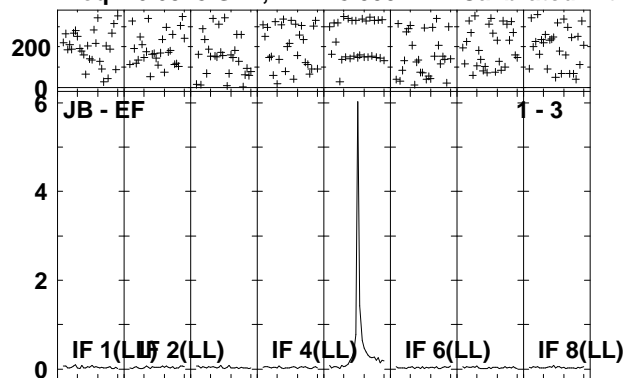

Lower frame: Ampl Jy Top frame: Phas deg
 Vector averaged cross-power spectrum Several baselines displayed
 Timerange: 00/06:12:05 to 00/06:13:05

Plot file version 175 created 19-AUG-2009 15:53:23
 DR21A EB039B 2.UVDATA.1
 Freq = 6.6328 GHz, Bw = 8.000 MH Calibrated with CL # 3 and BP # 1 (BP mode 1)

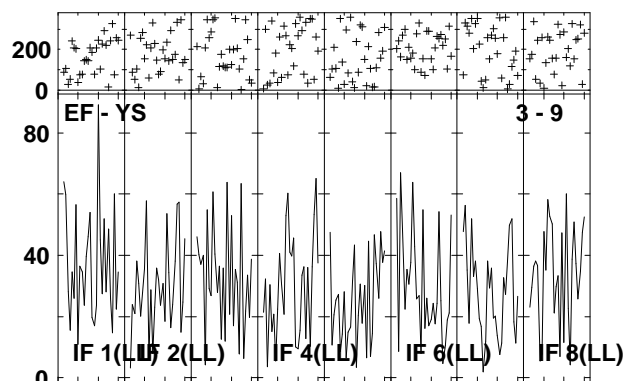
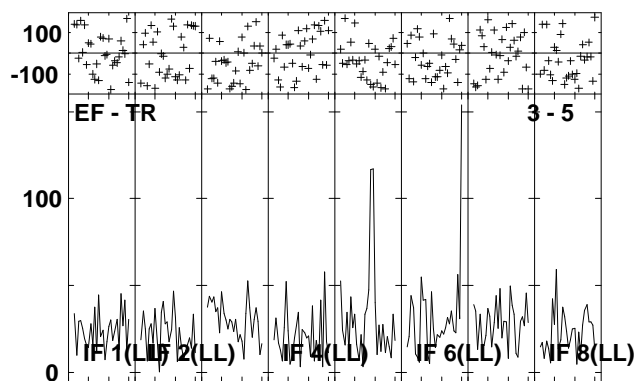
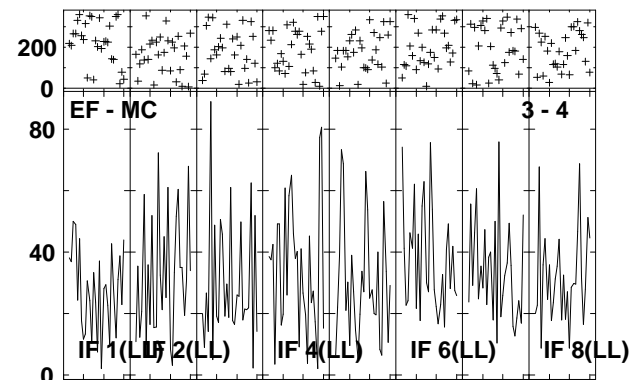
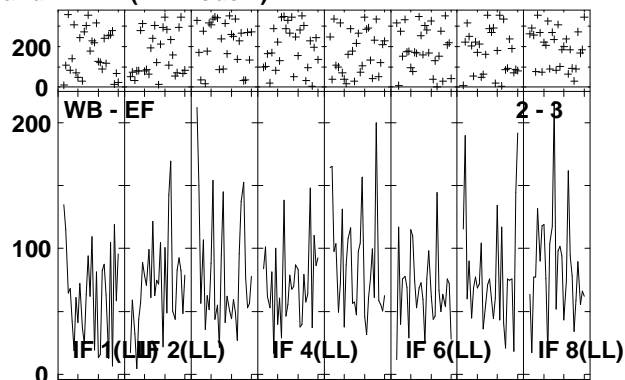
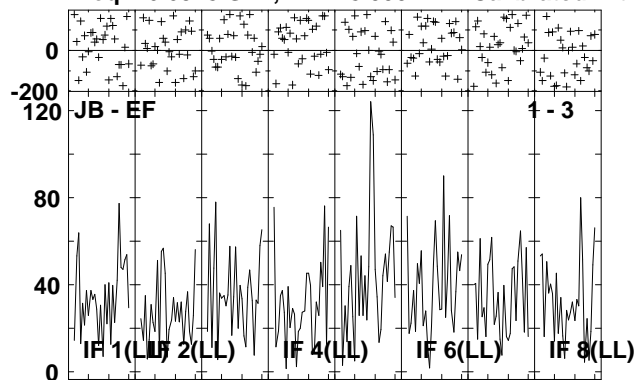

Lower frame: Milli Ampl Jy Top frame: Phas deg
 Vector averaged cross-power spectrum Several baselines displayed
 Timerange: 00/06:13:06 to 00/06:14:34

Plot file version 176 created 19-AUG-2009 15:53:24
 W75 EB039B 2.UVDATA.1
 Freq = 6.6328 GHz, Bw = 8.000 MH Calibrated with CL # 3 and BP # 1 (BP mode 1)

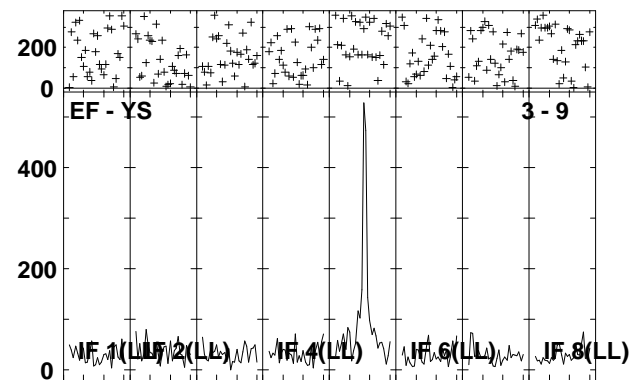
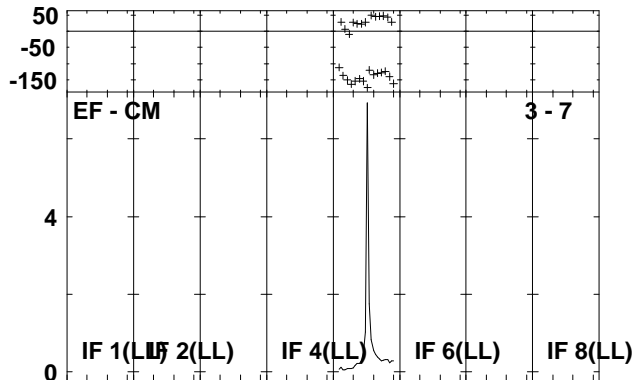
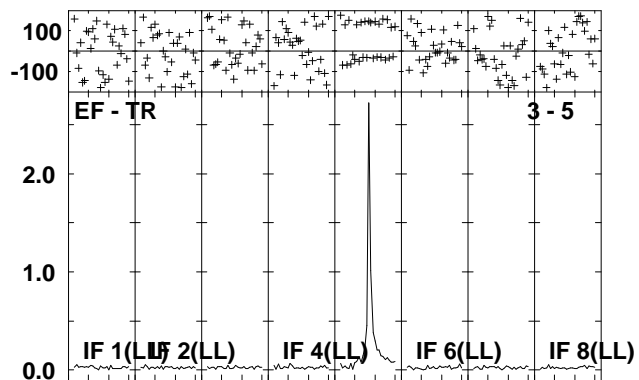
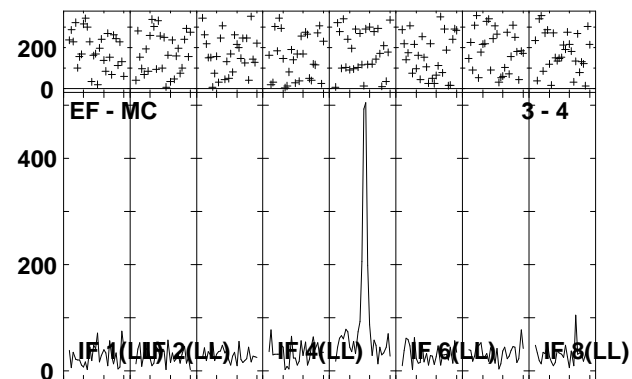
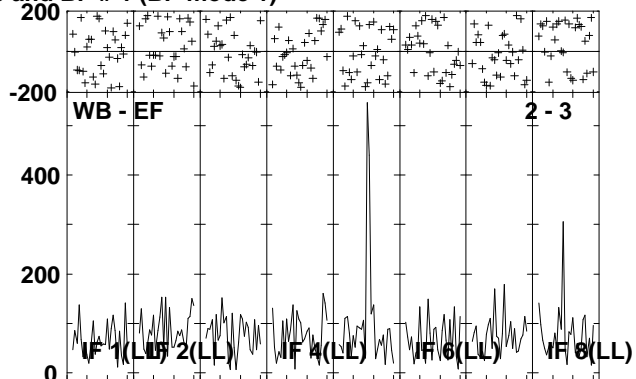
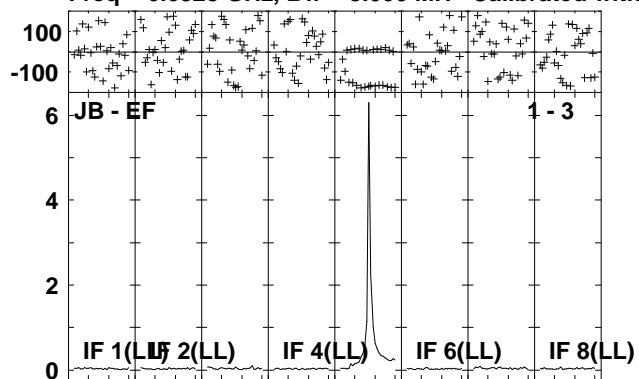

Lower frame: Ampl Jy Top frame: Phas deg
 Vector averaged cross-power spectrum Several baselines displayed
 Timerange: 00/06:14:35 to 00/06:16:03

Plot file version 177 created 19-AUG-2009 15:53:27
 DR21B EB039B 2.UVDATA.1
 Freq = 6.6328 GHz, Bw = 8.000 MH Calibrated with CL # 3 and BP # 1 (BP mode 1)

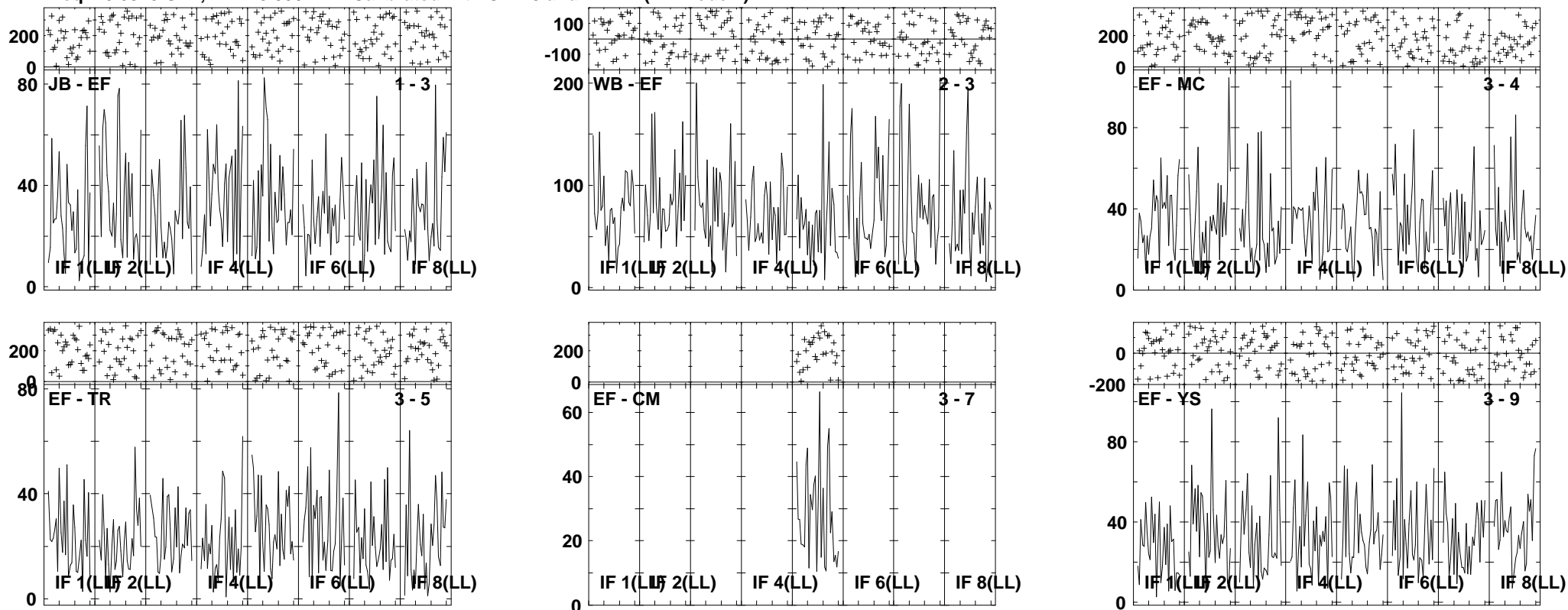

Lower frame: Milli Ampl Jy Top frame: Phas deg
 Vector averaged cross-power spectrum Several baselines displayed
 Timerange: 00/06:16:06 to 00/06:17:34

Plot file version 178 created 19-AUG-2009 15:53:29
 W75 EB039B 2.UVDATA.1
 Freq = 6.6328 GHz, Bw = 8.000 MH Calibrated with CL # 3 and BP # 1 (BP mode 1)

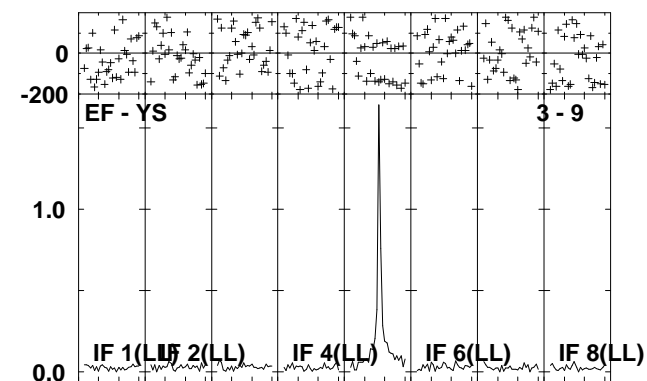
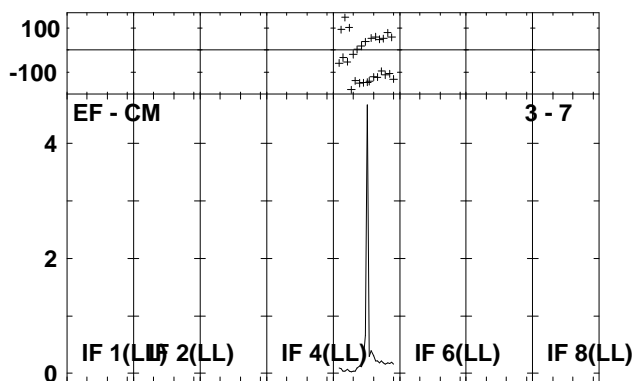
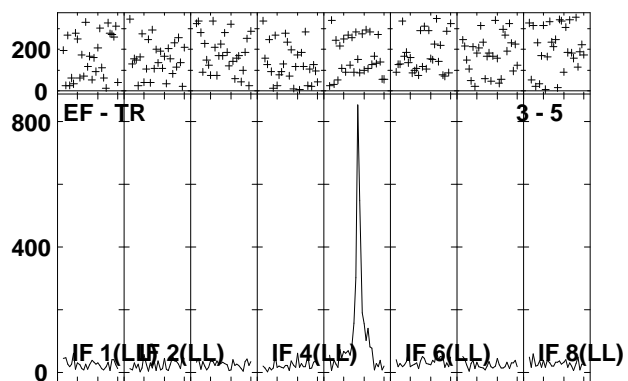
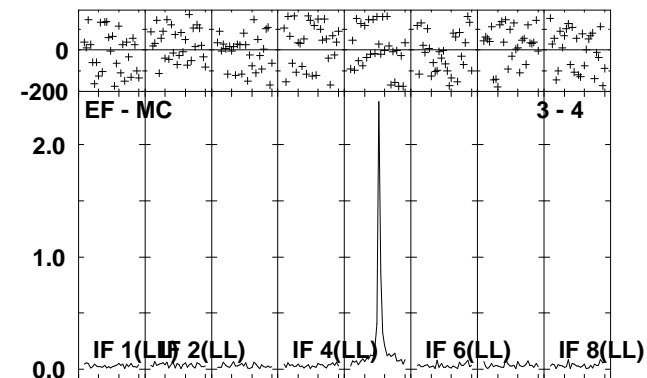
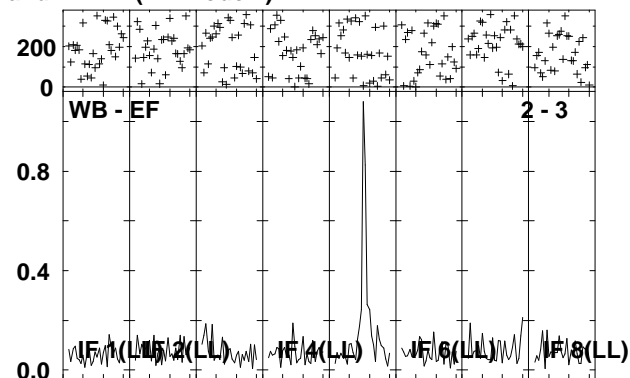
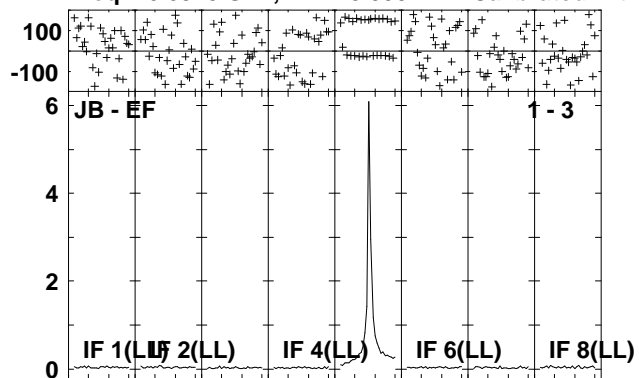

Lower frame: Ampl Jy Top frame: Phas deg
 Vector averaged cross-power spectrum Several baselines displayed
 Timerange: 00/06:17:36 to 00/06:19:05

Plot file version 179 created 19-AUG-2009 15:53:31
 DR21B2 EB039B 2.UVDATA.1
 Freq = 6.6328 GHz, Bw = 8.000 MH Calibrated with CL # 3 and BP # 1 (BP mode 1)

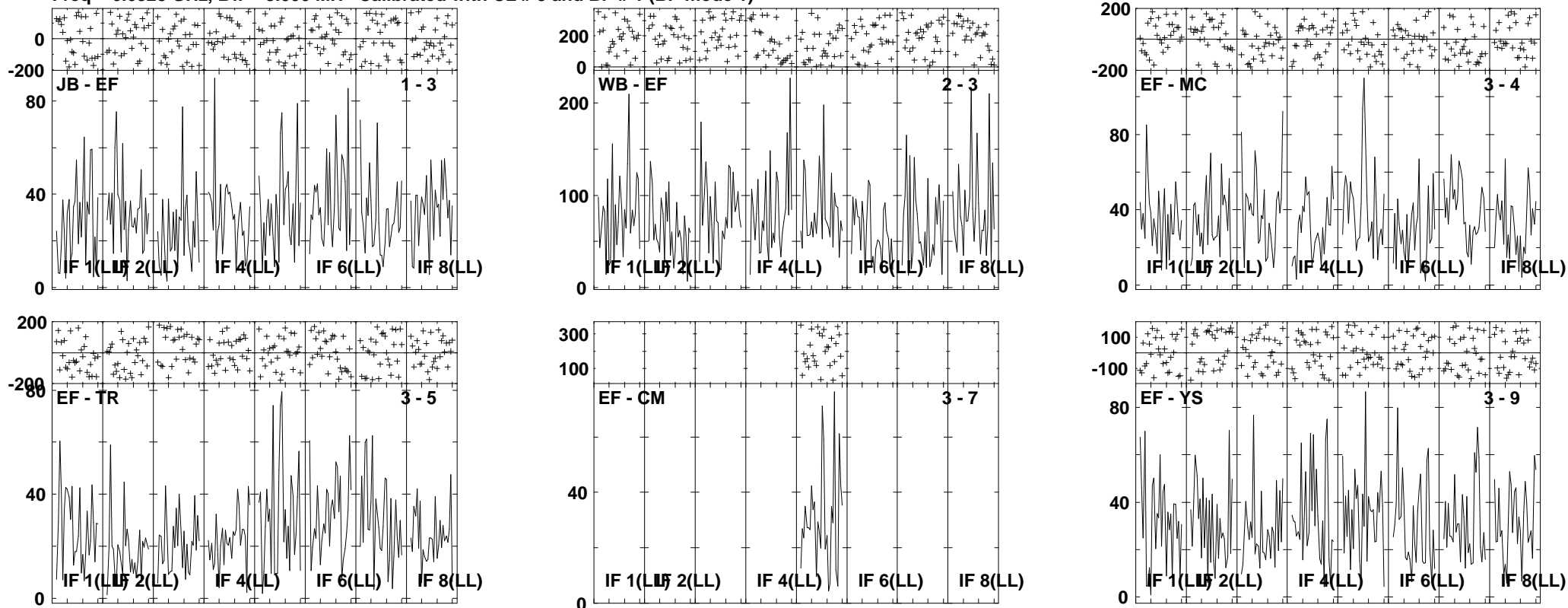

Lower frame: Milli Ampl Jy Top frame: Phas deg
 Vector averaged cross-power spectrum Several baselines displayed
 Timerange: 00/06:19:05 to 00/06:20:34

Plot file version 180 created 19-AUG-2009 15:53:34
 W75 EB039B 2.UVDATA.1
 Freq = 6.6328 GHz, Bw = 8.000 MH Calibrated with CL # 3 and BP # 1 (BP mode 1)

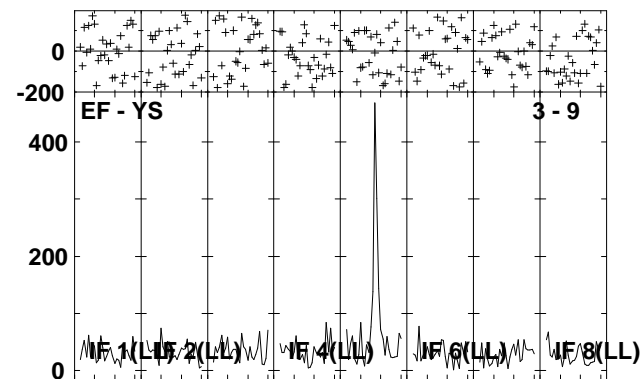
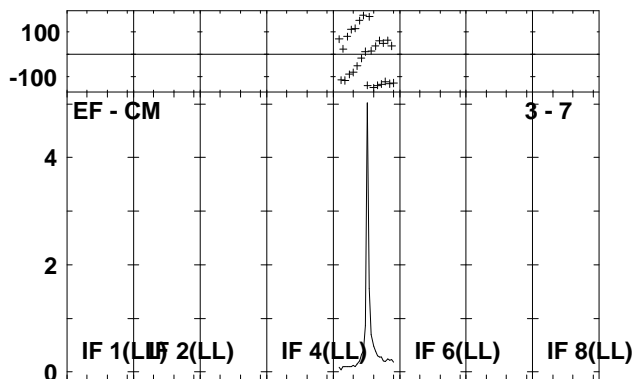
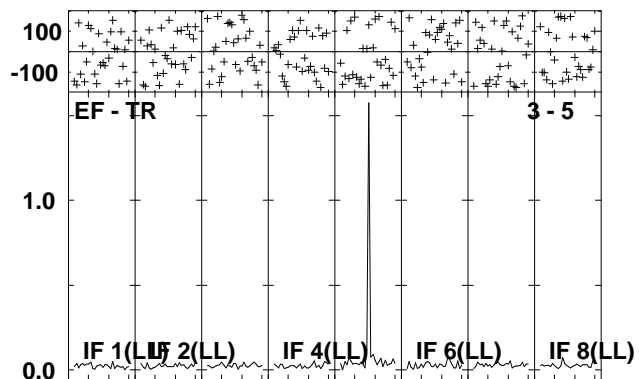
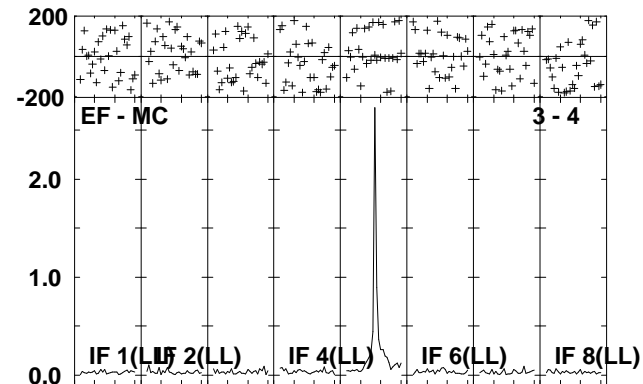
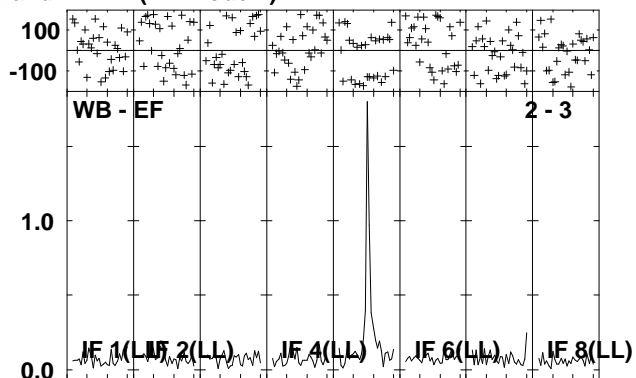
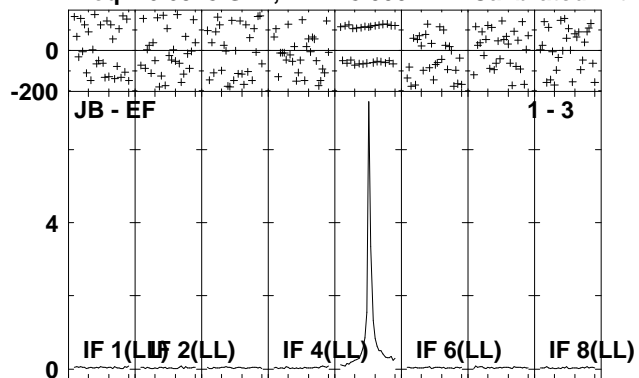

Lower frame: Ampl Jy Top frame: Phas deg
 Vector averaged cross-power spectrum Several baselines displayed
 Timerange: 00/06:20:36 to 00/06:22:05

Plot file version 181 created 19-AUG-2009 15:53:36

DR20 EB039B 2.UVDATA.1

Freq = 6.6328 GHz, Bw = 8.000 MH Calibrated with CL # 3 and BP # 1 (BP mode 1)

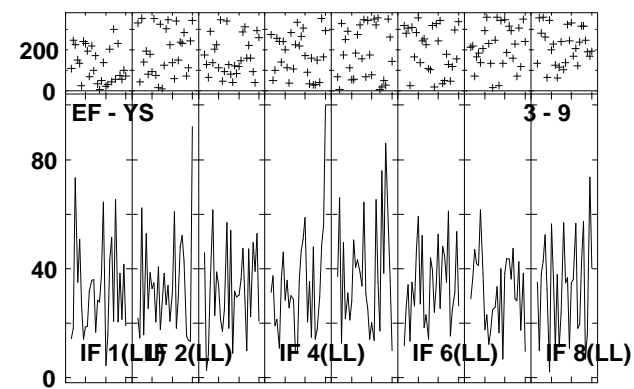
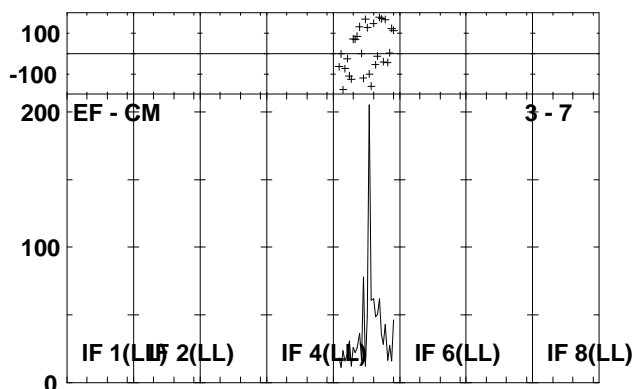
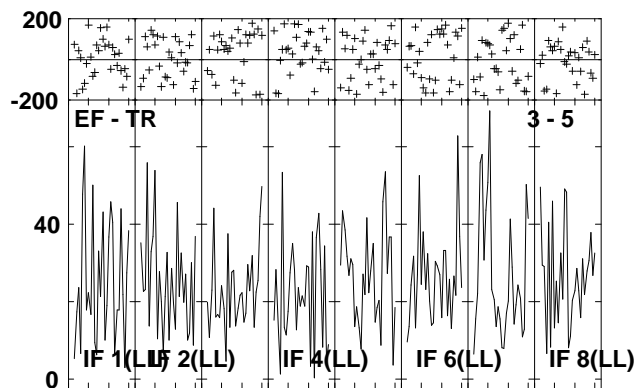
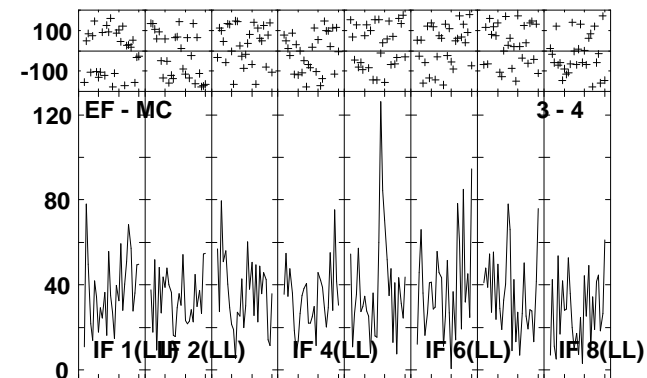
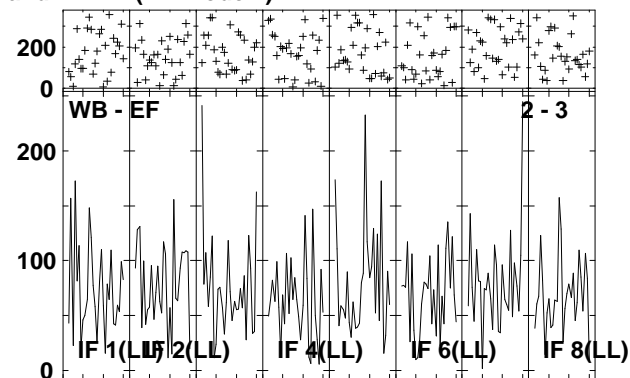
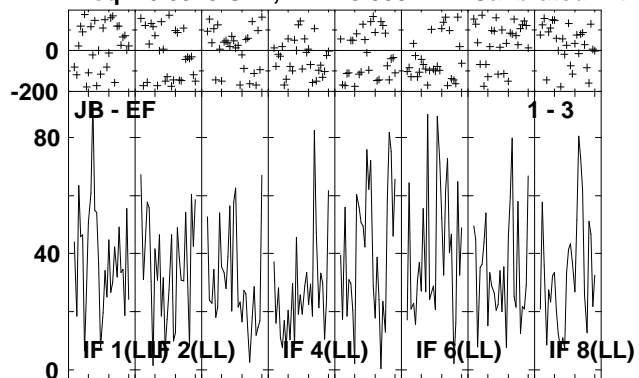

Lower frame: Milli Ampl Jy Top frame: Phas deg
Vector averaged cross-power spectrum Several baselines displayed
Timerange: 00/06:22:05 to 00/06:23:34

Plot file version 182 created 19-AUG-2009 15:53:38
 W75 EB039B 2.UVDATA.1
 Freq = 6.6328 GHz, Bw = 8.000 MH Calibrated with CL # 3 and BP # 1 (BP mode 1)

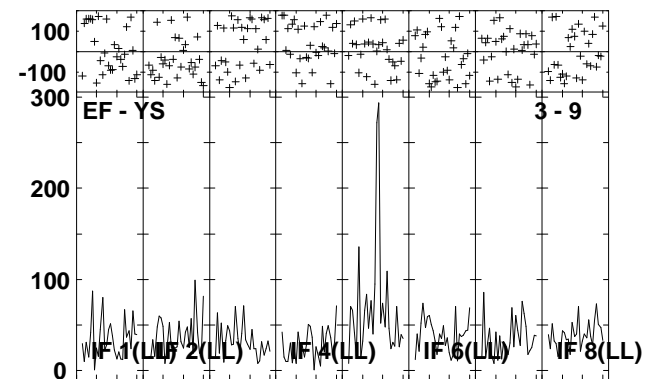
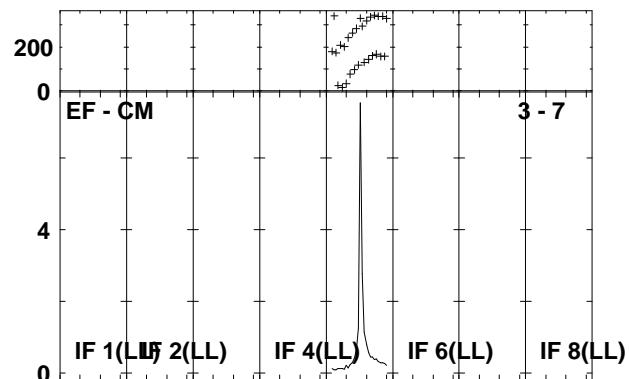
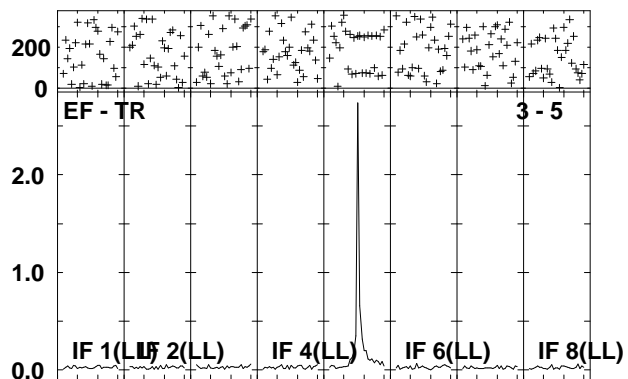
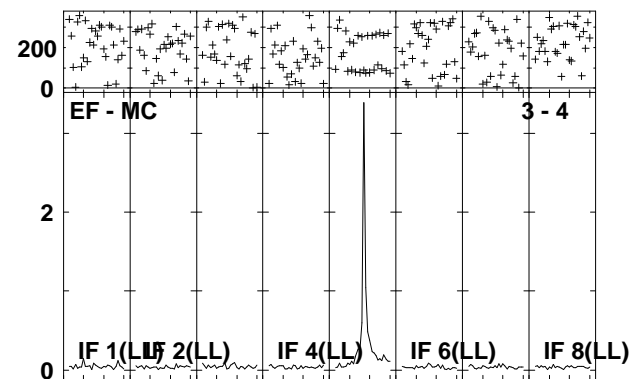
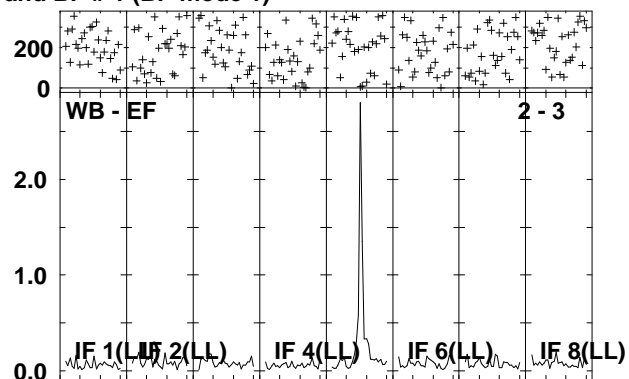
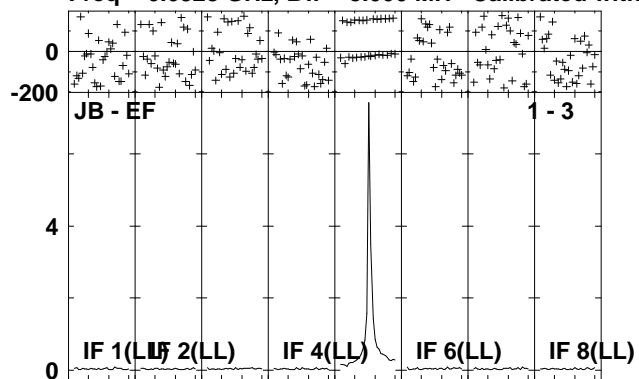

Lower frame: Ampl Jy Top frame: Phas deg
 Vector averaged cross-power spectrum Several baselines displayed
 Timerange: 00/06:24:07 to 00/06:25:05

Plot file version 183 created 19-AUG-2009 15:53:40
 J2029+46 EB039B 2.UVDATA.1
 Freq = 6.6328 GHz, Bw = 8.000 MH Calibrated with CL # 3 and BP # 1 (BP mode 1)

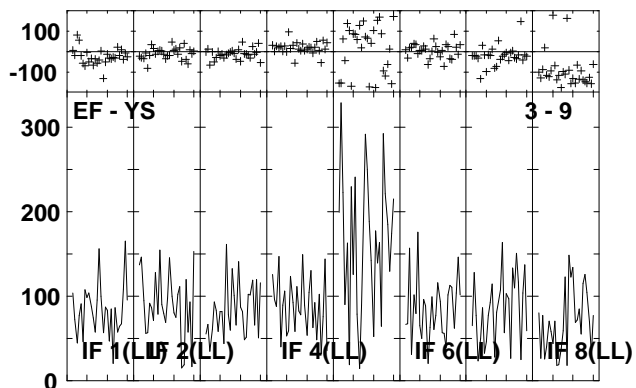
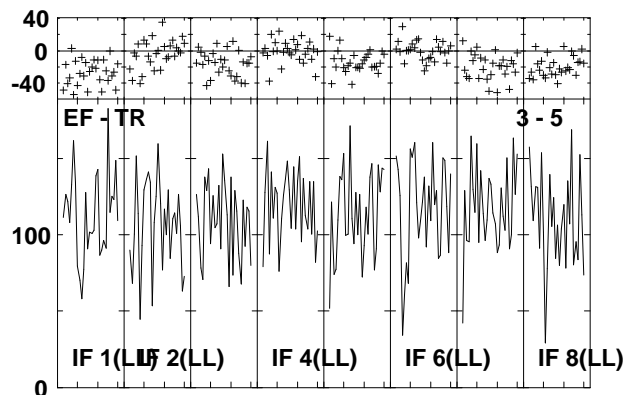
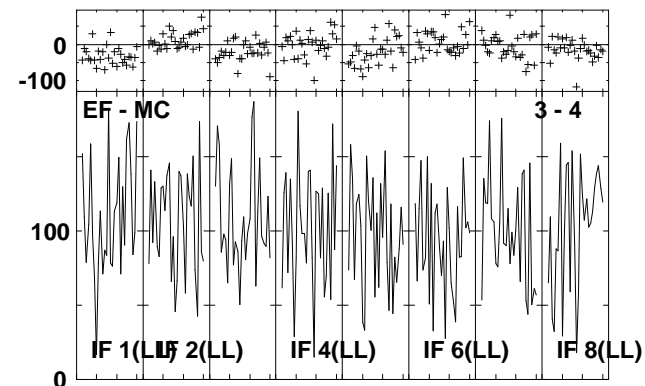
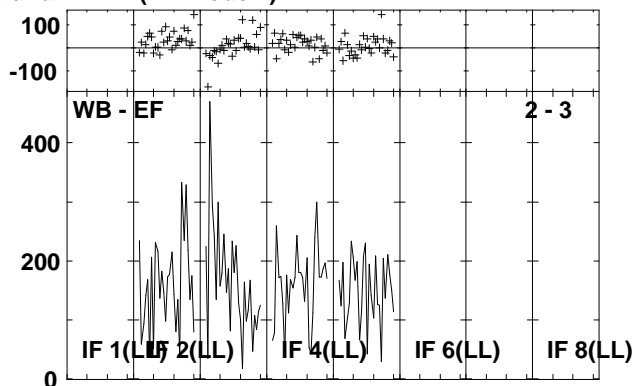
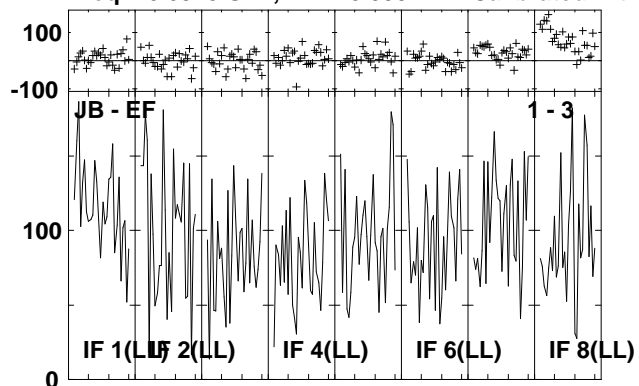

Lower frame: Milli Ampl Jy Top frame: Phas deg
 Vector averaged cross-power spectrum Several baselines displayed
 Timerange: 00/06:25:07 to 00/06:26:36

Plot file version 184 created 19-AUG-2009 15:53:42
 W75 EB039B 2.UVDATA.1
 Freq = 6.6328 GHz, Bw = 8.000 MH Calibrated with CL # 3 and BP # 1 (BP mode 1)

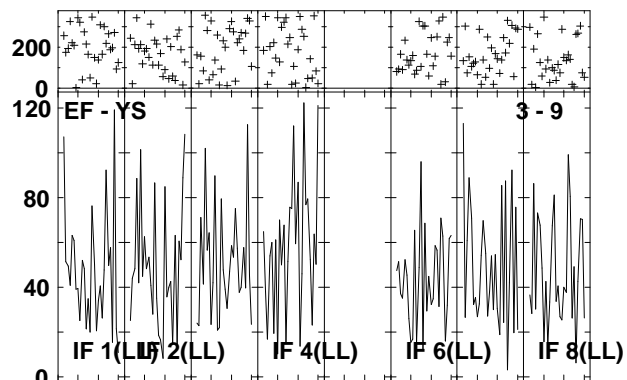
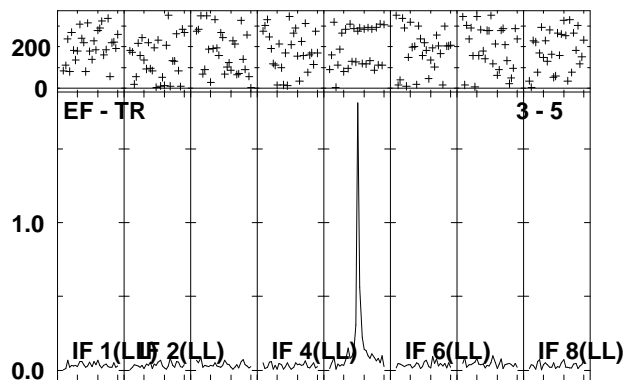
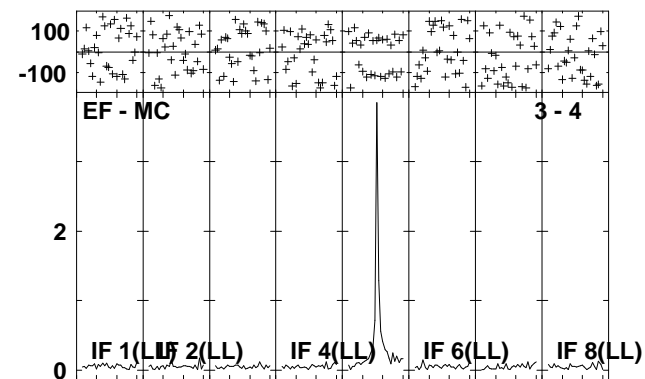
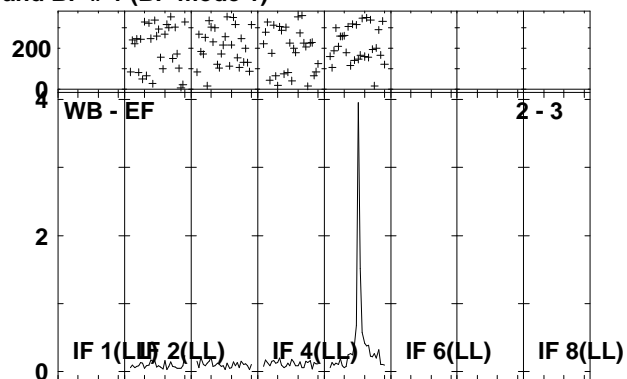
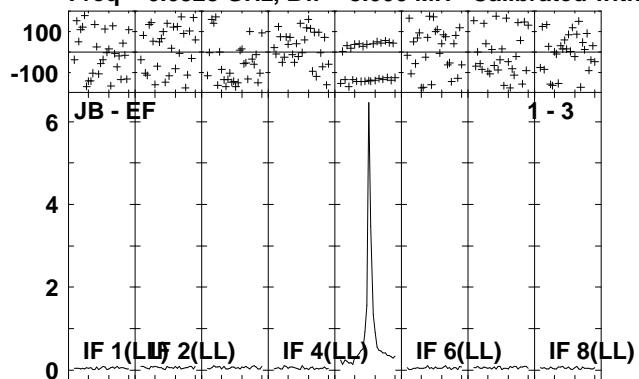

Lower frame: Ampl Jy Top frame: Phas deg
 Vector averaged cross-power spectrum Several baselines displayed
 Timerange: 00/06:26:36 to 00/06:28:05

Plot file version 185 created 19-AUG-2009 15:53:46

W75 EB039B 2.UVDATA.1

Freq = 6.6328 GHz, Bw = 8.000 MH Calibrated with CL # 3 and BP # 1 (BP mode 1)

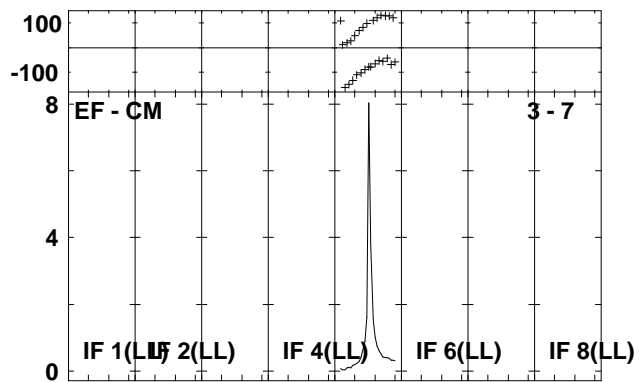
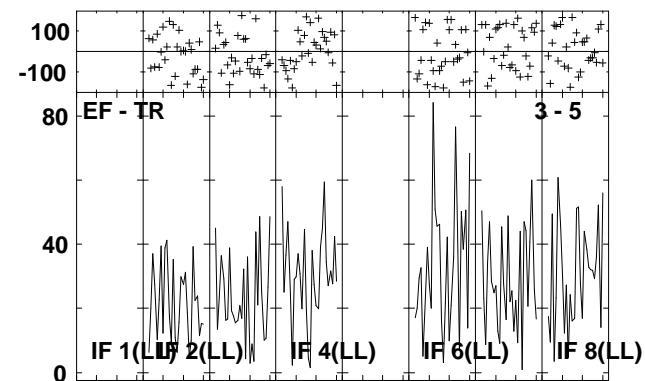
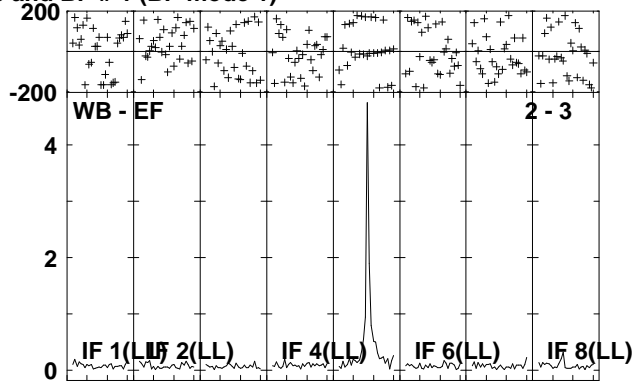
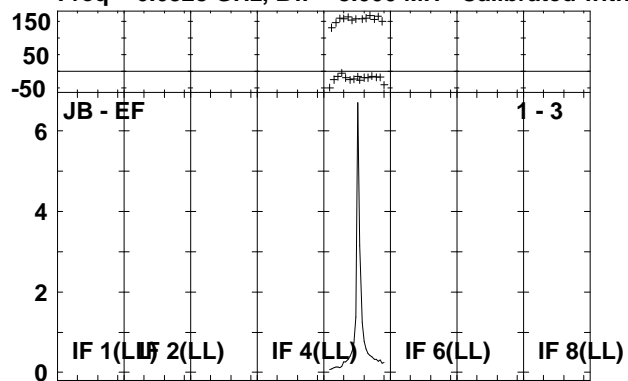

Lower frame: Ampl Jy Top frame: Phas deg
Vector averaged cross-power spectrum Several baselines displayed
Timerange: 00/06:29:36 to 00/06:31:05

Plot file version 186 created 19-AUG-2009 15:53:48
 2048+431 EB039B 2.UVDATA.1
 Freq = 6.6328 GHz, Bw = 8.000 MH Calibrated with CL # 3 and BP # 1 (BP mode 1)

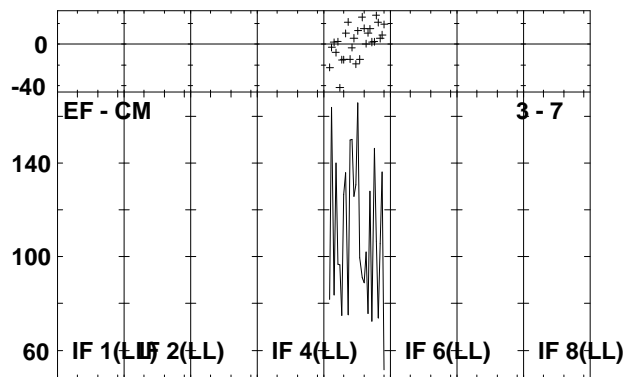
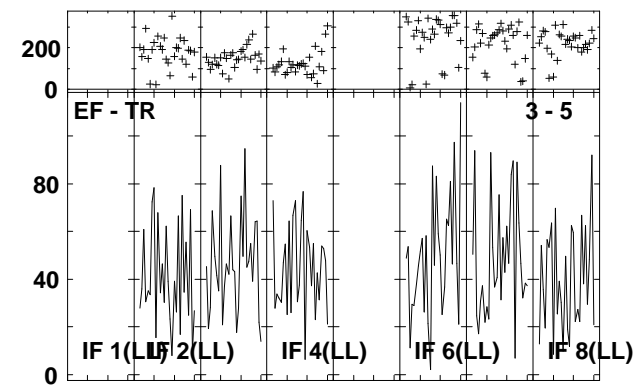
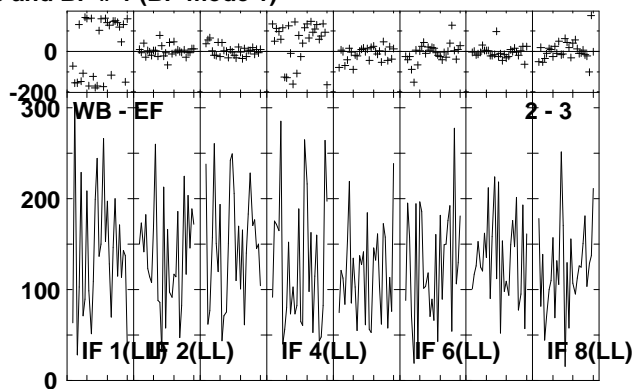
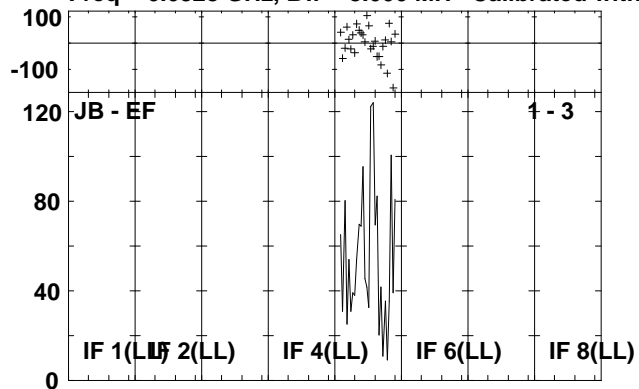

Lower frame: Milli Ampl Jy Top frame: Phas deg
 Vector averaged cross-power spectrum Several baselines displayed
 Timerange: 00/06:31:07 to 00/06:32:36

Plot file version 187 created 19-AUG-2009 15:53:50
 W75 EB039B 2.UVDATA.1
 Freq = 6.6328 GHz, Bw = 8.000 MH Calibrated with CL # 3 and BP # 1 (BP mode 1)

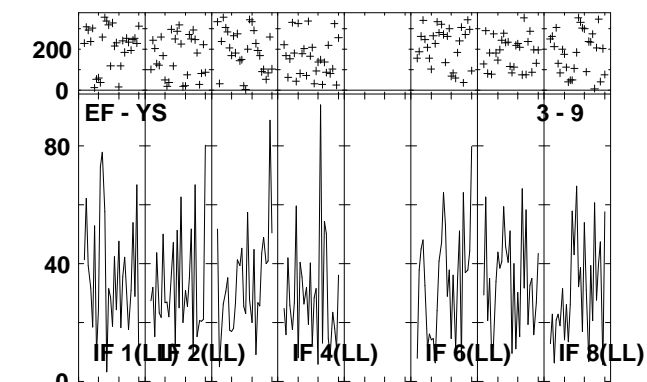
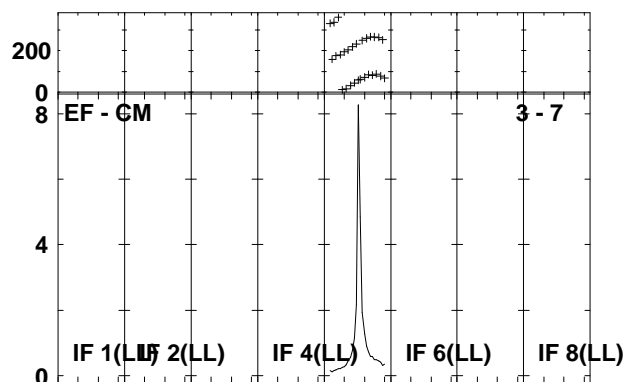
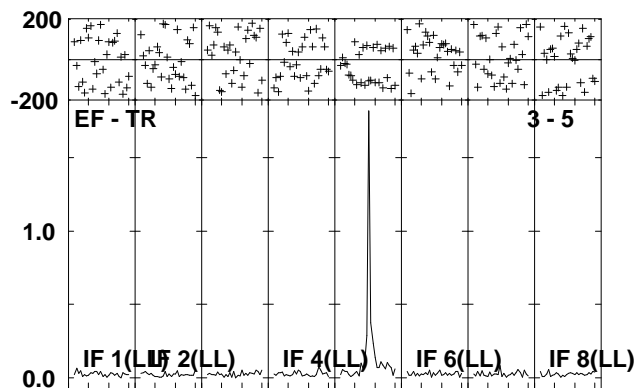
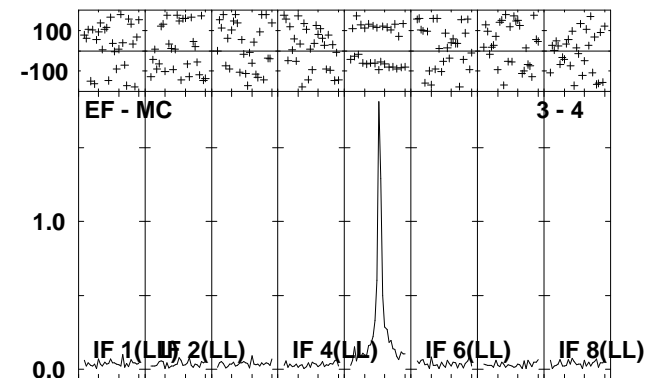
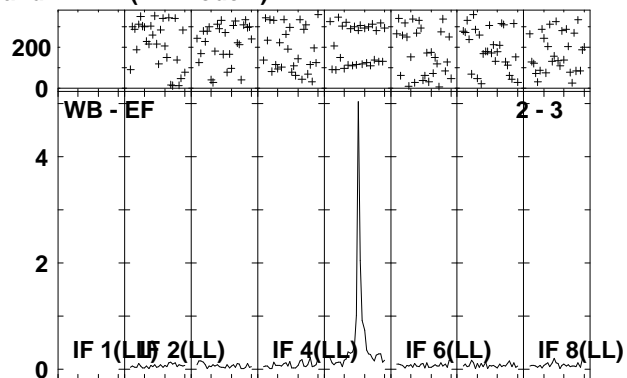
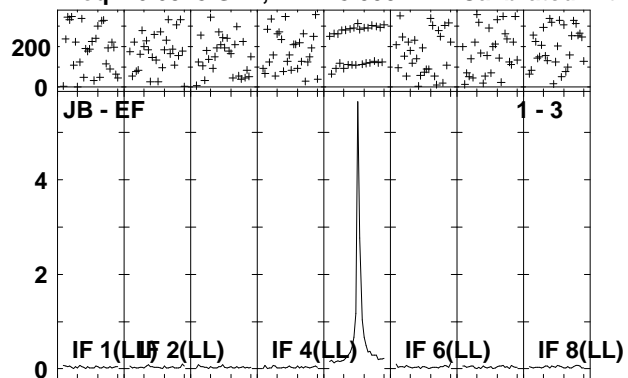

Lower frame: Ampl Jy Top frame: Phas deg
 Vector averaged cross-power spectrum Several baselines displayed
 Timerange: 00/06:32:36 to 00/06:34:05

Plot file version 188 created 19-AUG-2009 15:53:52
 OB2 EB039B 2.UVDATA.1
 Freq = 6.6328 GHz, Bw = 8.000 MH Calibrated with CL # 3 and BP # 1 (BP mode 1)

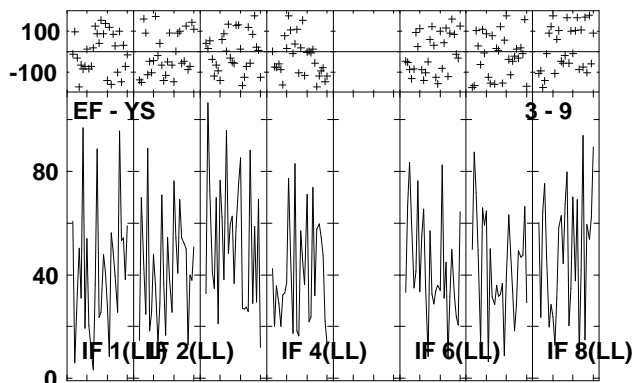
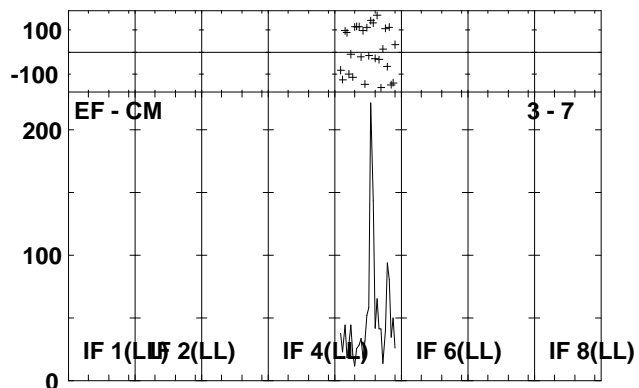
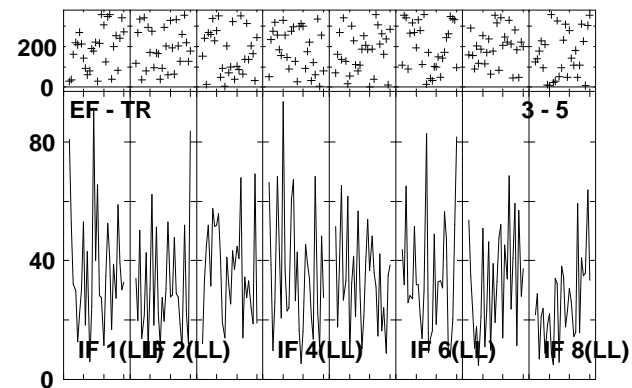
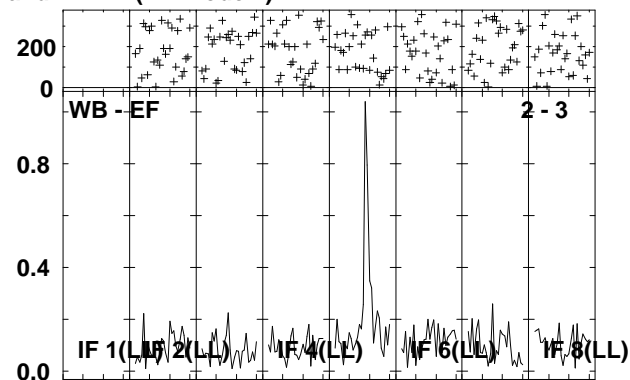
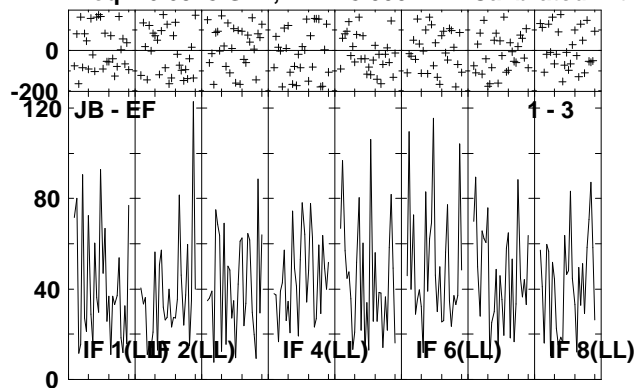

Lower frame: Milli Ampl Jy Top frame: Phas deg
 Vector averaged cross-power spectrum Several baselines displayed
 Timerange: 00/06:34:07 to 00/06:35:36

Plot file version 189 created 19-AUG-2009 15:53:53

W75 EB039B 2.UVDATA.1

Freq = 6.6328 GHz, Bw = 8.000 MH Calibrated with CL # 3 and BP # 1 (BP mode 1)

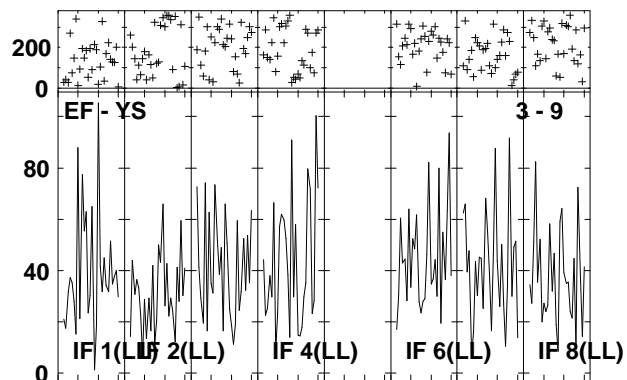
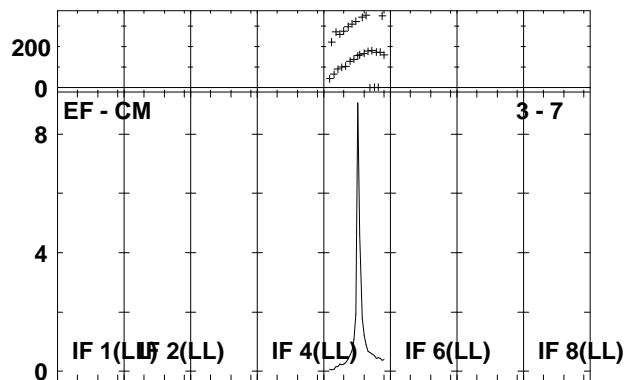
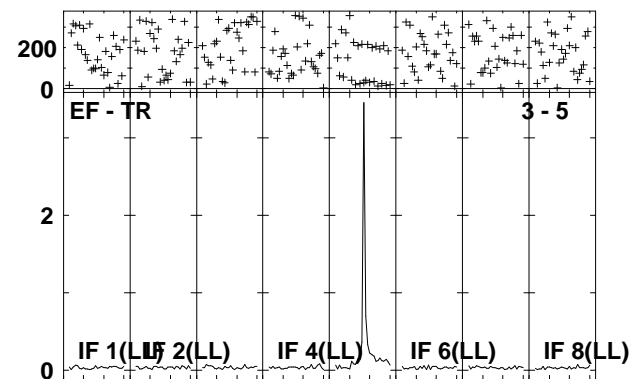
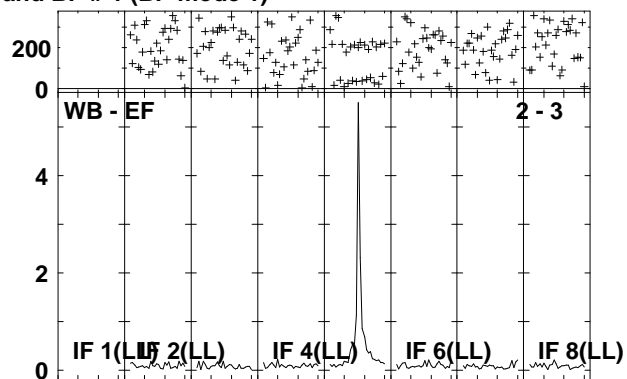
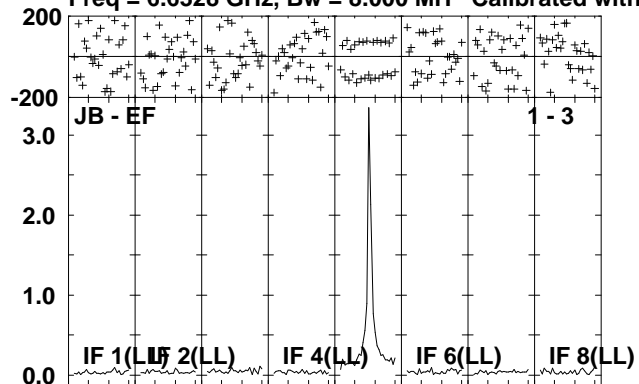

Lower frame: Ampl Jy Top frame: Phas deg
Vector averaged cross-power spectrum Several baselines displayed
Timerange: 00/06:36:18 to 00/06:37:18

Plot file version 190 created 19-AUG-2009 15:53:55
 DR21A EB039B 2.UVDATA.1
 Freq = 6.6328 GHz, Bw = 8.000 MH Calibrated with CL # 3 and BP # 1 (BP mode 1)

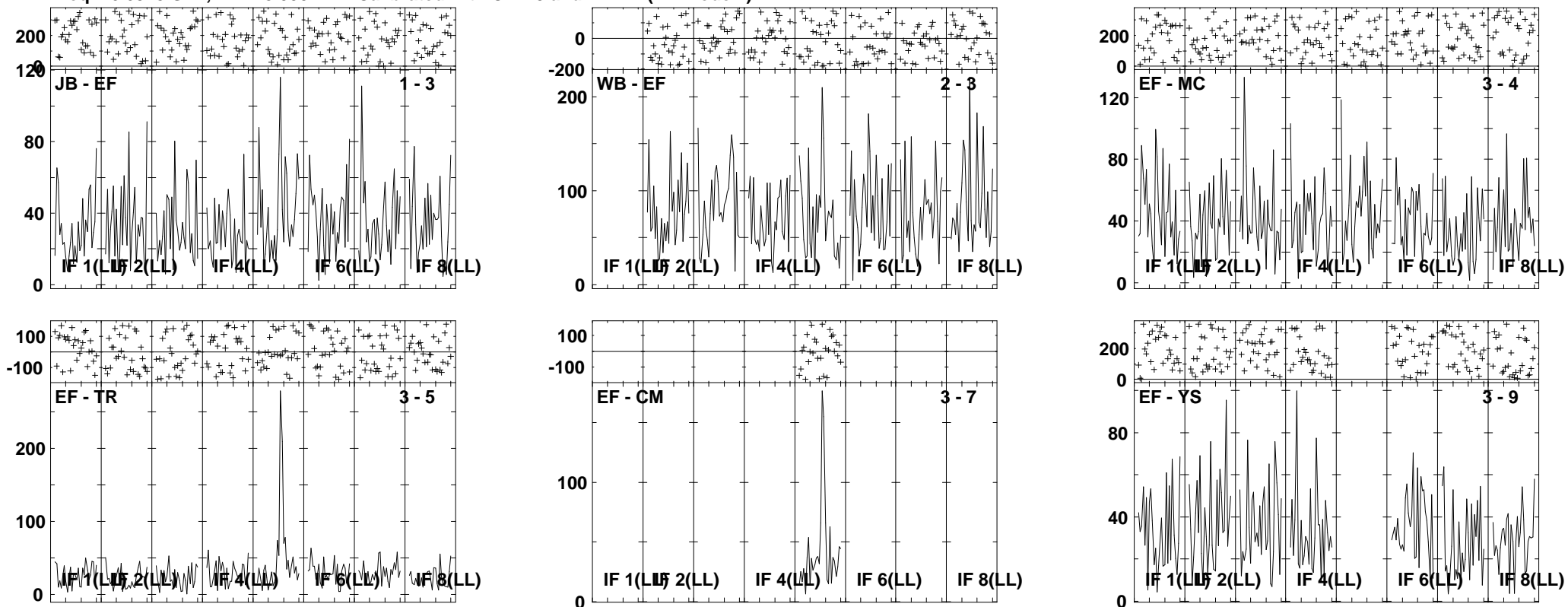

Lower frame: Milli Ampl Jy Top frame: Phas deg
 Vector averaged cross-power spectrum Several baselines displayed
 Timerange: 00/06:37:18 to 00/06:38:47

Plot file version 191 created 19-AUG-2009 15:53:57

W75 EB039B 2.UVDATA.1

Freq = 6.6328 GHz, Bw = 8.000 MH Calibrated with CL # 3 and BP # 1 (BP mode 1)

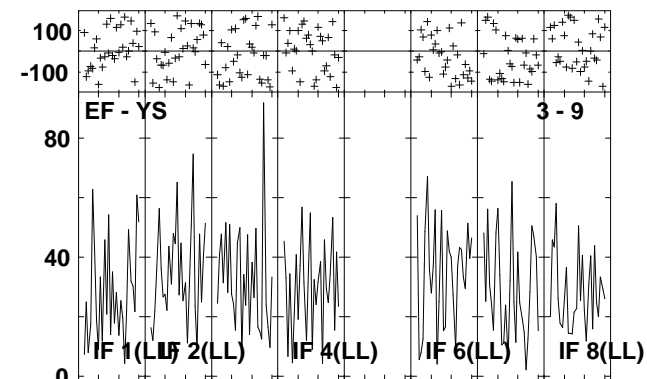
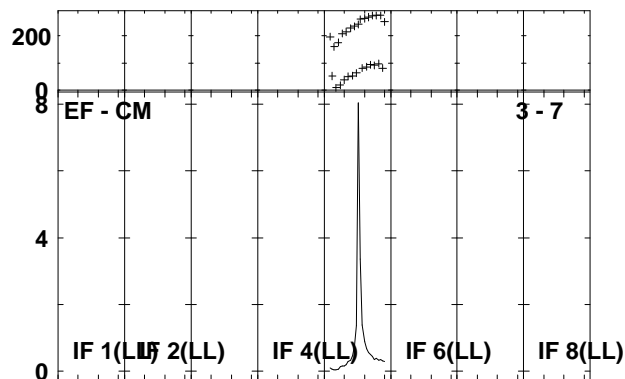
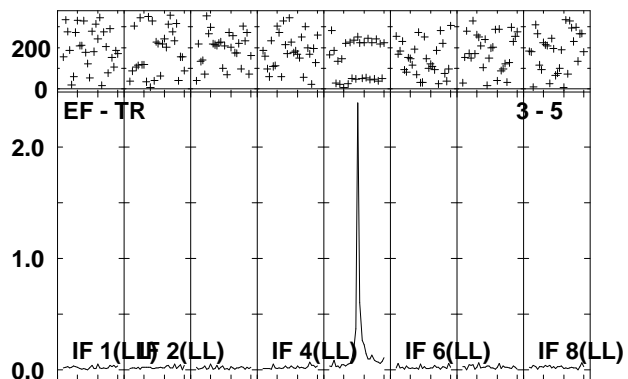
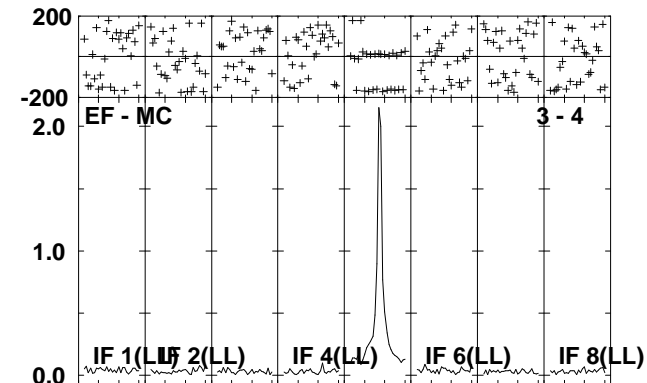
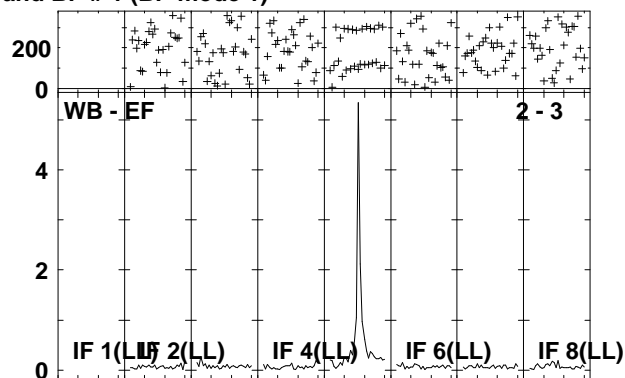
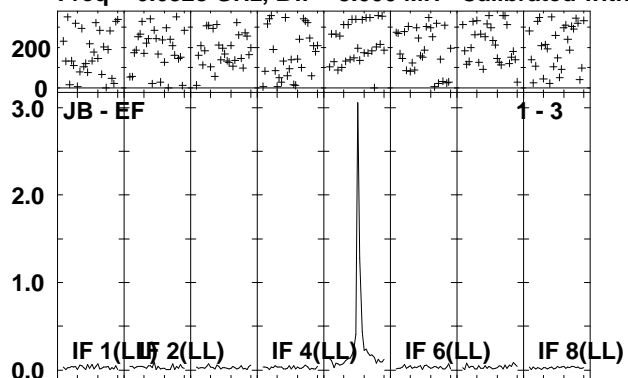

Lower frame: Ampl Jy Top frame: Phas deg
Vector averaged cross-power spectrum Several baselines displayed
Timerange: 00/06:38:49 to 00/06:40:18

Plot file version 192 created 19-AUG-2009 15:54:00
 DR21B EB039B 2.UVDATA.1
 Freq = 6.6328 GHz, Bw = 8.000 MH Calibrated with CL # 3 and BP # 1 (BP mode 1)

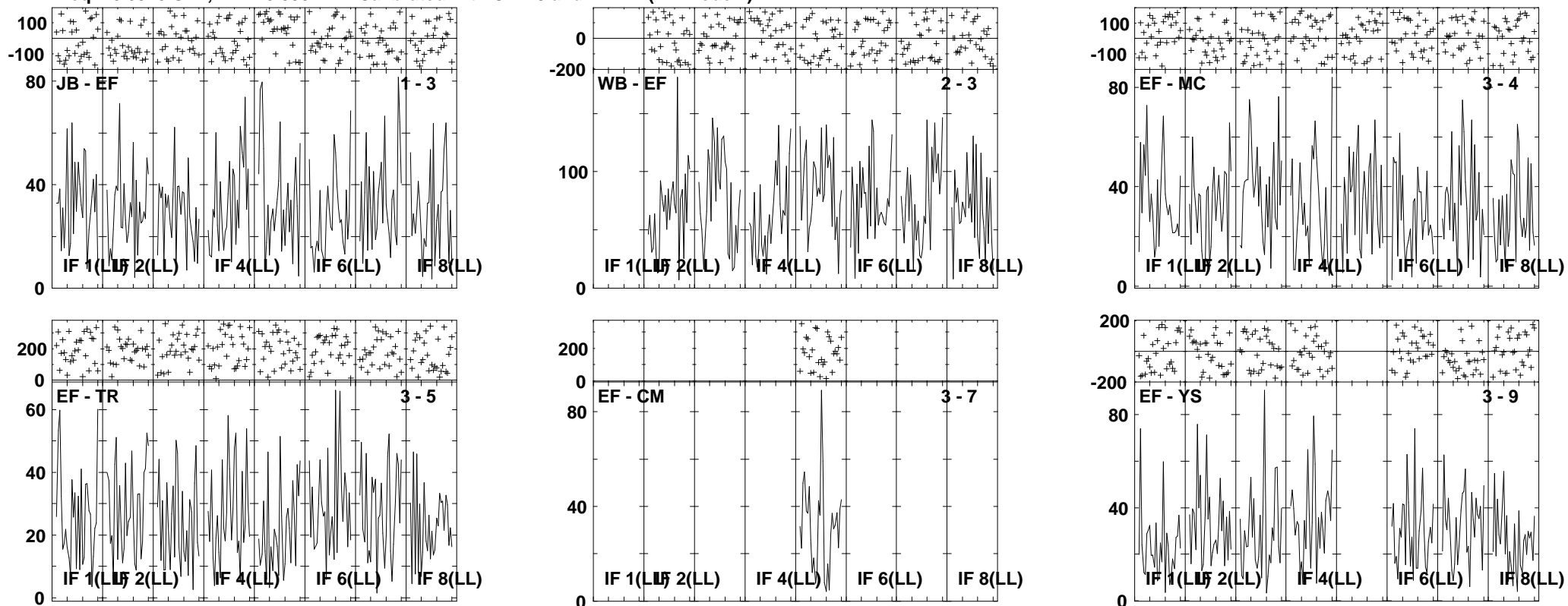

Lower frame: Milli Ampl Jy Top frame: Phas deg
 Vector averaged cross-power spectrum Several baselines displayed
 Timerange: 00/06:40:18 to 00/06:41:47

Plot file version 193 created 19-AUG-2009 15:54:02
 W75 EB039B 2.UVDATA.1
 Freq = 6.6328 GHz, Bw = 8.000 MH Calibrated with CL # 3 and BP # 1 (BP mode 1)

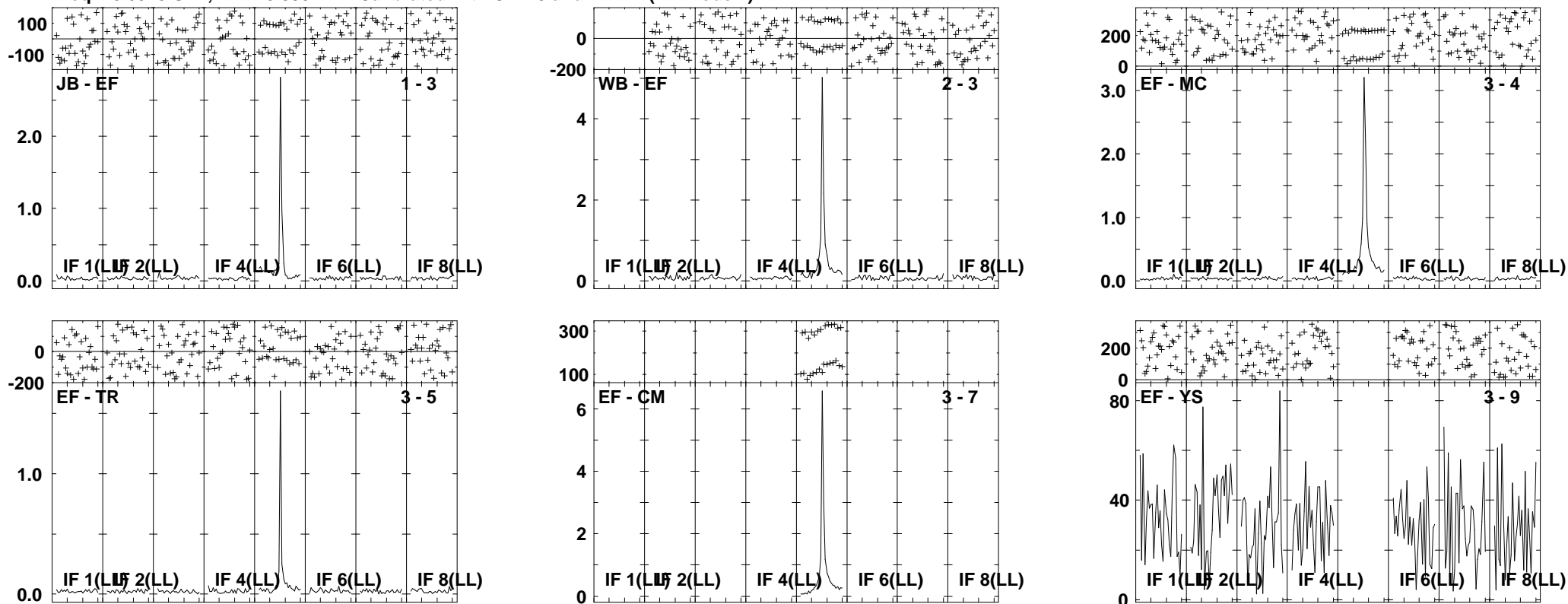

Lower frame: Ampl Jy Top frame: Phas deg
 Vector averaged cross-power spectrum Several baselines displayed
 Timerange: 00/06:41:49 to 00/06:43:18

Plot file version 194 created 19-AUG-2009 15:54:04
 DR21B2 EB039B 2.UVDATA.1
 Freq = 6.6328 GHz, Bw = 8.000 MH Calibrated with CL # 3 and BP # 1 (BP mode 1)

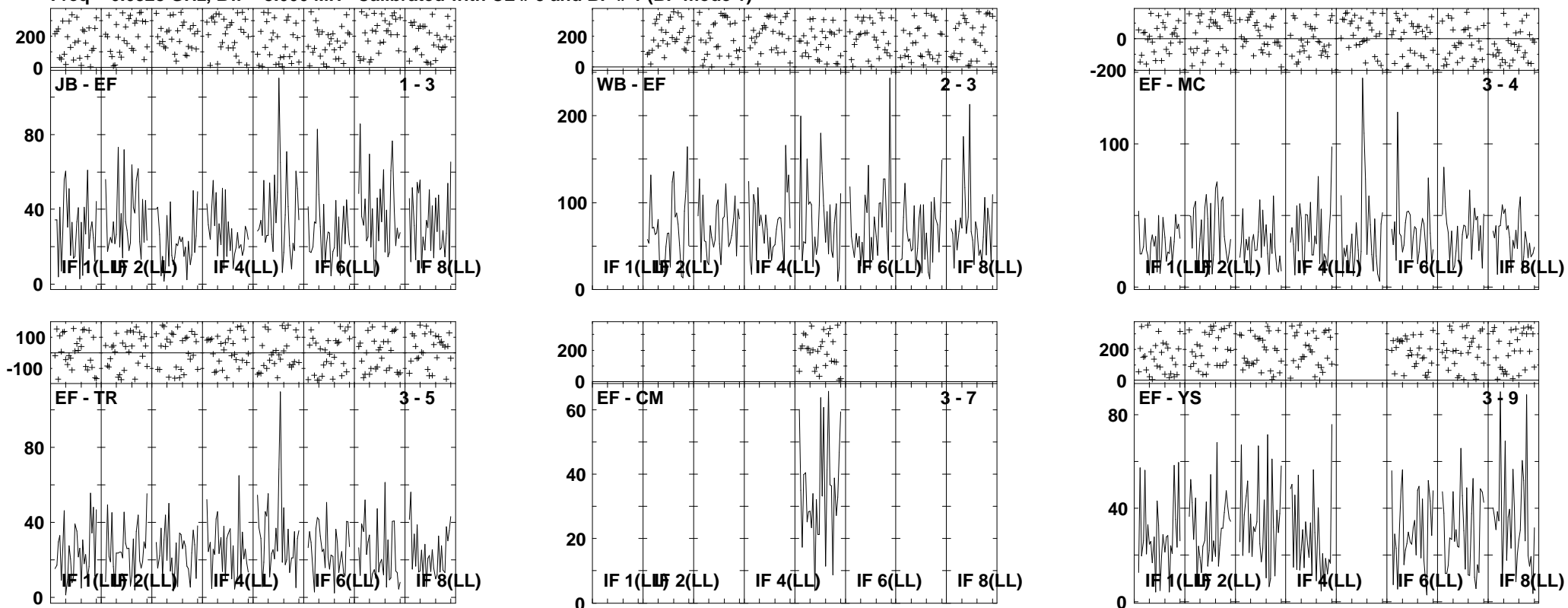

Lower frame: Milli Ampl Jy Top frame: Phas deg
 Vector averaged cross-power spectrum Several baselines displayed
 Timerange: 00/06:43:18 to 00/06:44:47

Plot file version 195 created 19-AUG-2009 15:54:06
 W75 EB039B 2.UVDATA.1
 Freq = 6.6328 GHz, Bw = 8.000 MH Calibrated with CL # 3 and BP # 1 (BP mode 1)

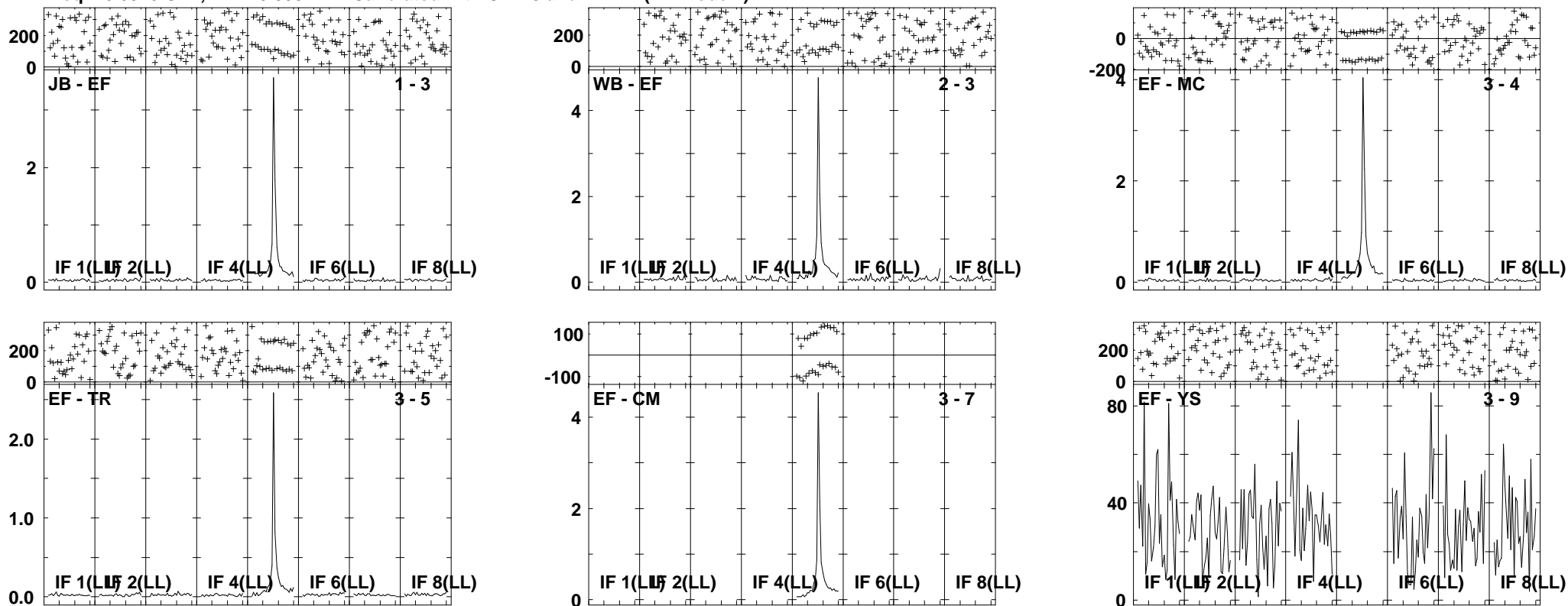

Lower frame: Ampl Jy Top frame: Phas deg
 Vector averaged cross-power spectrum Several baselines displayed
 Timerange: 00/06:44:49 to 00/06:46:17

Plot file version 196 created 19-AUG-2009 15:54:09
 DR20 EB039B 2.UVDATA.1
 Freq = 6.6328 GHz, Bw = 8.000 MH Calibrated with CL # 3 and BP # 1 (BP mode 1)

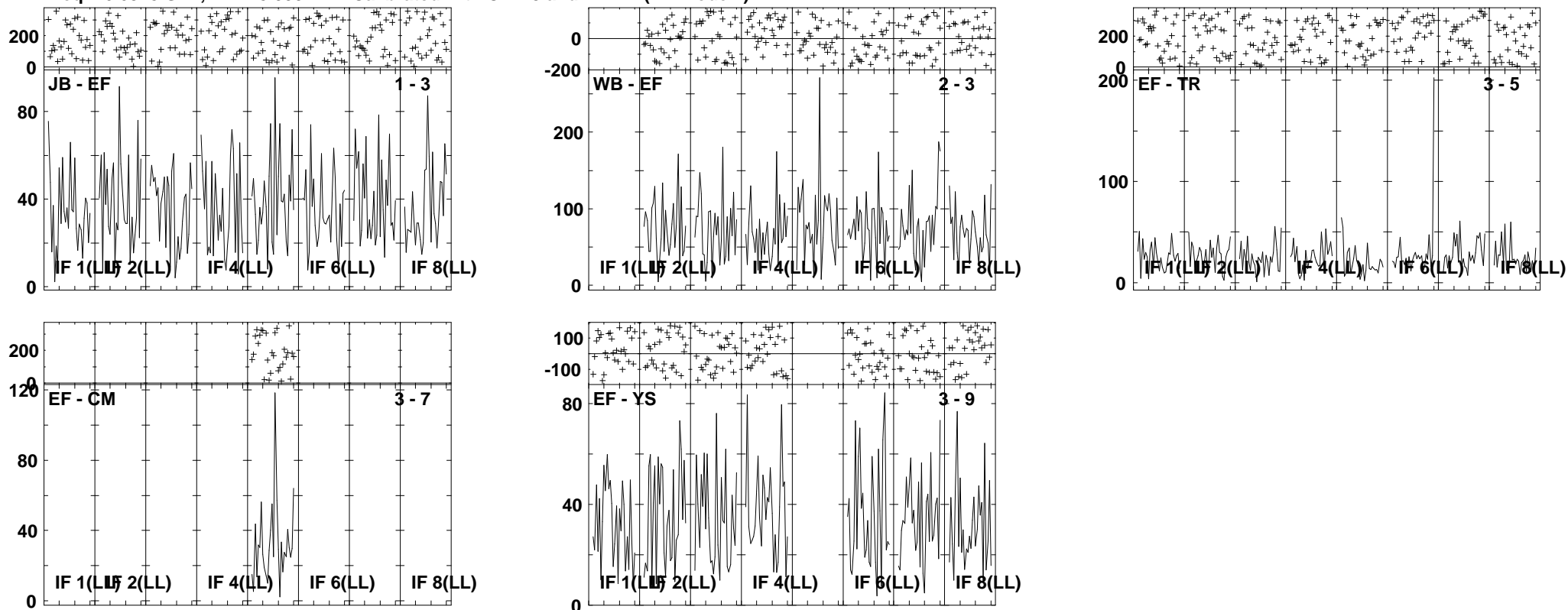

Lower frame: Milli Ampl Jy Top frame: Phas deg
 Vector averaged cross-power spectrum Several baselines displayed
 Timerange: 00/06:46:18 to 00/06:47:46

Plot file version 197 created 19-AUG-2009 15:54:11

W75 EB039B 2.UVDATA.1

Freq = 6.6328 GHz, Bw = 8.000 MH Calibrated with CL # 3 and BP # 1 (BP mode 1)

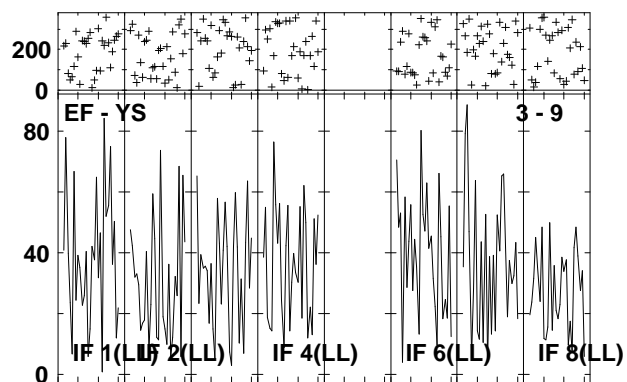
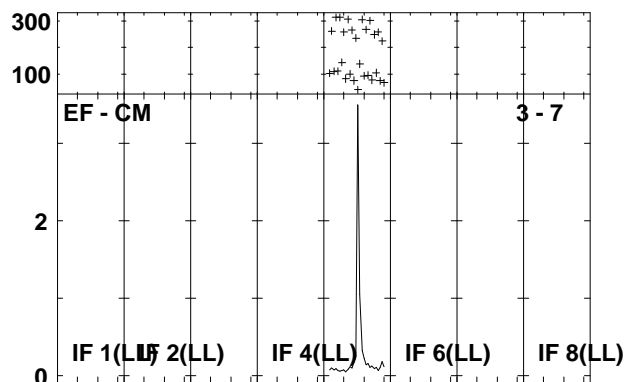
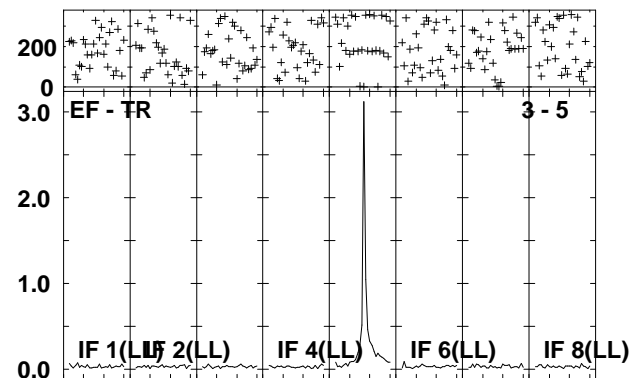
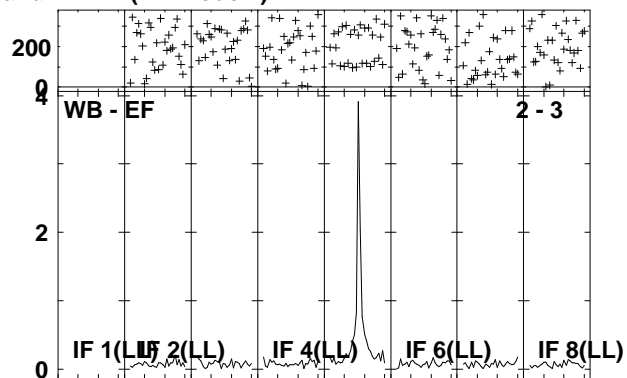
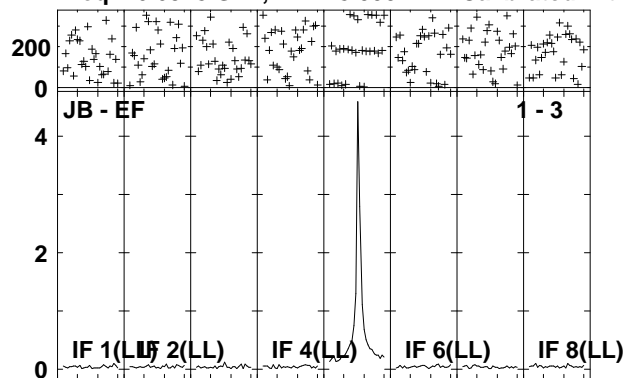

Lower frame: Ampl Jy Top frame: Phas deg
Vector averaged cross-power spectrum Several baselines displayed
Timerange: 00/06:48:22 to 00/06:49:20

Plot file version 198 created 19-AUG-2009 15:54:12

J2029+46 EB039B 2.UVDATA.1

Freq = 6.6328 GHz, Bw = 8.000 MH Calibrated with CL # 3 and BP # 1 (BP mode 1)

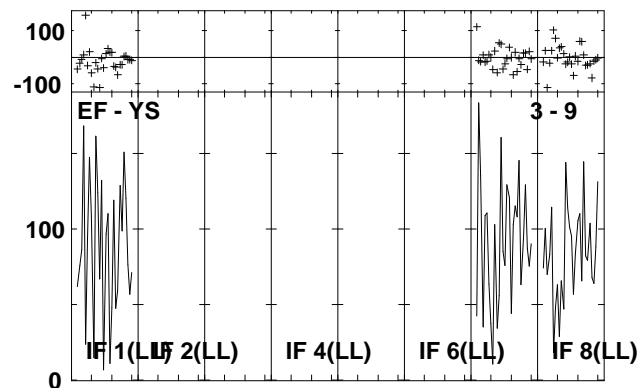
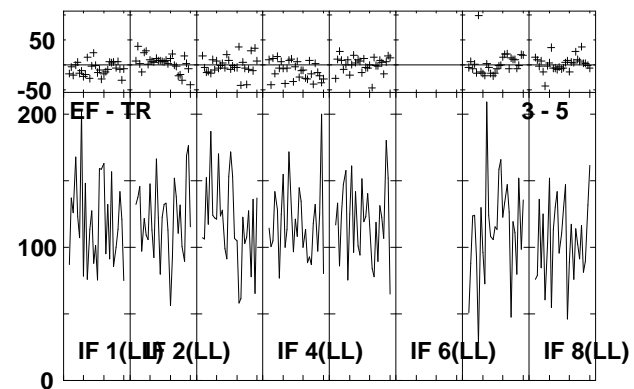
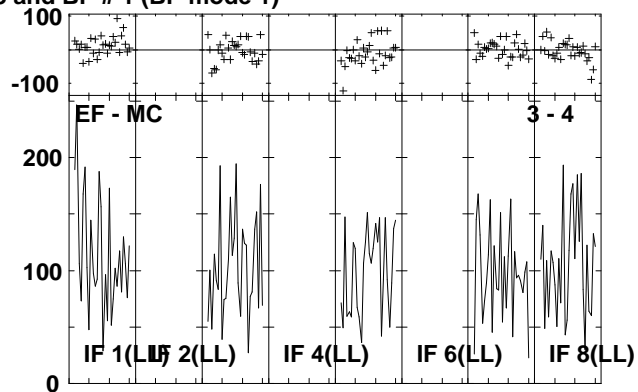
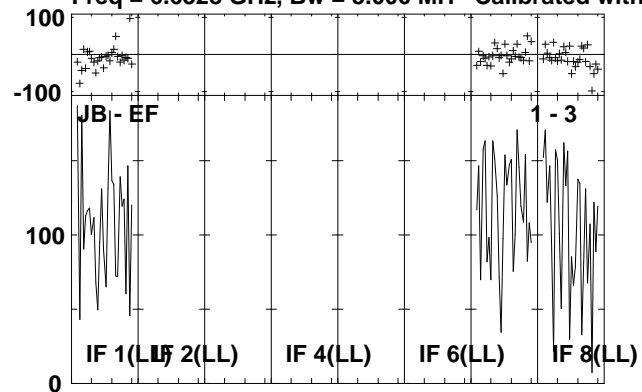

Lower frame: Milli Ampl Jy Top frame: Phas deg
Vector averaged cross-power spectrum Several baselines displayed
Timerange: 00/06:49:21 to 00/06:50:49

Plot file version 199 created 19-AUG-2009 15:54:14

W75 EB039B 2.UVDATA.1

Freq = 6.6328 GHz, Bw = 8.000 MH Calibrated with CL # 3 and BP # 1 (BP mode 1)

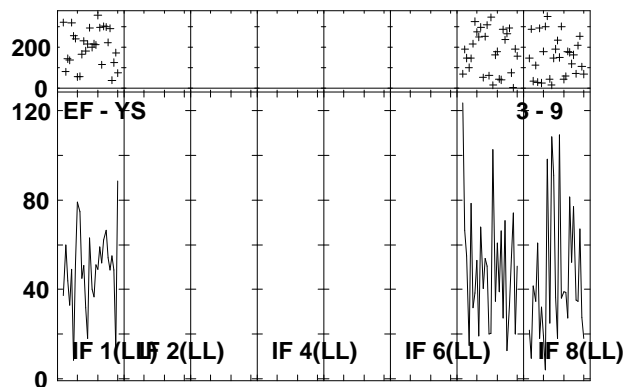
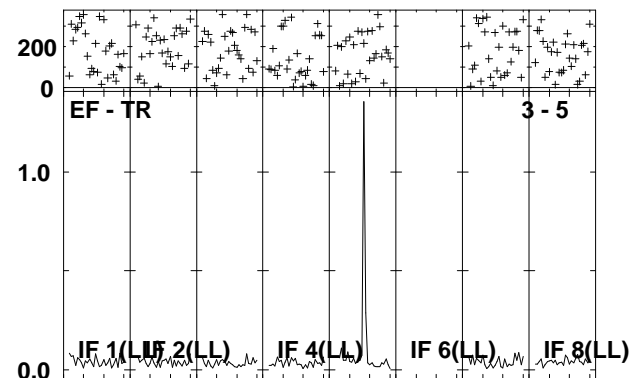
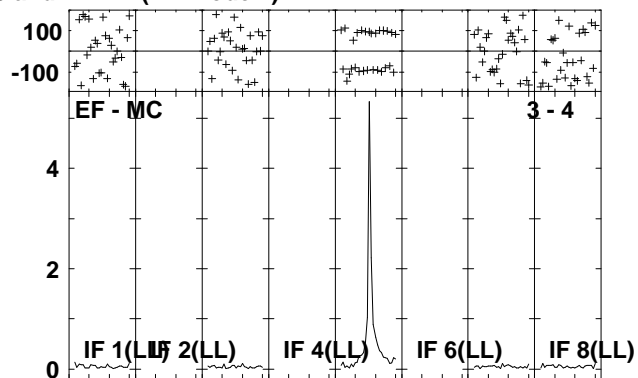
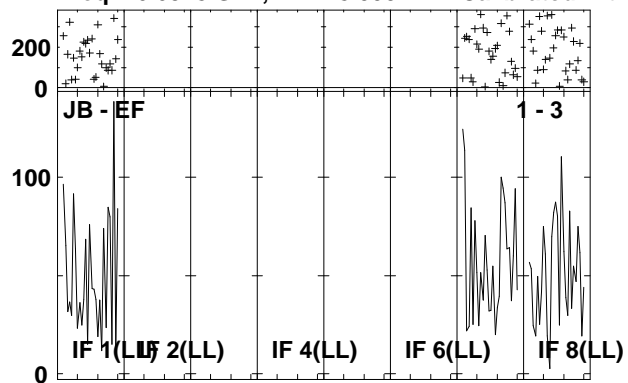

Lower frame: Milli Ampl Jy Top frame: Phas deg
Vector averaged cross-power spectrum Several baselines displayed
Timerange: 00/06:50:52 to 00/06:52:20

Plot file version 200 created 19-AUG-2009 15:54:18

W75 EB039B 2.UVDATA.1

Freq = 6.6328 GHz, Bw = 8.000 MH Calibrated with CL # 3 and BP # 1 (BP mode 1)

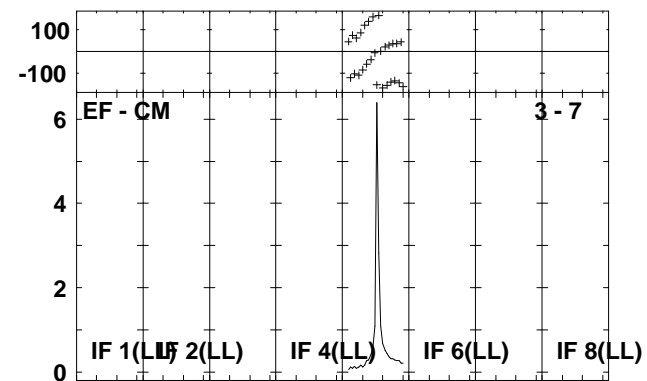
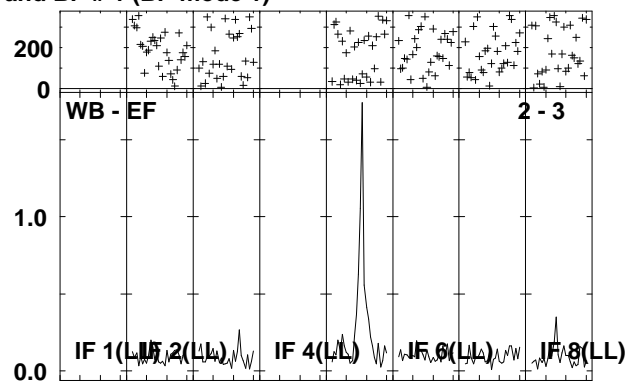
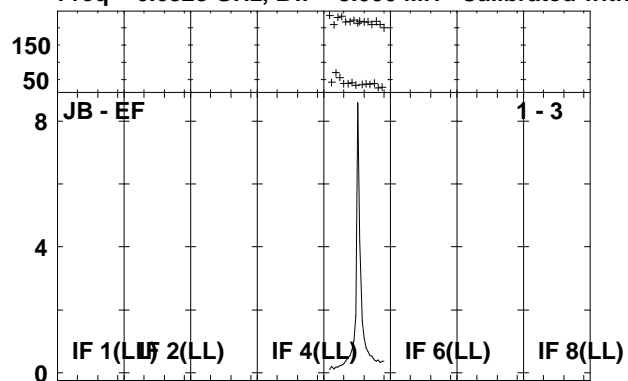

Lower frame: Ampl Jy Top frame: Phas deg
Vector averaged cross-power spectrum Several baselines displayed
Timerange: 00/06:53:51 to 00/06:55:20

Plot file version 201 created 19-AUG-2009 15:54:20
2048+431 EB039B 2.UVDATA.1
Freq = 6.6328 GHz, Bw = 8.000 MH Calibrated with CL # 3 and BP # 1 (BP mode 1)

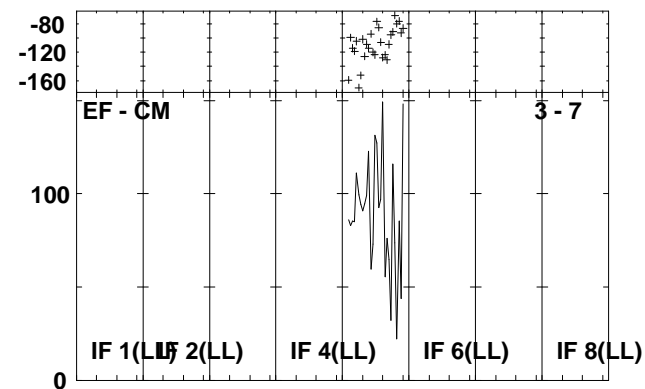
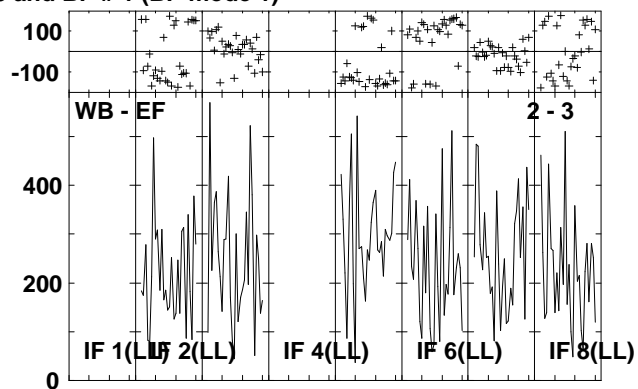
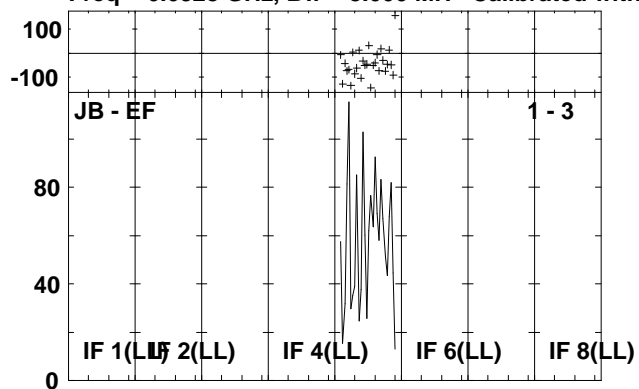

Lower frame: Milli Ampl Jy Top frame: Phas deg
Vector averaged cross-power spectrum Several baselines displayed
Timerange: 00/06:55:22 to 00/06:56:51

Plot file version 202 created 19-AUG-2009 15:54:22

W75 EB039B 2.UVDATA.1

Freq = 6.6328 GHz, Bw = 8.000 MH Calibrated with CL # 3 and BP # 1 (BP mode 1)

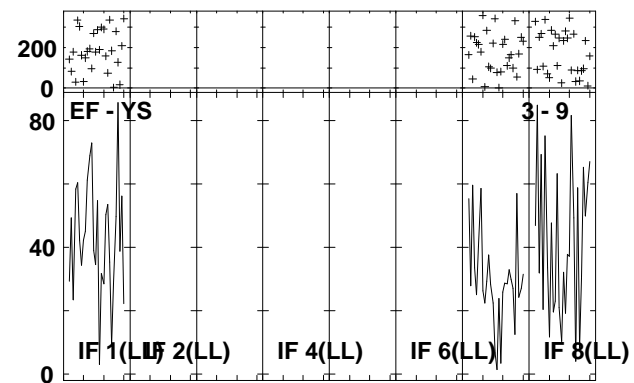
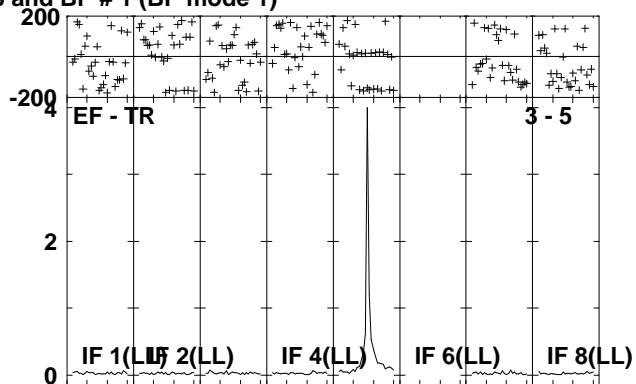
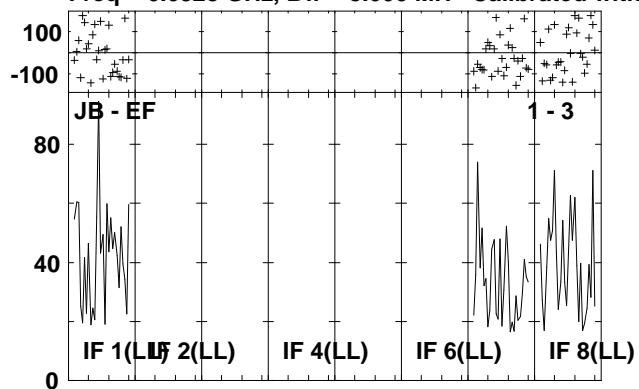

Lower frame: Milli Ampl Jy Top frame: Phas deg
Vector averaged cross-power spectrum Several baselines displayed
Timerange: 00/06:56:51 to 00/06:58:20

Plot file version 203 created 19-AUG-2009 15:54:24

OB2 EB039B 2.UVDATA.1

Freq = 6.6328 GHz, Bw = 8.000 MH Calibrated with CL # 3 and BP # 1 (BP mode 1)

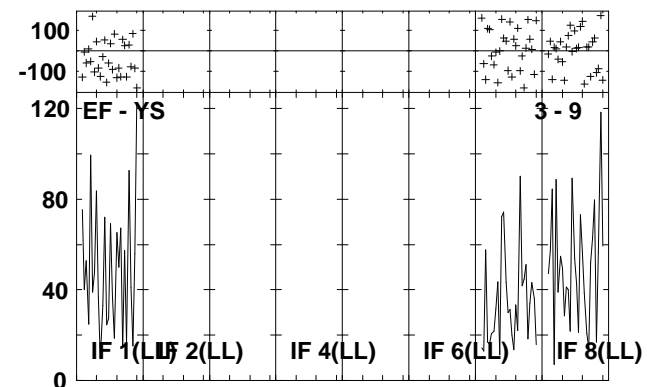
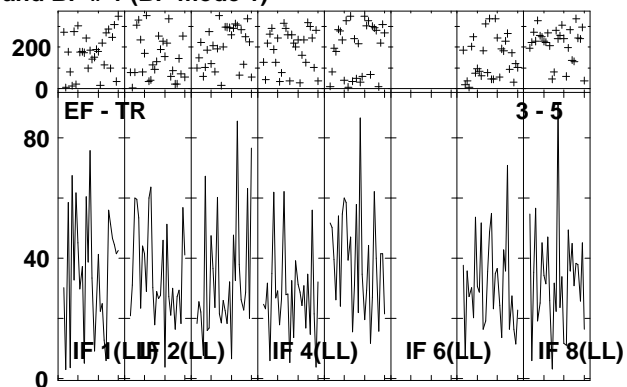
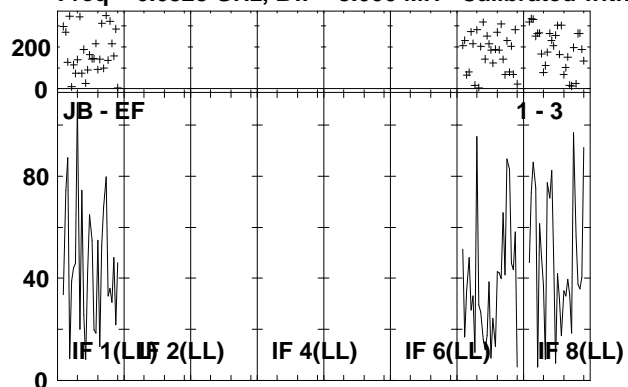

Lower frame: Milli Ampl Jy Top frame: Phas deg
Vector averaged cross-power spectrum Several baselines displayed
Timerange: 00/06:58:22 to 00/06:59:51

Plot file version 204 created 19-AUG-2009 15:54:26

W75 EB039B 2.UVDATA.1

Freq = 6.6328 GHz, Bw = 8.000 MH Calibrated with CL # 3 and BP # 1 (BP mode 1)

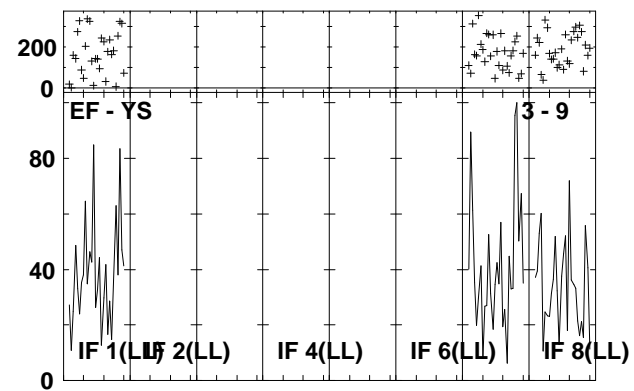
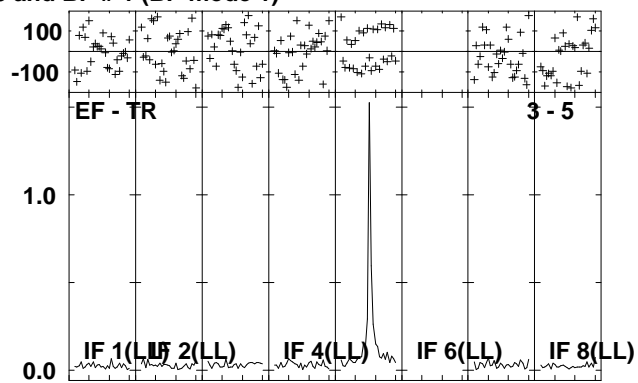
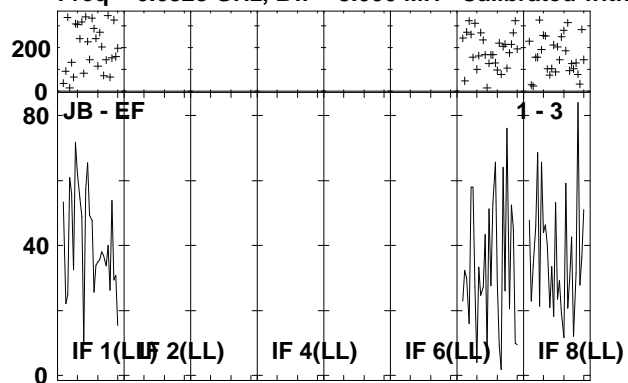

Lower frame: Milli Ampl Jy Top frame: Phas deg
Vector averaged cross-power spectrum Several baselines displayed
Timerange: 00/07:00:38 to 00/07:01:36

Plot file version 205 created 19-AUG-2009 15:54:27
DR21A EB039B 2.UVDATA.1
Freq = 6.6328 GHz, Bw = 8.000 MH Calibrated with CL # 3 and BP # 1 (BP mode 1)

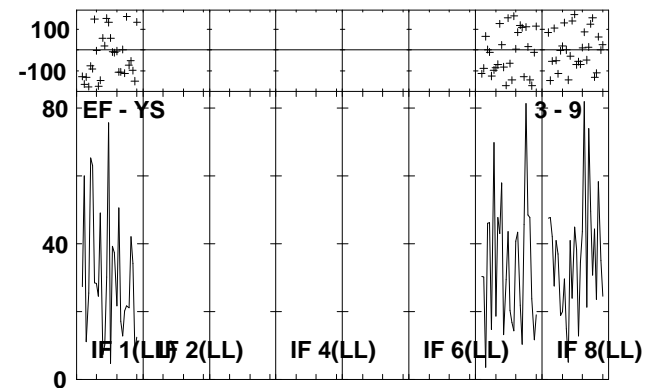
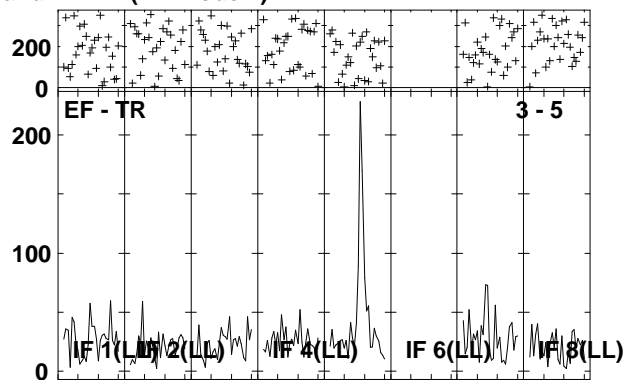
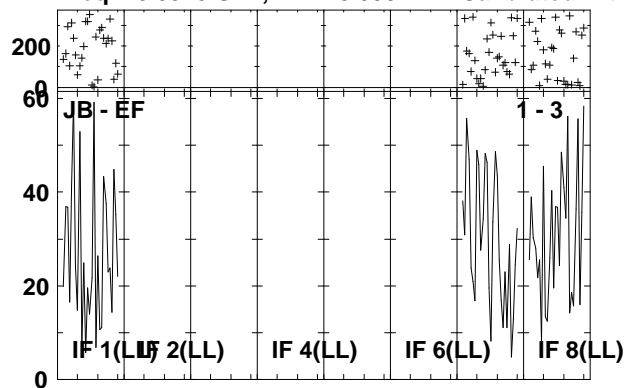

Lower frame: Milli Ampl Jy Top frame: Phas deg
Vector averaged cross-power spectrum Several baselines displayed
Timerange: 00/07:01:38 to 00/07:03:07

Plot file version 206 created 19-AUG-2009 15:54:29

W75 EB039B 2.UVDATA.1

Freq = 6.6328 GHz, Bw = 8.000 MH Calibrated with CL # 3 and BP # 1 (BP mode 1)

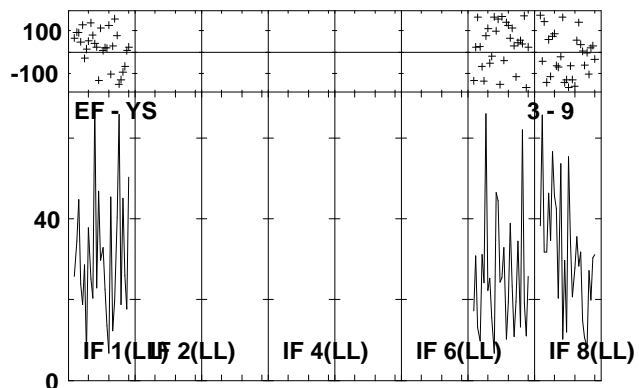
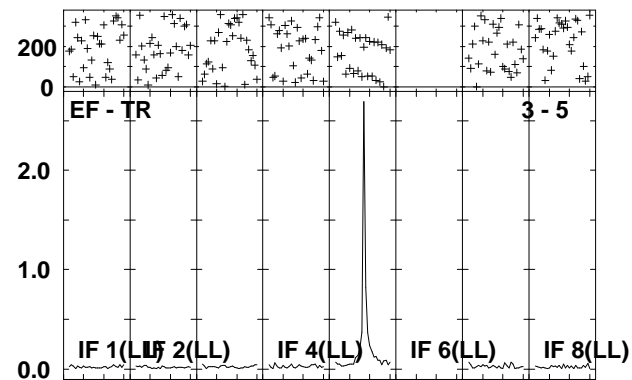
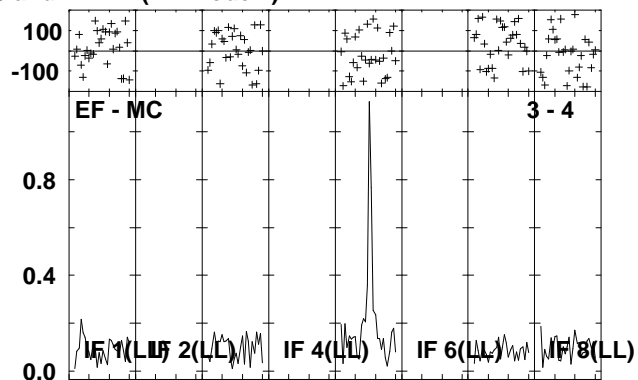
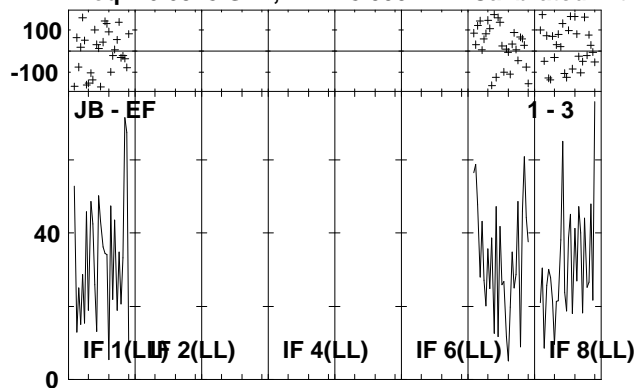

Lower frame: Milli Ampl Jy Top frame: Phas deg
Vector averaged cross-power spectrum Several baselines displayed
Timerange: 00/07:03:07 to 00/07:04:36

Plot file version 207 created 19-AUG-2009 15:54:31
 DR21B EB039B 2.UVDATA.1
 Freq = 6.6328 GHz, Bw = 8.000 MH Calibrated with CL # 3 and BP # 1 (BP mode 1)

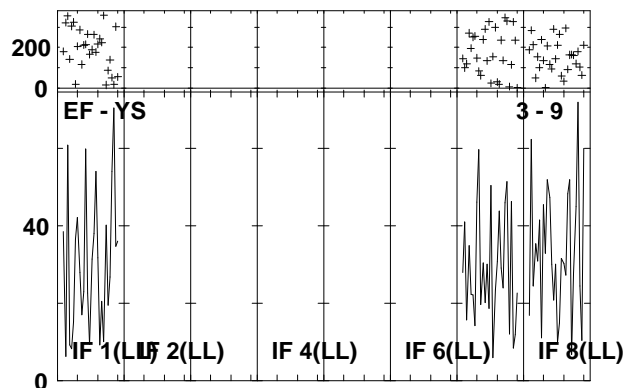
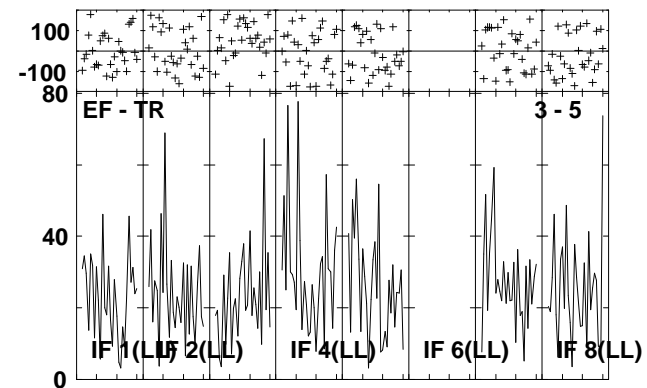
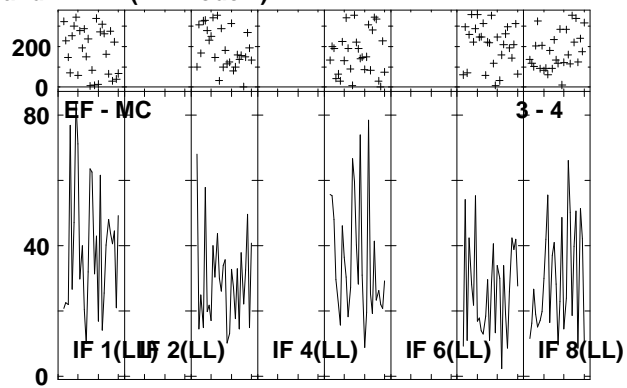
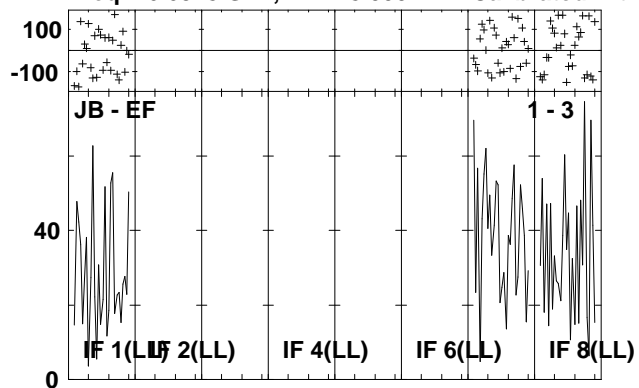

Lower frame: Milli Ampl Jy Top frame: Phas deg
 Vector averaged cross-power spectrum Several baselines displayed
 Timerange: 00/07:04:38 to 00/07:06:07

Plot file version 208 created 19-AUG-2009 15:54:33

W75 EB039B 2.UVDATA.1

Freq = 6.6328 GHz, Bw = 8.000 MH Calibrated with CL # 3 and BP # 1 (BP mode 1)

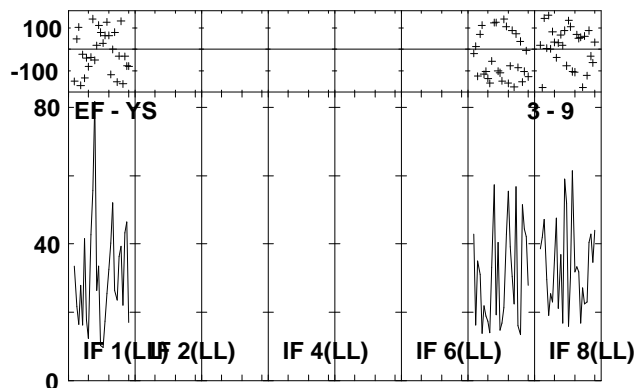
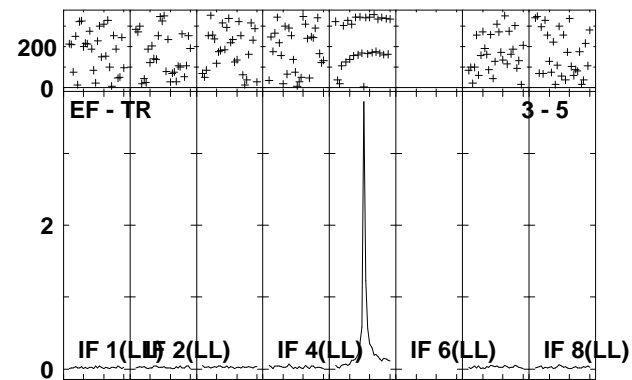
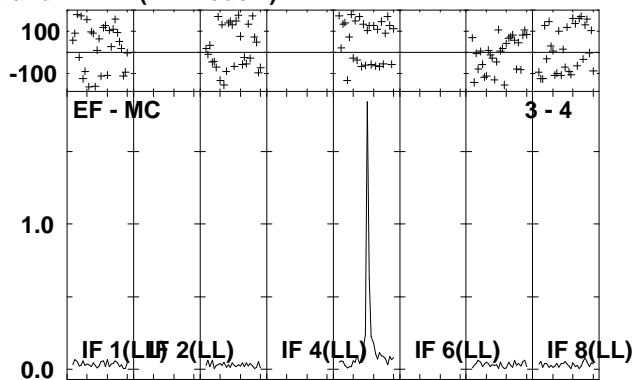
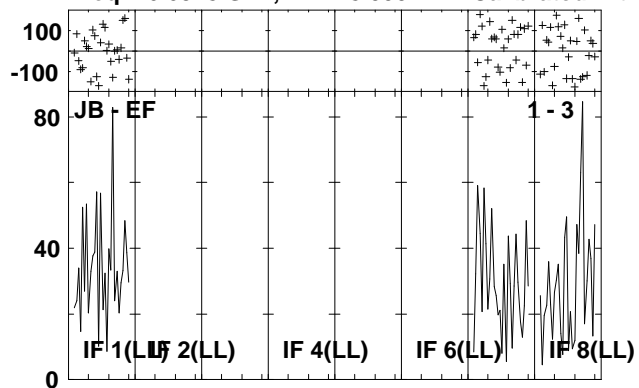

Lower frame: Milli Ampl Jy Top frame: Phas deg
Vector averaged cross-power spectrum Several baselines displayed
Timerange: 00/07:06:07 to 00/07:07:36

Plot file version 209 created 19-AUG-2009 15:54:35
 DR21B2 EB039B 2.UVDATA.1
 Freq = 6.6328 GHz, Bw = 8.000 MH Calibrated with CL # 3 and BP # 1 (BP mode 1)

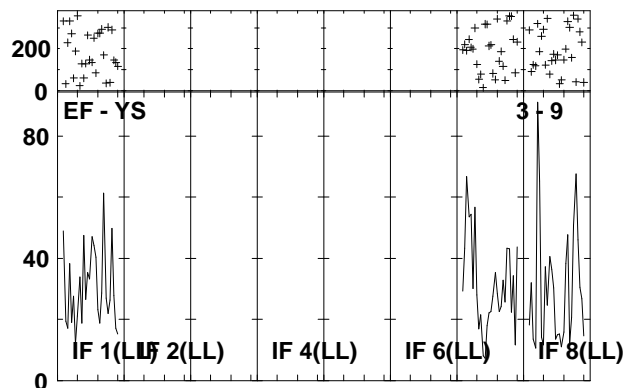
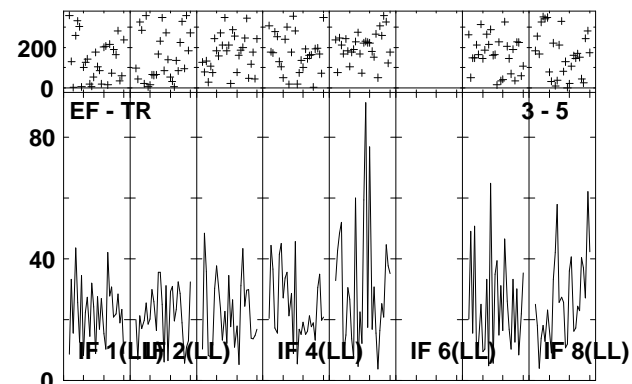
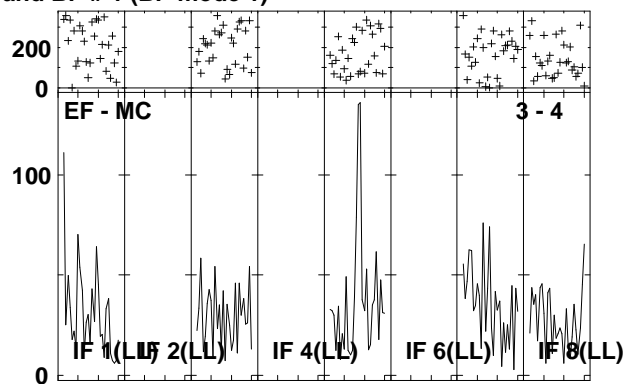
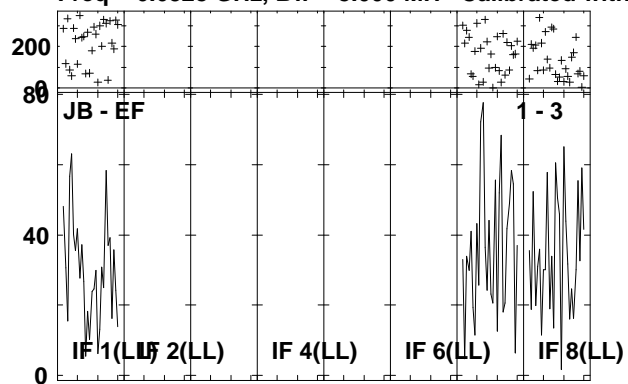

Lower frame: Milli Ampl Jy Top frame: Phas deg
 Vector averaged cross-power spectrum Several baselines displayed
 Timerange: 00/07:07:38 to 00/07:09:07

Plot file version 210 created 19-AUG-2009 15:54:37

W75 EB039B 2.UVDATA.1

Freq = 6.6328 GHz, Bw = 8.000 MH Calibrated with CL # 3 and BP # 1 (BP mode 1)

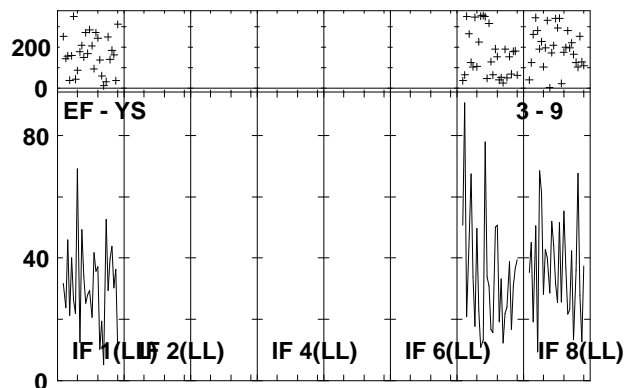
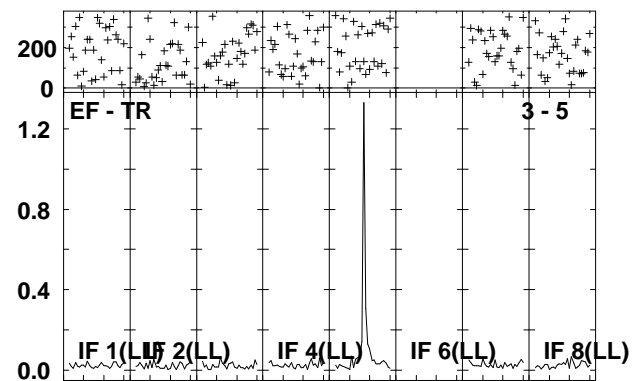
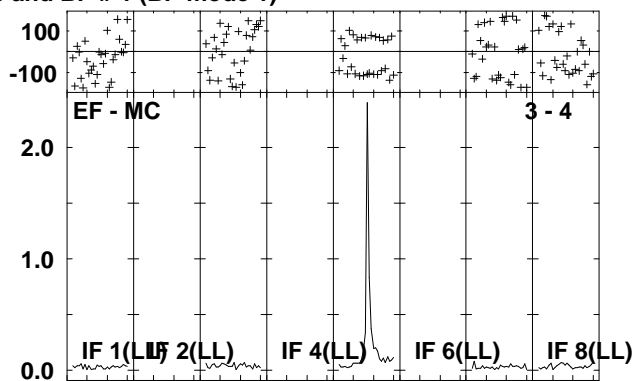
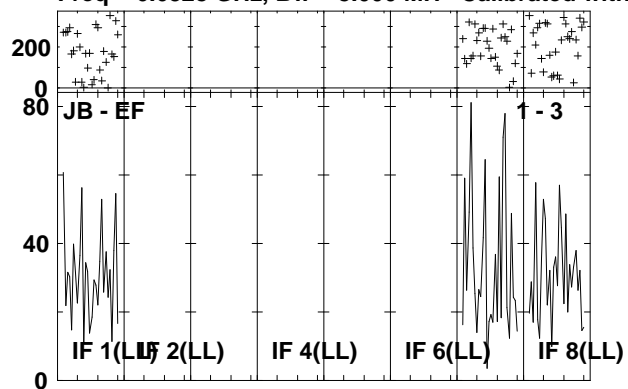

Lower frame: Milli Ampl Jy Top frame: Phas deg
Vector averaged cross-power spectrum Several baselines displayed
Timerange: 00/07:09:07 to 00/07:10:36

Plot file version 211 created 19-AUG-2009 15:54:39
 DR20 EB039B 2.UVDATA.1
 Freq = 6.6328 GHz, Bw = 8.000 MH Calibrated with CL # 3 and BP # 1 (BP mode 1)

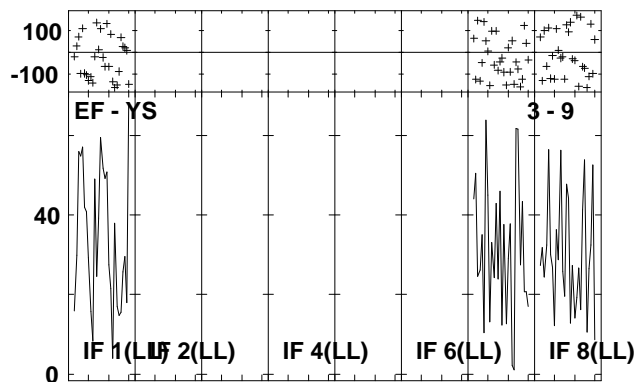
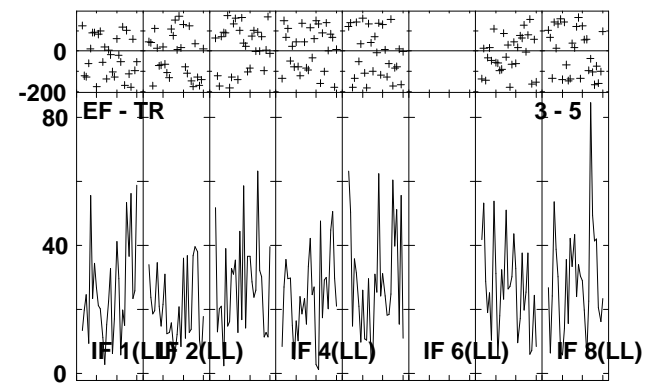
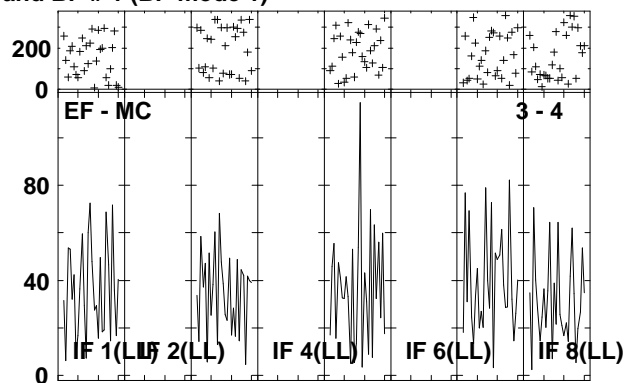
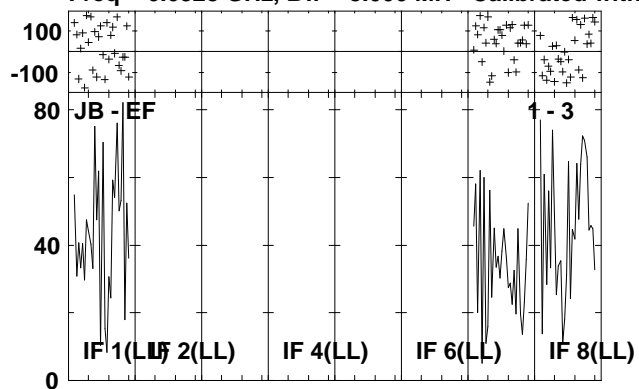

Lower frame: Milli Ampl Jy Top frame: Phas deg
 Vector averaged cross-power spectrum Several baselines displayed
 Timerange: 00/07:10:38 to 00/07:12:07

Plot file version 212 created 19-AUG-2009 15:54:41

W75 EB039B 2.UVDATA.1

Freq = 6.6328 GHz, Bw = 8.000 MH Calibrated with CL # 3 and BP # 1 (BP mode 1)

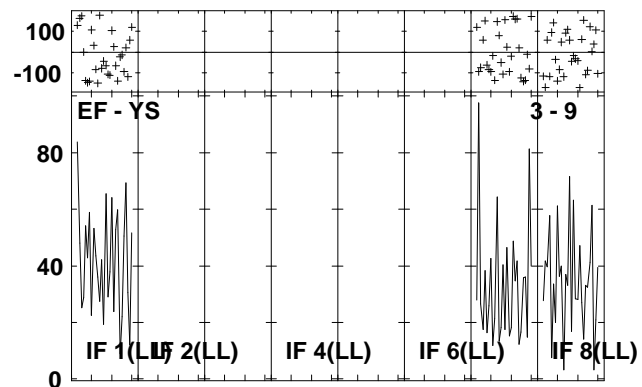
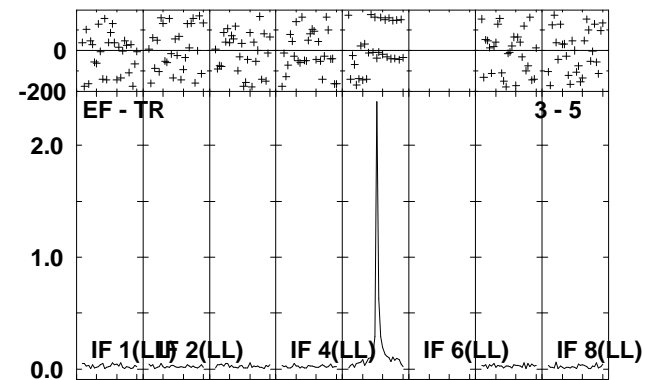
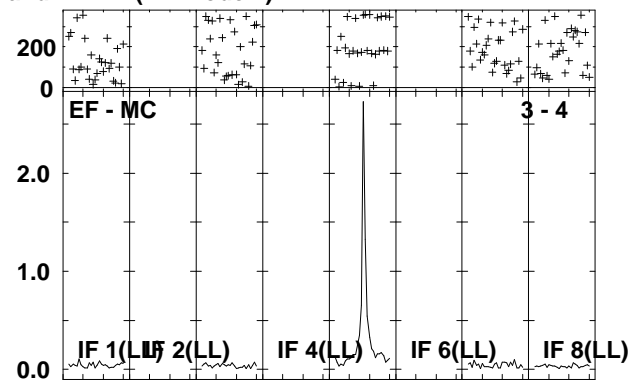
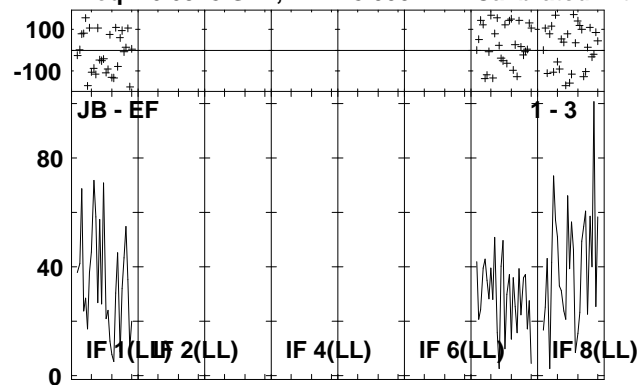

Lower frame: Milli Ampl Jy Top frame: Phas deg
Vector averaged cross-power spectrum Several baselines displayed
Timerange: 00/07:12:42 to 00/07:13:41

Plot file version 213 created 19-AUG-2009 15:55:10
 J2029+46 EB039B 2.UVDATA.1
 Freq = 6.6328 GHz, Bw = 8.000 MH Calibrated with CL # 3 and BP # 1 (BP mode 1)

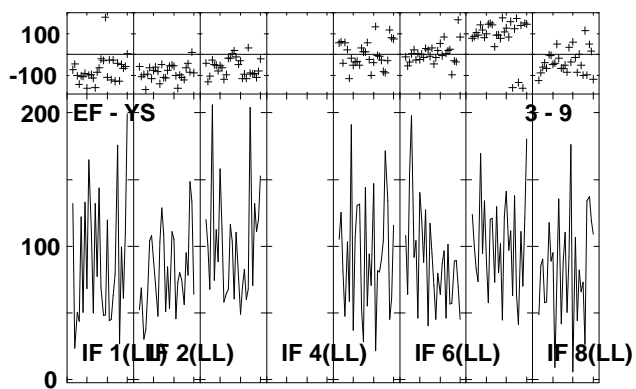
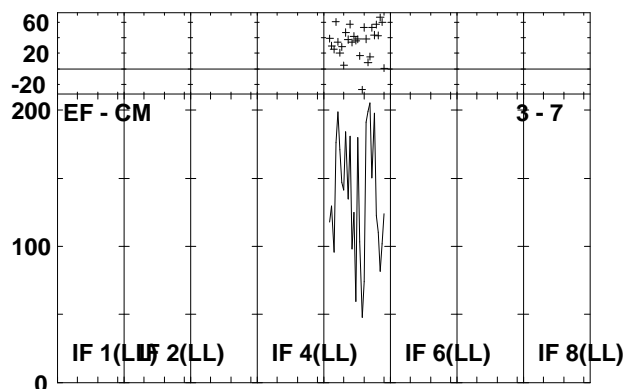
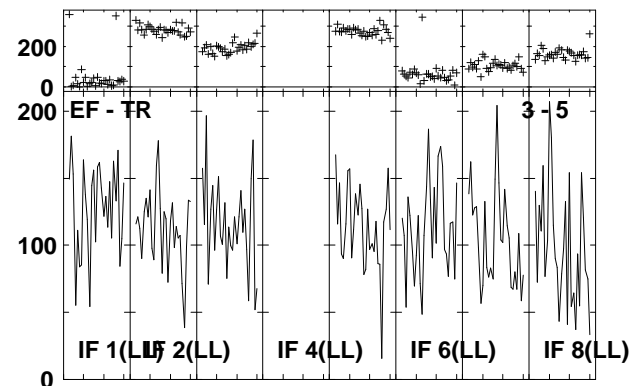
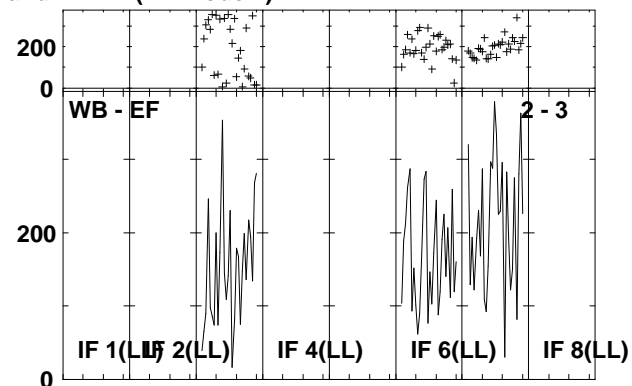
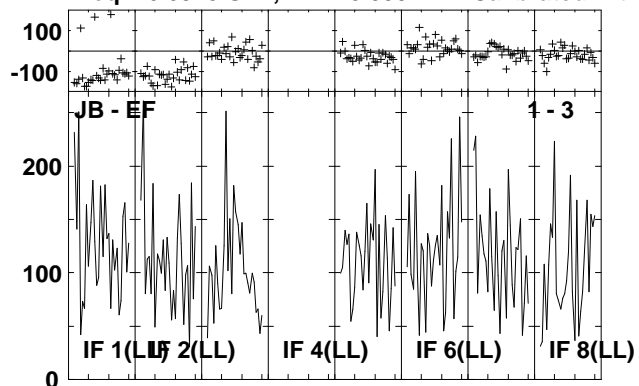

Lower frame: Milli Ampl Jy Top frame: Phas deg
 Vector averaged cross-power spectrum Several baselines displayed
 Timerange: 00/07:38:07 to 00/07:39:36

Plot file version 214 created 19-AUG-2009 15:55:12
 W75 EB039B 2.UVDATA.1
 Freq = 6.6328 GHz, Bw = 8.000 MH Calibrated with CL # 3 and BP # 1 (BP mode 1)

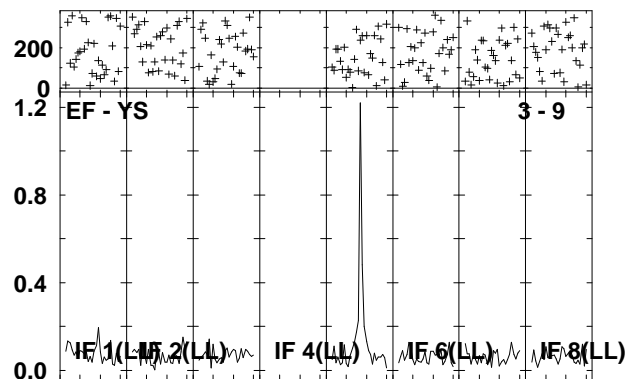
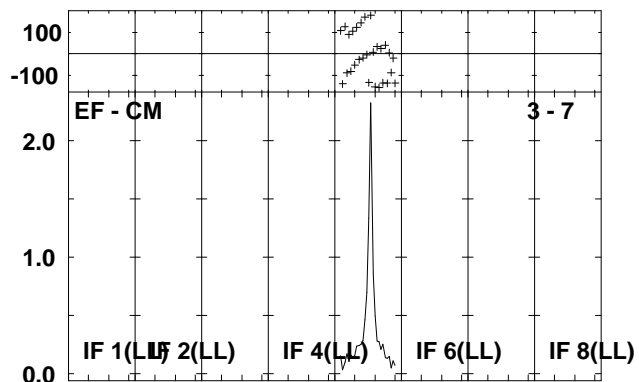
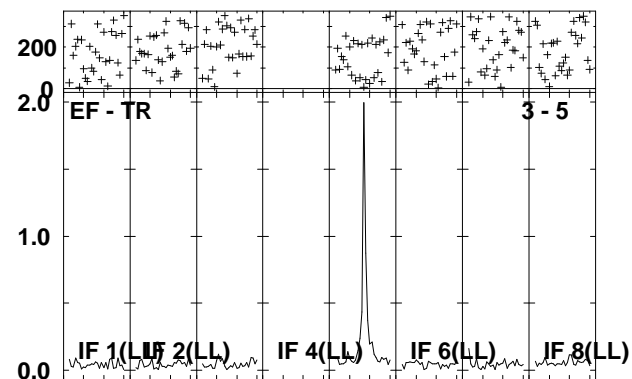
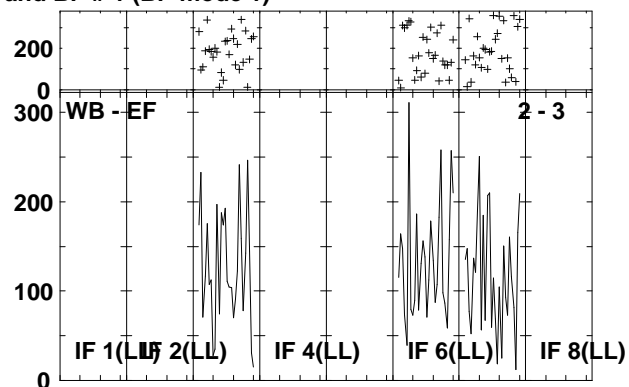
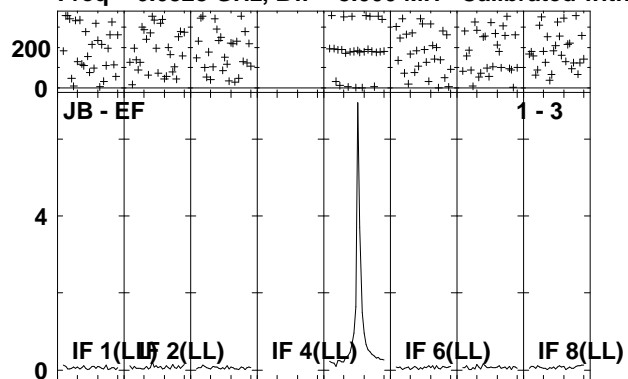

Lower frame: Ampl Jy Top frame: Phas deg
 Vector averaged cross-power spectrum Several baselines displayed
 Timerange: 00/07:39:38 to 00/07:41:07

Plot file version 215 created 19-AUG-2009 15:55:20
 W75 EB039B 2.UVDATA.1
 Freq = 6.6328 GHz, Bw = 8.000 MH Calibrated with CL # 3 and BP # 1 (BP mode 1)

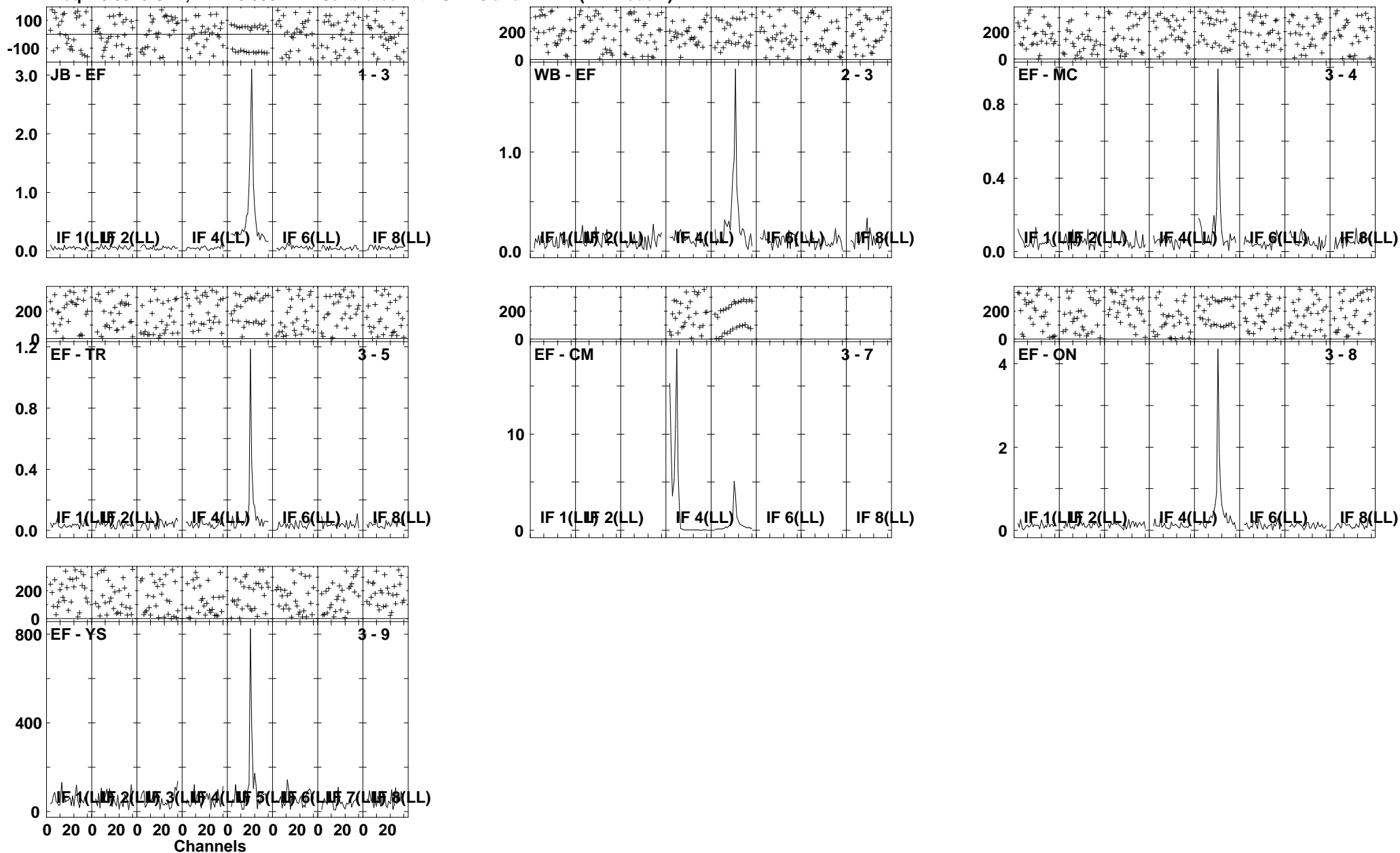

Lower frame: Ampl Jy Top frame: Phas deg
 Vector averaged cross-power spectrum Several baselines displayed
 Timerange: 00/07:45:38 to 00/07:47:06

Plot file version 216 created 19-AUG-2009 15:55:22

OB2 EB039B 2.UVDATA.1

Freq = 6.6328 GHz, Bw = 8.000 MH Calibrated with CL # 3 and BP # 1 (BP mode 1)

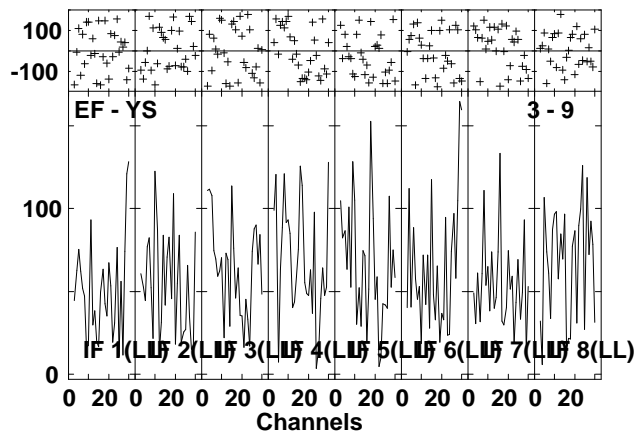
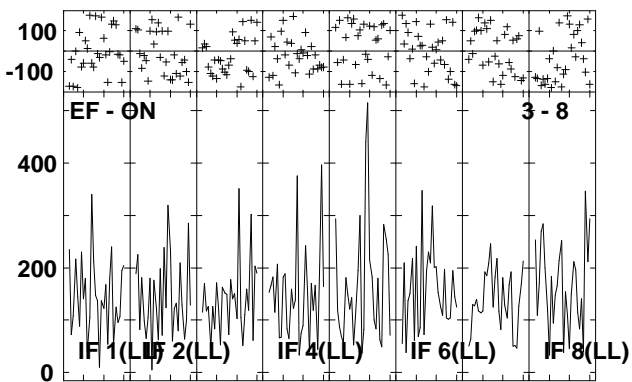
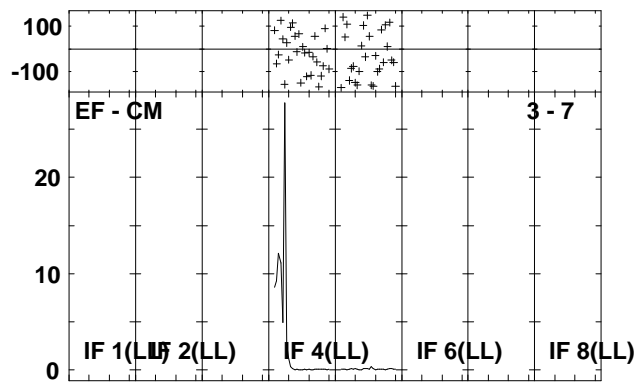
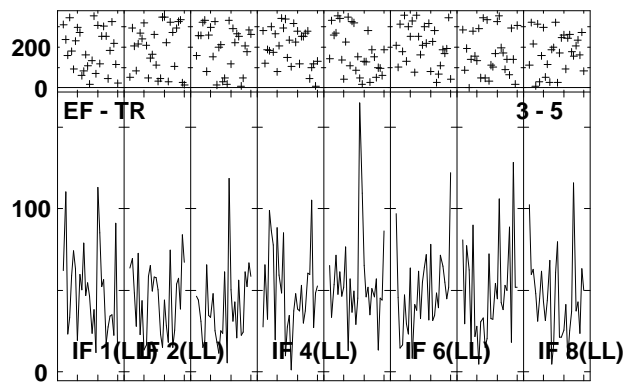
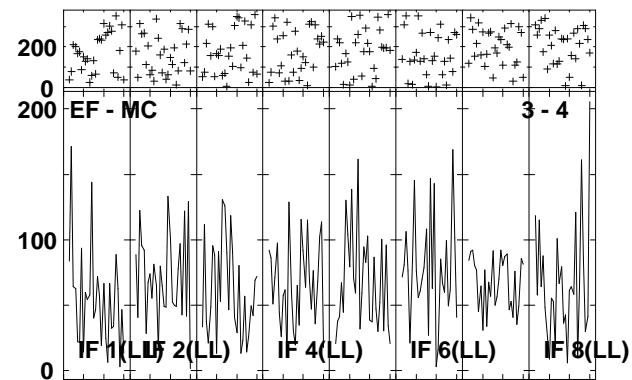
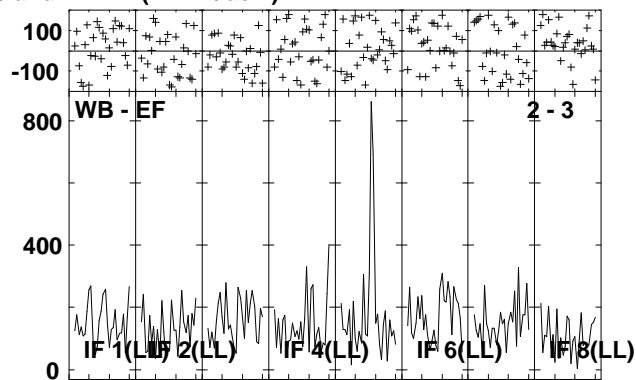
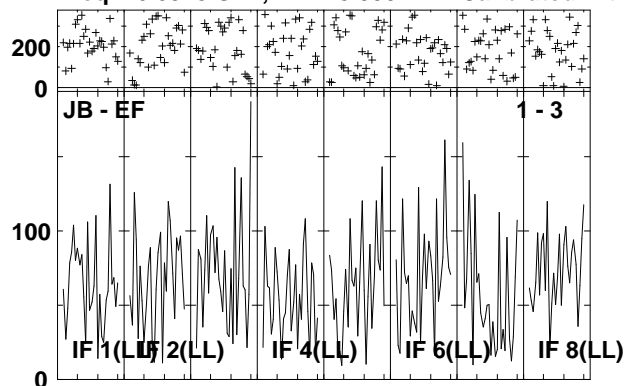

Lower frame: Milli Ampl Jy Top frame: Phas deg
Vector averaged cross-power spectrum Several baselines displayed
Timerange: 00/07:47:08 to 00/07:48:37

Plot file version 217 created 19-AUG-2009 15:55:24

W75 EB039B 2.UVDATA.1

Freq = 6.6328 GHz, Bw = 8.000 MH Calibrated with CL # 3 and BP # 1 (BP mode 1)

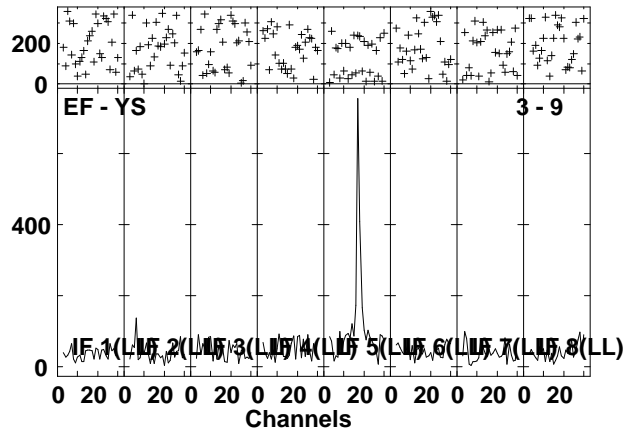
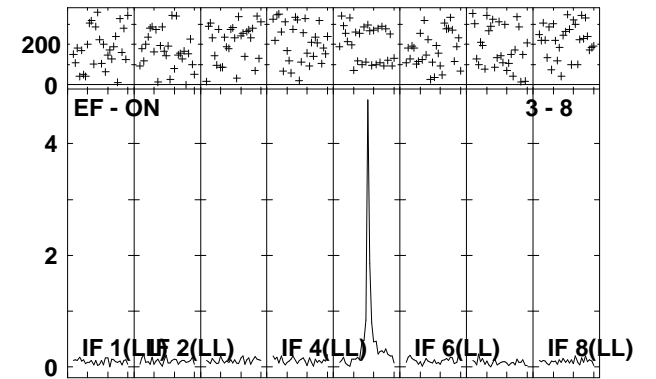
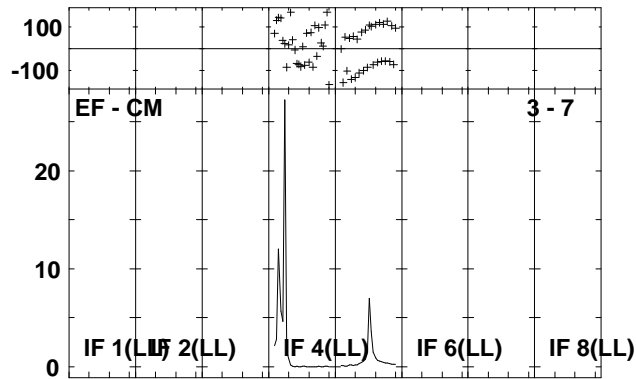
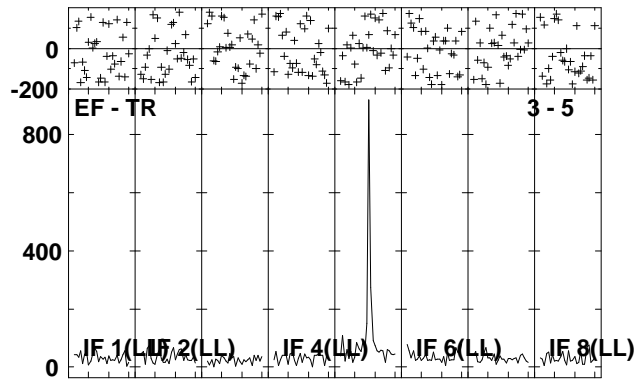
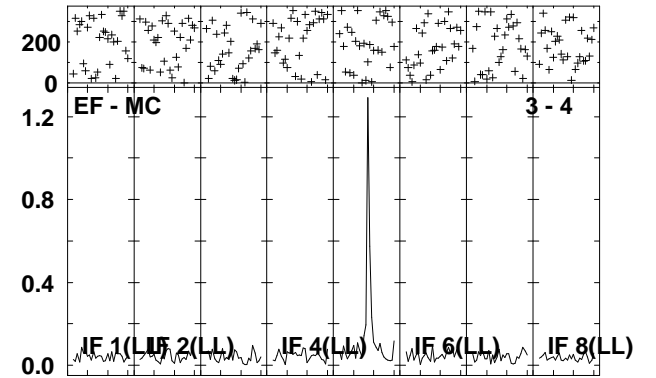
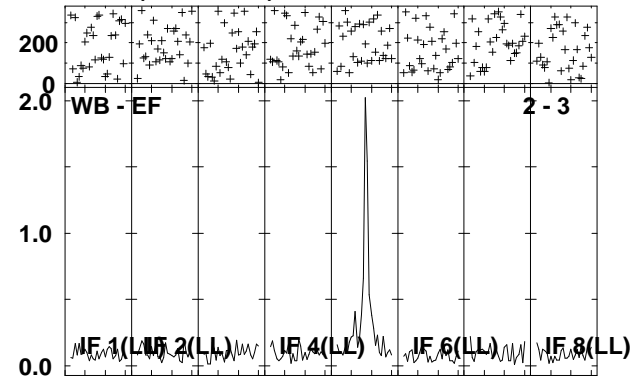
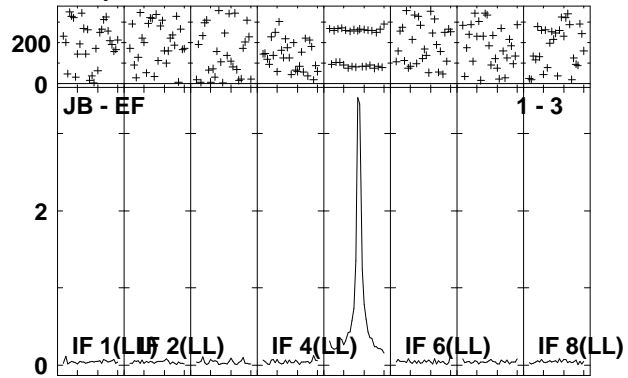

Lower frame: Ampl Jy Top frame: Phas deg
Vector averaged cross-power spectrum Several baselines displayed
Timerange: 00/07:49:31 to 00/07:50:31

Plot file version 218 created 19-AUG-2009 15:55:26
 DR21A EB039B 2.UVDATA.1
 Freq = 6.6328 GHz, Bw = 8.000 MH Calibrated with CL # 3 and BP # 1 (BP mode 1)

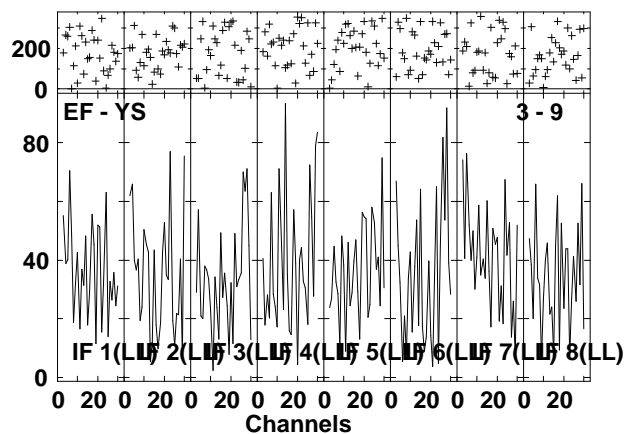
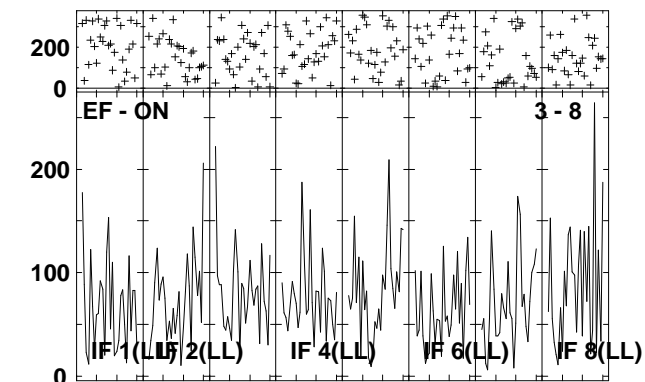
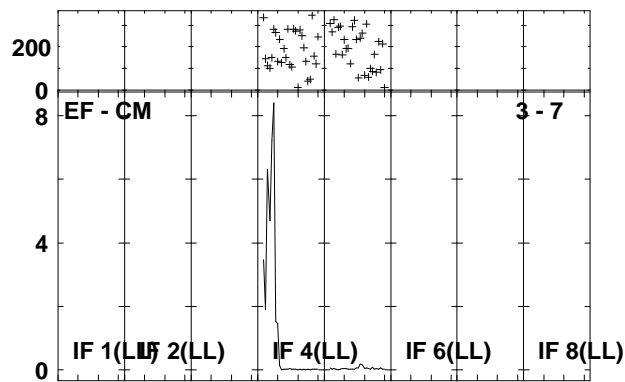
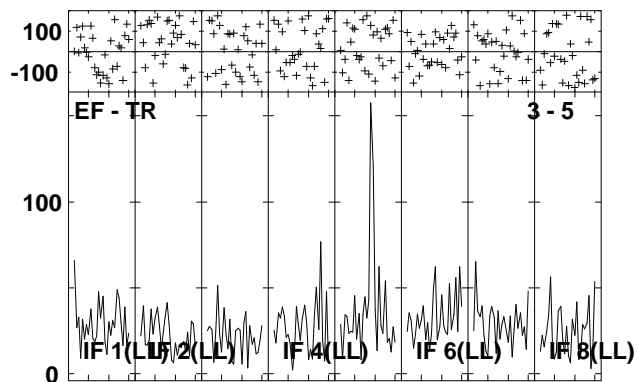
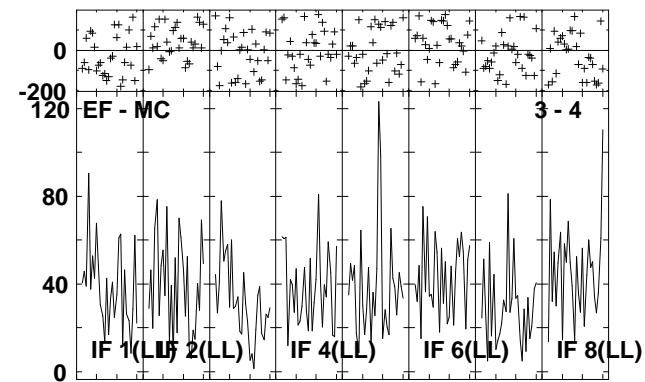
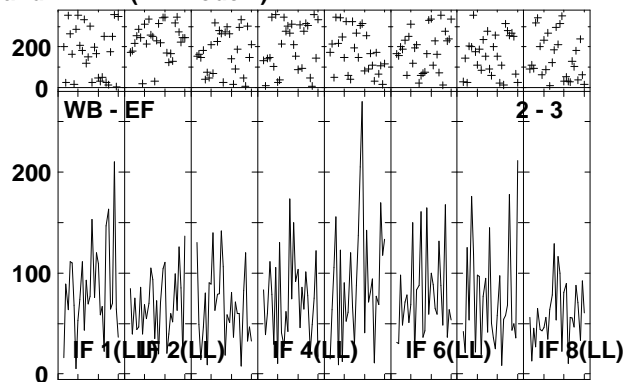
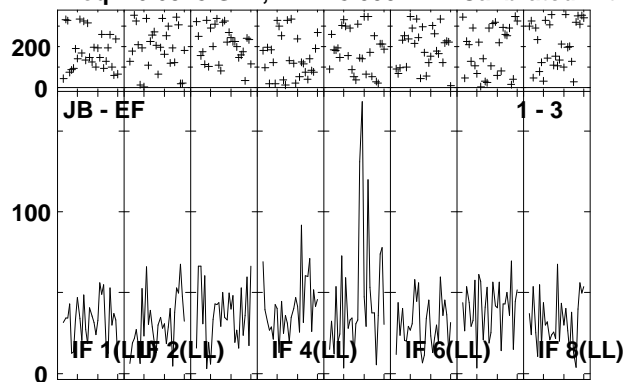

Lower frame: Milli Ampl Jy Top frame: Phas deg
 Vector averaged cross-power spectrum Several baselines displayed
 Timerange: 00/07:50:31 to 00/07:52:00

Plot file version 219 created 19-AUG-2009 15:55:29
 W75 EB039B 2.UVDATA.1
 Freq = 6.6328 GHz, Bw = 8.000 MH Calibrated with CL # 3 and BP # 1 (BP mode 1)

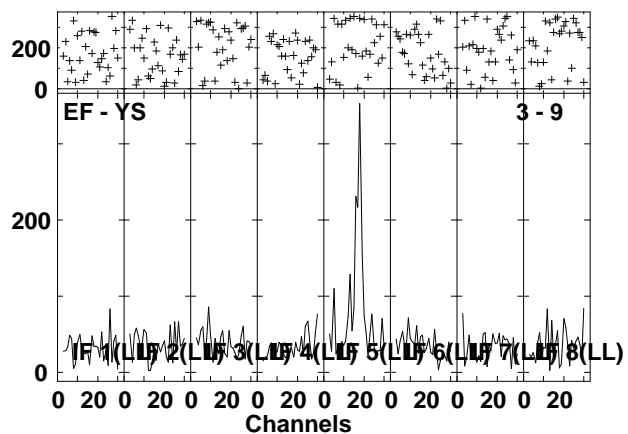
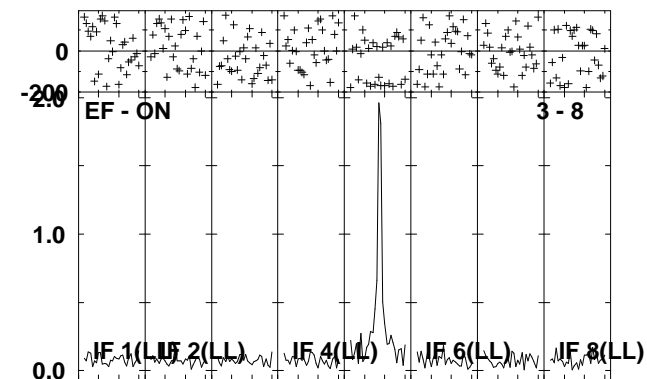
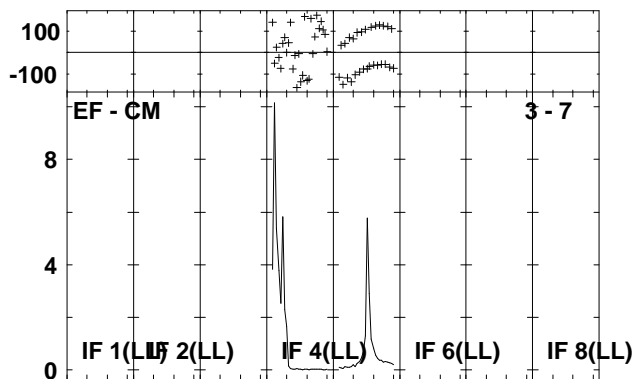
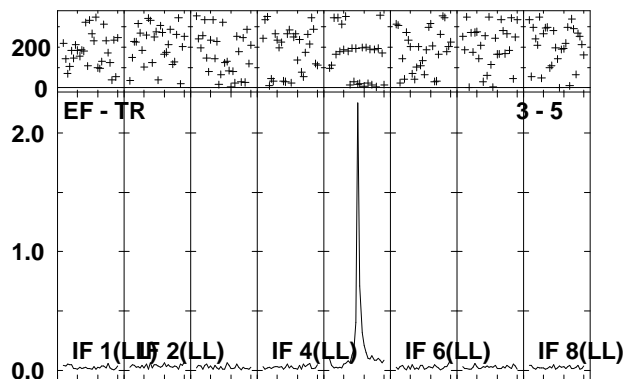
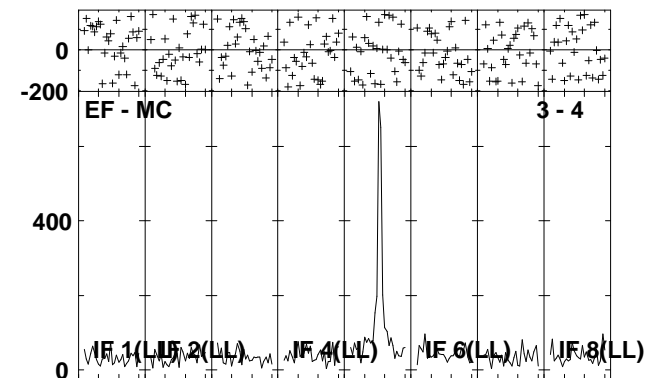
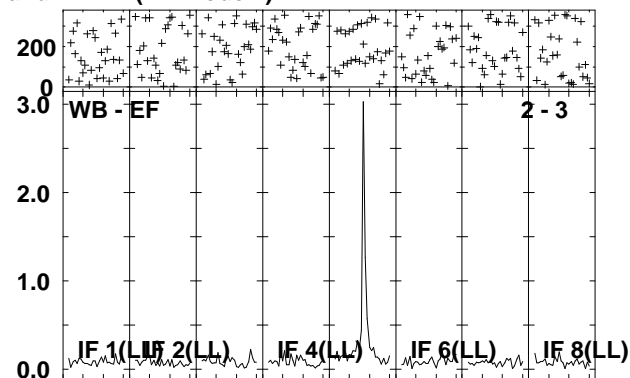
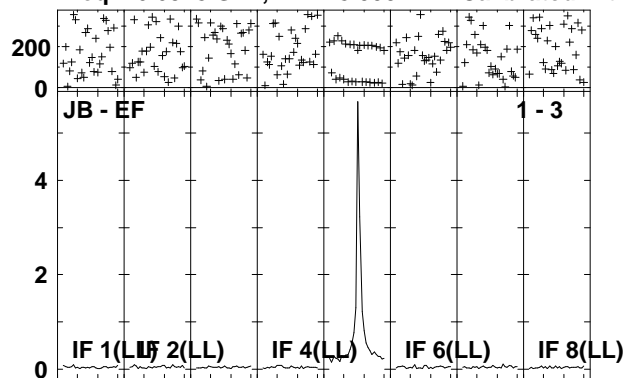

Lower frame: Ampl Jy Top frame: Phas deg
 Vector averaged cross-power spectrum Several baselines displayed
 Timerange: 00/07:52:02 to 00/07:53:31

Plot file version 220 created 19-AUG-2009 15:55:31
DR21B EB039B 2.UVDATA.1
Freq = 6.6328 GHz, Bw = 8.000 MH Calibrated with CL # 3 and BP # 1 (BP mode 1)

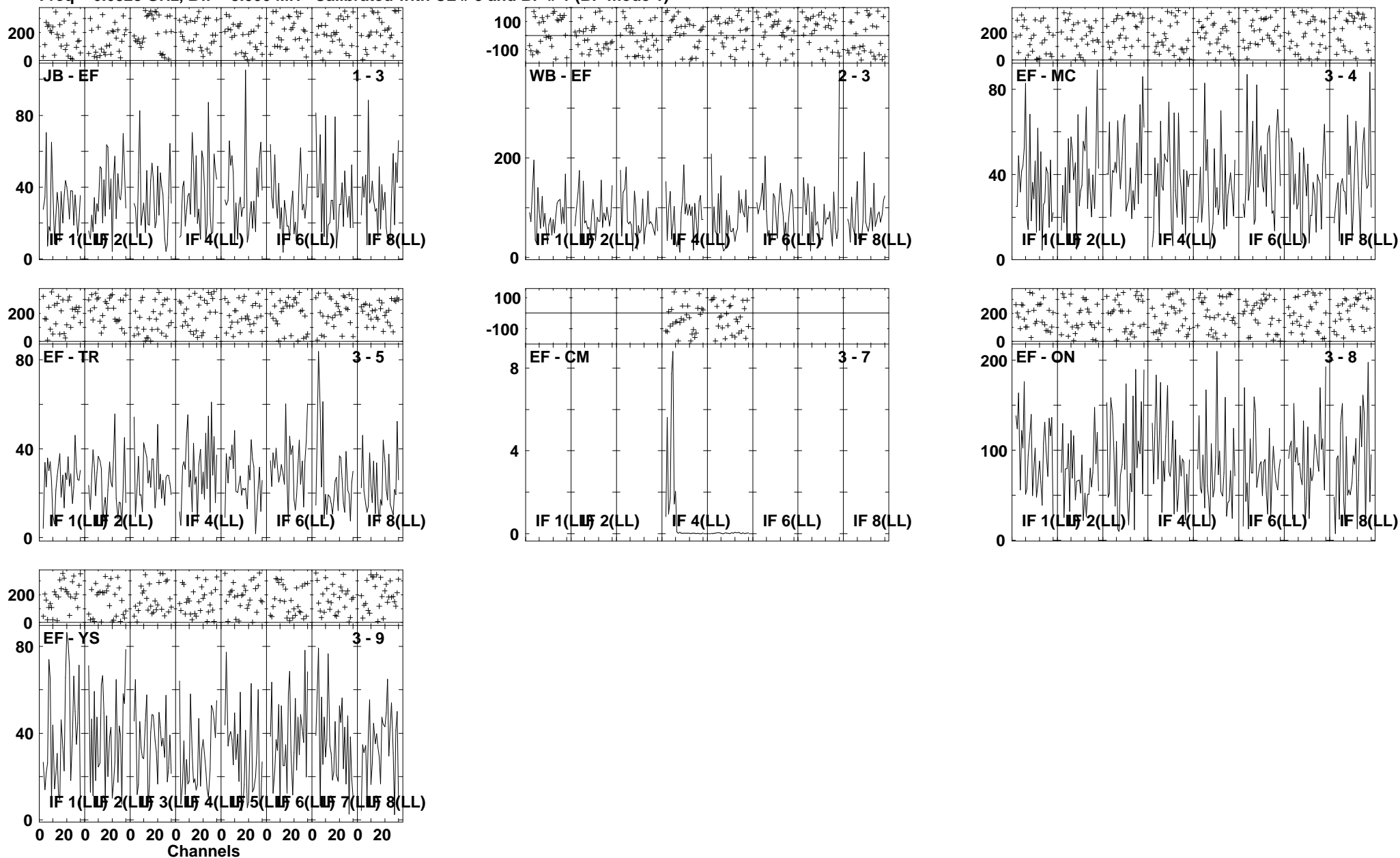

Lower frame: Milli Ampl Jy Top frame: Phas deg
Vector averaged cross-power spectrum Several baselines displayed
Timerange: 00/07:53:31 to 00/07:55:00

Plot file version 221 created 19-AUG-2009 15:55:34

W75 EB039B 2.UVDATA.1

Freq = 6.6328 GHz, Bw = 8.000 MH Calibrated with CL # 3 and BP # 1 (BP mode 1)

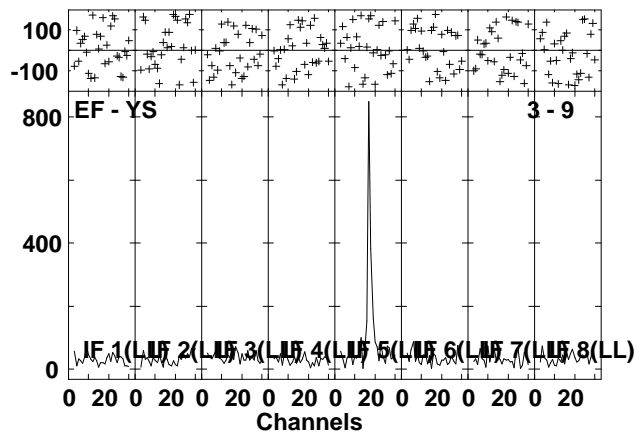
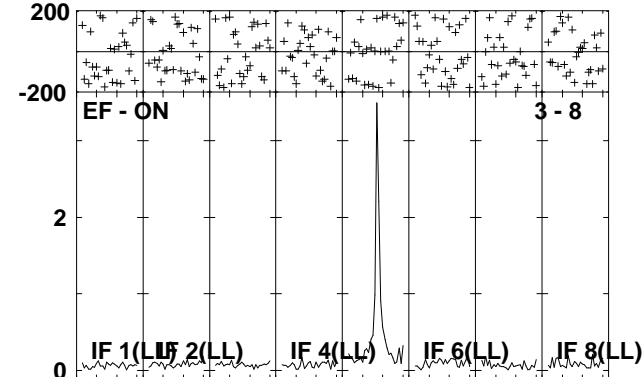
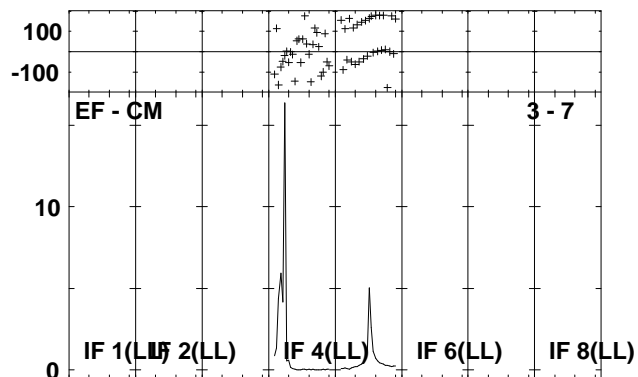
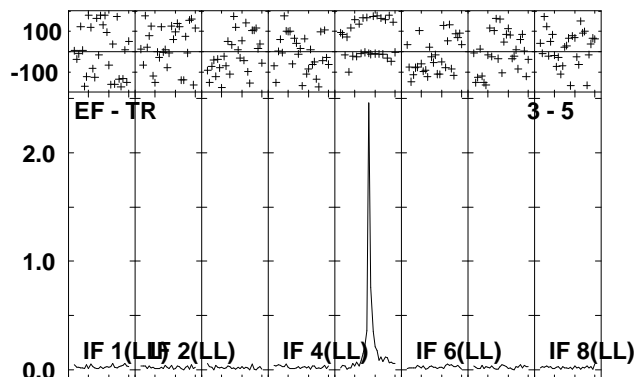
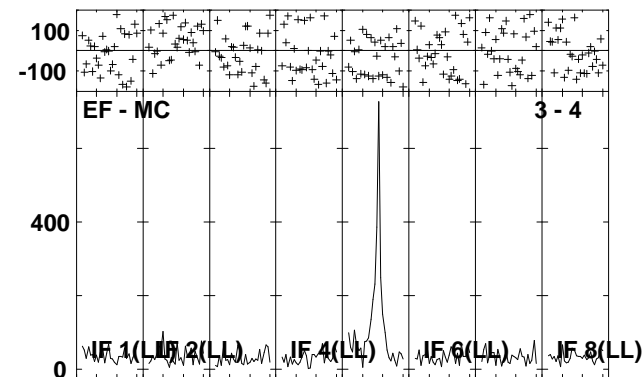
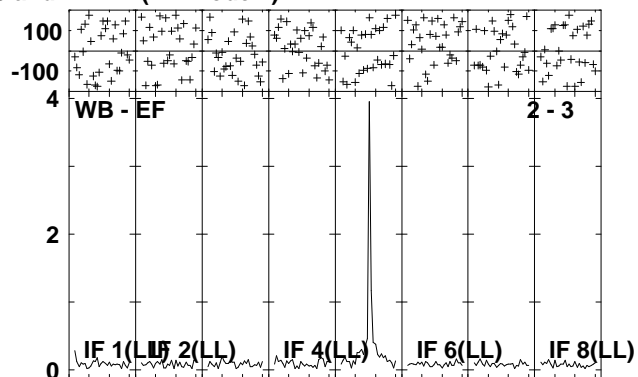
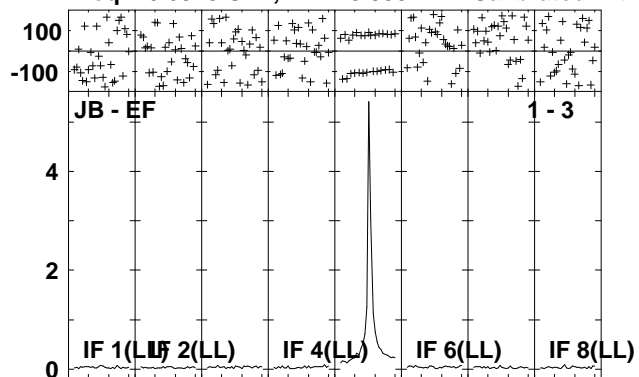

Lower frame: Ampl Jy Top frame: Phas deg
Vector averaged cross-power spectrum Several baselines displayed
Timerange: 00/07:55:02 to 00/07:56:31

Plot file version 222 created 19-AUG-2009 15:55:36
 DR21B2 EB039B 2.UVDATA.1
 Freq = 6.6328 GHz, Bw = 8.000 MH Calibrated with CL # 3 and BP # 1 (BP mode 1)

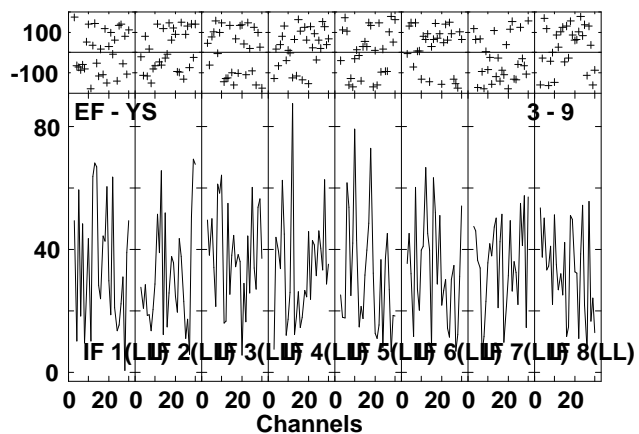
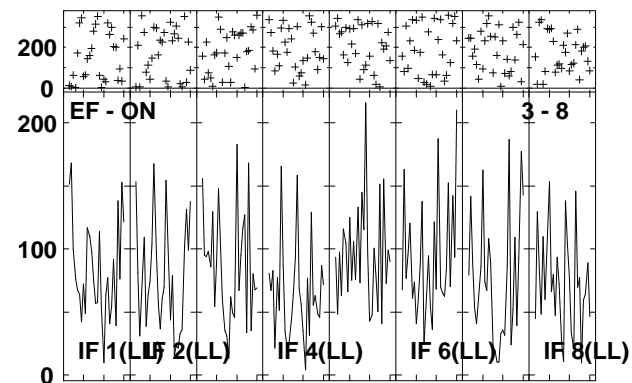
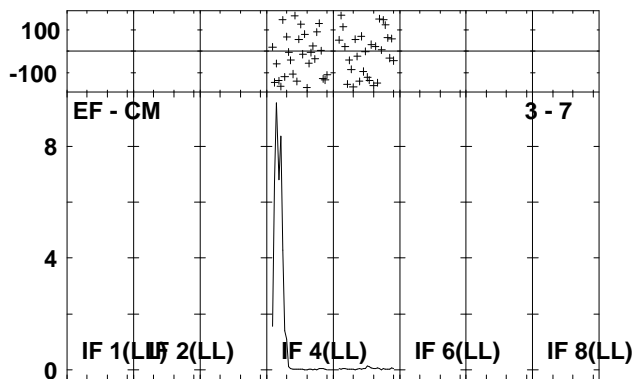
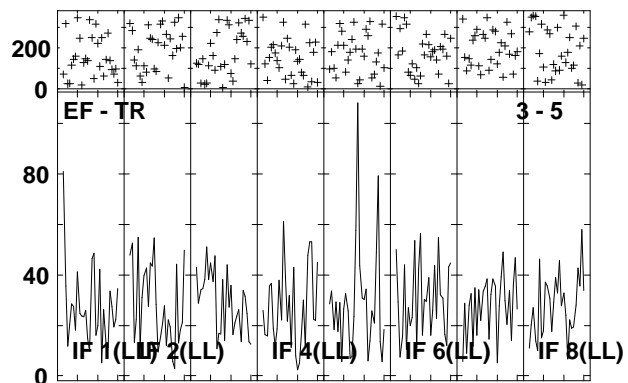
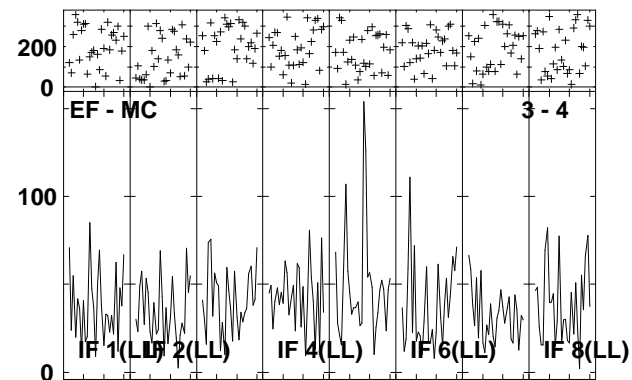
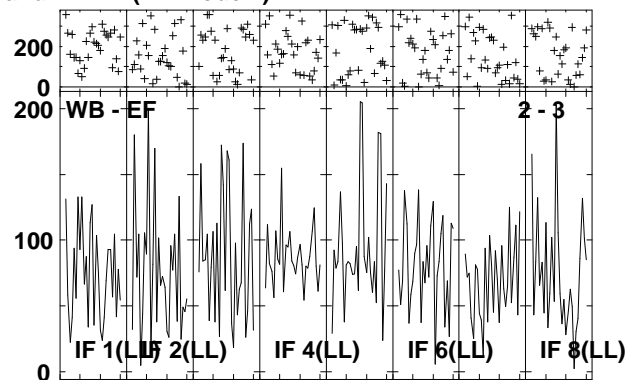
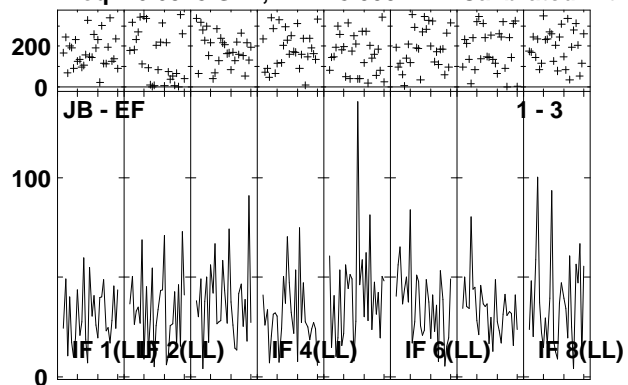

Lower frame: Milli Ampl Jy Top frame: Phas deg
 Vector averaged cross-power spectrum Several baselines displayed
 Timerange: 00/07:56:31 to 00/07:58:00

Plot file version 223 created 19-AUG-2009 15:55:39
 W75 EB039B 2.UVDATA.1
 Freq = 6.6328 GHz, Bw = 8.000 MH Calibrated with CL # 3 and BP # 1 (BP mode 1)

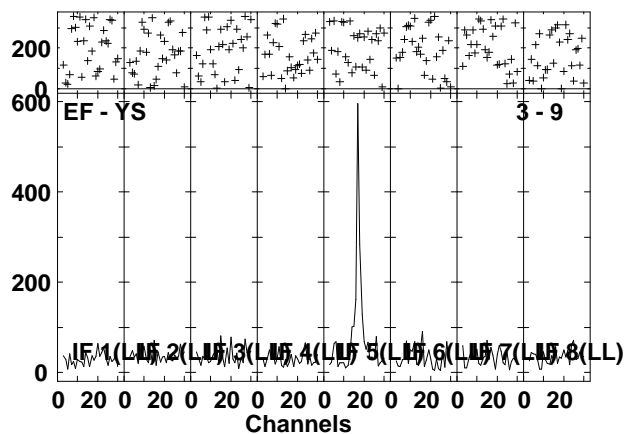
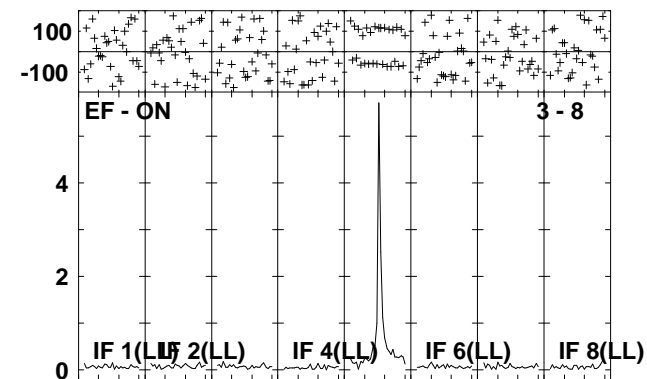
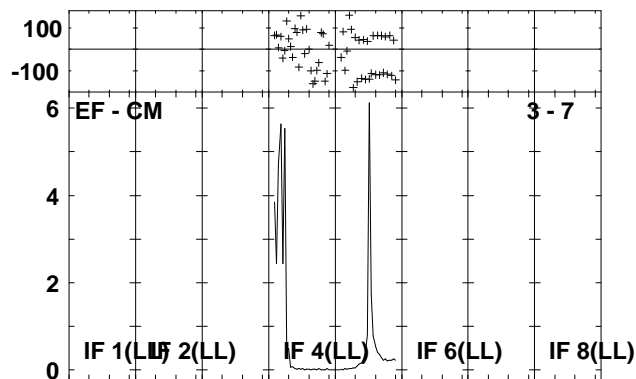
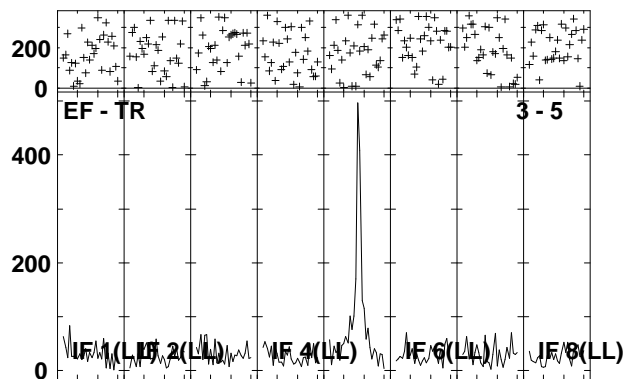
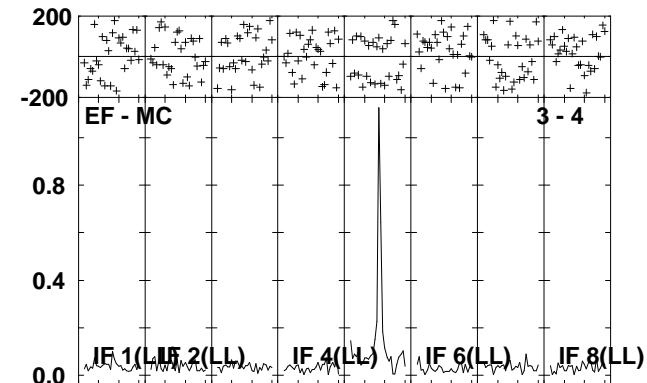
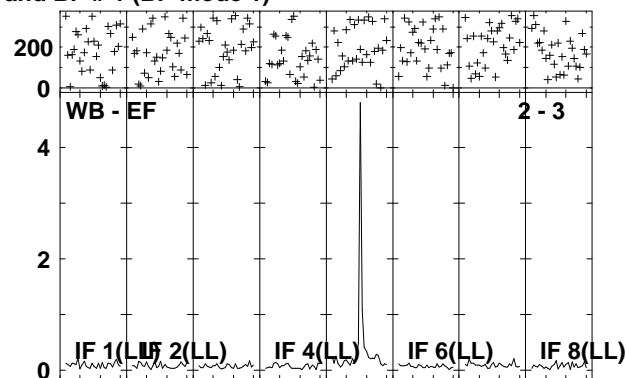
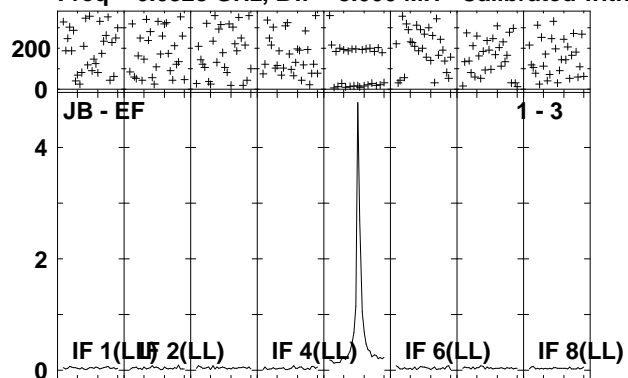

Lower frame: Ampl Jy Top frame: Phas deg
 Vector averaged cross-power spectrum Several baselines displayed
 Timerange: 00/07:58:02 to 00/07:59:30

Plot file version 224 created 19-AUG-2009 15:55:41
 DR20 EB039B 2.UVDATA.1
 Freq = 6.6328 GHz, Bw = 8.000 MH Calibrated with CL # 3 and BP # 1 (BP mode 1)

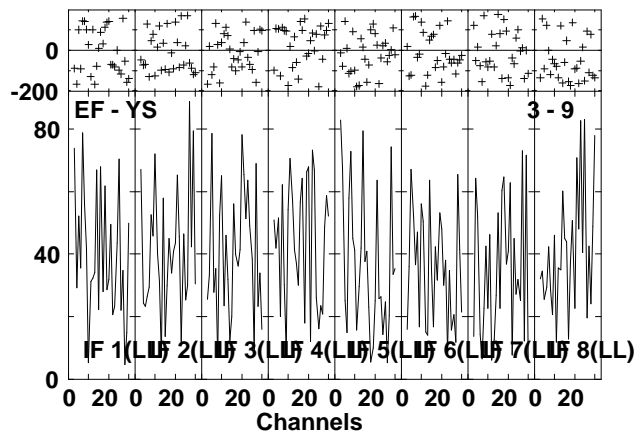
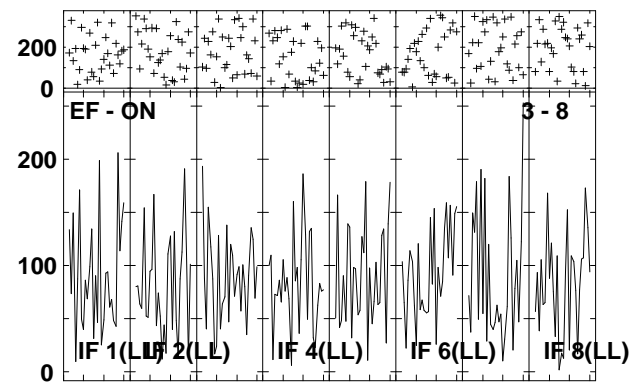
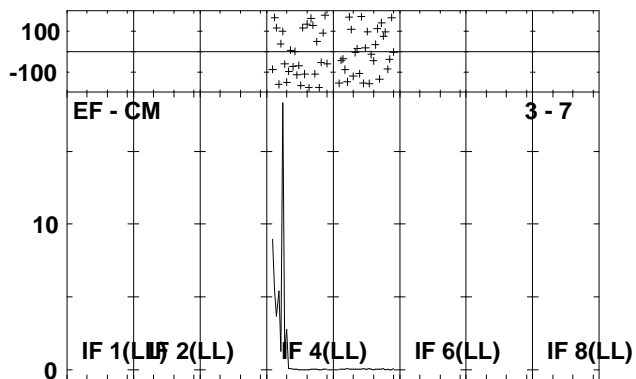
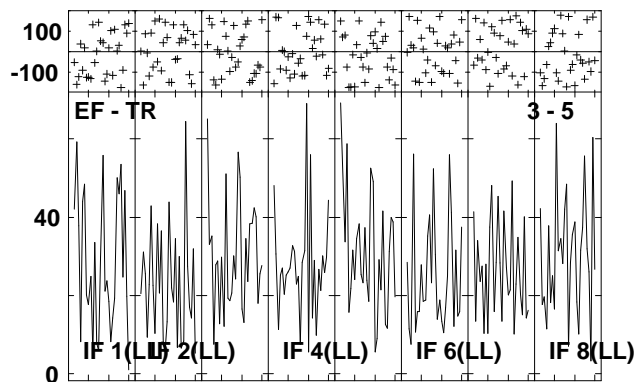
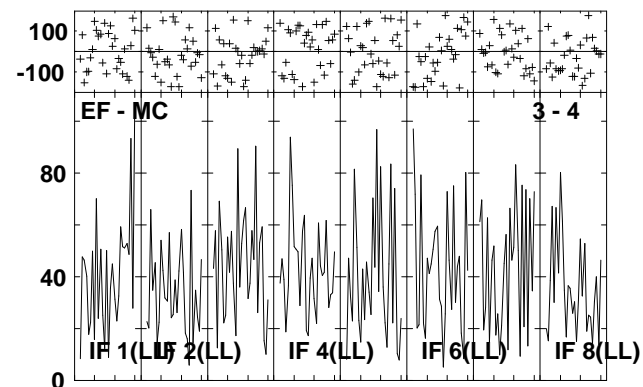
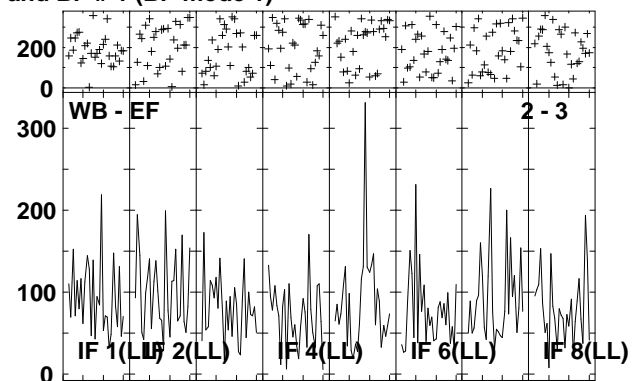
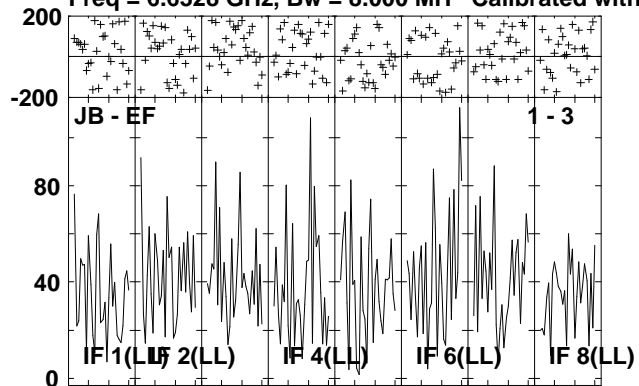

Lower frame: Milli Ampl Jy Top frame: Phas deg
 Vector averaged cross-power spectrum Several baselines displayed
 Timerange: 00/07:59:31 to 00/08:01:00

Plot file version 225 created 19-AUG-2009 15:55:43
 W75 EB039B 2.UVDATA.1
 Freq = 6.6328 GHz, Bw = 8.000 MH Calibrated with CL # 3 and BP # 1 (BP mode 1)

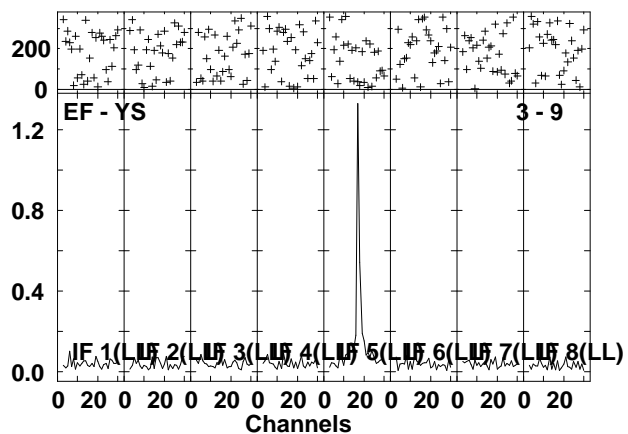
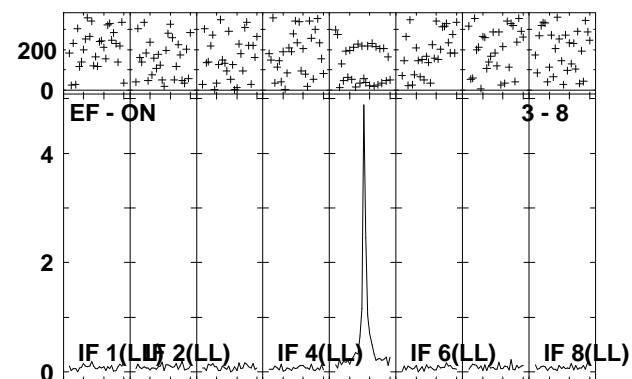
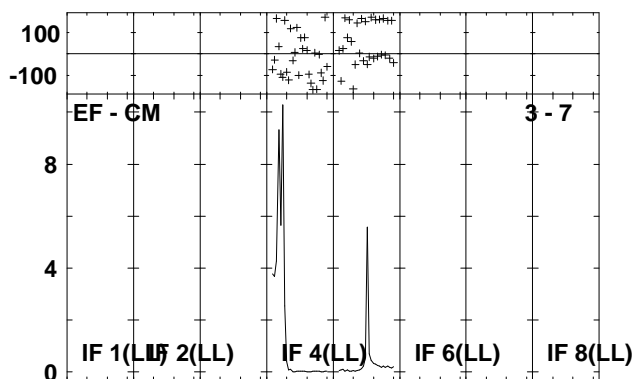
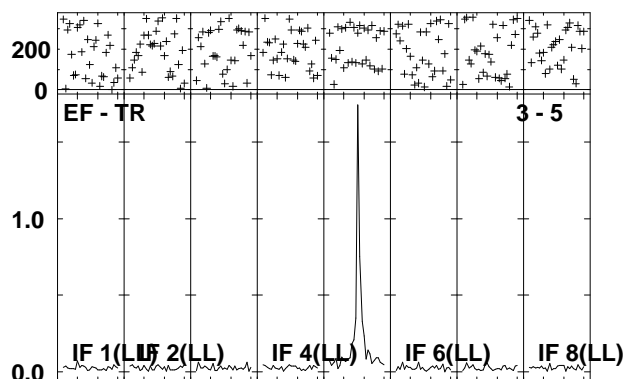
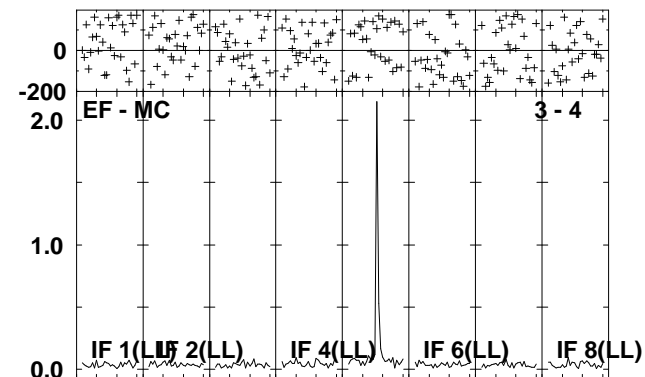
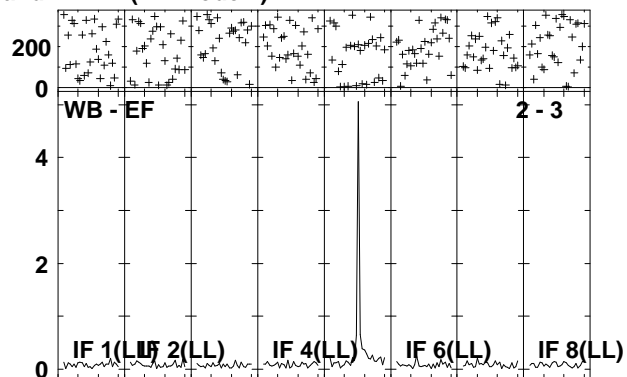
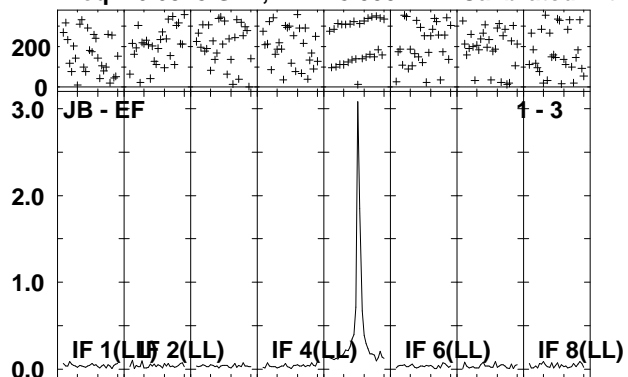

0 20 0 20 0 20 0 20 0 20 0 20 0 20 0 20 0 20 0 20
 Channels
 Lower frame: Ampl Jy Top frame: Phas deg
 Vector averaged cross-power spectrum Several baselines displayed
 Timerange: 00/08:01:38 to 00/08:02:38

Plot file version 226 created 19-AUG-2009 15:55:46
 J2038+51 EB039B 2.UVDATA.1
 Freq = 6.6328 GHz, Bw = 8.000 MH Calibrated with CL # 3 and BP # 1 (BP mode 1)

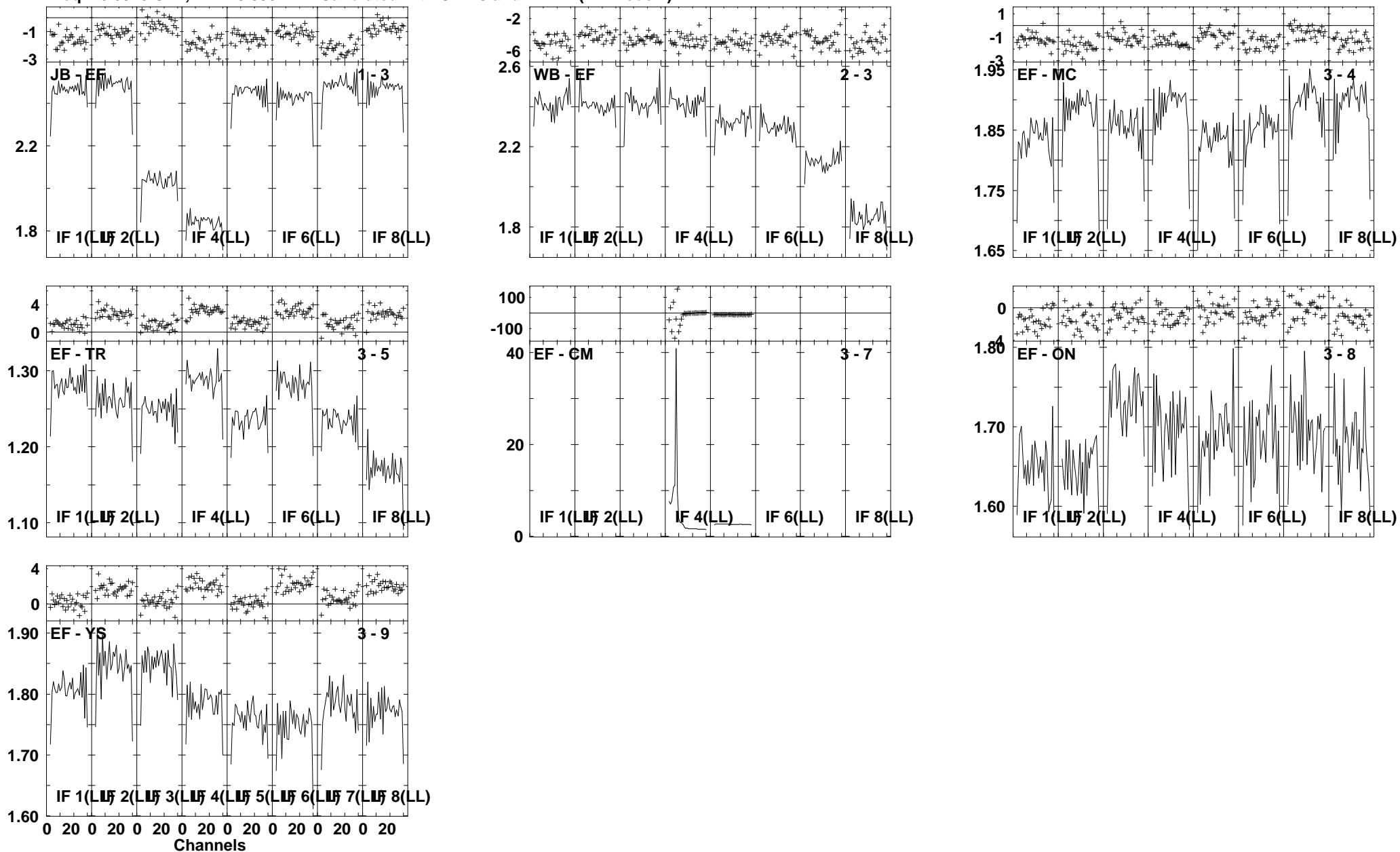

Lower frame: Ampl Jy Top frame: Phas deg
 Vector averaged cross-power spectrum Several baselines displayed
 Timerange: 00/08:05:44 to 00/08:08:41

Plot file version 227 created 19-AUG-2009 15:55:50
 W75 EB039B 2.UVDATA.1
 Freq = 6.6328 GHz, Bw = 8.000 MH Calibrated with CL # 3 and BP # 1 (BP mode 1)

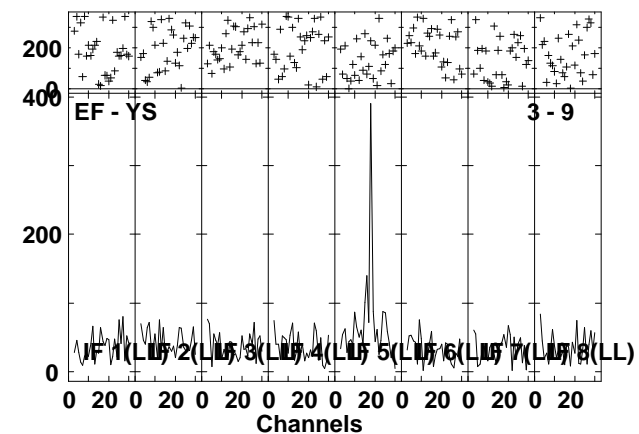
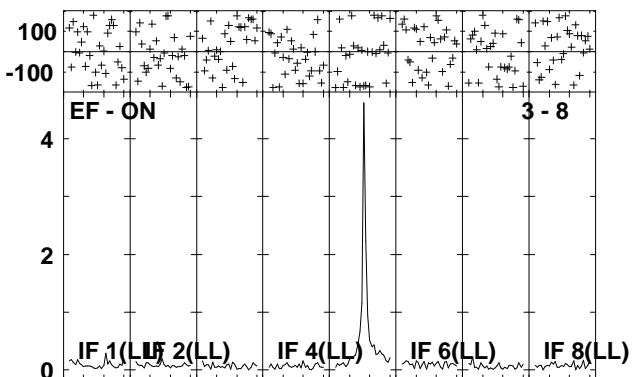
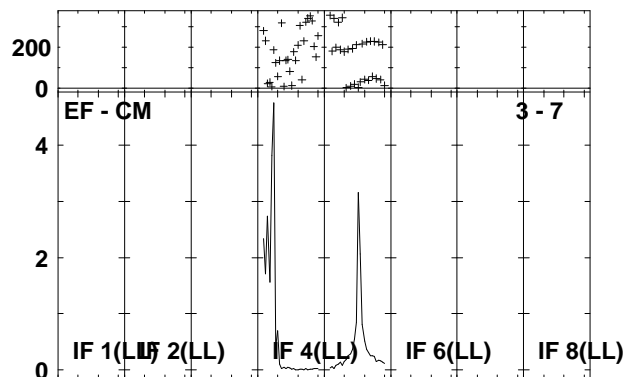
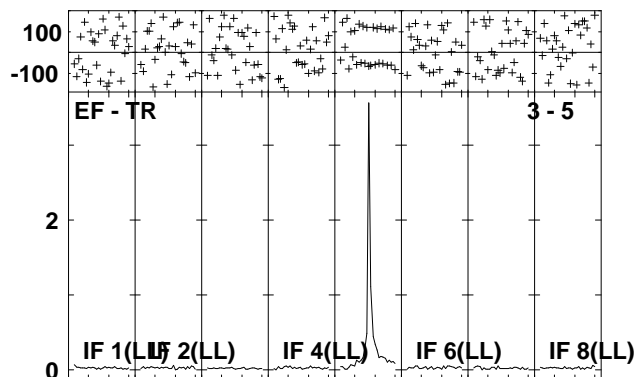
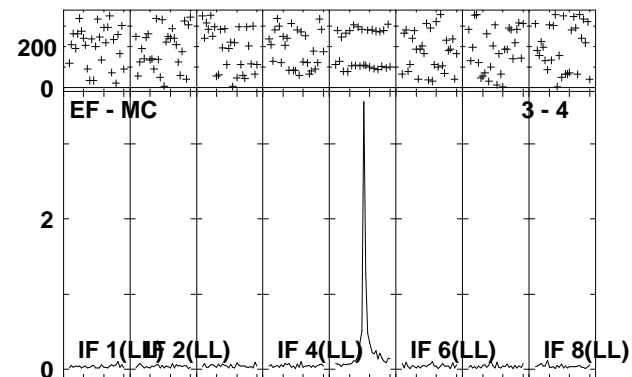
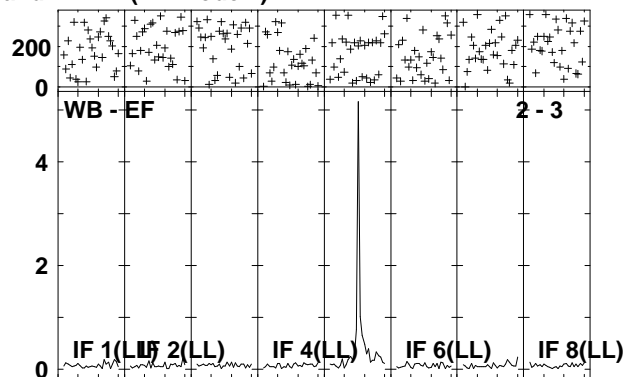
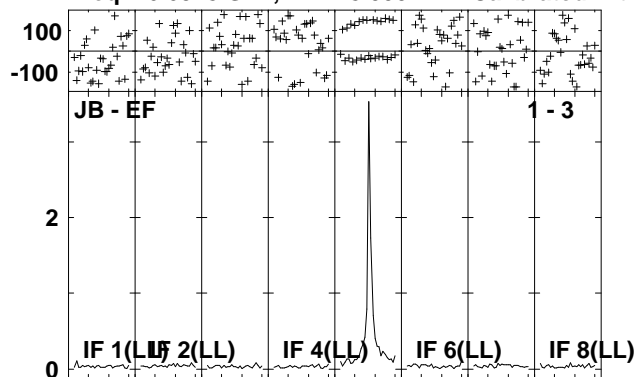

Lower frame: Ampl Jy Top frame: Phas deg
 Vector averaged cross-power spectrum Several baselines displayed
 Timerange: 00/08:12:12 to 00/08:13:12

Plot file version 228 created 19-AUG-2009 15:55:52
 J2029+46 EB039B 2.UVDATA.1
 Freq = 6.6328 GHz, Bw = 8.000 MH Calibrated with CL # 3 and BP # 1 (BP mode 1)

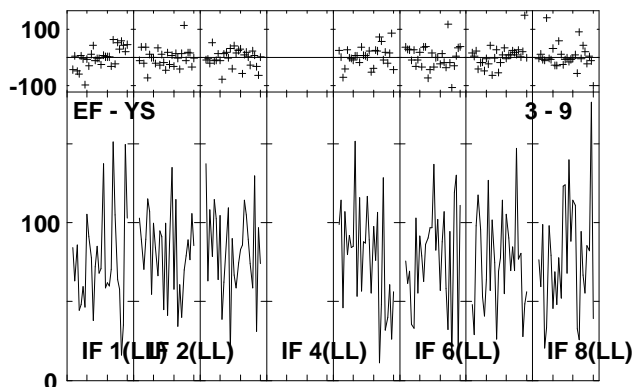
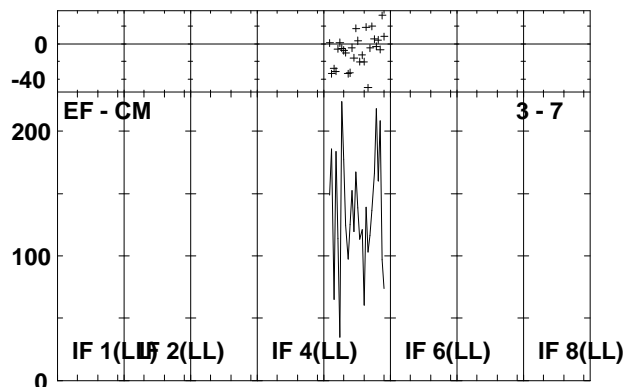
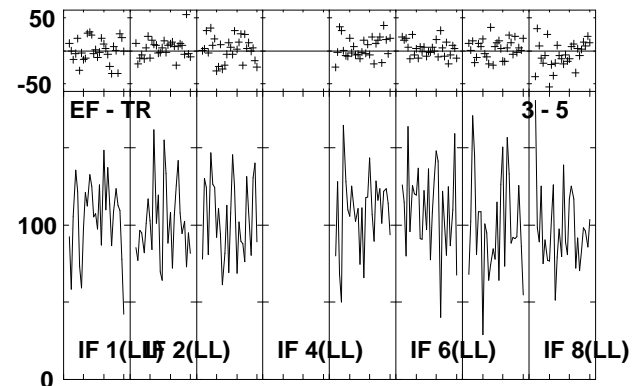
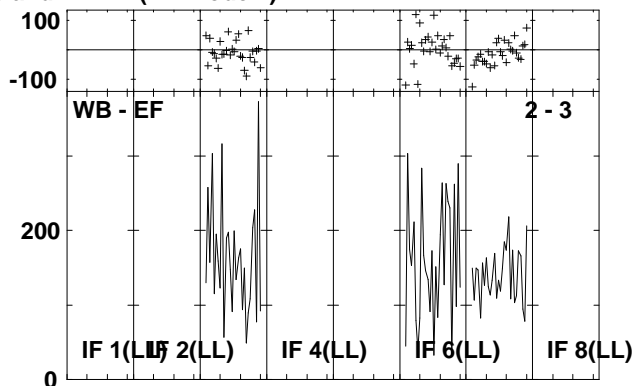
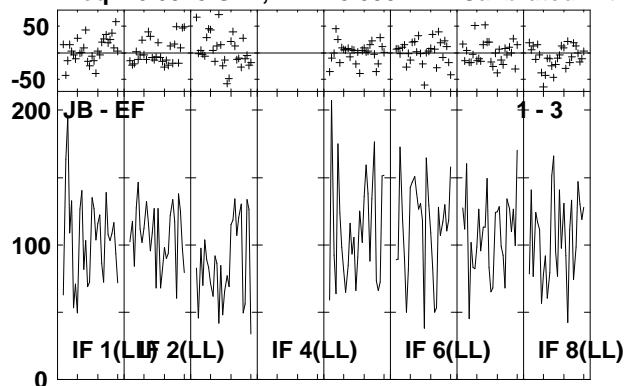

Lower frame: Milli Ampl Jy Top frame: Phas deg
 Vector averaged cross-power spectrum Several baselines displayed
 Timerange: 00/08:13:12 to 00/08:14:41

Plot file version 229 created 19-AUG-2009 15:55:53
 W75 EB039B 2.UVDATA.1
 Freq = 6.6328 GHz, Bw = 8.000 MH Calibrated with CL # 3 and BP # 1 (BP mode 1)

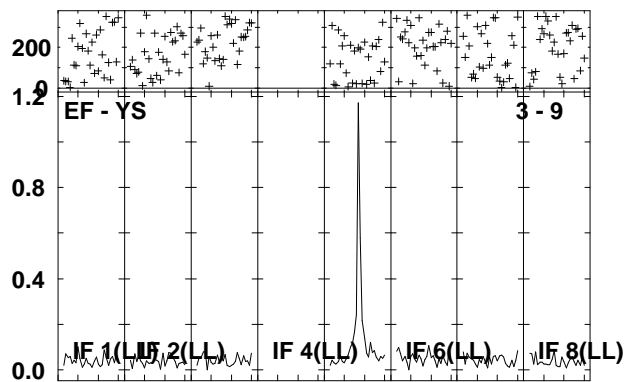
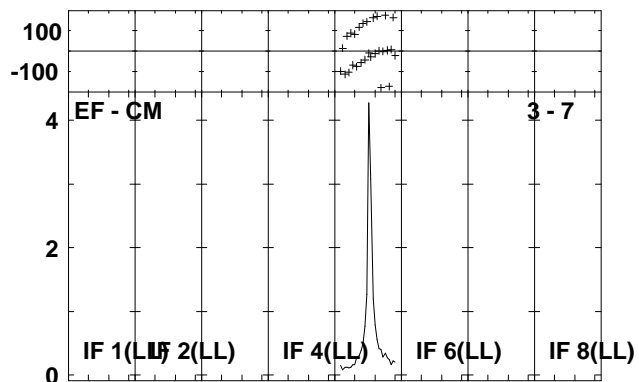
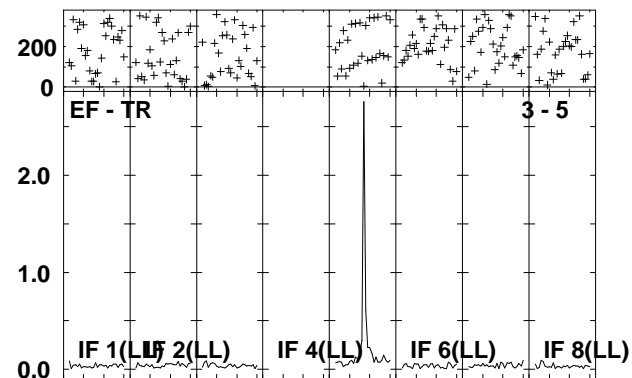
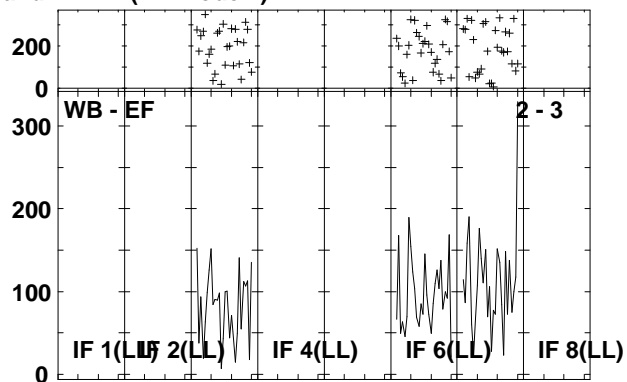
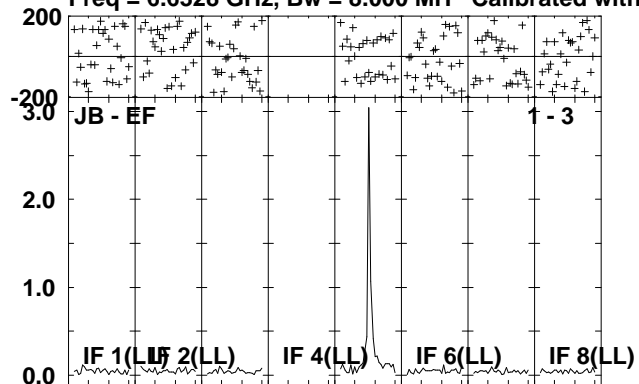

Lower frame: Ampl Jy Top frame: Phas deg
 Vector averaged cross-power spectrum Several baselines displayed
 Timerange: 00/08:14:43 to 00/08:16:12

Plot file version 230 created 19-AUG-2009 15:55:56
W75 EB039B 2.UVDATA.1
Freq = 6.6328 GHz, Bw = 8.000 MH Calibrated with CL # 3 and BP # 1 (BP mode 1)

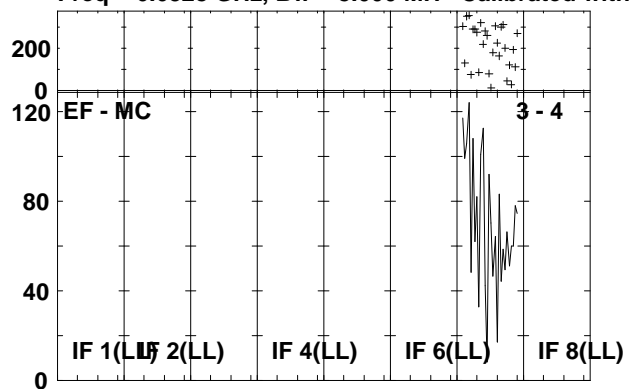

Lower frame: Milli Ampl Jy Top frame: Phas deg
Vector averaged cross-power spectrum Several baselines displayed
Timerange: 00/08:17:43 to 00/08:19:12

Plot file version 231 created 19-AUG-2009 15:55:59
 W75 EB039B 2.UVDATA.1
 Freq = 6.6328 GHz, Bw = 8.000 MH Calibrated with CL # 3 and BP # 1 (BP mode 1)

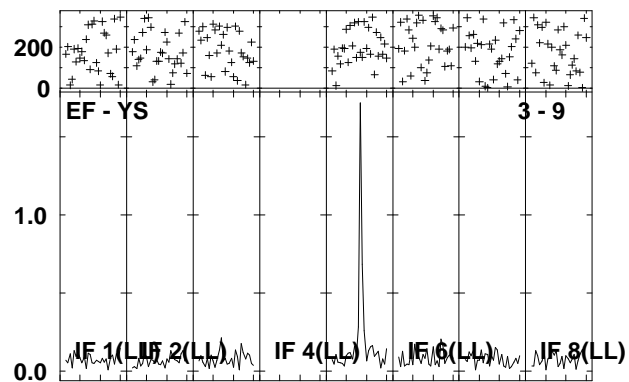
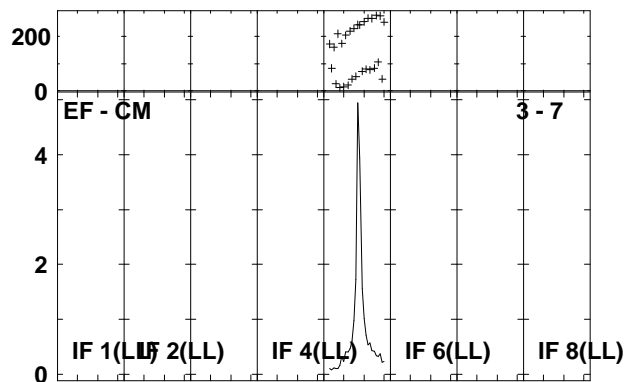
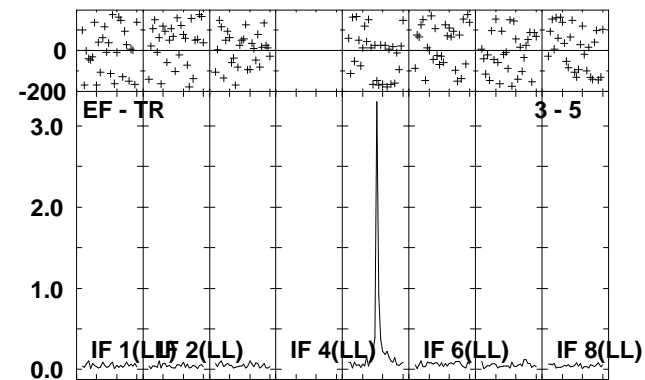
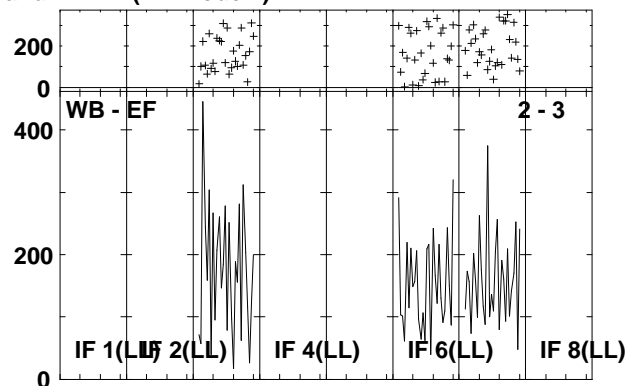
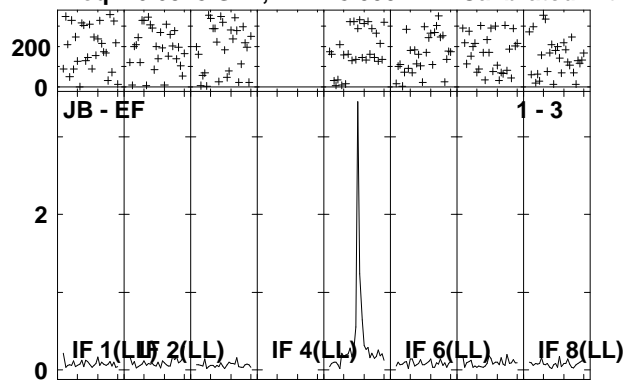

Lower frame: Ampl Jy Top frame: Phas deg
 Vector averaged cross-power spectrum Several baselines displayed
 Timerange: 00/08:20:43 to 00/08:22:12

Plot file version 232 created 19-AUG-2009 15:56:01
 OB2 EB039B 2.UVDATA.1
 Freq = 6.6328 GHz, Bw = 8.000 MH Calibrated with CL # 3 and BP # 1 (BP mode 1)

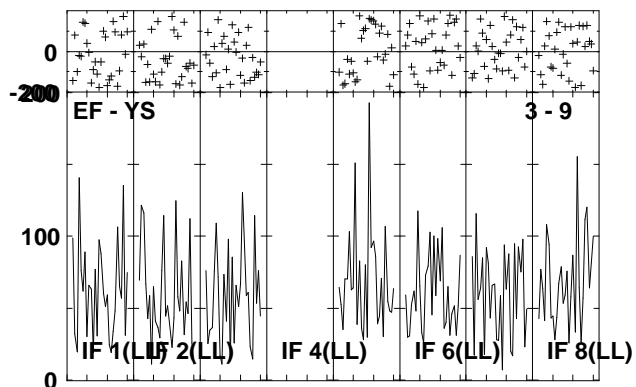
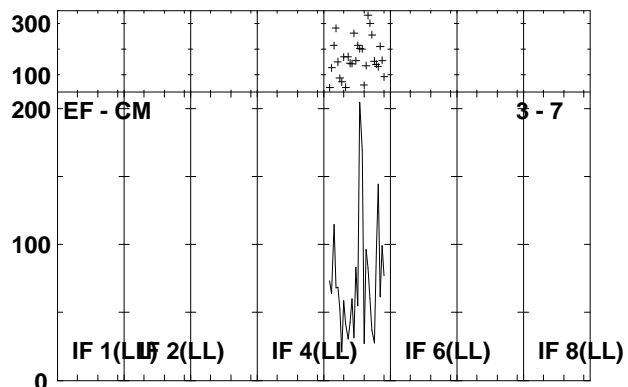
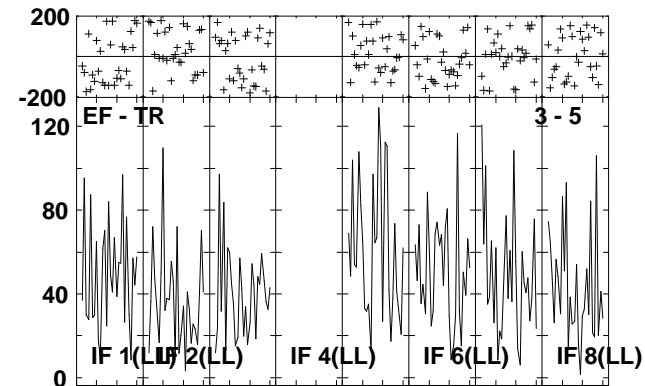
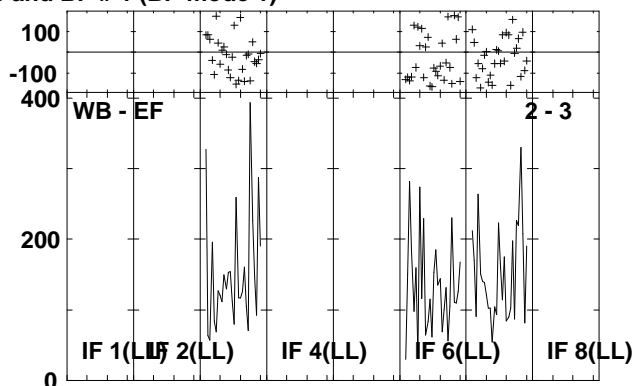
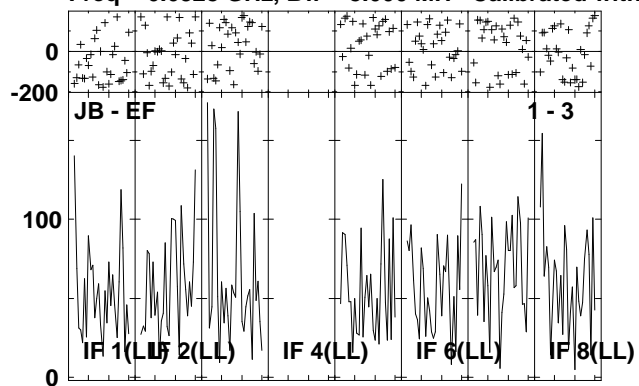

Lower frame: Milli Ampl Jy Top frame: Phas deg
 Vector averaged cross-power spectrum Several baselines displayed
 Timerange: 00/08:22:12 to 00/08:23:41

Plot file version 233 created 19-AUG-2009 15:56:02
 W75 EB039B 2.UVDATA.1
 Freq = 6.6328 GHz, Bw = 8.000 MH Calibrated with CL # 3 and BP # 1 (BP mode 1)

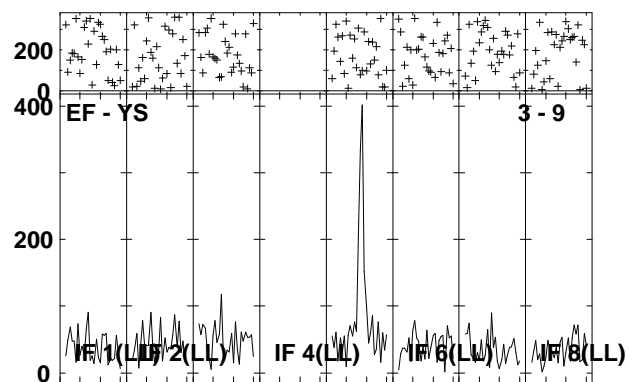
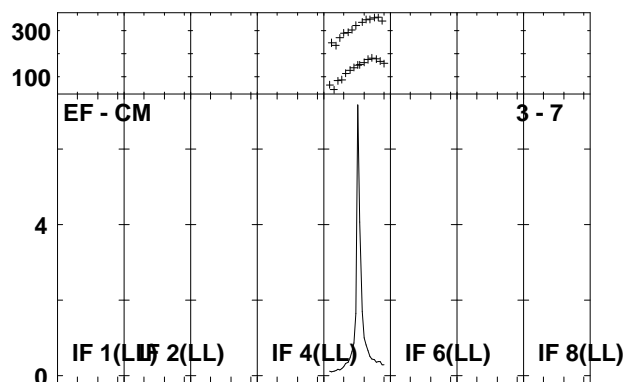
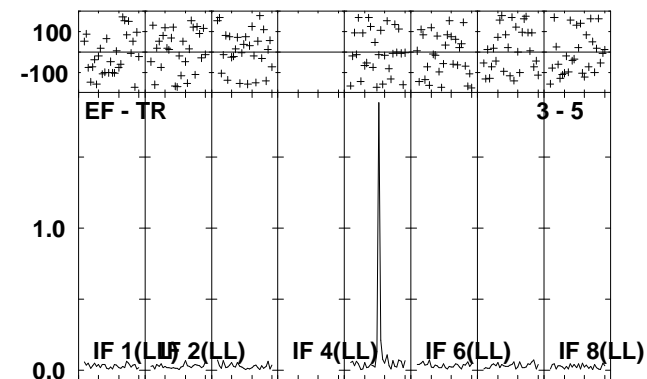
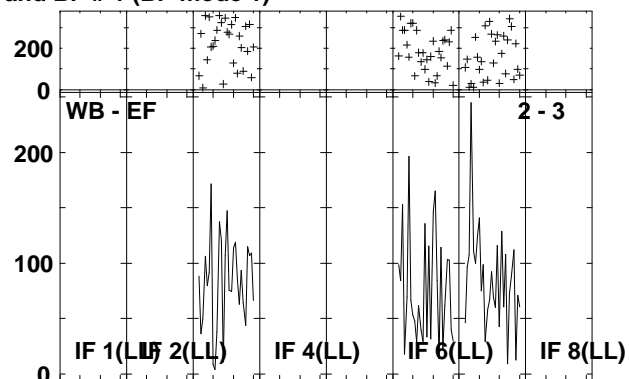
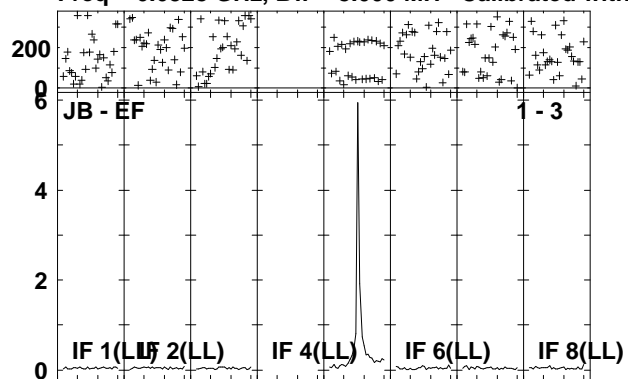

Lower frame: Ampl Jy Top frame: Phas deg
 Vector averaged cross-power spectrum Several baselines displayed
 Timerange: 00/08:24:35 to 00/08:25:34

Plot file version 234 created 19-AUG-2009 15:56:03
 DR21A EB039B 2.UVDATA.1
 Freq = 6.6328 GHz, Bw = 8.000 MH Calibrated with CL # 3 and BP # 1 (BP mode 1)

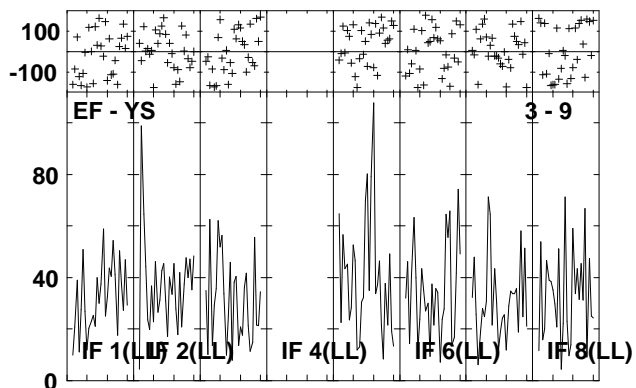
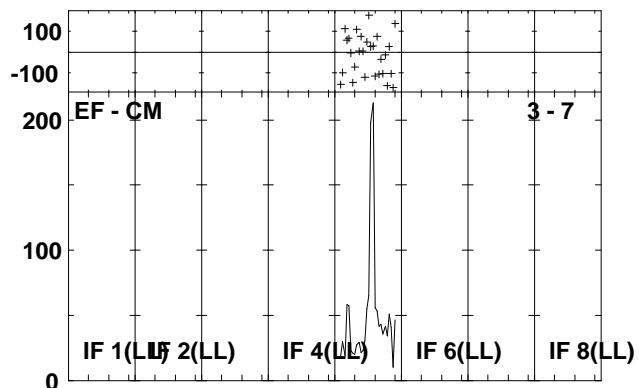
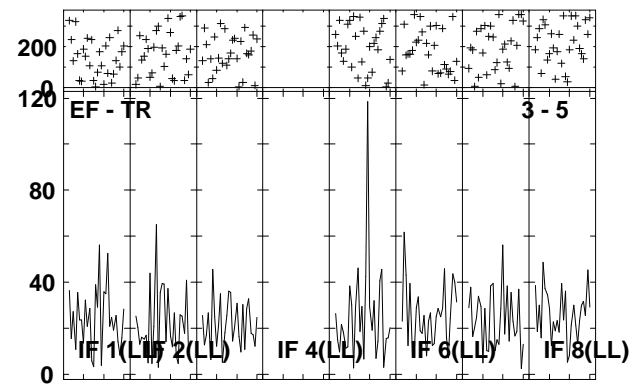
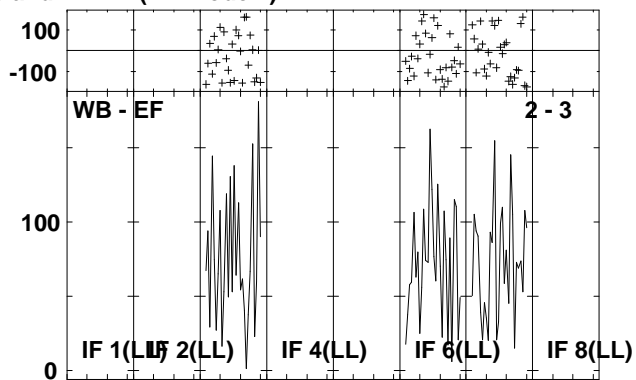
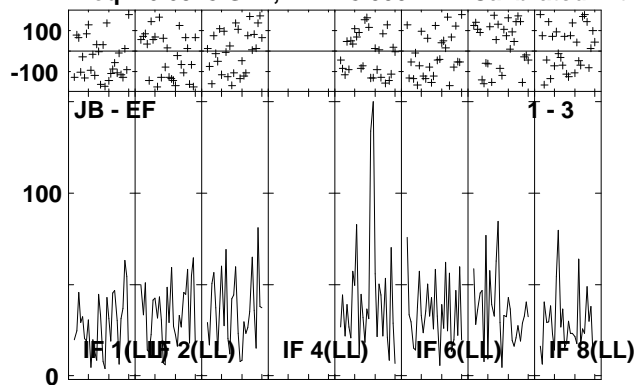

Lower frame: Milli Ampl Jy Top frame: Phas deg
 Vector averaged cross-power spectrum Several baselines displayed
 Timerange: 00/08:25:36 to 00/08:27:05

Plot file version 235 created 19-AUG-2009 15:56:05
 W75 EB039B 2.UVDATA.1
 Freq = 6.6328 GHz, Bw = 8.000 MH Calibrated with CL # 3 and BP # 1 (BP mode 1)

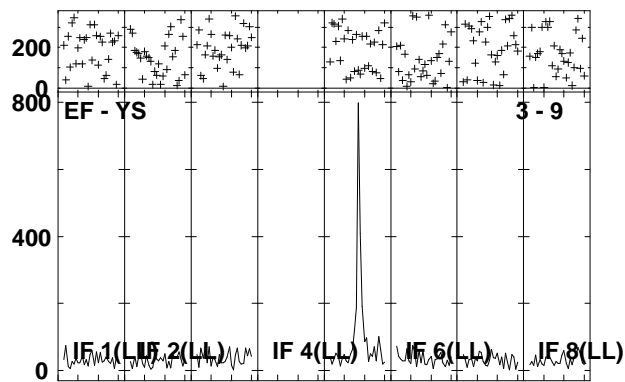
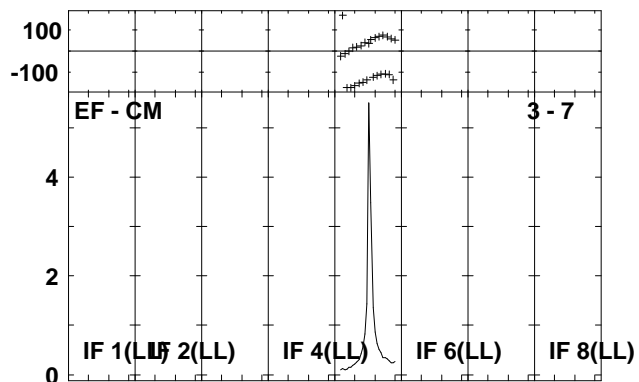
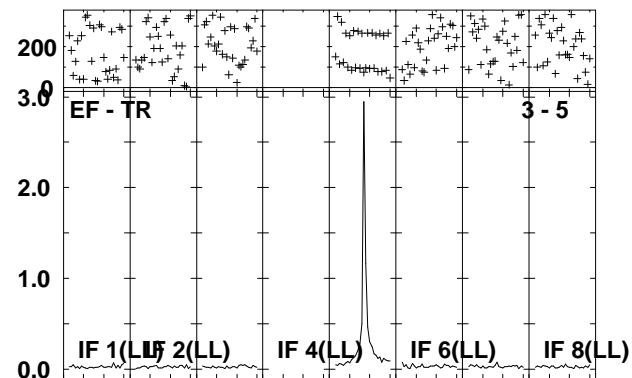
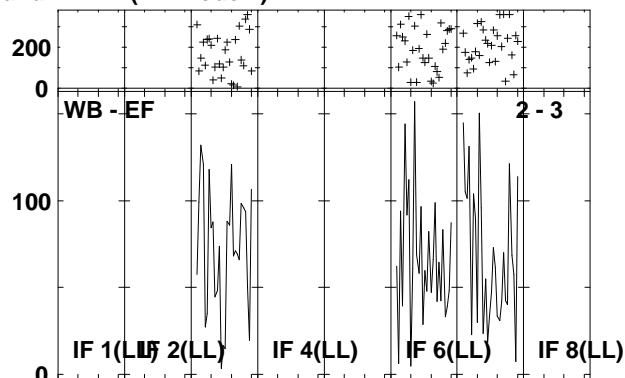
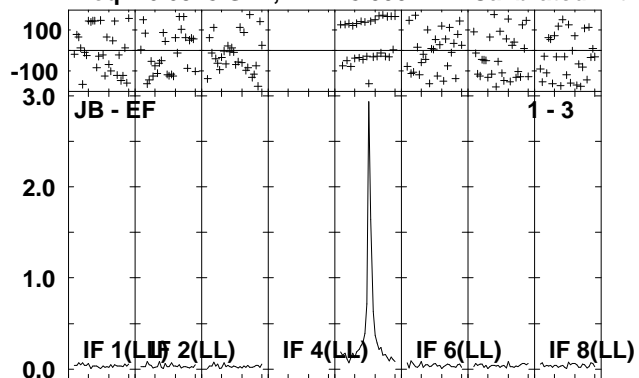

Lower frame: Ampl Jy Top frame: Phas deg
 Vector averaged cross-power spectrum Several baselines displayed
 Timerange: 00/08:27:05 to 00/08:28:34

Plot file version 236 created 19-AUG-2009 15:56:07
 DR21B EB039B 2.UVDATA.1
 Freq = 6.6328 GHz, Bw = 8.000 MH Calibrated with CL # 3 and BP # 1 (BP mode 1)

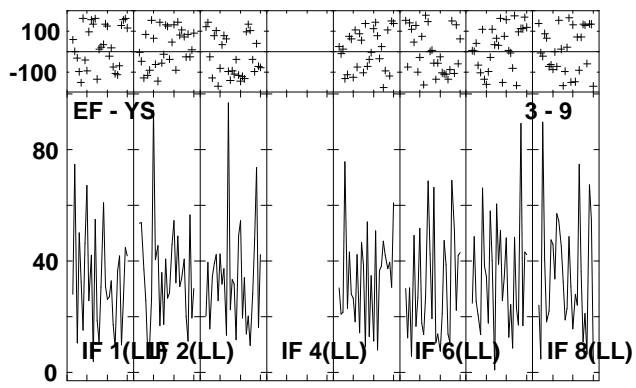
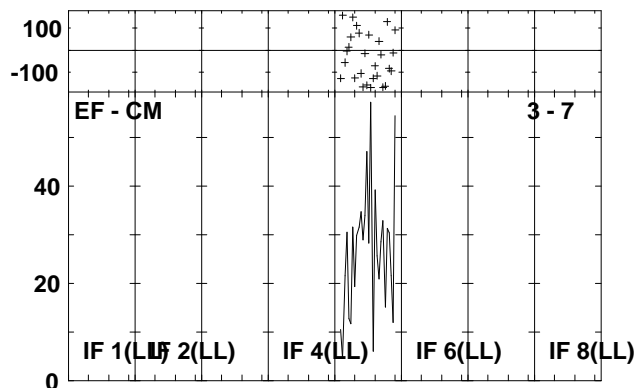
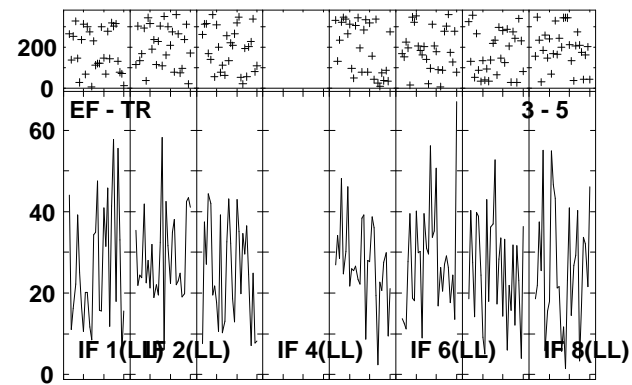
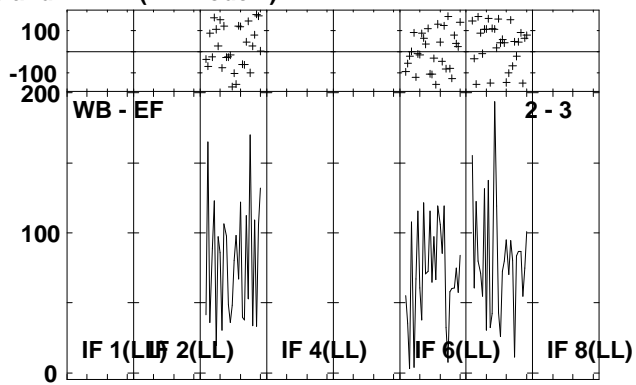
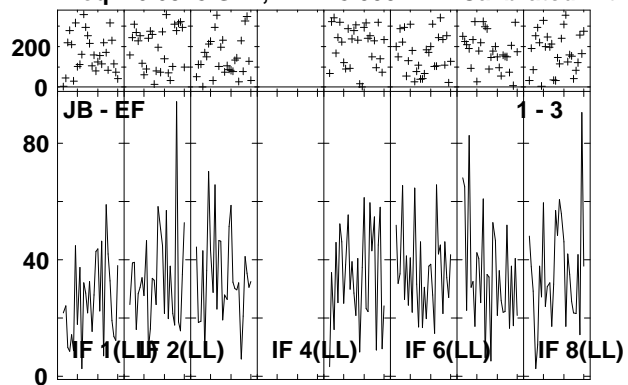

Lower frame: Milli Ampl Jy Top frame: Phas deg
 Vector averaged cross-power spectrum Several baselines displayed
 Timerange: 00/08:28:36 to 00/08:30:05

Plot file version 237 created 19-AUG-2009 15:56:09
 W75 EB039B 2.UVDATA.1
 Freq = 6.6328 GHz, Bw = 8.000 MH Calibrated with CL # 3 and BP # 1 (BP mode 1)

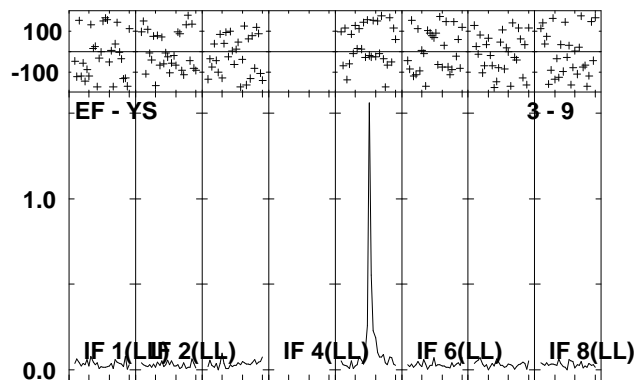
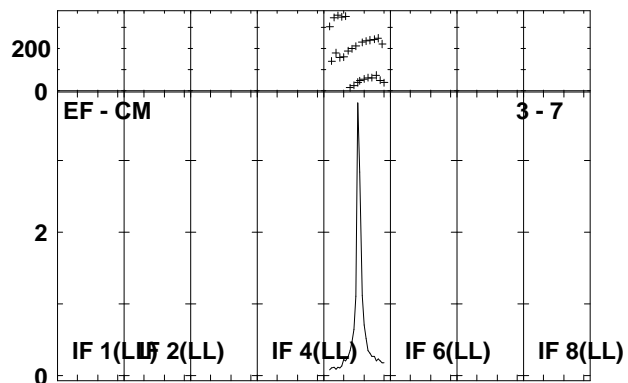
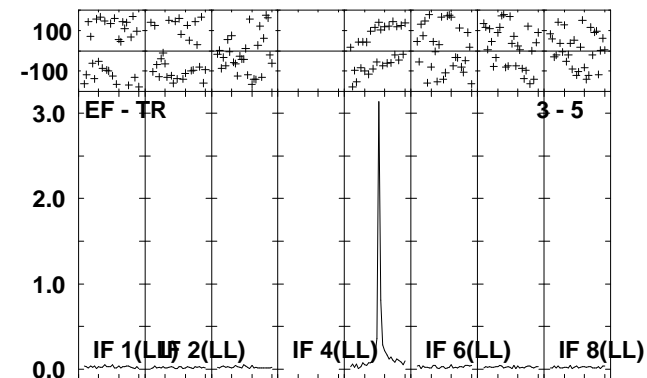
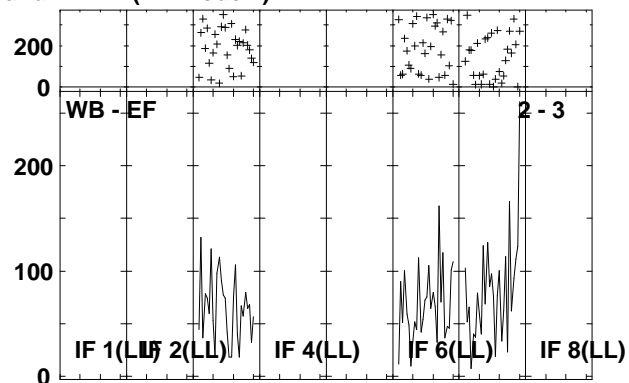
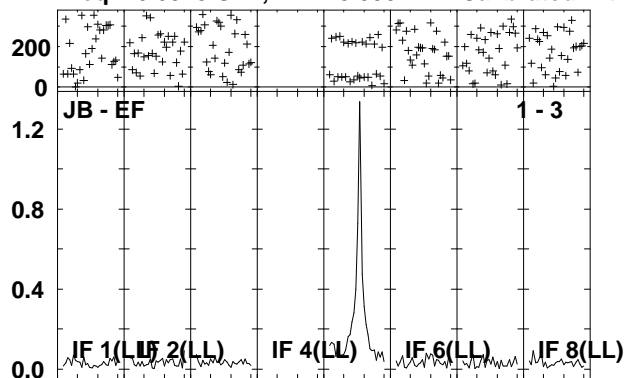

Lower frame: Ampl Jy Top frame: Phas deg
 Vector averaged cross-power spectrum Several baselines displayed
 Timerange: 00/08:30:05 to 00/08:31:34

Plot file version 238 created 19-AUG-2009 15:56:11
 DR21B2 EB039B 2.UVDATA.1
 Freq = 6.6328 GHz, Bw = 8.000 MH Calibrated with CL # 3 and BP # 1 (BP mode 1)

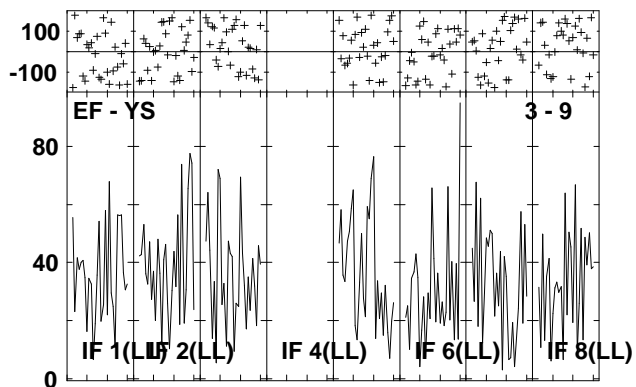
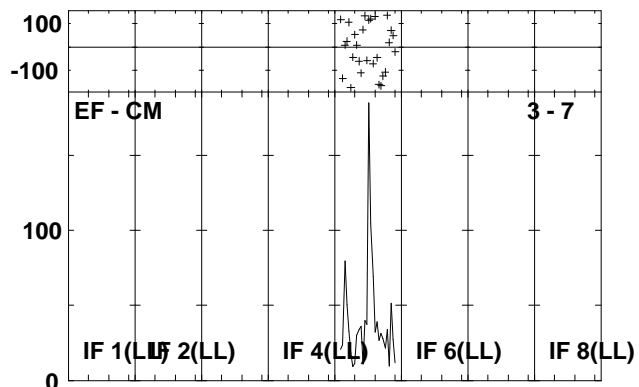
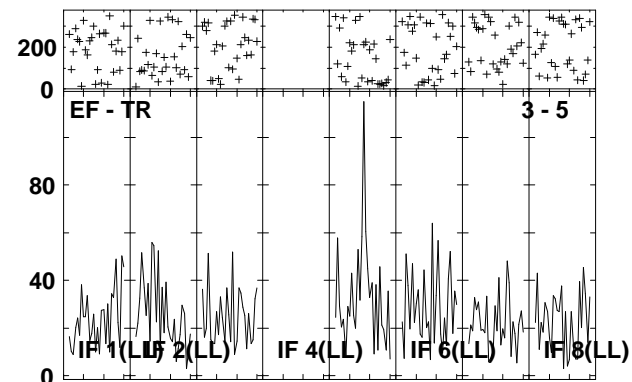
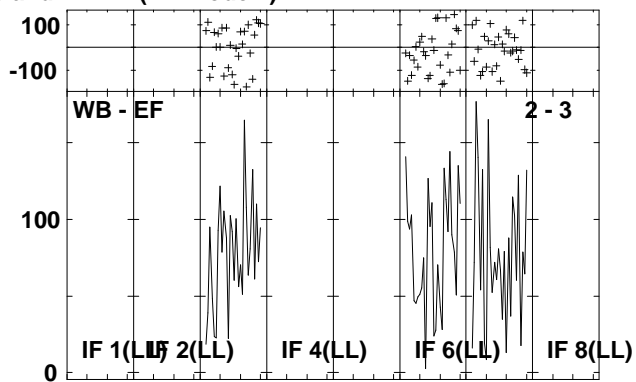
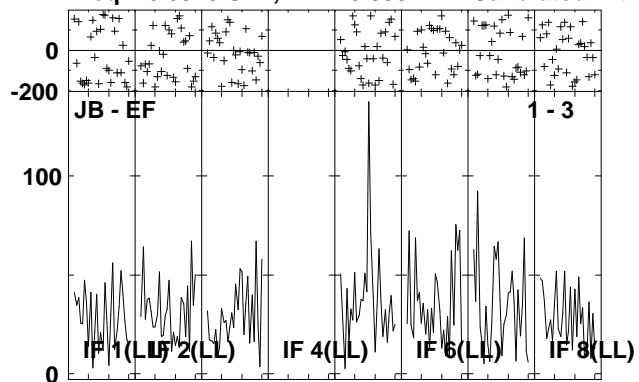

Lower frame: Milli Ampl Jy Top frame: Phas deg
 Vector averaged cross-power spectrum Several baselines displayed
 Timerange: 00/08:31:36 to 00/08:33:04

Plot file version 239 created 19-AUG-2009 15:56:12
 W75 EB039B 2.UVDATA.1
 Freq = 6.6328 GHz, Bw = 8.000 MH Calibrated with CL # 3 and BP # 1 (BP mode 1)

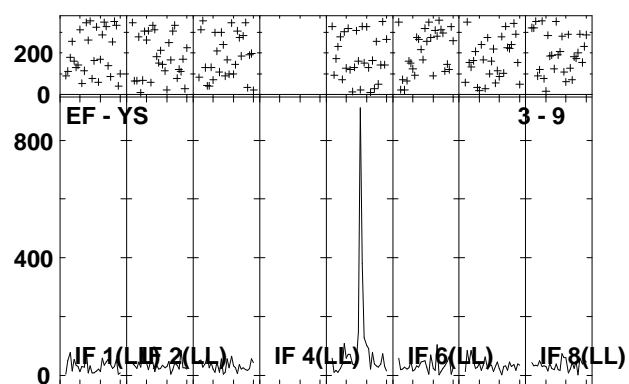
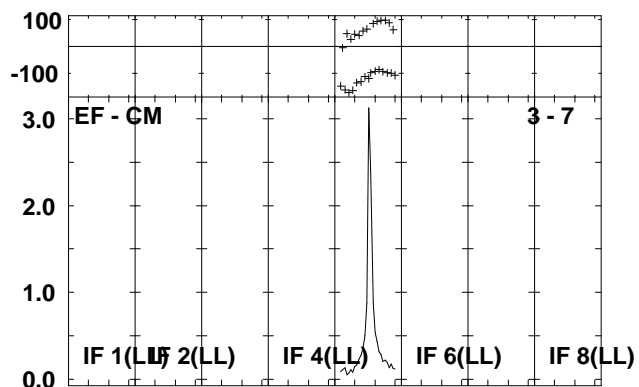
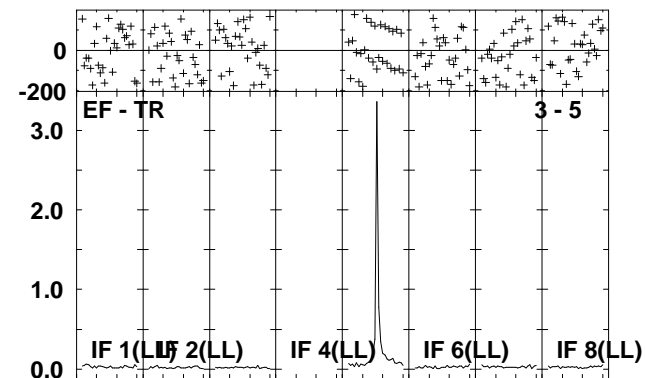
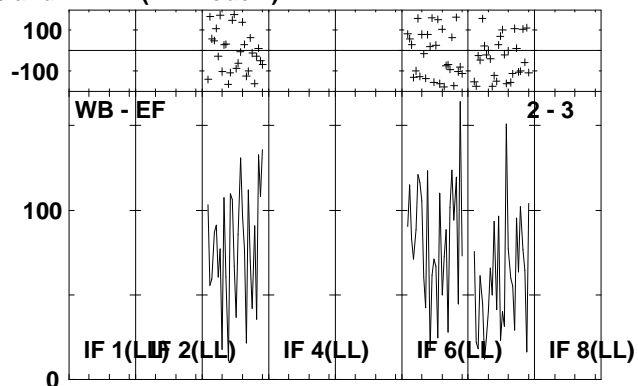
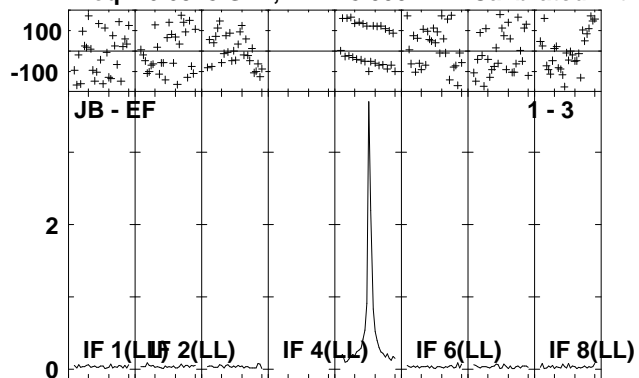

Lower frame: Ampl Jy Top frame: Phas deg
 Vector averaged cross-power spectrum Several baselines displayed
 Timerange: 00/08:33:05 to 00/08:34:34

Plot file version 240 created 19-AUG-2009 15:56:14
 DR20 EB039B 2.UVDATA.1
 Freq = 6.6328 GHz, Bw = 8.000 MH Calibrated with CL # 3 and BP # 1 (BP mode 1)

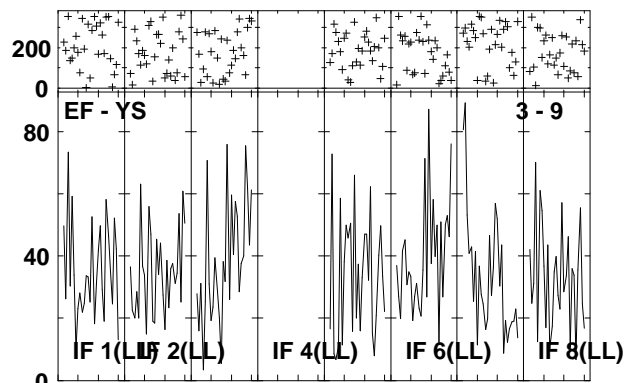
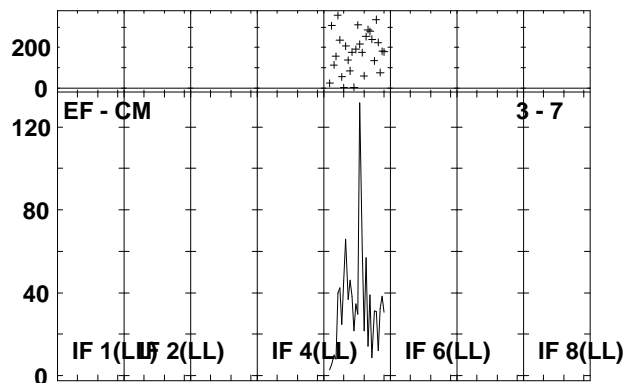
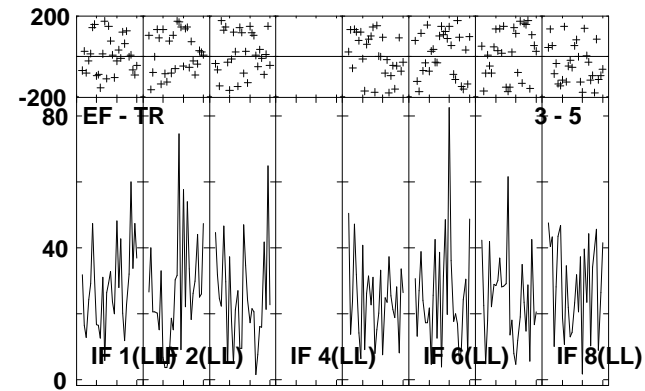
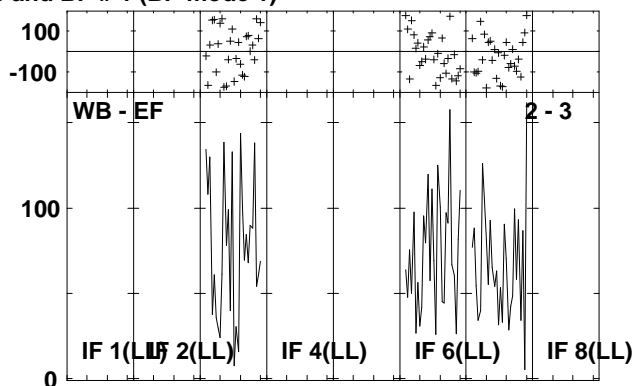
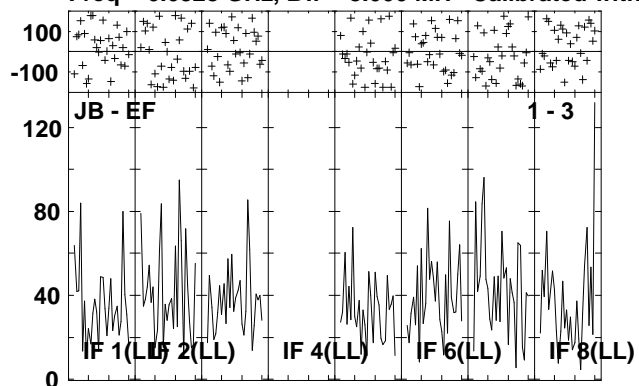

Lower frame: Milli Ampl Jy Top frame: Phas deg
 Vector averaged cross-power spectrum Several baselines displayed
 Timerange: 00/08:34:36 to 00/08:36:04

Plot file version 241 created 19-AUG-2009 15:56:16
 W75 EB039B 2.UVDATA.1
 Freq = 6.6328 GHz, Bw = 8.000 MH Calibrated with CL # 3 and BP # 1 (BP mode 1)

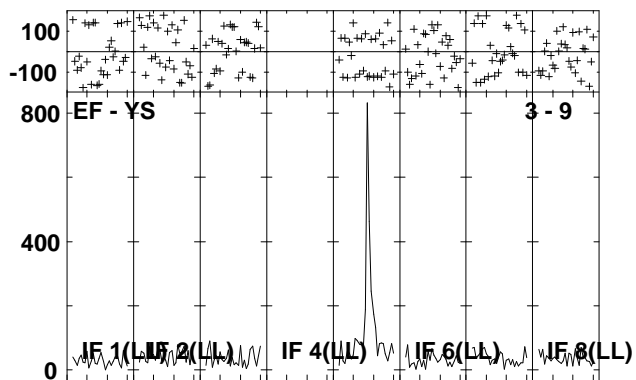
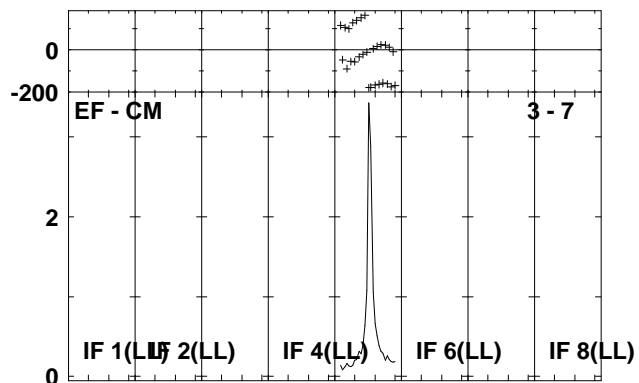
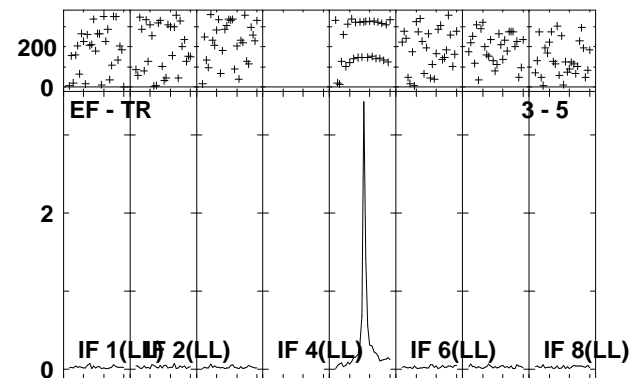
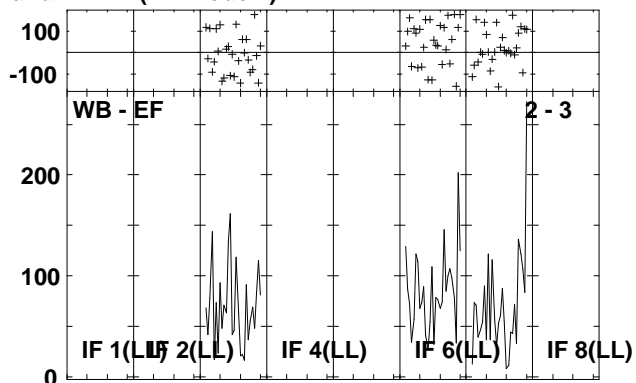
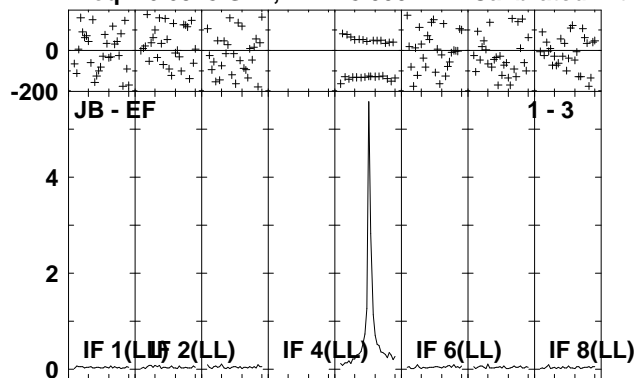

Lower frame: Ampl Jy Top frame: Phas deg
 Vector averaged cross-power spectrum Several baselines displayed
 Timerange: 00/08:36:38 to 00/08:37:36

Plot file version 242 created 19-AUG-2009 15:56:51
2048+431 EB039B 2.UVDATA.1
Freq = 6.6328 GHz, Bw = 8.000 MH Calibrated with CL # 3 and BP # 1 (BP mode 1)

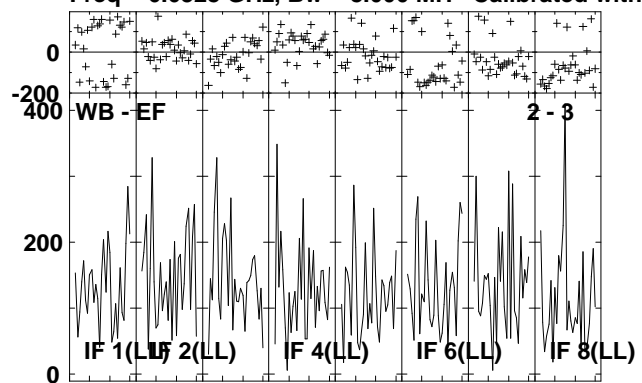

Lower frame: Milli Ampl Jy Top frame: Phas deg
Vector averaged cross-power spectrum Several baselines displayed
Timerange: 00/09:07:53 to 00/09:09:22

Plot file version 243 created 19-AUG-2009 15:56:53
W75 EB039B 2.UVDATA.1
Freq = 6.6328 GHz, Bw = 8.000 MH Calibrated with CL # 3 and BP # 1 (BP mode 1)

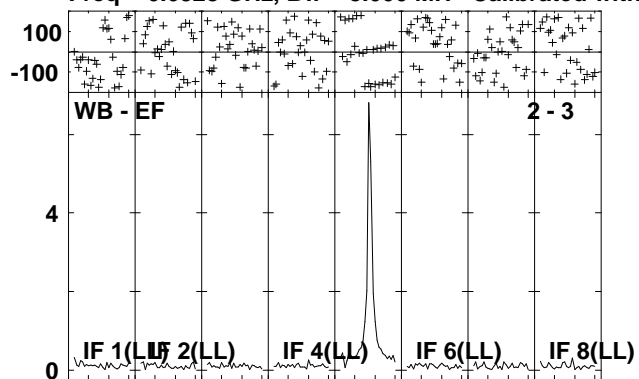

Lower frame: Ampl Jy Top frame: Phas deg
Vector averaged cross-power spectrum Several baselines displayed
Timerange: 00/09:09:24 to 00/09:10:53

Plot file version 244 created 19-AUG-2009 15:56:55
OB2 EB039B 2.UVDATA.1
Freq = 6.6328 GHz, Bw = 8.000 MH Calibrated with CL # 3 and BP # 1 (BP mode 1)

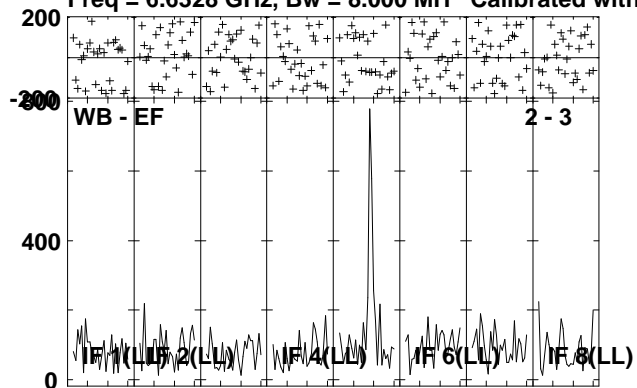

Lower frame: Milli Ampl Jy Top frame: Phas deg
Vector averaged cross-power spectrum Several baselines displayed
Timerange: 00/09:10:53 to 00/09:12:22

Plot file version 245 created 19-AUG-2009 15:56:56
W75 EB039B 2.UVDATA.1
Freq = 6.6328 GHz, Bw = 8.000 MH Calibrated with CL # 3 and BP # 1 (BP mode 1)

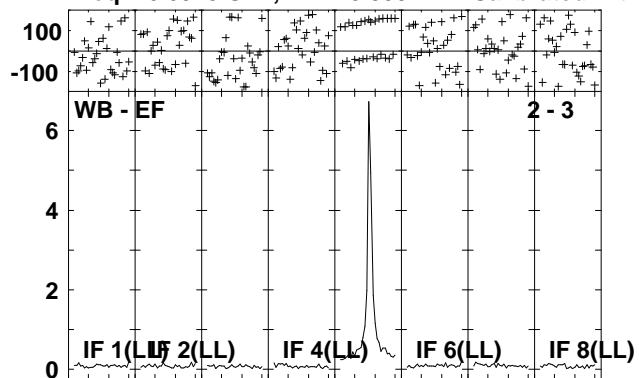

Lower frame: Ampl Jy Top frame: Phas deg
Vector averaged cross-power spectrum Several baselines displayed
Timerange: 00/09:13:01 to 00/09:14:01

Plot file version 246 created 19-AUG-2009 15:56:57
DR21A EB039B 2.UVDATA.1
Freq = 6.6328 GHz, Bw = 8.000 MH Calibrated with CL # 3 and BP # 1 (BP mode 1)

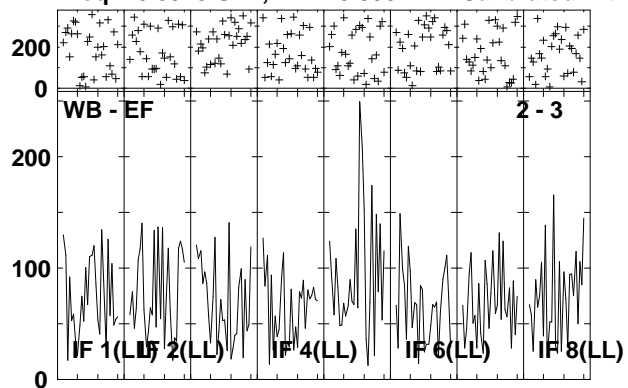

Lower frame: Milli Ampl Jy Top frame: Phas deg
Vector averaged cross-power spectrum Several baselines displayed
Timerange: 00/09:14:01 to 00/09:15:30

Plot file version 247 created 19-AUG-2009 15:56:59
W75 EB039B 2.UVDATA.1
Freq = 6.6328 GHz, Bw = 8.000 MH Calibrated with CL # 3 and BP # 1 (BP mode 1)

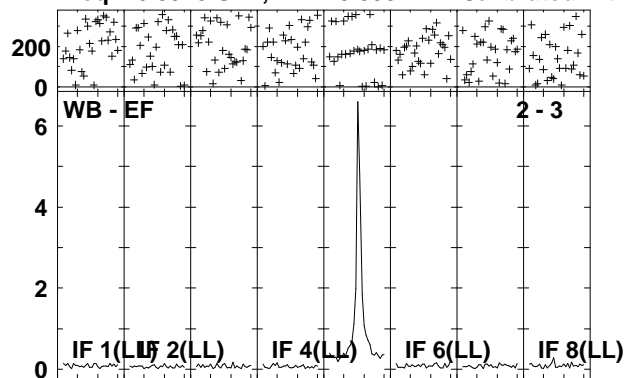

Lower frame: Ampl Jy Top frame: Phas deg
Vector averaged cross-power spectrum Several baselines displayed
Timerange: 00/09:15:32 to 00/09:17:01

Plot file version 248 created 19-AUG-2009 15:57:04
DR21B2 EB039B 2.UVDATA.1
Freq = 6.6328 GHz, Bw = 8.000 MH Calibrated with CL # 3 and BP # 1 (BP mode 1)

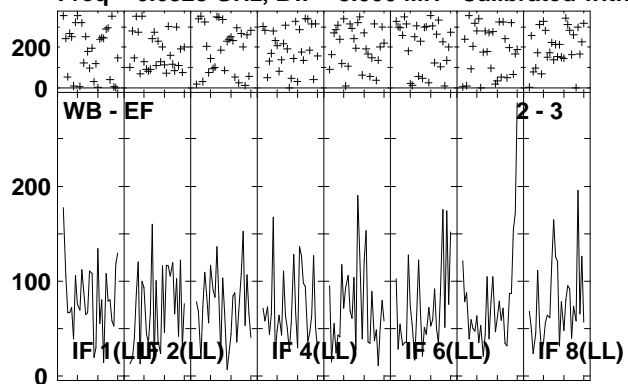

Lower frame: Milli Ampl Jy Top frame: Phas deg
Vector averaged cross-power spectrum Several baselines displayed
Timerange: 00/09:20:01 to 00/09:21:30

Plot file version 249 created 19-AUG-2009 15:57:06
W75 EB039B 2.UVDATA.1
Freq = 6.6328 GHz, Bw = 8.000 MH Calibrated with CL # 3 and BP # 1 (BP mode 1)

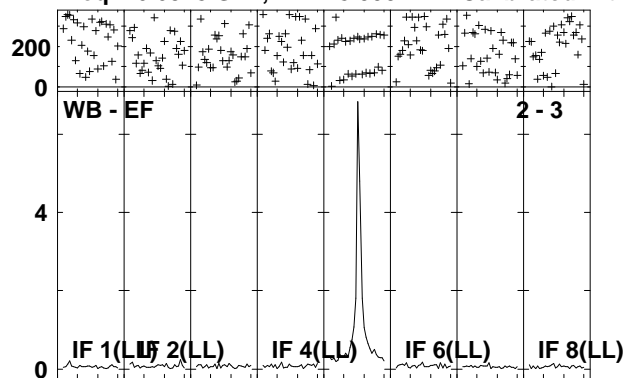

Lower frame: Ampl Jy Top frame: Phas deg
Vector averaged cross-power spectrum Several baselines displayed
Timerange: 00/09:21:32 to 00/09:23:00

Plot file version 250 created 19-AUG-2009 15:57:08
DR20 EB039B 2.UVDATA.1
Freq = 6.6328 GHz, Bw = 8.000 MH Calibrated with CL # 3 and BP # 1 (BP mode 1)

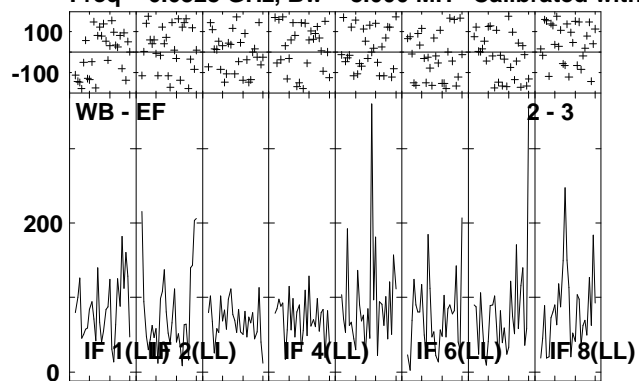

Lower frame: Milli Ampl Jy Top frame: Phas deg
Vector averaged cross-power spectrum Several baselines displayed
Timerange: 00/09:23:02 to 00/09:24:31

Plot file version 251 created 19-AUG-2009 15:57:09
W75 EB039B 2.UVDATA.1
Freq = 6.6328 GHz, Bw = 8.000 MH Calibrated with CL # 3 and BP # 1 (BP mode 1)

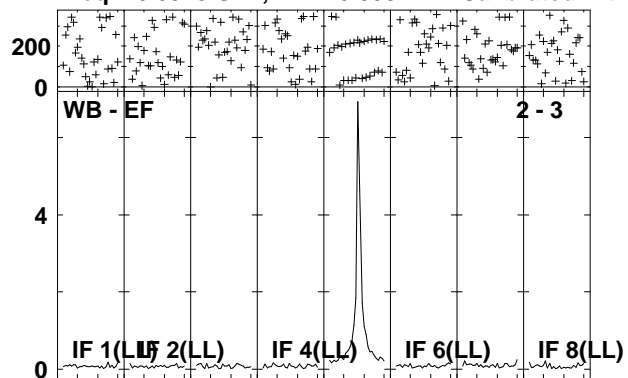

Lower frame: Ampl Jy Top frame: Phas deg
Vector averaged cross-power spectrum Several baselines displayed
Timerange: 00/09:25:08 to 00/09:26:06

Plot file version 252 created 19-AUG-2009 15:57:16
W75 EB039B 2.UVDATA.1
Freq = 6.6328 GHz, Bw = 8.000 MH Calibrated with CL # 3 and BP # 1 (BP mode 1)

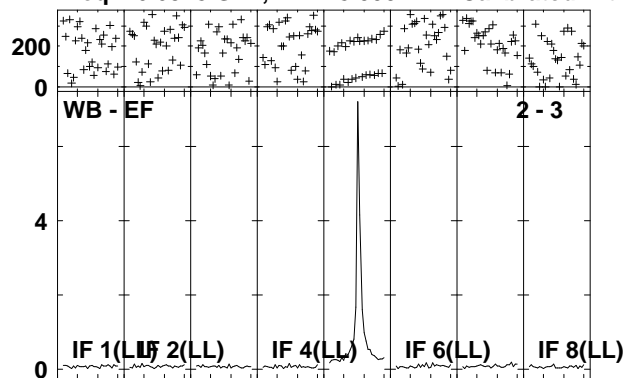

Lower frame: Ampl Jy Top frame: Phas deg
Vector averaged cross-power spectrum Several baselines displayed
Timerange: 00/09:30:37 to 00/09:32:06

Plot file version 253 created 19-AUG-2009 15:57:18
2048+431 EB039B 2.UVDATA.1
Freq = 6.6328 GHz, Bw = 8.000 MH Calibrated with CL # 3 and BP # 1 (BP mode 1)

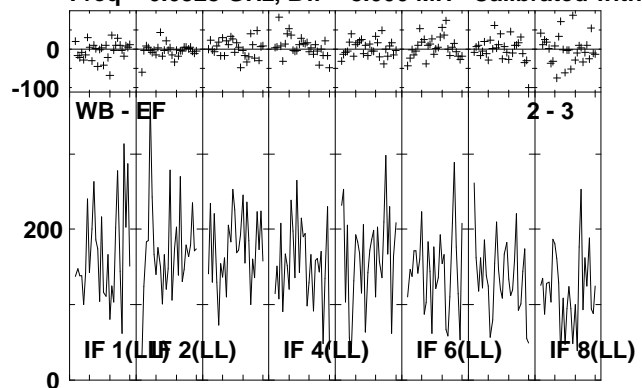

Lower frame: Milli Ampl Jy Top frame: Phas deg
Vector averaged cross-power spectrum Several baselines displayed
Timerange: 00/09:32:08 to 00/09:33:37

Plot file version 254 created 19-AUG-2009 15:57:20
W75 EB039B 2.UVDATA.1
Freq = 6.6328 GHz, Bw = 8.000 MH Calibrated with CL # 3 and BP # 1 (BP mode 1)

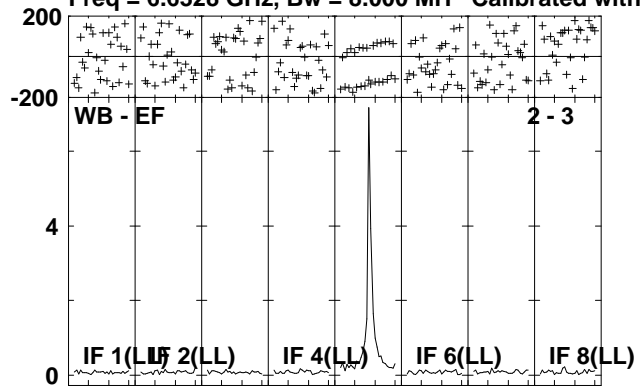

Lower frame: Ampl Jy Top frame: Phas deg
Vector averaged cross-power spectrum Several baselines displayed
Timerange: 00/09:33:37 to 00/09:35:06

Plot file version 255 created 19-AUG-2009 15:57:22

OB2 EB039B 2.UVDATA.1

Freq = 6.6328 GHz, Bw = 8.000 MH Calibrated with CL # 3 and BP # 1 (BP mode 1)

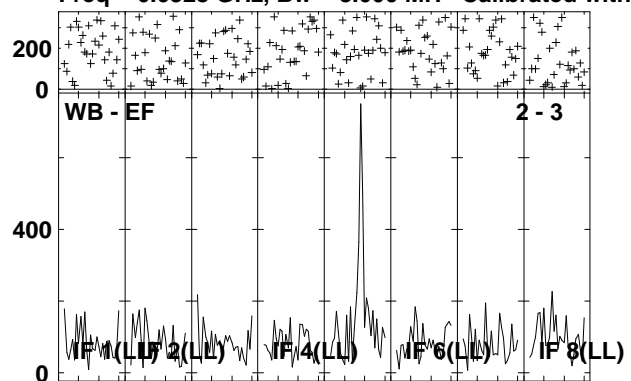

Lower frame: Milli Ampl Jy Top frame: Phas deg
Vector averaged cross-power spectrum Several baselines displayed
Timerange: 00/09:35:08 to 00/09:36:37

Plot file version 256 created 19-AUG-2009 15:57:24
W75 EB039B 2.UVDATA.1
Freq = 6.6328 GHz, Bw = 8.000 MH Calibrated with CL # 3 and BP # 1 (BP mode 1)

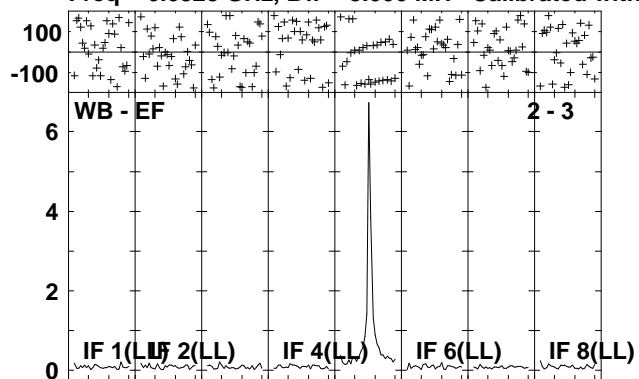

Lower frame: Ampl Jy Top frame: Phas deg
Vector averaged cross-power spectrum Several baselines displayed
Timerange: 00/09:37:13 to 00/09:38:13

Plot file version 257 created 19-AUG-2009 15:57:25
DR21A EB039B 2.UVDATA.1
Freq = 6.6328 GHz, Bw = 8.000 MH Calibrated with CL # 3 and BP # 1 (BP mode 1)

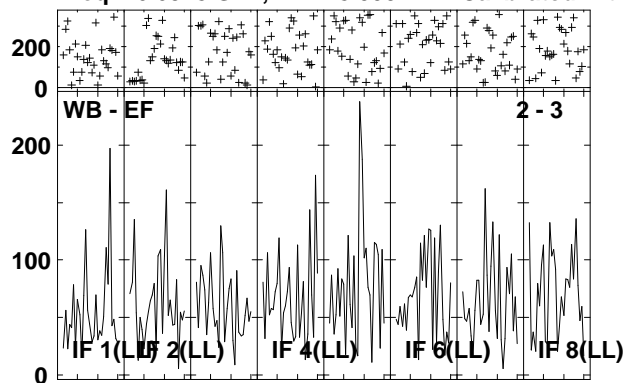

Lower frame: Milli Ampl Jy Top frame: Phas deg
Vector averaged cross-power spectrum Several baselines displayed
Timerange: 00/09:38:13 to 00/09:39:42

Plot file version 258 created 19-AUG-2009 15:57:27
W75 EB039B 2.UVDATA.1
Freq = 6.6328 GHz, Bw = 8.000 MH Calibrated with CL # 3 and BP # 1 (BP mode 1)

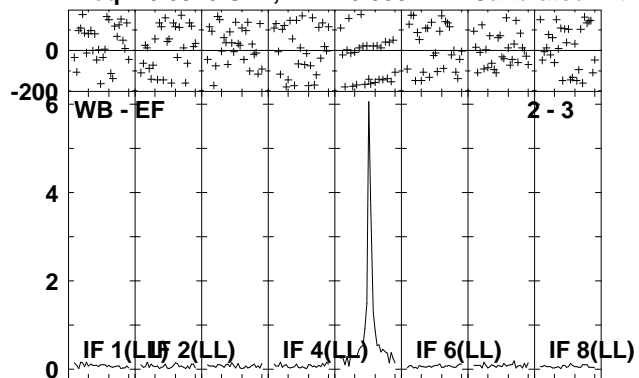

Lower frame: Ampl Jy Top frame: Phas deg
Vector averaged cross-power spectrum Several baselines displayed
Timerange: 00/09:39:44 to 00/09:41:13

Plot file version 259 created 19-AUG-2009 15:57:29
DR21B EB039B 2.UVDATA.1
Freq = 6.6328 GHz, Bw = 8.000 MH Calibrated with CL # 3 and BP # 1 (BP mode 1)

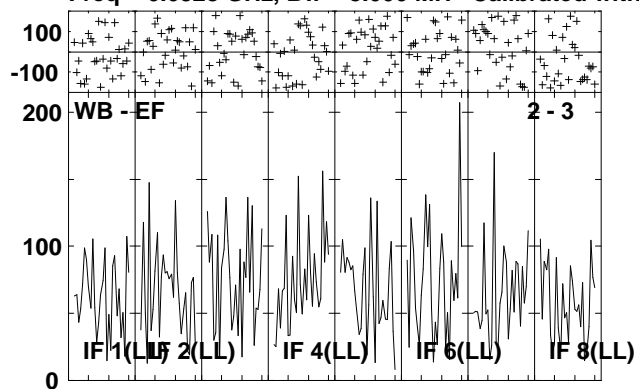

Lower frame: Milli Ampl Jy Top frame: Phas deg
Vector averaged cross-power spectrum Several baselines displayed
Timerange: 00/09:41:13 to 00/09:42:42

Plot file version 260 created 19-AUG-2009 15:57:31
W75 EB039B 2.UVDATA.1
Freq = 6.6328 GHz, Bw = 8.000 MH Calibrated with CL # 3 and BP # 1 (BP mode 1)

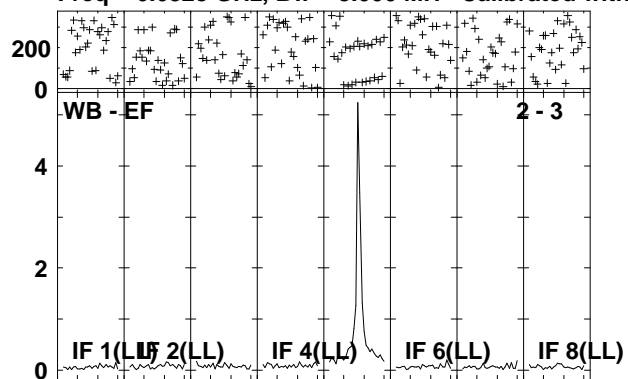

Lower frame: Ampl Jy Top frame: Phas deg
Vector averaged cross-power spectrum Several baselines displayed
Timerange: 00/09:42:44 to 00/09:44:13

Plot file version 261 created 19-AUG-2009 15:57:33
DR21B2 EB039B 2.UVDATA.1
Freq = 6.6328 GHz, Bw = 8.000 MH Calibrated with CL # 3 and BP # 1 (BP mode 1)

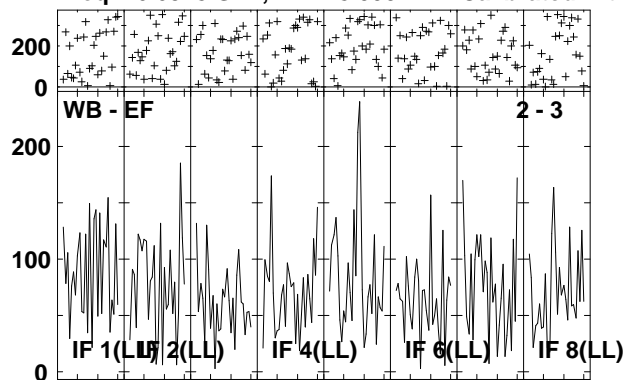

Lower frame: Milli Ampl Jy Top frame: Phas deg
Vector averaged cross-power spectrum Several baselines displayed
Timerange: 00/09:44:13 to 00/09:45:42

Plot file version 262 created 19-AUG-2009 15:57:35
W75 EB039B 2.UVDATA.1
Freq = 6.6328 GHz, Bw = 8.000 MH Calibrated with CL # 3 and BP # 1 (BP mode 1)

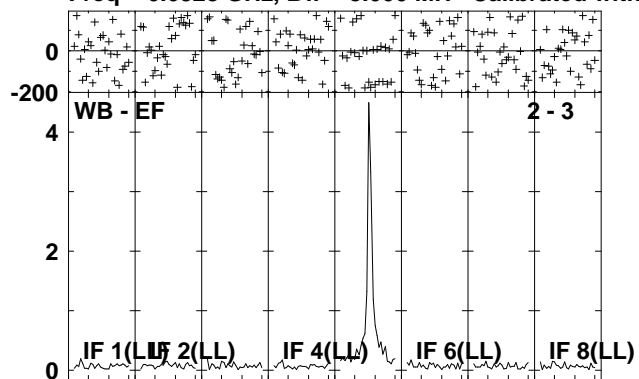

Lower frame: Ampl Jy Top frame: Phas deg
Vector averaged cross-power spectrum Several baselines displayed
Timerange: 00/09:45:44 to 00/09:47:13

Plot file version 263 created 19-AUG-2009 15:57:37
DR20 EB039B 2.UVDATA.1
Freq = 6.6328 GHz, Bw = 8.000 MH Calibrated with CL # 3 and BP # 1 (BP mode 1)

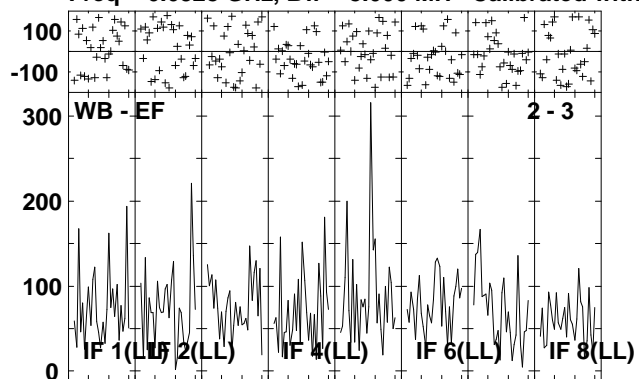

Lower frame: Milli Ampl Jy Top frame: Phas deg
Vector averaged cross-power spectrum Several baselines displayed
Timerange: 00/09:47:13 to 00/09:48:42

Plot file version 264 created 19-AUG-2009 15:57:39
W75 EB039B 2.UVDATA.1
Freq = 6.6328 GHz, Bw = 8.000 MH Calibrated with CL # 3 and BP # 1 (BP mode 1)

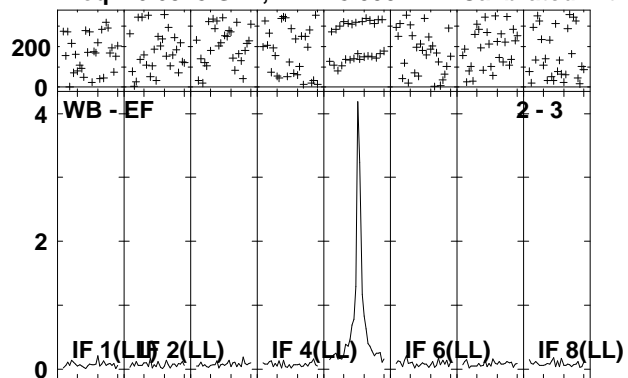

Lower frame: Ampl Jy Top frame: Phas deg
Vector averaged cross-power spectrum Several baselines displayed
Timerange: 00/09:49:15 to 00/09:50:15

Plot file version 265 created 19-AUG-2009 15:57:46
W75 EB039B 2.UVDATA.1
Freq = 6.6328 GHz, Bw = 8.000 MH Calibrated with CL # 3 and BP # 1 (BP mode 1)

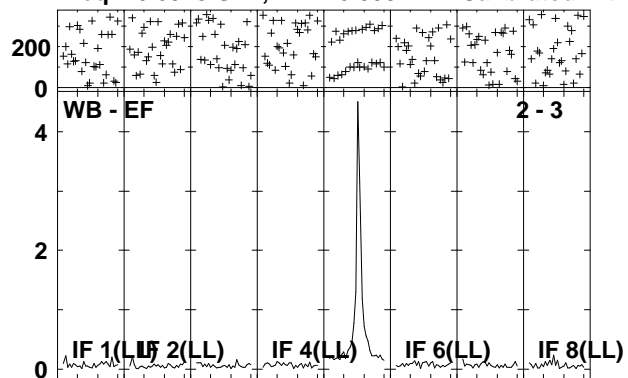

Lower frame: Ampl Jy Top frame: Phas deg
Vector averaged cross-power spectrum Several baselines displayed
Timerange: 00/09:54:46 to 00/09:56:15

Plot file version 266 created 19-AUG-2009 15:57:48
2048+431 EB039B 2.UVDATA.1
Freq = 6.6328 GHz, Bw = 8.000 MH Calibrated with CL # 3 and BP # 1 (BP mode 1)

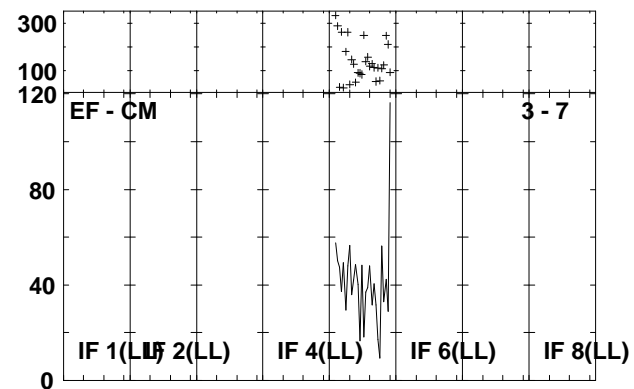
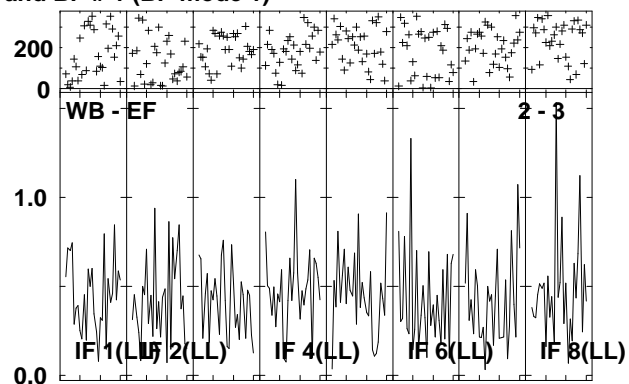
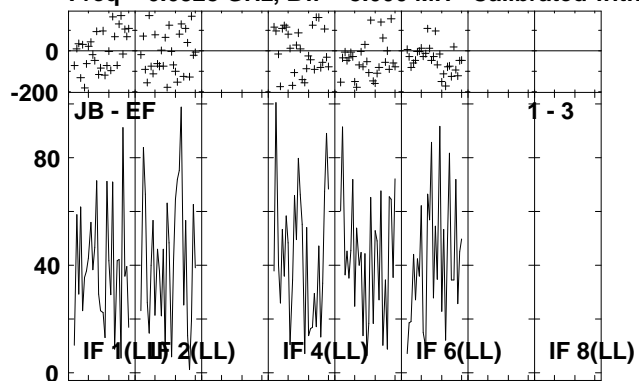

Lower frame: Milli Ampl Jy Top frame: Phas deg
Vector averaged cross-power spectrum Several baselines displayed
Timerange: 00/09:56:15 to 00/09:57:44

Plot file version 267 created 19-AUG-2009 15:57:50

W75 EB039B 2.UVDATA.1

Freq = 6.6328 GHz, Bw = 8.000 MH Calibrated with CL # 3 and BP # 1 (BP mode 1)

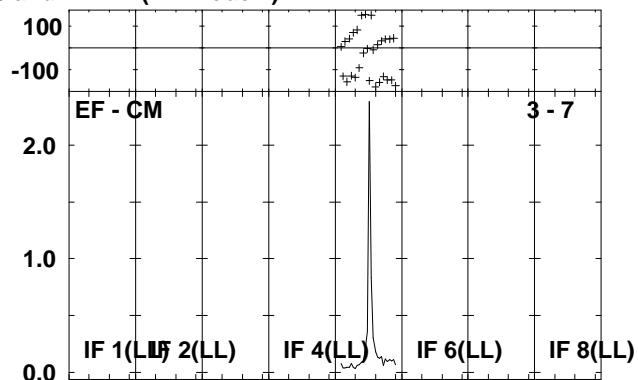
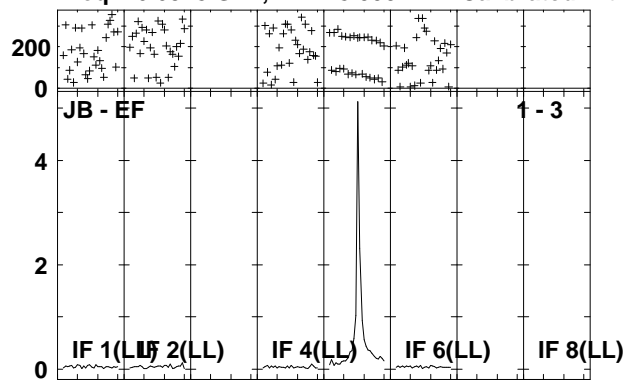

Lower frame: Ampl Jy Top frame: Phas deg
Vector averaged cross-power spectrum Several baselines displayed
Timerange: 00/09:57:46 to 00/09:59:15

Plot file version 268 created 19-AUG-2009 15:57:51

OB2 EB039B 2.UVDATA.1

Freq = 6.6328 GHz, Bw = 8.000 MH Calibrated with CL # 3 and BP # 1 (BP mode 1)

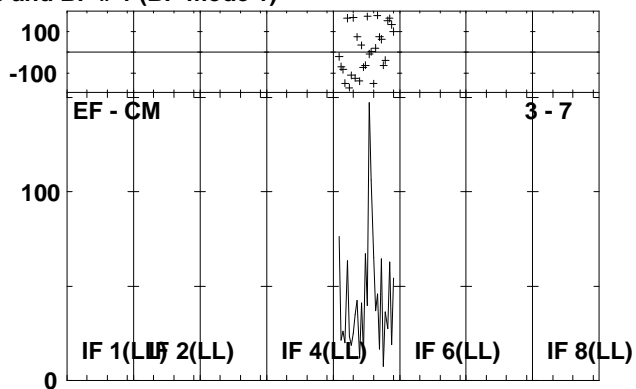
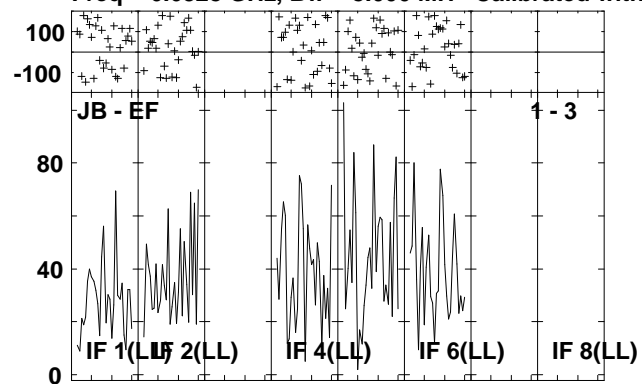

Lower frame: Milli Ampl Jy Top frame: Phas deg
Vector averaged cross-power spectrum Several baselines displayed
Timerange: 00/09:59:15 to 00/10:00:44

Plot file version 269 created 19-AUG-2009 15:57:53

W75 EB039B 2.UVDATA.1

Freq = 6.6328 GHz, Bw = 8.000 MH Calibrated with CL # 3 and BP # 1 (BP mode 1)

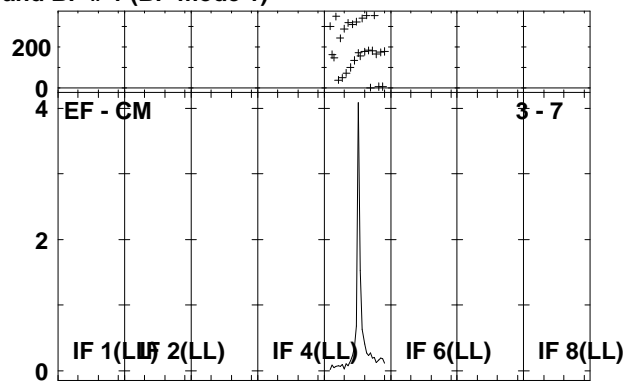
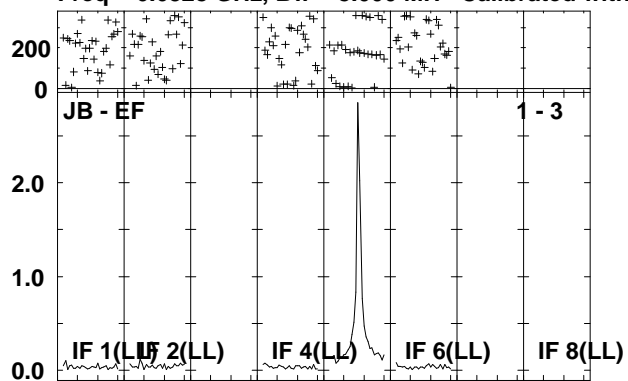

Lower frame: Ampl Jy Top frame: Phas deg
Vector averaged cross-power spectrum Several baselines displayed
Timerange: 00/10/01:14 to 00/10/02:14

Plot file version 270 created 19-AUG-2009 15:57:55

DR21A EB039B 2.UVDATA.1

Freq = 6.6328 GHz, Bw = 8.000 MH Calibrated with CL # 3 and BP # 1 (BP mode 1)

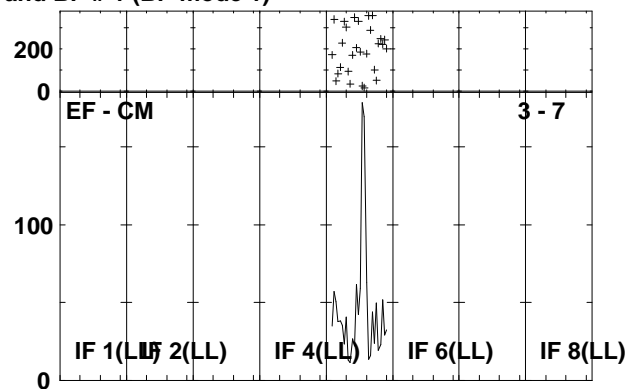
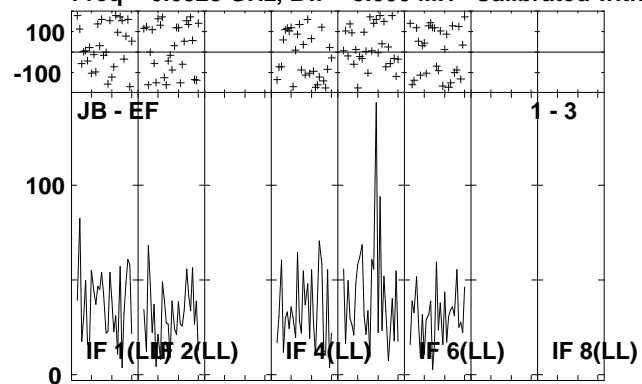

Lower frame: Milli Ampl Jy Top frame: Phas deg
Vector averaged cross-power spectrum Several baselines displayed
Timerange: 00/10:02:15 to 00/10:03:43

Plot file version 271 created 19-AUG-2009 15:57:57

W75 EB039B 2.UVDATA.1

Freq = 6.6328 GHz, Bw = 8.000 MH Calibrated with CL # 3 and BP # 1 (BP mode 1)

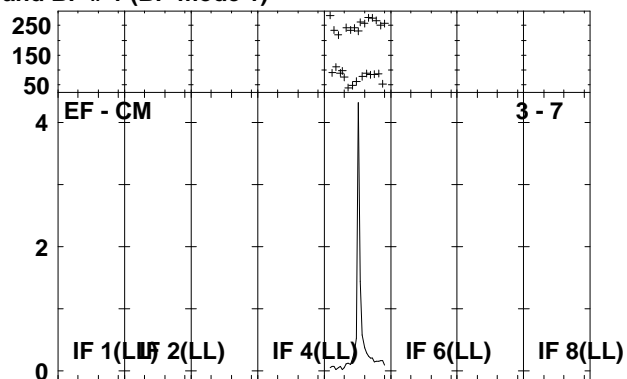
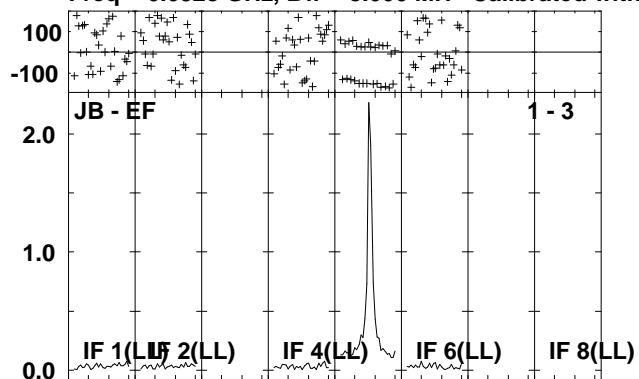

Lower frame: Ampl Jy Top frame: Phas deg
Vector averaged cross-power spectrum Several baselines displayed
Timerange: 00/10:03:44 to 00/10:05:13

Plot file version 272 created 19-AUG-2009 15:57:59
DR21B EB039B 2.UVDATA.1
Freq = 6.6328 GHz, Bw = 8.000 MH Calibrated with CL # 3 and BP # 1 (BP mode 1)

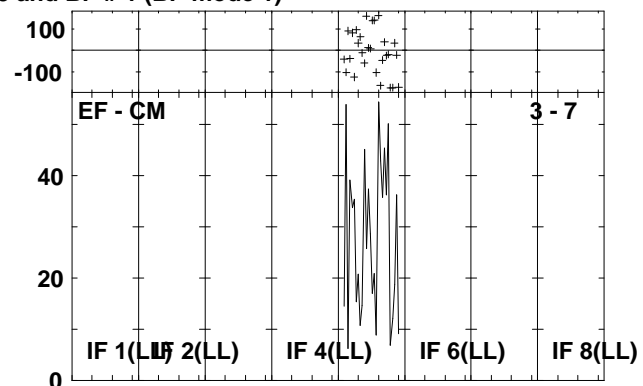
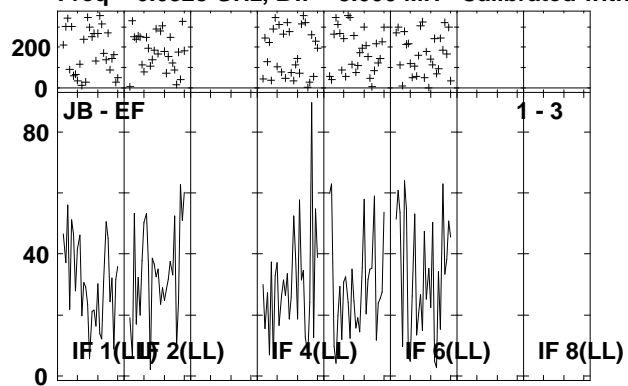

Lower frame: Milli Ampl Jy Top frame: Phas deg
Vector averaged cross-power spectrum Several baselines displayed
Timerange: 00/10:05:14 to 00/10:06:43

Plot file version 273 created 19-AUG-2009 15:58:01

W75 EB039B 2.UVDATA.1

Freq = 6.6328 GHz, Bw = 8.000 MH Calibrated with CL # 3 and BP # 1 (BP mode 1)

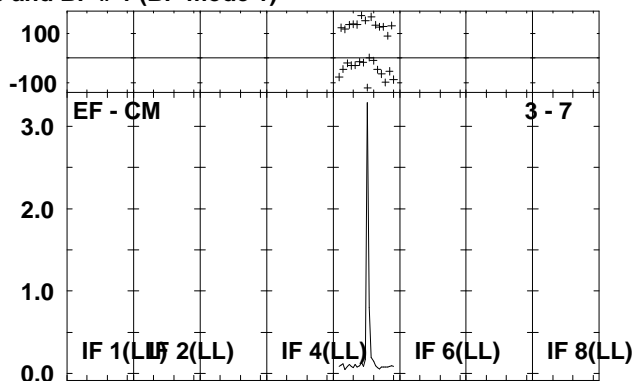
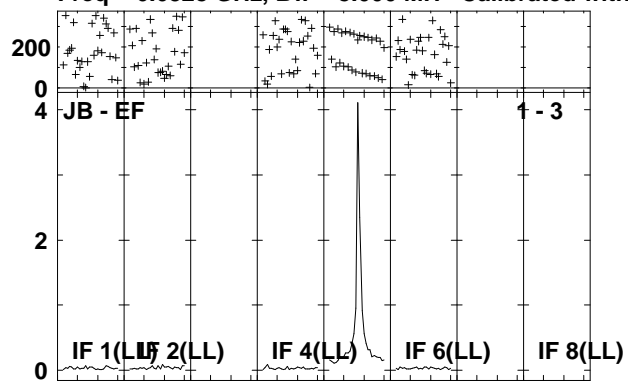

Lower frame: Ampl Jy Top frame: Phas deg
Vector averaged cross-power spectrum Several baselines displayed
Timerange: 00/10:06:45 to 00/10:08:14

Plot file version 274 created 19-AUG-2009 15:58:03
DR21B2 EB039B 2.UVDATA.1
Freq = 6.6328 GHz, Bw = 8.000 MH Calibrated with CL # 3 and BP # 1 (BP mode 1)

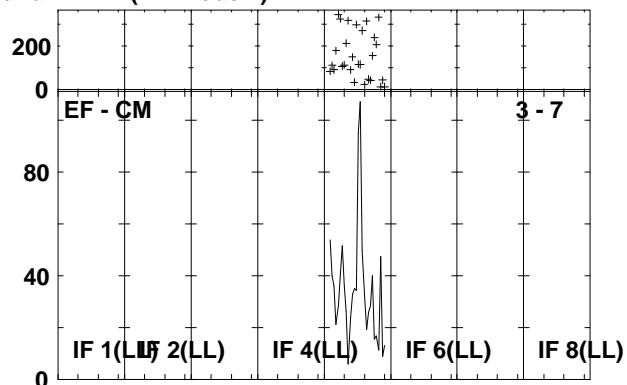
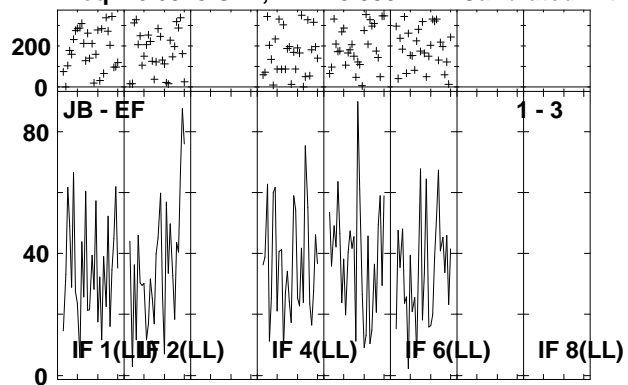

Lower frame: Milli Ampl Jy Top frame: Phas deg
Vector averaged cross-power spectrum Several baselines displayed
Timerange: 00/10:08:14 to 00/10:09:43

Plot file version 275 created 19-AUG-2009 15:58:05

W75 EB039B 2.UVDATA.1

Freq = 6.6328 GHz, Bw = 8.000 MH Calibrated with CL # 3 and BP # 1 (BP mode 1)

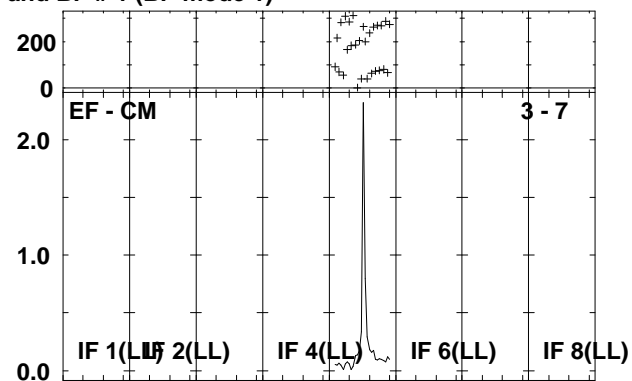
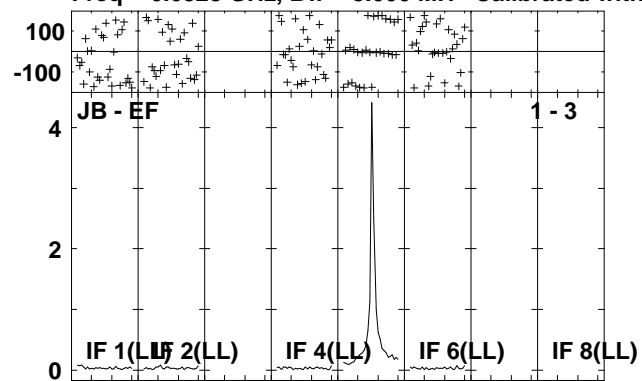

Lower frame: Ampl Jy Top frame: Phas deg
Vector averaged cross-power spectrum Several baselines displayed
Timerange: 00/10/09:45 to 00/10/11:14

Plot file version 276 created 19-AUG-2009 15:58:07
DR20 EB039B 2.UVDATA.1
Freq = 6.6328 GHz, Bw = 8.000 MH Calibrated with CL # 3 and BP # 1 (BP mode 1)

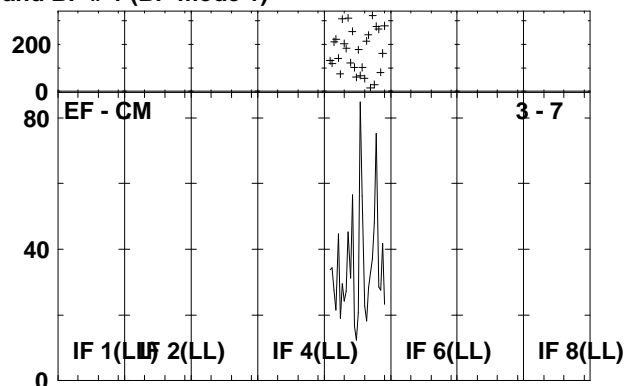
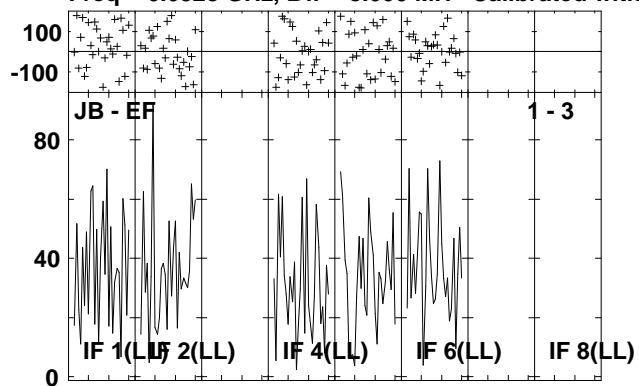

Lower frame: Milli Ampl Jy Top frame: Phas deg
Vector averaged cross-power spectrum Several baselines displayed
Timerange: 00/10:11:14 to 00/10:12:43

Plot file version 277 created 19-AUG-2009 15:58:08
W75 EB039B 2.UVDATA.1
Freq = 6.6328 GHz, Bw = 8.000 MH Calibrated with CL # 3 and BP # 1 (BP mode 1)

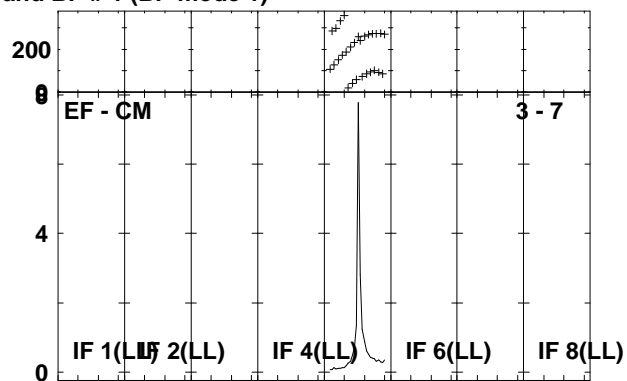
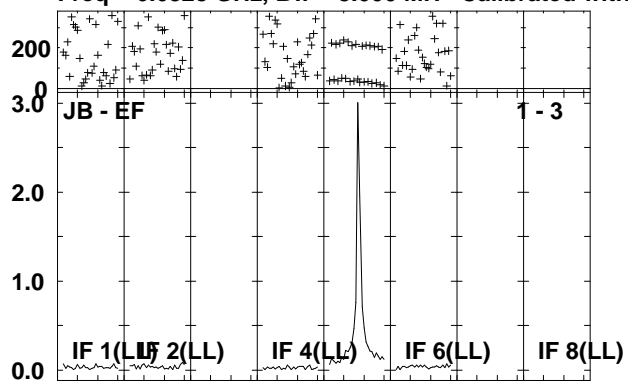

Lower frame: Ampl Jy Top frame: Phas deg
Vector averaged cross-power spectrum Several baselines displayed
Timerange: 00/10:13:15 to 00/10:14:14

Plot file version 278 created 19-AUG-2009 15:58:15

W75 EB039B 2.UVDATA.1

Freq = 6.6328 GHz, Bw = 8.000 MH Calibrated with CL # 3 and BP # 1 (BP mode 1)

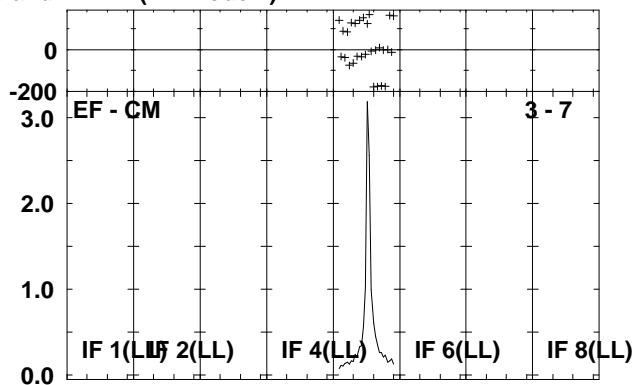
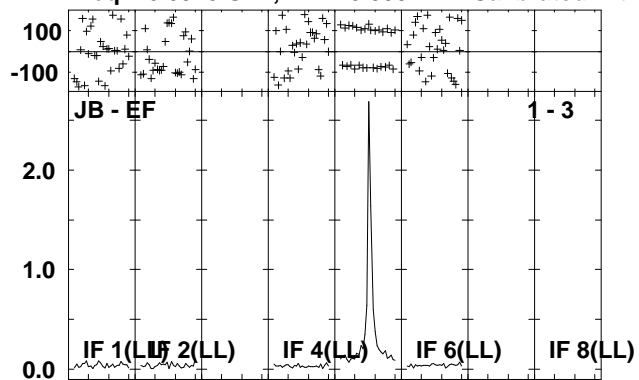

Lower frame: Ampl Jy Top frame: Phas deg
Vector averaged cross-power spectrum Several baselines displayed
Timerange: 00/10:18:45 to 00/10:20:14

Plot file version 279 created 19-AUG-2009 15:58:17

2048+431 EB039B 2.UVDATA.1

Freq = 6.6328 GHz, Bw = 8.000 MH Calibrated with CL # 3 and BP # 1 (BP mode 1)

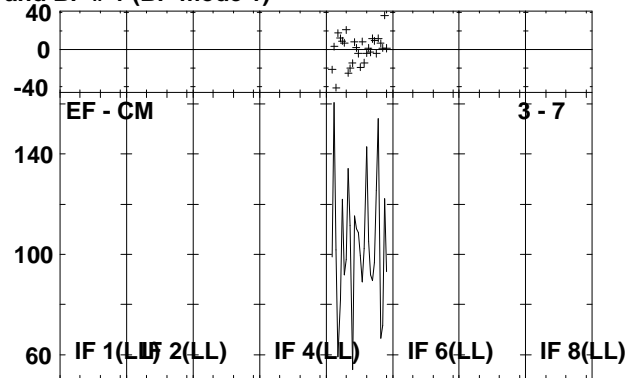
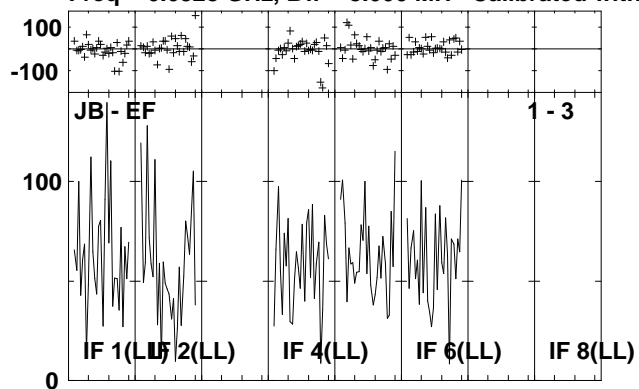

Lower frame: Milli Ampl Jy Top frame: Phas deg
Vector averaged cross-power spectrum Several baselines displayed
Timerange: 00/10:20:14 to 00/10:21:43

Plot file version 280 created 19-AUG-2009 15:58:19

W75 EB039B 2.UVDATA.1

Freq = 6.6328 GHz, Bw = 8.000 MH Calibrated with CL # 3 and BP # 1 (BP mode 1)

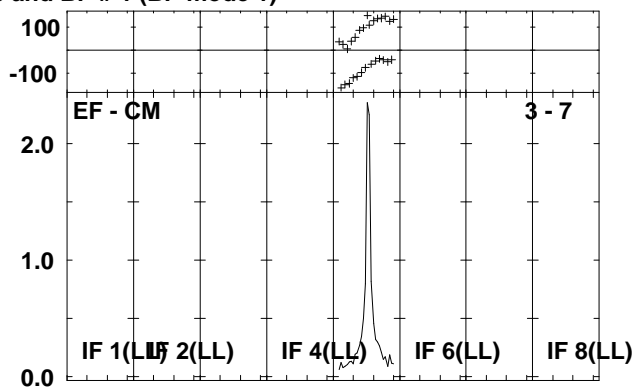
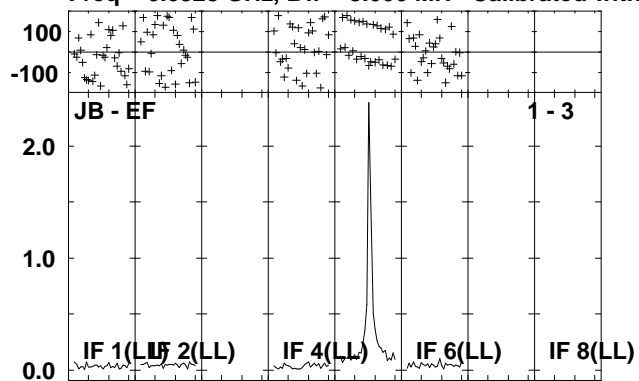

Lower frame: Ampl Jy Top frame: Phas deg
Vector averaged cross-power spectrum Several baselines displayed
Timerange: 00/10:21:45 to 00/10:23:13

Plot file version 281 created 19-AUG-2009 15:58:21

OB2 EB039B 2.UVDATA.1

Freq = 6.6328 GHz, Bw = 8.000 MH Calibrated with CL # 3 and BP # 1 (BP mode 1)

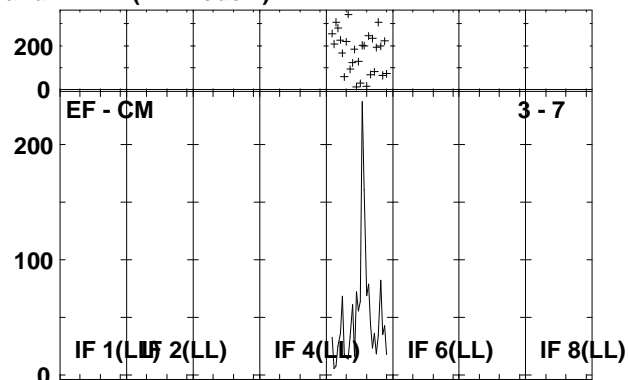
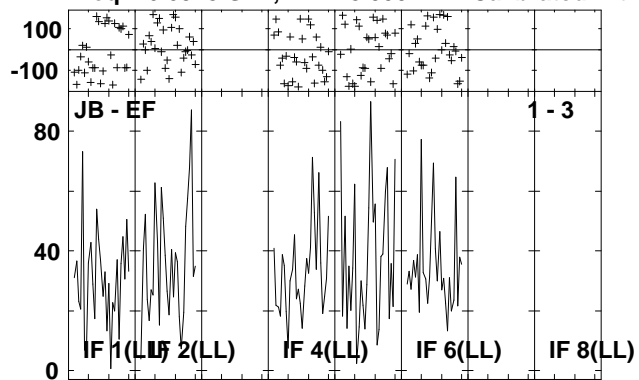

Lower frame: Milli Ampl Jy Top frame: Phas deg
Vector averaged cross-power spectrum Several baselines displayed
Timerange: 00/10:23:14 to 00/10:24:42

Plot file version 282 created 19-AUG-2009 15:58:23

W75 EB039B 2.UVDATA.1

Freq = 6.6328 GHz, Bw = 8.000 MH Calibrated with CL # 3 and BP # 1 (BP mode 1)

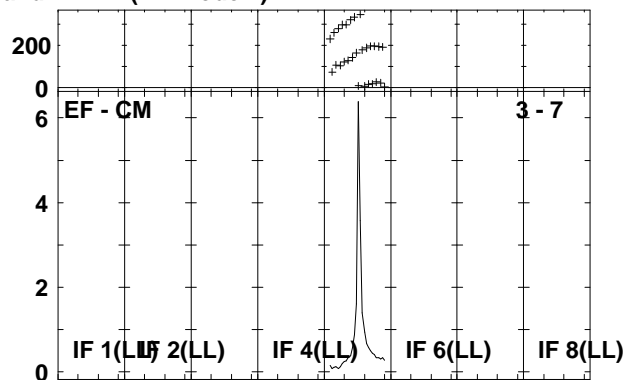
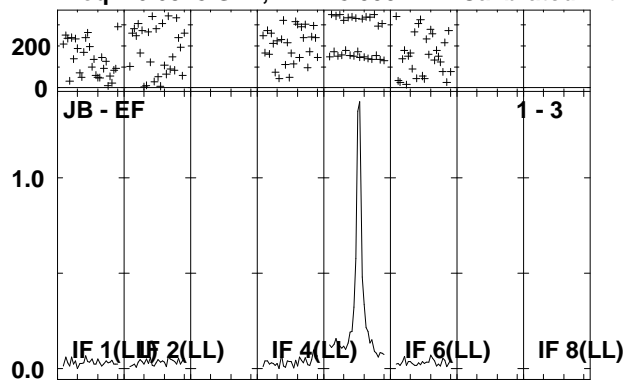

Lower frame: Ampl Jy Top frame: Phas deg
Vector averaged cross-power spectrum Several baselines displayed
Timerange: 00/10:25:13 to 00/10:26:13

Plot file version 283 created 19-AUG-2009 15:58:25
DR21A EB039B 2.UVDATA.1
Freq = 6.6328 GHz, Bw = 8.000 MH Calibrated with CL # 3 and BP # 1 (BP mode 1)

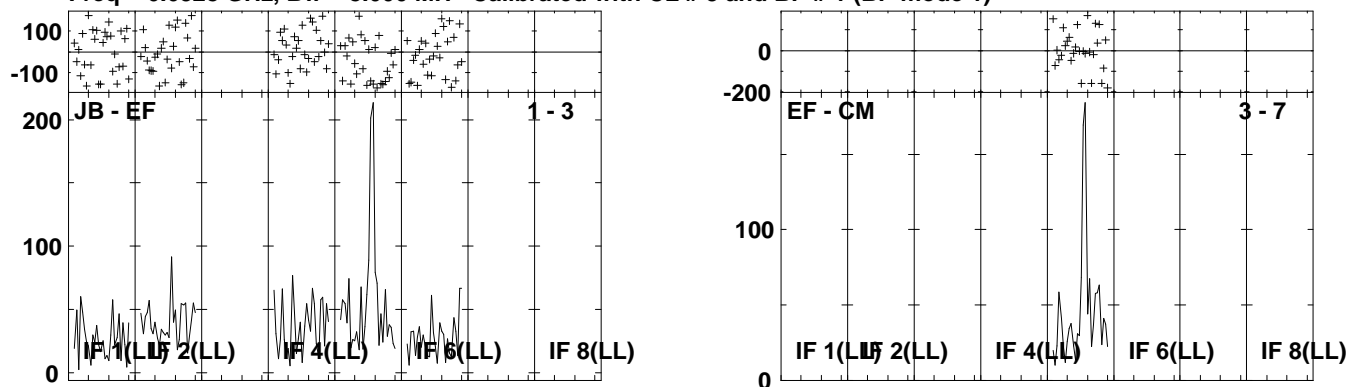

Lower frame: Milli Ampl Jy Top frame: Phas deg
Vector averaged cross-power spectrum Several baselines displayed
Timerange: 00/10:26:13 to 00/10:27:42

Plot file version 284 created 19-AUG-2009 15:58:26

W75 EB039B 2.UVDATA.1

Freq = 6.6328 GHz, Bw = 8.000 MH Calibrated with CL # 3 and BP # 1 (BP mode 1)

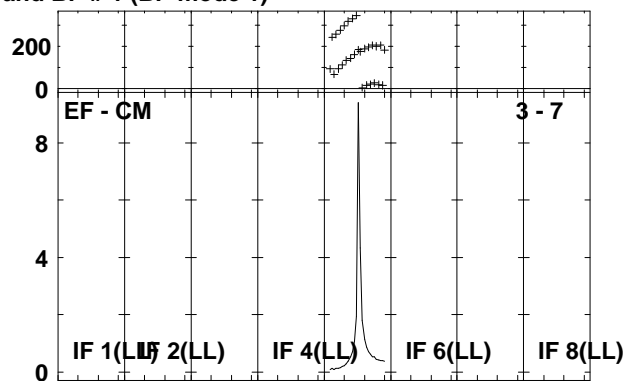
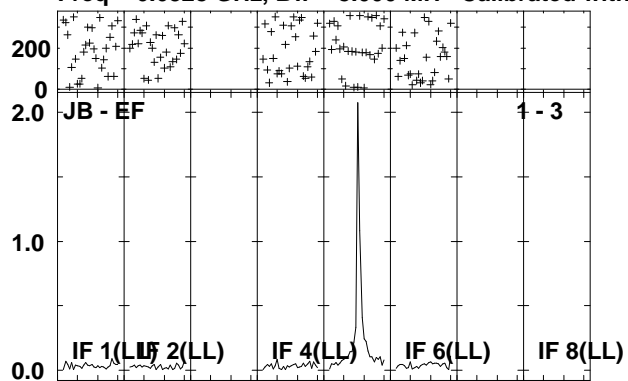

Lower frame: Ampl Jy Top frame: Phas deg
Vector averaged cross-power spectrum Several baselines displayed
Timerange: 00/10:27:44 to 00/10:29:13

Plot file version 285 created 19-AUG-2009 15:58:28

DR21B EB039B 2.UVDATA.1

Freq = 6.6328 GHz, Bw = 8.000 MH Calibrated with CL # 3 and BP # 1 (BP mode 1)

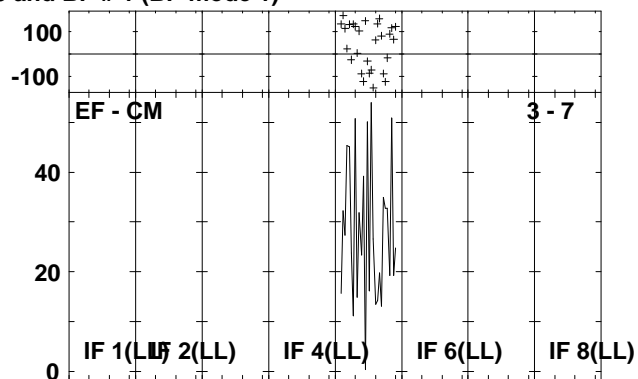
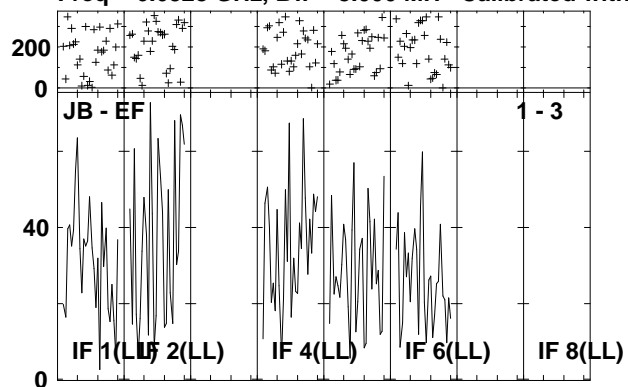

Lower frame: Milli Ampl Jy Top frame: Phas deg
Vector averaged cross-power spectrum Several baselines displayed
Timerange: 00/10:29:13 to 00/10:30:42

Plot file version 286 created 19-AUG-2009 15:58:30

W75 EB039B 2.UVDATA.1

Freq = 6.6328 GHz, Bw = 8.000 MH Calibrated with CL # 3 and BP # 1 (BP mode 1)

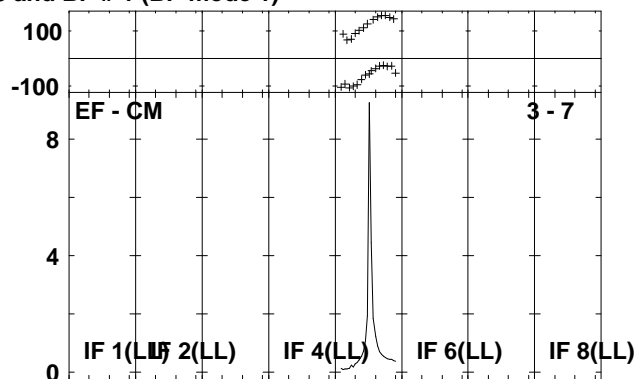
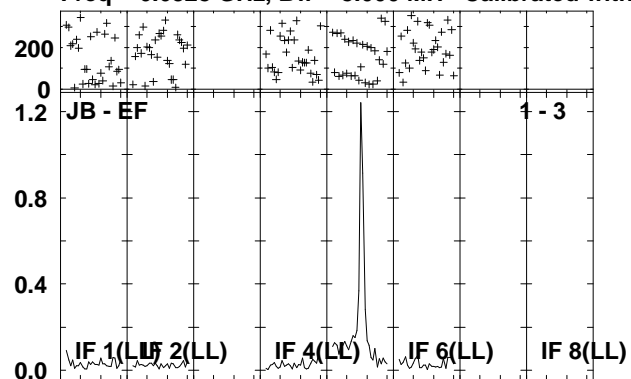

Lower frame: Ampl Jy Top frame: Phas deg
Vector averaged cross-power spectrum Several baselines displayed
Timerange: 00/10:30:44 to 00/10:32:13

Plot file version 287 created 19-AUG-2009 15:58:32
DR21B2 EB039B 2.UVDATA.1
Freq = 6.6328 GHz, Bw = 8.000 MH Calibrated with CL # 3 and BP # 1 (BP mode 1)

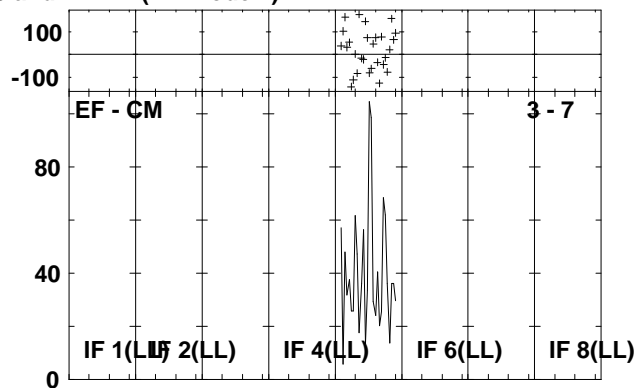
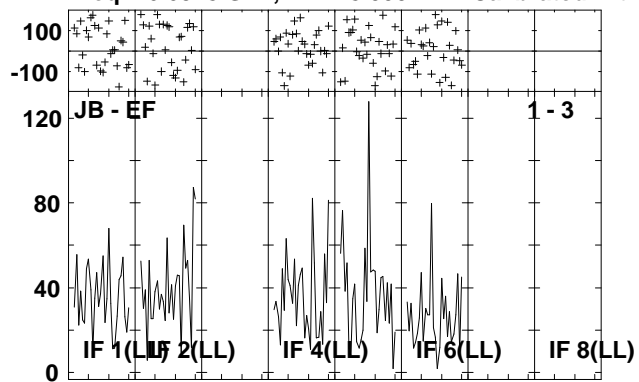

Lower frame: Milli Ampl Jy Top frame: Phas deg
Vector averaged cross-power spectrum Several baselines displayed
Timerange: 00/10:32:13 to 00/10:33:42

Plot file version 288 created 19-AUG-2009 15:58:34

W75 EB039B 2.UVDATA.1

Freq = 6.6328 GHz, Bw = 8.000 MH Calibrated with CL # 3 and BP # 1 (BP mode 1)

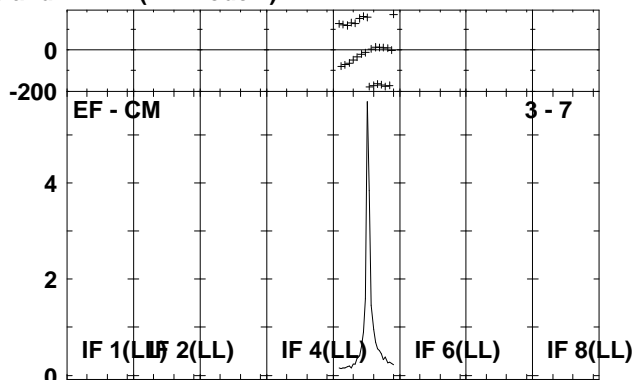
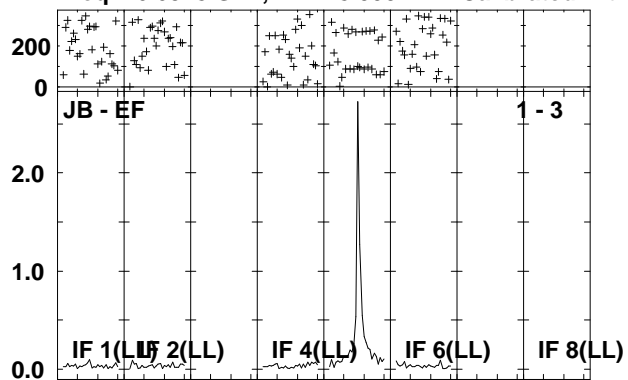

Lower frame: Ampl Jy Top frame: Phas deg
Vector averaged cross-power spectrum Several baselines displayed
Timerange: 00/10:33:44 to 00/10:35:13

Plot file version 289 created 19-AUG-2009 15:58:36

DR20 EB039B 2.UVDATA.1

Freq = 6.6328 GHz, Bw = 8.000 MH Calibrated with CL # 3 and BP # 1 (BP mode 1)

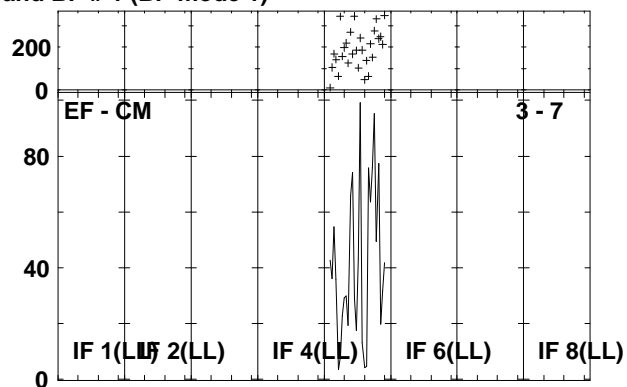
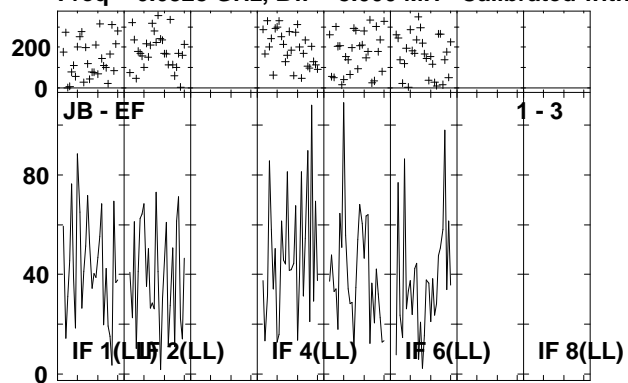

Lower frame: Milli Ampl Jy Top frame: Phas deg
Vector averaged cross-power spectrum Several baselines displayed
Timerange: 00/10:35:13 to 00/10:36:42

Plot file version 290 created 19-AUG-2009 15:58:38

W75 EB039B 2.UVDATA.1

Freq = 6.6328 GHz, Bw = 8.000 MH Calibrated with CL # 3 and BP # 1 (BP mode 1)

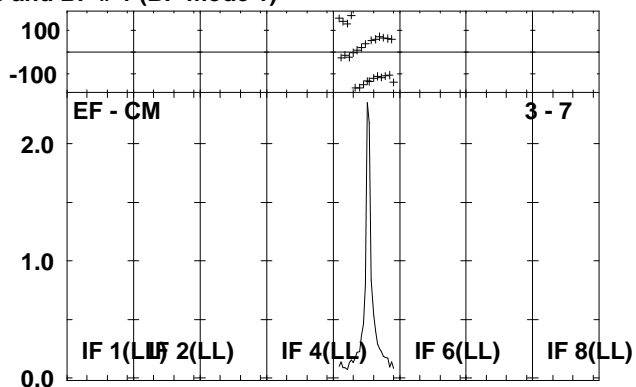
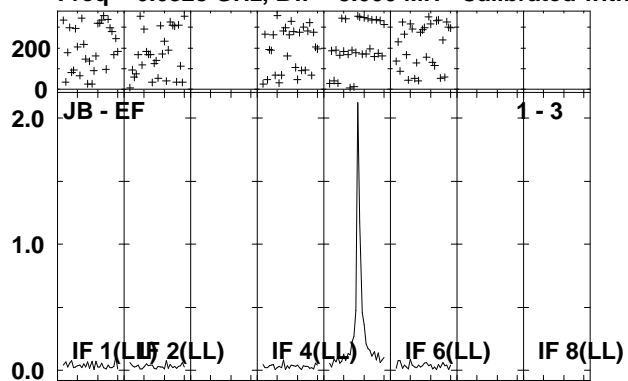

Lower frame: Ampl Jy Top frame: Phas deg
Vector averaged cross-power spectrum Several baselines displayed
Timerange: 00/10:37:12 to 00/10:38:12

Plot file version 291 created 19-AUG-2009 15:58:45

W75 EB039B 2.UVDATA.1

Freq = 6.6328 GHz, Bw = 8.000 MH Calibrated with CL # 3 and BP # 1 (BP mode 1)

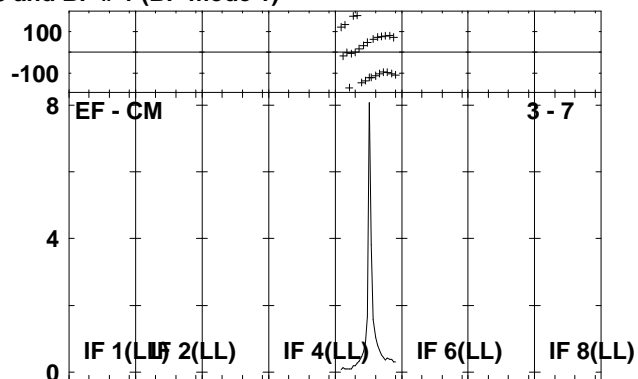
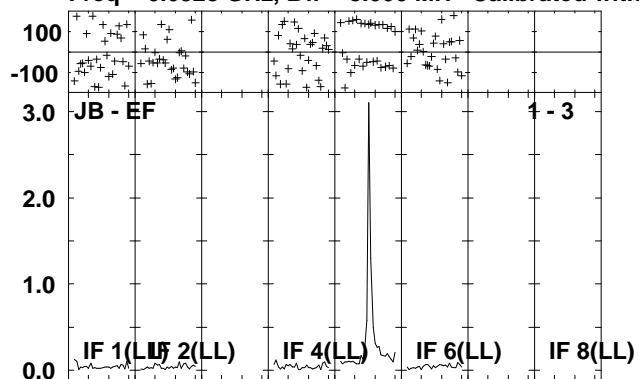

Lower frame: Ampl Jy Top frame: Phas deg
Vector averaged cross-power spectrum Several baselines displayed
Timerange: 00/10:42:43 to 00/10:44:12

Plot file version 292 created 19-AUG-2009 15:58:47

2048+431 EB039B 2.UVDATA.1

Freq = 6.6328 GHz, Bw = 8.000 MH Calibrated with CL # 3 and BP # 1 (BP mode 1)

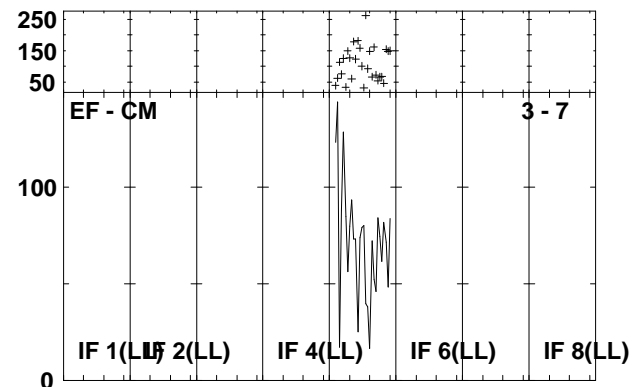
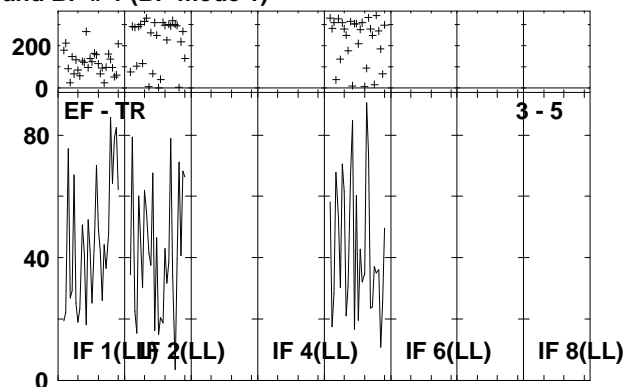
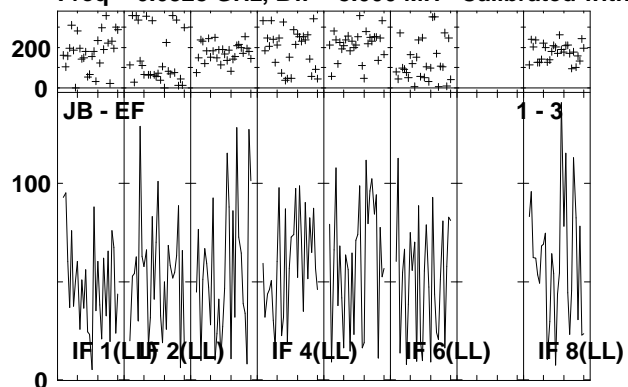

Lower frame: Milli Ampl Jy Top frame: Phas deg
Vector averaged cross-power spectrum Several baselines displayed
Timerange: 00/10:44:12 to 00/10:45:41

Plot file version 293 created 19-AUG-2009 15:58:49

W75 EB039B 2.UVDATA.1

Freq = 6.6328 GHz, Bw = 8.000 MH Calibrated with CL # 3 and BP # 1 (BP mode 1)

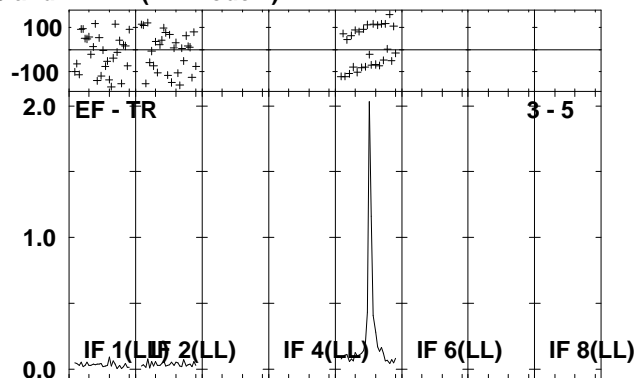
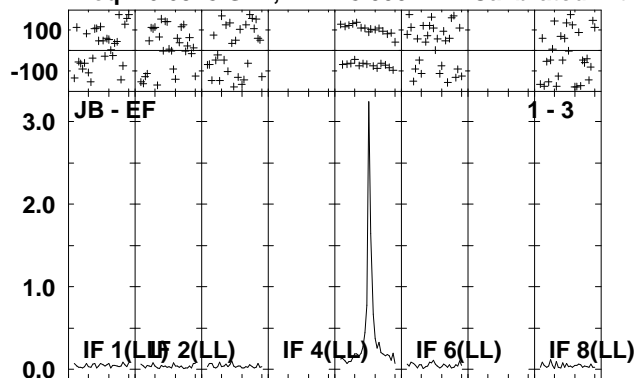

Lower frame: Ampl Jy Top frame: Phas deg
Vector averaged cross-power spectrum Several baselines displayed
Timerange: 00/10:45:43 to 00/10:47:12

Plot file version 294 created 19-AUG-2009 15:58:51

OB2 EB039B 2.UVDATA.1

Freq = 6.6328 GHz, Bw = 8.000 MH Calibrated with CL # 3 and BP # 1 (BP mode 1)

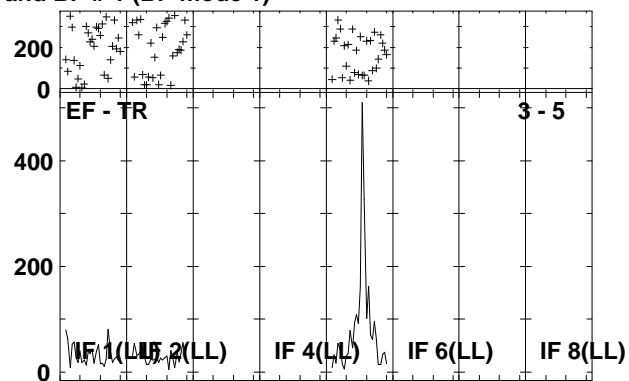
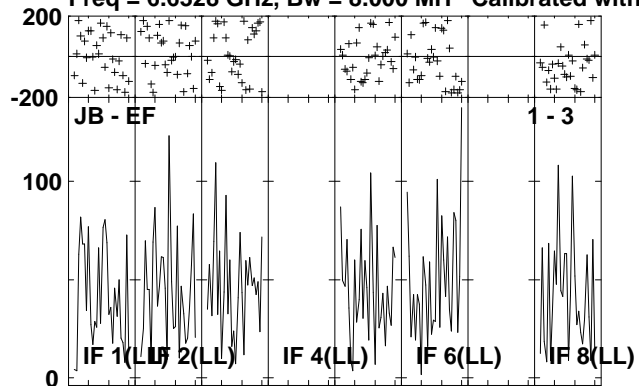

Lower frame: Milli Ampl Jy Top frame: Phas deg
Vector averaged cross-power spectrum Several baselines displayed
Timerange: 00/10:47:12 to 00/10:48:41

Plot file version 295 created 19-AUG-2009 15:58:53

W75 EB039B 2.UVDATA.1

Freq = 6.6328 GHz, Bw = 8.000 MH Calibrated with CL # 3 and BP # 1 (BP mode 1)

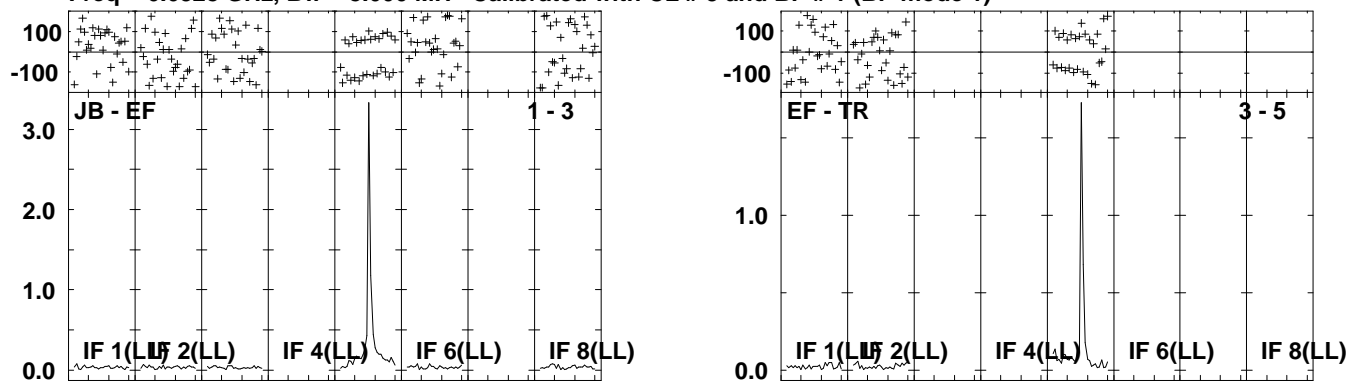

Lower frame: Ampl Jy Top frame: Phas deg
Vector averaged cross-power spectrum Several baselines displayed
Timerange: 00/10:49:13 to 00/10:50:12

Plot file version 296 created 19-AUG-2009 15:58:54
DR21A EB039B 2.UVDATA.1
Freq = 6.6328 GHz, Bw = 8.000 MH Calibrated with CL # 3 and BP # 1 (BP mode 1)

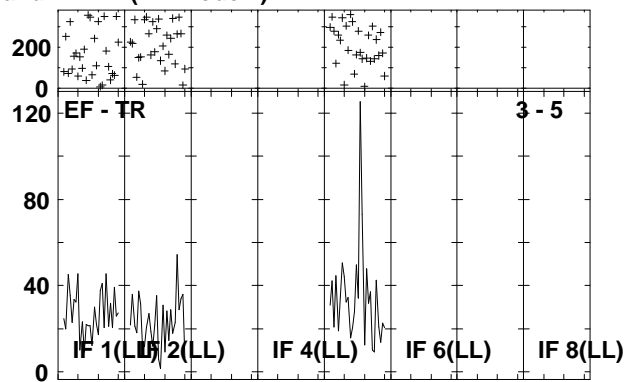
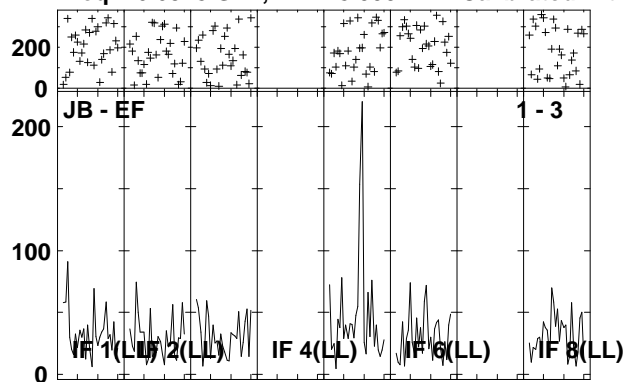

Lower frame: Milli Ampl Jy Top frame: Phas deg
Vector averaged cross-power spectrum Several baselines displayed
Timerange: 00/10:50:12 to 00/10:51:41

Plot file version 297 created 19-AUG-2009 15:58:56

W75 EB039B 2.UVDATA.1

Freq = 6.6328 GHz, Bw = 8.000 MH Calibrated with CL # 3 and BP # 1 (BP mode 1)

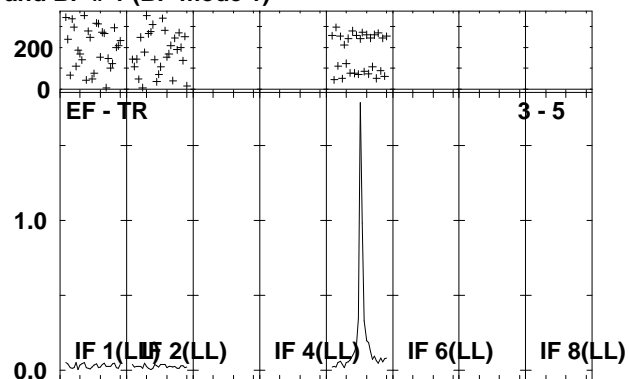
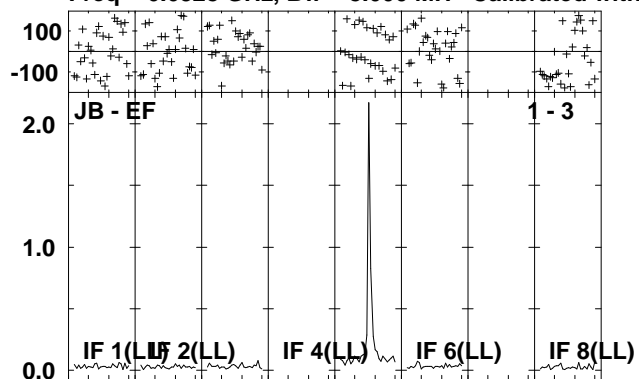

Lower frame: Ampl Jy Top frame: Phas deg
Vector averaged cross-power spectrum Several baselines displayed
Timerange: 00/10:51:43 to 00/10:53:11

Plot file version 298 created 19-AUG-2009 15:58:58

DR21B EB039B 2.UVDATA.1

Freq = 6.6328 GHz, Bw = 8.000 MH Calibrated with CL # 3 and BP # 1 (BP mode 1)

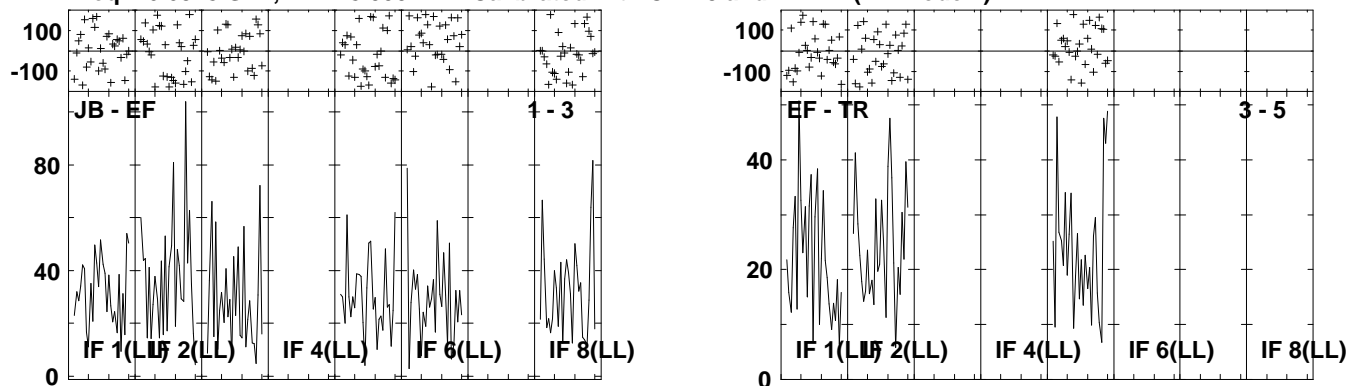

Lower frame: Milli Ampl Jy Top frame: Phas deg
Vector averaged cross-power spectrum Several baselines displayed
Timerange: 00/10:53:13 to 00/10:54:42

Plot file version 299 created 19-AUG-2009 15:59:00

W75 EB039B 2.UVDATA.1

Freq = 6.6328 GHz, Bw = 8.000 MH Calibrated with CL # 3 and BP # 1 (BP mode 1)

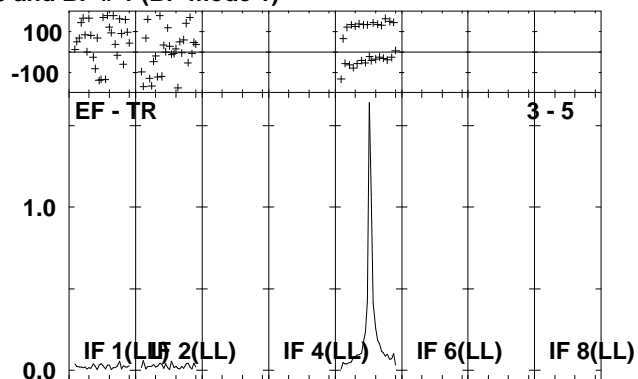
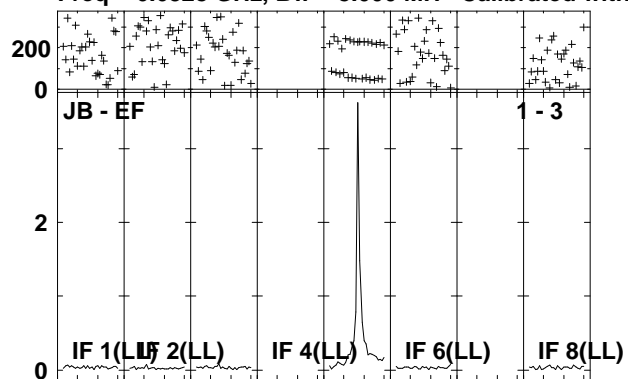

Lower frame: Ampl Jy Top frame: Phas deg
Vector averaged cross-power spectrum Several baselines displayed
Timerange: 00/10:54:43 to 00/10:56:11

Plot file version 300 created 19-AUG-2009 15:59:02
DR21B2 EB039B 2.UVDATA.1
Freq = 6.6328 GHz, Bw = 8.000 MH Calibrated with CL # 3 and BP # 1 (BP mode 1)

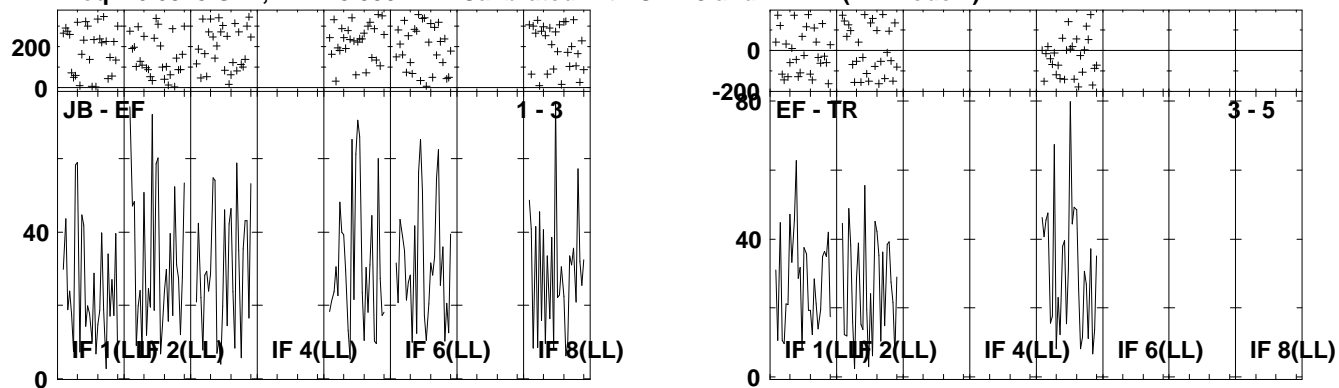

Lower frame: Milli Ampl Jy Top frame: Phas deg
Vector averaged cross-power spectrum Several baselines displayed
Timerange: 00/10:56:12 to 00/10:57:41

Plot file version 301 created 19-AUG-2009 15:59:04

W75 EB039B 2.UVDATA.1

Freq = 6.6328 GHz, Bw = 8.000 MH Calibrated with CL # 3 and BP # 1 (BP mode 1)

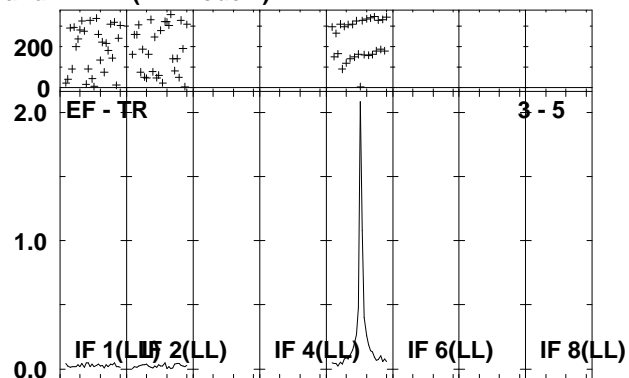
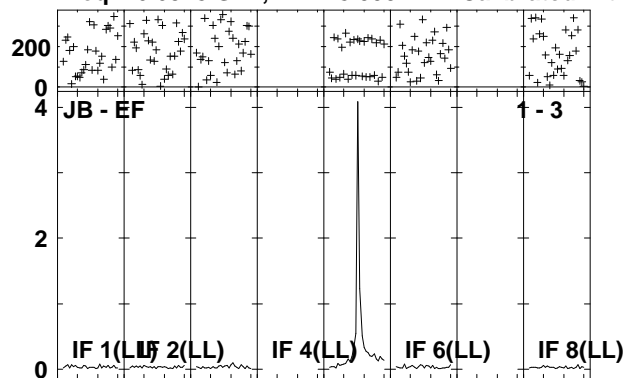

Lower frame: Ampl Jy Top frame: Phas deg
Vector averaged cross-power spectrum Several baselines displayed
Timerange: 00/10:57:43 to 00/10:59:11

Plot file version 302 created 19-AUG-2009 15:59:06

DR20 EB039B 2.UVDATA.1

Freq = 6.6328 GHz, Bw = 8.000 MH Calibrated with CL # 3 and BP # 1 (BP mode 1)

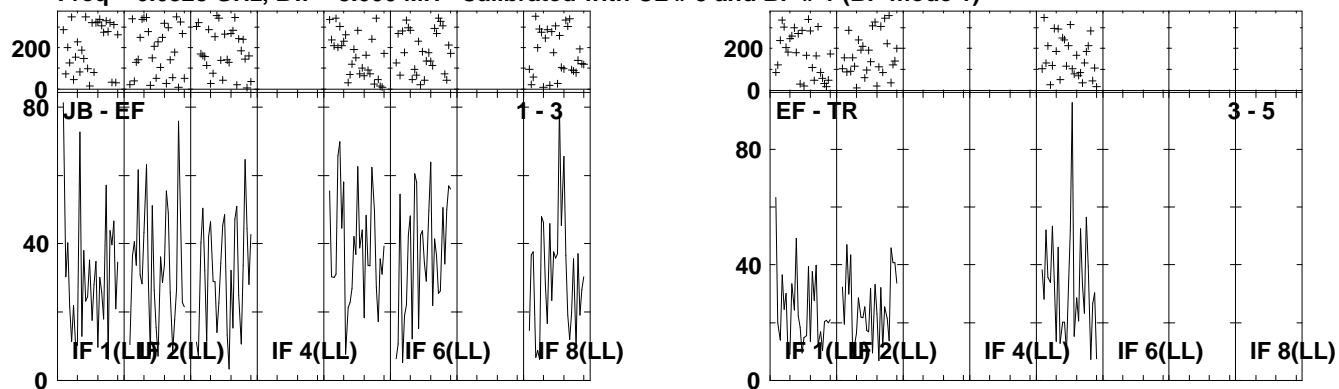

Lower frame: Milli Ampl Jy Top frame: Phas deg
Vector averaged cross-power spectrum Several baselines displayed
Timerange: 00/10:59:13 to 00/11:00:42

Plot file version 303 created 19-AUG-2009 15:59:08

W75 EB039B 2.UVDATA.1

Freq = 6.6328 GHz, Bw = 8.000 MH Calibrated with CL # 3 and BP # 1 (BP mode 1)

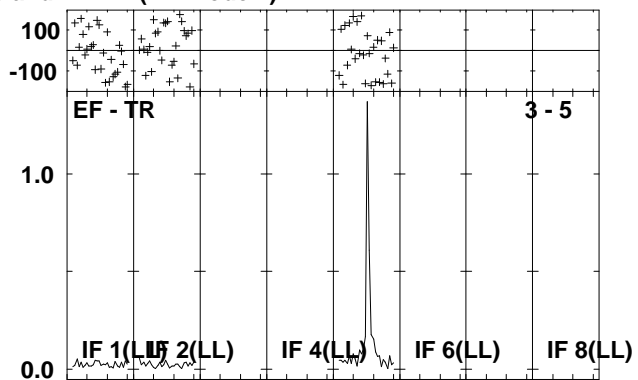
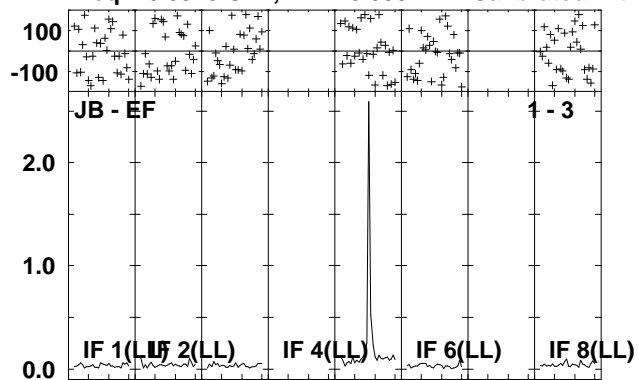

Lower frame: Ampl Jy Top frame: Phas deg
Vector averaged cross-power spectrum Several baselines displayed
Timerange: 00/11:01:10 to 00/11:02:08

Plot file version 304 created 19-AUG-2009 15:59:15

W75 EB039B 2.UVDATA.1

Freq = 6.6328 GHz, Bw = 8.000 MH Calibrated with CL # 3 and BP # 1 (BP mode 1)

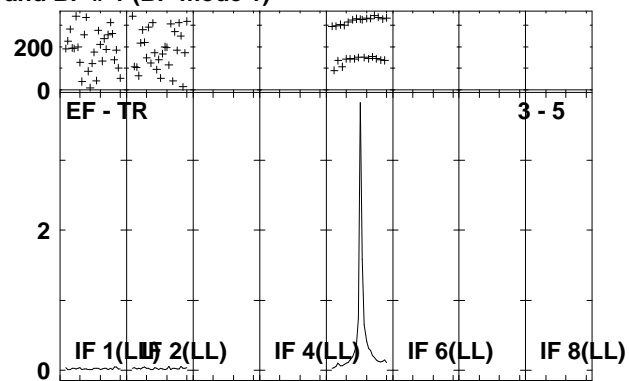
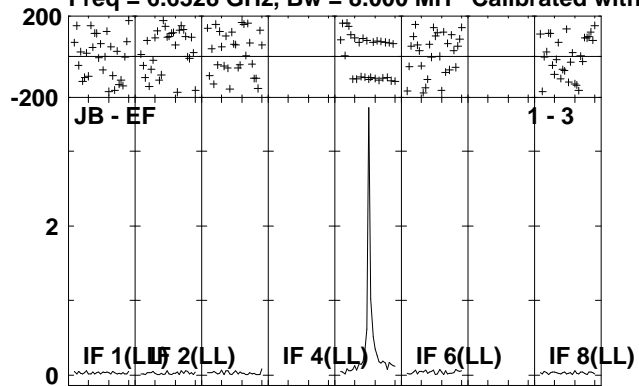

Lower frame: Ampl Jy Top frame: Phas deg
Vector averaged cross-power spectrum Several baselines displayed
Timerange: 00/11:06:39 to 00/11:08:08

Plot file version 305 created 19-AUG-2009 15:59:17

2048+431 EB039B 2.UVDATA.1

Freq = 6.6328 GHz, Bw = 8.000 MH Calibrated with CL # 3 and BP # 1 (BP mode 1)

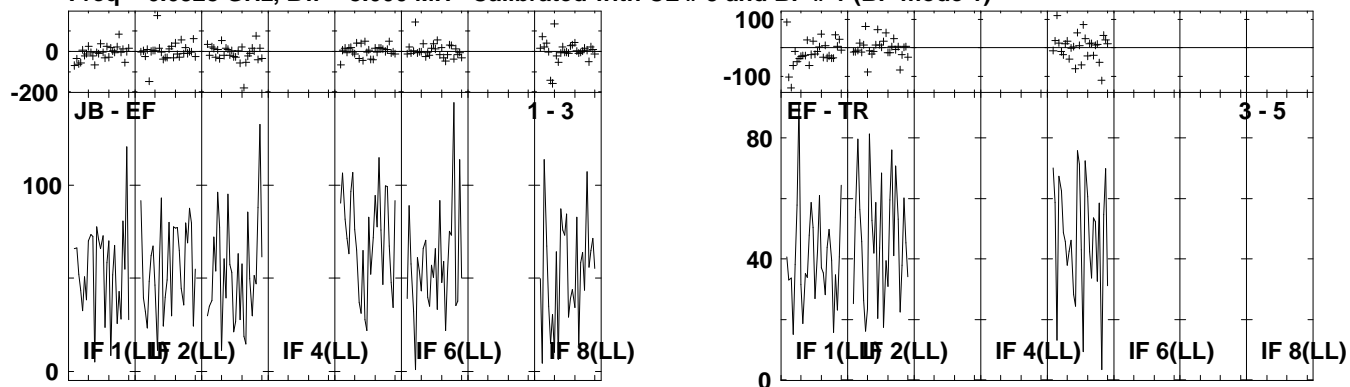

Lower frame: Milli Ampl Jy Top frame: Phas deg
Vector averaged cross-power spectrum Several baselines displayed
Timerange: 00/11:08:10 to 00/11:09:39

Plot file version 306 created 19-AUG-2009 15:59:19
 W75 EB039B 2.UVDATA.1
 Freq = 6.6328 GHz, Bw = 8.000 MH Calibrated with CL # 3 and BP # 1 (BP mode 1)

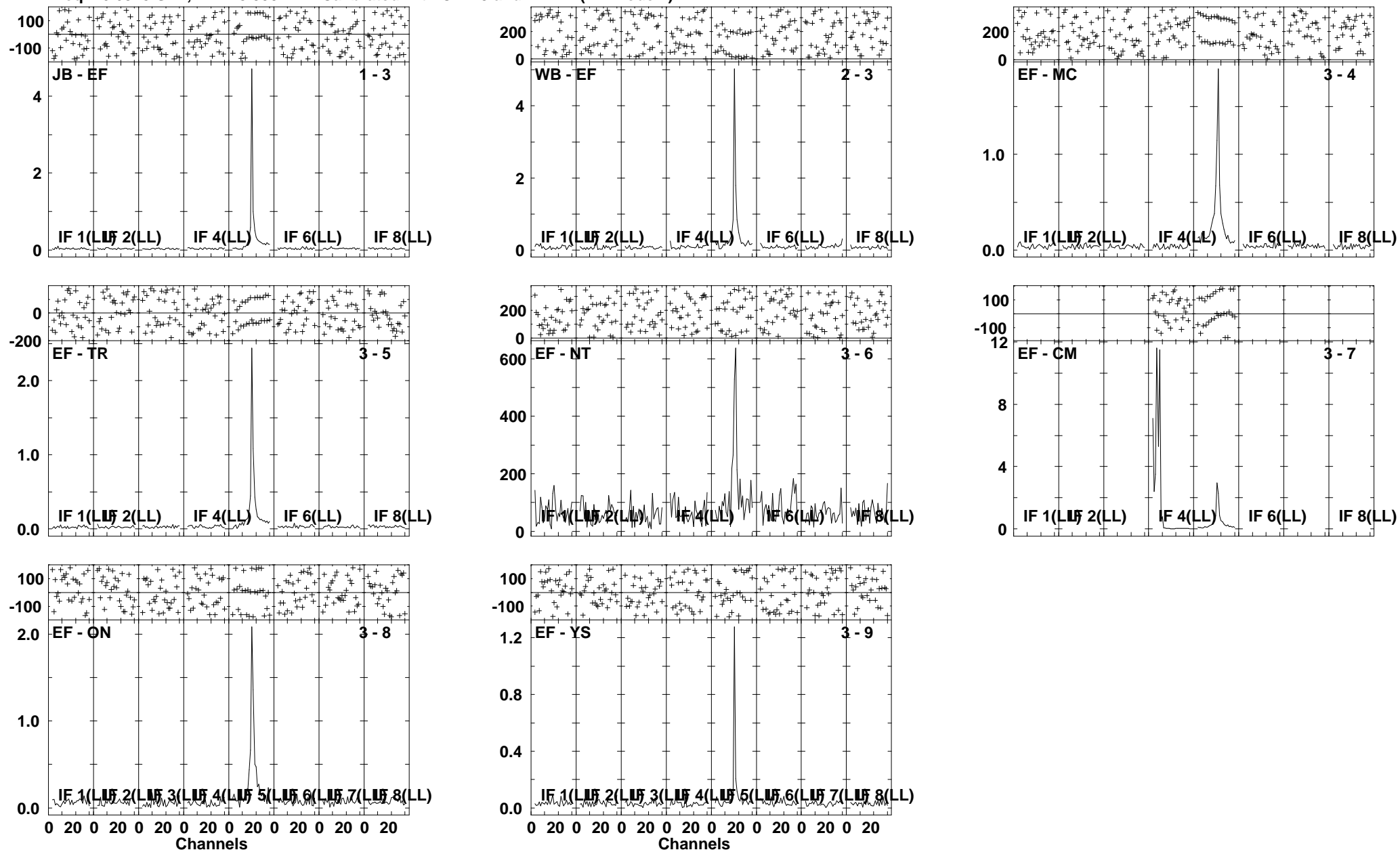

Lower frame: Ampl Jy Top frame: Phas deg
 Vector averaged cross-power spectrum Several baselines displayed
 Timerange: 00/11:09:39 to 00/11:11:08

Plot file version 307 created 19-AUG-2009 15:59:22
 OB2 EB039B 2.UVDATA.1
 Freq = 6.6328 GHz, Bw = 8.000 MH Calibrated with CL # 3 and BP # 1 (BP mode 1)

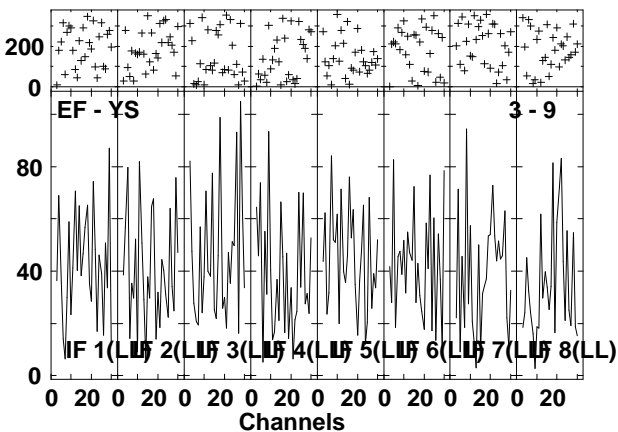
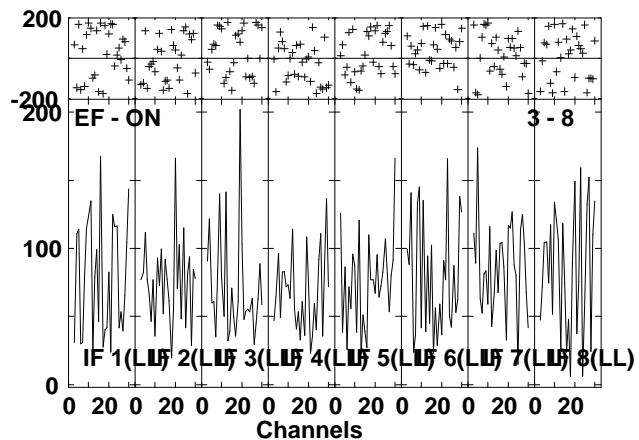
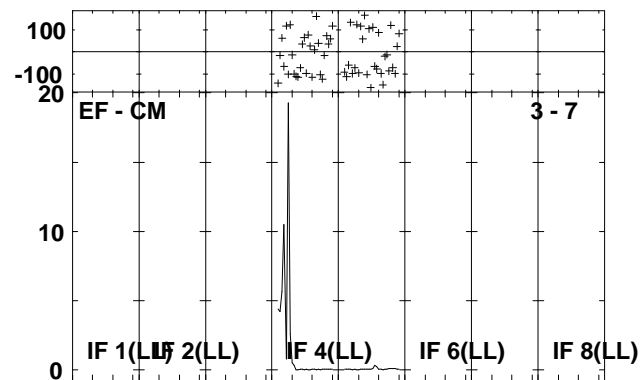
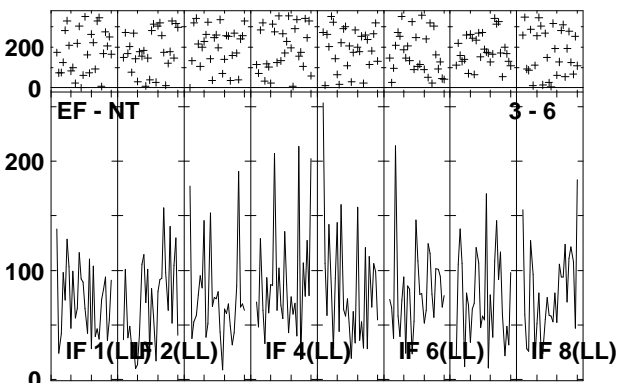
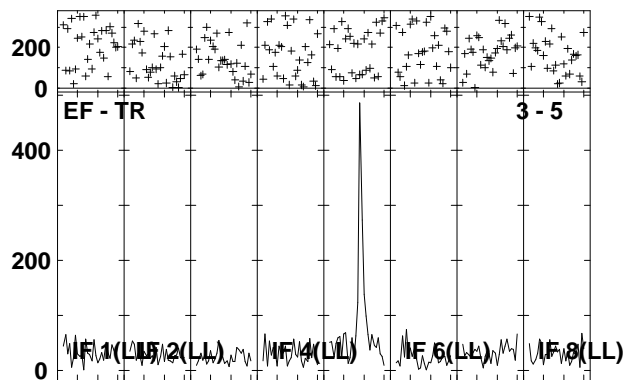
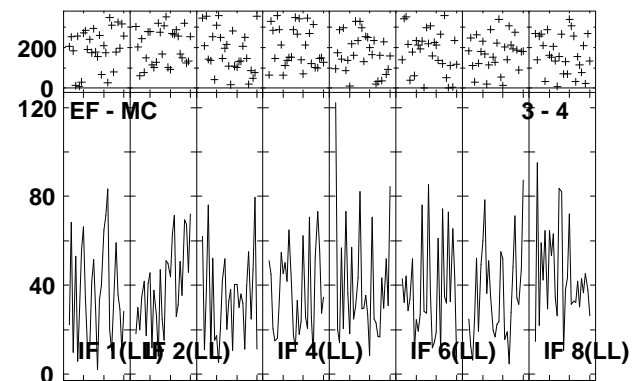
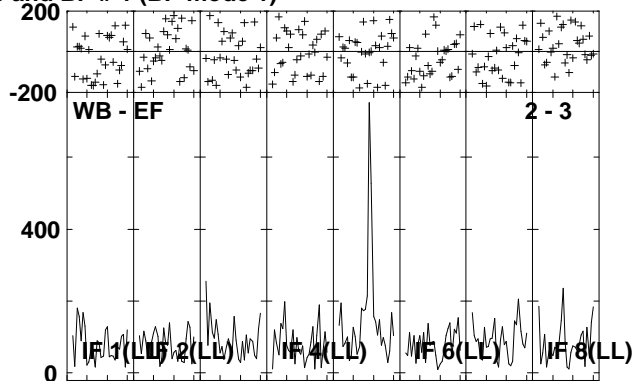
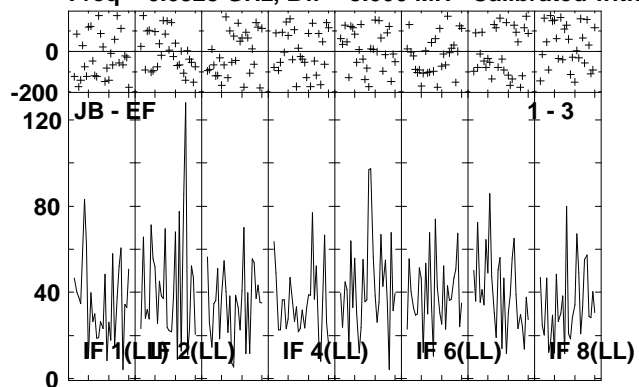

Lower frame: Milli Ampl Jy Top frame: Phas deg
 Vector averaged cross-power spectrum Several baselines displayed
 Timerange: 00/11:11:10 to 00/11:12:39

Plot file version 308 created 19-AUG-2009 15:59:24

W75 EB039B 2.UVDATA.1

Freq = 6.6328 GHz, Bw = 8.000 MH Calibrated with CL # 3 and BP # 1 (BP mode 1)

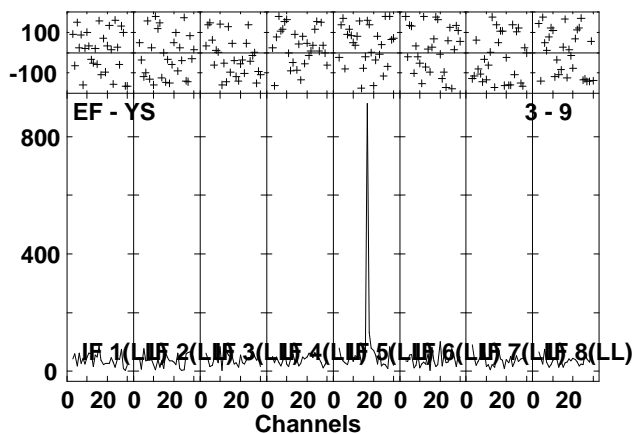
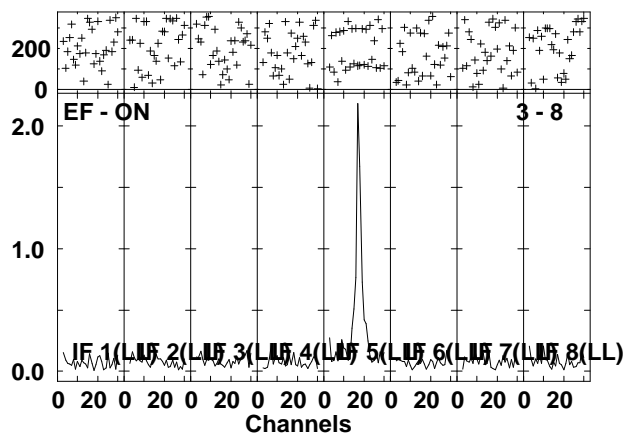
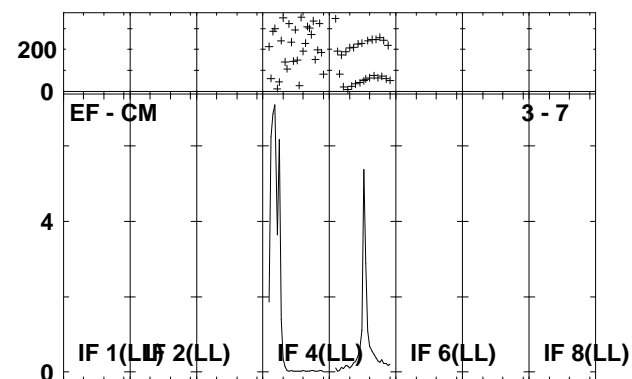
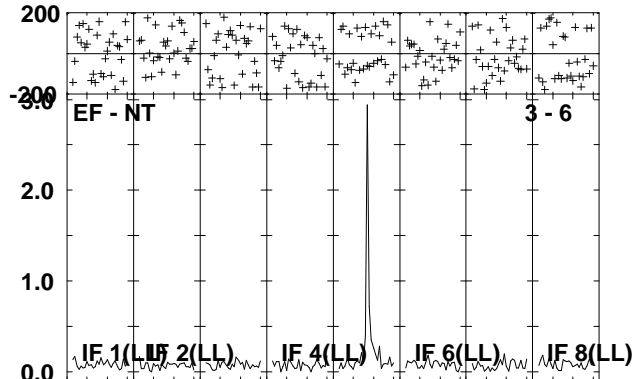
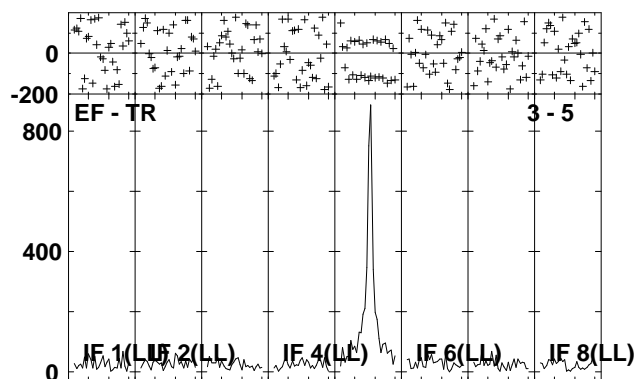
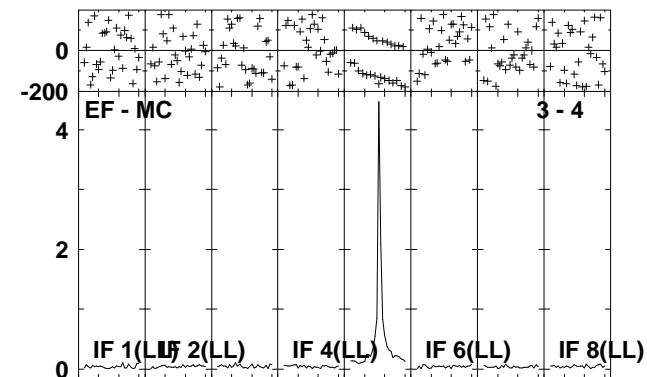
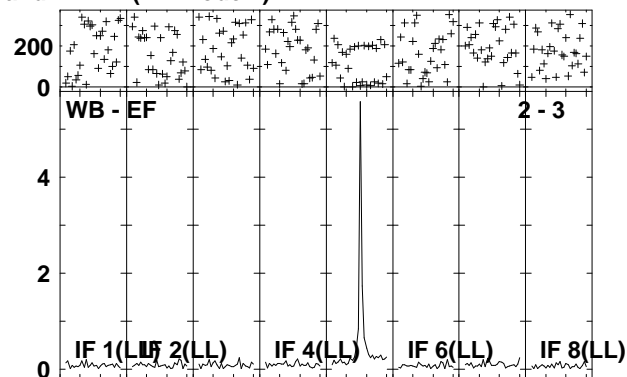
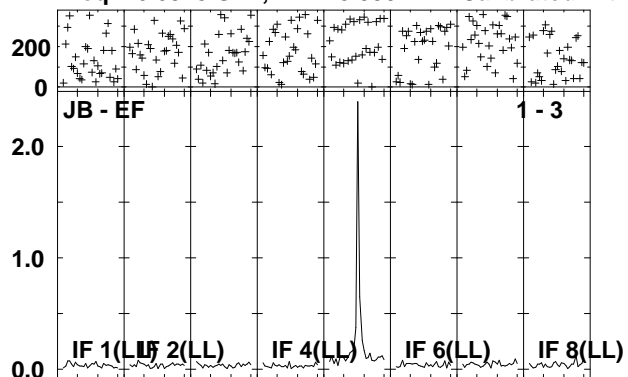

Lower frame: Ampl Jy Top frame: Phas deg
Vector averaged cross-power spectrum Several baselines displayed
Timerange: 00/11:13:09 to 00/11:14:07

Plot file version 309 created 19-AUG-2009 15:59:26
DR21A EB039B 2.UVDATA.1
Freq = 6.6328 GHz, Bw = 8.000 MH Calibrated with CL # 3 and BP # 1 (BP mode 1)

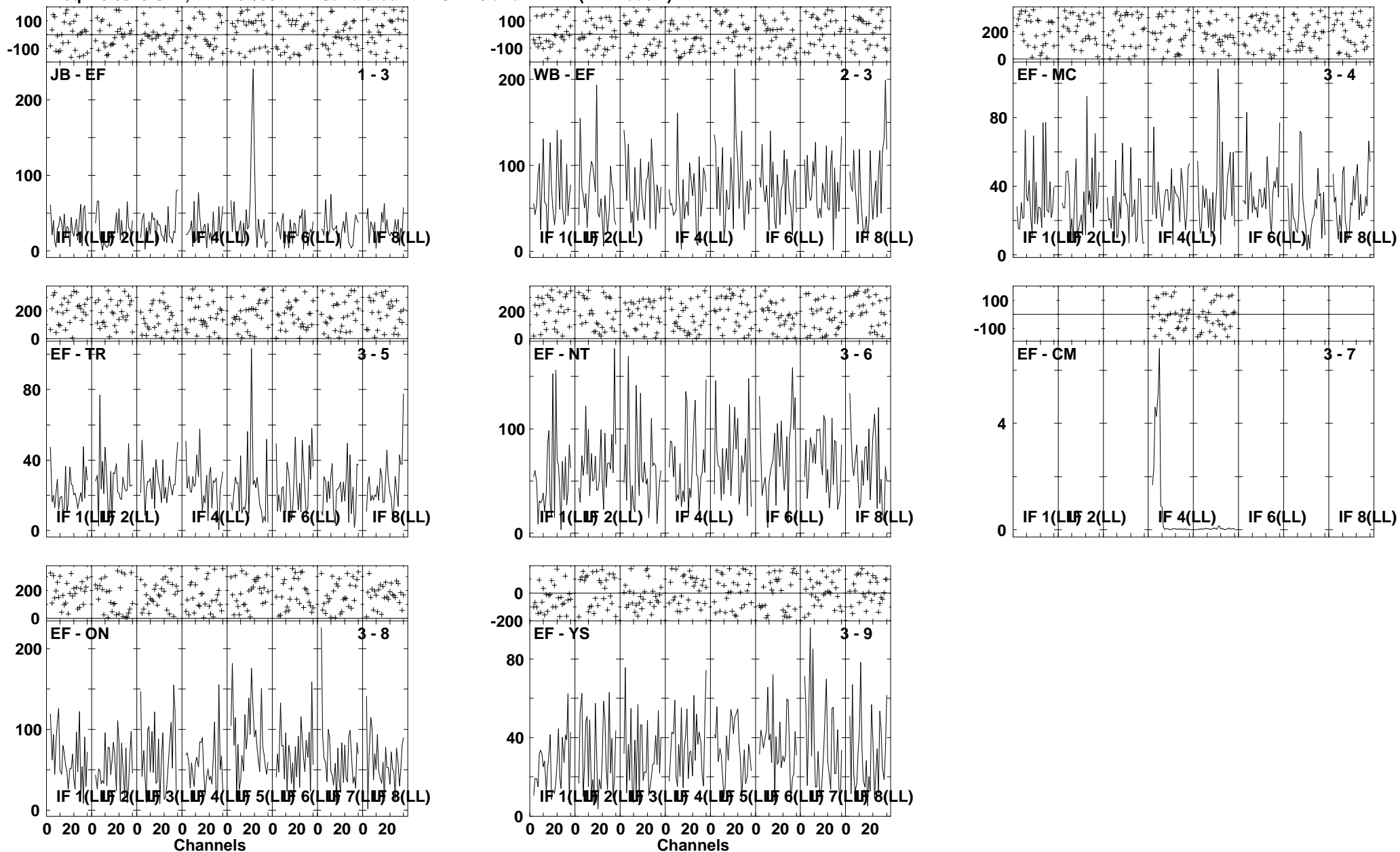

Lower frame: Milli Ampl Jy Top frame: Phas deg
Vector averaged cross-power spectrum Several baselines displayed
Timerange: 00/11:14:09 to 00/11:15:38

Plot file version 310 created 19-AUG-2009 15:59:29
 W75 EB039B 2.UVDATA.1
 Freq = 6.6328 GHz, Bw = 8.000 MH Calibrated with CL # 3 and BP # 1 (BP mode 1)

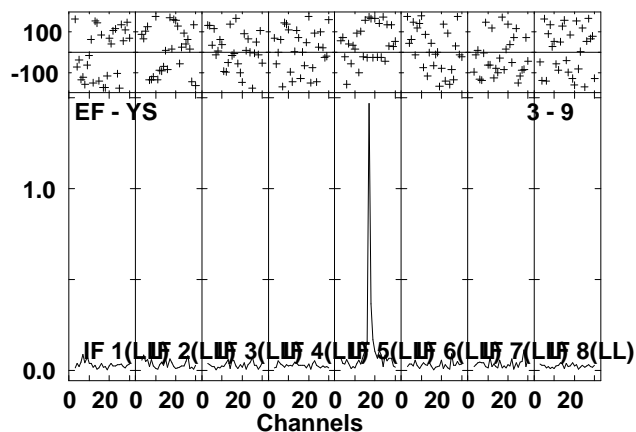
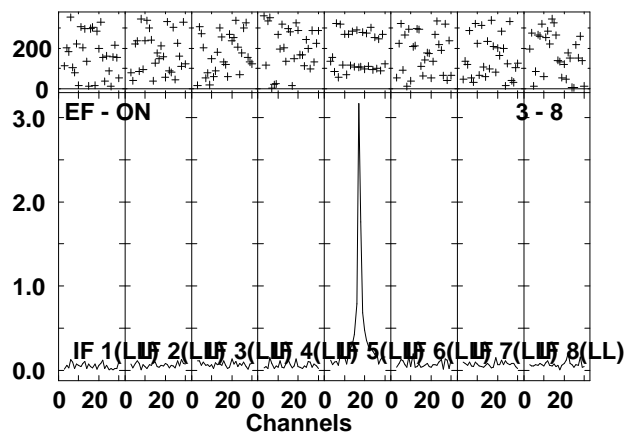
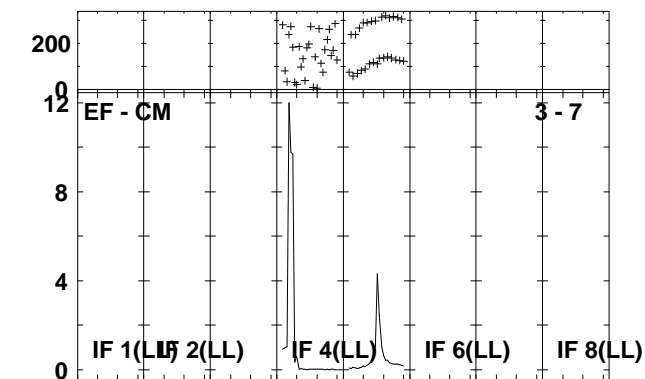
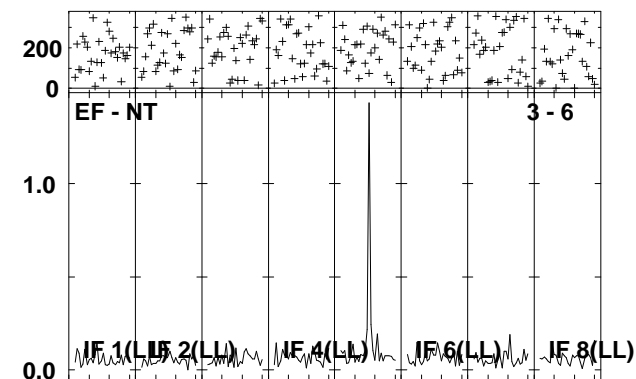
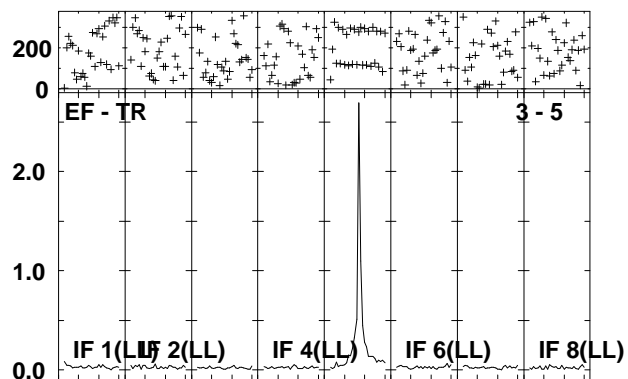
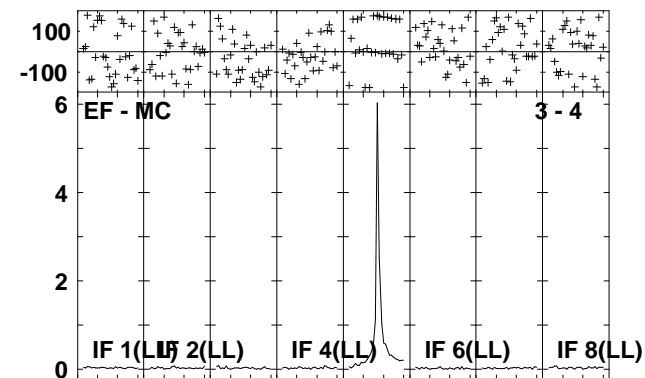
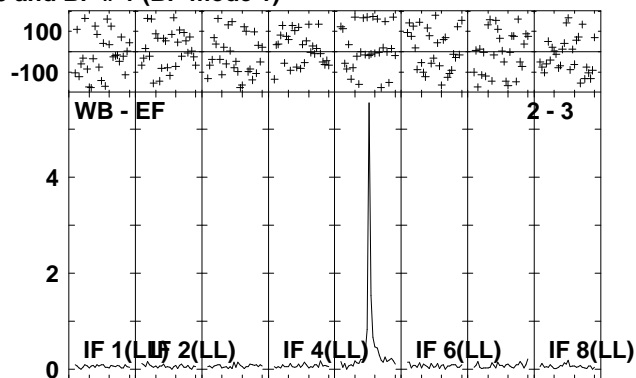
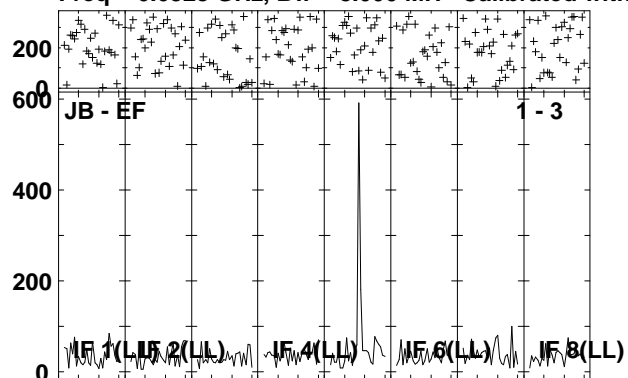

Lower frame: Milli Ampl Jy Top frame: Phas deg
 Vector averaged cross-power spectrum Several baselines displayed
 Timerange: 00/11:15:39 to 00/11:17:07

Plot file version 311 created 19-AUG-2009 15:59:31
 DR21B EB039B 2.UVDATA.1
 Freq = 6.6328 GHz, Bw = 8.000 MH Calibrated with CL # 3 and BP # 1 (BP mode 1)

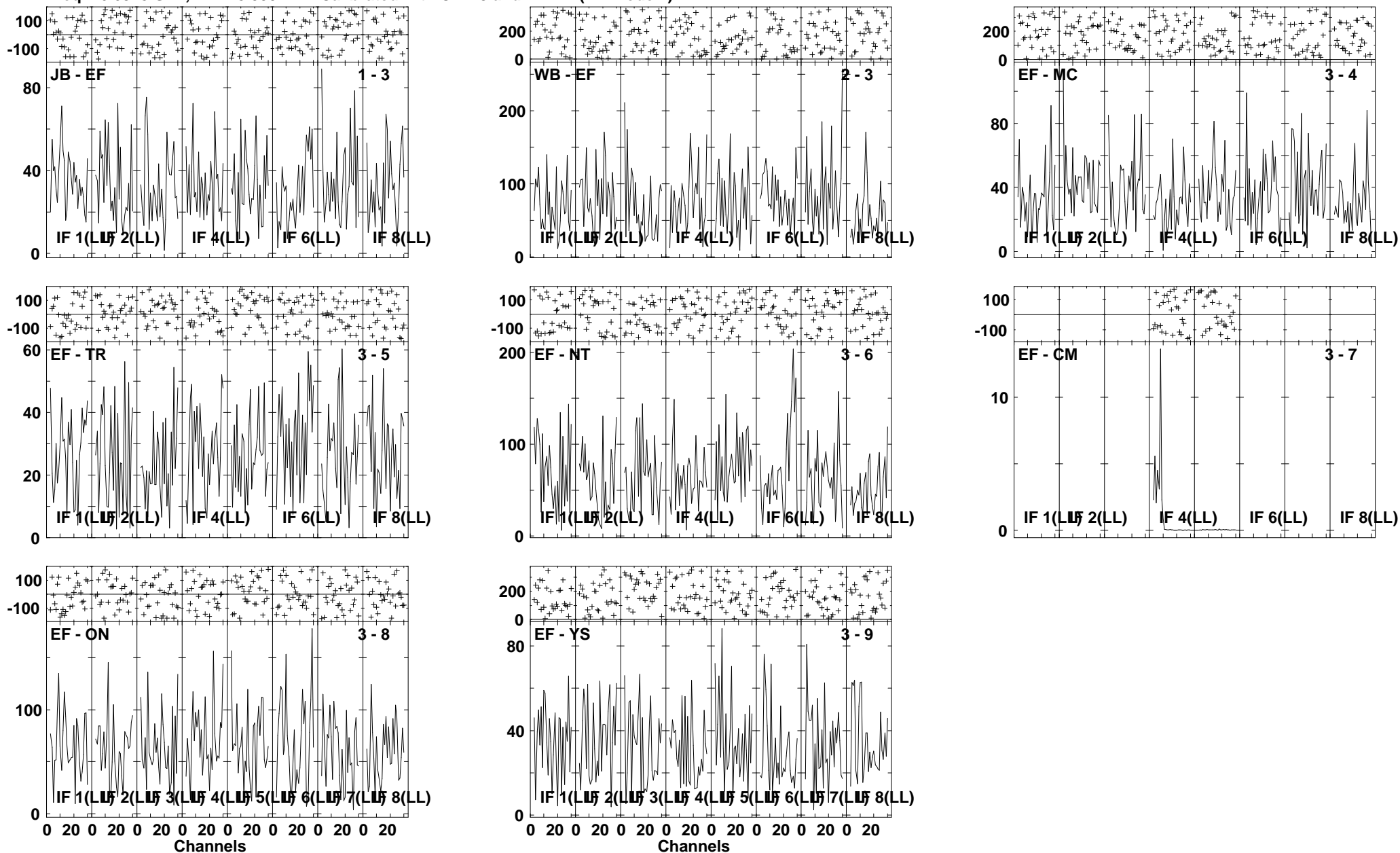

Lower frame: Milli Ampl Jy Top frame: Phas deg
 Vector averaged cross-power spectrum Several baselines displayed
 Timerange: 00/11:17:08 to 00/11:18:37

Plot file version 312 created 19-AUG-2009 15:59:34
 W75 EB039B 2.UVDATA.1
 Freq = 6.6328 GHz, Bw = 8.000 MH Calibrated with CL # 3 and BP # 1 (BP mode 1)

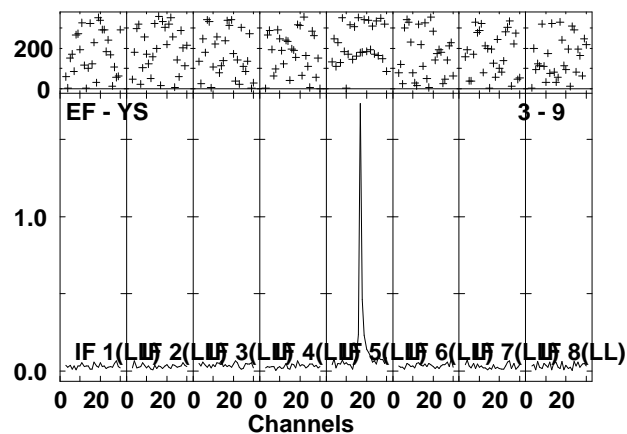
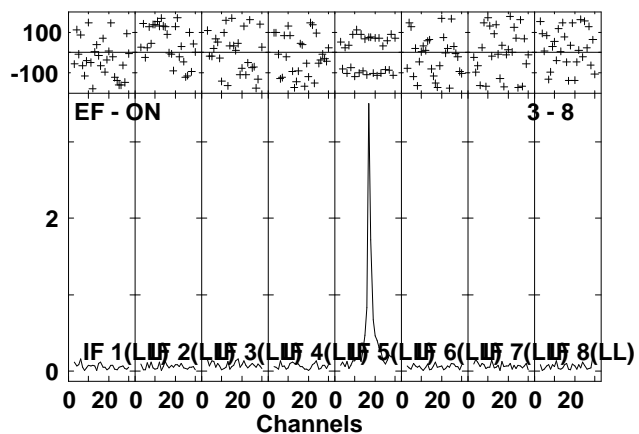
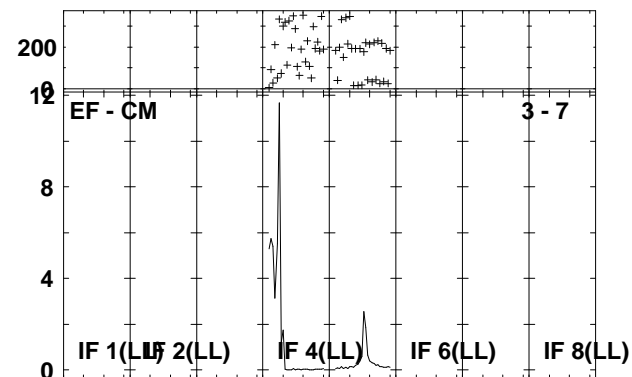
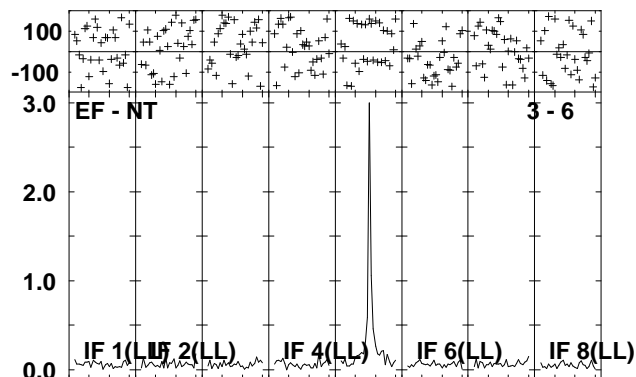
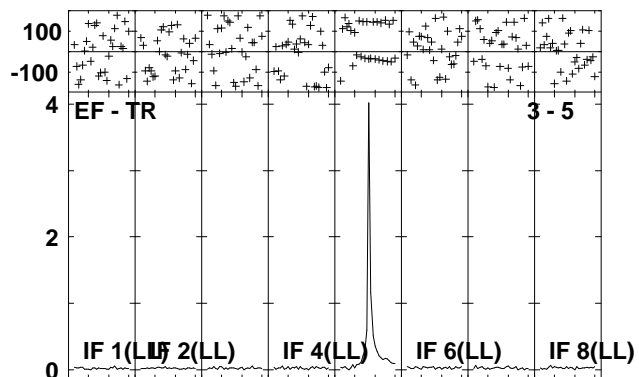
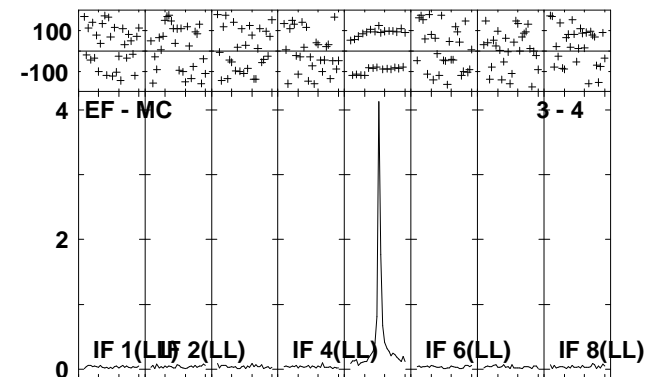
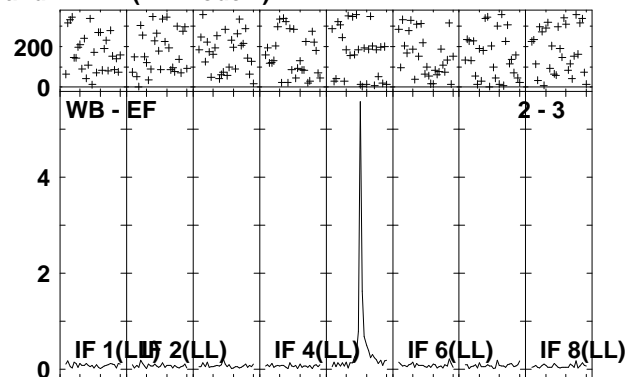
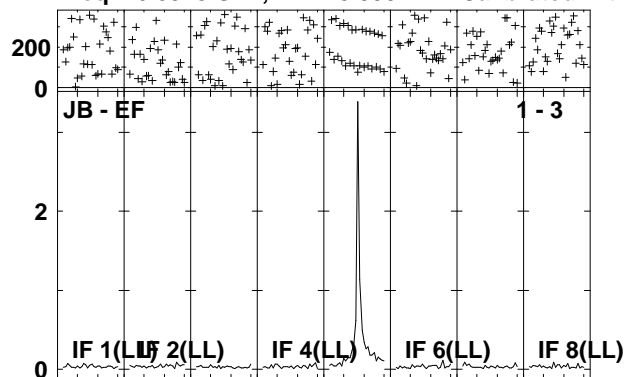

Lower frame: Ampl Jy Top frame: Phas deg
 Vector averaged cross-power spectrum Several baselines displayed
 Timerange: 00/11:18:39 to 00/11:20:07

Plot file version 313 created 19-AUG-2009 15:59:37
 DR21B2 EB039B 2.UVDATA.1
 Freq = 6.6328 GHz, Bw = 8.000 MH Calibrated with CL # 3 and BP # 1 (BP mode 1)

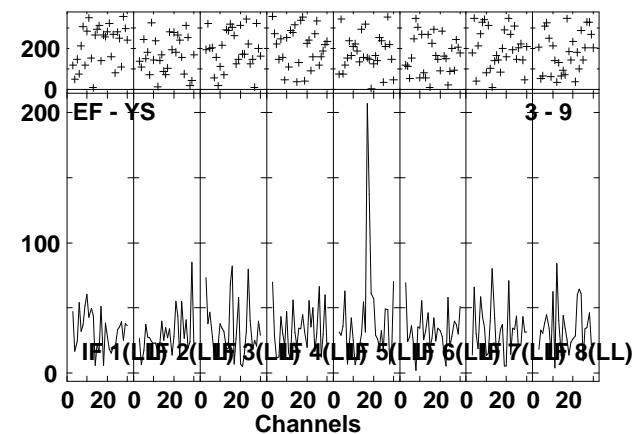
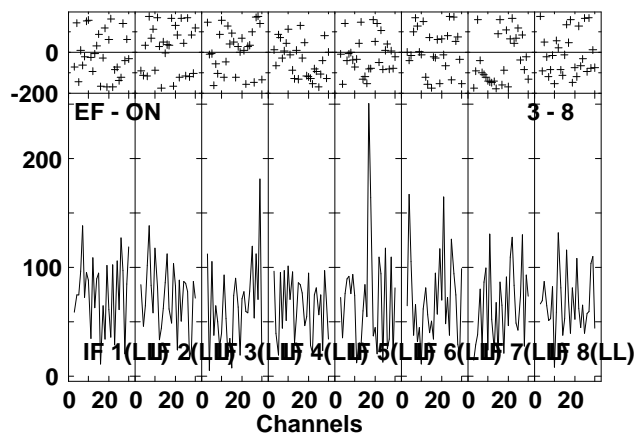
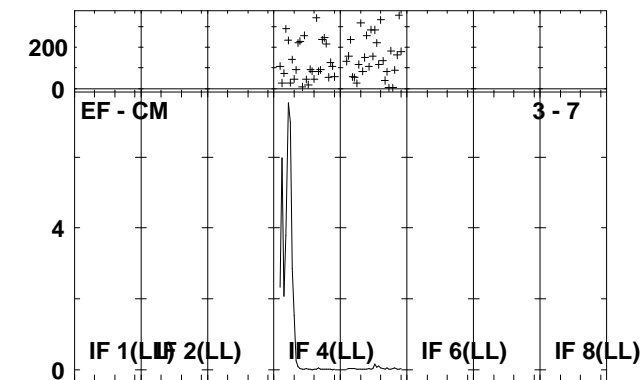
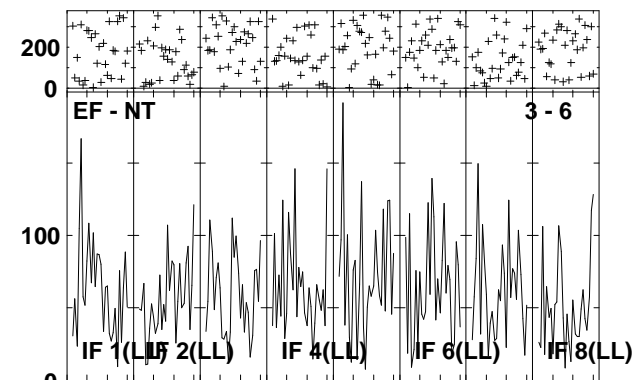
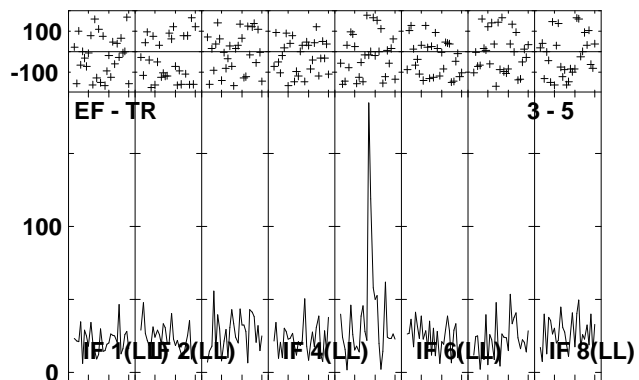
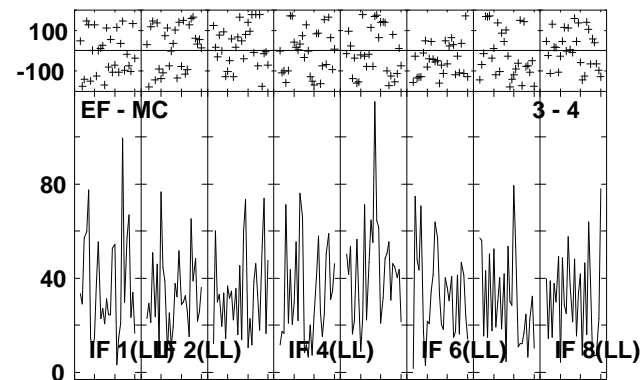
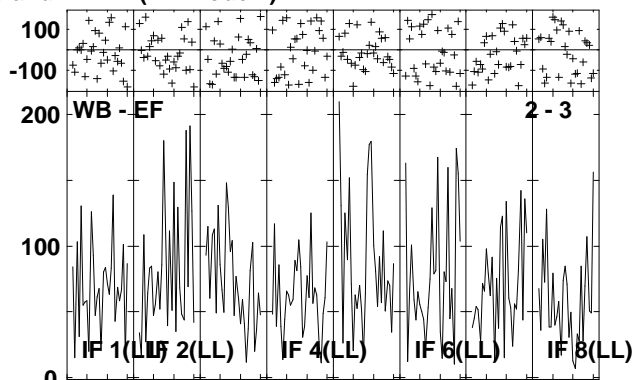
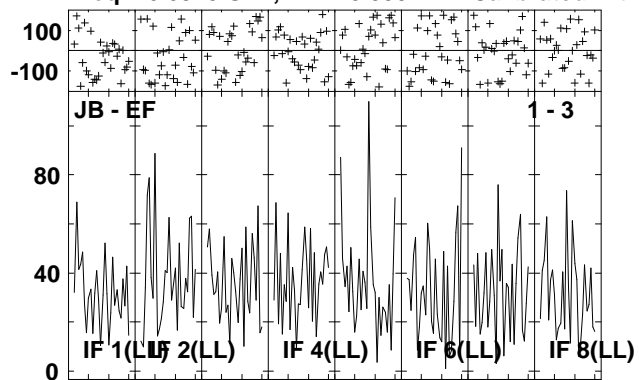

Lower frame: Milli Ampl Jy Top frame: Phas deg
 Vector averaged cross-power spectrum Several baselines displayed
 Timerange: 00/11:20:09 to 00/11:21:38

Plot file version 314 created 19-AUG-2009 15:59:40

W75 EB039B 2.UVDATA.1

Freq = 6.6328 GHz, Bw = 8.000 MH Calibrated with CL # 3 and BP # 1 (BP mode 1)

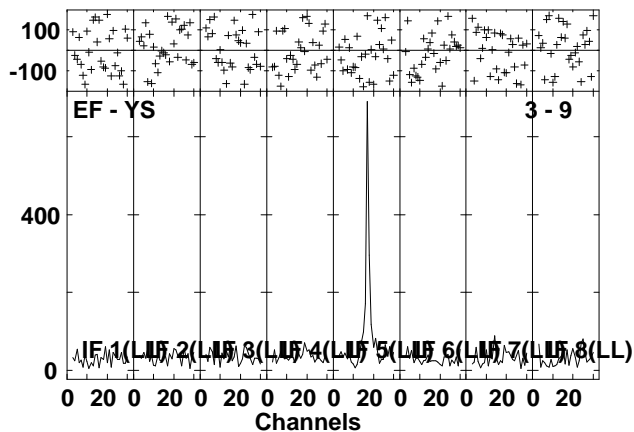
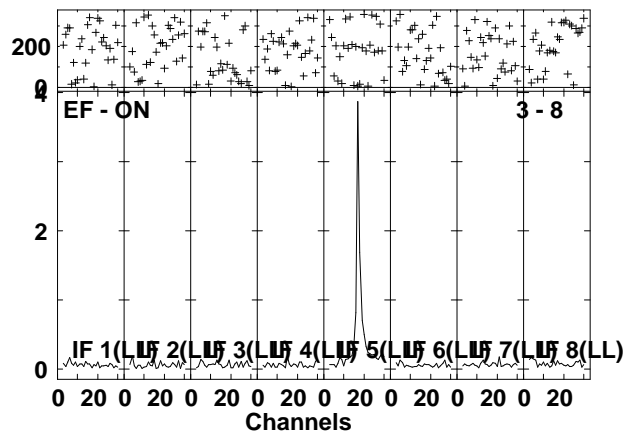
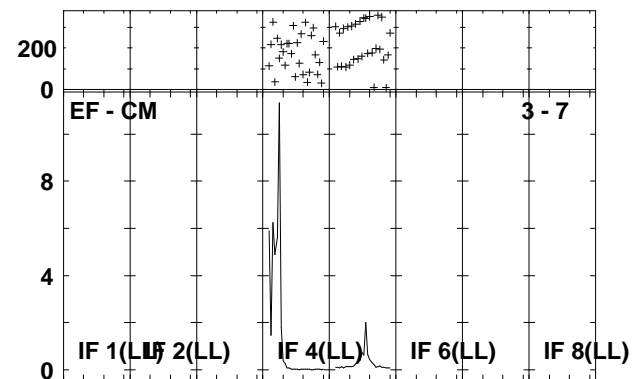
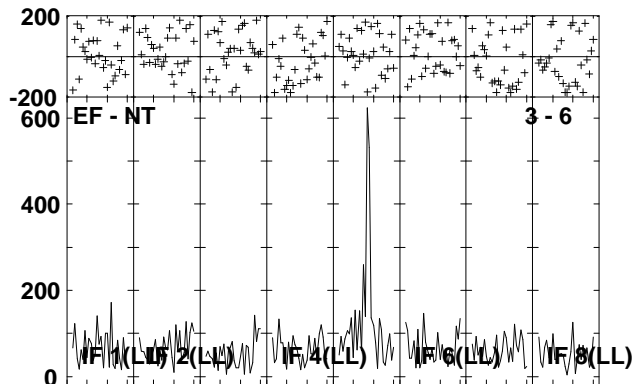
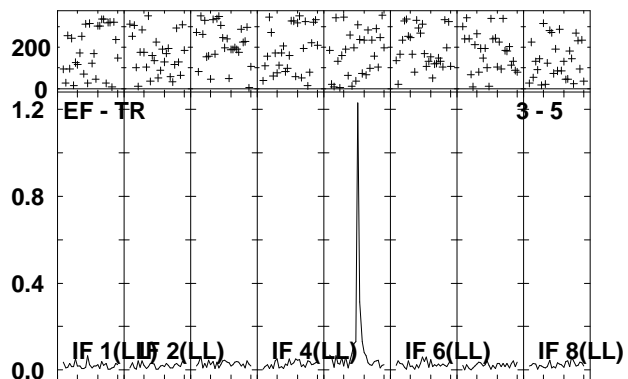
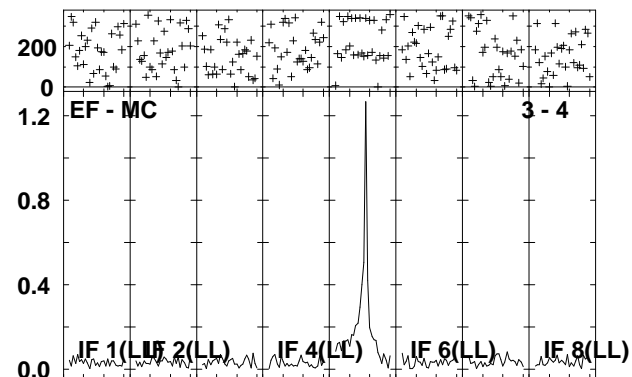
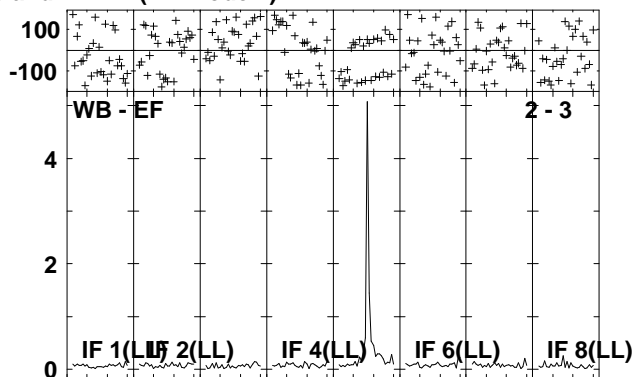
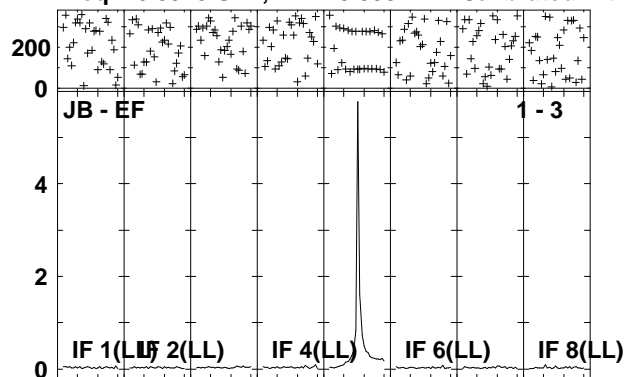

Lower frame: Ampl Jy Top frame: Phas deg
Vector averaged cross-power spectrum Several baselines displayed
Timerange: 00/11:21:38 to 00/11:23:07

Plot file version 315 created 19-AUG-2009 15:59:42

DR20 EB039B 2.UVDATA.1

Freq = 6.6328 GHz, Bw = 8.000 MH Calibrated with CL # 3 and BP # 1 (BP mode 1)

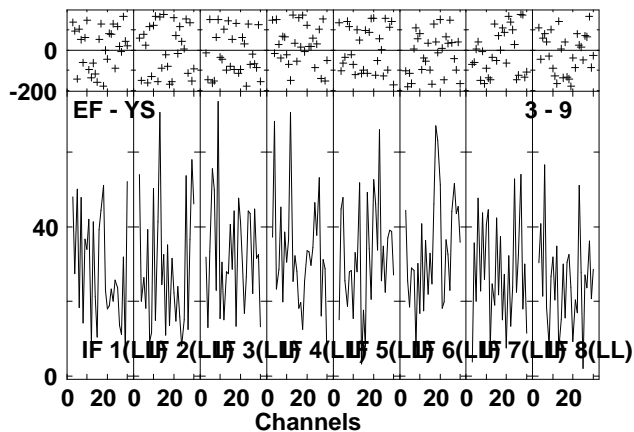
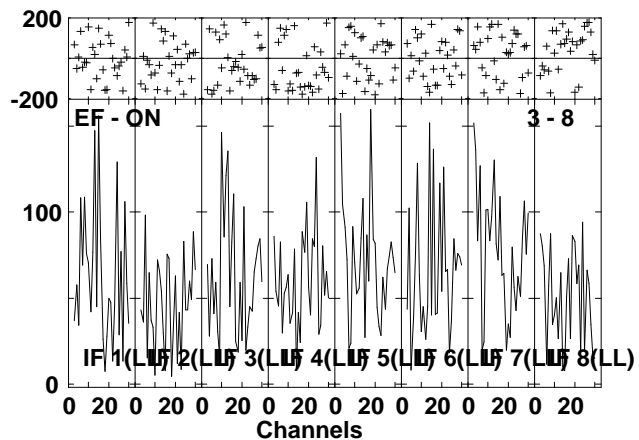
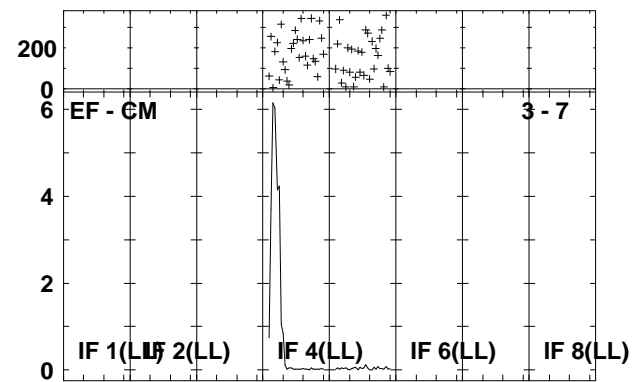
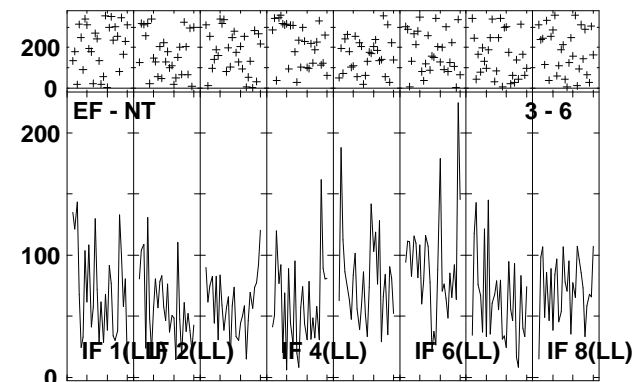
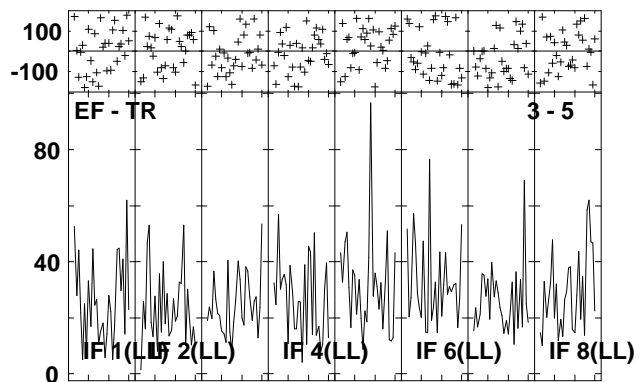
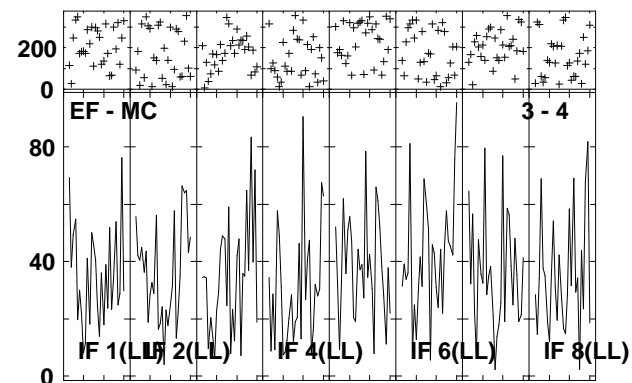
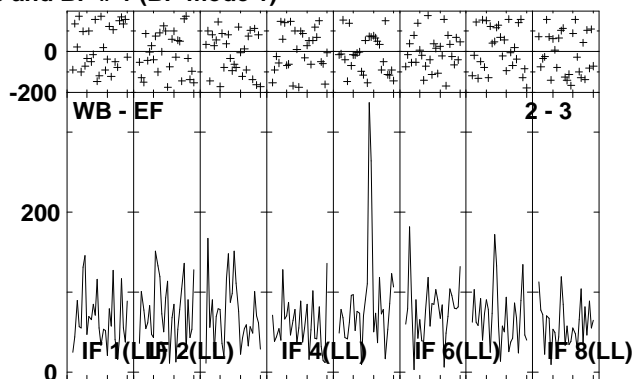
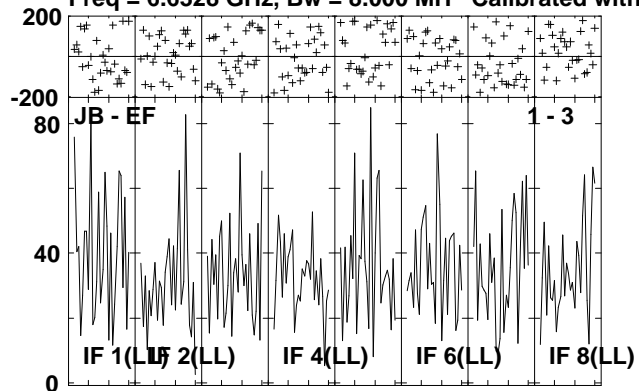

Lower frame: Milli Ampl Jy Top frame: Phas deg
Vector averaged cross-power spectrum Several baselines displayed
Timerange: 00/11:23:09 to 00/11:24:38

Plot file version 316 created 19-AUG-2009 15:59:45

W75 EB039B 2.UVDATA.1

Freq = 6.6328 GHz, Bw = 8.000 MH Calibrated with CL # 3 and BP # 1 (BP mode 1)

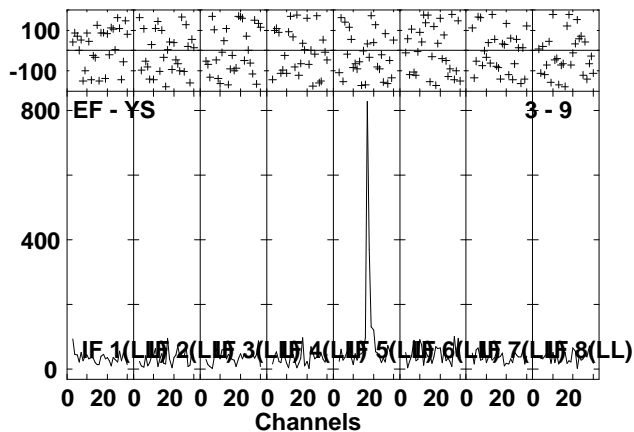
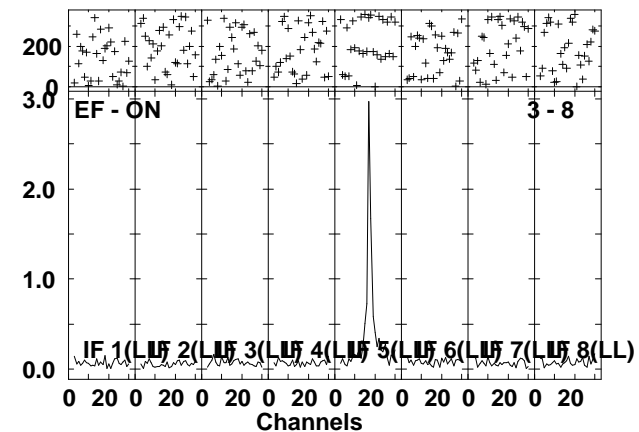
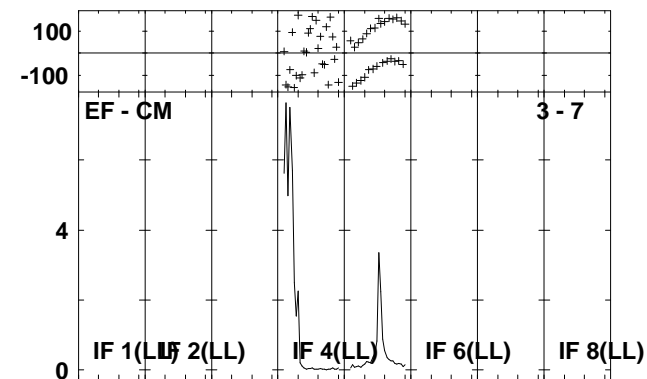
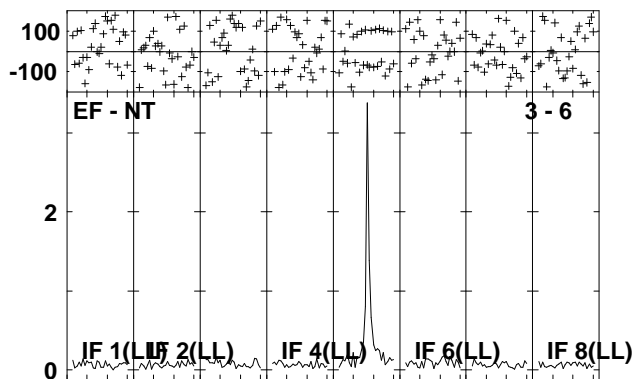
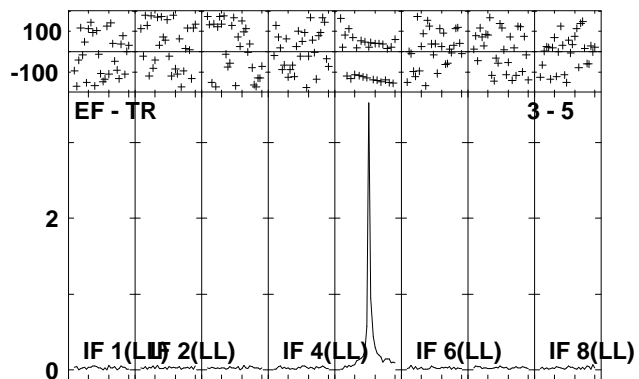
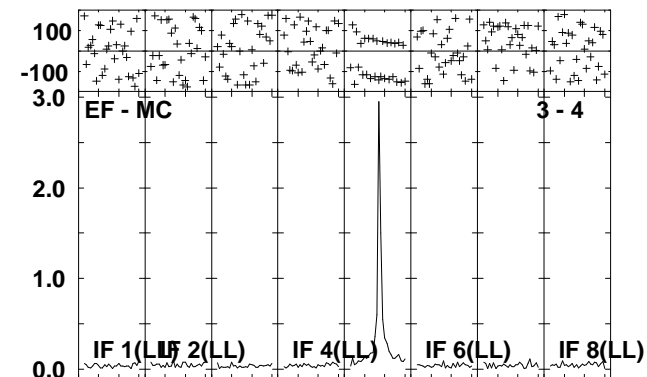
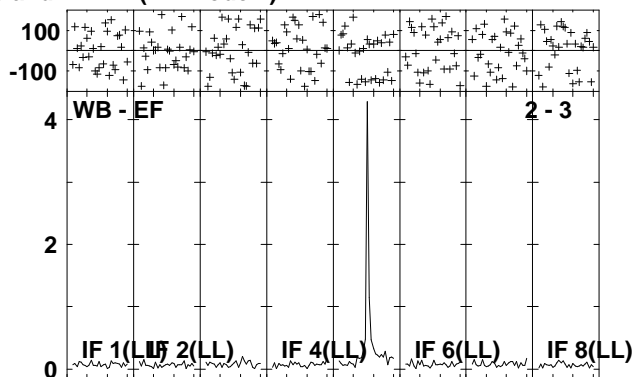
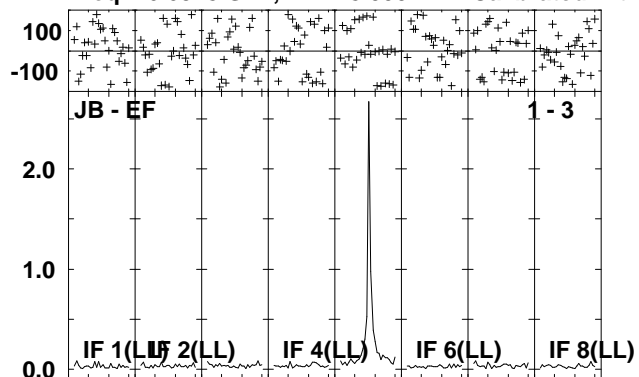

Lower frame: Ampl Jy Top frame: Phas deg
Vector averaged cross-power spectrum Several baselines displayed
Timerange: 00/11:25:06 to 00/11:26:04

Plot file version 317 created 19-AUG-2009 15:59:47
 J2038+51 EB039B 2.UVDATA.1
 Freq = 6.6328 GHz, Bw = 8.000 MH Calibrated with CL # 3 and BP # 1 (BP mode 1)

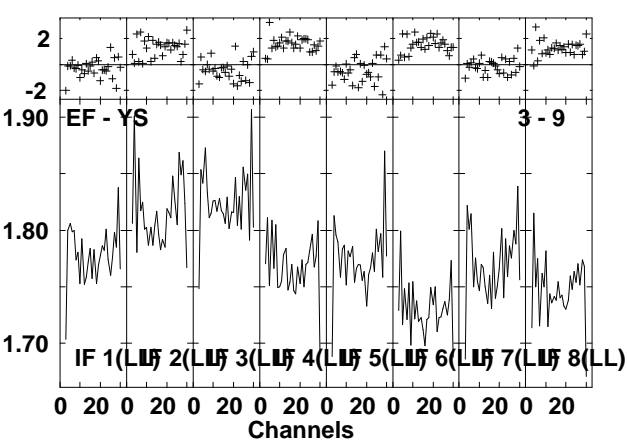
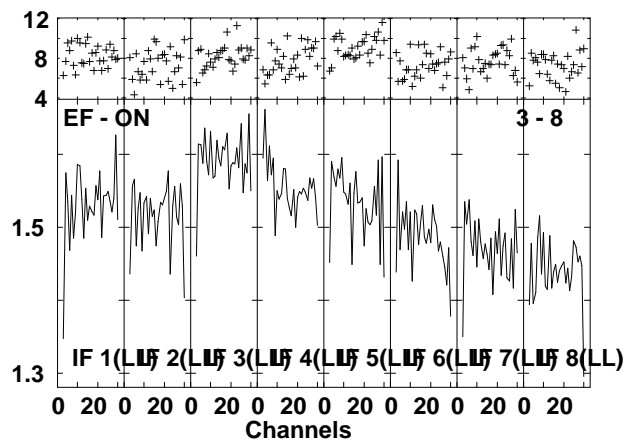
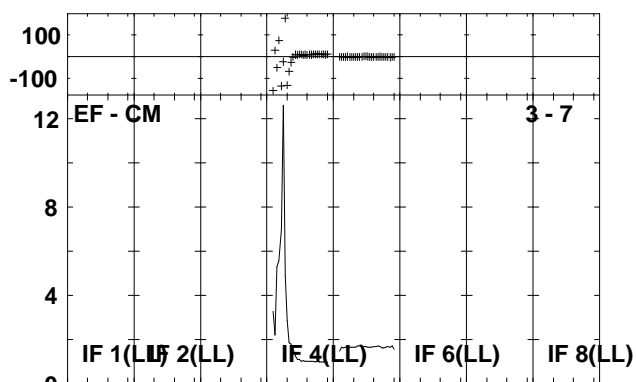
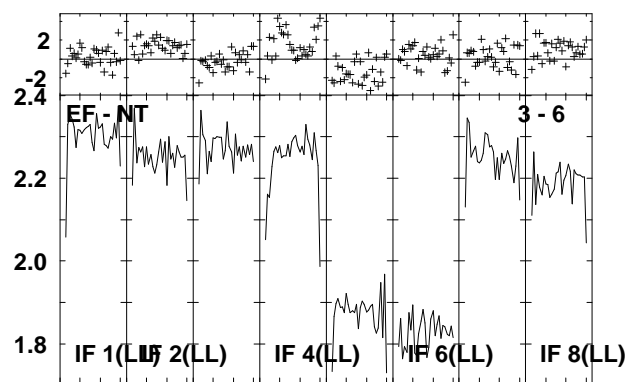
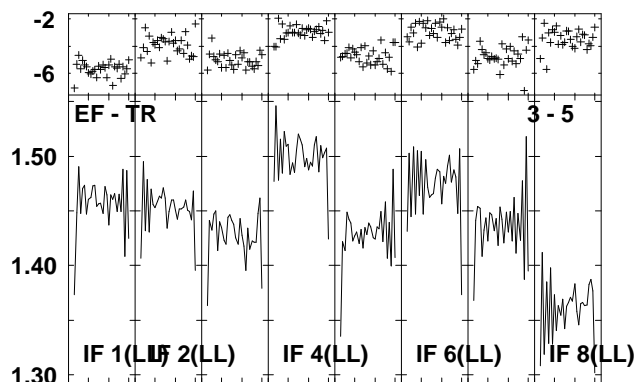
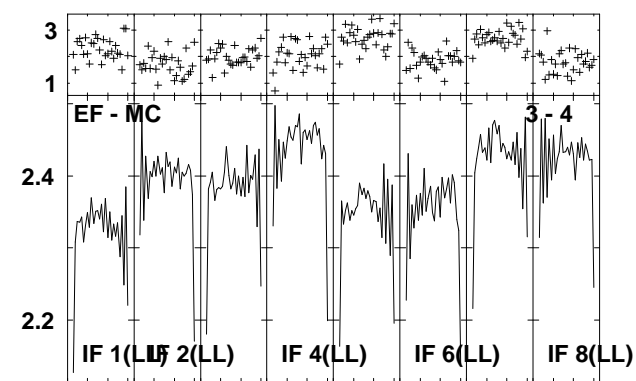
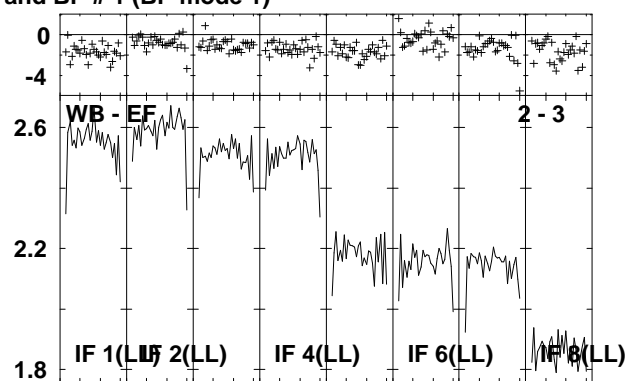
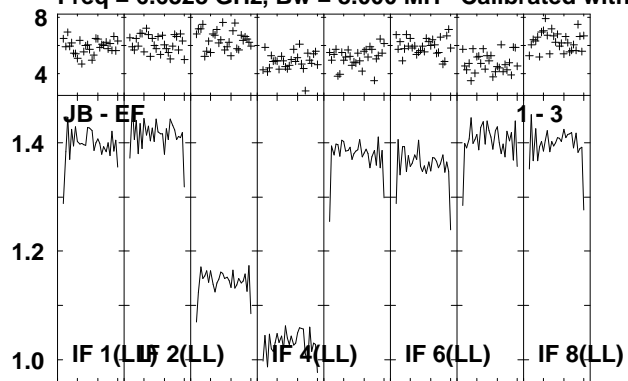

Lower frame: Ampl Jy Top frame: Phas deg
 Vector averaged cross-power spectrum Several baselines displayed
 Timerange: 00/11:27:19 to 00/11:30:16