

Plot file version 1 created 30-AUG-2019 17:53:05

J1722+2458 EB070.UVDATA.1

Freq = 1.5950 GHz, Bw = 16.000 MH No calibration applied and no bandpass applied

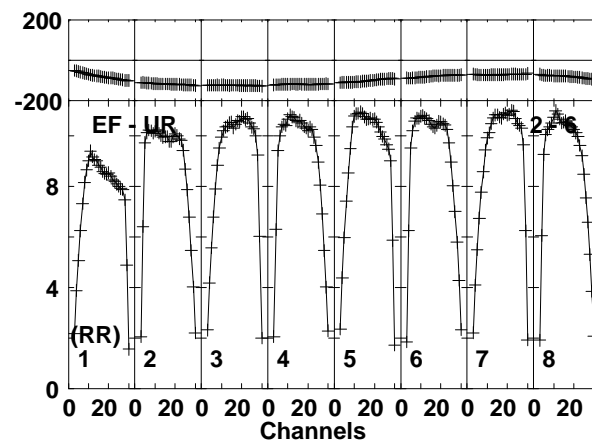
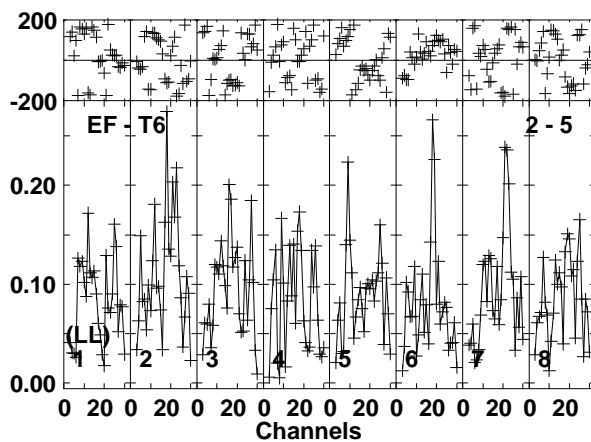
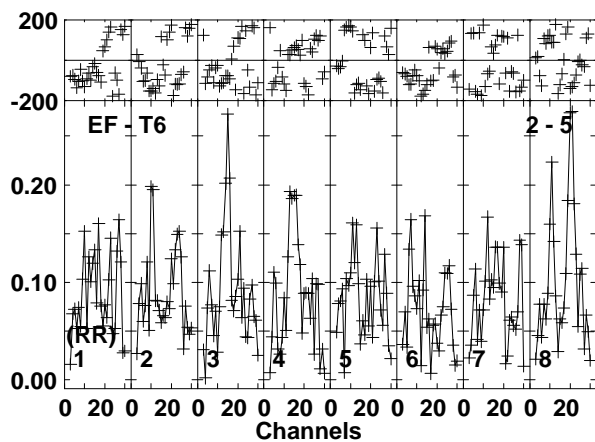
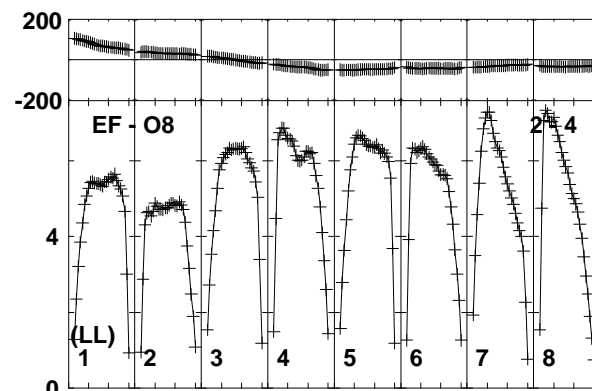
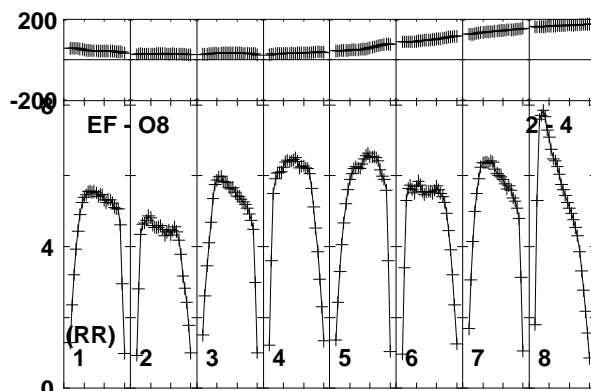
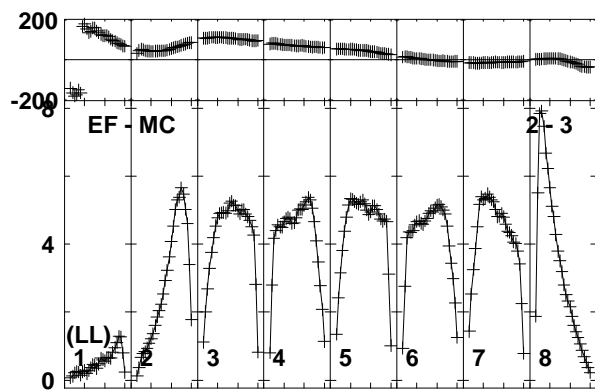
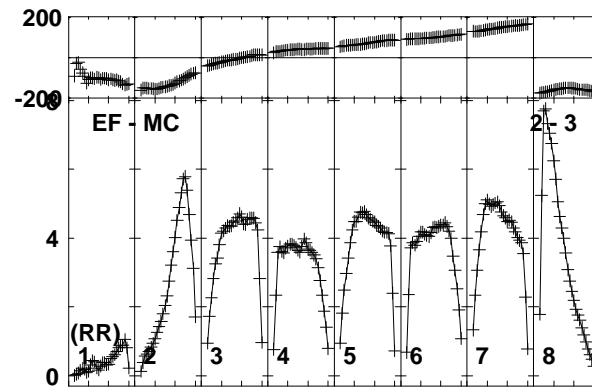
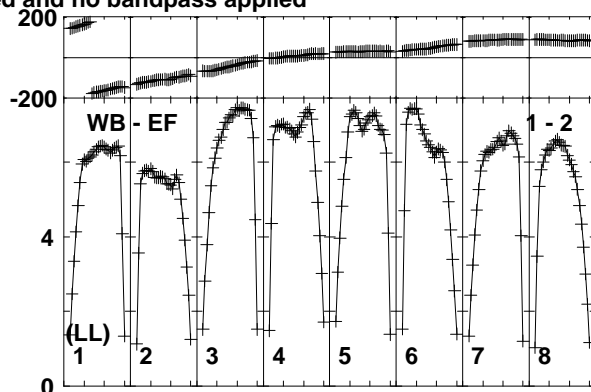
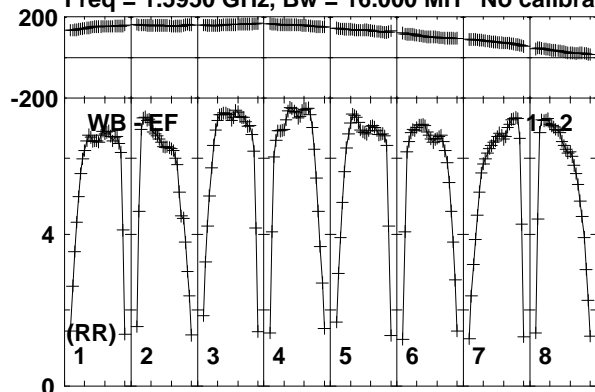

Lower frame: Milli Ampl Jy Top frame: Phas deg  
Vector averaged cross-power spectrum Baseline: WB (01) - EF (02)  
Timerange: 00/02:00:01 to 00/02:01:59

Plot file version 2 created 30-AUG-2019 17:53:05

J1722+2458 EB070.UVDATA.1

Freq = 1.5950 GHz, Bw = 16.000 MH No calibration applied and no bandpass applied

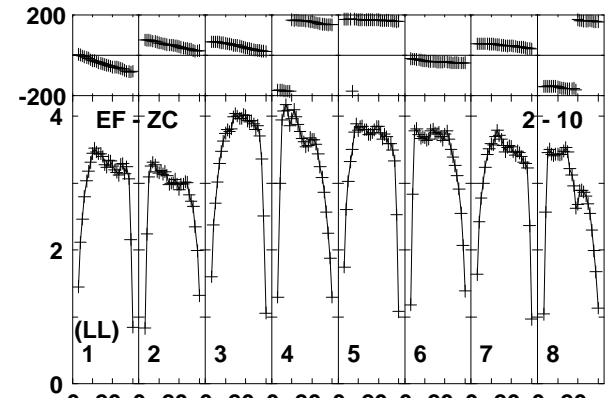
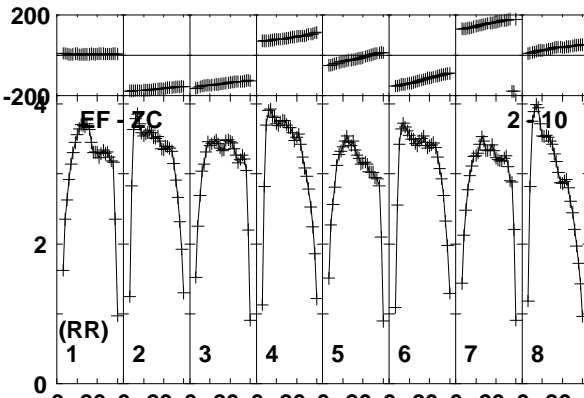
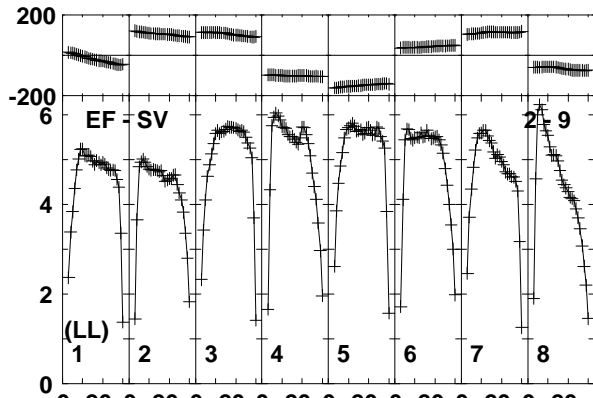
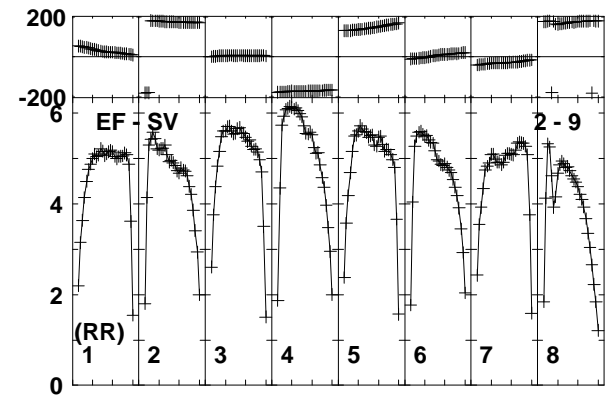
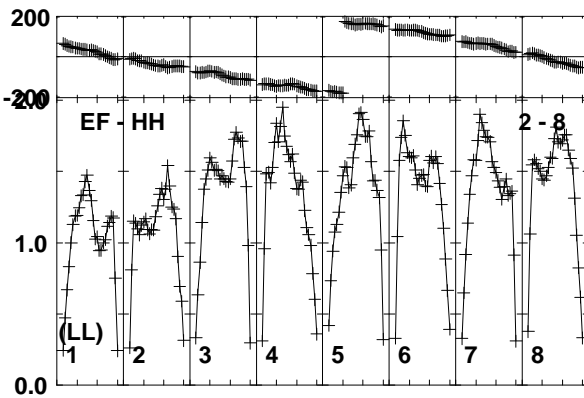
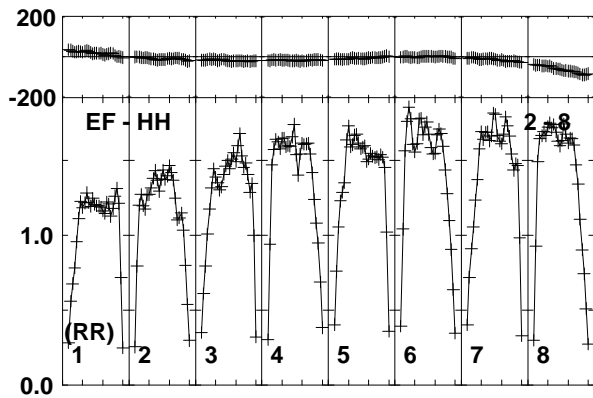
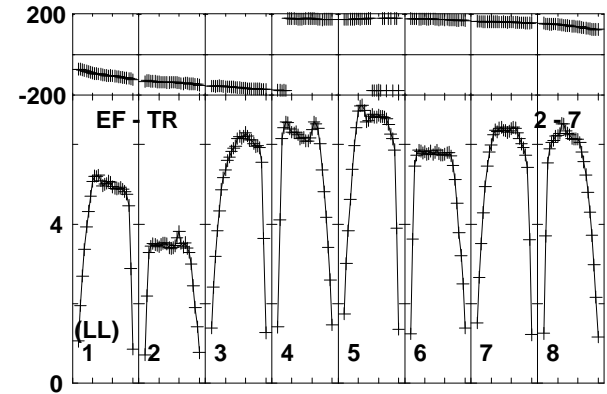
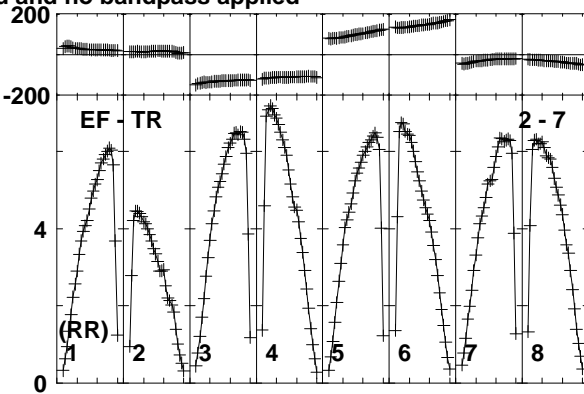
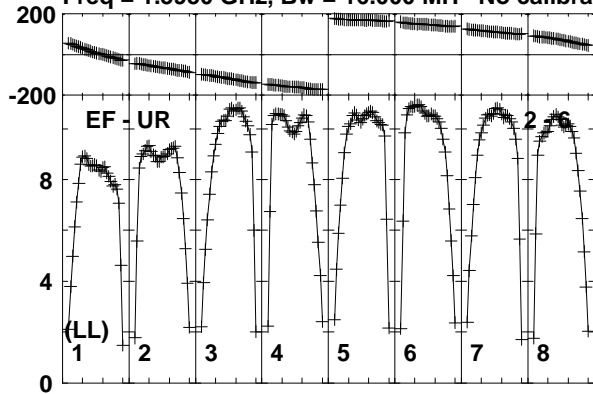

Lower frame: Milli Ampl Jy Top frame: Phas deg  
Vector averaged cross-power spectrum Baseline: EF (02) - UR (06)  
Timerange: 00/02:00:01 to 00/02:01:59

Plot file version 3 created 30-AUG-2019 17:53:05

J1722+2458 EB070.UVDATA.1

Freq = 1.5950 GHz, Bw = 16.000 MH No calibration applied and no bandpass applied

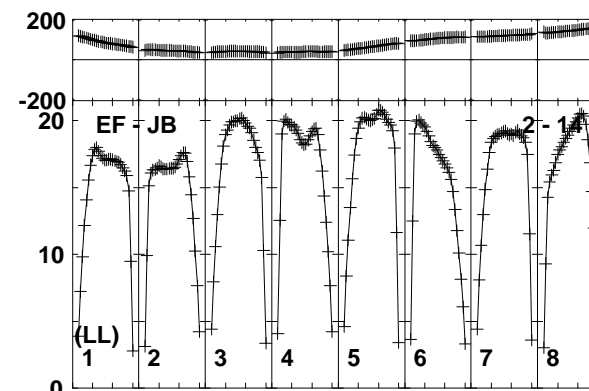
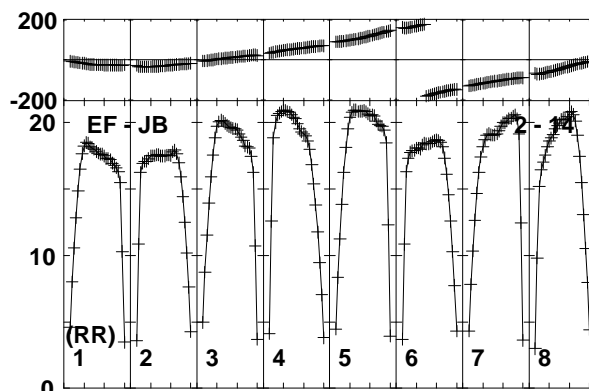
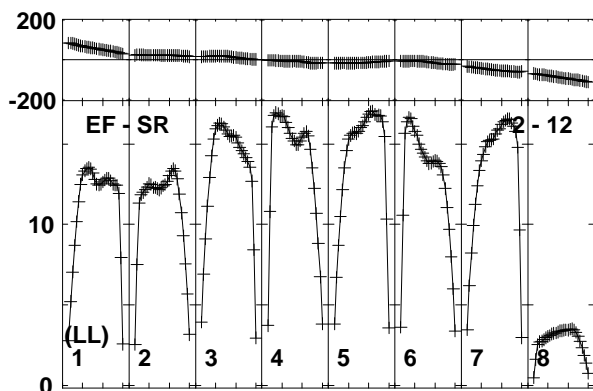
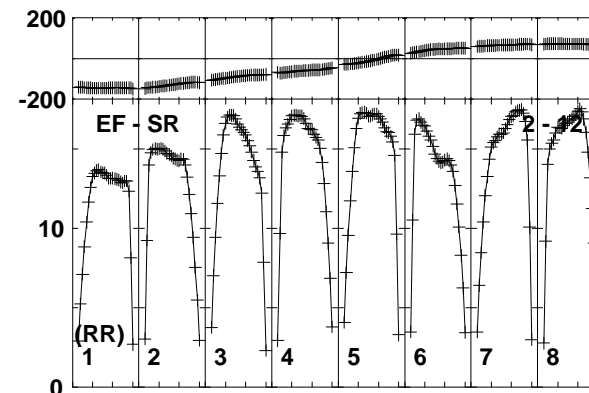
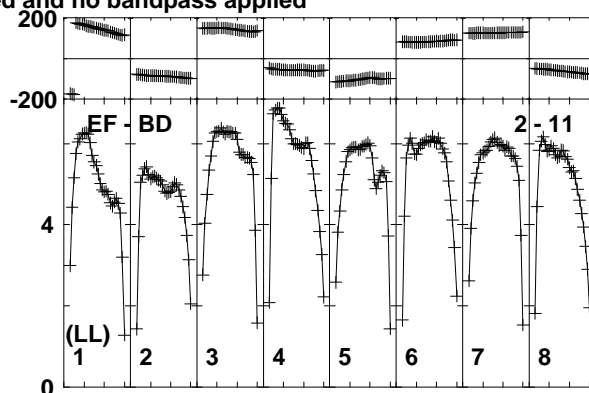
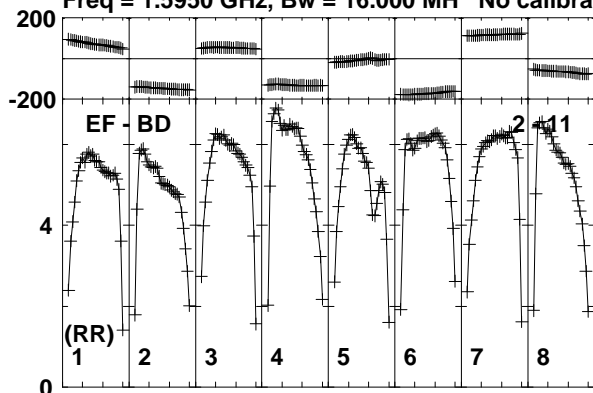

Channels

Lower frame: Milli Ampl Jy Top frame: Phas deg

Vector averaged cross-power spectrum Baseline: EF (02) - BD (11)

Timerange: 00/02:00:01 to 00/02:01:59

Plot file version 4 created 30-AUG-2019 17:53:05

ROSS867 EB070.UVDATA.1

Freq = 1.5950 GHz, Bw = 16.000 MH No calibration applied and no bandpass applied

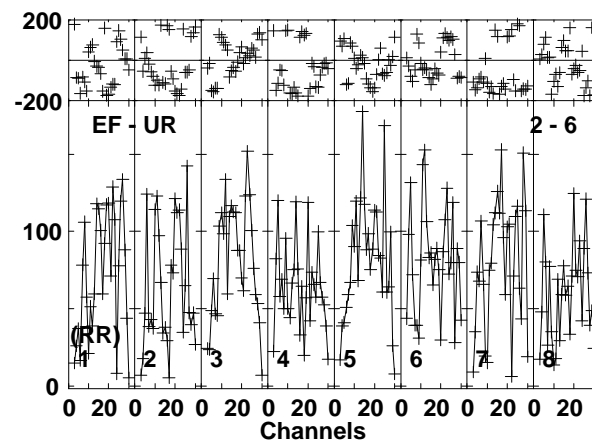
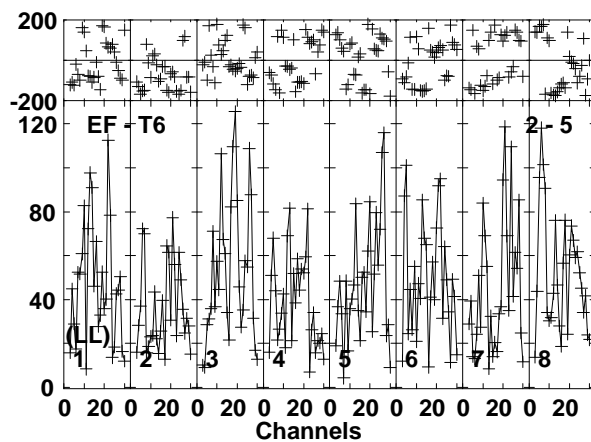
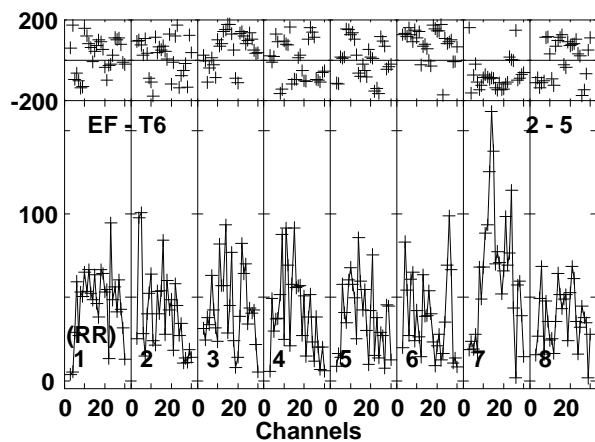
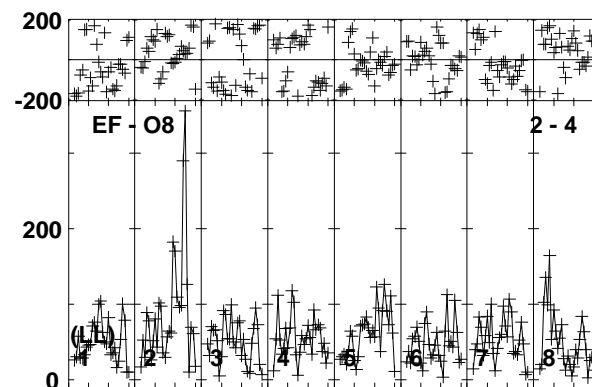
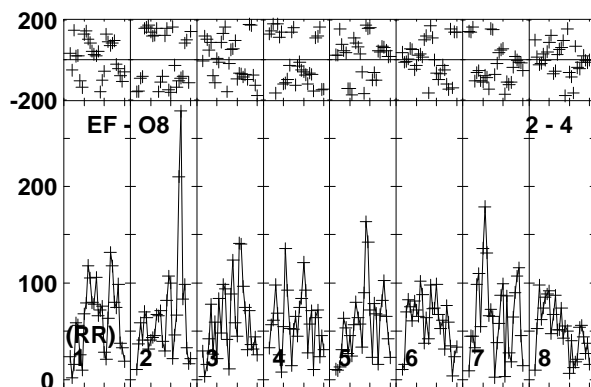
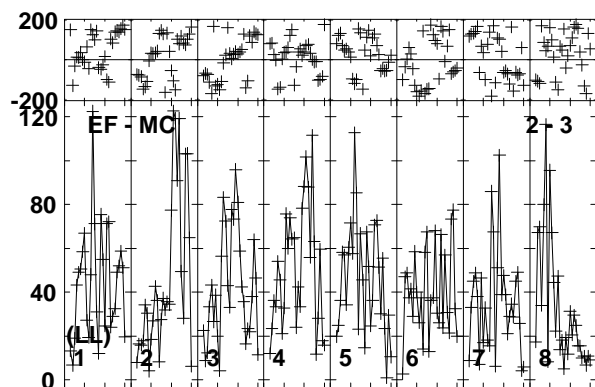
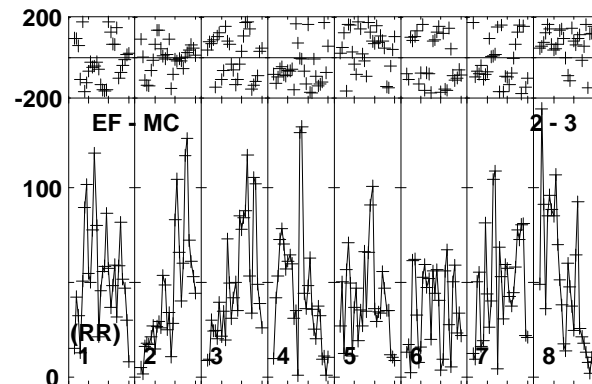
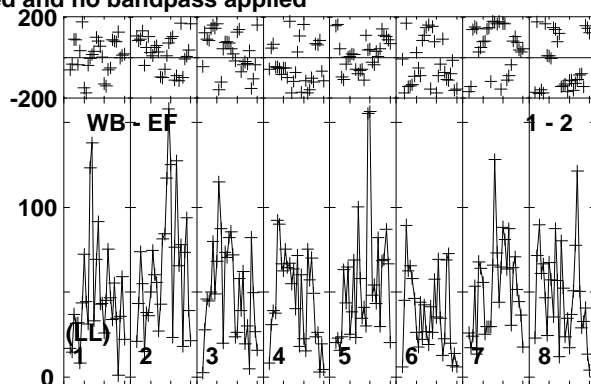
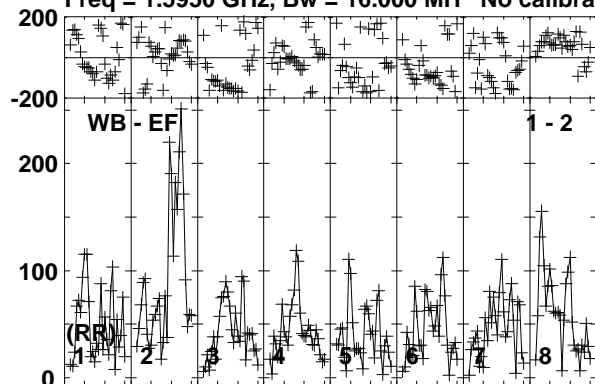

Lower frame: Micro Ampl Jy Top frame: Phas deg  
Vector averaged cross-power spectrum Baseline: WB (01) - EF (02)  
Timerange: 00/02:02:01 to 00/02:09:59

Plot file version 5 created 30-AUG-2019 17:53:06

ROSS867 EB070.UVDATA.1

Freq = 1.5950 GHz, Bw = 16.000 MH No calibration applied and no bandpass applied

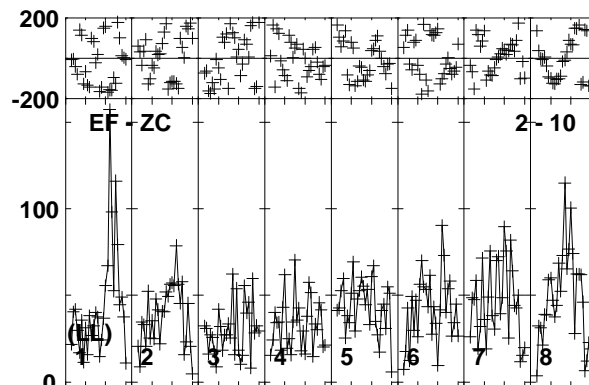
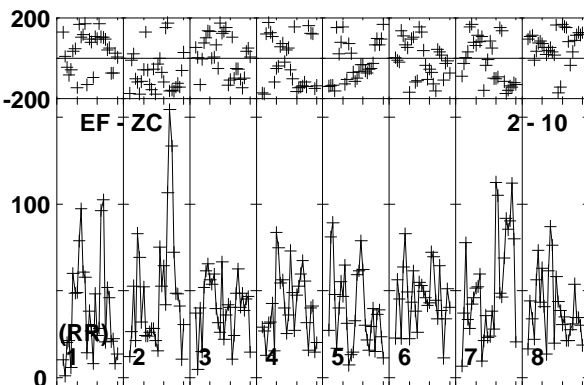
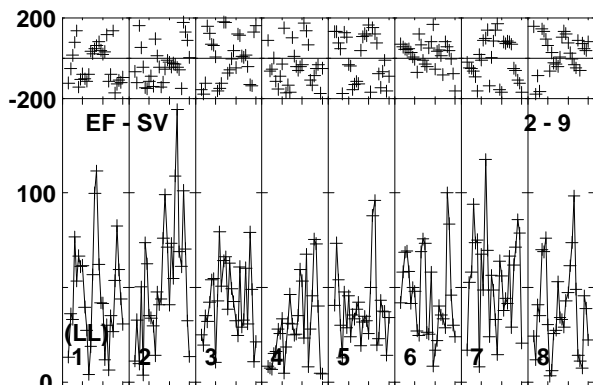
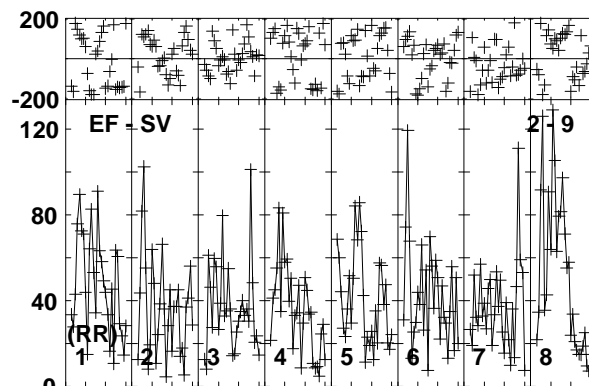
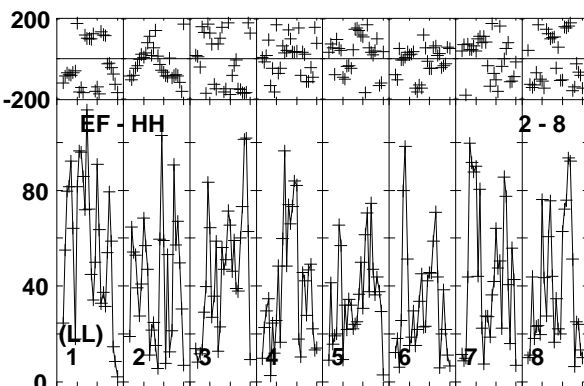
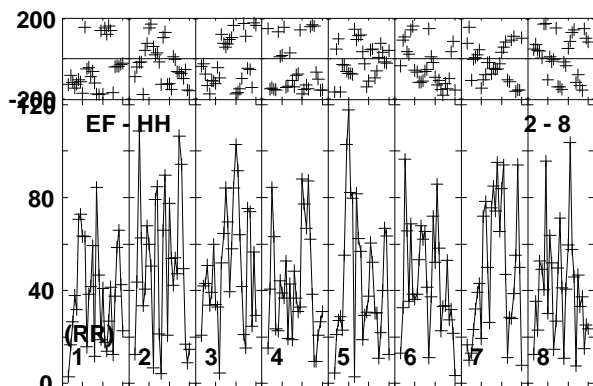
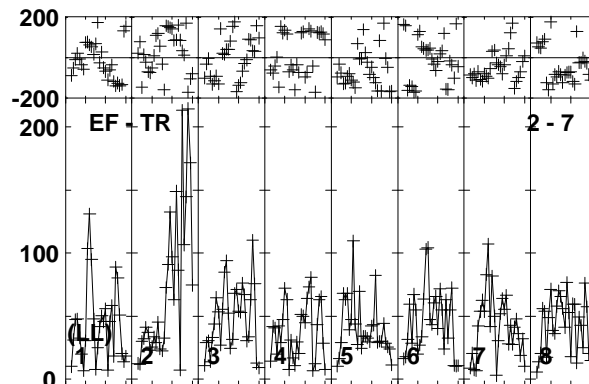
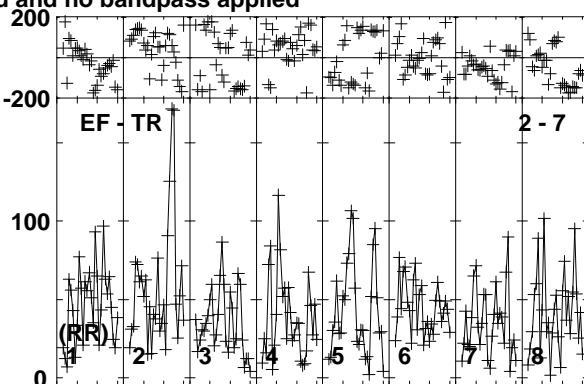
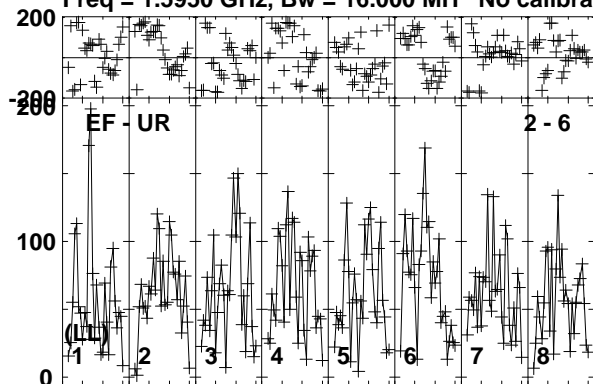

Lower frame: Micro Ampl Jy Top frame: Phas deg  
Vector averaged cross-power spectrum Baseline: EF (02) - UR (06)  
Timerange: 00/02:02:01 to 00/02:09:59

Plot file version 6 created 30-AUG-2019 17:53:06

ROSS867 EB070.UVDATA.1

Freq = 1.5950 GHz, Bw = 16.000 MH No calibration applied and no bandpass applied

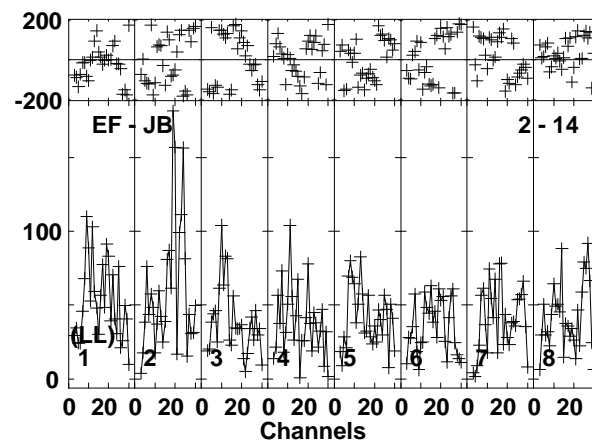
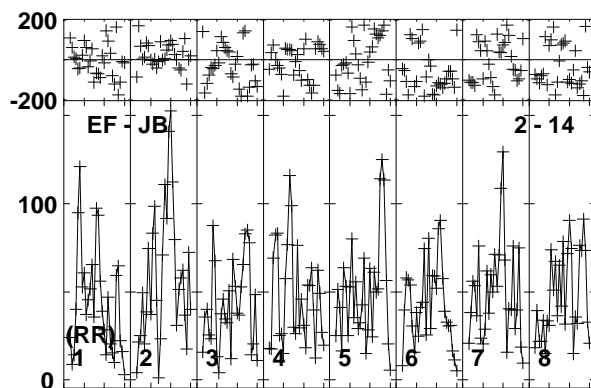
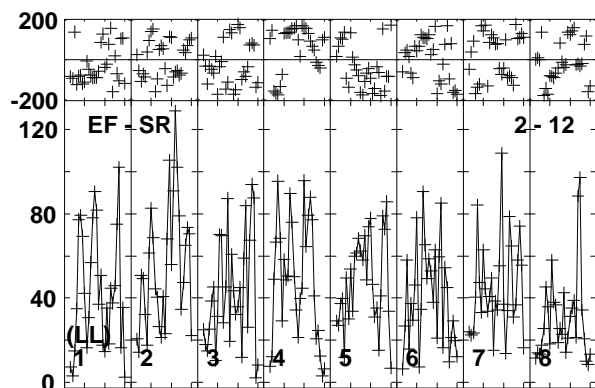
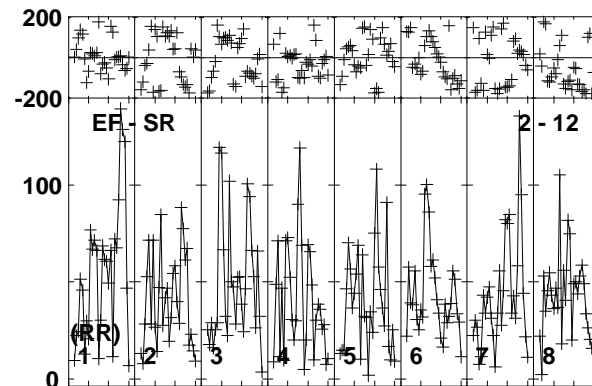
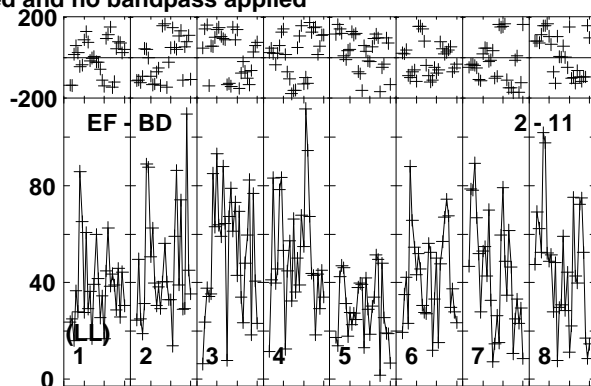
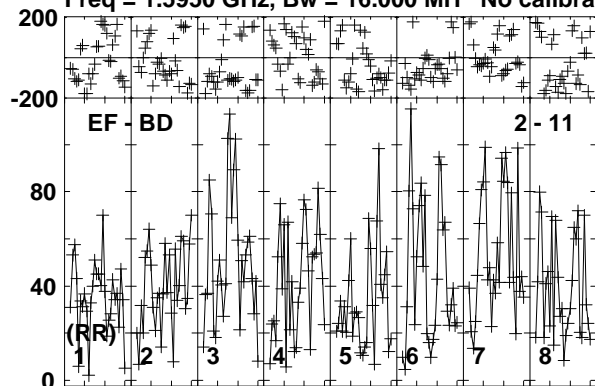

Lower frame: Micro Ampl Jy Top frame: Phas deg  
Vector averaged cross-power spectrum Baseline: EF (02) - BD (11)  
Timerange: 00/02:02:01 to 00/02:09:59

Plot file version 7 created 30-AUG-2019 17:53:06

J1722+2458 EB070.UVDATA.1

Freq = 1.5950 GHz, Bw = 16.000 MH No calibration applied and no bandpass applied

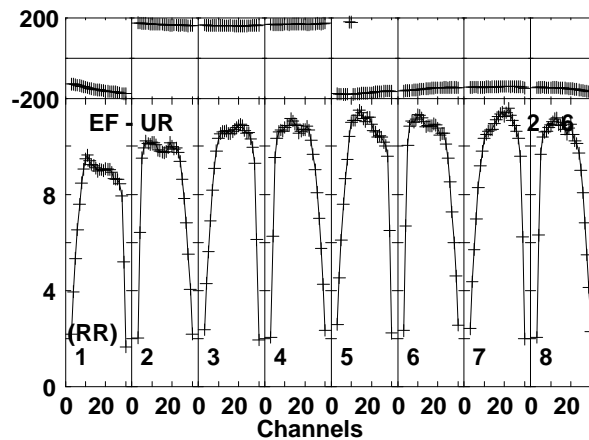
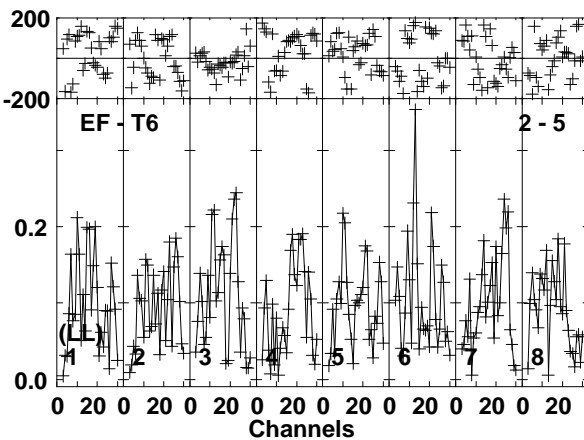
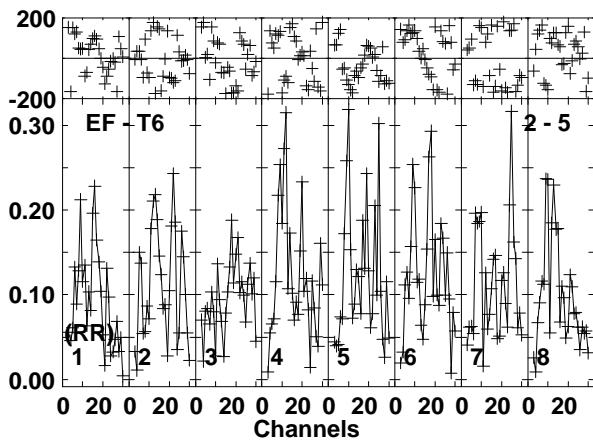
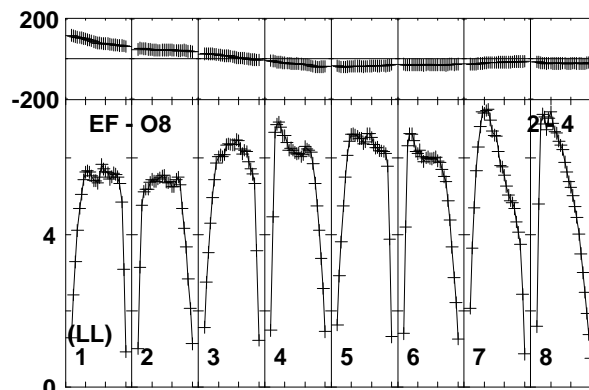
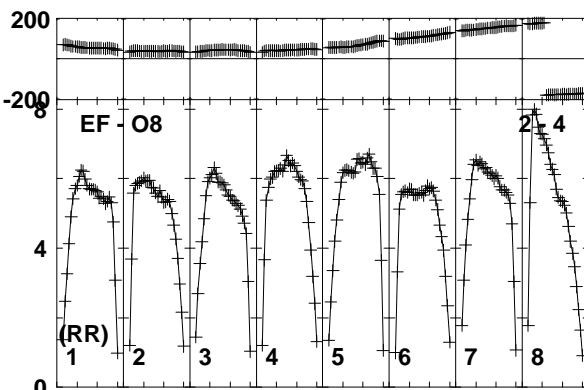
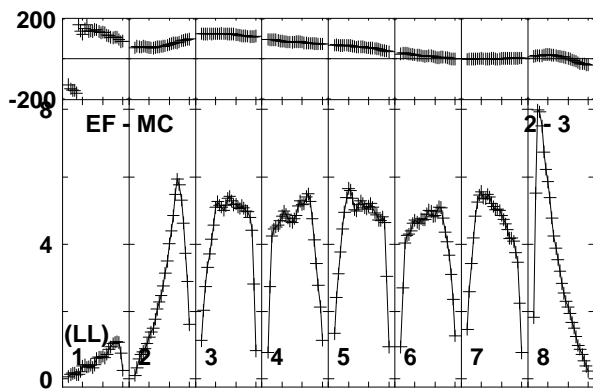
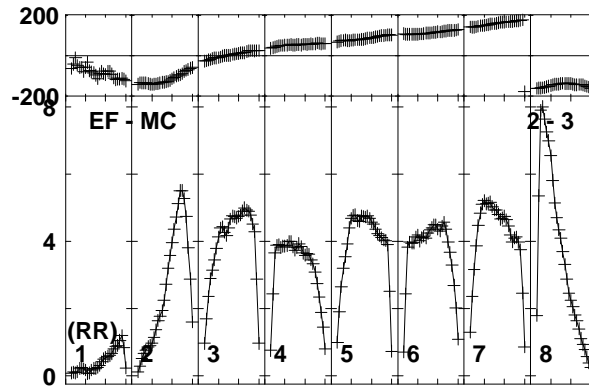
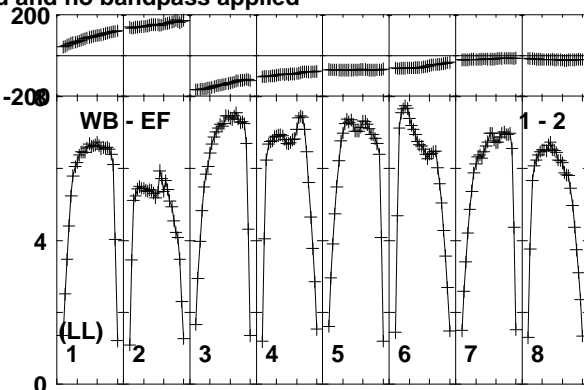
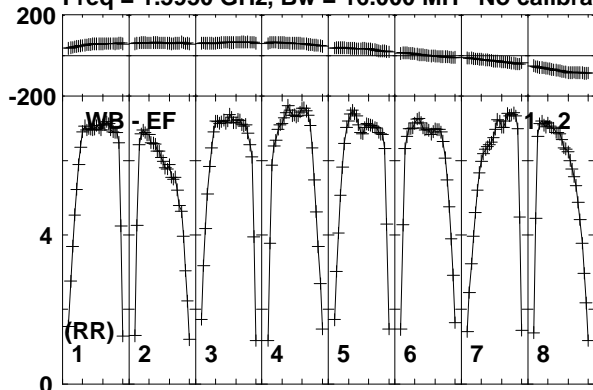

Lower frame: Milli Ampl Jy Top frame: Phas deg  
Vector averaged cross-power spectrum Baseline: WB (01) - EF (02)  
Timerange: 00/02:10:41 to 00/02:11:59

Plot file version 8 created 30-AUG-2019 17:53:06

J1722+2458 EB070.UVDATA.1

Freq = 1.5950 GHz, Bw = 16.000 MH No calibration applied and no bandpass applied

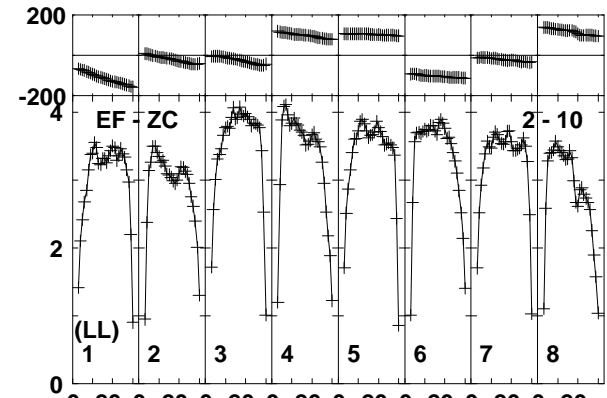
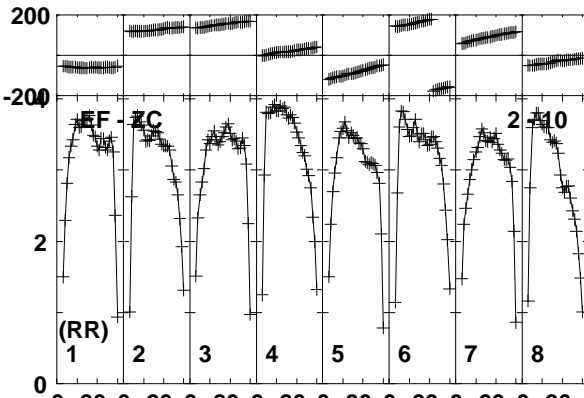
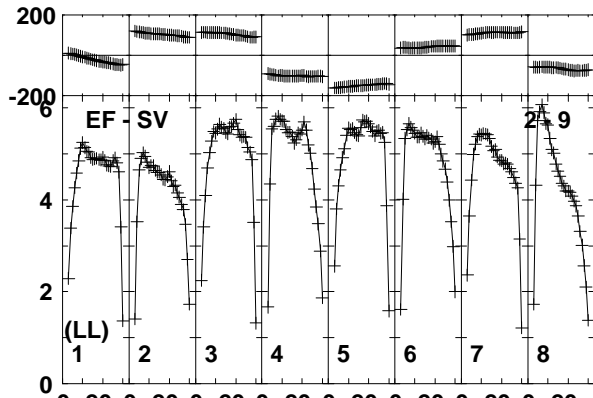
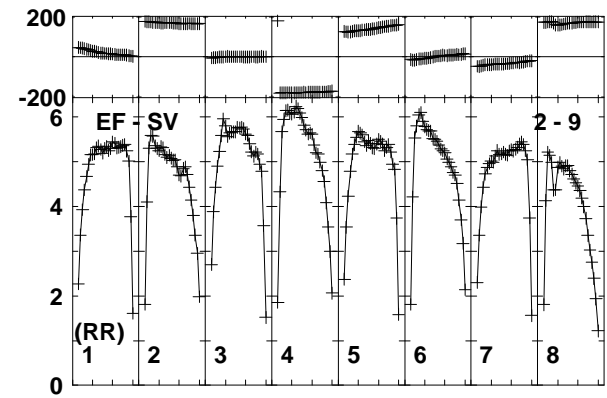
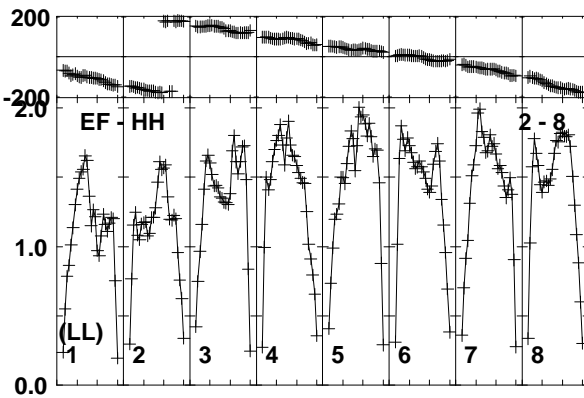
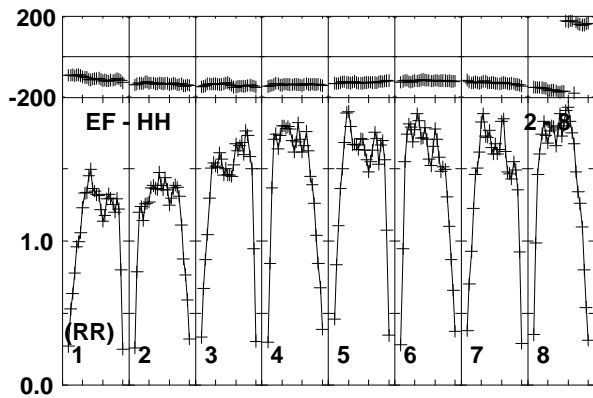
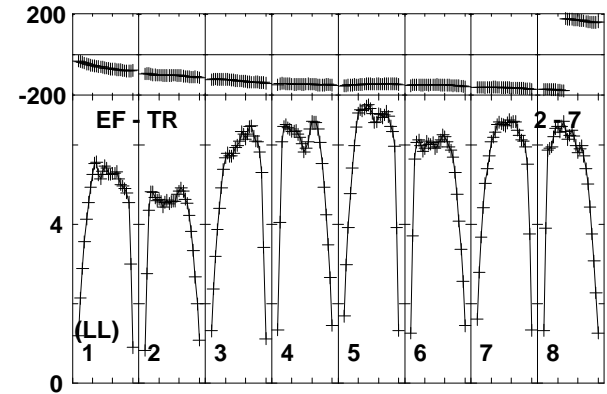
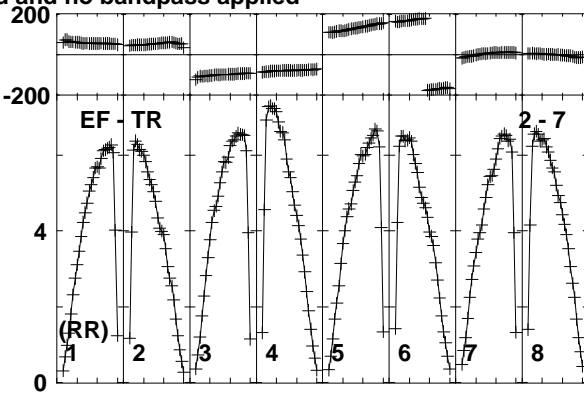
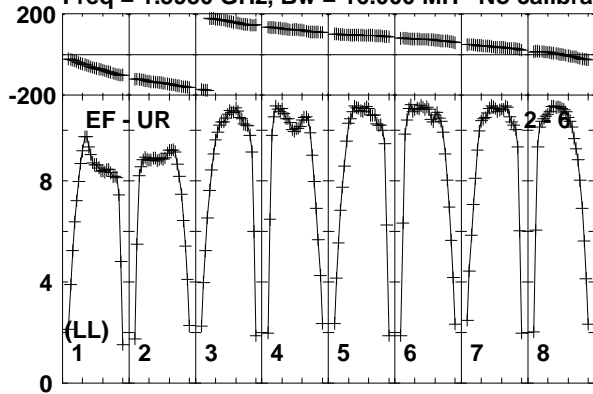

Lower frame: Milli Ampl Jy Top frame: Phas deg  
Vector averaged cross-power spectrum Baseline: EF (02) - UR (06)  
Timerange: 00/02:10:41 to 00/02:11:59



Plot file version 9 created 30-AUG-2019 17:53:06

J1722+2458 EB070.UVDATA.1

Freq = 1.5950 GHz, Bw = 16.000 MH No calibration applied and no bandpass applied

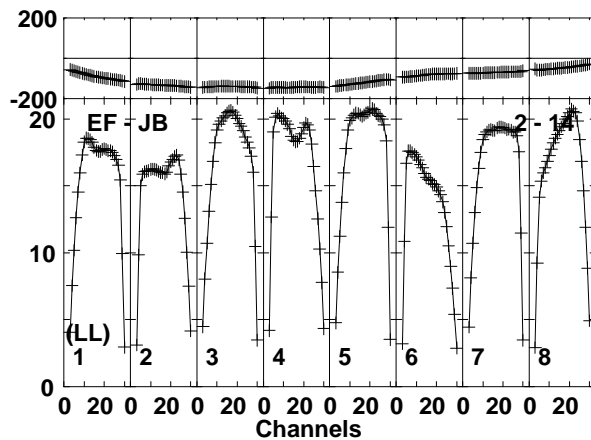
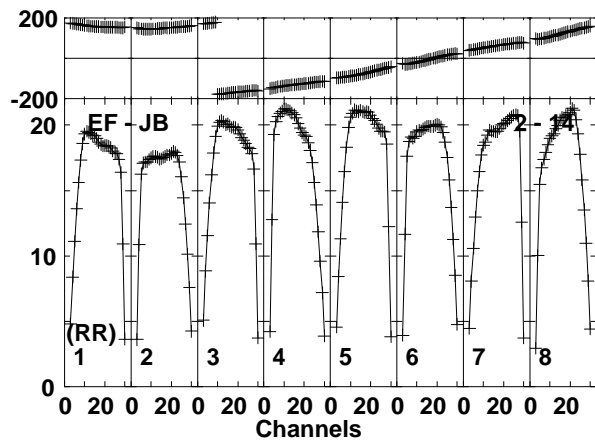
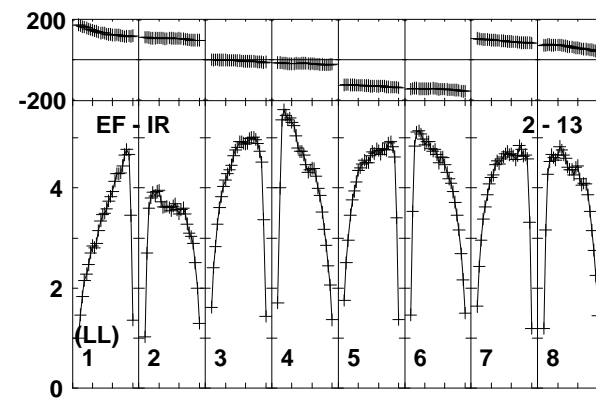
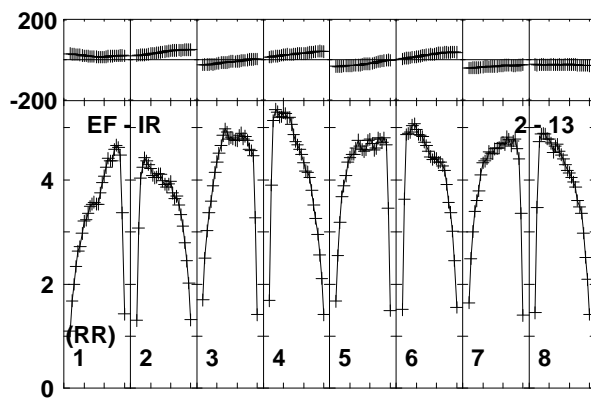
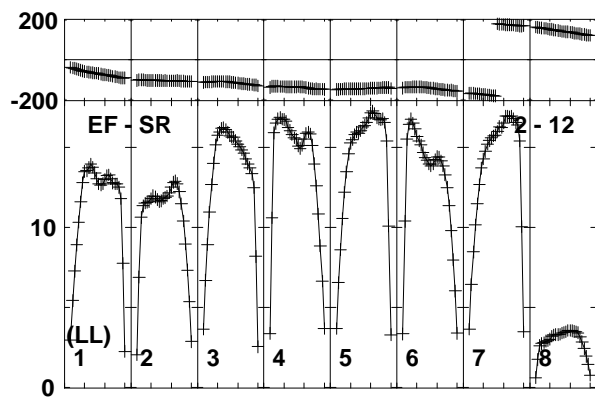
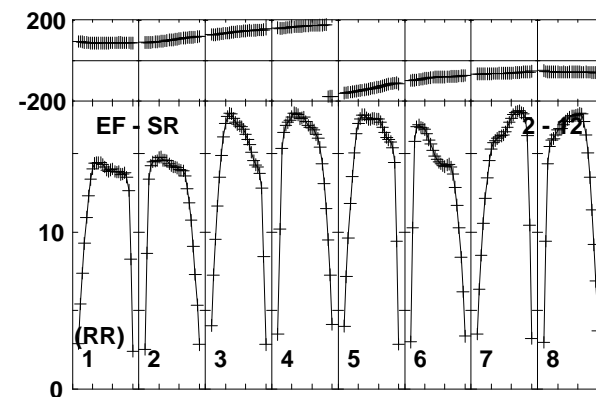
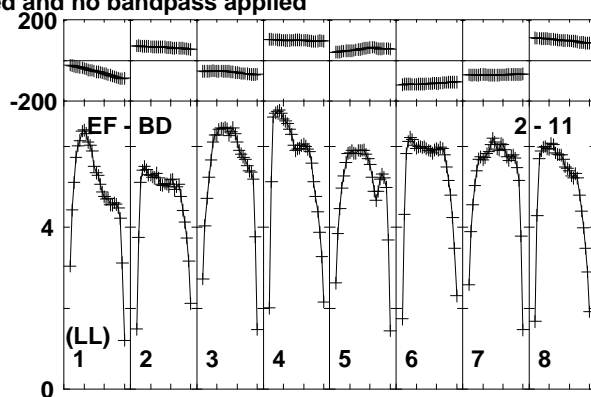
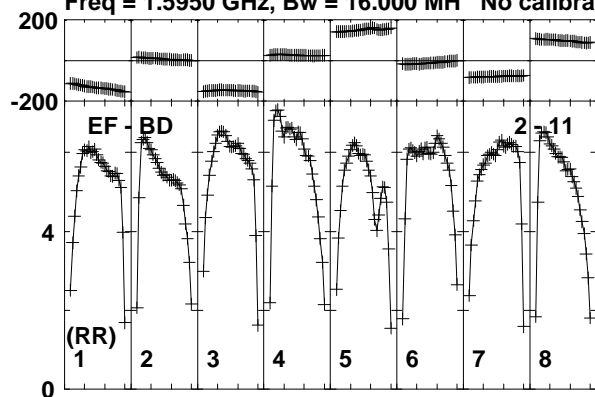

Lower frame: Milli Ampl Jy Top frame: Phas deg  
Vector averaged cross-power spectrum Baseline: EF (02) - BD (11)  
Timerange: 00/02:10:41 to 00/02:11:59

Plot file version 10 created 30-AUG-2019 17:53:07

ROSS867 EB070.UVDATA.1

Freq = 1.5950 GHz, Bw = 16.000 MH No calibration applied and no bandpass applied

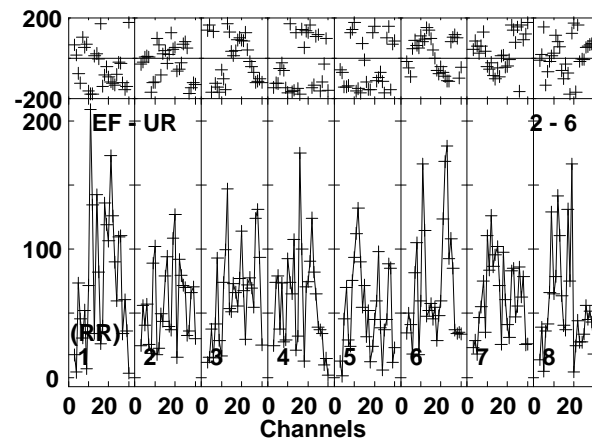
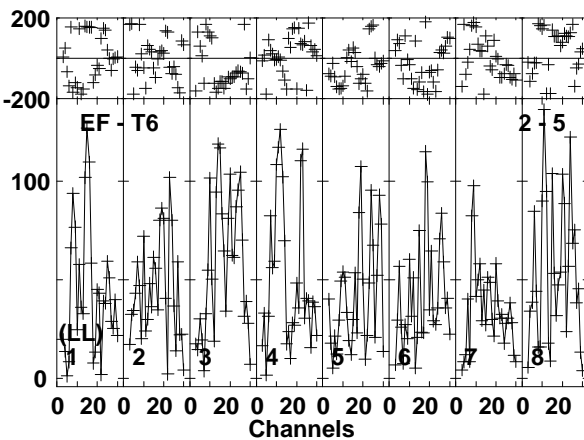
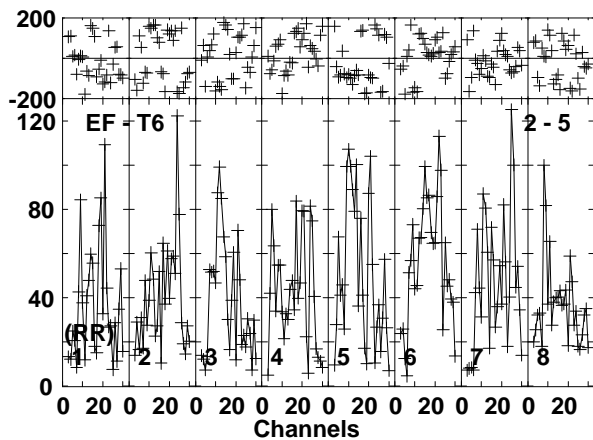
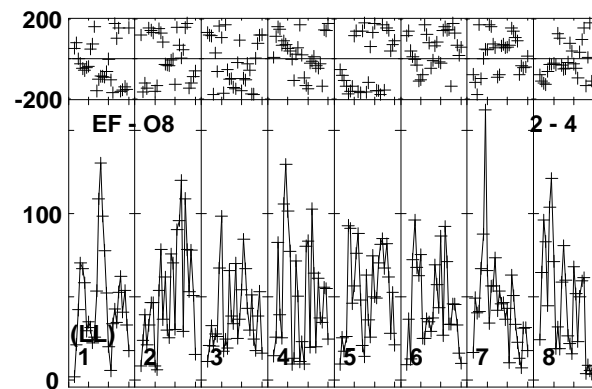
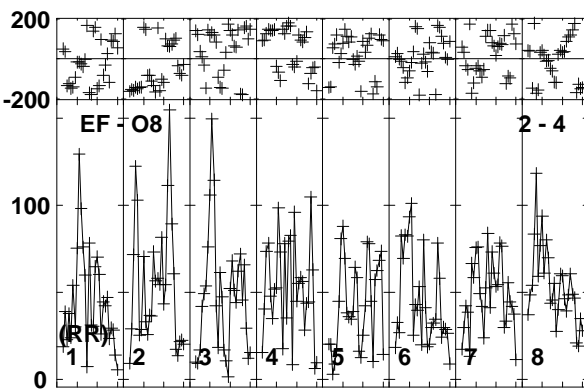
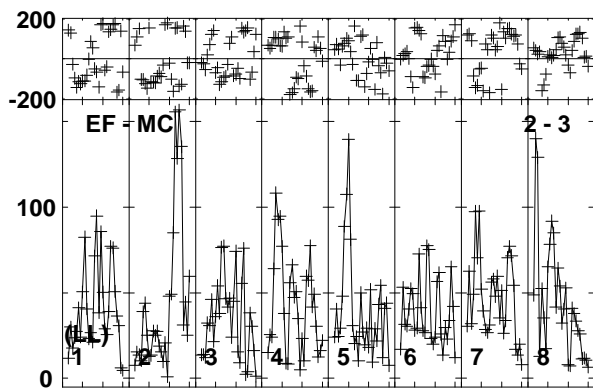
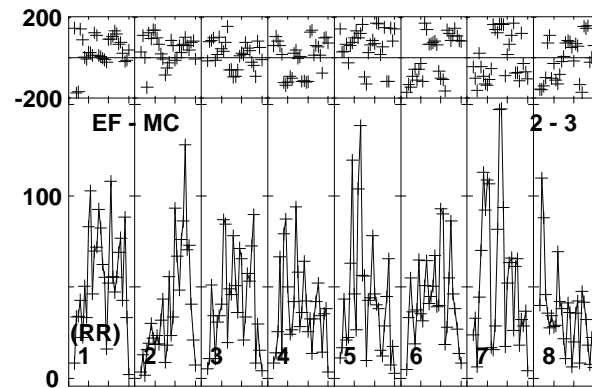
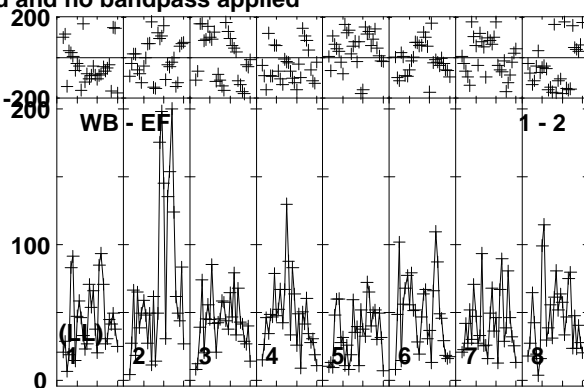
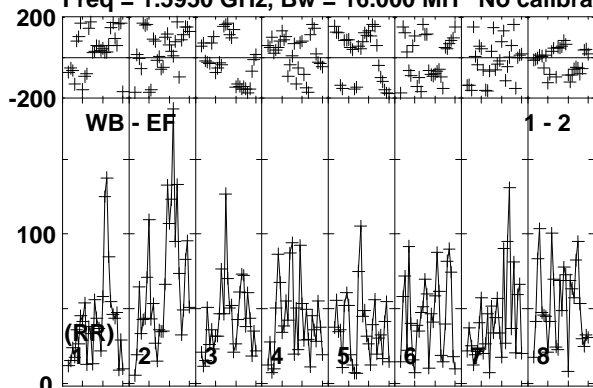

Lower frame: Micro Ampl Jy Top frame: Phas deg  
Vector averaged cross-power spectrum Baseline: WB (01) - EF (02)  
Timerange: 00/02:12:01 to 00/02:19:59

Plot file version 11 created 30-AUG-2019 17:53:07

ROSS867 EB070.UVDATA.1

Freq = 1.5950 GHz, Bw = 16.000 MH No calibration applied and no bandpass applied

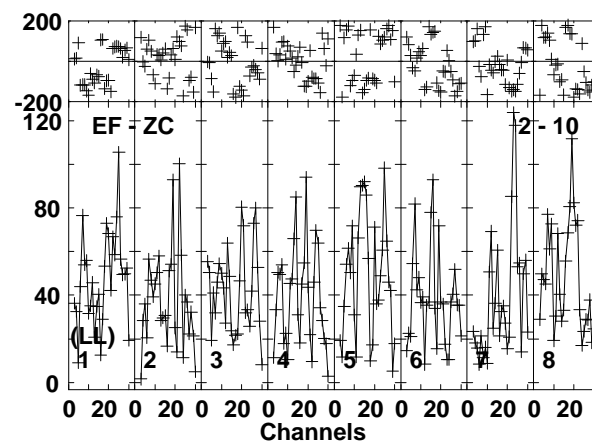
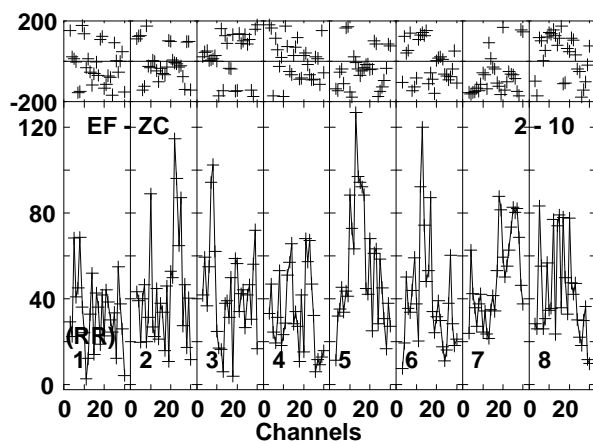
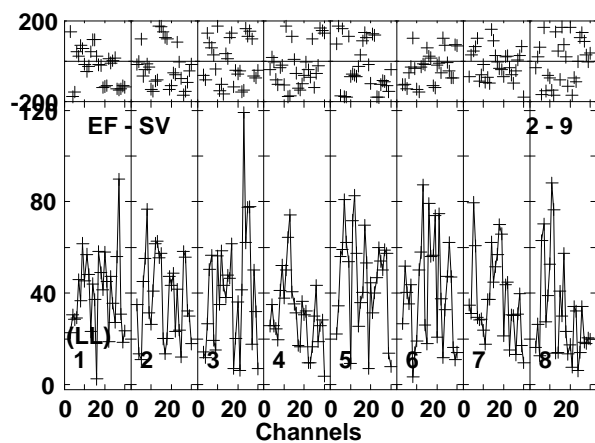
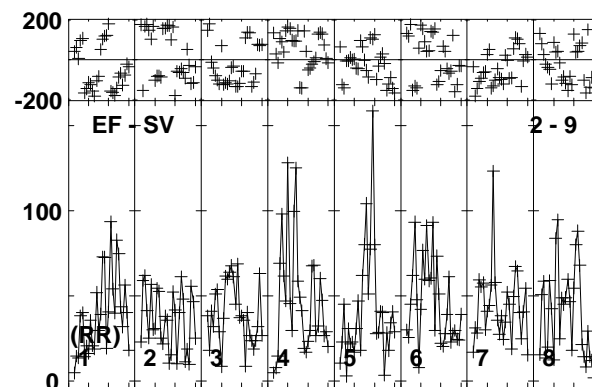
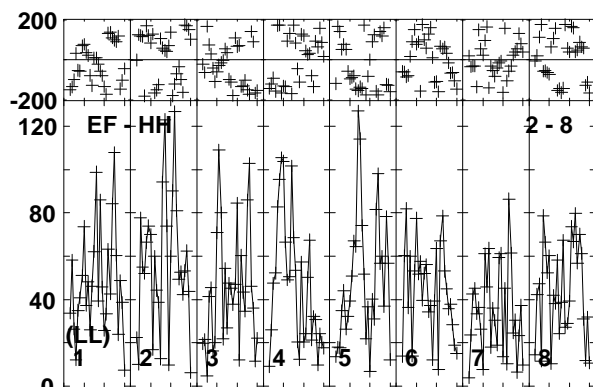
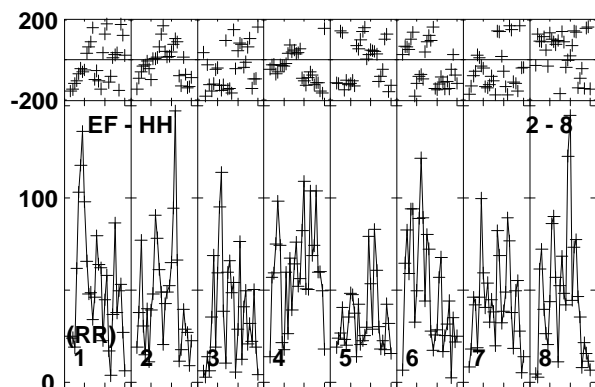
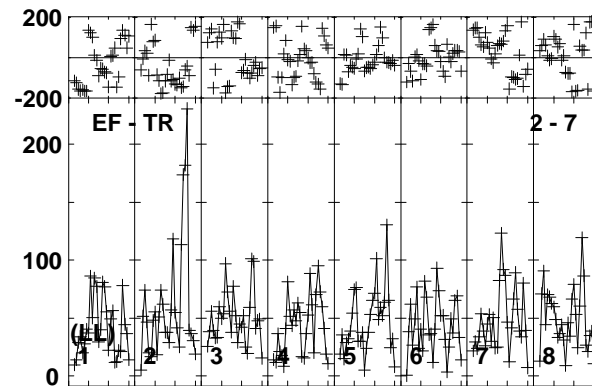
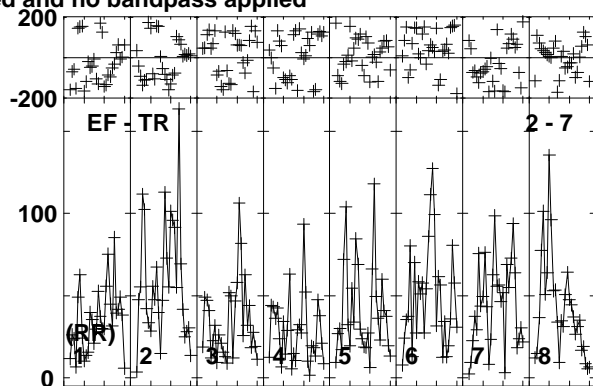
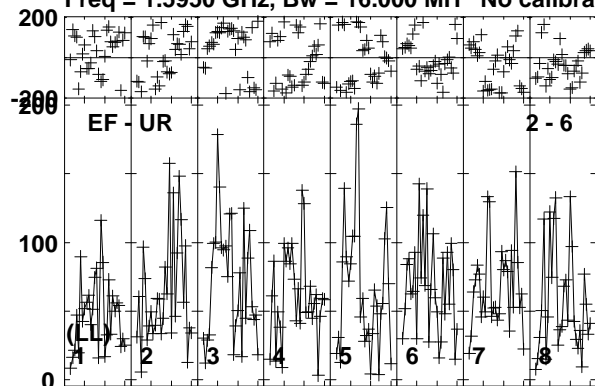

Lower frame: Micro Ampl Jy Top frame: Phas deg  
Vector averaged cross-power spectrum Baseline: EF (02) - UR (06)  
Timerange: 00/02:12:01 to 00/02:19:59

Plot file version 12 created 30-AUG-2019 17:53:07

ROSS867 EB070.UVDATA.1

Freq = 1.5950 GHz, Bw = 16.000 MH No calibration applied and no bandpass applied

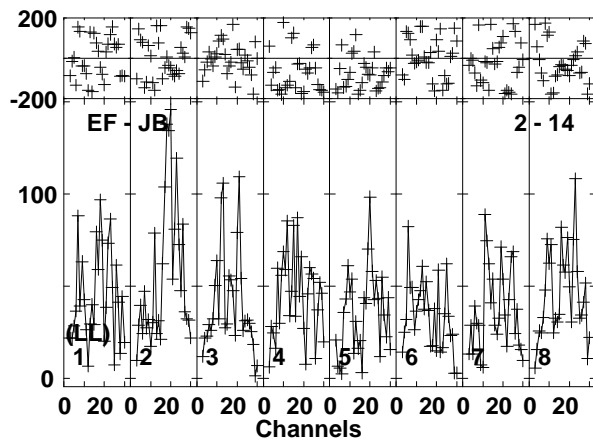
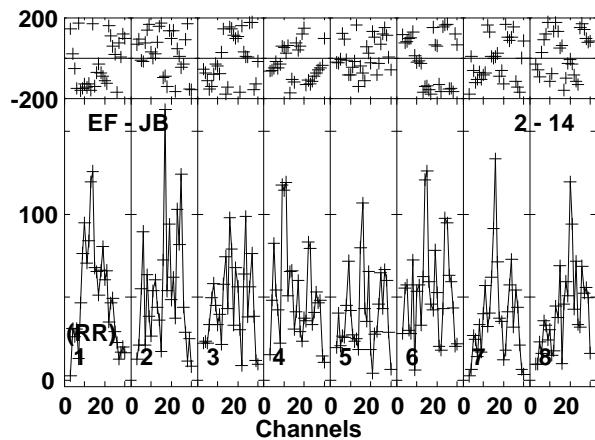
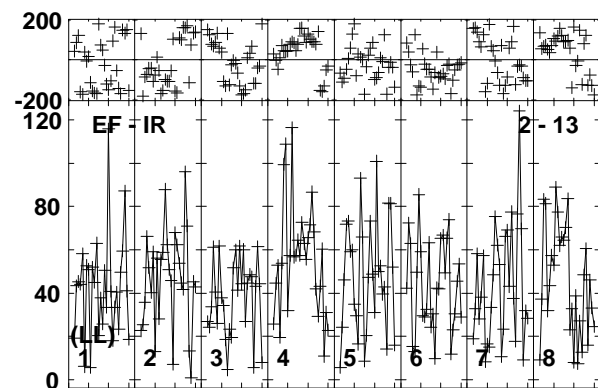
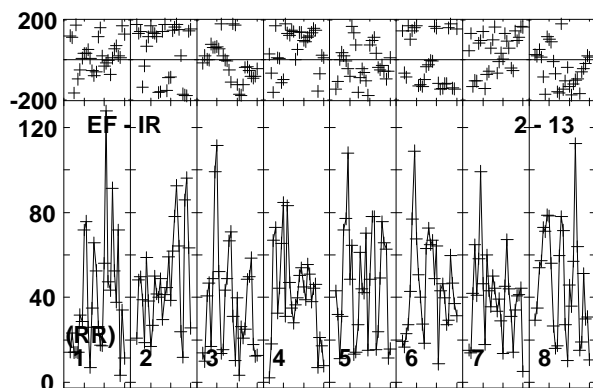
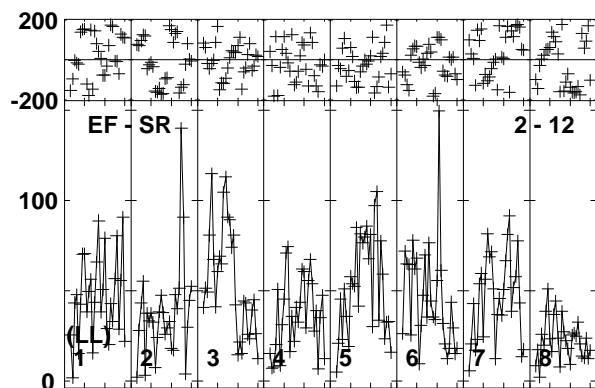
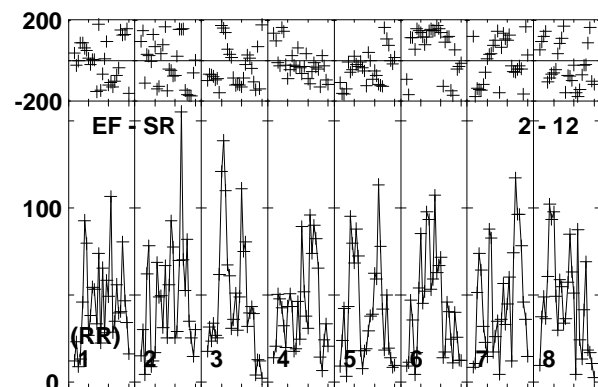
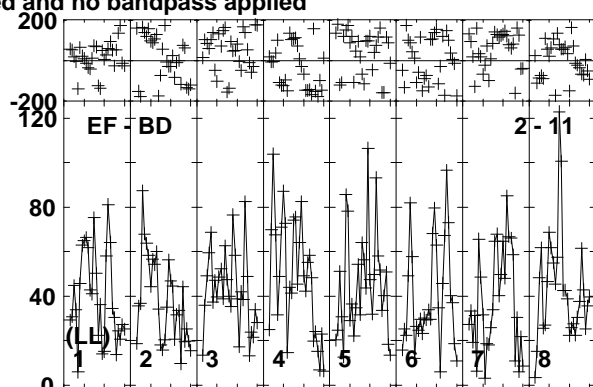
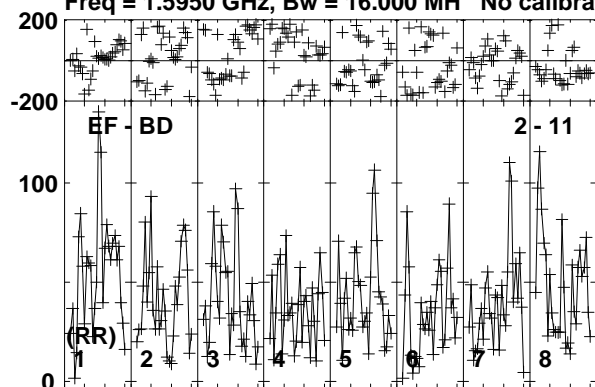

Lower frame: Micro Ampl Jy Top frame: Phas deg  
Vector averaged cross-power spectrum Baseline: EF (02) - BD (11)  
Timerange: 00/02:12:01 to 00/02:19:59

Plot file version 13 created 30-AUG-2019 17:53:07

J1722+2458 EB070.UVDATA.1

Freq = 1.5950 GHz, Bw = 16.000 MH No calibration applied and no bandpass applied

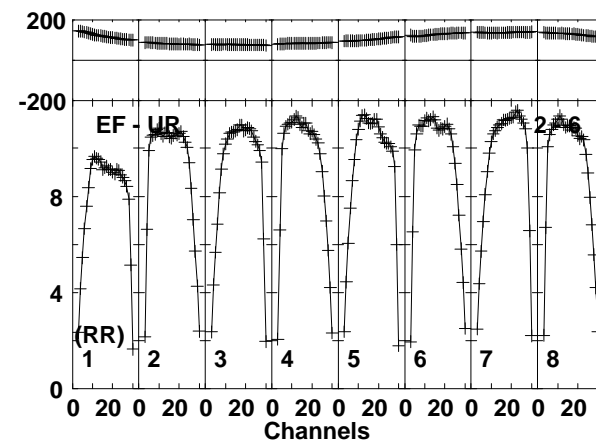
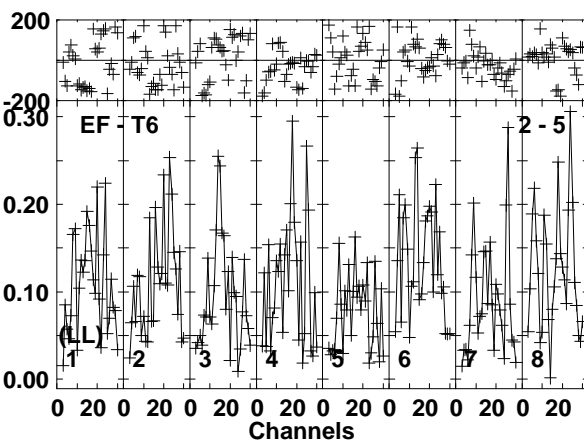
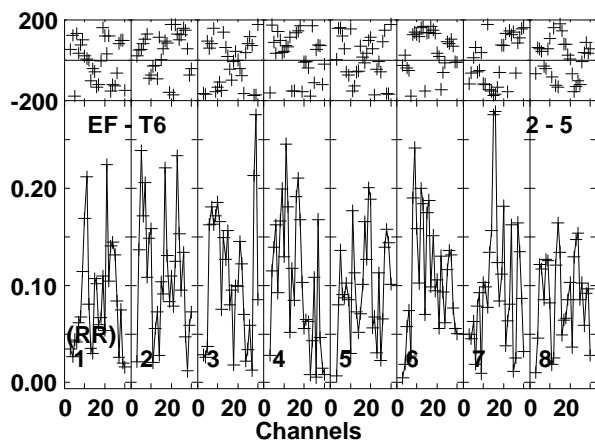
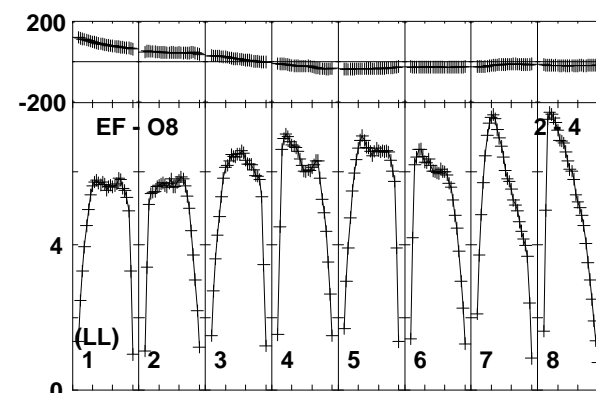
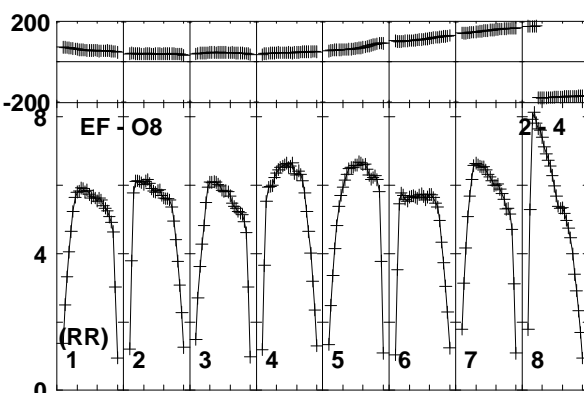
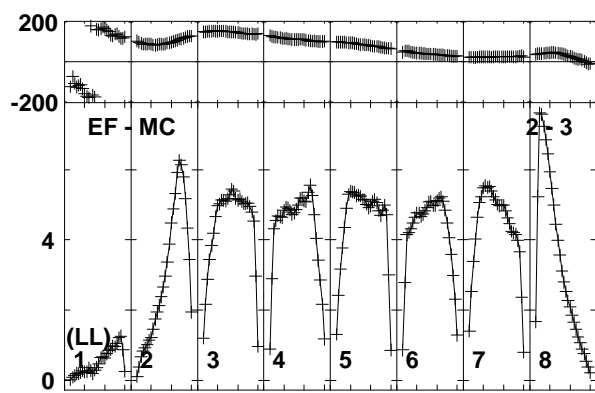
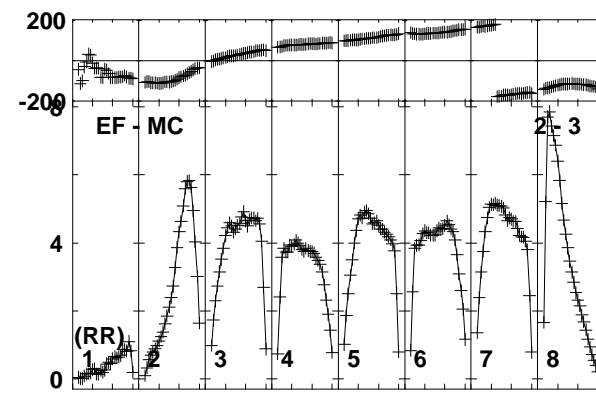
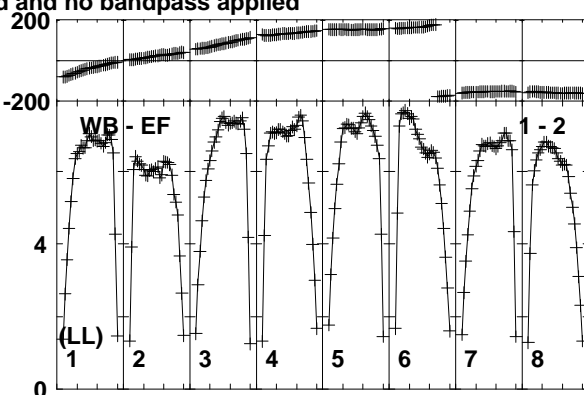
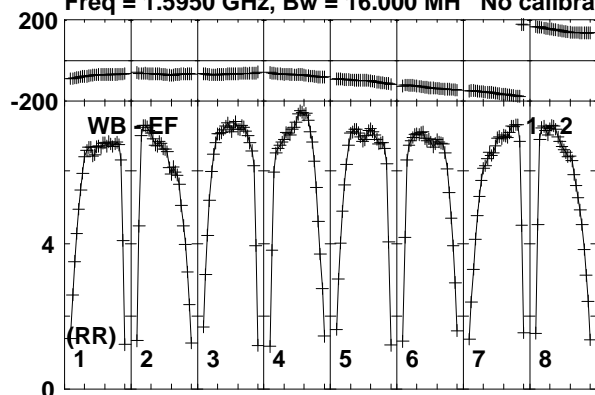

Lower frame: Milli Ampl Jy Top frame: Phas deg  
Vector averaged cross-power spectrum Baseline: WB (01) - EF (02)  
Timerange: 00/02:20:01 to 00/02:21:59

Plot file version 14 created 30-AUG-2019 17:53:08

J1722+2458 EB070.UVDATA.1

Freq = 1.5950 GHz, Bw = 16.000 MH No calibration applied and no bandpass applied

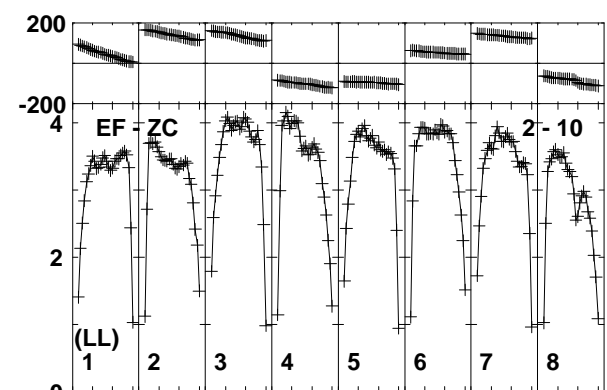
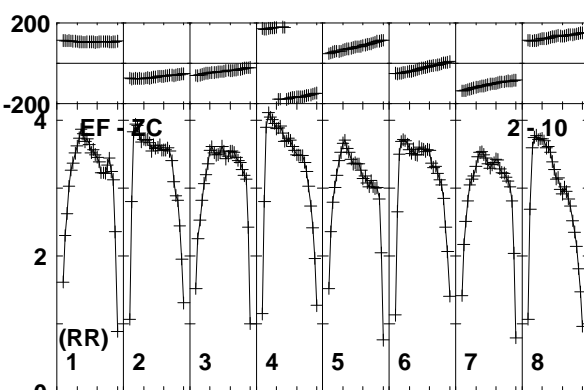
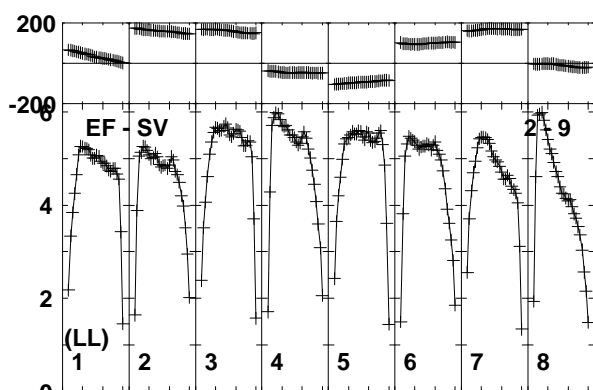
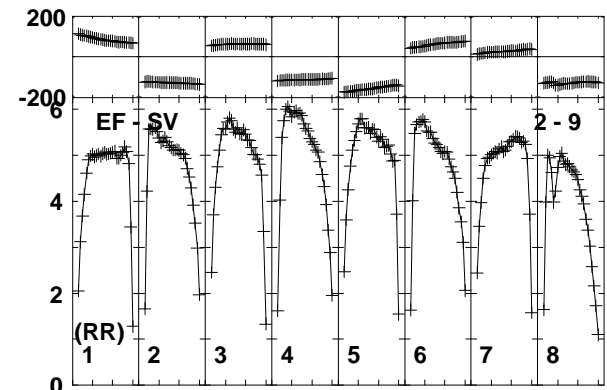
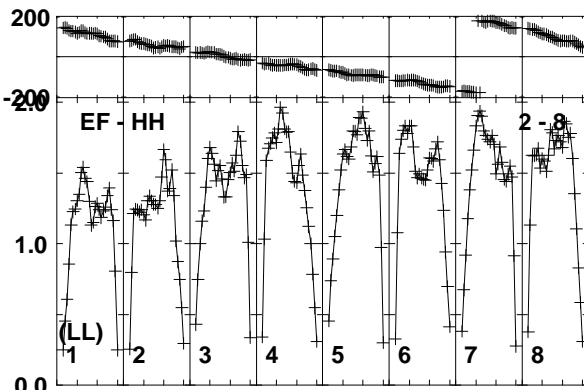
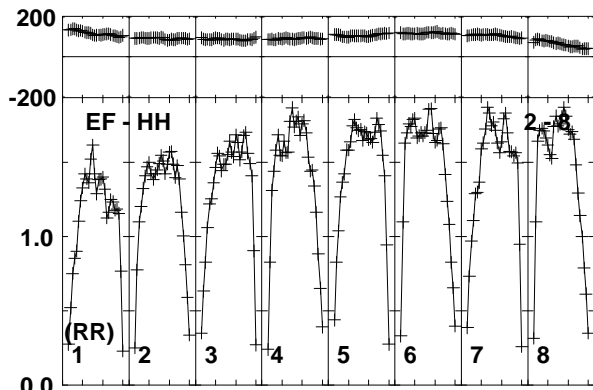
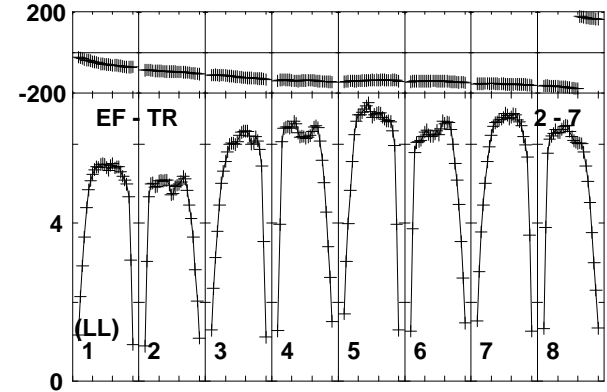
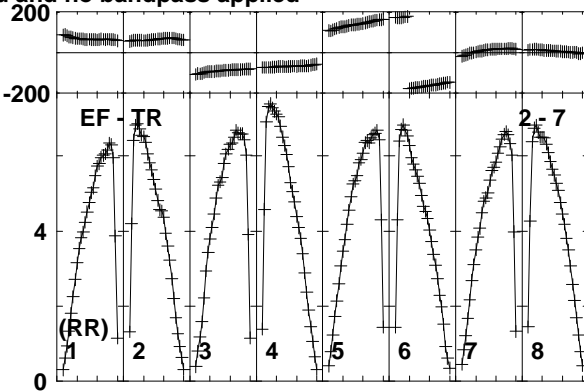
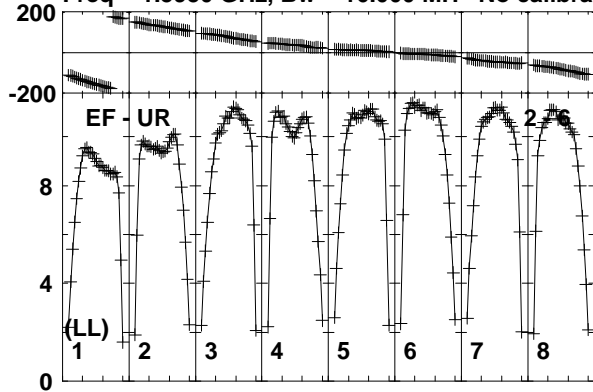

Lower frame: Milli Ampl Jy Top frame: Phas deg  
Vector averaged cross-power spectrum Baseline: EF (02) - UR (06)  
Timerange: 00/02:20:01 to 00/02:21:59

Plot file version 15 created 30-AUG-2019 17:53:08

J1722+2458 EB070.UVDATA.1

Freq = 1.5950 GHz, Bw = 16.000 MH No calibration applied and no bandpass applied

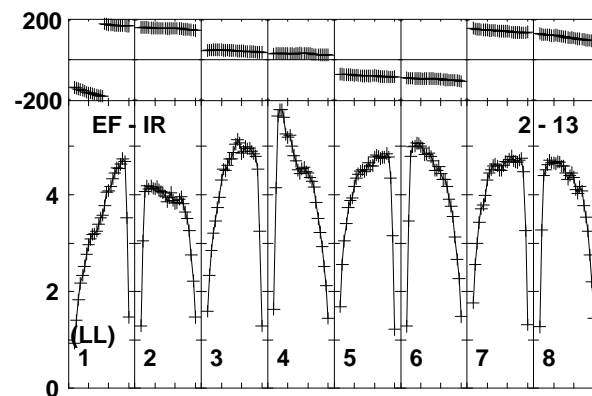
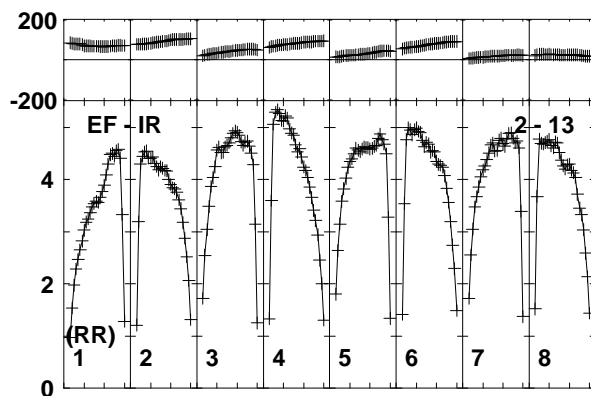
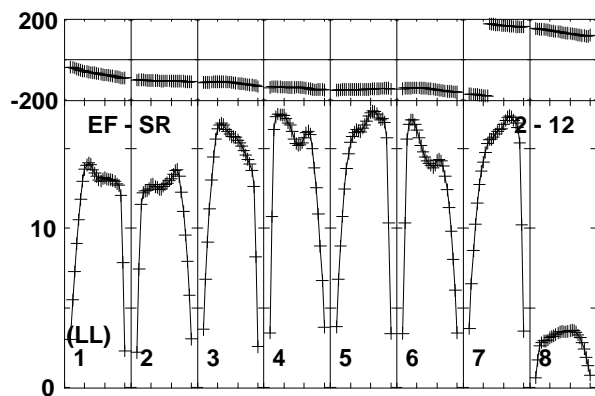
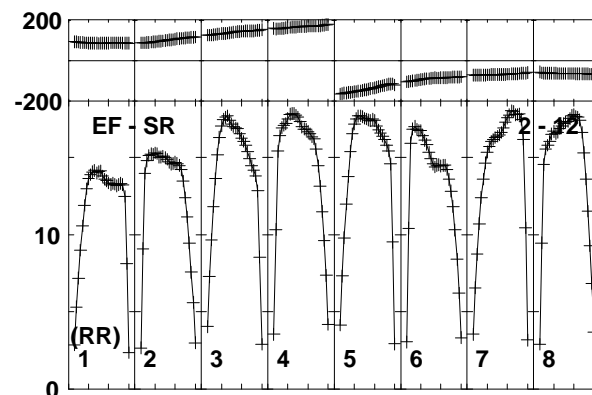
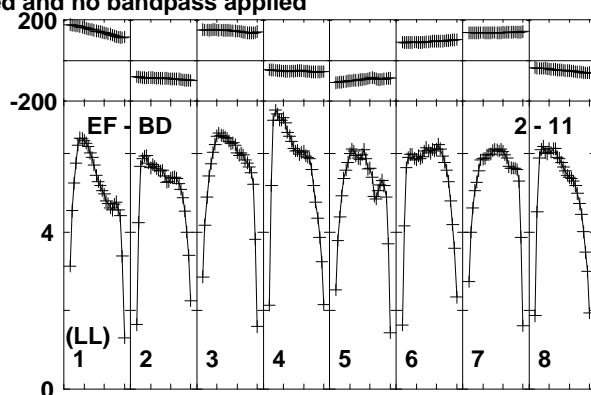
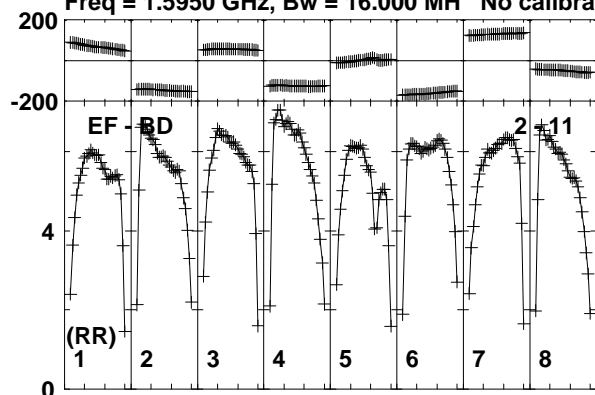

Channels

Lower frame: Milli Ampl Jy Top frame: Phas deg  
Vector averaged cross-power spectrum Baseline: EF (02) - BD (11)  
Timerange: 00/02:20:01 to 00/02:21:59

Plot file version 16 created 30-AUG-2019 17:53:08  
ROSS867 EB070.UVDATA.1

Freq = 1.5950 GHz, Bw = 16.000 MH No calibration applied and no bandpass applied

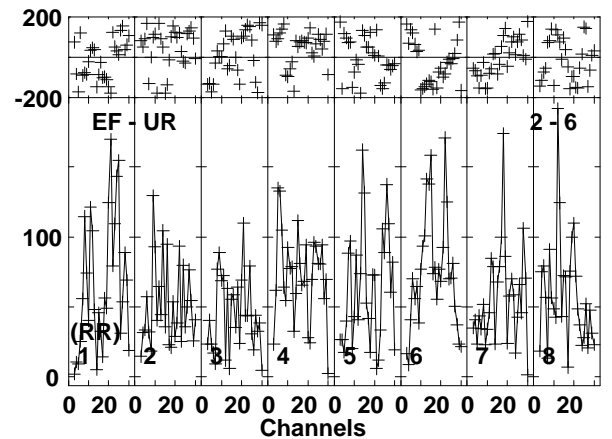
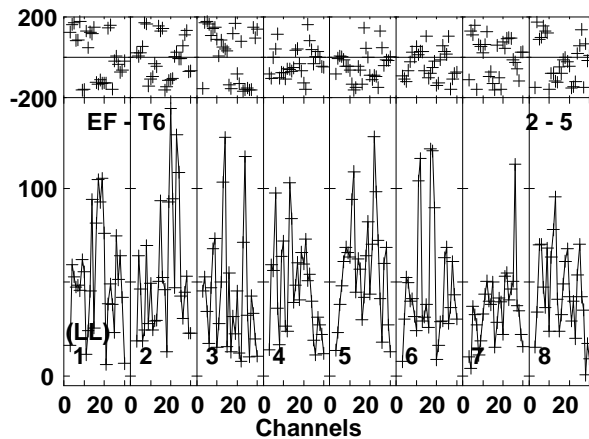
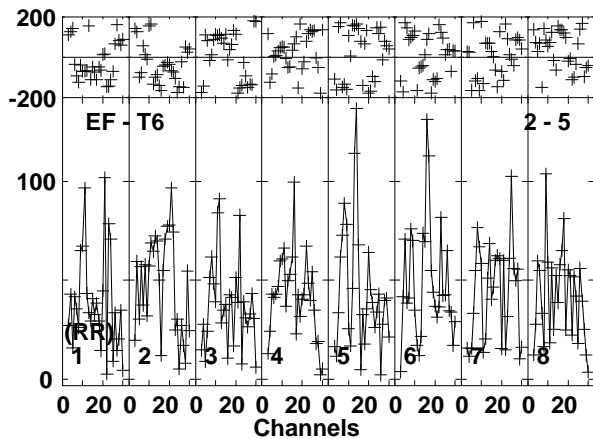
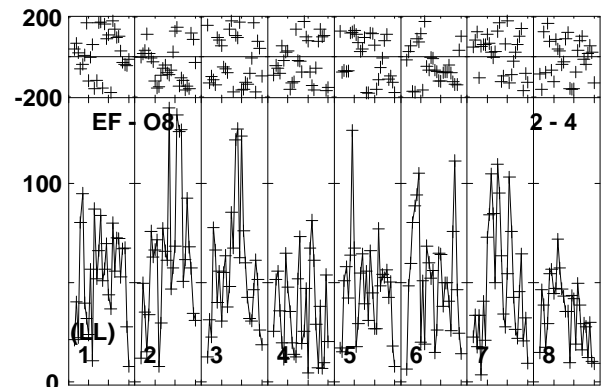
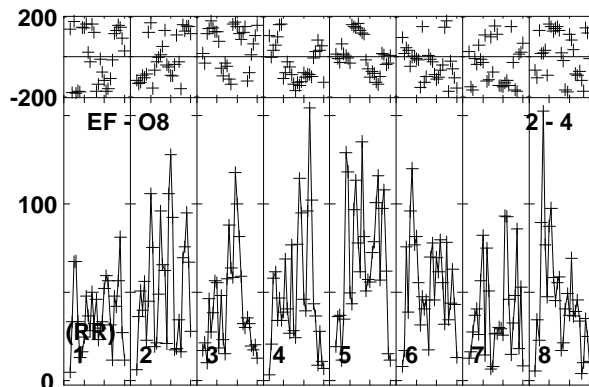
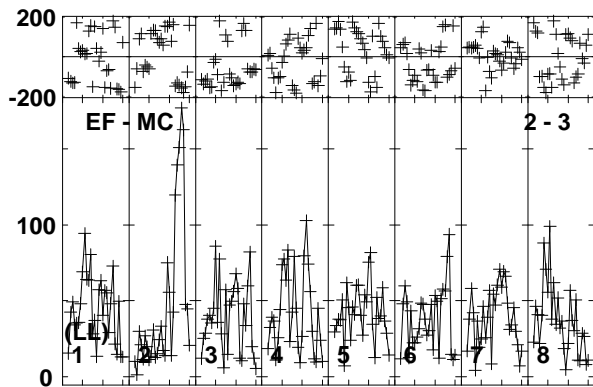
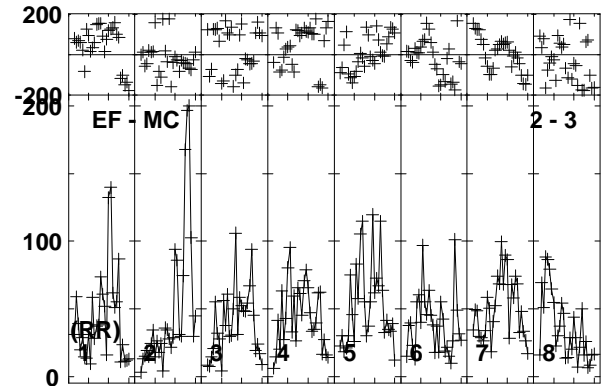
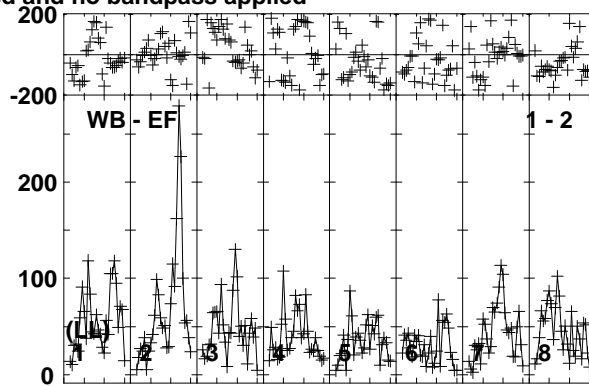
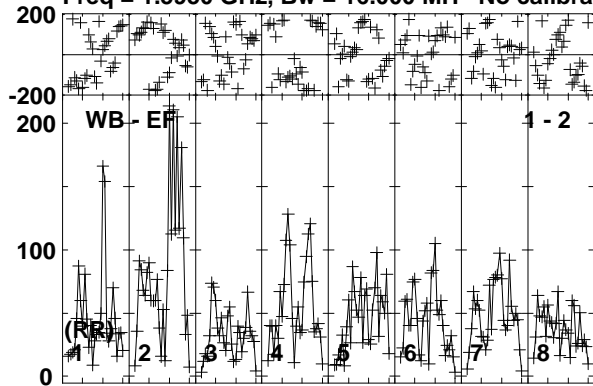

Lower frame: Micro Ampl Jy Top frame: Phas deg  
Vector averaged cross-power spectrum Baseline: WB (01) - EF (02)  
Timerange: 00/02:22:01 to 00/02:29:59



Plot file version 17 created 30-AUG-2019 17:53:08

ROSS867 EB070.UVDATA.1

Freq = 1.5950 GHz, Bw = 16.000 MH No calibration applied and no bandpass applied

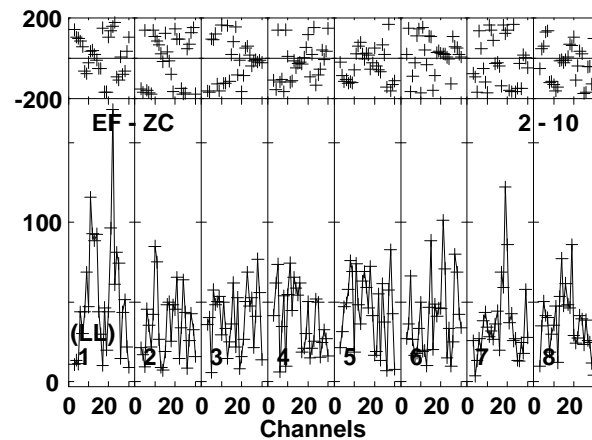
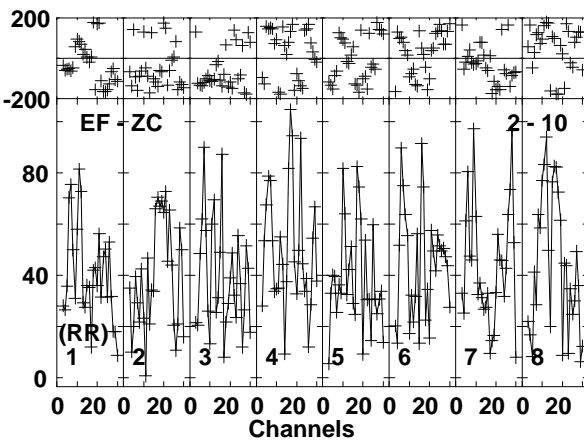
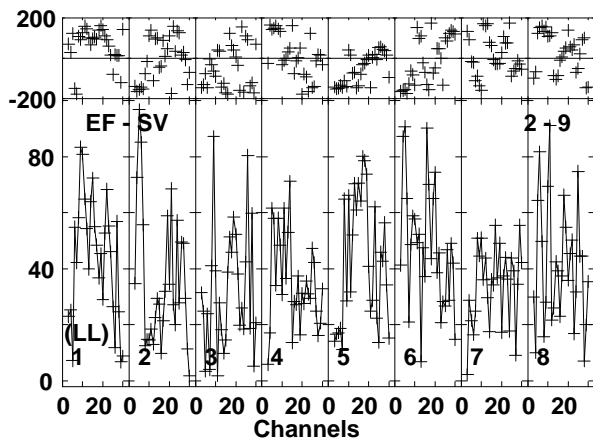
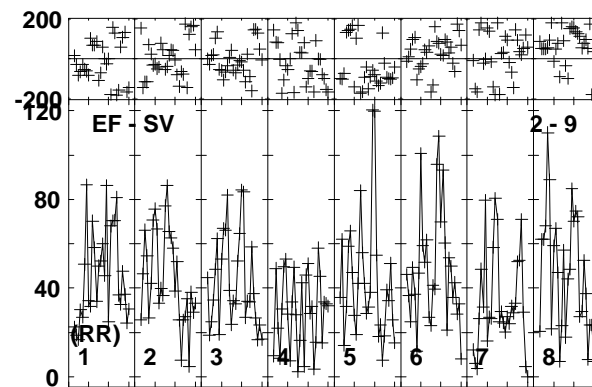
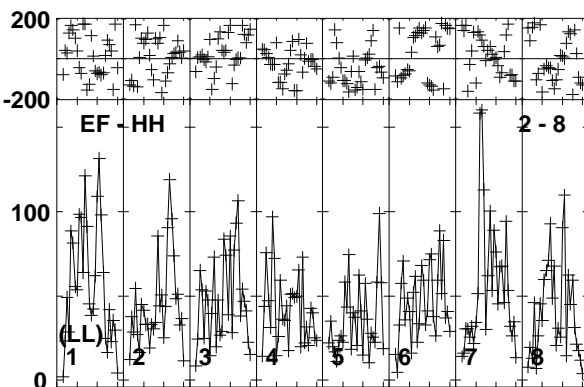
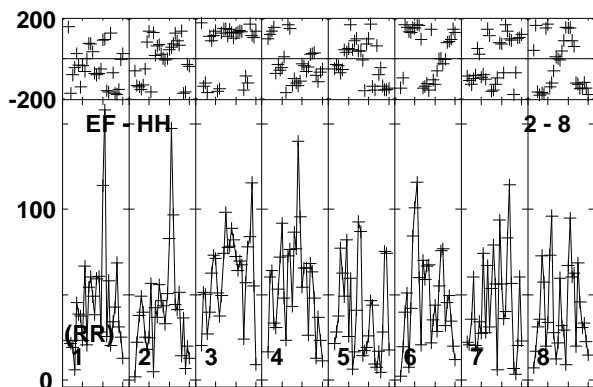
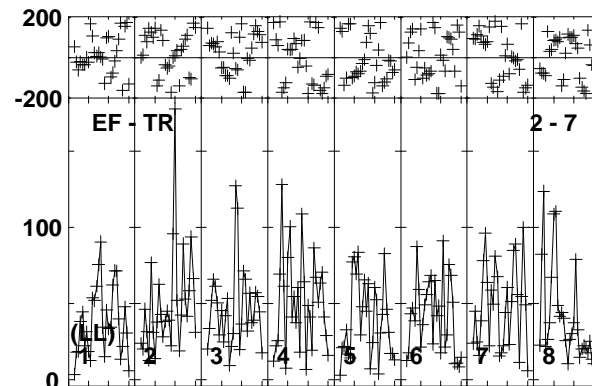
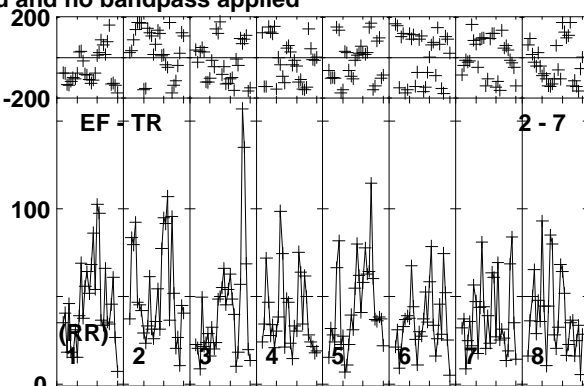
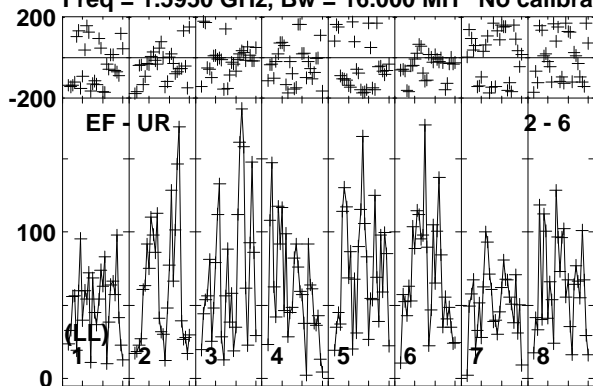

Lower frame: Micro Ampl Jy Top frame: Phas deg  
Vector averaged cross-power spectrum Baseline: EF (02) - UR (06)  
Timerange: 00/02:22:01 to 00/02:29:59

Plot file version 18 created 30-AUG-2019 17:53:08

ROSS867 EB070.UVDATA.1

Freq = 1.5950 GHz, Bw = 16.000 MH No calibration applied and no bandpass applied

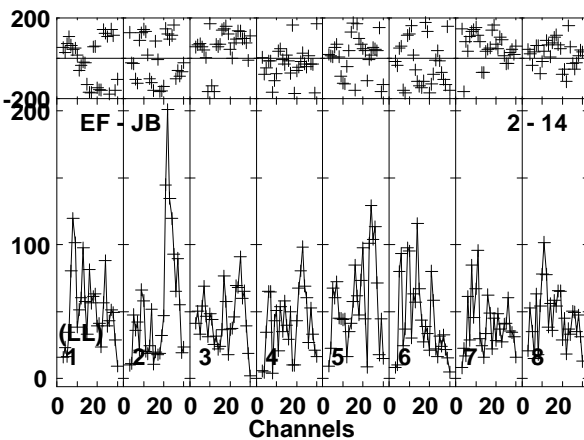
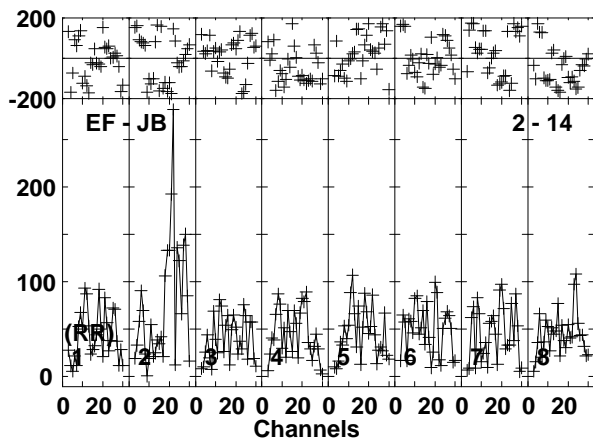
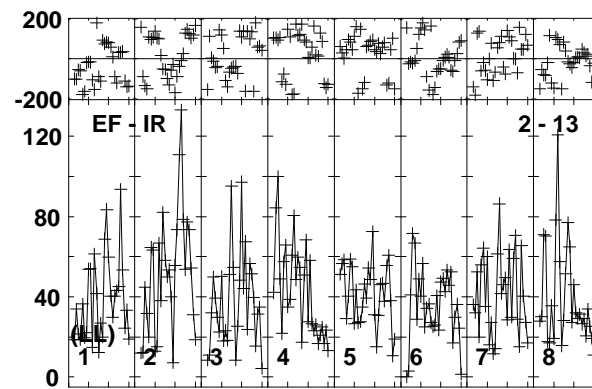
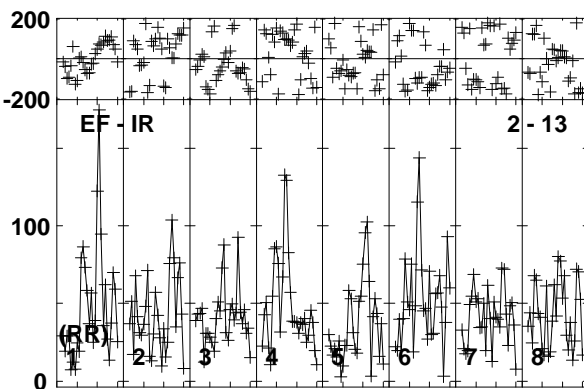
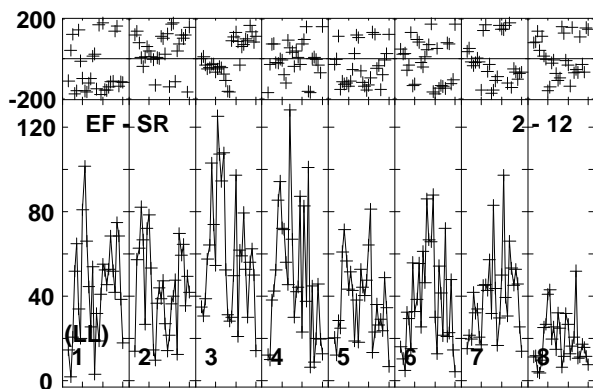
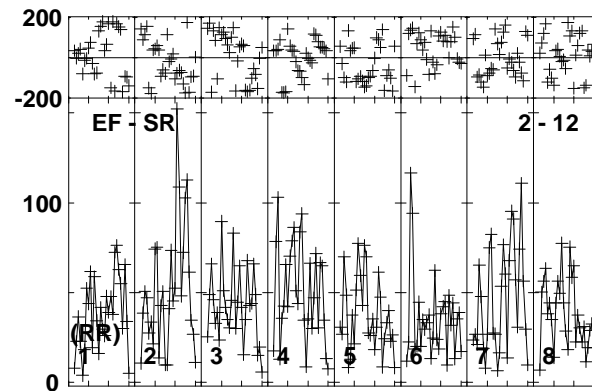
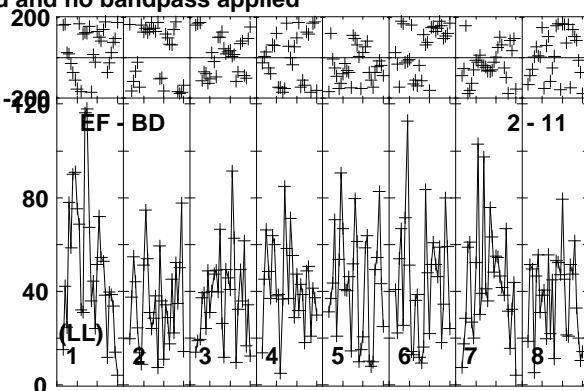
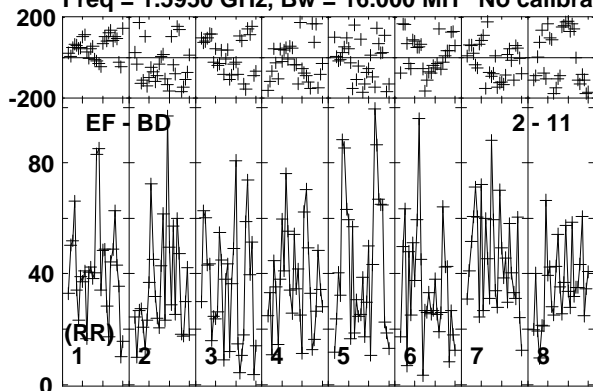

Lower frame: Micro Ampl Jy Top frame: Phas deg  
Vector averaged cross-power spectrum Baseline: EF (02) - BD (11)  
Timerange: 00/02:22:01 to 00/02:29:59

Plot file version 19 created 30-AUG-2019 17:53:09

J1722+2458 EB070.UVDATA.1

Freq = 1.5950 GHz, Bw = 16.000 MH No calibration applied and no bandpass applied

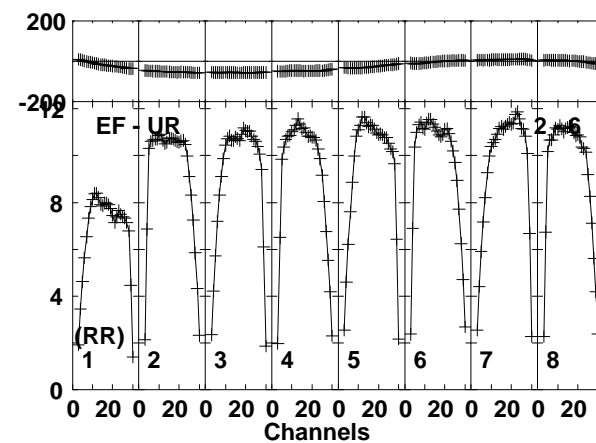
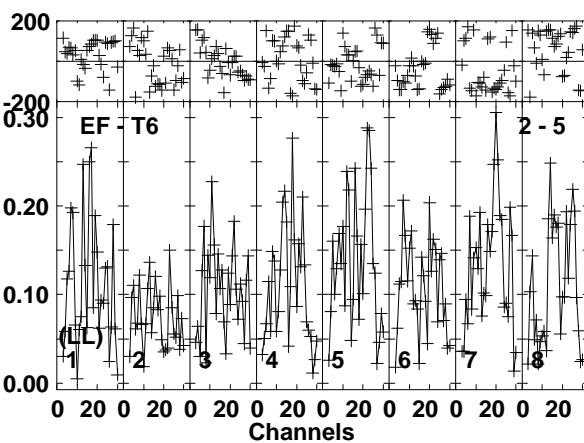
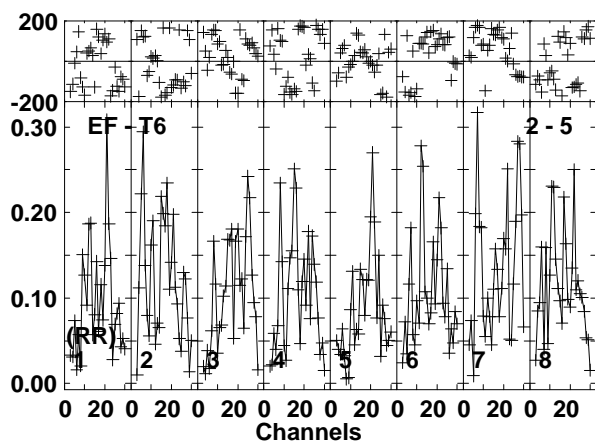
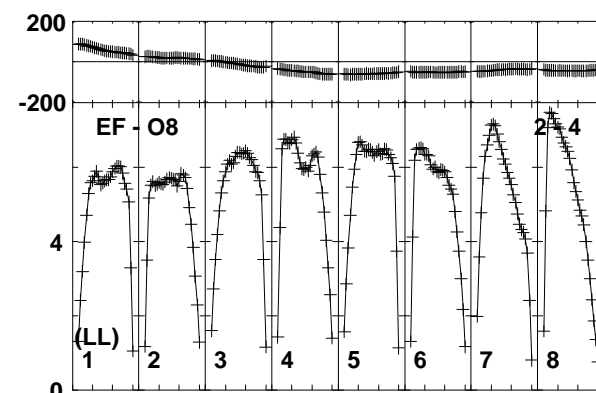
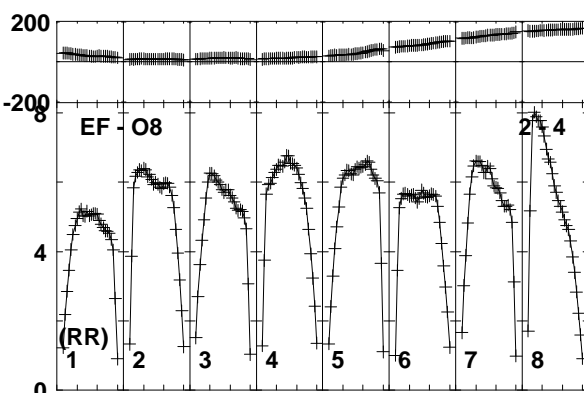
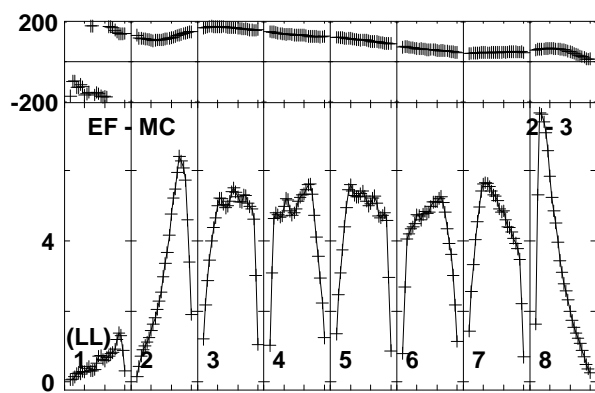
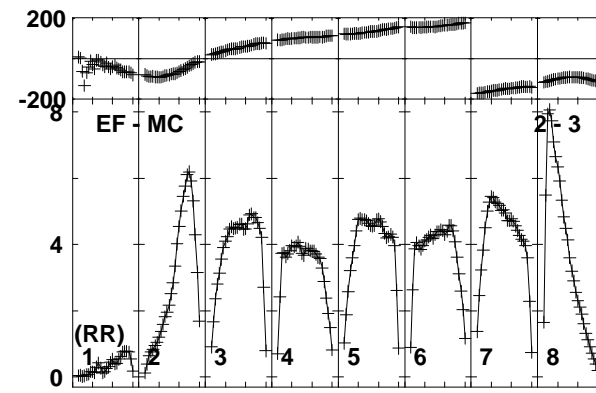
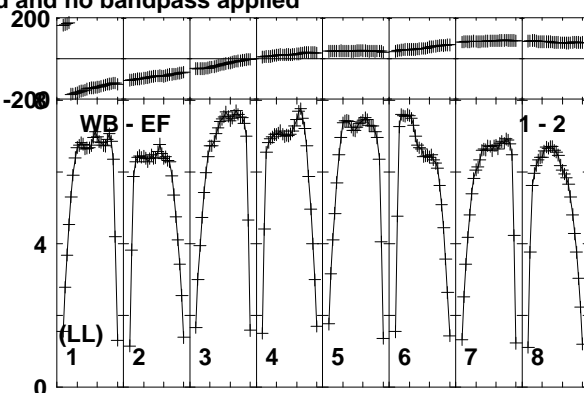
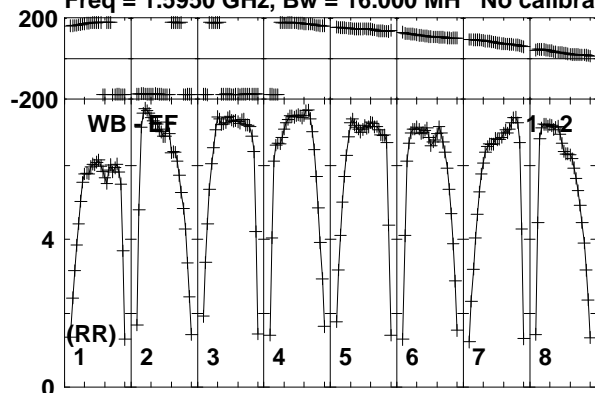

Lower frame: Milli Ampl Jy Top frame: Phas deg  
Vector averaged cross-power spectrum Baseline: WB (01) - EF (02)  
Timerange: 00/02:30:41 to 00/02:31:59

Plot file version 20 created 30-AUG-2019 17:53:09

J1722+2458 EB070.UVDATA.1

Freq = 1.5950 GHz, Bw = 16.000 MH No calibration applied and no bandpass applied

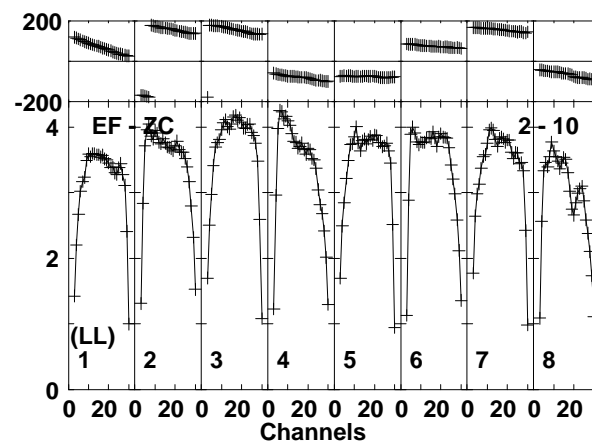
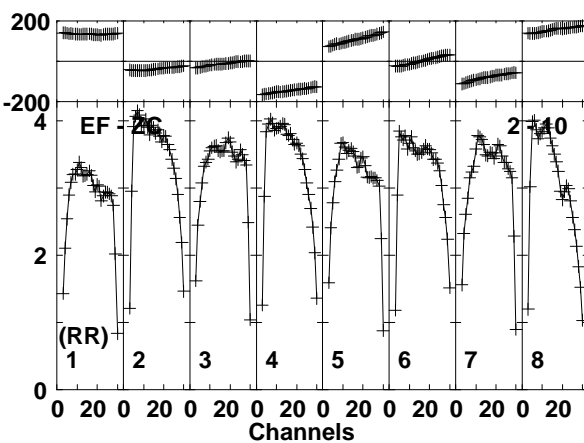
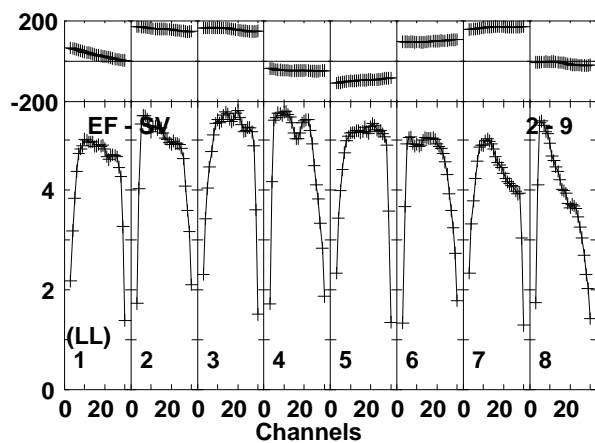
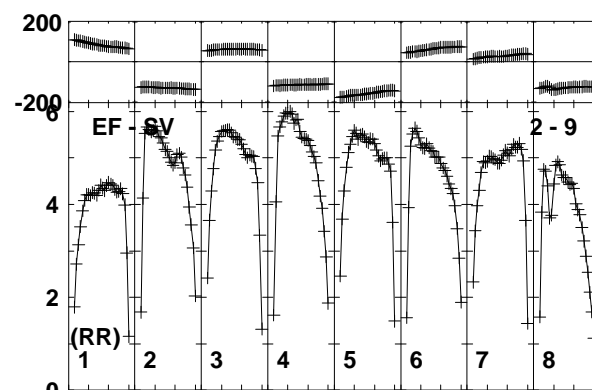
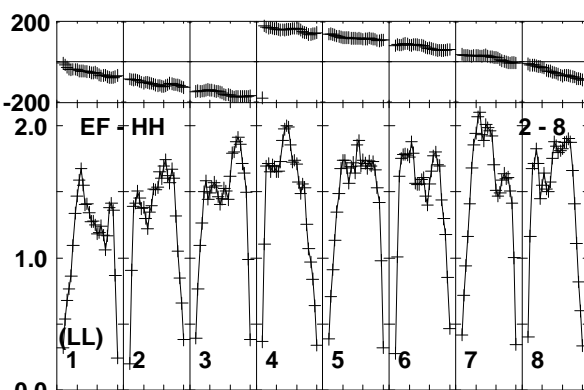
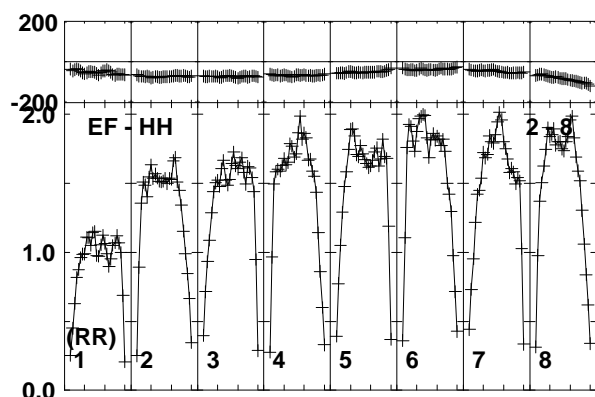
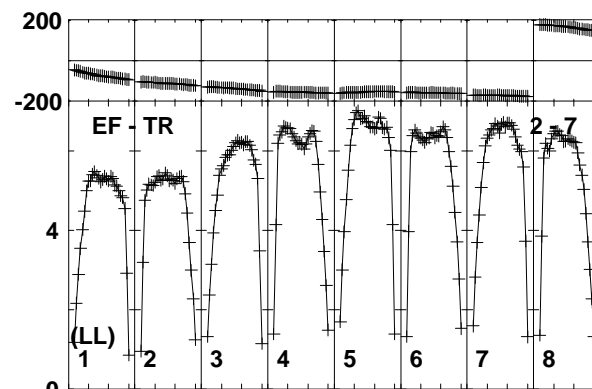
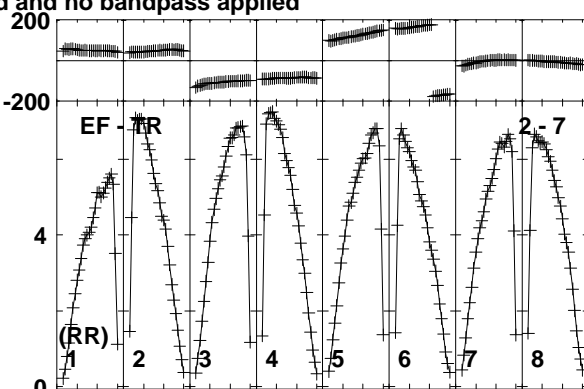
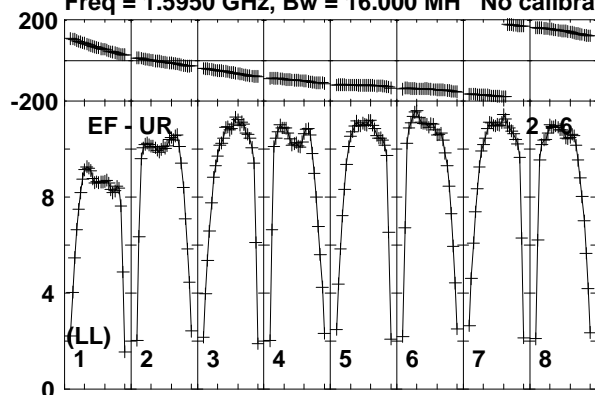

Lower frame: Milli Ampl Jy Top frame: Phas deg  
Vector averaged cross-power spectrum Baseline: EF (02) - UR (06)  
Timerange: 00/02:30:41 to 00/02:31:59

Plot file version 21 created 30-AUG-2019 17:53:09

J1722+2458 EB070.UVDATA.1

Freq = 1.5950 GHz, Bw = 16.000 MH No calibration applied and no bandpass applied

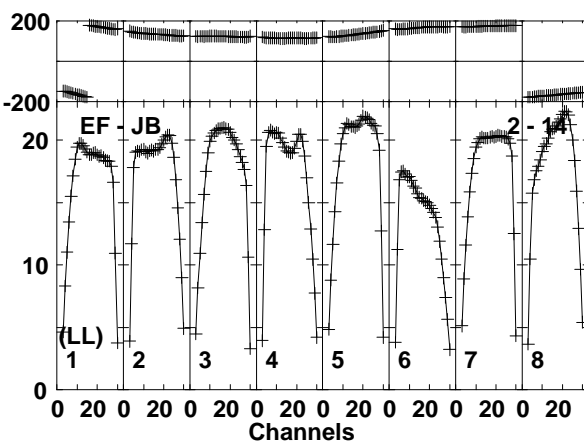
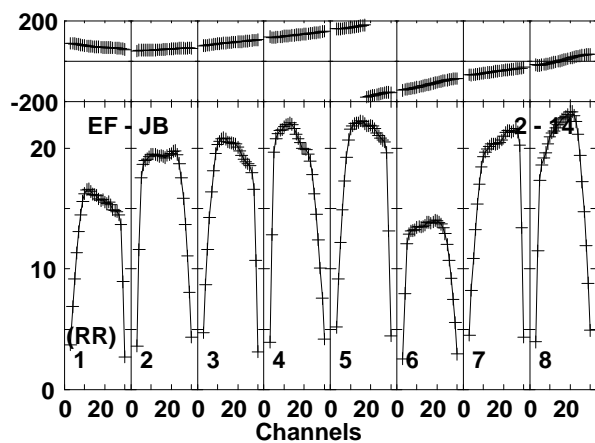
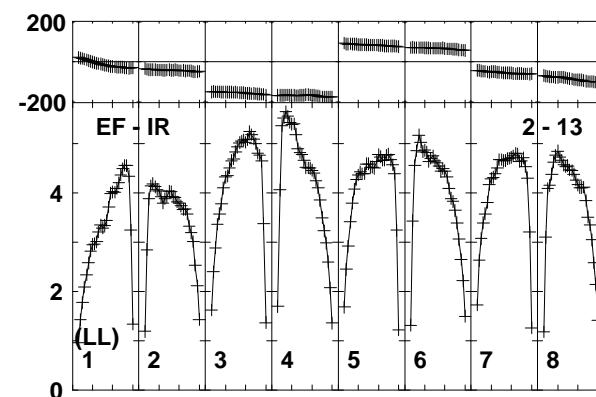
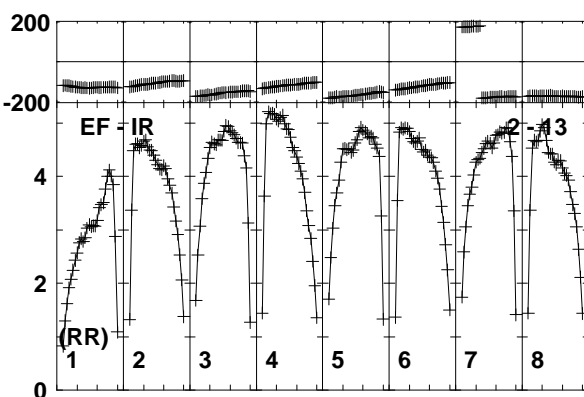
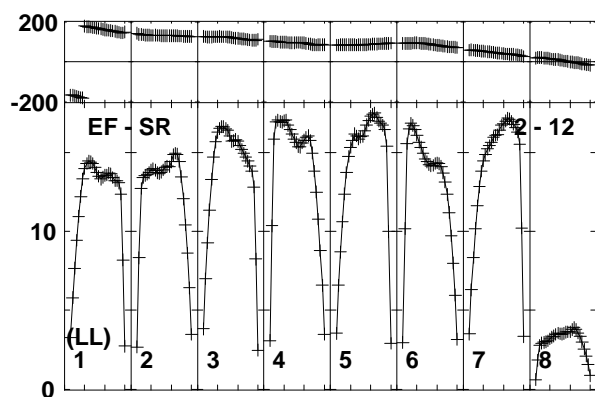
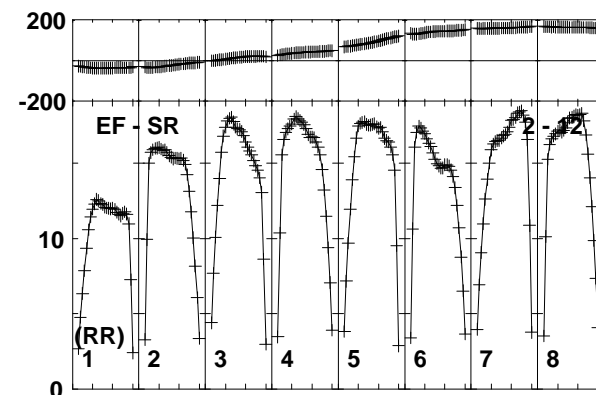
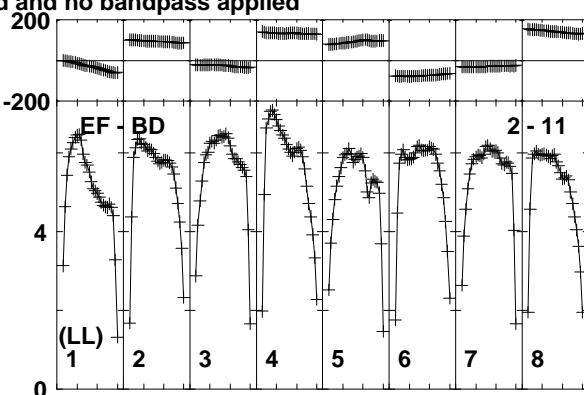
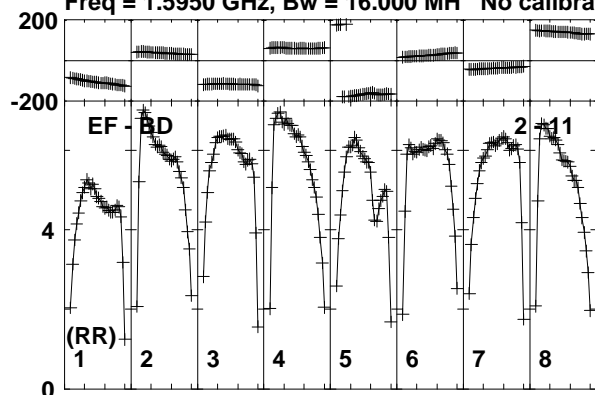

Lower frame: Milli Ampl Jy Top frame: Phas deg  
Vector averaged cross-power spectrum Baseline: EF (02) - BD (11)  
Timerange: 00/02:30:41 to 00/02:31:59

Plot file version 22 created 30-AUG-2019 17:53:09

ROSS867 EB070.UVDATA.1

Freq = 1.5950 GHz, Bw = 16.000 MH No calibration applied and no bandpass applied

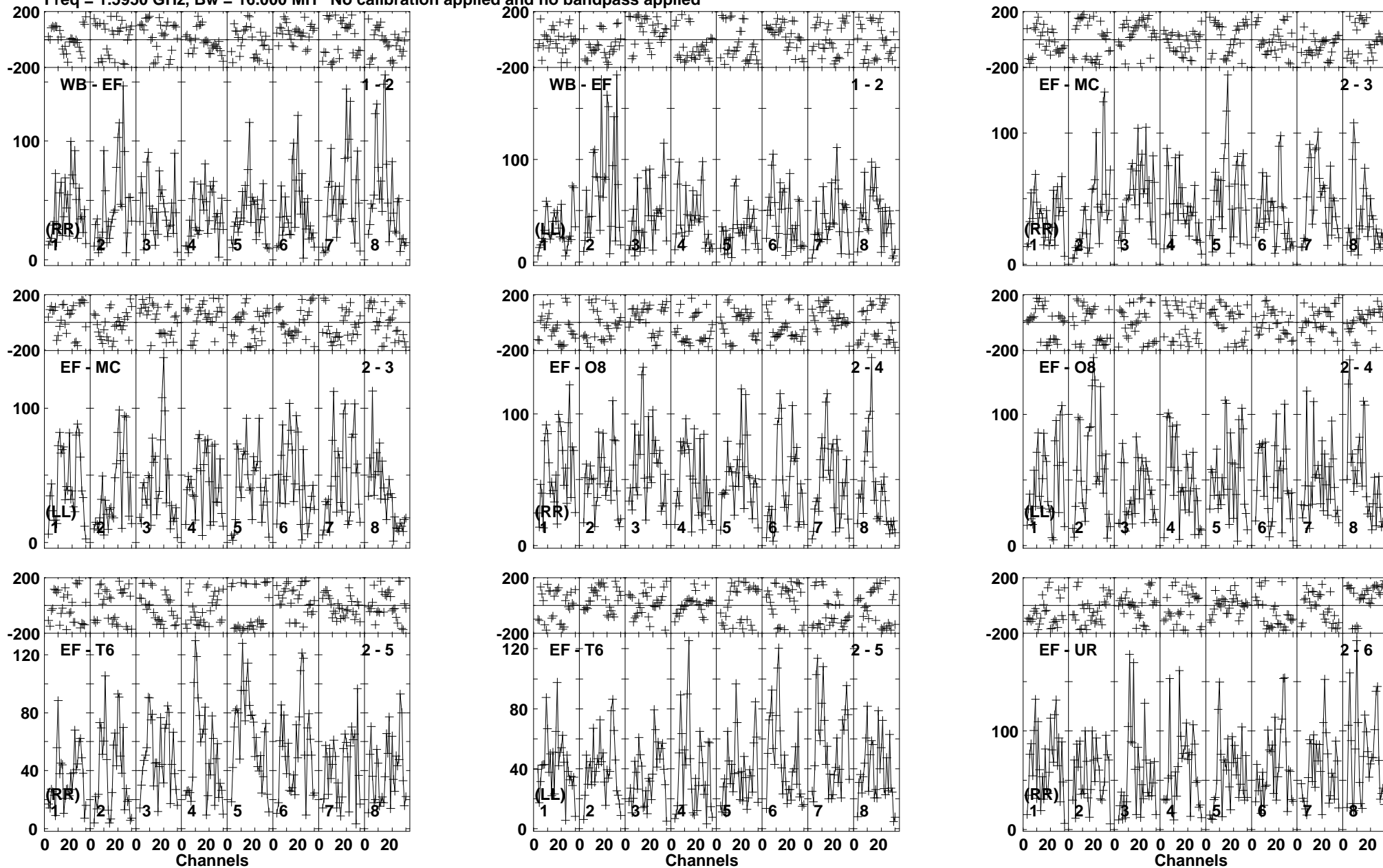

Lower frame: Micro Ampl Jy Top frame: Phas deg  
Vector averaged cross-power spectrum Baseline: WB (01) - EF (02)  
Timerange: 00/02:32:01 to 00/02:39:59

Plot file version 23 created 30-AUG-2019 17:53:09

ROSS867 EB070.UVDATA.1

Freq = 1.5950 GHz, Bw = 16.000 MH No calibration applied and no bandpass applied

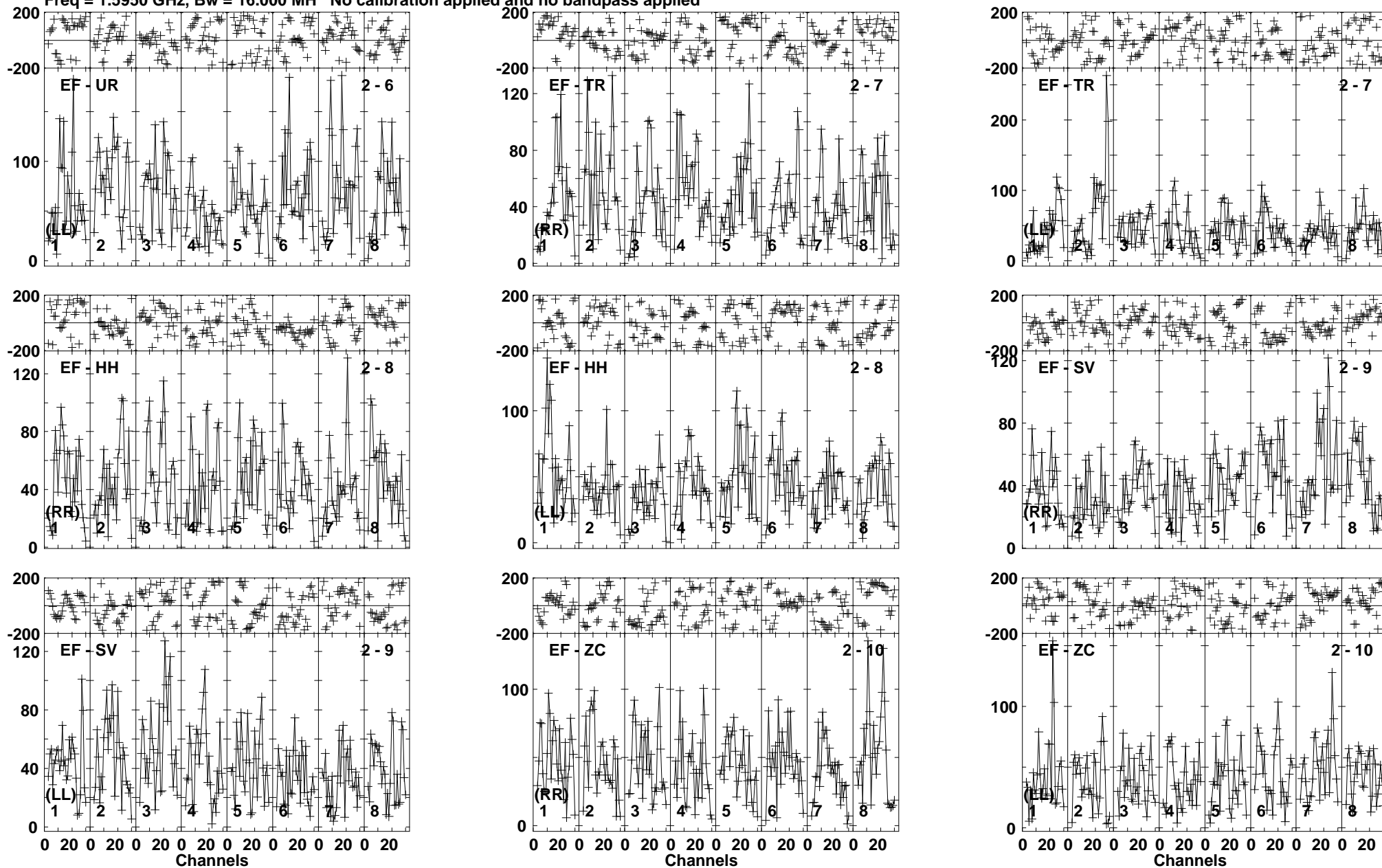

Lower frame: Micro Ampl Jy Top frame: Phas deg  
Vector averaged cross-power spectrum Baseline: EF (02) - UR (06)  
Timerange: 00/02:32:01 to 00/02:39:59

Plot file version 24 created 30-AUG-2019 17:53:10

ROSS867 EB070.UVDATA.1

Freq = 1.5950 GHz, Bw = 16.000 MH No calibration applied and no bandpass applied

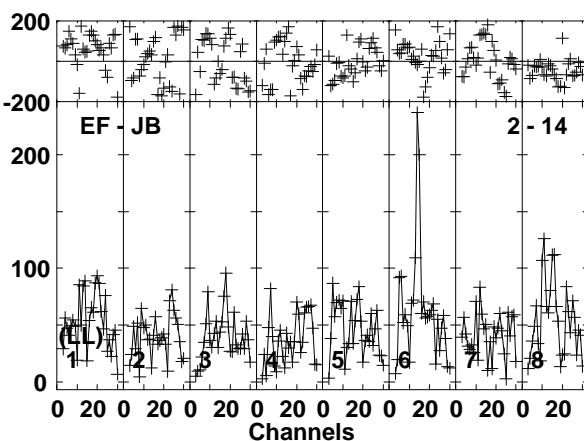
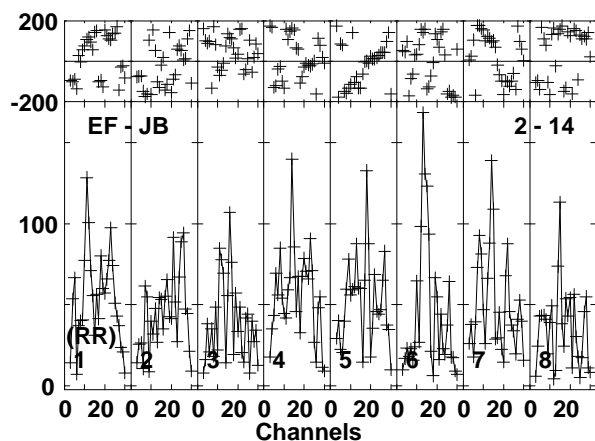
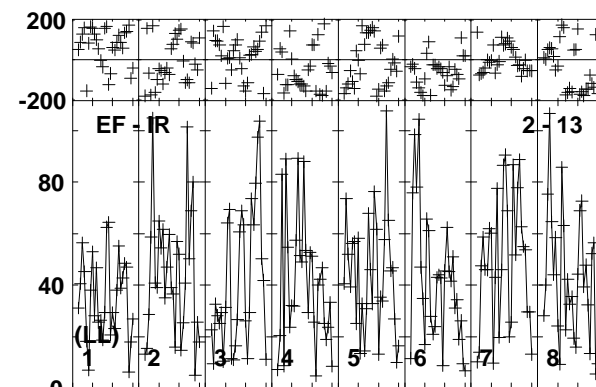
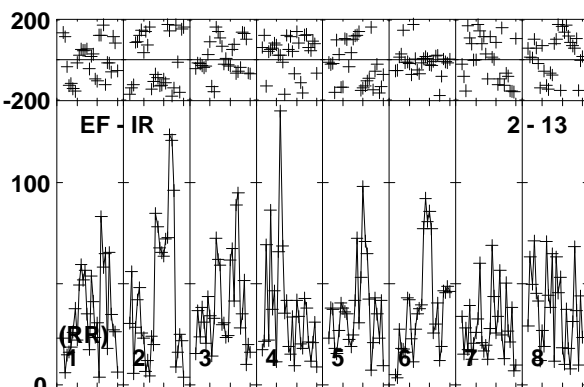
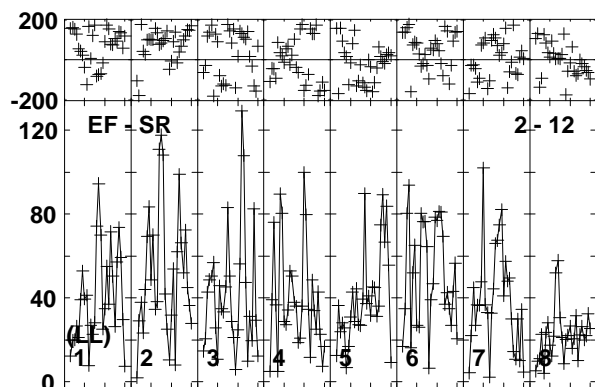
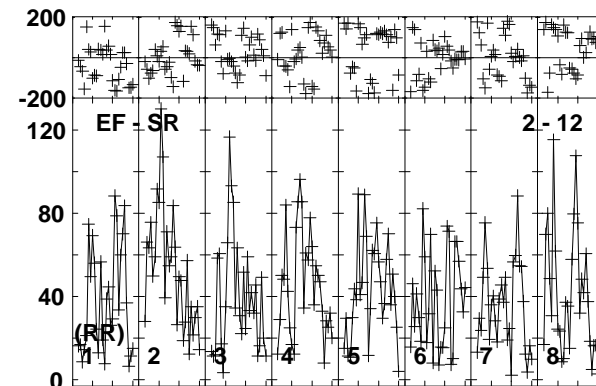
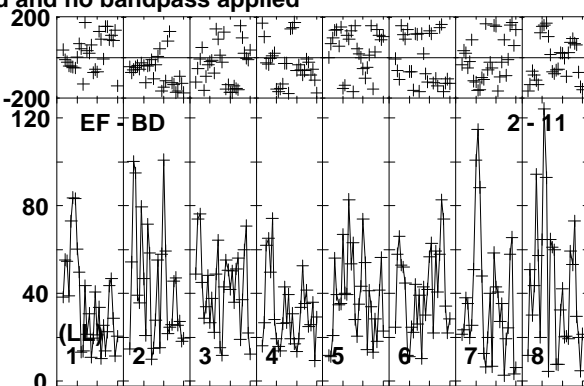
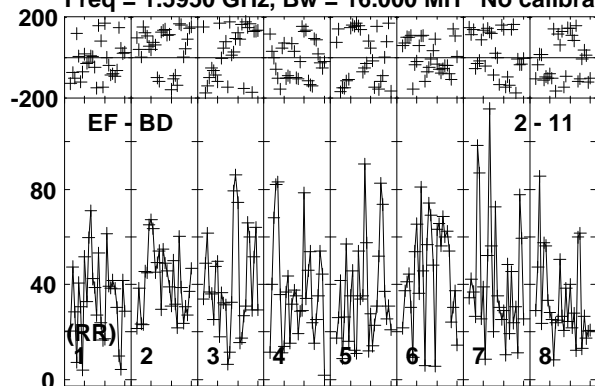

Lower frame: Micro Ampl Jy Top frame: Phas deg  
Vector averaged cross-power spectrum Baseline: EF (02) - BD (11)  
Timerange: 00/02:32:01 to 00/02:39:59



Plot file version 25 created 30-AUG-2019 17:53:10

J1722+2458 EB070.UVDATA.1

Freq = 1.5950 GHz, Bw = 16.000 MH No calibration applied and no bandpass applied

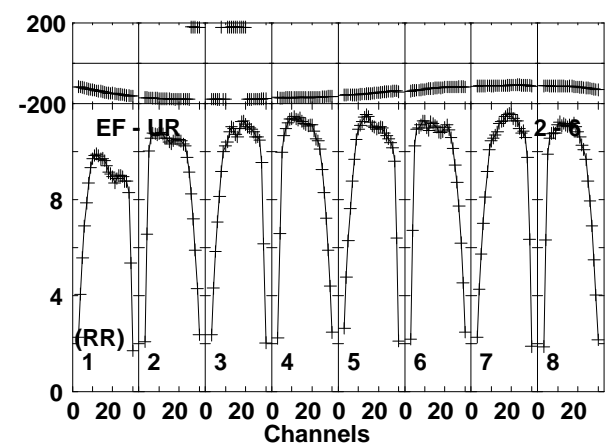
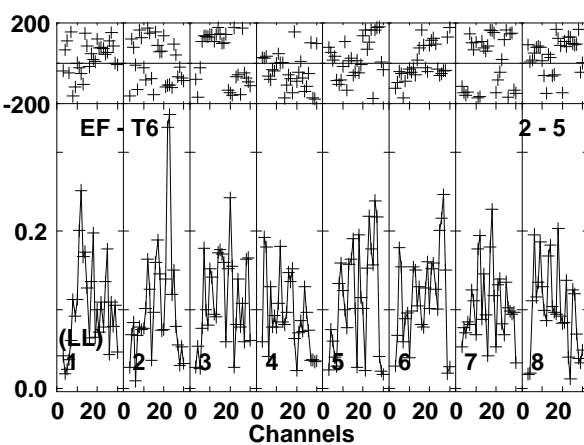
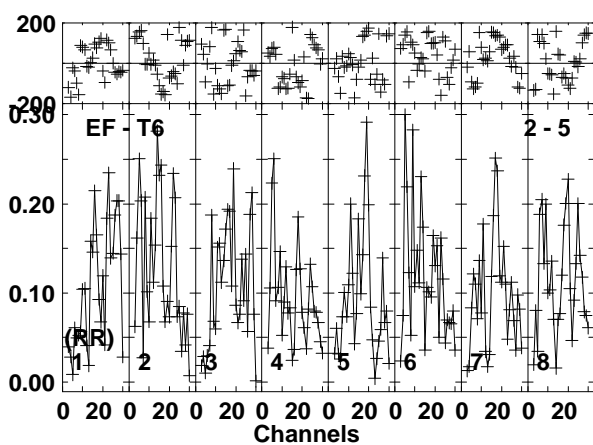
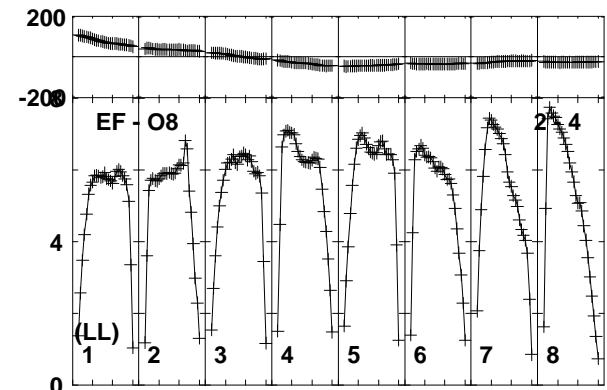
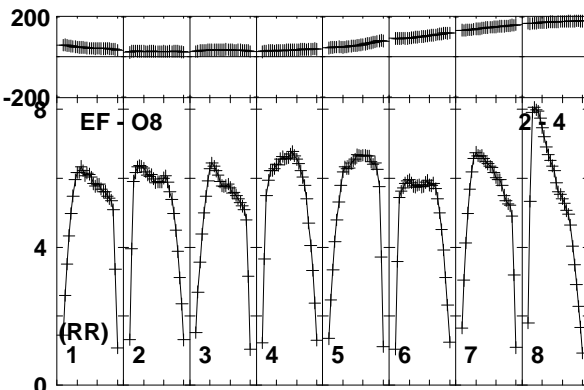
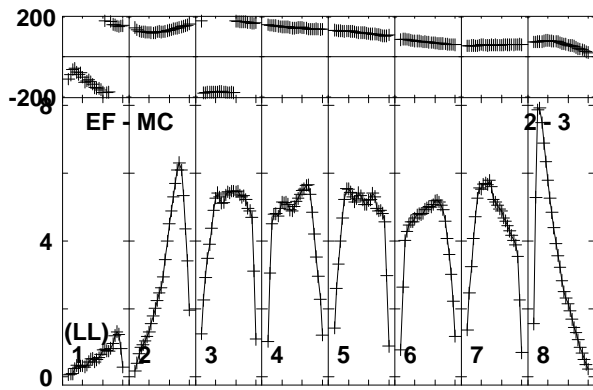
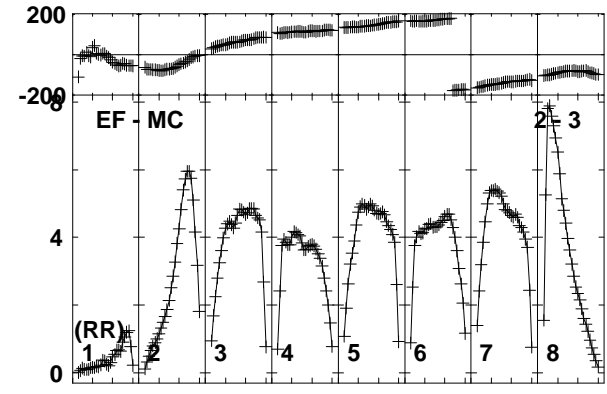
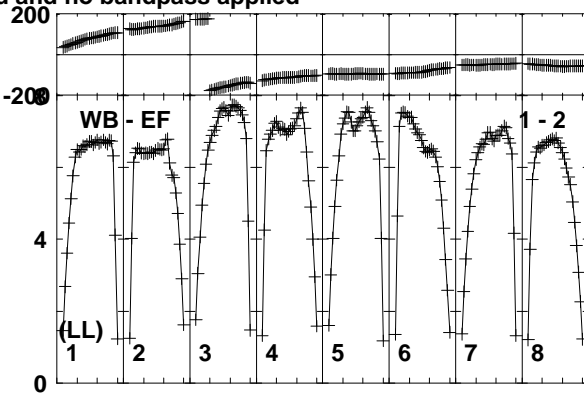
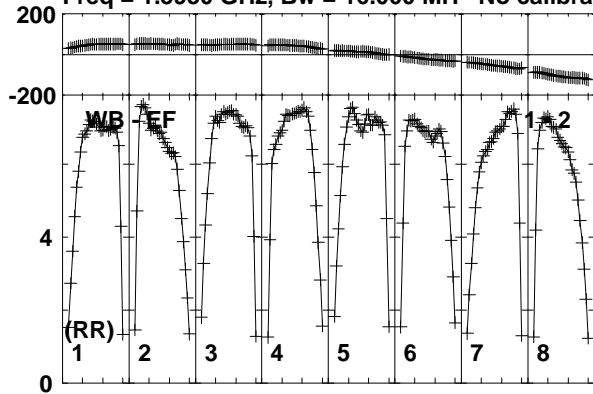

Lower frame: Milli Ampl Jy Top frame: Phas deg  
Vector averaged cross-power spectrum Baseline: WB (01) - EF (02)  
Timerange: 00/02:40:01 to 00/02:41:59

Plot file version 26 created 30-AUG-2019 17:53:10

J1722+2458 EB070.UVDATA.1

Freq = 1.5950 GHz, Bw = 16.000 MH No calibration applied and no bandpass applied

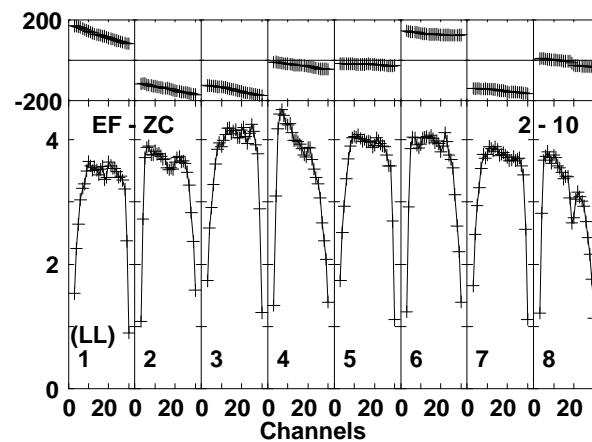
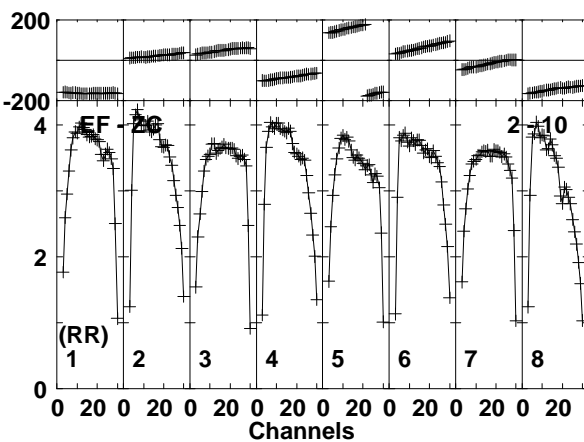
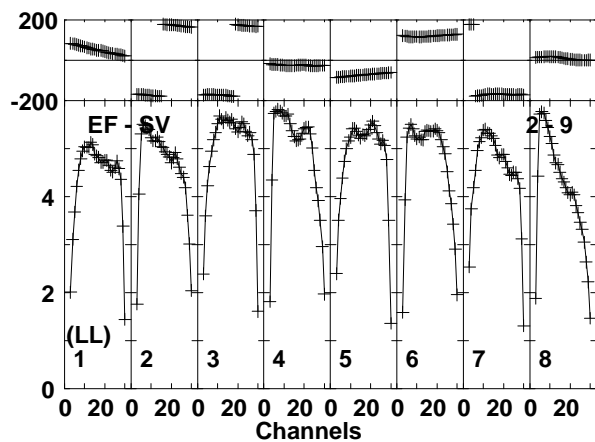
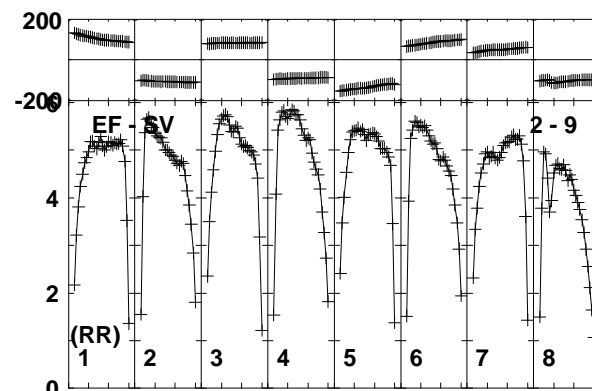
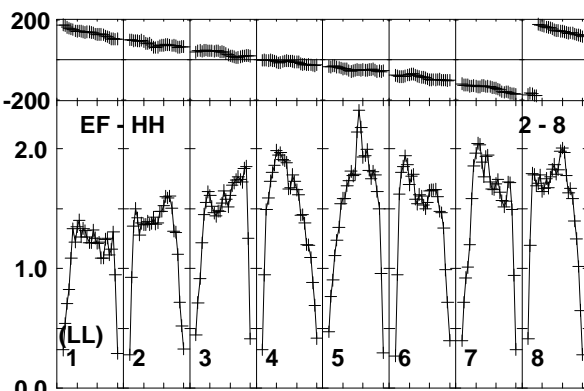
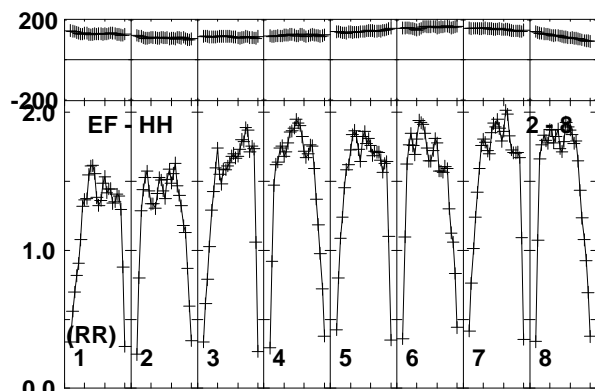
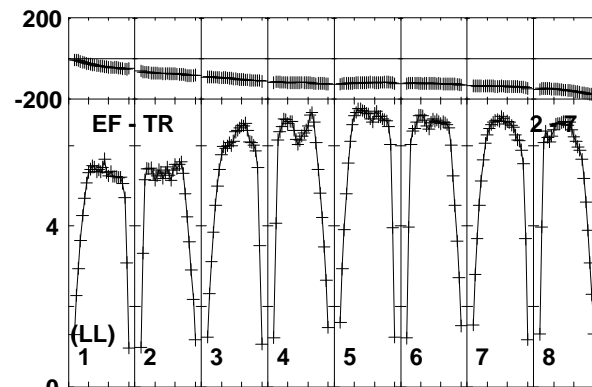
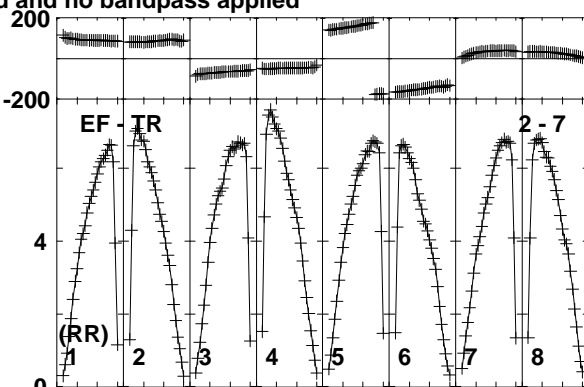
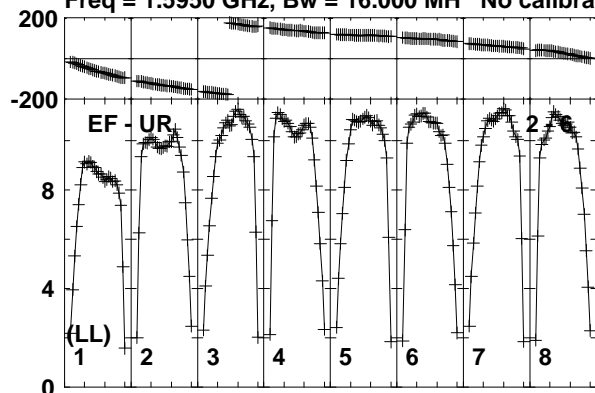

Lower frame: Milli Ampl Jy Top frame: Phas deg  
Vector averaged cross-power spectrum Baseline: EF (02) - UR (06)  
Timerange: 00/02:40:01 to 00/02:41:59

Plot file version 27 created 30-AUG-2019 17:53:10

J1722+2458 EB070.UVDATA.1

Freq = 1.5950 GHz, Bw = 16.000 MH No calibration applied and no bandpass applied

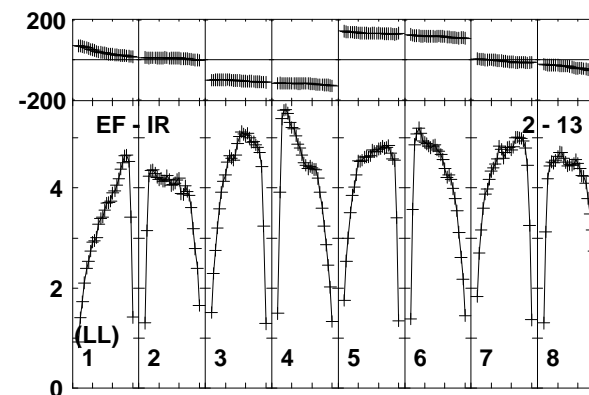
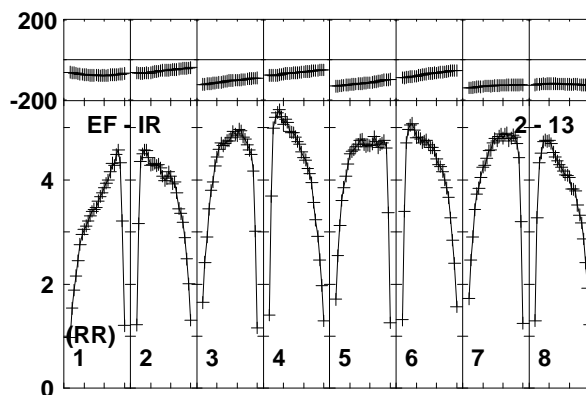
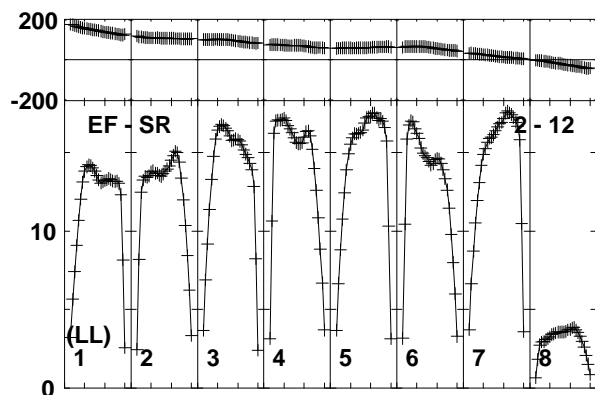
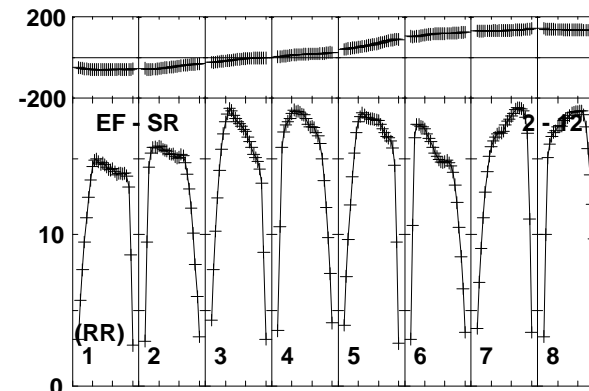
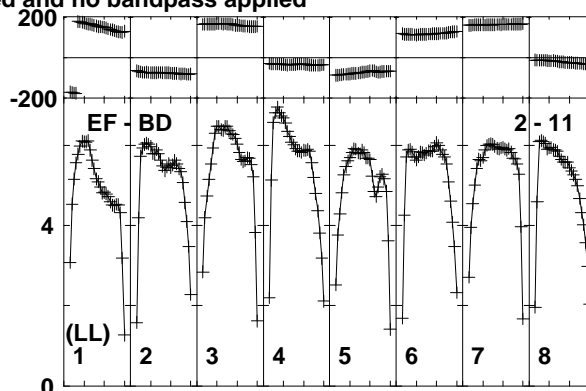
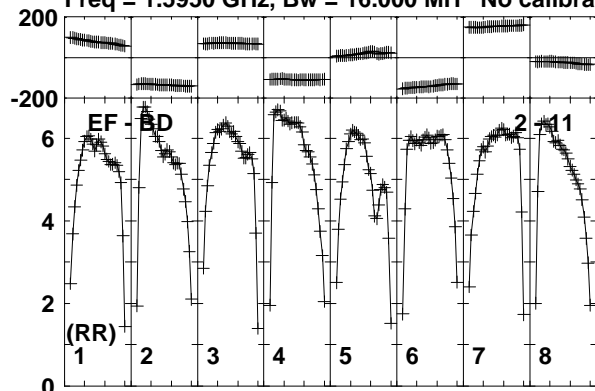

Channels

Lower frame: Milli Ampl Jy Top frame: Phas deg

Vector averaged cross-power spectrum Baseline: EF (02) - BD (11)

Timerange: 00/02:40:01 to 00/02:41:59

Plot file version 28 created 30-AUG-2019 17:53:10

ROSS867 EB070.UVDATA.1

Freq = 1.5950 GHz, Bw = 16.000 MH No calibration applied and no bandpass applied

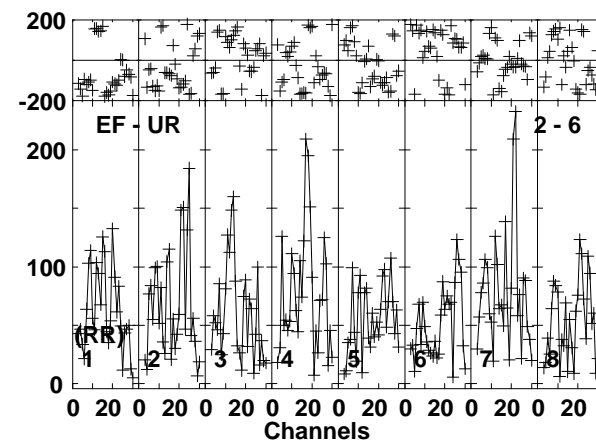
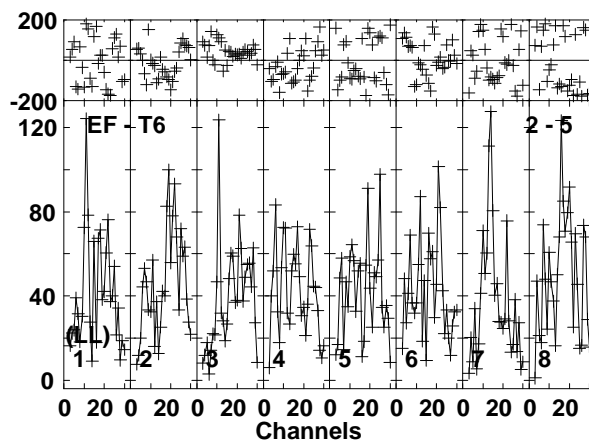
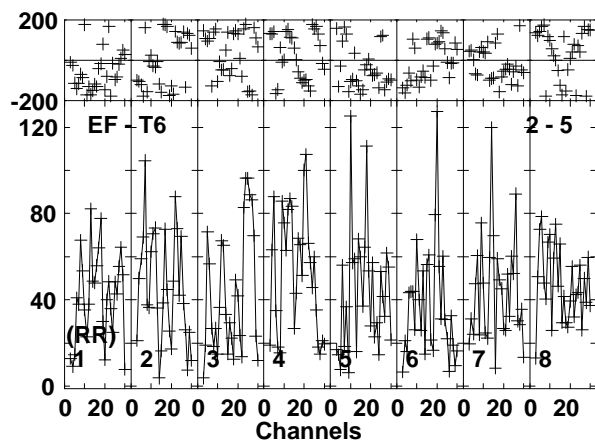
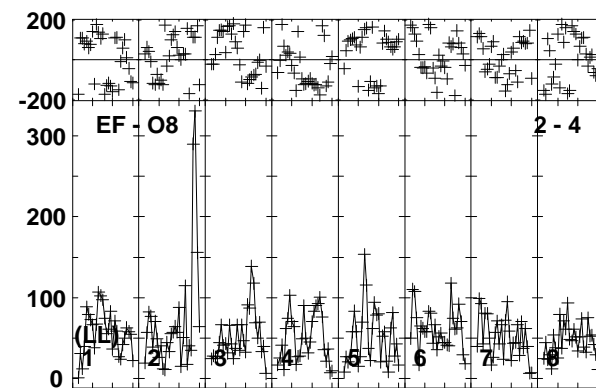
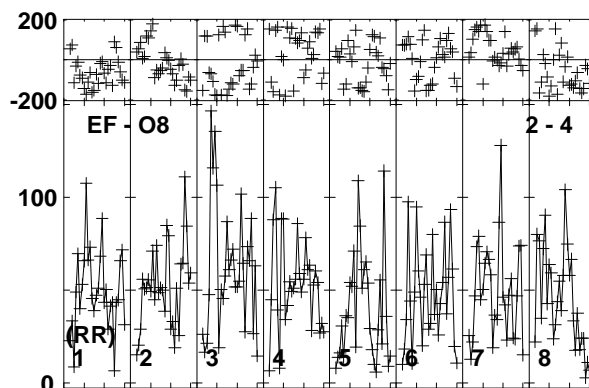
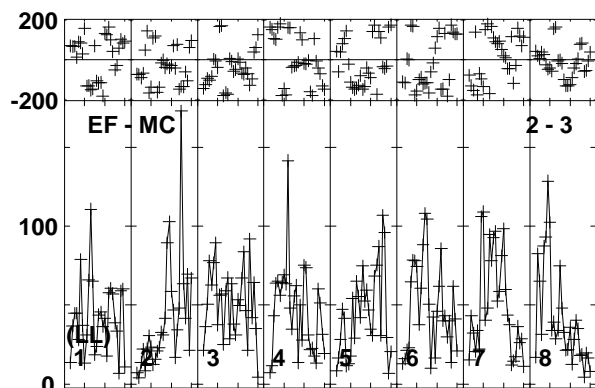
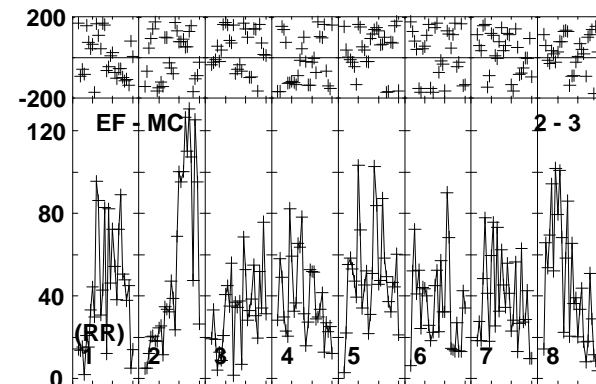
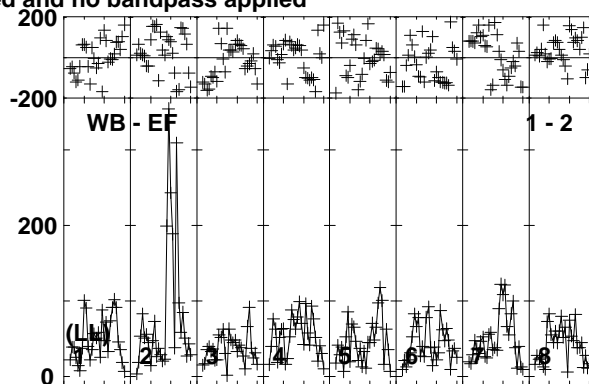
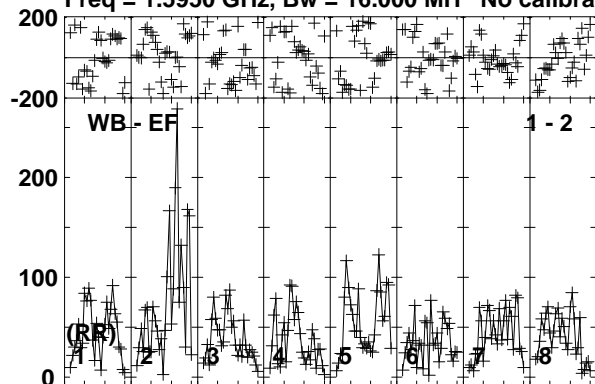

Lower frame: Micro Ampl Jy Top frame: Phas deg  
Vector averaged cross-power spectrum Baseline: WB (01) - EF (02)  
Timerange: 00/02:42:01 to 00/02:49:59

Plot file version 29 created 30-AUG-2019 17:53:11

ROSS867 EB070.UVDATA.1

Freq = 1.5950 GHz, Bw = 16.000 MH No calibration applied and no bandpass applied

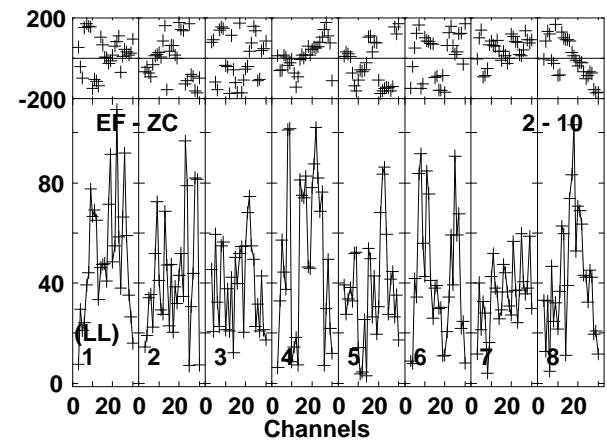
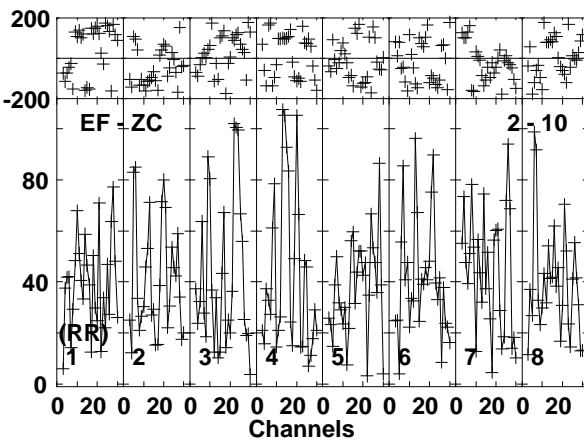
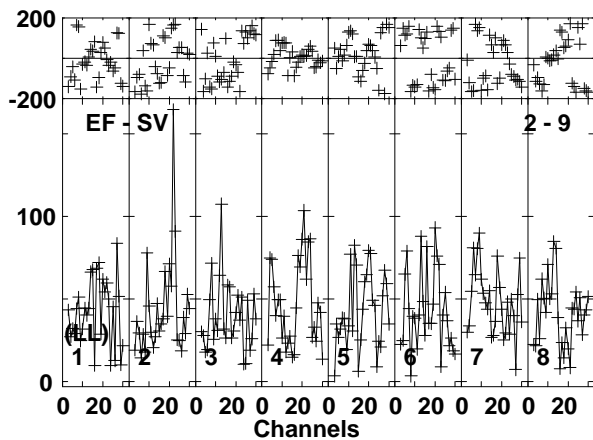
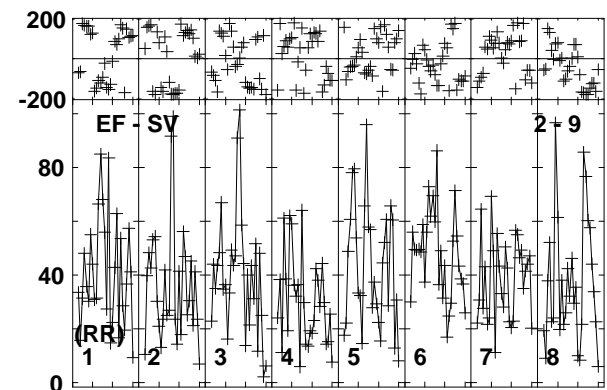
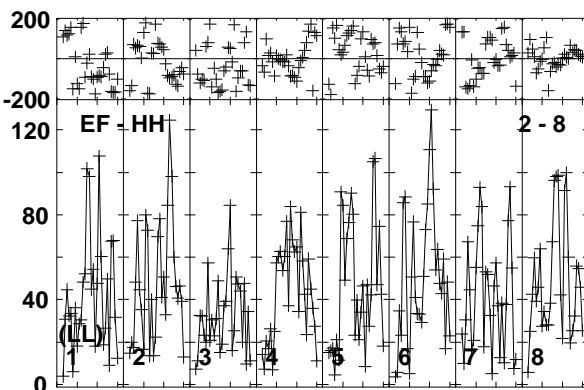
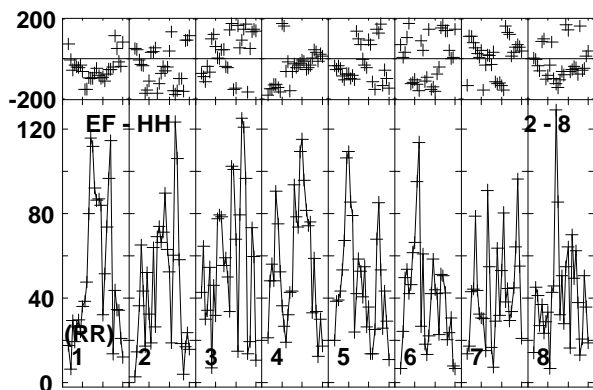
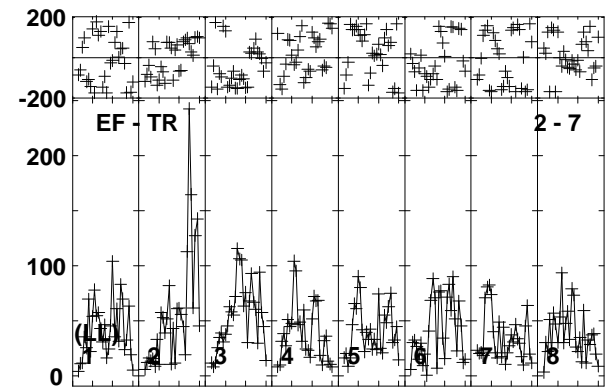
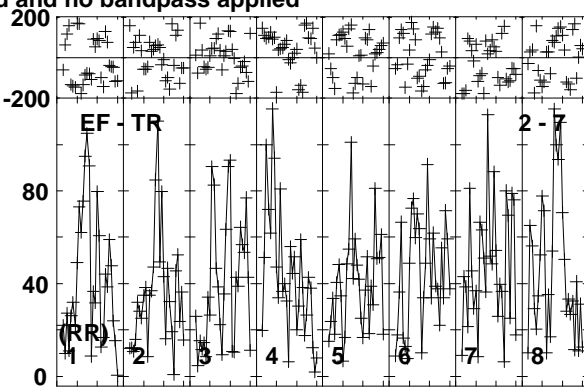
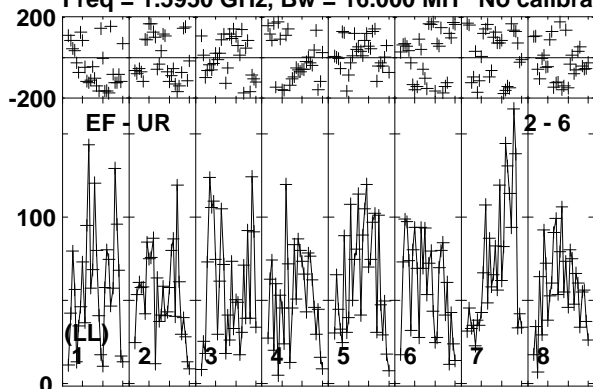

Lower frame: Micro Ampl Jy Top frame: Phas deg  
Vector averaged cross-power spectrum Baseline: EF (02) - UR (06)  
Timerange: 00/02:42:01 to 00/02:49:59

Plot file version 30 created 30-AUG-2019 17:53:11

ROSS867 EB070.UVDATA.1

Freq = 1.5950 GHz, Bw = 16.000 MH No calibration applied and no bandpass applied

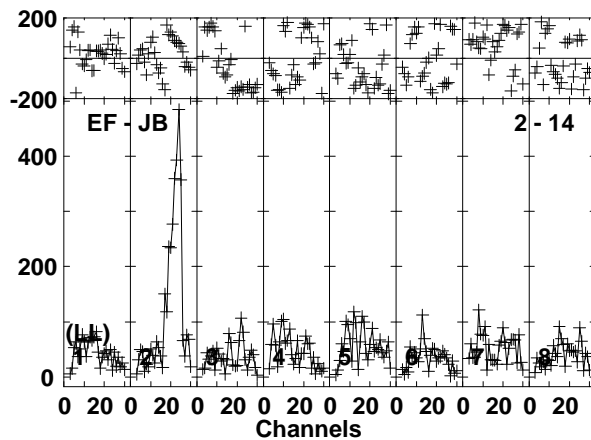
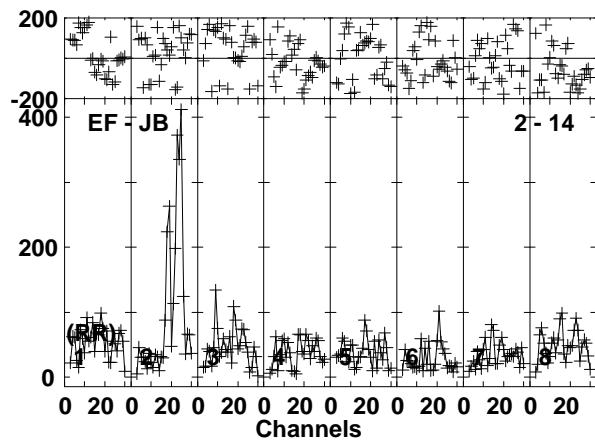
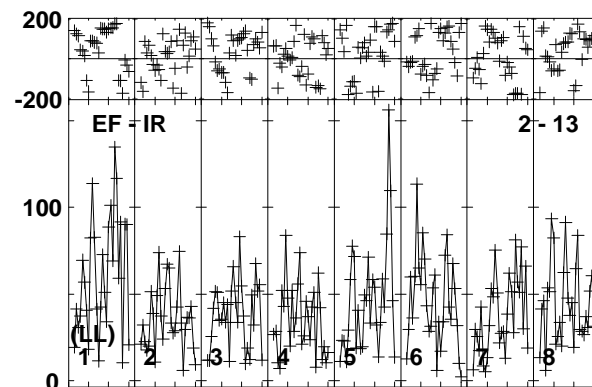
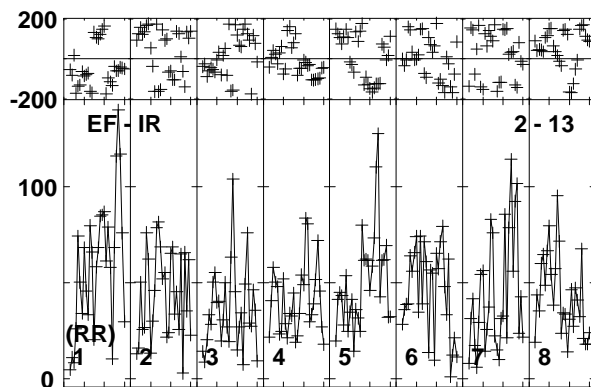
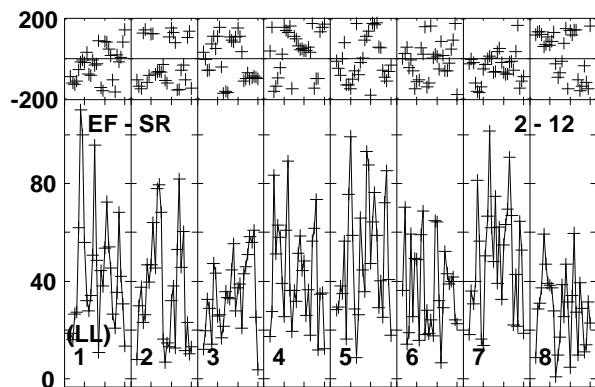
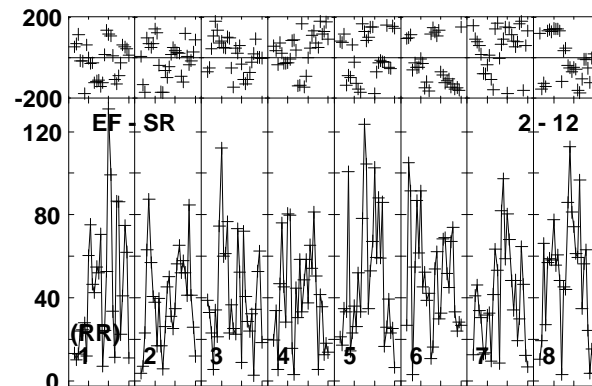
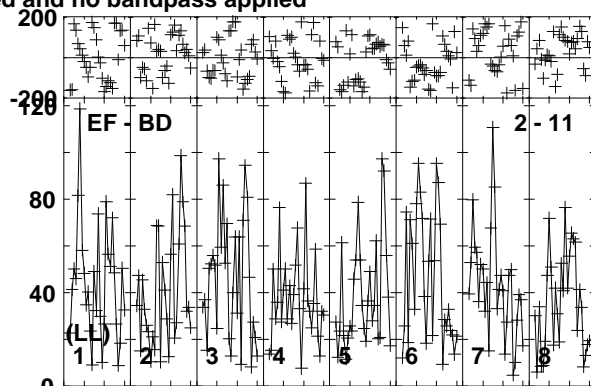
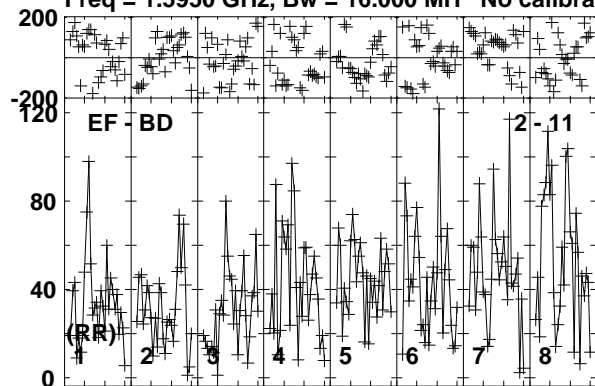

Lower frame: Micro Ampl Jy Top frame: Phas deg  
Vector averaged cross-power spectrum Baseline: EF (02) - BD (11)  
Timerange: 00/02:42:01 to 00/02:49:59

Plot file version 31 created 30-AUG-2019 17:53:11

J1722+2458 EB070.UVDATA.1

Freq = 1.5950 GHz, Bw = 16.000 MH No calibration applied and no bandpass applied

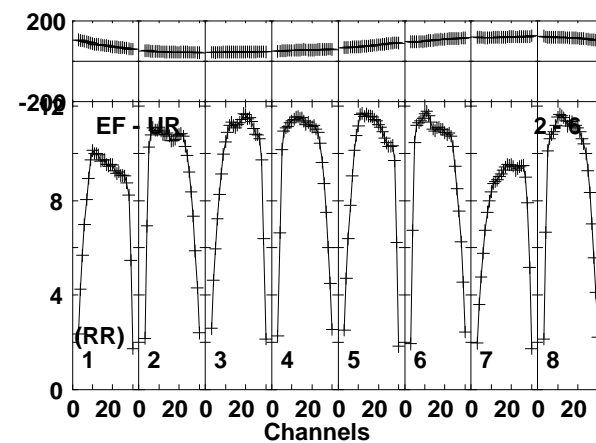
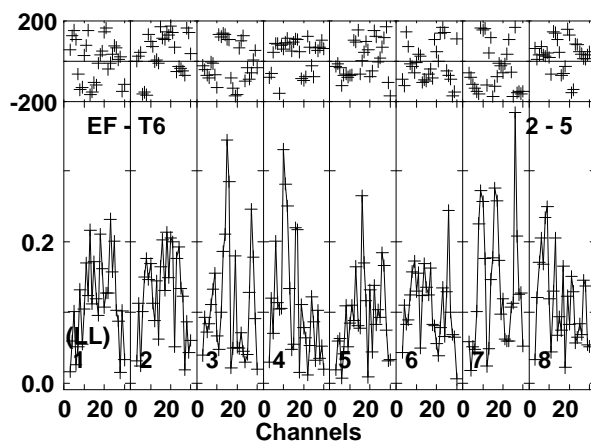
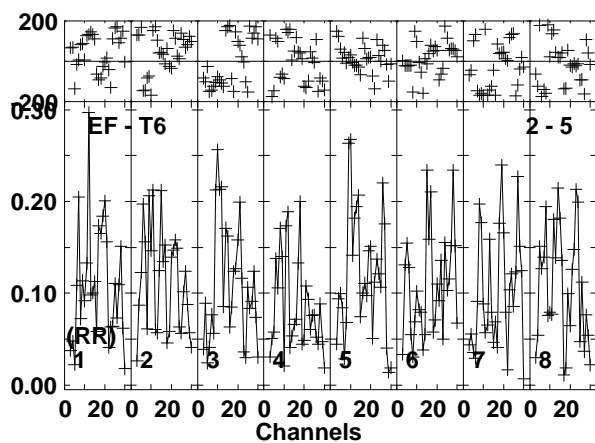
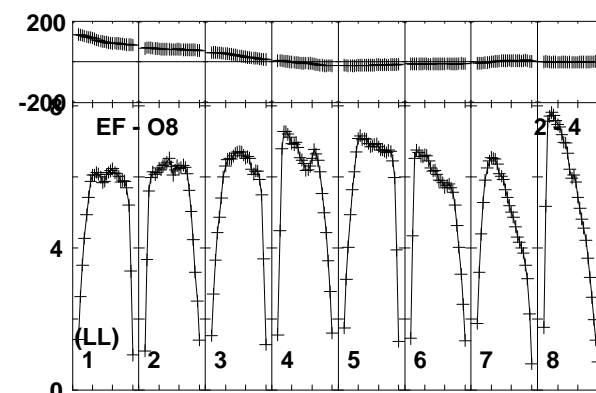
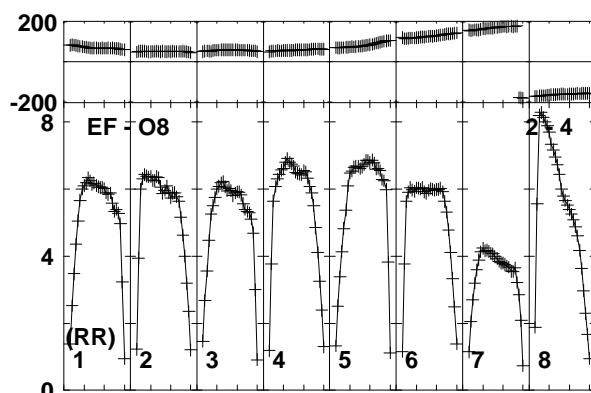
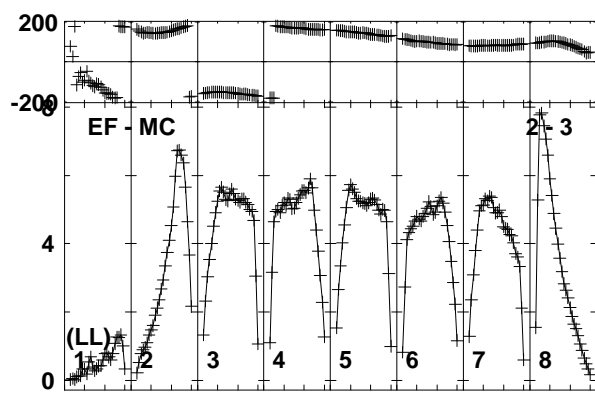
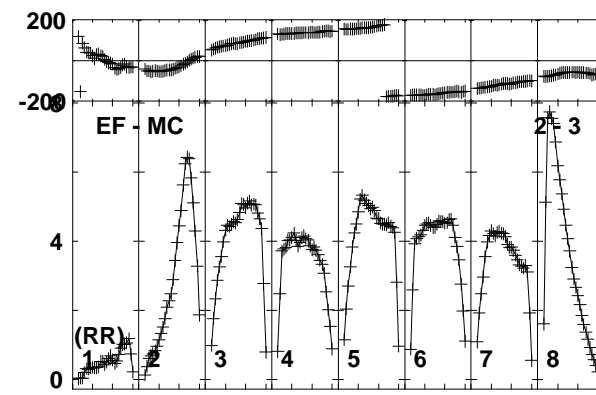
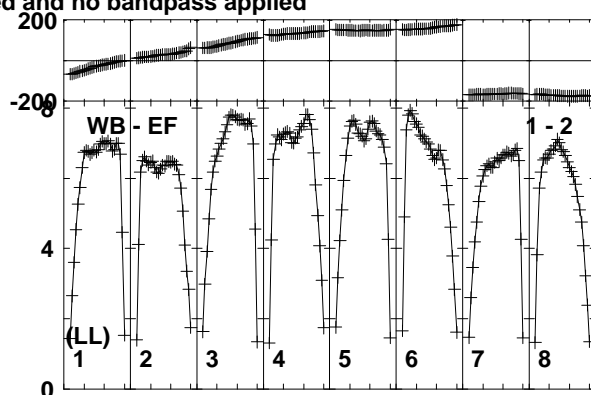
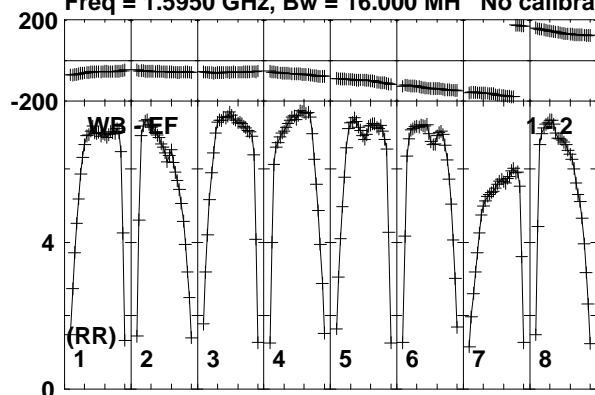

Lower frame: Milli Ampl Jy Top frame: Phas deg  
Vector averaged cross-power spectrum Baseline: WB (01) - EF (02)  
Timerange: 00/02:50:41 to 00/02:51:59

Plot file version 32 created 30-AUG-2019 17:53:11

J1722+2458 EB070.UVDATA.1

Freq = 1.5950 GHz, Bw = 16.000 MH No calibration applied and no bandpass applied

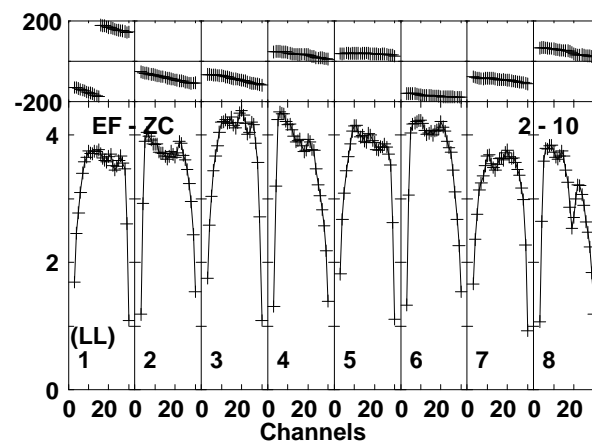
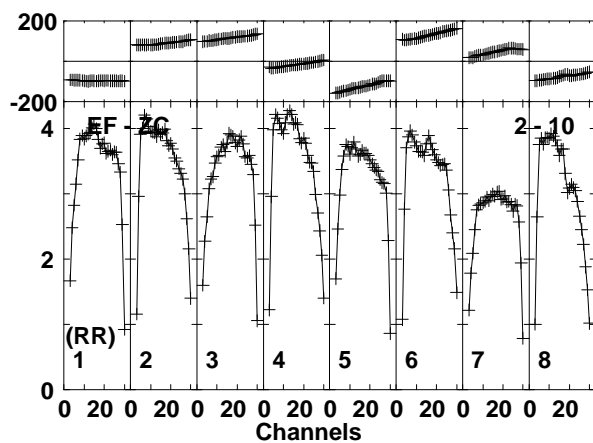
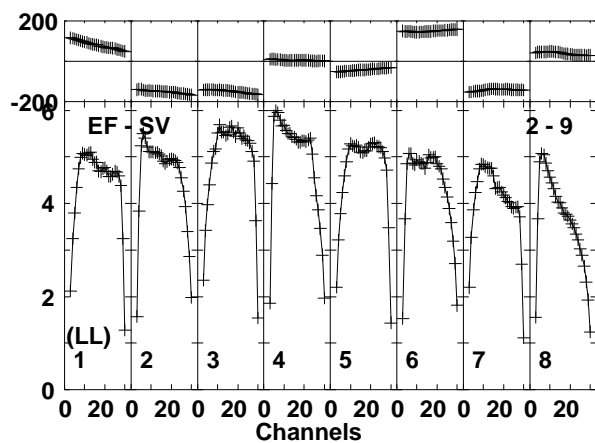
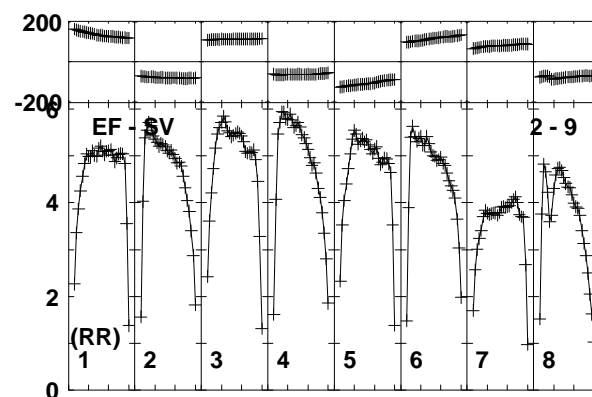
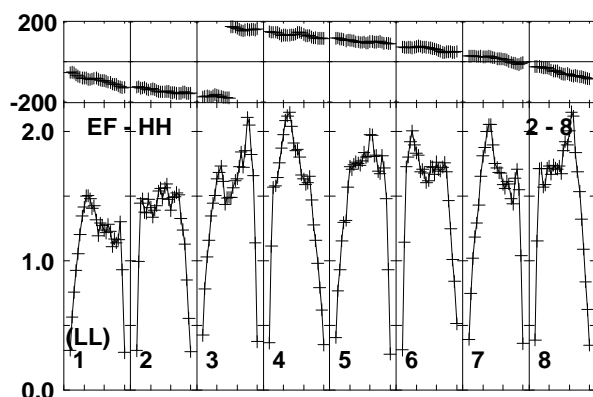
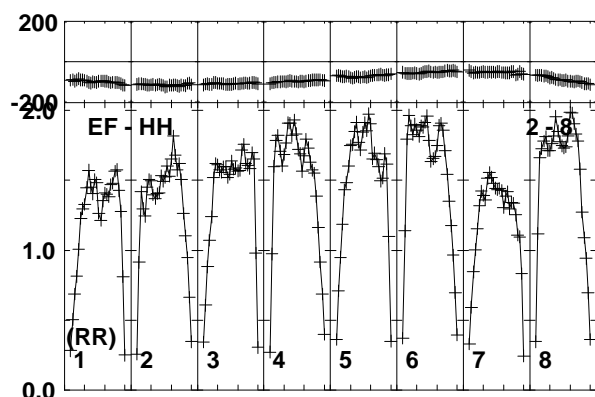
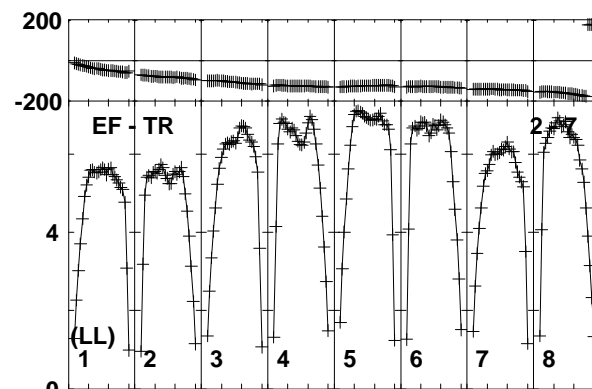
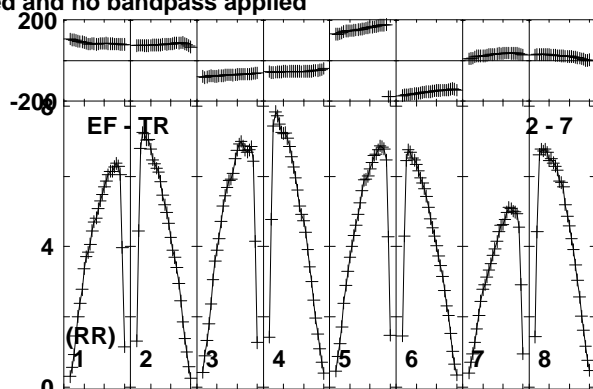
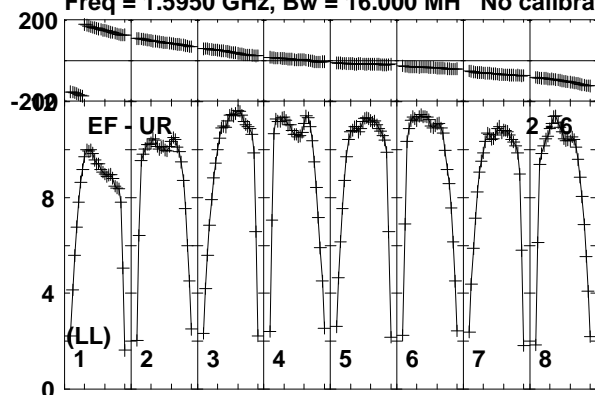

Lower frame: Milli Ampl Jy Top frame: Phas deg  
Vector averaged cross-power spectrum Baseline: EF (02) - UR (06)  
Timerange: 00/02:50:41 to 00/02:51:59



Plot file version 33 created 30-AUG-2019 17:53:12

J1722+2458 EB070.UVDATA.1

Freq = 1.5950 GHz, Bw = 16.000 MH No calibration applied and no bandpass applied

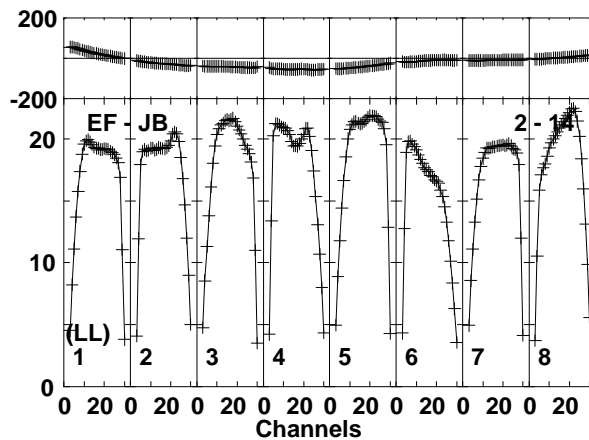
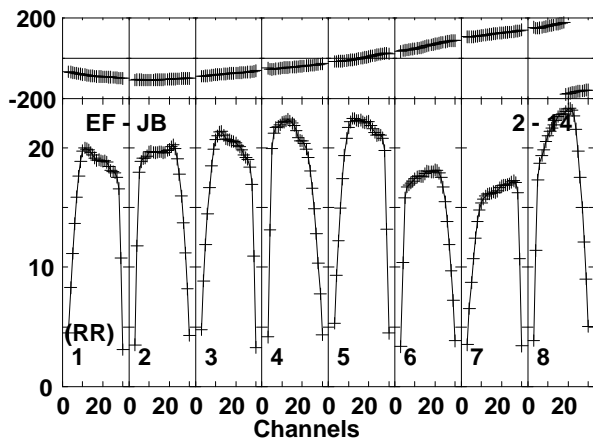
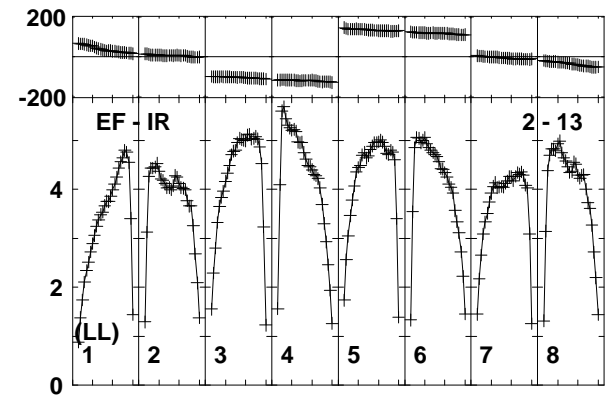
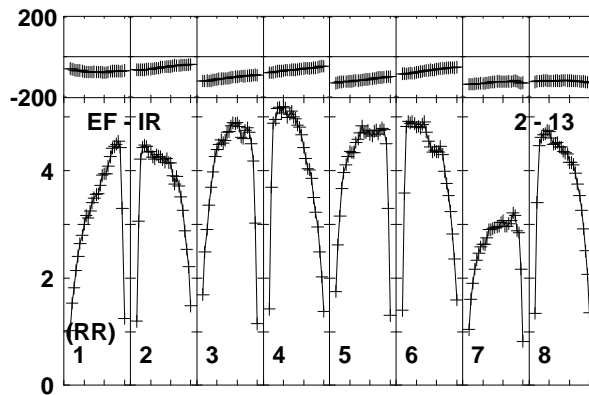
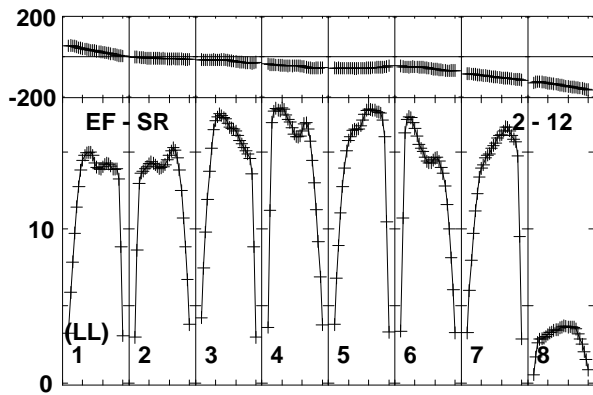
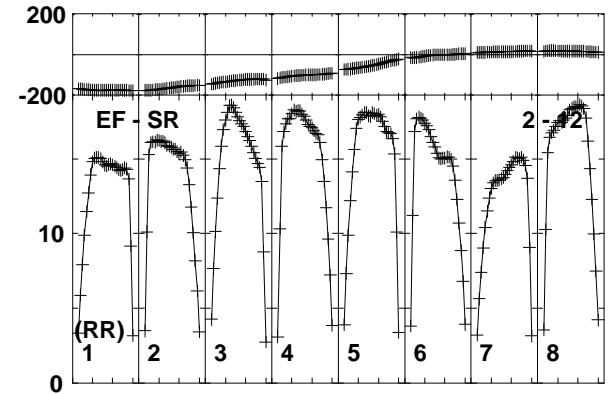
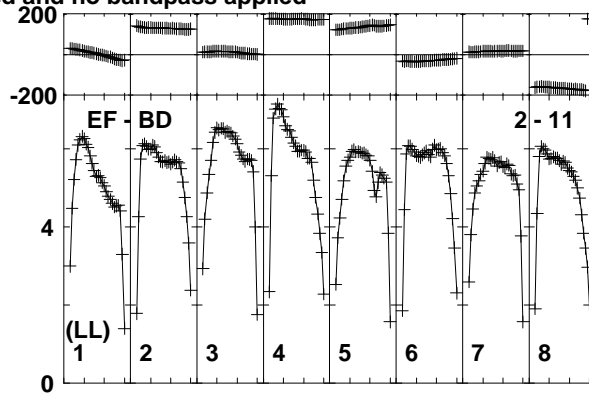
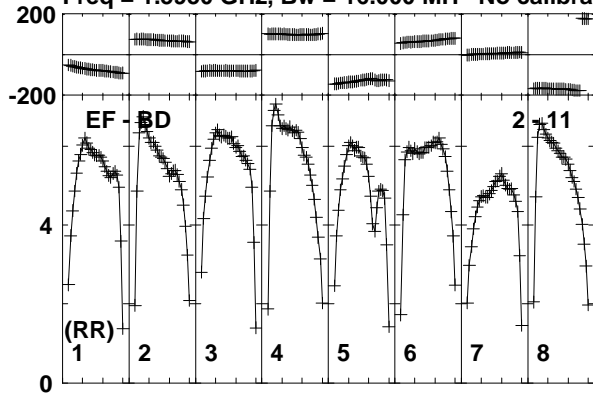

Lower frame: Milli Ampl Jy Top frame: Phas deg  
Vector averaged cross-power spectrum Baseline: EF (02) - BD (11)  
Timerange: 00/02:50:41 to 00/02:51:59

Plot file version 34 created 30-AUG-2019 17:53:12

ROSS867 EB070.UVDATA.1

Freq = 1.5950 GHz, Bw = 16.000 MH No calibration applied and no bandpass applied

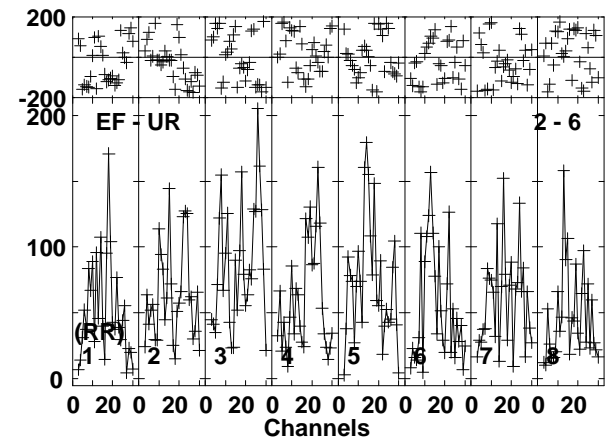
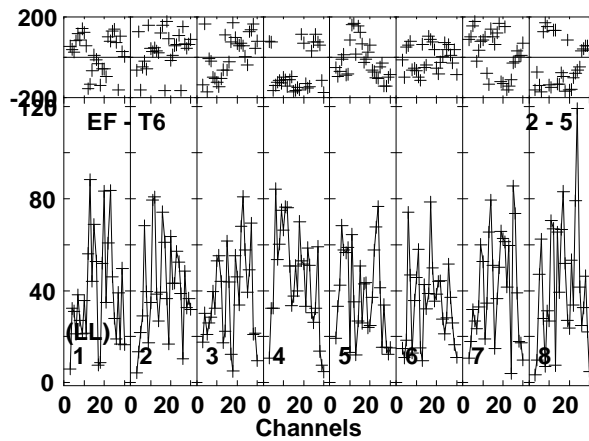
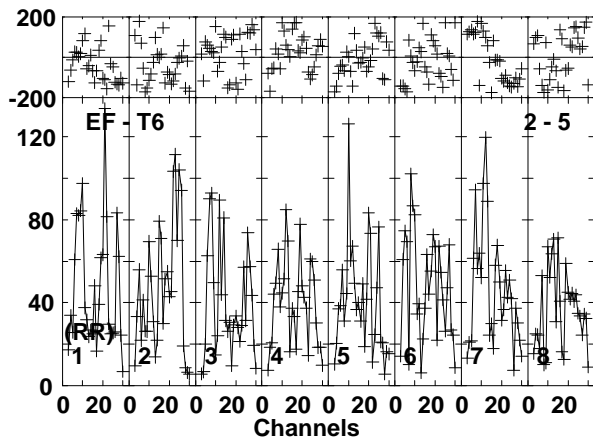
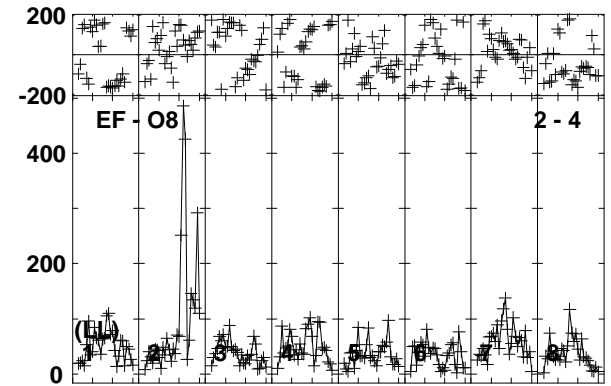
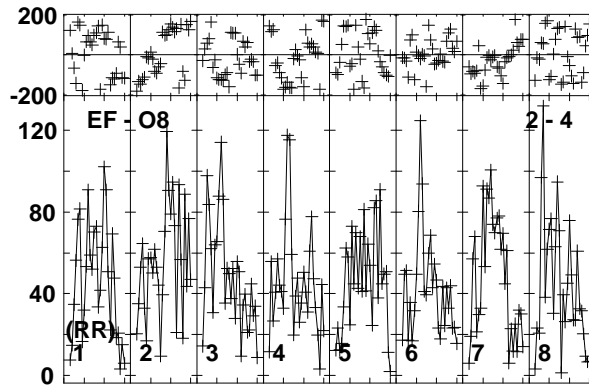
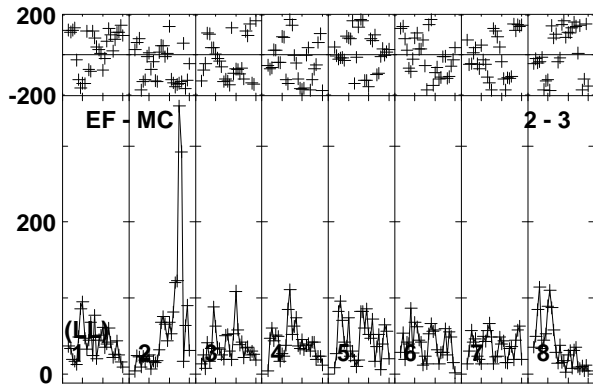
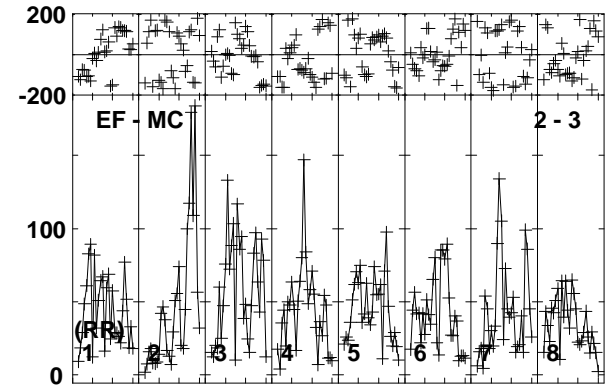
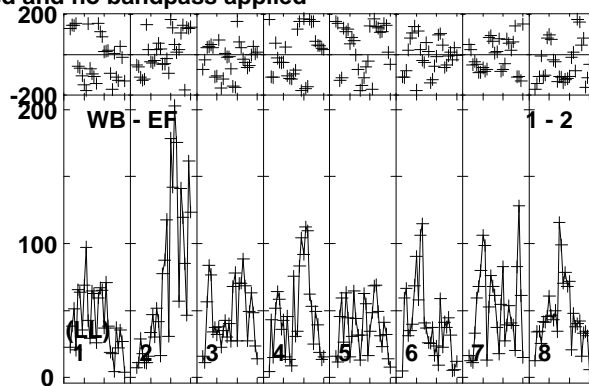
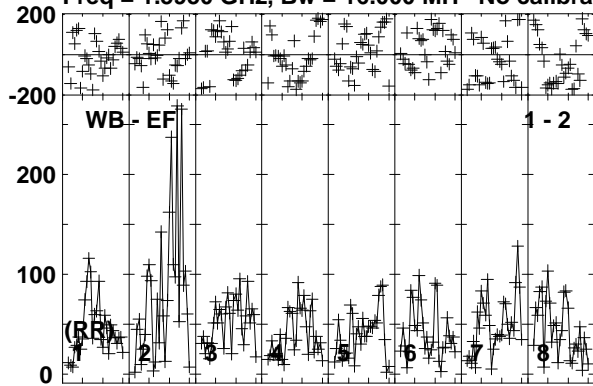

Lower frame: Micro Ampl Jy Top frame: Phas deg  
Vector averaged cross-power spectrum Baseline: WB (01) - EF (02)  
Timerange: 00/02:52:01 to 00/02:59:59

Plot file version 35 created 30-AUG-2019 17:53:12

ROSS867 EB070.UVDATA.1

Freq = 1.5950 GHz, Bw = 16.000 MH No calibration applied and no bandpass applied

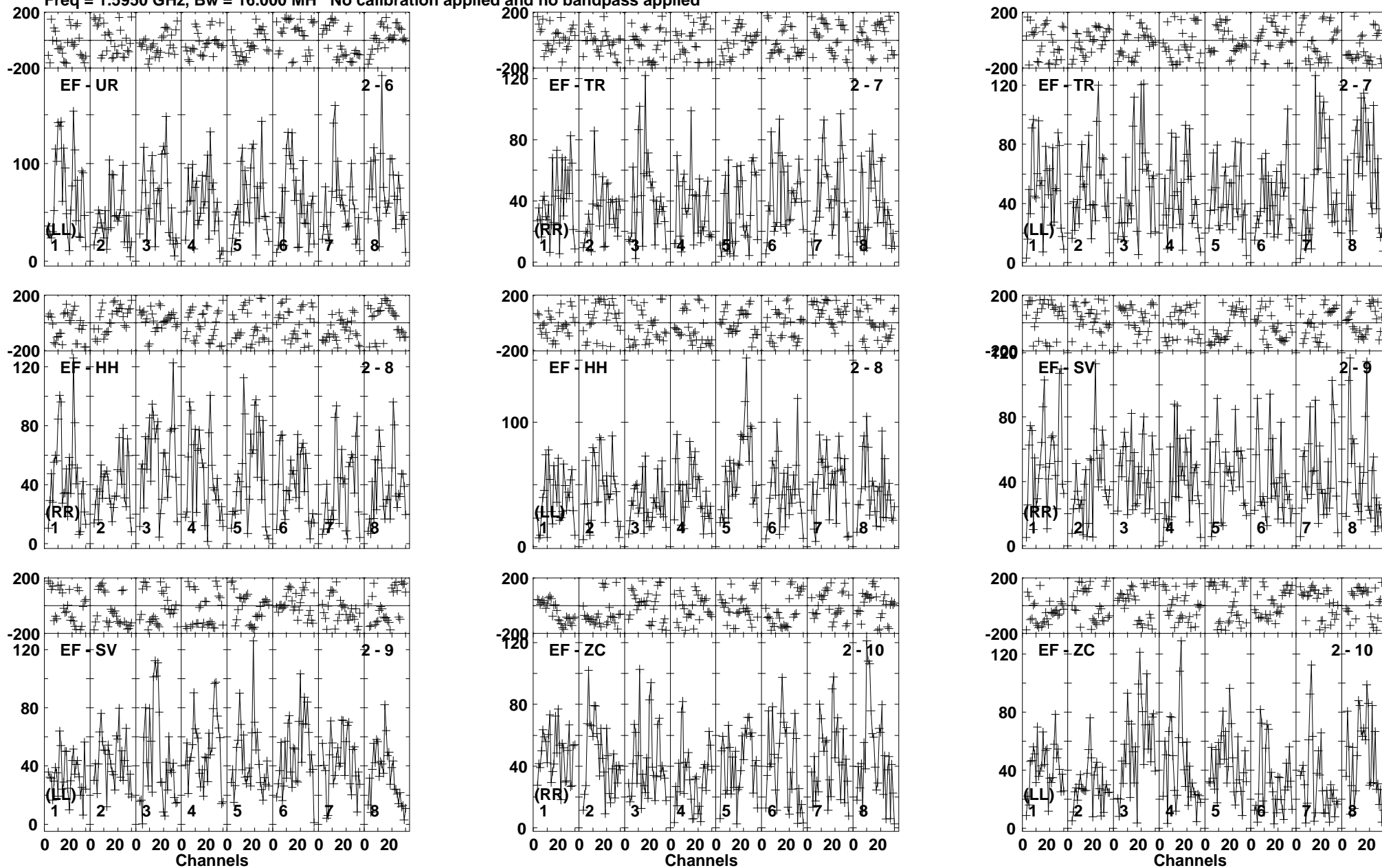

Lower frame: Micro Ampl Jy Top frame: Phas deg  
Vector averaged cross-power spectrum Baseline: EF (02) - UR (06)  
Timerange: 00/02:52:01 to 00/02:59:59

Plot file version 36 created 30-AUG-2019 17:53:12

ROSS867 EB070.UVDATA.1

Freq = 1.5950 GHz, Bw = 16.000 MH No calibration applied and no bandpass applied

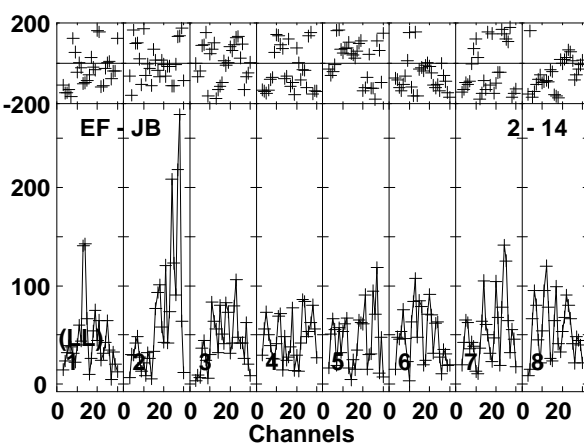
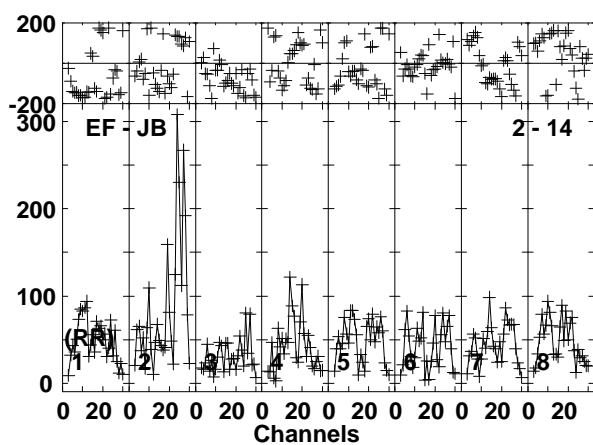
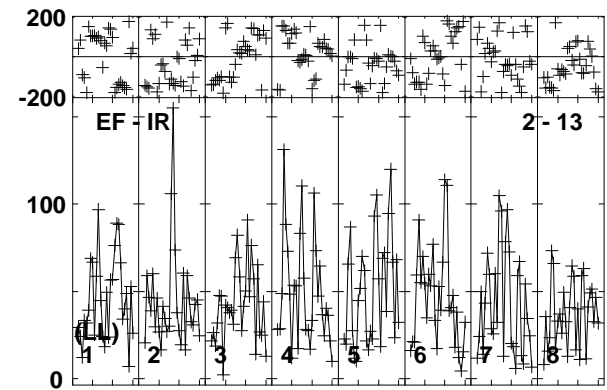
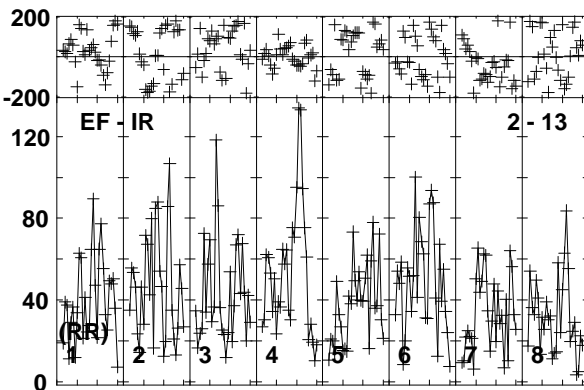
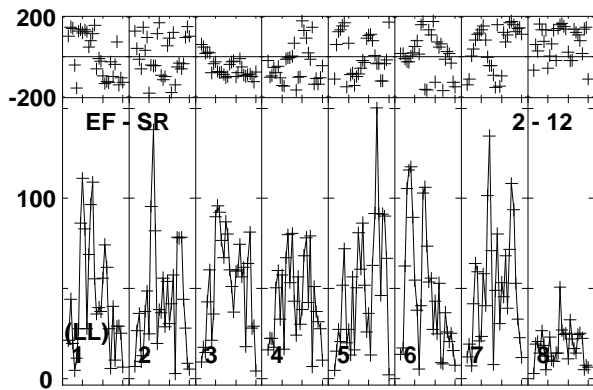
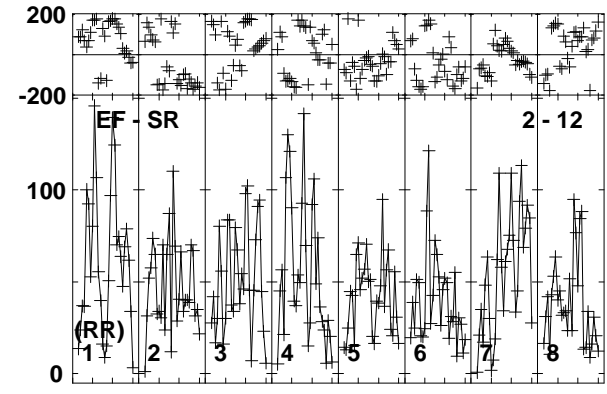
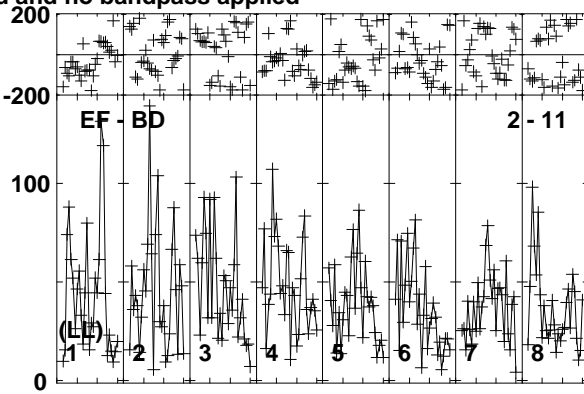
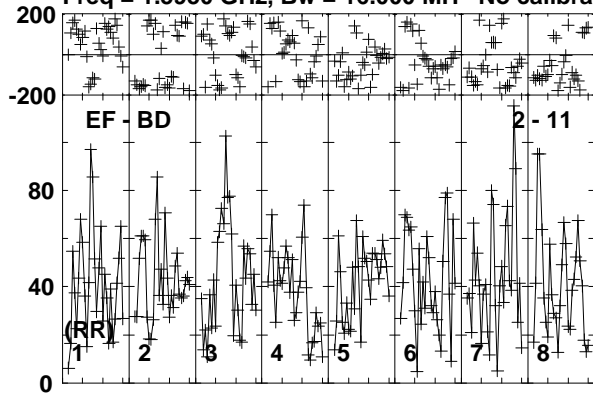

Lower frame: Micro Ampl Jy Top frame: Phas deg  
Vector averaged cross-power spectrum Baseline: EF (02) - BD (11)  
Timerange: 00/02:52:01 to 00/02:59:59

Plot file version 37 created 30-AUG-2019 17:53:12

J1722+2458 EB070.UVDATA.1

Freq = 1.5950 GHz, Bw = 16.000 MH No calibration applied and no bandpass applied

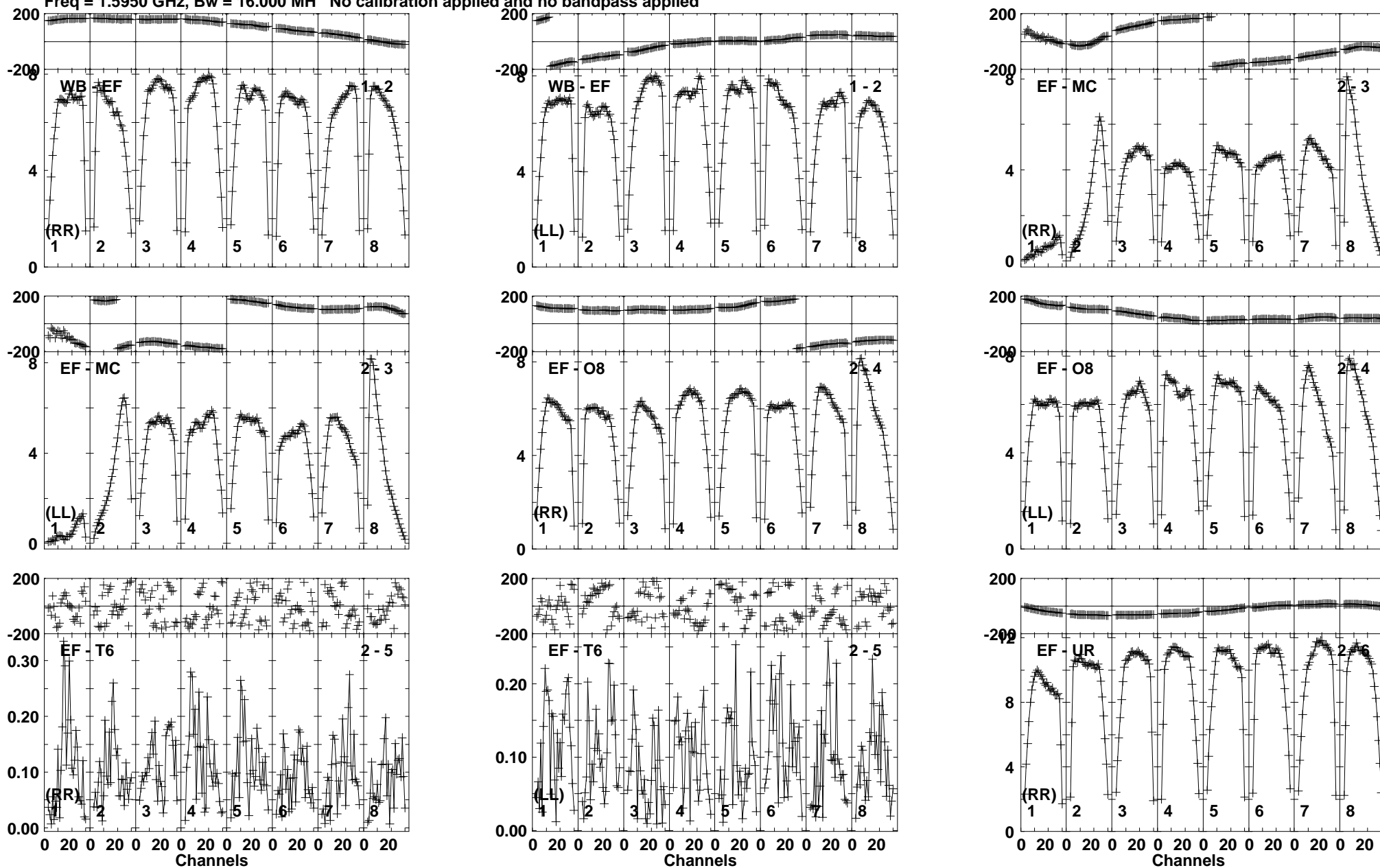

Lower frame: Milli Ampl Jy Top frame: Phas deg  
Vector averaged cross-power spectrum Baseline: WB (01) - EF (02)  
Timerange: 00/03:00:01 to 00/03:01:59

Plot file version 38 created 30-AUG-2019 17:53:13

J1722+2458 EB070.UVDATA.1

Freq = 1.5950 GHz, Bw = 16.000 MH No calibration applied and no bandpass applied

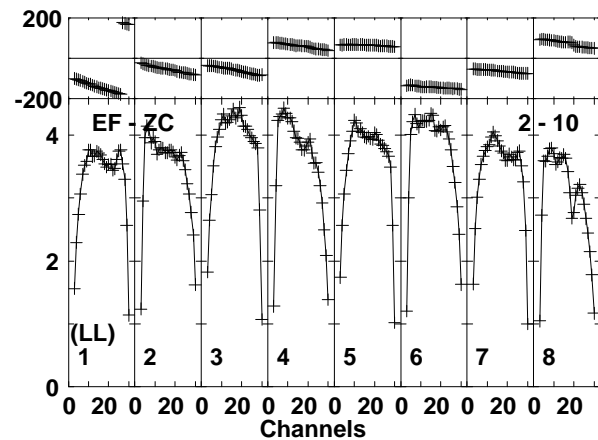
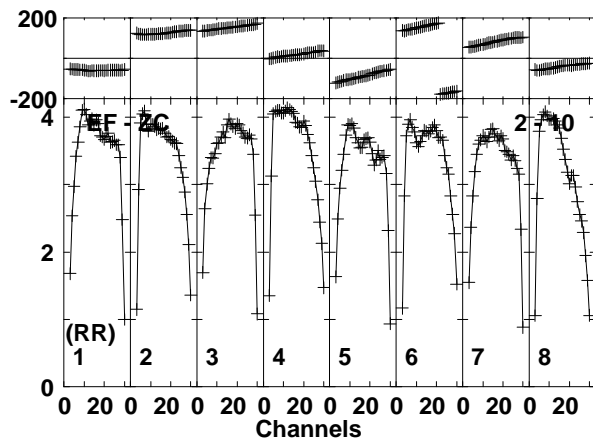
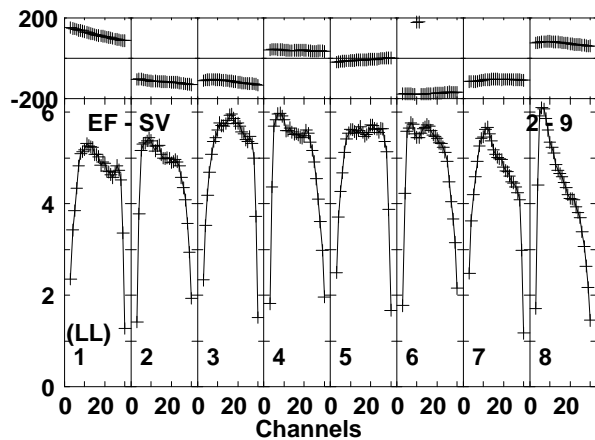
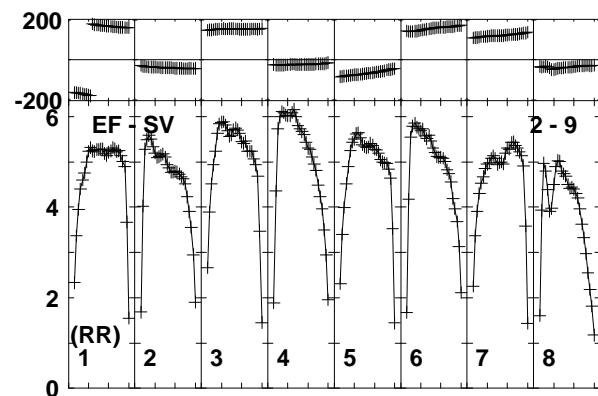
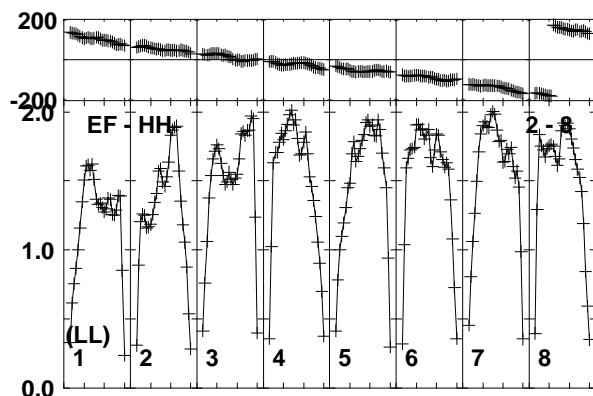
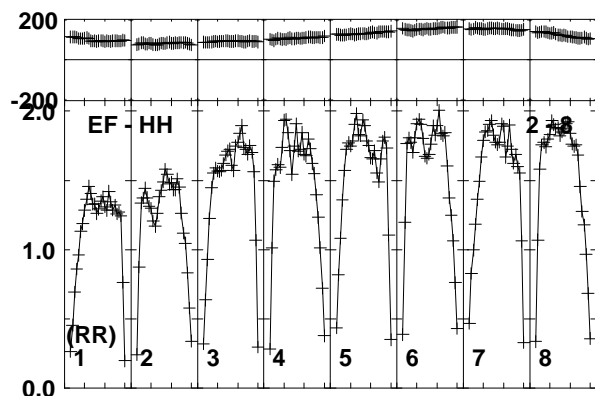
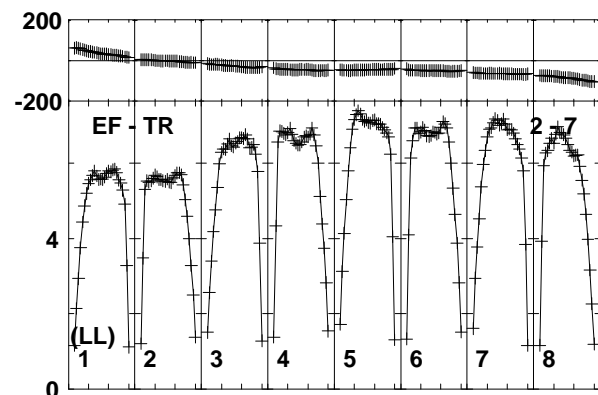
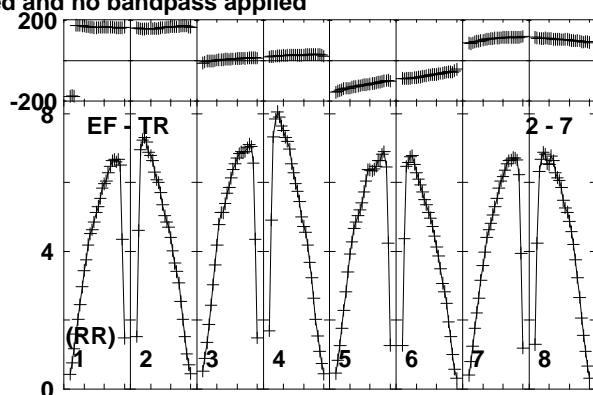
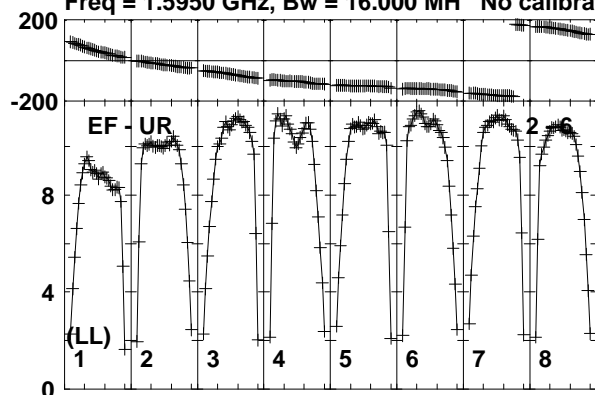

Lower frame: Milli Ampl Jy Top frame: Phas deg  
Vector averaged cross-power spectrum Baseline: EF (02) - UR (06)  
Timerange: 00/03:00:01 to 00/03:01:59

Plot file version 39 created 30-AUG-2019 17:53:13

J1722+2458 EB070.UVDATA.1

Freq = 1.5950 GHz, Bw = 16.000 MH No calibration applied and no bandpass applied

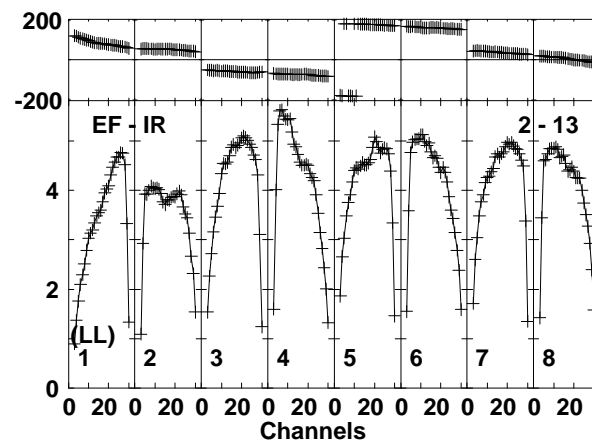
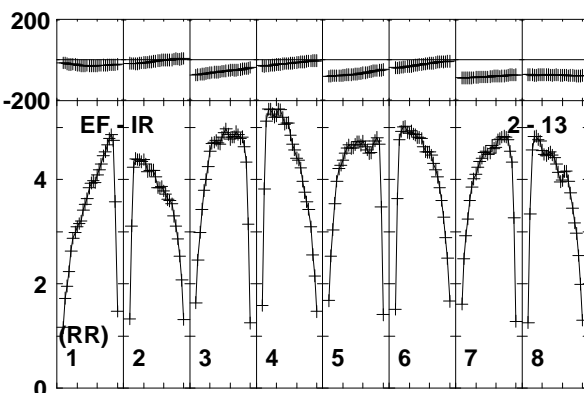
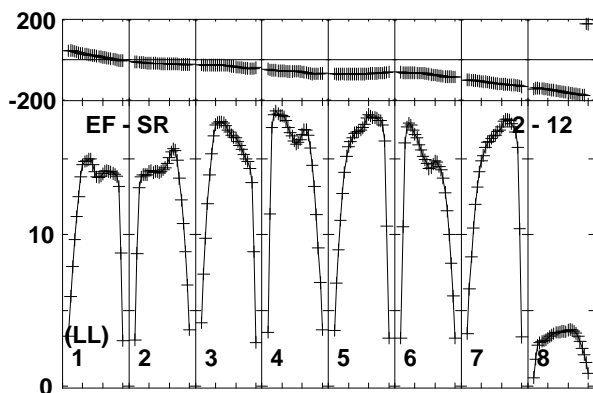
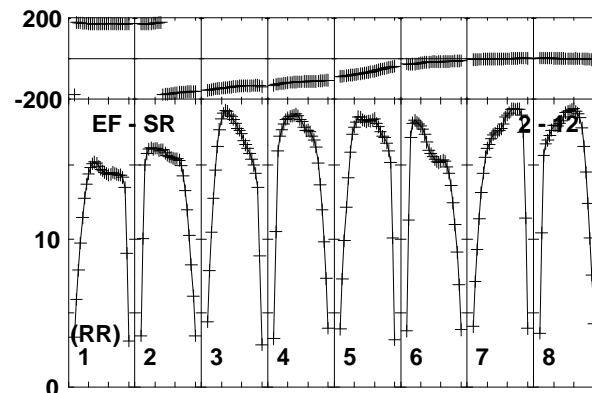
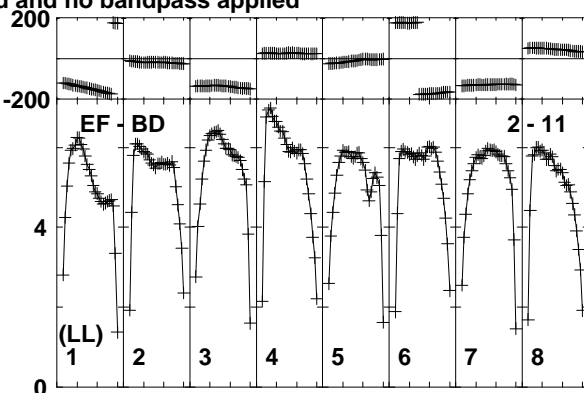
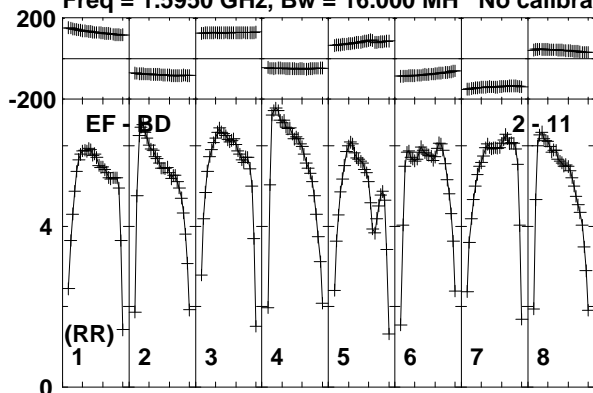

Lower frame: Milli Ampl Jy Top frame: Phas deg  
Vector averaged cross-power spectrum Baseline: EF (02) - BD (11)  
Timerange: 00/03:00:01 to 00/03:01:59

Plot file version 40 created 30-AUG-2019 17:53:13

ROSS867 EB070.UVDATA.1

Freq = 1.5950 GHz, Bw = 16.000 MH No calibration applied and no bandpass applied

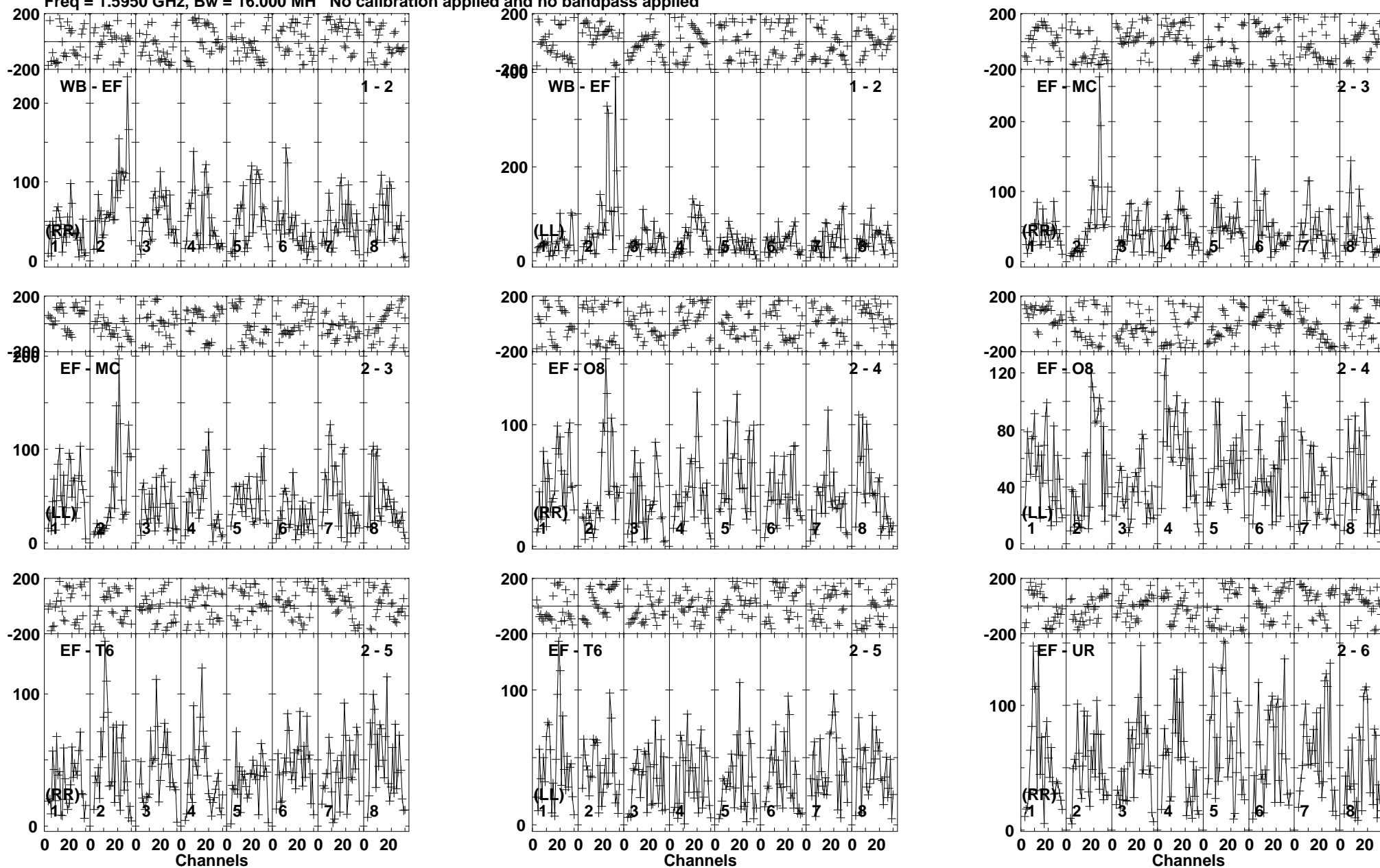

Lower frame: Micro Ampl Jy Top frame: Phas deg  
Vector averaged cross-power spectrum Baseline: WB (01) - EF (02)  
Timerange: 00/03:02:01 to 00/03:09:59



Plot file version 41 created 30-AUG-2019 17:53:13

ROSS867 EB070.UVDATA.1

Freq = 1.5950 GHz, Bw = 16.000 MH No calibration applied and no bandpass applied

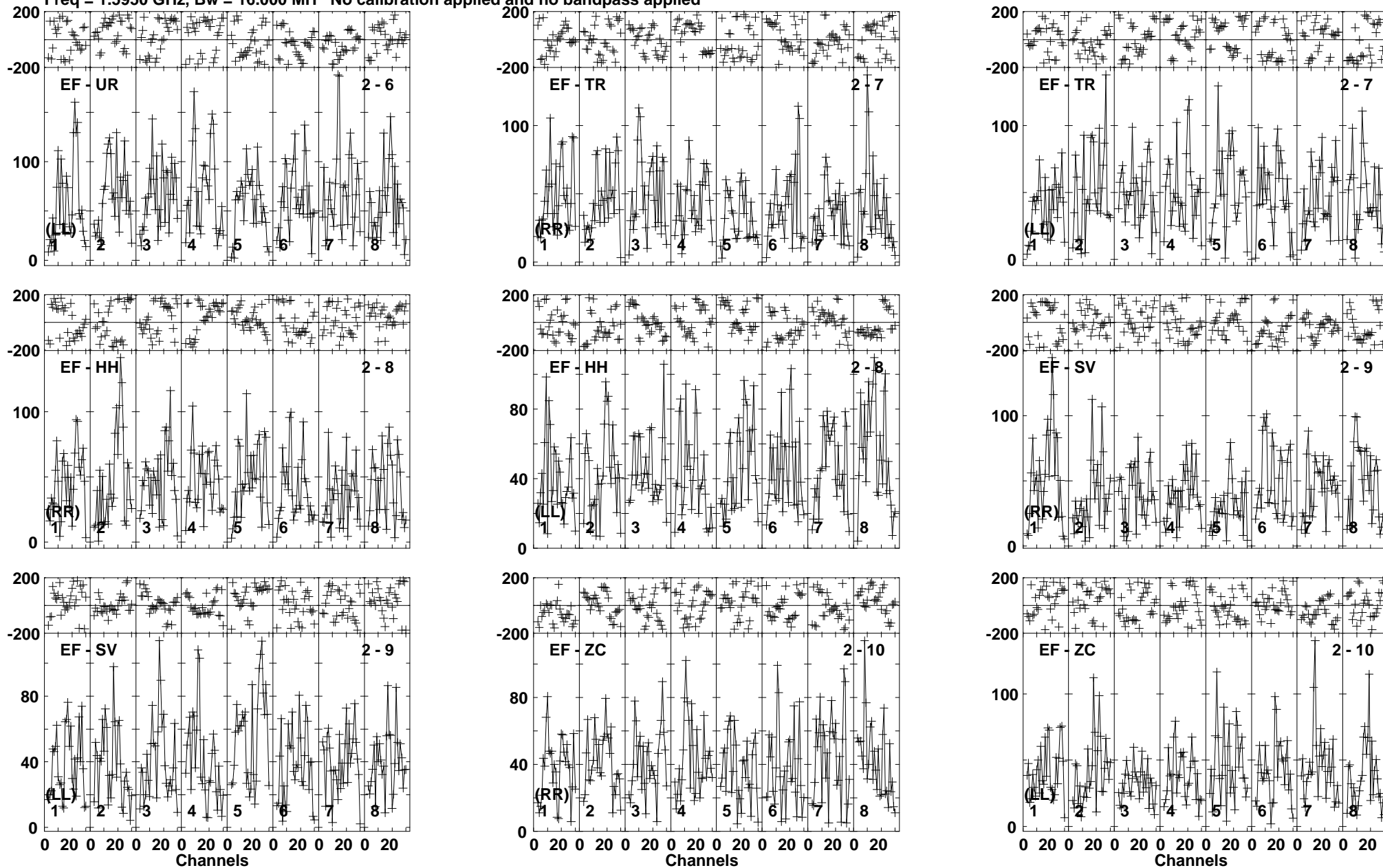

Lower frame: Micro Ampl Jy Top frame: Phas deg  
Vector averaged cross-power spectrum Baseline: EF (02) - UR (06)  
Timerange: 00/03:02:01 to 00/03:09:59

Plot file version 42 created 30-AUG-2019 17:53:14

ROSS867 EB070.UVDATA.1

Freq = 1.5950 GHz, Bw = 16.000 MH No calibration applied and no bandpass applied

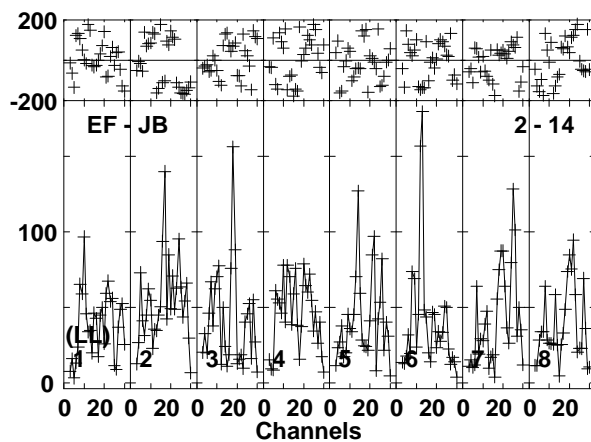
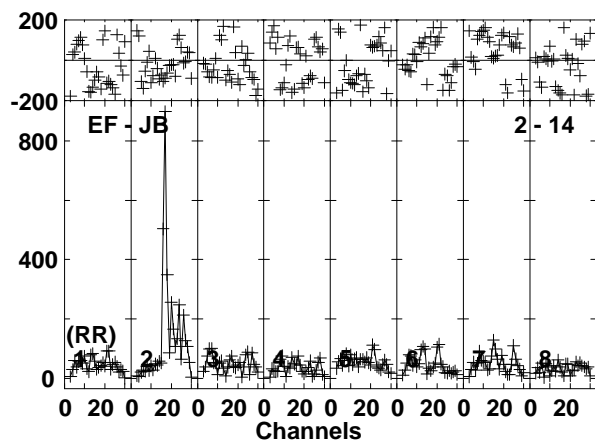
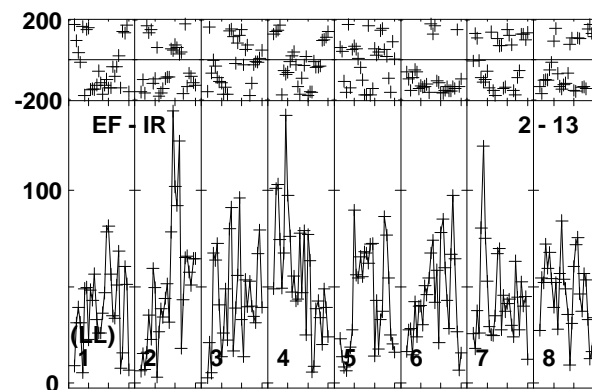
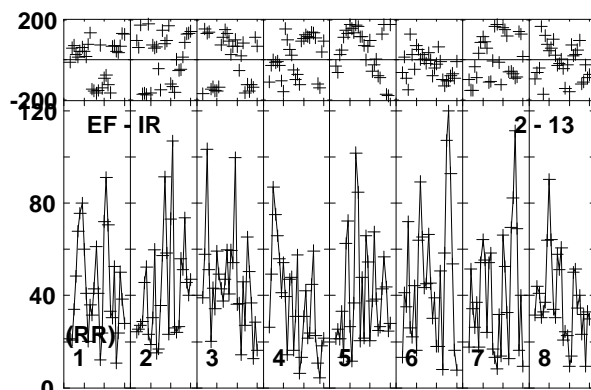
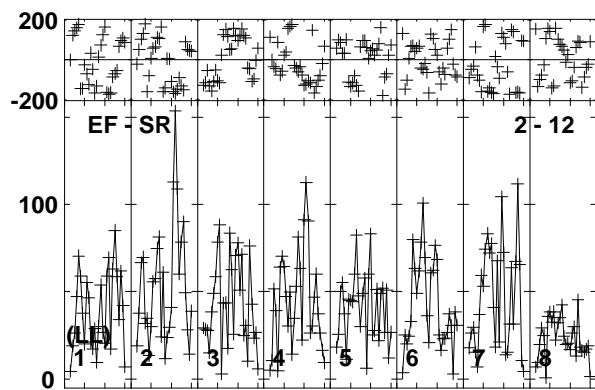
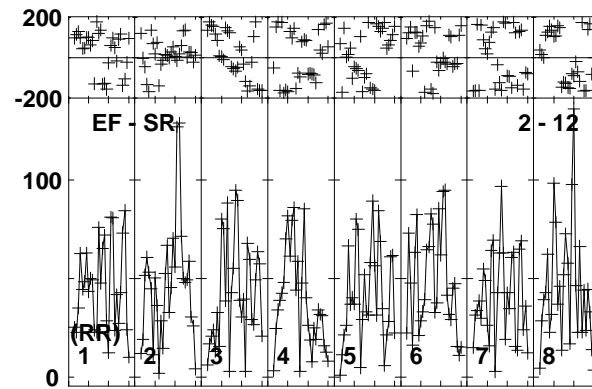
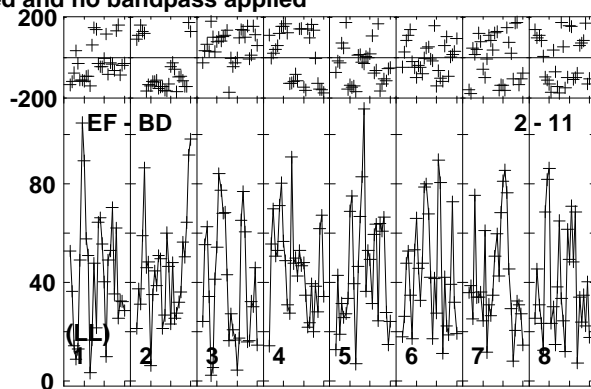
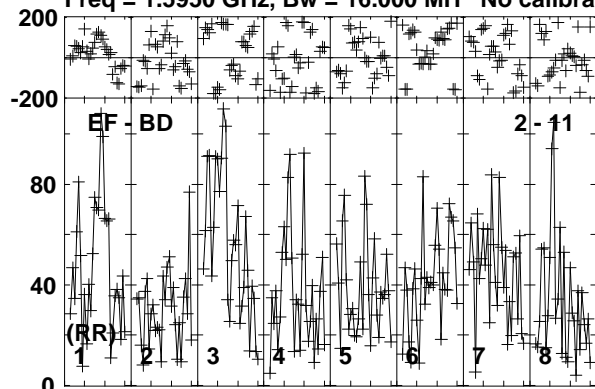

Lower frame: Micro Ampl Jy Top frame: Phas deg  
Vector averaged cross-power spectrum Baseline: EF (02) - BD (11)  
Timerange: 00/03:02:01 to 00/03:09:59

Plot file version 43 created 30-AUG-2019 17:53:14

J1722+2458 EB070.UVDATA.1

Freq = 1.5950 GHz, Bw = 16.000 MH No calibration applied and no bandpass applied

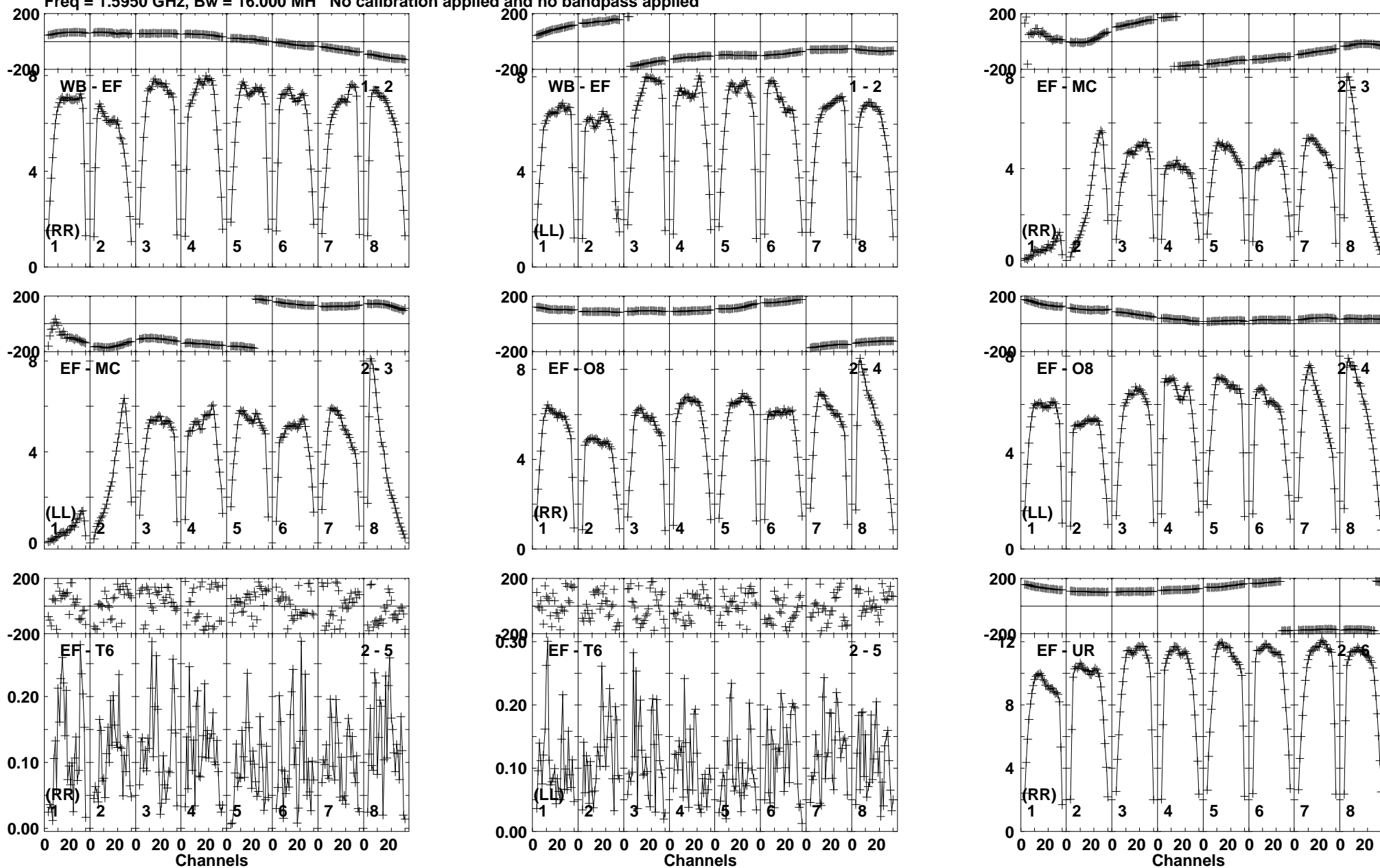

Lower frame: Milli Ampl Jy Top frame: Phas deg  
Vector averaged cross-power spectrum Baseline: WB (01) - EF (02)  
Timerange: 00/03:10:41 to 00/03:11:59

Plot file version 44 created 30-AUG-2019 17:53:14

J1722+2458 EB070.UVDATA.1

Freq = 1.5950 GHz, Bw = 16.000 MH No calibration applied and no bandpass applied

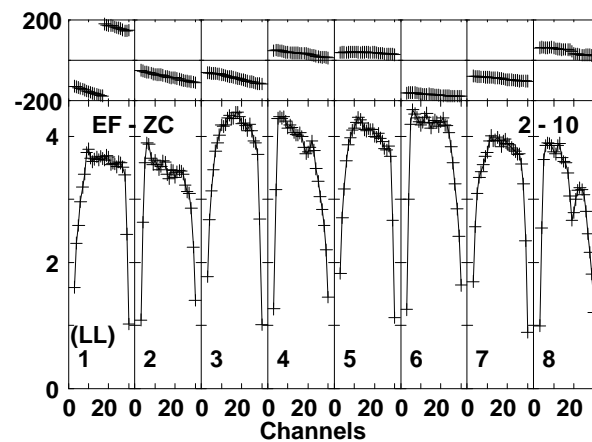
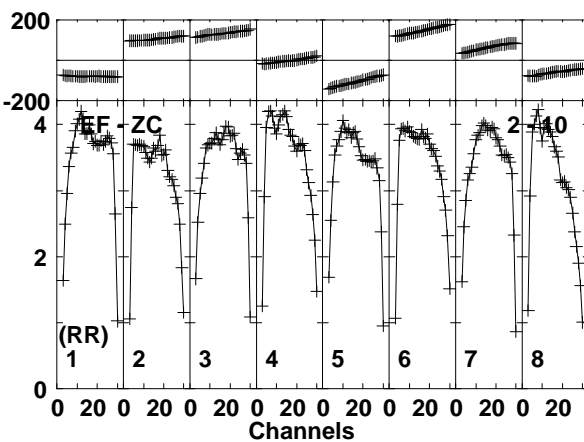
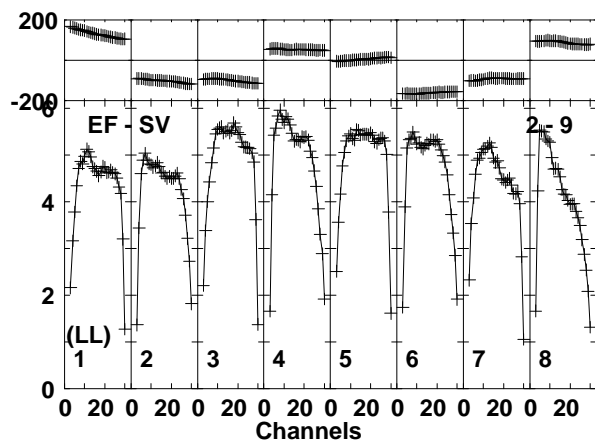
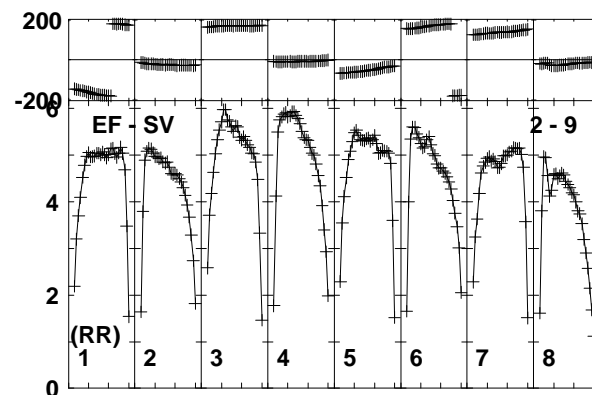
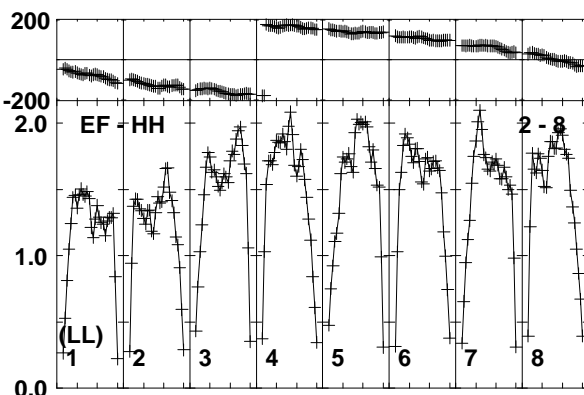
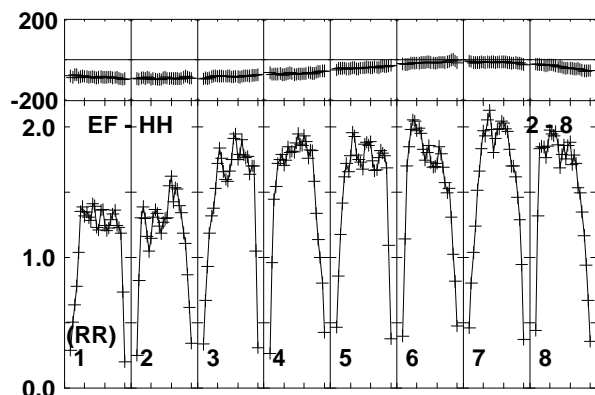
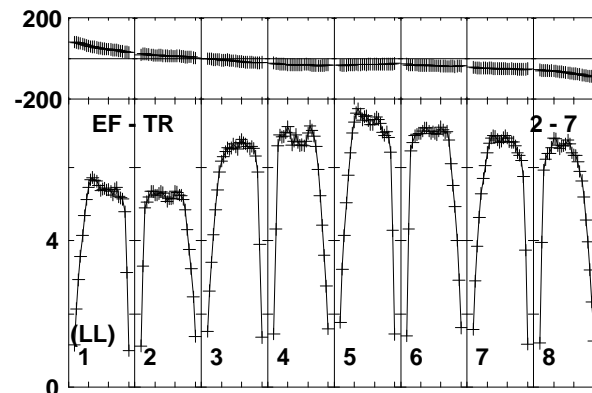
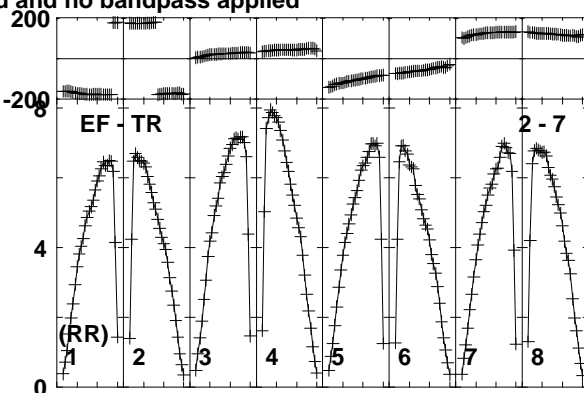
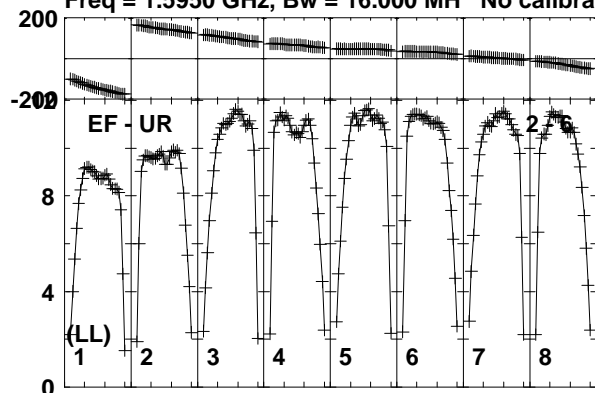

Lower frame: Milli Ampl Jy Top frame: Phas deg  
Vector averaged cross-power spectrum Baseline: EF (02) - UR (06)  
Timerange: 00/03:10:41 to 00/03:11:59

Plot file version 45 created 30-AUG-2019 17:53:14

J1722+2458 EB070.UVDATA.1

Freq = 1.5950 GHz, Bw = 16.000 MH No calibration applied and no bandpass applied

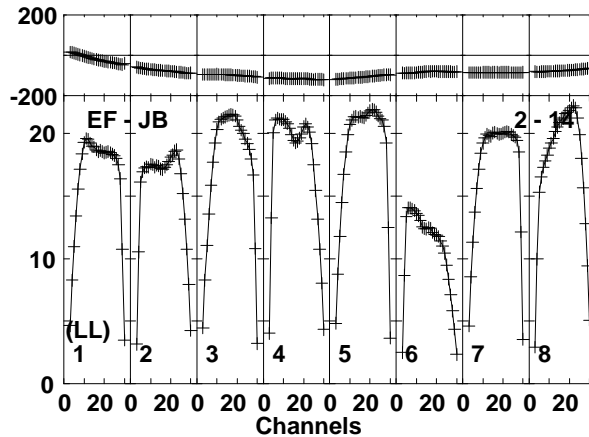
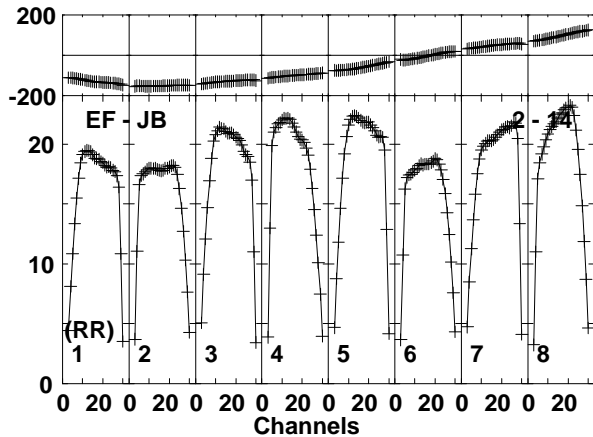
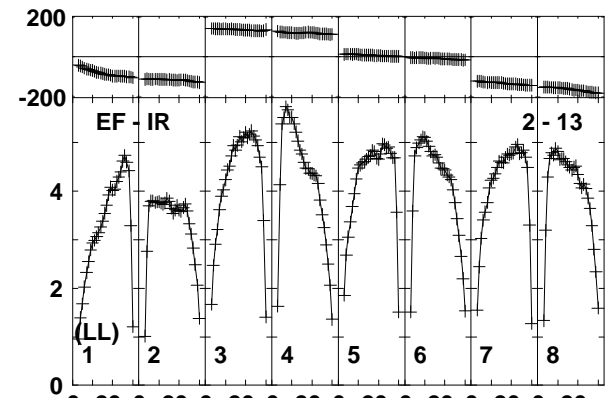
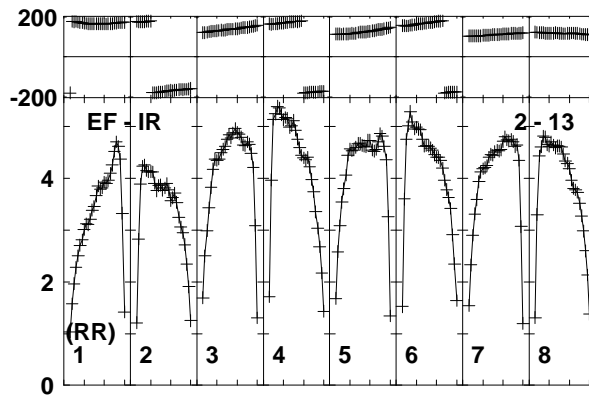
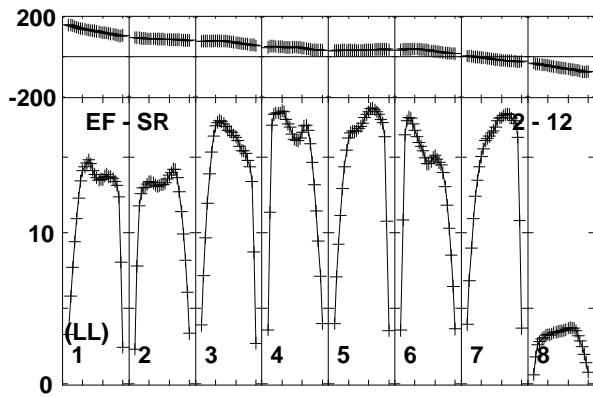
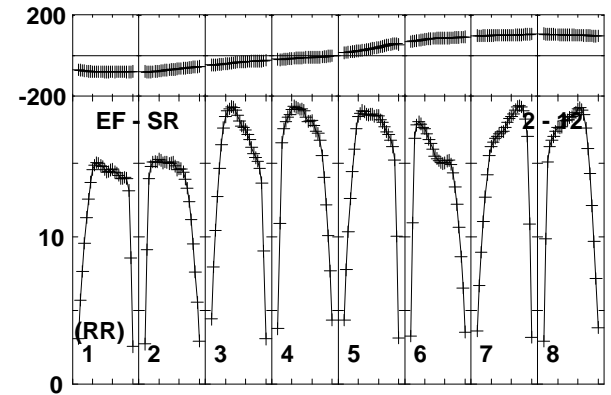
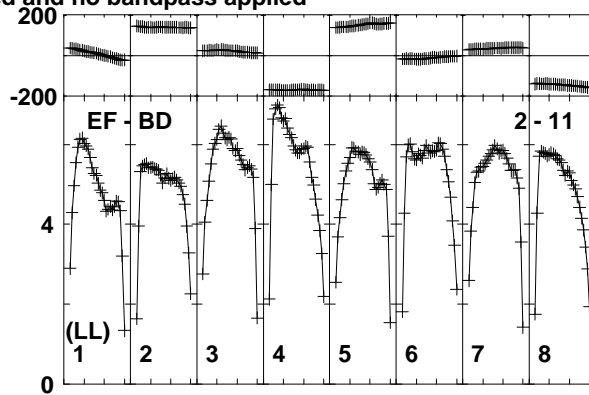
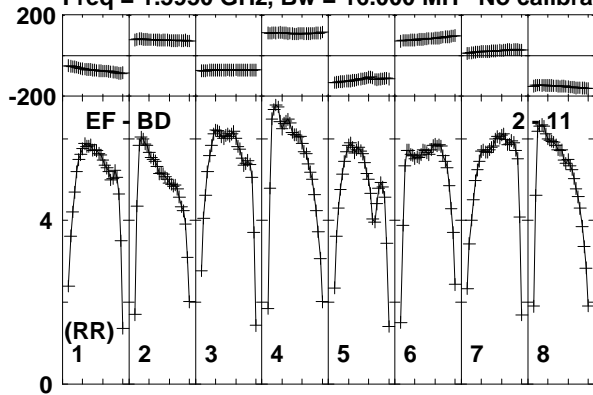

Lower frame: Milli Ampl Jy Top frame: Phas deg  
Vector averaged cross-power spectrum Baseline: EF (02) - BD (11)  
Timerange: 00/03:10:41 to 00/03:11:59

Plot file version 46 created 30-AUG-2019 17:53:14

ROSS867 EB070.UVDATA.1

Freq = 1.5950 GHz, Bw = 16.000 MH No calibration applied and no bandpass applied

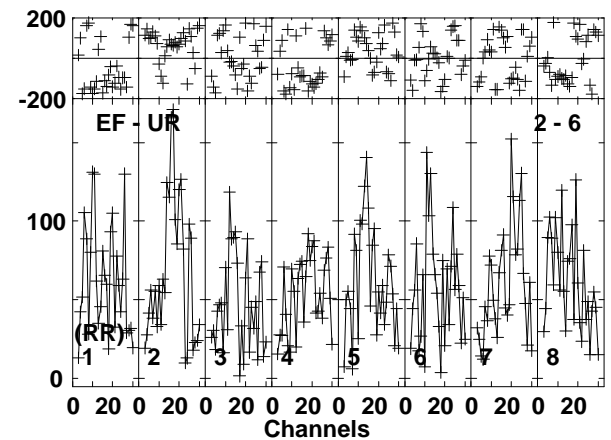
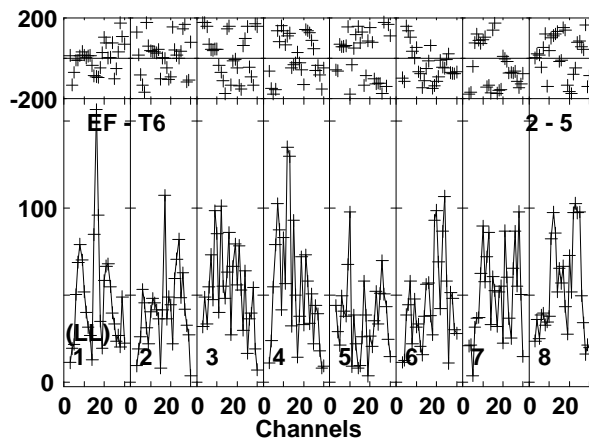
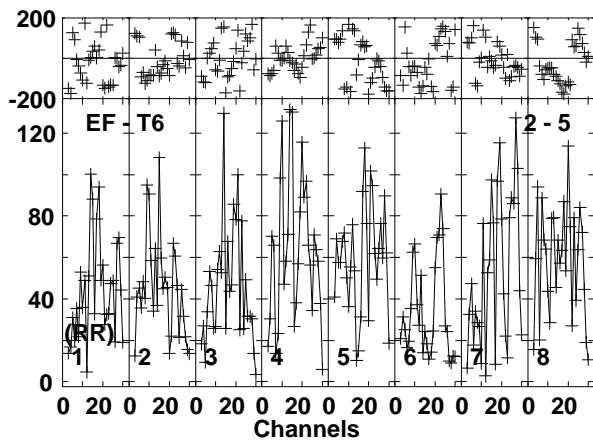
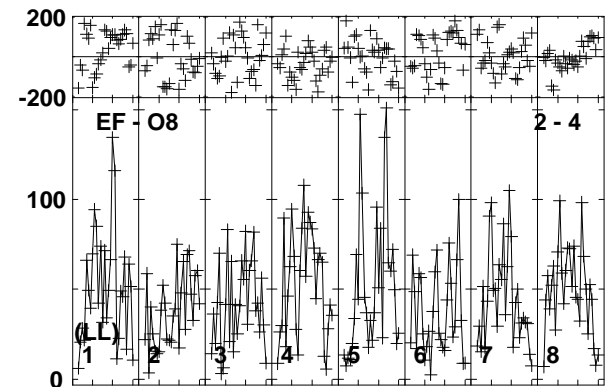
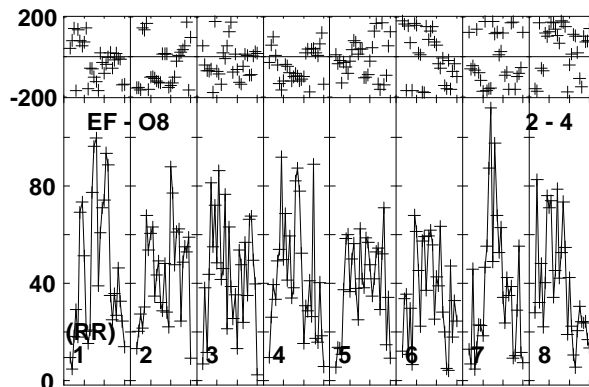
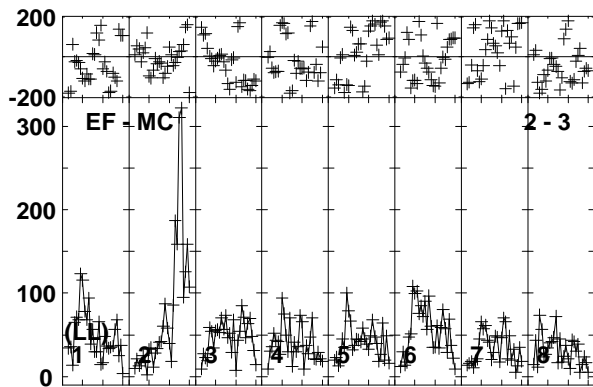
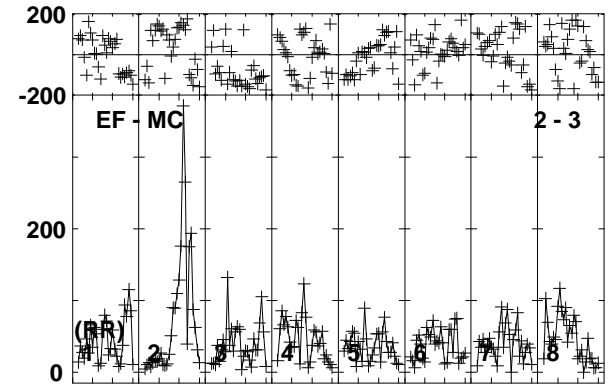
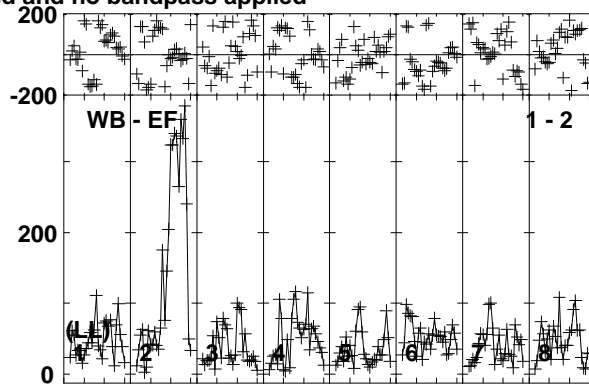
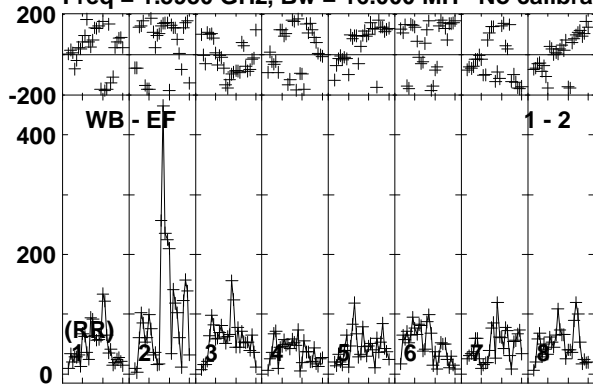

Lower frame: Micro Ampl Jy Top frame: Phas deg  
Vector averaged cross-power spectrum Baseline: WB (01) - EF (02)  
Timerange: 00/03:12:01 to 00/03:19:59

Plot file version 47 created 30-AUG-2019 17:53:14

ROSS867 EB070.UVDATA.1

Freq = 1.5950 GHz, Bw = 16.000 MH No calibration applied and no bandpass applied

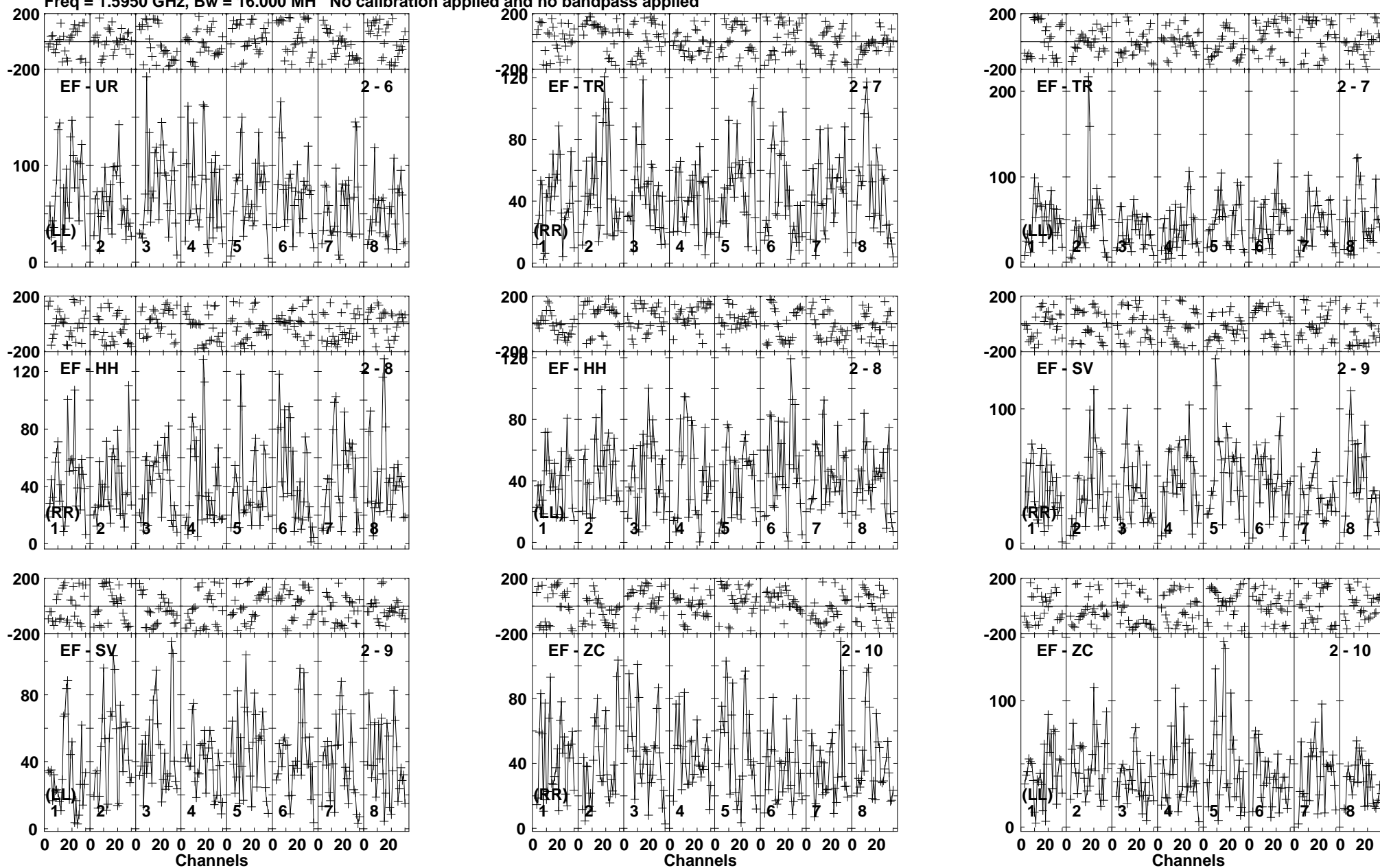

Lower frame: Micro Ampl Jy Top frame: Phas deg  
Vector averaged cross-power spectrum Baseline: EF (02) - UR (06)  
Timerange: 00/03:12:01 to 00/03:19:59

Plot file version 48 created 30-AUG-2019 17:53:15

ROSS867 EB070.UVDATA.1

Freq = 1.5950 GHz, Bw = 16.000 MH No calibration applied and no bandpass applied

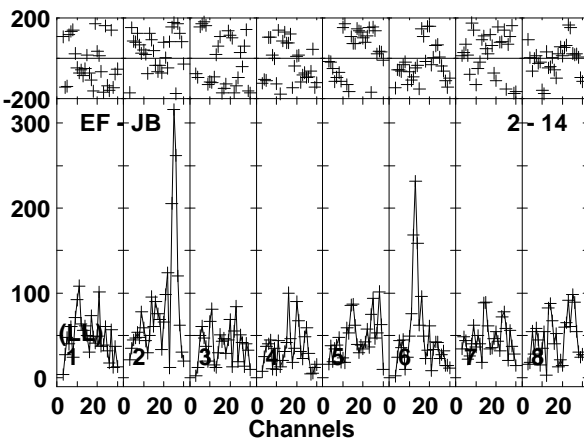
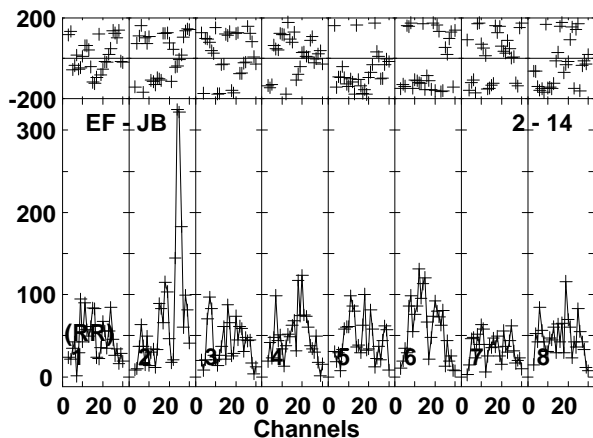
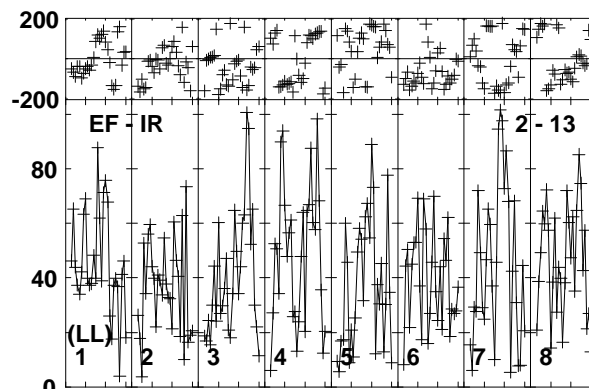
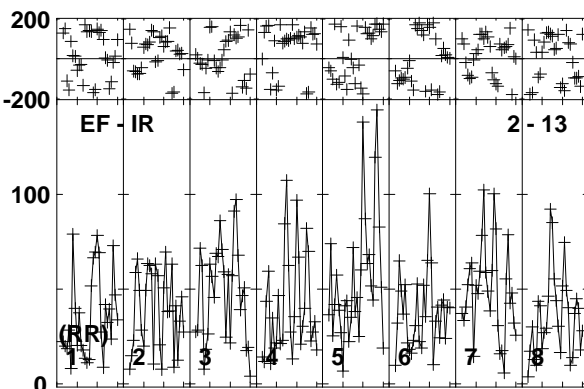
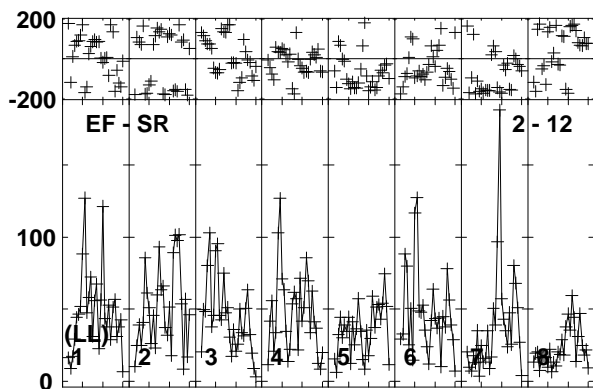
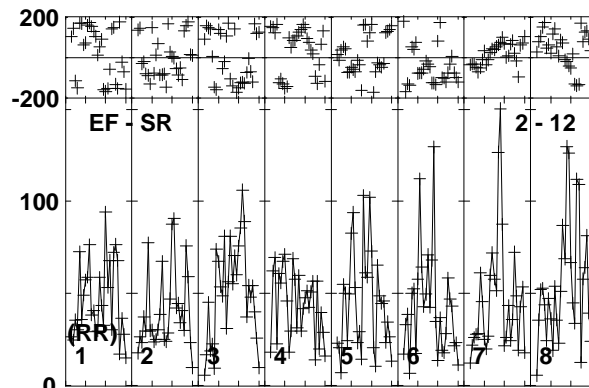
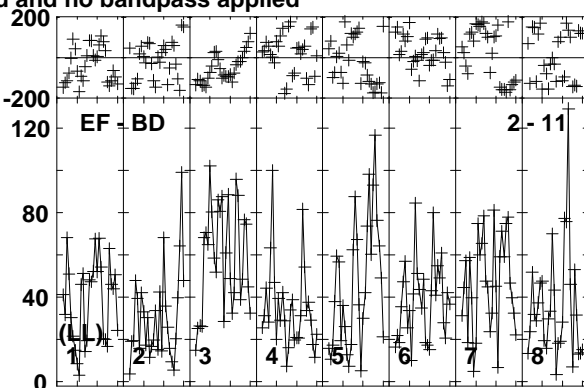
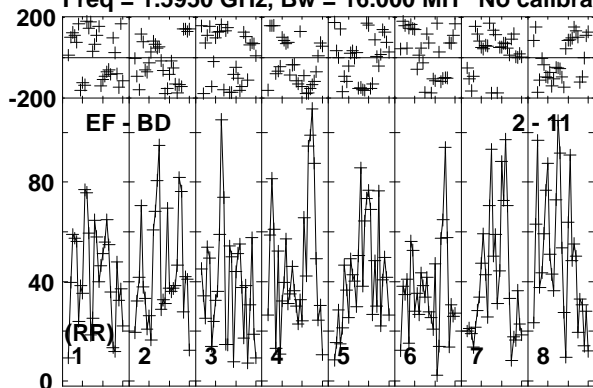

Lower frame: Micro Ampl Jy Top frame: Phas deg  
Vector averaged cross-power spectrum Baseline: EF (02) - BD (11)  
Timerange: 00/03:12:01 to 00/03:19:59



Plot file version 49 created 30-AUG-2019 17:53:15

J1722+2458 EB070.UVDATA.1

Freq = 1.5950 GHz, Bw = 16.000 MH No calibration applied and no bandpass applied

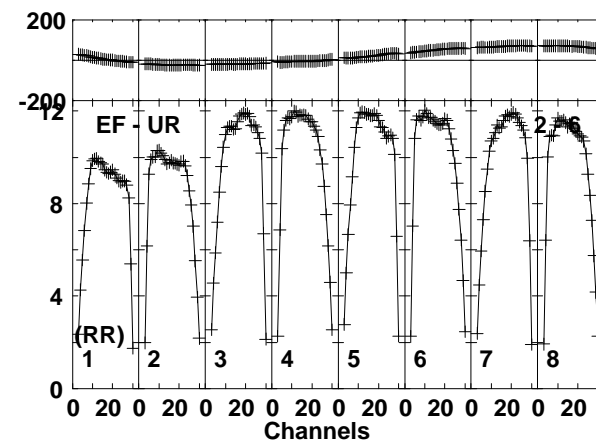
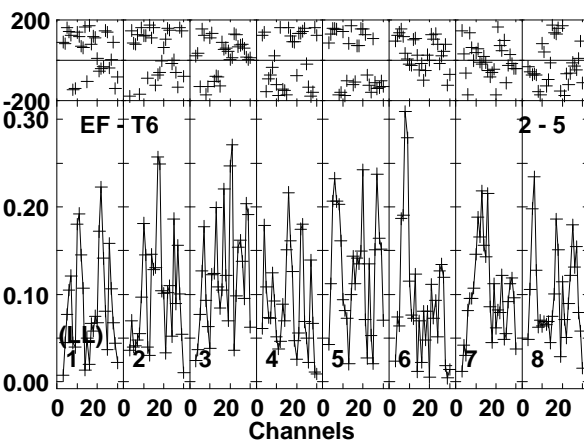
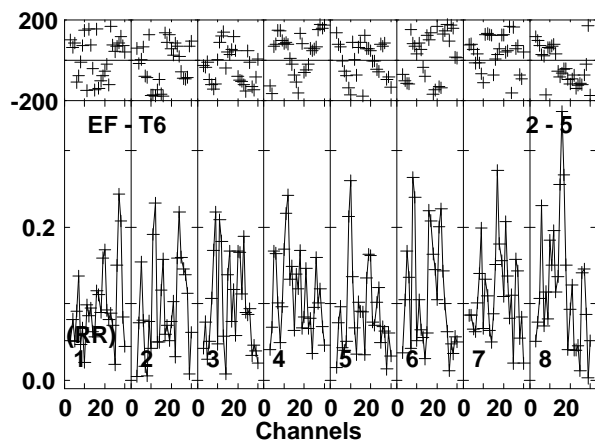
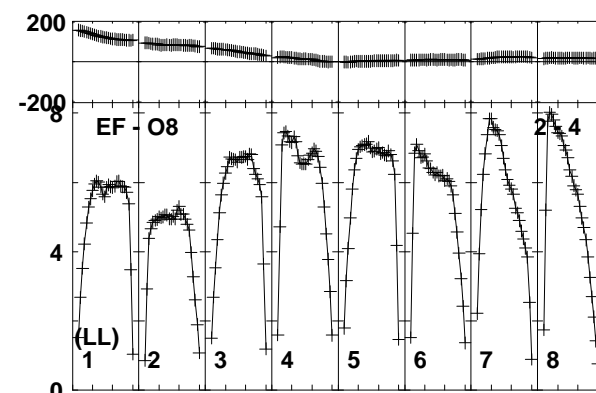
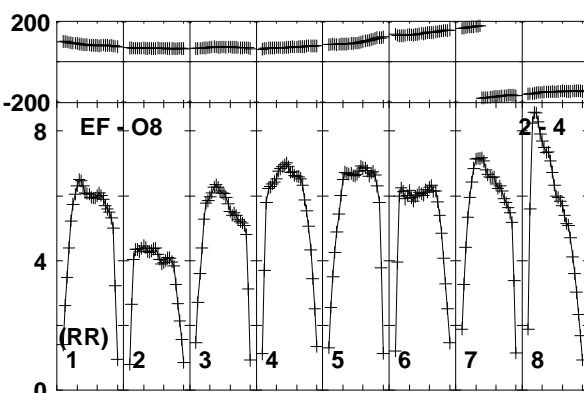
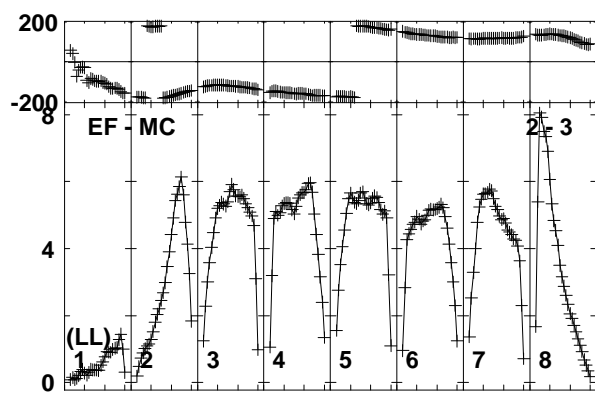
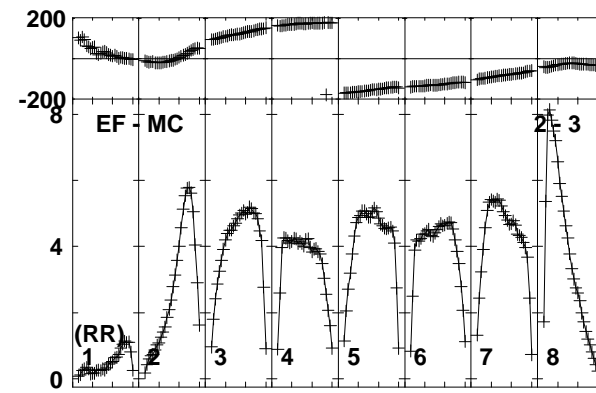
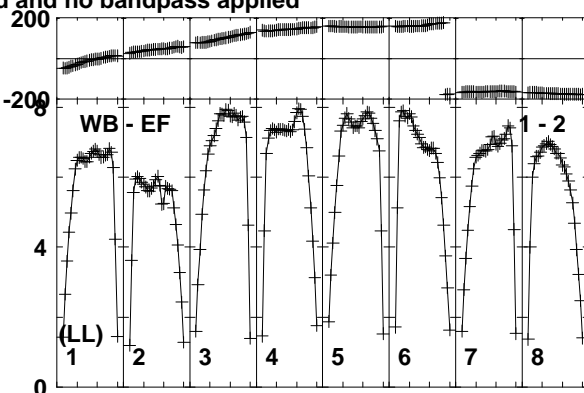
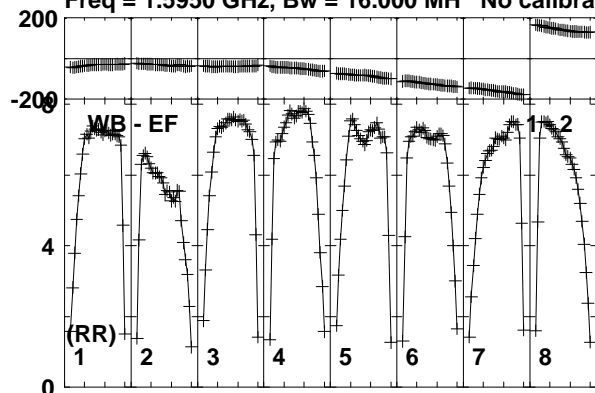

Lower frame: Milli Ampl Jy Top frame: Phas deg  
Vector averaged cross-power spectrum Baseline: WB (01) - EF (02)  
Timerange: 00/03:20:01 to 00/03:21:59

Plot file version 50 created 30-AUG-2019 17:53:15

J1722+2458 EB070.UVDATA.1

Freq = 1.5950 GHz, Bw = 16.000 MH No calibration applied and no bandpass applied

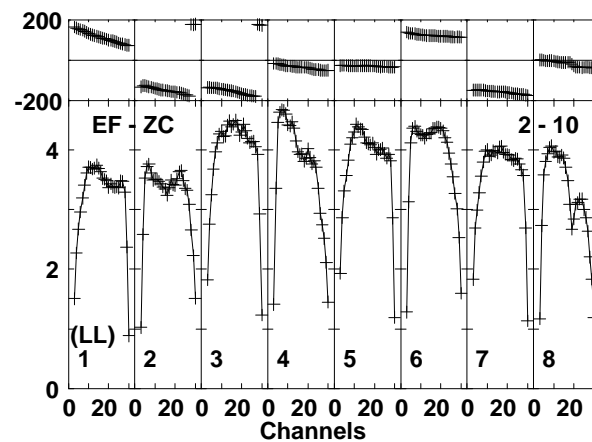
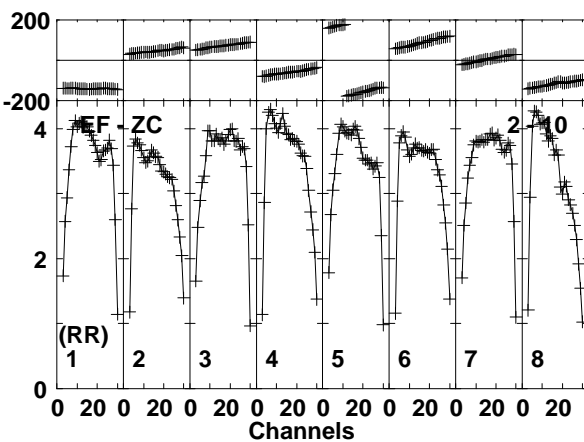
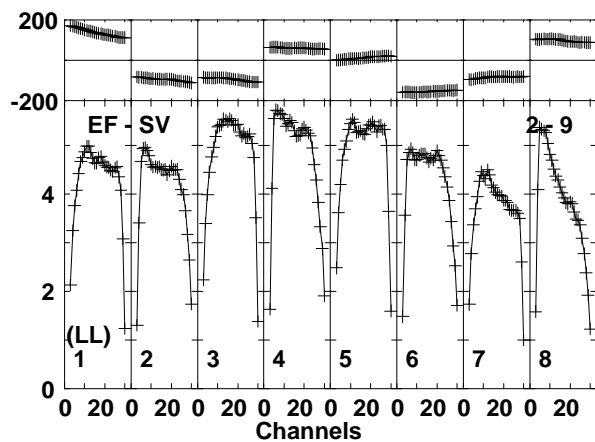
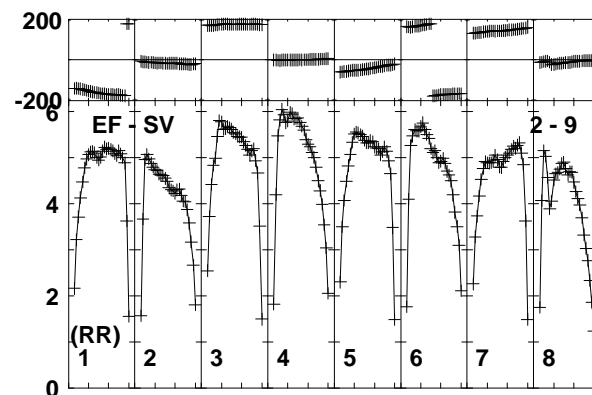
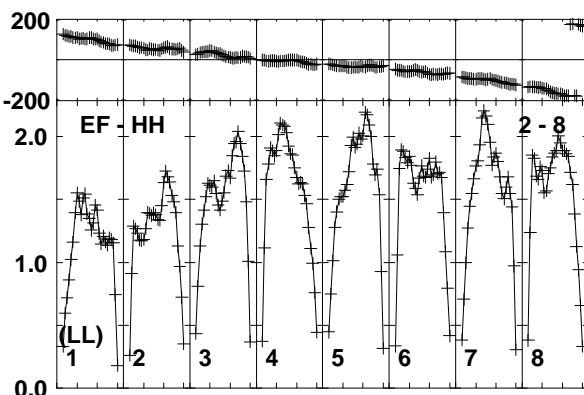
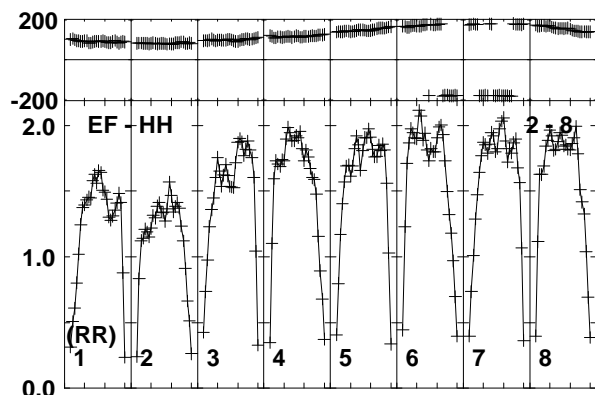
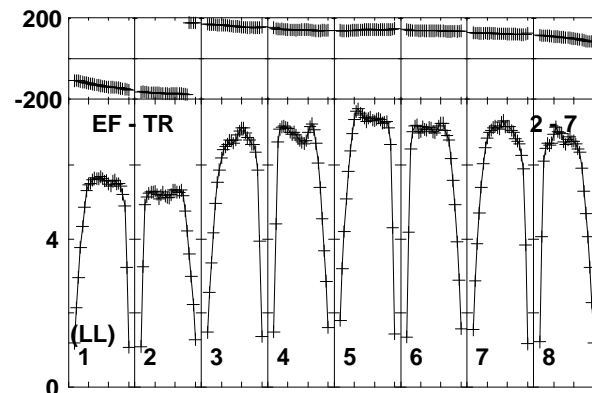
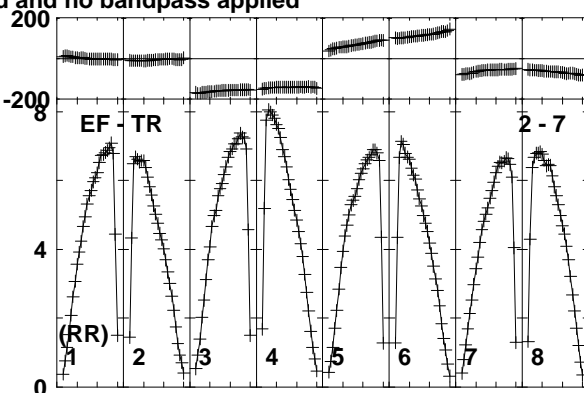
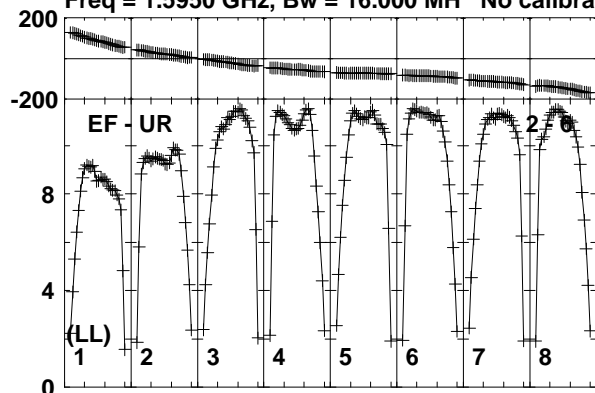

Lower frame: Milli Ampl Jy Top frame: Phas deg  
Vector averaged cross-power spectrum Baseline: EF (02) - UR (06)  
Timerange: 00/03:20:01 to 00/03:21:59

Plot file version 51 created 30-AUG-2019 17:53:15

J1722+2458 EB070.UVDATA.1

Freq = 1.5950 GHz, Bw = 16.000 MH No calibration applied and no bandpass applied

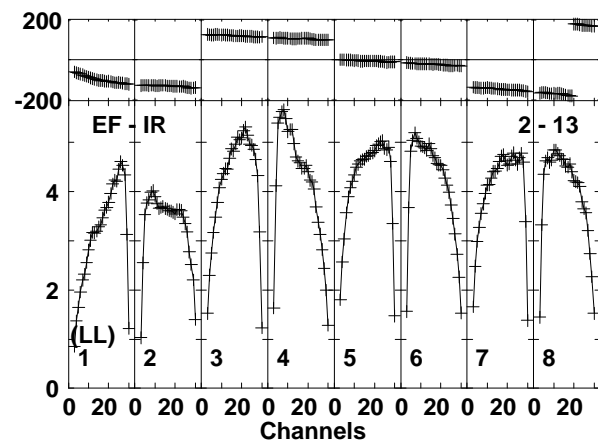
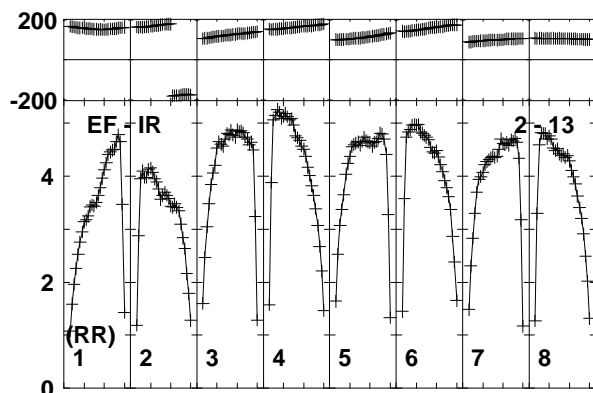
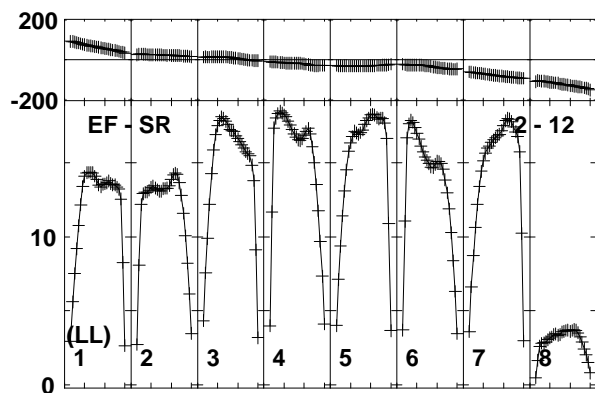
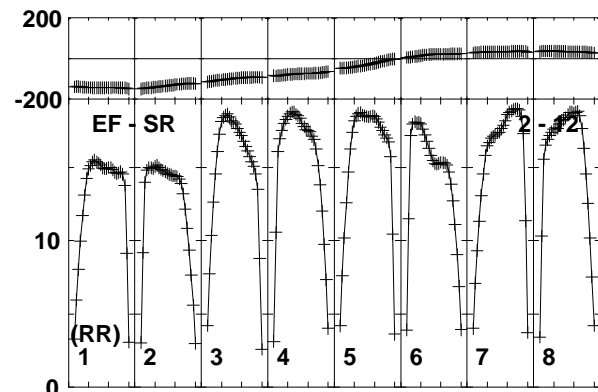
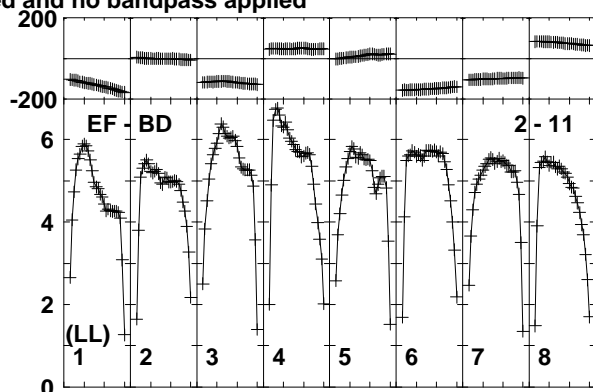
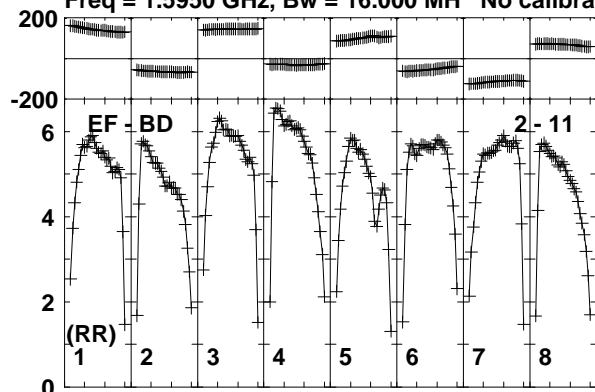

Lower frame: Milli Ampl Jy Top frame: Phas deg  
Vector averaged cross-power spectrum Baseline: EF (02) - BD (11)  
Timerange: 00/03:20:01 to 00/03:21:59

Plot file version 52 created 30-AUG-2019 17:53:15

ROSS867 EB070.UVDATA.1

Freq = 1.5950 GHz, Bw = 16.000 MH No calibration applied and no bandpass applied

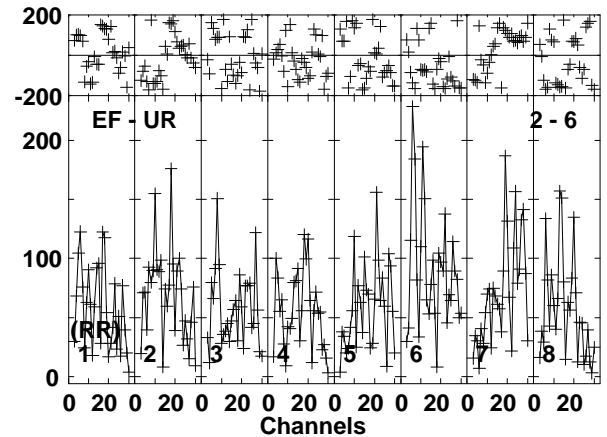
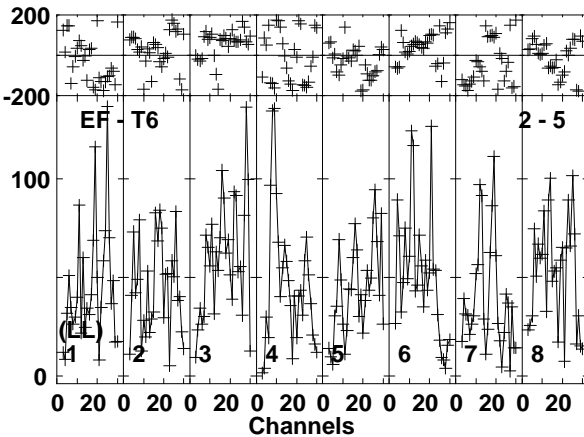
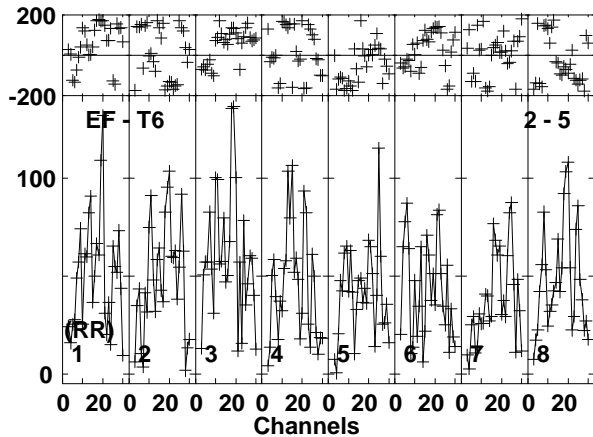
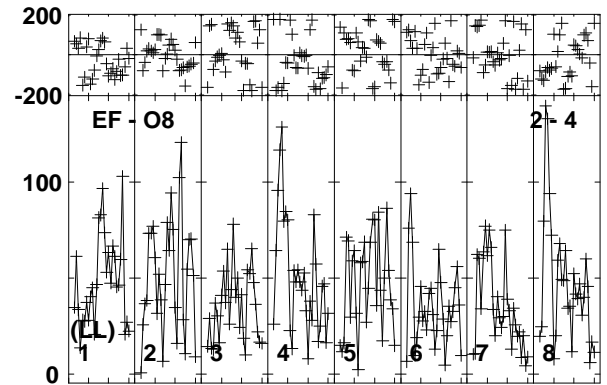
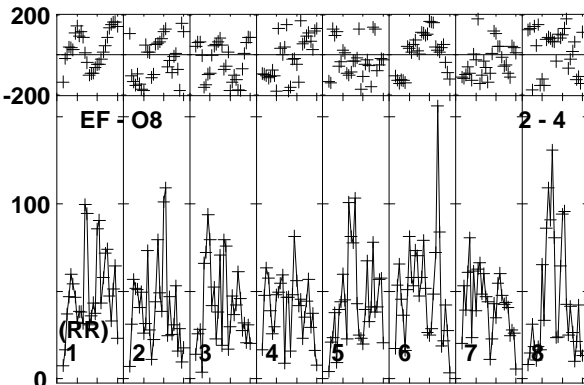
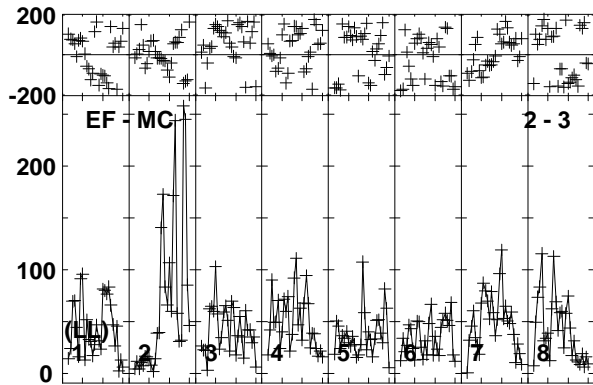
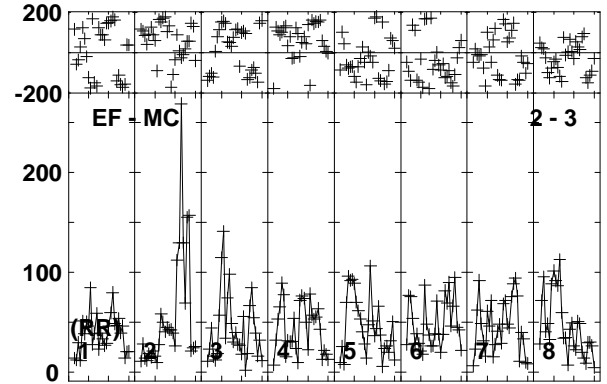
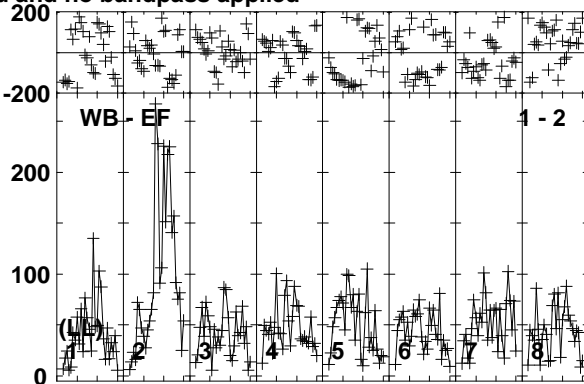
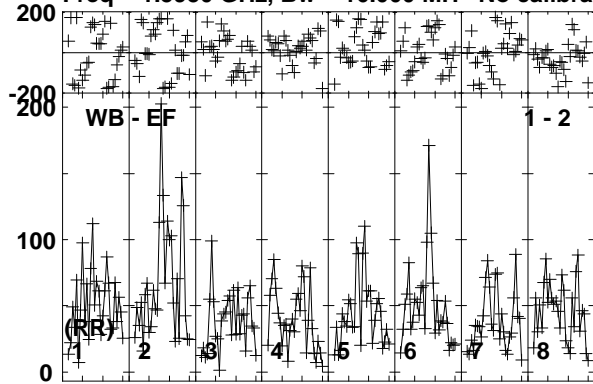

Lower frame: Micro Ampl Jy Top frame: Phas deg  
Vector averaged cross-power spectrum Baseline: WB (01) - EF (02)  
Timerange: 00/03:22:01 to 00/03:29:59

Plot file version 53 created 30-AUG-2019 17:53:16

ROSS867 EB070.UVDATA.1

Freq = 1.5950 GHz, Bw = 16.000 MH No calibration applied and no bandpass applied

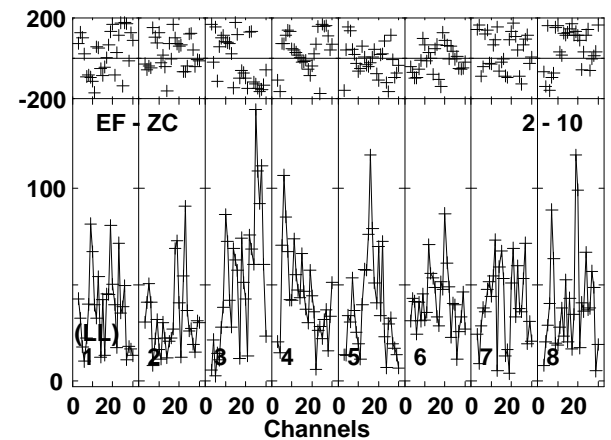
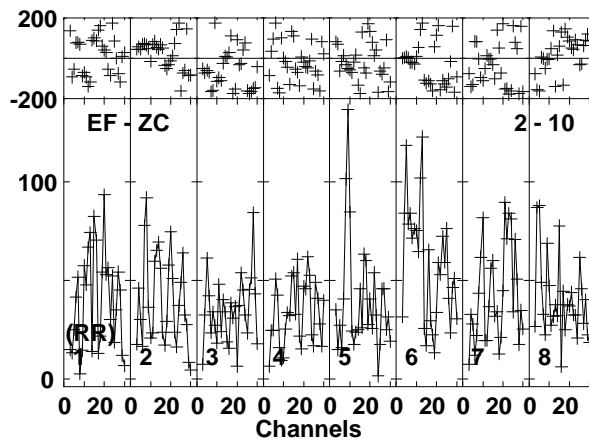
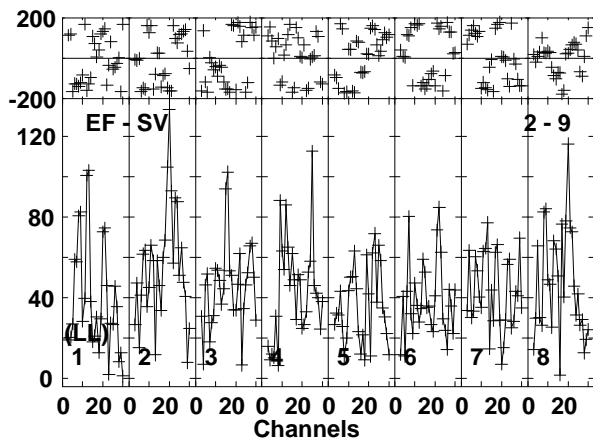
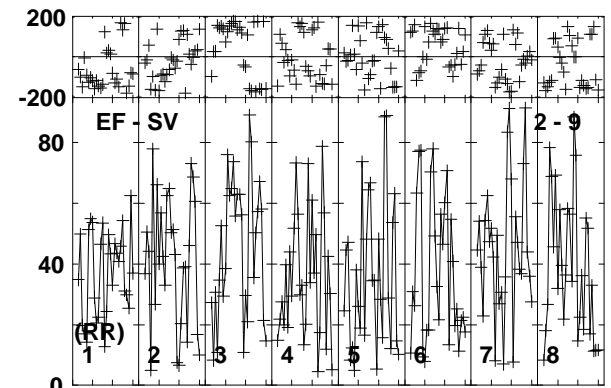
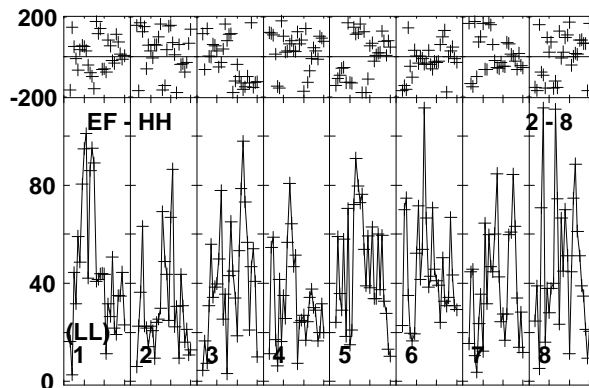
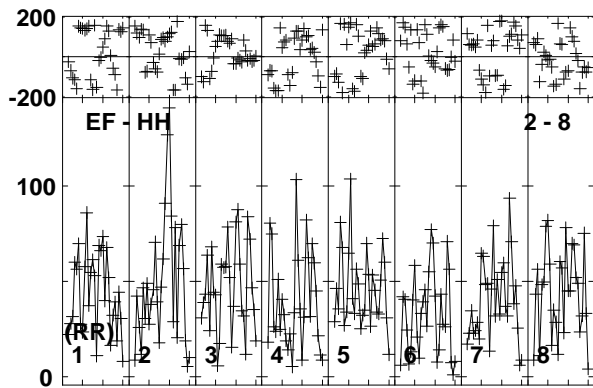
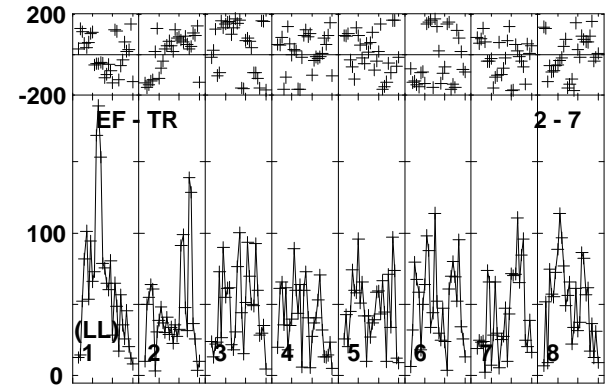
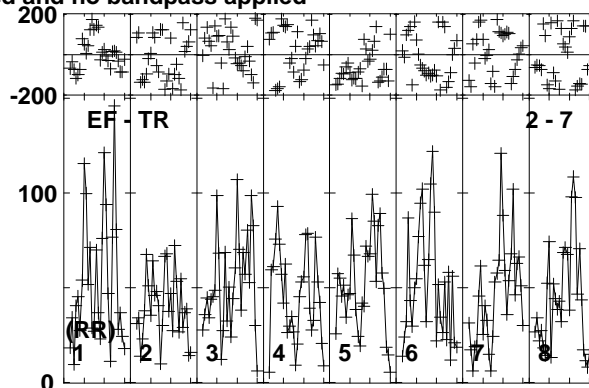
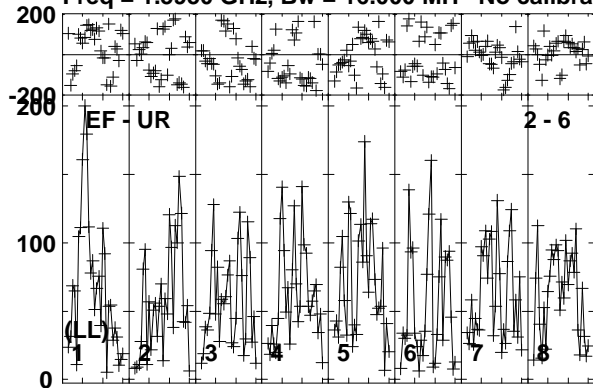

Lower frame: Micro Ampl Jy Top frame: Phas deg  
Vector averaged cross-power spectrum Baseline: EF (02) - UR (06)  
Timerange: 00/03:22:01 to 00/03:29:59

Plot file version 54 created 30-AUG-2019 17:53:16

ROSS867 EB070.UVDATA.1

Freq = 1.5950 GHz, Bw = 16.000 MH No calibration applied and no bandpass applied

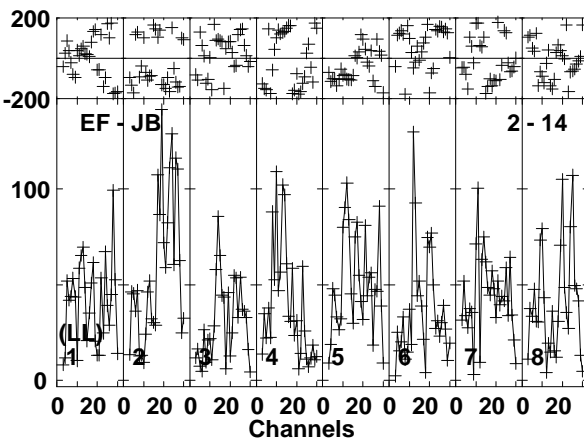
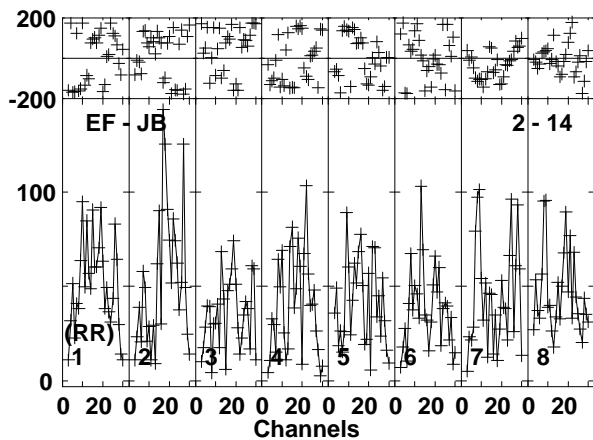
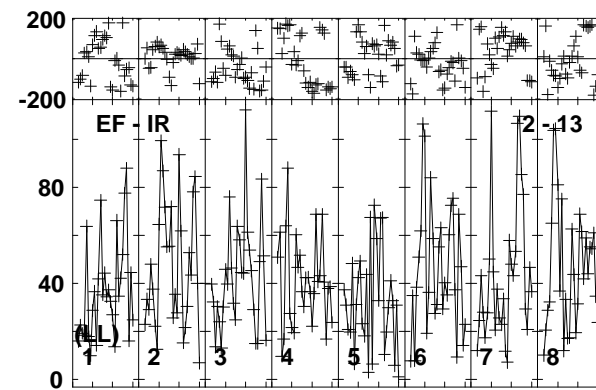
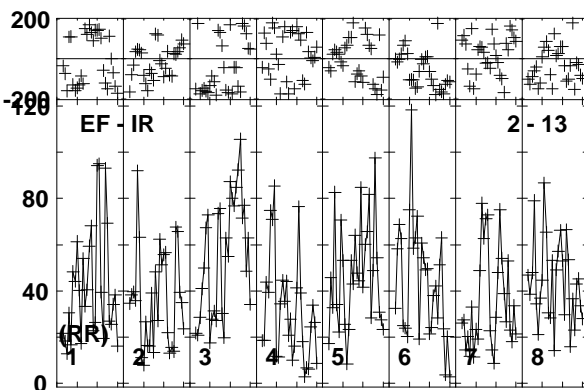
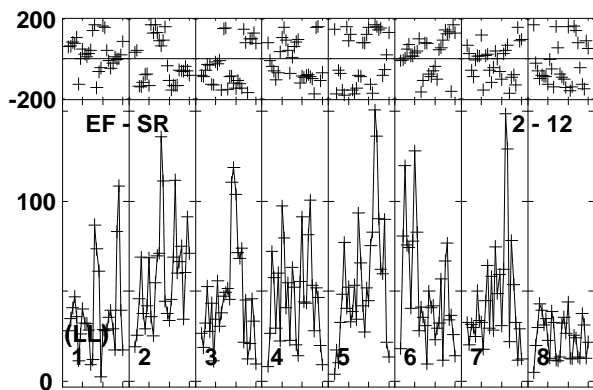
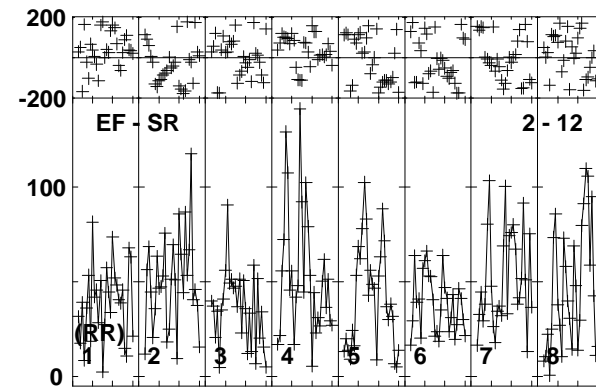
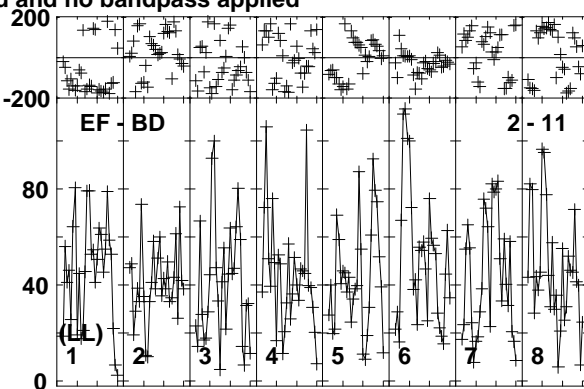
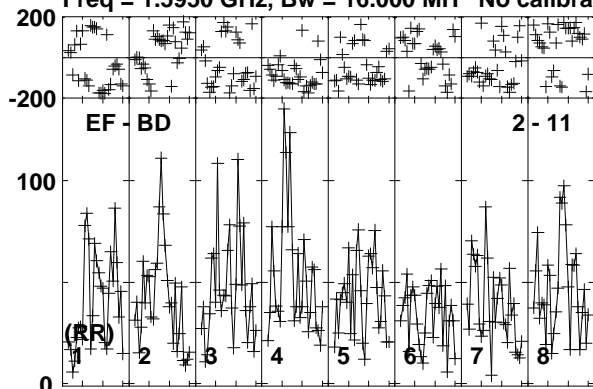

Lower frame: Micro Ampl Jy Top frame: Phas deg  
Vector averaged cross-power spectrum Baseline: EF (02) - BD (11)  
Timerange: 00/03:22:01 to 00/03:29:59

Plot file version 55 created 30-AUG-2019 17:53:16

J1722+2458 EB070.UVDATA.1

Freq = 1.5950 GHz, Bw = 16.000 MH No calibration applied and no bandpass applied

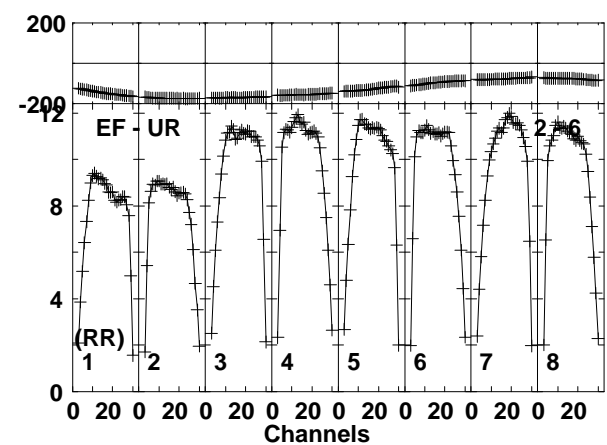
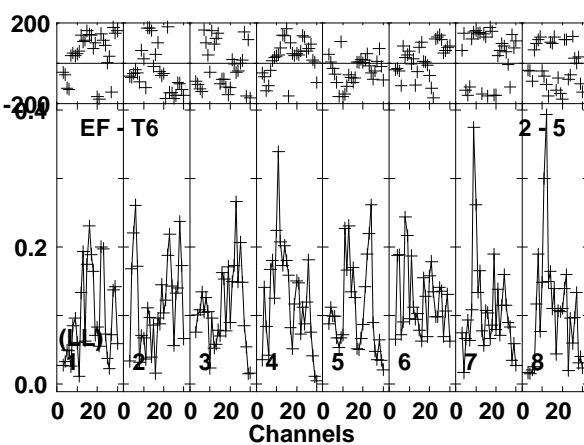
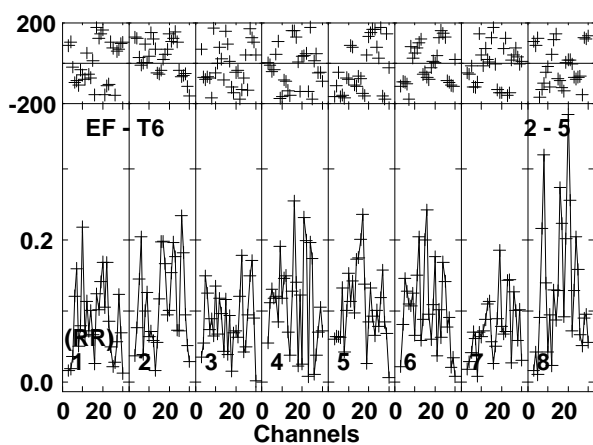
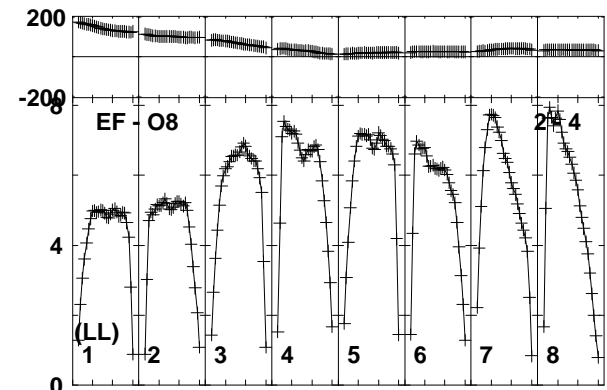
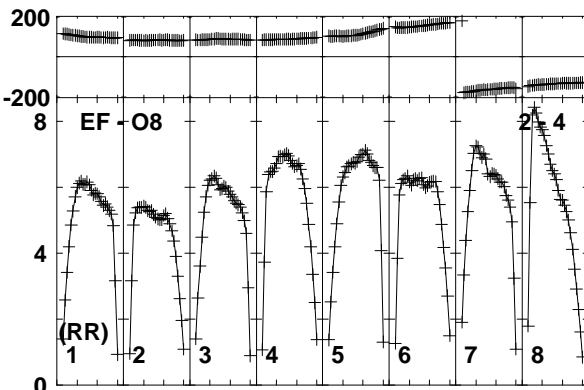
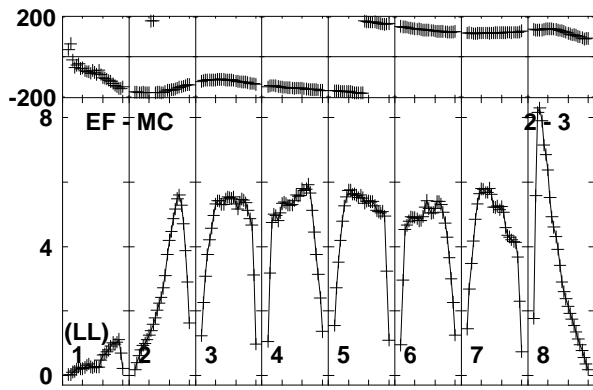
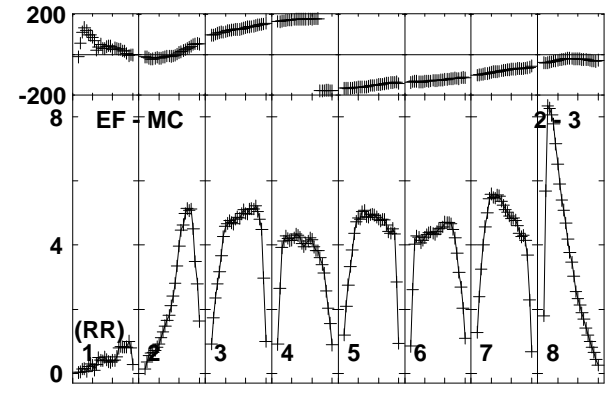
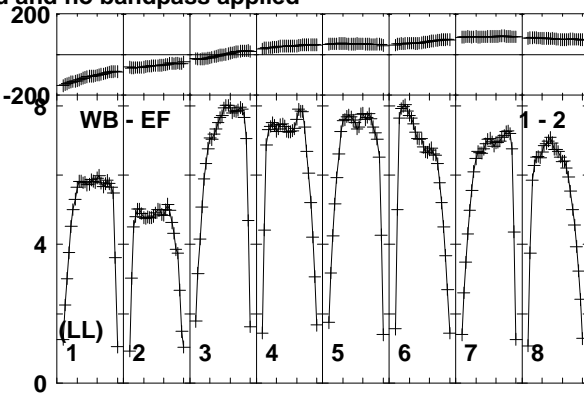
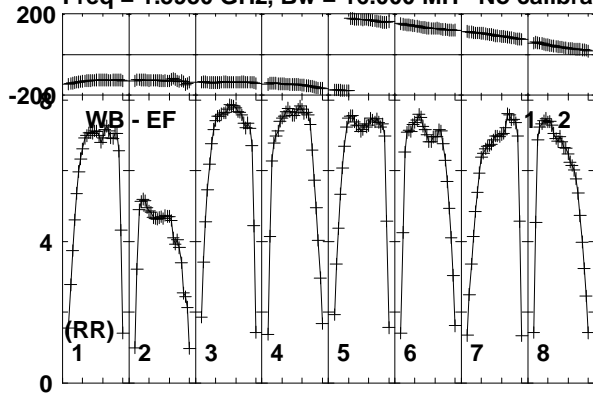

Lower frame: Milli Ampl Jy Top frame: Phas deg  
Vector averaged cross-power spectrum Baseline: WB (01) - EF (02)  
Timerange: 00/03:30:41 to 00/03:31:59

Plot file version 56 created 30-AUG-2019 17:53:16

J1722+2458 EB070.UVDATA.1

Freq = 1.5950 GHz, Bw = 16.000 MH No calibration applied and no bandpass applied

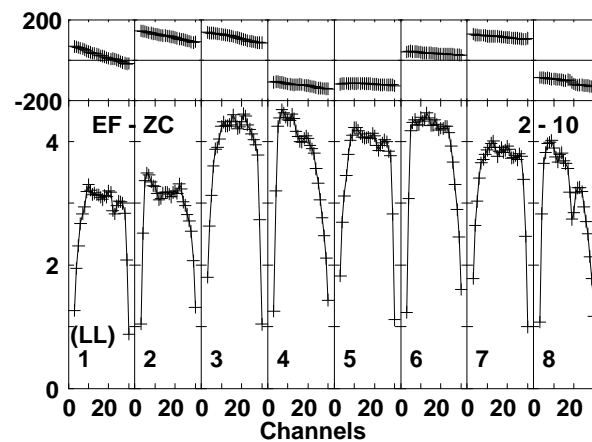
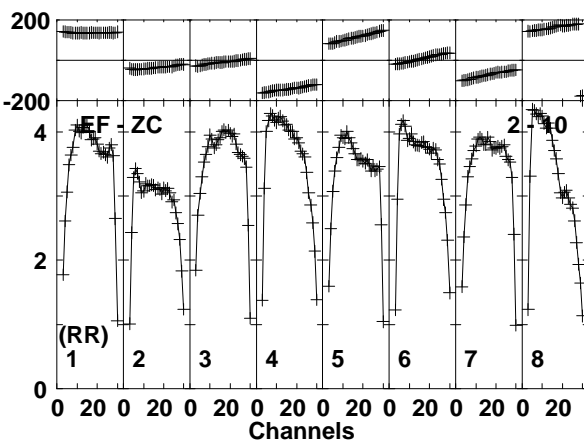
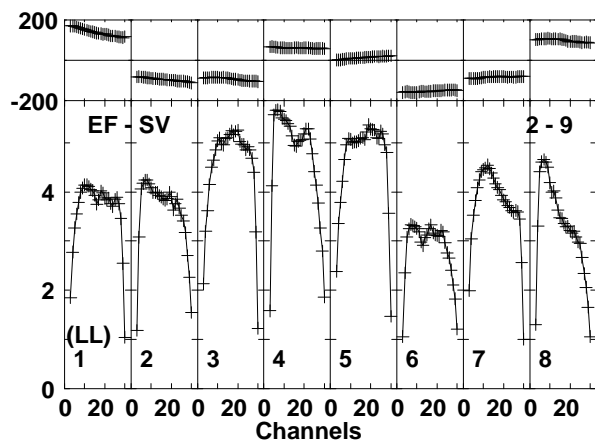
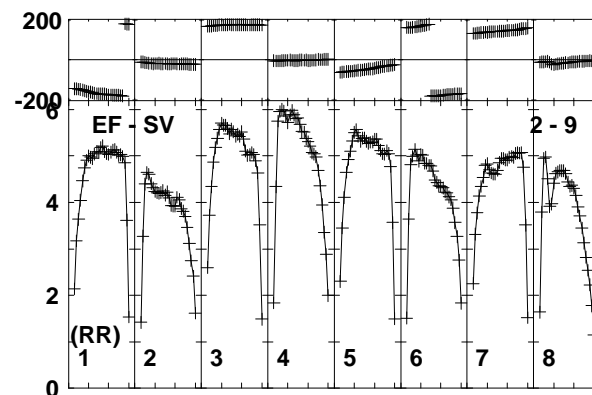
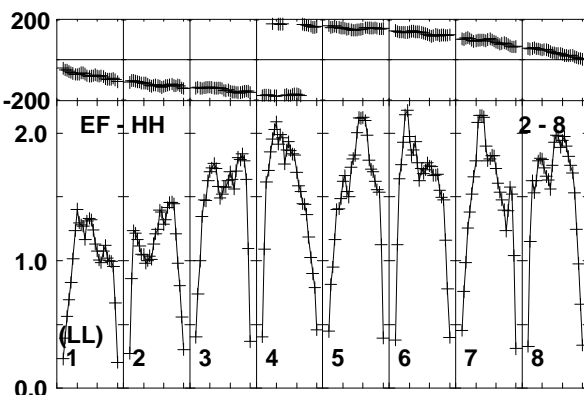
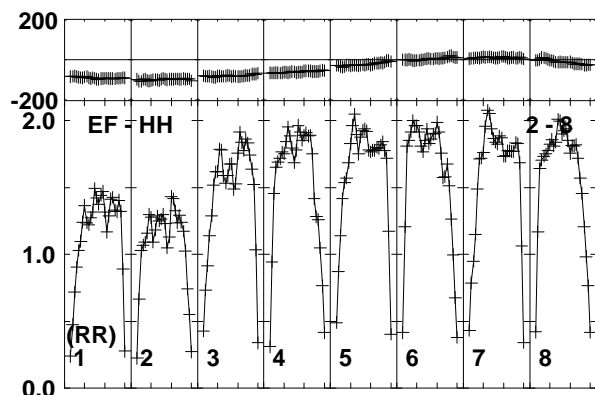
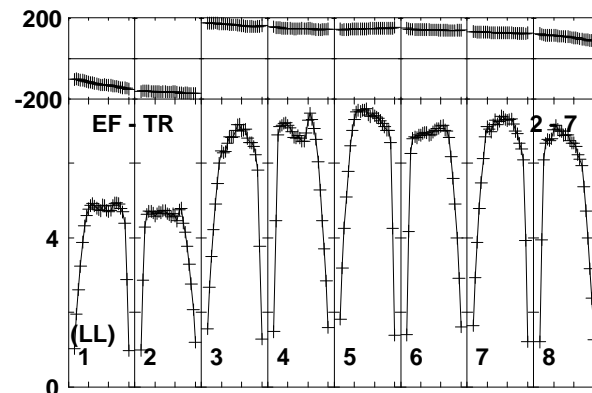
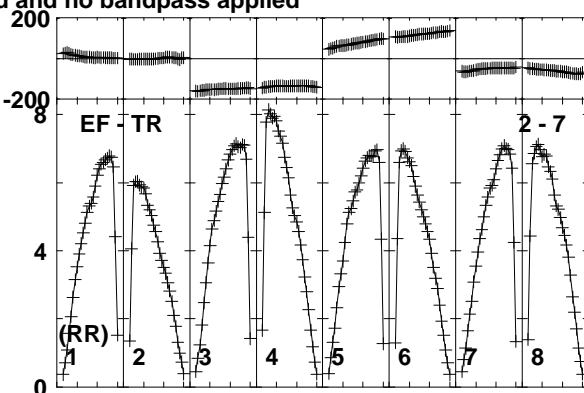
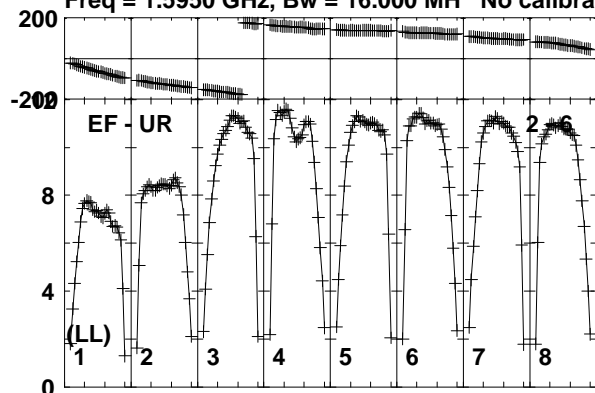

Lower frame: Milli Ampl Jy Top frame: Phas deg  
Vector averaged cross-power spectrum Baseline: EF (02) - UR (06)  
Timerange: 00/03:30:41 to 00/03:31:59



Plot file version 57 created 30-AUG-2019 17:53:17

J1722+2458 EB070.UVDATA.1

Freq = 1.5950 GHz, Bw = 16.000 MH No calibration applied and no bandpass applied

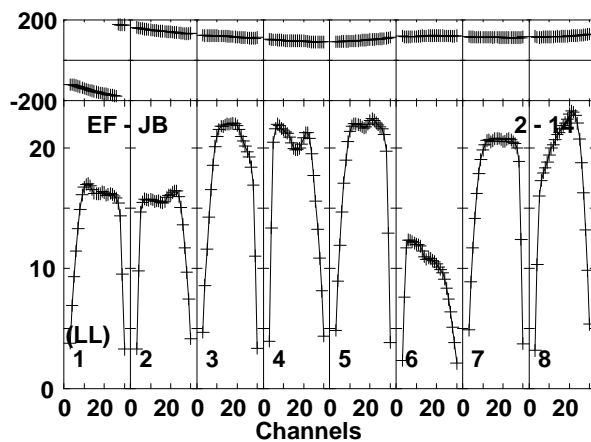
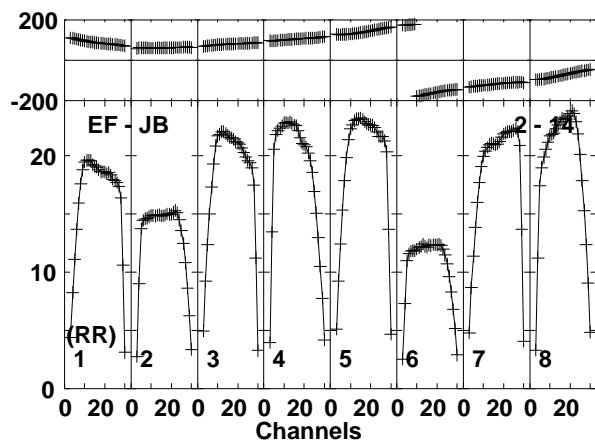
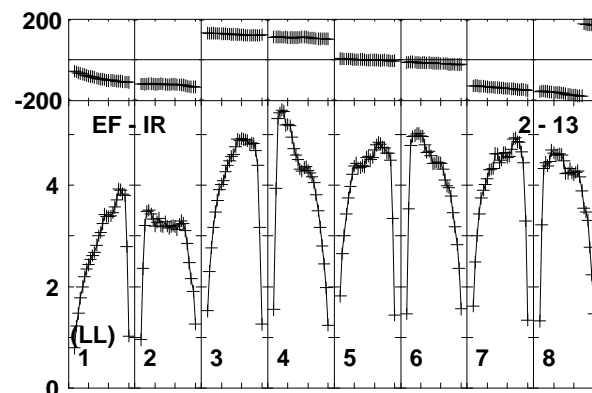
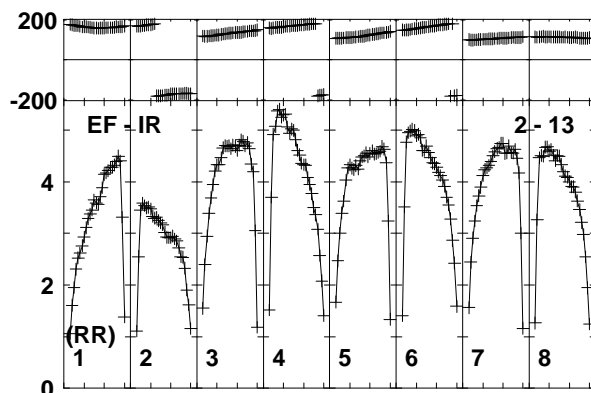
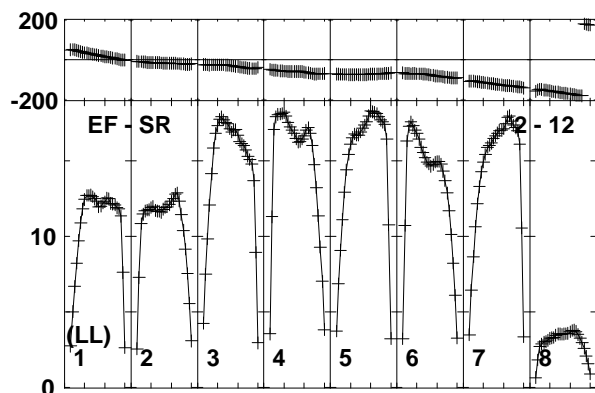
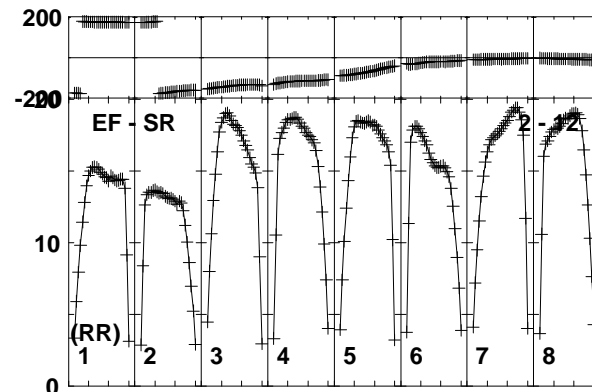
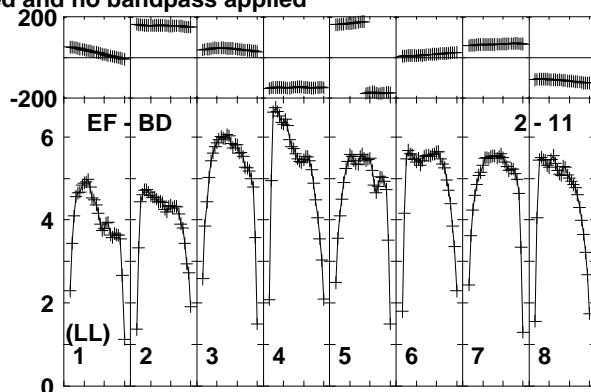
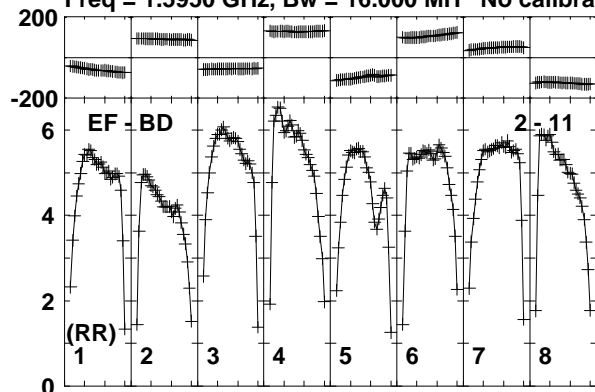

Lower frame: Milli Ampl Jy Top frame: Phas deg  
Vector averaged cross-power spectrum Baseline: EF (02) - BD (11)  
Timerange: 00/03:30:41 to 00/03:31:59

Plot file version 58 created 30-AUG-2019 17:53:17

ROSS867 EB070.UVDATA.1

Freq = 1.5950 GHz, Bw = 16.000 MH No calibration applied and no bandpass applied

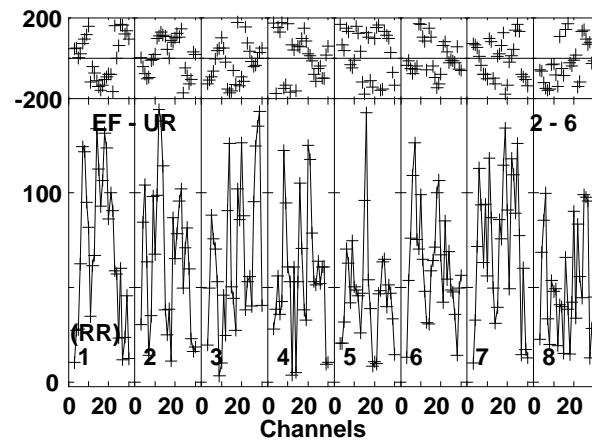
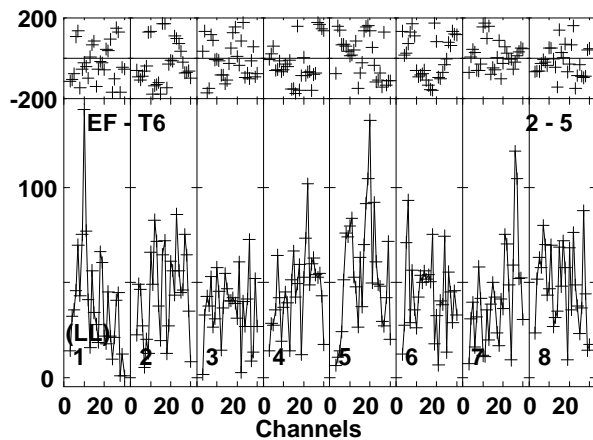
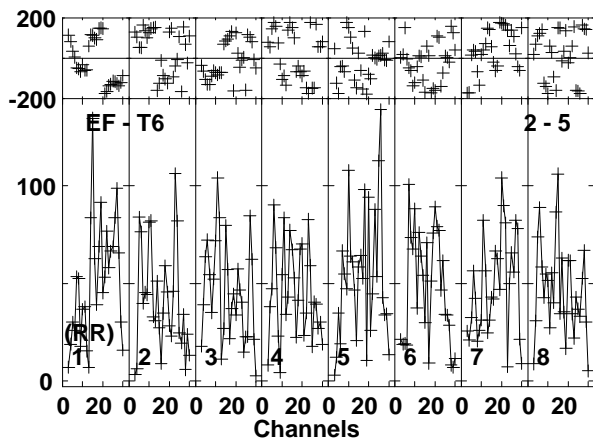
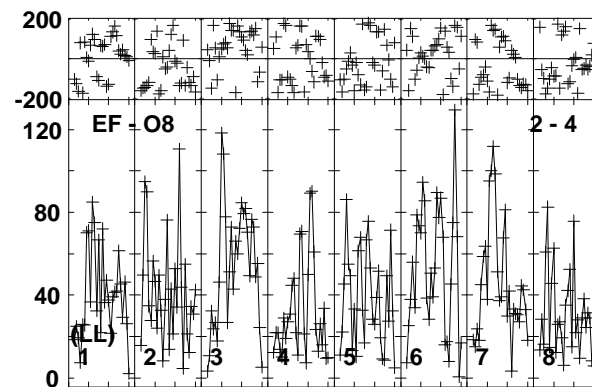
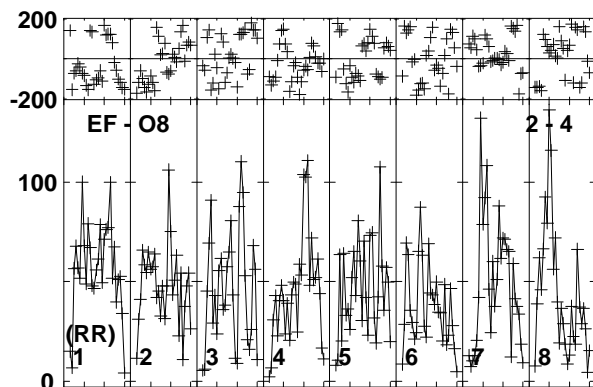
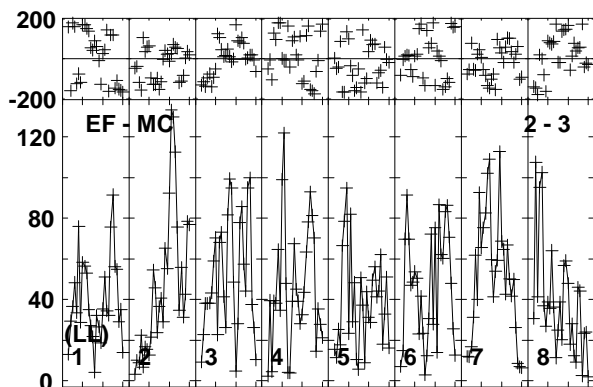
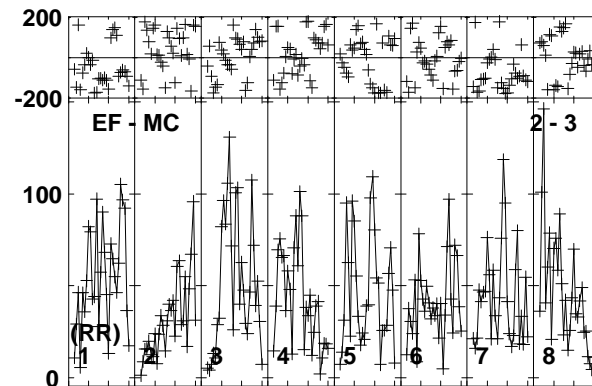
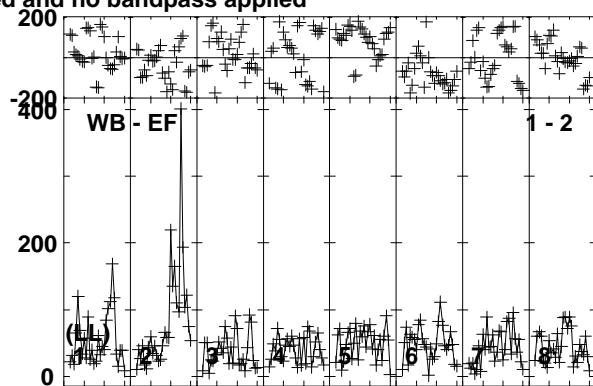
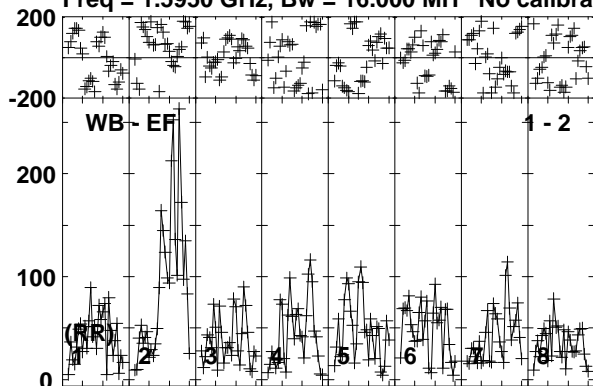

Lower frame: Micro Ampl Jy Top frame: Phas deg  
Vector averaged cross-power spectrum Baseline: WB (01) - EF (02)  
Timerange: 00/03:32:01 to 00/03:39:59

Plot file version 59 created 30-AUG-2019 17:53:17

ROSS867 EB070.UVDATA.1

Freq = 1.5950 GHz, Bw = 16.000 MH No calibration applied and no bandpass applied

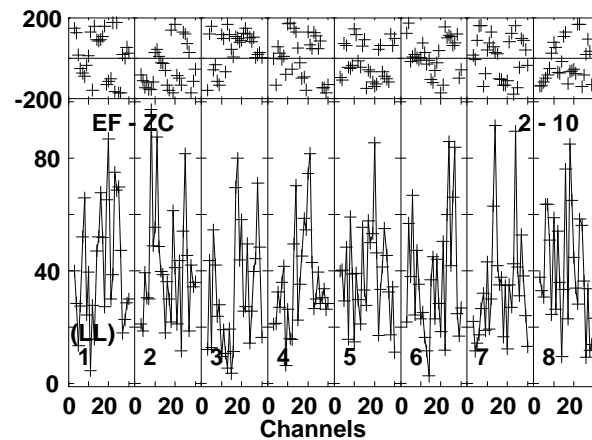
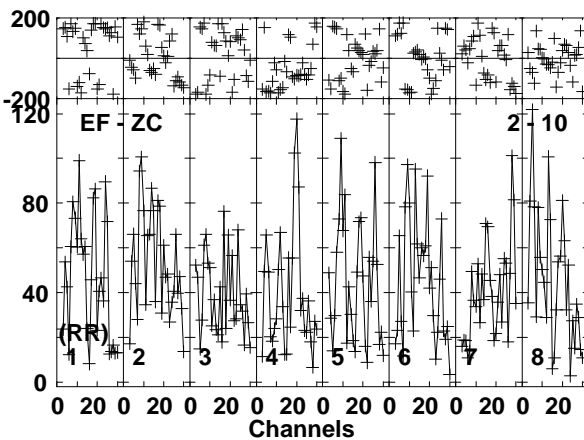
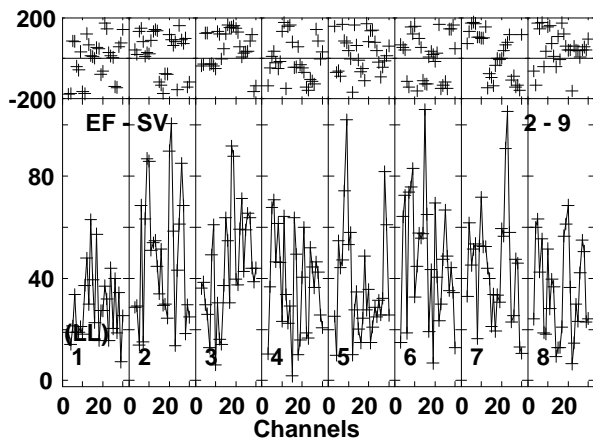
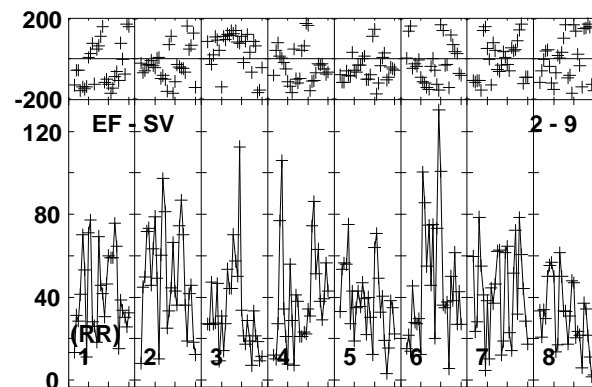
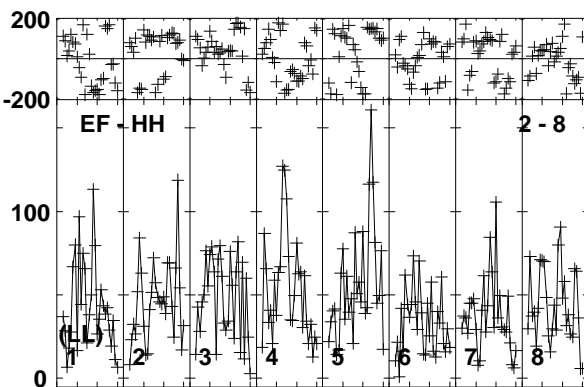
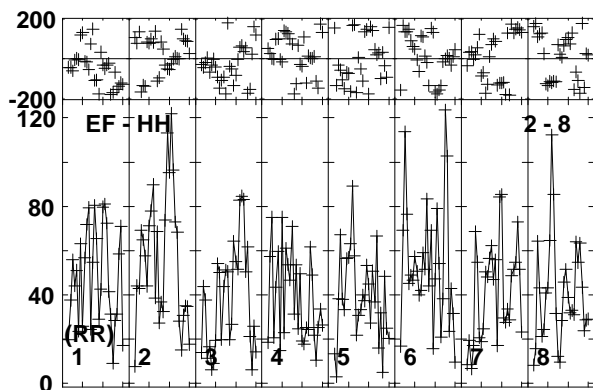
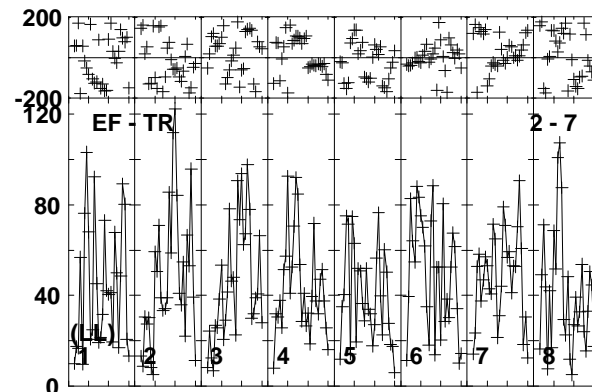
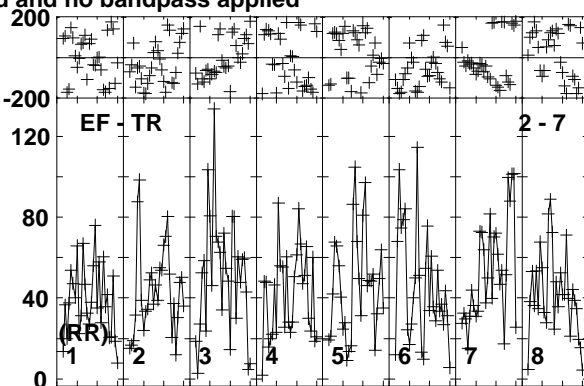
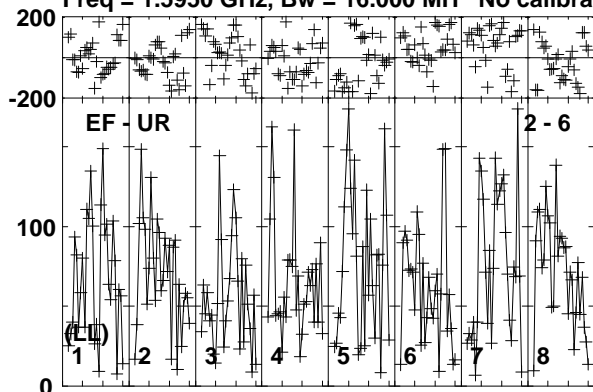

Lower frame: Micro Ampl Jy Top frame: Phas deg  
Vector averaged cross-power spectrum Baseline: EF (02) - UR (06)  
Timerange: 00/03:32:01 to 00/03:39:59

Plot file version 60 created 30-AUG-2019 17:53:17

ROSS867 EB070.UVDATA.1

Freq = 1.5950 GHz, Bw = 16.000 MH No calibration applied and no bandpass applied

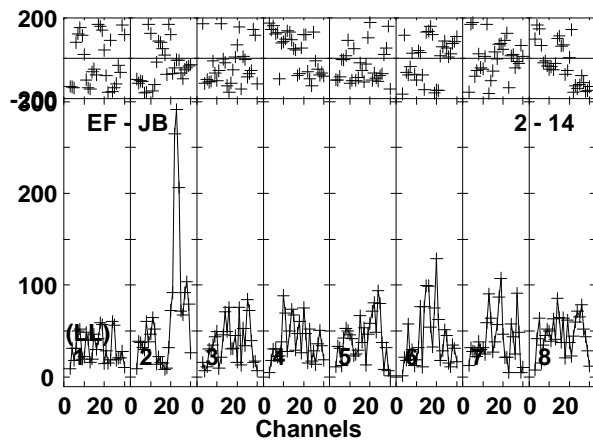
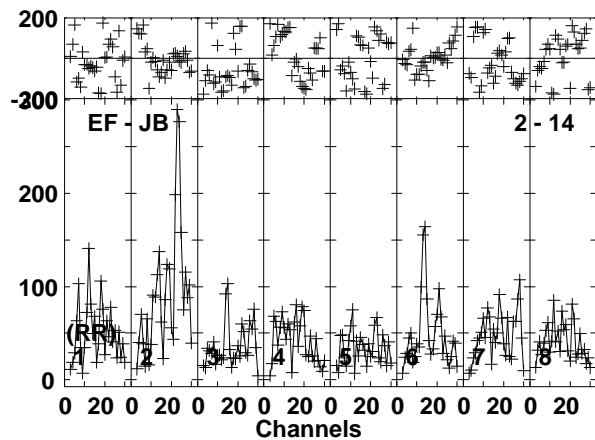
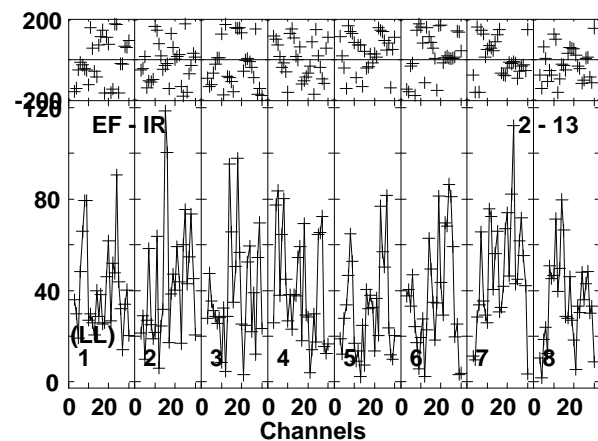
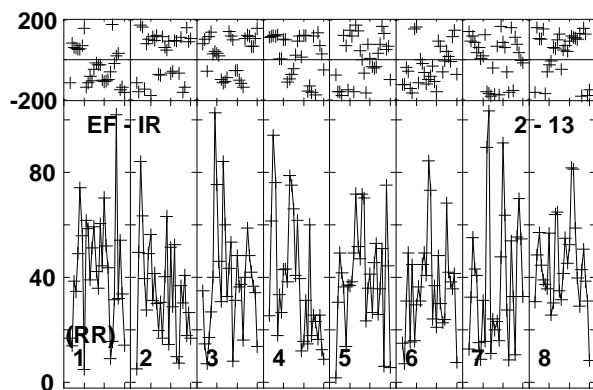
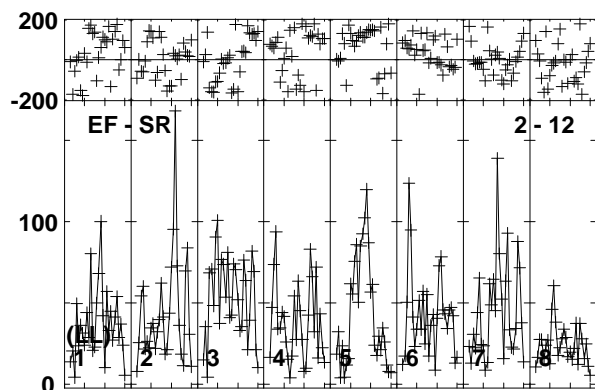
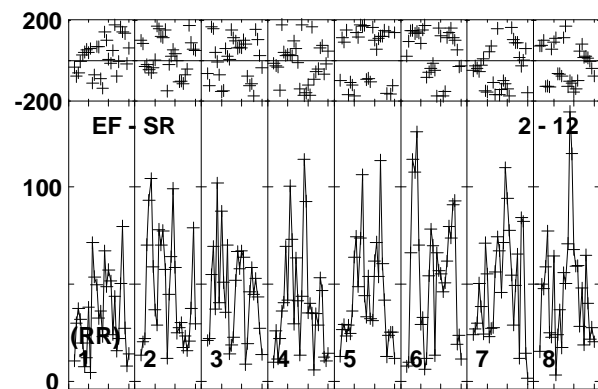
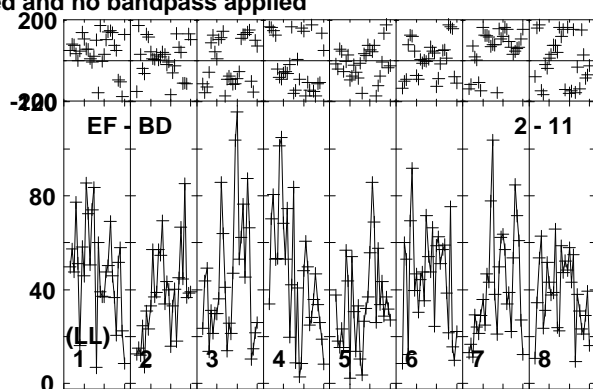
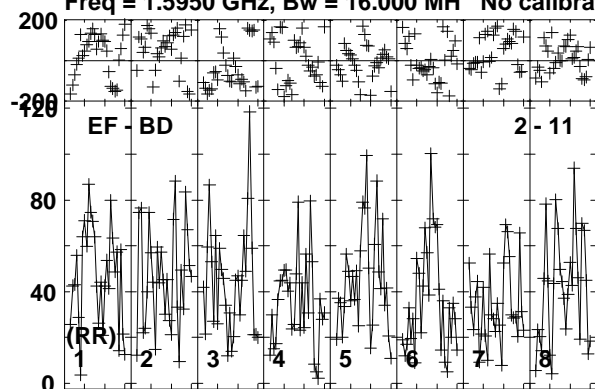

Lower frame: Micro Ampl Jy Top frame: Phas deg  
Vector averaged cross-power spectrum Baseline: EF (02) - BD (11)  
Timerange: 00/03:32:01 to 00/03:39:59

Plot file version 61 created 30-AUG-2019 17:53:18

J1722+2458 EB070.UVDATA.1

Freq = 1.5950 GHz, Bw = 16.000 MH No calibration applied and no bandpass applied

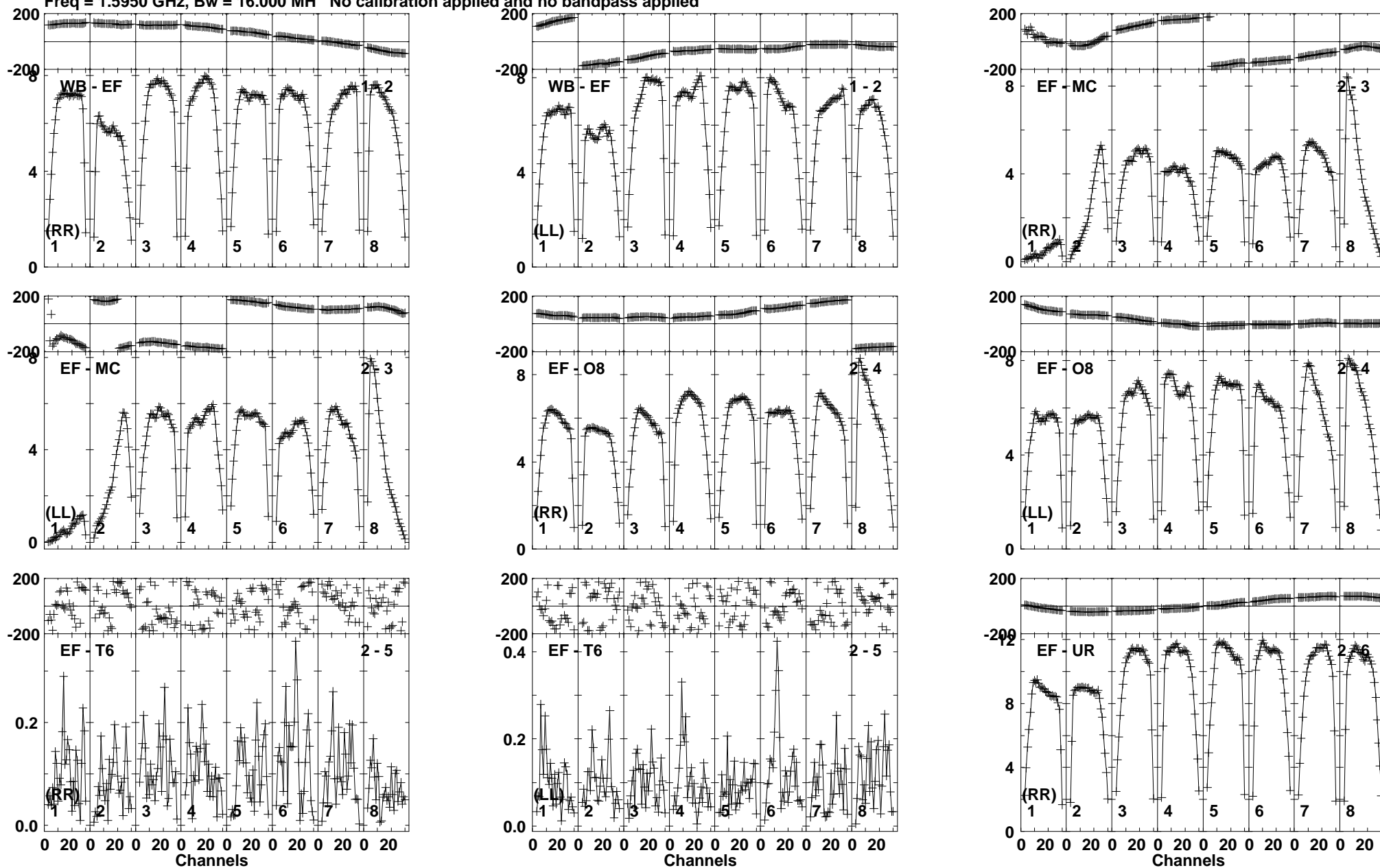

Lower frame: Milli Ampl Jy Top frame: Phas deg  
Vector averaged cross-power spectrum Baseline: WB (01) - EF (02)  
Timerange: 00/03:40:01 to 00/03:41:59

Plot file version 62 created 30-AUG-2019 17:53:18

J1722+2458 EB070.UVDATA.1

Freq = 1.5950 GHz, Bw = 16.000 MH No calibration applied and no bandpass applied

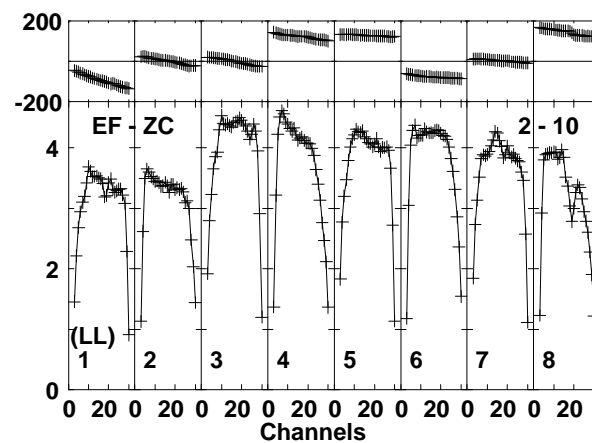
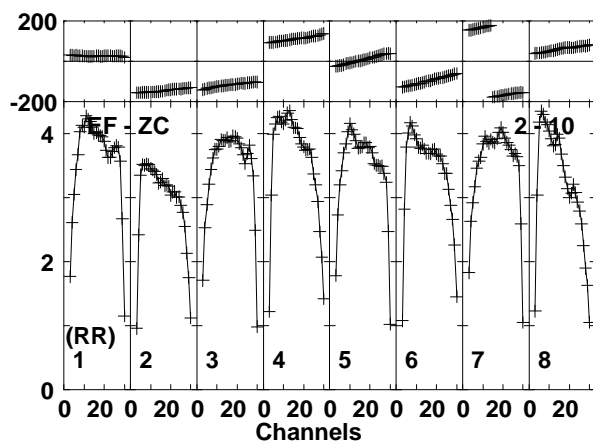
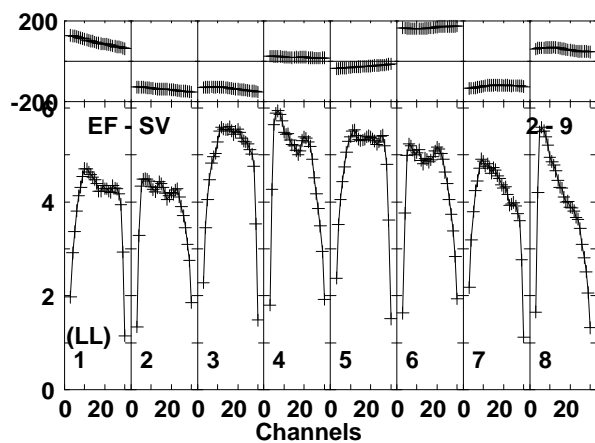
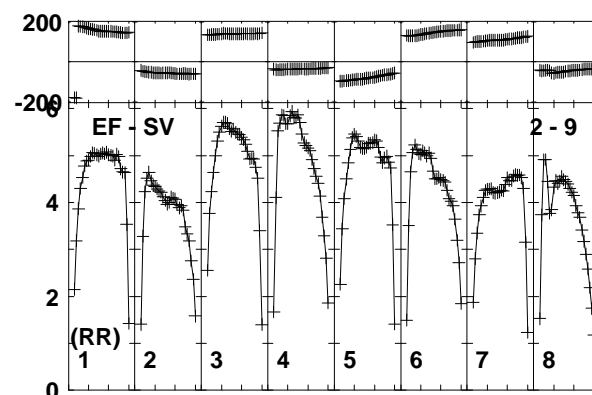
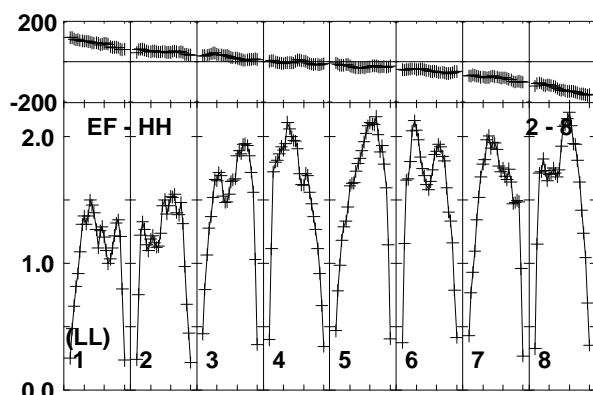
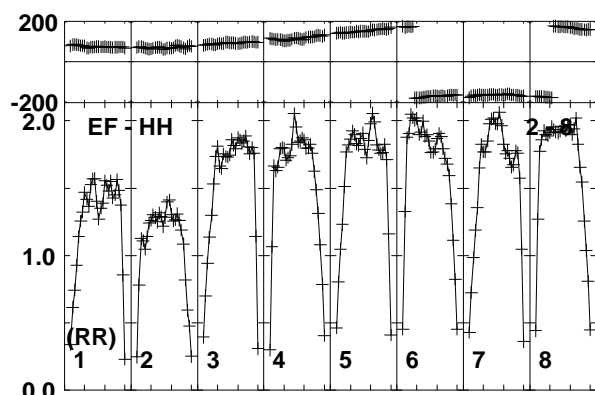
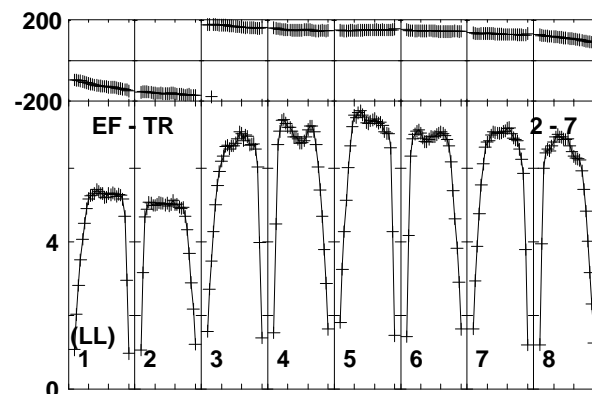
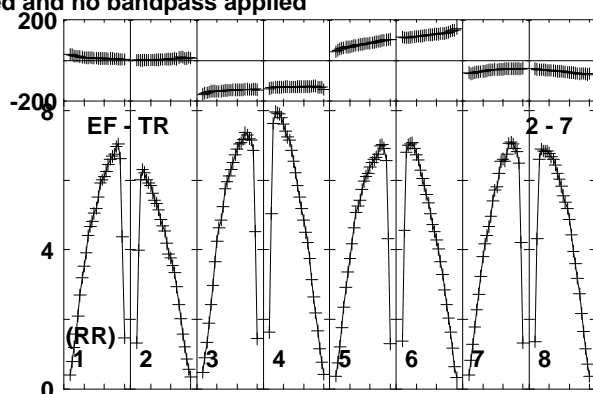
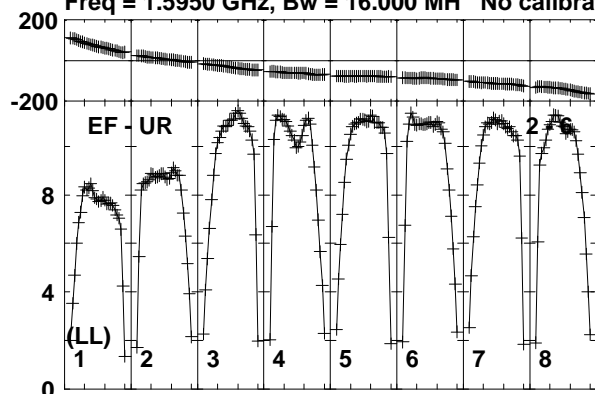

Lower frame: Milli Ampl Jy Top frame: Phas deg  
Vector averaged cross-power spectrum Baseline: EF (02) - UR (06)  
Timerange: 00/03:40:01 to 00/03:41:59

Plot file version 63 created 30-AUG-2019 17:53:18

J1722+2458 EB070.UVDATA.1

Freq = 1.5950 GHz, Bw = 16.000 MH No calibration applied and no bandpass applied

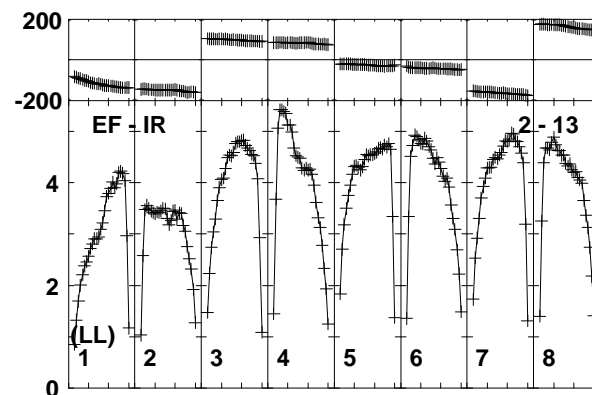
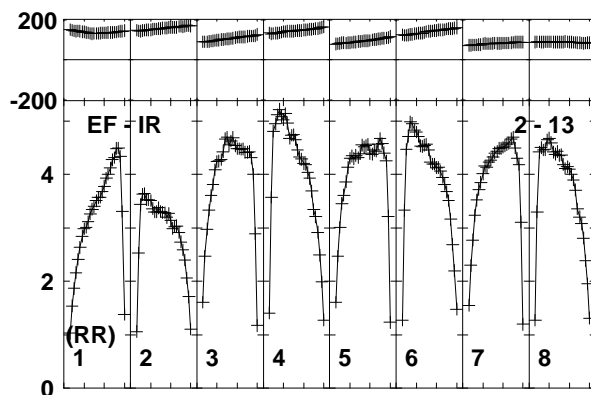
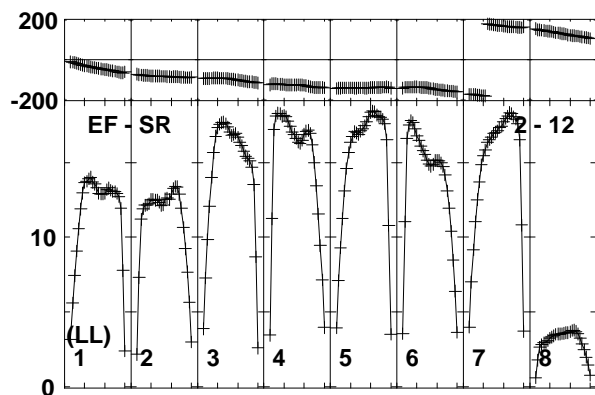
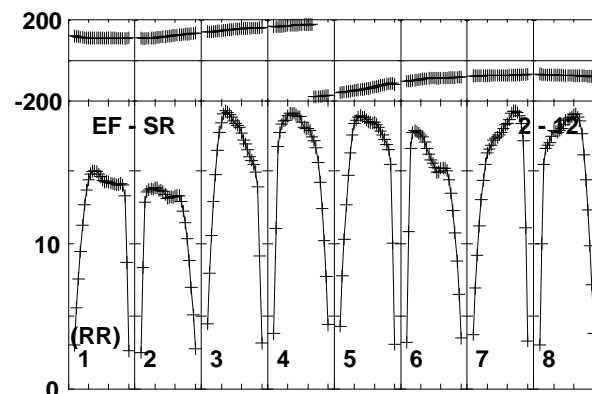
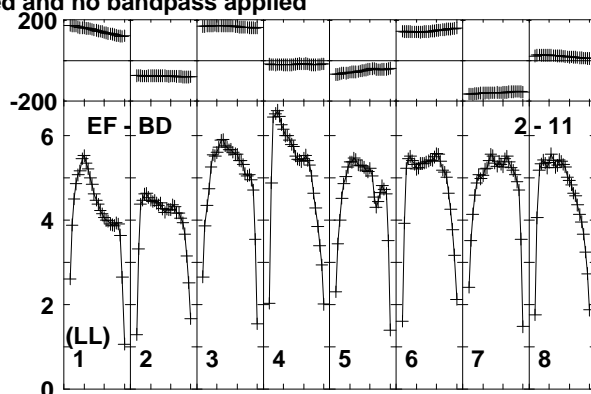
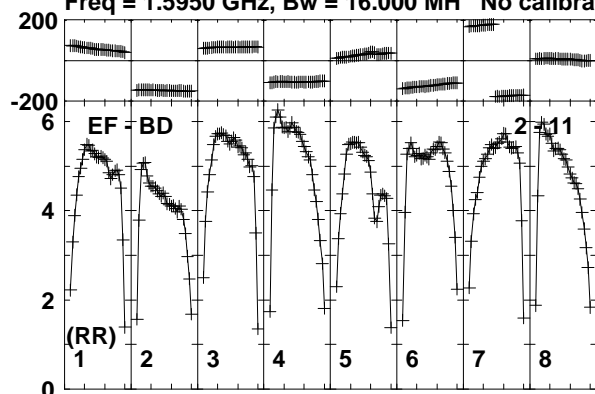

Channels

Lower frame: Milli Ampl Jy Top frame: Phas deg

Vector averaged cross-power spectrum Baseline: EF (02) - BD (11)

Timerange: 00/03:40:01 to 00/03:41:59

Plot file version 64 created 30-AUG-2019 17:53:18

ROSS867 EB070.UVDATA.1

Freq = 1.5950 GHz, Bw = 16.000 MH No calibration applied and no bandpass applied

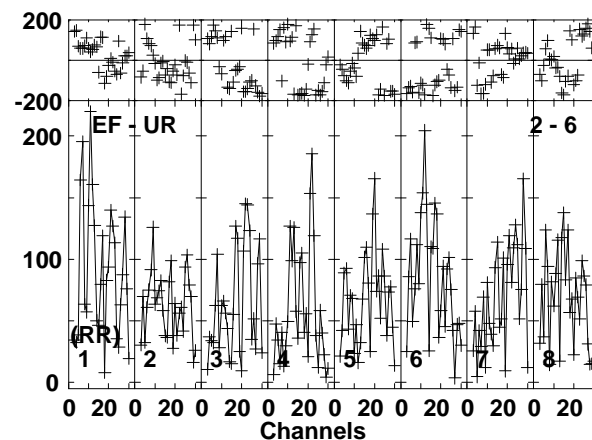
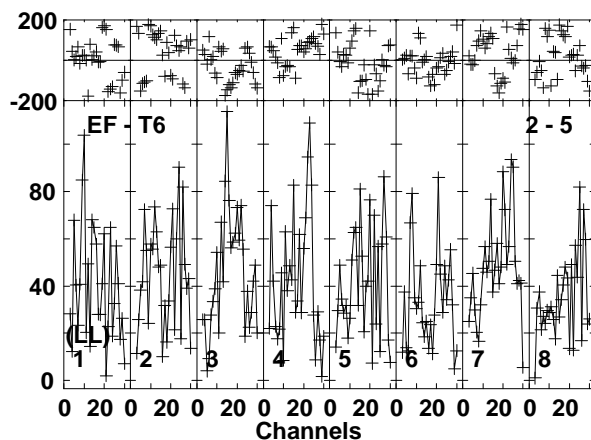
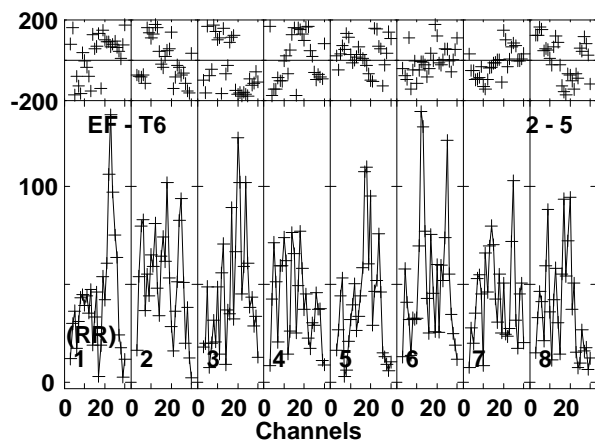
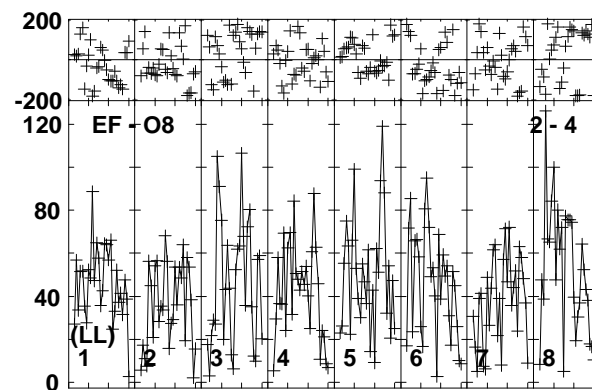
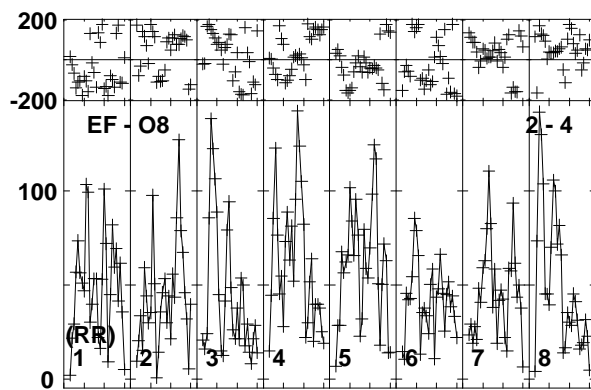
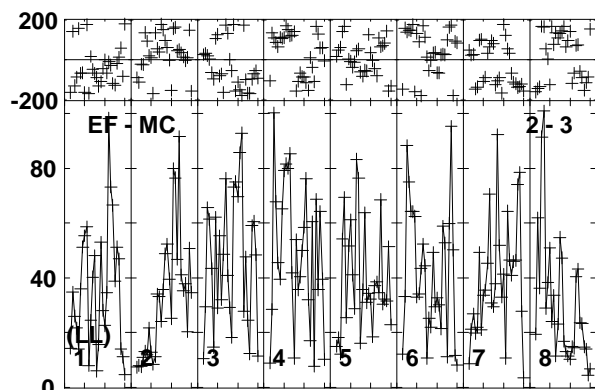
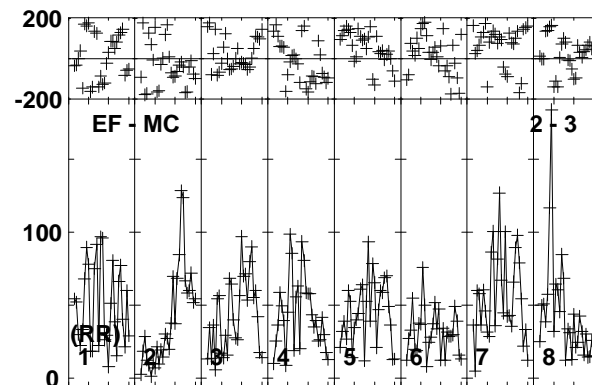
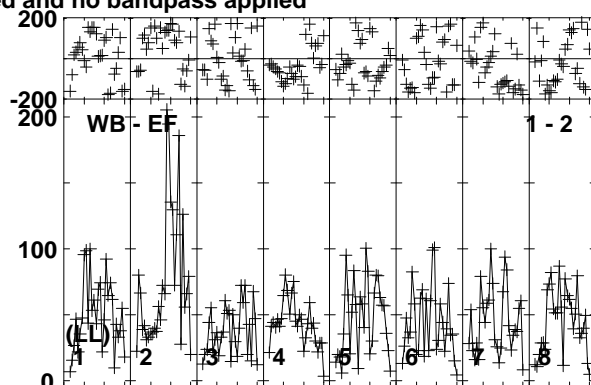
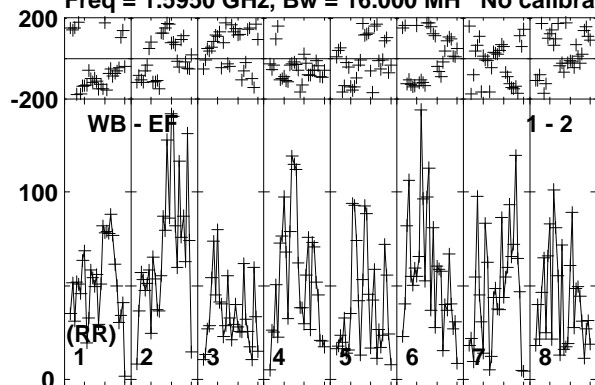

Lower frame: Micro Ampl Jy Top frame: Phas deg  
Vector averaged cross-power spectrum Baseline: WB (01) - EF (02)  
Timerange: 00/03:42:01 to 00/03:49:59



Plot file version 65 created 30-AUG-2019 17:53:18

ROSS867 EB070.UVDATA.1

Freq = 1.5950 GHz, Bw = 16.000 MH No calibration applied and no bandpass applied

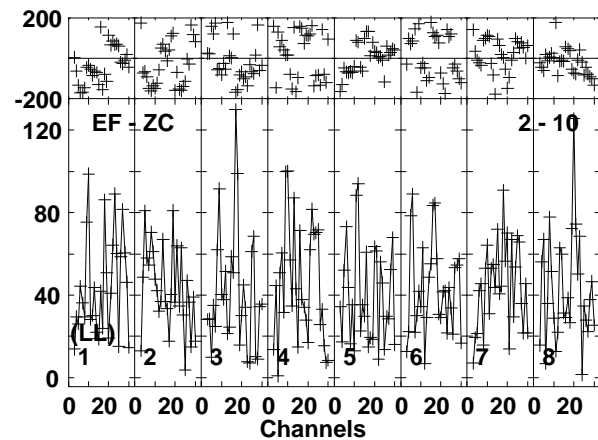
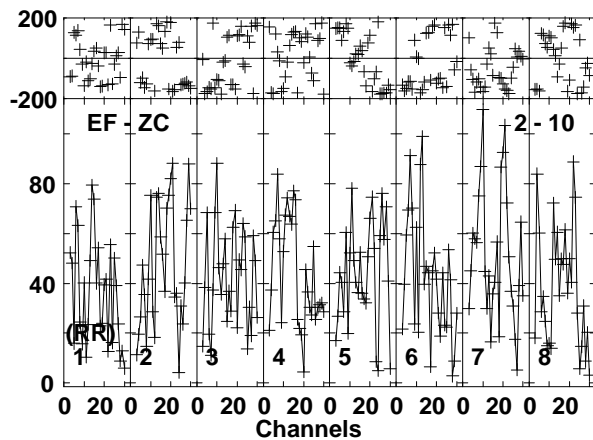
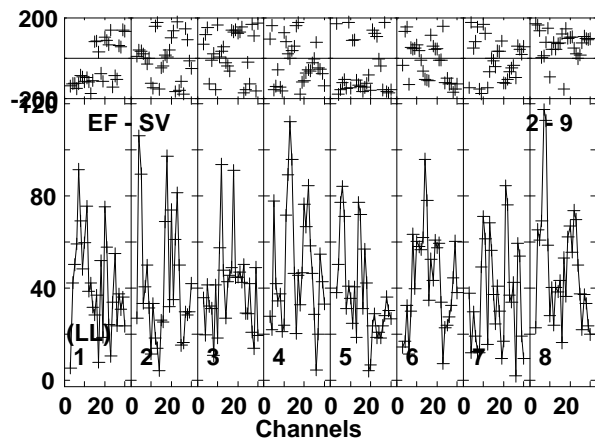
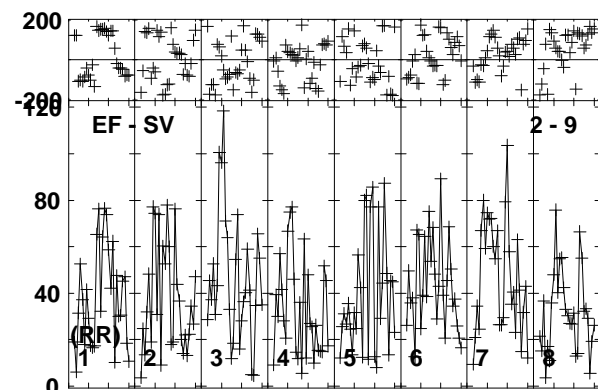
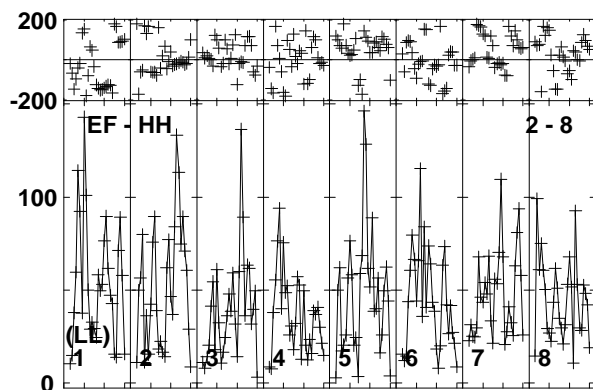
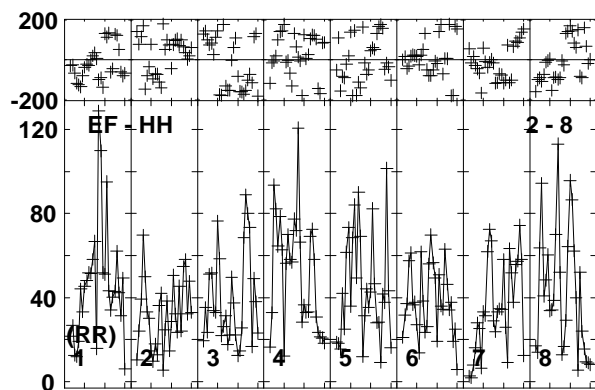
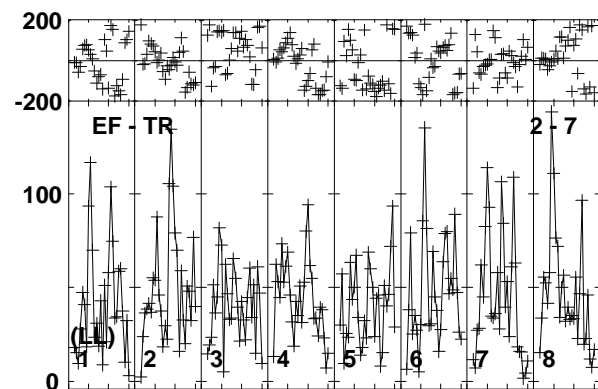
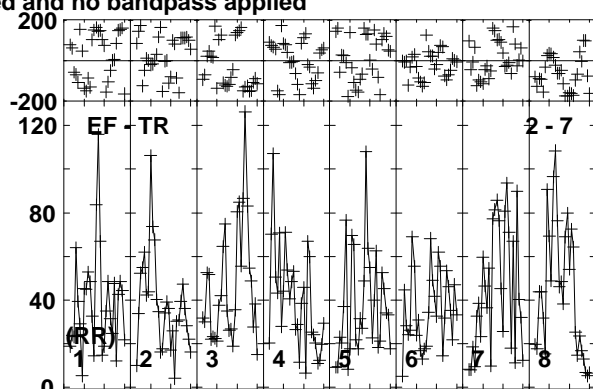
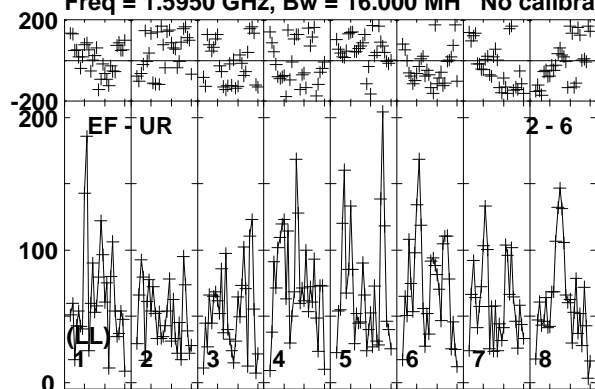

Lower frame: Micro Ampl Jy Top frame: Phas deg  
Vector averaged cross-power spectrum Baseline: EF (02) - UR (06)  
Timerange: 00/03:42:01 to 00/03:49:59

Plot file version 66 created 30-AUG-2019 17:53:19

ROSS867 EB070.UVDATA.1

Freq = 1.5950 GHz, Bw = 16.000 MH No calibration applied and no bandpass applied

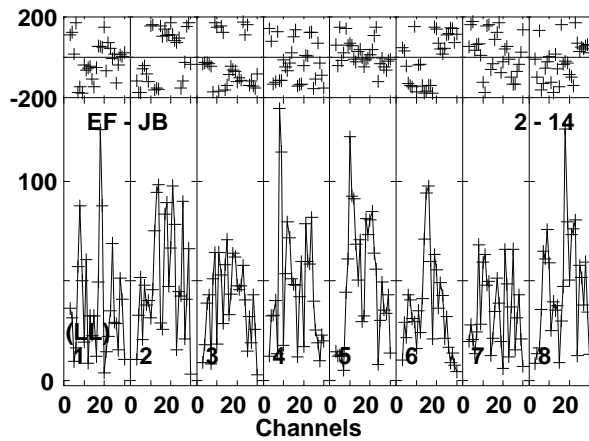
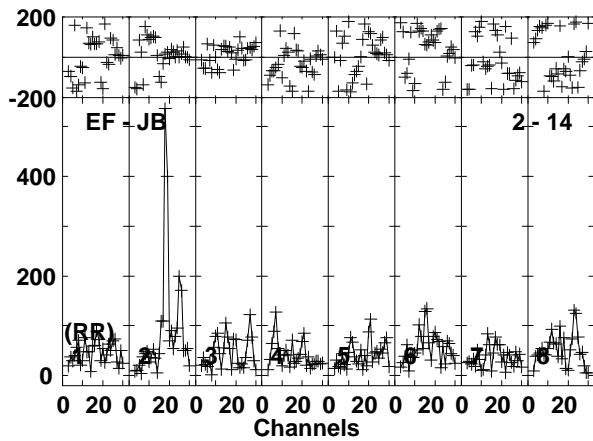
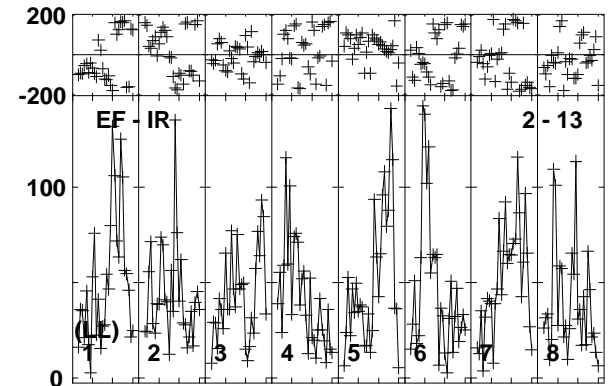
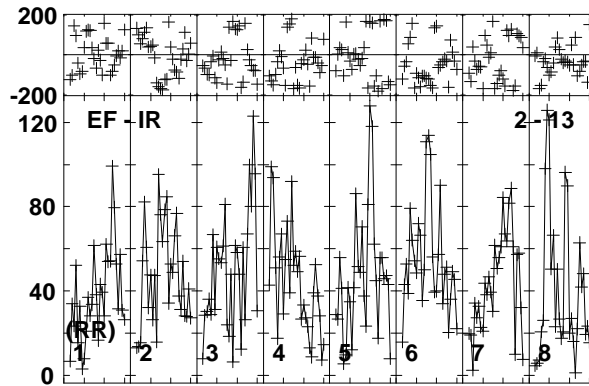
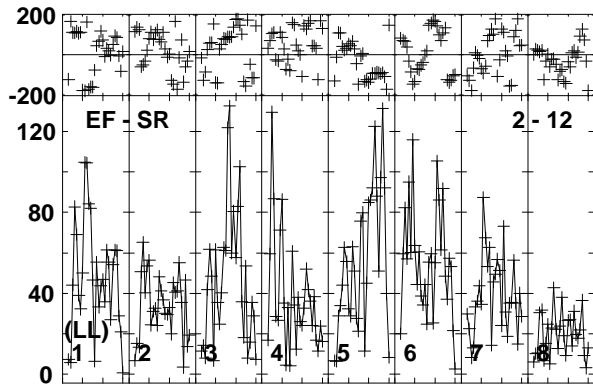
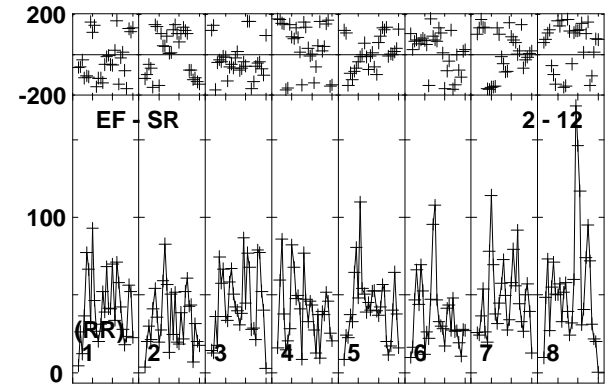
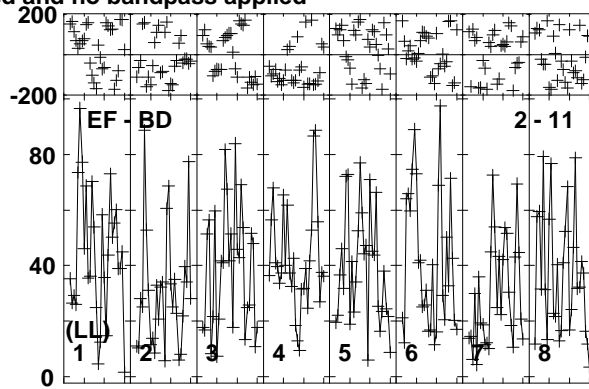
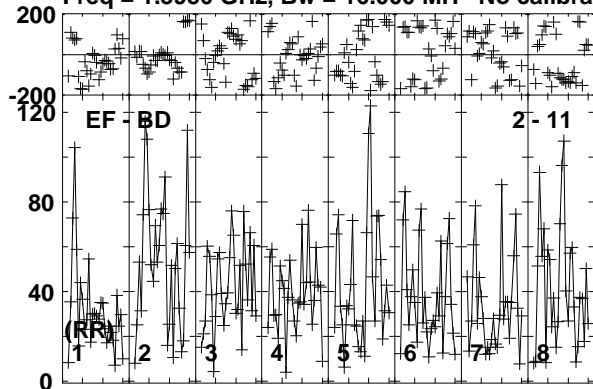

Lower frame: Micro Ampl Jy Top frame: Phas deg  
Vector averaged cross-power spectrum Baseline: EF (02) - BD (11)  
Timerange: 00/03:42:01 to 00/03:49:59

Plot file version 67 created 30-AUG-2019 17:53:19

J1722+2458 EB070.UVDATA.1

Freq = 1.5950 GHz, Bw = 16.000 MH No calibration applied and no bandpass applied

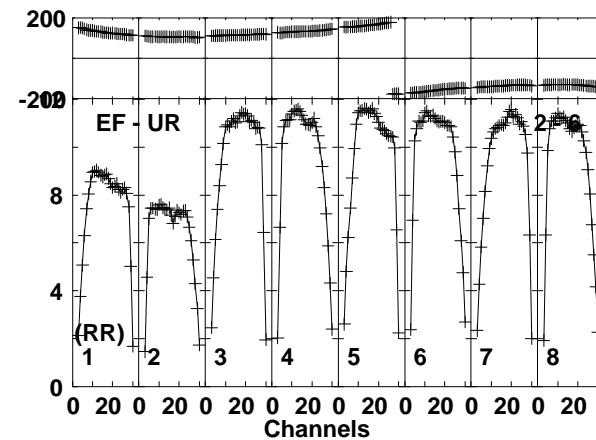
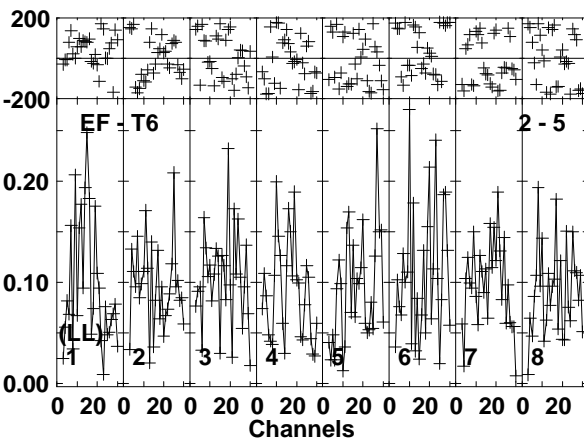
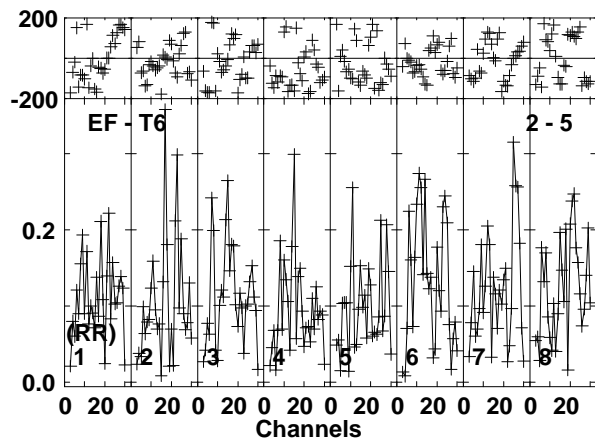
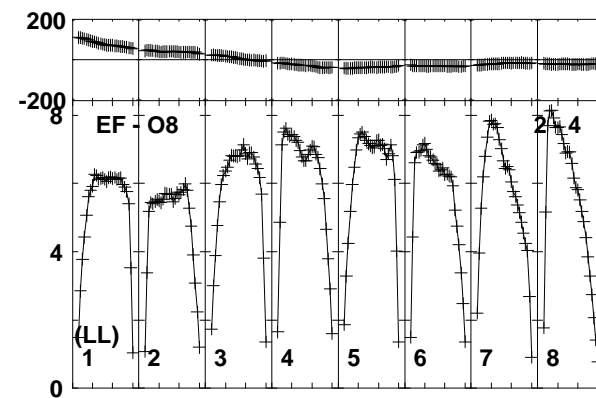
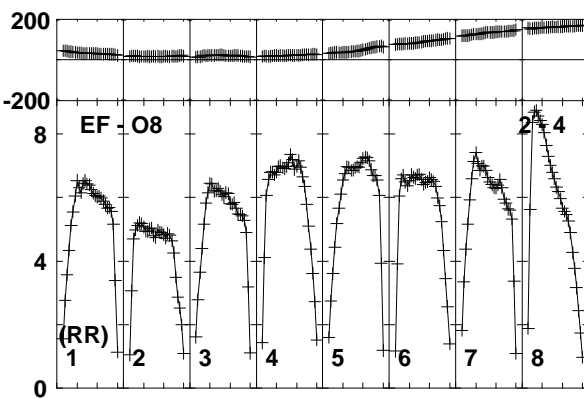
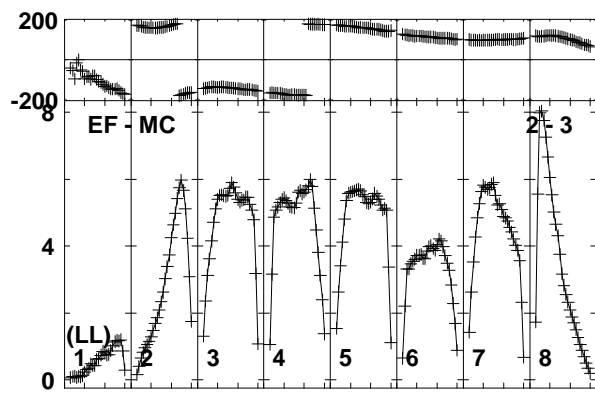
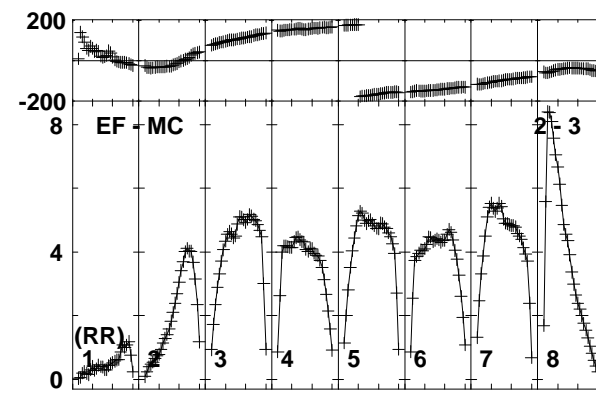
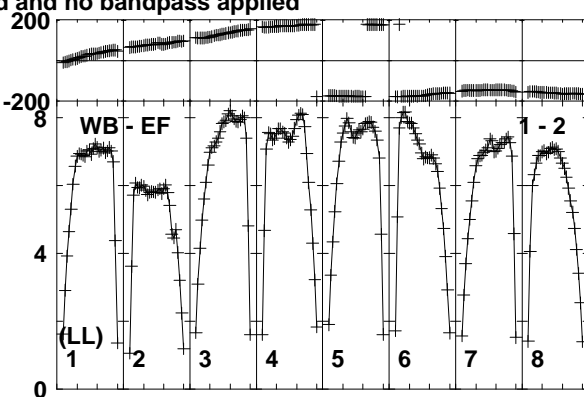
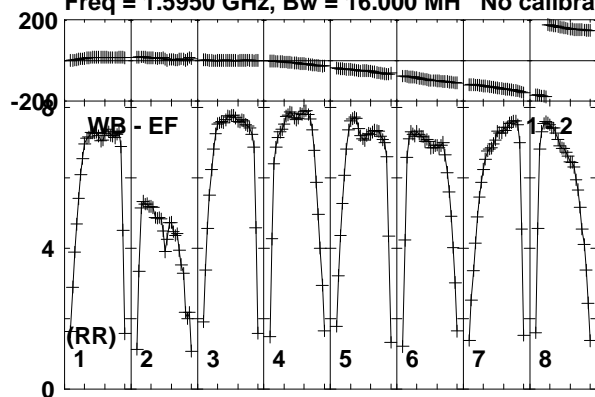

Lower frame: Milli Ampl Jy Top frame: Phas deg  
Vector averaged cross-power spectrum Baseline: WB (01) - EF (02)  
Timerange: 00/03:50:41 to 00/03:51:59

Plot file version 68 created 30-AUG-2019 17:53:19

J1722+2458 EB070.UVDATA.1

Freq = 1.5950 GHz, Bw = 16.000 MH No calibration applied and no bandpass applied

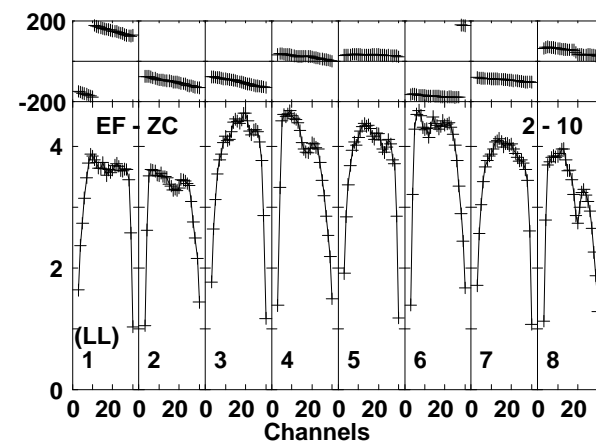
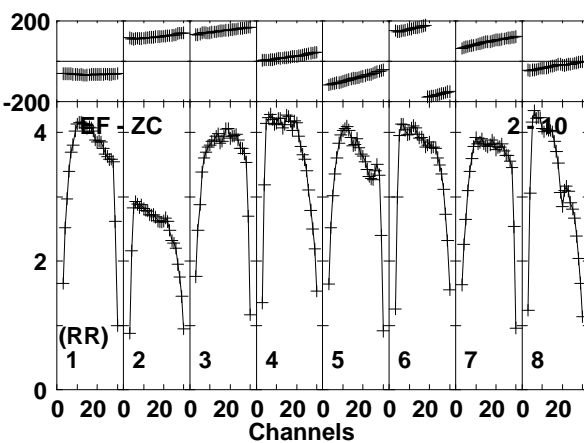
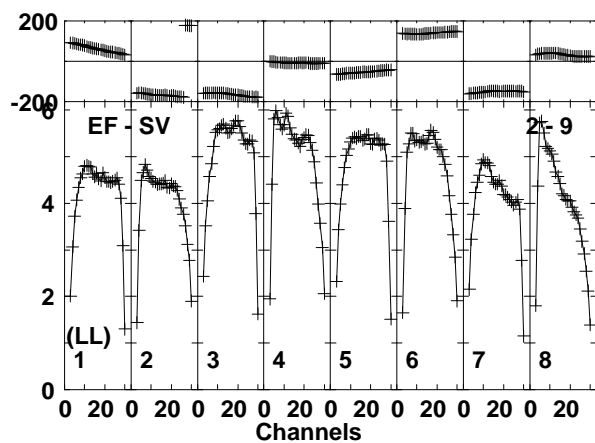
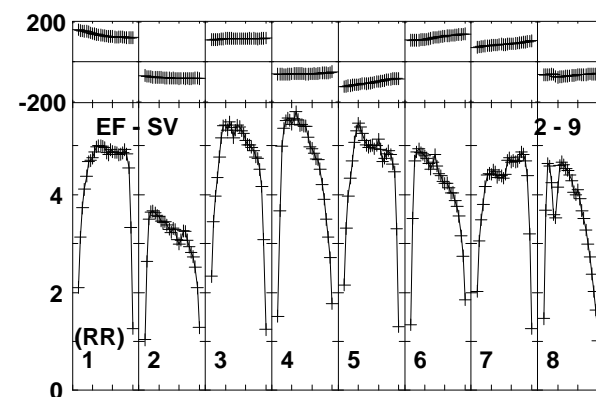
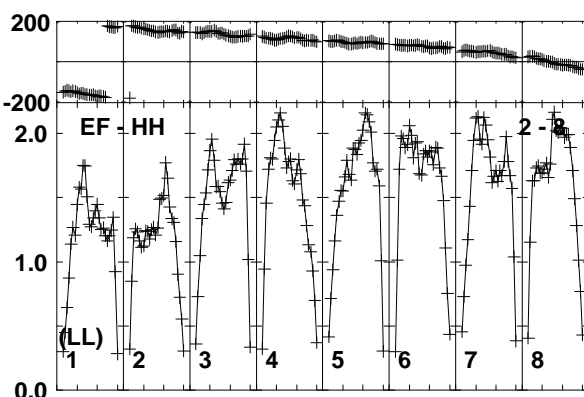
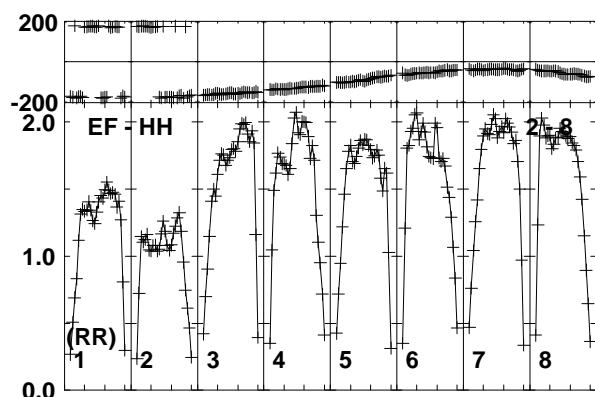
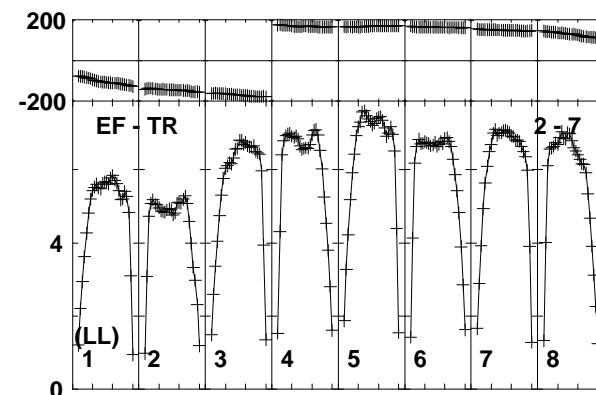
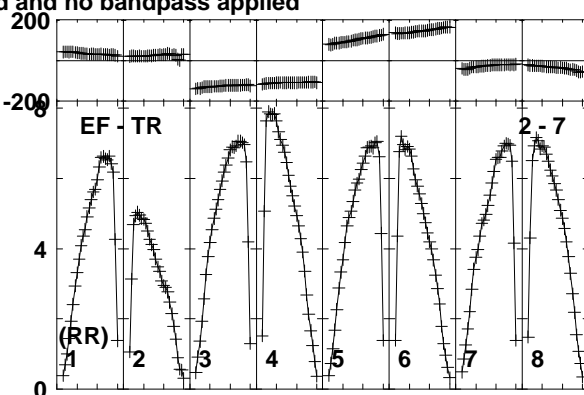
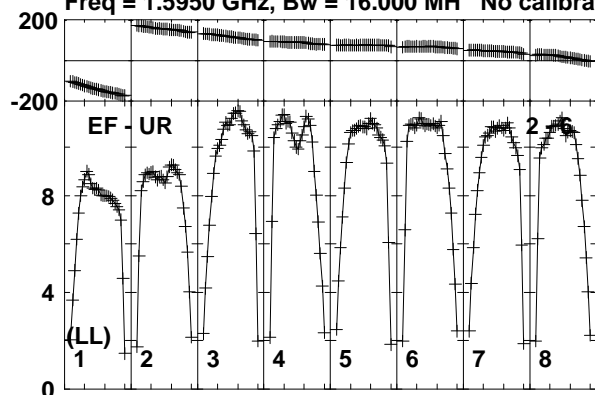

Lower frame: Milli Ampl Jy Top frame: Phas deg  
Vector averaged cross-power spectrum Baseline: EF (02) - UR (06)  
Timerange: 00/03:50:41 to 00/03:51:59

Plot file version 69 created 30-AUG-2019 17:53:19

J1722+2458 EB070.UVDATA.1

Freq = 1.5950 GHz, Bw = 16.000 MH No calibration applied and no bandpass applied

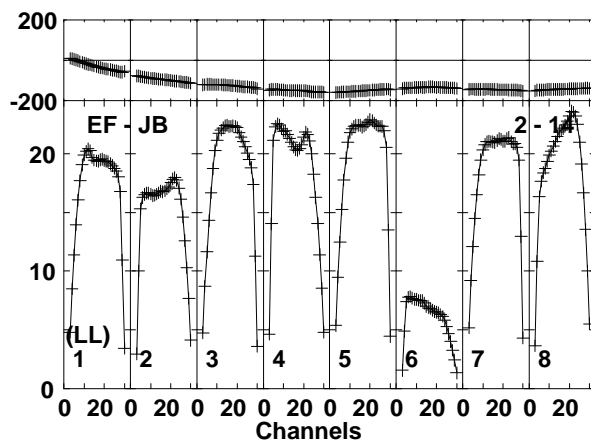
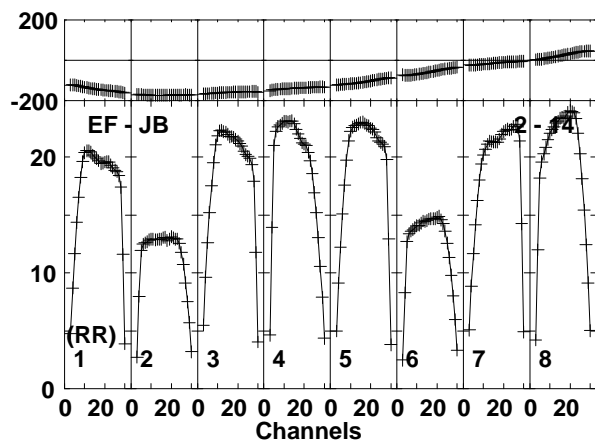
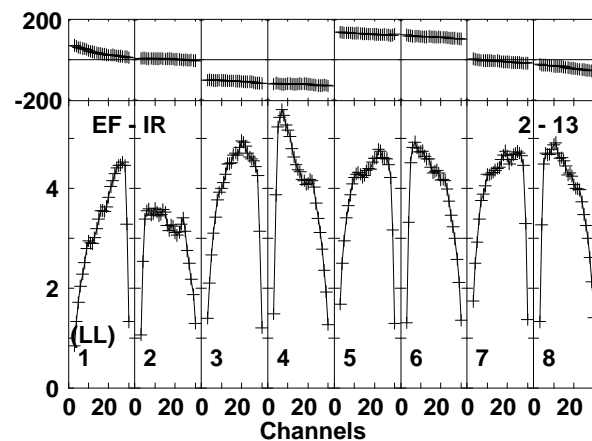
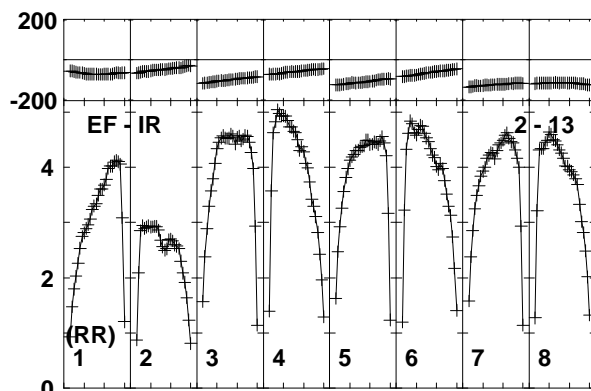
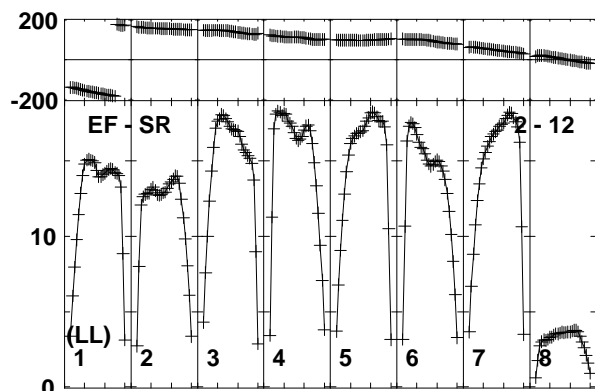
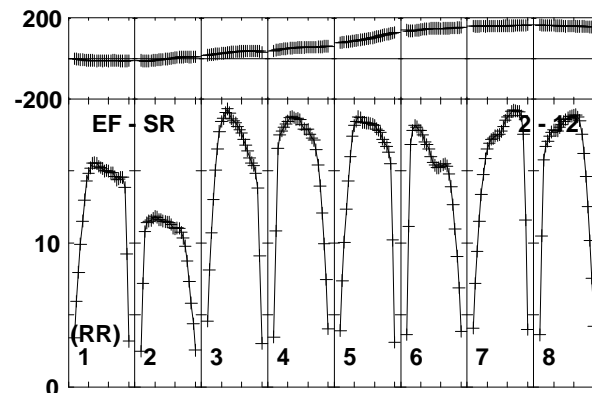
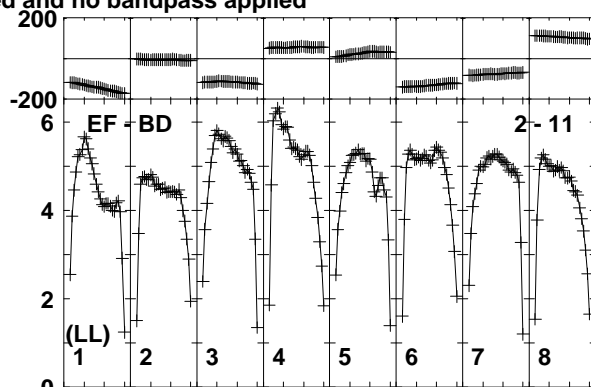
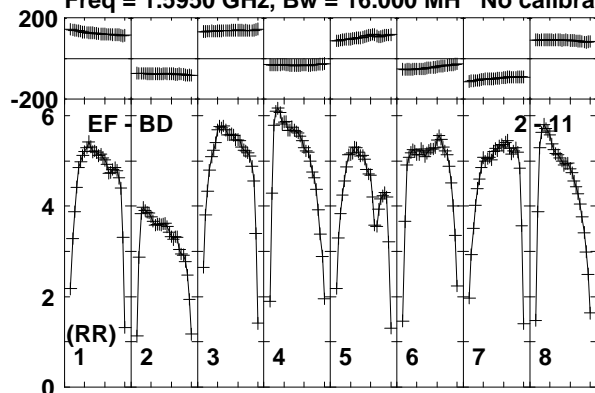

Lower frame: Milli Ampl Jy Top frame: Phas deg  
Vector averaged cross-power spectrum Baseline: EF (02) - BD (11)  
Timerange: 00/03:50:41 to 00/03:51:59

Plot file version 70 created 30-AUG-2019 17:53:19  
 3C345 EB070.UVDATA.1

Freq = 1.5950 GHz, Bw = 16.000 MH No calibration applied and no bandpass applied

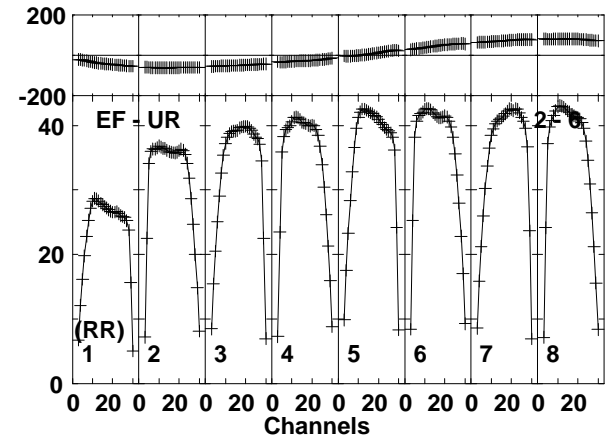
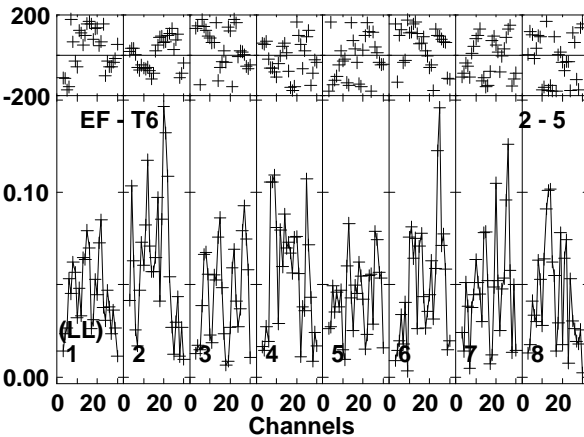
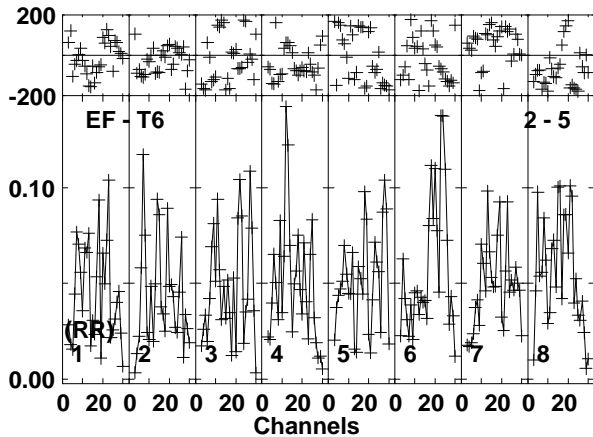
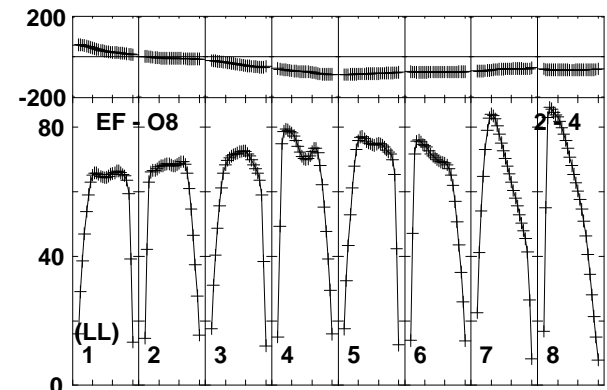
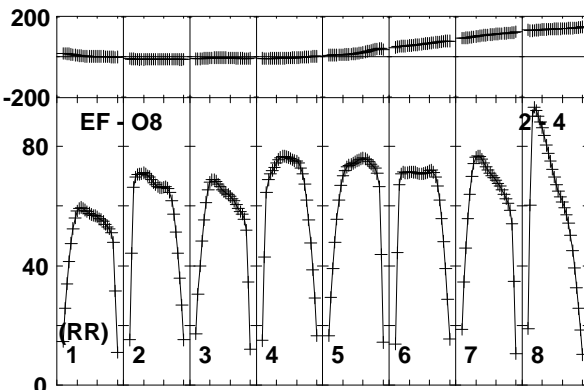
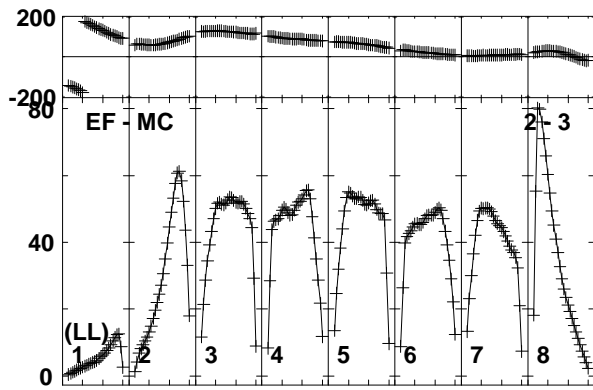
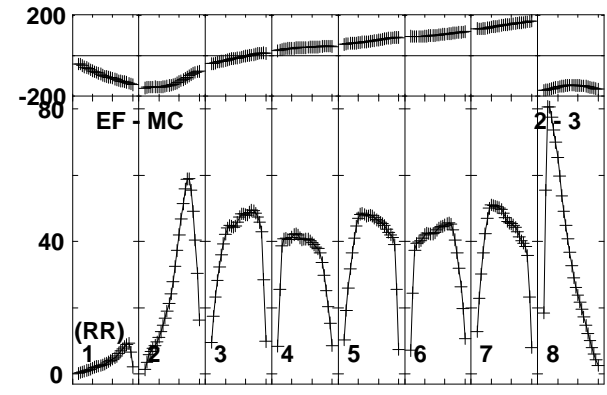
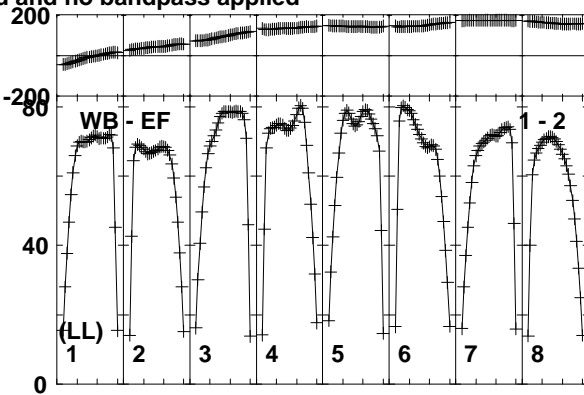
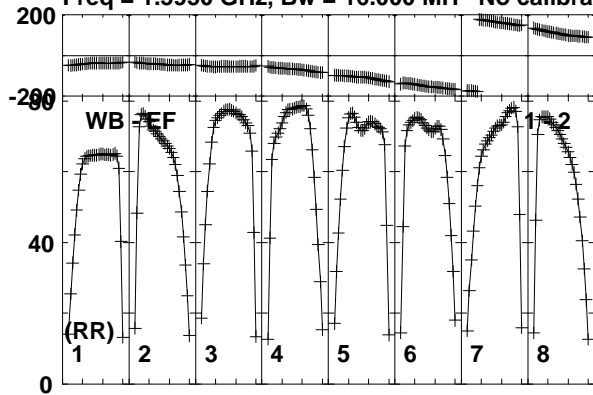

Lower frame: Milli Ampl Jy Top frame: Phas deg  
 Vector averaged cross-power spectrum Baseline: WB (01) - EF (02)  
 Timerange: 00/03:52:01 to 00/03:59:59

Plot file version 71 created 30-AUG-2019 17:53:19

3C345 EB070.UVDATA.1

Freq = 1.5950 GHz, Bw = 16.000 MH No calibration applied and no bandpass applied

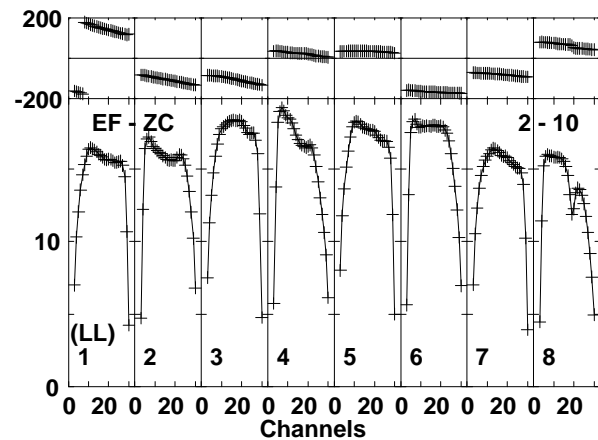
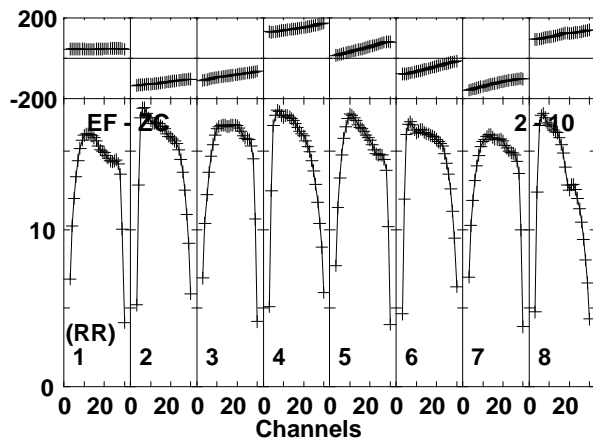
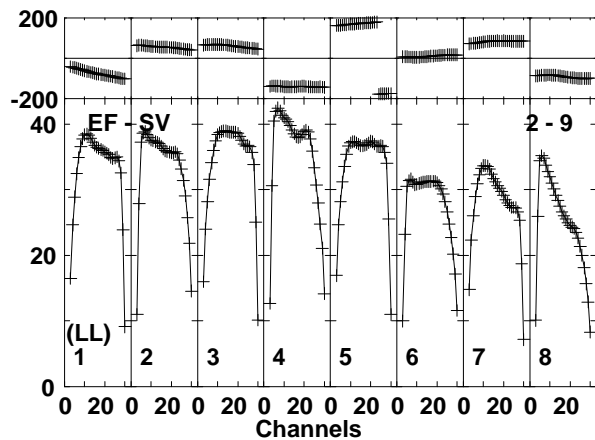
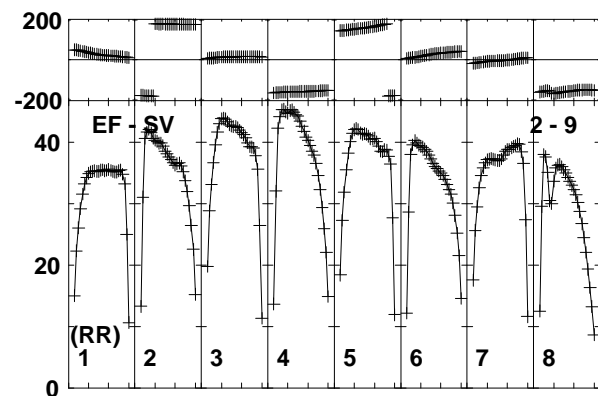
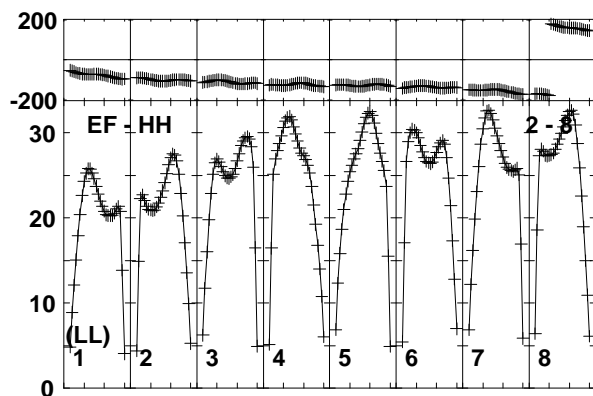
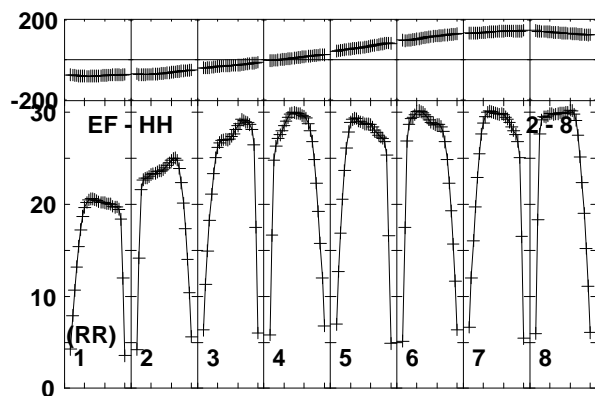
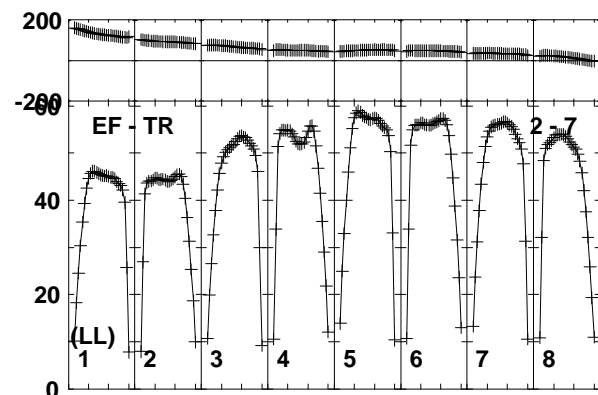
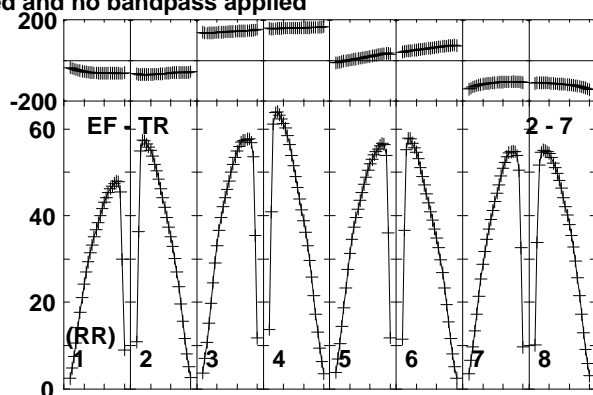
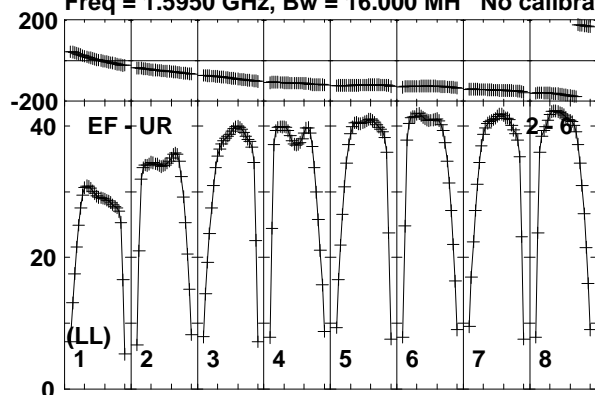

Lower frame: Milli Ampl Jy Top frame: Phas deg  
Vector averaged cross-power spectrum Baseline: EF (02) - UR (06)  
Timerange: 00/03:52:01 to 00/03:59:59

Plot file version 72 created 30-AUG-2019 17:53:20

3C345 EB070.UVDATA.1

Freq = 1.5950 GHz, Bw = 16.000 MH No calibration applied and no bandpass applied

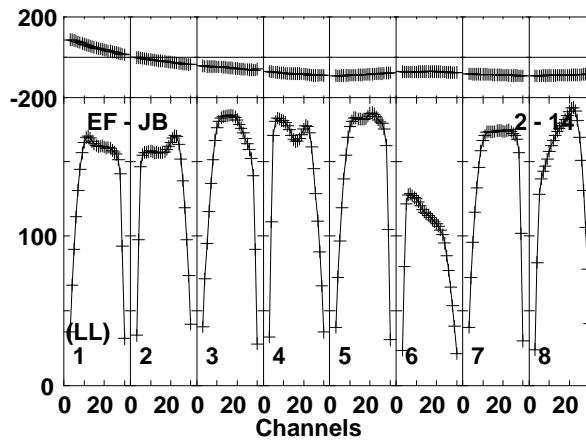
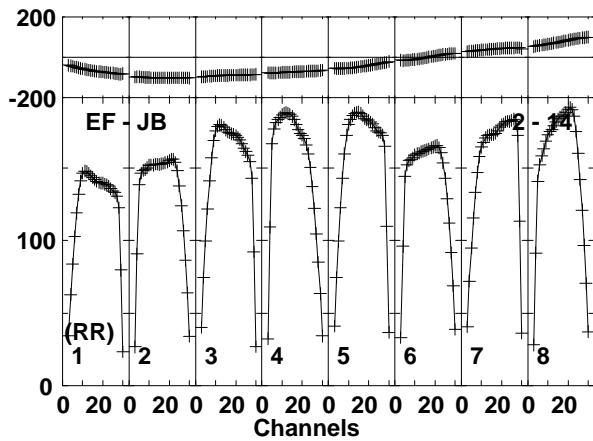
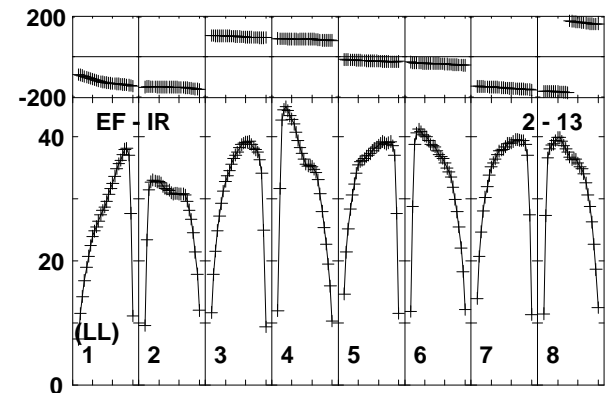
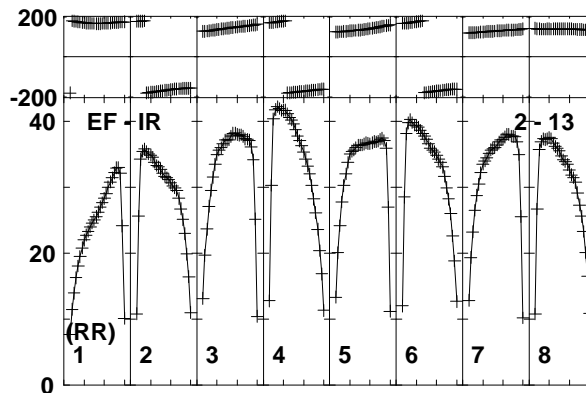
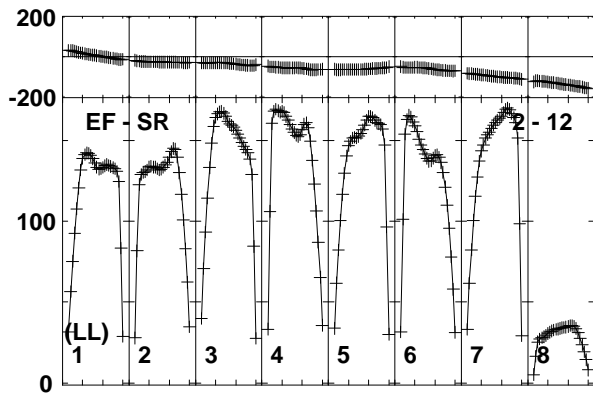
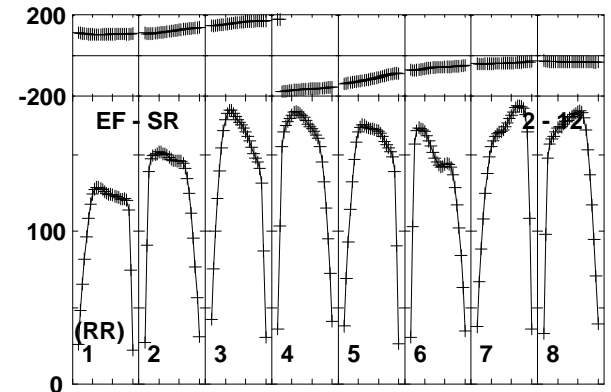
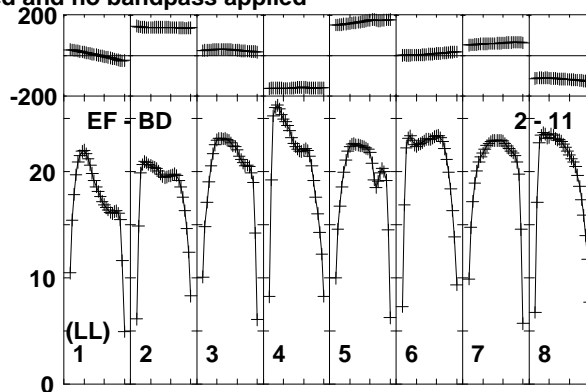
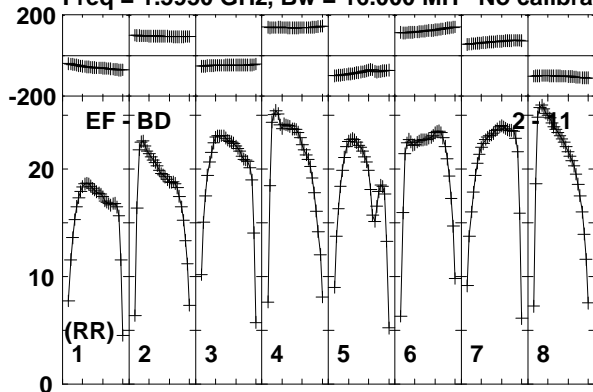

Lower frame: Milli Ampl Jy Top frame: Phas deg  
Vector averaged cross-power spectrum Baseline: EF (02) - BD (11)  
Timerange: 00/03:52:01 to 00/03:59:59



Plot file version 73 created 30-AUG-2019 17:53:20

ROSS867 EB070.UVDATA.1

Freq = 1.5950 GHz, Bw = 16.000 MH No calibration applied and no bandpass applied

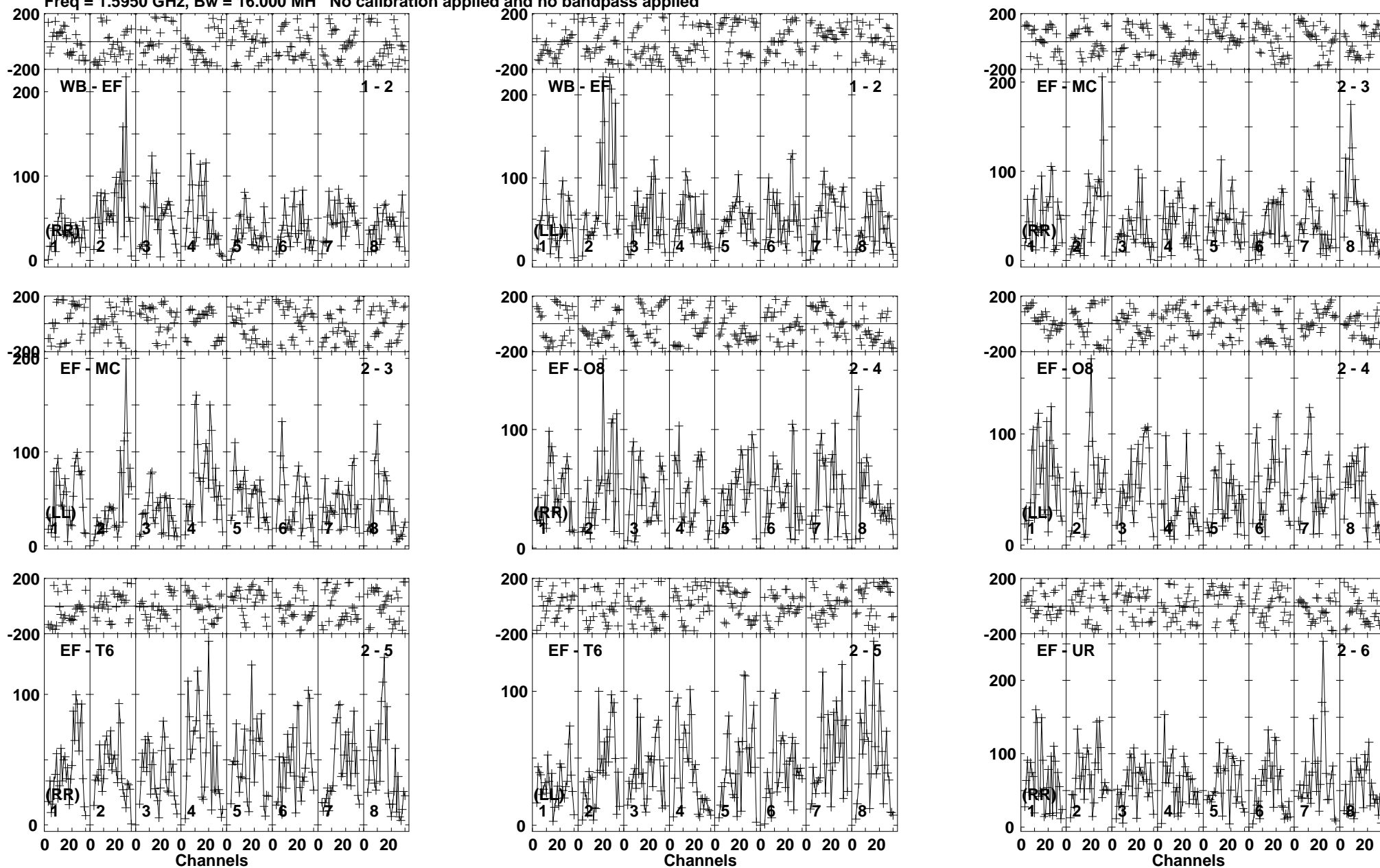

Lower frame: Micro Ampl Jy Top frame: Phas deg  
Vector averaged cross-power spectrum Baseline: WB (01) - EF (02)  
Timerange: 00/04:02:01 to 00/04:09:59

Plot file version 74 created 30-AUG-2019 17:53:21

ROSS867 EB070.UVDATA.1

Freq = 1.5950 GHz, Bw = 16.000 MH No calibration applied and no bandpass applied

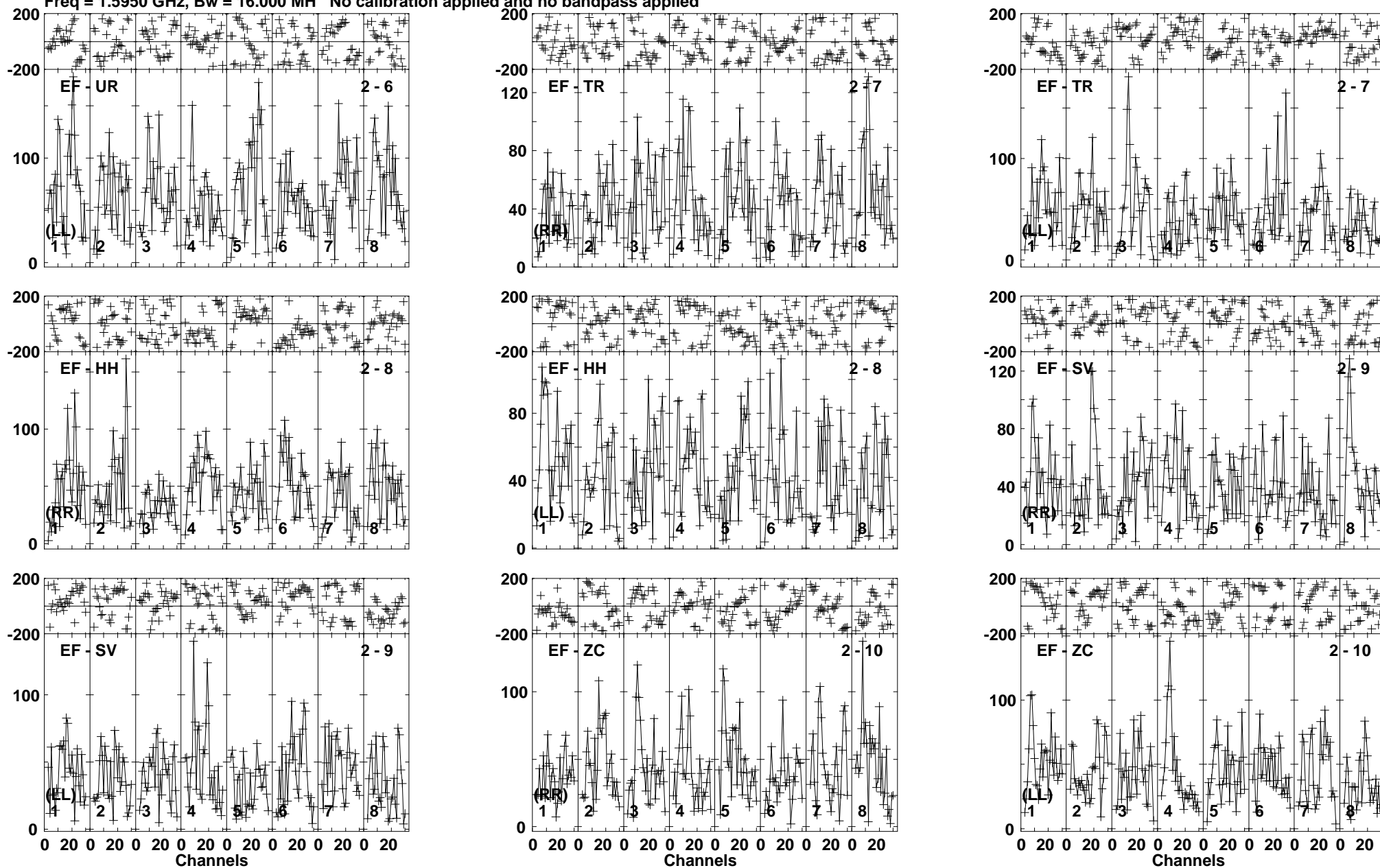

Lower frame: Micro Ampl Jy Top frame: Phas deg  
Vector averaged cross-power spectrum Baseline: EF (02) - UR (06)  
Timerange: 00/04:02:01 to 00/04:09:59

Plot file version 75 created 30-AUG-2019 17:53:21

ROSS867 EB070.UVDATA.1

Freq = 1.5950 GHz, Bw = 16.000 MH No calibration applied and no bandpass applied

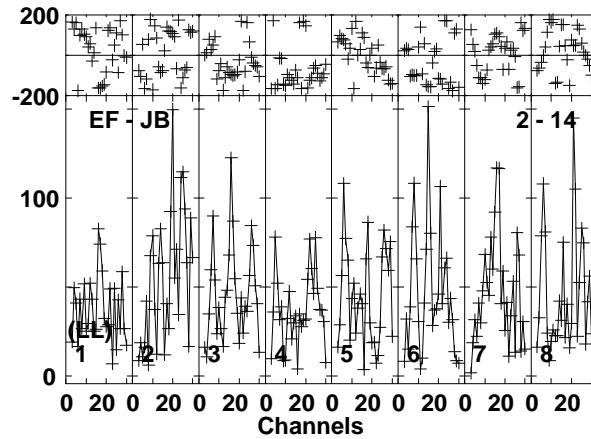
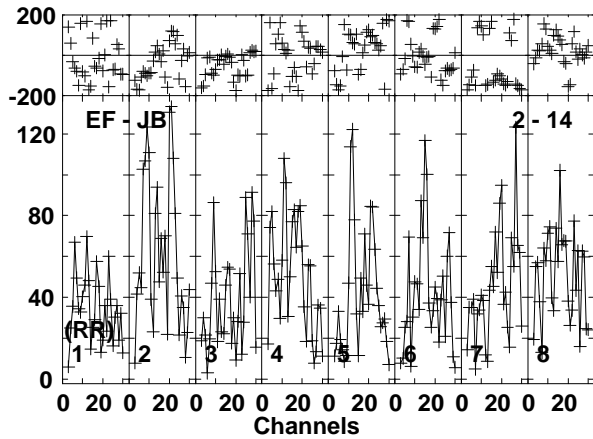
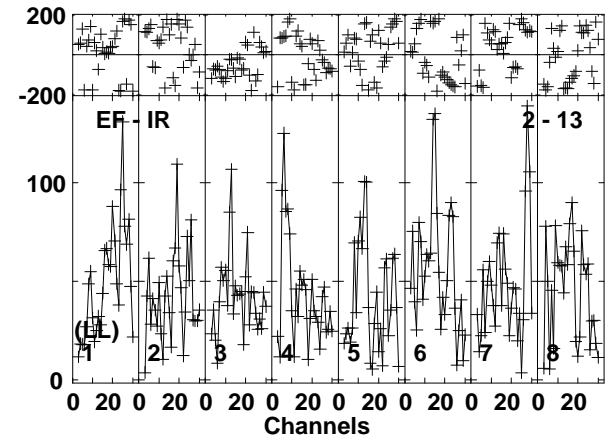
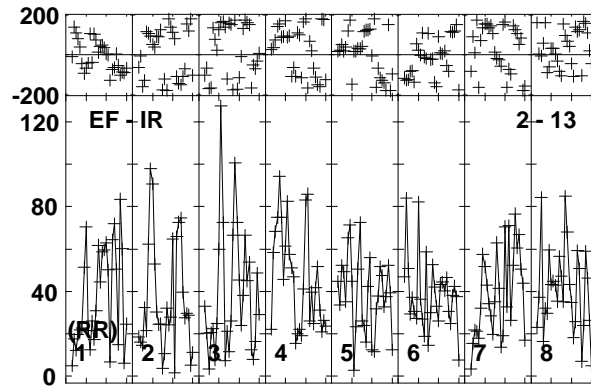
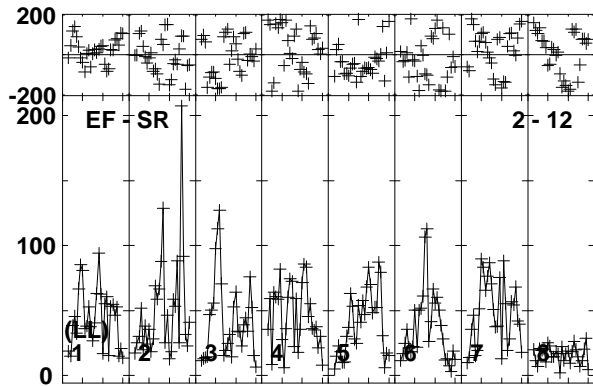
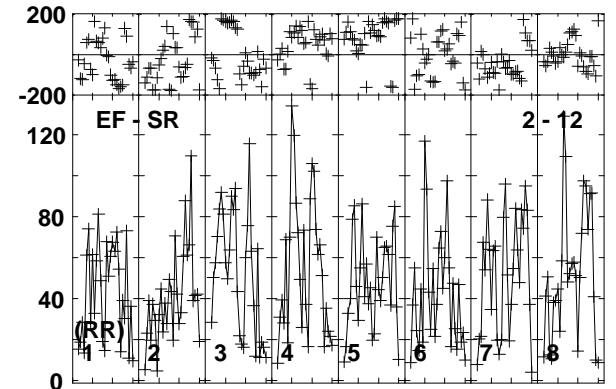
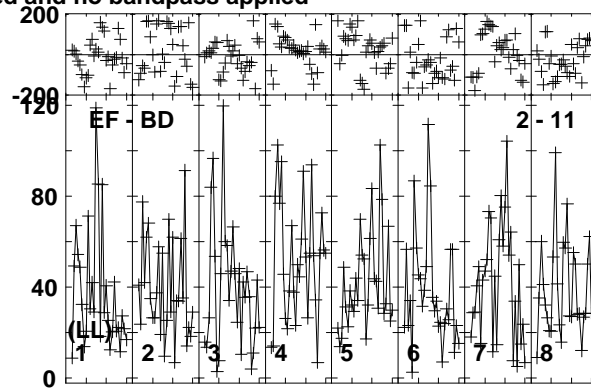
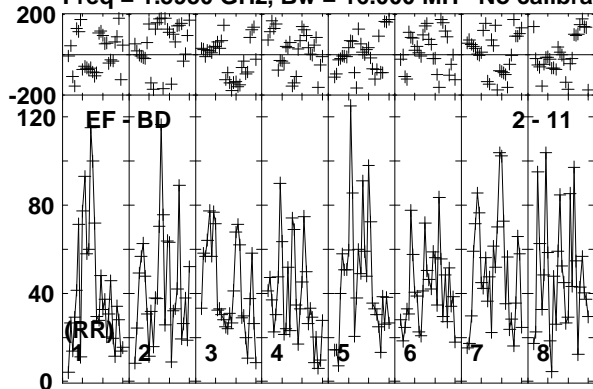

Lower frame: Micro Ampl Jy Top frame: Phas deg  
Vector averaged cross-power spectrum Baseline: EF (02) - BD (11)  
Timerange: 00/04:02:01 to 00/04:09:59

Plot file version 76 created 30-AUG-2019 17:53:21

J1722+2458 EB070.UVDATA.1

Freq = 1.5950 GHz, Bw = 16.000 MH No calibration applied and no bandpass applied

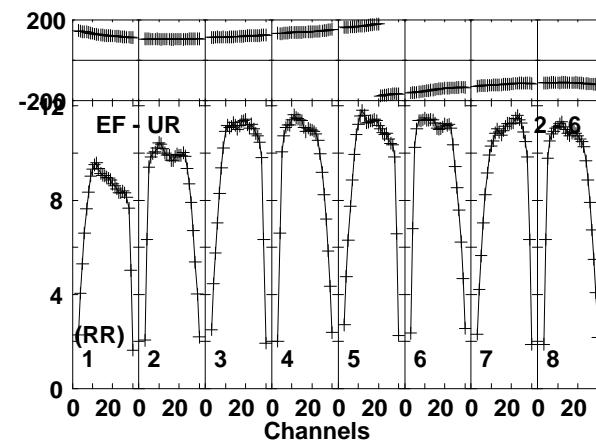
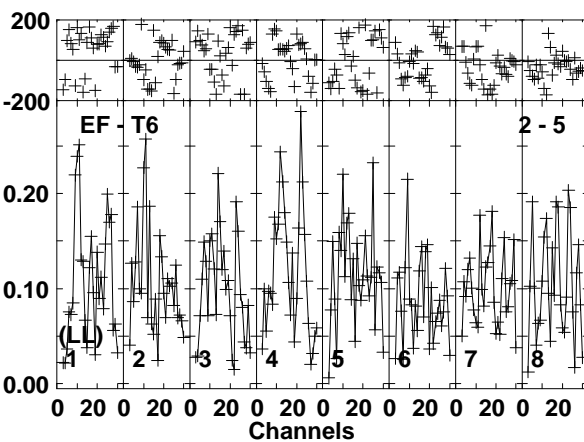
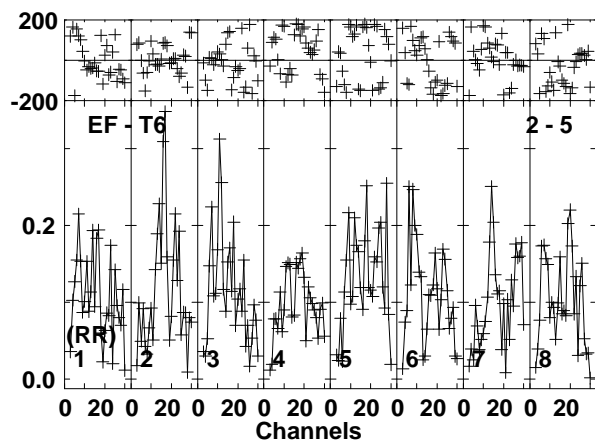
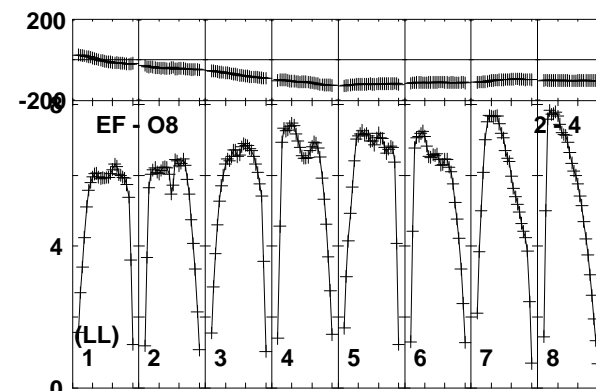
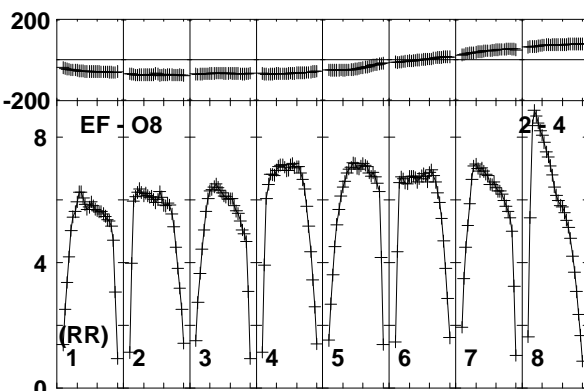
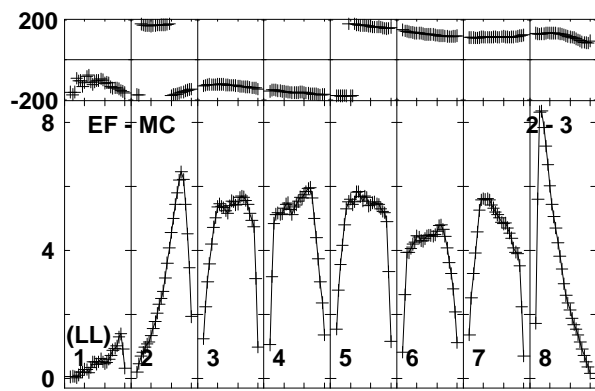
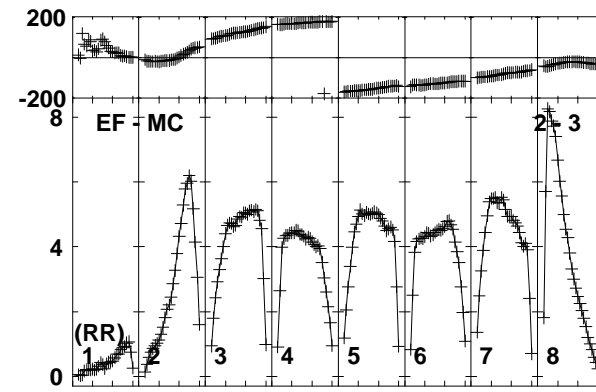
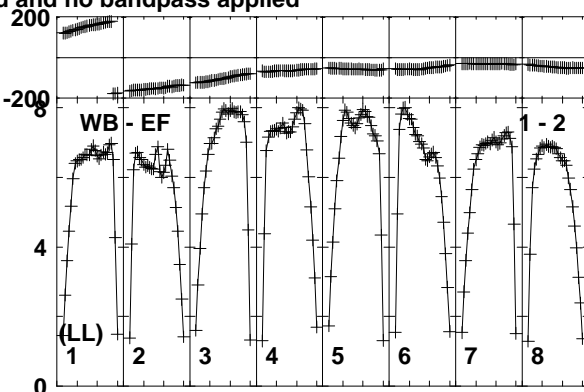
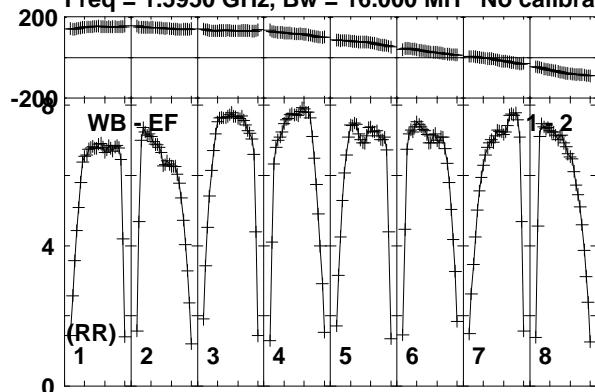

Lower frame: Milli Ampl Jy Top frame: Phas deg  
Vector averaged cross-power spectrum Baseline: WB (01) - EF (02)  
Timerange: 00/04:10:41 to 00/04:11:59

Plot file version 77 created 30-AUG-2019 17:53:21

J1722+2458 EB070.UVDATA.1

Freq = 1.5950 GHz, Bw = 16.000 MH No calibration applied and no bandpass applied

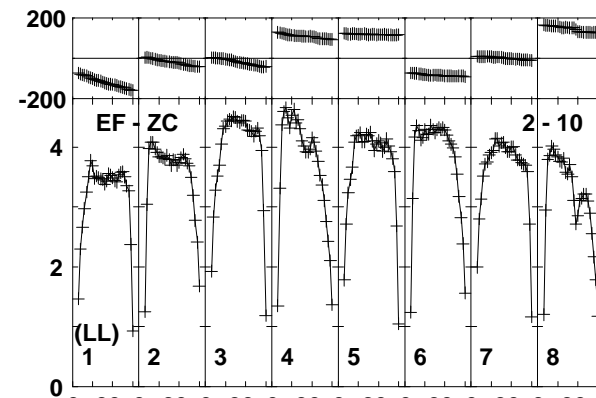
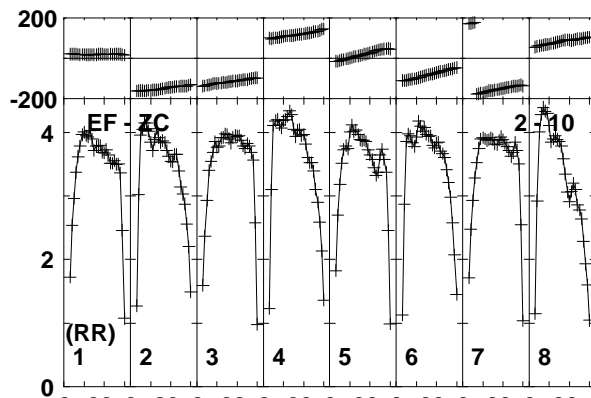
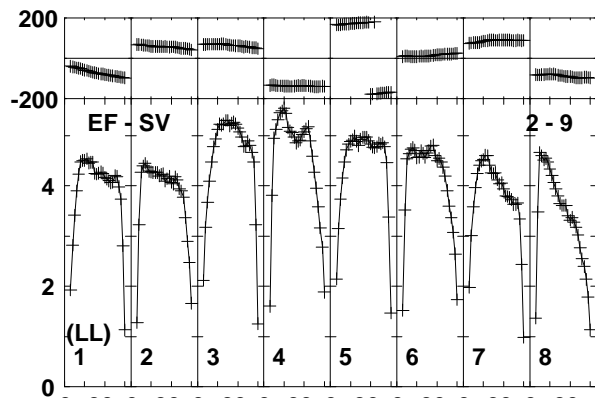
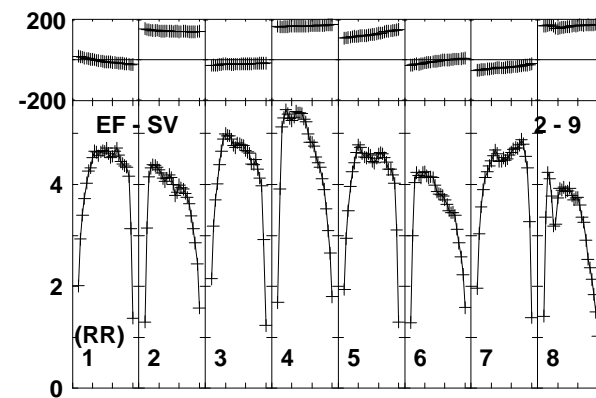
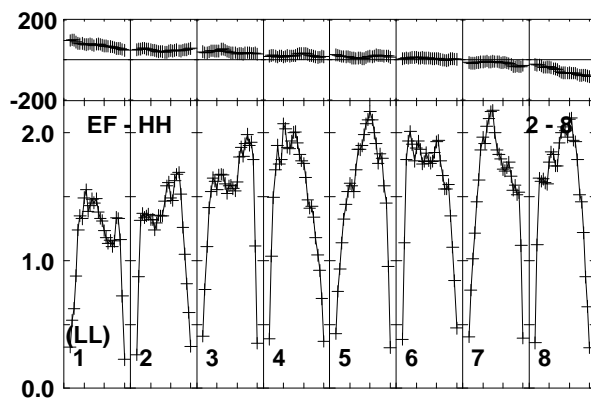
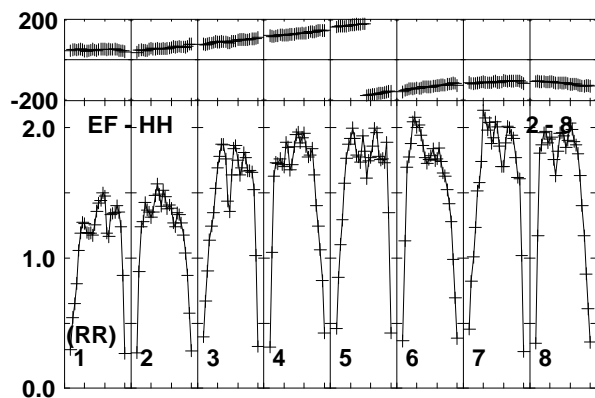
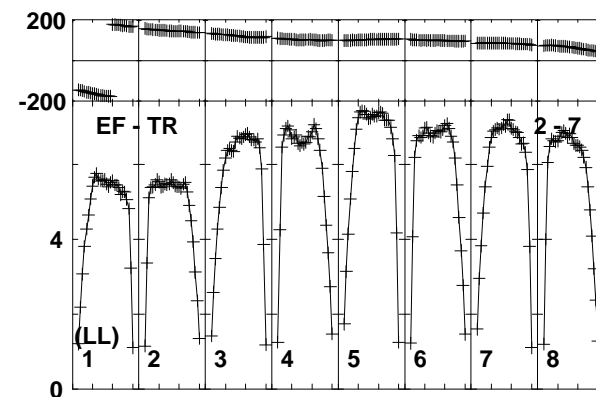
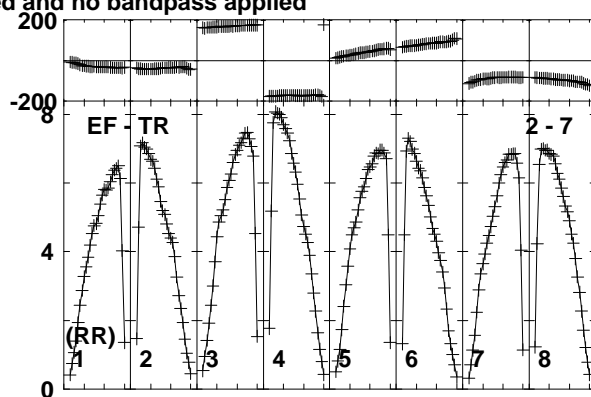
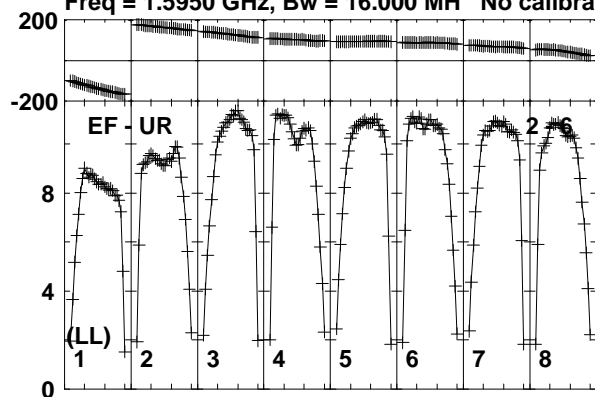

Lower frame: Milli Ampl Jy Top frame: Phas deg  
Vector averaged cross-power spectrum Baseline: EF (02) - UR (06)  
Timerange: 00/04:10:41 to 00/04:11:59

Plot file version 78 created 30-AUG-2019 17:53:21

J1722+2458 EB070.UVDATA.1

Freq = 1.5950 GHz, Bw = 16.000 MH No calibration applied and no bandpass applied

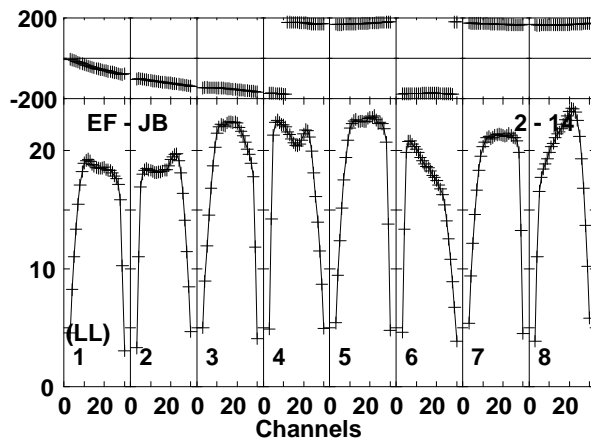
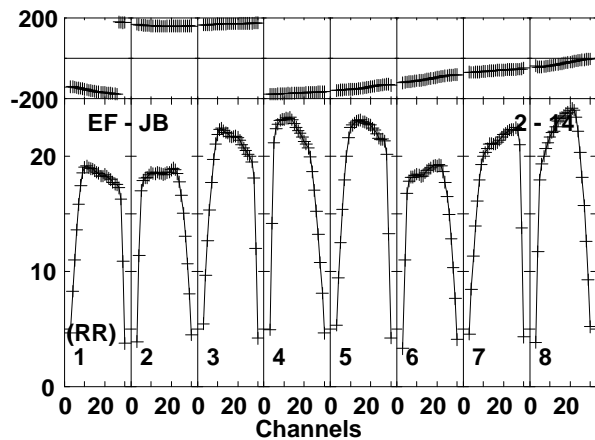
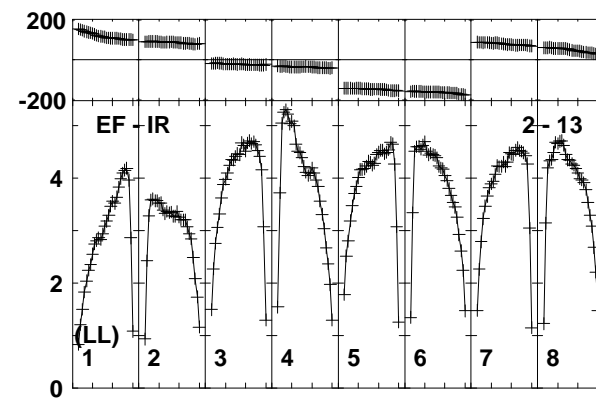
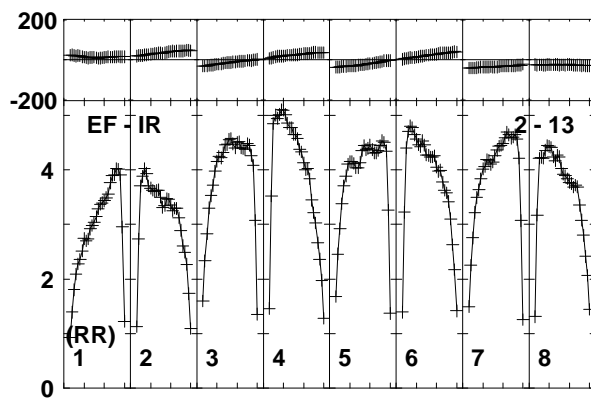
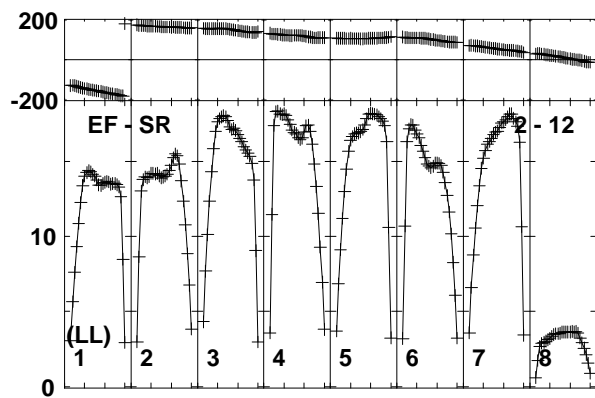
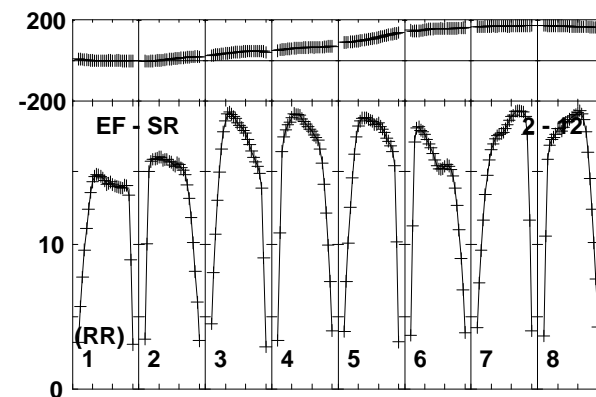
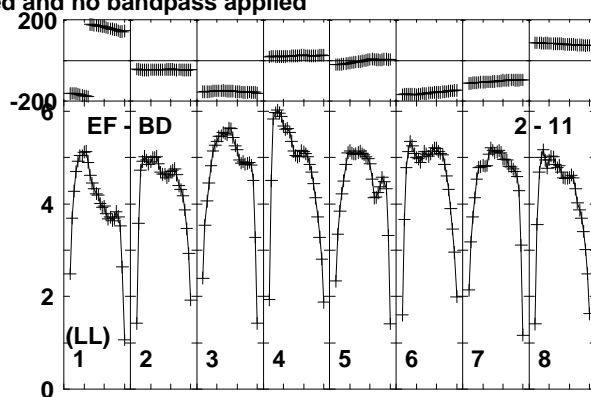
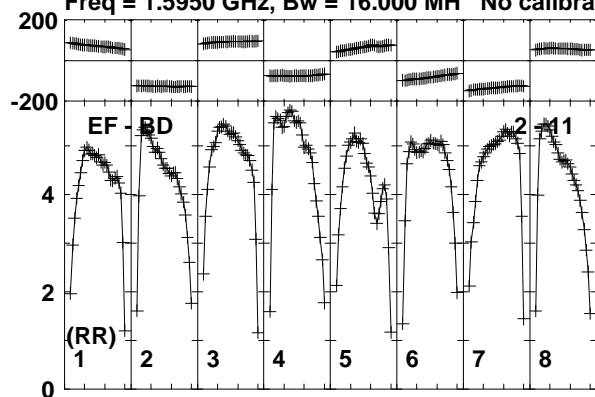

Lower frame: Milli Ampl Jy Top frame: Phas deg  
Vector averaged cross-power spectrum Baseline: EF (02) - BD (11)  
Timerange: 00/04:10:41 to 00/04:11:59

Plot file version 79 created 30-AUG-2019 17:53:22

ROSS867 EB070.UVDATA.1

Freq = 1.5950 GHz, Bw = 16.000 MH No calibration applied and no bandpass applied

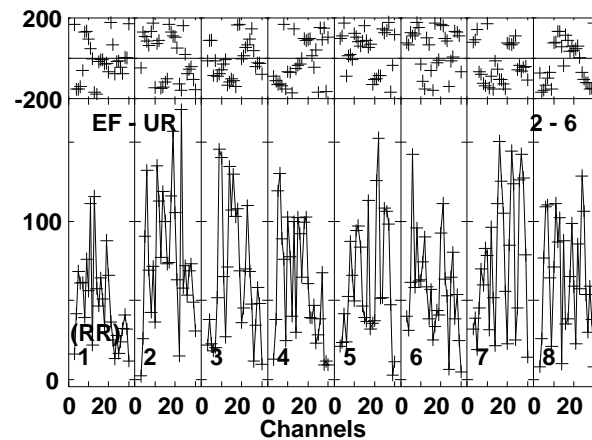
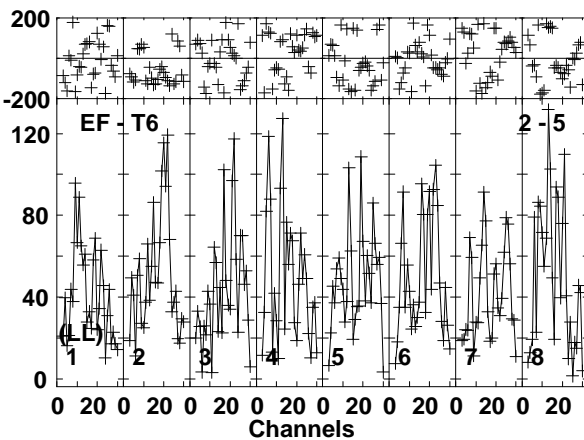
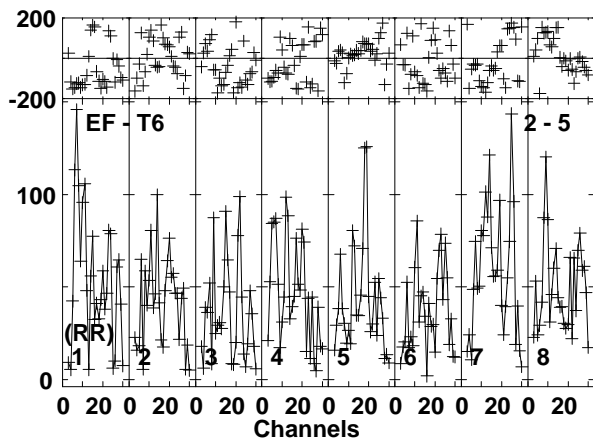
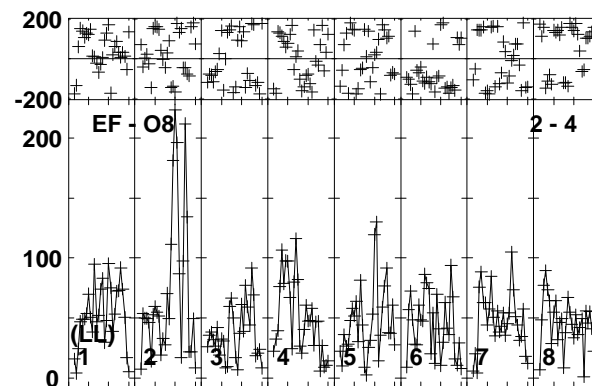
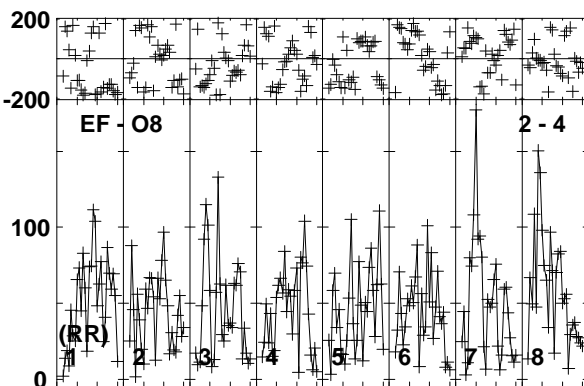
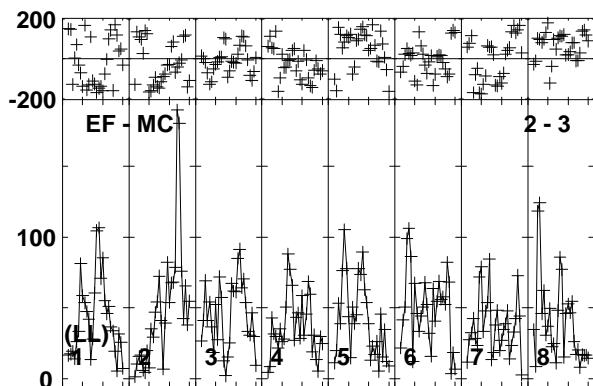
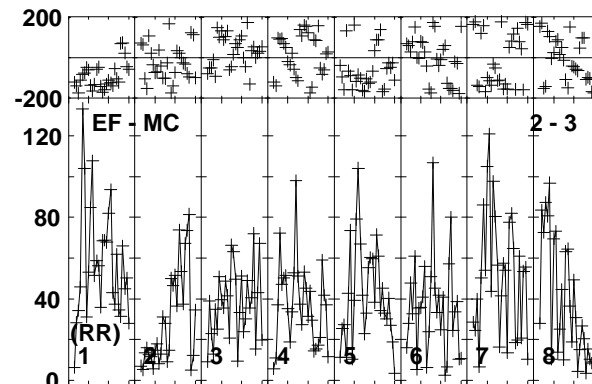
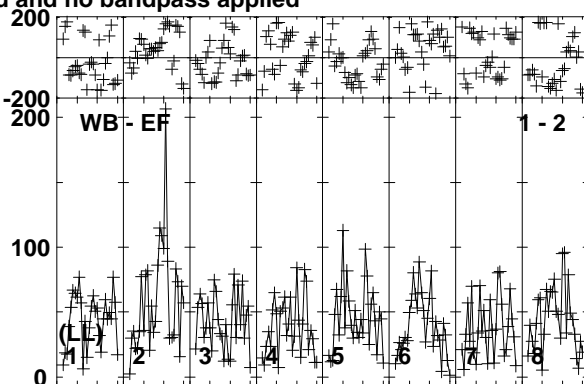
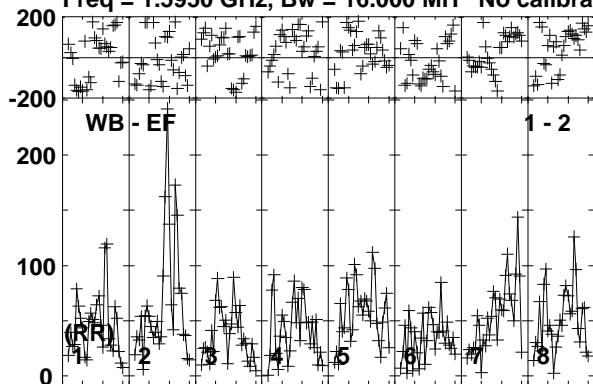

Lower frame: Micro Ampl Jy Top frame: Phas deg  
Vector averaged cross-power spectrum Baseline: WB (01) - EF (02)  
Timerange: 00/04:12:01 to 00/04:19:59

Plot file version 80 created 30-AUG-2019 17:53:22

ROSS867 EB070.UVDATA.1

Freq = 1.5950 GHz, Bw = 16.000 MH No calibration applied and no bandpass applied

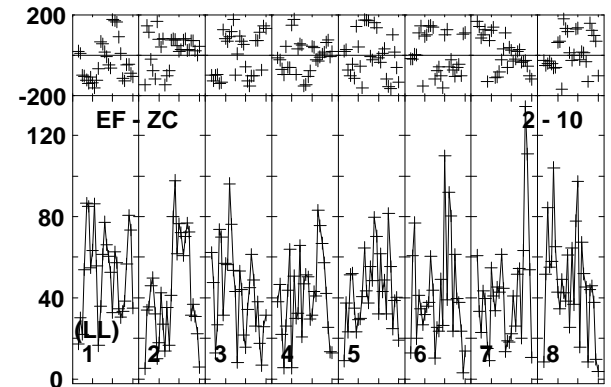
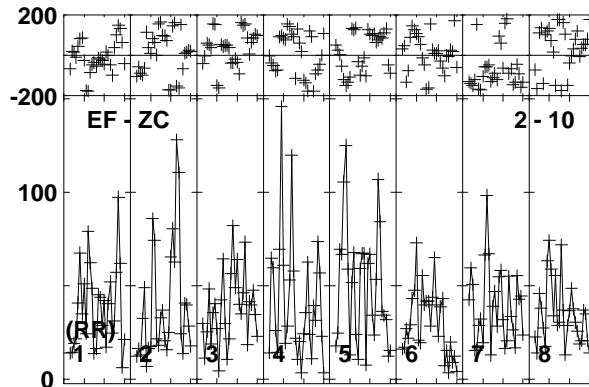
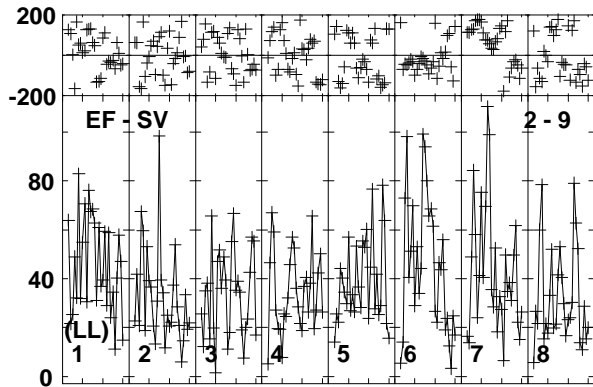
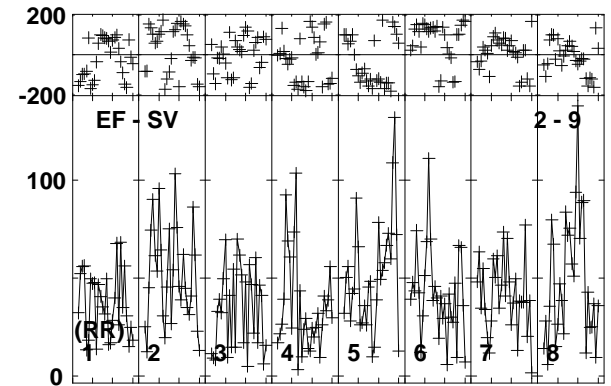
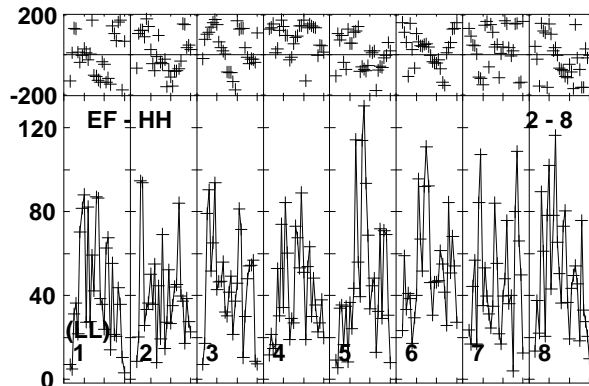
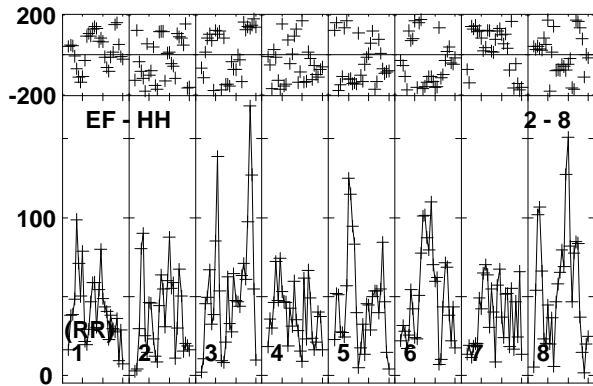
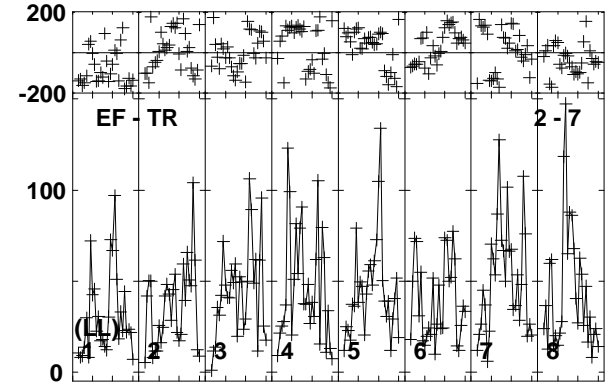
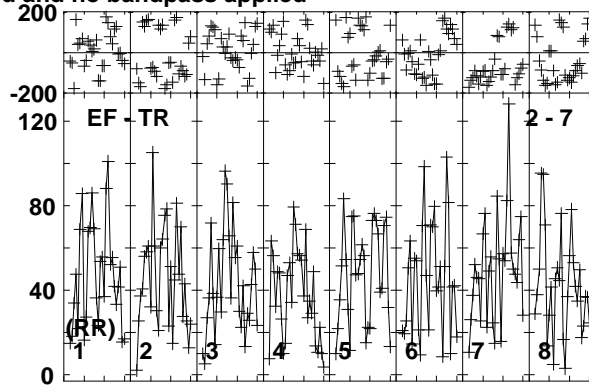
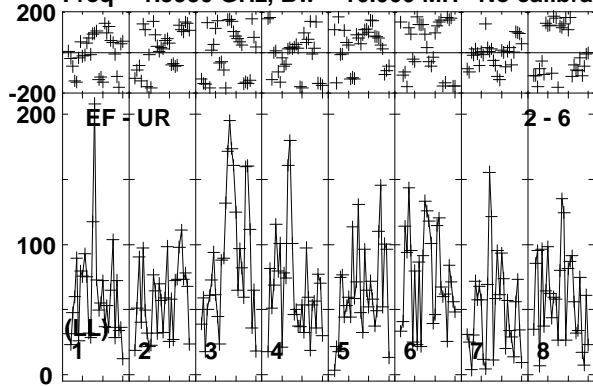

Lower frame: Micro Ampl Jy Top frame: Phas deg  
Vector averaged cross-power spectrum Baseline: EF (02) - UR (06)  
Timerange: 00/04:12:01 to 00/04:19:59



Plot file version 81 created 30-AUG-2019 17:53:22

ROSS867 EB070.UVDATA.1

Freq = 1.5950 GHz, Bw = 16.000 MH No calibration applied and no bandpass applied

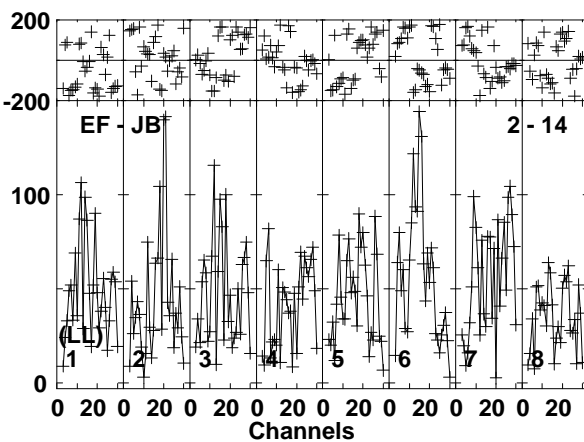
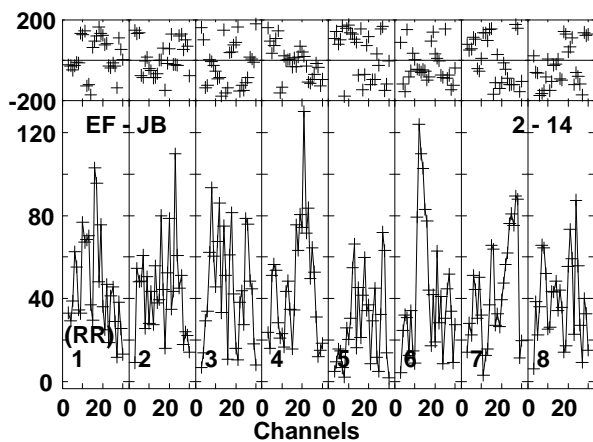
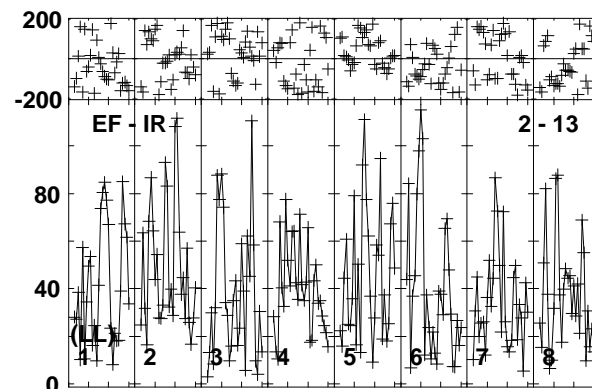
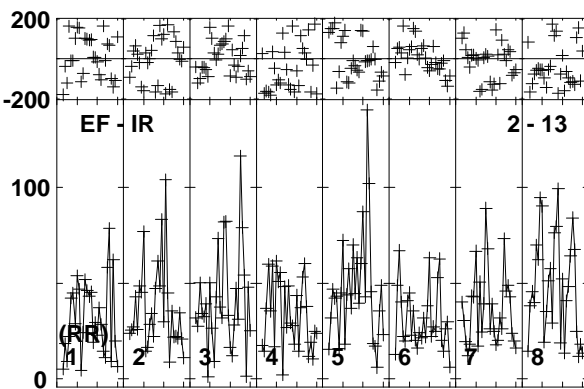
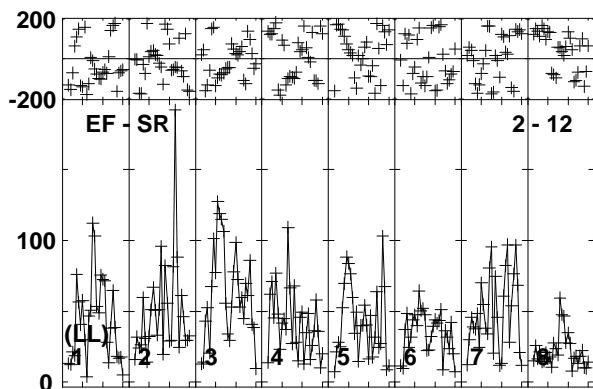
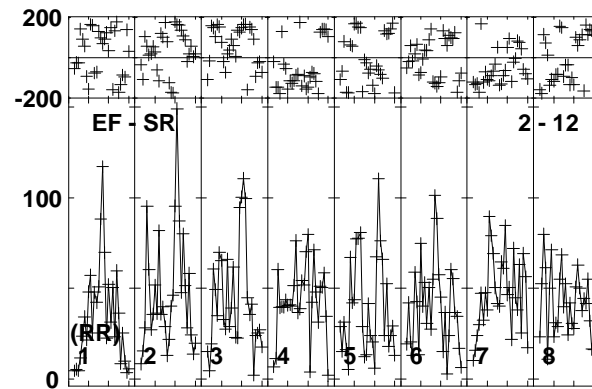
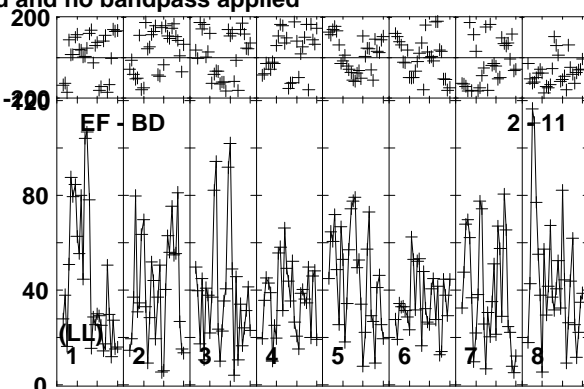
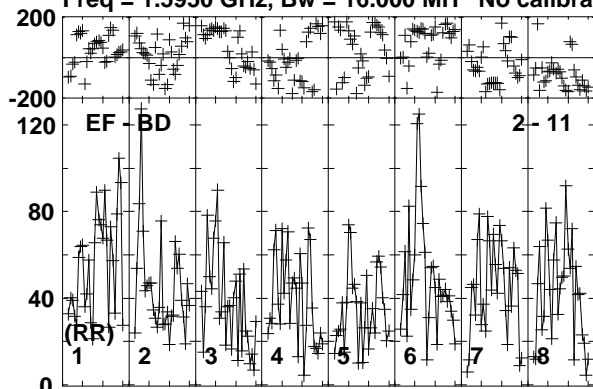

Lower frame: Micro Ampl Jy Top frame: Phas deg  
Vector averaged cross-power spectrum Baseline: EF (02) - BD (11)  
Timerange: 00/04:12:01 to 00/04:19:59

Plot file version 82 created 30-AUG-2019 17:53:22

J1722+2458 EB070.UVDATA.1

Freq = 1.5950 GHz, Bw = 16.000 MH No calibration applied and no bandpass applied

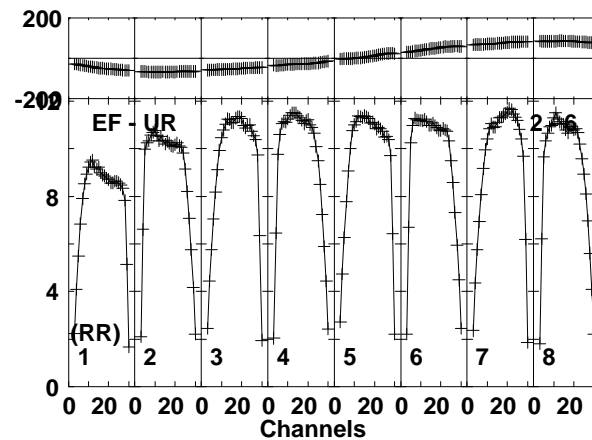
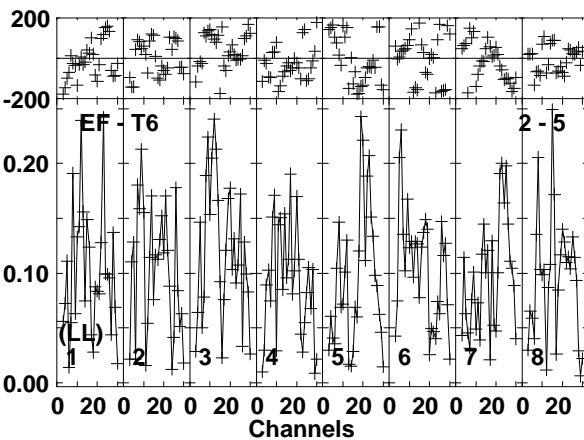
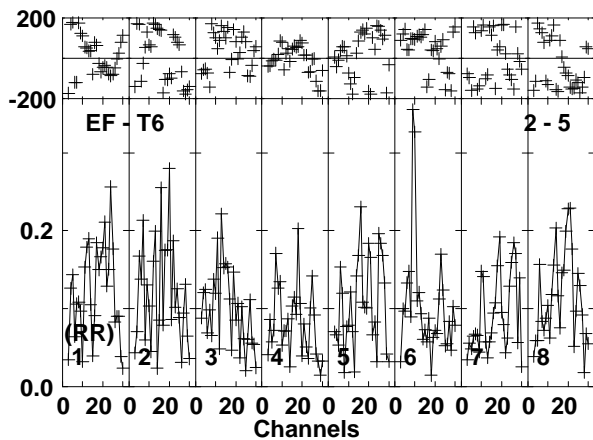
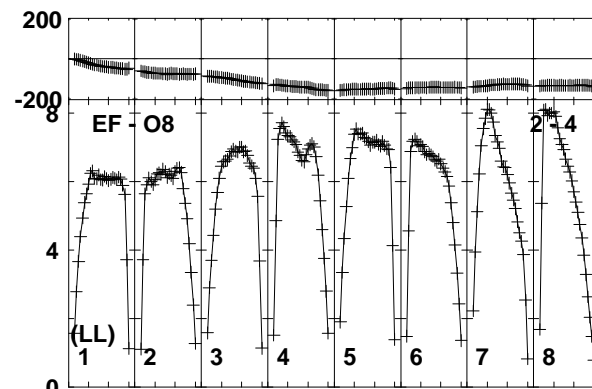
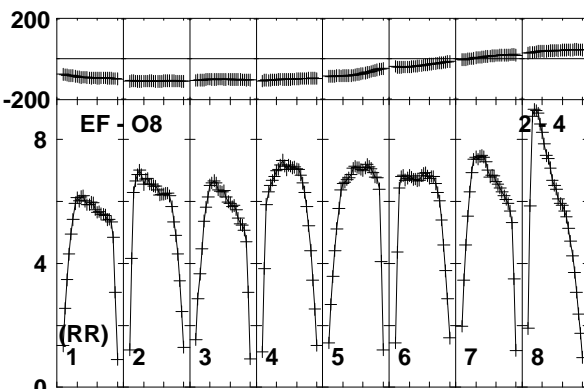
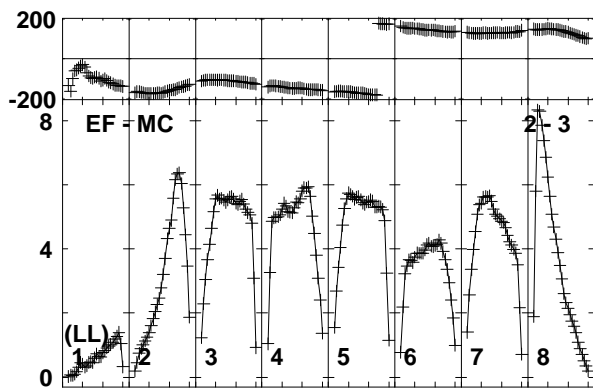
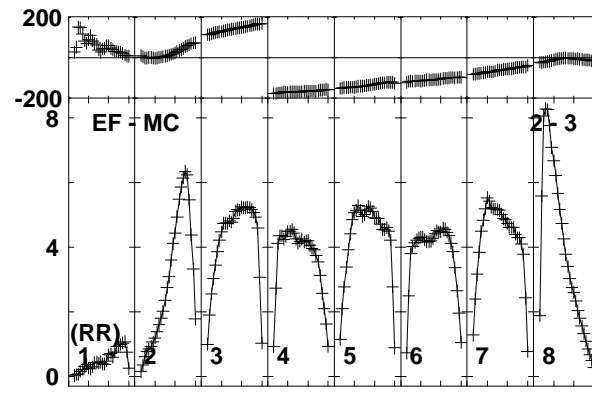
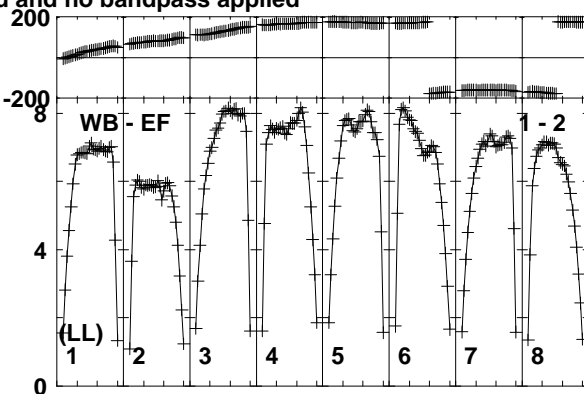
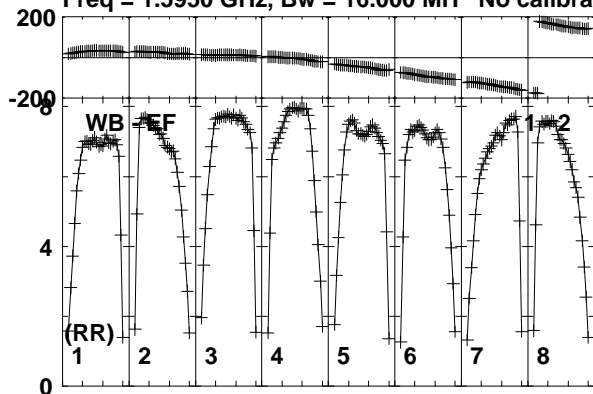

Lower frame: Milli Ampl Jy Top frame: Phas deg  
Vector averaged cross-power spectrum Baseline: WB (01) - EF (02)  
Timerange: 00/04:20:01 to 00/04:21:59

Plot file version 83 created 30-AUG-2019 17:53:23

J1722+2458 EB070.UVDATA.1

Freq = 1.5950 GHz, Bw = 16.000 MH No calibration applied and no bandpass applied

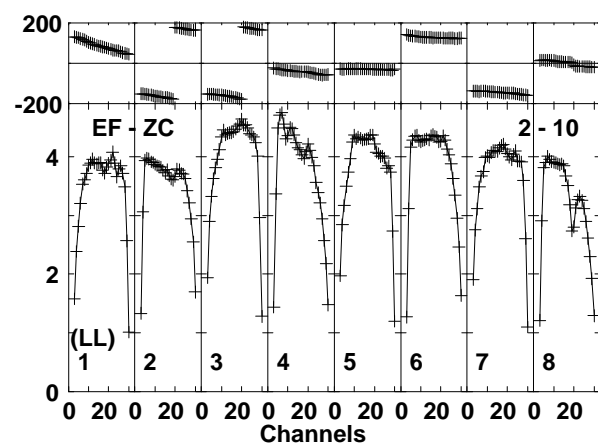
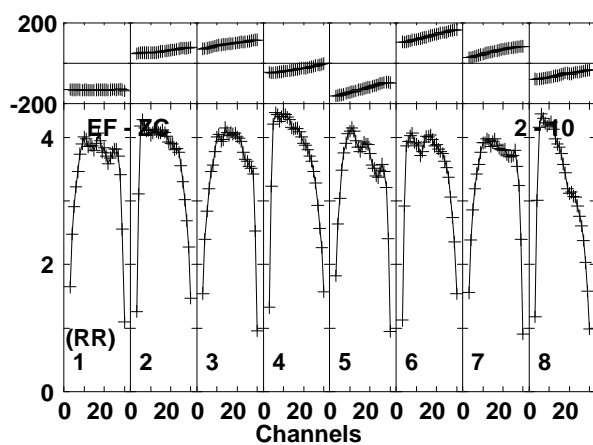
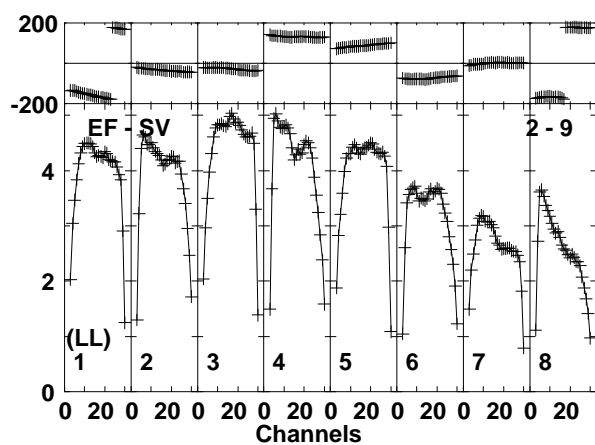
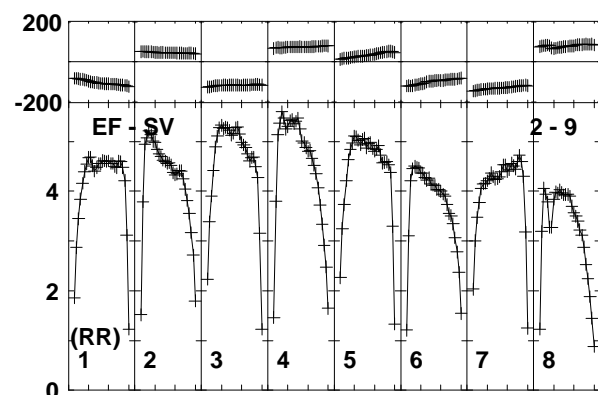
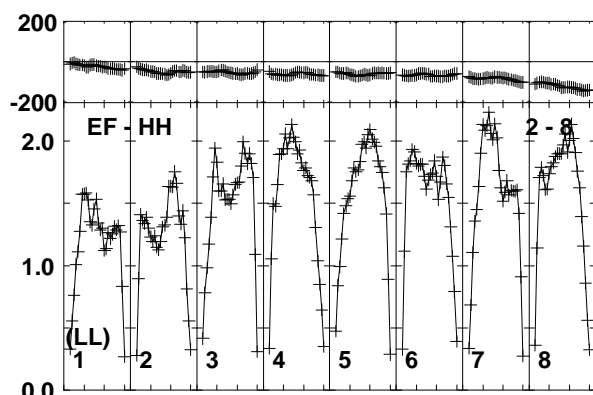
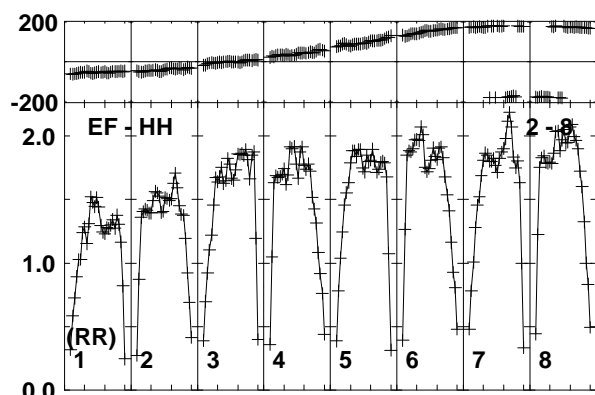
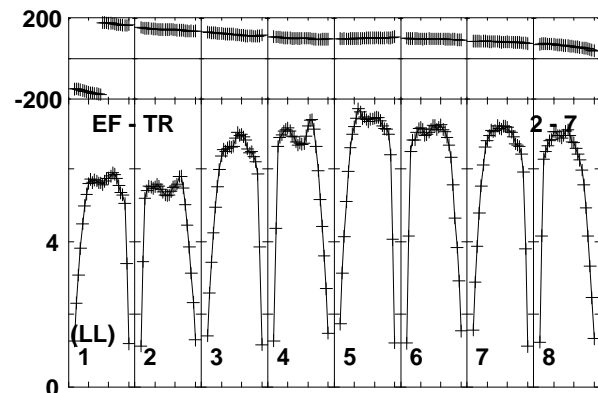
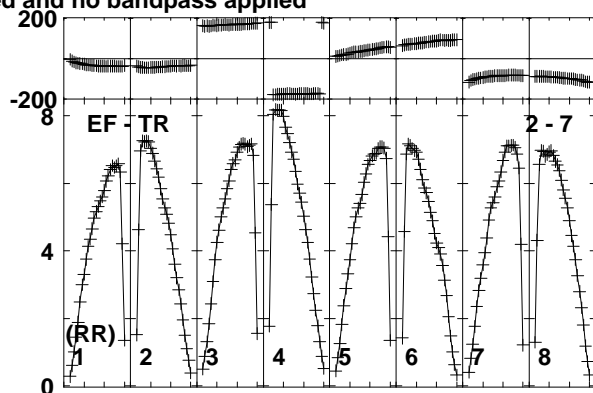
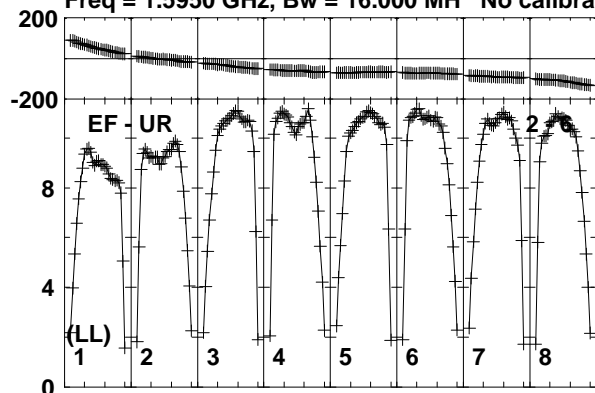

Lower frame: Milli Ampl Jy Top frame: Phas deg  
Vector averaged cross-power spectrum Baseline: EF (02) - UR (06)  
Timerange: 00/04:20:01 to 00/04:21:59

Plot file version 84 created 30-AUG-2019 17:53:23

J1722+2458 EB070.UVDATA.1

Freq = 1.5950 GHz, Bw = 16.000 MH No calibration applied and no bandpass applied

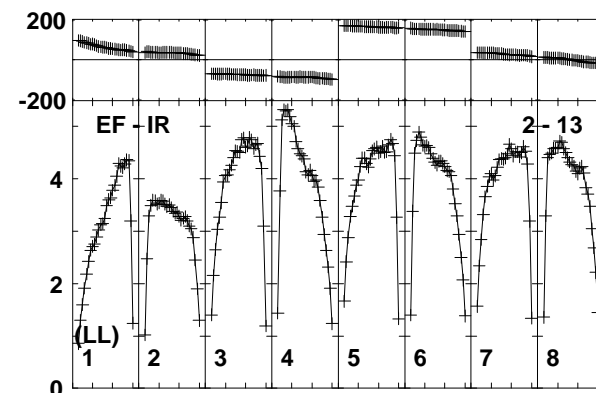
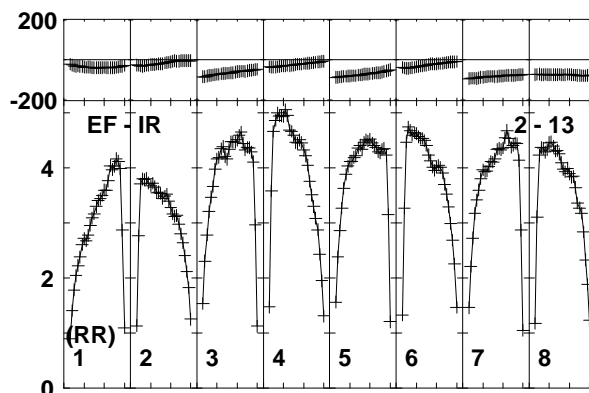
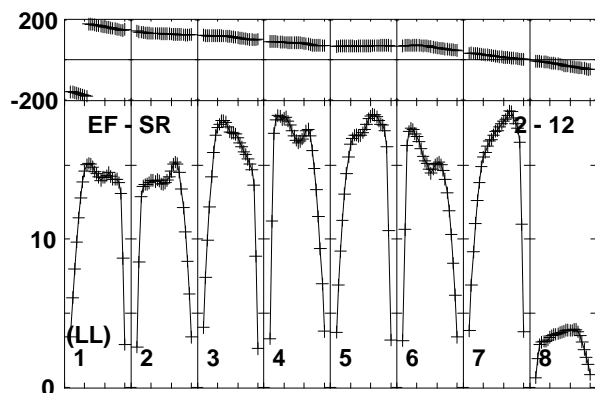
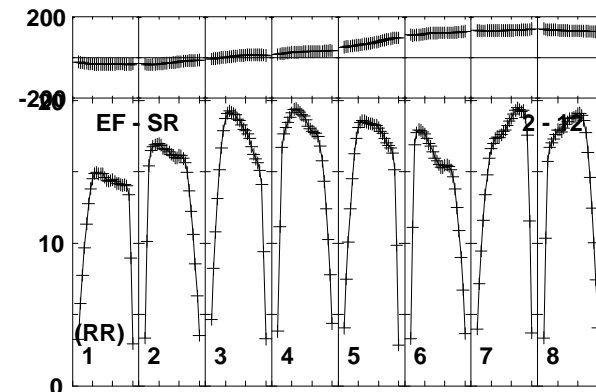
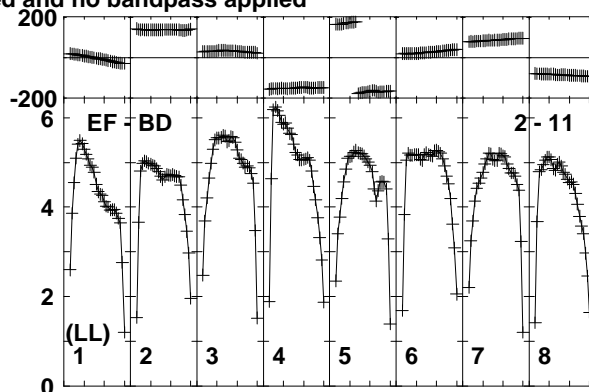
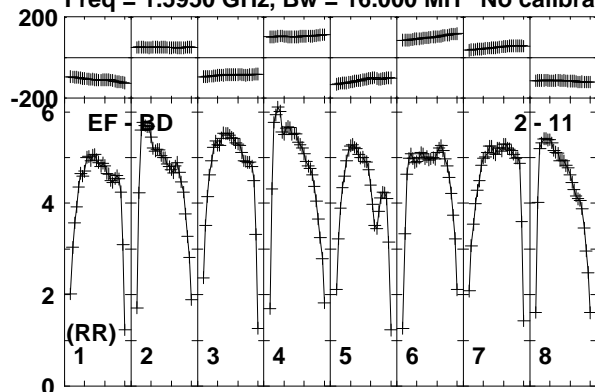

Channels

Lower frame: Milli Ampl Jy Top frame: Phas deg  
Vector averaged cross-power spectrum Baseline: EF (02) - BD (11)  
Timerange: 00/04:20:01 to 00/04:21:59

Plot file version 85 created 30-AUG-2019 17:53:23

ROSS867 EB070.UVDATA.1

Freq = 1.5950 GHz, Bw = 16.000 MH No calibration applied and no bandpass applied

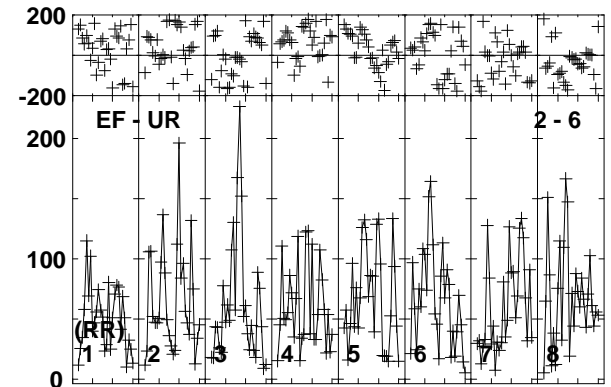
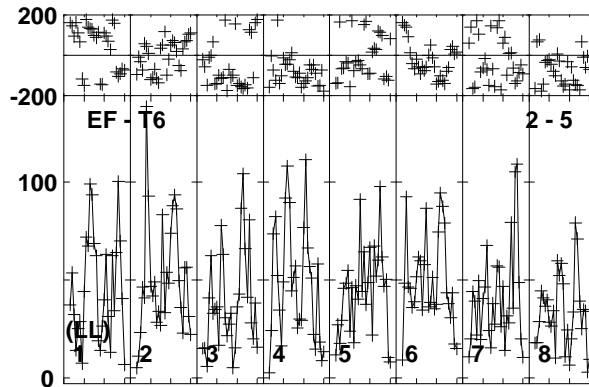
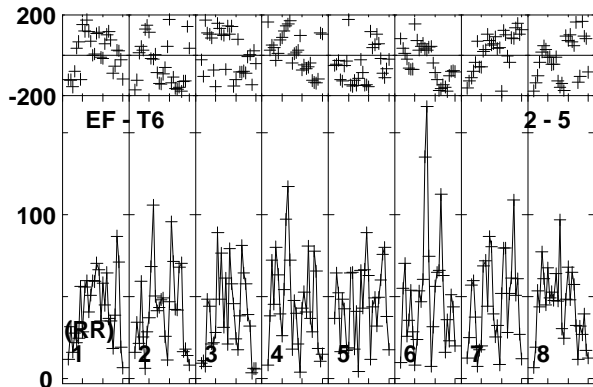
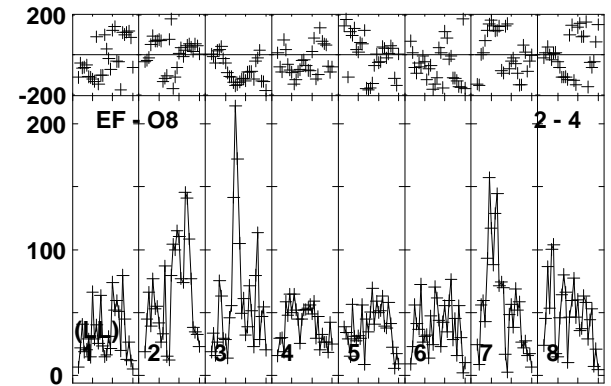
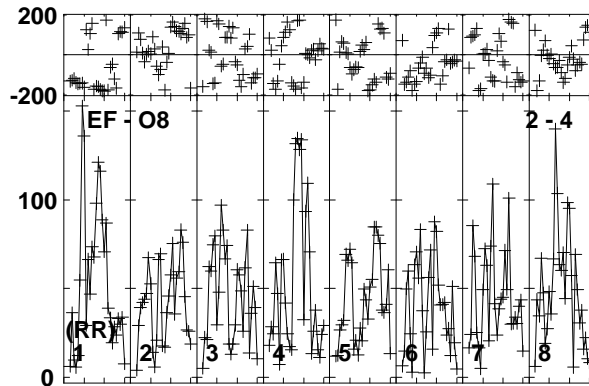
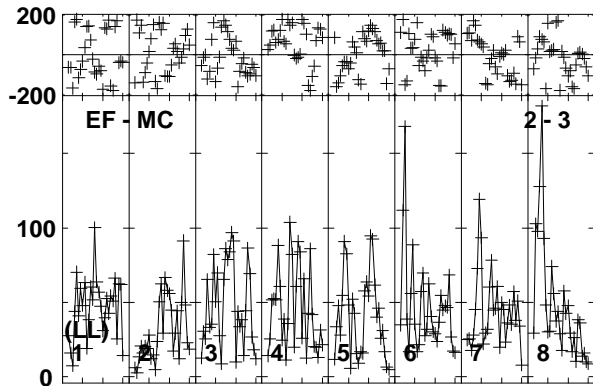
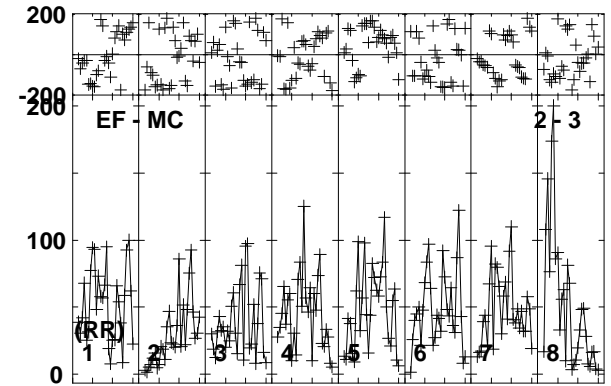
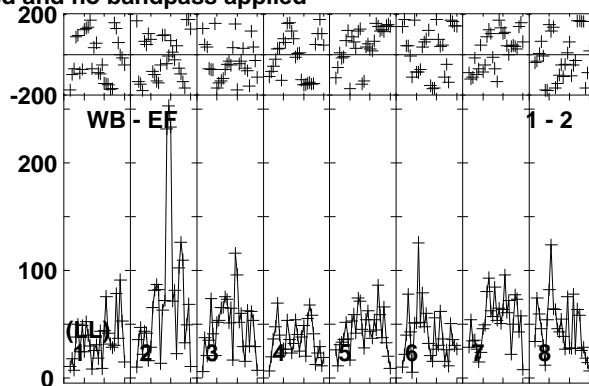
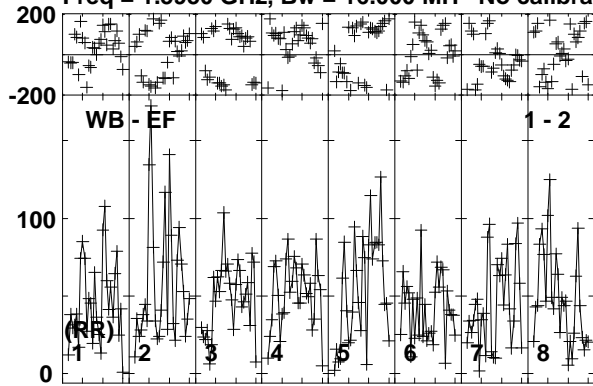

Lower frame: Micro Ampl Jy Top frame: Phas deg  
Vector averaged cross-power spectrum Baseline: WB (01) - EF (02)  
Timerange: 00/04:22:01 to 00/04:29:59

Plot file version 86 created 30-AUG-2019 17:53:23

ROSS867 EB070.UVDATA.1

Freq = 1.5950 GHz, Bw = 16.000 MH No calibration applied and no bandpass applied

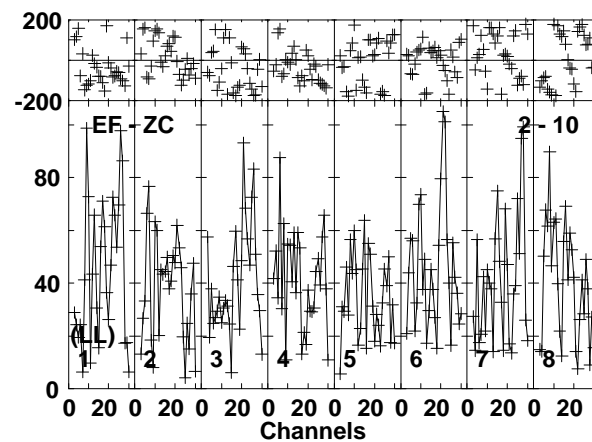
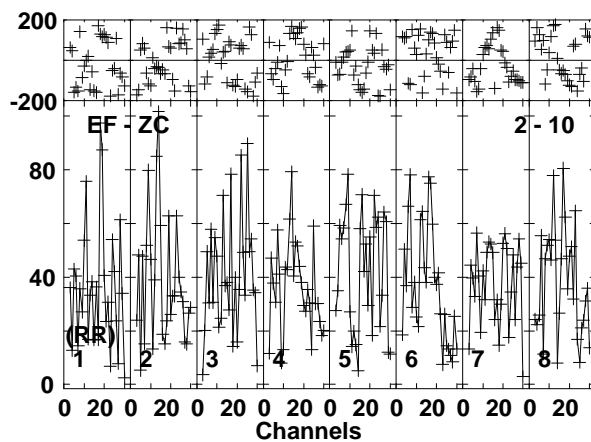
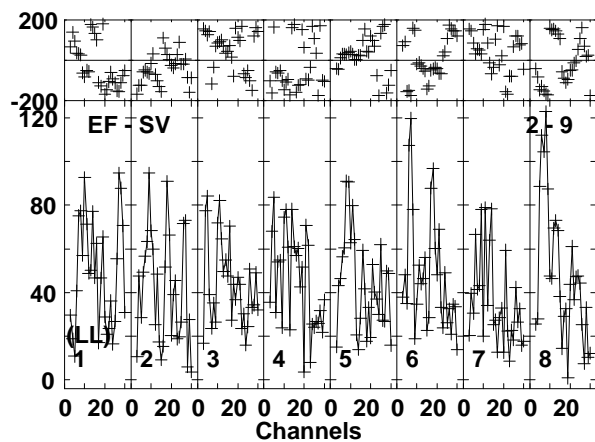
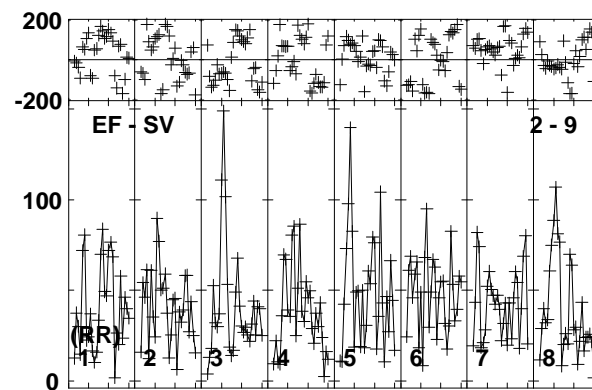
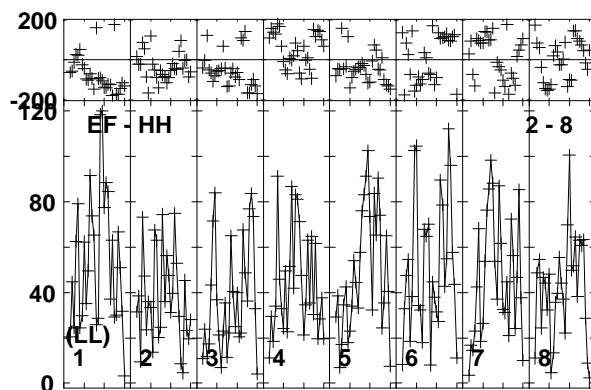
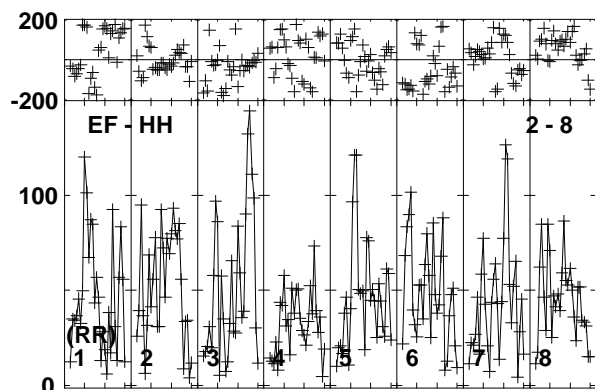
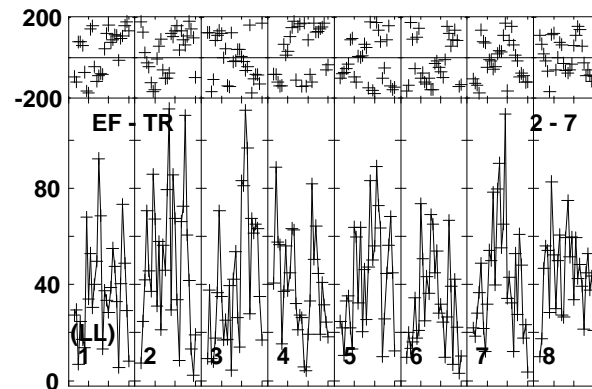
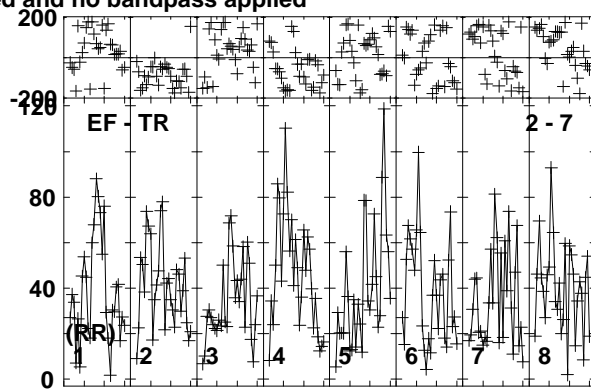
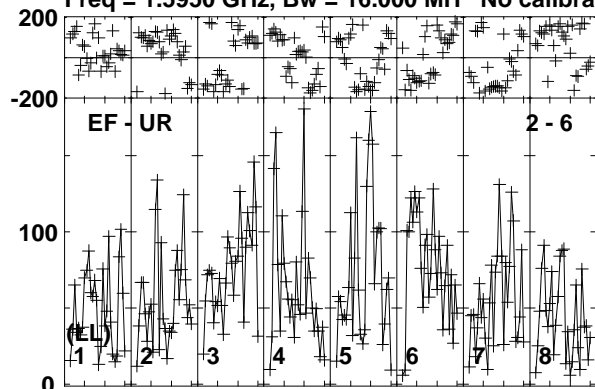

Lower frame: Micro Ampl Jy Top frame: Phas deg  
Vector averaged cross-power spectrum Baseline: EF (02) - UR (06)  
Timerange: 00/04:22:01 to 00/04:29:59

Plot file version 87 created 30-AUG-2019 17:53:23

ROSS867 EB070.UVDATA.1

Freq = 1.5950 GHz, Bw = 16.000 MH No calibration applied and no bandpass applied

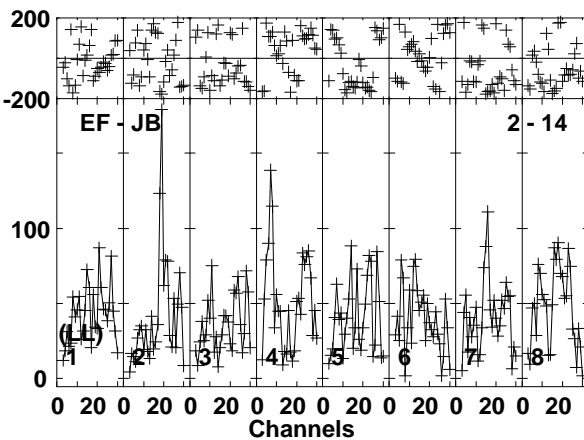
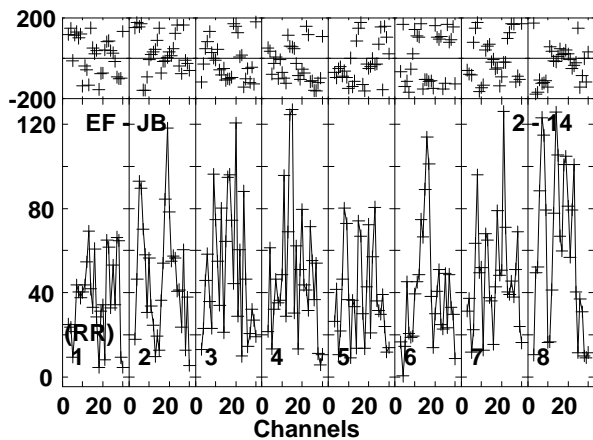
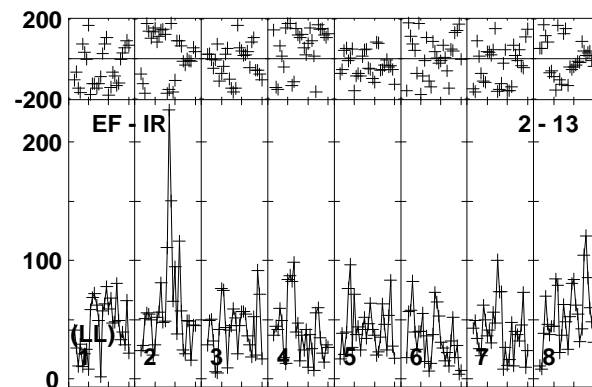
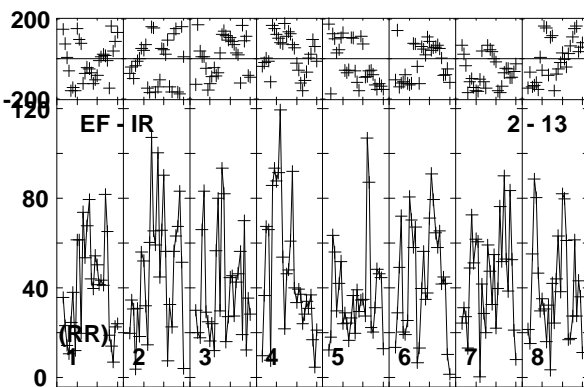
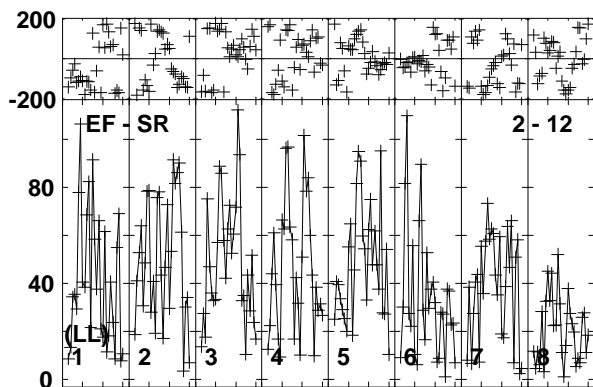
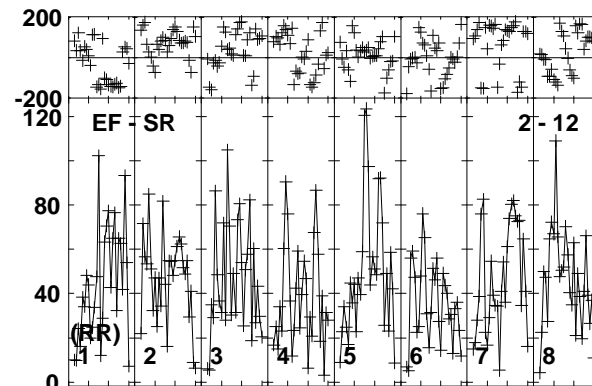
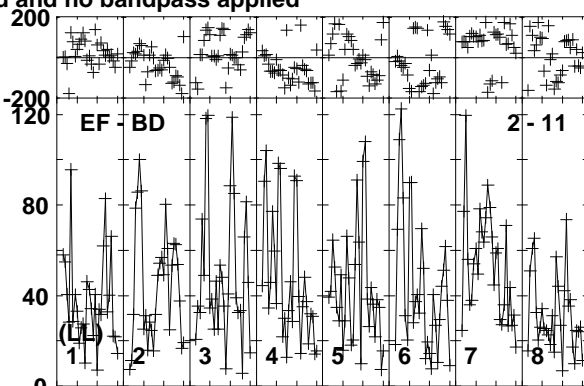
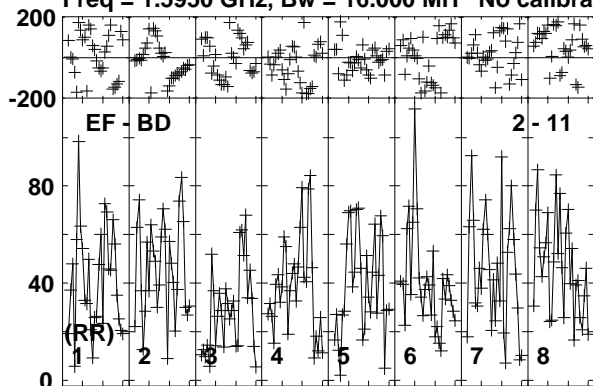

Lower frame: Micro Ampl Jy Top frame: Phas deg

Vector averaged cross-power spectrum Baseline: EF (02) - BD (11)

Timerange: 00/04:22:01 to 00/04:29:59

Plot file version 88 created 30-AUG-2019 17:53:24

J1722+2458 EB070.UVDATA.1

Freq = 1.5950 GHz, Bw = 16.000 MH No calibration applied and no bandpass applied

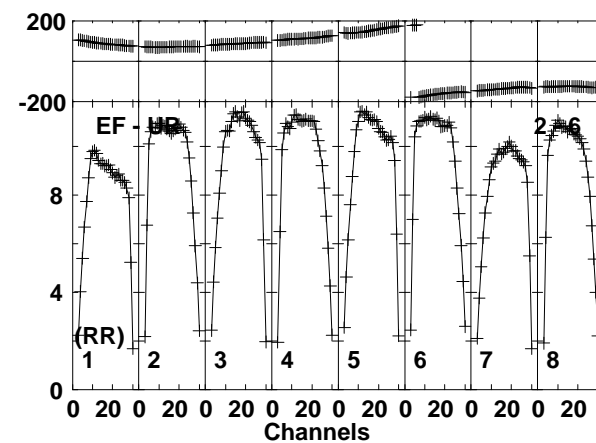
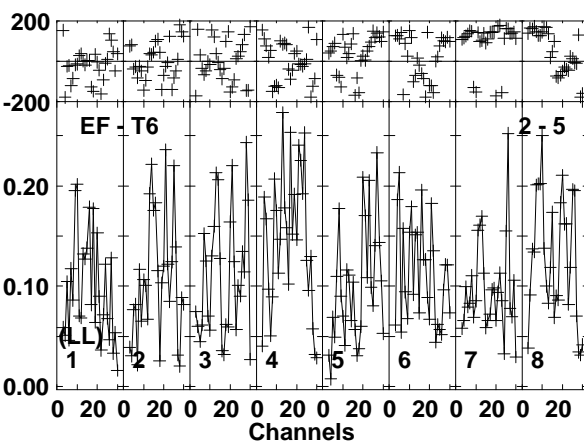
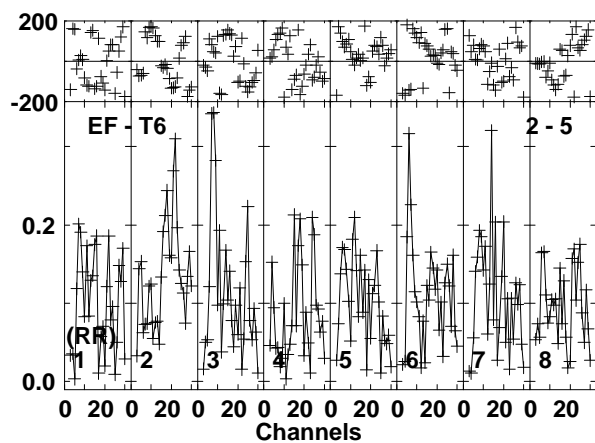
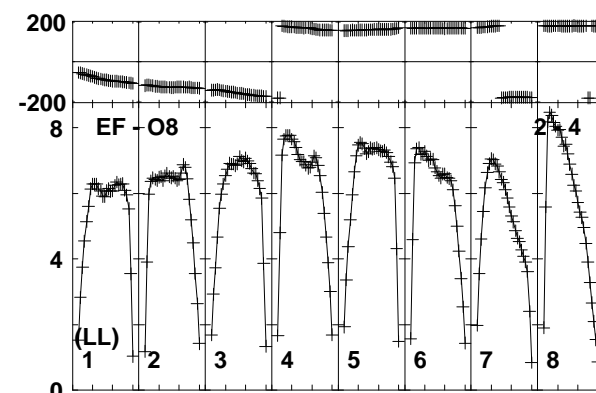
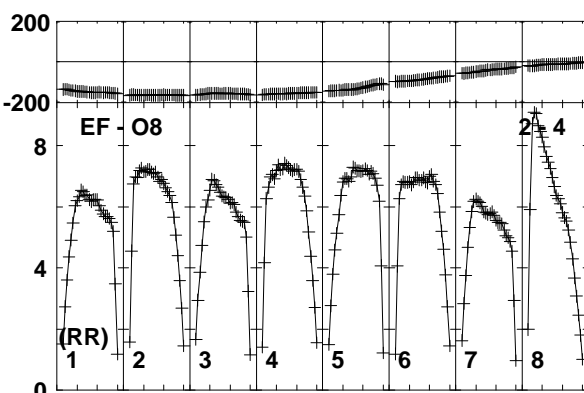
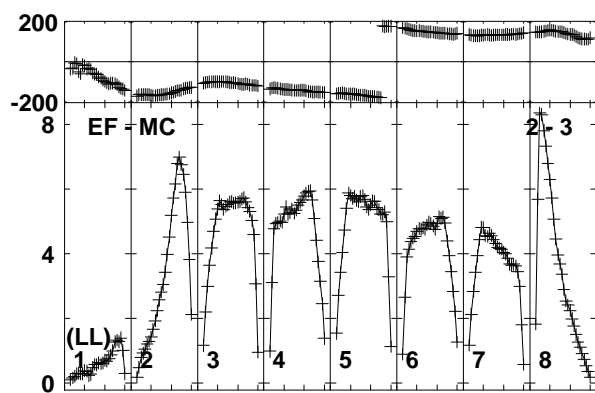
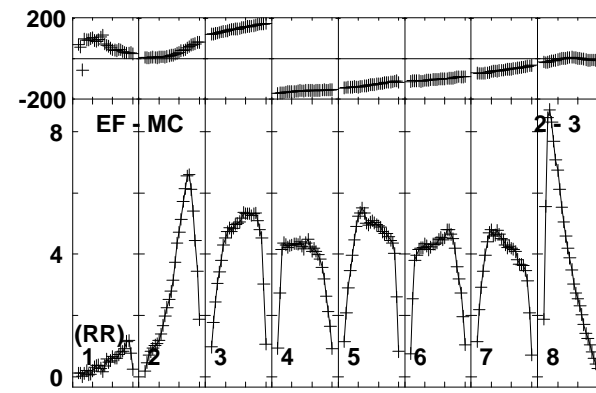
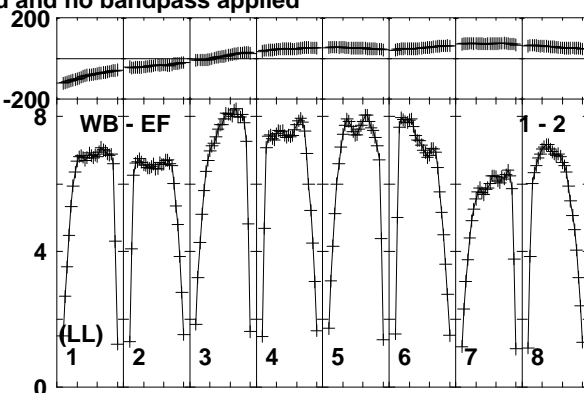
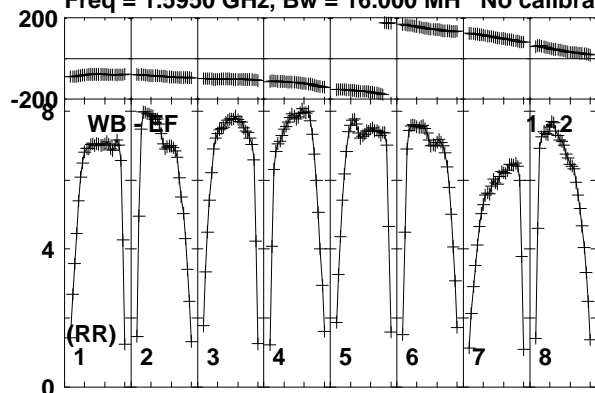

Lower frame: Milli Ampl Jy Top frame: Phas deg  
Vector averaged cross-power spectrum Baseline: WB (01) - EF (02)  
Timerange: 00/04:30:41 to 00/04:31:59



Plot file version 89 created 30-AUG-2019 17:53:24

J1722+2458 EB070.UVDATA.1

Freq = 1.5950 GHz, Bw = 16.000 MH No calibration applied and no bandpass applied

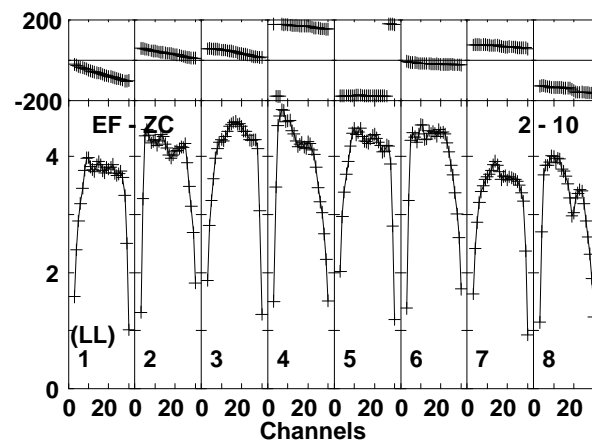
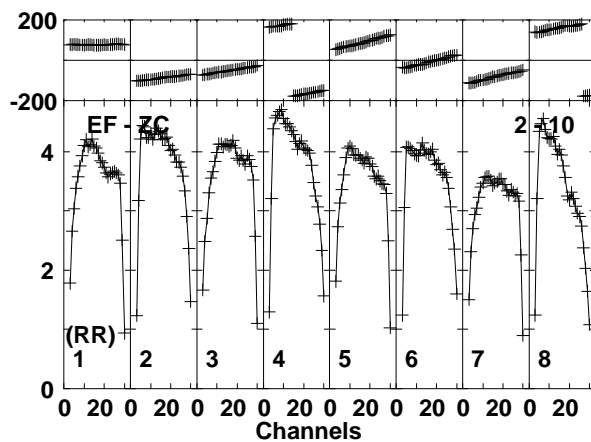
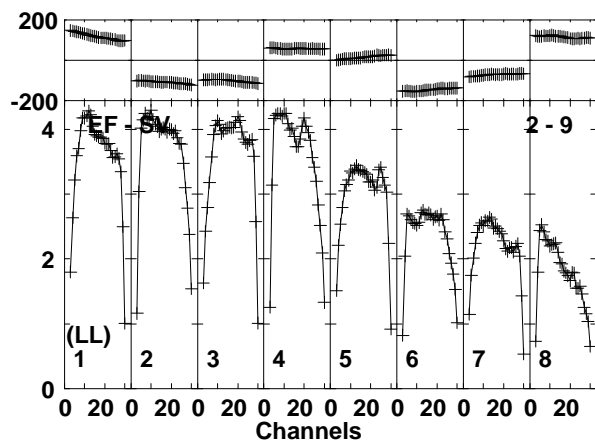
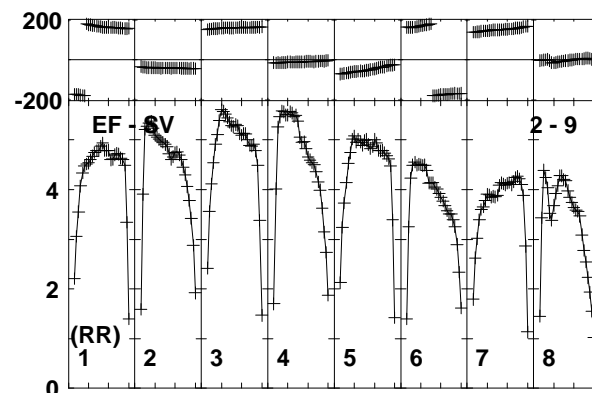
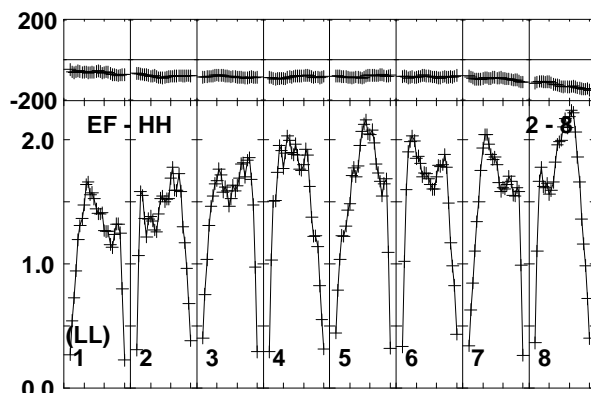
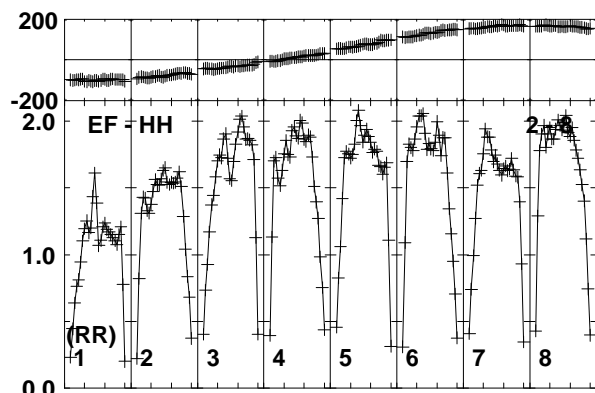
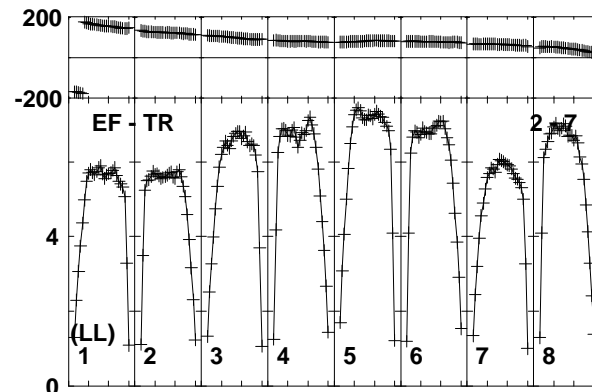
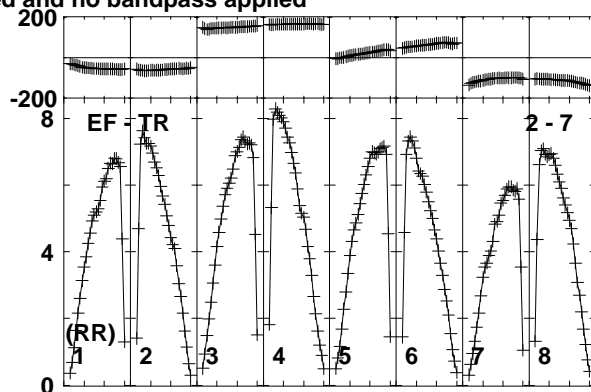
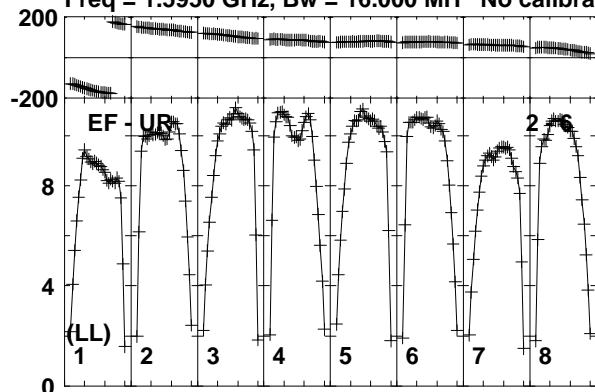

Lower frame: Milli Ampl Jy Top frame: Phas deg  
Vector averaged cross-power spectrum Baseline: EF (02) - UR (06)  
Timerange: 00/04:30:41 to 00/04:31:59

Plot file version 90 created 30-AUG-2019 17:53:24

J1722+2458 EB070.UVDATA.1

Freq = 1.5950 GHz, Bw = 16.000 MH No calibration applied and no bandpass applied

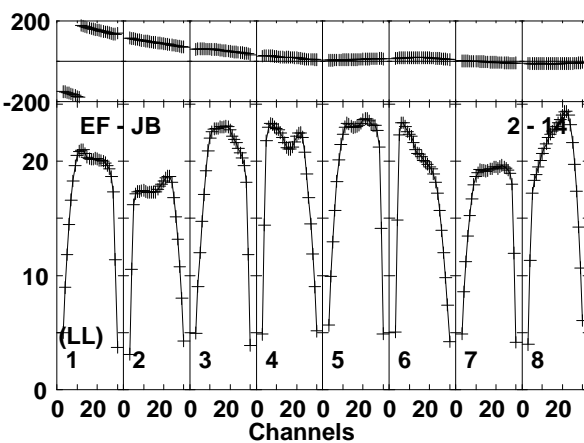
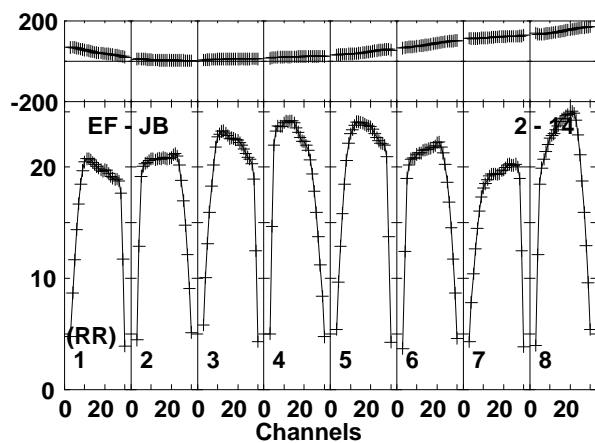
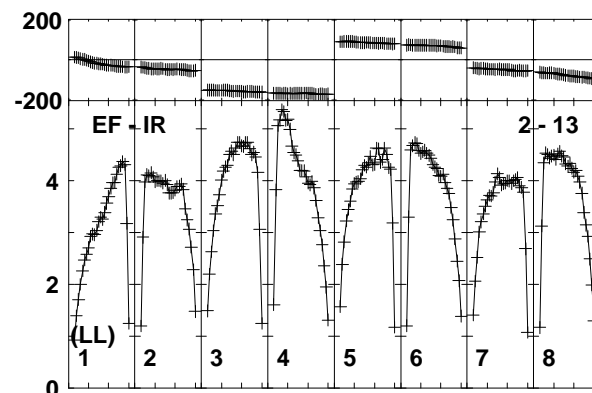
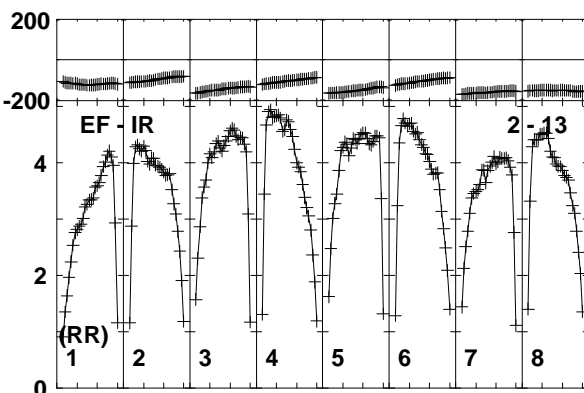
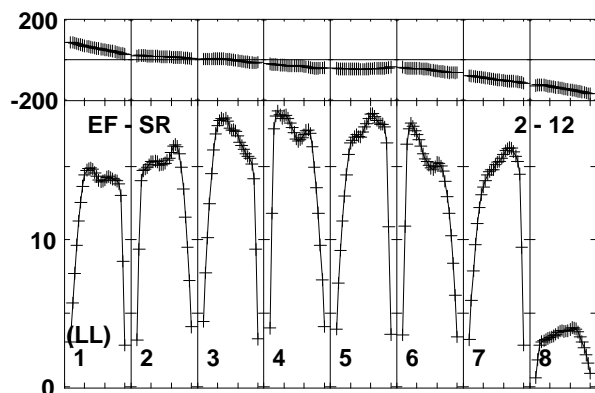
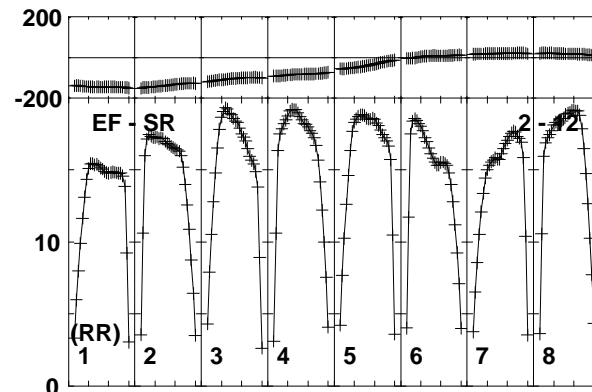
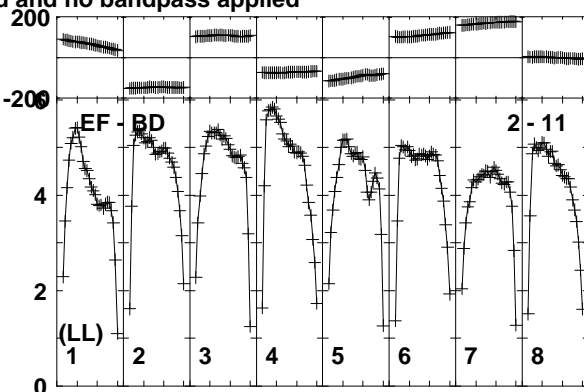
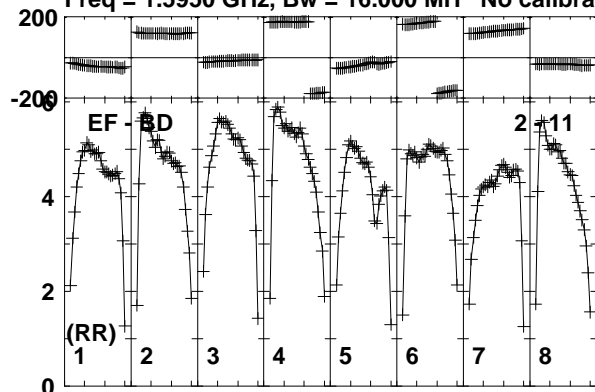

Lower frame: Milli Ampl Jy Top frame: Phas deg  
Vector averaged cross-power spectrum Baseline: EF (02) - BD (11)  
Timerange: 00/04:30:41 to 00/04:31:59

Plot file version 91 created 30-AUG-2019 17:53:24

ROSS867 EB070.UVDATA.1

Freq = 1.5950 GHz, Bw = 16.000 MH No calibration applied and no bandpass applied

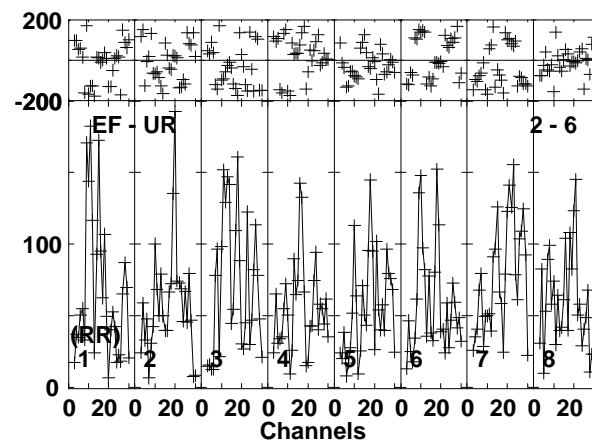
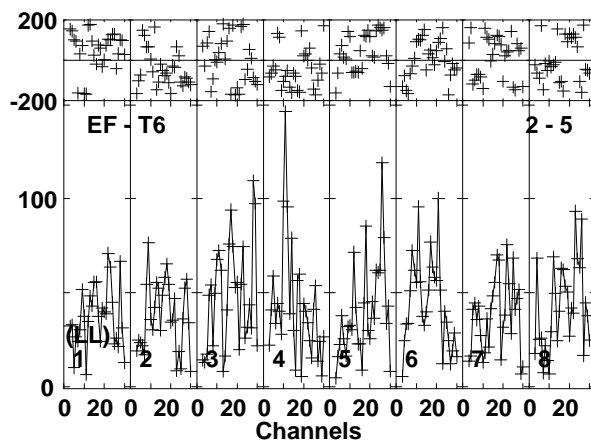
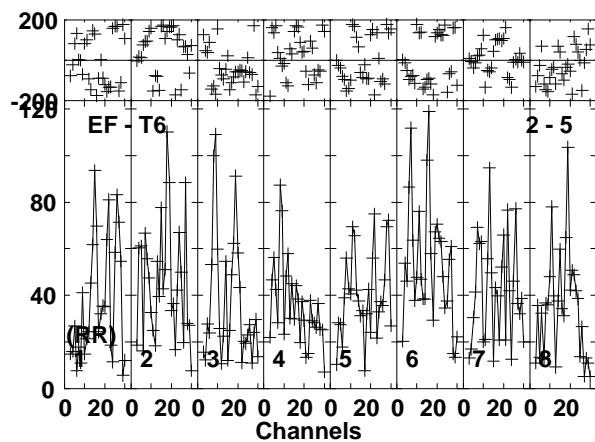
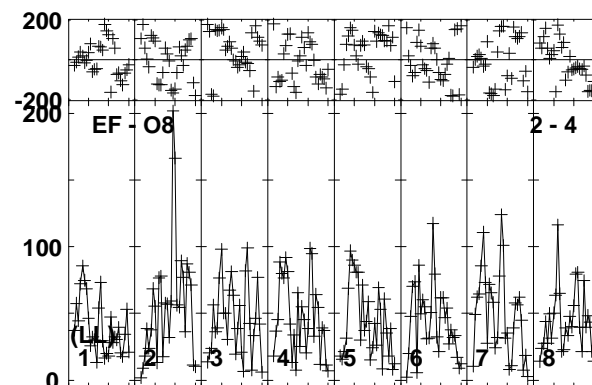
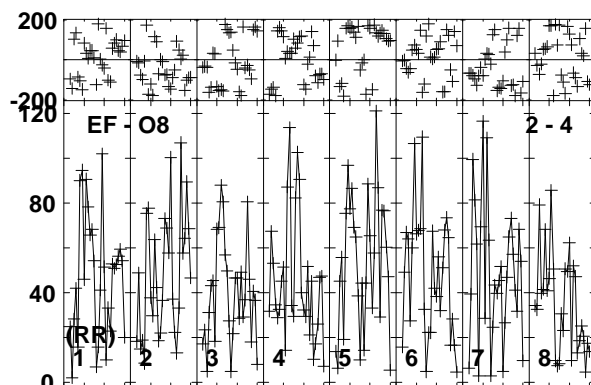
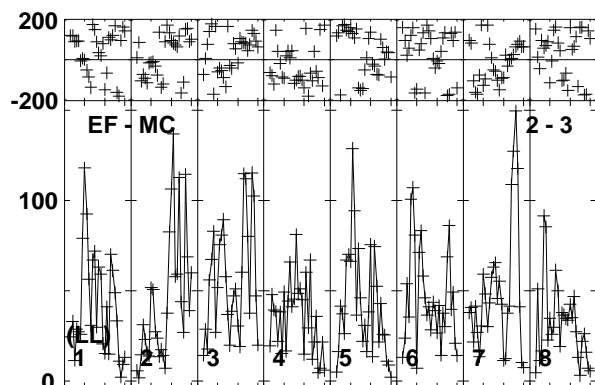
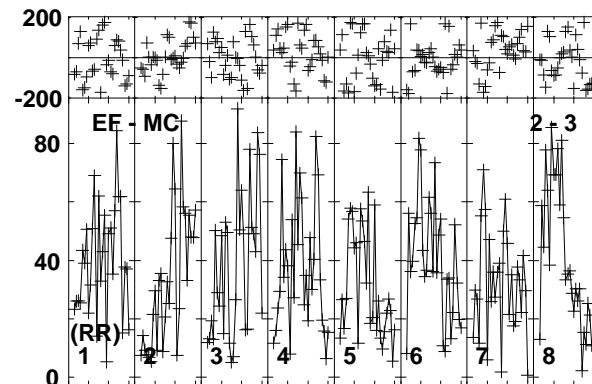
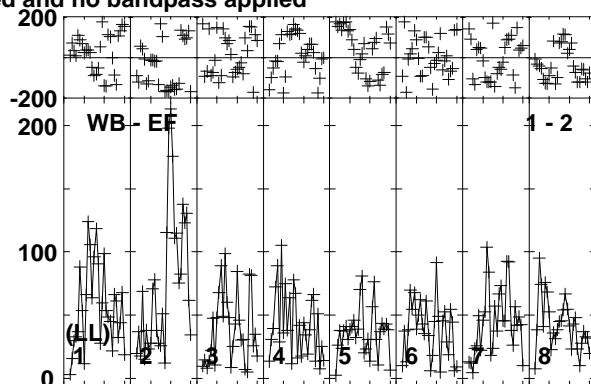
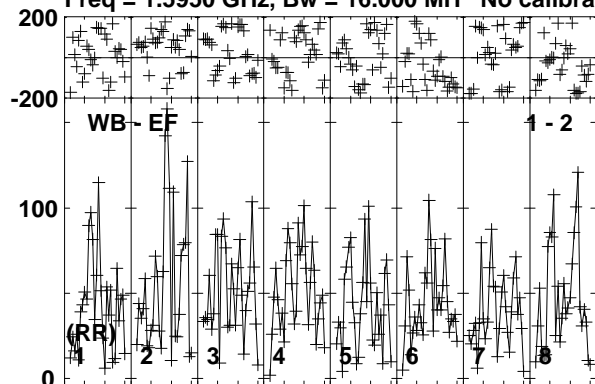

Lower frame: Micro Ampl Jy Top frame: Phas deg  
Vector averaged cross-power spectrum Baseline: WB (01) - EF (02)  
Timerange: 00/04:32:01 to 00/04:39:59

Plot file version 92 created 30-AUG-2019 17:53:24

ROSS867 EB070.UVDATA.1

Freq = 1.5950 GHz, Bw = 16.000 MH No calibration applied and no bandpass applied

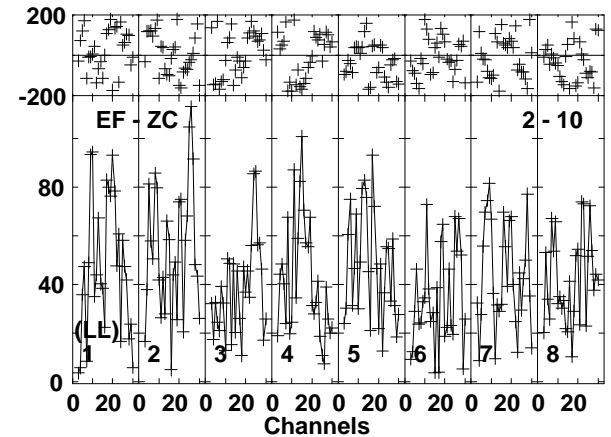
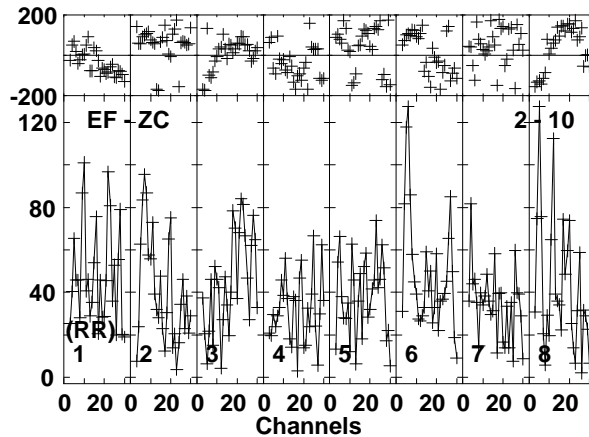
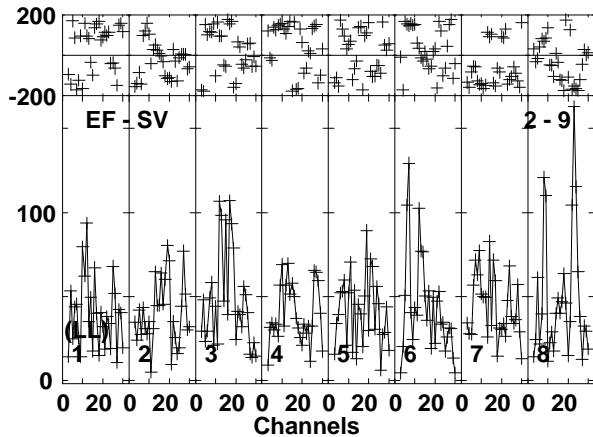
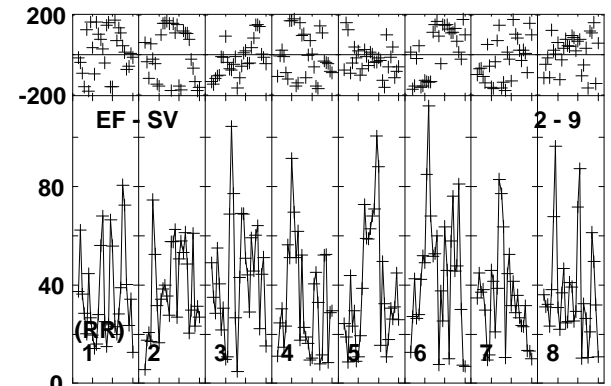
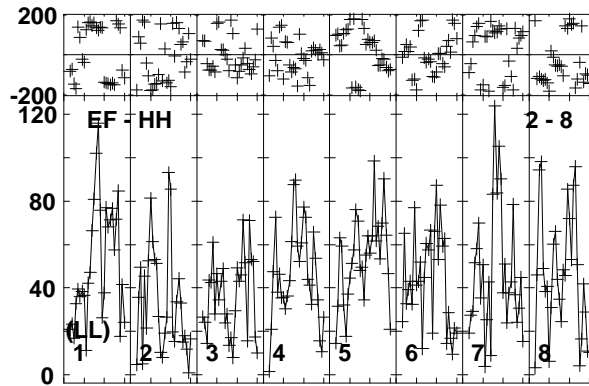
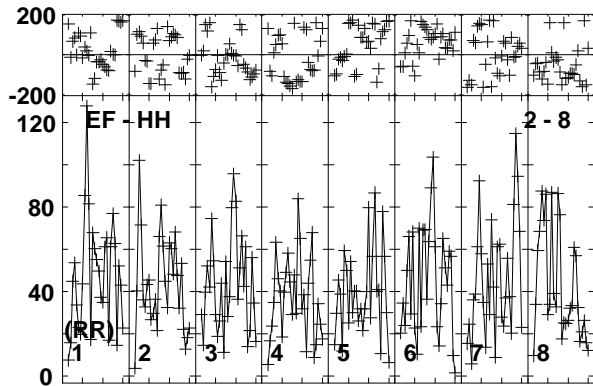
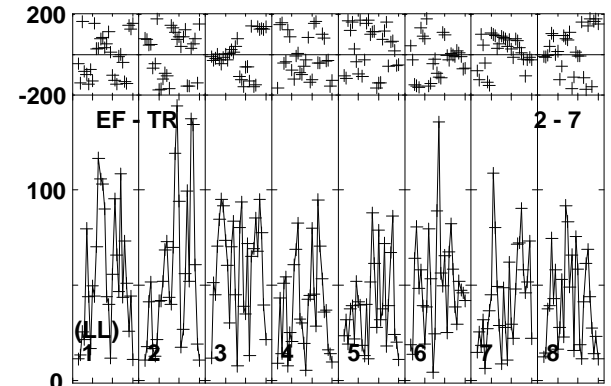
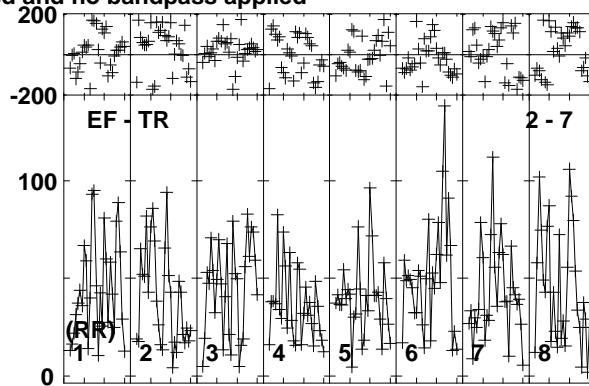
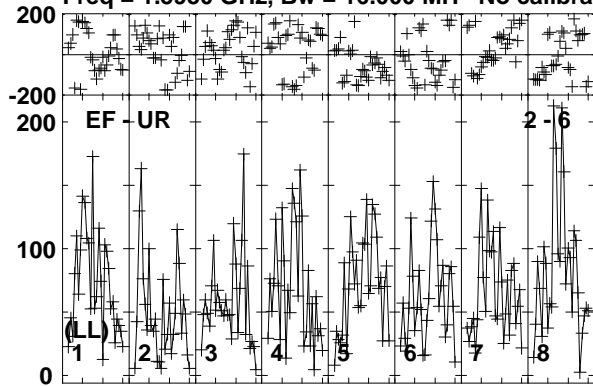

Lower frame: Micro Ampl Jy Top frame: Phas deg  
Vector averaged cross-power spectrum Baseline: EF (02) - UR (06)  
Timerange: 00/04:32:01 to 00/04:39:59

Plot file version 93 created 30-AUG-2019 17:53:25

ROSS867 EB070.UVDATA.1

Freq = 1.5950 GHz, Bw = 16.000 MH No calibration applied and no bandpass applied

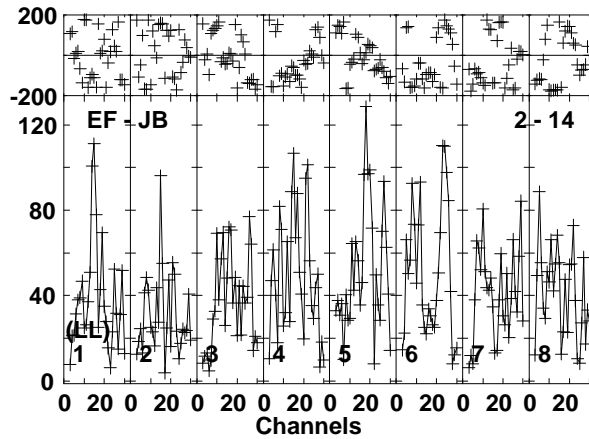
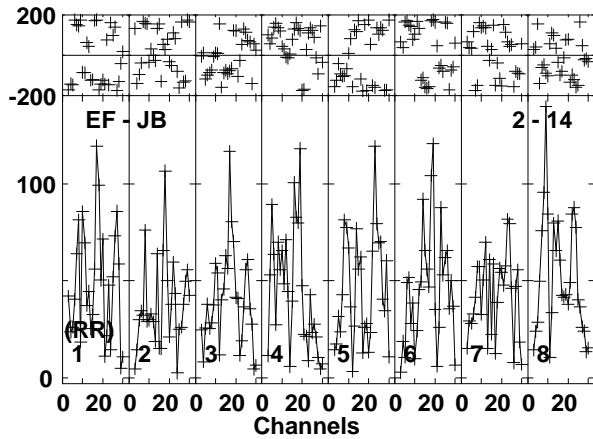
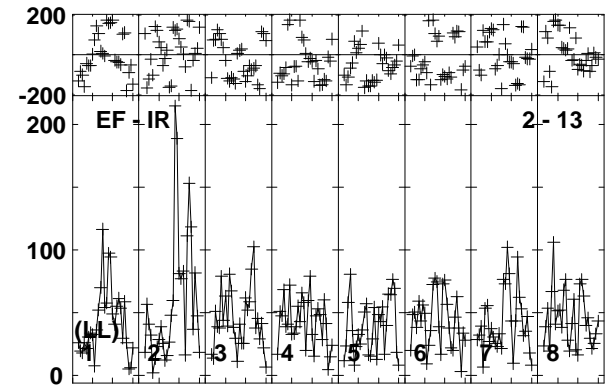
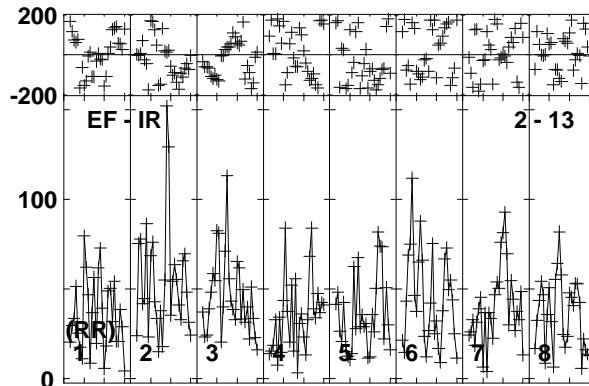
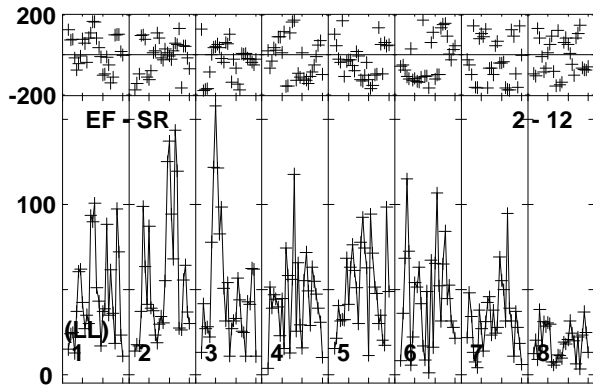
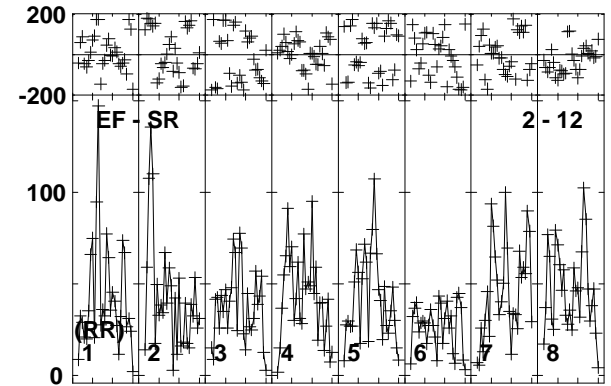
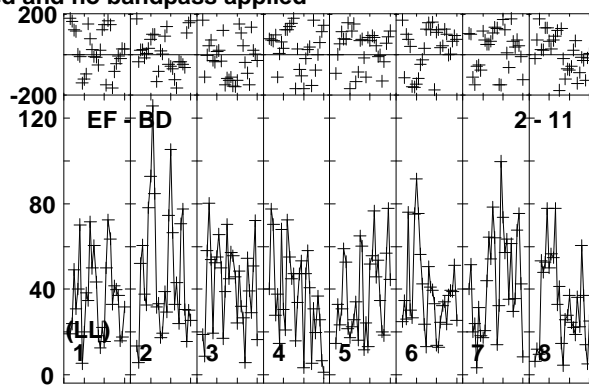
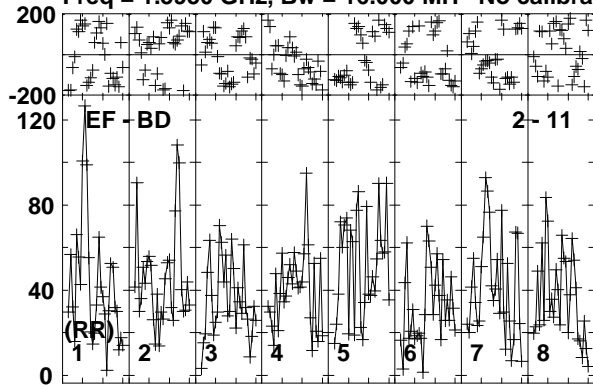

Lower frame: Micro Ampl Jy Top frame: Phas deg  
Vector averaged cross-power spectrum Baseline: EF (02) - BD (11)  
Timerange: 00/04:32:01 to 00/04:39:59

Plot file version 94 created 30-AUG-2019 17:53:25

J1722+2458 EB070.UVDATA.1

Freq = 1.5950 GHz, Bw = 16.000 MH No calibration applied and no bandpass applied

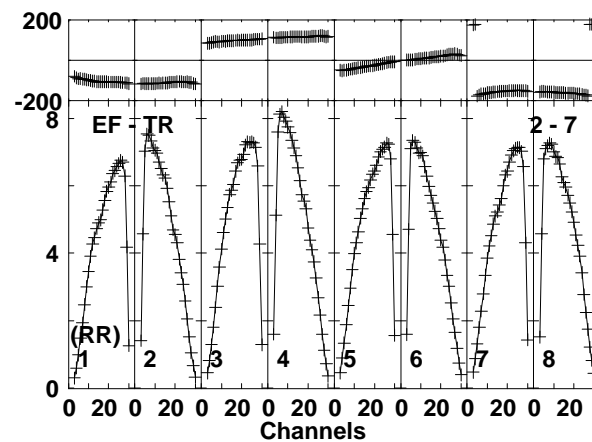
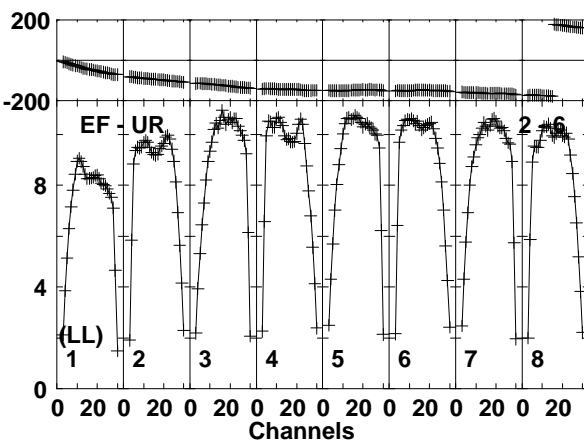
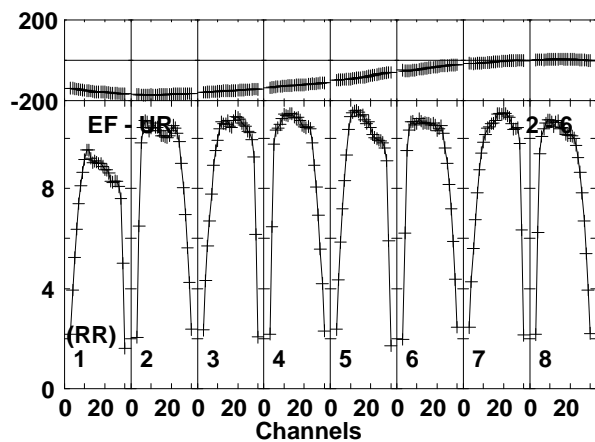
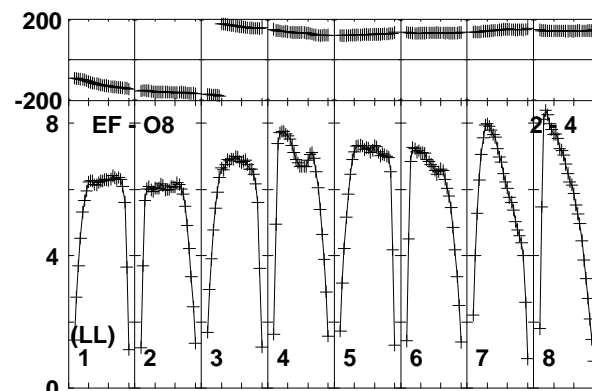
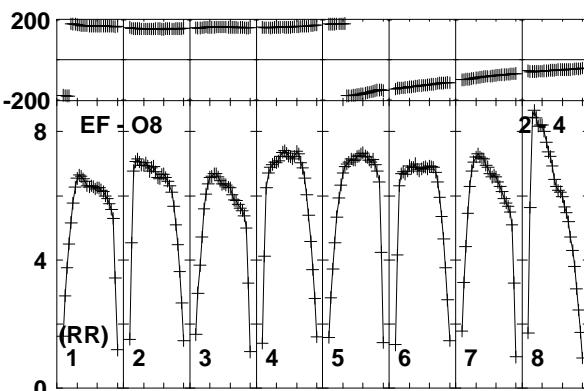
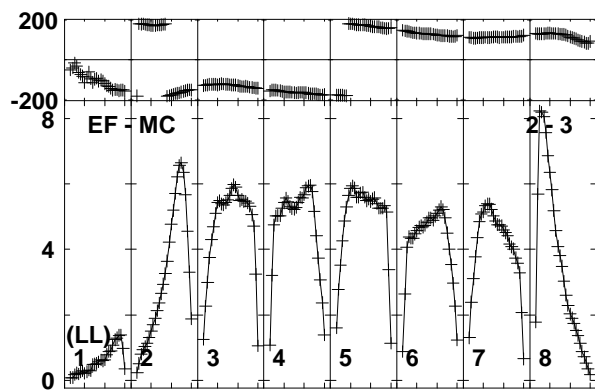
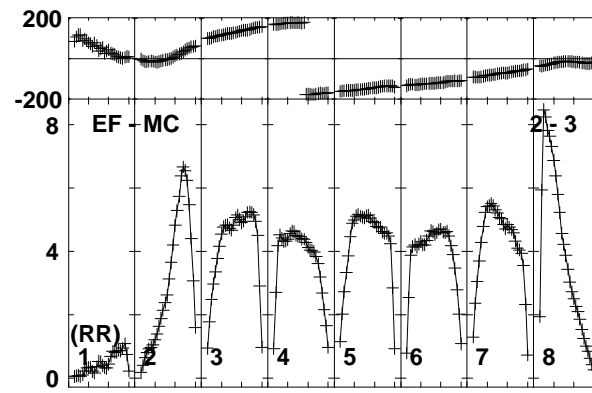
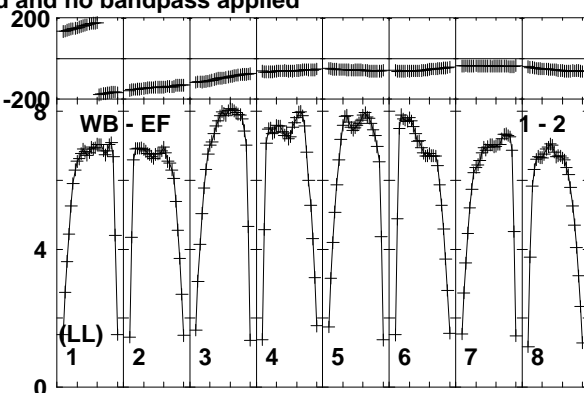
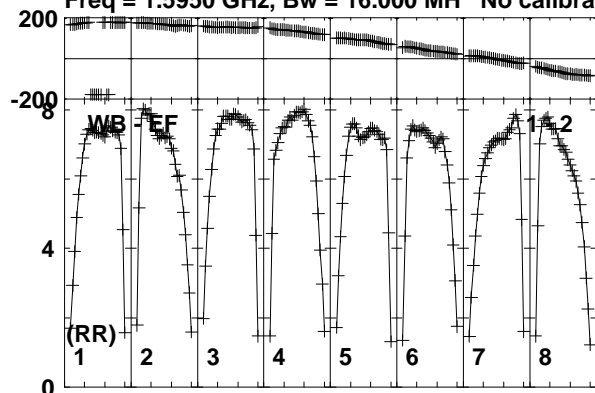

Lower frame: Milli Ampl Jy Top frame: Phas deg  
Vector averaged cross-power spectrum Baseline: WB (01) - EF (02)  
Timerange: 00/04:40:01 to 00/04:41:59

Plot file version 95 created 30-AUG-2019 17:53:25

J1722+2458 EB070.UVDATA.1

Freq = 1.5950 GHz, Bw = 16.000 MH No calibration applied and no bandpass applied

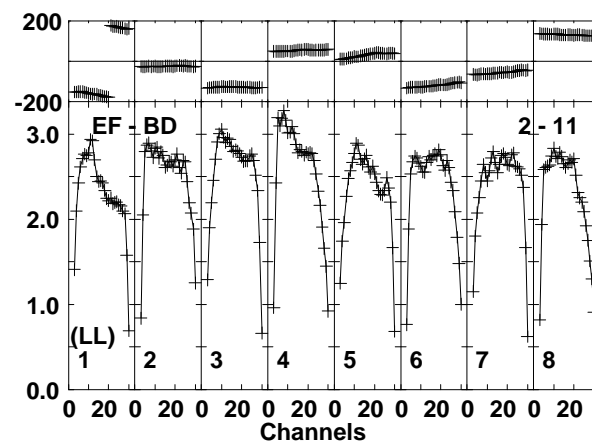
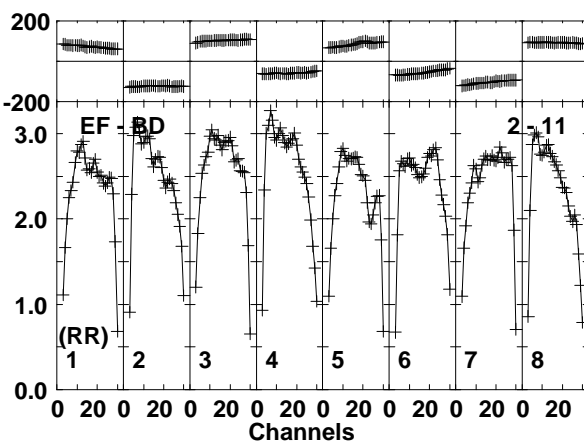
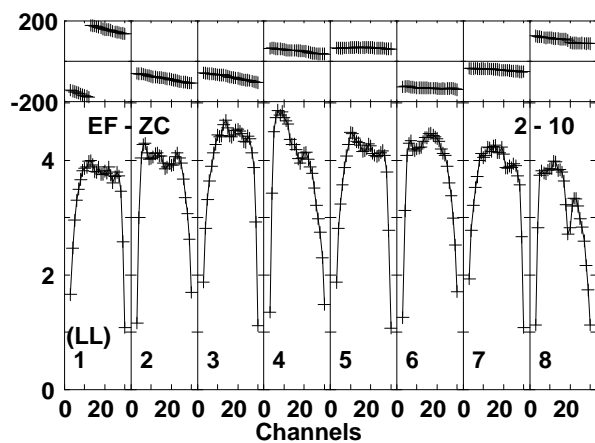
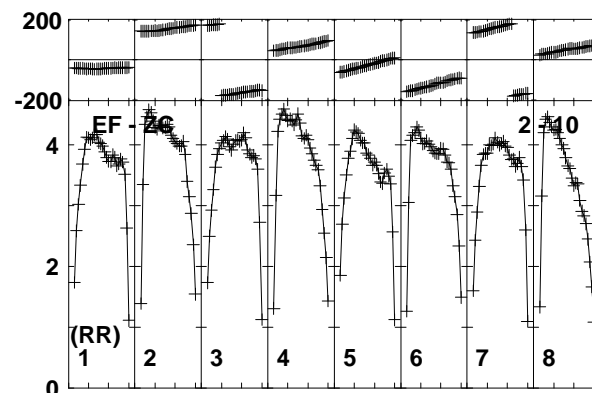
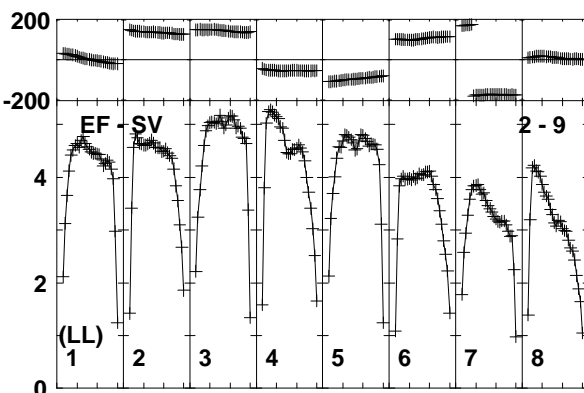
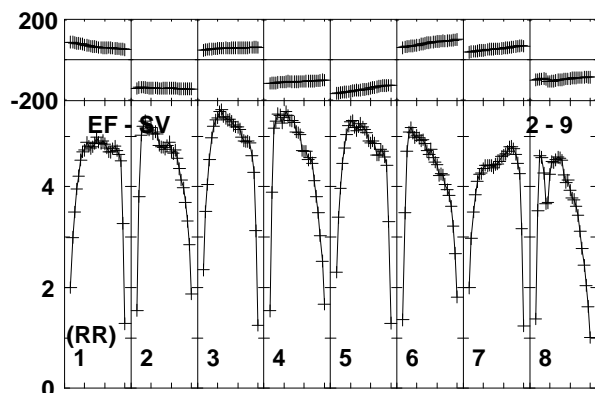
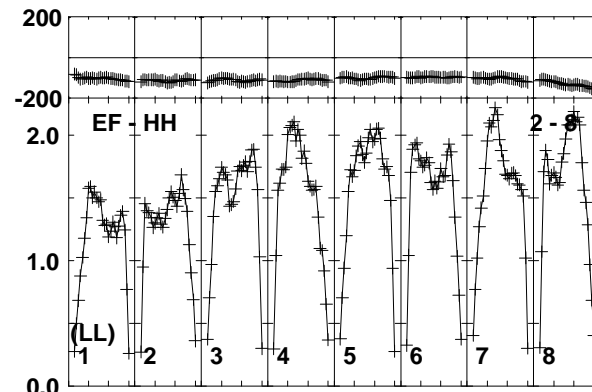
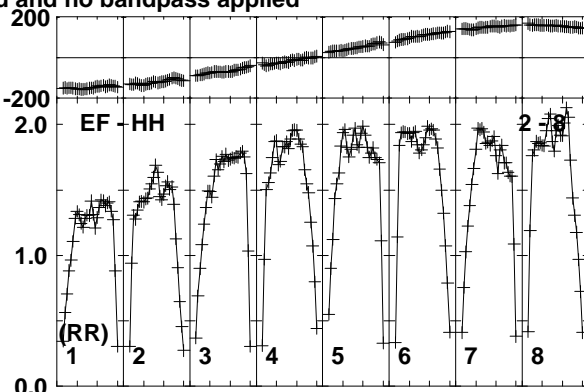
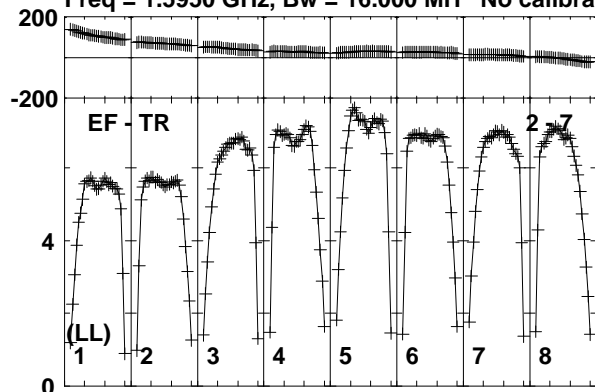

Lower frame: Milli Ampl Jy Top frame: Phas deg  
Vector averaged cross-power spectrum Baseline: EF (02) - TR (07)  
Timerange: 00/04:40:01 to 00/04:41:59

Plot file version 96 created 30-AUG-2019 17:53:25

J1722+2458 EB070.UVDATA.1

Freq = 1.5950 GHz, Bw = 16.000 MH No calibration applied and no bandpass applied

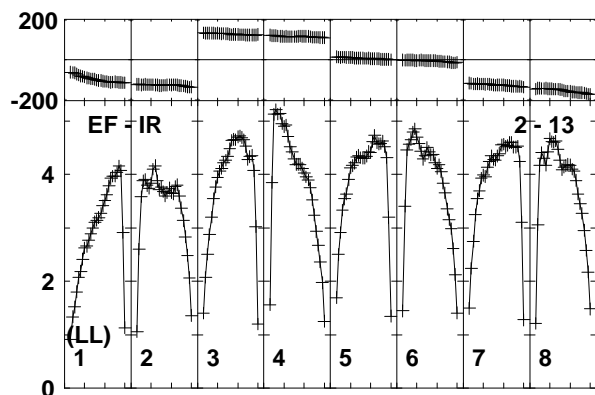
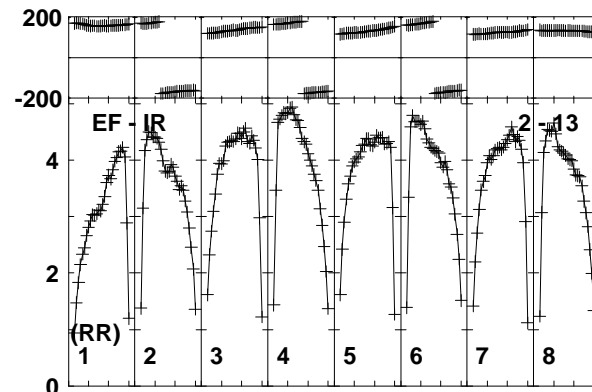
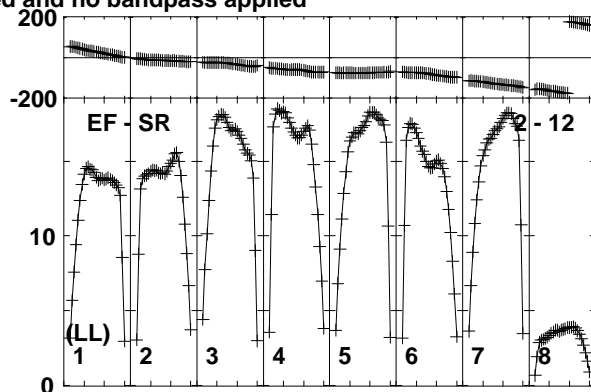
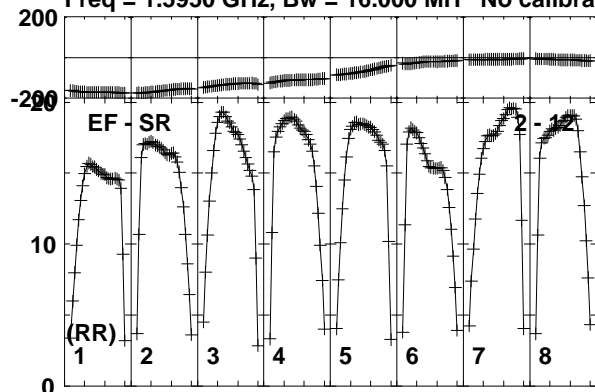

Lower frame: Milli Ampl Jy Top frame: Phas deg  
Vector averaged cross-power spectrum Baseline: EF (02) - SR (12)  
Timerange: 00/04:40:01 to 00/04:41:59



Plot file version 97 created 30-AUG-2019 17:53:25

ROSS867 EB070.UVDATA.1

Freq = 1.5950 GHz, Bw = 16.000 MH No calibration applied and no bandpass applied

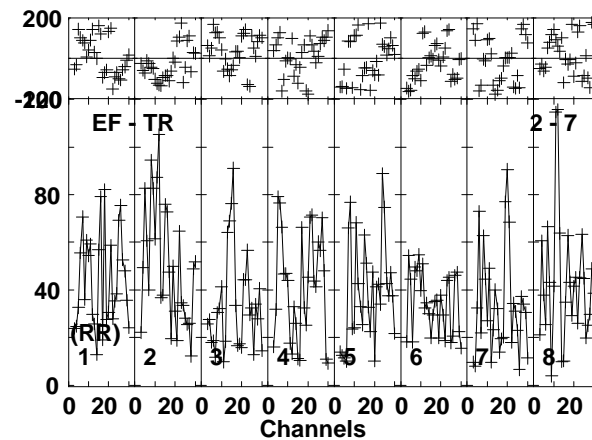
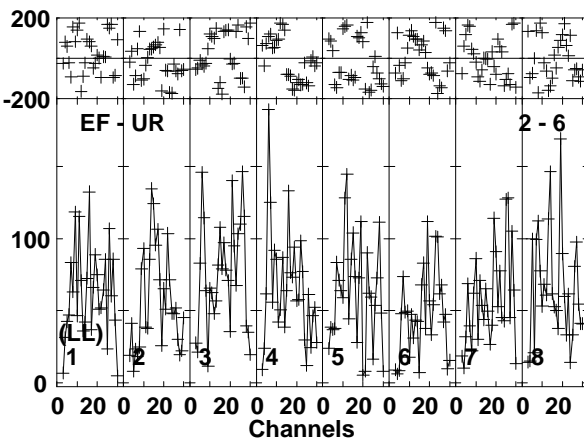
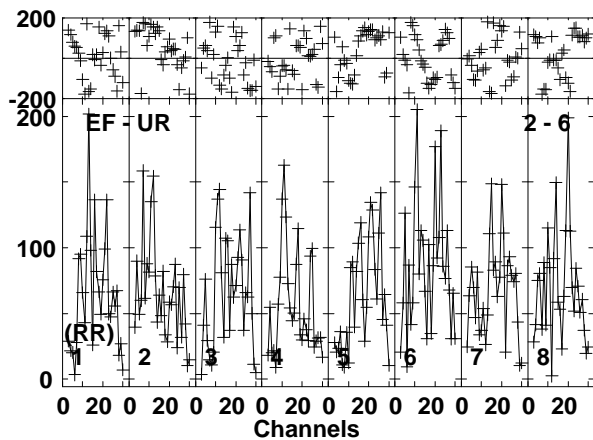
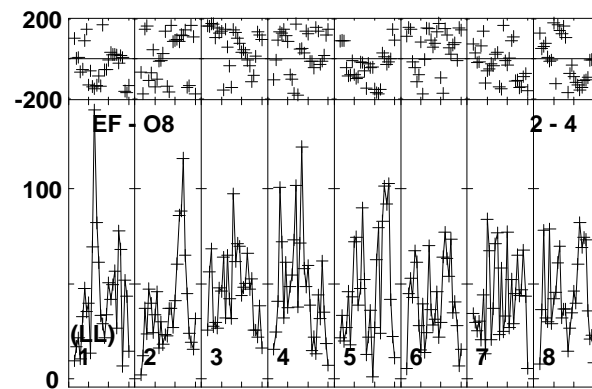
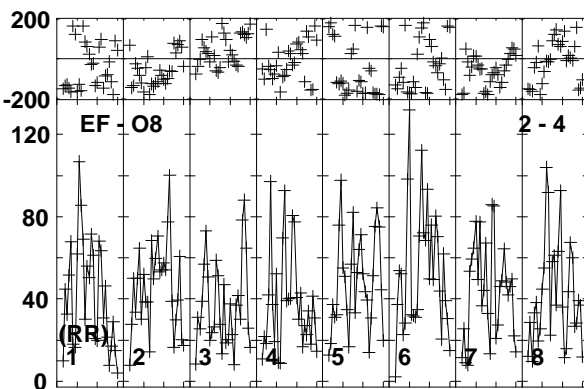
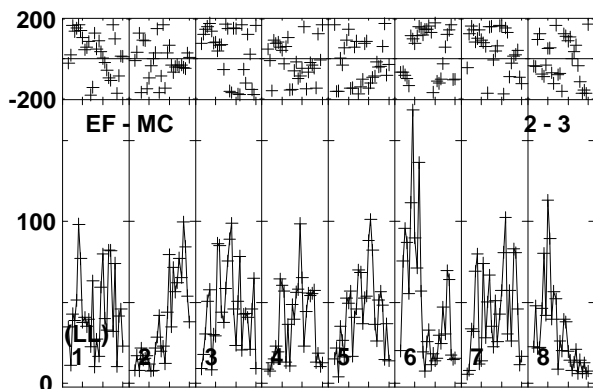
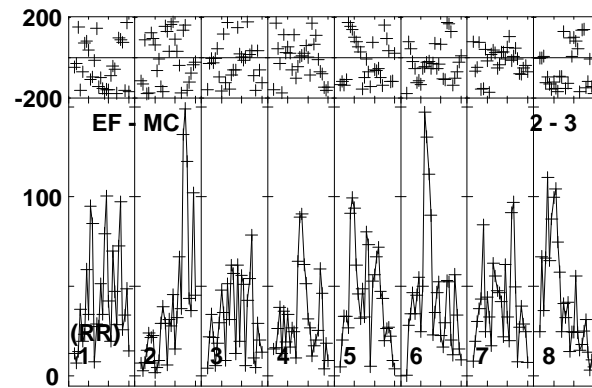
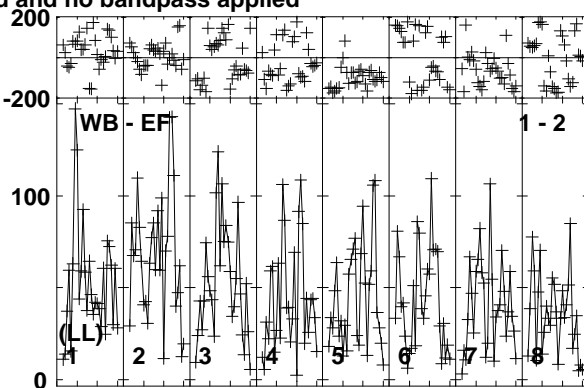
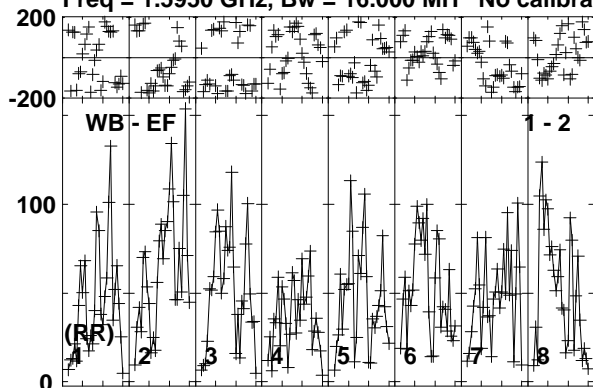

Lower frame: Micro Ampl Jy Top frame: Phas deg  
Vector averaged cross-power spectrum Baseline: WB (01) - EF (02)  
Timerange: 00/04:42:01 to 00/04:49:59

Plot file version 98 created 30-AUG-2019 17:53:26

ROSS867 EB070.UVDATA.1

Freq = 1.5950 GHz, Bw = 16.000 MH No calibration applied and no bandpass applied

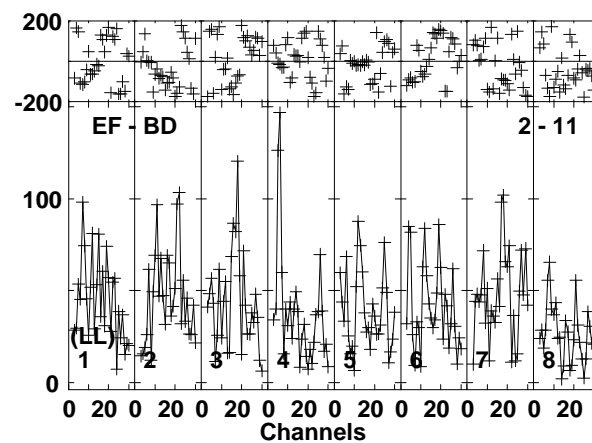
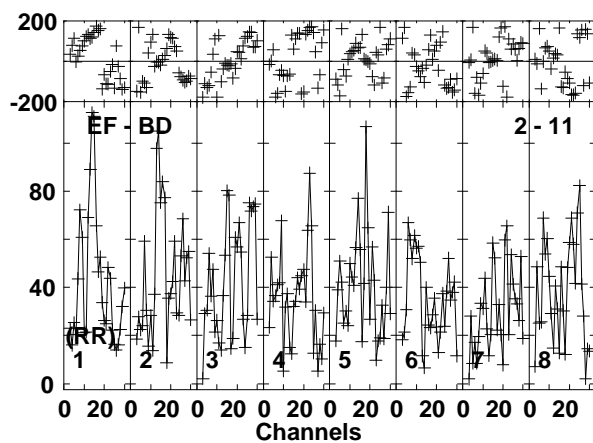
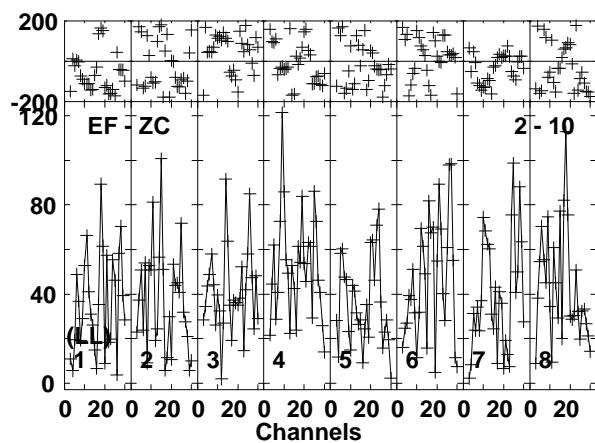
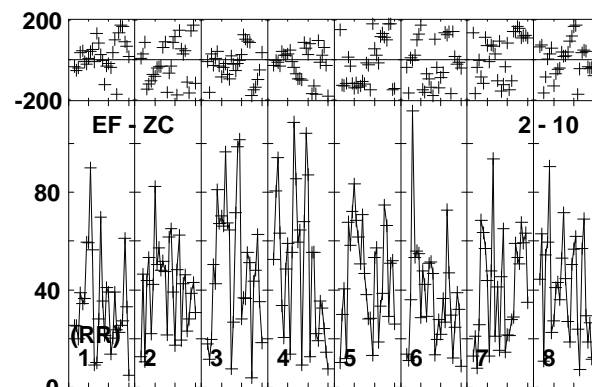
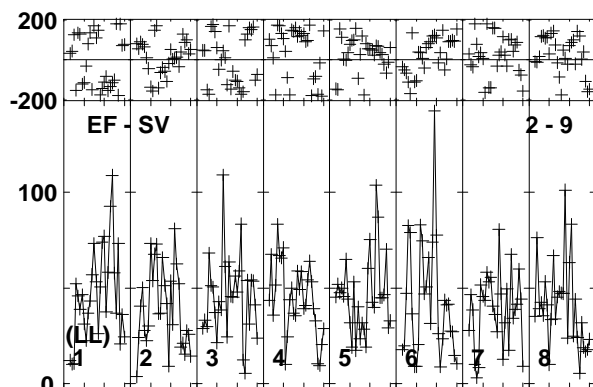
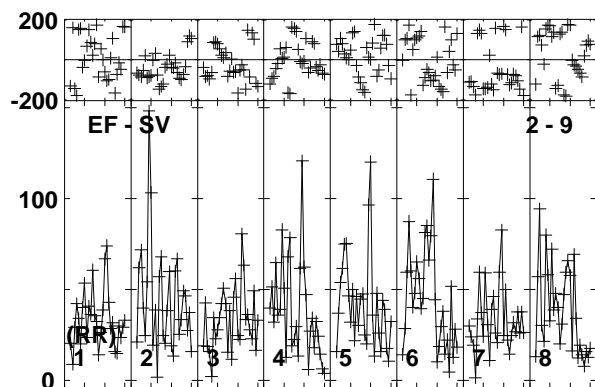
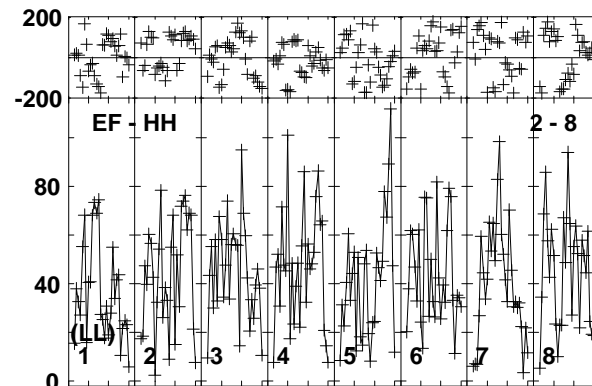
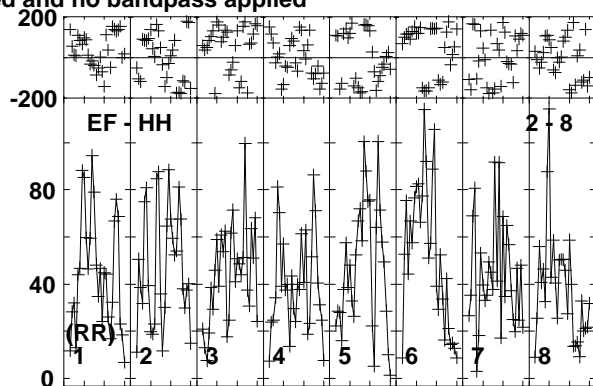
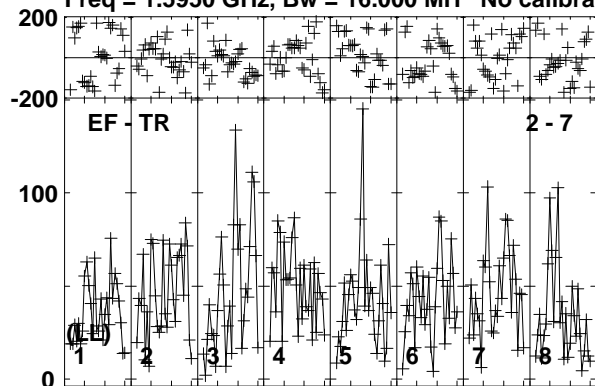

Lower frame: Micro Ampl Jy Top frame: Phas deg  
Vector averaged cross-power spectrum Baseline: EF (02) - TR (07)  
Timerange: 00/04:42:01 to 00/04:49:59

Plot file version 99 created 30-AUG-2019 17:53:26

ROSS867 EB070.UVDATA.1

Freq = 1.5950 GHz, Bw = 16.000 MH No calibration applied and no bandpass applied

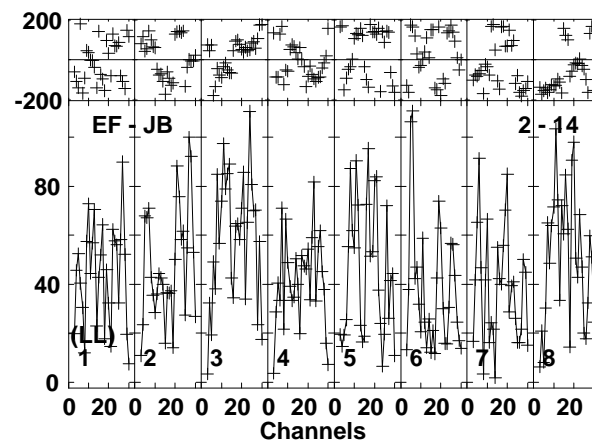
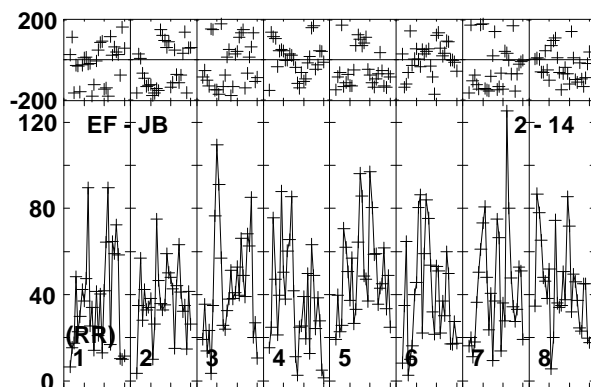
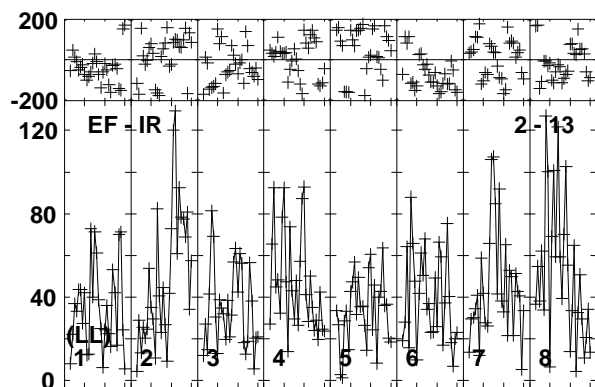
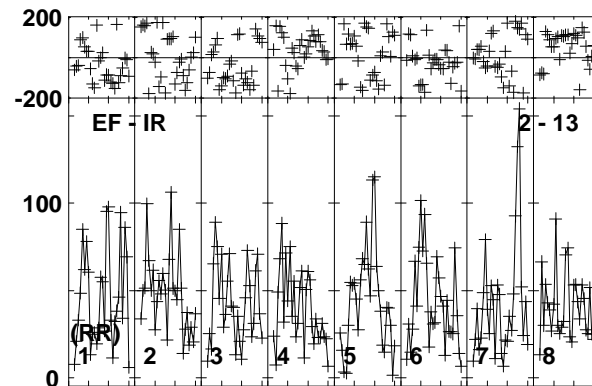
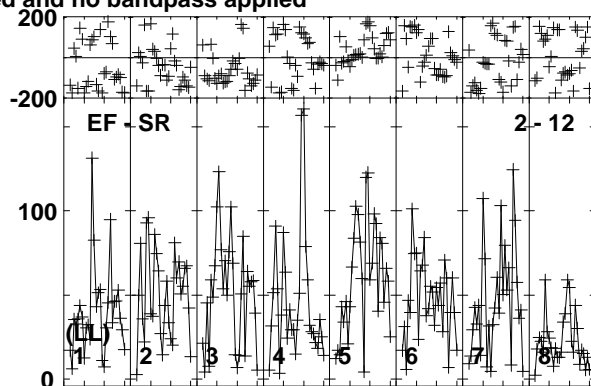
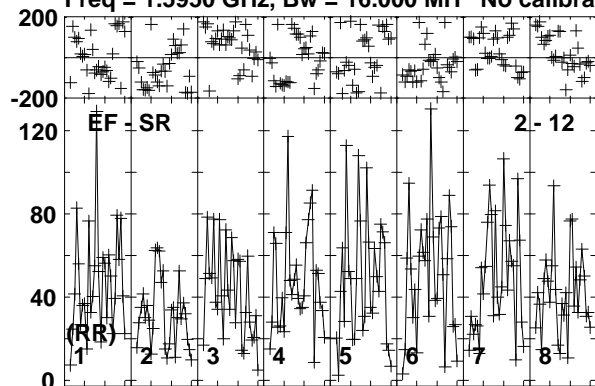

Lower frame: Micro Ampl Jy Top frame: Phas deg  
Vector averaged cross-power spectrum Baseline: EF (02) - SR (12)  
Timerange: 00/04:42:01 to 00/04:49:59

Plot file version 100 created 30-AUG-2019 17:53:26

J1722+2458 EB070.UVDATA.1

Freq = 1.5950 GHz, Bw = 16.000 MH No calibration applied and no bandpass applied

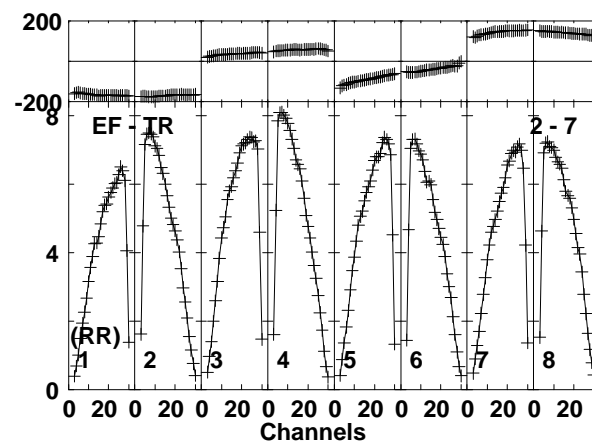
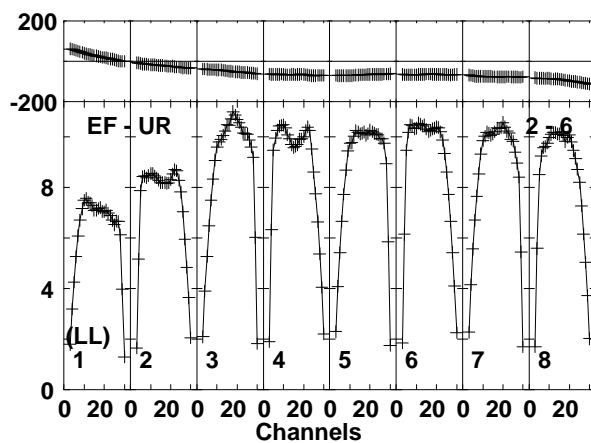
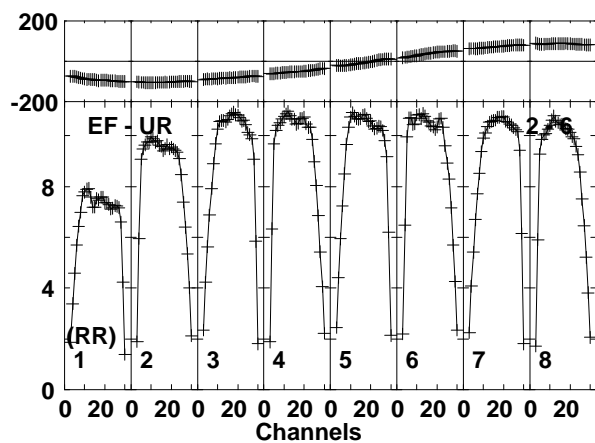
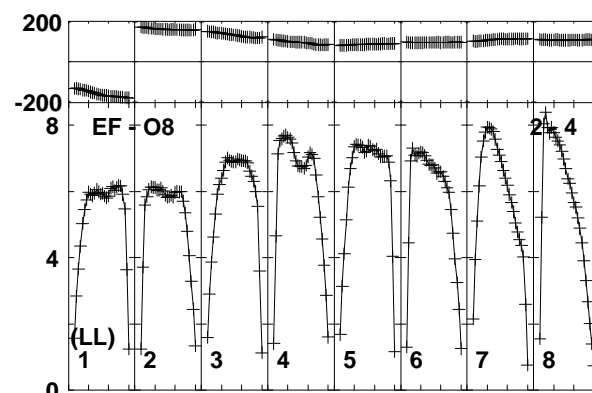
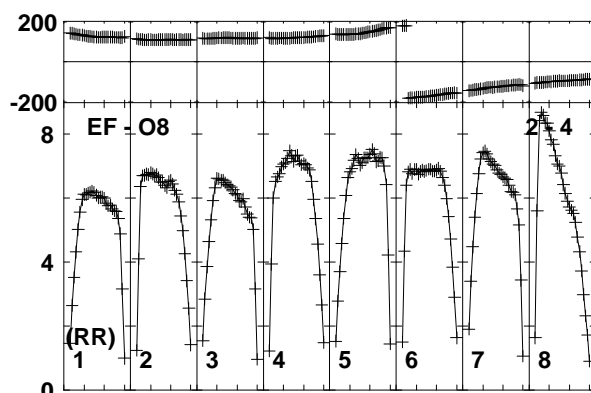
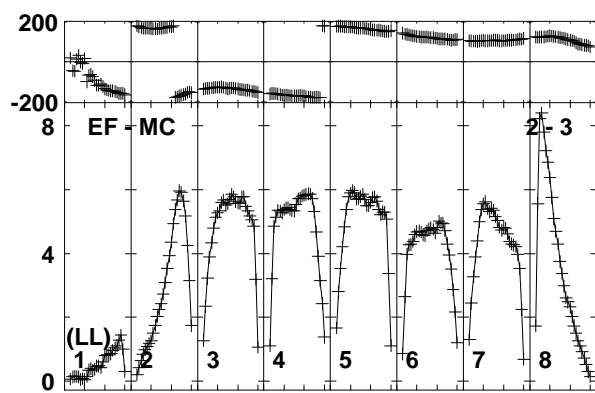
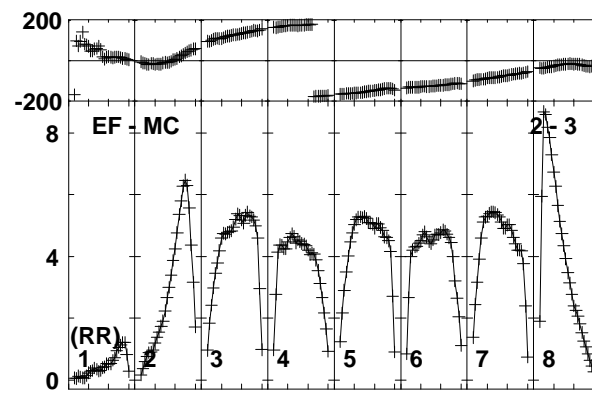
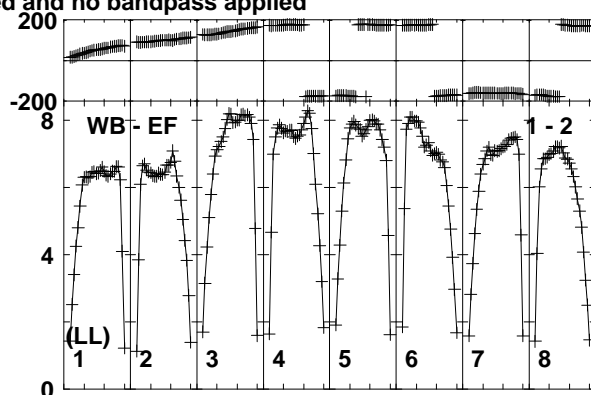
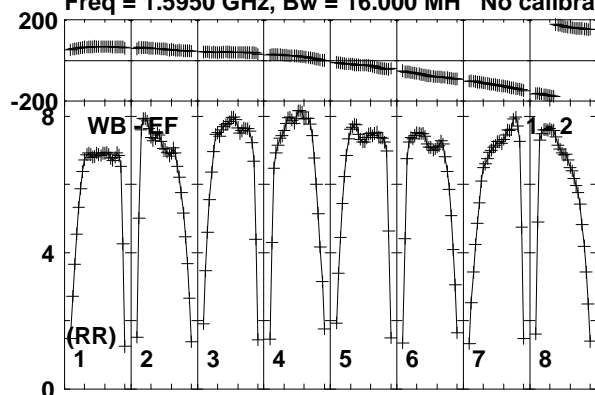

Lower frame: Milli Ampl Jy Top frame: Phas deg  
Vector averaged cross-power spectrum Baseline: WB (01) - EF (02)  
Timerange: 00/04:50:41 to 00/04:51:59

Plot file version 101 created 30-AUG-2019 17:53:26

J1722+2458 EB070.UVDATA.1

Freq = 1.5950 GHz, Bw = 16.000 MH No calibration applied and no bandpass applied

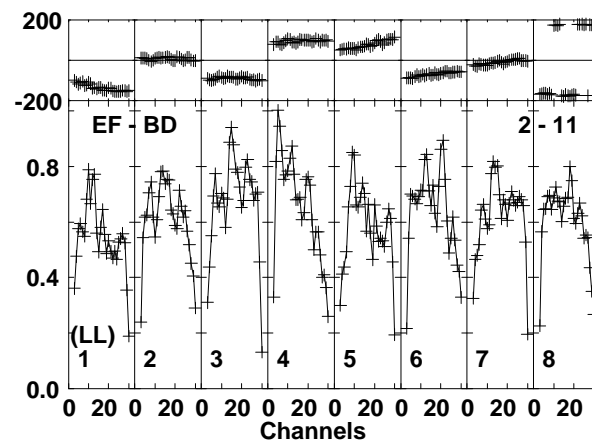
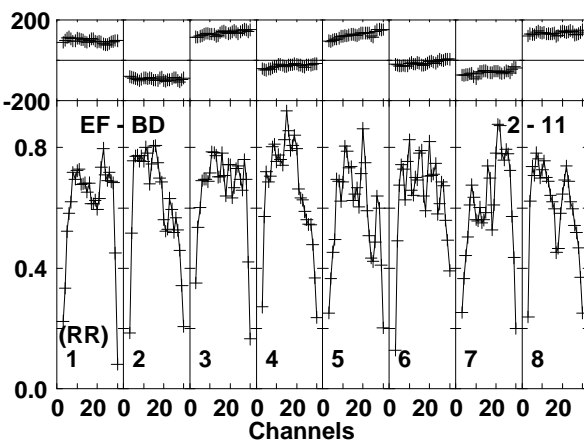
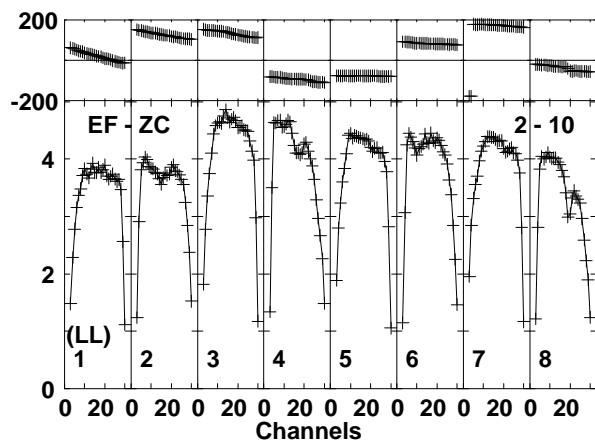
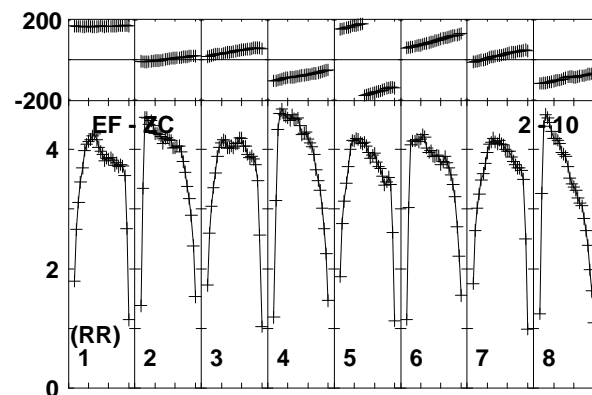
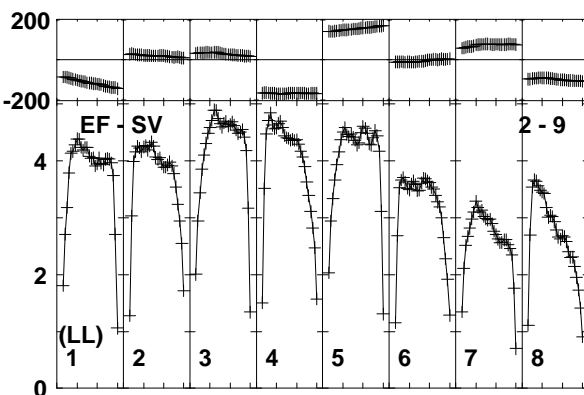
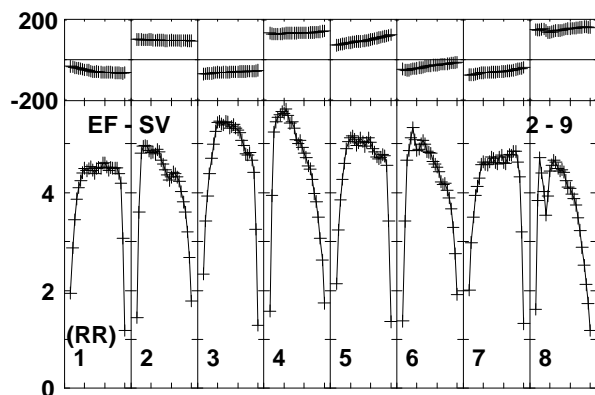
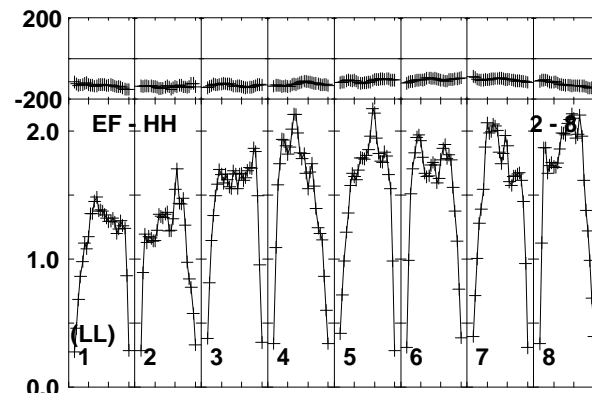
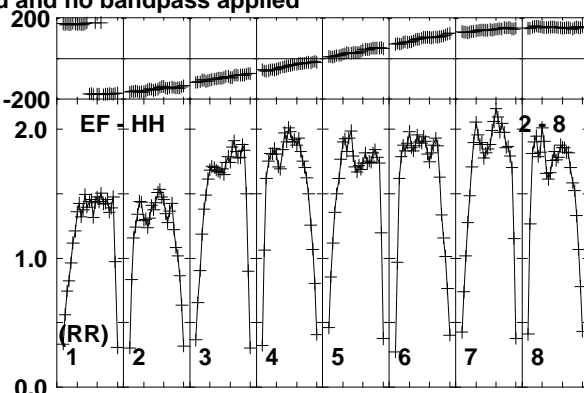
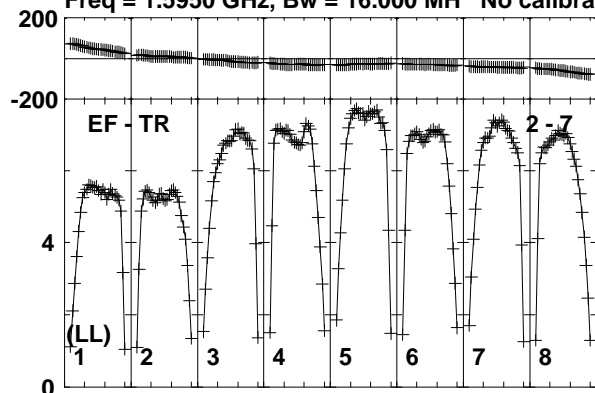

Lower frame: Milli Ampl Jy Top frame: Phas deg  
Vector averaged cross-power spectrum Baseline: EF (02) - TR (07)  
Timerange: 00/04:50:41 to 00/04:51:59

Plot file version 102 created 30-AUG-2019 17:53:27

J1722+2458 EB070.UVDATA.1

Freq = 1.5950 GHz, Bw = 16.000 MH No calibration applied and no bandpass applied

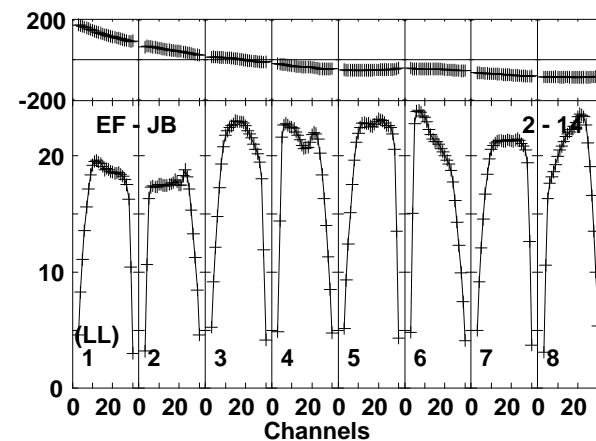
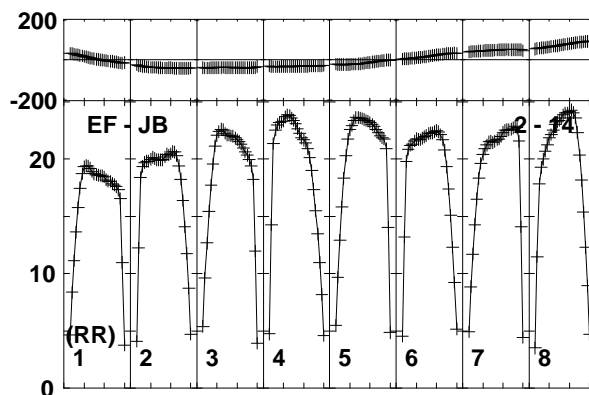
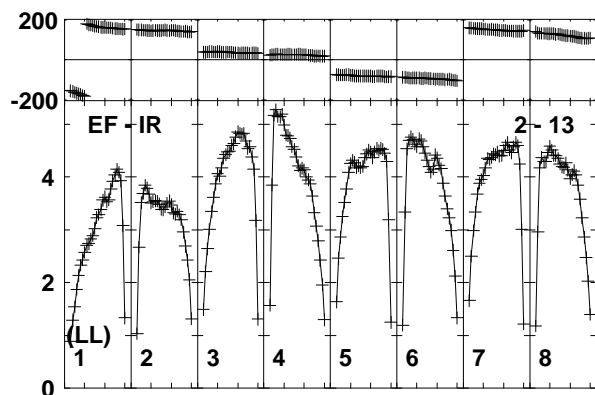
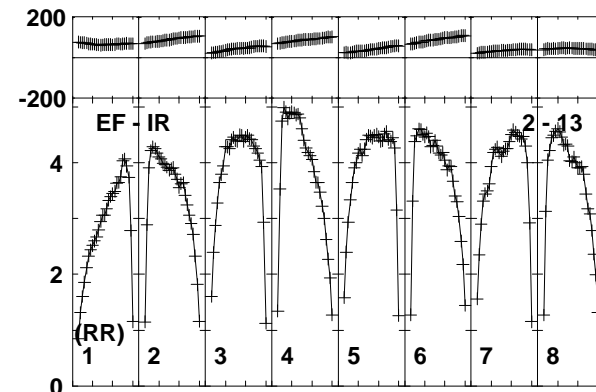
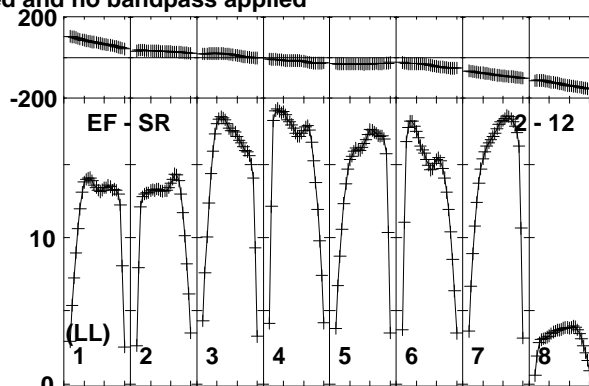
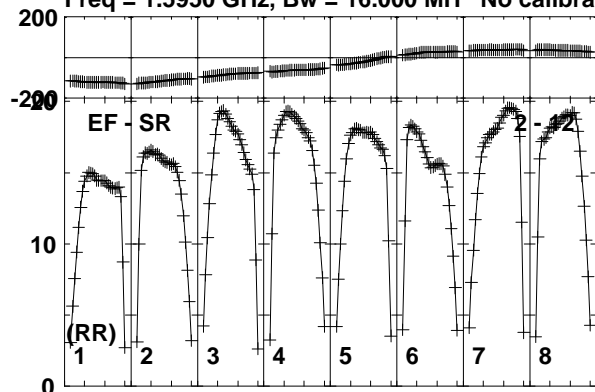

Lower frame: Milli Ampl Jy Top frame: Phas deg  
Vector averaged cross-power spectrum Baseline: EF (02) - SR (12)  
Timerange: 00/04:50:41 to 00/04:51:59

Plot file version 103 created 30-AUG-2019 17:53:27

ROSS867 EB070.UVDATA.1

Freq = 1.5950 GHz, Bw = 16.000 MH No calibration applied and no bandpass applied

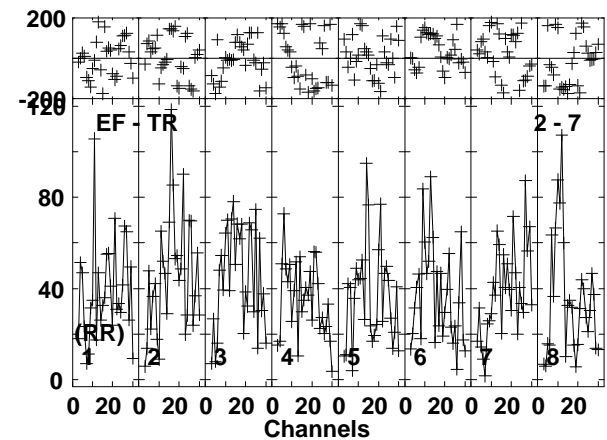
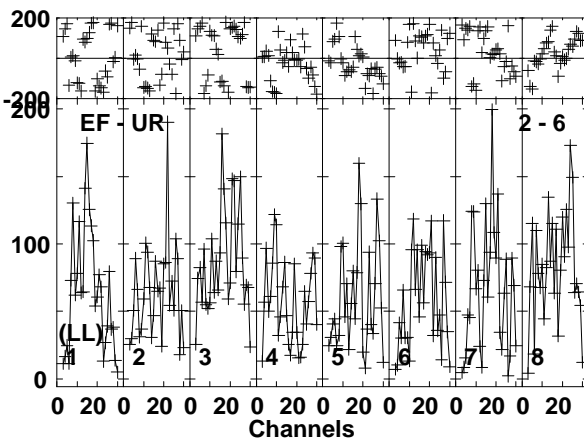
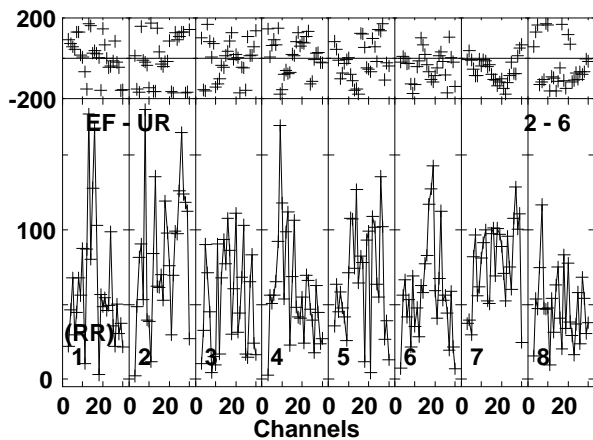
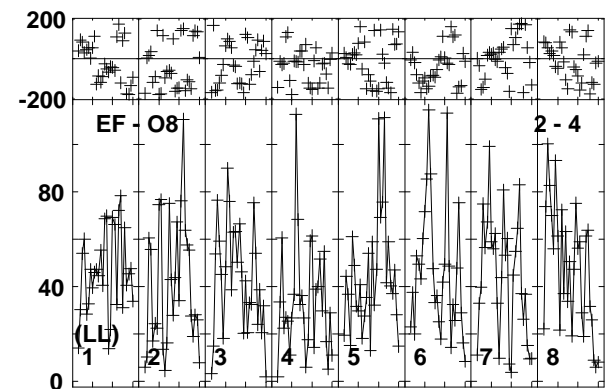
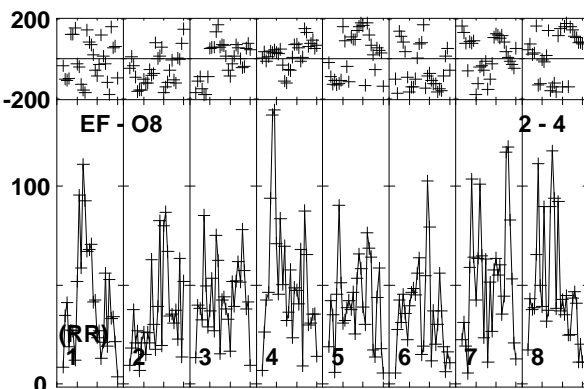
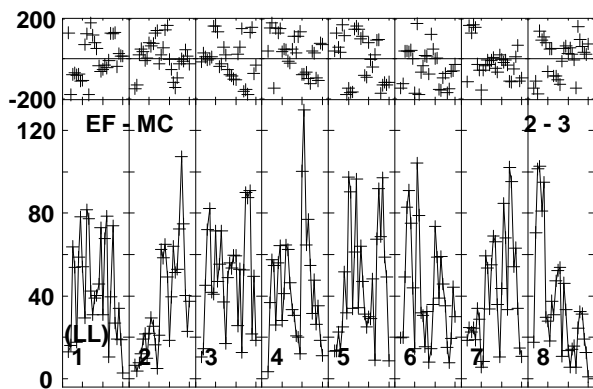
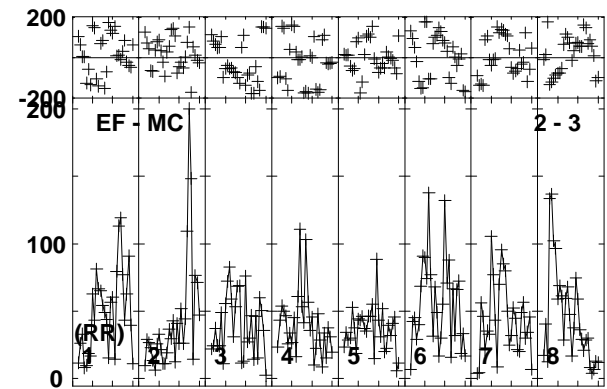
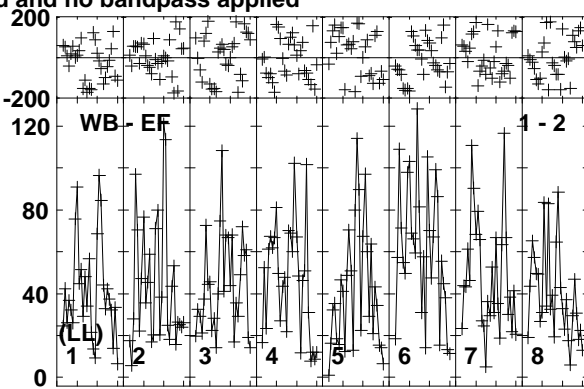
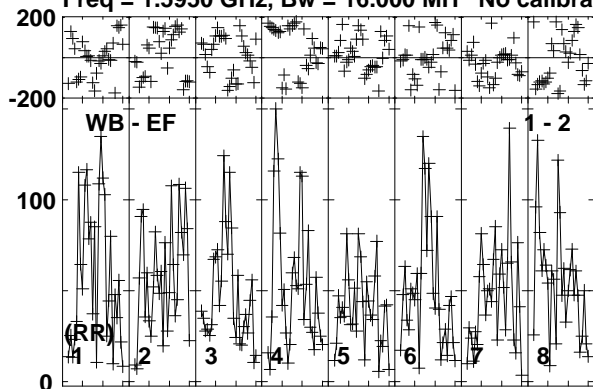

Lower frame: Micro Ampl Jy Top frame: Phas deg  
Vector averaged cross-power spectrum Baseline: WB (01) - EF (02)  
Timerange: 00/04:52:01 to 00/04:59:59

Plot file version 104 created 30-AUG-2019 17:53:27

ROSS867 EB070.UVDATA.1

Freq = 1.5950 GHz, Bw = 16.000 MH No calibration applied and no bandpass applied

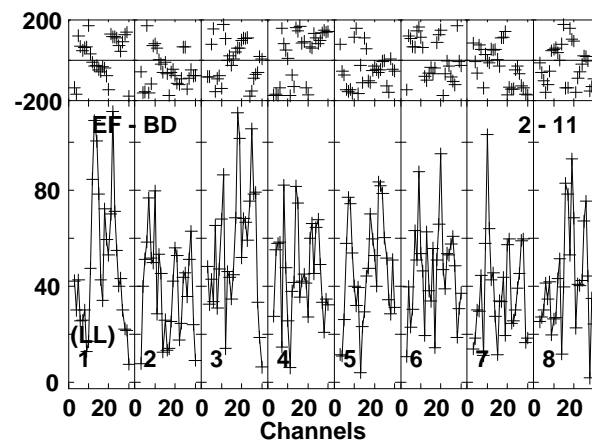
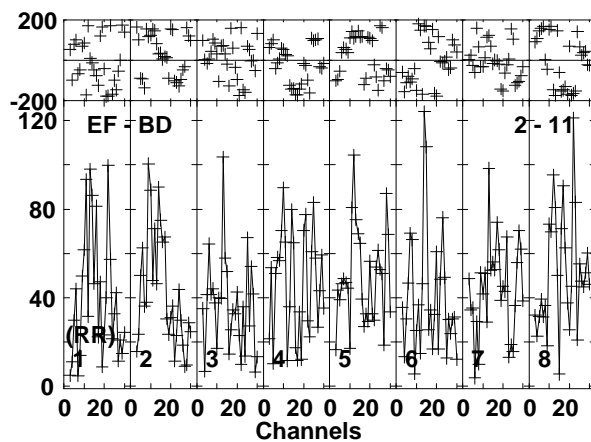
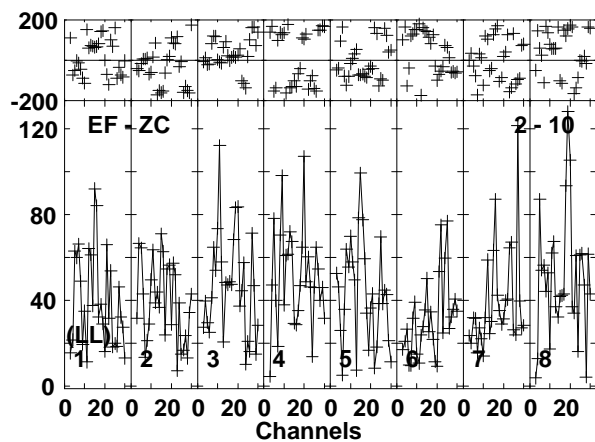
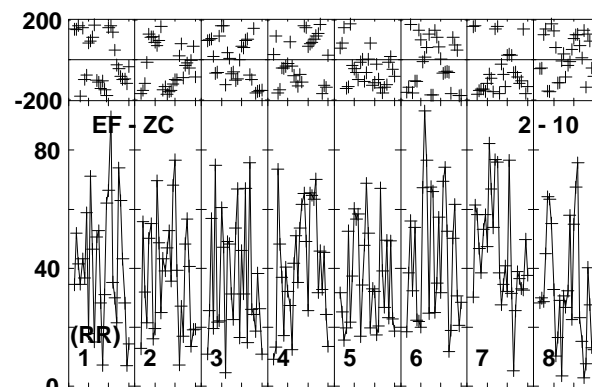
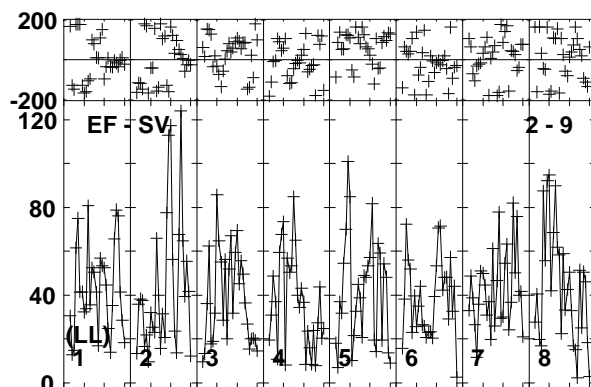
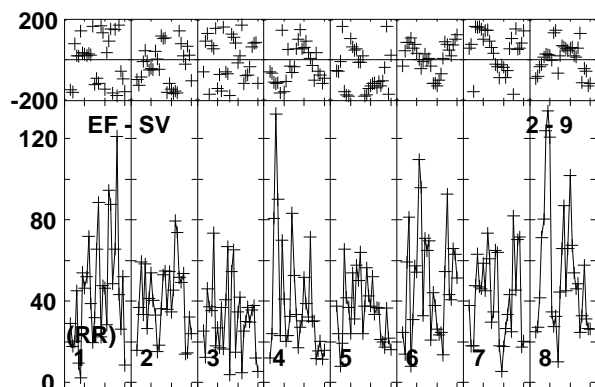
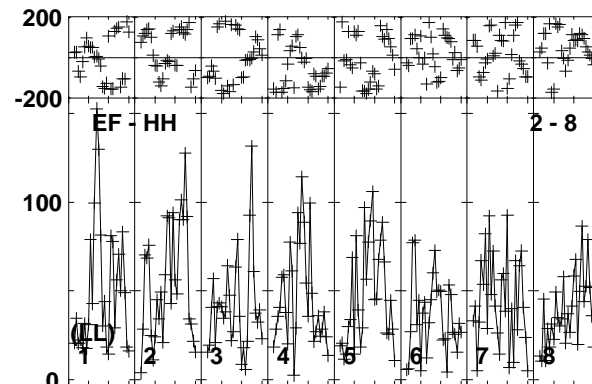
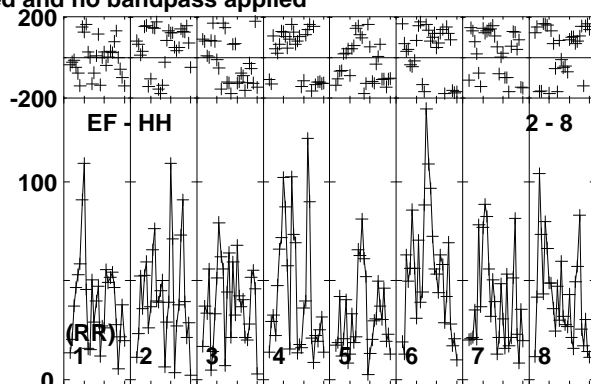
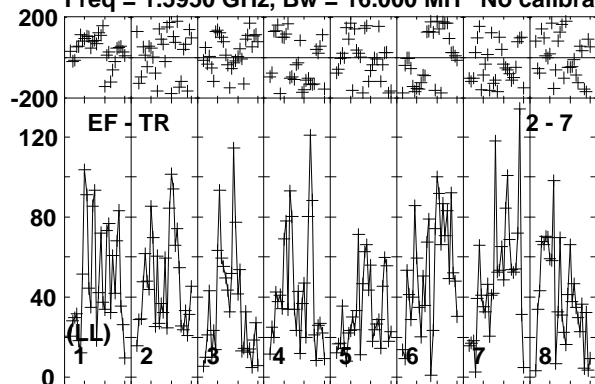

Lower frame: Micro Ampl Jy Top frame: Phas deg  
Vector averaged cross-power spectrum Baseline: EF (02) - TR (07)  
Timerange: 00/04:52:01 to 00/04:59:59



Plot file version 105 created 30-AUG-2019 17:53:27

ROSS867 EB070.UVDATA.1

Freq = 1.5950 GHz, Bw = 16.000 MH No calibration applied and no bandpass applied

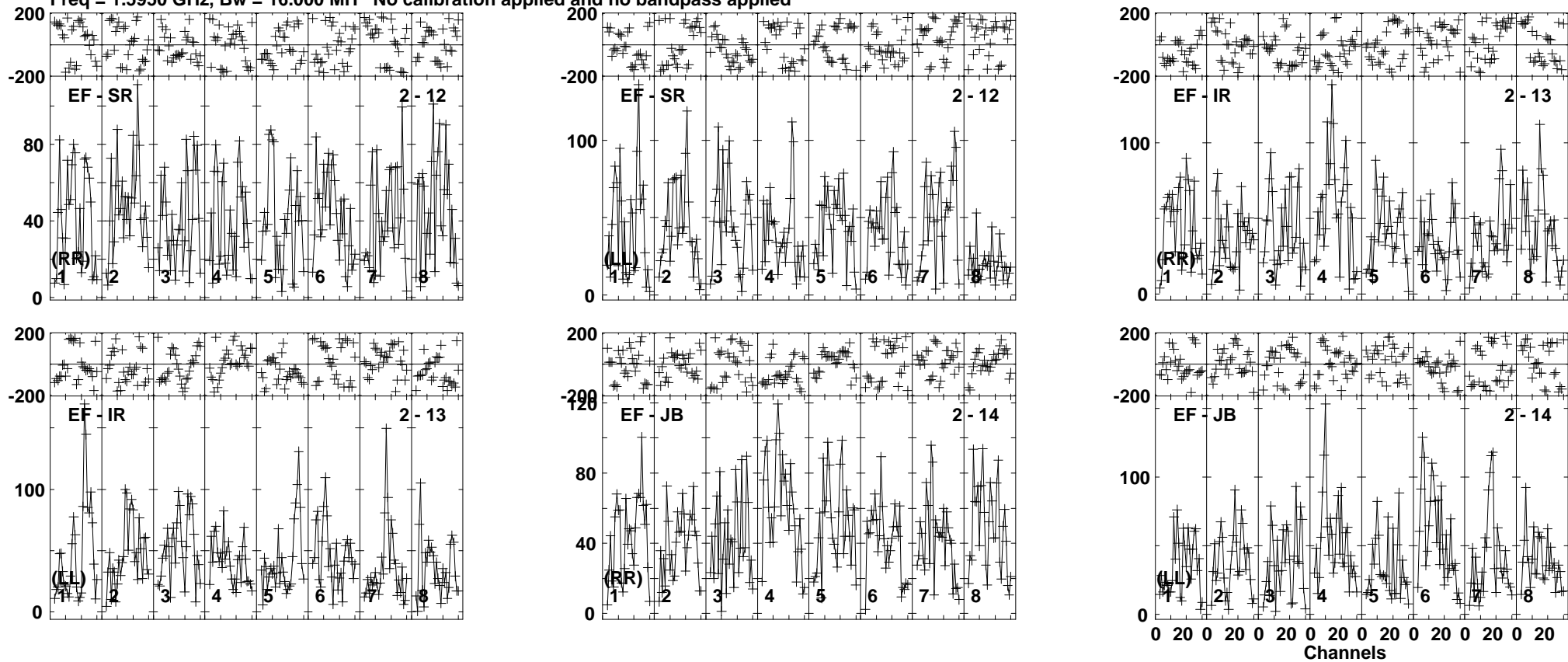

Lower frame: Micro Ampl Jy Top frame: Phas deg  
Vector averaged cross-power spectrum Baseline: EF (02) - SR (12)  
Timerange: 00/04:52:01 to 00/04:59:59

Plot file version 106 created 30-AUG-2019 17:53:27

J1722+2458 EB070.UVDATA.1

Freq = 1.5950 GHz, Bw = 16.000 MH No calibration applied and no bandpass applied

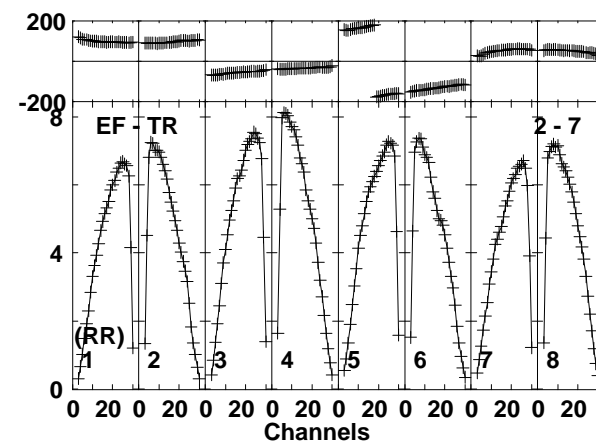
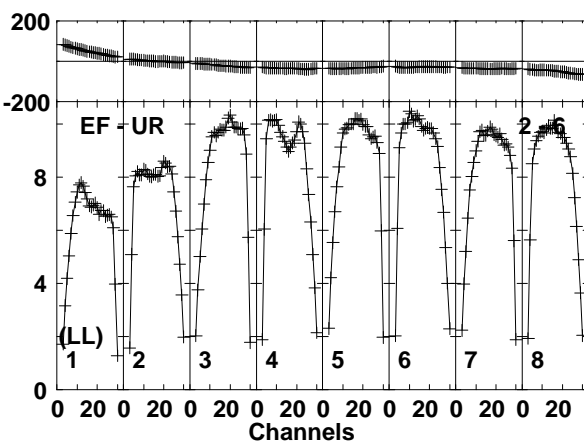
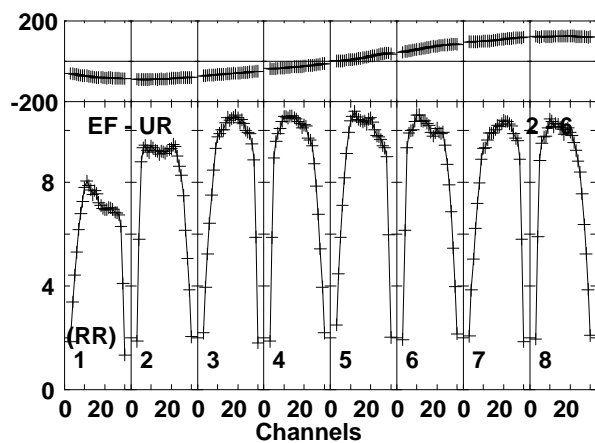
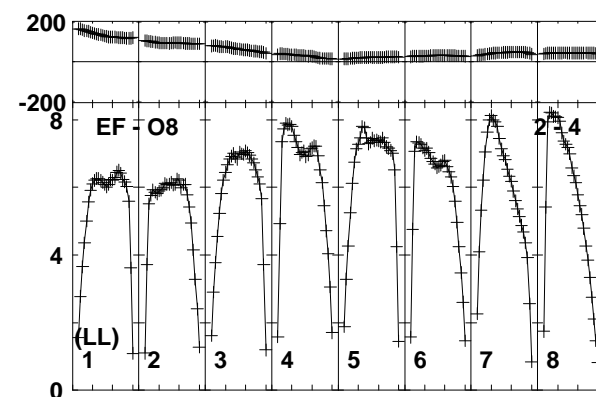
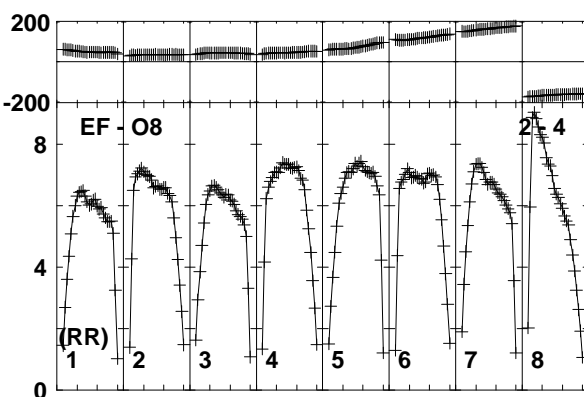
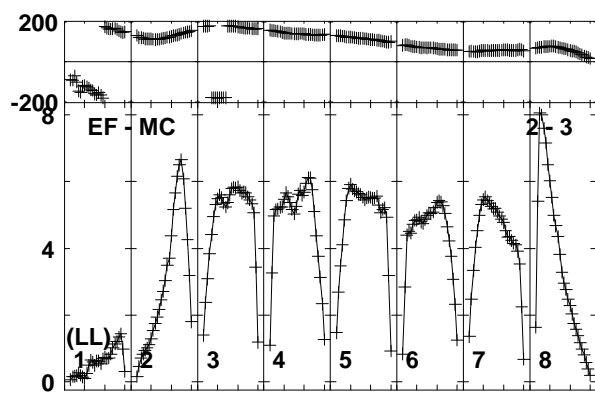
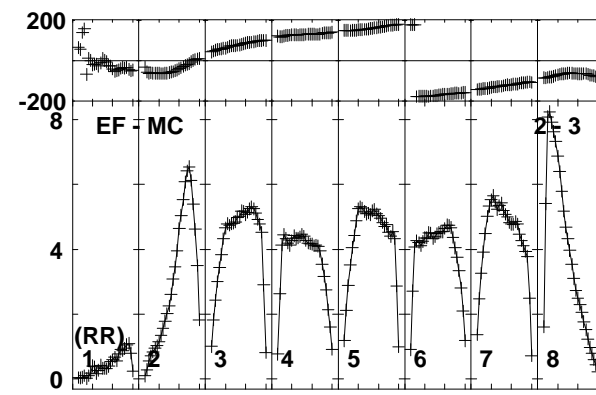
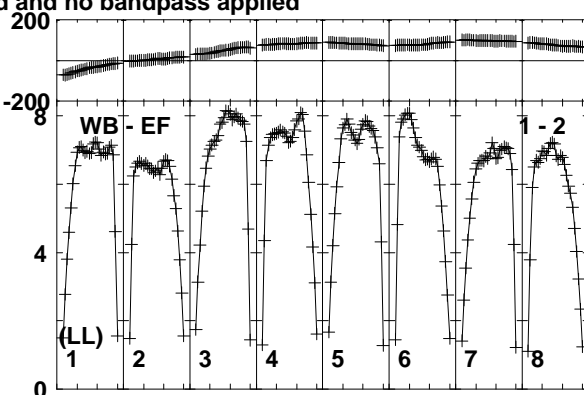
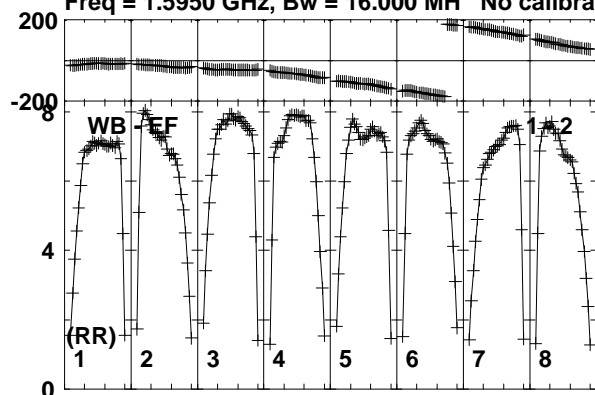

Lower frame: Milli Ampl Jy Top frame: Phas deg  
Vector averaged cross-power spectrum Baseline: WB (01) - EF (02)  
Timerange: 00/05:00:01 to 00/05:01:59

Plot file version 107 created 30-AUG-2019 17:53:27

J1722+2458 EB070.UVDATA.1

Freq = 1.5950 GHz, Bw = 16.000 MH No calibration applied and no bandpass applied

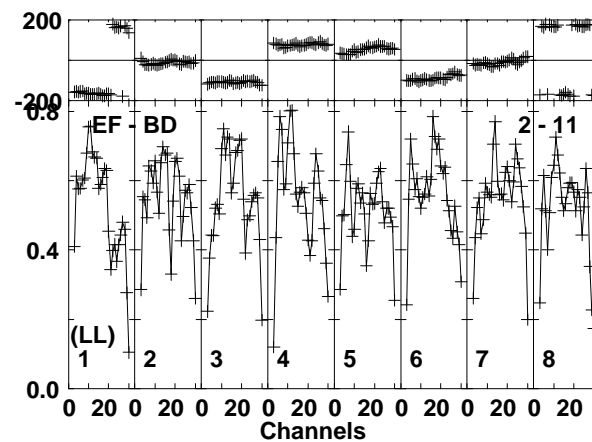
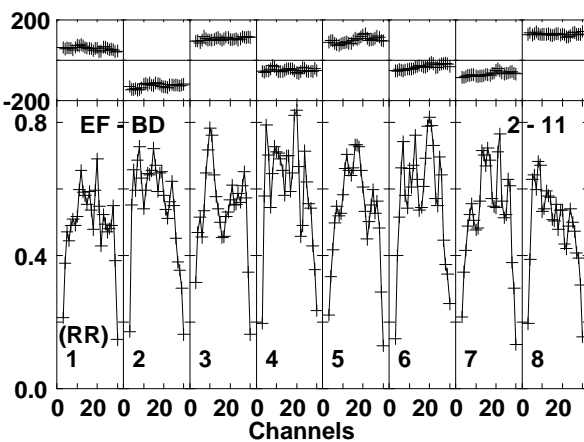
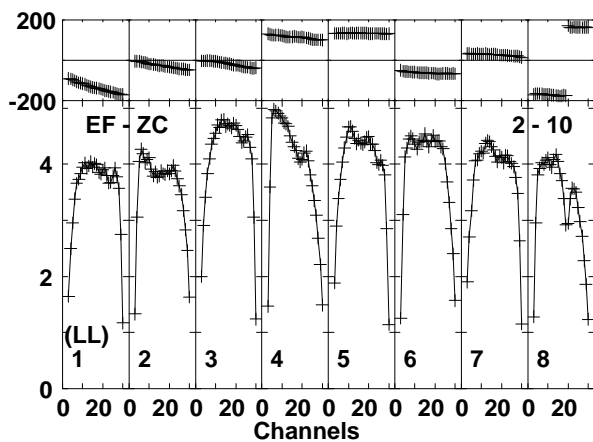
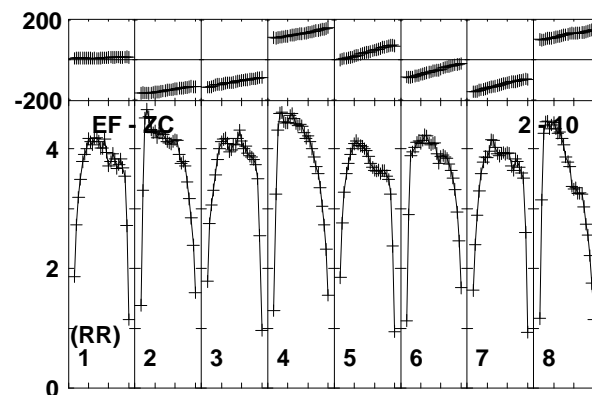
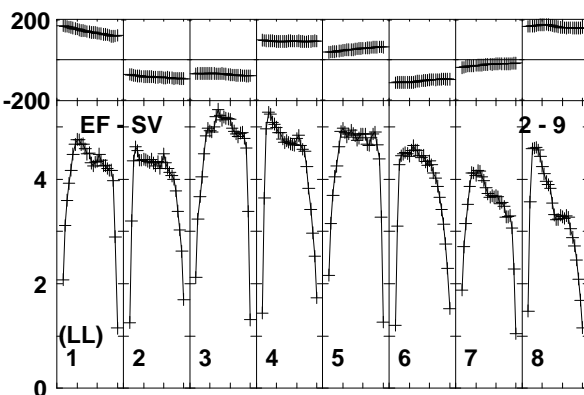
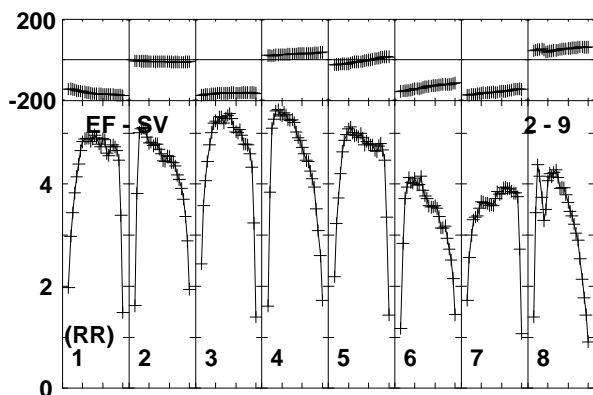
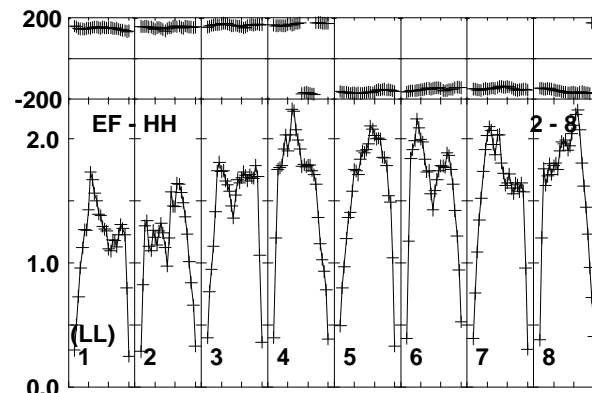
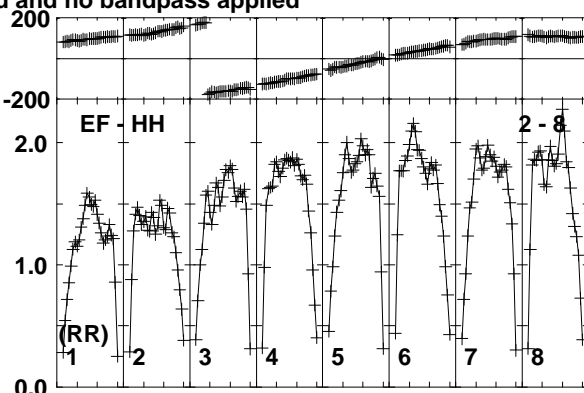
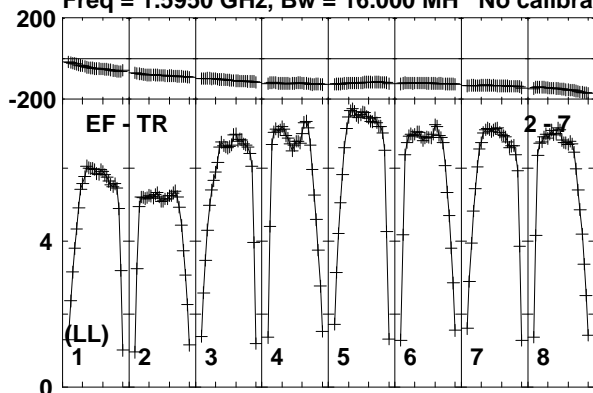

Lower frame: Milli Ampl Jy Top frame: Phas deg  
Vector averaged cross-power spectrum Baseline: EF (02) - TR (07)  
Timerange: 00/05:00:01 to 00/05:01:59

Plot file version 108 created 30-AUG-2019 17:53:28

J1722+2458 EB070.UVDATA.1

Freq = 1.5950 GHz, Bw = 16.000 MH No calibration applied and no bandpass applied

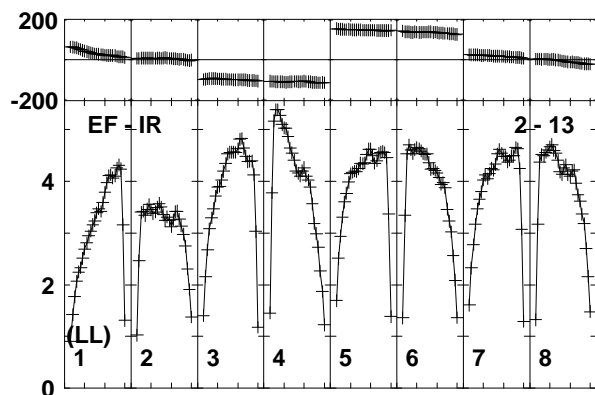
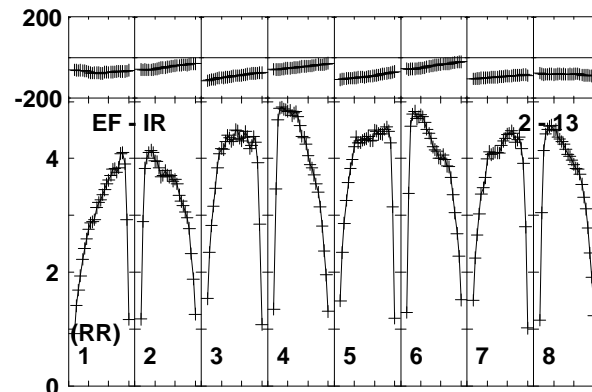
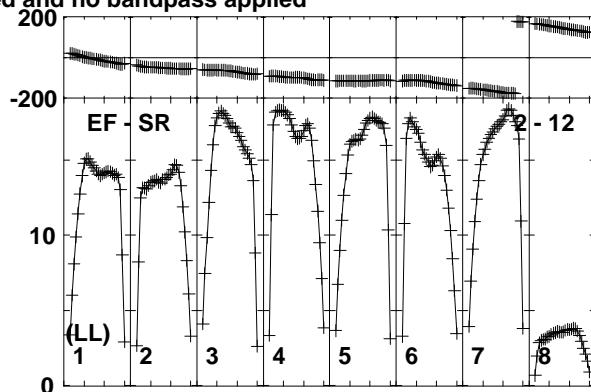
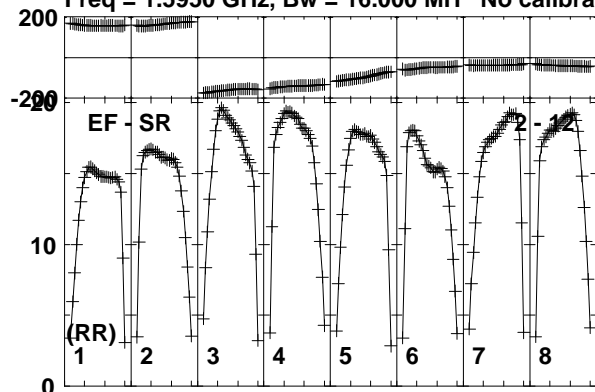

Lower frame: Milli Ampl Jy Top frame: Phas deg  
Vector averaged cross-power spectrum Baseline: EF (02) - SR (12)  
Timerange: 00/05:00:01 to 00/05:01:59

Plot file version 109 created 30-AUG-2019 17:53:28

ROSS867 EB070.UVDATA.1

Freq = 1.5950 GHz, Bw = 16.000 MH No calibration applied and no bandpass applied

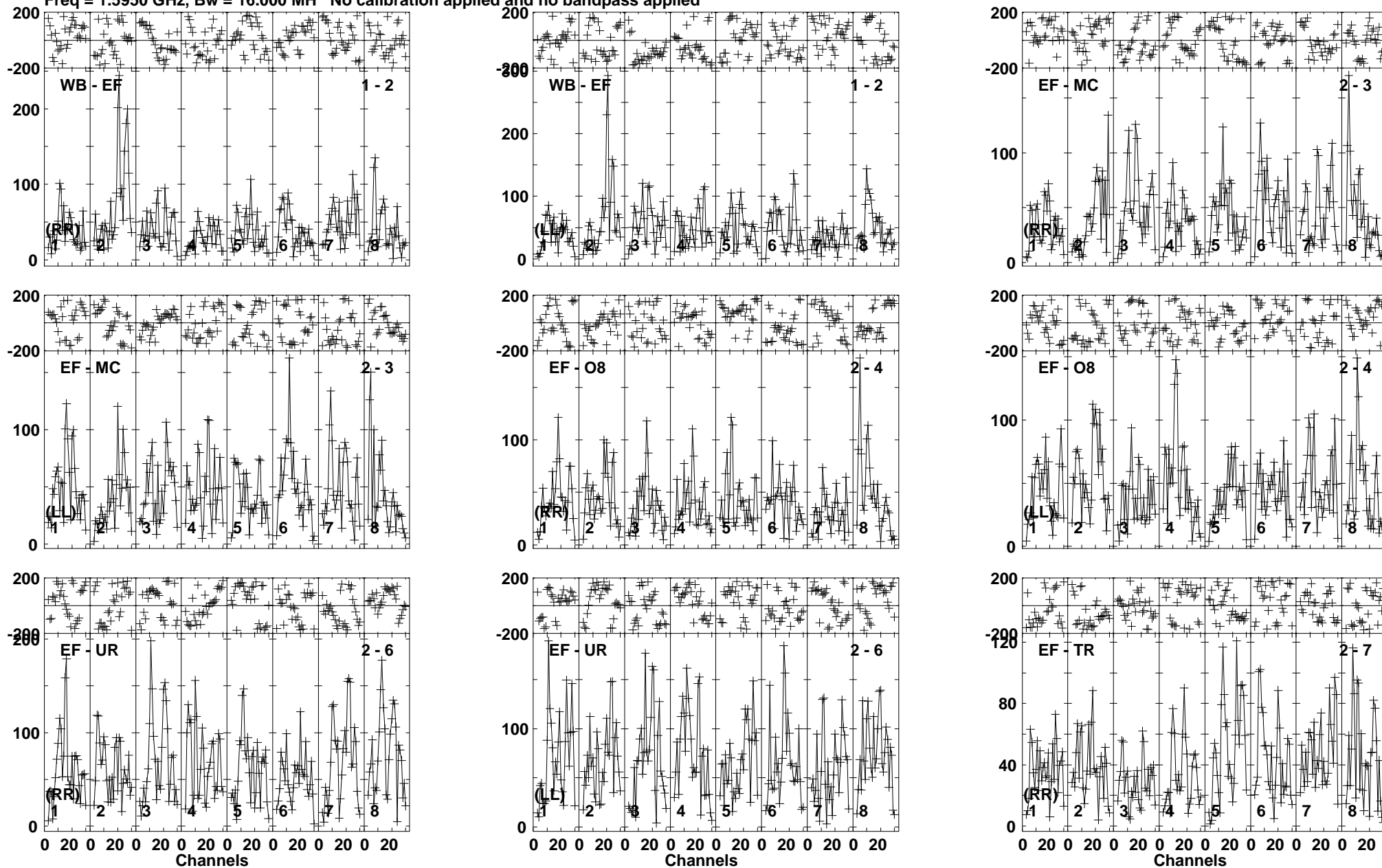

Lower frame: Micro Ampl Jy Top frame: Phas deg  
Vector averaged cross-power spectrum Baseline: WB (01) - EF (02)  
Timerange: 00/05:02:01 to 00/05:09:59

Plot file version 110 created 30-AUG-2019 17:53:28

ROSS867 EB070.UVDATA.1

Freq = 1.5950 GHz, Bw = 16.000 MH No calibration applied and no bandpass applied

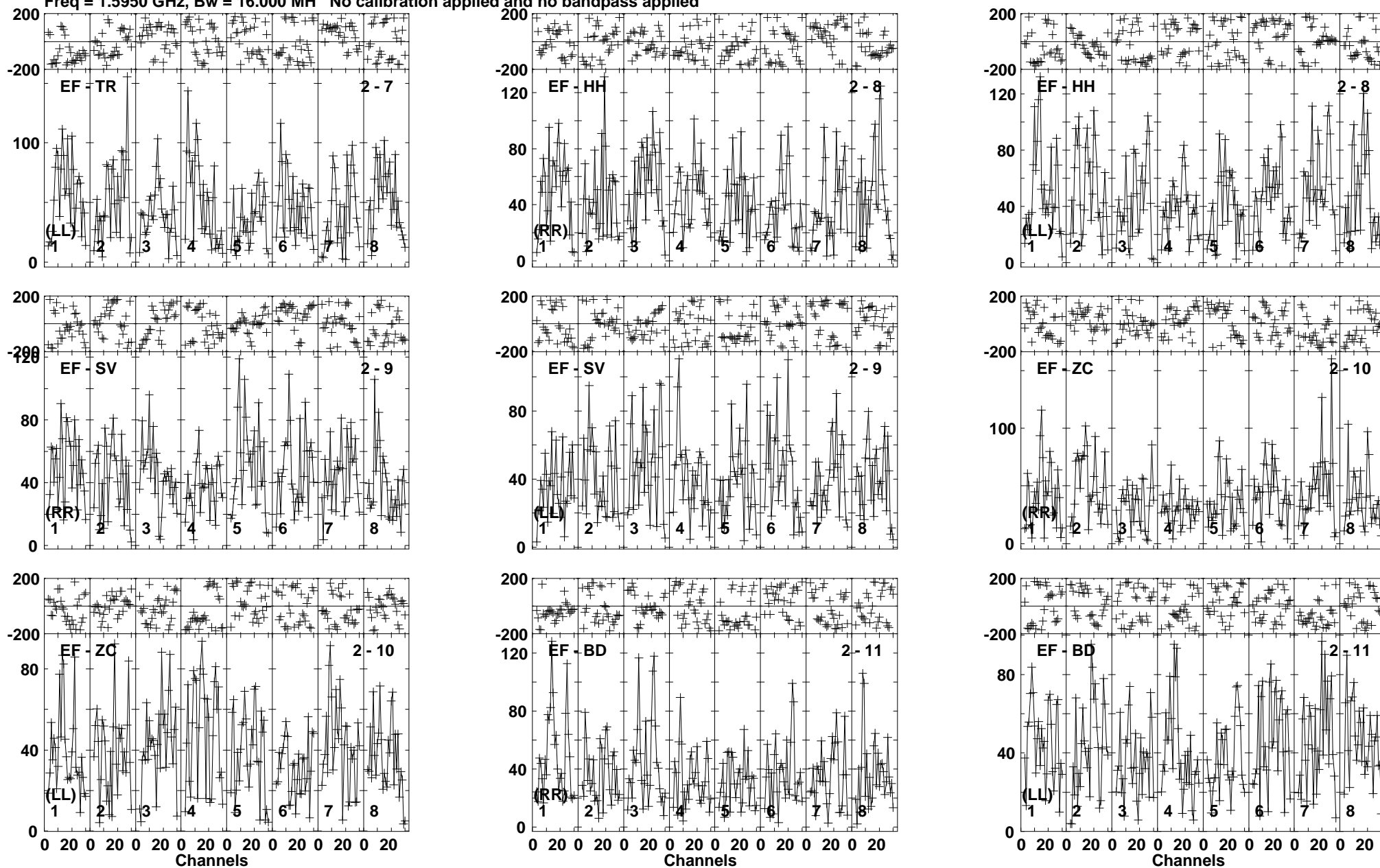

Lower frame: Micro Ampl Jy Top frame: Phas deg  
Vector averaged cross-power spectrum Baseline: EF (02) - TR (07)  
Timerange: 00/05:02:01 to 00/05:09:59

Plot file version 111 created 30-AUG-2019 17:53:28

ROSS867 EB070.UVDATA.1

Freq = 1.5950 GHz, Bw = 16.000 MH No calibration applied and no bandpass applied

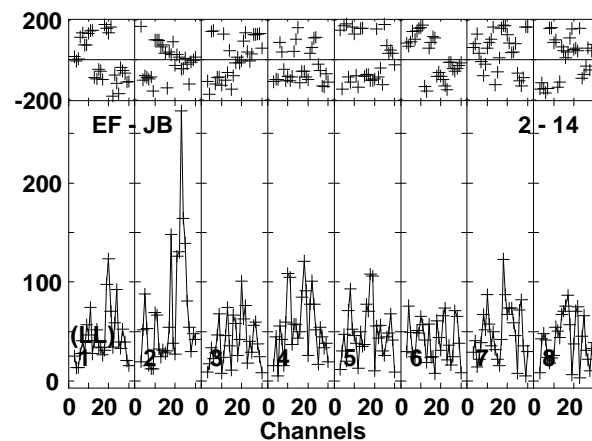
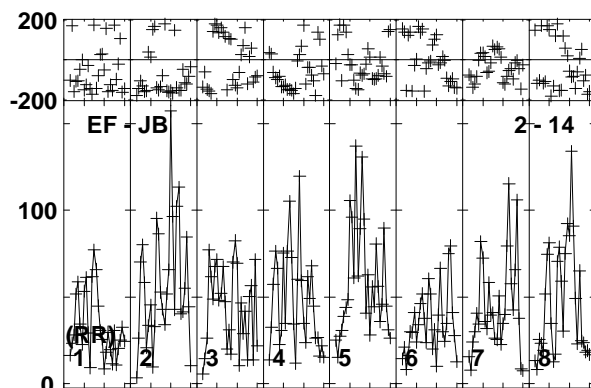
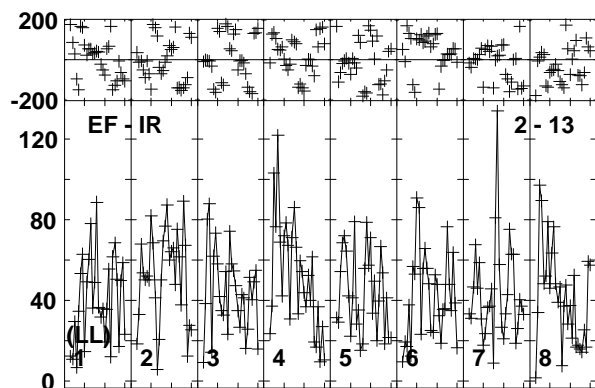
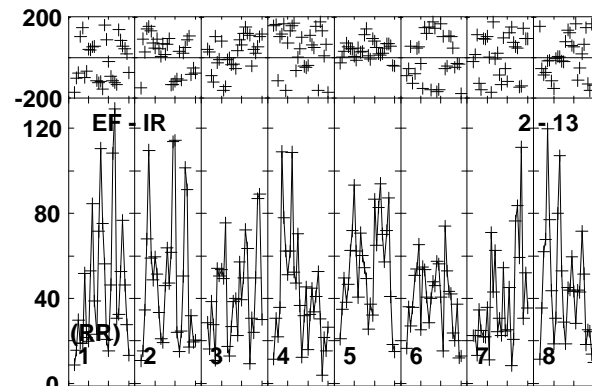
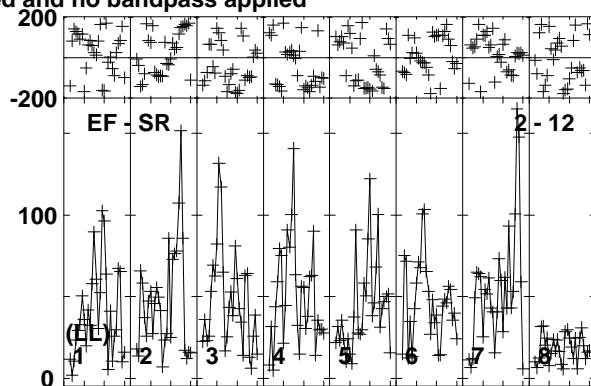
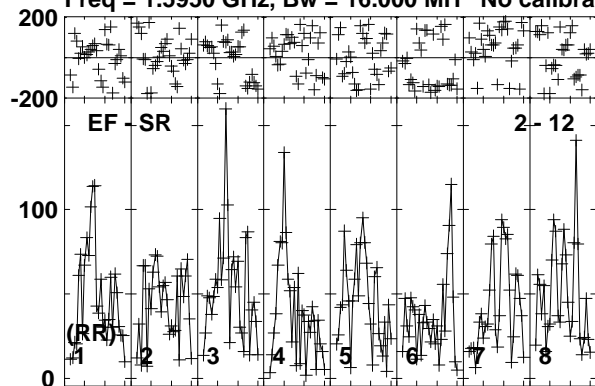

Lower frame: Micro Ampl Jy Top frame: Phas deg  
Vector averaged cross-power spectrum Baseline: EF (02) - SR (12)  
Timerange: 00/05:02:01 to 00/05:09:59

Plot file version 112 created 30-AUG-2019 17:53:28

J1722+2458 EB070.UVDATA.1

Freq = 1.5950 GHz, Bw = 16.000 MH No calibration applied and no bandpass applied

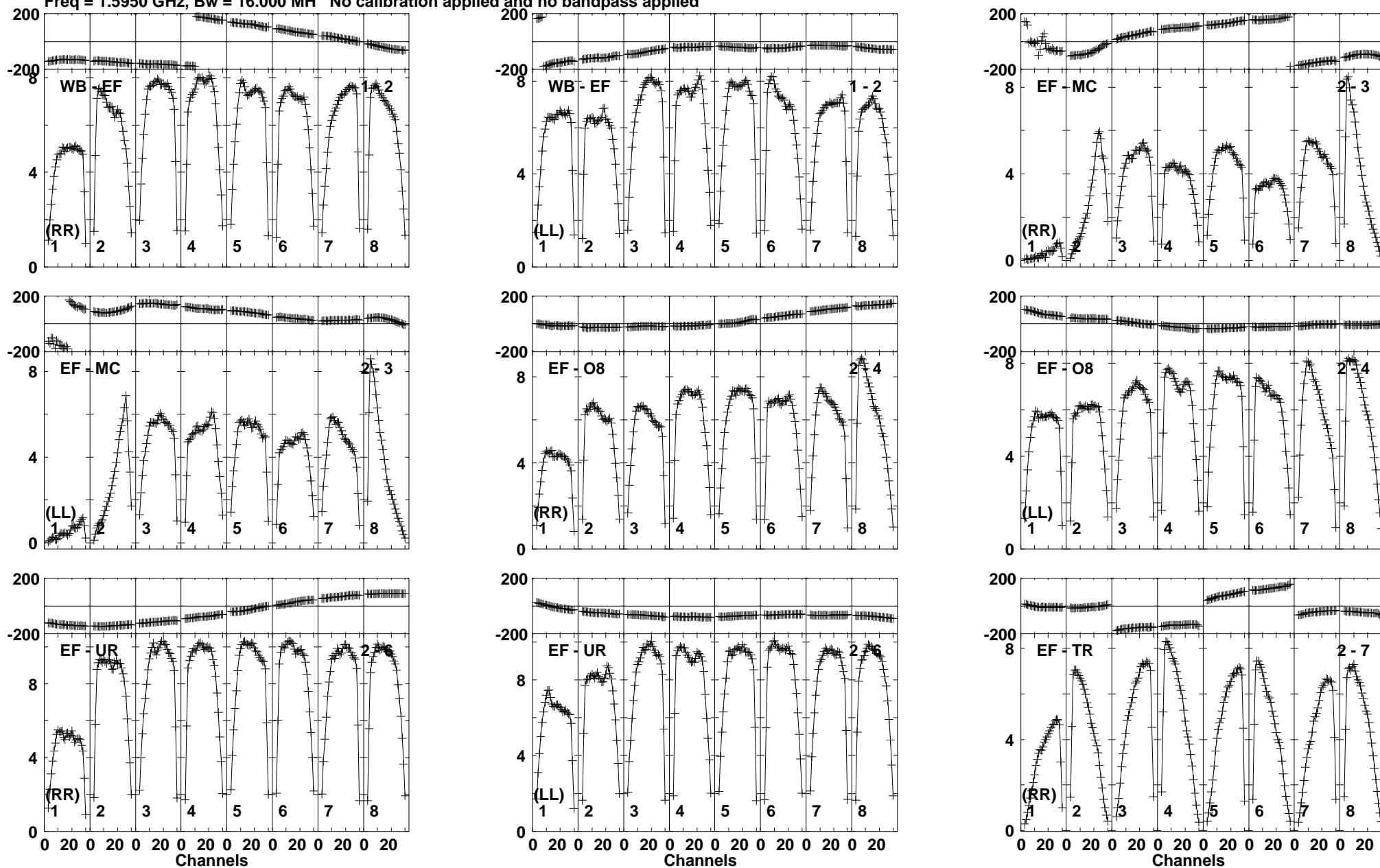

Lower frame: Milli Ampl Jy Top frame: Phas deg  
Vector averaged cross-power spectrum Baseline: WB (01) - EF (02)  
Timerange: 00/05:10:41 to 00/05:11:59



Plot file version 113 created 30-AUG-2019 17:53:29

J1722+2458 EB070.UVDATA.1

Freq = 1.5950 GHz, Bw = 16.000 MH No calibration applied and no bandpass applied

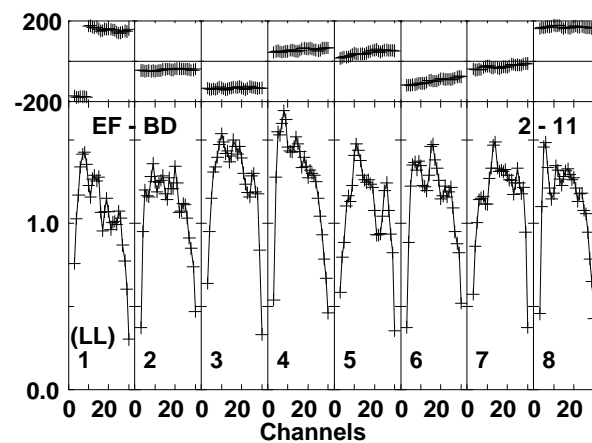
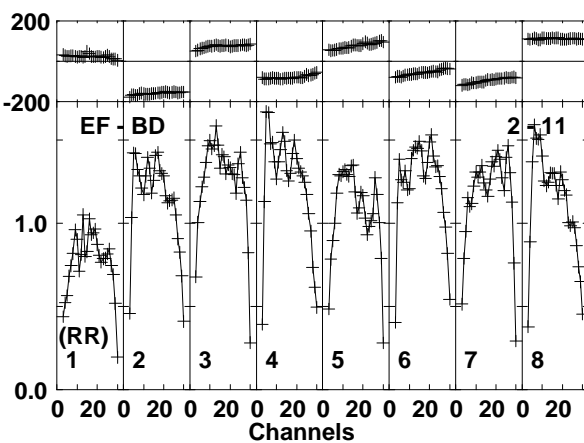
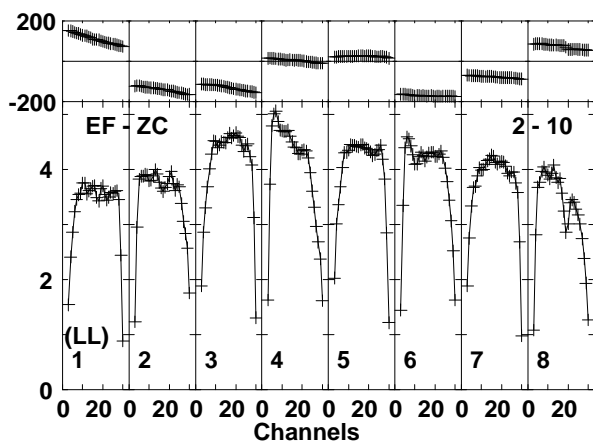
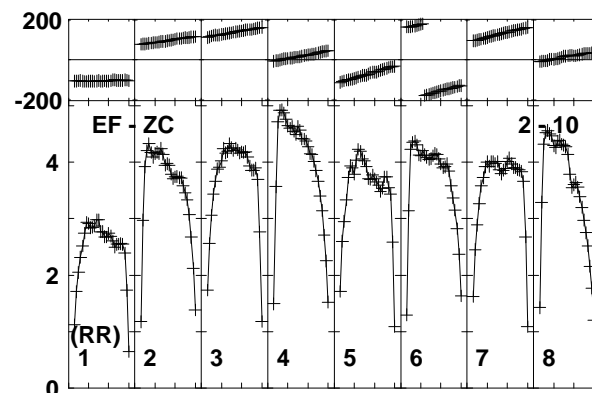
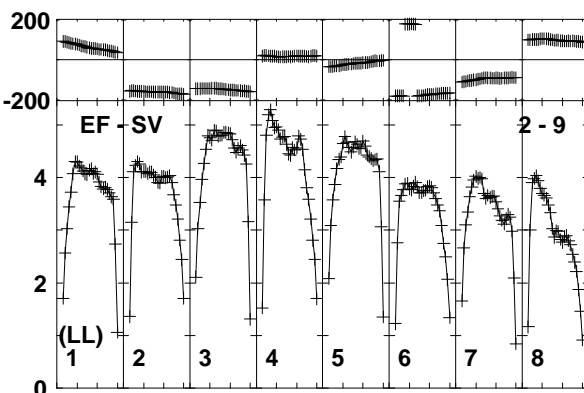
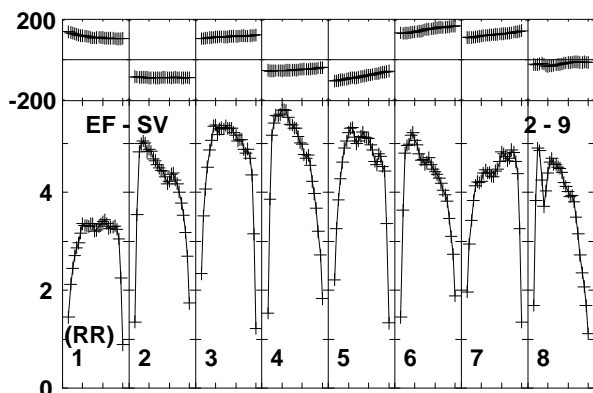
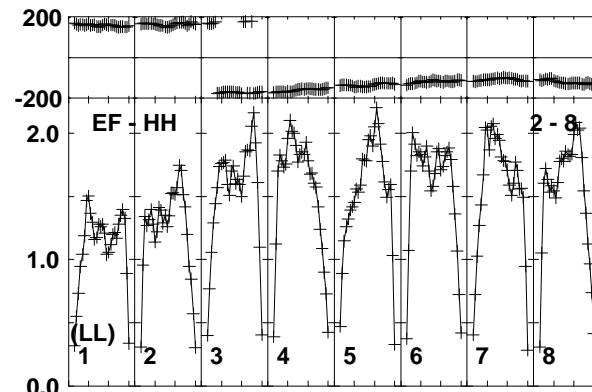
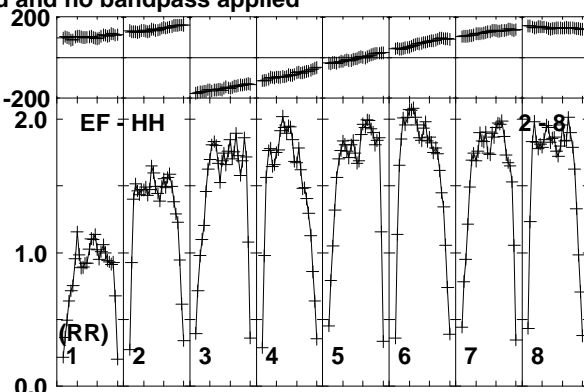
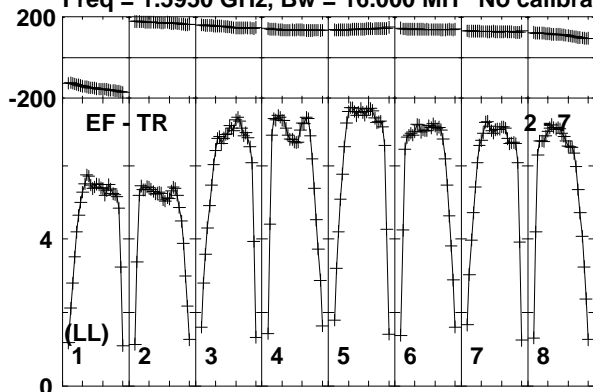

Lower frame: Milli Ampl Jy Top frame: Phas deg  
Vector averaged cross-power spectrum Baseline: EF (02) - TR (07)  
Timerange: 00/05:10:41 to 00/05:11:59

Plot file version 114 created 30-AUG-2019 17:53:29

J1722+2458 EB070.UVDATA.1

Freq = 1.5950 GHz, Bw = 16.000 MH No calibration applied and no bandpass applied

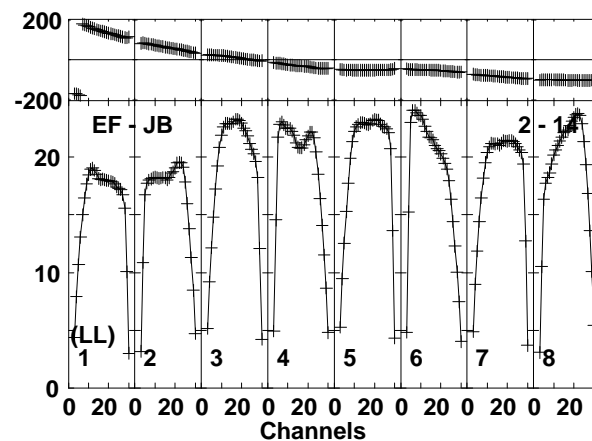
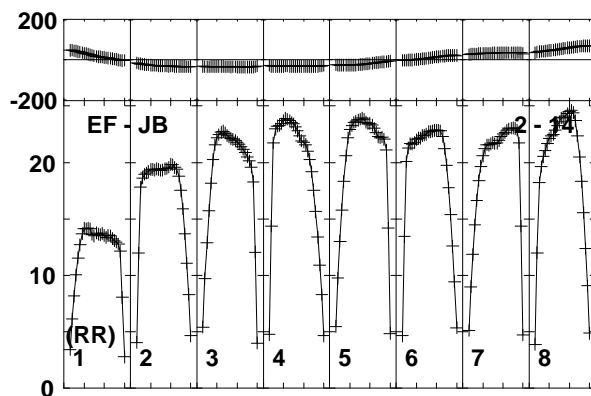
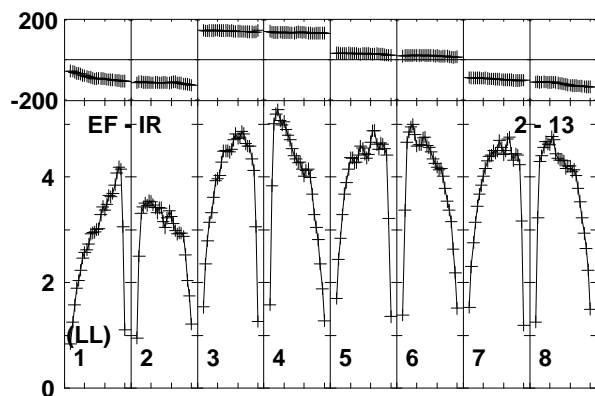
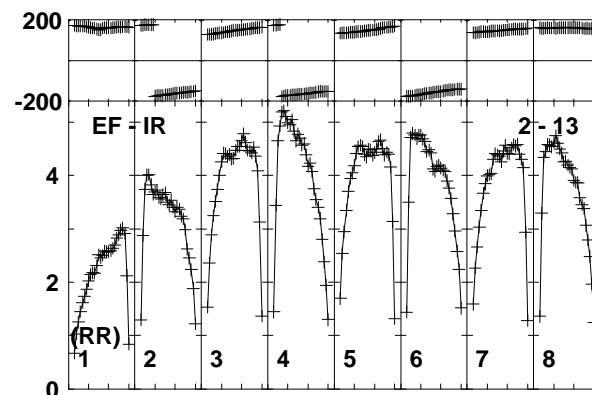
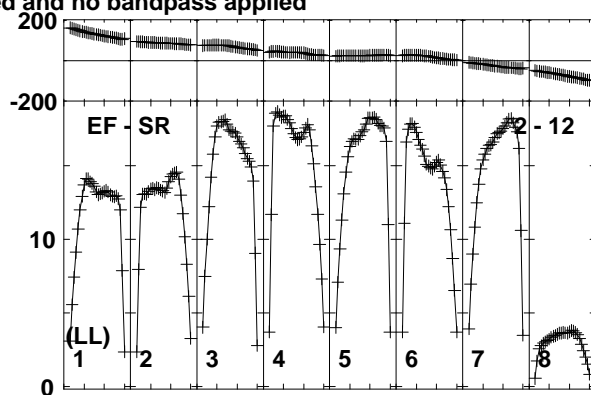
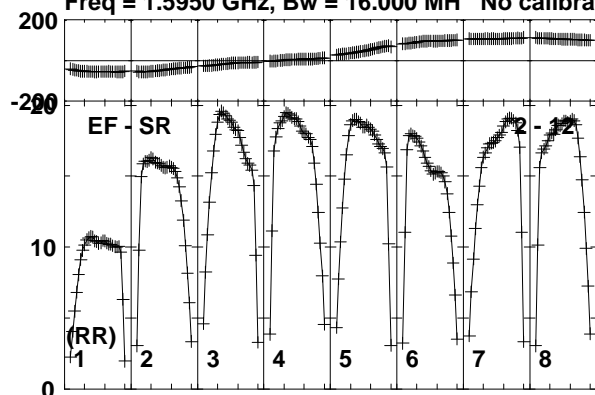

Lower frame: Milli Ampl Jy Top frame: Phas deg  
Vector averaged cross-power spectrum Baseline: EF (02) - SR (12)  
Timerange: 00/05:10:41 to 00/05:11:59

Plot file version 115 created 30-AUG-2019 17:53:29

ROSS867 EB070.UVDATA.1

Freq = 1.5950 GHz, Bw = 16.000 MH No calibration applied and no bandpass applied

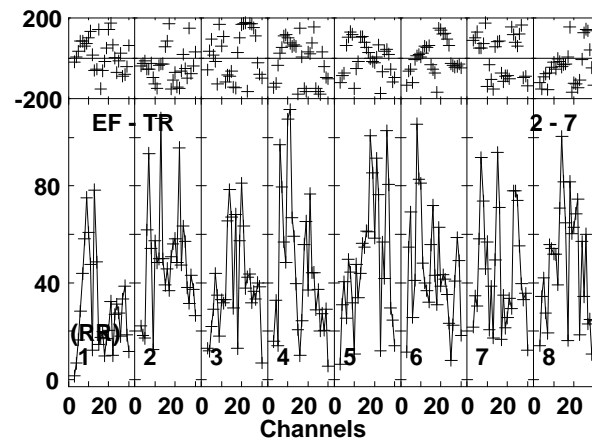
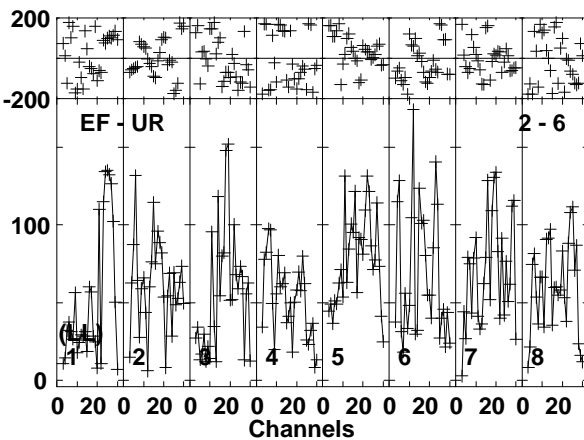
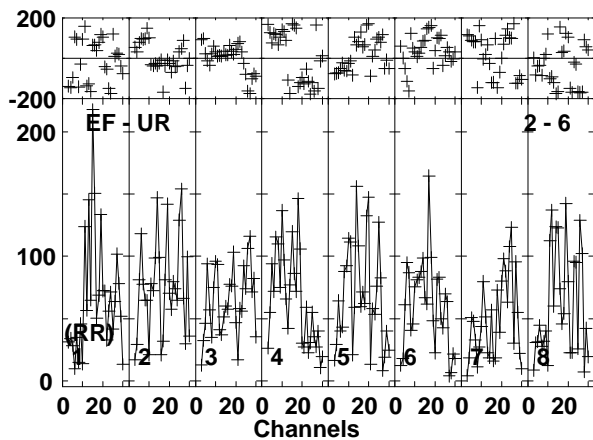
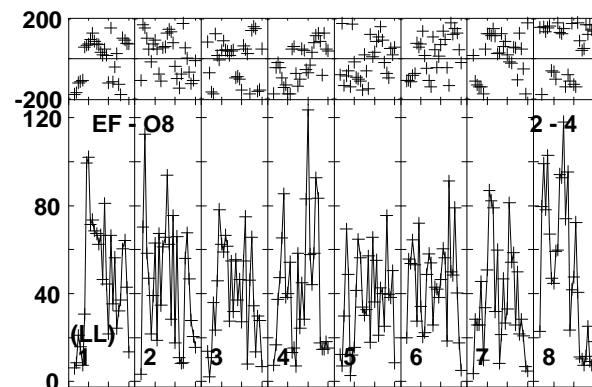
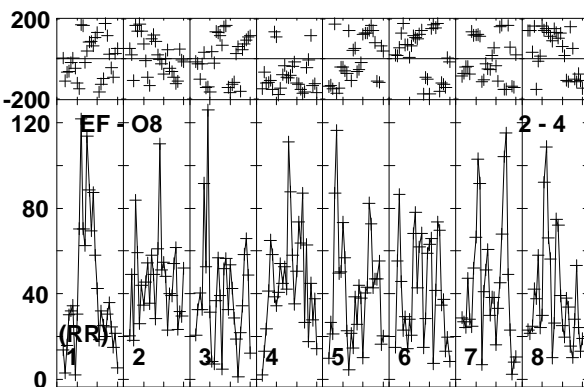
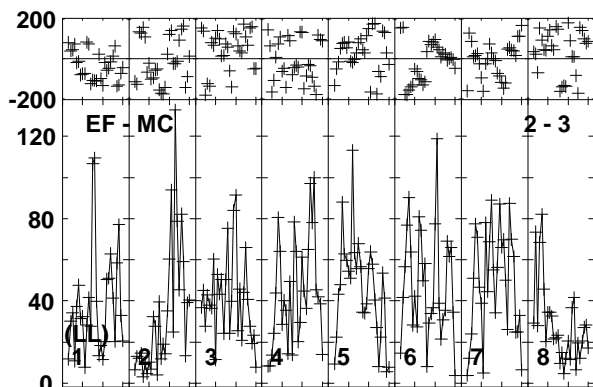
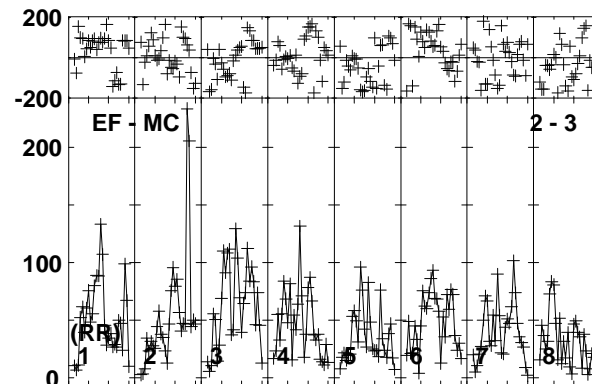
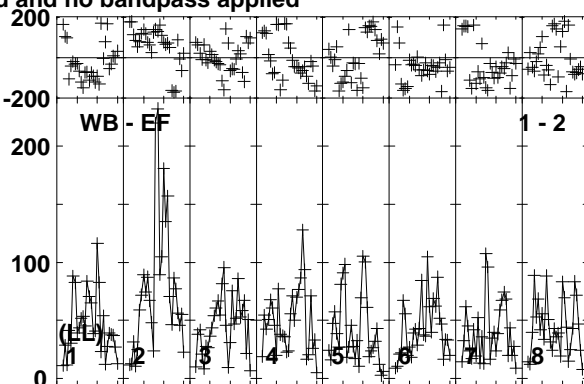
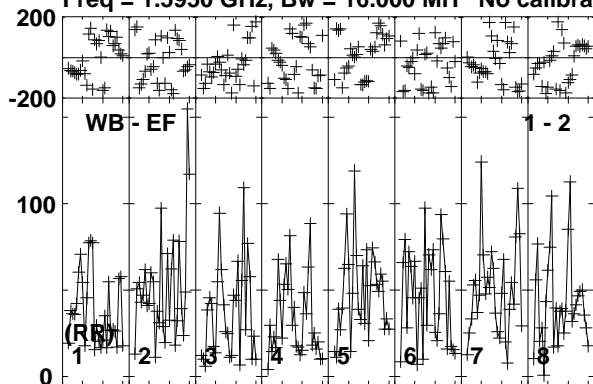

Lower frame: Micro Ampl Jy Top frame: Phas deg  
Vector averaged cross-power spectrum Baseline: WB (01) - EF (02)  
Timerange: 00/05:12:01 to 00/05:19:59

Plot file version 116 created 30-AUG-2019 17:53:29

ROSS867 EB070.UVDATA.1

Freq = 1.5950 GHz, Bw = 16.000 MH No calibration applied and no bandpass applied

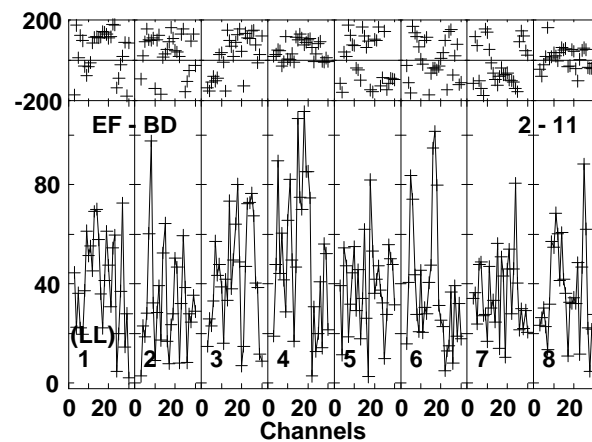
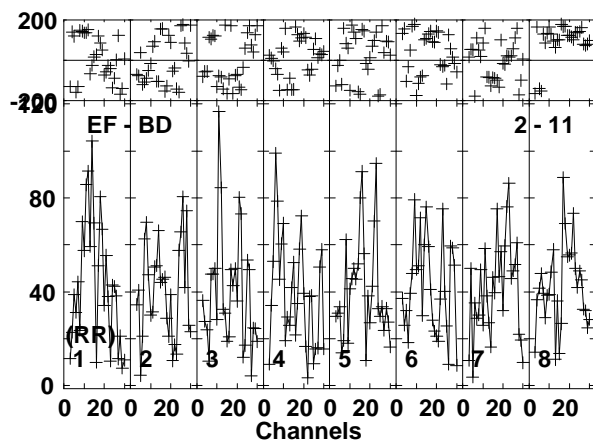
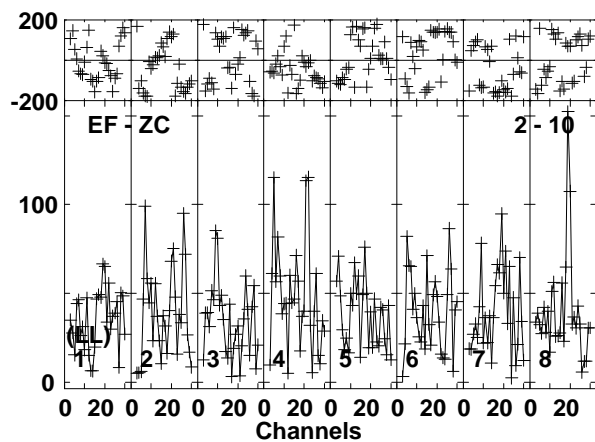
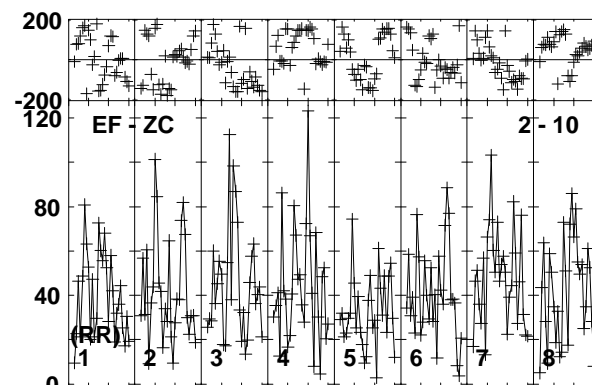
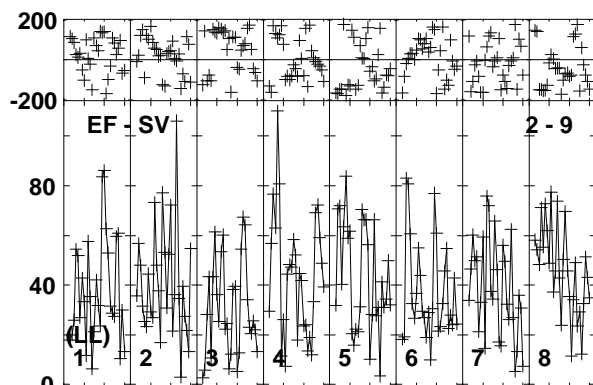
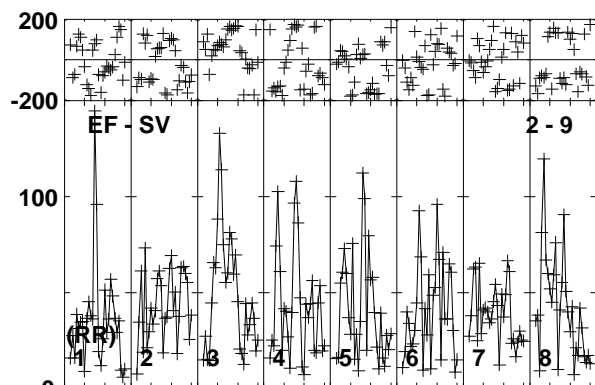
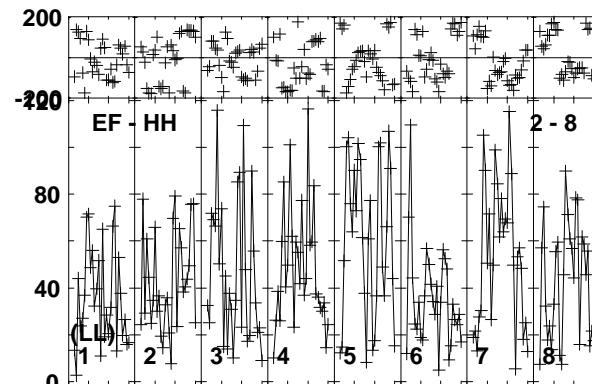
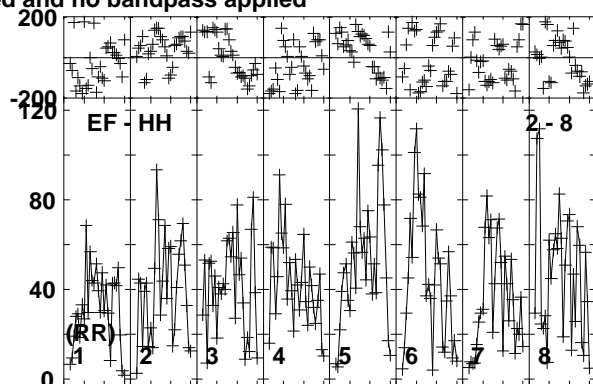
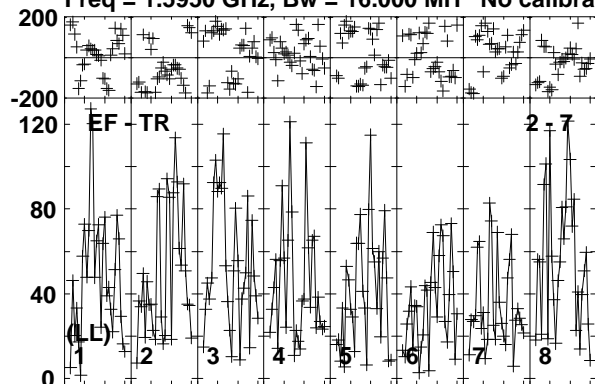

Lower frame: Micro Ampl Jy Top frame: Phas deg  
Vector averaged cross-power spectrum Baseline: EF (02) - TR (07)  
Timerange: 00/05:12:01 to 00/05:19:59

Plot file version 117 created 30-AUG-2019 17:53:29

ROSS867 EB070.UVDATA.1

Freq = 1.5950 GHz, Bw = 16.000 MH No calibration applied and no bandpass applied

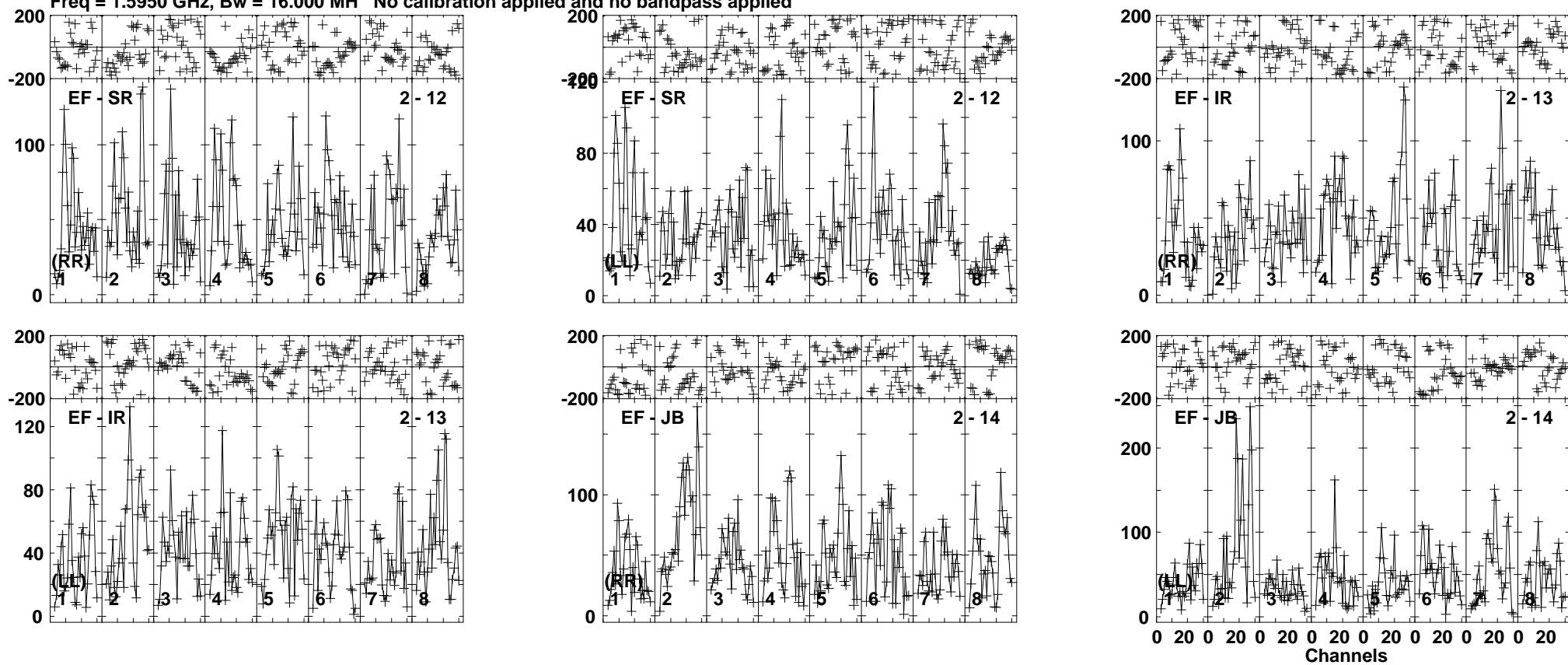

Lower frame: Micro Ampl Jy Top frame: Phas deg  
Vector averaged cross-power spectrum Baseline: EF (02) - SR (12)  
Timerange: 00/05:12:01 to 00/05:19:59

Plot file version 118 created 30-AUG-2019 17:53:29

J1722+2458 EB070.UVDATA.1

Freq = 1.5950 GHz, Bw = 16.000 MH No calibration applied and no bandpass applied

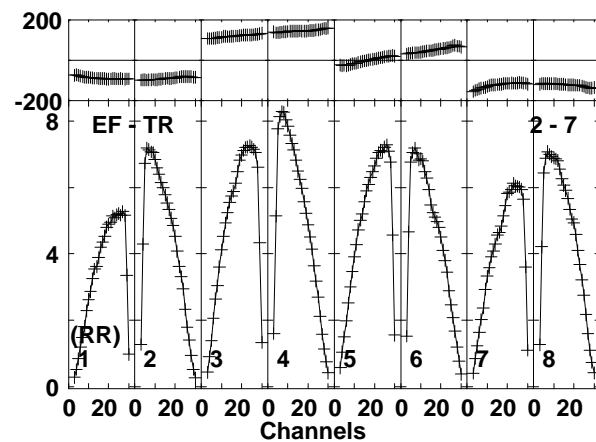
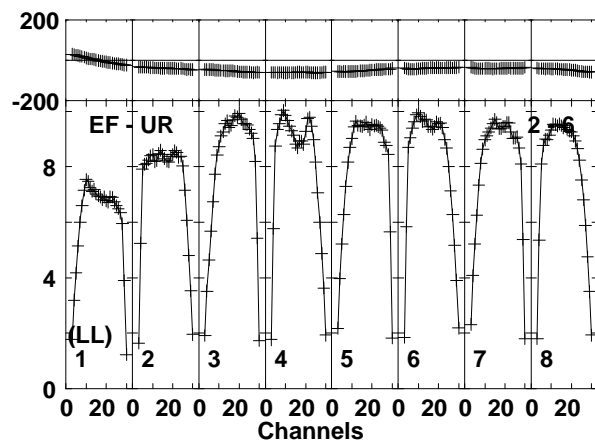
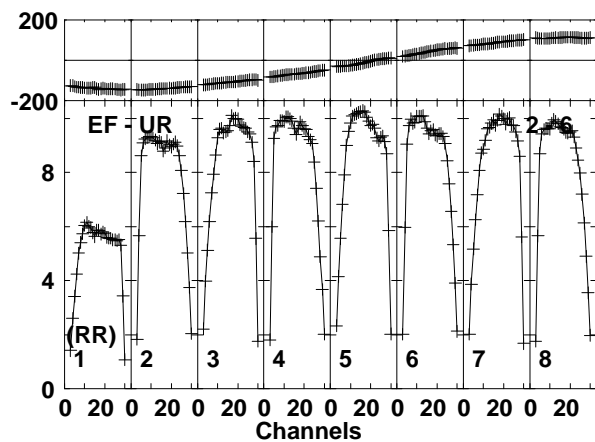
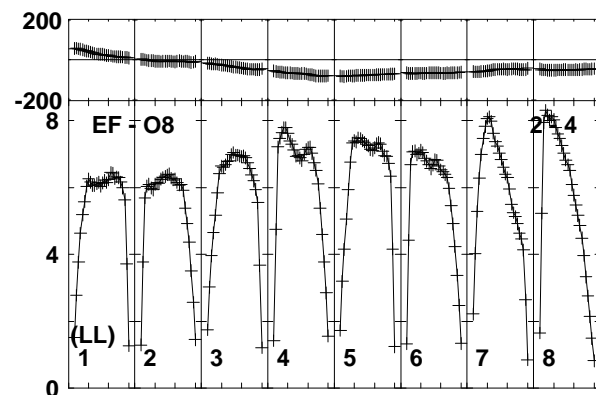
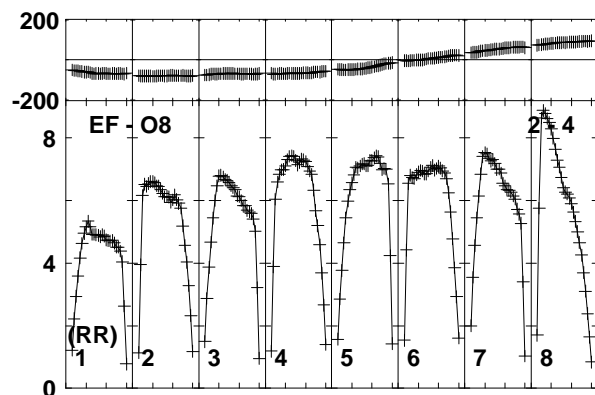
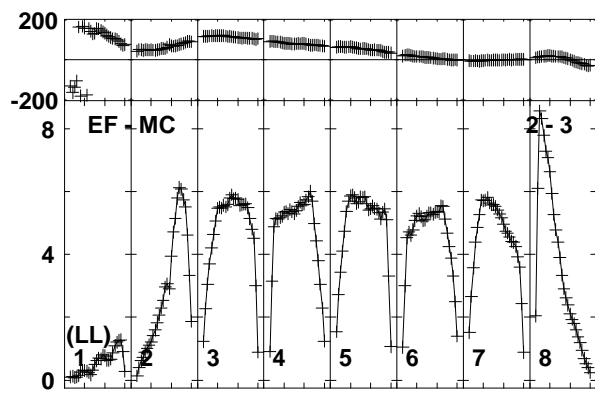
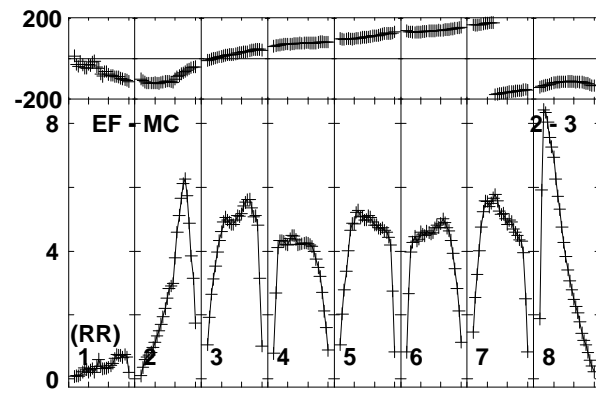
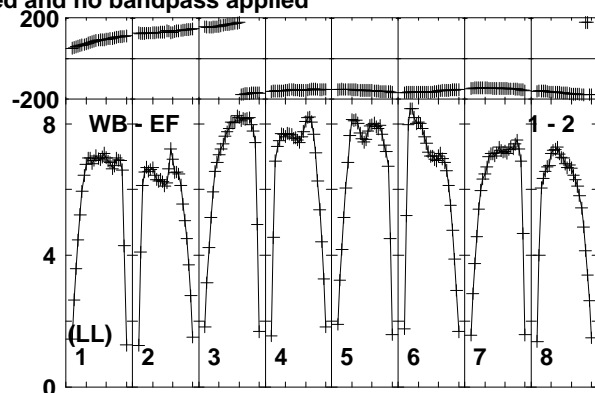
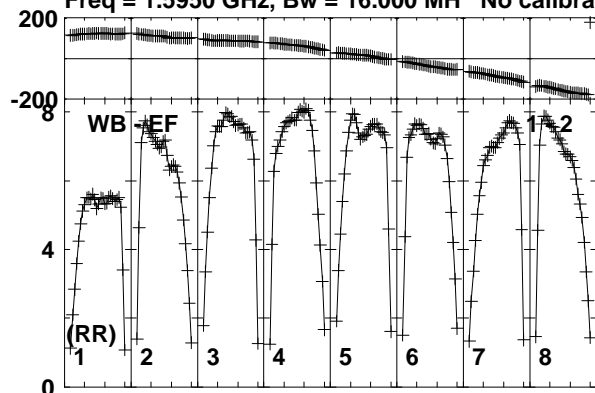

Lower frame: Milli Ampl Jy Top frame: Phas deg  
Vector averaged cross-power spectrum Baseline: WB (01) - EF (02)  
Timerange: 00/05:20:01 to 00/05:21:59

Plot file version 119 created 30-AUG-2019 17:53:30

J1722+2458 EB070.UVDATA.1

Freq = 1.5950 GHz, Bw = 16.000 MH No calibration applied and no bandpass applied

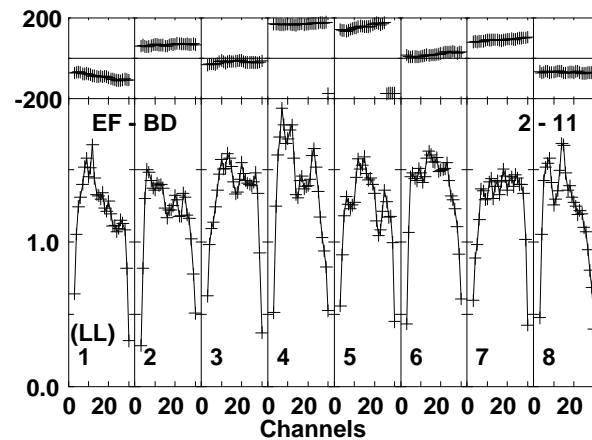
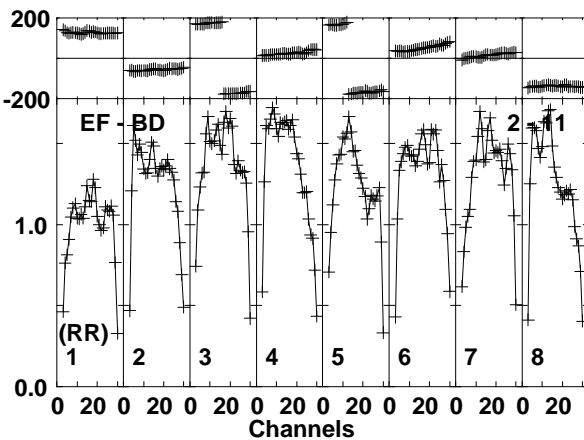
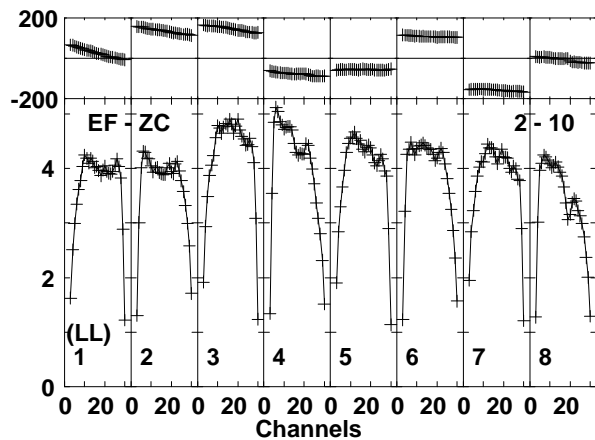
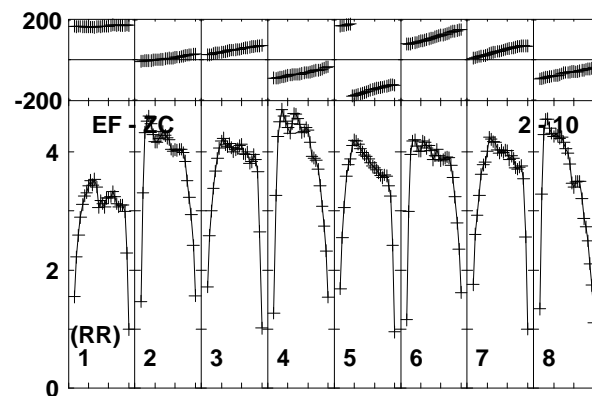
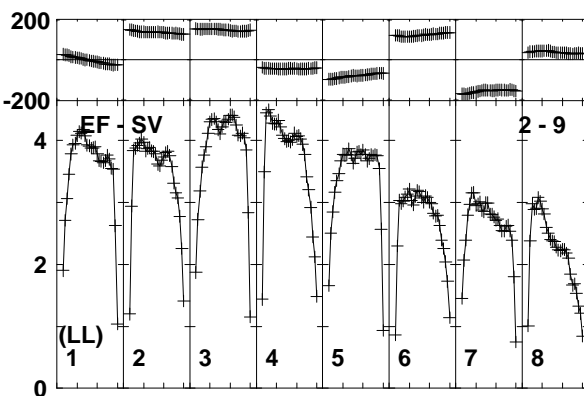
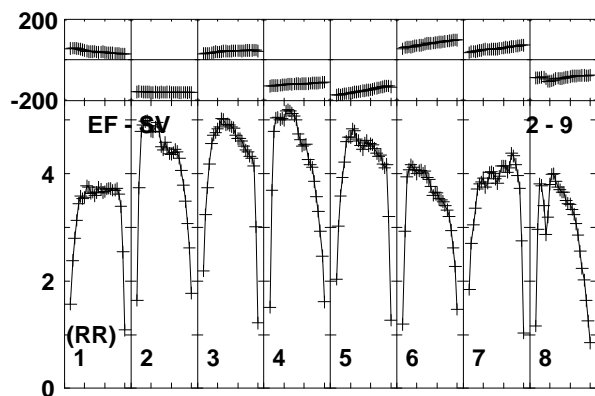
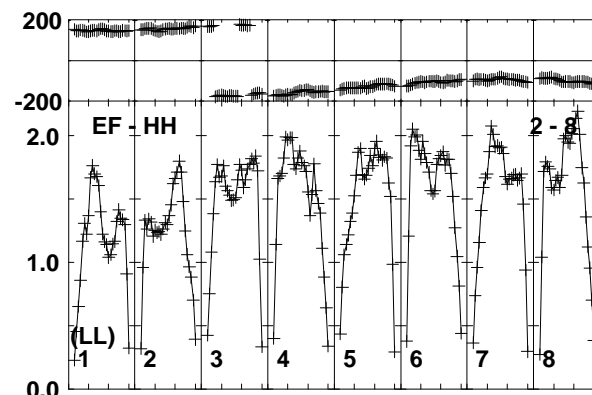
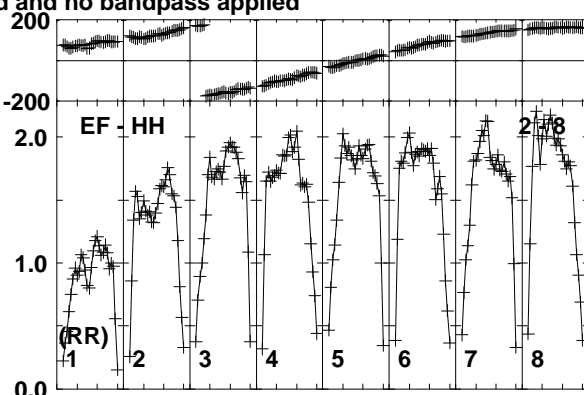
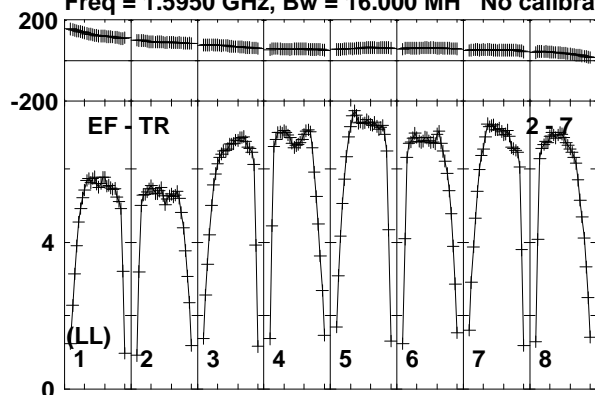

Lower frame: Milli Ampl Jy Top frame: Phas deg  
Vector averaged cross-power spectrum Baseline: EF (02) - TR (07)  
Timerange: 00/05:20:01 to 00/05:21:59

Plot file version 120 created 30-AUG-2019 17:53:30

J1722+2458 EB070.UVDATA.1

Freq = 1.5950 GHz, Bw = 16.000 MH No calibration applied and no bandpass applied

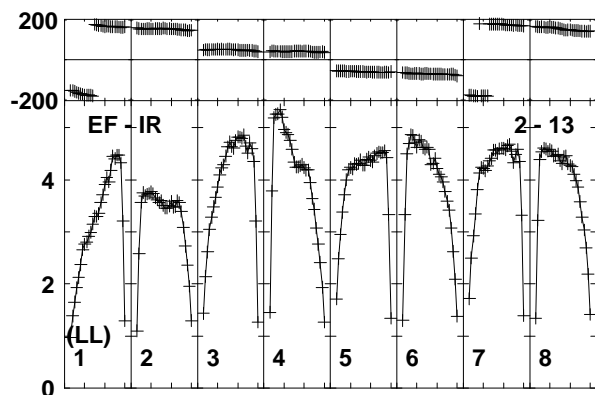
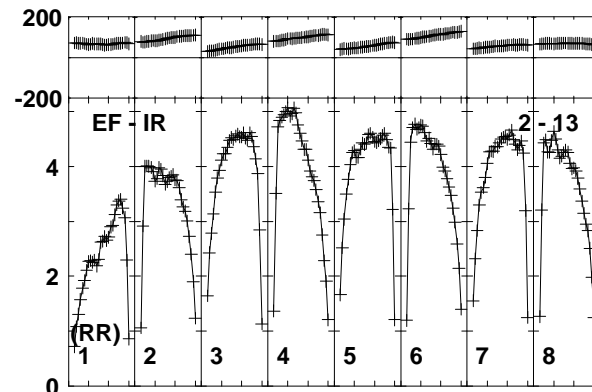
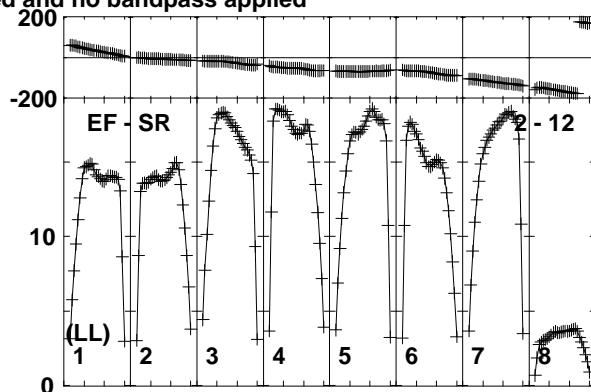
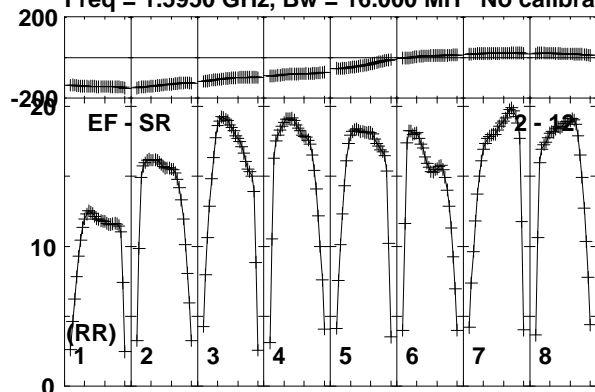

Lower frame: Milli Ampl Jy Top frame: Phas deg  
Vector averaged cross-power spectrum Baseline: EF (02) - SR (12)  
Timerange: 00/05:20:01 to 00/05:21:59



Plot file version 121 created 30-AUG-2019 17:53:30

ROSS867 EB070.UVDATA.1

Freq = 1.5950 GHz, Bw = 16.000 MH No calibration applied and no bandpass applied

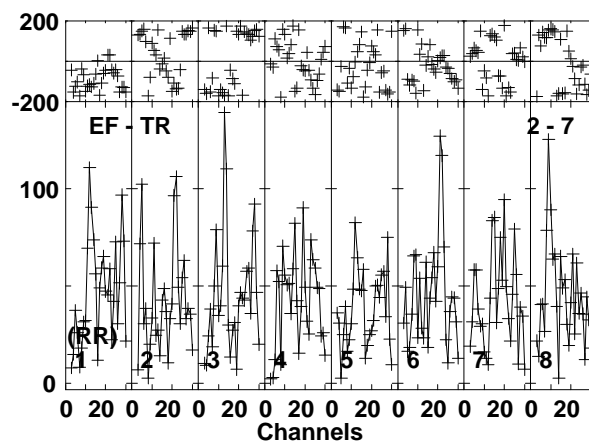
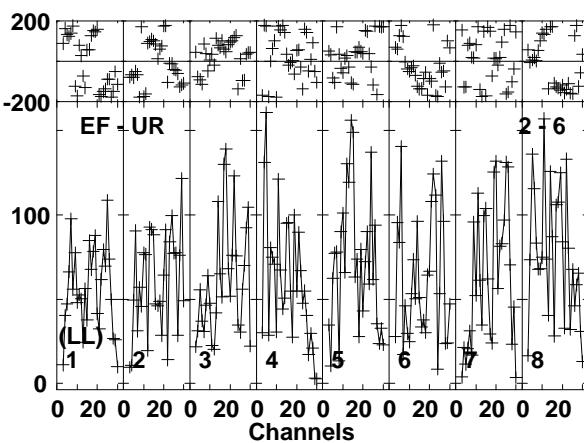
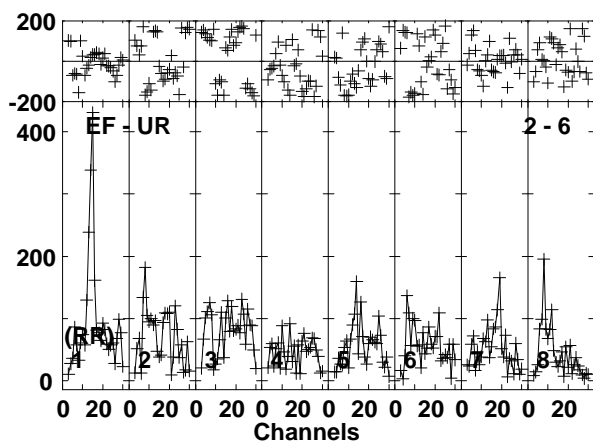
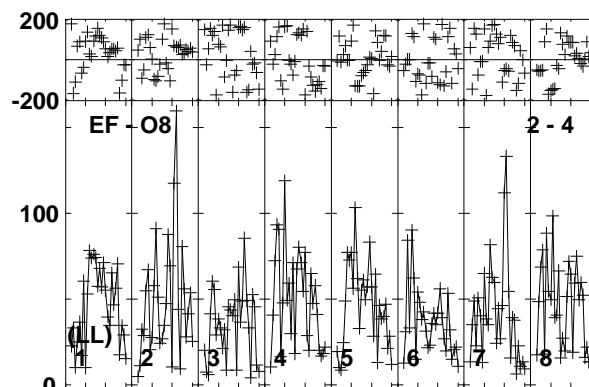
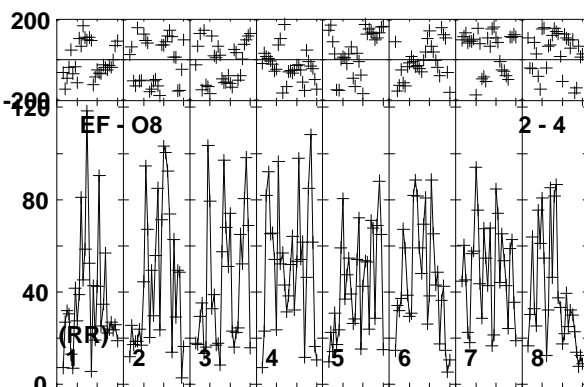
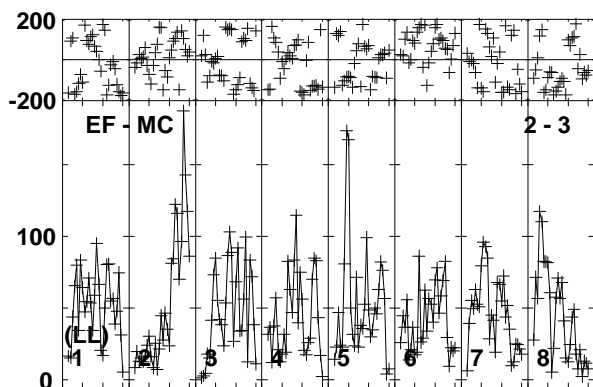
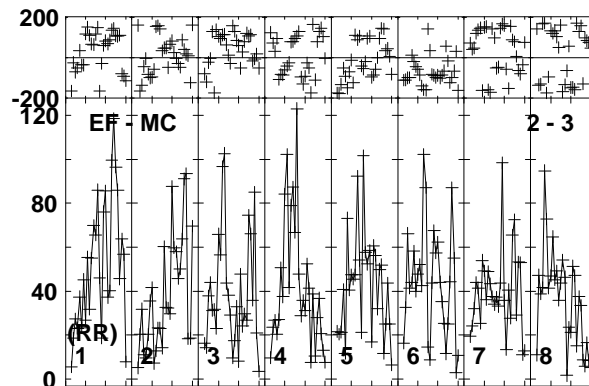
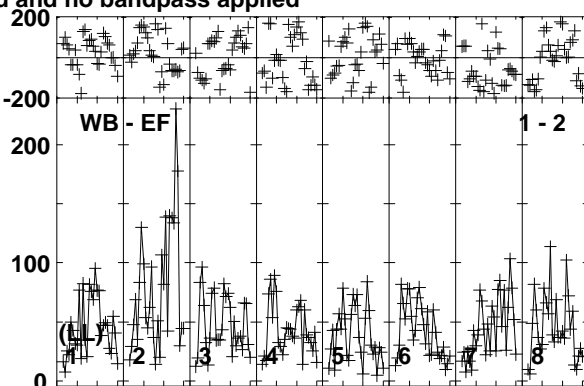
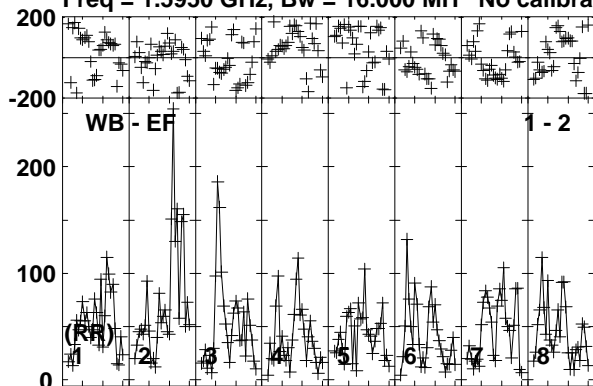

Lower frame: Micro Ampl Jy Top frame: Phas deg  
Vector averaged cross-power spectrum Baseline: WB (01) - EF (02)  
Timerange: 00/05:22:01 to 00/05:29:59

Plot file version 122 created 30-AUG-2019 17:53:30

ROSS867 EB070.UVDATA.1

Freq = 1.5950 GHz, Bw = 16.000 MH No calibration applied and no bandpass applied

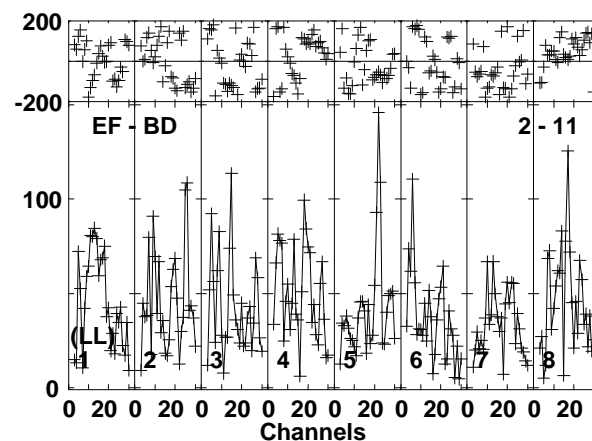
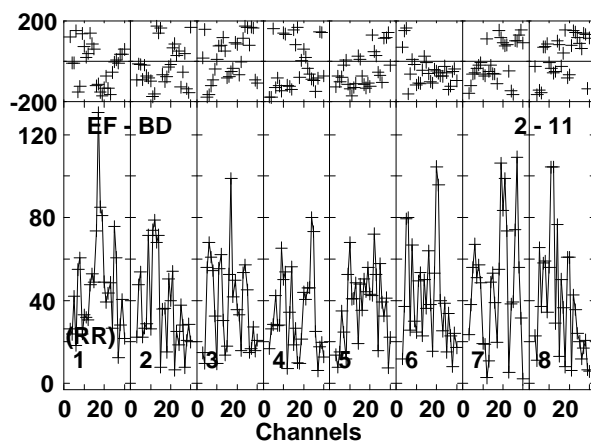
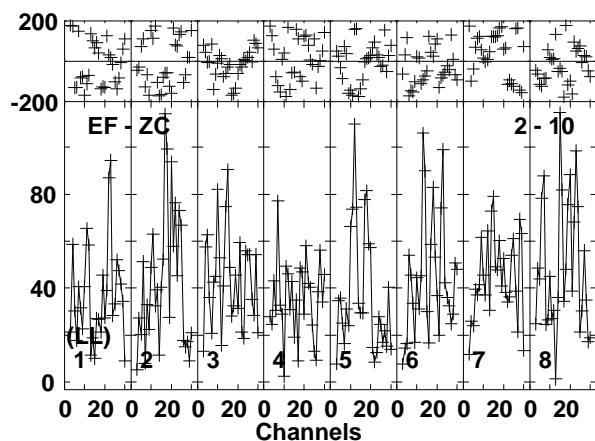
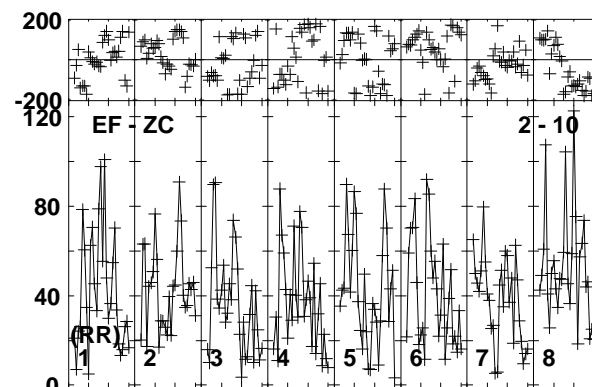
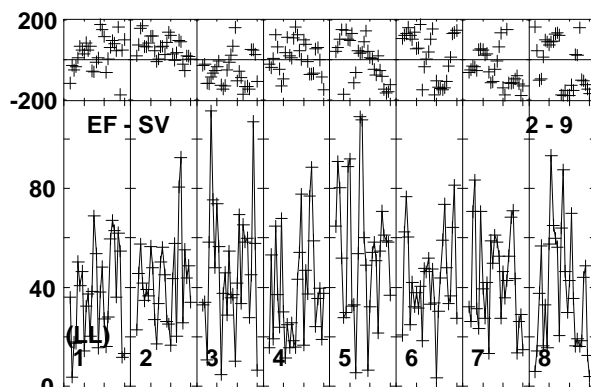
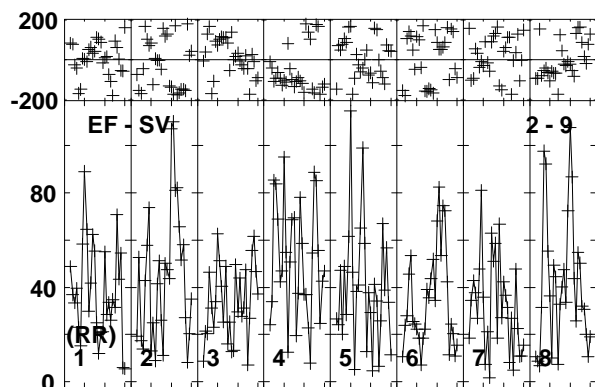
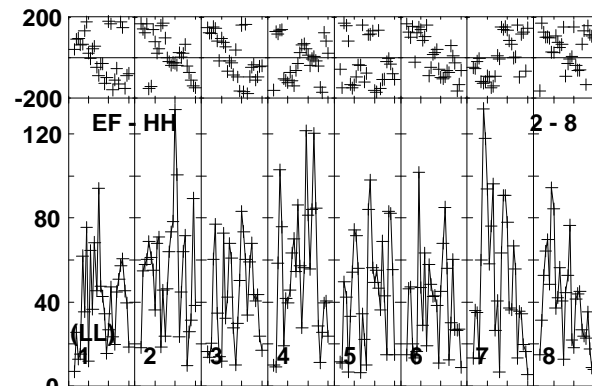
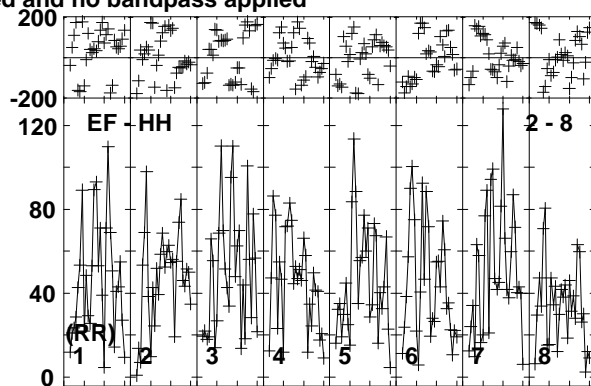
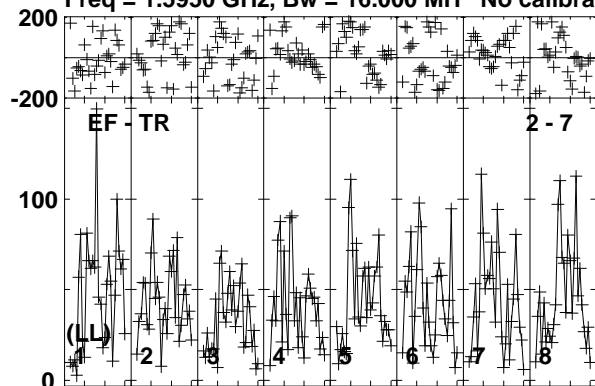

Lower frame: Micro Ampl Jy Top frame: Phas deg  
Vector averaged cross-power spectrum Baseline: EF (02) - TR (07)  
Timerange: 00/05:22:01 to 00/05:29:59

Plot file version 123 created 30-AUG-2019 17:53:30

ROSS867 EB070.UVDATA.1

Freq = 1.5950 GHz, Bw = 16.000 MH No calibration applied and no bandpass applied

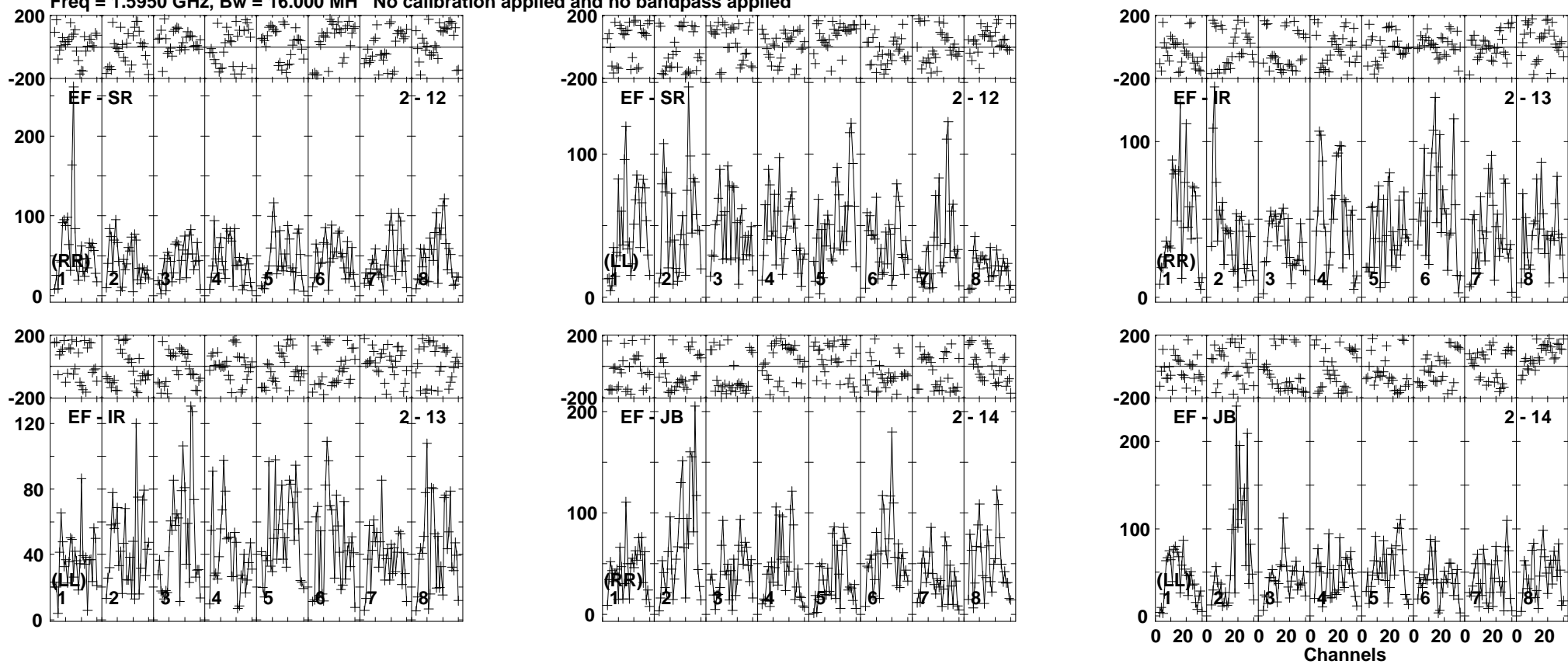

Lower frame: Micro Ampl Jy Top frame: Phas deg  
Vector averaged cross-power spectrum Baseline: EF (02) - SR (12)  
Timerange: 00/05:22:01 to 00/05:29:59

Plot file version 124 created 30-AUG-2019 17:53:31

J1722+2458 EB070.UVDATA.1

Freq = 1.5950 GHz, Bw = 16.000 MH No calibration applied and no bandpass applied

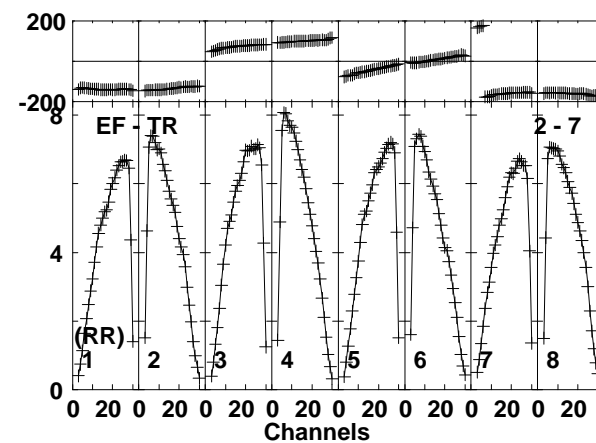
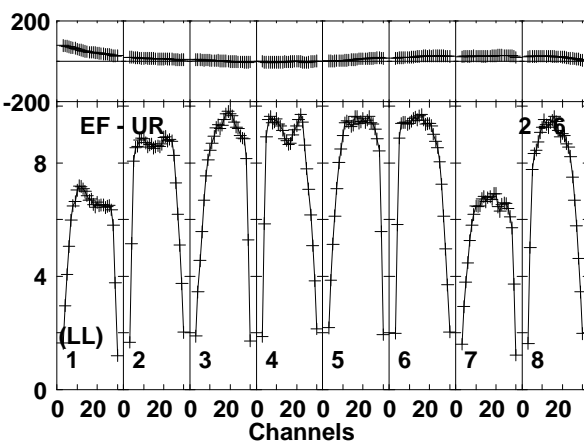
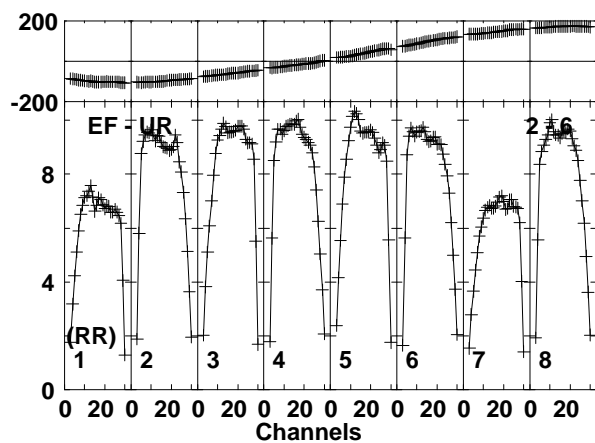
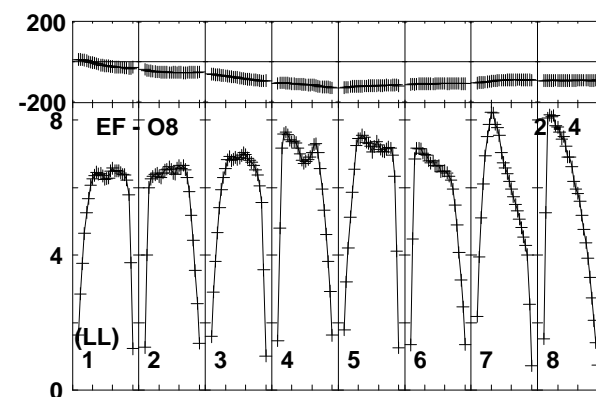
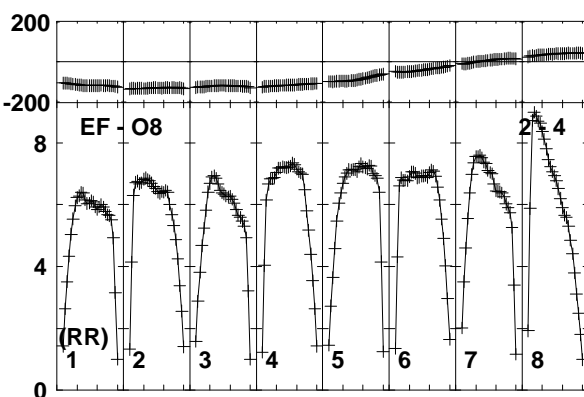
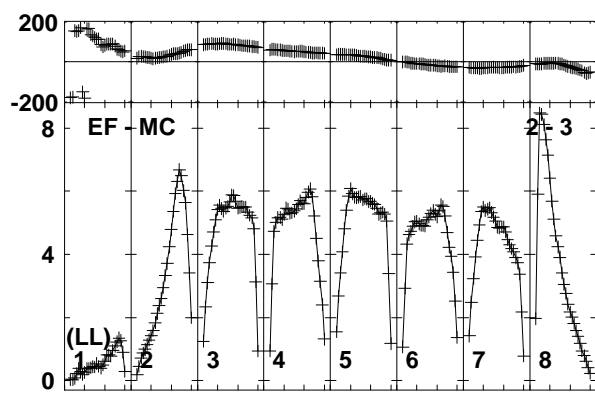
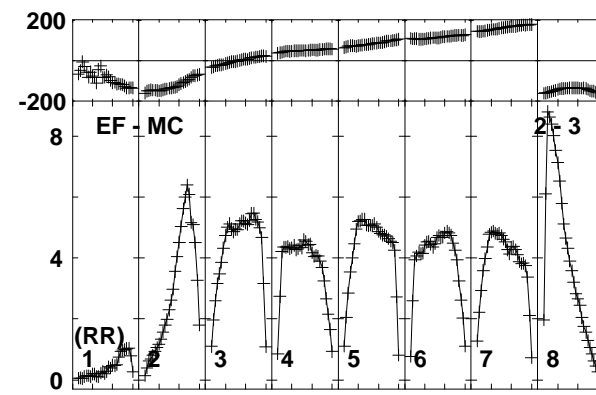
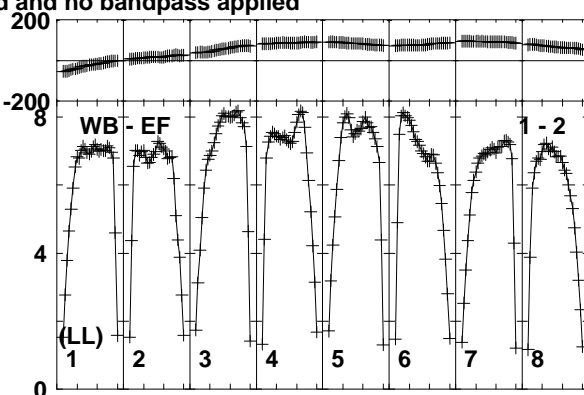
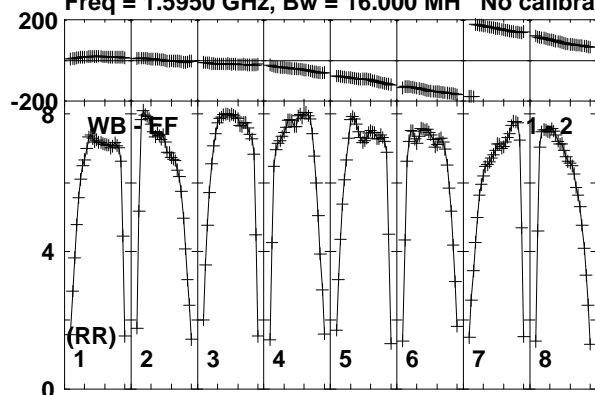

Lower frame: Milli Ampl Jy Top frame: Phas deg  
Vector averaged cross-power spectrum Baseline: WB (01) - EF (02)  
Timerange: 00/05:30:41 to 00/05:31:59

Plot file version 125 created 30-AUG-2019 17:53:31

J1722+2458 EB070.UVDATA.1

Freq = 1.5950 GHz, Bw = 16.000 MH No calibration applied and no bandpass applied

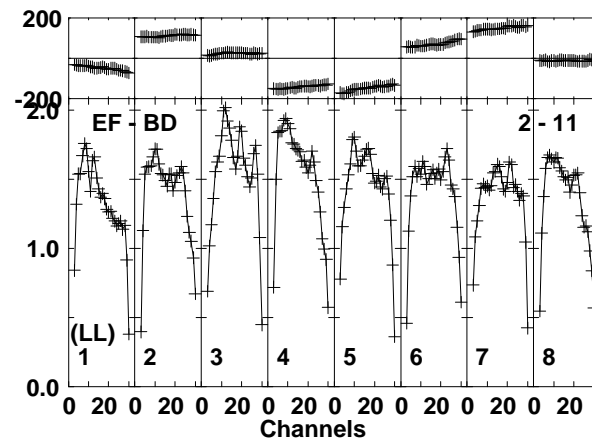
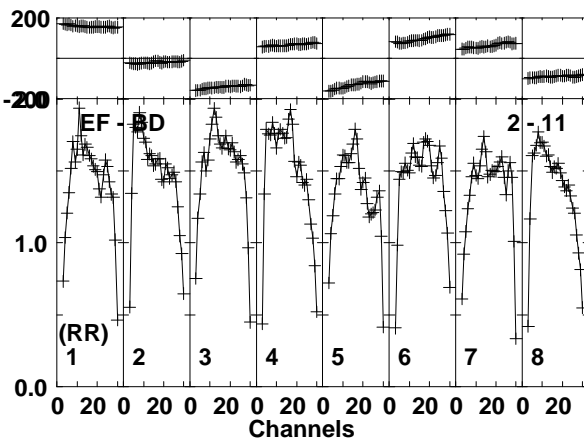
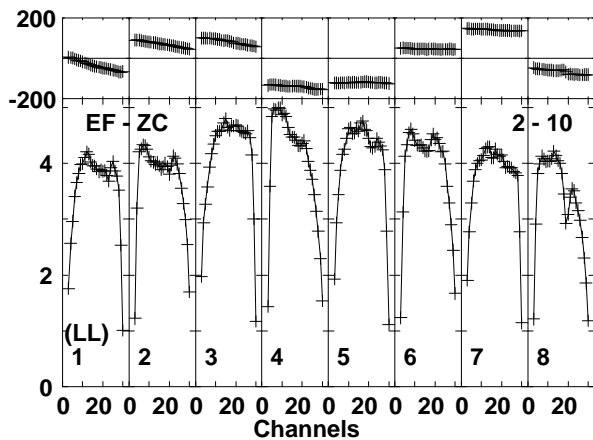
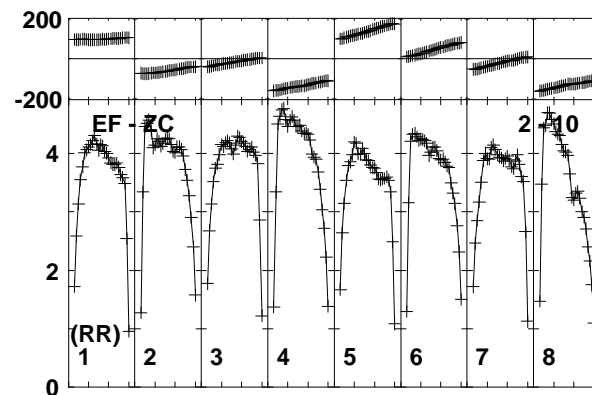
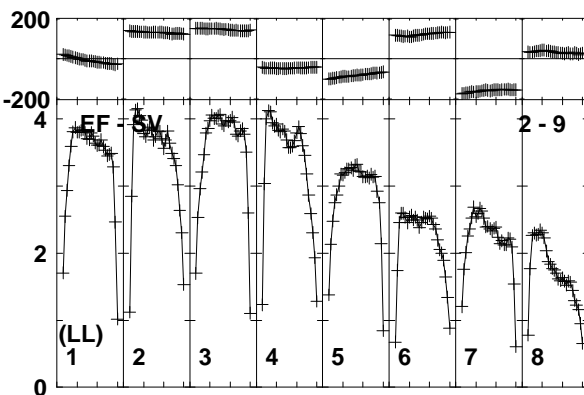
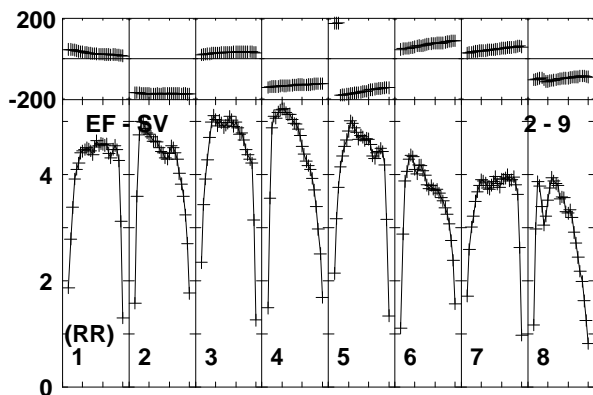
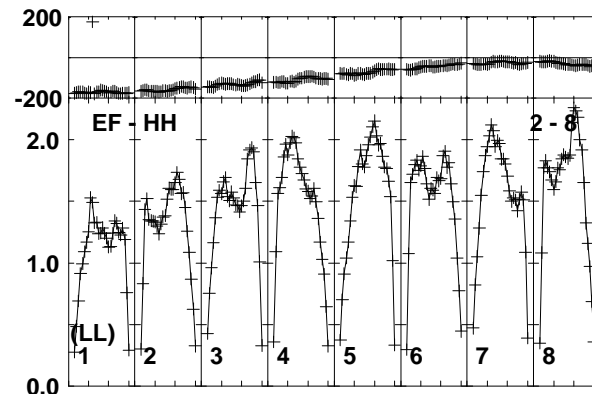
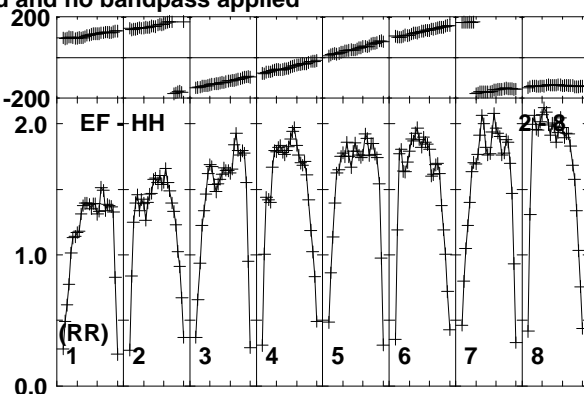
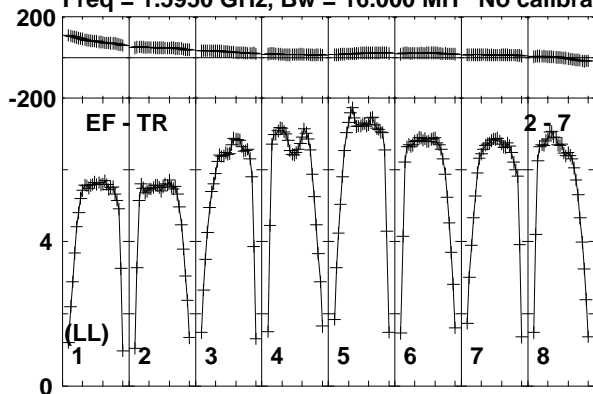

Lower frame: Milli Ampl Jy Top frame: Phas deg  
Vector averaged cross-power spectrum Baseline: EF (02) - TR (07)  
Timerange: 00/05:30:41 to 00/05:31:59

Plot file version 126 created 30-AUG-2019 17:53:31

J1722+2458 EB070.UVDATA.1

Freq = 1.5950 GHz, Bw = 16.000 MH No calibration applied and no bandpass applied

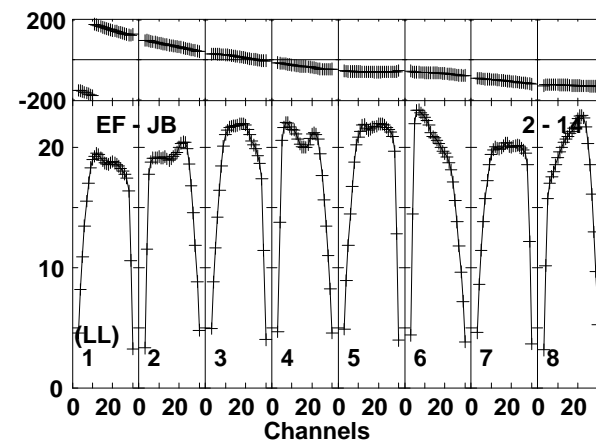
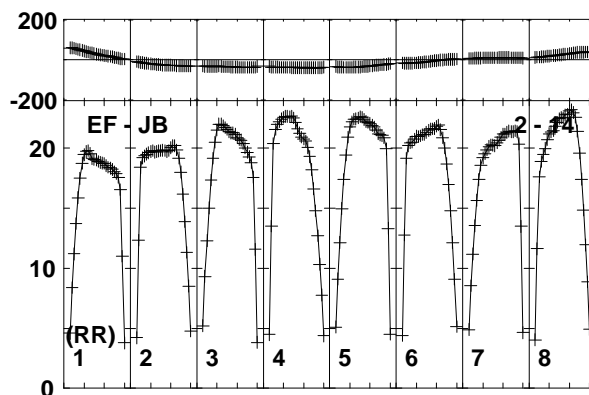
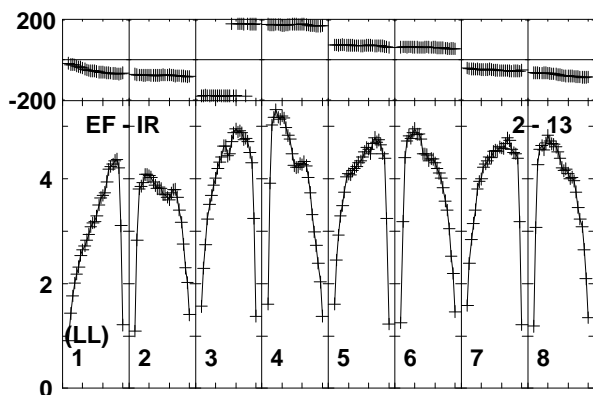
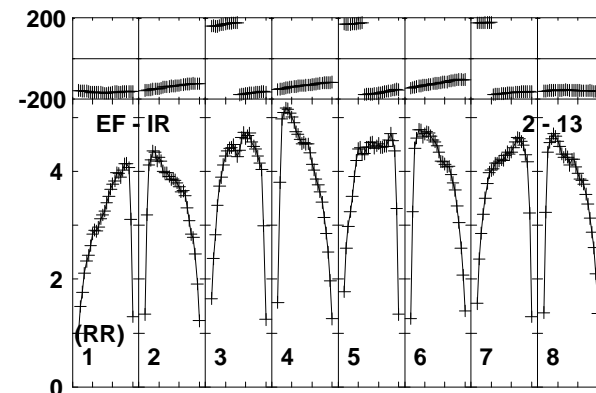
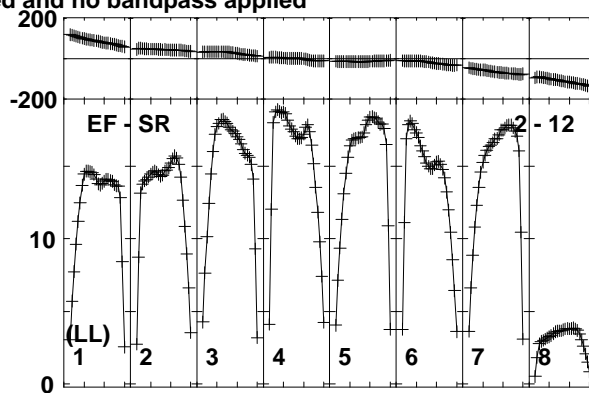
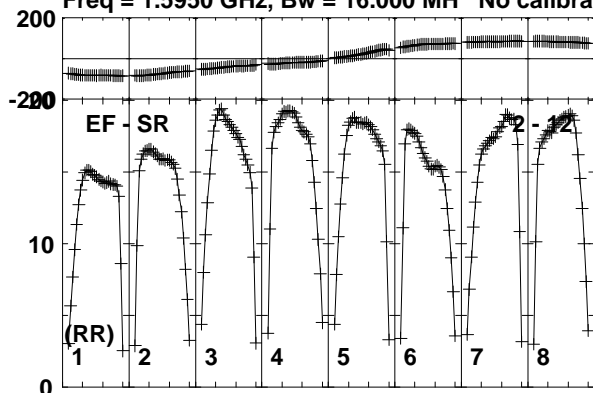

Lower frame: Milli Ampl Jy Top frame: Phas deg  
Vector averaged cross-power spectrum Baseline: EF (02) - SR (12)  
Timerange: 00/05:30:41 to 00/05:31:59

Plot file version 127 created 30-AUG-2019 17:53:31

ROSS867 EB070.UVDATA.1

Freq = 1.5950 GHz, Bw = 16.000 MH No calibration applied and no bandpass applied

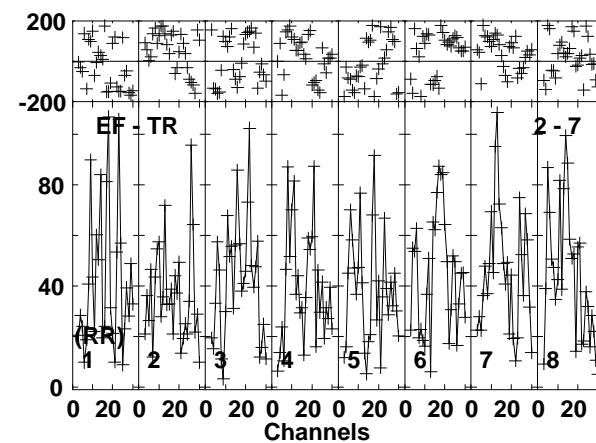
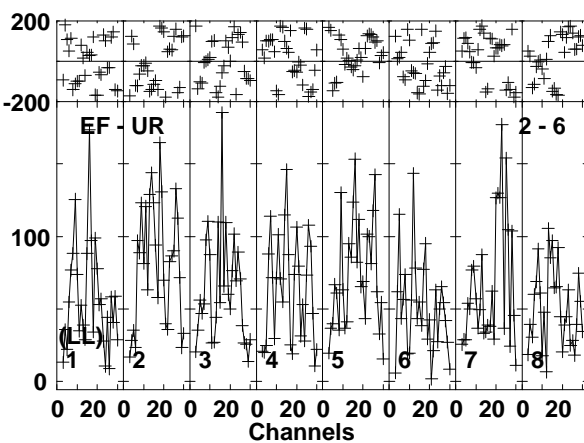
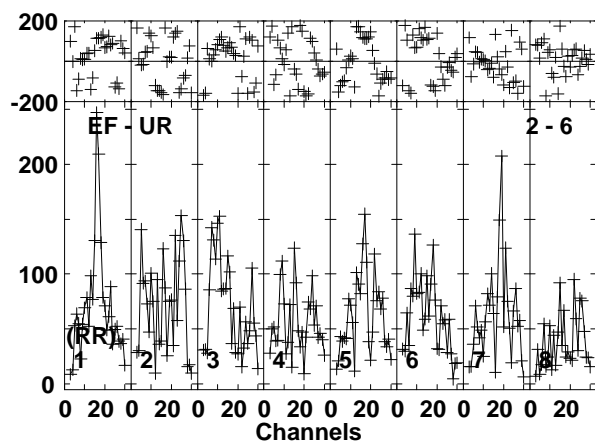
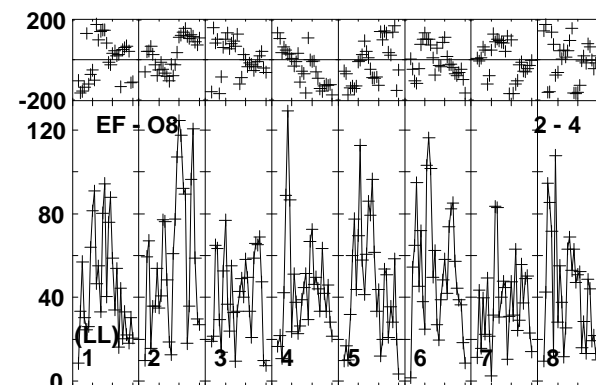
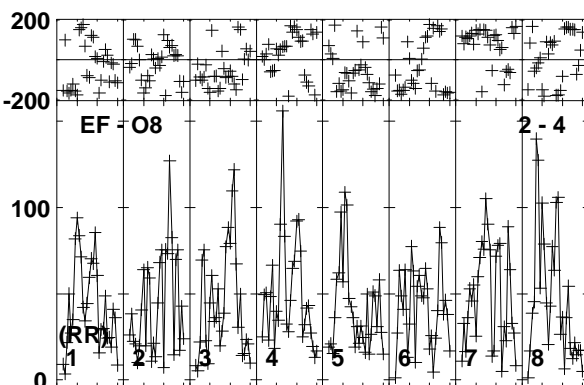
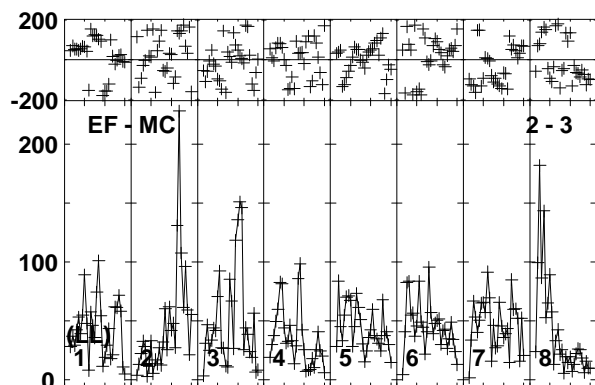
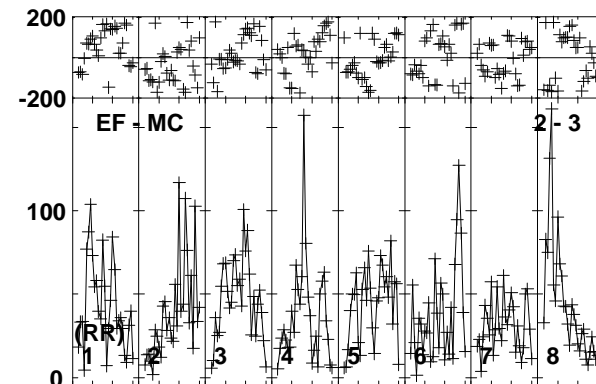
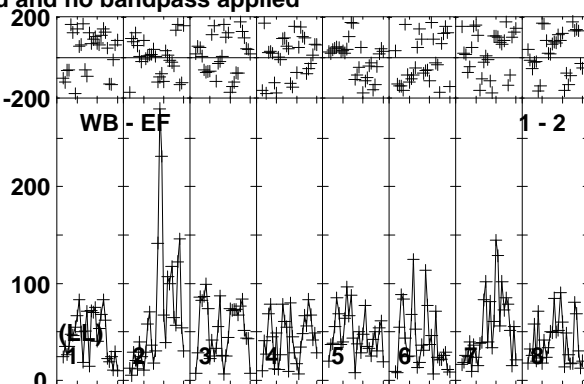
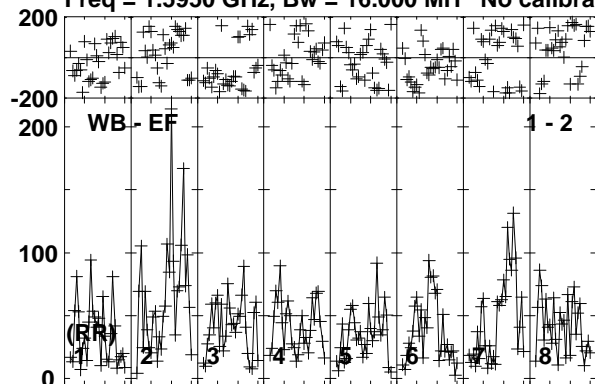

Lower frame: Micro Ampl Jy Top frame: Phas deg  
Vector averaged cross-power spectrum Baseline: WB (01) - EF (02)  
Timerange: 00/05:32:01 to 00/05:39:59

Plot file version 128 created 30-AUG-2019 17:53:31

ROSS867 EB070.UVDATA.1

Freq = 1.5950 GHz, Bw = 16.000 MH No calibration applied and no bandpass applied

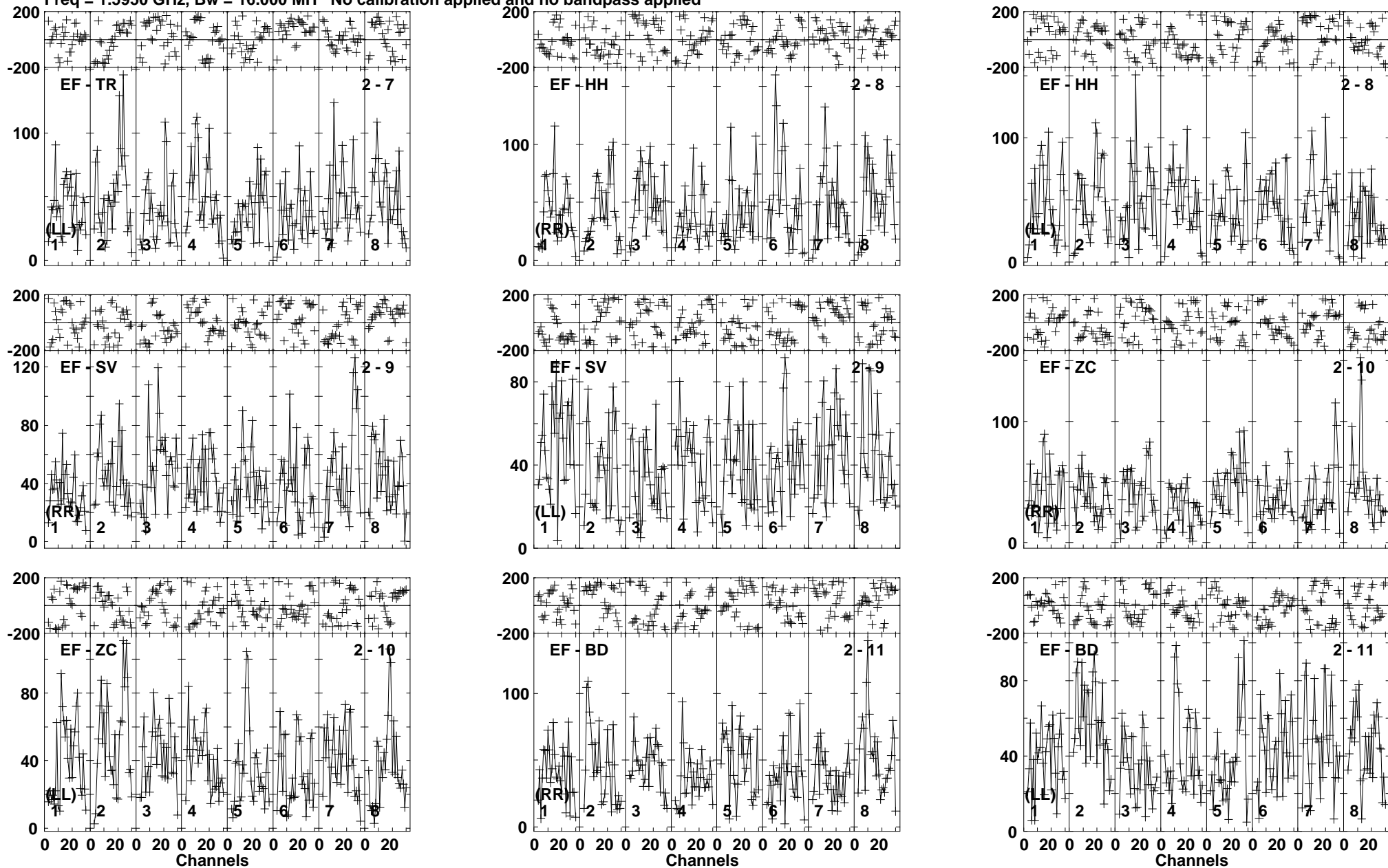

Lower frame: Micro Ampl Jy Top frame: Phas deg  
Vector averaged cross-power spectrum Baseline: EF (02) - TR (07)  
Timerange: 00/05:32:01 to 00/05:39:59



Plot file version 129 created 30-AUG-2019 17:53:32

ROSS867 EB070.UVDATA.1

Freq = 1.5950 GHz, Bw = 16.000 MH No calibration applied and no bandpass applied

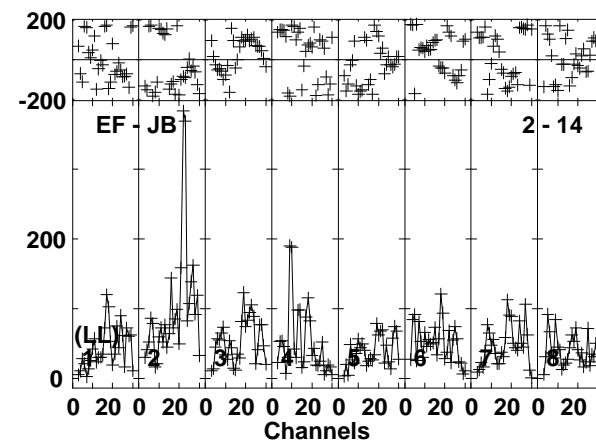
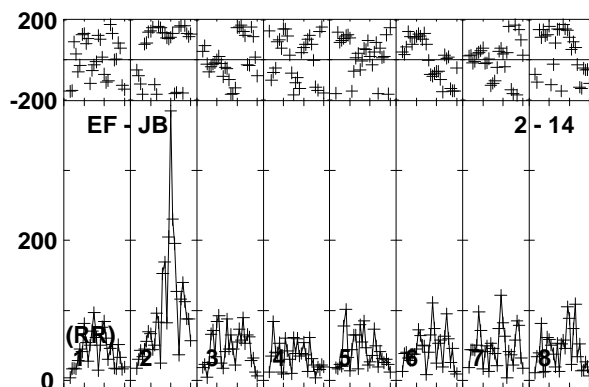
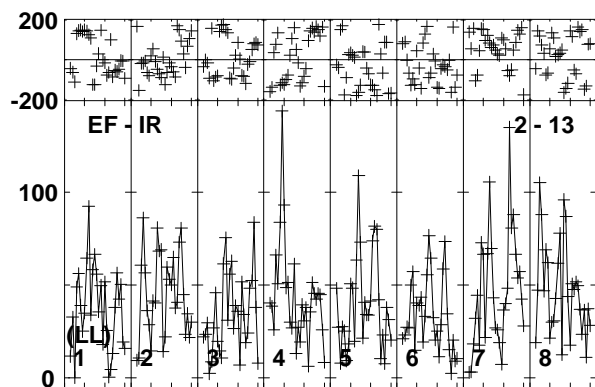
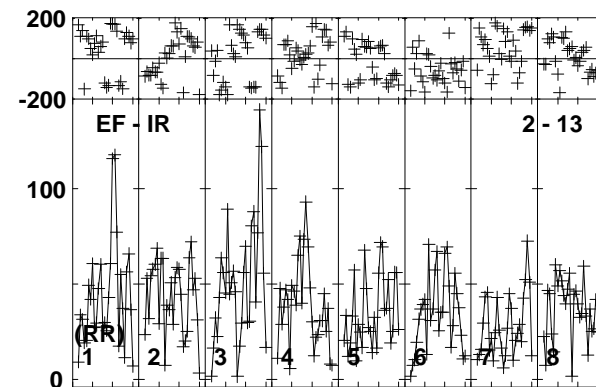
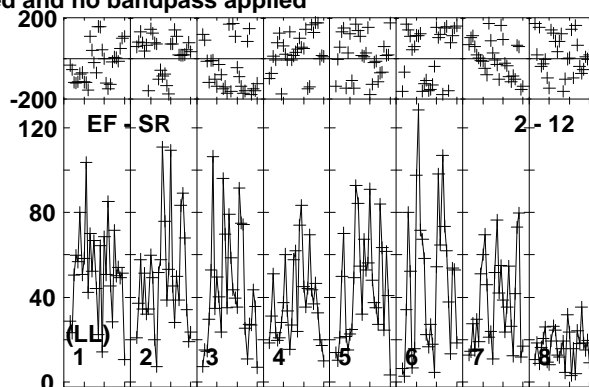
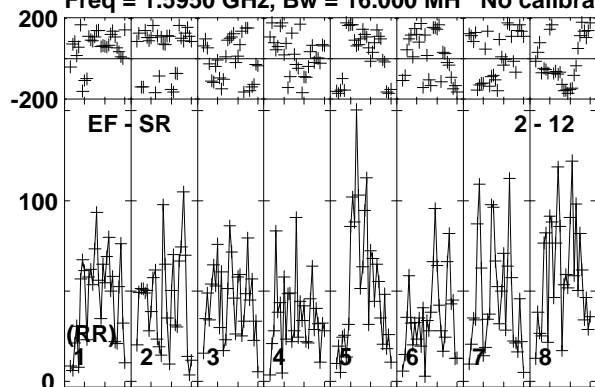

Lower frame: Micro Ampl Jy Top frame: Phas deg  
Vector averaged cross-power spectrum Baseline: EF (02) - SR (12)  
Timerange: 00/05:32:01 to 00/05:39:59

Plot file version 130 created 30-AUG-2019 17:53:32

J1722+2458 EB070.UVDATA.1

Freq = 1.5950 GHz, Bw = 16.000 MH No calibration applied and no bandpass applied

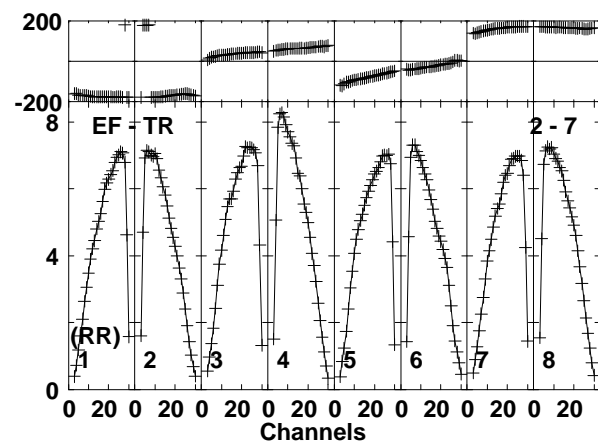
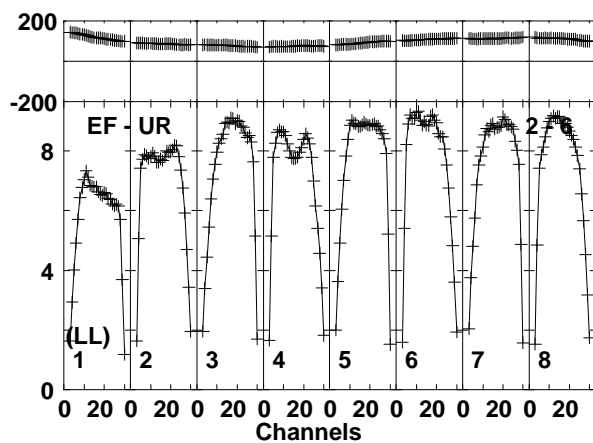
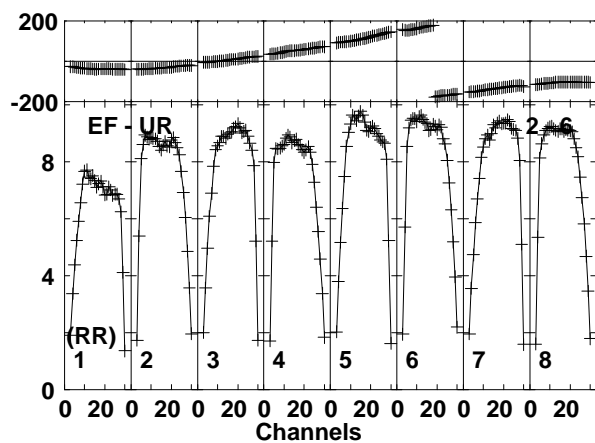
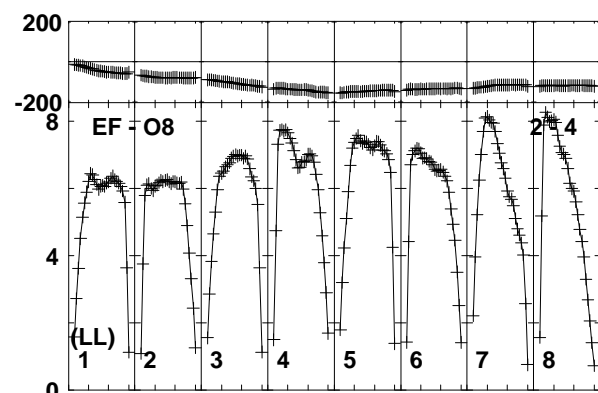
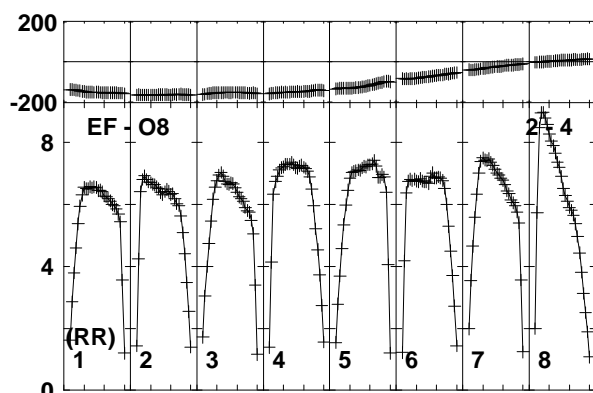
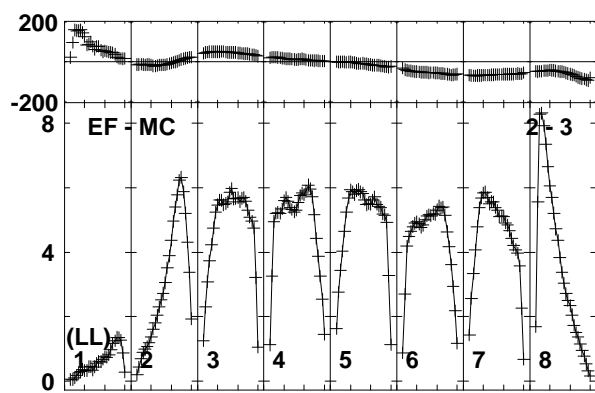
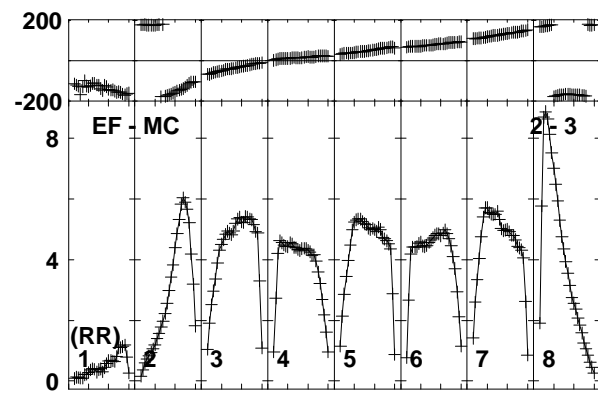
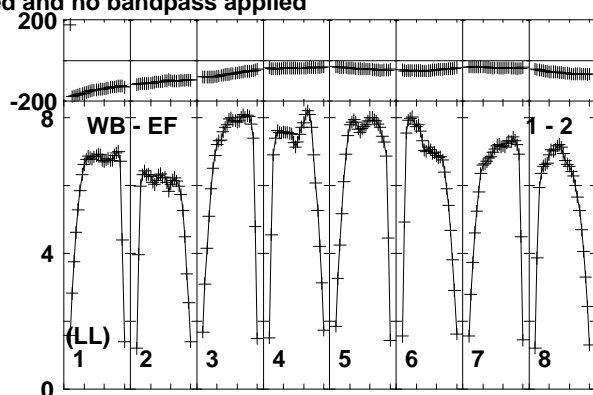
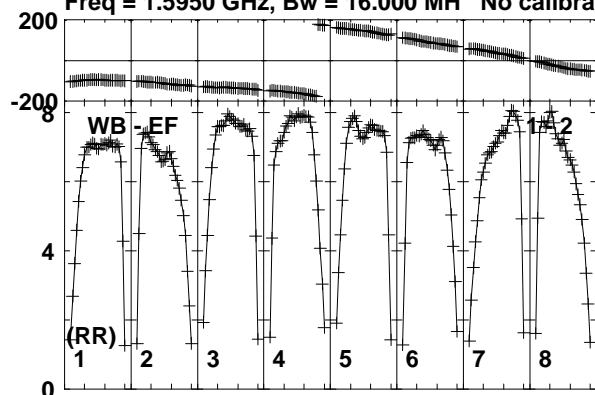

Lower frame: Milli Ampl Jy Top frame: Phas deg  
Vector averaged cross-power spectrum Baseline: WB (01) - EF (02)  
Timerange: 00/05:40:01 to 00/05:41:59

Plot file version 131 created 30-AUG-2019 17:53:32

J1722+2458 EB070.UVDATA.1

Freq = 1.5950 GHz, Bw = 16.000 MH No calibration applied and no bandpass applied

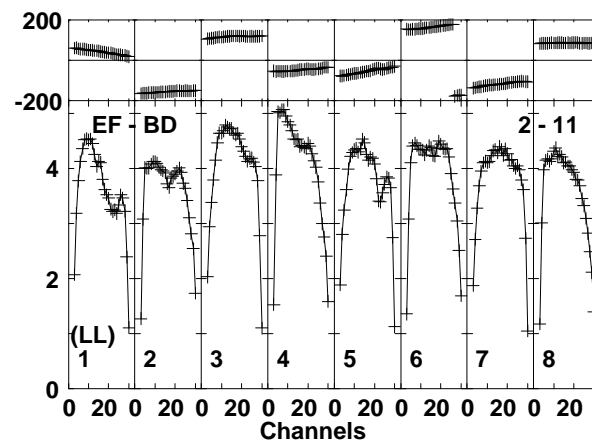
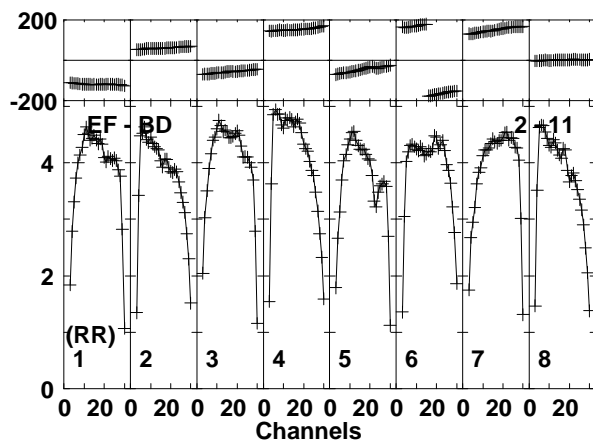
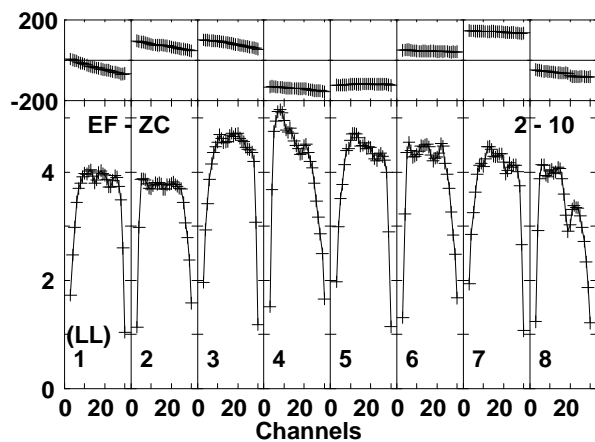
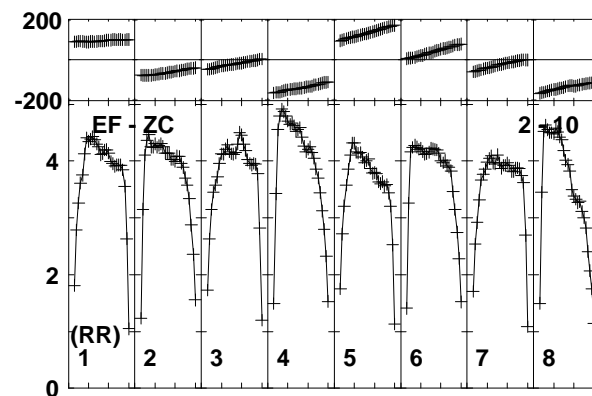
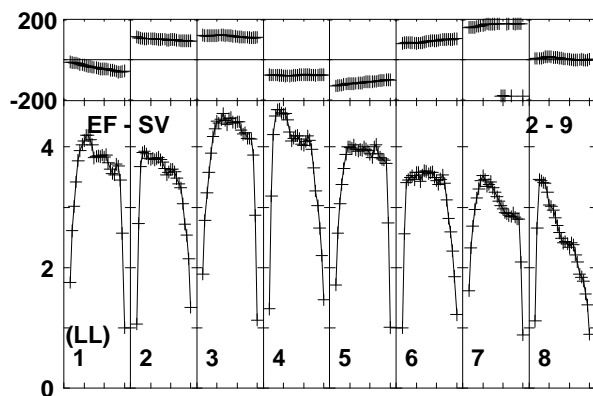
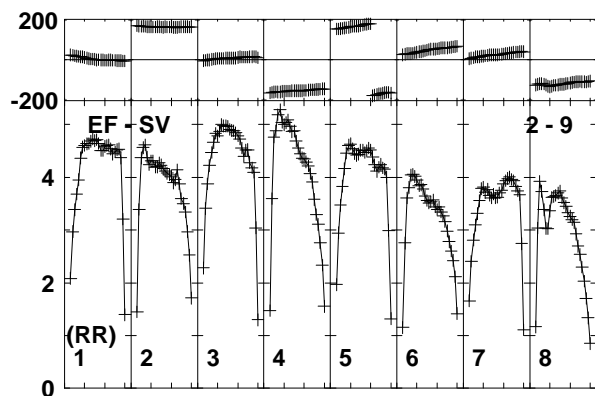
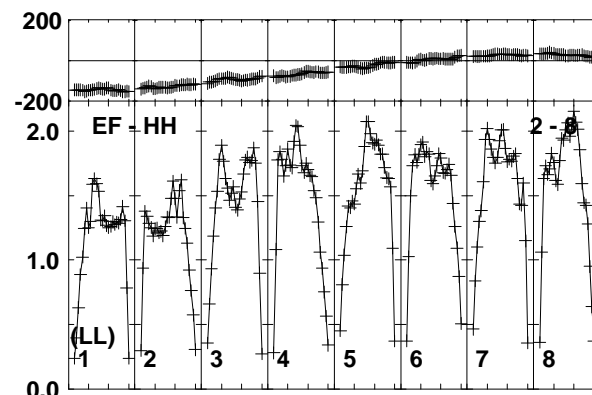
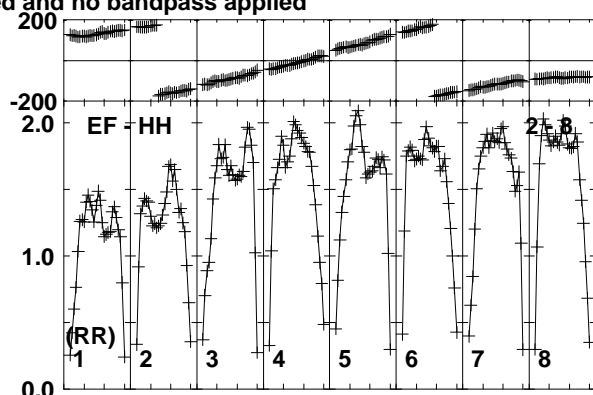
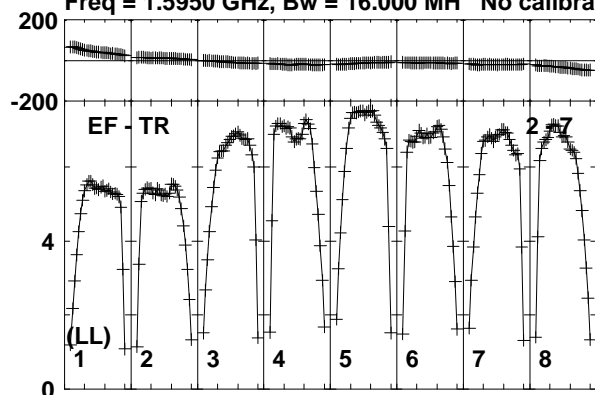

Lower frame: Milli Ampl Jy Top frame: Phas deg  
Vector averaged cross-power spectrum Baseline: EF (02) - TR (07)  
Timerange: 00/05:40:01 to 00/05:41:59

Plot file version 132 created 30-AUG-2019 17:53:32

J1722+2458 EB070.UVDATA.1

Freq = 1.5950 GHz, Bw = 16.000 MH No calibration applied and no bandpass applied

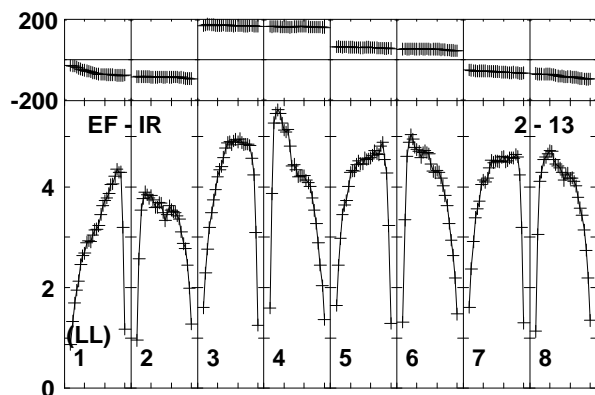
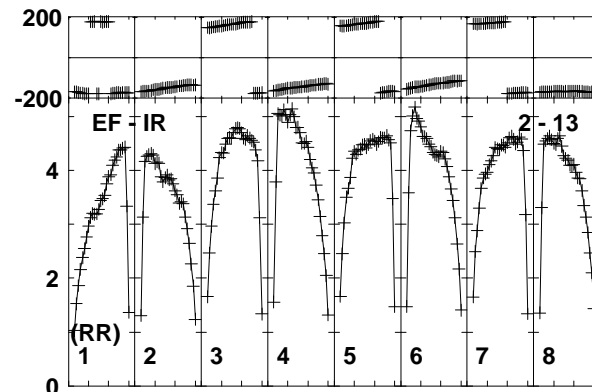
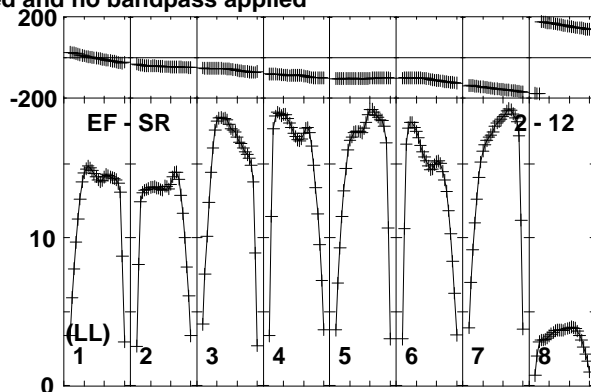
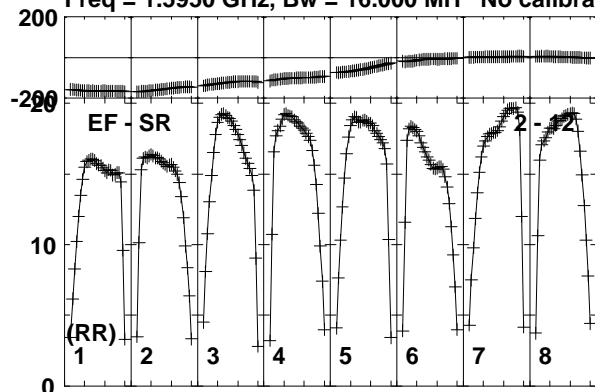

Lower frame: Milli Ampl Jy Top frame: Phas deg  
Vector averaged cross-power spectrum Baseline: EF (02) - SR (12)  
Timerange: 00/05:40:01 to 00/05:41:59

Plot file version 133 created 30-AUG-2019 17:53:32

ROSS867 EB070.UVDATA.1

Freq = 1.5950 GHz, Bw = 16.000 MH No calibration applied and no bandpass applied

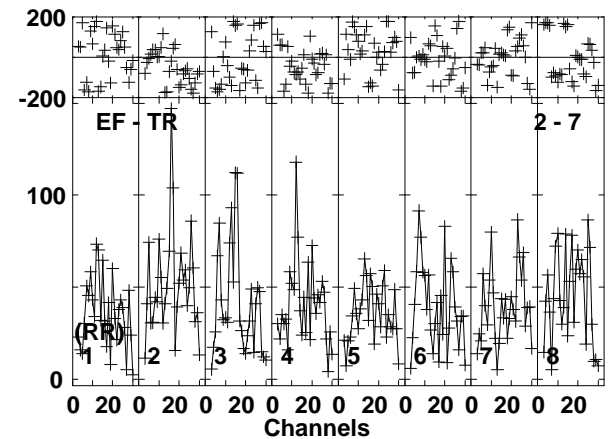
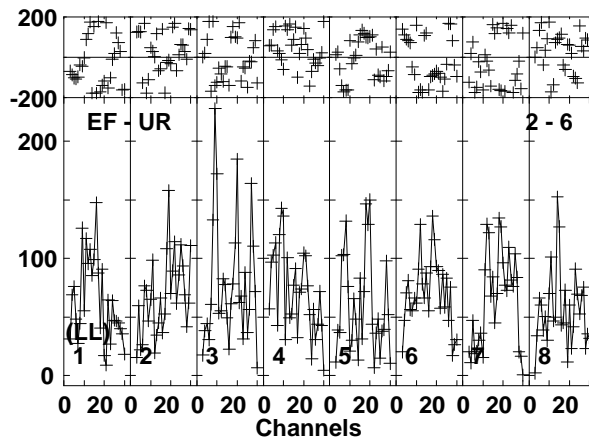
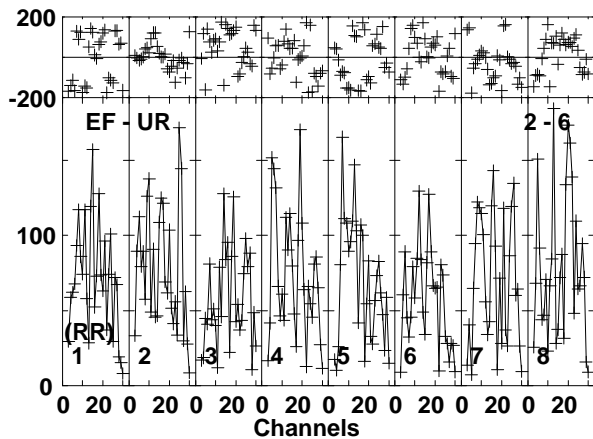
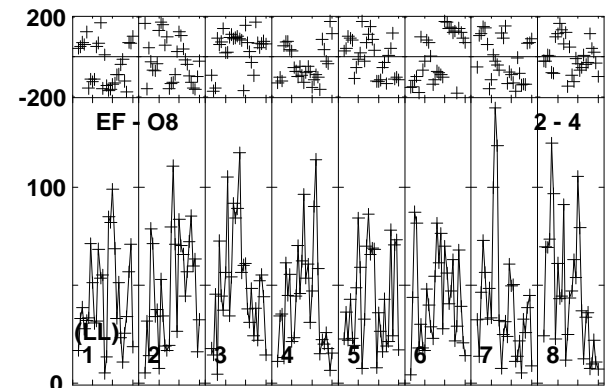
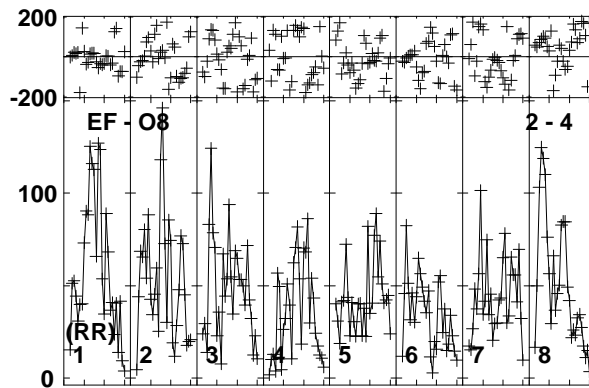
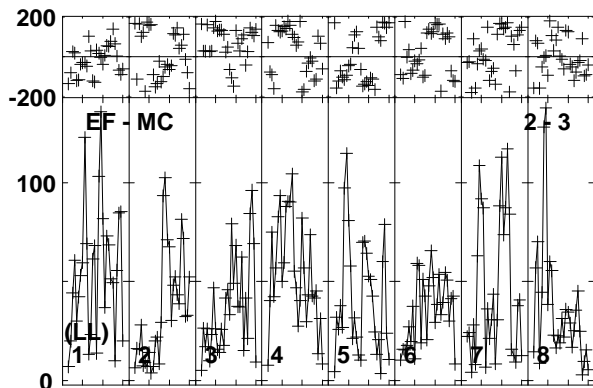
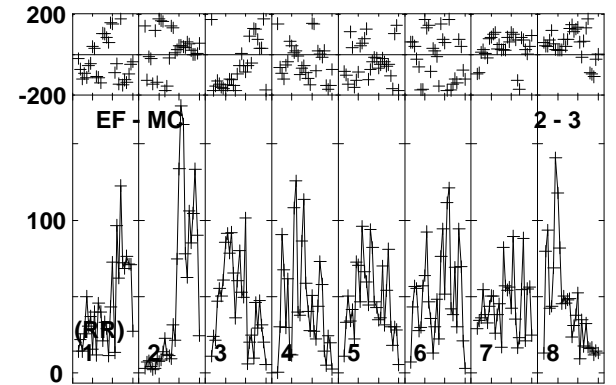
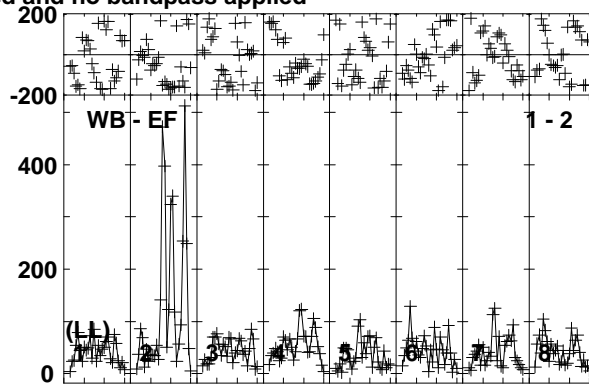
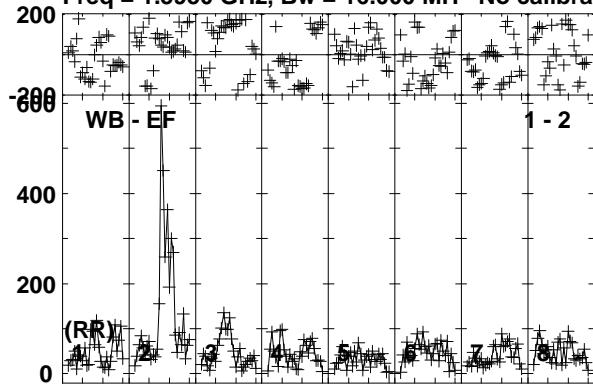

Lower frame: Micro Ampl Jy Top frame: Phas deg  
Vector averaged cross-power spectrum Baseline: WB (01) - EF (02)  
Timerange: 00/05:42:01 to 00/05:49:59

Plot file version 134 created 30-AUG-2019 17:53:32

ROSS867 EB070.UVDATA.1

Freq = 1.5950 GHz, Bw = 16.000 MH No calibration applied and no bandpass applied

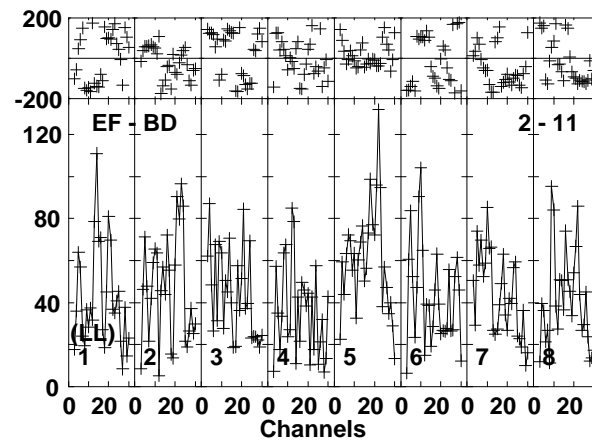
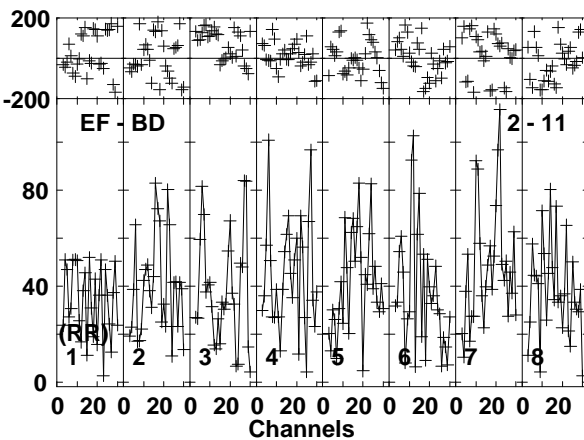
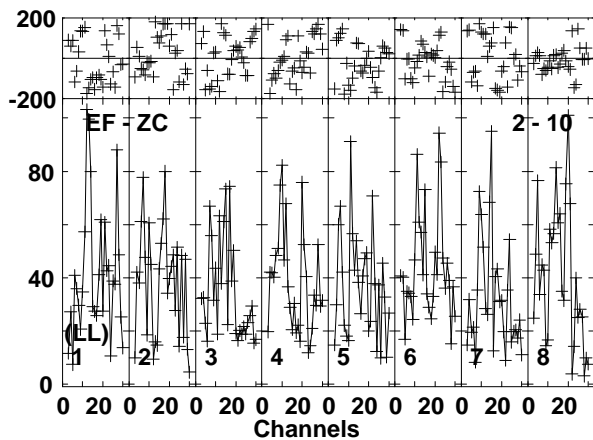
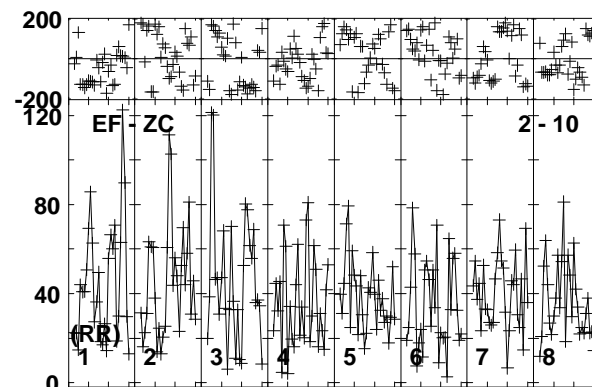
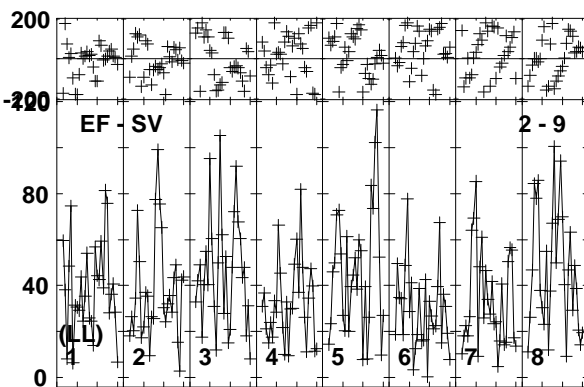
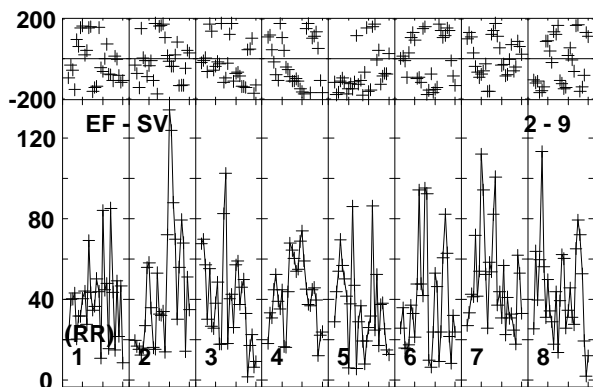
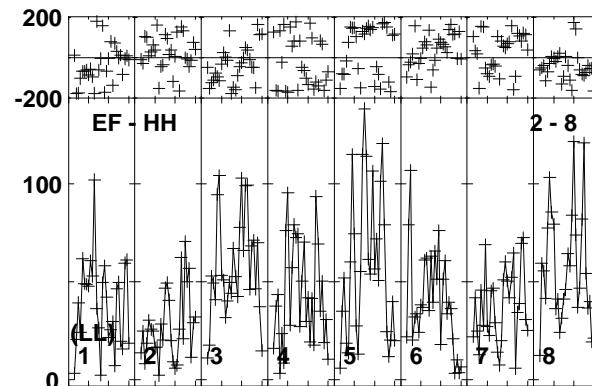
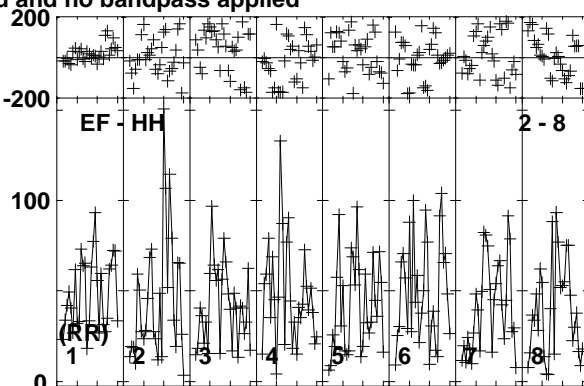
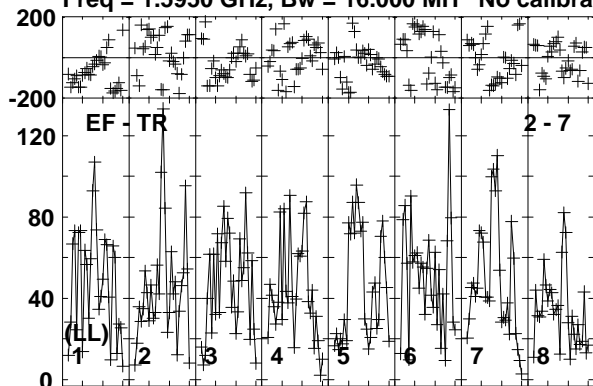

Lower frame: Micro Ampl Jy Top frame: Phas deg  
Vector averaged cross-power spectrum Baseline: EF (02) - TR (07)  
Timerange: 00/05:42:01 to 00/05:49:59

Plot file version 135 created 30-AUG-2019 17:53:33

ROSS867 EB070.UVDATA.1

Freq = 1.5950 GHz, Bw = 16.000 MH No calibration applied and no bandpass applied

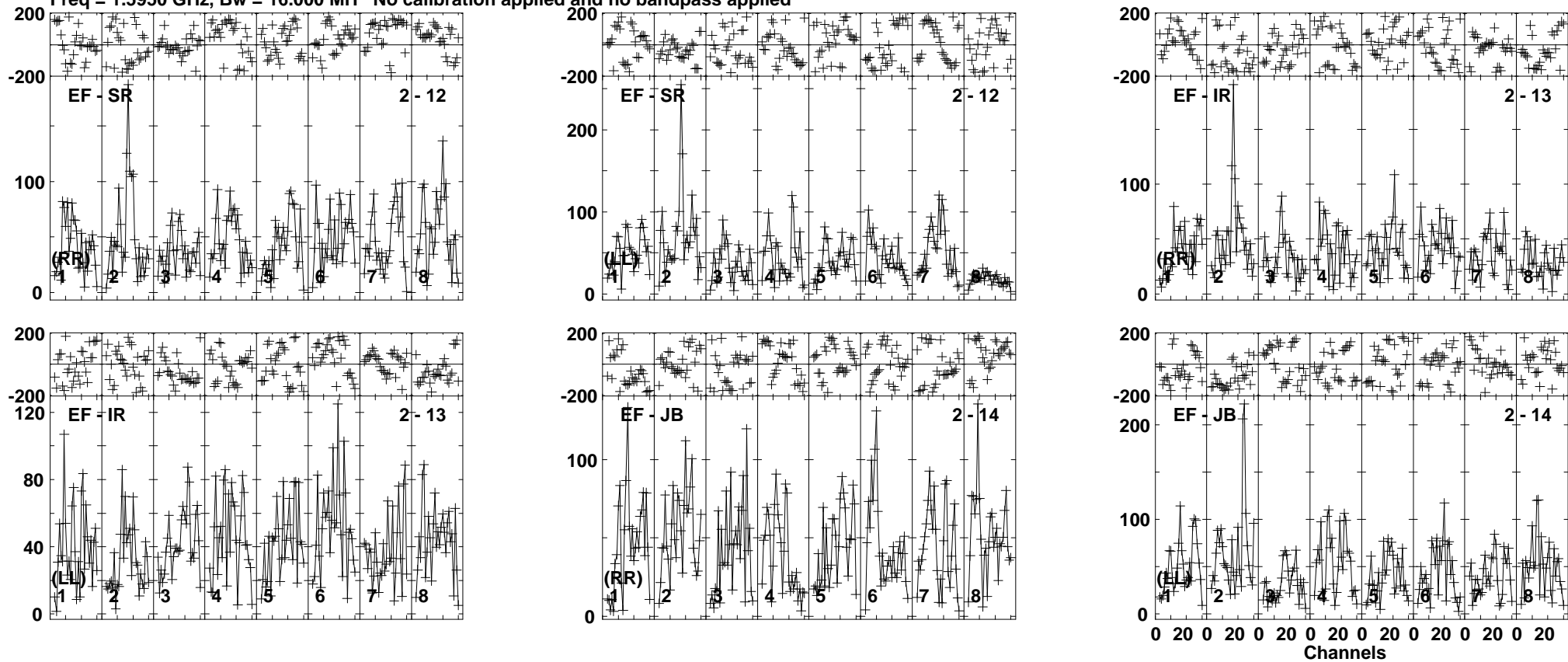

Lower frame: Micro Ampl Jy Top frame: Phas deg  
Vector averaged cross-power spectrum Baseline: EF (02) - SR (12)  
Timerange: 00/05:42:01 to 00/05:49:59

Plot file version 136 created 30-AUG-2019 17:53:33

J1722+2458 EB070.UVDATA.1

Freq = 1.5950 GHz, Bw = 16.000 MH No calibration applied and no bandpass applied

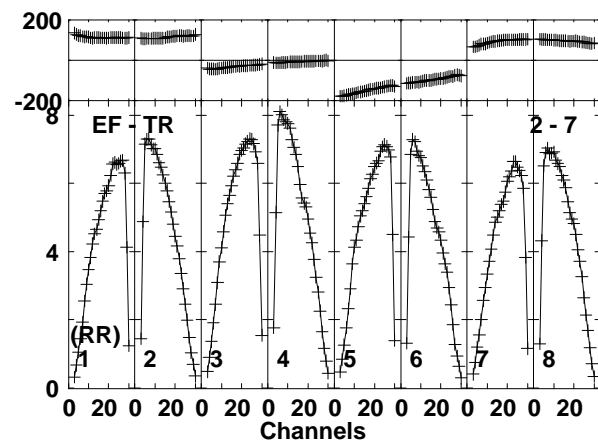
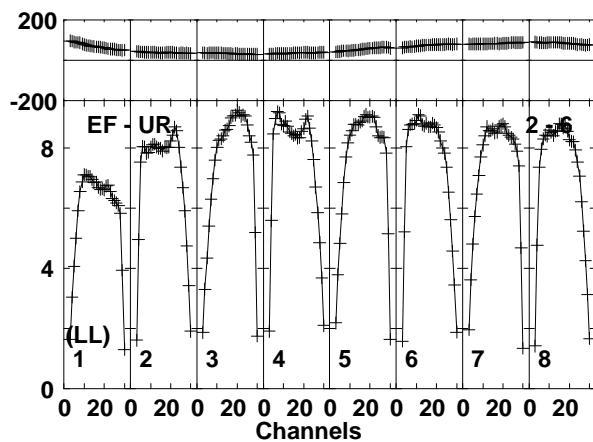
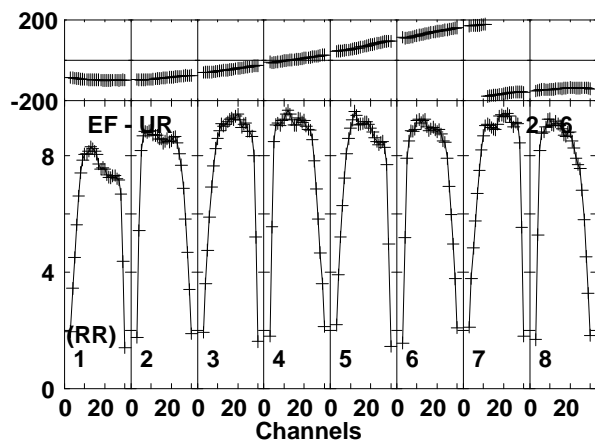
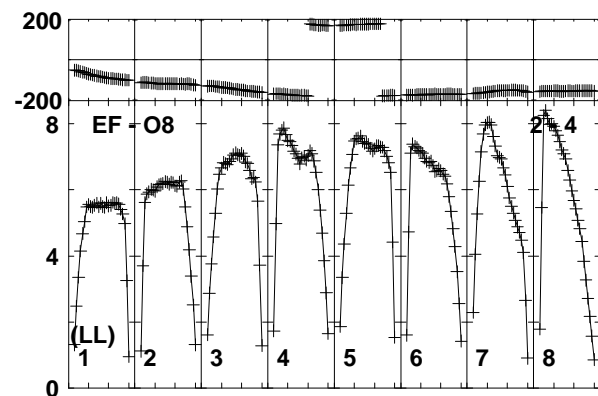
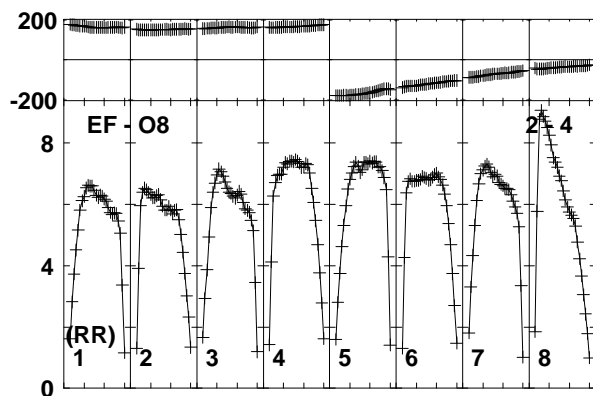
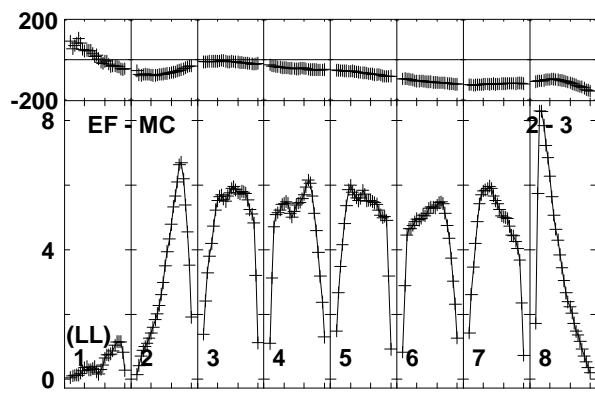
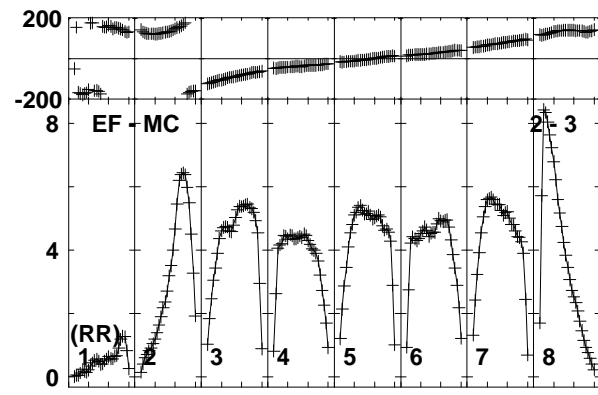
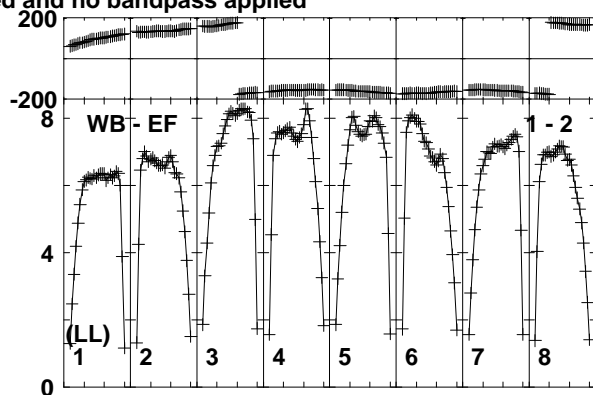
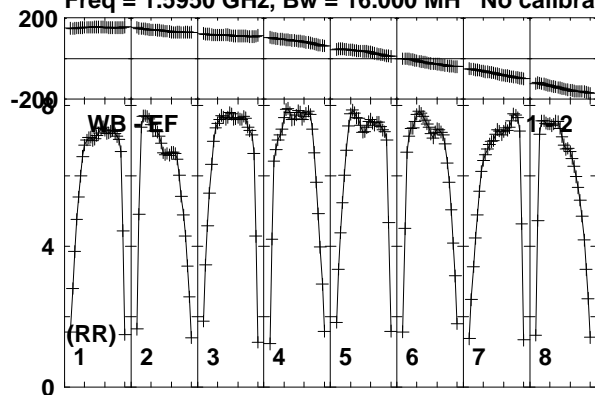

Lower frame: Milli Ampl Jy Top frame: Phas deg  
Vector averaged cross-power spectrum Baseline: WB (01) - EF (02)  
Timerange: 00/05:50:41 to 00/05:51:59



Plot file version 137 created 30-AUG-2019 17:53:33

J1722+2458 EB070.UVDATA.1

Freq = 1.5950 GHz, Bw = 16.000 MH No calibration applied and no bandpass applied

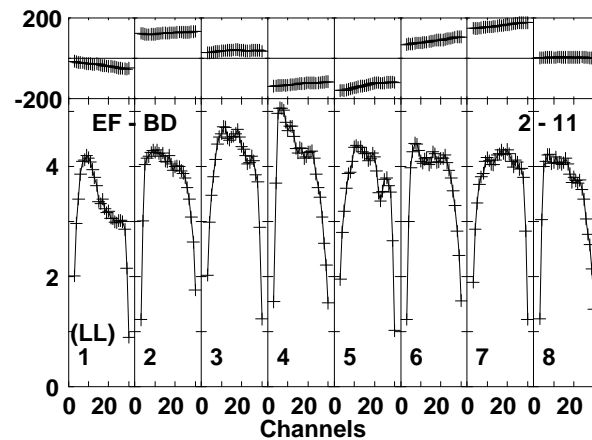
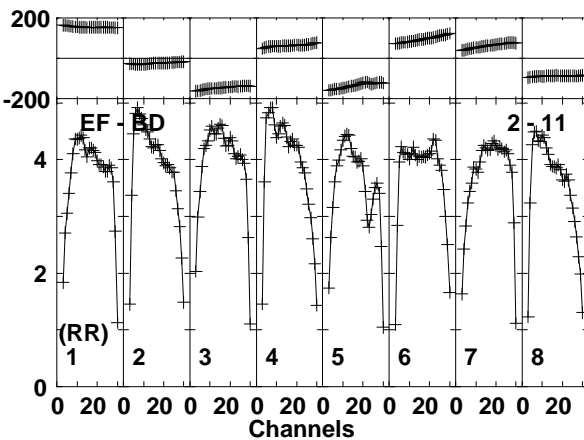
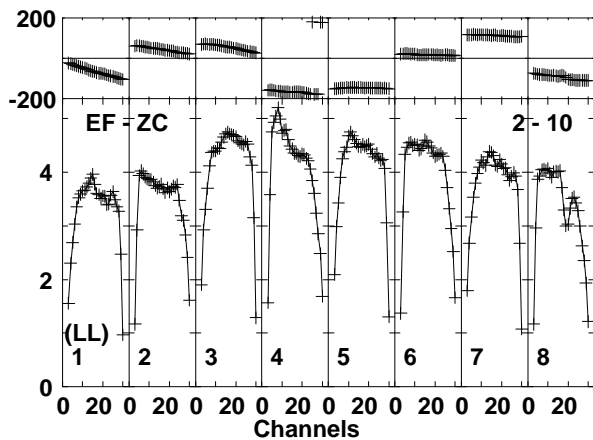
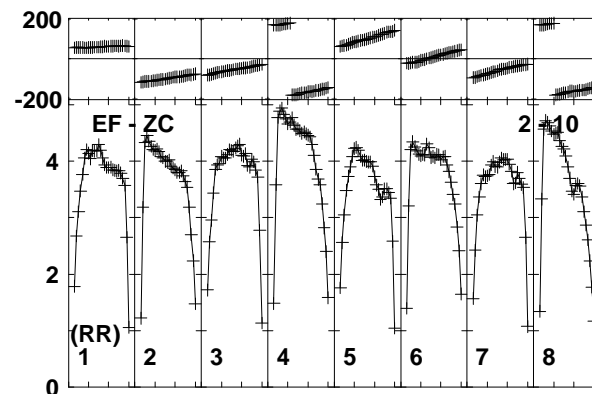
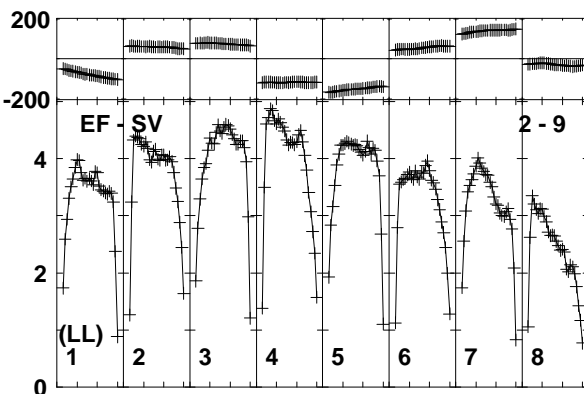
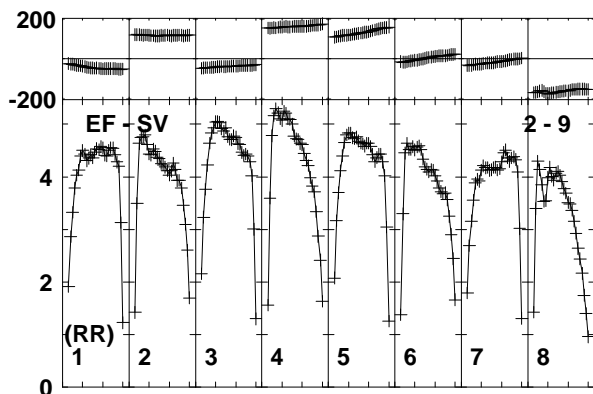
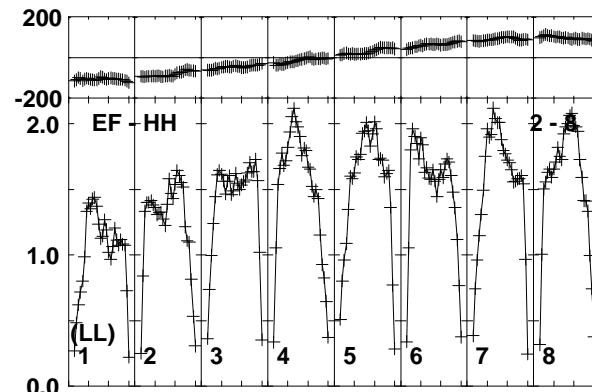
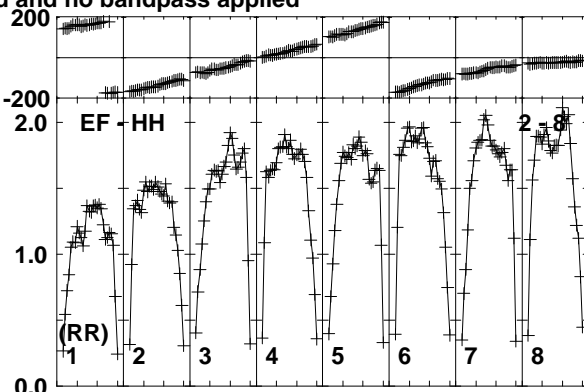
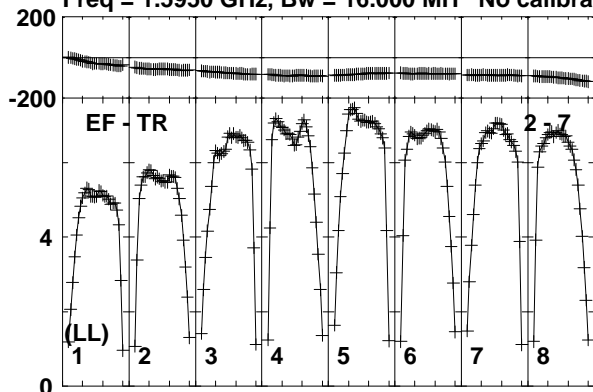

Lower frame: Milli Ampl Jy Top frame: Phas deg  
Vector averaged cross-power spectrum Baseline: EF (02) - TR (07)  
Timerange: 00/05:50:41 to 00/05:51:59

Plot file version 138 created 30-AUG-2019 17:53:33

J1722+2458 EB070.UVDATA.1

Freq = 1.5950 GHz, Bw = 16.000 MH No calibration applied and no bandpass applied

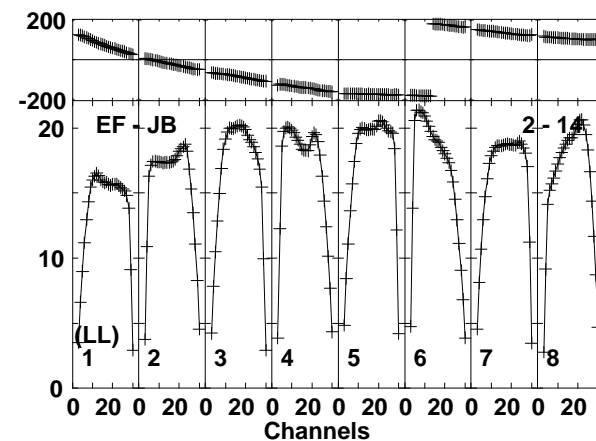
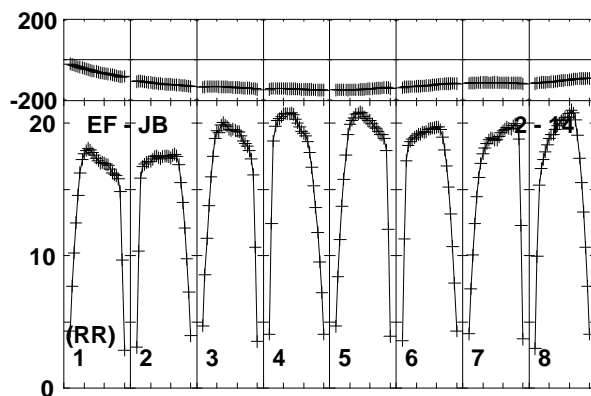
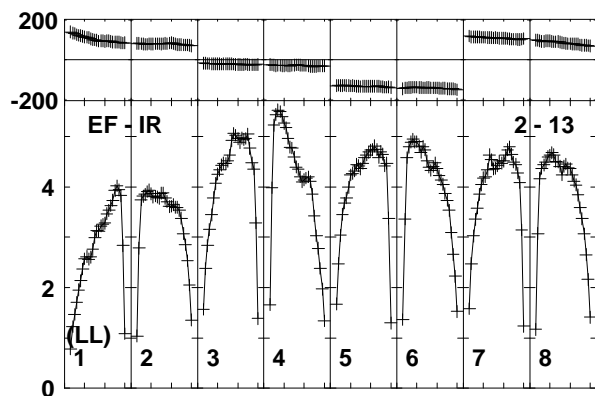
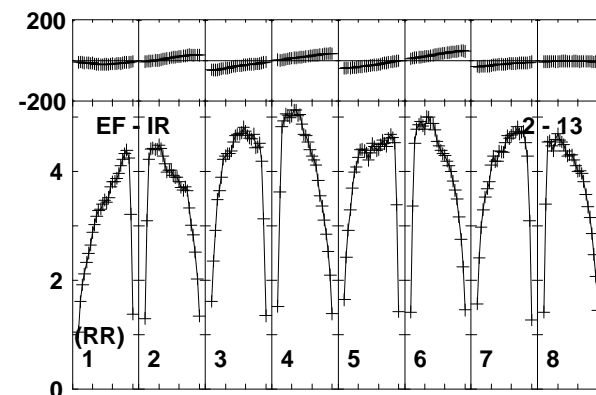
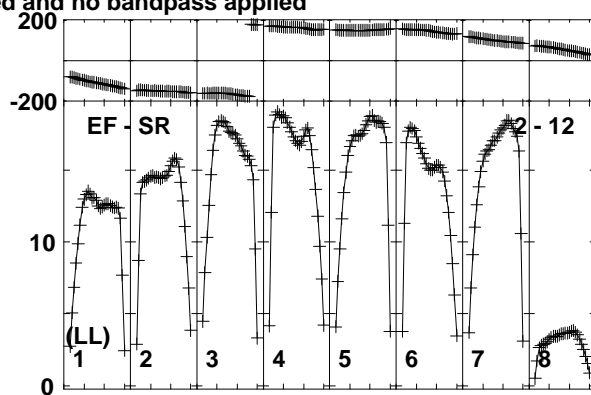
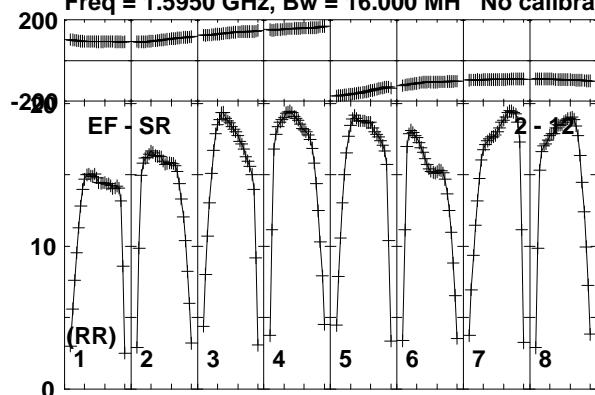

Lower frame: Milli Ampl Jy Top frame: Phas deg  
Vector averaged cross-power spectrum Baseline: EF (02) - SR (12)  
Timerange: 00/05:50:41 to 00/05:51:59

Plot file version 139 created 30-AUG-2019 17:53:33

ROSS867 EB070.UVDATA.1

Freq = 1.5950 GHz, Bw = 16.000 MH No calibration applied and no bandpass applied

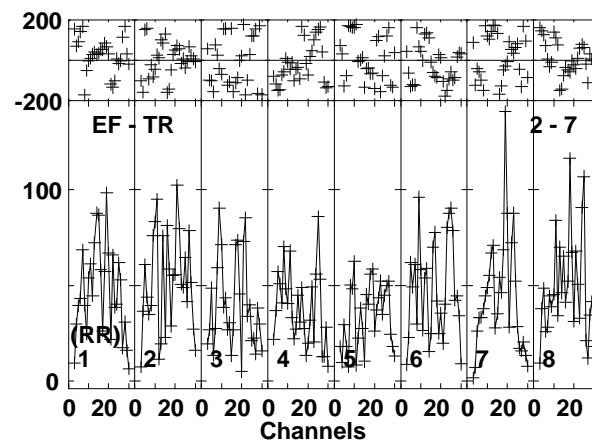
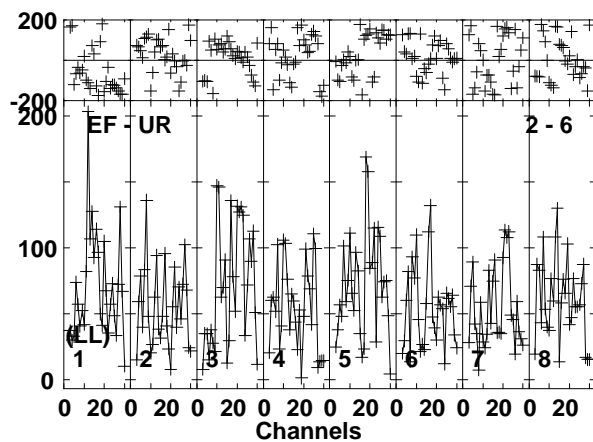
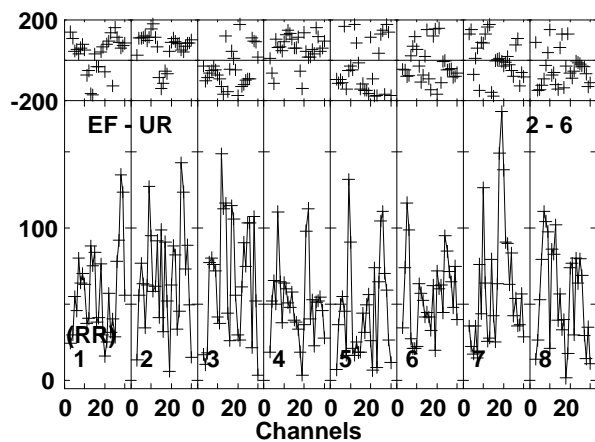
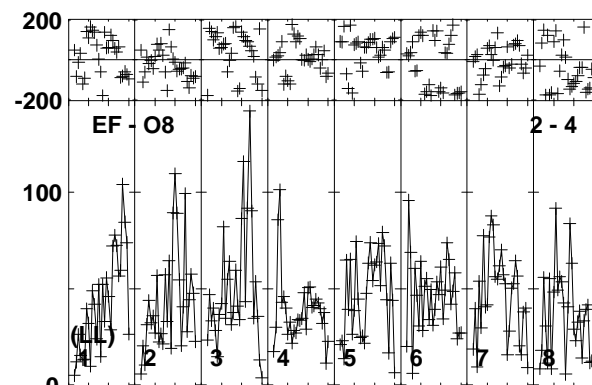
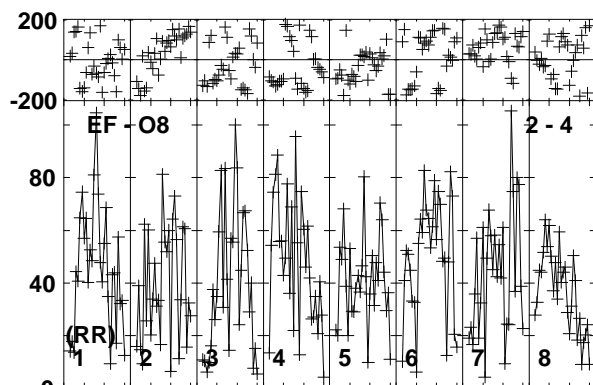
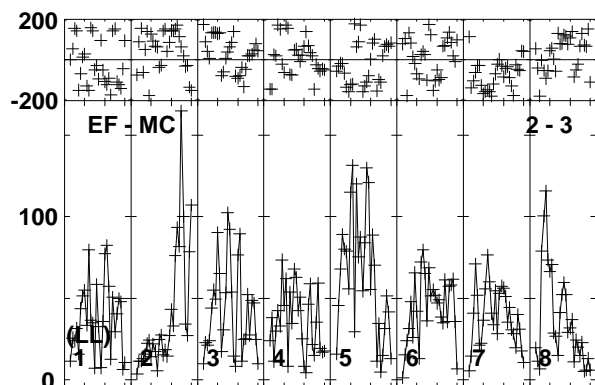
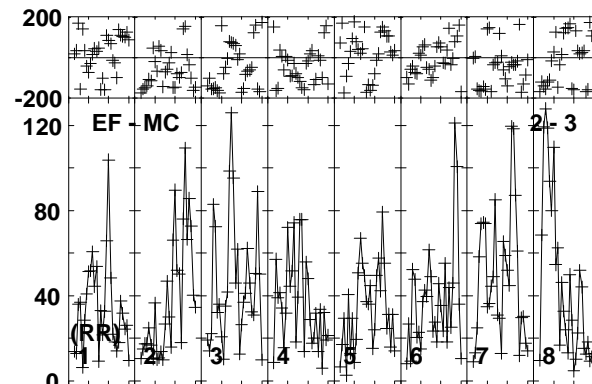
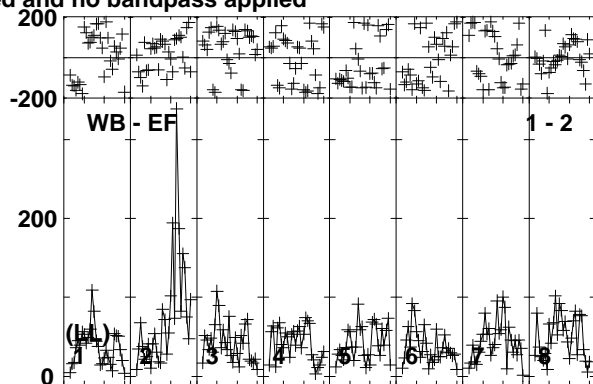
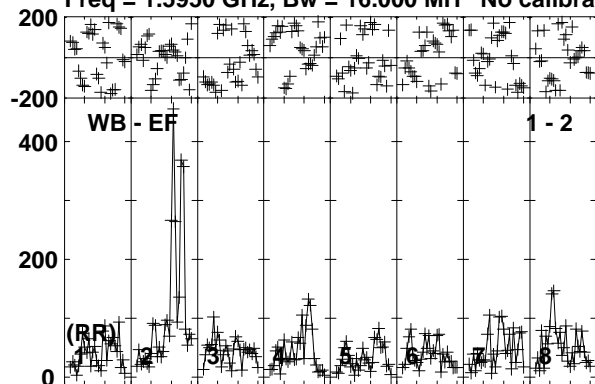

Lower frame: Micro Ampl Jy Top frame: Phas deg  
Vector averaged cross-power spectrum Baseline: WB (01) - EF (02)  
Timerange: 00/05:52:01 to 00/05:59:59

Plot file version 140 created 30-AUG-2019 17:53:34

ROSS867 EB070.UVDATA.1

Freq = 1.5950 GHz, Bw = 16.000 MH No calibration applied and no bandpass applied

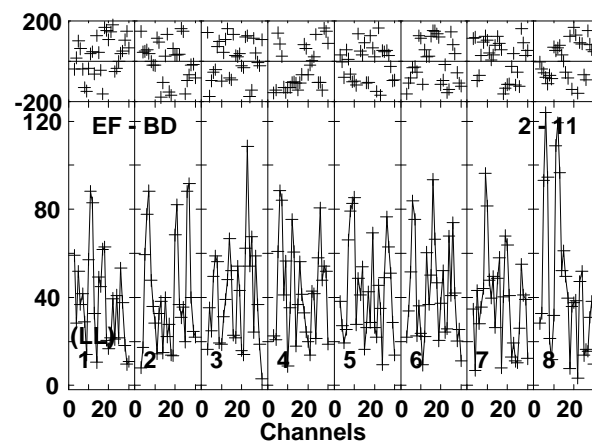
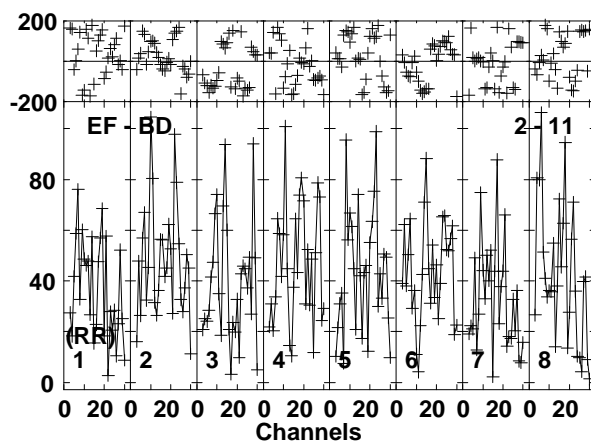
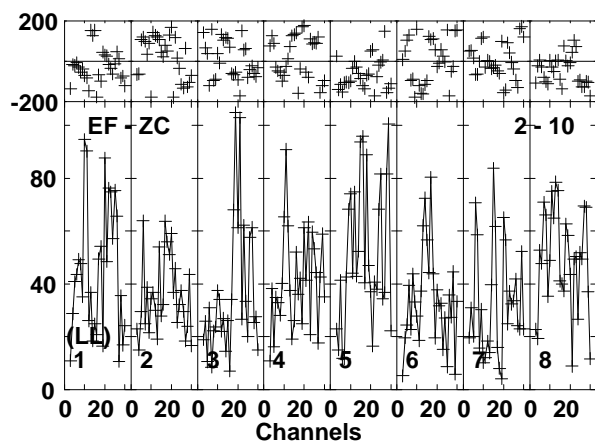
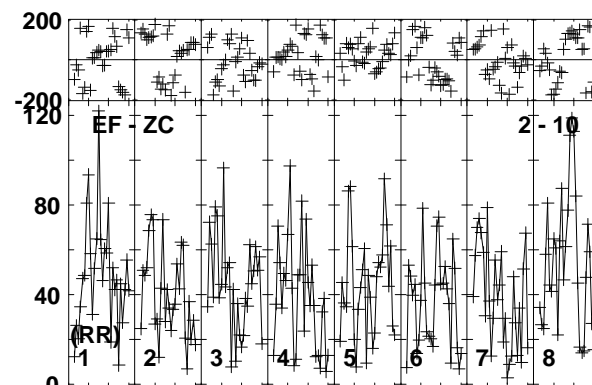
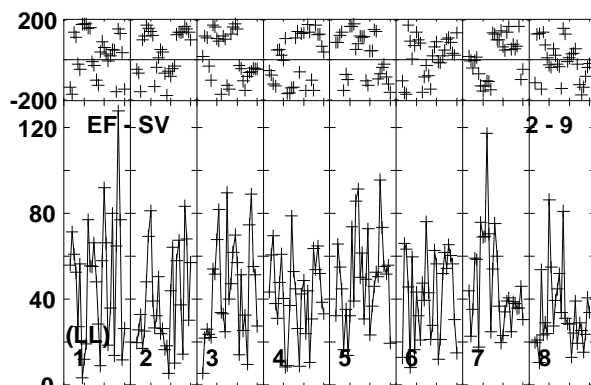
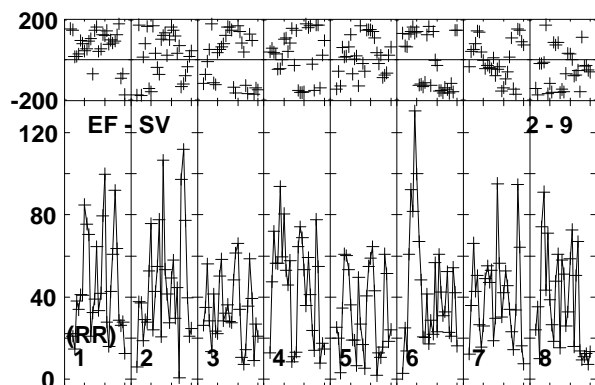
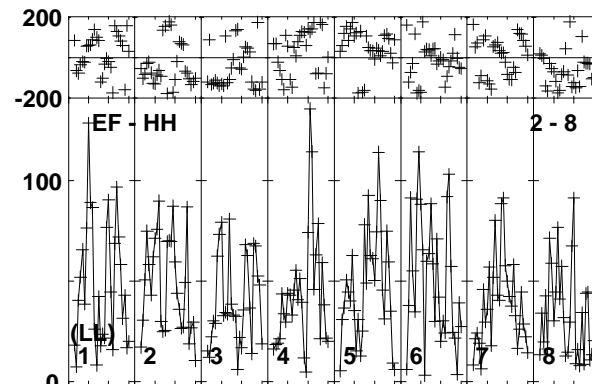
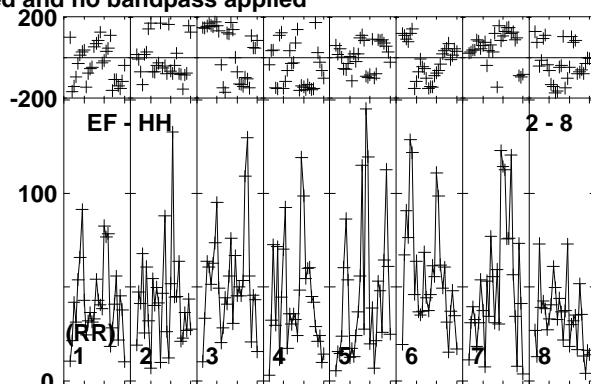
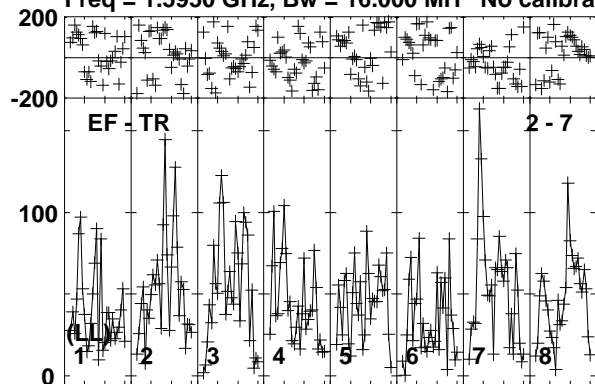

Lower frame: Micro Ampl Jy Top frame: Phas deg  
Vector averaged cross-power spectrum Baseline: EF (02) - TR (07)  
Timerange: 00/05:52:01 to 00/05:59:59

Plot file version 141 created 30-AUG-2019 17:53:34

ROSS867 EB070.UVDATA.1

Freq = 1.5950 GHz, Bw = 16.000 MH No calibration applied and no bandpass applied

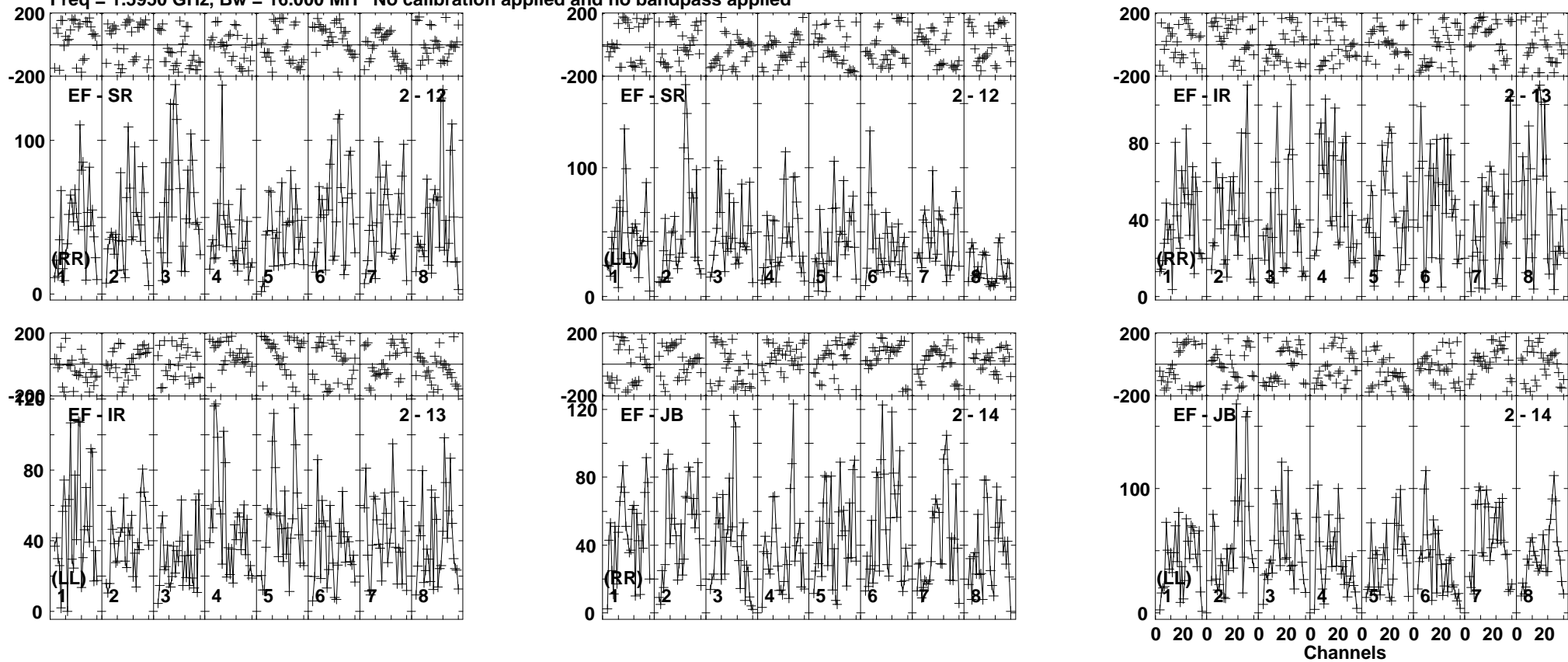

Lower frame: Micro Ampl Jy Top frame: Phas deg  
Vector averaged cross-power spectrum Baseline: EF (02) - SR (12)  
Timerange: 00/05:52:01 to 00/05:59:59

Plot file version 142 created 30-AUG-2019 17:53:34

J1722+2458 EB070.UVDATA.1

Freq = 1.5950 GHz, Bw = 16.000 MH No calibration applied and no bandpass applied

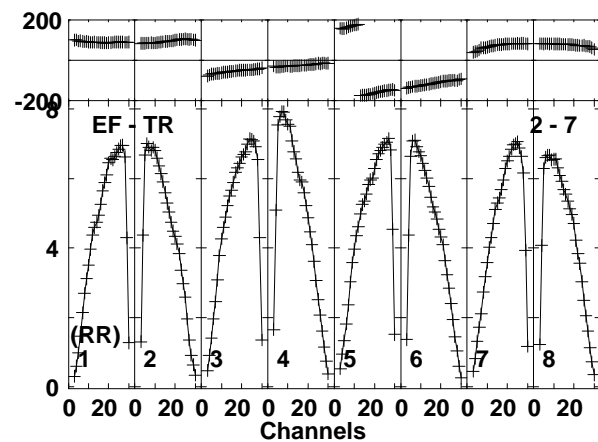
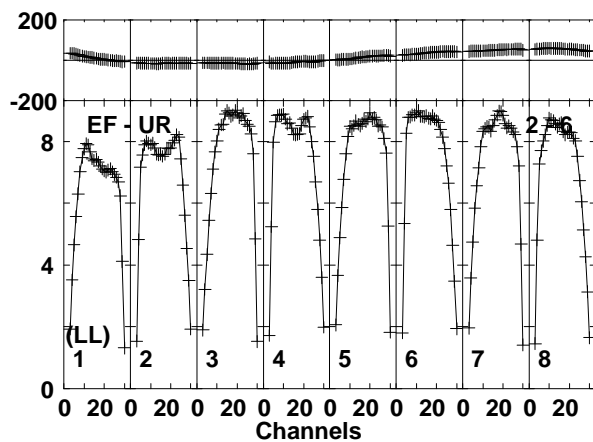
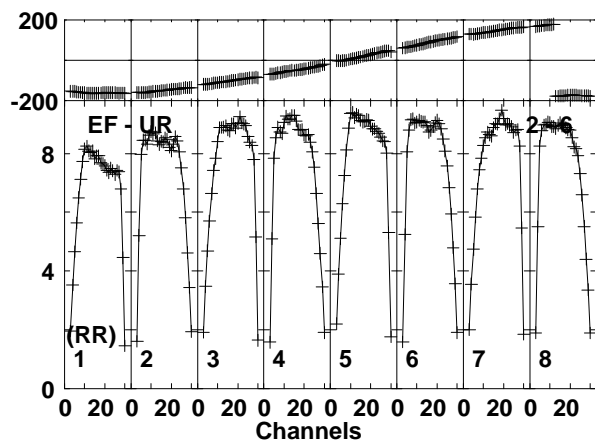
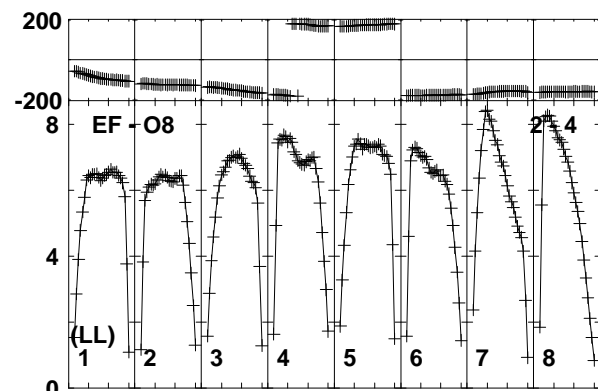
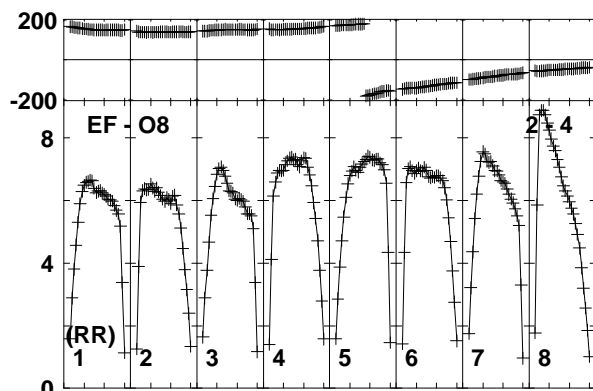
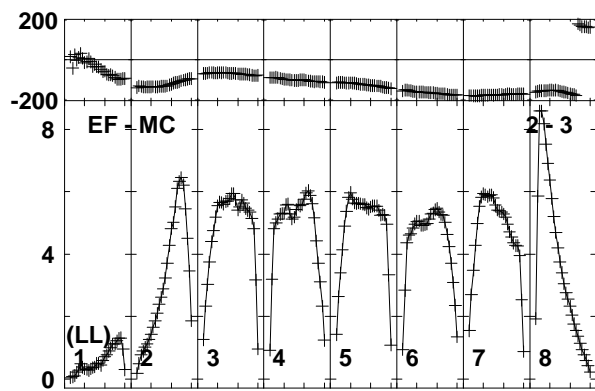
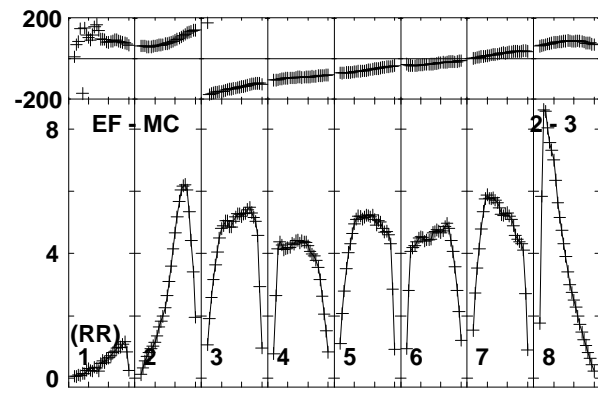
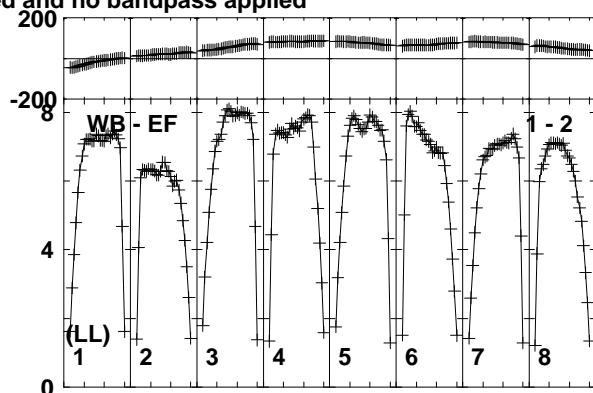
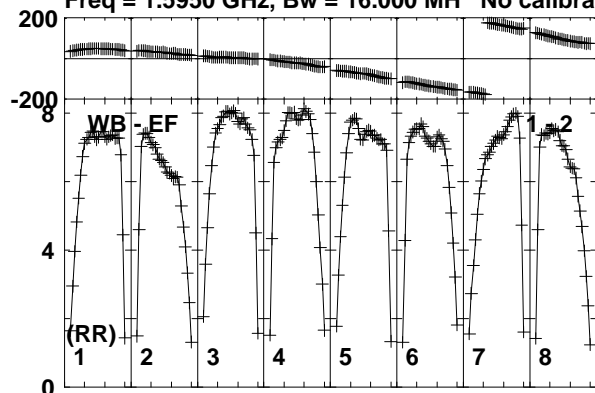

Lower frame: Milli Ampl Jy Top frame: Phas deg  
Vector averaged cross-power spectrum Baseline: WB (01) - EF (02)  
Timerange: 00/06:00:01 to 00/06:01:59

Plot file version 143 created 30-AUG-2019 17:53:34

J1722+2458 EB070.UVDATA.1

Freq = 1.5950 GHz, Bw = 16.000 MH No calibration applied and no bandpass applied

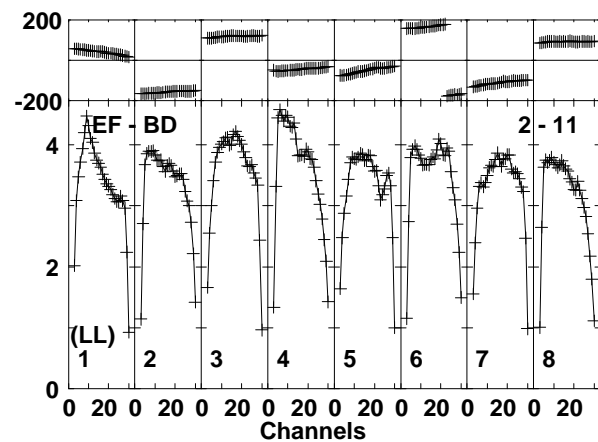
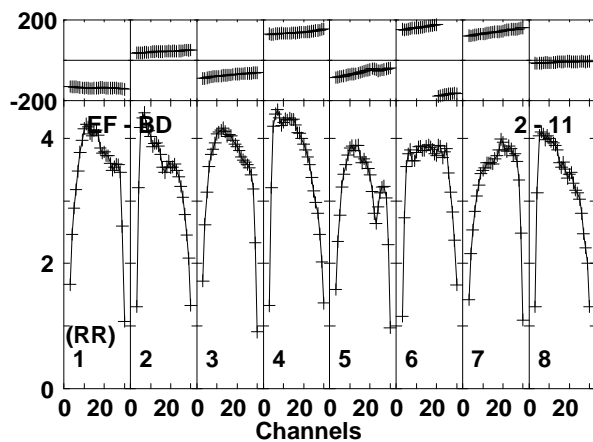
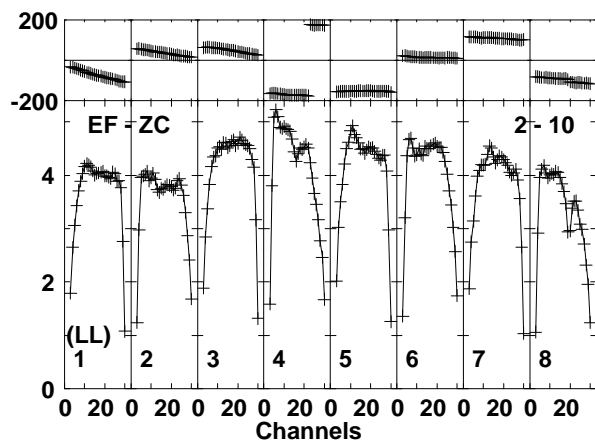
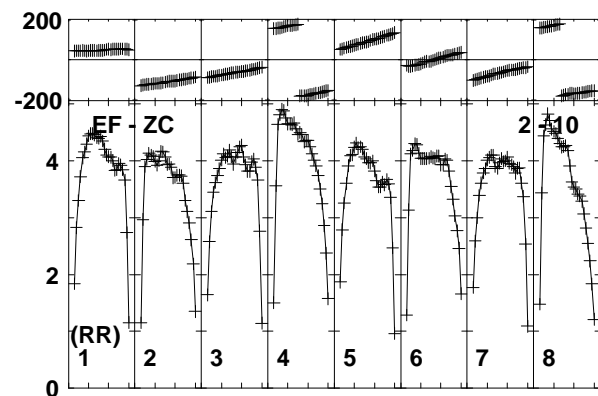
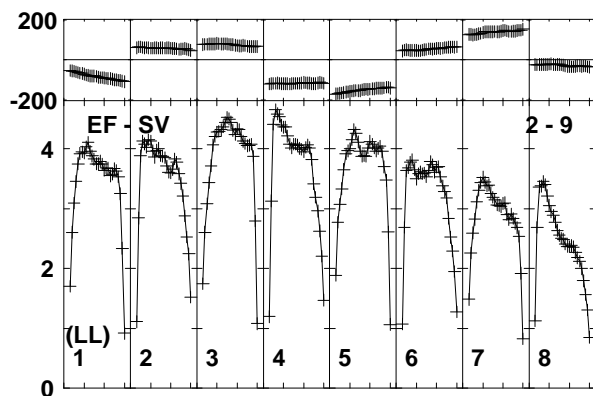
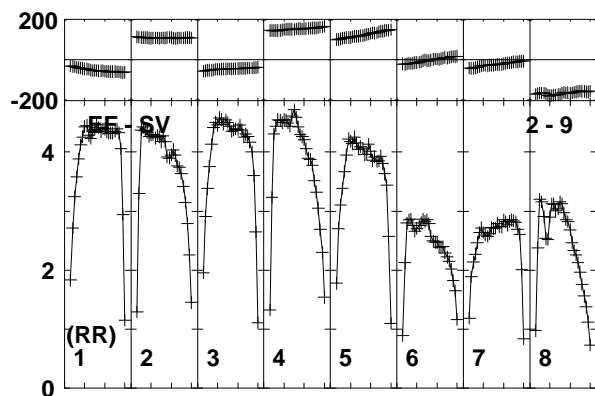
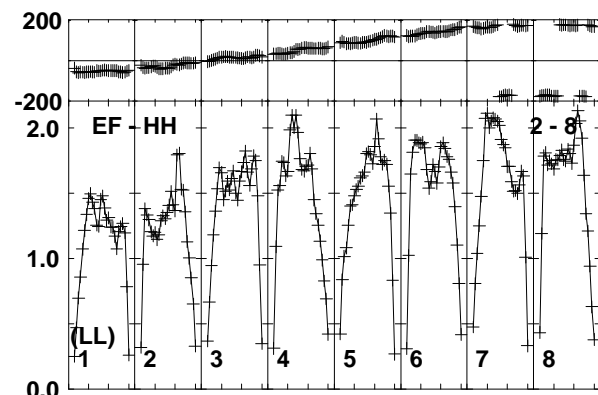
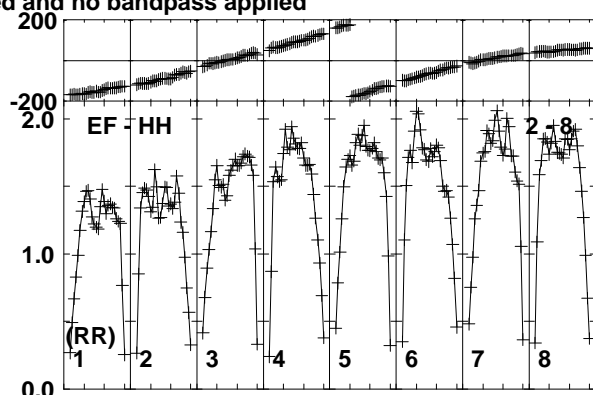
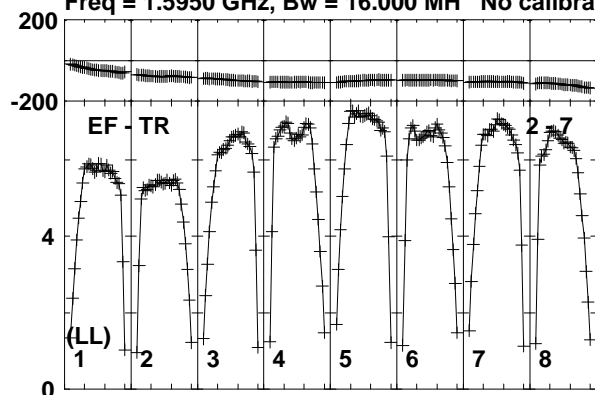

Lower frame: Milli Ampl Jy Top frame: Phas deg  
Vector averaged cross-power spectrum Baseline: EF (02) - TR (07)  
Timerange: 00/06:00:01 to 00/06:01:59

Plot file version 144 created 30-AUG-2019 17:53:34

J1722+2458 EB070.UVDATA.1

Freq = 1.5950 GHz, Bw = 16.000 MH No calibration applied and no bandpass applied

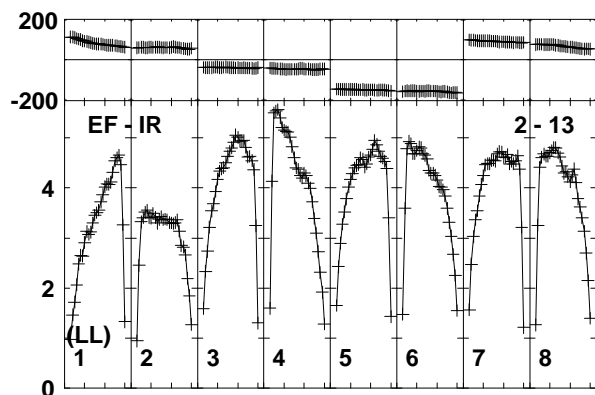
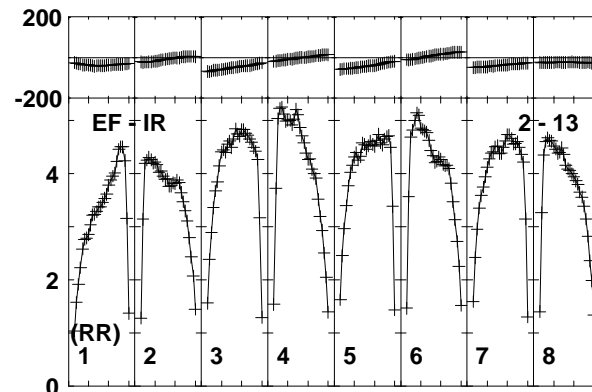
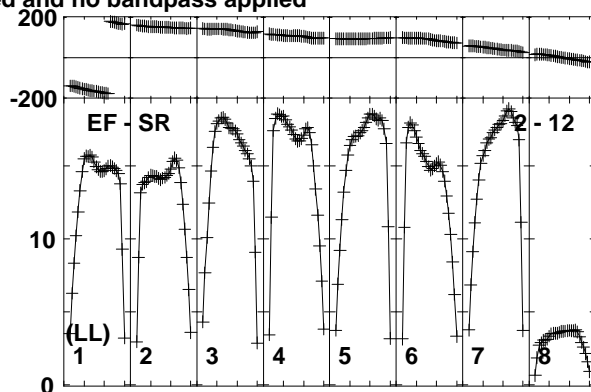
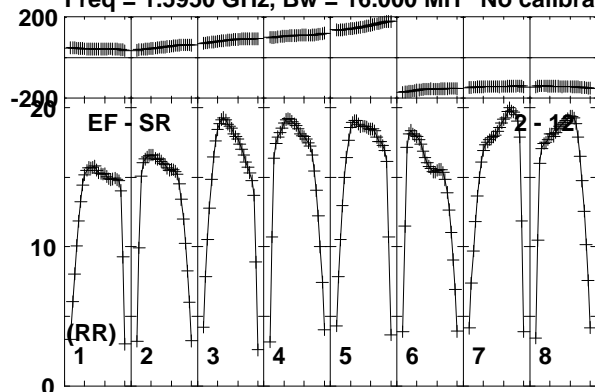

Lower frame: Milli Ampl Jy Top frame: Phas deg  
Vector averaged cross-power spectrum Baseline: EF (02) - SR (12)  
Timerange: 00/06:00:01 to 00/06:01:59



Plot file version 145 created 30-AUG-2019 17:53:35

ROSS867 EB070.UVDATA.1

Freq = 1.5950 GHz, Bw = 16.000 MH No calibration applied and no bandpass applied

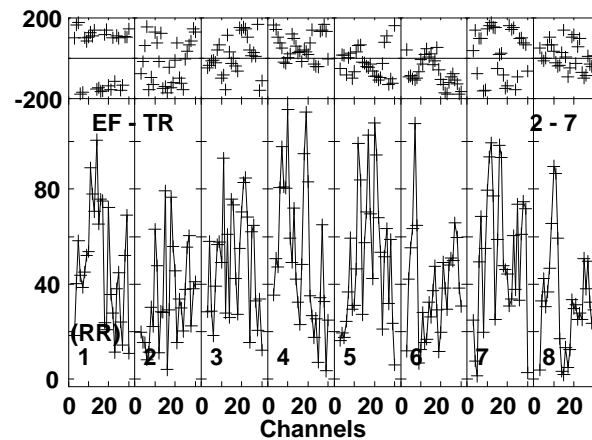
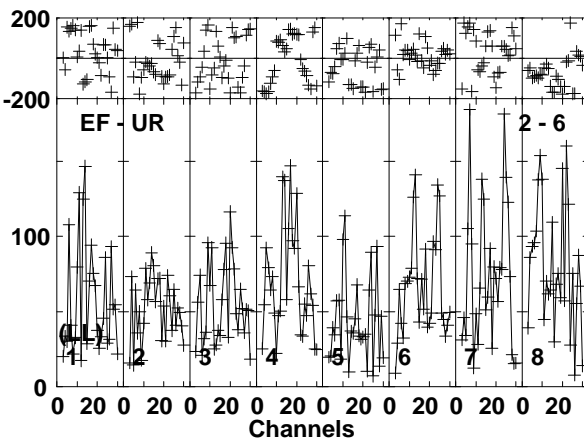
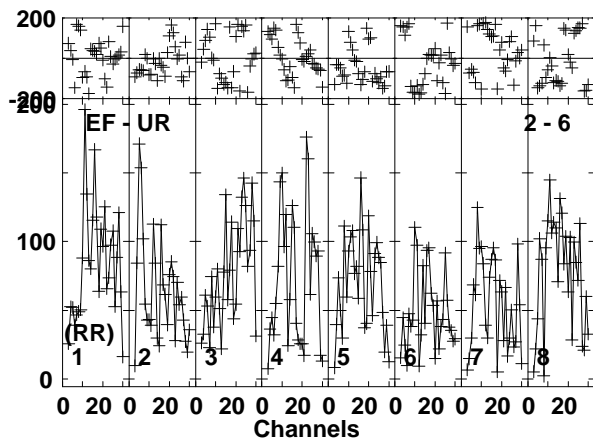
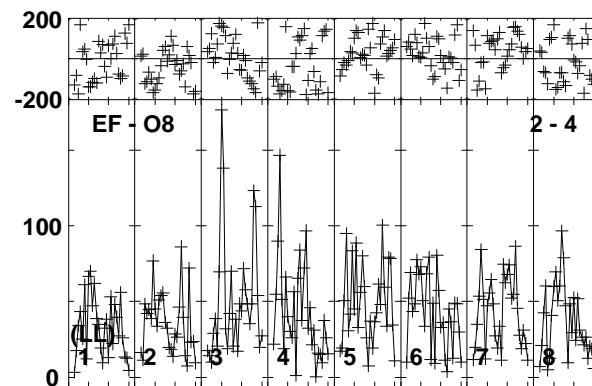
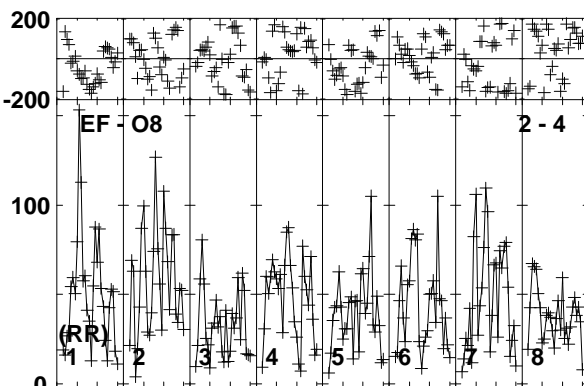
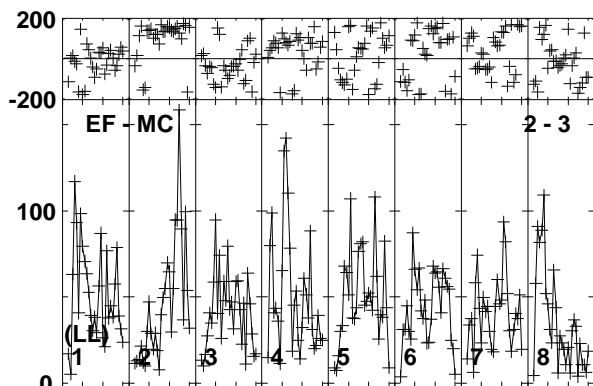
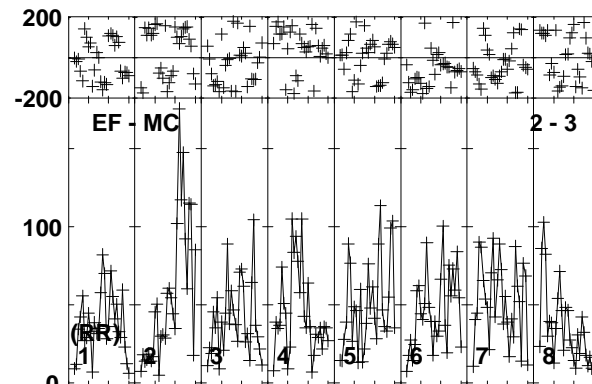
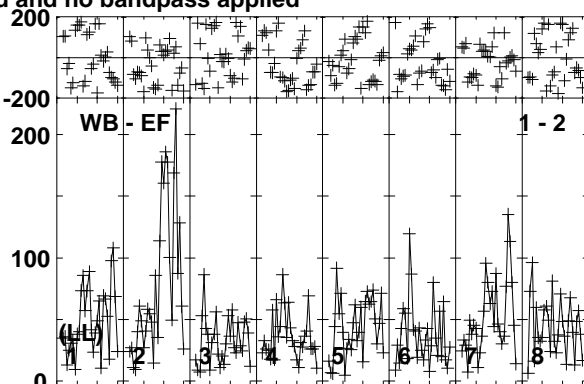
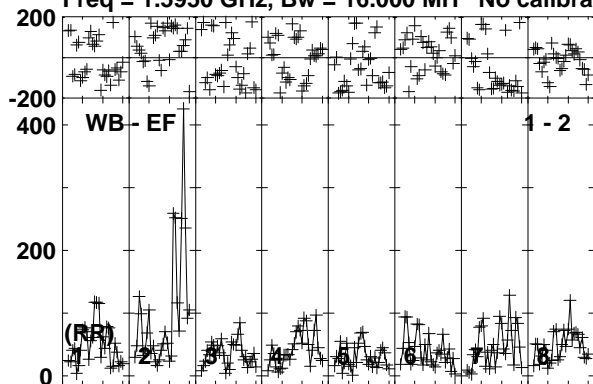

Lower frame: Micro Ampl Jy Top frame: Phas deg  
Vector averaged cross-power spectrum Baseline: WB (01) - EF (02)  
Timerange: 00/06:02:01 to 00/06:09:59

Plot file version 146 created 30-AUG-2019 17:53:35

ROSS867 EB070.UVDATA.1

Freq = 1.5950 GHz, Bw = 16.000 MH No calibration applied and no bandpass applied

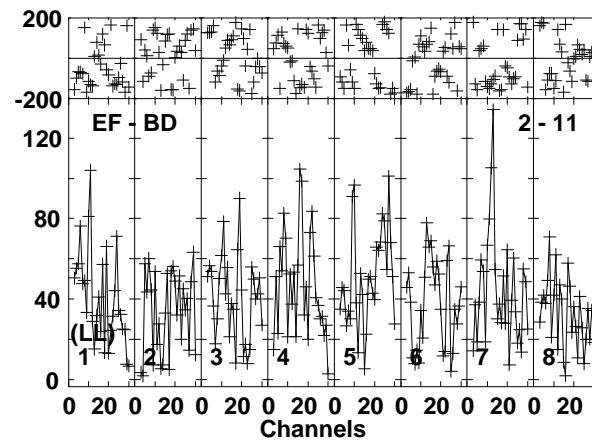
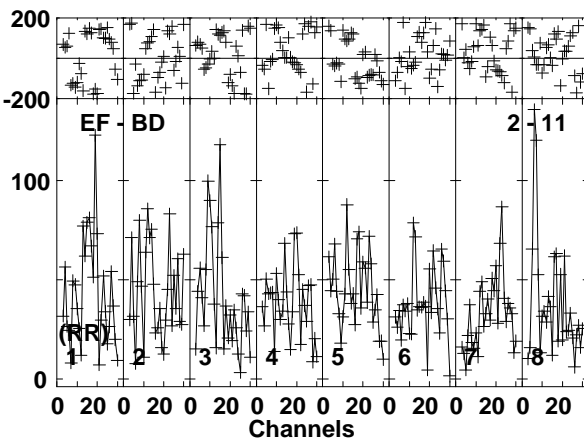
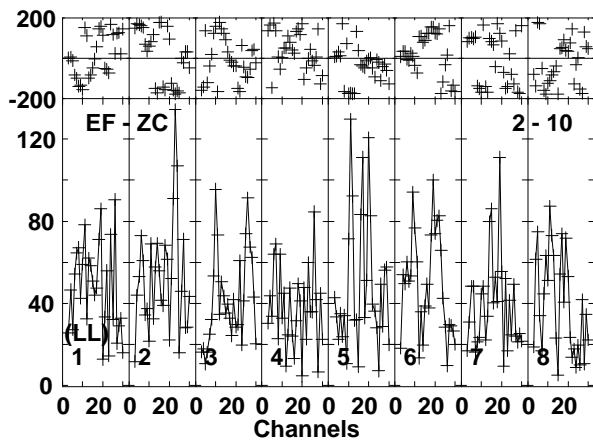
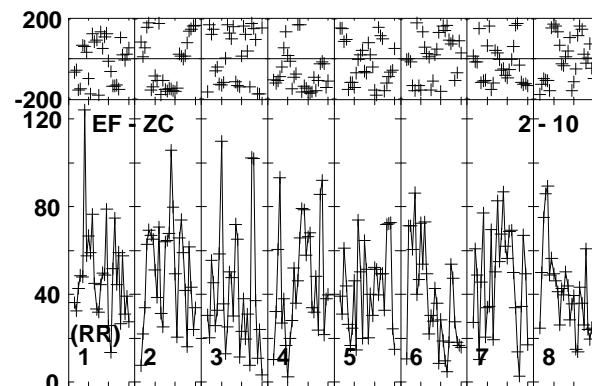
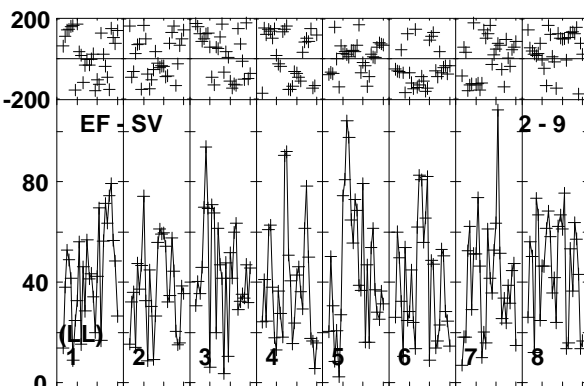
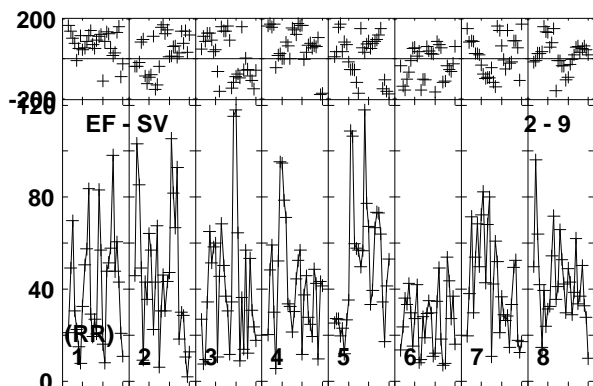
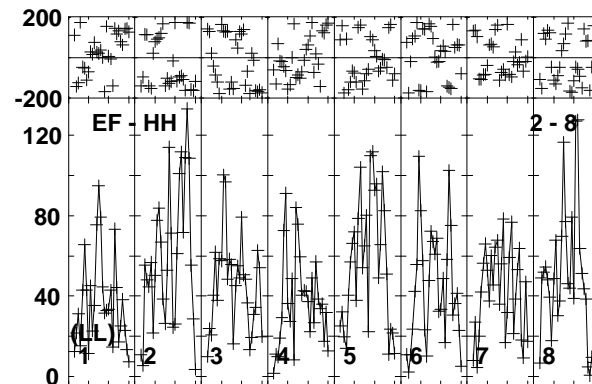
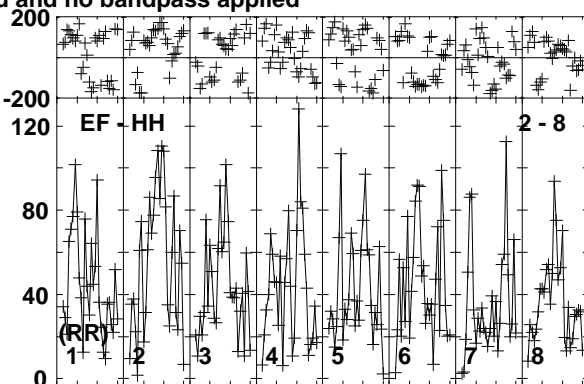
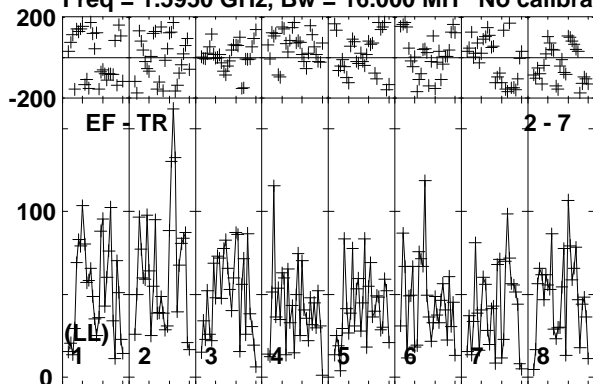

Lower frame: Micro Ampl Jy Top frame: Phas deg  
Vector averaged cross-power spectrum Baseline: EF (02) - TR (07)  
Timerange: 00/06:02:01 to 00/06:09:59

Plot file version 147 created 30-AUG-2019 17:53:35

ROSS867 EB070.UVDATA.1

Freq = 1.5950 GHz, Bw = 16.000 MH No calibration applied and no bandpass applied

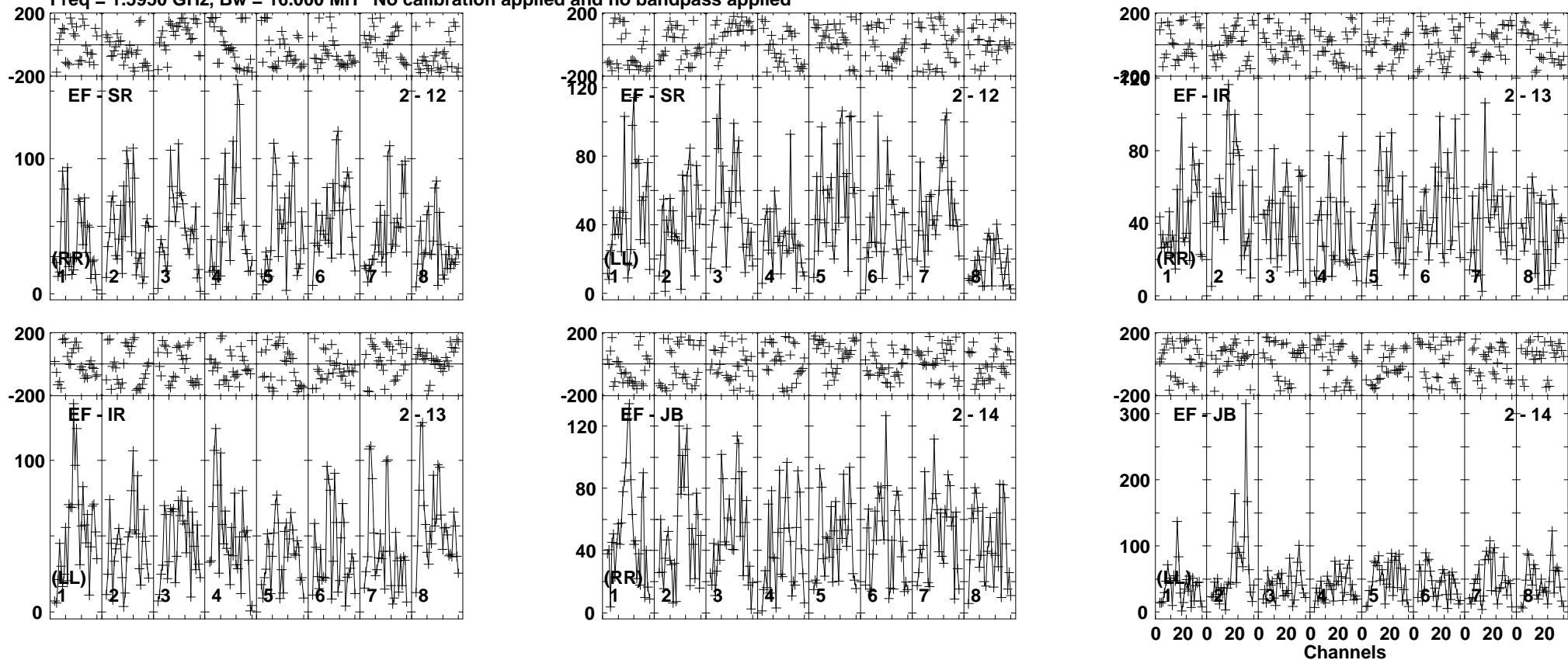

Lower frame: Micro Ampl Jy Top frame: Phas deg  
Vector averaged cross-power spectrum Baseline: EF (02) - SR (12)  
Timerange: 00/06:02:01 to 00/06:09:59

Plot file version 148 created 30-AUG-2019 17:53:35

J1722+2458 EB070.UVDATA.1

Freq = 1.5950 GHz, Bw = 16.000 MH No calibration applied and no bandpass applied

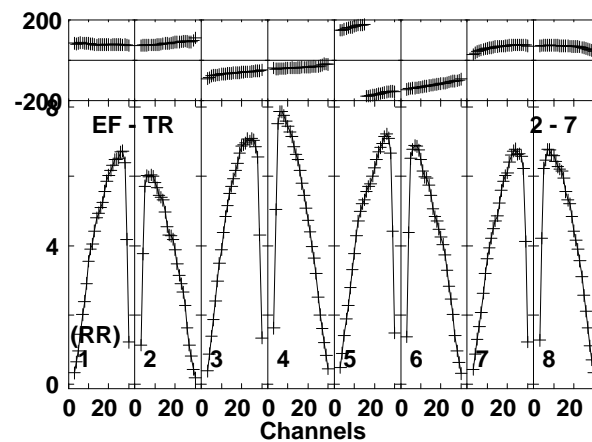
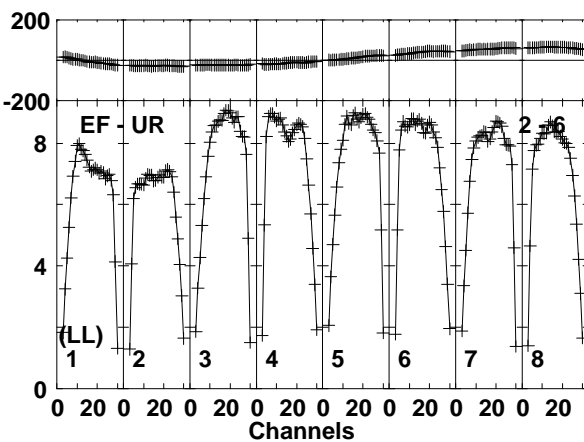
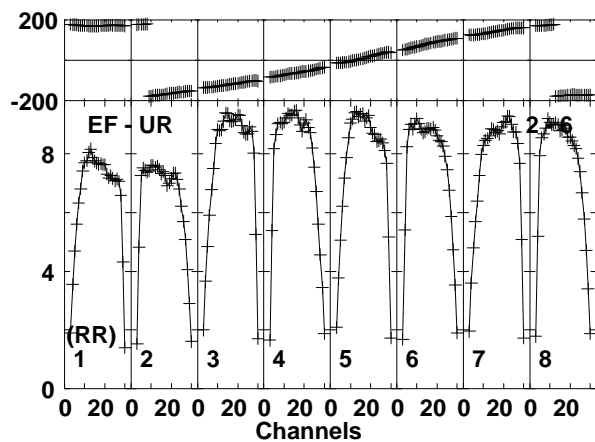
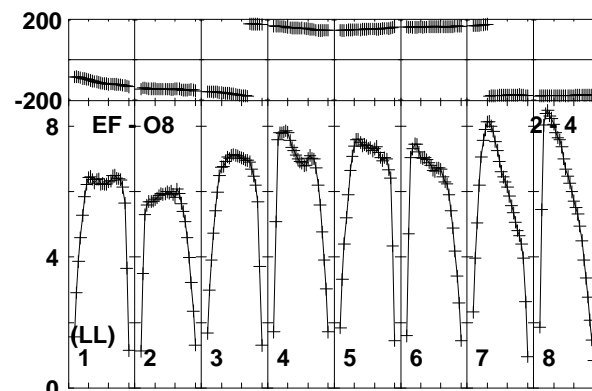
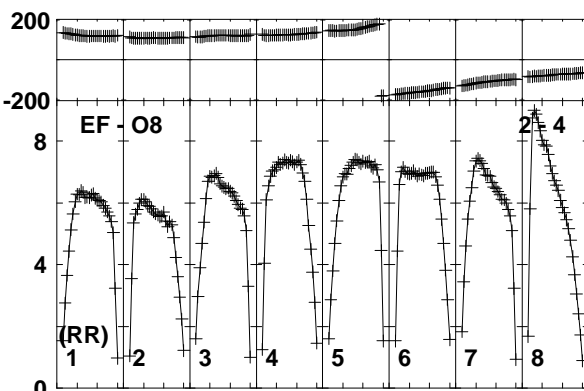
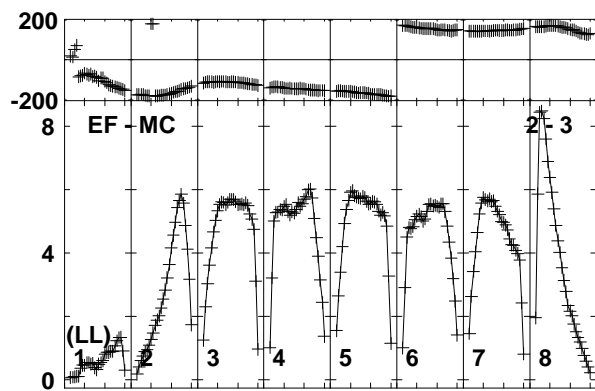
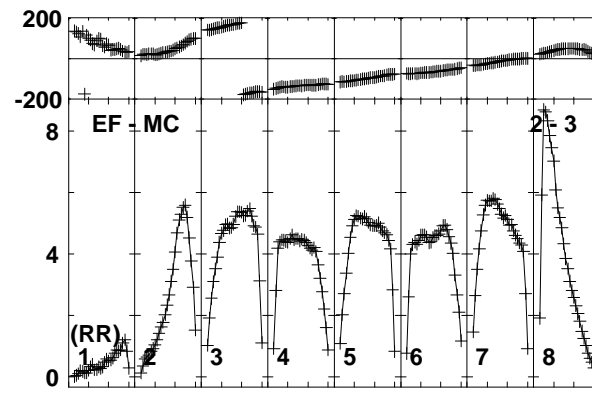
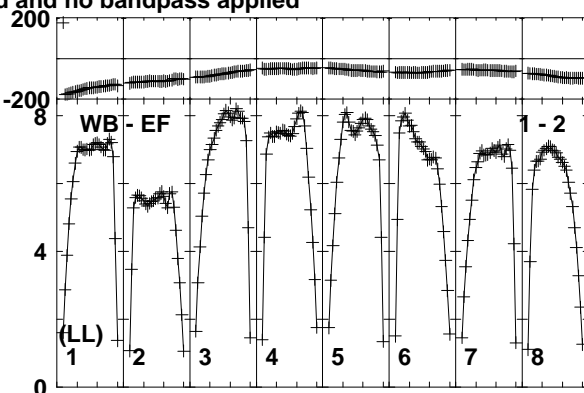
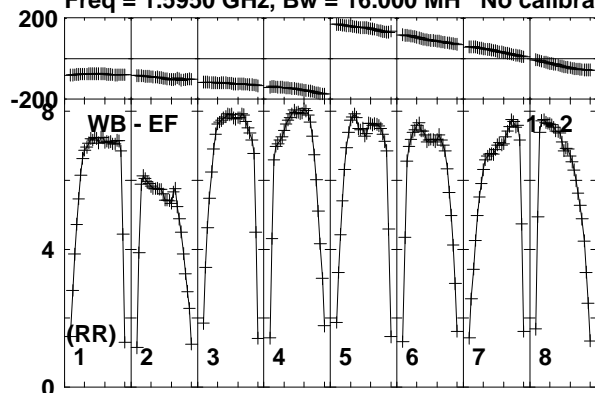

Lower frame: Milli Ampl Jy Top frame: Phas deg  
Vector averaged cross-power spectrum Baseline: WB (01) - EF (02)  
Timerange: 00/06:10:41 to 00/06:11:59

Plot file version 149 created 30-AUG-2019 17:53:35

J1722+2458 EB070.UVDATA.1

Freq = 1.5950 GHz, Bw = 16.000 MH No calibration applied and no bandpass applied

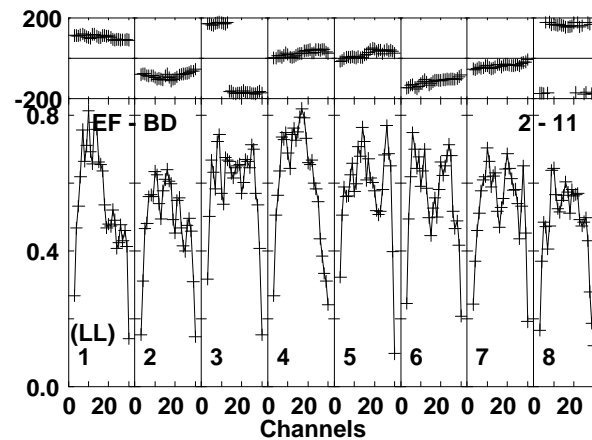
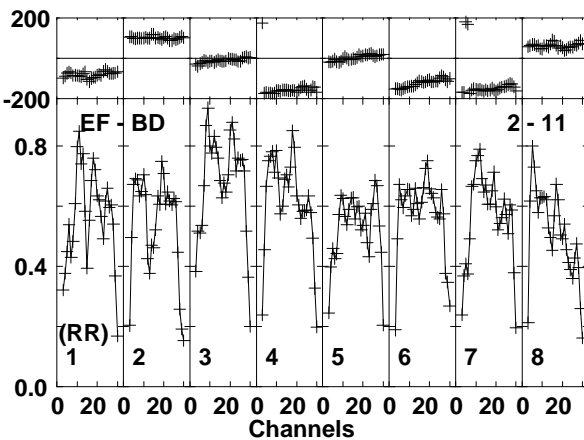
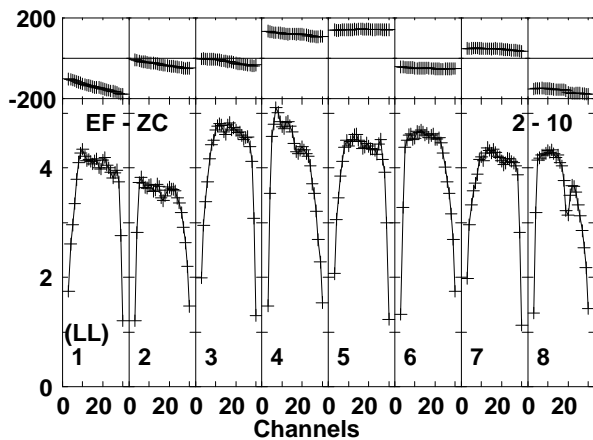
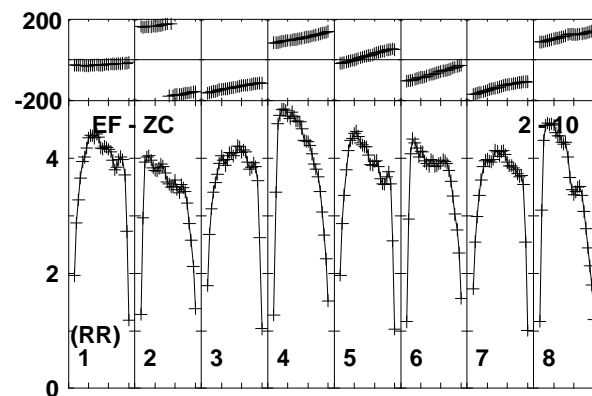
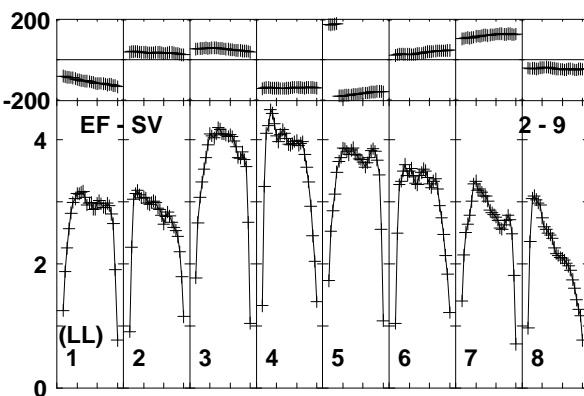
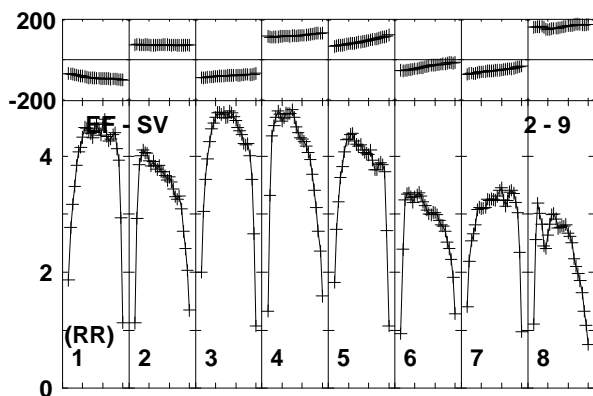
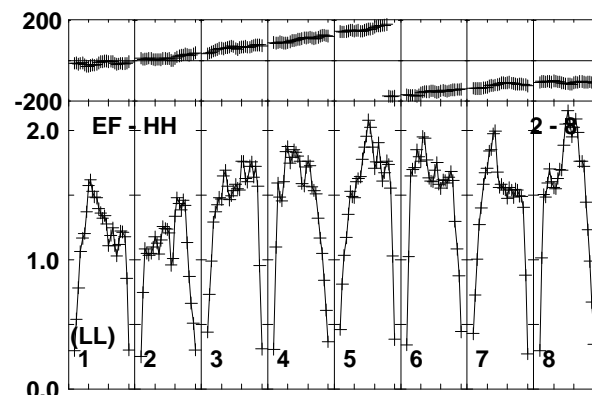
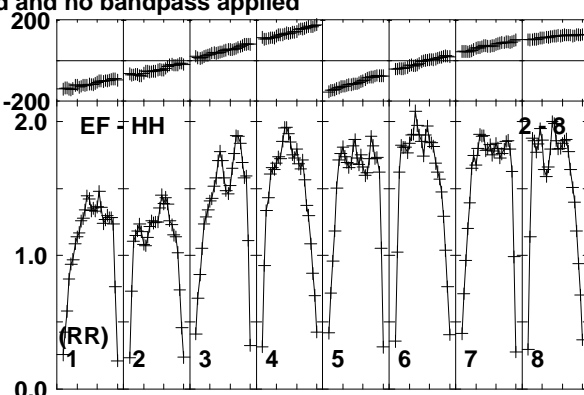
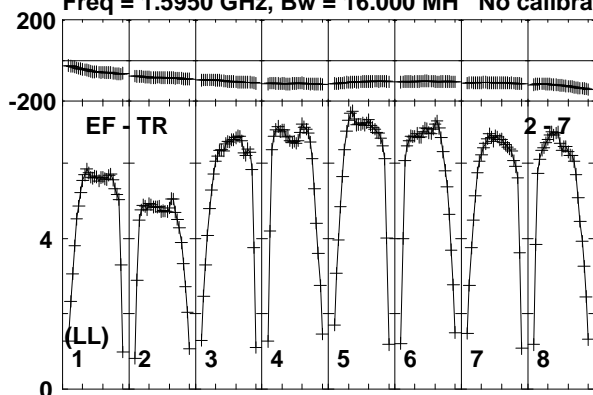

Lower frame: Milli Ampl Jy Top frame: Phas deg  
Vector averaged cross-power spectrum Baseline: EF (02) - TR (07)  
Timerange: 00/06:10:41 to 00/06:11:59

Plot file version 150 created 30-AUG-2019 17:53:36

J1722+2458 EB070.UVDATA.1

Freq = 1.5950 GHz, Bw = 16.000 MH No calibration applied and no bandpass applied

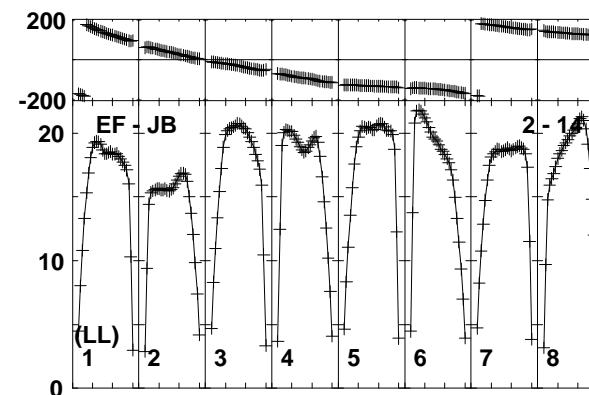
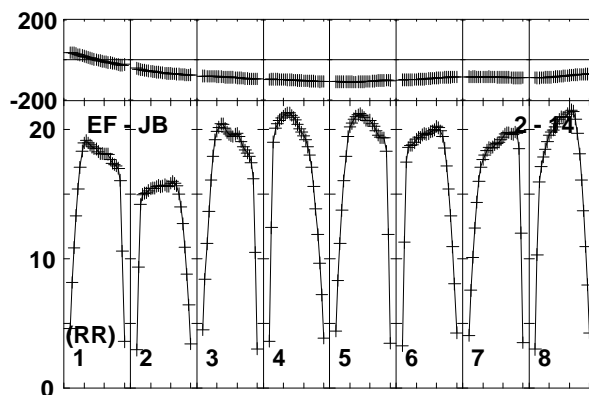
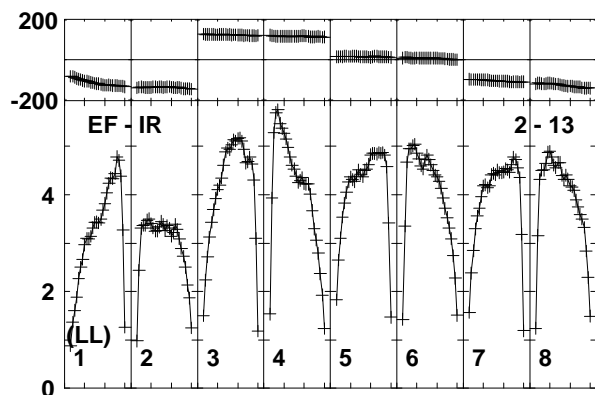
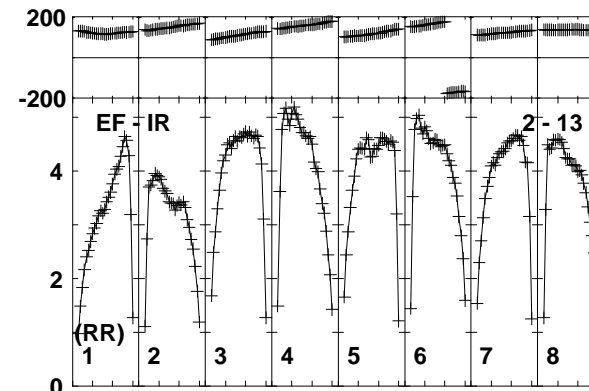
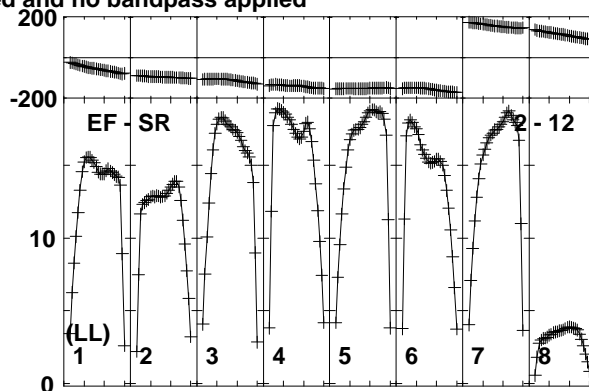
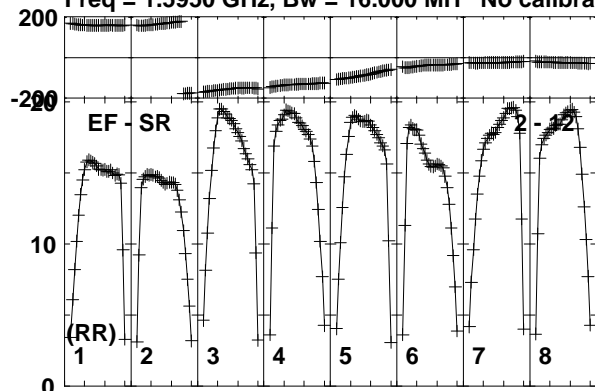

Lower frame: Milli Ampl Jy Top frame: Phas deg  
Vector averaged cross-power spectrum Baseline: EF (02) - SR (12)  
Timerange: 00/06:10:41 to 00/06:11:59

Plot file version 151 created 30-AUG-2019 17:53:36

ROSS867 EB070.UVDATA.1

Freq = 1.5950 GHz, Bw = 16.000 MH No calibration applied and no bandpass applied

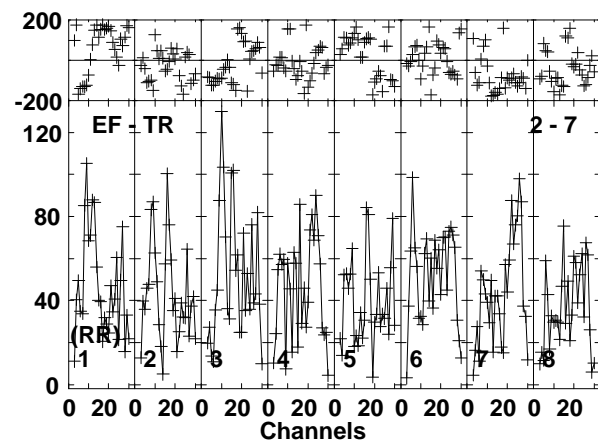
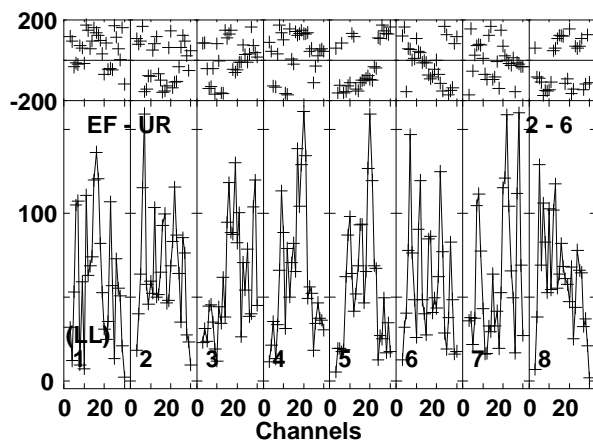
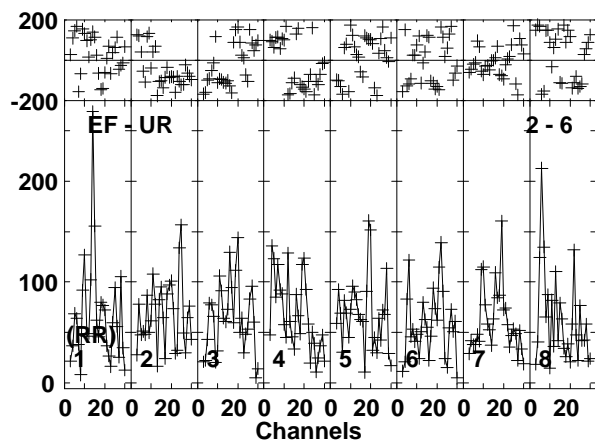
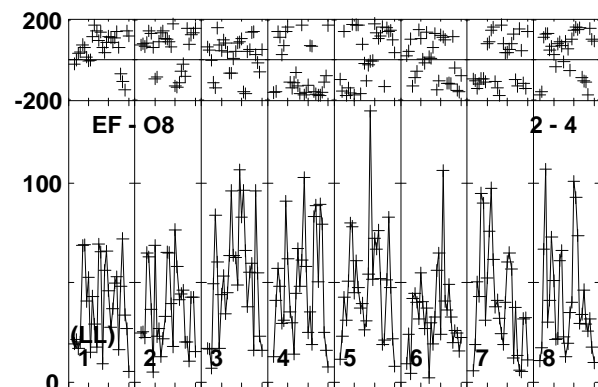
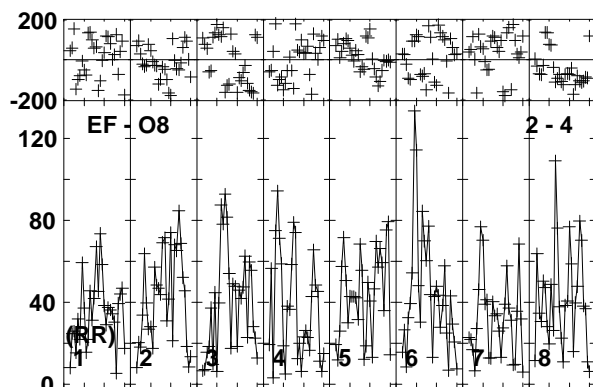
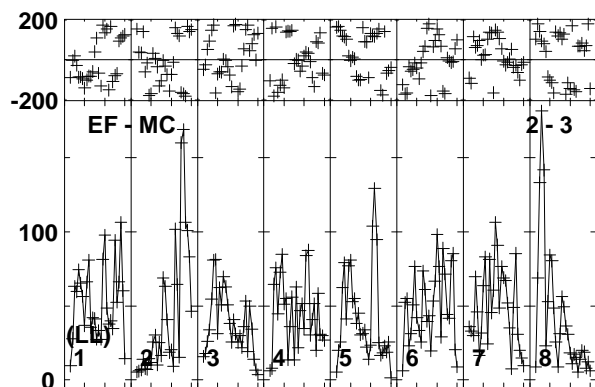
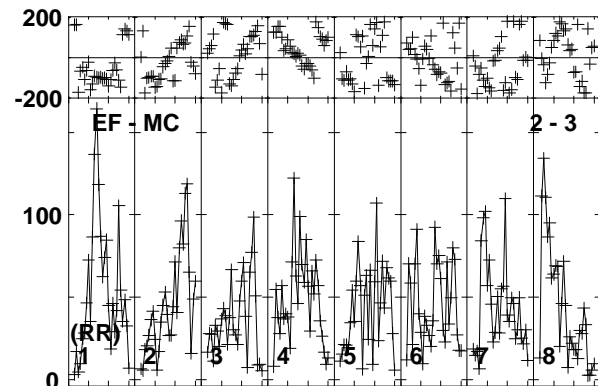
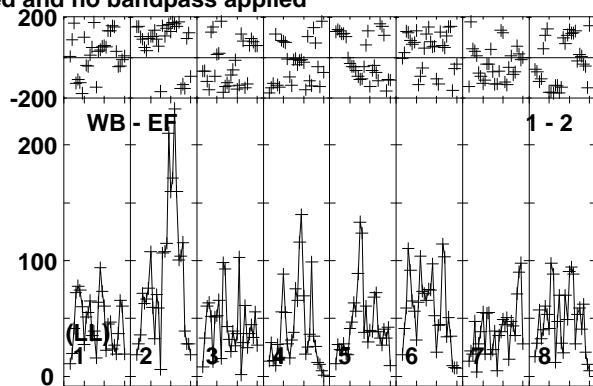
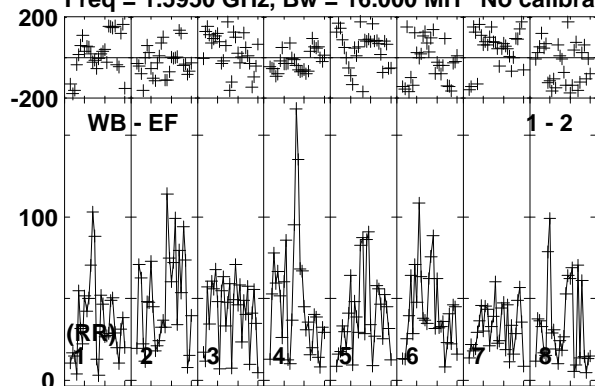

Lower frame: Micro Ampl Jy Top frame: Phas deg  
Vector averaged cross-power spectrum Baseline: WB (01) - EF (02)  
Timerange: 00/06:12:01 to 00/06:19:59

Plot file version 152 created 30-AUG-2019 17:53:36

ROSS867 EB070.UVDATA.1

Freq = 1.5950 GHz, Bw = 16.000 MH No calibration applied and no bandpass applied

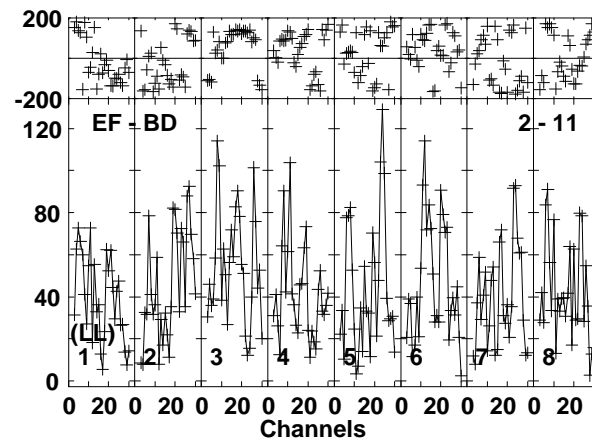
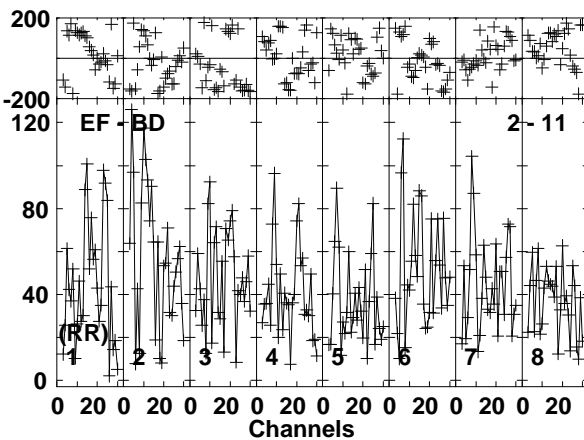
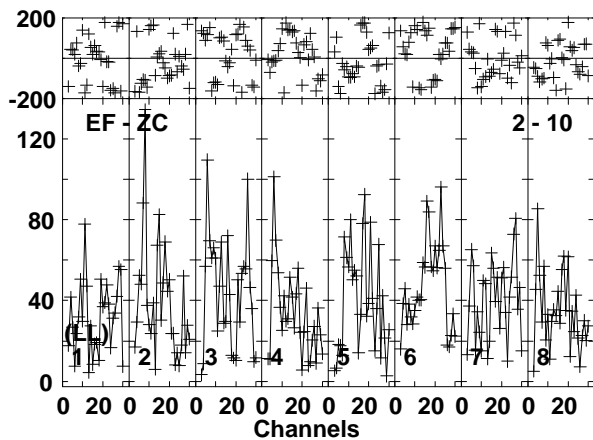
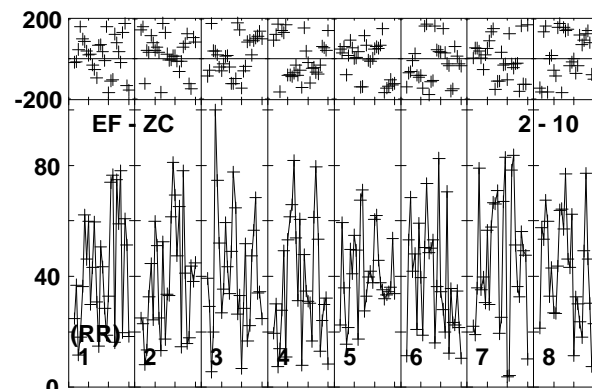
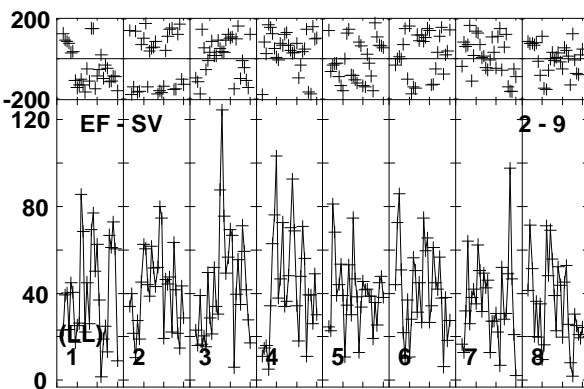
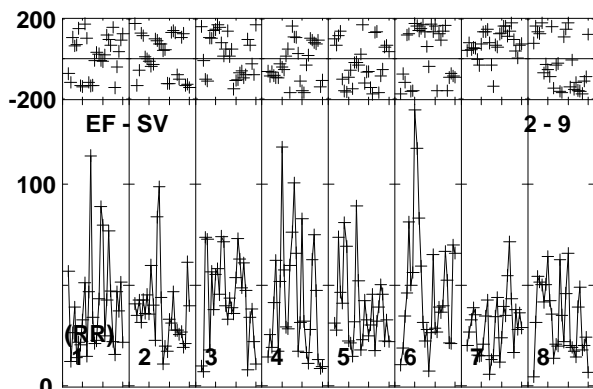
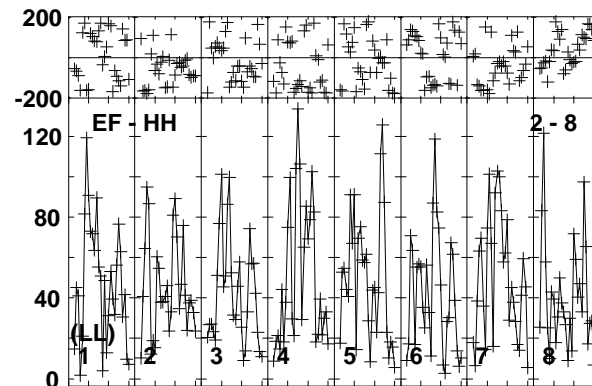
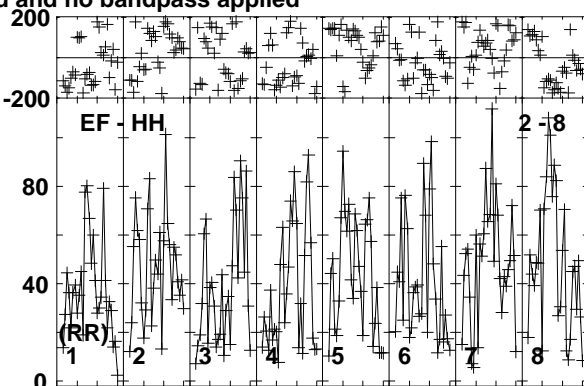
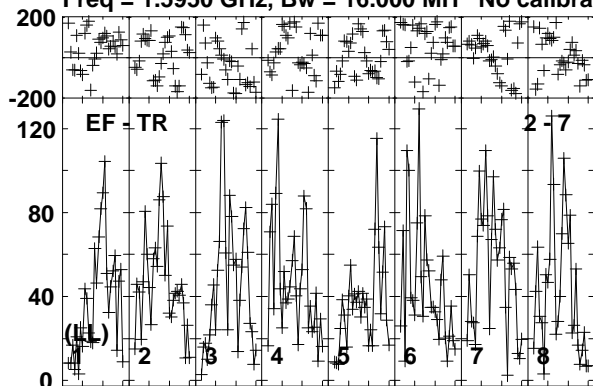

Lower frame: Micro Ampl Jy Top frame: Phas deg  
Vector averaged cross-power spectrum Baseline: EF (02) - TR (07)  
Timerange: 00/06:12:01 to 00/06:19:59



Plot file version 153 created 30-AUG-2019 17:53:36

ROSS867 EB070.UVDATA.1

Freq = 1.5950 GHz, Bw = 16.000 MH No calibration applied and no bandpass applied

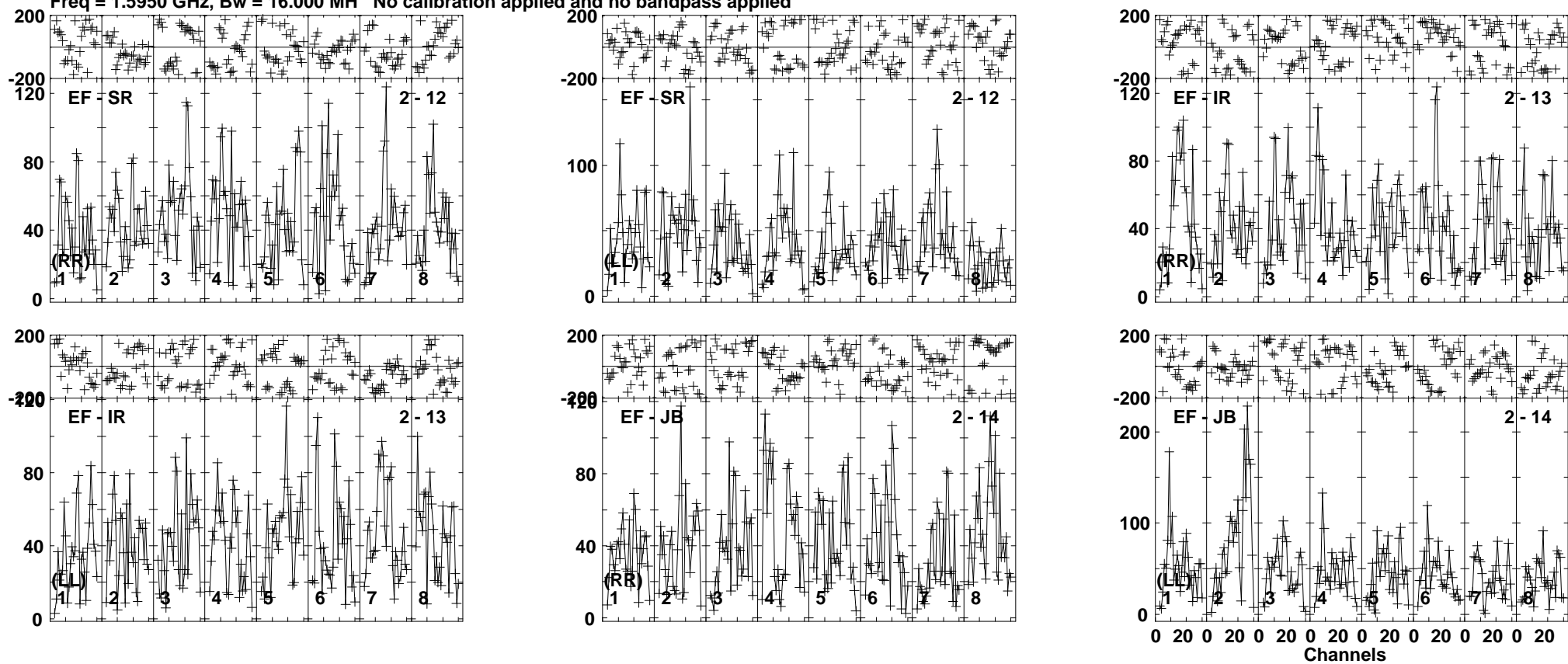

Lower frame: Micro Ampl Jy Top frame: Phas deg  
Vector averaged cross-power spectrum Baseline: EF (02) - SR (12)  
Timerange: 00/06:12:01 to 00/06:19:59

Plot file version 154 created 30-AUG-2019 17:53:37

J1722+2458 EB070.UVDATA.1

Freq = 1.5950 GHz, Bw = 16.000 MH No calibration applied and no bandpass applied

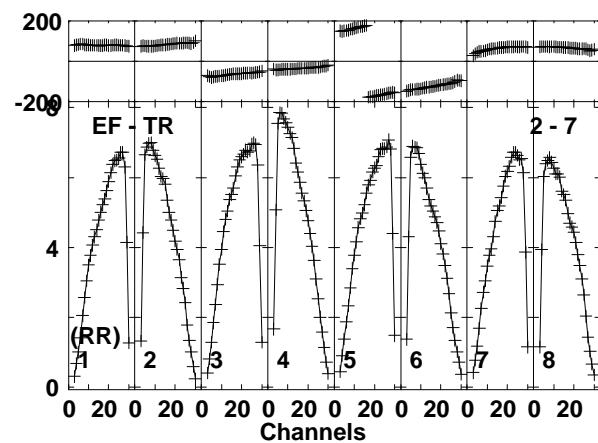
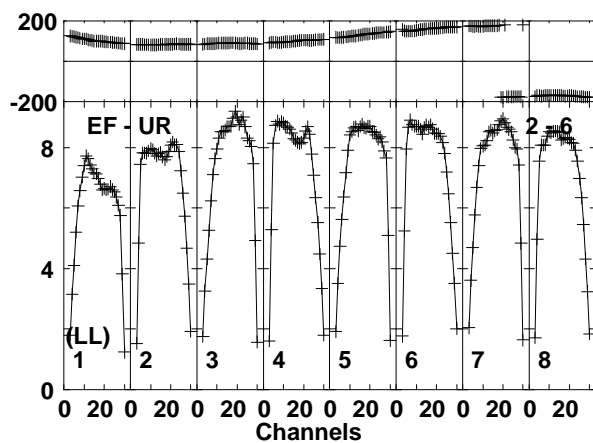
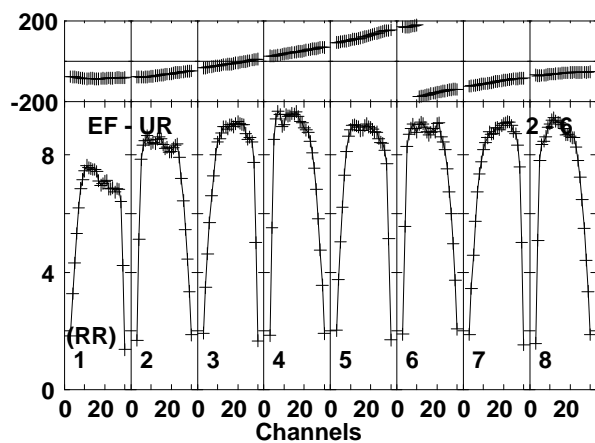
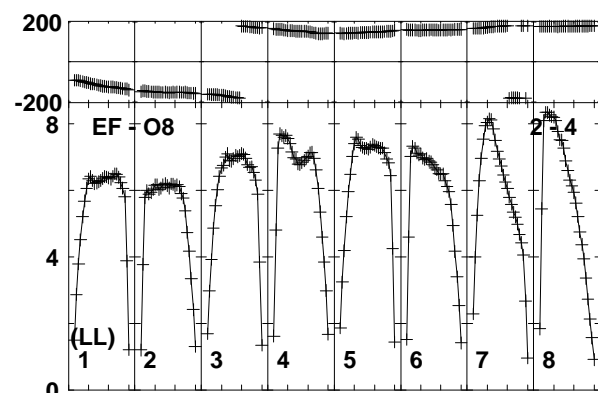
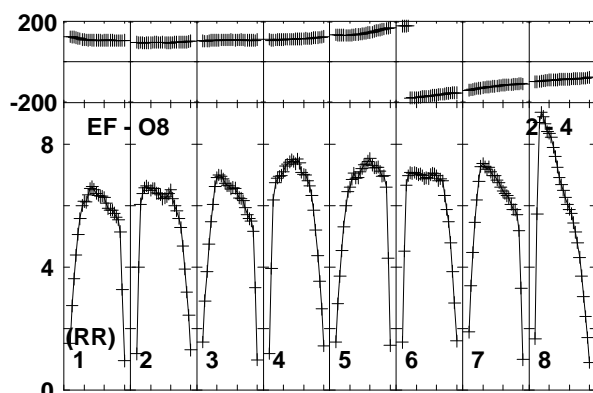
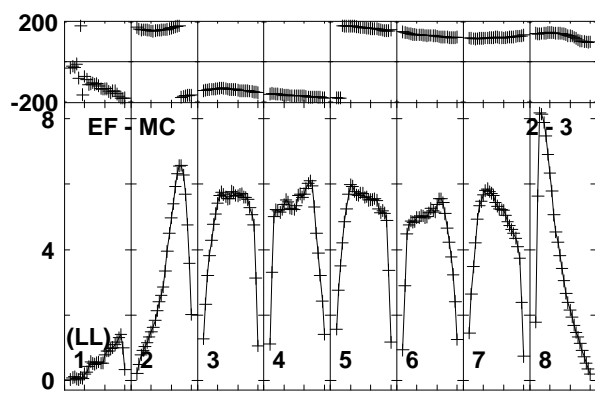
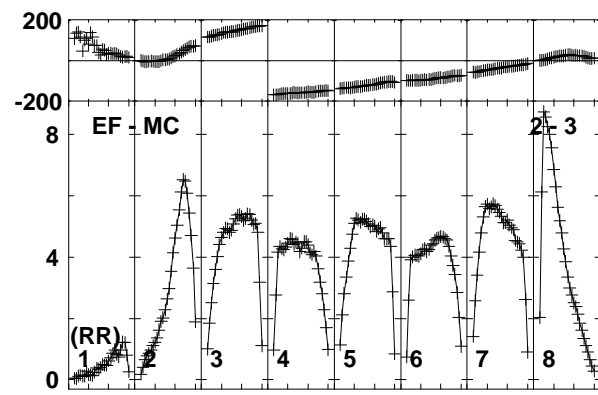
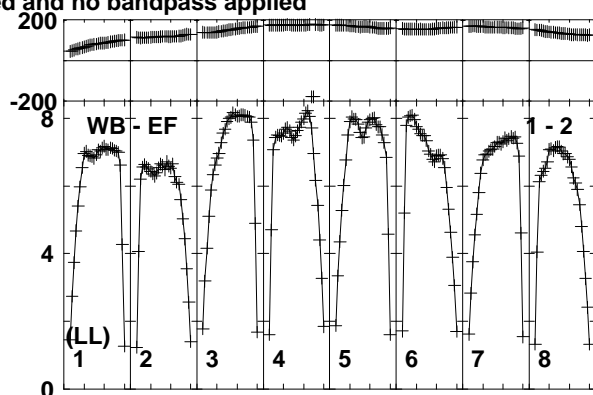
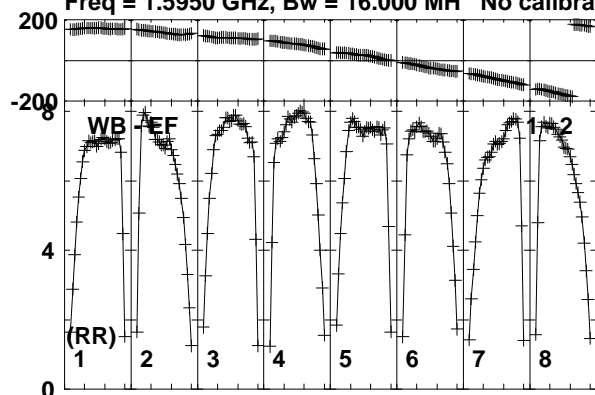

Lower frame: Milli Ampl Jy Top frame: Phas deg  
Vector averaged cross-power spectrum Baseline: WB (01) - EF (02)  
Timerange: 00/06:20:01 to 00/06:21:59

Plot file version 155 created 30-AUG-2019 17:53:37

J1722+2458 EB070.UVDATA.1

Freq = 1.5950 GHz, Bw = 16.000 MH No calibration applied and no bandpass applied

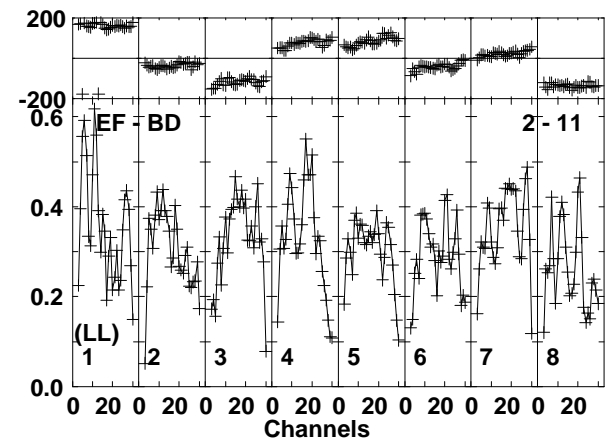
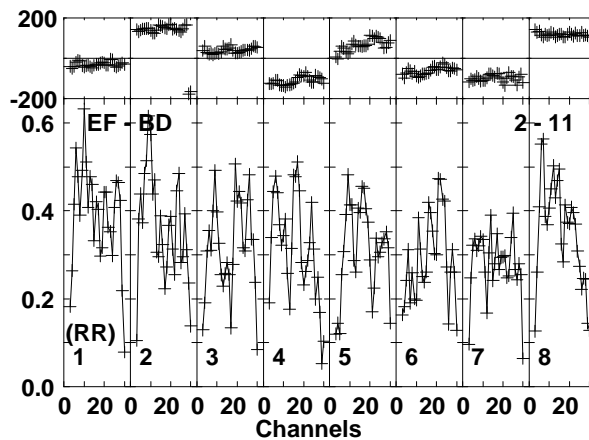
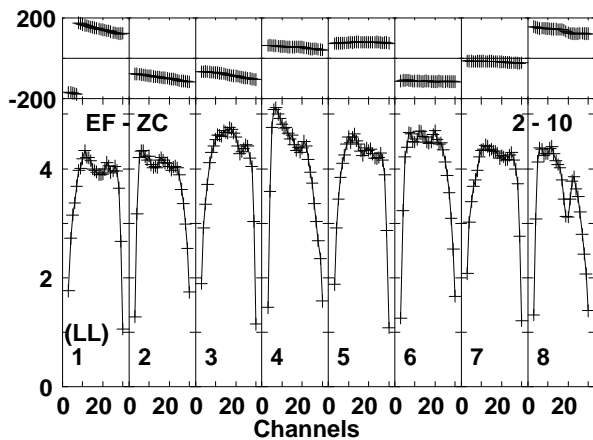
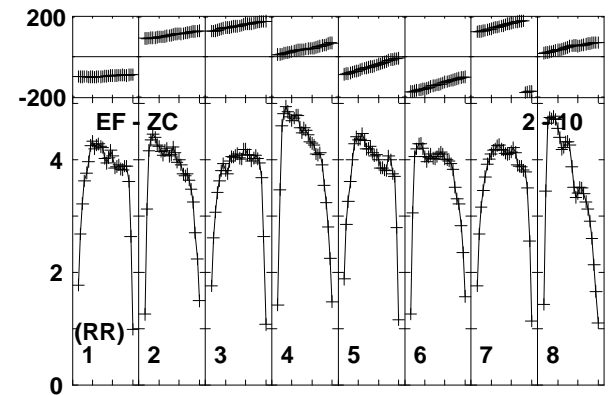
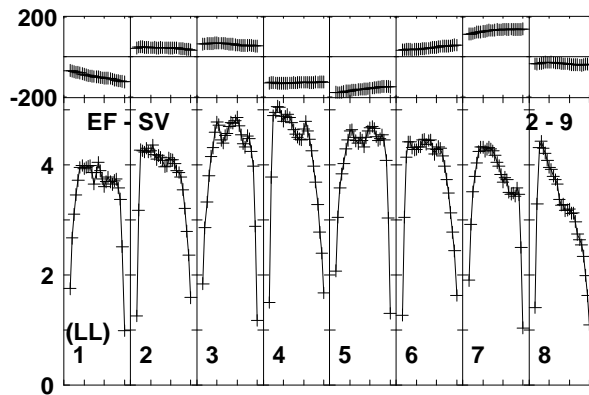
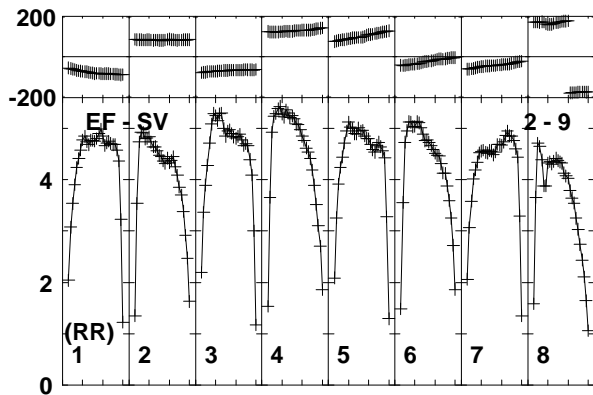
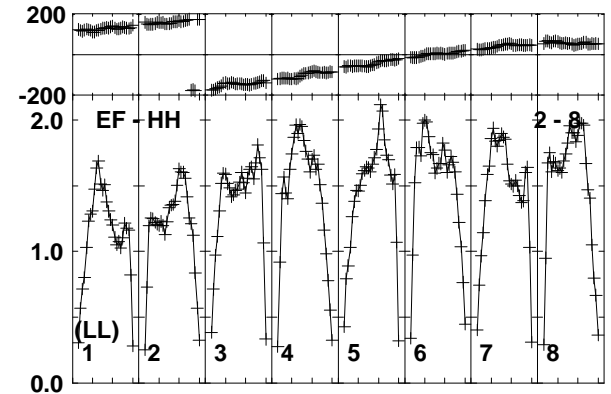
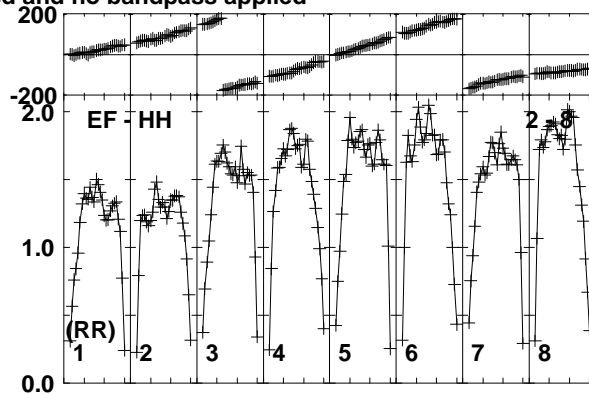
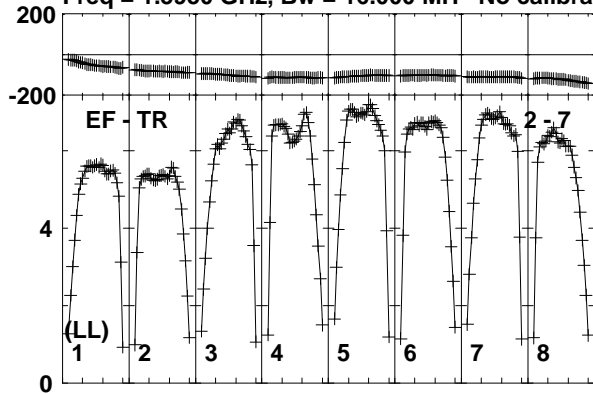

Lower frame: Milli Ampl Jy Top frame: Phas deg  
Vector averaged cross-power spectrum Baseline: EF (02) - TR (07)  
Timerange: 00/06:20:01 to 00/06:21:59

Plot file version 156 created 30-AUG-2019 17:53:37

J1722+2458 EB070.UVDATA.1

Freq = 1.5950 GHz, Bw = 16.000 MH No calibration applied and no bandpass applied

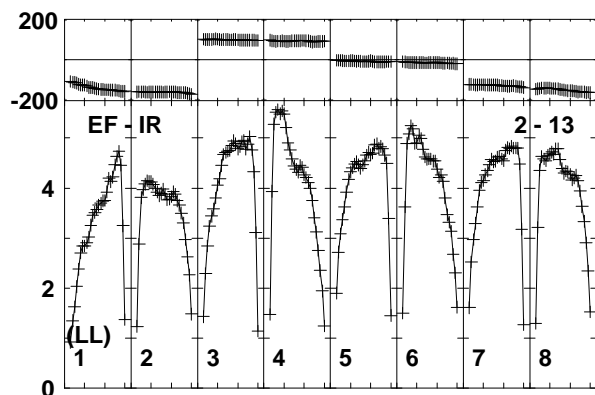
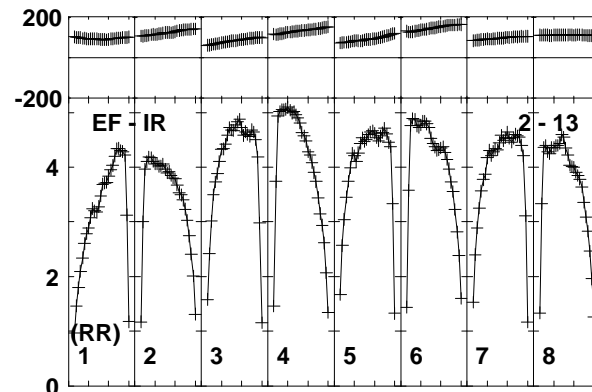
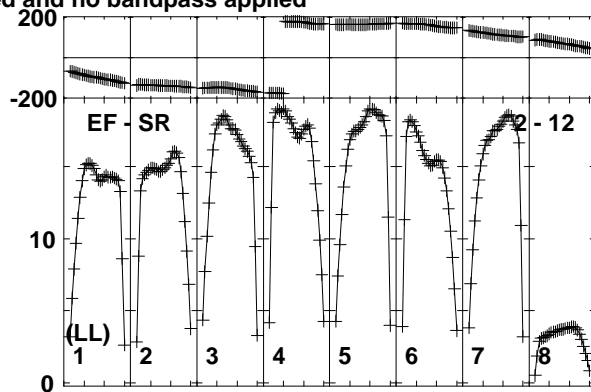
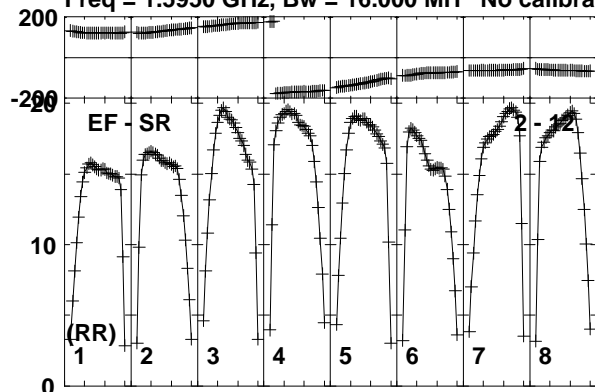

Lower frame: Milli Ampl Jy Top frame: Phas deg  
Vector averaged cross-power spectrum Baseline: EF (02) - SR (12)  
Timerange: 00/06:20:01 to 00/06:21:59

Plot file version 157 created 30-AUG-2019 17:53:37

ROSS867 EB070.UVDATA.1

Freq = 1.5950 GHz, Bw = 16.000 MH No calibration applied and no bandpass applied

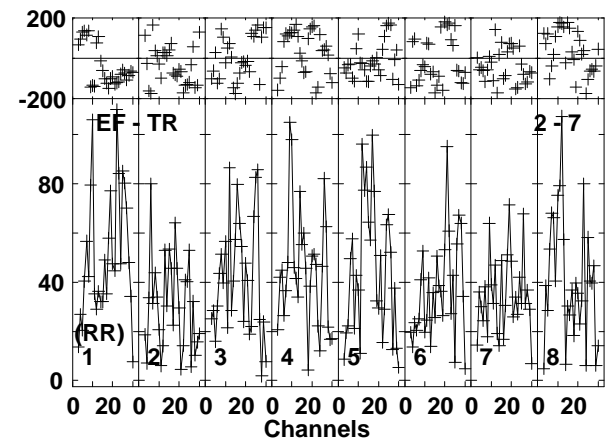
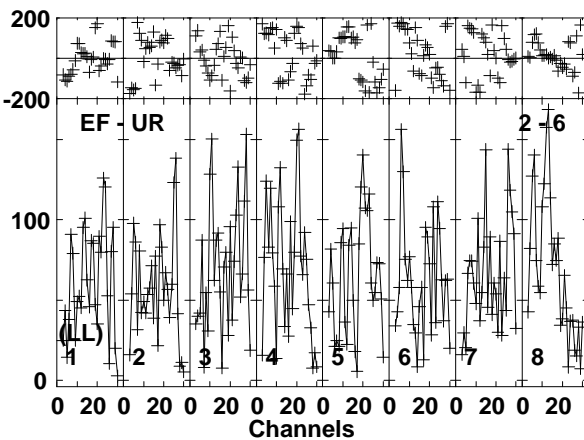
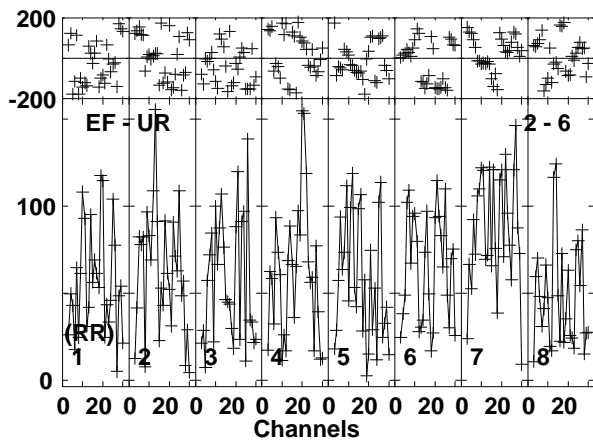
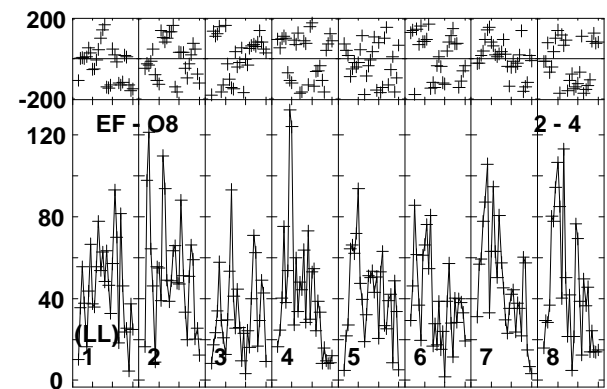
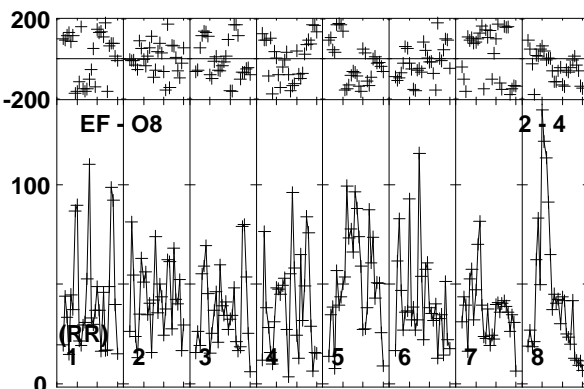
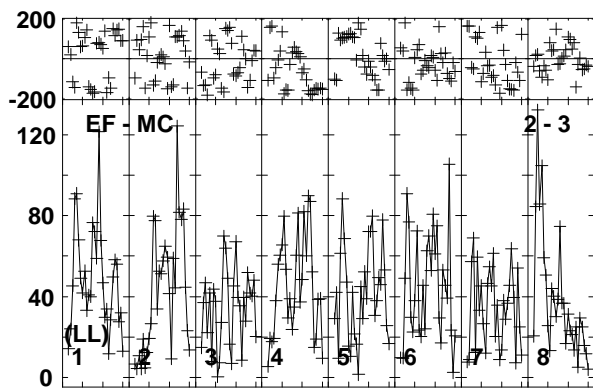
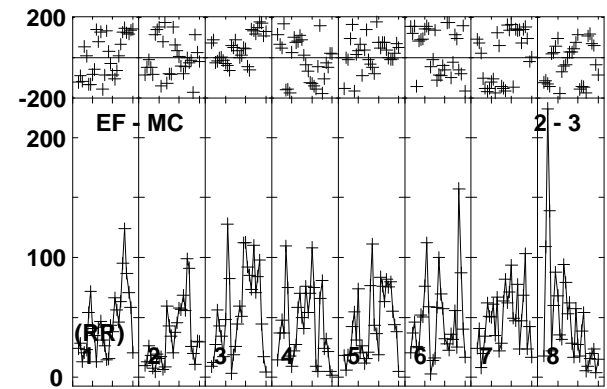
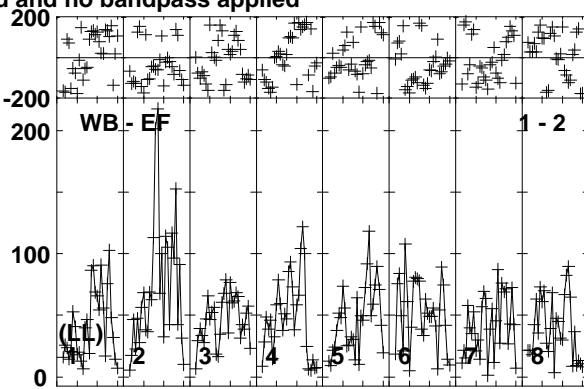
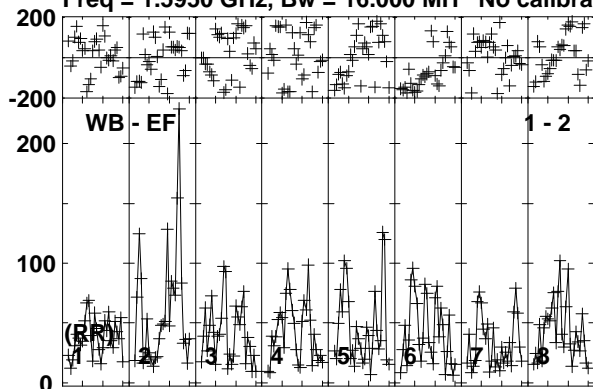

Lower frame: Micro Ampl Jy Top frame: Phas deg  
Vector averaged cross-power spectrum Baseline: WB (01) - EF (02)  
Timerange: 00/06:22:01 to 00/06:29:59

Plot file version 158 created 30-AUG-2019 17:53:37

ROSS867 EB070.UVDATA.1

Freq = 1.5950 GHz, Bw = 16.000 MH No calibration applied and no bandpass applied

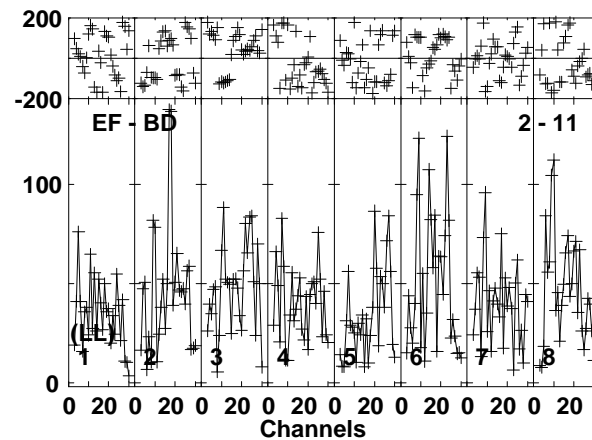
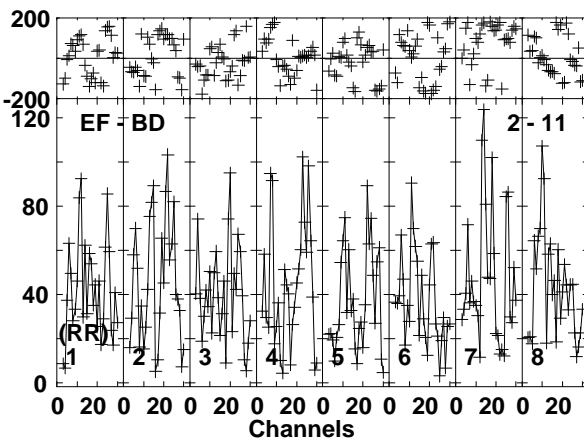
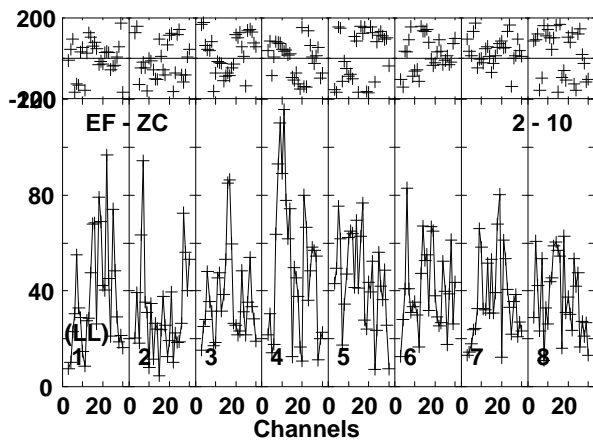
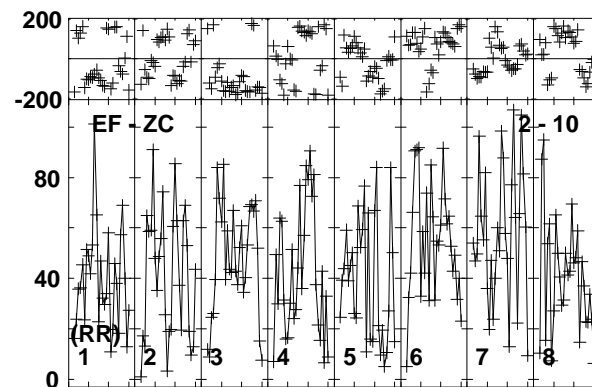
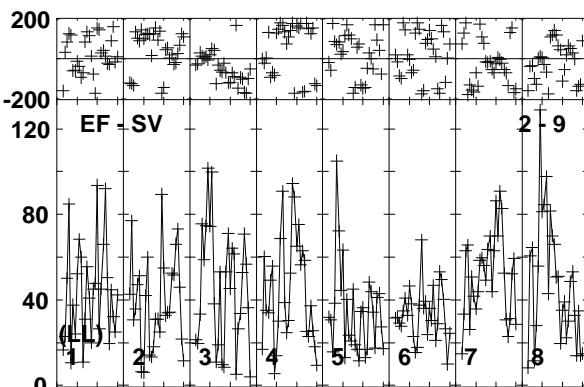
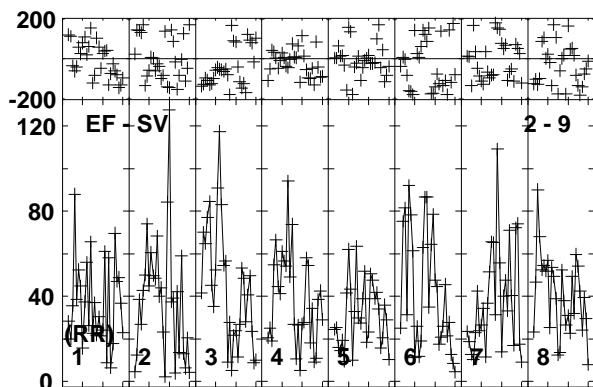
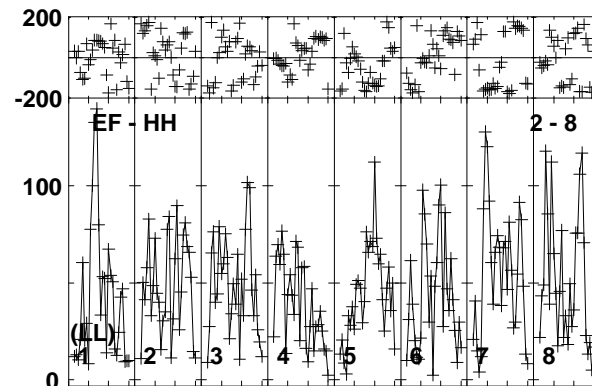
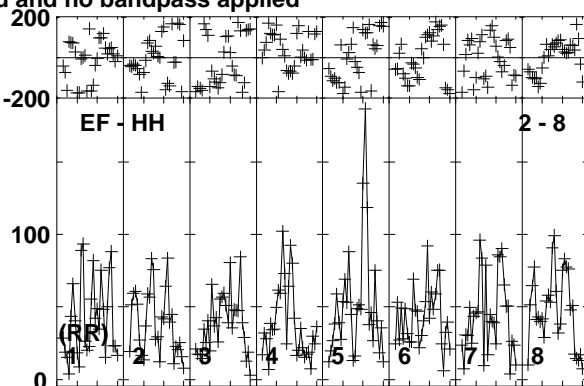
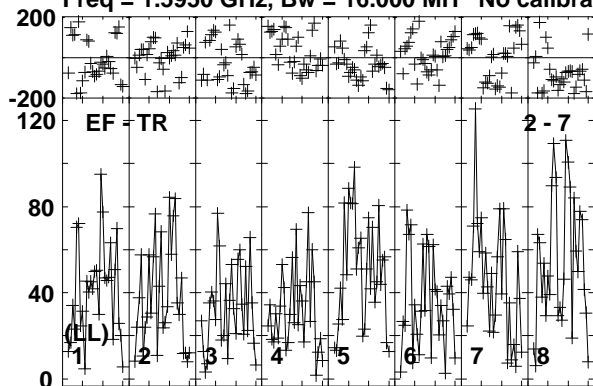

Lower frame: Micro Ampl Jy Top frame: Phas deg  
Vector averaged cross-power spectrum Baseline: EF (02) - TR (07)  
Timerange: 00/06:22:01 to 00/06:29:59

Plot file version 159 created 30-AUG-2019 17:53:38

ROSS867 EB070.UVDATA.1

Freq = 1.5950 GHz, Bw = 16.000 MH No calibration applied and no bandpass applied

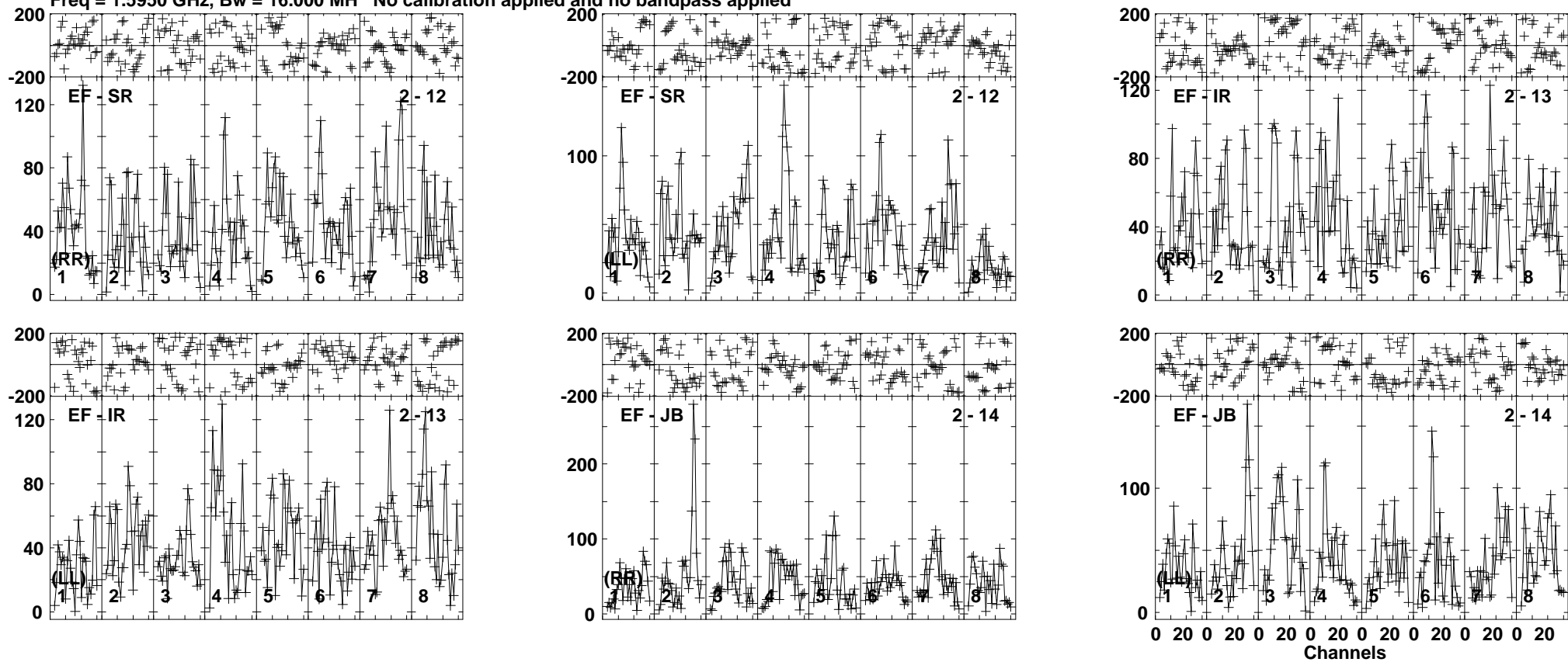

Lower frame: Micro Ampl Jy Top frame: Phas deg  
Vector averaged cross-power spectrum Baseline: EF (02) - SR (12)  
Timerange: 00/06:22:01 to 00/06:29:59

Plot file version 160 created 30-AUG-2019 17:53:38

J1722+2458 EB070.UVDATA.1

Freq = 1.5950 GHz, Bw = 16.000 MH No calibration applied and no bandpass applied

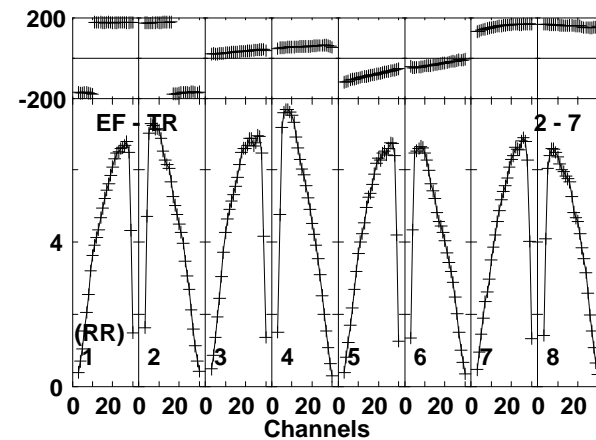
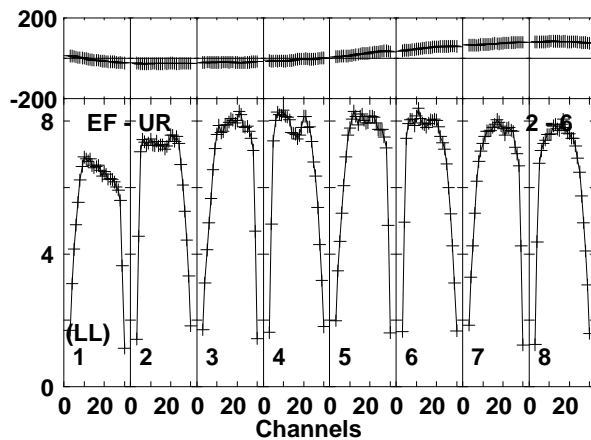
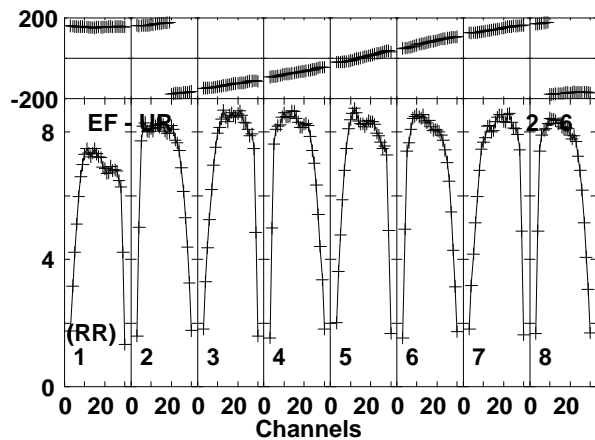
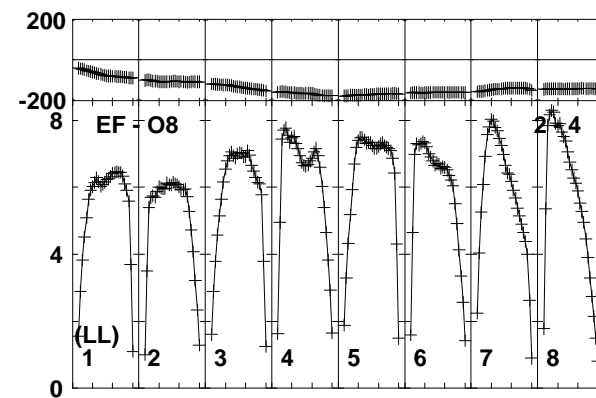
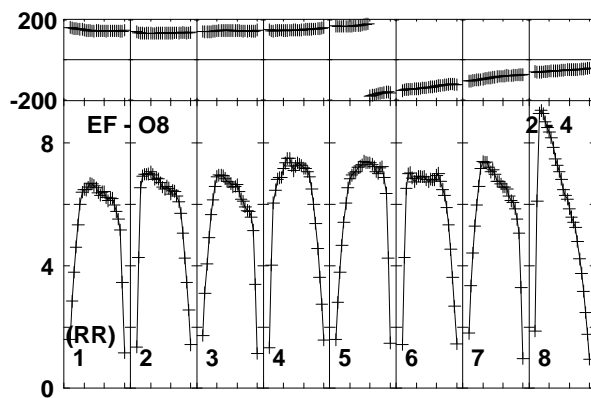
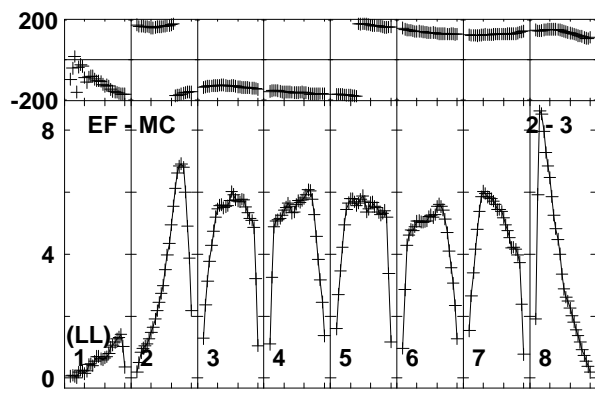
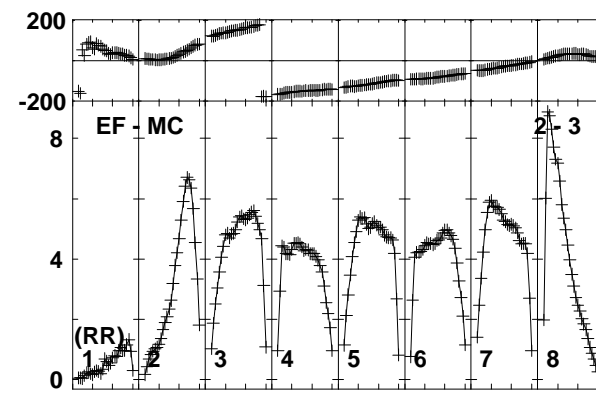
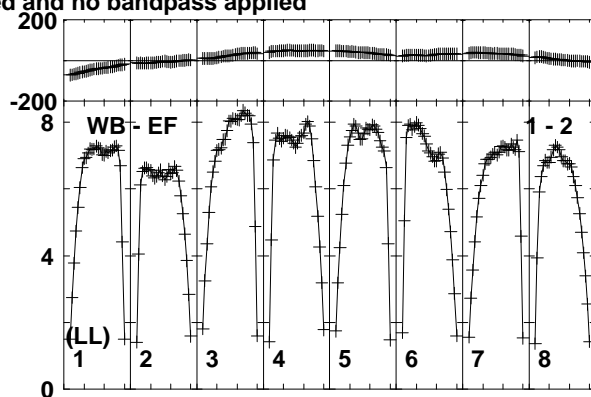
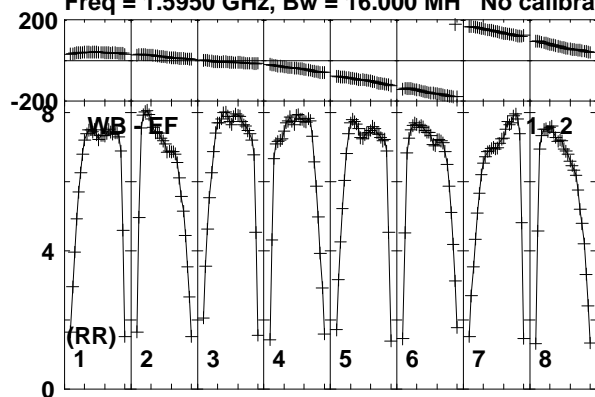

Lower frame: Milli Ampl Jy Top frame: Phas deg  
Vector averaged cross-power spectrum Baseline: WB (01) - EF (02)  
Timerange: 00/06:30:41 to 00/06:31:59



Plot file version 161 created 30-AUG-2019 17:53:38

J1722+2458 EB070.UVDATA.1

Freq = 1.5950 GHz, Bw = 16.000 MH No calibration applied and no bandpass applied

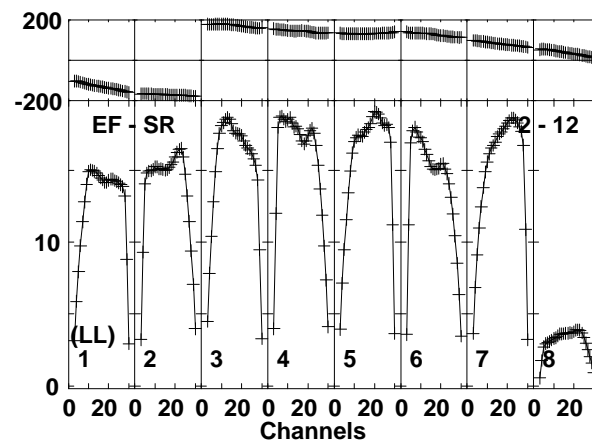
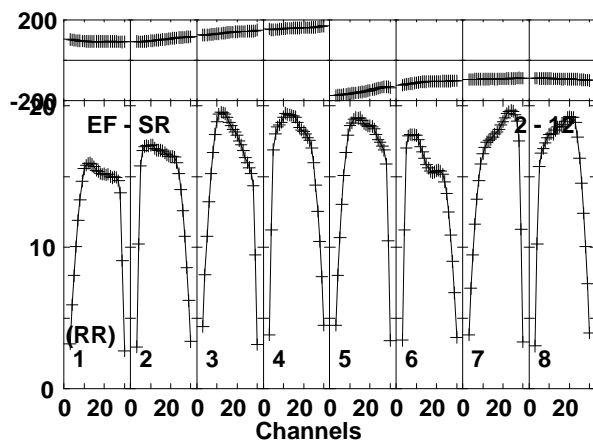
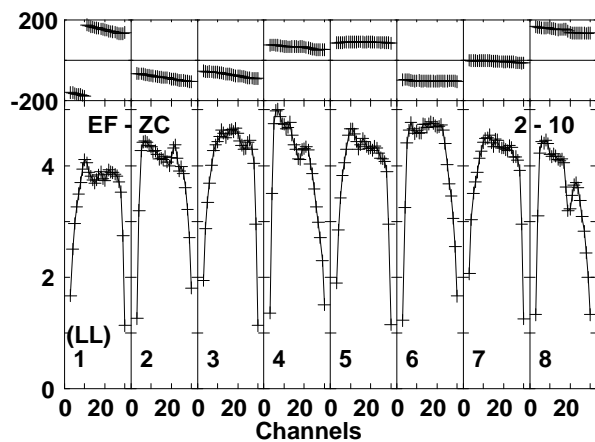
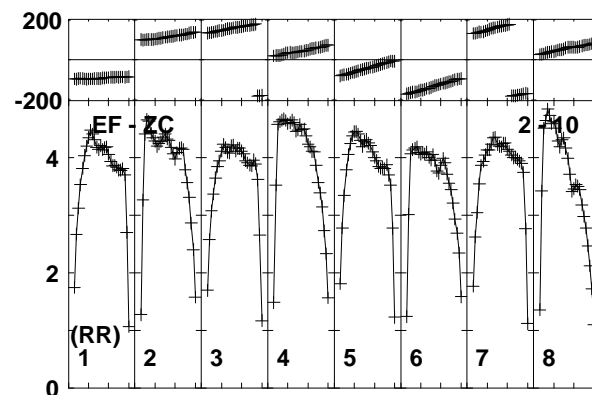
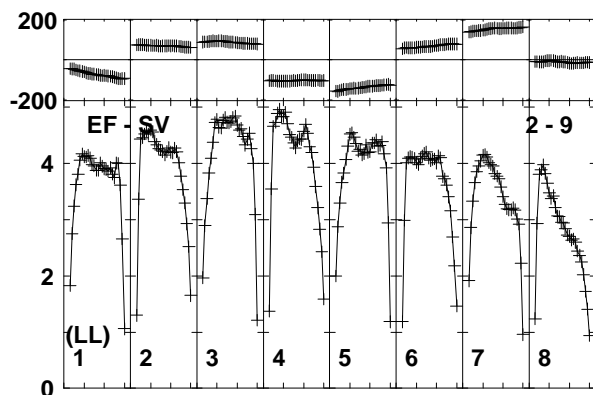
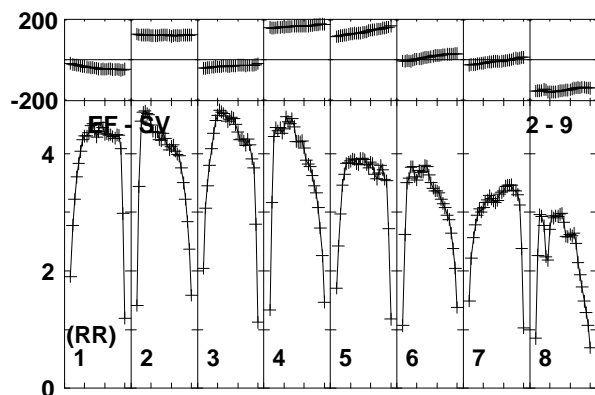
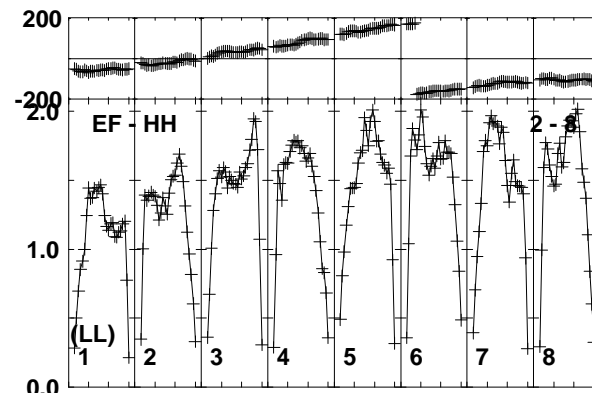
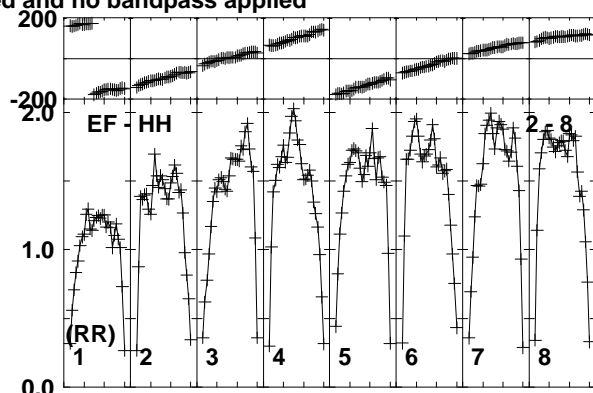
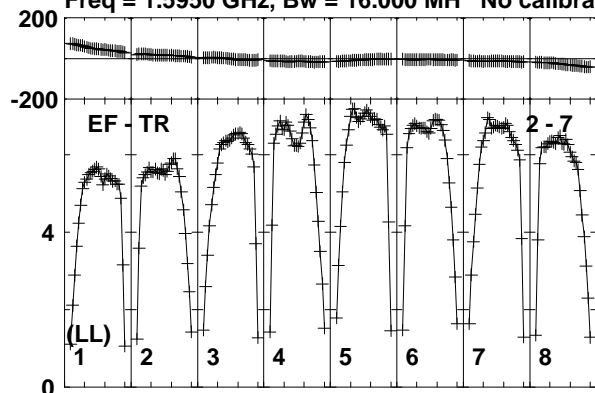

Lower frame: Milli Ampl Jy Top frame: Phas deg  
Vector averaged cross-power spectrum Baseline: EF (02) - TR (07)  
Timerange: 00/06:30:41 to 00/06:31:59

Plot file version 162 created 30-AUG-2019 17:53:38

J1722+2458 EB070.UVDATA.1

Freq = 1.5950 GHz, Bw = 16.000 MH No calibration applied and no bandpass applied

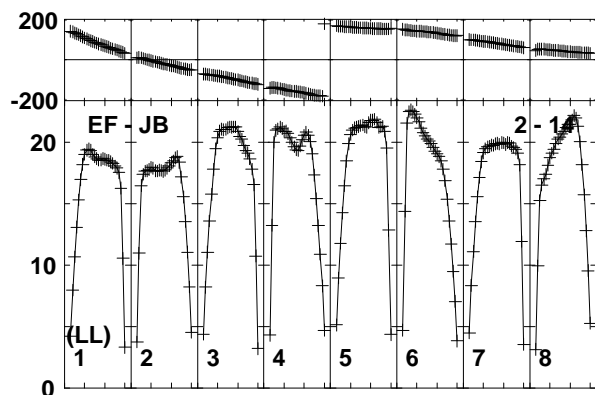
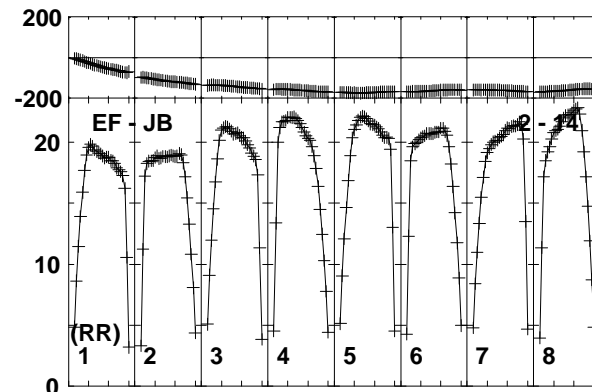
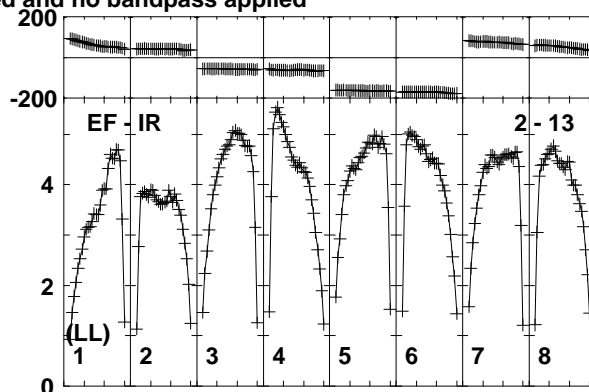
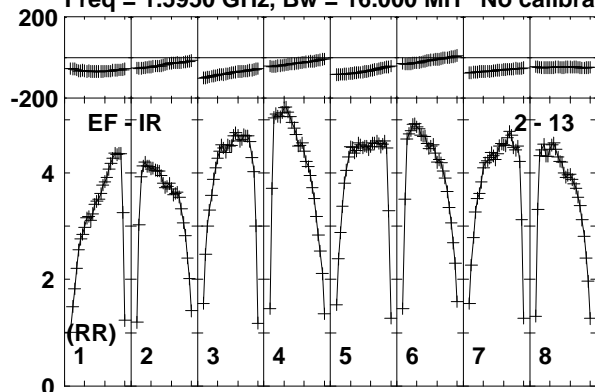

Lower frame: Milli Ampl Jy Top frame: Phas deg  
Vector averaged cross-power spectrum Baseline: EF (02) - IR (13)  
Timerange: 00/06:30:41 to 00/06:31:59

Plot file version 163 created 30-AUG-2019 17:53:38

ROSS867 EB070.UVDATA.1

Freq = 1.5950 GHz, Bw = 16.000 MH No calibration applied and no bandpass applied

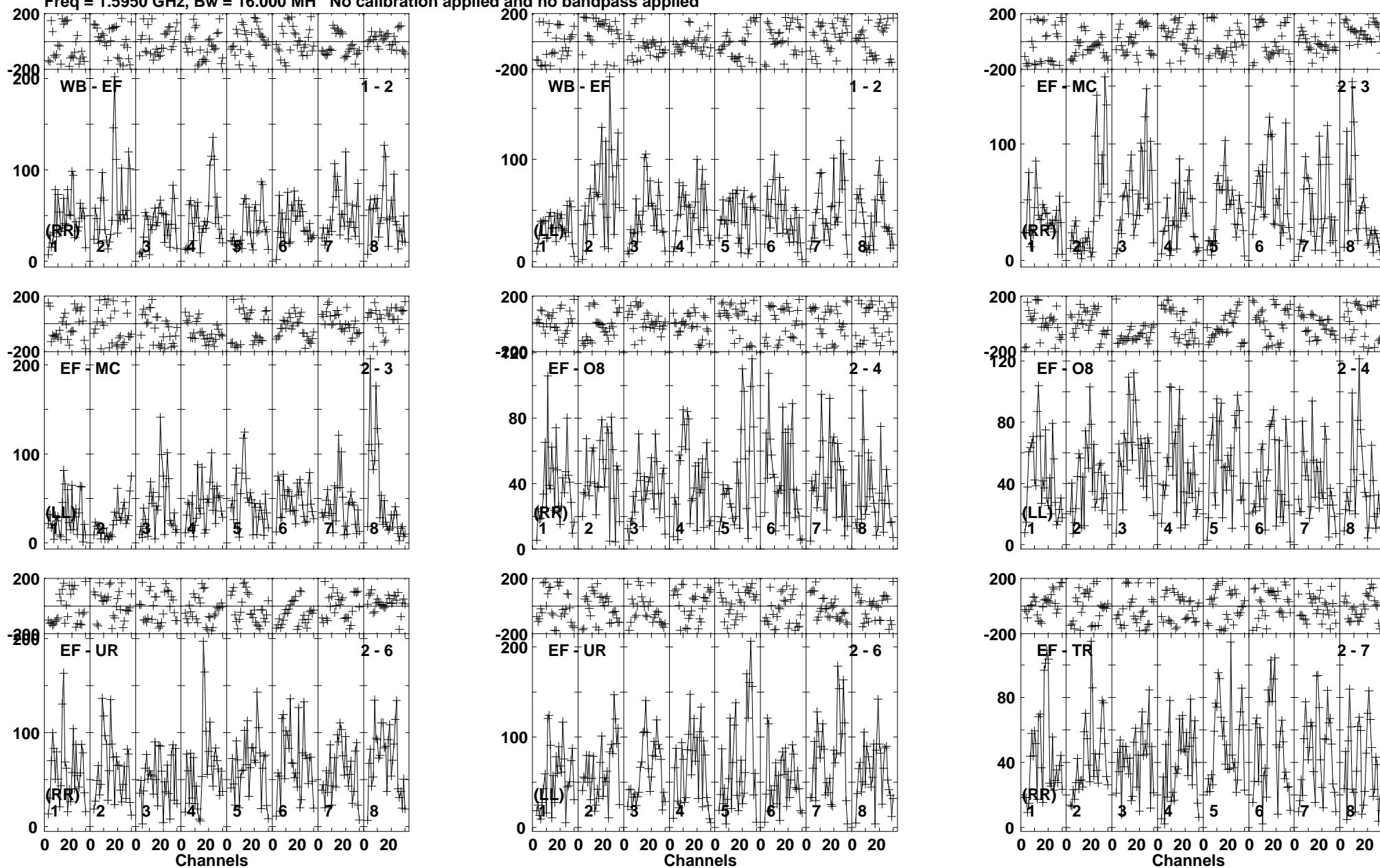

Lower frame: Micro Ampl Jy Top frame: Phas deg  
Vector averaged cross-power spectrum Baseline: WB (01) - EF (02)  
Timerange: 00/06:32:01 to 00/06:39:59

Plot file version 164 created 30-AUG-2019 17:53:38

ROSS867 EB070.UVDATA.1

Freq = 1.5950 GHz, Bw = 16.000 MH No calibration applied and no bandpass applied

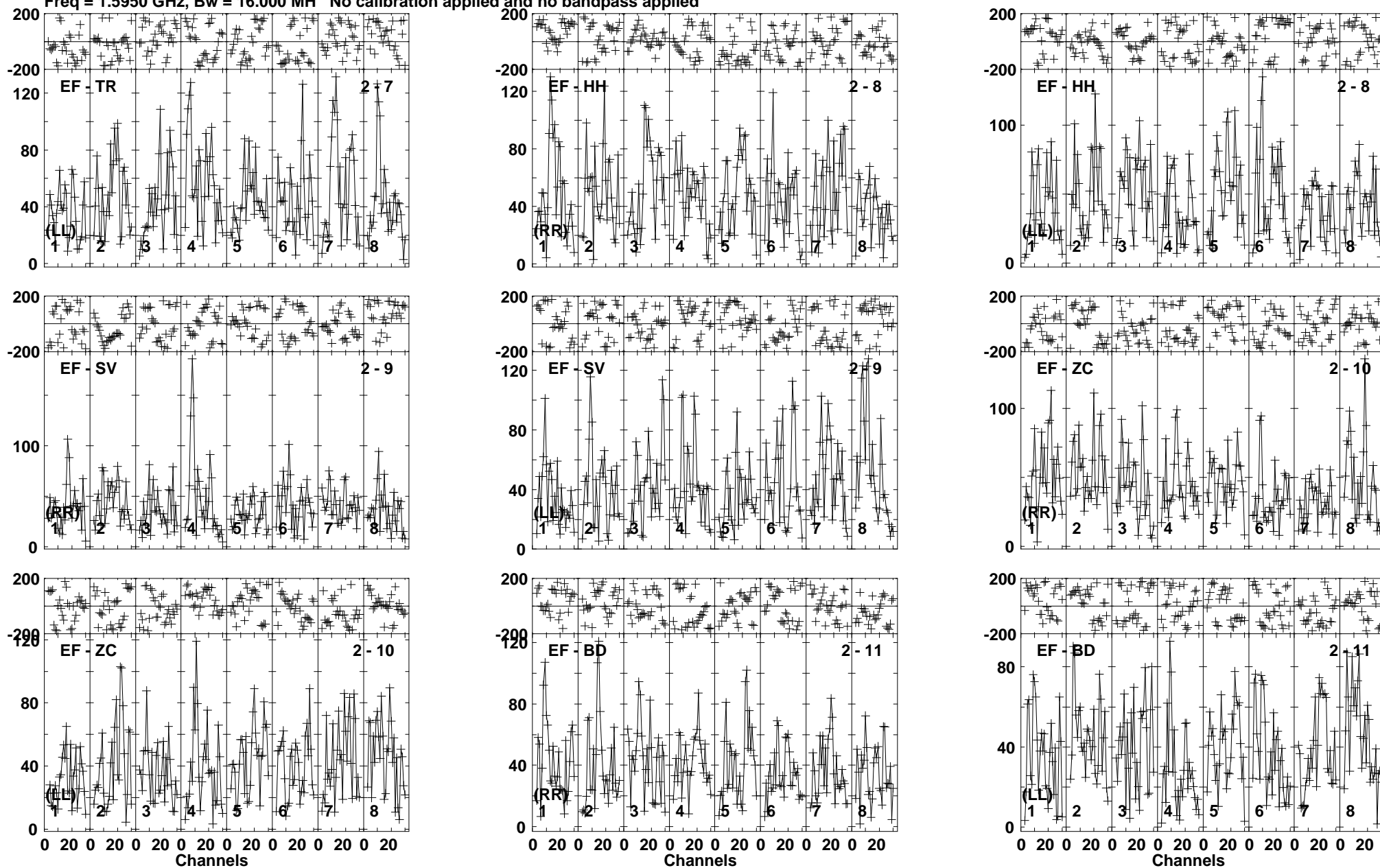

Lower frame: Micro Ampl Jy Top frame: Phas deg  
Vector averaged cross-power spectrum Baseline: EF (02) - TR (07)  
Timerange: 00/06:32:01 to 00/06:39:59

Plot file version 165 created 30-AUG-2019 17:53:39

ROSS867 EB070.UVDATA.1

Freq = 1.5950 GHz, Bw = 16.000 MH No calibration applied and no bandpass applied

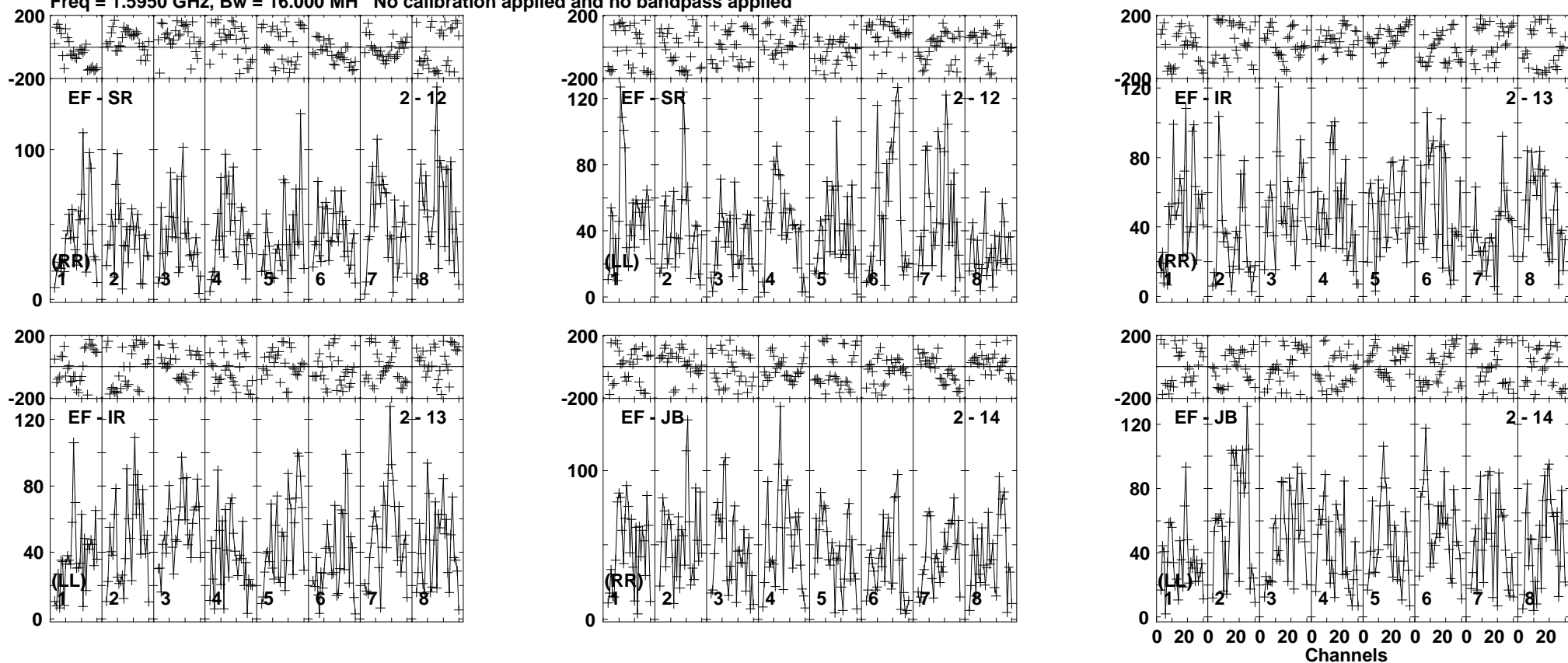

Lower frame: Micro Ampl Jy Top frame: Phas deg  
Vector averaged cross-power spectrum Baseline: EF (02) - SR (12)  
Timerange: 00/06:32:01 to 00/06:39:59

Plot file version 166 created 30-AUG-2019 17:53:39

J1722+2458 EB070.UVDATA.1

Freq = 1.5950 GHz, Bw = 16.000 MH No calibration applied and no bandpass applied

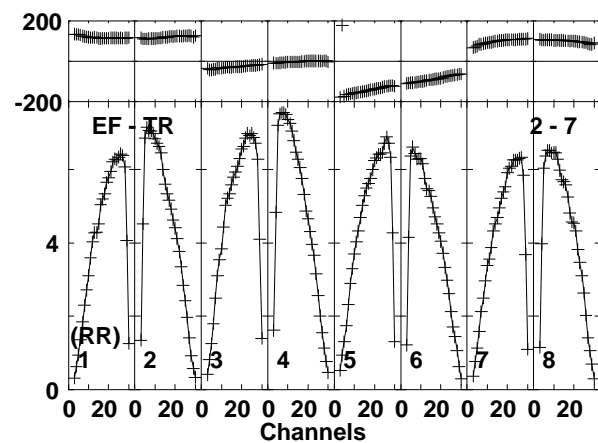
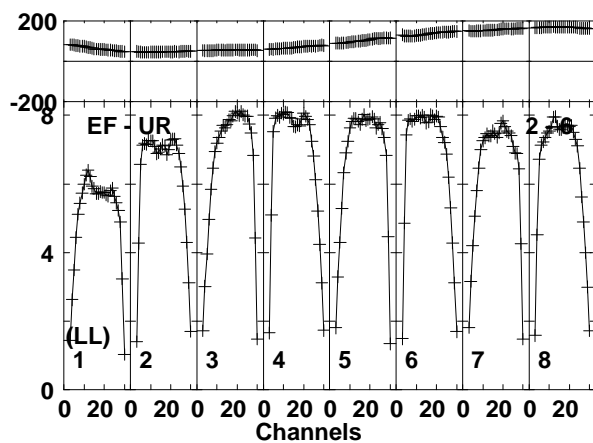
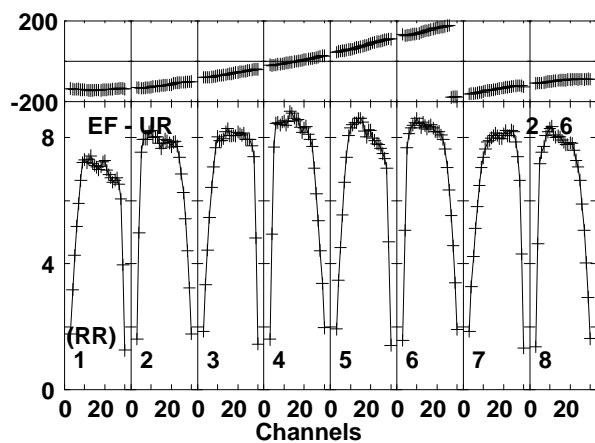
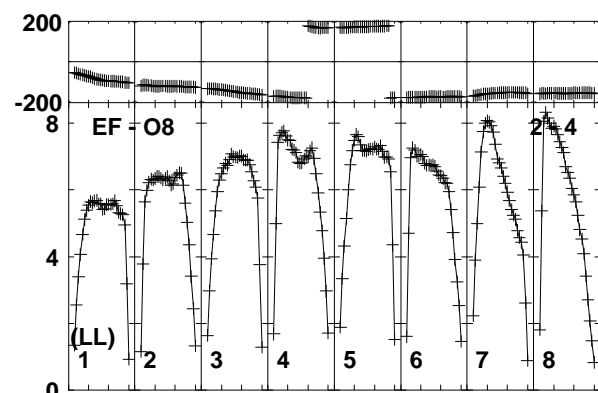
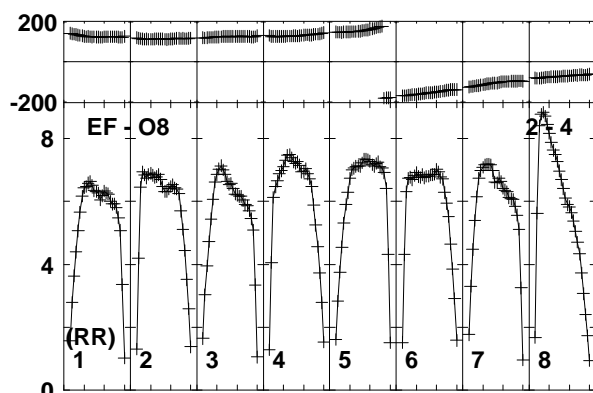
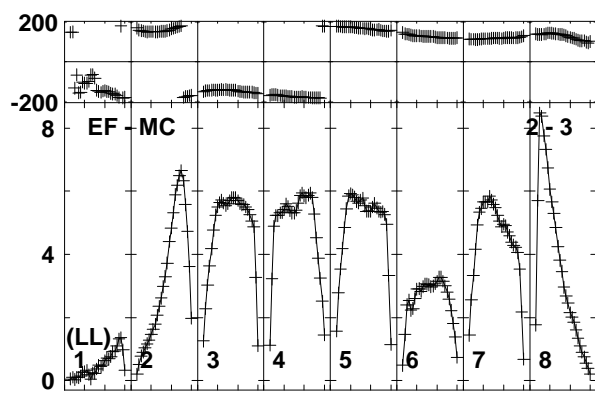
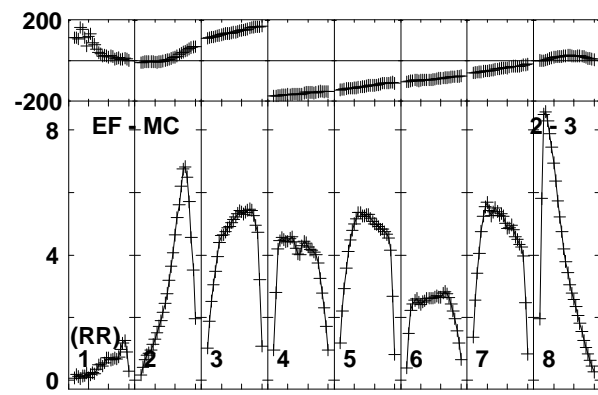
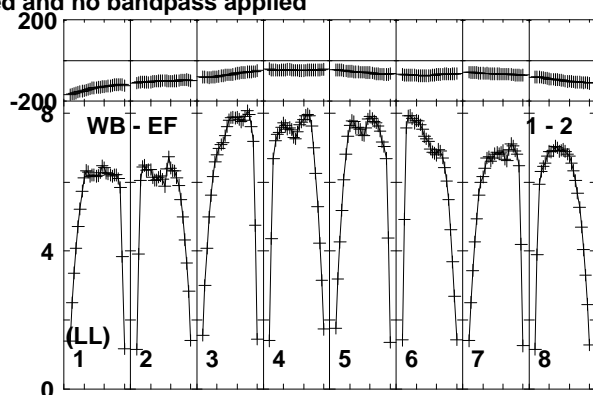
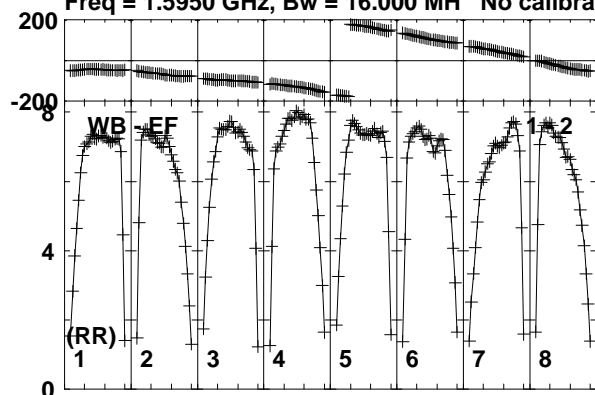

Lower frame: Milli Ampl Jy Top frame: Phas deg  
Vector averaged cross-power spectrum Baseline: WB (01) - EF (02)  
Timerange: 00/06:40:01 to 00/06:41:59

Plot file version 167 created 30-AUG-2019 17:53:39

J1722+2458 EB070.UVDATA.1

Freq = 1.5950 GHz, Bw = 16.000 MH No calibration applied and no bandpass applied

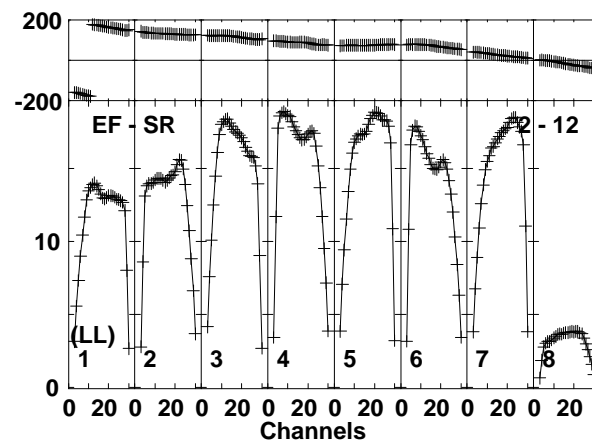
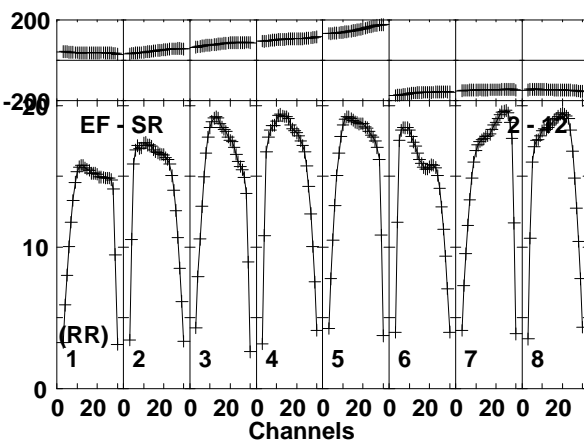
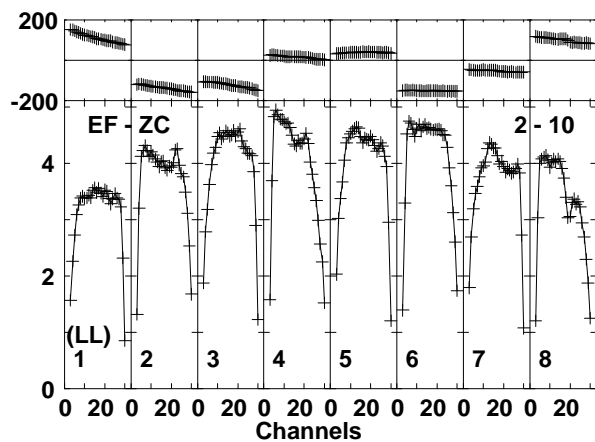
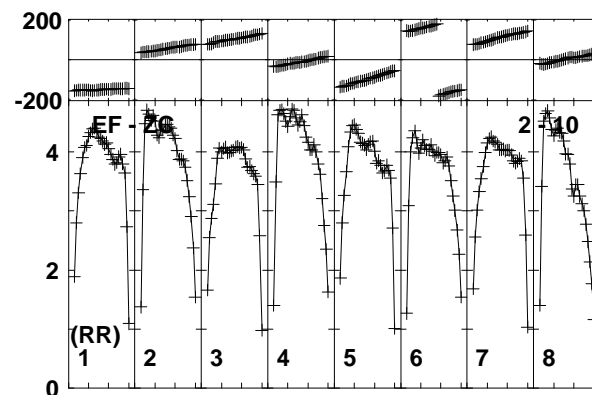
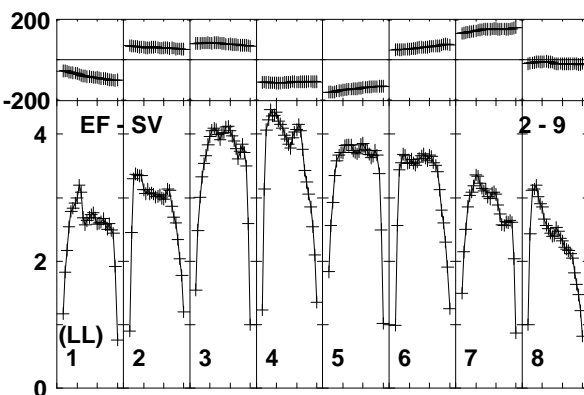
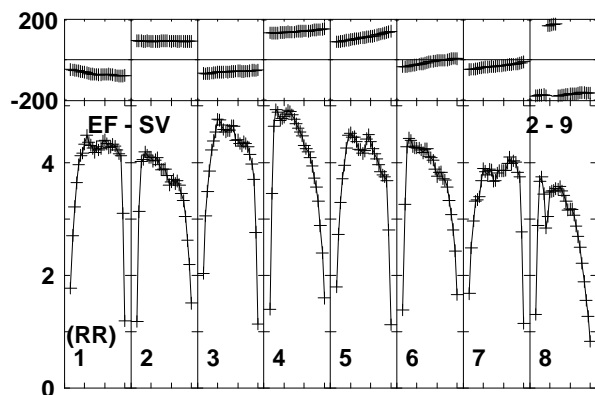
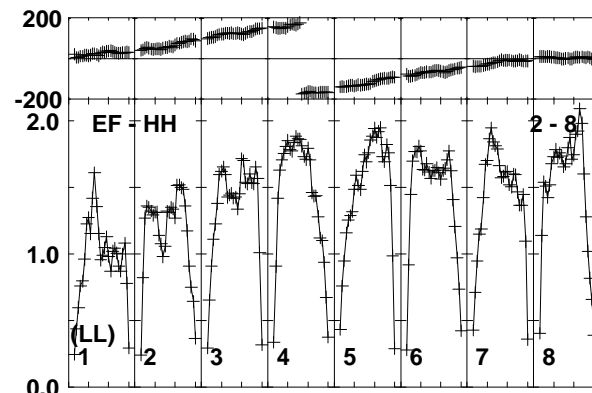
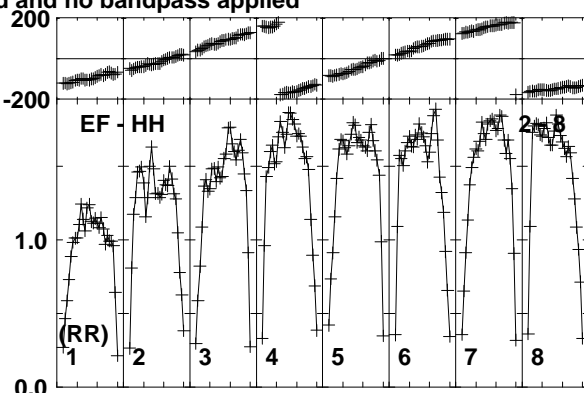
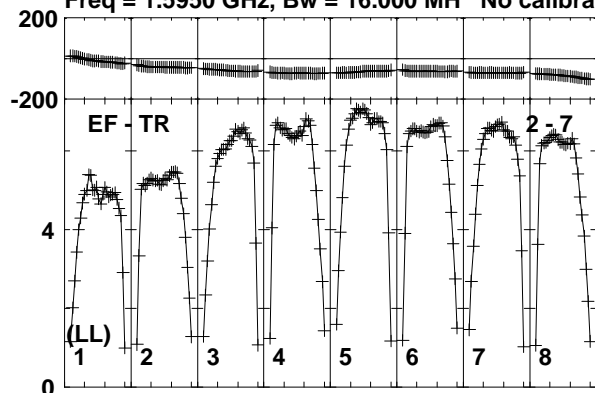

Lower frame: Milli Ampl Jy Top frame: Phas deg  
Vector averaged cross-power spectrum Baseline: EF (02) - TR (07)  
Timerange: 00/06:40:01 to 00/06:41:59

Plot file version 168 created 30-AUG-2019 17:53:39

J1722+2458 EB070.UVDATA.1

Freq = 1.5950 GHz, Bw = 16.000 MH No calibration applied and no bandpass applied

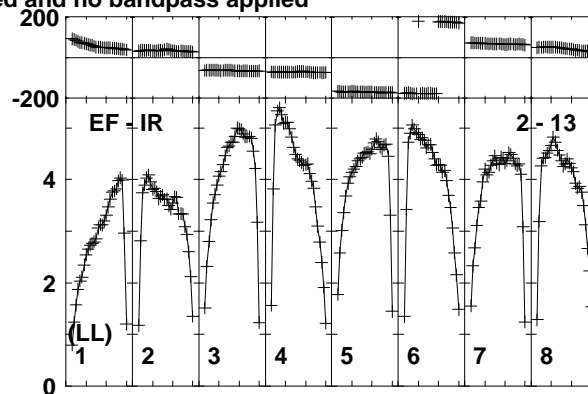
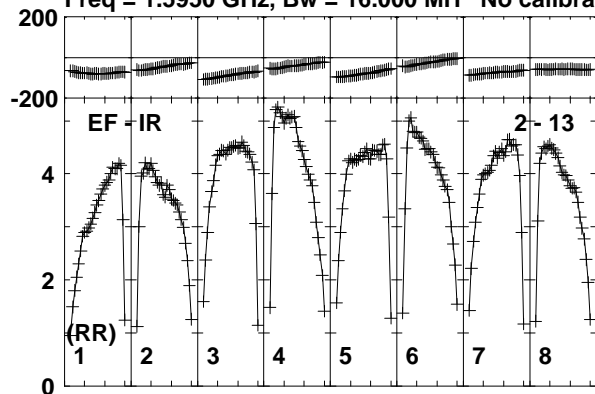

Lower frame: Milli Ampl Jy Top frame: Phas deg  
Vector averaged cross-power spectrum Baseline: EF (02) - IR (13)  
Timerange: 00/06:40:01 to 00/06:41:59



Plot file version 169 created 30-AUG-2019 17:53:39  
ROSS867 EB070.UVDATA.1

Freq = 1.5950 GHz, Bw = 16.000 MH No calibration applied and no bandpass applied

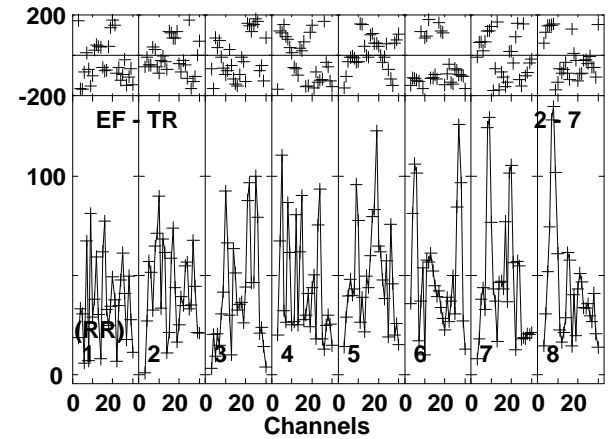
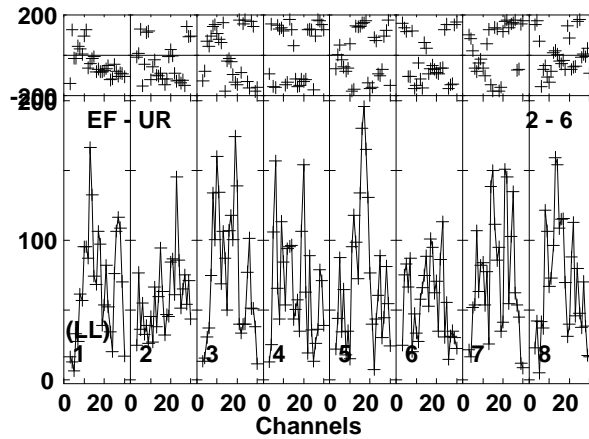
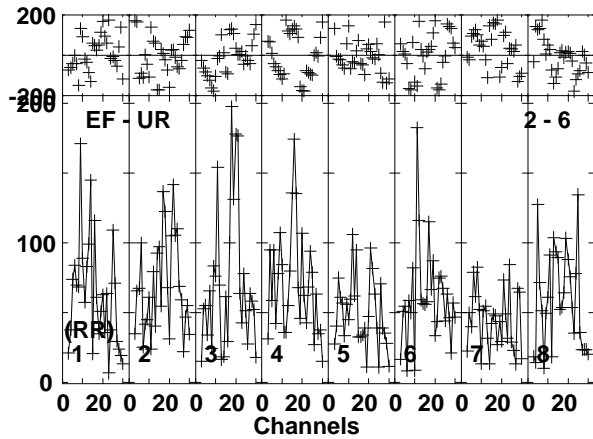
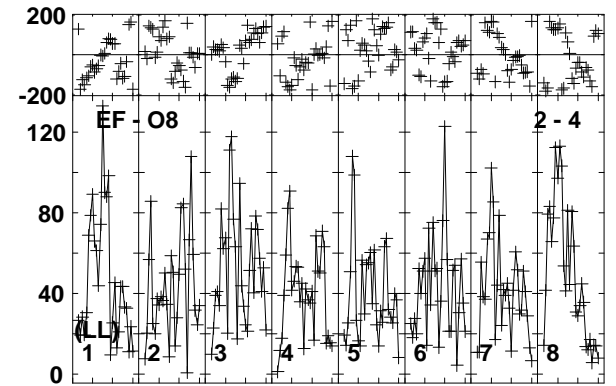
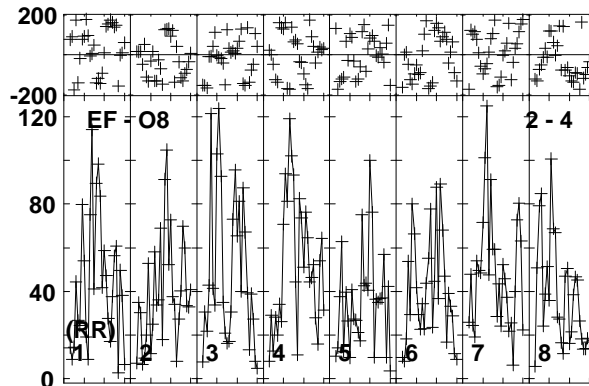
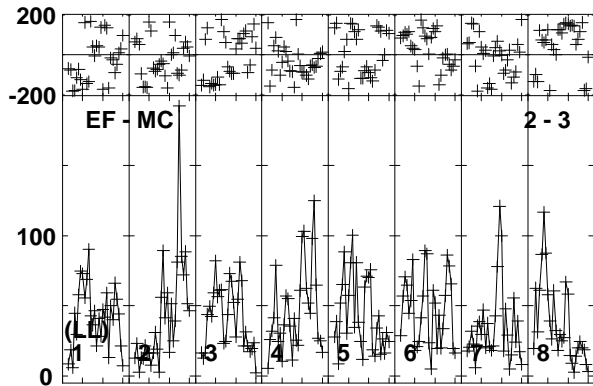
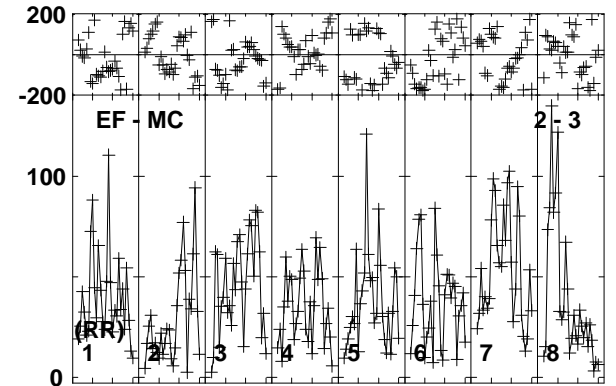
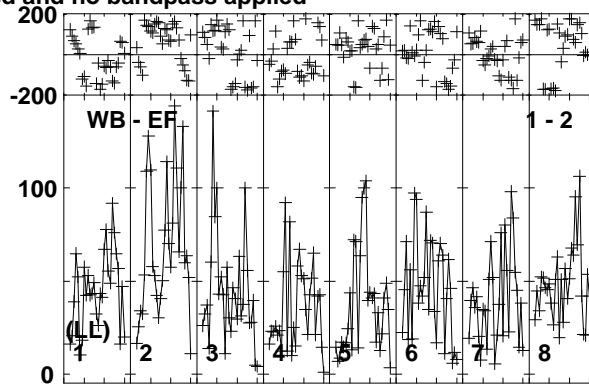
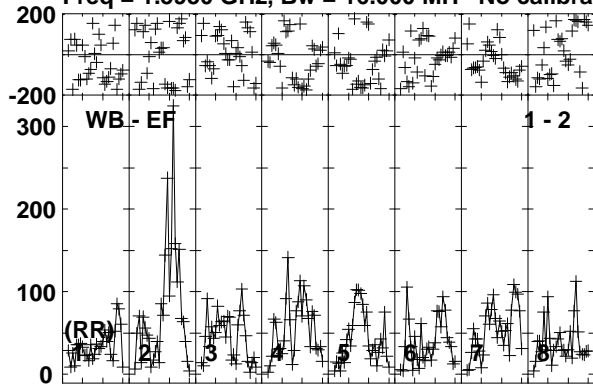

Lower frame: Micro Ampl Jy Top frame: Phas deg  
Vector averaged cross-power spectrum Baseline: WB (01) - EF (02)  
Timerange: 00/06:42:01 to 00/06:49:59

Plot file version 170 created 30-AUG-2019 17:53:40

ROSS867 EB070.UVDATA.1

Freq = 1.5950 GHz, Bw = 16.000 MH No calibration applied and no bandpass applied

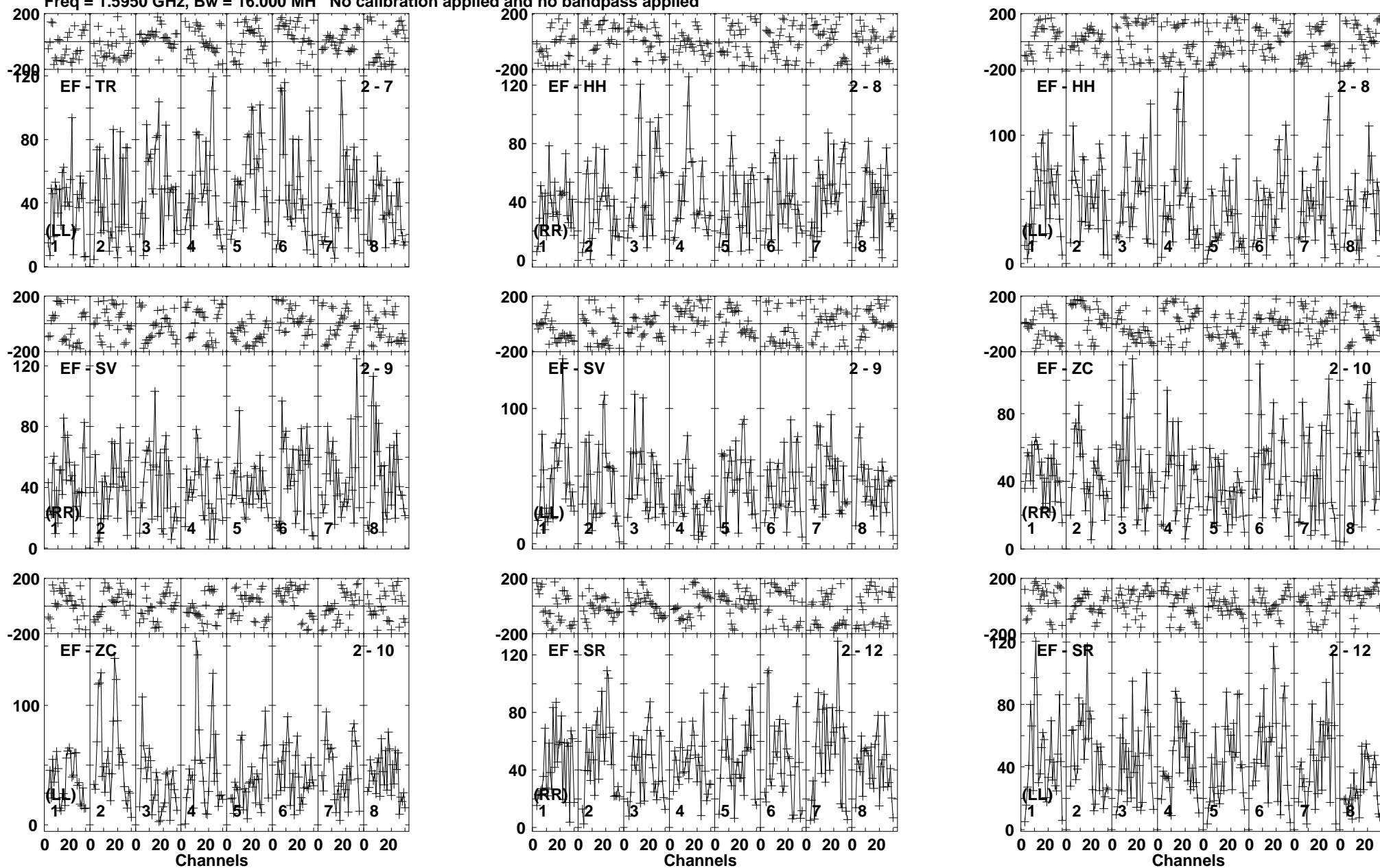

Lower frame: Micro Ampl Jy Top frame: Phas deg  
Vector averaged cross-power spectrum Baseline: EF (02) - TR (07)  
Timerange: 00/06:42:01 to 00/06:49:59

Plot file version 171 created 30-AUG-2019 17:53:40

ROSS867 EB070.UVDATA.1

Freq = 1.5950 GHz, Bw = 16.000 MH No calibration applied and no bandpass applied

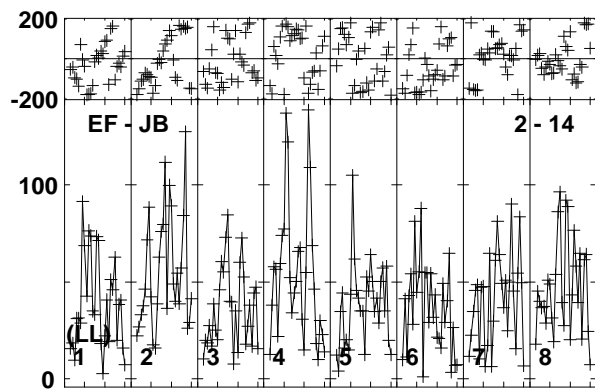
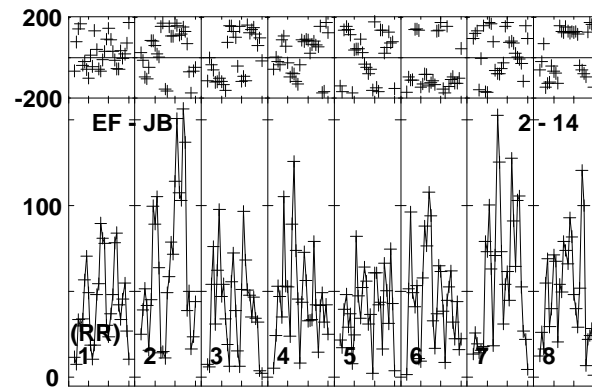
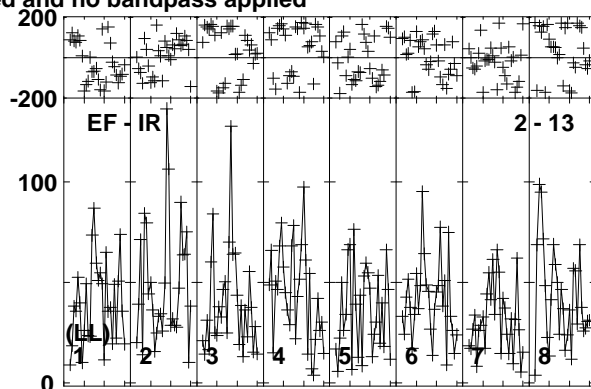
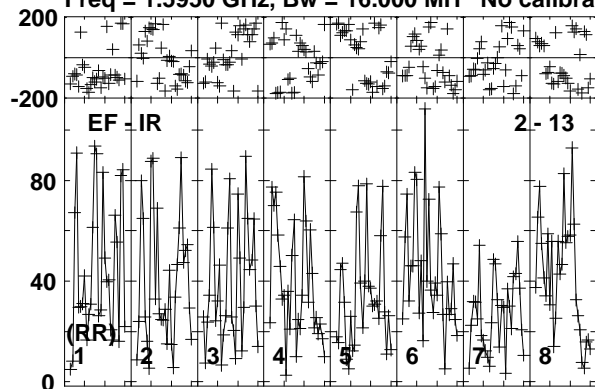

Lower frame: Micro Ampl Jy Top frame: Phas deg  
Vector averaged cross-power spectrum Baseline: EF (02) - IR (13)  
Timerange: 00/06:42:01 to 00/06:49:59

Plot file version 172 created 30-AUG-2019 17:53:40

J1722+2458 EB070.UVDATA.1

Freq = 1.5950 GHz, Bw = 16.000 MH No calibration applied and no bandpass applied

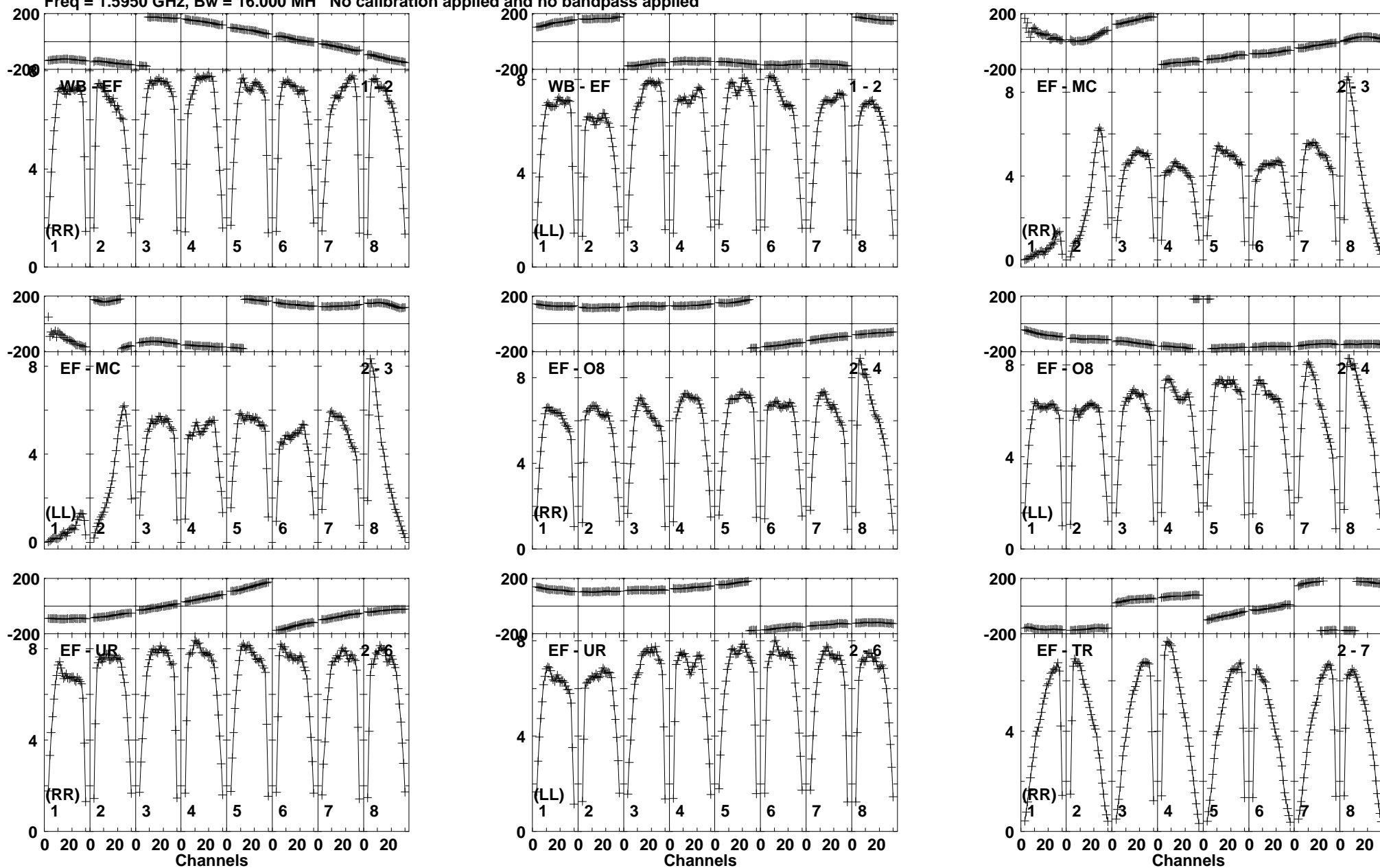

Lower frame: Milli Ampl Jy Top frame: Phas deg  
Vector averaged cross-power spectrum Baseline: WB (01) - EF (02)  
Timerange: 00/06:50:41 to 00/06:51:59

Plot file version 173 created 30-AUG-2019 17:53:40

J1722+2458 EB070.UVDATA.1

Freq = 1.5950 GHz, Bw = 16.000 MH No calibration applied and no bandpass applied

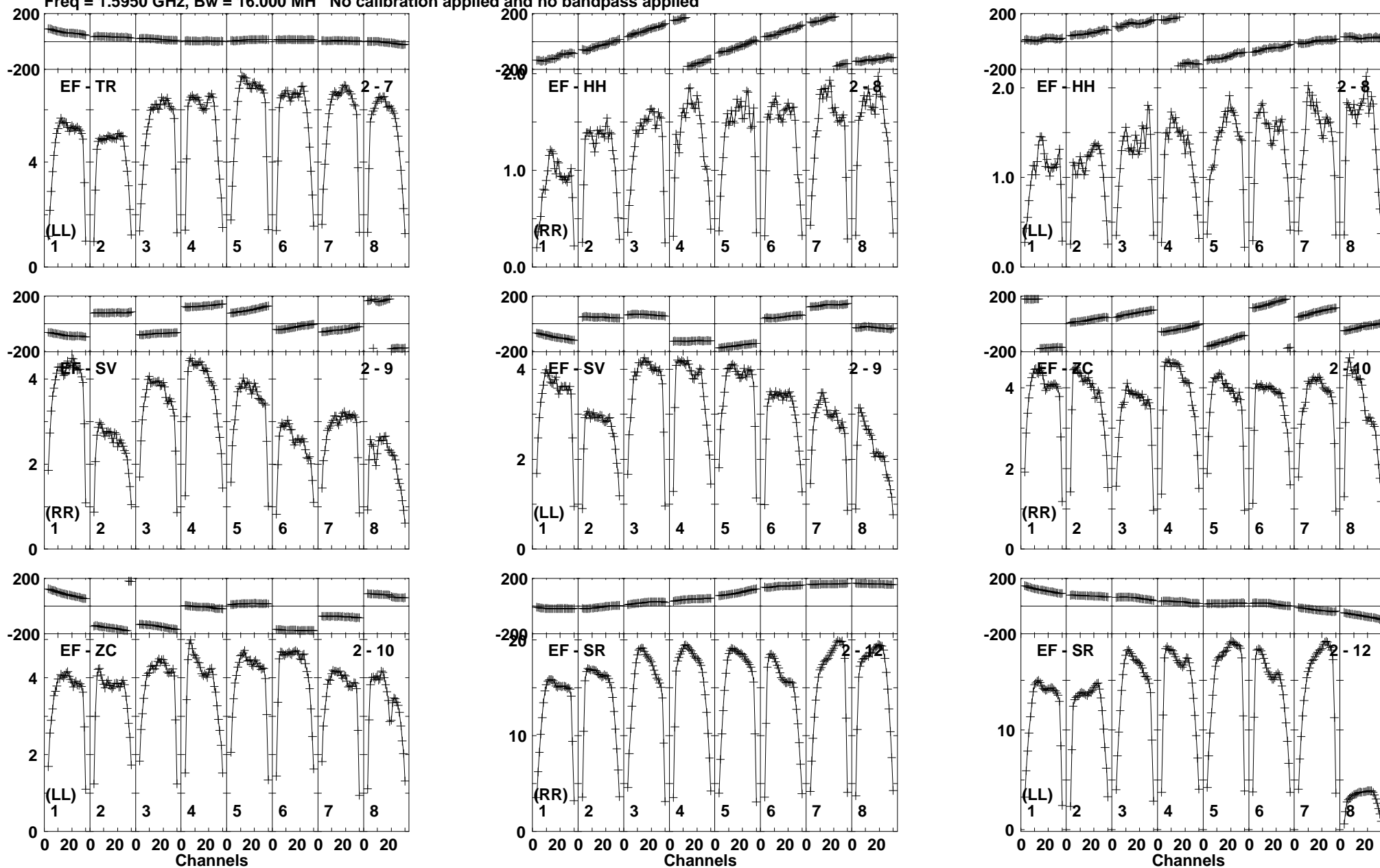

Lower frame: Milli Ampl Jy Top frame: Phas deg  
Vector averaged cross-power spectrum Baseline: EF (02) - TR (07)  
Timerange: 00/06:50:41 to 00/06:51:59

Plot file version 174 created 30-AUG-2019 17:53:40

J1722+2458 EB070.UVDATA.1

Freq = 1.5950 GHz, Bw = 16.000 MH No calibration applied and no bandpass applied

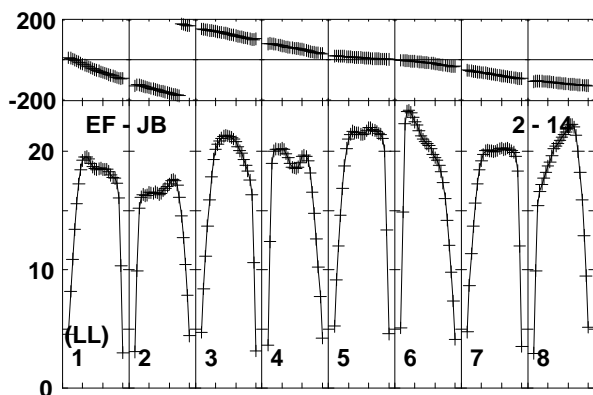
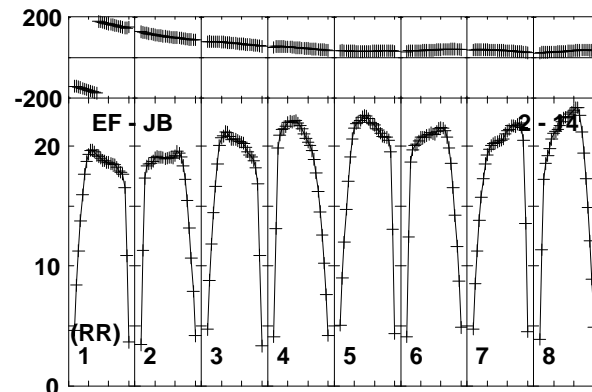
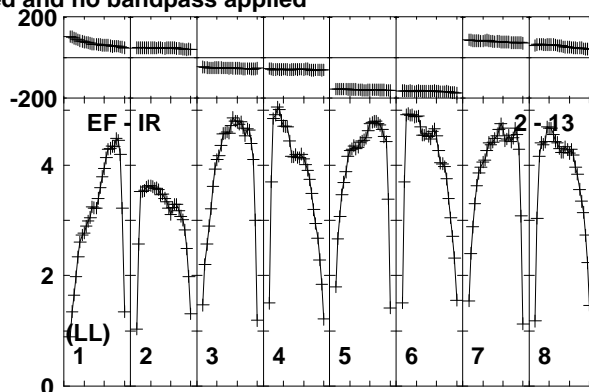
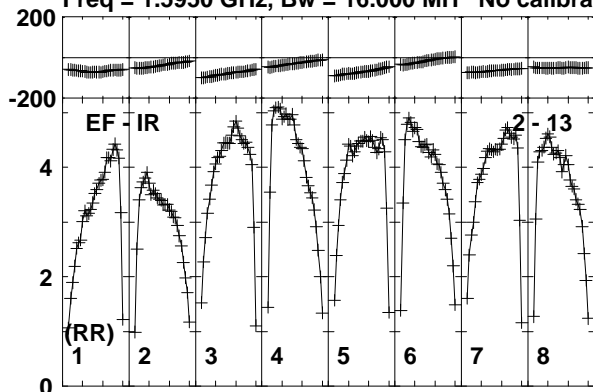

Lower frame: Milli Ampl Jy Top frame: Phas deg  
Vector averaged cross-power spectrum Baseline: EF (02) - IR (13)  
Timerange: 00/06:50:41 to 00/06:51:59

Plot file version 175 created 30-AUG-2019 17:53:40

3C345 EB070.UVDATA.1

Freq = 1.5950 GHz, Bw = 16.000 MH No calibration applied and no bandpass applied

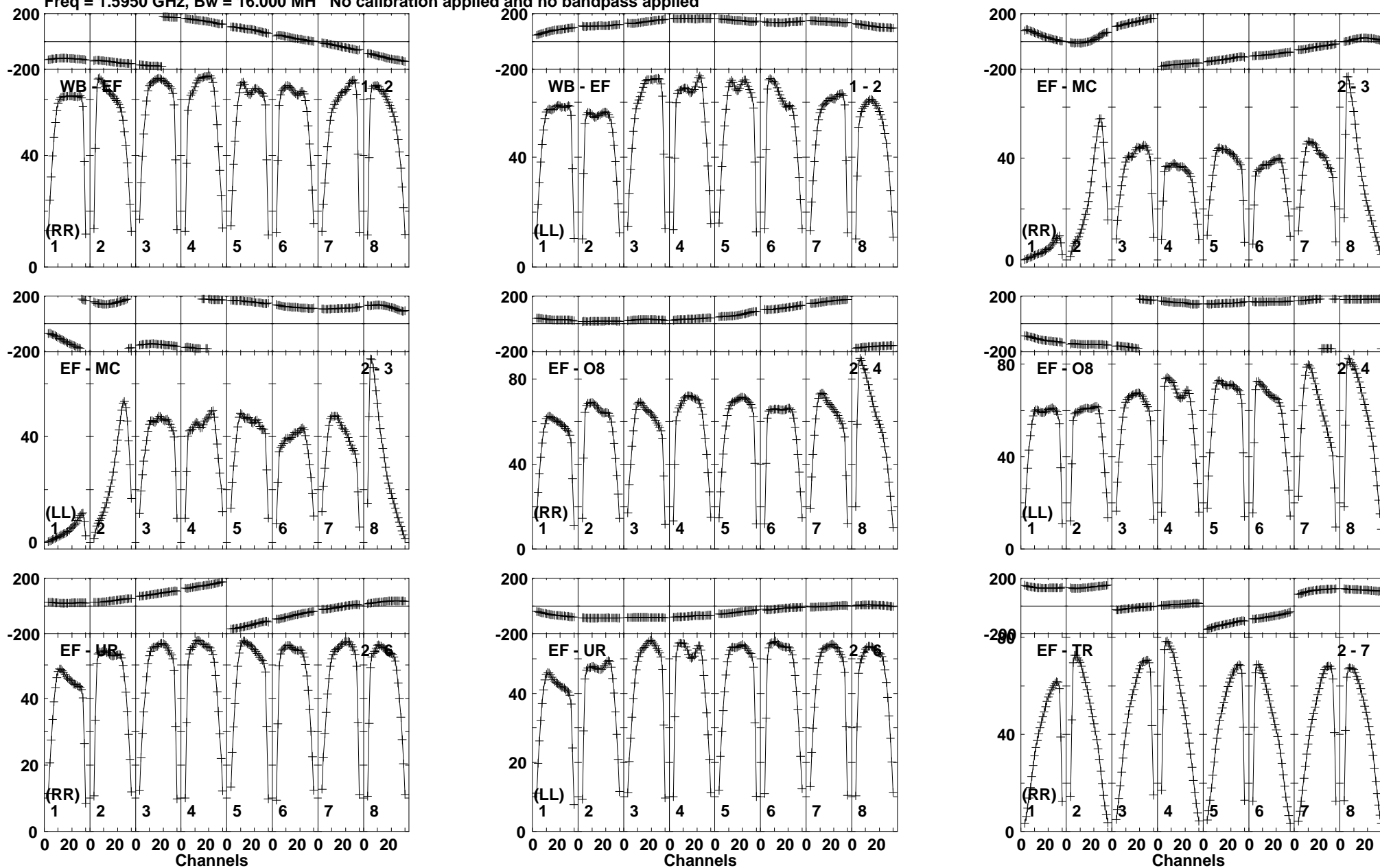

Lower frame: Milli Ampl Jy Top frame: Phas deg  
Vector averaged cross-power spectrum Baseline: WB (01) - EF (02)  
Timerange: 00/06:52:01 to 00/06:59:59

Plot file version 176 created 30-AUG-2019 17:53:41

3C345 EB070.UVDATA.1

Freq = 1.5950 GHz, Bw = 16.000 MH No calibration applied and no bandpass applied

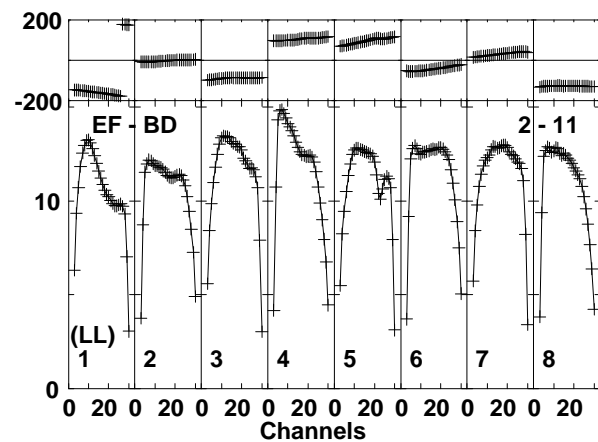
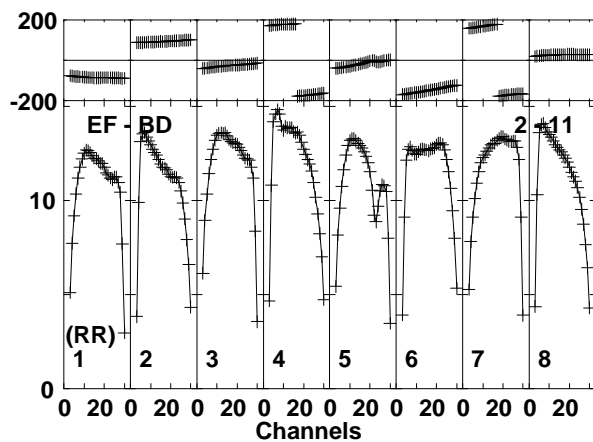
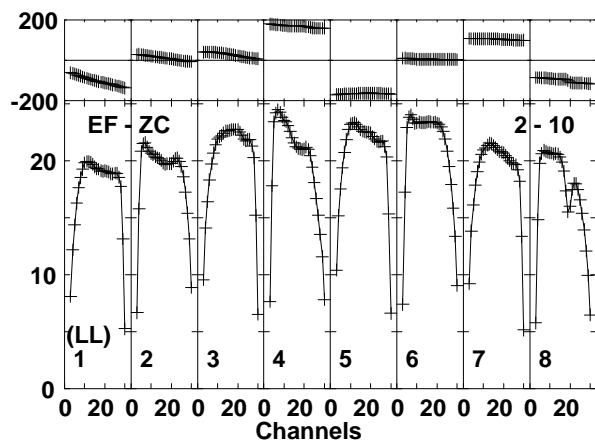
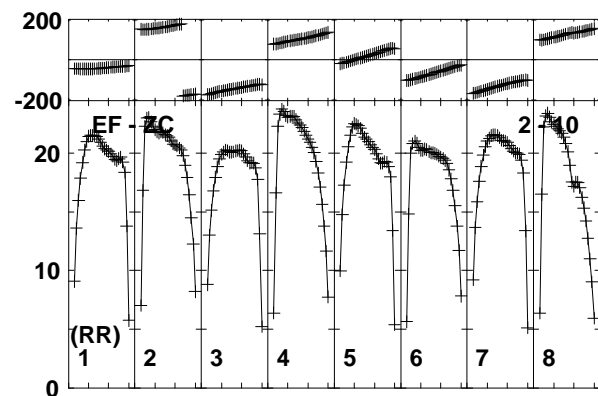
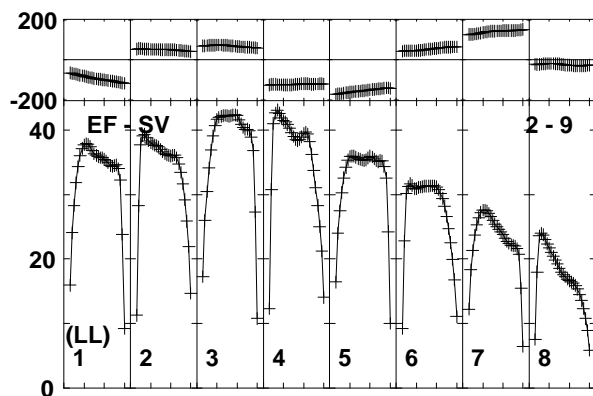
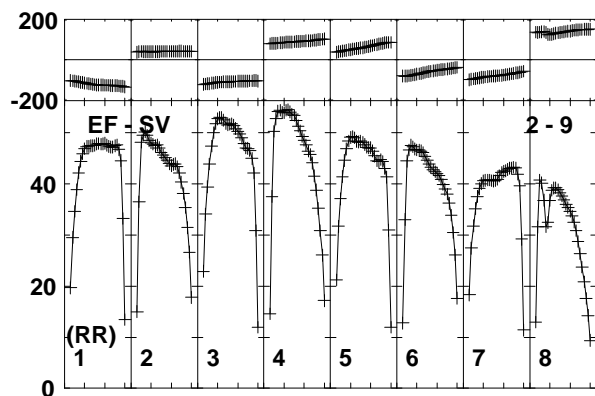
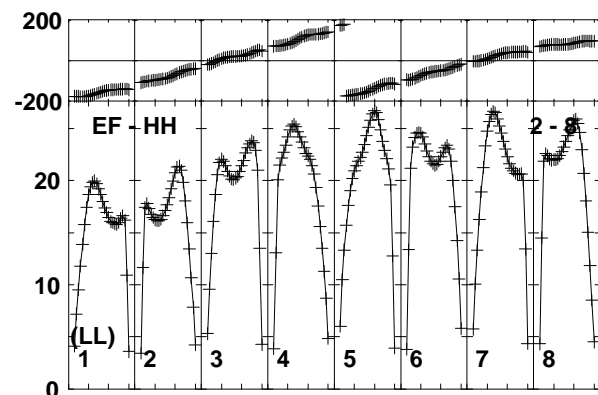
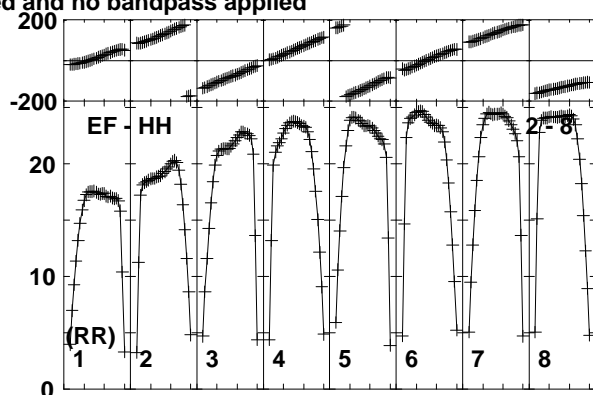
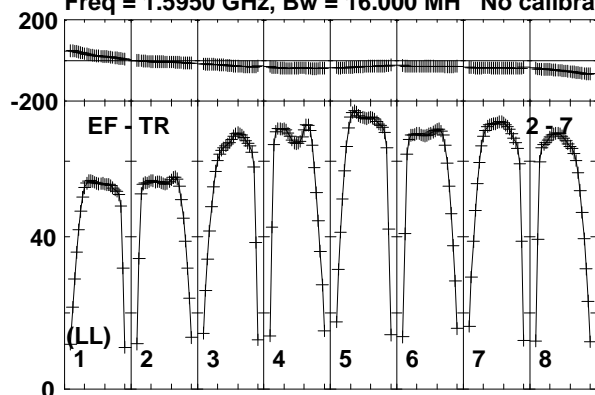

Lower frame: Milli Ampl Jy Top frame: Phas deg  
Vector averaged cross-power spectrum Baseline: EF (02) - TR (07)  
Timerange: 00/06:52:01 to 00/06:59:59



Plot file version 177 created 30-AUG-2019 17:53:41

3C345 EB070.UVDATA.1

Freq = 1.5950 GHz, Bw = 16.000 MH No calibration applied and no bandpass applied

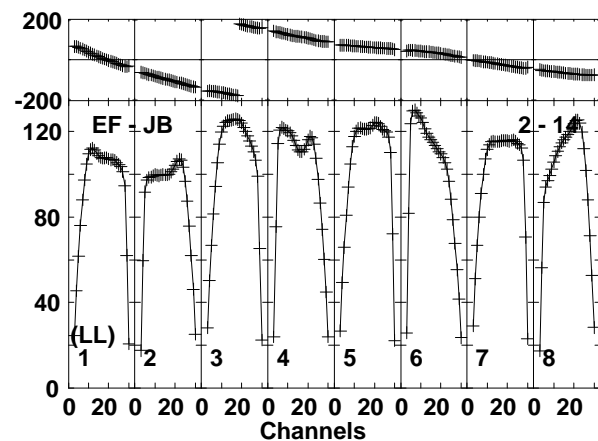
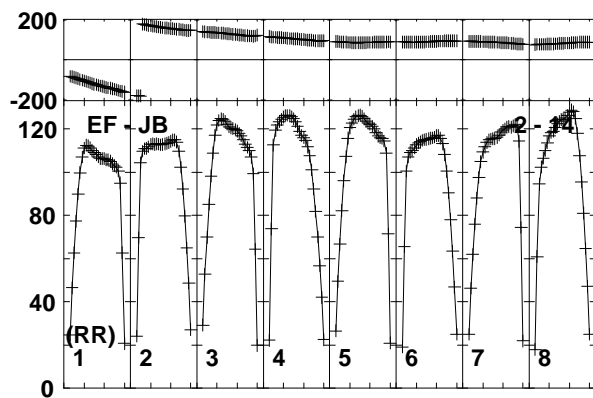
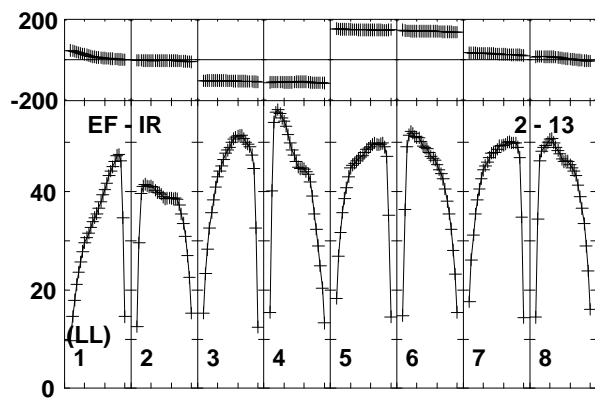
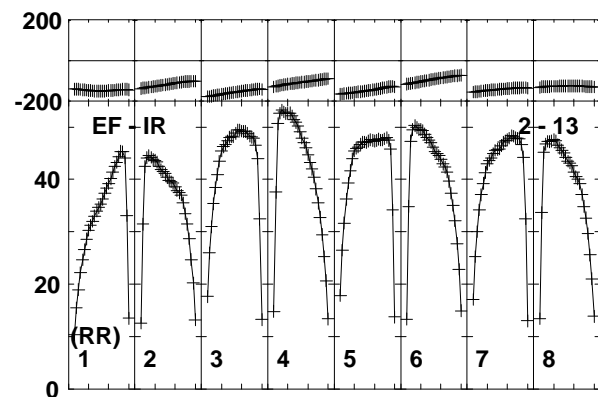
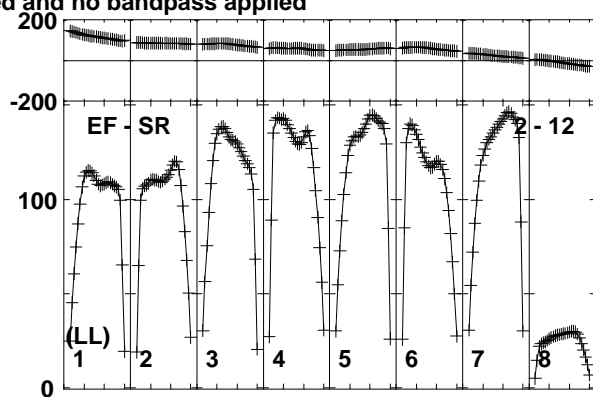
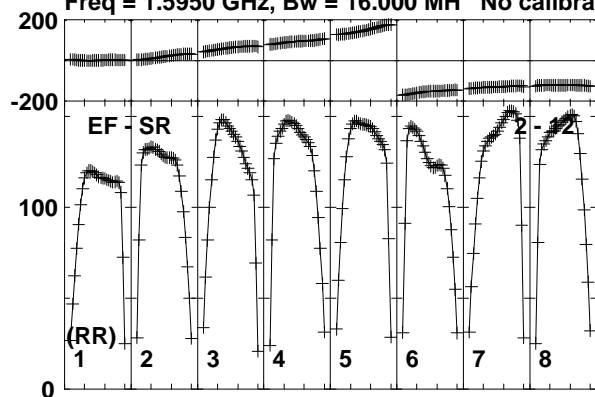

Lower frame: Milli Ampl Jy Top frame: Phas deg  
Vector averaged cross-power spectrum Baseline: EF (02) - SR (12)  
Timerange: 00/06:52:01 to 00/06:59:59