

Plot file version 1 created 22-OCT-2014 16:25:15

J1635+3808 EC048.UVDATA.1

Freq = 1.6270 GHz, Bw = 8.000 MH No calibration applied and no bandpass applied

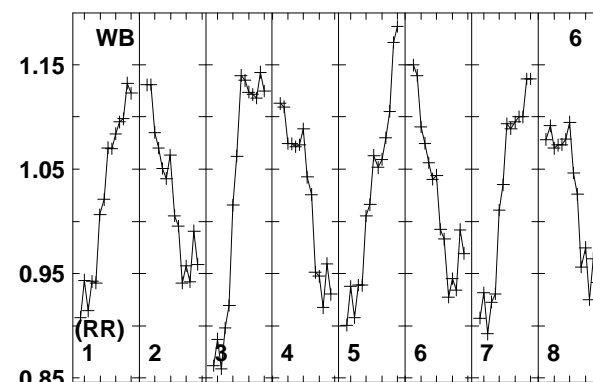
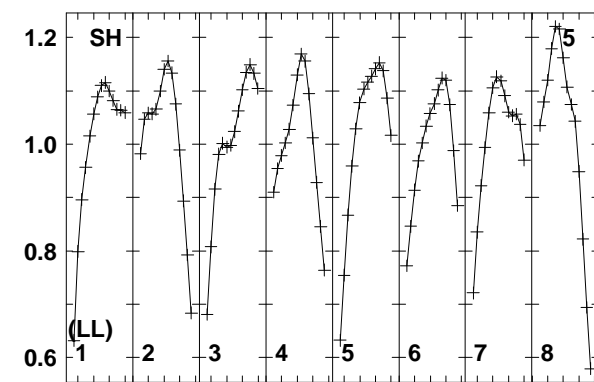
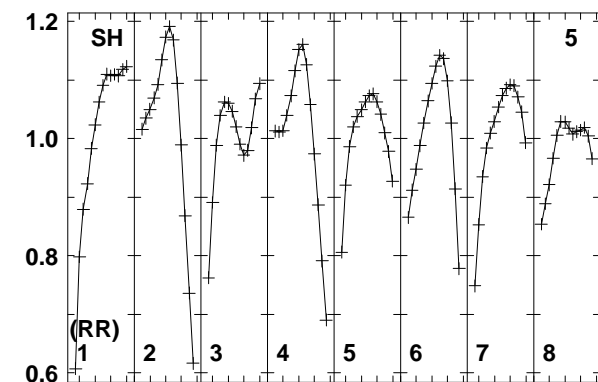
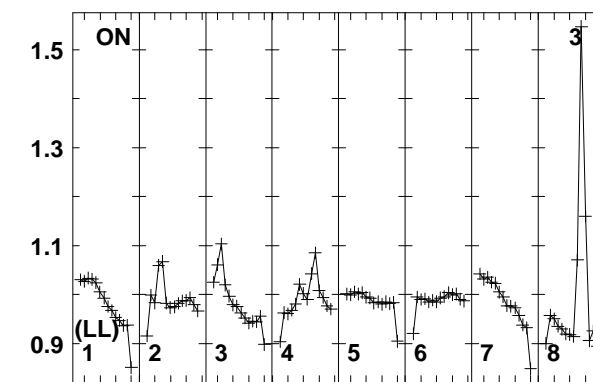
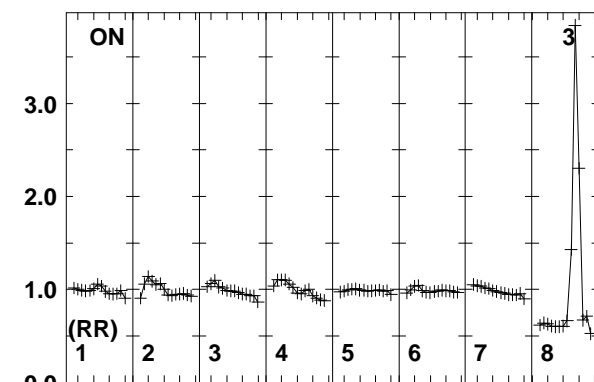
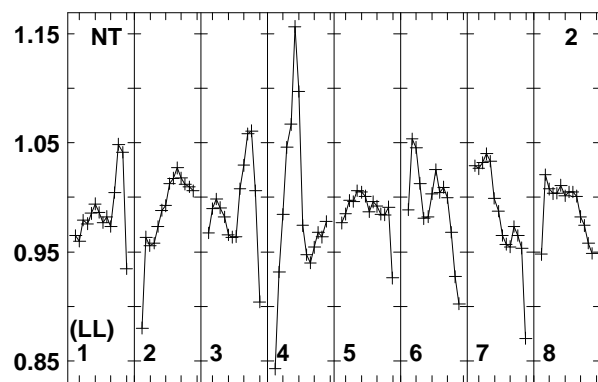
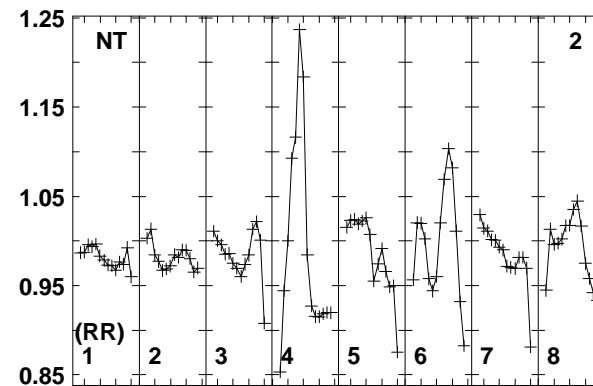
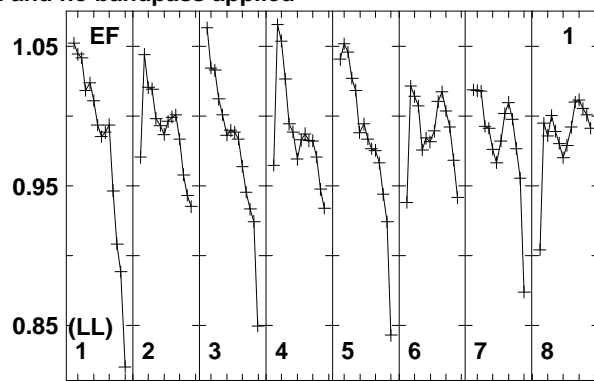
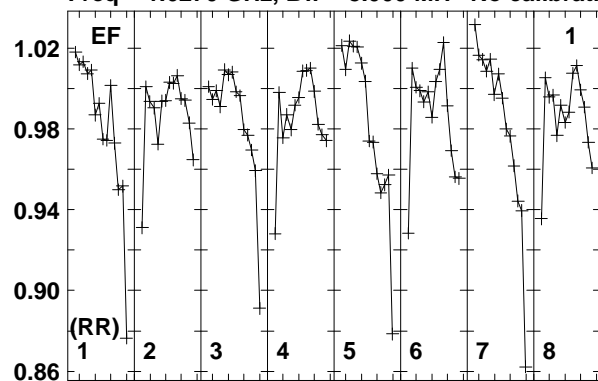

162816341640164416501656166016661672167616821688
FREQ MHz

162816341640164416501656166016661672167616821688
FREQ MHz

162816341640164416501656166016661672167616821688
FREQ MHz

Lower frame: Real Jy
Total-power spectrum Antenna: EF (01)
Timerange: 00/20:00 to 00/20:03:19

Plot file version 2 created 22-OCT-2014 16:25:15

J1635+3808 EC048.UVDATA.1

Freq = 1.6270 GHz, Bw = 8.000 MH No calibration applied and no bandpass applied

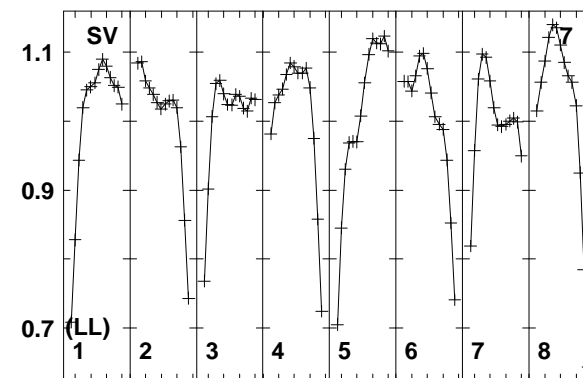
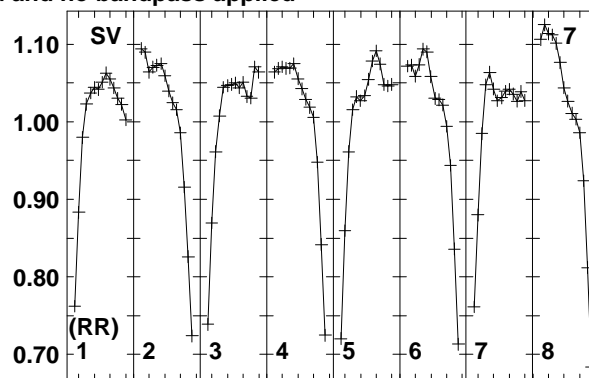
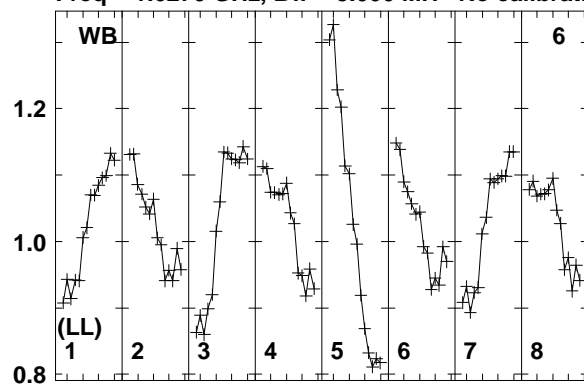

Lower frame: Real Jy
Total-power spectrum Antenna: WB (06)
Timerange: 00/20:00:03 to 00/20:03:19

Plot file version 3 created 22-OCT-2014 16:25:15

J1432+3014 EC048.UVDATA.1

Freq = 1.6270 GHz, Bw = 8.000 MH No calibration applied and no bandpass applied

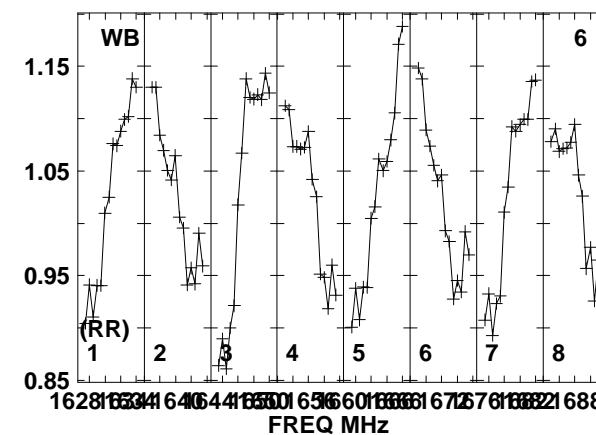
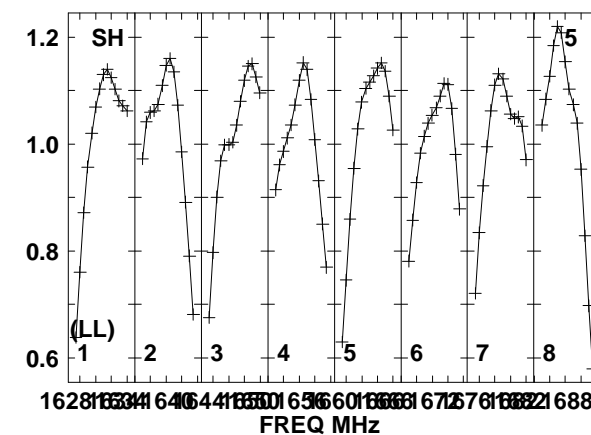
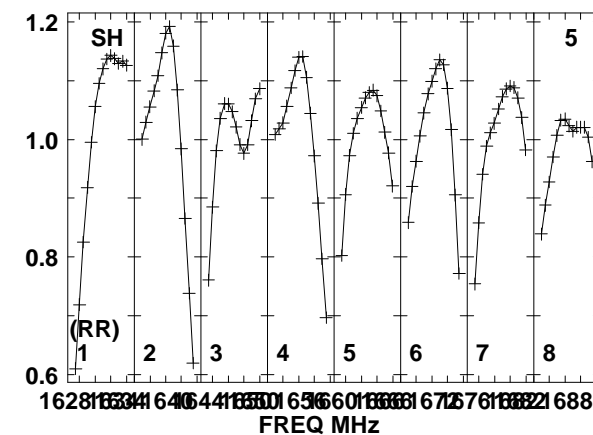
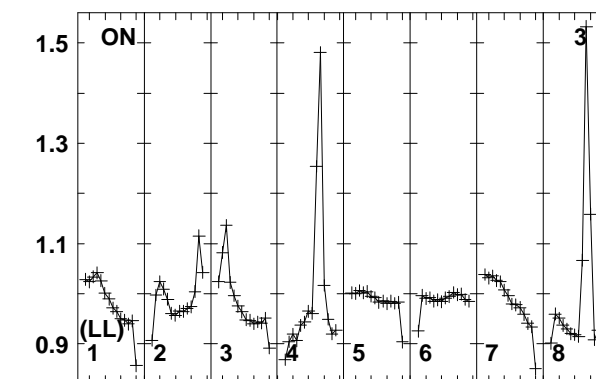
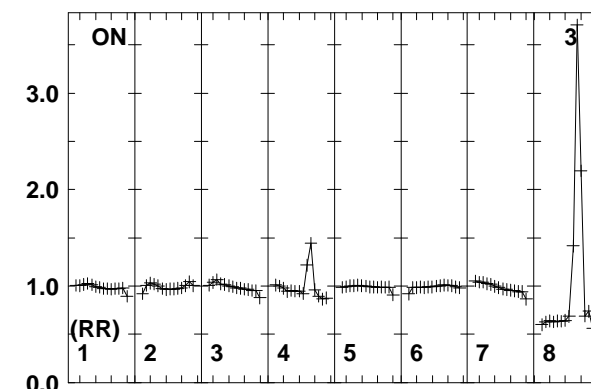
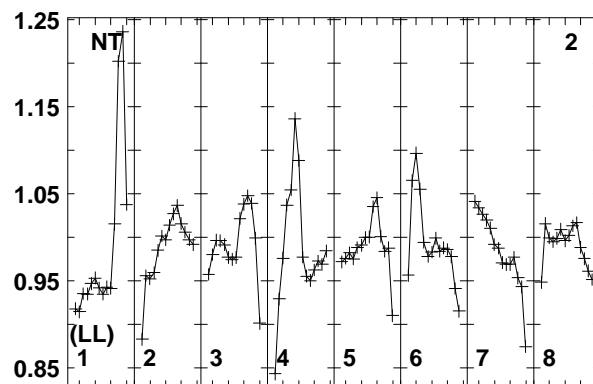
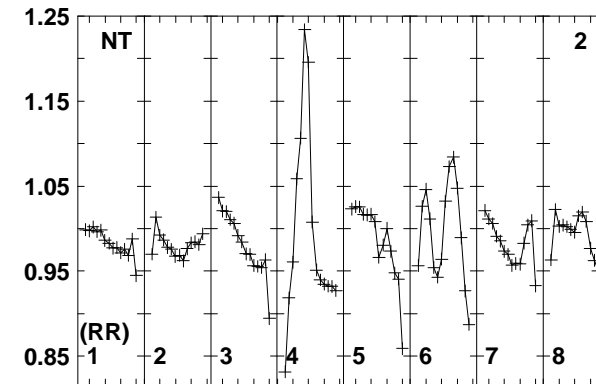
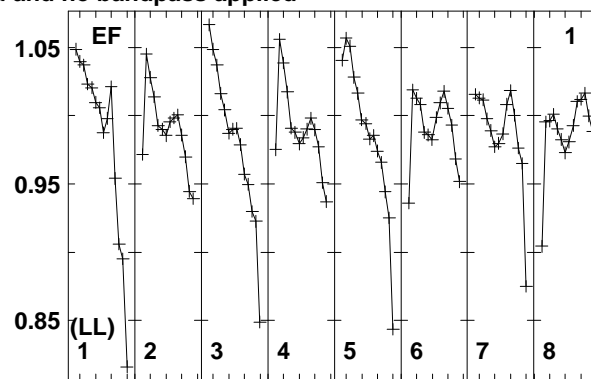
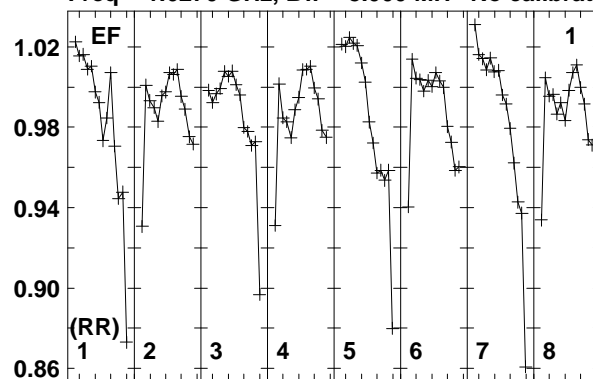

Lower frame: Real Jy
Total-power spectrum Antenna: EF (01)
Timerange: 00/20:04:09 to 00/20:07:29

Plot file version 4 created 22-OCT-2014 16:25:15

J1432+3014 EC048.UVDATA.1

Freq = 1.6270 GHz, Bw = 8.000 MH No calibration applied and no bandpass applied

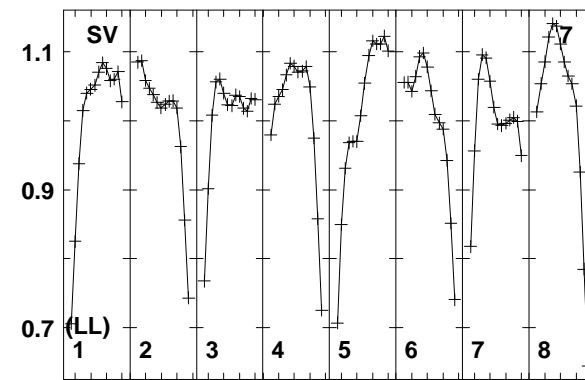
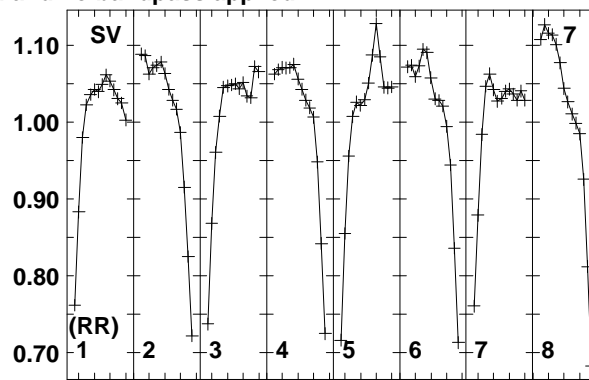
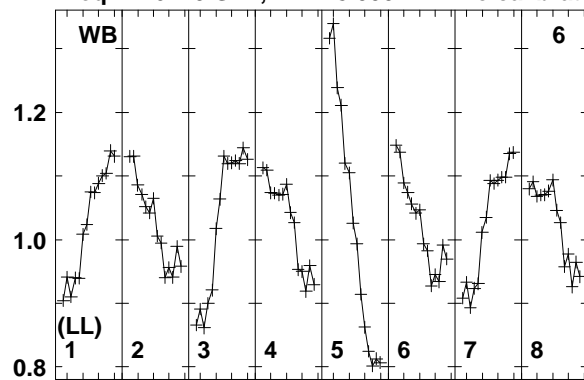

Lower frame: Real Jy
Total-power spectrum Antenna: WB (06)
Timerange: 00/20:04:09 to 00/20:07:29

Plot file version 5 created 22-OCT-2014 16:25:15

J1435+3012 EC048.UVDATA.1

Freq = 1.6270 GHz, Bw = 8.000 MH No calibration applied and no bandpass applied

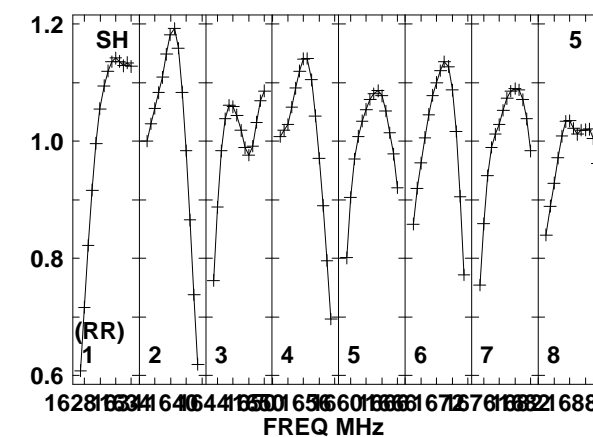
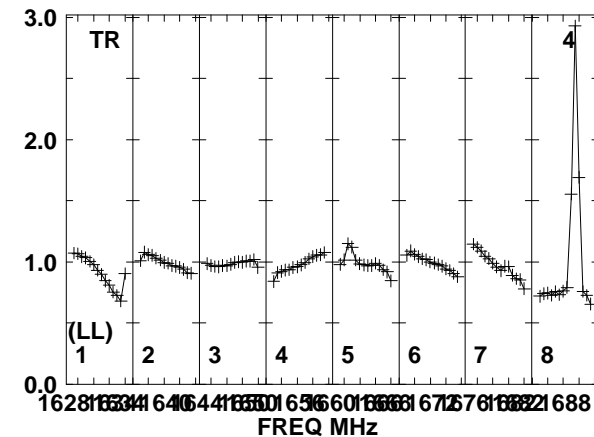
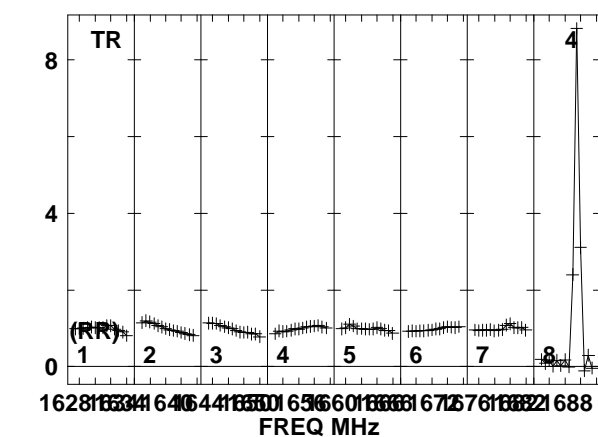
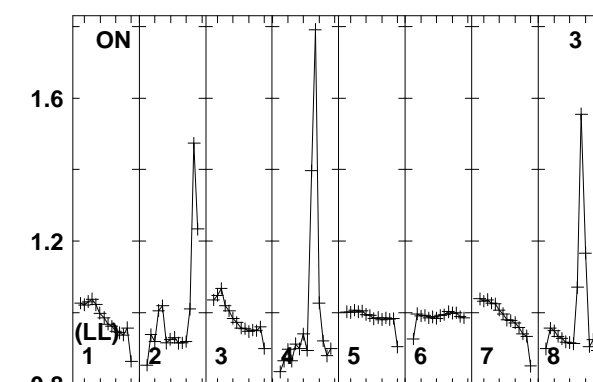
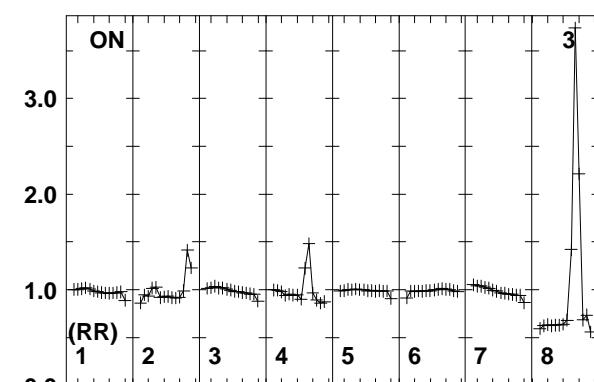
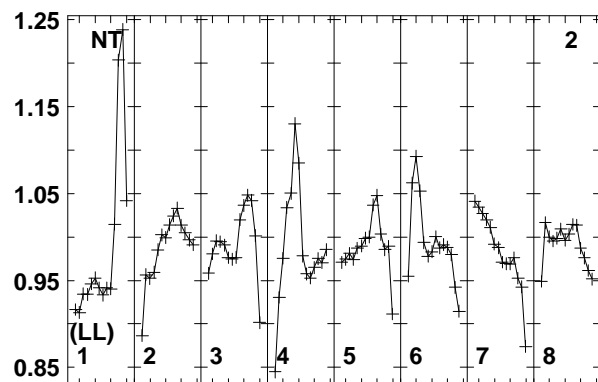
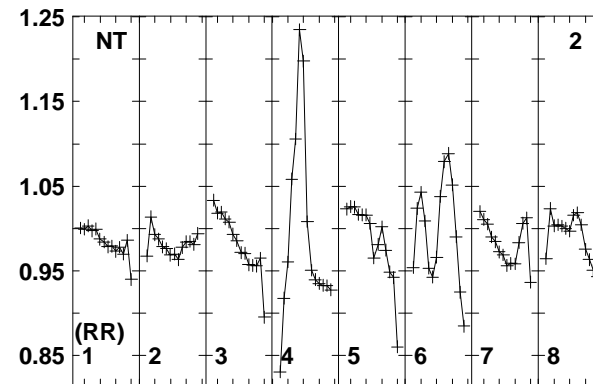
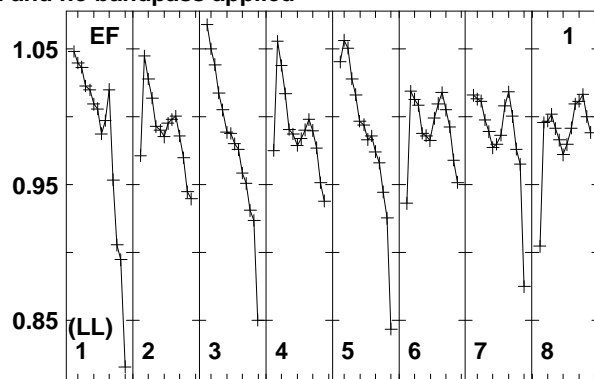
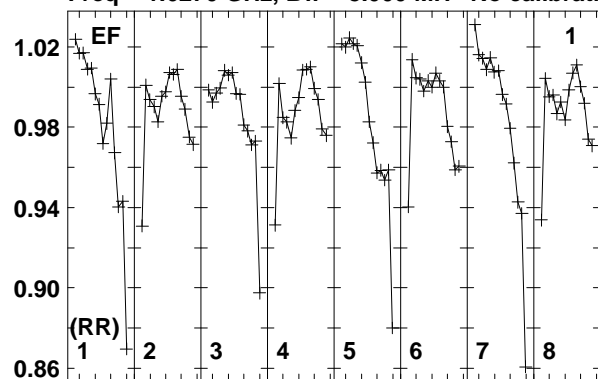

Lower frame: Real Jy
Total-power spectrum Antenna: EF (01)
Timerange: 00/20:08:13 to 00/20:09:19

Plot file version 6 created 22-OCT-2014 16:25:15
J1435+3012 EC048.UVDATA.1
Freq = 1.6270 GHz, Bw = 8.000 MH No calibration applied and no bandpass applied

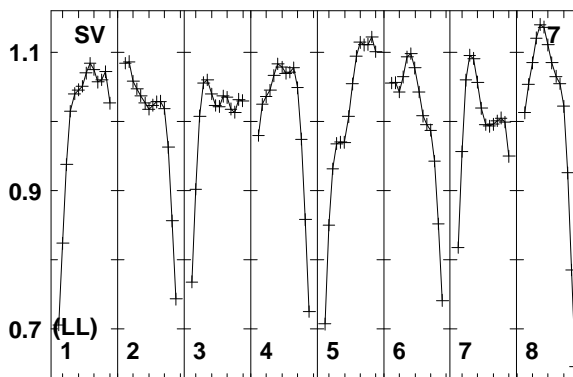
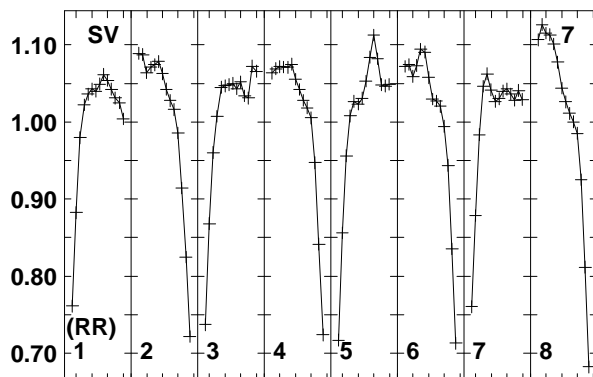
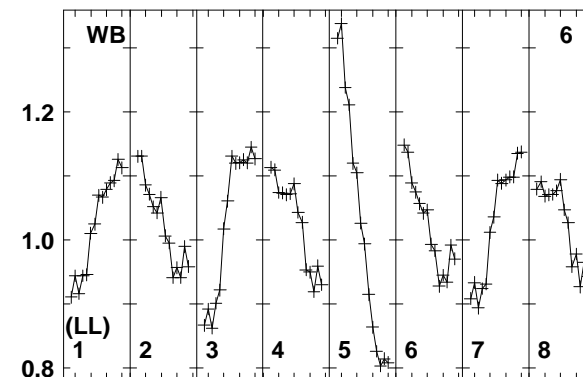
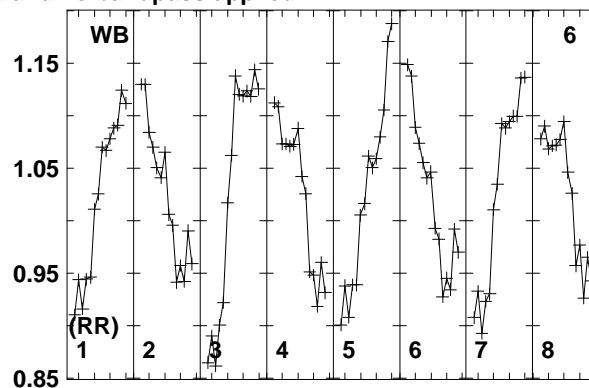
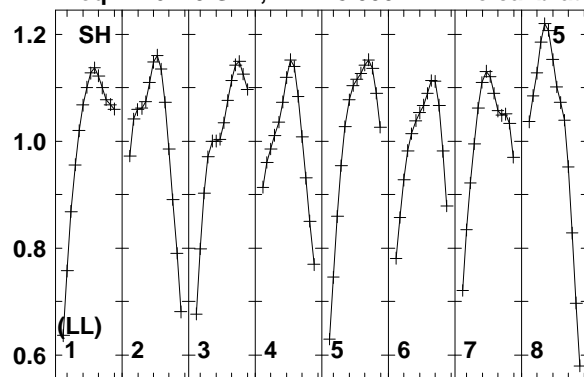

Lower frame: Real Jy
Total-power spectrum Antenna: SH (05)
Timerange: 00/20:08:13 to 00/20:09:19

Plot file version 7 created 22-OCT-2014 16:25:15

J1432+3014 EC048.UVDATA.1

Freq = 1.6270 GHz, Bw = 8.000 MH No calibration applied and no bandpass applied

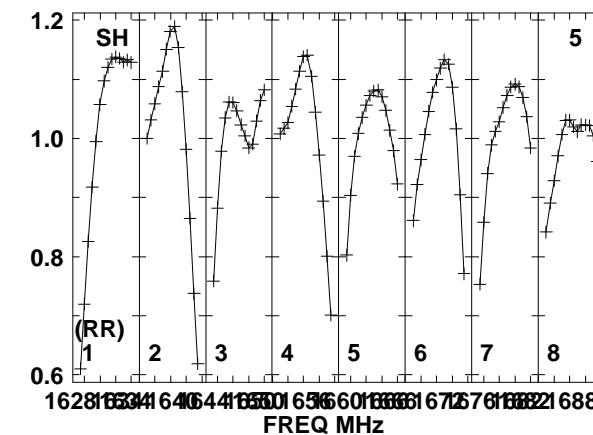
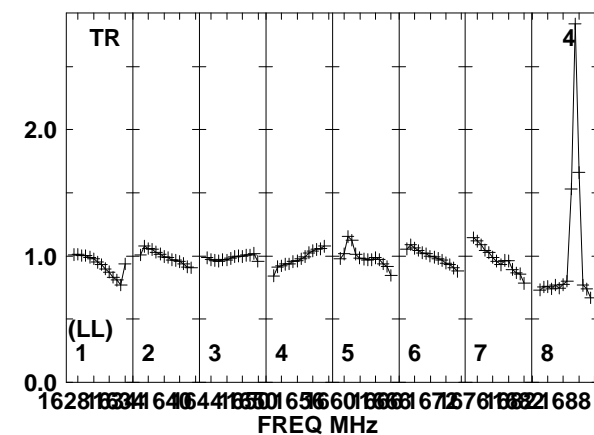
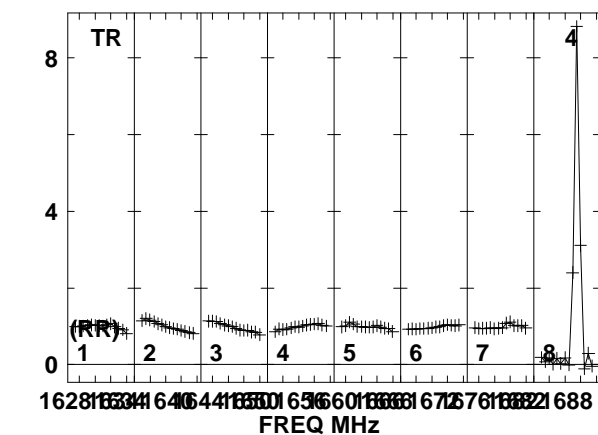
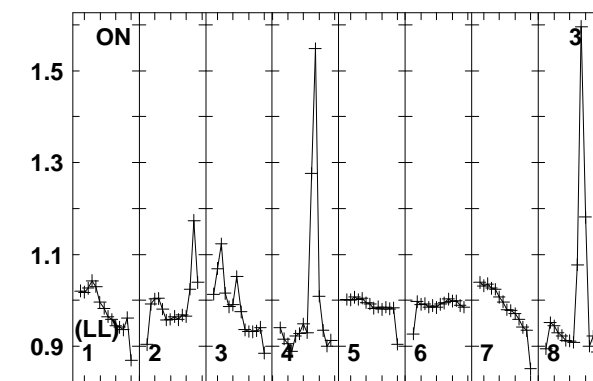
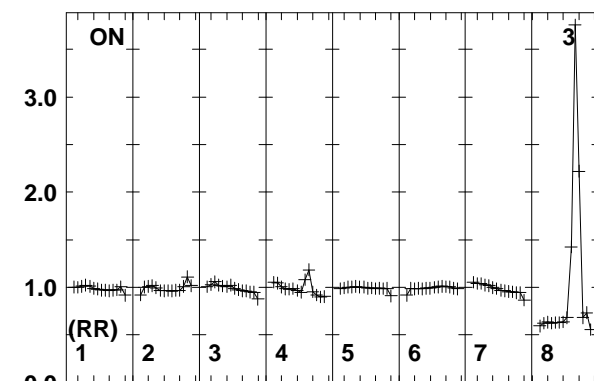
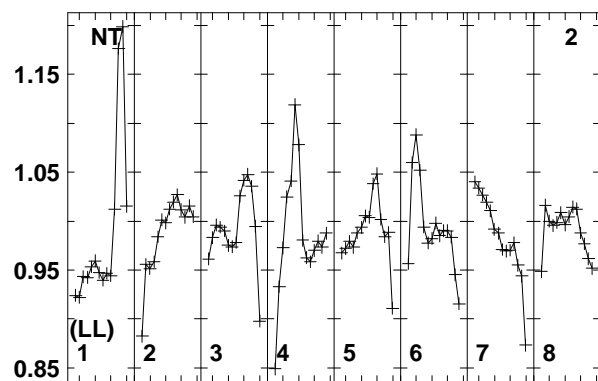
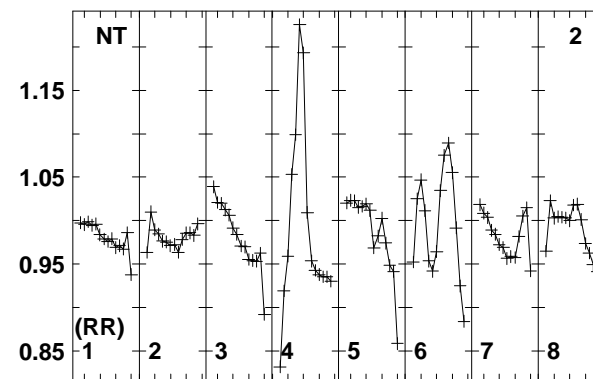
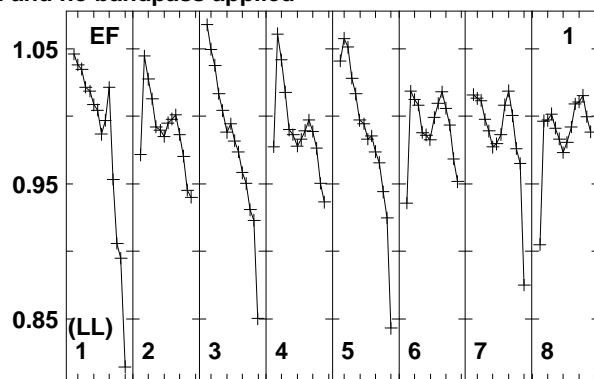
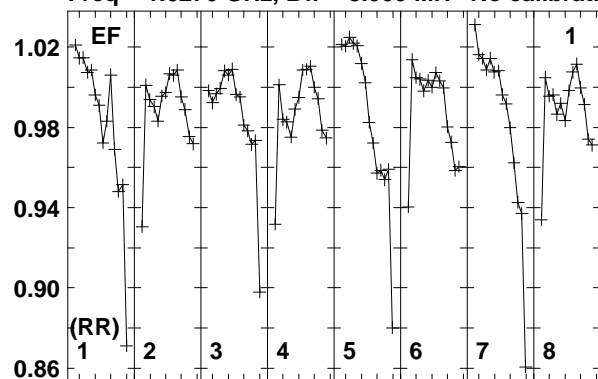

Lower frame: Real Jy
Total-power spectrum Antenna: EF (01)
Timerange: 00/20:09:26 to 00/20:17:04

Plot file version 8 created 22-OCT-2014 16:25:15
J1432+3014 EC048.UVDATA.1
Freq = 1.6270 GHz, Bw = 8.000 MH No calibration applied and no bandpass applied

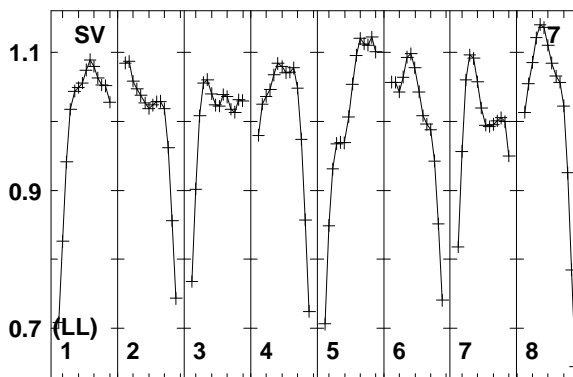
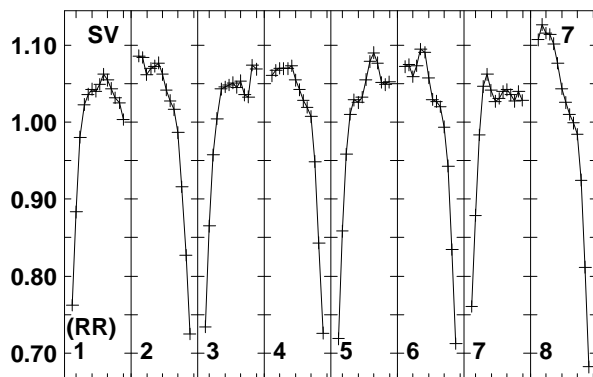
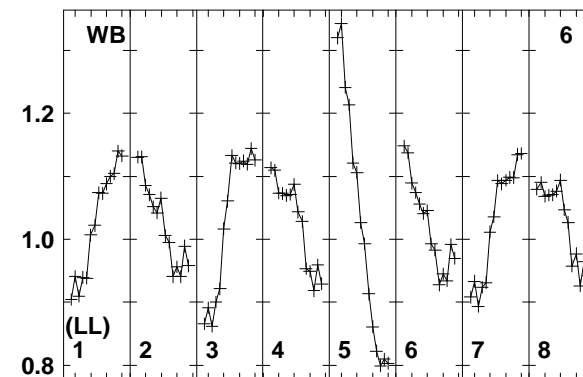
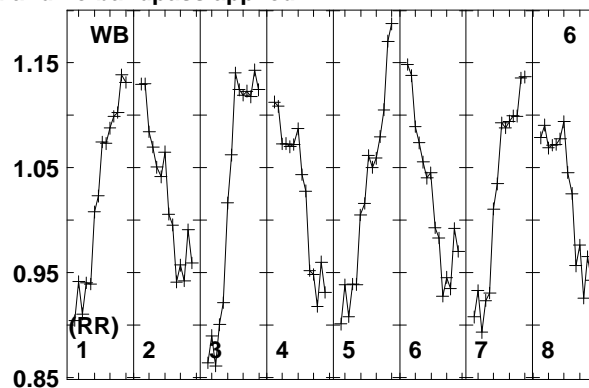
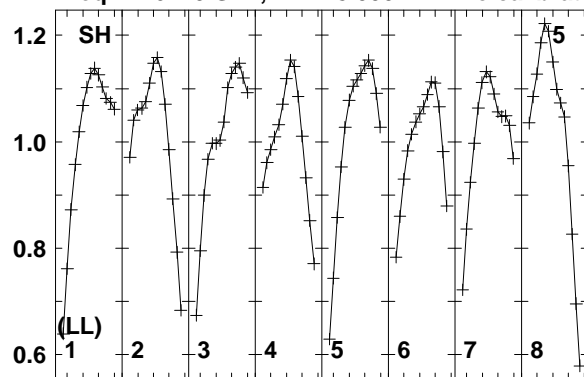

Lower frame: Real Jy
Total-power spectrum Antenna: SH (05)
Timerange: 00/20:09:26 to 00/20:17:04

Plot file version 9 created 22-OCT-2014 16:25:15

J1435+3012 EC048.UVDATA.1

Freq = 1.6270 GHz, Bw = 8.000 MH No calibration applied and no bandpass applied

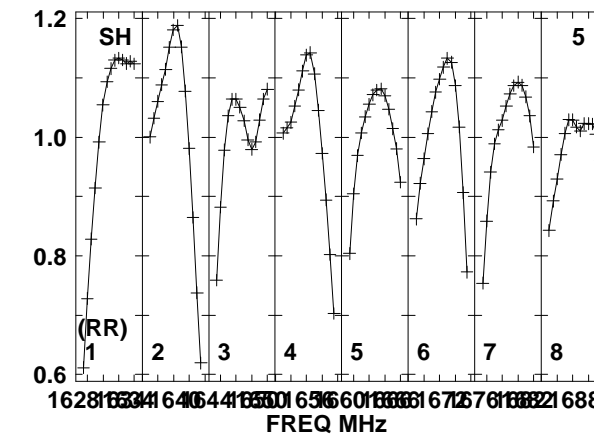
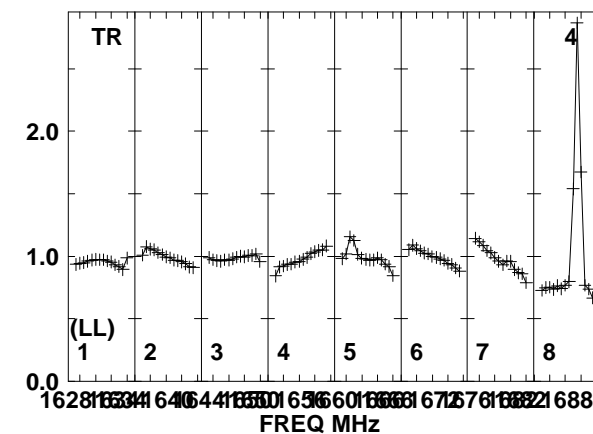
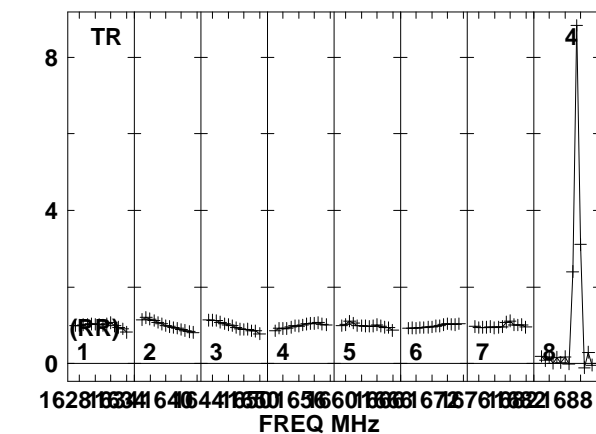
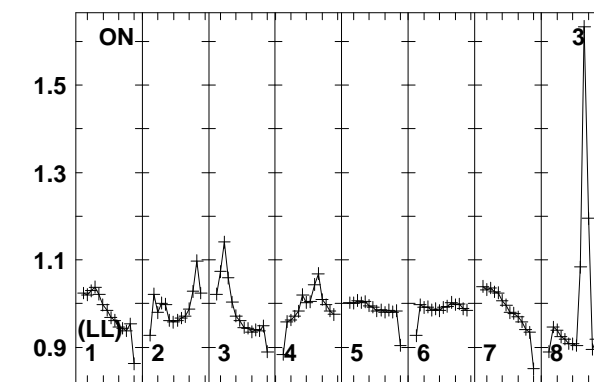
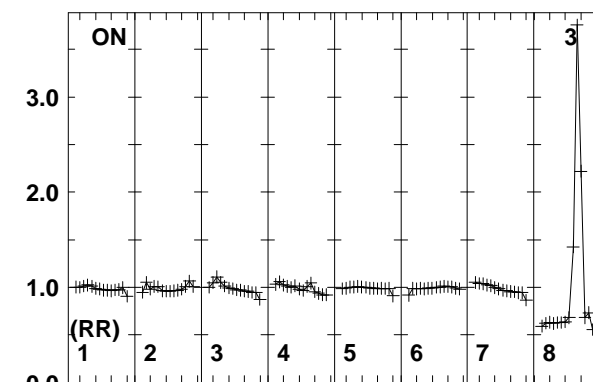
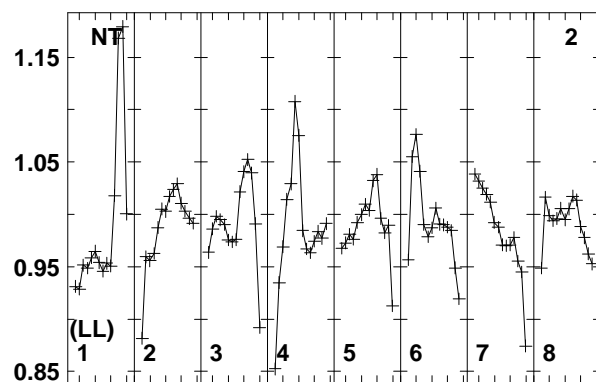
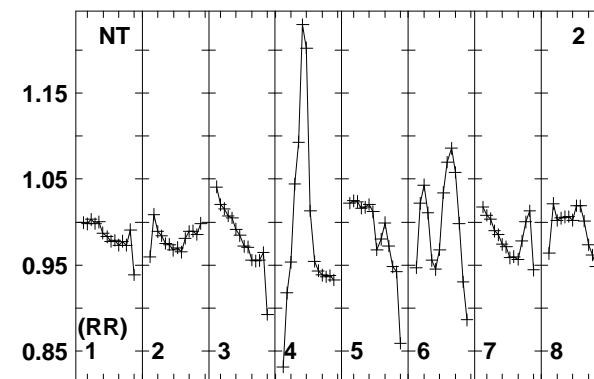
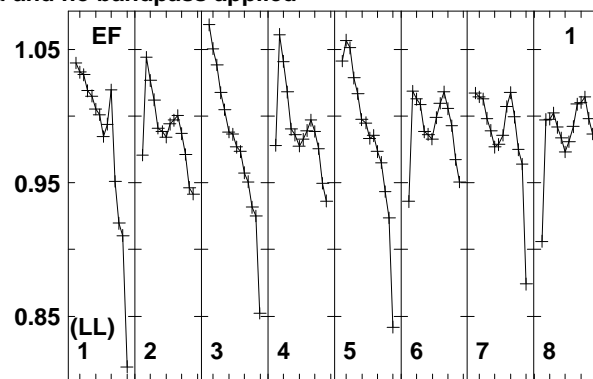
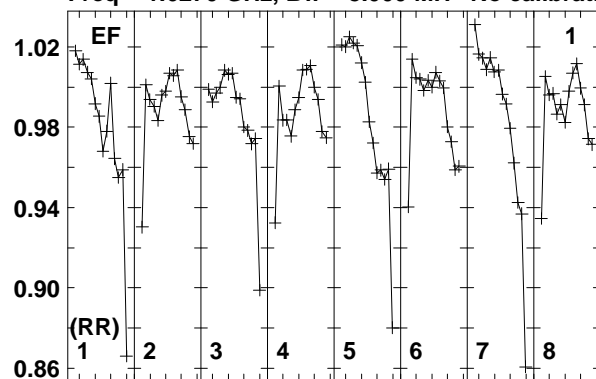

Lower frame: Real Jy
Total-power spectrum Antenna: EF (01)
Timerange: 00/20:17:48 to 00/20:19:34

Plot file version 10 created 22-OCT-2014 16:25:15
J1435+3012 EC048.UVDATA.1
Freq = 1.6270 GHz, Bw = 8.000 MH No calibration applied and no bandpass applied

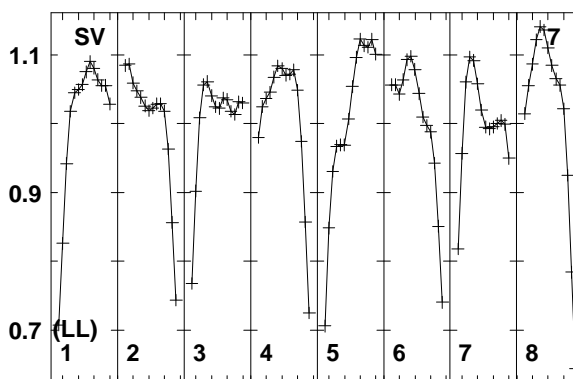
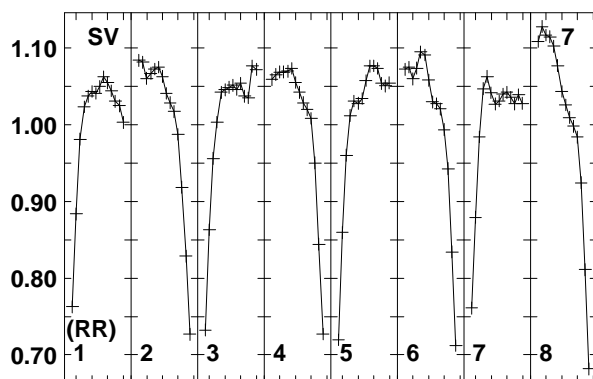
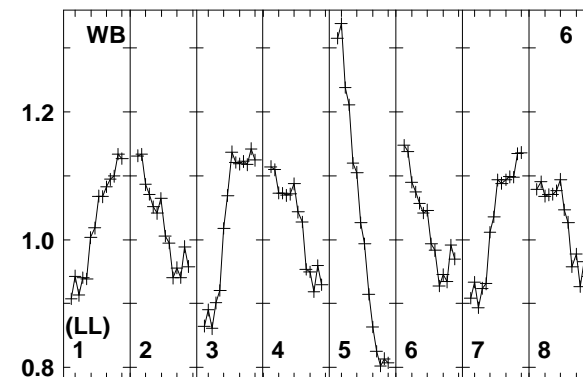
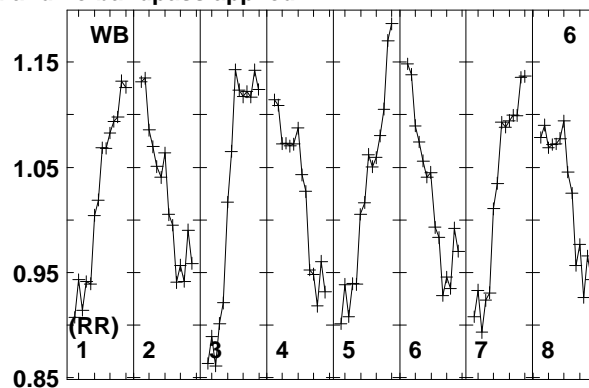
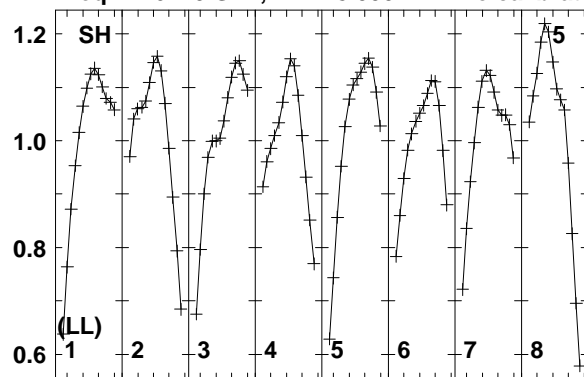

Lower frame: Real Jy
Total-power spectrum Antenna: SH (05)
Timerange: 00/20:17:48 to 00/20:19:34

Plot file version 11 created 22-OCT-2014 16:25:15

J1432+3014 EC048.UVDATA.1

Freq = 1.6270 GHz, Bw = 8.000 MH No calibration applied and no bandpass applied

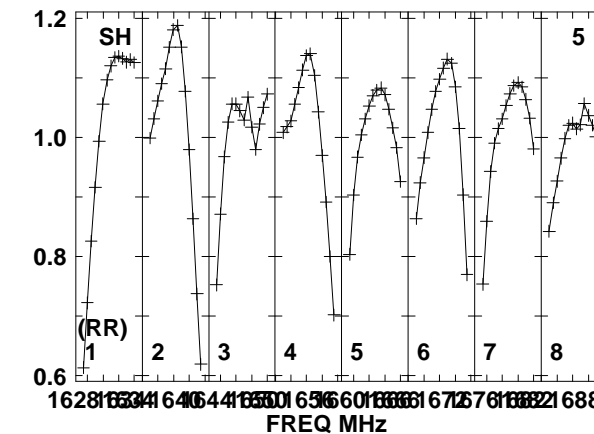
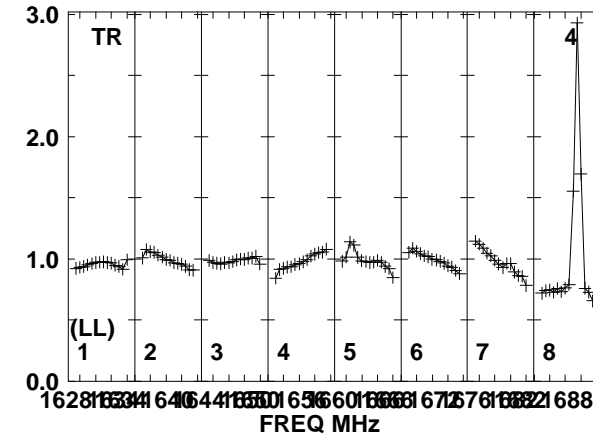
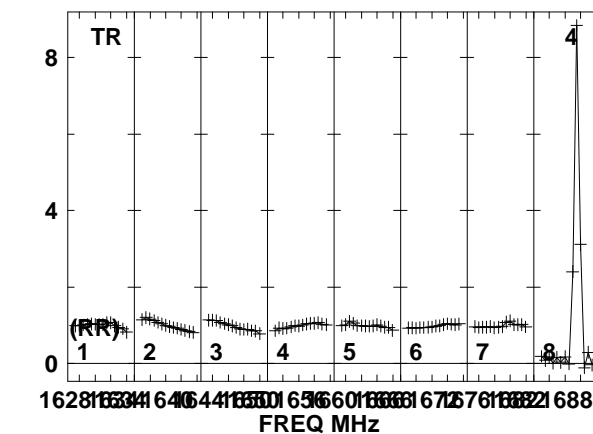
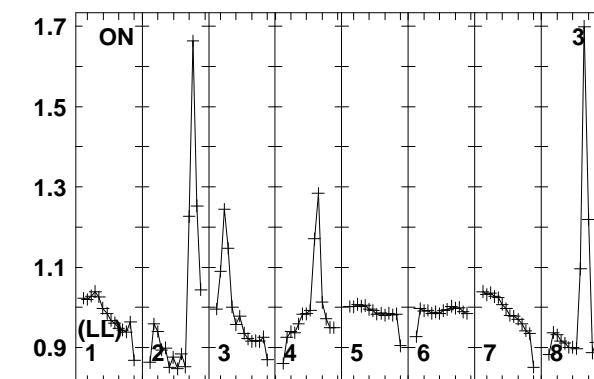
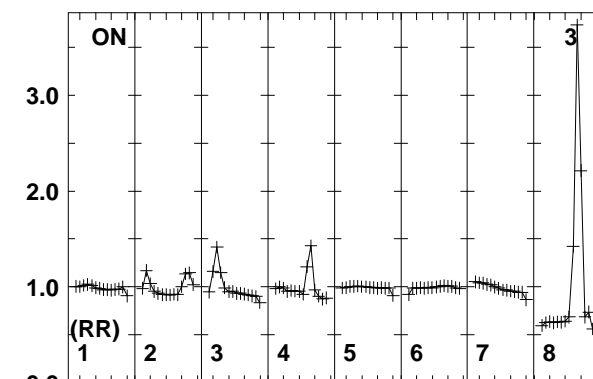
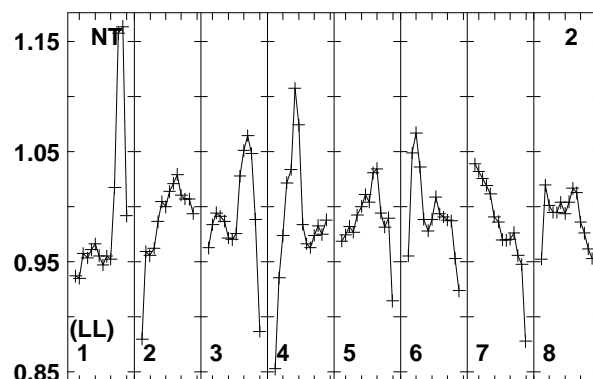
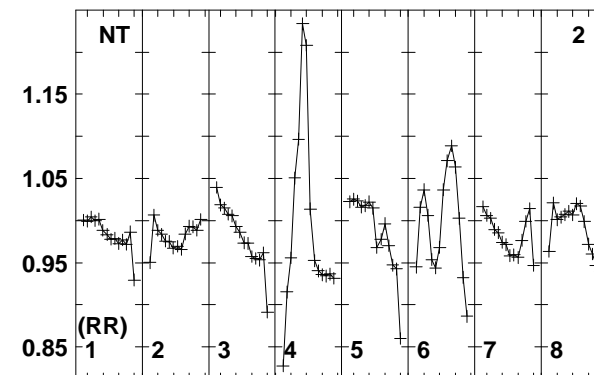
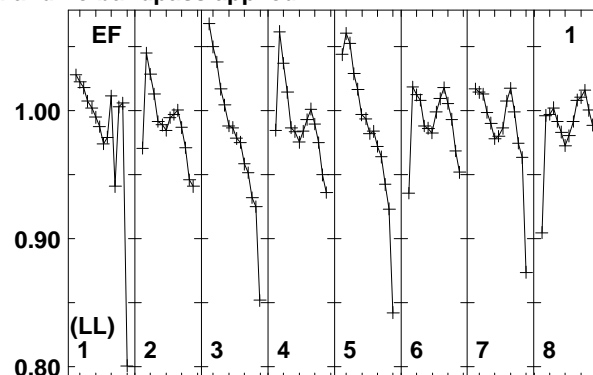
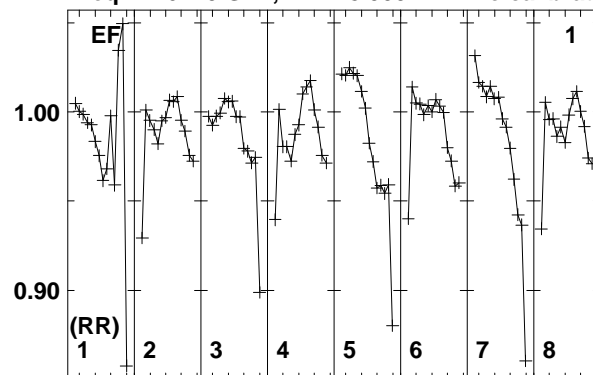

Lower frame: Real Jy
Total-power spectrum Antenna: EF (01)
Timerange: 00/20:19:41 to 00/20:27:19

Plot file version 12 created 22-OCT-2014 16:25:15

J1432+3014 EC048.UVDATA.1

Freq = 1.6270 GHz, Bw = 8.000 MH No calibration applied and no bandpass applied

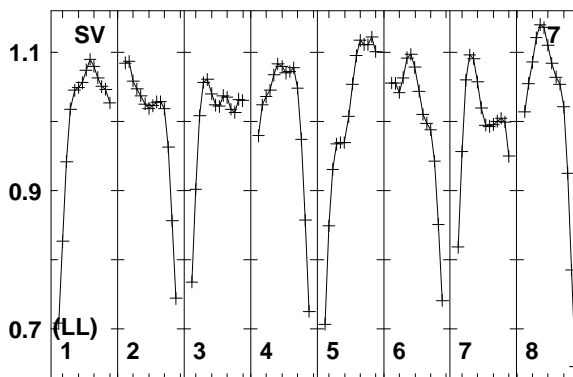
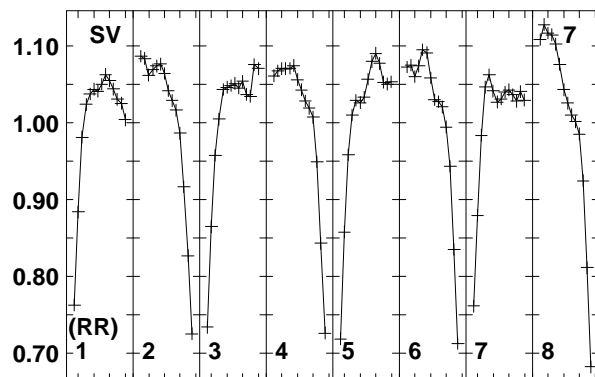
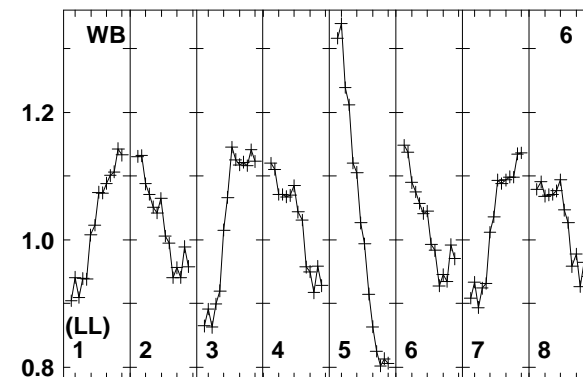
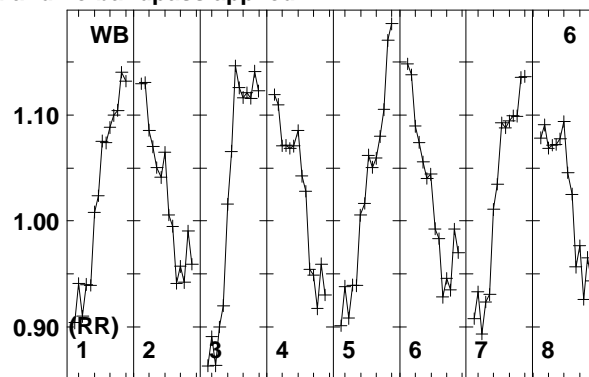
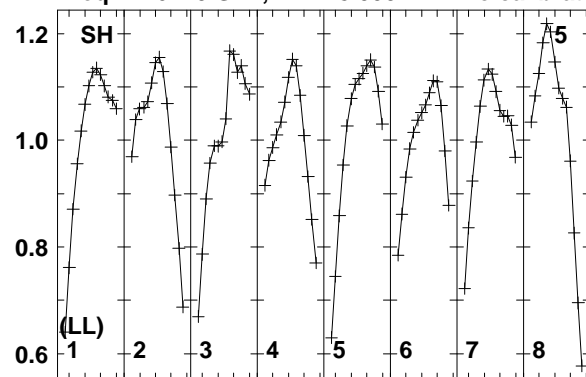

Lower frame: Real Jy
Total-power spectrum Antenna: SH (05)
Timerange: 00/20:19:41 to 00/20:27:19

Plot file version 13 created 22-OCT-2014 16:25:15

J1435+3012 EC048.UVDATA.1

Freq = 1.6270 GHz, Bw = 8.000 MH No calibration applied and no bandpass applied

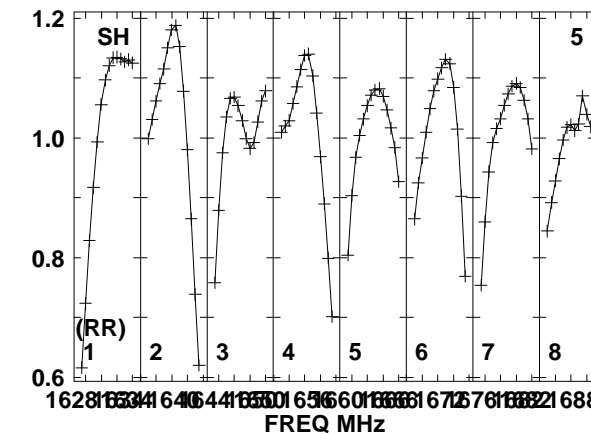
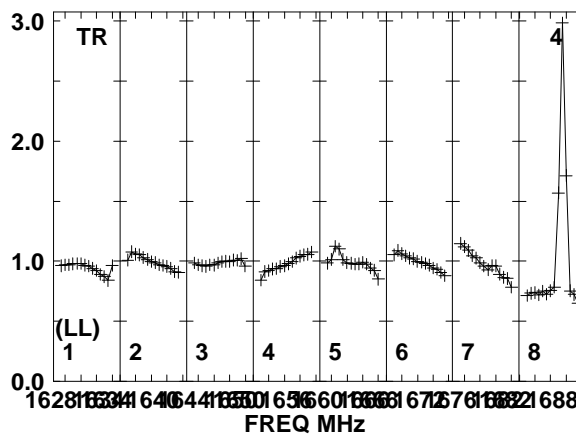
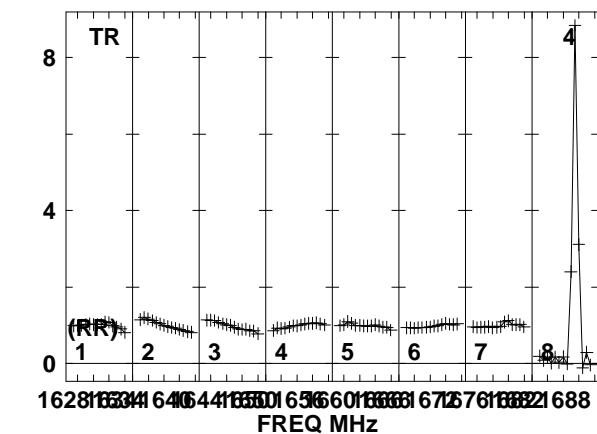
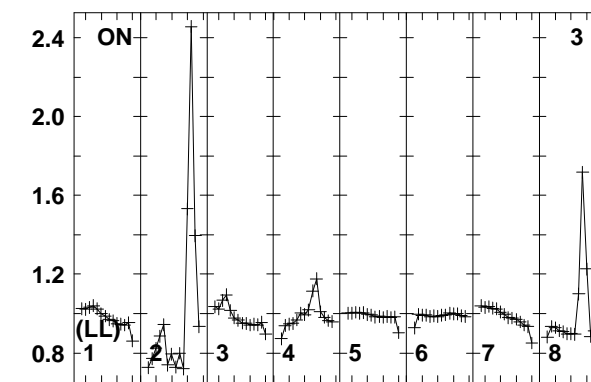
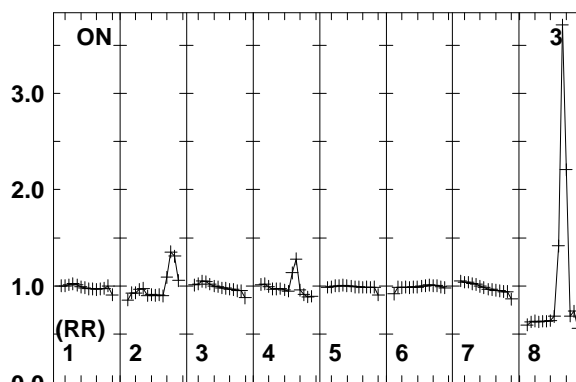
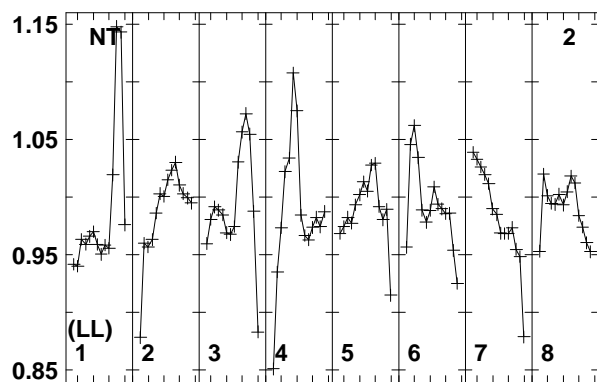
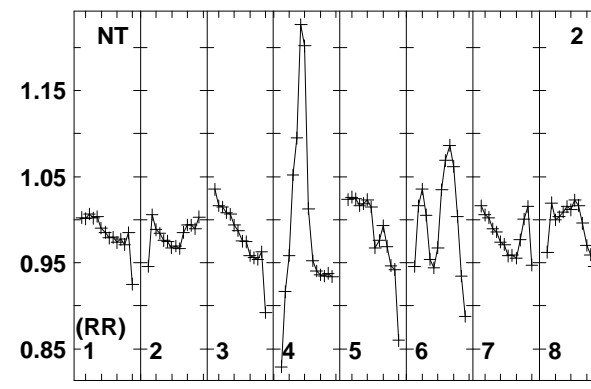
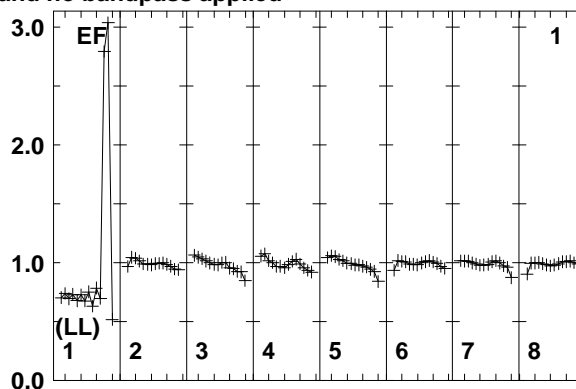
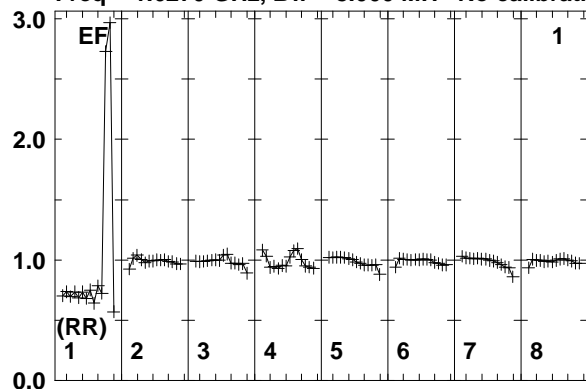

Lower frame: Real Jy
Total-power spectrum Antenna: EF (01)
Timerange: 00/20:28:03 to 00/20:29:49

Plot file version 14 created 22-OCT-2014 16:25:15

J1435+3012 EC048.UVDATA.1

Freq = 1.6270 GHz, Bw = 8.000 MH No calibration applied and no bandpass applied

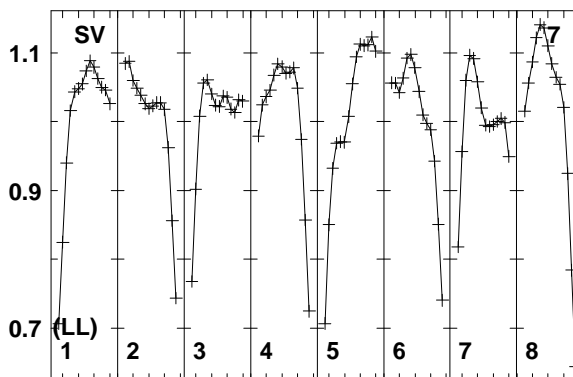
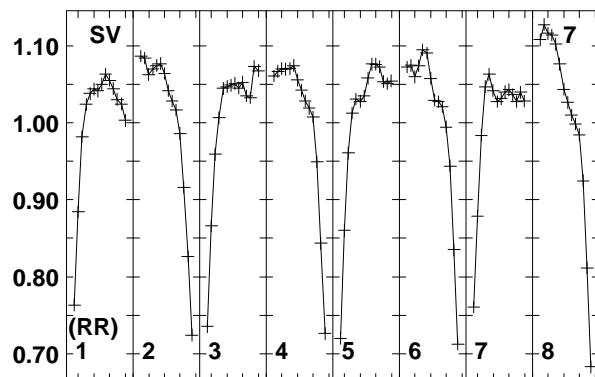
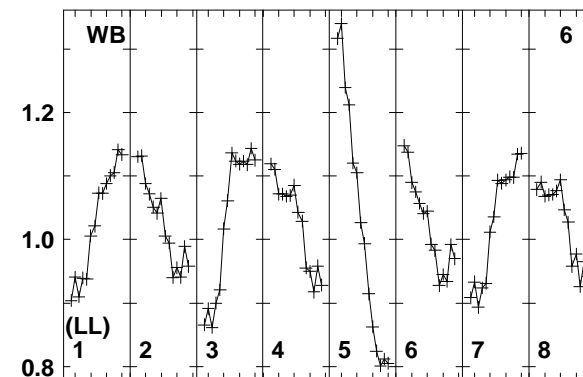
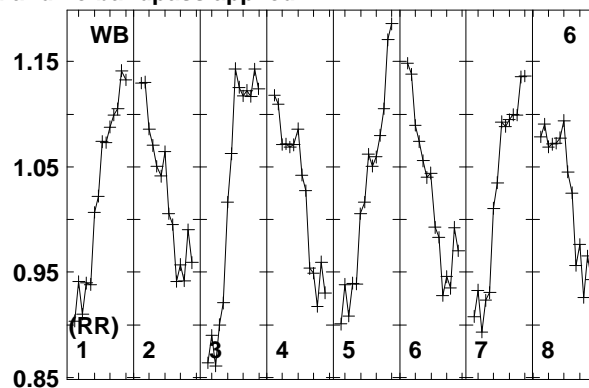
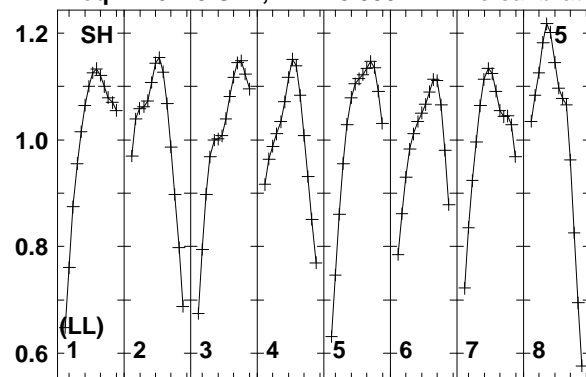

Lower frame: Real Jy
Total-power spectrum Antenna: SH (05)
Timerange: 00/20:28:03 to 00/20:29:49

Plot file version 15 created 22-OCT-2014 16:25:15

J1432+3014 EC048.UVDATA.1

Freq = 1.6270 GHz, Bw = 8.000 MH No calibration applied and no bandpass applied

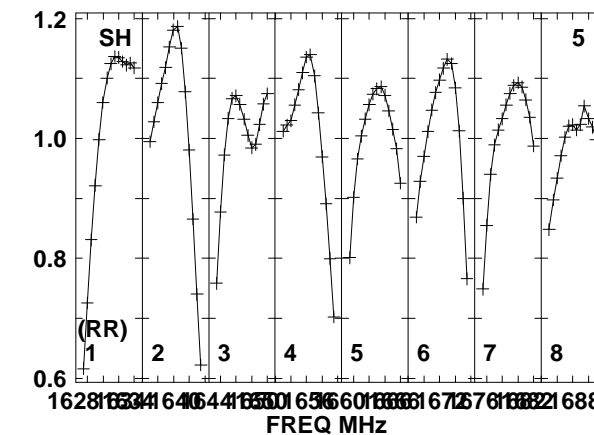
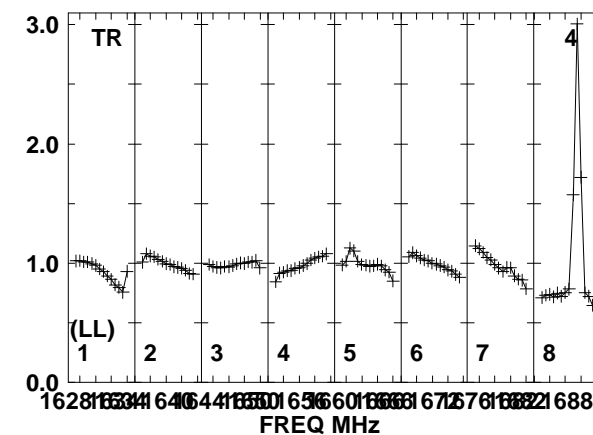
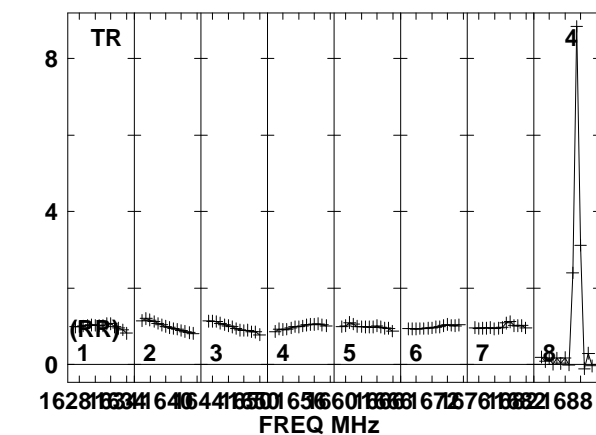
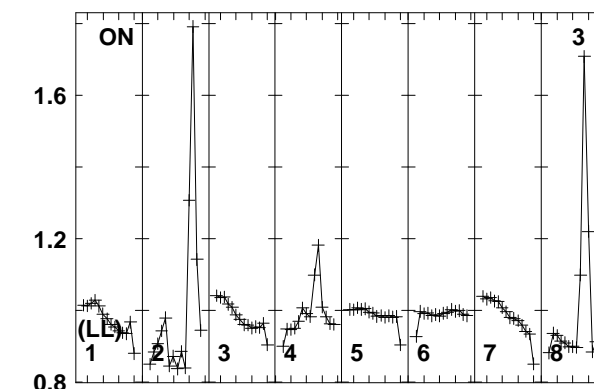
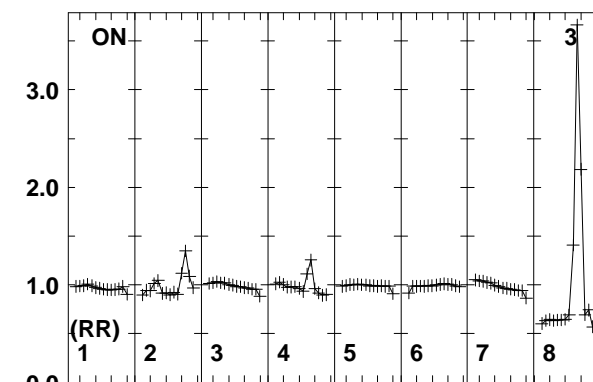
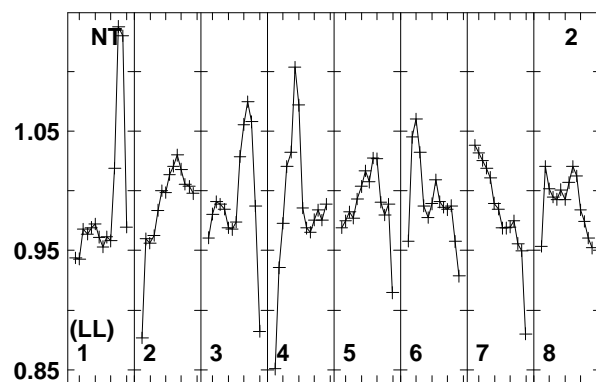
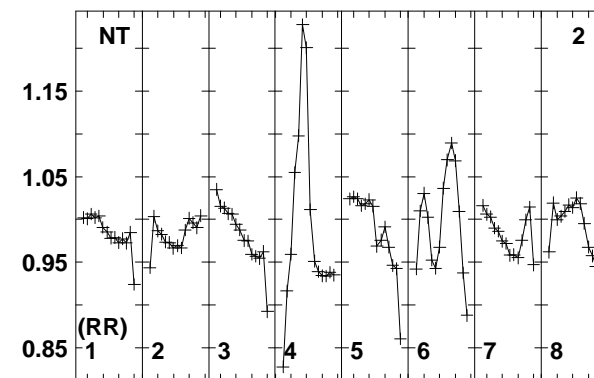
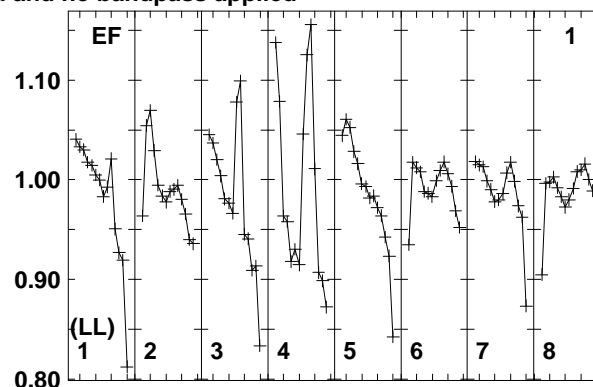
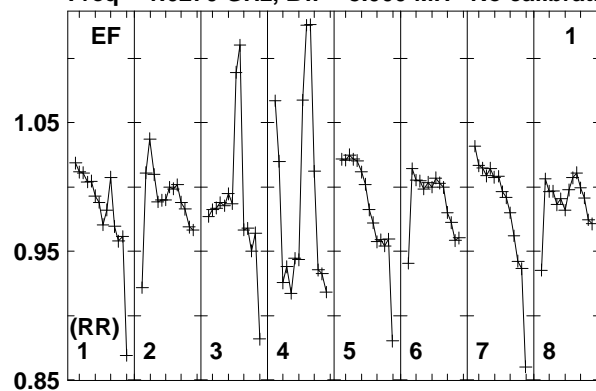

Lower frame: Real Jy
Total-power spectrum Antenna: EF (01)
Timerange: 00/20:29:56 to 00/20:37:34

Plot file version 16 created 22-OCT-2014 16:25:15

J1432+3014 EC048.UVDATA.1

Freq = 1.6270 GHz, Bw = 8.000 MH No calibration applied and no bandpass applied

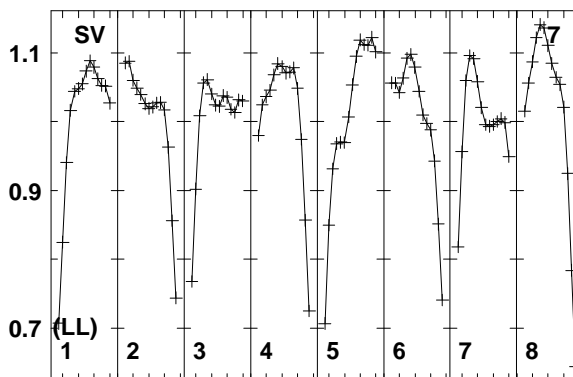
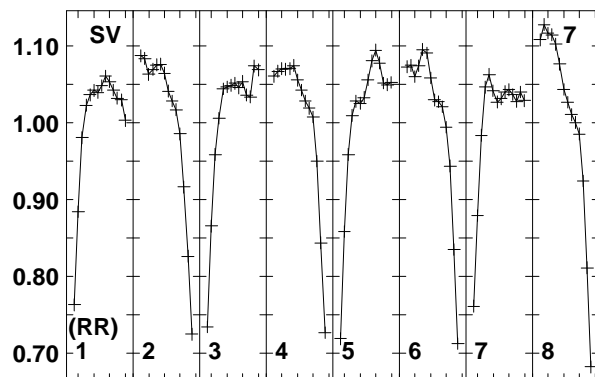
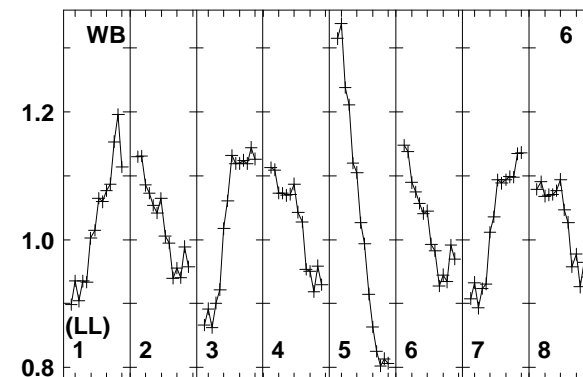
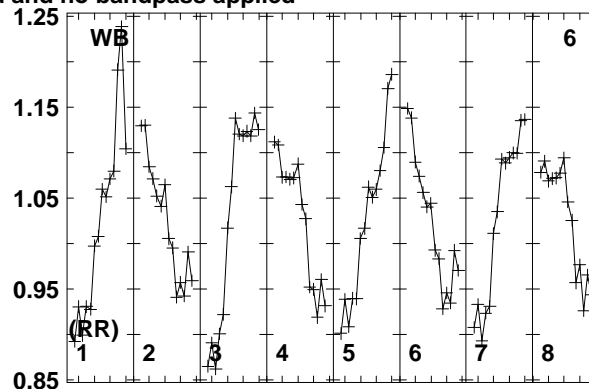
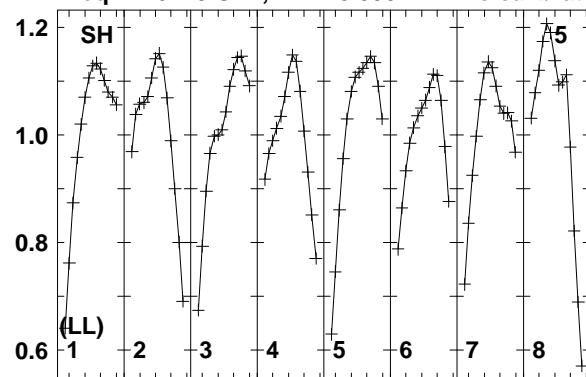

Lower frame: Real Jy
Total-power spectrum Antenna: SH (05)
Timerange: 00/20:29:56 to 00/20:37:34

Plot file version 17 created 22-OCT-2014 16:25:15

J1435+3012 EC048.UVDATA.1

Freq = 1.6270 GHz, Bw = 8.000 MH No calibration applied and no bandpass applied

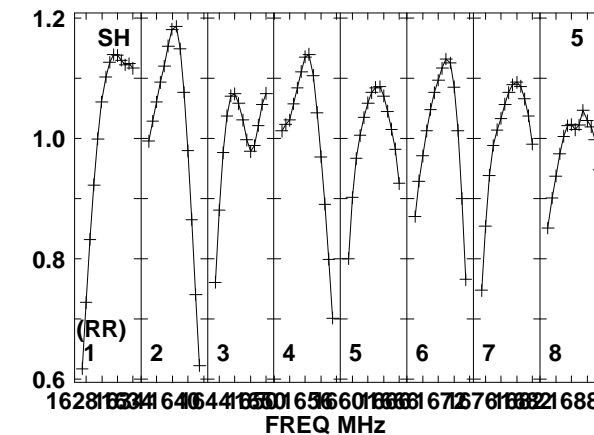
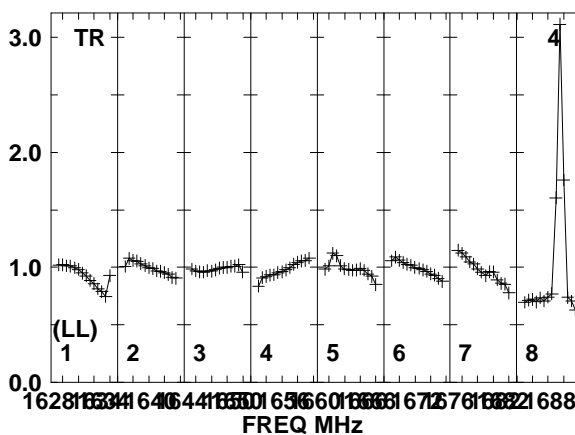
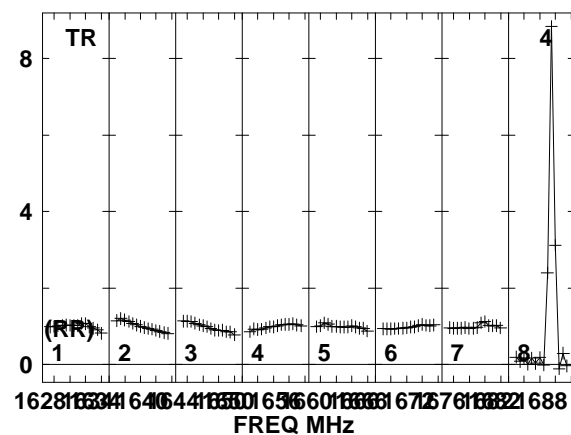
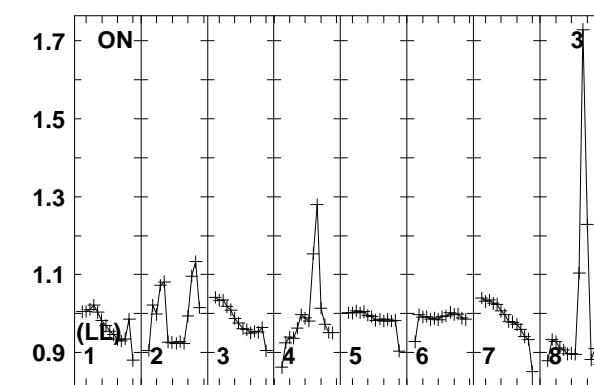
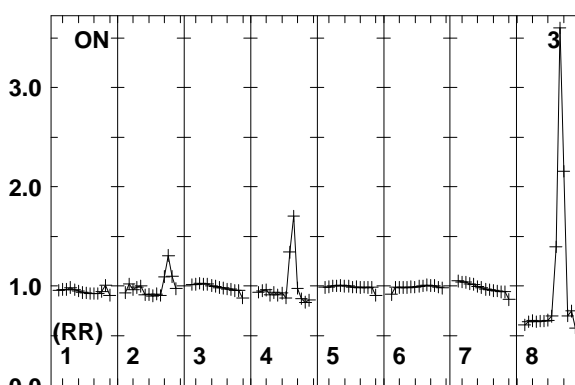
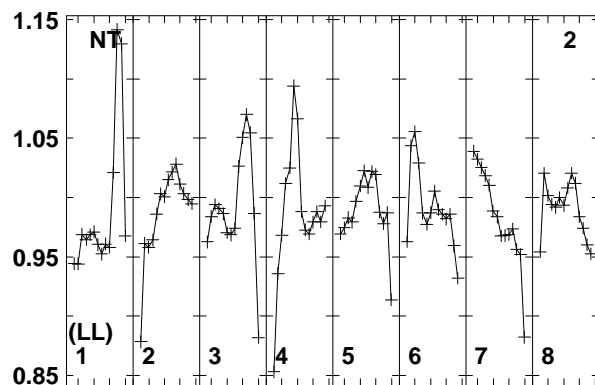
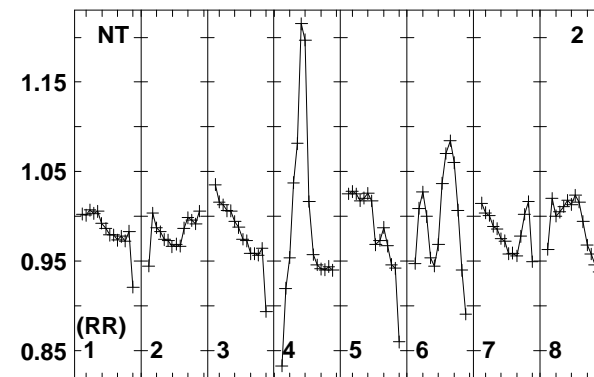
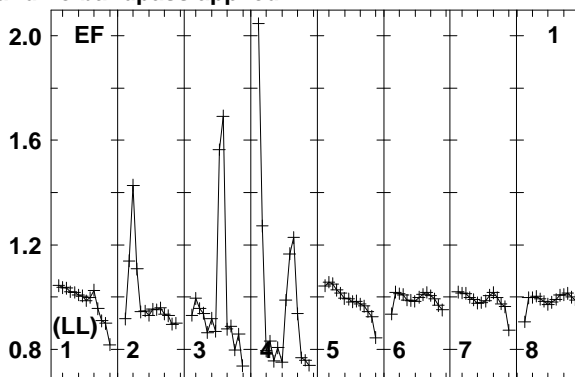
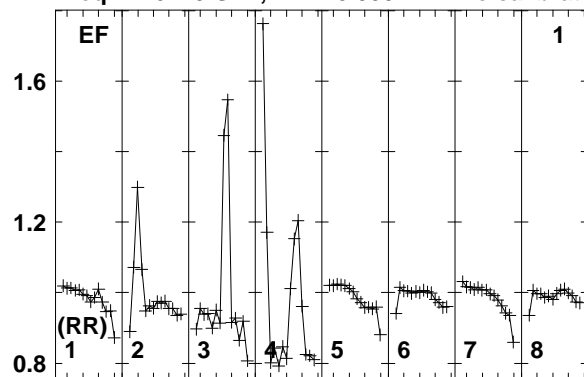

Lower frame: Real Jy
Total-power spectrum Antenna: EF (01)
Timerange: 00/20:38:18 to 00/20:40:04

Plot file version 18 created 22-OCT-2014 16:25:15

J1435+3012 EC048.UVDATA.1

Freq = 1.6270 GHz, Bw = 8.000 MH No calibration applied and no bandpass applied

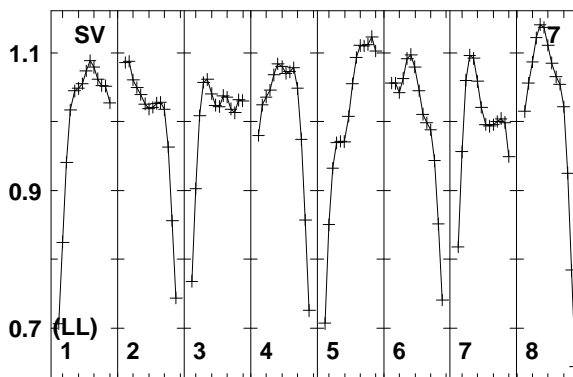
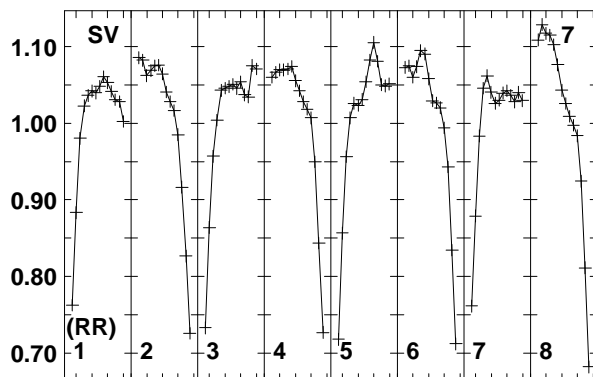
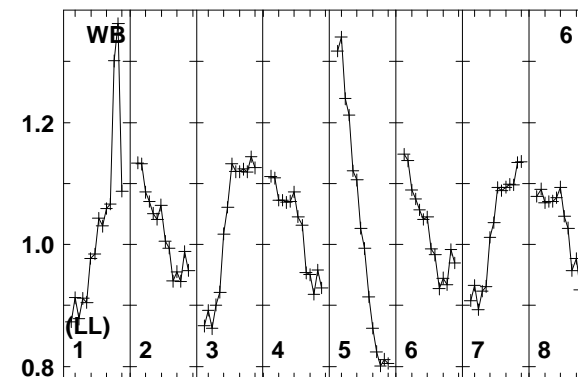
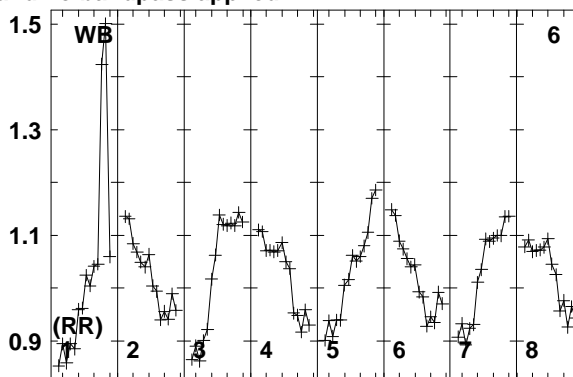
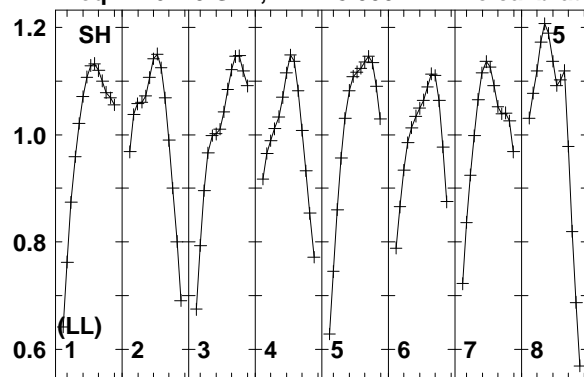

Lower frame: Real Jy
Total-power spectrum Antenna: SH (05)
Timerange: 00/20:38:18 to 00/20:40:04

Plot file version 19 created 22-OCT-2014 16:25:15

J1635+3808 EC048.UVDATA.1

Freq = 1.6270 GHz, Bw = 8.000 MH No calibration applied and no bandpass applied

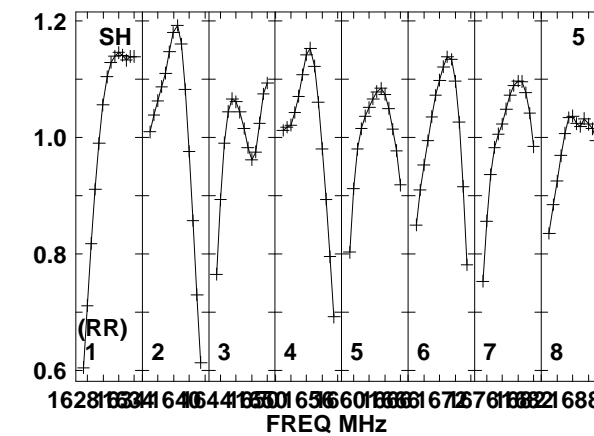
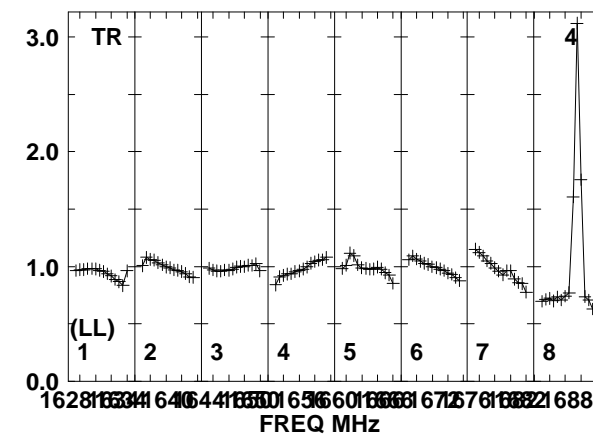
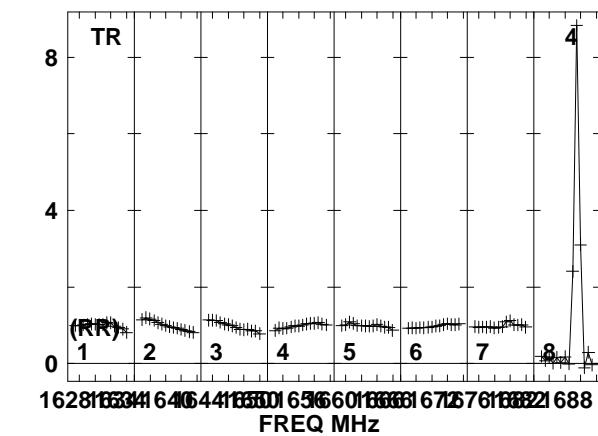
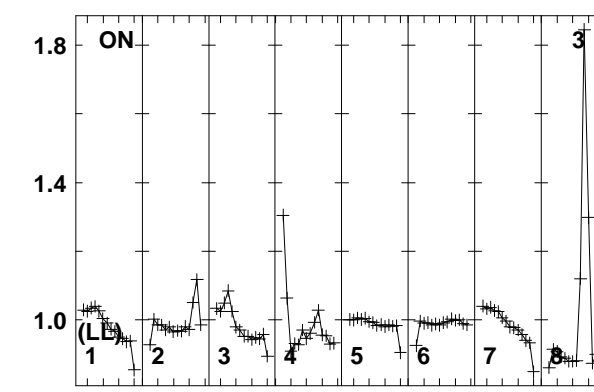
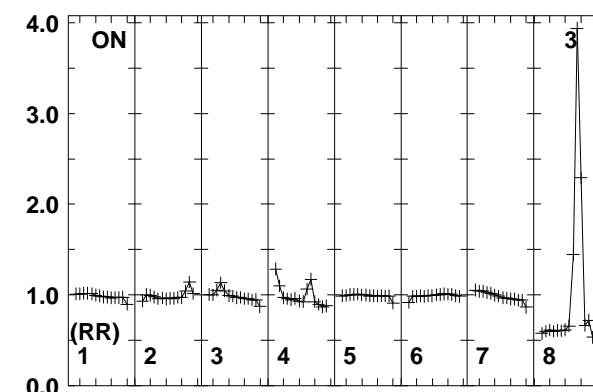
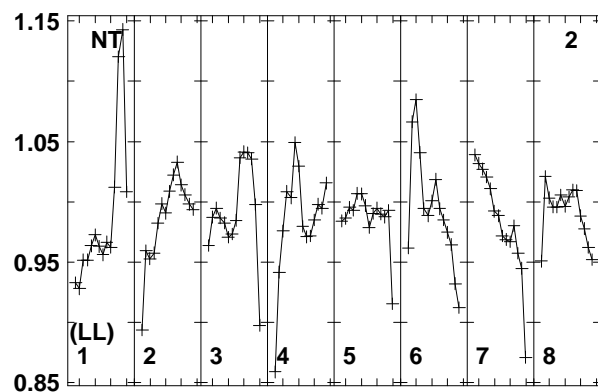
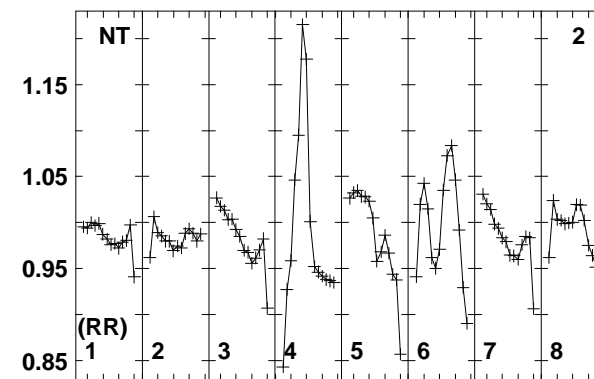
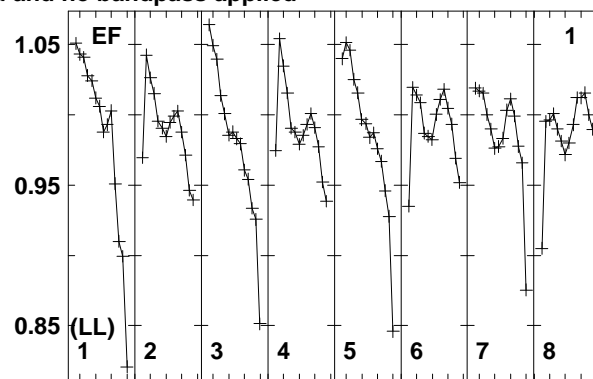
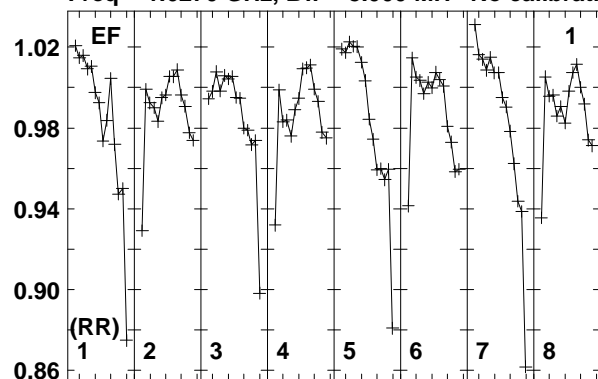

Lower frame: Real Jy
Total-power spectrum Antenna: EF (01)
Timerange: 00/20:41:28 to 00/20:43:24

Plot file version 20 created 22-OCT-2014 16:25:15

J1635+3808 EC048.UVDATA.1

Freq = 1.6270 GHz, Bw = 8.000 MH No calibration applied and no bandpass applied

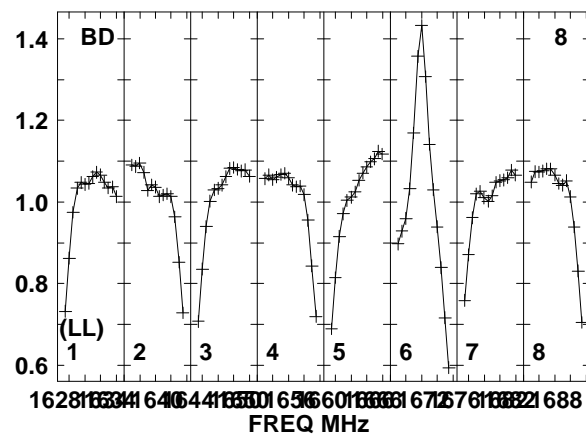
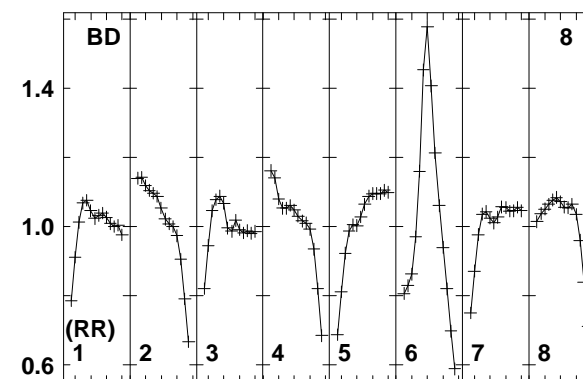
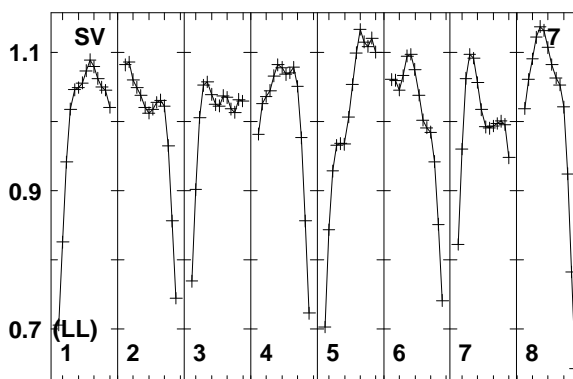
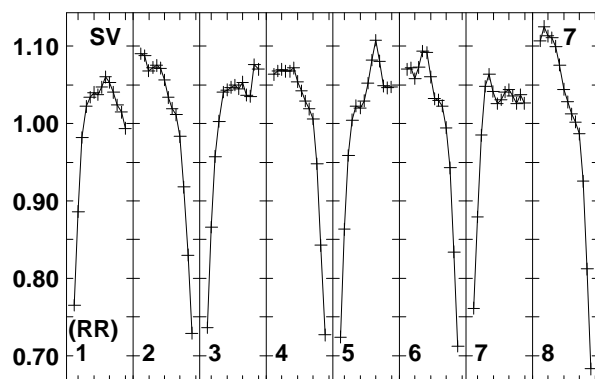
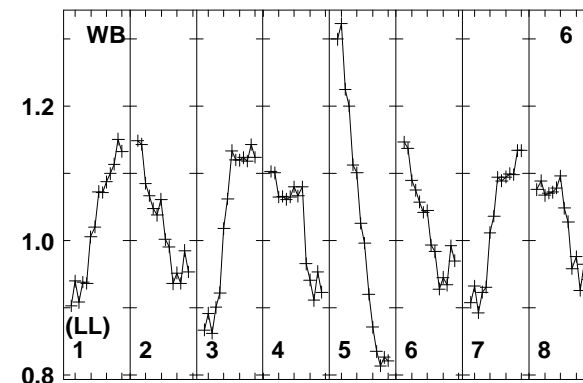
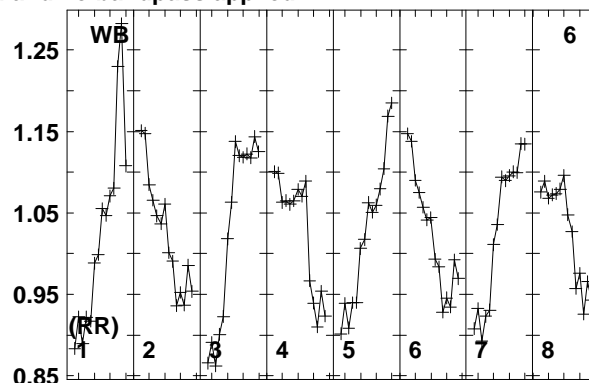
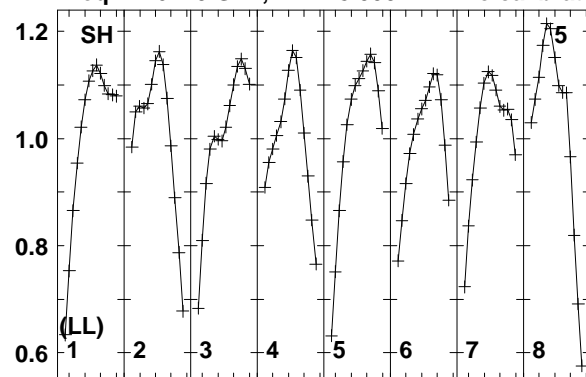

162816341640644165016566016681672167816821688
FREQ MHz

Lower frame: Real Jy

Total-power spectrum Antenna: SH (05)

Timerange: 00/20:41:28 to 00/20:43:24

Plot file version 21 created 22-OCT-2014 16:25:15

J1432+3014 EC048.UVDATA.1

Freq = 1.6270 GHz, Bw = 8.000 MH No calibration applied and no bandpass applied

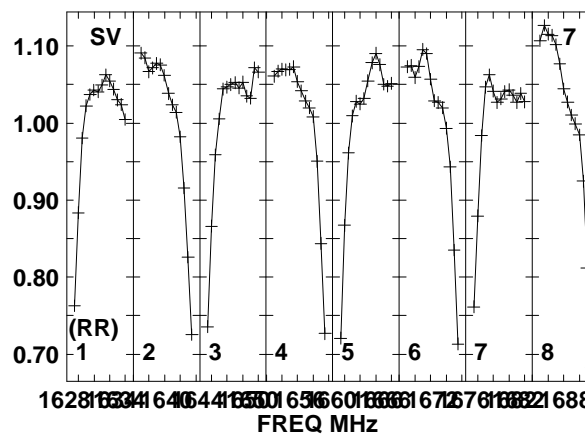
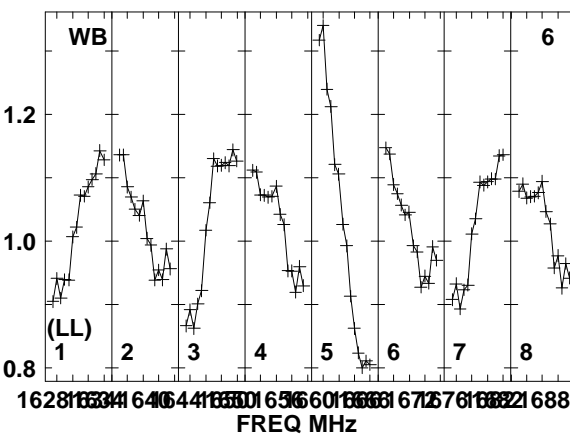
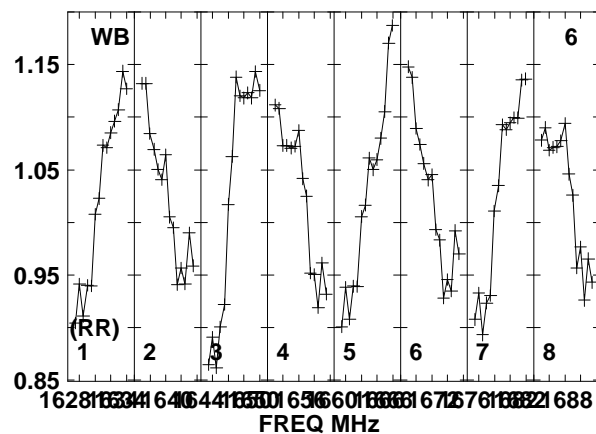
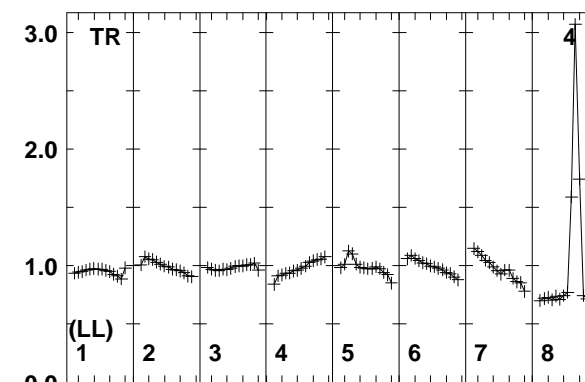
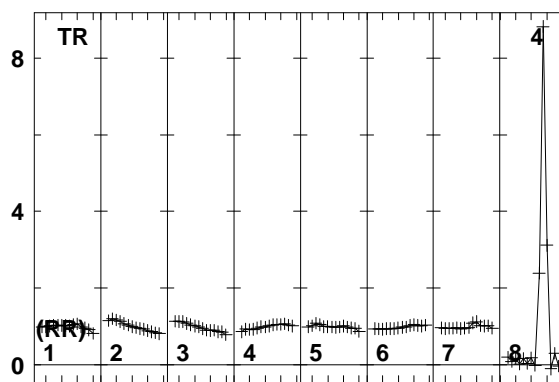
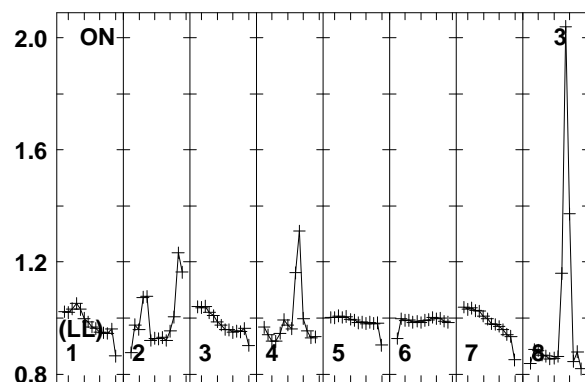
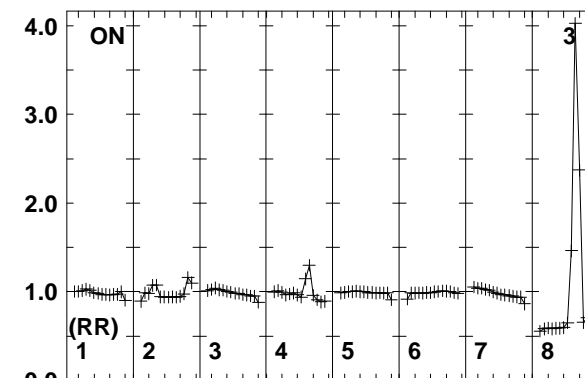
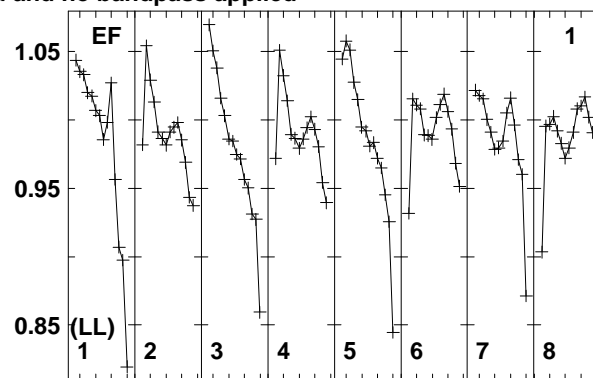
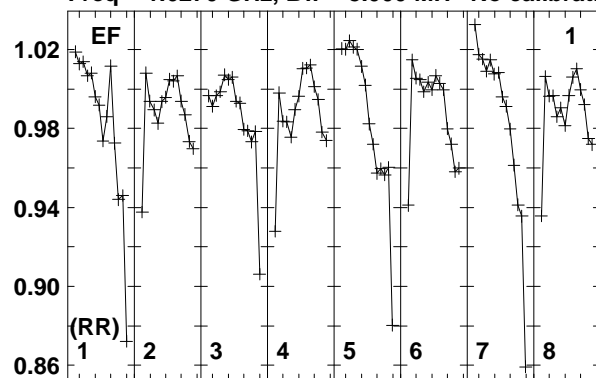

Lower frame: Real Jy
Total-power spectrum Antenna: EF (01)
Timerange: 00/20:44:29 to 00/20:51:09

Plot file version 22 created 22-OCT-2014 16:25:15

J1432+3014 EC048.UVDATA.1

Freq = 1.6270 GHz, Bw = 8.000 MH No calibration applied and no bandpass applied

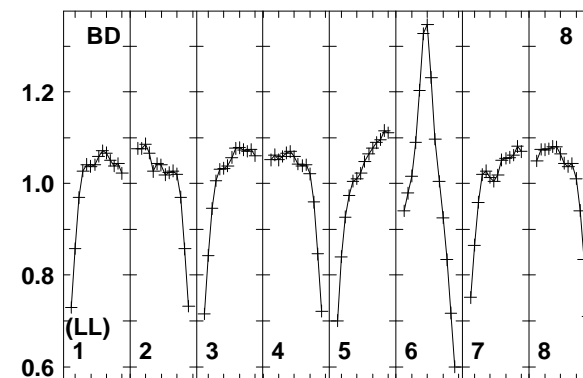
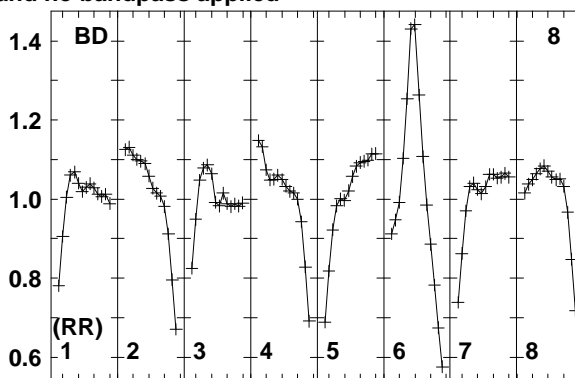
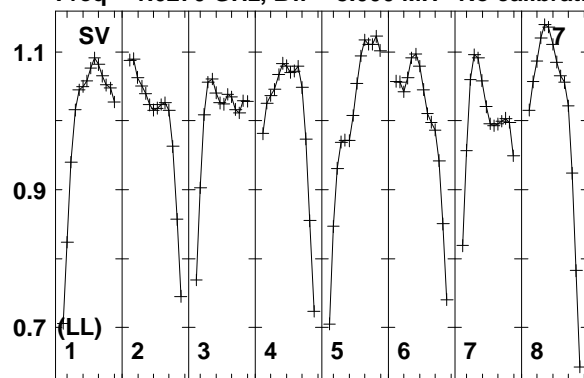

Lower frame: Real Jy
Total-power spectrum Antenna: SV (07)
Timerange: 00/20:44:29 to 00/20:51:09

Plot file version 23 created 22-OCT-2014 16:25:15

J1435+3012 EC048.UVDATA.1

Freq = 1.6270 GHz, Bw = 8.000 MH No calibration applied and no bandpass applied

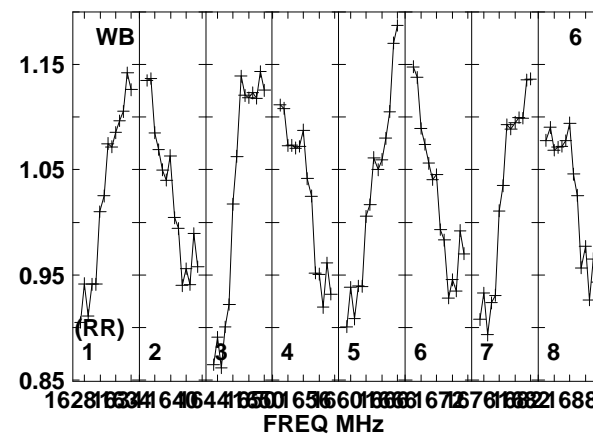
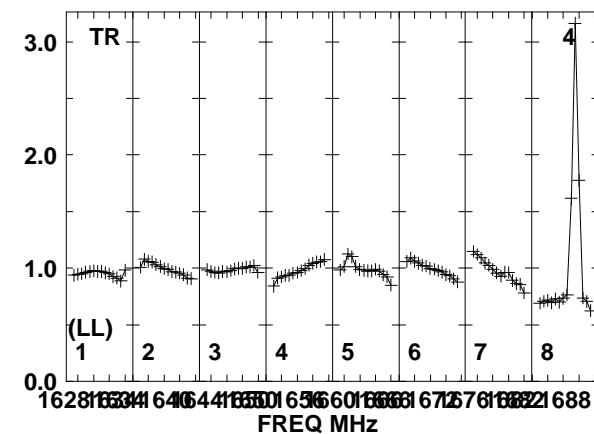
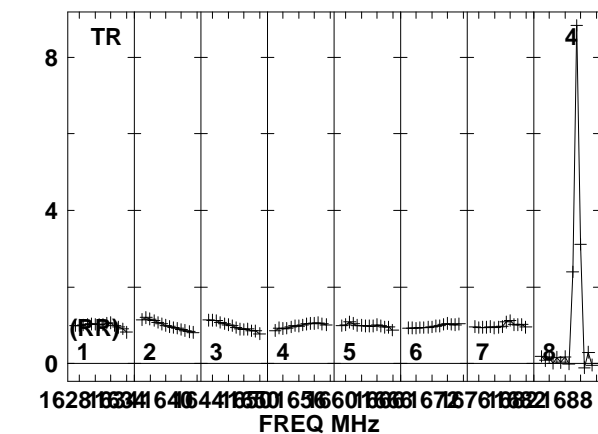
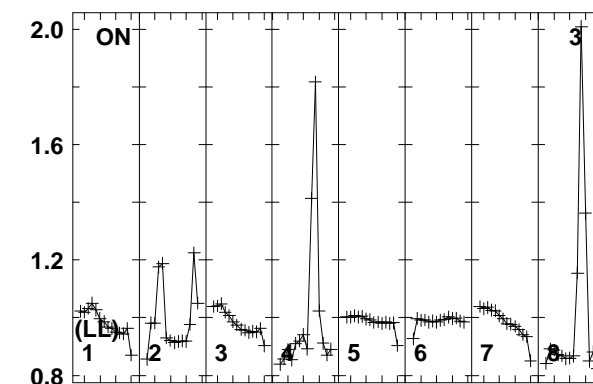
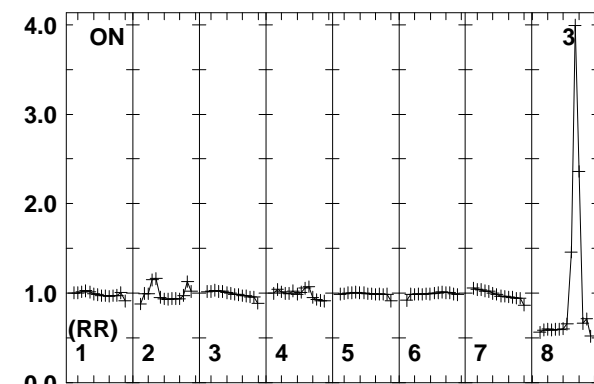
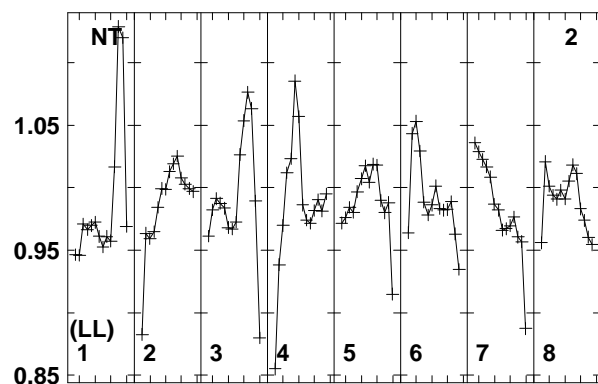
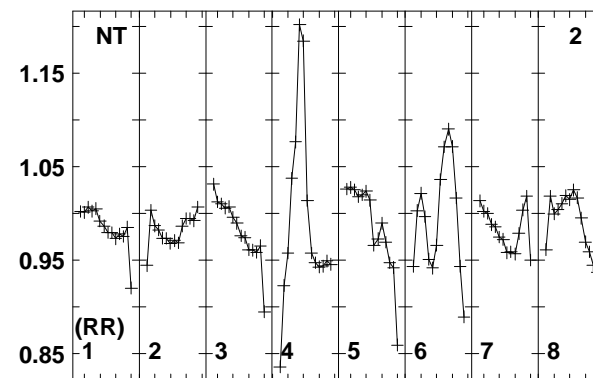
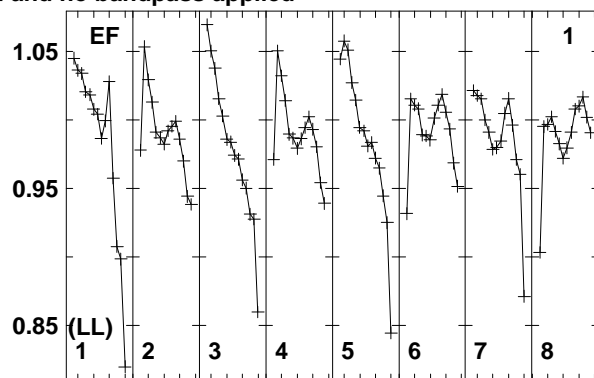
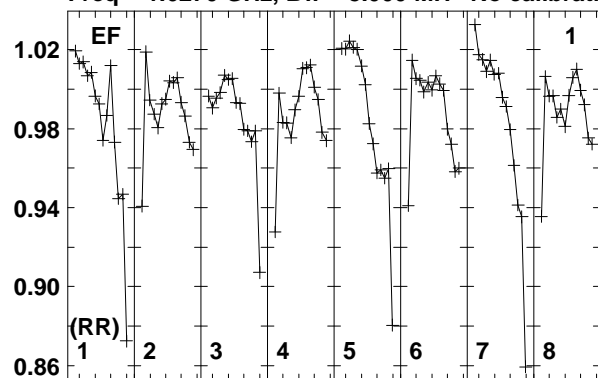

Lower frame: Real Jy
Total-power spectrum Antenna: EF (01)
Timerange: 00:20:51:53 to 00:20:53:39

Plot file version 24 created 22-OCT-2014 16:25:15

J1435+3012 EC048.UVDATA.1

Freq = 1.6270 GHz, Bw = 8.000 MH No calibration applied and no bandpass applied

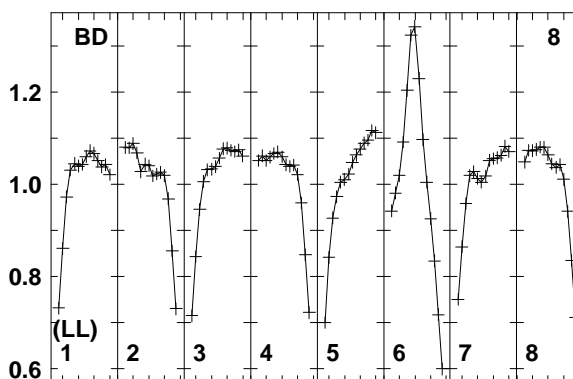
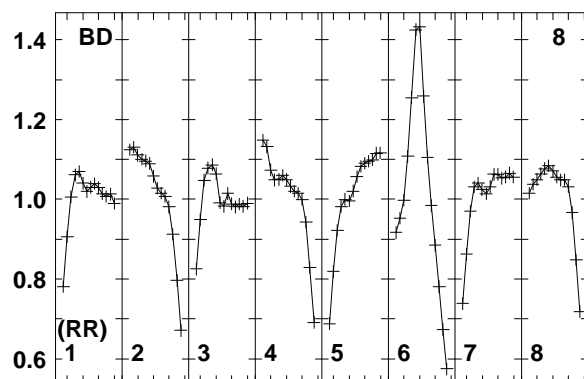
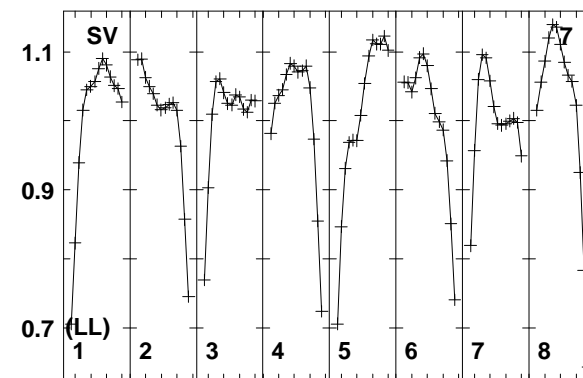
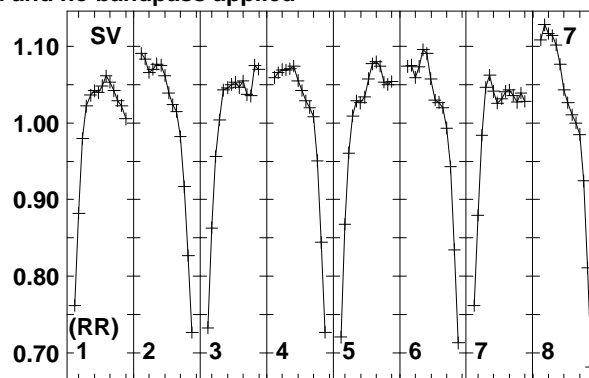
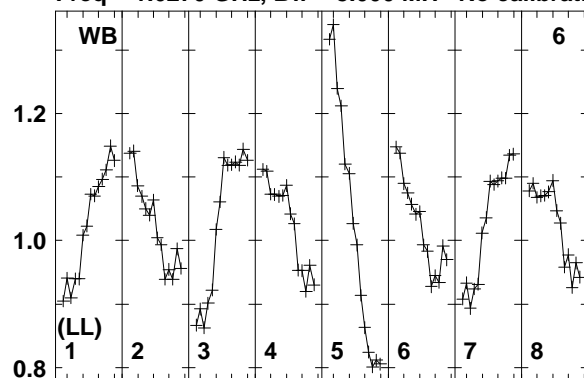

Lower frame: Real Jy
Total-power spectrum Antenna: WB (06)
Timerange: 00/20:51:53 to 00/20:53:39

Plot file version 25 created 22-OCT-2014 16:25:15

J1432+3014 EC048.UVDATA.1

Freq = 1.6270 GHz, Bw = 8.000 MH No calibration applied and no bandpass applied

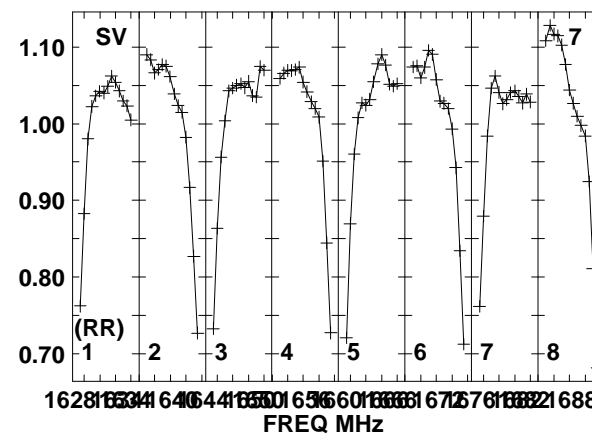
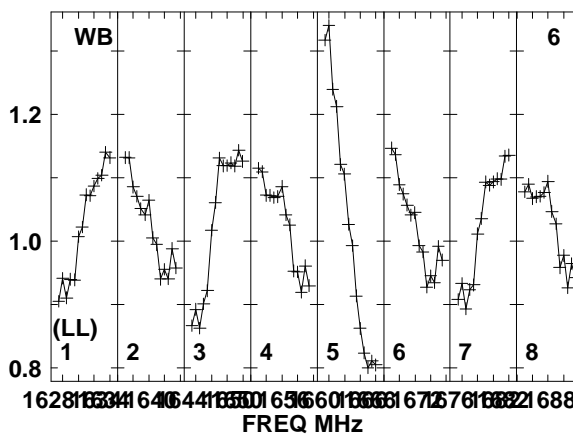
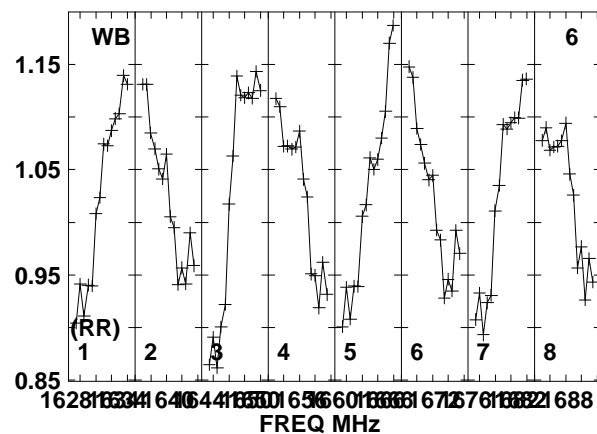
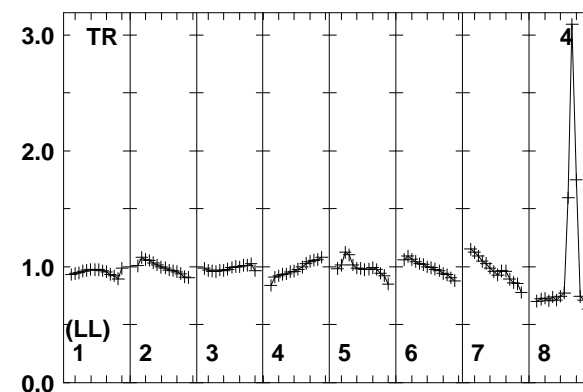
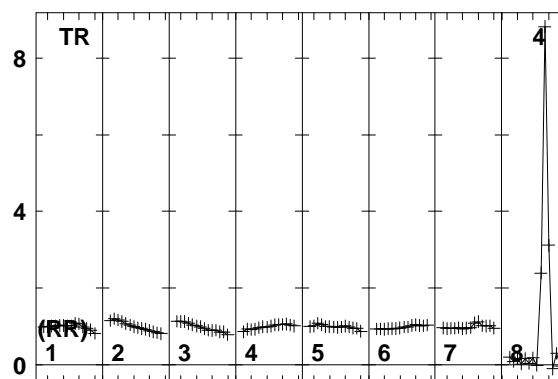
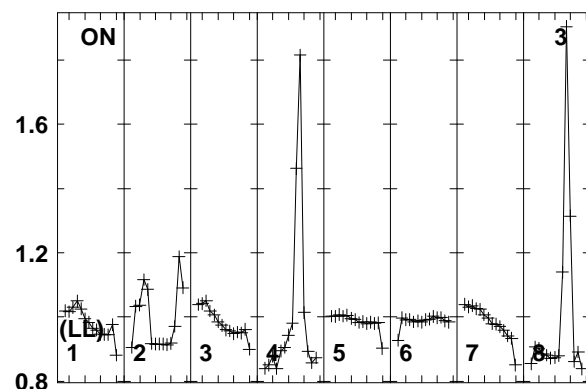
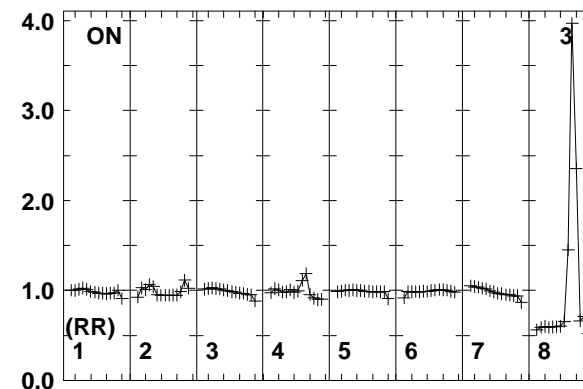
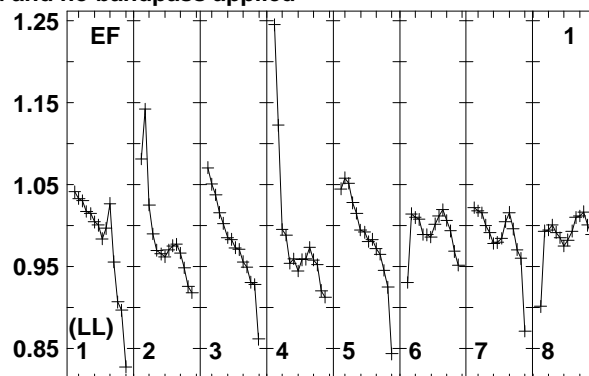
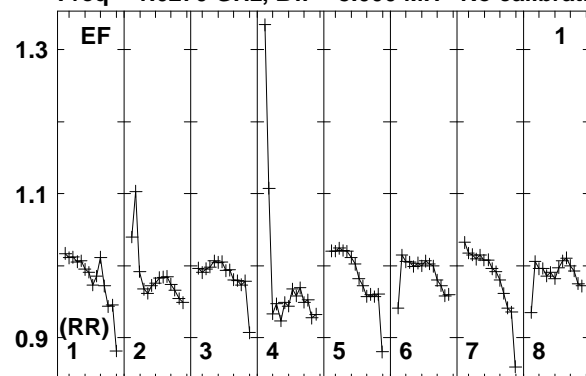

Lower frame: Real Jy
Total-power spectrum Antenna: EF (01)
Timerange: 00/20:53:51 to 00/21:01:23

Plot file version 26 created 22-OCT-2014 16:25:15

J1432+3014 EC048.UVDATA.1

Freq = 1.6270 GHz, Bw = 8.000 MH No calibration applied and no bandpass applied

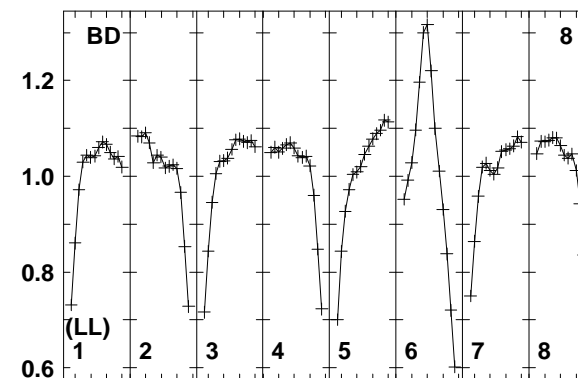
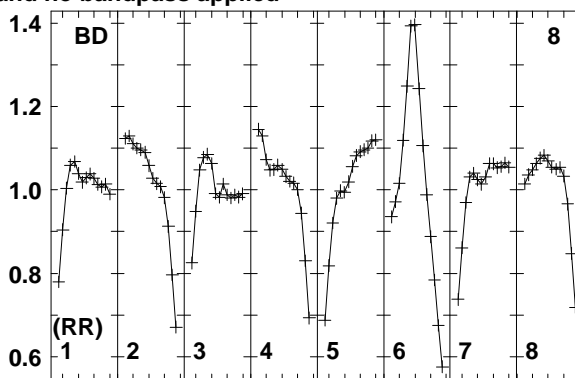
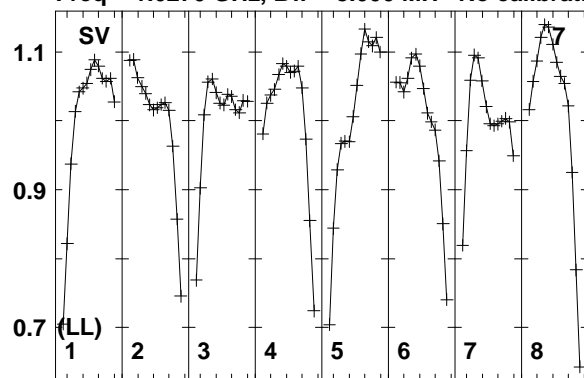

Lower frame: Real Jy
Total-power spectrum Antenna: SV (07)
Timerange: 00/20:53:51 to 00/21:01:23

Plot file version 27 created 22-OCT-2014 16:25:15

J1435+3012 EC048.UVDATA.1

Freq = 1.6270 GHz, Bw = 8.000 MH No calibration applied and no bandpass applied

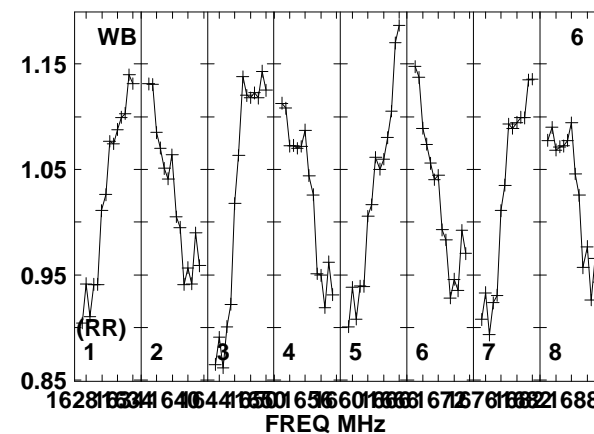
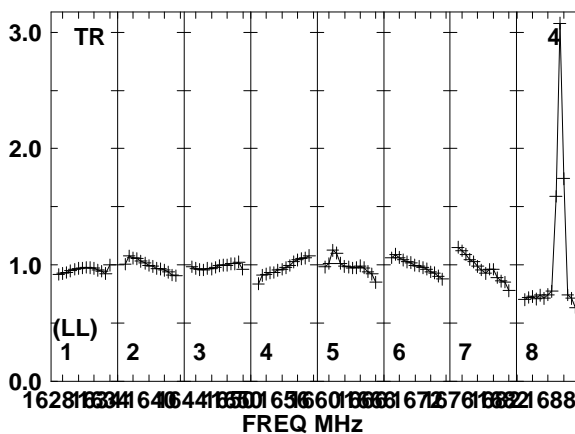
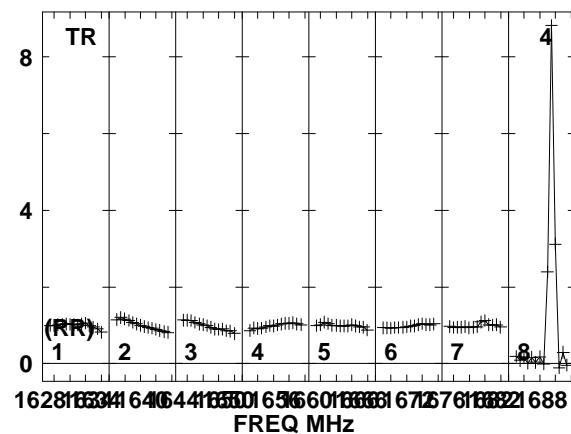
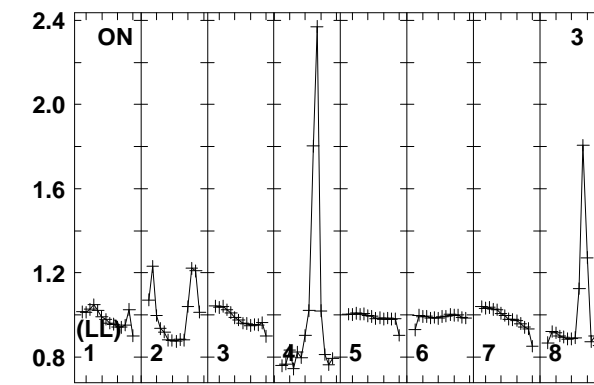
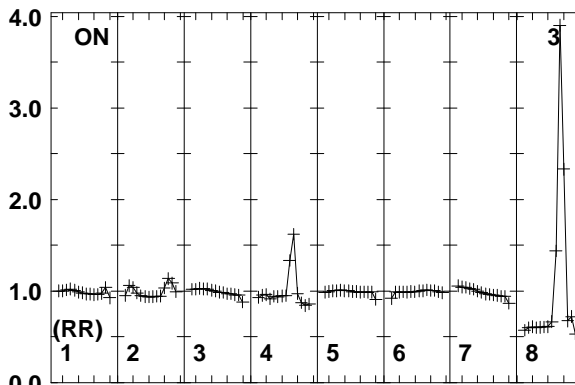
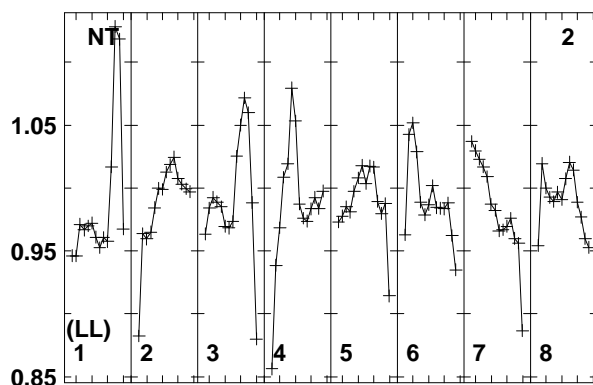
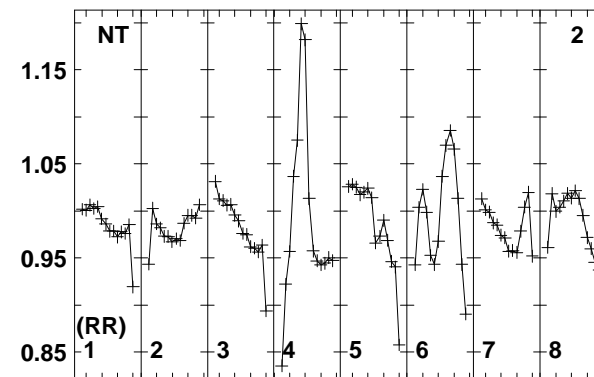
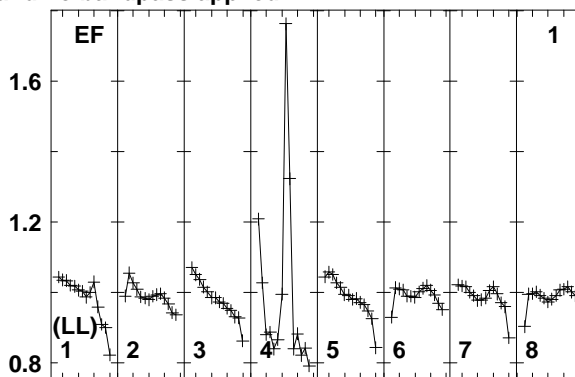
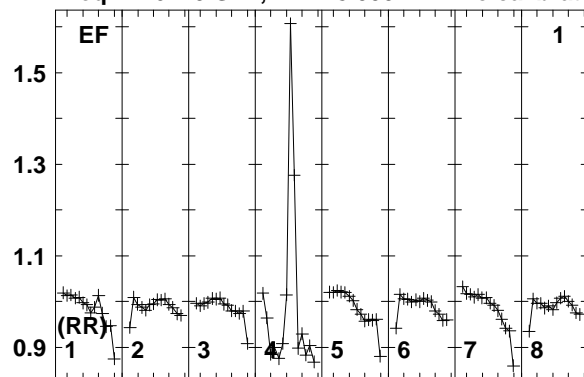

Lower frame: Real Jy
Total-power spectrum Antenna: EF (01)
Timerange: 00/21:02:08 to 00/21:03:54

Plot file version 28 created 22-OCT-2014 16:25:15

J1435+3012 EC048.UVDATA.1

Freq = 1.6270 GHz, Bw = 8.000 MH No calibration applied and no bandpass applied

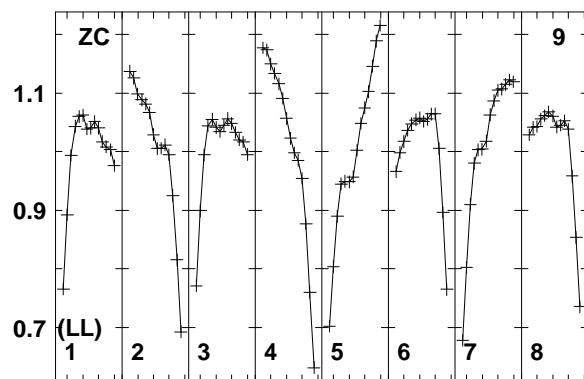
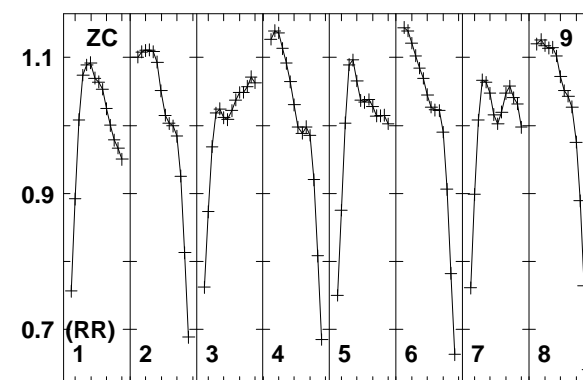
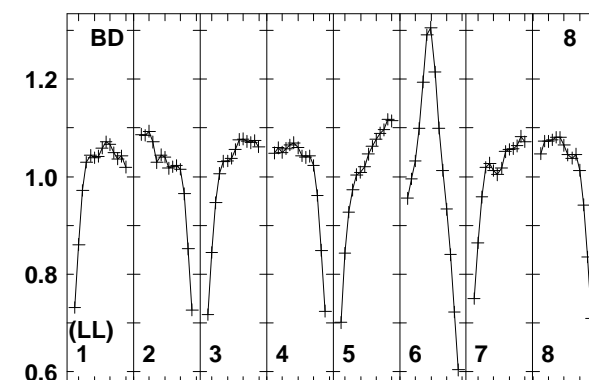
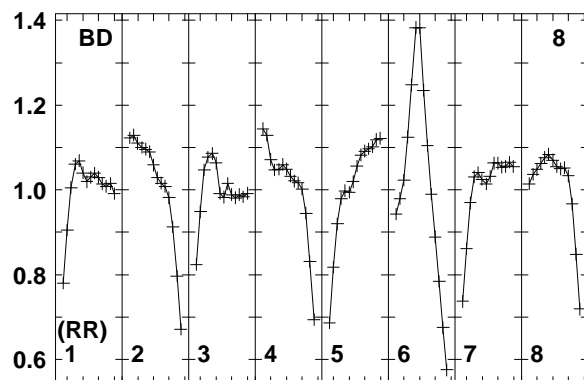
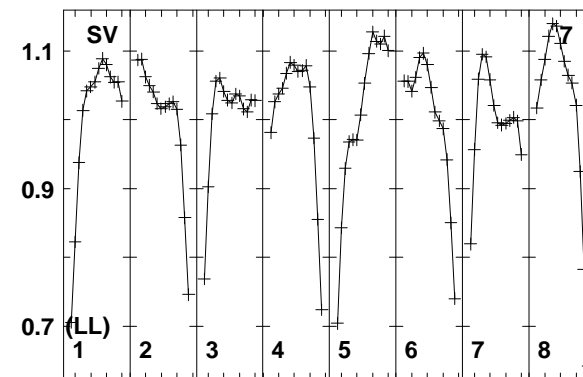
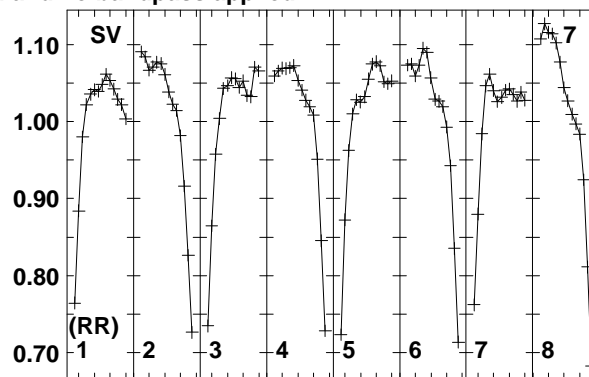
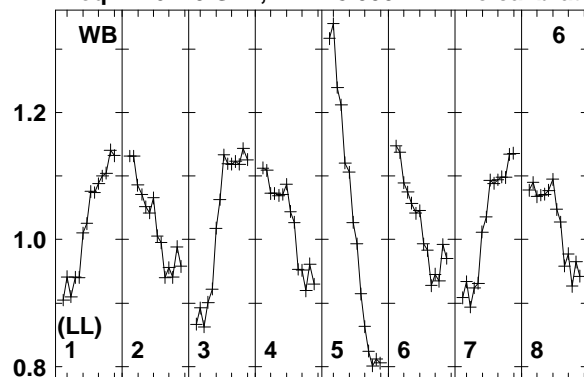

16281634164064416501656601663672678682688
FREQ MHz

Lower frame: Real Jy
Total-power spectrum Antenna: WB (06)
Timerange: 00/21:02:08 to 00/21:03:54

Plot file version 29 created 22-OCT-2014 16:25:15

J1432+3014 EC048.UVDATA.1

Freq = 1.6270 GHz, Bw = 8.000 MH No calibration applied and no bandpass applied

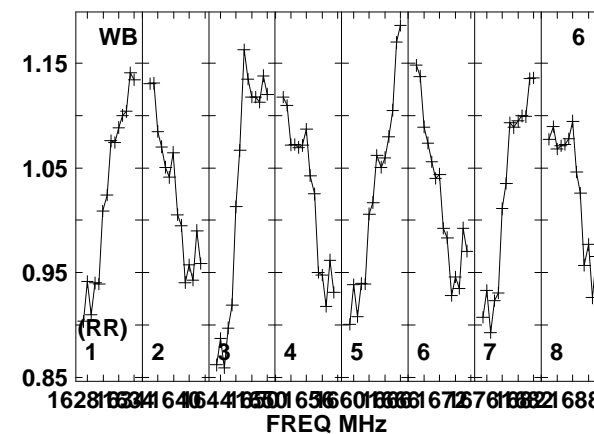
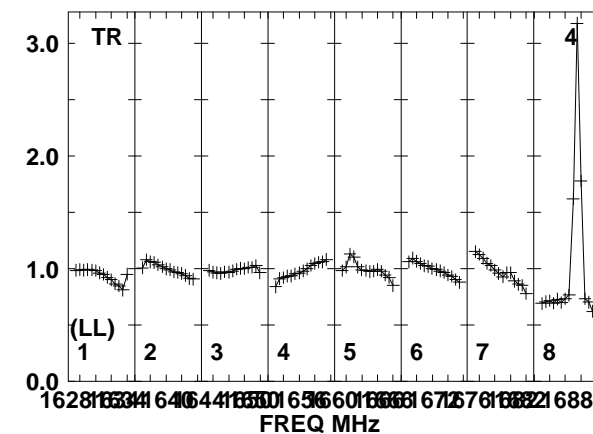
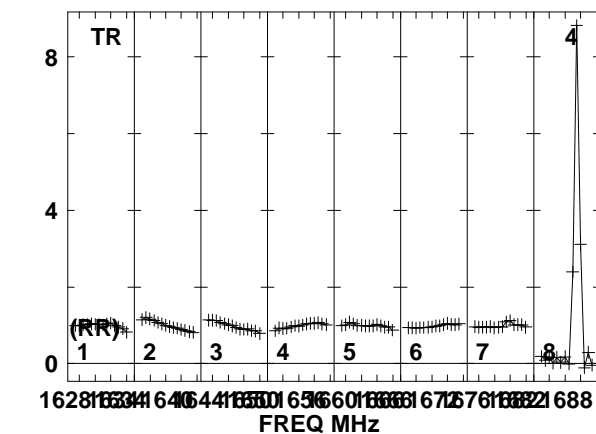
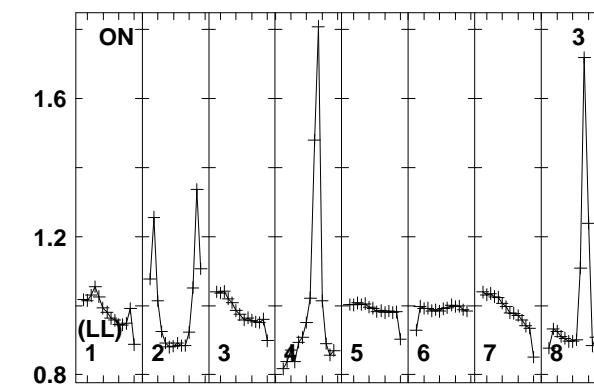
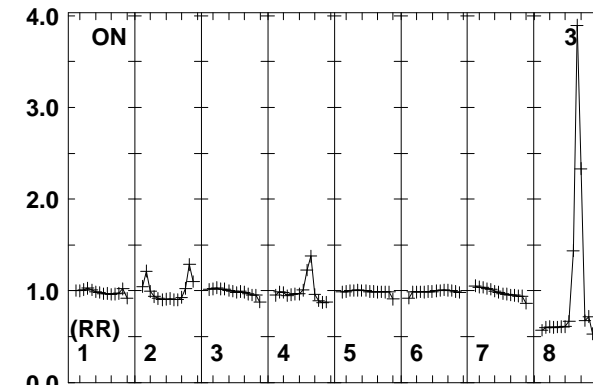
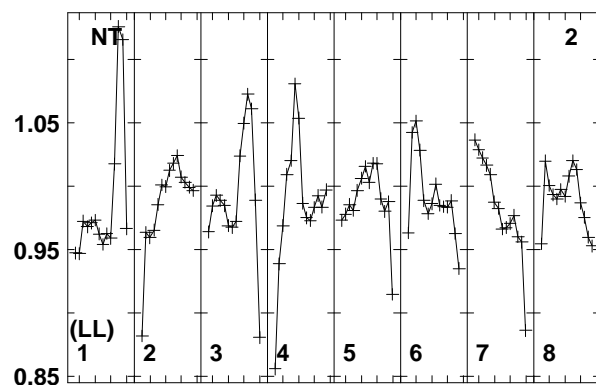
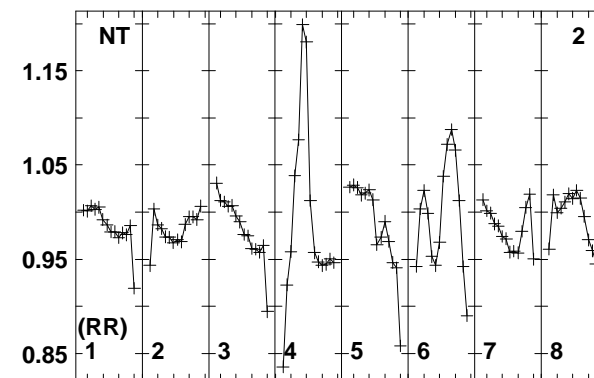
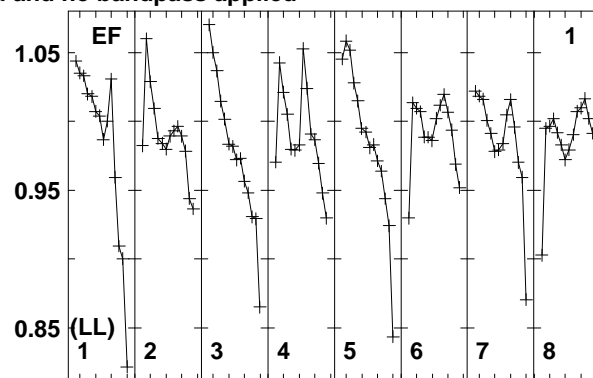
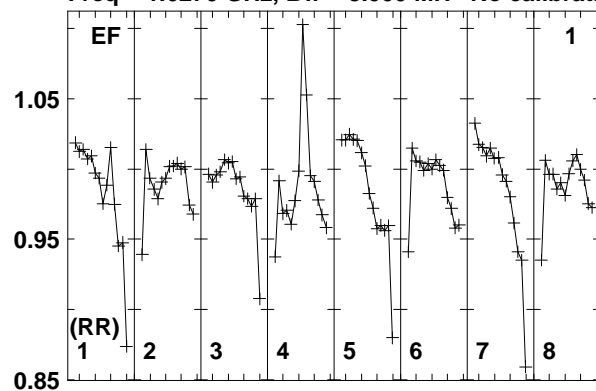

Lower frame: Real Jy
Total-power spectrum Antenna: EF (01)
Timerange: 00/21:04:05 to 00/21:11:39

Plot file version 30 created 22-OCT-2014 16:25:15

J1432+3014 EC048.UVDATA.1

Freq = 1.6270 GHz, Bw = 8.000 MH No calibration applied and no bandpass applied

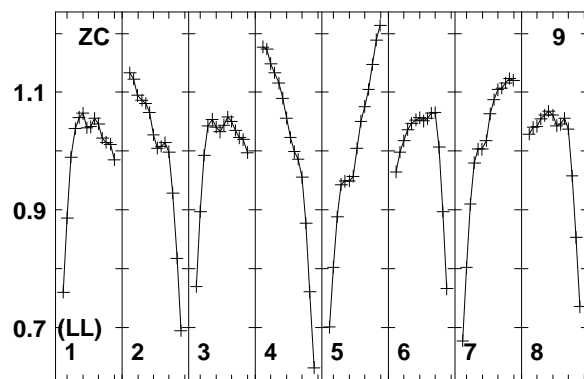
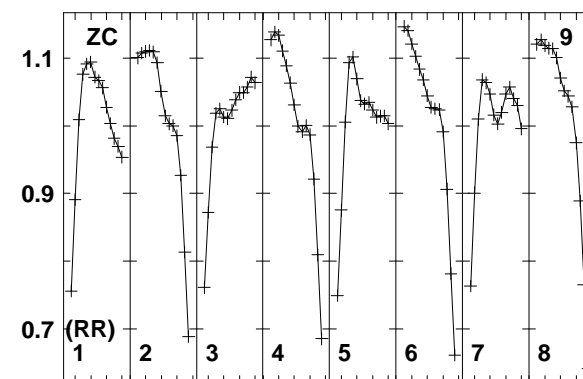
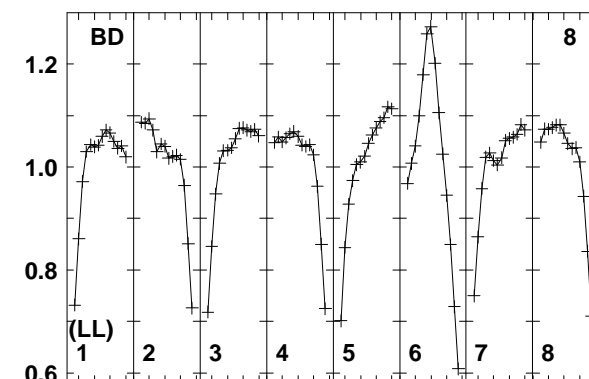
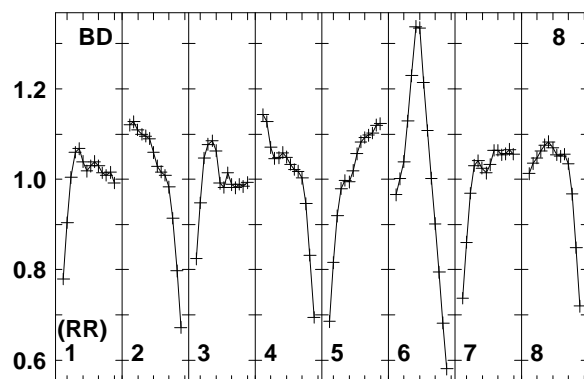
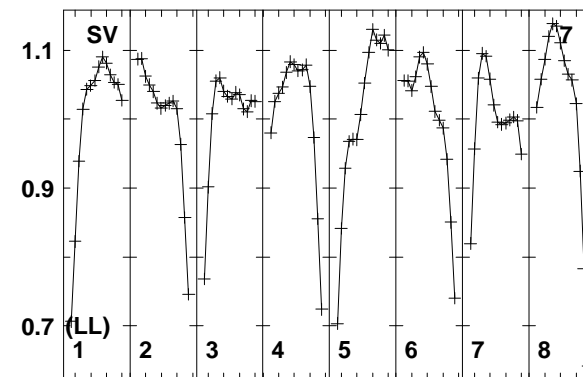
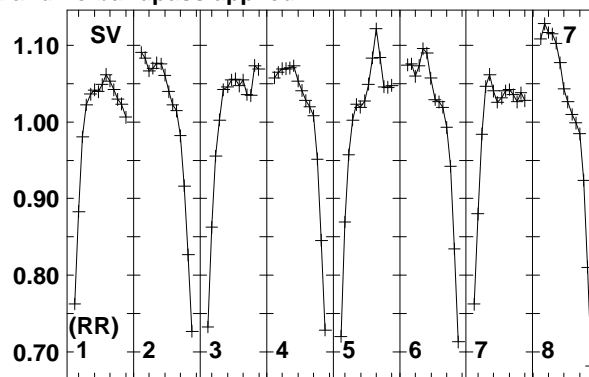
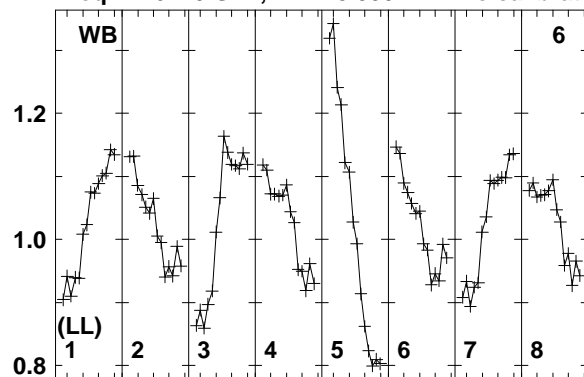

16281634164064416501656601663672678682688
FREQ MHz

Lower frame: Real Jy
Total-power spectrum Antenna: WB (06)
Timerange: 00/21:04:05 to 00/21:11:39

Plot file version 31 created 22-OCT-2014 16:25:16

J1435+3012 EC048.UVDATA.1

Freq = 1.6270 GHz, Bw = 8.000 MH No calibration applied and no bandpass applied

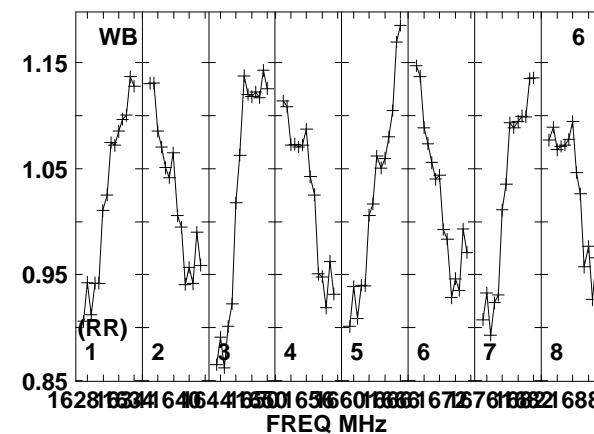
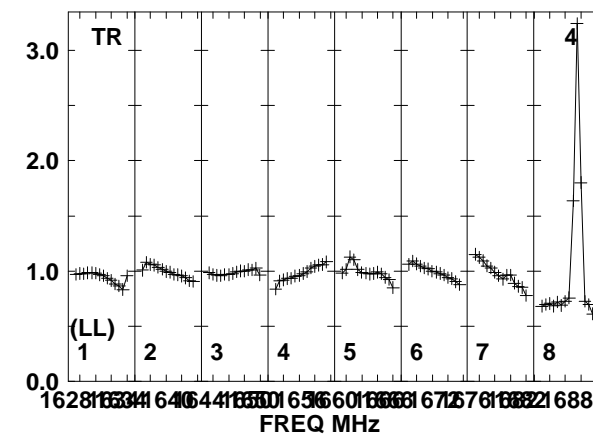
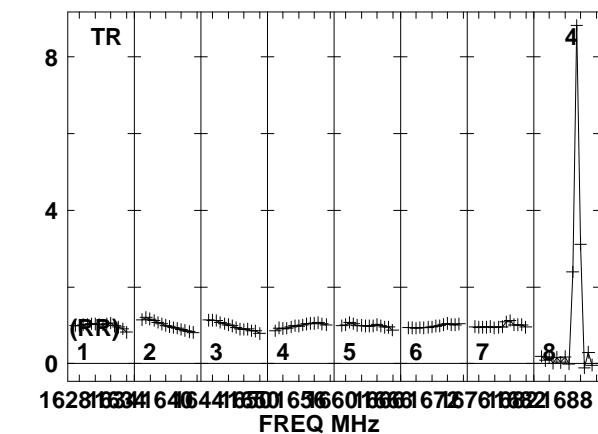
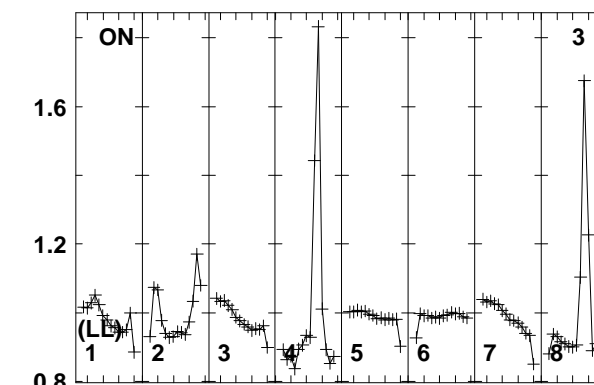
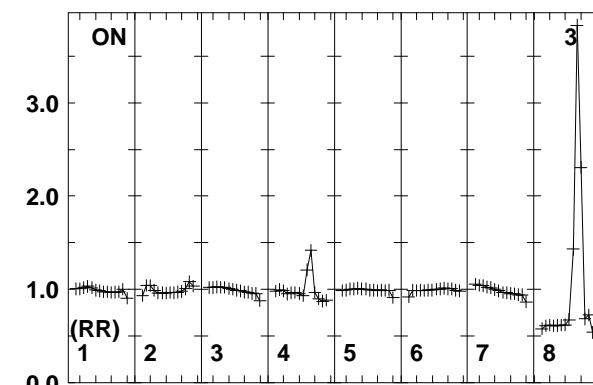
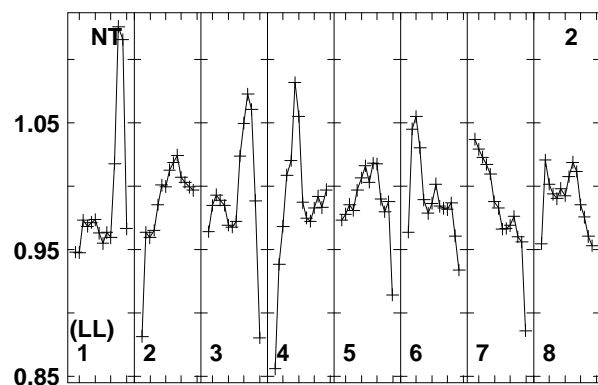
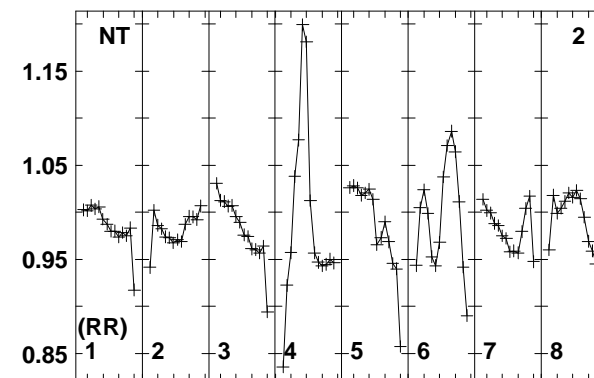
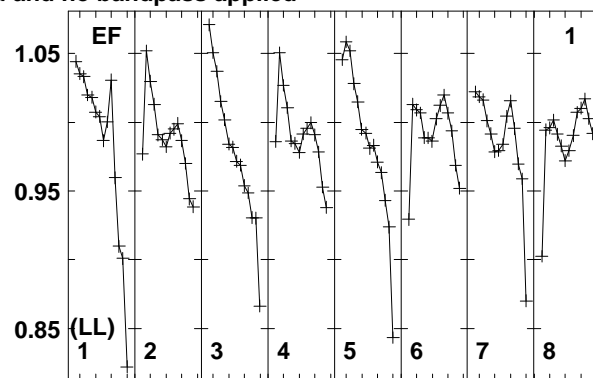
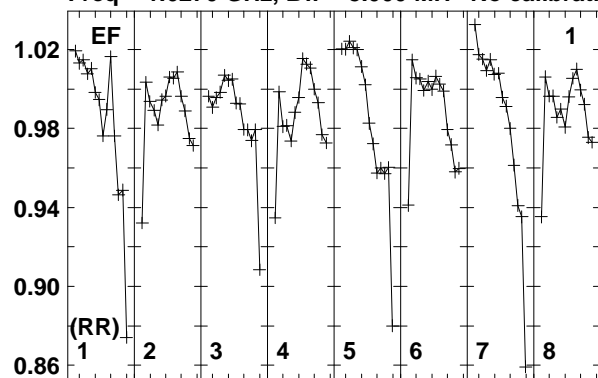

Lower frame: Real Jy
Total-power spectrum Antenna: EF (01)
Timerange: 00/21:12:23 to 00/21:14:09

Plot file version 32 created 22-OCT-2014 16:25:16

J1435+3012 EC048.UVDATA.1

Freq = 1.6270 GHz, Bw = 8.000 MH No calibration applied and no bandpass applied

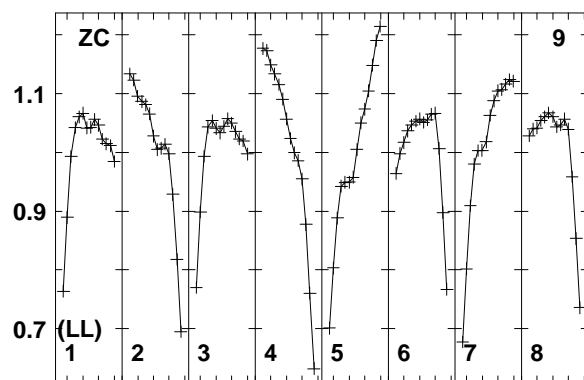
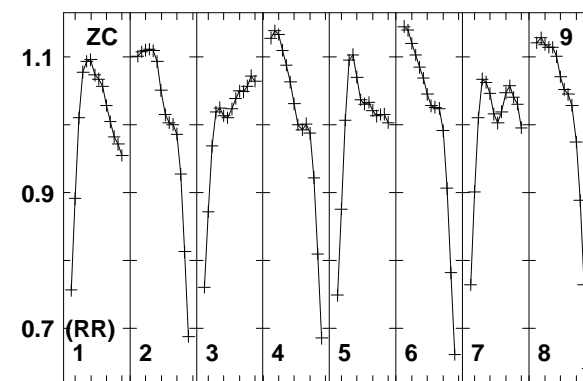
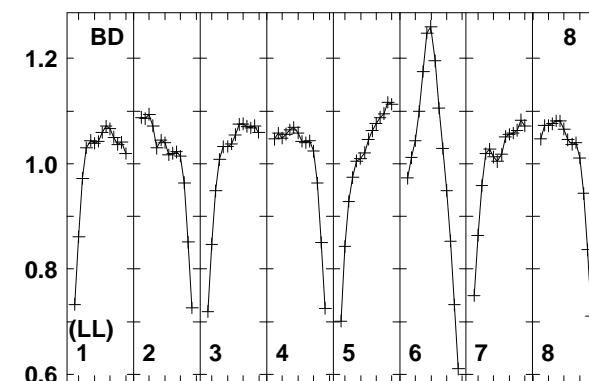
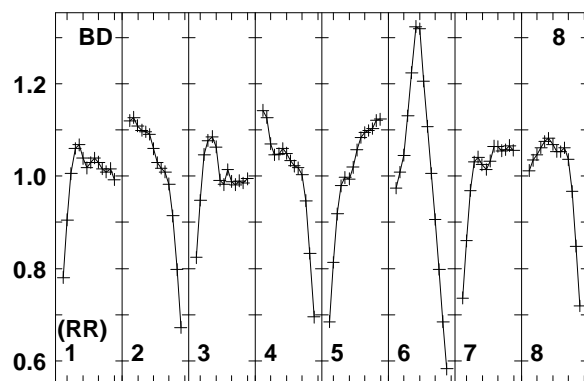
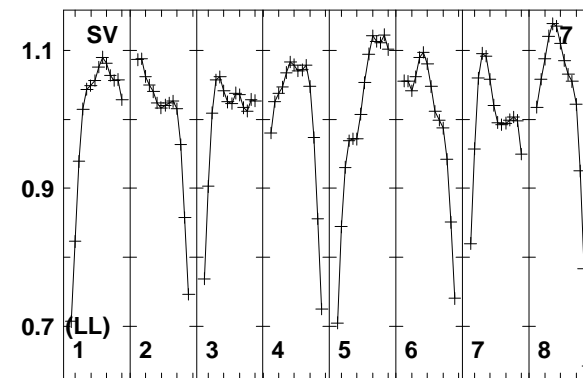
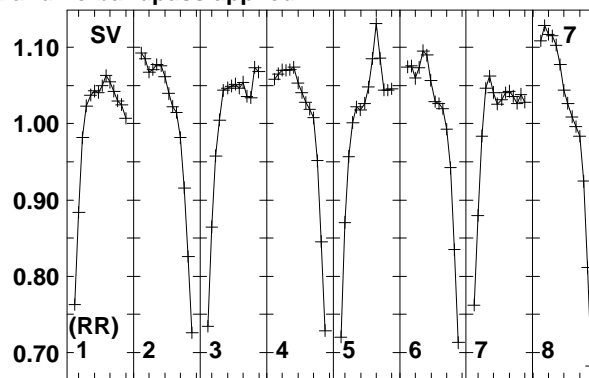
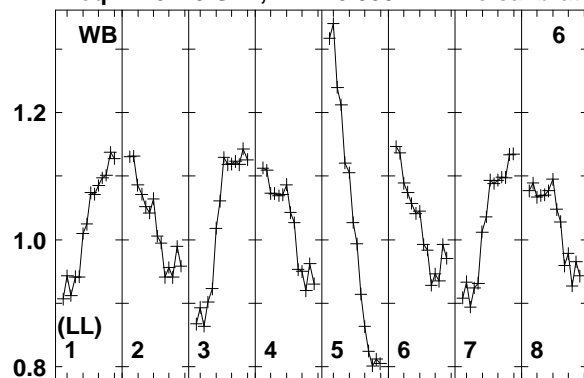

16281634164064416501656601663672678682688
FREQ MHz

Lower frame: Real Jy
Total-power spectrum Antenna: WB (06)
Timerange: 00/21:12:23 to 00/21:14:09

Plot file version 33 created 22-OCT-2014 16:25:16

J1432+3014 EC048.UVDATA.1

Freq = 1.6270 GHz, Bw = 8.000 MH No calibration applied and no bandpass applied

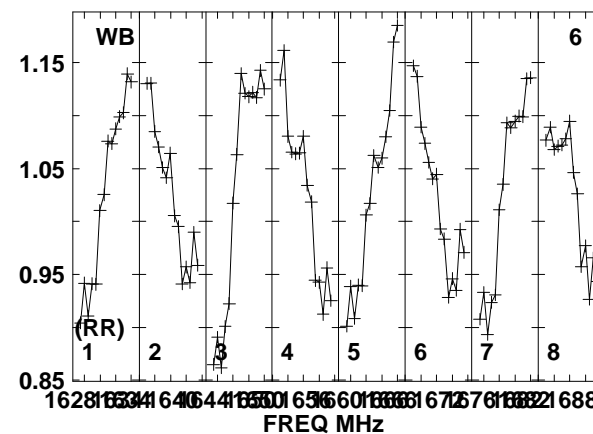
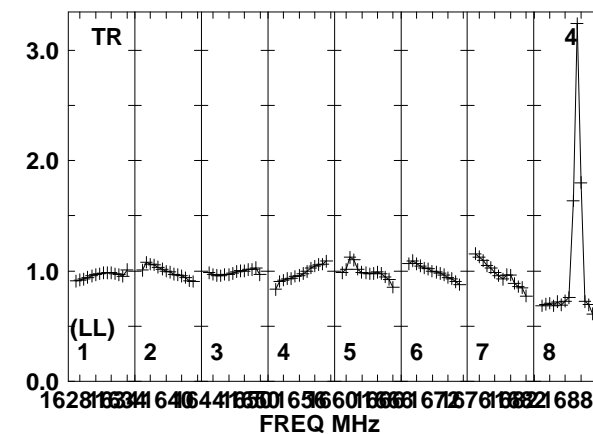
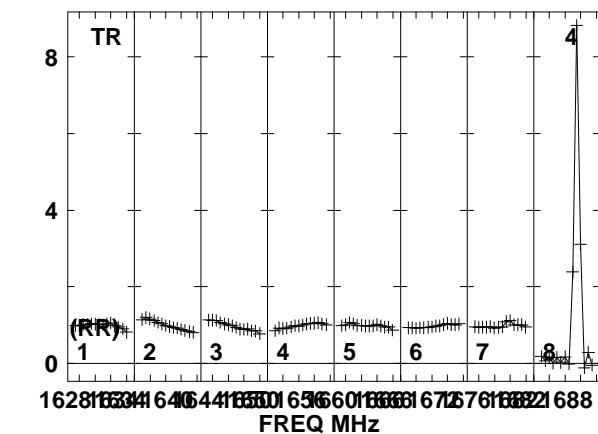
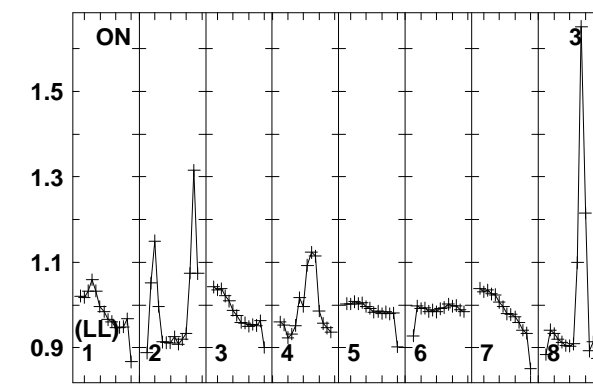
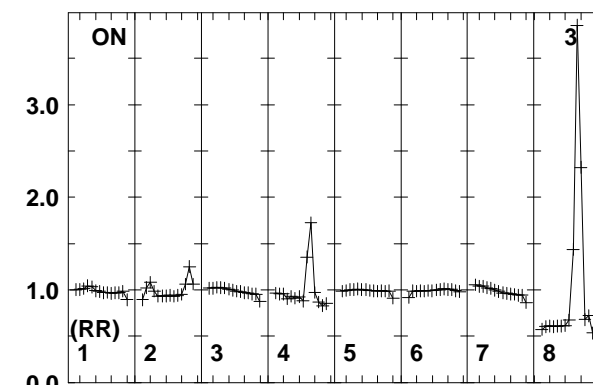
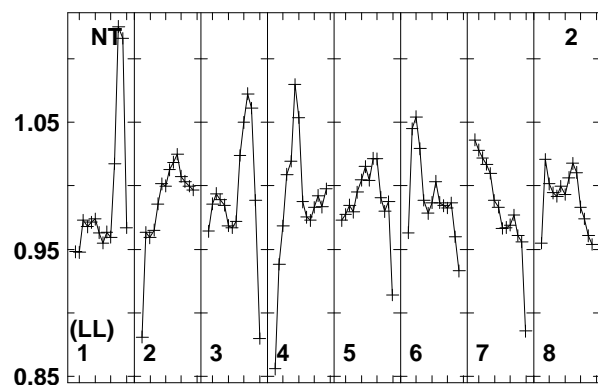
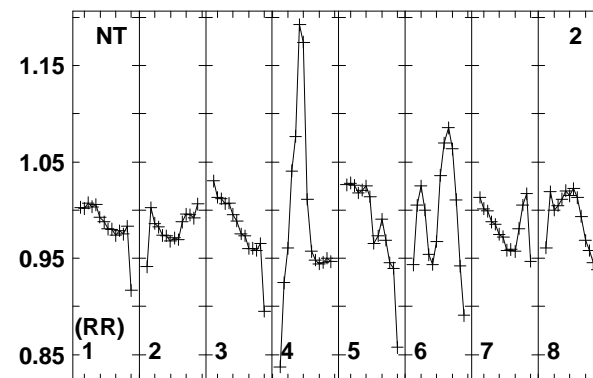
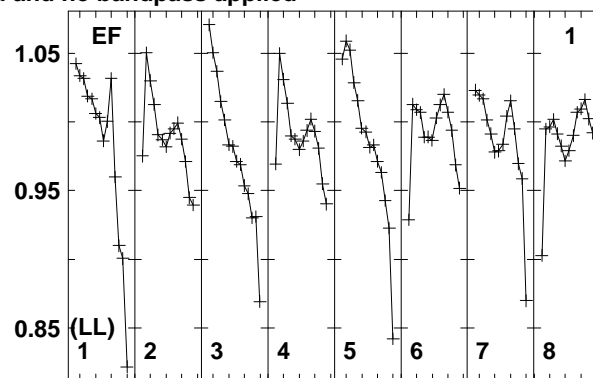
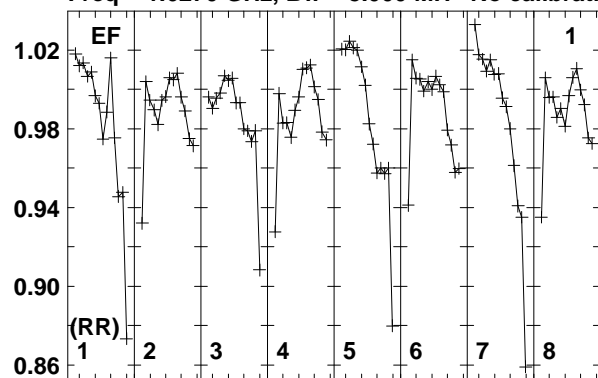

Lower frame: Real Jy
Total-power spectrum Antenna: EF (01)
Timerange: 00/21:14:19 to 00/21:21:53

Plot file version 34 created 22-OCT-2014 16:25:16

J1432+3014 EC048.UVDATA.1

Freq = 1.6270 GHz, Bw = 8.000 MH No calibration applied and no bandpass applied

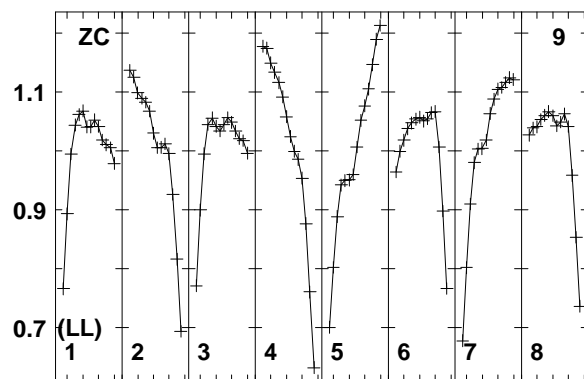
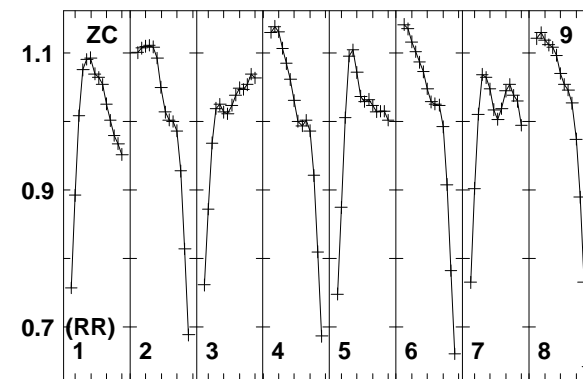
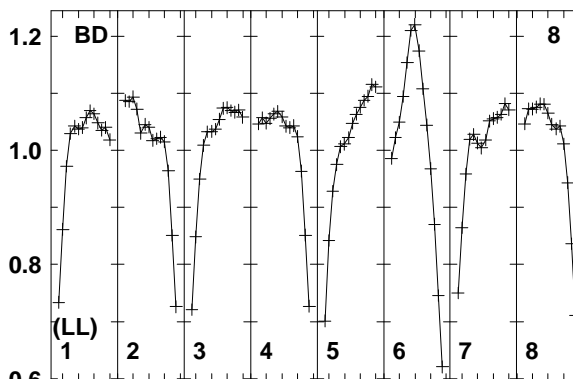
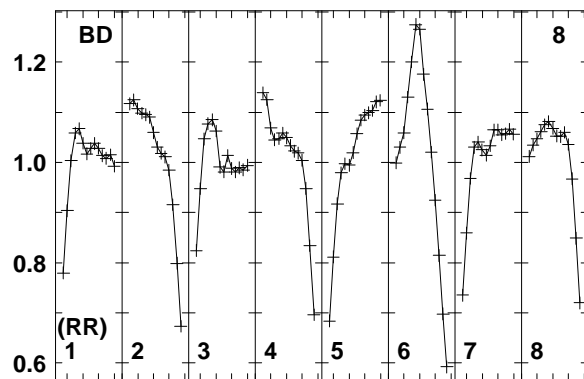
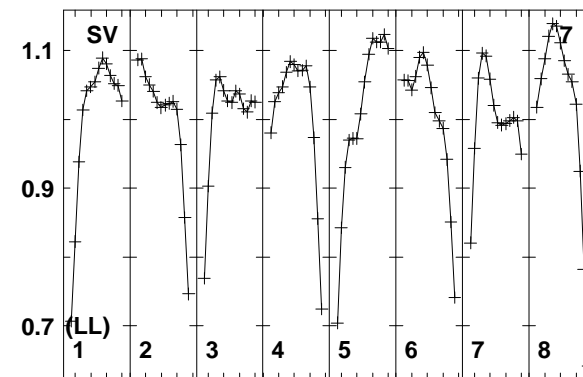
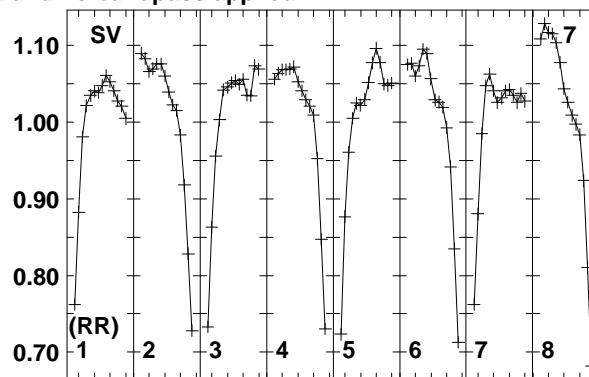
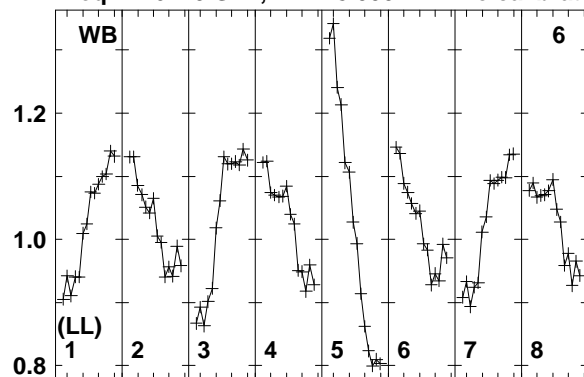

16281634164064416501656601663672678682688
FREQ MHz

Lower frame: Real Jy
Total-power spectrum Antenna: WB (06)
Timerange: 00/21:14:19 to 00/21:21:53

Plot file version 35 created 22-OCT-2014 16:25:16

J1435+3012 EC048.UVDATA.1

Freq = 1.6270 GHz, Bw = 8.000 MH No calibration applied and no bandpass applied

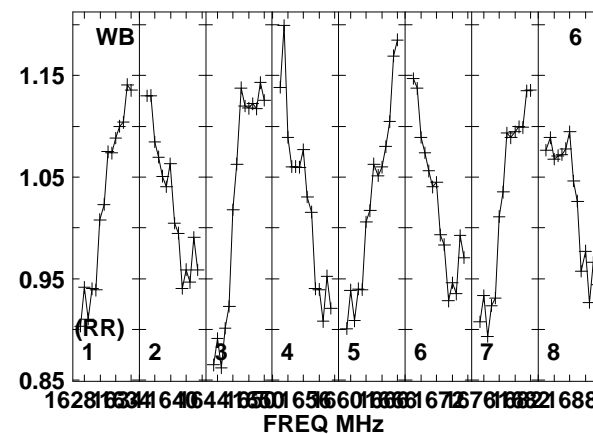
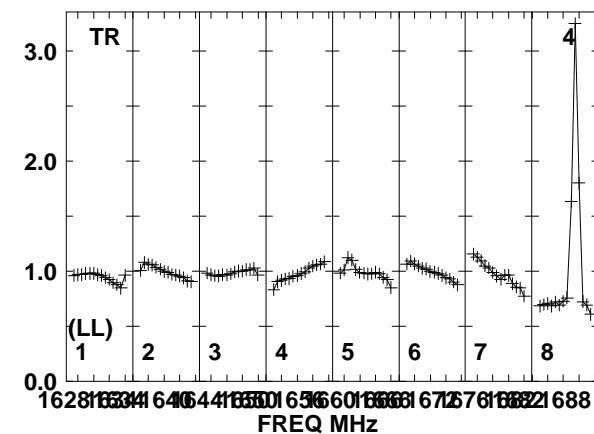
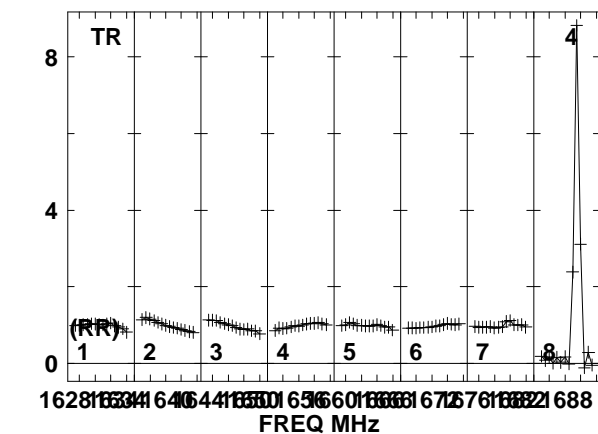
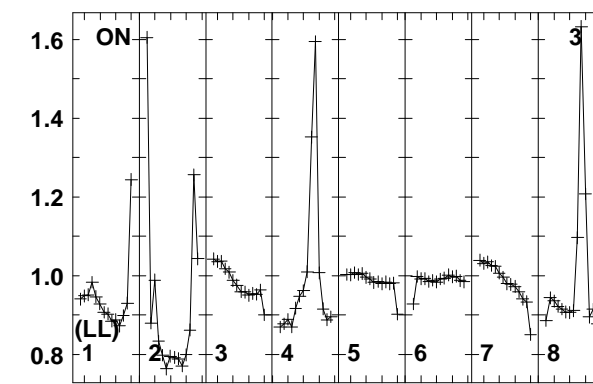
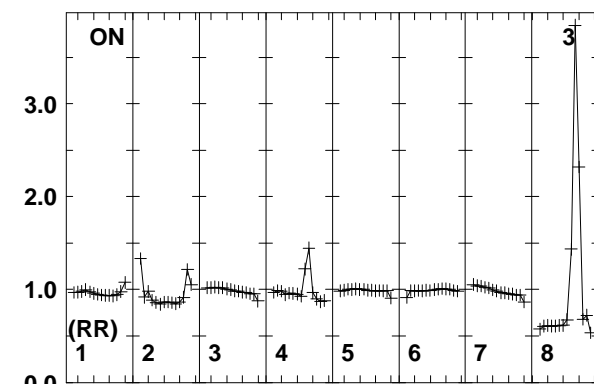
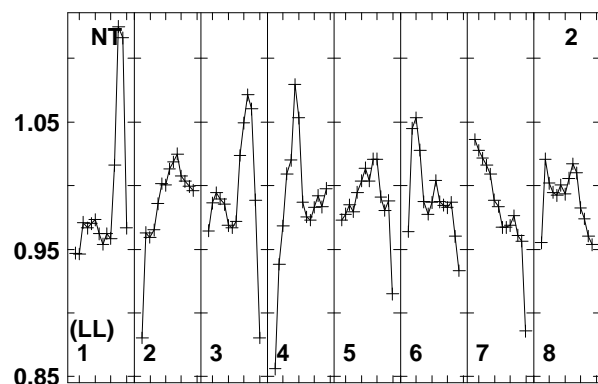
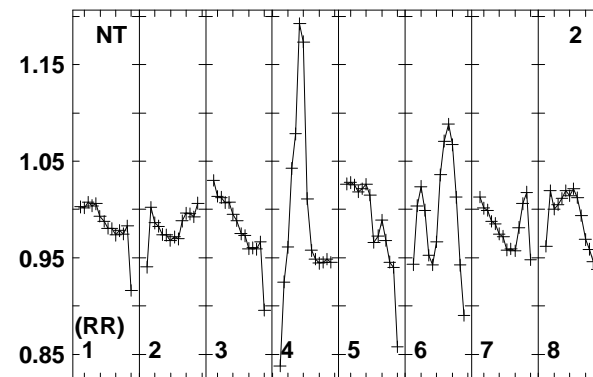
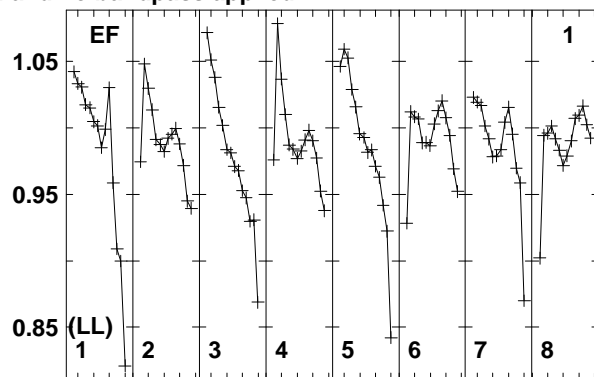
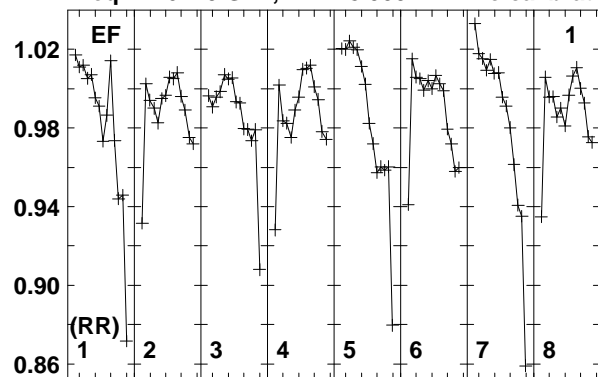

1628 1634 1640 1644 1650 1656 1660 1666 1672 1676 1682 1688
FREQ MHz
Lower frame: Real Jy
Total-power spectrum Antenna: EF (01)
Timerange: 00/21:22:38 to 00/21:24:24

Plot file version 36 created 22-OCT-2014 16:25:16

J1435+3012 EC048.UVDATA.1

Freq = 1.6270 GHz, Bw = 8.000 MH No calibration applied and no bandpass applied

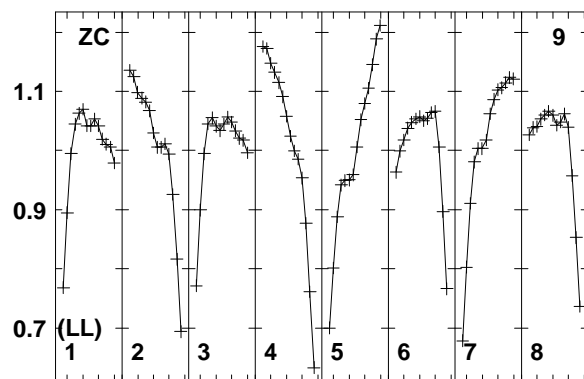
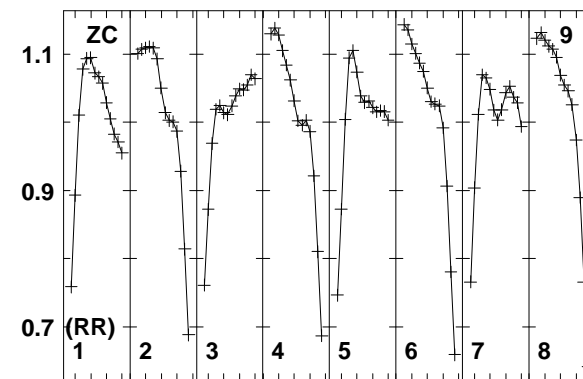
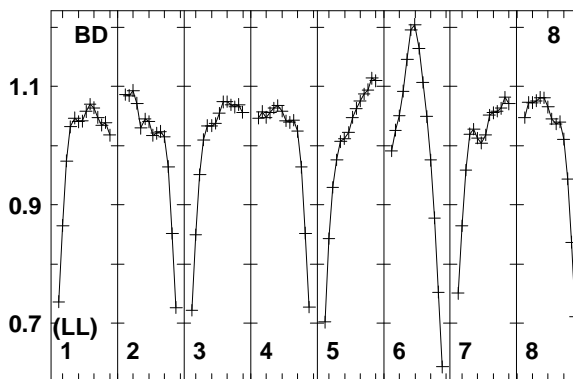
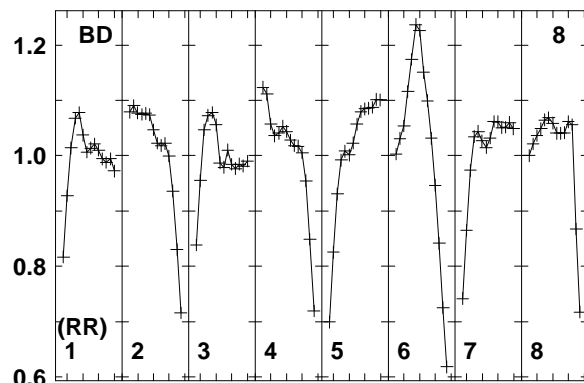
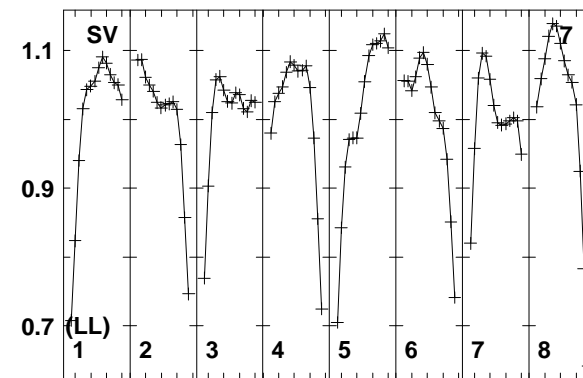
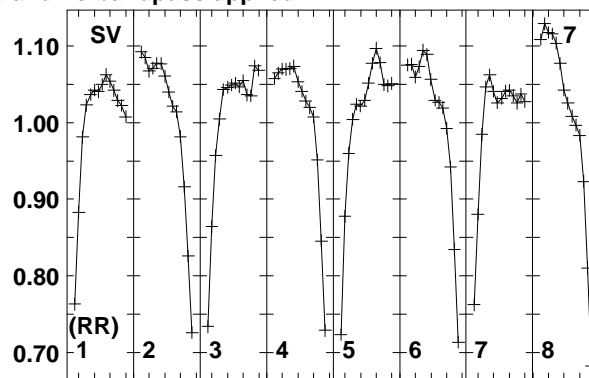
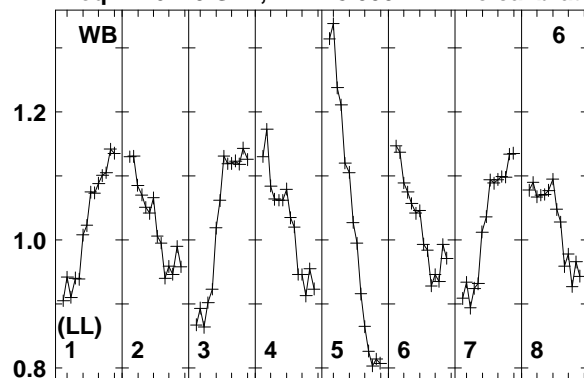

1628163416406441650165660166316727816821688

FREQ MHz

Lower frame: Real Jy

Total-power spectrum Antenna: WB (06)

Timerange: 00/21:22:38 to 00/21:24:24

Plot file version 37 created 22-OCT-2014 16:25:16

J1432+3014 EC048.UVDATA.1

Freq = 1.6270 GHz, Bw = 8.000 MH No calibration applied and no bandpass applied

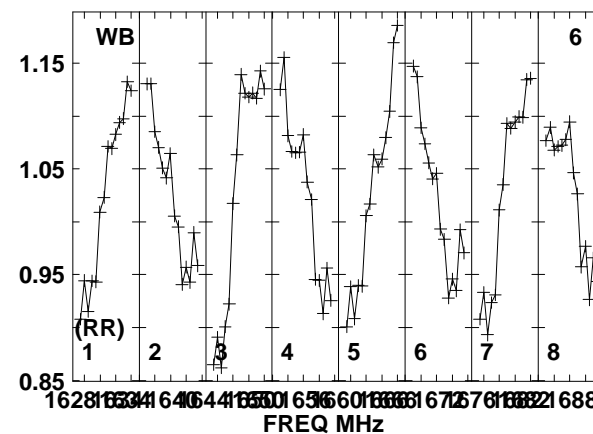
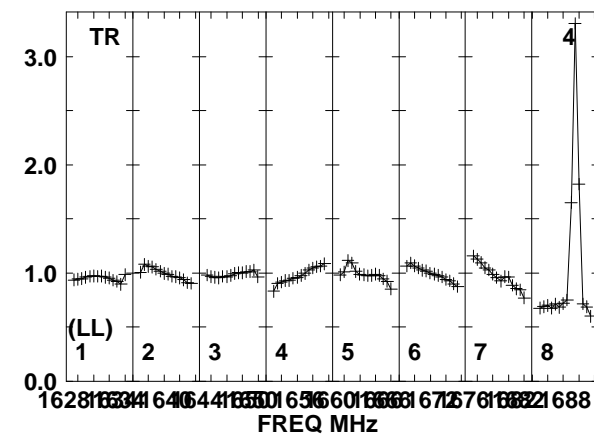
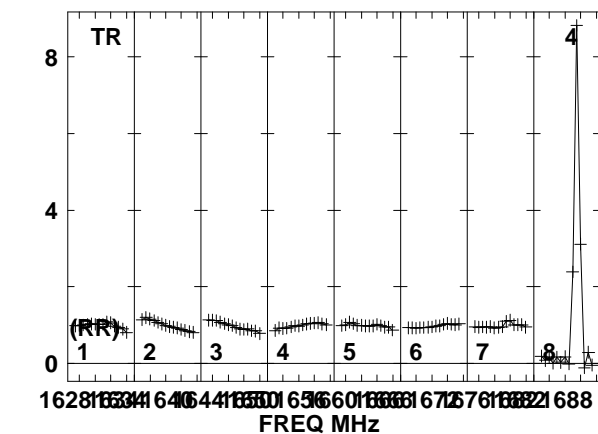
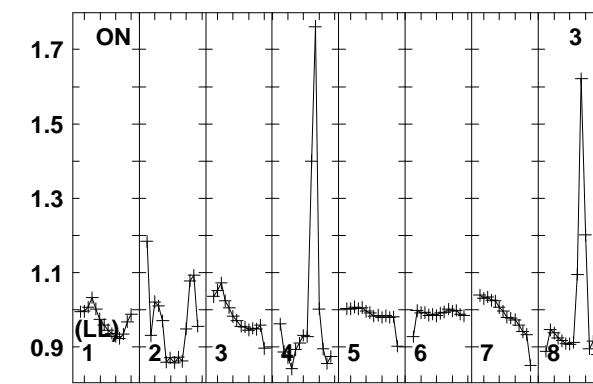
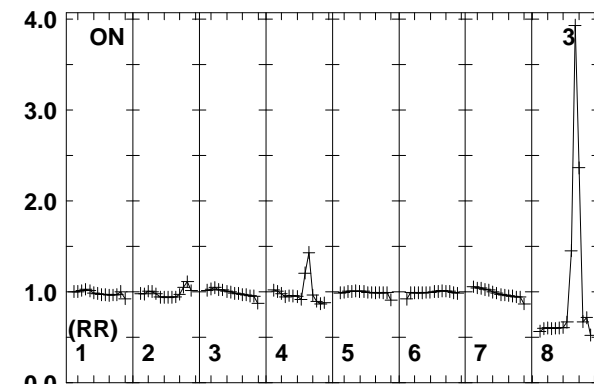
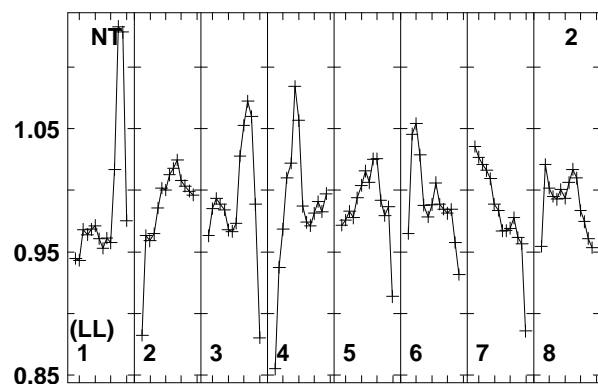
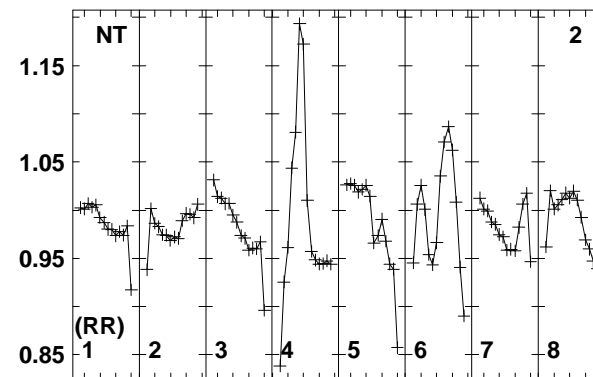
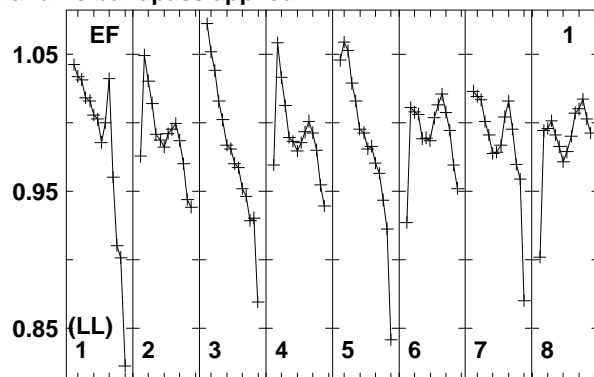
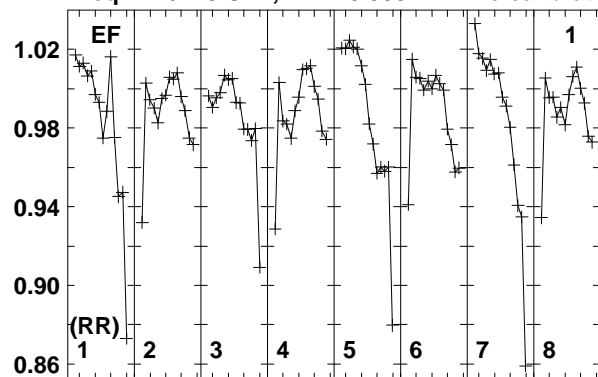

Lower frame: Real Jy
Total-power spectrum Antenna: EF (01)
Timerange: 00/21:24:32 to 00/21:32:08

Plot file version 38 created 22-OCT-2014 16:25:16

J1432+3014 EC048.UVDATA.1

Freq = 1.6270 GHz, Bw = 8.000 MH No calibration applied and no bandpass applied

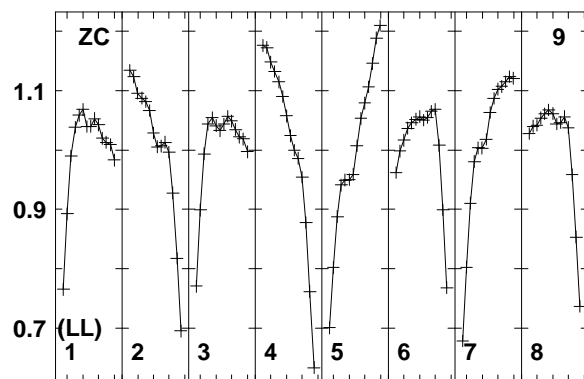
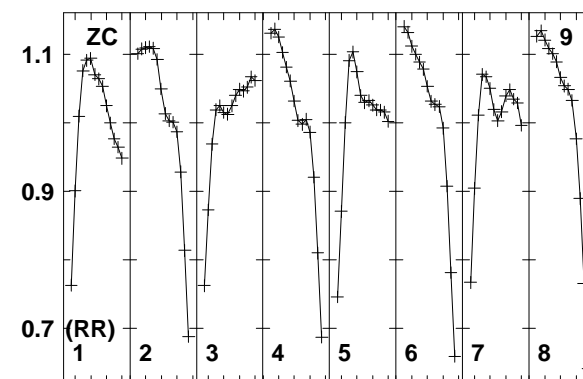
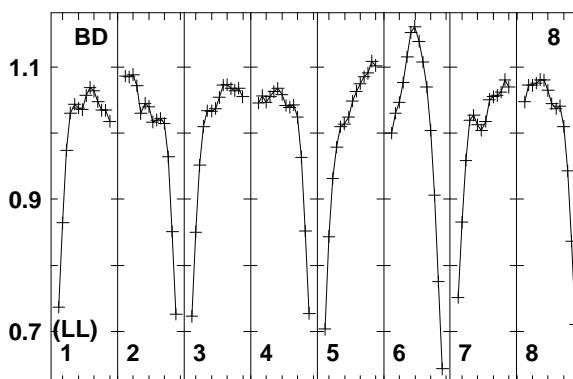
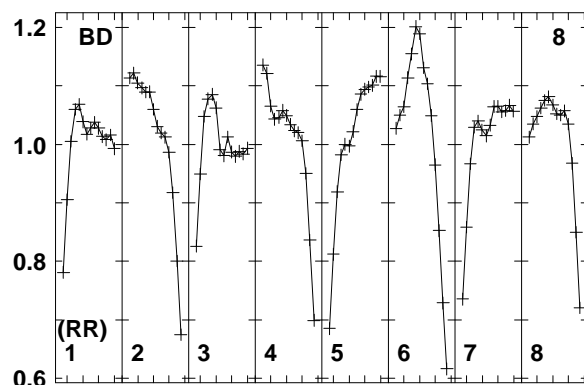
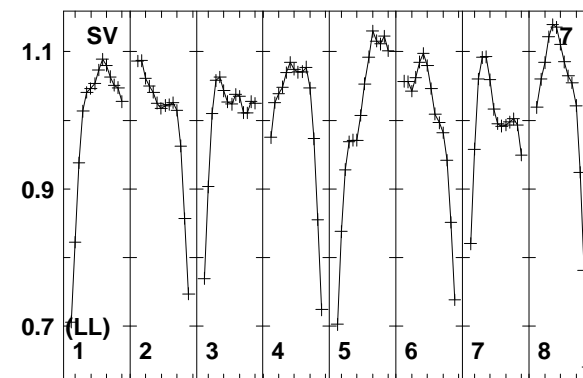
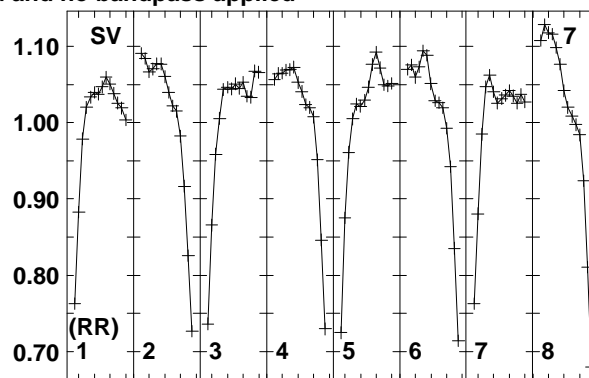
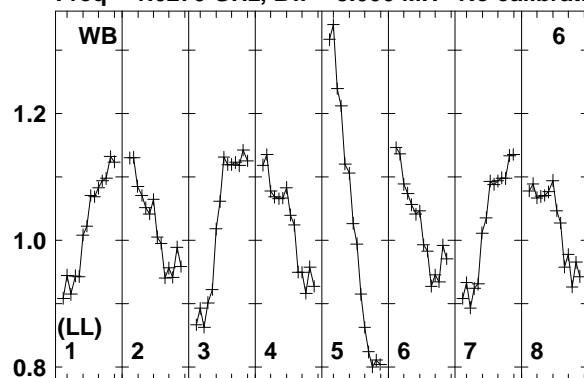

162816341640644165016566016681672167816821688
FREQ MHz

Lower frame: Real Jy
Total-power spectrum Antenna: WB (06)
Timerange: 00/21:24:32 to 00/21:32:08

Plot file version 39 created 22-OCT-2014 16:25:16

J1435+3012 EC048.UVDATA.1

Freq = 1.6270 GHz, Bw = 8.000 MH No calibration applied and no bandpass applied

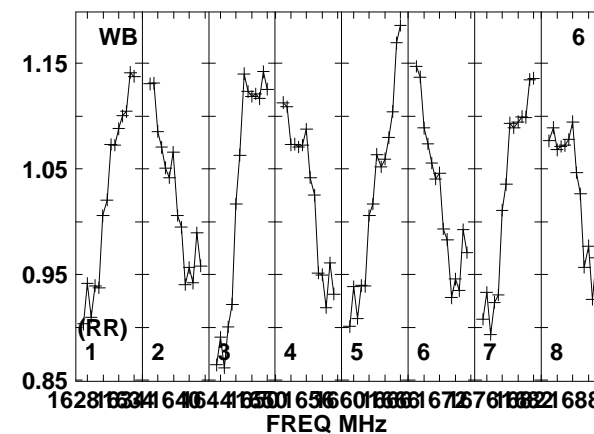
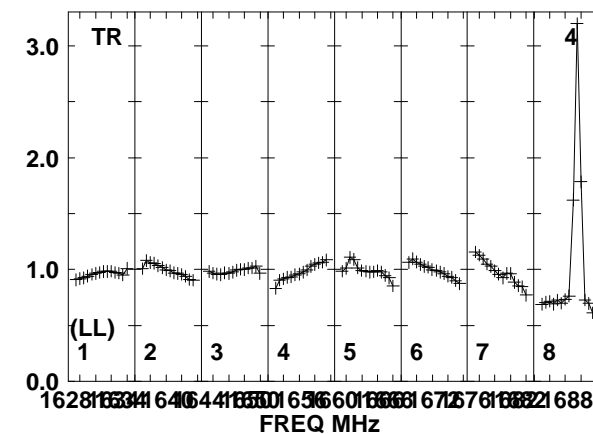
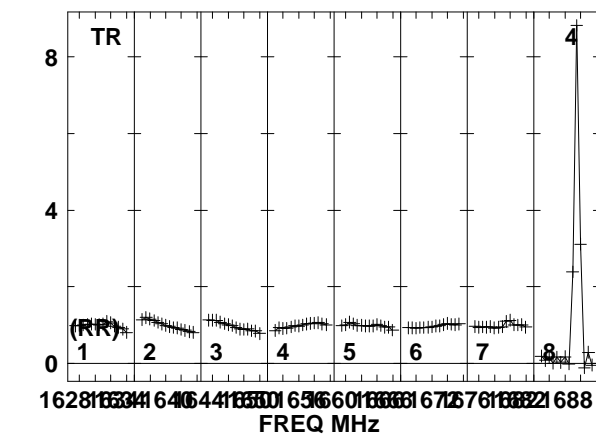
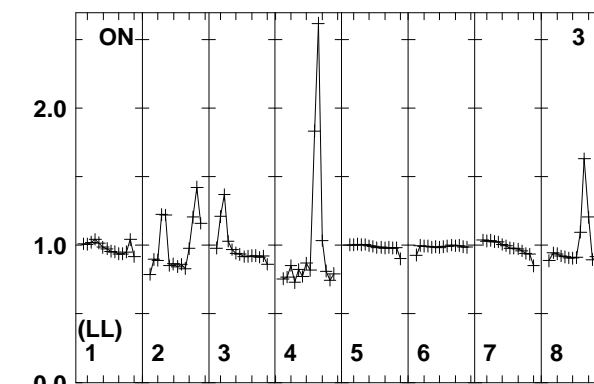
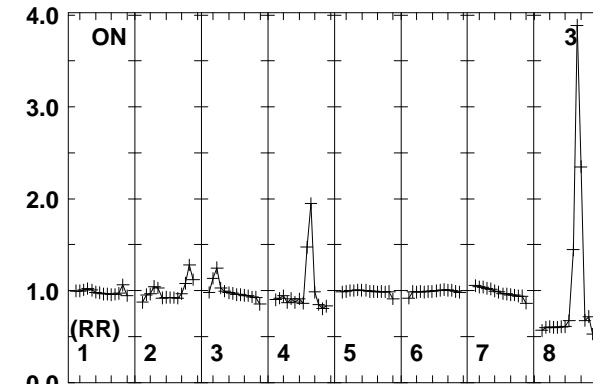
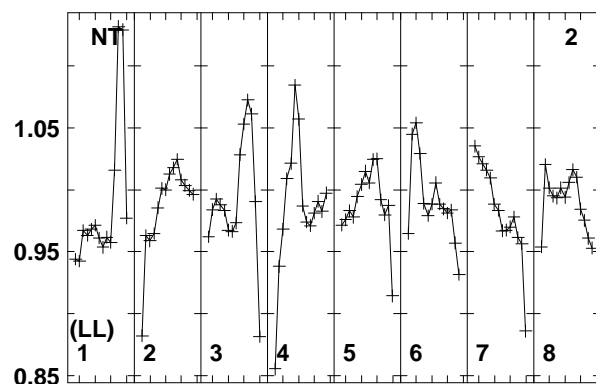
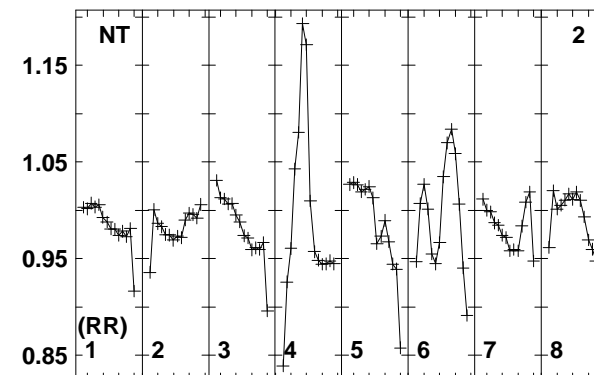
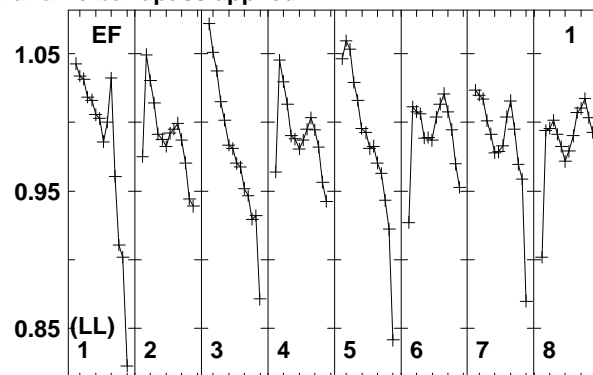
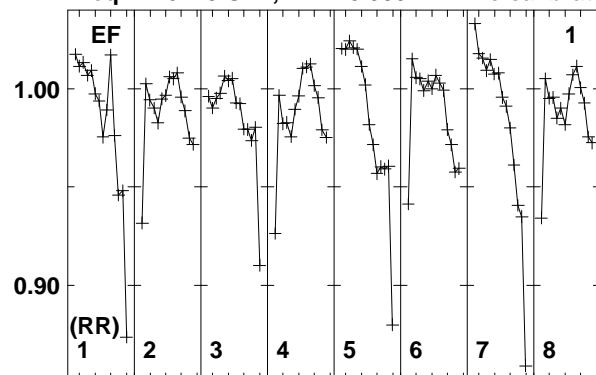

Lower frame: Real Jy
Total-power spectrum Antenna: EF (01)
Timerange: 00/21:32:53 to 00/21:34:39

Plot file version 40 created 22-OCT-2014 16:25:16

J1435+3012 EC048.UVDATA.1

Freq = 1.6270 GHz, Bw = 8.000 MH No calibration applied and no bandpass applied

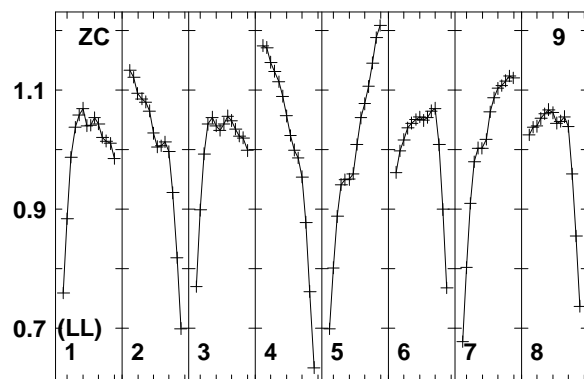
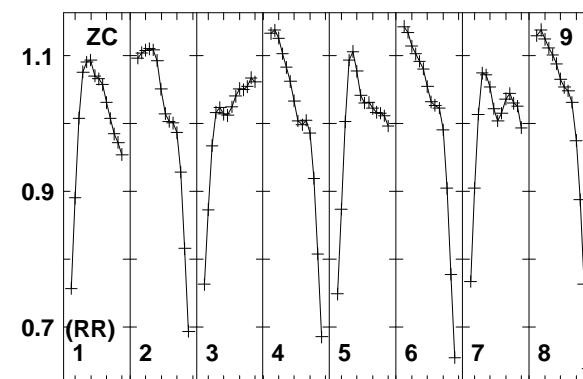
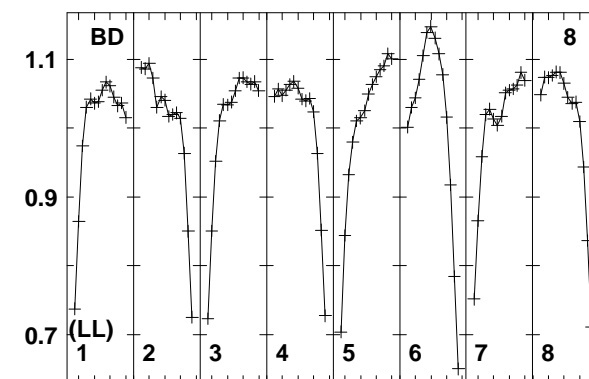
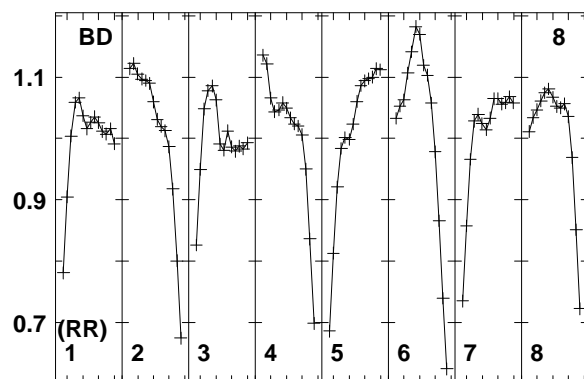
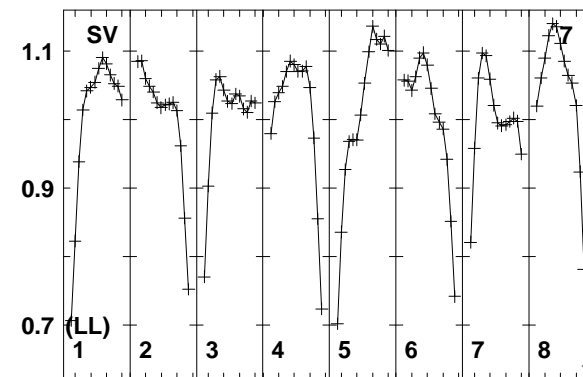
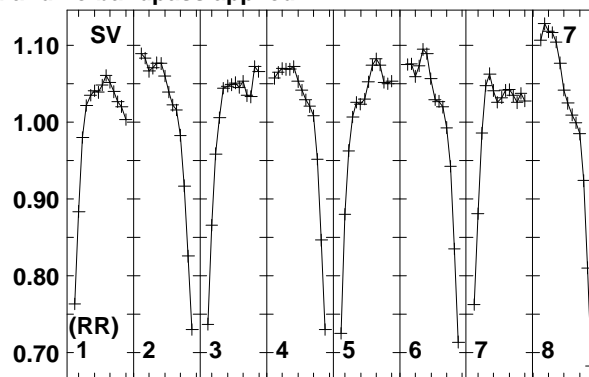
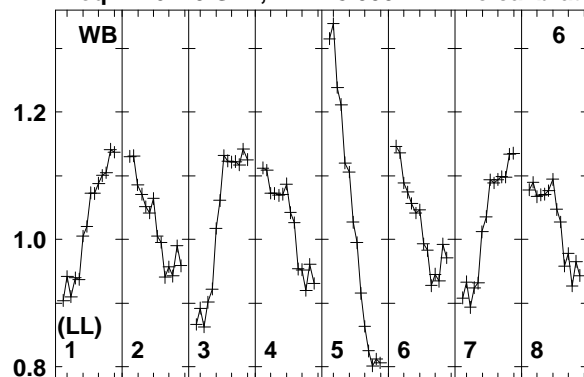

162816341640644165016566016681672167816821688
FREQ MHz

Lower frame: Real Jy
Total-power spectrum Antenna: WB (06)
Timerange: 00/21:32:53 to 00/21:34:39

Plot file version 41 created 22-OCT-2014 16:25:16

J1432+3014 EC048.UVDATA.1

Freq = 1.6270 GHz, Bw = 8.000 MH No calibration applied and no bandpass applied

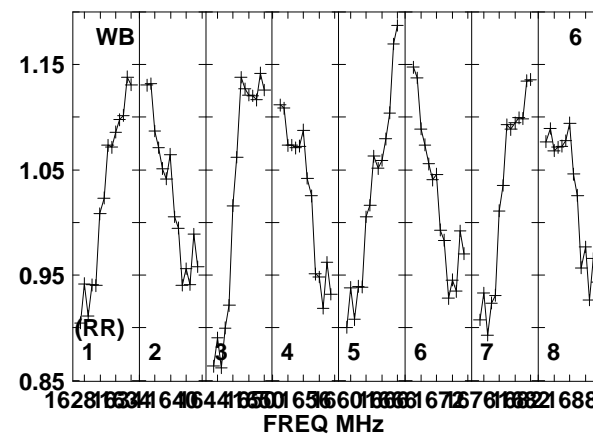
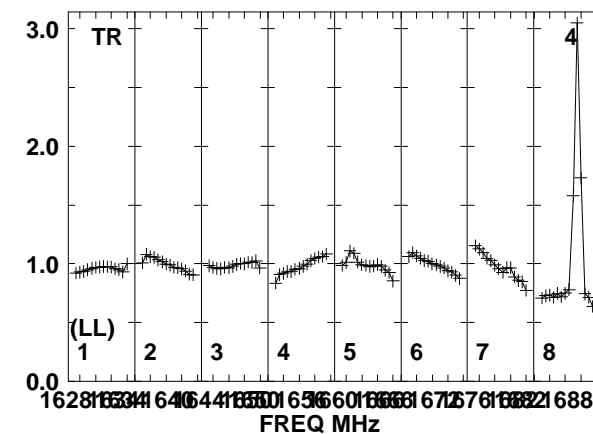
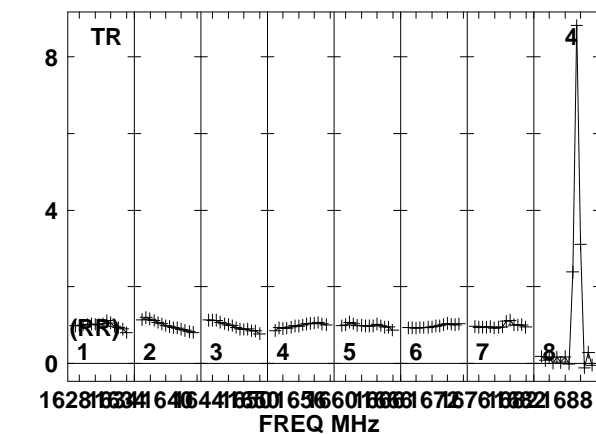
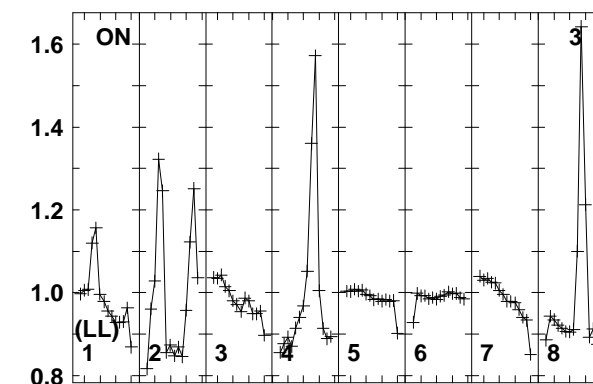
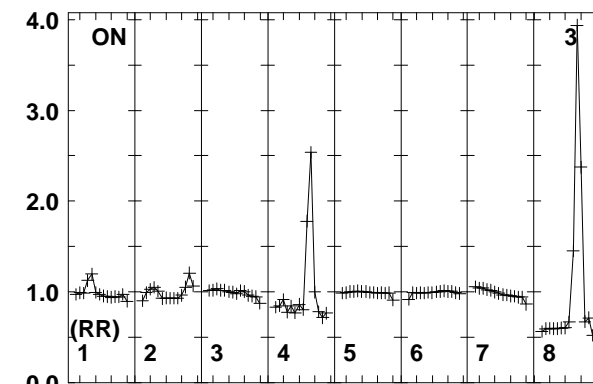
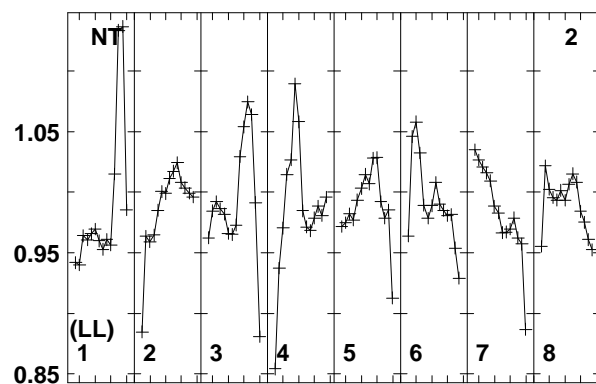
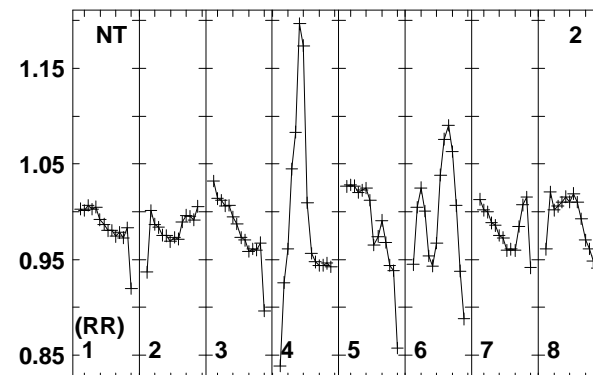
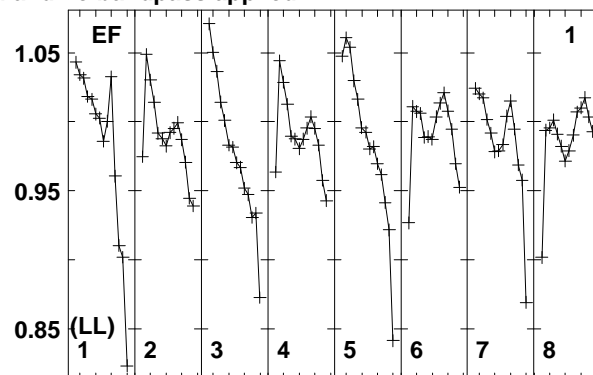
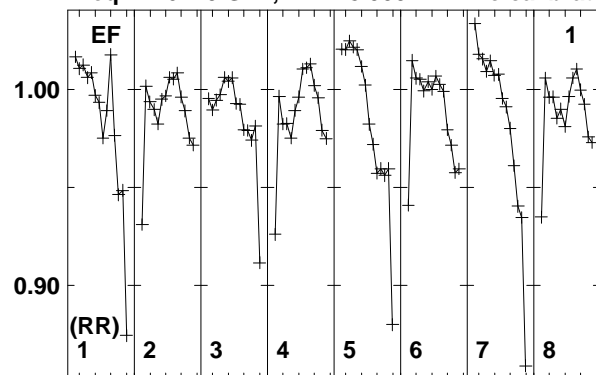

Lower frame: Real Jy
Total-power spectrum Antenna: EF (01)
Timerange: 00/21:34:46 to 00/21:42:24

Plot file version 42 created 22-OCT-2014 16:25:16

J1432+3014 EC048.UVDATA.1

Freq = 1.6270 GHz, Bw = 8.000 MH No calibration applied and no bandpass applied

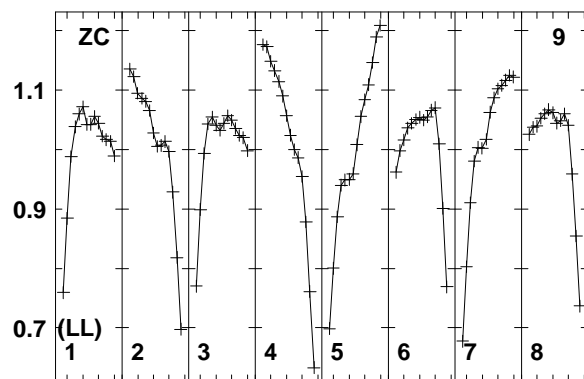
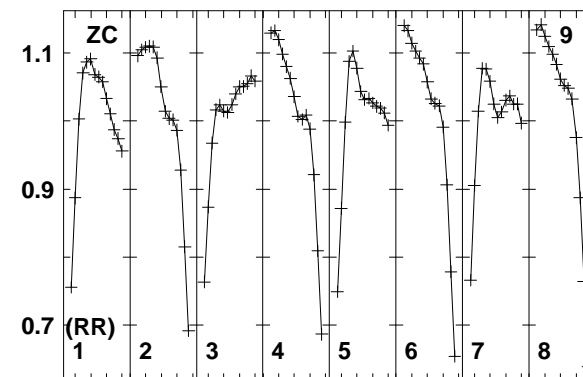
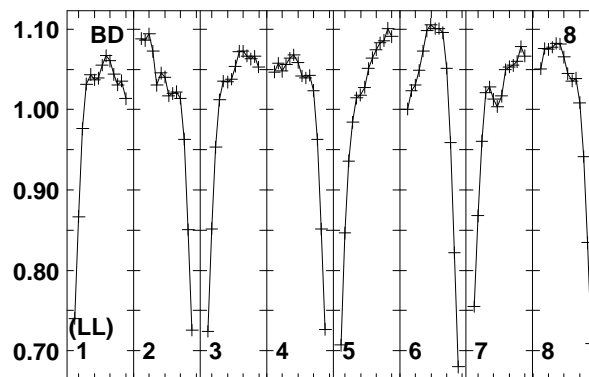
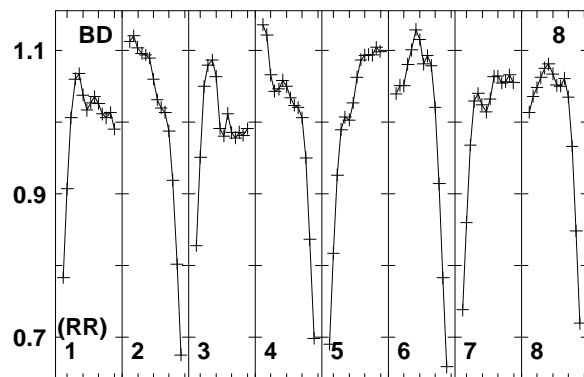
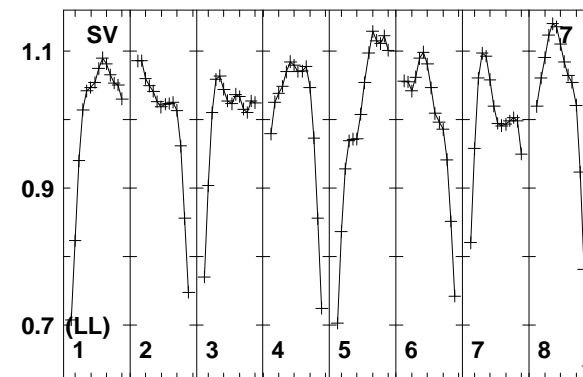
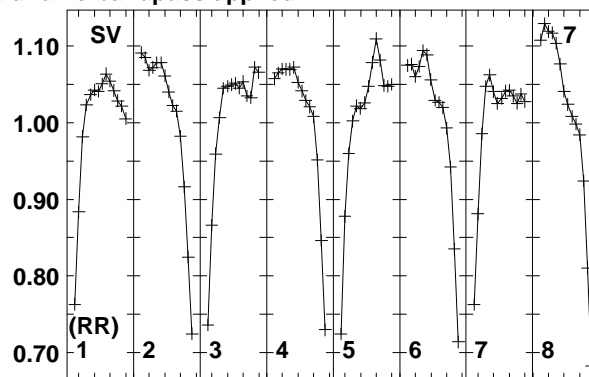
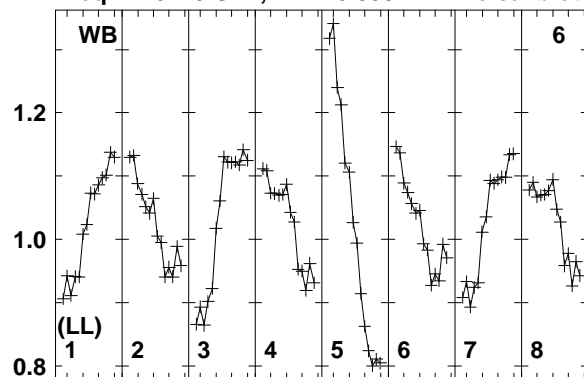

162816341640644165016566016631669167516821688
FREQ MHz

Lower frame: Real Jy
Total-power spectrum Antenna: WB (06)
Timerange: 00/21:34:46 to 00/21:42:24

Plot file version 43 created 22-OCT-2014 16:25:16

J1435+3012 EC048.UVDATA.1

Freq = 1.6270 GHz, Bw = 8.000 MH No calibration applied and no bandpass applied

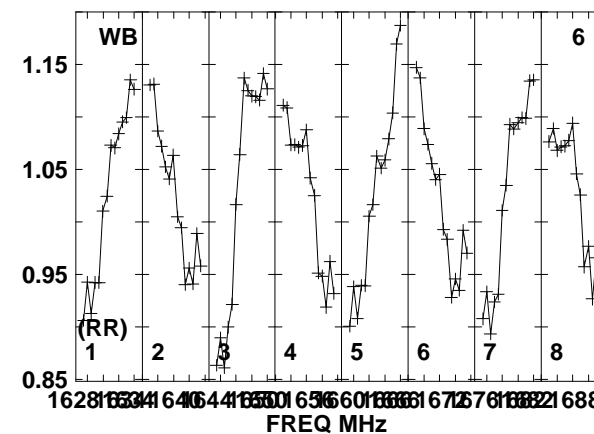
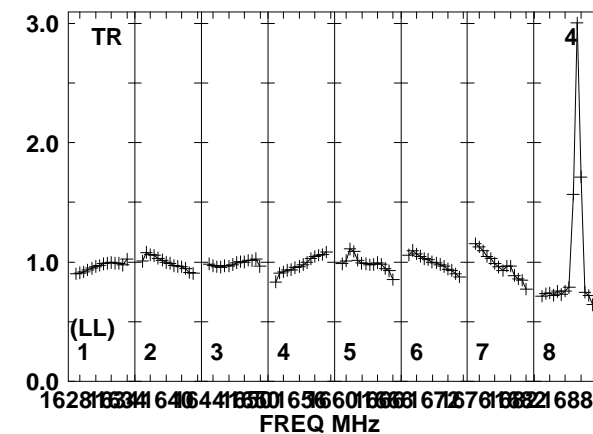
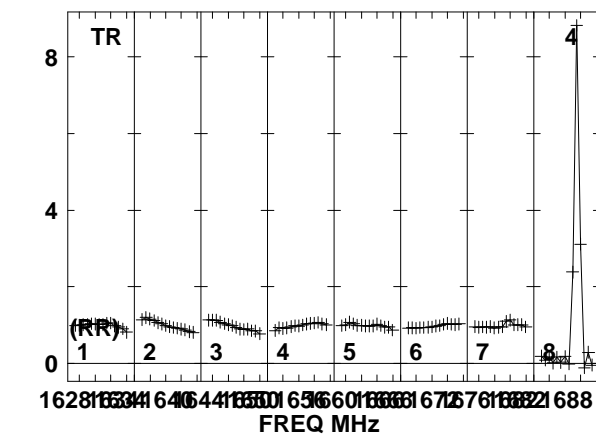
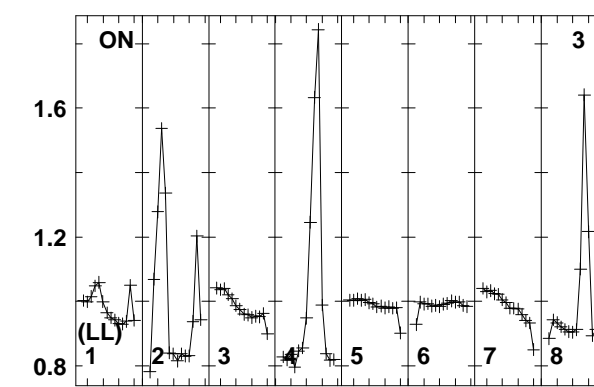
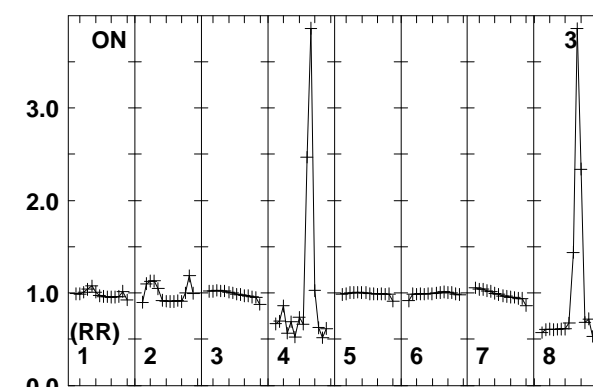
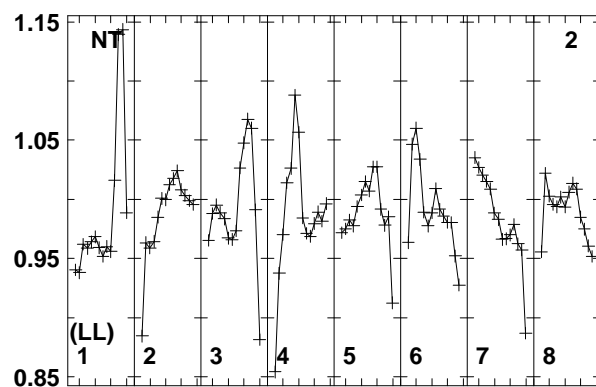
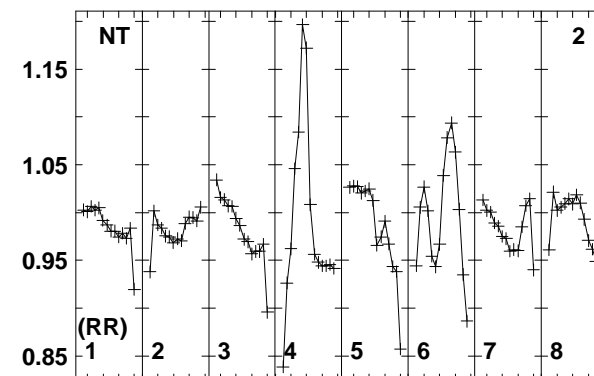
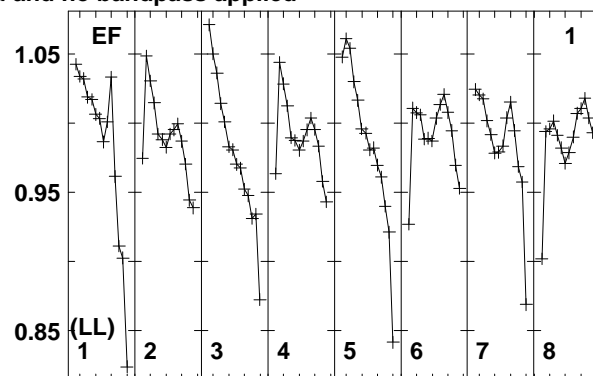
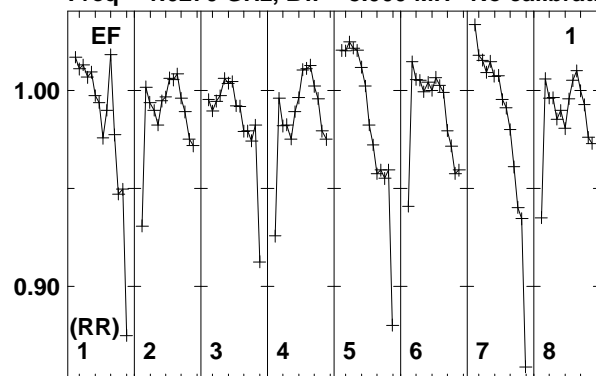

Lower frame: Real Jy
Total-power spectrum Antenna: EF (01)
Timerange: 00/21:43:08 to 00/21:44:54

Plot file version 44 created 22-OCT-2014 16:25:16

J1435+3012 EC048.UVDATA.1

Freq = 1.6270 GHz, Bw = 8.000 MH No calibration applied and no bandpass applied

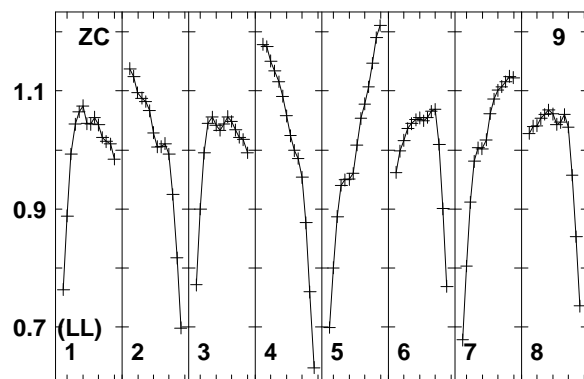
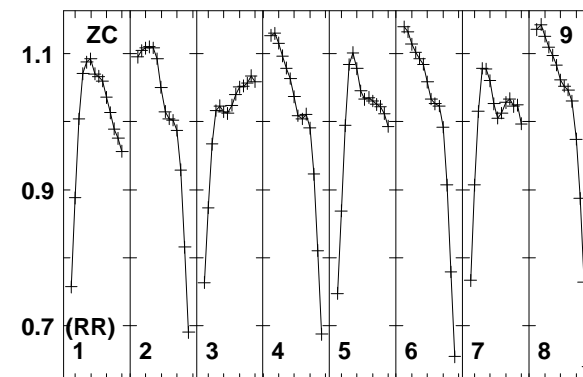
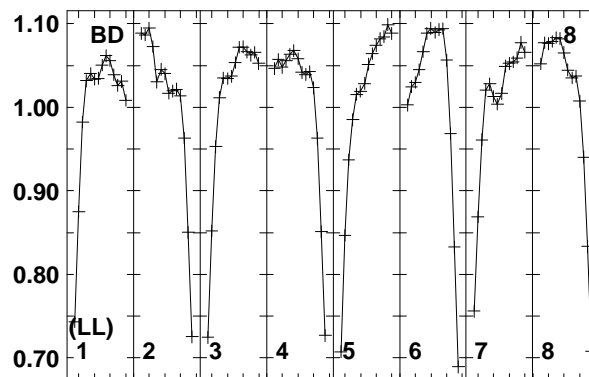
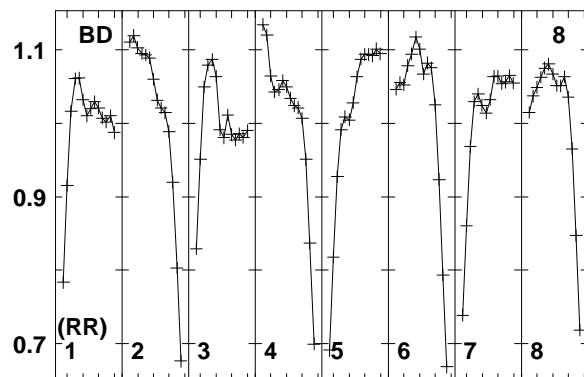
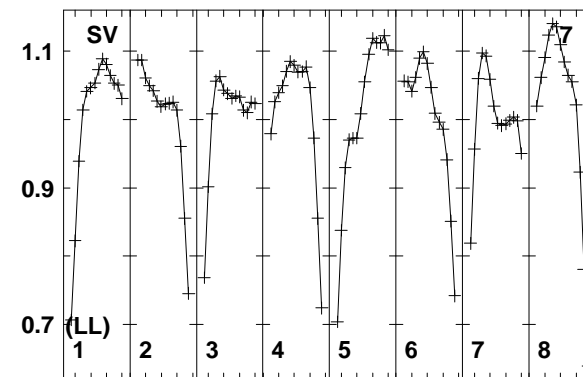
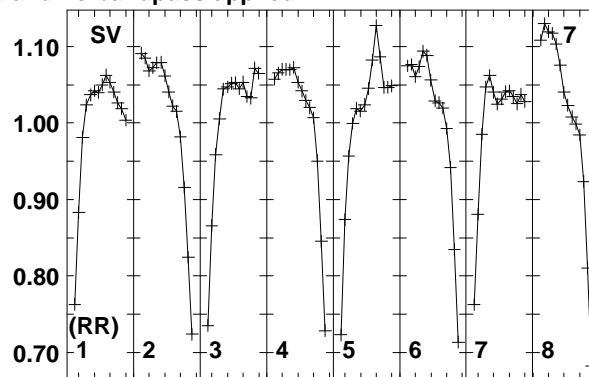
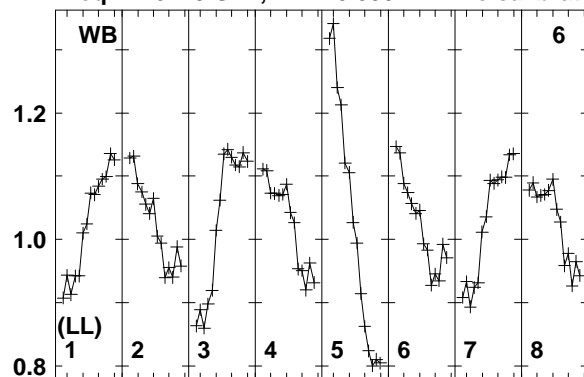

16281634164064416501656601663672678682688
FREQ MHz

Lower frame: Real Jy
Total-power spectrum Antenna: WB (06)
Timerange: 00/21:43:08 to 00/21:44:54

Plot file version 45 created 22-OCT-2014 16:25:16

J1432+3014 EC048.UVDATA.1

Freq = 1.6270 GHz, Bw = 8.000 MH No calibration applied and no bandpass applied

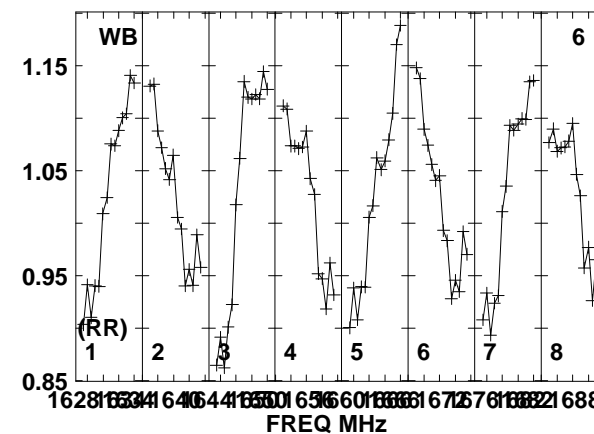
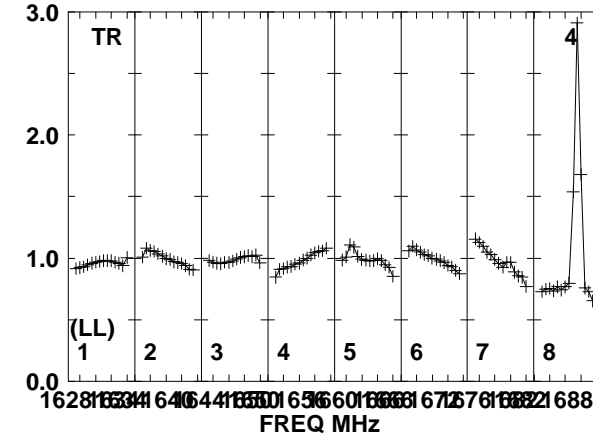
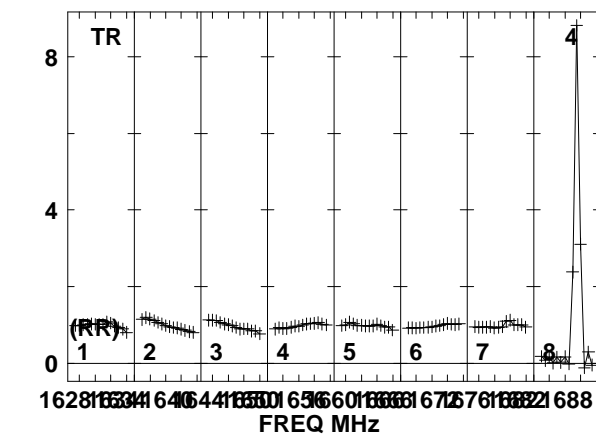
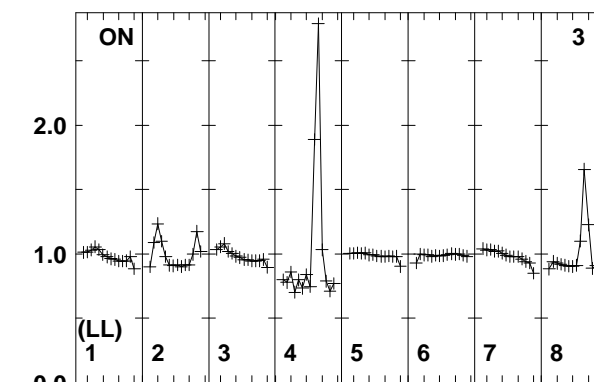
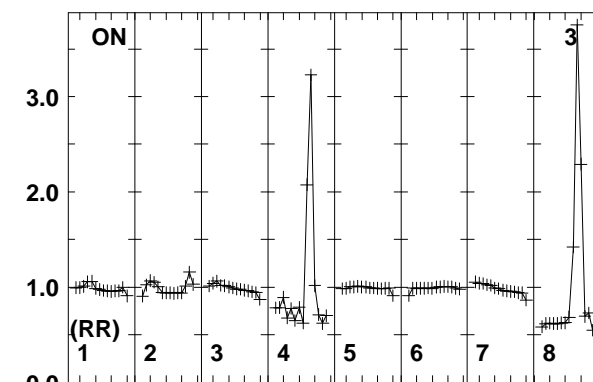
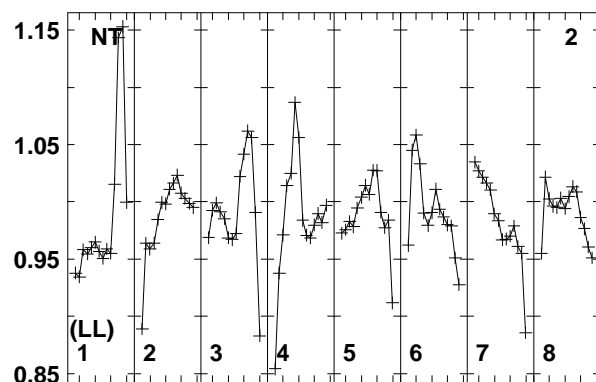
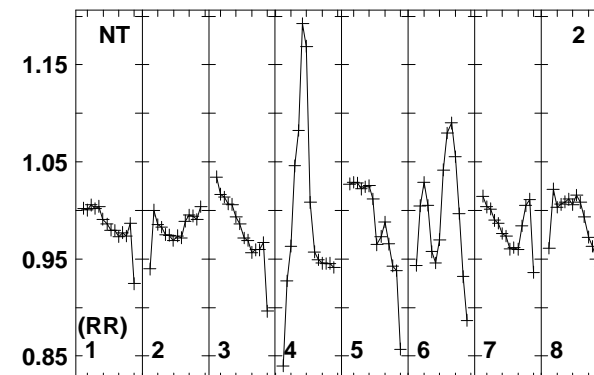
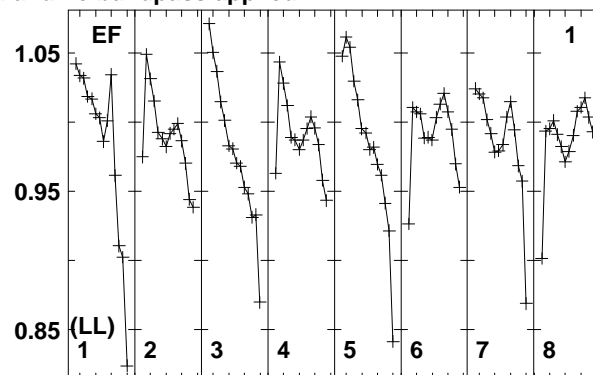
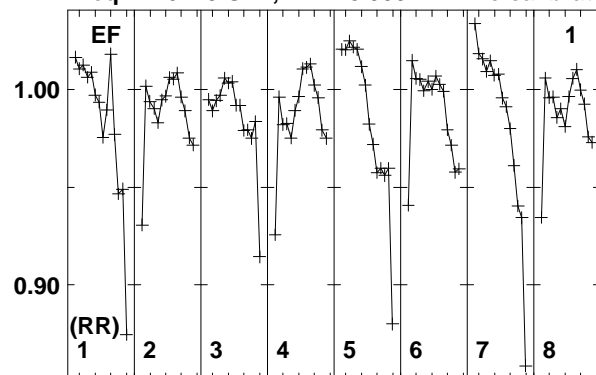

Lower frame: Real Jy
Total-power spectrum Antenna: EF (01)
Timerange: 00/21:45:01 to 00/21:52:39

Plot file version 46 created 22-OCT-2014 16:25:16

J1432+3014 EC048.UVDATA.1

Freq = 1.6270 GHz, Bw = 8.000 MH No calibration applied and no bandpass applied

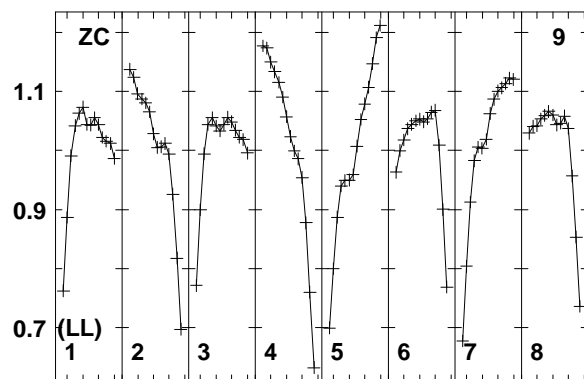
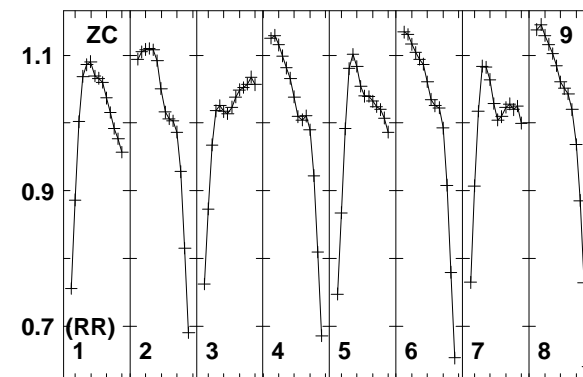
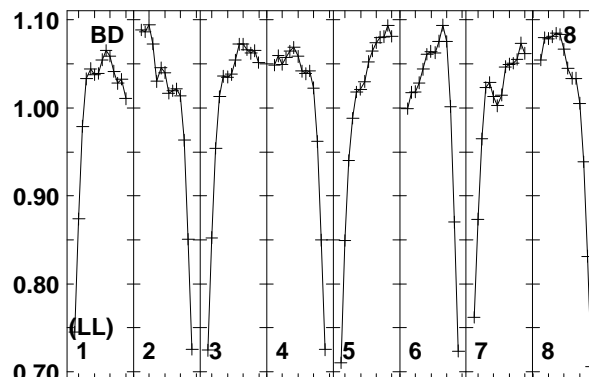
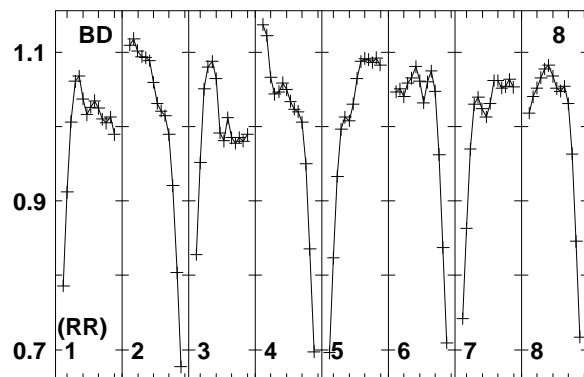
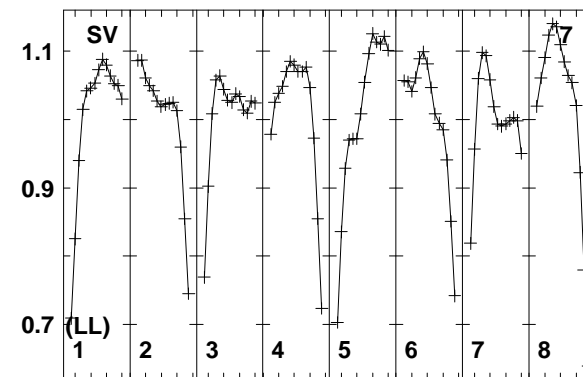
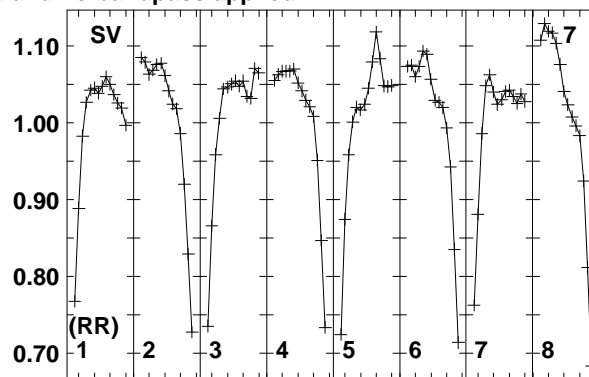
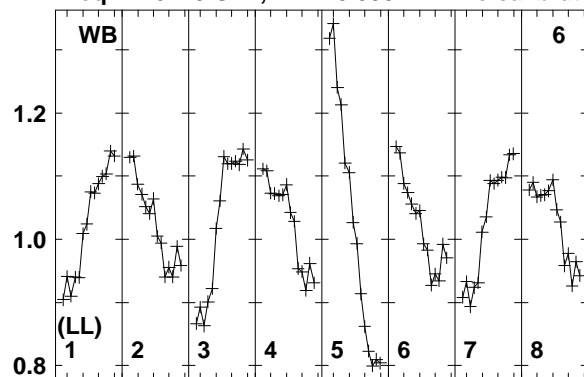

16281634164064416501656601663672678682688
FREQ MHz

Lower frame: Real Jy
Total-power spectrum Antenna: WB (06)
Timerange: 00/21:45:01 to 00/21:52:39

Plot file version 47 created 22-OCT-2014 16:25:16

J1435+3012 EC048.UVDATA.1

Freq = 1.6270 GHz, Bw = 8.000 MH No calibration applied and no bandpass applied

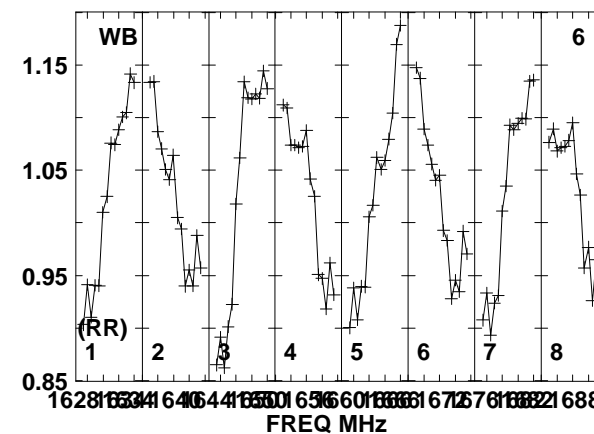
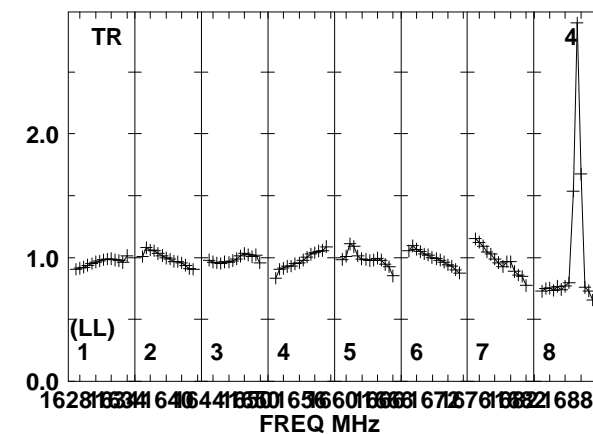
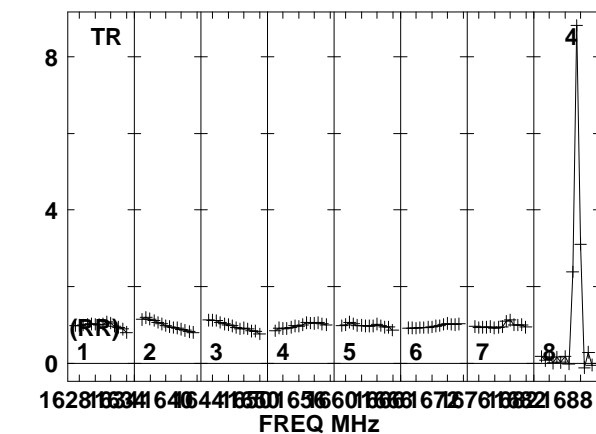
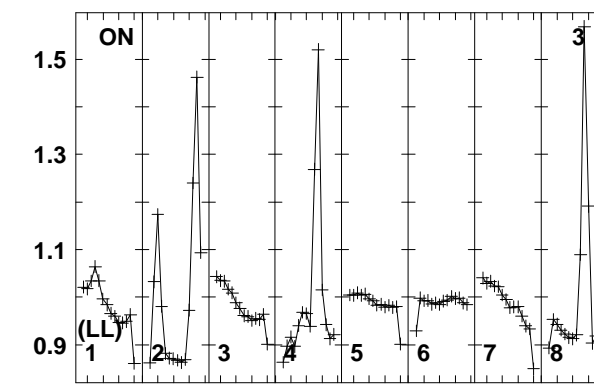
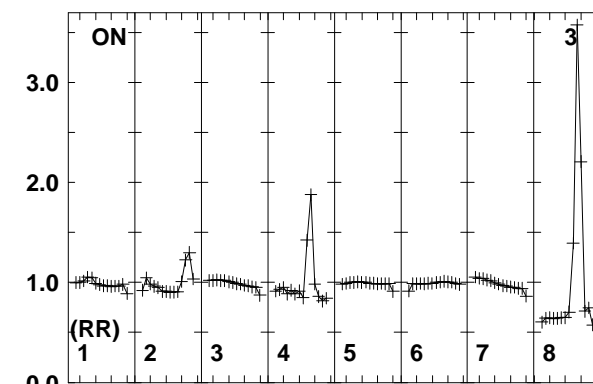
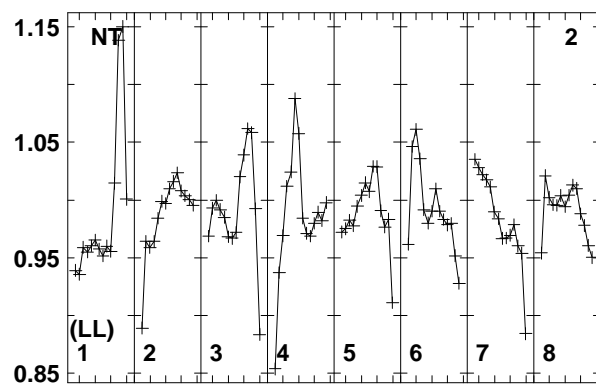
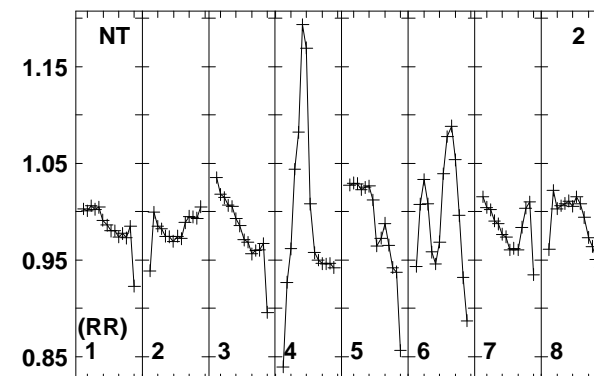
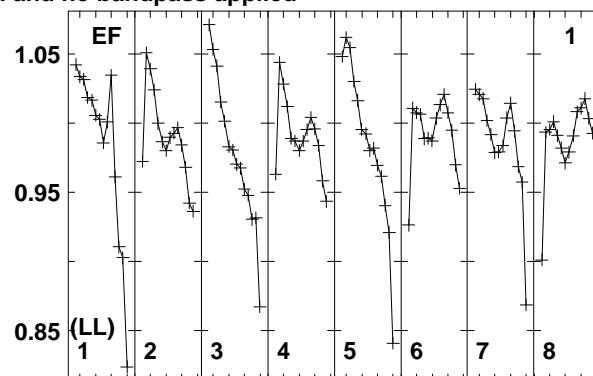
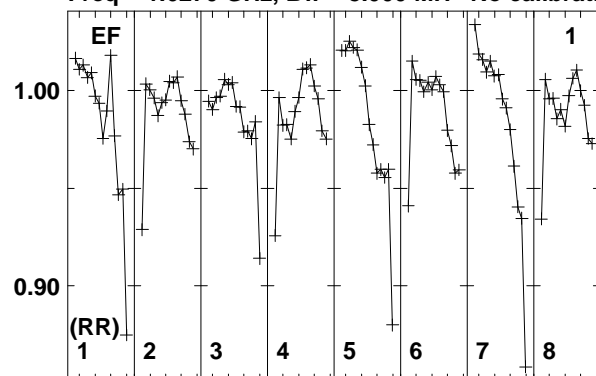

Lower frame: Real Jy
Total-power spectrum Antenna: EF (01)
Timerange: 00/21:53:23 to 00/21:55:09

Plot file version 48 created 22-OCT-2014 16:25:16

J1435+3012 EC048.UVDATA.1

Freq = 1.6270 GHz, Bw = 8.000 MH No calibration applied and no bandpass applied

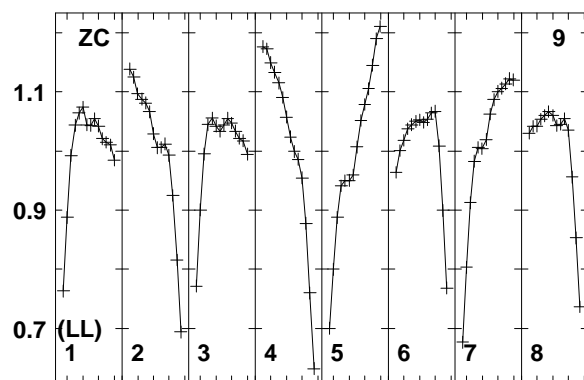
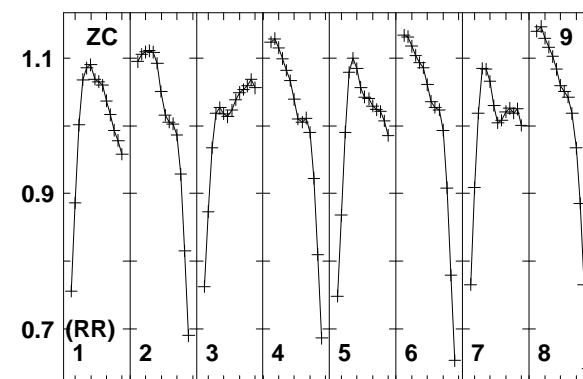
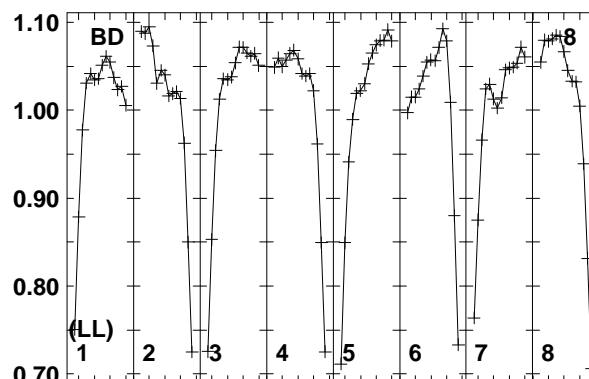
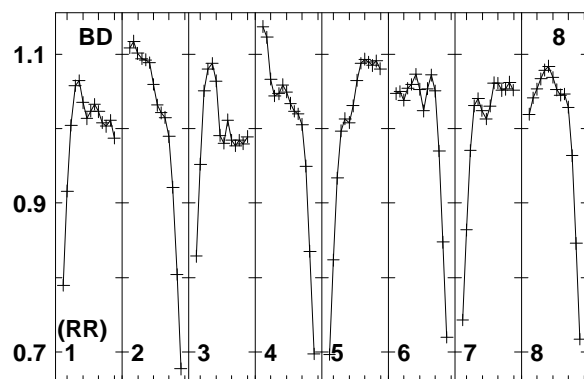
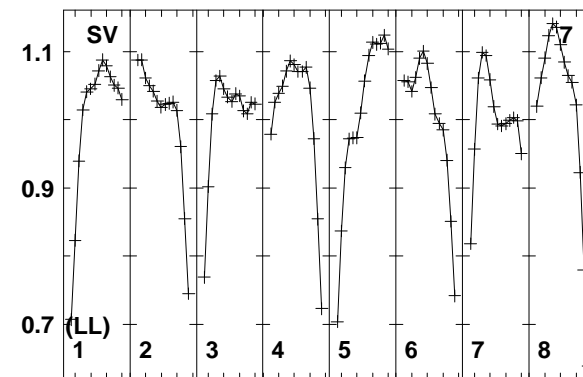
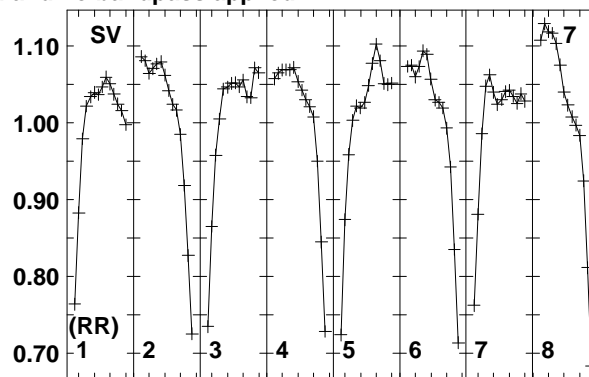
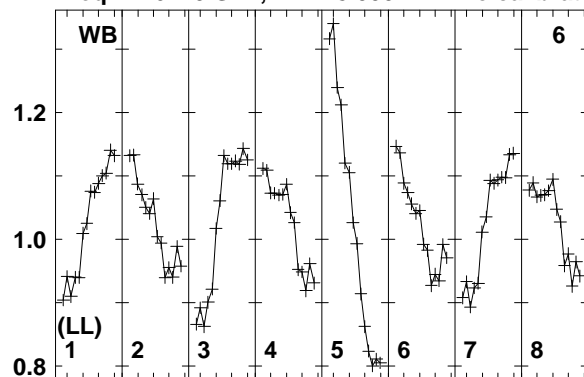

16281634164064416501656601663672678682688
FREQ MHz

Lower frame: Real Jy
Total-power spectrum Antenna: WB (06)
Timerange: 00/21:53:23 to 00/21:55:09

Plot file version 49 created 22-OCT-2014 16:25:16

J1432+3014 EC048.UVDATA.1

Freq = 1.6270 GHz, Bw = 8.000 MH No calibration applied and no bandpass applied

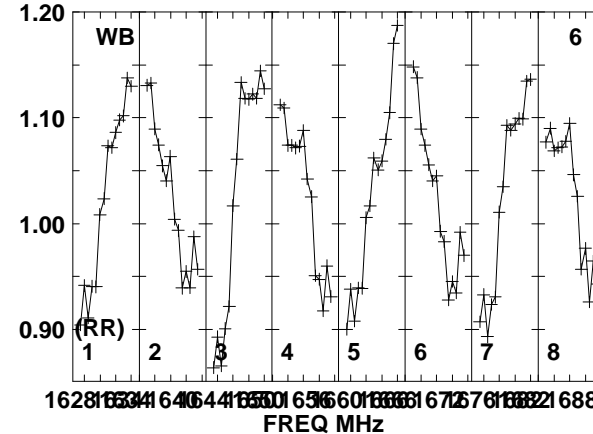
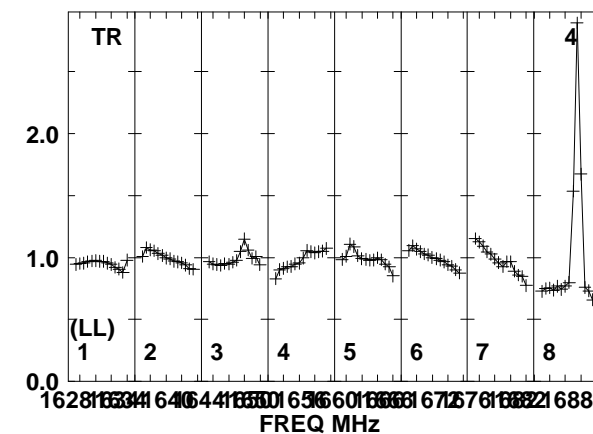
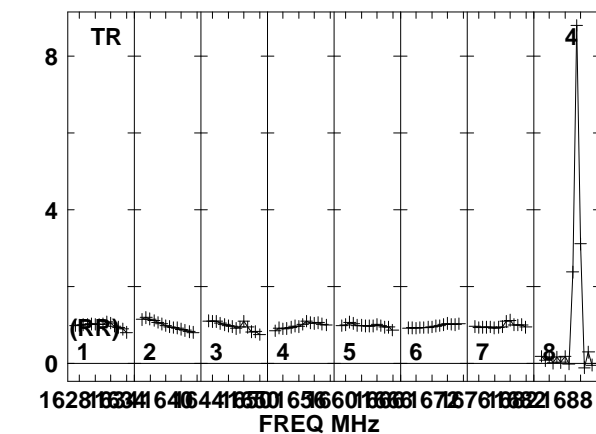
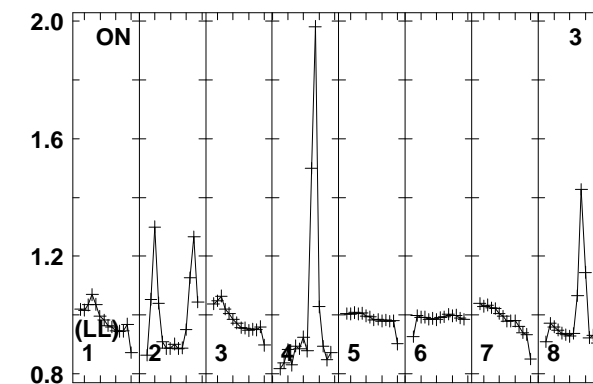
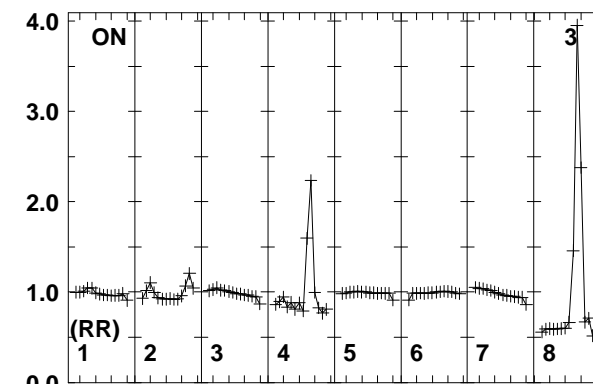
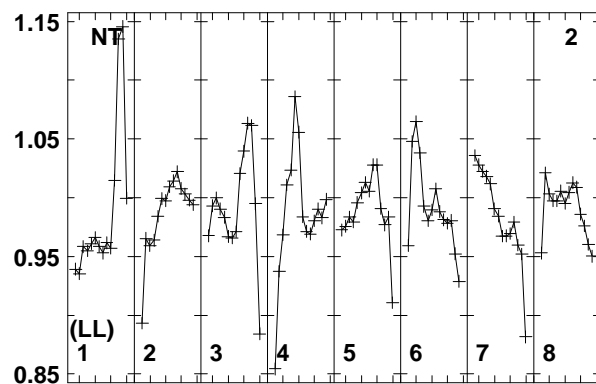
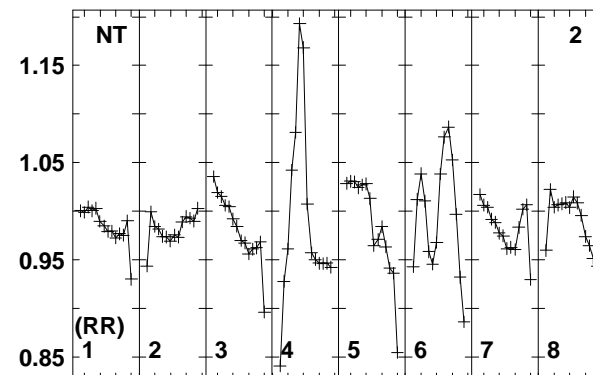
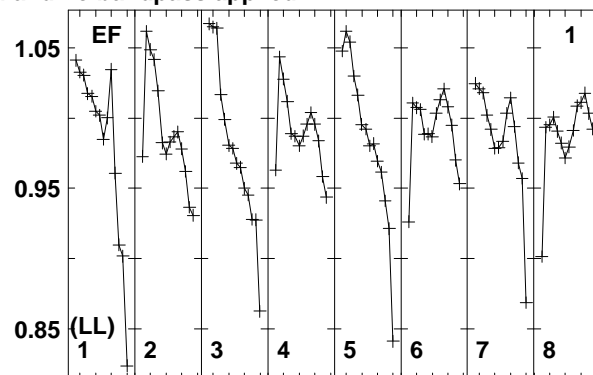
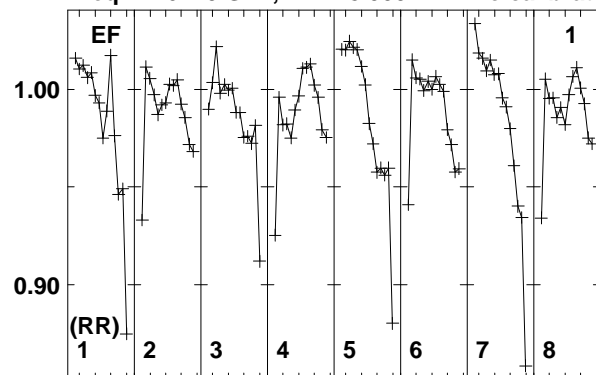

1628 1634 1640 1644 1650 1656 1660 1666 1672 1676 1682 1688
FREQ MHz
Lower frame: Real Jy
Total-power spectrum Antenna: EF (01)
Timerange: 00/21:55:15 to 00/22:02:53

Plot file version 50 created 22-OCT-2014 16:25:16

J1432+3014 EC048.UVDATA.1

Freq = 1.6270 GHz, Bw = 8.000 MH No calibration applied and no bandpass applied

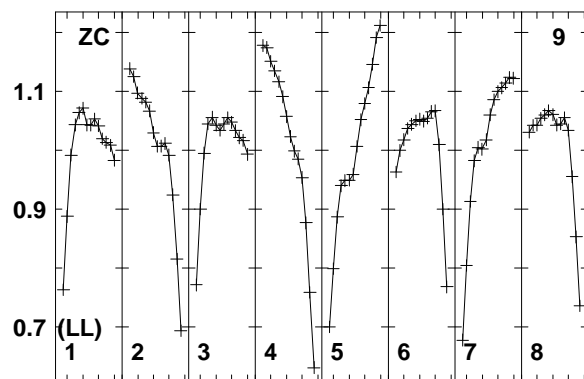
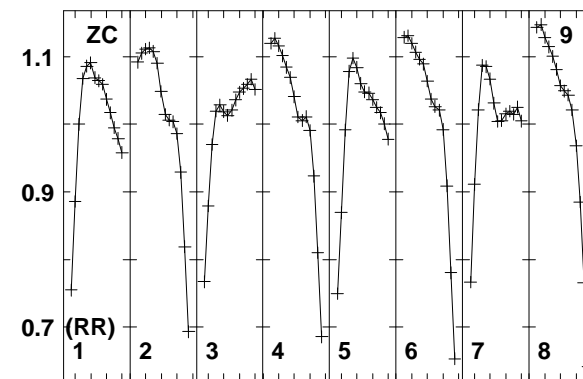
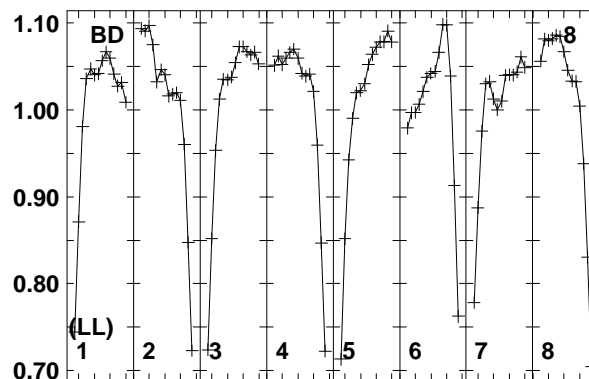
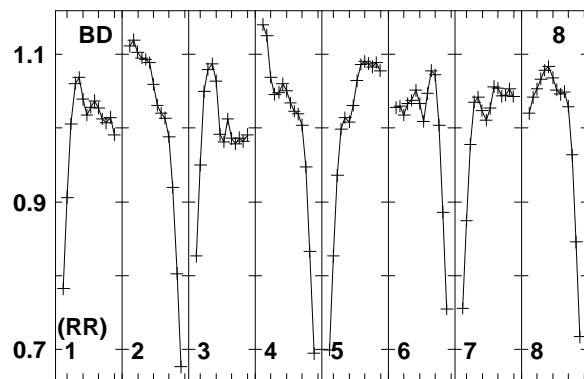
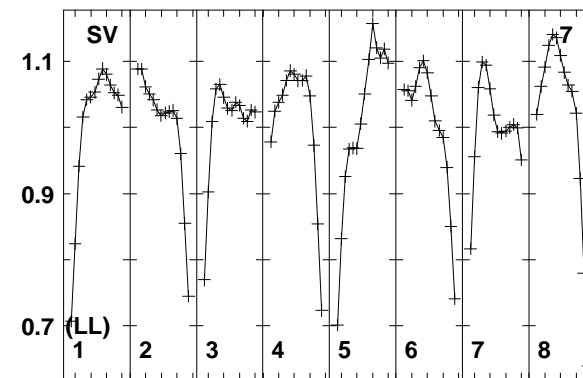
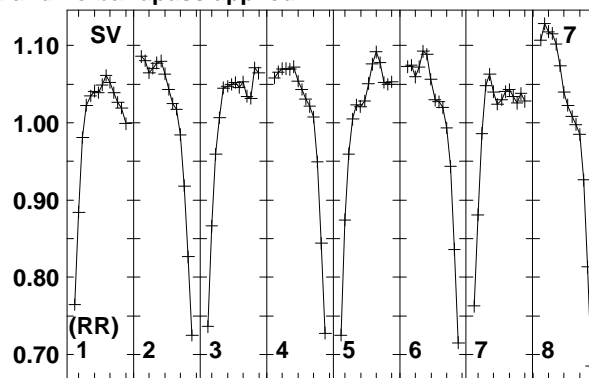
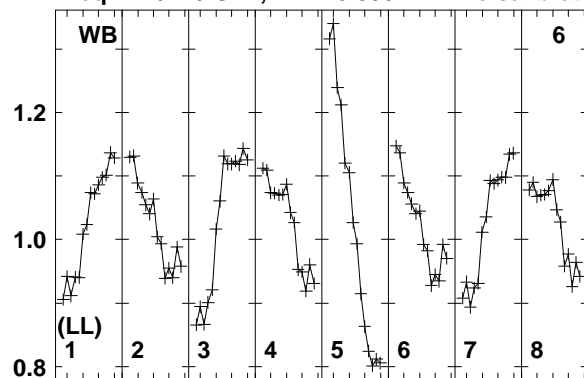

1628163416406441650165660166216681672167816821688
FREQ MHz

Lower frame: Real Jy
Total-power spectrum Antenna: WB (06)
Timerange: 00/21:55:15 to 00/22:02:53

Plot file version 51 created 22-OCT-2014 16:25:16

J1435+3012 EC048.UVDATA.1

Freq = 1.6270 GHz, Bw = 8.000 MH No calibration applied and no bandpass applied

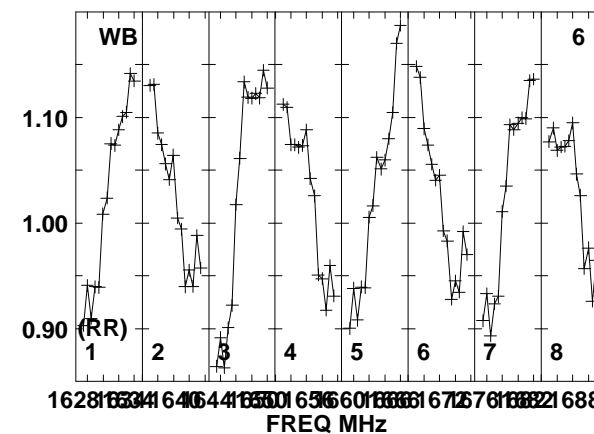
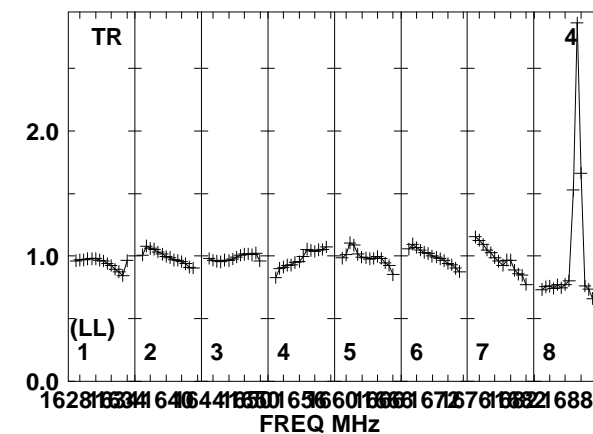
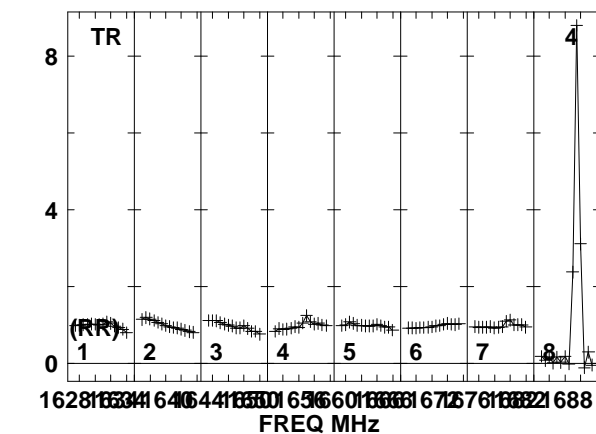
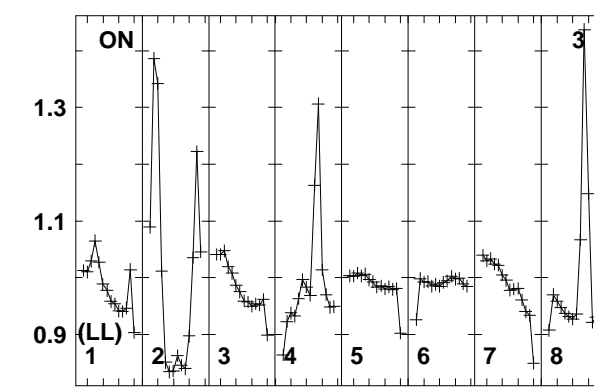
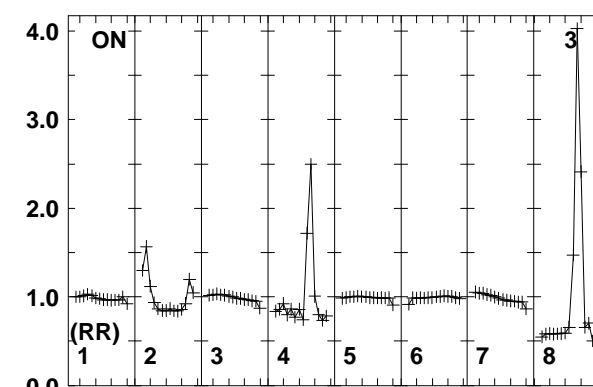
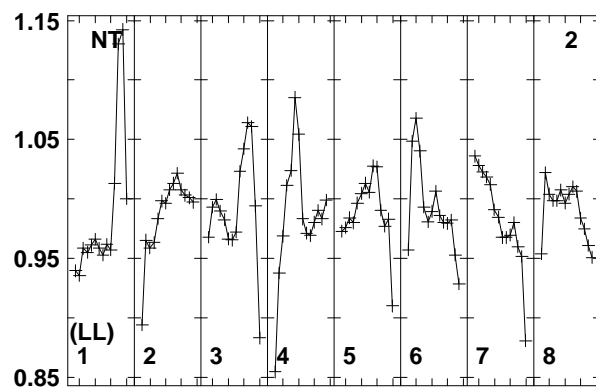
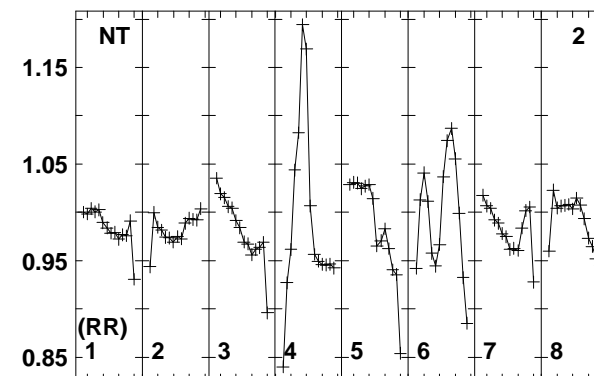
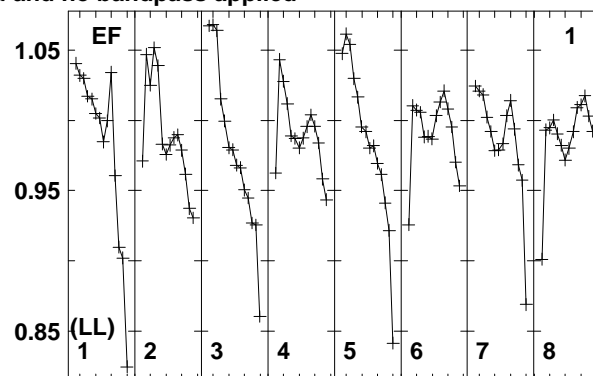
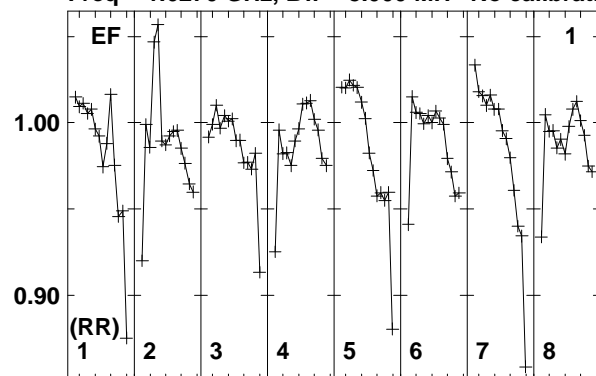

Lower frame: Real Jy
Total-power spectrum Antenna: EF (01)
Timerange: 00/22:03:38 to 00/22:05:24

Plot file version 52 created 22-OCT-2014 16:25:16

J1435+3012 EC048.UVDATA.1

Freq = 1.6270 GHz, Bw = 8.000 MH No calibration applied and no bandpass applied

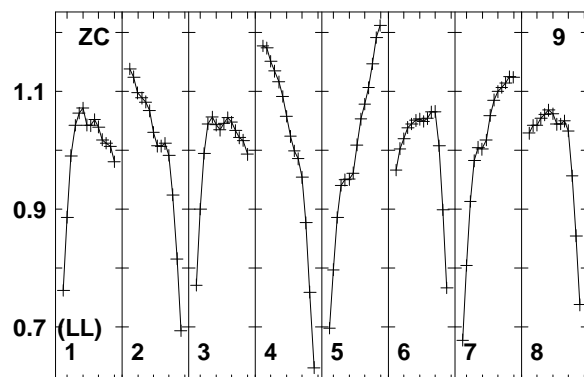
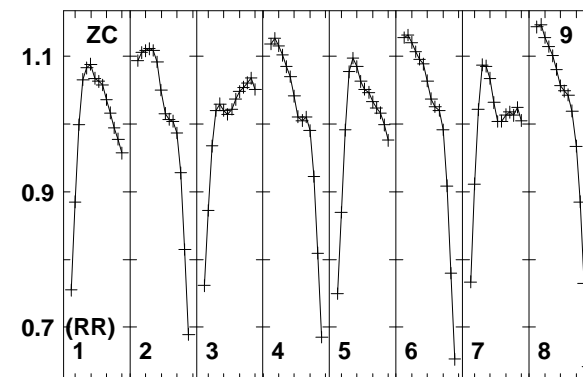
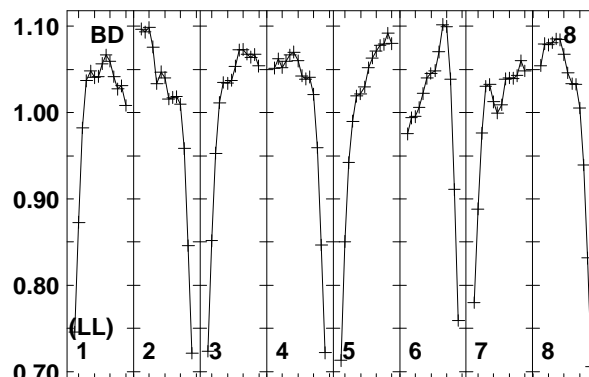
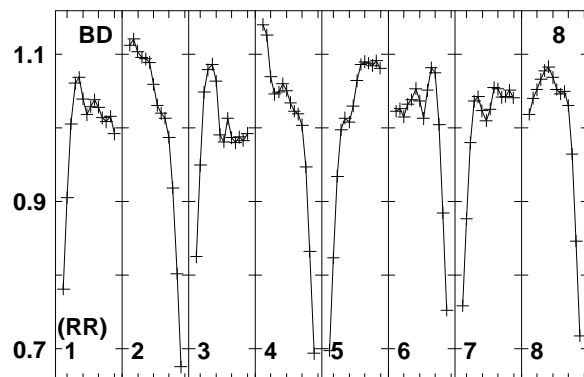
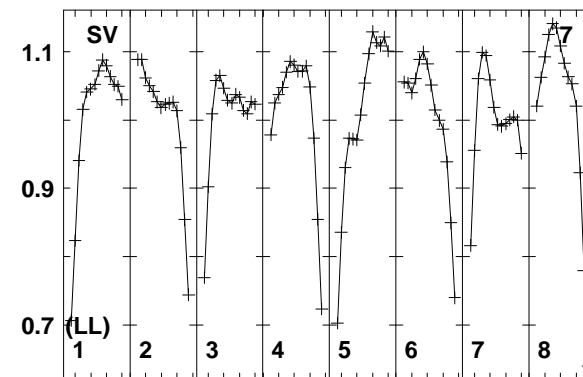
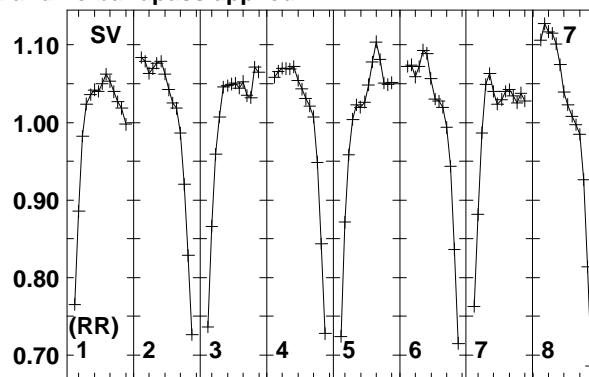
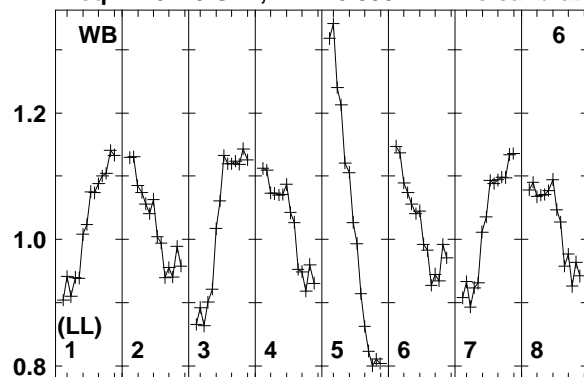

16281634164064416501656601663668672678682688

FREQ MHz

Lower frame: Real Jy

Total-power spectrum Antenna: WB (06)

Timerange: 00/22:03:38 to 00/22:05:24

Plot file version 53 created 22-OCT-2014 16:25:16

J1432+3014 EC048.UVDATA.1

Freq = 1.6270 GHz, Bw = 8.000 MH No calibration applied and no bandpass applied

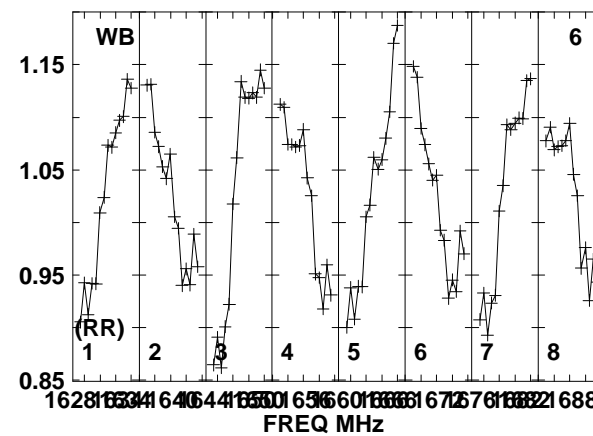
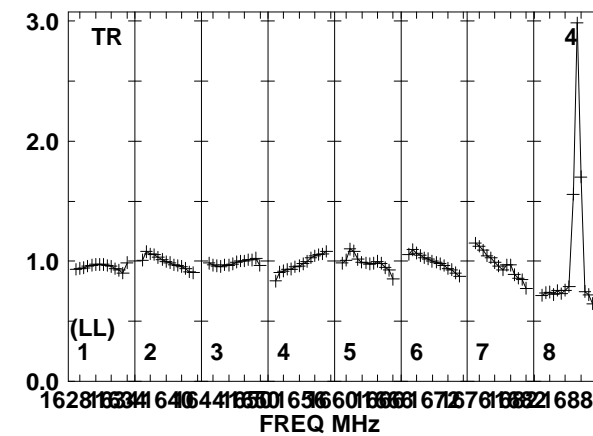
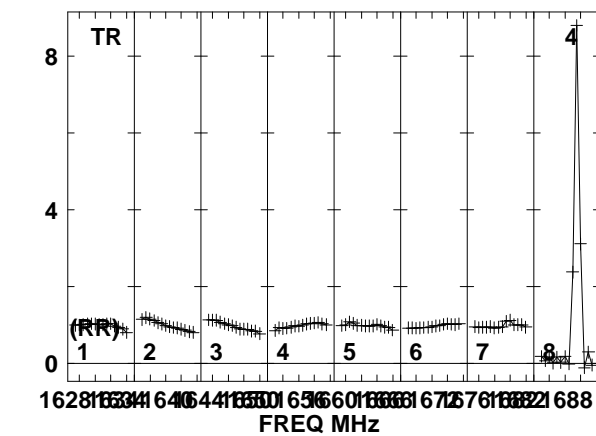
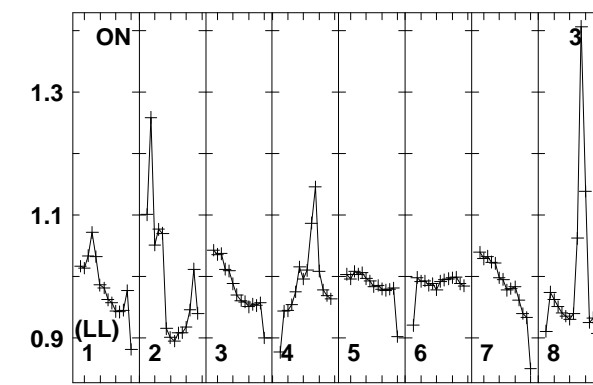
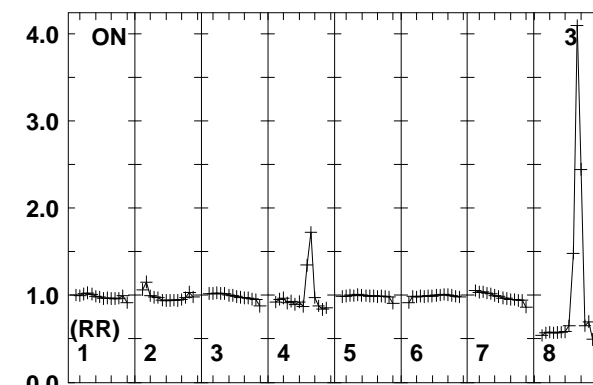
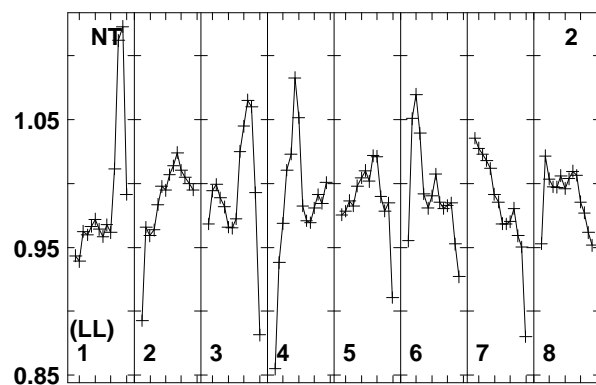
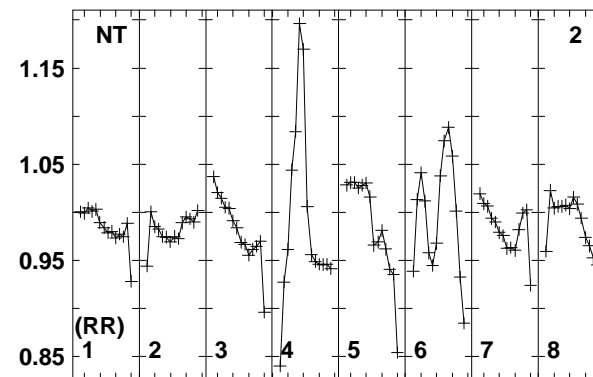
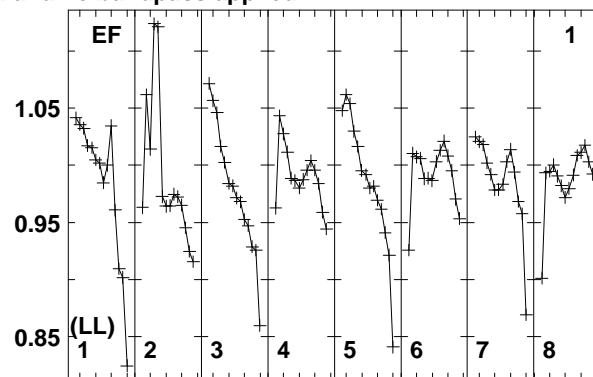
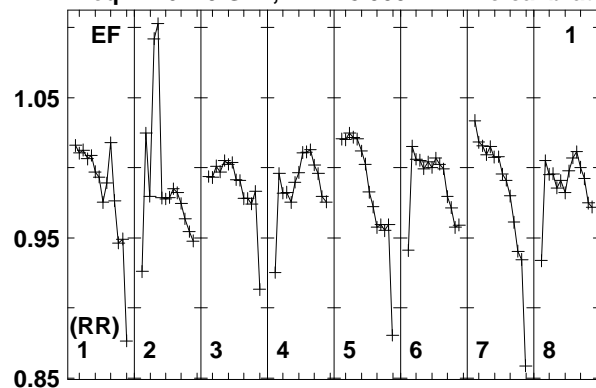

Lower frame: Real Jy
Total-power spectrum Antenna: EF (01)
Timerange: 00/22:05:30 to 00/22:13:08

Plot file version 54 created 22-OCT-2014 16:25:16

J1432+3014 EC048.UVDATA.1

Freq = 1.6270 GHz, Bw = 8.000 MH No calibration applied and no bandpass applied

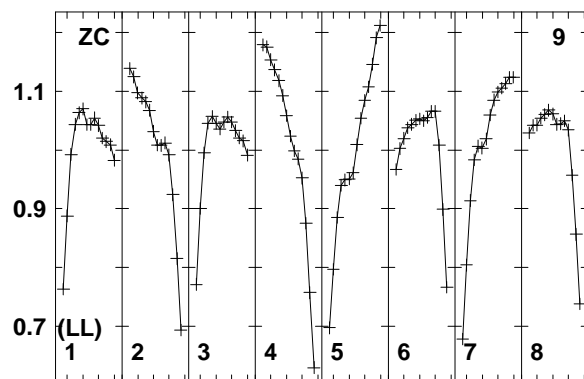
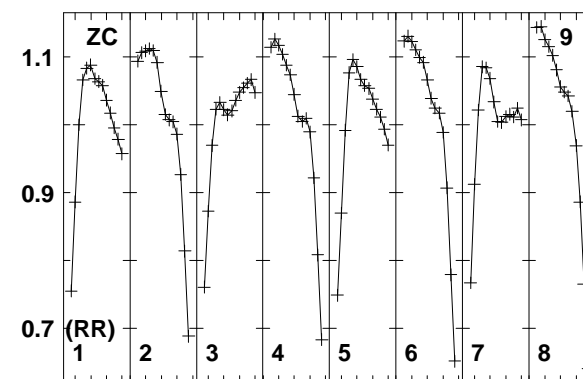
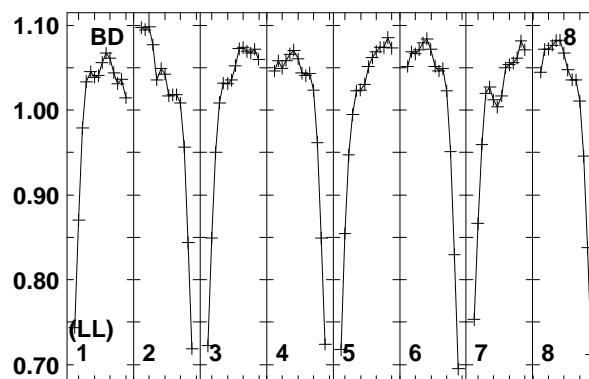
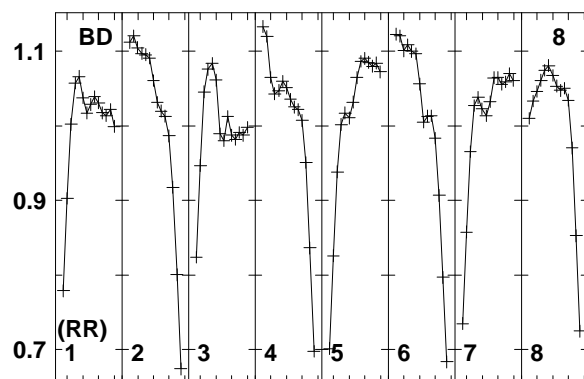
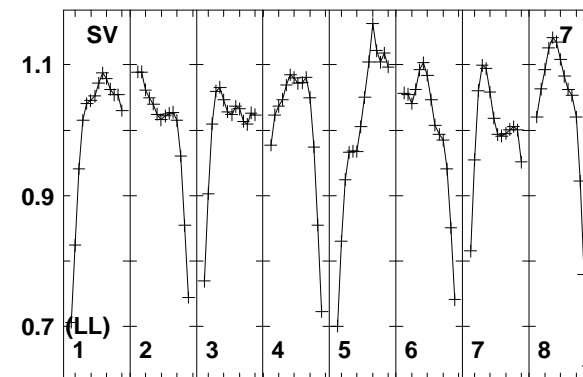
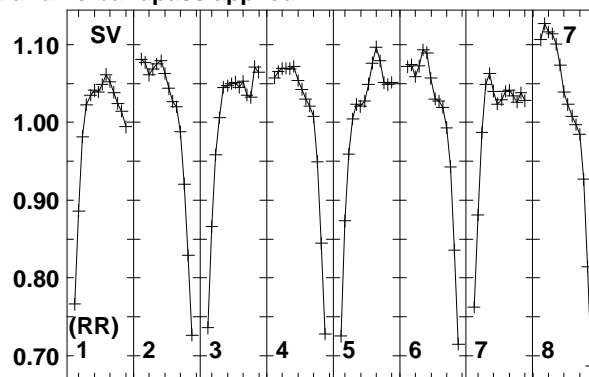
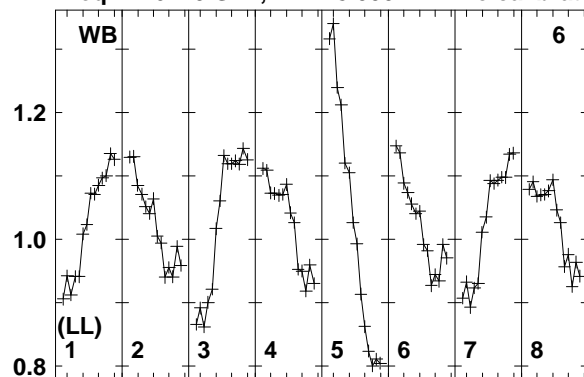

16281634164064416501656601663672678682688
FREQ MHz

Lower frame: Real Jy
Total-power spectrum Antenna: WB (06)
Timerange: 00/22:05:30 to 00/22:13:08

Plot file version 55 created 22-OCT-2014 16:25:17

J1435+3012 EC048.UVDATA.1

Freq = 1.6270 GHz, Bw = 8.000 MH No calibration applied and no bandpass applied

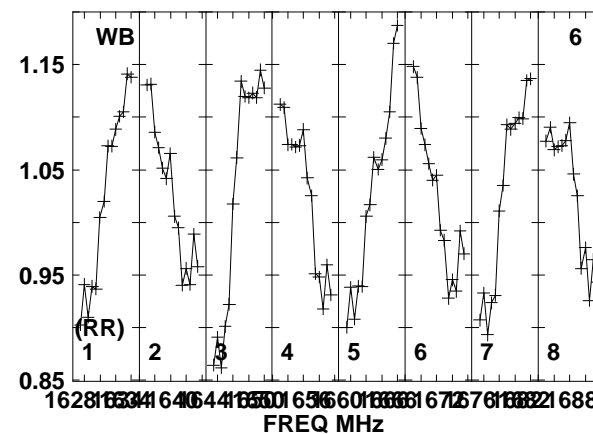
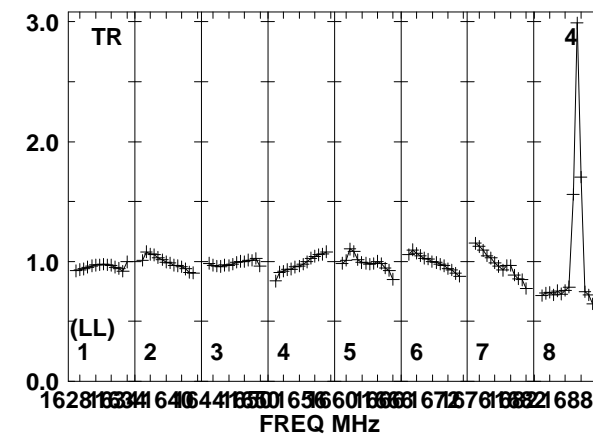
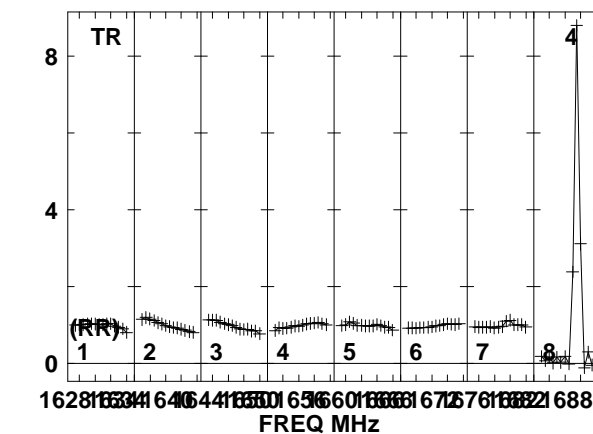
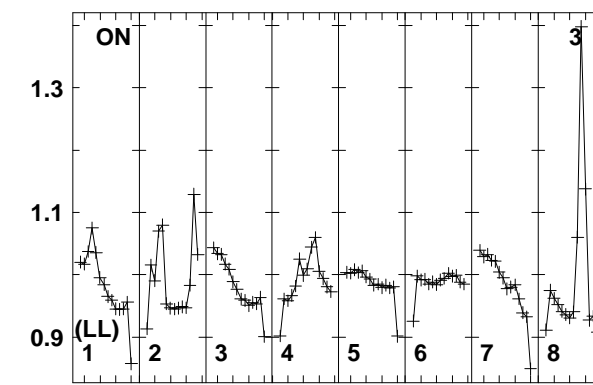
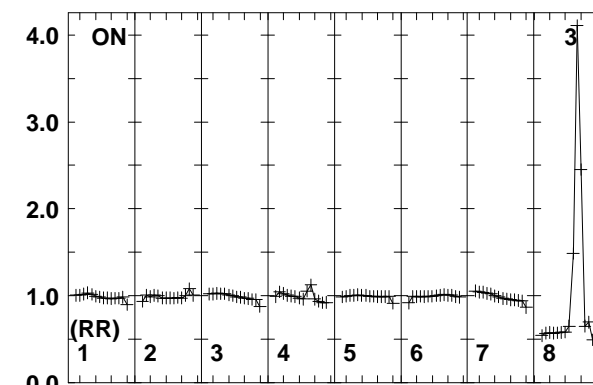
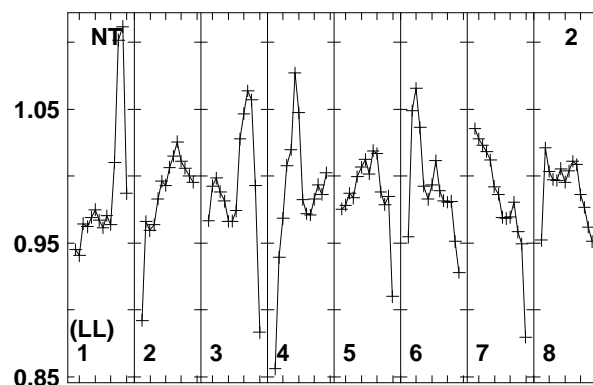
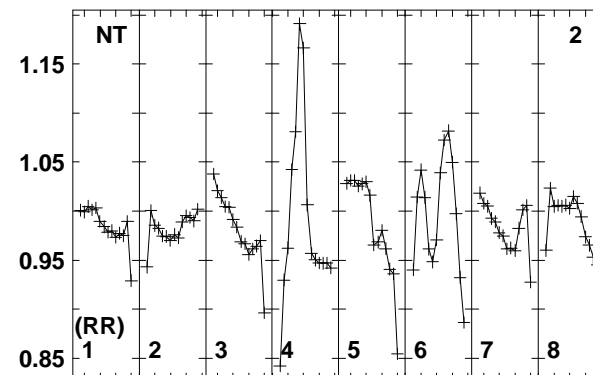
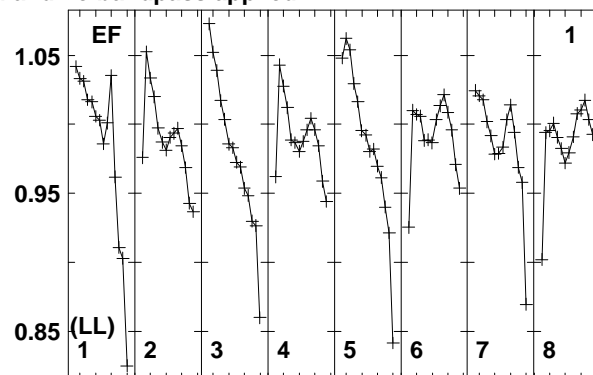
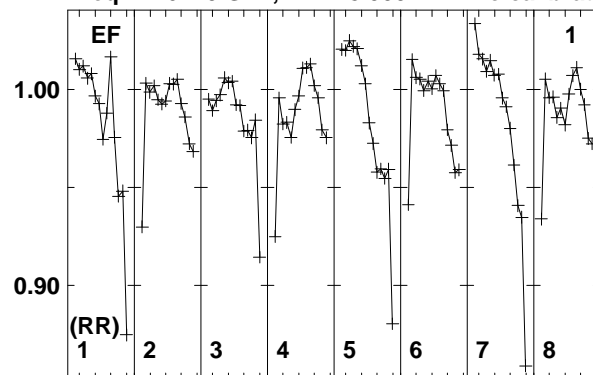

Lower frame: Real Jy
Total-power spectrum Antenna: EF (01)
Timerange: 00/22:13:53 to 00/22:15:39

Plot file version 56 created 22-OCT-2014 16:25:17

J1435+3012 EC048.UVDATA.1

Freq = 1.6270 GHz, Bw = 8.000 MH No calibration applied and no bandpass applied

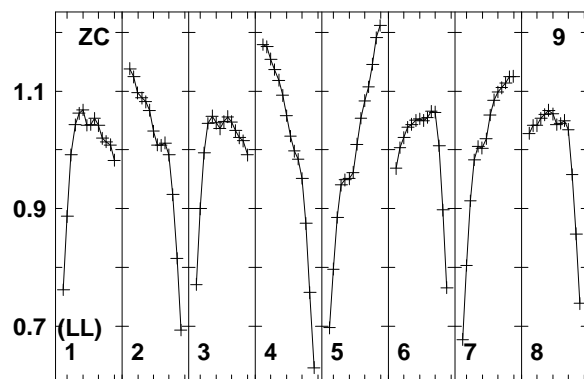
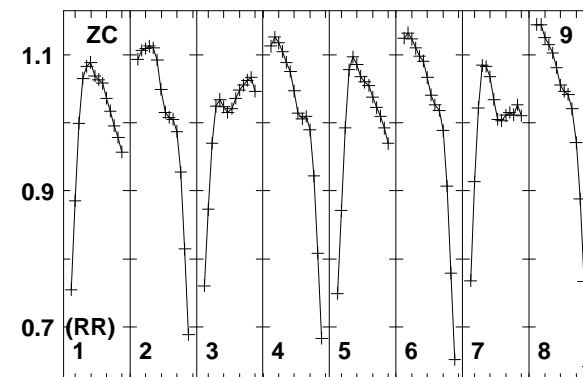
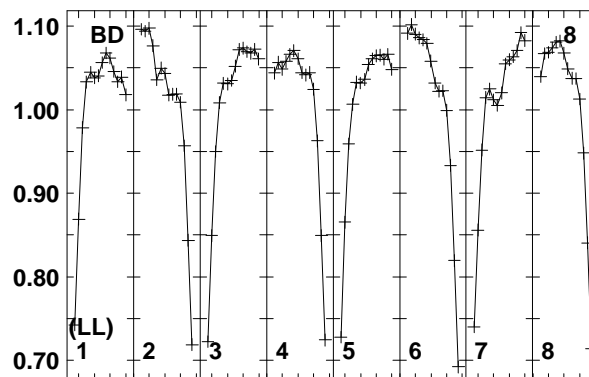
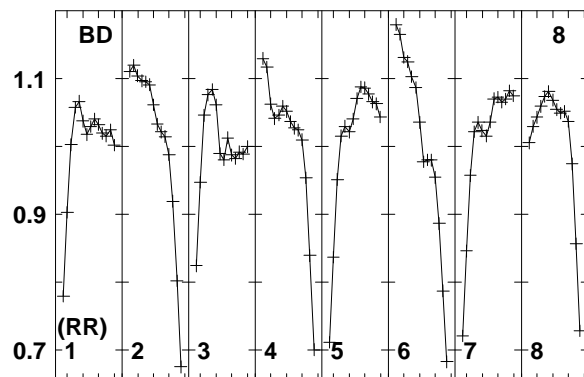
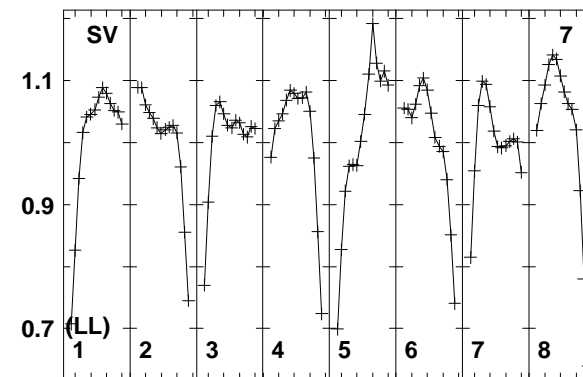
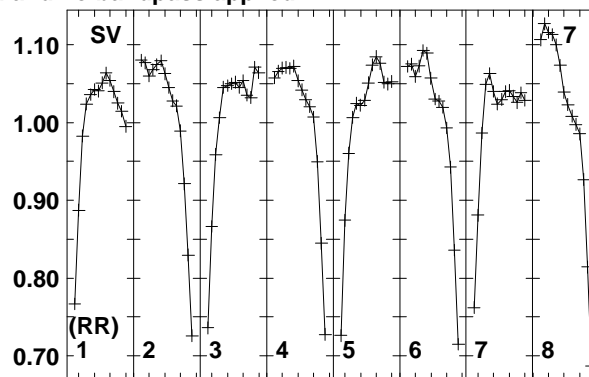
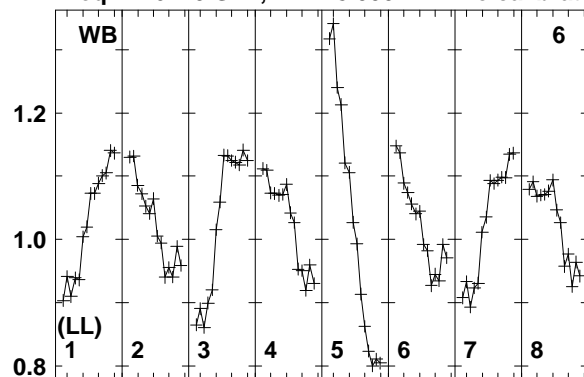

16281634164064416501656601663672678682688
FREQ MHz

Lower frame: Real Jy
Total-power spectrum Antenna: WB (06)
Timerange: 00/22:13:53 to 00/22:15:39

Plot file version 57 created 22-OCT-2014 16:25:17

J1432+3014 EC048.UVDATA.1

Freq = 1.6270 GHz, Bw = 8.000 MH No calibration applied and no bandpass applied

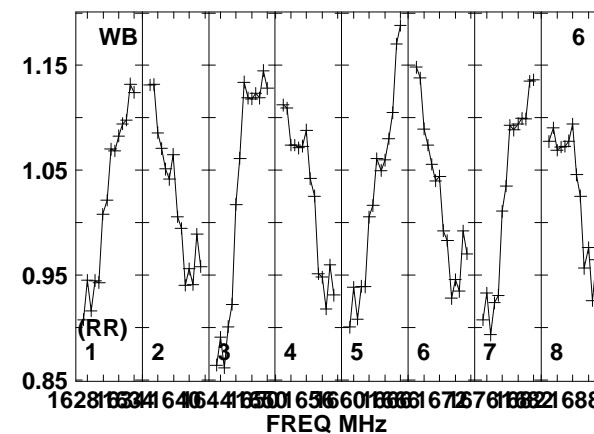
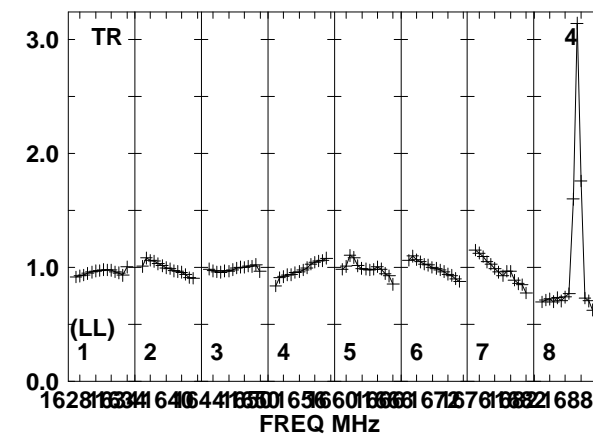
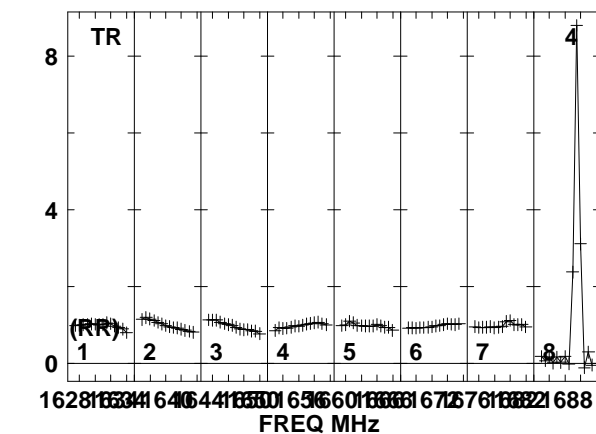
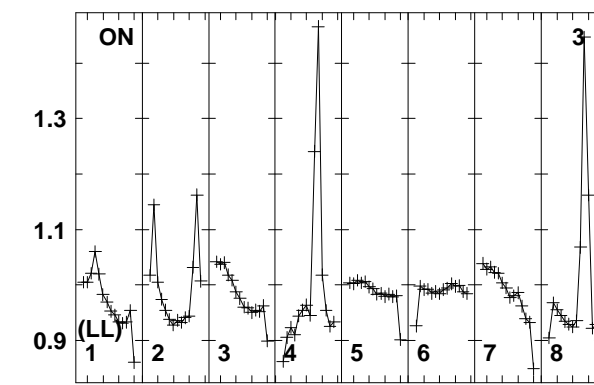
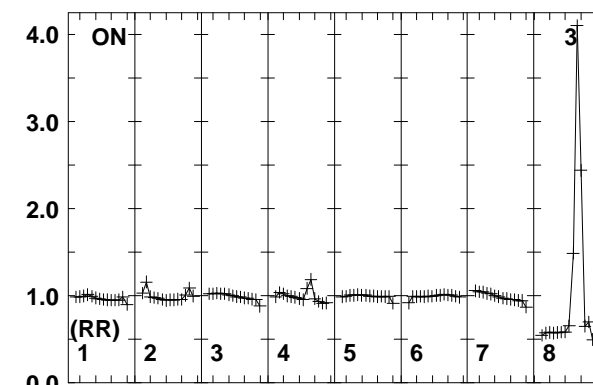
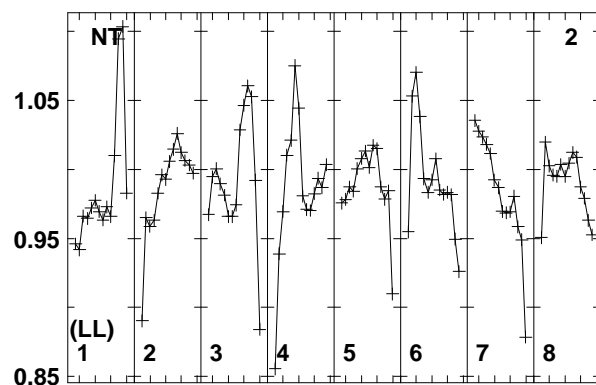
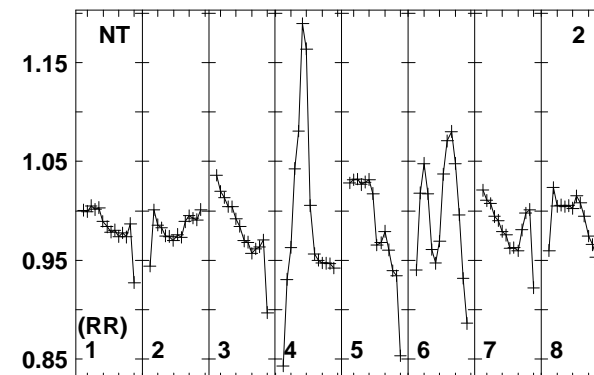
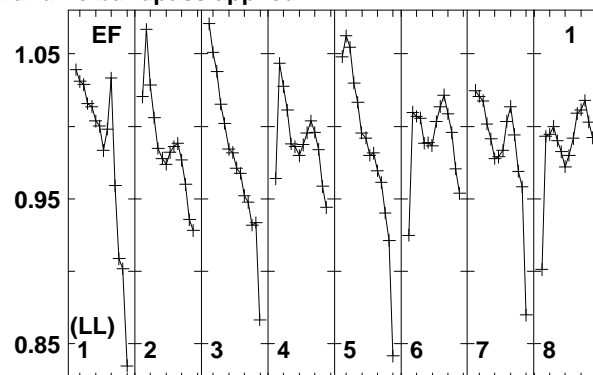
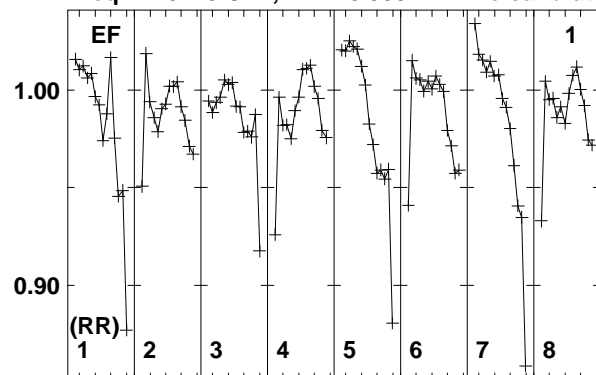

1628 1634 1640 1644 1650 1656 1660 1666 1672 1676 1682 1688
FREQ MHz
Lower frame: Real Jy
Total-power spectrum Antenna: EF (01)
Timerange: 00/22:15:44 to 00/22:23:24

Plot file version 58 created 22-OCT-2014 16:25:17

J1432+3014 EC048.UVDATA.1

Freq = 1.6270 GHz, Bw = 8.000 MH No calibration applied and no bandpass applied

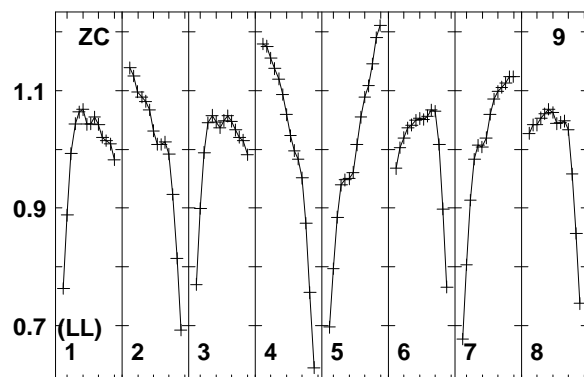
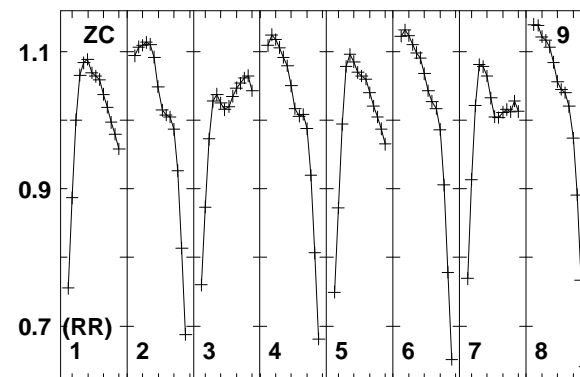
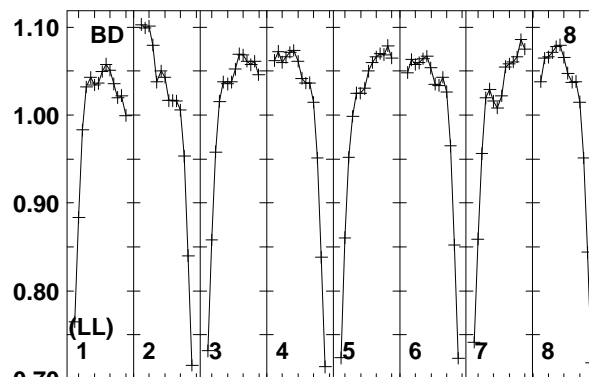
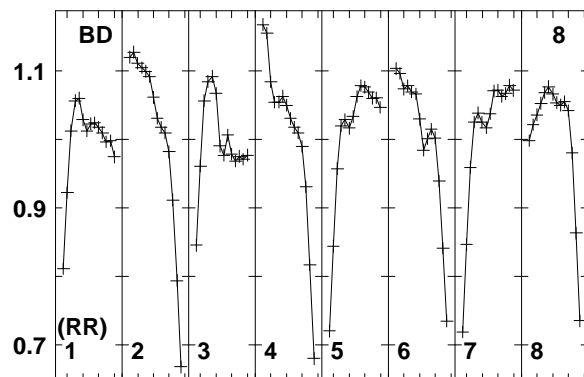
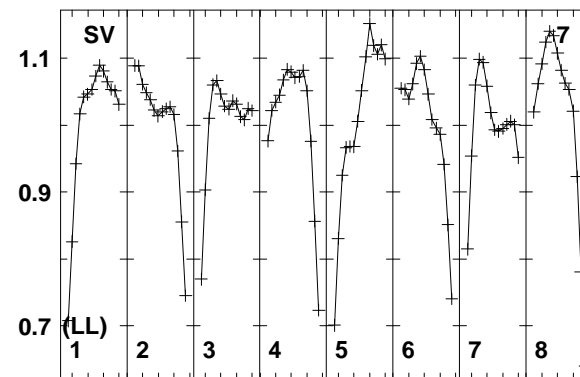
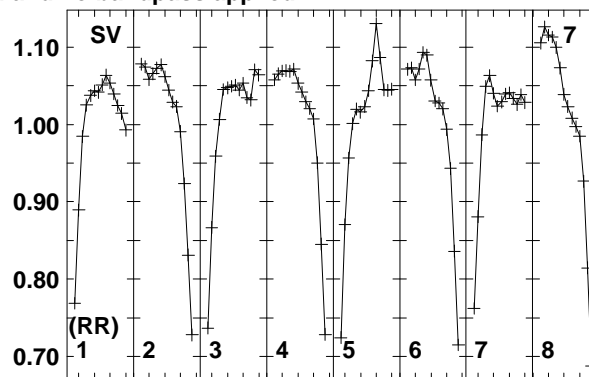
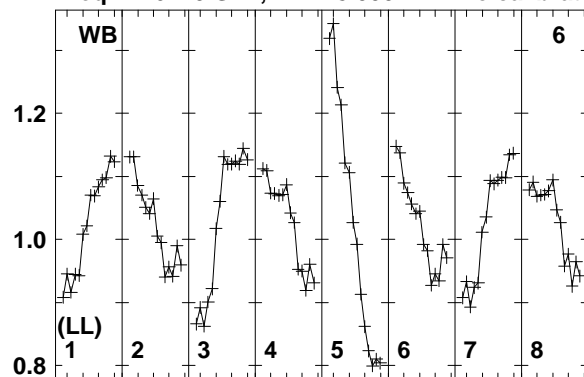

16281634164064416501656601663672678682688

FREQ MHz

Lower frame: Real Jy

Total-power spectrum Antenna: WB (06)

Timerange: 00/22:15:44 to 00/22:23:24

Plot file version 59 created 22-OCT-2014 16:25:17

J1435+3012 EC048.UVDATA.1

Freq = 1.6270 GHz, Bw = 8.000 MH No calibration applied and no bandpass applied

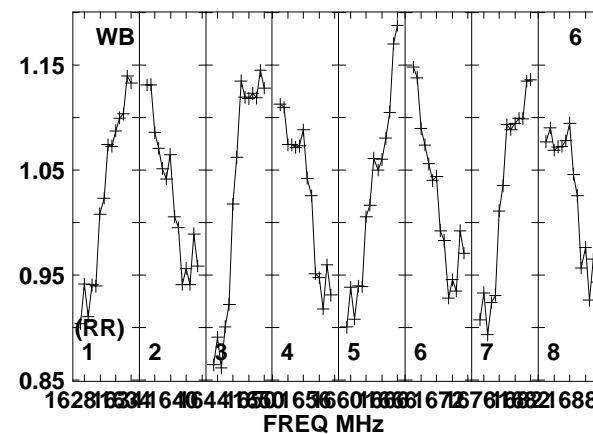
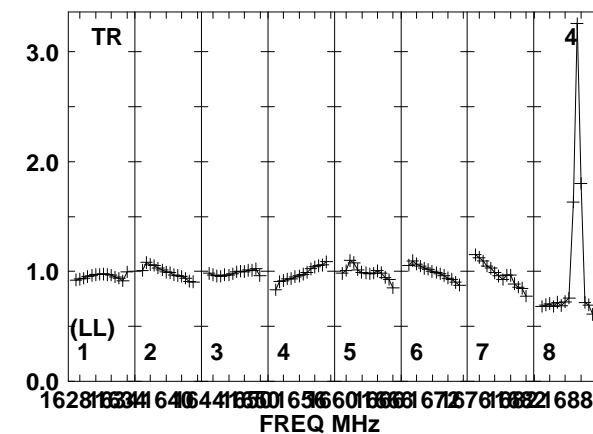
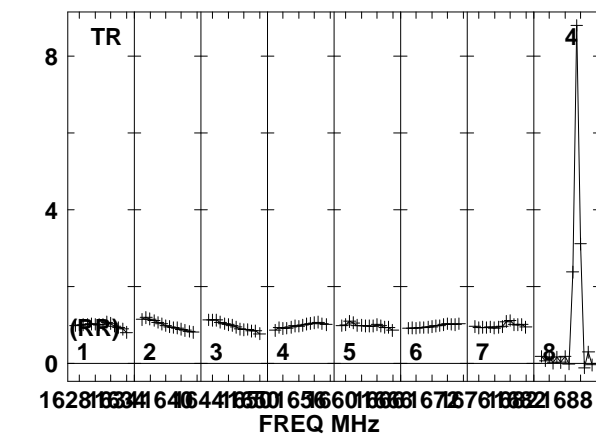
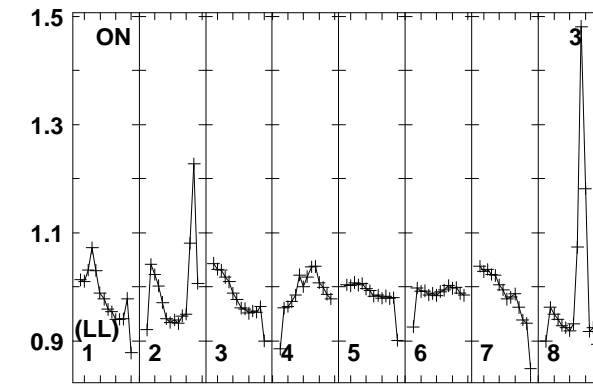
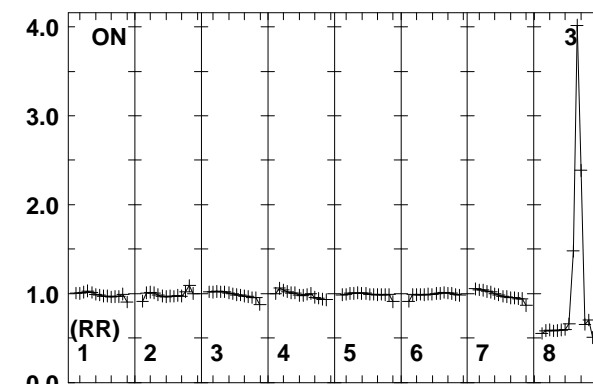
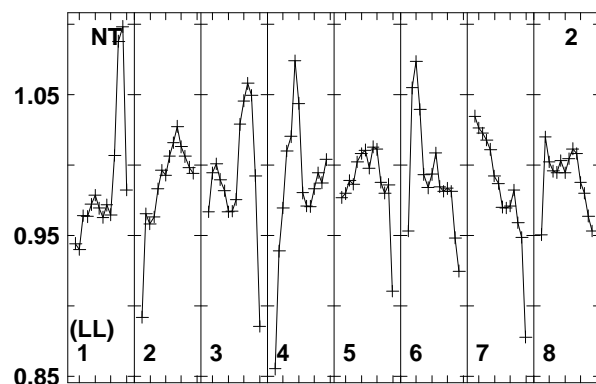
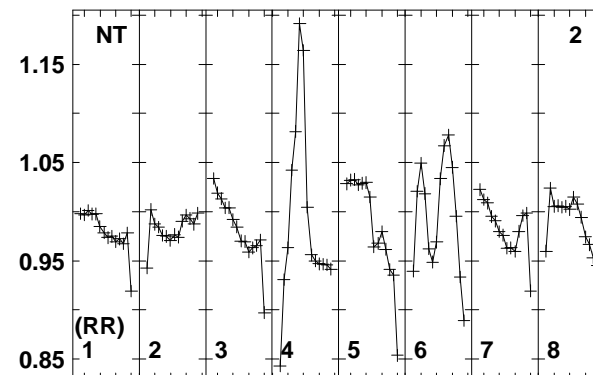
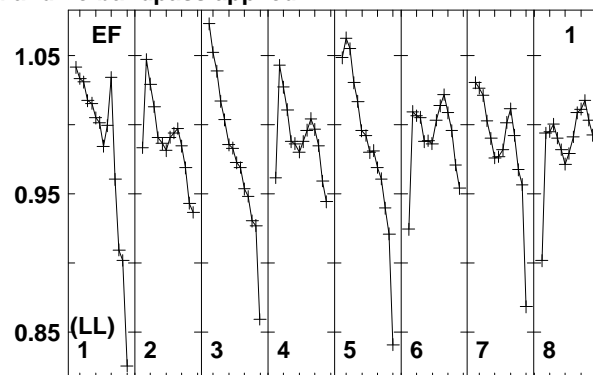
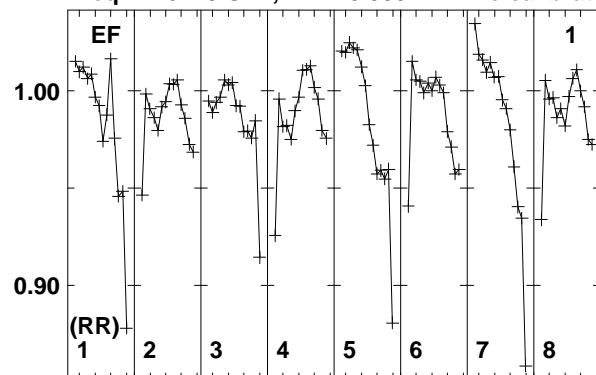

Lower frame: Real Jy
Total-power spectrum Antenna: EF (01)
Timerange: 00/22:24:08 to 00/22:25:54

Plot file version 60 created 22-OCT-2014 16:25:17

J1435+3012 EC048.UVDATA.1

Freq = 1.6270 GHz, Bw = 8.000 MH No calibration applied and no bandpass applied

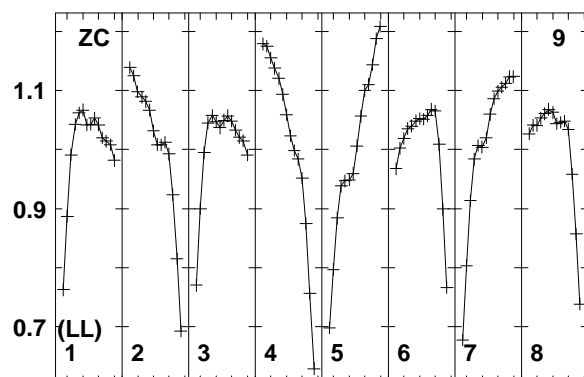
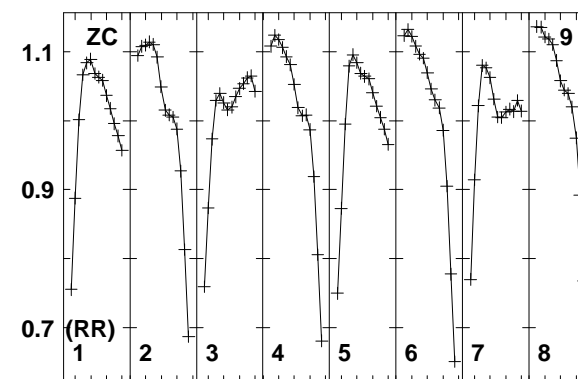
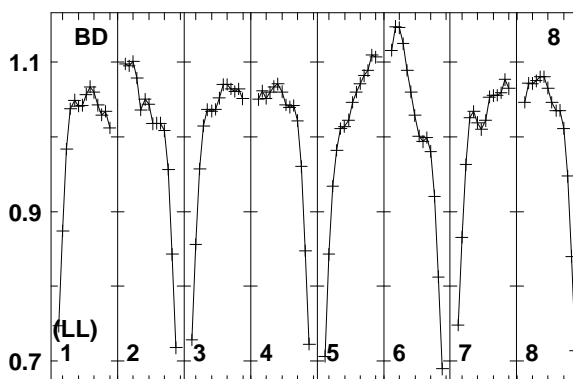
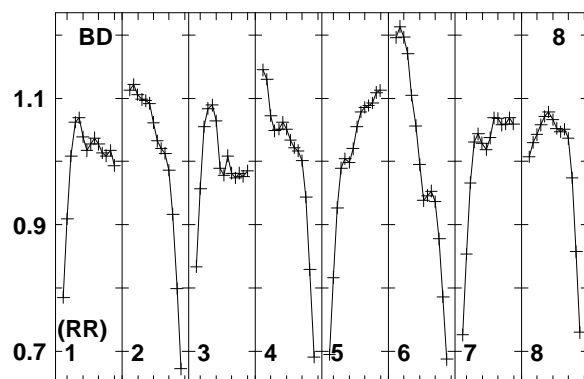
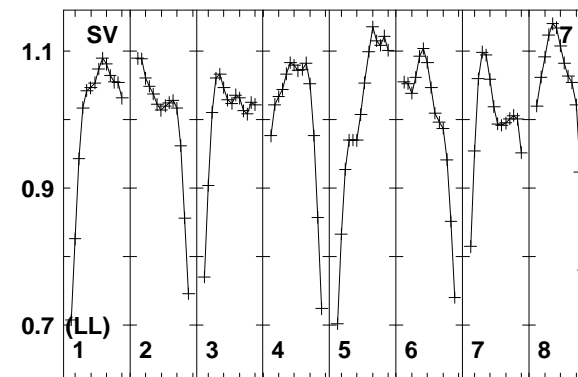
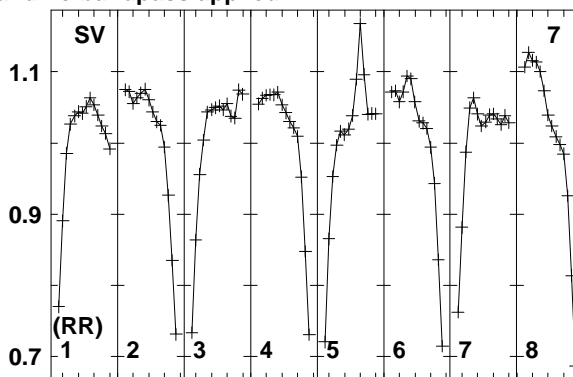
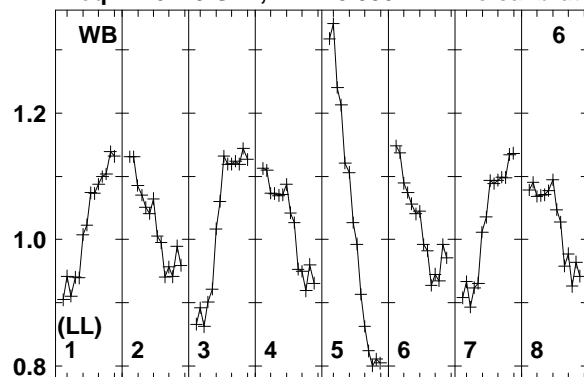

1628163416406441650165660166216681672167816821688
FREQ MHz

Lower frame: Real Jy
Total-power spectrum Antenna: WB (06)
Timerange: 00/22:24:08 to 00/22:25:54

Plot file version 61 created 22-OCT-2014 16:25:17

J1432+3014 EC048.UVDATA.1

Freq = 1.6270 GHz, Bw = 8.000 MH No calibration applied and no bandpass applied

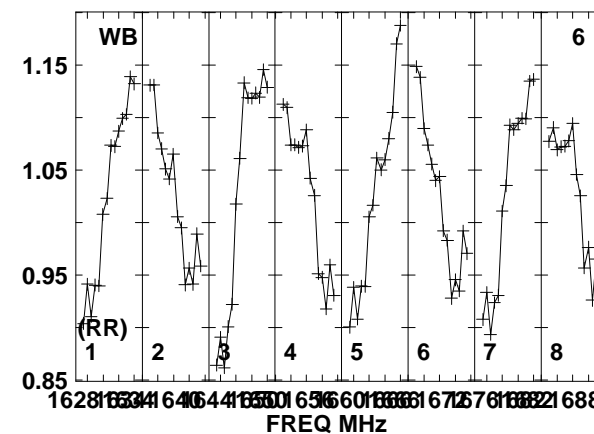
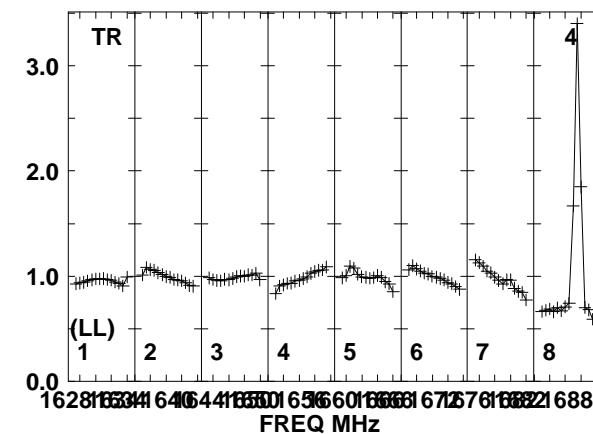
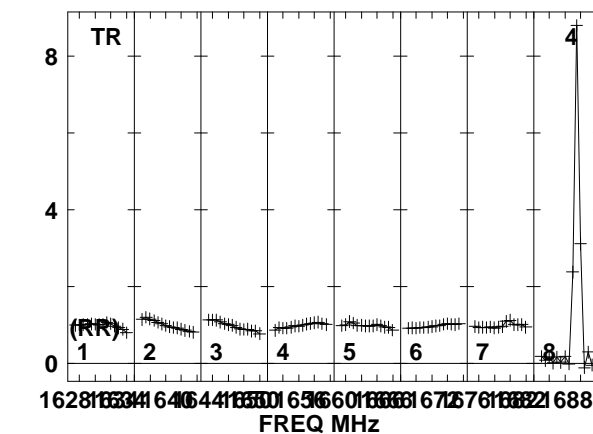
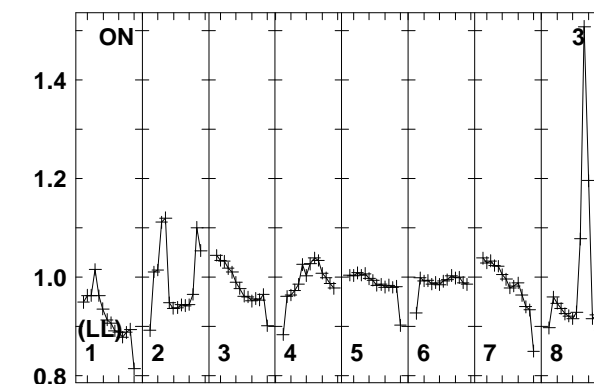
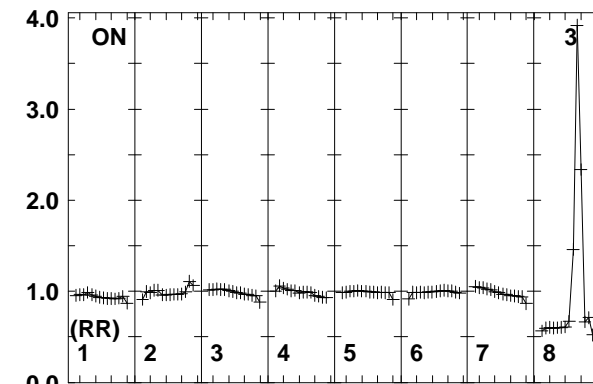
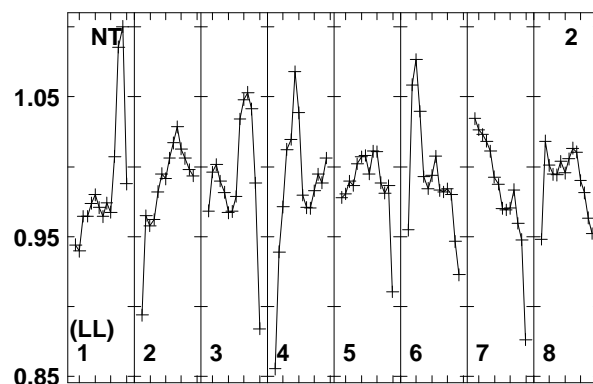
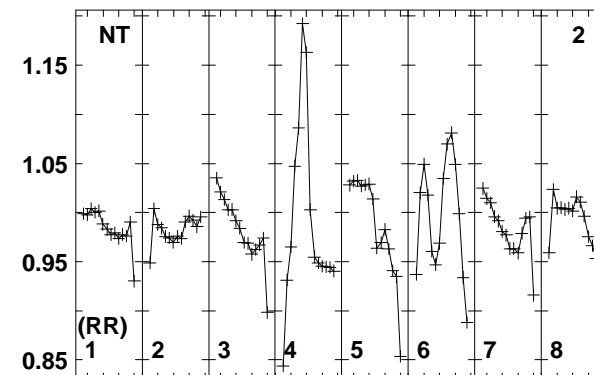
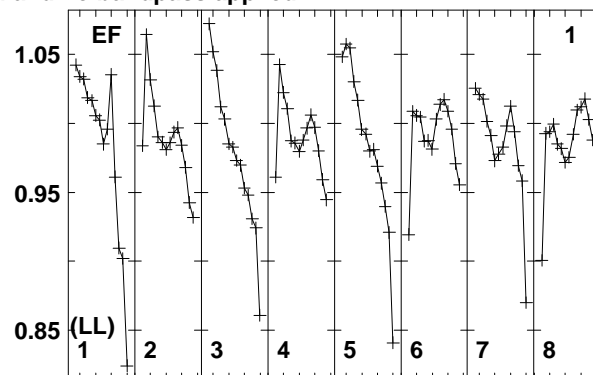
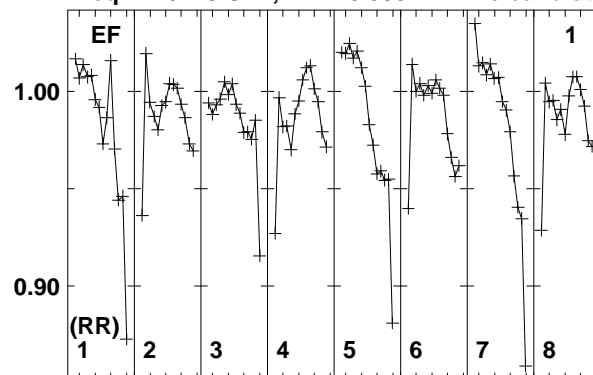

Lower frame: Real Jy
Total-power spectrum Antenna: EF (01)
Timerange: 00/22:25:59 to 00/22:33:39

Plot file version 62 created 22-OCT-2014 16:25:17

J1432+3014 EC048.UVDATA.1

Freq = 1.6270 GHz, Bw = 8.000 MH No calibration applied and no bandpass applied

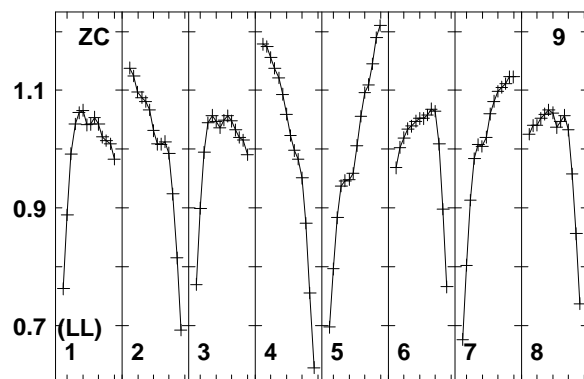
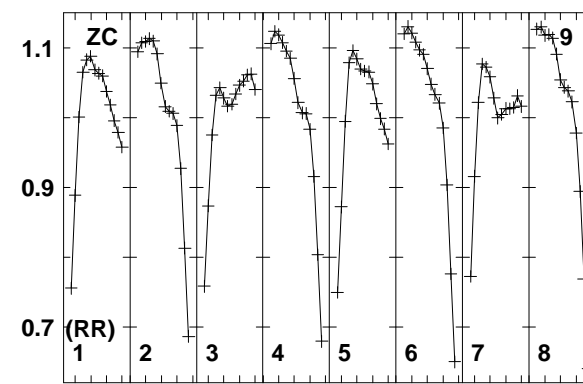
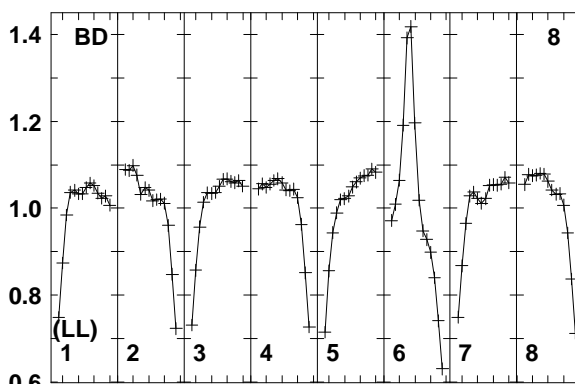
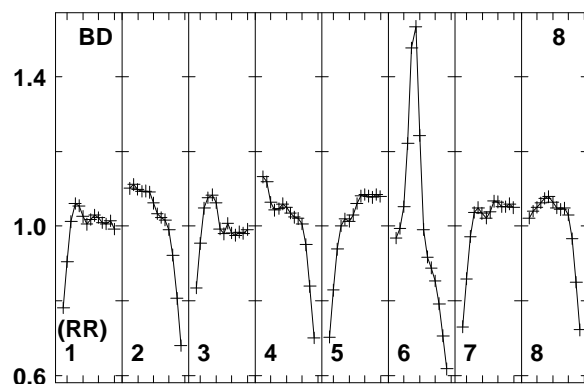
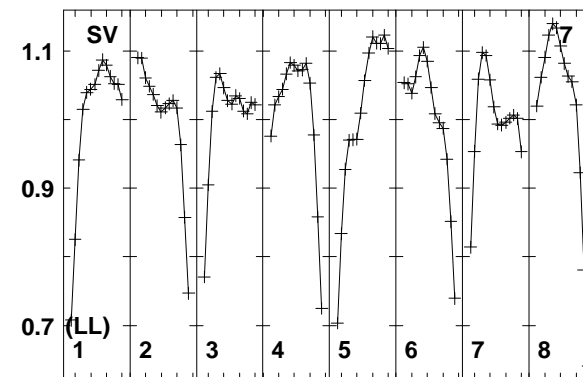
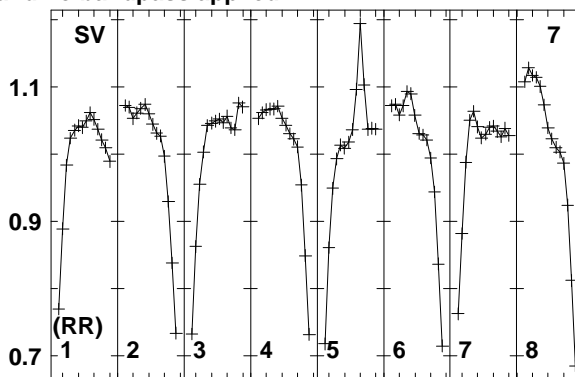
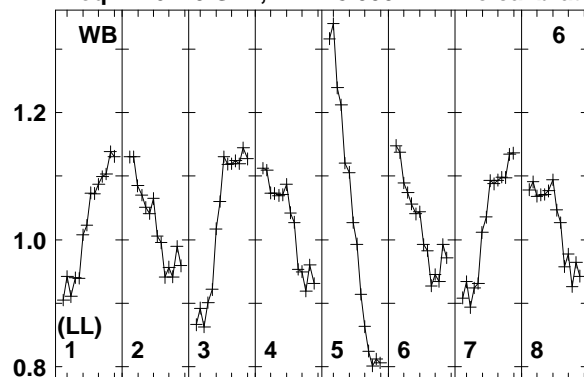

16281634164064416501656601663672678682688
FREQ MHz

Lower frame: Real Jy
Total-power spectrum Antenna: WB (06)
Timerange: 00/22:25:59 to 00/22:33:39

Plot file version 63 created 22-OCT-2014 16:25:17

J1435+3012 EC048.UVDATA.1

Freq = 1.6270 GHz, Bw = 8.000 MH No calibration applied and no bandpass applied

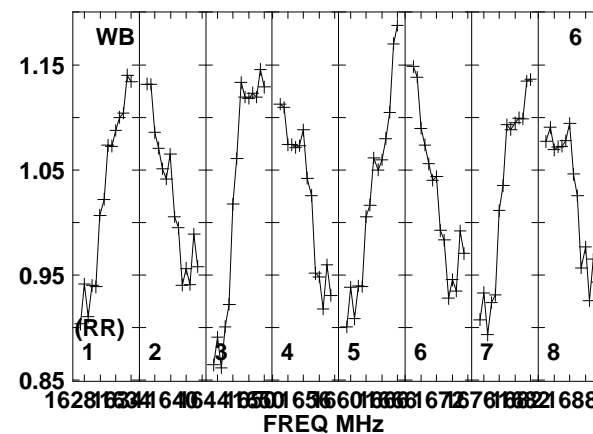
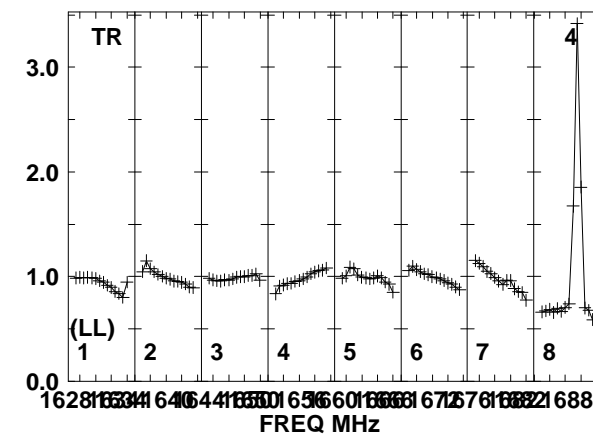
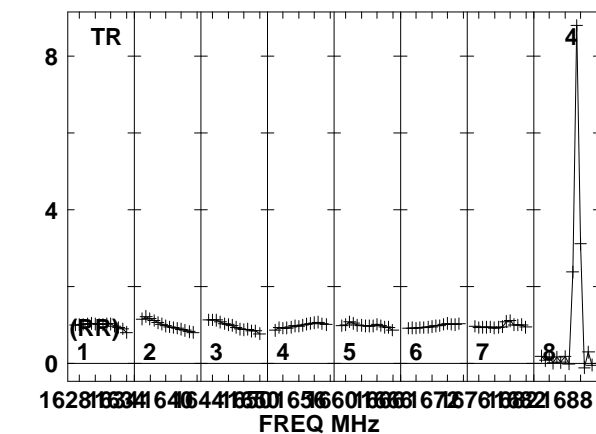
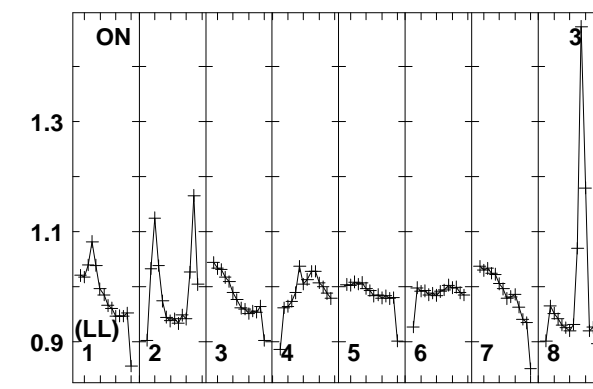
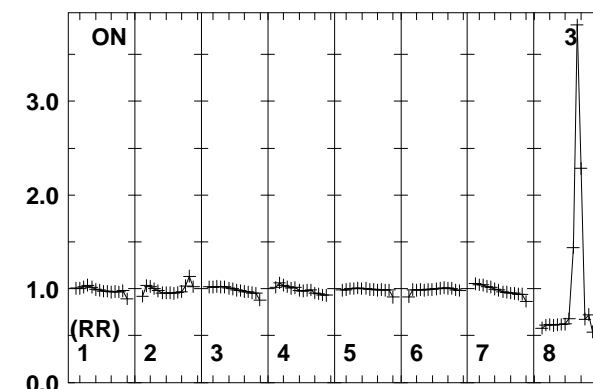
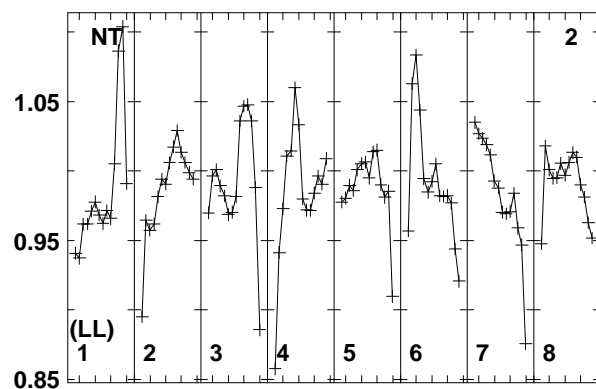
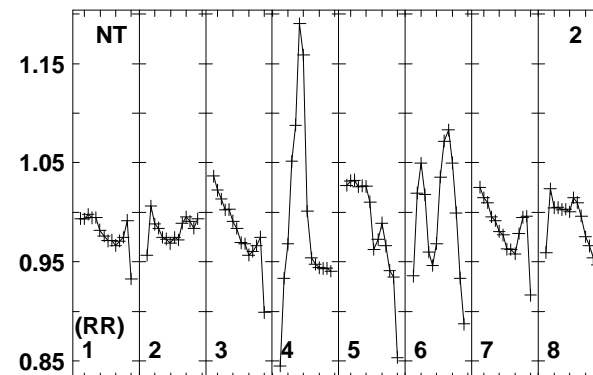
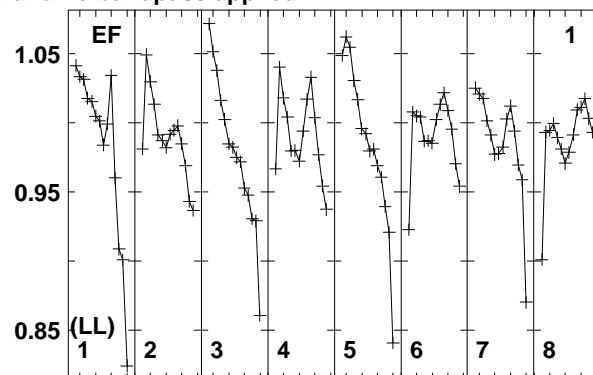
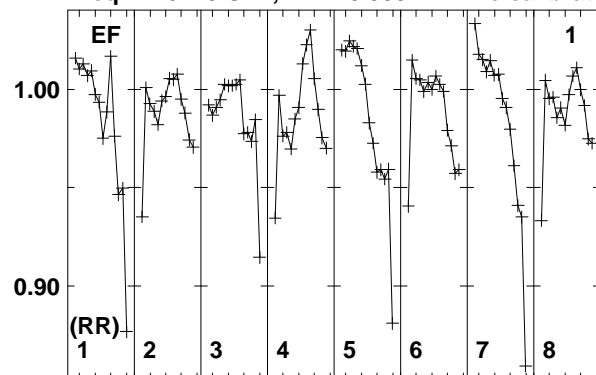

16281634164016441650165660166616727616821688
FREQ MHz
Lower frame: Real Jy
Total-power spectrum Antenna: EF (01)
Timerange: 00/22:34:23 to 00/22:36:09

Plot file version 64 created 22-OCT-2014 16:25:17

J1435+3012 EC048.UVDATA.1

Freq = 1.6270 GHz, Bw = 8.000 MH No calibration applied and no bandpass applied

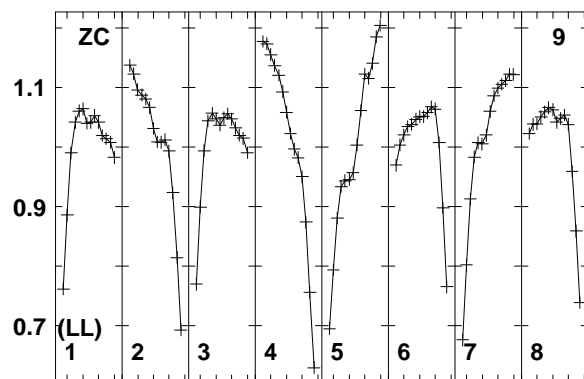
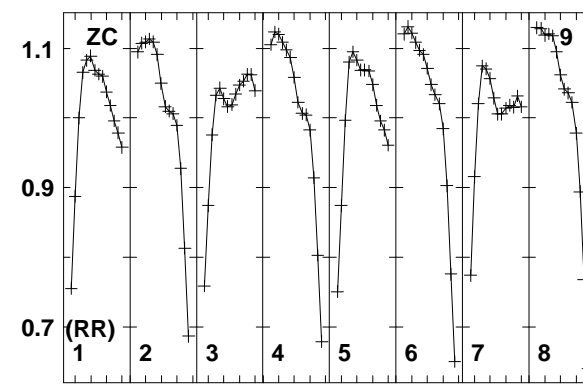
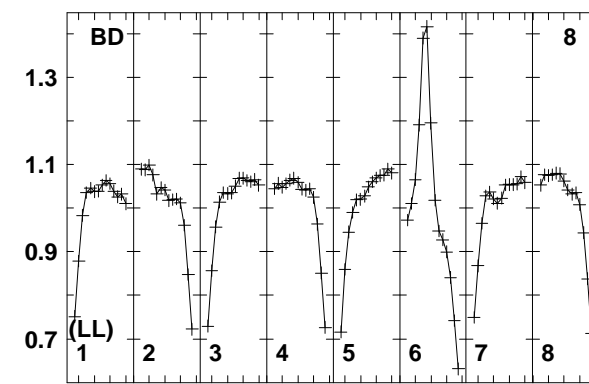
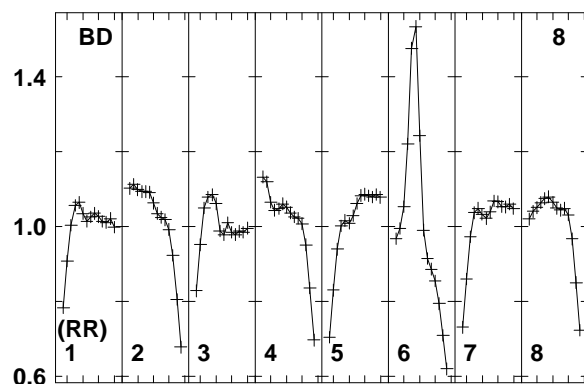
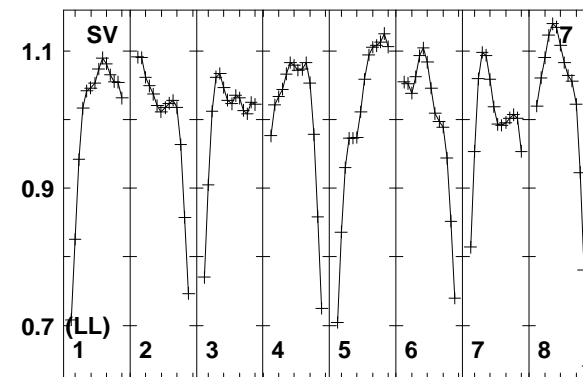
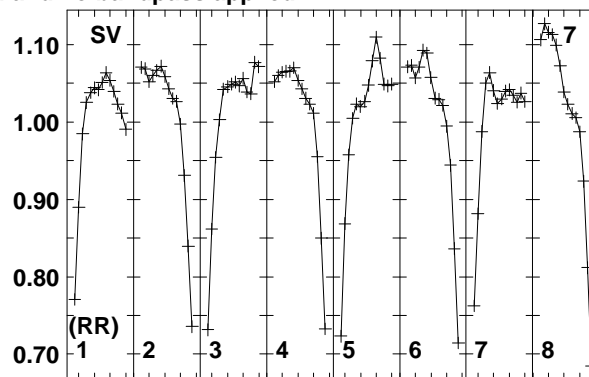
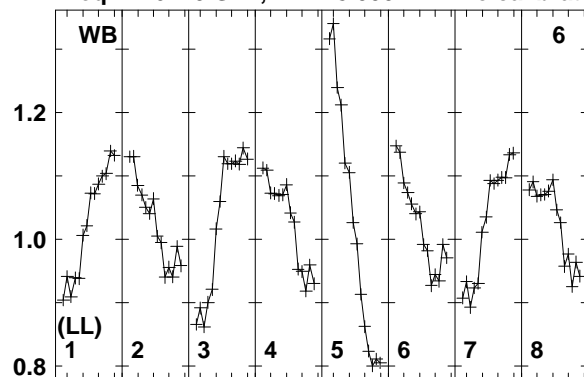

16281634164064416501656601663672678682688
FREQ MHz

Lower frame: Real Jy
Total-power spectrum Antenna: WB (06)
Timerange: 00/22:34:23 to 00/22:36:09

Plot file version 65 created 22-OCT-2014 16:25:17

J1432+3014 EC048.UVDATA.1

Freq = 1.6270 GHz, Bw = 8.000 MH No calibration applied and no bandpass applied

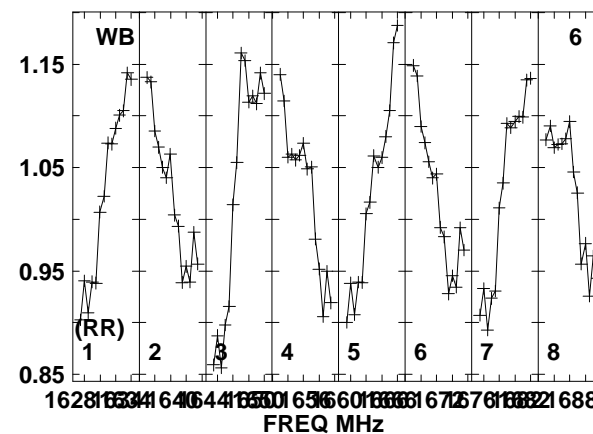
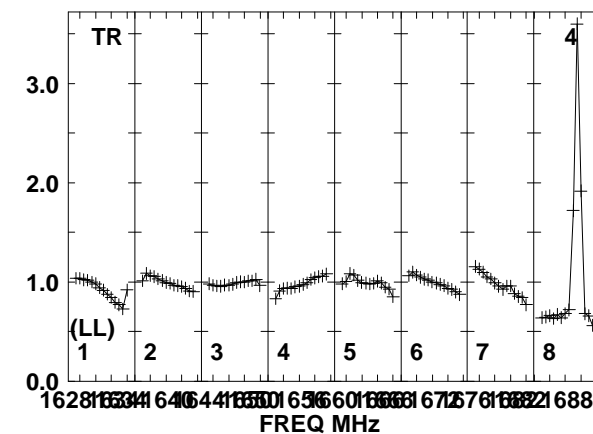
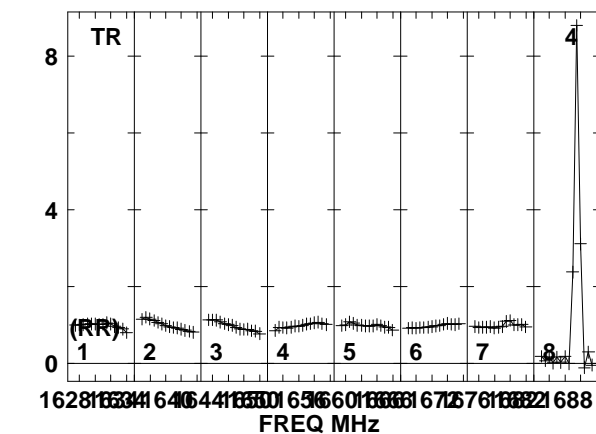
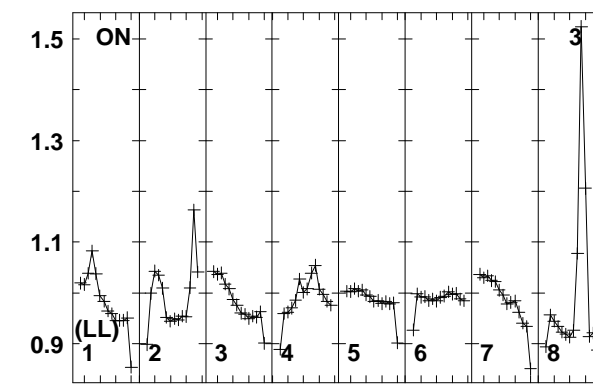
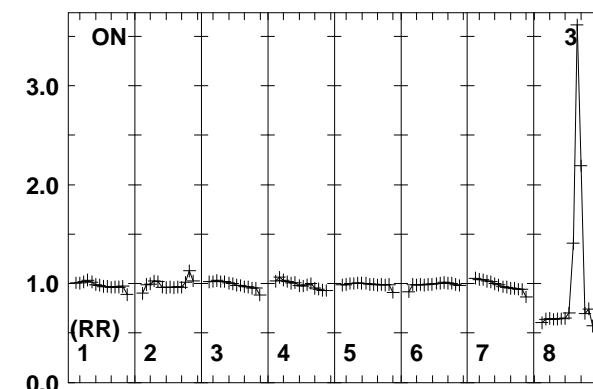
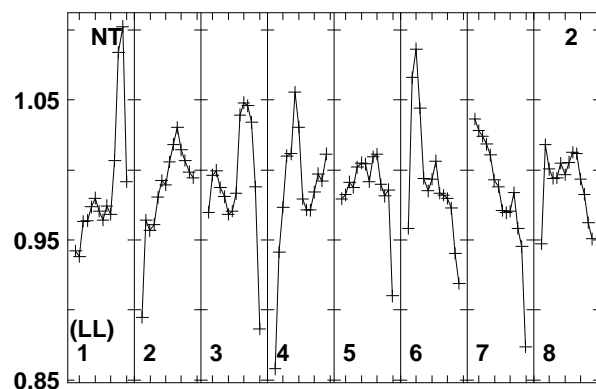
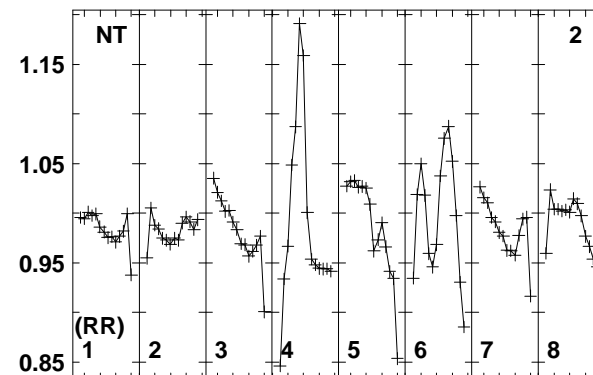
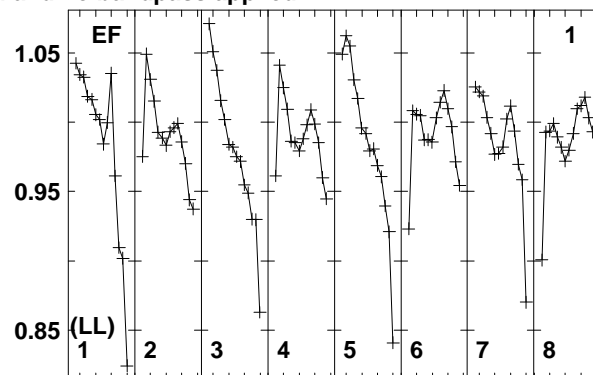
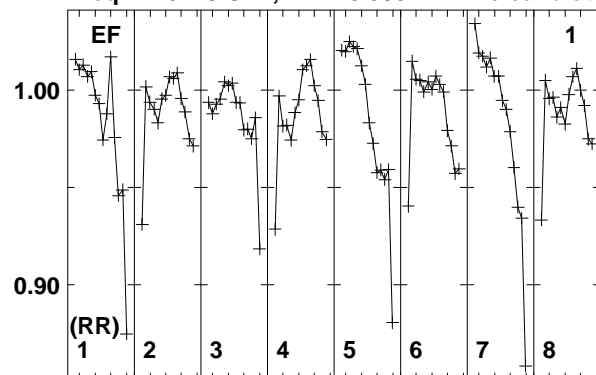

Lower frame: Real Jy
Total-power spectrum Antenna: EF (01)
Timerange: 00/22:36:14 to 00/22:43:54

Plot file version 66 created 22-OCT-2014 16:25:17

J1432+3014 EC048.UVDATA.1

Freq = 1.6270 GHz, Bw = 8.000 MH No calibration applied and no bandpass applied

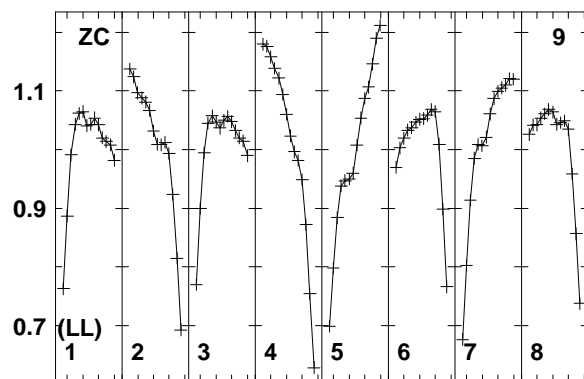
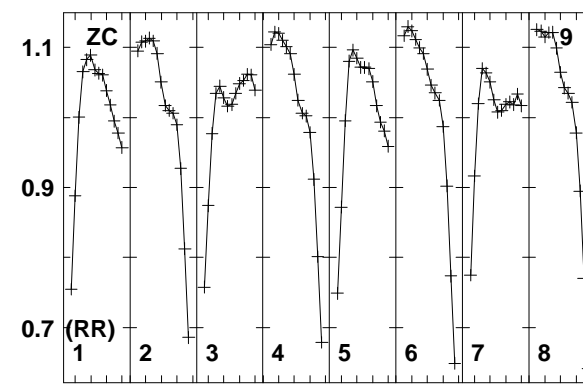
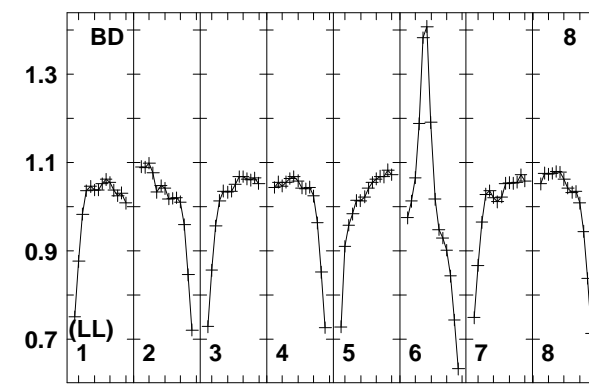
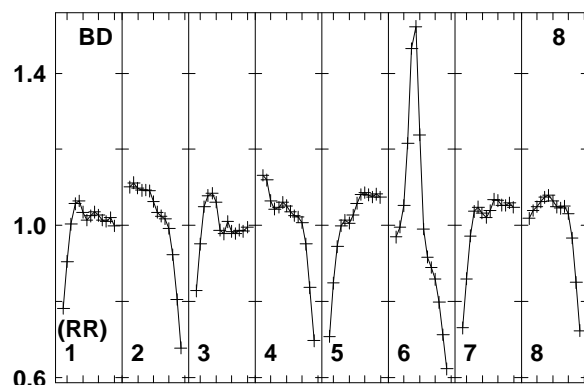
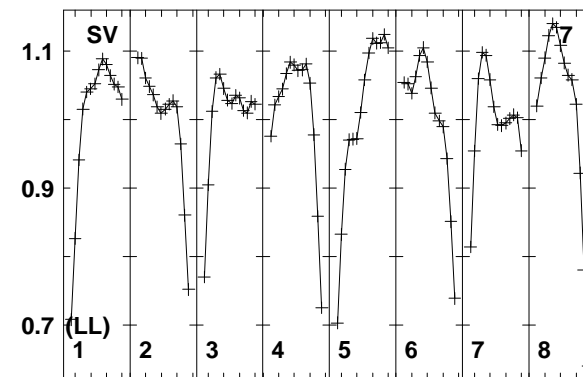
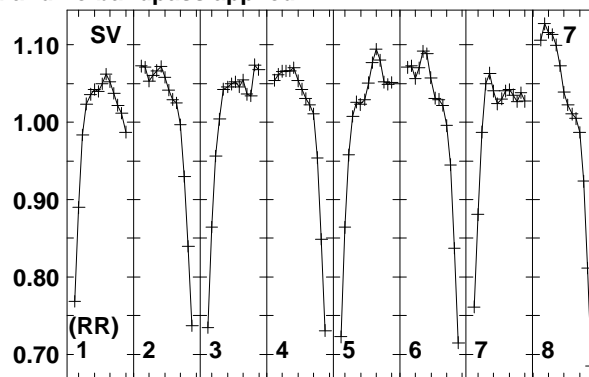
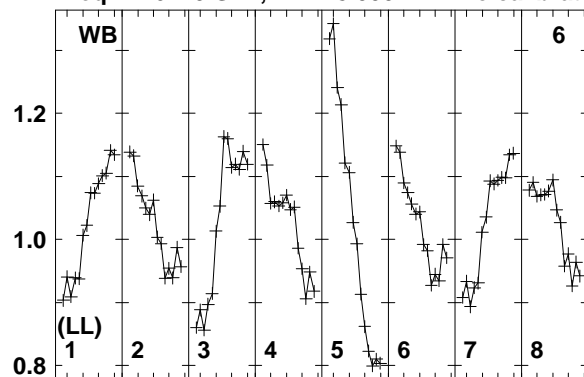

16281634164064416501656601663672678682688
FREQ MHz

Lower frame: Real Jy
Total-power spectrum Antenna: WB (06)
Timerange: 00/22:36:14 to 00/22:43:54

Plot file version 67 created 22-OCT-2014 16:25:17

J1435+3012 EC048.UVDATA.1

Freq = 1.6270 GHz, Bw = 8.000 MH No calibration applied and no bandpass applied

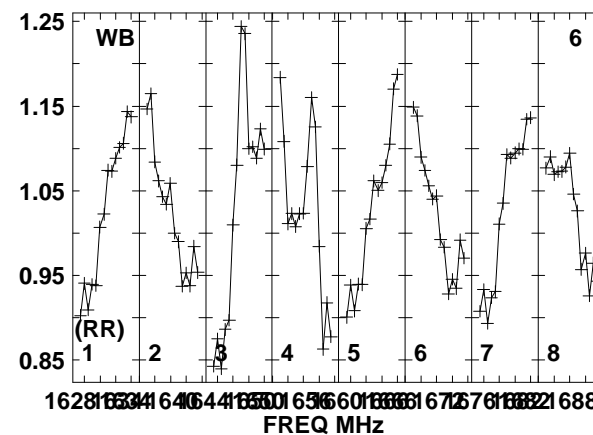
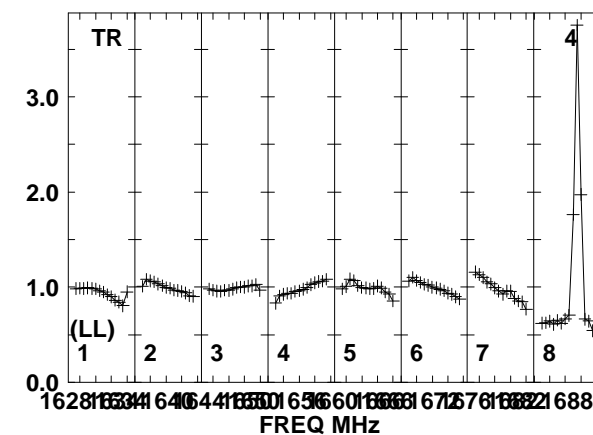
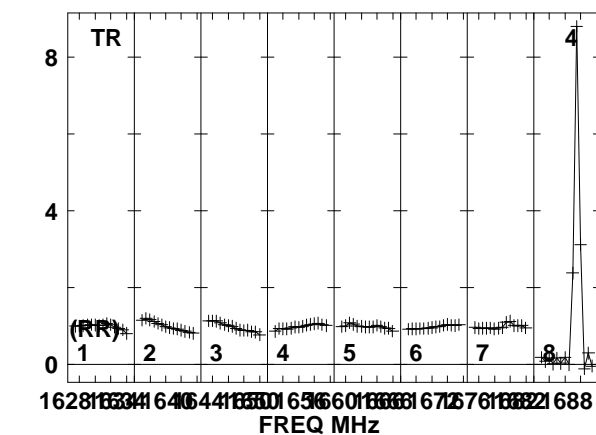
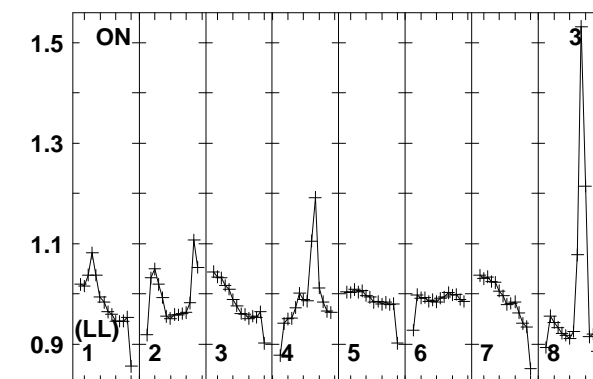
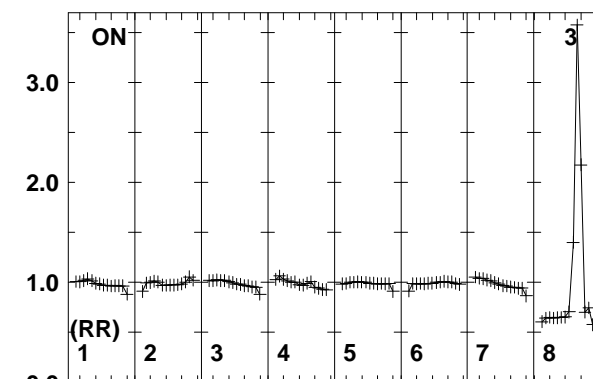
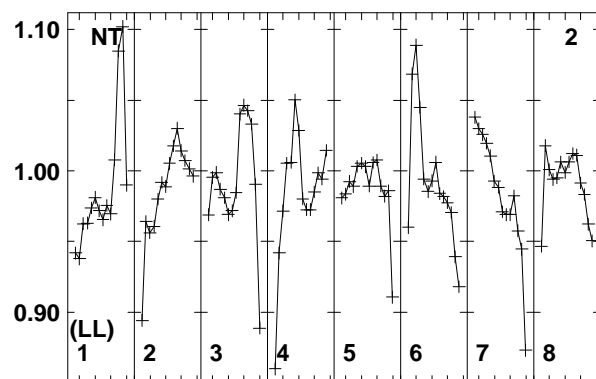
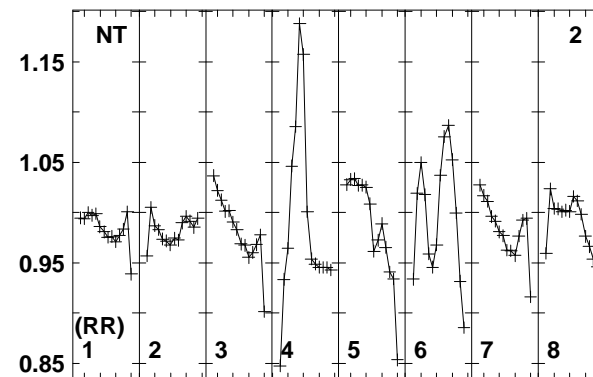
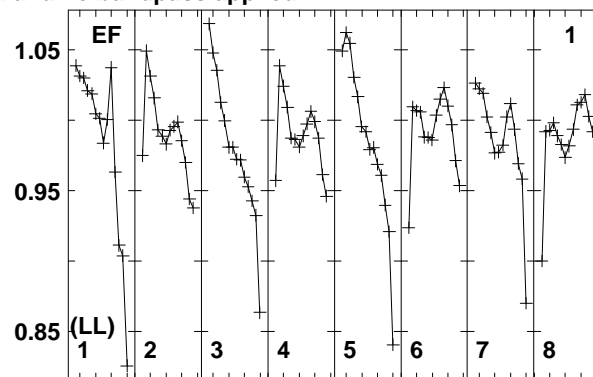
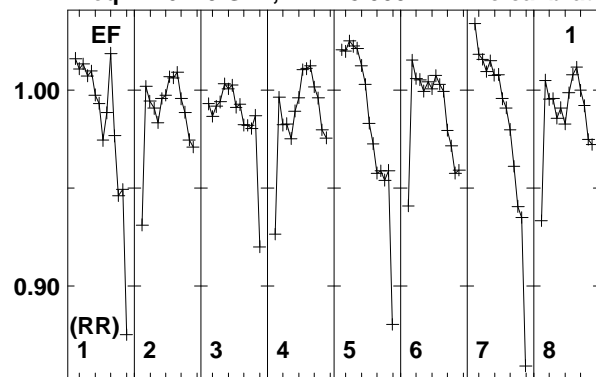

Lower frame: Real Jy
Total-power spectrum Antenna: EF (01)
Timerange: 00/22:44:38 to 00/22:46:24

Plot file version 68 created 22-OCT-2014 16:25:17

J1435+3012 EC048.UVDATA.1

Freq = 1.6270 GHz, Bw = 8.000 MH No calibration applied and no bandpass applied

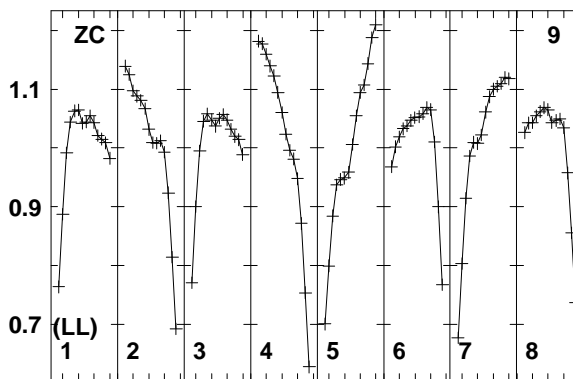
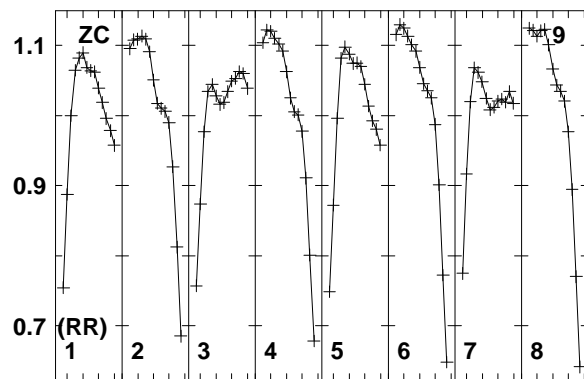
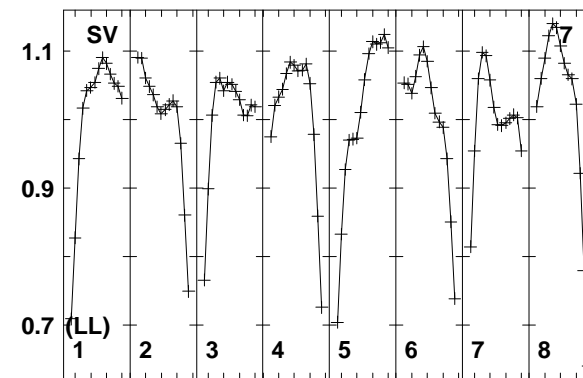
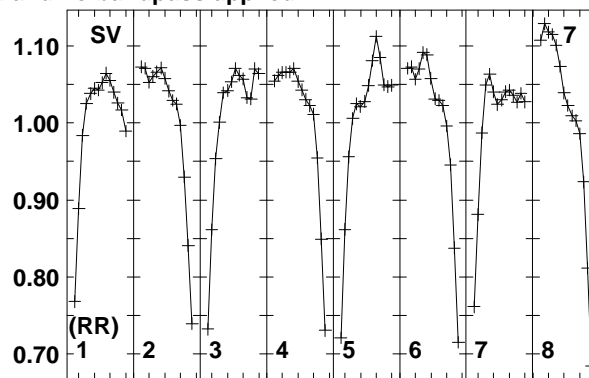
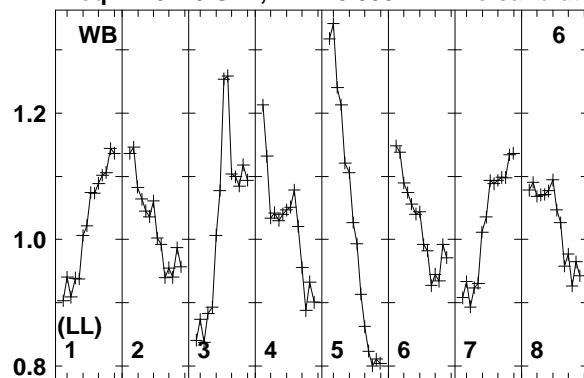

Lower frame: Real Jy
Total-power spectrum Antenna: WB (06)
Timerange: 00/22:44:38 to 00/22:46:24

Plot file version 69 created 22-OCT-2014 16:25:17

J1635+3808 EC048.UVDATA.1

Freq = 1.6270 GHz, Bw = 8.000 MH No calibration applied and no bandpass applied

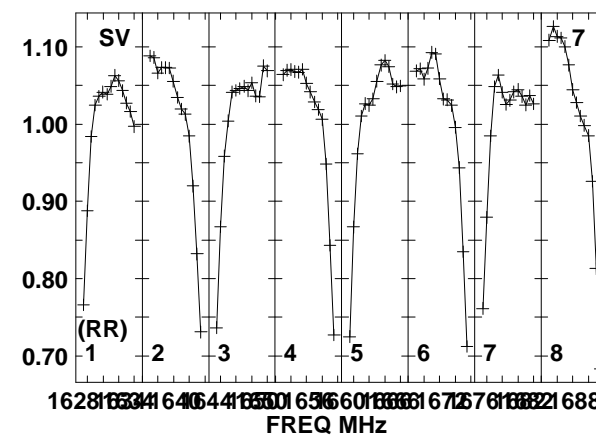
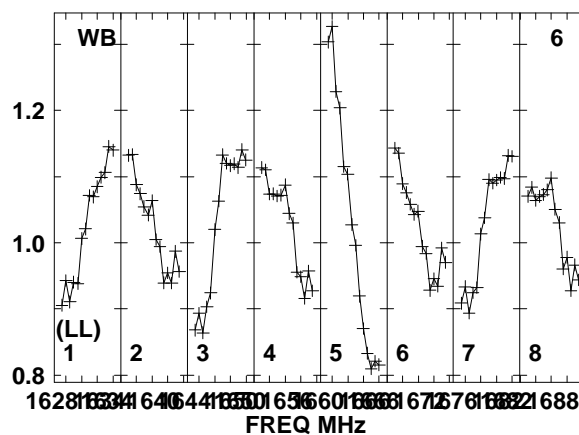
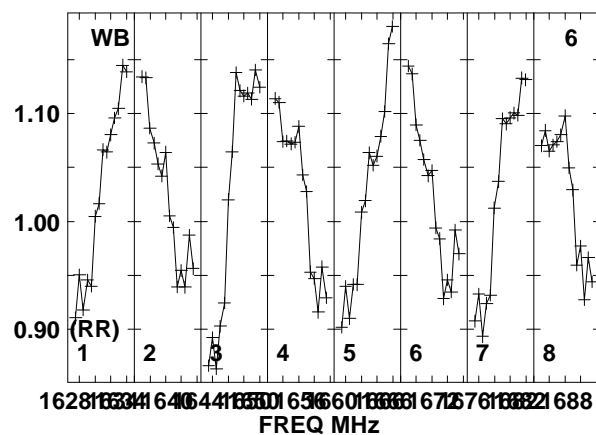
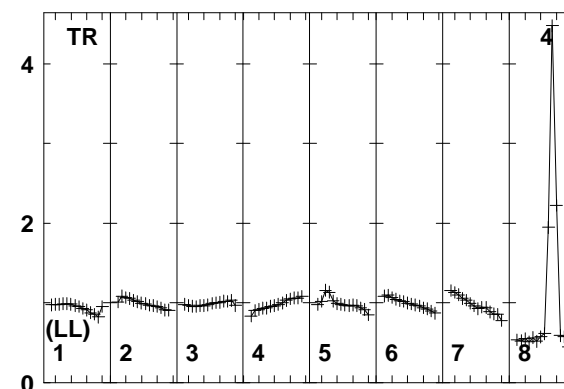
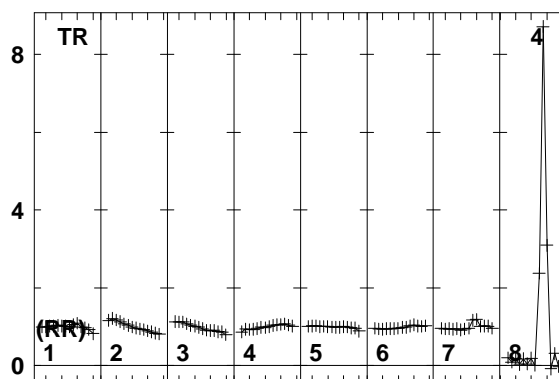
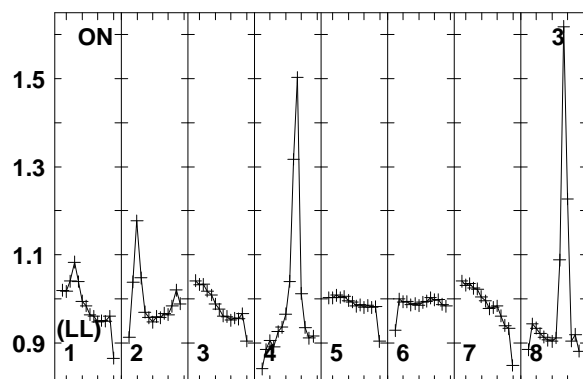
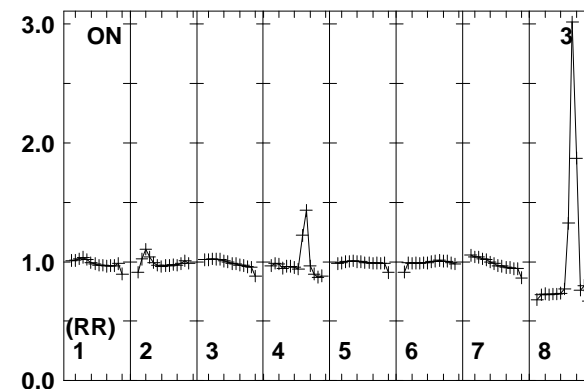
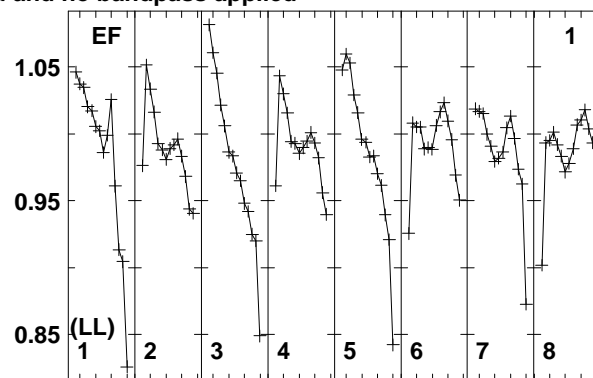
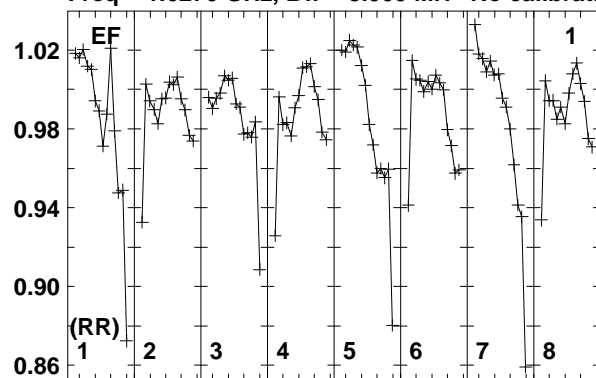

1628 1634 1640 1644 1650 1656 1660 1666 1672 1676 1682 1688
FREQ MHz

1628 1634 1640 1644 1650 1656 1660 1666 1672 1676 1682 1688
FREQ MHz

1628 1634 1640 1644 1650 1656 1660 1666 1672 1676 1682 1688
FREQ MHz

Lower frame: Real Jy
Total-power spectrum Antenna: EF (01)
Timerange: 00/22:50:13 to 00/22:52:09

Plot file version 70 created 22-OCT-2014 16:25:17

J1635+3808 EC048.UVDATA.1

Freq = 1.6270 GHz, Bw = 8.000 MH No calibration applied and no bandpass applied

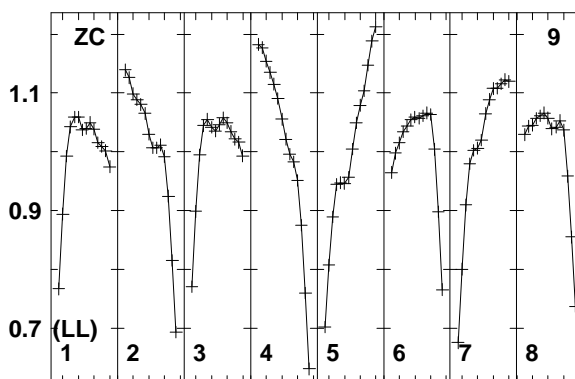
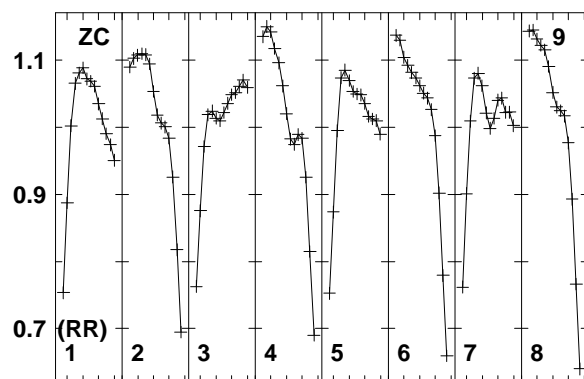
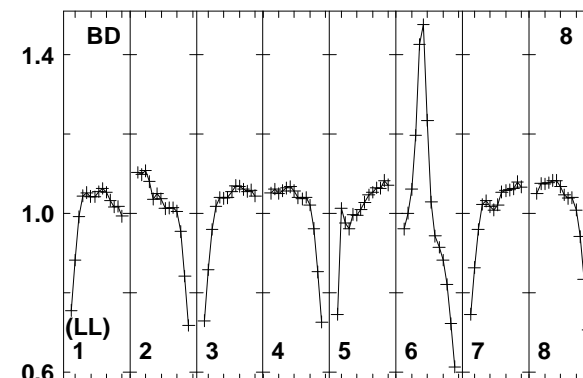
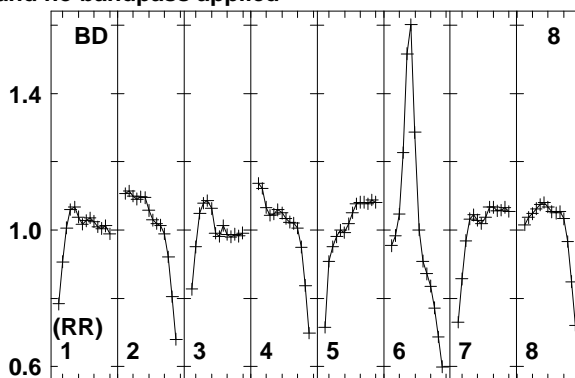
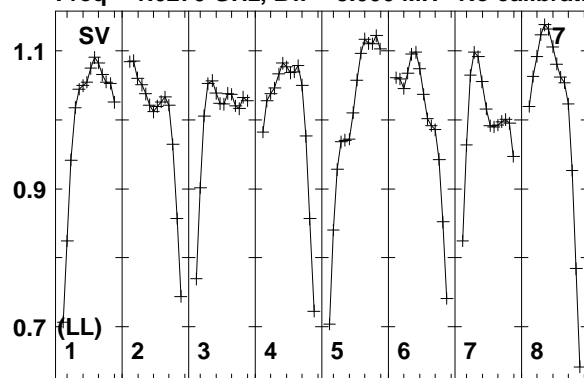

Lower frame: Real Jy
Total-power spectrum Antenna: SV (07)
Timerange: 00/22:50:13 to 00/22:52:09

Plot file version 71 created 22-OCT-2014 16:25:17

J1432+3014 EC048.UVDATA.1

Freq = 1.6270 GHz, Bw = 8.000 MH No calibration applied and no bandpass applied

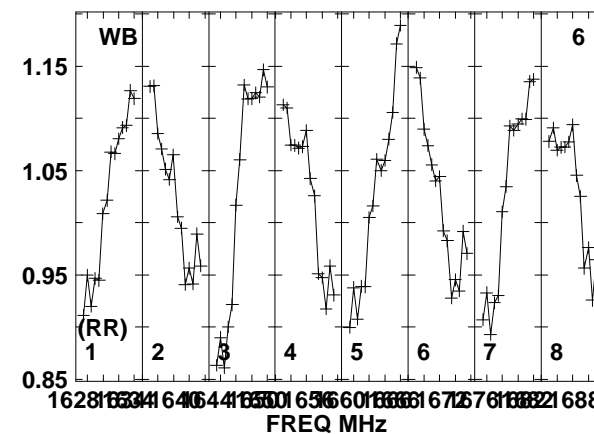
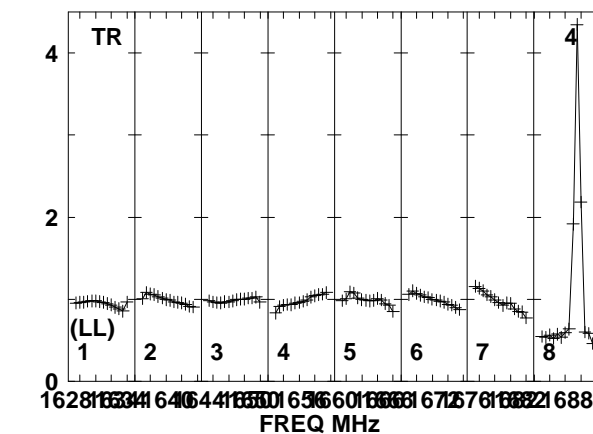
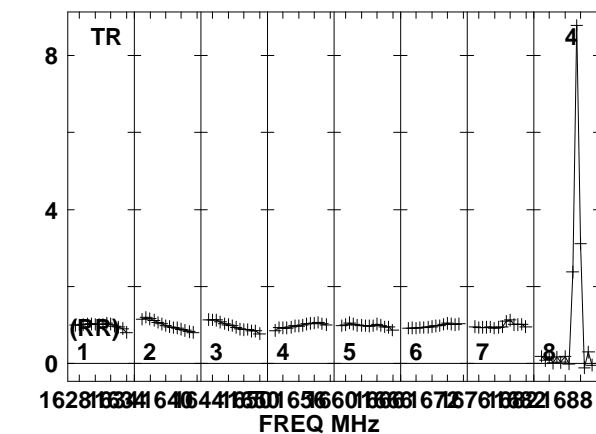
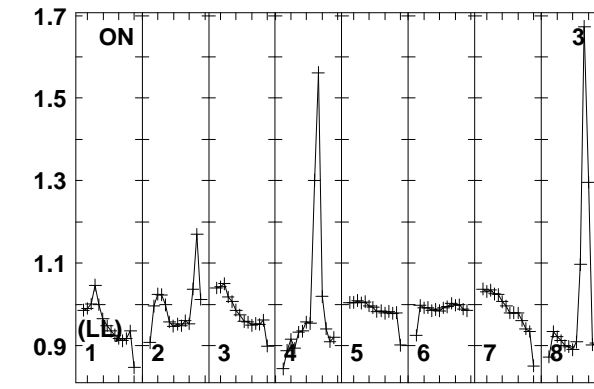
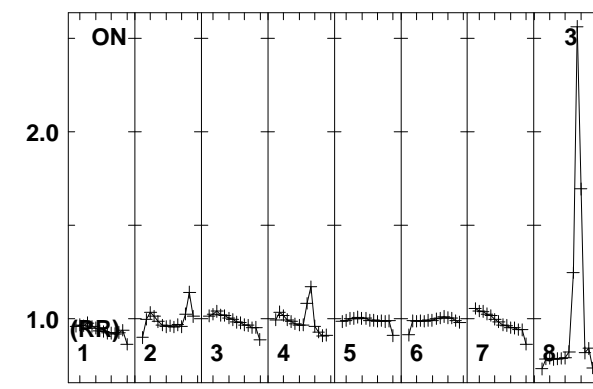
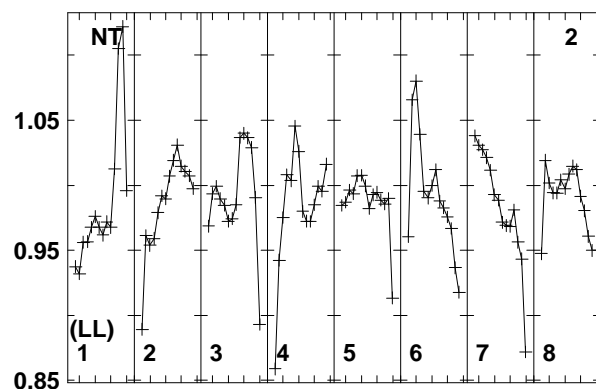
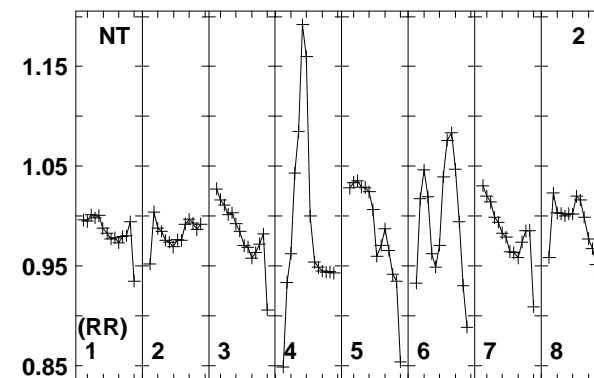
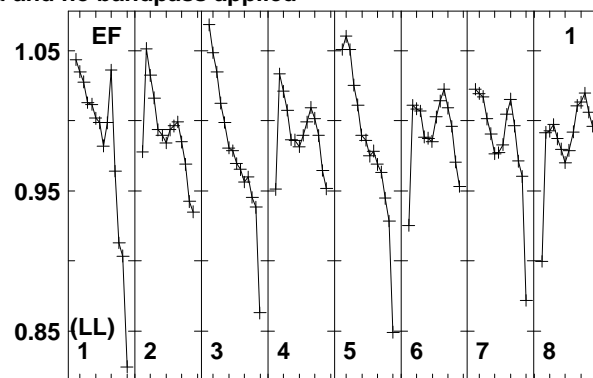
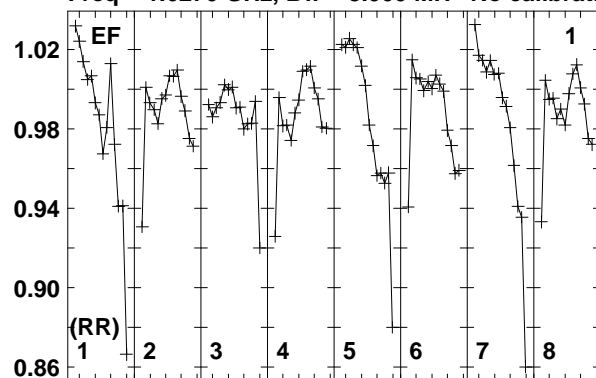

Lower frame: Real Jy
Total-power spectrum Antenna: EF (01)
Timerange: 00/22:52:13 to 00/22:59:53

Plot file version 72 created 22-OCT-2014 16:25:17

J1432+3014 EC048.UVDATA.1

Freq = 1.6270 GHz, Bw = 8.000 MH No calibration applied and no bandpass applied

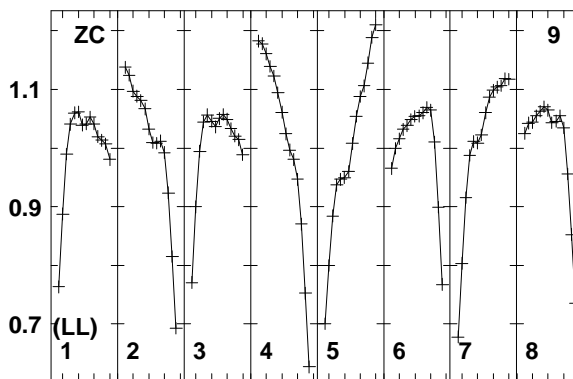
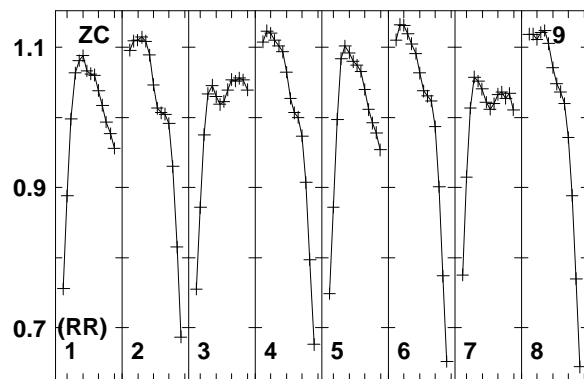
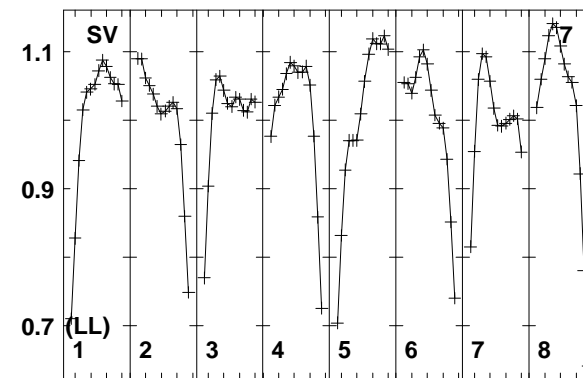
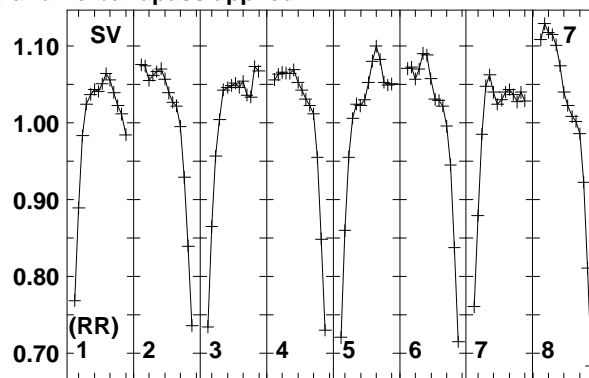
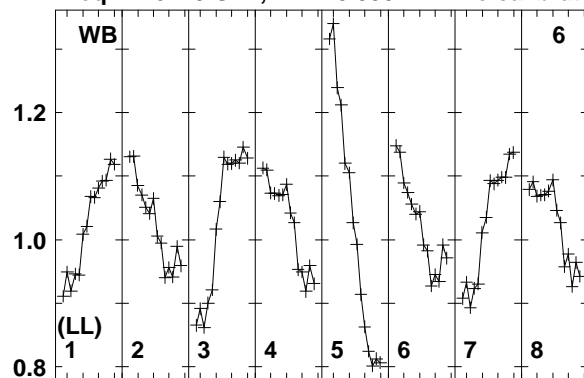

Lower frame: Real Jy
Total-power spectrum Antenna: WB (06)
Timerange: 00/22:52:13 to 00/22:59:53

Plot file version 73 created 22-OCT-2014 16:25:17

J1435+3012 EC048.UVDATA.1

Freq = 1.6270 GHz, Bw = 8.000 MH No calibration applied and no bandpass applied

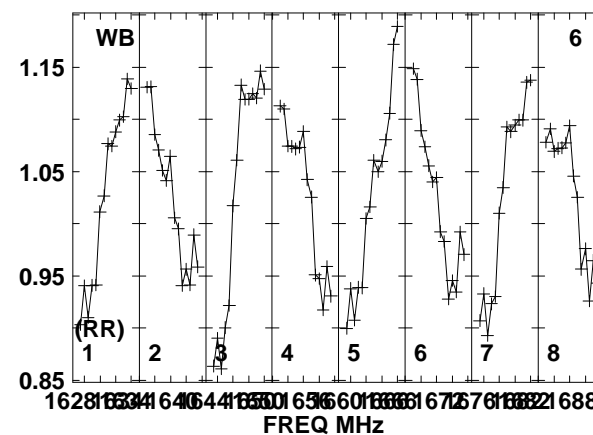
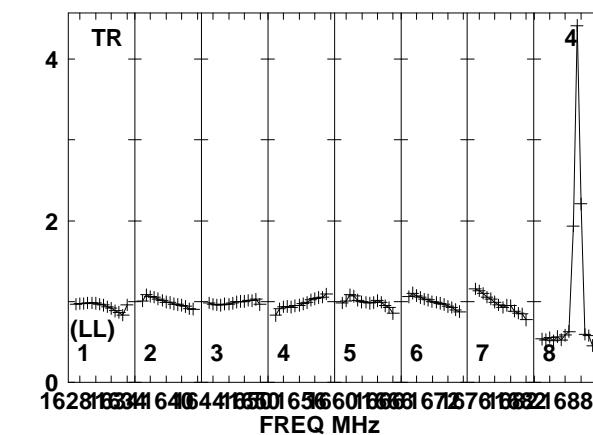
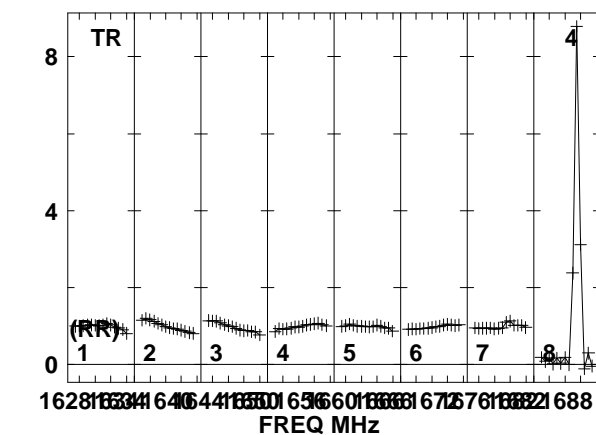
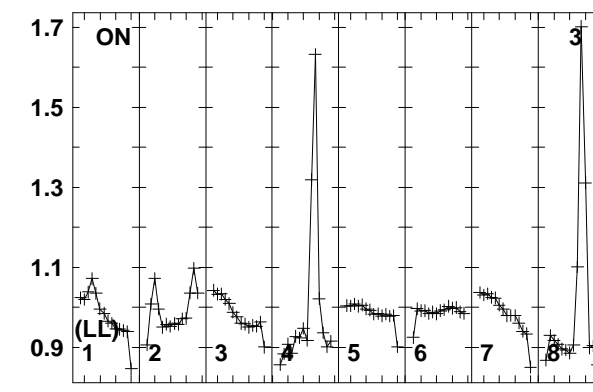
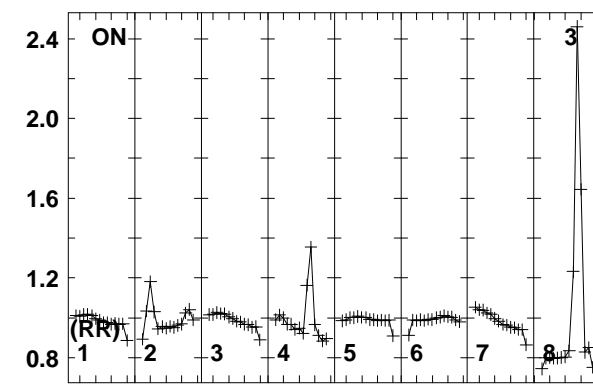
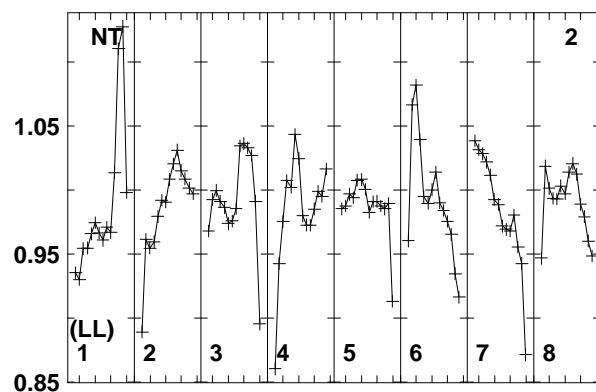
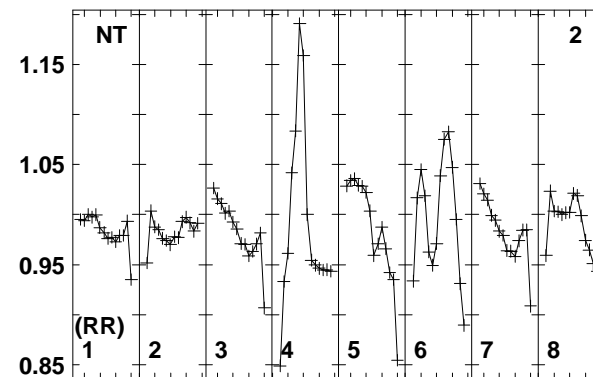
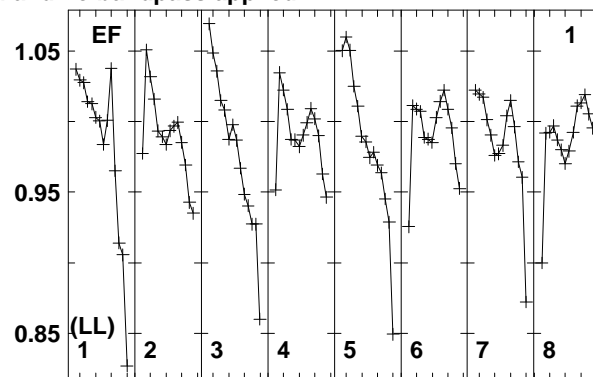
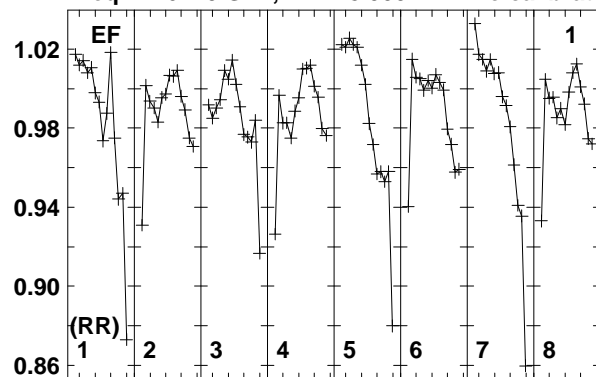

Lower frame: Real Jy
Total-power spectrum Antenna: EF (01)
Timerange: 00/23:00:38 to 00/23:02:24

Plot file version 74 created 22-OCT-2014 16:25:17

J1435+3012 EC048.UVDATA.1

Freq = 1.6270 GHz, Bw = 8.000 MH No calibration applied and no bandpass applied

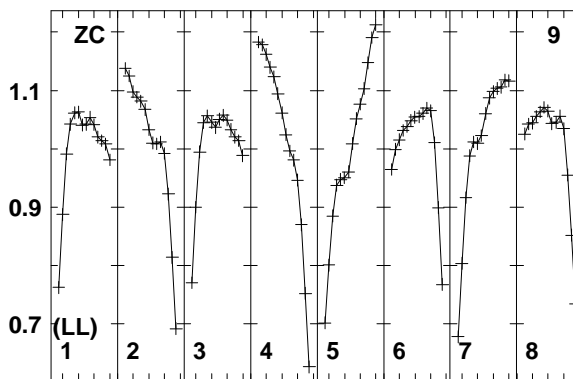
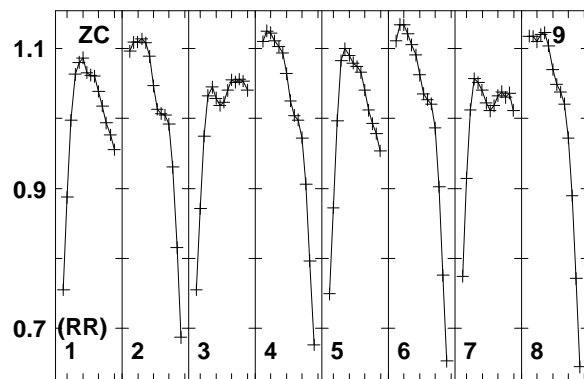
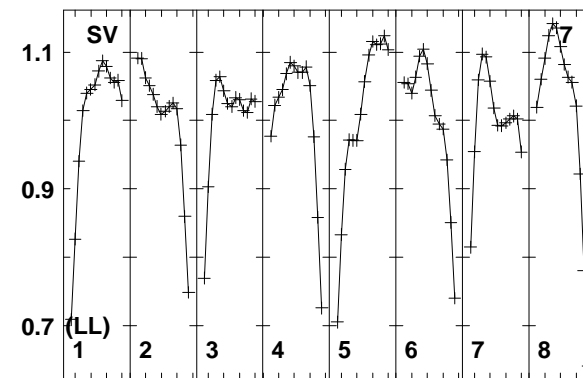
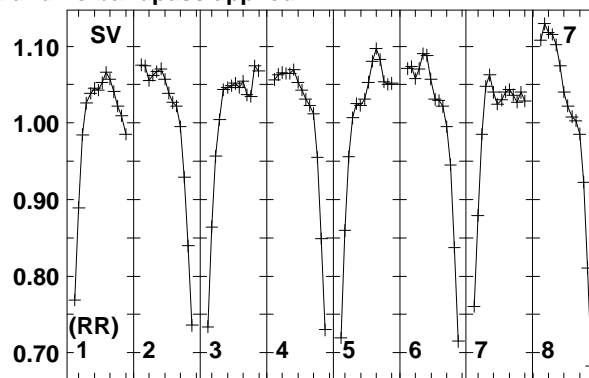
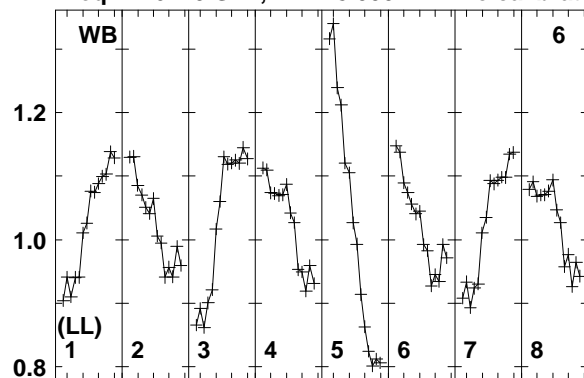

Lower frame: Real Jy
Total-power spectrum Antenna: WB (06)
Timerange: 00/23:00:38 to 00/23:02:24

Plot file version 75 created 22-OCT-2014 16:25:17

J1432+3014 EC048.UVDATA.1

Freq = 1.6270 GHz, Bw = 8.000 MH No calibration applied and no bandpass applied

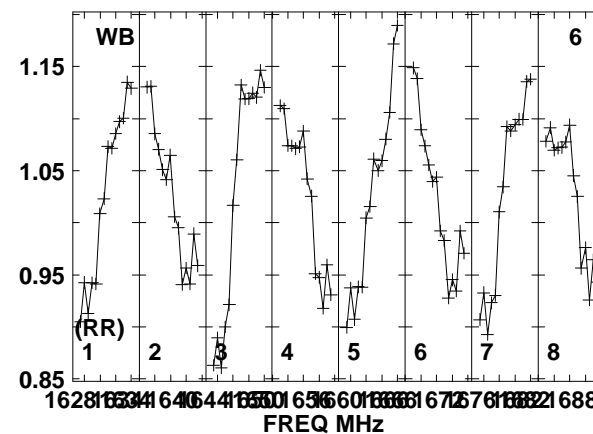
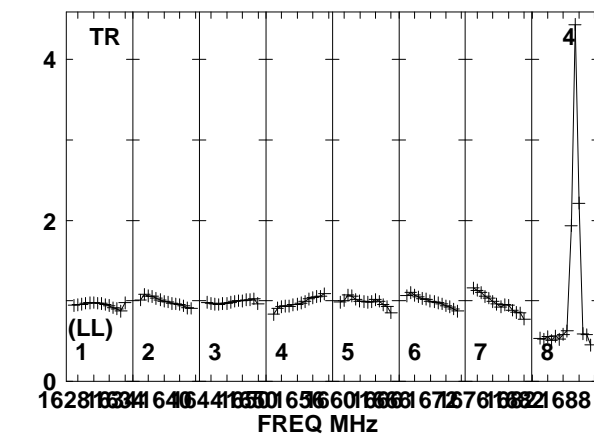
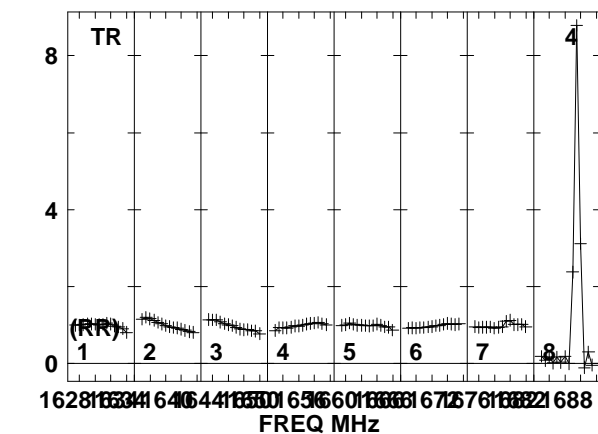
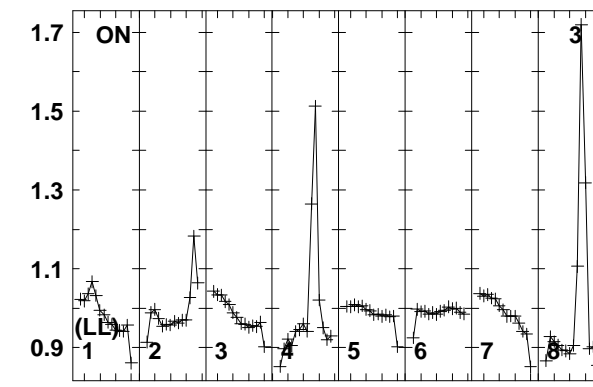
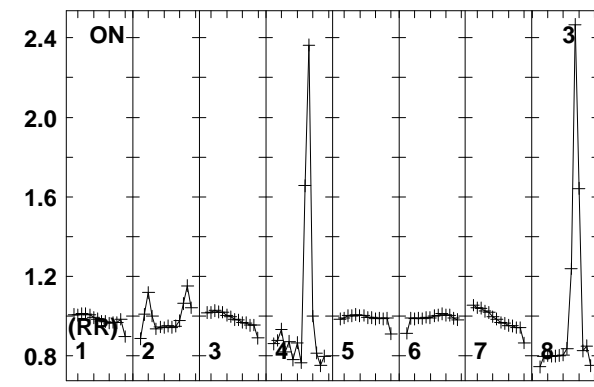
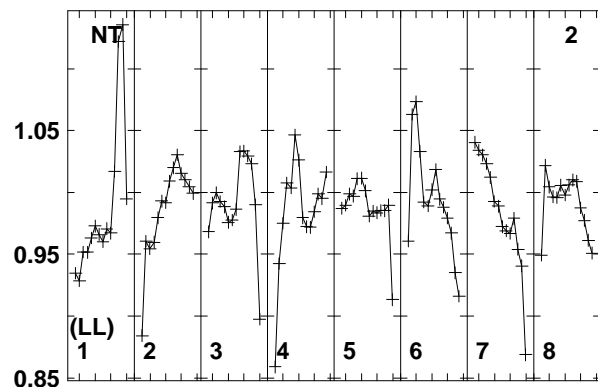
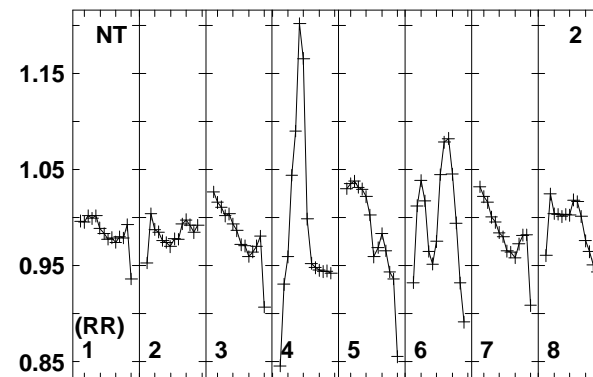
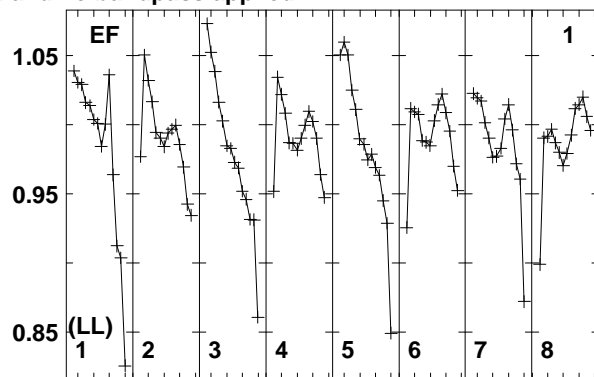
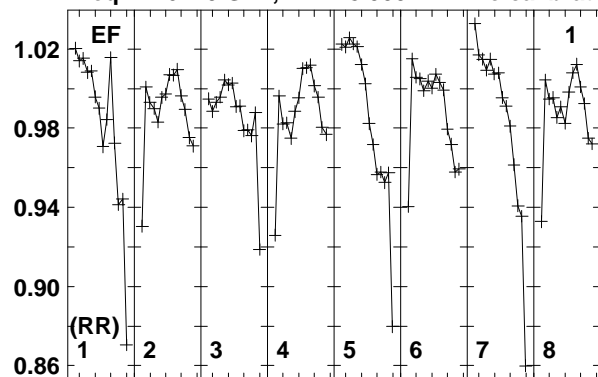

Lower frame: Real Jy
Total-power spectrum Antenna: EF (01)
Timerange: 00/23:02:29 to 00/23:10:09

Plot file version 76 created 22-OCT-2014 16:25:17

J1432+3014 EC048.UVDATA.1

Freq = 1.6270 GHz, Bw = 8.000 MH No calibration applied and no bandpass applied

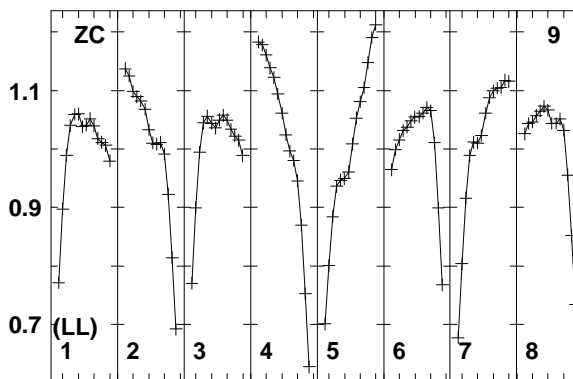
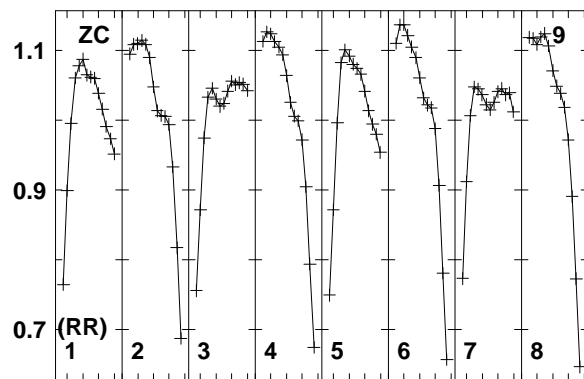
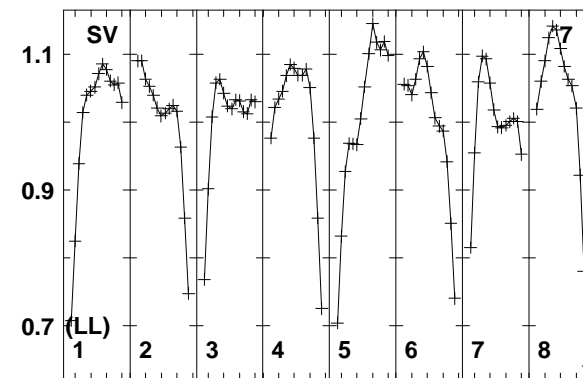
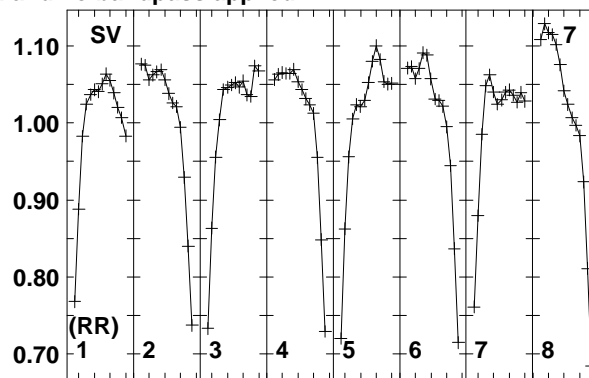
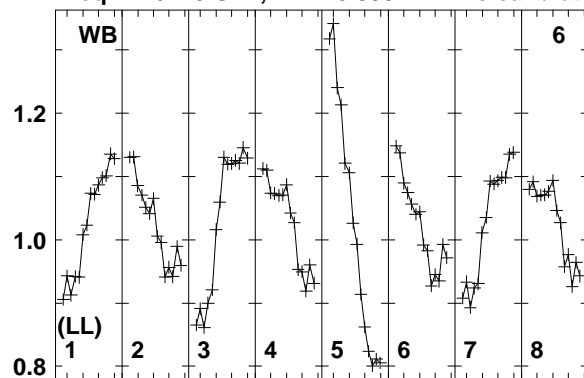

Lower frame: Real Jy
Total-power spectrum Antenna: WB (06)
Timerange: 00/23:02:29 to 00/23:10:09

Plot file version 77 created 22-OCT-2014 16:25:17

J1435+3012 EC048.UVDATA.1

Freq = 1.6270 GHz, Bw = 8.000 MH No calibration applied and no bandpass applied

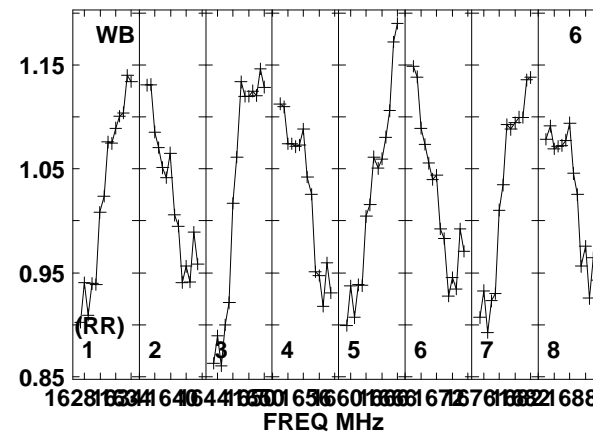
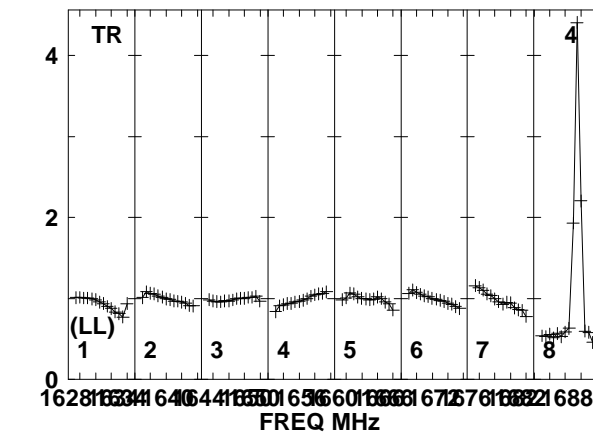
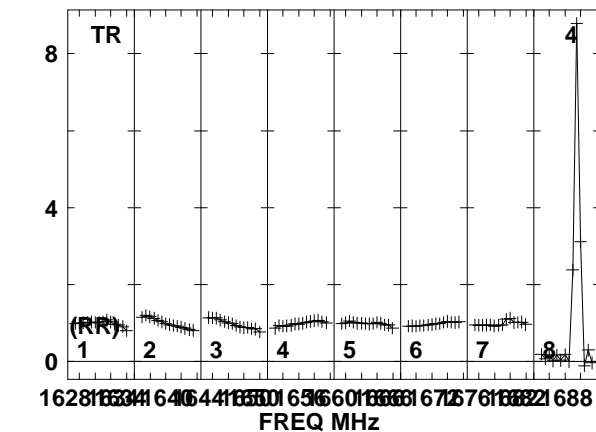
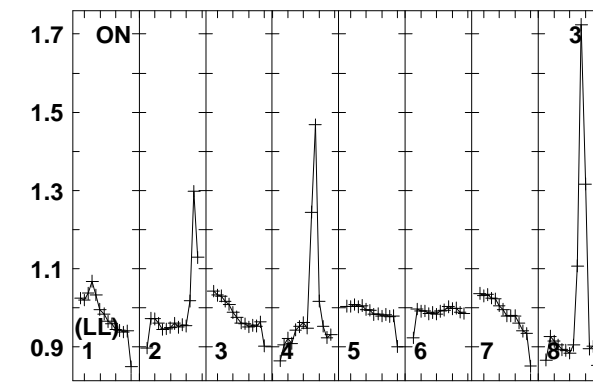
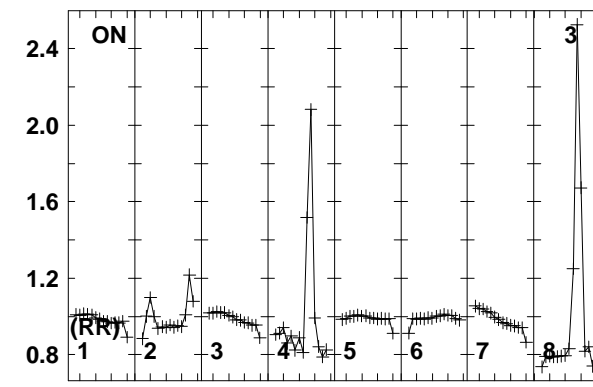
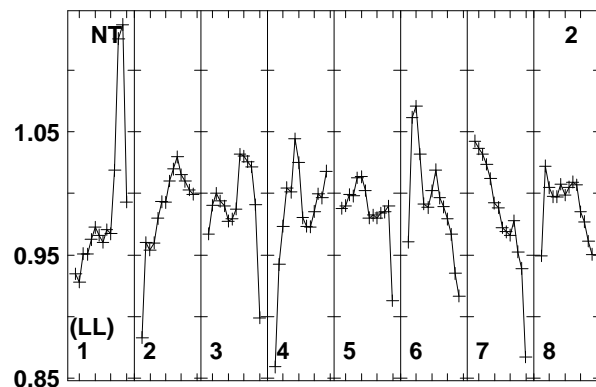
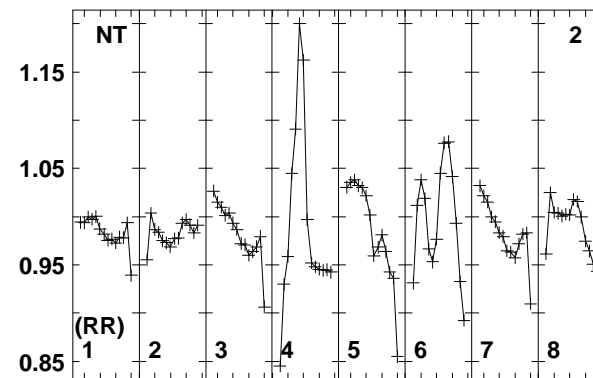
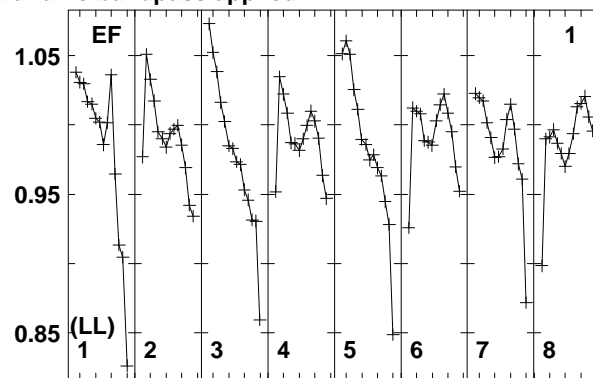
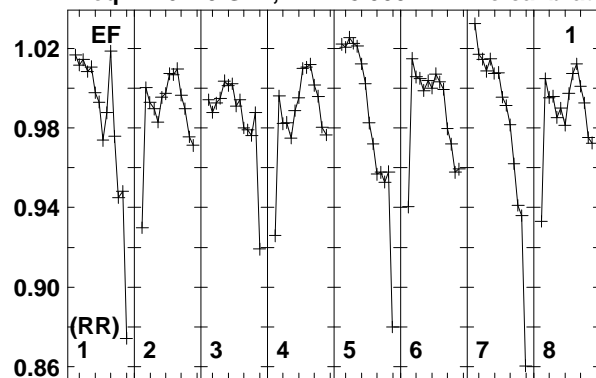

Lower frame: Real Jy
Total-power spectrum Antenna: EF (01)
Timerange: 00/23:10:53 to 00/23:12:39

Plot file version 78 created 22-OCT-2014 16:25:17

J1435+3012 EC048.UVDATA.1

Freq = 1.6270 GHz, Bw = 8.000 MH No calibration applied and no bandpass applied

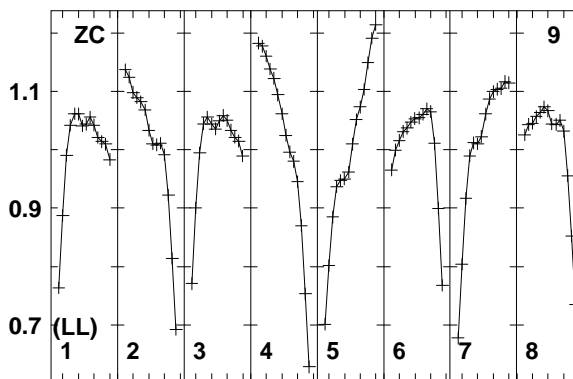
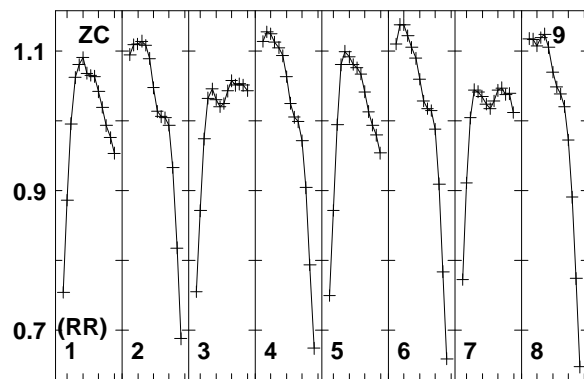
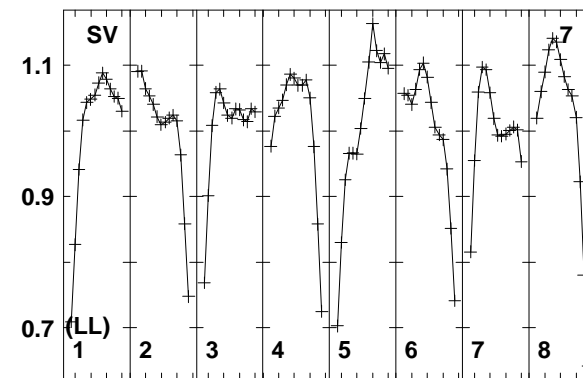
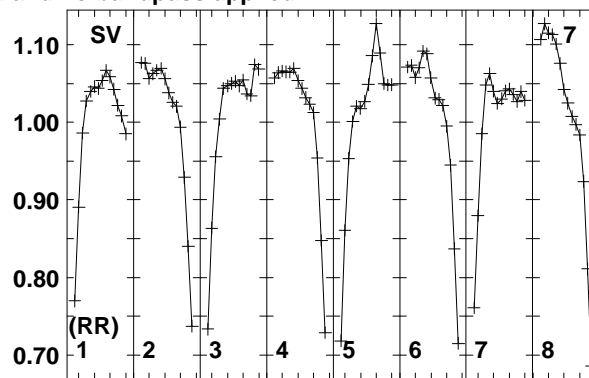
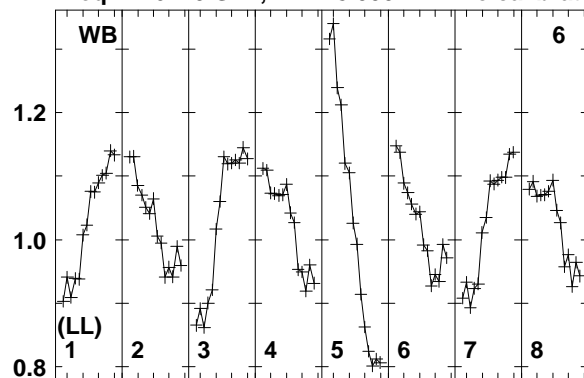

Lower frame: Real Jy
Total-power spectrum Antenna: WB (06)
Timerange: 00/23:10:53 to 00/23:12:39

Plot file version 79 created 22-OCT-2014 16:25:17

J1432+3014 EC048.UVDATA.1

Freq = 1.6270 GHz, Bw = 8.000 MH No calibration applied and no bandpass applied

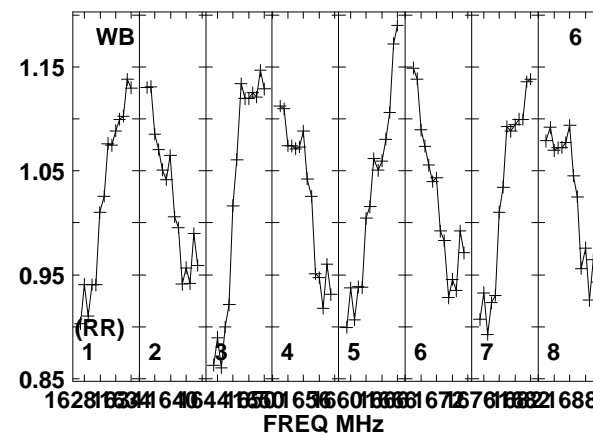
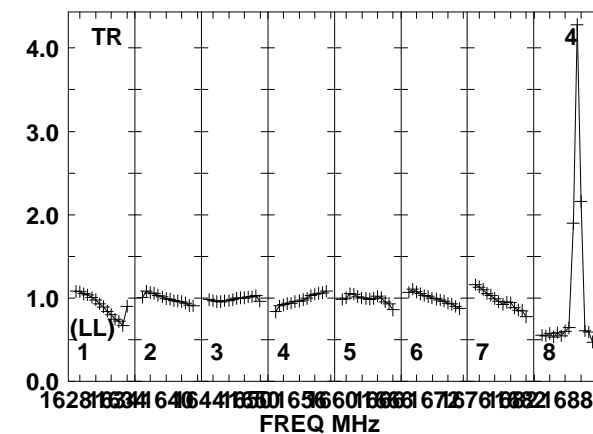
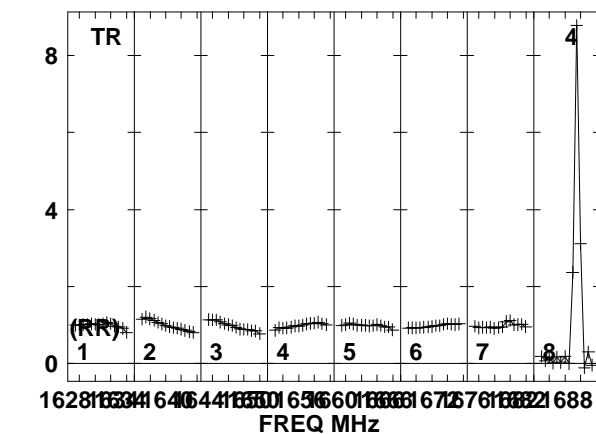
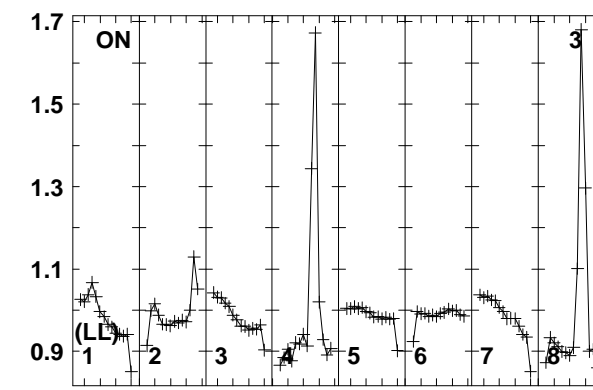
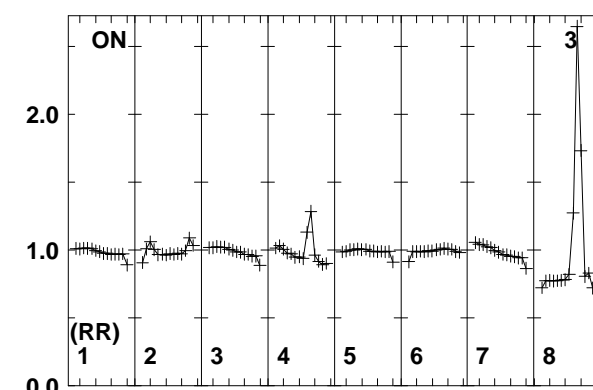
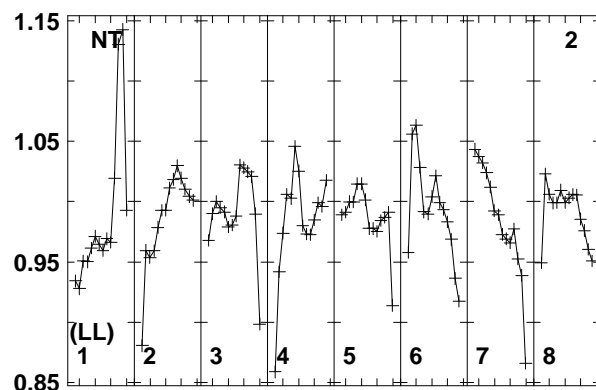
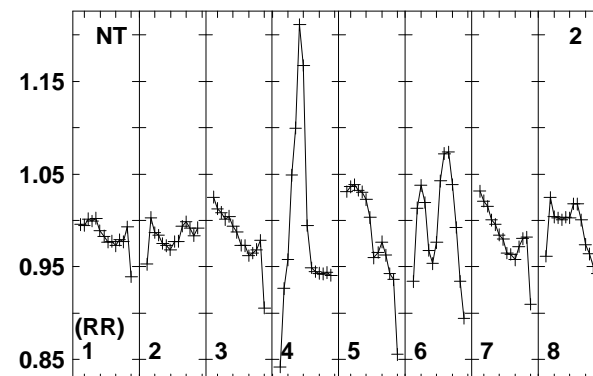
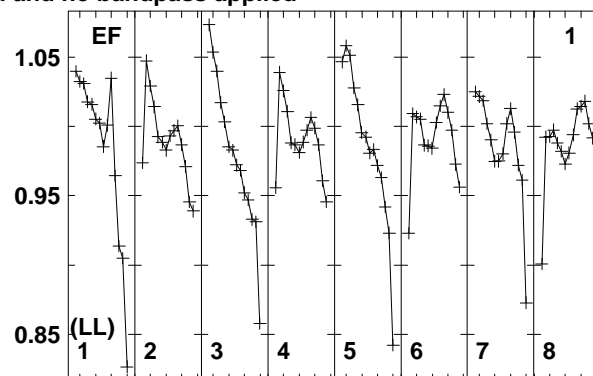
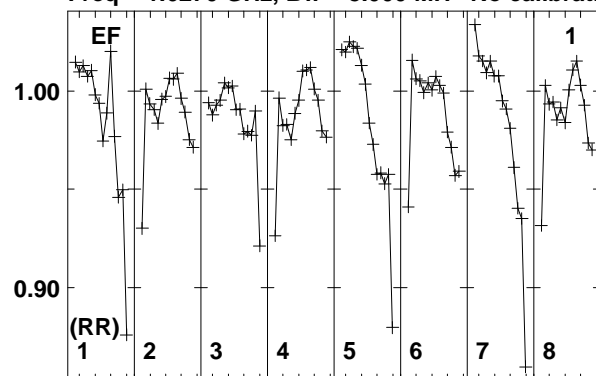

Lower frame: Real Jy
Total-power spectrum Antenna: EF (01)
Timerange: 00/23:12:44 to 00/23:20:24

Plot file version 80 created 22-OCT-2014 16:25:17

J1432+3014 EC048.UVDATA.1

Freq = 1.6270 GHz, Bw = 8.000 MH No calibration applied and no bandpass applied

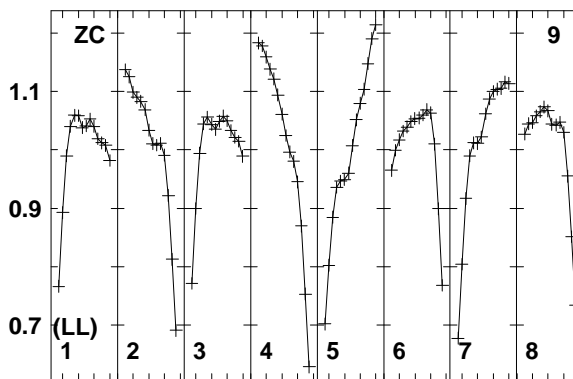
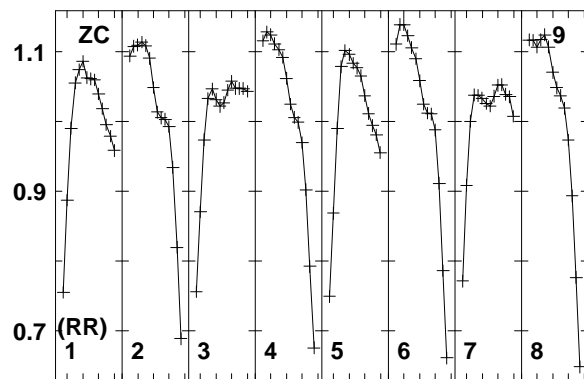
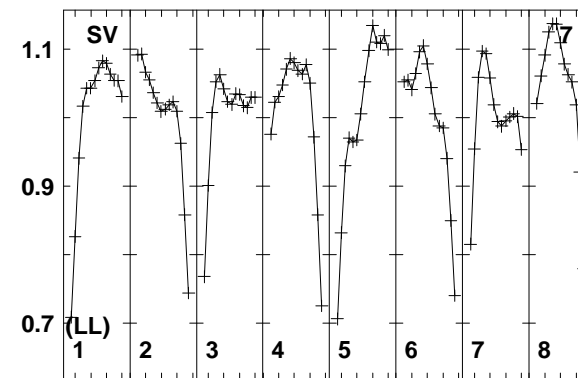
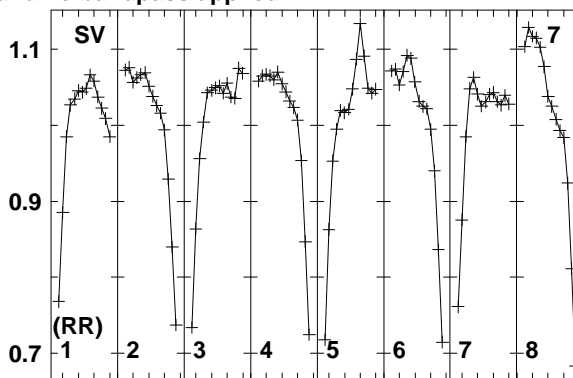
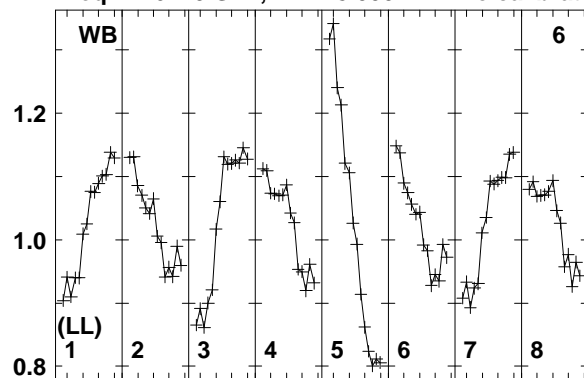

Lower frame: Real Jy
Total-power spectrum Antenna: WB (06)
Timerange: 00/23:12:44 to 00/23:20:24

Plot file version 81 created 22-OCT-2014 16:25:17

J1435+3012 EC048.UVDATA.1

Freq = 1.6270 GHz, Bw = 8.000 MH No calibration applied and no bandpass applied

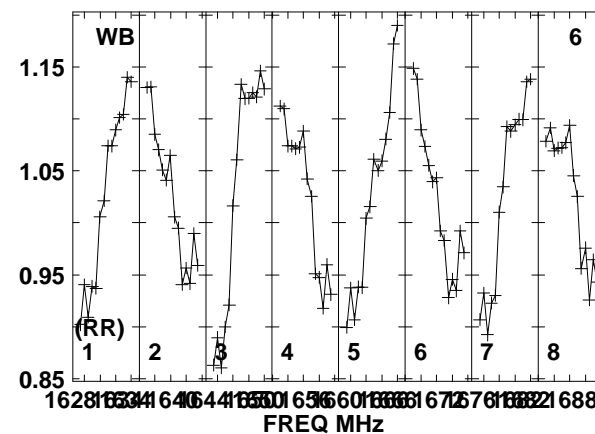
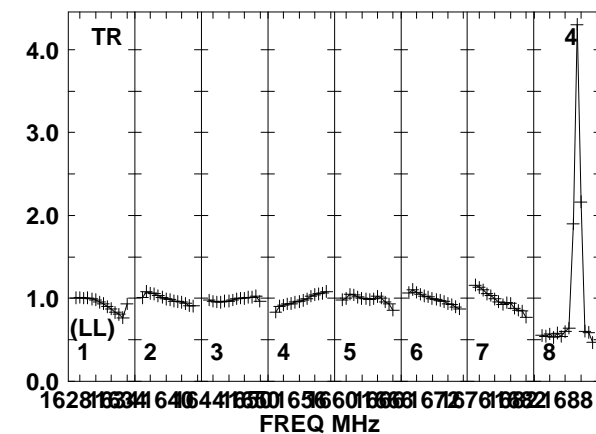
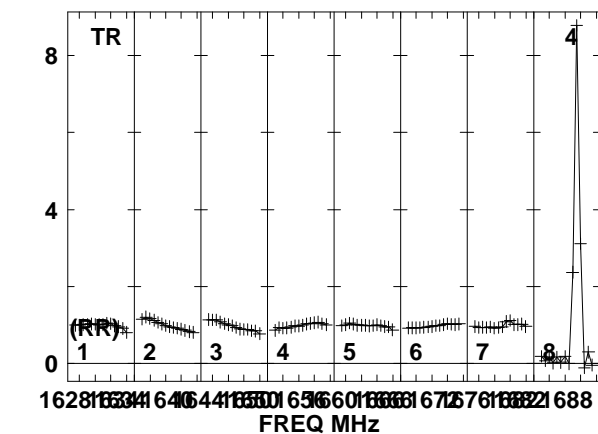
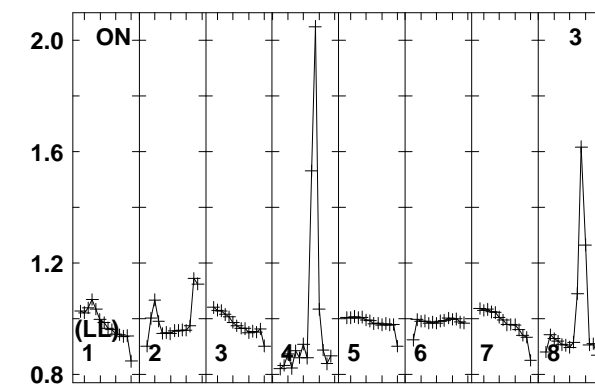
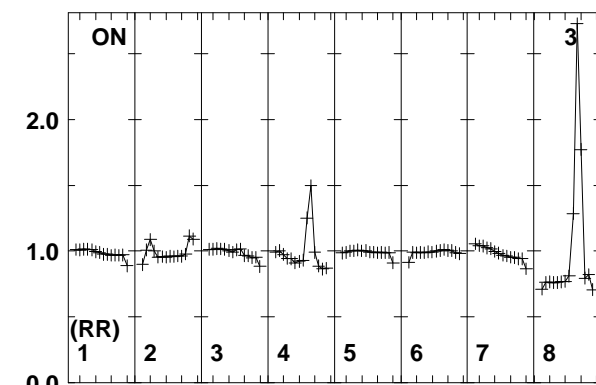
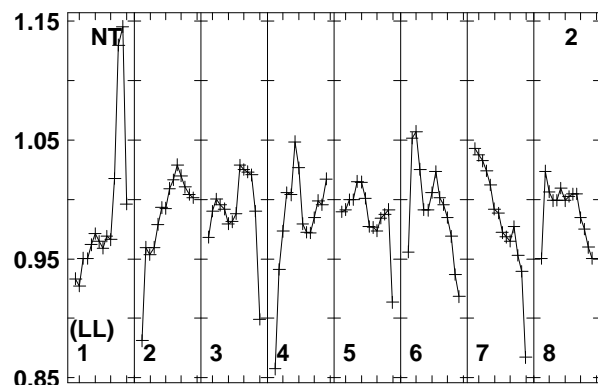
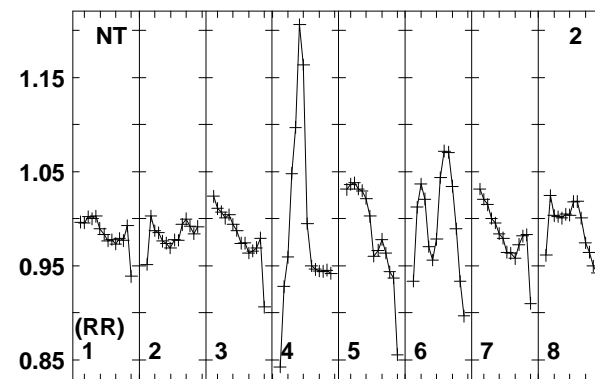
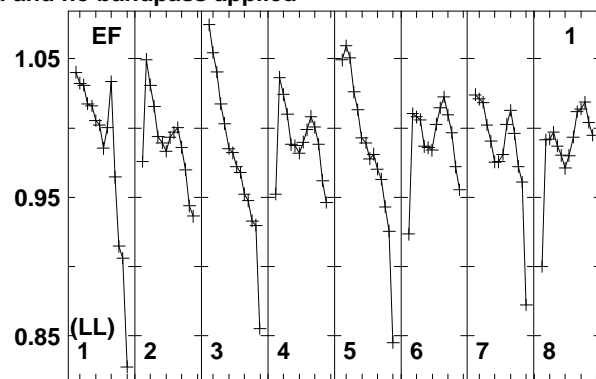
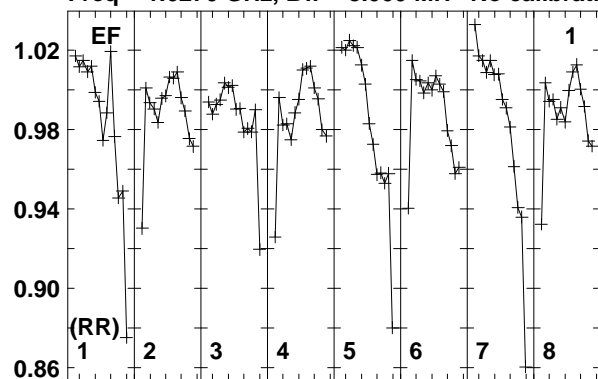

Lower frame: Real Jy
Total-power spectrum Antenna: EF (01)
Timerange: 00/23:21:08 to 00/23:22:54

Plot file version 82 created 22-OCT-2014 16:25:17

J1435+3012 EC048.UVDATA.1

Freq = 1.6270 GHz, Bw = 8.000 MH No calibration applied and no bandpass applied

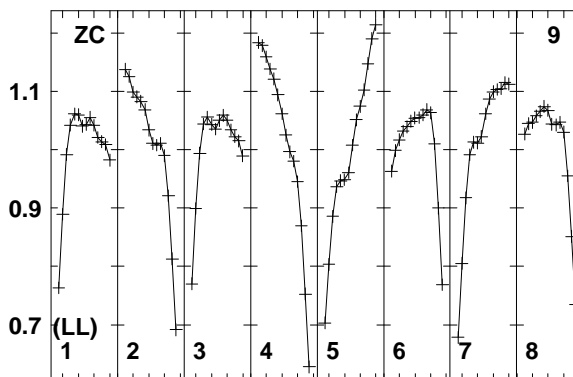
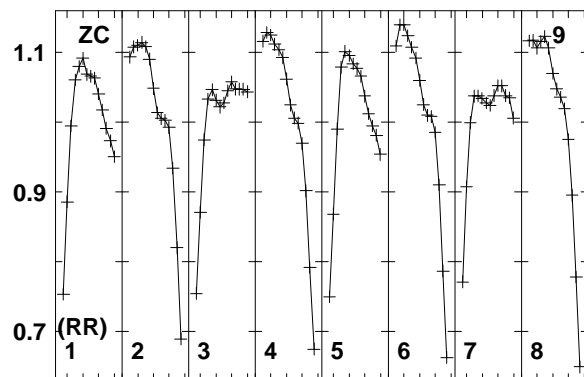
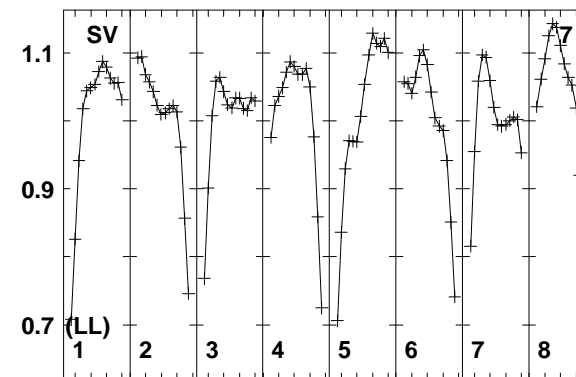
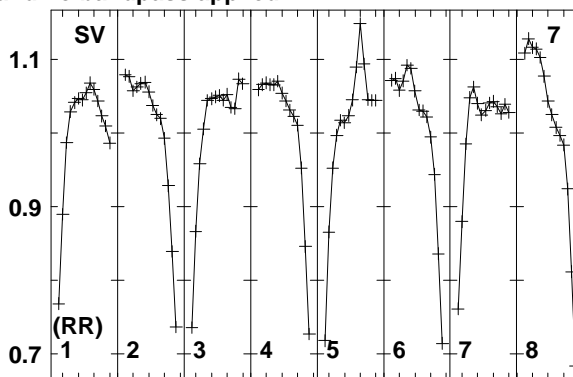
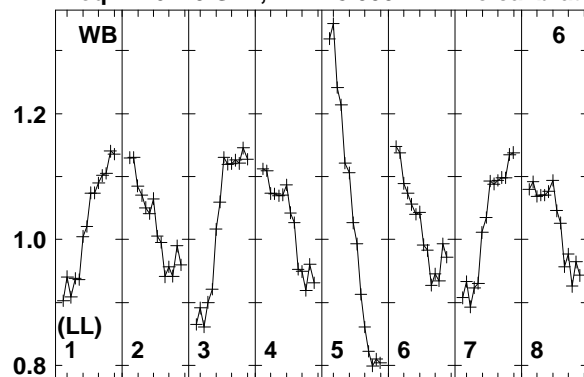

Lower frame: Real Jy
Total-power spectrum Antenna: WB (06)
Timerange: 00/23:21:08 to 00/23:22:54

Plot file version 83 created 22-OCT-2014 16:25:18

J1432+3014 EC048.UVDATA.1

Freq = 1.6270 GHz, Bw = 8.000 MH No calibration applied and no bandpass applied

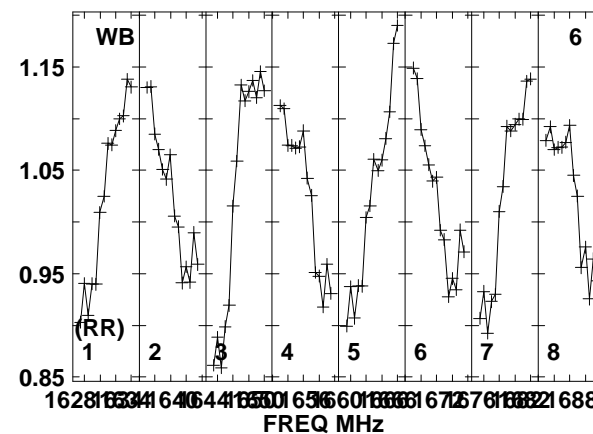
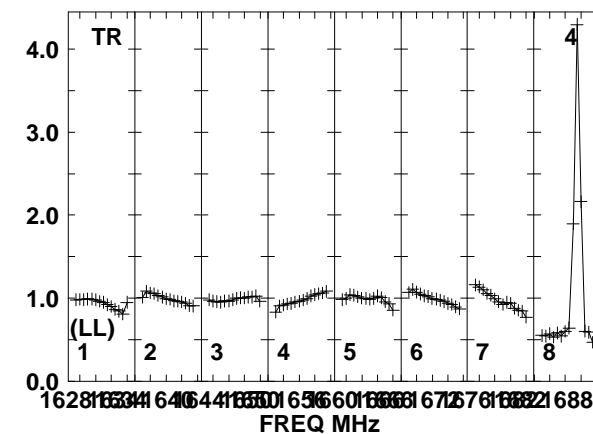
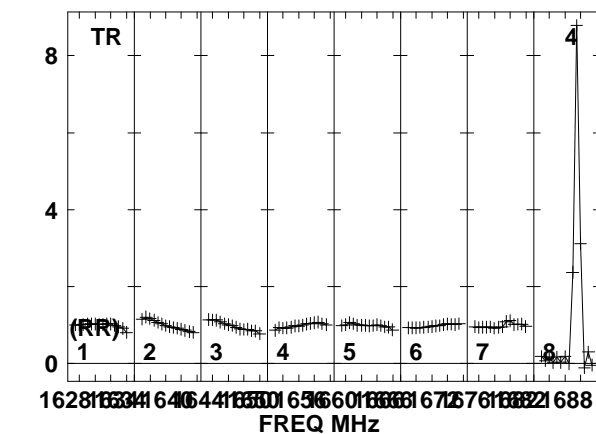
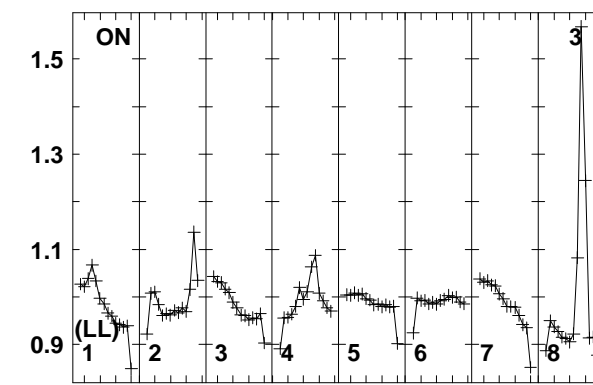
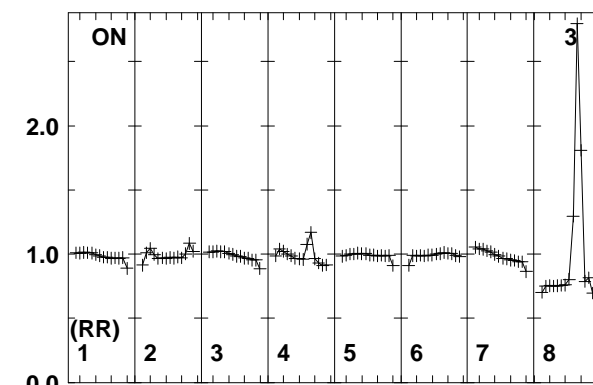
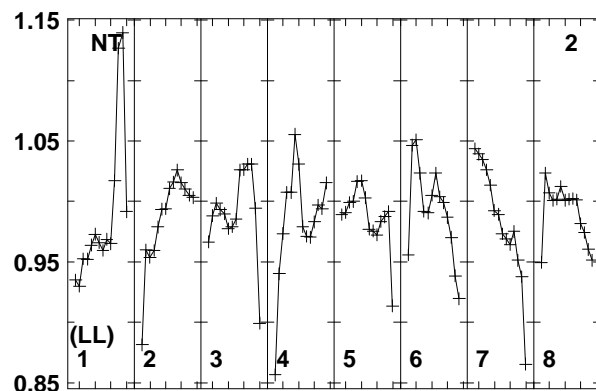
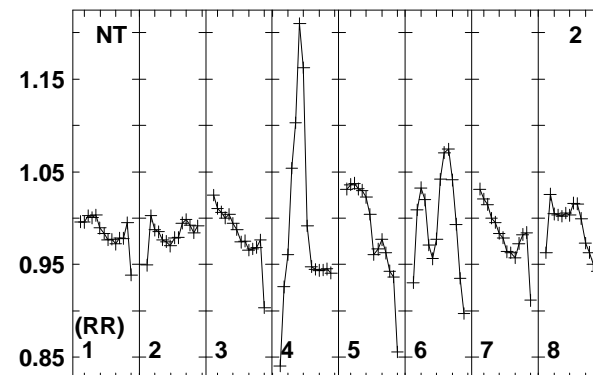
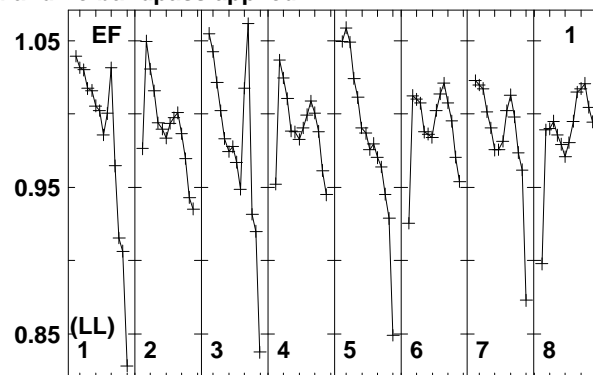
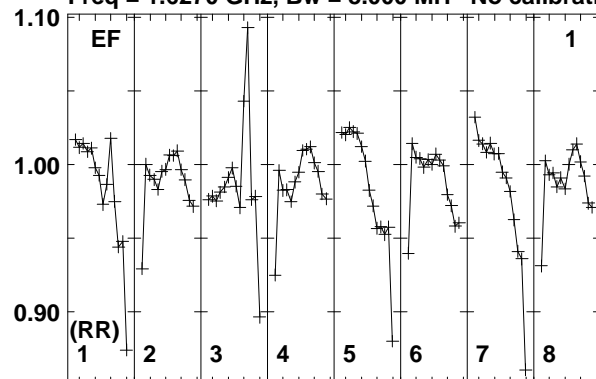

Lower frame: Real Jy
Total-power spectrum Antenna: EF (01)
Timerange: 00/23:22:59 to 00/23:30:39

Plot file version 84 created 22-OCT-2014 16:25:18

J1432+3014 EC048.UVDATA.1

Freq = 1.6270 GHz, Bw = 8.000 MH No calibration applied and no bandpass applied

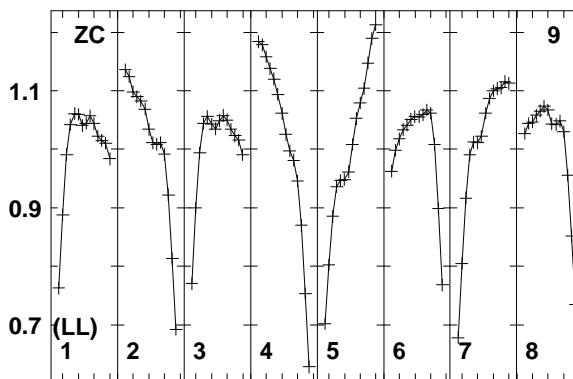
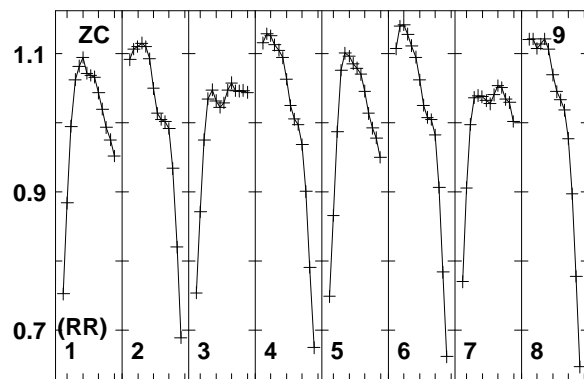
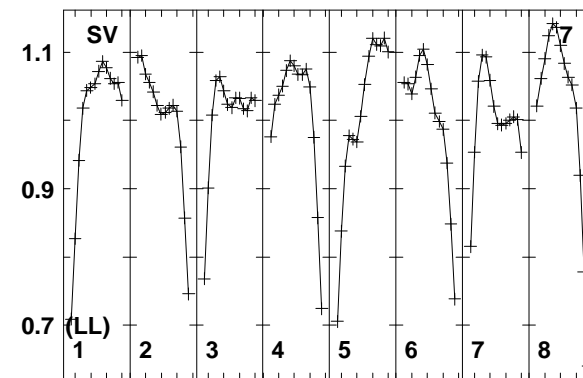
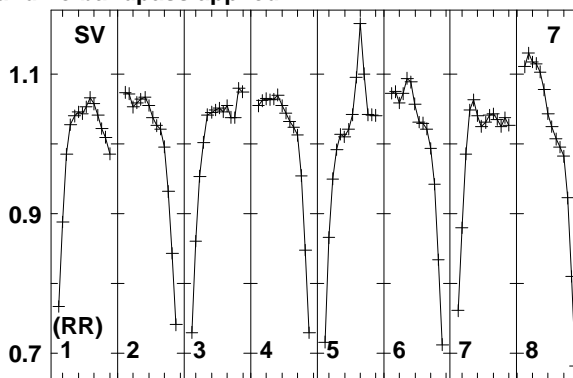
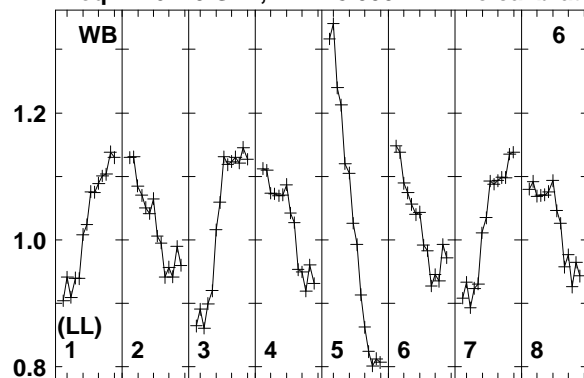

Lower frame: Real Jy
Total-power spectrum Antenna: WB (06)
Timerange: 00/23:22:59 to 00/23:30:39

Plot file version 85 created 22-OCT-2014 16:25:18

J1435+3012 EC048.UVDATA.1

Freq = 1.6270 GHz, Bw = 8.000 MH No calibration applied and no bandpass applied

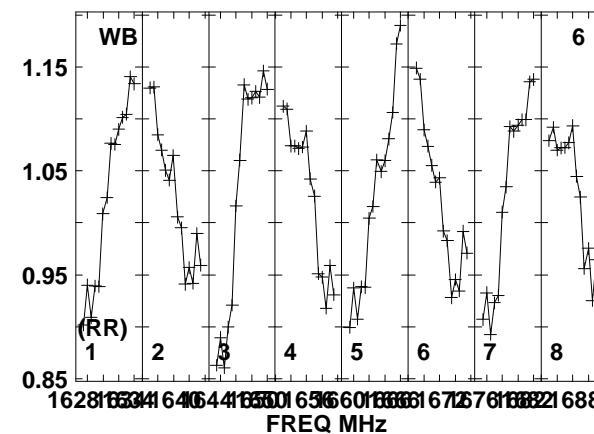
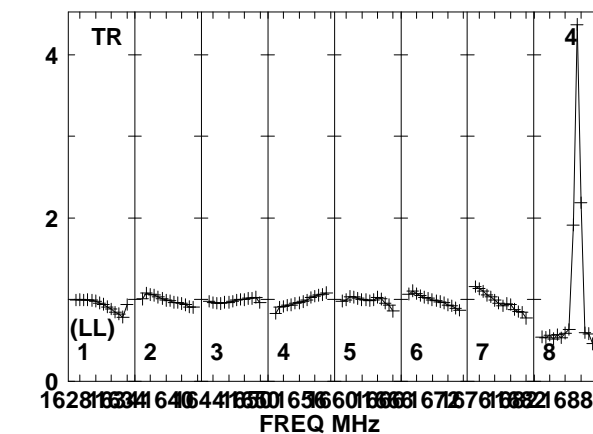
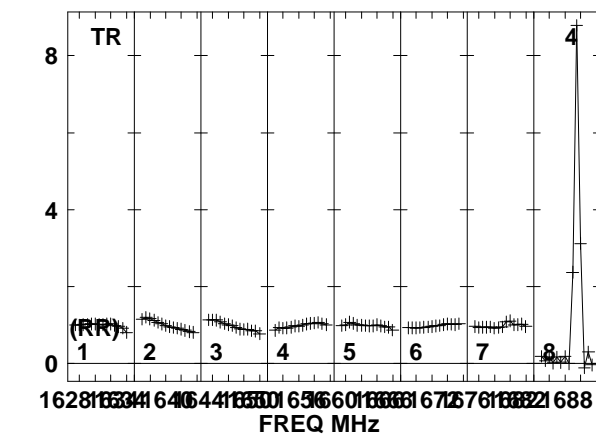
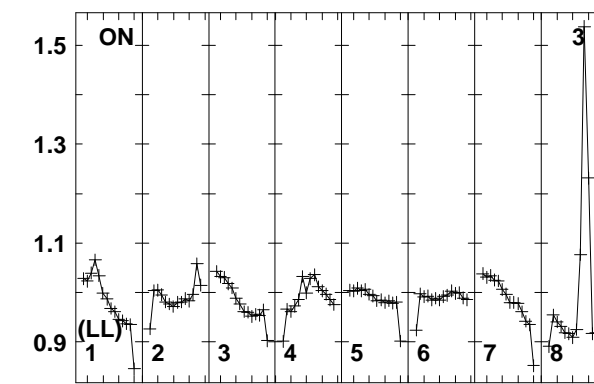
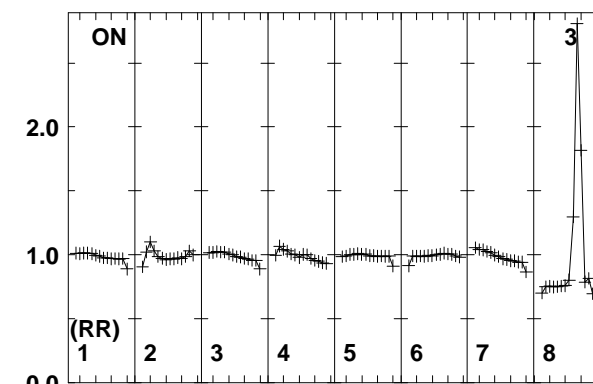
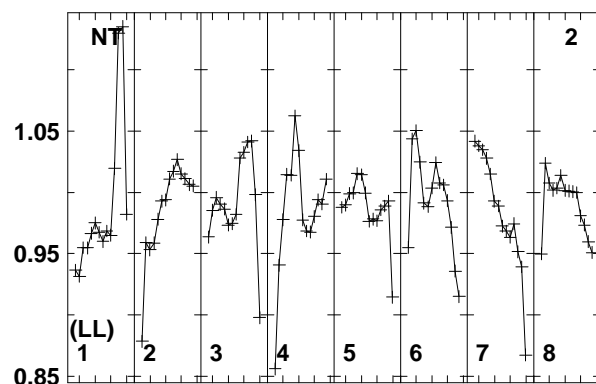
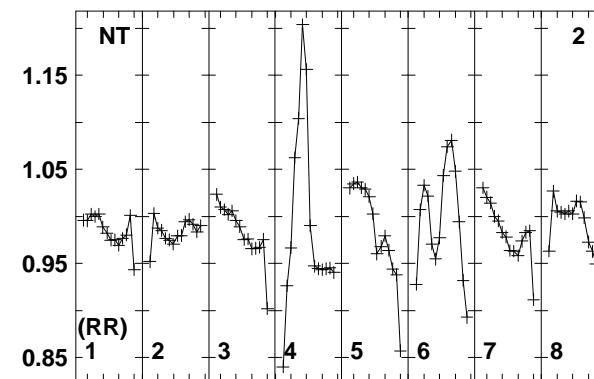
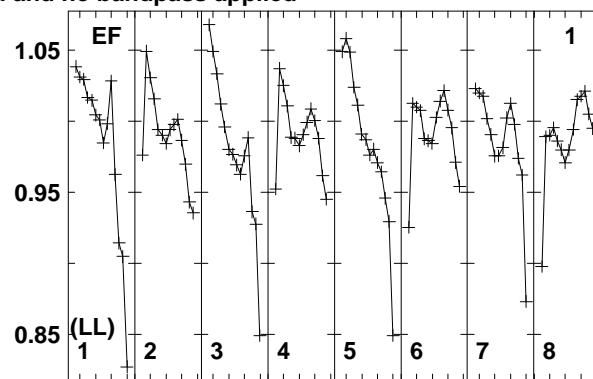
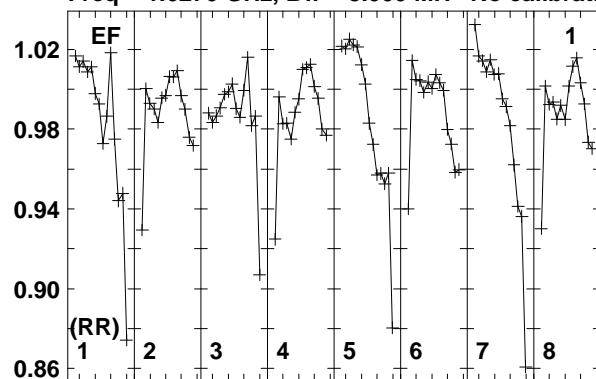

Lower frame: Real Jy
Total-power spectrum Antenna: EF (01)
Timerange: 00:23:31:23 to 00:23:33:09

Plot file version 86 created 22-OCT-2014 16:25:18

J1435+3012 EC048.UVDATA.1

Freq = 1.6270 GHz, Bw = 8.000 MH No calibration applied and no bandpass applied

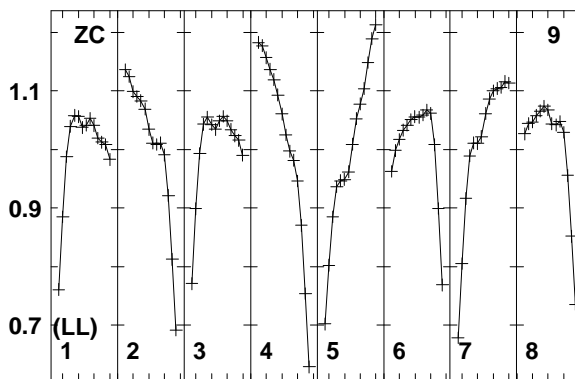
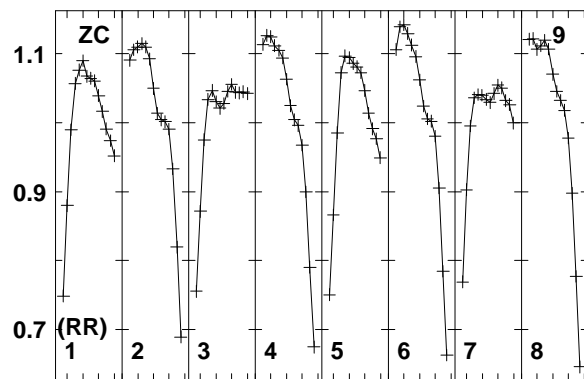
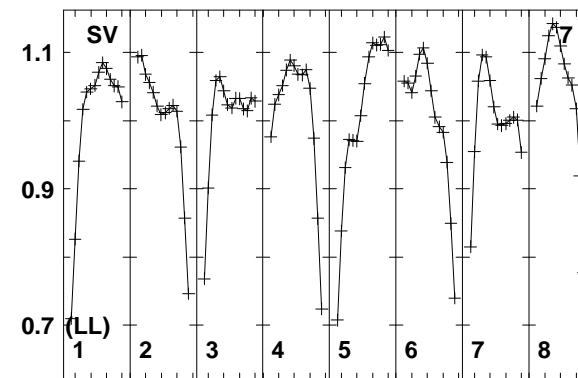
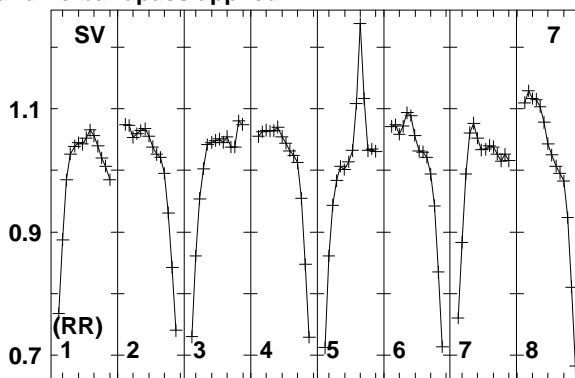
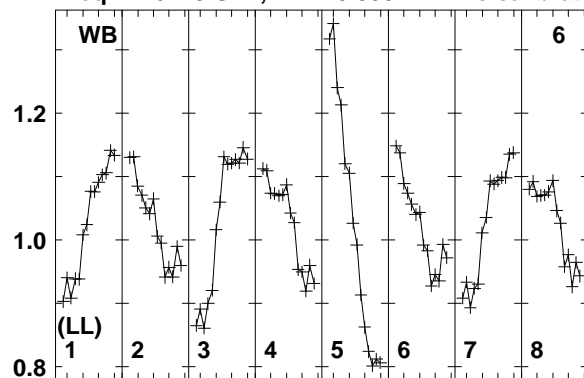

Lower frame: Real Jy
Total-power spectrum Antenna: WB (06)
Timerange: 00/23:31:23 to 00/23:33:09

Plot file version 87 created 22-OCT-2014 16:25:18

J1432+3014 EC048.UVDATA.1

Freq = 1.6270 GHz, Bw = 8.000 MH No calibration applied and no bandpass applied

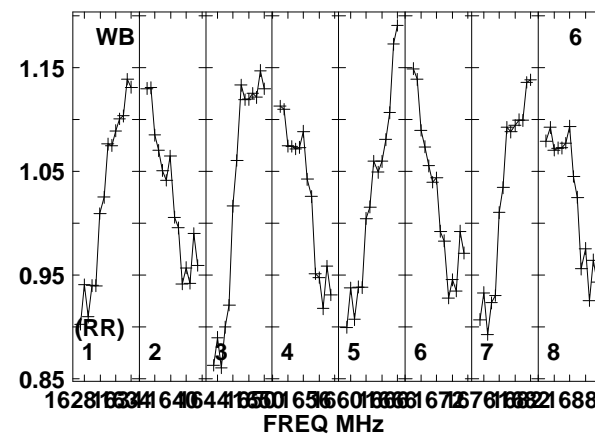
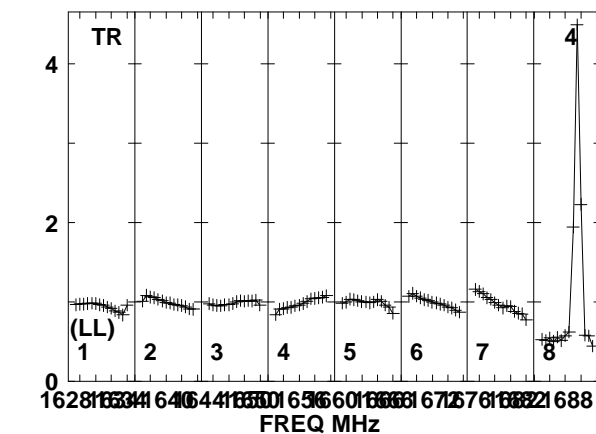
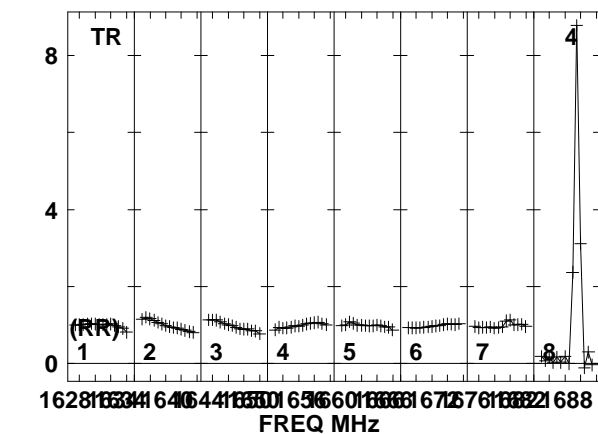
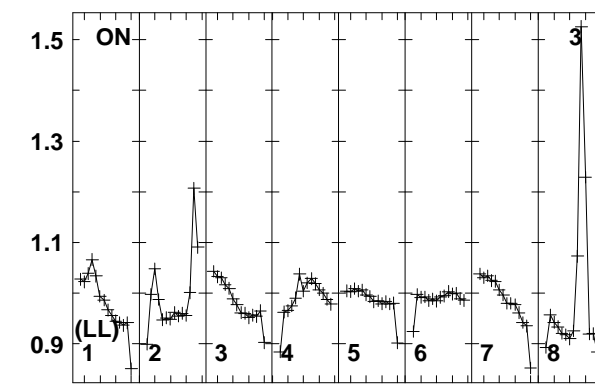
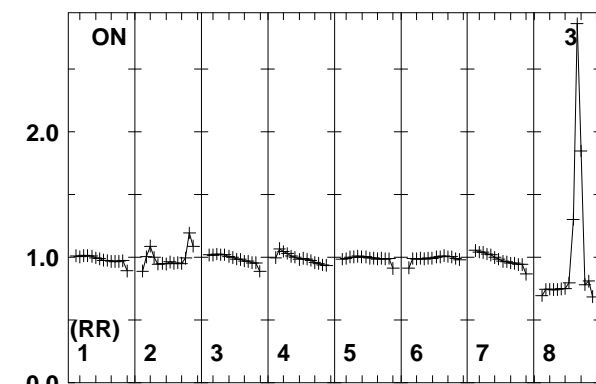
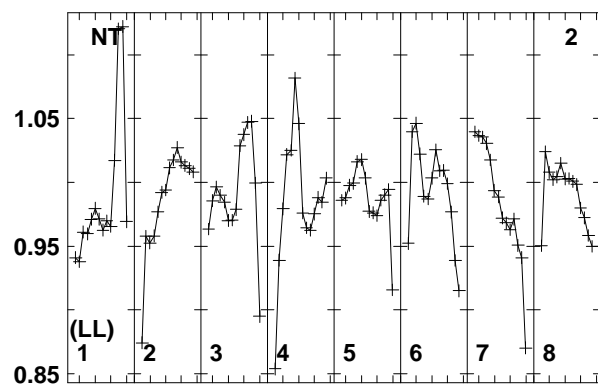
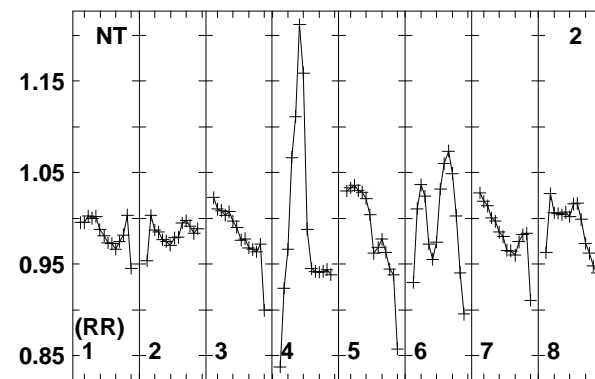
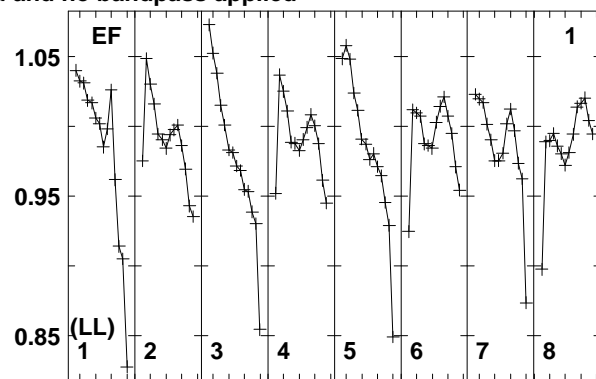
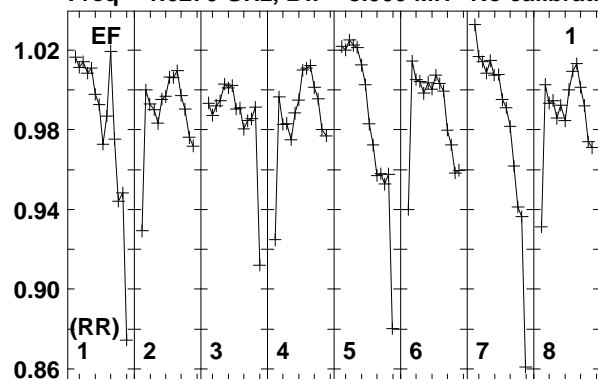

Lower frame: Real Jy
Total-power spectrum Antenna: EF (01)
Timerange: 00/23:33:14 to 00/23:40:54

Plot file version 88 created 22-OCT-2014 16:25:18

J1432+3014 EC048.UVDATA.1

Freq = 1.6270 GHz, Bw = 8.000 MH No calibration applied and no bandpass applied

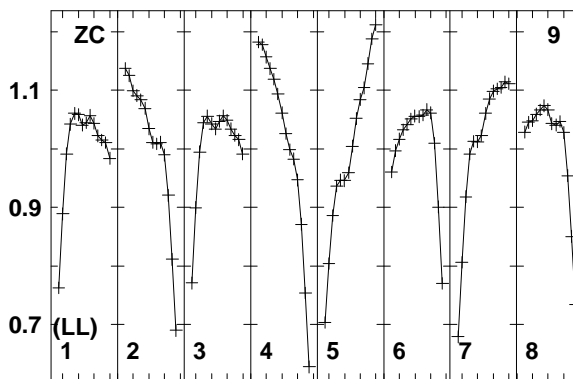
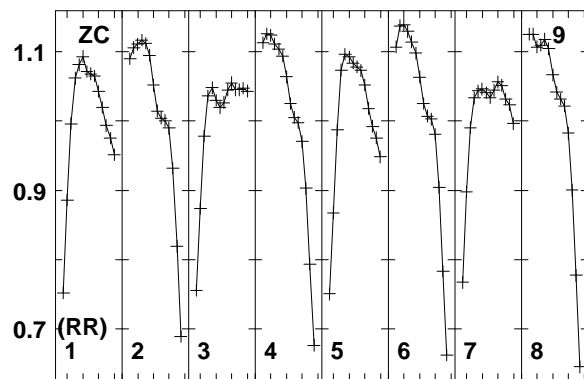
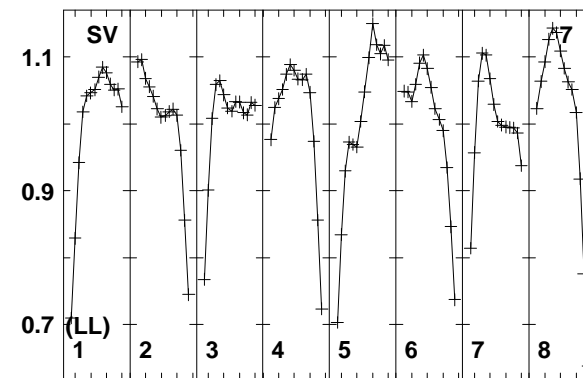
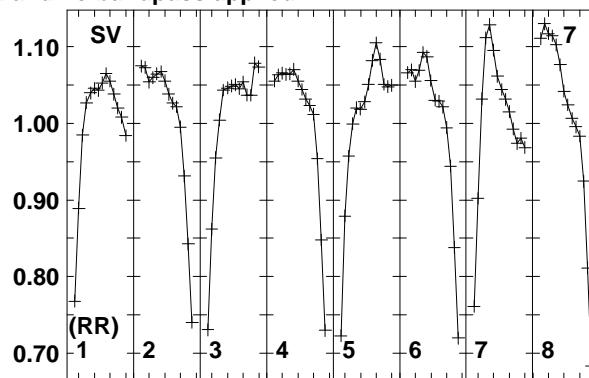
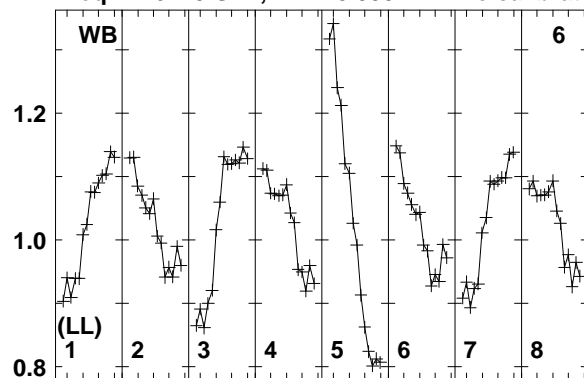

Lower frame: Real Jy
Total-power spectrum Antenna: WB (06)
Timerange: 00/23:33:14 to 00/23:40:54

Plot file version 89 created 22-OCT-2014 16:25:18

J1435+3012 EC048.UVDATA.1

Freq = 1.6270 GHz, Bw = 8.000 MH No calibration applied and no bandpass applied

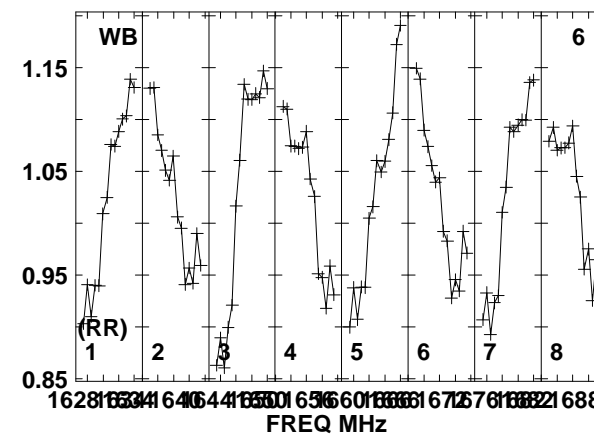
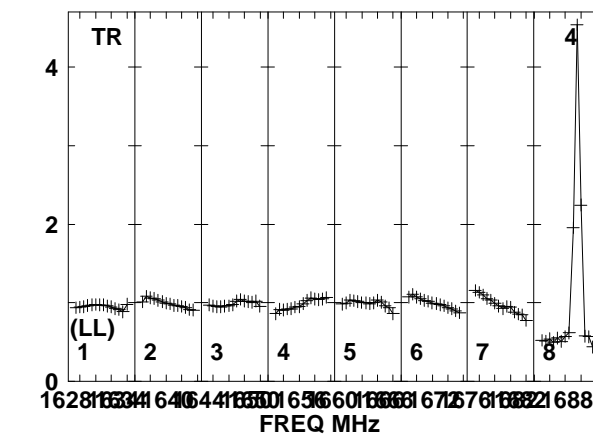
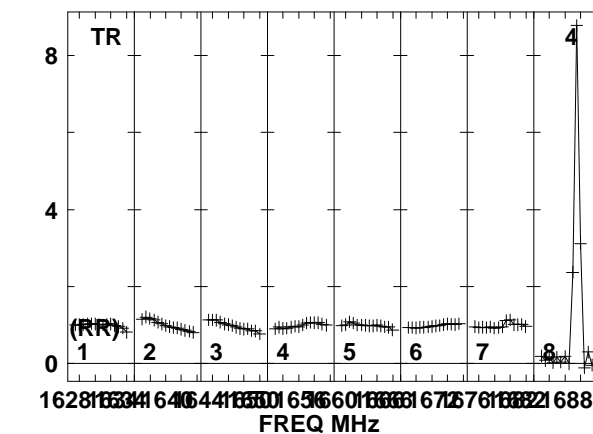
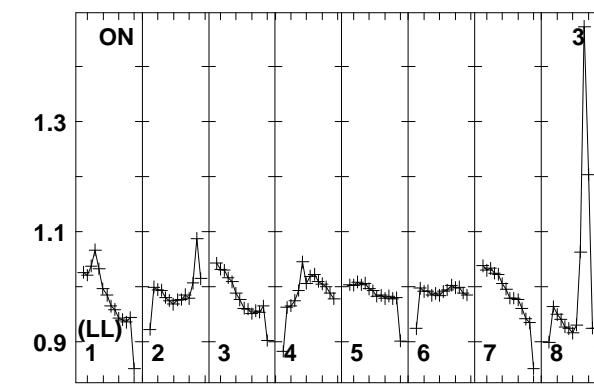
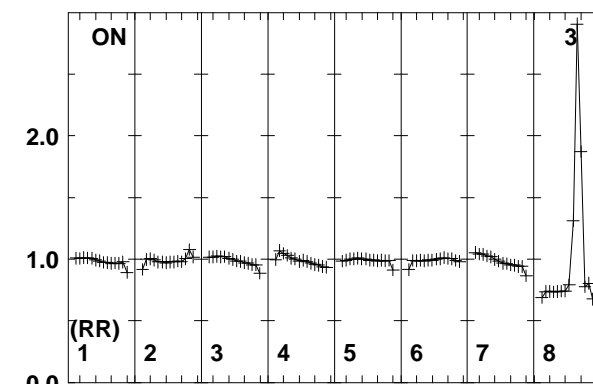
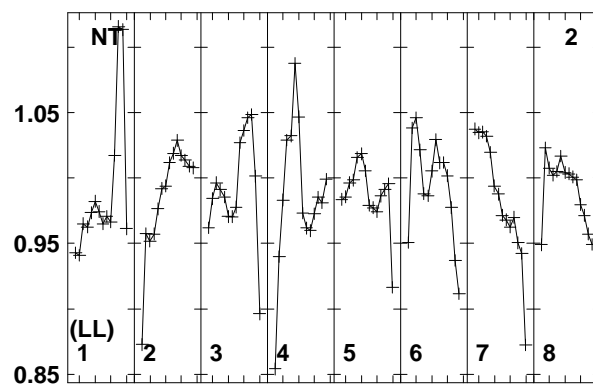
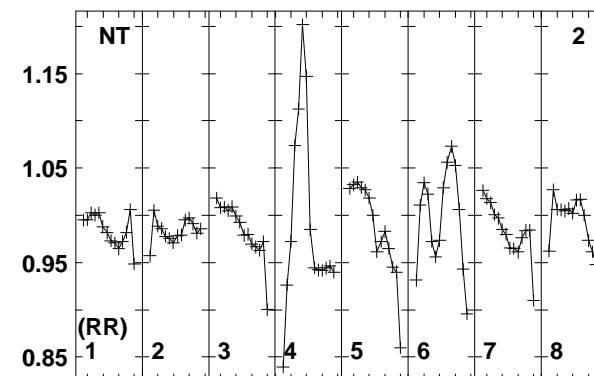
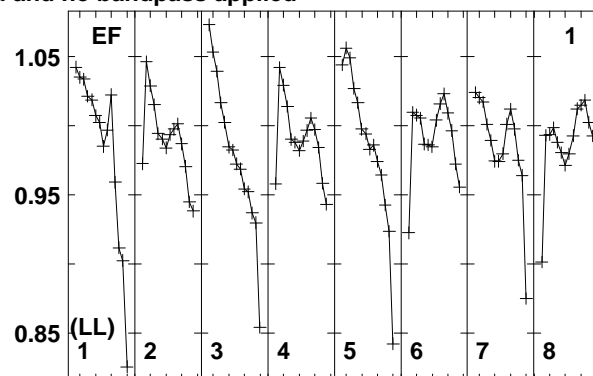
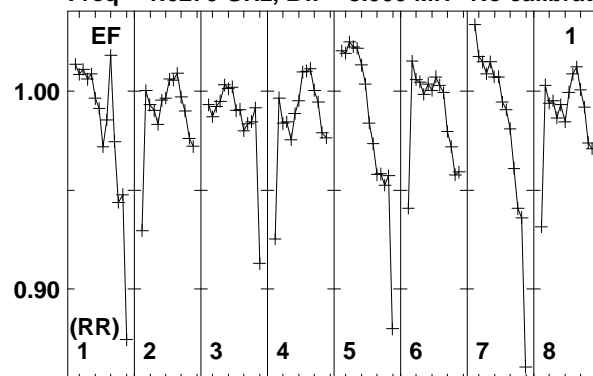

Lower frame: Real Jy
Total-power spectrum Antenna: EF (01)
Timerange: 00/23:41:38 to 00/23:43:24

Plot file version 90 created 22-OCT-2014 16:25:18

J1435+3012 EC048.UVDATA.1

Freq = 1.6270 GHz, Bw = 8.000 MH No calibration applied and no bandpass applied

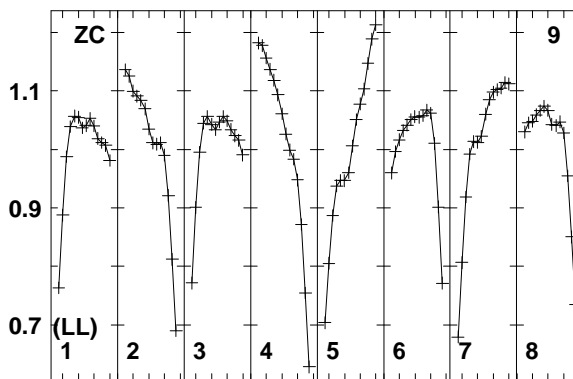
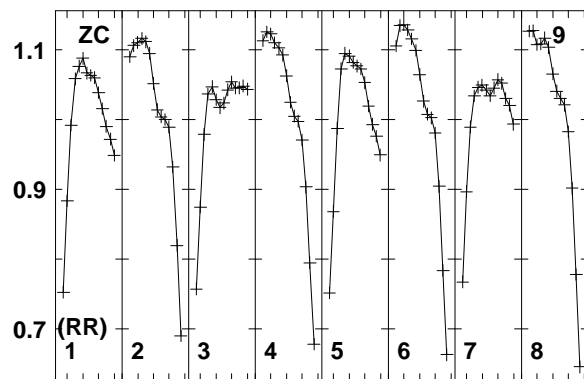
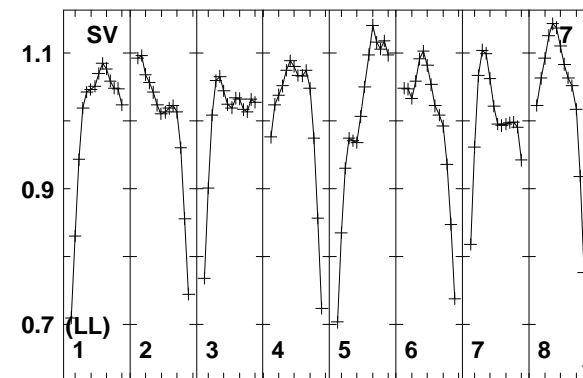
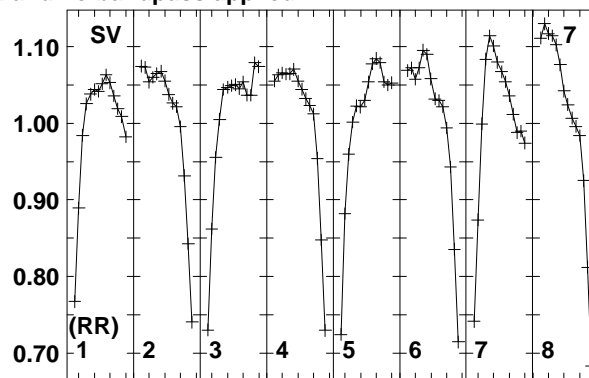
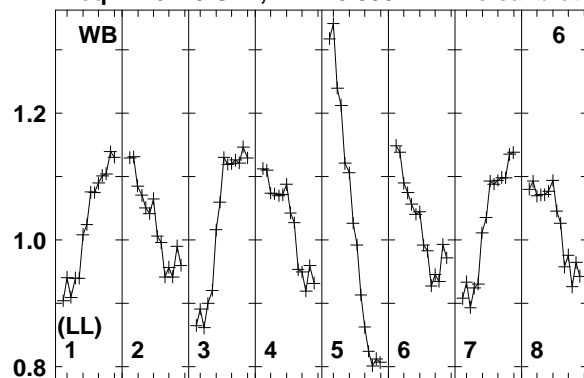

Lower frame: Real Jy
Total-power spectrum Antenna: WB (06)
Timerange: 00/23:41:38 to 00/23:43:24

Plot file version 91 created 22-OCT-2014 16:25:18

J1432+3014 EC048.UVDATA.1

Freq = 1.6270 GHz, Bw = 8.000 MH No calibration applied and no bandpass applied

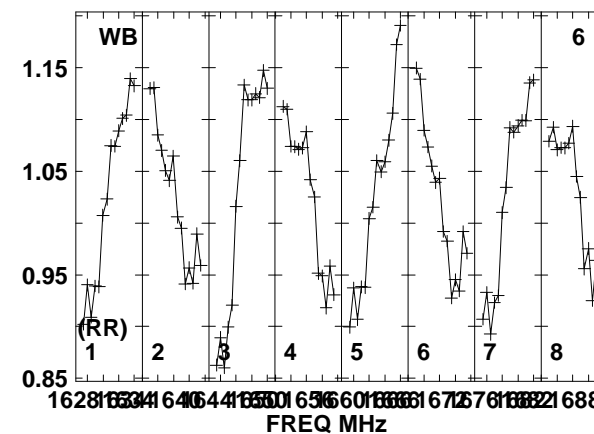
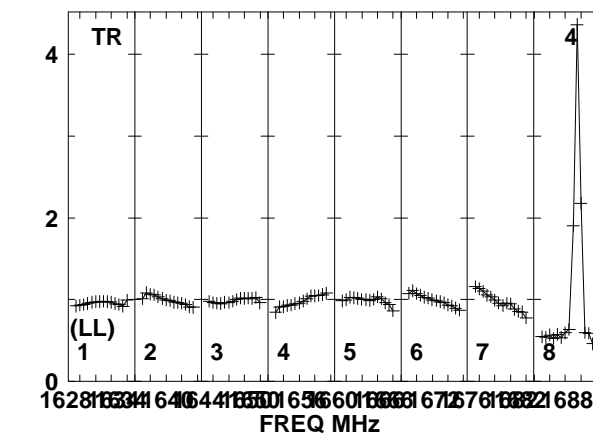
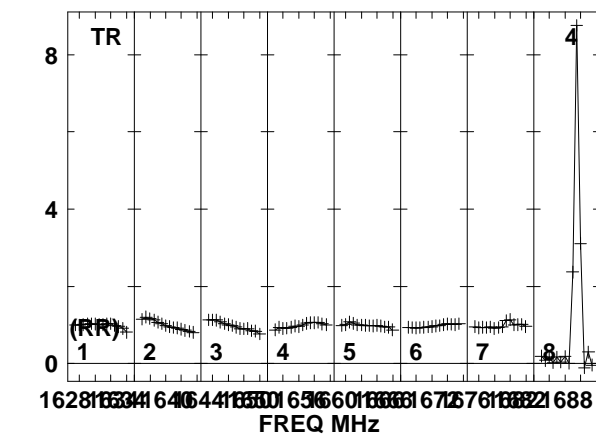
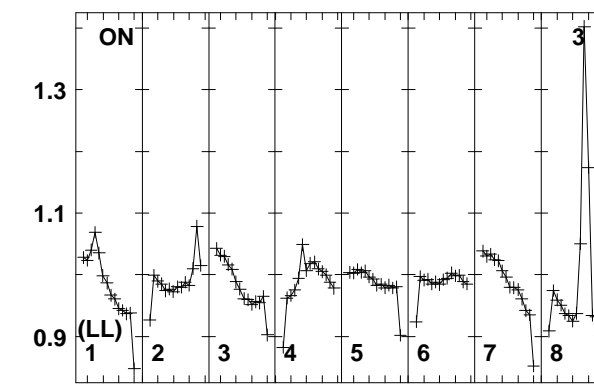
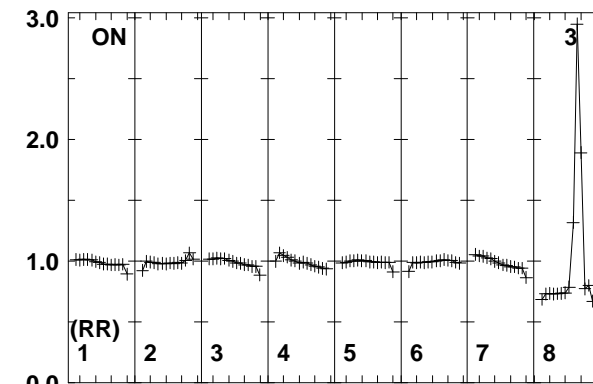
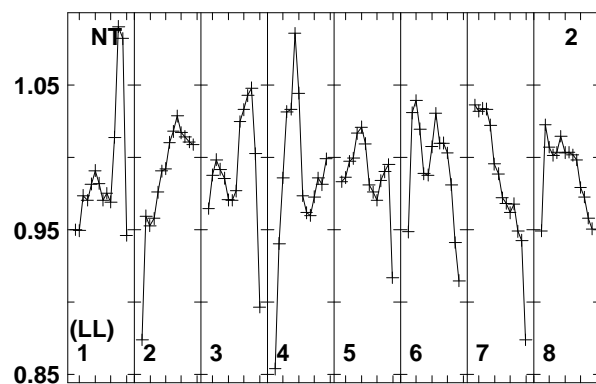
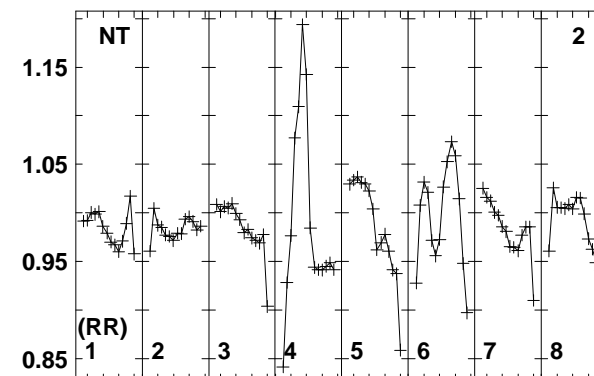
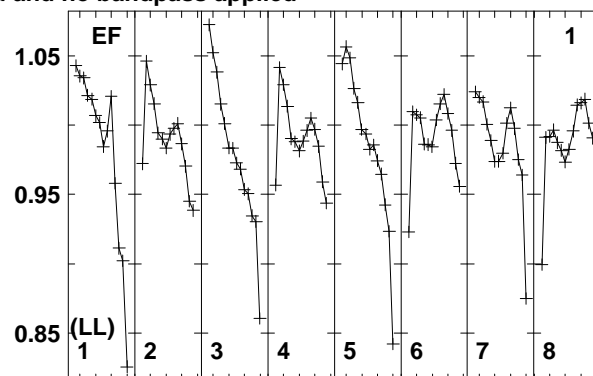
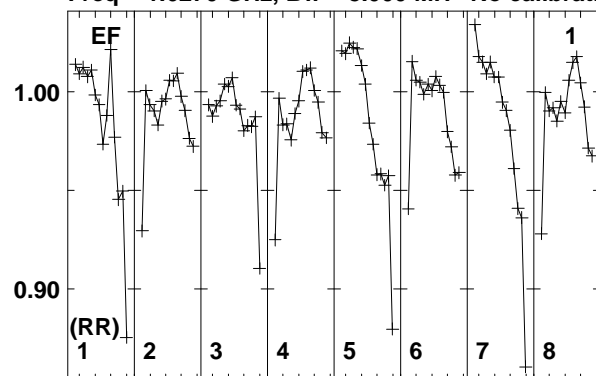

Lower frame: Real Jy
Total-power spectrum Antenna: EF (01)
Timerange: 00:23:43:29 to 00:23:51:09

Plot file version 92 created 22-OCT-2014 16:25:18
J1432+3014 EC048.UVDATA.1
Freq = 1.6270 GHz, Bw = 8.000 MH No calibration applied and no bandpass applied

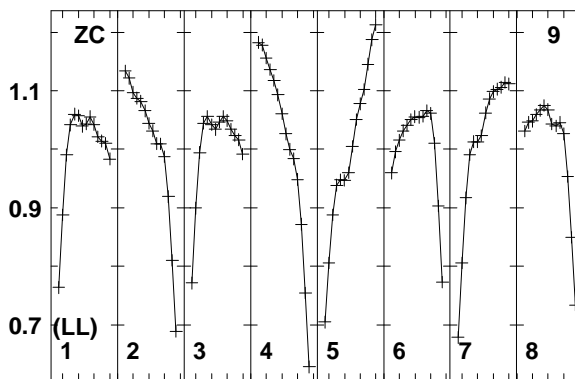
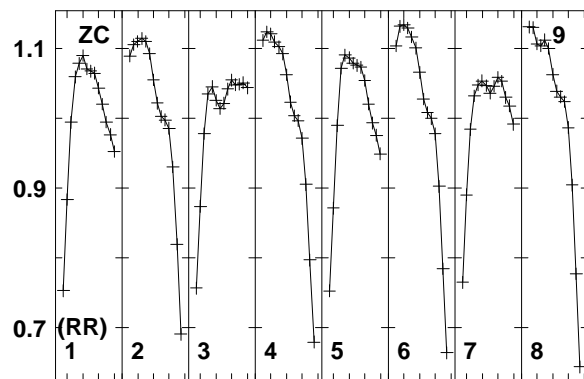
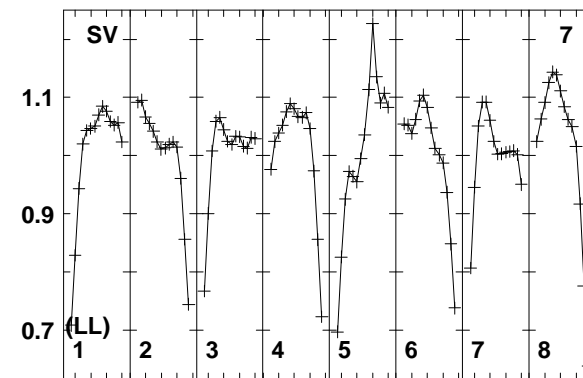
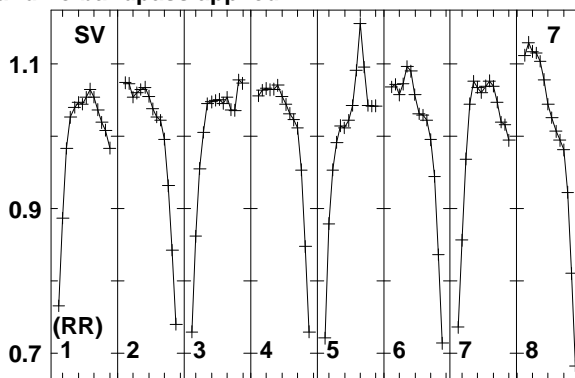
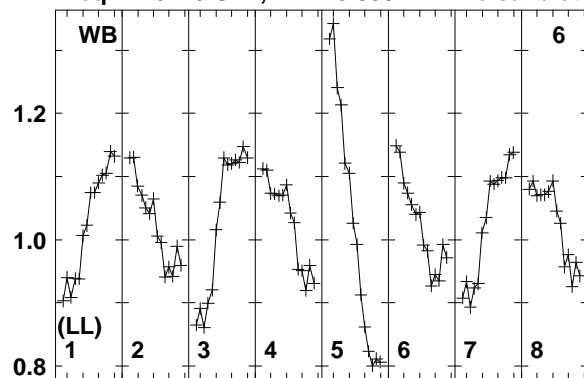

Lower frame: Real Jy
Total-power spectrum Antenna: WB (06)
Timerange: 00/23:43:29 to 00/23:51:09

Plot file version 93 created 22-OCT-2014 16:25:18

J1435+3012 EC048.UVDATA.1

Freq = 1.6270 GHz, Bw = 8.000 MH No calibration applied and no bandpass applied

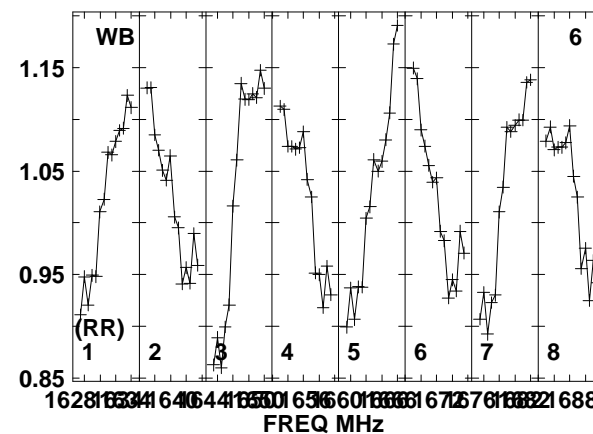
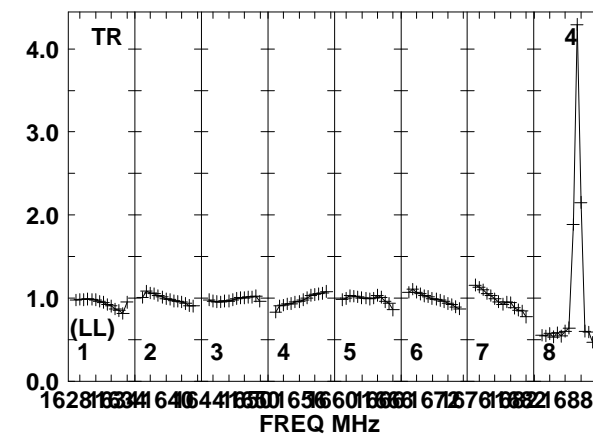
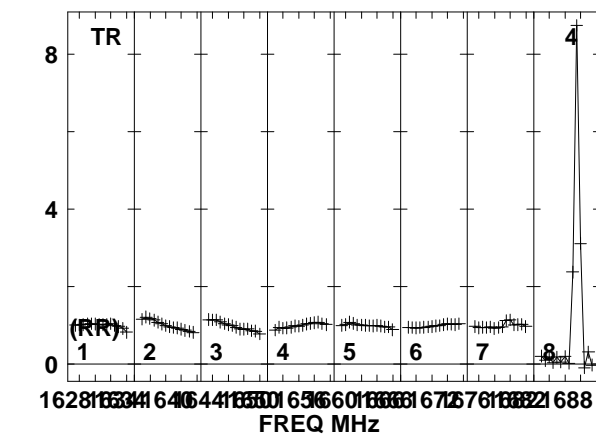
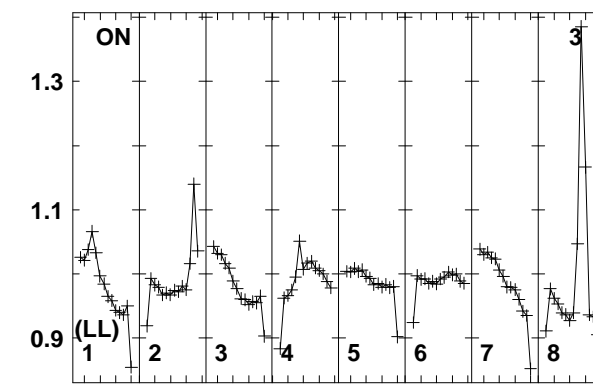
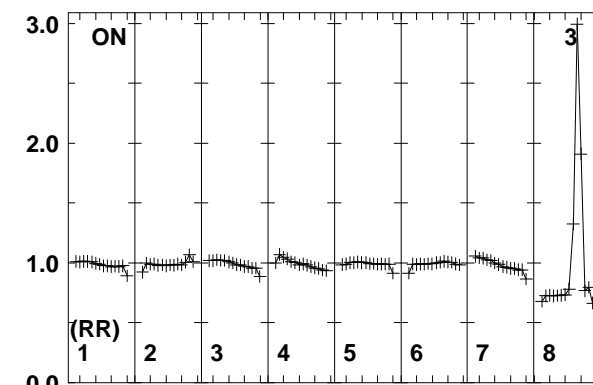
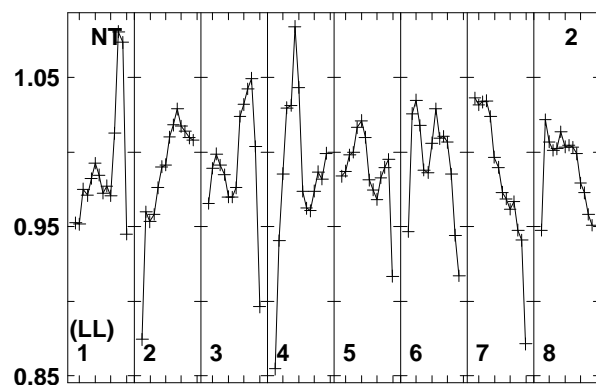
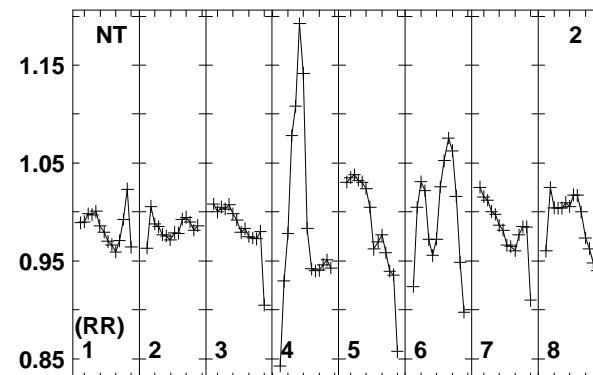
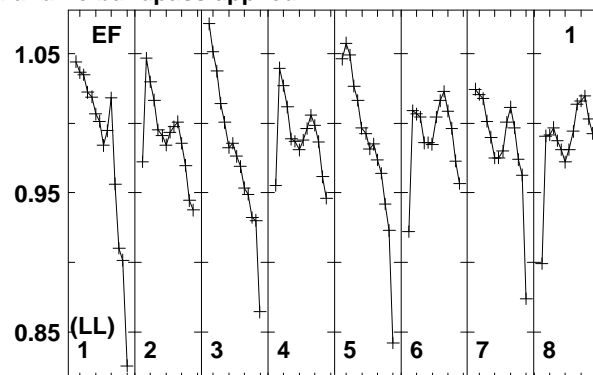
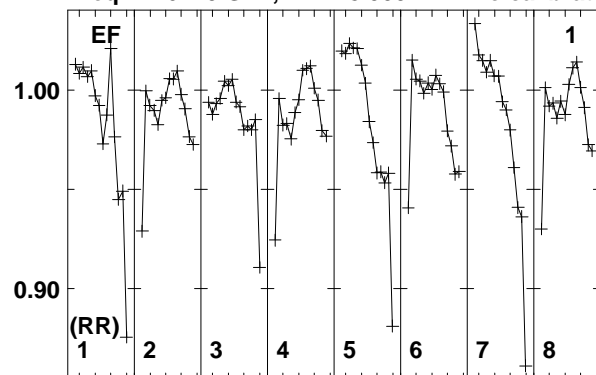

Lower frame: Real Jy
Total-power spectrum Antenna: EF (01)
Timerange: 00/23:51:53 to 00/23:53:39

Plot file version 94 created 22-OCT-2014 16:25:18

J1435+3012 EC048.UVDATA.1

Freq = 1.6270 GHz, Bw = 8.000 MH No calibration applied and no bandpass applied

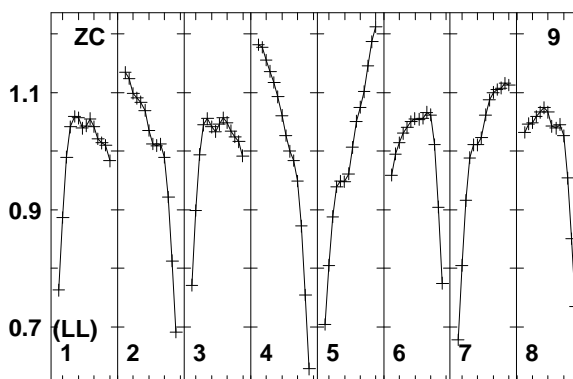
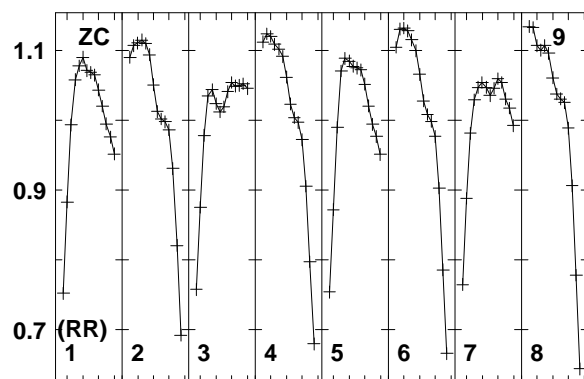
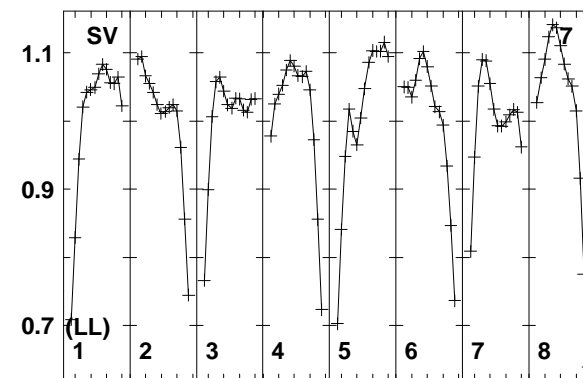
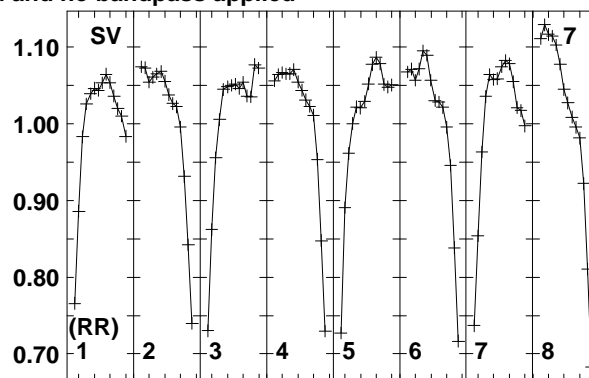
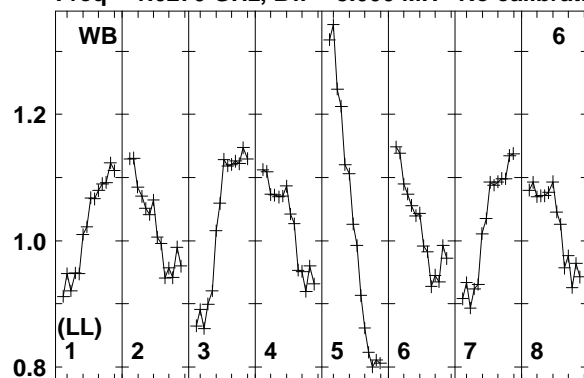

Lower frame: Real Jy
Total-power spectrum Antenna: WB (06)
Timerange: 00/23:51:53 to 00/23:53:39

Plot file version 95 created 22-OCT-2014 16:25:18

J1432+3014 EC048.UVDATA.1

Freq = 1.6270 GHz, Bw = 8.000 MH No calibration applied and no bandpass applied

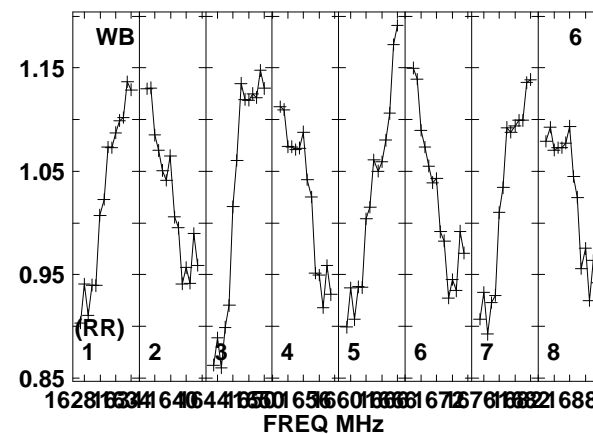
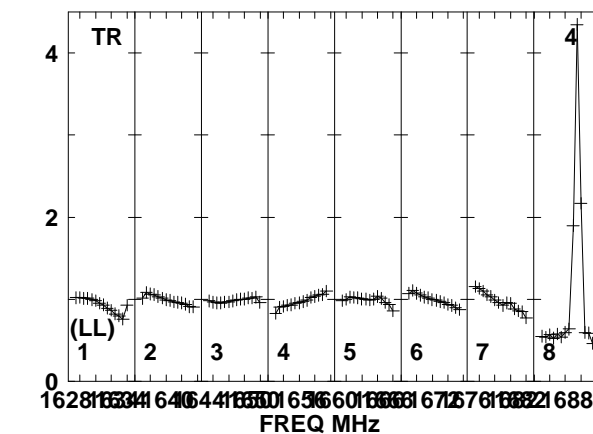
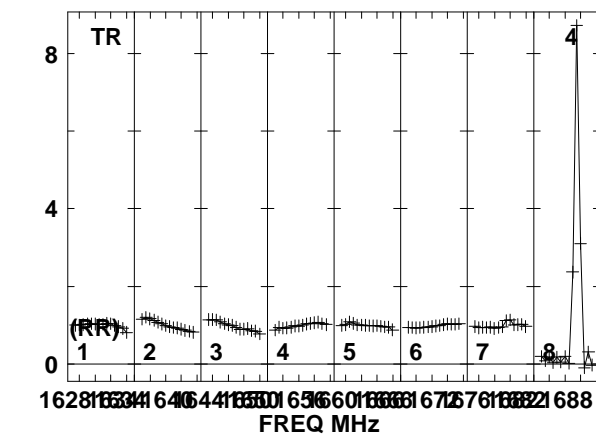
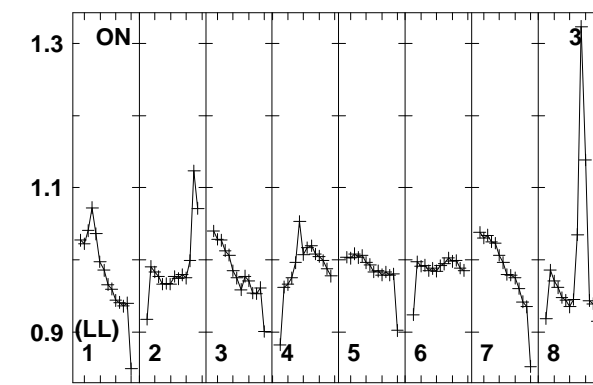
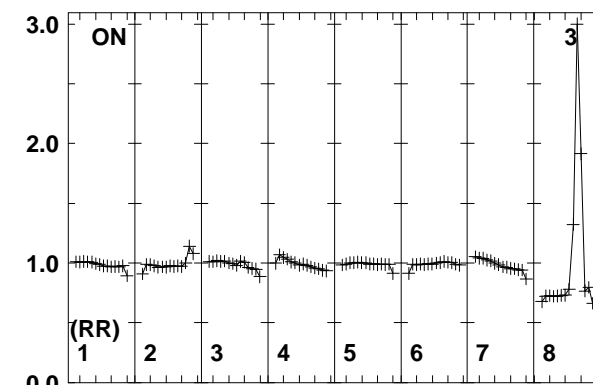
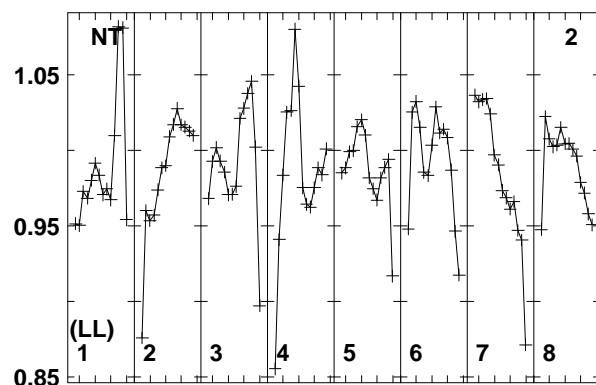
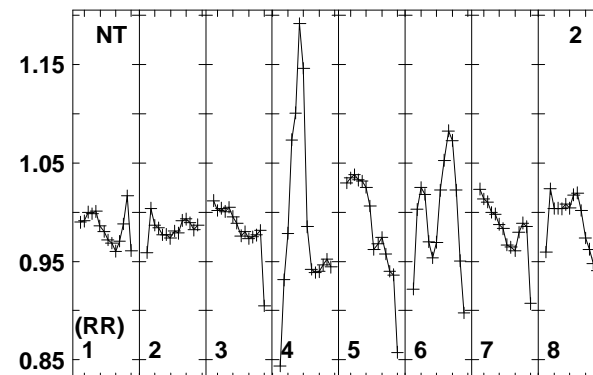
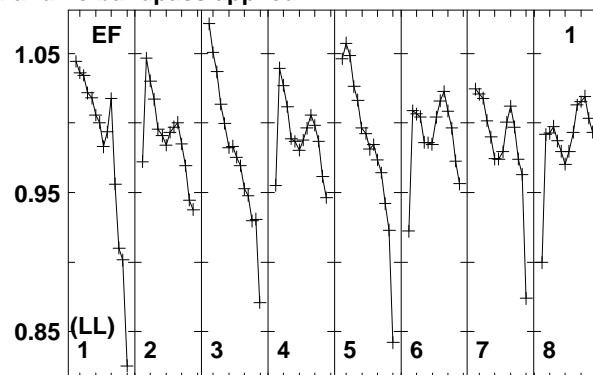
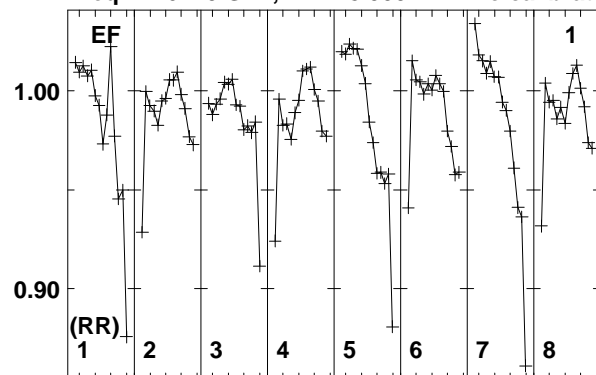

16281634164016441650165660166616727616821688
FREQ MHz
Lower frame: Real Jy
Total-power spectrum Antenna: EF (01)
Timerange: 00/23:53:44 to 01/00:01:24

Plot file version 96 created 22-OCT-2014 16:25:18

J1432+3014 EC048.UVDATA.1

Freq = 1.6270 GHz, Bw = 8.000 MH No calibration applied and no bandpass applied

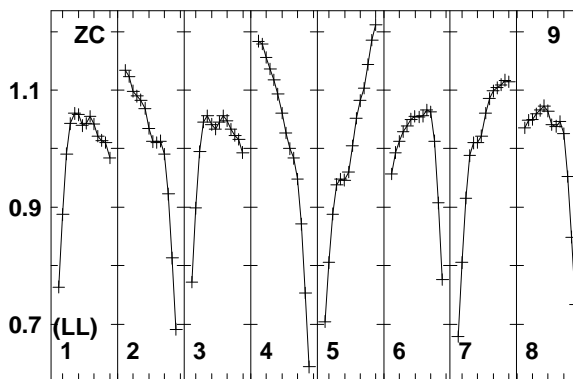
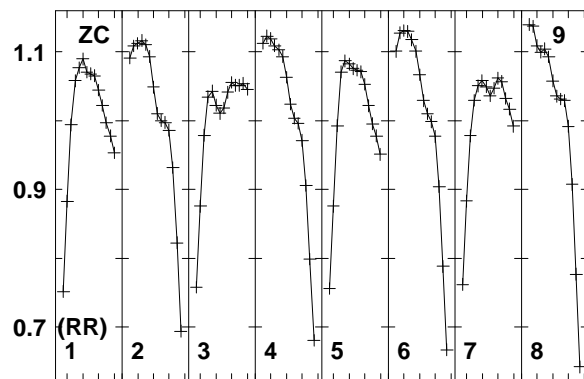
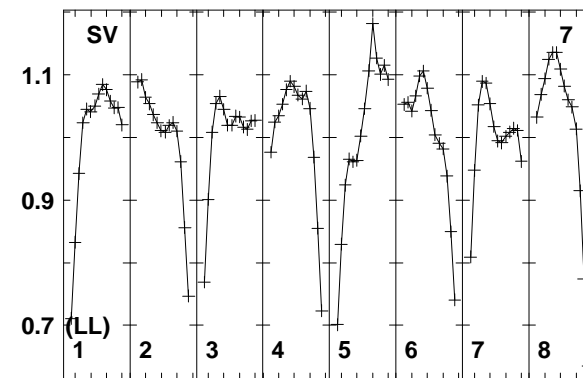
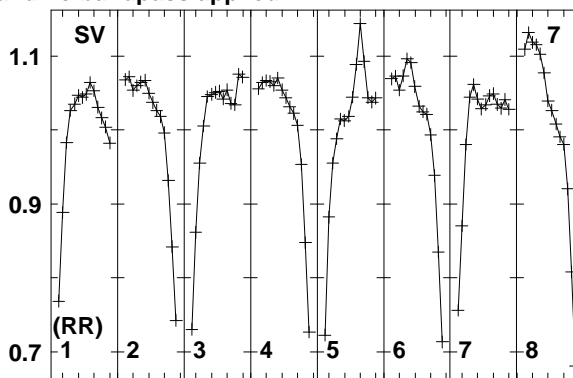
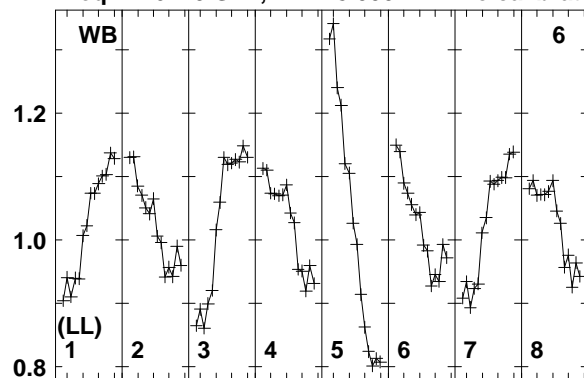

Lower frame: Real Jy
Total-power spectrum Antenna: WB (06)
Timerange: 00/23:53:44 to 01/00:01:24

Plot file version 97 created 22-OCT-2014 16:25:18

J1435+3012 EC048.UVDATA.1

Freq = 1.6270 GHz, Bw = 8.000 MH No calibration applied and no bandpass applied

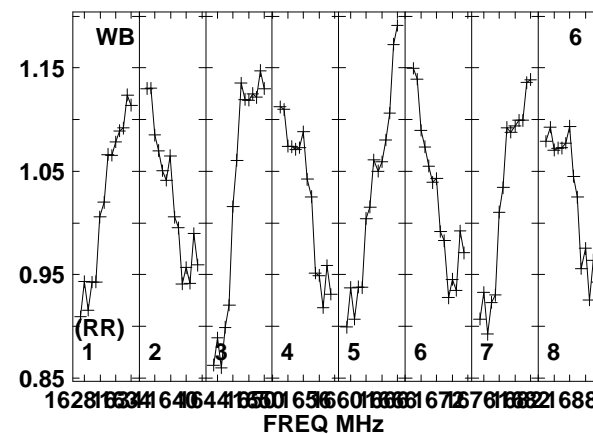
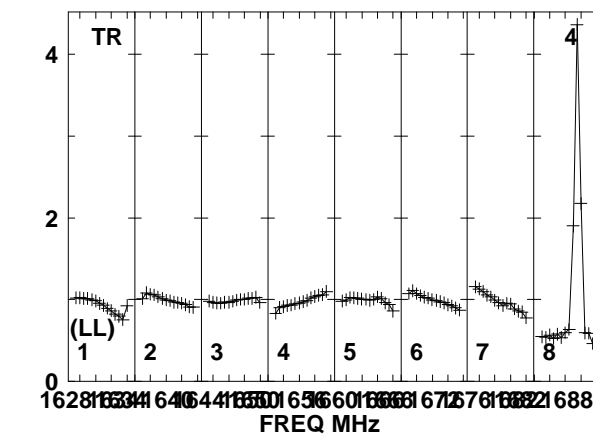
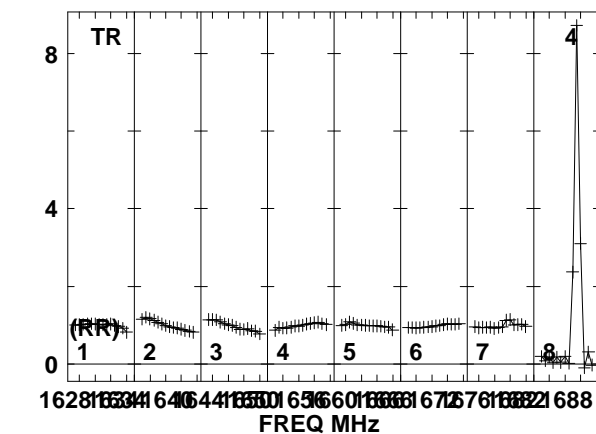
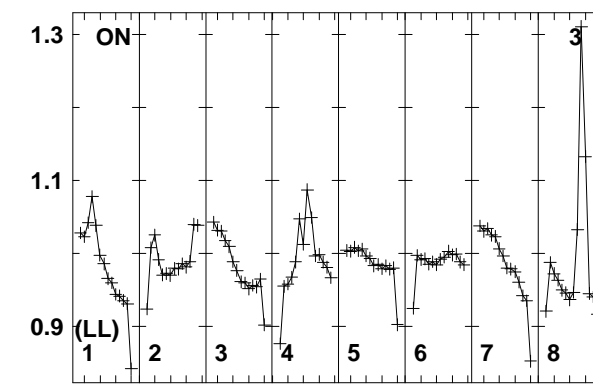
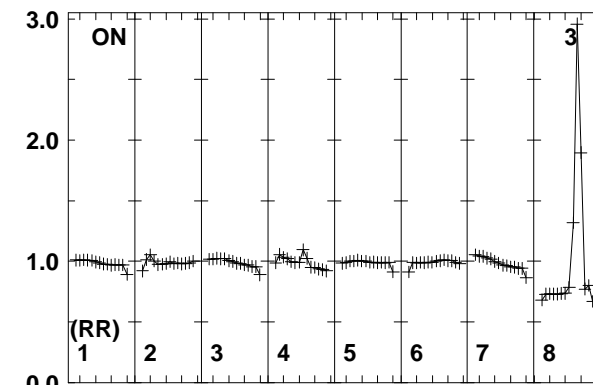
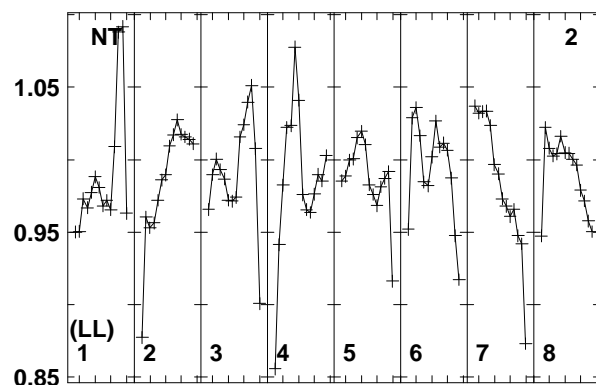
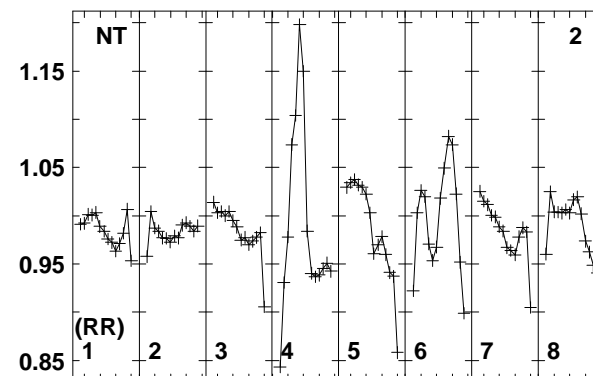
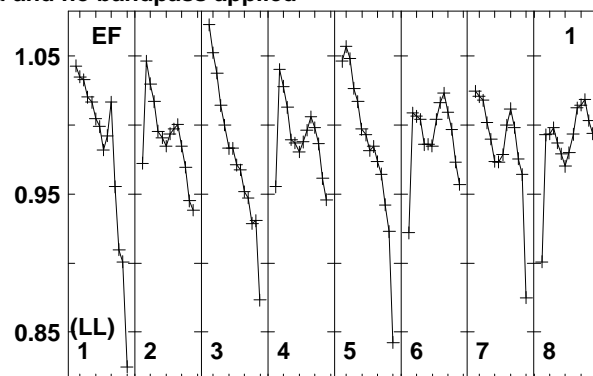
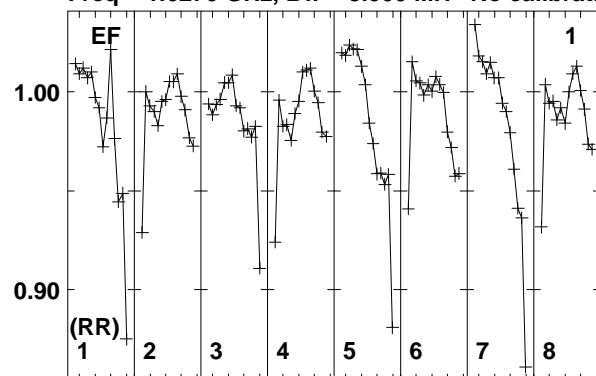

1628 1634 1640 1644 1650 1656 1660 1666 1672 1676 1682 1688
FREQ MHz
Lower frame: Real Jy
Total-power spectrum Antenna: EF (01)
Timerange: 01/00:02:08 to 01/00:03:54

Plot file version 98 created 22-OCT-2014 16:25:18

J1435+3012 EC048.UVDATA.1

Freq = 1.6270 GHz, Bw = 8.000 MH No calibration applied and no bandpass applied

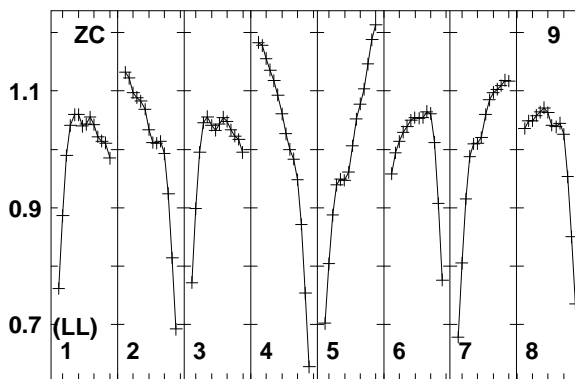
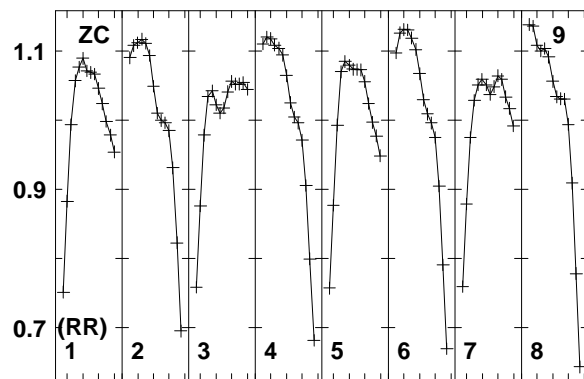
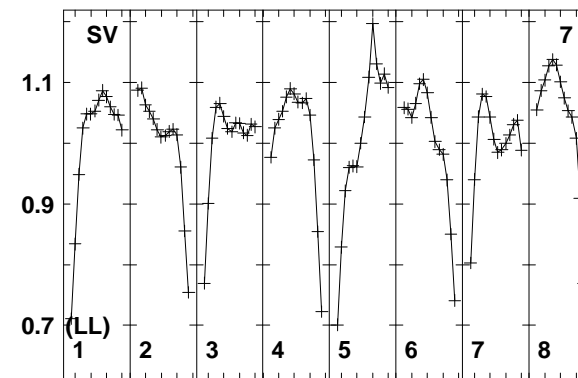
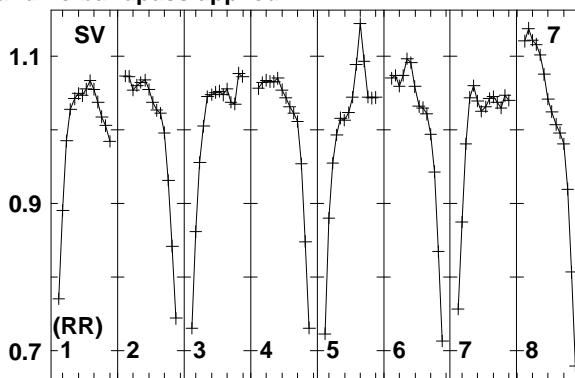
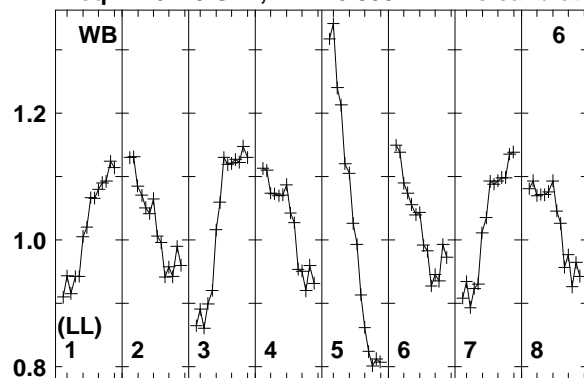

Lower frame: Real Jy
Total-power spectrum Antenna: WB (06)
Timerange: 01/00:02:08 to 01/00:03:54

Plot file version 99 created 22-OCT-2014 16:25:18

J1432+3014 EC048.UVDATA.1

Freq = 1.6270 GHz, Bw = 8.000 MH No calibration applied and no bandpass applied

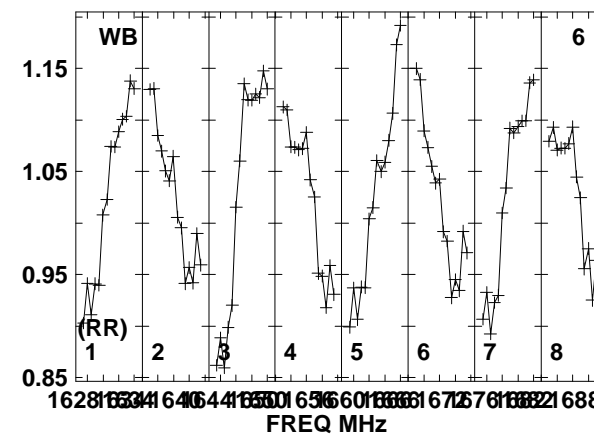
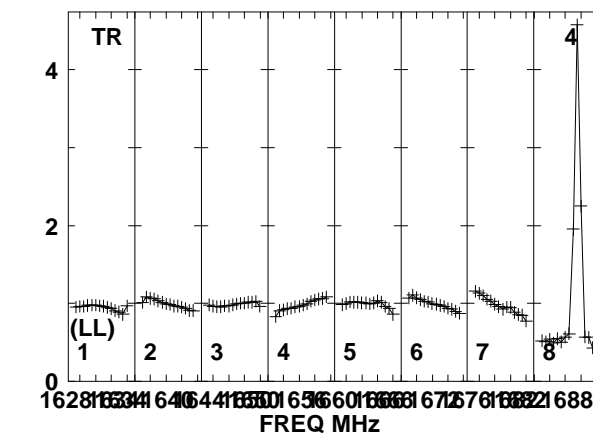
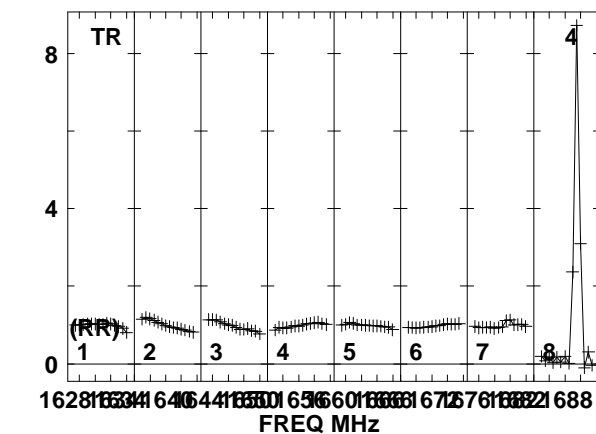
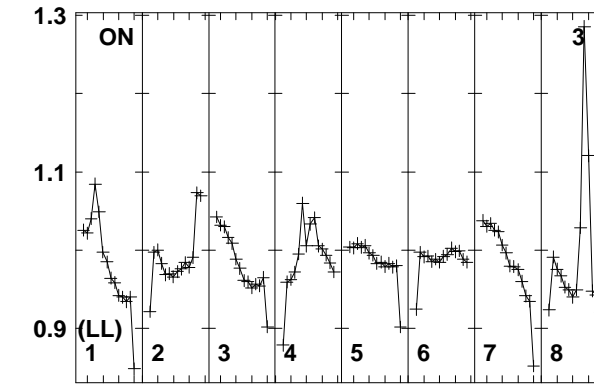
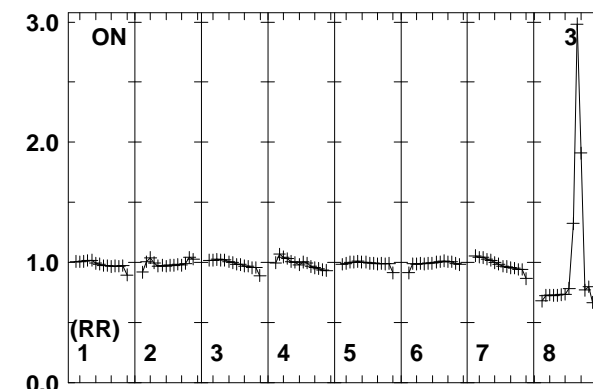
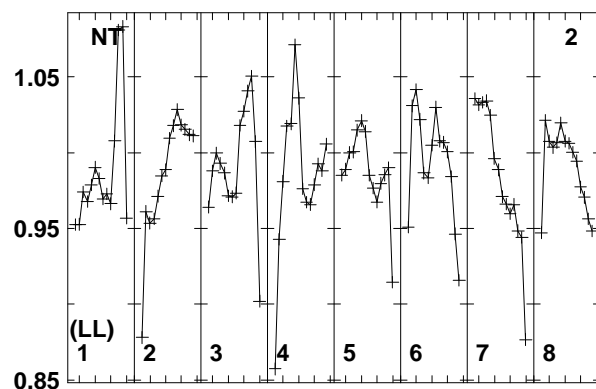
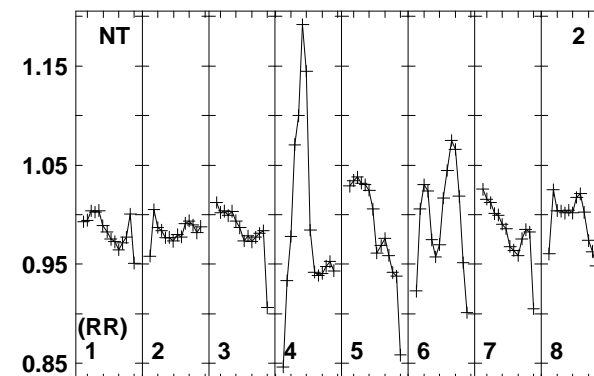
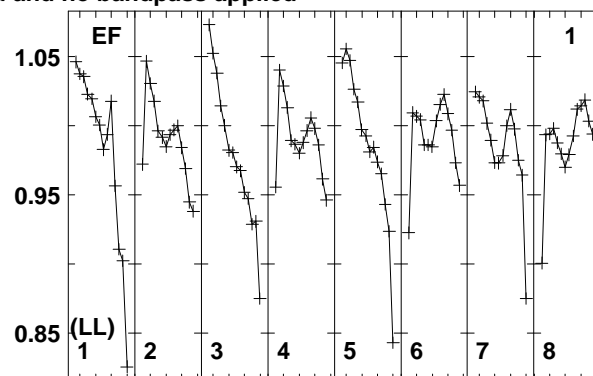
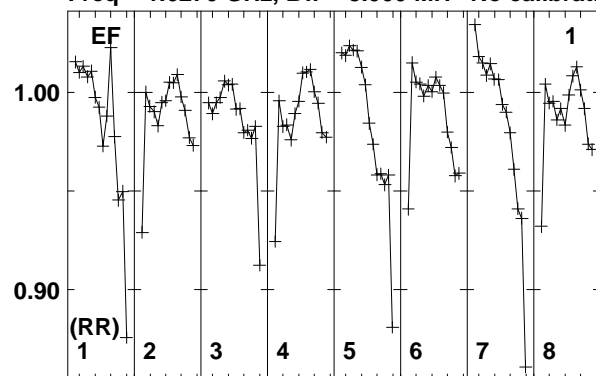

Lower frame: Real Jy
Total-power spectrum Antenna: EF (01)
Timerange: 01/00:03:59 to 01/00:11:39

Plot file version 100 created 22-OCT-2014 16:25:18

J1432+3014 EC048.UVDATA.1

Freq = 1.6270 GHz, Bw = 8.000 MH No calibration applied and no bandpass applied

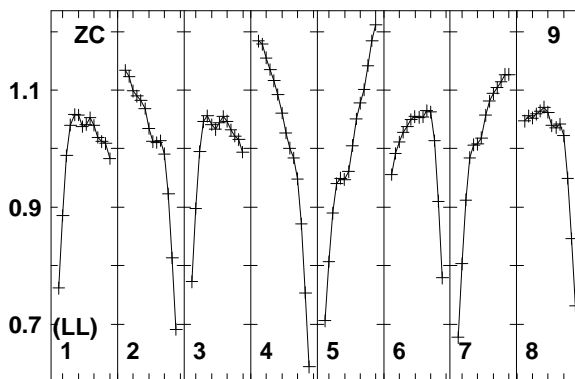
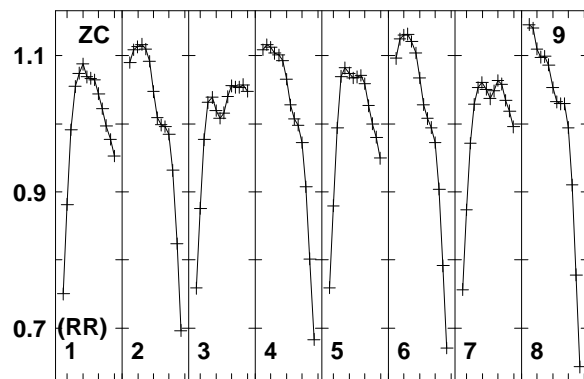
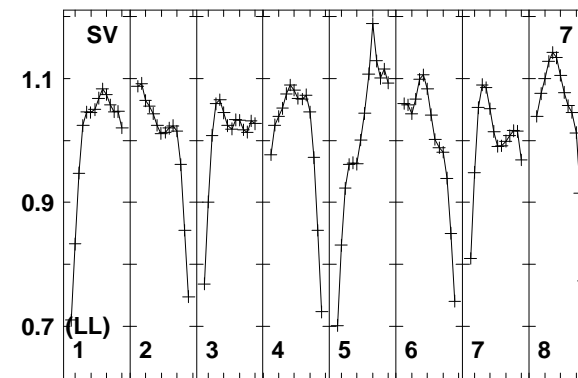
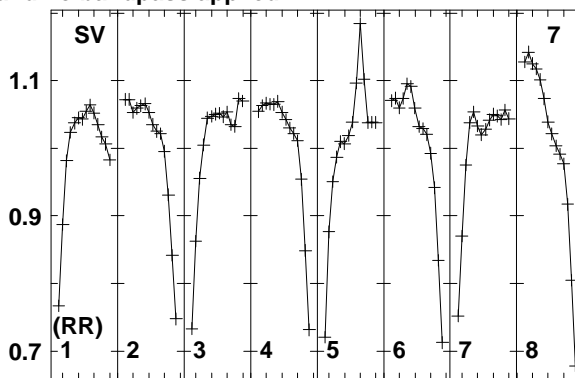
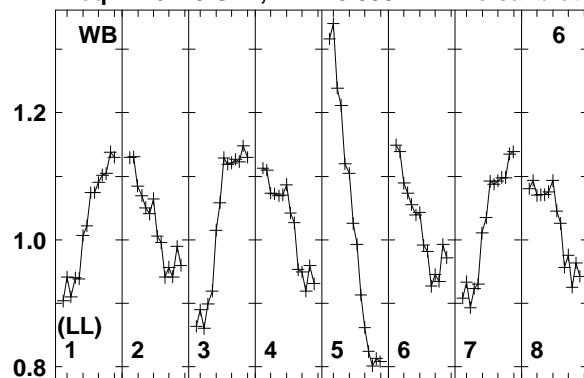

Lower frame: Real Jy
Total-power spectrum Antenna: WB (06)
Timerange: 01/00:03:59 to 01/00:11:39

Plot file version 101 created 22-OCT-2014 16:25:18

J1435+3012 EC048.UVDATA.1

Freq = 1.6270 GHz, Bw = 8.000 MH No calibration applied and no bandpass applied

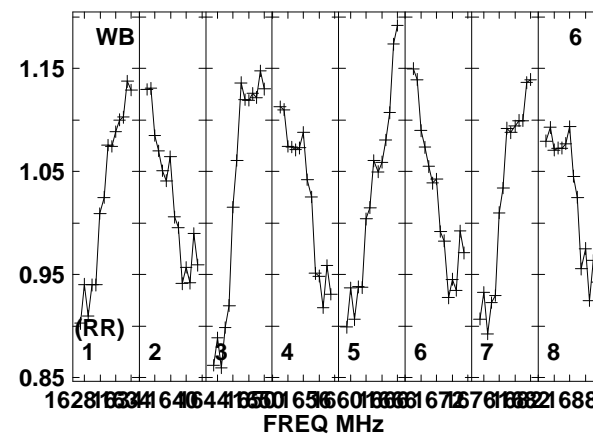
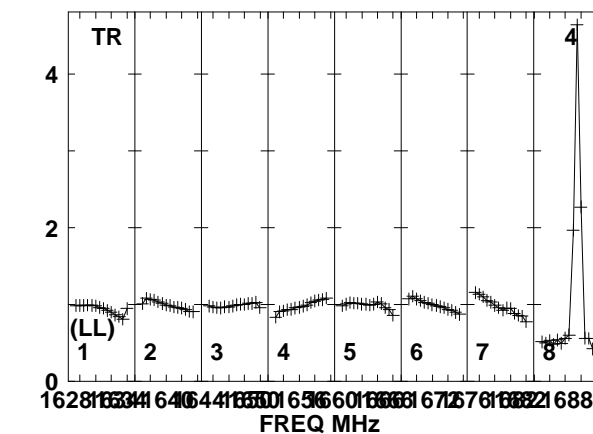
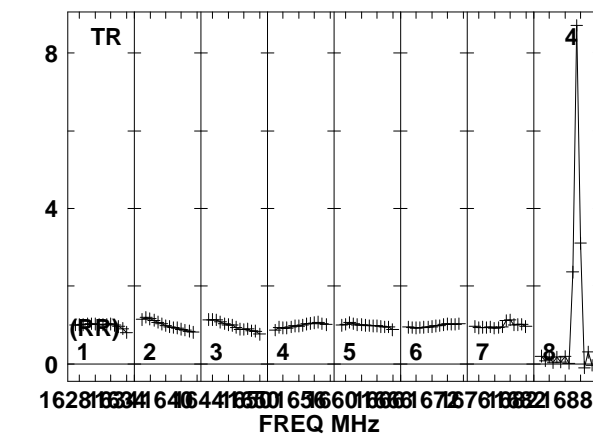
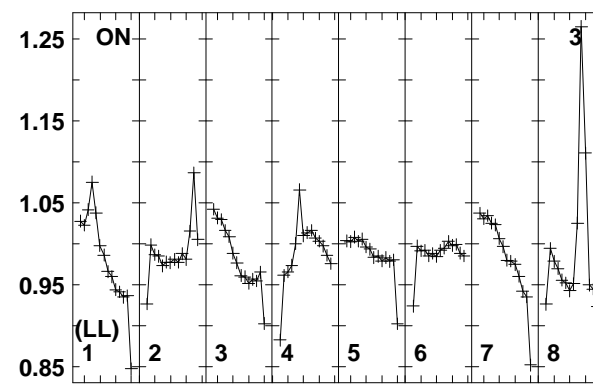
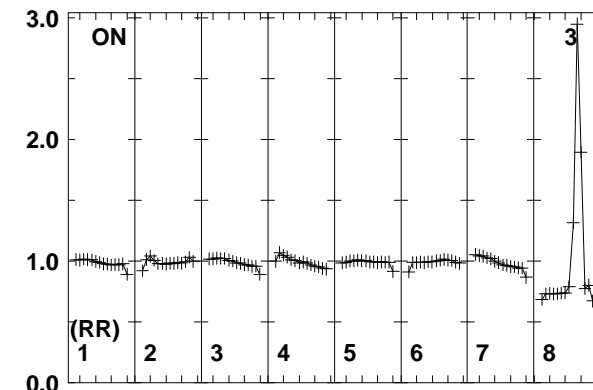
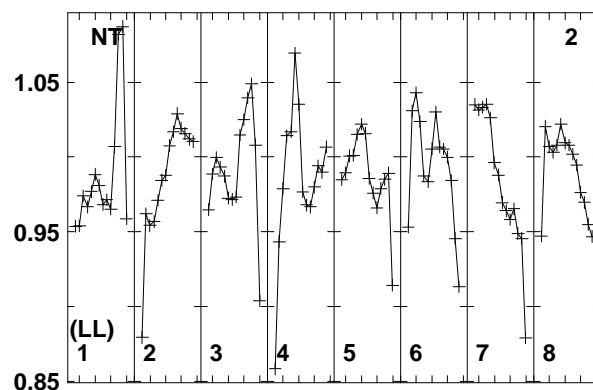
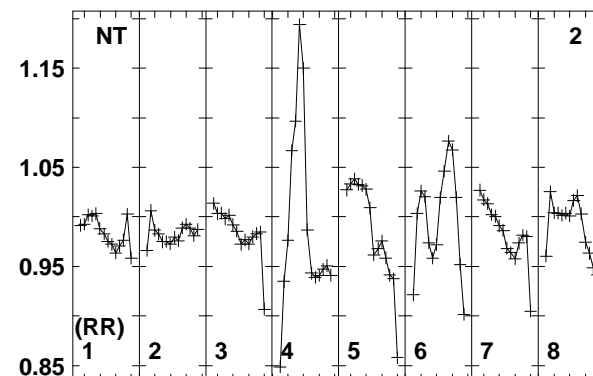
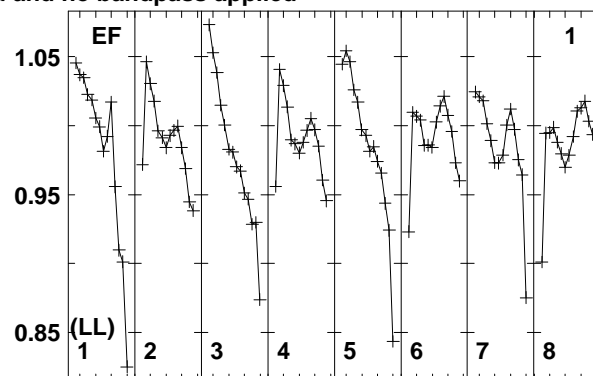
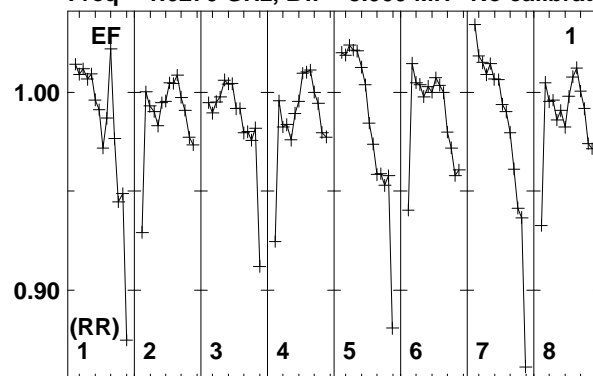

Lower frame: Real Jy
Total-power spectrum Antenna: EF (01)
Timerange: 01/00:12:23 to 01/00:14:09

Plot file version 102 created 22-OCT-2014 16:25:18

J1435+3012 EC048.UVDATA.1

Freq = 1.6270 GHz, Bw = 8.000 MH No calibration applied and no bandpass applied

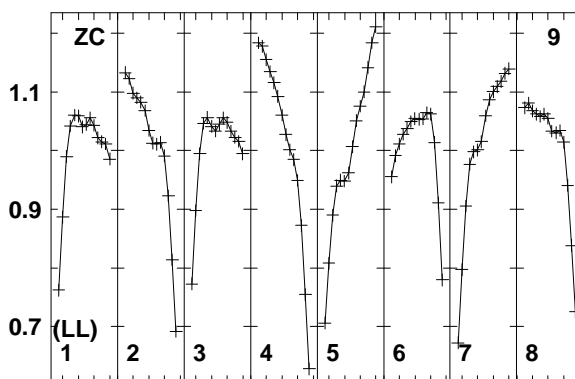
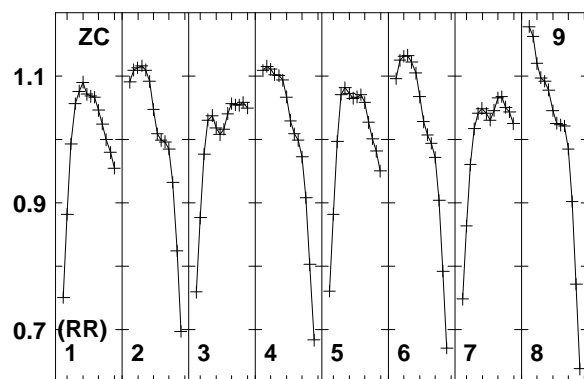
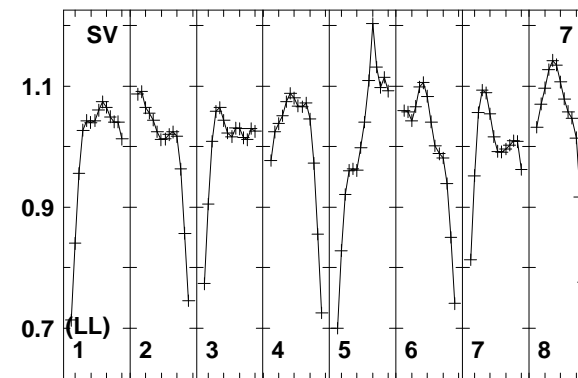
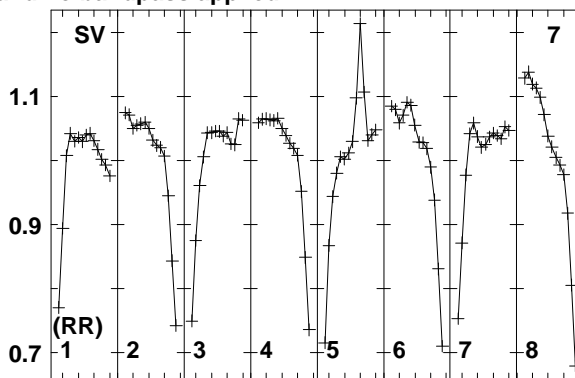
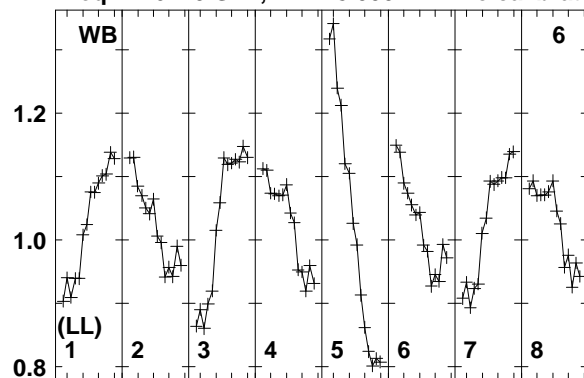

Lower frame: Real Jy
Total-power spectrum Antenna: WB (06)
Timerange: 01/00:12:23 to 01/00:14:09

Plot file version 103 created 22-OCT-2014 16:25:18

J1432+3014 EC048.UVDATA.1

Freq = 1.6270 GHz, Bw = 8.000 MH No calibration applied and no bandpass applied

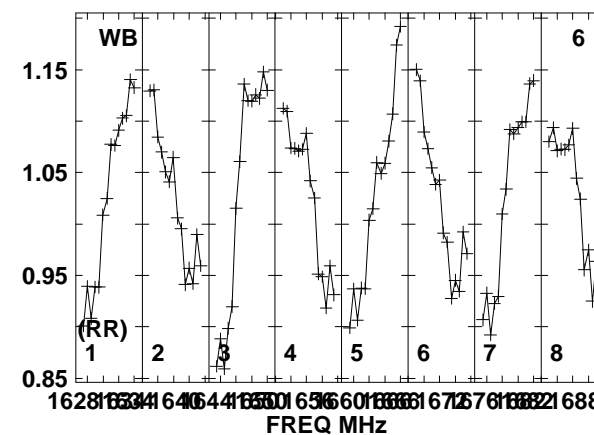
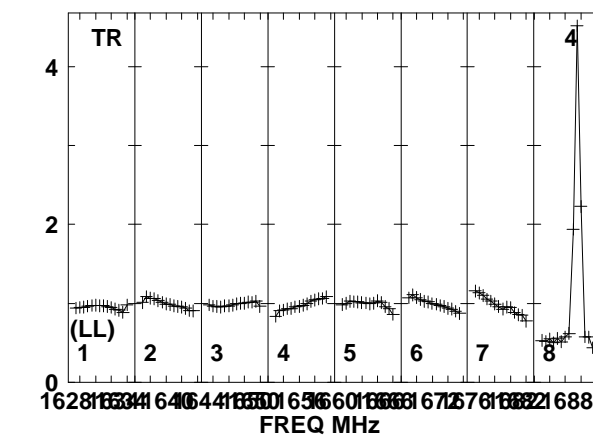
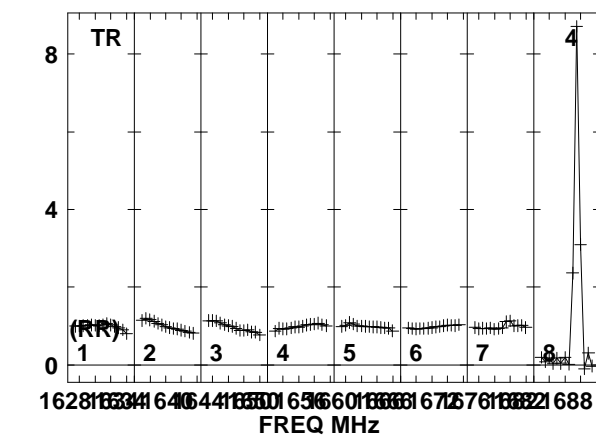
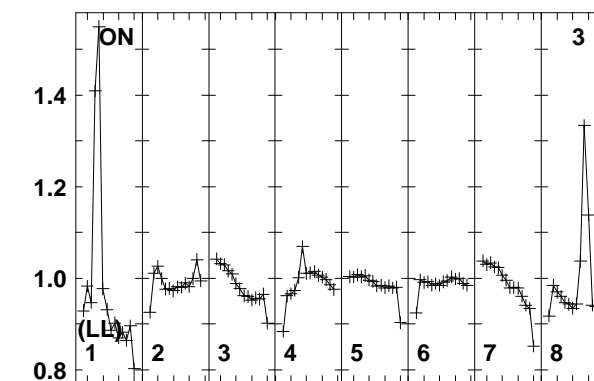
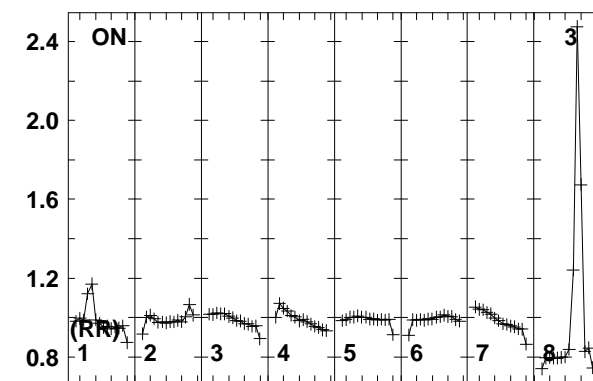
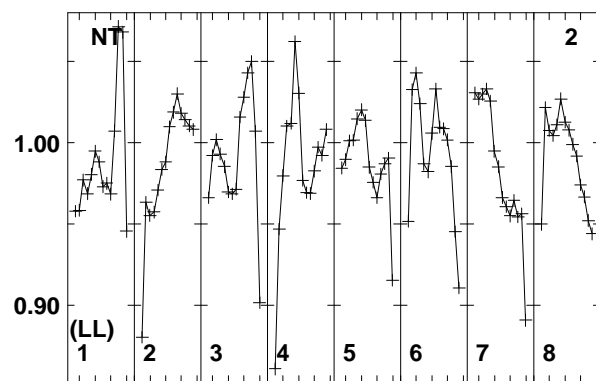
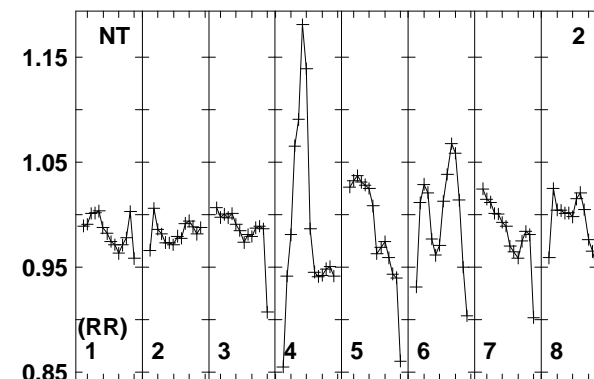
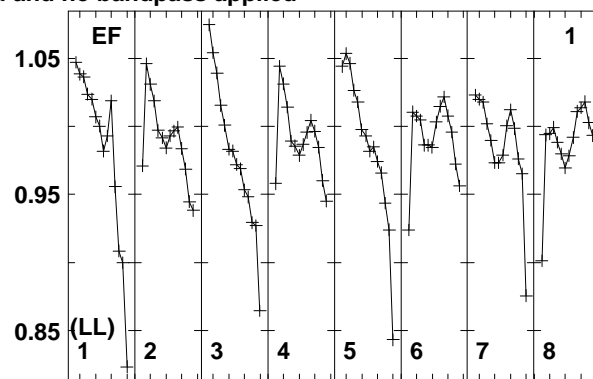
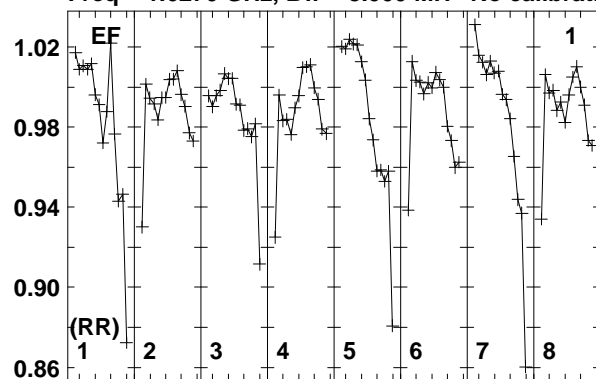

Lower frame: Real Jy
Total-power spectrum Antenna: EF (01)
Timerange: 01/00:14:14 to 01/00:21:54

Plot file version 104 created 22-OCT-2014 16:25:18

J1432+3014 EC048.UVDATA.1

Freq = 1.6270 GHz, Bw = 8.000 MH No calibration applied and no bandpass applied

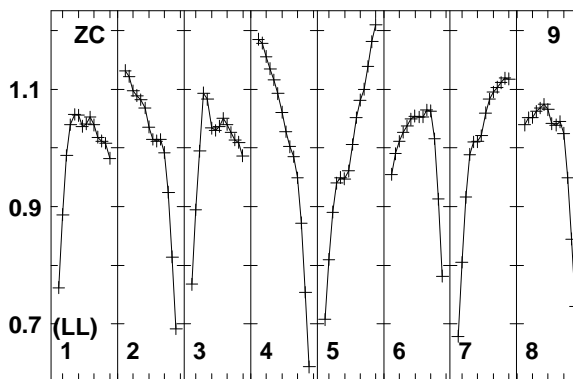
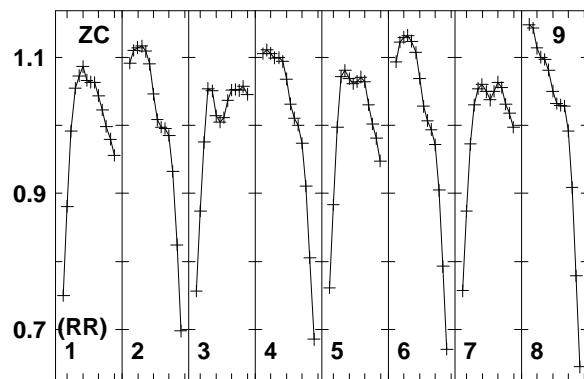
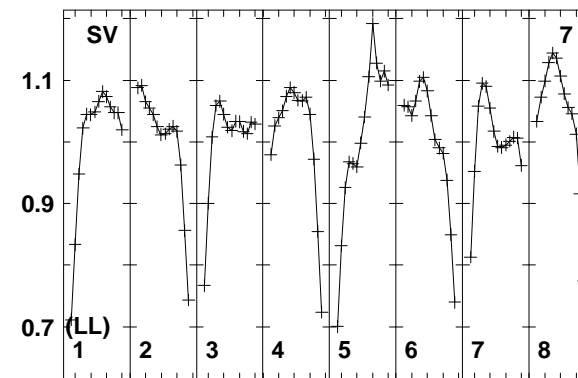
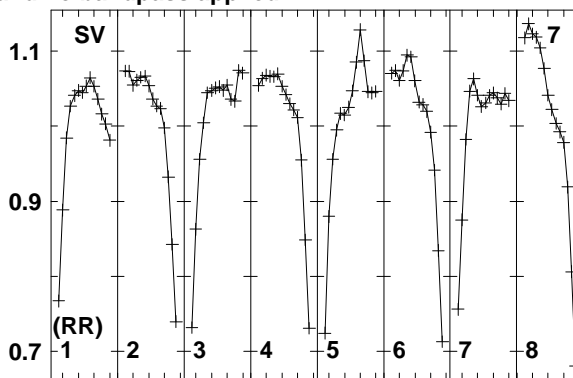
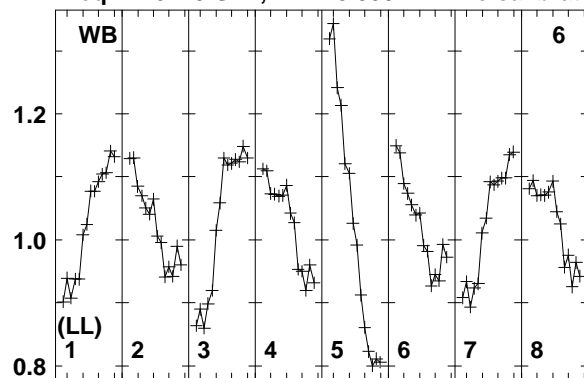

Lower frame: Real Jy
Total-power spectrum Antenna: WB (06)
Timerange: 01/00:14:14 to 01/00:21:54

Plot file version 105 created 22-OCT-2014 16:25:18

J1435+3012 EC048.UVDATA.1

Freq = 1.6270 GHz, Bw = 8.000 MH No calibration applied and no bandpass applied

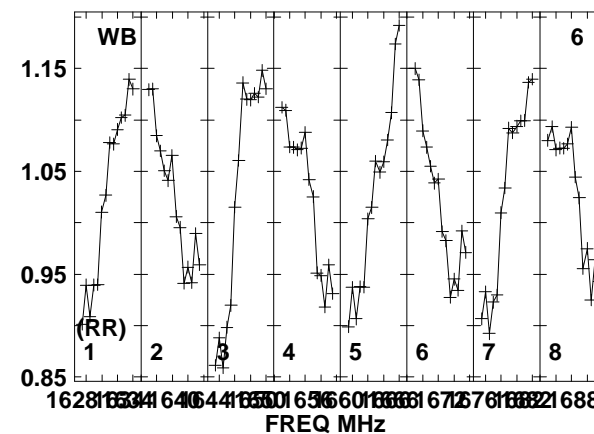
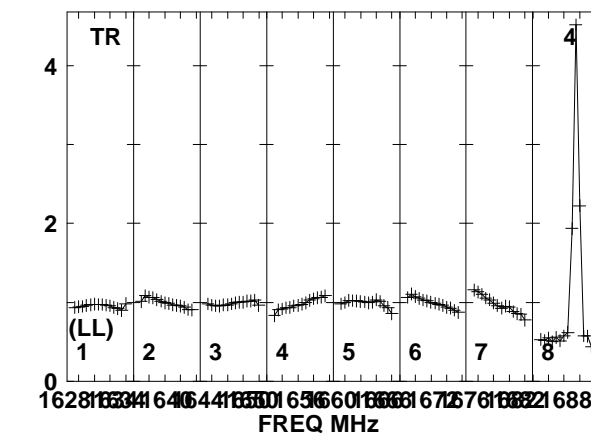
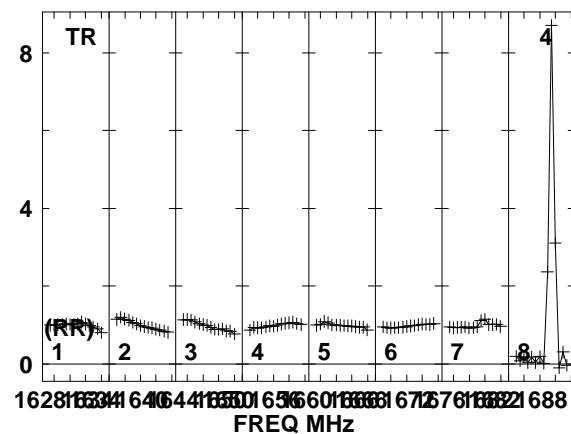
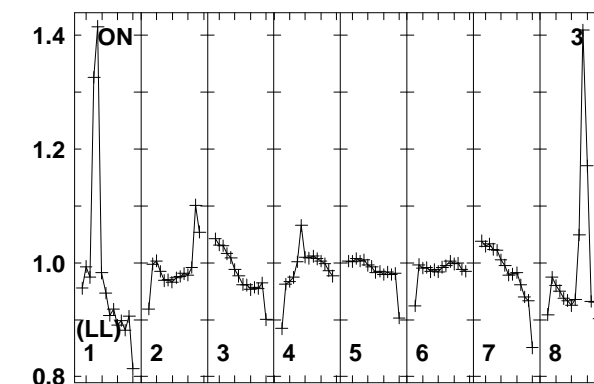
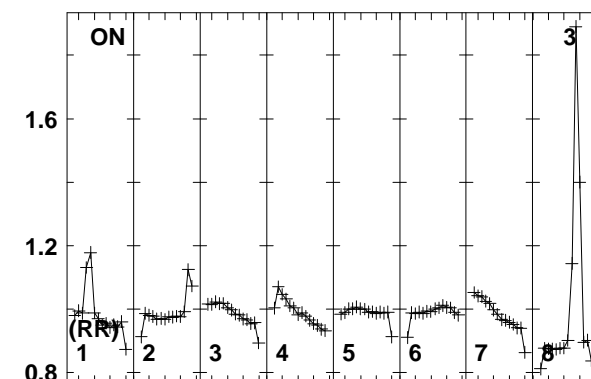
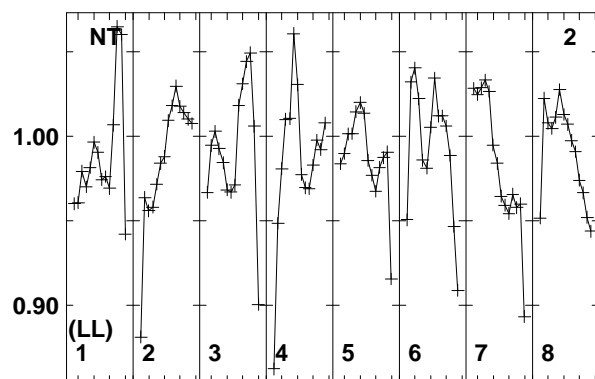
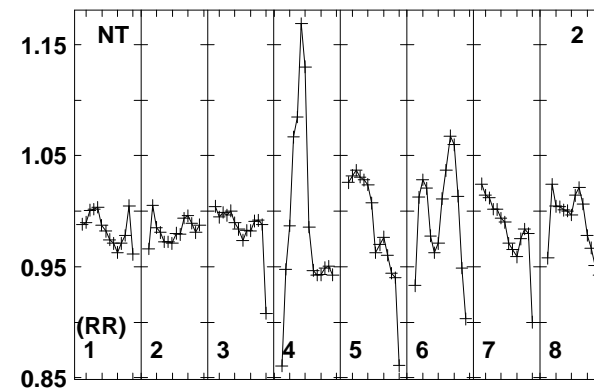
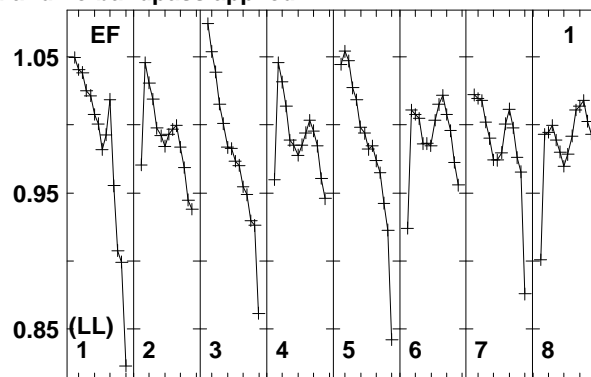
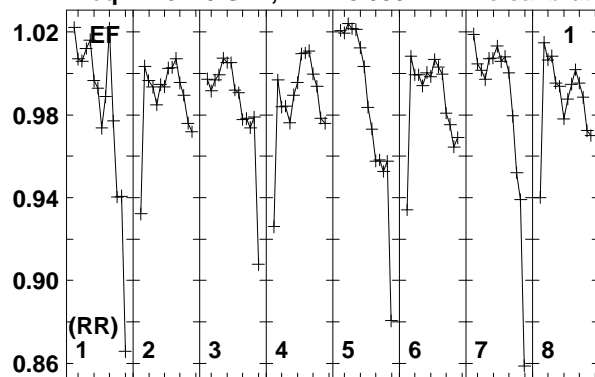

Lower frame: Real Jy
Total-power spectrum Antenna: EF (01)
Timerange: 01/00:22:38 to 01/00:24:24

Plot file version 106 created 22-OCT-2014 16:25:18

J1435+3012 EC048.UVDATA.1

Freq = 1.6270 GHz, Bw = 8.000 MH No calibration applied and no bandpass applied

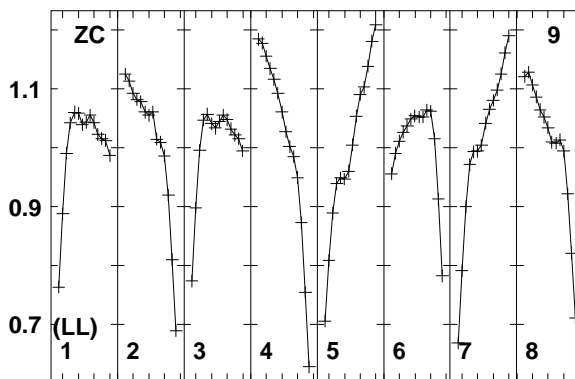
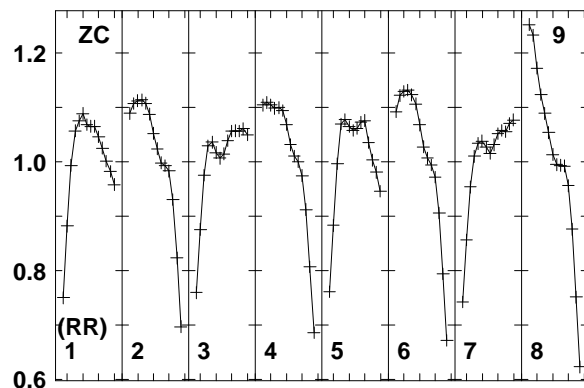
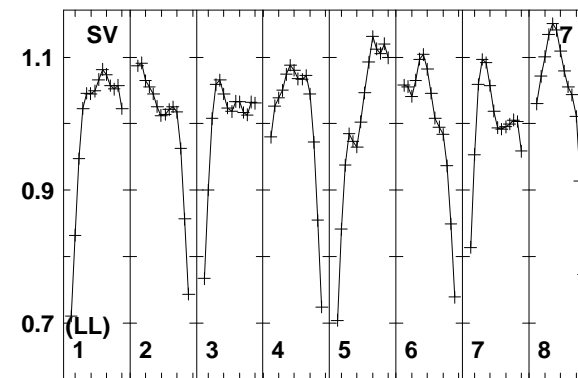
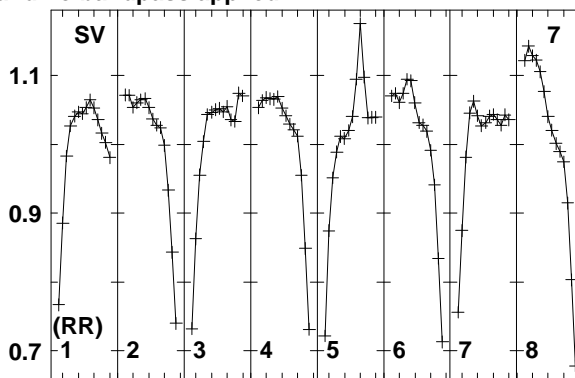
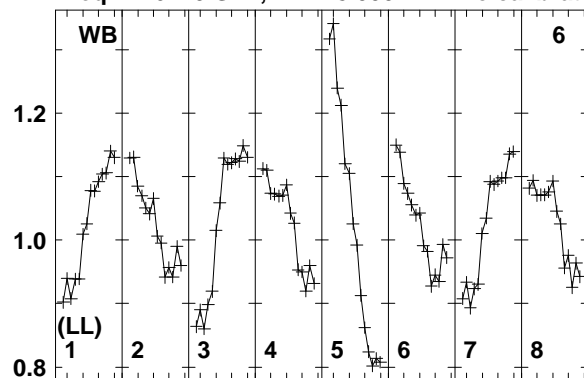

Lower frame: Real Jy
Total-power spectrum Antenna: WB (06)
Timerange: 01/00:22:38 to 01/00:24:24

Plot file version 107 created 22-OCT-2014 16:25:18

J1432+3014 EC048.UVDATA.1

Freq = 1.6270 GHz, Bw = 8.000 MH No calibration applied and no bandpass applied

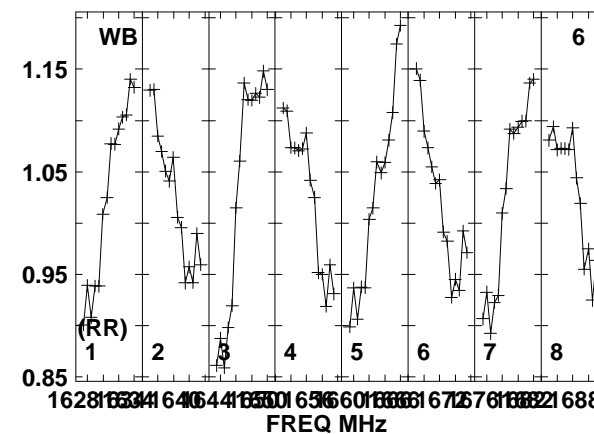
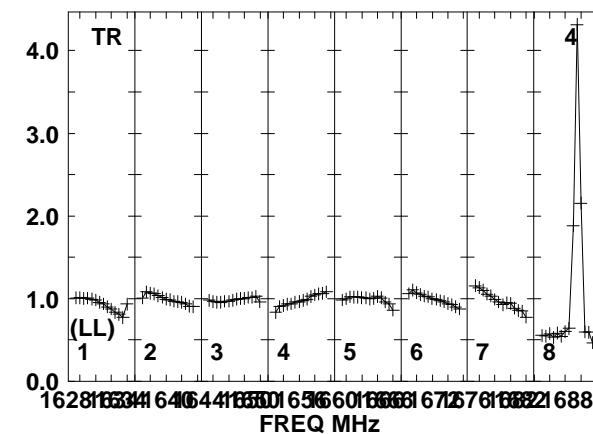
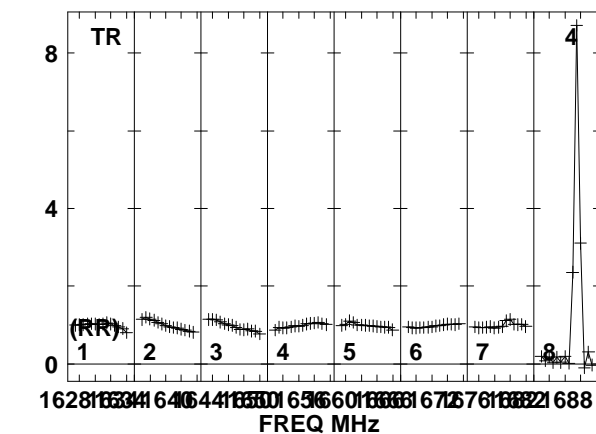
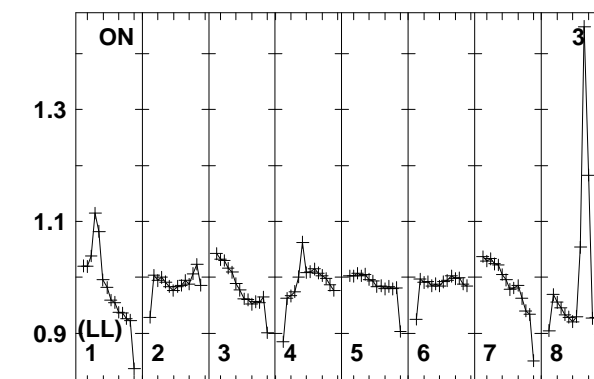
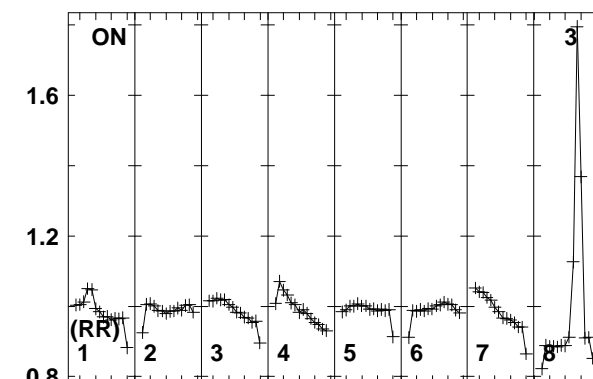
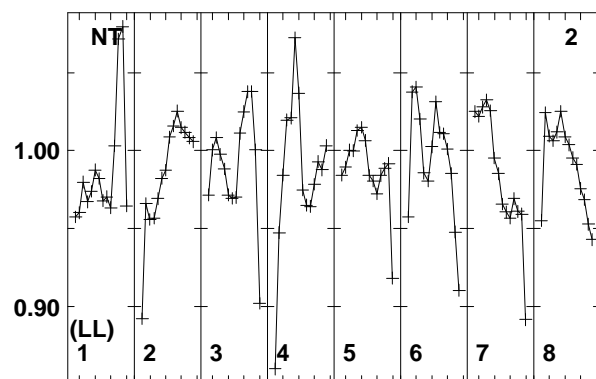
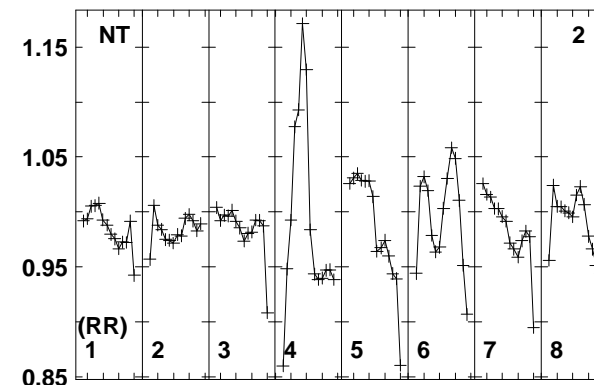
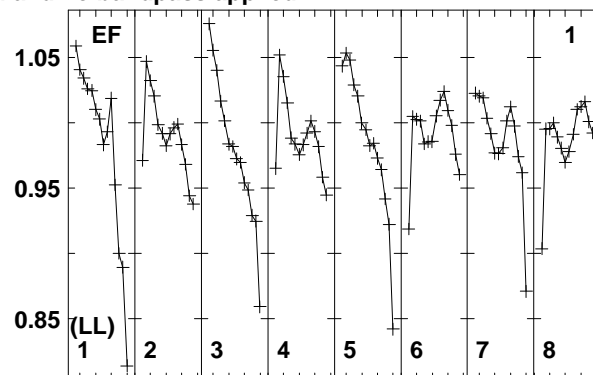
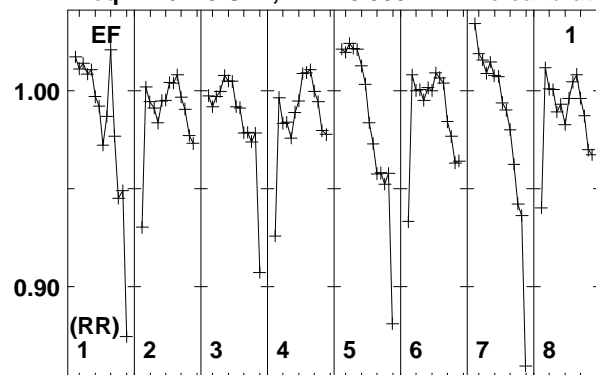

Lower frame: Real Jy
Total-power spectrum Antenna: EF (01)
Timerange: 01/00:24:29 to 01/00:32:09

Plot file version 108 created 22-OCT-2014 16:25:18

J1432+3014 EC048.UVDATA.1

Freq = 1.6270 GHz, Bw = 8.000 MH No calibration applied and no bandpass applied

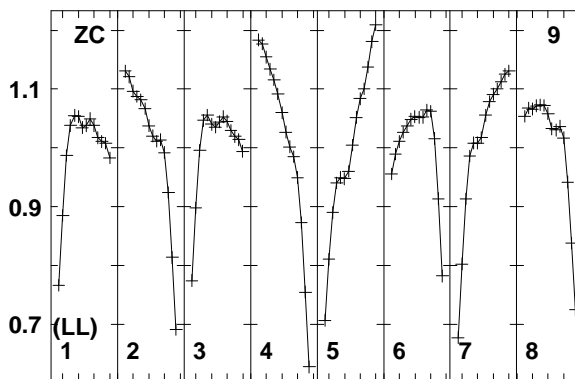
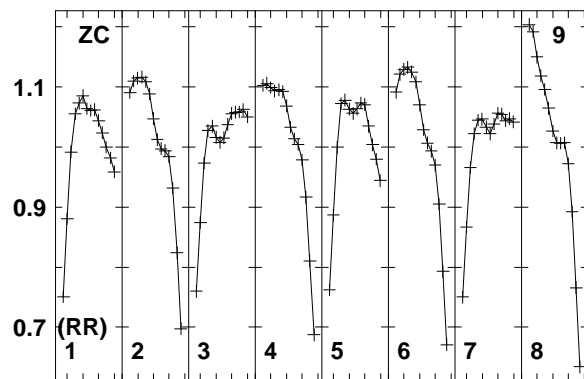
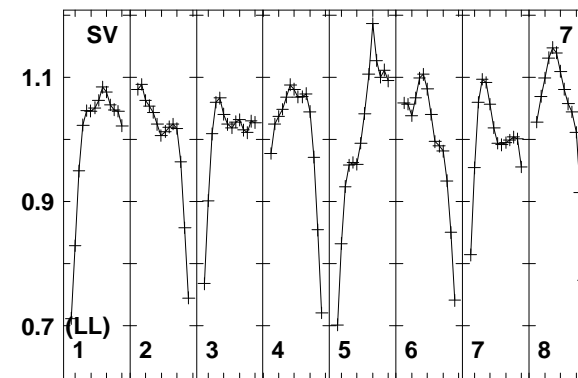
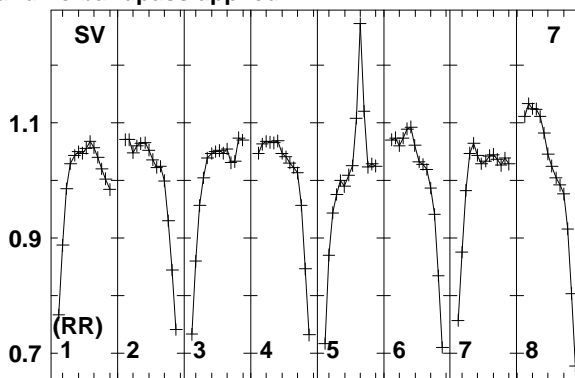
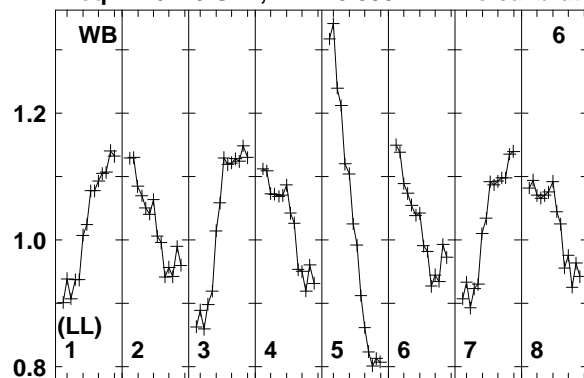

Lower frame: Real Jy
Total-power spectrum Antenna: WB (06)
Timerange: 01/00:24:29 to 01/00:32:09

Plot file version 109 created 22-OCT-2014 16:25:18

J1435+3012 EC048.UVDATA.1

Freq = 1.6270 GHz, Bw = 8.000 MH No calibration applied and no bandpass applied

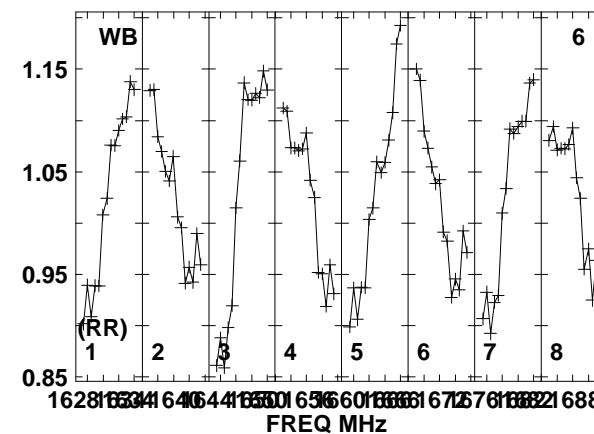
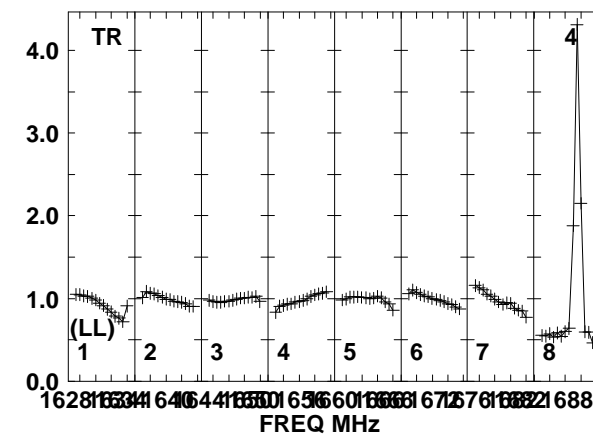
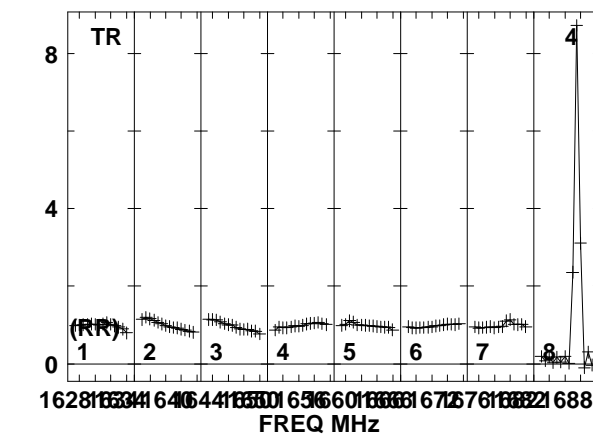
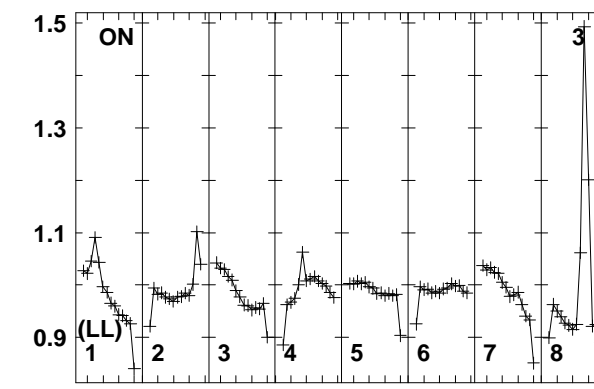
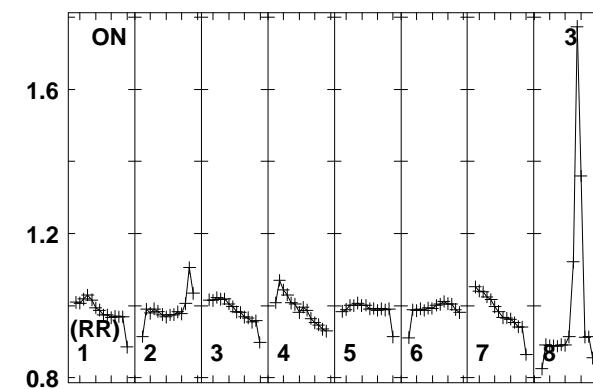
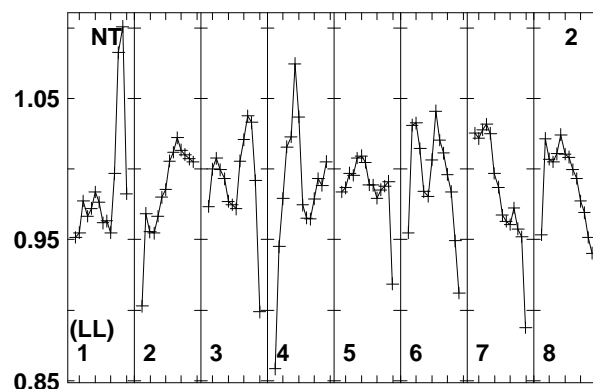
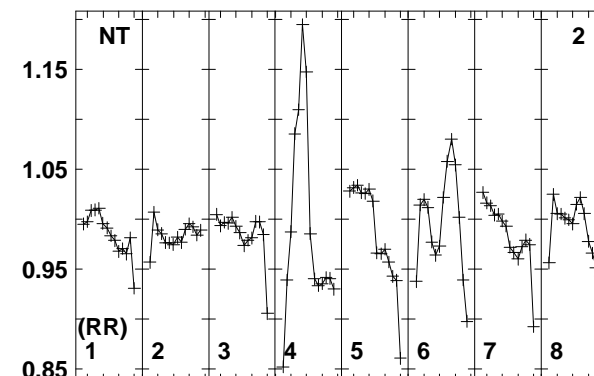
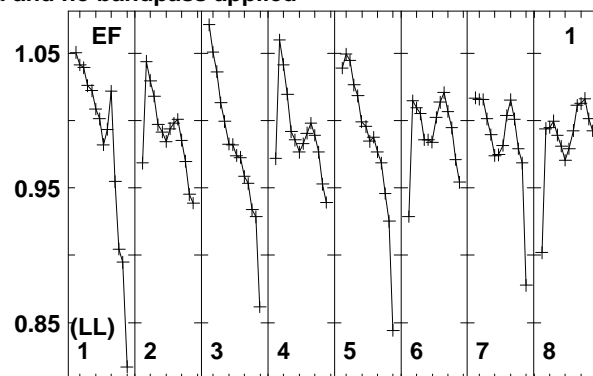
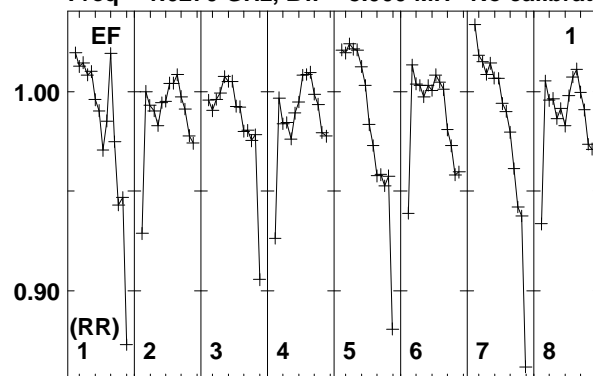

Lower frame: Real Jy
Total-power spectrum Antenna: EF (01)
Timerange: 01/00:32:53 to 01/00:34:39

Plot file version 110 created 22-OCT-2014 16:25:18

J1435+3012 EC048.UVDATA.1

Freq = 1.6270 GHz, Bw = 8.000 MH No calibration applied and no bandpass applied

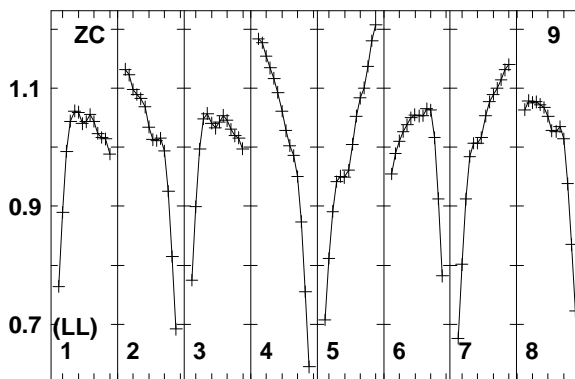
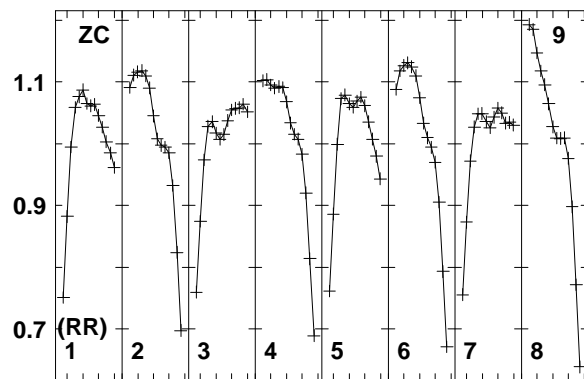
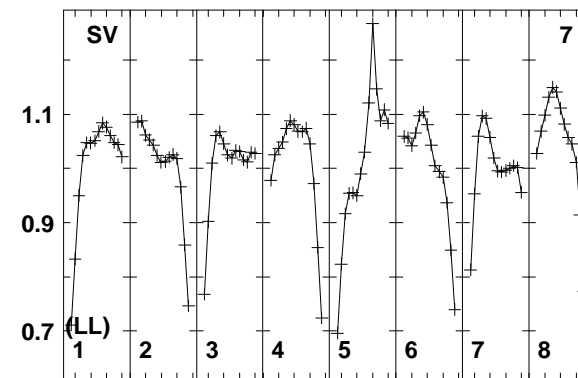
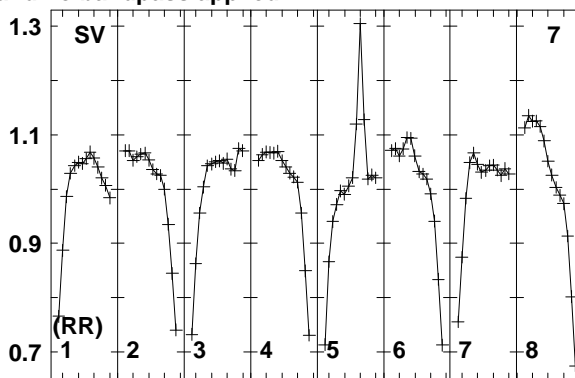
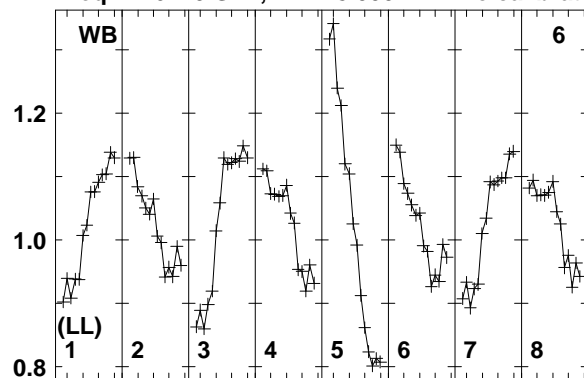

Lower frame: Real Jy
Total-power spectrum Antenna: WB (06)
Timerange: 01/00:32:53 to 01/00:34:39

Plot file version 111 created 22-OCT-2014 16:25:18

J1432+3014 EC048.UVDATA.1

Freq = 1.6270 GHz, Bw = 8.000 MH No calibration applied and no bandpass applied

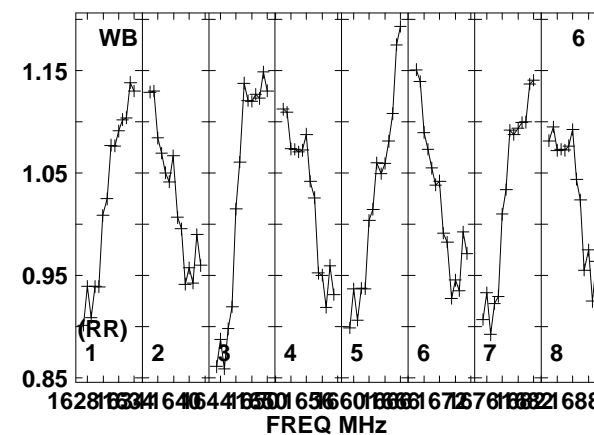
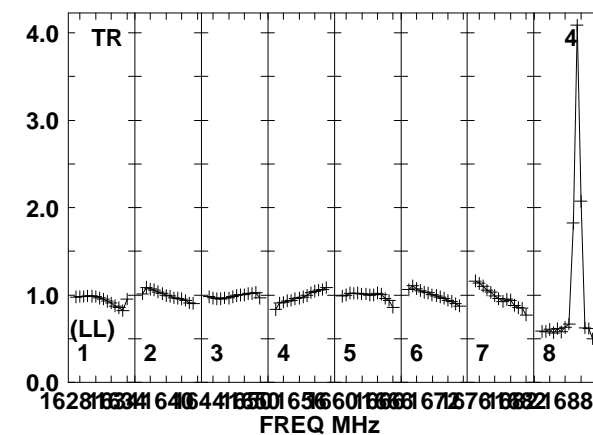
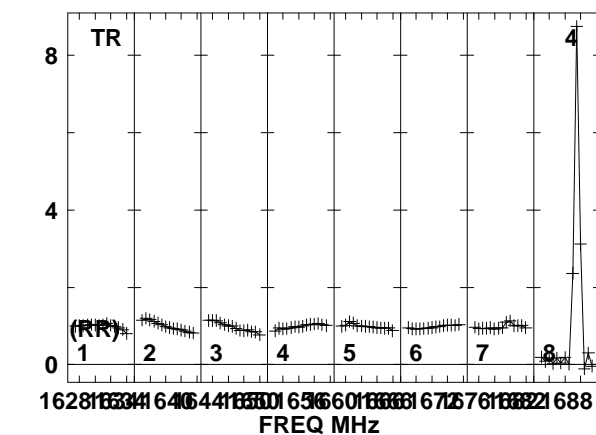
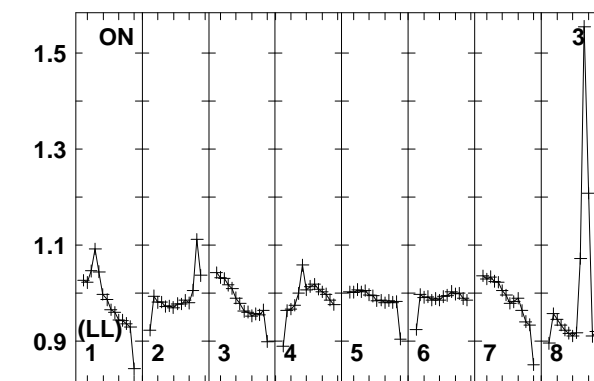
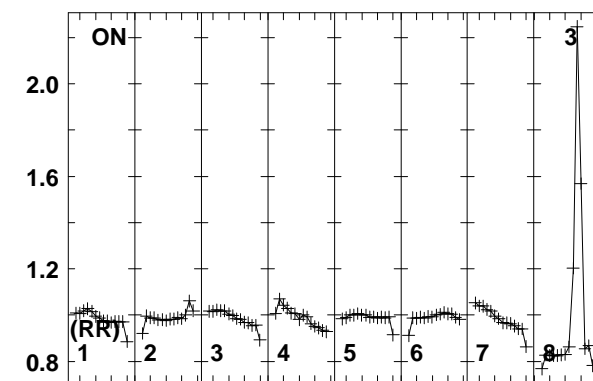
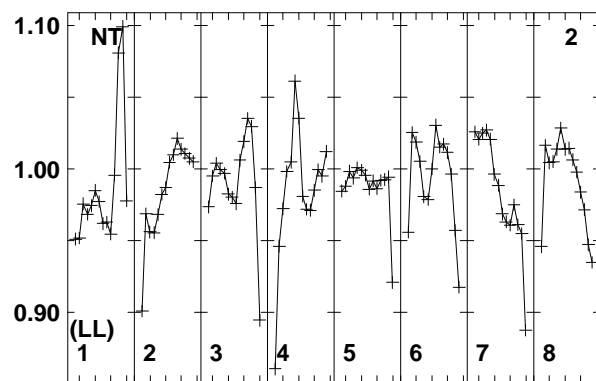
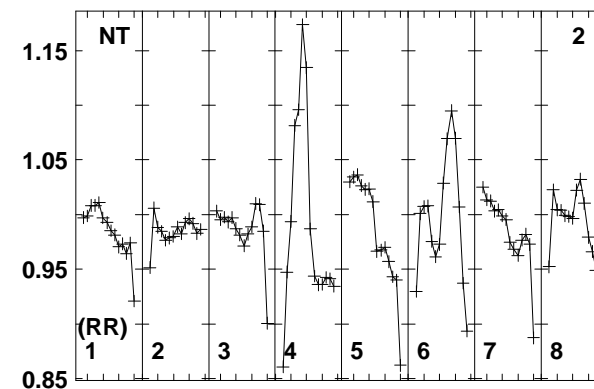
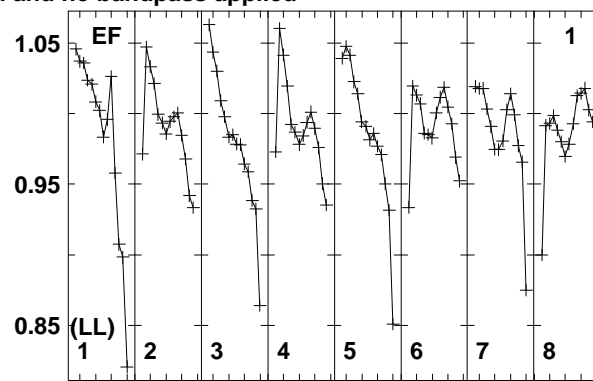
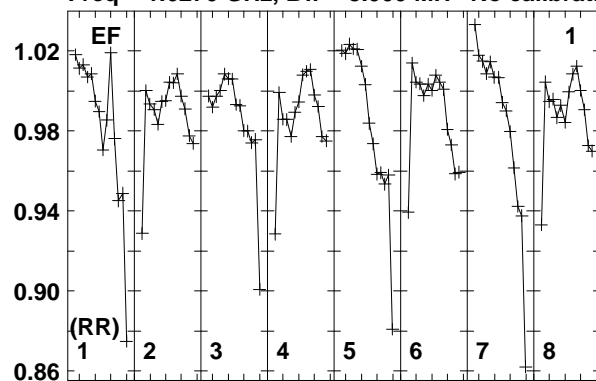

Lower frame: Real Jy
Total-power spectrum Antenna: EF (01)
Timerange: 01/00:34:44 to 01/00:42:24

Plot file version 112 created 22-OCT-2014 16:25:18

J1432+3014 EC048.UVDATA.1

Freq = 1.6270 GHz, Bw = 8.000 MH No calibration applied and no bandpass applied

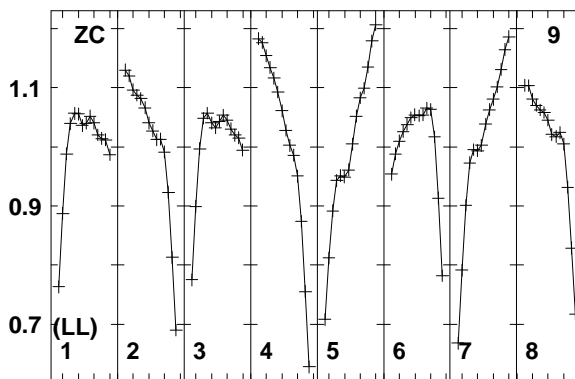
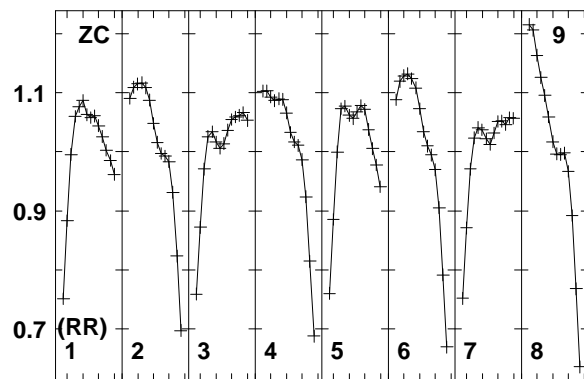
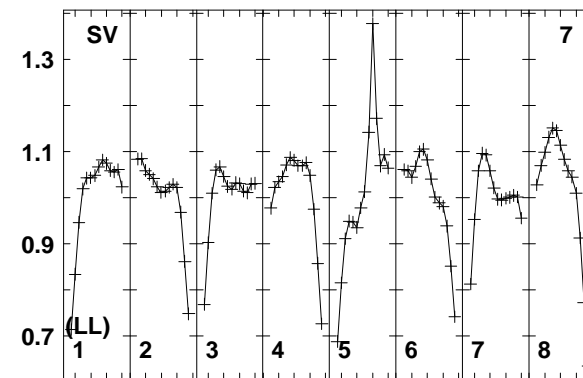
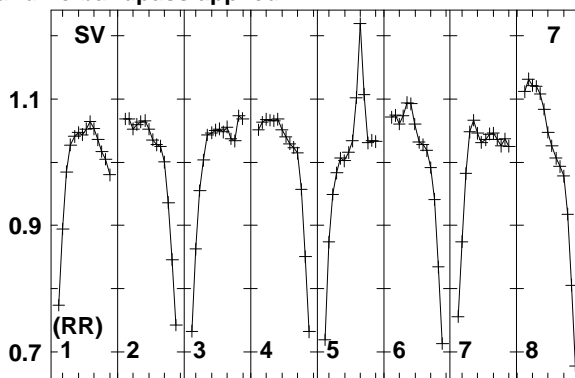
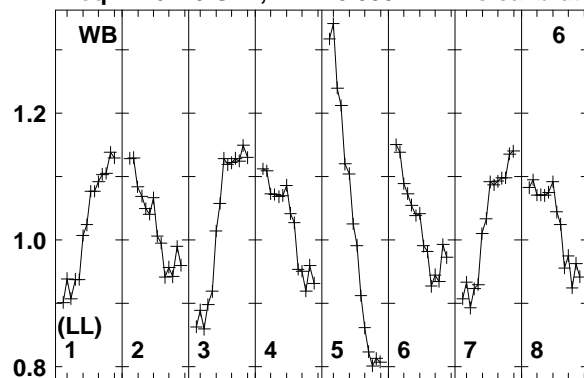

Lower frame: Real Jy
Total-power spectrum Antenna: WB (06)
Timerange: 01/00:34:44 to 01/00:42:24

Plot file version 113 created 22-OCT-2014 16:25:18

J1435+3012 EC048.UVDATA.1

Freq = 1.6270 GHz, Bw = 8.000 MH No calibration applied and no bandpass applied

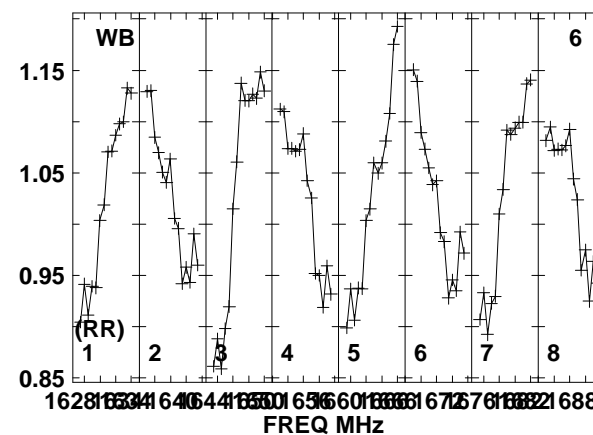
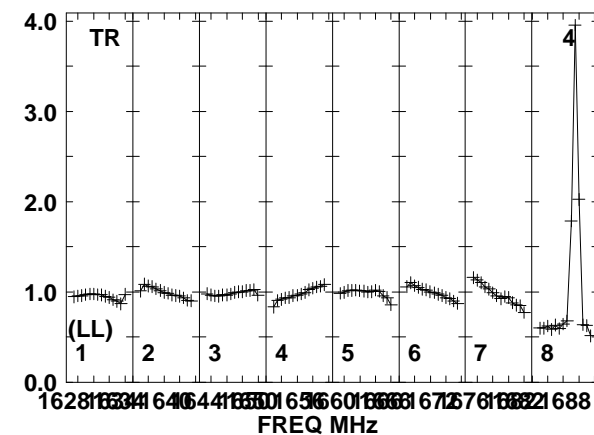
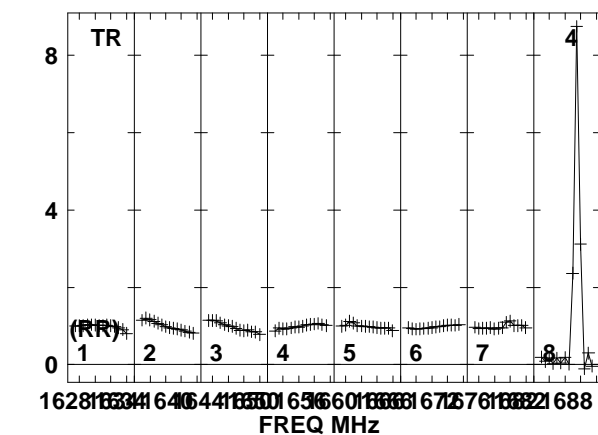
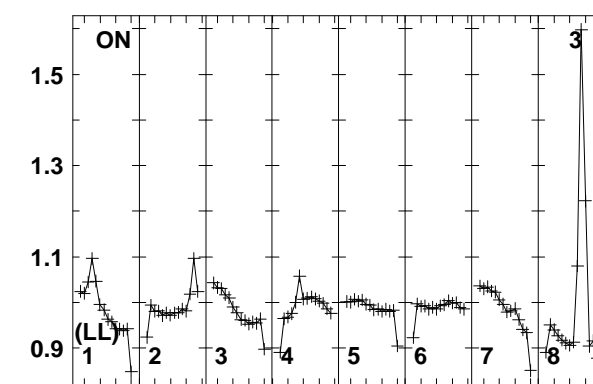
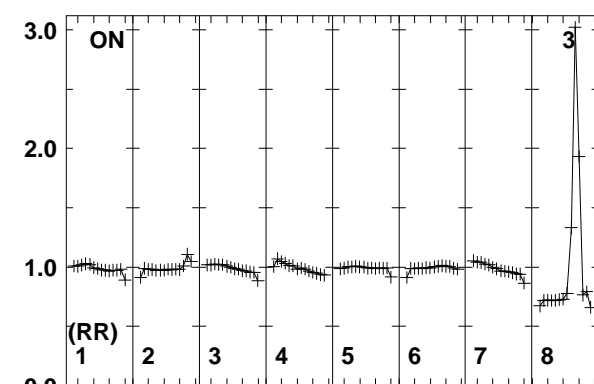
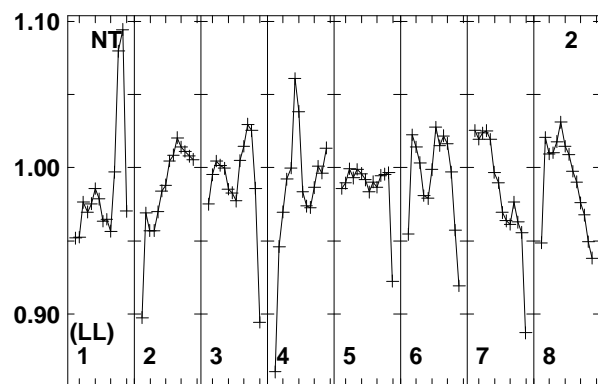
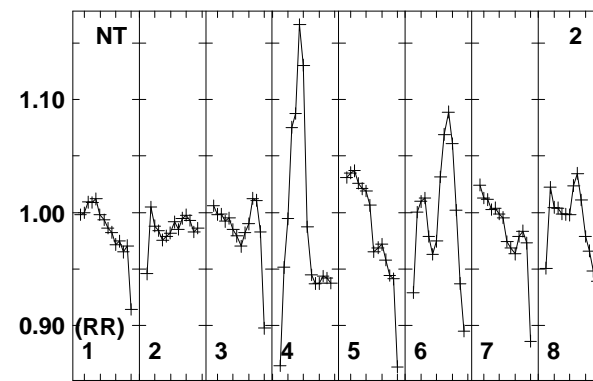
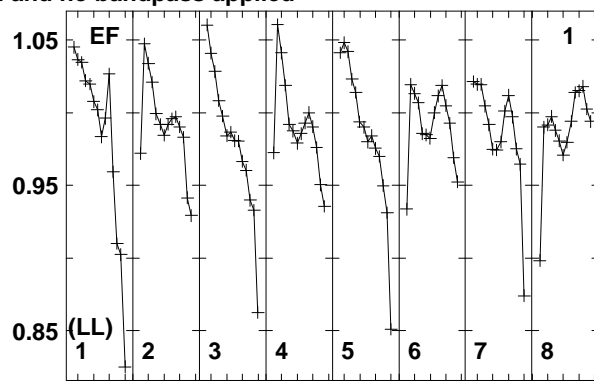
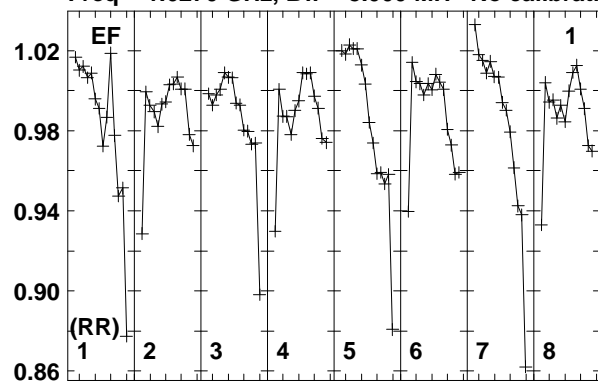

Lower frame: Real Jy
Total-power spectrum Antenna: EF (01)
Timerange: 01/00:43:08 to 01/00:44:54

Plot file version 114 created 22-OCT-2014 16:25:19

J1435+3012 EC048.UVDATA.1

Freq = 1.6270 GHz, Bw = 8.000 MH No calibration applied and no bandpass applied

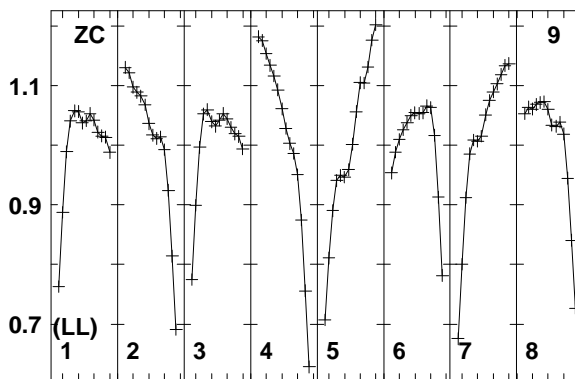
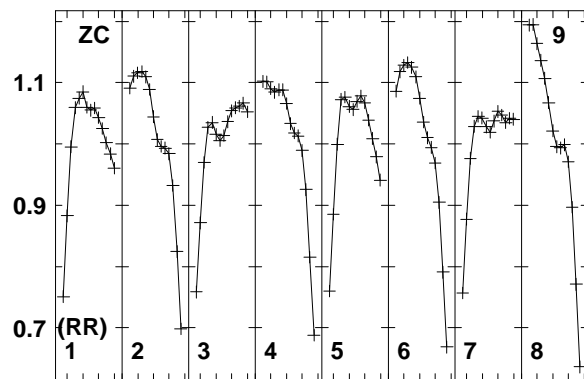
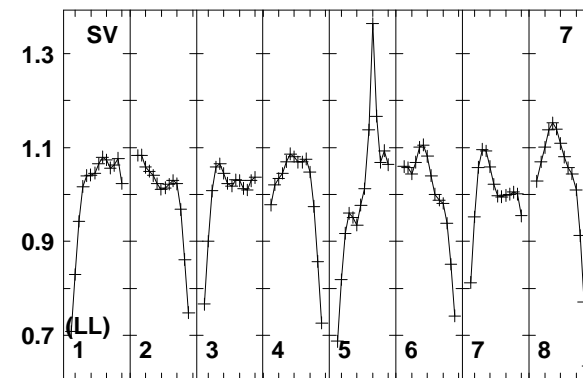
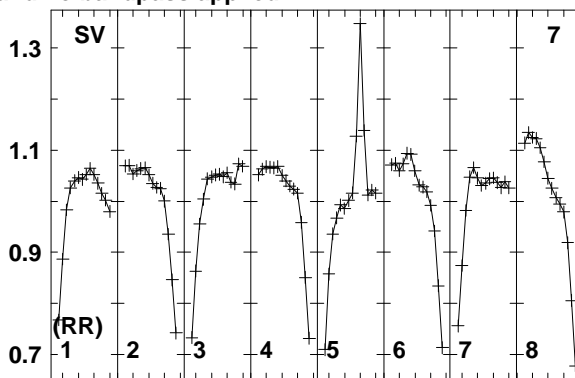
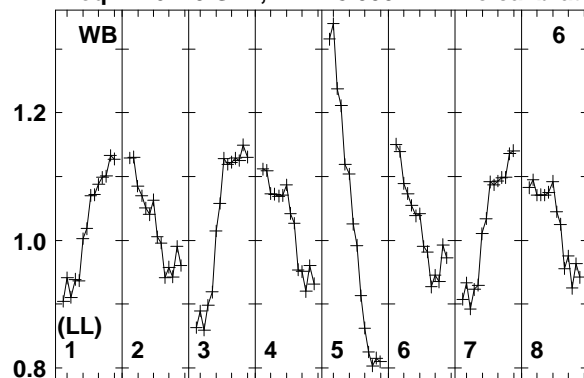

Lower frame: Real Jy
Total-power spectrum Antenna: WB (06)
Timerange: 01/00:43:08 to 01/00:44:54

Plot file version 115 created 22-OCT-2014 16:25:19

J1432+3014 EC048.UVDATA.1

Freq = 1.6270 GHz, Bw = 8.000 MH No calibration applied and no bandpass applied

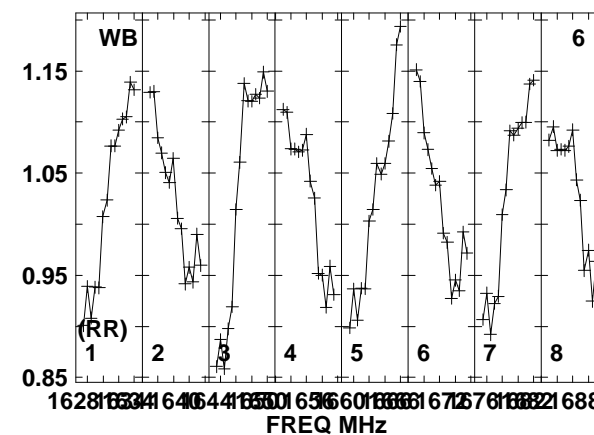
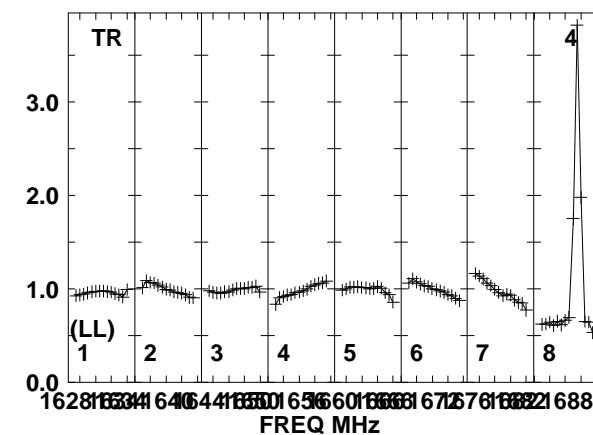
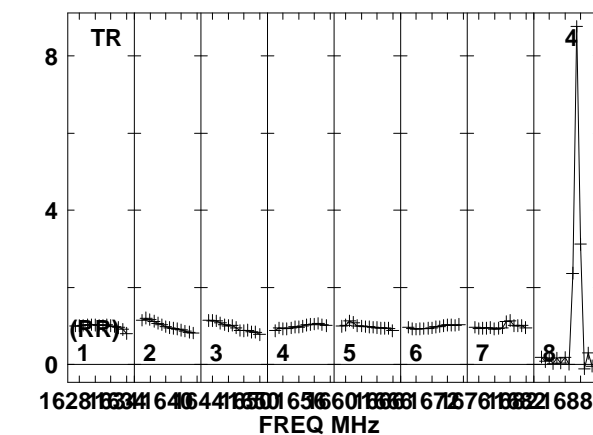
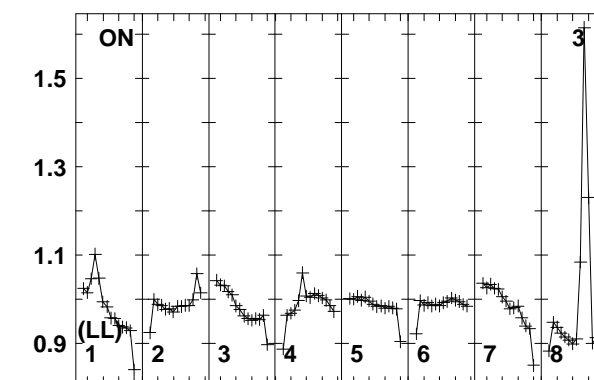
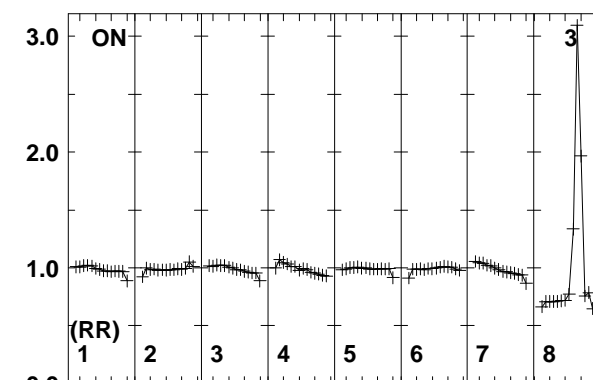
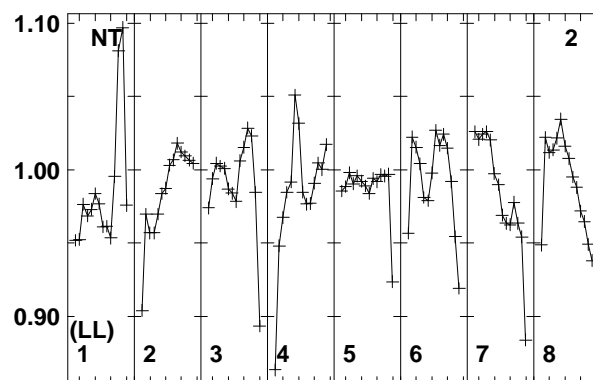
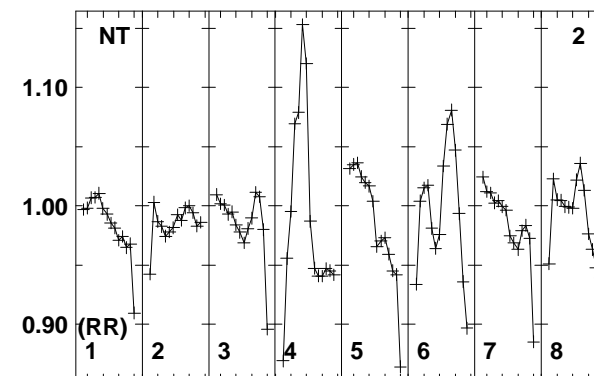
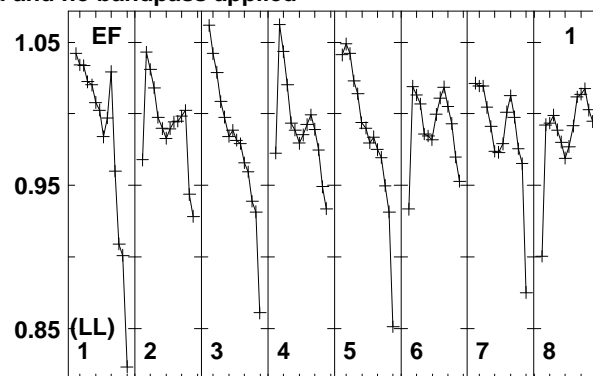
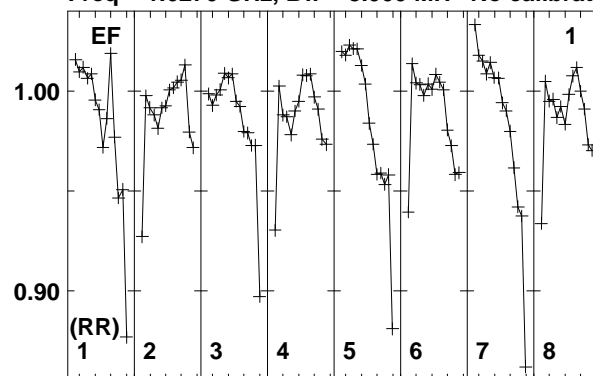

Lower frame: Real Jy
Total-power spectrum Antenna: EF (01)
Timerange: 01/00:44:59 to 01/00:52:39

Plot file version 116 created 22-OCT-2014 16:25:19

J1432+3014 EC048.UVDATA.1

Freq = 1.6270 GHz, Bw = 8.000 MH No calibration applied and no bandpass applied

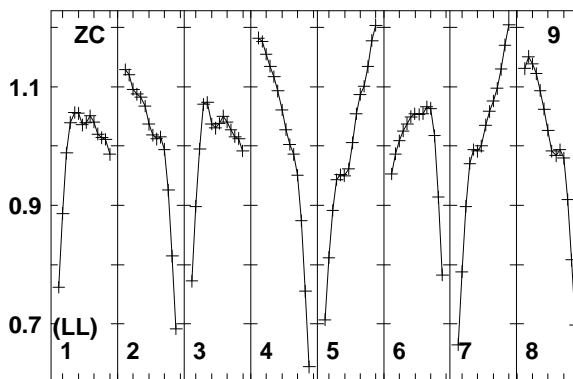
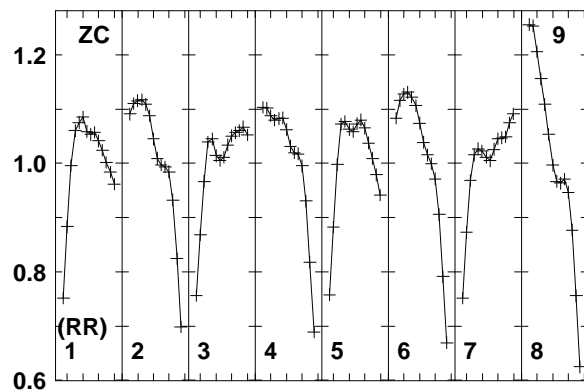
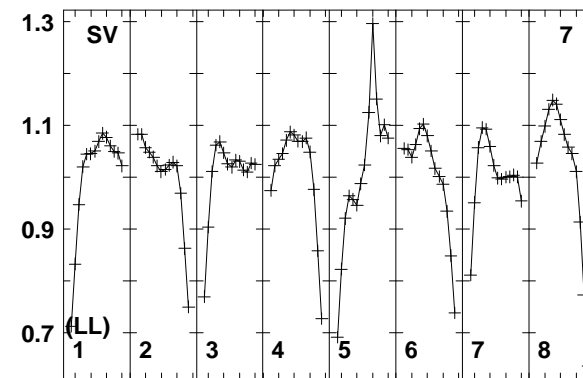
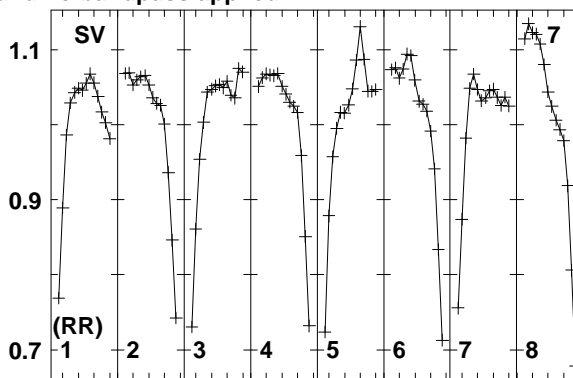
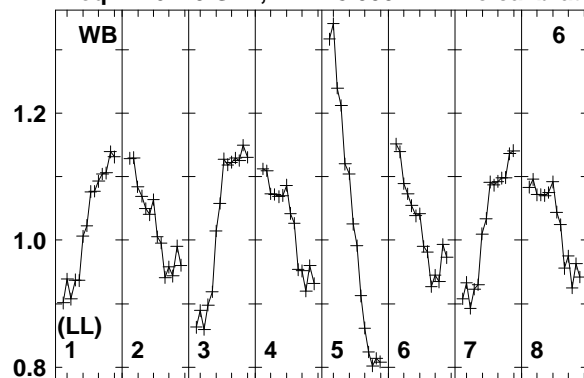

Lower frame: Real Jy
Total-power spectrum Antenna: WB (06)
Timerange: 01/00:44:59 to 01/00:52:39

Plot file version 117 created 22-OCT-2014 16:25:19

J1435+3012 EC048.UVDATA.1

Freq = 1.6270 GHz, Bw = 8.000 MH No calibration applied and no bandpass applied

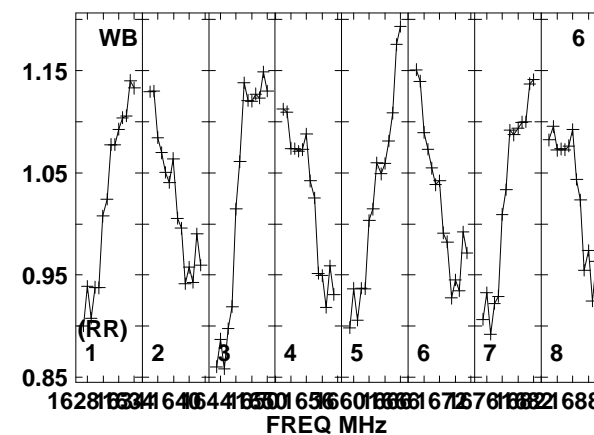
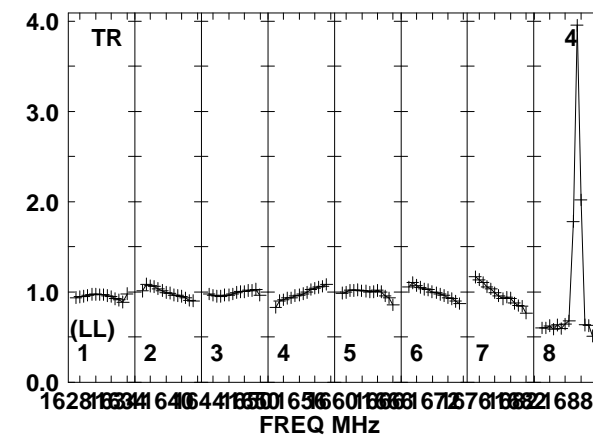
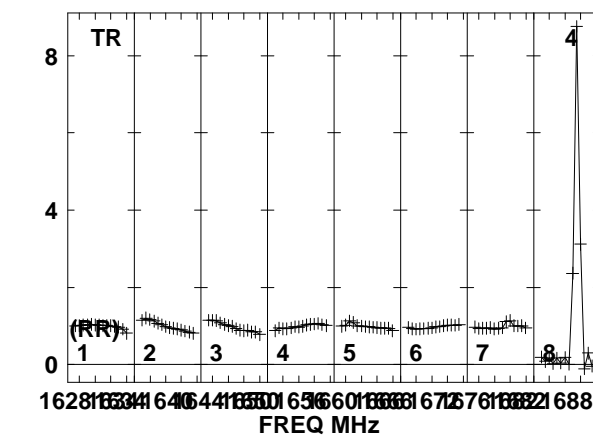
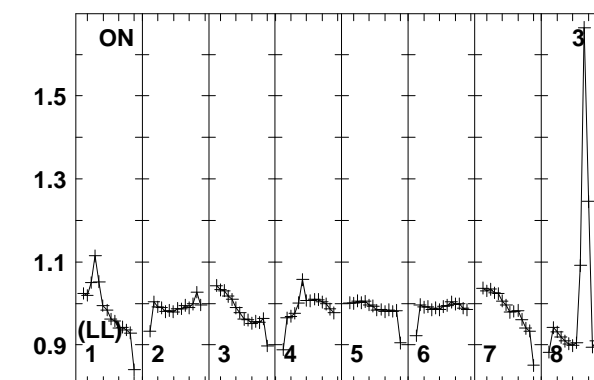
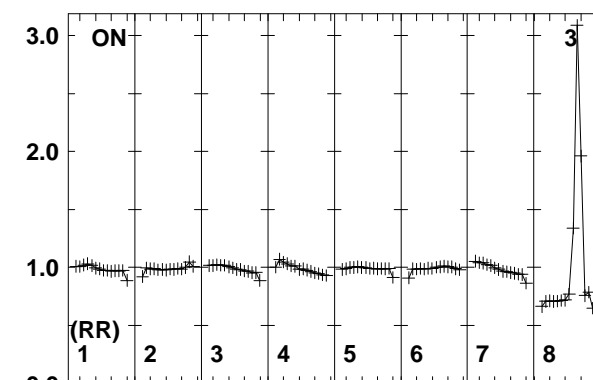
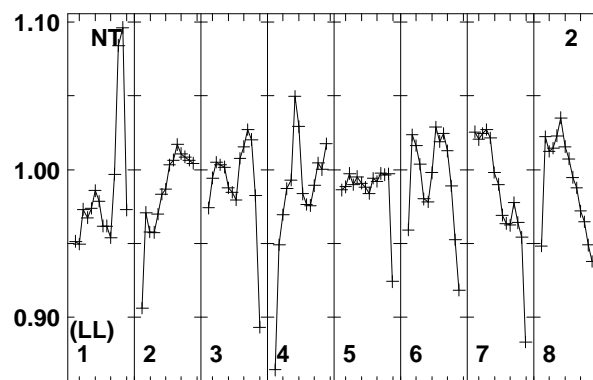
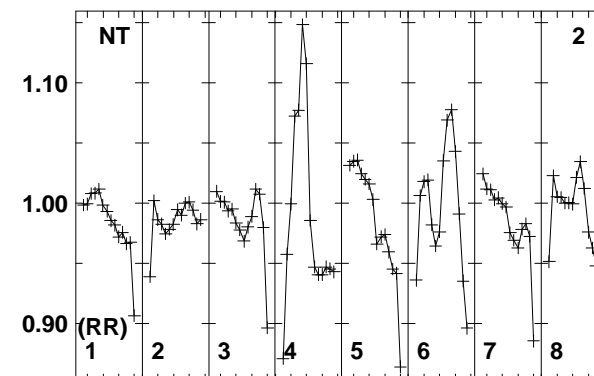
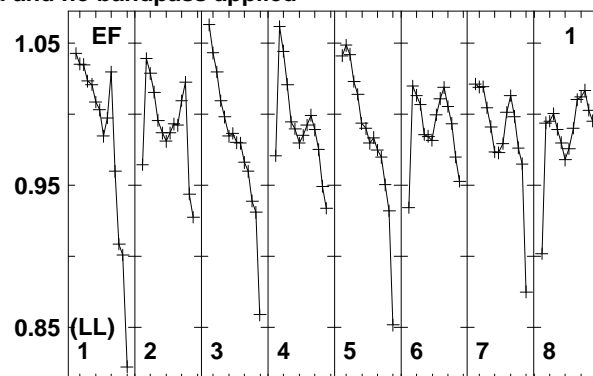
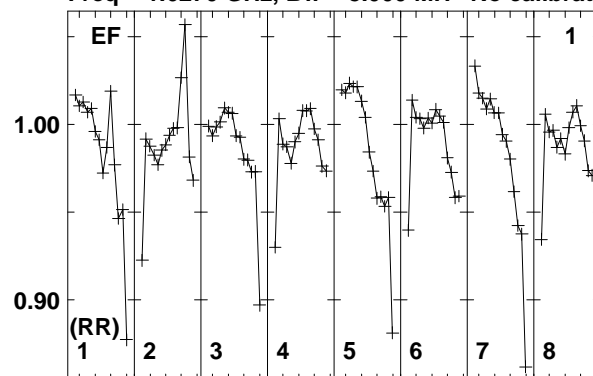

Lower frame: Real Jy
Total-power spectrum Antenna: EF (01)
Timerange: 01/00:53:23 to 01/00:55:09

Plot file version 118 created 22-OCT-2014 16:25:19

J1435+3012 EC048.UVDATA.1

Freq = 1.6270 GHz, Bw = 8.000 MH No calibration applied and no bandpass applied

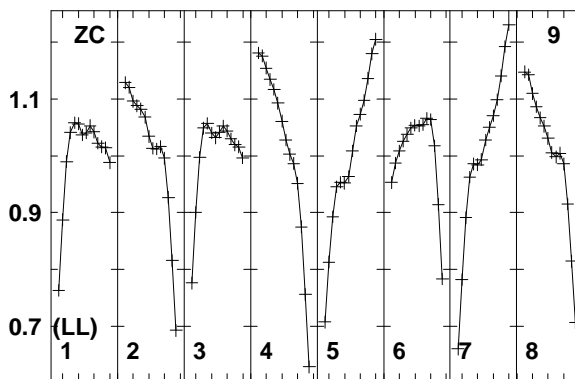
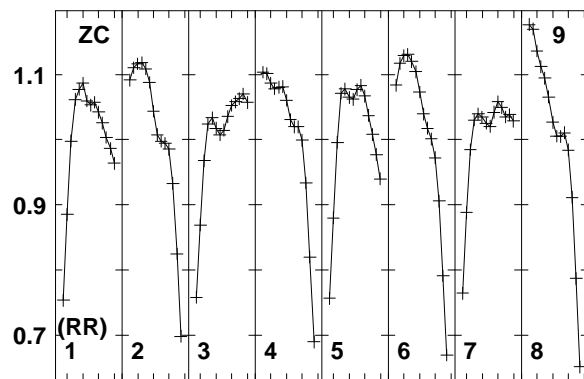
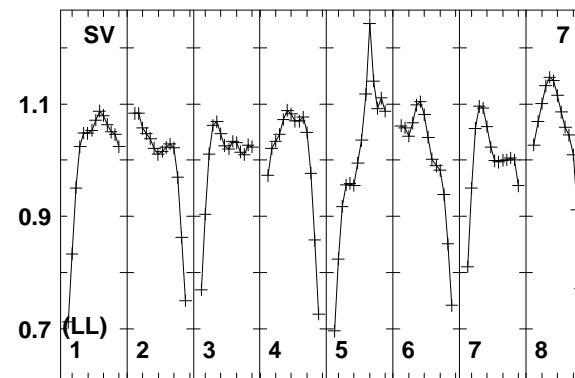
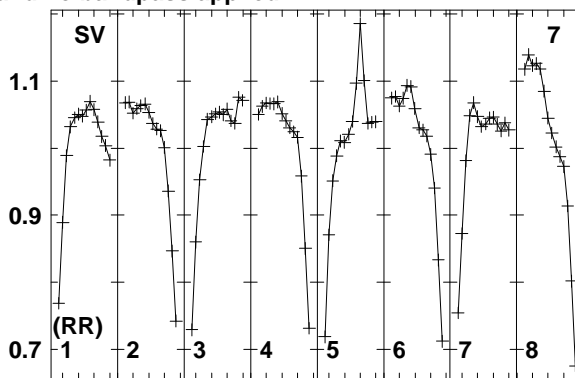
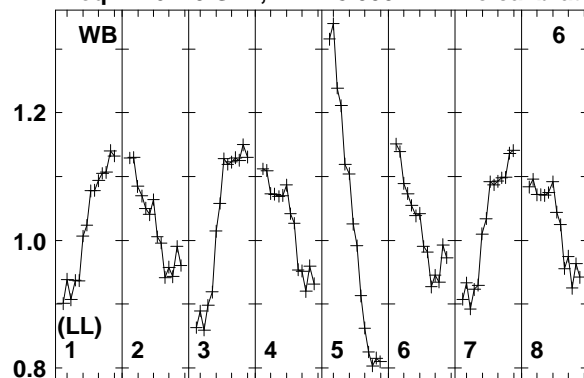

Lower frame: Real Jy
Total-power spectrum Antenna: WB (06)
Timerange: 01/00:53:23 to 01/00:55:09

Plot file version 119 created 22-OCT-2014 16:25:19

J1635+3808 EC048.UVDATA.1

Freq = 1.6270 GHz, Bw = 8.000 MH No calibration applied and no bandpass applied

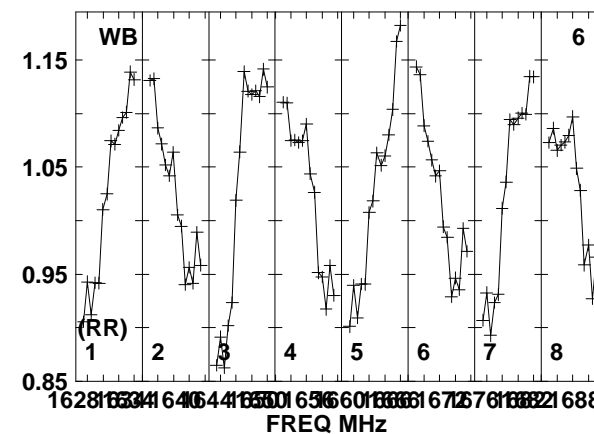
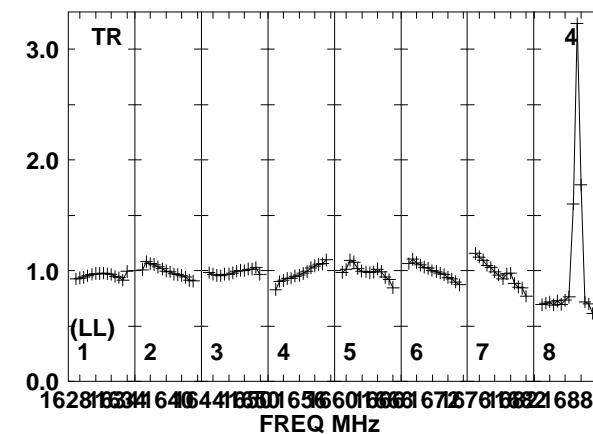
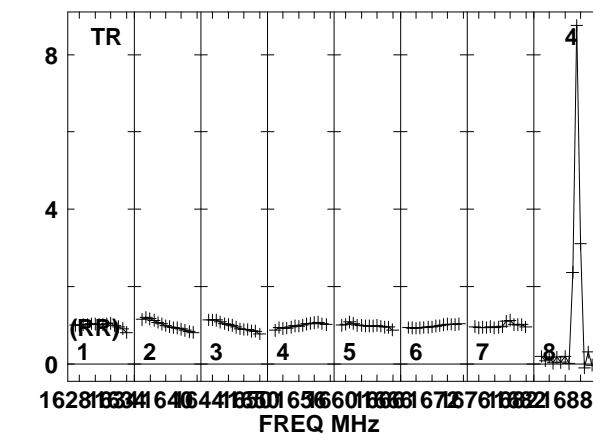
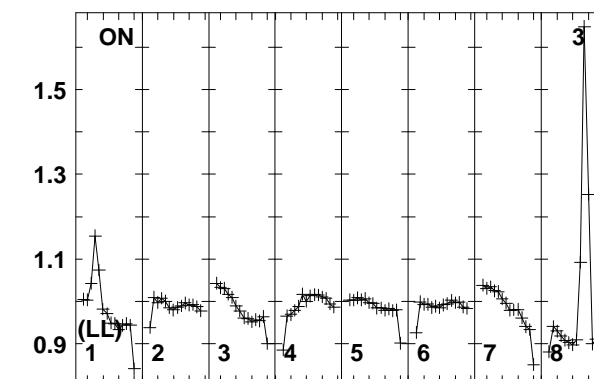
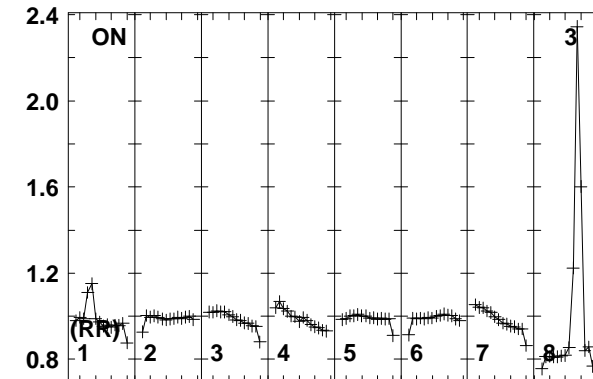
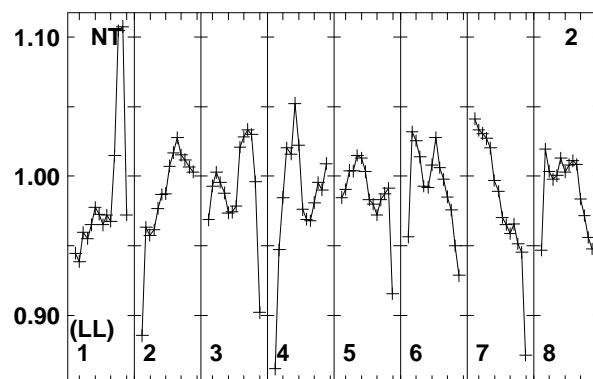
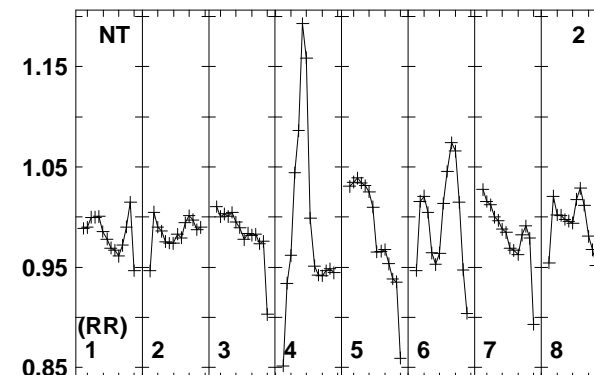
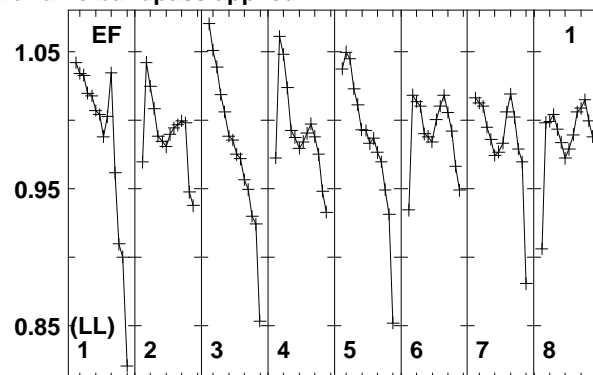
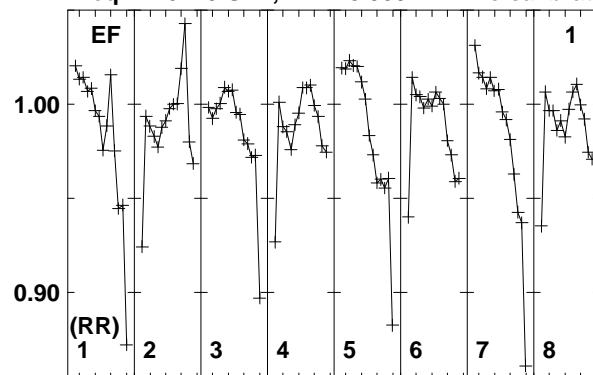

Lower frame: Real Jy
Total-power spectrum Antenna: EF (01)
Timerange: 01/00:56:33 to 01/00:58:29

Plot file version 120 created 22-OCT-2014 16:25:19

J1635+3808 EC048.UVDATA.1

Freq = 1.6270 GHz, Bw = 8.000 MH No calibration applied and no bandpass applied

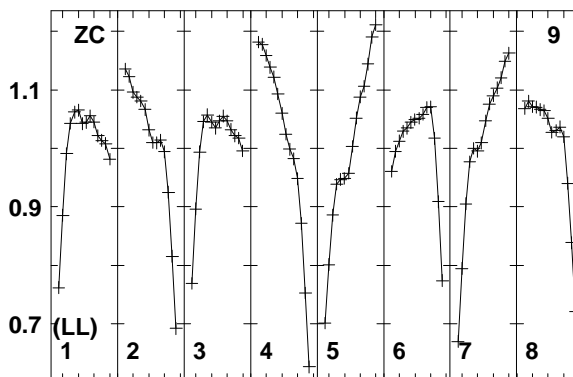
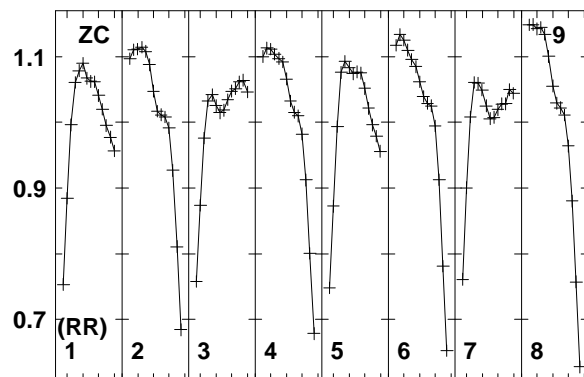
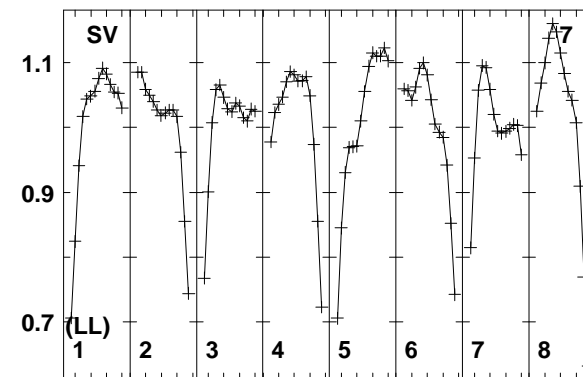
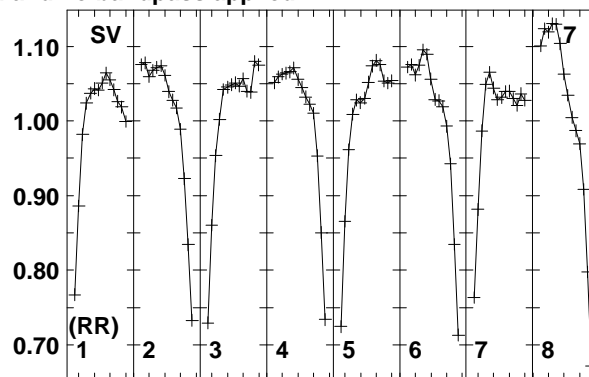
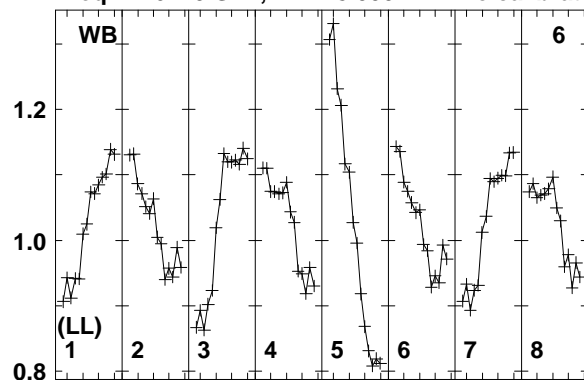

Lower frame: Real Jy
Total-power spectrum Antenna: WB (06)
Timerange: 01/00:56:33 to 01/00:58:29

Plot file version 121 created 22-OCT-2014 16:25:19

J1432+3014 EC048.UVDATA.1

Freq = 1.6270 GHz, Bw = 8.000 MH No calibration applied and no bandpass applied

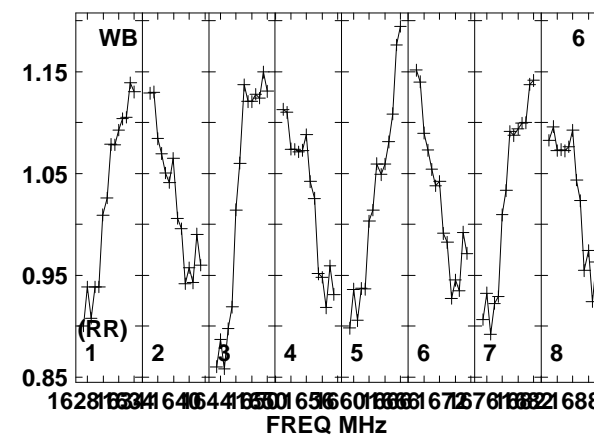
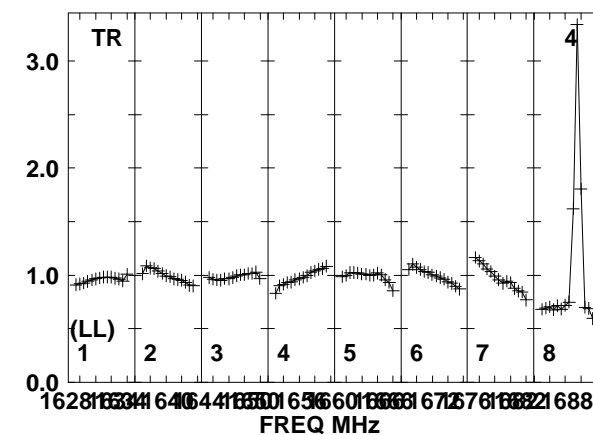
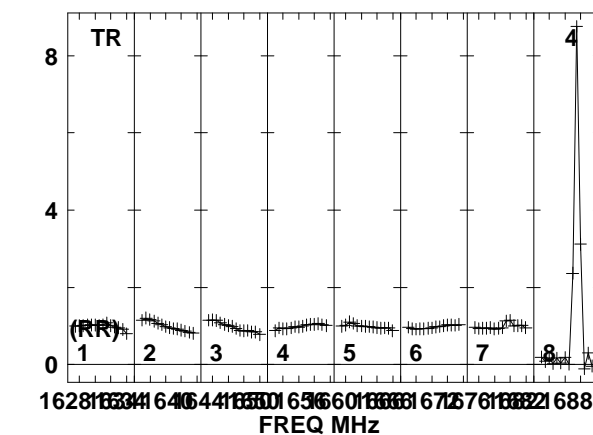
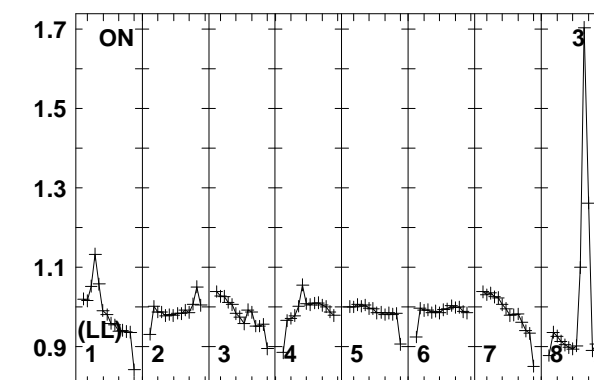
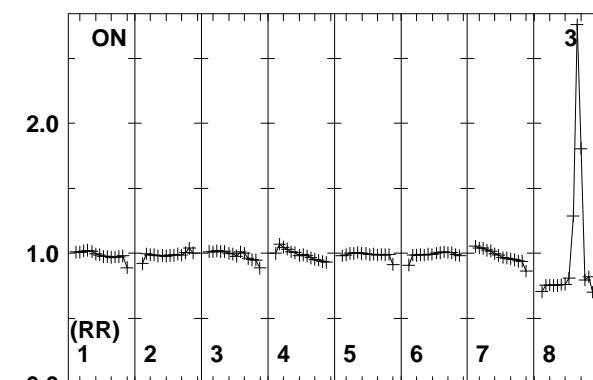
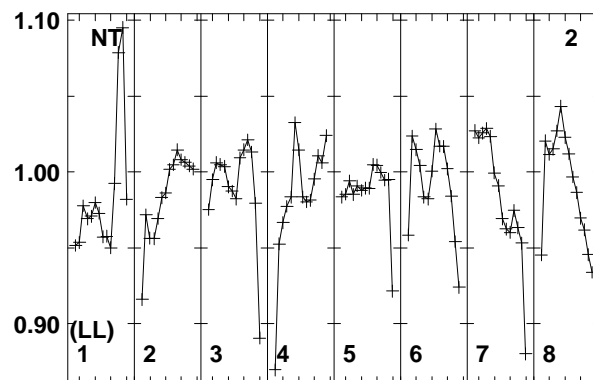
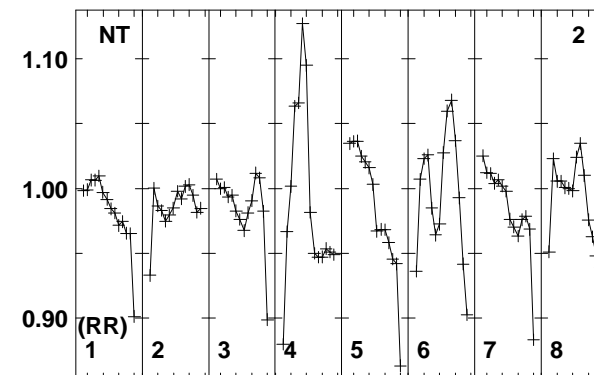
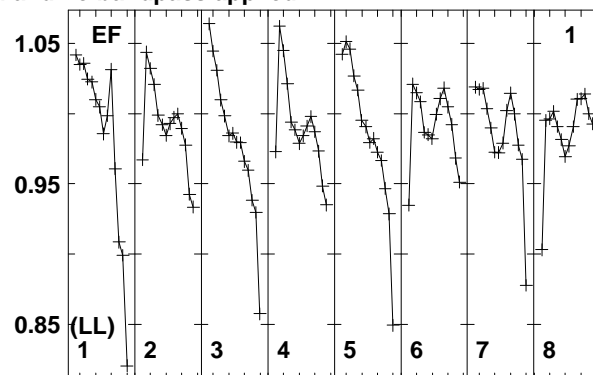
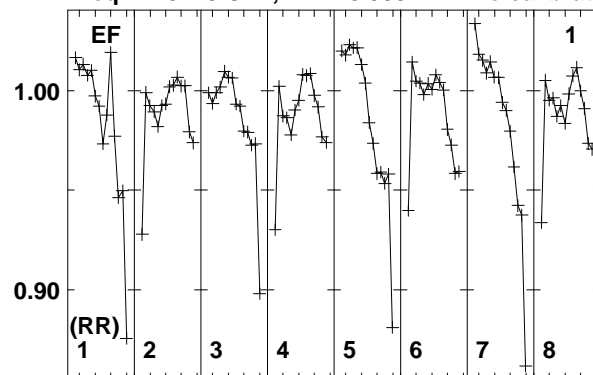

Lower frame: Real Jy
Total-power spectrum Antenna: EF (01)
Timerange: 01/00:59:26 to 01/01:06:14

Plot file version 122 created 22-OCT-2014 16:25:19
J1432+3014 EC048.UVDATA.1
Freq = 1.6270 GHz, Bw = 8.000 MH No calibration applied and no bandpass applied

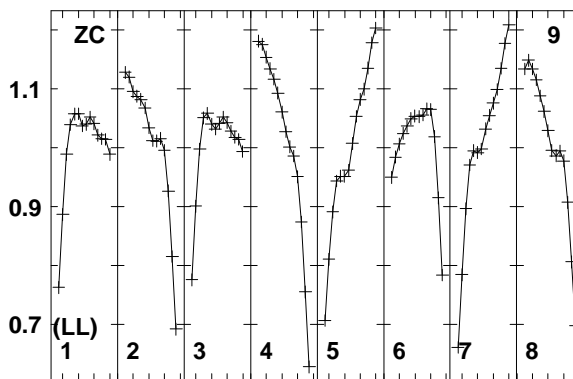
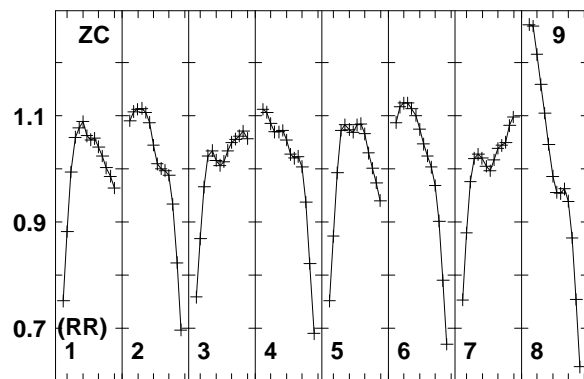
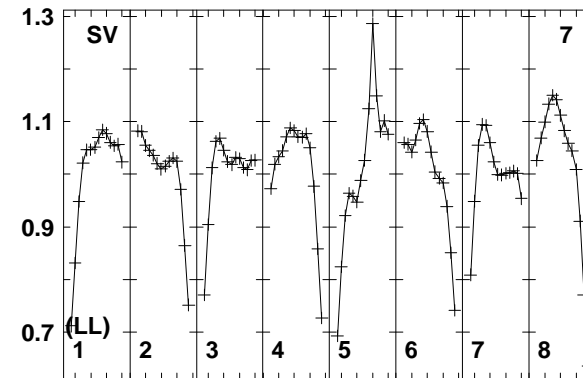
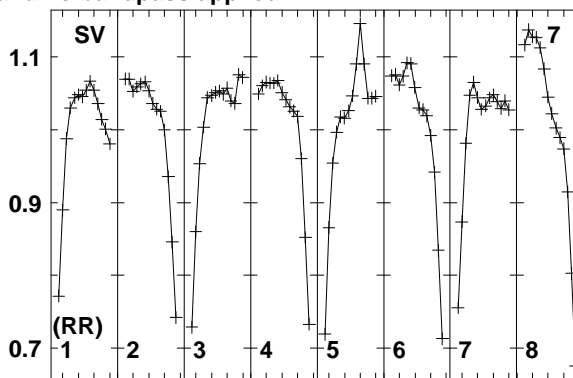
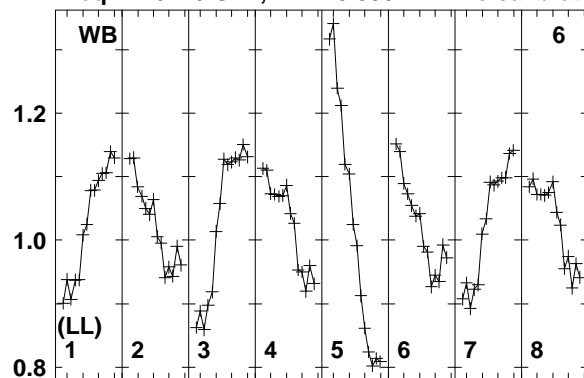

Lower frame: Real Jy
Total-power spectrum Antenna: WB (06)
Timerange: 01/00:59:26 to 01/01:06:14

Plot file version 123 created 22-OCT-2014 16:25:19

J1435+3012 EC048.UVDATA.1

Freq = 1.6270 GHz, Bw = 8.000 MH No calibration applied and no bandpass applied

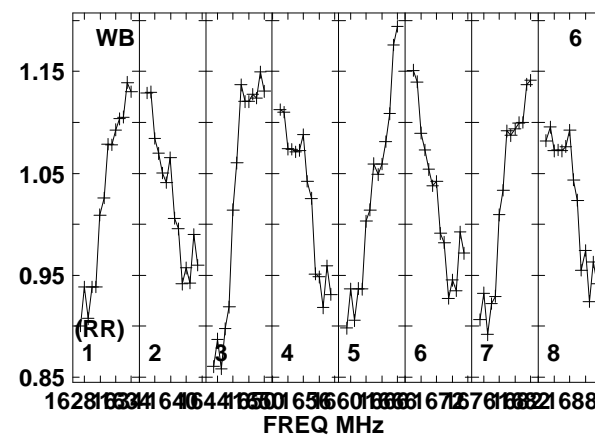
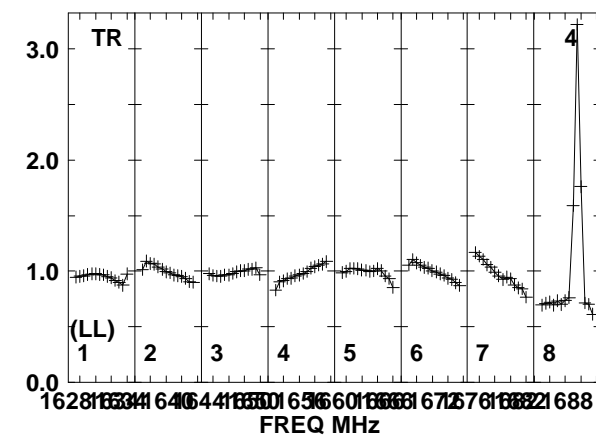
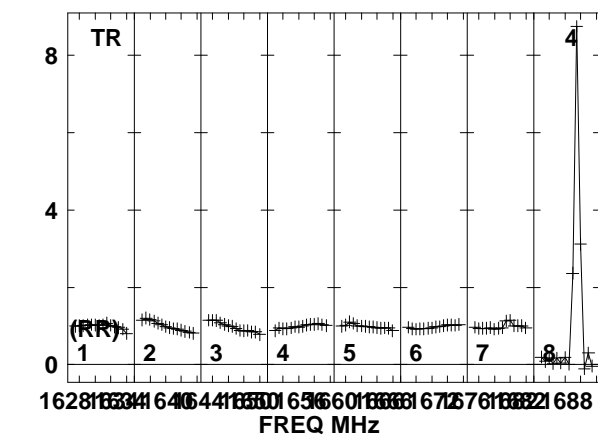
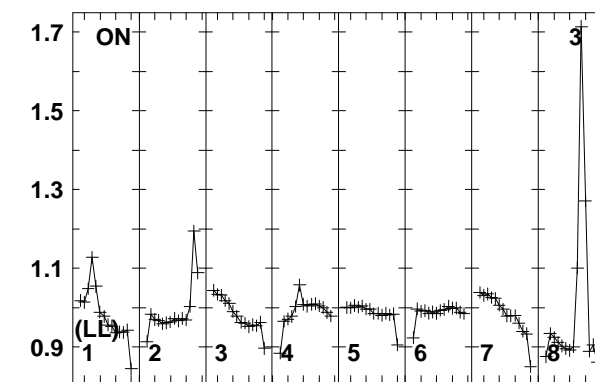
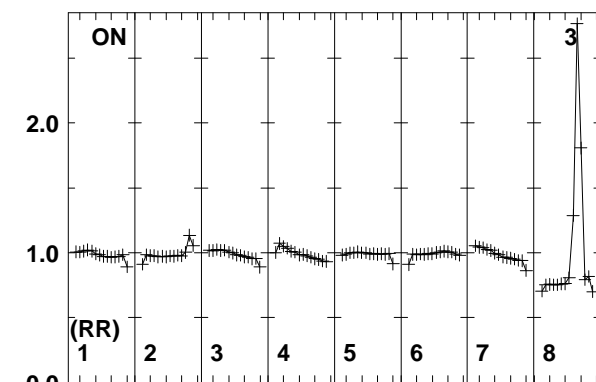
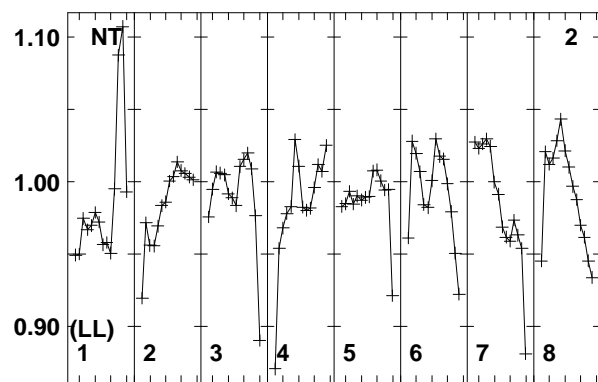
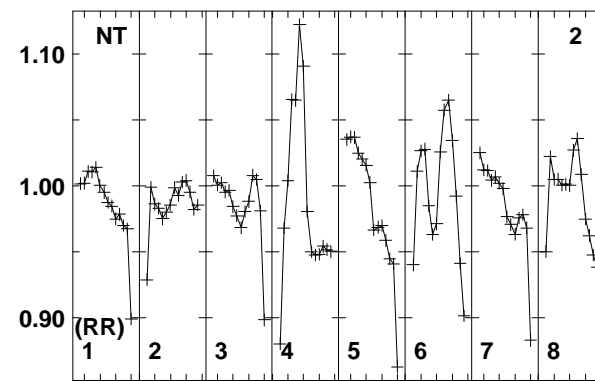
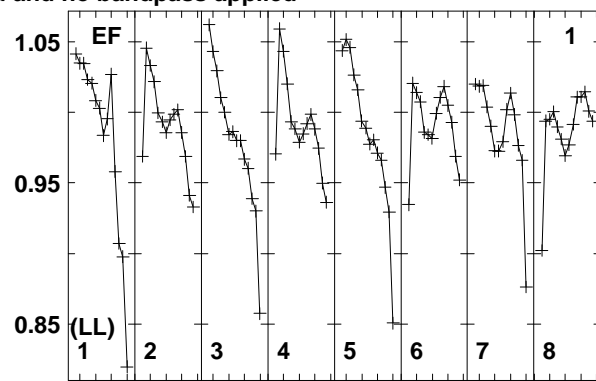
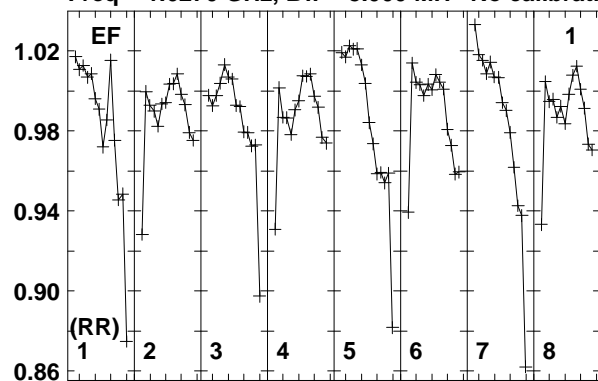

Lower frame: Real Jy
Total-power spectrum Antenna: EF (01)
Timerange: 01/01:06:58 to 01/01:08:44

Plot file version 124 created 22-OCT-2014 16:25:19

J1435+3012 EC048.UVDATA.1

Freq = 1.6270 GHz, Bw = 8.000 MH No calibration applied and no bandpass applied

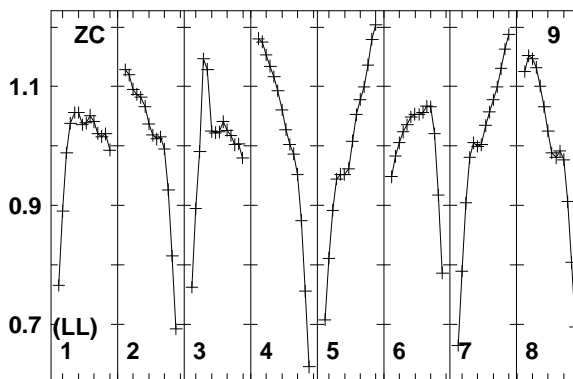
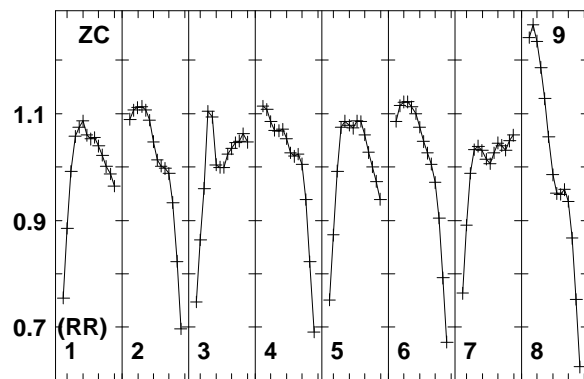
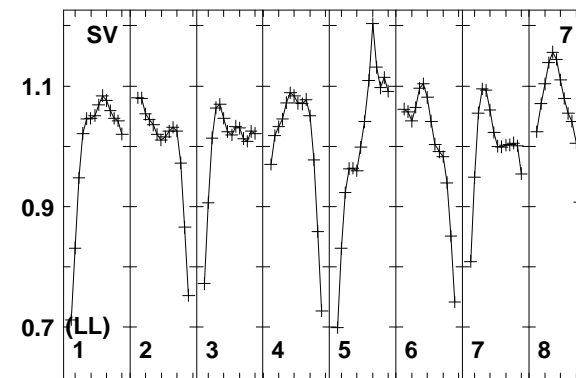
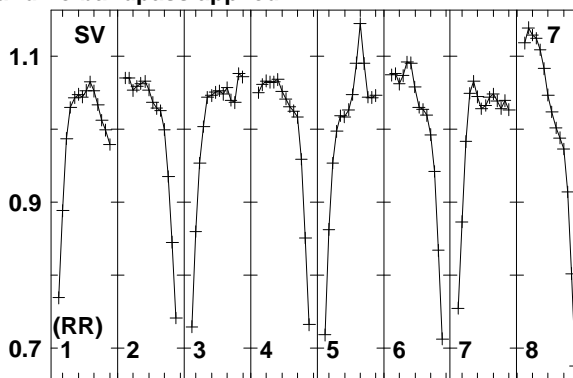
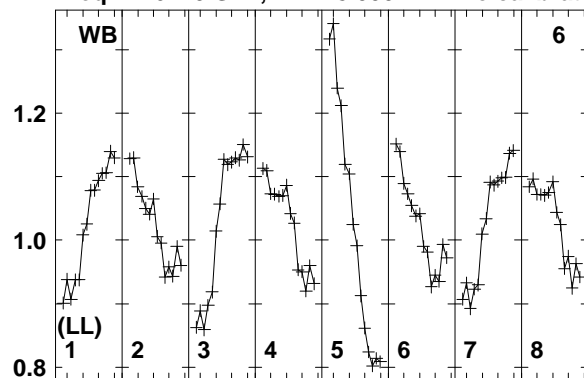

Lower frame: Real Jy
Total-power spectrum Antenna: WB (06)
Timerange: 01/01:06:58 to 01/01:08:44

Plot file version 125 created 22-OCT-2014 16:25:19

J1432+3014 EC048.UVDATA.1

Freq = 1.6270 GHz, Bw = 8.000 MH No calibration applied and no bandpass applied

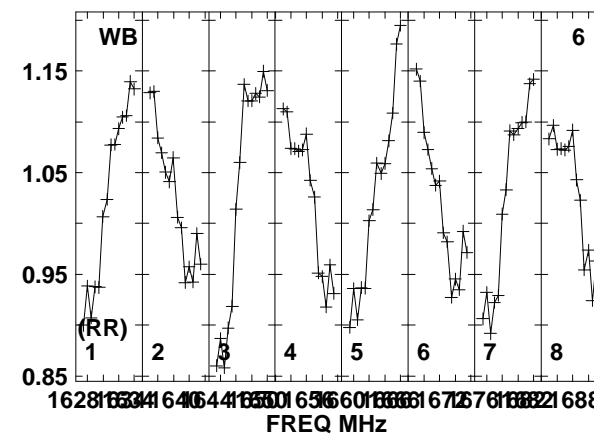
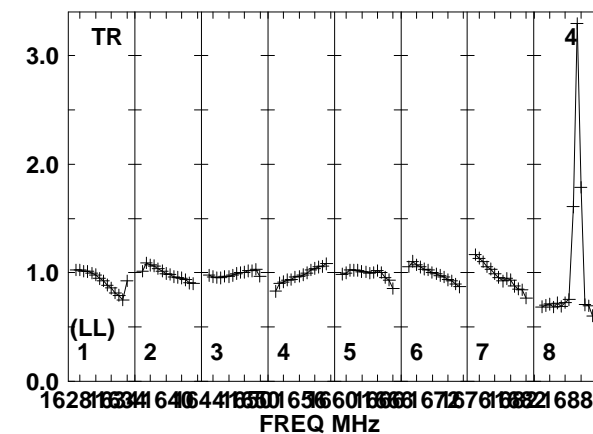
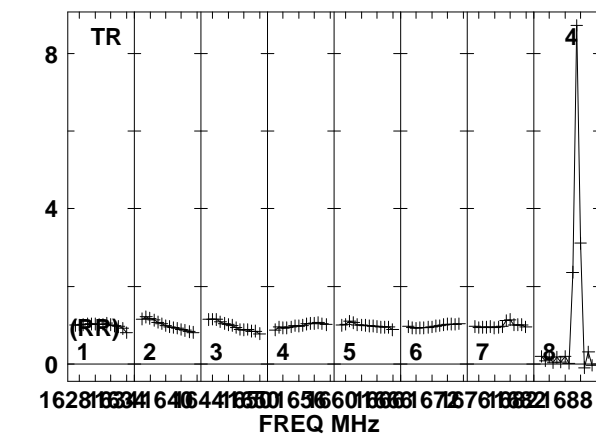
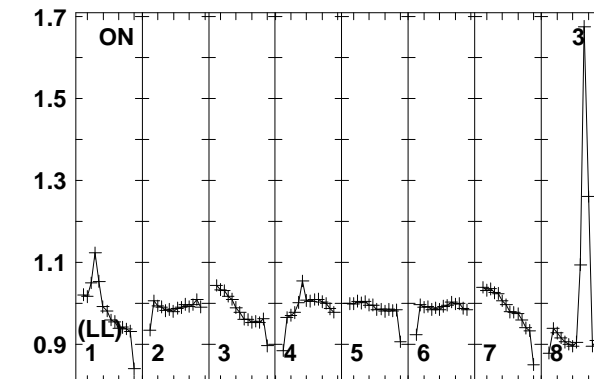
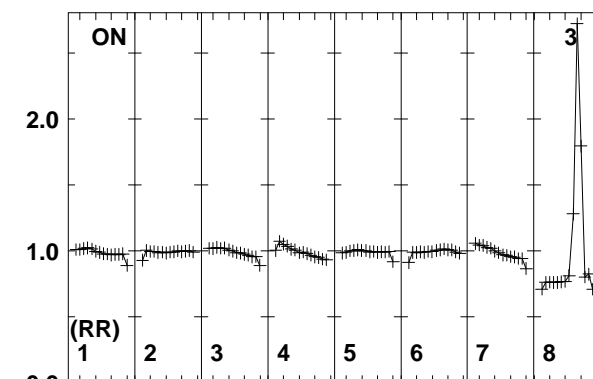
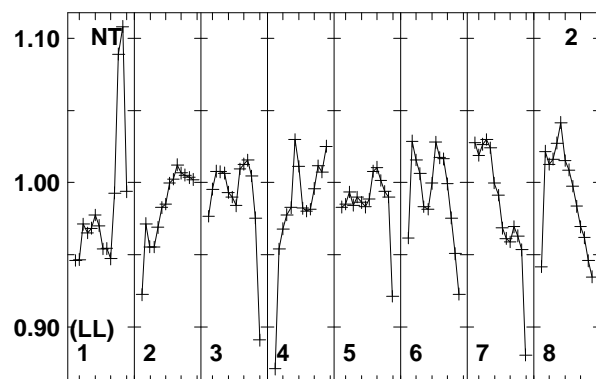
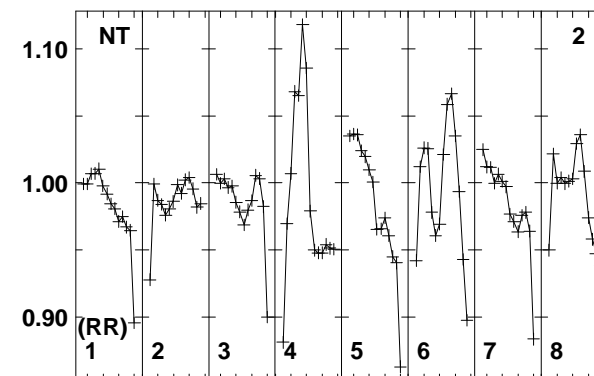
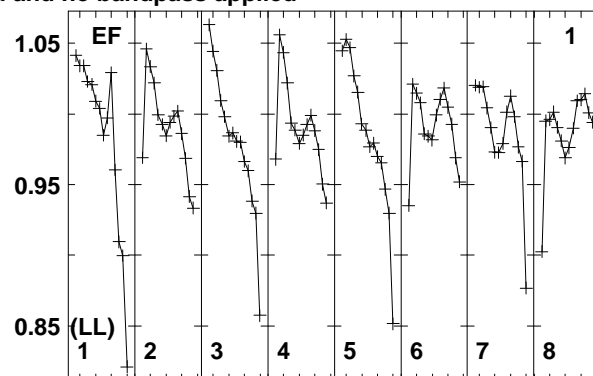
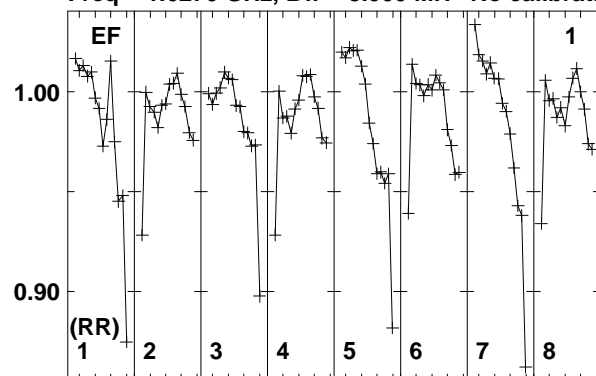

Lower frame: Real Jy
Total-power spectrum Antenna: EF (01)
Timerange: 01/01:08:49 to 01/01:16:29

Plot file version 126 created 22-OCT-2014 16:25:19

J1432+3014 EC048.UVDATA.1

Freq = 1.6270 GHz, Bw = 8.000 MH No calibration applied and no bandpass applied

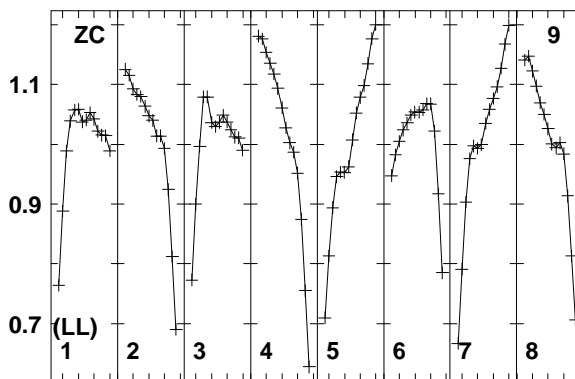
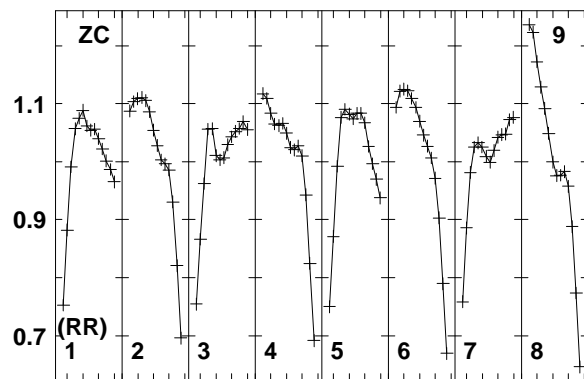
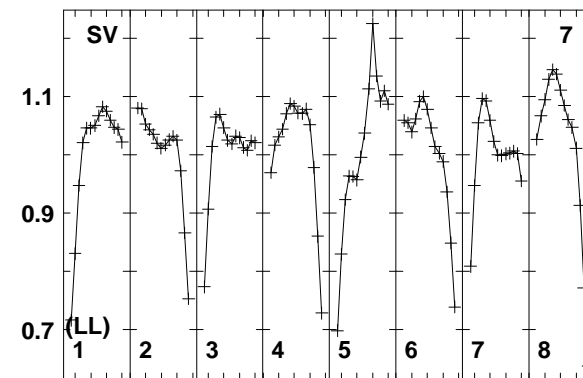
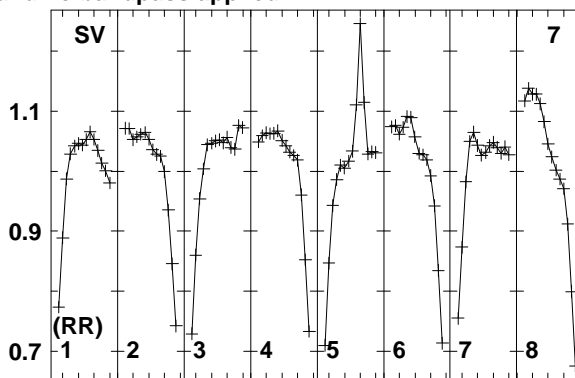
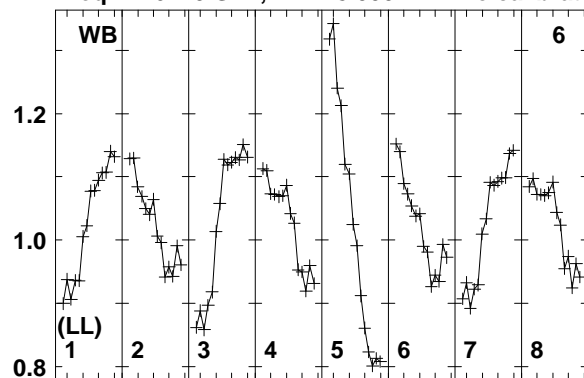

Lower frame: Real Jy
Total-power spectrum Antenna: WB (06)
Timerange: 01/01:08:49 to 01/01:16:29

Plot file version 127 created 22-OCT-2014 16:25:19

J1435+3012 EC048.UVDATA.1

Freq = 1.6270 GHz, Bw = 8.000 MH No calibration applied and no bandpass applied

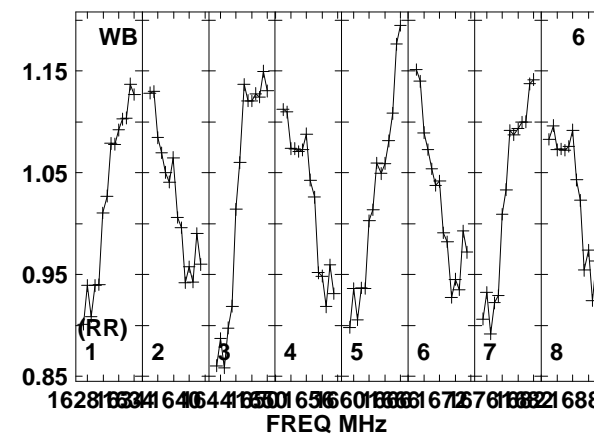
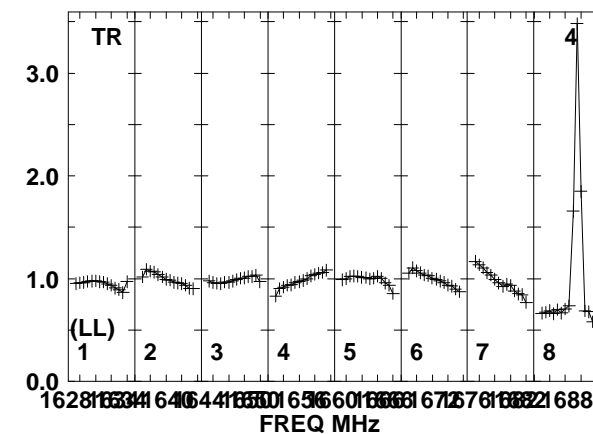
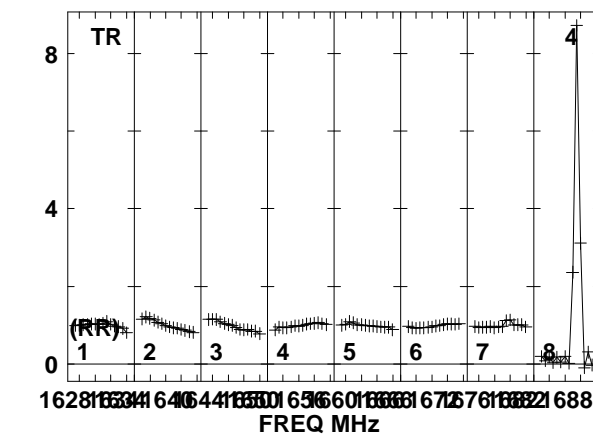
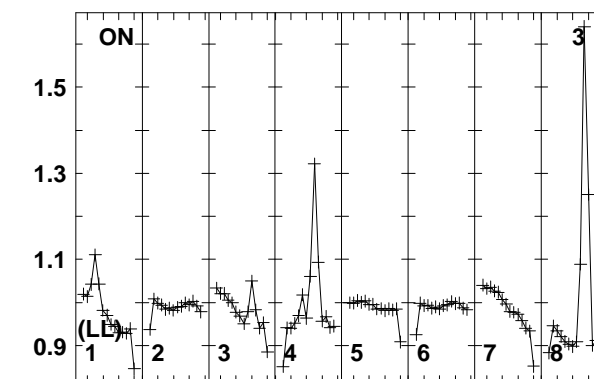
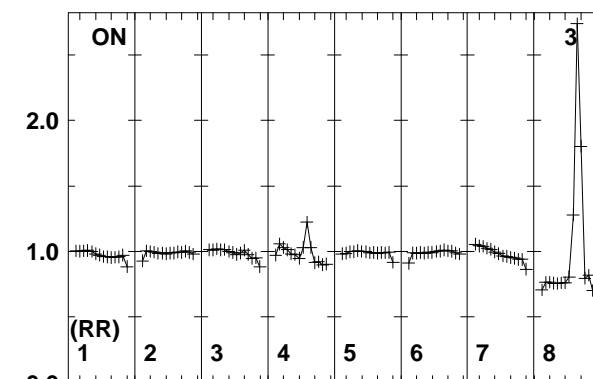
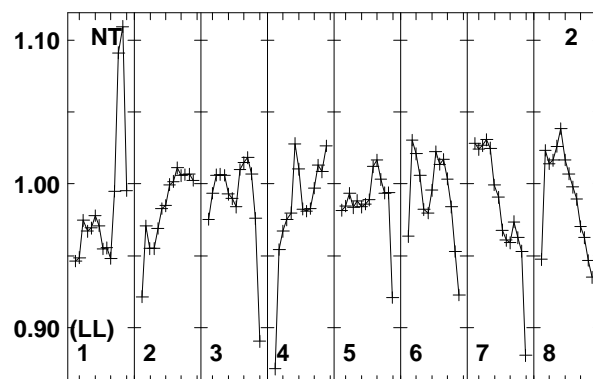
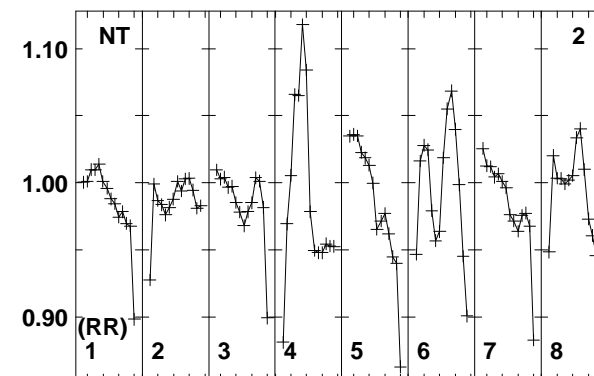
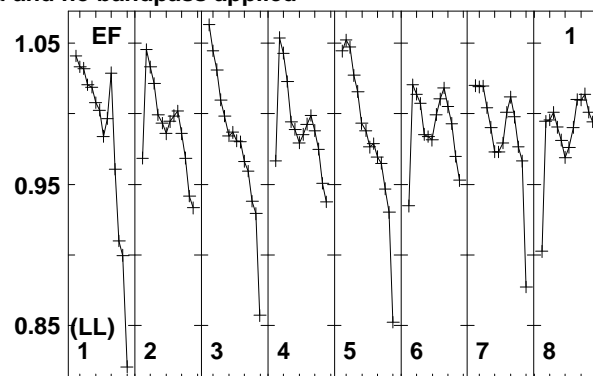
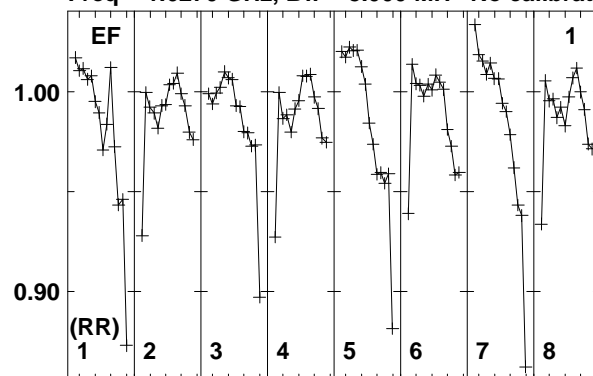

Lower frame: Real Jy
Total-power spectrum Antenna: EF (01)
Timerange: 01/01:17:13 to 01/01:18:59

Plot file version 128 created 22-OCT-2014 16:25:19

J1435+3012 EC048.UVDATA.1

Freq = 1.6270 GHz, Bw = 8.000 MH No calibration applied and no bandpass applied

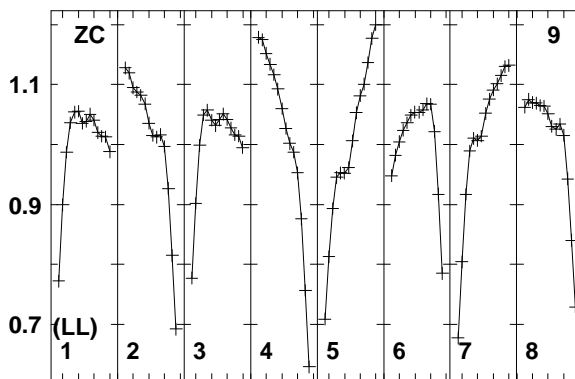
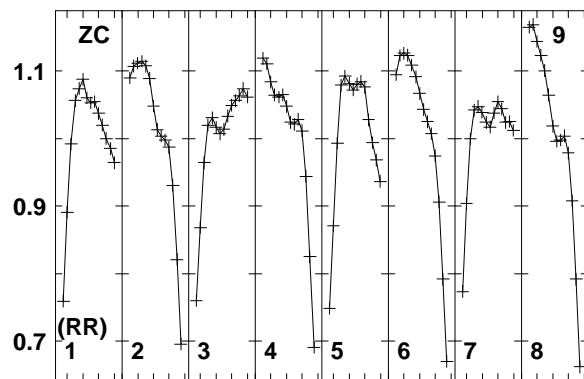
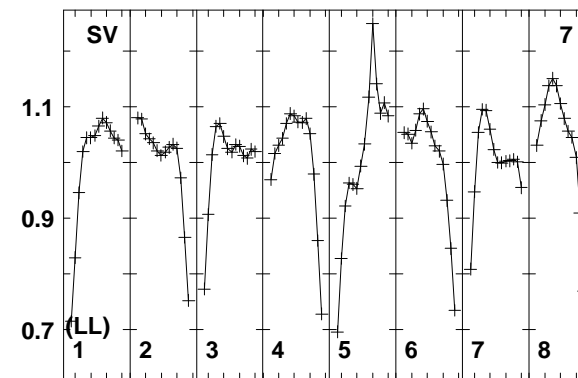
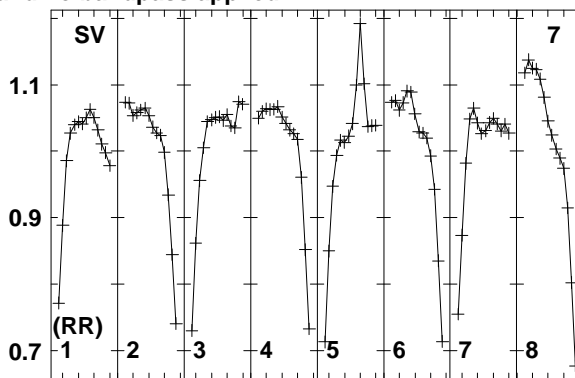
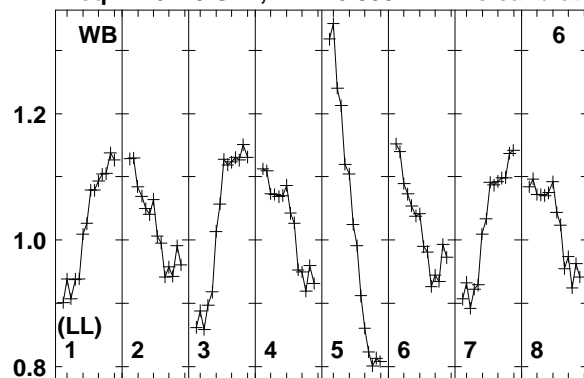

Lower frame: Real Jy
Total-power spectrum Antenna: WB (06)
Timerange: 01/01:17:13 to 01/01:18:59

Plot file version 129 created 22-OCT-2014 16:25:19

J1432+3014 EC048.UVDATA.1

Freq = 1.6270 GHz, Bw = 8.000 MH No calibration applied and no bandpass applied

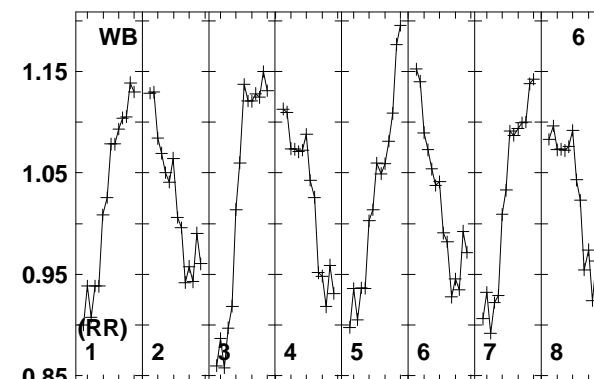
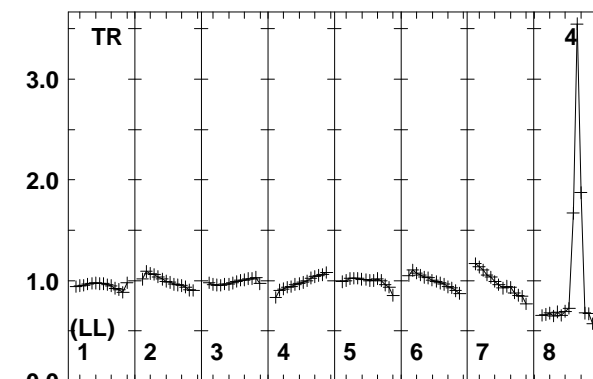
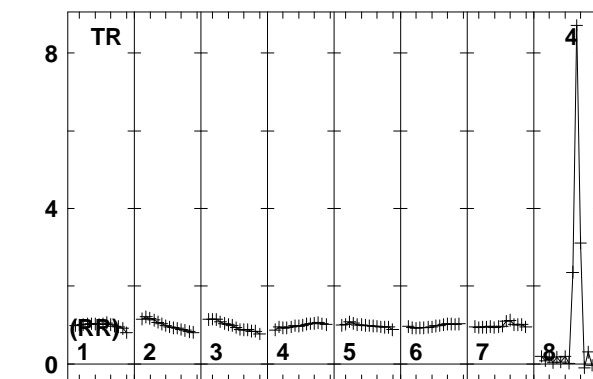
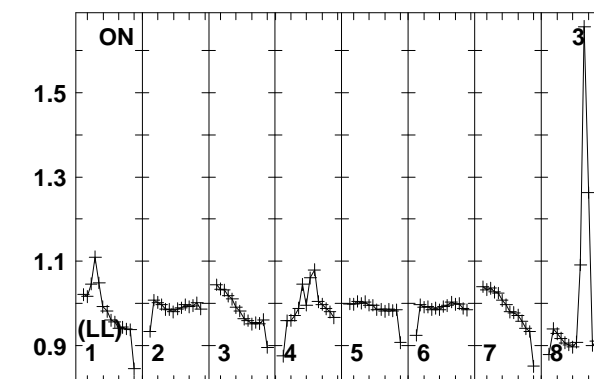
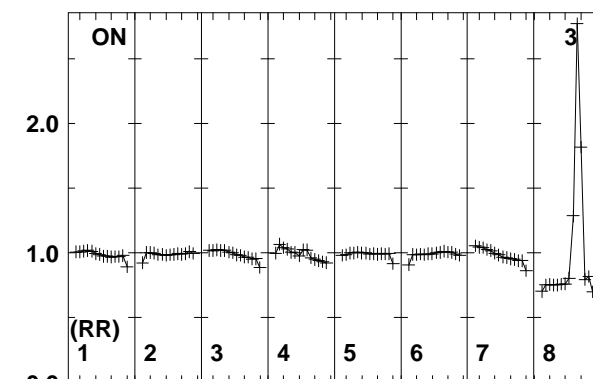
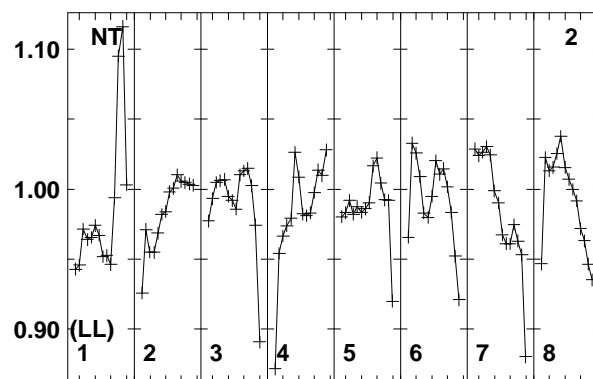
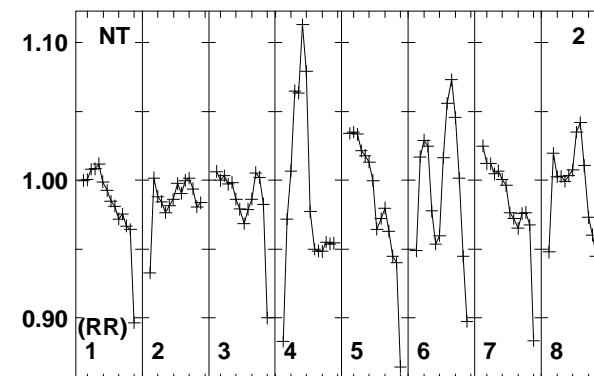
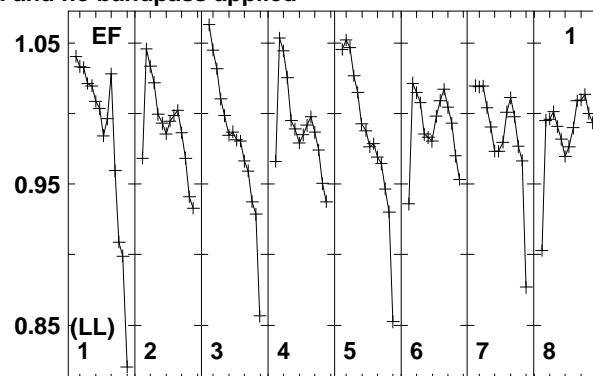
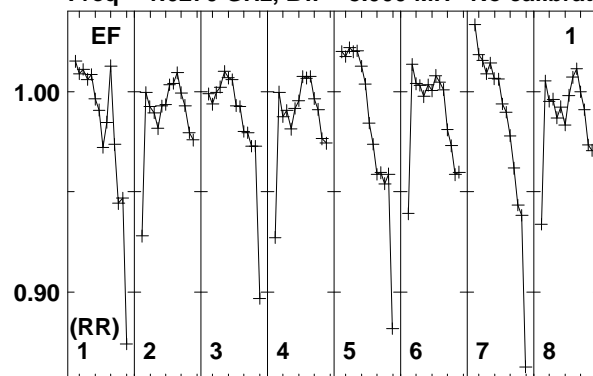

1628 1634 1640 1644 1650 1656 1660 1666 1672 1676 1682 1688
FREQ MHz

Lower frame: Real Jy
Total-power spectrum Antenna: EF (01)
Timerange: 01/01:19:04 to 01/01:26:44

Plot file version 130 created 22-OCT-2014 16:25:19

J1432+3014 EC048.UVDATA.1

Freq = 1.6270 GHz, Bw = 8.000 MH No calibration applied and no bandpass applied

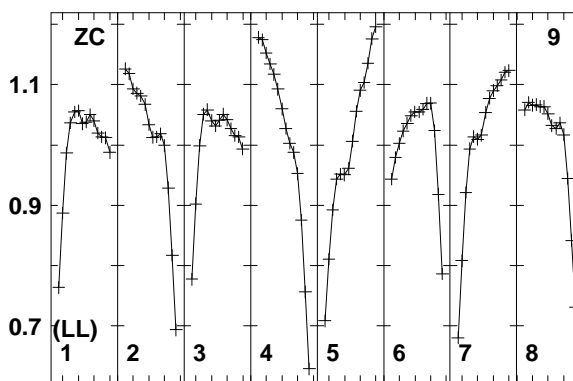
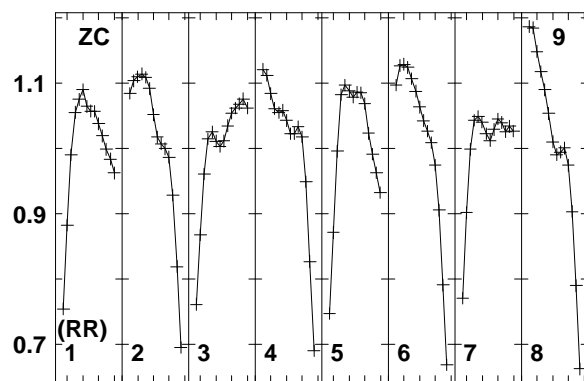
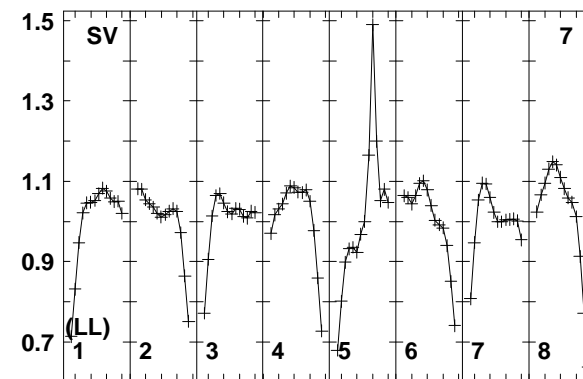
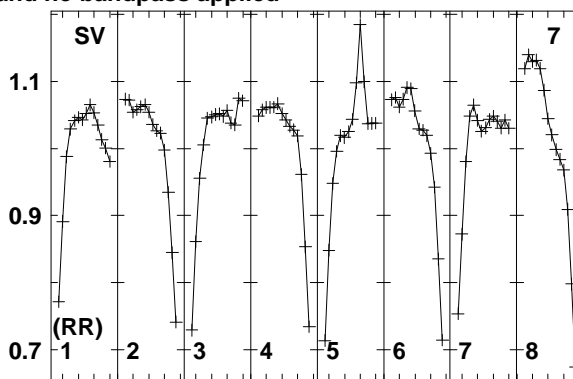
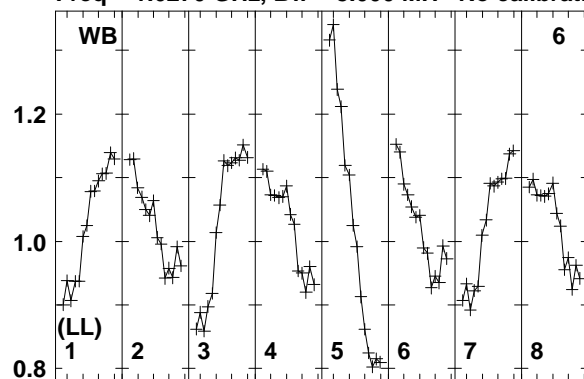

Lower frame: Real Jy
Total-power spectrum Antenna: WB (06)
Timerange: 01/01:19:04 to 01/01:26:44

Plot file version 131 created 22-OCT-2014 16:25:19

J1435+3012 EC048.UVDATA.1

Freq = 1.6270 GHz, Bw = 8.000 MH No calibration applied and no bandpass applied

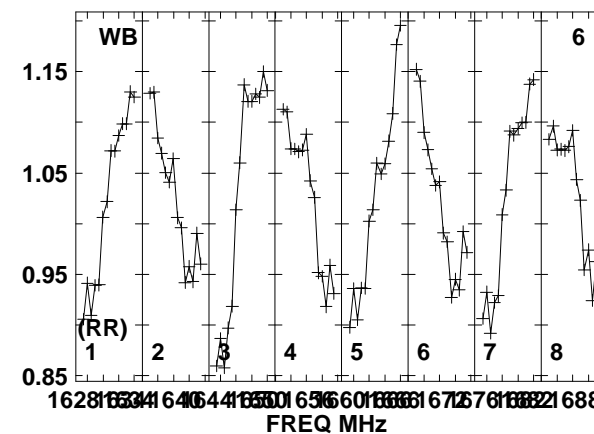
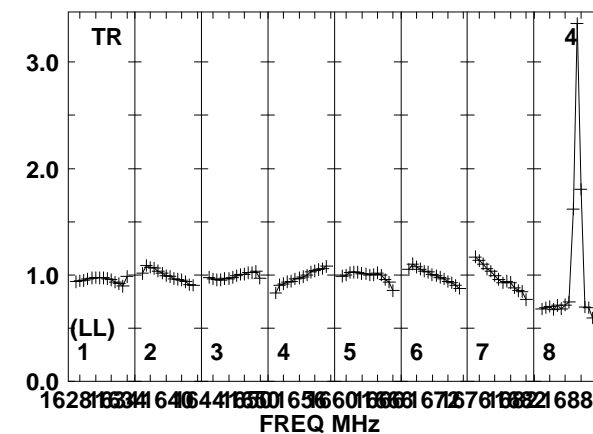
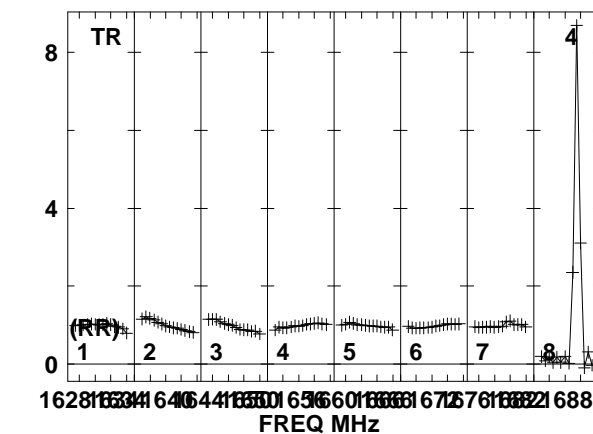
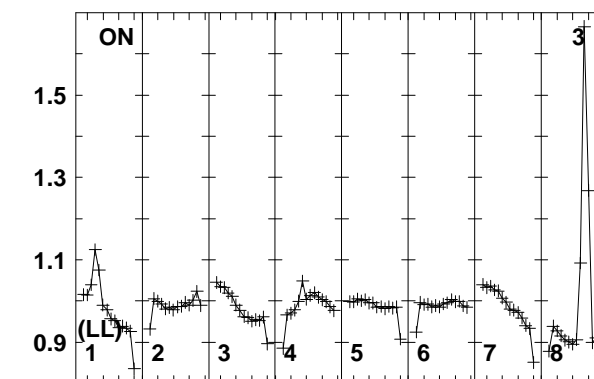
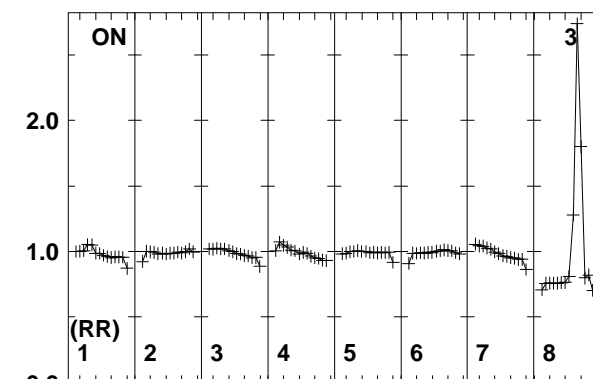
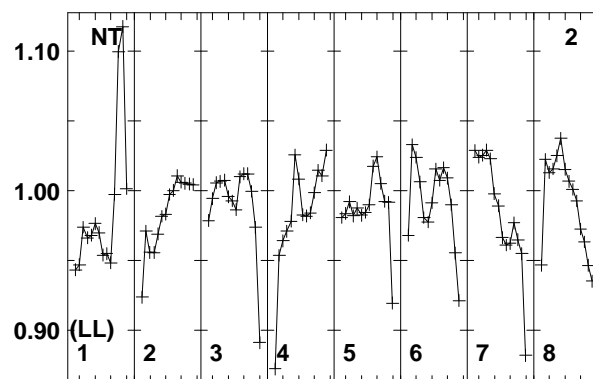
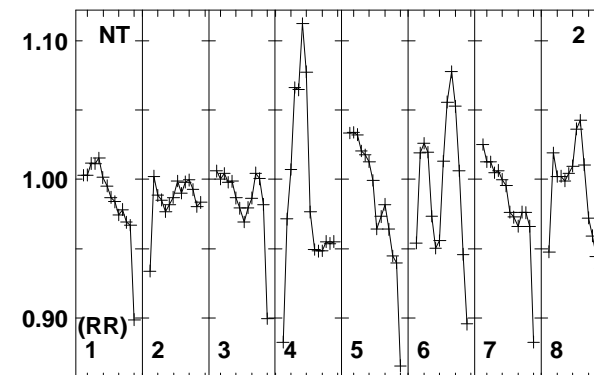
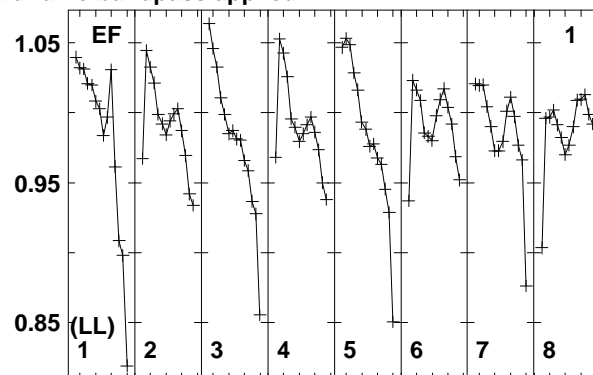
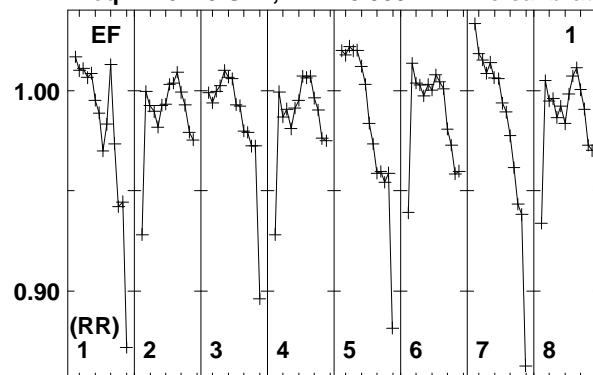

Lower frame: Real Jy
Total-power spectrum Antenna: EF (01)
Timerange: 01/01:27:28 to 01/01:29:14

Plot file version 132 created 22-OCT-2014 16:25:19

J1435+3012 EC048.UVDATA.1

Freq = 1.6270 GHz, Bw = 8.000 MH No calibration applied and no bandpass applied

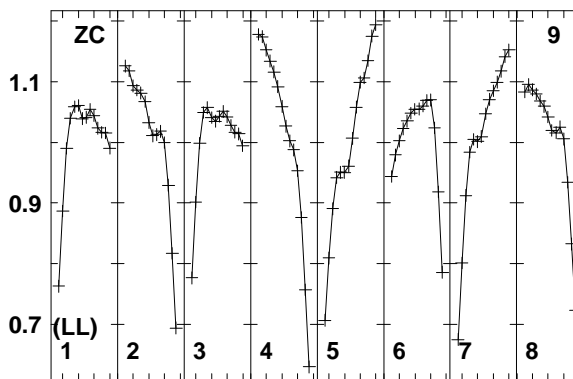
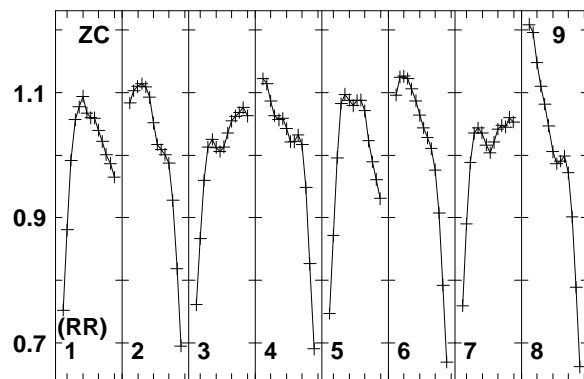
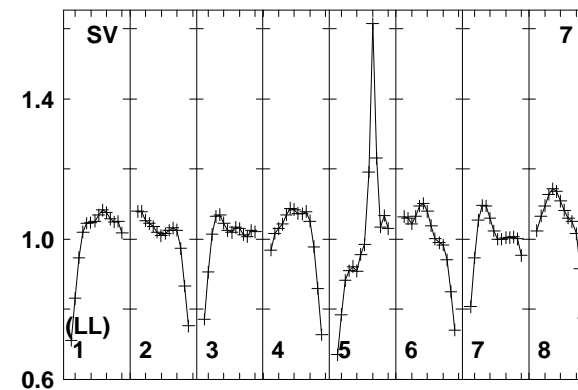
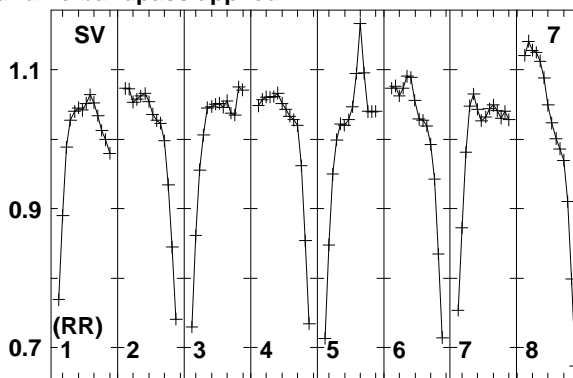
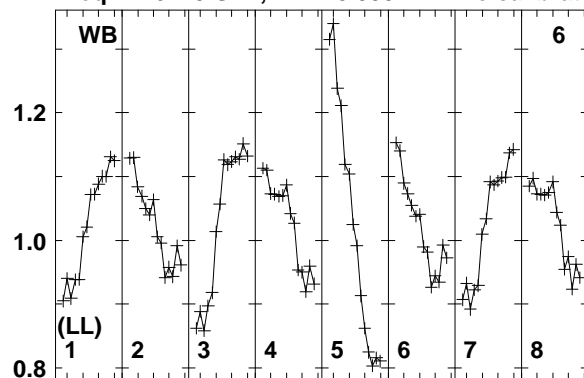

Lower frame: Real Jy
Total-power spectrum Antenna: WB (06)
Timerange: 01/01:27:28 to 01/01:29:14

Plot file version 133 created 22-OCT-2014 16:25:19

J1432+3014 EC048.UVDATA.1

Freq = 1.6270 GHz, Bw = 8.000 MH No calibration applied and no bandpass applied

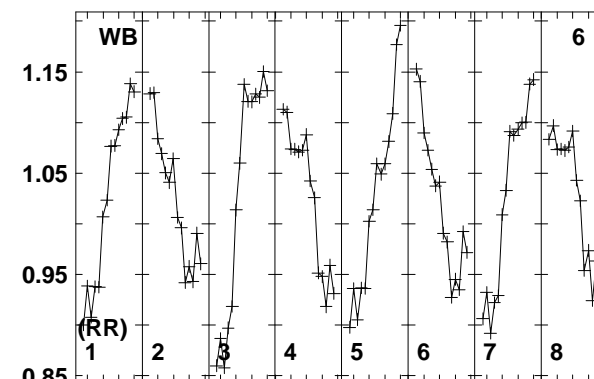
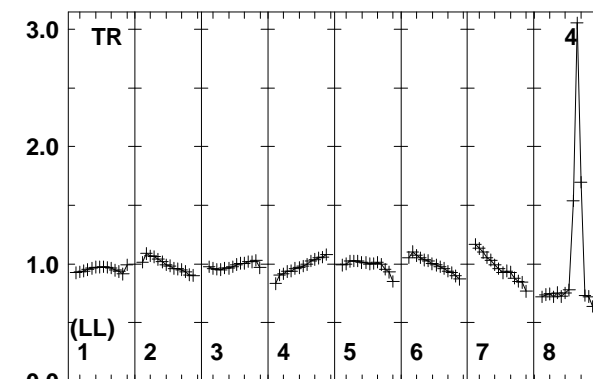
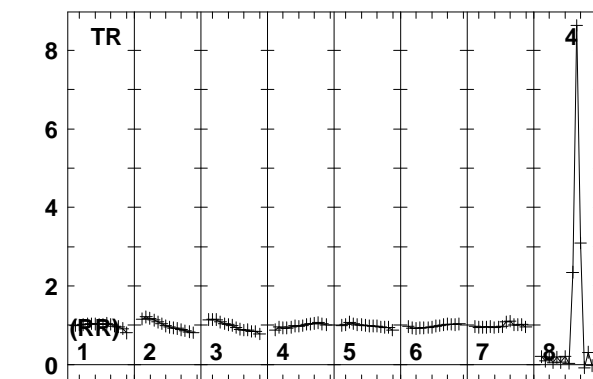
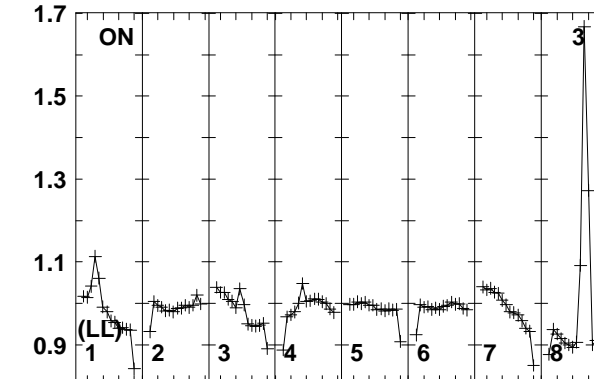
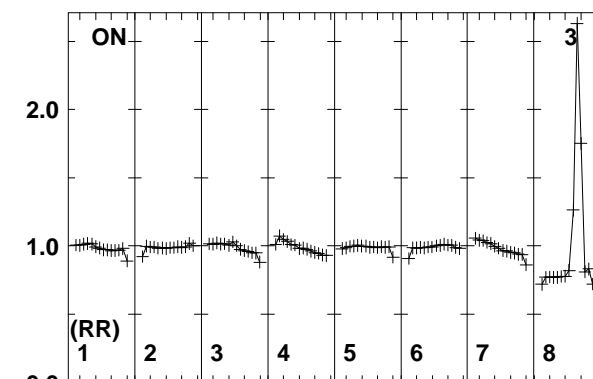
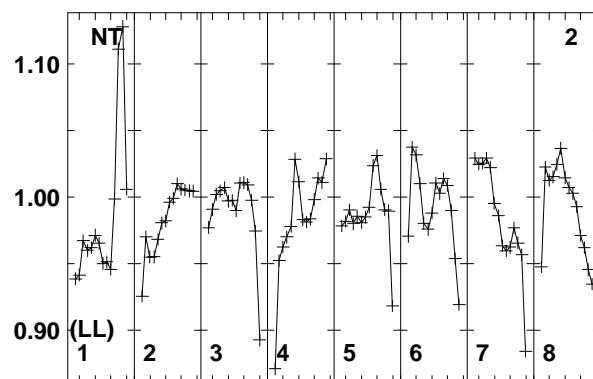
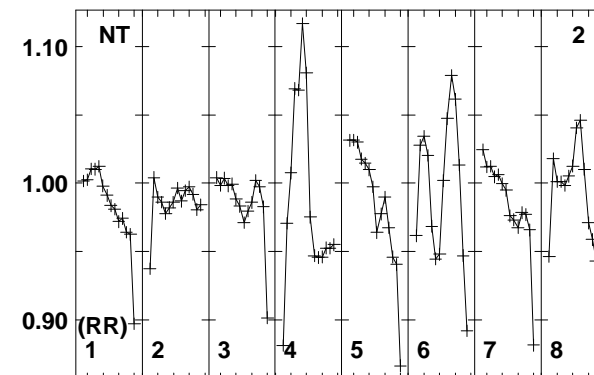
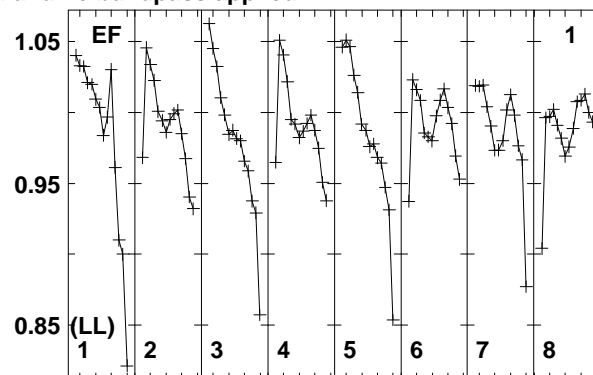
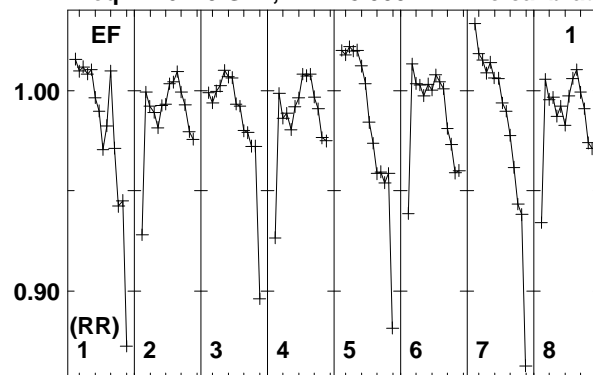

1628 1634 1640 1644 1650 1656 1660 1666 1672 1676 1682 1688
FREQ MHz

Lower frame: Real Jy
Total-power spectrum Antenna: EF (01)
Timerange: 01/01:29:19 to 01/01:36:59

Plot file version 134 created 22-OCT-2014 16:25:19

J1432+3014 EC048.UVDATA.1

Freq = 1.6270 GHz, Bw = 8.000 MH No calibration applied and no bandpass applied

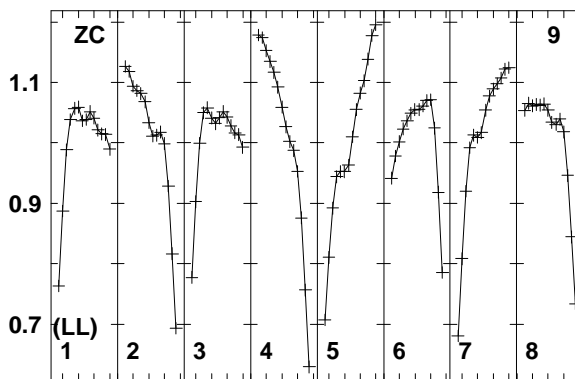
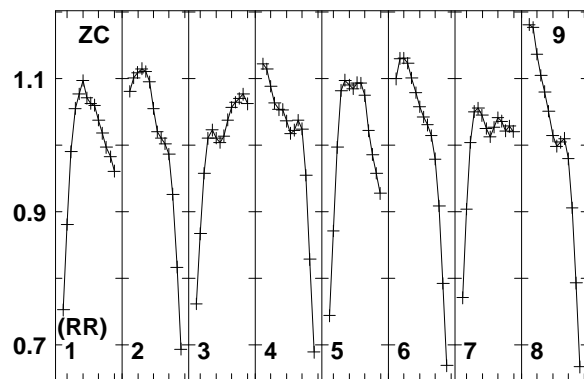
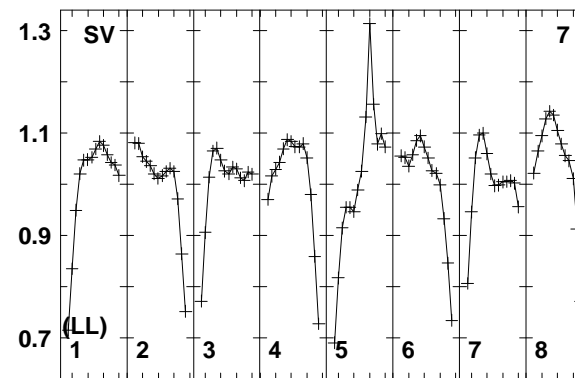
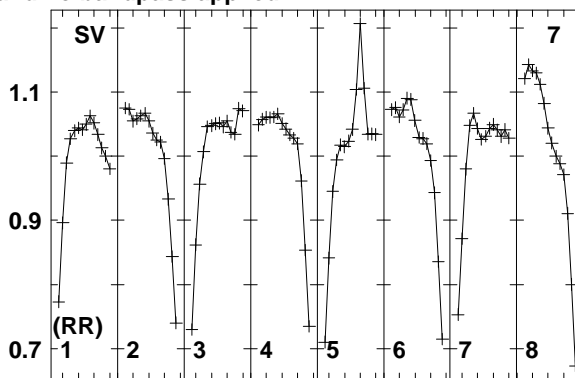
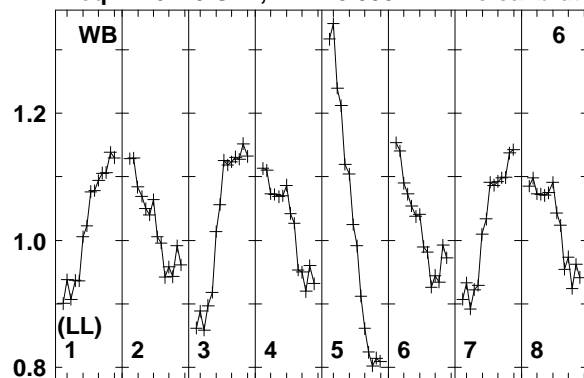

Lower frame: Real Jy
Total-power spectrum Antenna: WB (06)
Timerange: 01/01:29:19 to 01/01:36:59

Plot file version 135 created 22-OCT-2014 16:25:19

J1435+3012 EC048.UVDATA.1

Freq = 1.6270 GHz, Bw = 8.000 MH No calibration applied and no bandpass applied

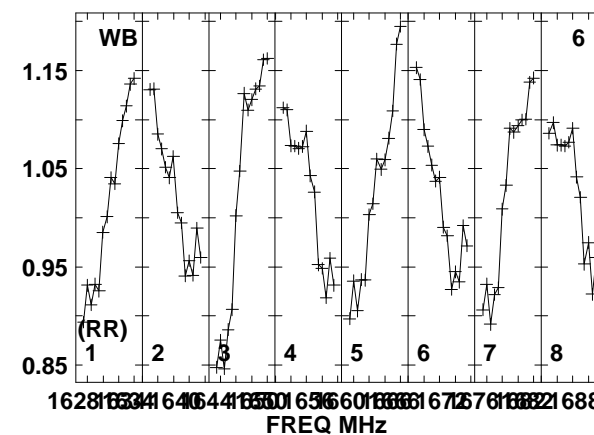
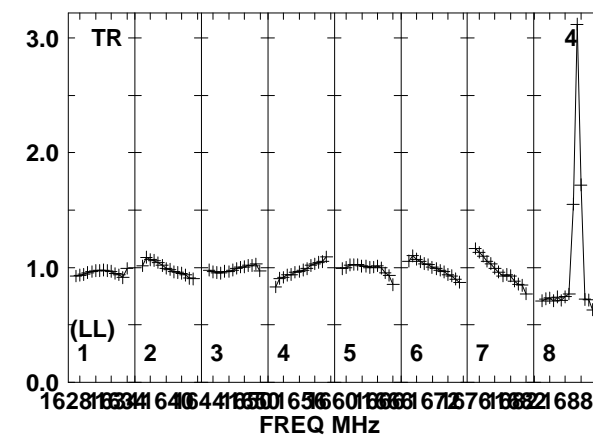
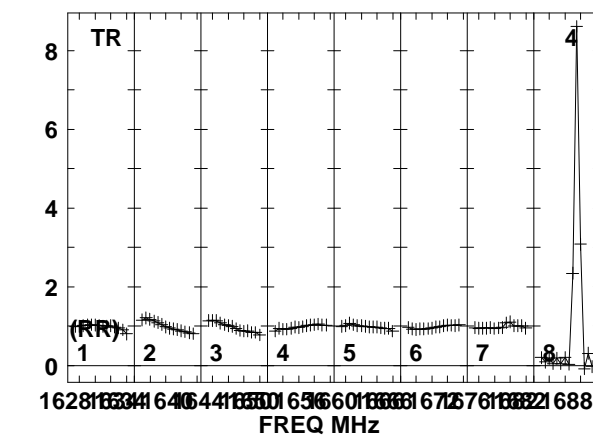
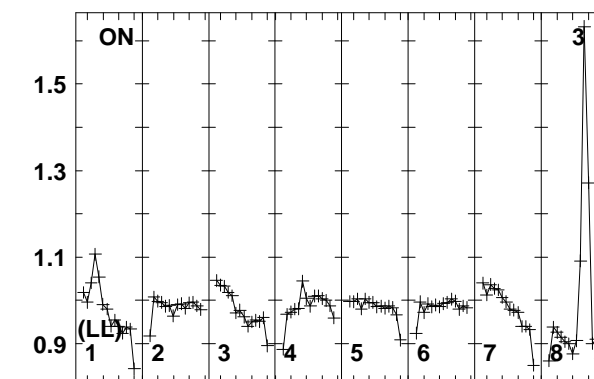
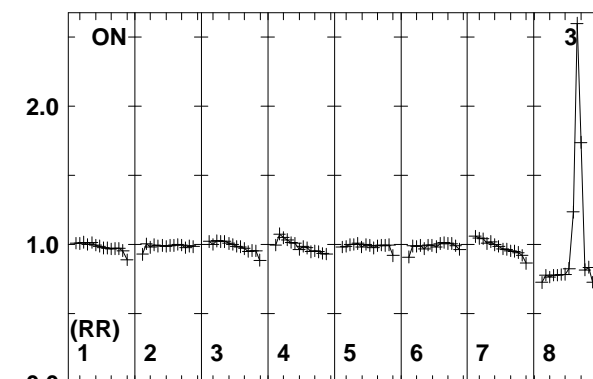
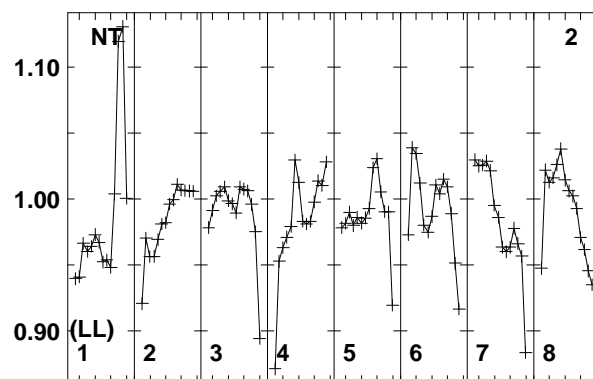
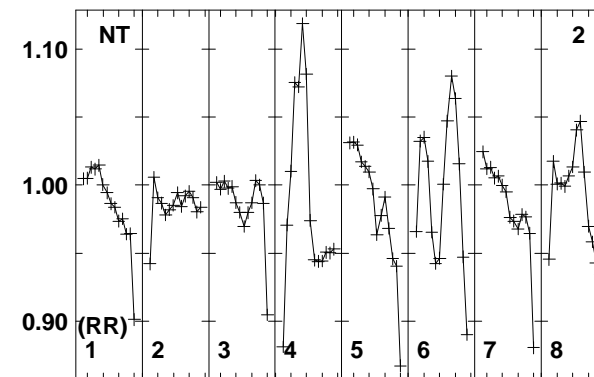
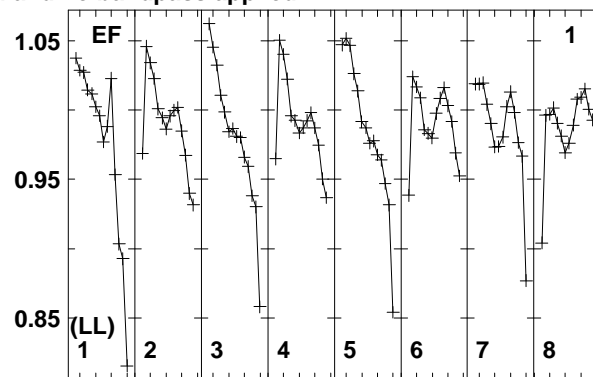
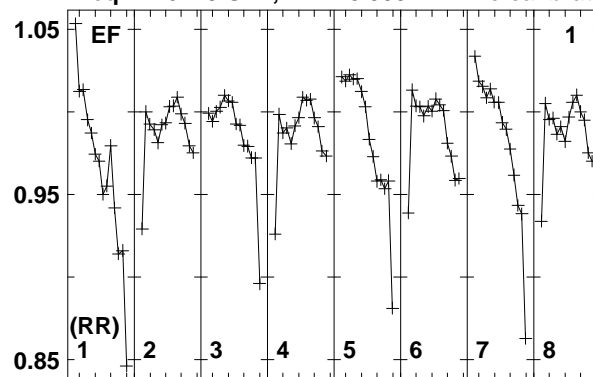

Lower frame: Real Jy
Total-power spectrum Antenna: EF (01)
Timerange: 01/01:37:43 to 01/01:39:29

Plot file version 136 created 22-OCT-2014 16:25:19

J1435+3012 EC048.UVDATA.1

Freq = 1.6270 GHz, Bw = 8.000 MH No calibration applied and no bandpass applied

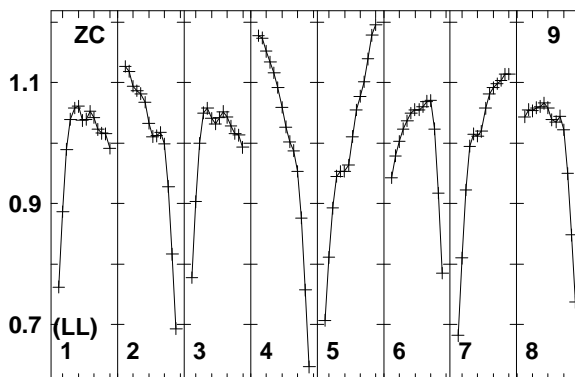
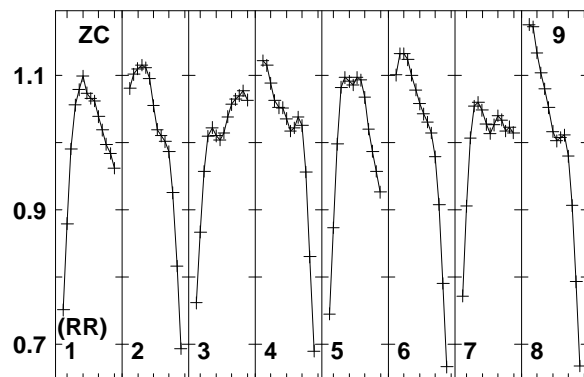
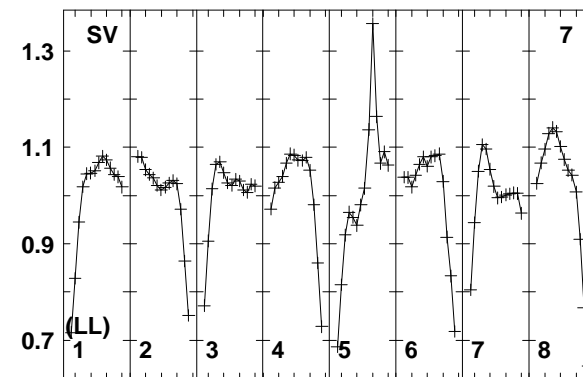
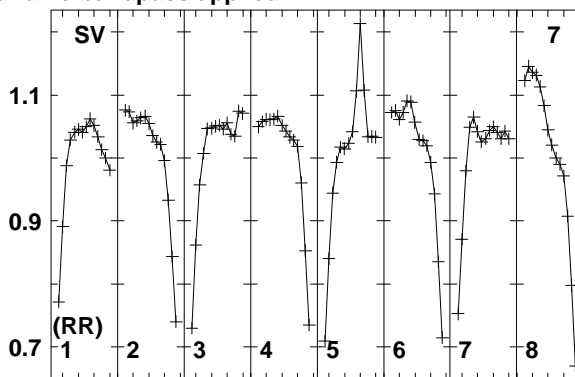
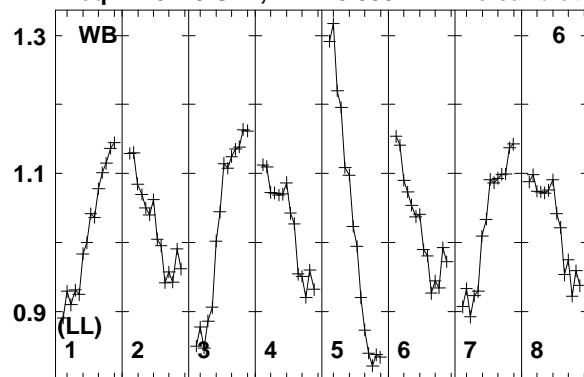

Lower frame: Real Jy
Total-power spectrum Antenna: WB (06)
Timerange: 01/01:37:43 to 01/01:39:29

Plot file version 137 created 22-OCT-2014 16:25:19

J1432+3014 EC048.UVDATA.1

Freq = 1.6270 GHz, Bw = 8.000 MH No calibration applied and no bandpass applied

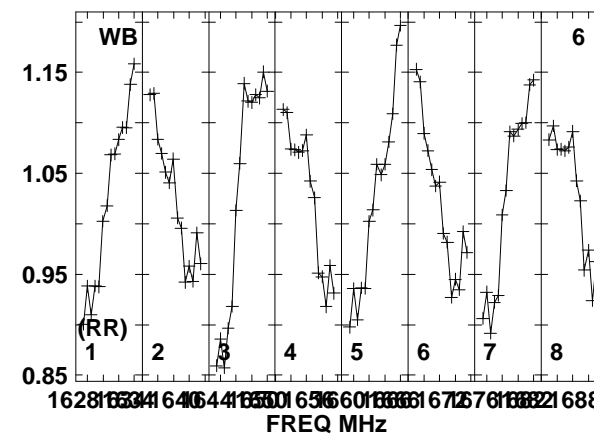
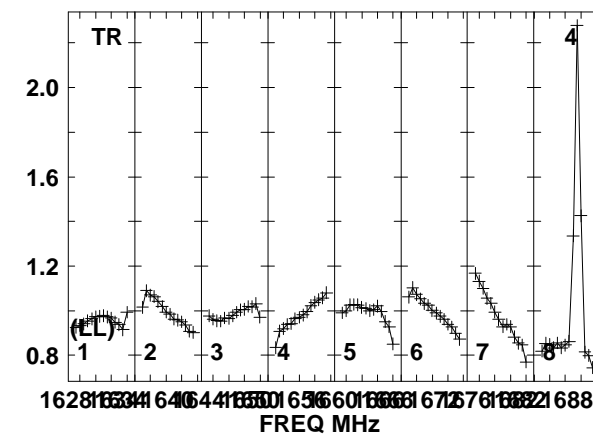
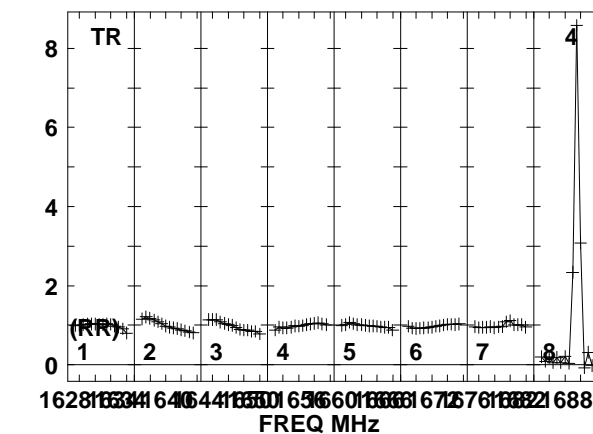
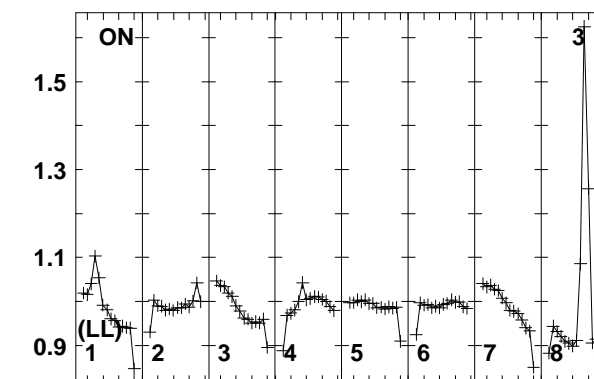
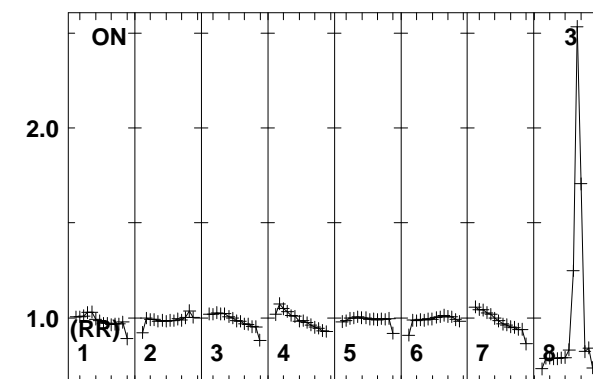
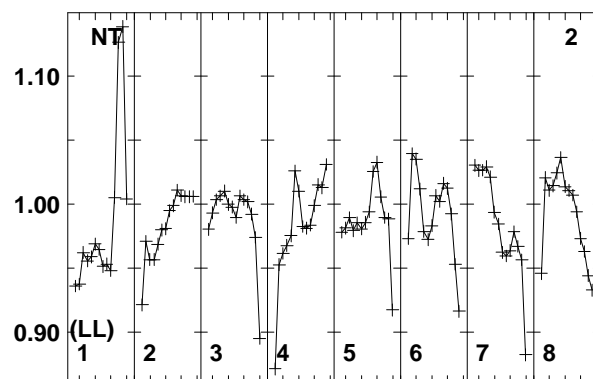
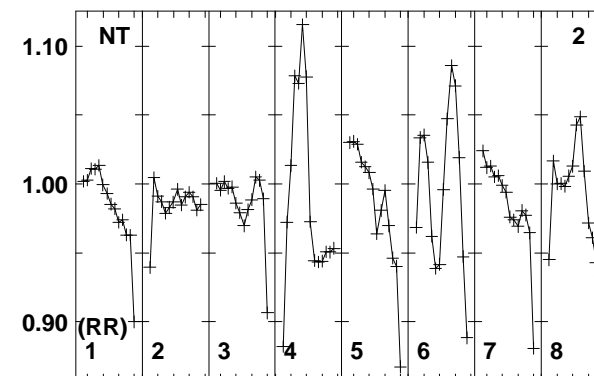
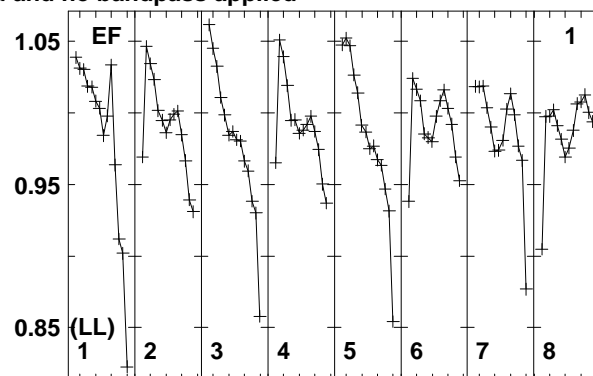
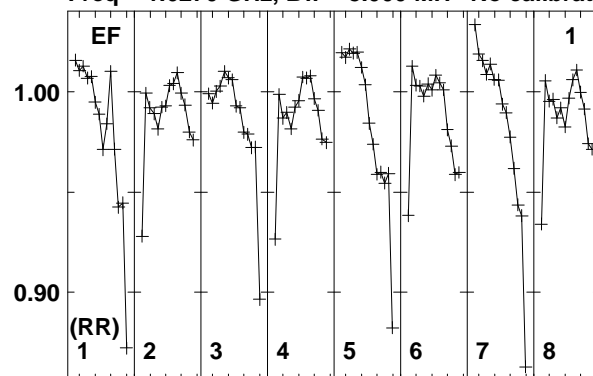

Lower frame: Real Jy
Total-power spectrum Antenna: EF (01)
Timerange: 01/01:39:34 to 01/01:47:14

Plot file version 138 created 22-OCT-2014 16:25:19
J1432+3014 EC048.UVDATA.1
Freq = 1.6270 GHz, Bw = 8.000 MH No calibration applied and no bandpass applied

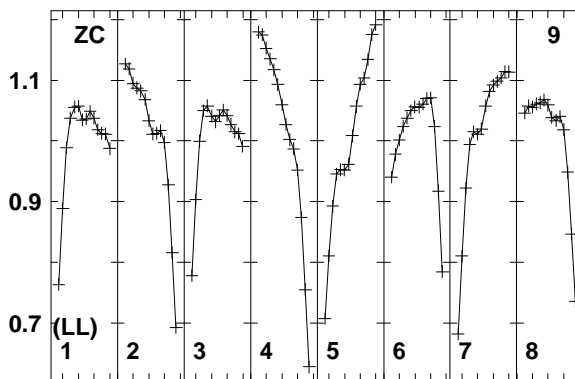
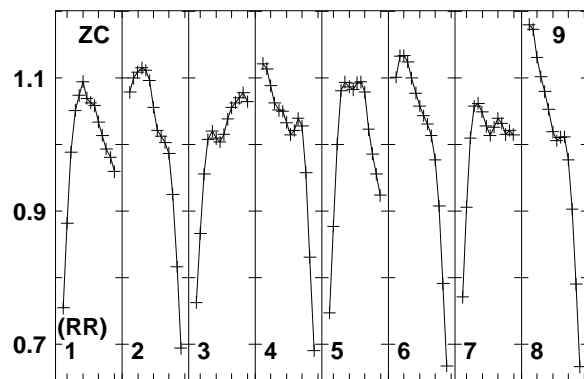
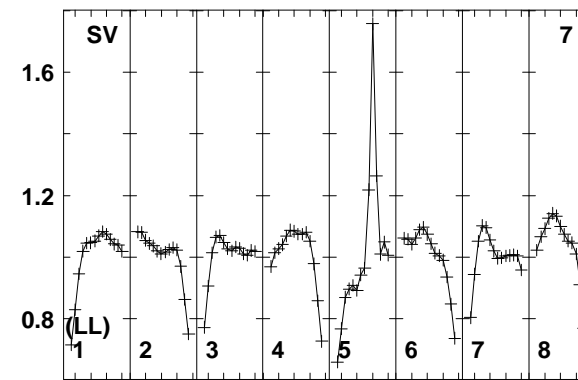
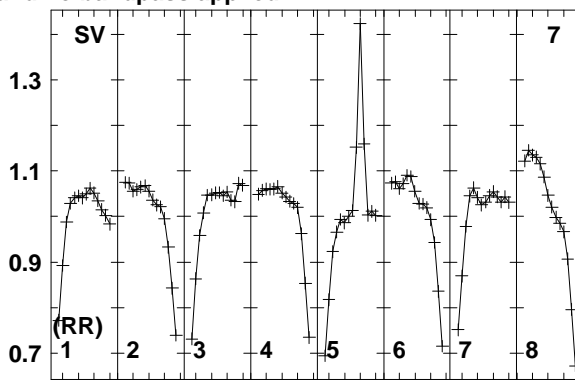
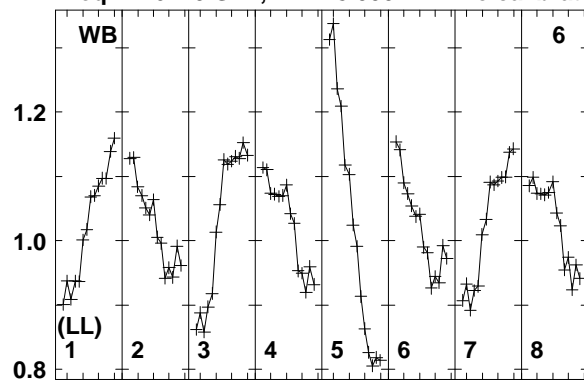

Lower frame: Real Jy
Total-power spectrum Antenna: WB (06)
Timerange: 01/01:39:34 to 01/01:47:14

Plot file version 139 created 22-OCT-2014 16:25:19

J1435+3012 EC048.UVDATA.1

Freq = 1.6270 GHz, Bw = 8.000 MH No calibration applied and no bandpass applied

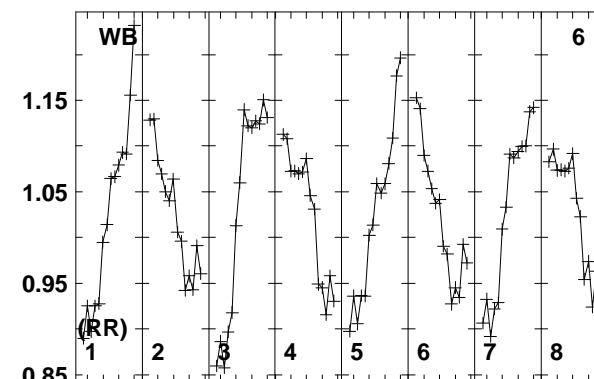
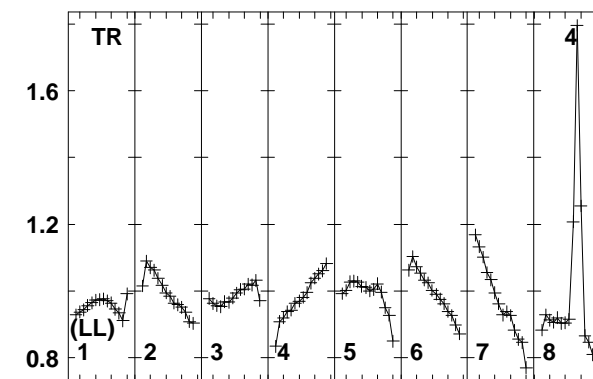
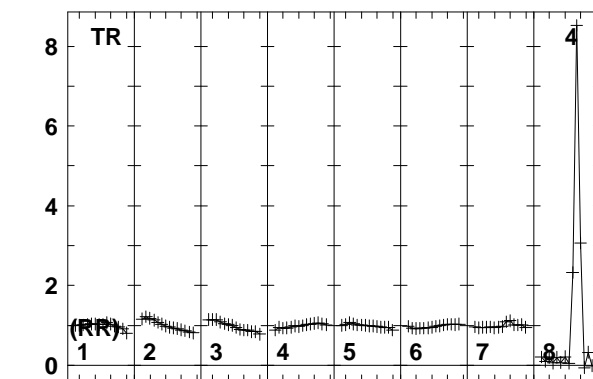
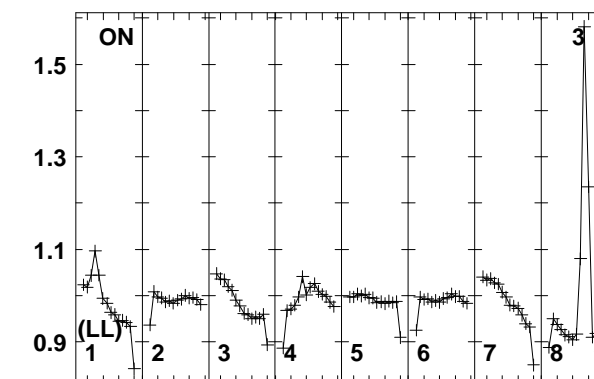
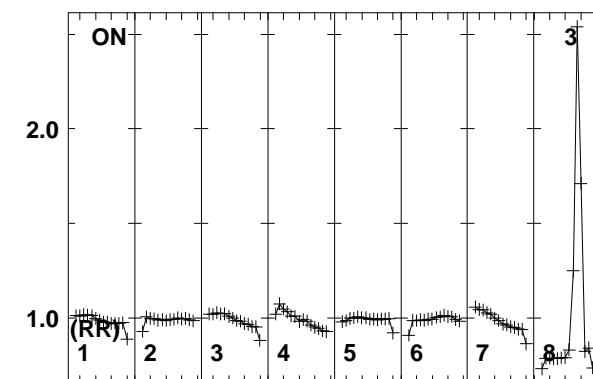
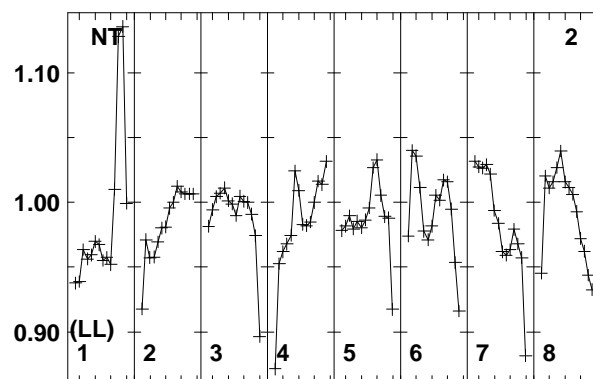
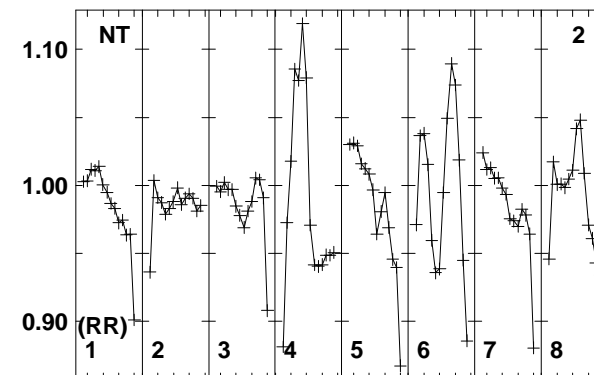
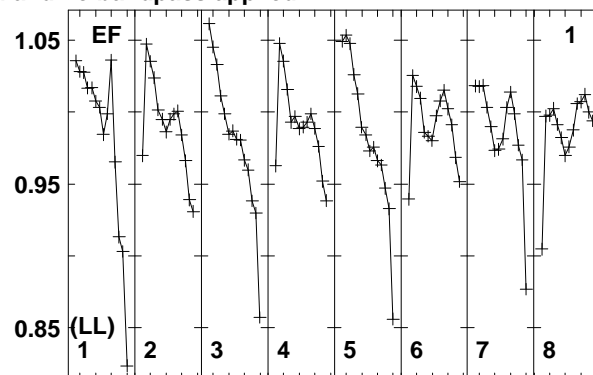
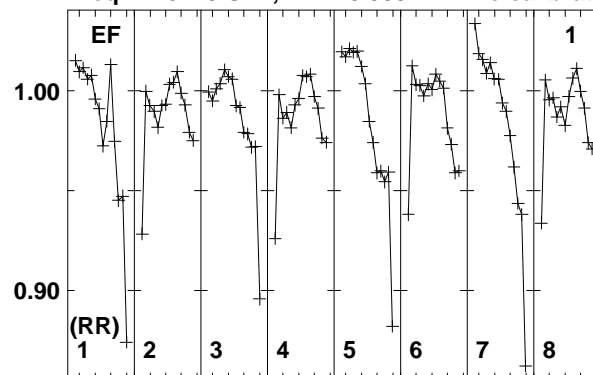

1628 1634 1640 1644 1650 1656 1660 1666 1672 1676 1682 1688
FREQ MHz

1628 1634 1640 1644 1650 1656 1660 1666 1672 1676 1682 1688
FREQ MHz

1628 1634 1640 1644 1650 1656 1660 1666 1672 1676 1682 1688
FREQ MHz

Lower frame: Real Jy
Total-power spectrum Antenna: EF (01)
Timerange: 01/01:47:58 to 01/01:49:44

Plot file version 140 created 22-OCT-2014 16:25:19

J1435+3012 EC048.UVDATA.1

Freq = 1.6270 GHz, Bw = 8.000 MH No calibration applied and no bandpass applied

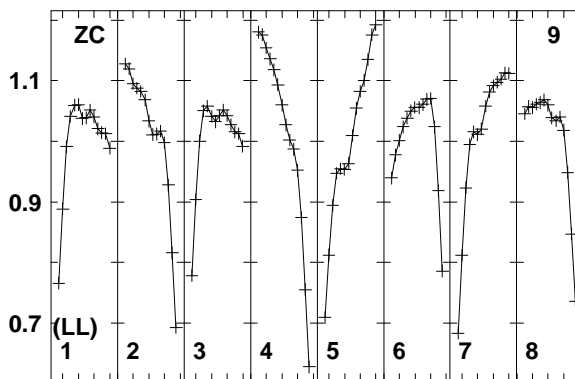
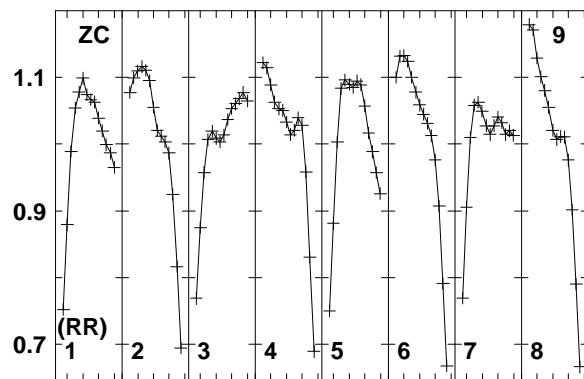
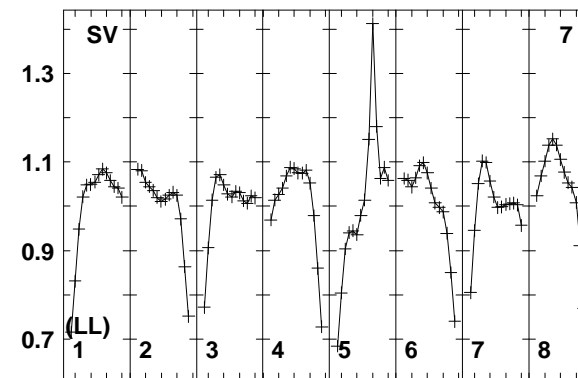
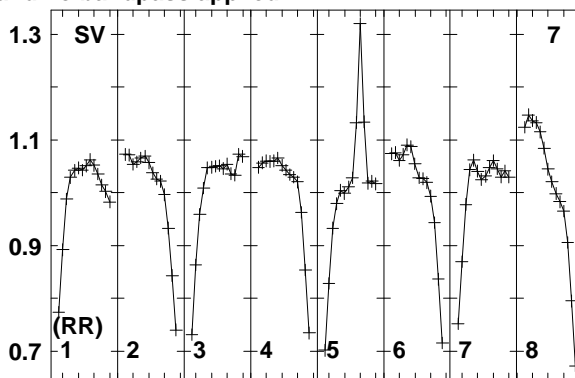
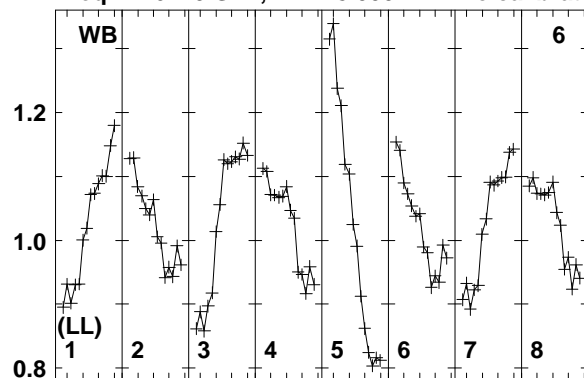

Lower frame: Real Jy
Total-power spectrum Antenna: WB (06)
Timerange: 01/01:47:58 to 01/01:49:44

Plot file version 141 created 22-OCT-2014 16:25:19

J1432+3014 EC048.UVDATA.1

Freq = 1.6270 GHz, Bw = 8.000 MH No calibration applied and no bandpass applied

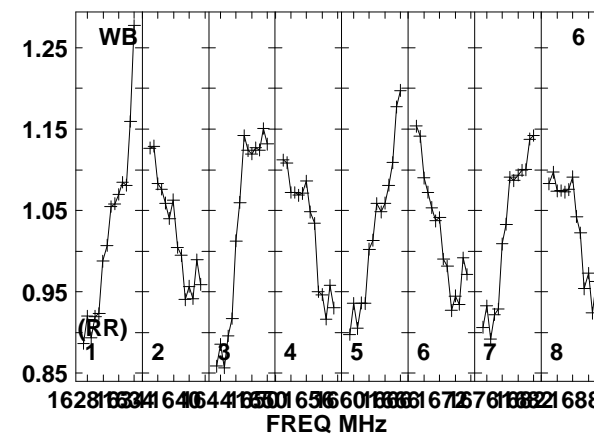
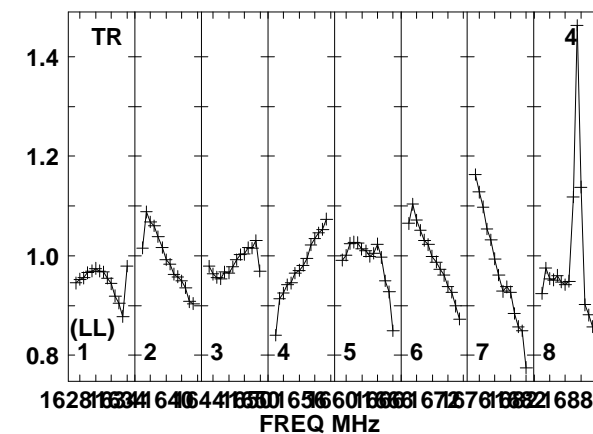
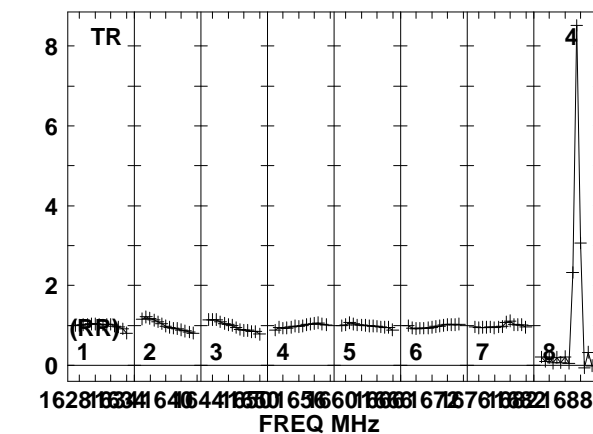
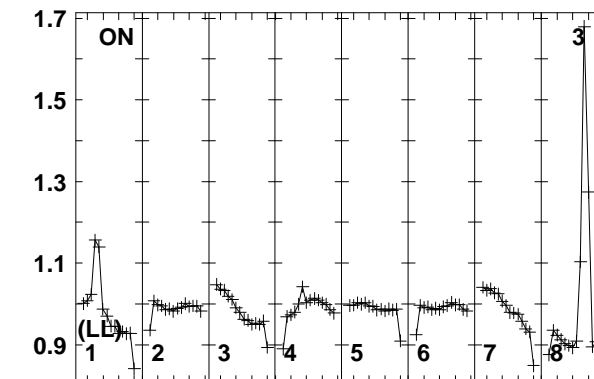
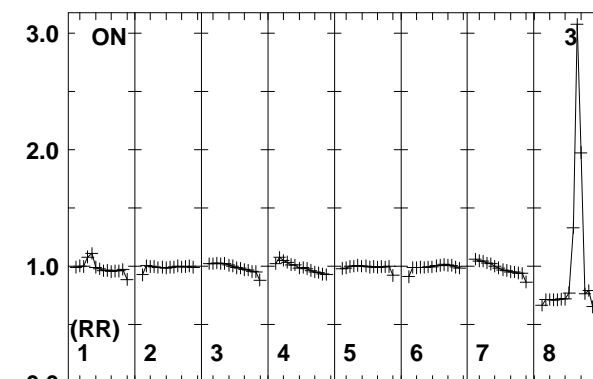
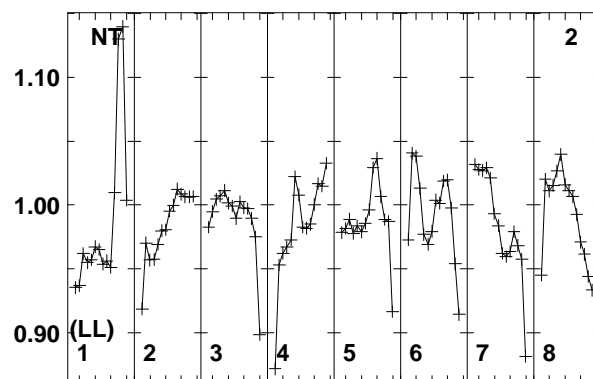
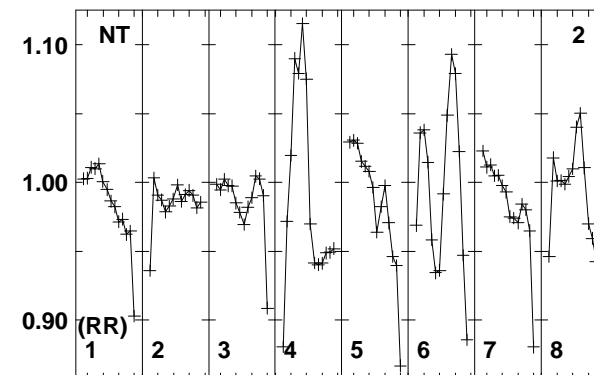
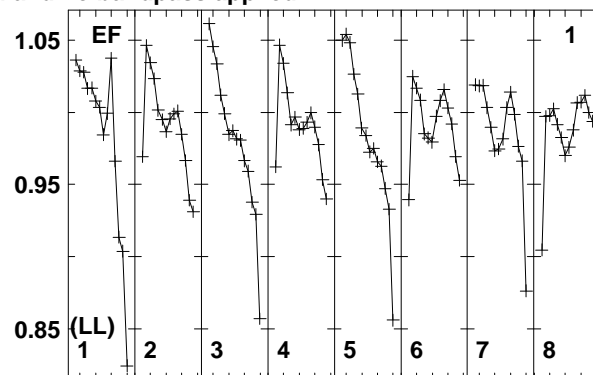
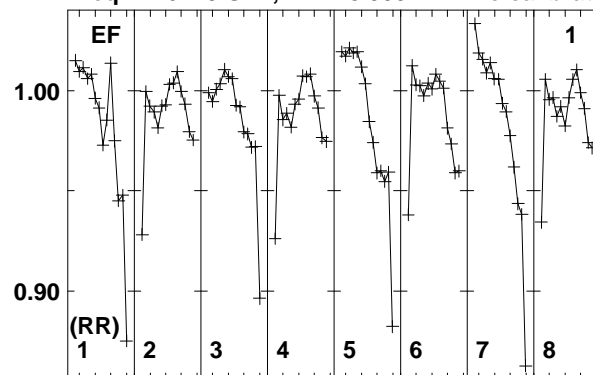

Lower frame: Real Jy
Total-power spectrum Antenna: EF (01)
Timerange: 01/01:49 to 01/01:57:29

Plot file version 142 created 22-OCT-2014 16:25:19

J1432+3014 EC048.UVDATA.1

Freq = 1.6270 GHz, Bw = 8.000 MH No calibration applied and no bandpass applied

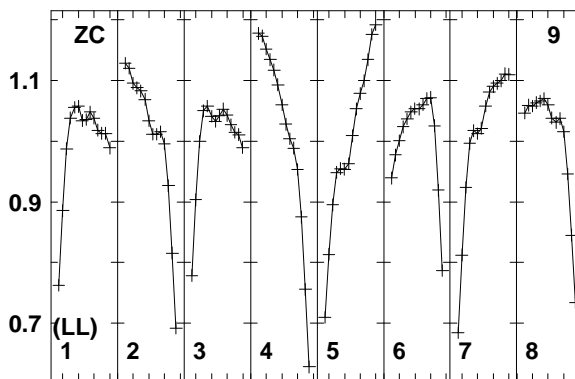
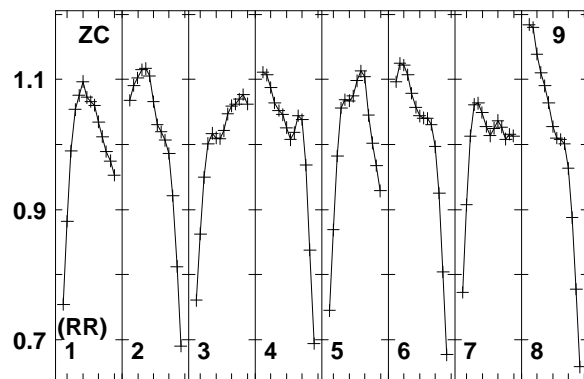
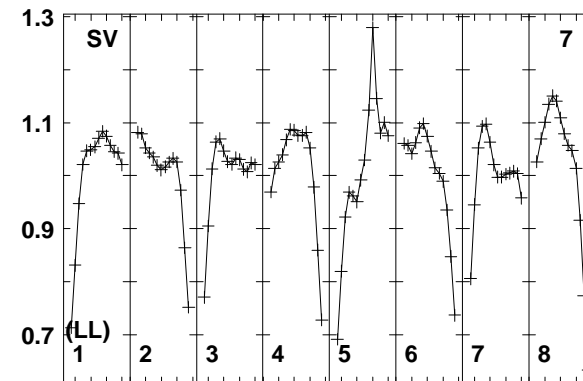
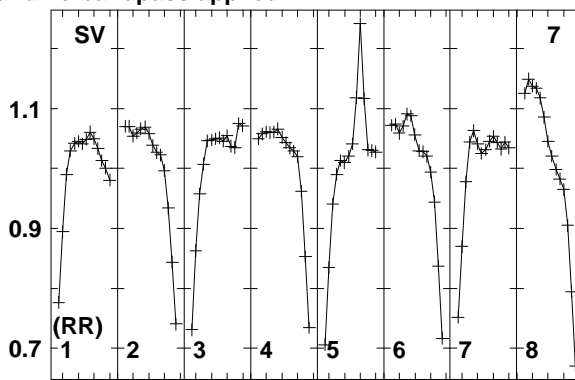
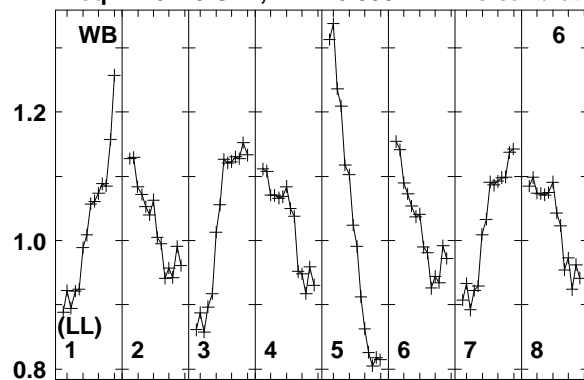

Lower frame: Real Jy
Total-power spectrum Antenna: WB (06)
Timerange: 01/01:49:49 to 01/01:57:29

Plot file version 143 created 22-OCT-2014 16:25:19

J1435+3012 EC048.UVDATA.1

Freq = 1.6270 GHz, Bw = 8.000 MH No calibration applied and no bandpass applied

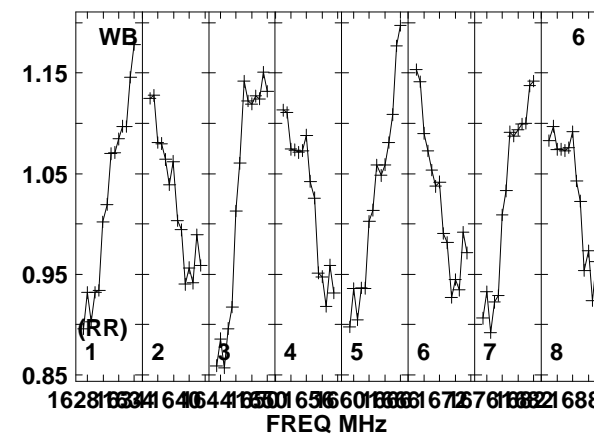
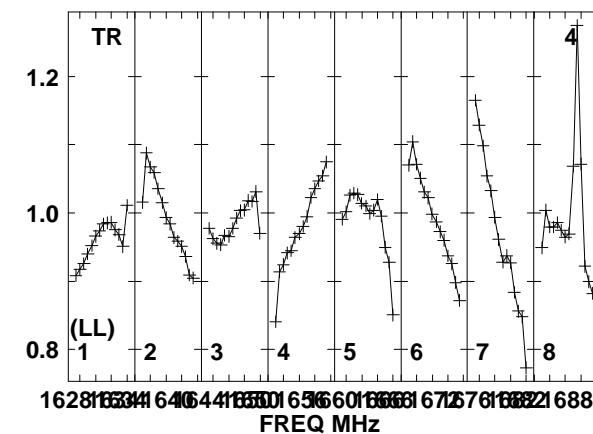
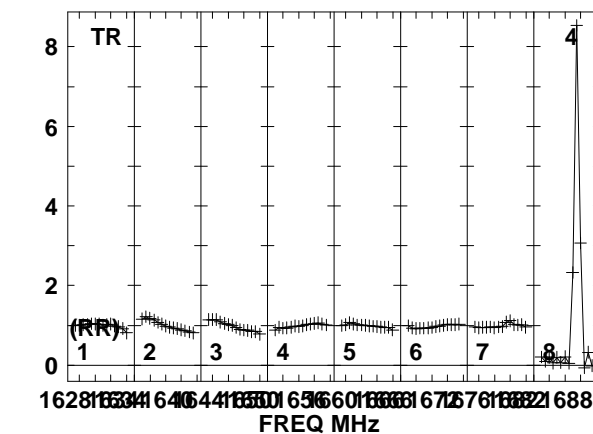
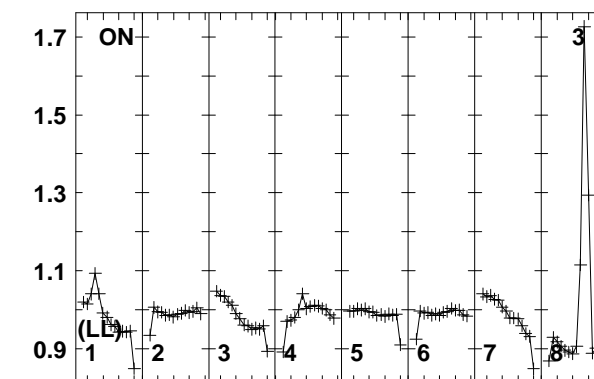
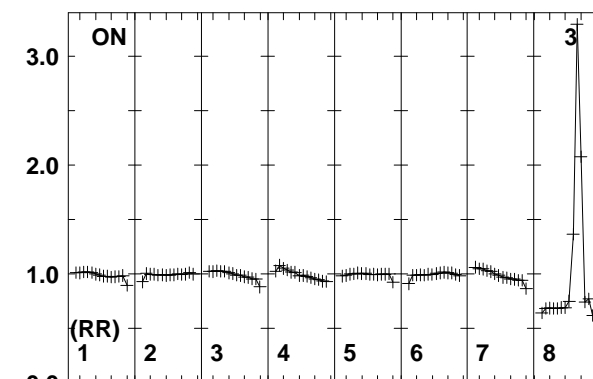
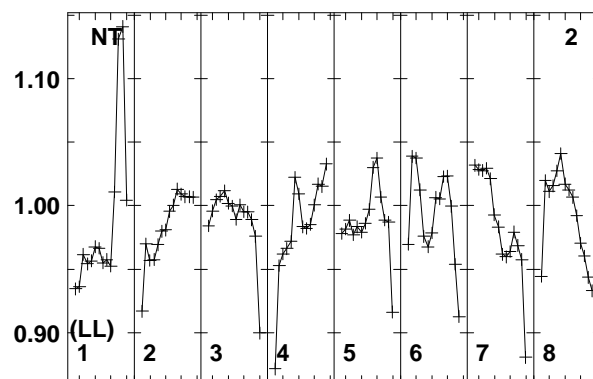
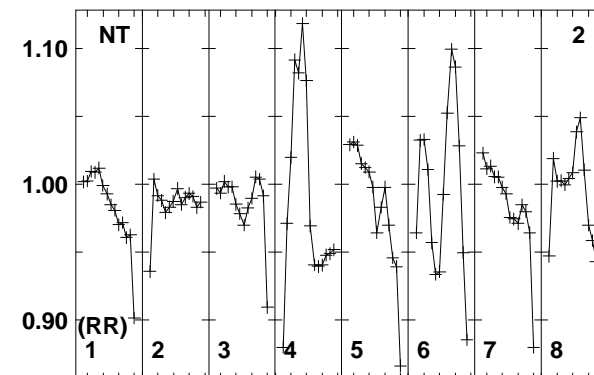
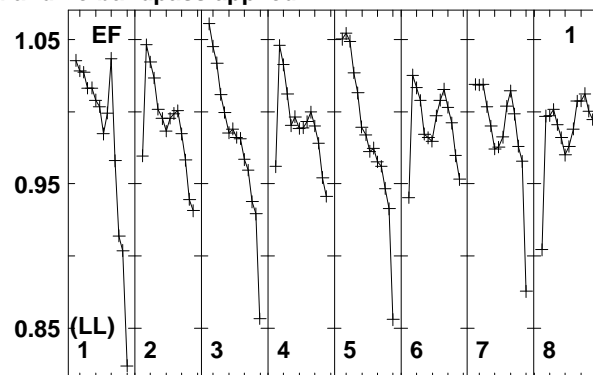
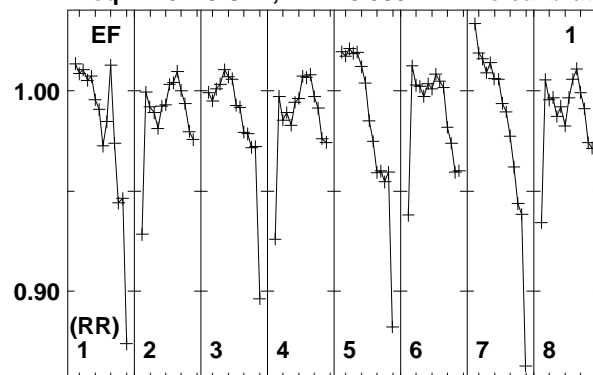

Lower frame: Real Jy
Total-power spectrum Antenna: EF (01)
Timerange: 01/01:58:13 to 01/01:59:59

Plot file version 144 created 22-OCT-2014 16:25:19

J1435+3012 EC048.UVDATA.1

Freq = 1.6270 GHz, Bw = 8.000 MH No calibration applied and no bandpass applied

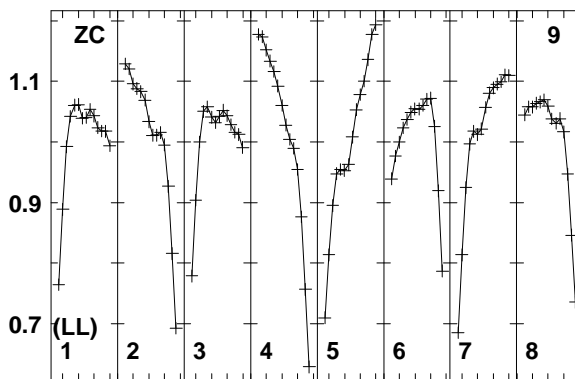
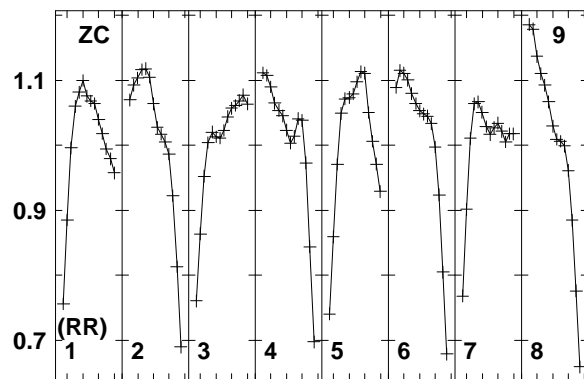
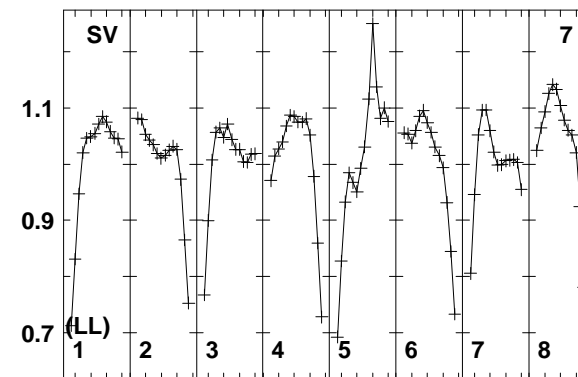
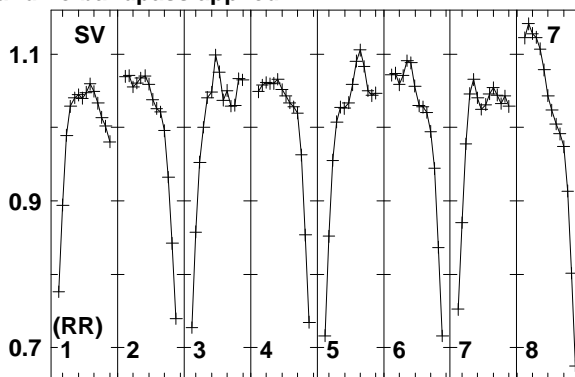
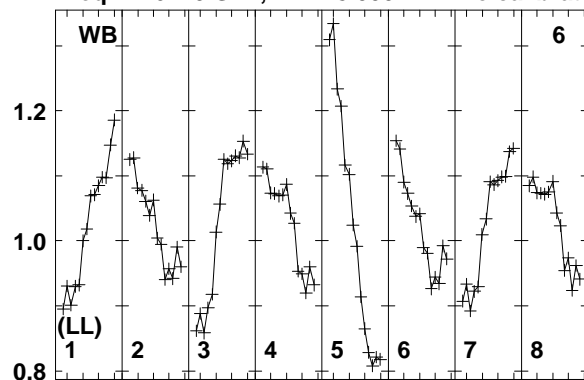

Lower frame: Real Jy
Total-power spectrum Antenna: WB (06)
Timerange: 01/01:58:13 to 01/01:59:59