

Plot file version 1 created 17-SEP-2012 11:59:49

J0423-0120 EE008D 1.UVDATA.1

Freq = 22.2290 GHz, Bw = 8.000 MH No calibration applied and no bandpass applied

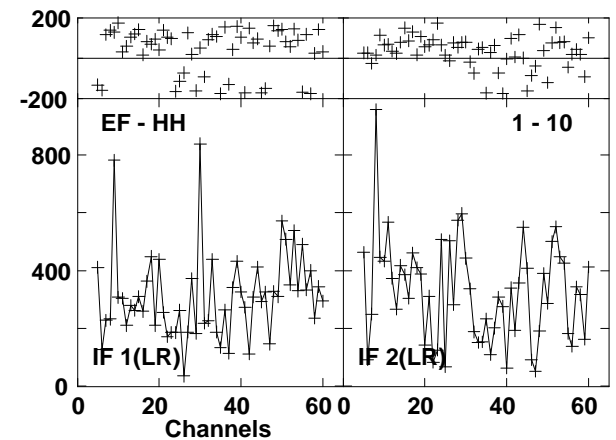
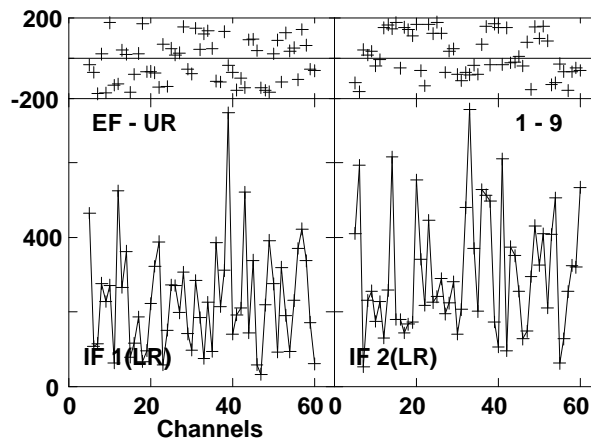
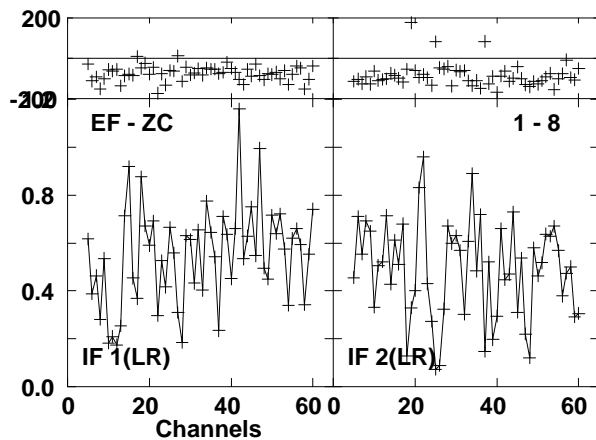
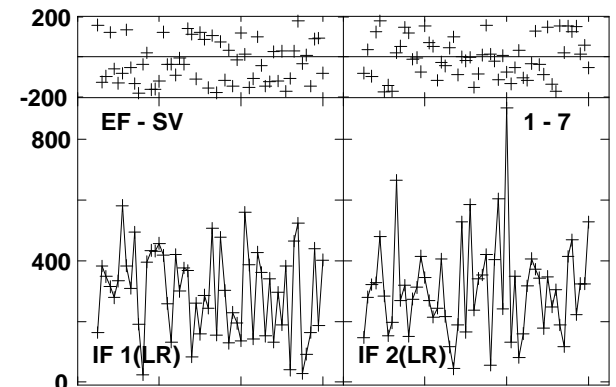
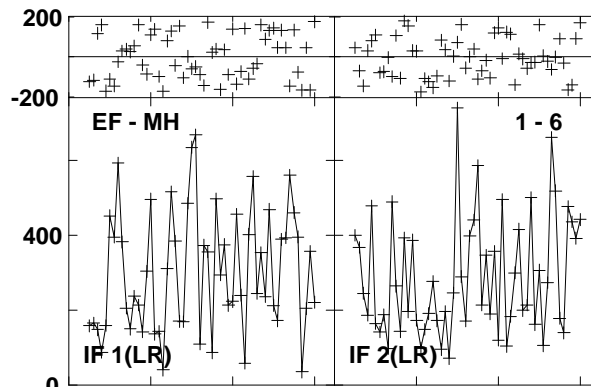
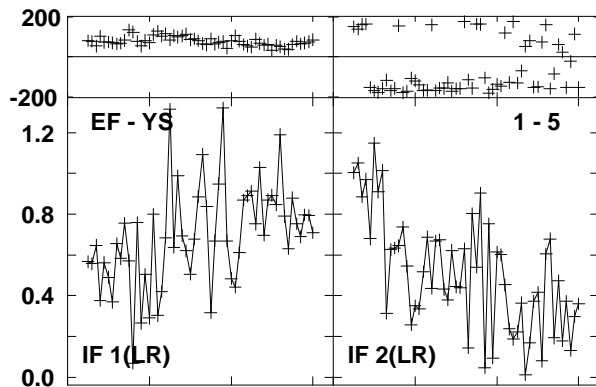
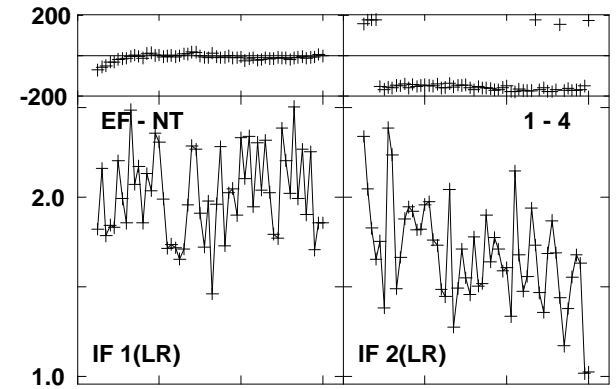
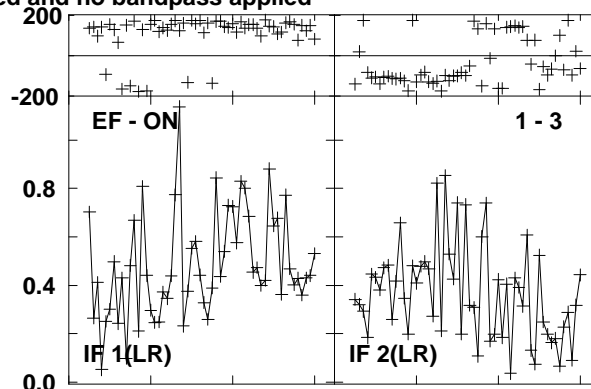
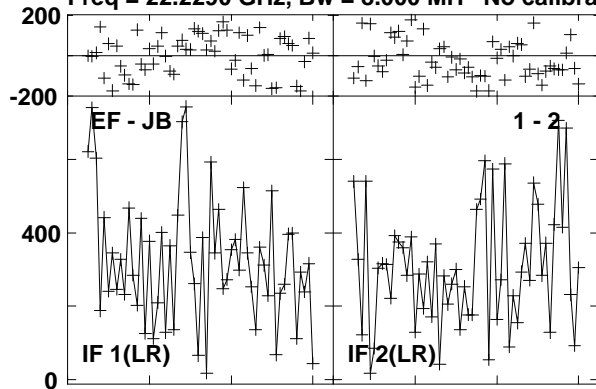

Lower frame: Micro Ampl Jy Top frame: Phas deg
Vector averaged cross-power spectrum Several baselines displayed
Timerange: 00/09:47:02 to 00/09:56:31

Plot file version 2 created 17-SEP-2012 12:00:20

J0423-0120 EE008D 1.UVDATA.1

Freq = 22.2290 GHz, Bw = 8.000 MH No calibration applied and no bandpass applied

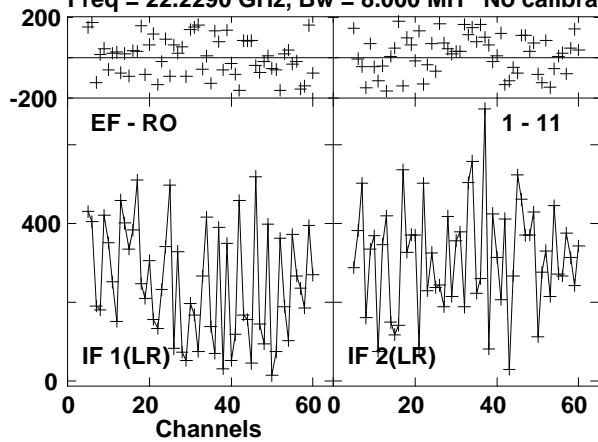

Lower frame: Micro Ampl Jy Top frame: Phas deg
Vector averaged cross-power spectrum Several baselines displayed
Timerange: 00/09:47:02 to 00/09:56:31

Plot file version 3 created 17-SEP-2012 12:00:21

J0423-0120 EE008D 1.UVDATA.1

Freq = 22.2290 GHz, Bw = 8.000 MH No calibration applied and no bandpass applied

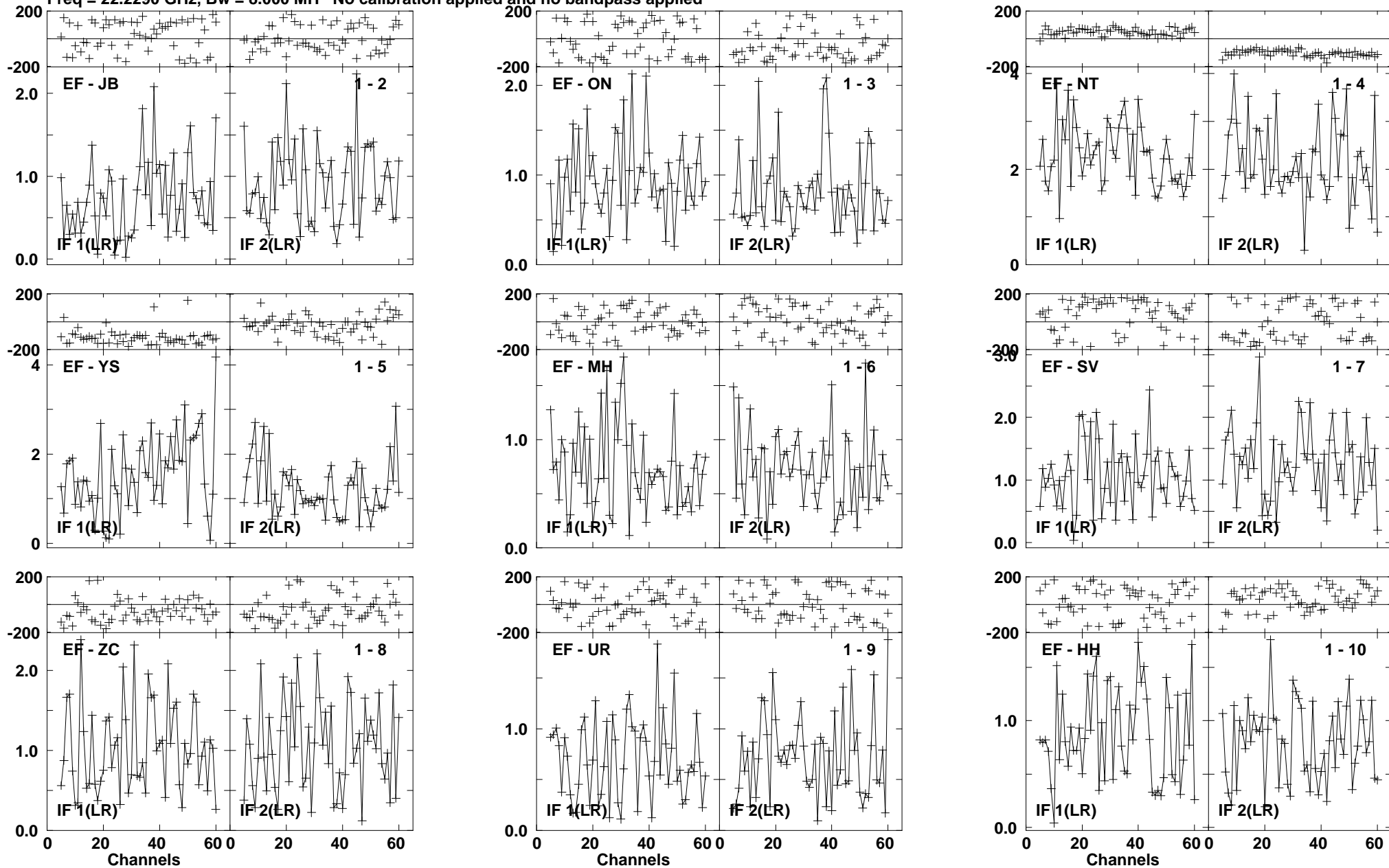

Lower frame: Milli Ampl Jy Top frame: Phas deg
Vector averaged cross-power spectrum Several baselines displayed
Timerange: 00/09:56:47 to 00/09:57:01

Plot file version 4 created 17-SEP-2012 12:00:22

J0423-0120 EE008D 1.UVDATA.1

Freq = 22.2290 GHz, Bw = 8.000 MH No calibration applied and no bandpass applied

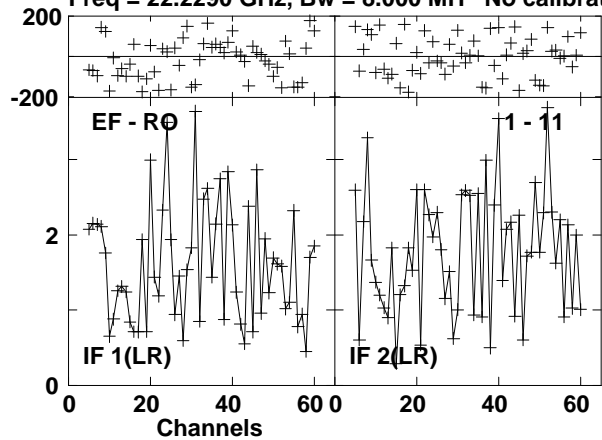

Lower frame: Milli Ampl Jy Top frame: Phas deg
Vector averaged cross-power spectrum Several baselines displayed
Timerange: 00/09:56:47 to 00/09:57:01

Plot file version 5 created 17-SEP-2012 12:00:26
3C84 EE008D 1.UVDATA.1

Freq = 22.2290 GHz, Bw = 8.000 MH No calibration applied and no bandpass applied

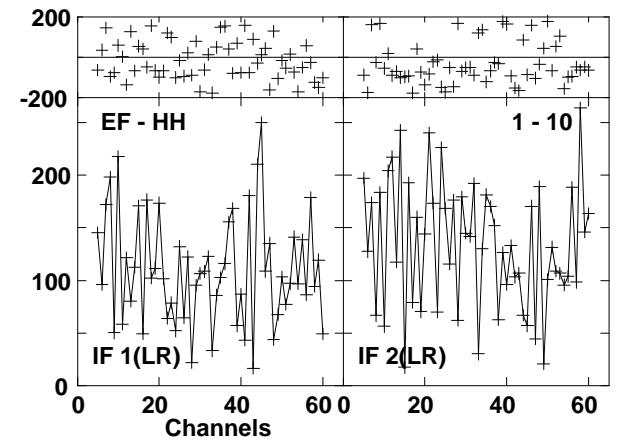
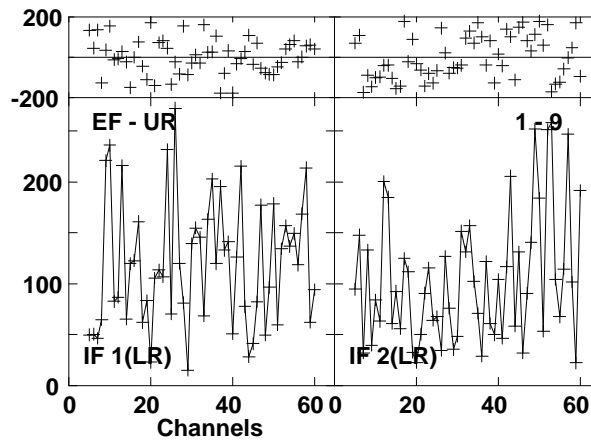
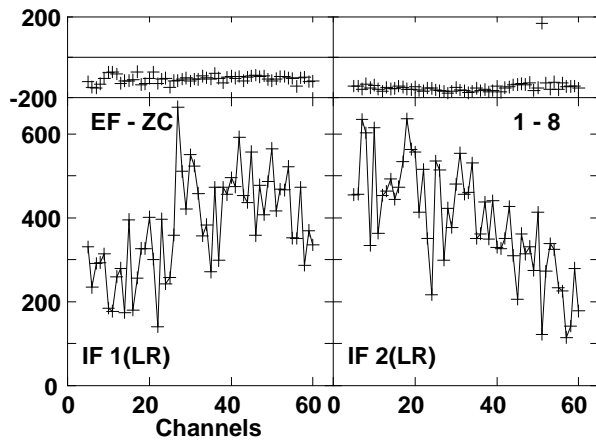
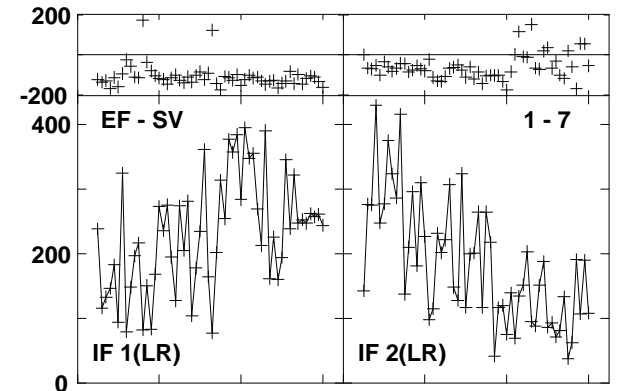
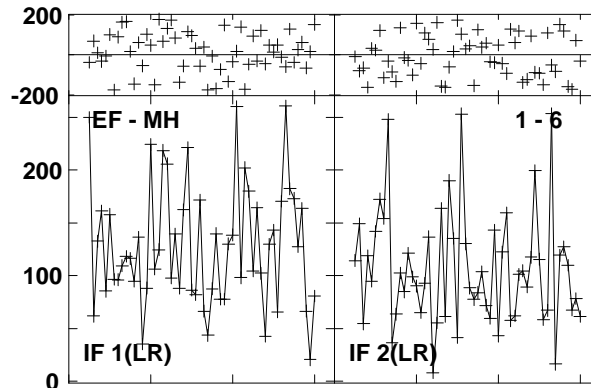
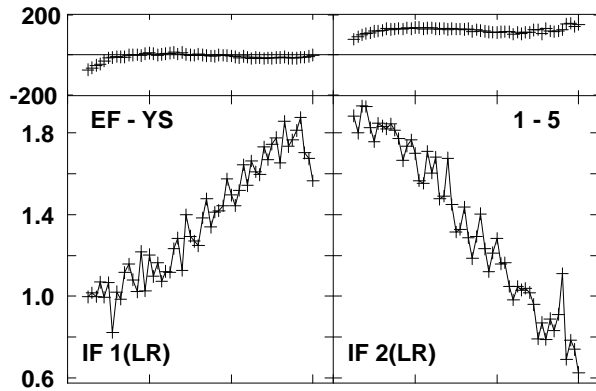
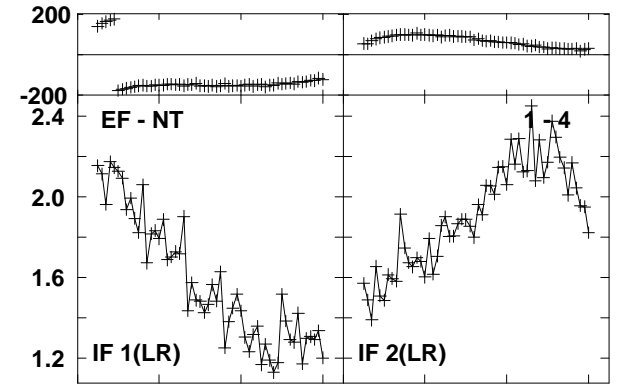
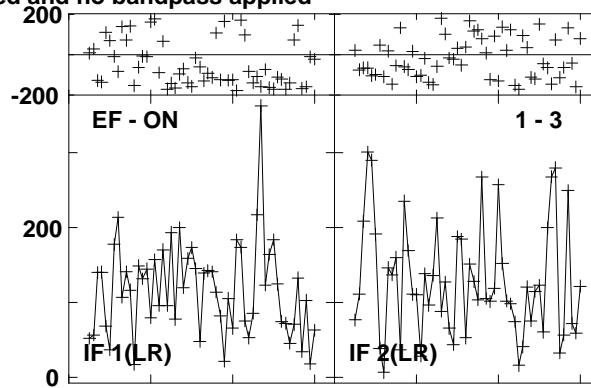
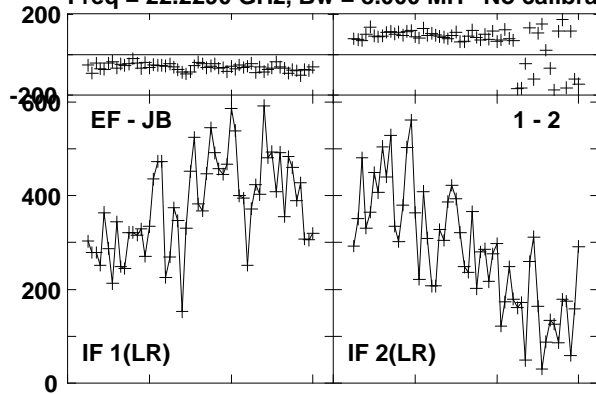

Lower frame: Micro Ampl Jy Top frame: Phas deg
Vector averaged cross-power spectrum Several baselines displayed
Timerange: 00/10:00:37 to 00/10:10:06

Plot file version 6 created 17-SEP-2012 12:01:02
3C84 EE008D 1.UVDATA.1
Freq = 22.2290 GHz, Bw = 8.000 MH No calibration applied and no bandpass applied

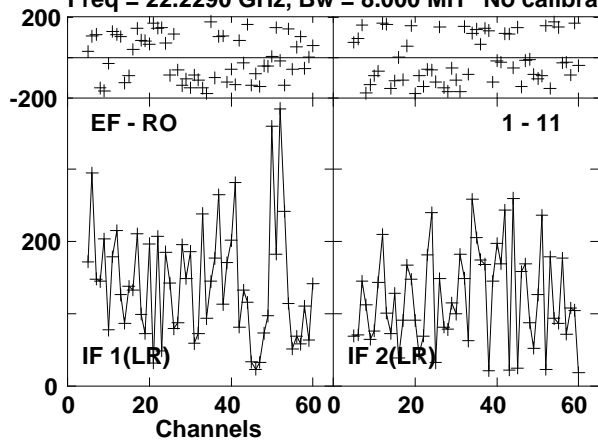

Lower frame: Micro Ampl Jy Top frame: Phas deg
Vector averaged cross-power spectrum Several baselines displayed
Timerange: 00/10:00:37 to 00/10:10:06

Plot file version 7 created 17-SEP-2012 12:01:02

3C84 EE008D 1.UVDATA.1

Freq = 22.2290 GHz, Bw = 8.000 MH No calibration applied and no bandpass applied

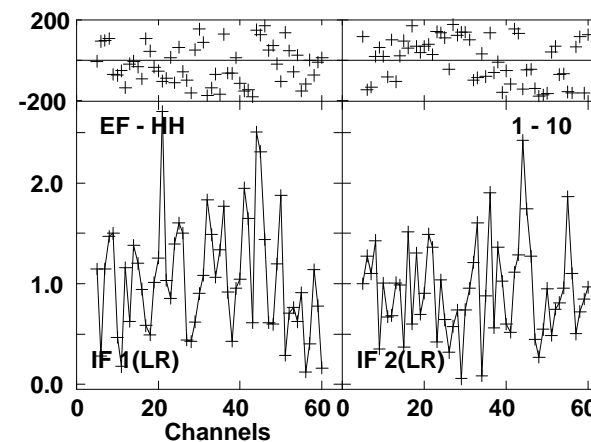
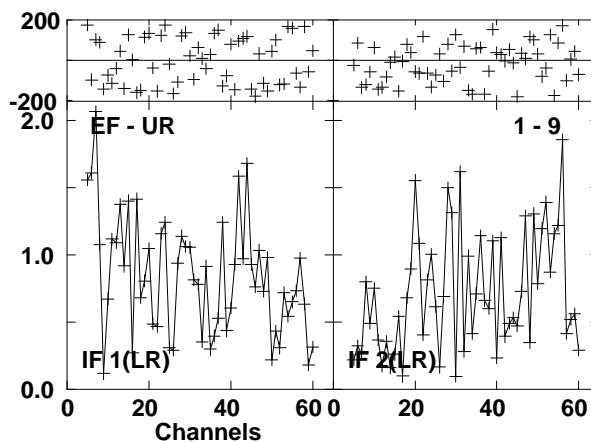
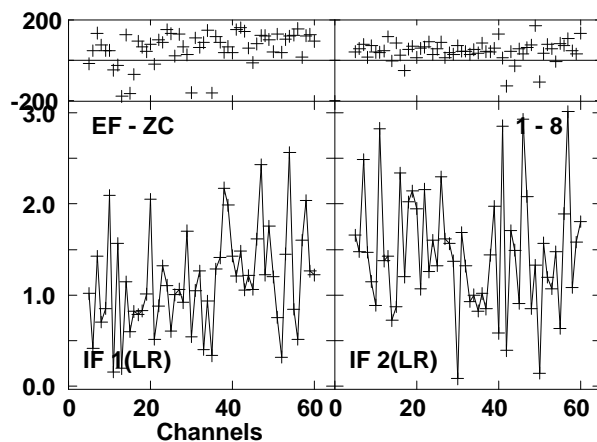
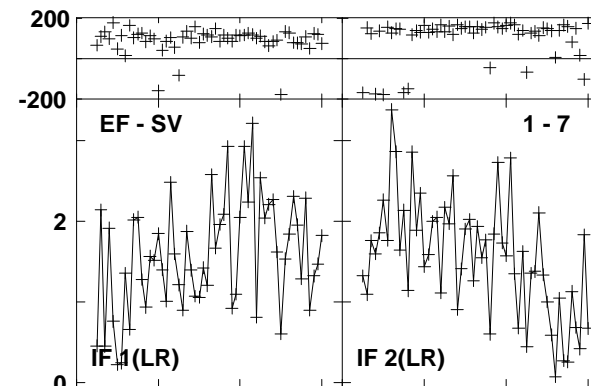
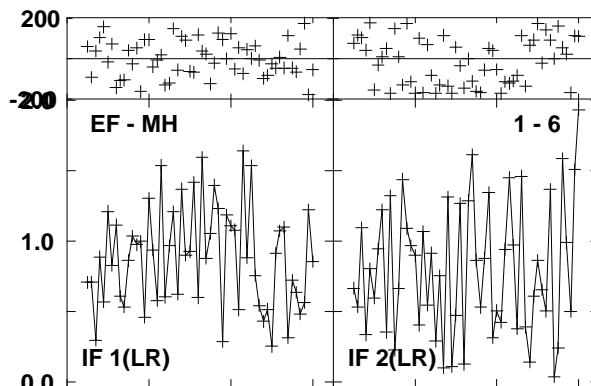
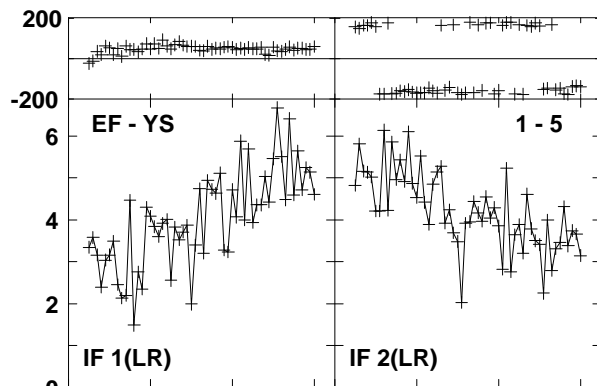
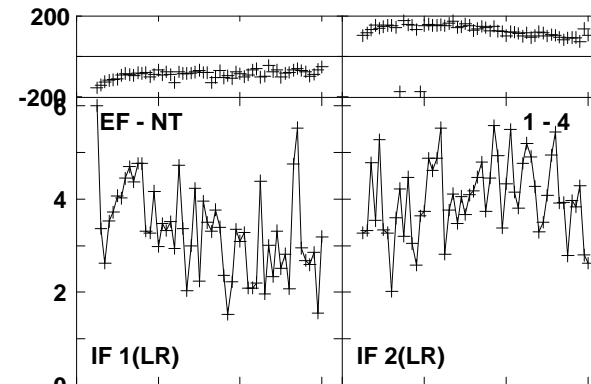
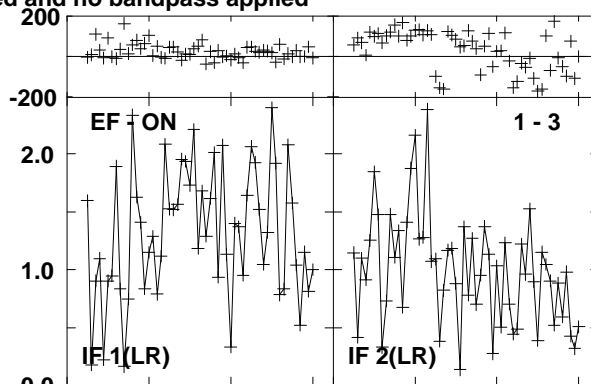
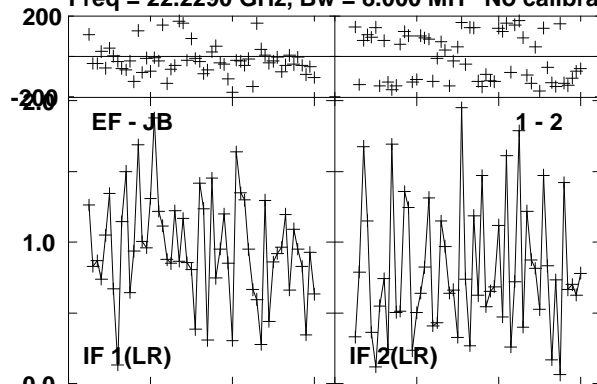

Lower frame: Milli Ampl Jy Top frame: Phas deg
Vector averaged cross-power spectrum Several baselines displayed
Timerange: 00/10/10:22 to 00/10/10:36

Plot file version 8 created 17-SEP-2012 12:01:03

3C84 EE008D 1.UVDATA.1

Freq = 22.2290 GHz, Bw = 8.000 MH No calibration applied and no bandpass applied

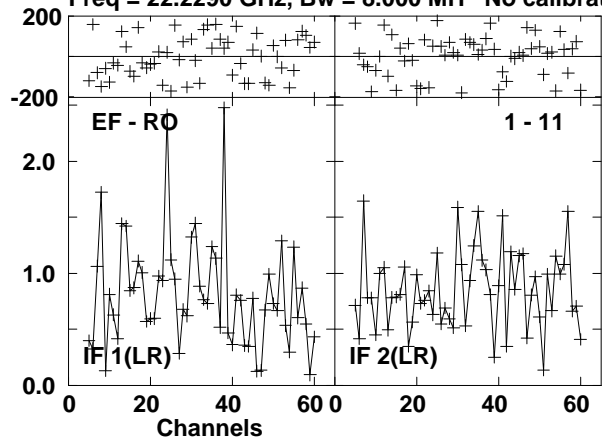

Lower frame: Milli Ampl Jy Top frame: Phas deg
Vector averaged cross-power spectrum Several baselines displayed
Timerange: 00/10:10:22 to 00/10:10:36

Plot file version 9 created 17-SEP-2012 12:01:03

J0541-0541 EE008D 1.UVDATA.1

Freq = 22.2290 GHz, Bw = 8.000 MH No calibration applied and no bandpass applied

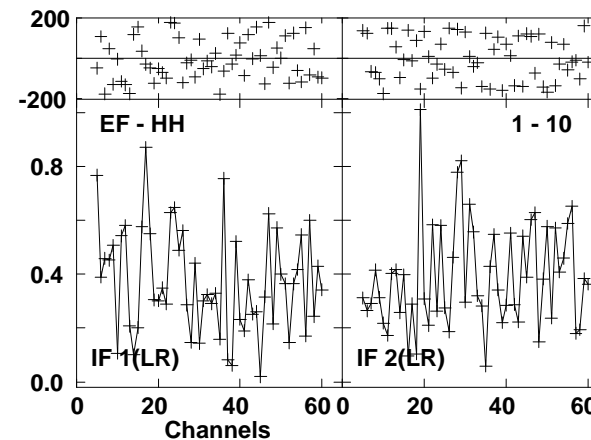
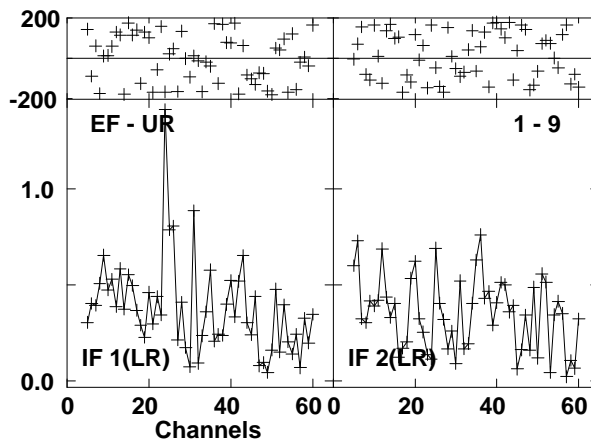
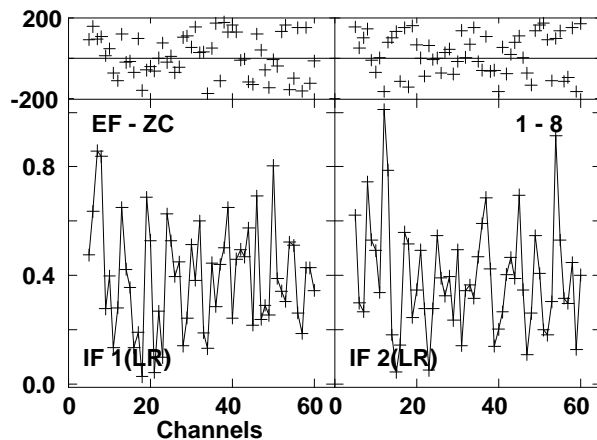
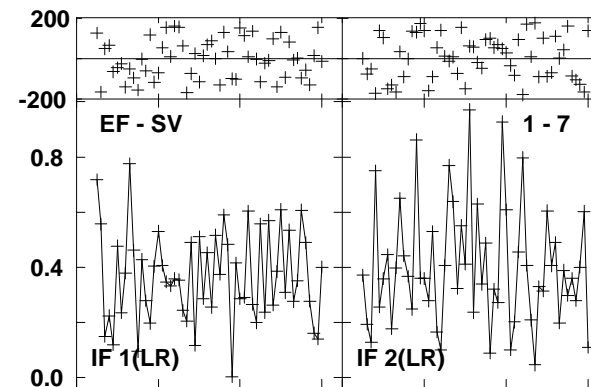
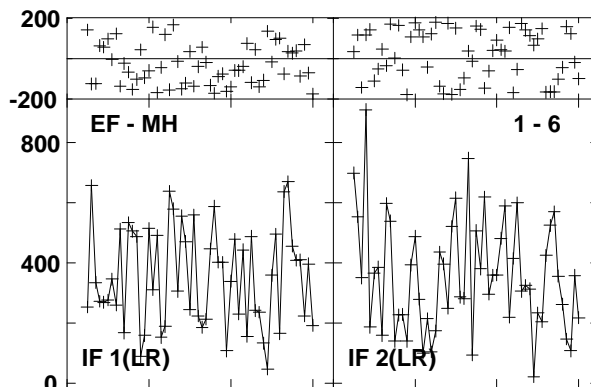
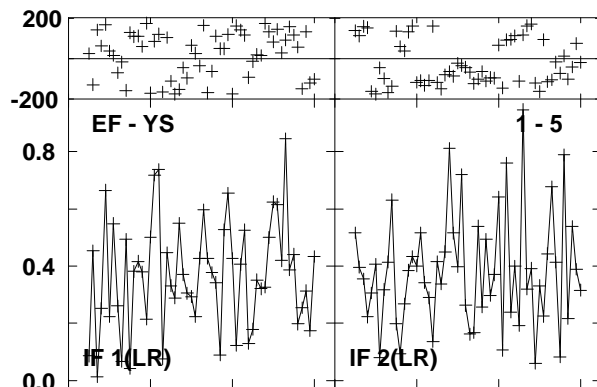
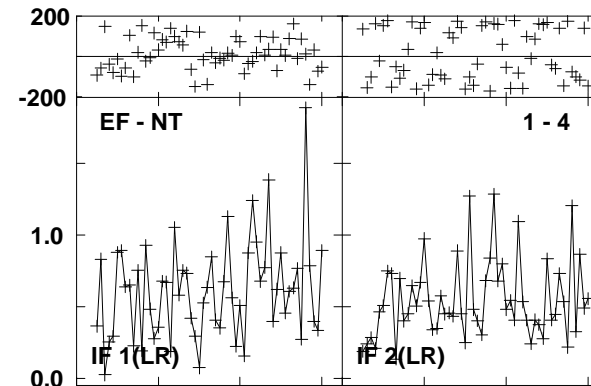
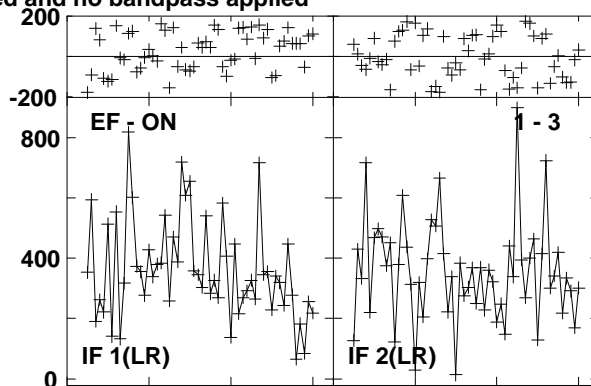
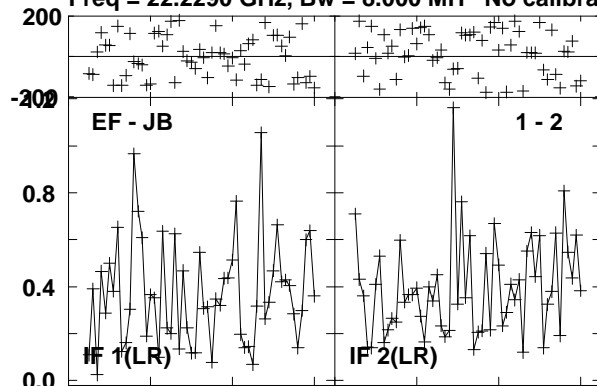

Lower frame: Milli Ampl Jy Top frame: Phas deg
Vector averaged cross-power spectrum Several baselines displayed
Timerange: 00/10/14:47 to 00/10/15:46

Plot file version 10 created 17-SEP-2012 12:01:07

J0541-0541 EE008D 1.UVDATA.1

Freq = 22.2290 GHz, Bw = 8.000 MH No calibration applied and no bandpass applied

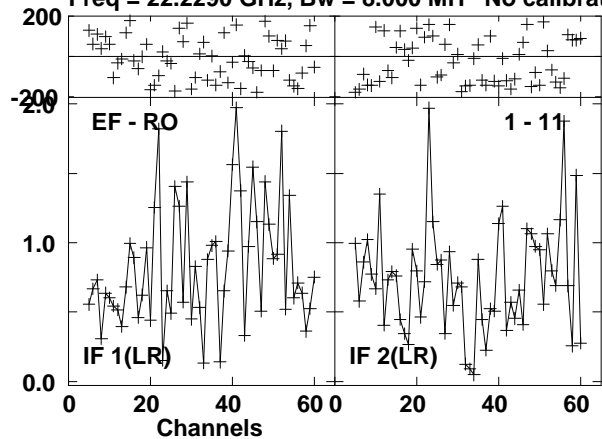

Lower frame: Milli Ampl Jy Top frame: Phas deg
Vector averaged cross-power spectrum Several baselines displayed
Timerange: 00/10:14:47 to 00/10:15:46

Plot file version 11 created 17-SEP-2012 12:01:07

ORIKL1 EE008D 1.UVDATA.1

Freq = 22.2290 GHz, Bw = 8.000 MH No calibration applied and no bandpass applied

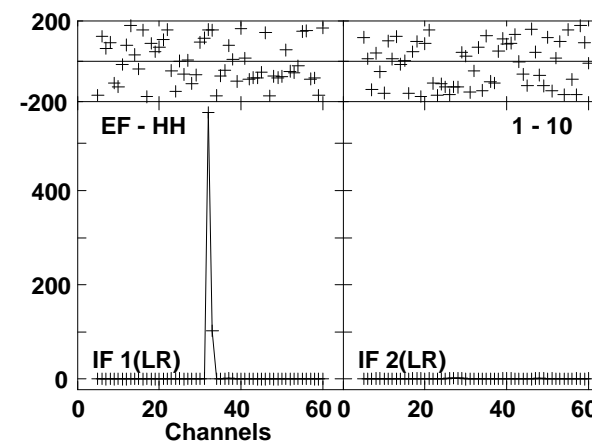
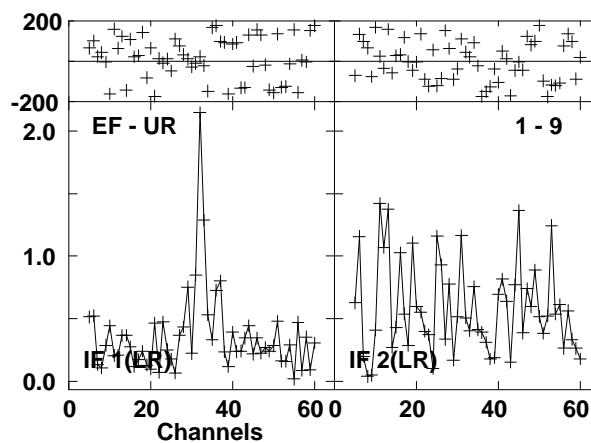
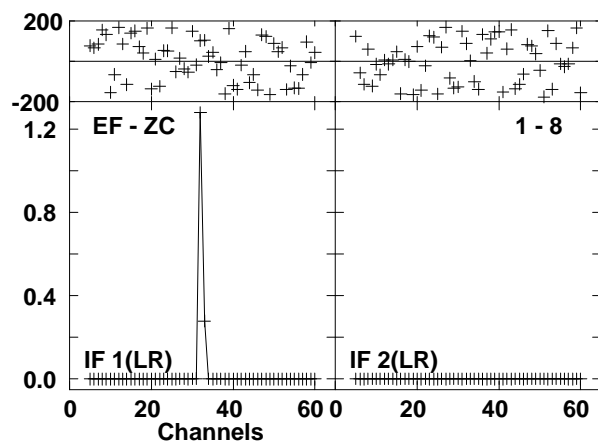
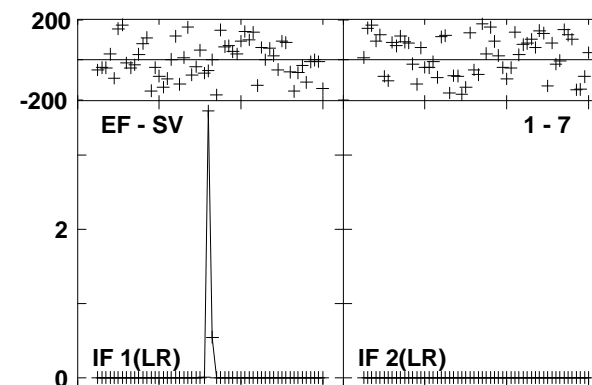
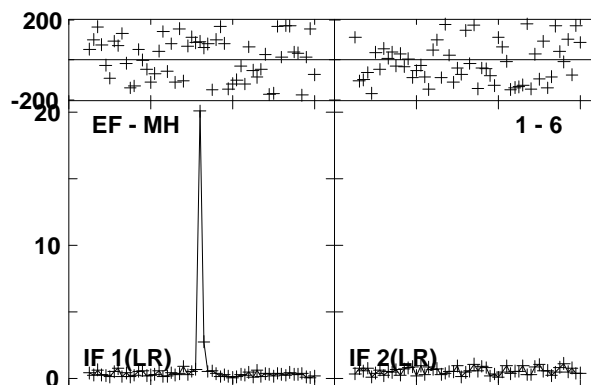
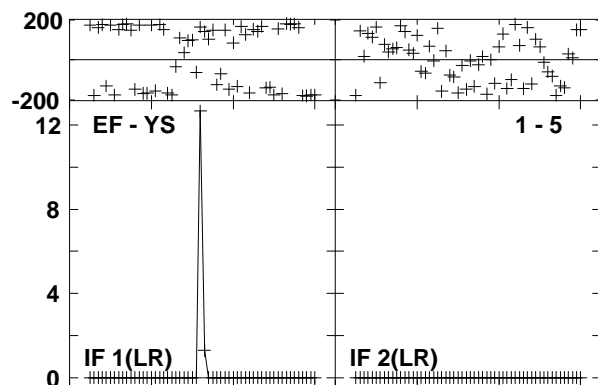
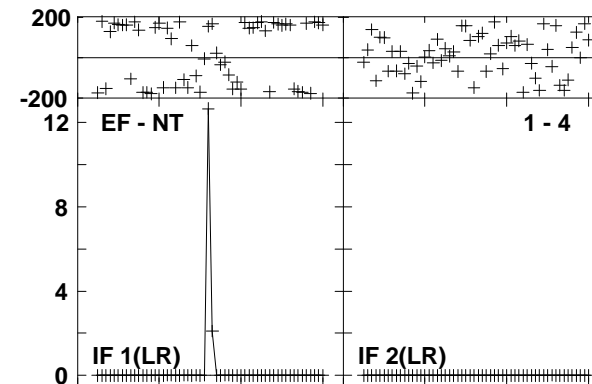
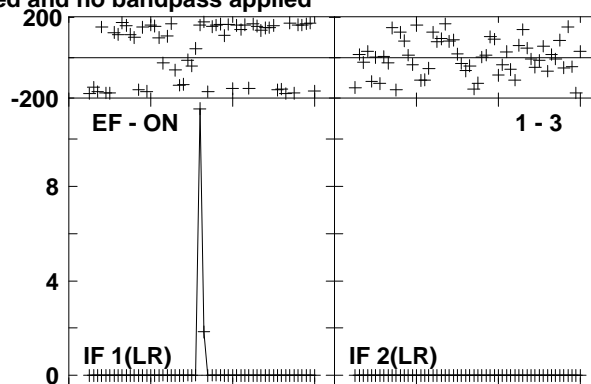
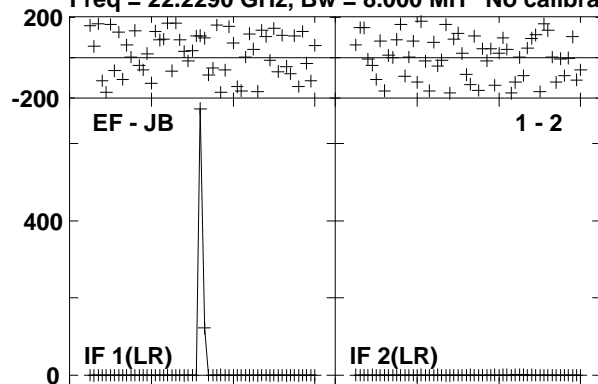

Lower frame: Milli Ampl Jy Top frame: Phas deg
Vector averaged cross-power spectrum Several baselines displayed
Timerange: 00/10:15:52 to 00/10:16:46

Plot file version 12 created 17-SEP-2012 12:01:09

ORIKL1 EE008D 1.UVDATA.1

Freq = 22.2290 GHz, Bw = 8.000 MH No calibration applied and no bandpass applied

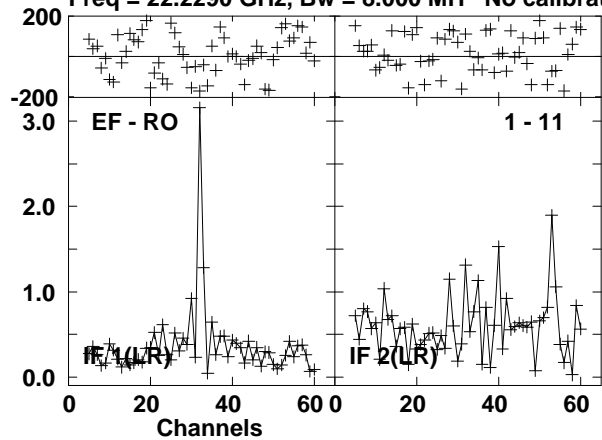

Lower frame: Milli Ampl Jy Top frame: Phas deg
Vector averaged cross-power spectrum Several baselines displayed
Timerange: 00/10:15:52 to 00/10:16:46

Plot file version 13 created 17-SEP-2012 12:01:10

J0541-0541 EE008D 1.UVDATA.1

Freq = 22.2290 GHz, Bw = 8.000 MH No calibration applied and no bandpass applied

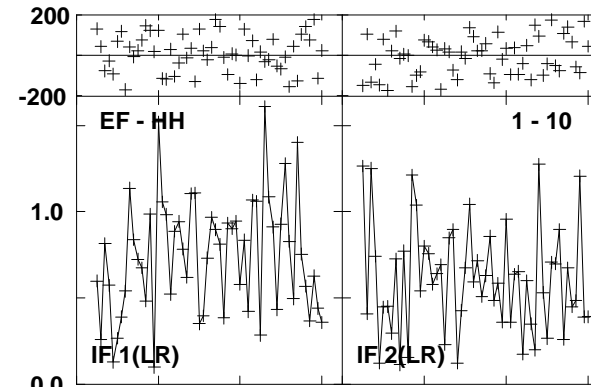
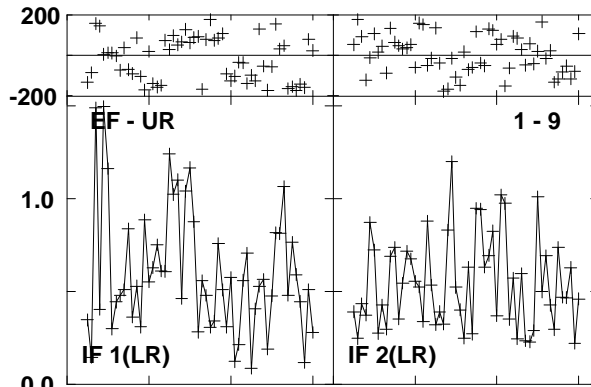
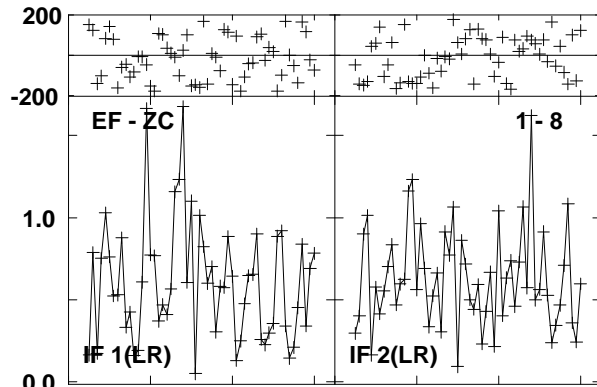
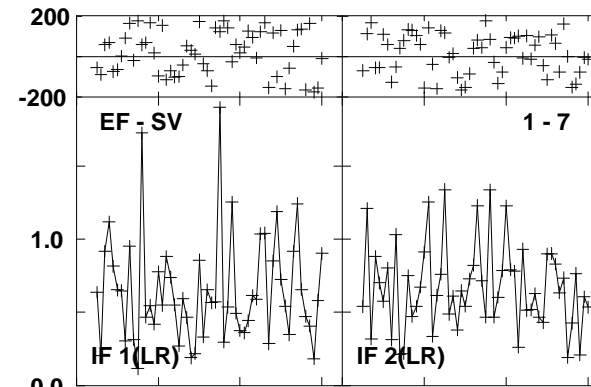
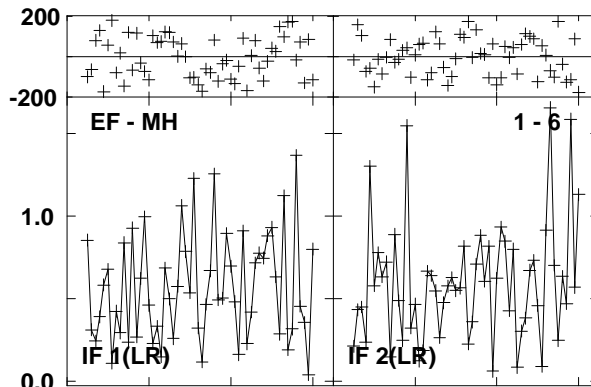
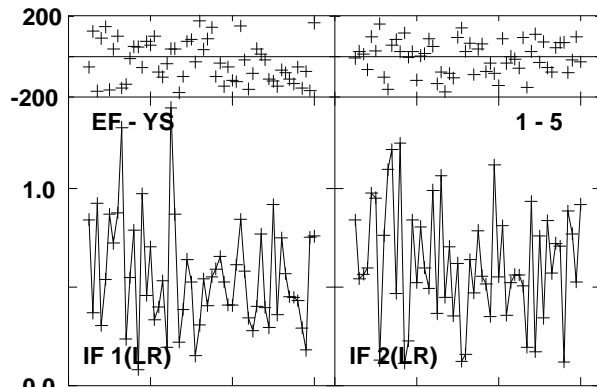
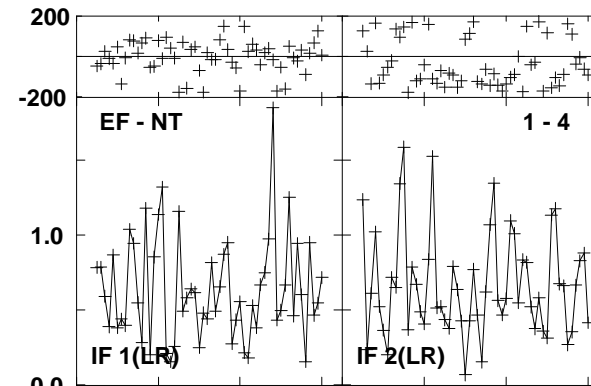
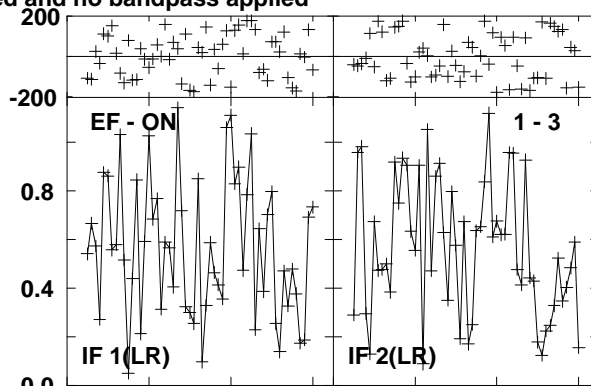
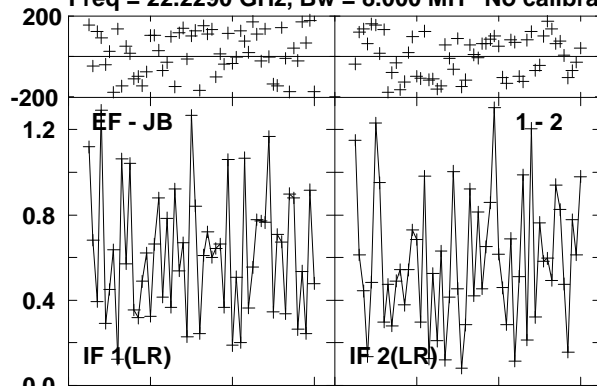

Lower frame: Milli Ampl Jy Top frame: Phas deg
Vector averaged cross-power spectrum Several baselines displayed
Timerange: 00/10/16:51 to 00/10/17:46

Plot file version 14 created 17-SEP-2012 12:01:13

J0541-0541 EE008D 1.UVDATA.1

Freq = 22.2290 GHz, Bw = 8.000 MH No calibration applied and no bandpass applied

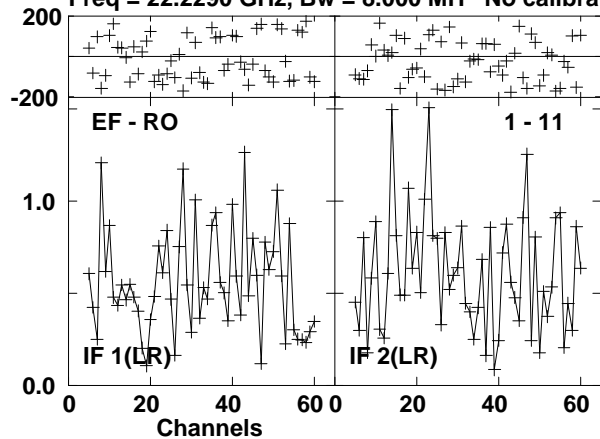

Lower frame: Milli Ampl Jy Top frame: Phas deg
Vector averaged cross-power spectrum Several baselines displayed
Timerange: 00/10:16:51 to 00/10:17:46

Plot file version 15 created 17-SEP-2012 12:01:13

ORIKL1 EE008D 1.UVDATA.1

Freq = 22.2290 GHz, Bw = 8.000 MH No calibration applied and no bandpass applied

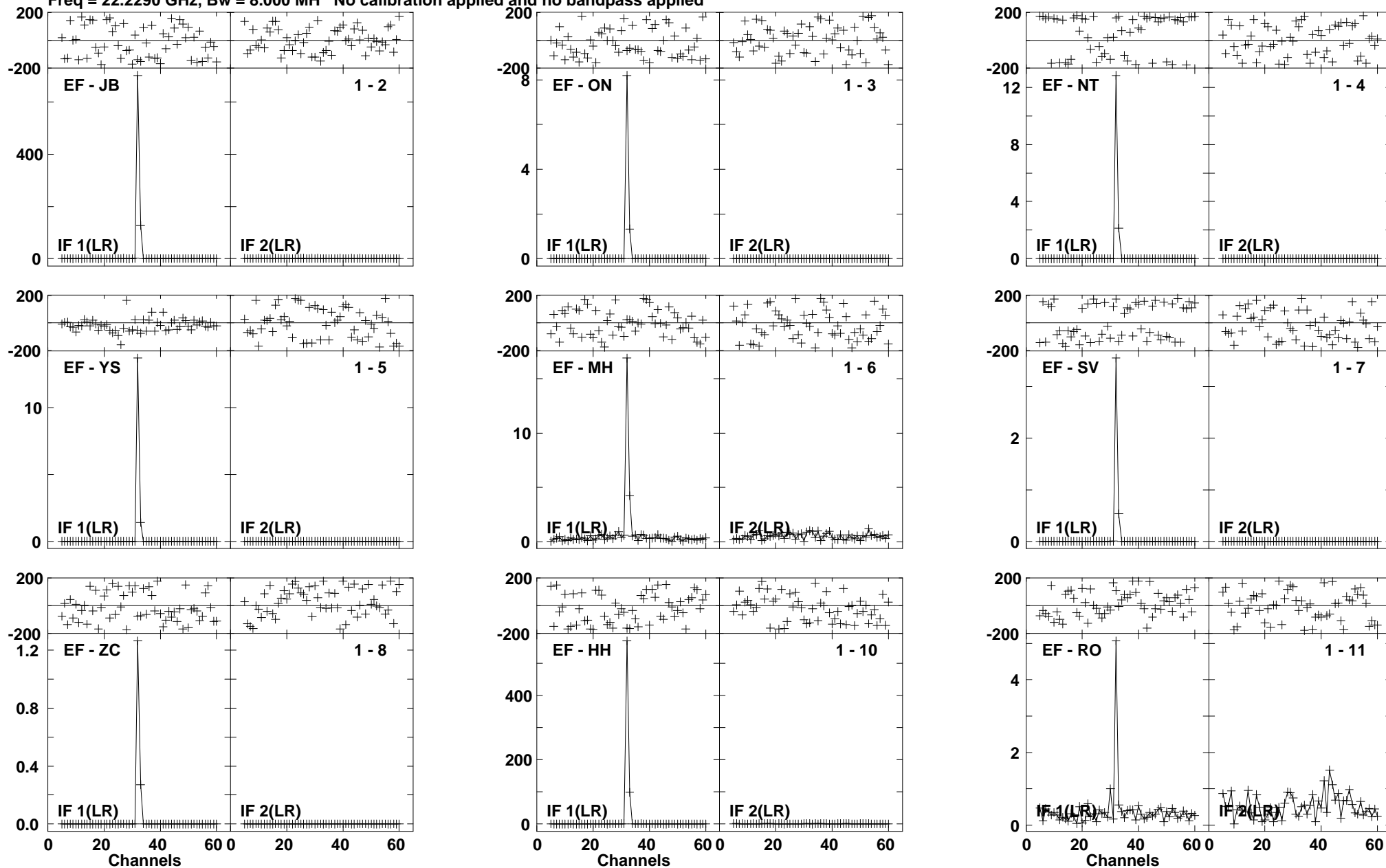

Lower frame: Milli Ampl Jy Top frame: Phas deg
Vector averaged cross-power spectrum Several baselines displayed
Timerange: 00/10:17:51 to 00/10:18:46

Plot file version 16 created 17-SEP-2012 12:01:15

J0541-0541 EE008D 1.UVDATA.1

Freq = 22.2290 GHz, Bw = 8.000 MH No calibration applied and no bandpass applied

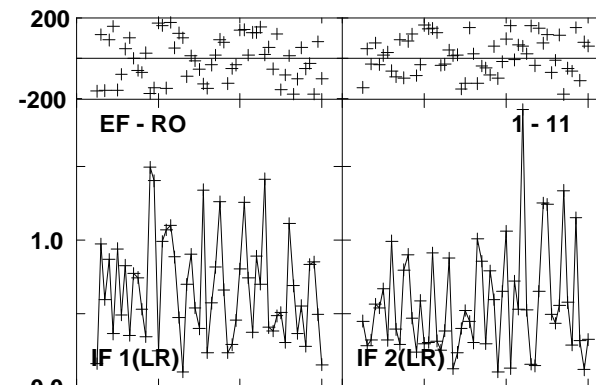
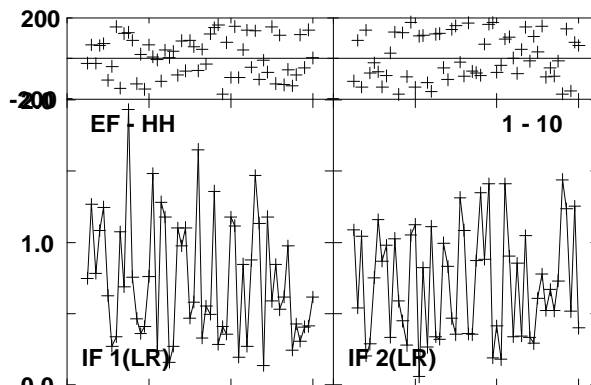
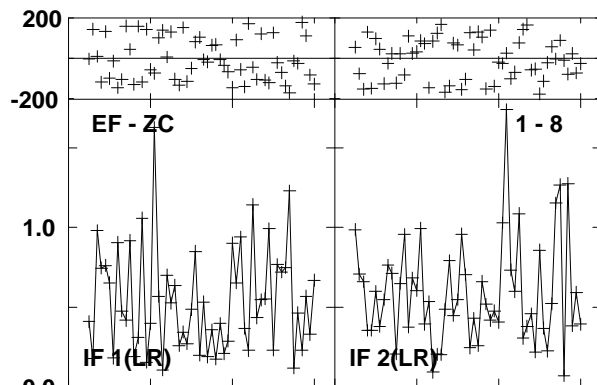
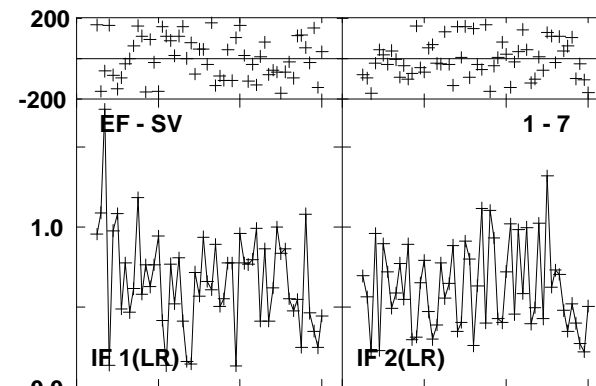
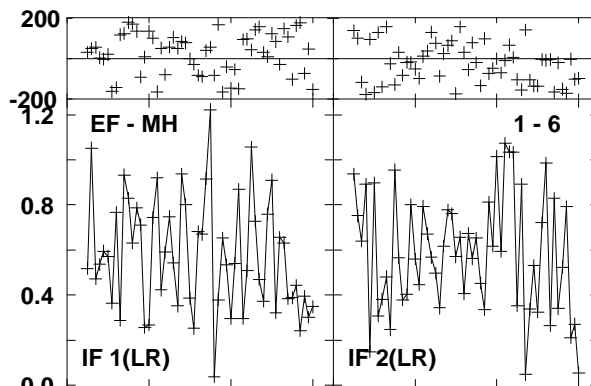
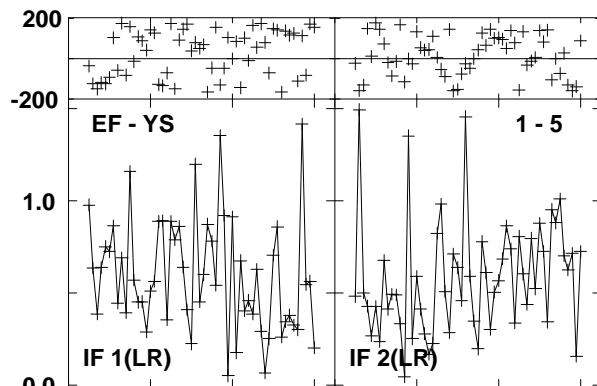
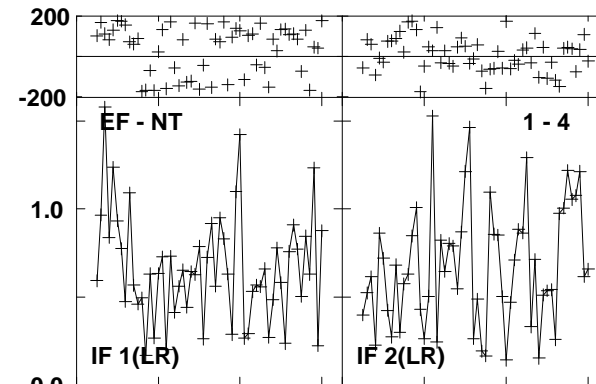
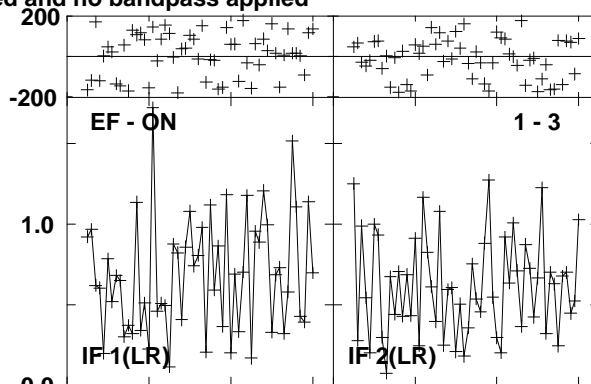
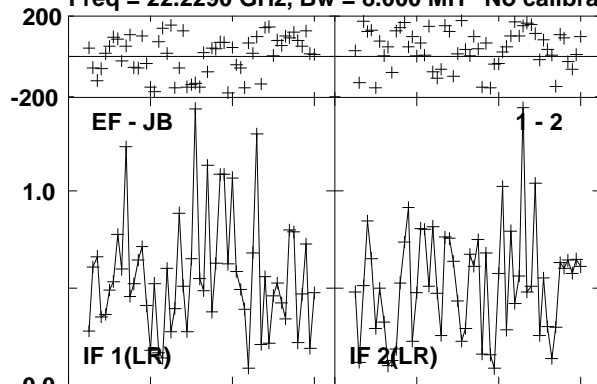

Lower frame: Milli Ampl Jy Top frame: Phas deg
Vector averaged cross-power spectrum Several baselines displayed
Timerange: 00/10:18:51 to 00/10:19:46

Plot file version 17 created 17-SEP-2012 12:01:18

J0529-0519 EE008D 1.UVDATA.1

Freq = 22.2290 GHz, Bw = 8.000 MH No calibration applied and no bandpass applied

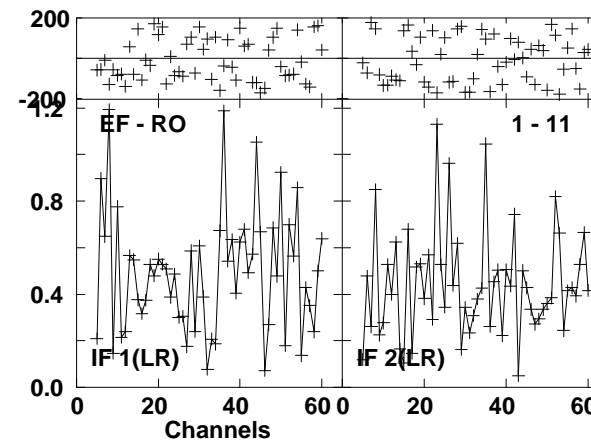
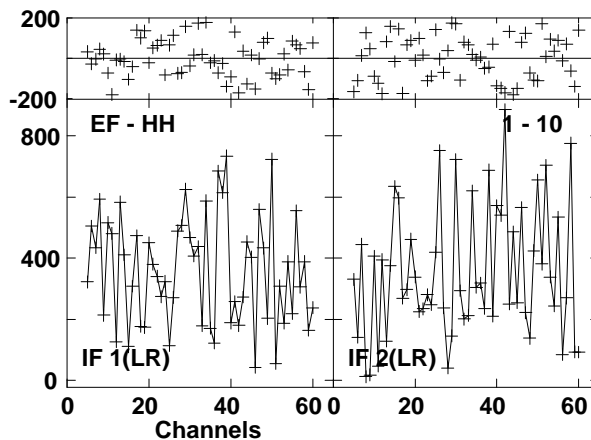
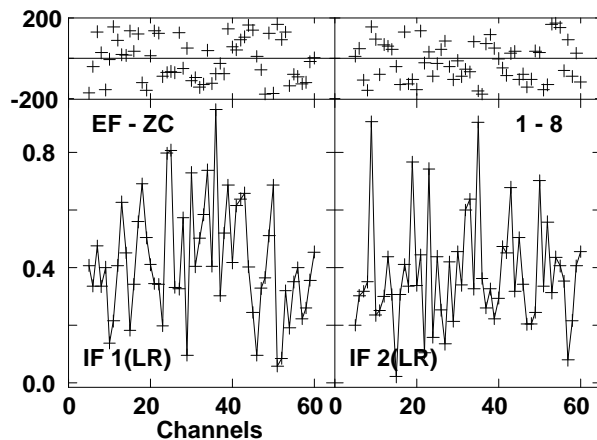
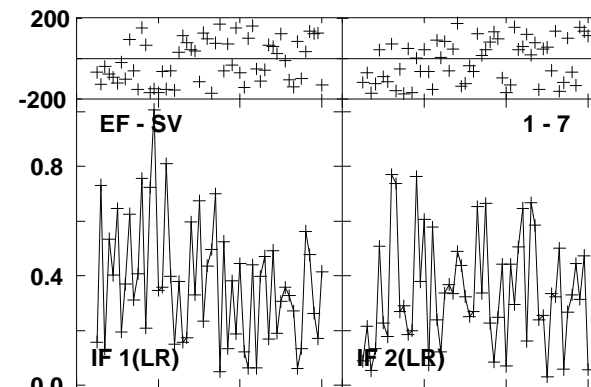
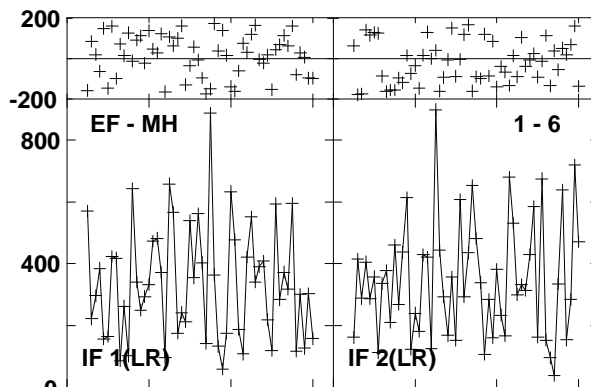
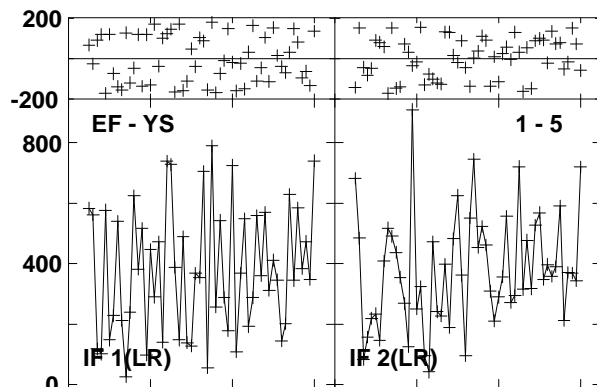
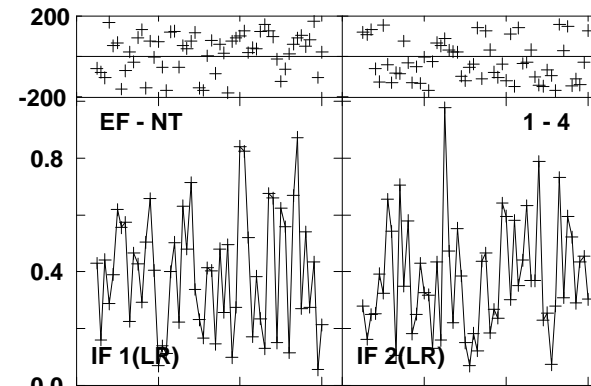
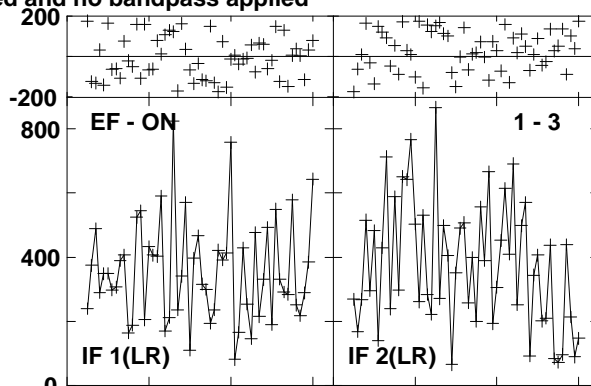
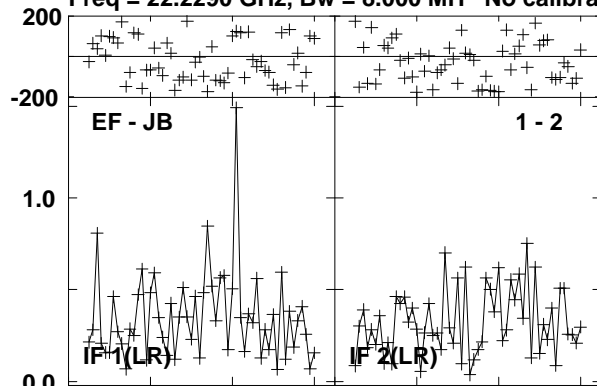

Lower frame: Milli Ampl Jy Top frame: Phas deg
Vector averaged cross-power spectrum Several baselines displayed
Timerange: 00/10/20:32 to 00/10/21:31

Plot file version 18 created 17-SEP-2012 12:01:21

ORIKL1 EE008D 1.UVDATA.1

Freq = 22.2290 GHz, Bw = 8.000 MH No calibration applied and no bandpass applied

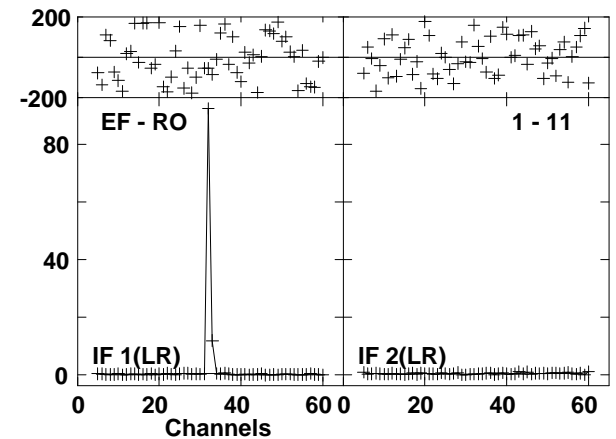
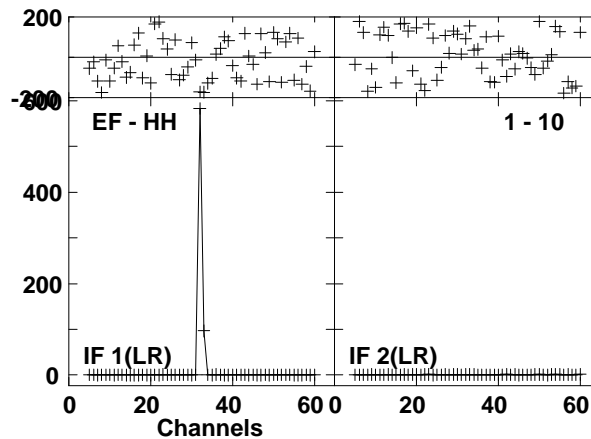
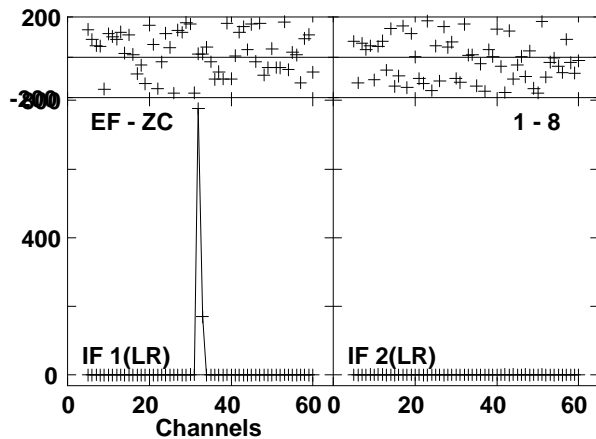
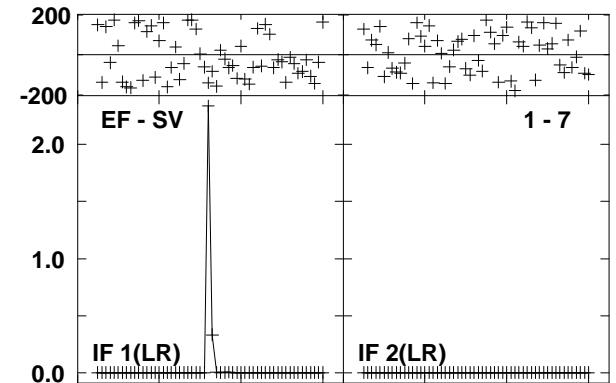
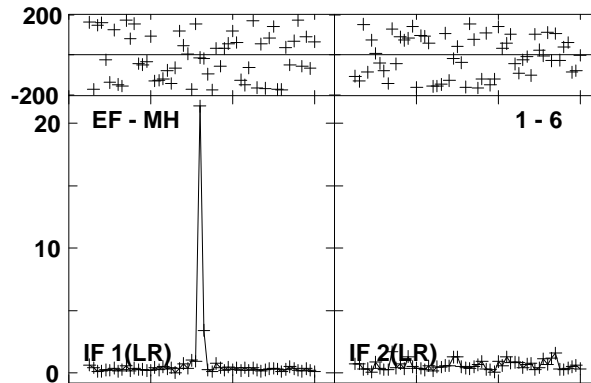
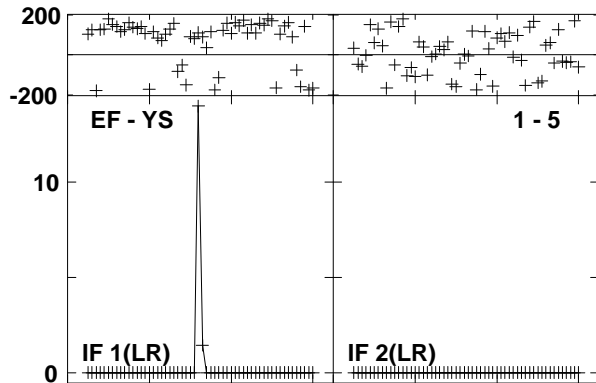
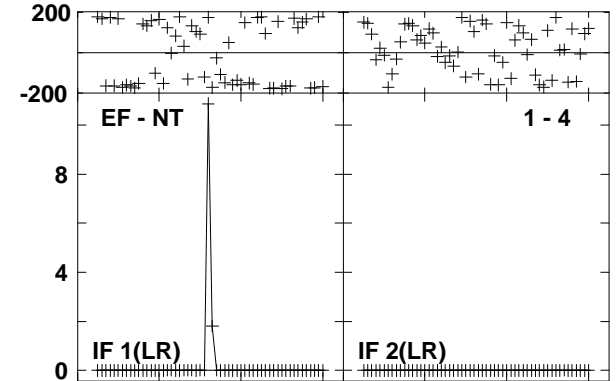
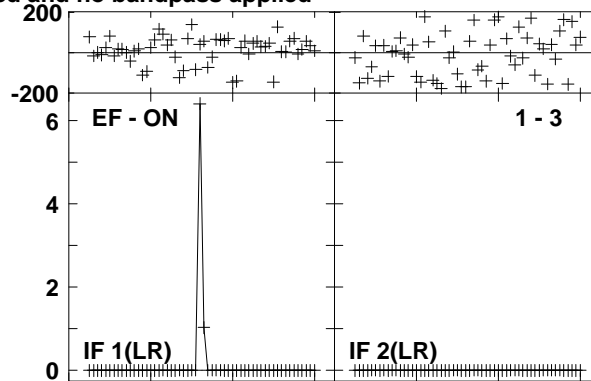
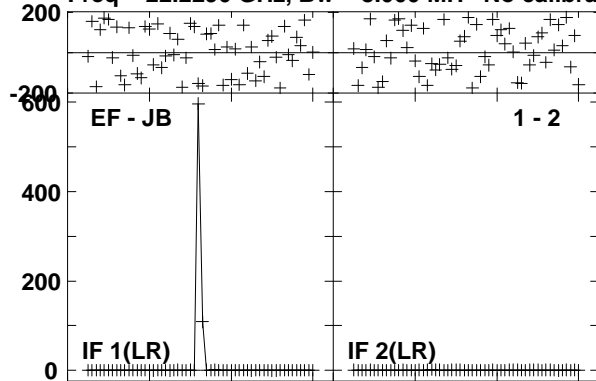

Lower frame: Milli Ampl Jy Top frame: Phas deg
Vector averaged cross-power spectrum Several baselines displayed
Timerange: 00/10:21:34 to 00/10:22:31

Plot file version 19 created 17-SEP-2012 12:01:24

J0529-0519 EE008D 1.UVDATA.1

Freq = 22.2290 GHz, Bw = 8.000 MH No calibration applied and no bandpass applied

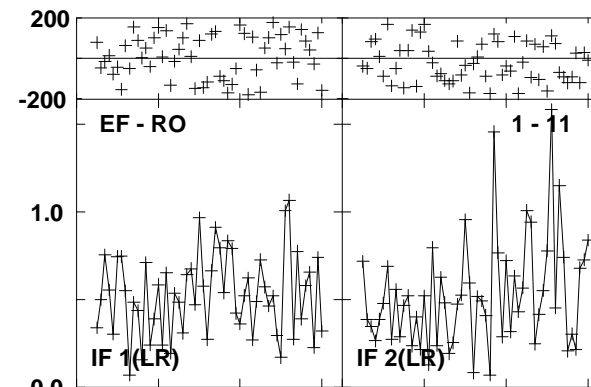
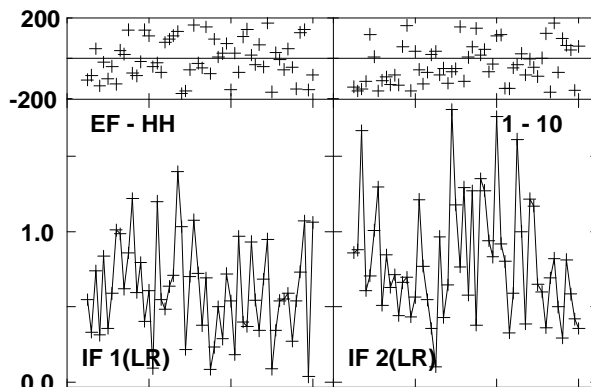
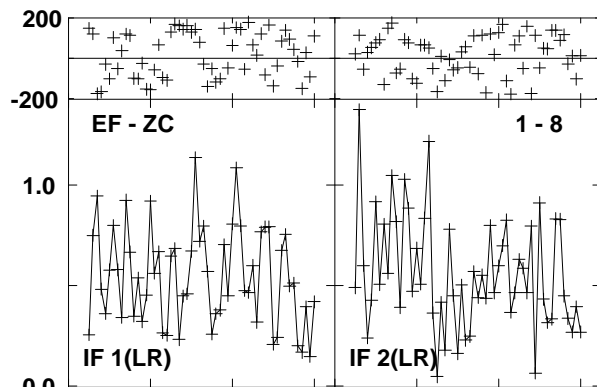
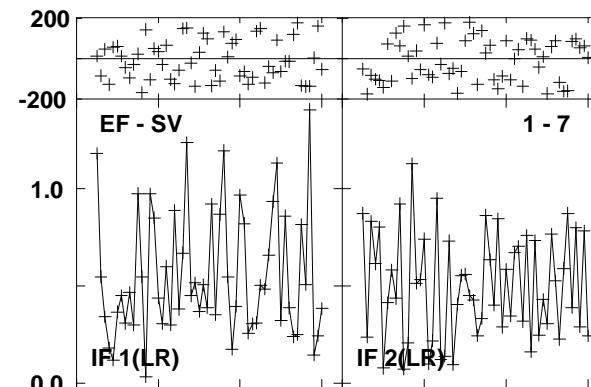
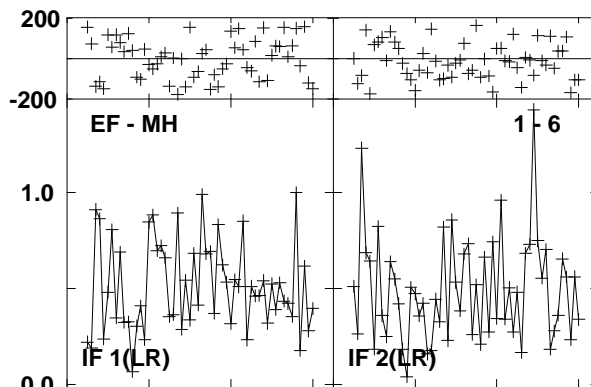
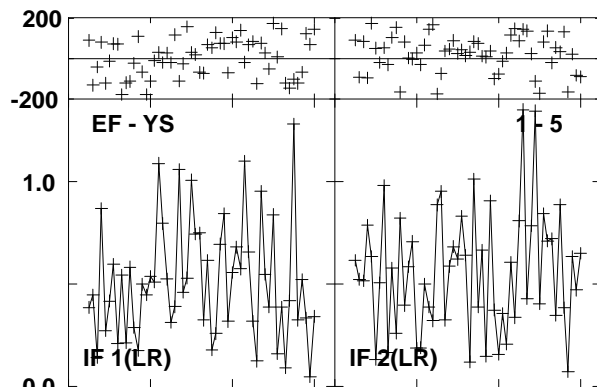
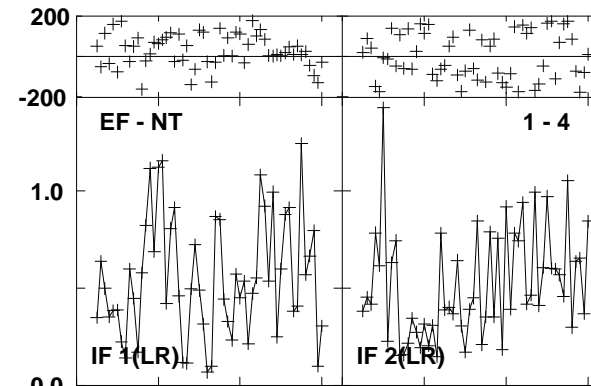
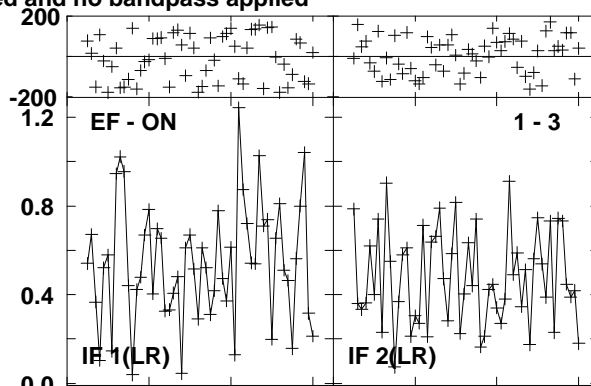
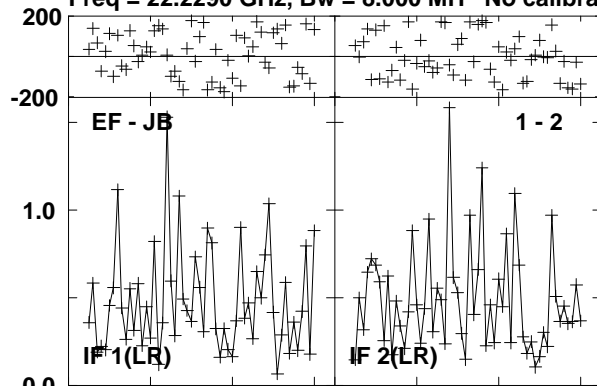

Lower frame: Milli Ampl Jy Top frame: Phas deg
Vector averaged cross-power spectrum Several baselines displayed
Timerange: 00/10/22:35 to 00/10/23:31

Plot file version 20 created 17-SEP-2012 12:01:26

ORIKL1 EE008D 1.UVDATA.1

Freq = 22.2290 GHz, Bw = 8.000 MH No calibration applied and no bandpass applied

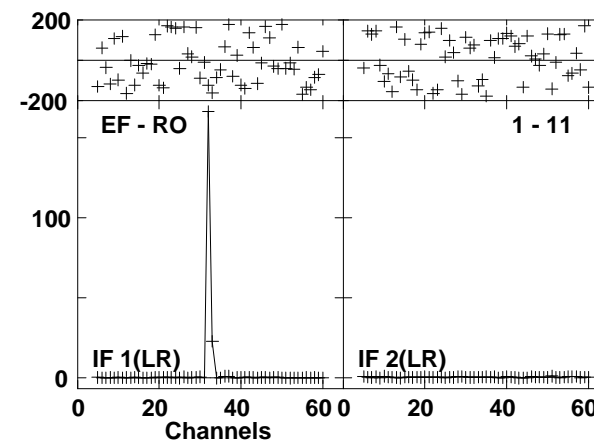
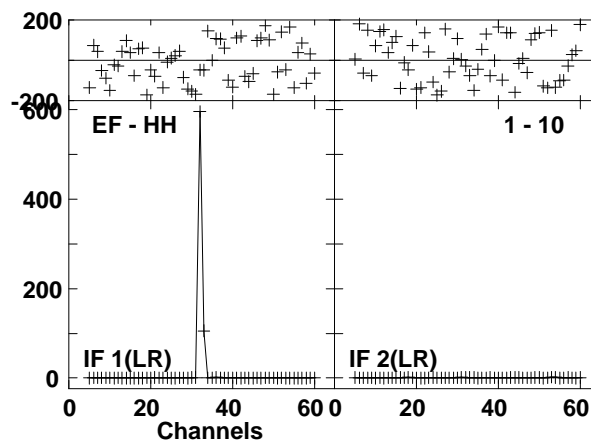
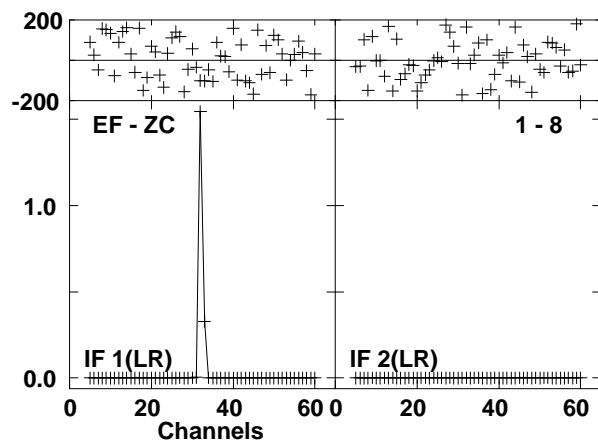
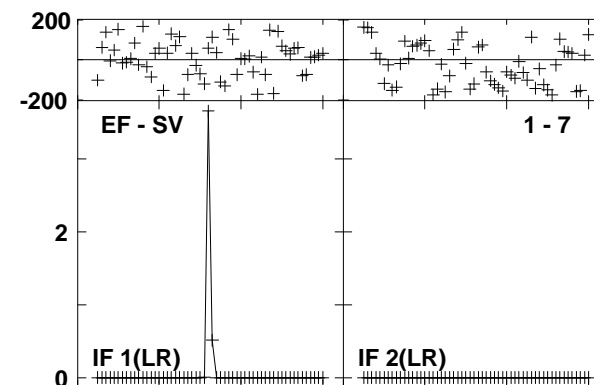
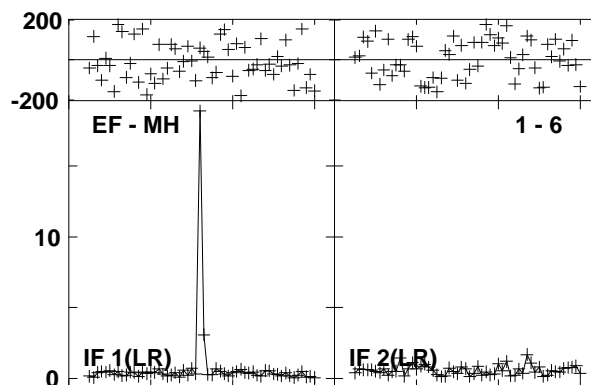
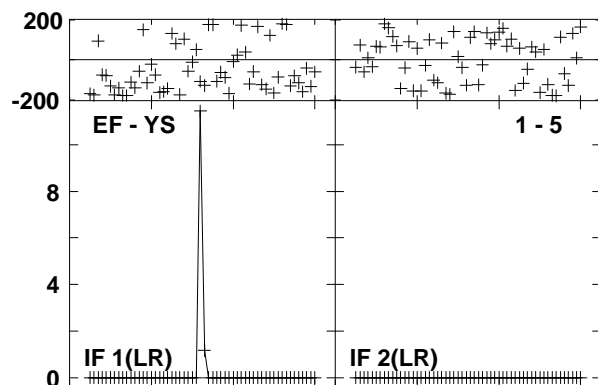
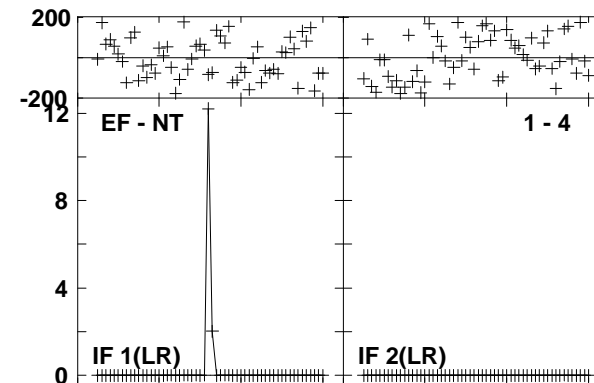
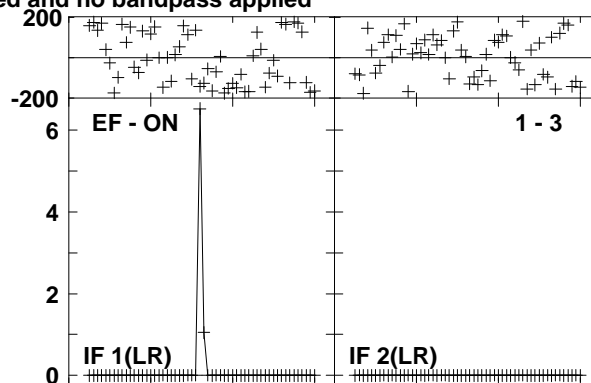
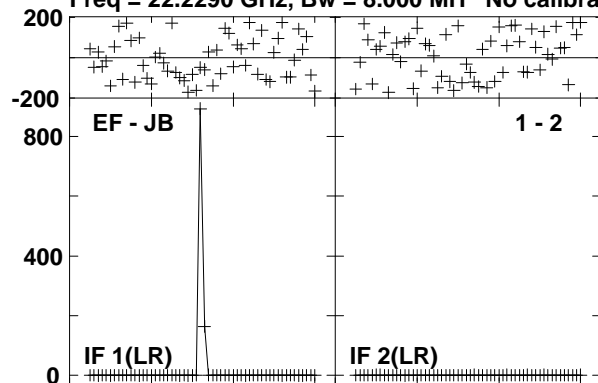

Lower frame: Milli Ampl Jy Top frame: Phas deg
Vector averaged cross-power spectrum Several baselines displayed
Timerange: 00/10:23:35 to 00/10:24:31

Plot file version 21 created 17-SEP-2012 12:01:29

J0529-0519 EE008D 1.UVDATA.1

Freq = 22.2290 GHz, Bw = 8.000 MH No calibration applied and no bandpass applied

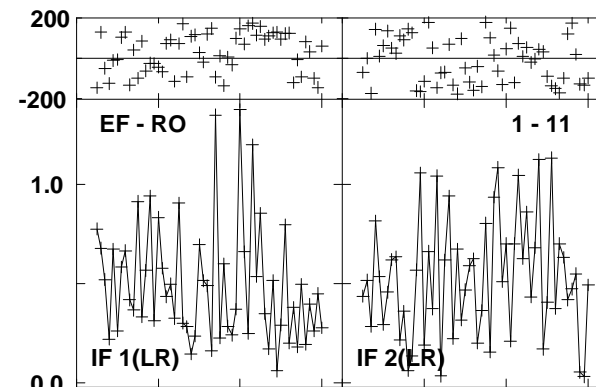
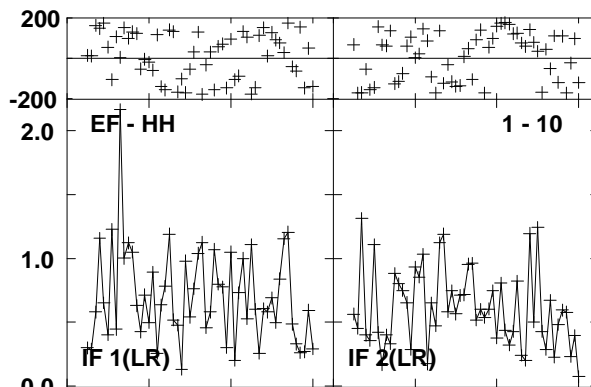
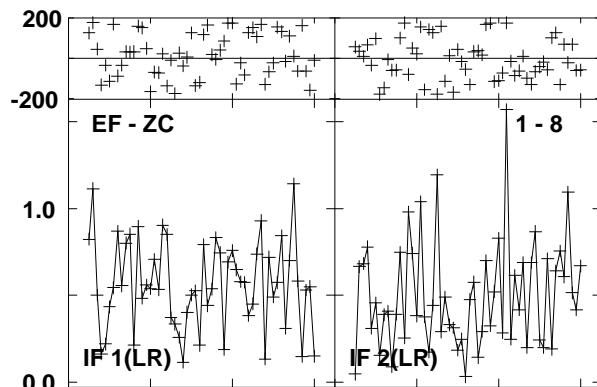
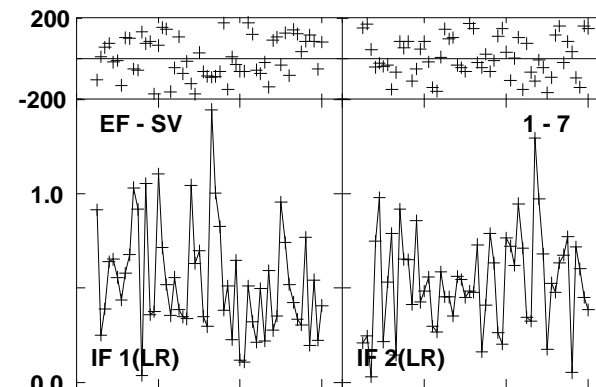
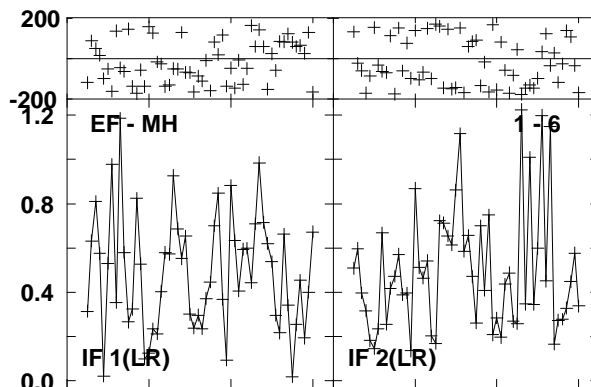
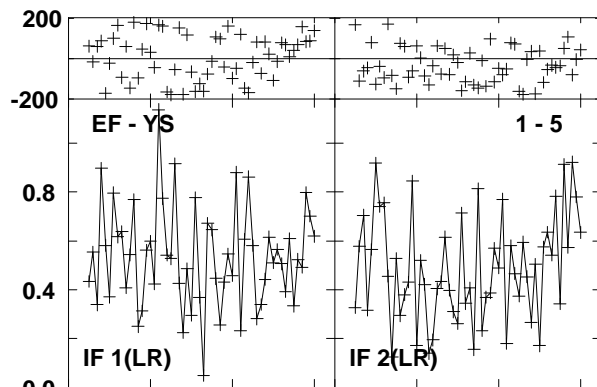
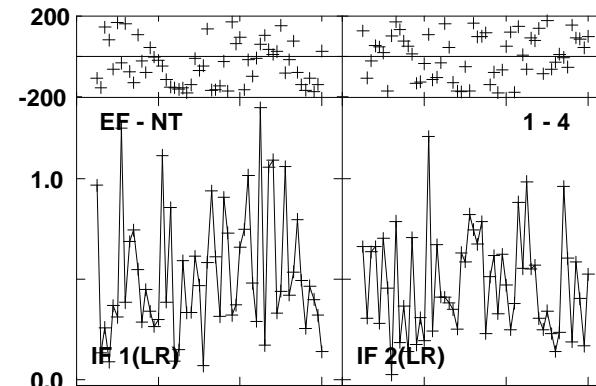
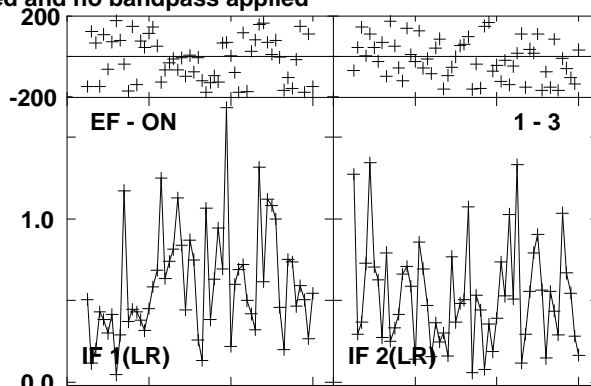
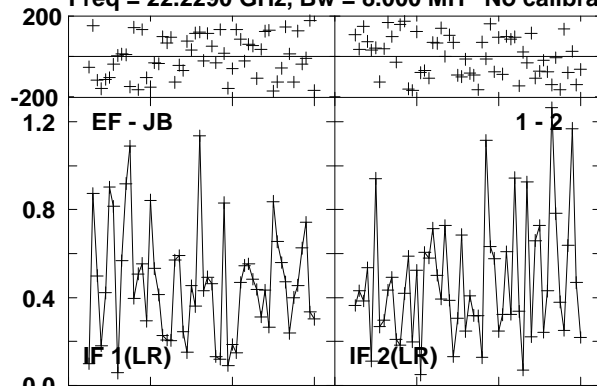

Channels
Lower frame: Milli Ampl Jy Top frame: Phas deg
Vector averaged cross-power spectrum Several baselines displayed
Timerange: 00/10/24:37 to 00/10/25:31

Plot file version 22 created 17-SEP-2012 12:01:31

J0541-0541 EE008D 1.UVDATA.1

Freq = 22.2290 GHz, Bw = 8.000 MH No calibration applied and no bandpass applied

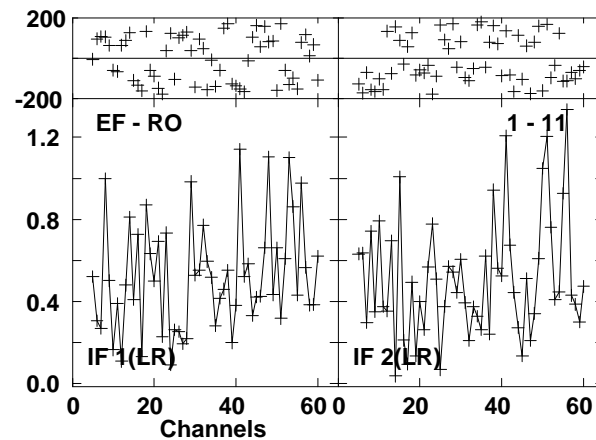
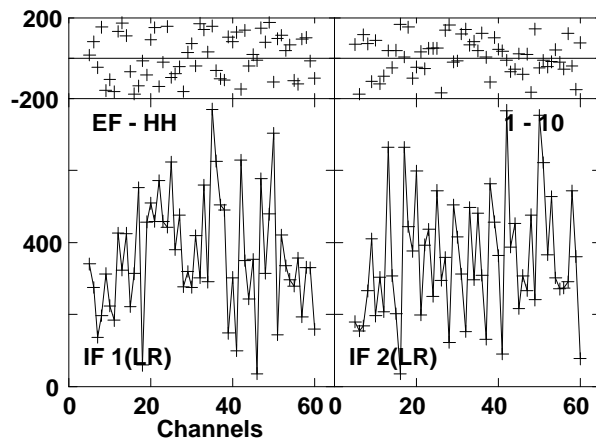
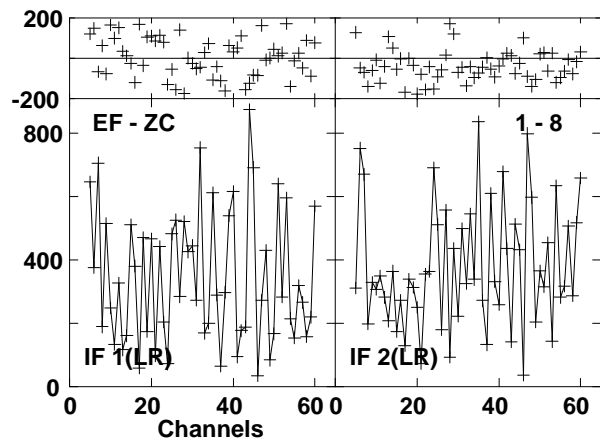
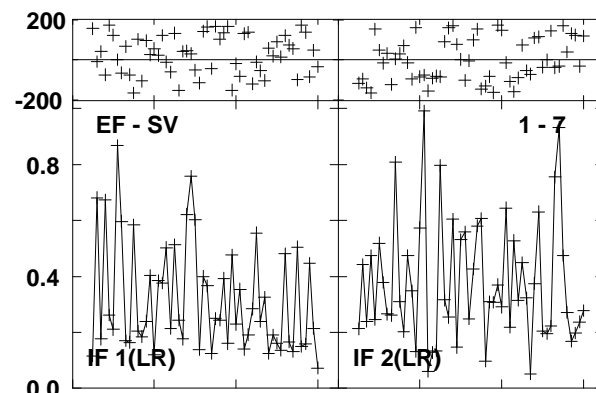
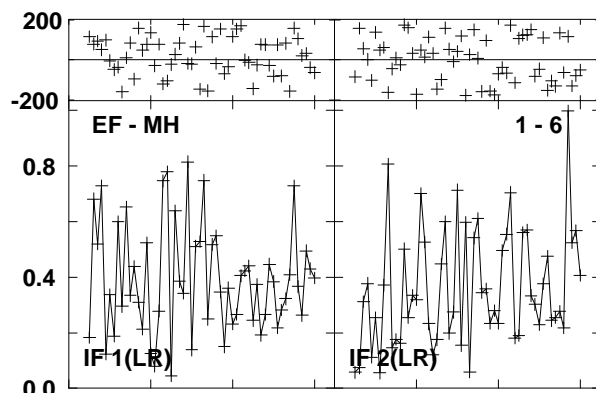
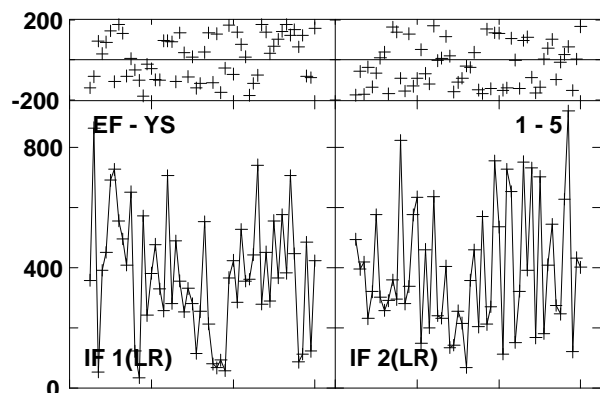
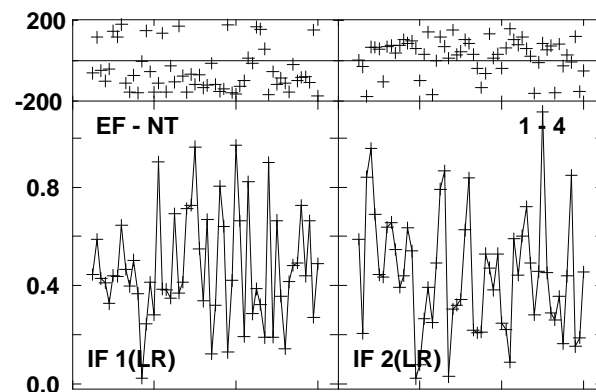
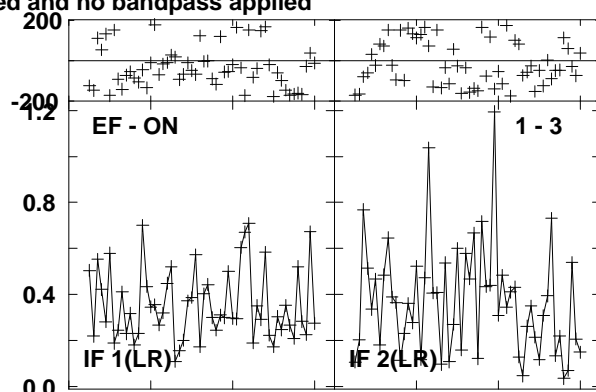
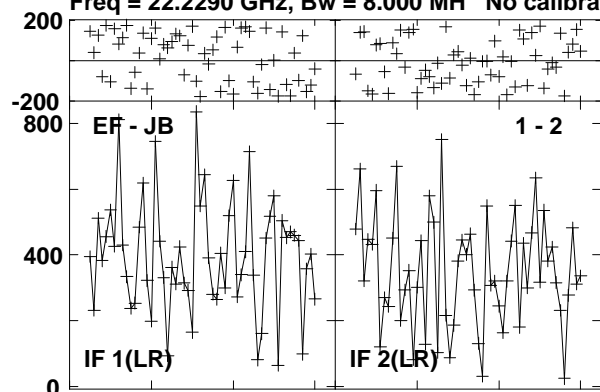

Lower frame: Micro Ampl Jy Top frame: Phas deg
Vector averaged cross-power spectrum Several baselines displayed
Timerange: 00/10:26:17 to 00/10:27:16

Plot file version 23 created 17-SEP-2012 12:01:34

ORIKL1 EE008D 1.UVDATA.1

Freq = 22.2290 GHz, Bw = 8.000 MH No calibration applied and no bandpass applied

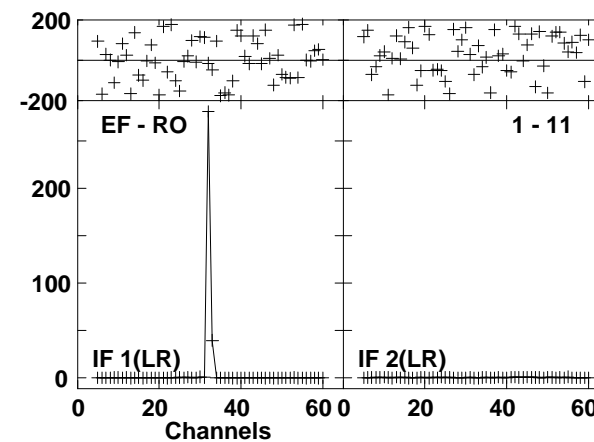
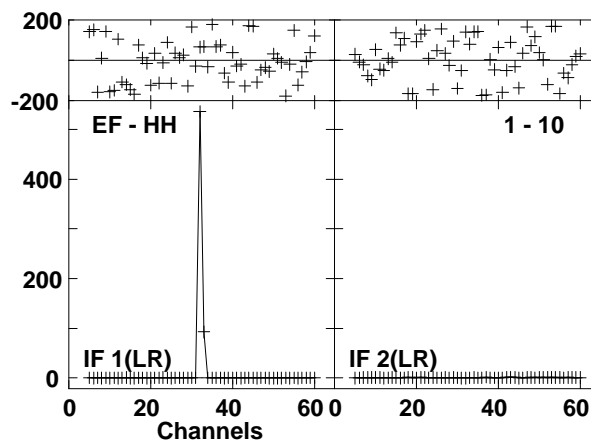
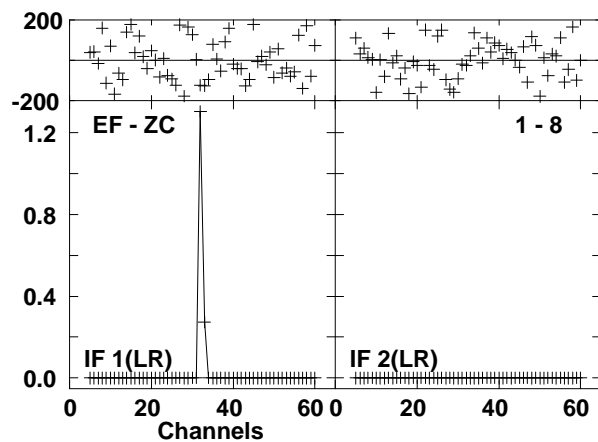
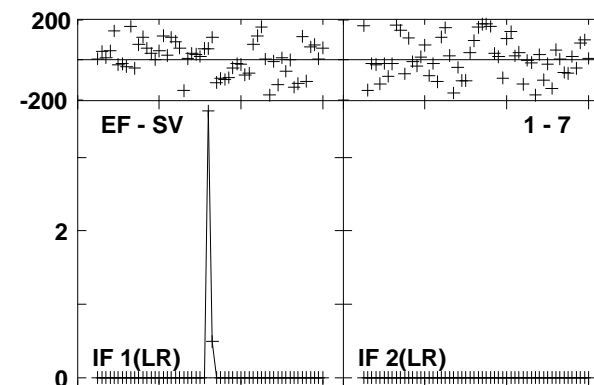
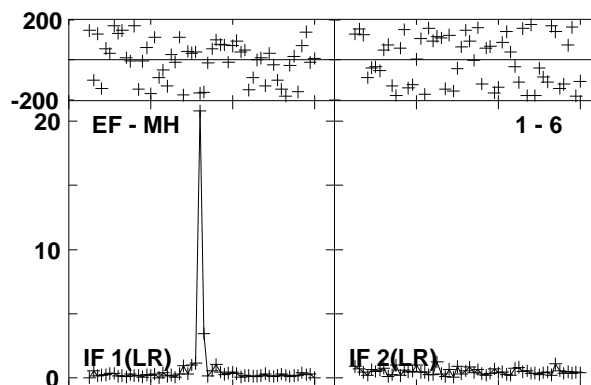
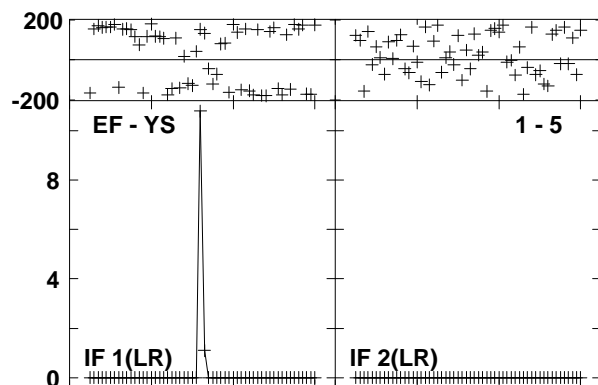
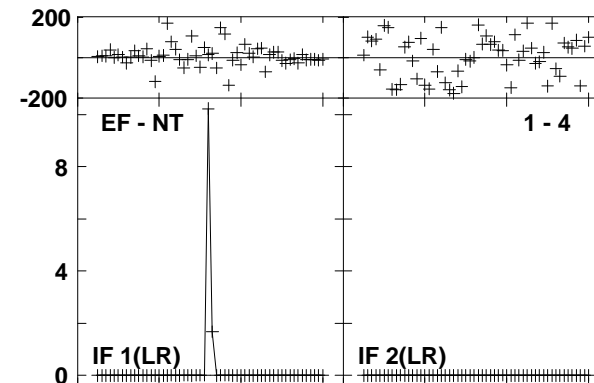
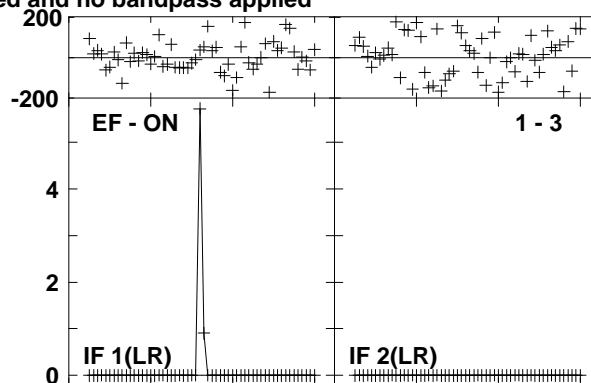
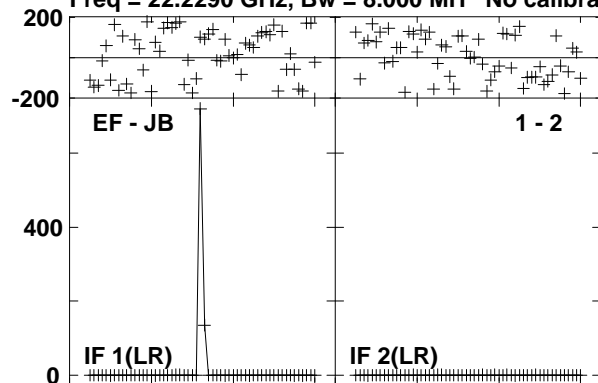

Lower frame: Milli Ampl Jy Top frame: Phas deg
Vector averaged cross-power spectrum Several baselines displayed
Timerange: 00/10:27:20 to 00/10:28:16

Plot file version 24 created 17-SEP-2012 12:01:36

J0541-0541 EE008D 1.UVDATA.1

Freq = 22.2290 GHz, Bw = 8.000 MH No calibration applied and no bandpass applied

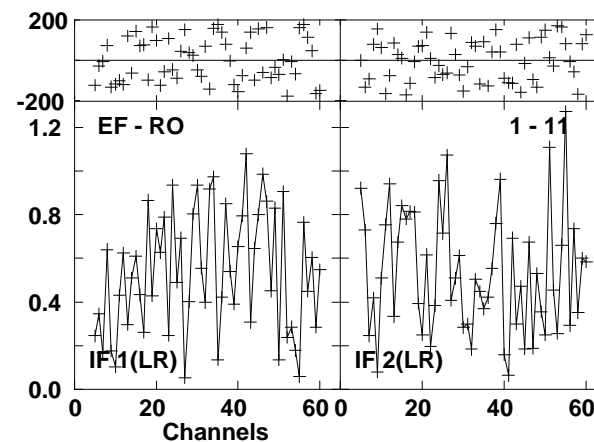
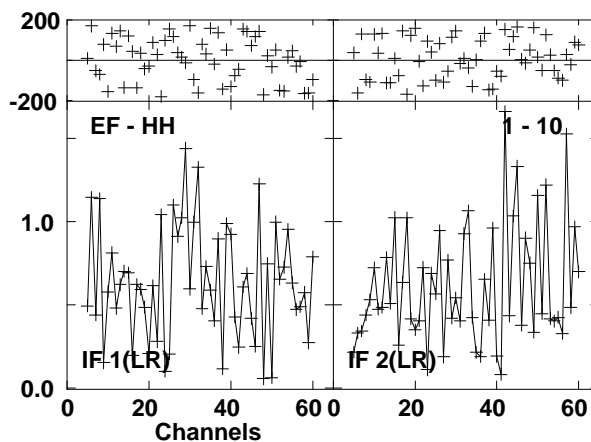
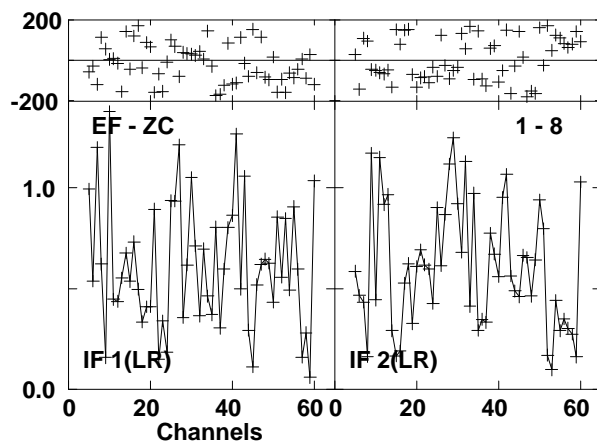
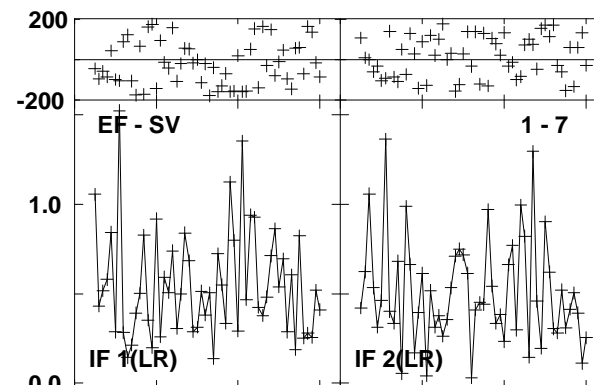
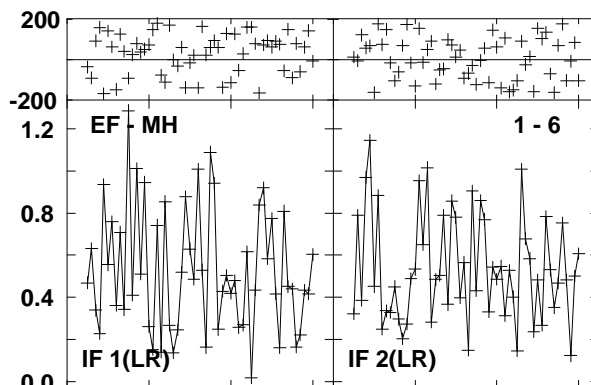
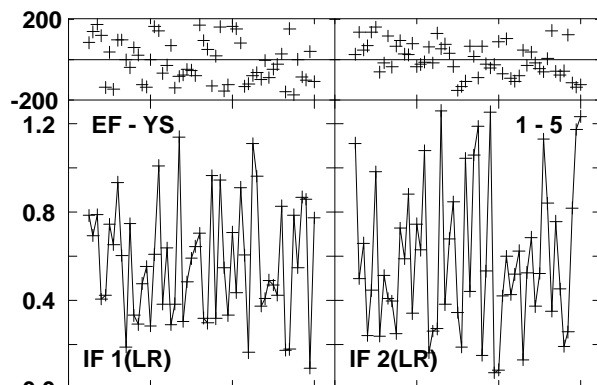
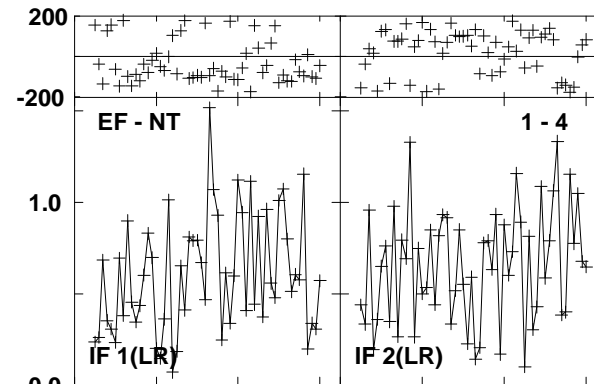
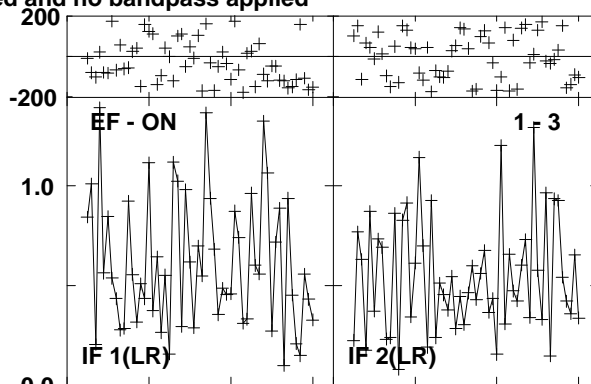
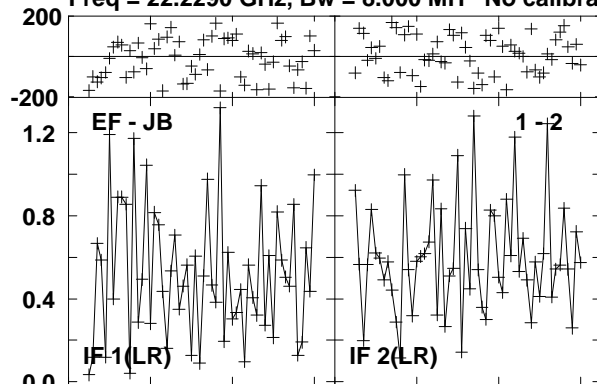

Lower frame: Milli Ampl Jy Top frame: Phas deg
Vector averaged cross-power spectrum Several baselines displayed
Timerange: 00/10:28:21 to 00/10:29:16

Plot file version 25 created 17-SEP-2012 12:01:39

ORIKL1 EE008D 1.UVDATA.1

Freq = 22.2290 GHz, Bw = 8.000 MH No calibration applied and no bandpass applied

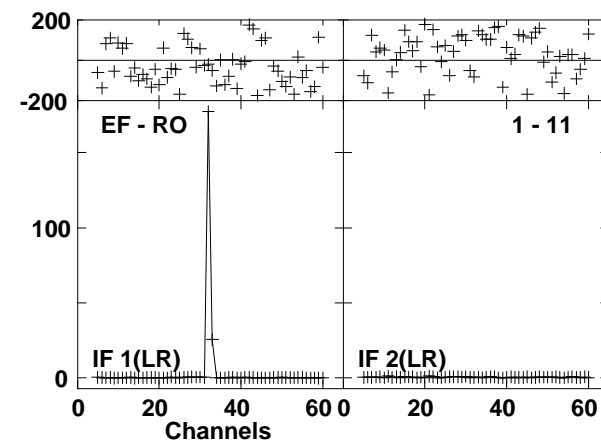
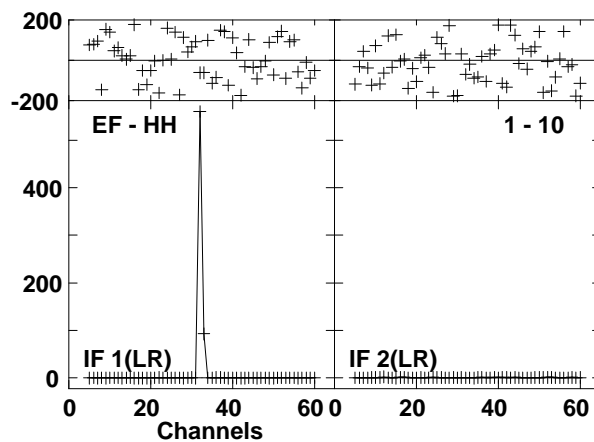
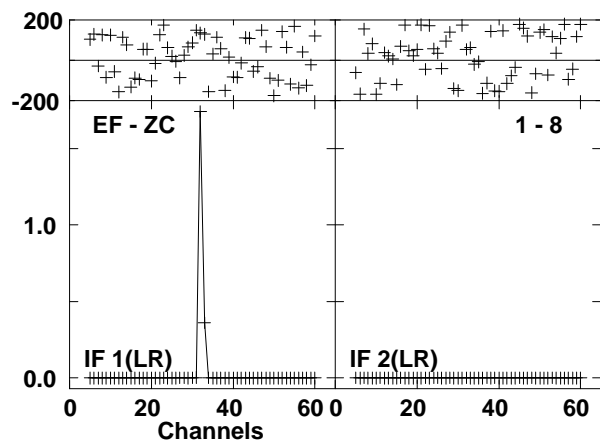
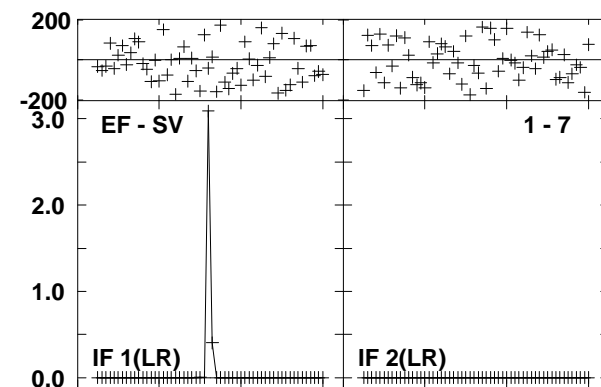
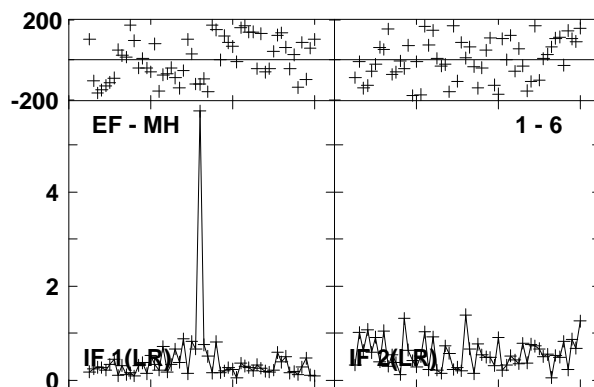
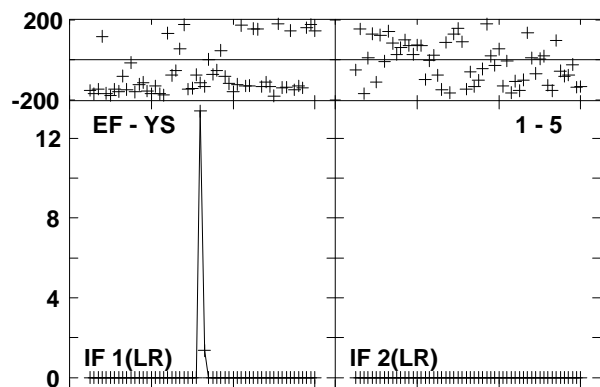
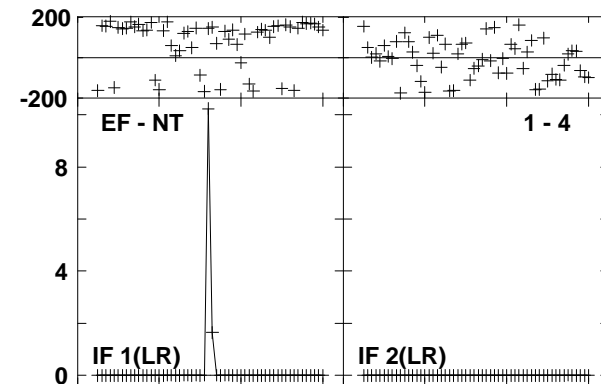
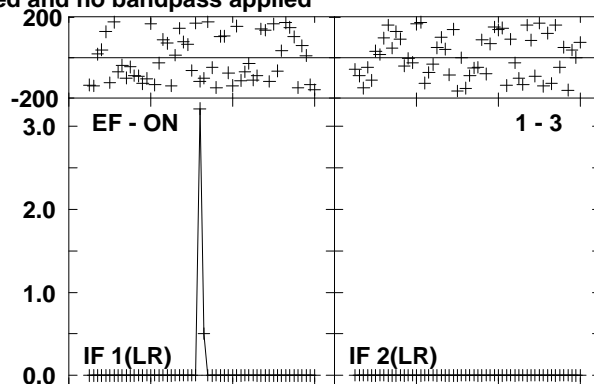
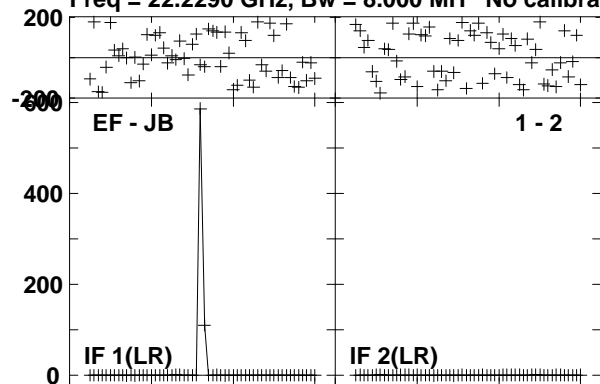

Lower frame: Milli Ampl Jy Top frame: Phas deg
Vector averaged cross-power spectrum Several baselines displayed
Timerange: 00/10:29:21 to 00/10:30:16

Plot file version 26 created 17-SEP-2012 12:01:41

J0541-0541 EE008D 1.UVDATA.1

Freq = 22.2290 GHz, Bw = 8.000 MH No calibration applied and no bandpass applied

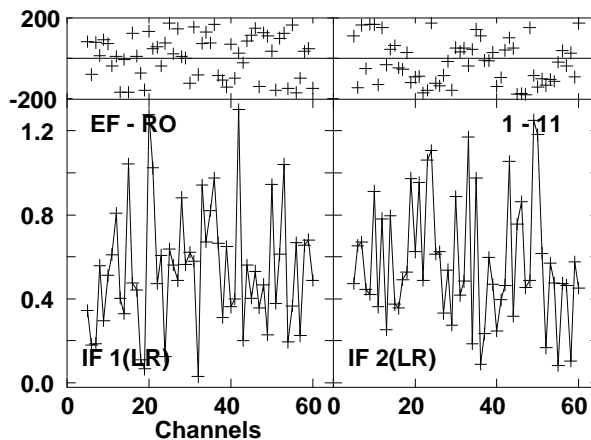
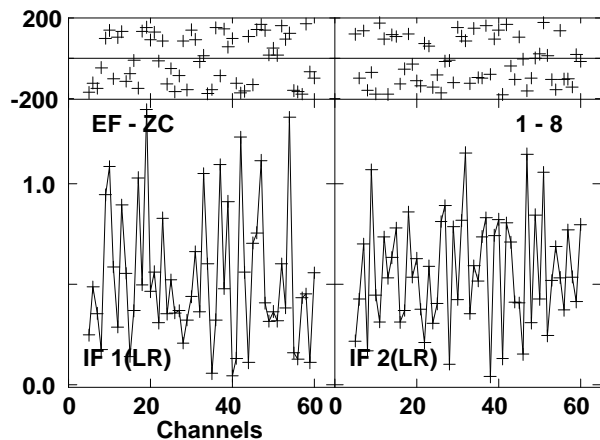
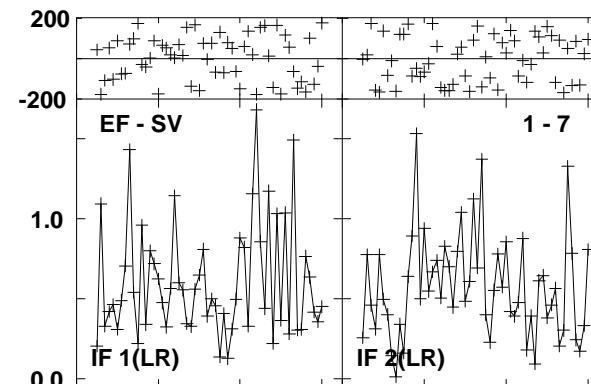
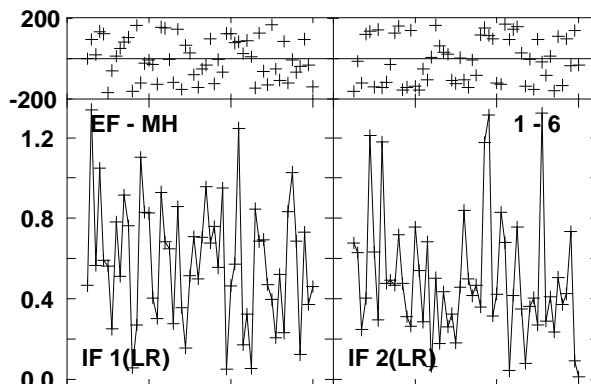
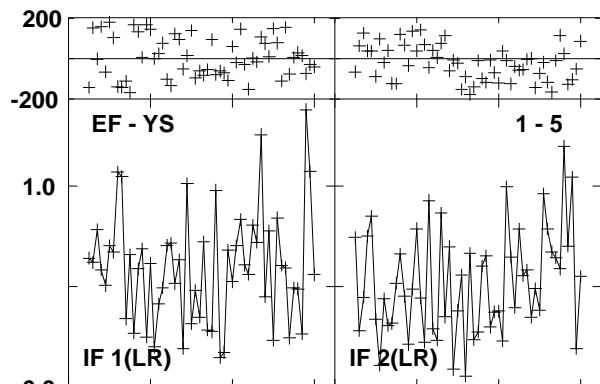
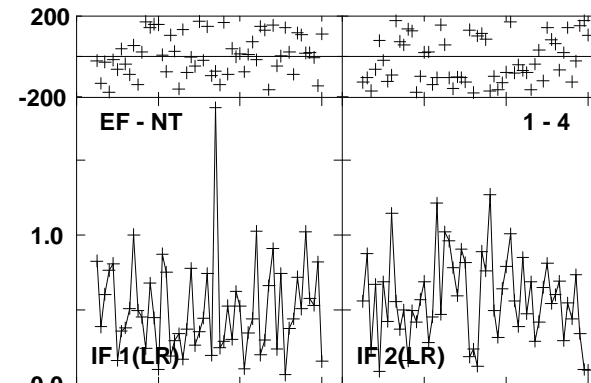
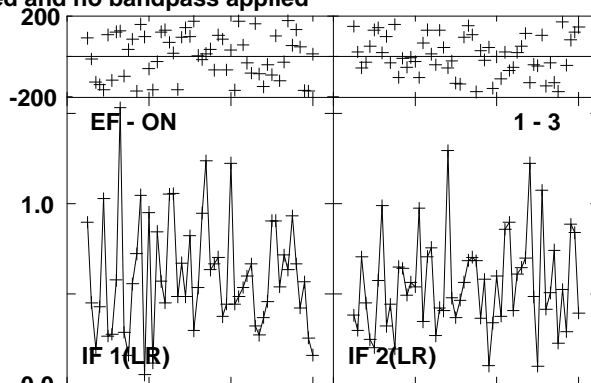
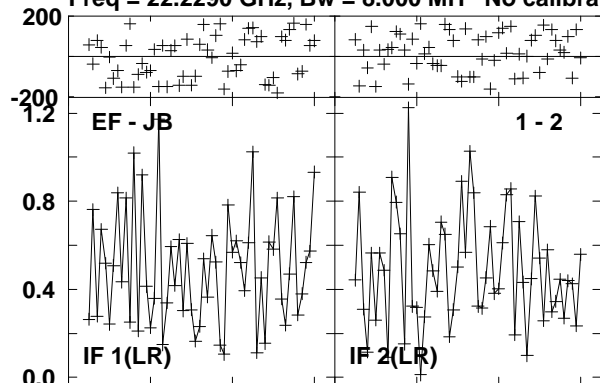

Lower frame: Milli Ampl Jy Top frame: Phas deg
Vector averaged cross-power spectrum Several baselines displayed
Timerange: 00/10/30:21 to 00/10/31:16

Plot file version 27 created 17-SEP-2012 12:01:43

J0529-0519 EE008D 1.UVDATA.1

Freq = 22.2290 GHz, Bw = 8.000 MH No calibration applied and no bandpass applied

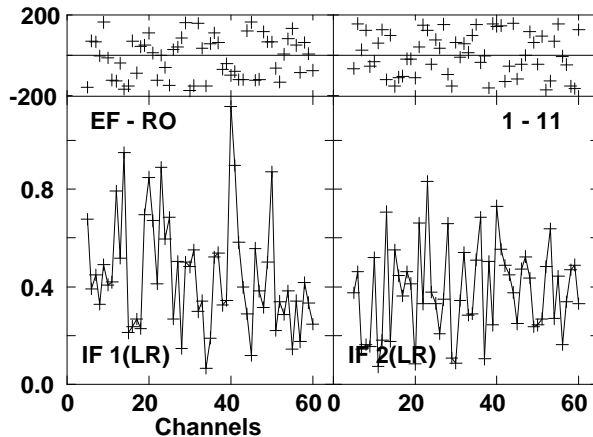
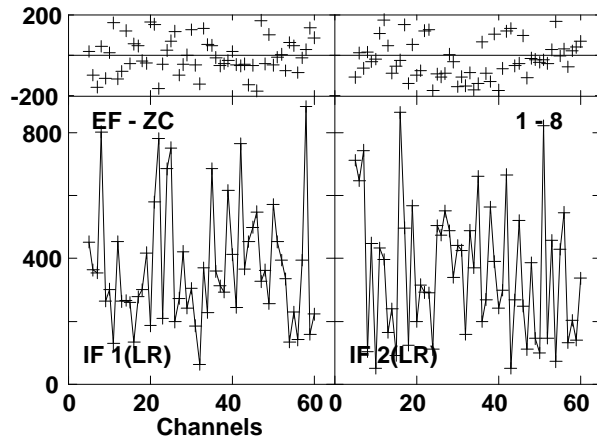
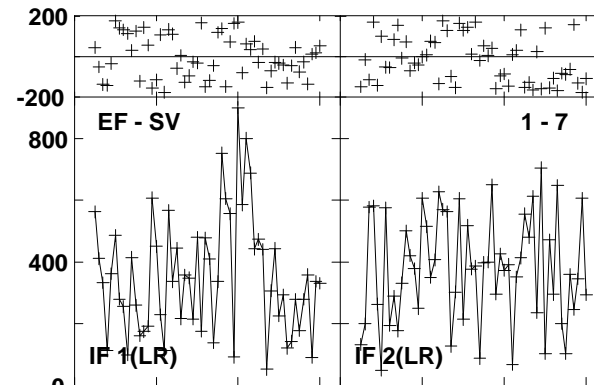
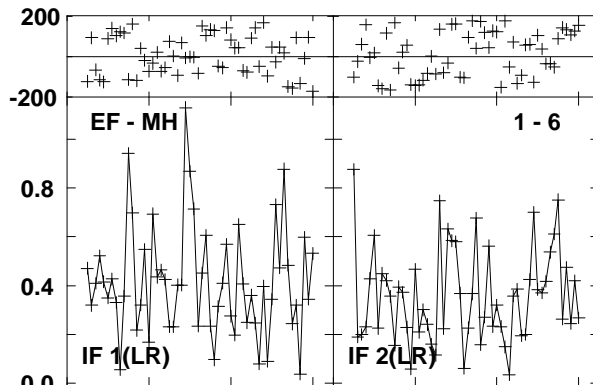
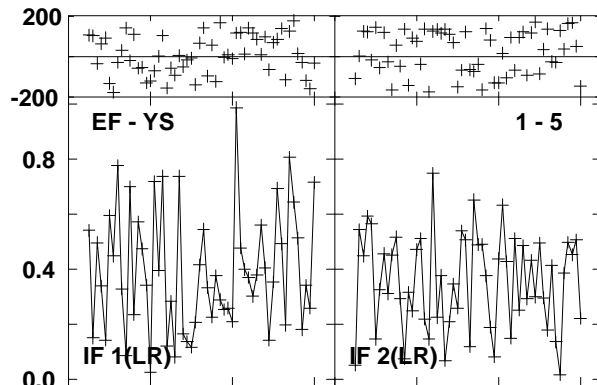
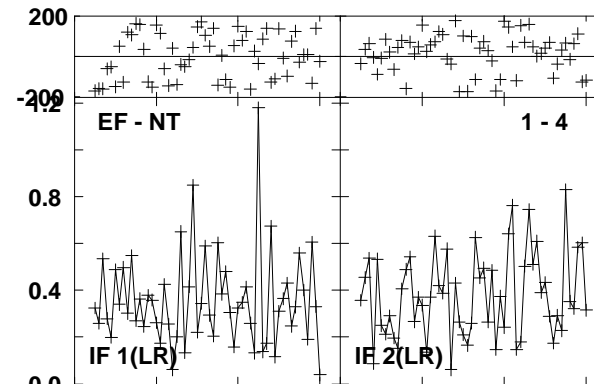
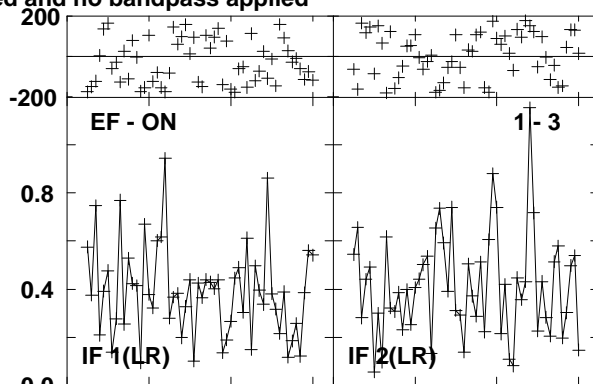
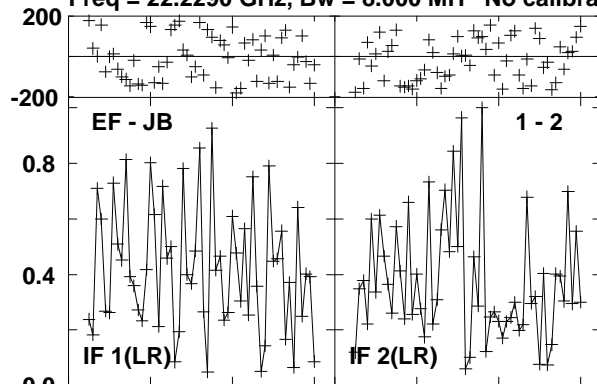

Lower frame: Milli Ampl Jy Top frame: Phas deg
Vector averaged cross-power spectrum Several baselines displayed
Timerange: 00/10/32:02 to 00/10/33:01

Plot file version 28 created 17-SEP-2012 12:01:46

ORIKL1 EE008D 1.UVDATA.1

Freq = 22.2290 GHz, Bw = 8.000 MH No calibration applied and no bandpass applied

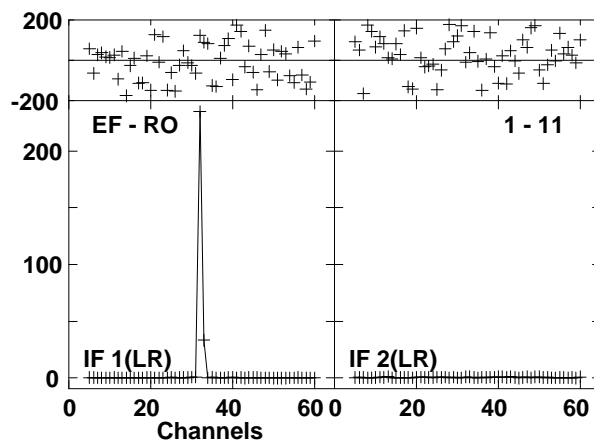
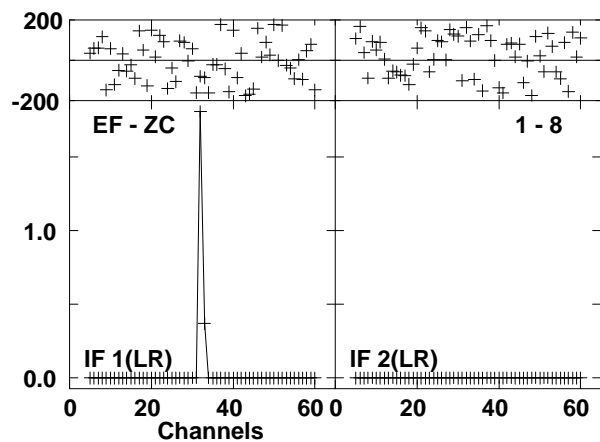
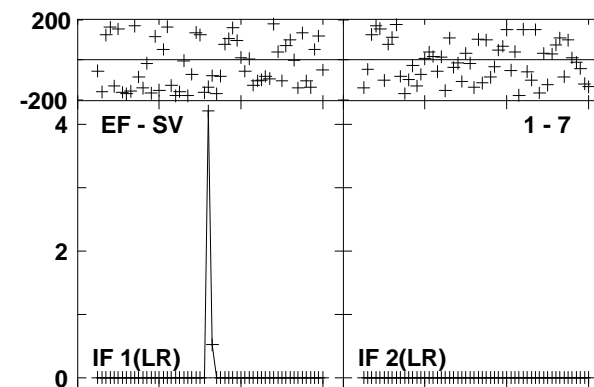
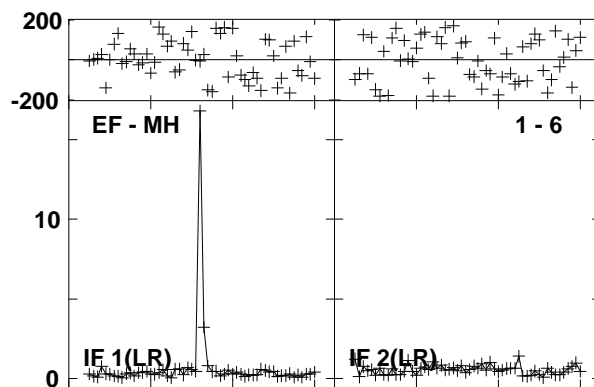
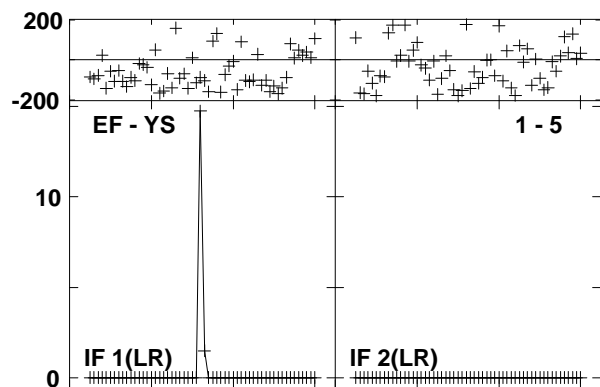
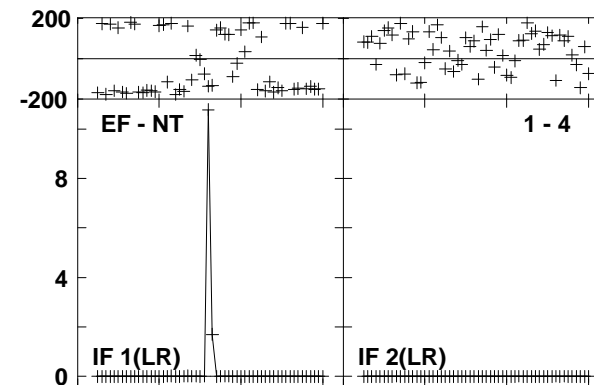
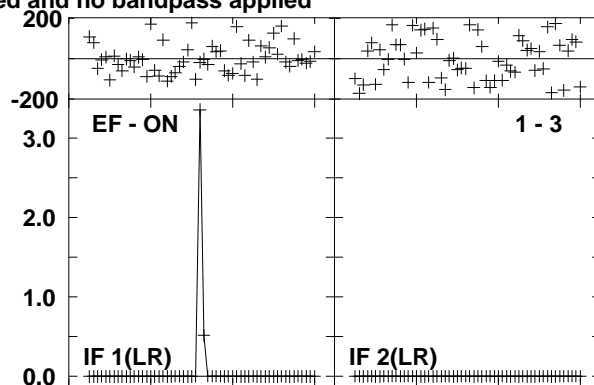
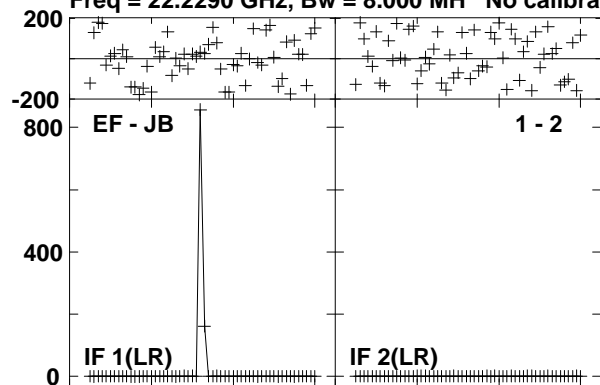

Lower frame: Milli Ampl Jy Top frame: Phas deg

Vector averaged cross-power spectrum Several baselines displayed

Timerange: 00/10:33:06 to 00/10:34:01

Plot file version 29 created 17-SEP-2012 12:01:48

J0529-0519 EE008D 1.UVDATA.1

Freq = 22.2290 GHz, Bw = 8.000 MH No calibration applied and no bandpass applied

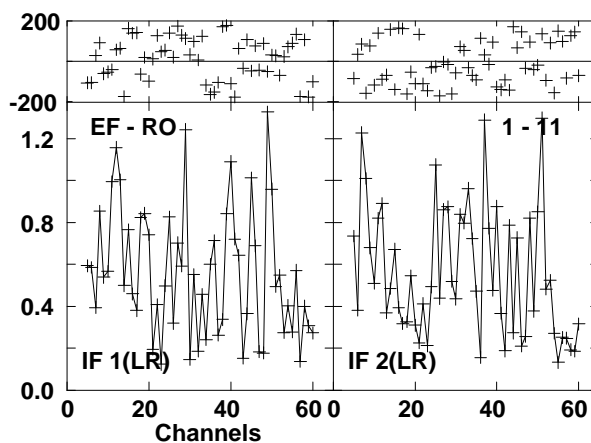
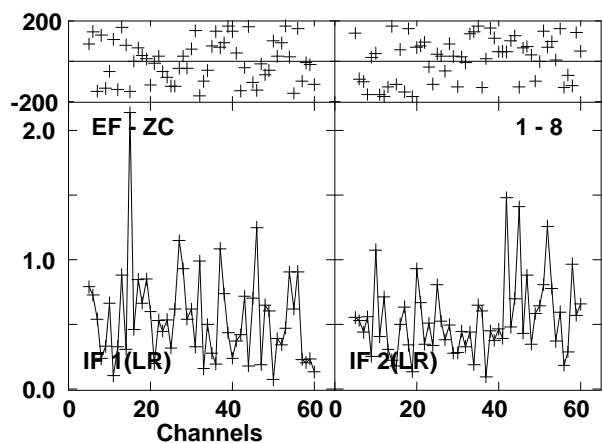
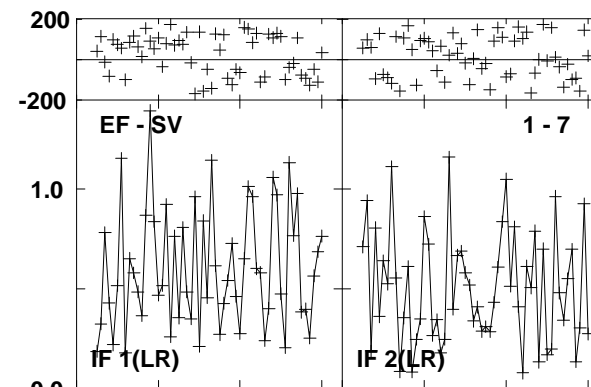
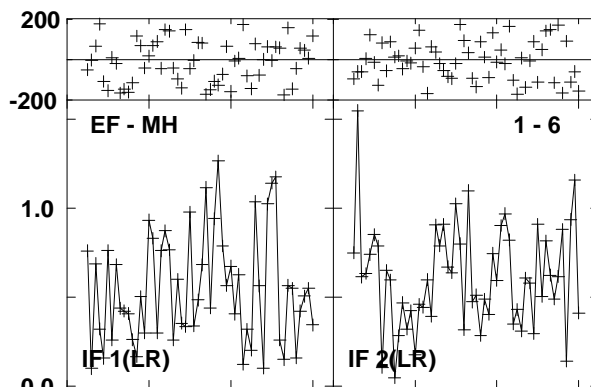
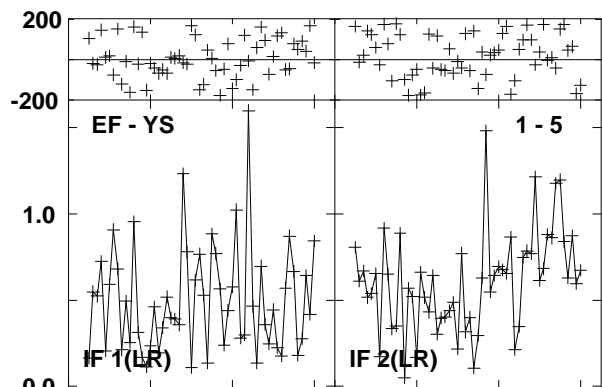
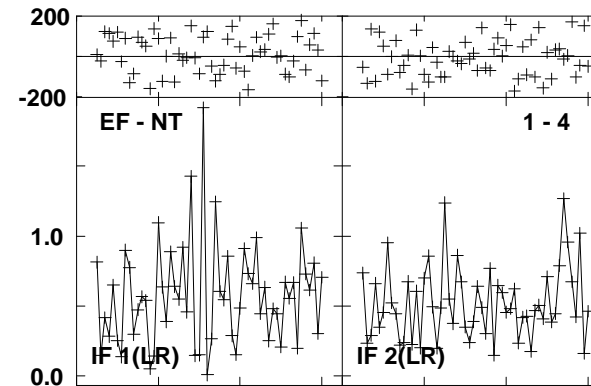
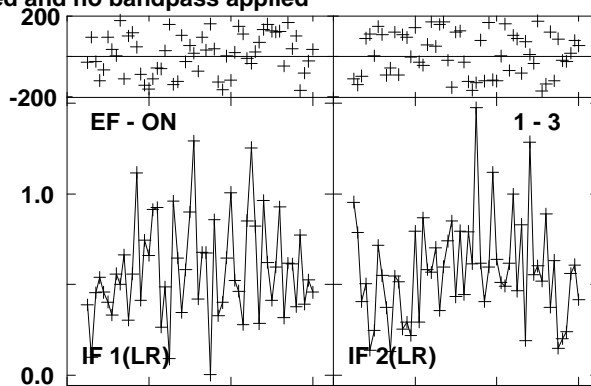
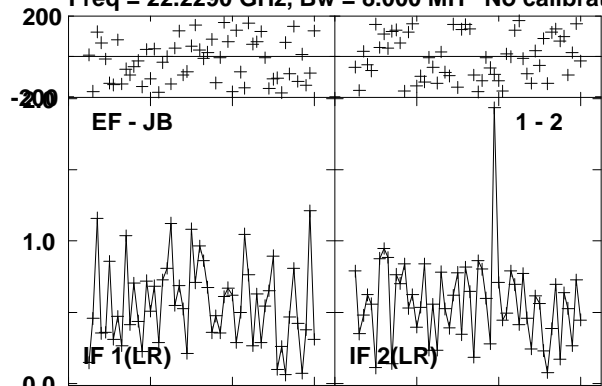

Lower frame: Milli Ampl Jy Top frame: Phas deg
Vector averaged cross-power spectrum Several baselines displayed
Timerange: 00/10:34:06 to 00/10:35:01

Plot file version 30 created 17-SEP-2012 12:01:50

ORIKL1 EE008D 1.UVDATA.1

Freq = 22.2290 GHz, Bw = 8.000 MH No calibration applied and no bandpass applied

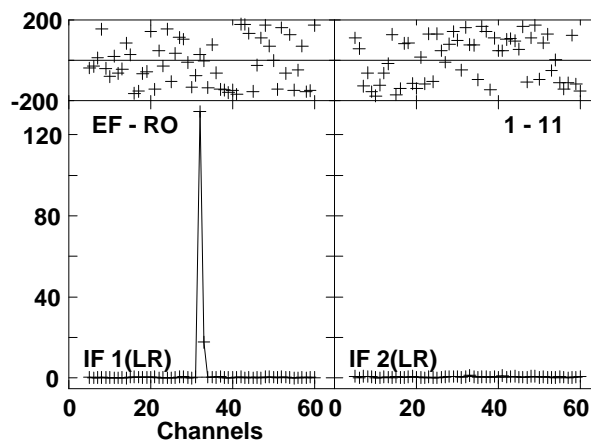
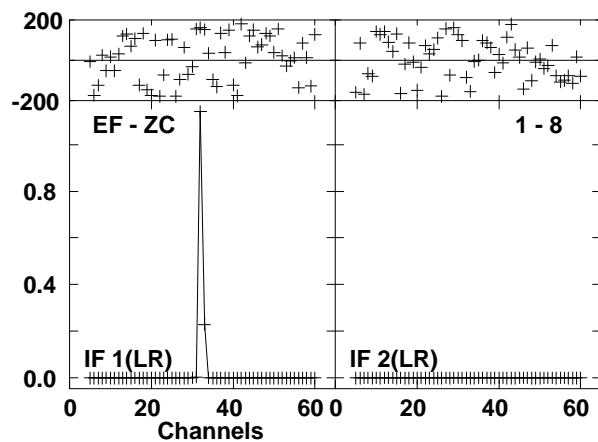
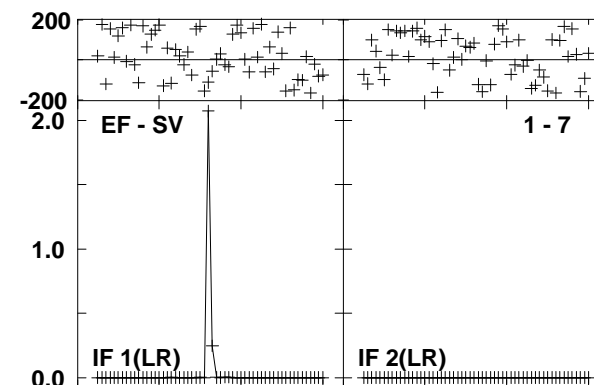
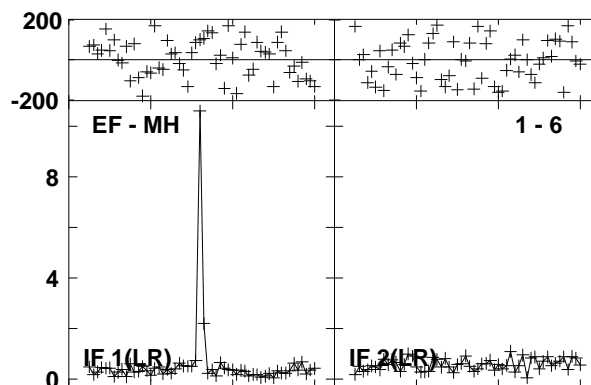
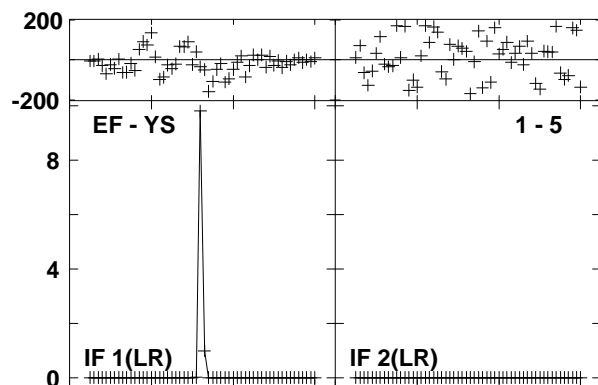
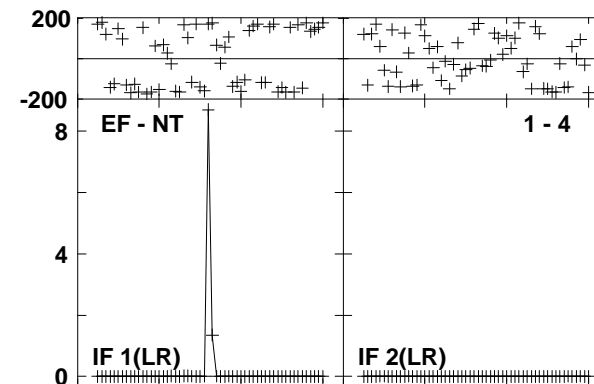
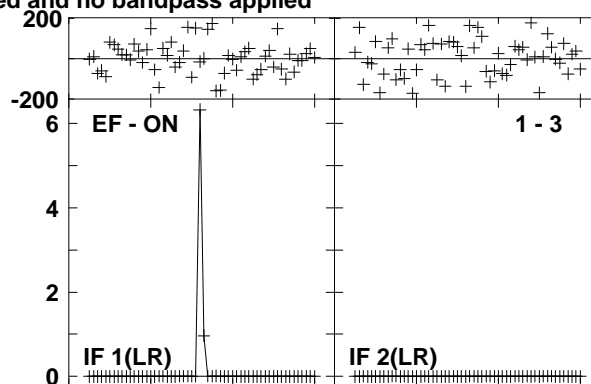
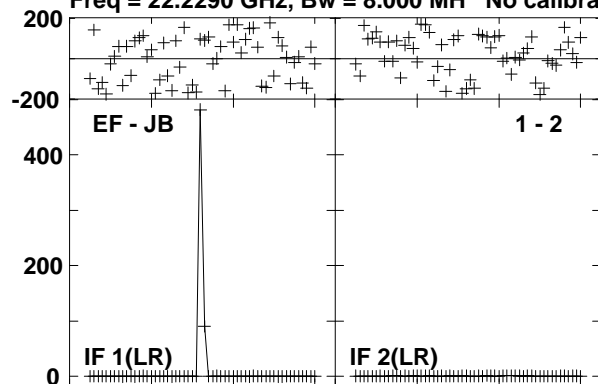

Lower frame: Milli Ampl Jy Top frame: Phas deg
Vector averaged cross-power spectrum Several baselines displayed
Timerange: 00/10:35:06 to 00/10:36:01

Plot file version 31 created 17-SEP-2012 12:01:52

J0529-0519 EE008D 1.UVDATA.1

Freq = 22.2290 GHz, Bw = 8.000 MH No calibration applied and no bandpass applied

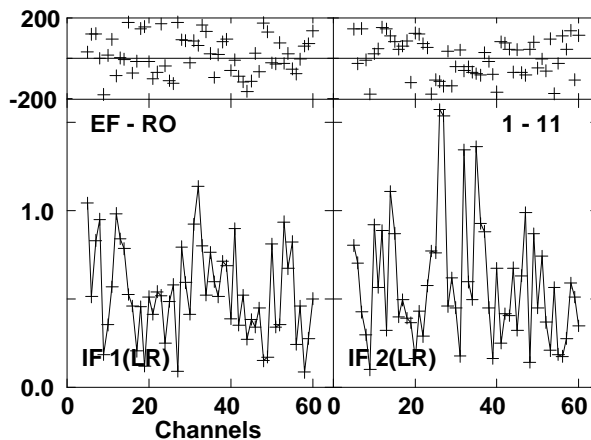
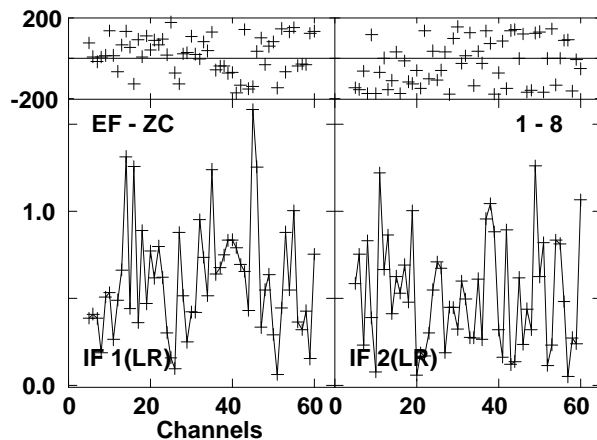
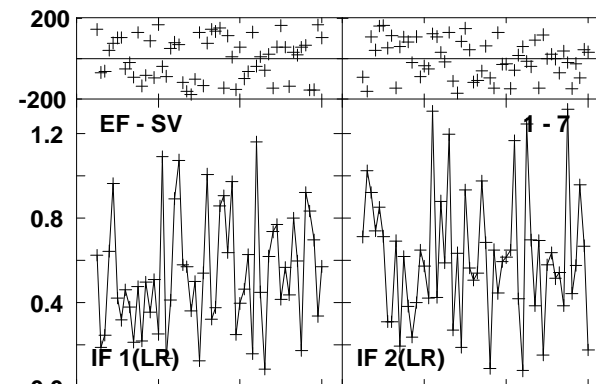
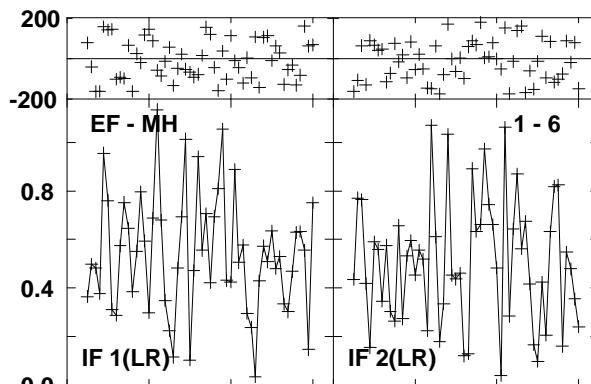
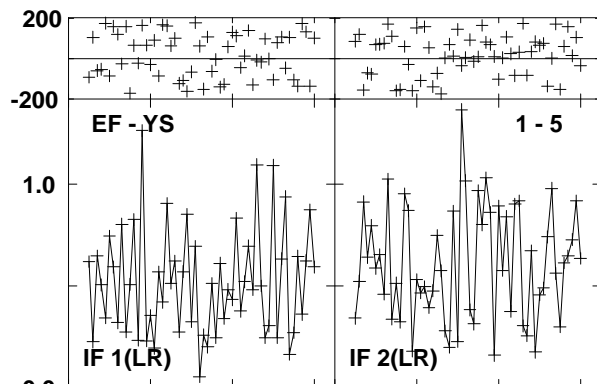
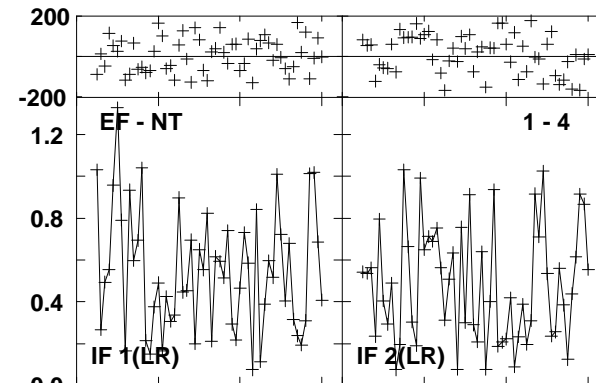
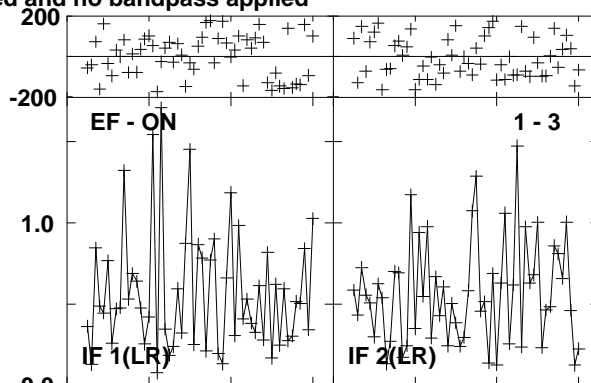
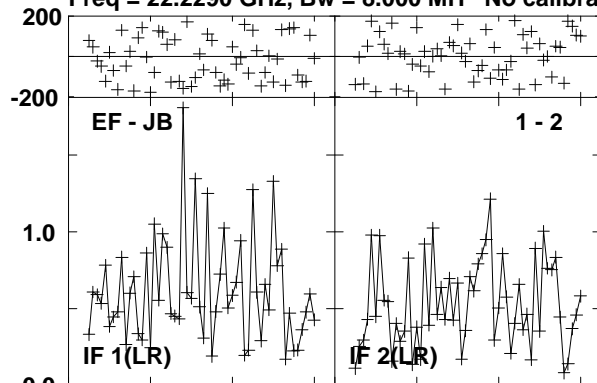

Lower frame: Milli Ampl Jy Top frame: Phas deg
Vector averaged cross-power spectrum Several baselines displayed
Timerange: 00/10/36:06 to 00/10/37:01

Plot file version 32 created 17-SEP-2012 12:01:54

J0541-0541 EE008D 1.UVDATA.1

Freq = 22.2290 GHz, Bw = 8.000 MH No calibration applied and no bandpass applied

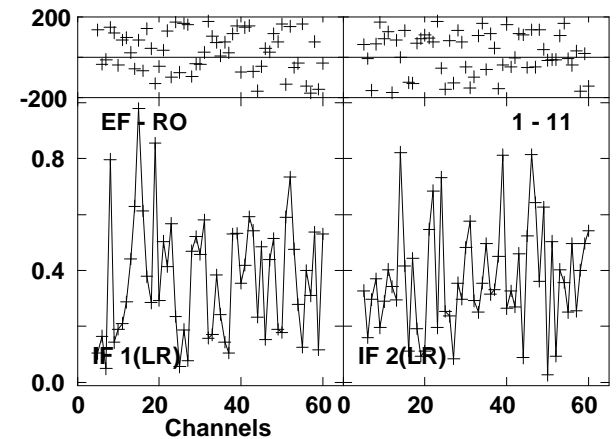
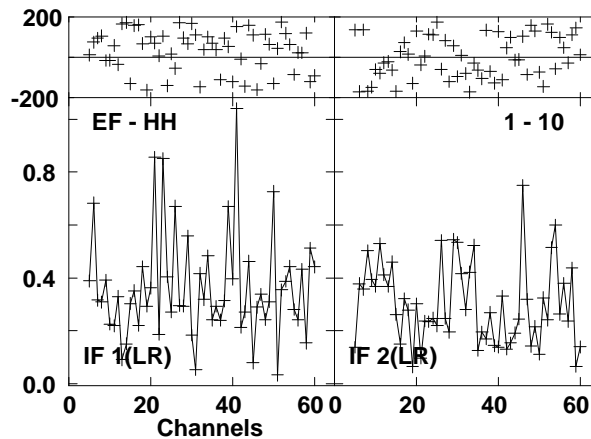
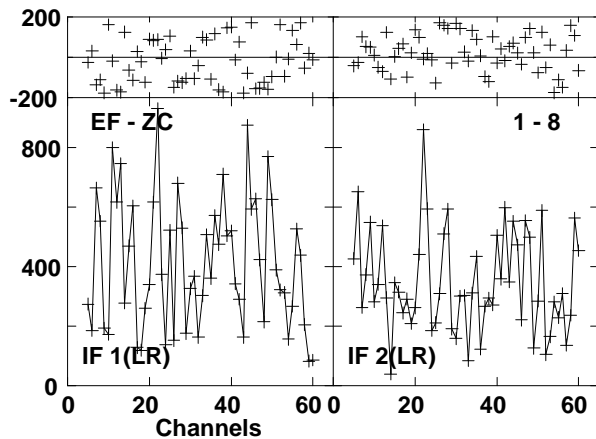
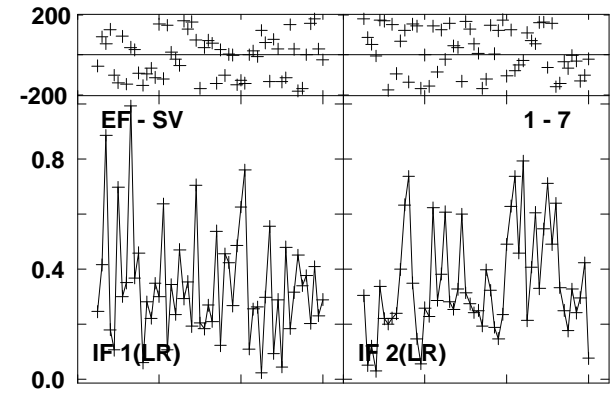
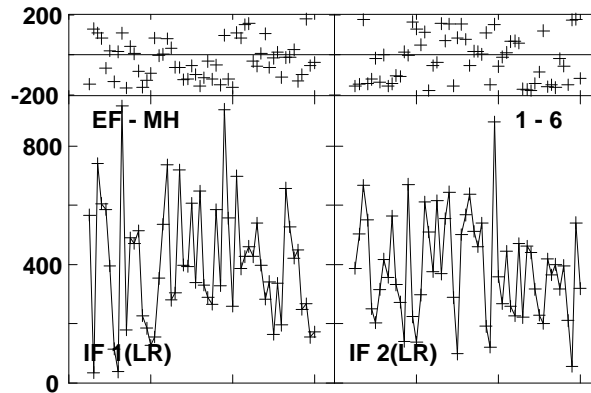
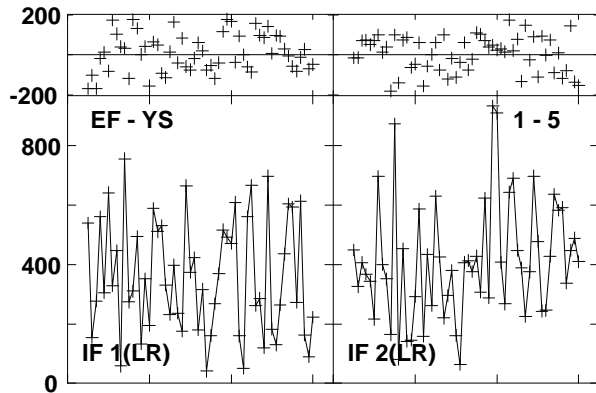
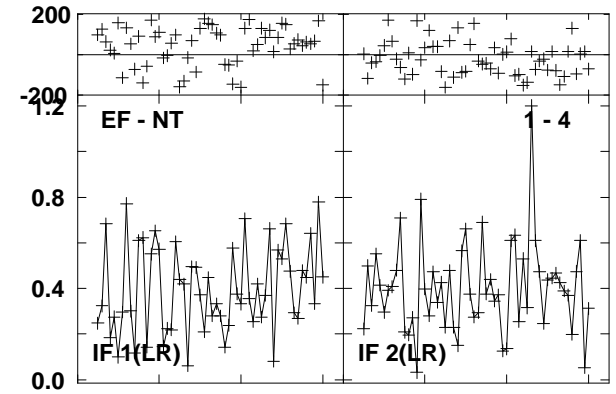
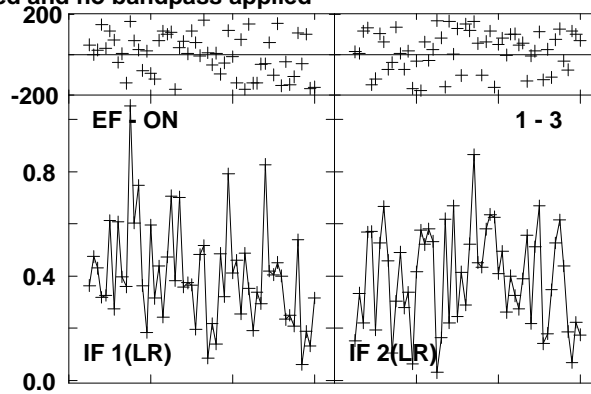
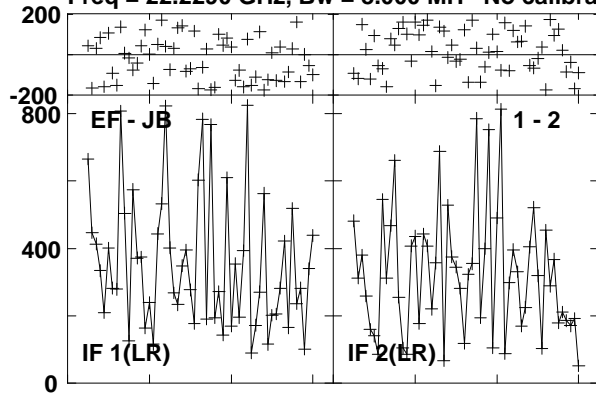

Plot file version 33 created 17-SEP-2012 12:01:58

ORIKL1 EE008D 1.UVDATA.1

Freq = 22.2290 GHz, Bw = 8.000 MH No calibration applied and no bandpass applied

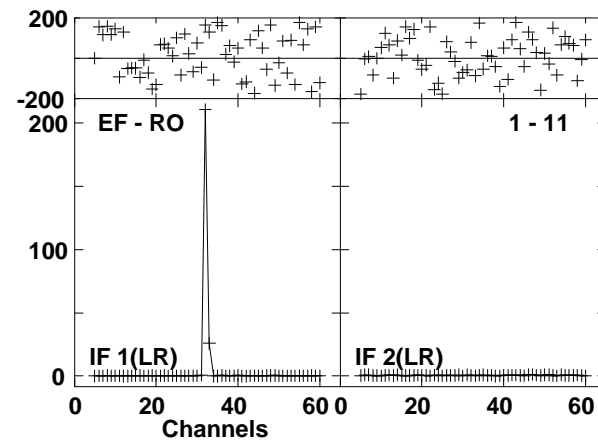
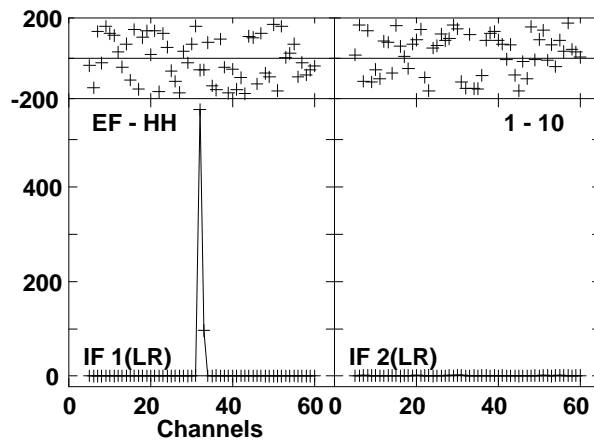
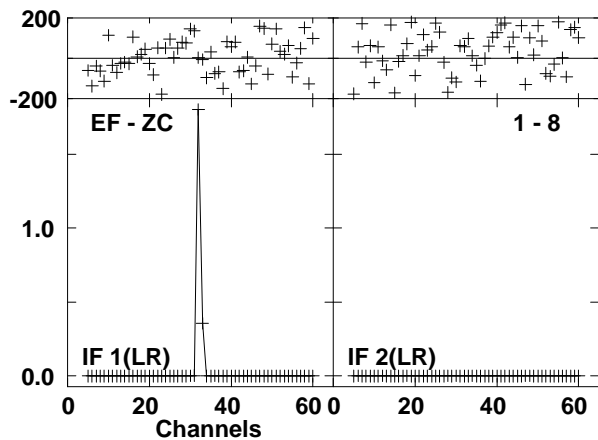
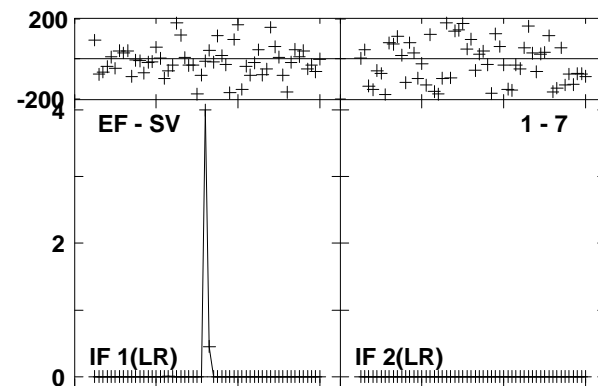
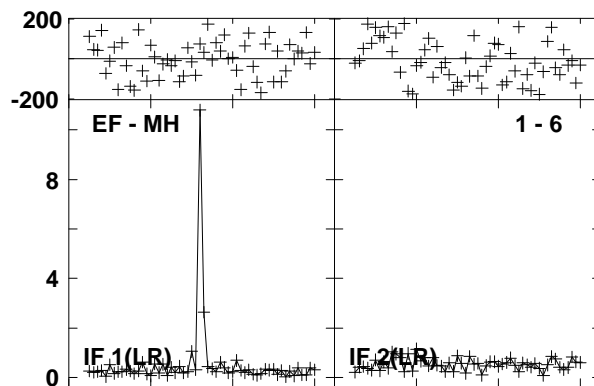
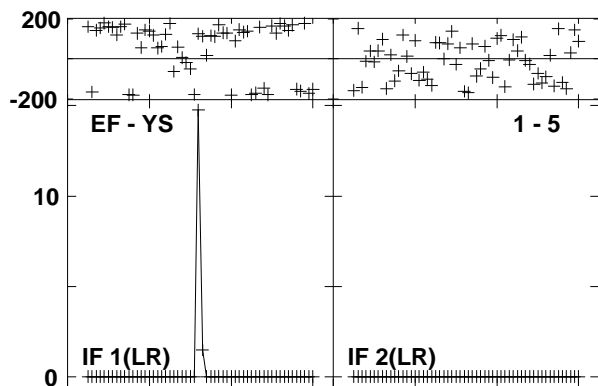
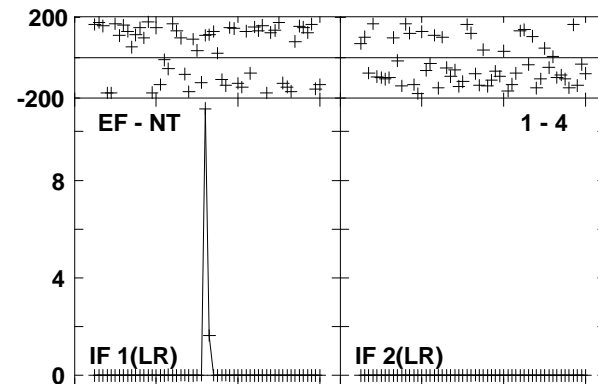
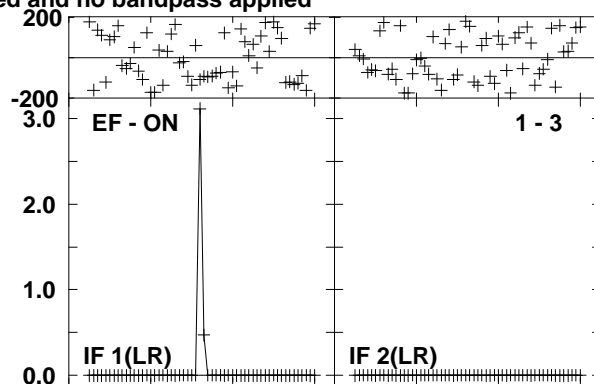
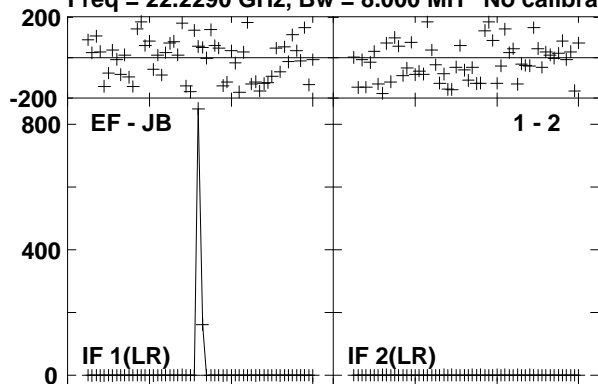

Lower frame: Milli Ampl Jy Top frame: Phas deg
Vector averaged cross-power spectrum Several baselines displayed
Timerange: 00/10:38:50 to 00/10:39:46

Plot file version 34 created 17-SEP-2012 12:02:00

J0541-0541 EE008D 1.UVDATA.1

Freq = 22.2290 GHz, Bw = 8.000 MH No calibration applied and no bandpass applied

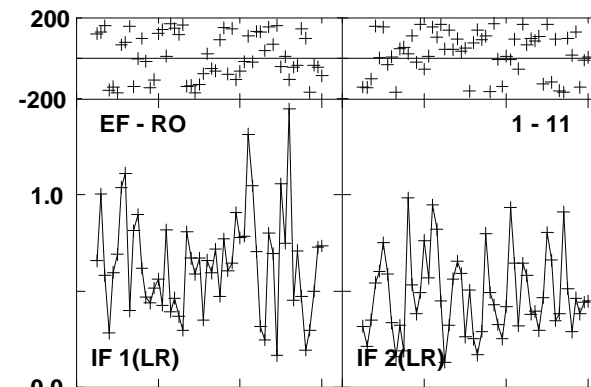
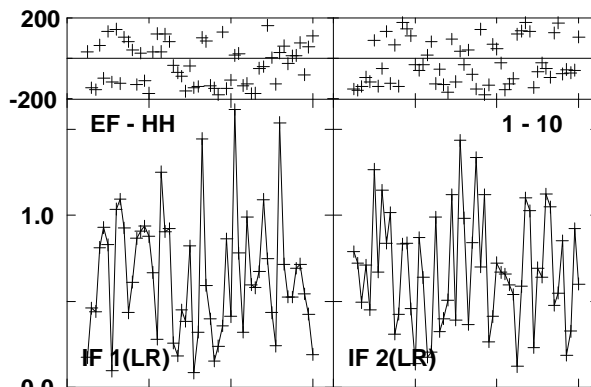
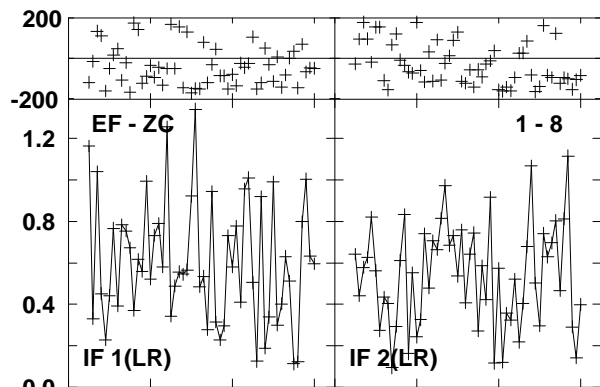
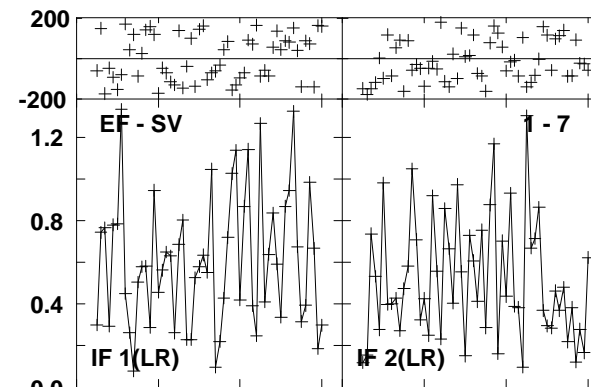
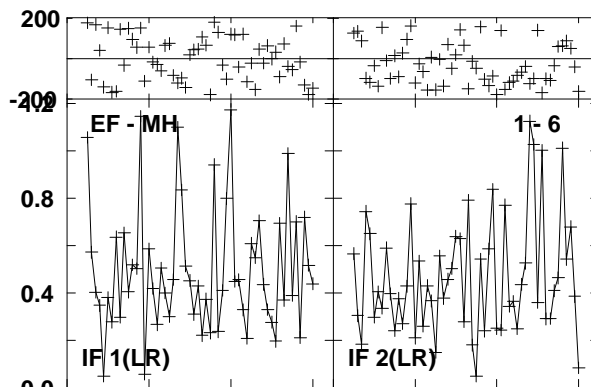
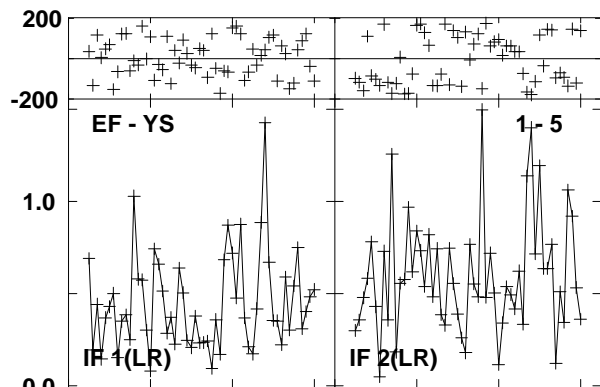
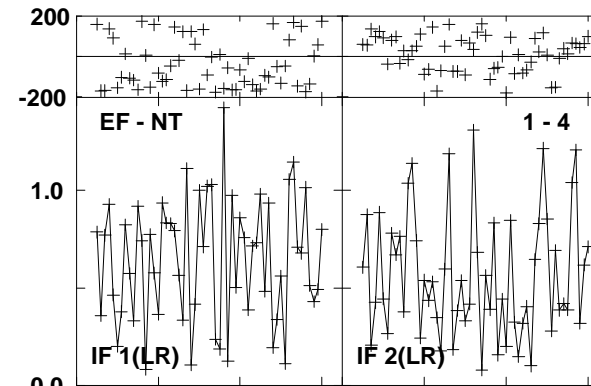
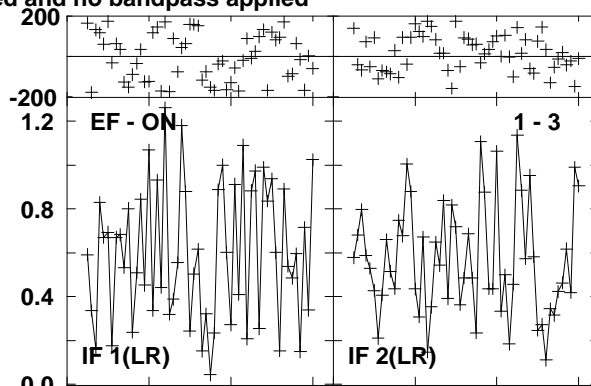
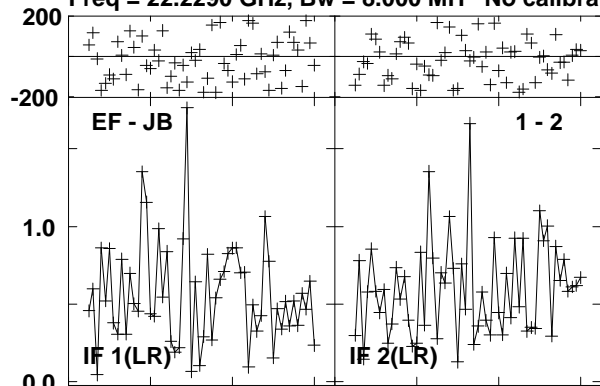

Lower frame: Milli Ampl Jy Top frame: Phas deg
Vector averaged cross-power spectrum Several baselines displayed
Timerange: 00/10:39:51 to 00/10:40:46

Plot file version 35 created 17-SEP-2012 12:02:02

ORIKL1 EE008D 1.UVDATA.1

Freq = 22.2290 GHz, Bw = 8.000 MH No calibration applied and no bandpass applied

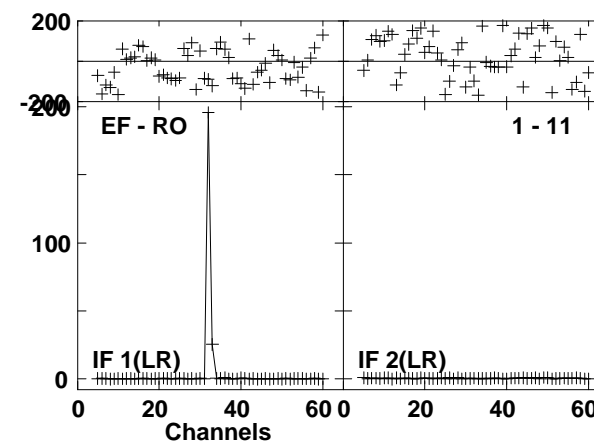
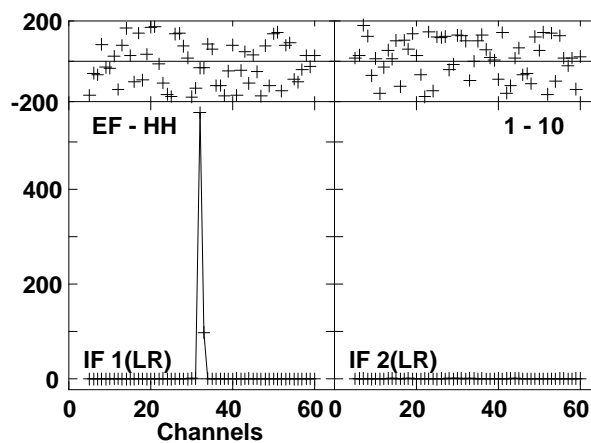
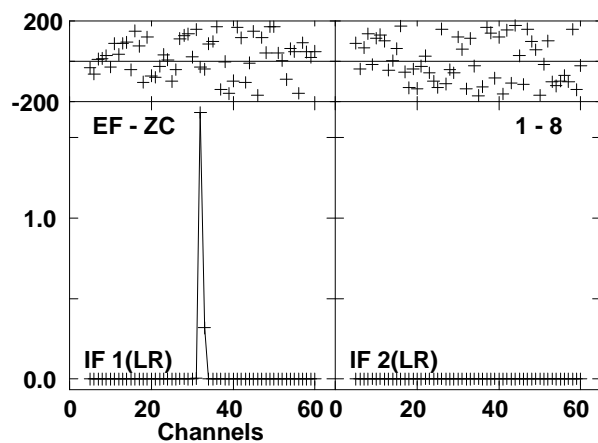
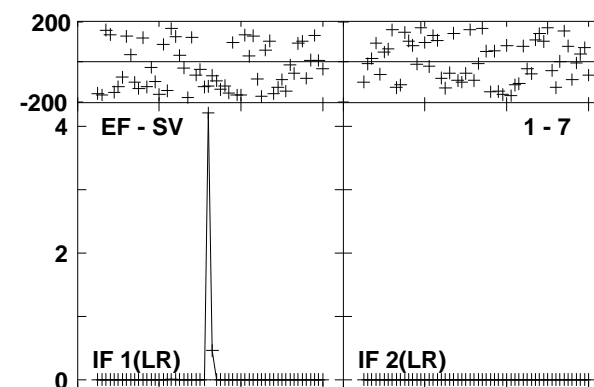
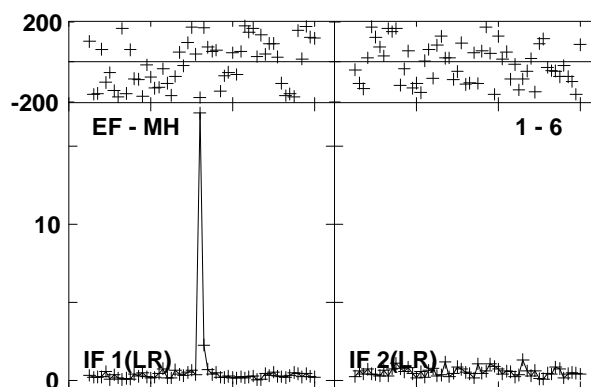
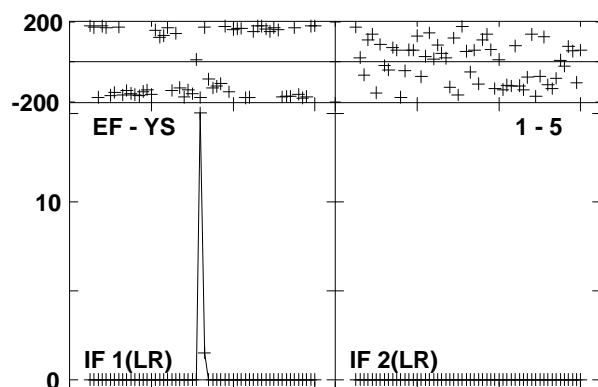
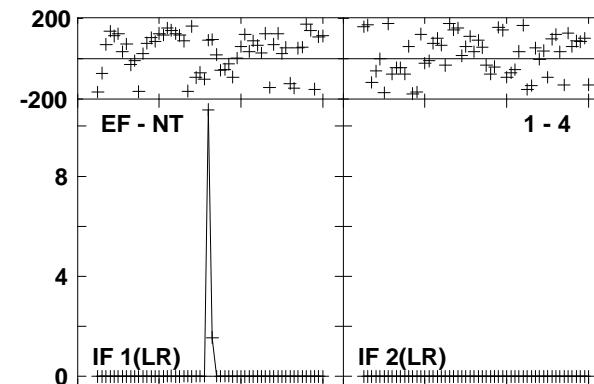
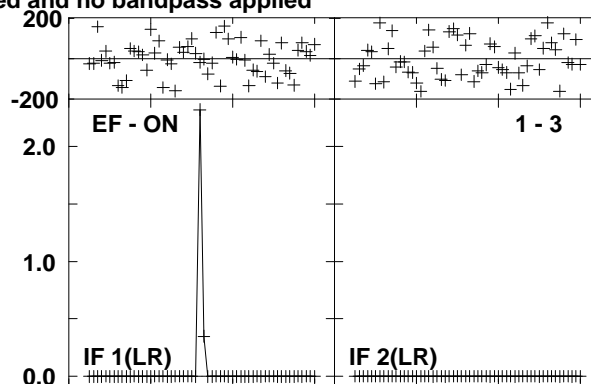
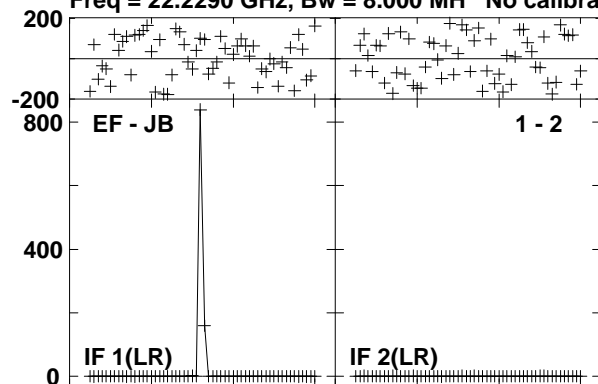

Lower frame: Milli Ampl Jy Top frame: Phas deg
Vector averaged cross-power spectrum Several baselines displayed
Timerange: 00/10:40:51 to 00/10:41:46

Plot file version 36 created 17-SEP-2012 12:02:05

J0541-0541 EE008D 1.UVDATA.1

Freq = 22.2290 GHz, Bw = 8.000 MH No calibration applied and no bandpass applied

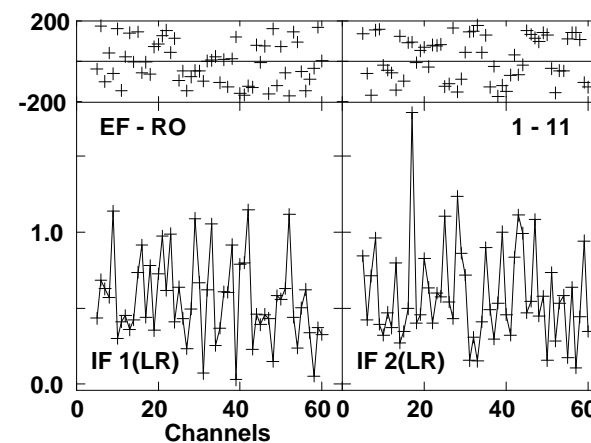
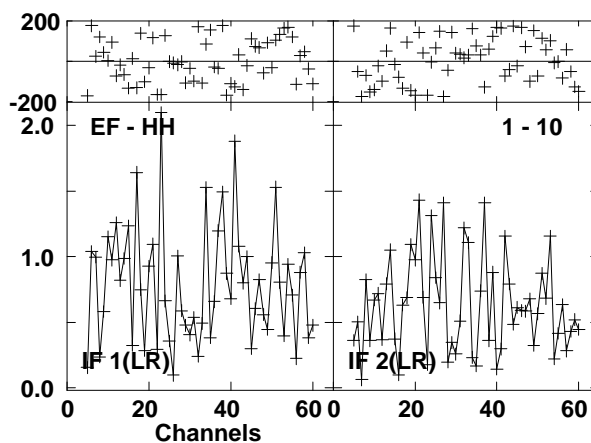
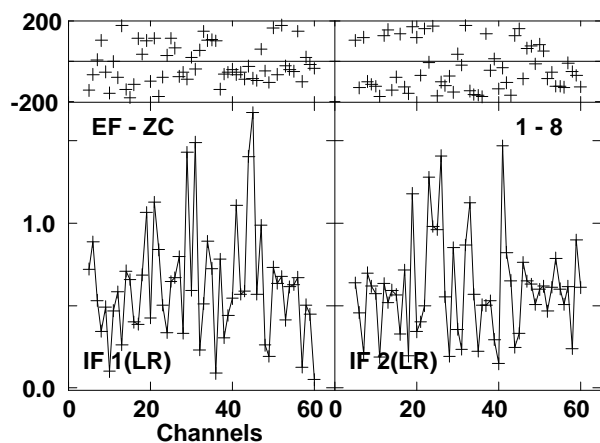
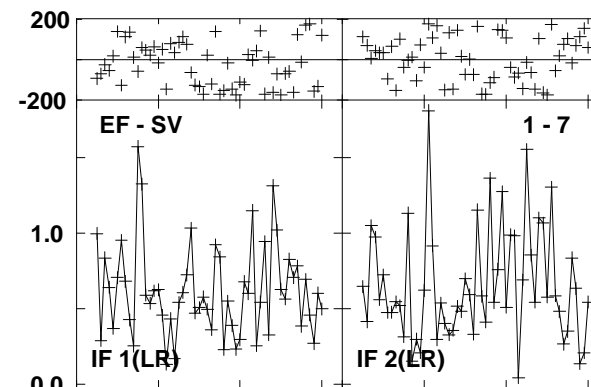
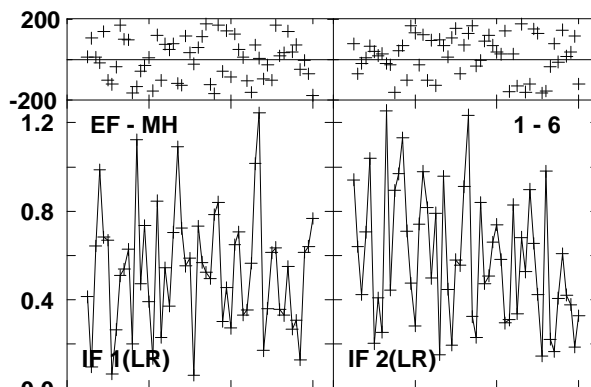
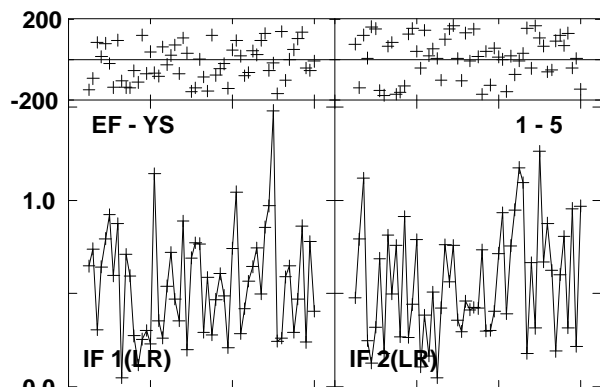
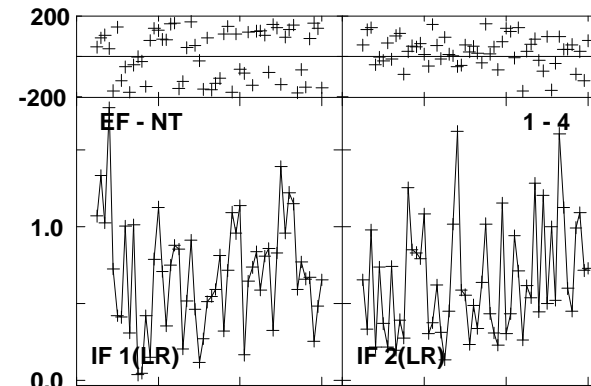
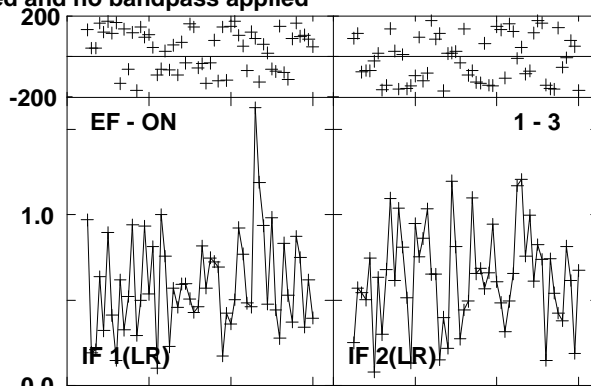
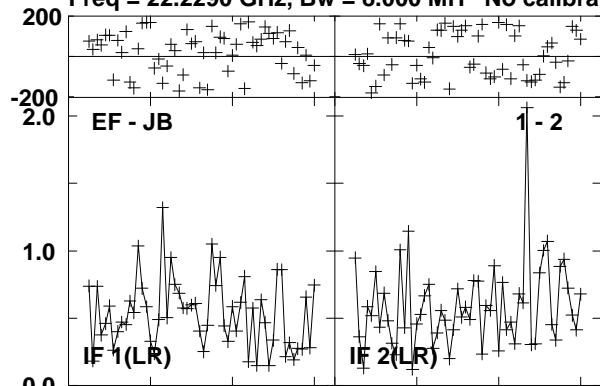

Lower frame: Milli Ampl Jy Top frame: Phas deg
Vector averaged cross-power spectrum Several baselines displayed
Timerange: 00/10:41:53 to 00/10:42:46

Plot file version 37 created 17-SEP-2012 12:02:07

J0529-0519 EE008D 1.UVDATA.1

Freq = 22.2290 GHz, Bw = 8.000 MH No calibration applied and no bandpass applied

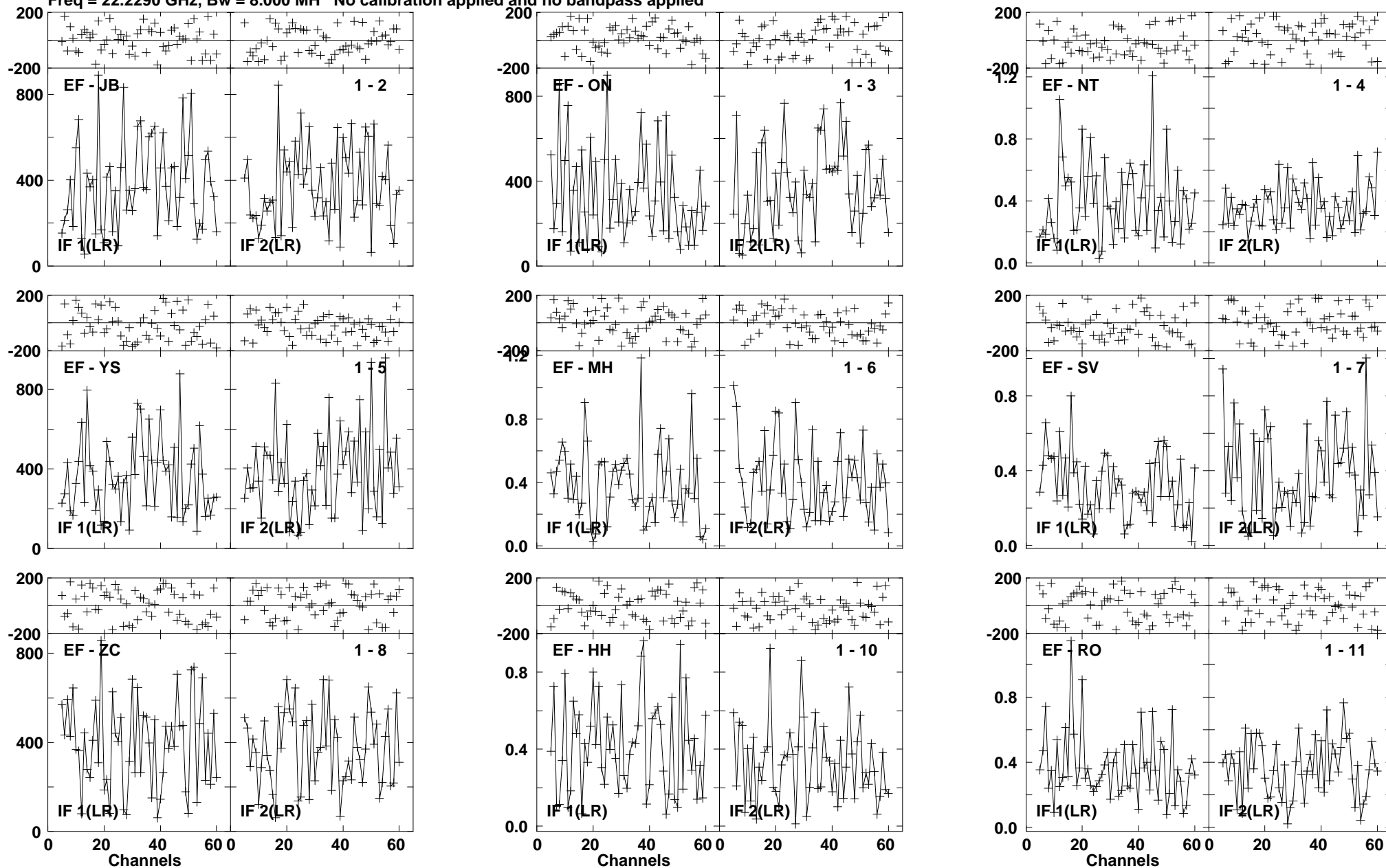

Lower frame: Micro Ampl Jy Top frame: Phas deg
Vector averaged cross-power spectrum Several baselines displayed
Timerange: 00/10:43:32 to 00/10:44:31

Plot file version 38 created 17-SEP-2012 12:02:11

ORIKL1 EE008D 1.UVDATA.1

Freq = 22.2290 GHz, Bw = 8.000 MH No calibration applied and no bandpass applied

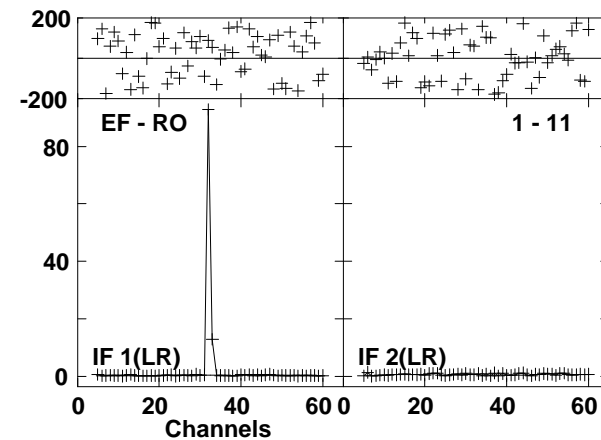
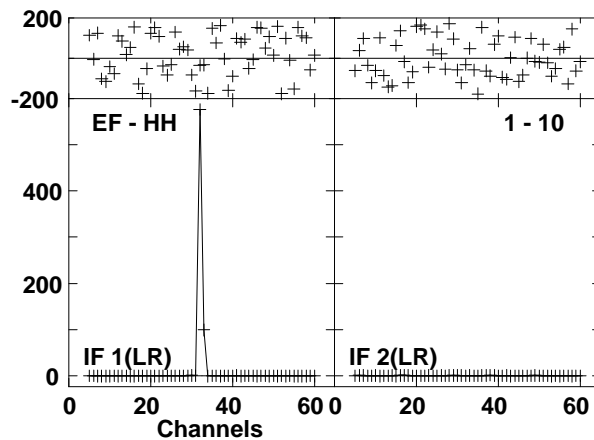
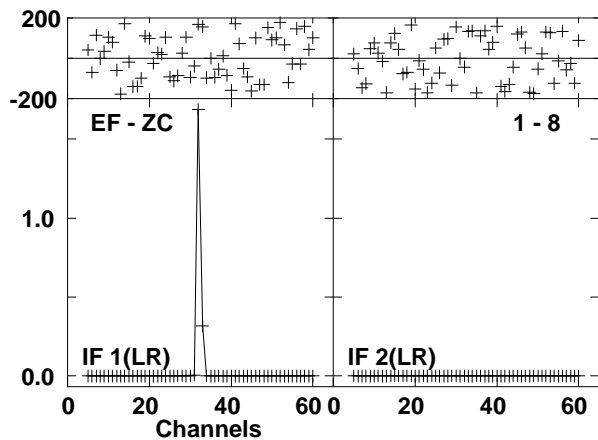
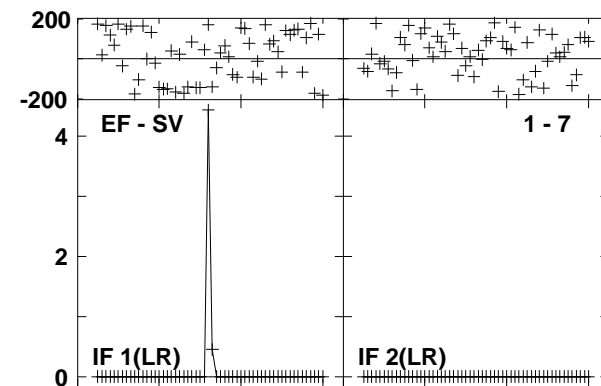
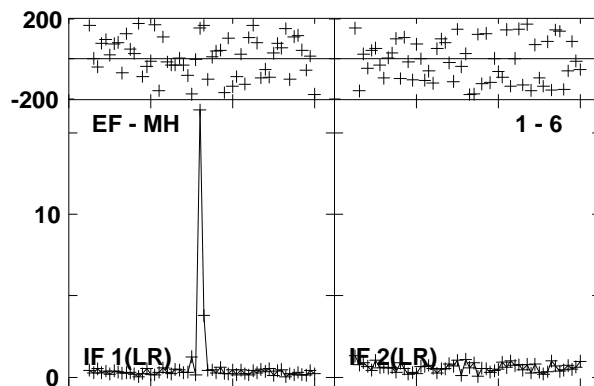
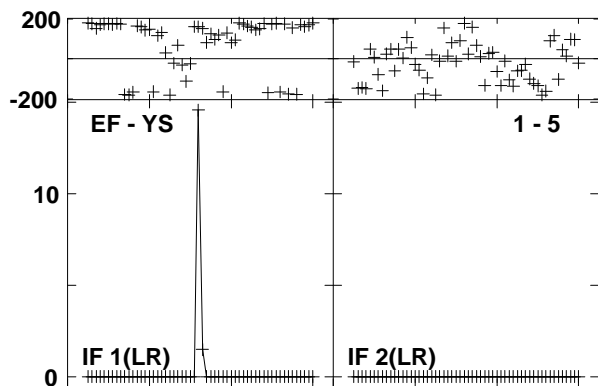
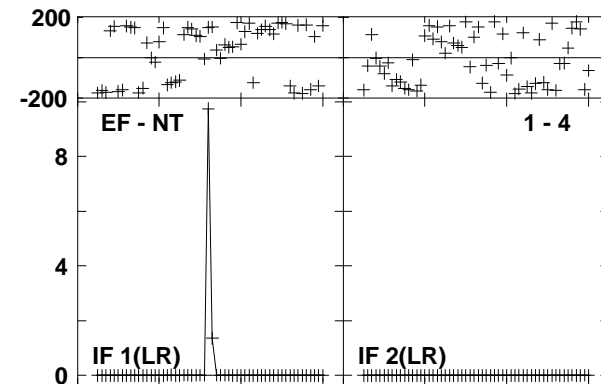
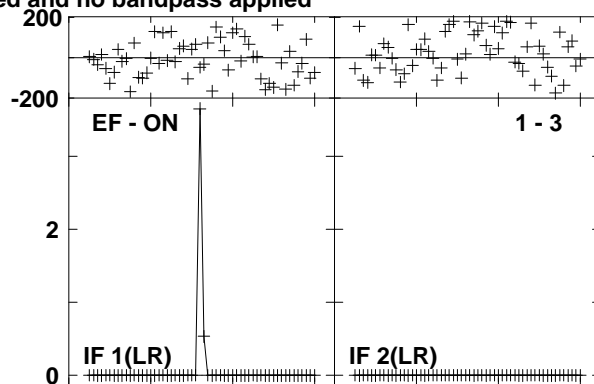
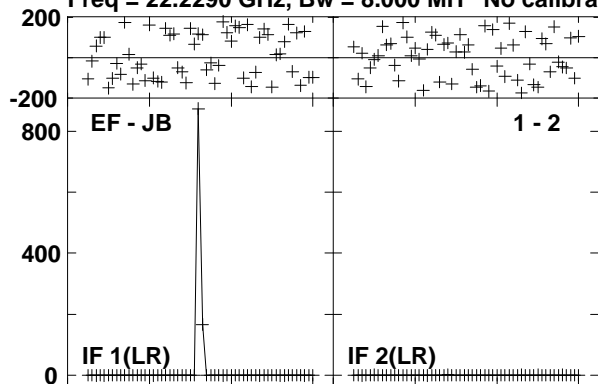

Lower frame: Milli Ampl Jy Top frame: Phas deg
Vector averaged cross-power spectrum Several baselines displayed
Timerange: 00/10:44:35 to 00/10:45:31

Plot file version 39 created 17-SEP-2012 12:02:13

J0529-0519 EE008D 1.UVDATA.1

Freq = 22.2290 GHz, Bw = 8.000 MH No calibration applied and no bandpass applied

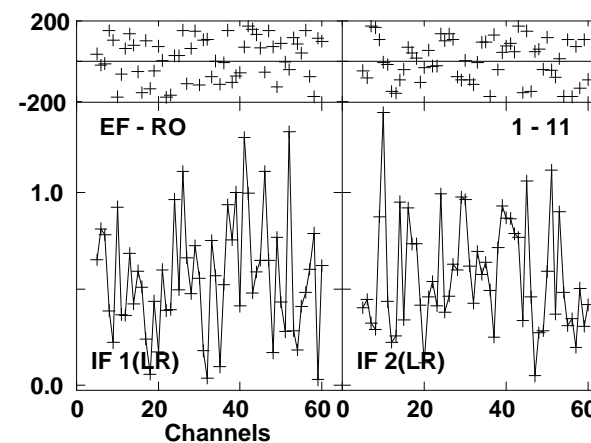
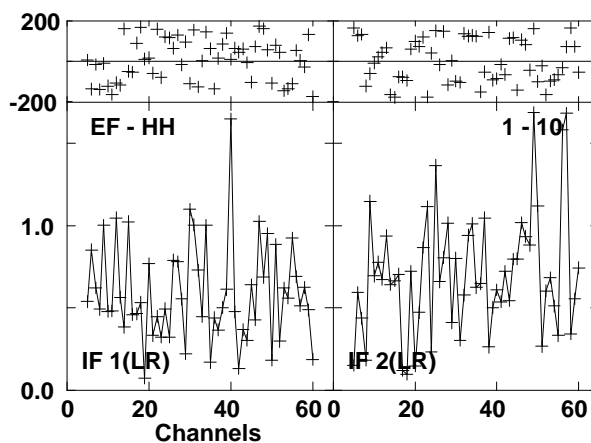
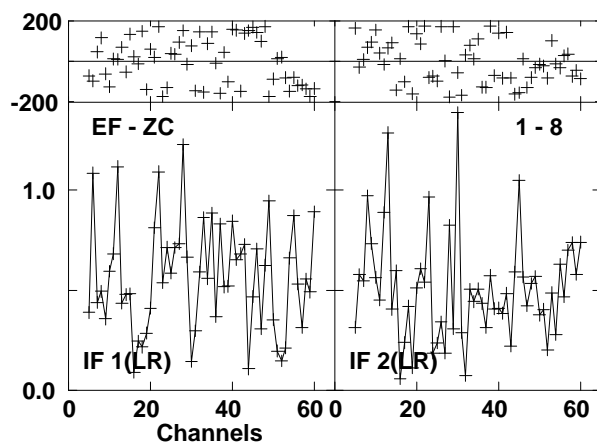
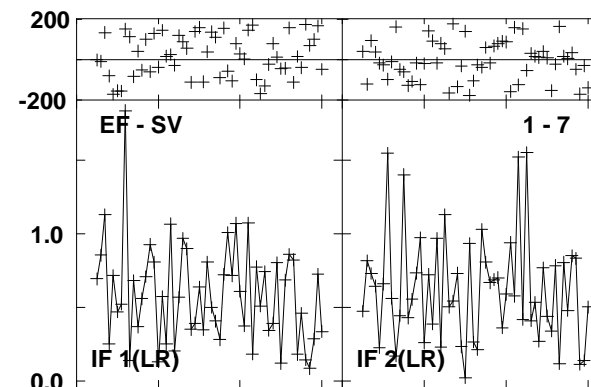
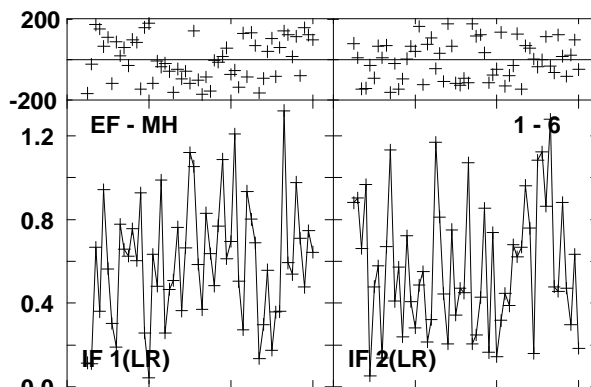
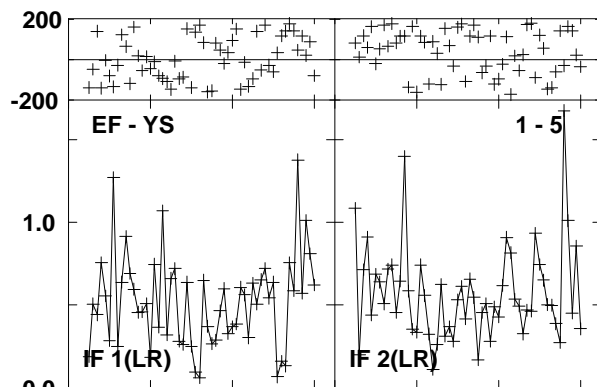
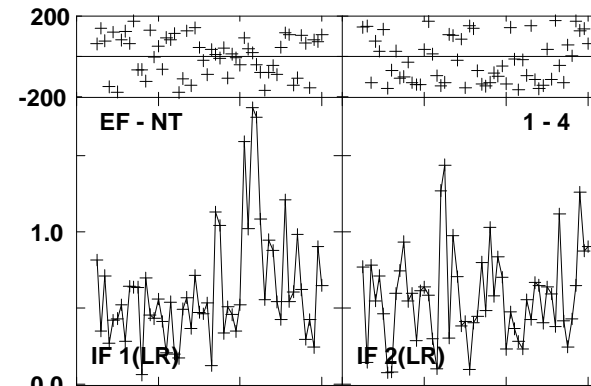
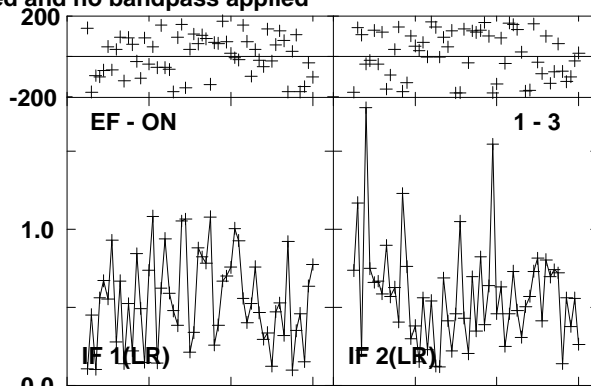
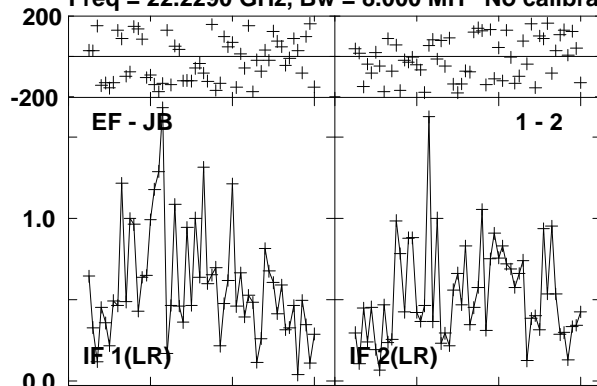

Lower frame: Milli Ampl Jy Top frame: Phas deg
Vector averaged cross-power spectrum Several baselines displayed
Timerange: 00/10:45:36 to 00/10:46:31

Plot file version 40 created 17-SEP-2012 12:02:16

ORIKL1 EE008D 1.UVDATA.1

Freq = 22.2290 GHz, Bw = 8.000 MH No calibration applied and no bandpass applied

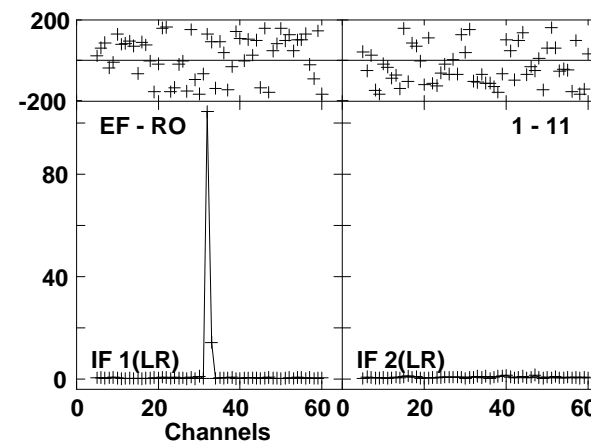
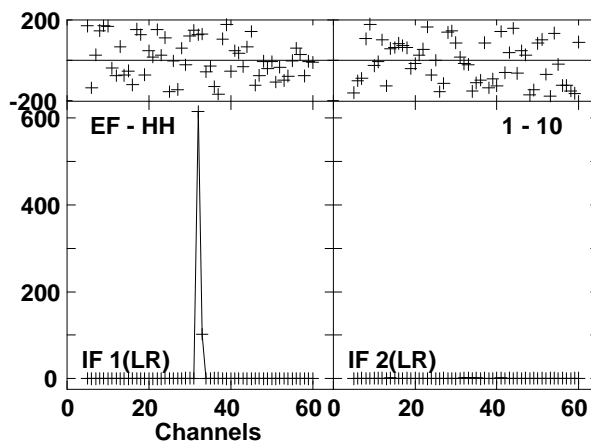
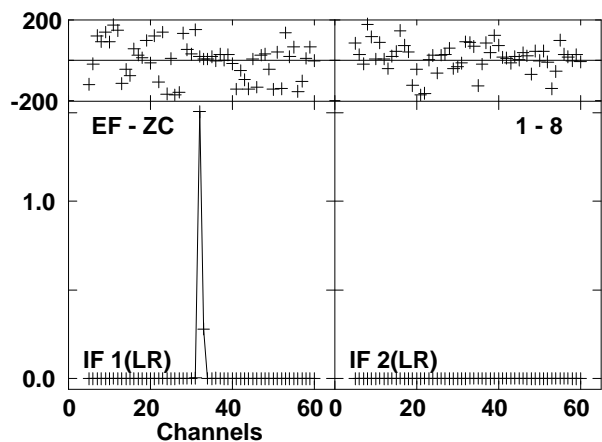
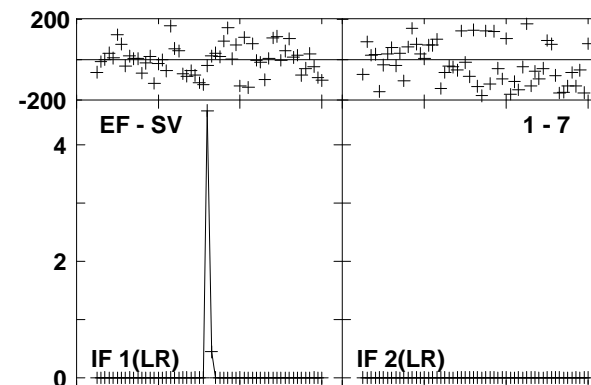
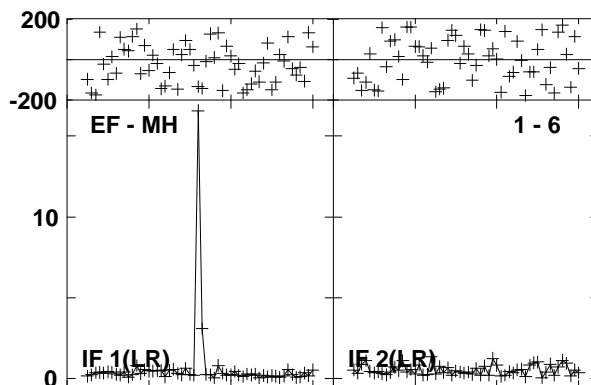
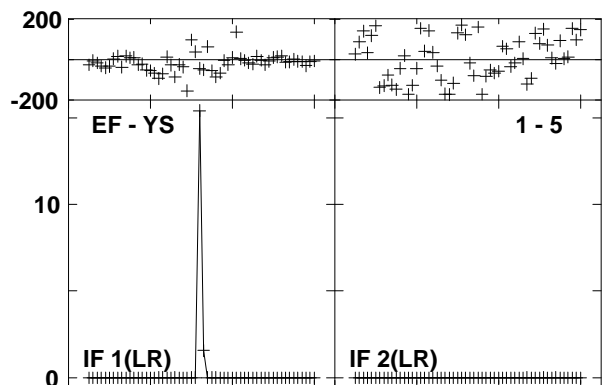
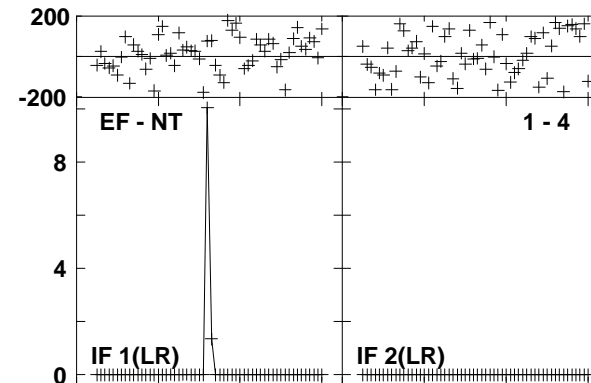
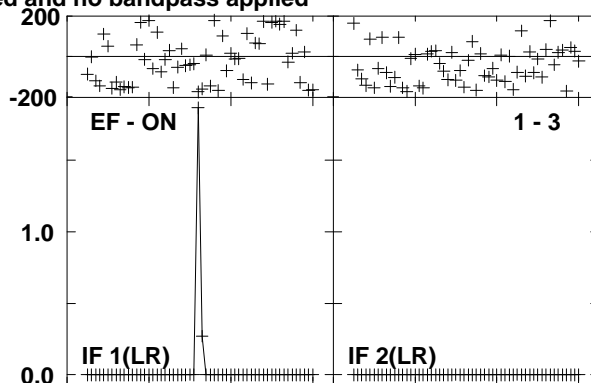
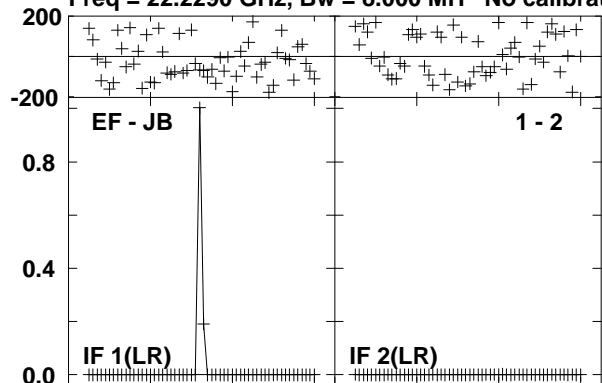

Lower frame: Ampl Jy Top frame: Phas deg
Vector averaged cross-power spectrum Several baselines displayed
Timerange: 00/10:46:36 to 00/10:47:31

Plot file version 41 created 17-SEP-2012 12:02:18

J0529-0519 EE008D 1.UVDATA.1

Freq = 22.2290 GHz, Bw = 8.000 MH No calibration applied and no bandpass applied

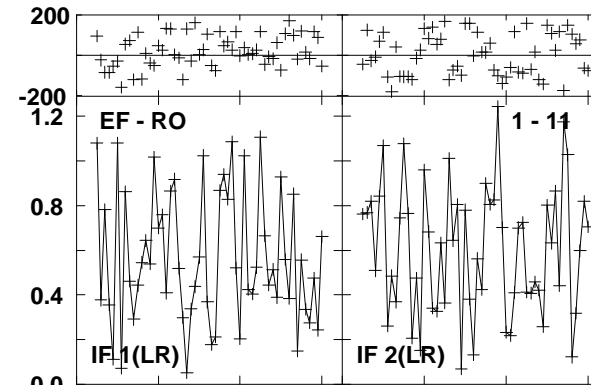
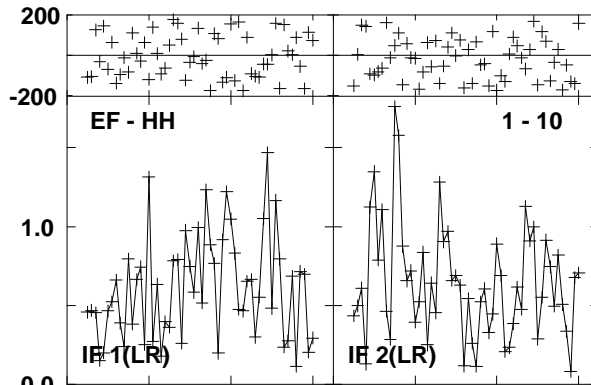
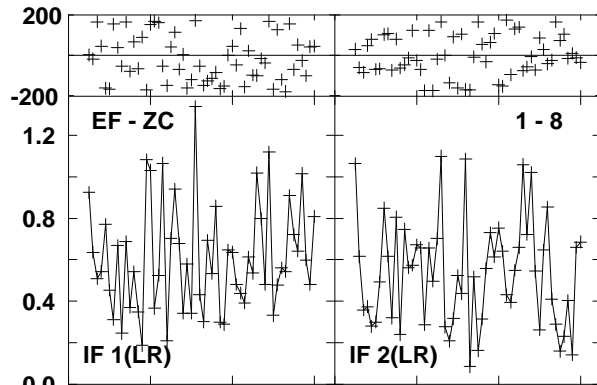
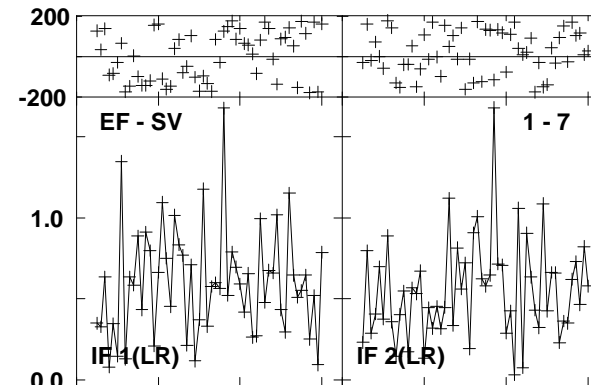
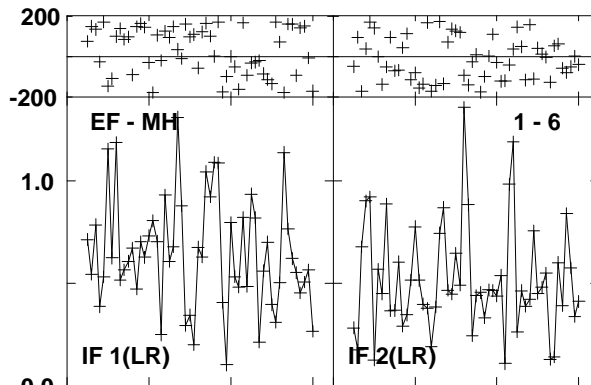
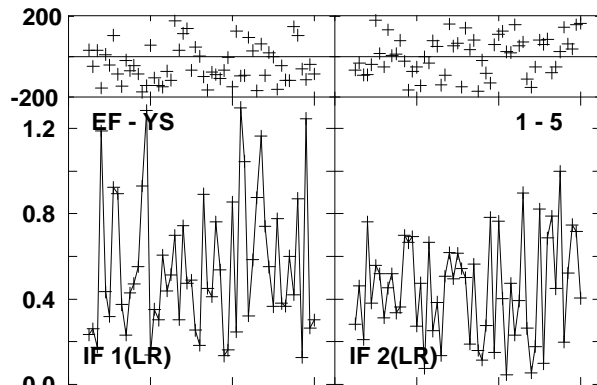
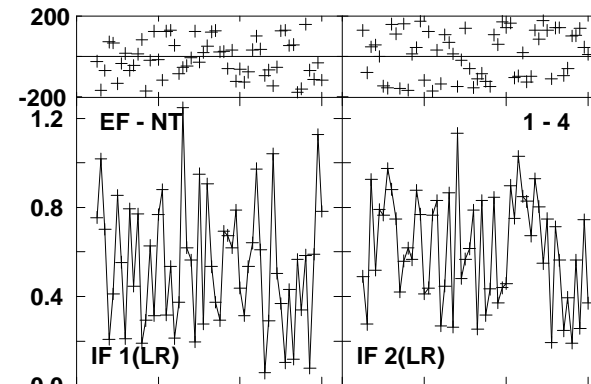
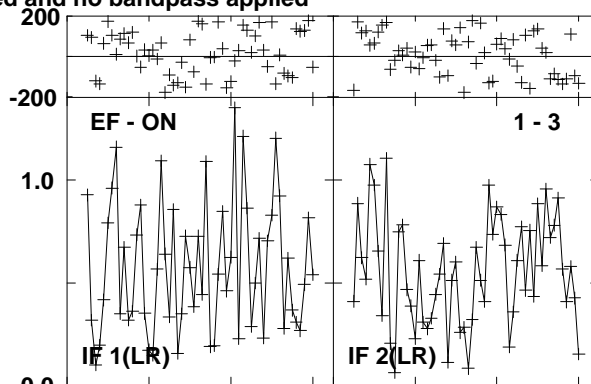
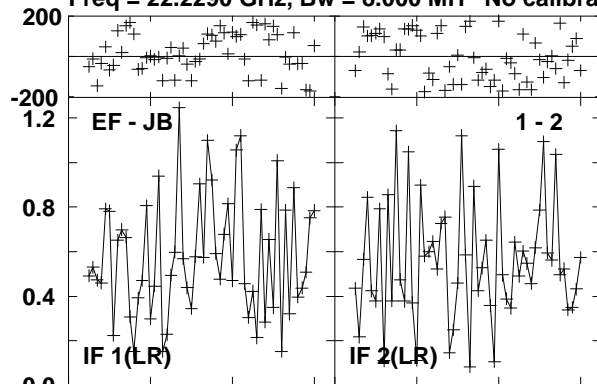

Lower frame: Milli Ampl Jy Top frame: Phas deg
Vector averaged cross-power spectrum Several baselines displayed
Timerange: 00/10:47:36 to 00/10:48:31

Plot file version 42 created 17-SEP-2012 12:02:21

J0541-0541 EE008D 1.UVDATA.1

Freq = 22.2290 GHz, Bw = 8.000 MH No calibration applied and no bandpass applied

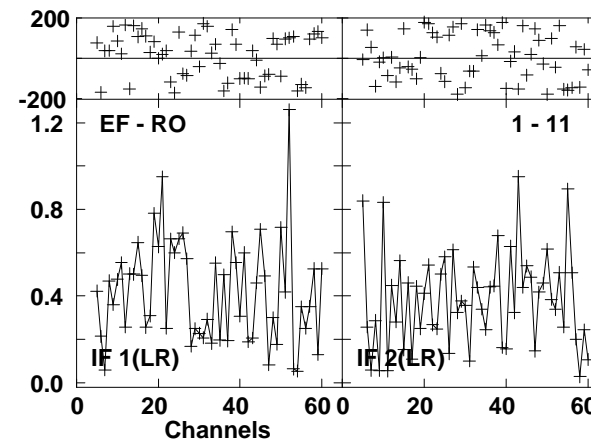
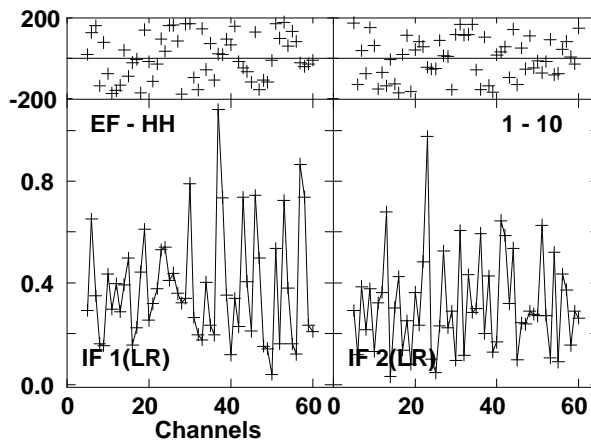
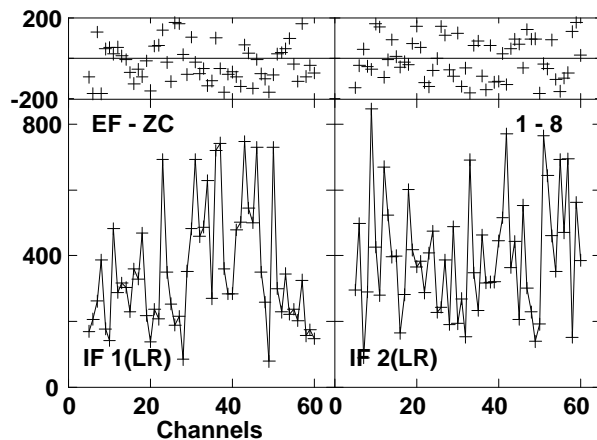
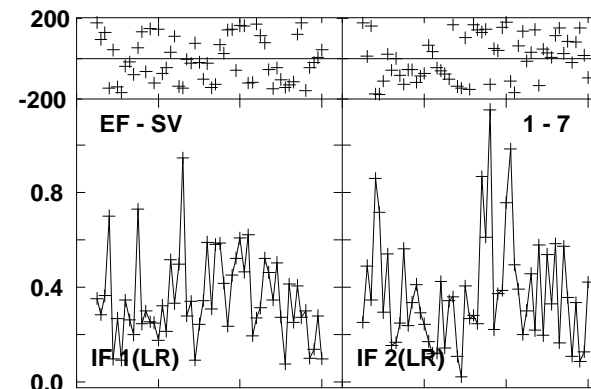
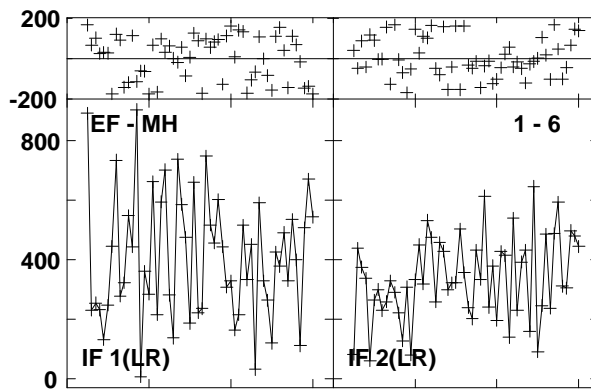
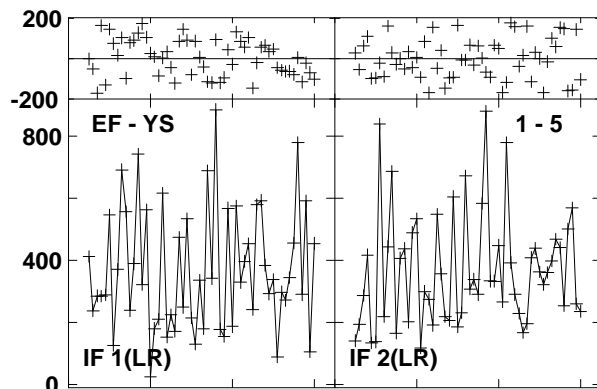
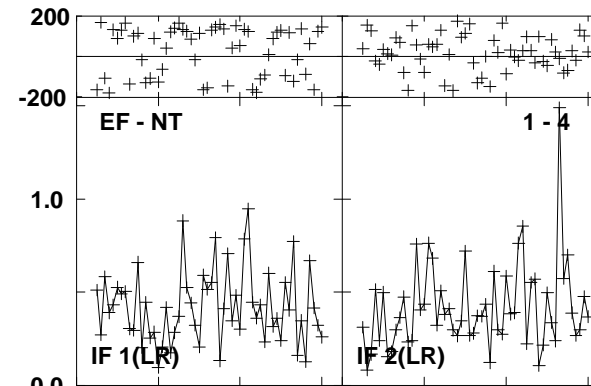
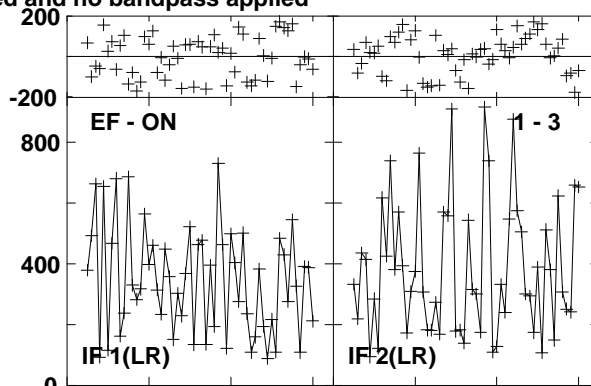
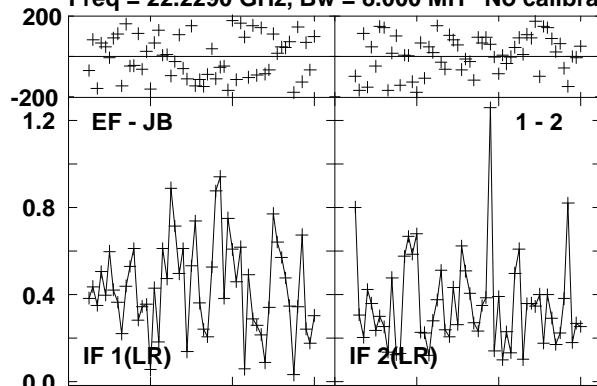

Lower frame: Milli Ampl Jy Top frame: Phas deg
Vector averaged cross-power spectrum Several baselines displayed
Timerange: 00/10:49:17 to 00/10:50:16

Plot file version 43 created 17-SEP-2012 12:02:24

ORIKL1 EE008D 1.UVDATA.1

Freq = 22.2290 GHz, Bw = 8.000 MH No calibration applied and no bandpass applied

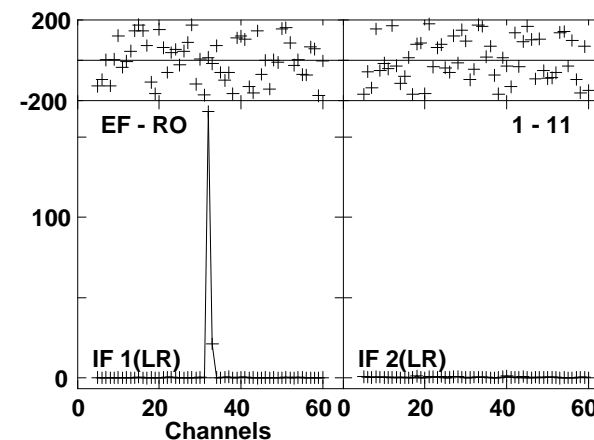
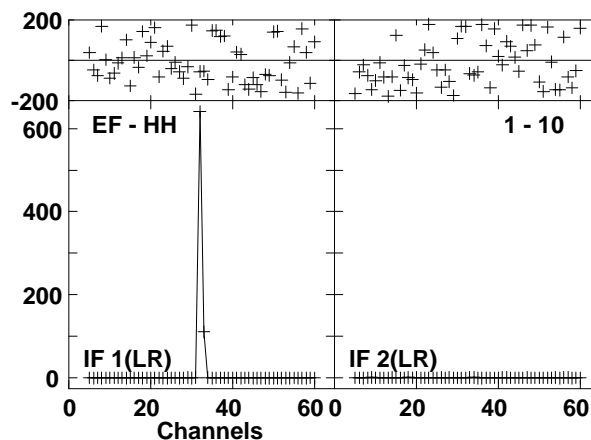
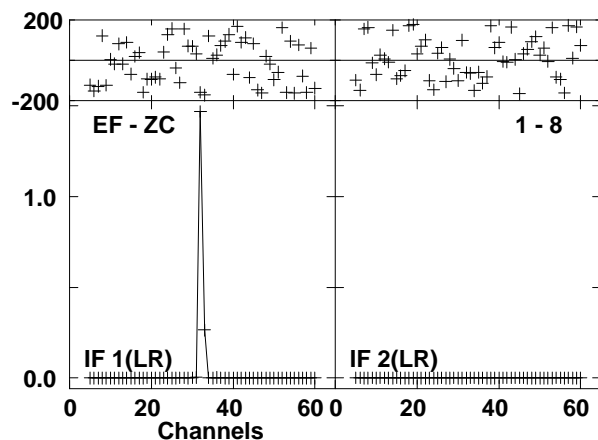
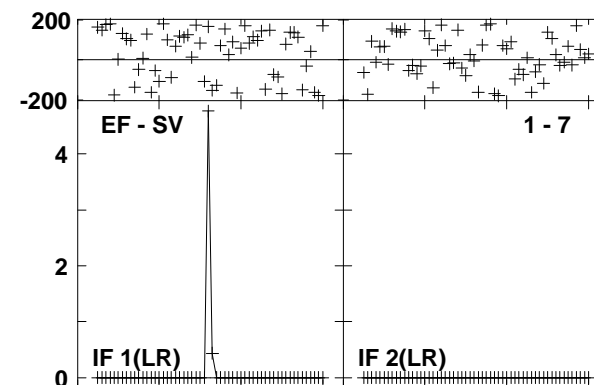
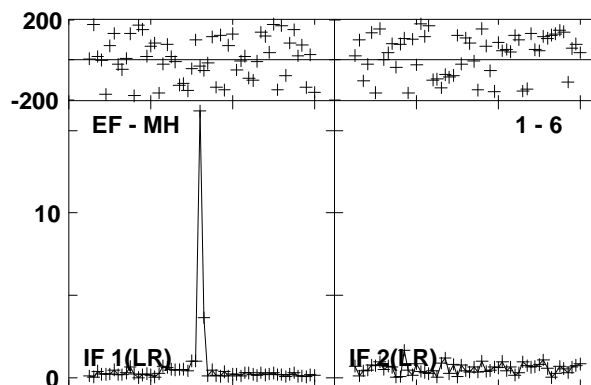
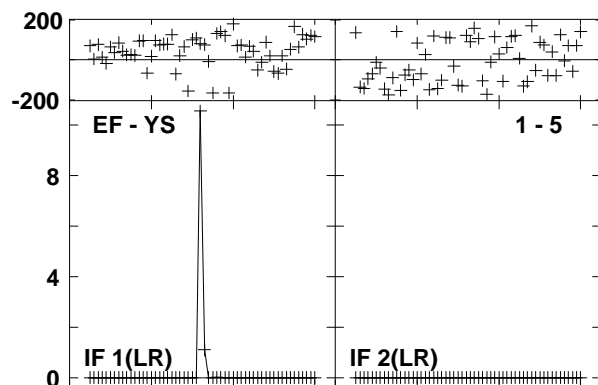
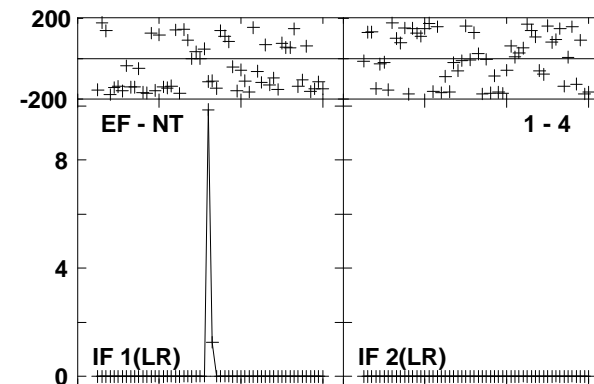
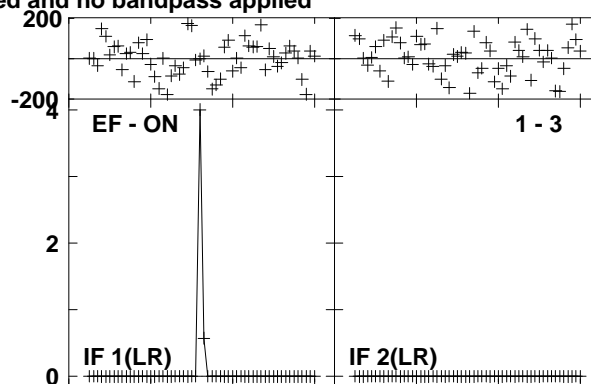
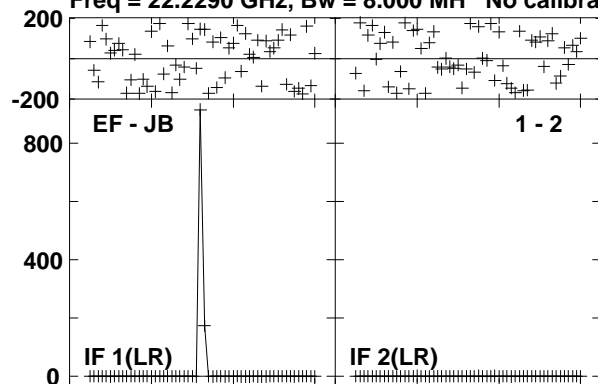

Lower frame: Milli Ampl Jy Top frame: Phas deg
Vector averaged cross-power spectrum Several baselines displayed
Timerange: 00/10:50:20 to 00/10:51:16

Plot file version 44 created 17-SEP-2012 12:02:27

J0541-0541 EE008D 1.UVDATA.1

Freq = 22.2290 GHz, Bw = 8.000 MH No calibration applied and no bandpass applied

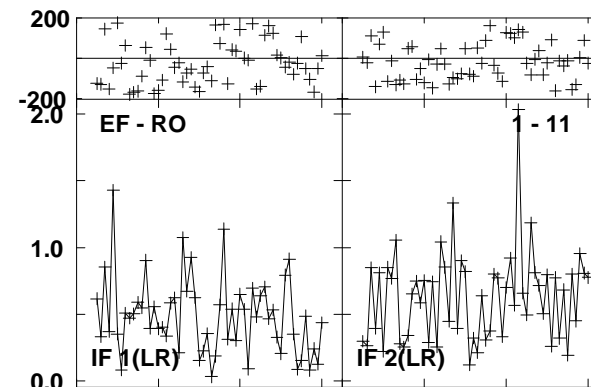
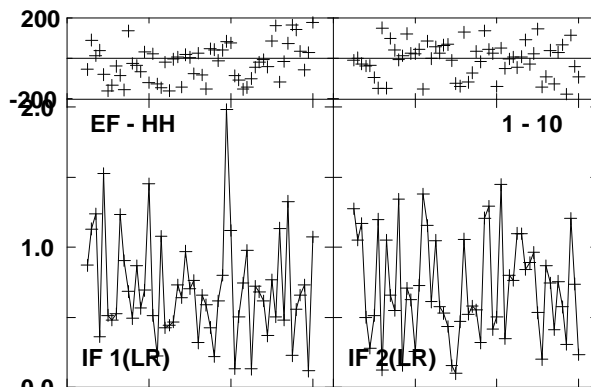
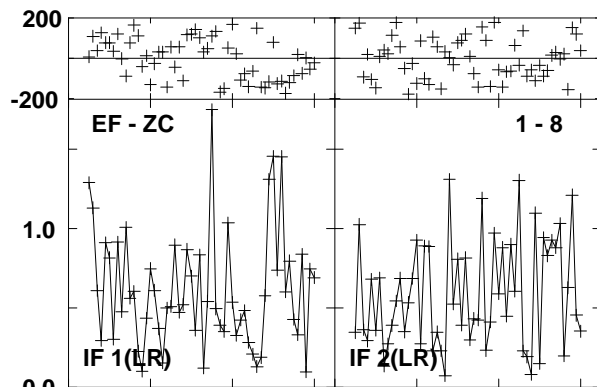
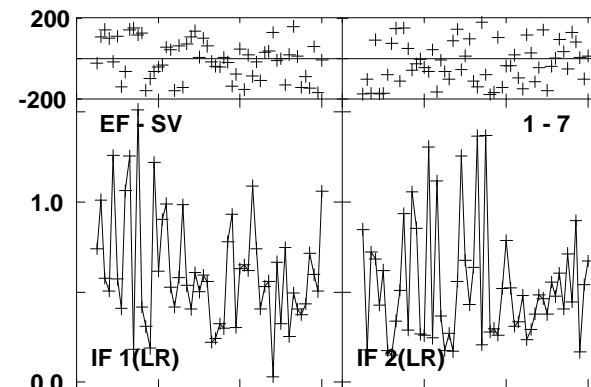
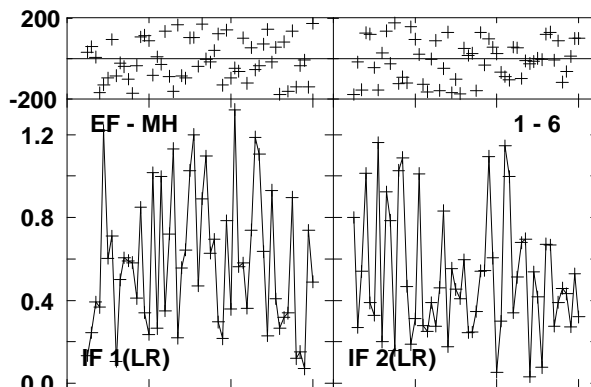
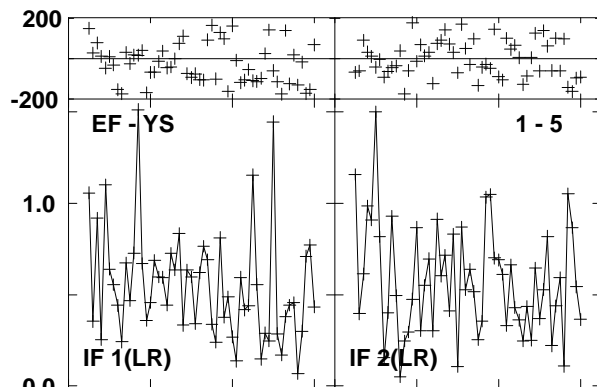
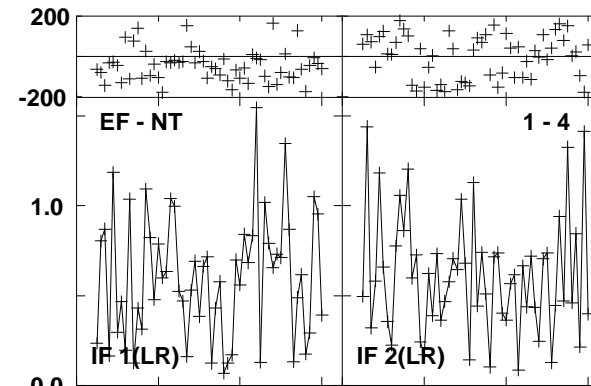
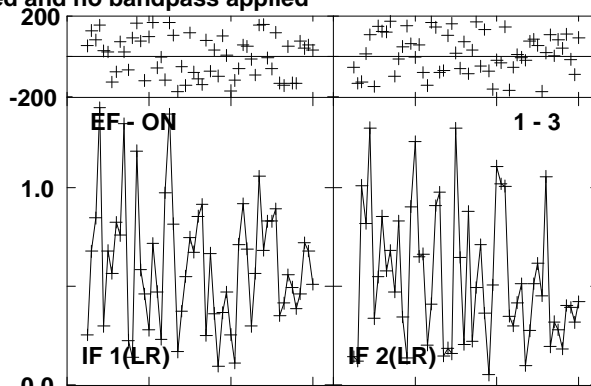
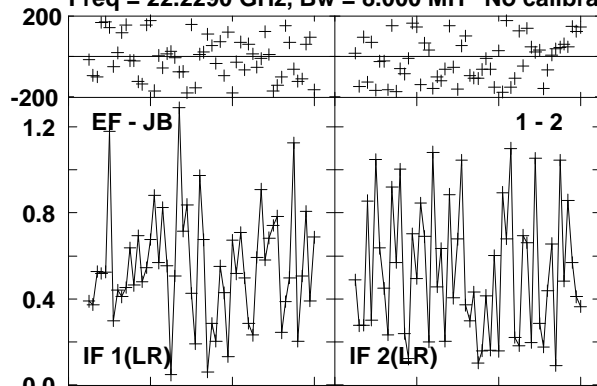

Lower frame: Milli Ampl Jy Top frame: Phas deg
Vector averaged cross-power spectrum Several baselines displayed
Timerange: 00/10:51:21 to 00/10:52:16

Plot file version 45 created 17-SEP-2012 12:02:29

ORIKL1 EE008D 1.UVDATA.1

Freq = 22.2290 GHz, Bw = 8.000 MH No calibration applied and no bandpass applied

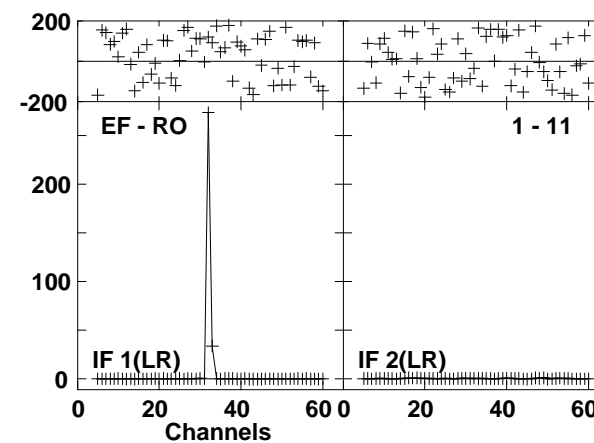
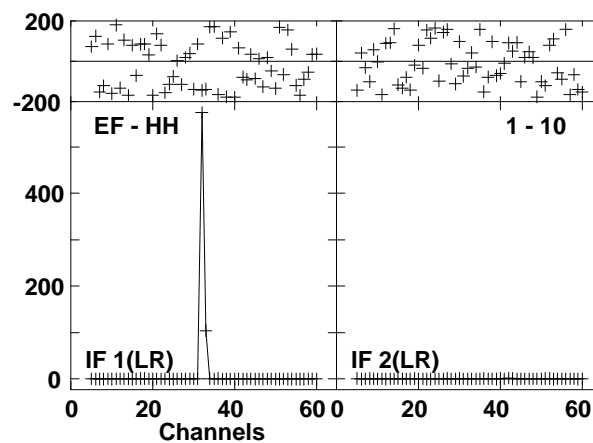
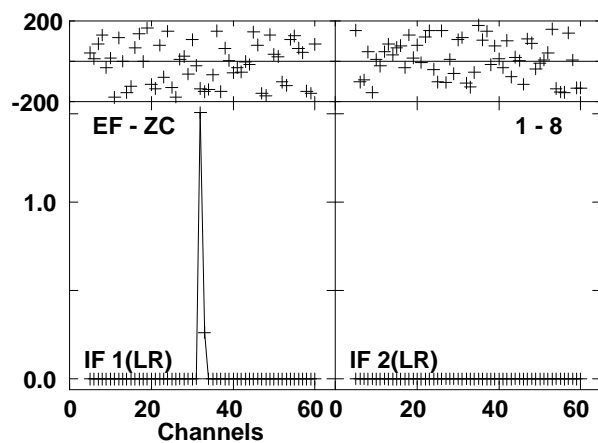
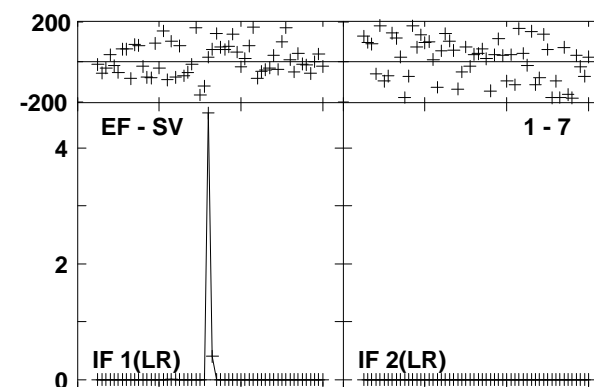
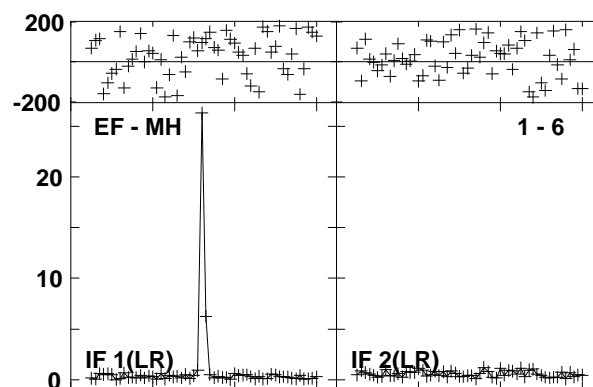
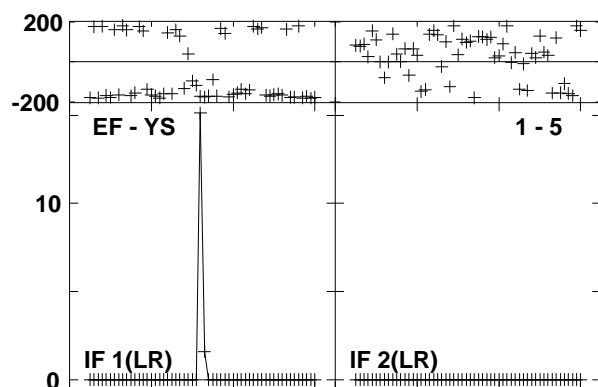
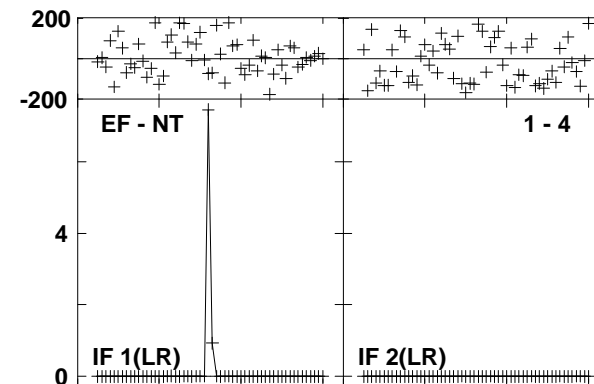
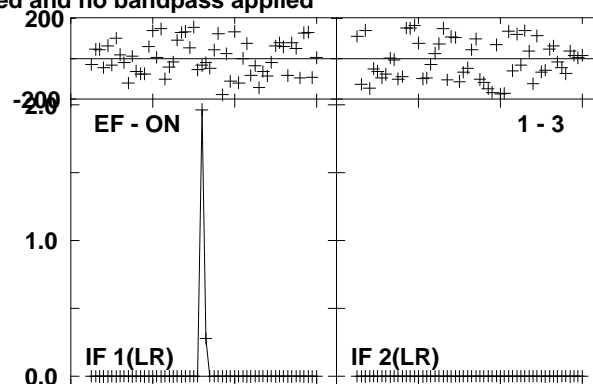
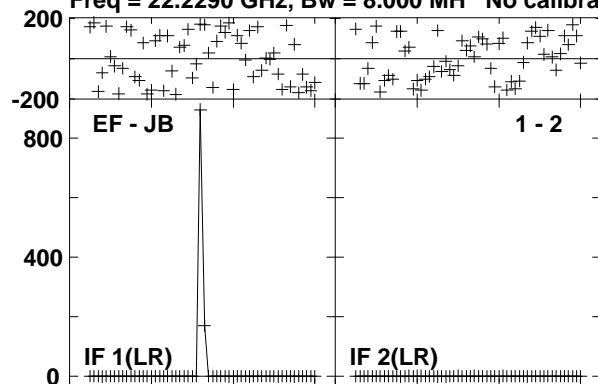

Lower frame: Milli Ampl Jy Top frame: Phas deg
Vector averaged cross-power spectrum Several baselines displayed
Timerange: 00/10:52:21 to 00/10:53:16

Plot file version 46 created 17-SEP-2012 12:02:32

J0541-0541 EE008D 1.UVDATA.1

Freq = 22.2290 GHz, Bw = 8.000 MH No calibration applied and no bandpass applied

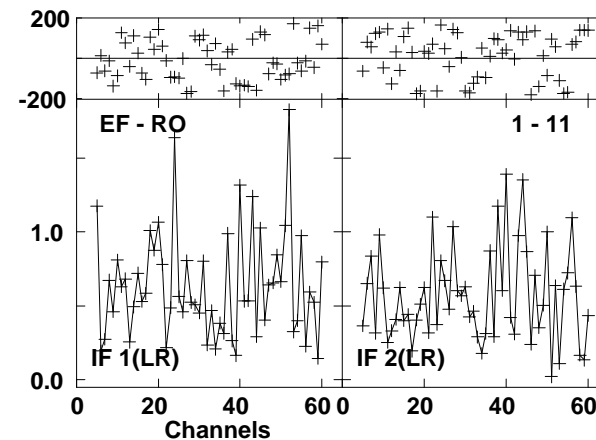
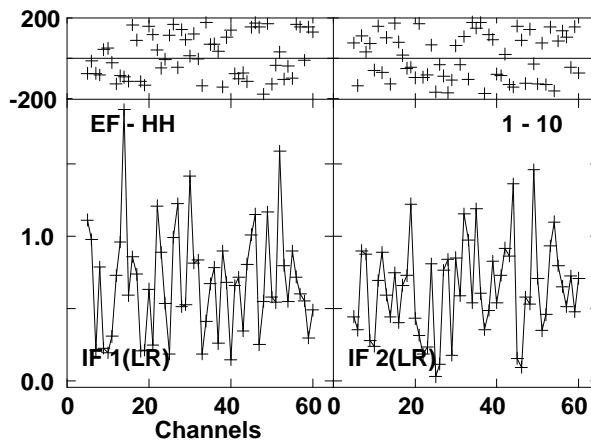
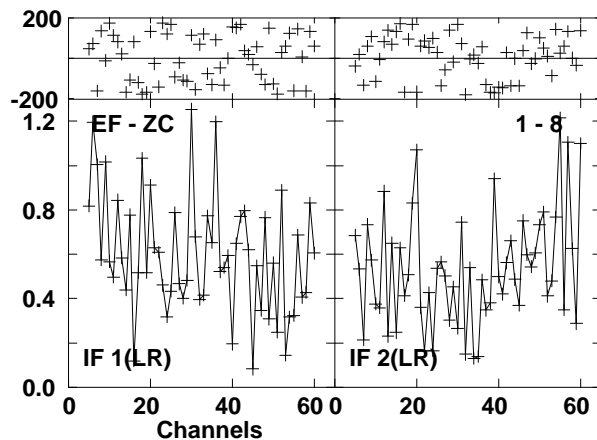
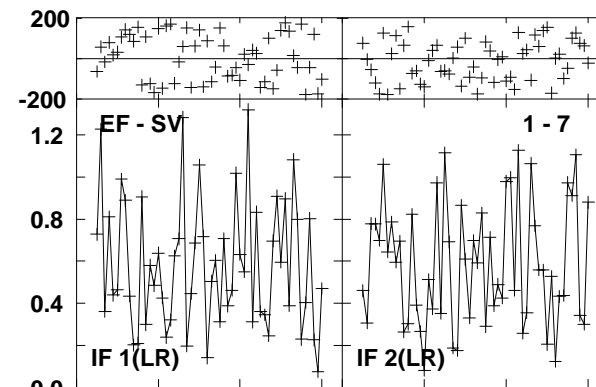
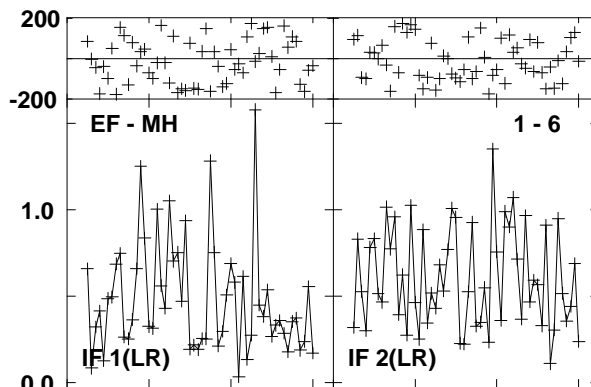
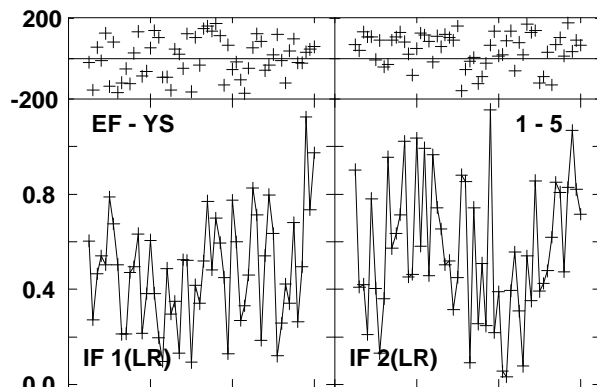
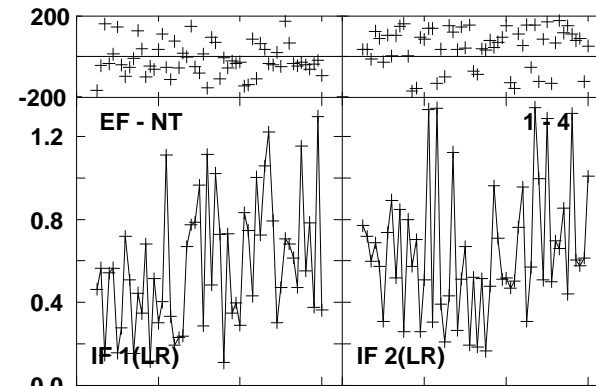
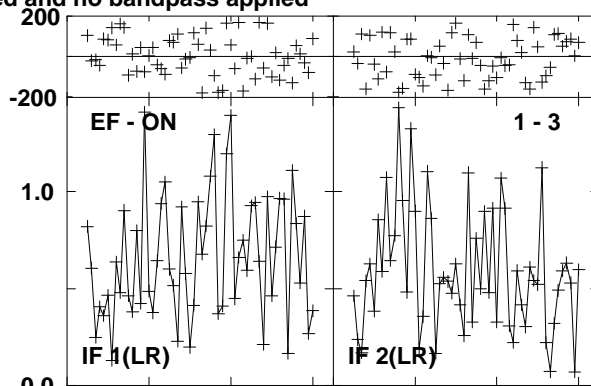
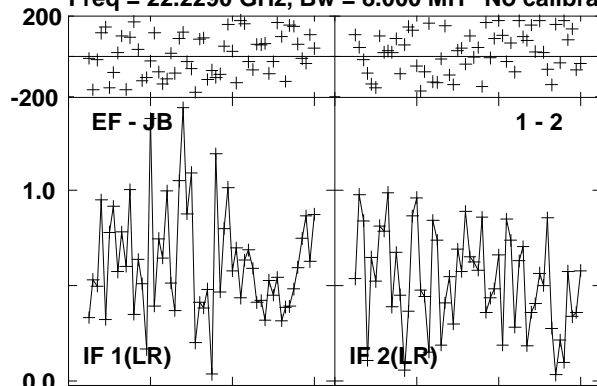

Lower frame: Milli Ampl Jy Top frame: Phas deg
Vector averaged cross-power spectrum Several baselines displayed
Timerange: 00/10:53:21 to 00/10:54:16

Plot file version 47 created 17-SEP-2012 12:02:34

J0529-0519 EE008D 1.UVDATA.1

Freq = 22.2290 GHz, Bw = 8.000 MH No calibration applied and no bandpass applied

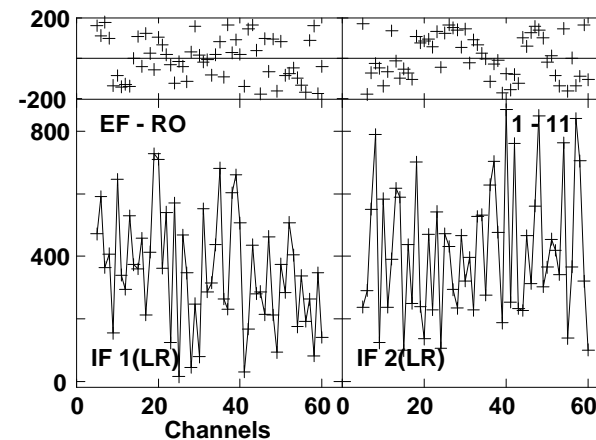
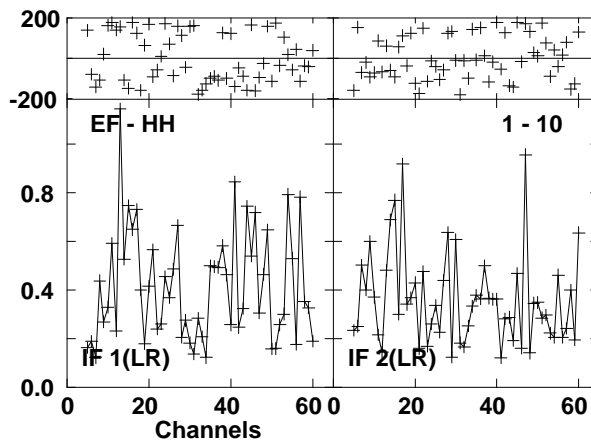
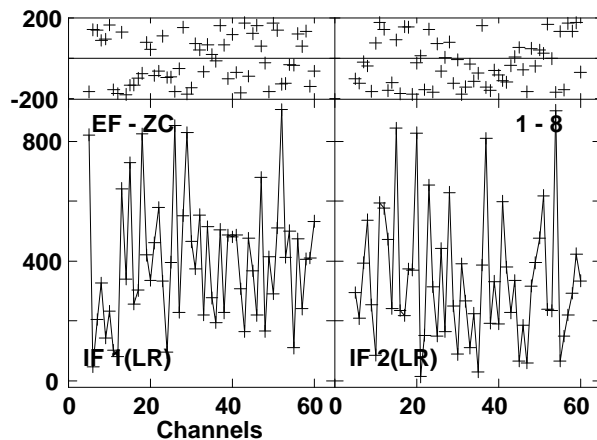
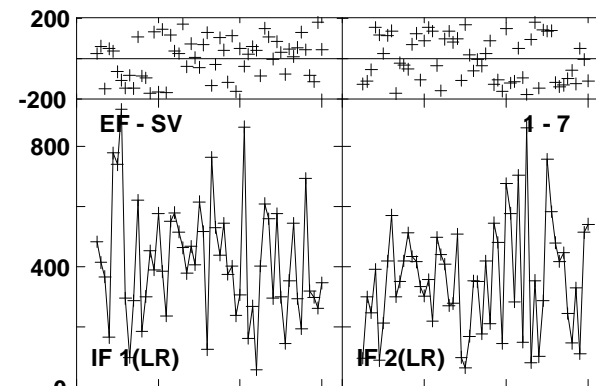
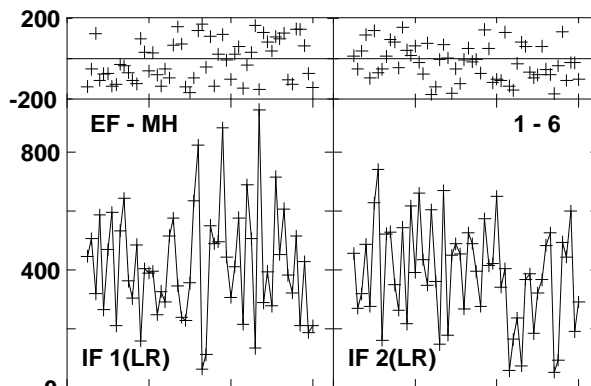
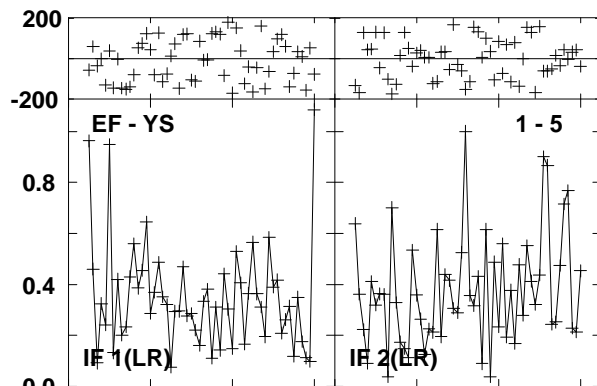
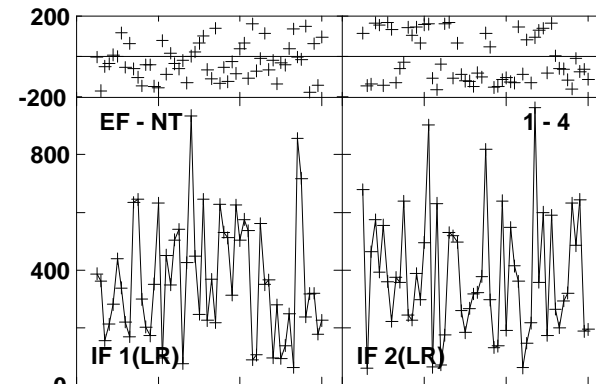
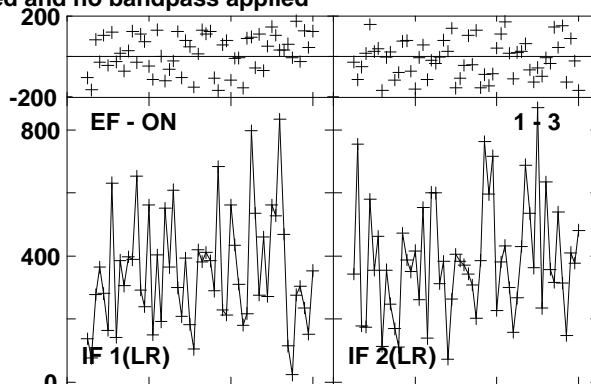
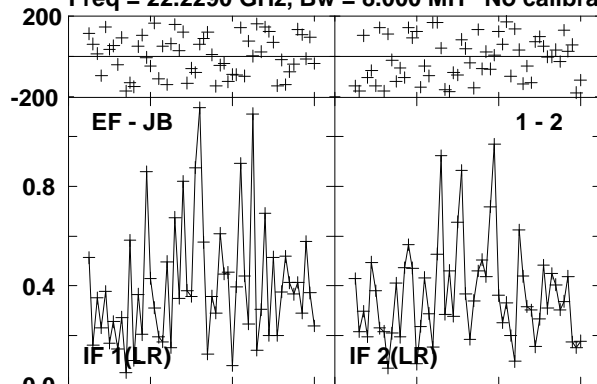

Lower frame: Milli Ampl Jy Top frame: Phas deg
Vector averaged cross-power spectrum Several baselines displayed
Timerange: 00/10:55:02 to 00/10:56:01

Plot file version 48 created 17-SEP-2012 12:02:38

ORIKL1 EE008D 1.UVDATA.1

Freq = 22.2290 GHz, Bw = 8.000 MH No calibration applied and no bandpass applied

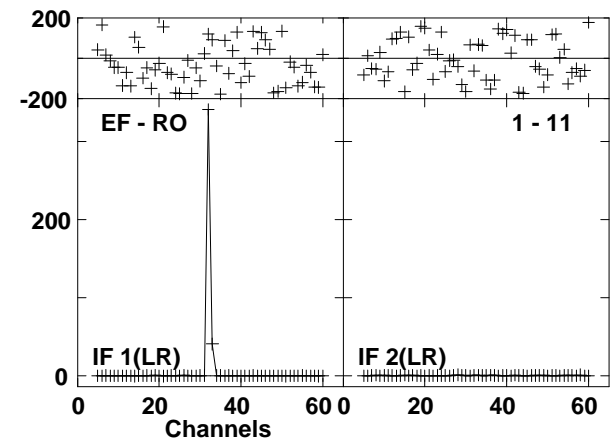
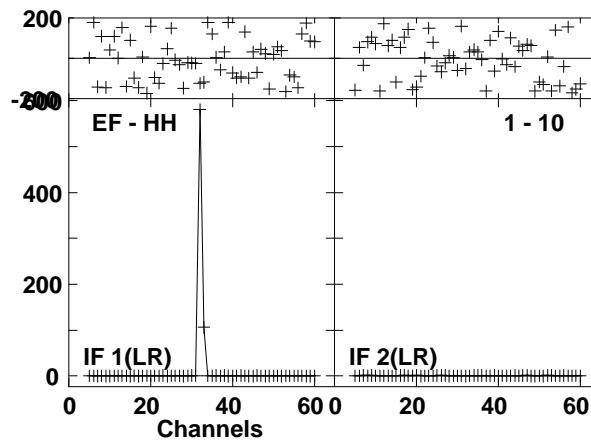
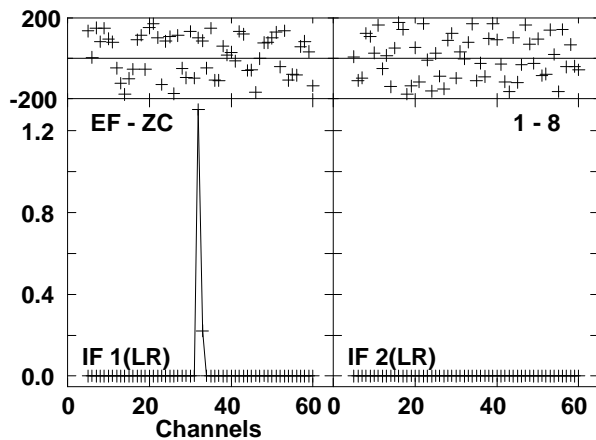
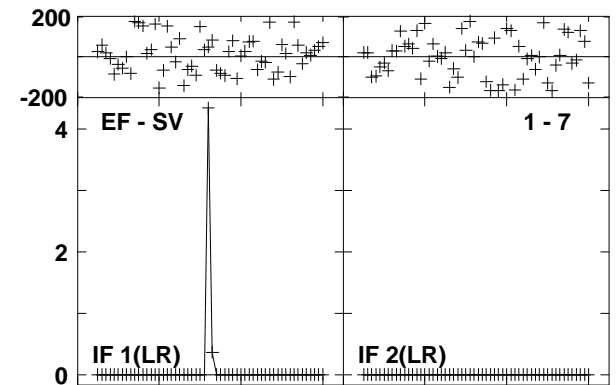
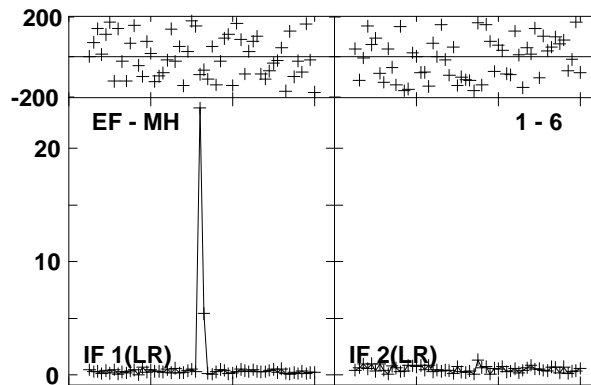
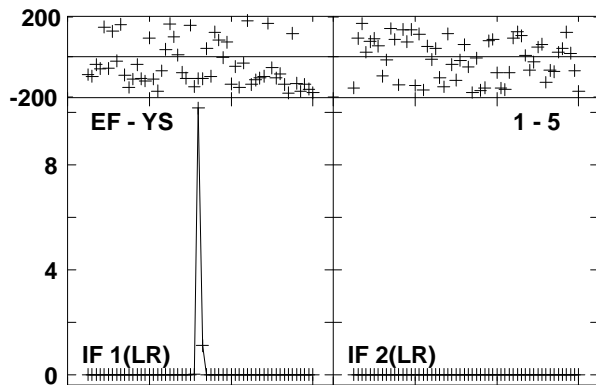
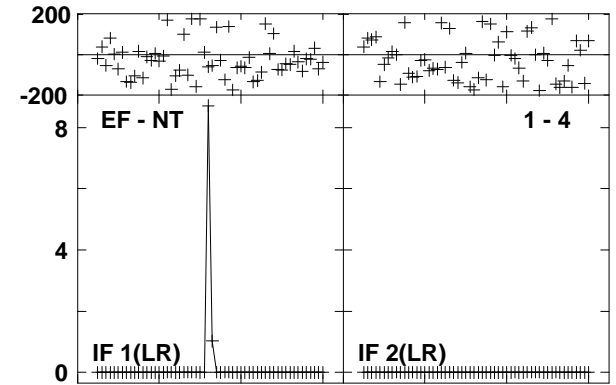
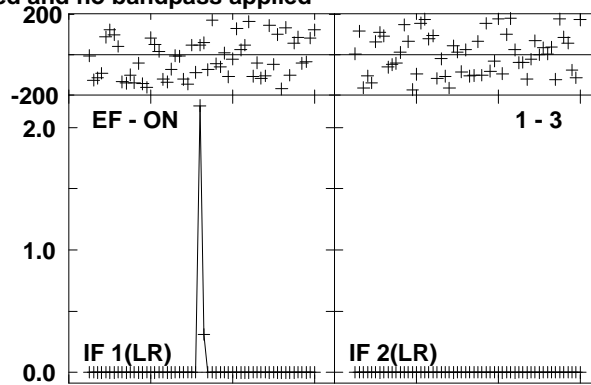
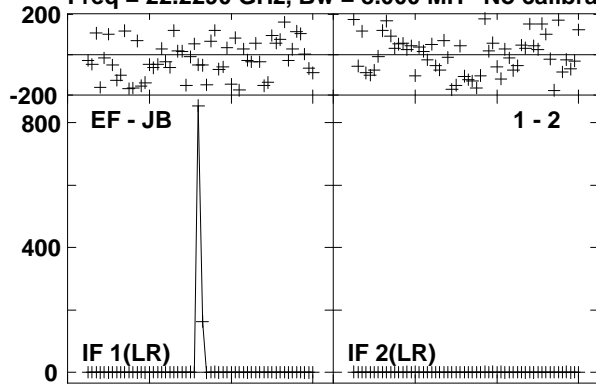

Lower frame: Milli Ampl Jy Top frame: Phas deg
Vector averaged cross-power spectrum Several baselines displayed
Timerange: 00/10:56:05 to 00/10:57:01

Plot file version 49 created 17-SEP-2012 12:02:41

J0529-0519 EE008D 1.UVDATA.1

Freq = 22.2290 GHz, Bw = 8.000 MH No calibration applied and no bandpass applied

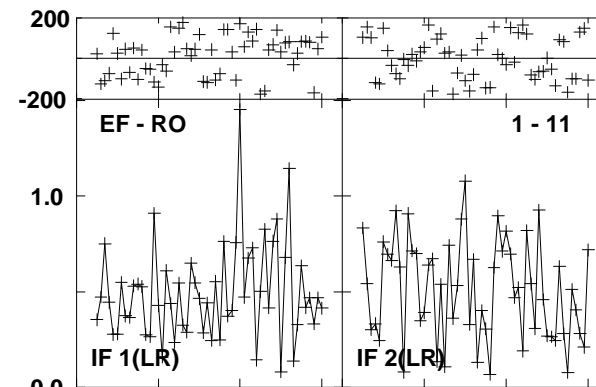
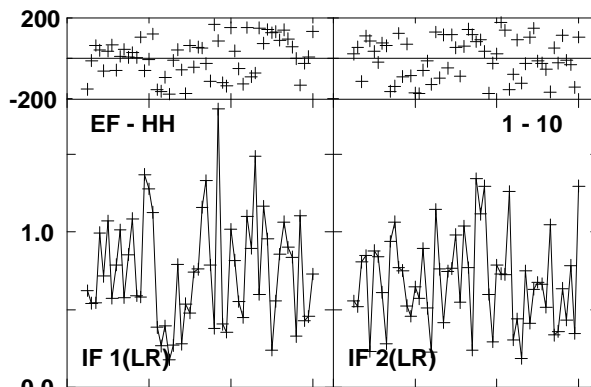
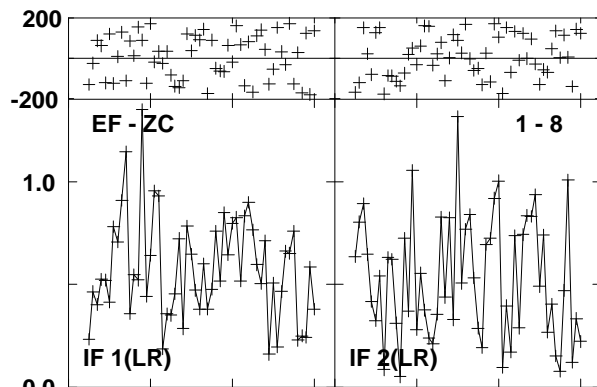
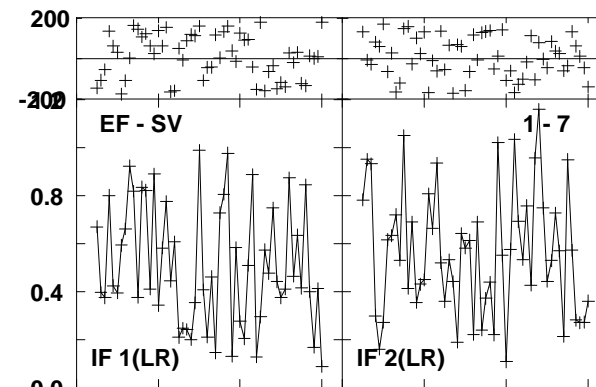
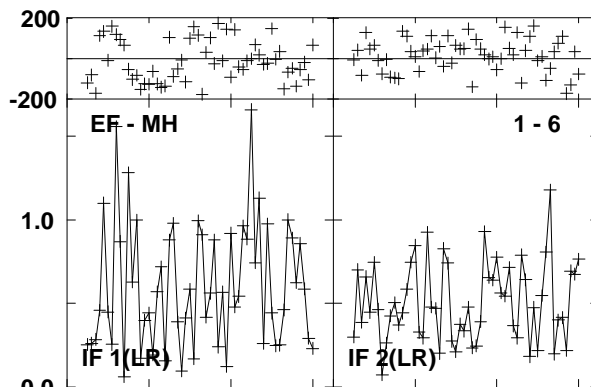
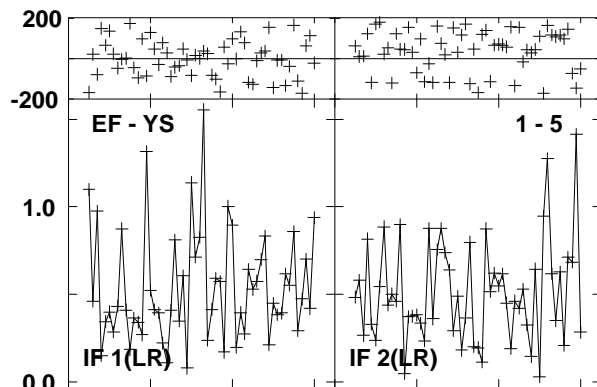
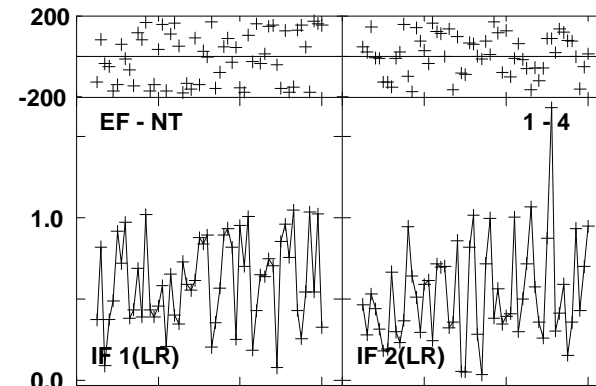
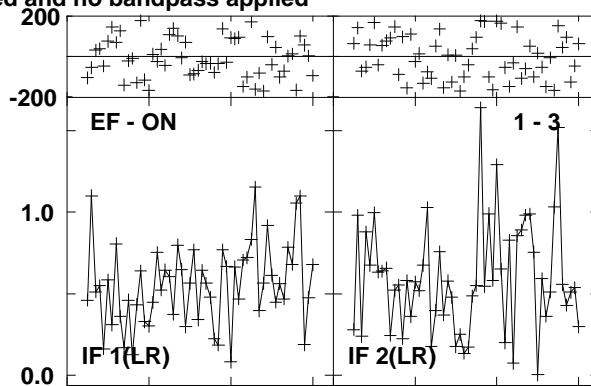
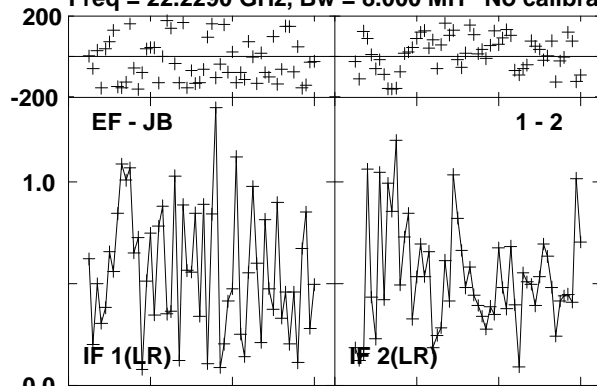

Lower frame: Milli Ampl Jy Top frame: Phas deg
Vector averaged cross-power spectrum Several baselines displayed
Timerange: 00/10:57:06 to 00/10:58:01

Plot file version 50 created 17-SEP-2012 12:02:43

ORIKL1 EE008D 1.UVDATA.1

Freq = 22.2290 GHz, Bw = 8.000 MH No calibration applied and no bandpass applied

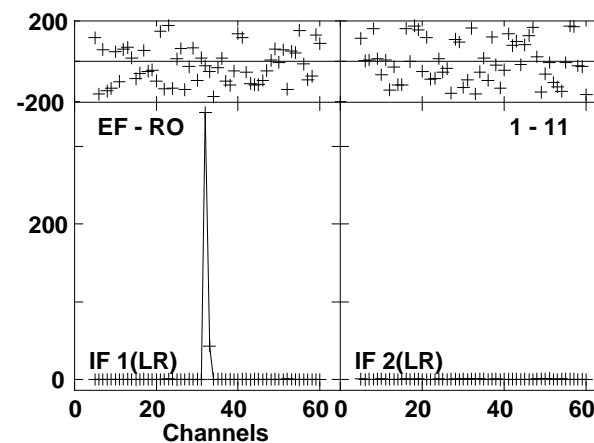
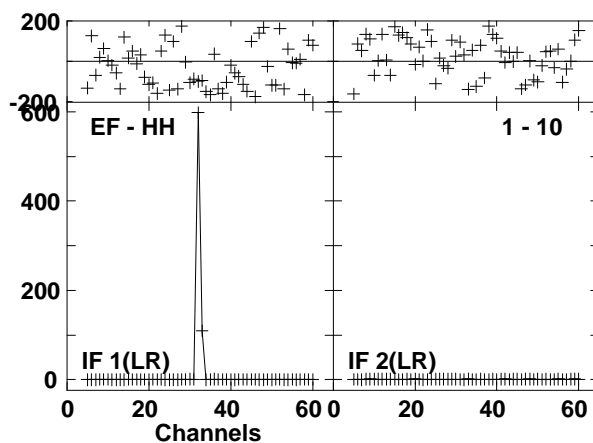
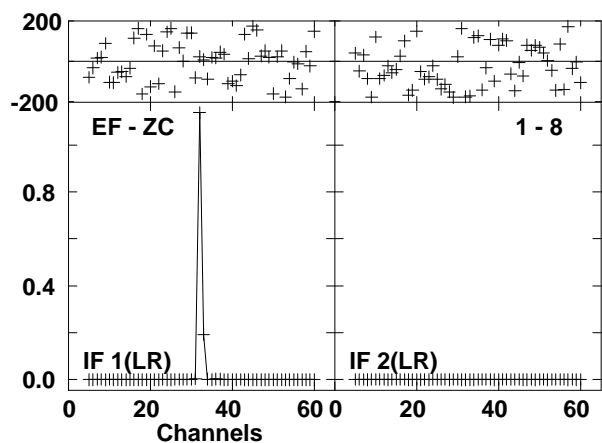
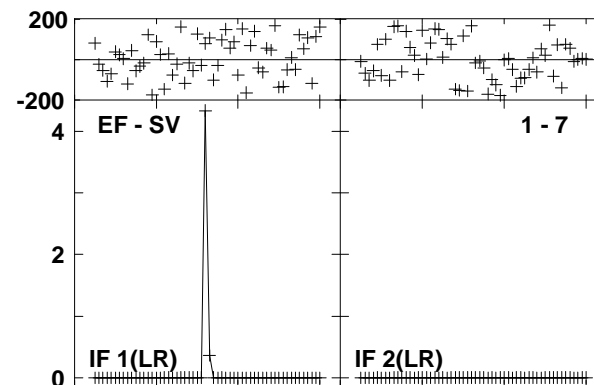
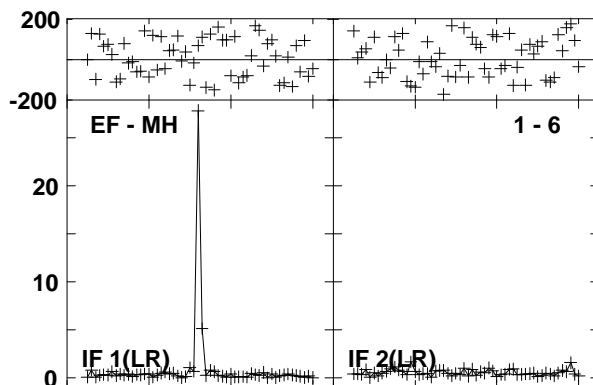
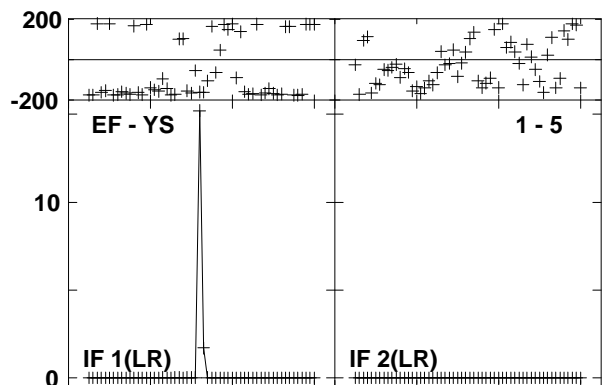
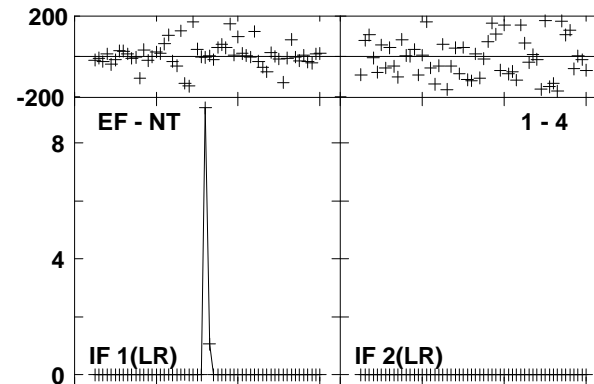
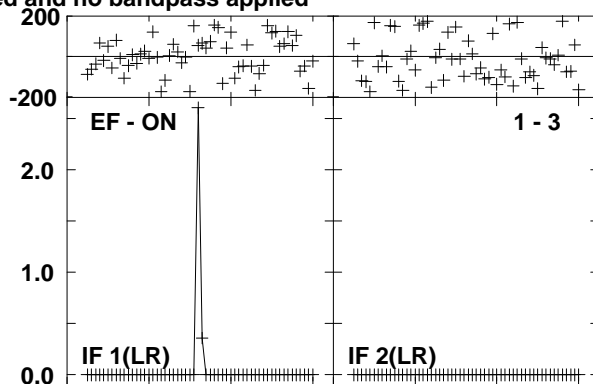
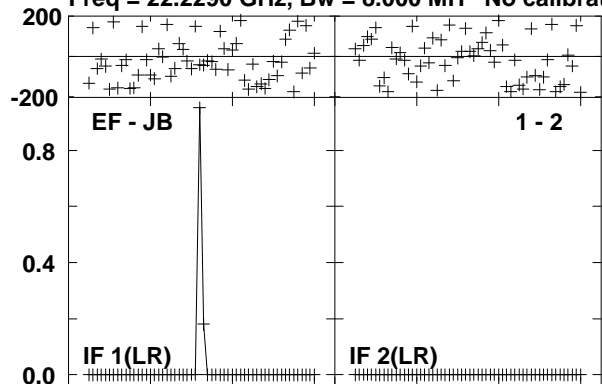

Lower frame: Ampl Jy Top frame: Phas deg
Vector averaged cross-power spectrum Several baselines displayed
Timerange: 00/10:58:06 to 00/10:59:01

Plot file version 51 created 17-SEP-2012 12:02:45

J0529-0519 EE008D 1.UVDATA.1

Freq = 22.2290 GHz, Bw = 8.000 MH No calibration applied and no bandpass applied

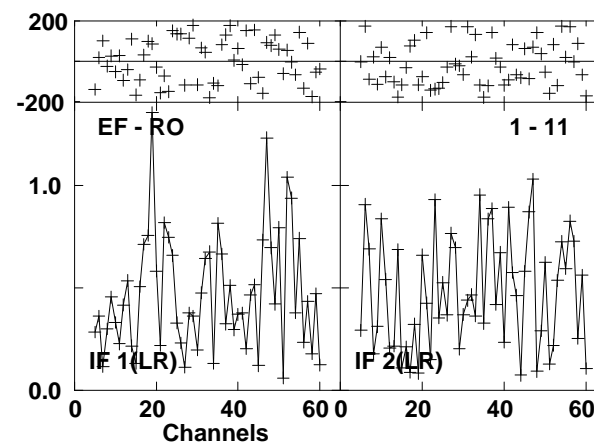
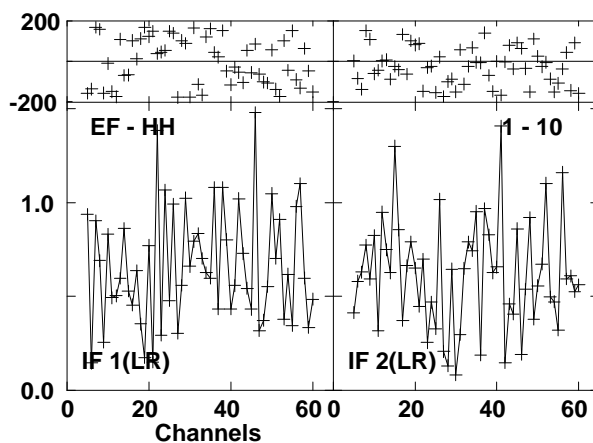
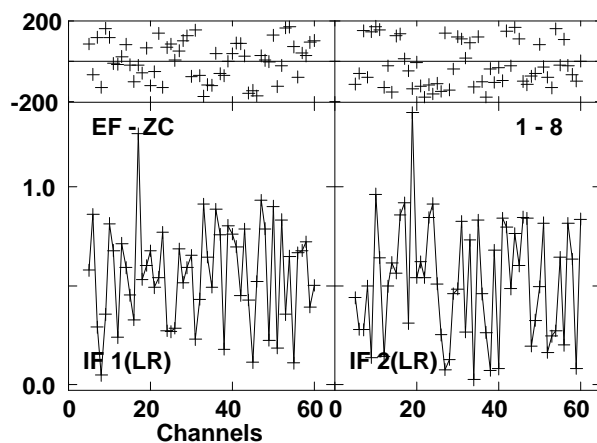
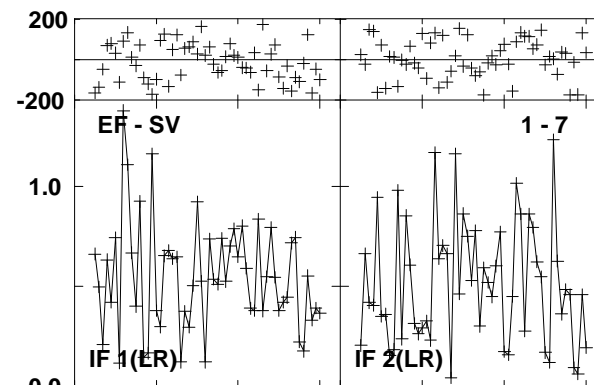
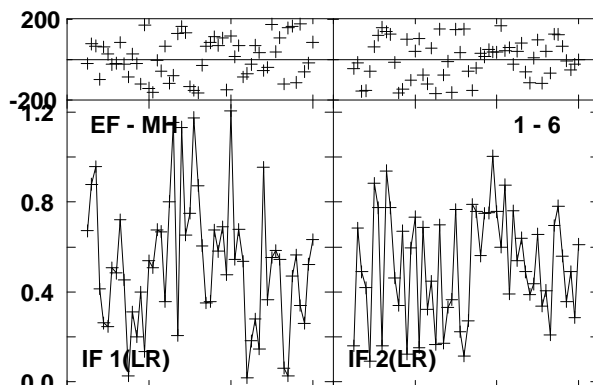
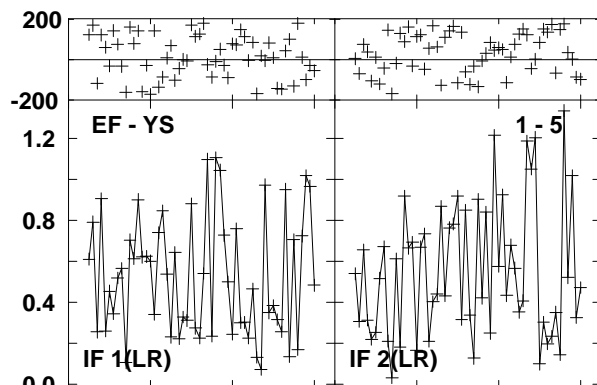
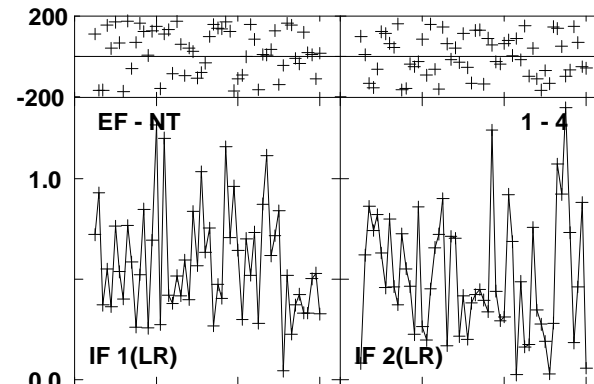
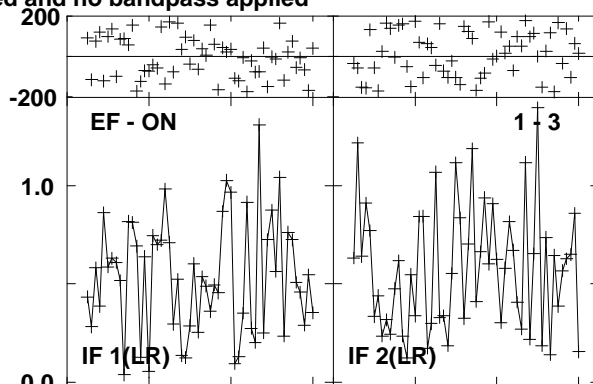
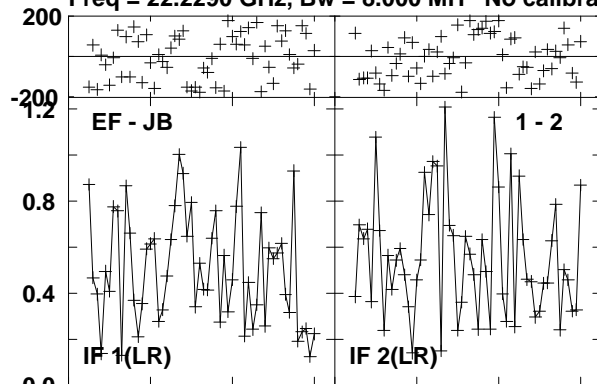

Lower frame: Milli Ampl Jy Top frame: Phas deg
Vector averaged cross-power spectrum Several baselines displayed
Timerange: 00/10:59:07 to 00/11:00:01

Plot file version 52 created 17-SEP-2012 12:02:48

J0541-0541 EE008D 1.UVDATA.1

Freq = 22.2290 GHz, Bw = 8.000 MH No calibration applied and no bandpass applied

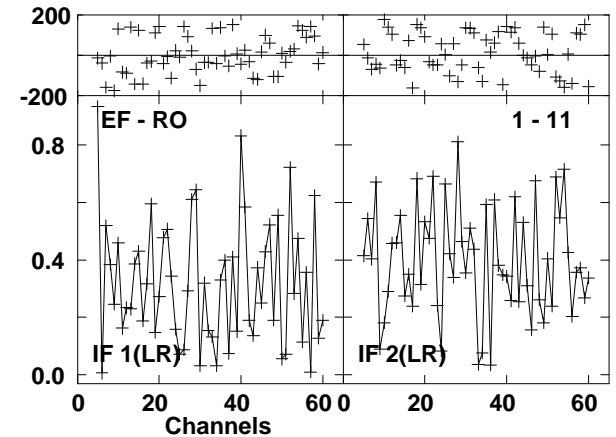
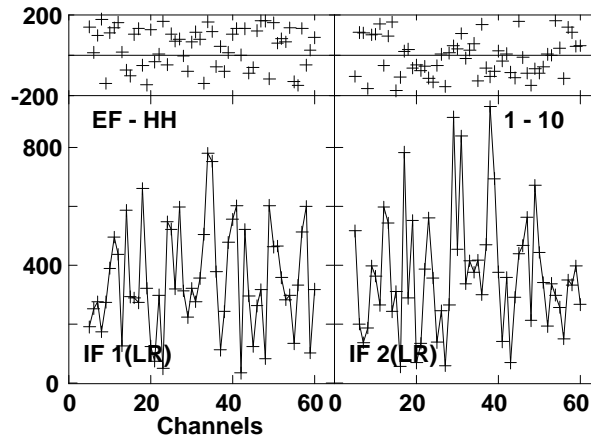
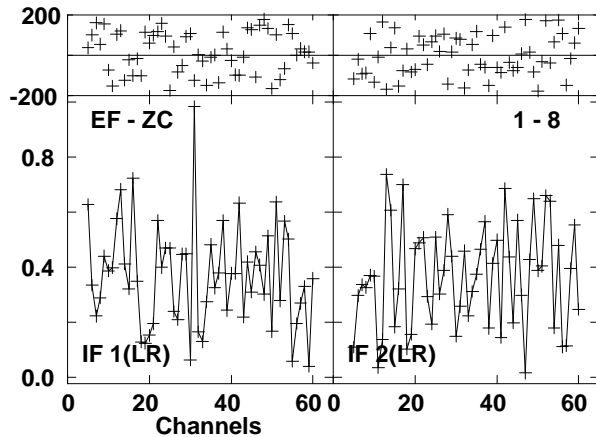
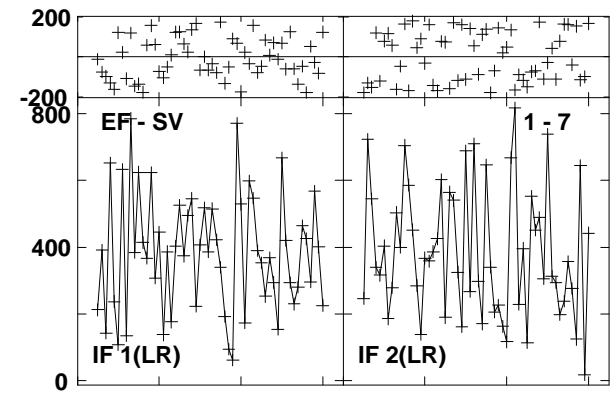
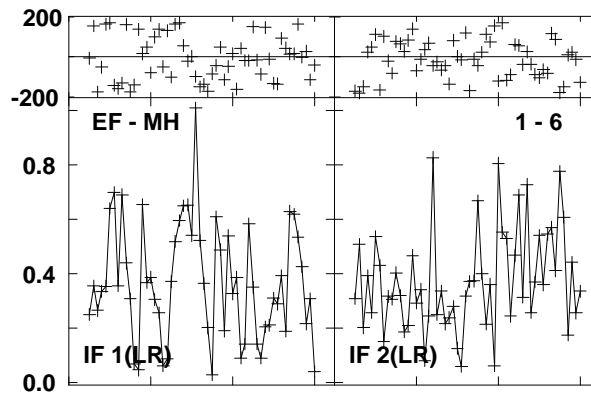
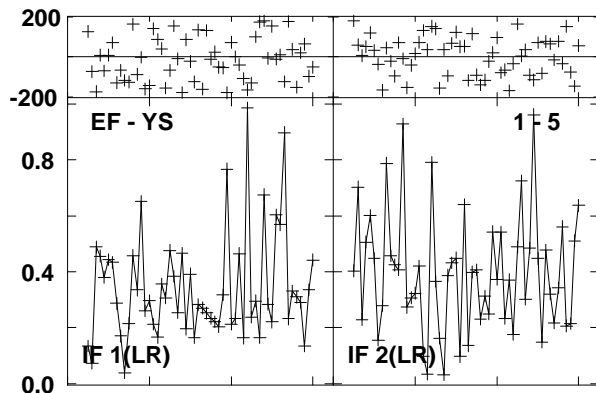
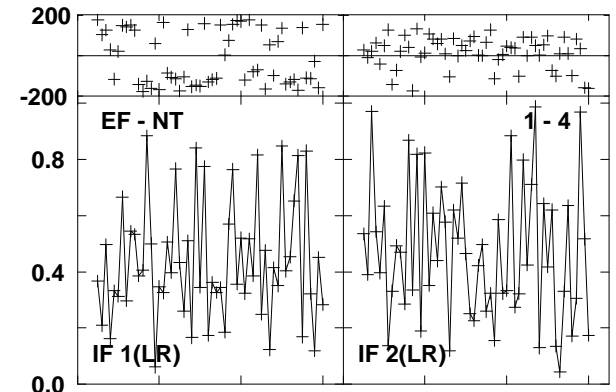
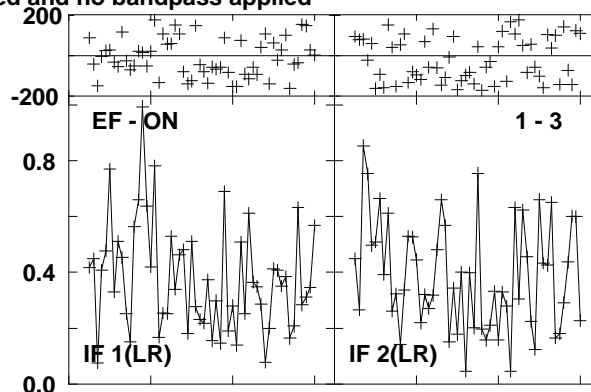
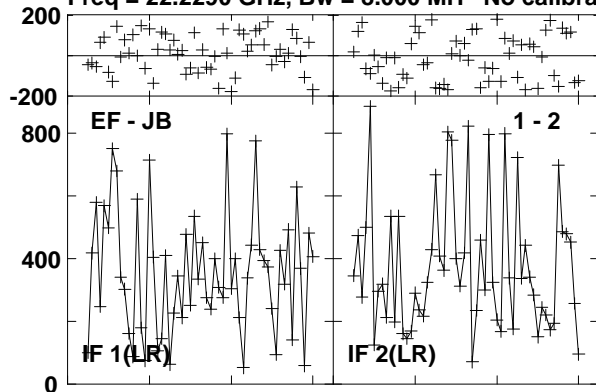

Lower frame: Micro Ampl Jy Top frame: Phas deg
Vector averaged cross-power spectrum Several baselines displayed
Timerange: 00/11:00:47 to 00/11:01:46

Plot file version 53 created 17-SEP-2012 12:02:51

ORIKL1 EE008D 1.UVDATA.1

Freq = 22.2290 GHz, Bw = 8.000 MH No calibration applied and no bandpass applied

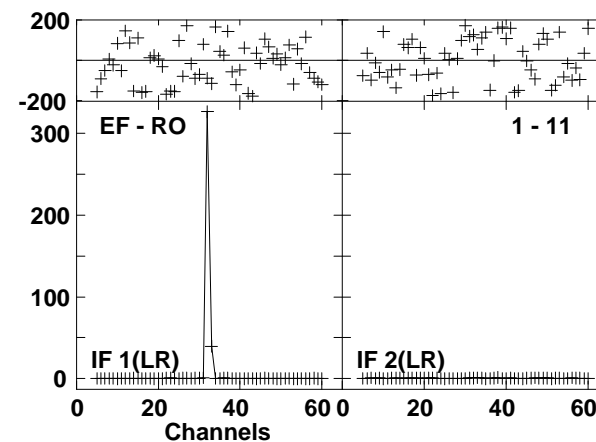
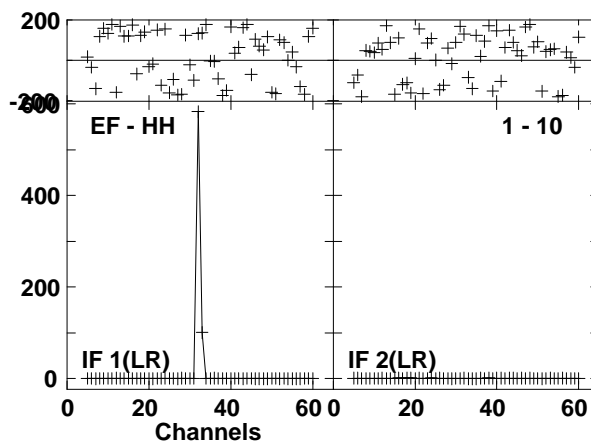
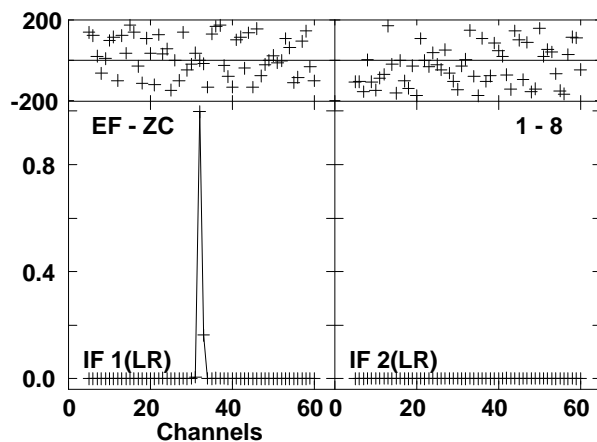
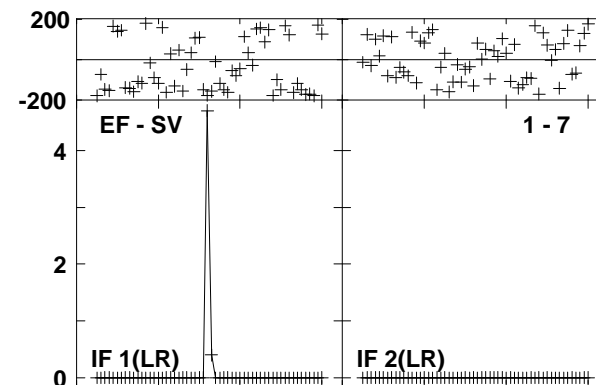
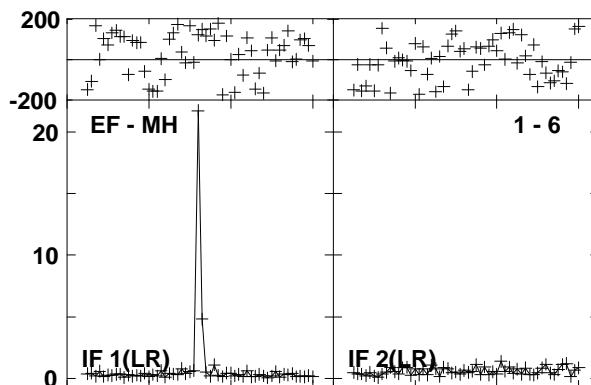
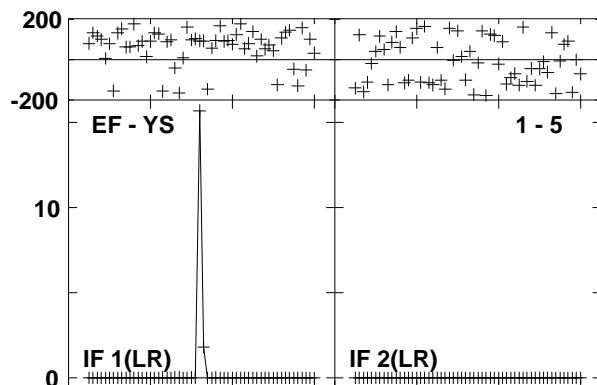
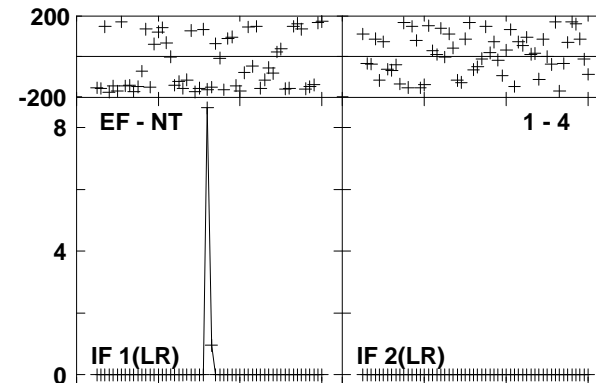
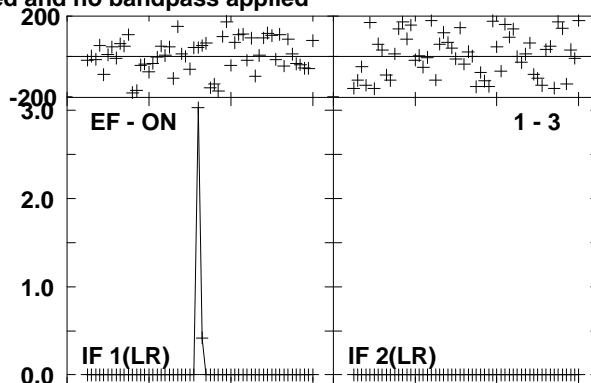
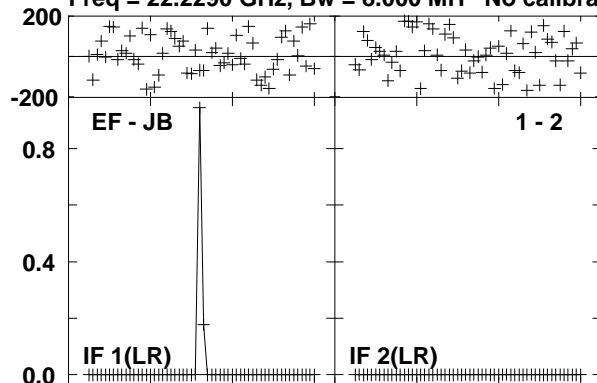

Lower frame: Ampl Jy Top frame: Phas deg
Vector averaged cross-power spectrum Several baselines displayed
Timerange: 00/11:01:50 to 00/11:02:46

Plot file version 54 created 17-SEP-2012 12:02:53

J0541-0541 EE008D 1.UVDATA.1

Freq = 22.2290 GHz, Bw = 8.000 MH No calibration applied and no bandpass applied

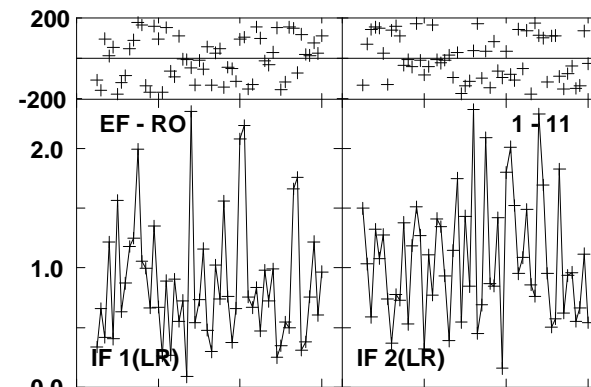
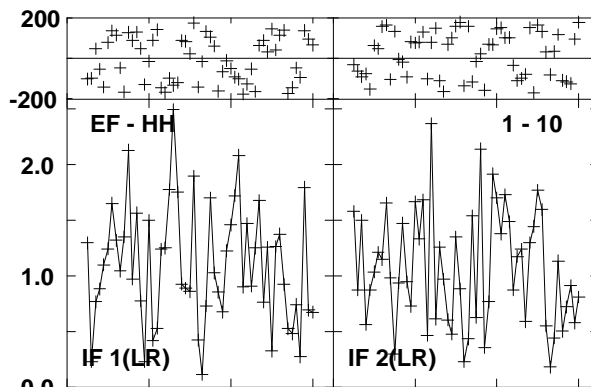
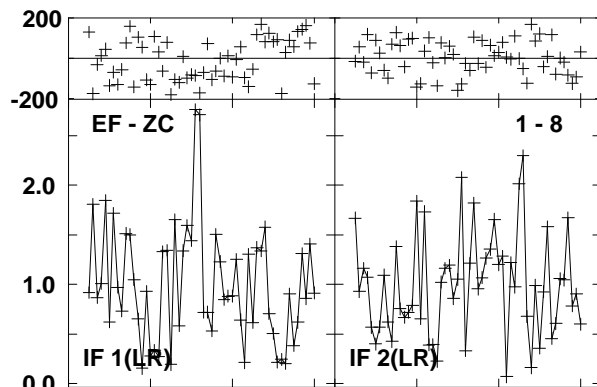
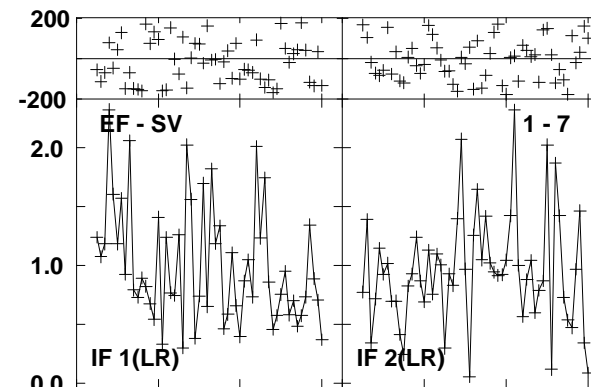
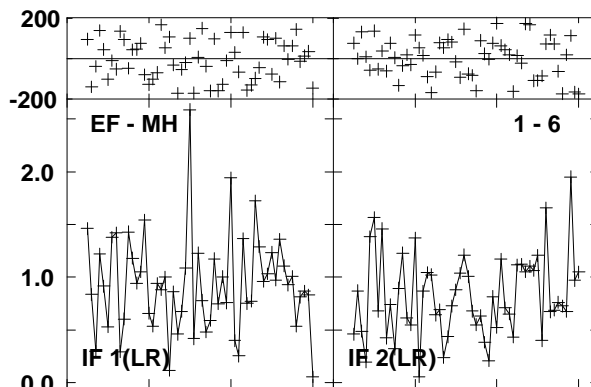
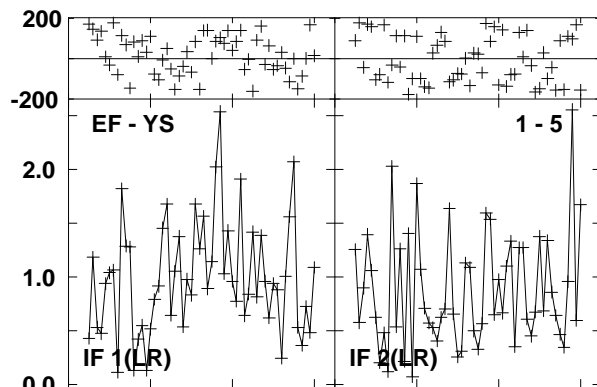
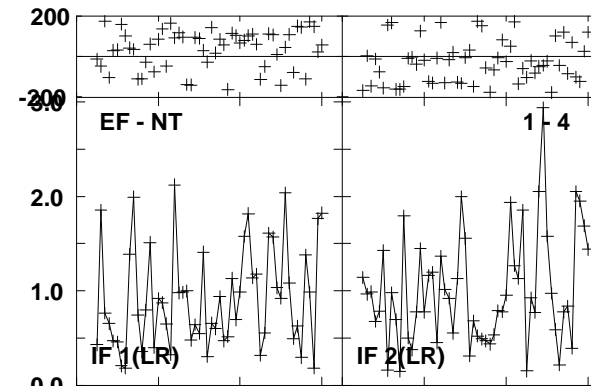
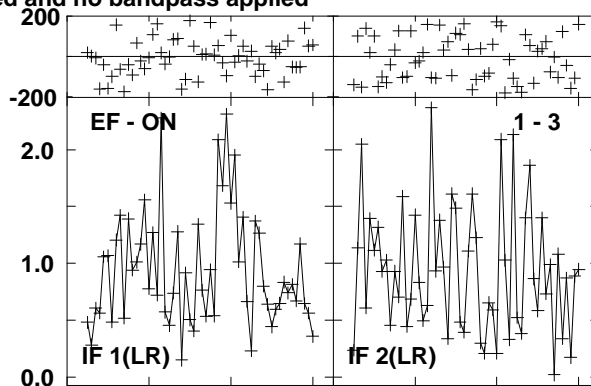
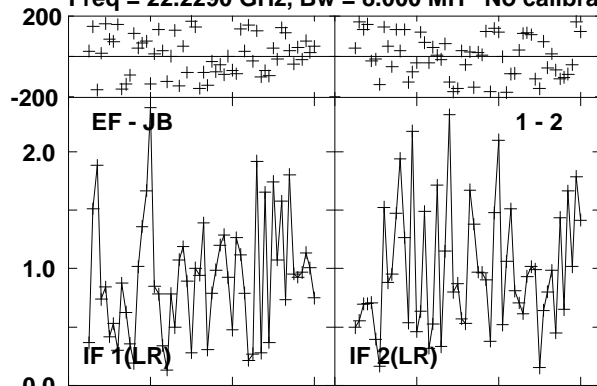

Lower frame: Milli Ampl Jy Top frame: Phas deg
Vector averaged cross-power spectrum Several baselines displayed
Timerange: 00/11:02:51 to 00/11:03:46

Plot file version 55 created 17-SEP-2012 12:02:56

ORIKL1 EE008D 1.UVDATA.1

Freq = 22.2290 GHz, Bw = 8.000 MH No calibration applied and no bandpass applied

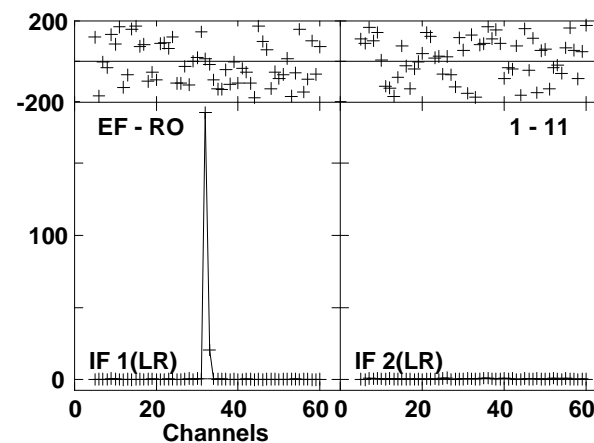
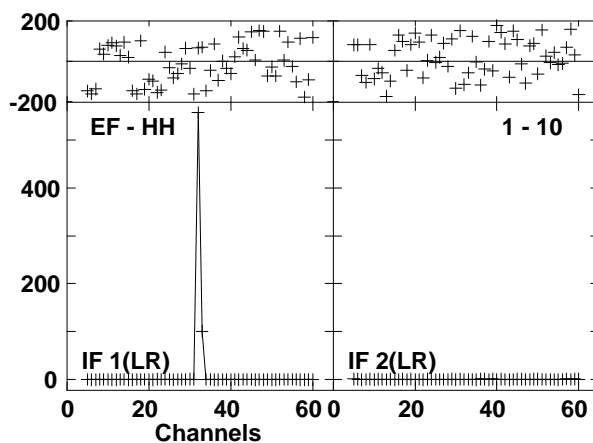
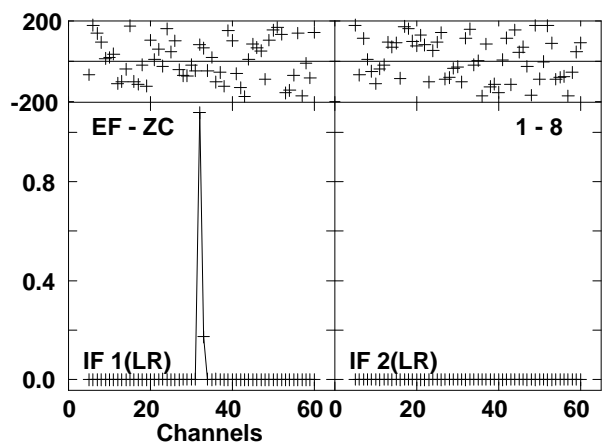
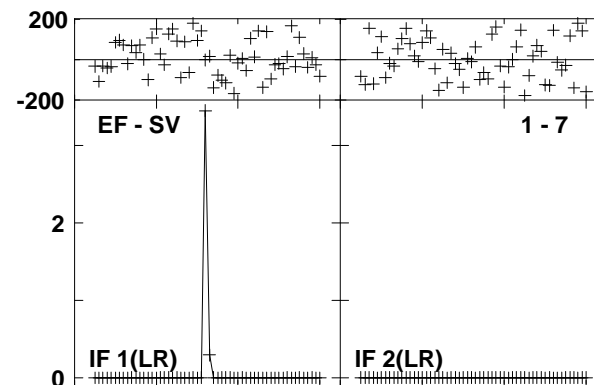
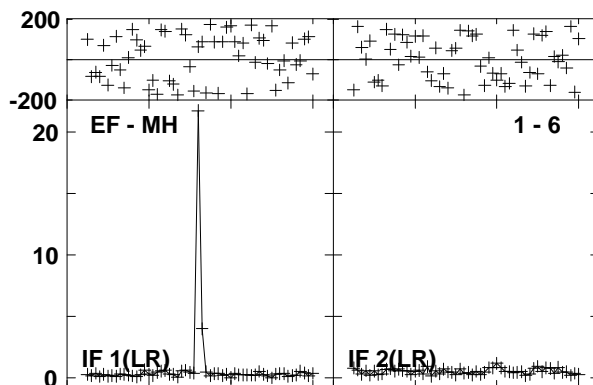
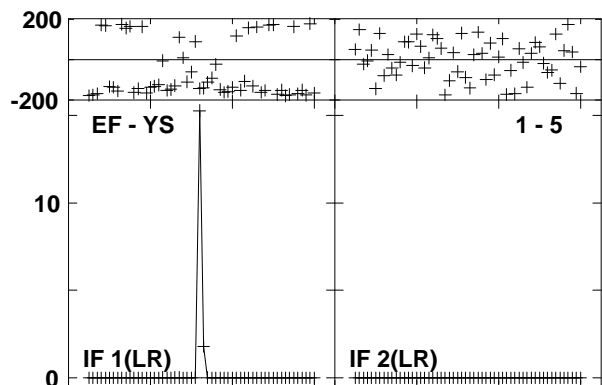
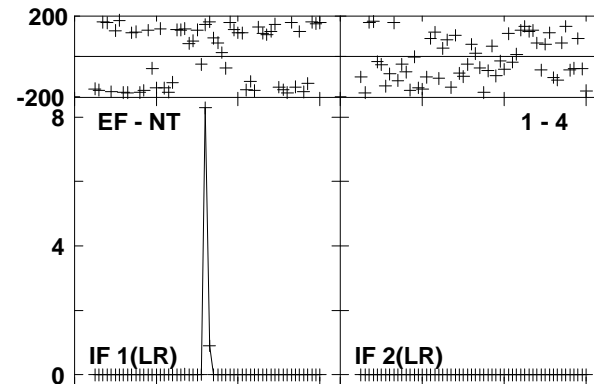
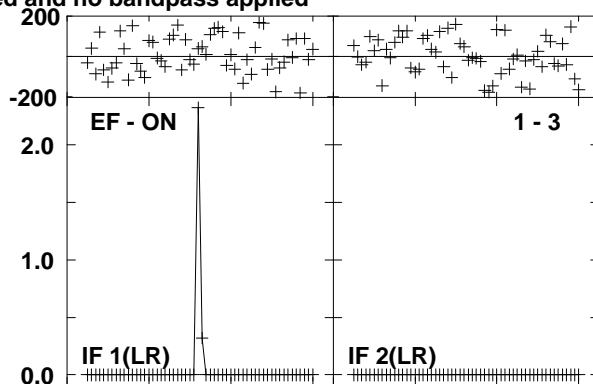
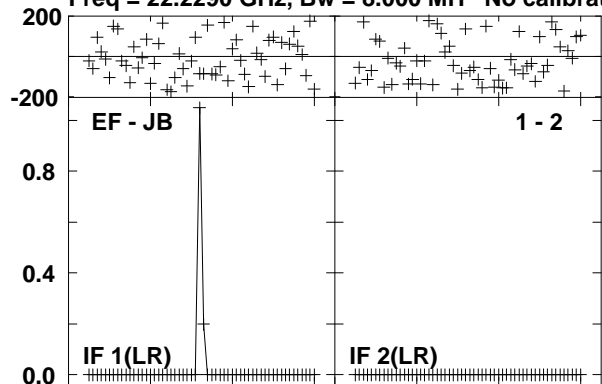

Lower frame: Ampl Jy Top frame: Phas deg
Vector averaged cross-power spectrum Several baselines displayed
Timerange: 00/11:03:51 to 00/11:04:46

Plot file version 56 created 17-SEP-2012 12:02:58

J0541-0541 EE008D 1.UVDATA.1

Freq = 22.2290 GHz, Bw = 8.000 MH No calibration applied and no bandpass applied

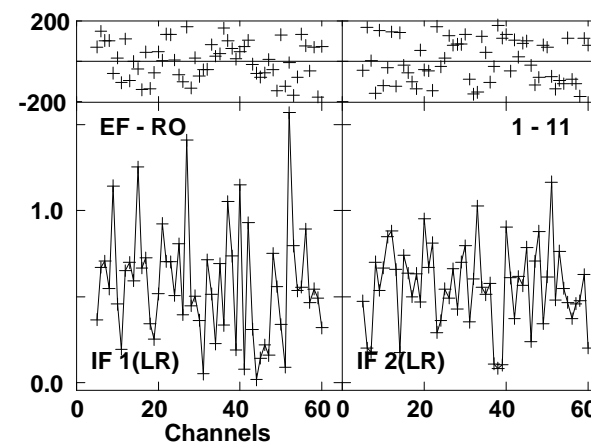
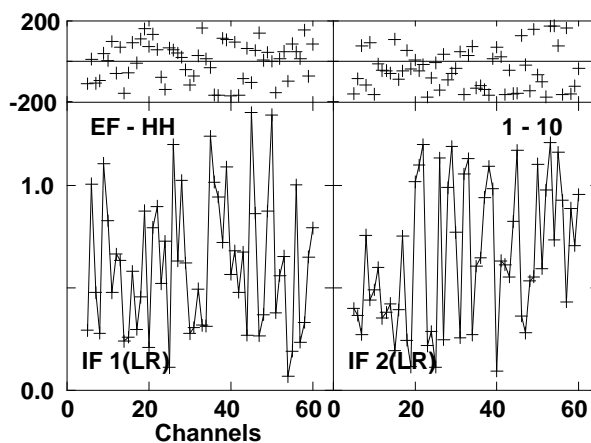
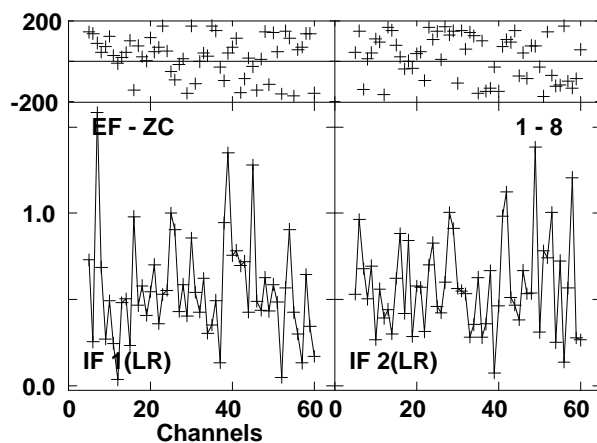
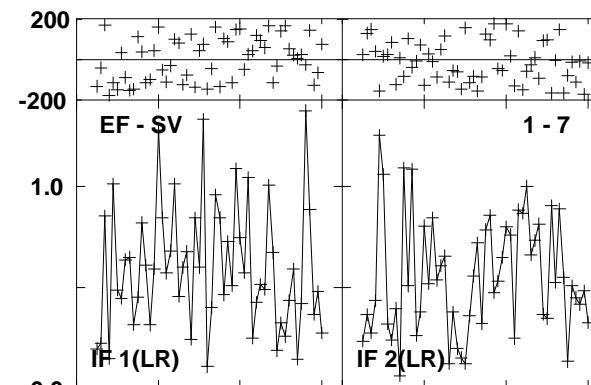
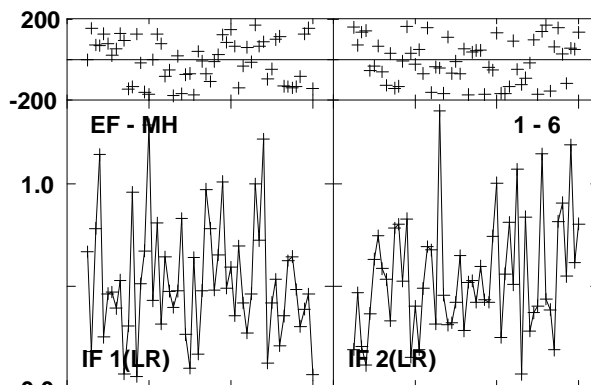
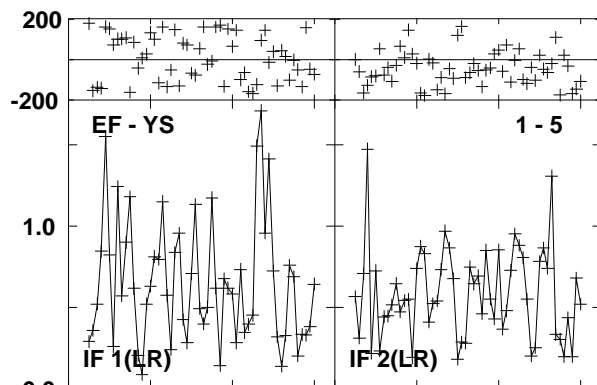
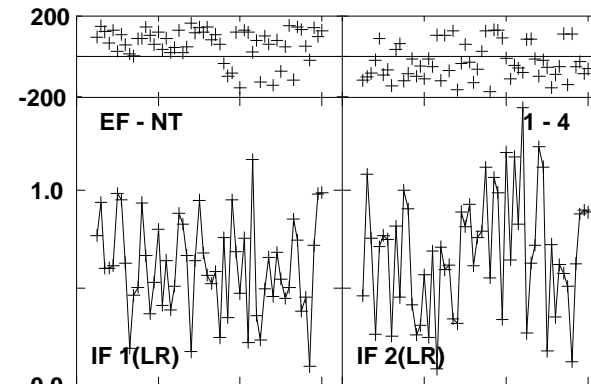
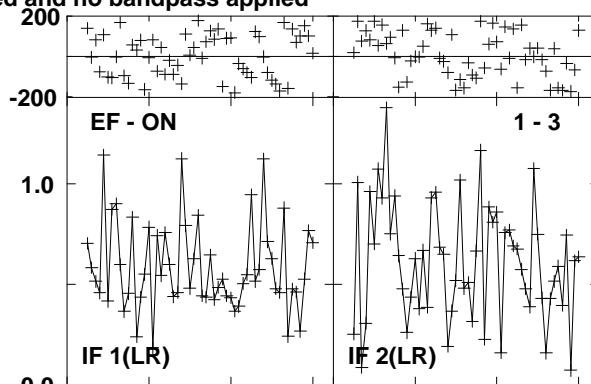
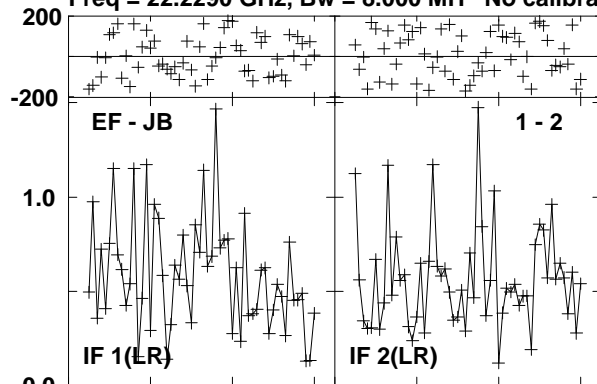

Lower frame: Milli Ampl Jy Top frame: Phas deg
Vector averaged cross-power spectrum Several baselines displayed
Timerange: 00/11:04:51 to 00/11:05:46

Plot file version 57 created 17-SEP-2012 12:03:01

J0529-0519 EE008D 1.UVDATA.1

Freq = 22.2290 GHz, Bw = 8.000 MH No calibration applied and no bandpass applied

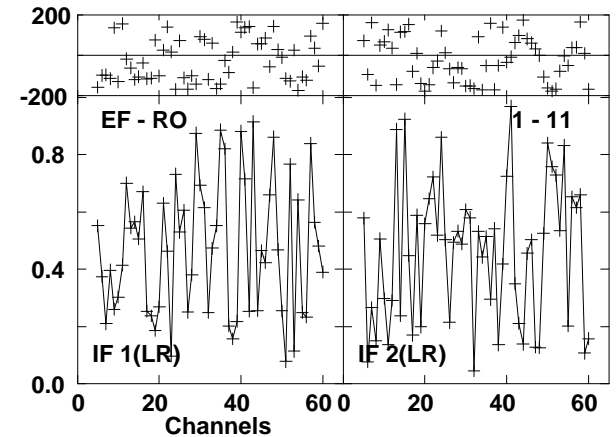
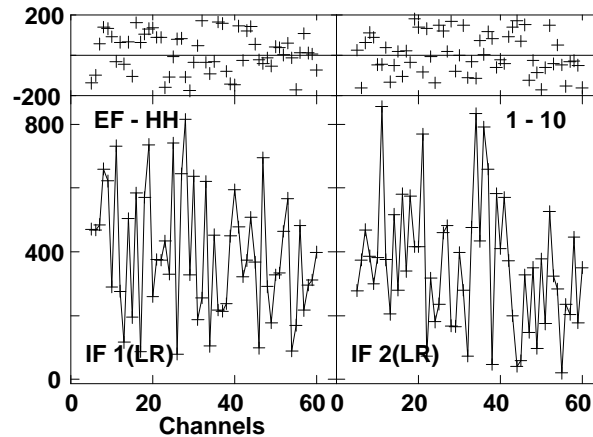
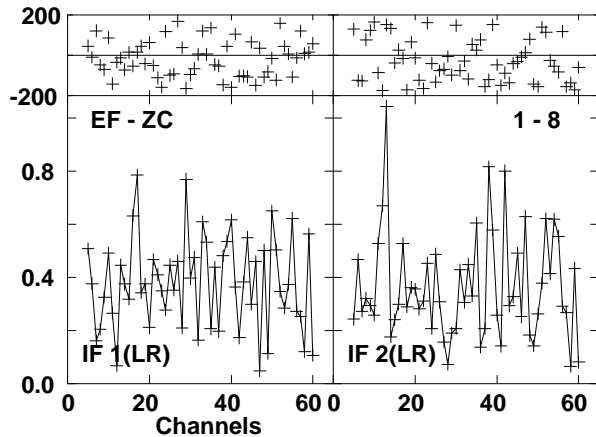
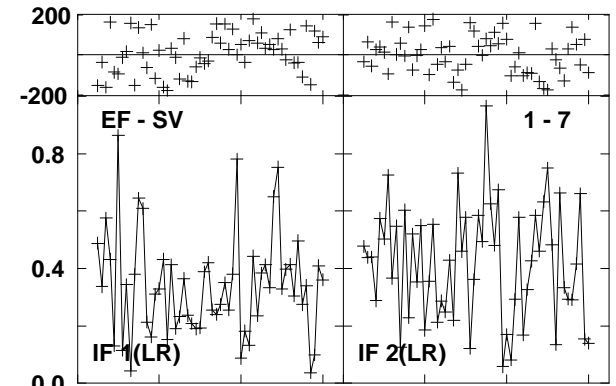
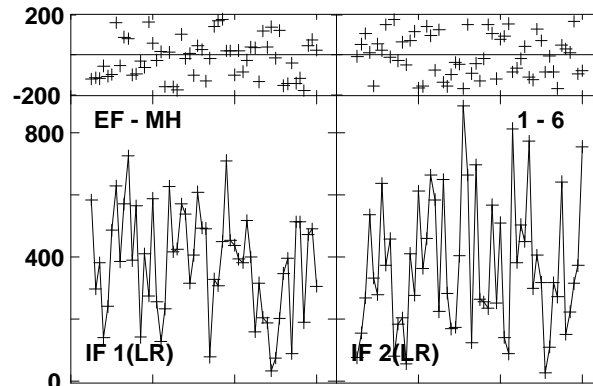
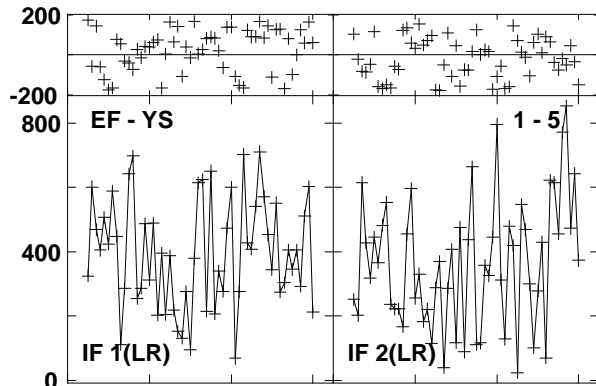
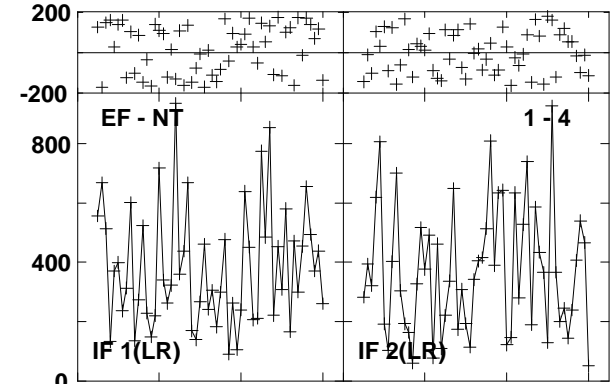
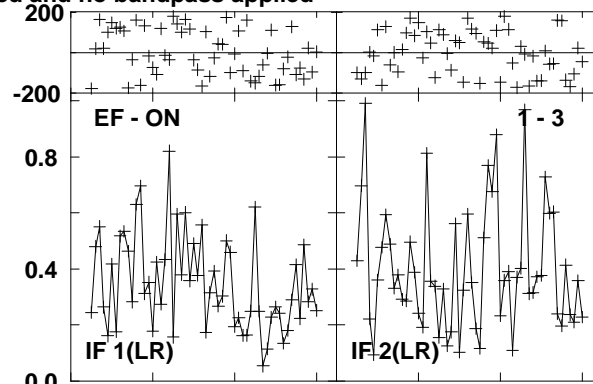
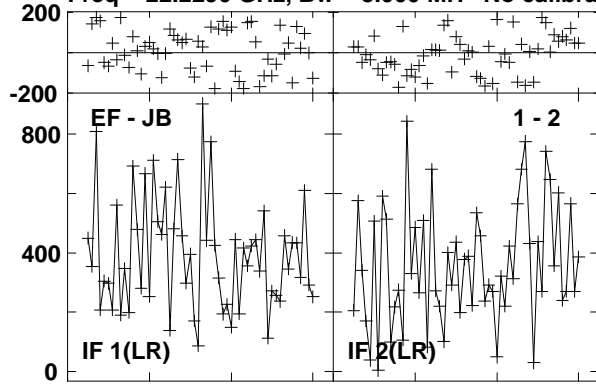

Lower frame: Micro Ampl Jy Top frame: Phas deg
Vector averaged cross-power spectrum Several baselines displayed
Timerange: 00/11:06:32 to 00/11:07:31

Plot file version 58 created 17-SEP-2012 12:03:04

ORIKL1 EE008D 1.UVDATA.1

Freq = 22.2290 GHz, Bw = 8.000 MH No calibration applied and no bandpass applied

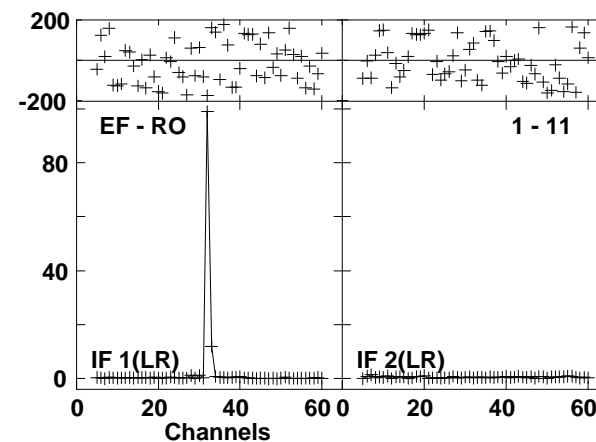
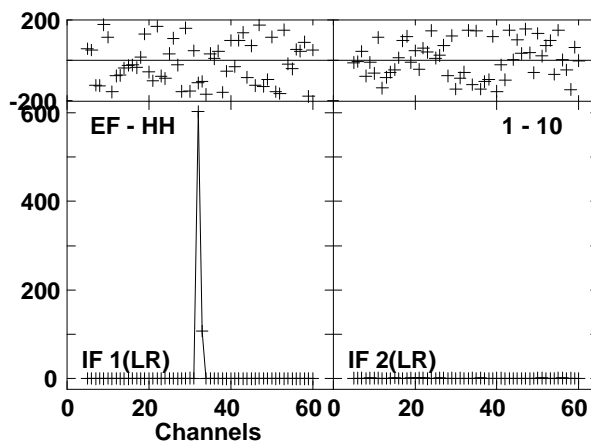
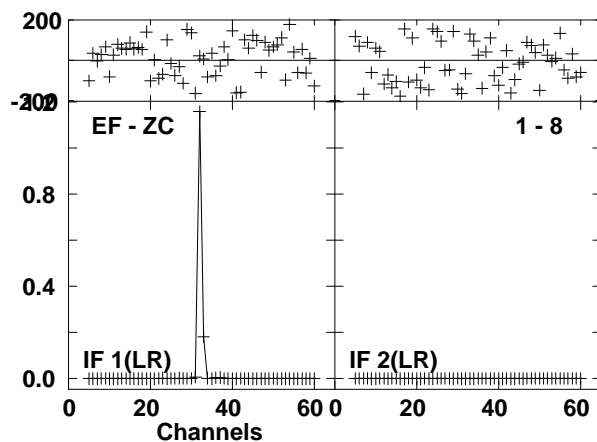
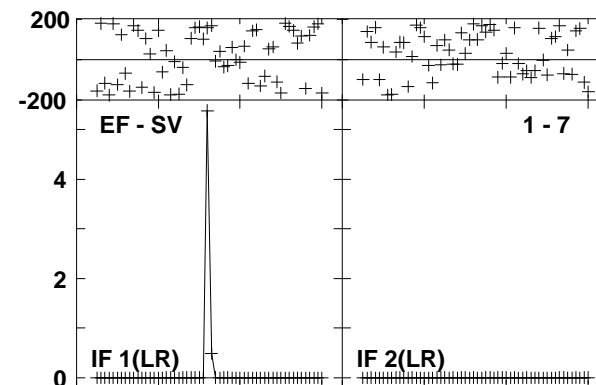
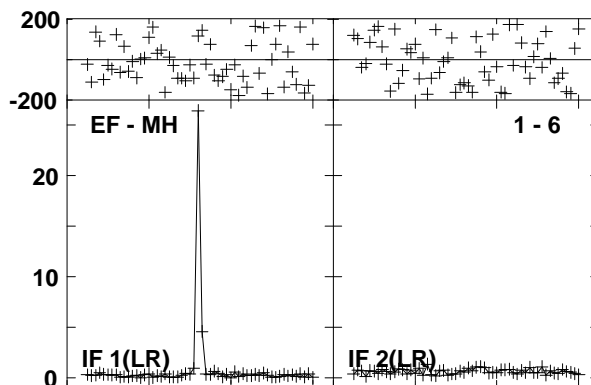
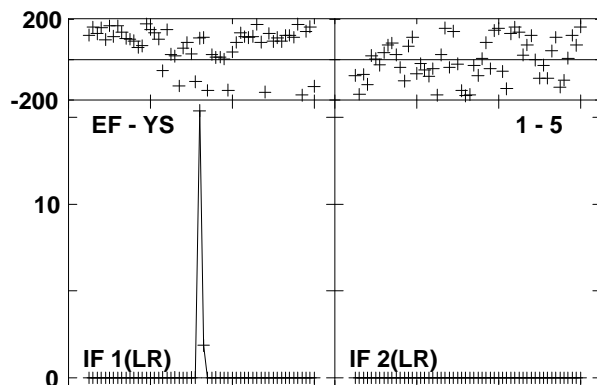
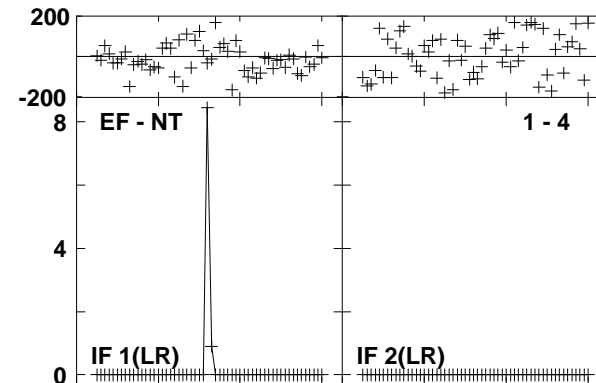
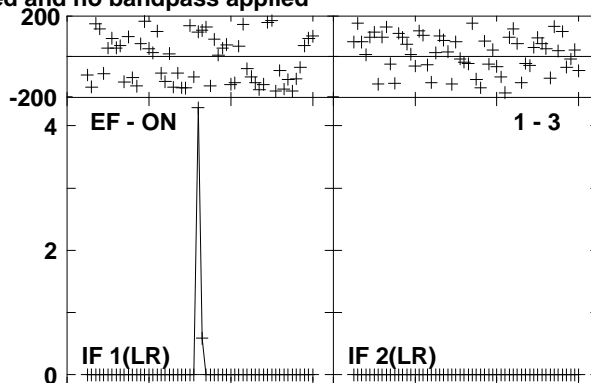
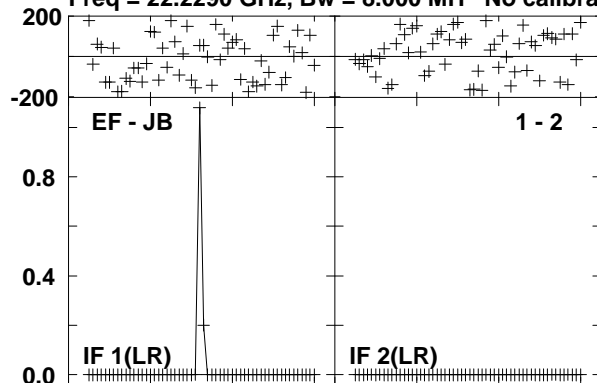

Lower frame: Ampl Jy Top frame: Phas deg
Vector averaged cross-power spectrum Several baselines displayed
Timerange: 00/11:07:35 to 00/11:08:31

Plot file version 59 created 17-SEP-2012 12:03:07

J0529-0519 EE008D 1.UVDATA.1

Freq = 22.2290 GHz, Bw = 8.000 MH No calibration applied and no bandpass applied

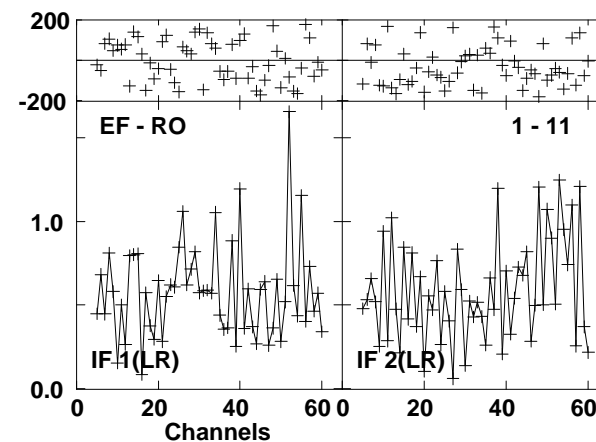
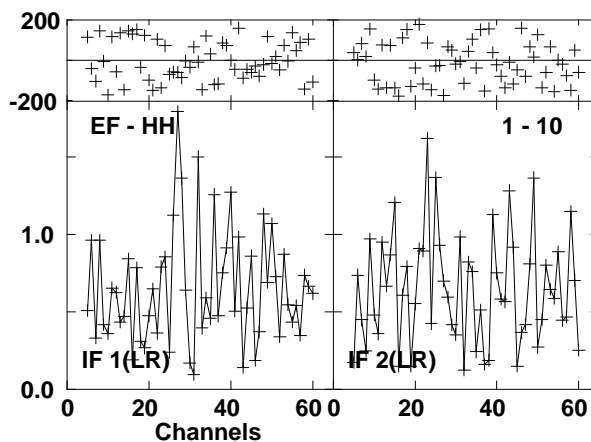
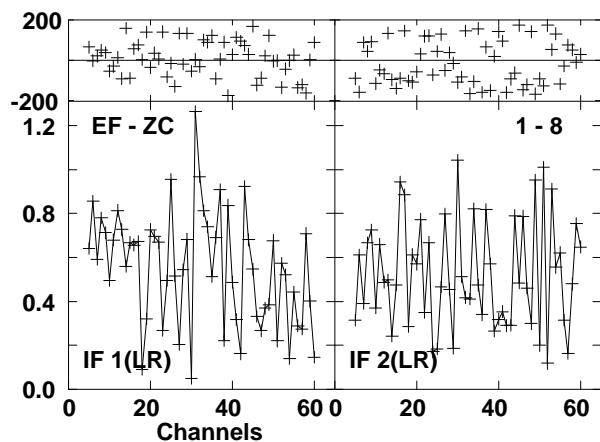
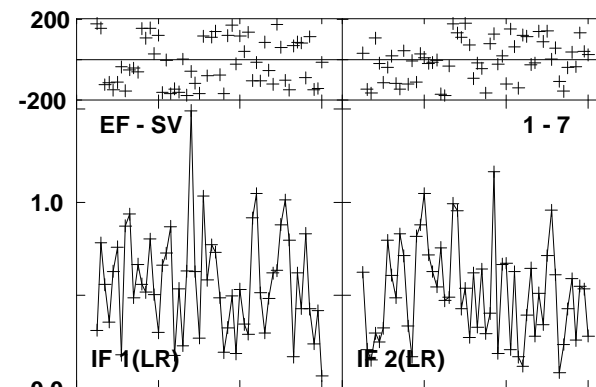
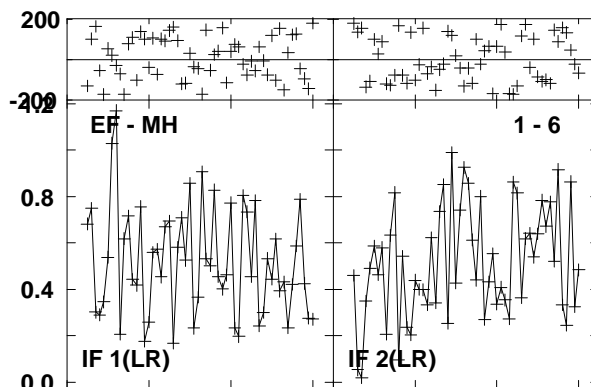
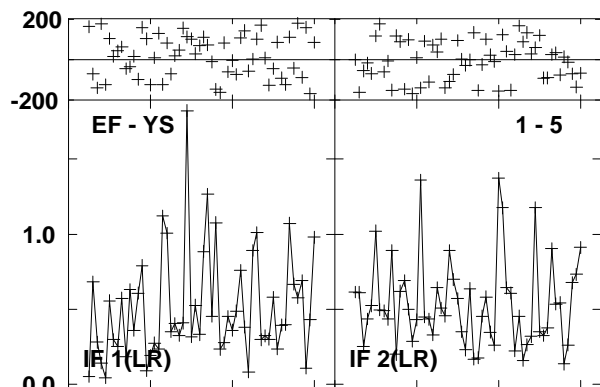
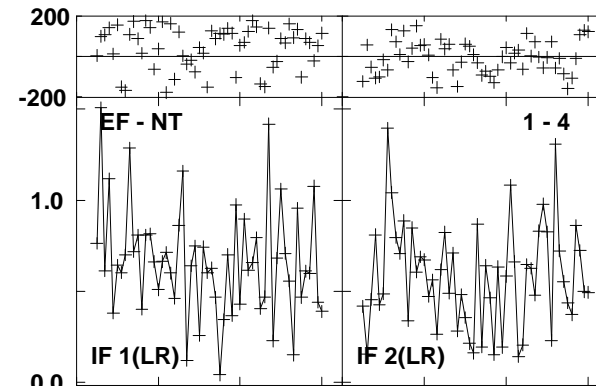
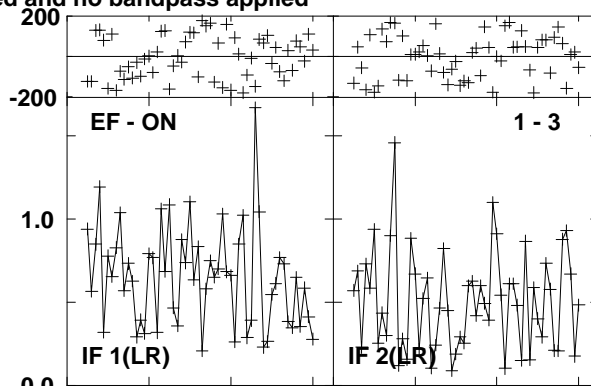
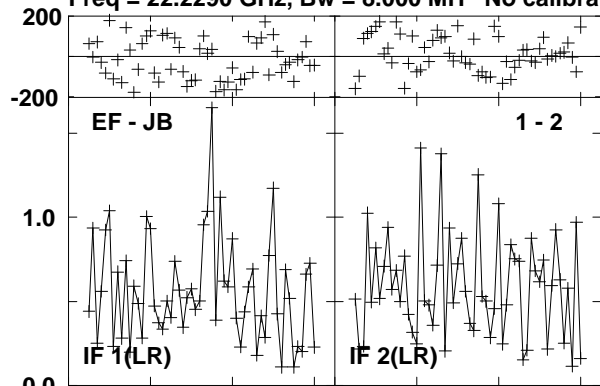

Lower frame: Milli Ampl Jy Top frame: Phas deg
Vector averaged cross-power spectrum Several baselines displayed
Timerange: 00/11:08:36 to 00/11:09:31

Plot file version 60 created 17-SEP-2012 12:03:09

ORIKL1 EE008D 1.UVDATA.1

Freq = 22.2290 GHz, Bw = 8.000 MH No calibration applied and no bandpass applied

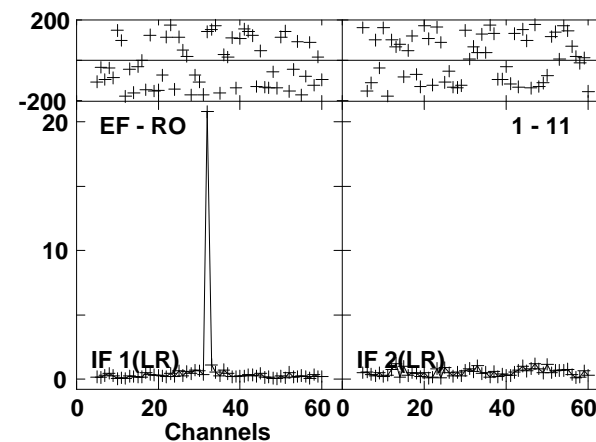
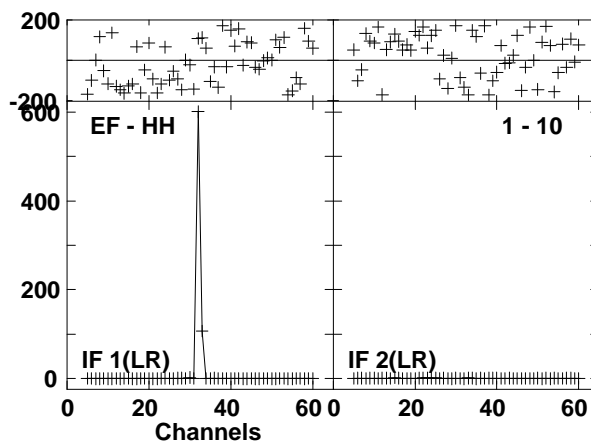
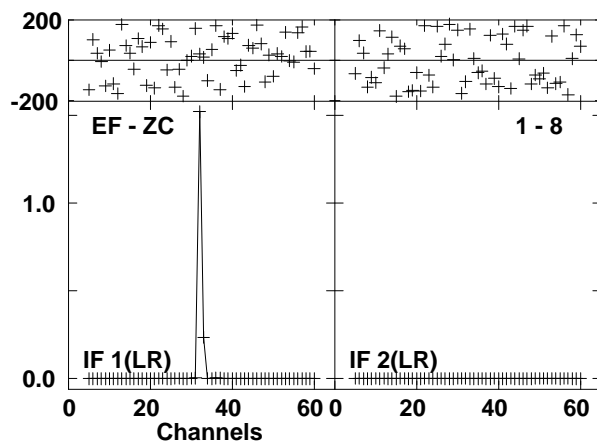
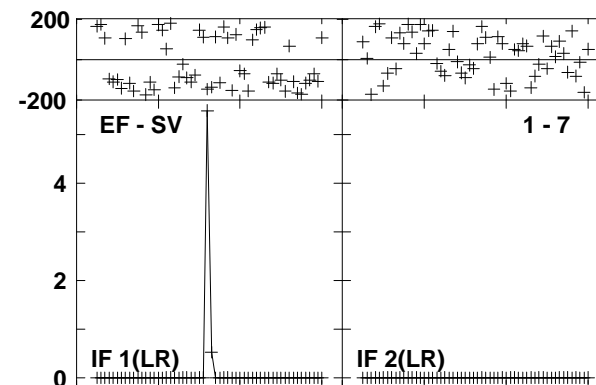
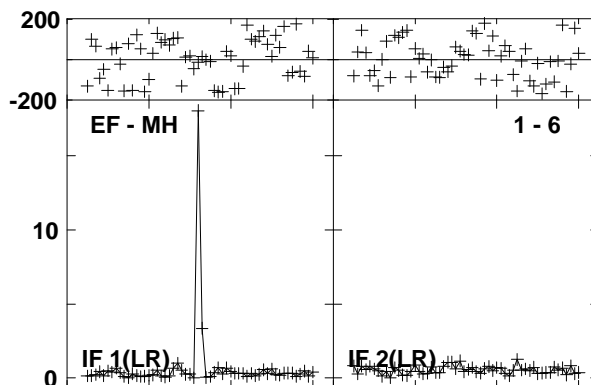
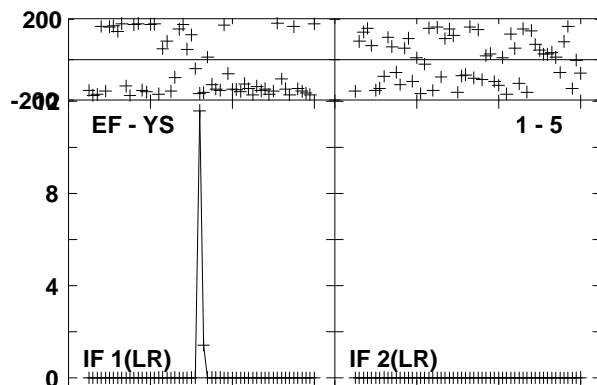
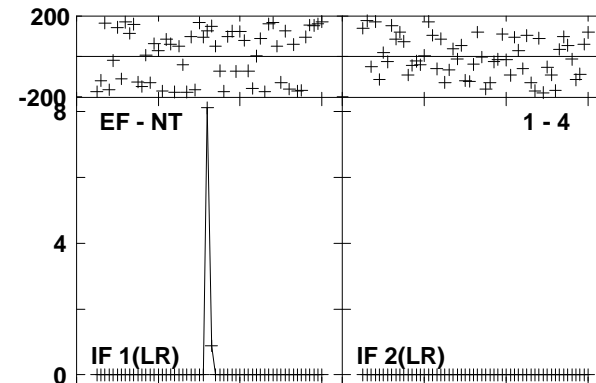
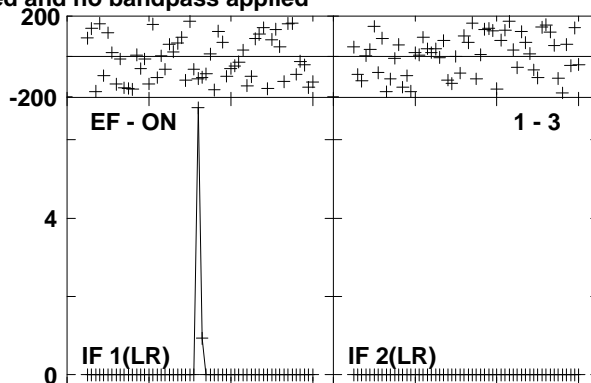
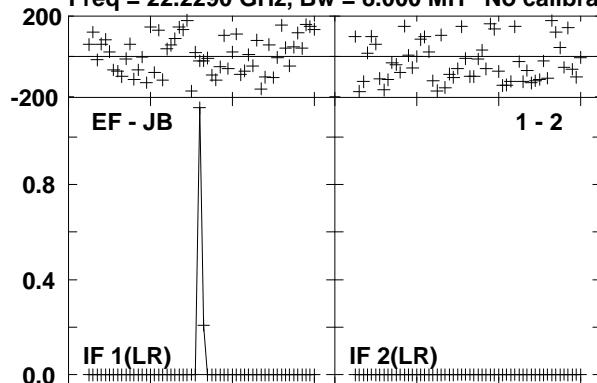

Lower frame: Ampl Jy Top frame: Phas deg
Vector averaged cross-power spectrum Several baselines displayed
Timerange: 00/11:09:36 to 00/11:10:31

Plot file version 61 created 17-SEP-2012 12:03:12

J0529-0519 EE008D 1.UVDATA.1

Freq = 22.2290 GHz, Bw = 8.000 MH No calibration applied and no bandpass applied

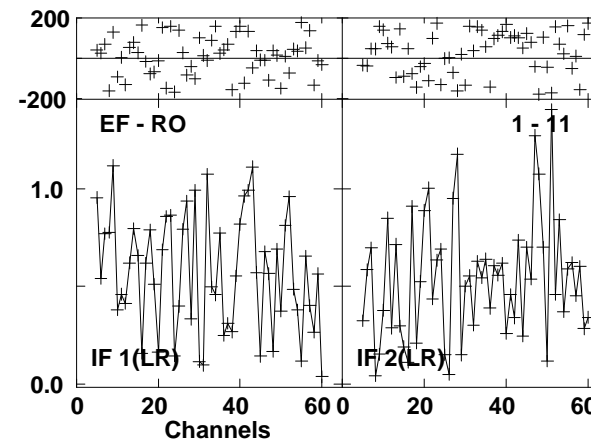
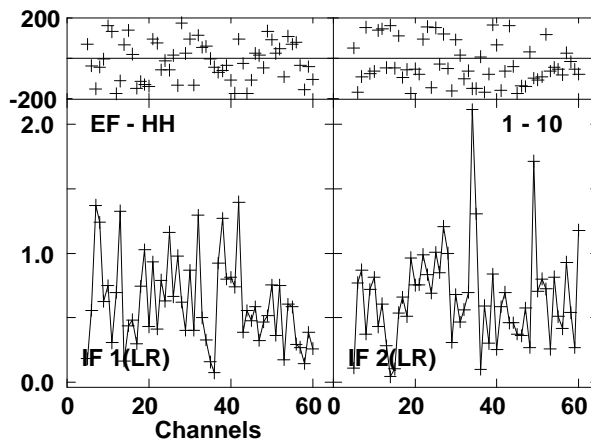
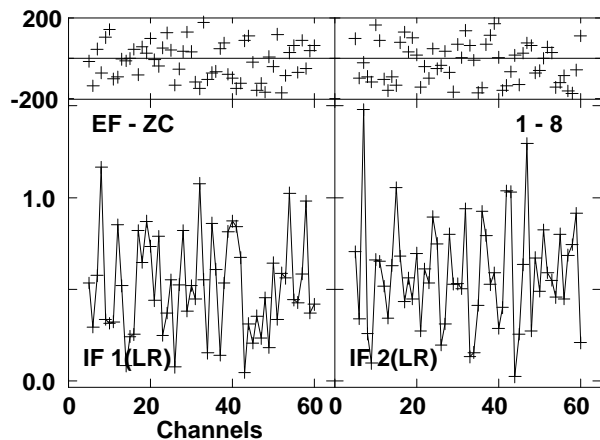
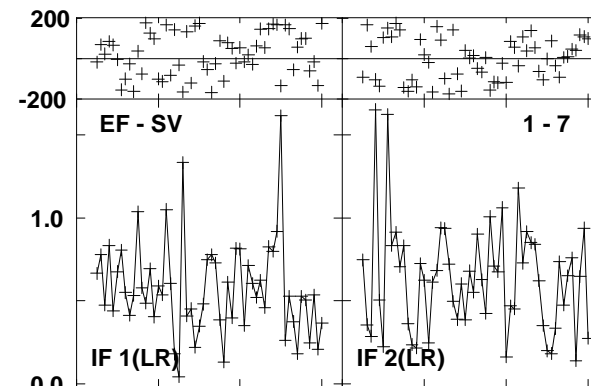
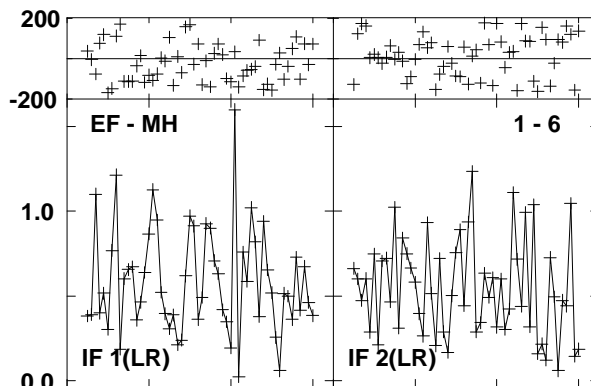
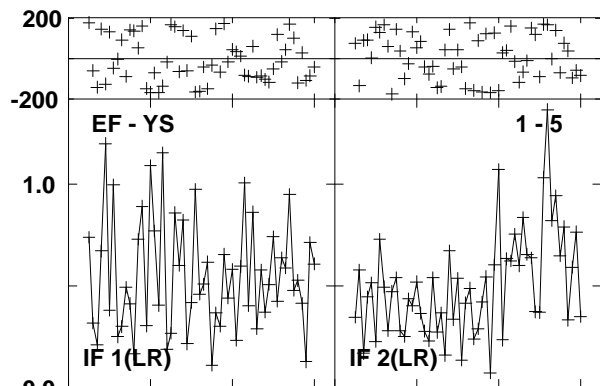
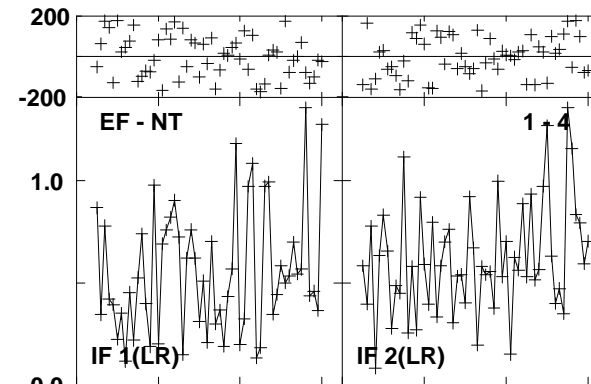
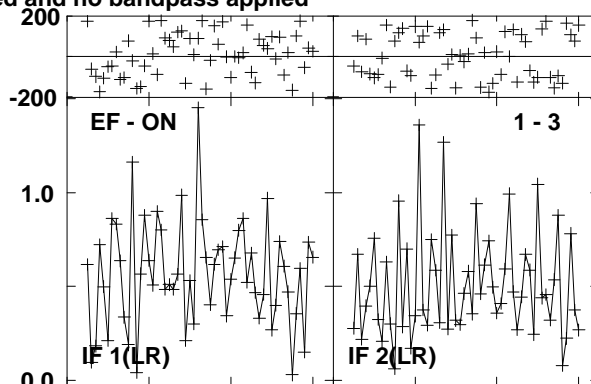
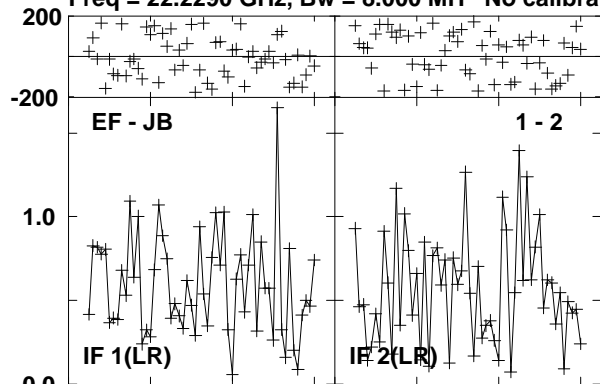

Lower frame: Milli Ampl Jy Top frame: Phas deg
Vector averaged cross-power spectrum Several baselines displayed
Timerange: 00/11:10:36 to 00/11:11:31

Plot file version 62 created 17-SEP-2012 12:03:15

J0541-0541 EE008D 1.UVDATA.1

Freq = 22.2290 GHz, Bw = 8.000 MH No calibration applied and no bandpass applied

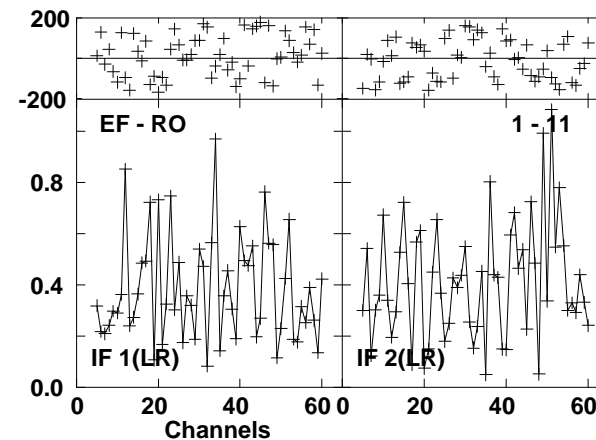
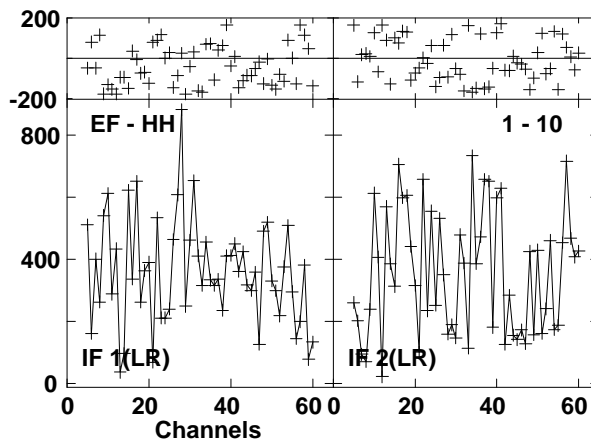
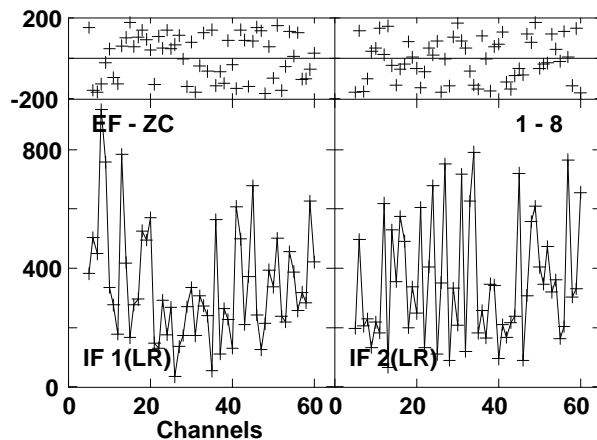
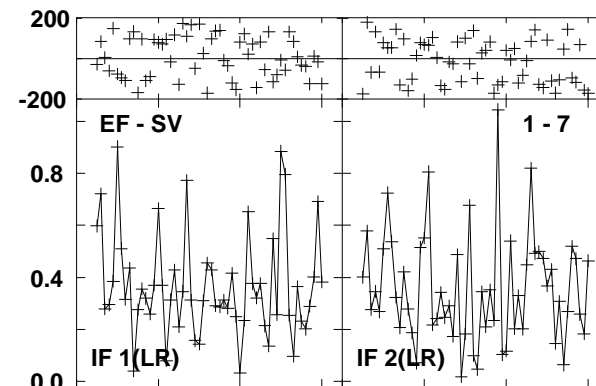
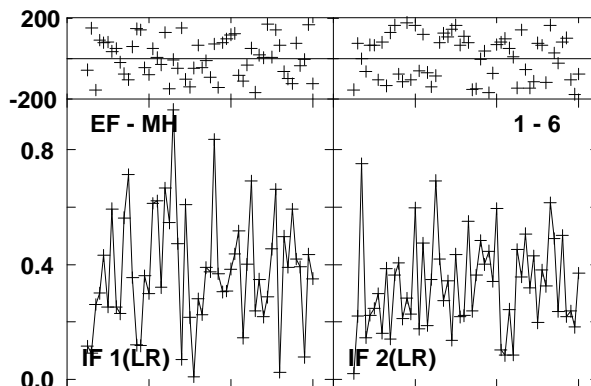
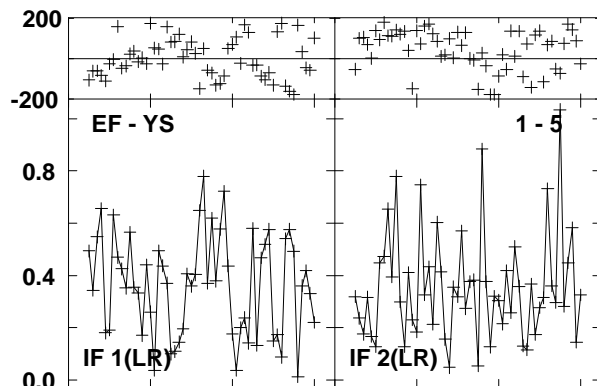
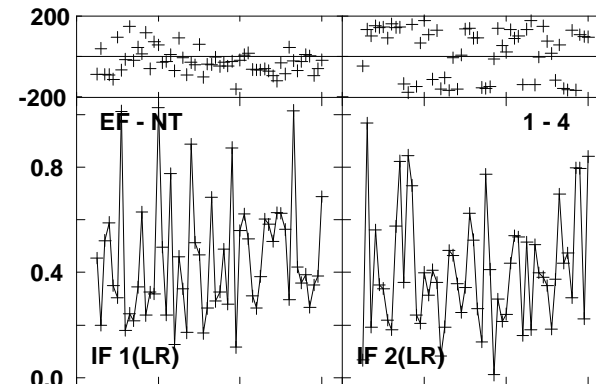
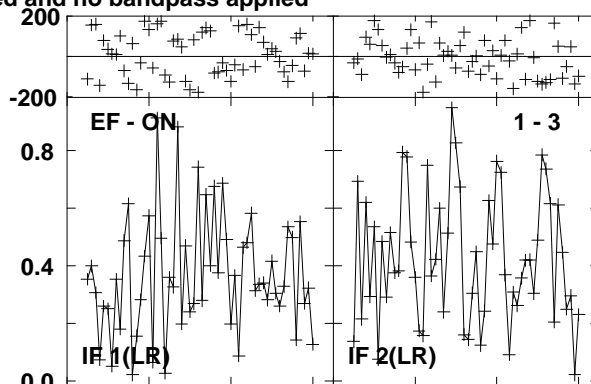
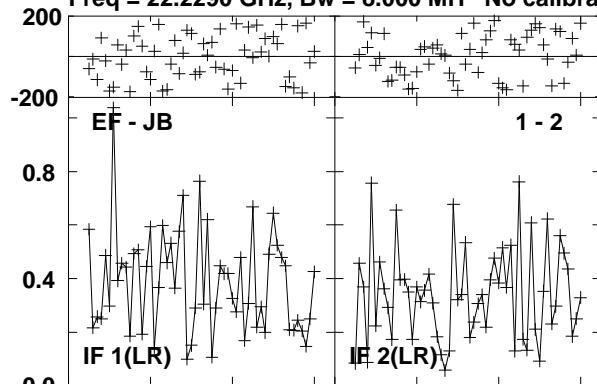

Lower frame: Milli Ampl Jy Top frame: Phas deg
Vector averaged cross-power spectrum Several baselines displayed
Timerange: 00/11:12:17 to 00/11:13:16

Plot file version 63 created 17-SEP-2012 12:03:18

ORIKL1 EE008D 1.UVDATA.1

Freq = 22.2290 GHz, Bw = 8.000 MH No calibration applied and no bandpass applied

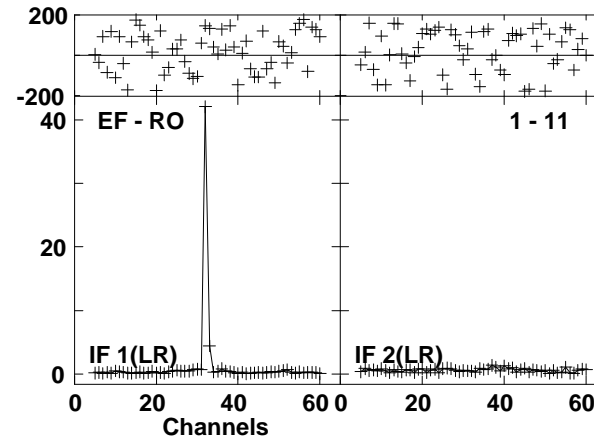
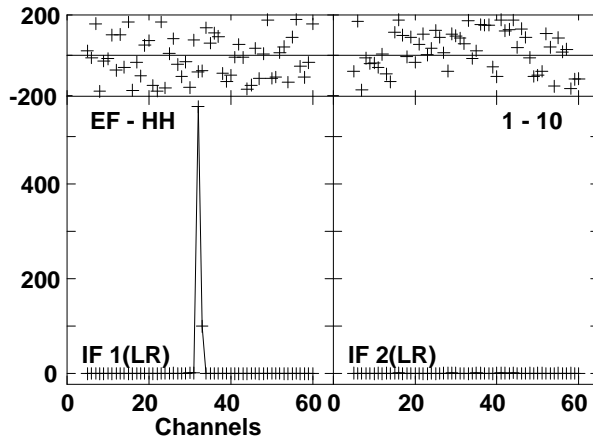
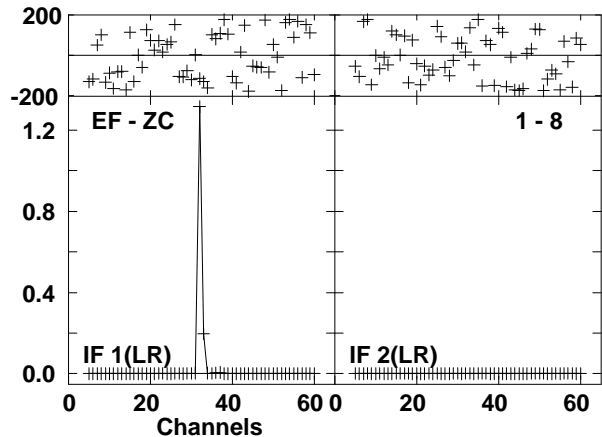
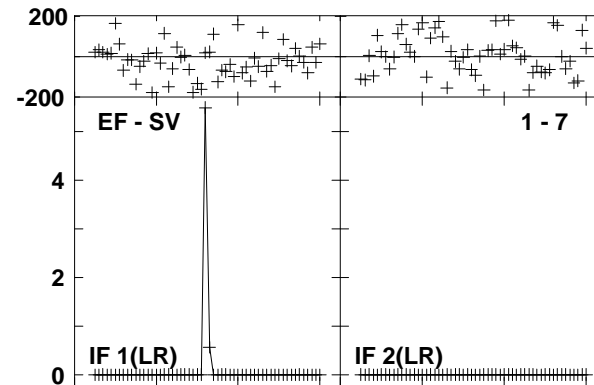
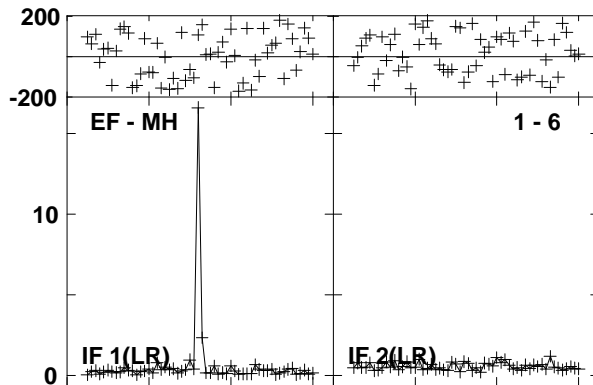
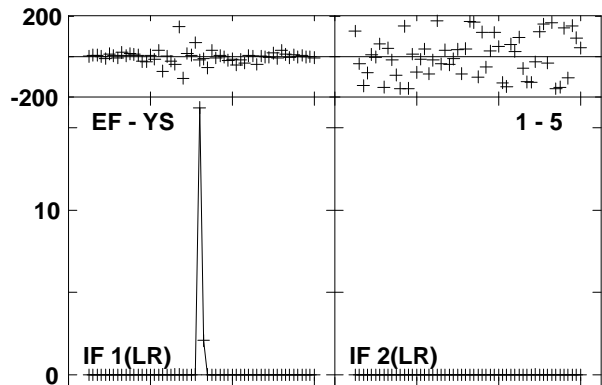
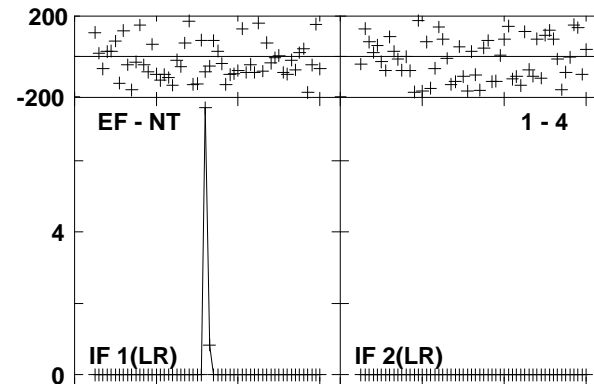
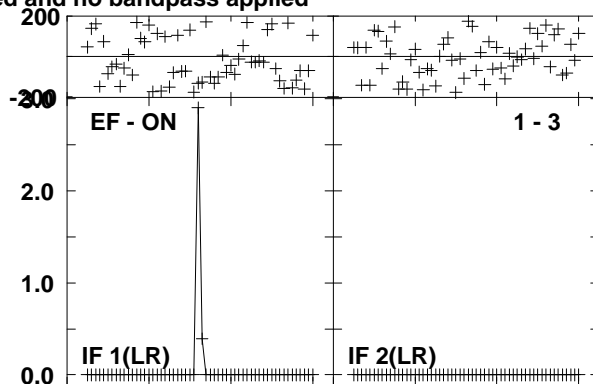
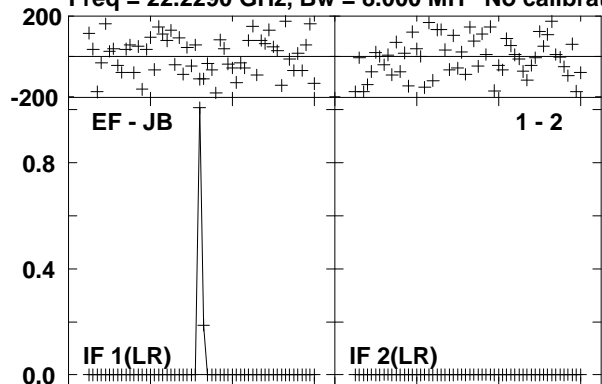

Lower frame: Ampl Jy Top frame: Phas deg
Vector averaged cross-power spectrum Several baselines displayed
Timerange: 00/11:13:20 to 00/11:14:16

Plot file version 64 created 17-SEP-2012 12:03:21

J0541-0541 EE008D 1.UVDATA.1

Freq = 22.2290 GHz, Bw = 8.000 MH No calibration applied and no bandpass applied

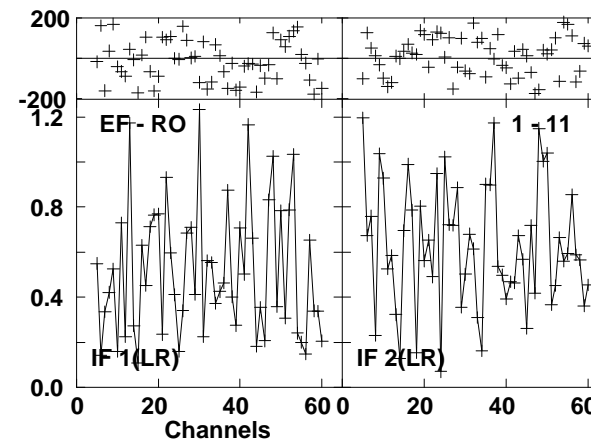
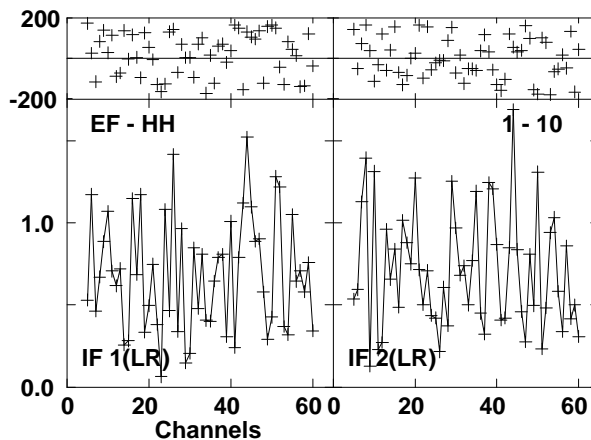
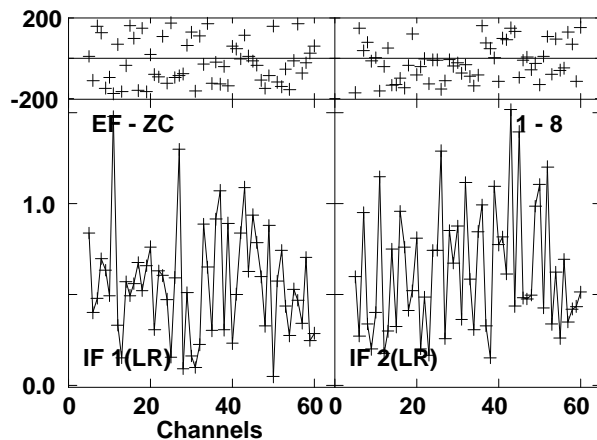
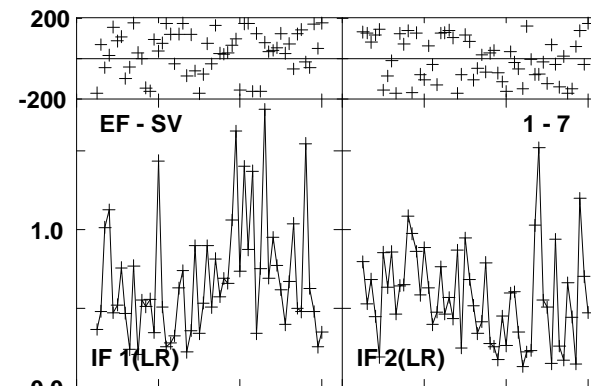
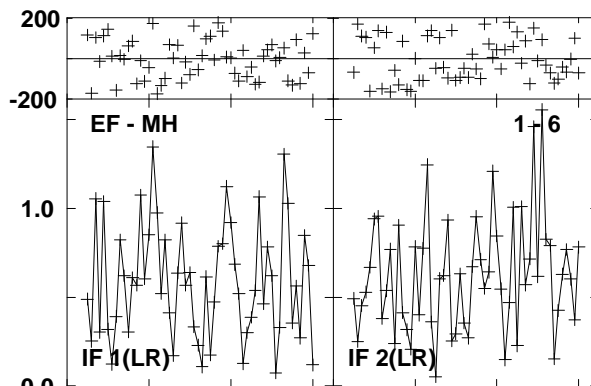
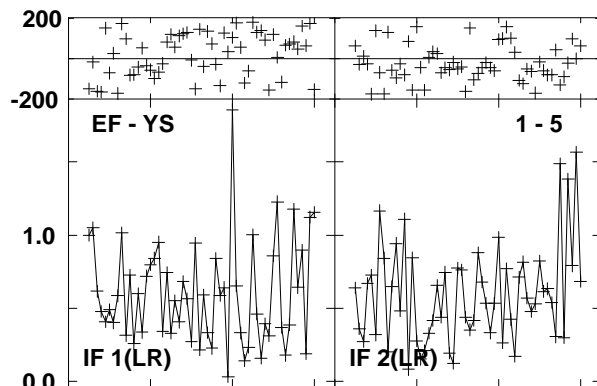
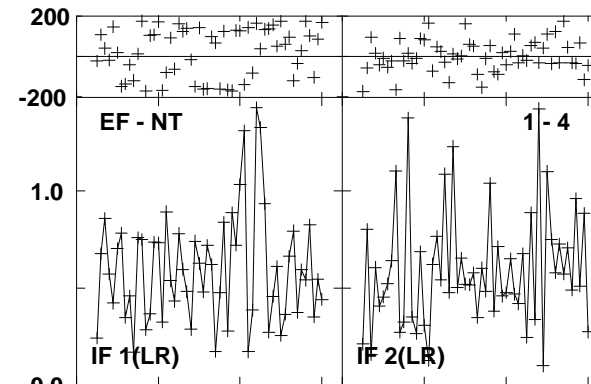
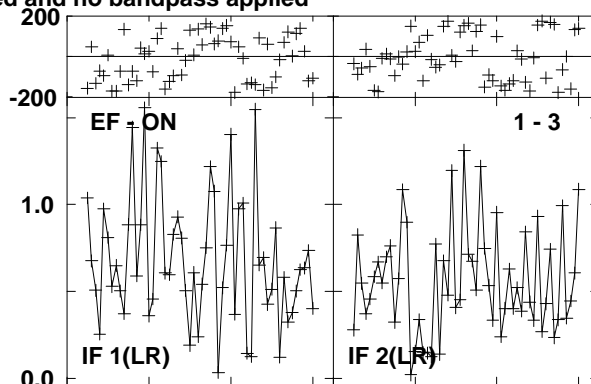
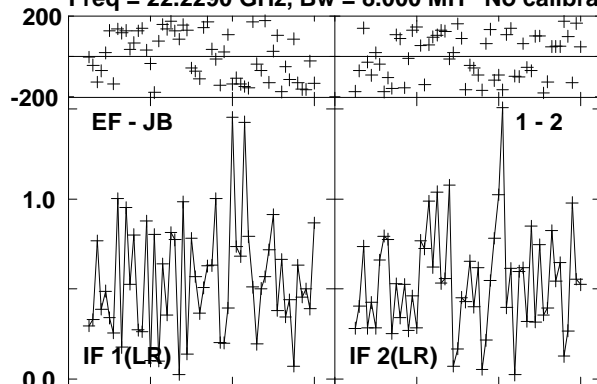

Lower frame: Milli Ampl Jy Top frame: Phas deg
Vector averaged cross-power spectrum Several baselines displayed
Timerange: 00/11:14:21 to 00/11:15:16

Plot file version 65 created 17-SEP-2012 12:03:23

ORIKL1 EE008D 1.UVDATA.1

Freq = 22.2290 GHz, Bw = 8.000 MH No calibration applied and no bandpass applied

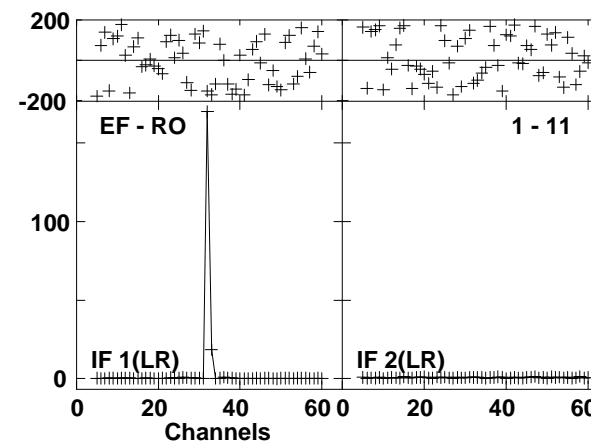
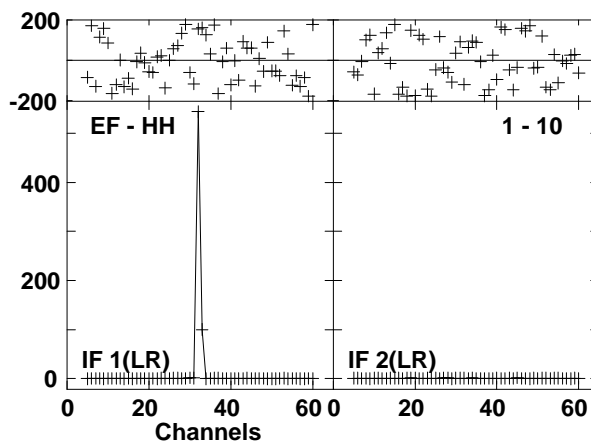
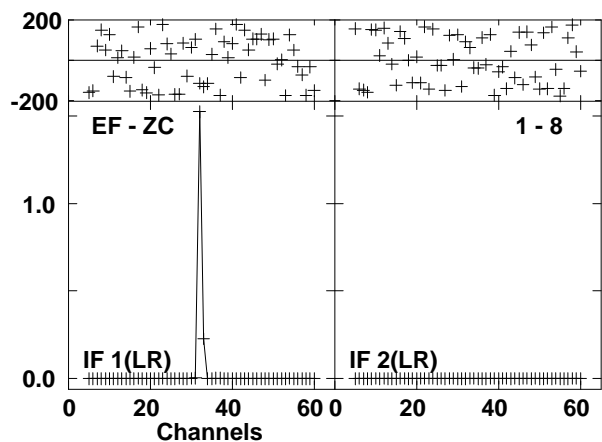
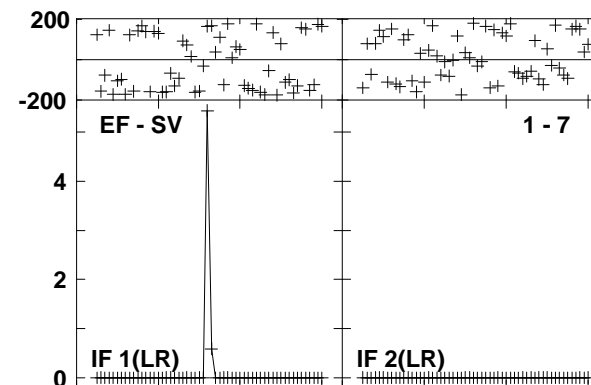
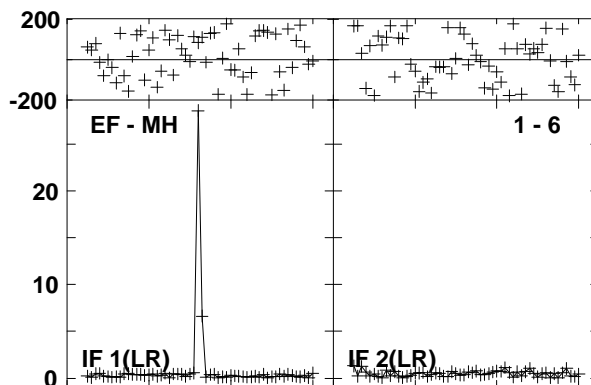
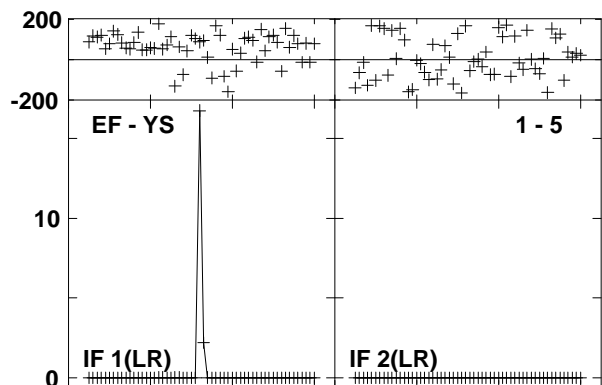
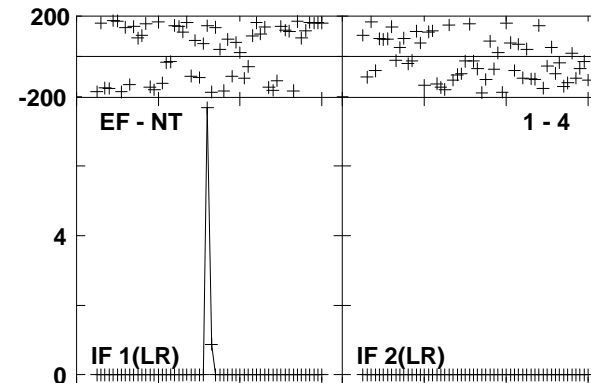
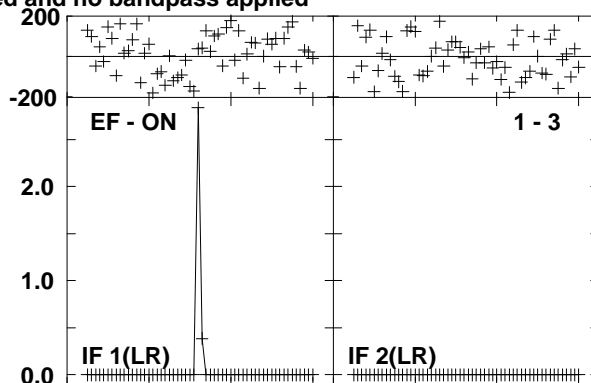
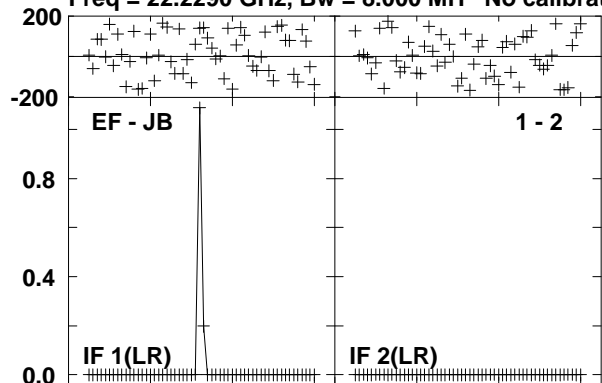

Lower frame: Ampl Jy Top frame: Phas deg
Vector averaged cross-power spectrum Several baselines displayed
Timerange: 00/11:15:21 to 00/11:16:16

Plot file version 66 created 17-SEP-2012 12:03:26

J0541-0541 EE008D 1.UVDATA.1

Freq = 22.2290 GHz, Bw = 8.000 MH No calibration applied and no bandpass applied

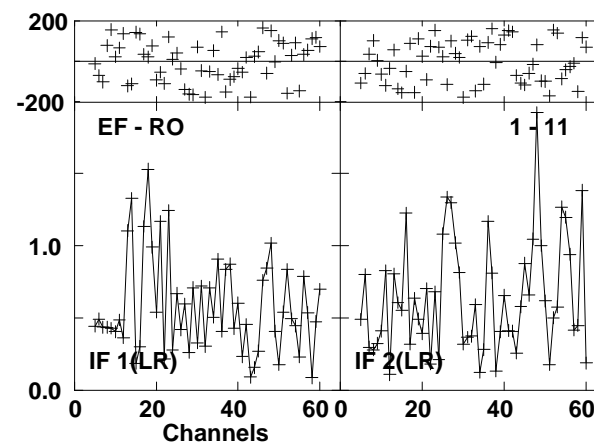
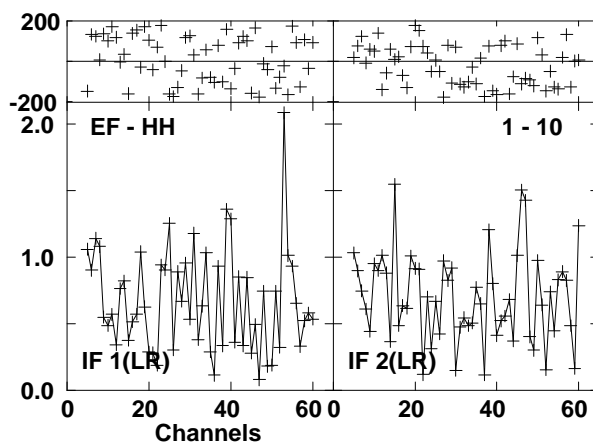
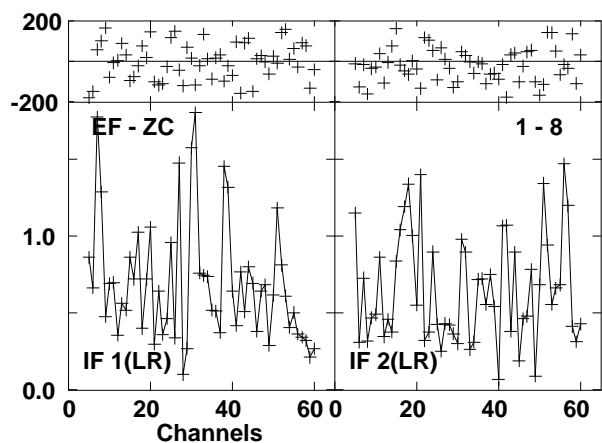
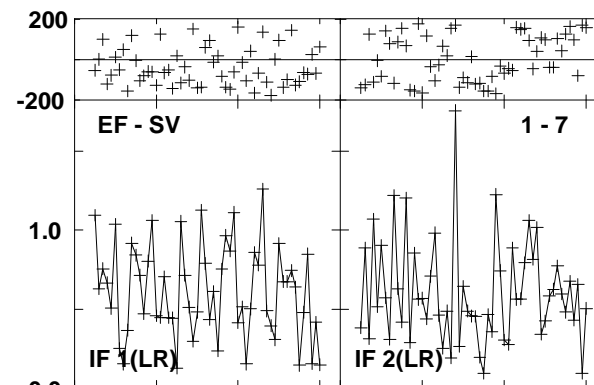
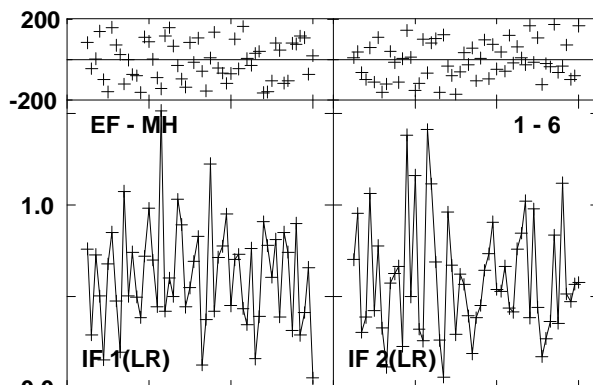
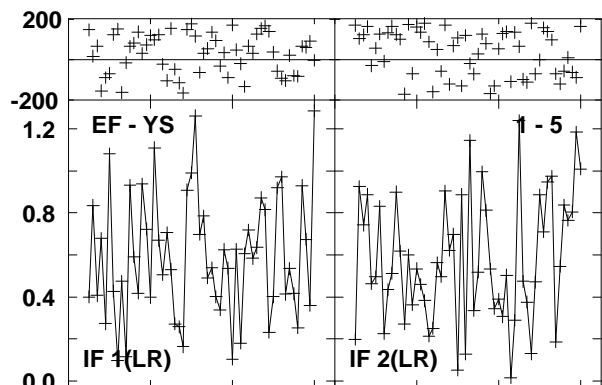
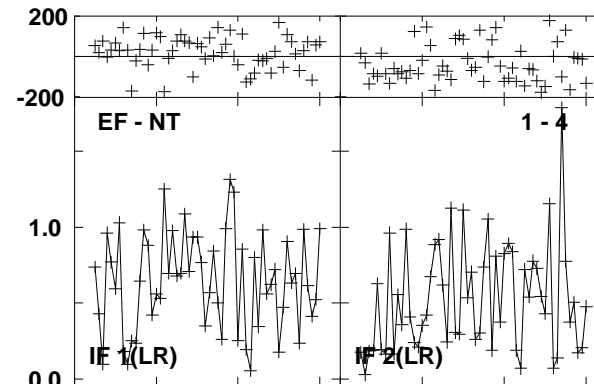
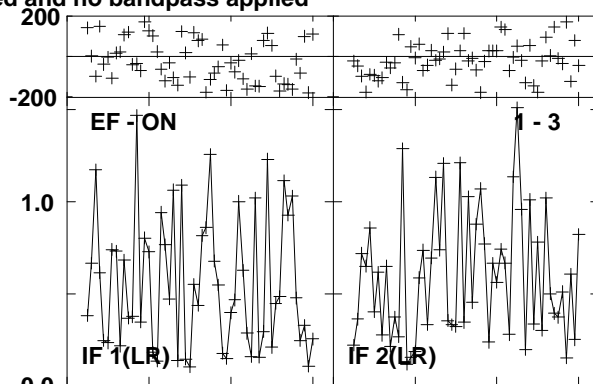
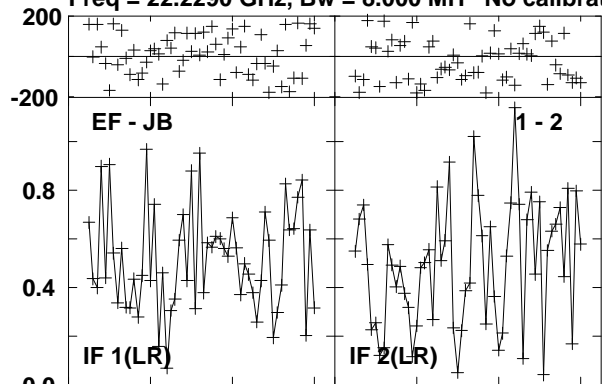

Lower frame: Milli Ampl Jy Top frame: Phas deg
Vector averaged cross-power spectrum Several baselines displayed
Timerange: 00/11:16:21 to 00/11:17:16

Plot file version 67 created 17-SEP-2012 12:03:29

J0529-0519 EE008D 1.UVDATA.1

Freq = 22.2290 GHz, Bw = 8.000 MH No calibration applied and no bandpass applied

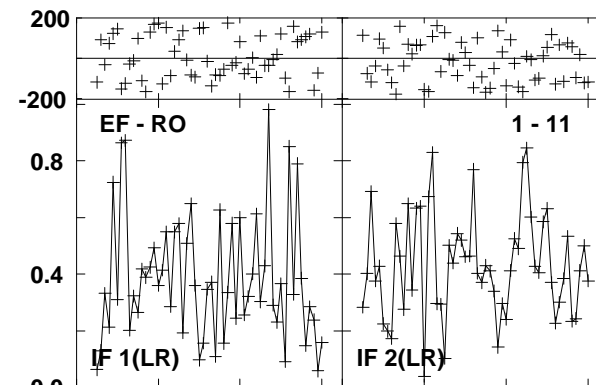
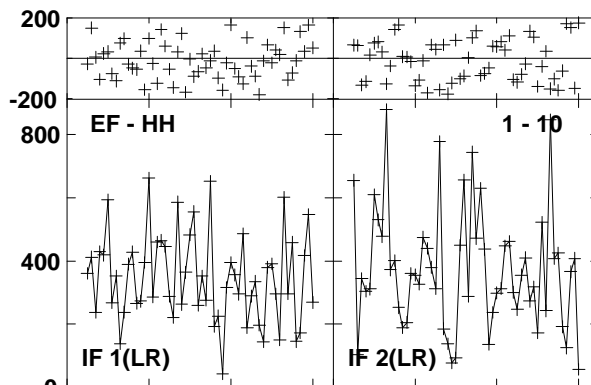
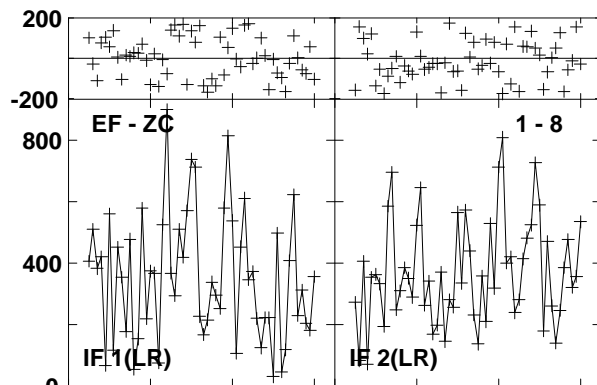
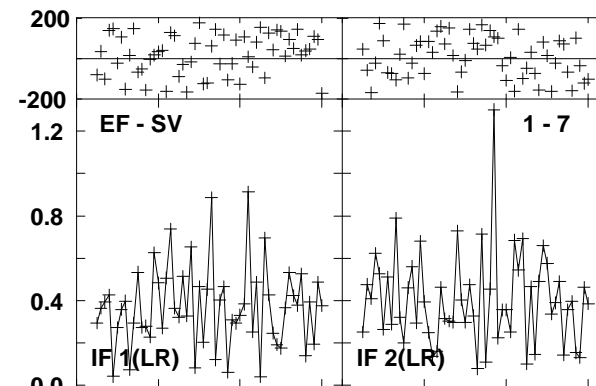
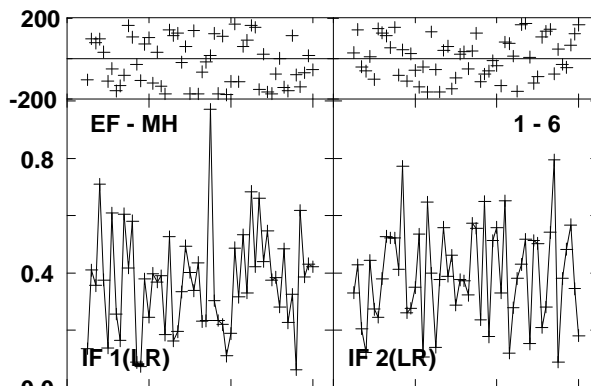
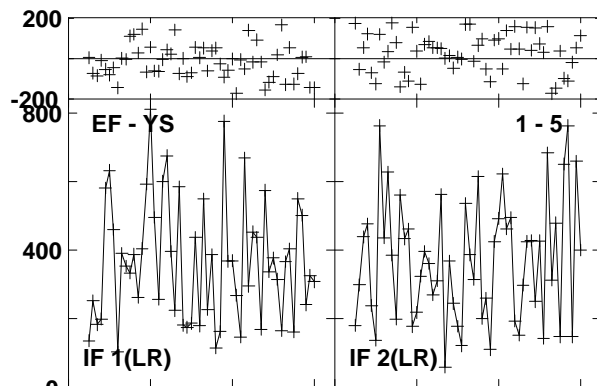
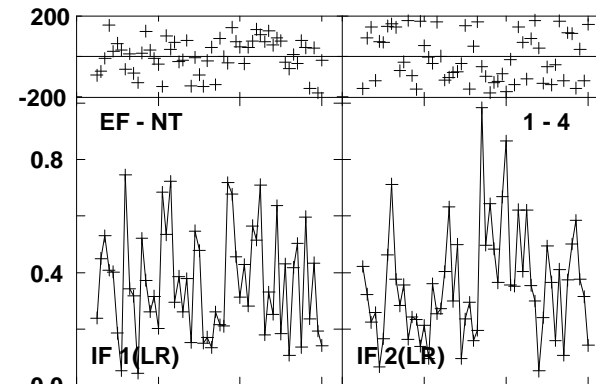
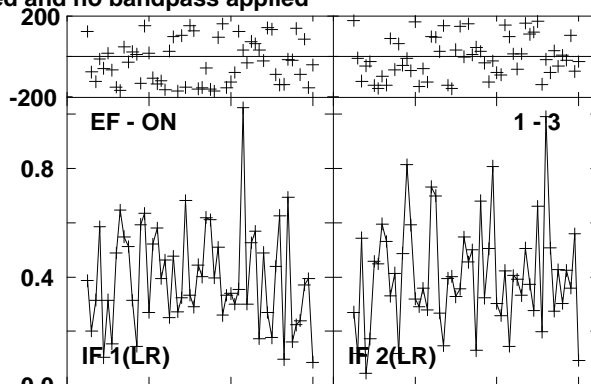
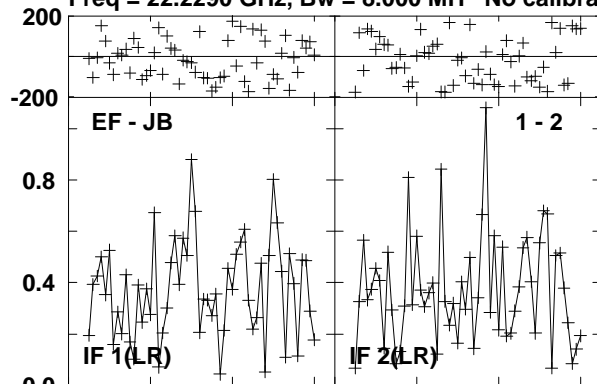

Lower frame: Milli Ampl Jy Top frame: Phas deg
Vector averaged cross-power spectrum Several baselines displayed
Timerange: 00/11:18:02 to 00/11:19:01

Plot file version 68 created 17-SEP-2012 12:03:32

ORIKL1 EE008D 1.UVDATA.1

Freq = 22.2290 GHz, Bw = 8.000 MH No calibration applied and no bandpass applied

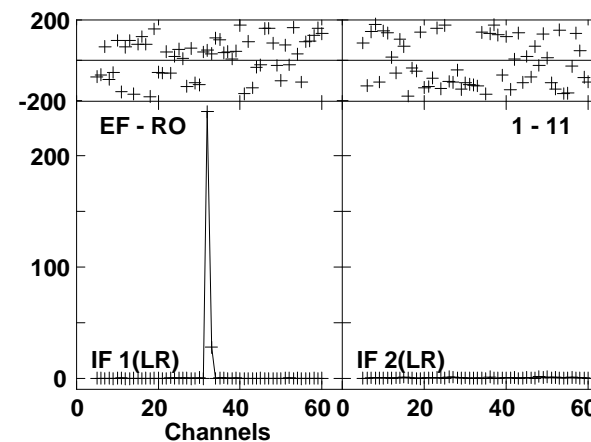
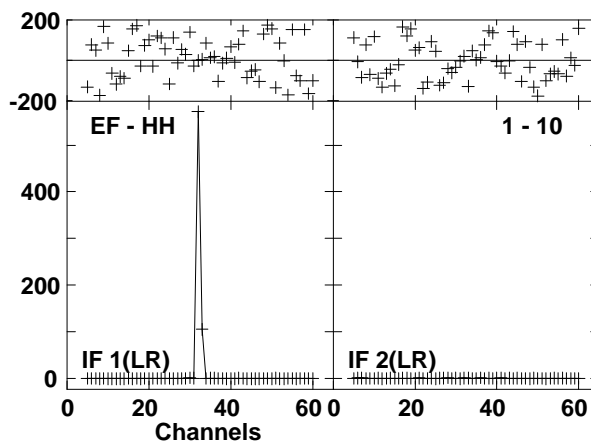
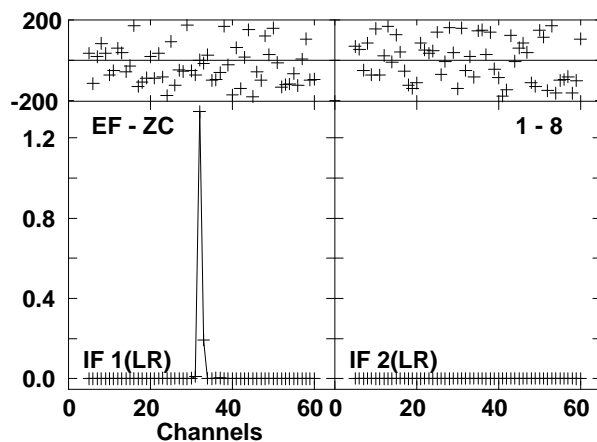
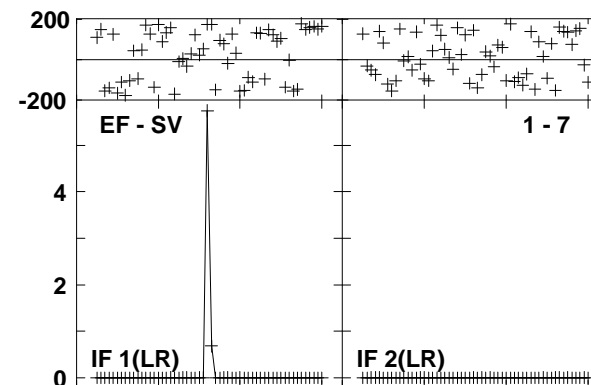
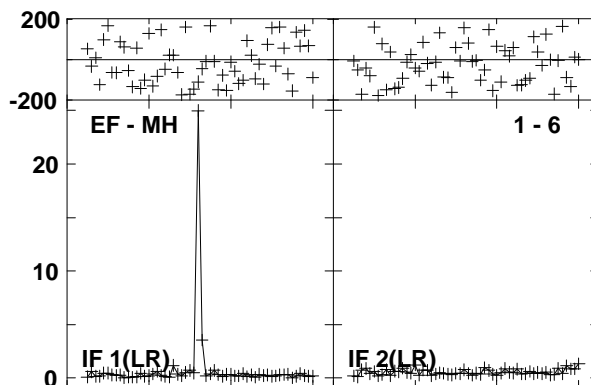
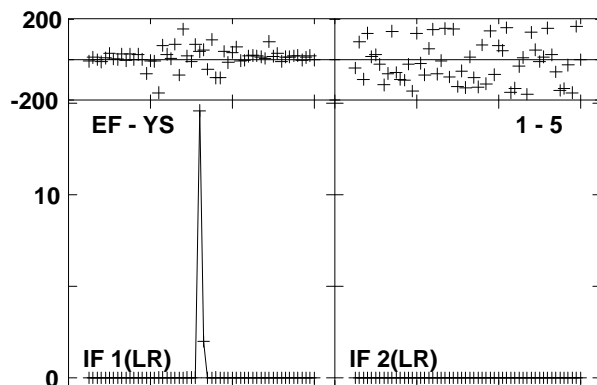
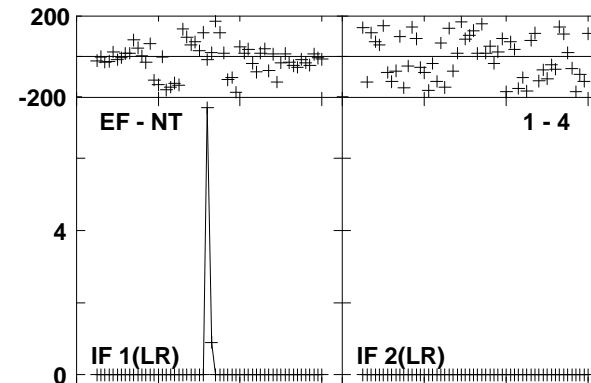
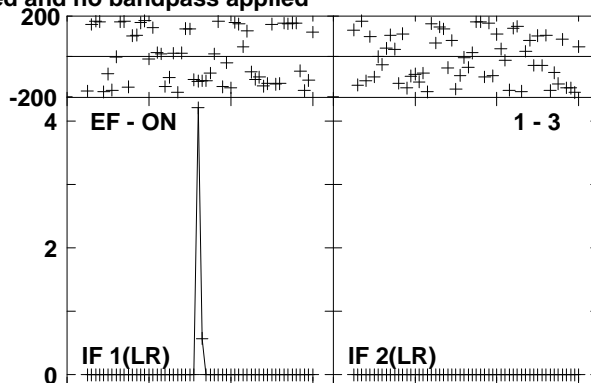
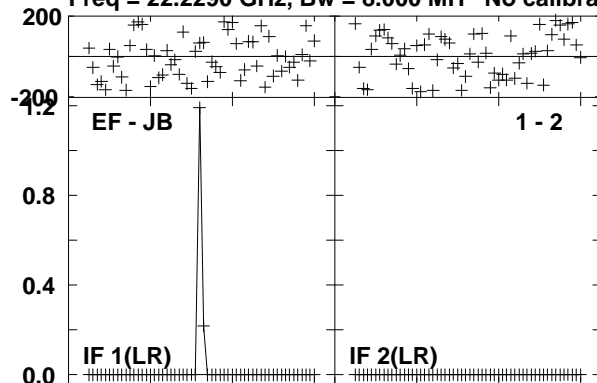

Lower frame: Ampl Jy Top frame: Phas deg
Vector averaged cross-power spectrum Several baselines displayed
Timerange: 00/11:19:05 to 00/11:20:01

Plot file version 69 created 17-SEP-2012 12:03:34

J0529-0519 EE008D 1.UVDATA.1

Freq = 22.2290 GHz, Bw = 8.000 MH No calibration applied and no bandpass applied

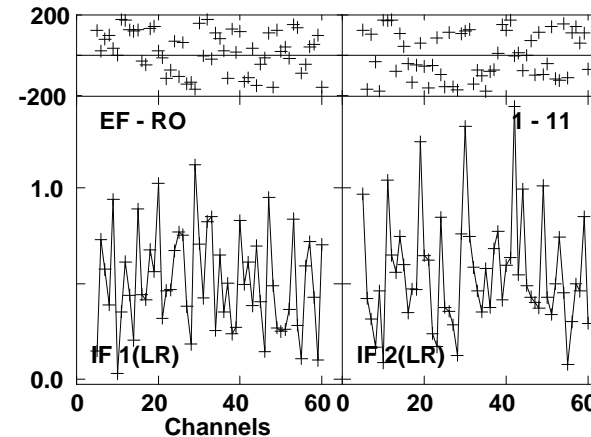
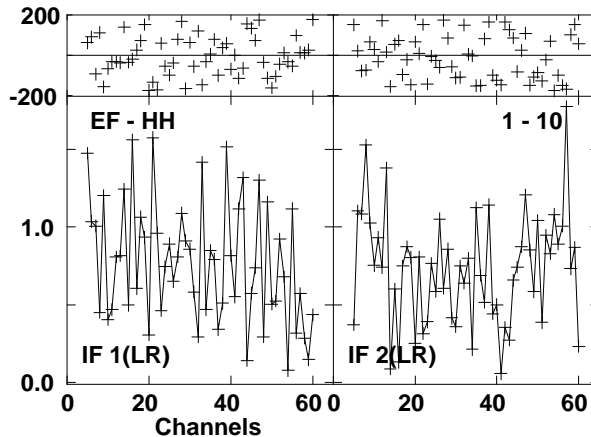
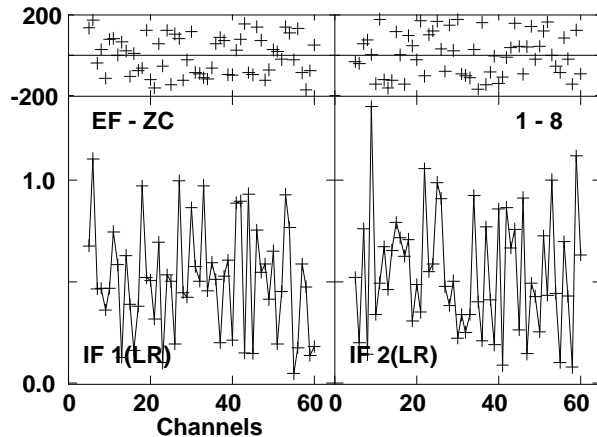
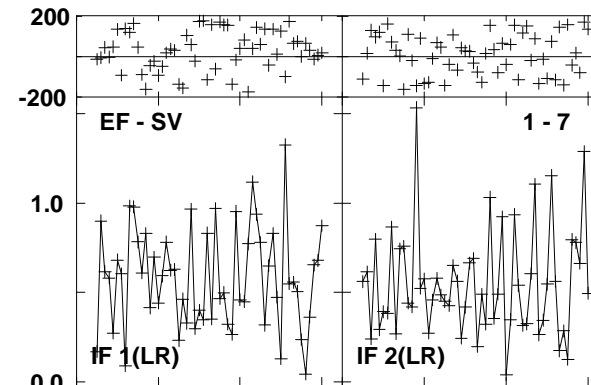
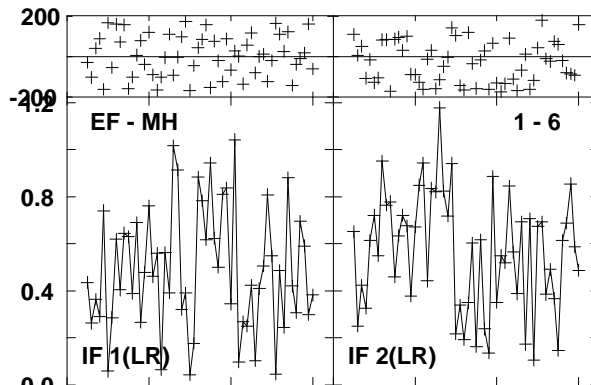
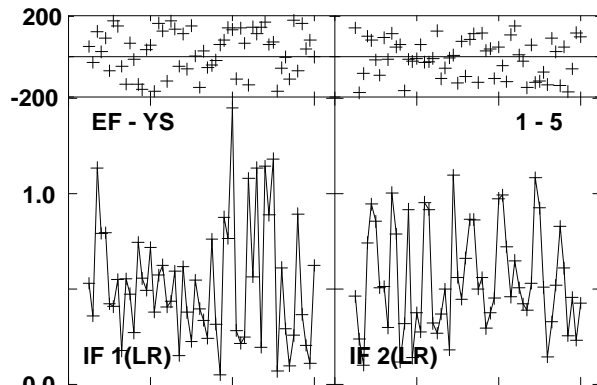
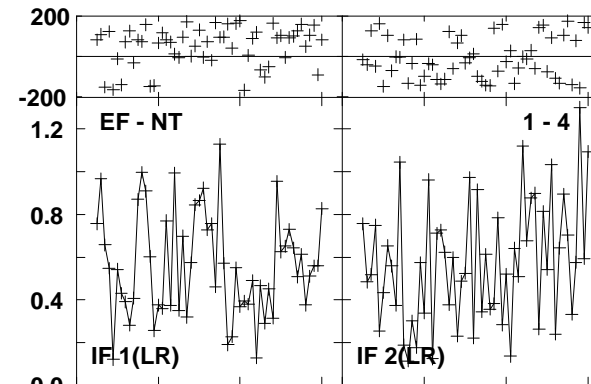
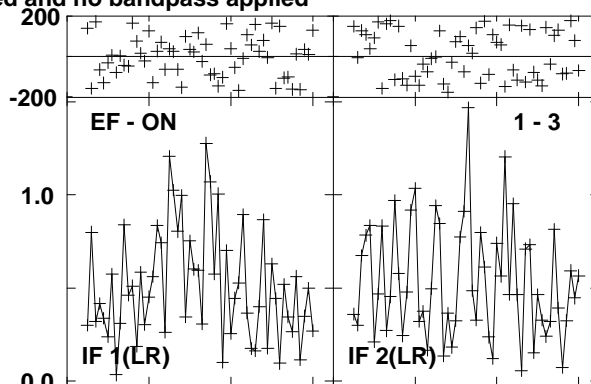
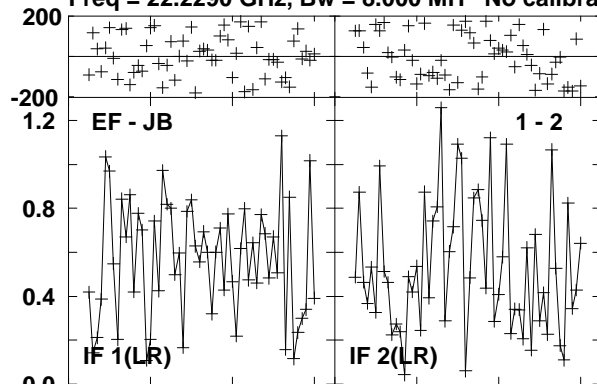

Lower frame: Milli Ampl Jy Top frame: Phas deg
Vector averaged cross-power spectrum Several baselines displayed
Timerange: 00/11:20:06 to 00/11:21:01

Plot file version 70 created 17-SEP-2012 12:03:37

ORIKL1 EE008D 1.UVDATA.1

Freq = 22.2290 GHz, Bw = 8.000 MH No calibration applied and no bandpass applied

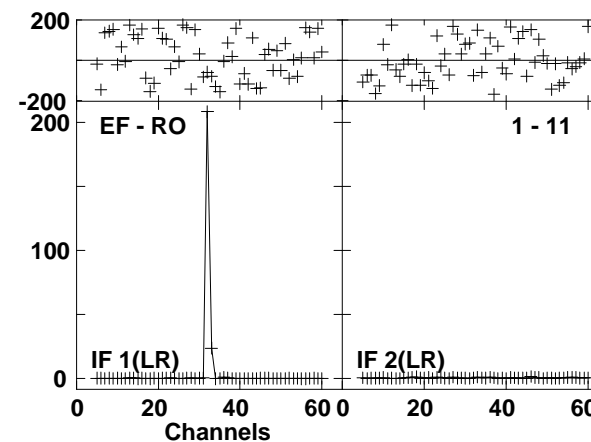
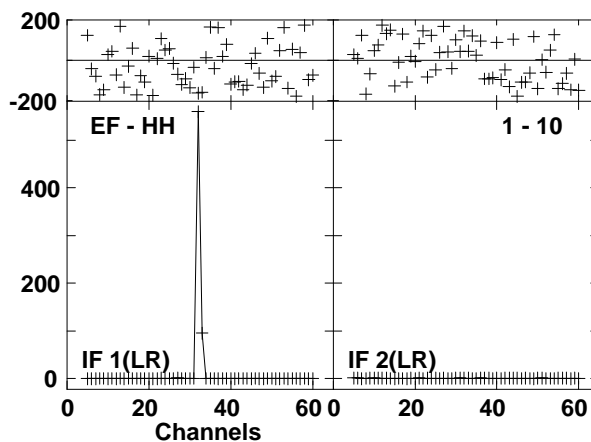
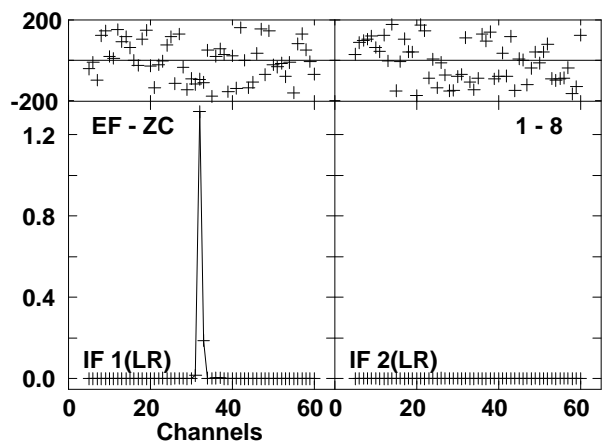
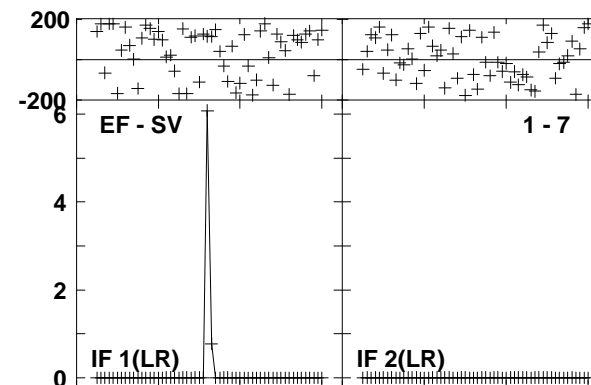
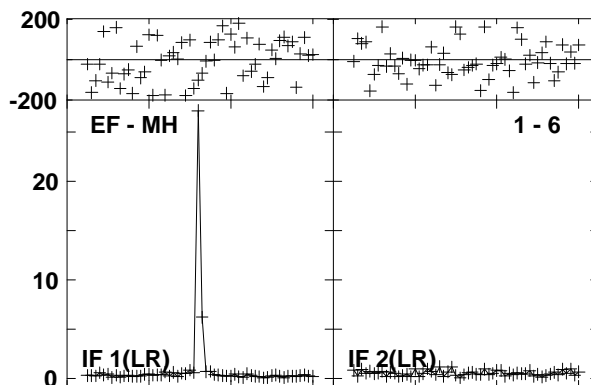
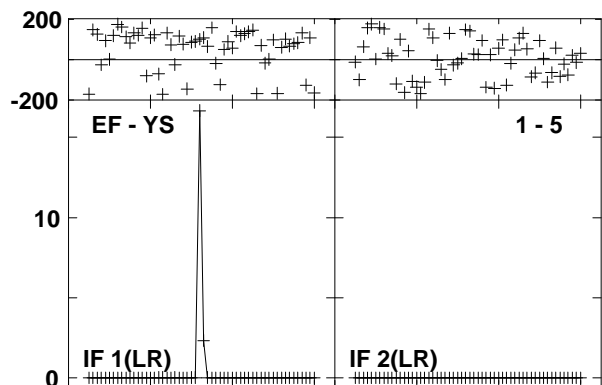
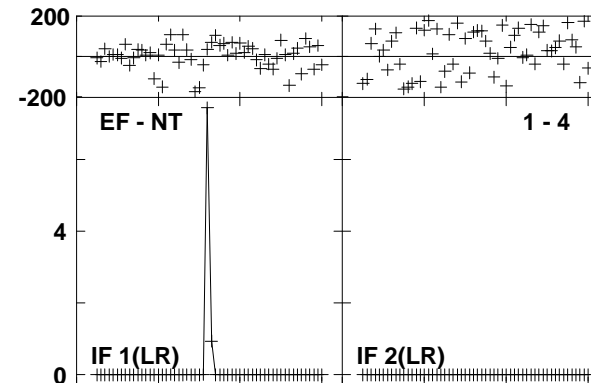
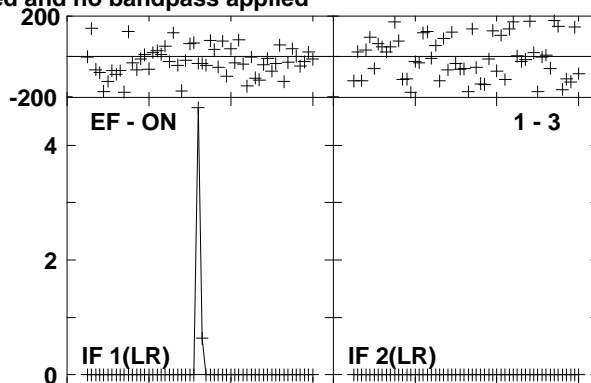
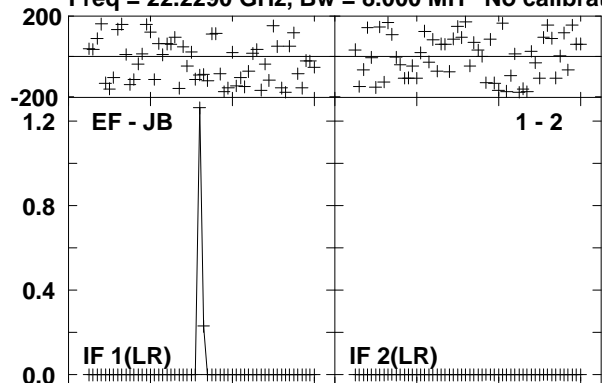

Lower frame: Ampl Jy Top frame: Phas deg
Vector averaged cross-power spectrum Several baselines displayed
Timerange: 00/11:21:06 to 00/11:22:01

Plot file version 71 created 17-SEP-2012 12:03:39

J0529-0519 EE008D 1.UVDATA.1

Freq = 22.2290 GHz, Bw = 8.000 MH No calibration applied and no bandpass applied

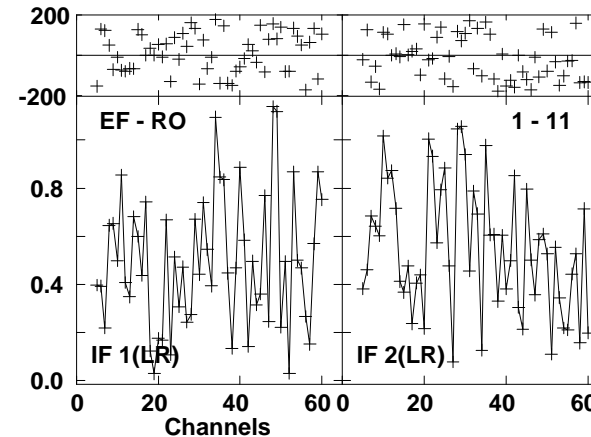
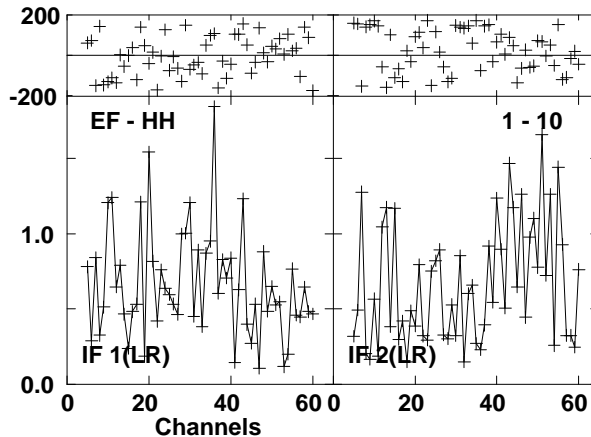
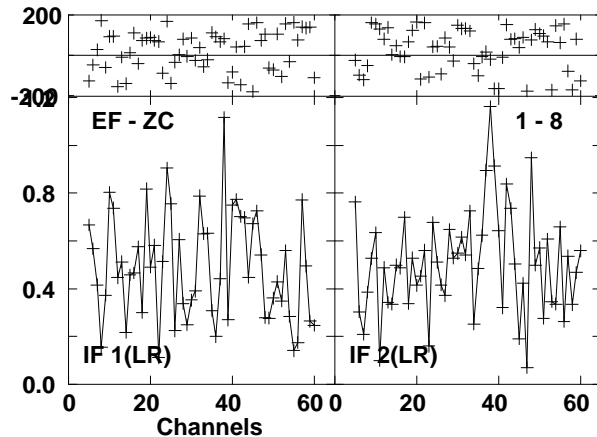
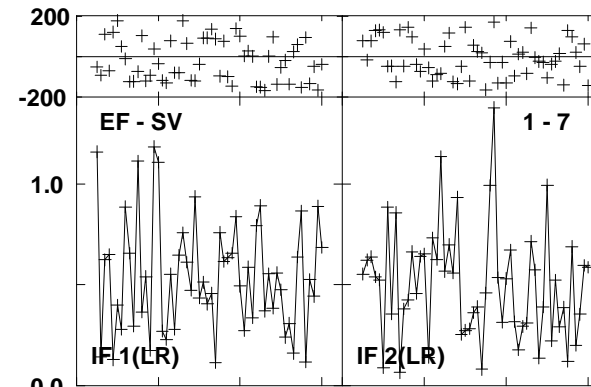
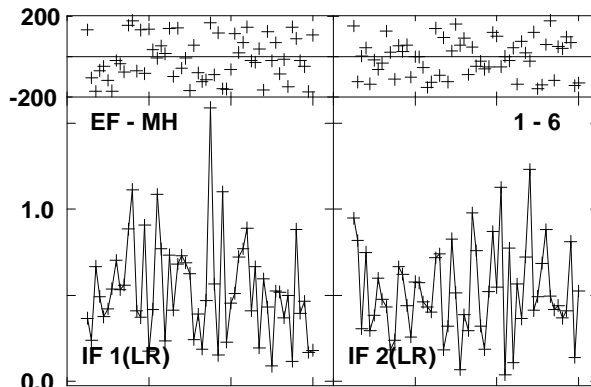
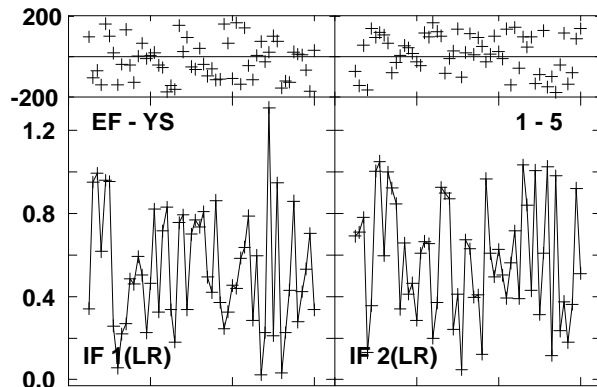
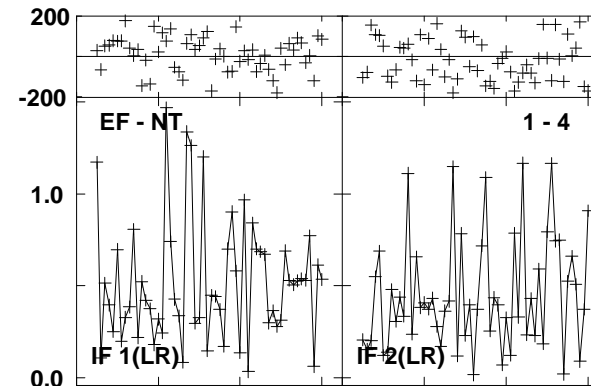
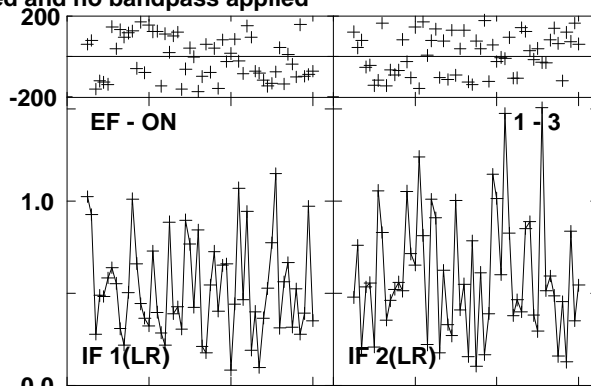
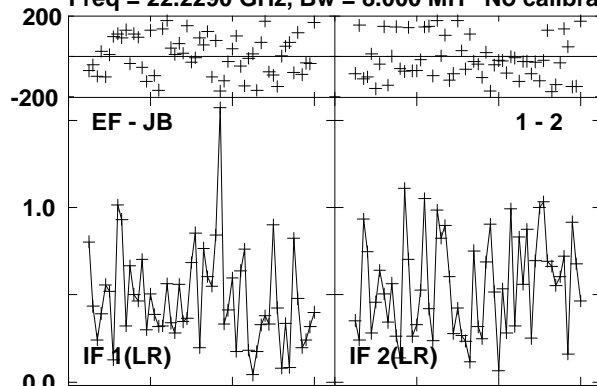

Lower frame: Milli Ampl Jy Top frame: Phas deg
Vector averaged cross-power spectrum Several baselines displayed
Timerange: 00/11:22:06 to 00/11:23:01

Plot file version 72 created 17-SEP-2012 12:03:42

J0541-0541 EE008D 1.UVDATA.1

Freq = 22.2290 GHz, Bw = 8.000 MH No calibration applied and no bandpass applied

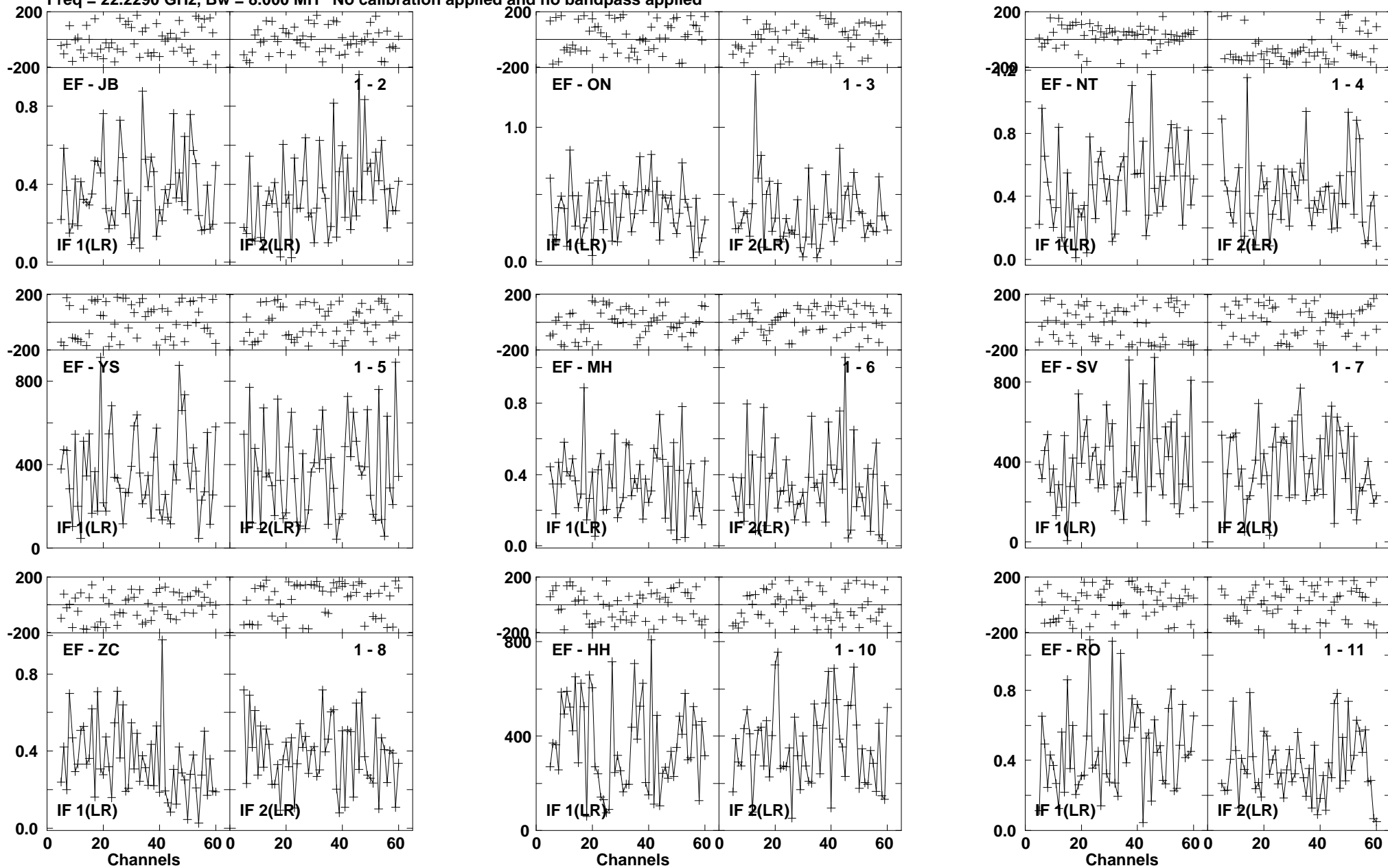

Lower frame: Milli Ampl Jy Top frame: Phas deg
Vector averaged cross-power spectrum Several baselines displayed
Timerange: 00/11:23:47 to 00/11:24:46

Plot file version 73 created 17-SEP-2012 12:03:45

ORIKL1 EE008D 1.UVDATA.1

Freq = 22.2290 GHz, Bw = 8.000 MH No calibration applied and no bandpass applied

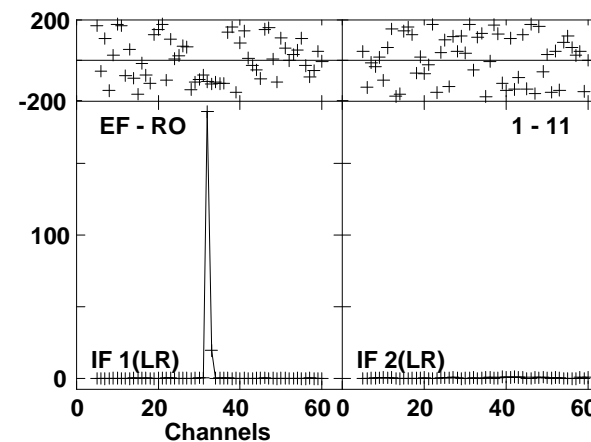
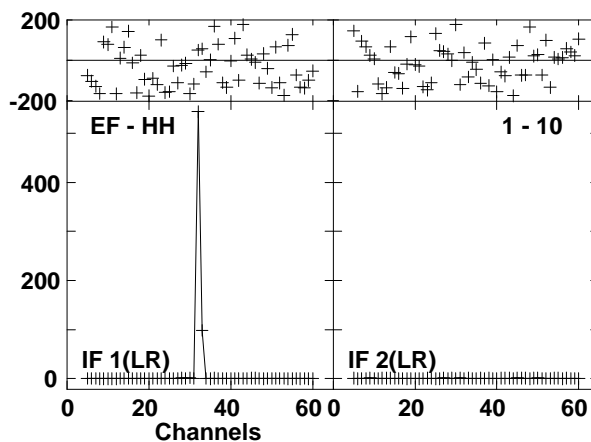
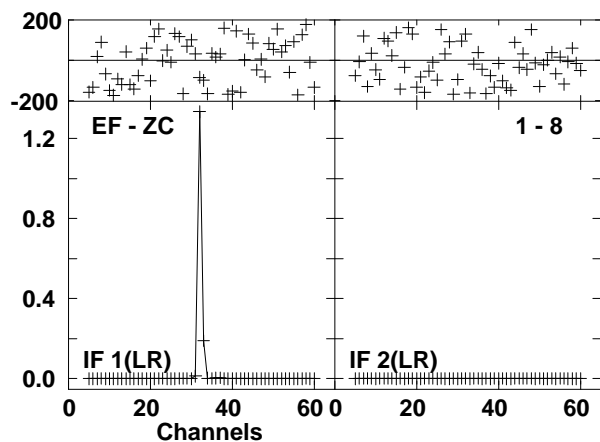
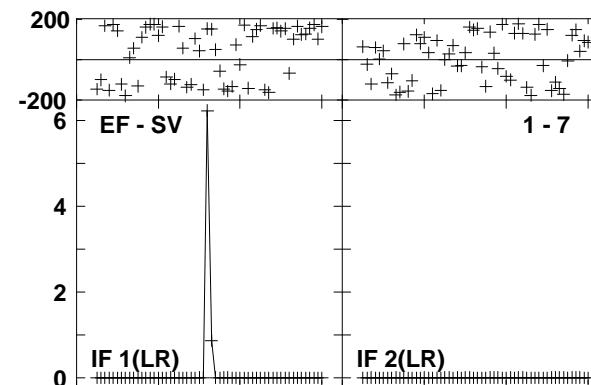
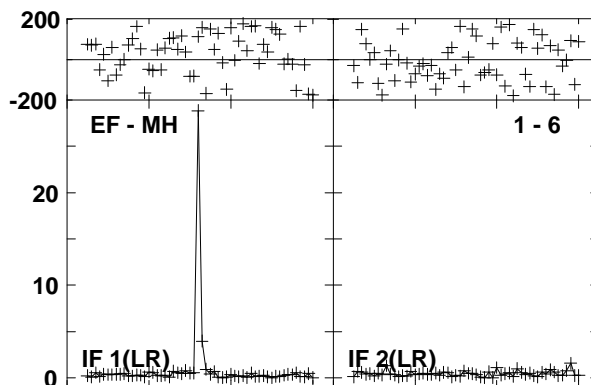
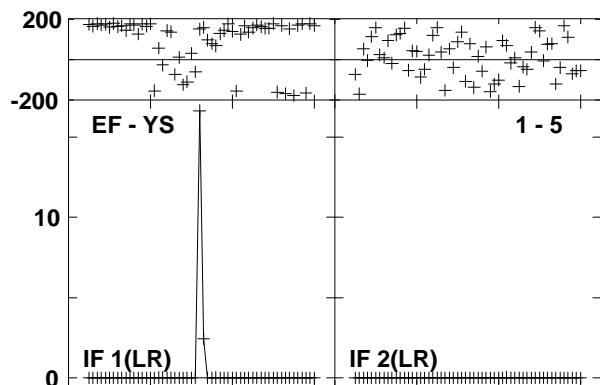
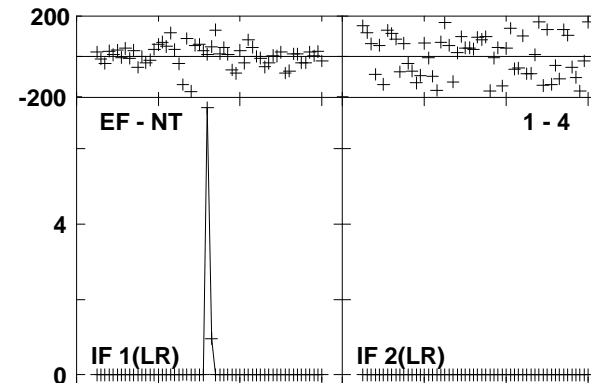
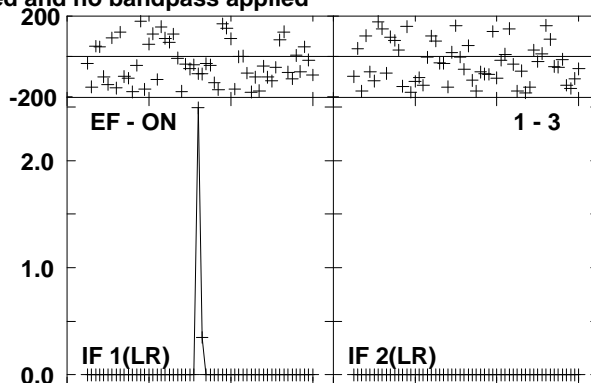
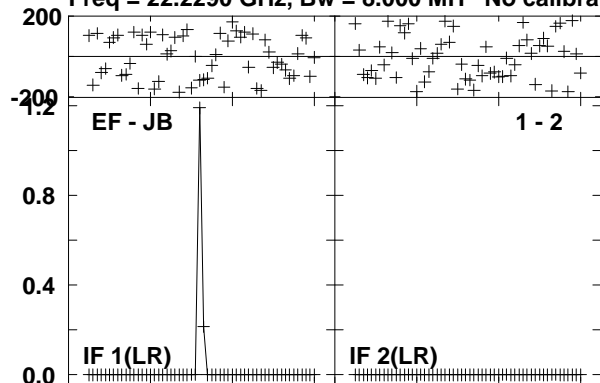

Lower frame: Ampl Jy Top frame: Phas deg
Vector averaged cross-power spectrum Several baselines displayed
Timerange: 00/11:24:50 to 00/11:25:46

Plot file version 74 created 17-SEP-2012 12:03:47

J0541-0541 EE008D 1.UVDATA.1

Freq = 22.2290 GHz, Bw = 8.000 MH No calibration applied and no bandpass applied

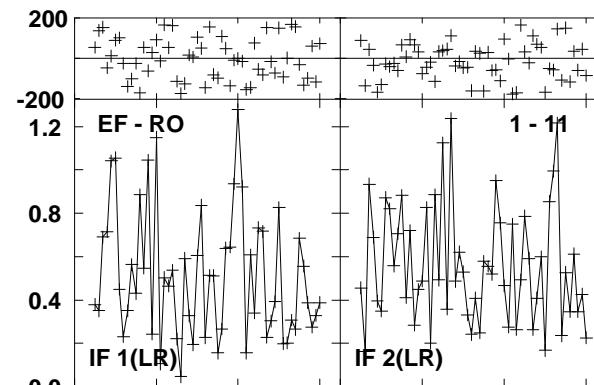
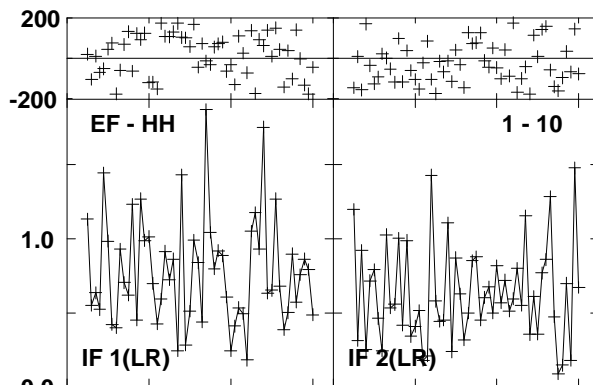
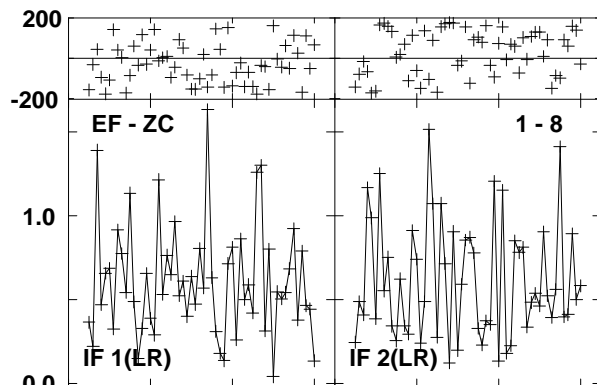
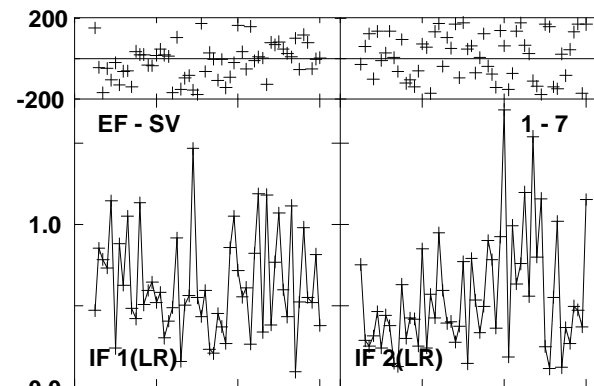
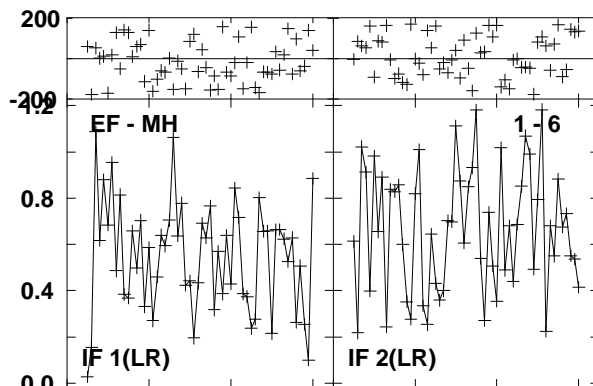
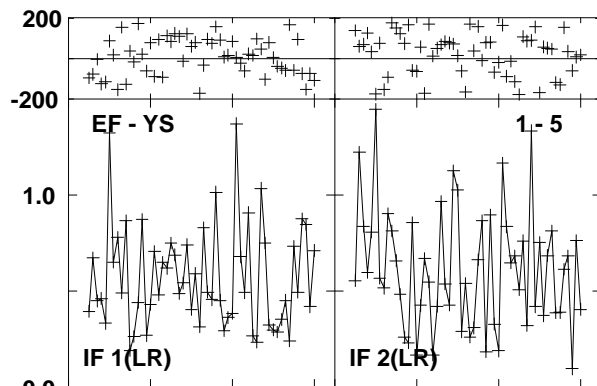
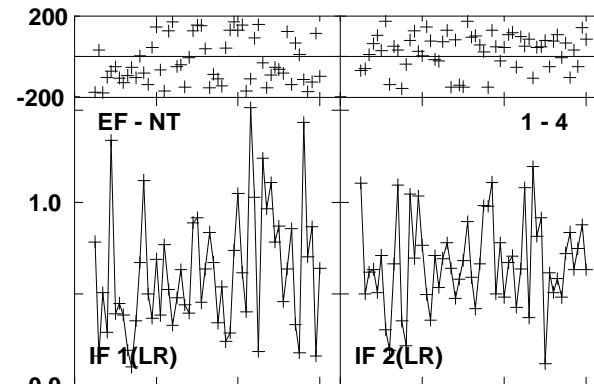
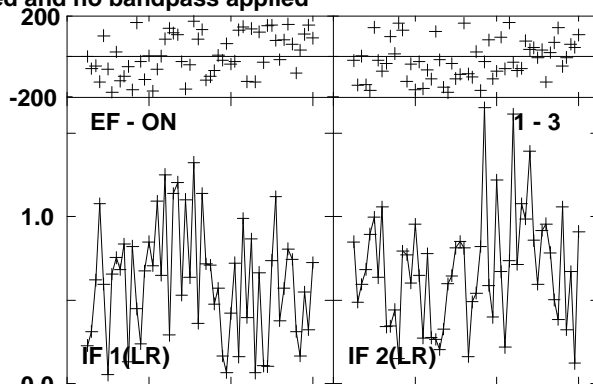
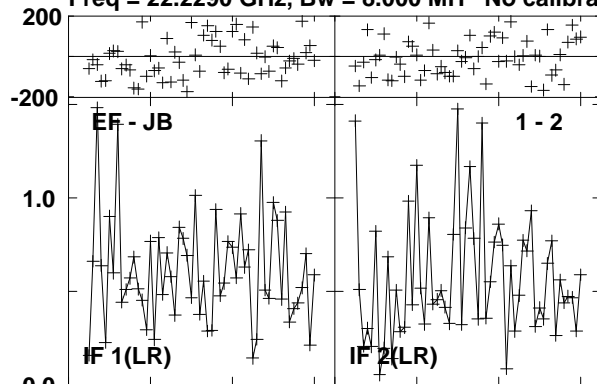

Lower frame: Milli Ampl Jy Top frame: Phas deg
Vector averaged cross-power spectrum Several baselines displayed
Timerange: 00/11:25:53 to 00/11:26:46

Plot file version 75 created 17-SEP-2012 12:03:50

ORIKL1 EE008D 1.UVDATA.1

Freq = 22.2290 GHz, Bw = 8.000 MH No calibration applied and no bandpass applied

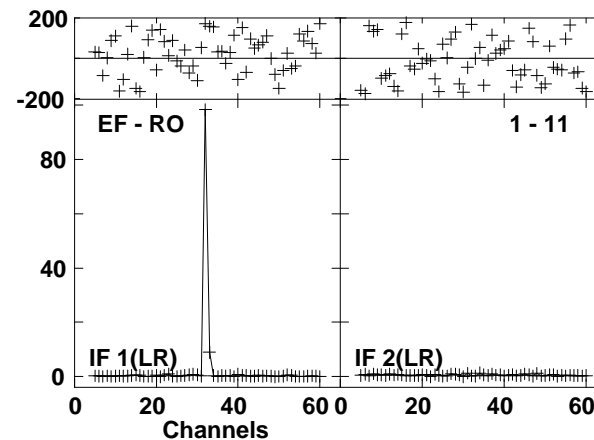
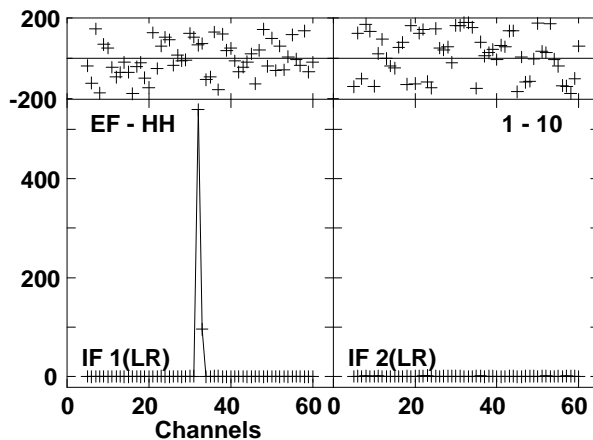
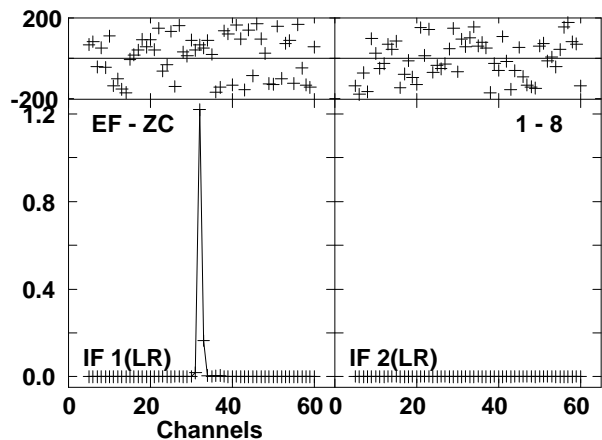
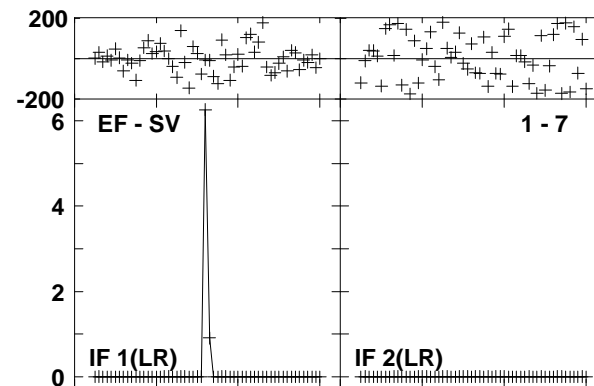
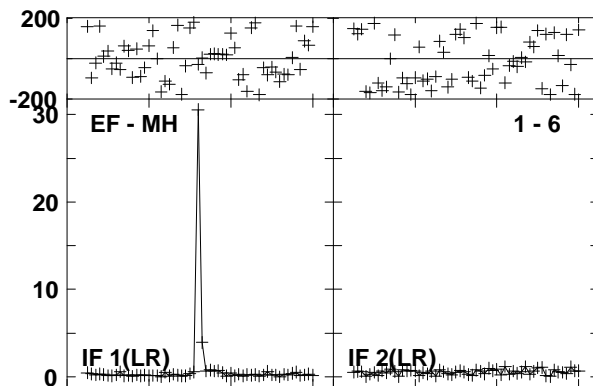
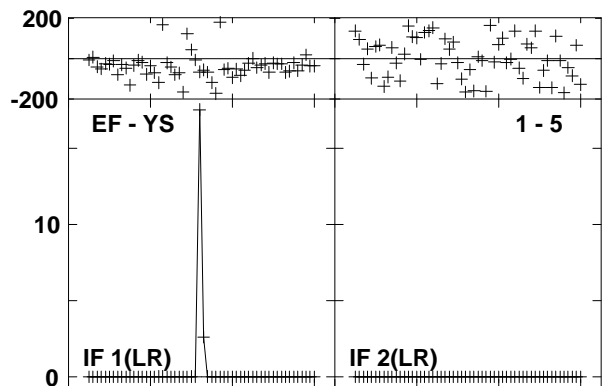
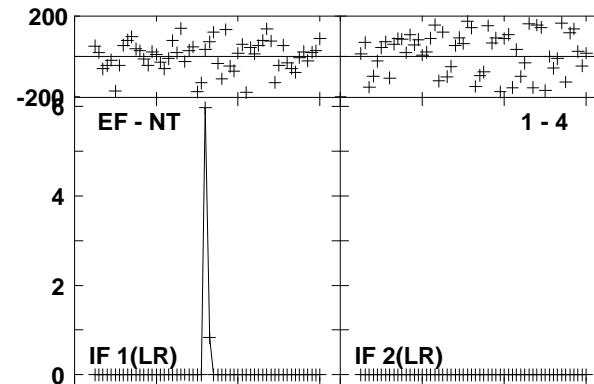
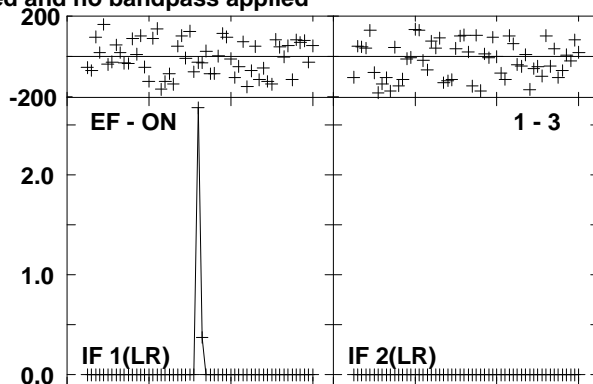
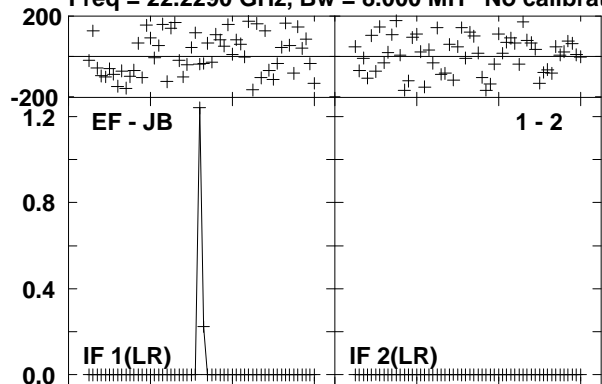

Lower frame: Ampl Jy Top frame: Phas deg
Vector averaged cross-power spectrum Several baselines displayed
Timerange: 00/11:26:51 to 00/11:27:46

Plot file version 76 created 17-SEP-2012 12:03:52

J0541-0541 EE008D 1.UVDATA.1

Freq = 22.2290 GHz, Bw = 8.000 MH No calibration applied and no bandpass applied

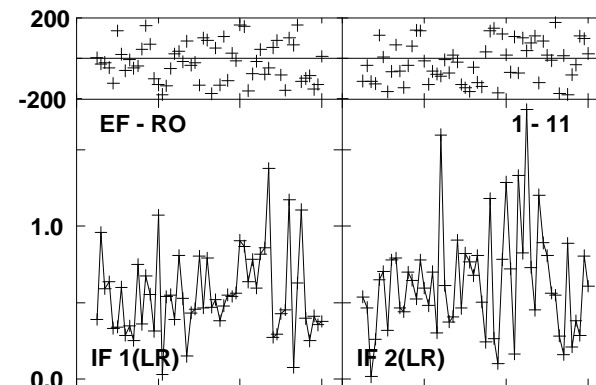
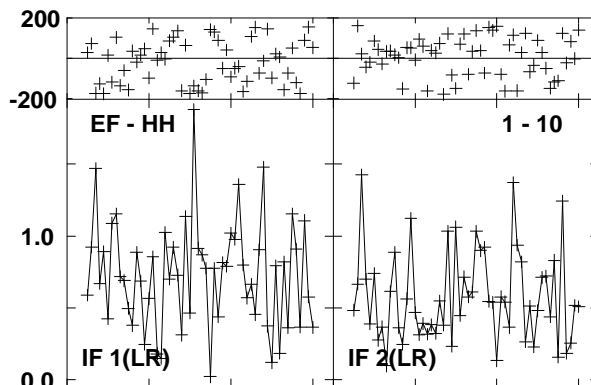
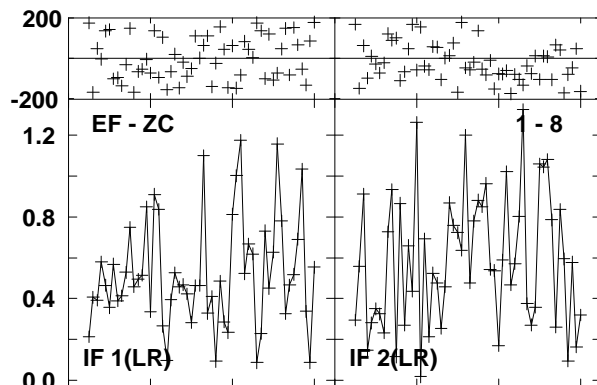
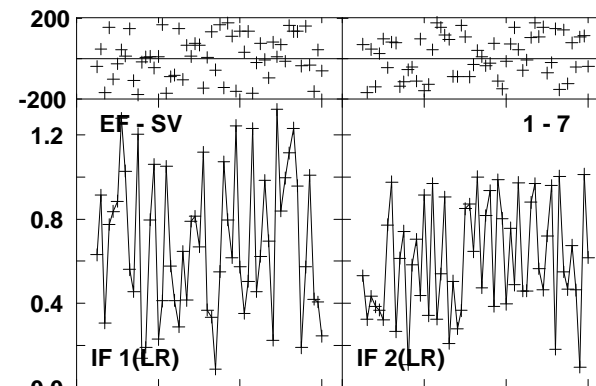
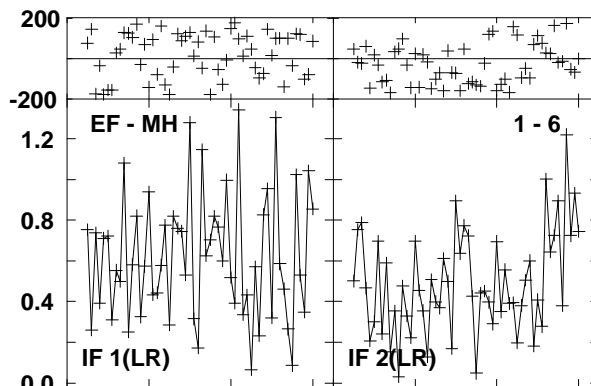
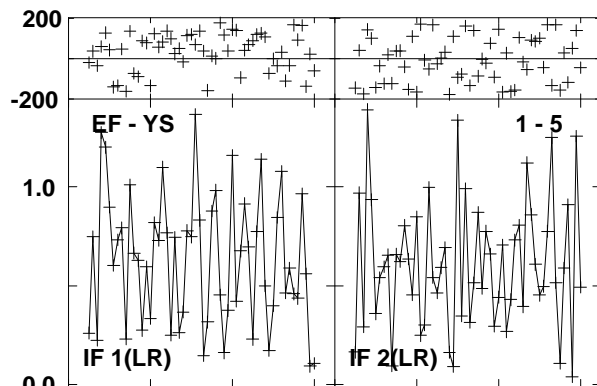
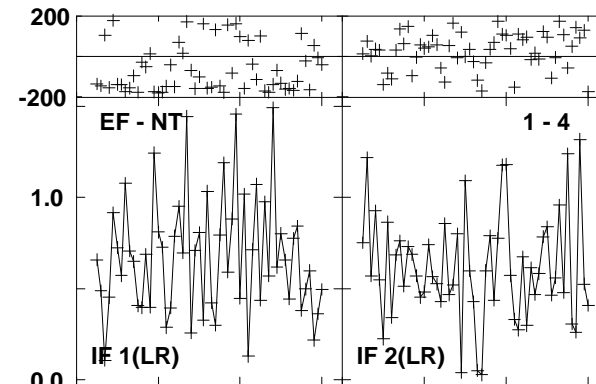
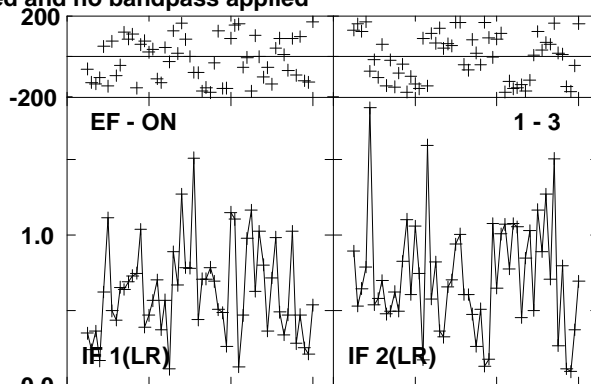
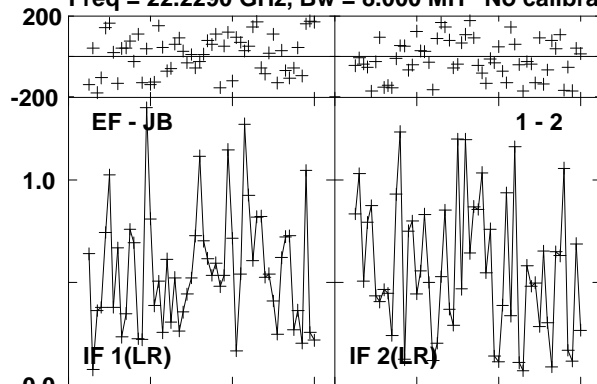

Lower frame: Milli Ampl Jy Top frame: Phas deg
Vector averaged cross-power spectrum Several baselines displayed
Timerange: 00/11:27:51 to 00/11:28:46

Plot file version 77 created 17-SEP-2012 12:03:55

J0529-0519 EE008D 1.UVDATA.1

Freq = 22.2290 GHz, Bw = 8.000 MH No calibration applied and no bandpass applied

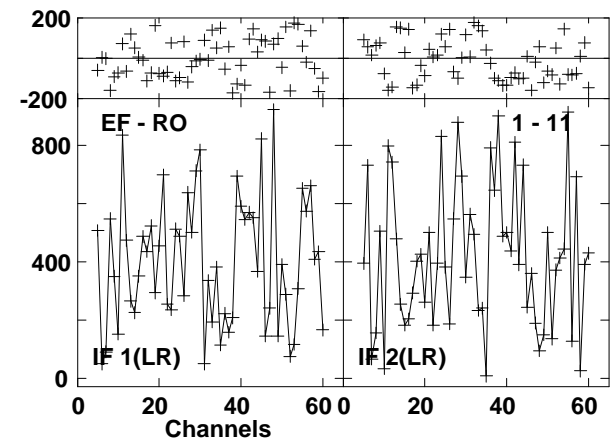
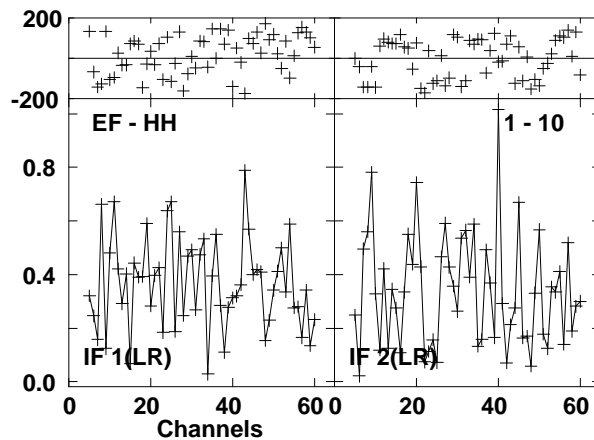
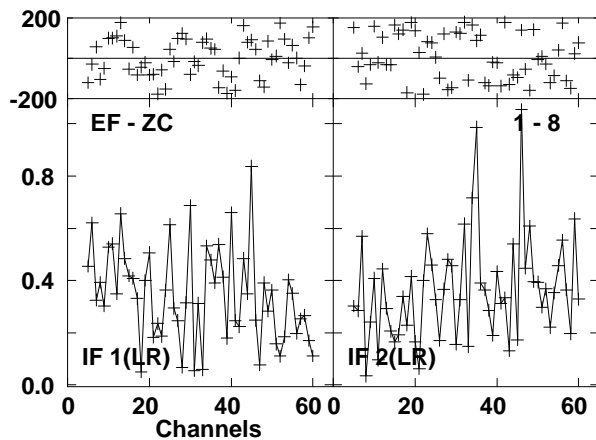
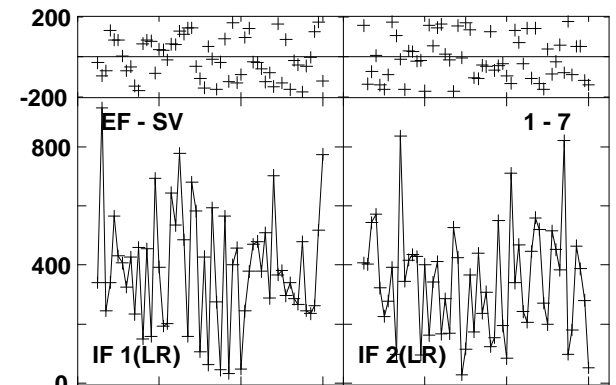
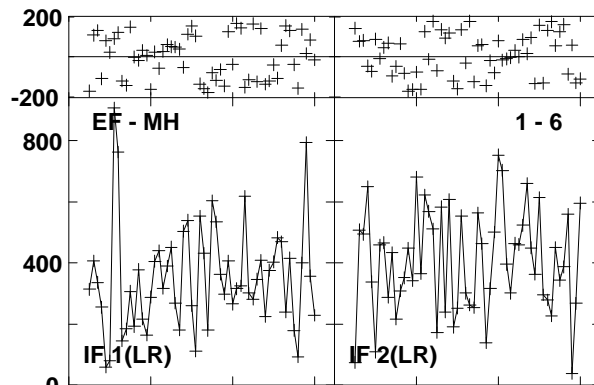
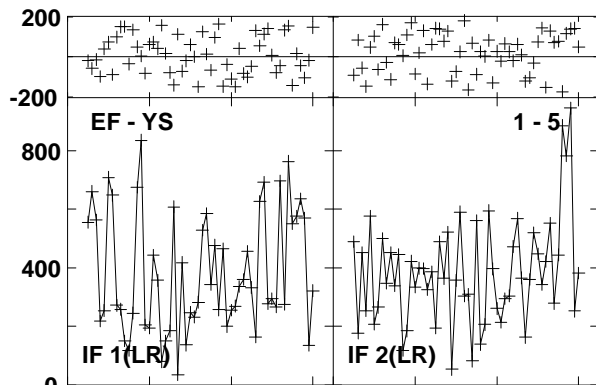
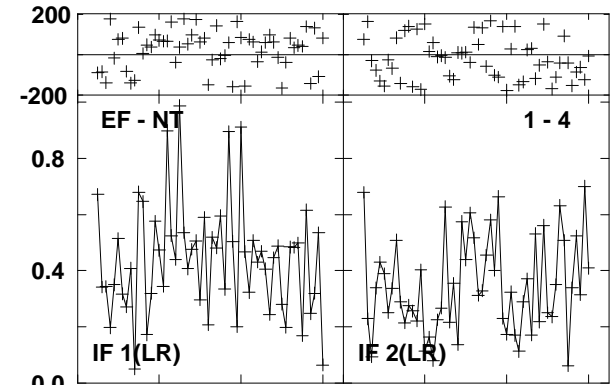
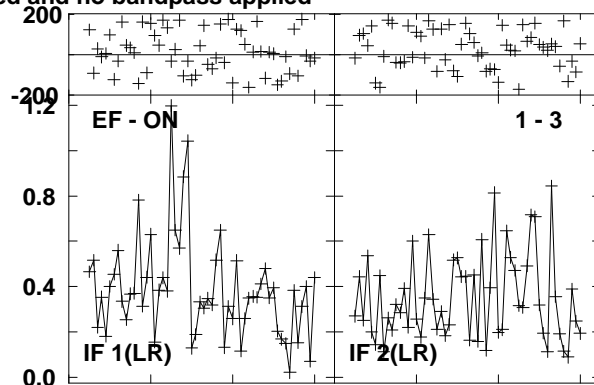
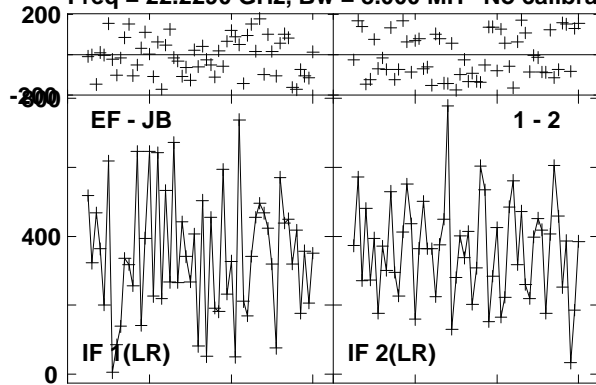

Lower frame: Micro Ampl Jy Top frame: Phas deg
Vector averaged cross-power spectrum Several baselines displayed
Timerange: 00/11:29:32 to 00/11:30:31

Plot file version 78 created 17-SEP-2012 12:03:58

ORIKL1 EE008D 1.UVDATA.1

Freq = 22.2290 GHz, Bw = 8.000 MH No calibration applied and no bandpass applied

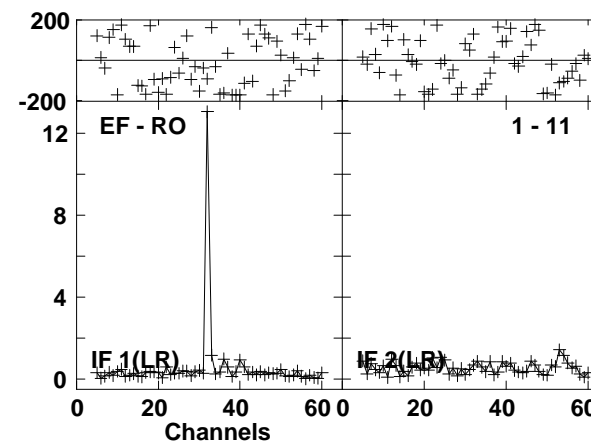
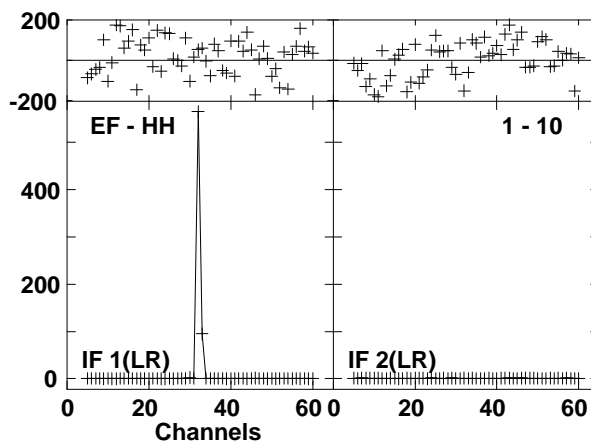
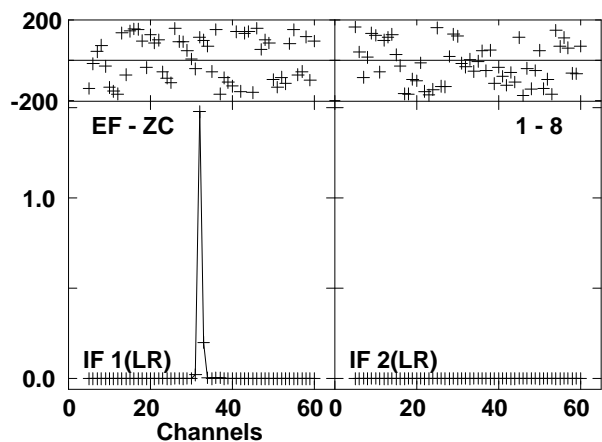
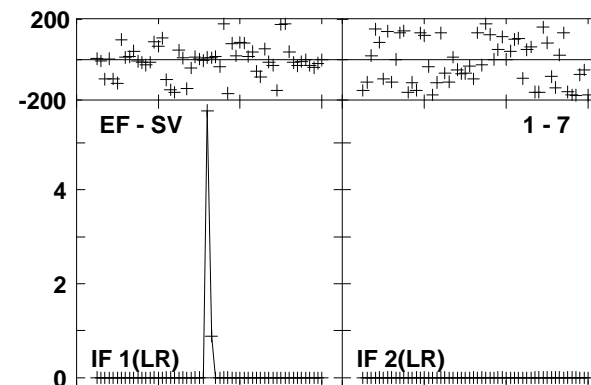
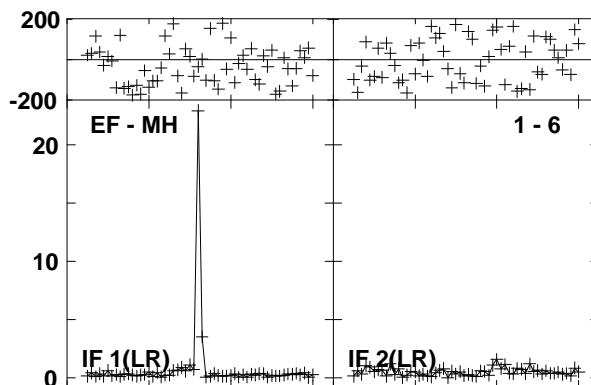
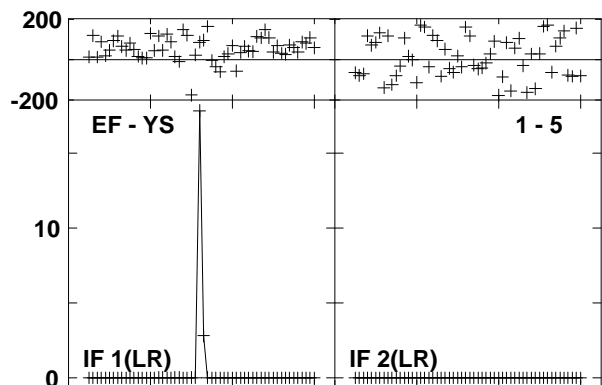
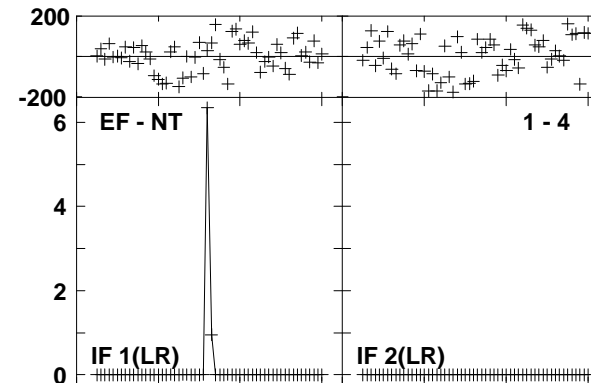
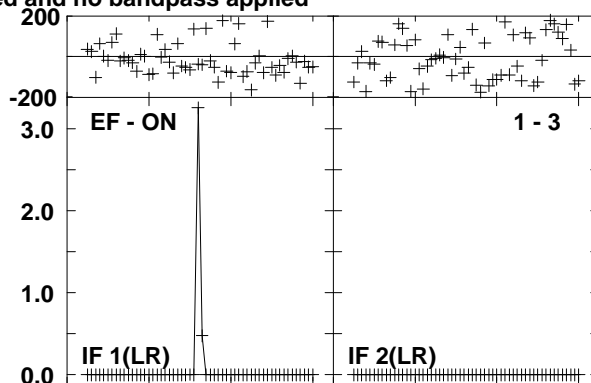
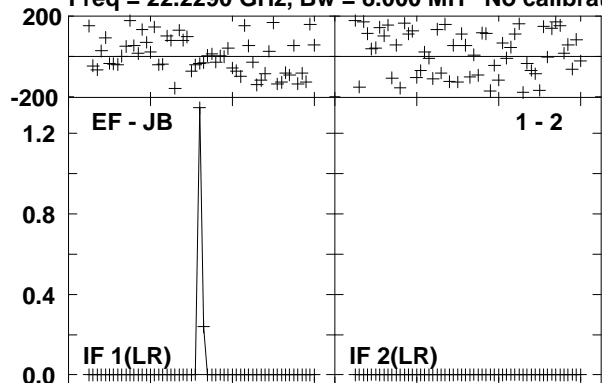

Lower frame: Ampl Jy Top frame: Phas deg
Vector averaged cross-power spectrum Several baselines displayed
Timerange: 00/11:30:35 to 00/11:31:31

Plot file version 79 created 17-SEP-2012 12:04:00

J0529-0519 EE008D 1.UVDATA.1

Freq = 22.2290 GHz, Bw = 8.000 MH No calibration applied and no bandpass applied

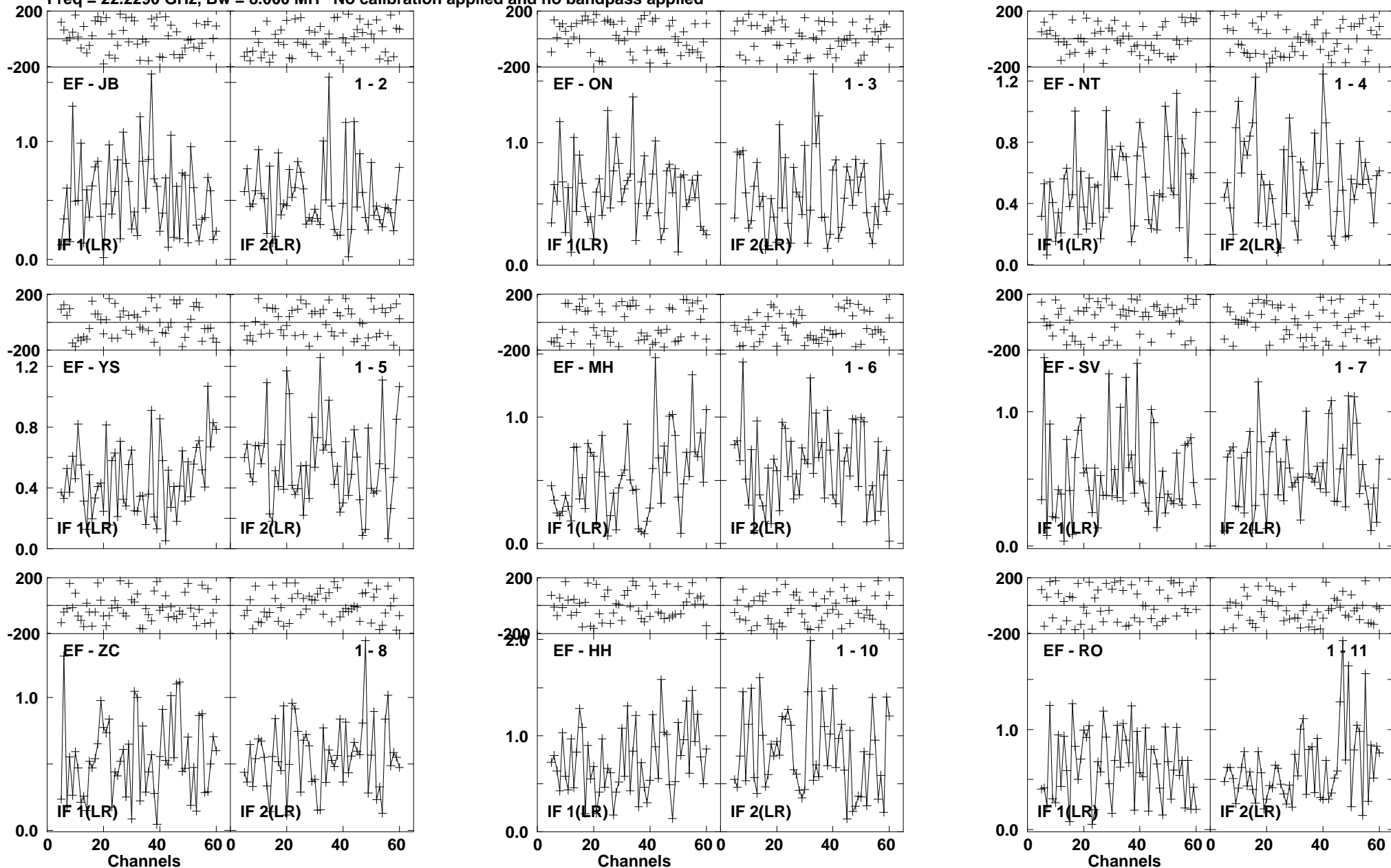

Lower frame: Milli Ampl Jy Top frame: Phas deg
Vector averaged cross-power spectrum Several baselines displayed
Timerange: 00/11:31:36 to 00/11:32:31

Plot file version 80 created 17-SEP-2012 12:04:03

ORIKL1 EE008D 1.UVDATA.1

Freq = 22.2290 GHz, Bw = 8.000 MH No calibration applied and no bandpass applied

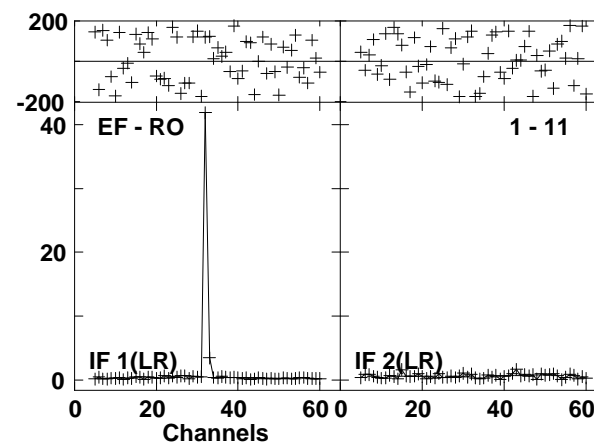
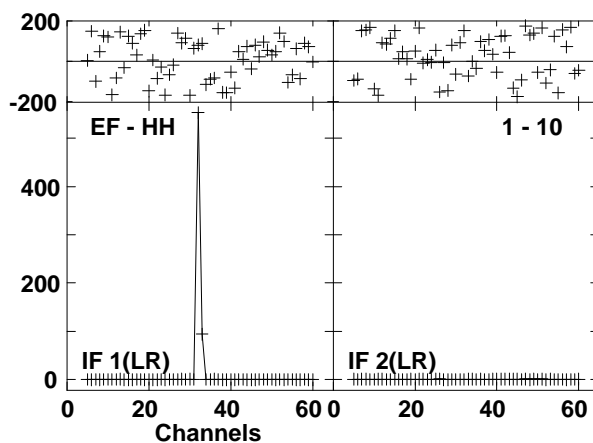
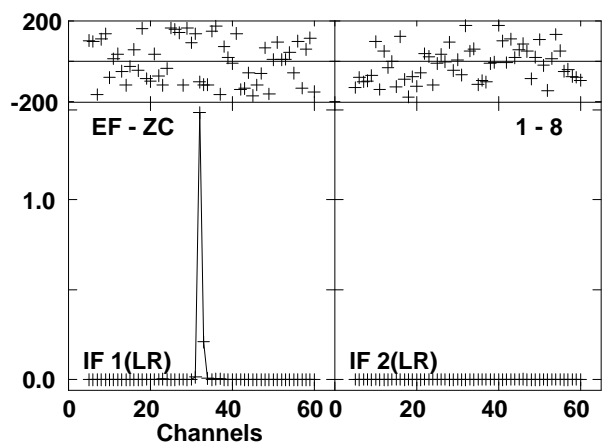
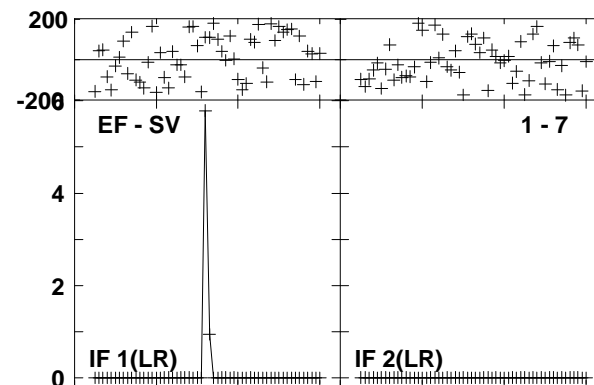
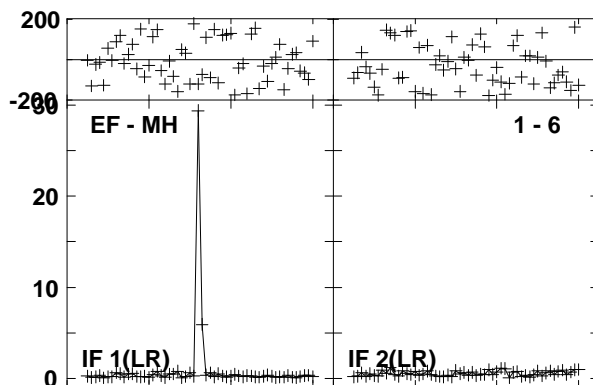
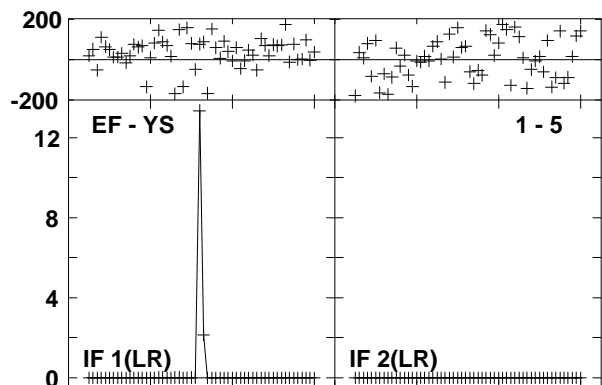
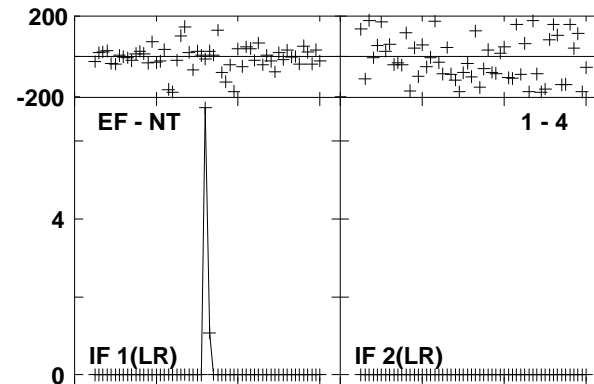
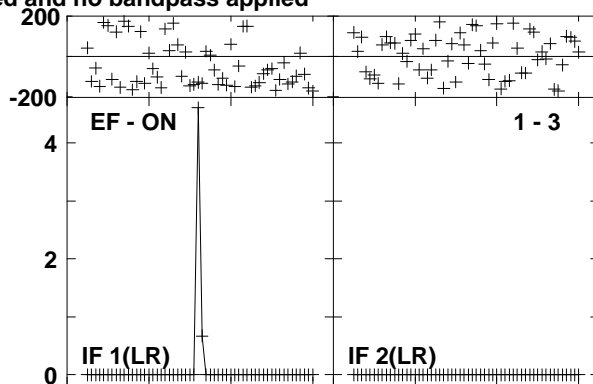
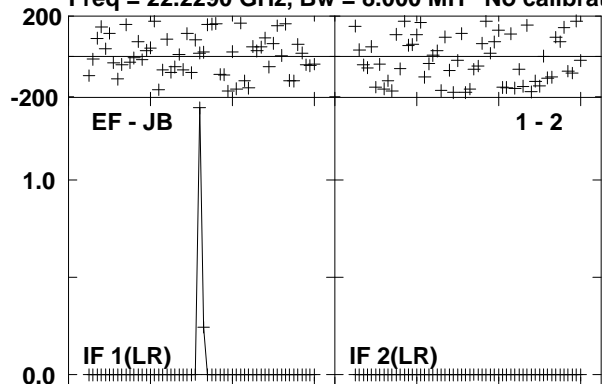

Lower frame: Ampl Jy Top frame: Phas deg
Vector averaged cross-power spectrum Several baselines displayed
Timerange: 00/11:32:36 to 00/11:33:31

Plot file version 81 created 17-SEP-2012 12:04:05

J0529-0519 EE008D 1.UVDATA.1

Freq = 22.2290 GHz, Bw = 8.000 MH No calibration applied and no bandpass applied

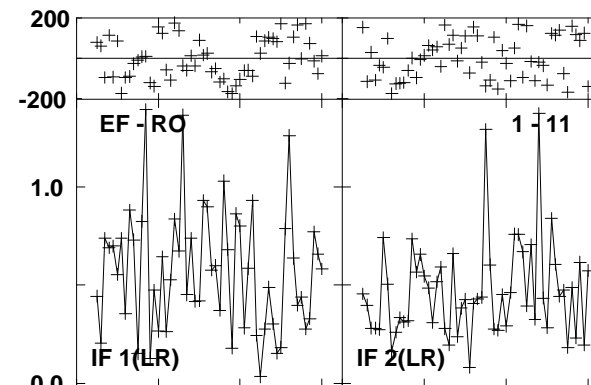
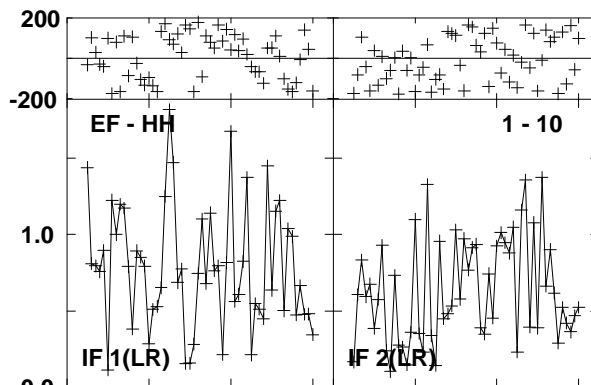
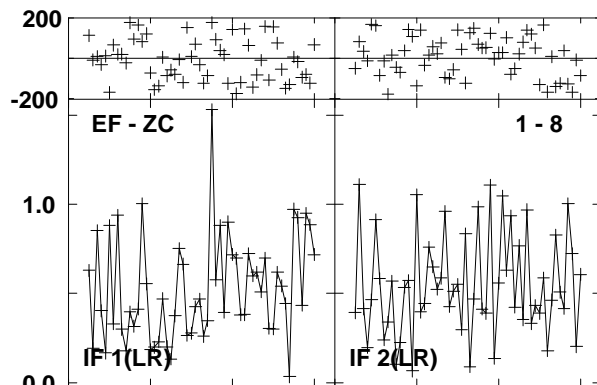
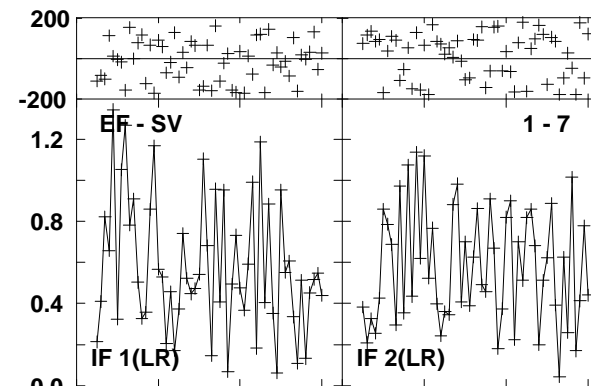
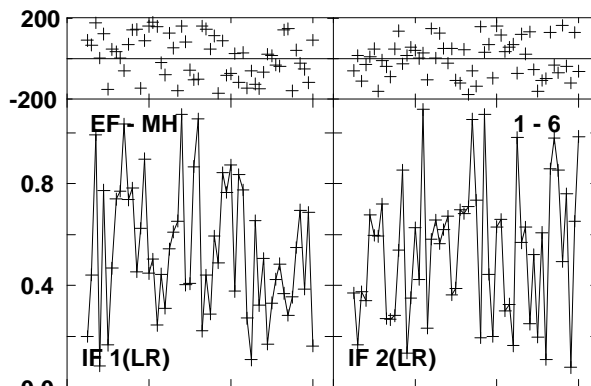
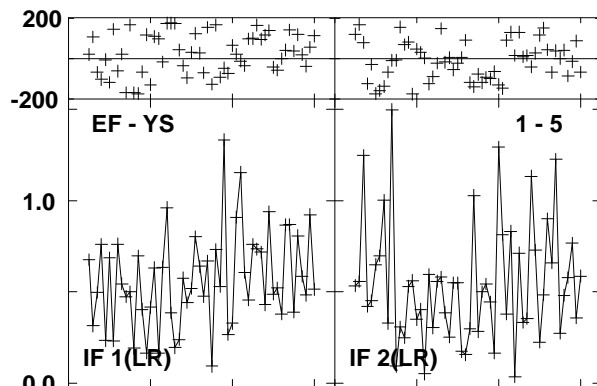
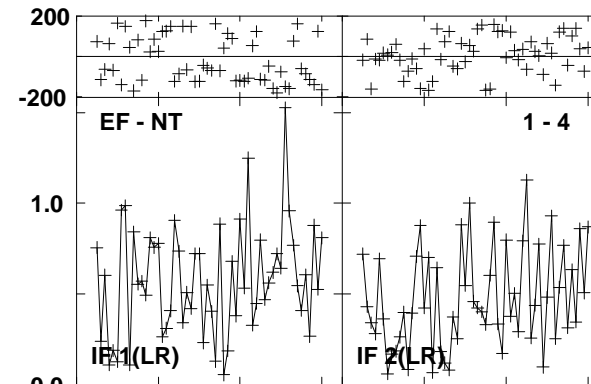
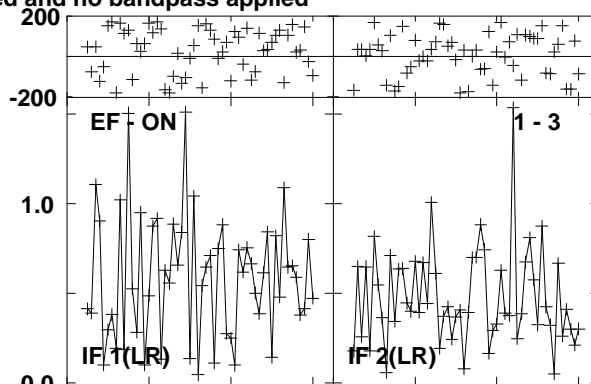
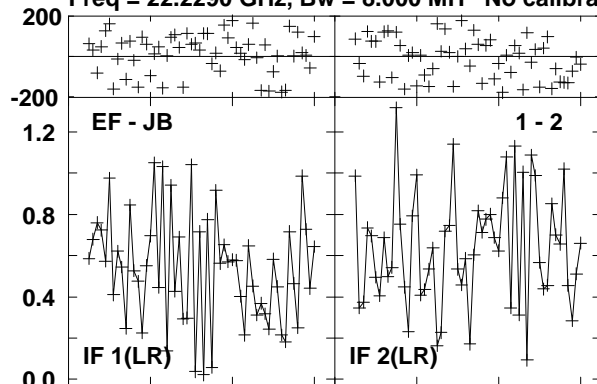

Lower frame: Milli Ampl Jy Top frame: Phas deg
Vector averaged cross-power spectrum Several baselines displayed
Timerange: 00/11:33:36 to 00/11:34:31

Plot file version 82 created 17-SEP-2012 12:04:08

J0541-0541 EE008D 1.UVDATA.1

Freq = 22.2290 GHz, Bw = 8.000 MH No calibration applied and no bandpass applied

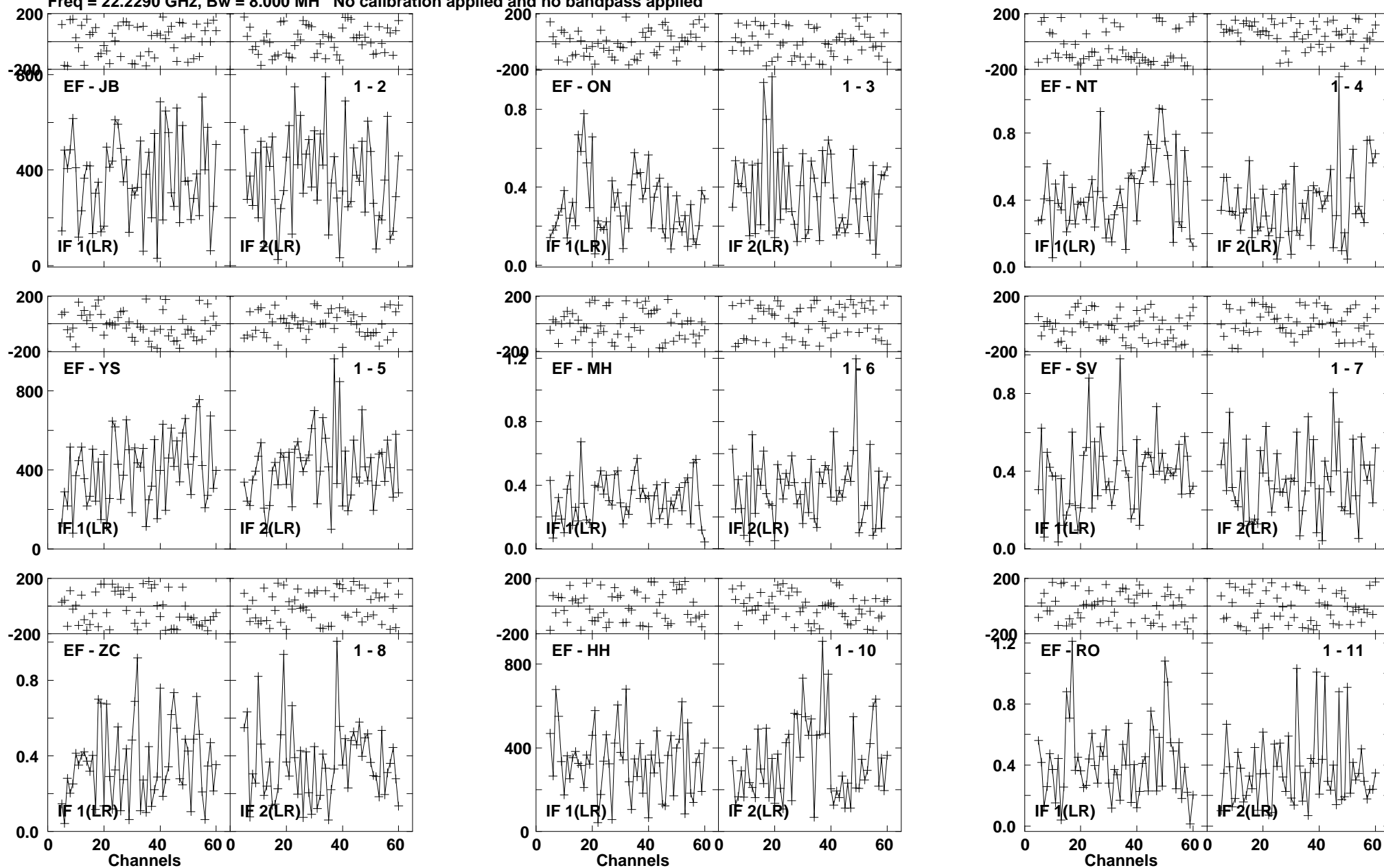

Lower frame: Micro Ampl Jy Top frame: Phas deg
Vector averaged cross-power spectrum Several baselines displayed
Timerange: 00/11:35:17 to 00/11:36:16

Plot file version 83 created 17-SEP-2012 12:04:11

ORIKL1 EE008D 1.UVDATA.1

Freq = 22.2290 GHz, Bw = 8.000 MH No calibration applied and no bandpass applied

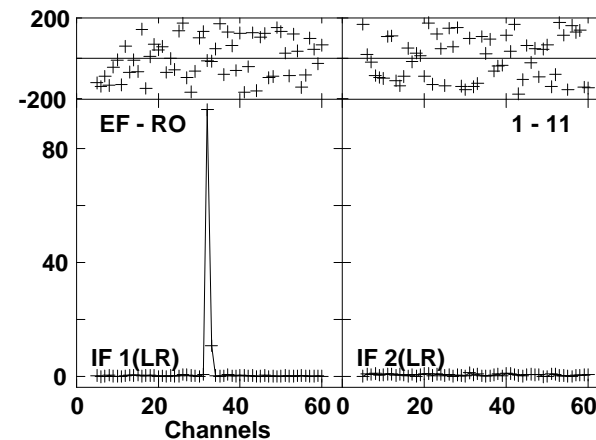
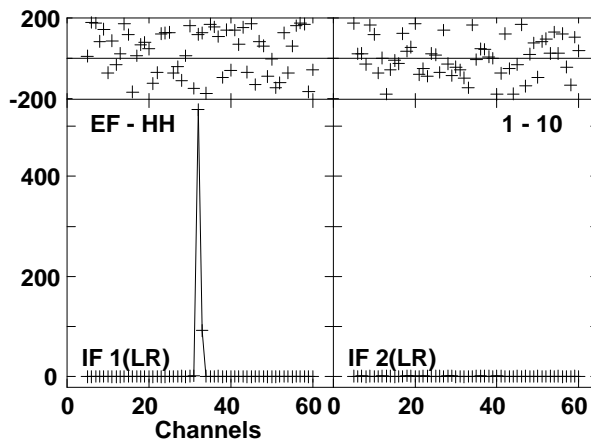
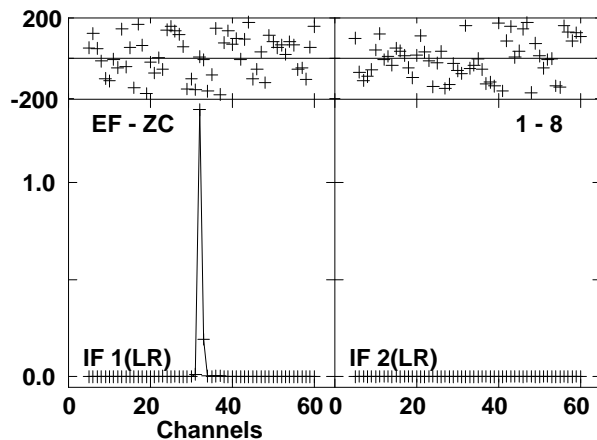
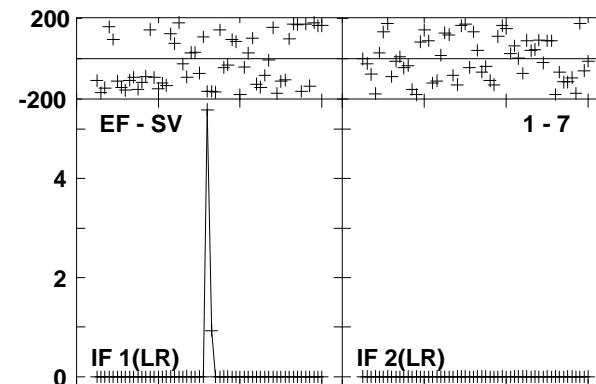
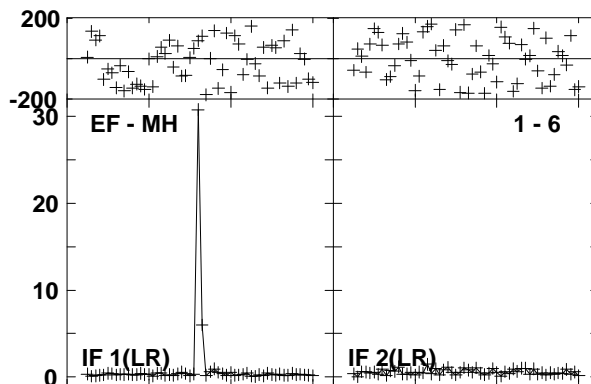
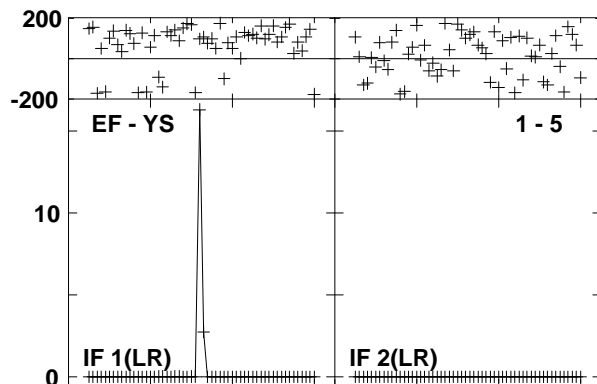
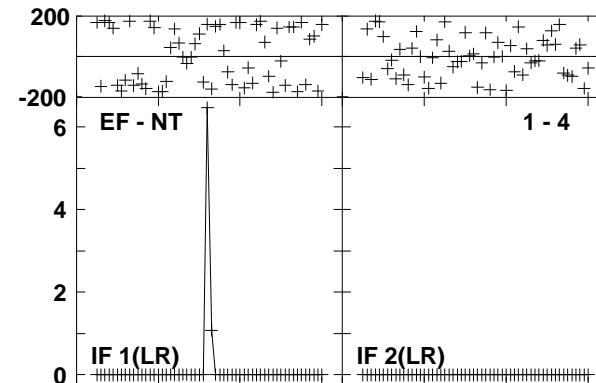
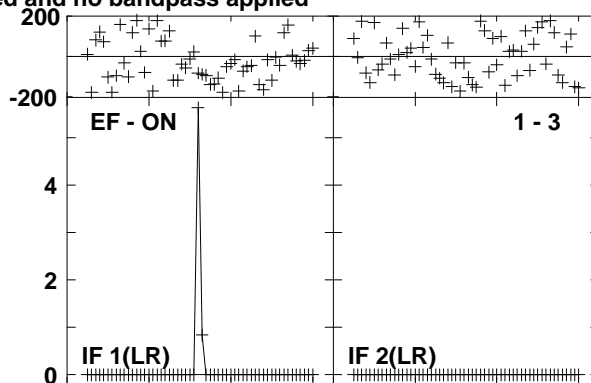
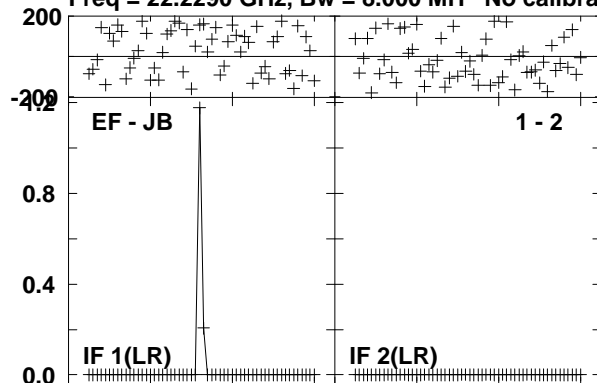

Lower frame: Ampl Jy Top frame: Phas deg
Vector averaged cross-power spectrum Several baselines displayed
Timerange: 00/11:36:20 to 00/11:37:16

Plot file version 84 created 17-SEP-2012 12:04:13

J0541-0541 EE008D 1.UVDATA.1

Freq = 22.2290 GHz, Bw = 8.000 MH No calibration applied and no bandpass applied

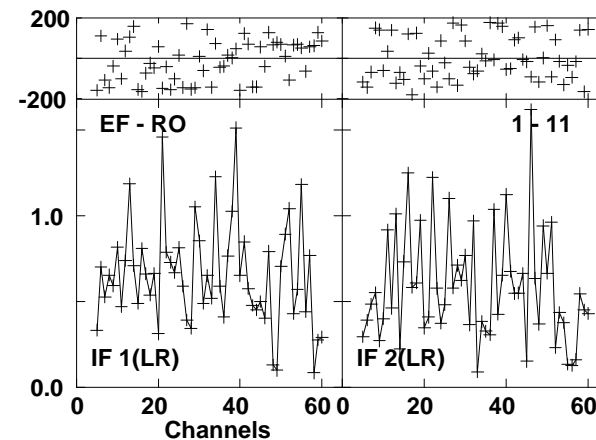
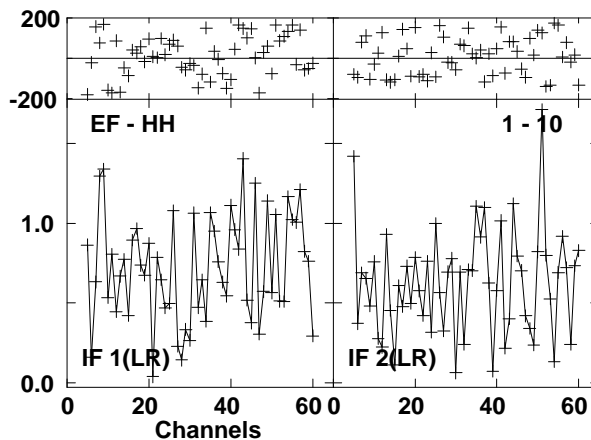
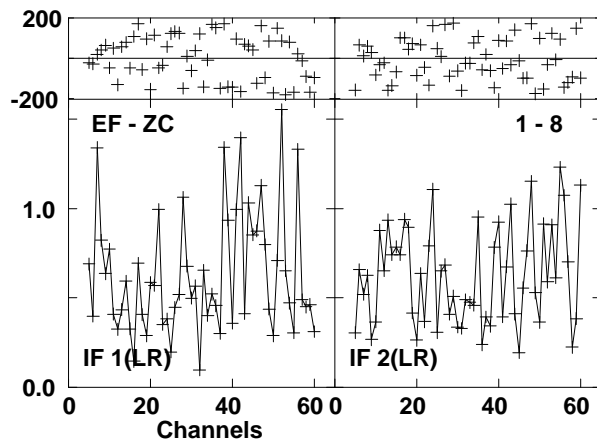
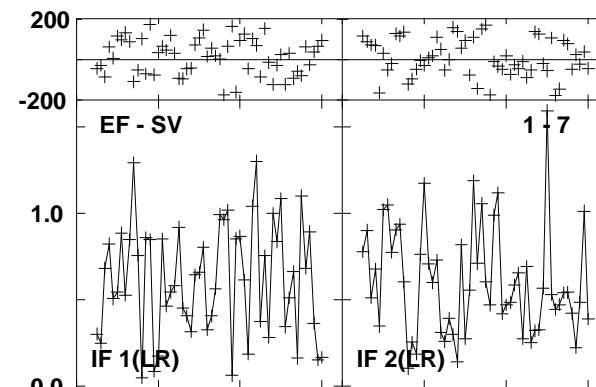
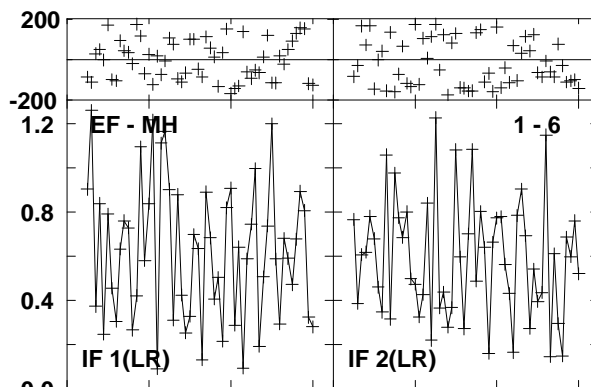
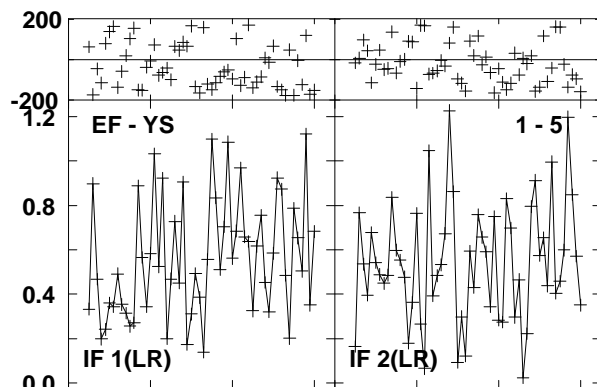
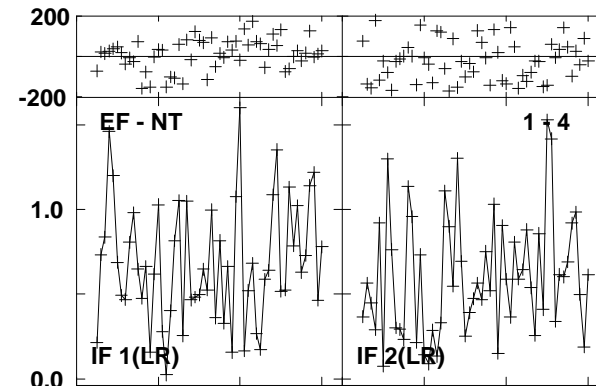
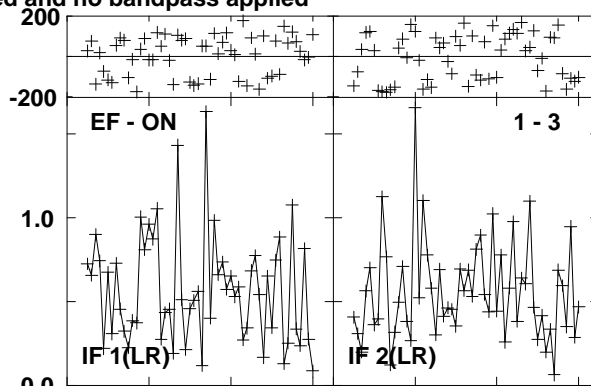
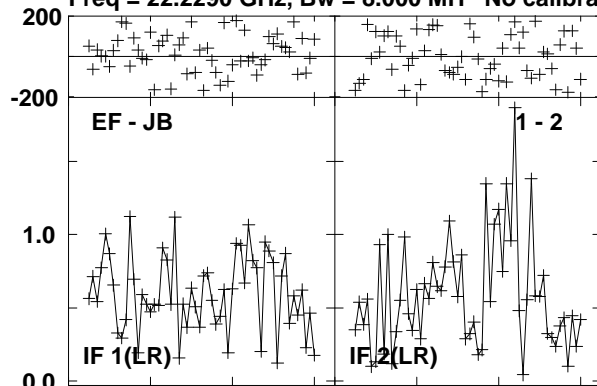

Lower frame: Milli Ampl Jy Top frame: Phas deg
Vector averaged cross-power spectrum Several baselines displayed
Timerange: 00/11:37:21 to 00/11:38:16

Plot file version 85 created 17-SEP-2012 12:04:16

ORIKL1 EE008D 1.UVDATA.1

Freq = 22.2290 GHz, Bw = 8.000 MH No calibration applied and no bandpass applied

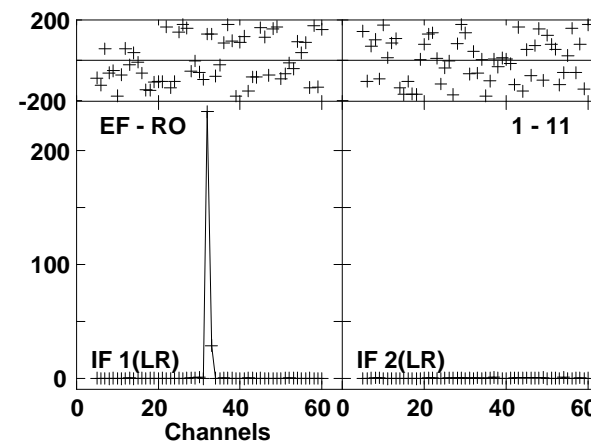
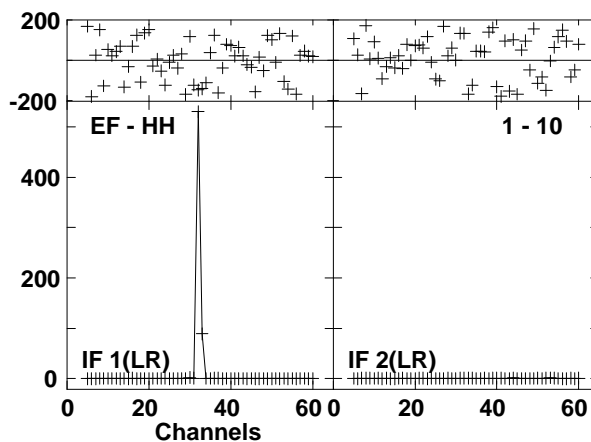
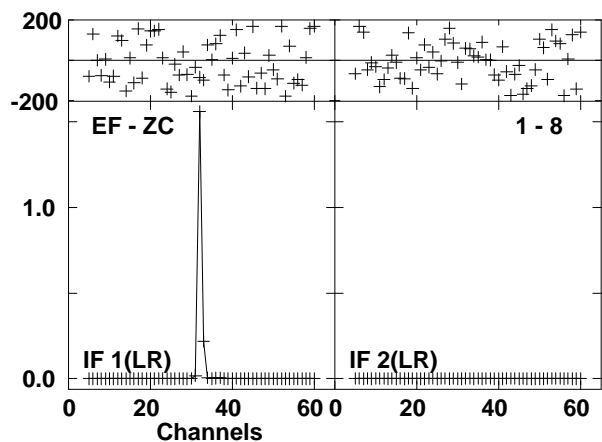
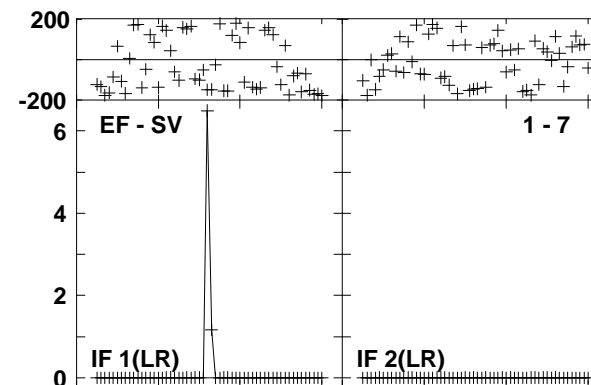
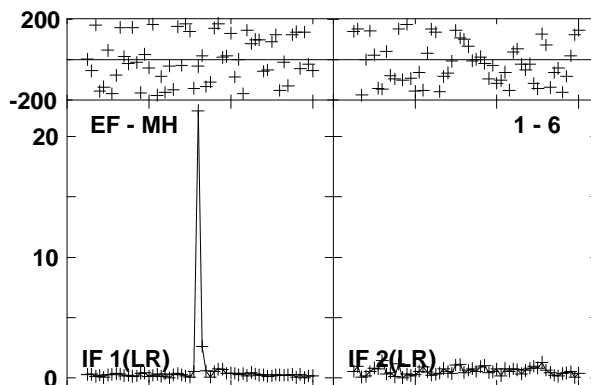
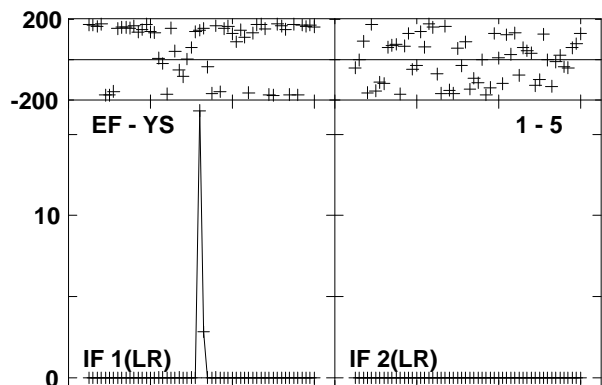
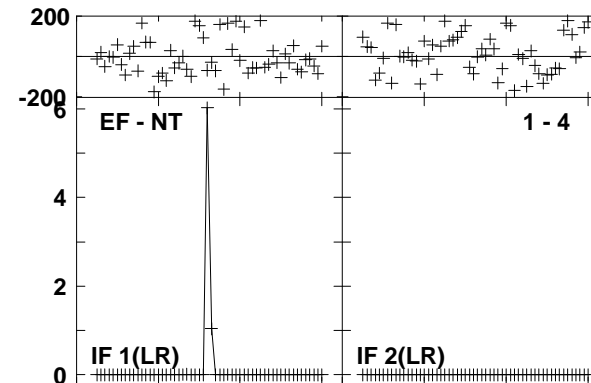
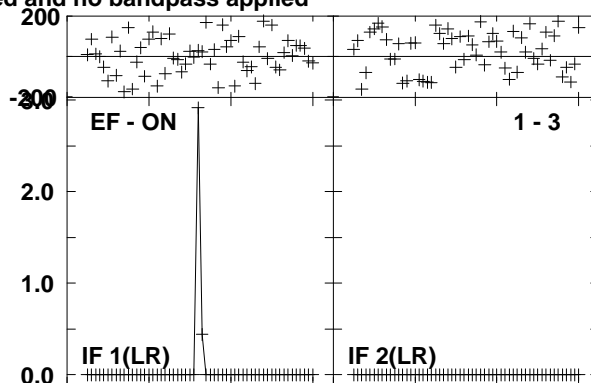
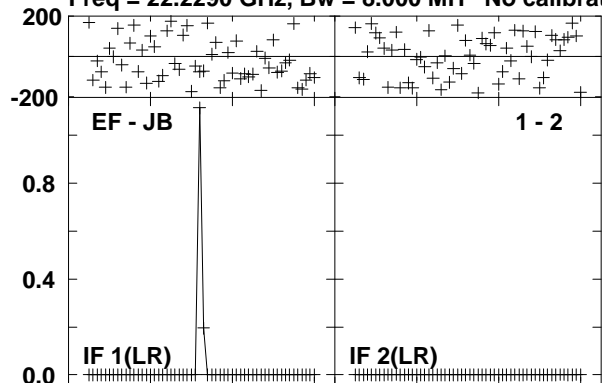

Lower frame: Ampl Jy Top frame: Phas deg
Vector averaged cross-power spectrum Several baselines displayed
Timerange: 00/11:38:21 to 00/11:39:16

Plot file version 86 created 17-SEP-2012 12:04:18

J0541-0541 EE008D 1.UVDATA.1

Freq = 22.2290 GHz, Bw = 8.000 MH No calibration applied and no bandpass applied

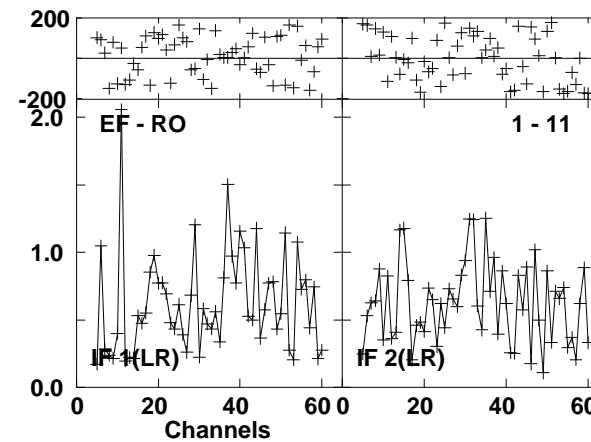
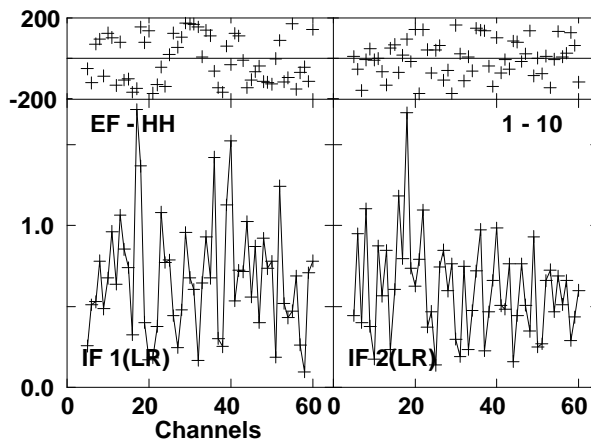
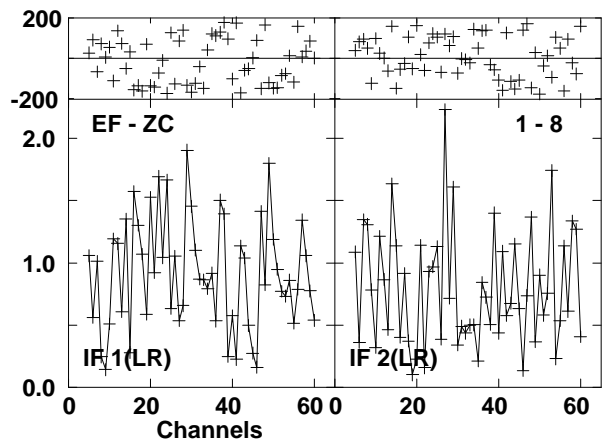
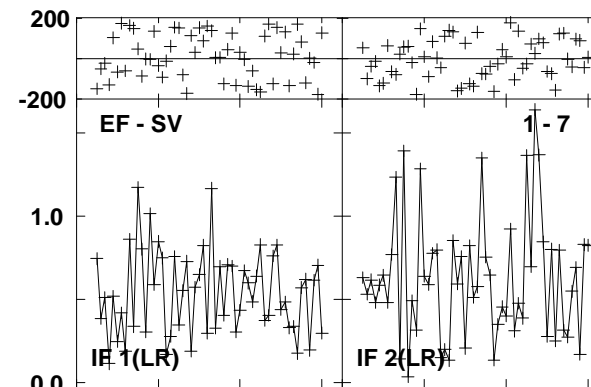
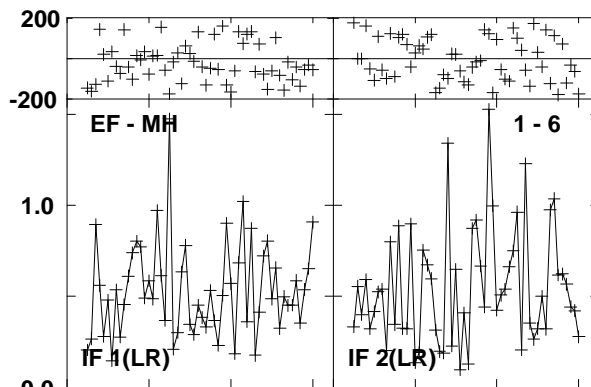
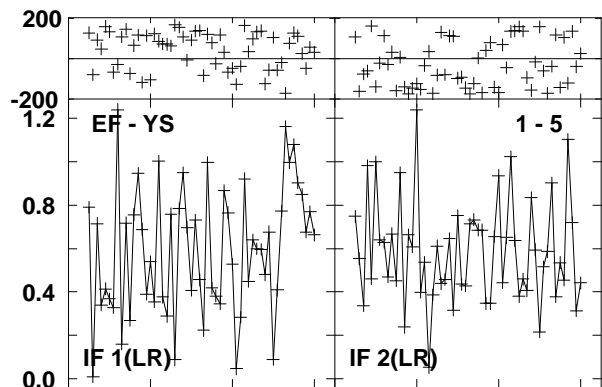
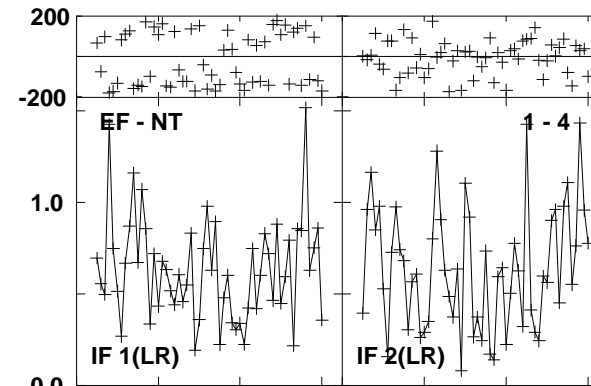
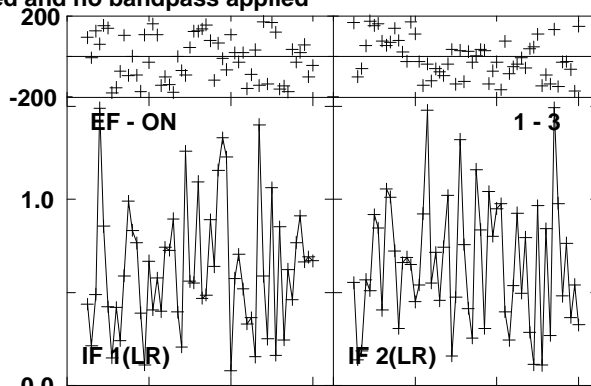
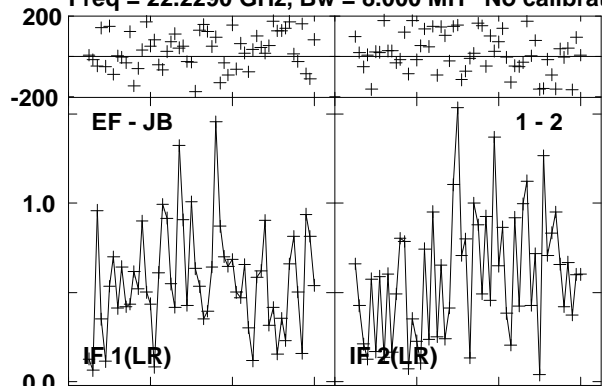

Lower frame: Milli Ampl Jy Top frame: Phas deg
Vector averaged cross-power spectrum Several baselines displayed
Timerange: 00/11:39:21 to 00/11:40:16

Plot file version 87 created 17-SEP-2012 12:04:21

J0529-0519 EE008D 1.UVDATA.1

Freq = 22.2290 GHz, Bw = 8.000 MH No calibration applied and no bandpass applied

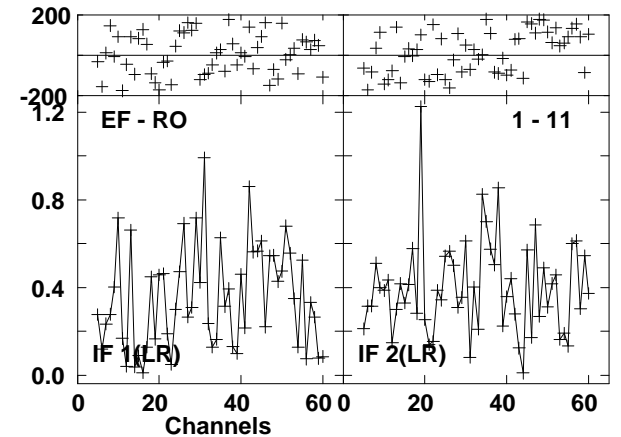
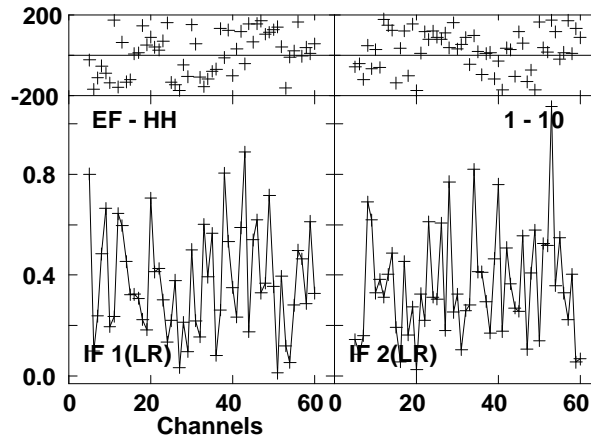
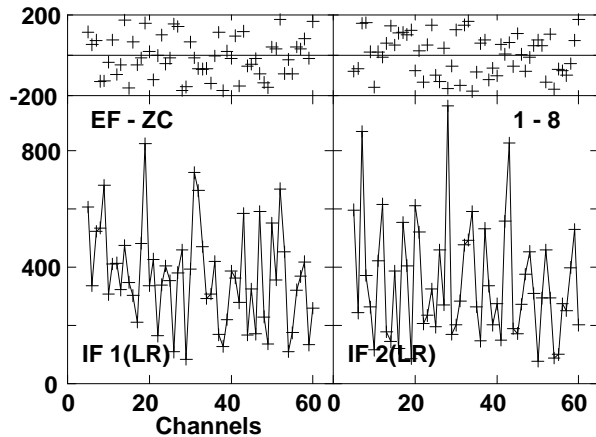
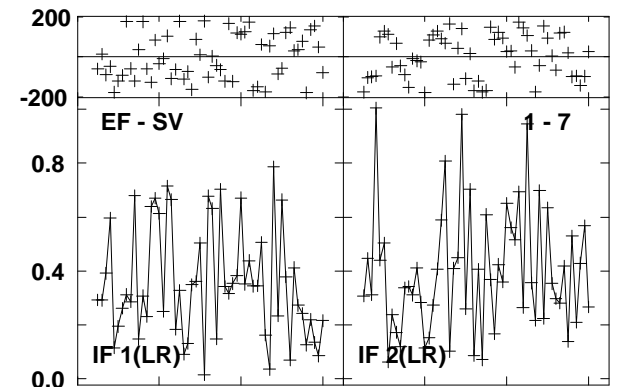
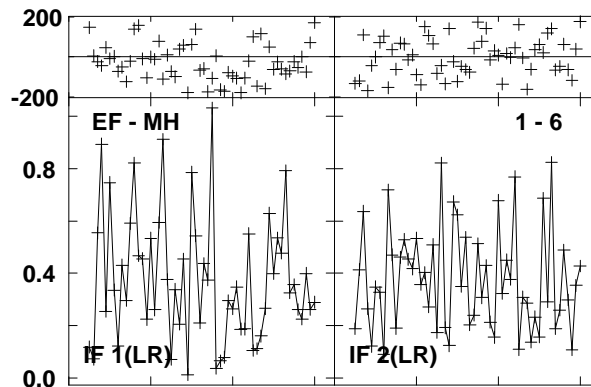
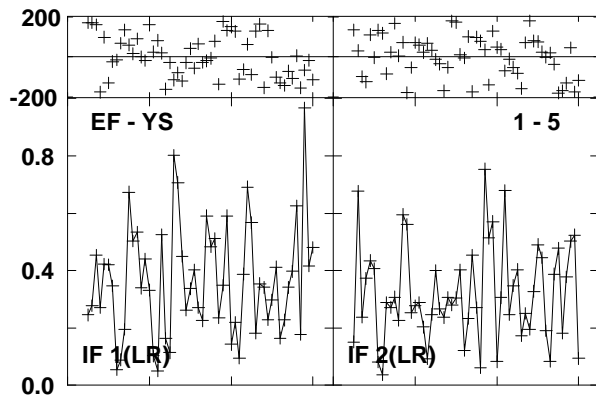
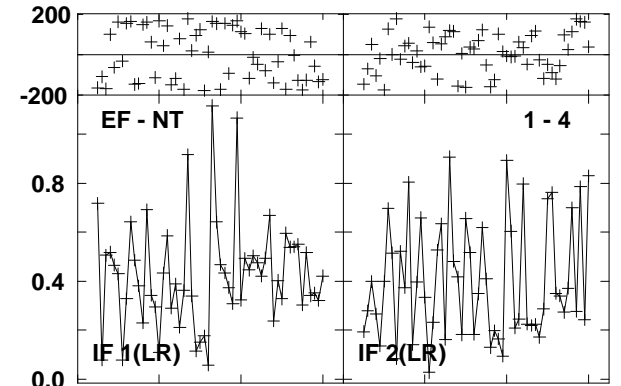
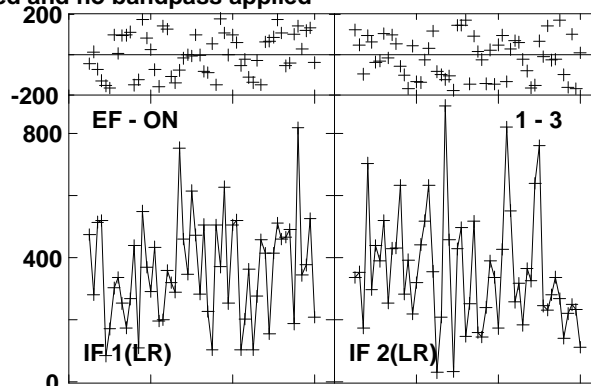
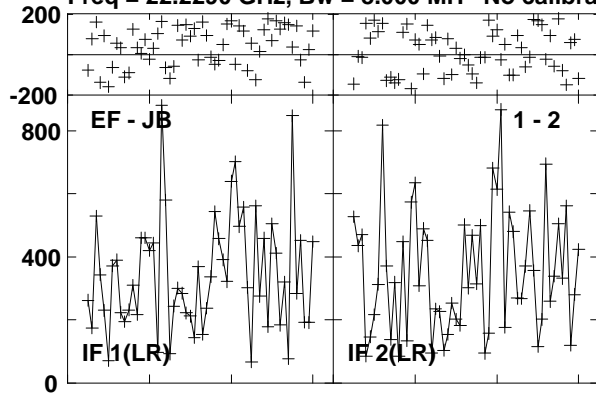

Lower frame: Micro Ampl Jy Top frame: Phas deg
Vector averaged cross-power spectrum Several baselines displayed
Timerange: 00/11:41:03 to 00/11:42:02

Plot file version 88 created 17-SEP-2012 12:04:24

ORIKL1 EE008D 1.UVDATA.1

Freq = 22.2290 GHz, Bw = 8.000 MH No calibration applied and no bandpass applied

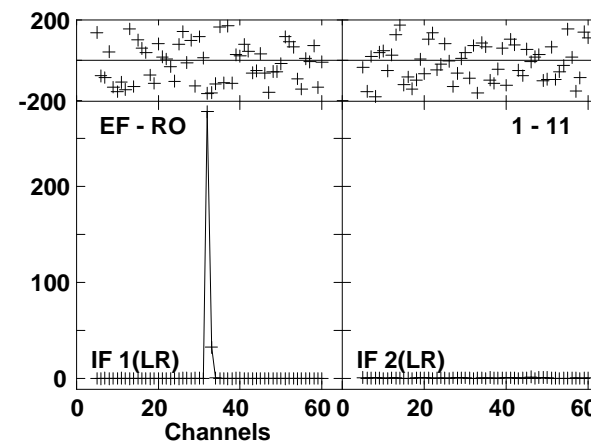
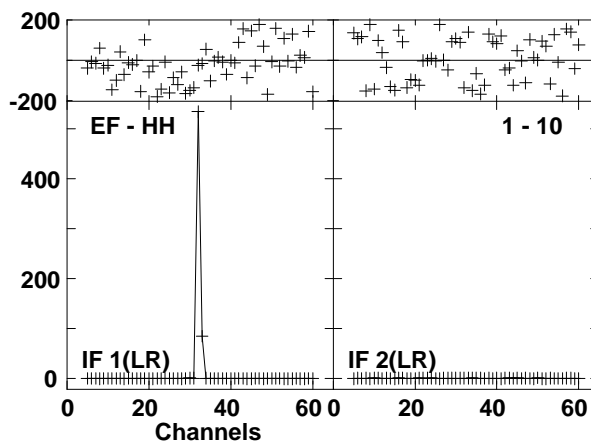
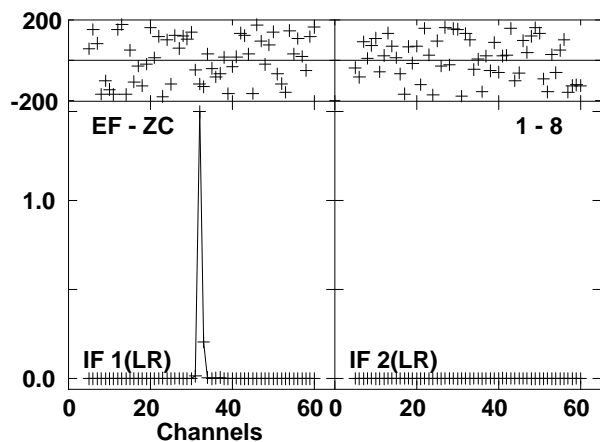
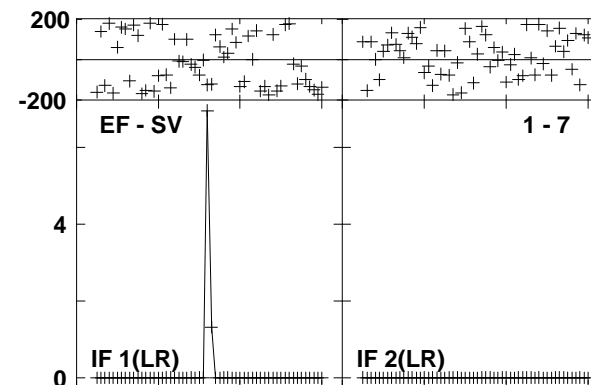
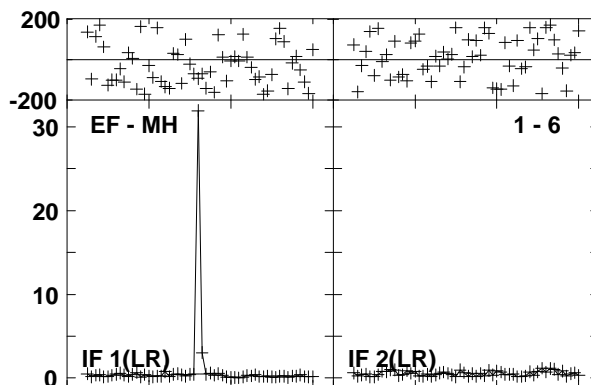
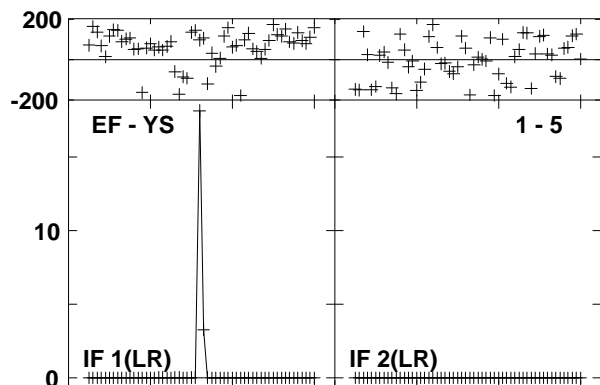
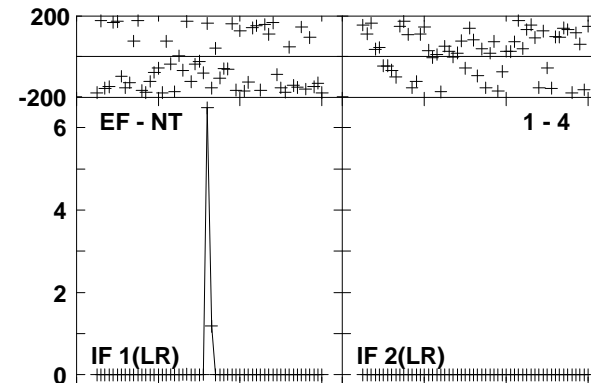
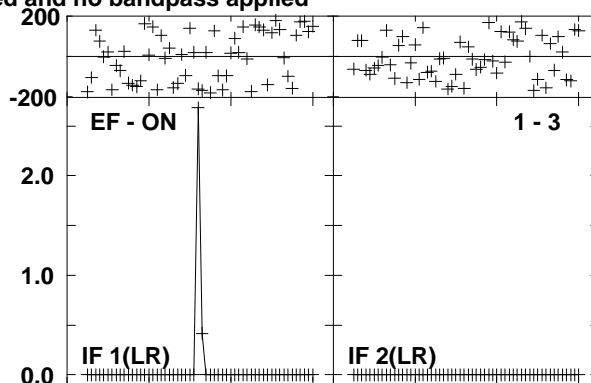
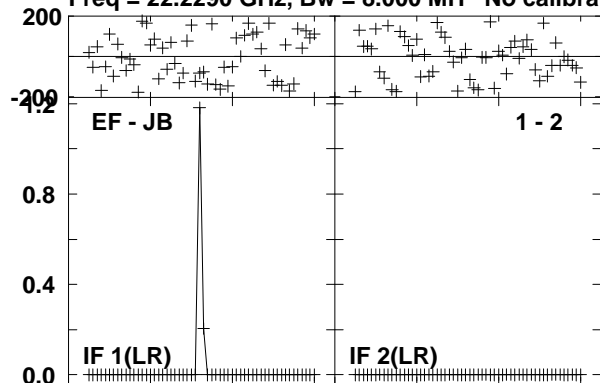

Lower frame: Ampl Jy Top frame: Phas deg
Vector averaged cross-power spectrum Several baselines displayed
Timerange: 00/11:42:06 to 00/11:43:02

Plot file version 89 created 17-SEP-2012 12:04:26

J0529-0519 EE008D 1.UVDATA.1

Freq = 22.2290 GHz, Bw = 8.000 MH No calibration applied and no bandpass applied

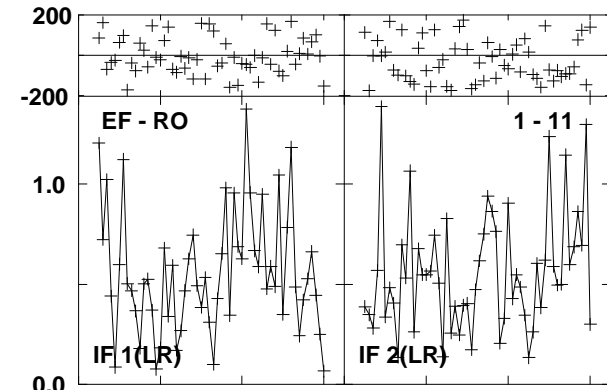
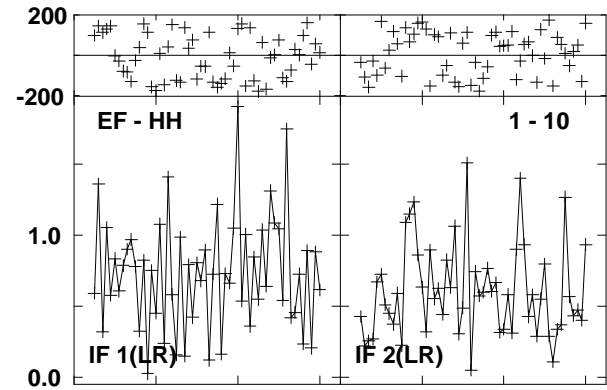
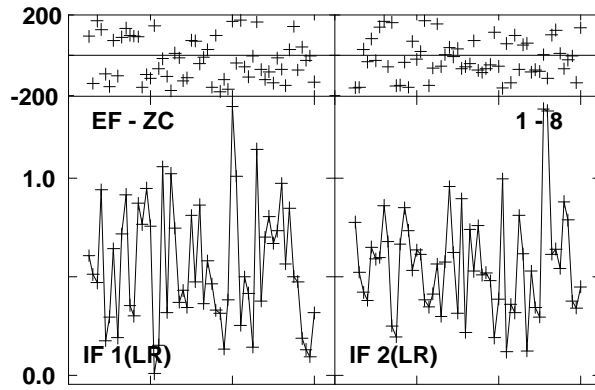
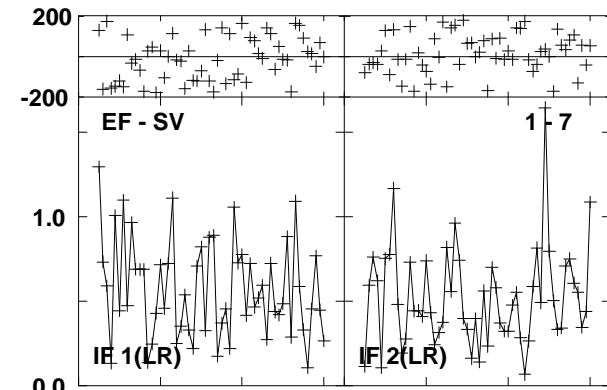
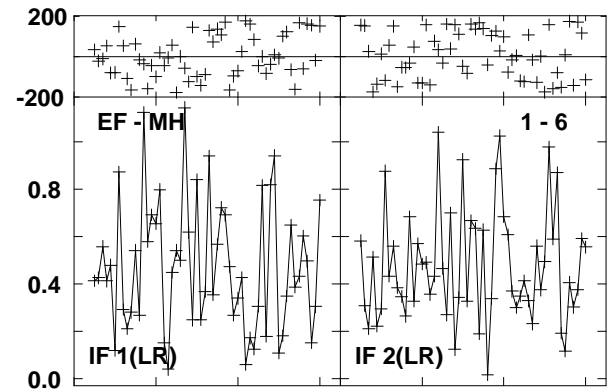
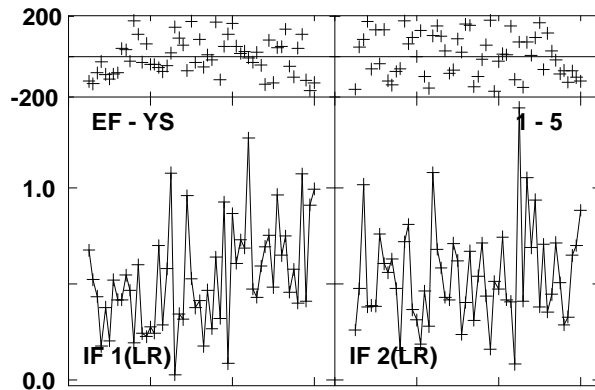
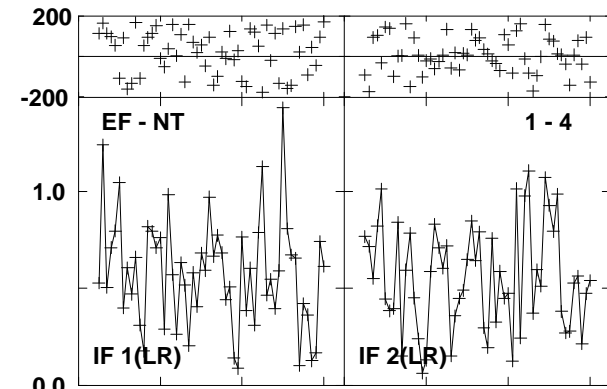
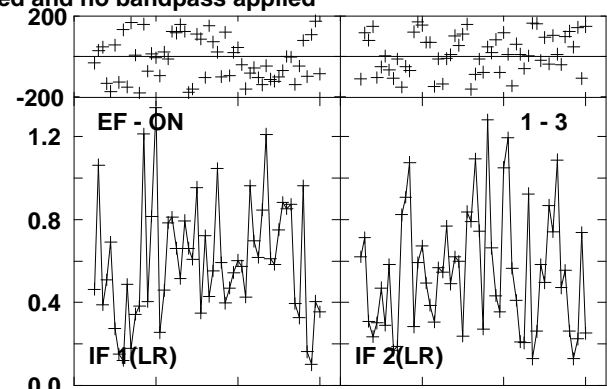
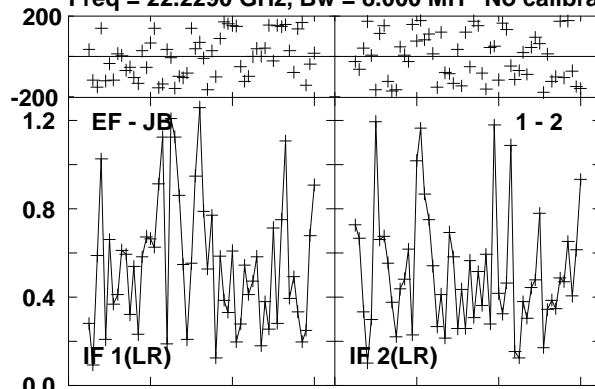

Lower frame: Milli Ampl Jy Top frame: Phas deg
Vector averaged cross-power spectrum Several baselines displayed
Timerange: 00/11:43:07 to 00/11:44:02

Plot file version 90 created 17-SEP-2012 12:04:29

ORIKL1 EE008D 1.UVDATA.1

Freq = 22.2290 GHz, Bw = 8.000 MH No calibration applied and no bandpass applied

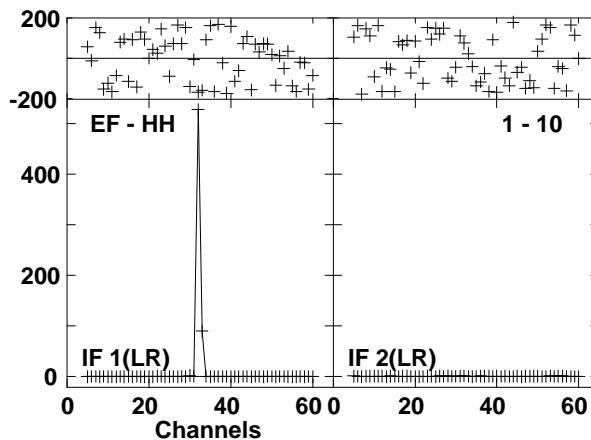
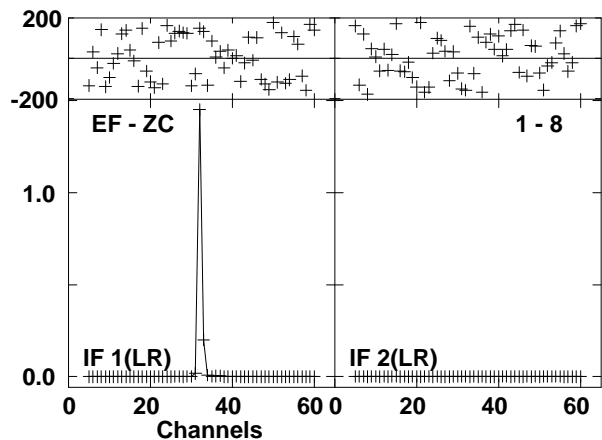
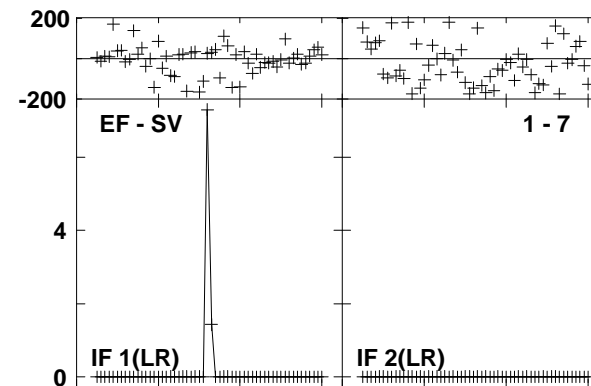
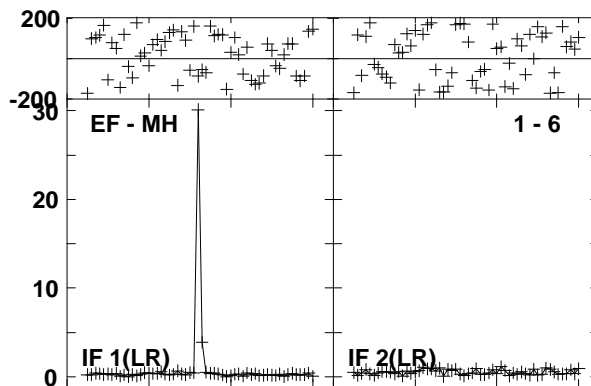
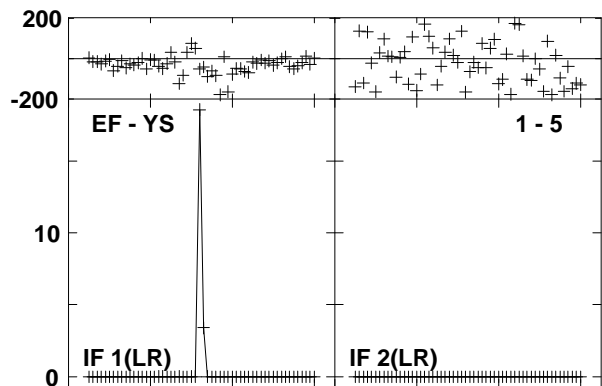
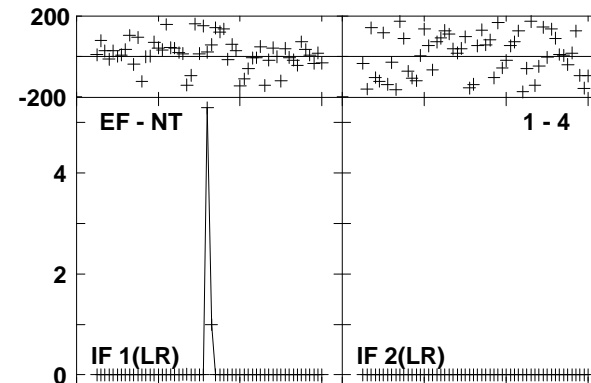
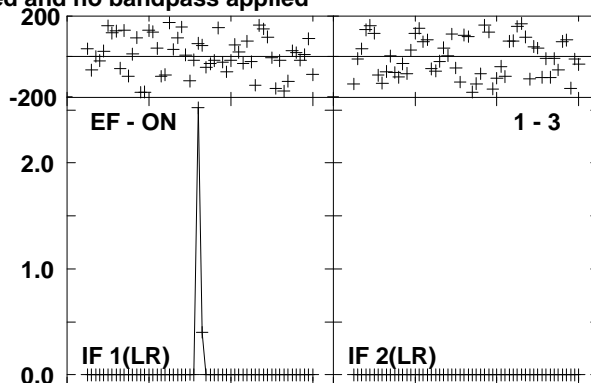
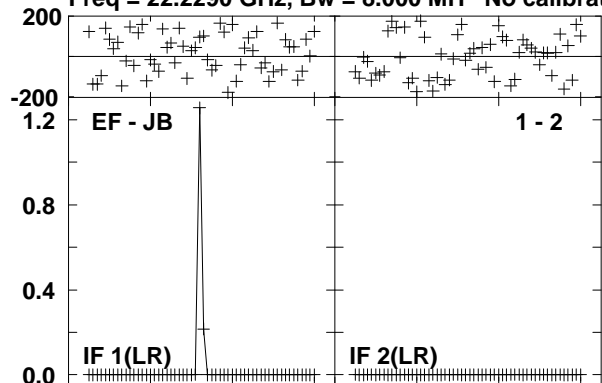

Lower frame: Ampl Jy Top frame: Phas deg
Vector averaged cross-power spectrum Several baselines displayed
Timerange: 00/11:44:07 to 00/11:45:02

Plot file version 91 created 17-SEP-2012 12:04:32

J0529-0519 EE008D 1.UVDATA.1

Freq = 22.2290 GHz, Bw = 8.000 MH No calibration applied and no bandpass applied

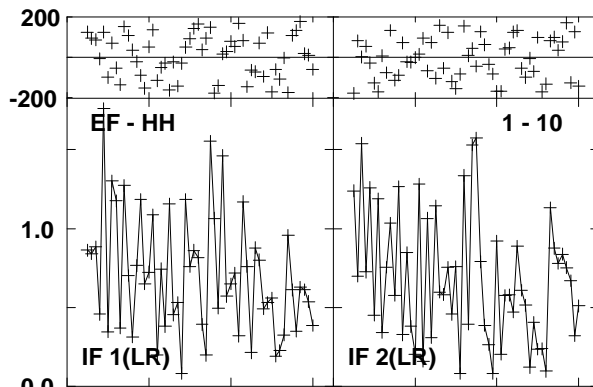
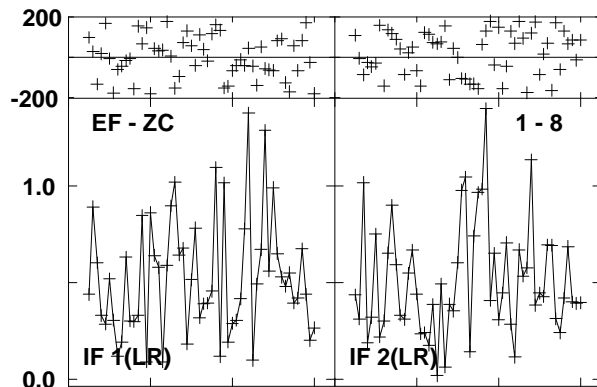
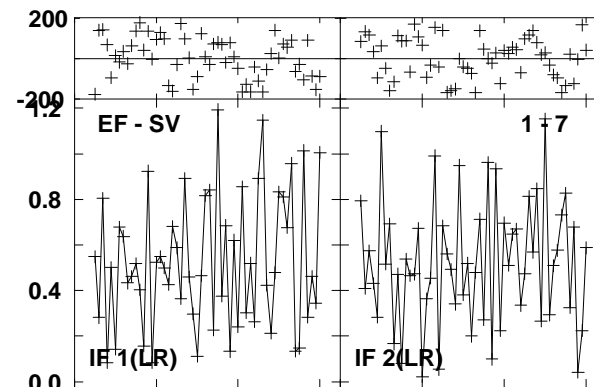
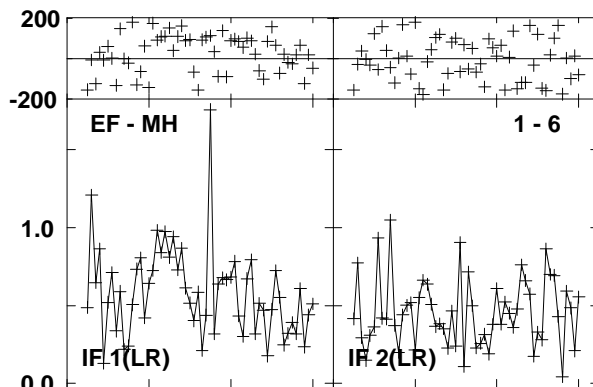
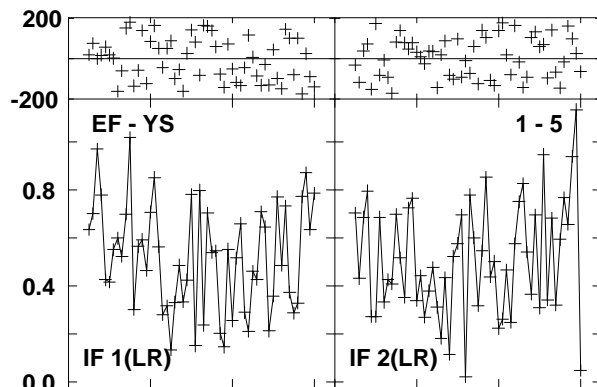
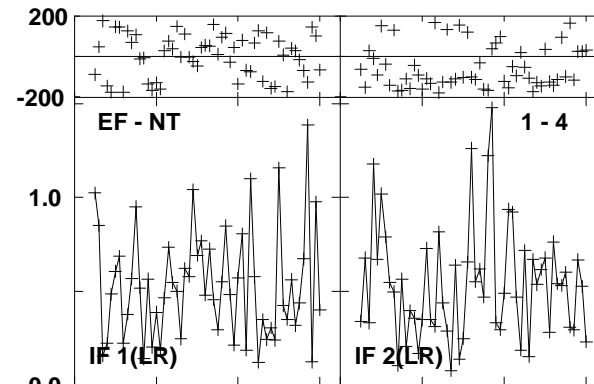
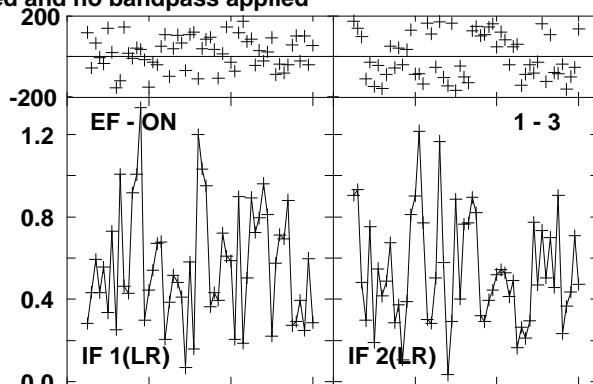
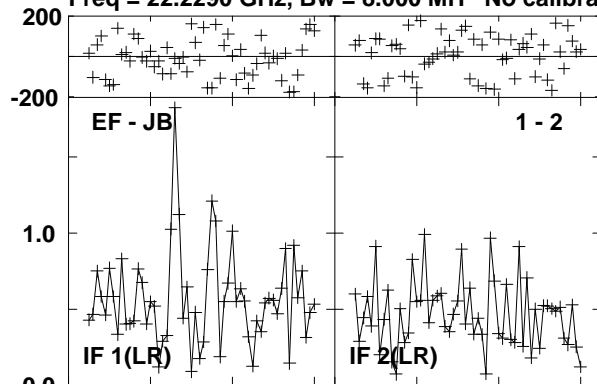

Lower frame: Milli Ampl Jy Top frame: Phas deg
Vector averaged cross-power spectrum Several baselines displayed
Timerange: 00/11:45:07 to 00/11:46:02

Plot file version 92 created 17-SEP-2012 12:04:37

J0423-0120 EE008D 1.UVDATA.1

Freq = 22.2290 GHz, Bw = 8.000 MH No calibration applied and no bandpass applied

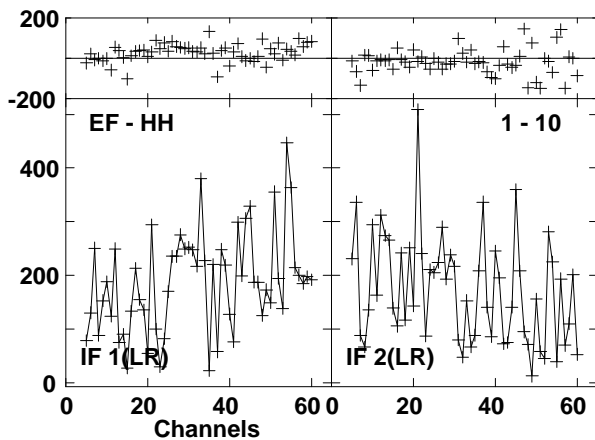
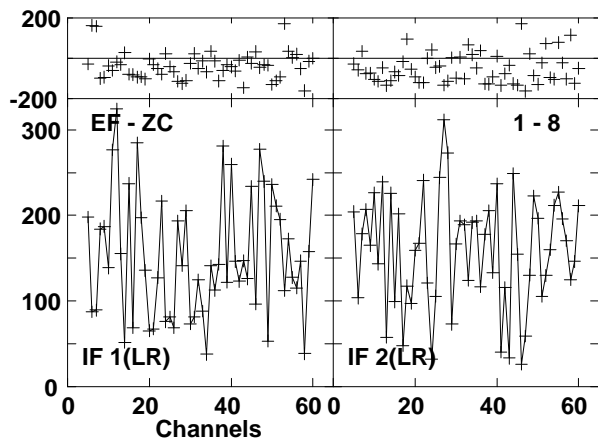
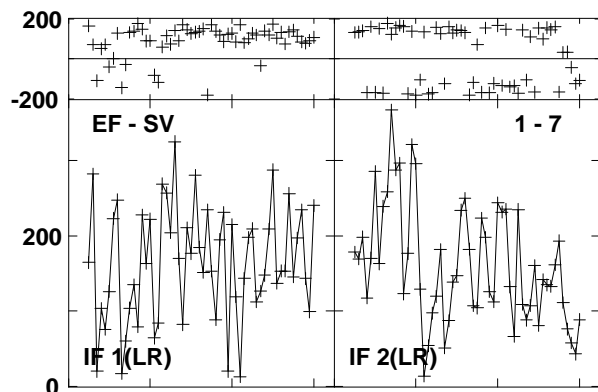
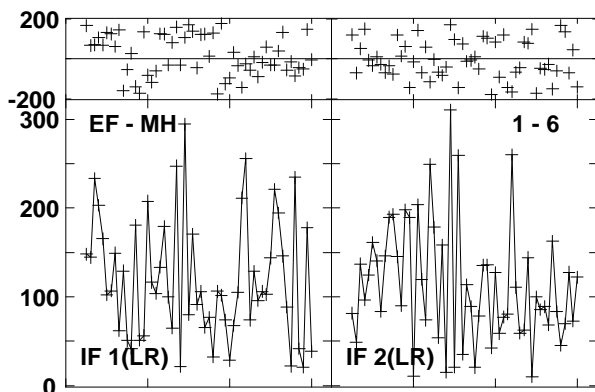
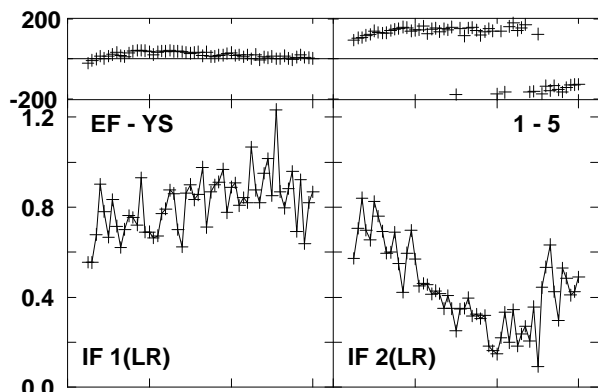
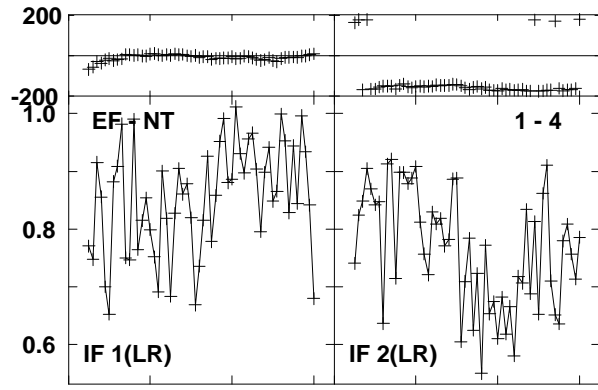
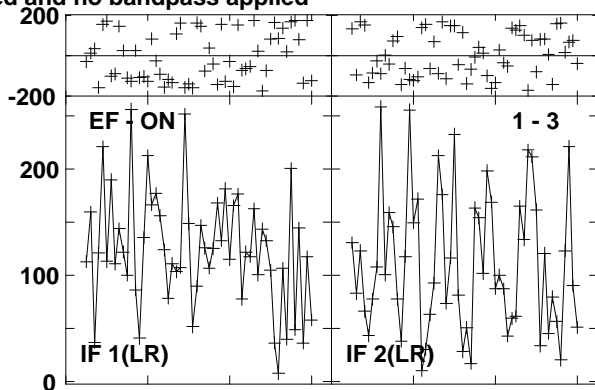
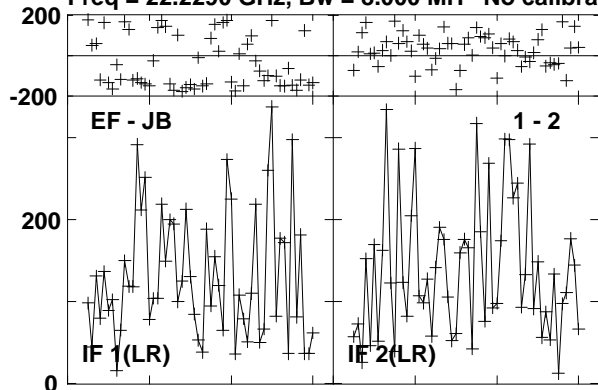

Lower frame: Micro Ampl Jy Top frame: Phas deg
Vector averaged cross-power spectrum Several baselines displayed
Timerange: 00/11:47:28 to 00/11:56:57

Plot file version 93 created 17-SEP-2012 12:05:01

J0423-0120 EE008D 1.UVDATA.1

Freq = 22.2290 GHz, Bw = 8.000 MH No calibration applied and no bandpass applied

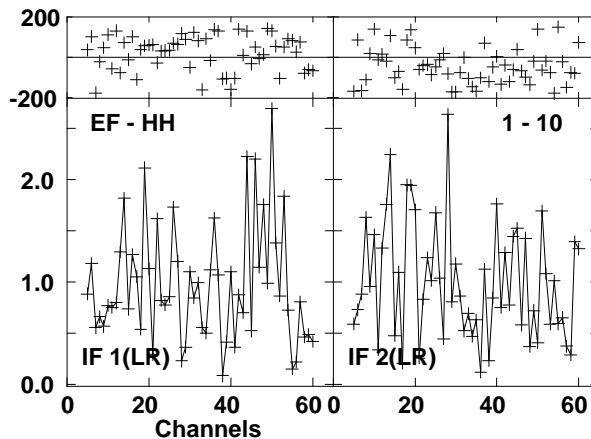
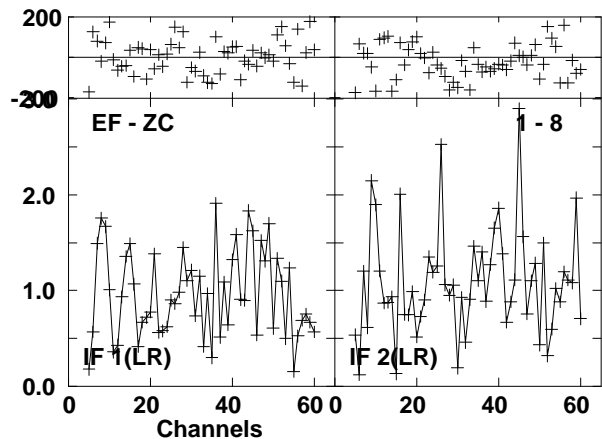
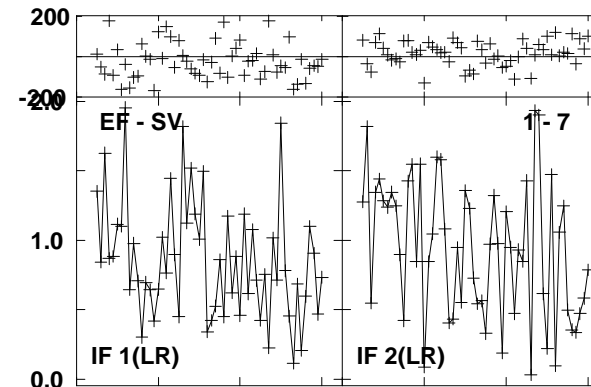
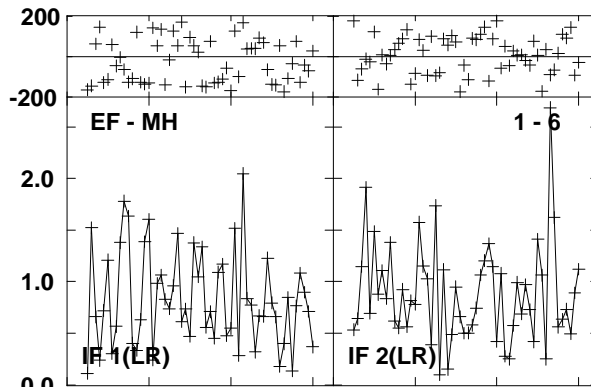
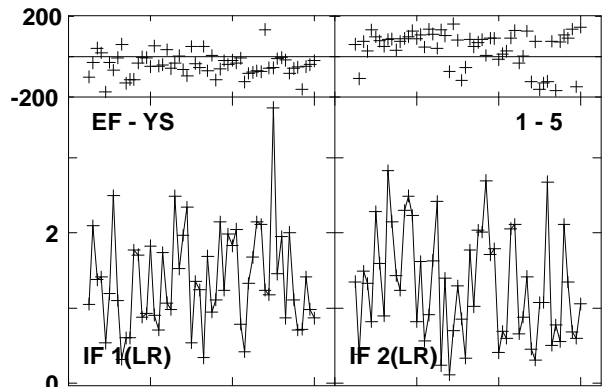
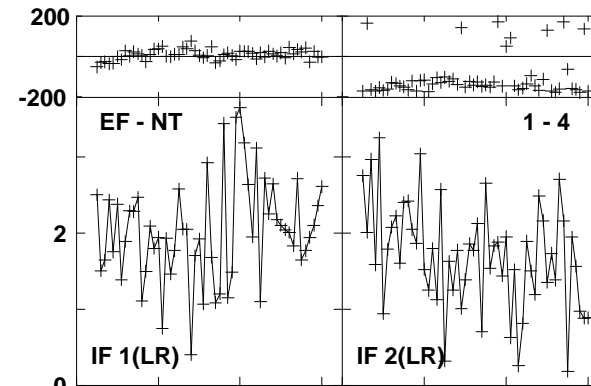
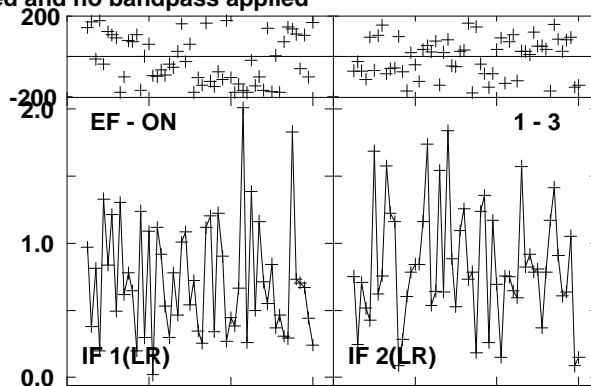
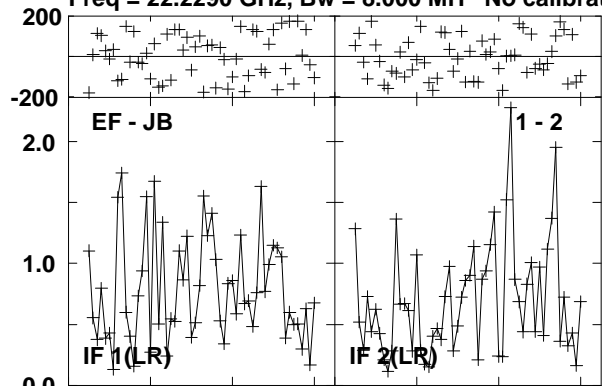

Lower frame: Milli Ampl Jy Top frame: Phas deg
Vector averaged cross-power spectrum Several baselines displayed
Timerange: 00/11:57:13 to 00/11:57:27

Plot file version 94 created 17-SEP-2012 12:05:05

4C39.25 EE008D 1.UVDATA.1

Freq = 22.2290 GHz, Bw = 8.000 MH No calibration applied and no bandpass applied

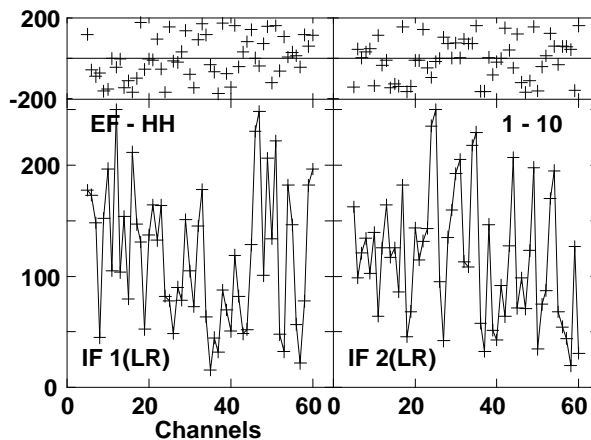
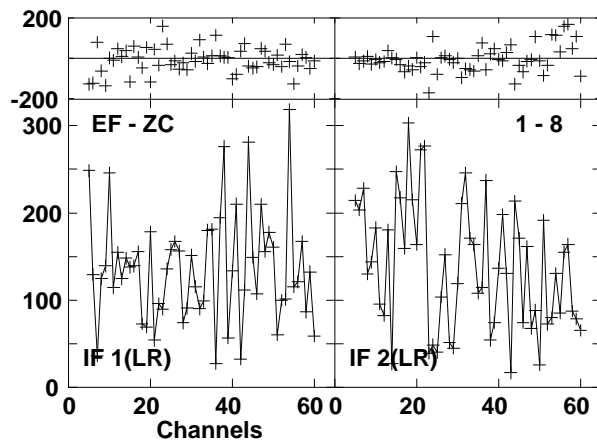
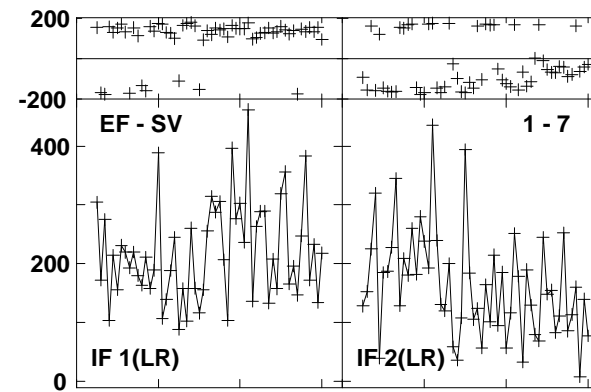
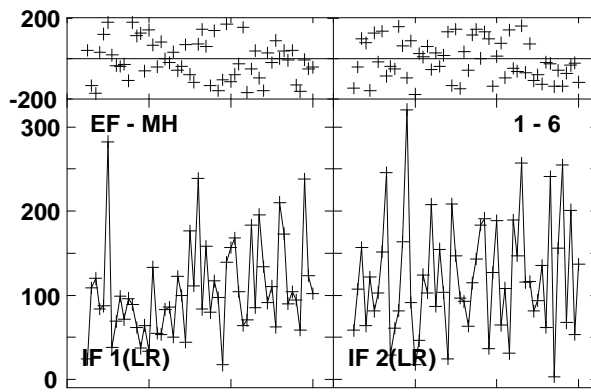
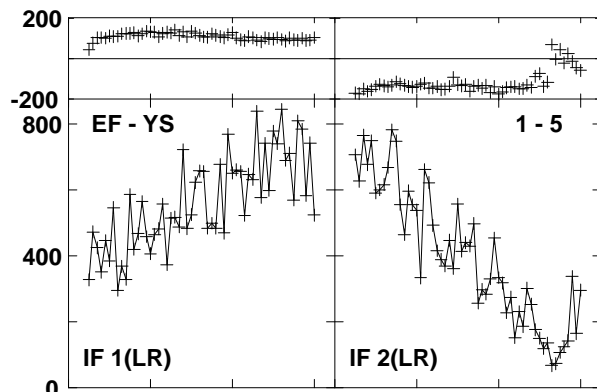
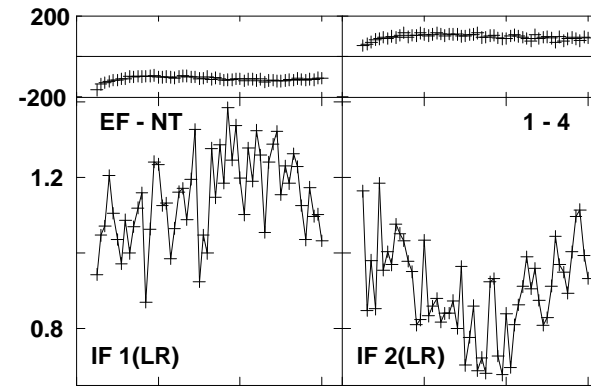
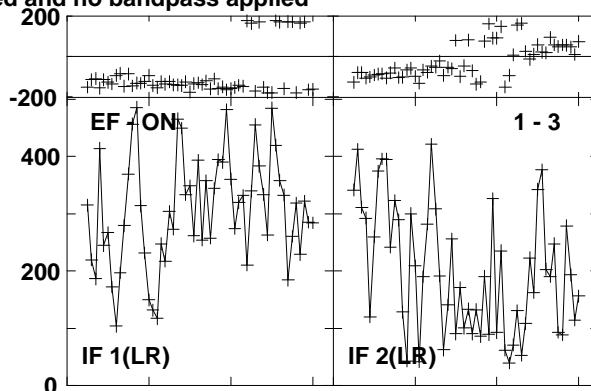
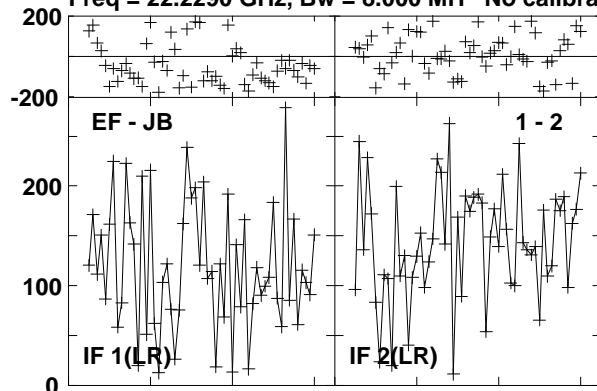

Lower frame: Micro Ampl Jy Top frame: Phas deg
Vector averaged cross-power spectrum Several baselines displayed
Timerange: 00/12:02:44 to 00/12:12:13

Plot file version 95 created 17-SEP-2012 12:05:28

4C39.25 EE008D 1.UVDATA.1

Freq = 22.2290 GHz, Bw = 8.000 MH No calibration applied and no bandpass applied

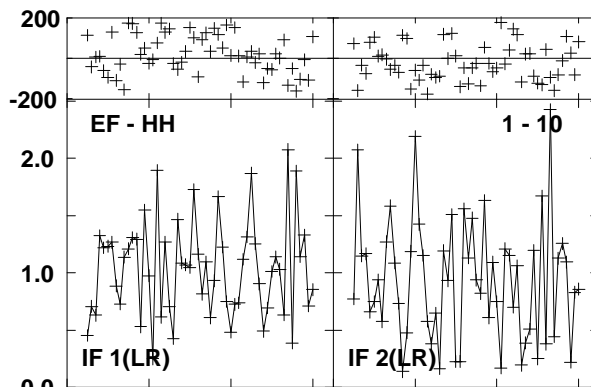
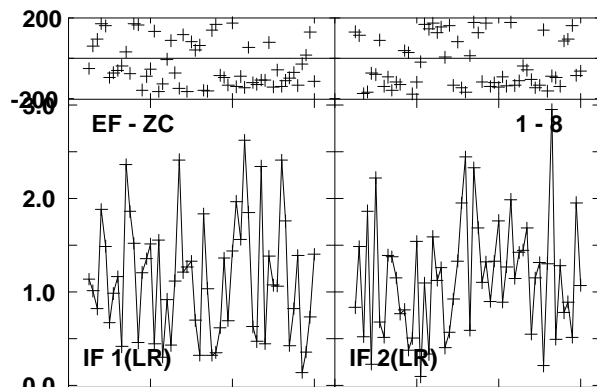
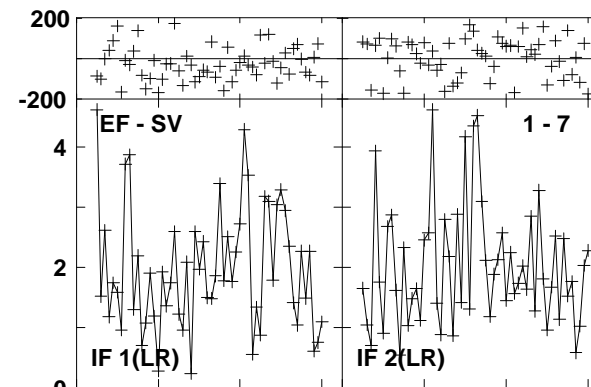
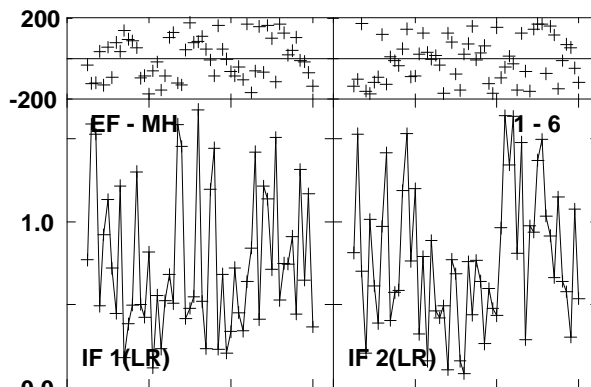
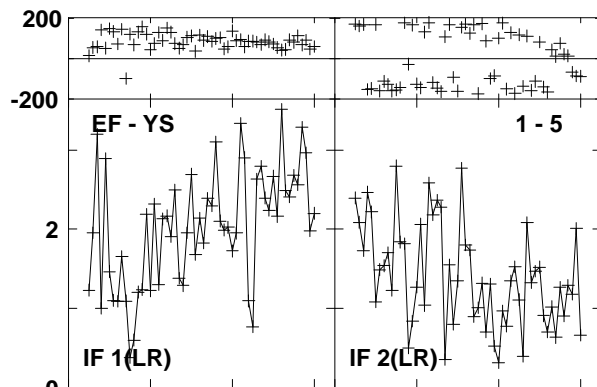
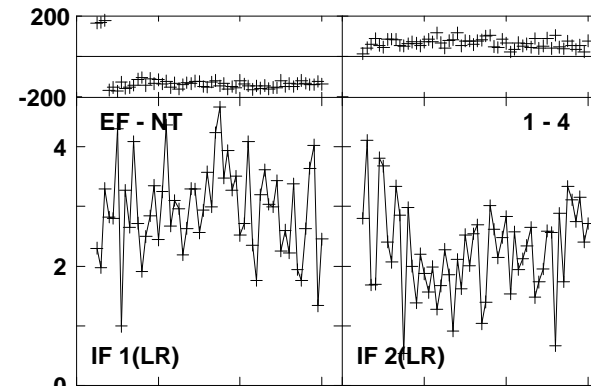
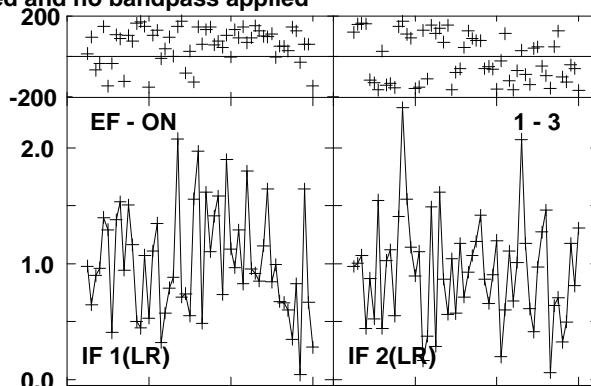
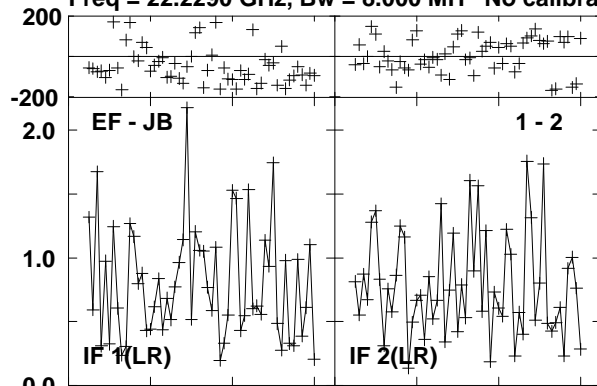

Lower frame: Milli Ampl Jy Top frame: Phas deg
Vector averaged cross-power spectrum Several baselines displayed
Timerange: 00/12:12:29 to 00/12:12:43

Plot file version 96 created 17-SEP-2012 12:05:29

J0541-0541 EE008D 1.UVDATA.1

Freq = 22.2290 GHz, Bw = 8.000 MH No calibration applied and no bandpass applied

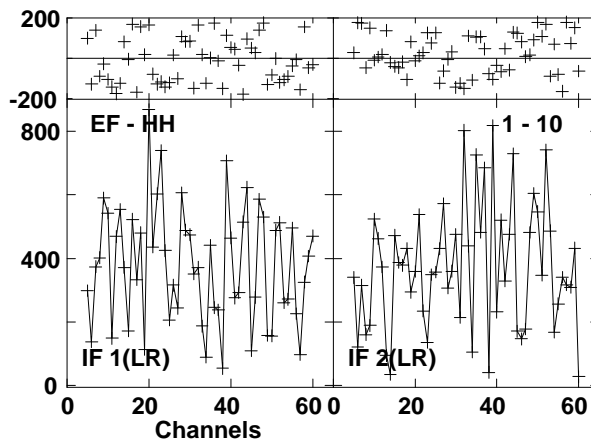
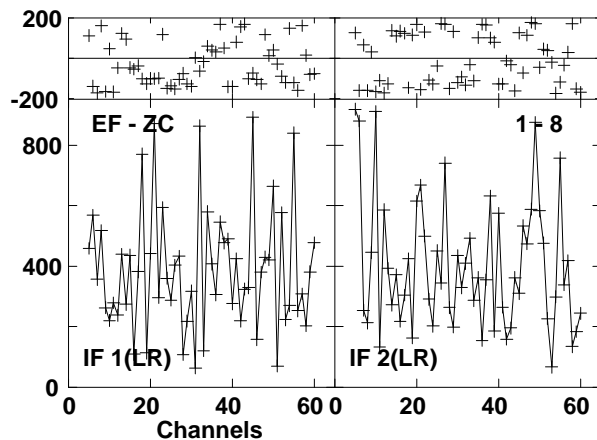
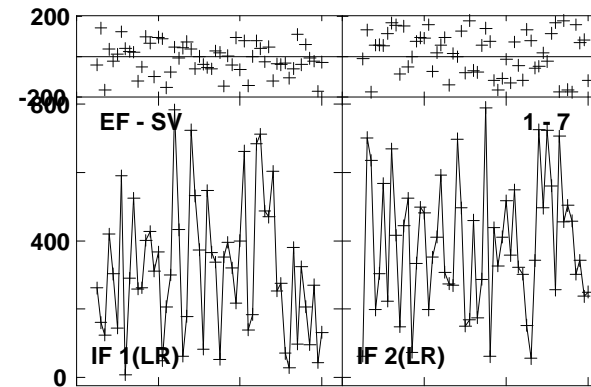
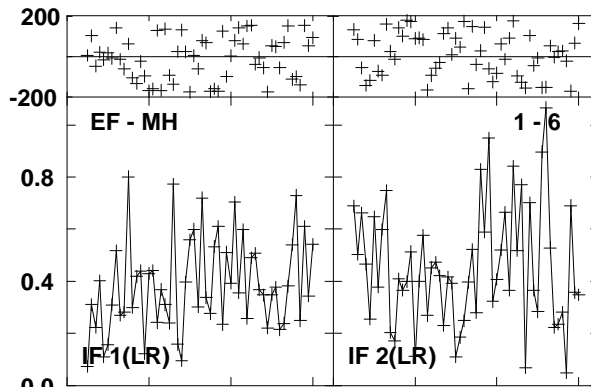
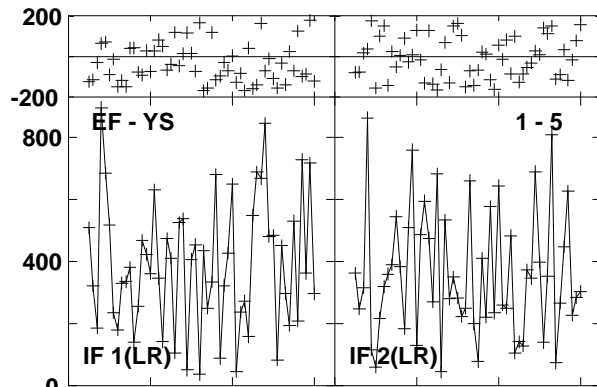
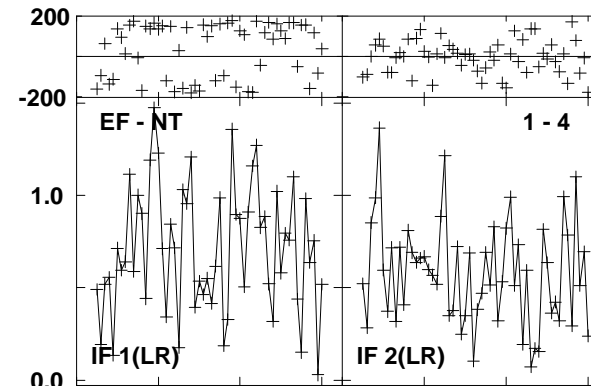
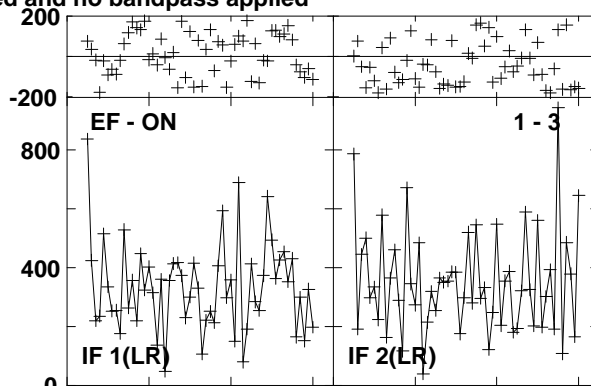
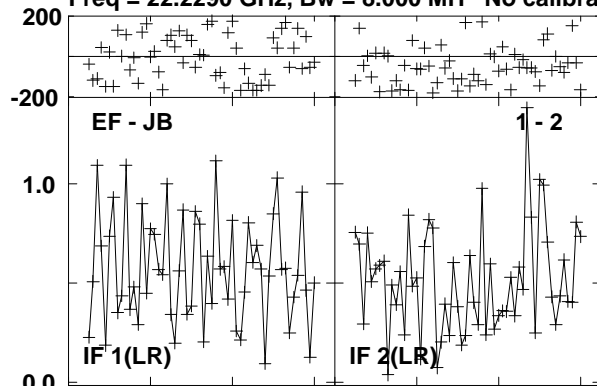

Lower frame: Milli Ampl Jy Top frame: Phas deg
Vector averaged cross-power spectrum Several baselines displayed
Timerange: 00/12:17:14 to 00/12:18:13

Plot file version 97 created 17-SEP-2012 12:05:32

ORIKL1 EE008D 1.UVDATA.1

Freq = 22.2290 GHz, Bw = 8.000 MH No calibration applied and no bandpass applied

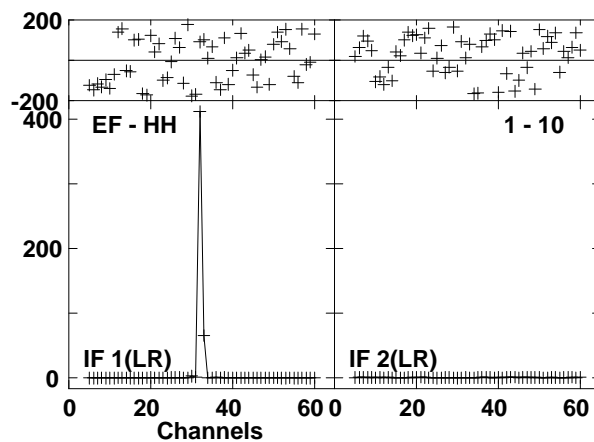
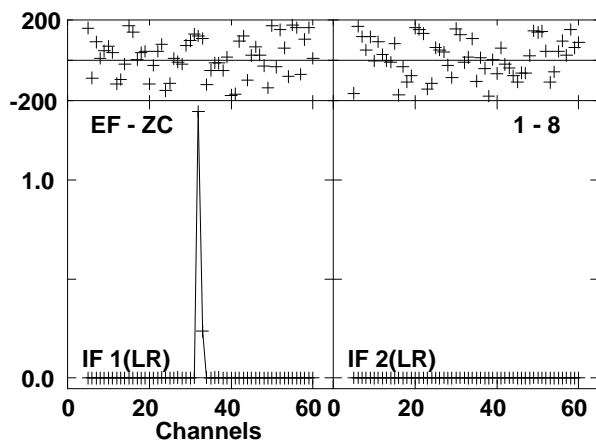
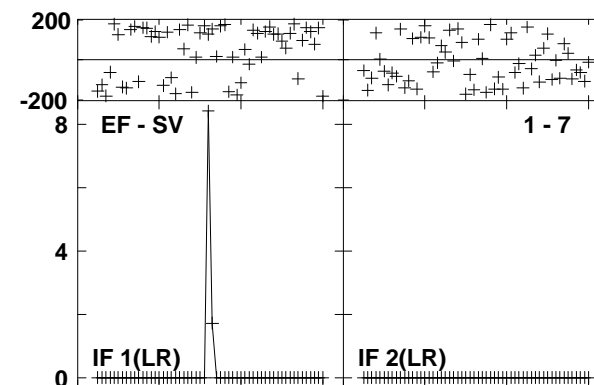
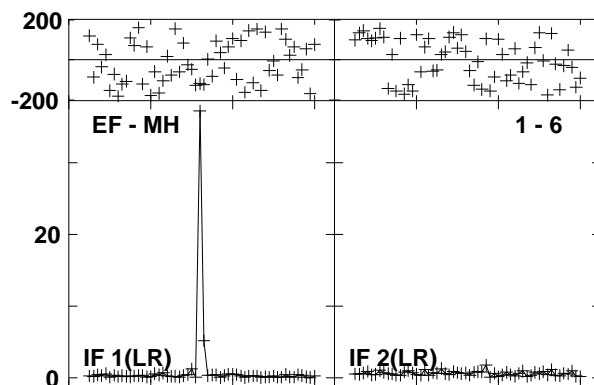
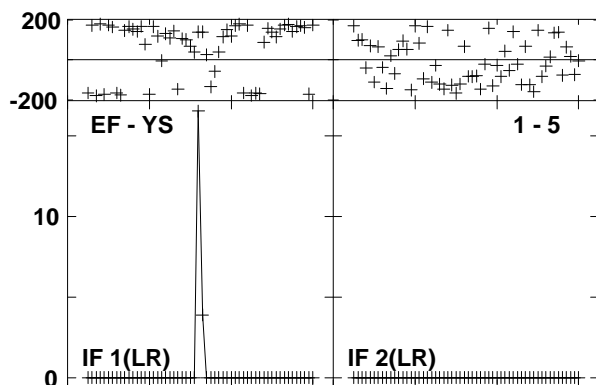
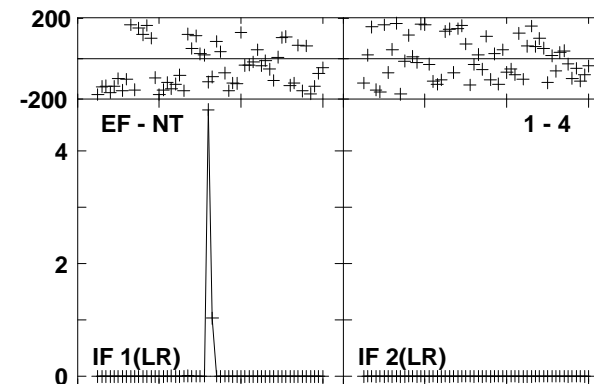
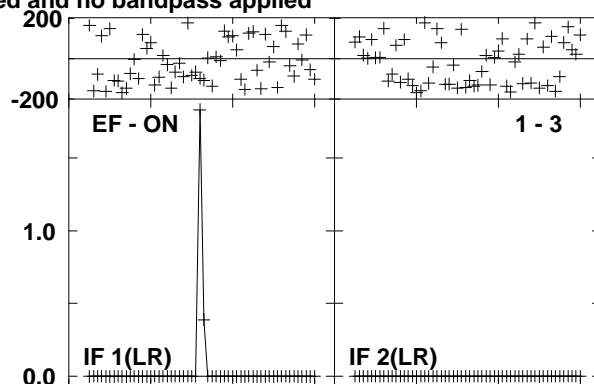
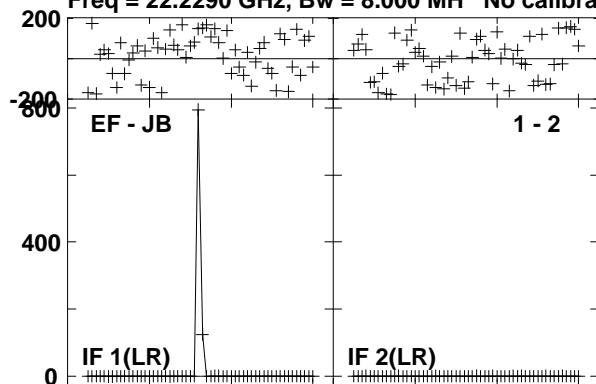

Lower frame: Milli Ampl Jy Top frame: Phas deg

Vector averaged cross-power spectrum Several baselines displayed

Timerange: 00/12:18:18 to 00/12:19:13

Plot file version 98 created 17-SEP-2012 12:05:34

J0541-0541 EE008D 1.UVDATA.1

Freq = 22.2290 GHz, Bw = 8.000 MH No calibration applied and no bandpass applied

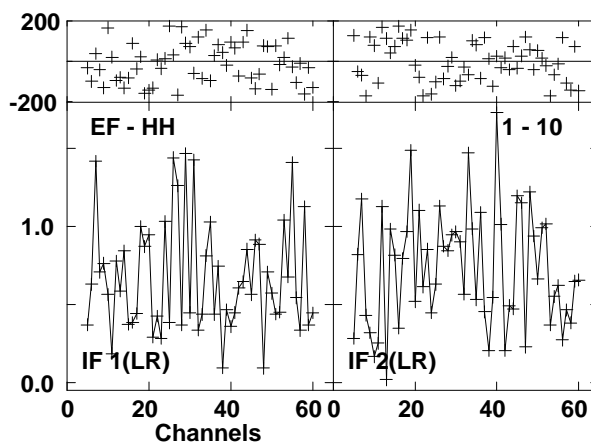
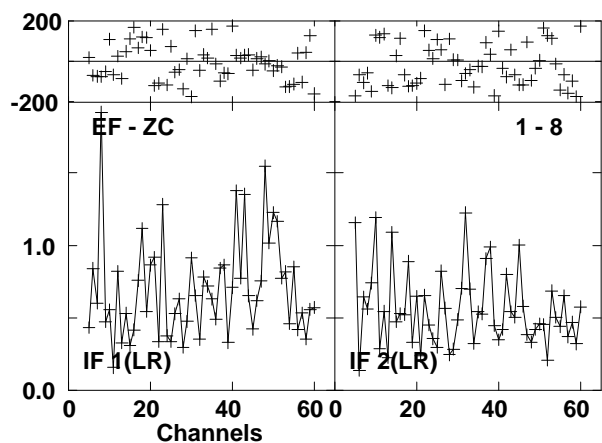
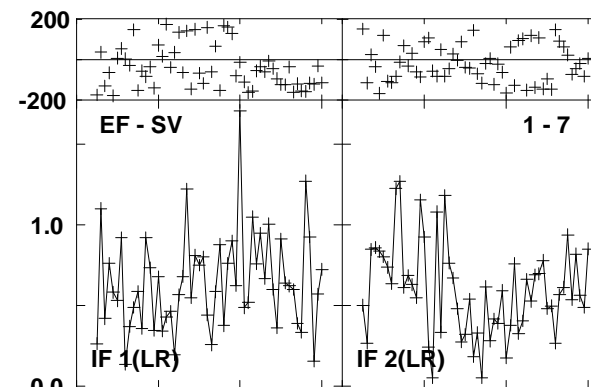
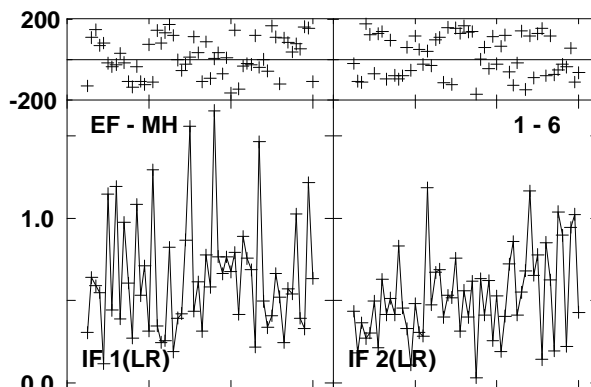
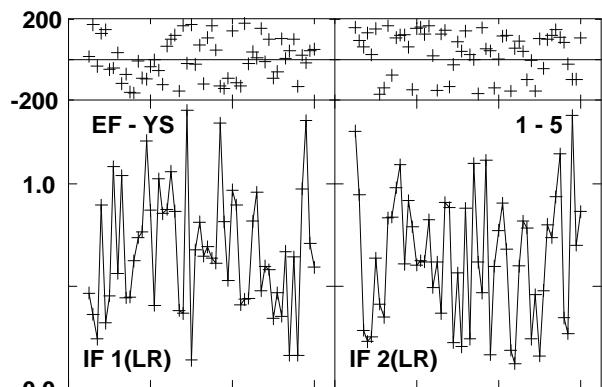
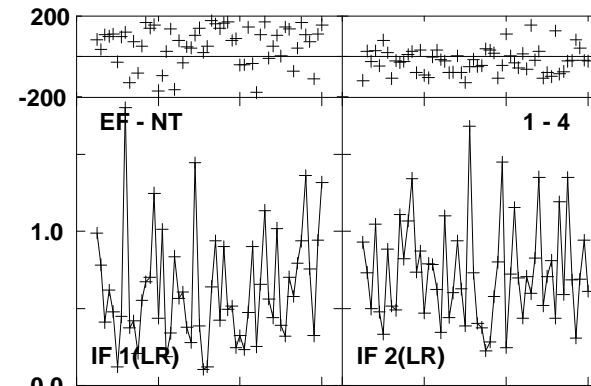
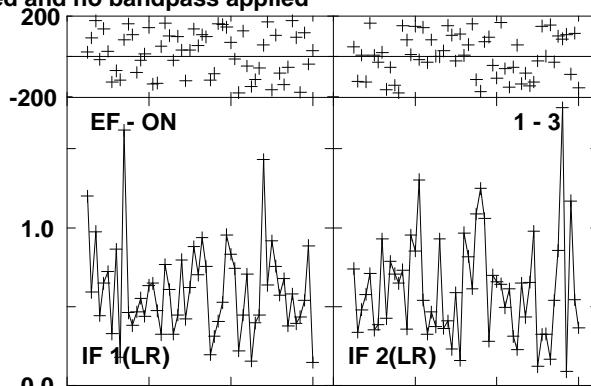
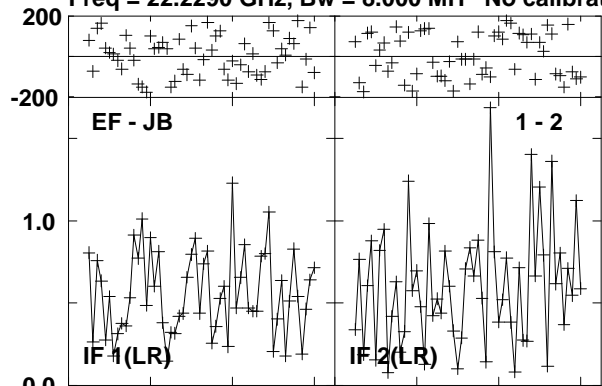

Lower frame: Milli Ampl Jy Top frame: Phas deg
Vector averaged cross-power spectrum Several baselines displayed
Timerange: 00/12:19:18 to 00/12:20:13

Plot file version 99 created 17-SEP-2012 12:05:36

ORIKL1 EE008D 1.UVDATA.1

Freq = 22.2290 GHz, Bw = 8.000 MH No calibration applied and no bandpass applied

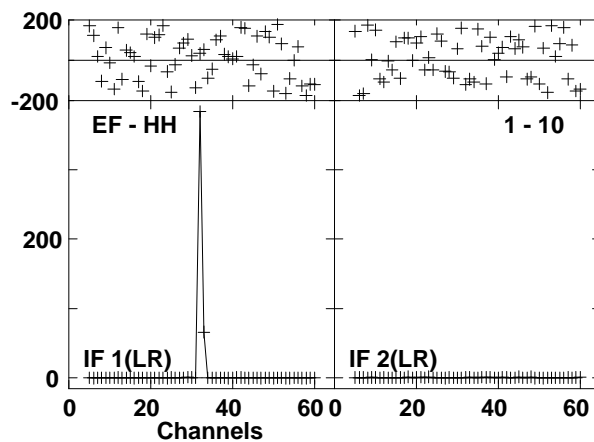
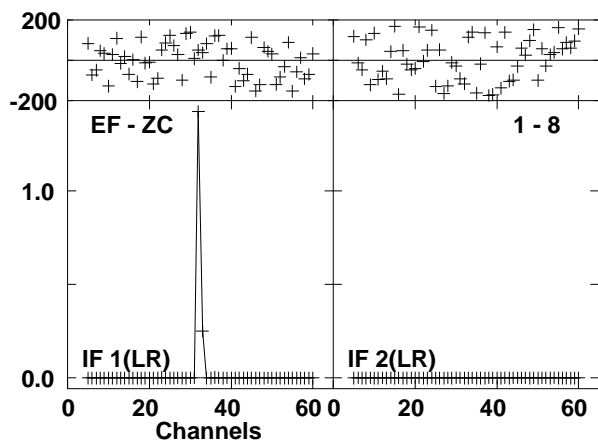
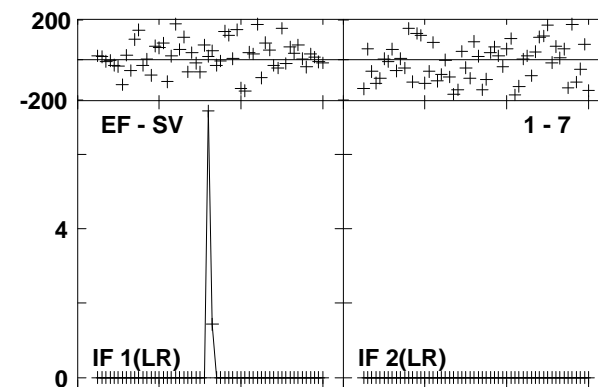
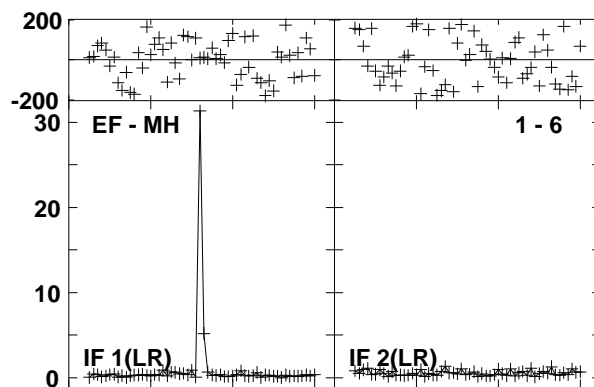
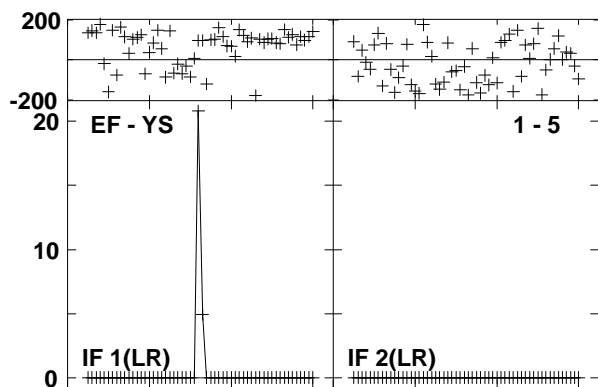
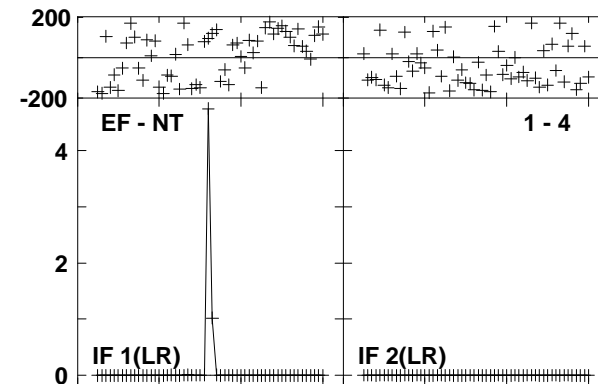
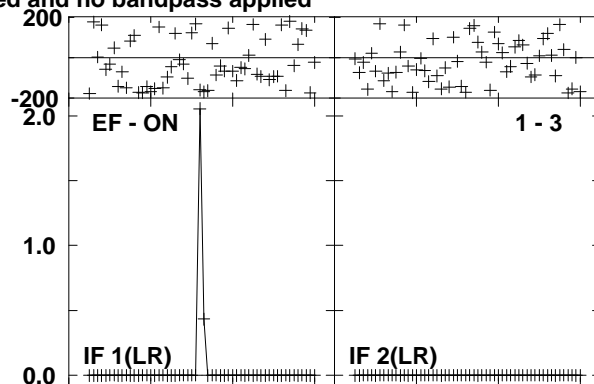
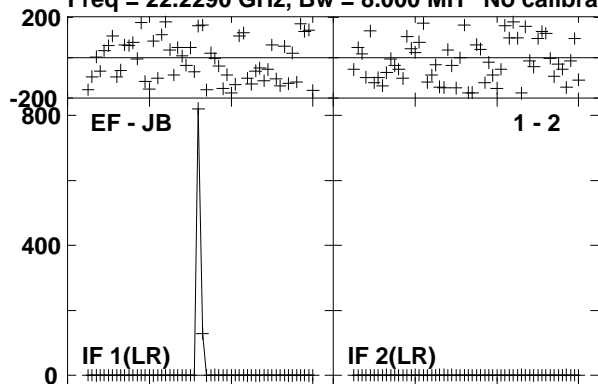

Lower frame: Milli Ampl Jy Top frame: Phas deg

Vector averaged cross-power spectrum Several baselines displayed

Timerange: 00/12:20:18 to 00/12:21:13

Plot file version 100 created 17-SEP-2012 12:05:37

J0541-0541 EE008D 1.UVDATA.1

Freq = 22.2290 GHz, Bw = 8.000 MH No calibration applied and no bandpass applied

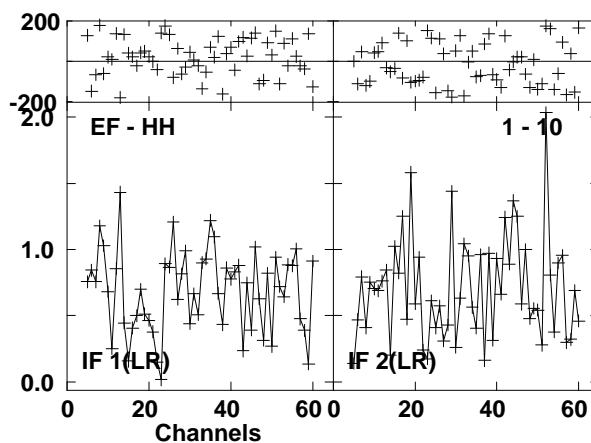
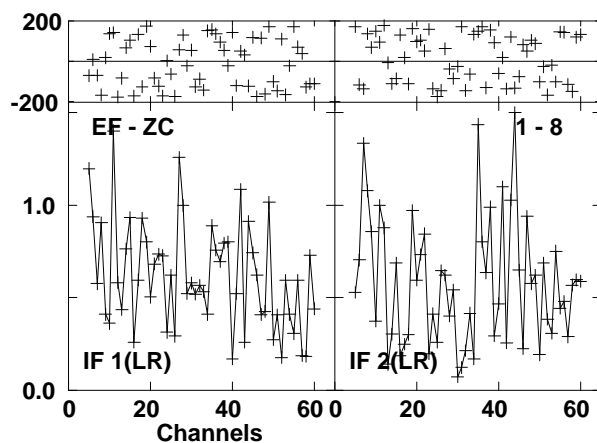
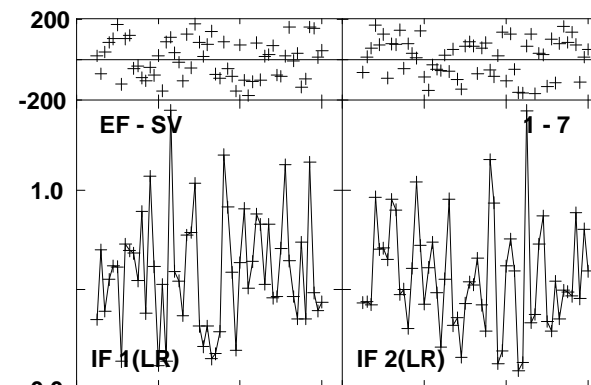
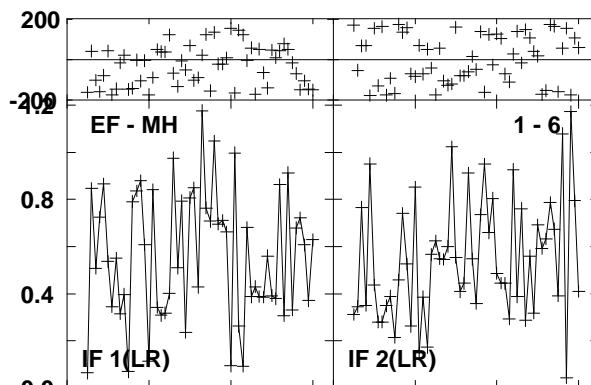
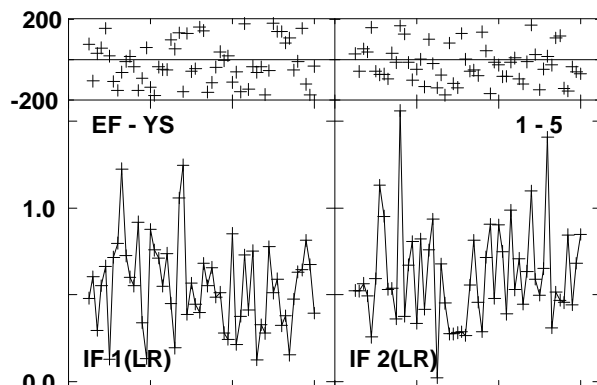
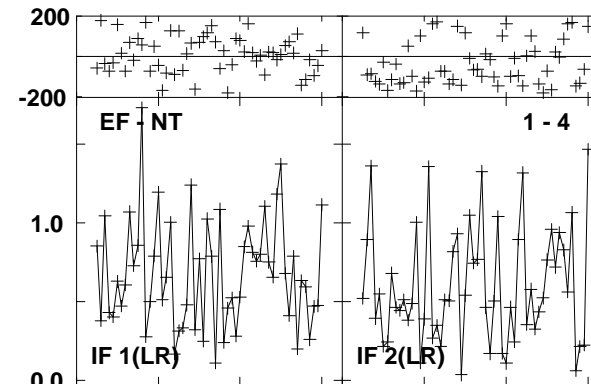
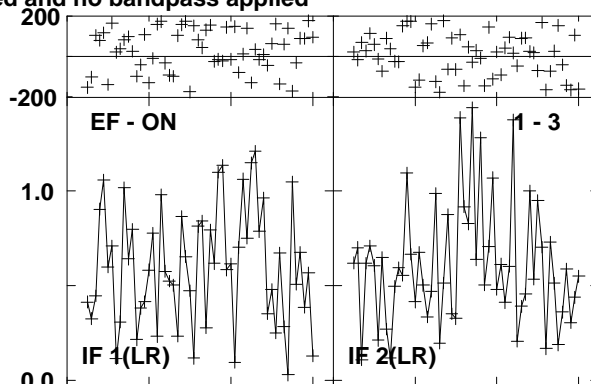
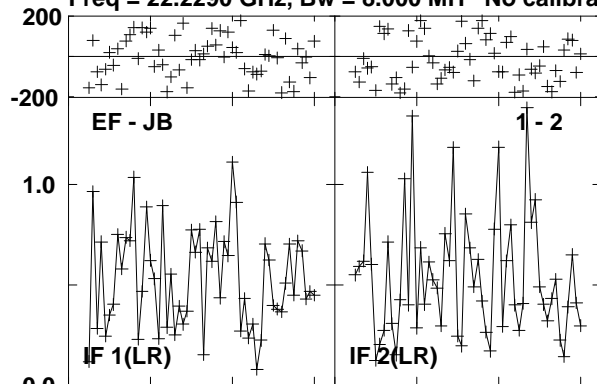

Lower frame: Milli Ampl Jy Top frame: Phas deg
Vector averaged cross-power spectrum Several baselines displayed
Timerange: 00/12:21:18 to 00/12:22:13

Plot file version 101 created 17-SEP-2012 12:05:39

J0529-0519 EE008D 1.UVDATA.1

Freq = 22.2290 GHz, Bw = 8.000 MH No calibration applied and no bandpass applied

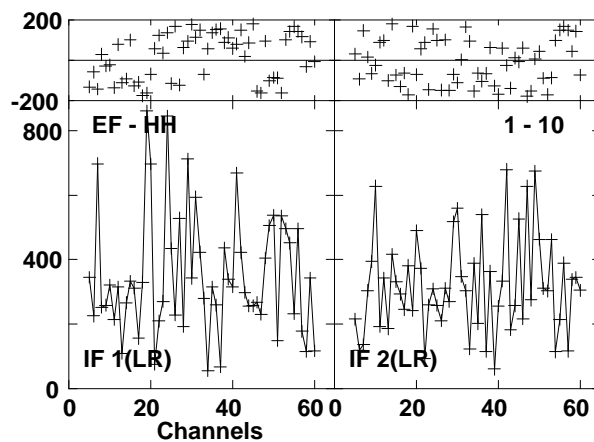
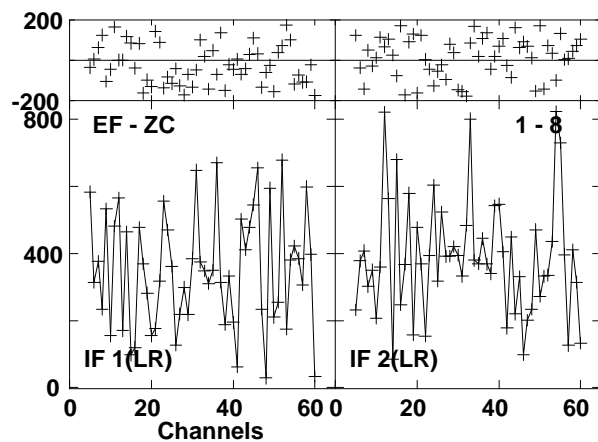
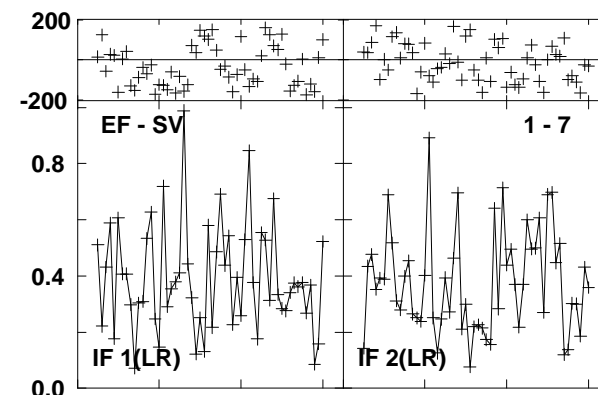
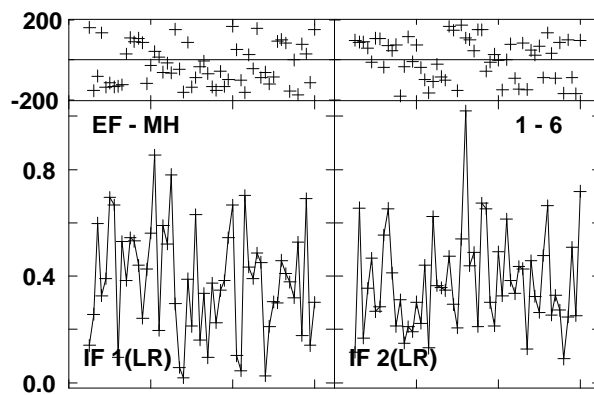
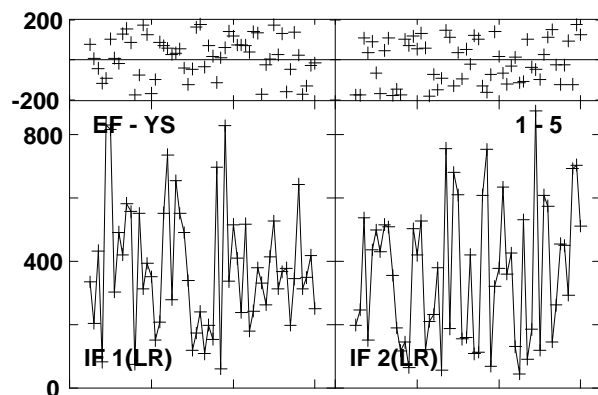
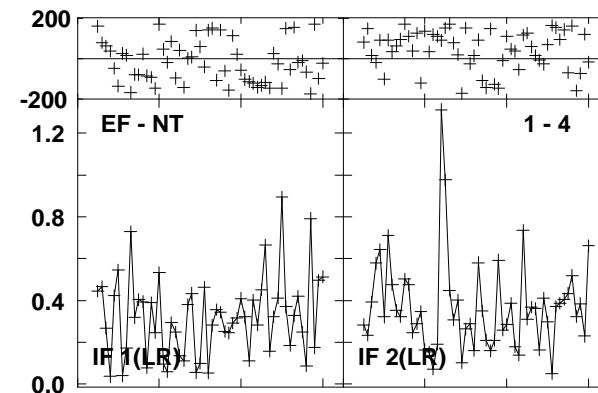
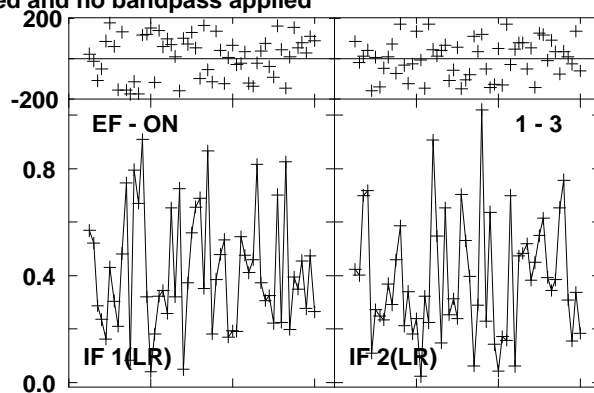
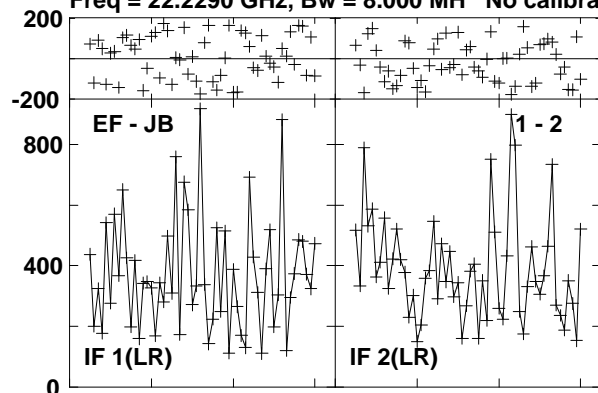

Lower frame: Micro Ampl Jy Top frame: Phas deg
Vector averaged cross-power spectrum Several baselines displayed
Timerange: 00/12:23:00 to 00/12:23:59

Plot file version 102 created 17-SEP-2012 12:05:42

ORIKL1 EE008D 1.UVDATA.1

Freq = 22.2290 GHz, Bw = 8.000 MH No calibration applied and no bandpass applied

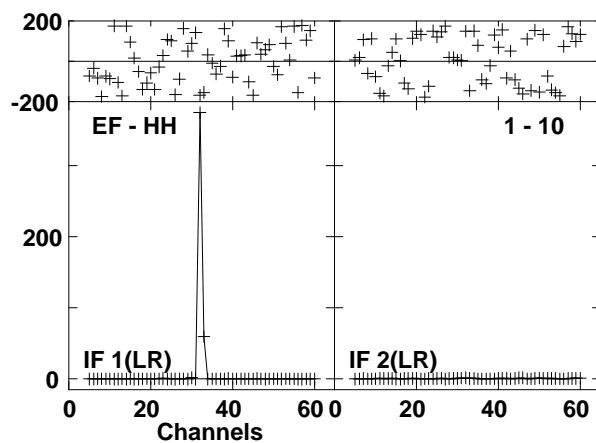
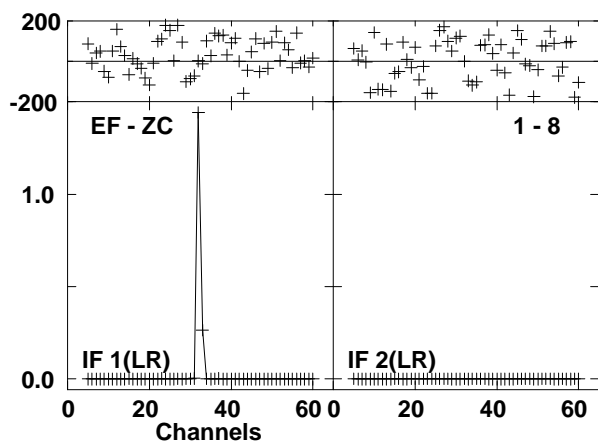
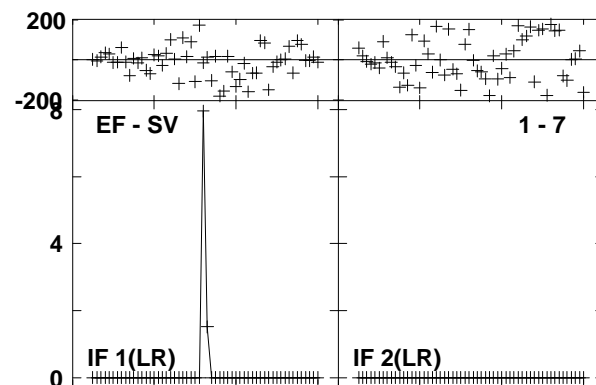
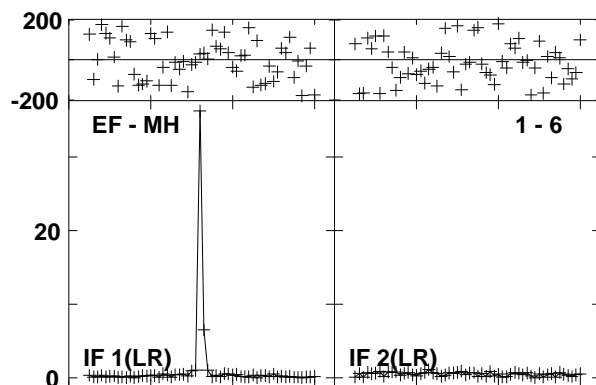
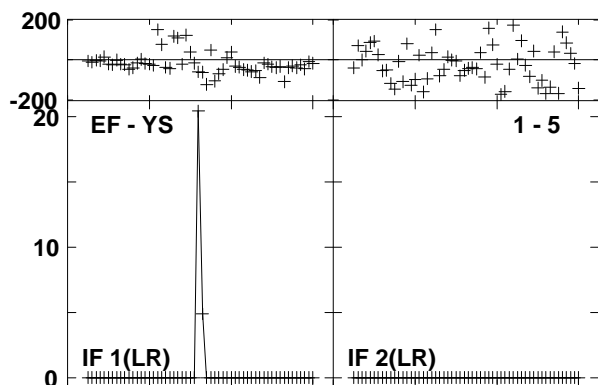
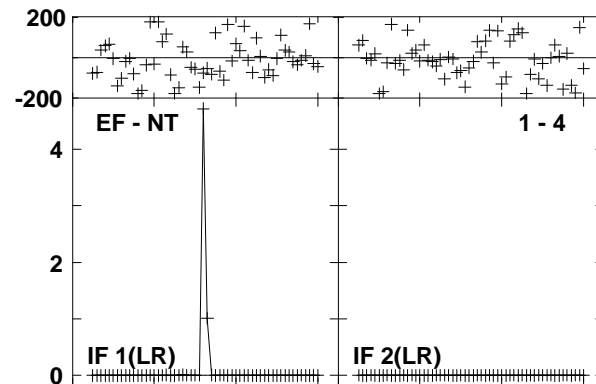
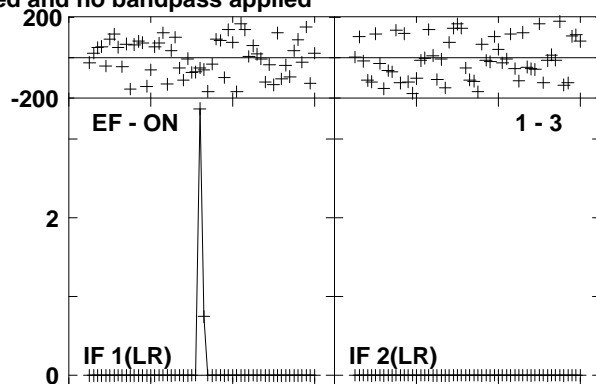
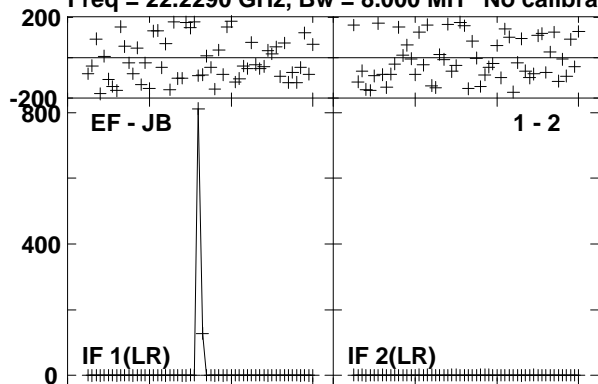

Lower frame: Milli Ampl Jy Top frame: Phas deg
Vector averaged cross-power spectrum Several baselines displayed
Timerange: 00/12:24:03 to 00/12:24:59

Plot file version 103 created 17-SEP-2012 12:05:44

J0529-0519 EE008D 1.UVDATA.1

Freq = 22.2290 GHz, Bw = 8.000 MH No calibration applied and no bandpass applied

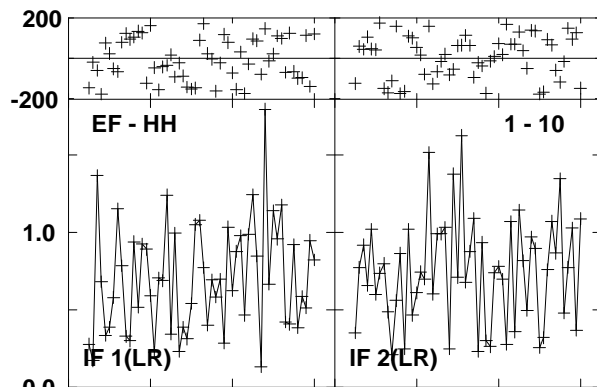
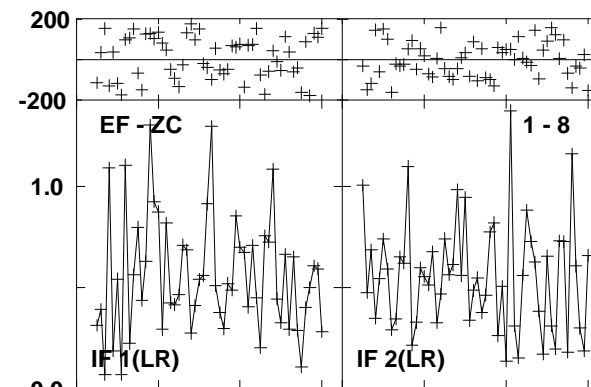
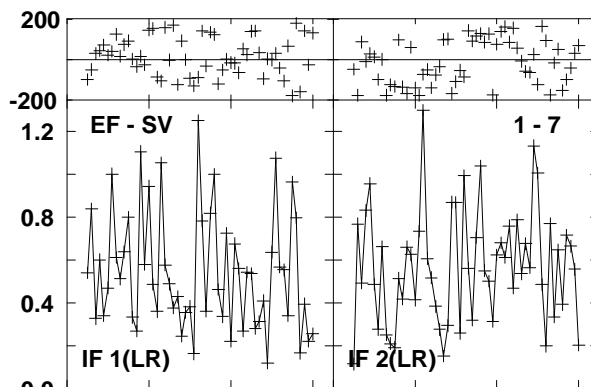
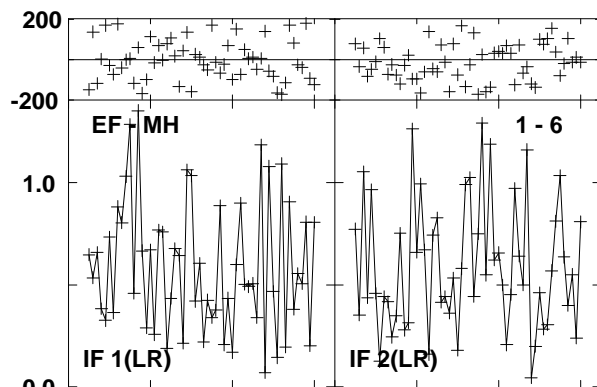
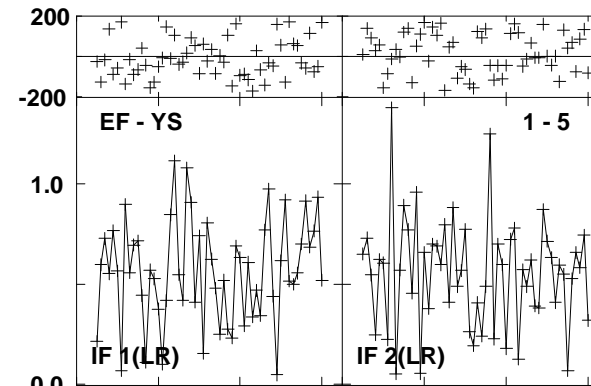
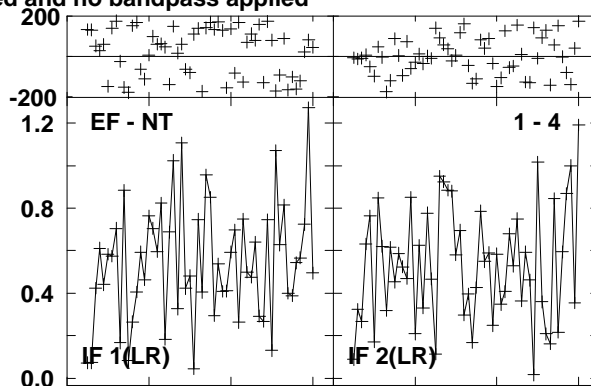
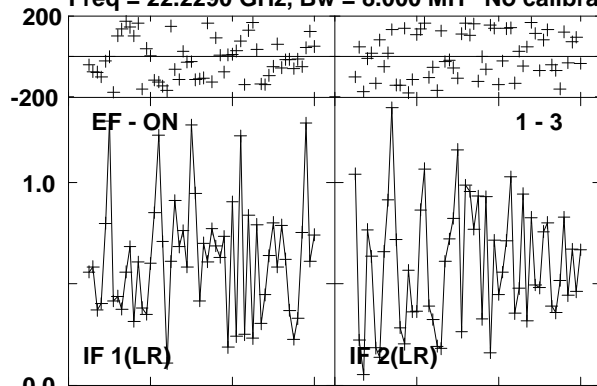

Lower frame: Milli Ampl Jy Top frame: Phas deg
Vector averaged cross-power spectrum Several baselines displayed
Timerange: 00/12:25:04 to 00/12:25:59

Plot file version 104 created 17-SEP-2012 12:05:46

ORIKL1 EE008D 1.UVDATA.1

Freq = 22.2290 GHz, Bw = 8.000 MH No calibration applied and no bandpass applied

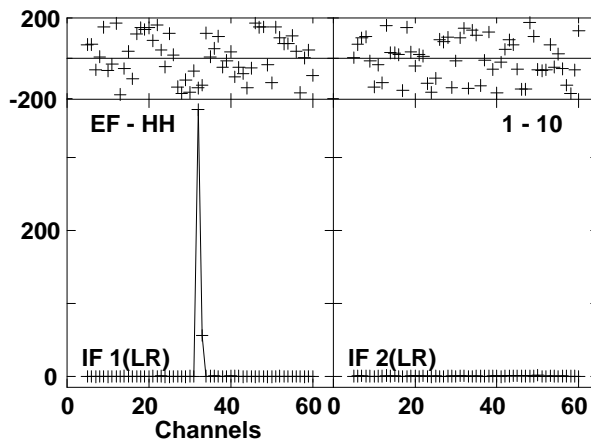
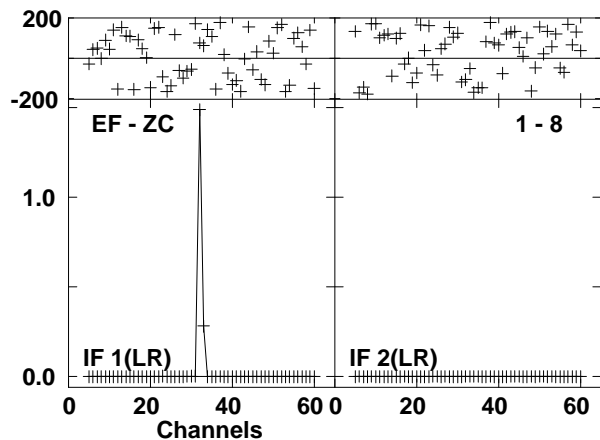
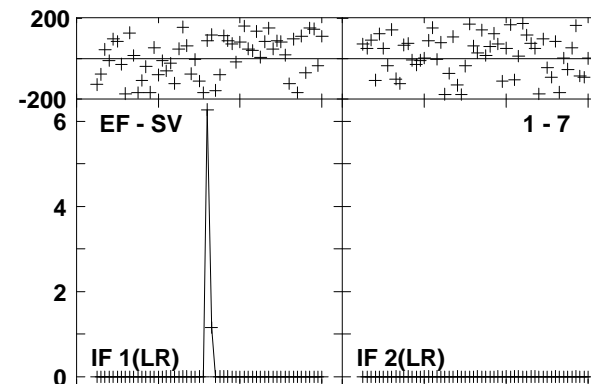
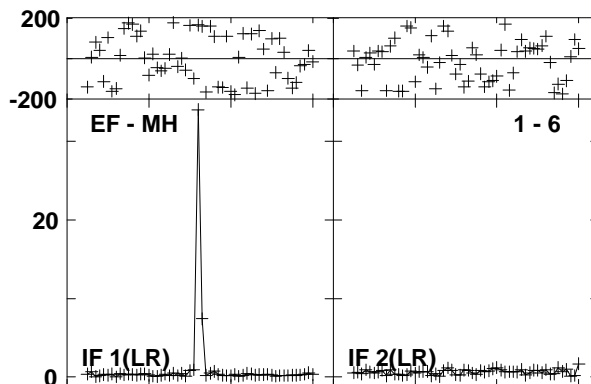
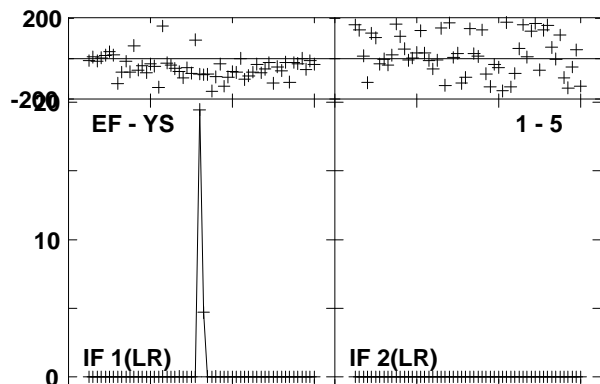
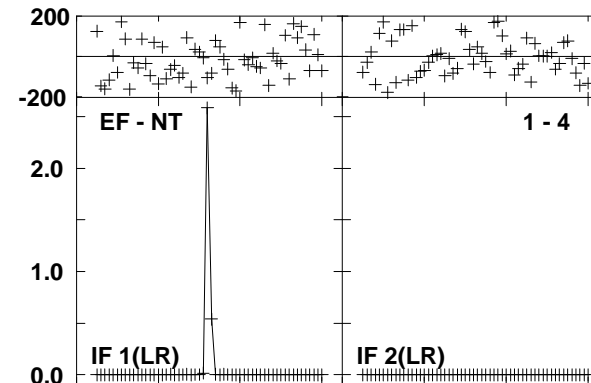
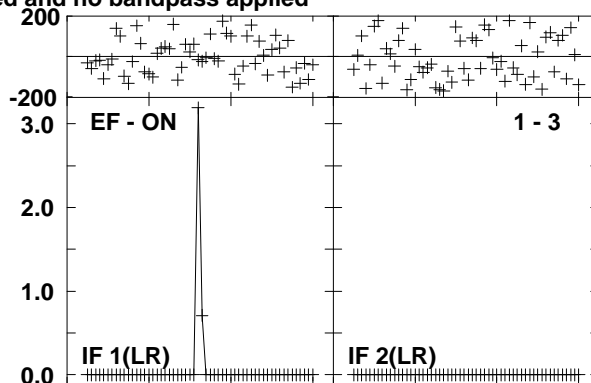
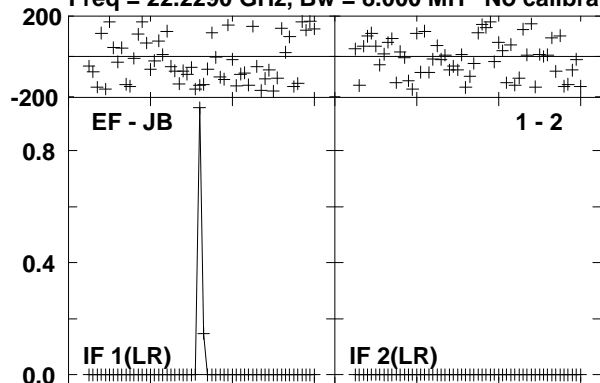

Lower frame: Ampl Jy Top frame: Phas deg
Vector averaged cross-power spectrum Several baselines displayed
Timerange: 00/12:26:04 to 00/12:26:59

Plot file version 105 created 17-SEP-2012 12:05:48

J0529-0519 EE008D 1.UVDATA.1

Freq = 22.2290 GHz, Bw = 8.000 MH No calibration applied and no bandpass applied

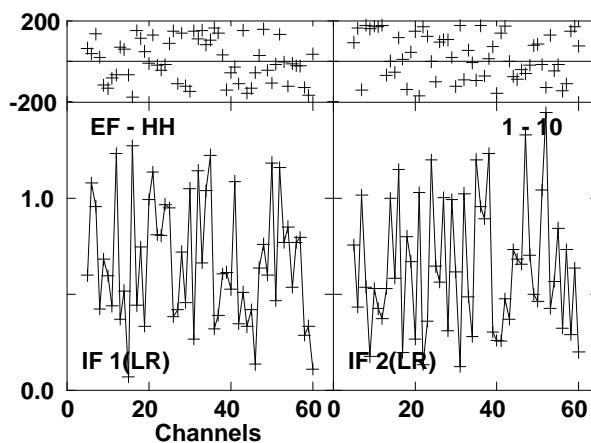
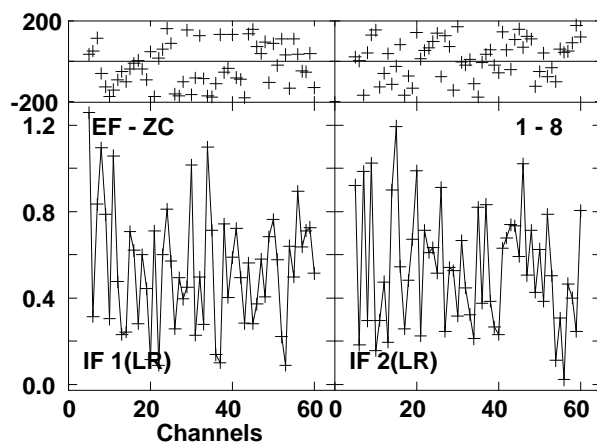
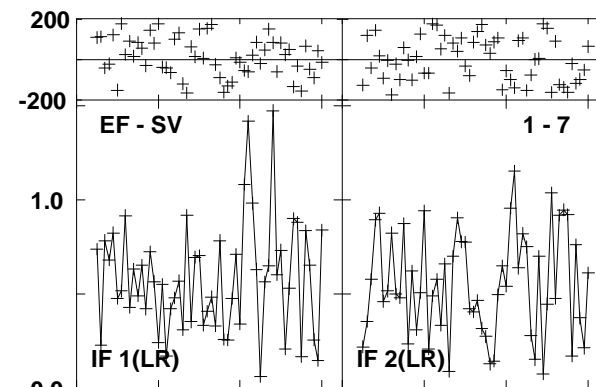
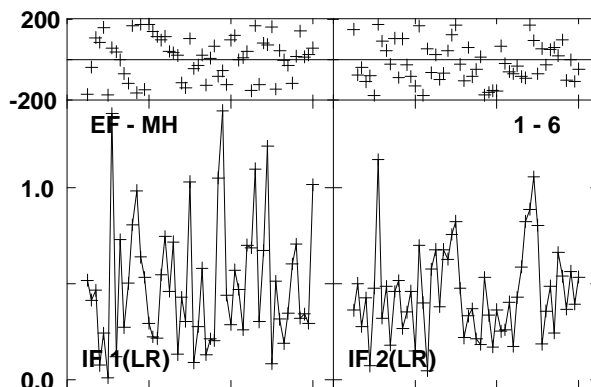
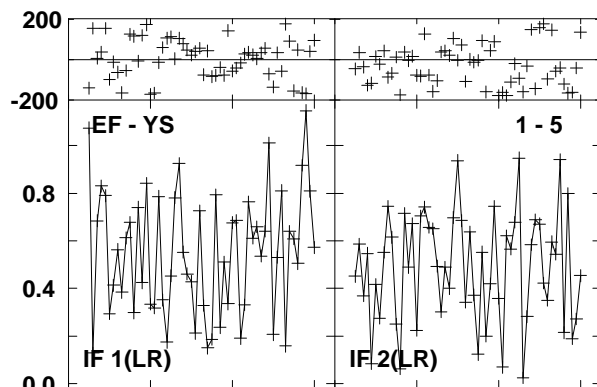
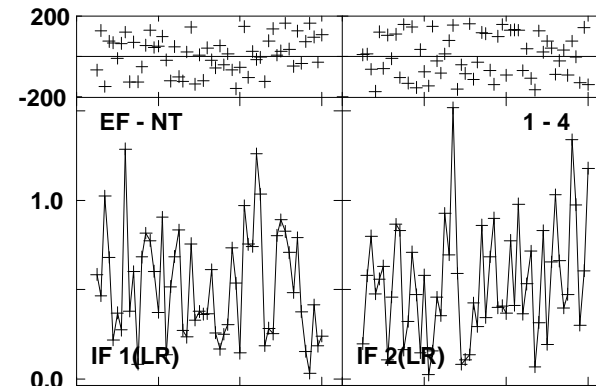
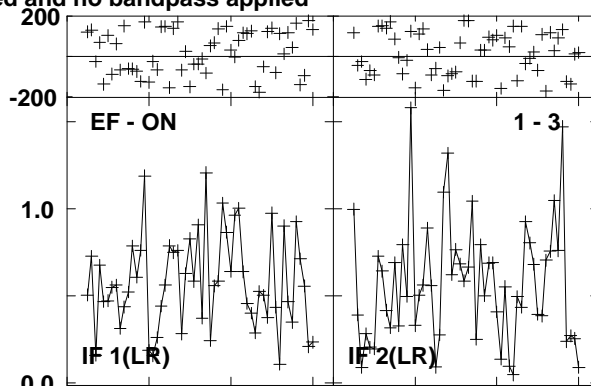
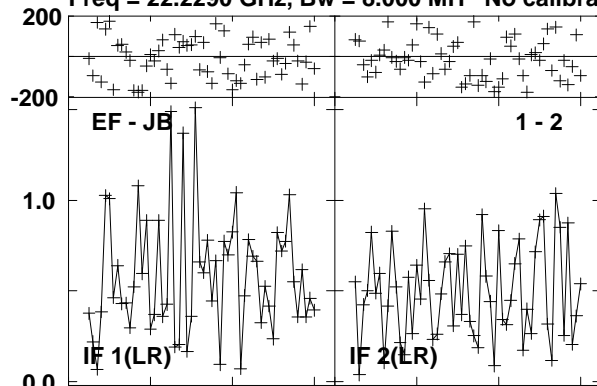

Lower frame: Milli Ampl Jy Top frame: Phas deg
Vector averaged cross-power spectrum Several baselines displayed
Timerange: 00/12:27:04 to 00/12:27:59

Plot file version 106 created 17-SEP-2012 12:05:50

J0541-0541 EE008D 1.UVDATA.1

Freq = 22.2290 GHz, Bw = 8.000 MH No calibration applied and no bandpass applied

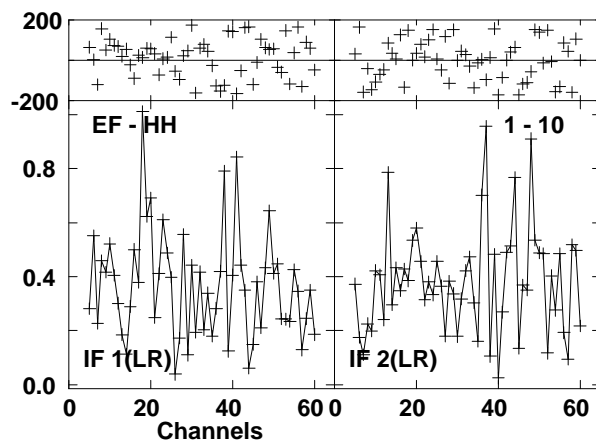
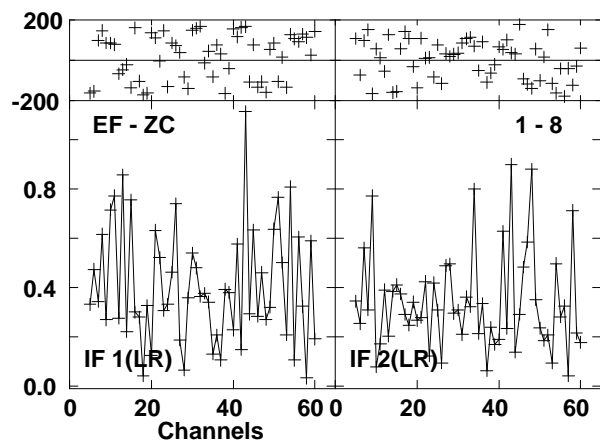
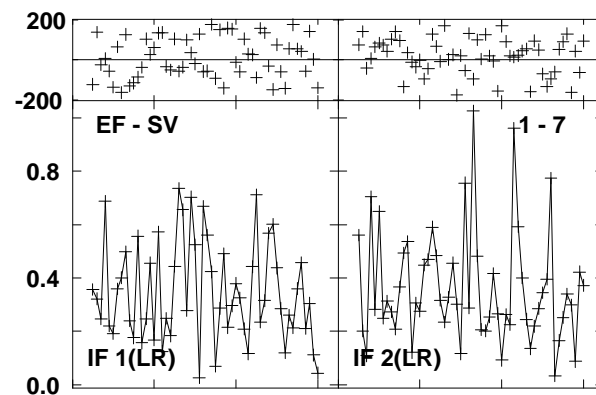
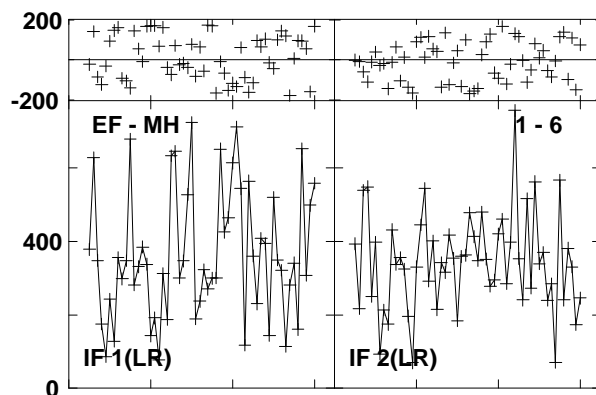
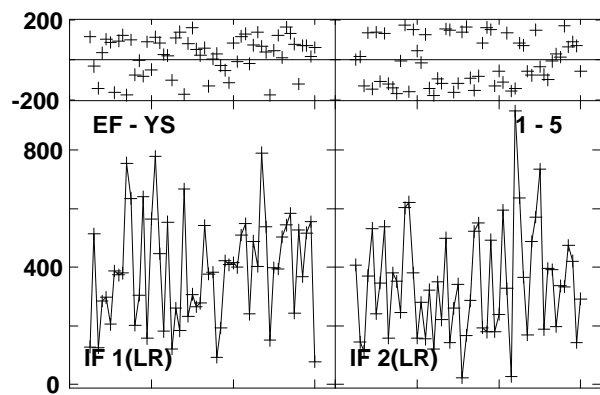
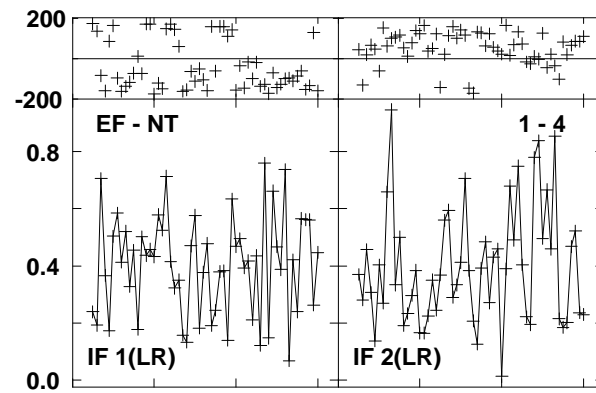
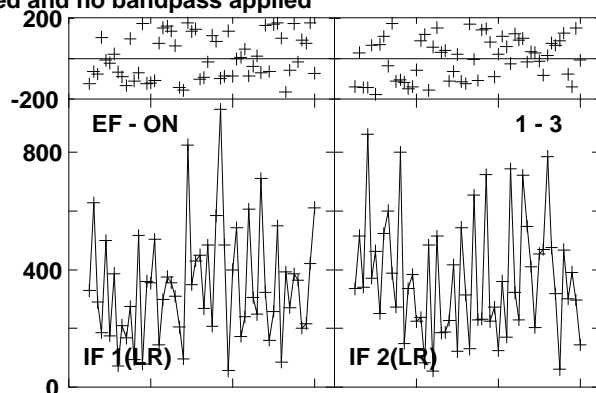
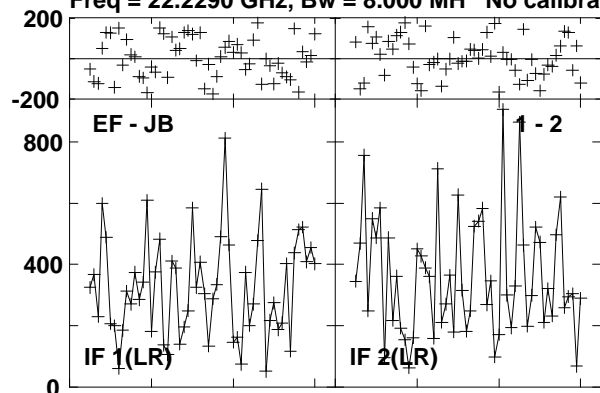

Lower frame: Micro Ampl Jy Top frame: Phas deg
Vector averaged cross-power spectrum Several baselines displayed
Timerange: 00/12:28:45 to 00/12:29:44

Plot file version 107 created 17-SEP-2012 12:05:53

ORIKL1 EE008D 1.UVDATA.1

Freq = 22.2290 GHz, Bw = 8.000 MH No calibration applied and no bandpass applied

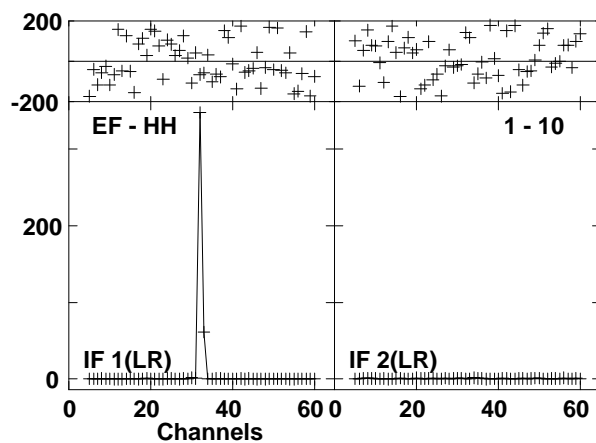
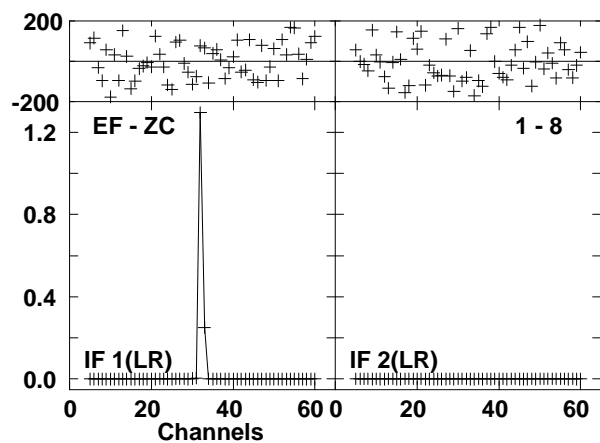
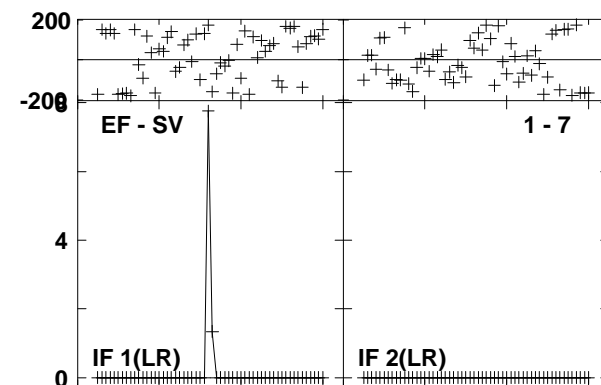
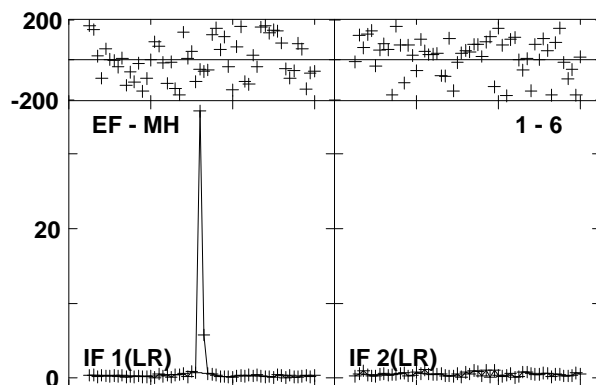
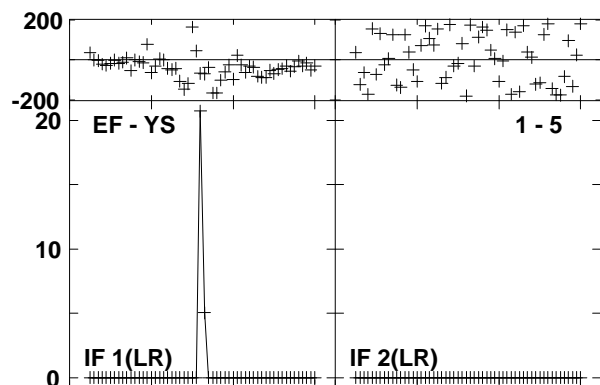
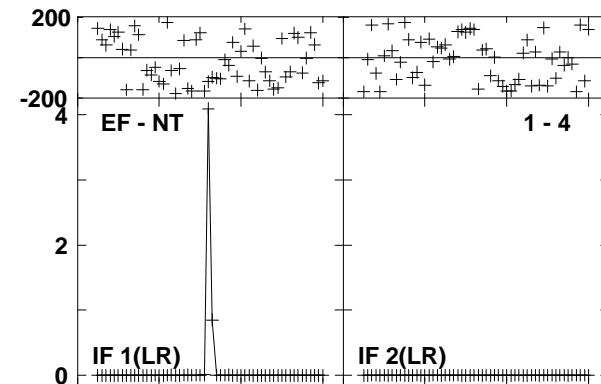
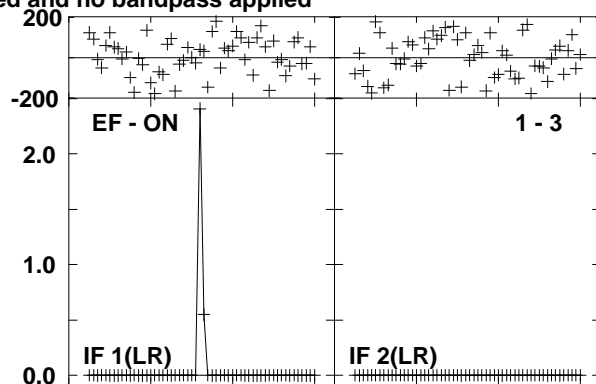
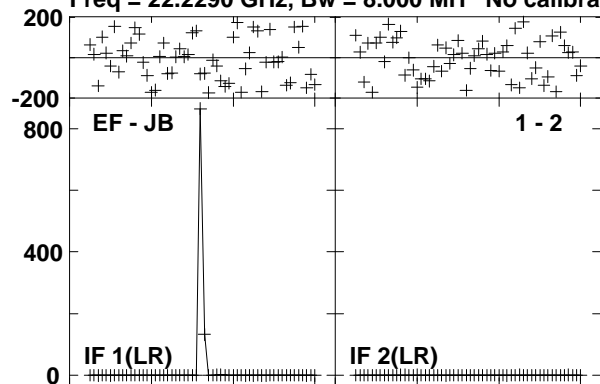

Lower frame: Milli Ampl Jy Top frame: Phas deg

Vector averaged cross-power spectrum Several baselines displayed

Timerange: 00/12:29:48 to 00/12:30:44

Plot file version 108 created 17-SEP-2012 12:05:54

J0541-0541 EE008D 1.UVDATA.1

Freq = 22.2290 GHz, Bw = 8.000 MH No calibration applied and no bandpass applied

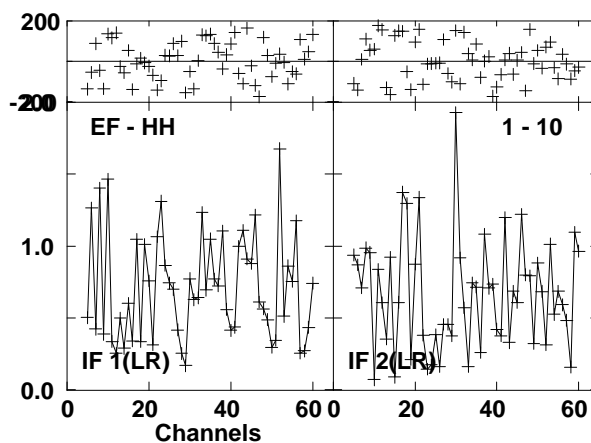
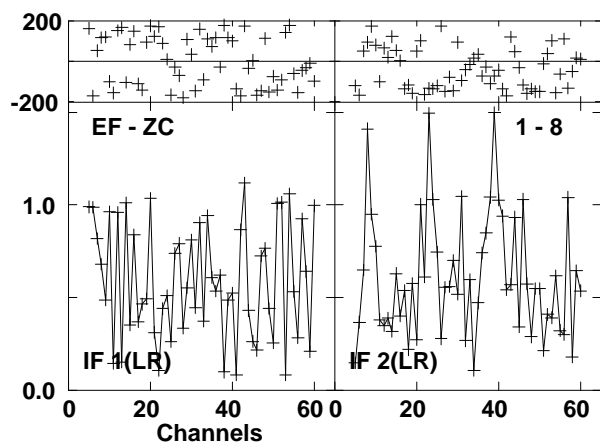
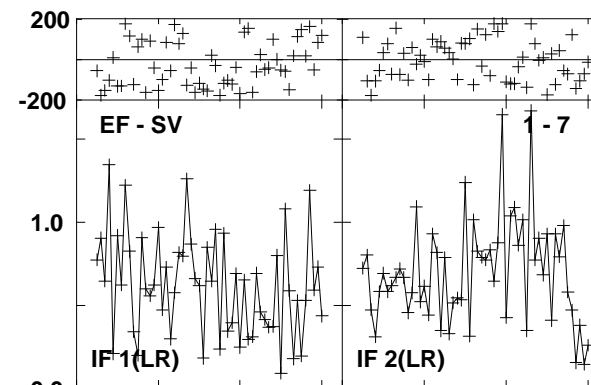
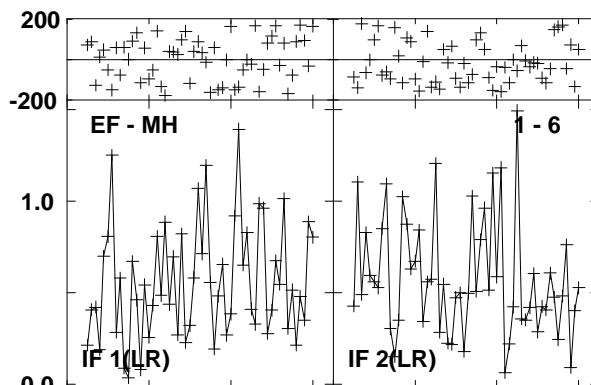
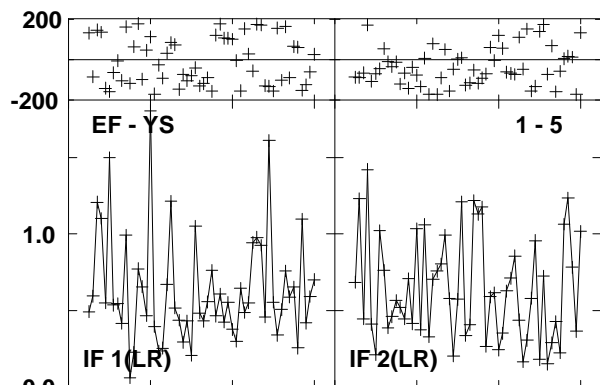
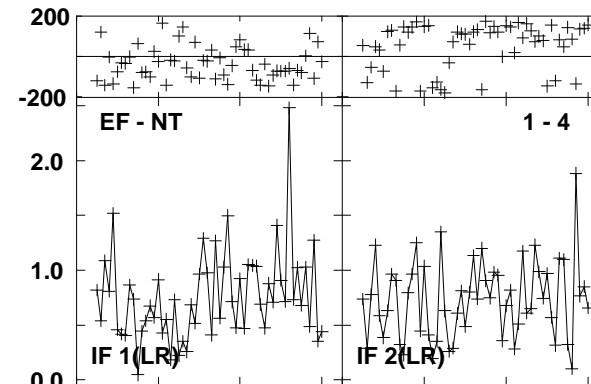
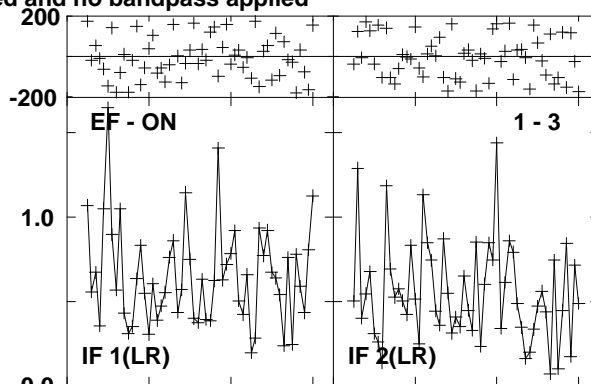
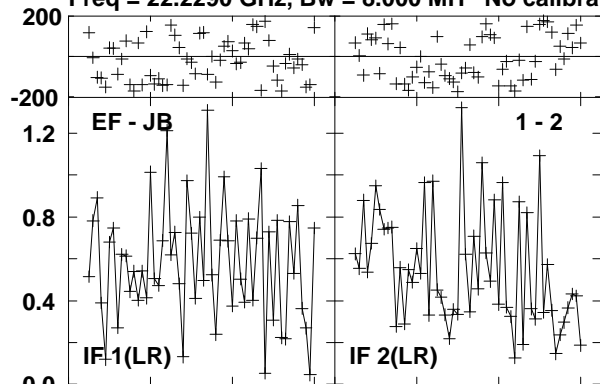

Lower frame: Milli Ampl Jy Top frame: Phas deg
Vector averaged cross-power spectrum Several baselines displayed
Timerange: 00/12:30:49 to 00/12:31:44

Plot file version 109 created 17-SEP-2012 12:05:57

ORIKL1 EE008D 1.UVDATA.1

Freq = 22.2290 GHz, Bw = 8.000 MH No calibration applied and no bandpass applied

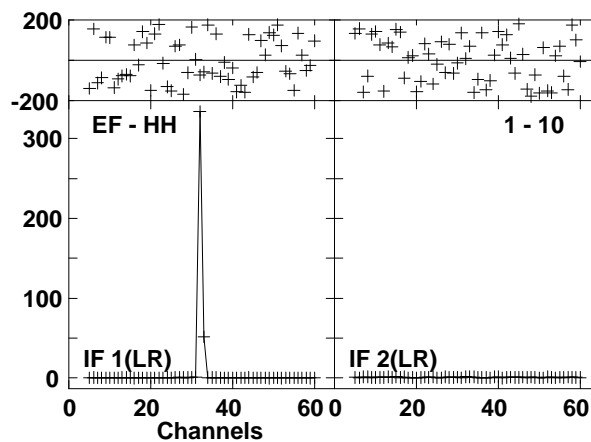
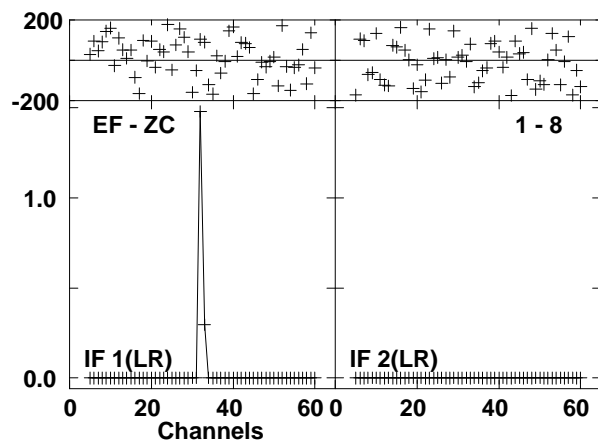
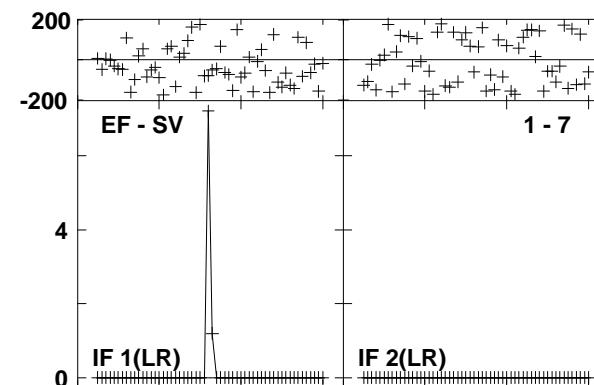
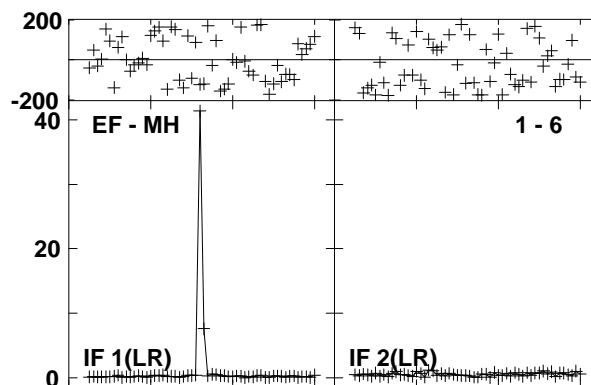
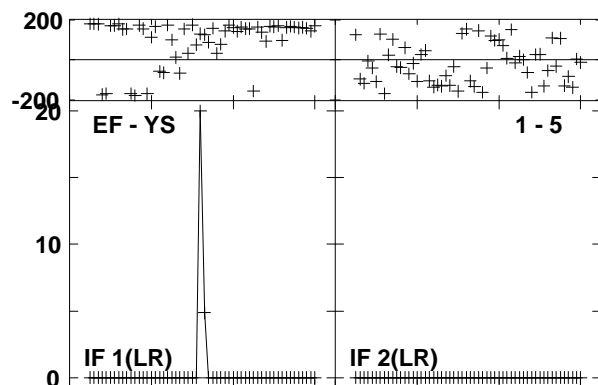
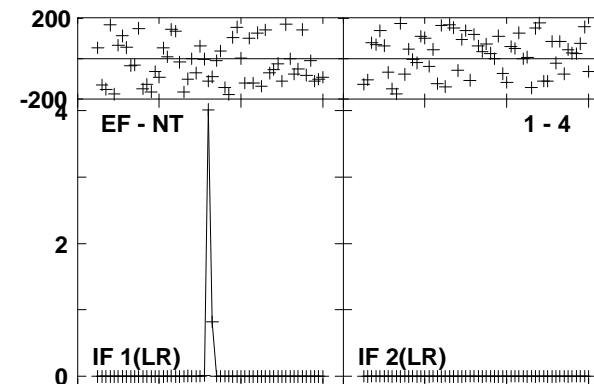
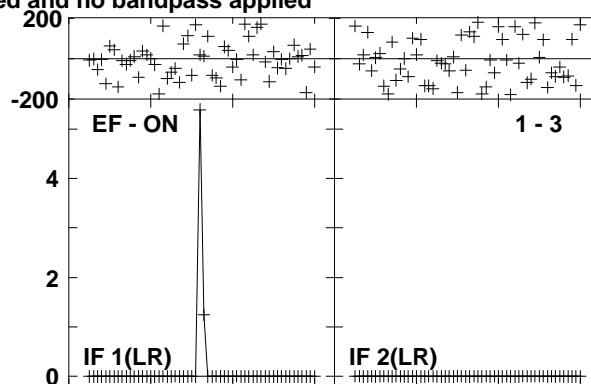
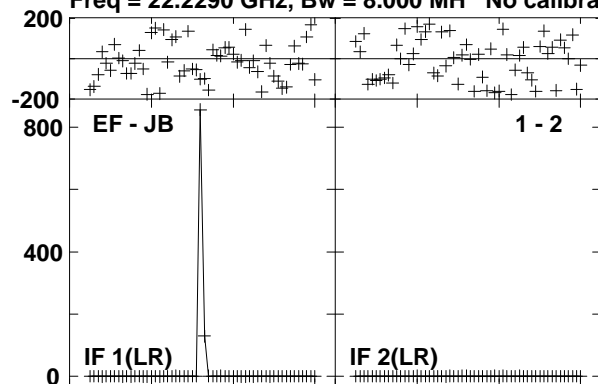

Lower frame: Milli Ampl Jy Top frame: Phas deg
Vector averaged cross-power spectrum Several baselines displayed
Timerange: 00/12:31:49 to 00/12:32:44

Plot file version 110 created 17-SEP-2012 12:05:58

J0541-0541 EE008D 1.UVDATA.1

Freq = 22.2290 GHz, Bw = 8.000 MH No calibration applied and no bandpass applied

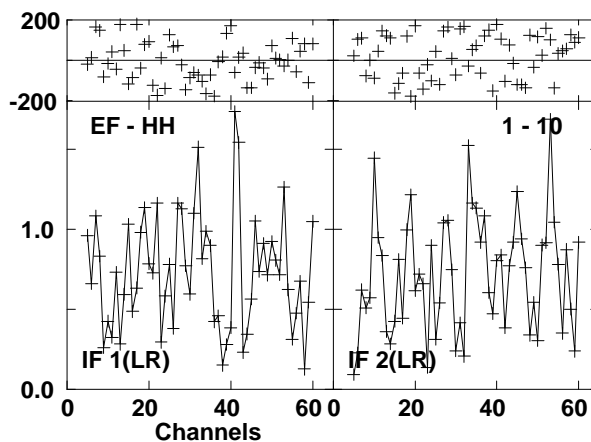
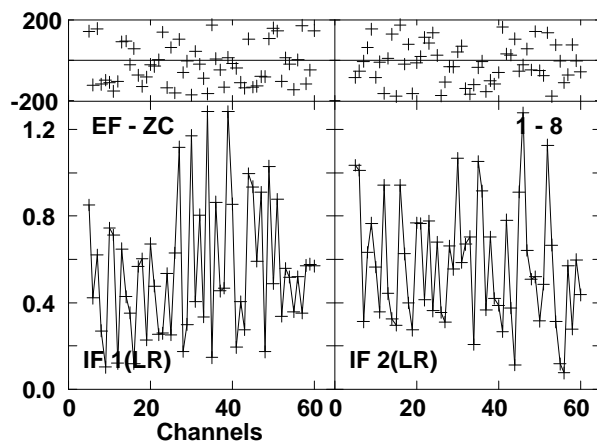
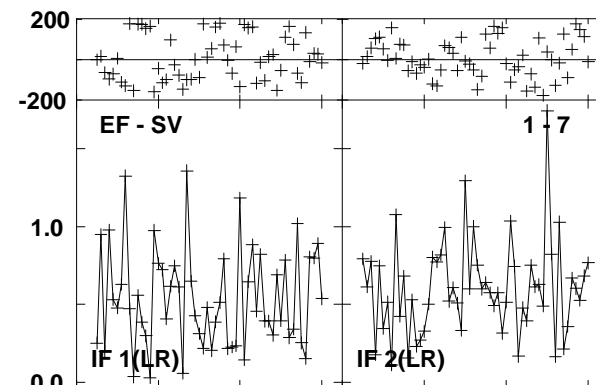
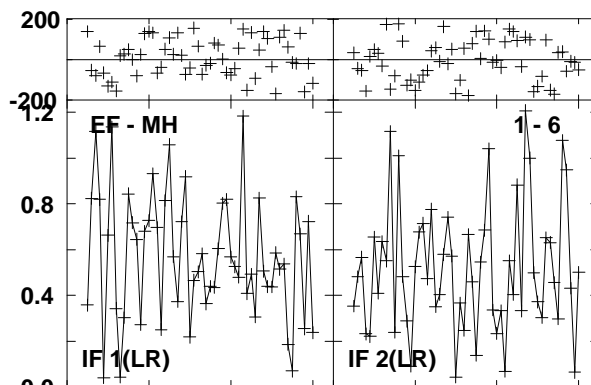
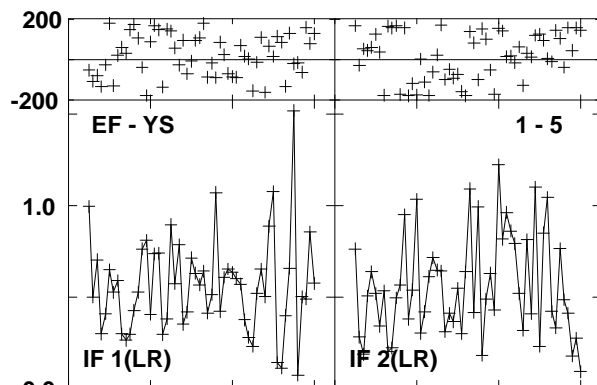
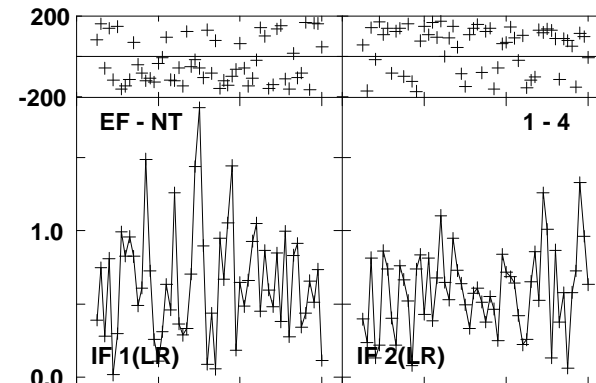
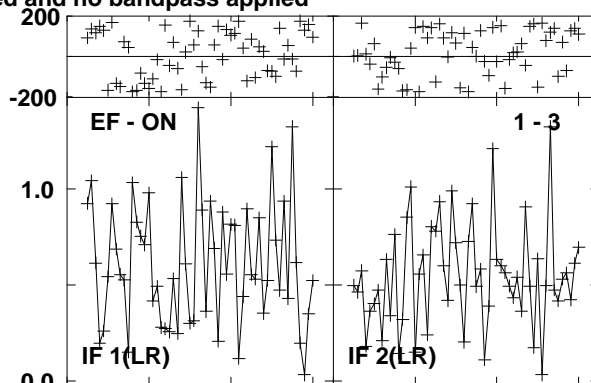
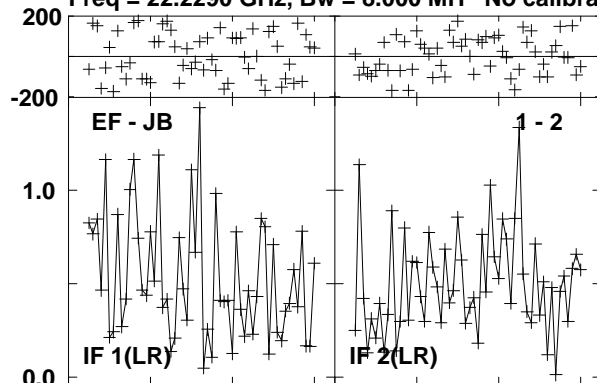

Lower frame: Milli Ampl Jy Top frame: Phas deg
Vector averaged cross-power spectrum Several baselines displayed
Timerange: 00/12:32:49 to 00/12:33:44

Plot file version 111 created 17-SEP-2012 12:06:00

J0529-0519 EE008D 1.UVDATA.1

Freq = 22.2290 GHz, Bw = 8.000 MH No calibration applied and no bandpass applied

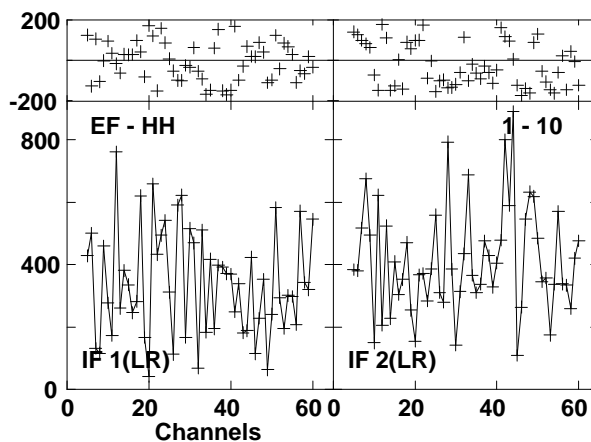
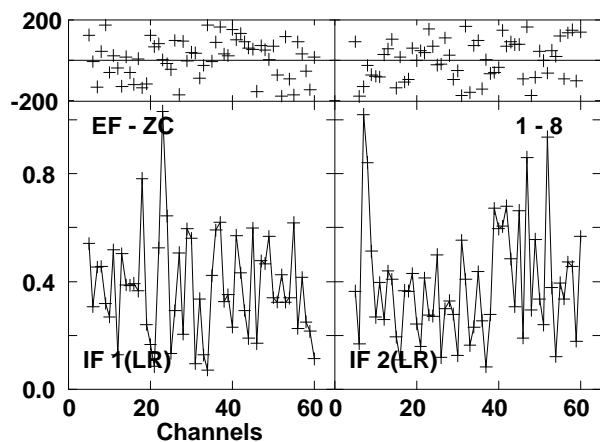
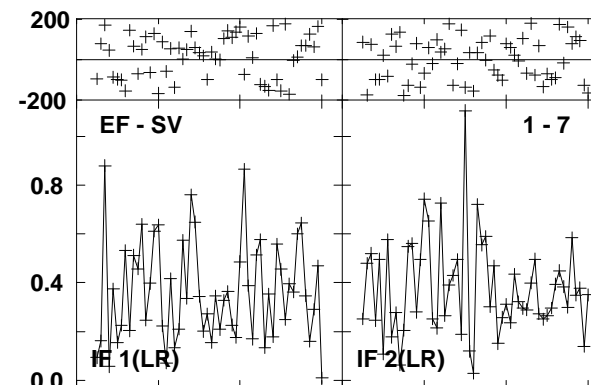
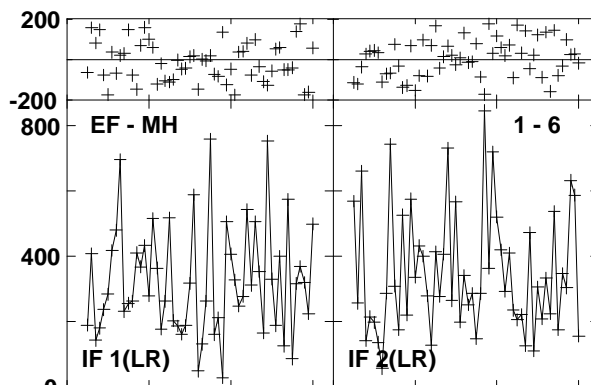
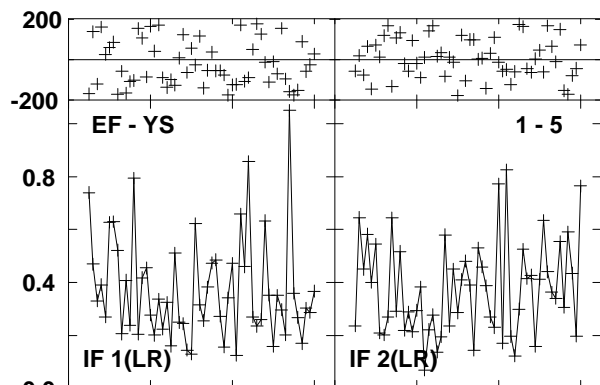
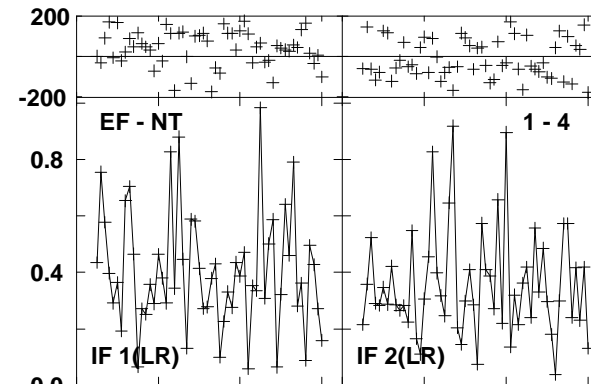
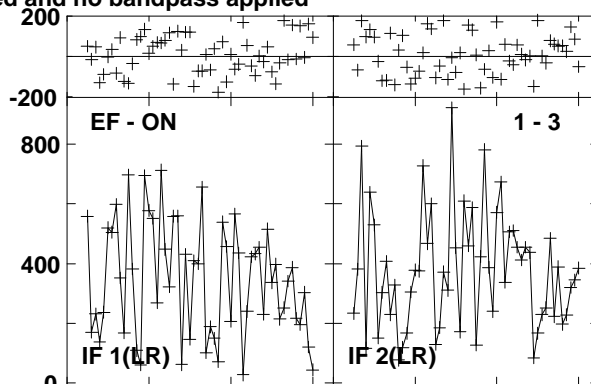
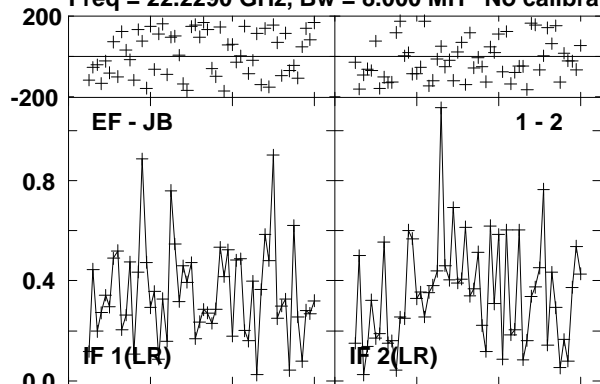

Lower frame: Milli Ampl Jy Top frame: Phas deg
Vector averaged cross-power spectrum Several baselines displayed
Timerange: 00/12:34:31 to 00/12:35:30

Plot file version 112 created 17-SEP-2012 12:06:03

ORIKL1 EE008D 1.UVDATA.1

Freq = 22.2290 GHz, Bw = 8.000 MH No calibration applied and no bandpass applied

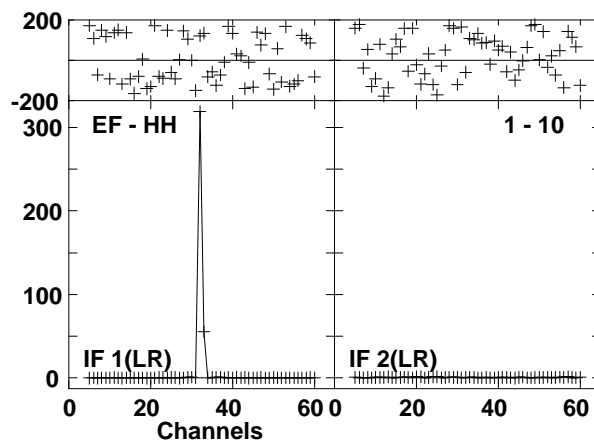
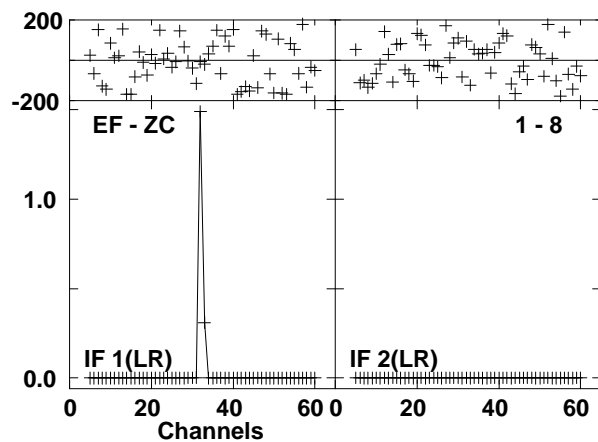
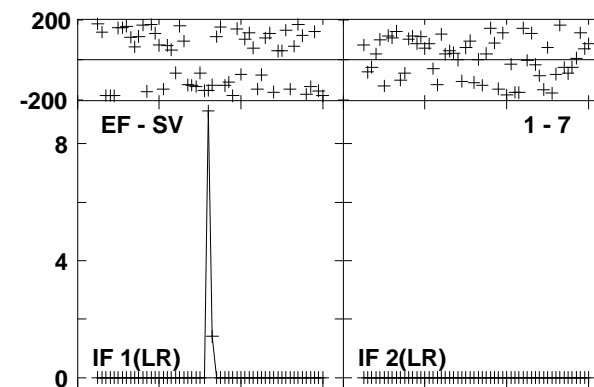
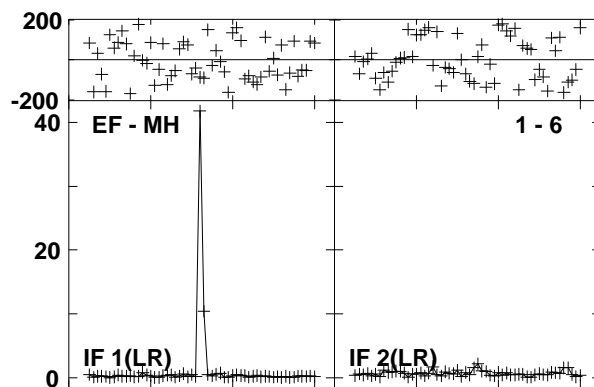
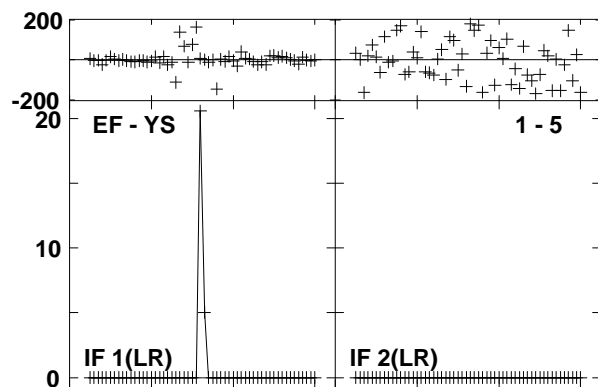
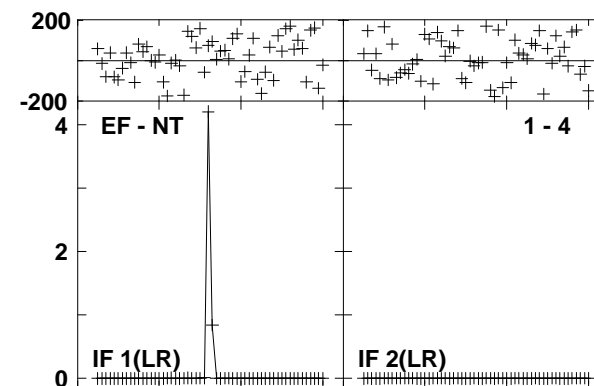
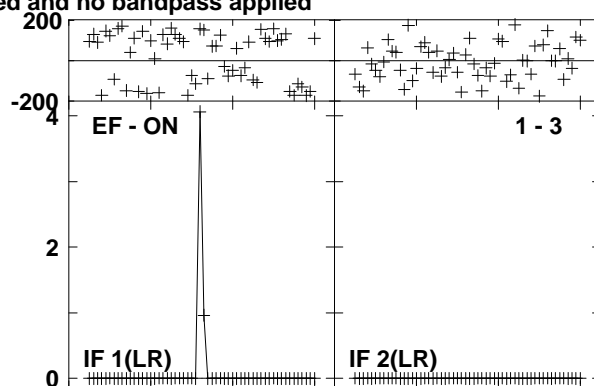
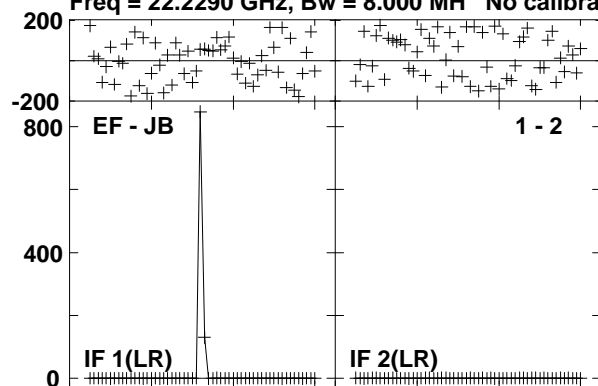

Lower frame: Milli Ampl Jy Top frame: Phas deg

Vector averaged cross-power spectrum Several baselines displayed

Timerange: 00/12:35:34 to 00/12:36:30

Plot file version 113 created 17-SEP-2012 12:06:05

J0529-0519 EE008D 1.UVDATA.1

Freq = 22.2290 GHz, Bw = 8.000 MH No calibration applied and no bandpass applied

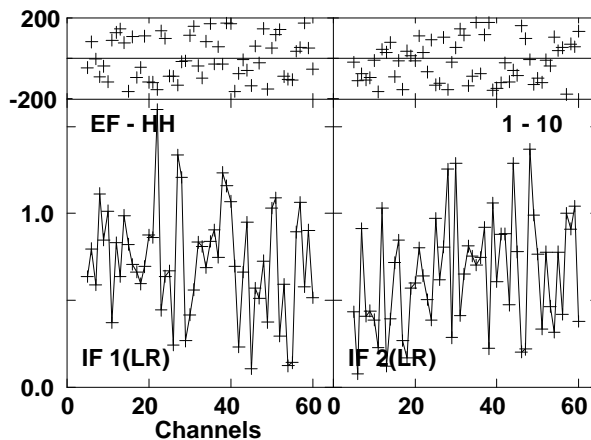
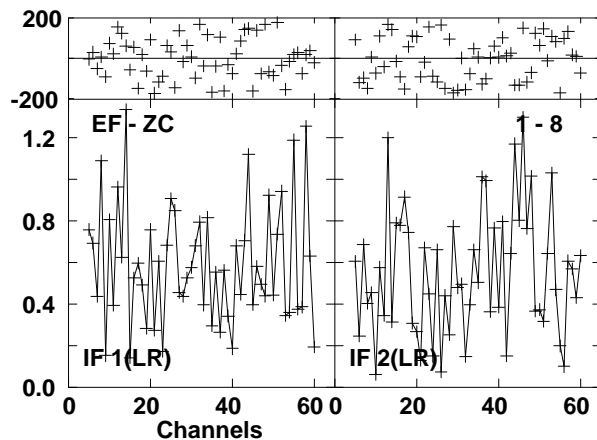
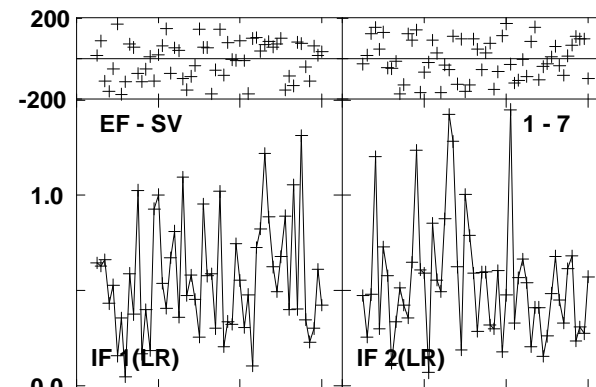
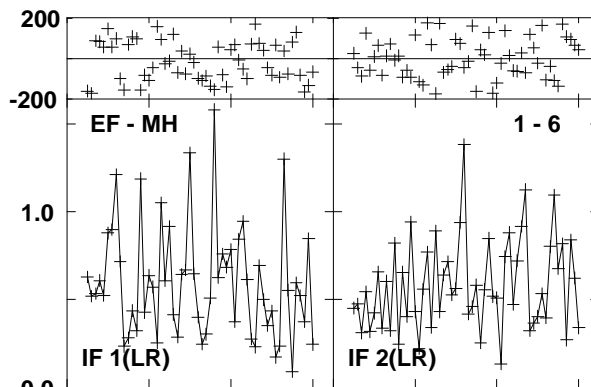
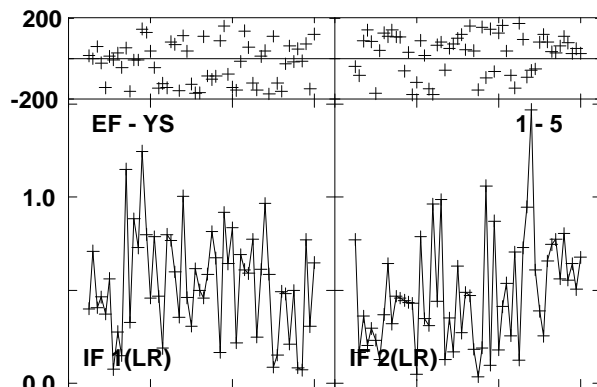
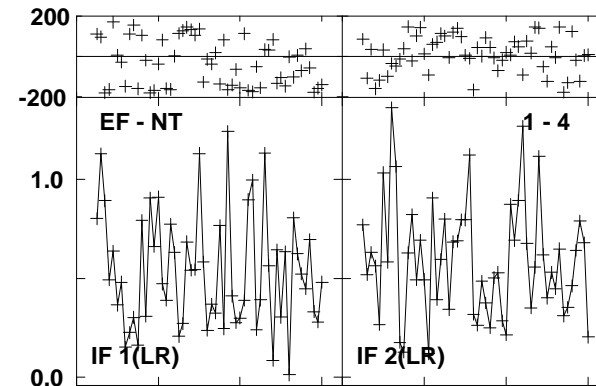
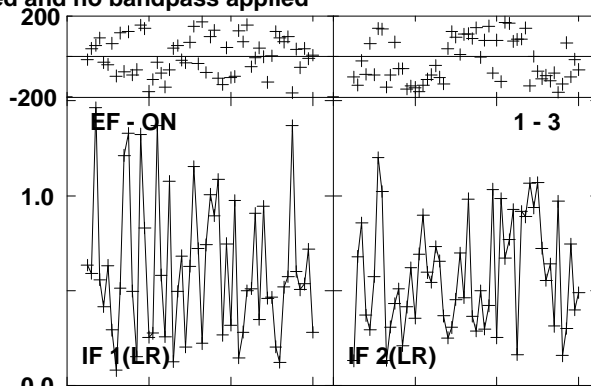
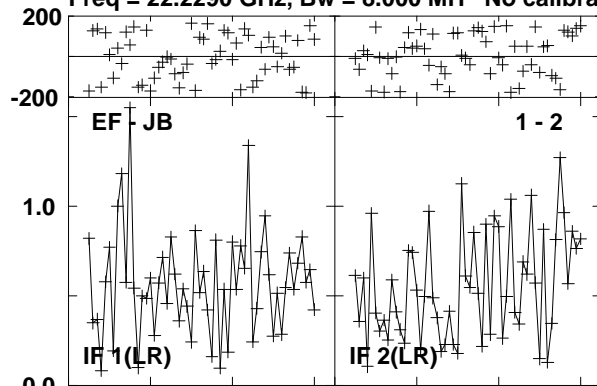

Lower frame: Milli Ampl Jy Top frame: Phas deg
Vector averaged cross-power spectrum Several baselines displayed
Timerange: 00/12:36:35 to 00/12:37:30

Plot file version 114 created 17-SEP-2012 12:06:07

ORIKL1 EE008D 1.UVDATA.1

Freq = 22.2290 GHz, Bw = 8.000 MH No calibration applied and no bandpass applied

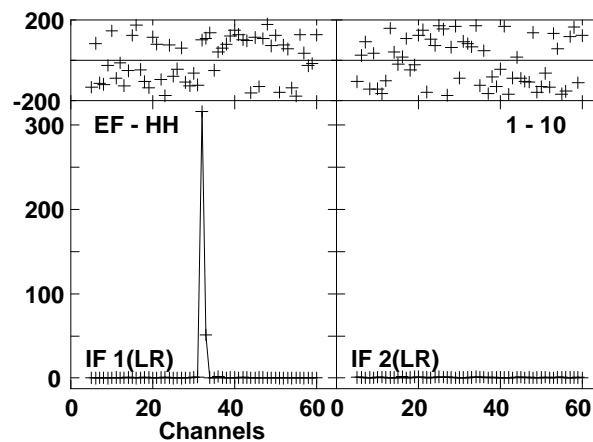
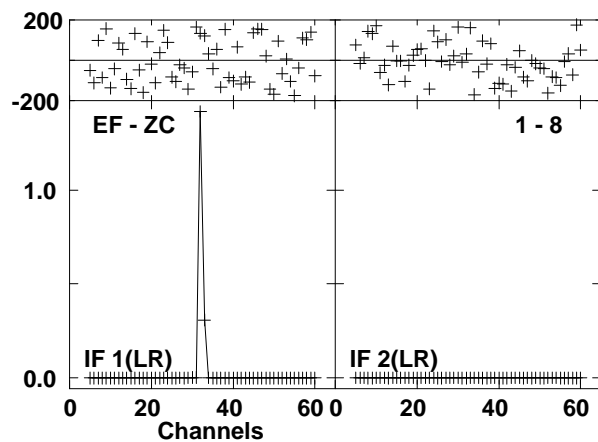
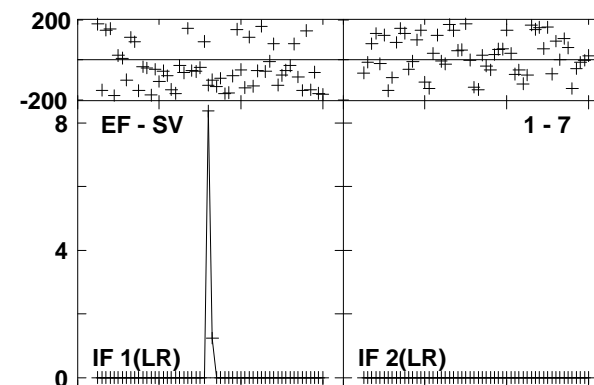
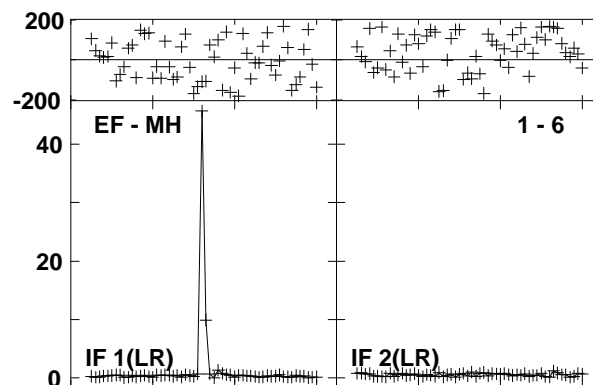
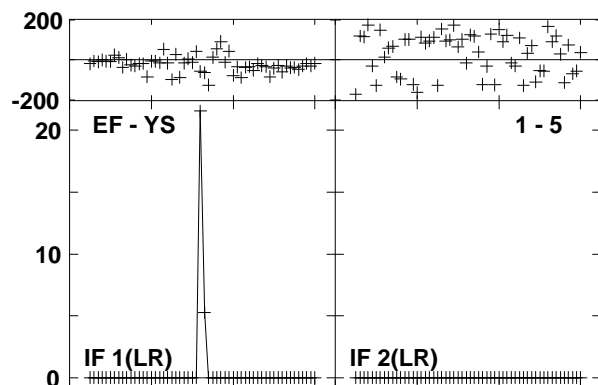
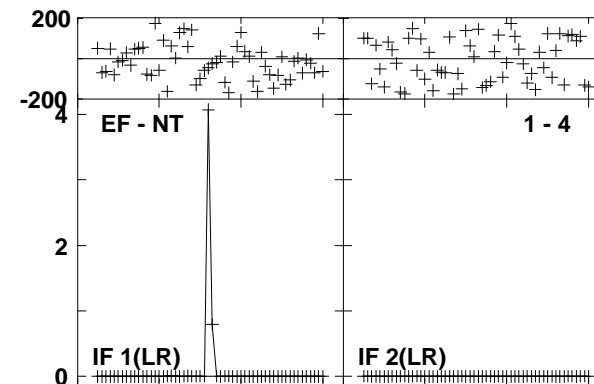
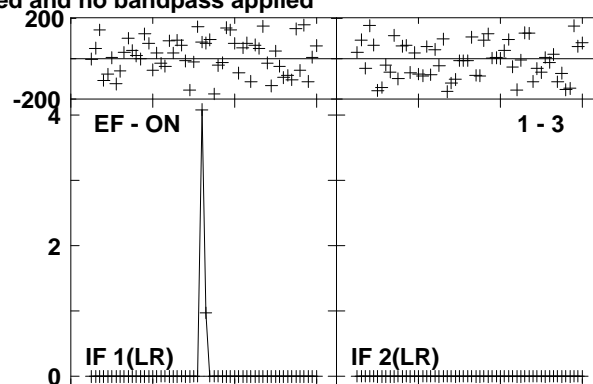
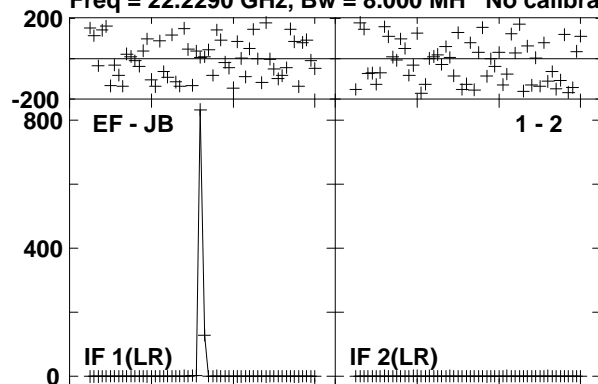

Lower frame: Milli Ampl Jy Top frame: Phas deg

Vector averaged cross-power spectrum Several baselines displayed

Timerange: 00/12:37:35 to 00/12:38:30

Plot file version 115 created 17-SEP-2012 12:06:09

J0529-0519 EE008D 1.UVDATA.1

Freq = 22.2290 GHz, Bw = 8.000 MH No calibration applied and no bandpass applied

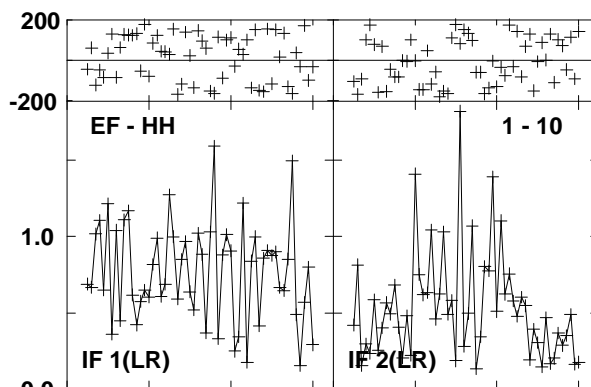
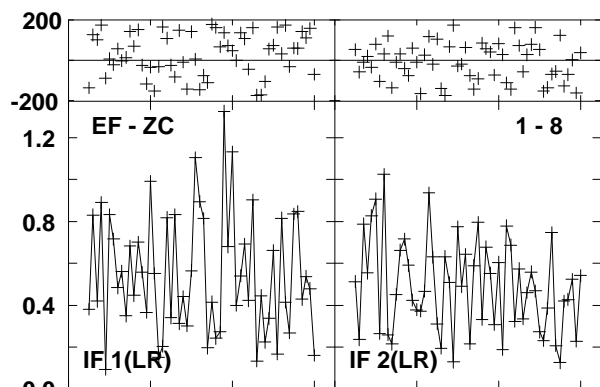
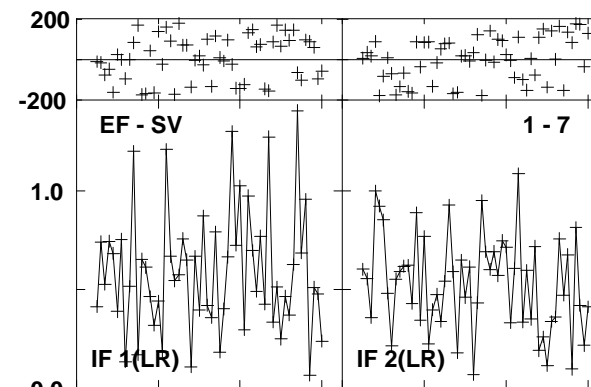
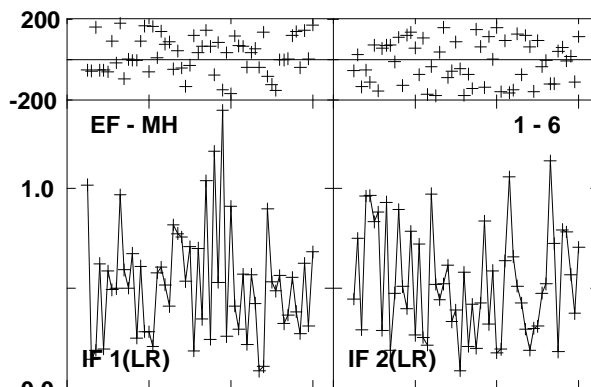
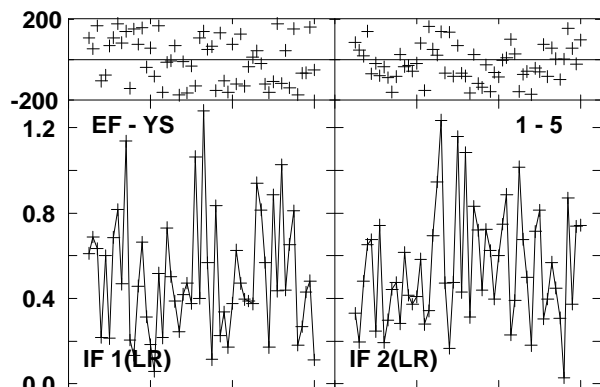
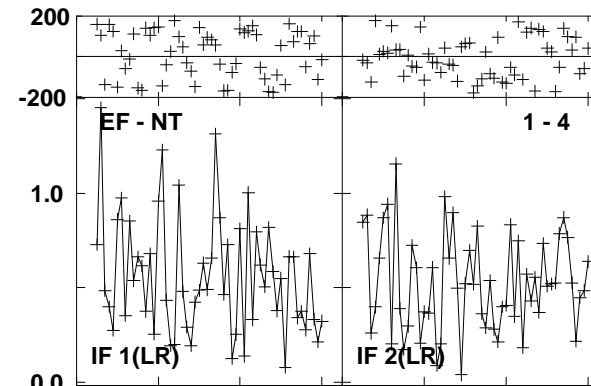
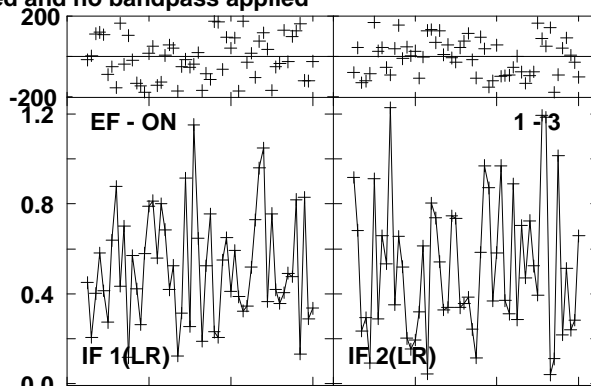
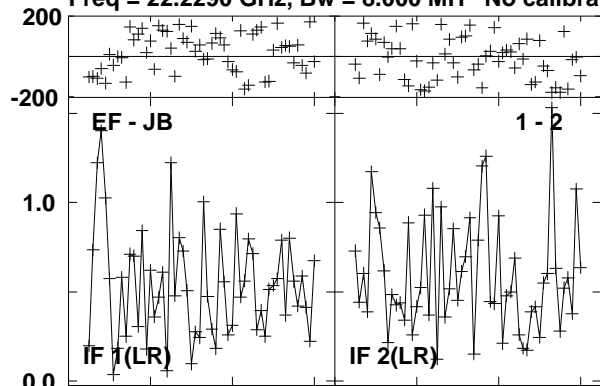

Channels
Lower frame: Milli Ampl Jy Top frame: Phas deg
Vector averaged cross-power spectrum Several baselines displayed
Timerange: 00/12:38:35 to 00/12:39:30

Plot file version 116 created 17-SEP-2012 12:06:11

J0541-0541 EE008D 1.UVDATA.1

Freq = 22.2290 GHz, Bw = 8.000 MH No calibration applied and no bandpass applied

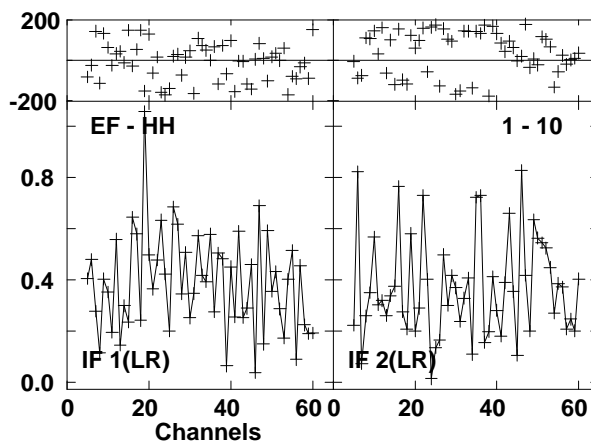
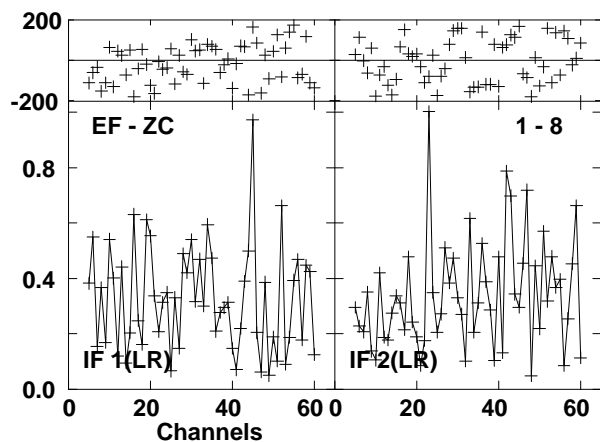
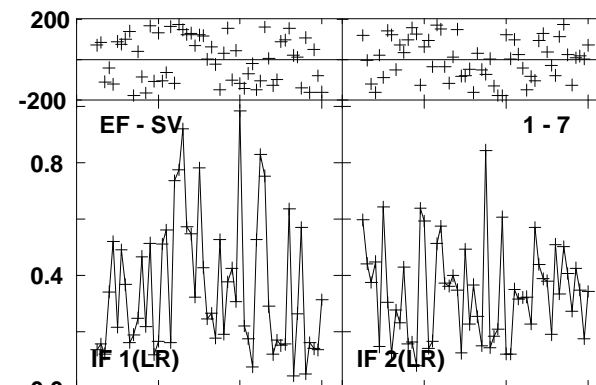
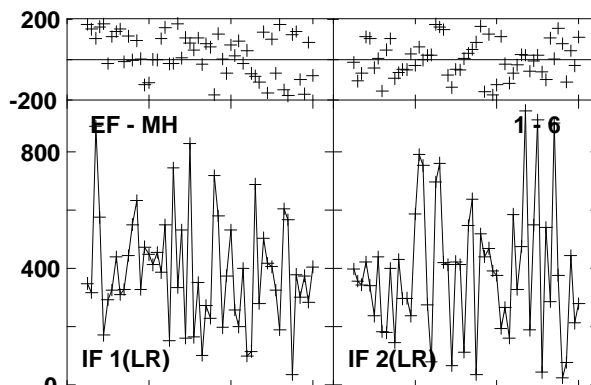
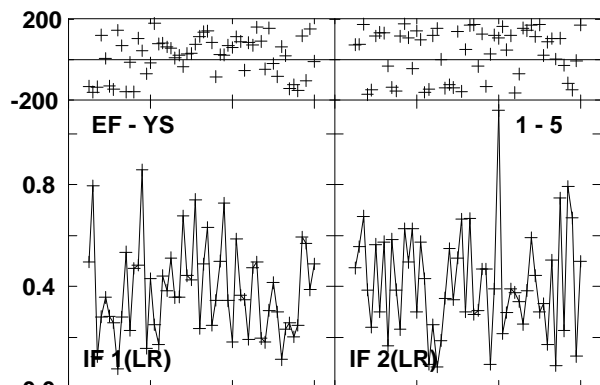
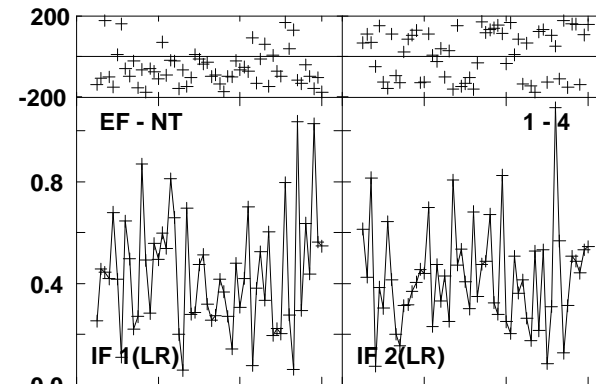
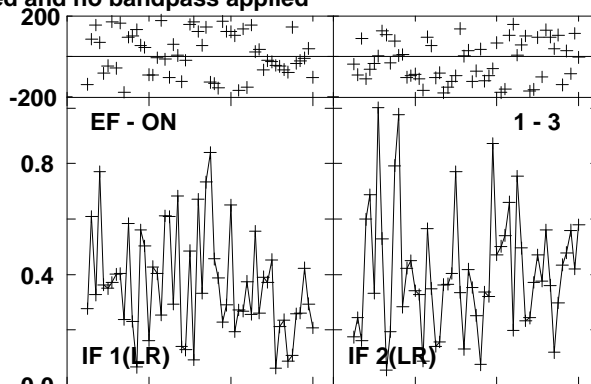
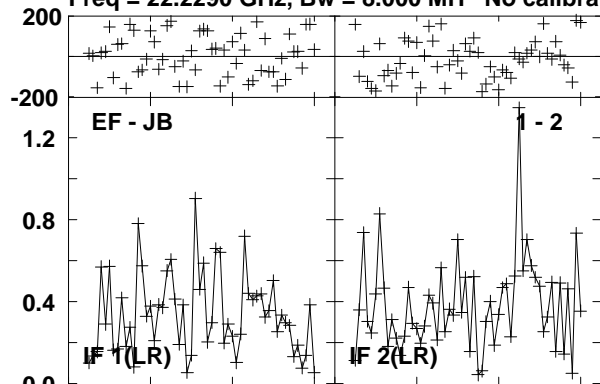

Lower frame: Milli Ampl Jy Top frame: Phas deg
Vector averaged cross-power spectrum Several baselines displayed
Timerange: 00/12:40:16 to 00/12:41:15

Plot file version 117 created 17-SEP-2012 12:06:14

ORIKL1 EE008D 1.UVDATA.1

Freq = 22.2290 GHz, Bw = 8.000 MH No calibration applied and no bandpass applied

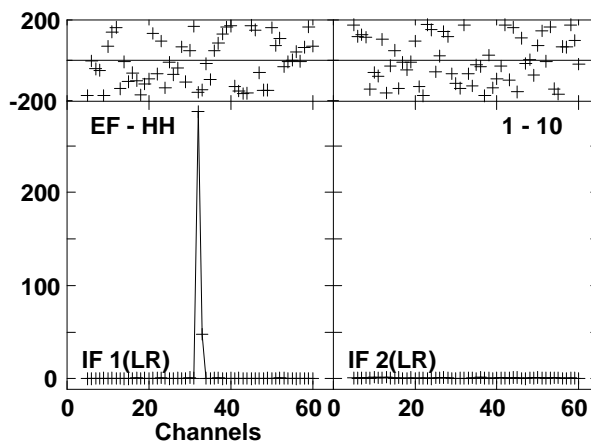
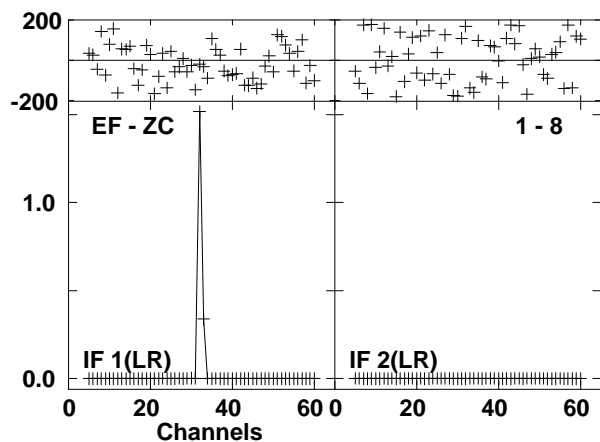
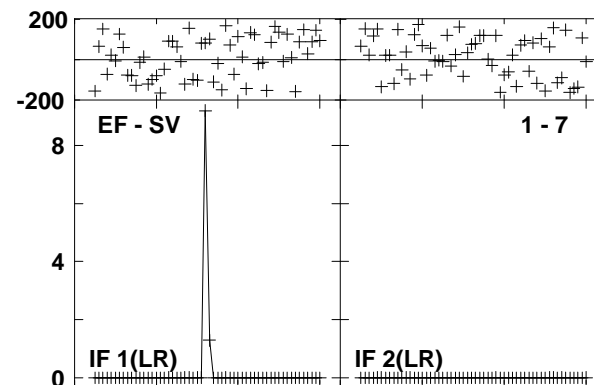
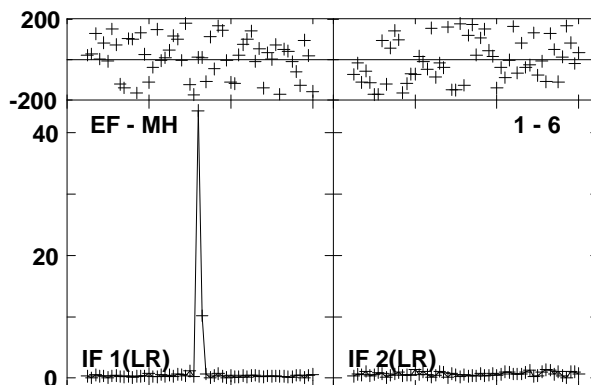
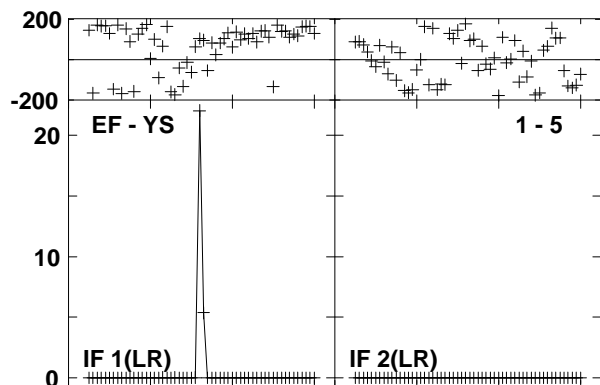
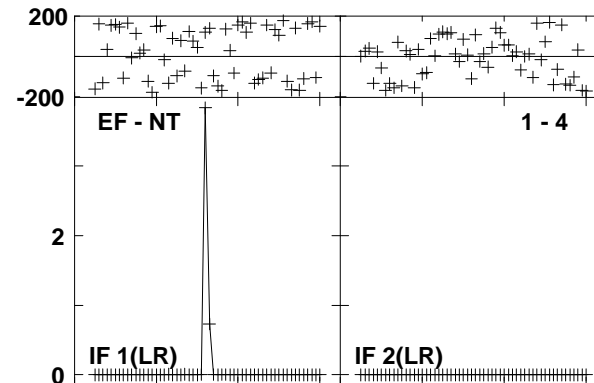
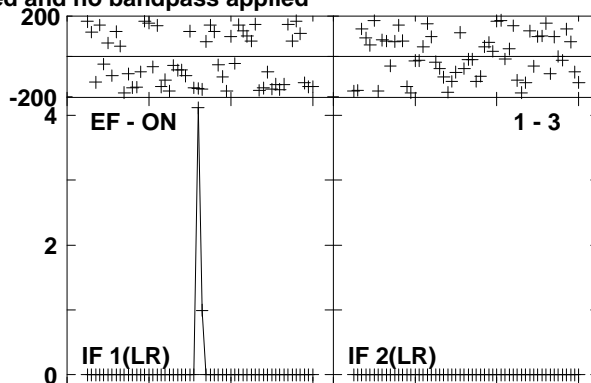
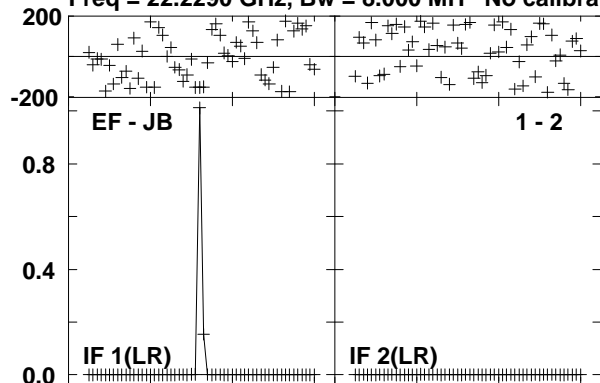

Lower frame: Ampl Jy Top frame: Phas deg
Vector averaged cross-power spectrum Several baselines displayed
Timerange: 00/12:41:19 to 00/12:42:15

Plot file version 118 created 17-SEP-2012 12:06:16

J0541-0541 EE008D 1.UVDATA.1

Freq = 22.2290 GHz, Bw = 8.000 MH No calibration applied and no bandpass applied

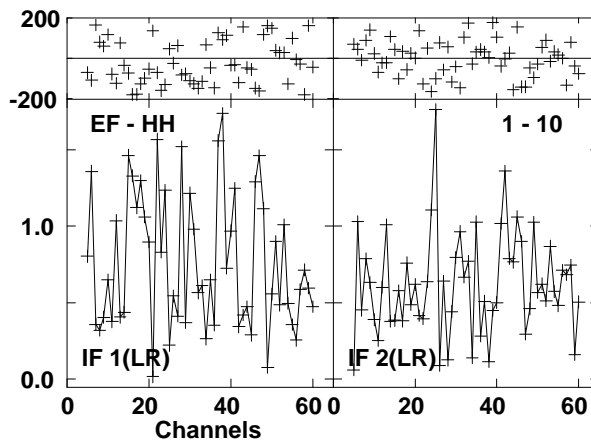
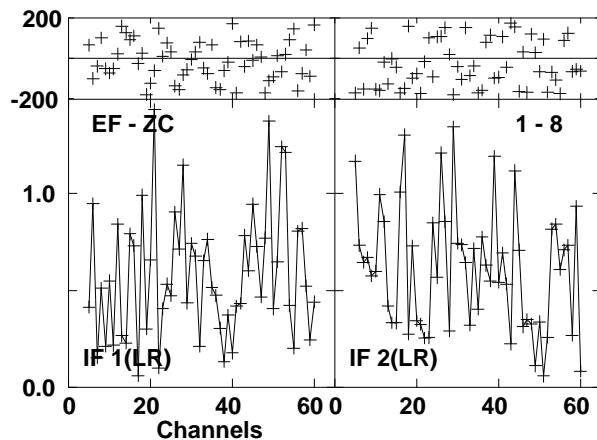
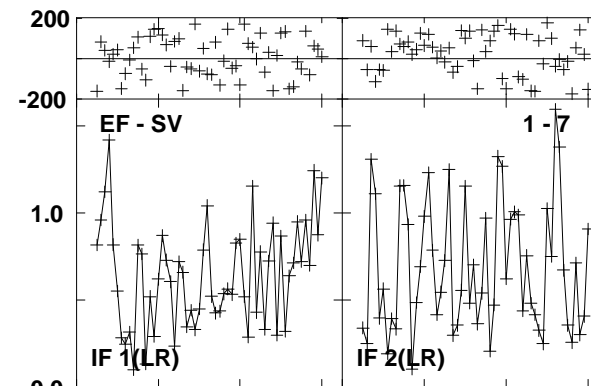
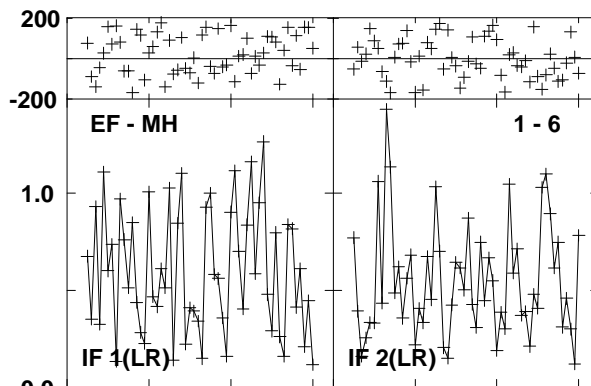
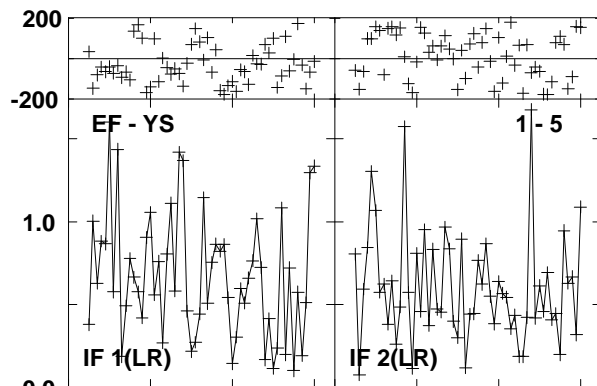
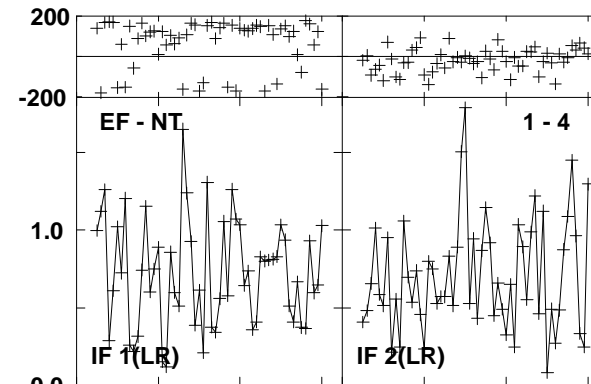
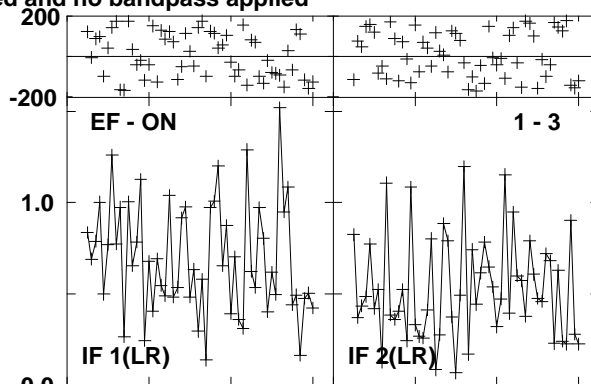
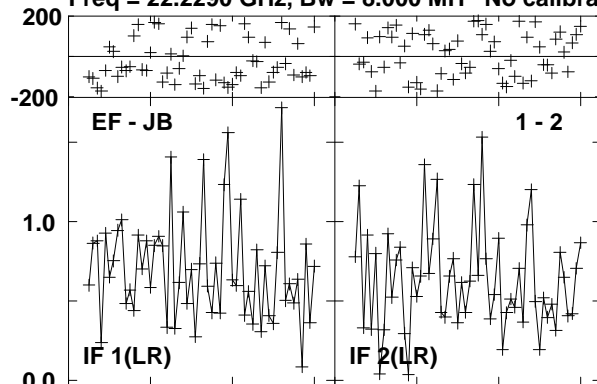

Lower frame: Milli Ampl Jy Top frame: Phas deg
Vector averaged cross-power spectrum Several baselines displayed
Timerange: 00/12:42:20 to 00/12:43:15

Plot file version 119 created 17-SEP-2012 12:06:18

ORIKL1 EE008D 1.UVDATA.1

Freq = 22.2290 GHz, Bw = 8.000 MH No calibration applied and no bandpass applied

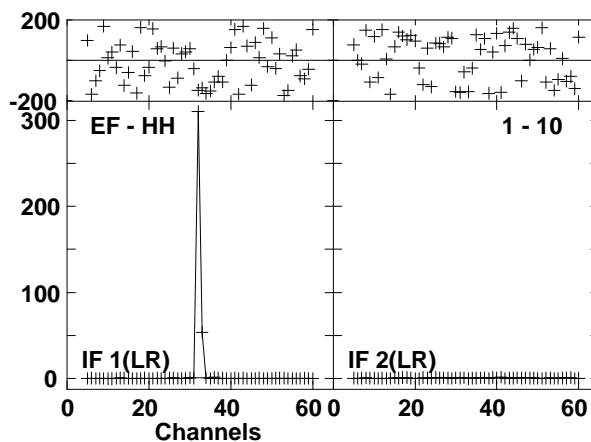
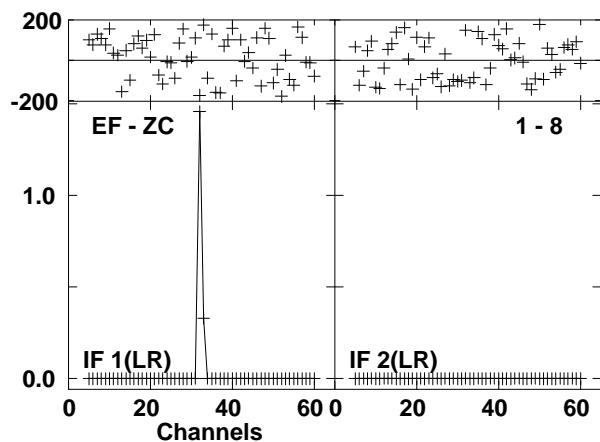
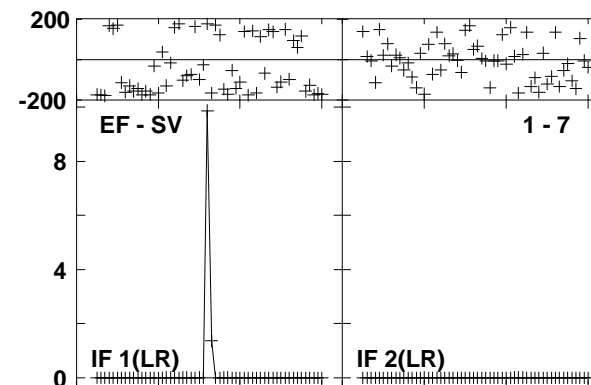
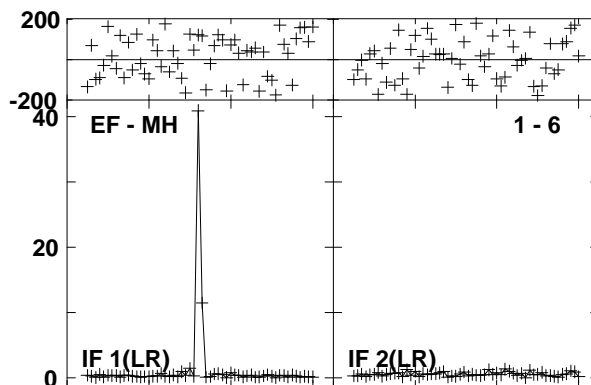
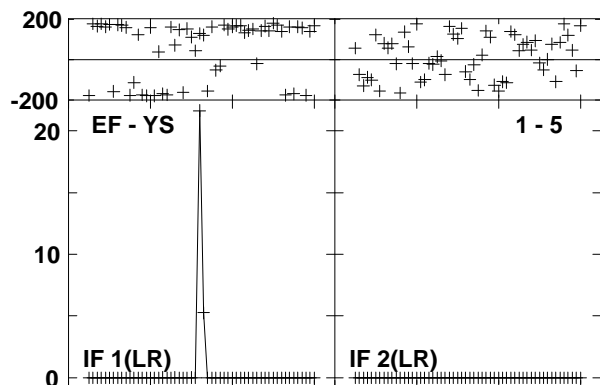
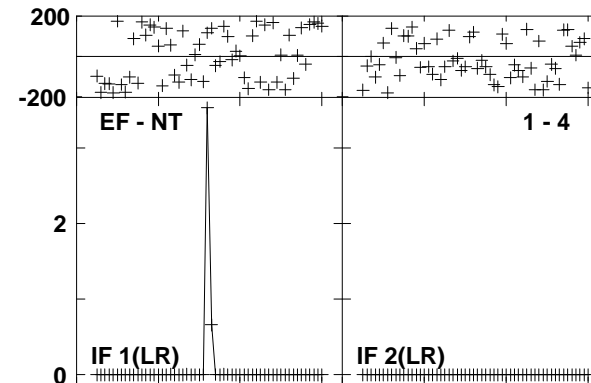
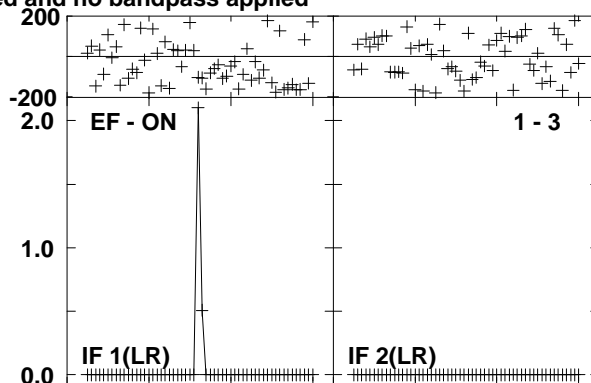
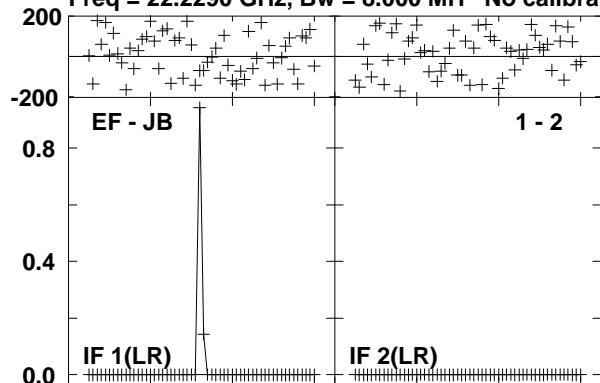

Lower frame: Ampl Jy Top frame: Phas deg

Vector averaged cross-power spectrum Several baselines displayed

Timerange: 00/12:43:20 to 00/12:44:15

Plot file version 120 created 17-SEP-2012 12:06:20

J0541-0541 EE008D 1.UVDATA.1

Freq = 22.2290 GHz, Bw = 8.000 MH No calibration applied and no bandpass applied

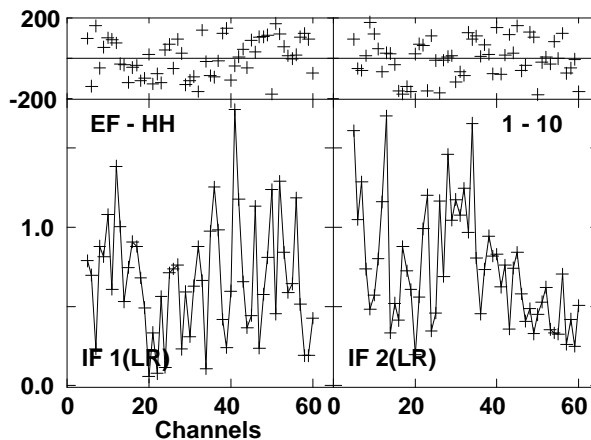
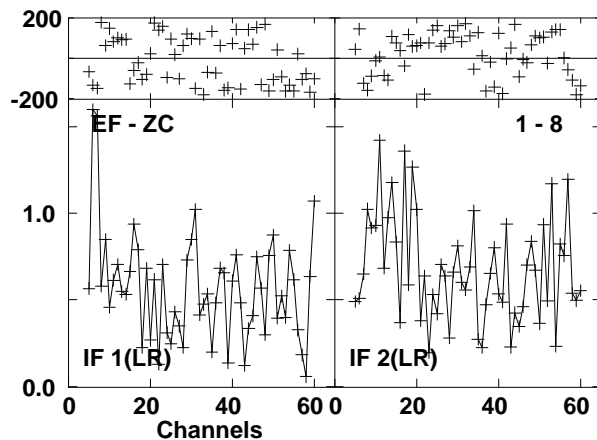
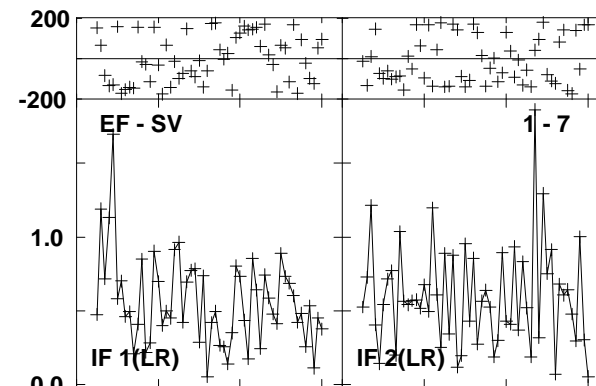
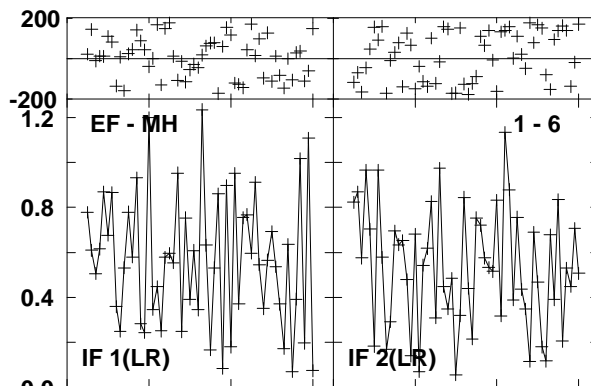
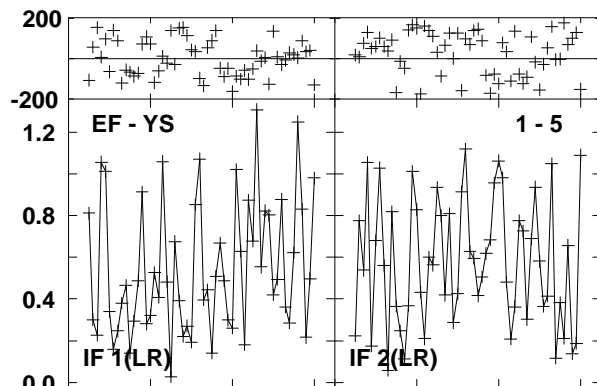
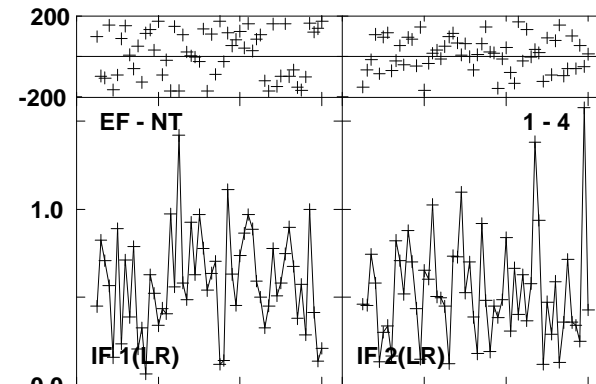
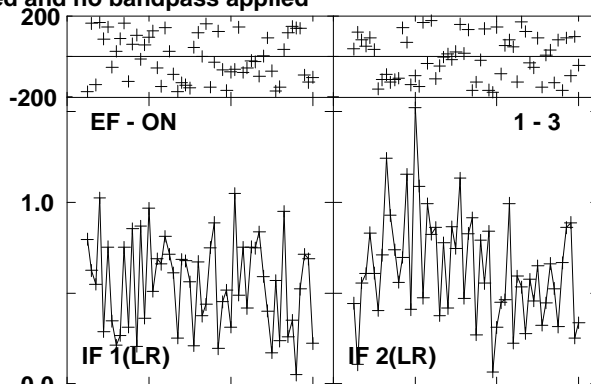
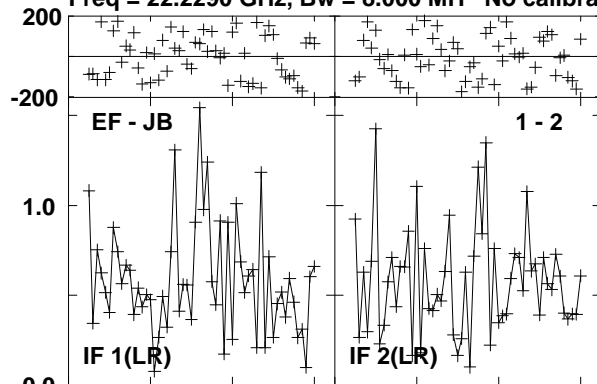

Lower frame: Milli Ampl Jy Top frame: Phas deg
Vector averaged cross-power spectrum Several baselines displayed
Timerange: 00/12:44:20 to 00/12:45:15

Plot file version 121 created 17-SEP-2012 12:06:22

J0529-0519 EE008D 1.UVDATA.1

Freq = 22.2290 GHz, Bw = 8.000 MH No calibration applied and no bandpass applied

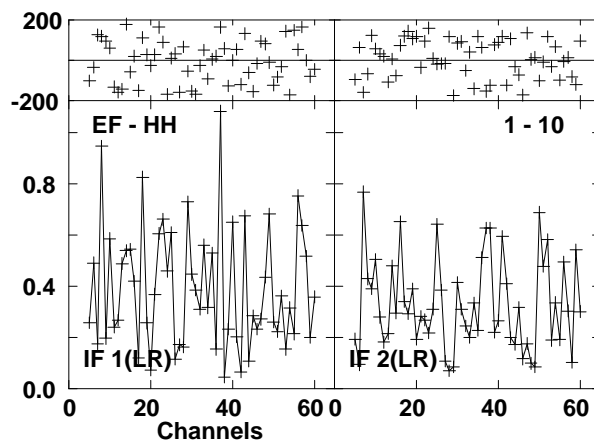
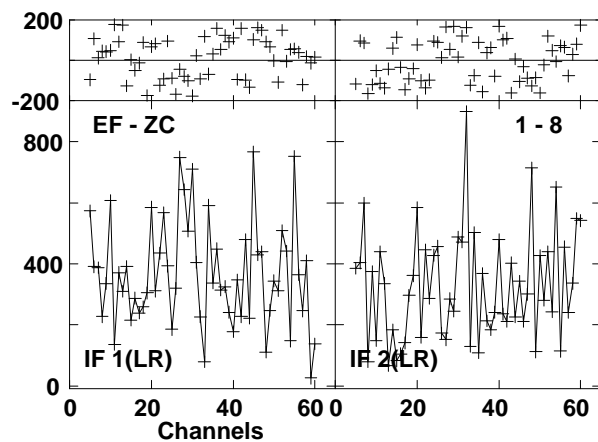
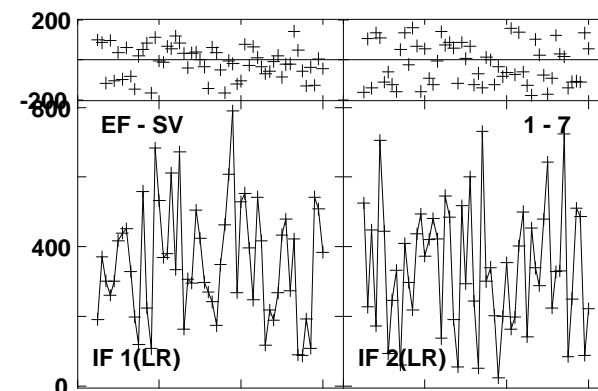
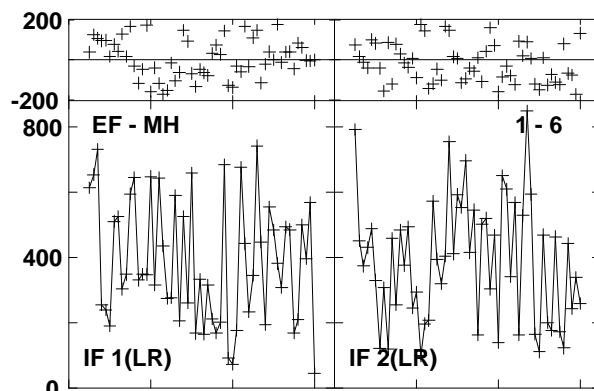
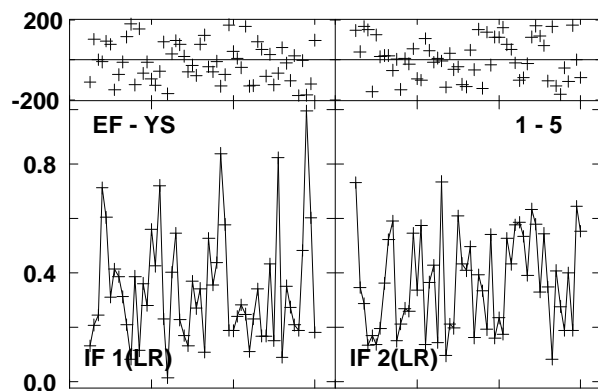
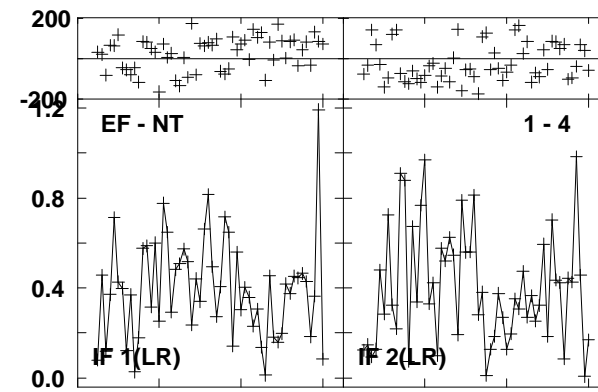
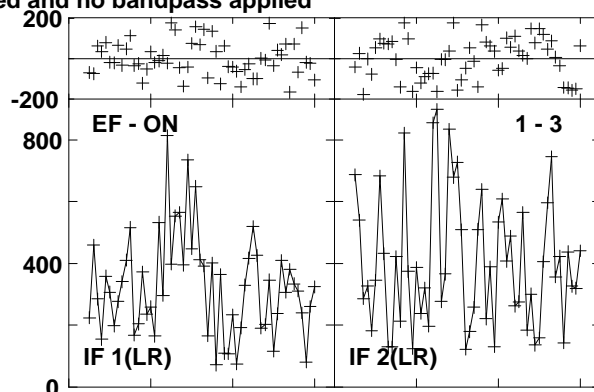
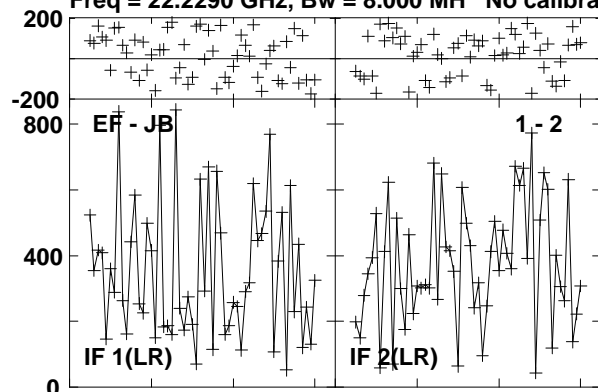

Lower frame: Micro Ampl Jy Top frame: Phas deg

Vector averaged cross-power spectrum Several baselines displayed

Timerange: 00/12:46:02 to 00/12:47:01

Plot file version 122 created 17-SEP-2012 12:06:25

ORIKL1 EE008D 1.UVDATA.1

Freq = 22.2290 GHz, Bw = 8.000 MH No calibration applied and no bandpass applied

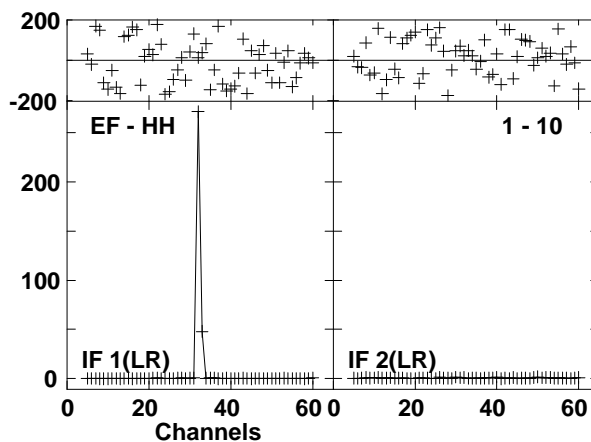
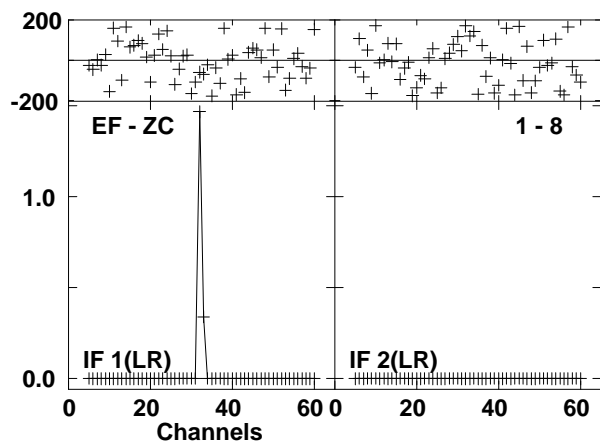
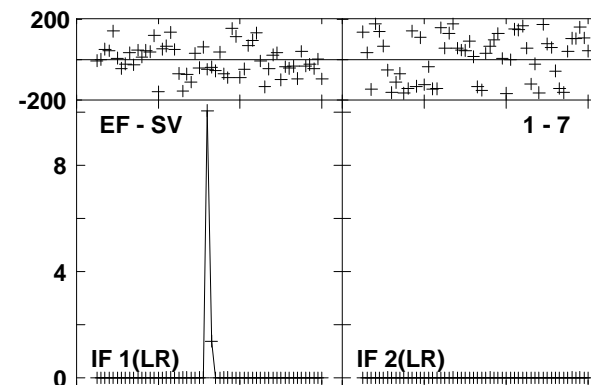
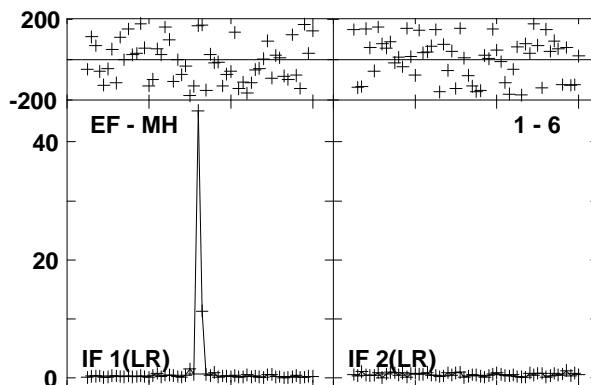
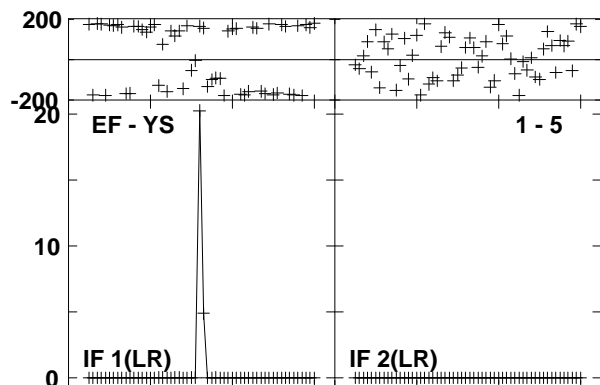
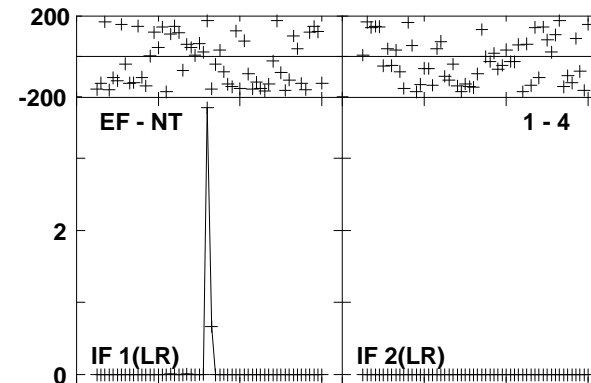
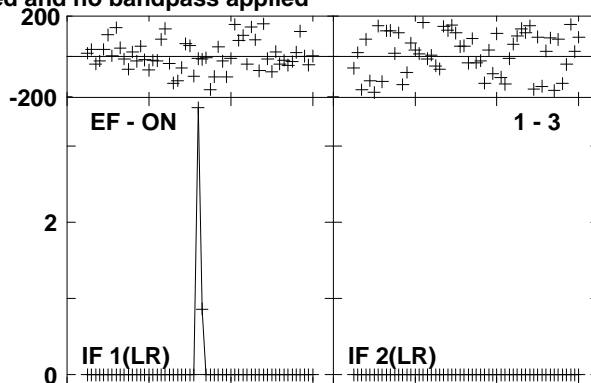
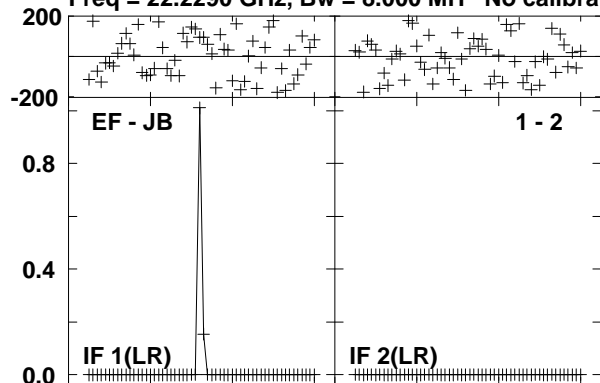

Lower frame: Ampl Jy Top frame: Phas deg

Vector averaged cross-power spectrum Several baselines displayed

Timerange: 00/12:47:06 to 00/12:48:01

Plot file version 123 created 17-SEP-2012 12:06:27

J0529-0519 EE008D 1.UVDATA.1

Freq = 22.2290 GHz, Bw = 8.000 MH No calibration applied and no bandpass applied

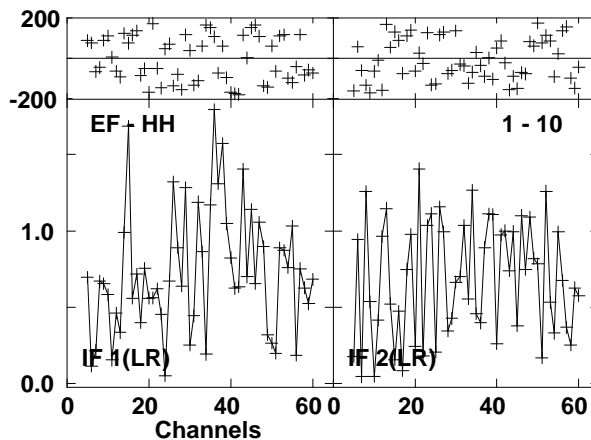
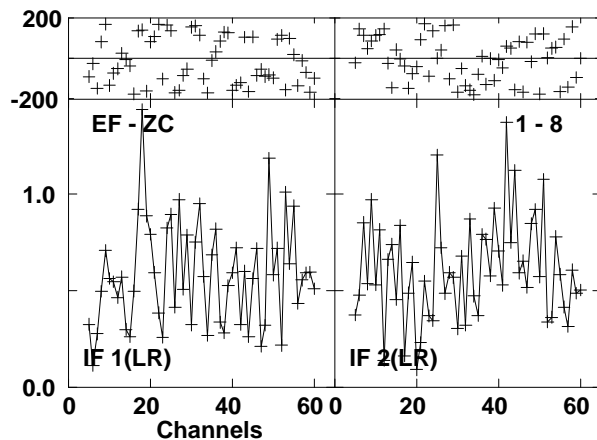
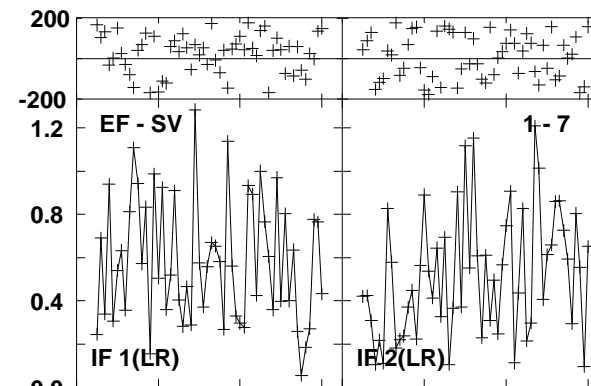
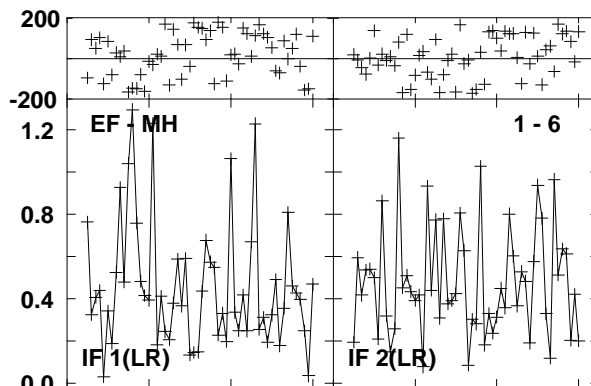
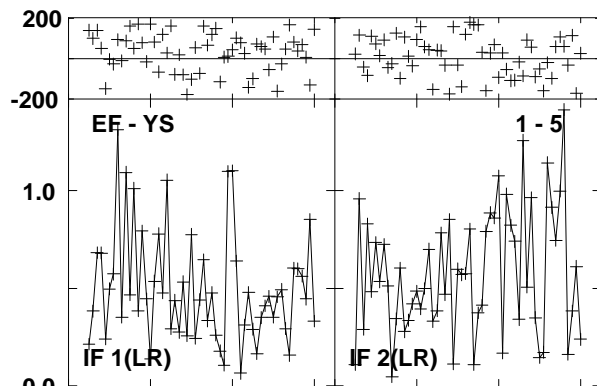
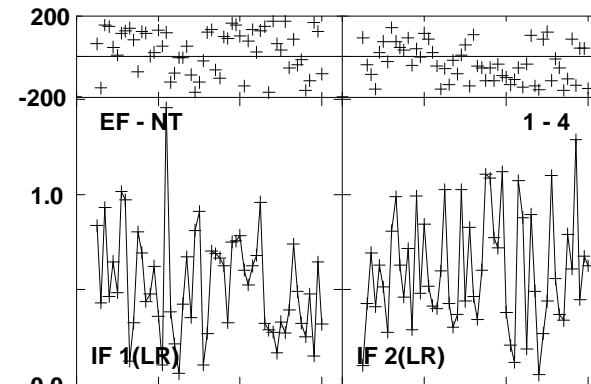
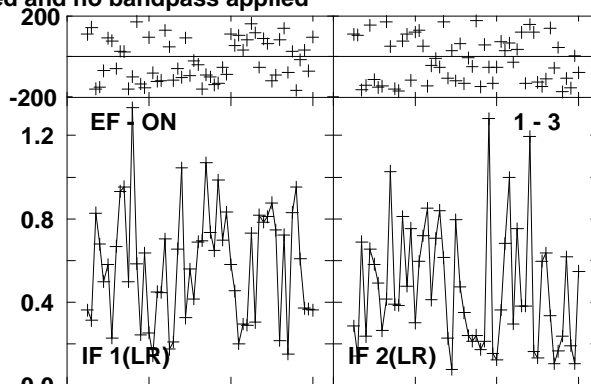
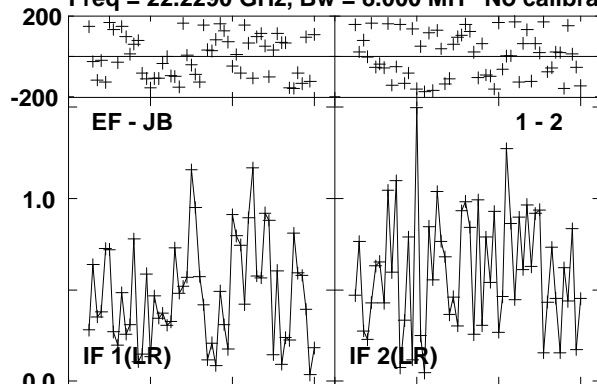

Lower frame: Milli Ampl Jy Top frame: Phas deg
Vector averaged cross-power spectrum Several baselines displayed
Timerange: 00/12:48:05 to 00/12:49:01

Plot file version 124 created 17-SEP-2012 12:06:30

ORIKL1 EE008D 1.UVDATA.1

Freq = 22.2290 GHz, Bw = 8.000 MH No calibration applied and no bandpass applied

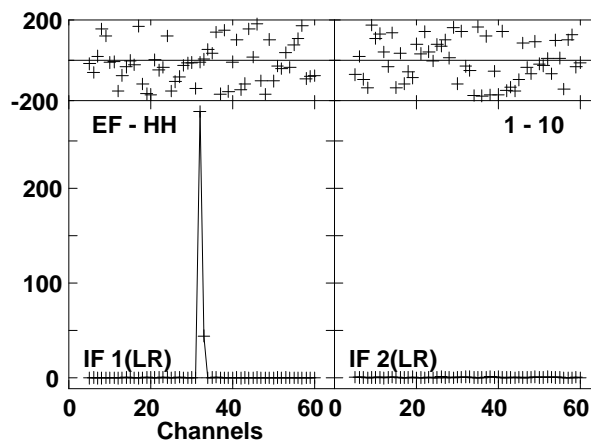
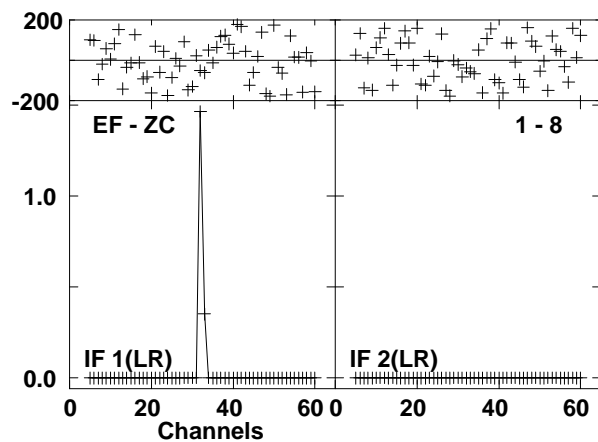
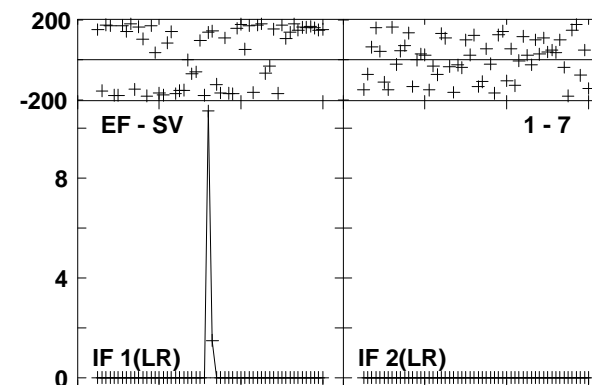
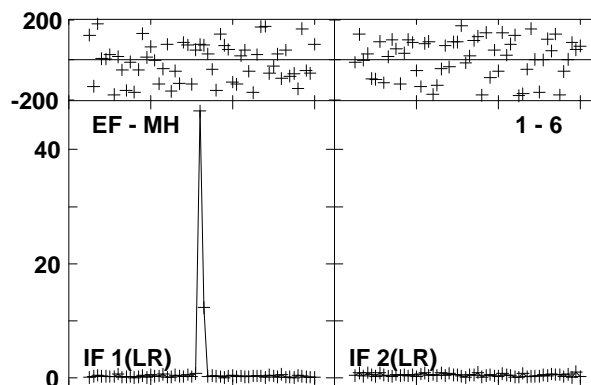
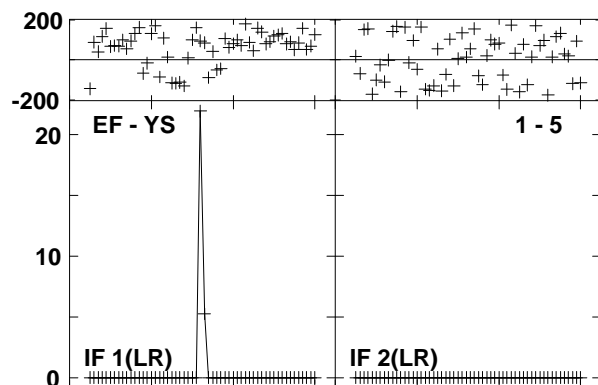
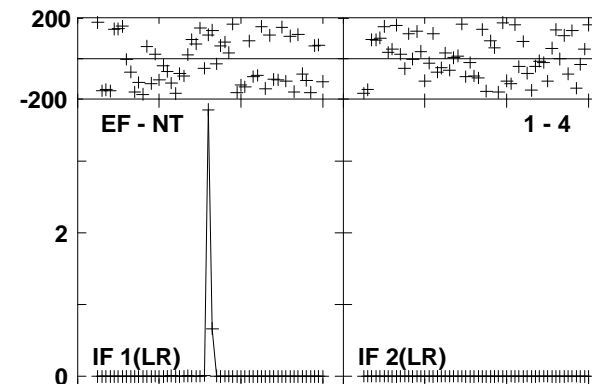
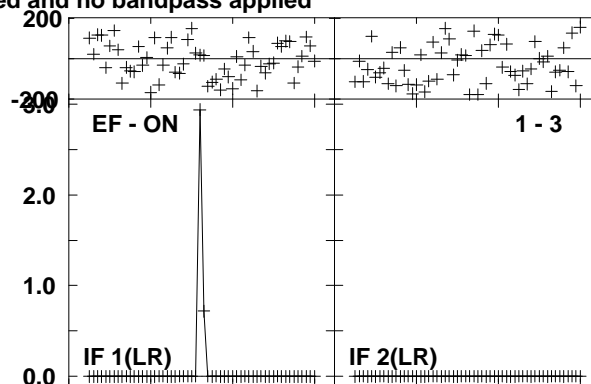
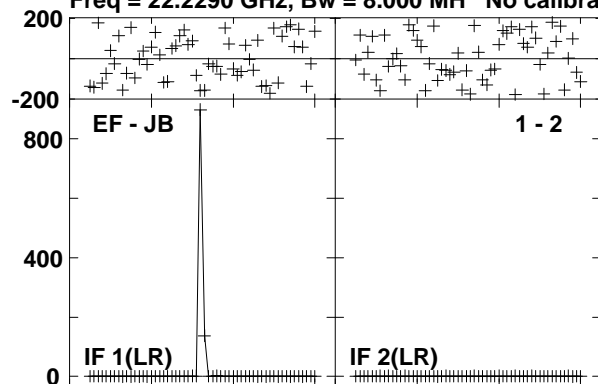

Lower frame: Milli Ampl Jy Top frame: Phas deg

Vector averaged cross-power spectrum Several baselines displayed

Timerange: 00/12:49:06 to 00/12:50:01

Plot file version 125 created 17-SEP-2012 12:06:32

J0529-0519 EE008D 1.UVDATA.1

Freq = 22.2290 GHz, Bw = 8.000 MH No calibration applied and no bandpass applied

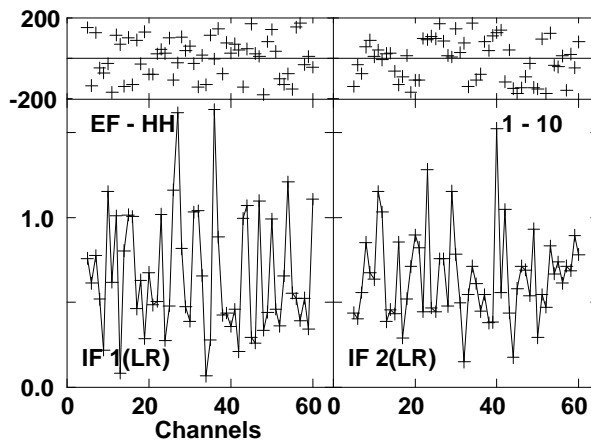
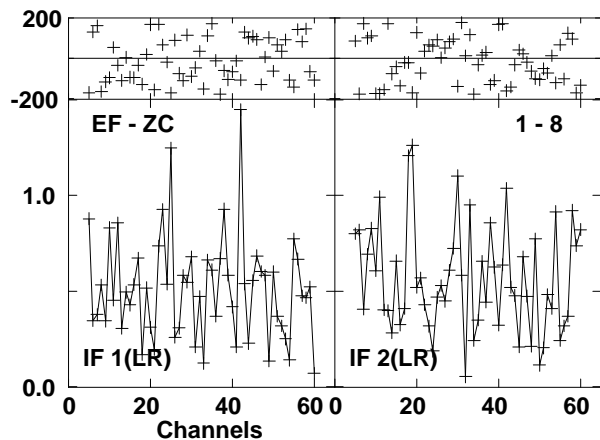
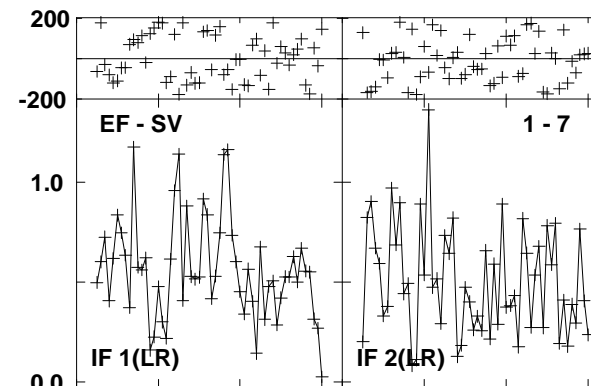
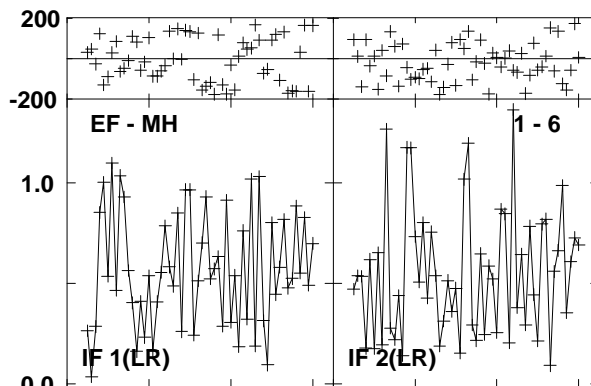
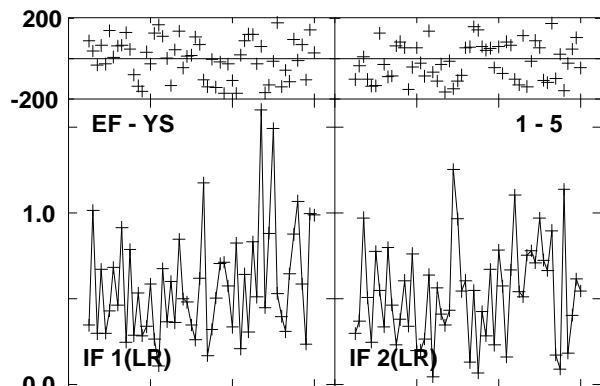
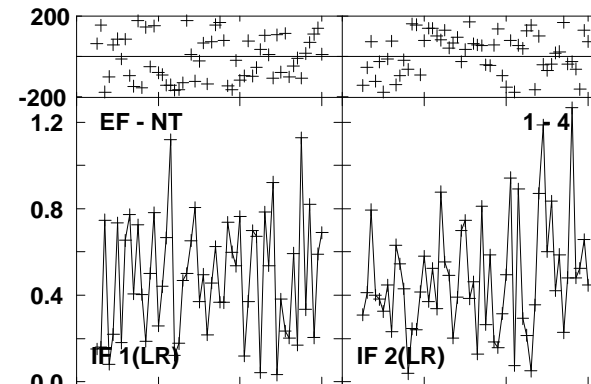
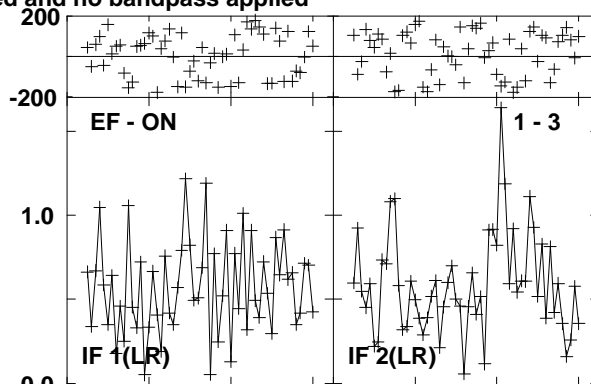
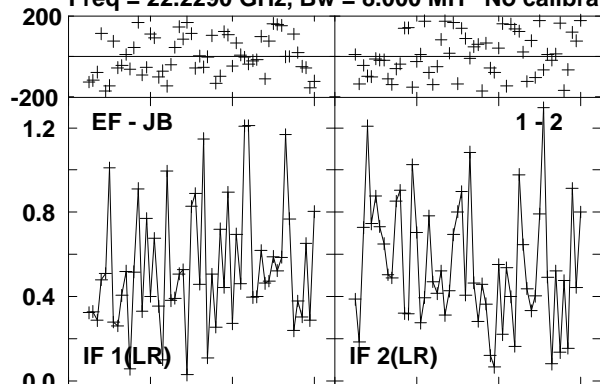

Lower frame: Milli Ampl Jy Top frame: Phas deg
Vector averaged cross-power spectrum Several baselines displayed
Timerange: 00/12:50:06 to 00/12:51:01

Plot file version 126 created 17-SEP-2012 12:06:34

J0541-0541 EE008D 1.UVDATA.1

Freq = 22.2290 GHz, Bw = 8.000 MH No calibration applied and no bandpass applied

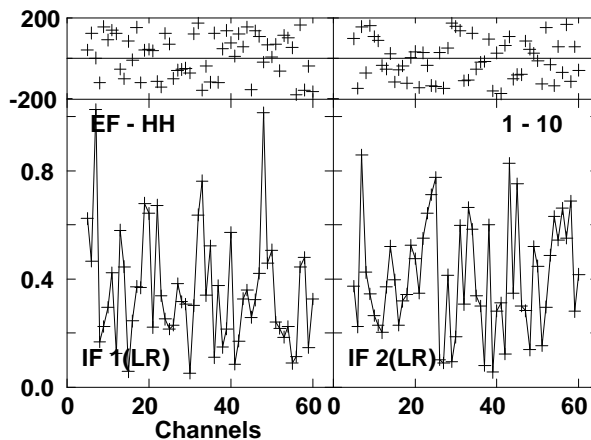
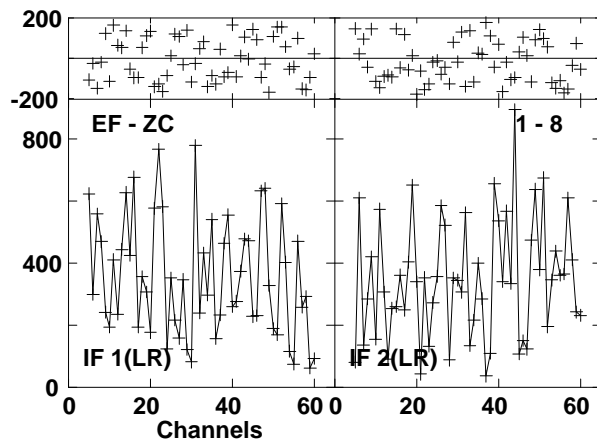
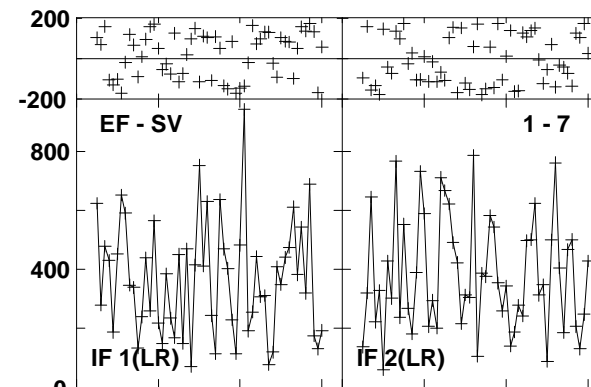
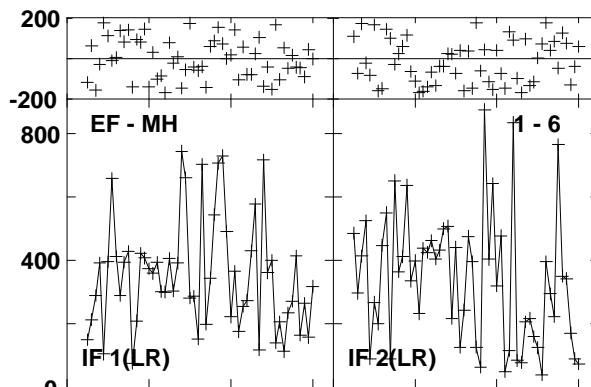
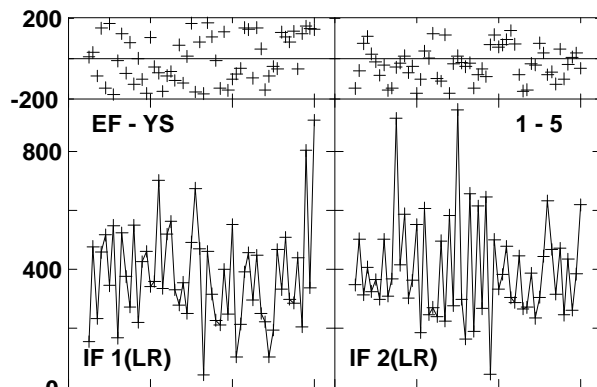
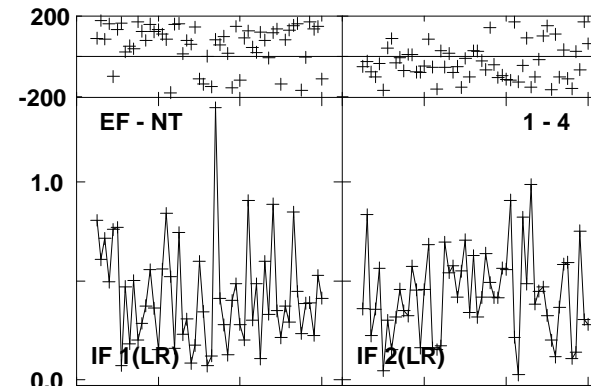
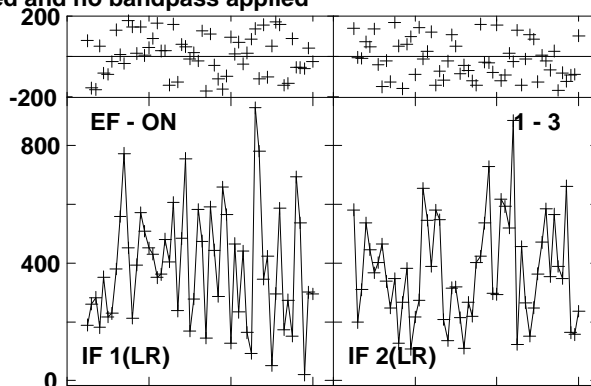
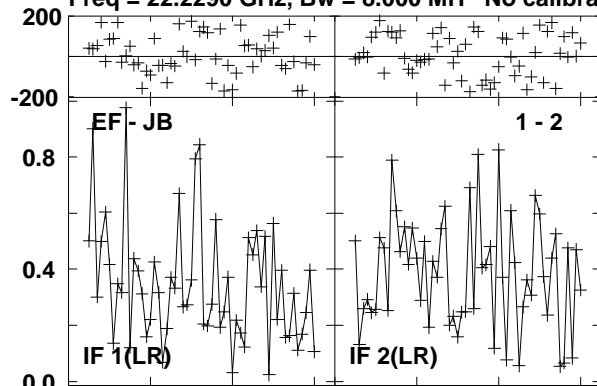

Lower frame: Milli Ampl Jy Top frame: Phas deg
Vector averaged cross-power spectrum Several baselines displayed
Timerange: 00/12:51:47 to 00/12:52:46

Plot file version 127 created 17-SEP-2012 12:06:37

ORIKL1 EE008D 1.UVDATA.1

Freq = 22.2290 GHz, Bw = 8.000 MH No calibration applied and no bandpass applied

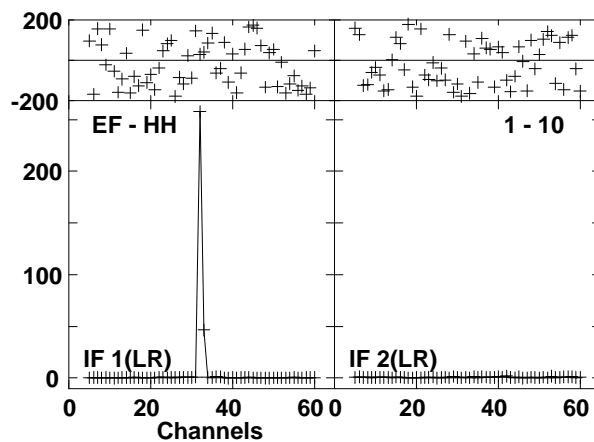
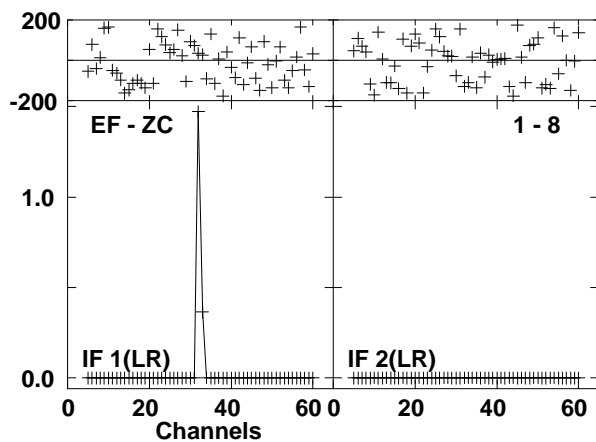
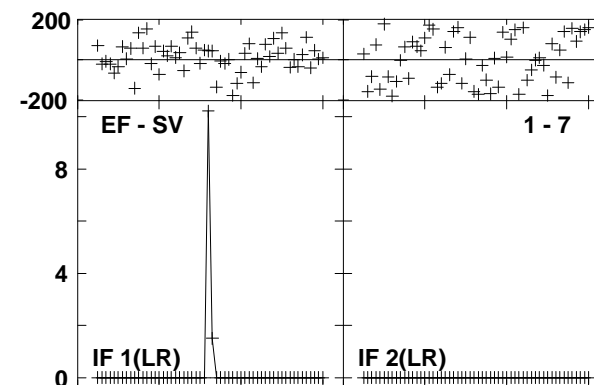
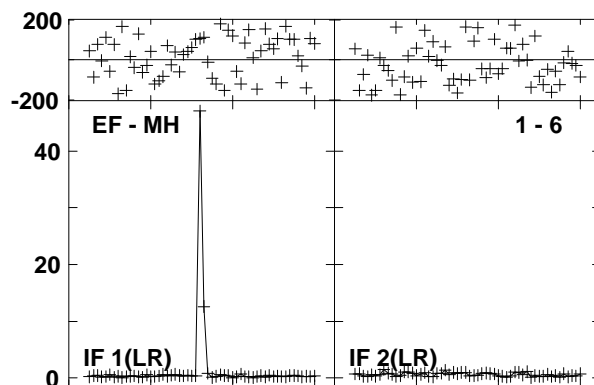
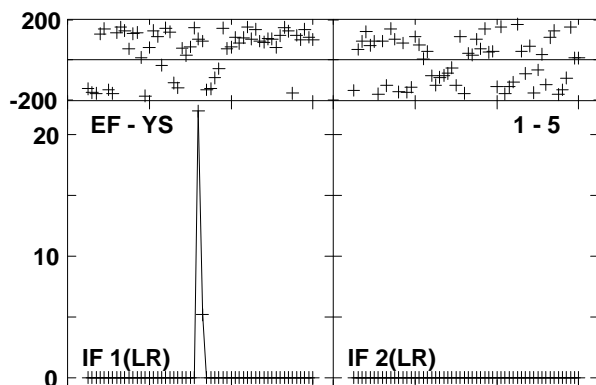
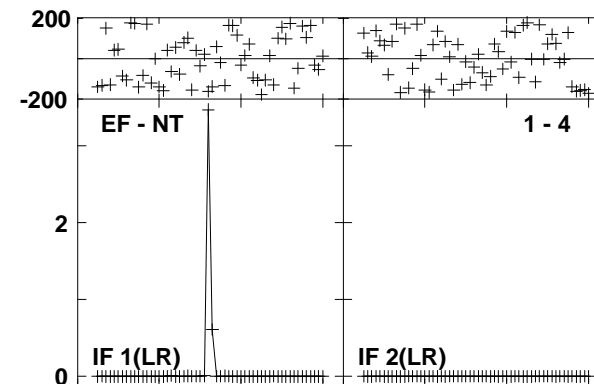
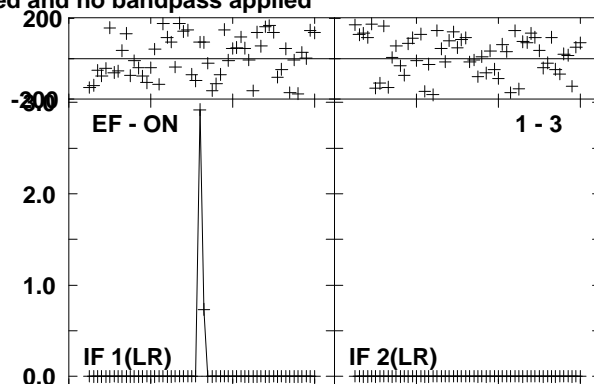
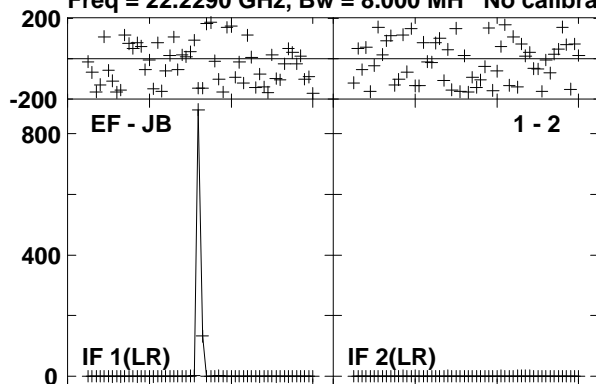

Lower frame: Milli Ampl Jy Top frame: Phas deg

Vector averaged cross-power spectrum Several baselines displayed

Timerange: 00/12:52:50 to 00/12:53:46

Plot file version 128 created 17-SEP-2012 12:06:39

J0541-0541 EE008D 1.UVDATA.1

Freq = 22.2290 GHz, Bw = 8.000 MH No calibration applied and no bandpass applied

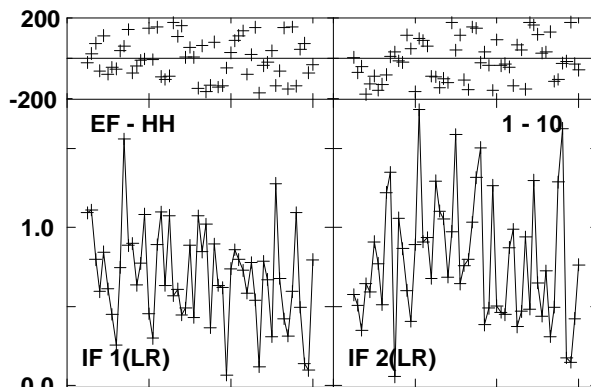
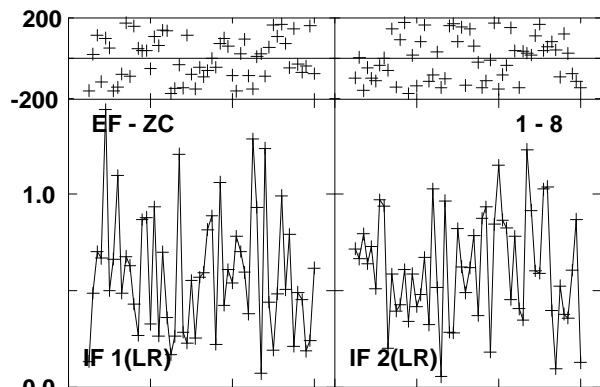
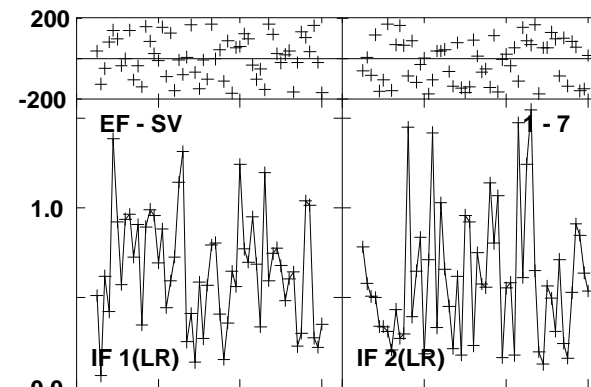
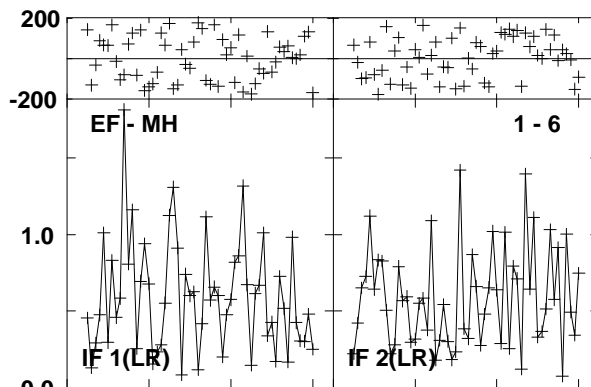
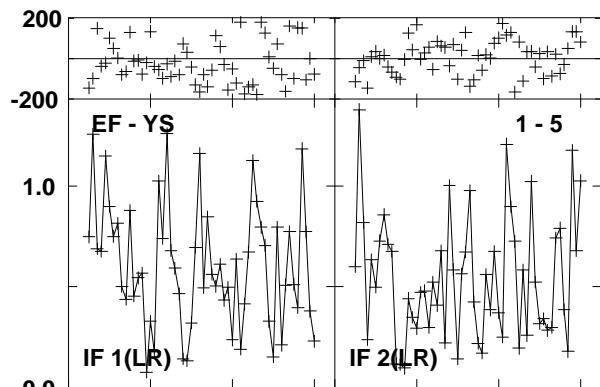
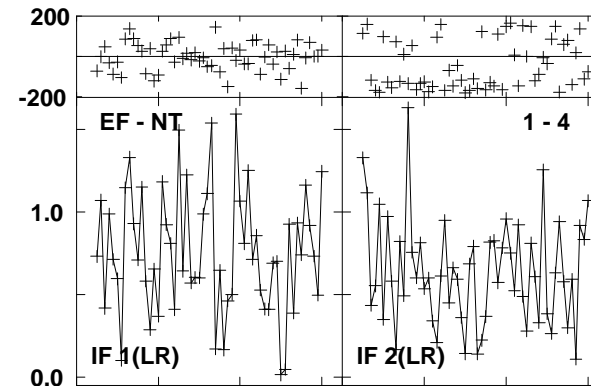
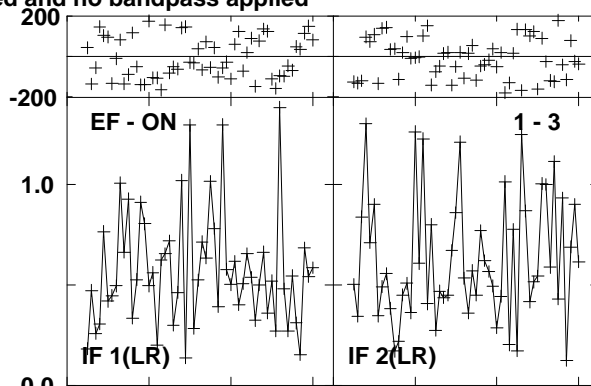
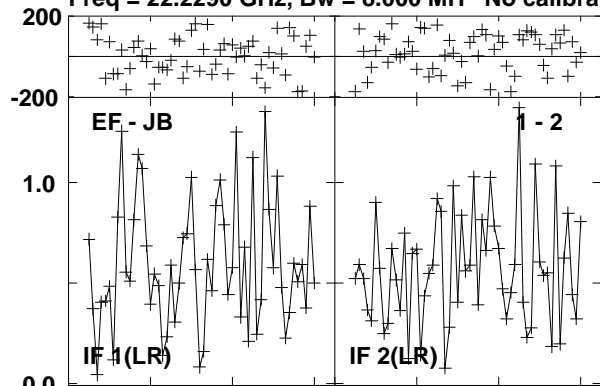

Lower frame: Milli Ampl Jy Top frame: Phas deg
Vector averaged cross-power spectrum Several baselines displayed
Timerange: 00/12:53:51 to 00/12:54:46

Plot file version 129 created 17-SEP-2012 12:06:41

ORIKL1 EE008D 1.UVDATA.1

Freq = 22.2290 GHz, Bw = 8.000 MH No calibration applied and no bandpass applied

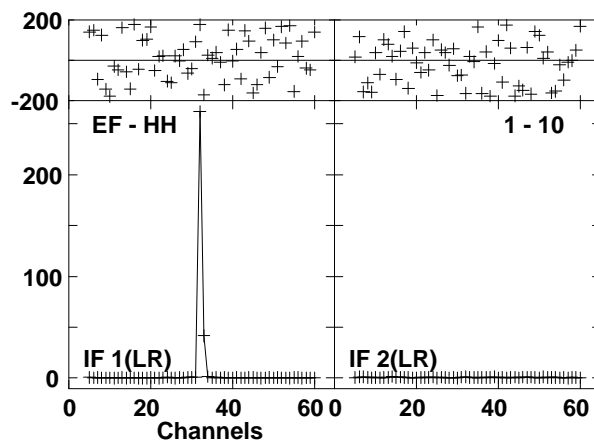
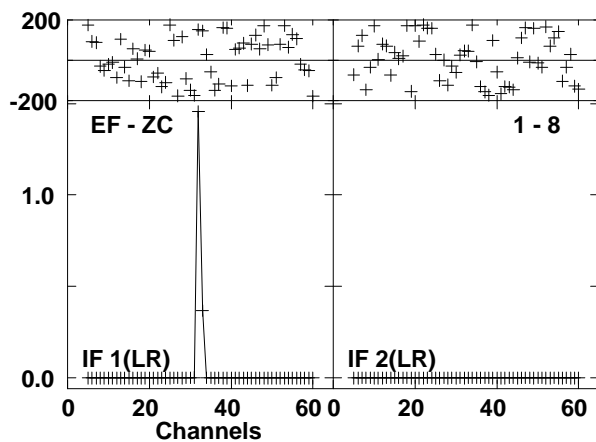
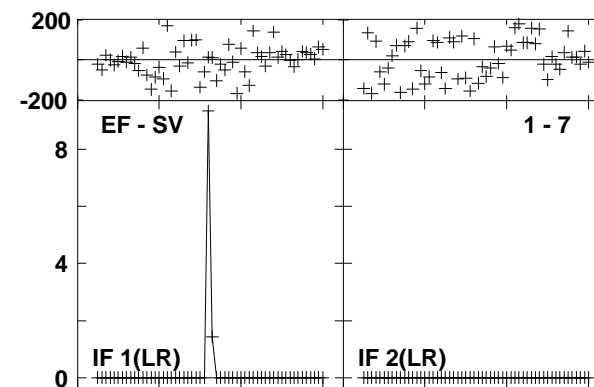
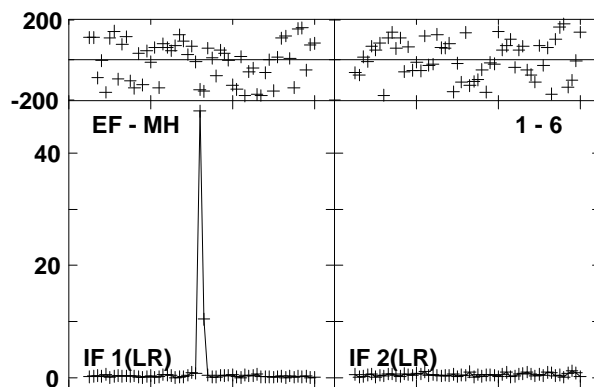
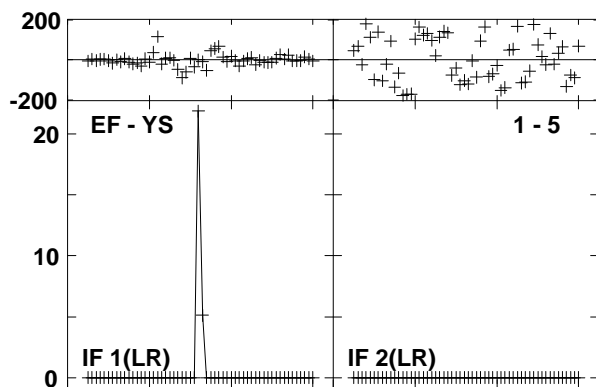
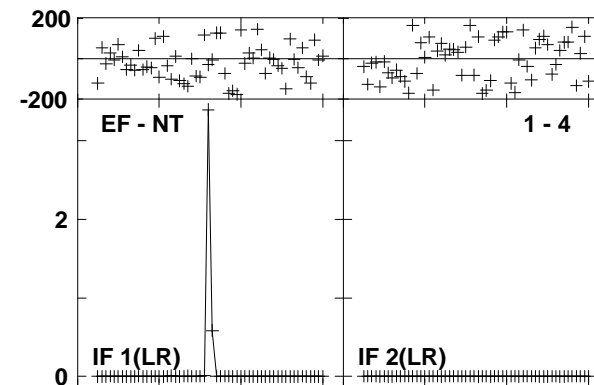
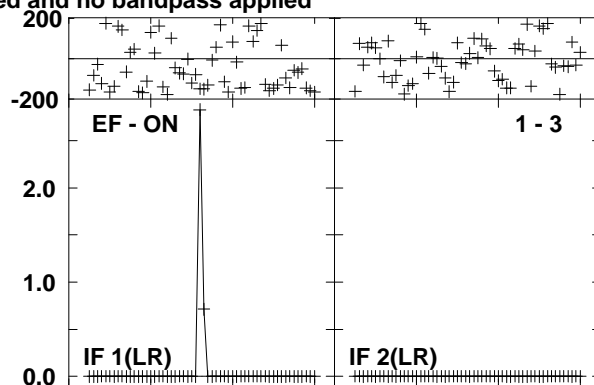
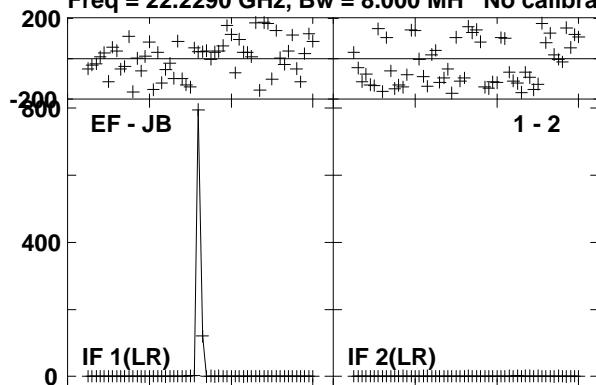

Lower frame: Milli Ampl Jy Top frame: Phas deg

Vector averaged cross-power spectrum Several baselines displayed

Timerange: 00/12:54:53 to 00/12:55:46

Plot file version 130 created 17-SEP-2012 12:06:43

J0541-0541 EE008D 1.UVDATA.1

Freq = 22.2290 GHz, Bw = 8.000 MH No calibration applied and no bandpass applied

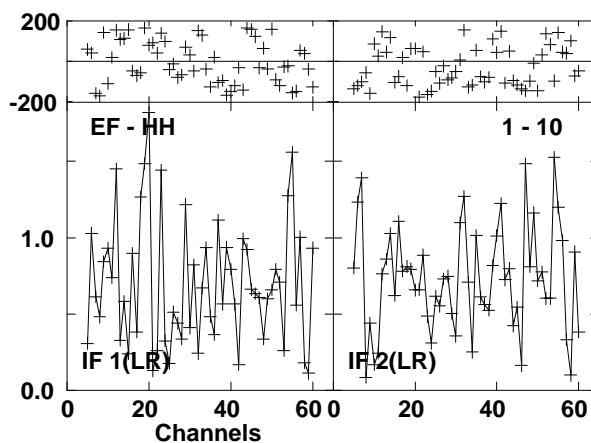
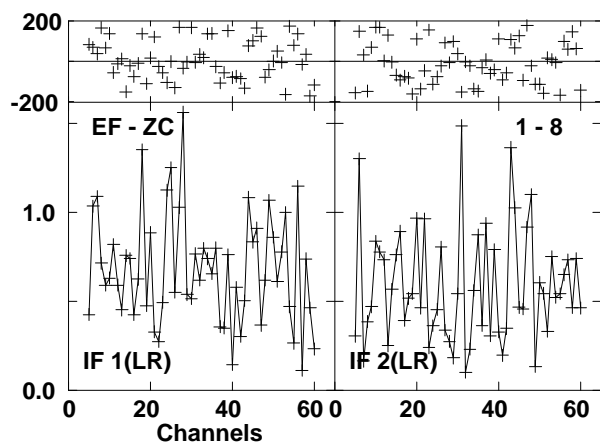
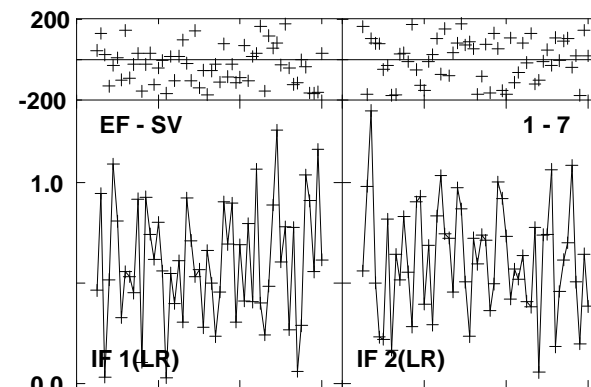
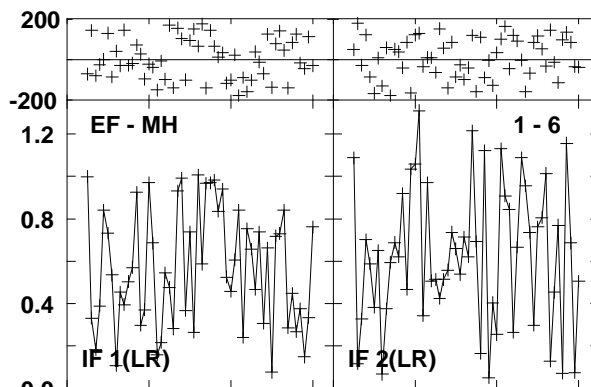
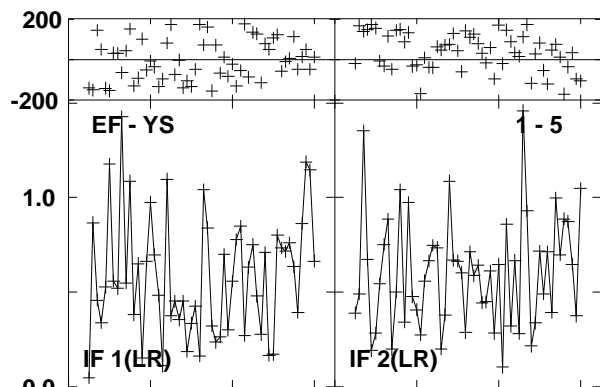
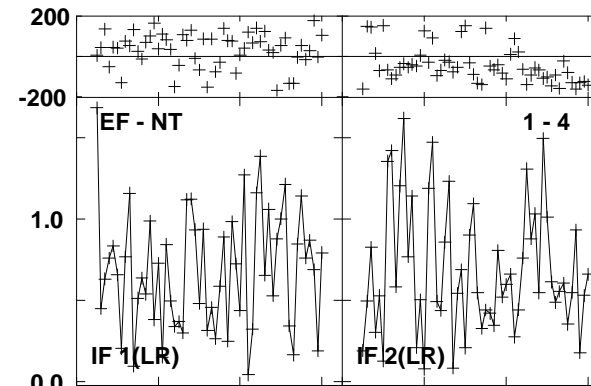
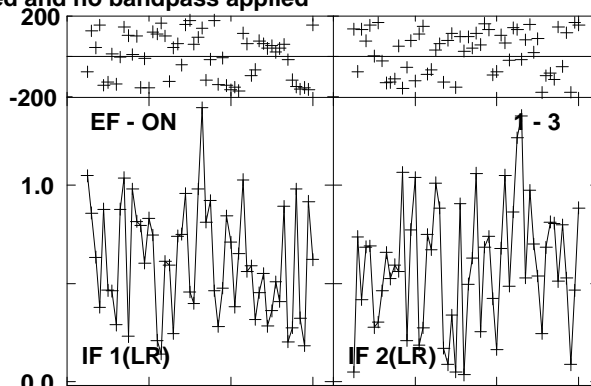
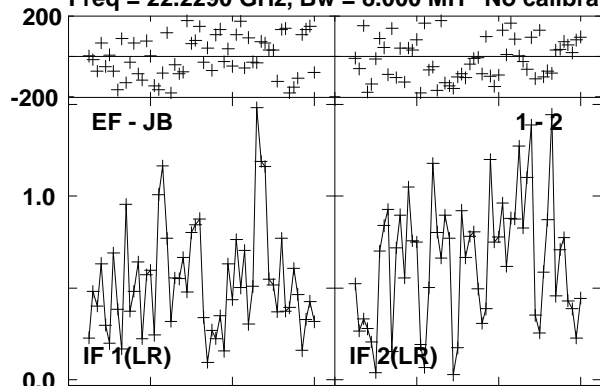

Lower frame: Milli Ampl Jy Top frame: Phas deg
Vector averaged cross-power spectrum Several baselines displayed
Timerange: 00/12:55:51 to 00/12:56:46

Plot file version 131 created 17-SEP-2012 12:06:45
J0529-0519 EE008D 1.UVDATA.1

Freq = 22.2290 GHz, Bw = 8.000 MH No calibration applied and no bandpass applied

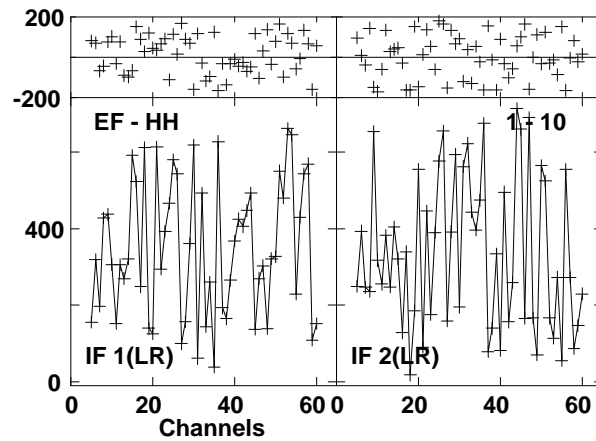
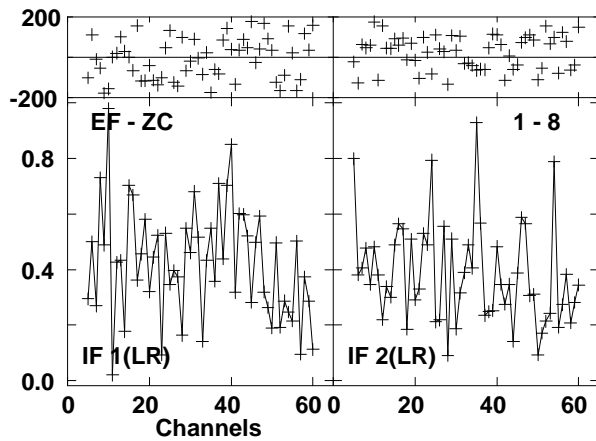
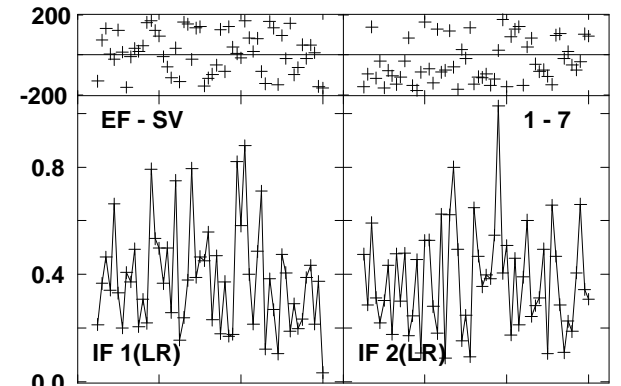
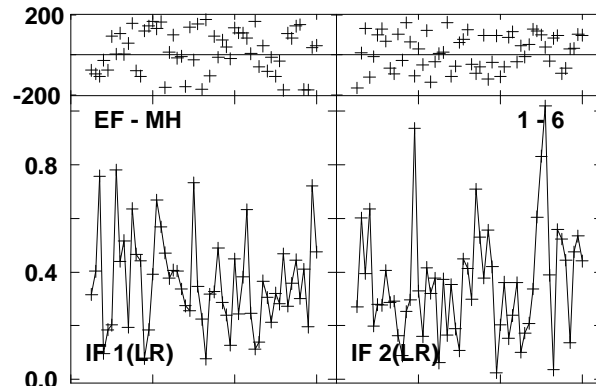
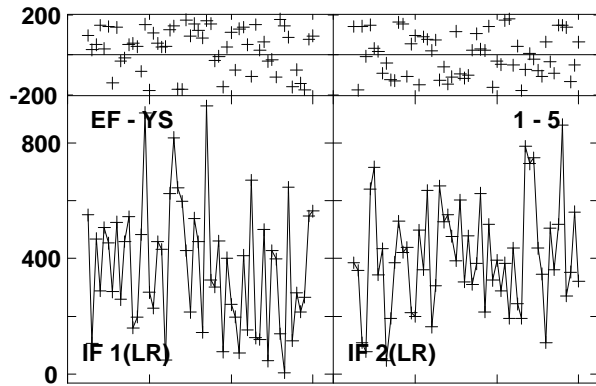
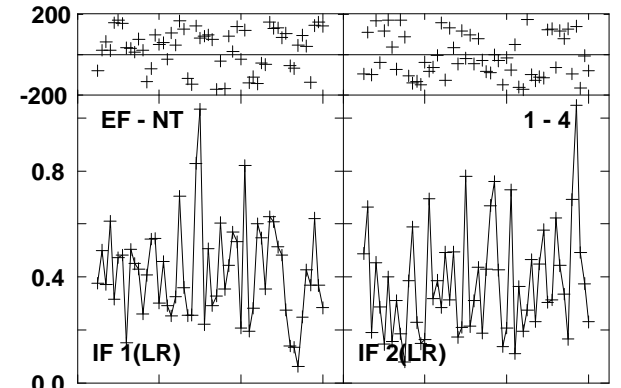
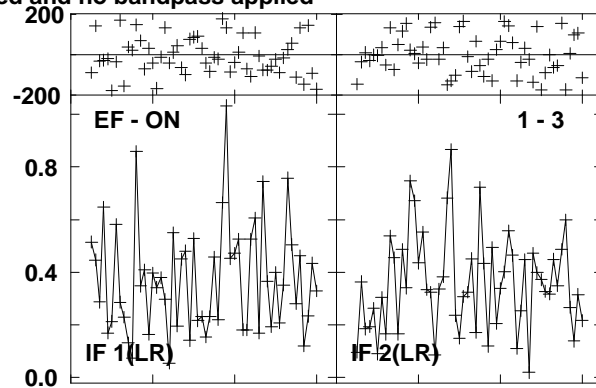
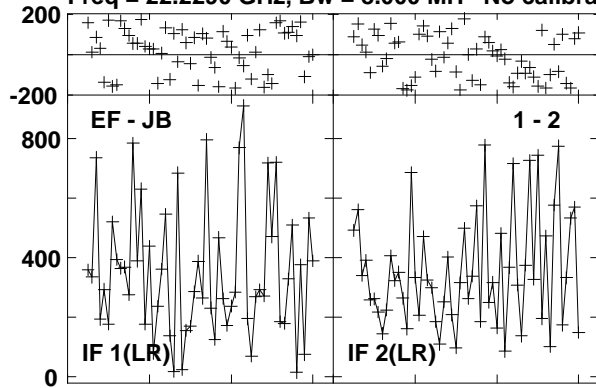

Lower frame: Micro Ampl Jy Top frame: Phas deg
Vector averaged cross-power spectrum Several baselines displayed
Timerange: 00:12:57:33 to 00:12:58:32

Plot file version 132 created 17-SEP-2012 12:06:48

ORIKL1 EE008D 1.UVDATA.1

Freq = 22.2290 GHz, Bw = 8.000 MH No calibration applied and no bandpass applied

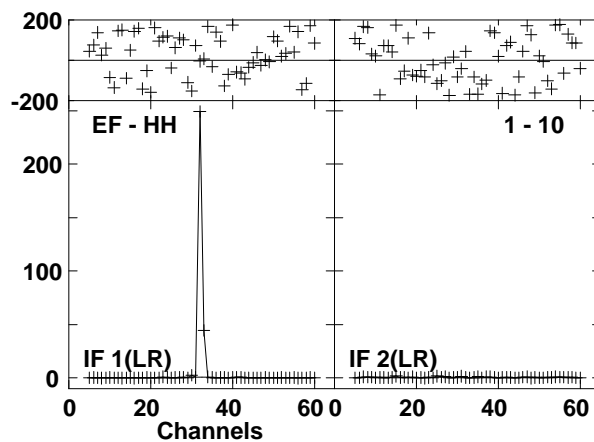
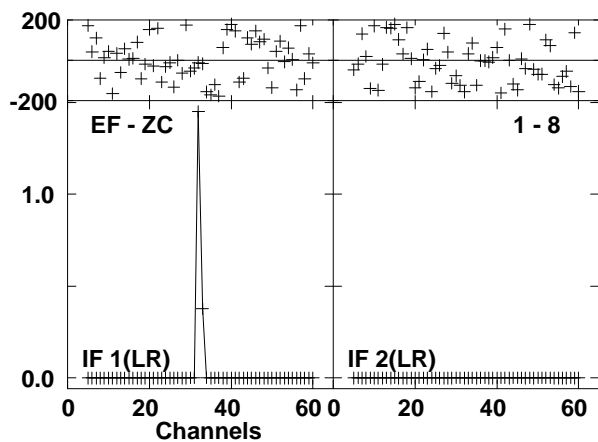
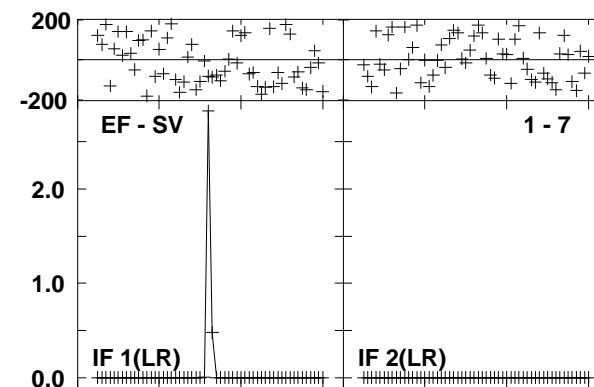
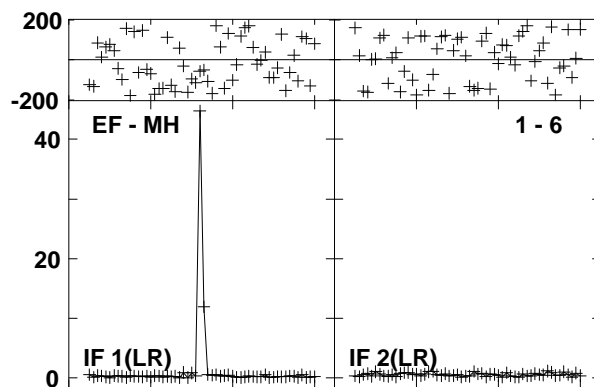
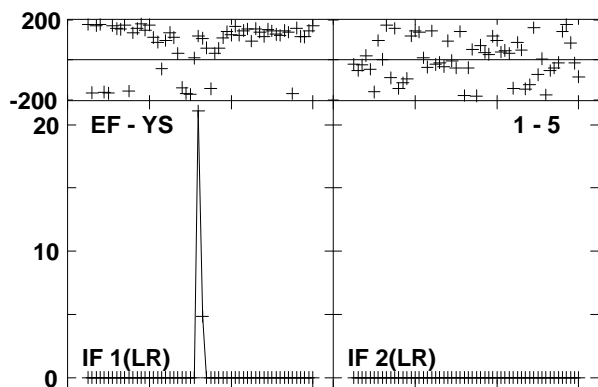
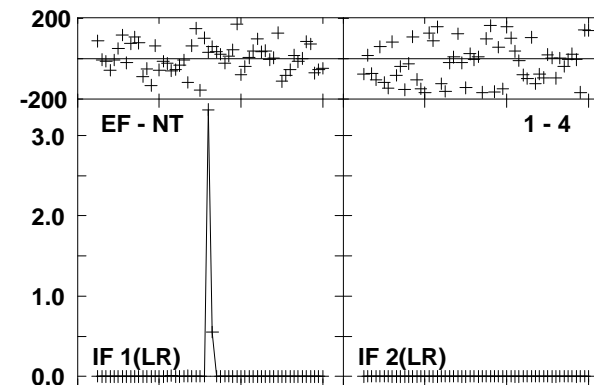
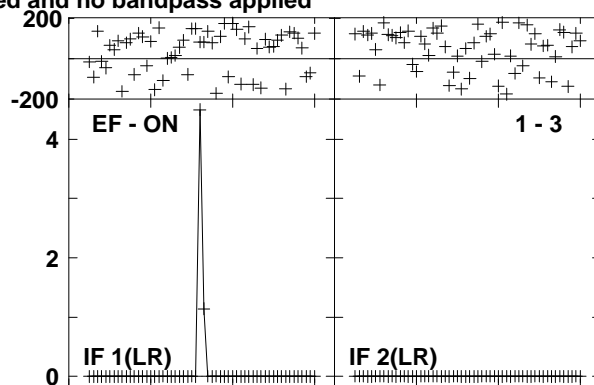
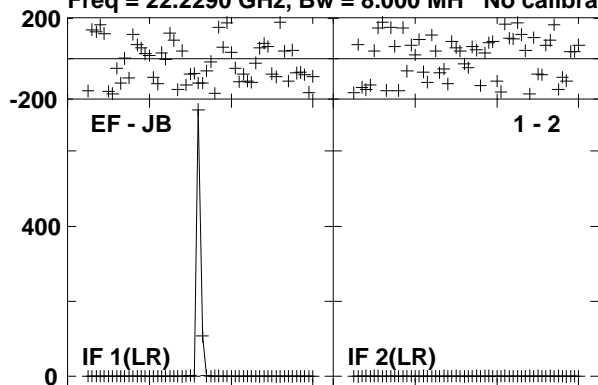

Lower frame: Milli Ampl Jy Top frame: Phas deg

Vector averaged cross-power spectrum Several baselines displayed

Timerange: 00/12:58:35 to 00/12:59:32

Plot file version 133 created 17-SEP-2012 12:06:50

J0529-0519 EE008D 1.UVDATA.1

Freq = 22.2290 GHz, Bw = 8.000 MH No calibration applied and no bandpass applied

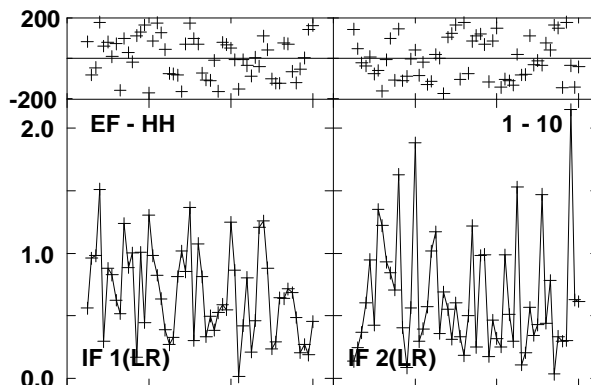
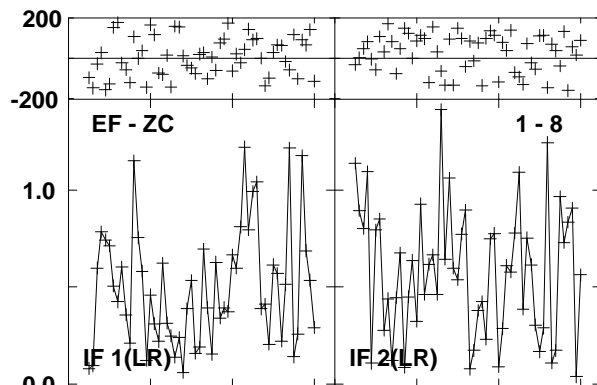
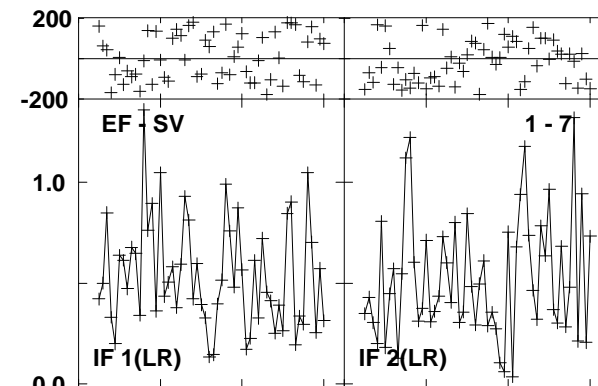
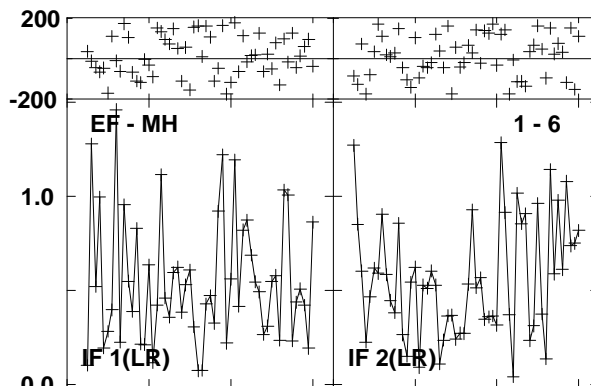
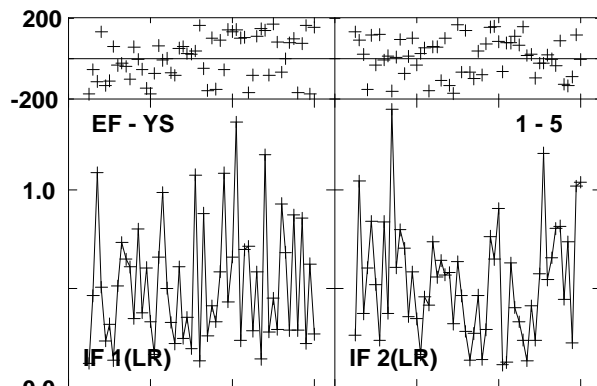
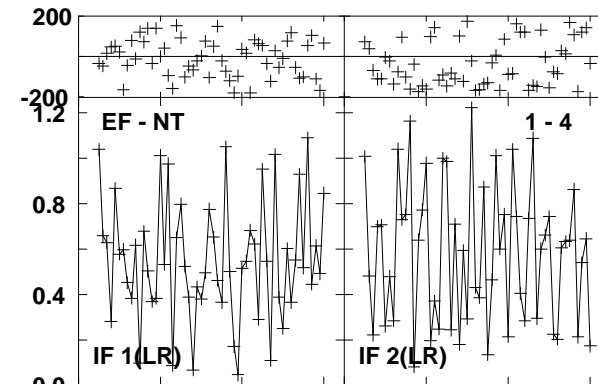
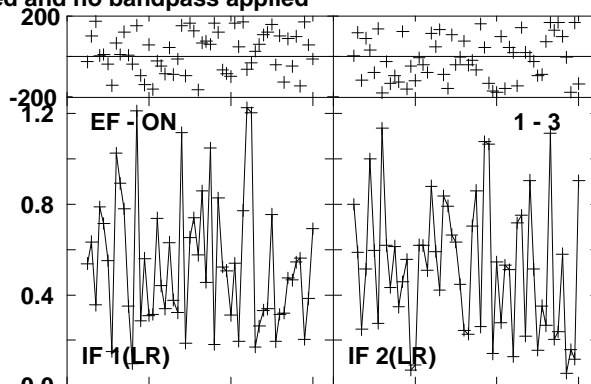
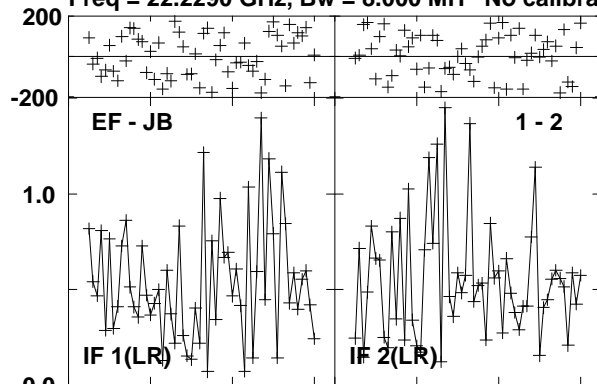

Lower frame: Milli Ampl Jy Top frame: Phas deg
Vector averaged cross-power spectrum Several baselines displayed
Timerange: 00/12:59:36 to 00/13:00:32

Plot file version 134 created 17-SEP-2012 12:06:52

ORIKL1 EE008D 1.UVDATA.1

Freq = 22.2290 GHz, Bw = 8.000 MH No calibration applied and no bandpass applied

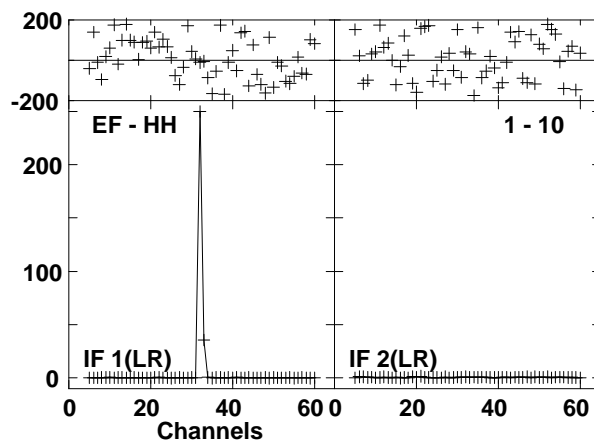
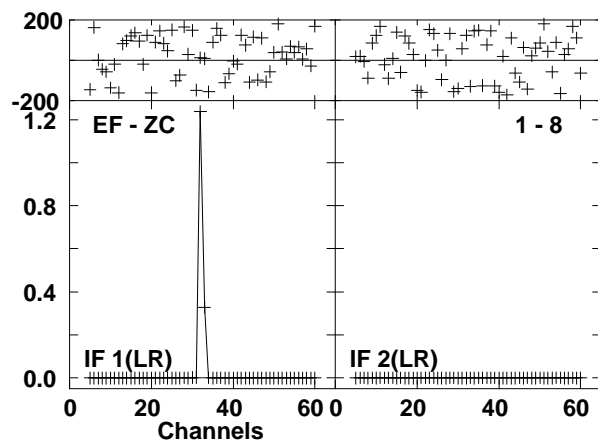
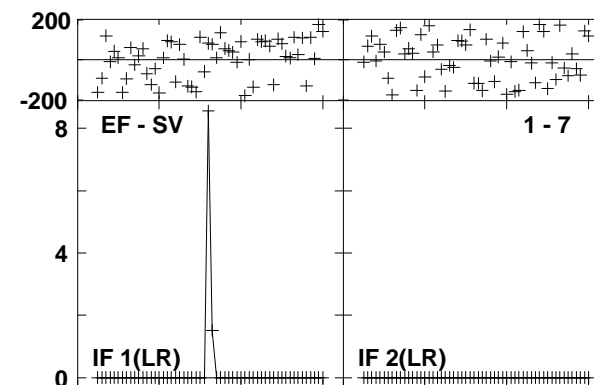
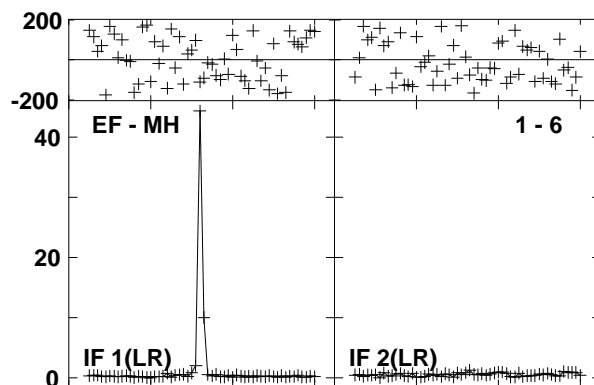
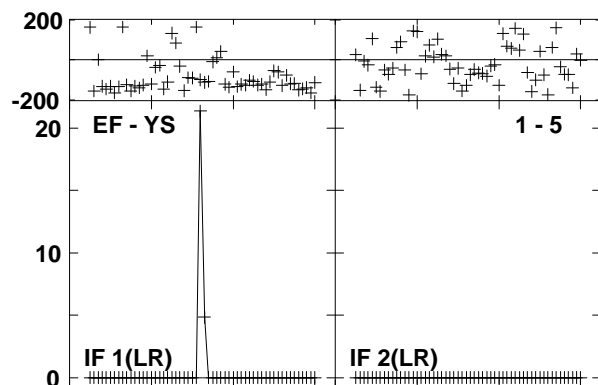
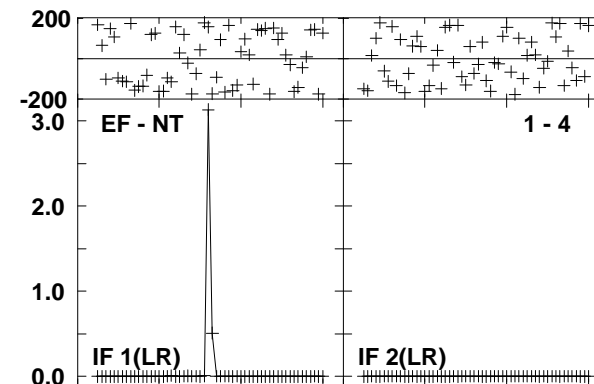
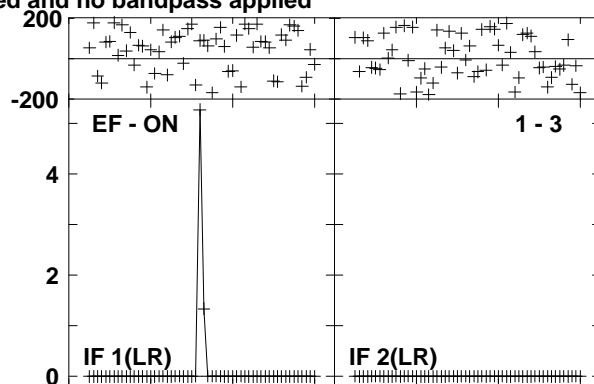
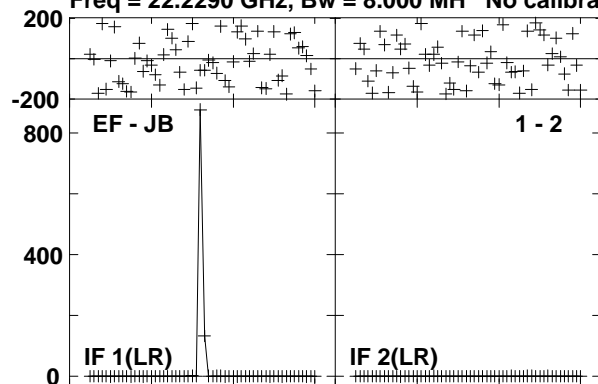

Lower frame: Milli Ampl Jy Top frame: Phas deg

Vector averaged cross-power spectrum Several baselines displayed

Timerange: 00/13:00:36 to 00/13:01:32

Plot file version 135 created 17-SEP-2012 12:06:54

J0529-0519 EE008D 1.UVDATA.1

Freq = 22.2290 GHz, Bw = 8.000 MH No calibration applied and no bandpass applied

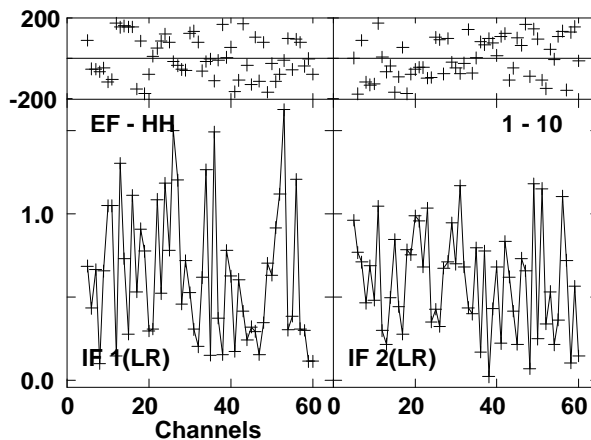
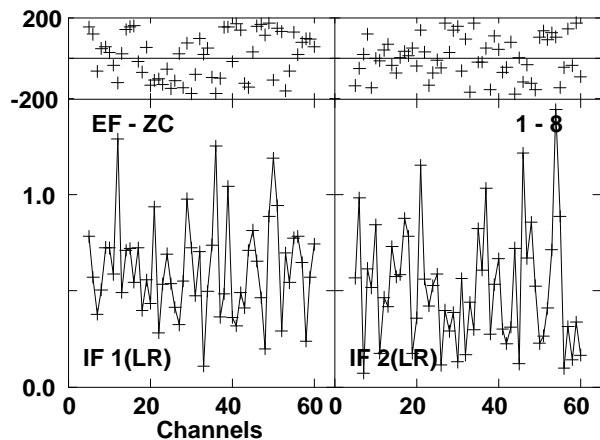
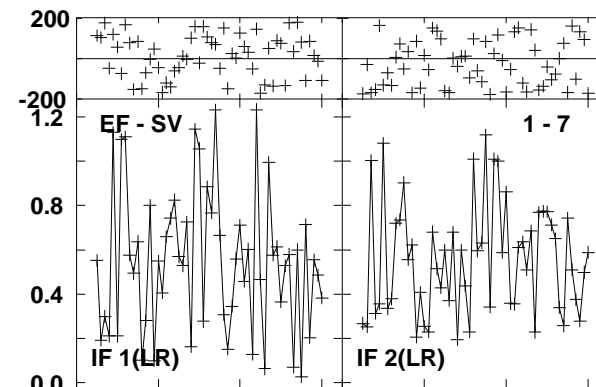
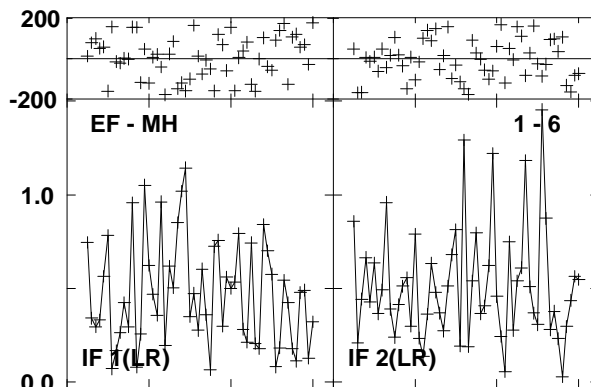
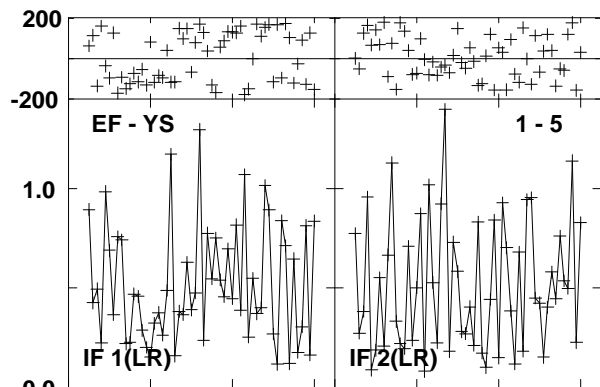
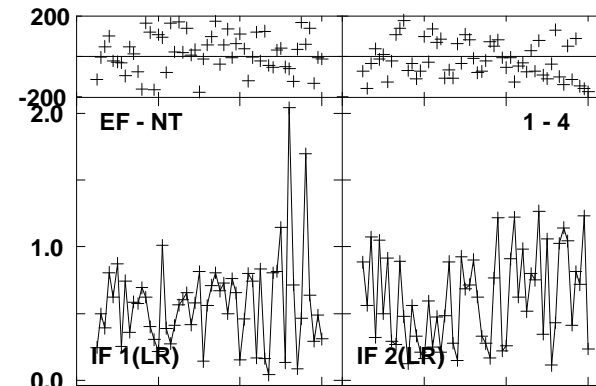
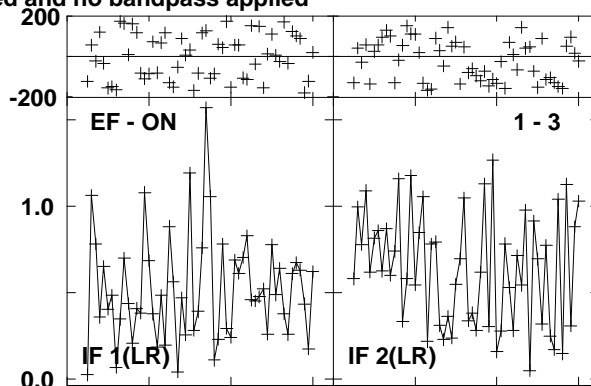
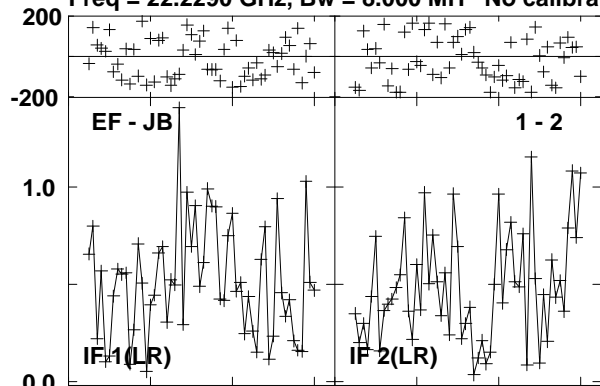

Lower frame: Milli Ampl Jy Top frame: Phas deg
Vector averaged cross-power spectrum Several baselines displayed
Timerange: 00/13:01:36 to 00/13:02:32

Plot file version 136 created 17-SEP-2012 12:06:56

J0541-0541 EE008D 1.UVDATA.1

Freq = 22.2290 GHz, Bw = 8.000 MH No calibration applied and no bandpass applied

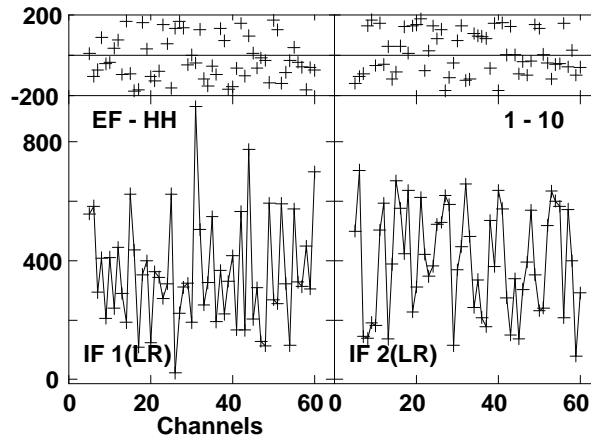
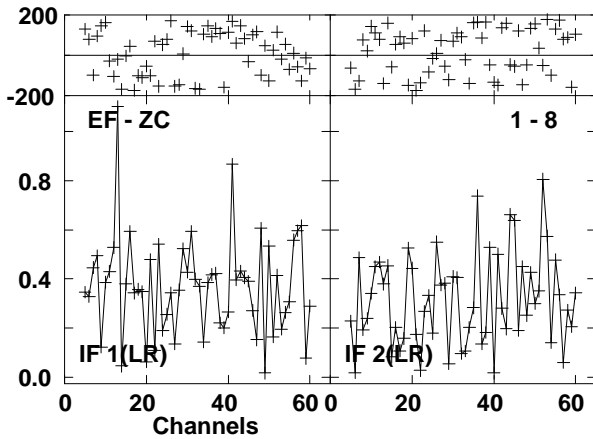
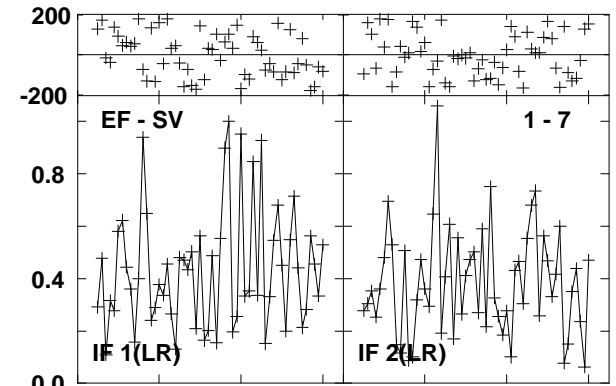
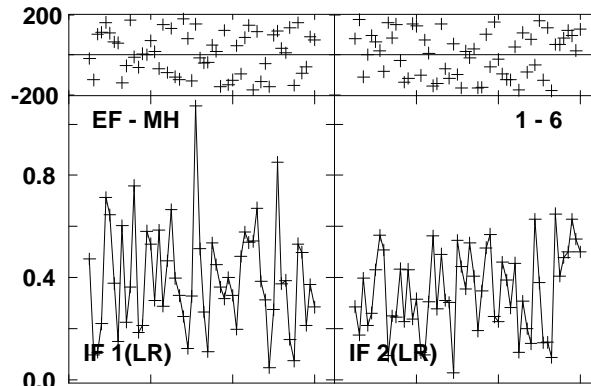
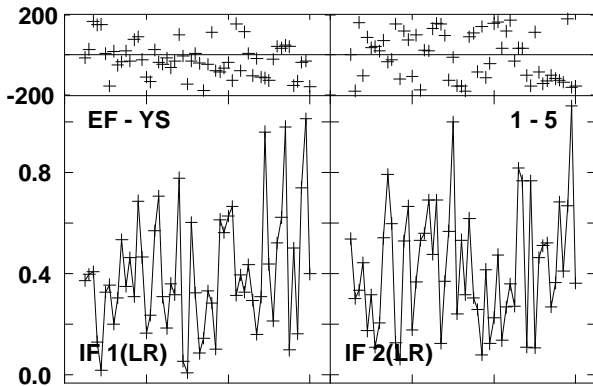
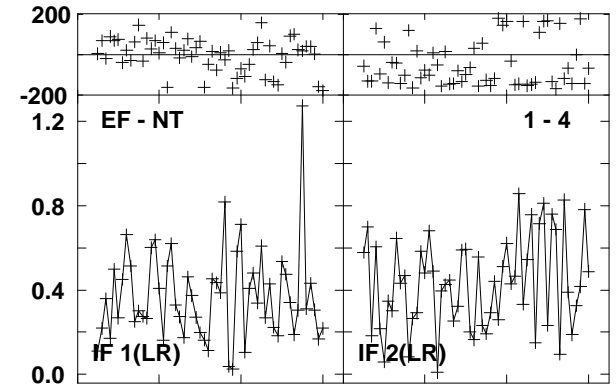
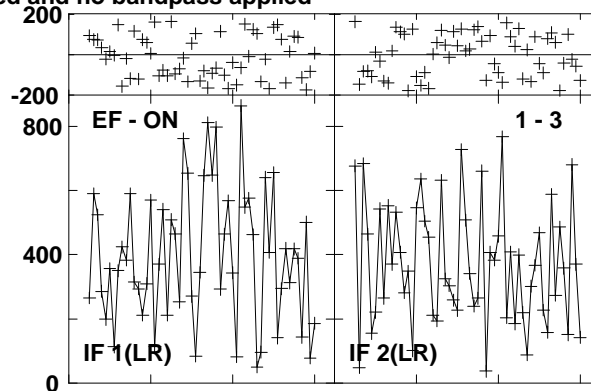
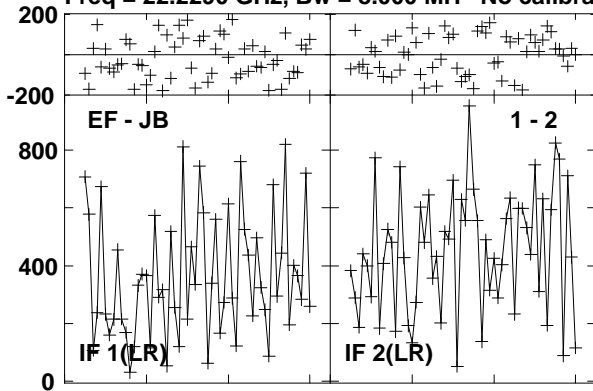

Lower frame: Micro Ampl Jy Top frame: Phas deg
Vector averaged cross-power spectrum Several baselines displayed
Timerange: 00/13:03:18 to 00/13:04:17

Plot file version 137 created 17-SEP-2012 12:06:59

ORIKL1 EE008D 1.UVDATA.1

Freq = 22.2290 GHz, Bw = 8.000 MH No calibration applied and no bandpass applied

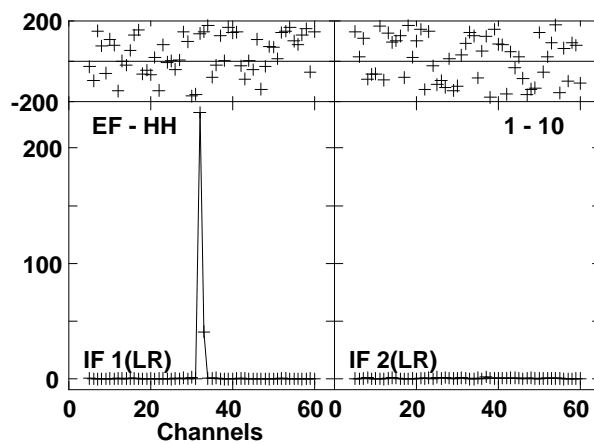
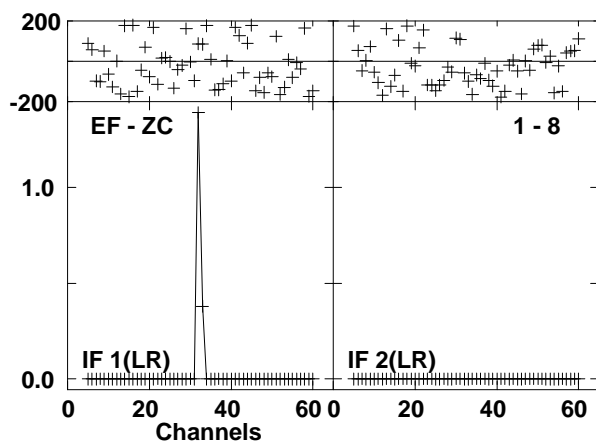
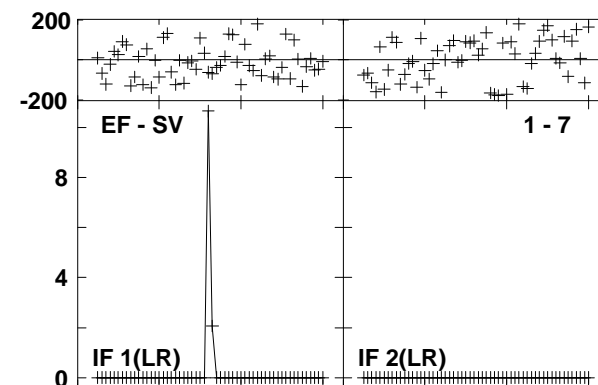
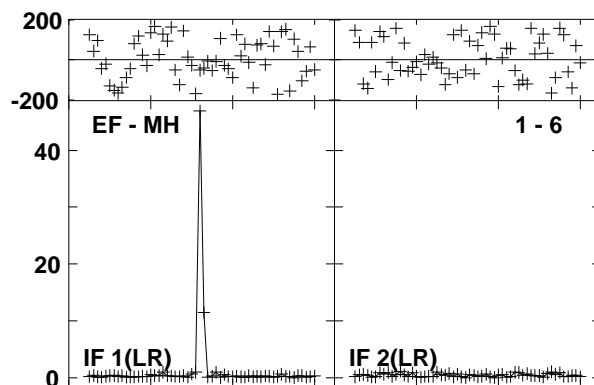
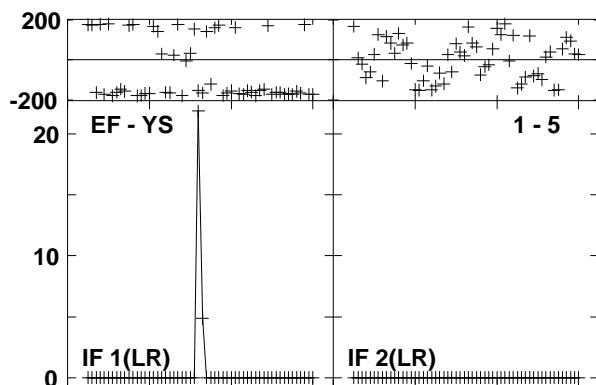
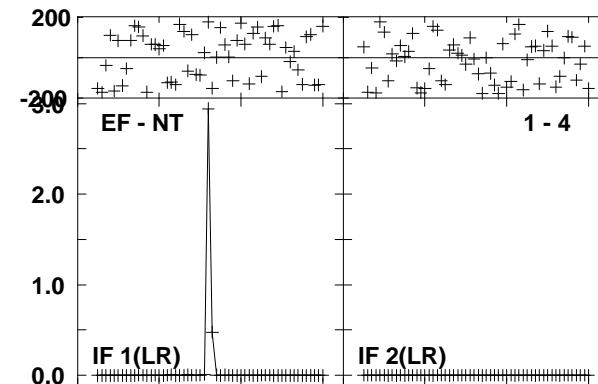
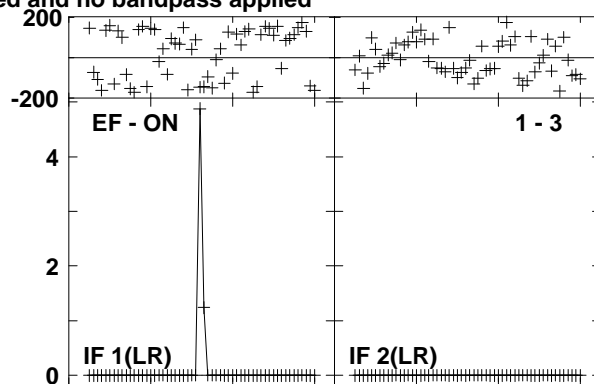
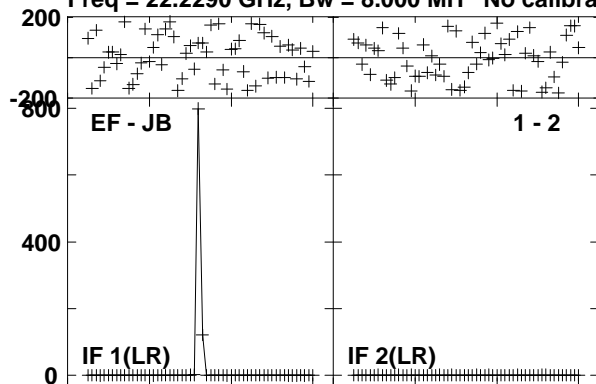

Lower frame: Milli Ampl Jy Top frame: Phas deg

Vector averaged cross-power spectrum Several baselines displayed

Timerange: 00/13:04:23 to 00/13:05:17

Plot file version 138 created 17-SEP-2012 12:07:00

J0541-0541 EE008D 1.UVDATA.1

Freq = 22.2290 GHz, Bw = 8.000 MH No calibration applied and no bandpass applied

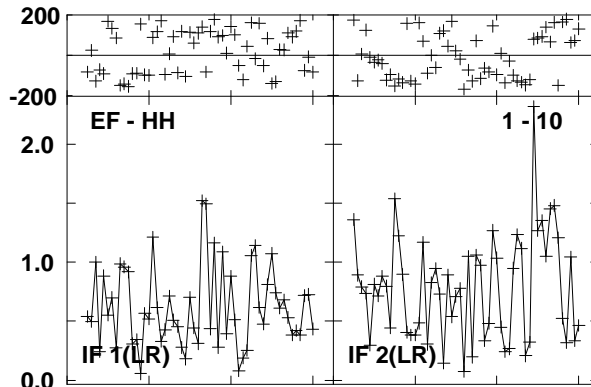
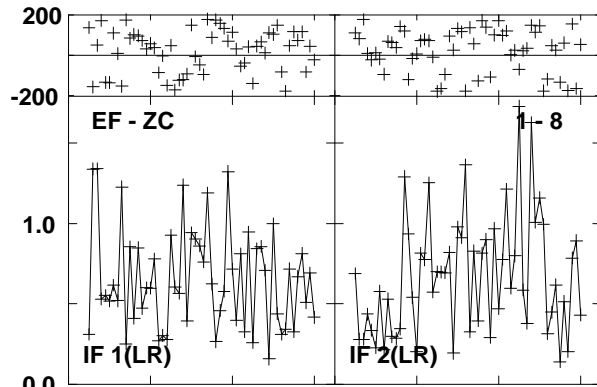
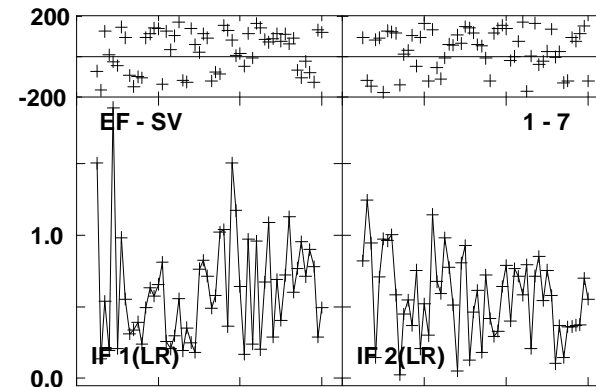
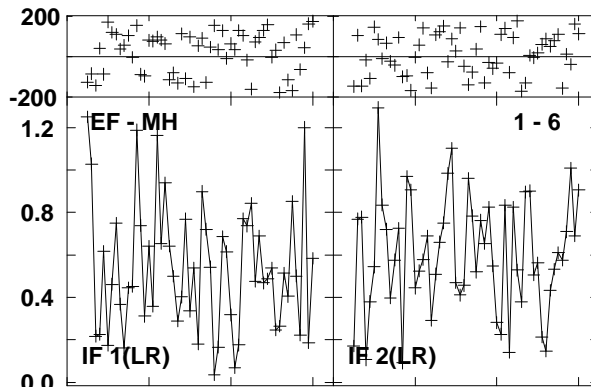
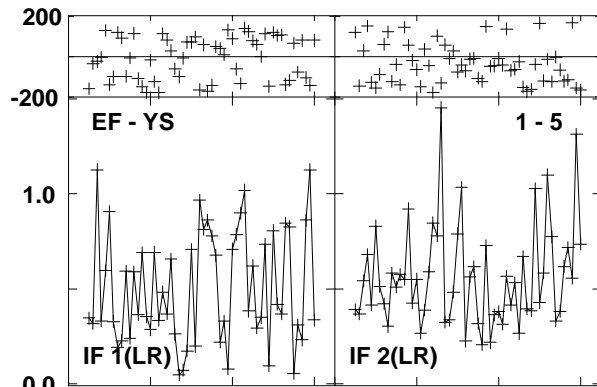
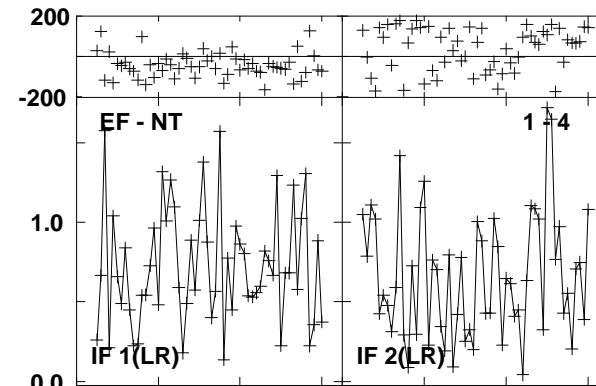
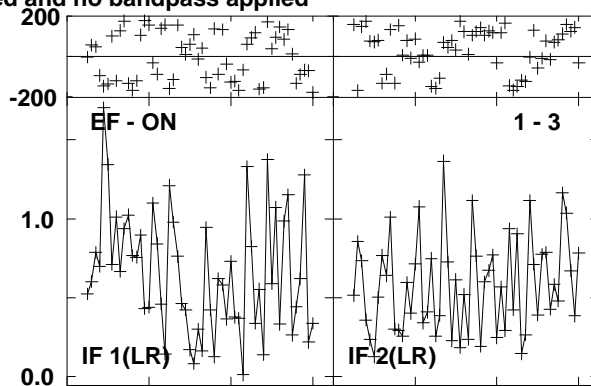
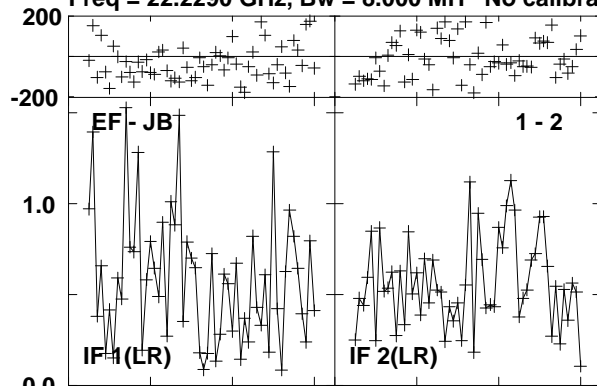

Lower frame: Milli Ampl Jy Top frame: Phas deg
Vector averaged cross-power spectrum Several baselines displayed
Timerange: 00/13:05:23 to 00/13:06:17

Plot file version 139 created 17-SEP-2012 12:07:02

ORIKL1 EE008D 1.UVDATA.1

Freq = 22.2290 GHz, Bw = 8.000 MH No calibration applied and no bandpass applied

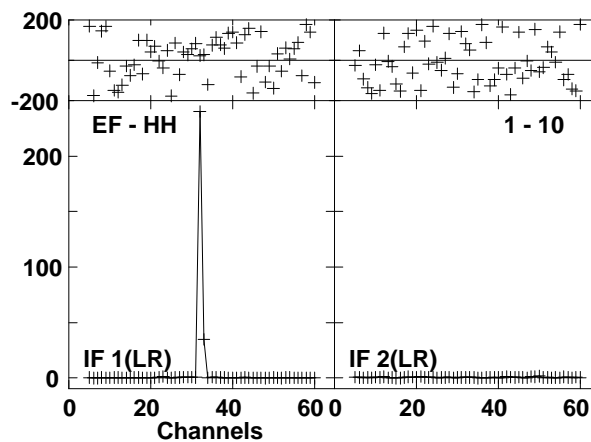
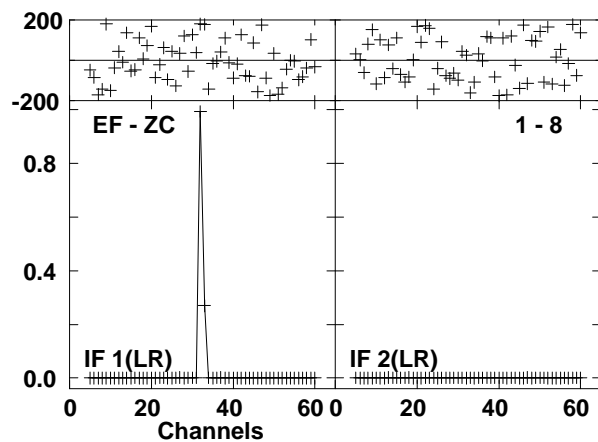
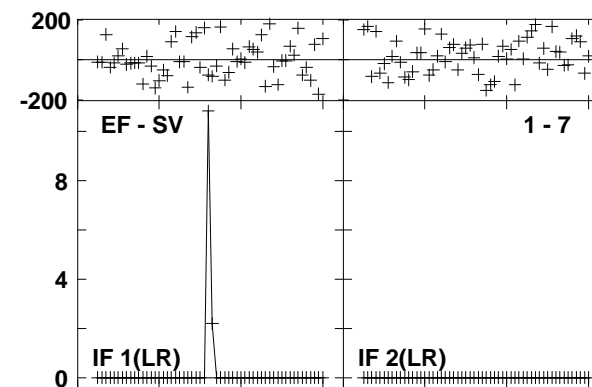
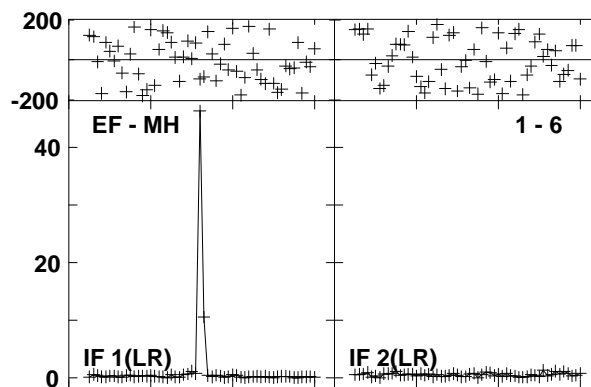
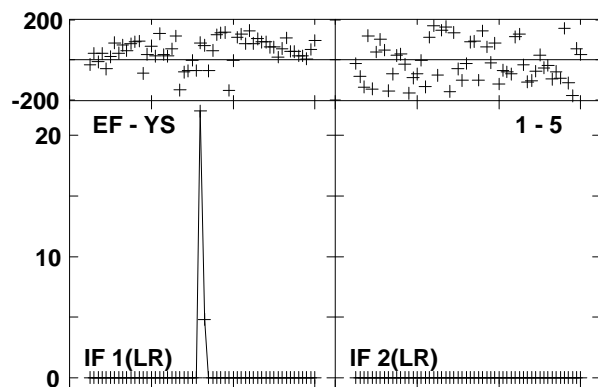
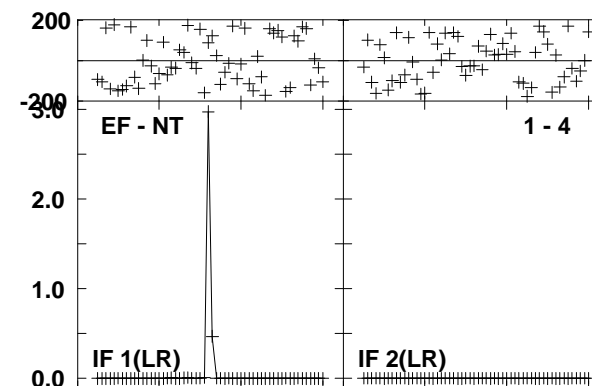
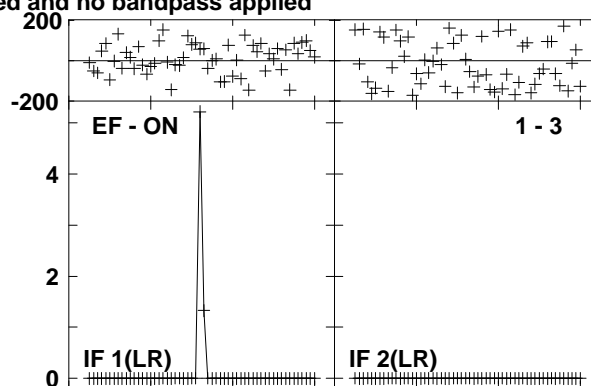
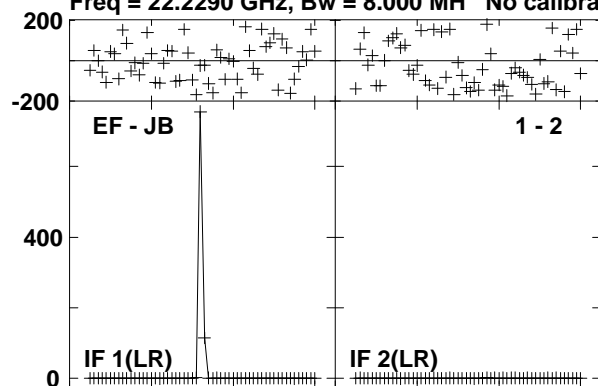

Lower frame: Milli Ampl Jy Top frame: Phas deg

Vector averaged cross-power spectrum Several baselines displayed

Timerange: 00/13:06:22 to 00/13:07:17

Plot file version 140 created 17-SEP-2012 12:07:05

J0541-0541 EE008D 1.UVDATA.1

Freq = 22.2290 GHz, Bw = 8.000 MH No calibration applied and no bandpass applied

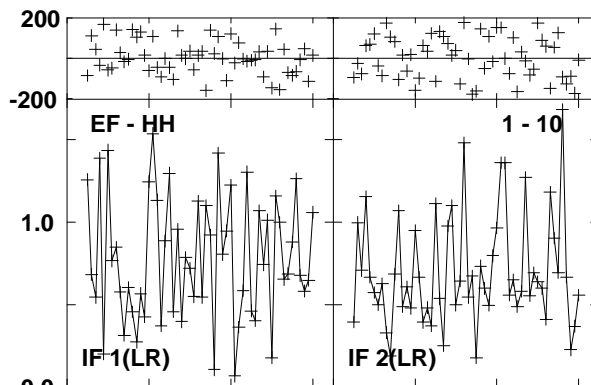
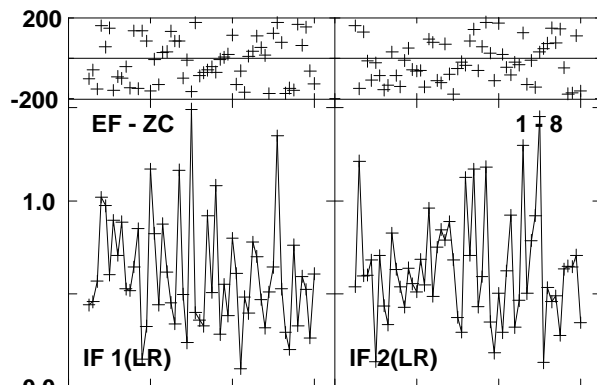
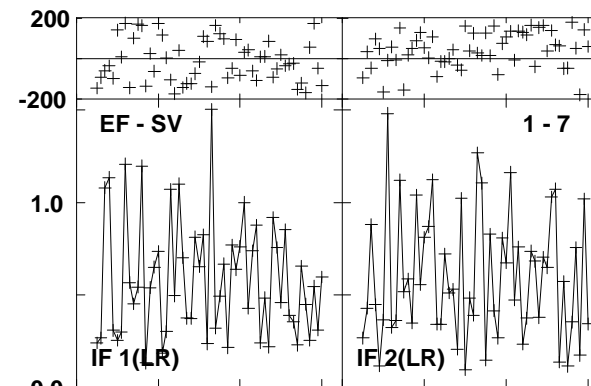
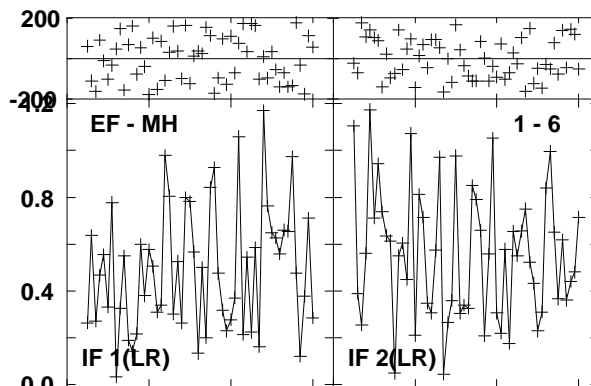
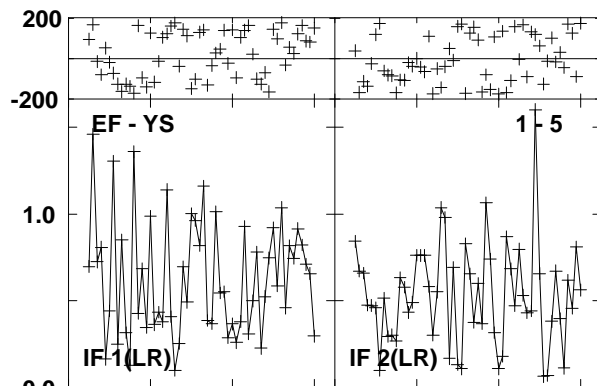
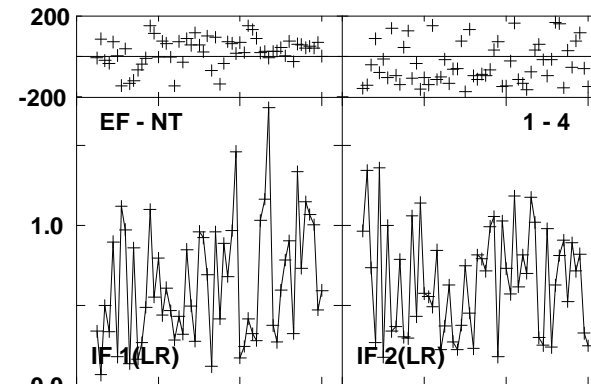
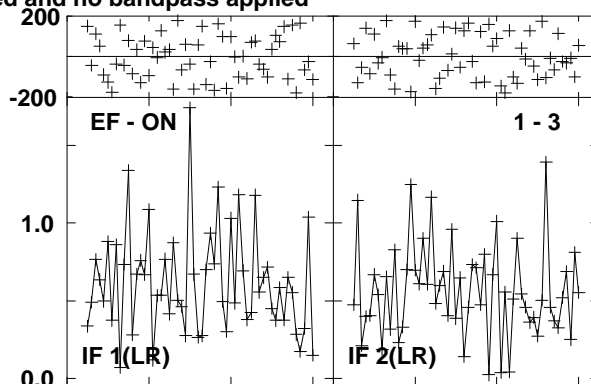
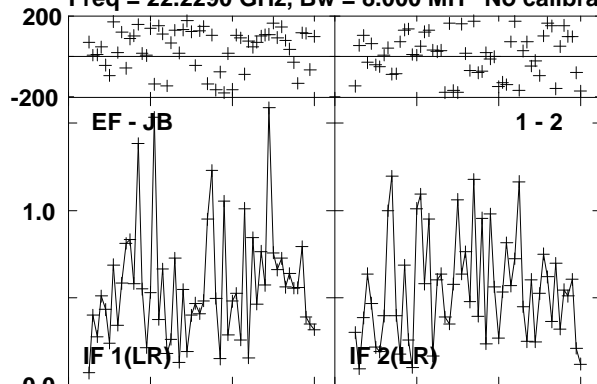

Lower frame: Milli Ampl Jy Top frame: Phas deg
Vector averaged cross-power spectrum Several baselines displayed
Timerange: 00/13:07:23 to 00/13:08:17

Plot file version 141 created 17-SEP-2012 12:07:07

J0529-0519 EE008D 1.UVDATA.1

Freq = 22.2290 GHz, Bw = 8.000 MH No calibration applied and no bandpass applied

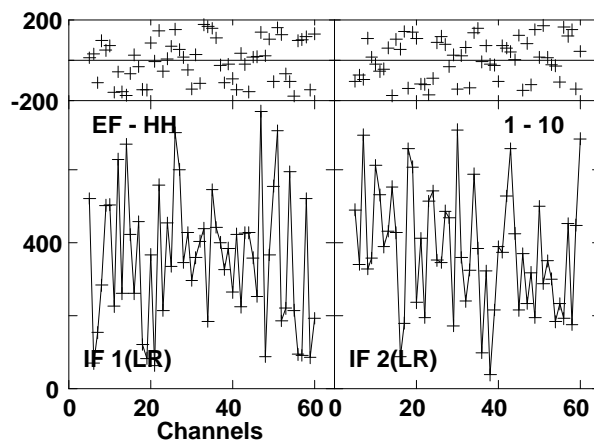
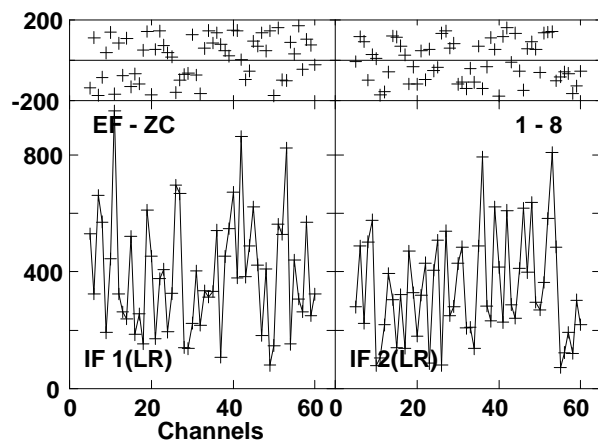
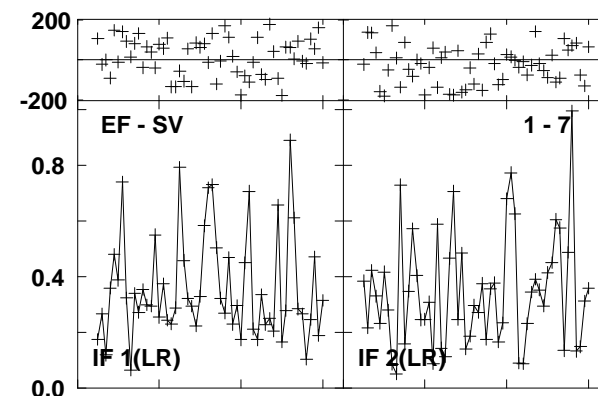
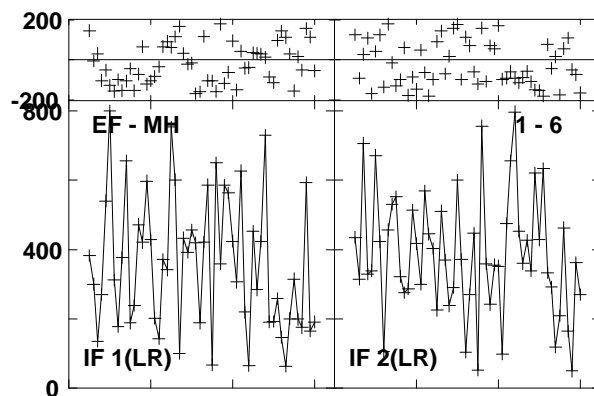
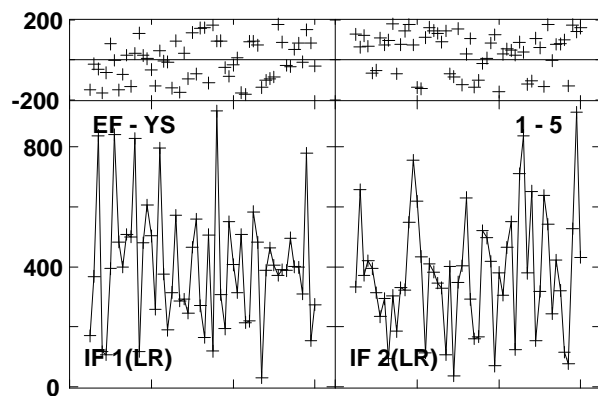
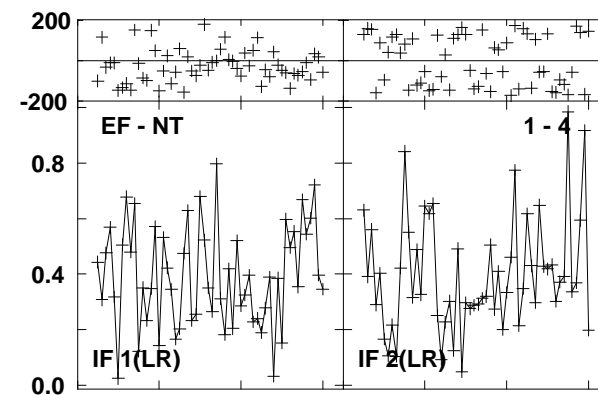
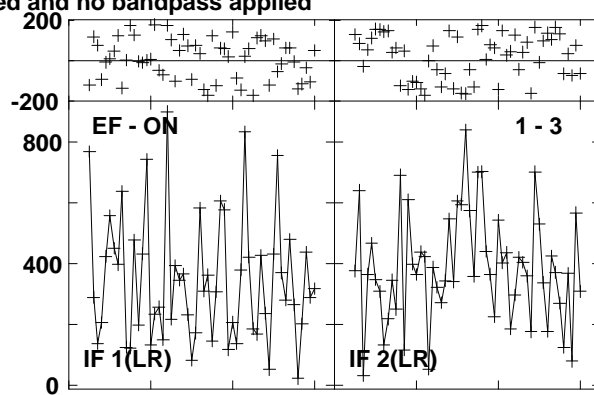
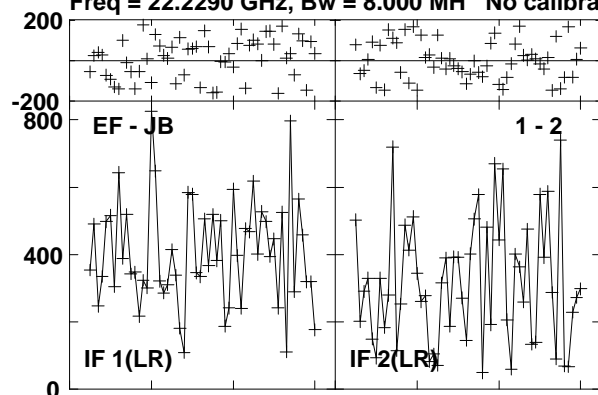

Lower frame: Micro Ampl Jy Top frame: Phas deg
Vector averaged cross-power spectrum Several baselines displayed
Timerange: 00/13:09:04 to 00/13:10:03

Plot file version 142 created 17-SEP-2012 12:07:09

ORIKL1 EE008D 1.UVDATA.1

Freq = 22.2290 GHz, Bw = 8.000 MH No calibration applied and no bandpass applied

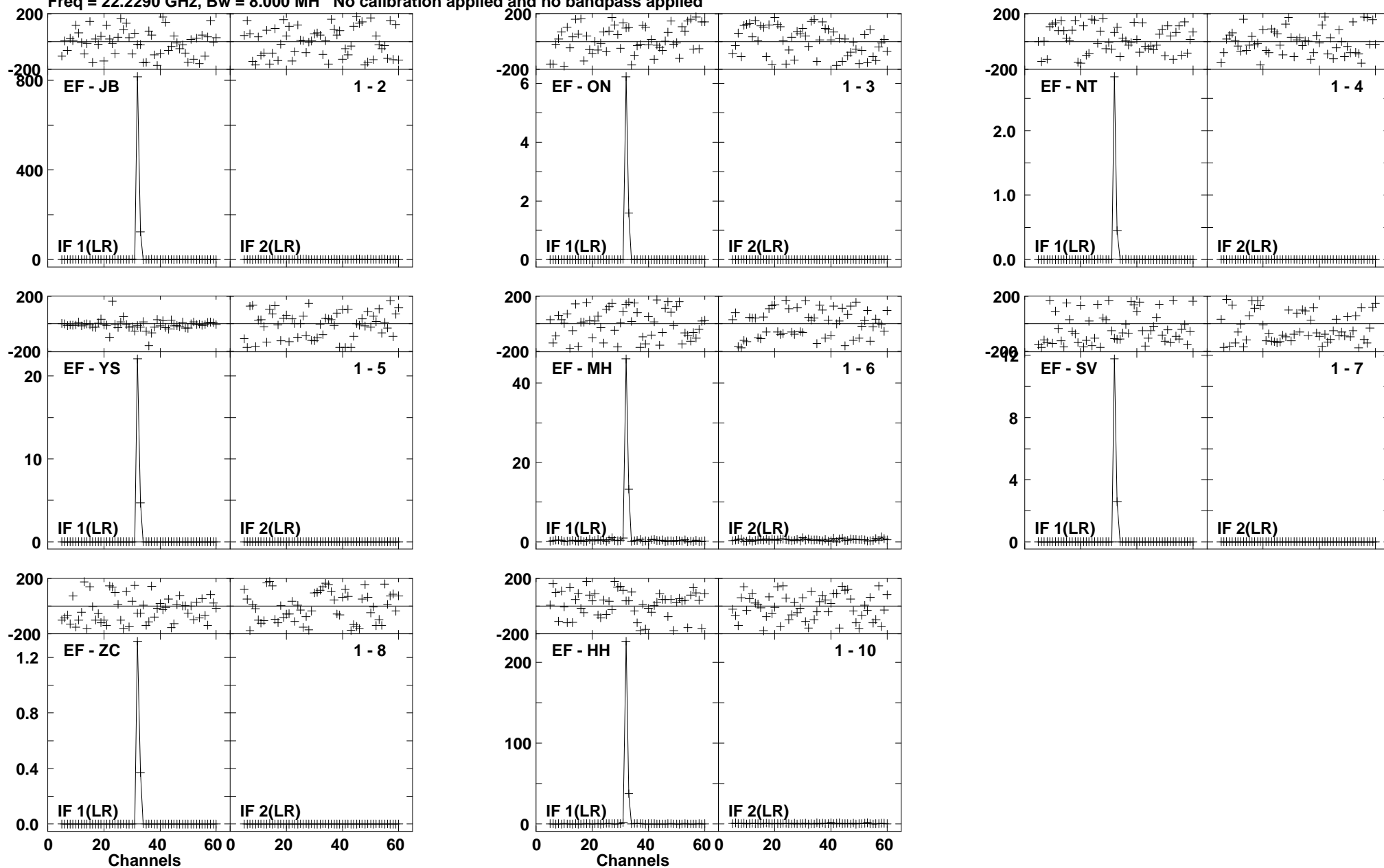

Lower frame: Milli Ampl Jy Top frame: Phas deg
Vector averaged cross-power spectrum Several baselines displayed
Timerange: 00/13:10:06 to 00/13:11:03

Plot file version 143 created 17-SEP-2012 12:07:11

J0529-0519 EE008D 1.UVDATA.1

Freq = 22.2290 GHz, Bw = 8.000 MH No calibration applied and no bandpass applied

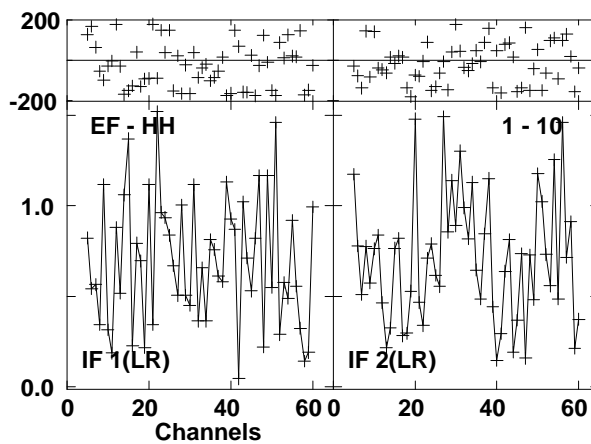
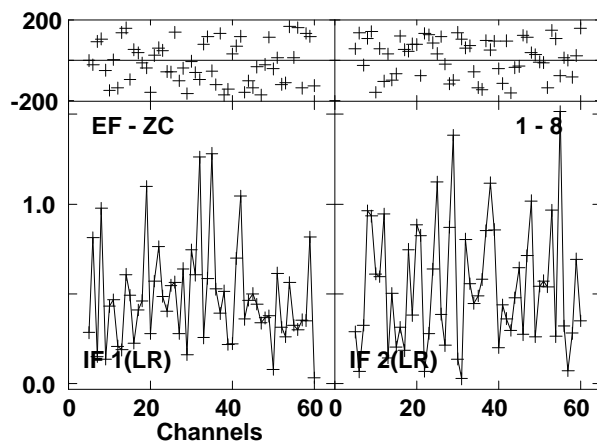
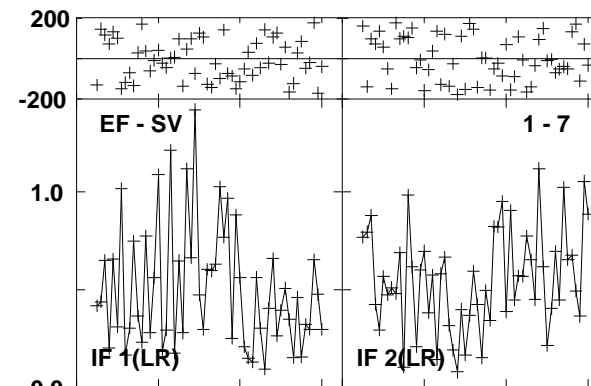
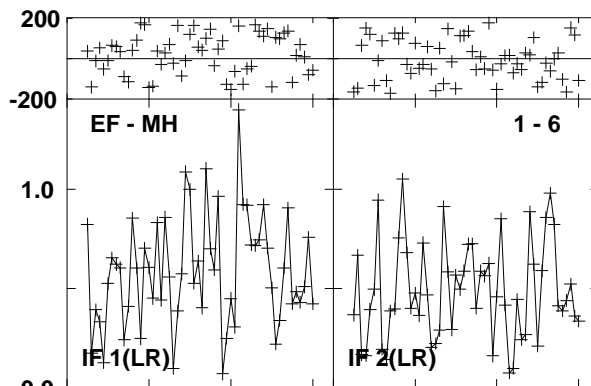
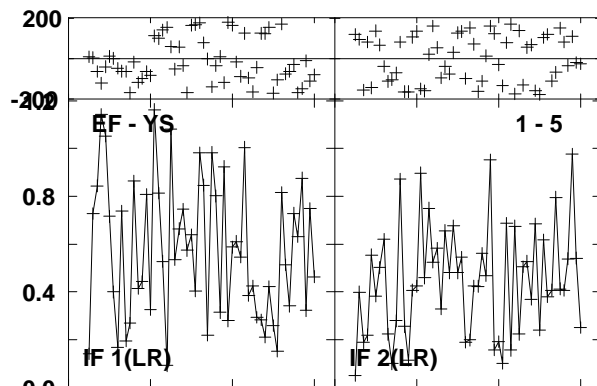
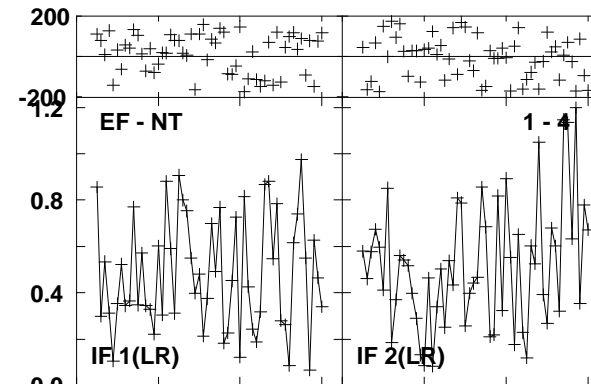
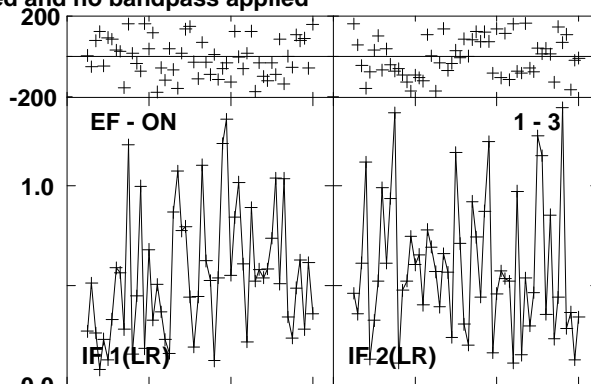
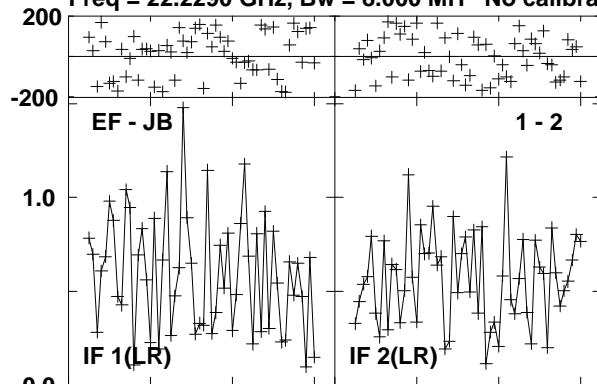

Lower frame: Milli Ampl Jy Top frame: Phas deg
Vector averaged cross-power spectrum Several baselines displayed
Timerange: 00/13:11:07 to 00/13:12:03

Plot file version 144 created 17-SEP-2012 12:07:13

ORIKL1 EE008D 1.UVDATA.1

Freq = 22.2290 GHz, Bw = 8.000 MH No calibration applied and no bandpass applied

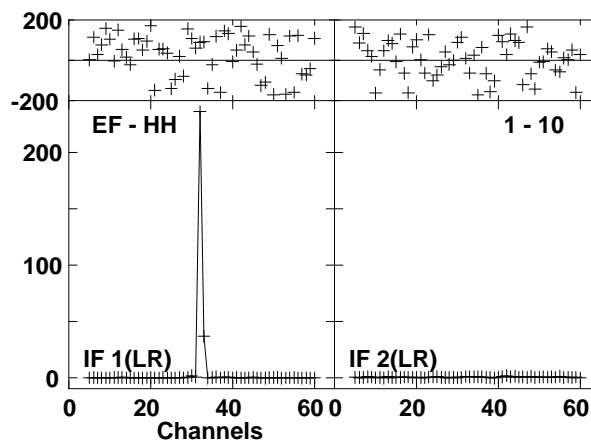
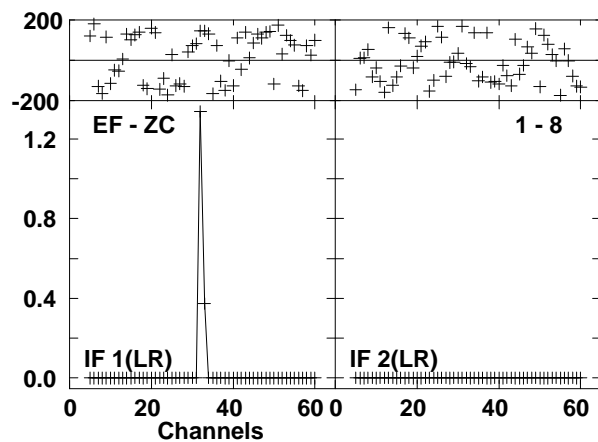
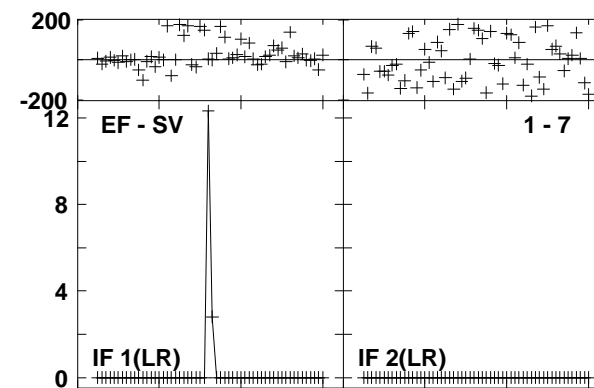
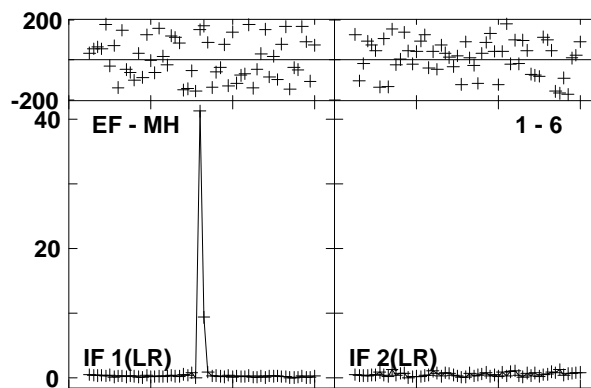
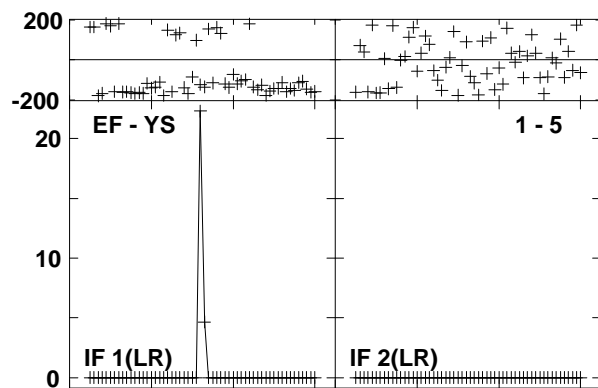
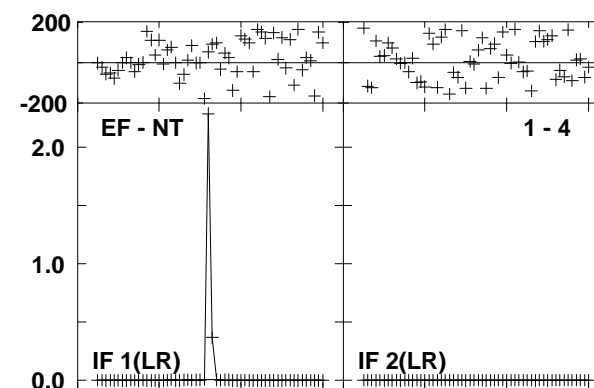
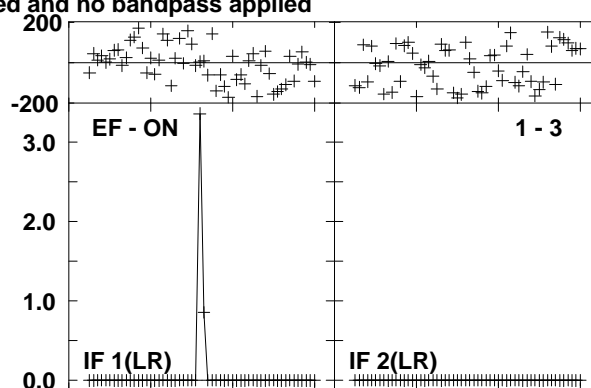
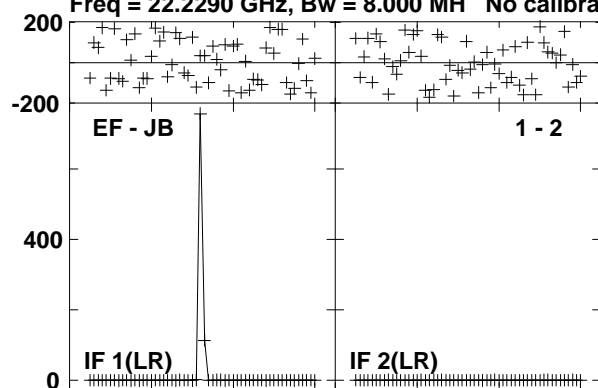

Lower frame: Milli Ampl Jy Top frame: Phas deg

Vector averaged cross-power spectrum Several baselines displayed

Timerange: 00/13:12:07 to 00/13:13:03

Plot file version 145 created 17-SEP-2012 12:07:16

J0529-0519 EE008D 1.UVDATA.1

Freq = 22.2290 GHz, Bw = 8.000 MH No calibration applied and no bandpass applied

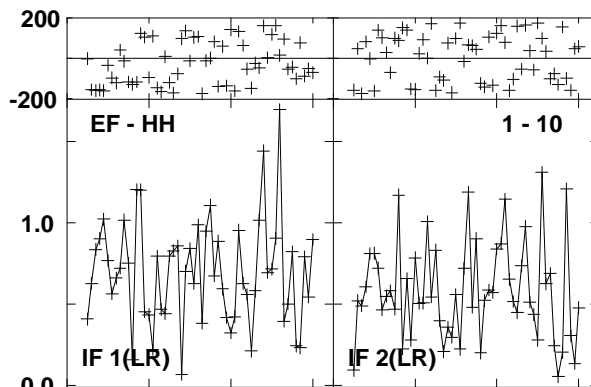
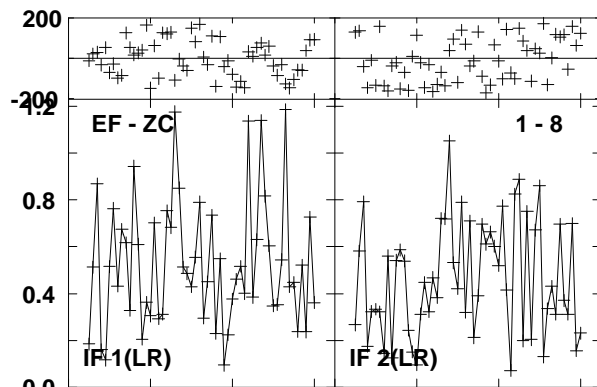
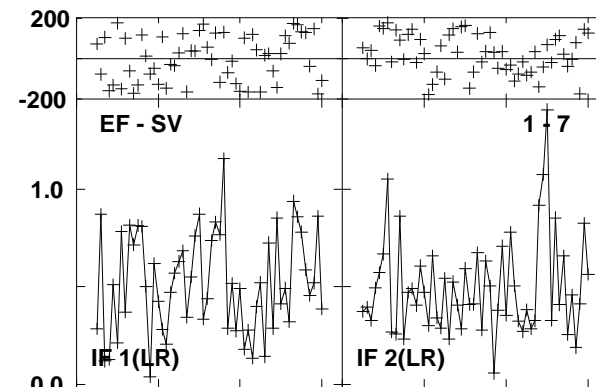
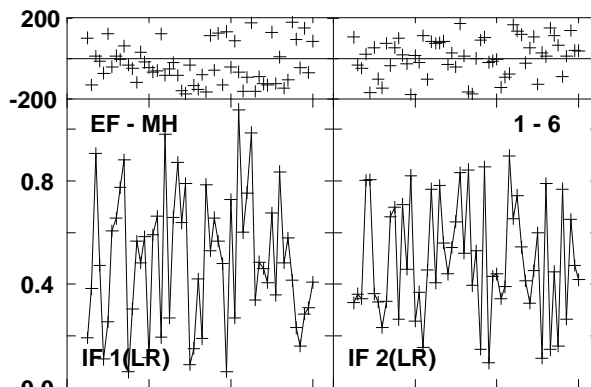
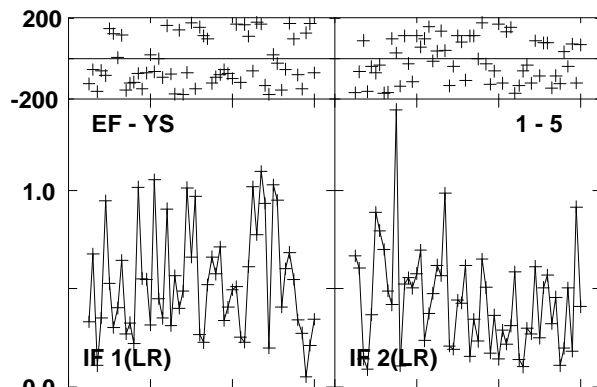
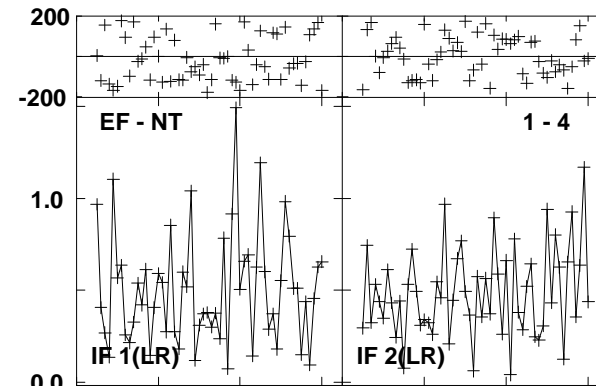
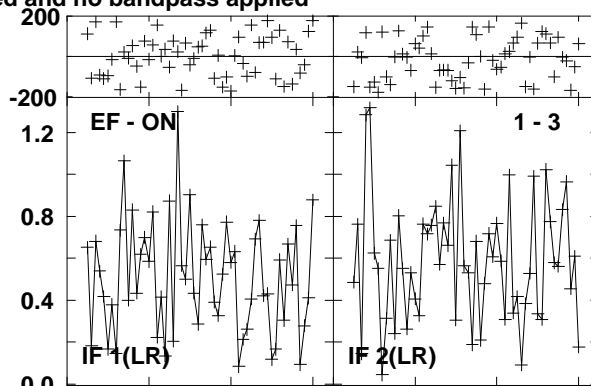
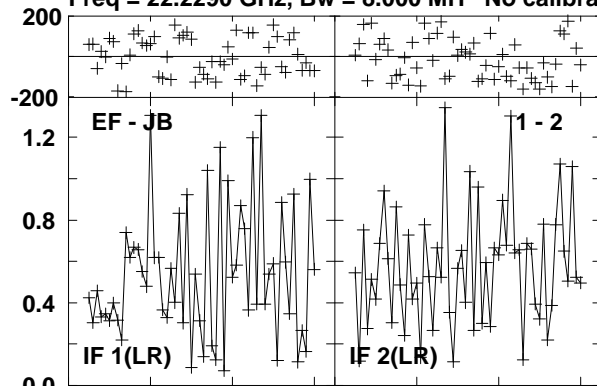

Lower frame: Milli Ampl Jy Top frame: Phas deg
Vector averaged cross-power spectrum Several baselines displayed
Timerange: 00/13:13:08 to 00/13:14:03

Plot file version 146 created 17-SEP-2012 12:07:18

J0541-0541 EE008D 1.UVDATA.1

Freq = 22.2290 GHz, Bw = 8.000 MH No calibration applied and no bandpass applied

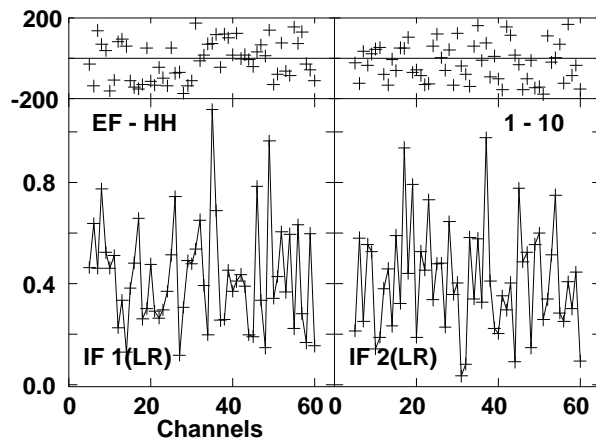
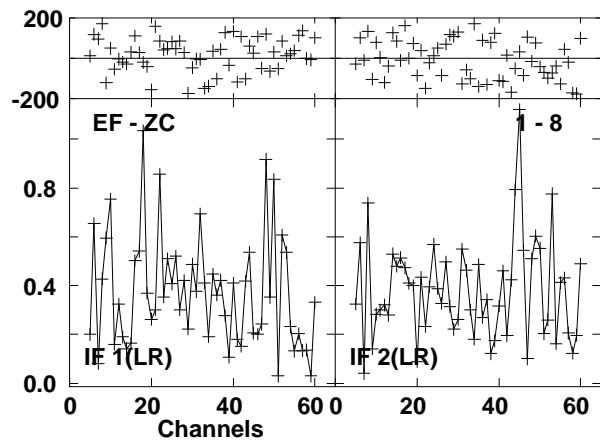
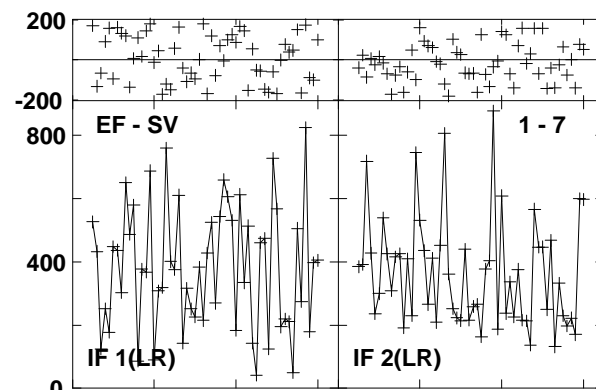
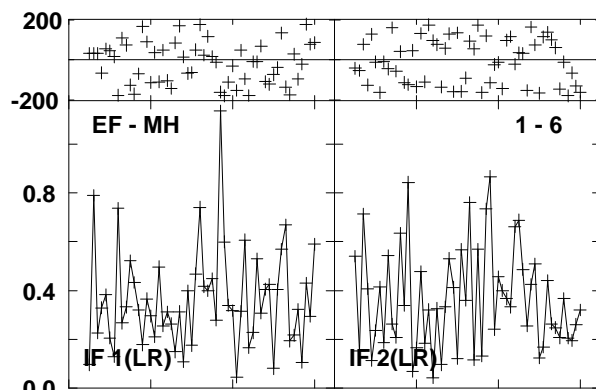
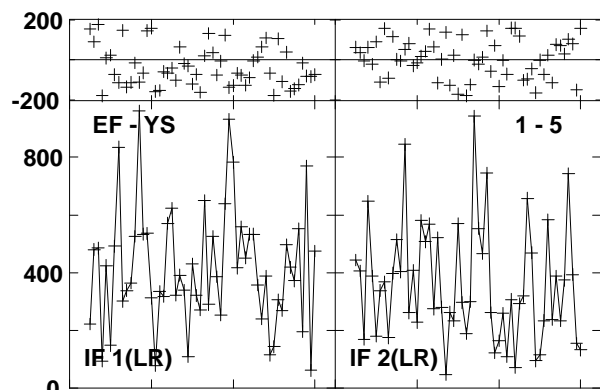
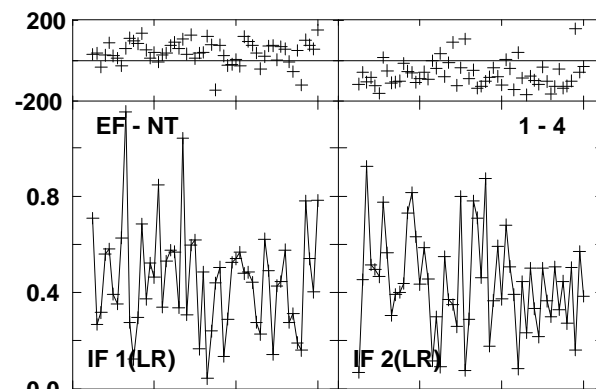
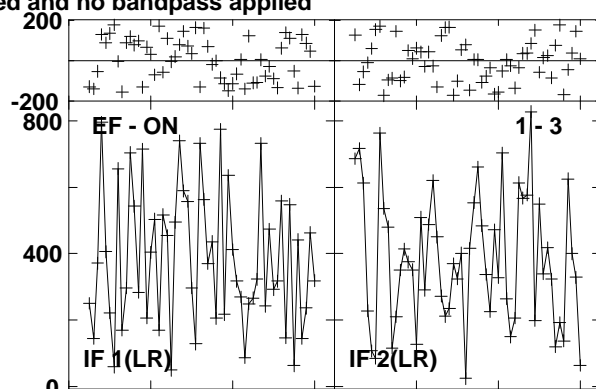
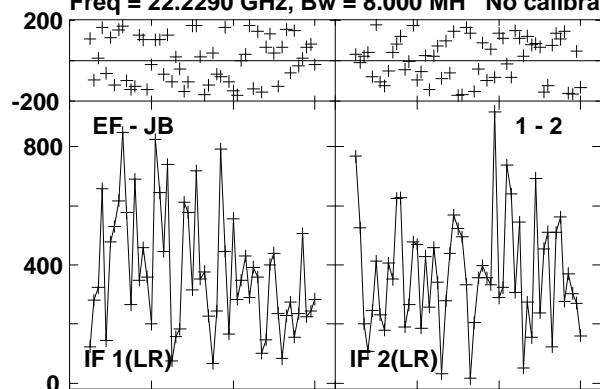

Lower frame: Micro Ampl Jy Top frame: Phas deg
Vector averaged cross-power spectrum Several baselines displayed
Timerange: 00/13:14:49 to 00/13:15:48

Plot file version 147 created 17-SEP-2012 12:07:21

ORIKL1 EE008D 1.UVDATA.1

Freq = 22.2290 GHz, Bw = 8.000 MH No calibration applied and no bandpass applied

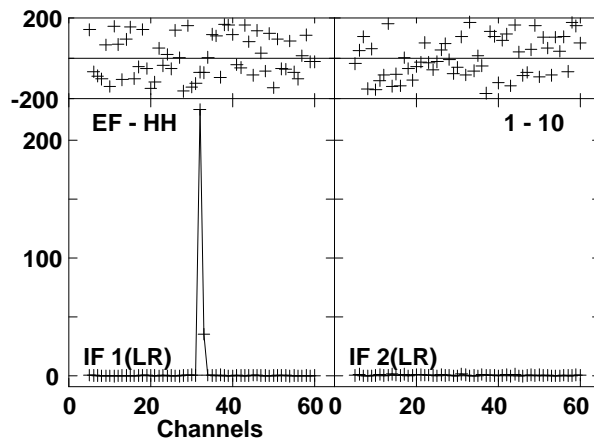
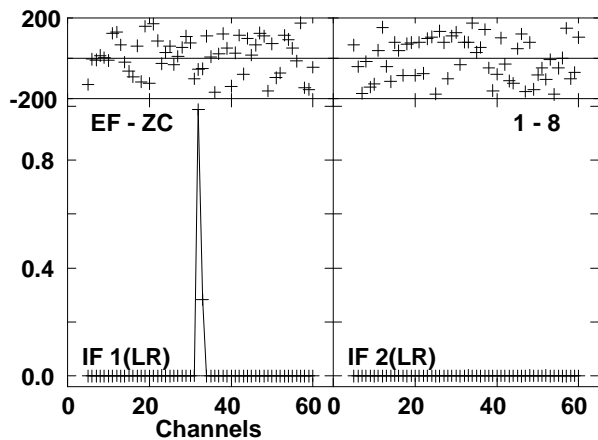
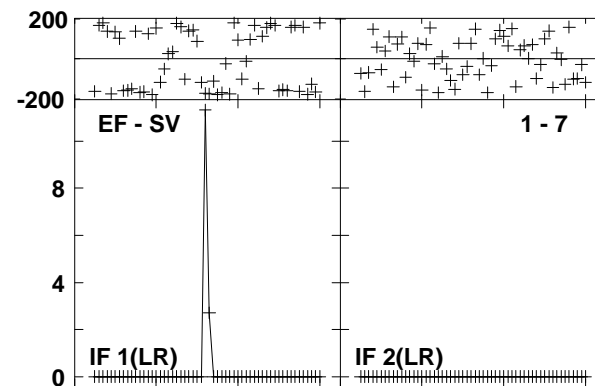
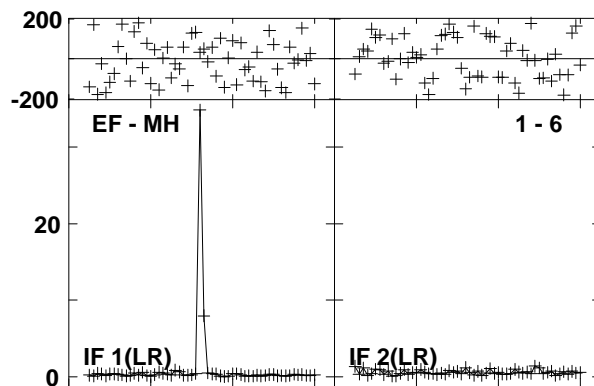
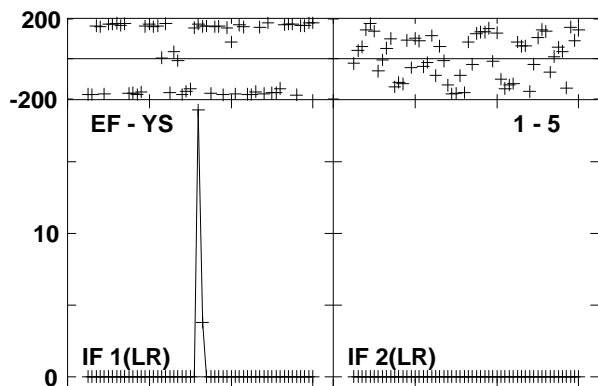
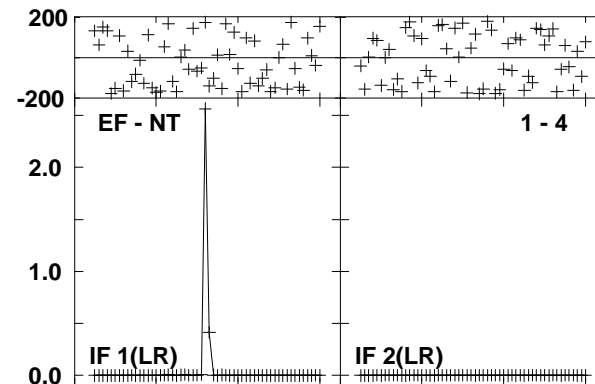
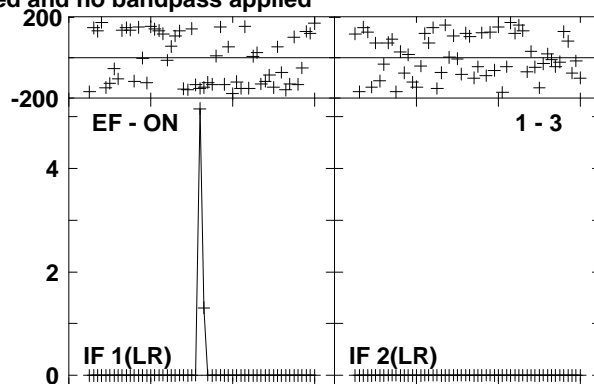
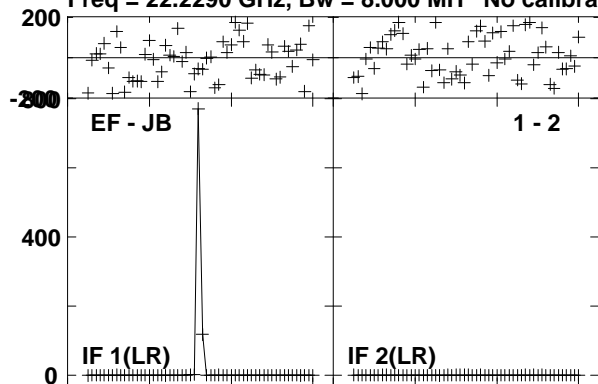

Lower frame: Milli Ampl Jy Top frame: Phas deg

Vector averaged cross-power spectrum Several baselines displayed

Timerange: 00/13:15:52 to 00/13:16:48

Plot file version 148 created 17-SEP-2012 12:07:23

J0541-0541 EE008D 1.UVDATA.1

Freq = 22.2290 GHz, Bw = 8.000 MH No calibration applied and no bandpass applied

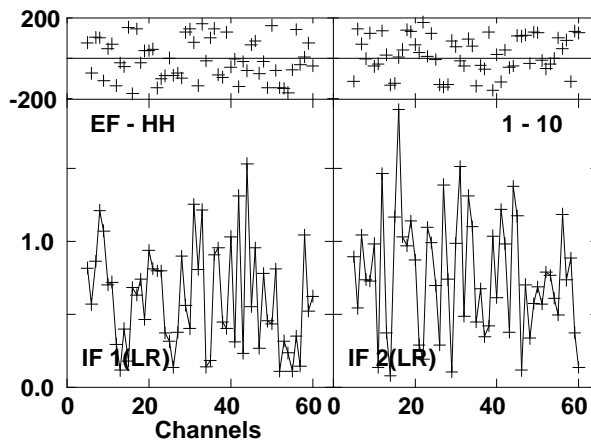
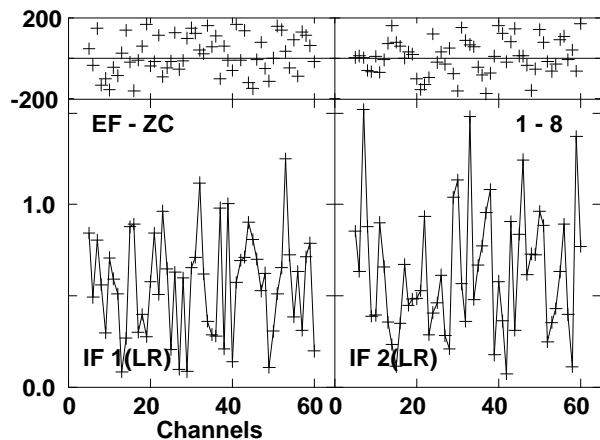
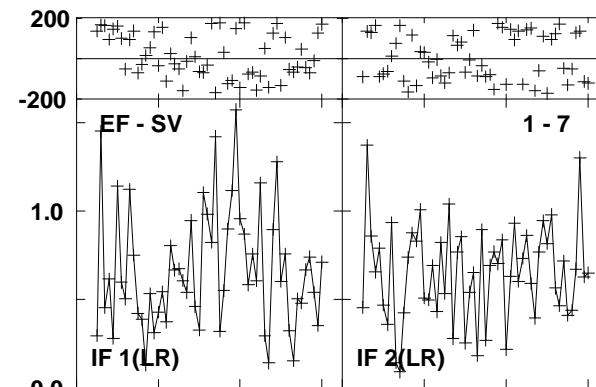
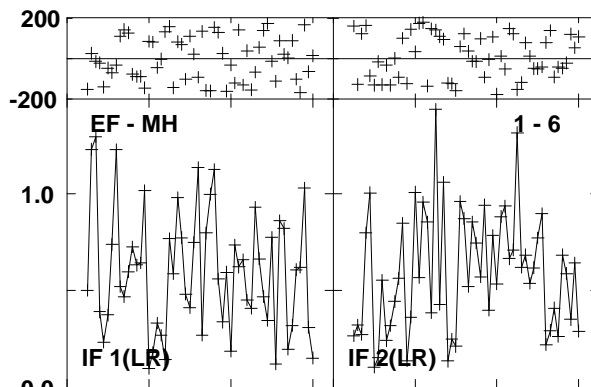
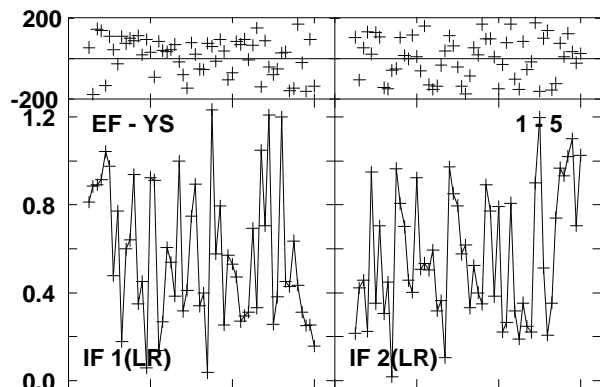
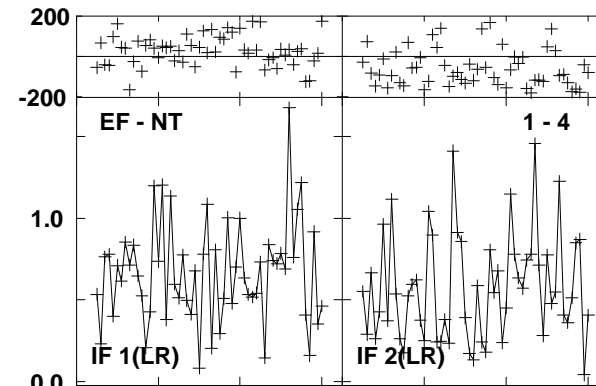
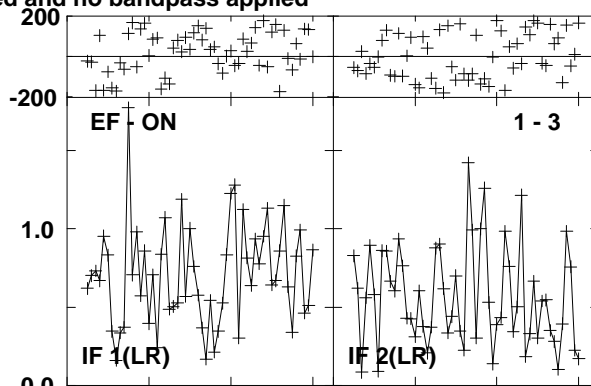
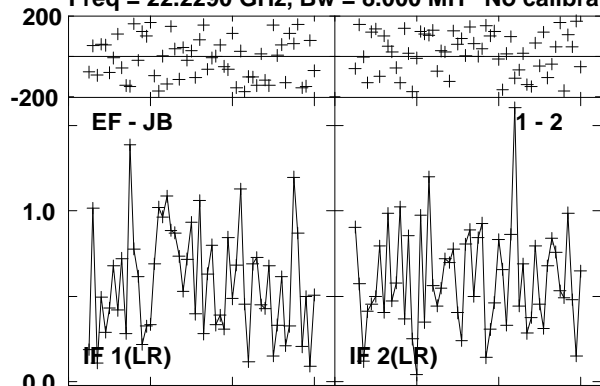

Lower frame: Milli Ampl Jy Top frame: Phas deg
Vector averaged cross-power spectrum Several baselines displayed
Timerange: 00/13:16:53 to 00/13:17:48

Plot file version 149 created 17-SEP-2012 12:07:25

ORIKL1 EE008D 1.UVDATA.1

Freq = 22.2290 GHz, Bw = 8.000 MH No calibration applied and no bandpass applied

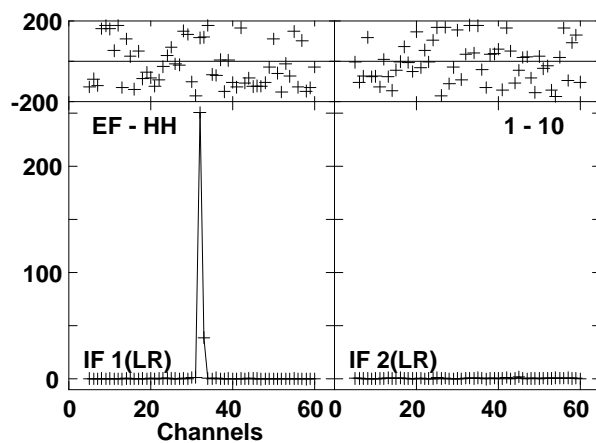
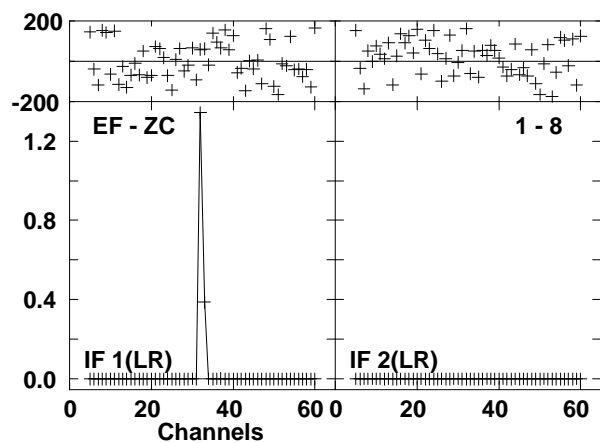
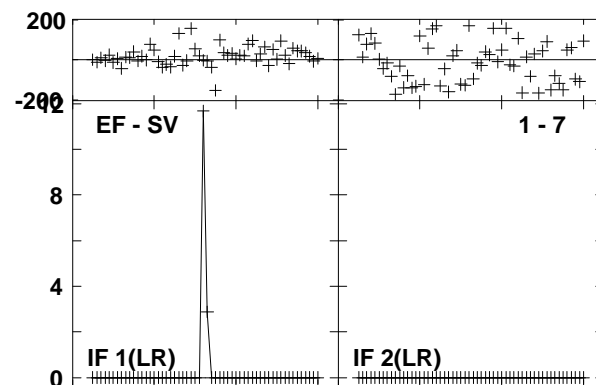
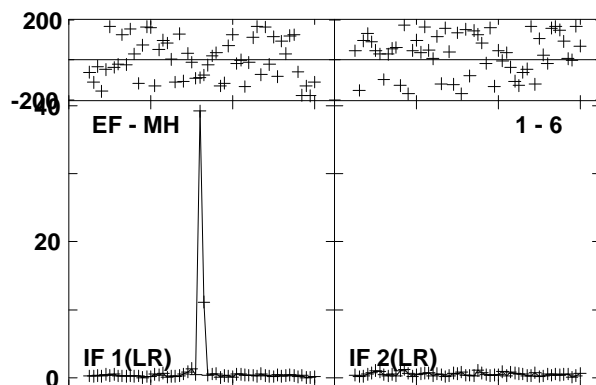
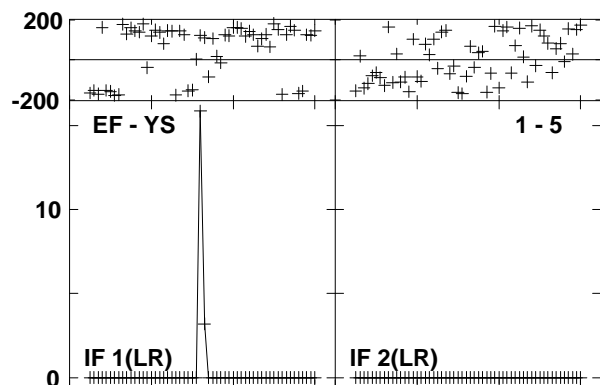
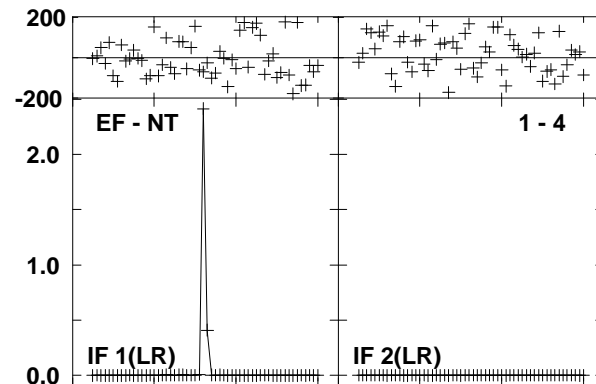
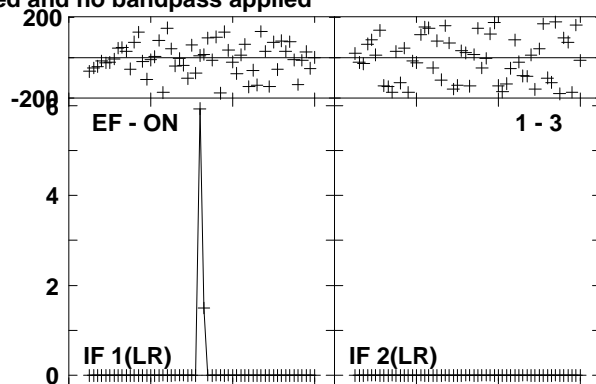
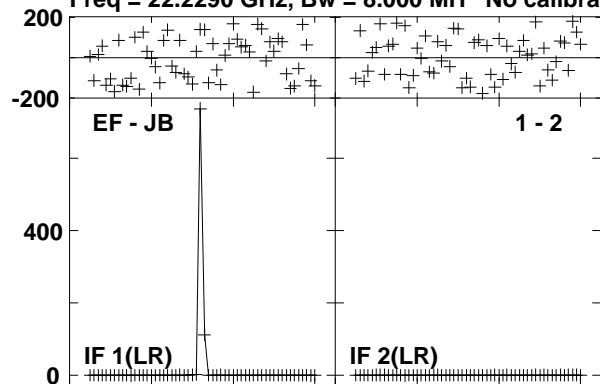

Lower frame: Milli Ampl Jy Top frame: Phas deg

Vector averaged cross-power spectrum Several baselines displayed

Timerange: 00/13:17:53 to 00/13:18:48

Plot file version 150 created 17-SEP-2012 12:07:27

J0541-0541 EE008D 1.UVDATA.1

Freq = 22.2290 GHz, Bw = 8.000 MH No calibration applied and no bandpass applied

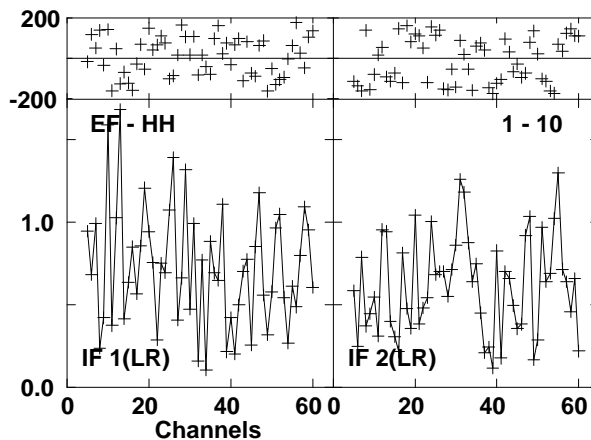
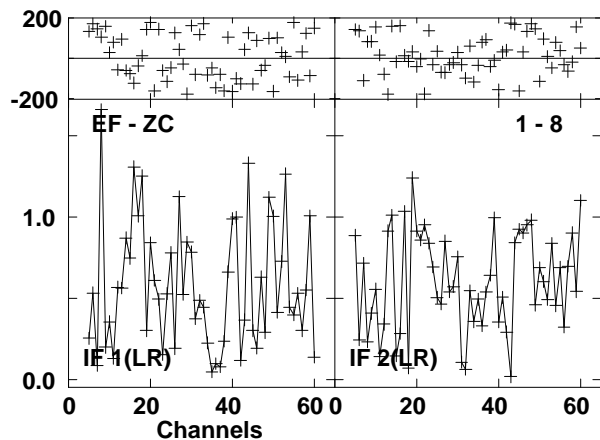
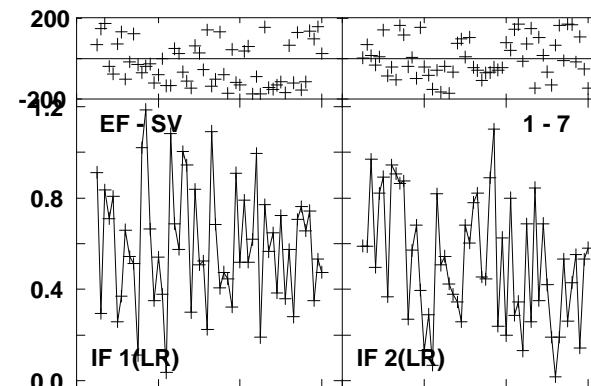
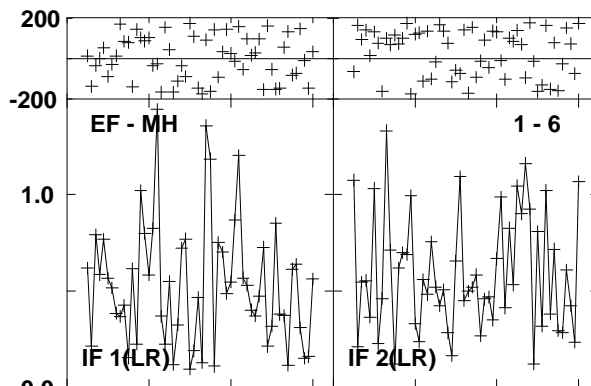
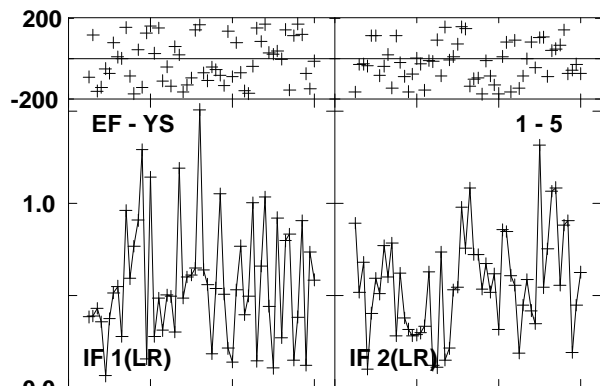
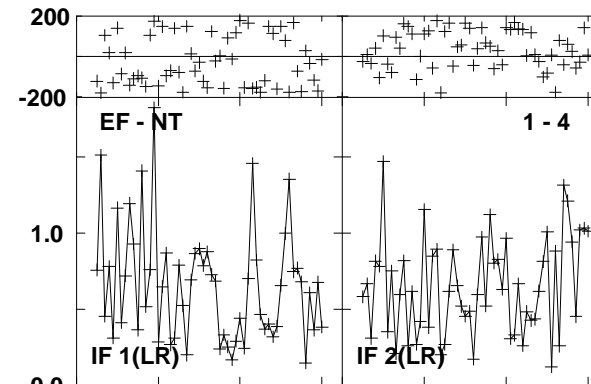
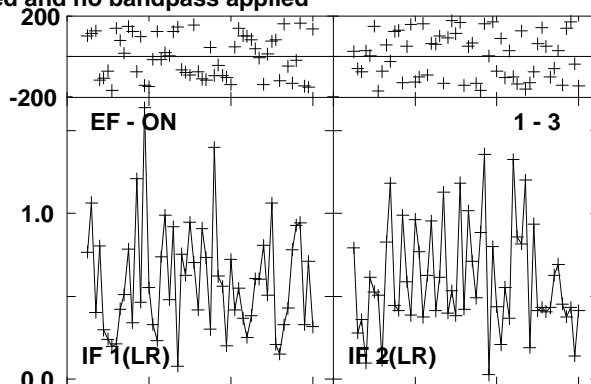
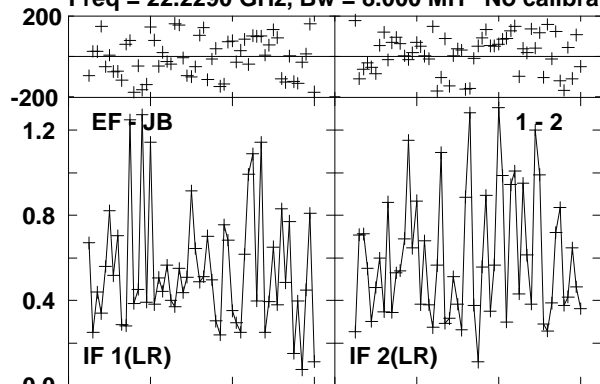

Plot file version 151 created 17-SEP-2012 12:07:29
J0529-0519 EE008D 1.UVDATA.1

Freq = 22.2290 GHz, Bw = 8.000 MH No calibration applied and no bandpass applied

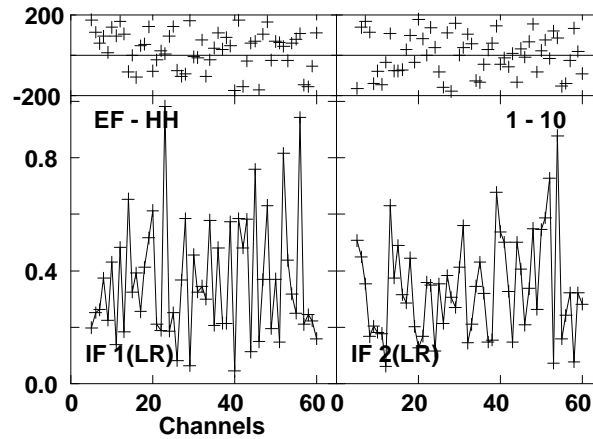
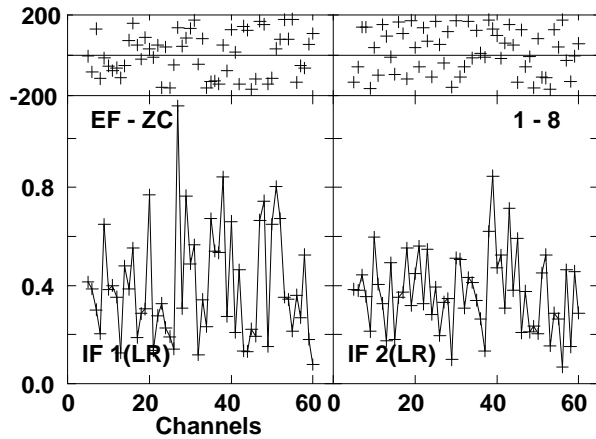
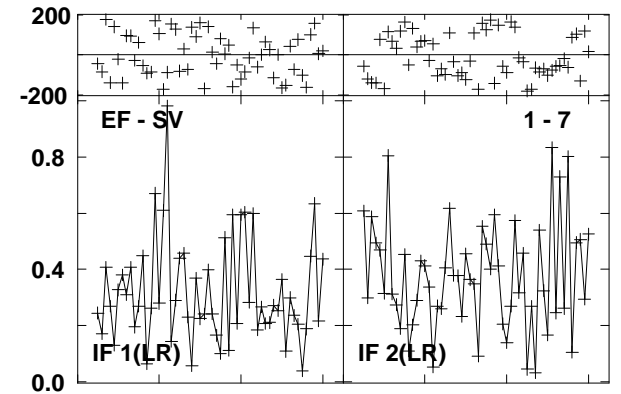
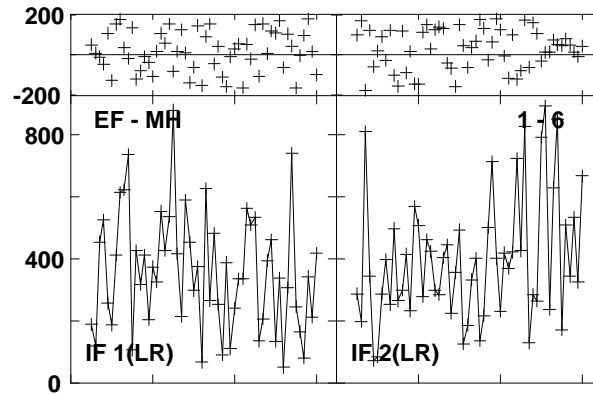
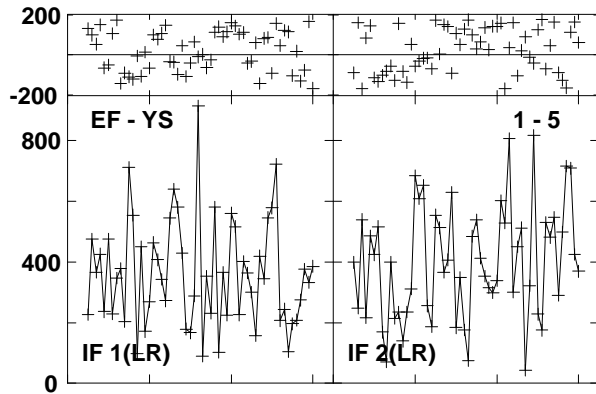
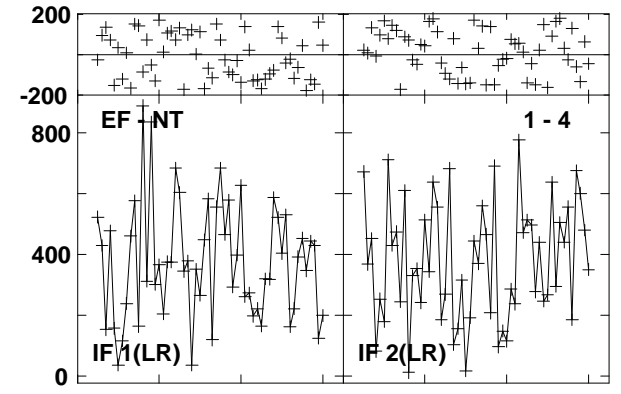
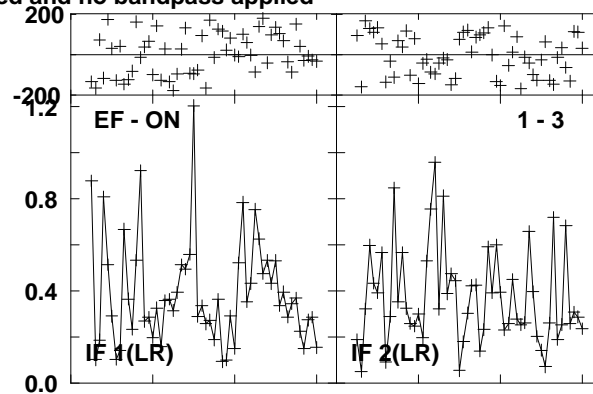
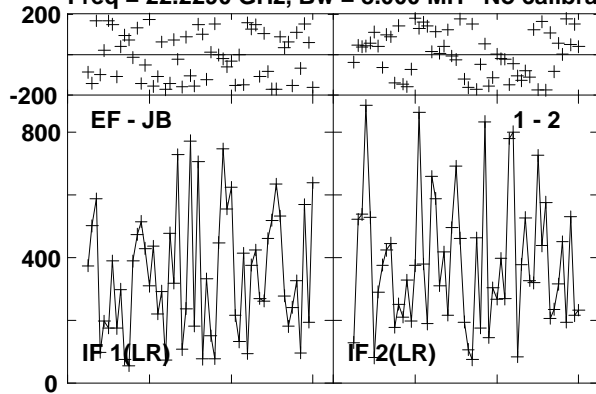

Lower frame: Micro Ampl Jy Top frame: Phas deg
Vector averaged cross-power spectrum Several baselines displayed
Timerange: 00/13:20:35 to 00/13:21:34

Plot file version 152 created 17-SEP-2012 12:07:32

ORIKL1 EE008D 1.UVDATA.1

Freq = 22.2290 GHz, Bw = 8.000 MH No calibration applied and no bandpass applied

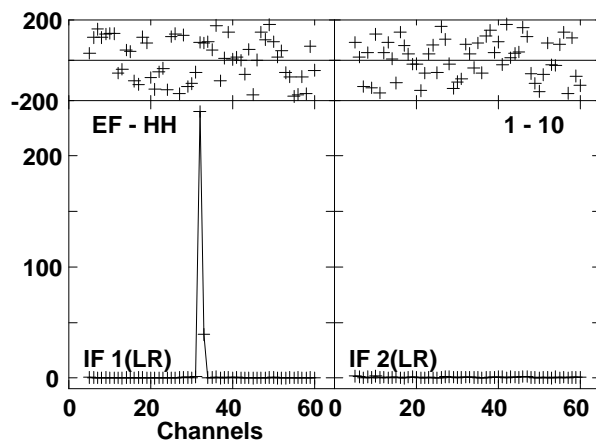
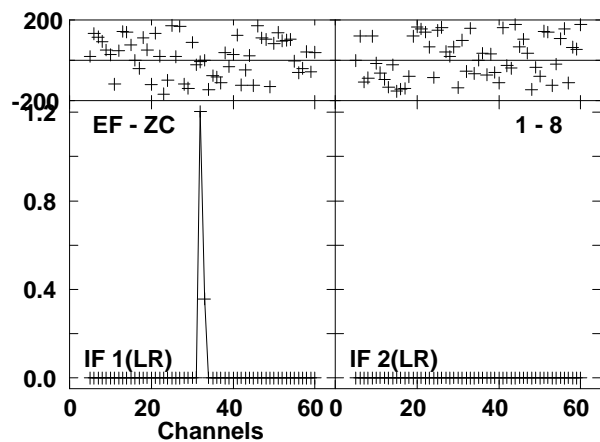
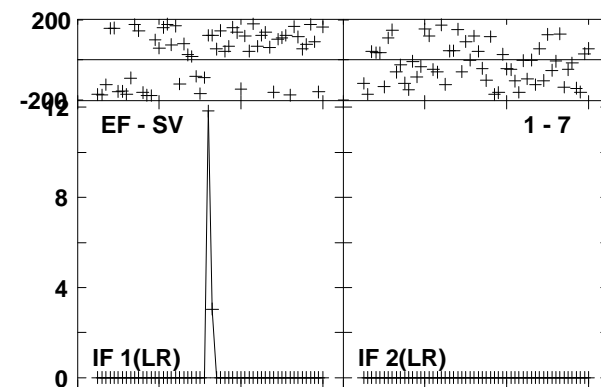
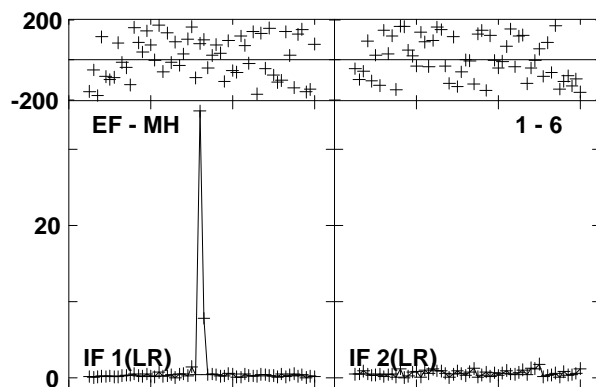
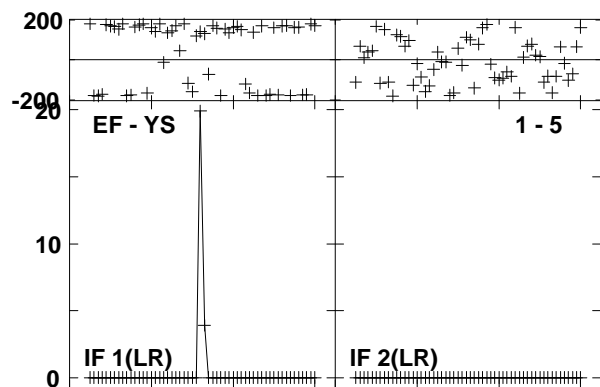
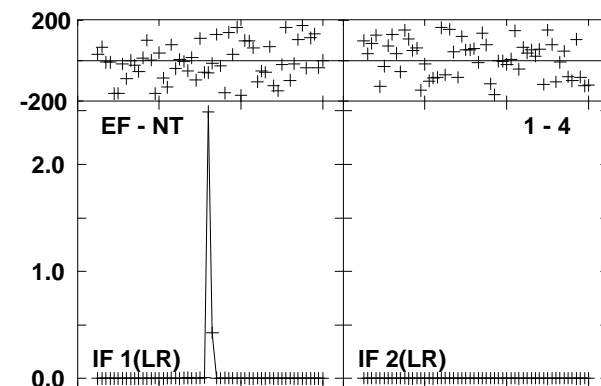
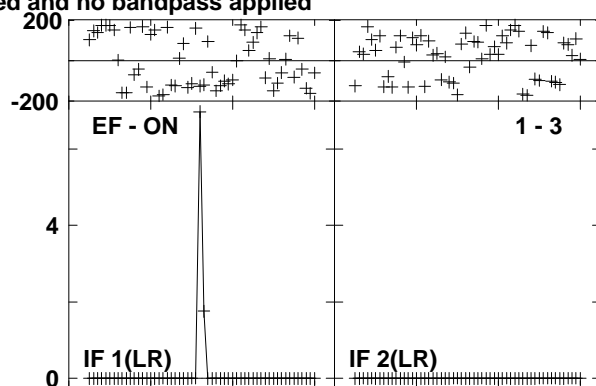
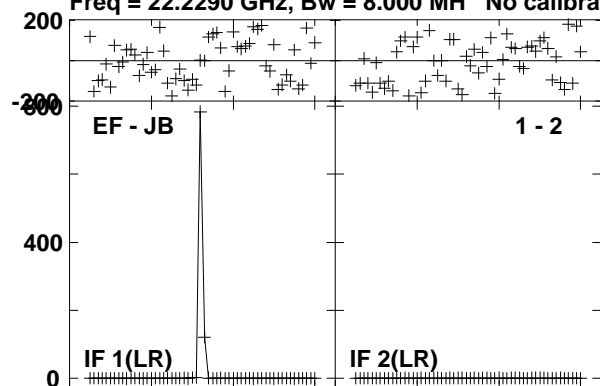

Lower frame: Milli Ampl Jy Top frame: Phas deg

Vector averaged cross-power spectrum Several baselines displayed

Timerange: 00/13:21:38 to 00/13:22:34

Plot file version 153 created 17-SEP-2012 12:07:34

J0529-0519 EE008D 1.UVDATA.1

Freq = 22.2290 GHz, Bw = 8.000 MH No calibration applied and no bandpass applied

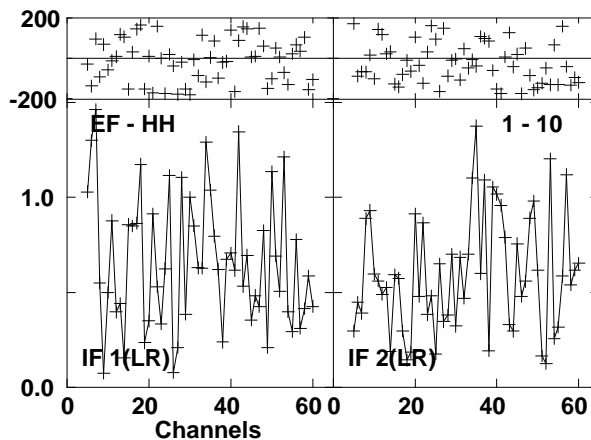
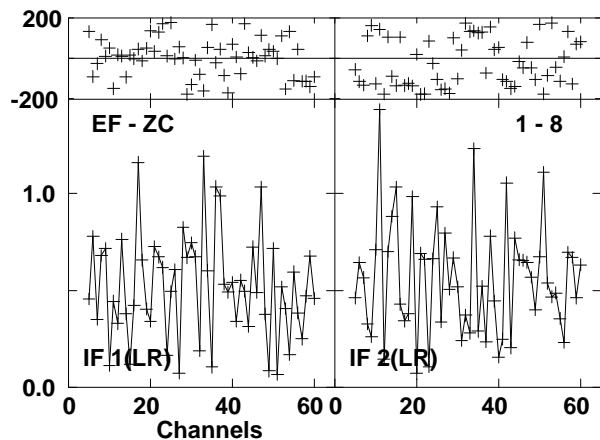
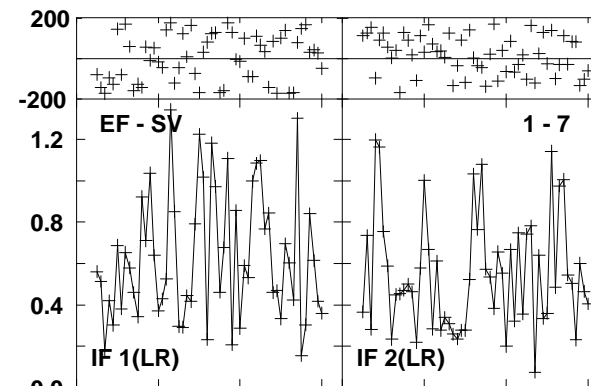
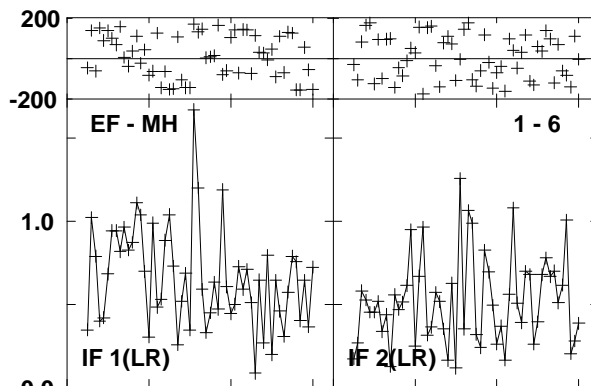
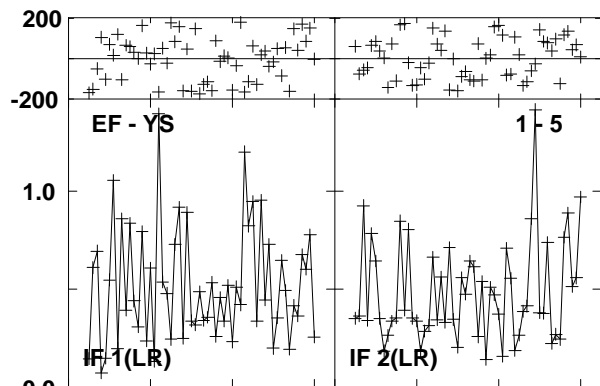
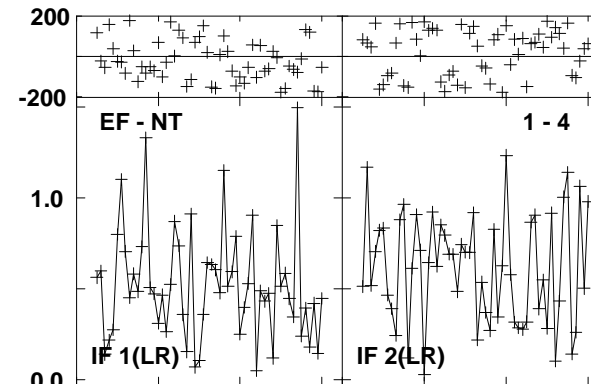
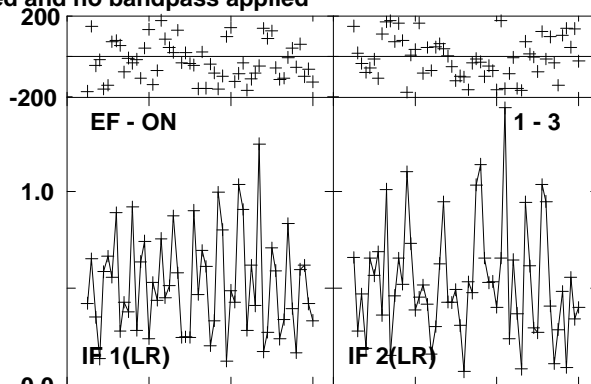
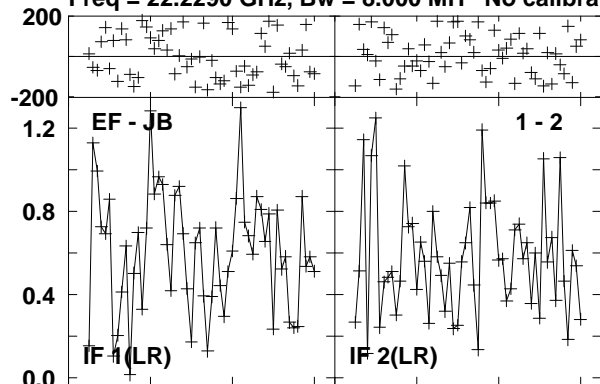

Lower frame: Milli Ampl Jy Top frame: Phas deg
Vector averaged cross-power spectrum Several baselines displayed
Timerange: 00/13:22:38 to 00/13:23:34

Plot file version 154 created 17-SEP-2012 12:07:36

ORIKL1 EE008D 1.UVDATA.1

Freq = 22.2290 GHz, Bw = 8.000 MH No calibration applied and no bandpass applied

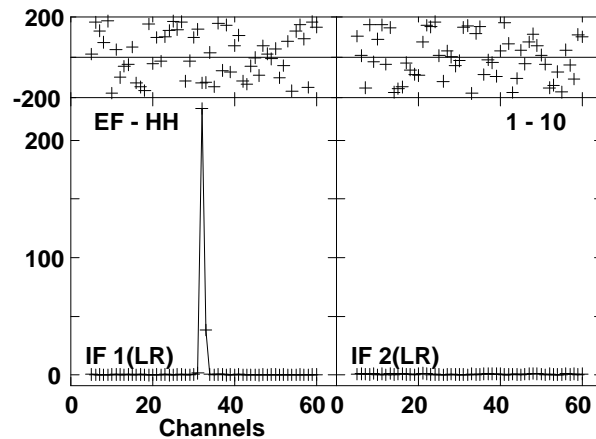
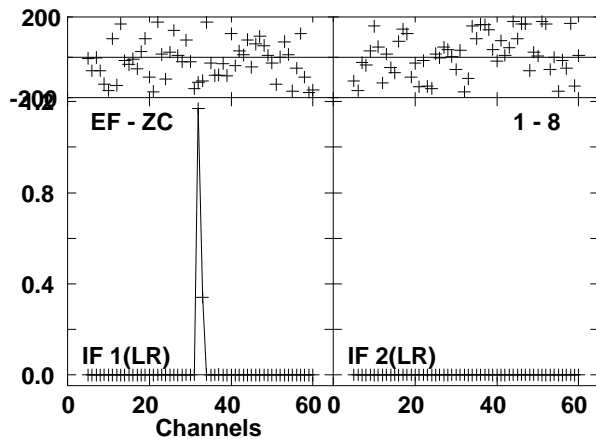
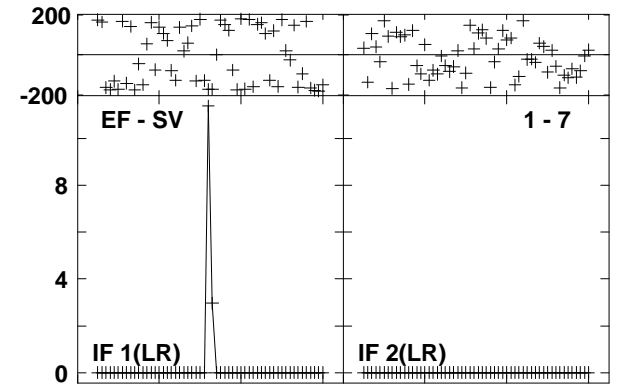
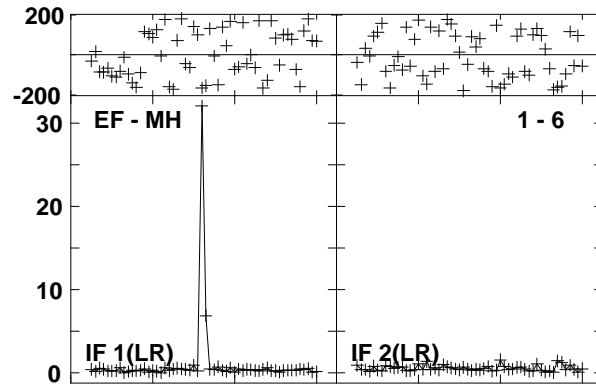
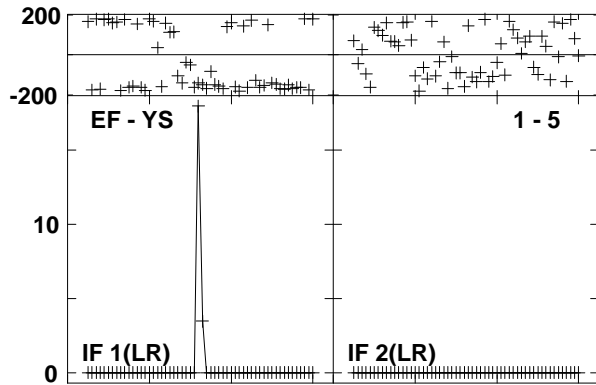
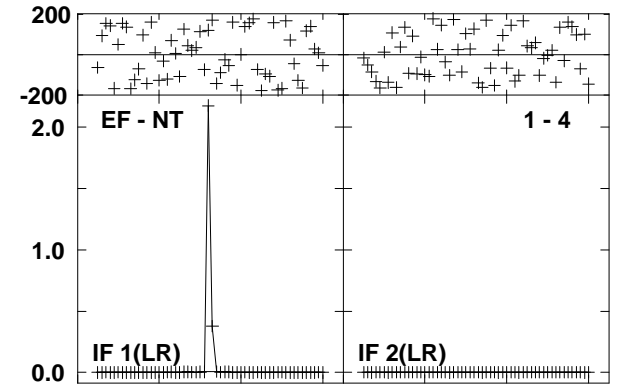
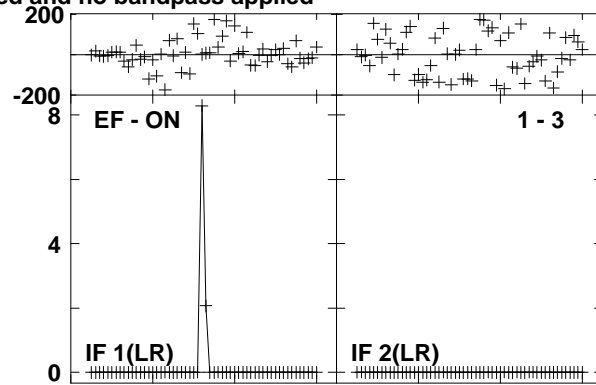
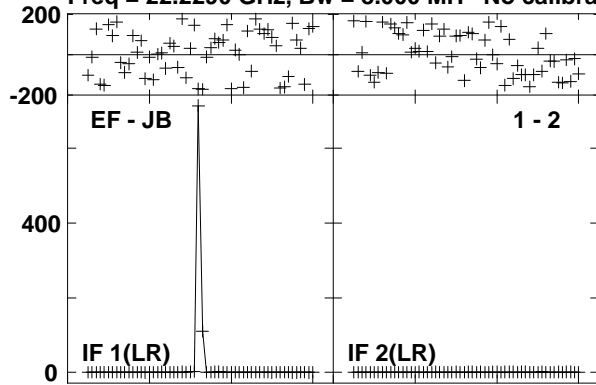

Lower frame: Milli Ampl Jy Top frame: Phas deg

Vector averaged cross-power spectrum Several baselines displayed

Timerange: 00/13:23:38 to 00/13:24:34

Plot file version 155 created 17-SEP-2012 12:07:38

J0529-0519 EE008D 1.UVDATA.1

Freq = 22.2290 GHz, Bw = 8.000 MH No calibration applied and no bandpass applied

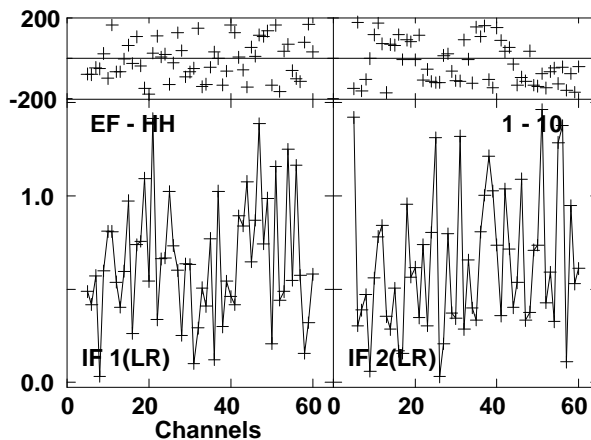
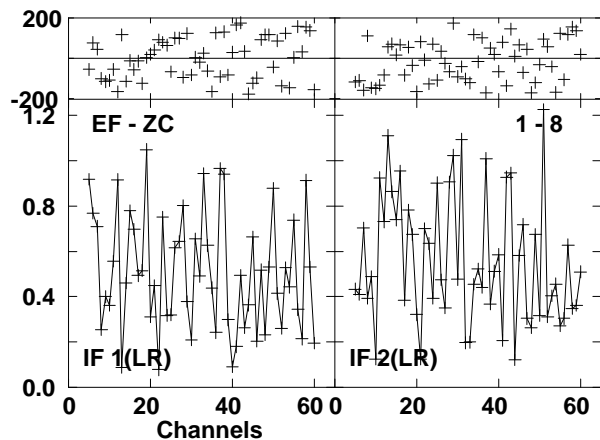
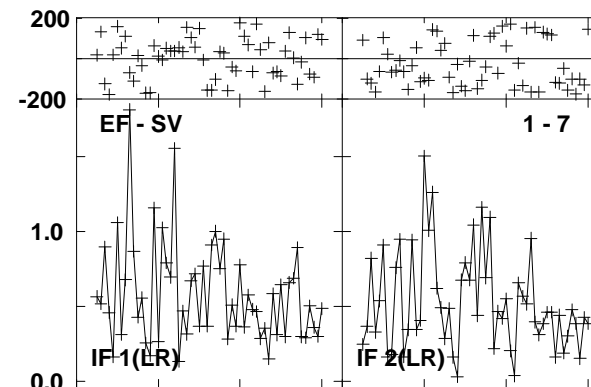
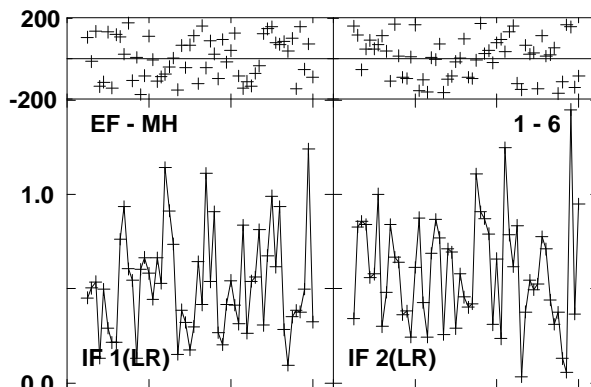
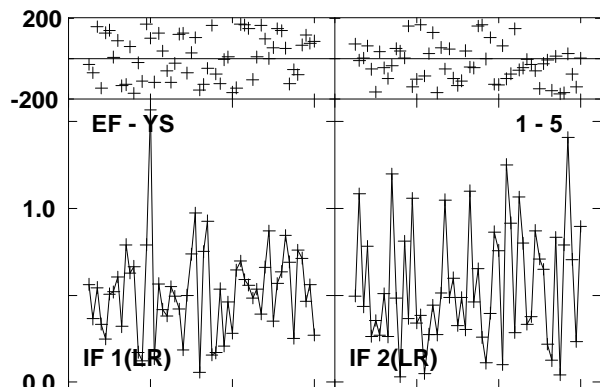
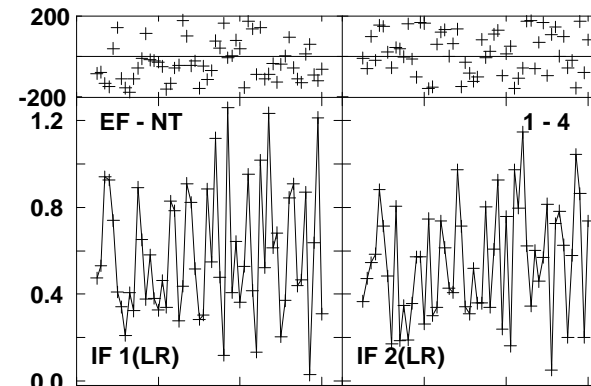
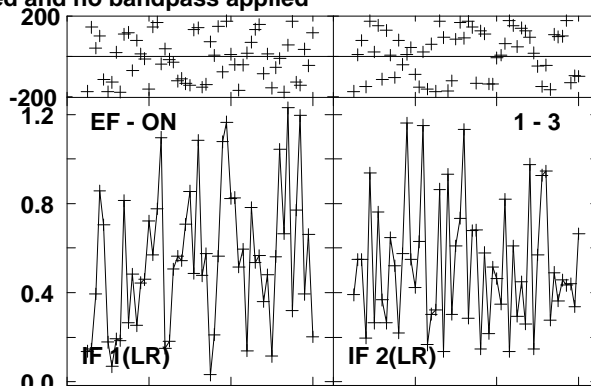
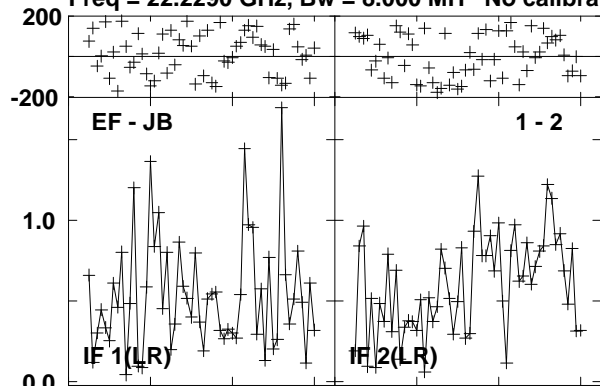

Lower frame: Milli Ampl Jy Top frame: Phas deg
Vector averaged cross-power spectrum Several baselines displayed
Timerange: 00/13:24:38 to 00/13:25:34

Plot file version 156 created 17-SEP-2012 12:07:41

J0541-0541 EE008D 1.UVDATA.1

Freq = 22.2290 GHz, Bw = 8.000 MH No calibration applied and no bandpass applied

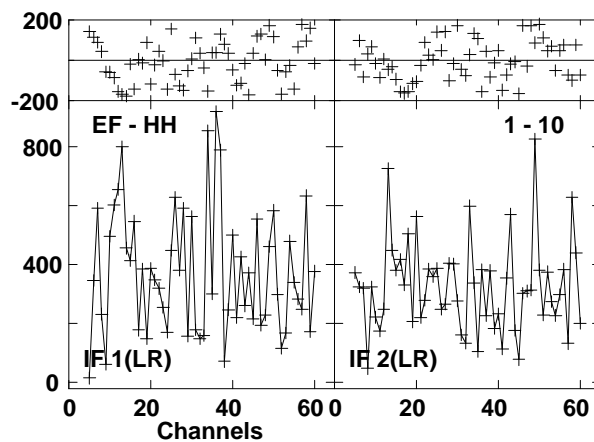
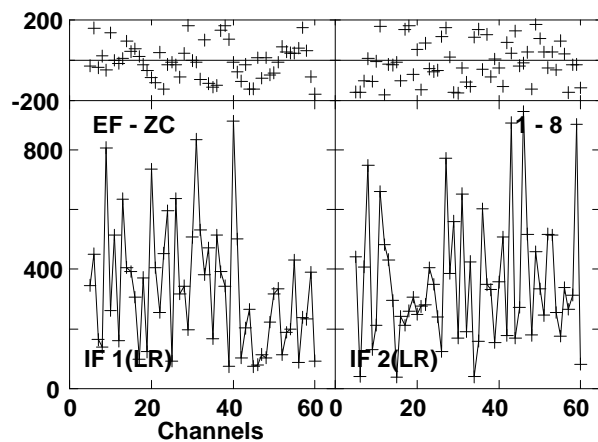
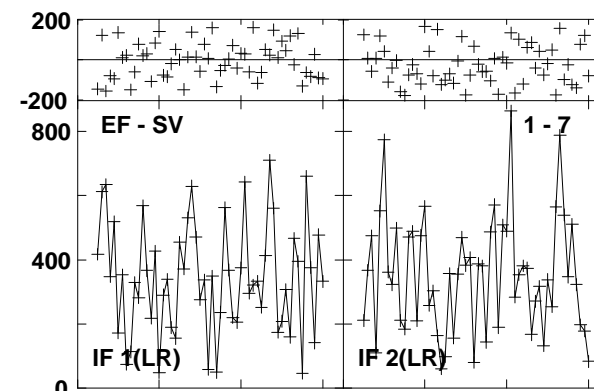
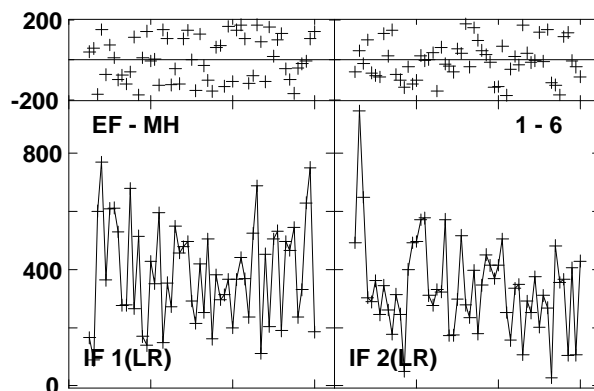
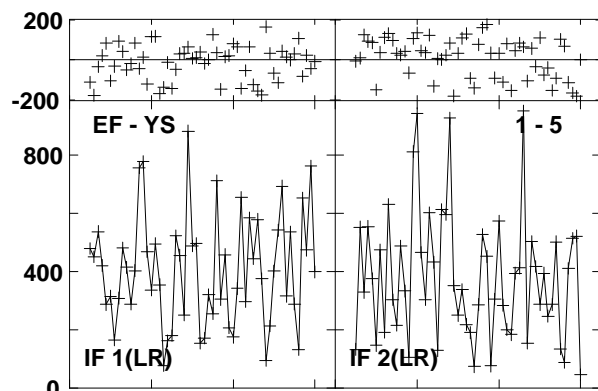
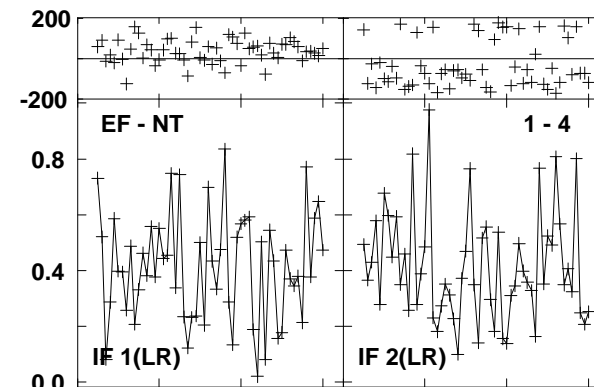
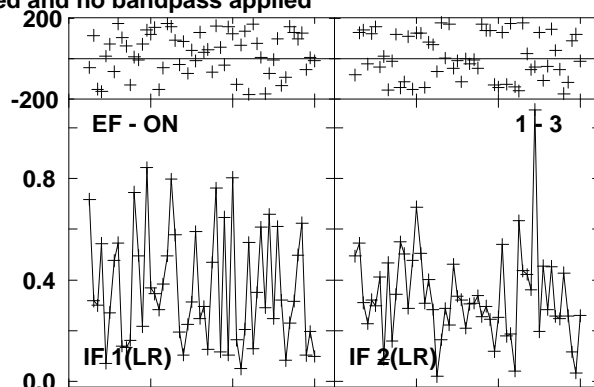
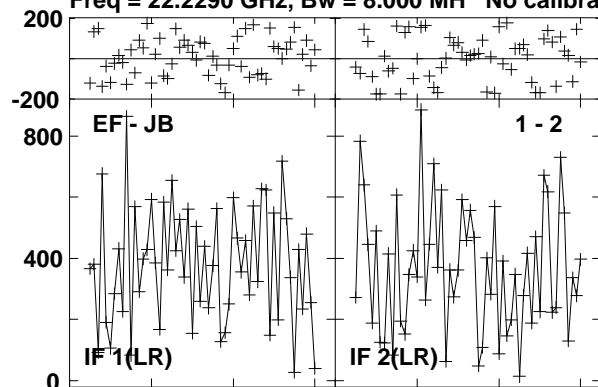

Lower frame: Micro Ampl Jy Top frame: Phas deg

Vector averaged cross-power spectrum Several baselines displayed

Timerange: 00/13:26:20 to 00/13:27:19

Plot file version 157 created 17-SEP-2012 12:07:44

ORIKL1 EE008D 1.UVDATA.1

Freq = 22.2290 GHz, Bw = 8.000 MH No calibration applied and no bandpass applied

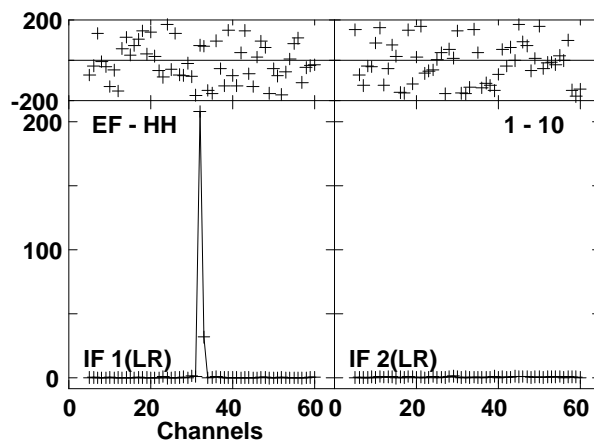
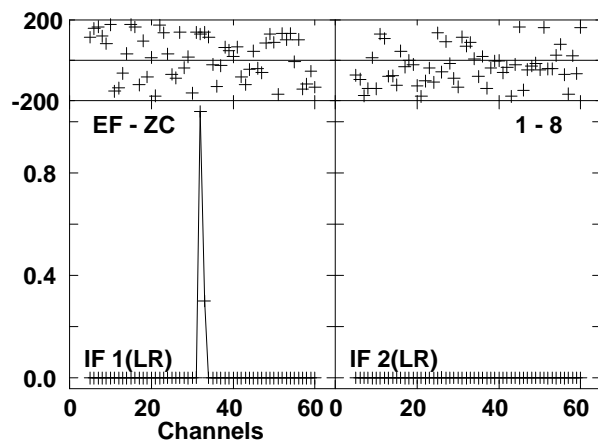
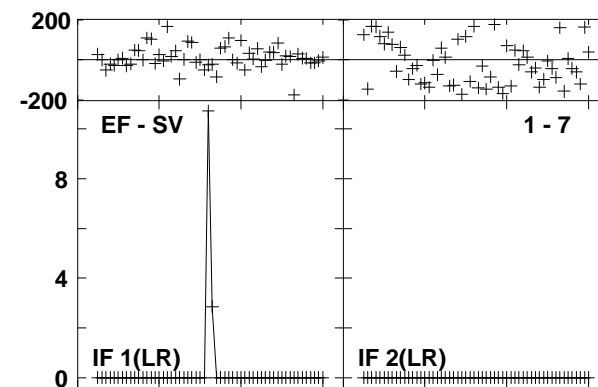
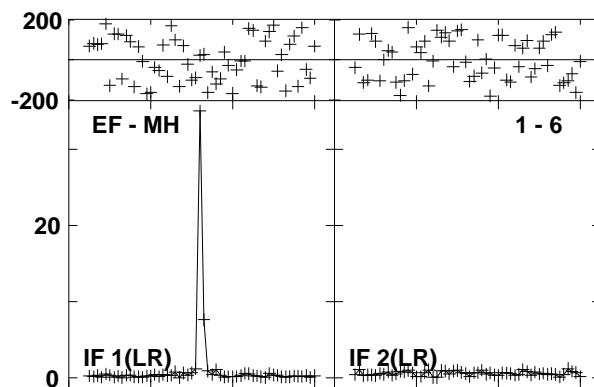
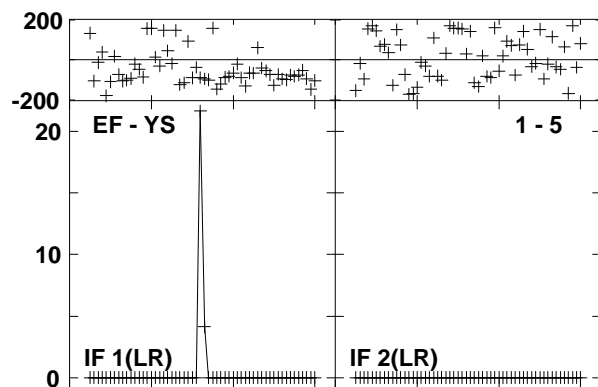
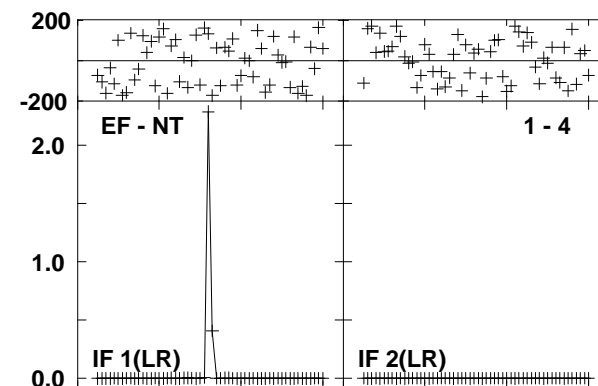
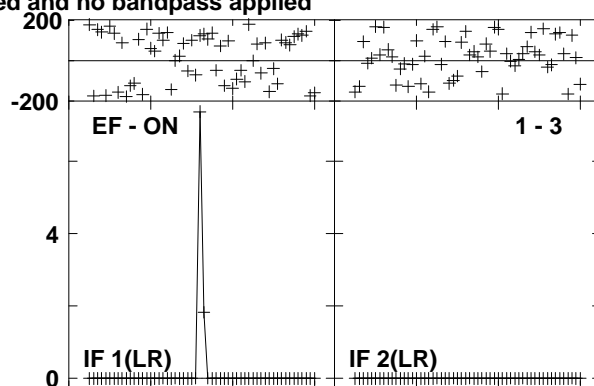
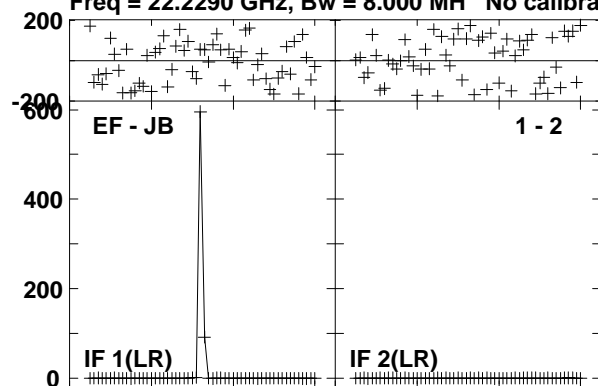

Lower frame: Milli Ampl Jy Top frame: Phas deg

Vector averaged cross-power spectrum Several baselines displayed

Timerange: 00/13:27:23 to 00/13:28:19

Plot file version 158 created 17-SEP-2012 12:07:46

J0541-0541 EE008D 1.UVDATA.1

Freq = 22.2290 GHz, Bw = 8.000 MH No calibration applied and no bandpass applied

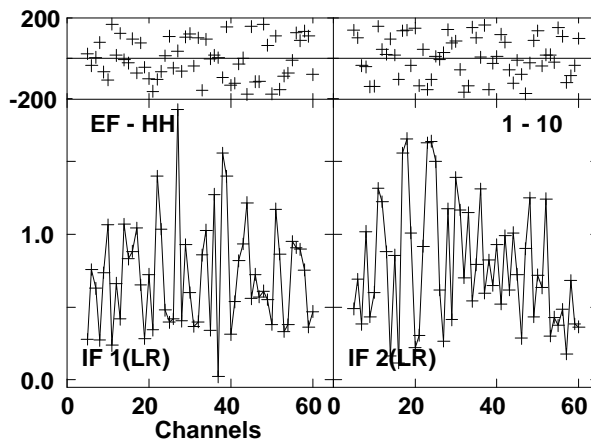
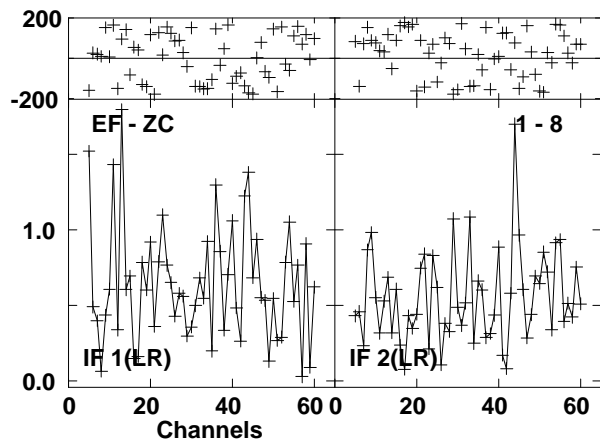
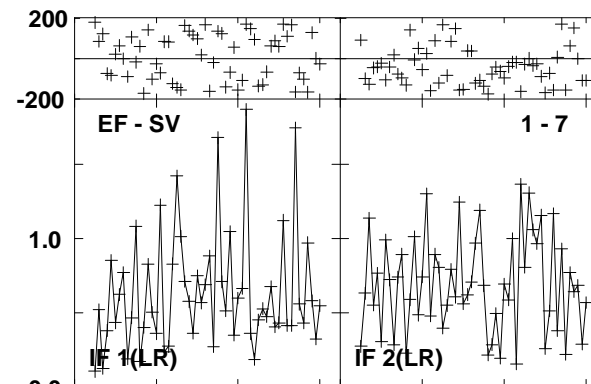
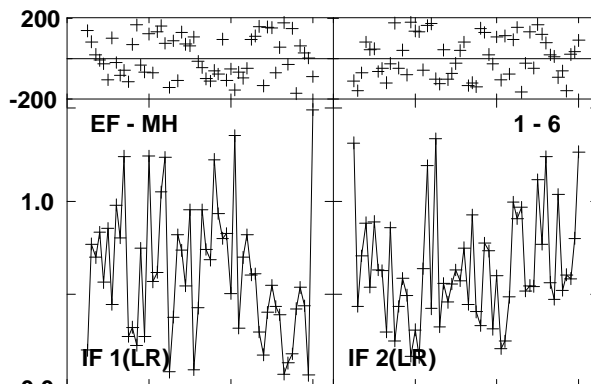
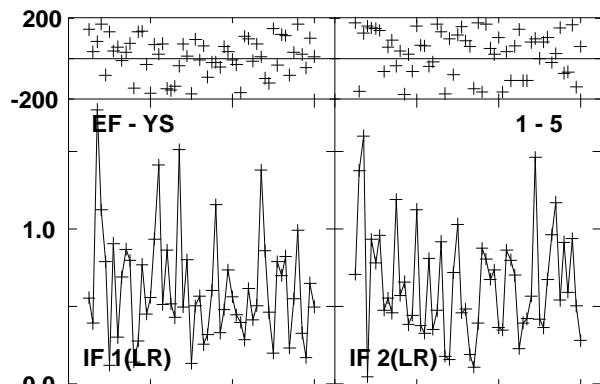
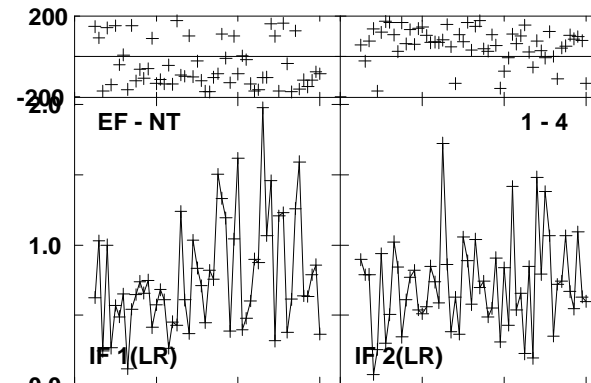
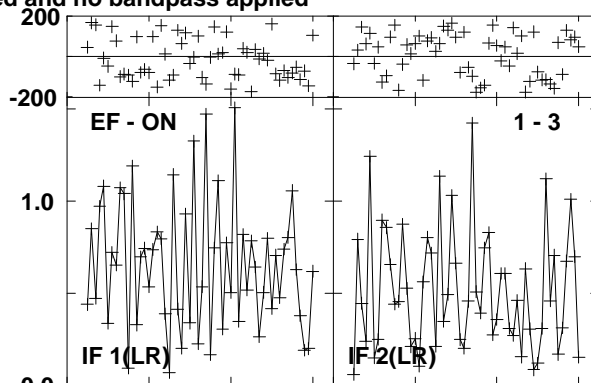
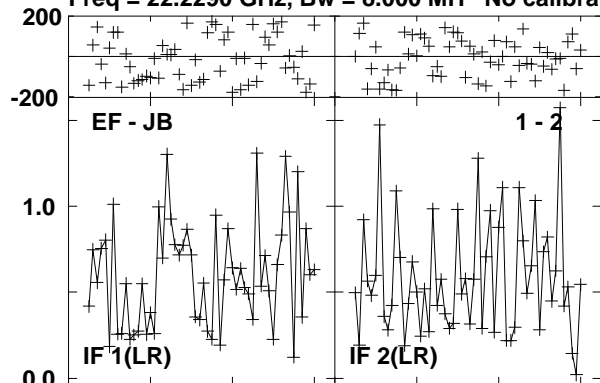

Lower frame: Milli Ampl Jy Top frame: Phas deg
Vector averaged cross-power spectrum Several baselines displayed
Timerange: 00/13:28:24 to 00/13:29:19

Plot file version 159 created 17-SEP-2012 12:07:48

ORIKL1 EE008D 1.UVDATA.1

Freq = 22.2290 GHz, Bw = 8.000 MH No calibration applied and no bandpass applied

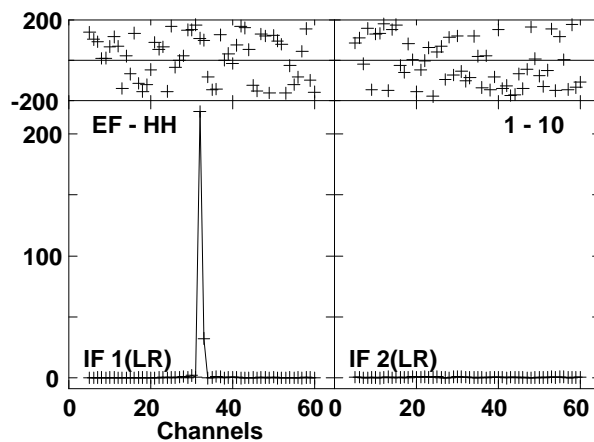
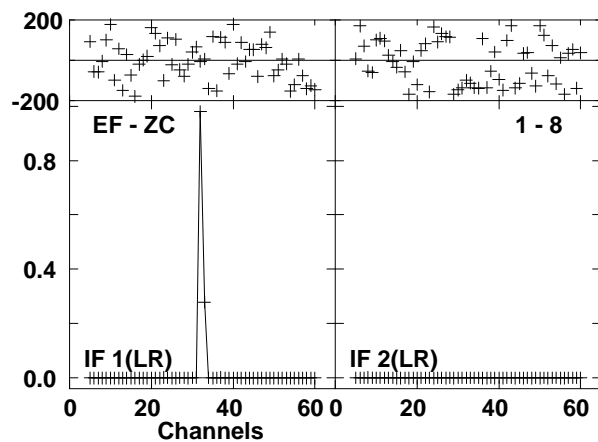
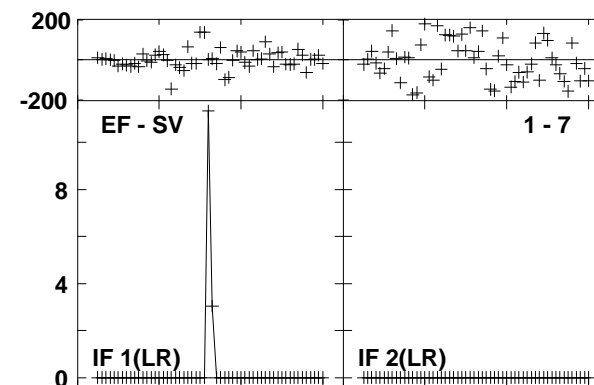
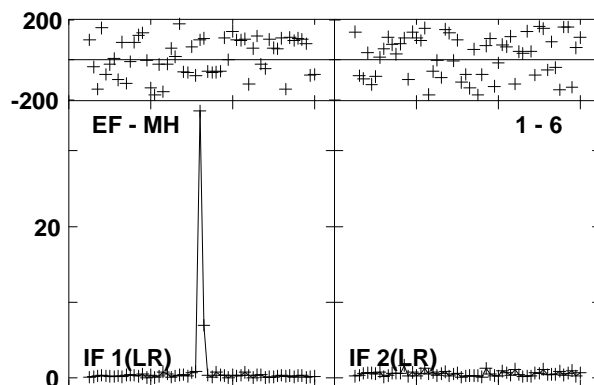
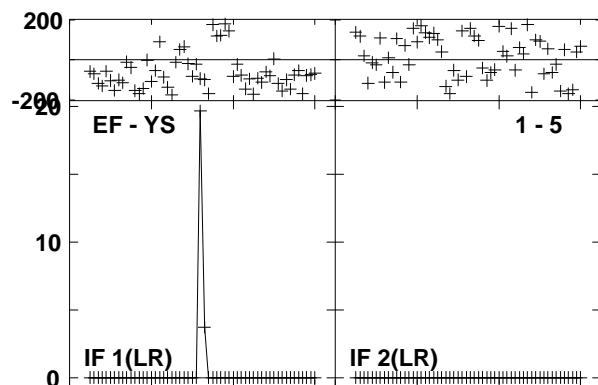
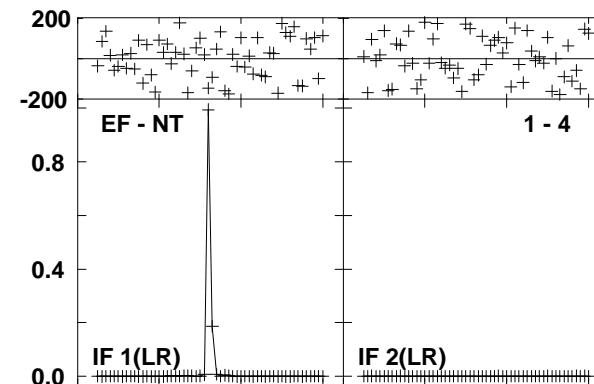
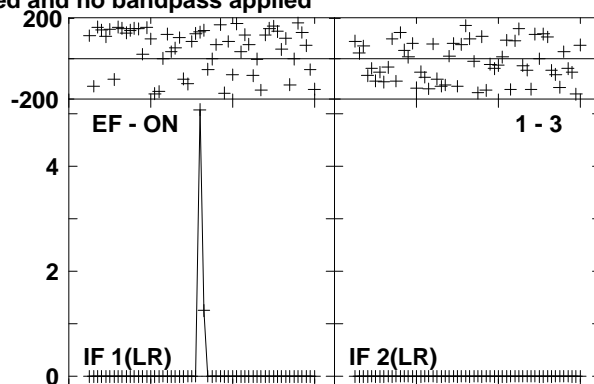
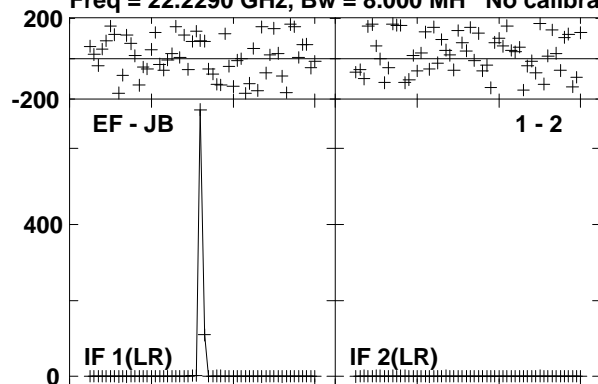

Lower frame: Milli Ampl Jy Top frame: Phas deg

Vector averaged cross-power spectrum Several baselines displayed

Timerange: 00/13:29:24 to 00/13:30:19

Plot file version 160 created 17-SEP-2012 12:07:50

J0541-0541 EE008D 1.UVDATA.1

Freq = 22.2290 GHz, Bw = 8.000 MH No calibration applied and no bandpass applied

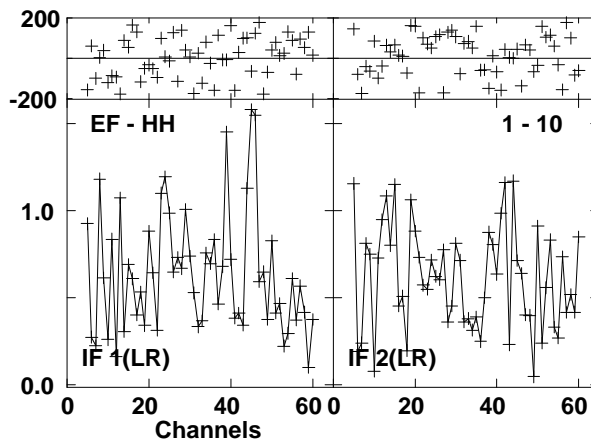
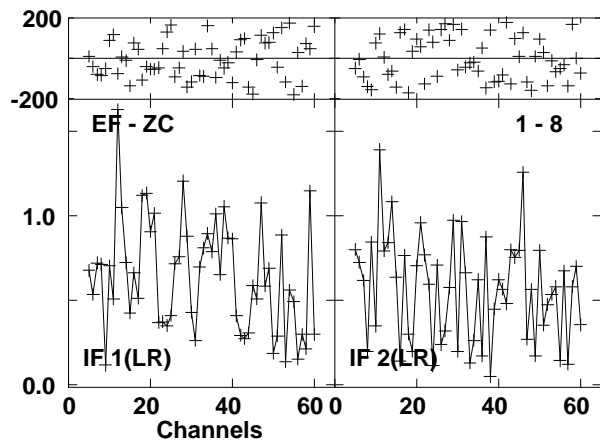
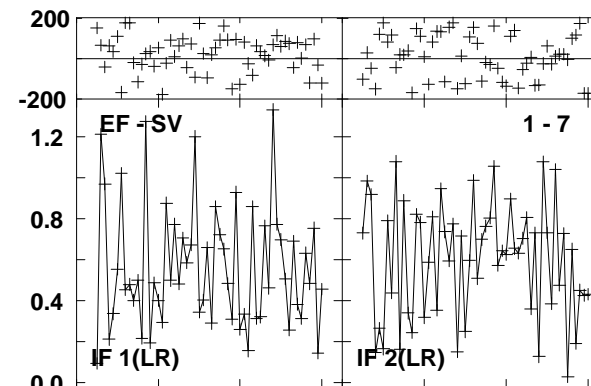
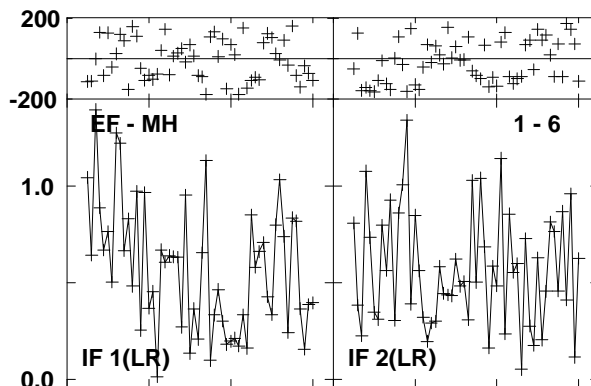
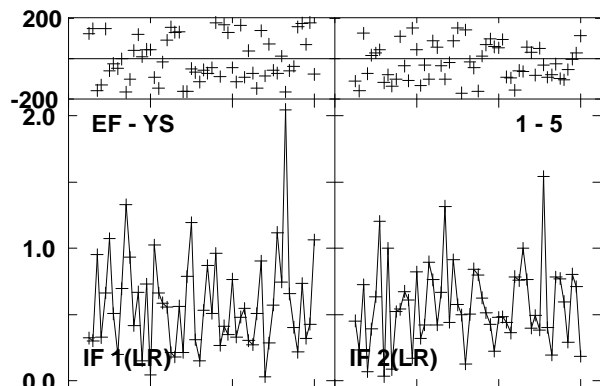
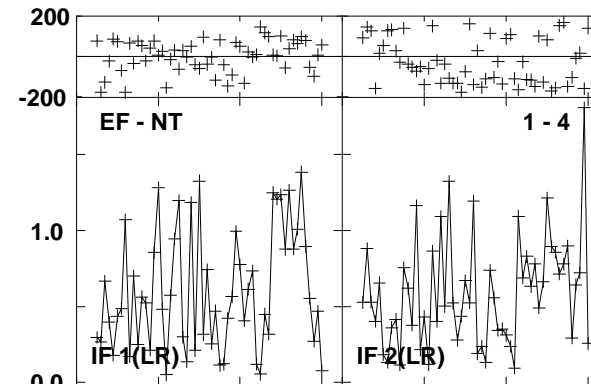
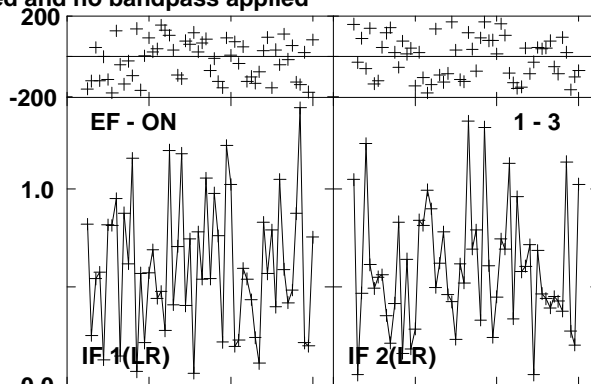
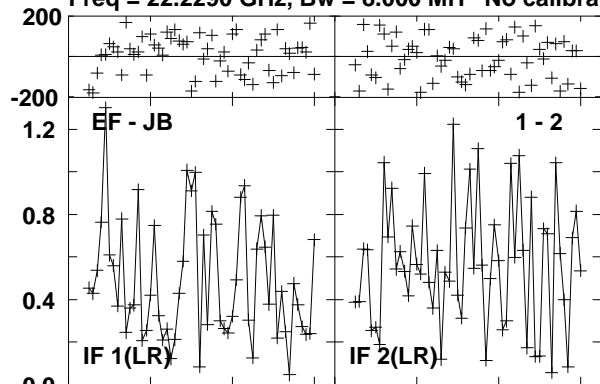

Lower frame: Milli Ampl Jy Top frame: Phas deg
Vector averaged cross-power spectrum Several baselines displayed
Timerange: 00/13:30:24 to 00/13:31:19

Plot file version 161 created 17-SEP-2012 12:07:52

J0529-0519 EE008D 1.UVDATA.1

Freq = 22.2290 GHz, Bw = 8.000 MH No calibration applied and no bandpass applied

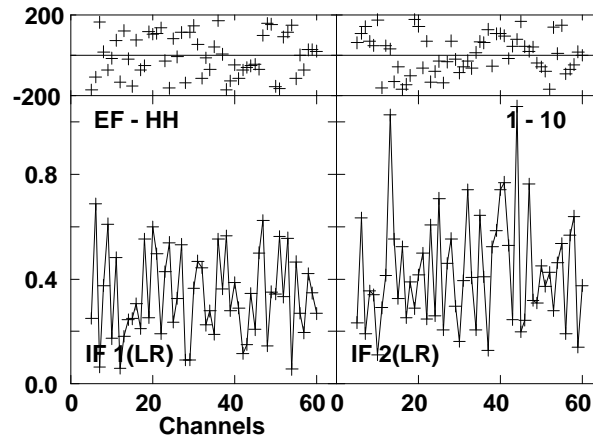
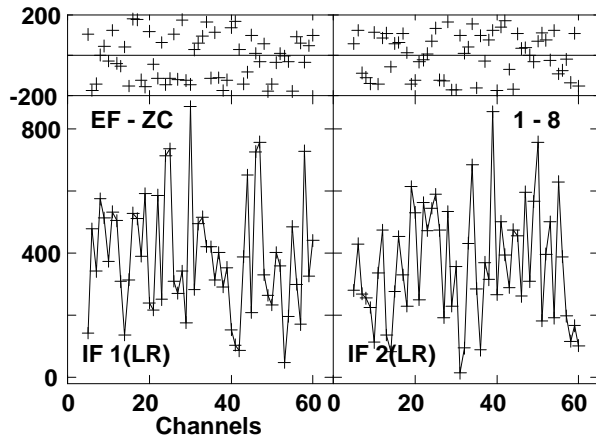
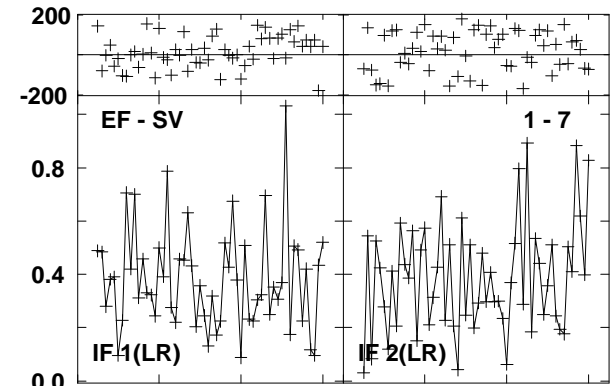
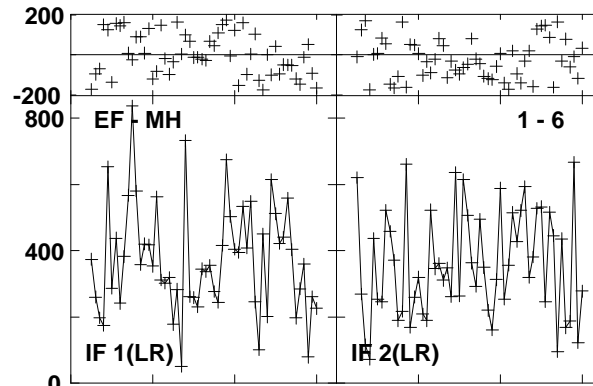
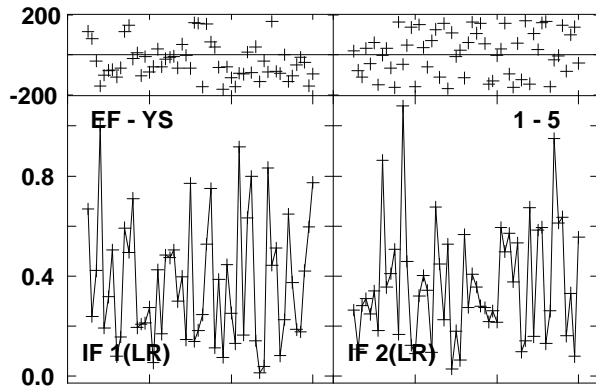
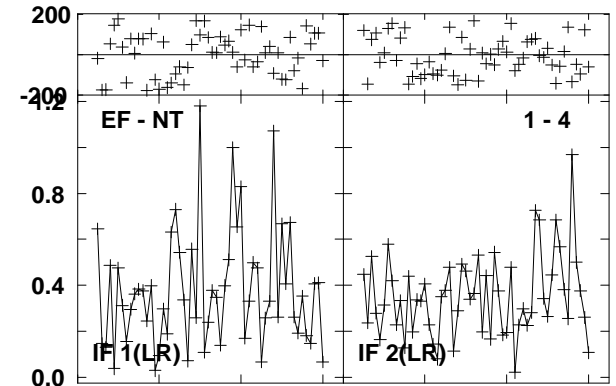
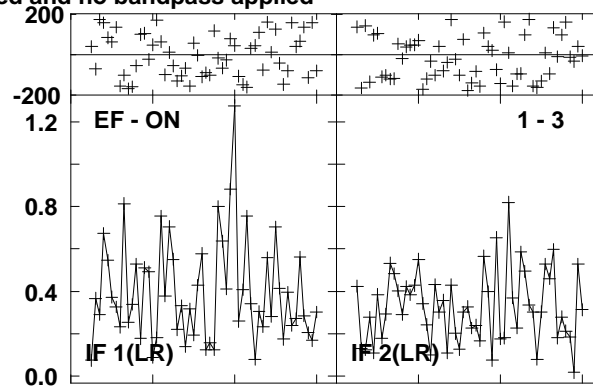
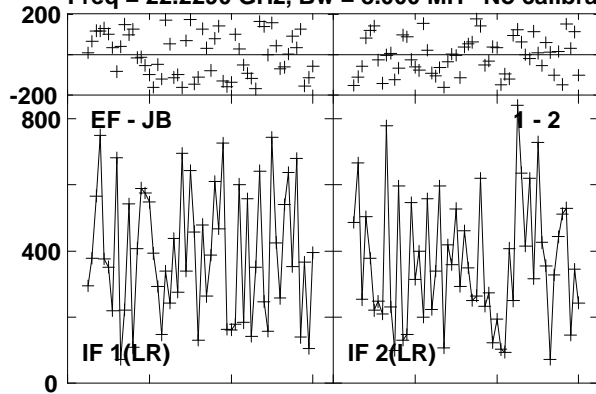

Lower frame: Micro Ampl Jy Top frame: Phas deg

Vector averaged cross-power spectrum Several baselines displayed

Timerange: 00/13:32:06 to 00/13:33:05

Plot file version 162 created 17-SEP-2012 12:07:55

ORIKL1 EE008D 1.UVDATA.1

Freq = 22.2290 GHz, Bw = 8.000 MH No calibration applied and no bandpass applied

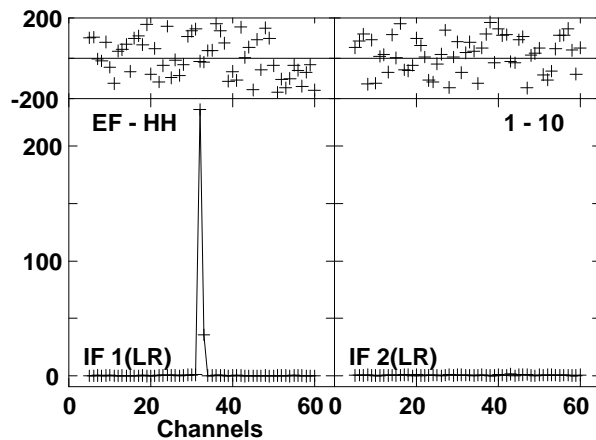
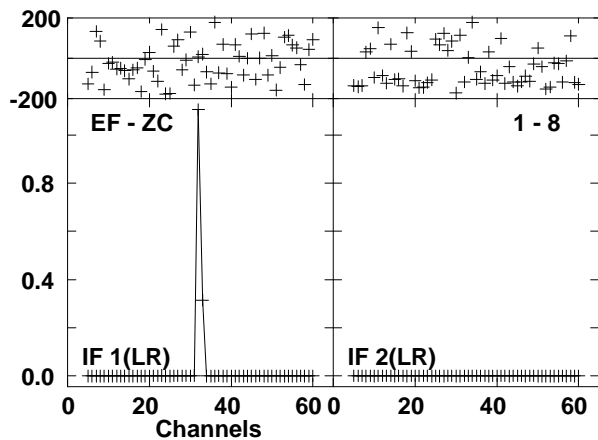
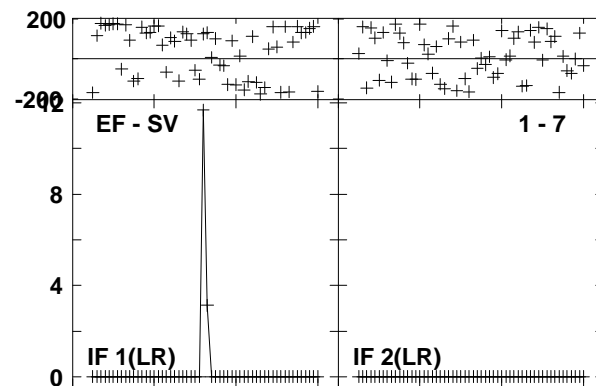
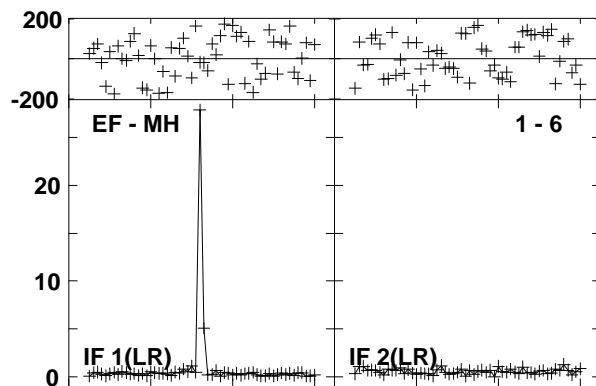
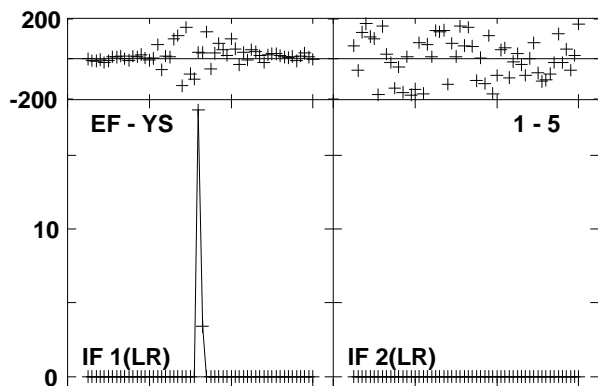
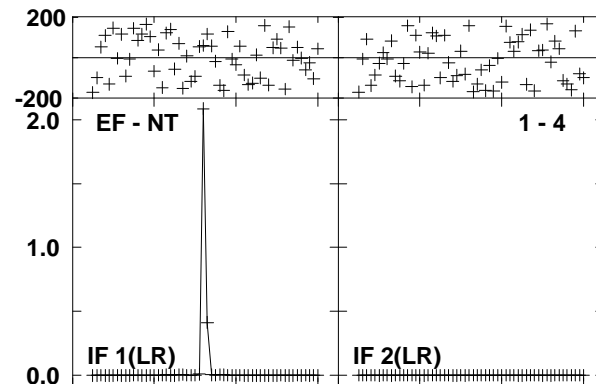
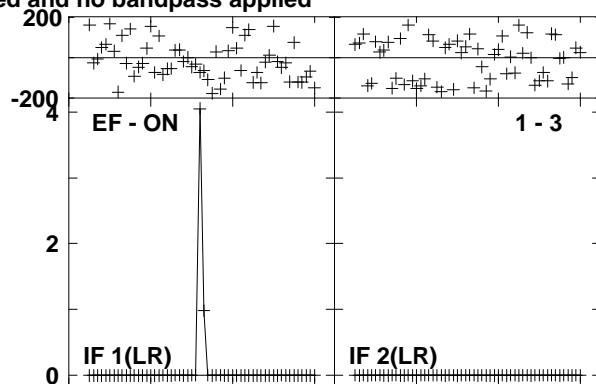
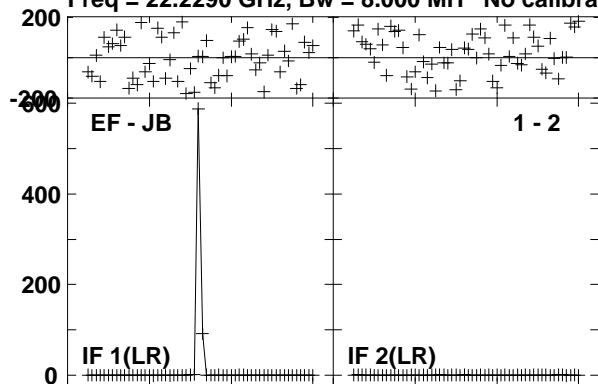

Lower frame: Milli Ampl Jy Top frame: Phas deg

Vector averaged cross-power spectrum Several baselines displayed

Timerange: 00/13:33:08 to 00/13:34:05

Plot file version 163 created 17-SEP-2012 12:07:57

J0529-0519 EE008D 1.UVDATA.1

Freq = 22.2290 GHz, Bw = 8.000 MH No calibration applied and no bandpass applied

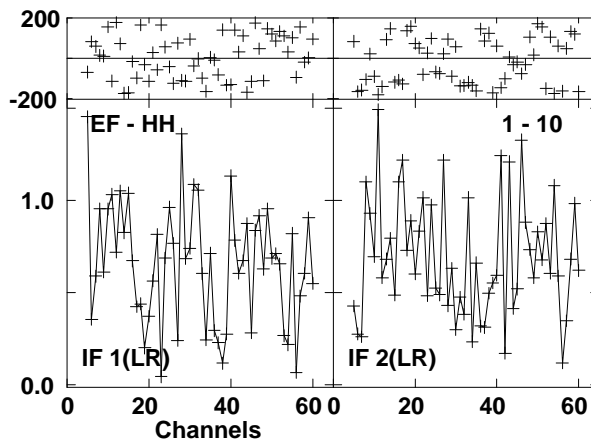
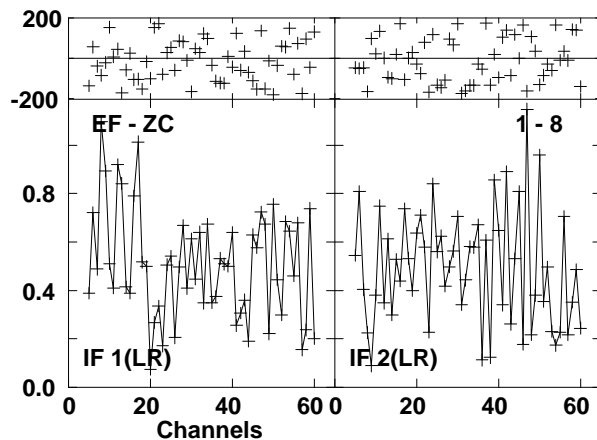
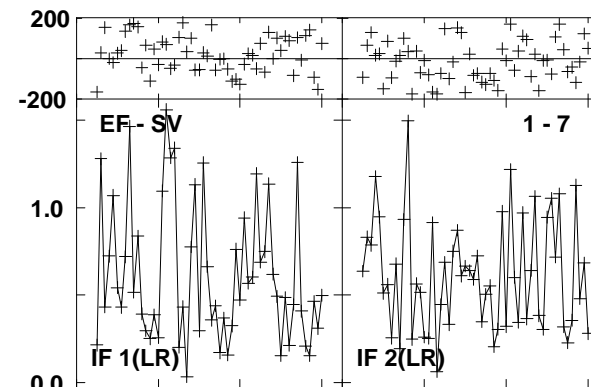
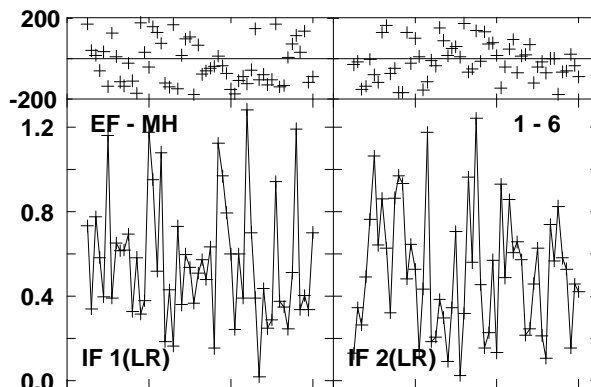
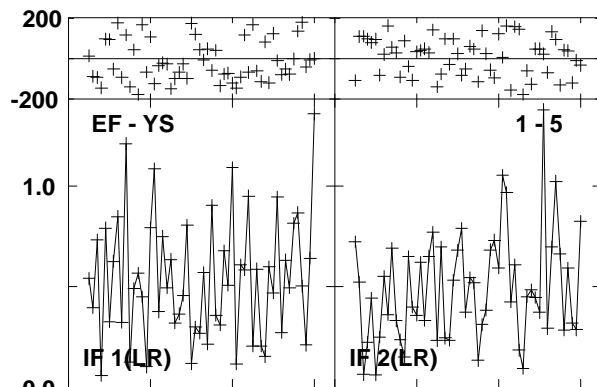
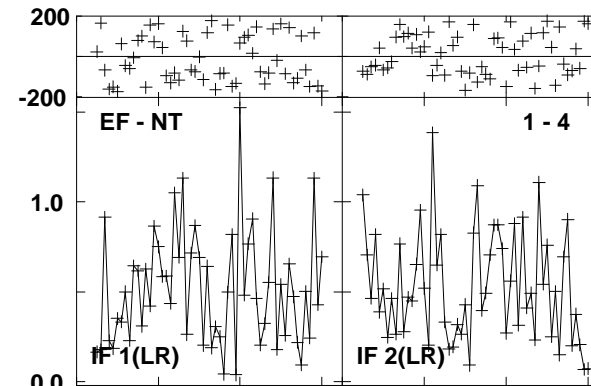
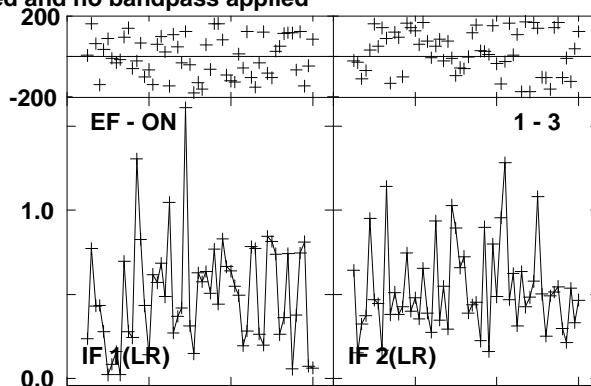
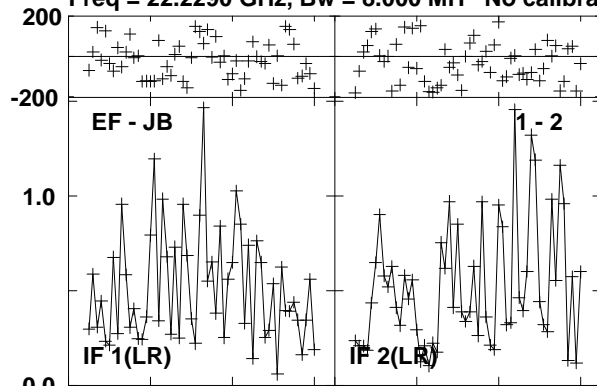

Lower frame: Milli Ampl Jy Top frame: Phas deg
Vector averaged cross-power spectrum Several baselines displayed
Timerange: 00/13:34:09 to 00/13:35:05

Plot file version 164 created 17-SEP-2012 12:07:59

ORIKL1 EE008D 1.UVDATA.1

Freq = 22.2290 GHz, Bw = 8.000 MH No calibration applied and no bandpass applied

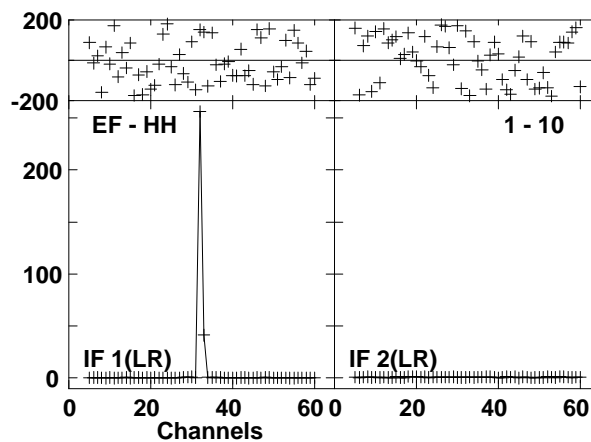
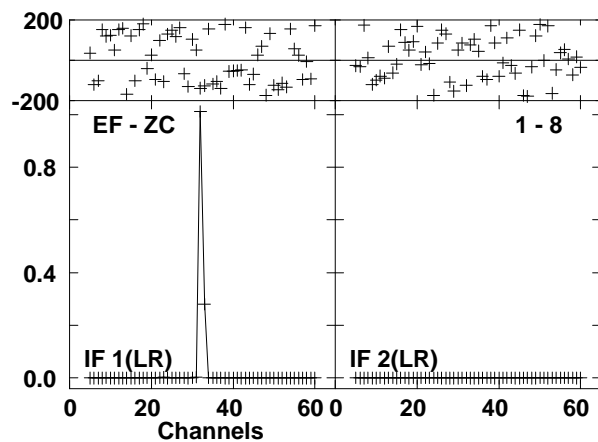
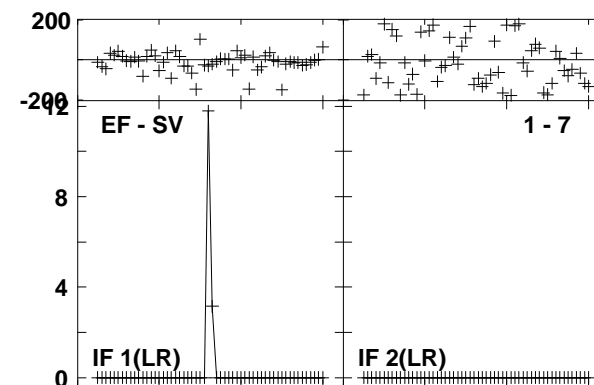
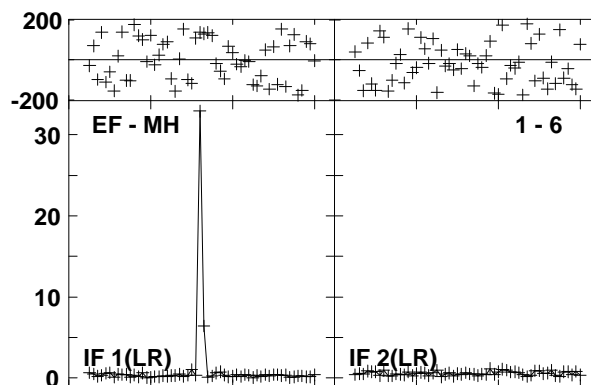
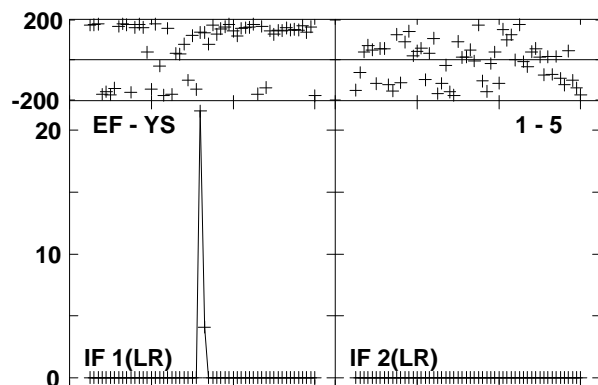
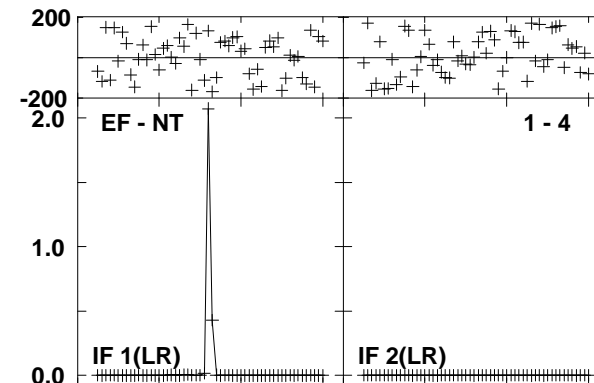
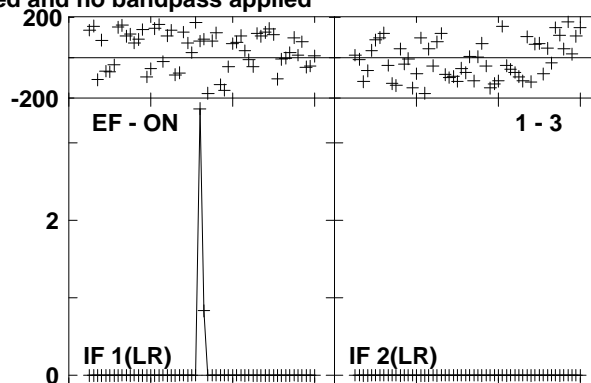
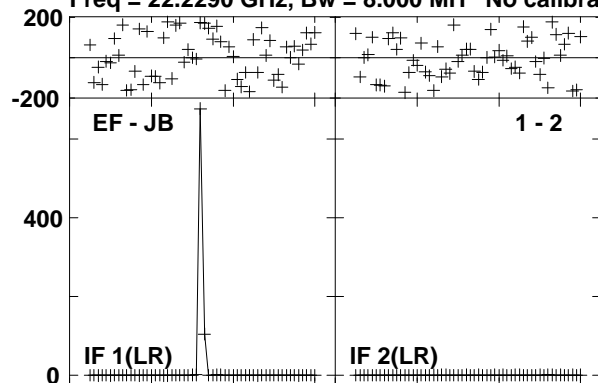

Lower frame: Milli Ampl Jy Top frame: Phas deg

Vector averaged cross-power spectrum Several baselines displayed

Timerange: 00/13:35:09 to 00/13:36:05

Plot file version 165 created 17-SEP-2012 12:08:02

J0529-0519 EE008D 1.UVDATA.1

Freq = 22.2290 GHz, Bw = 8.000 MH No calibration applied and no bandpass applied

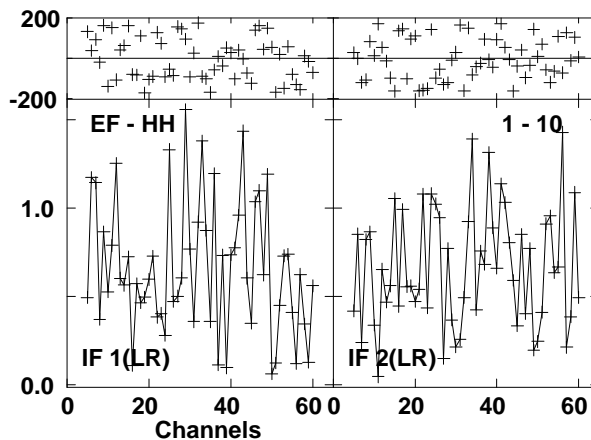
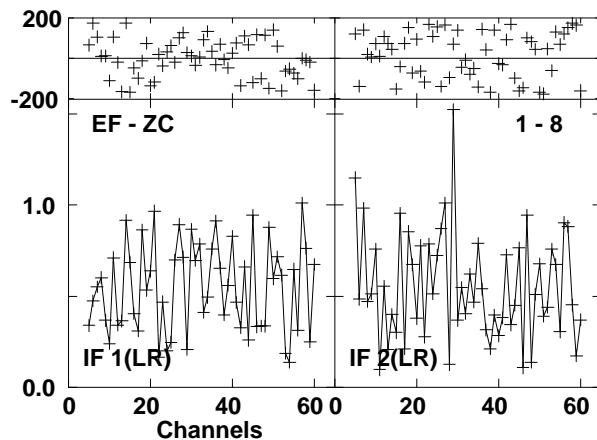
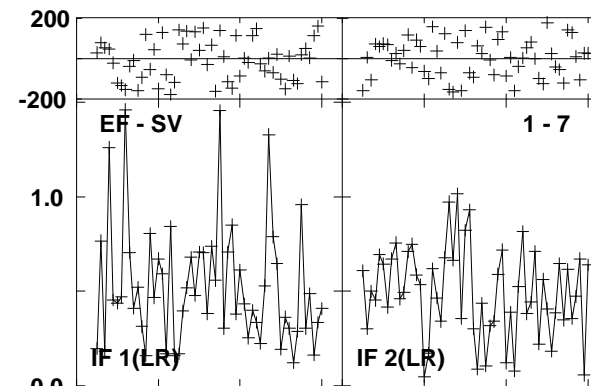
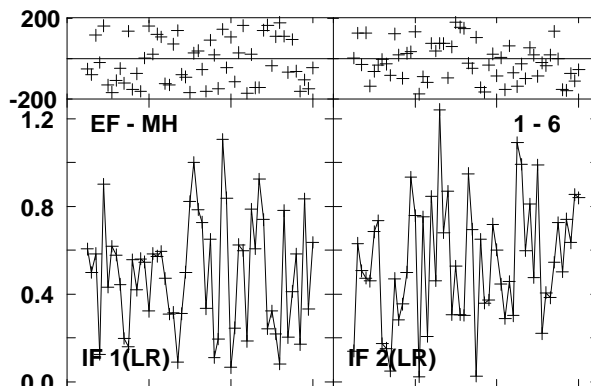
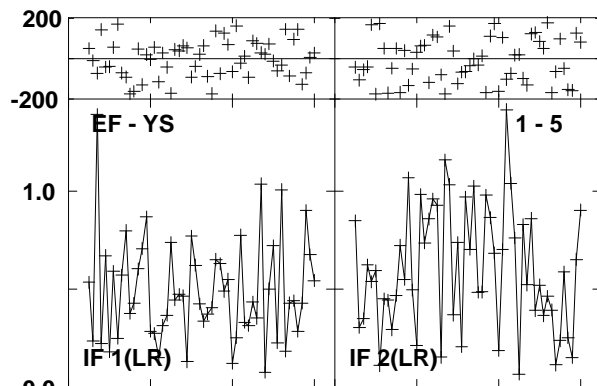
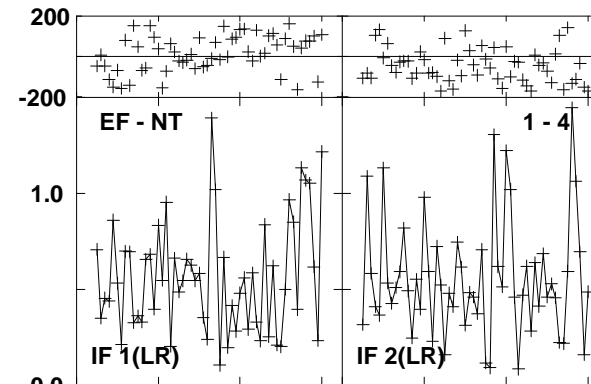
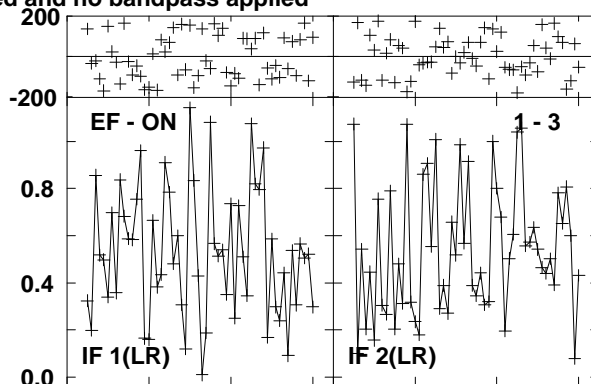
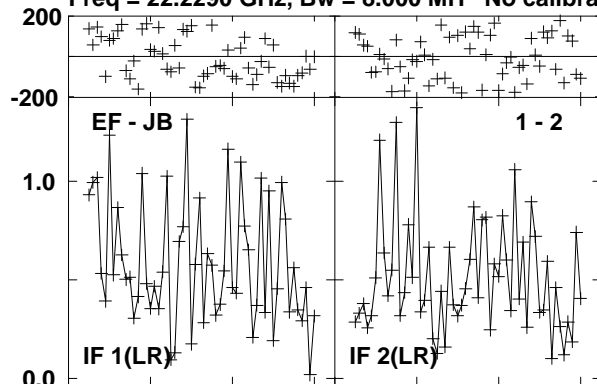

Lower frame: Milli Ampl Jy Top frame: Phas deg
Vector averaged cross-power spectrum Several baselines displayed
Timerange: 00/13:36:10 to 00/13:37:05

Plot file version 166 created 17-SEP-2012 12:08:06

J0423-0120 EE008D 1.UVDATA.1

Freq = 22.2290 GHz, Bw = 8.000 MH No calibration applied and no bandpass applied

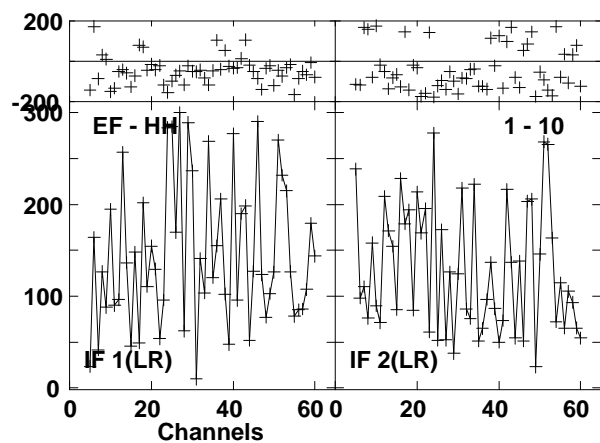
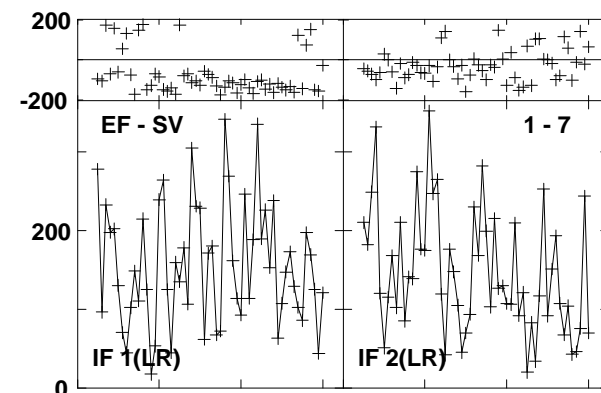
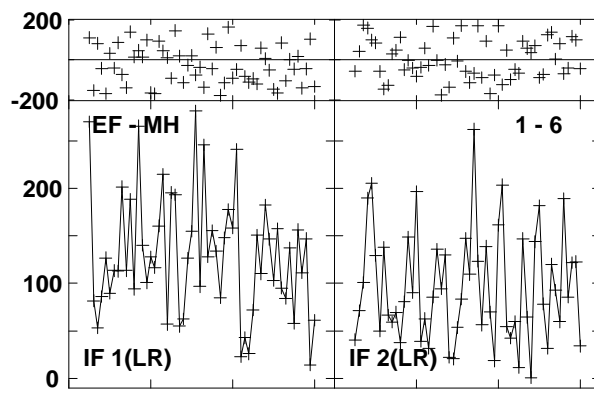
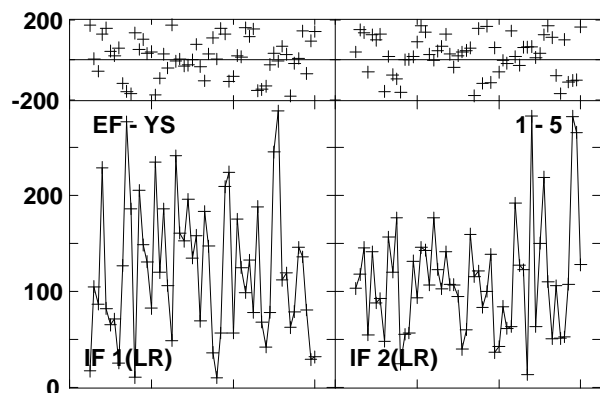
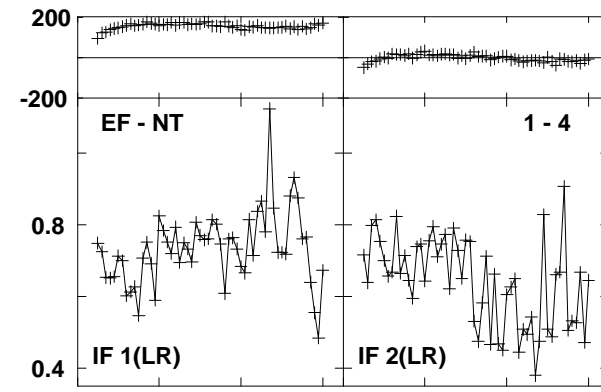
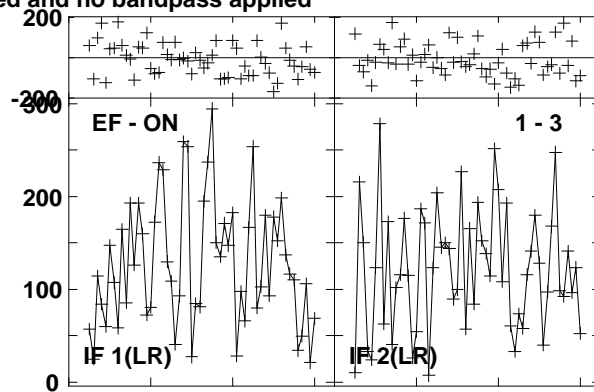
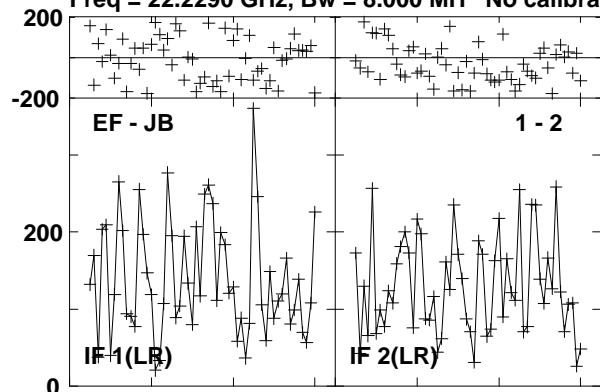

Lower frame: Micro Ampl Jy Top frame: Phas deg

Vector averaged cross-power spectrum Several baselines displayed

Timerange: 00/13:38:31 to 00/13:48:00

Plot file version 167 created 17-SEP-2012 12:08:26

J0423-0120 EE008D 1.UVDATA.1

Freq = 22.2290 GHz, Bw = 8.000 MH No calibration applied and no bandpass applied

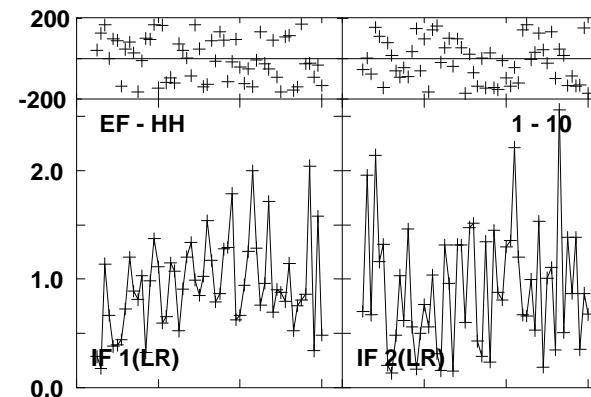
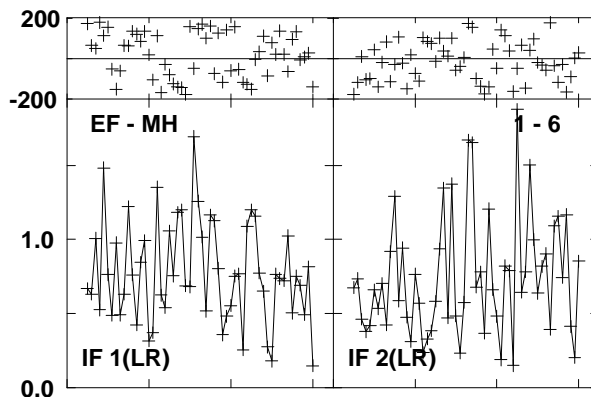
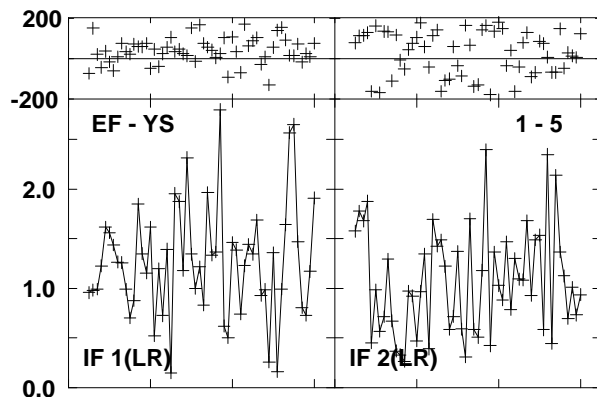
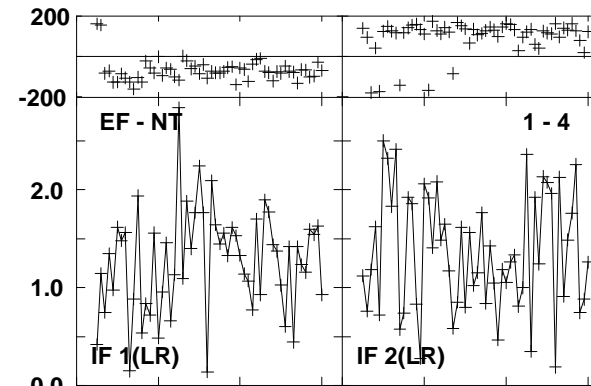
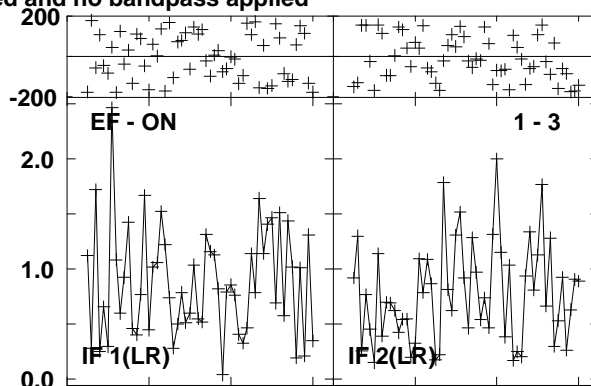
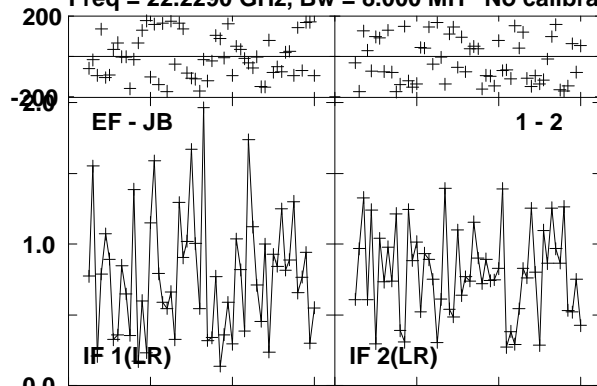

Lower frame: Milli Ampl Jy Top frame: Phas deg
Vector averaged cross-power spectrum Several baselines displayed
Timerange: 00/13:48:16 to 00/13:48:30

Plot file version 168 created 17-SEP-2012 12:08:30

4C39.25 EE008D 1.UVDATA.1

Freq = 22.2290 GHz, Bw = 8.000 MH No calibration applied and no bandpass applied

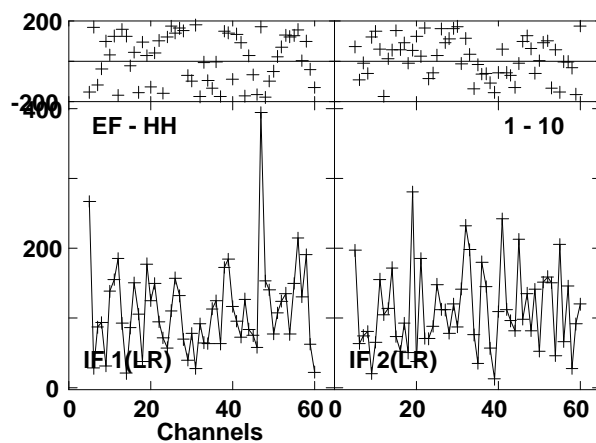
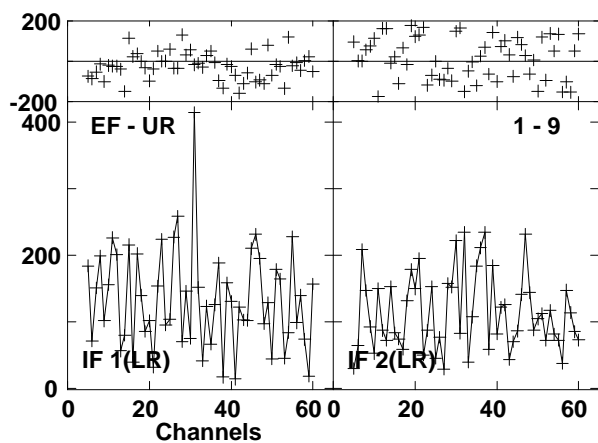
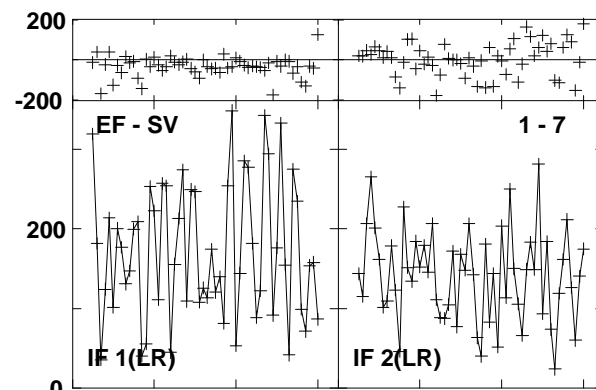
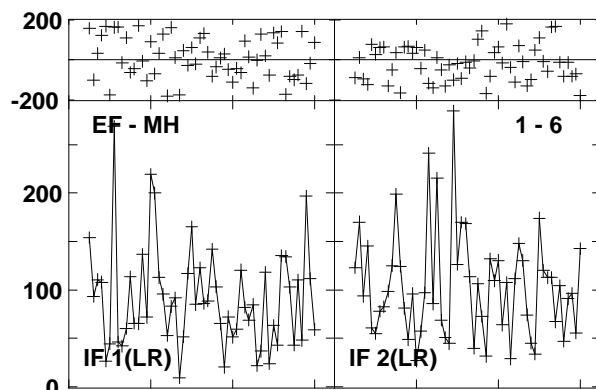
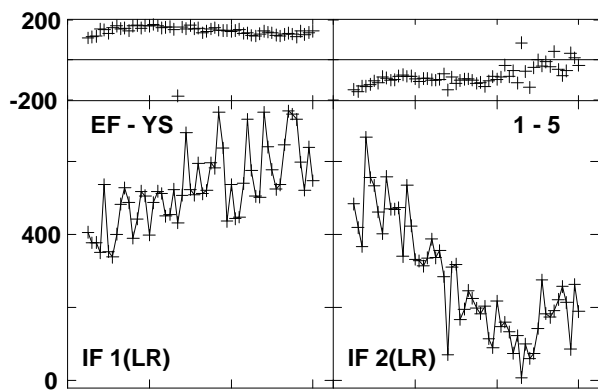
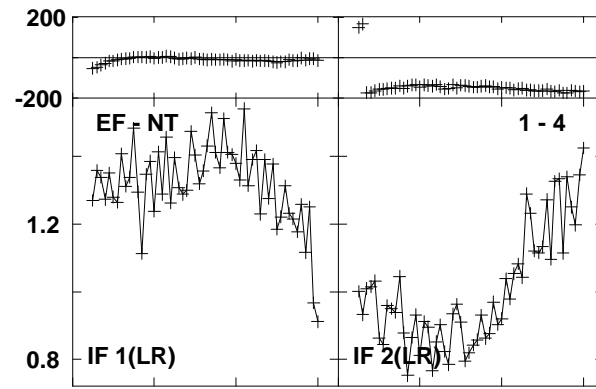
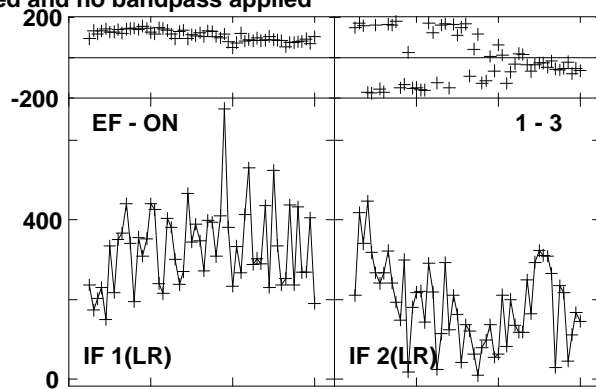
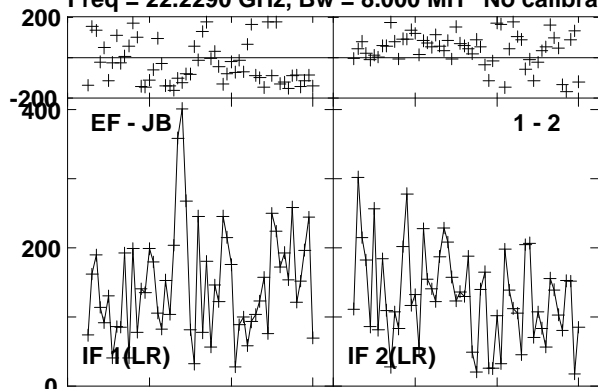

Lower frame: Micro Ampl Jy Top frame: Phas deg
Vector averaged cross-power spectrum Several baselines displayed
Timerange: 00/13:53:31 to 00/14:04:54

Plot file version 169 created 17-SEP-2012 12:08:58

4C39.25 EE008D 1.UVDATA.1

Freq = 22.2290 GHz, Bw = 8.000 MH No calibration applied and no bandpass applied

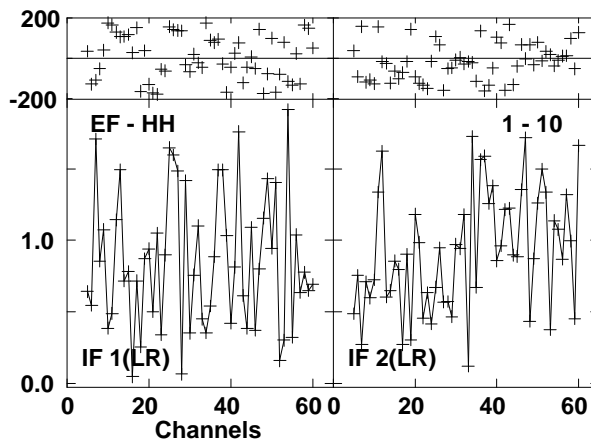
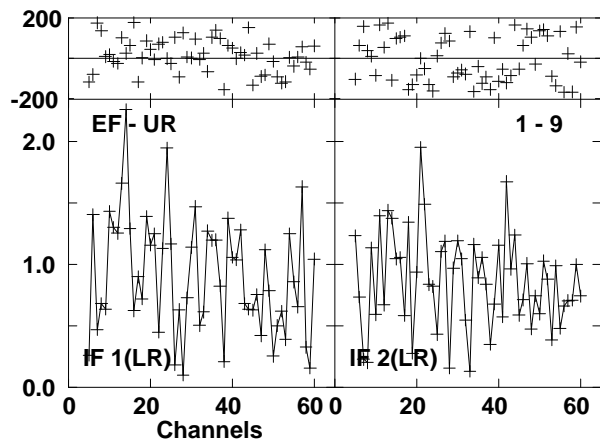
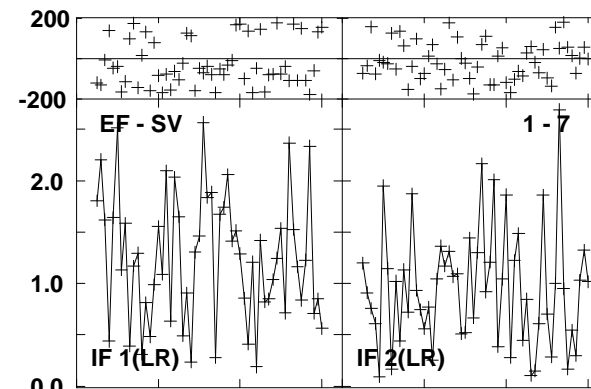
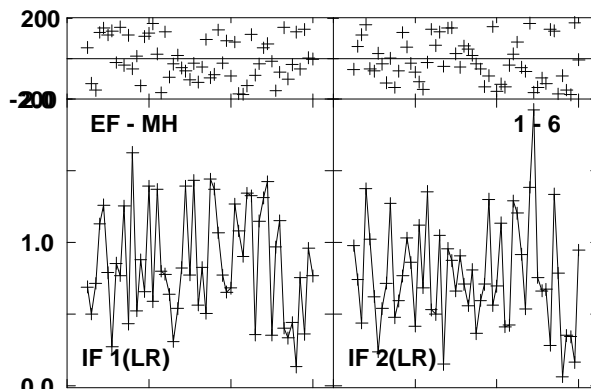
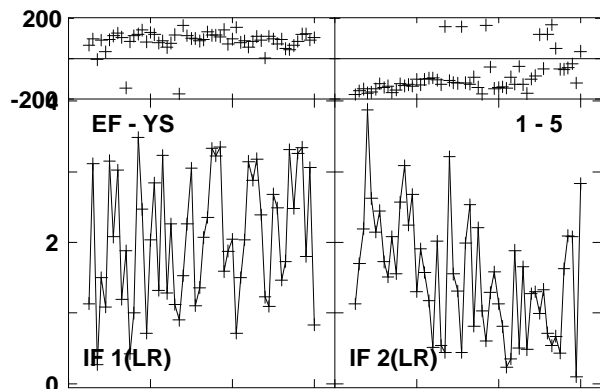
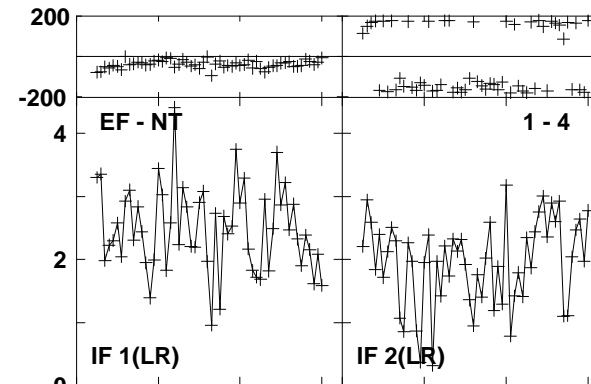
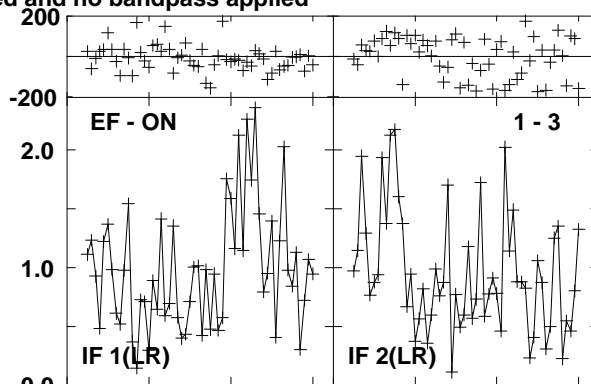
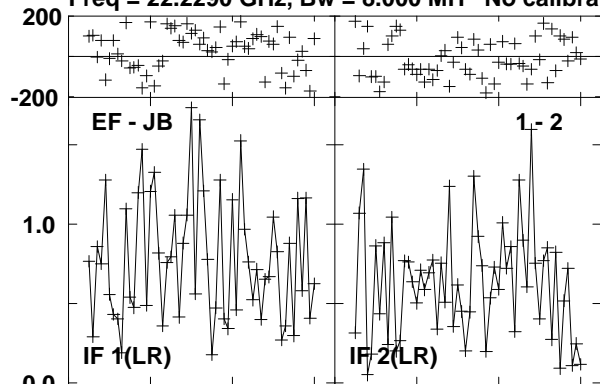

Lower frame: Milli Ampl Jy Top frame: Phas deg
Vector averaged cross-power spectrum Several baselines displayed
Timerange: 00/14:05:10 to 00/14:05:24

Plot file version 170 created 17-SEP-2012 12:08:59

J0541-0541 EE008D 1.UVDATA.1

Freq = 22.2290 GHz, Bw = 8.000 MH No calibration applied and no bandpass applied

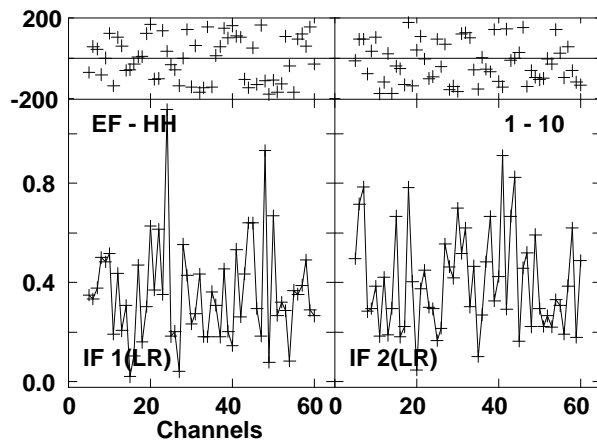
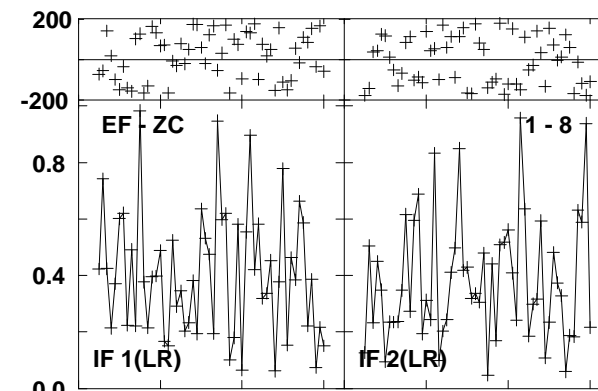
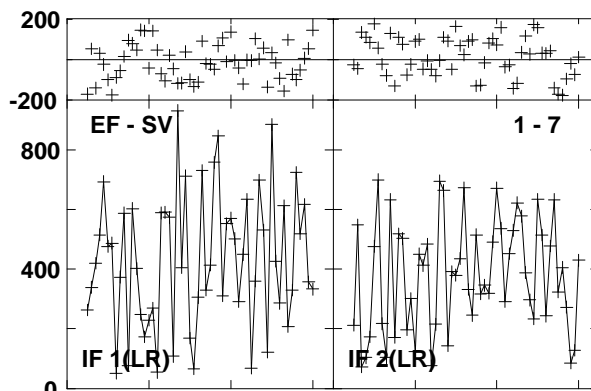
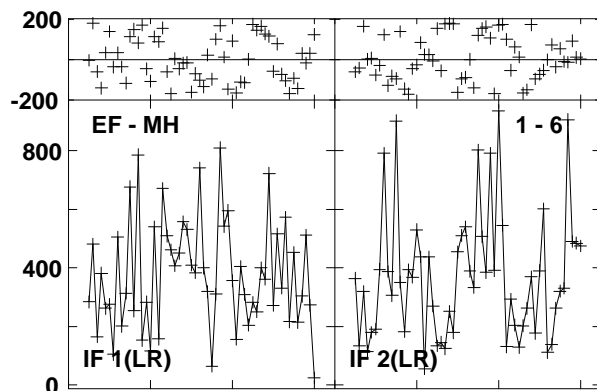
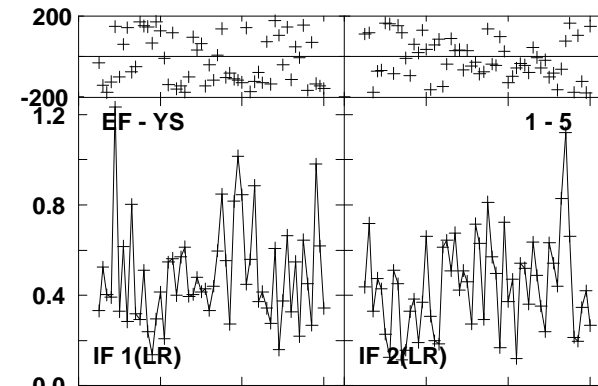
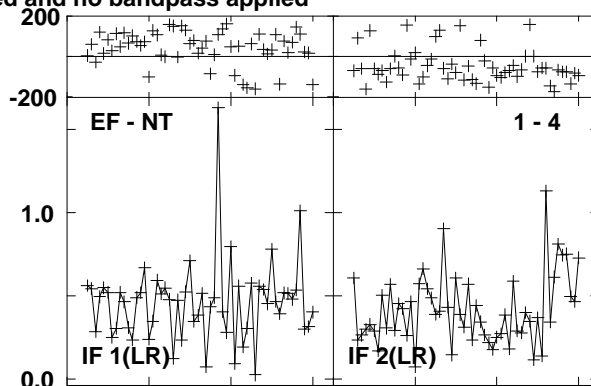
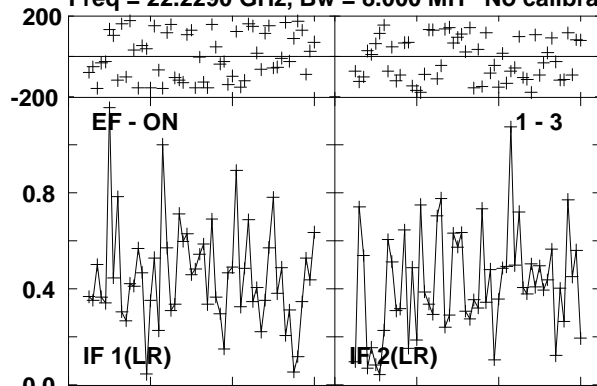

Lower frame: Milli Ampl Jy Top frame: Phas deg
Vector averaged cross-power spectrum Several baselines displayed
Timerange: 00/14:09:55 to 00/14:10:54

Plot file version 171 created 17-SEP-2012 12:09:01

ORIKL1 EE008D 1.UVDATA.1

Freq = 22.2290 GHz, Bw = 8.000 MH No calibration applied and no bandpass applied

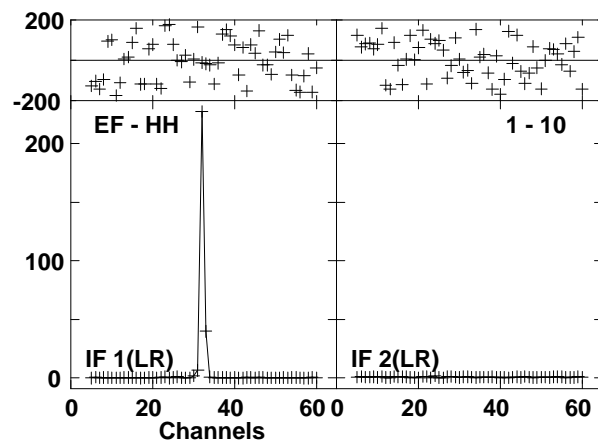
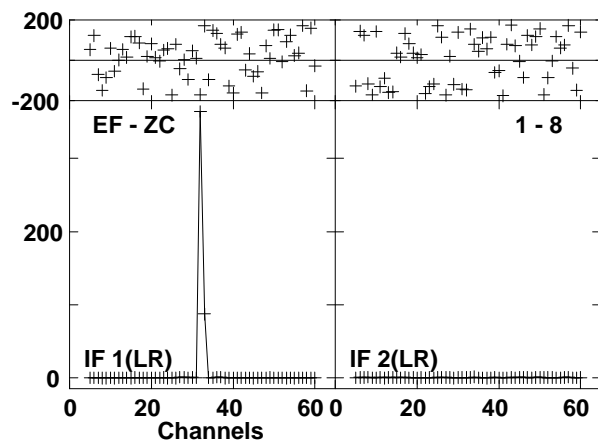
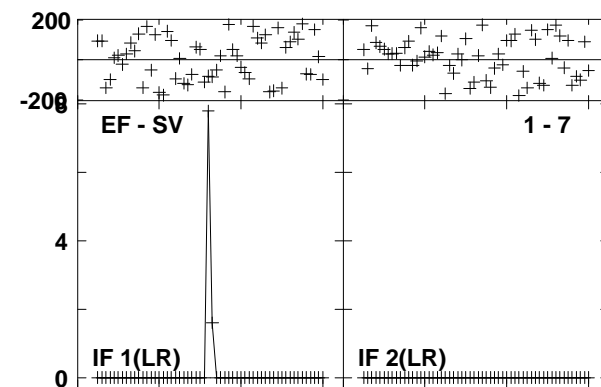
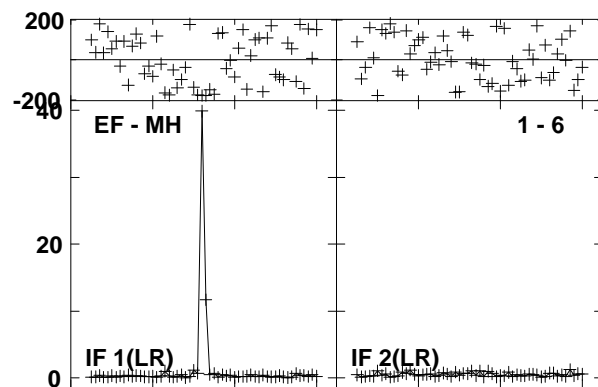
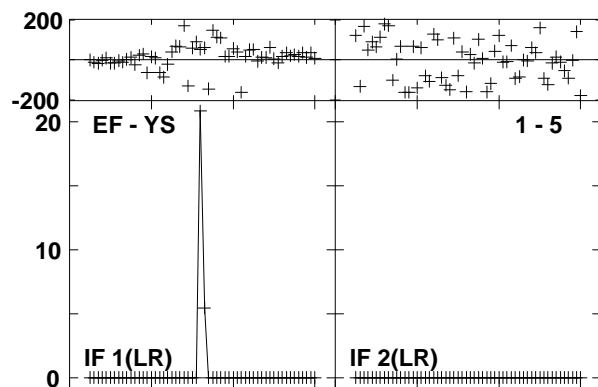
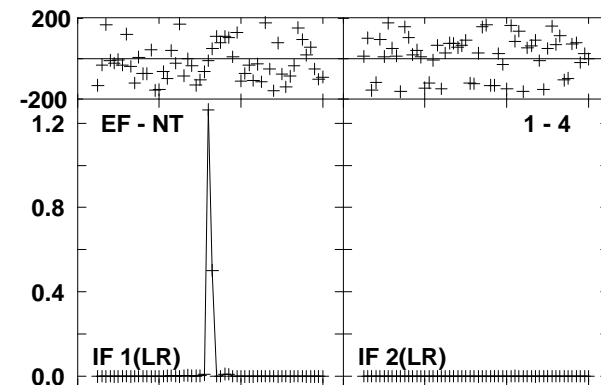
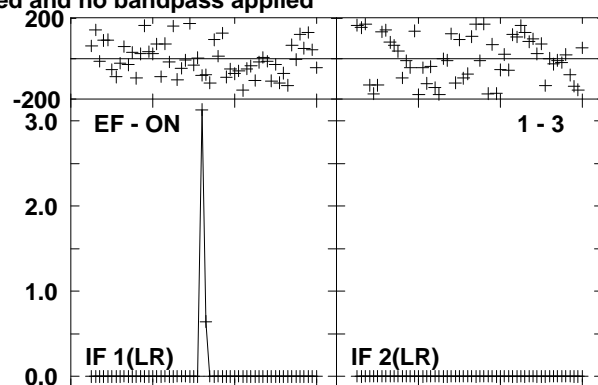
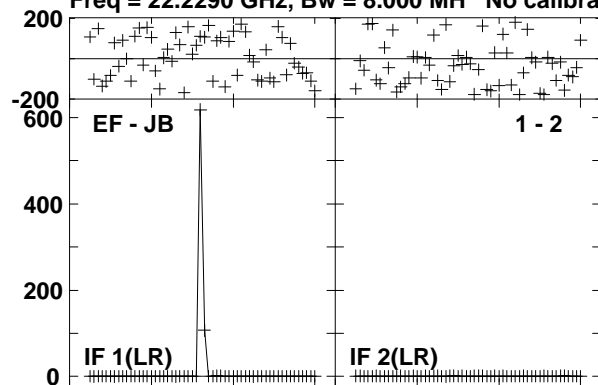

Lower frame: Milli Ampl Jy Top frame: Phas deg

Vector averaged cross-power spectrum Several baselines displayed

Timerange: 00/14:10:58 to 00/14:11:54

Plot file version 172 created 17-SEP-2012 12:09:03

J0541-0541 EE008D 1.UVDATA.1

Freq = 22.2290 GHz, Bw = 8.000 MH No calibration applied and no bandpass applied

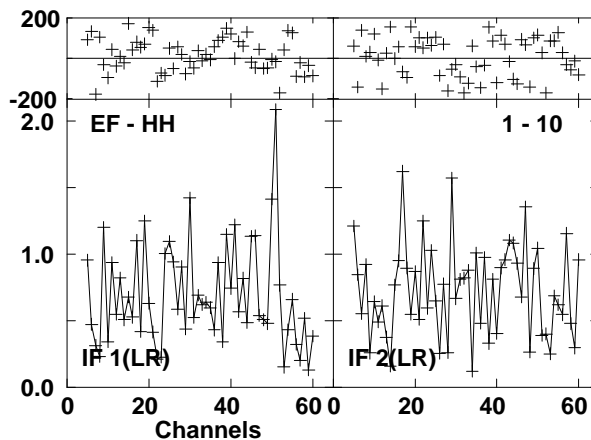
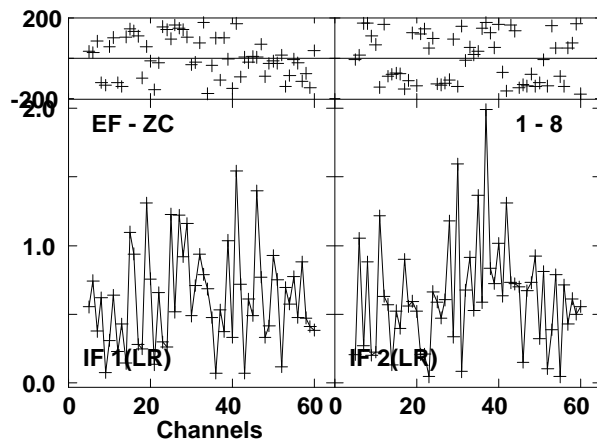
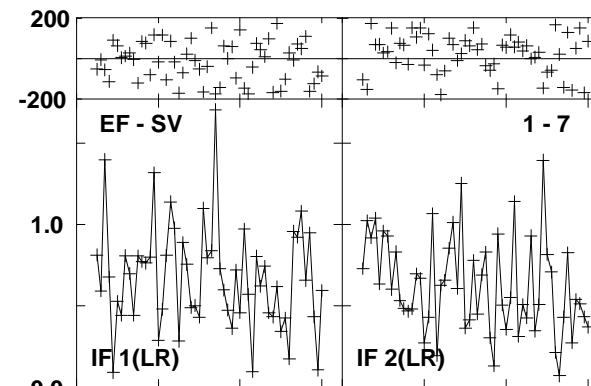
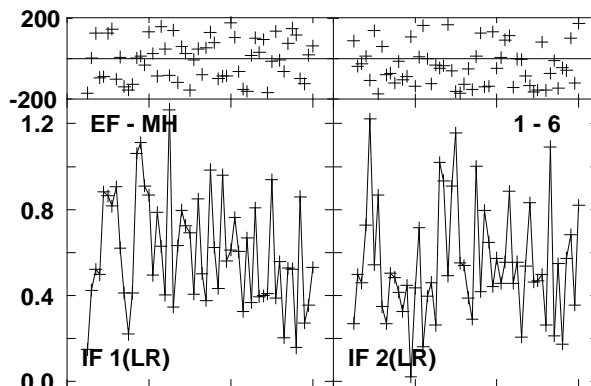
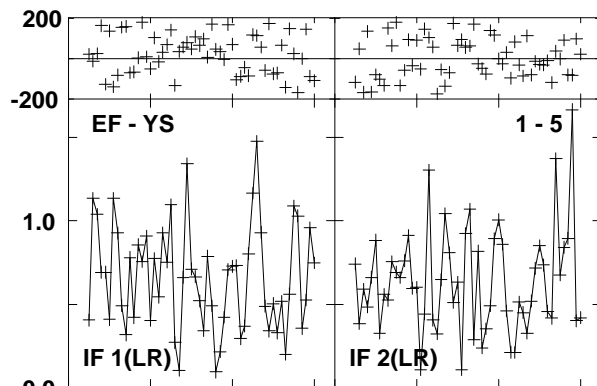
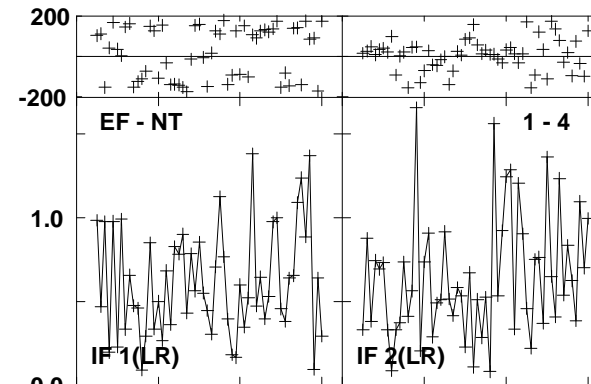
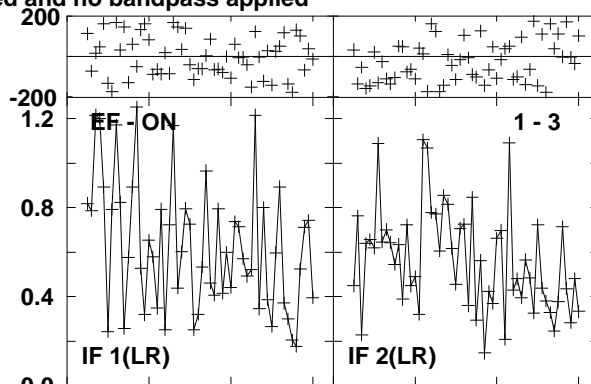
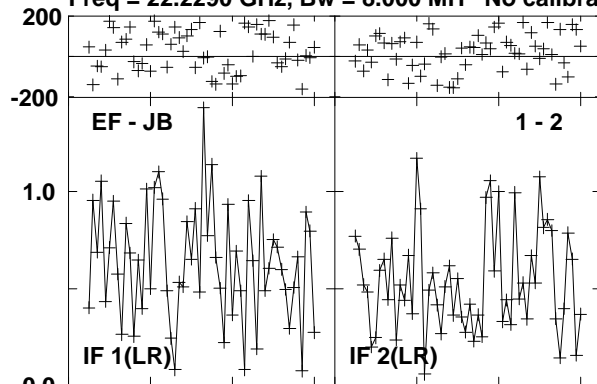

Lower frame: Milli Ampl Jy Top frame: Phas deg
Vector averaged cross-power spectrum Several baselines displayed
Timerange: 00/14:11:58 to 00/14:12:54

Plot file version 173 created 17-SEP-2012 12:09:05

ORIKL1 EE008D 1.UVDATA.1

Freq = 22.2290 GHz, Bw = 8.000 MH No calibration applied and no bandpass applied

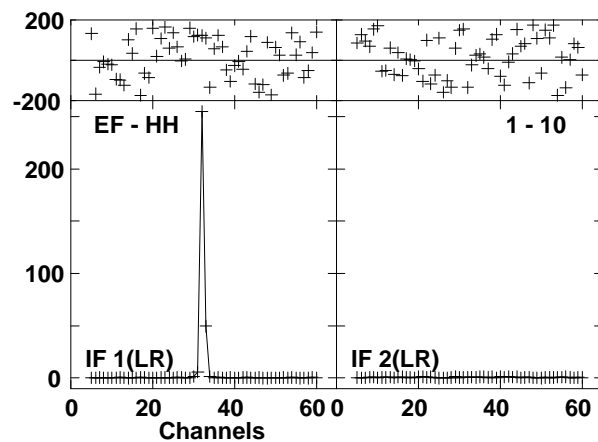
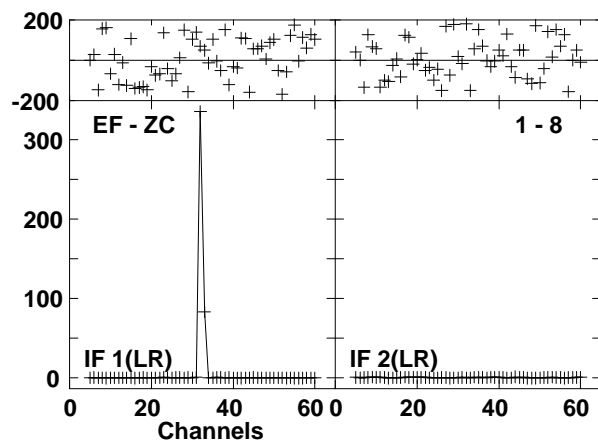
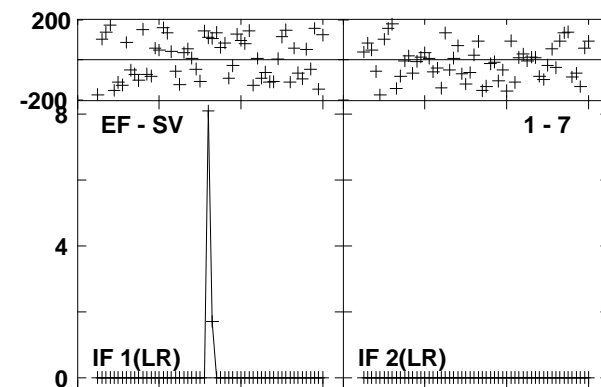
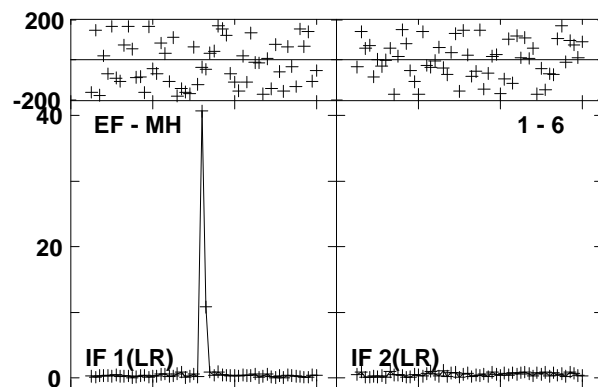
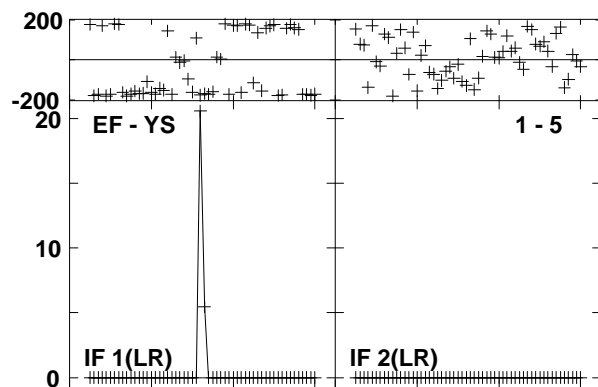
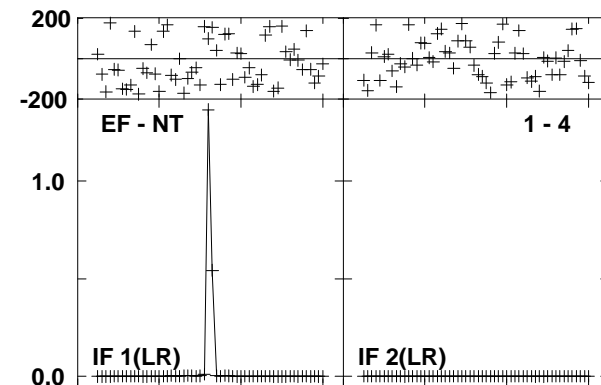
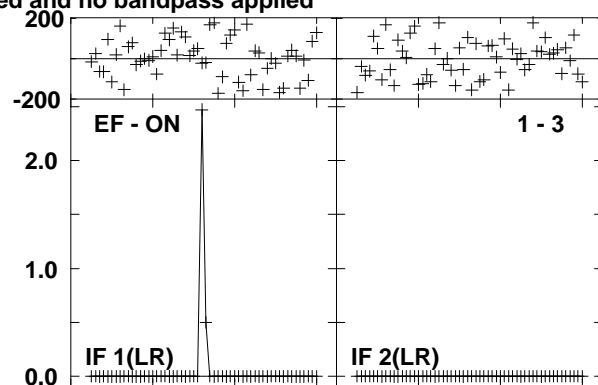
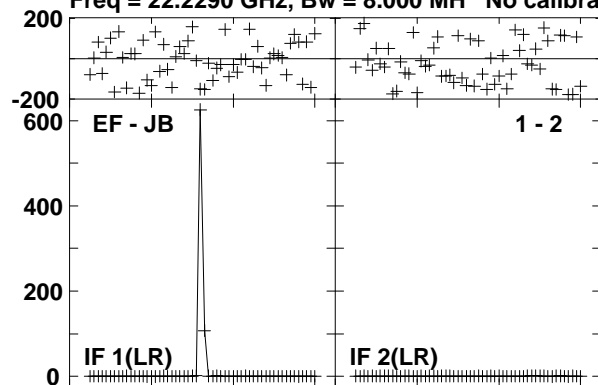

Lower frame: Milli Ampl Jy Top frame: Phas deg

Vector averaged cross-power spectrum Several baselines displayed

Timerange: 00/14:12:58 to 00/14:13:54

Plot file version 174 created 17-SEP-2012 12:09:07

J0541-0541 EE008D 1.UVDATA.1

Freq = 22.2290 GHz, Bw = 8.000 MH No calibration applied and no bandpass applied

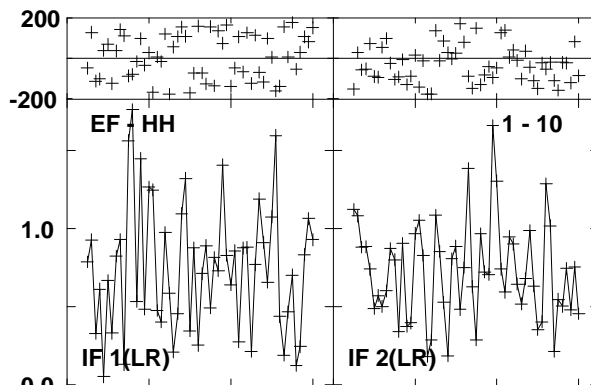
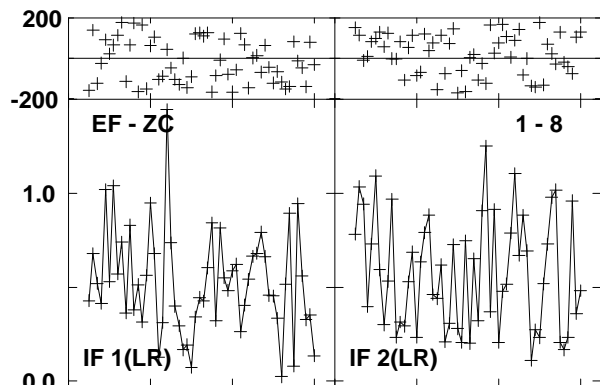
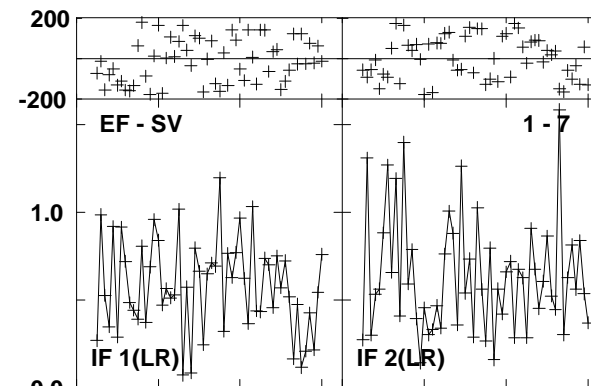
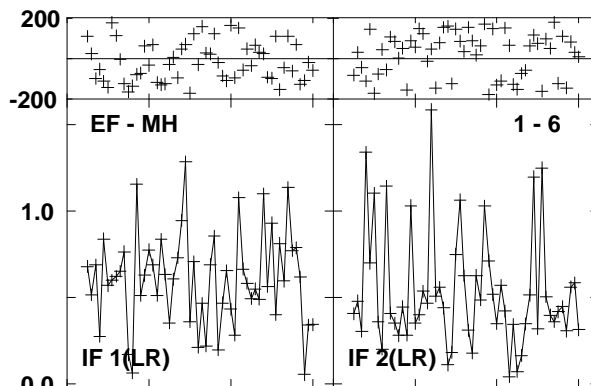
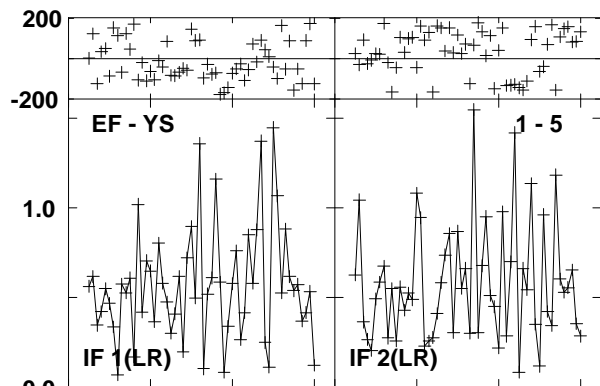
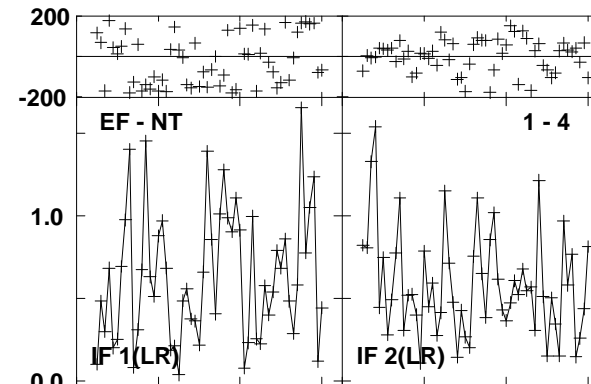
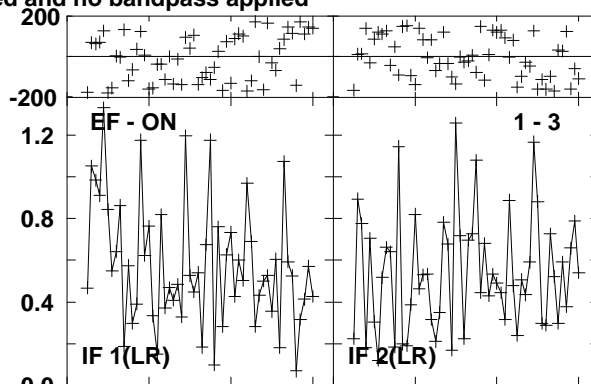
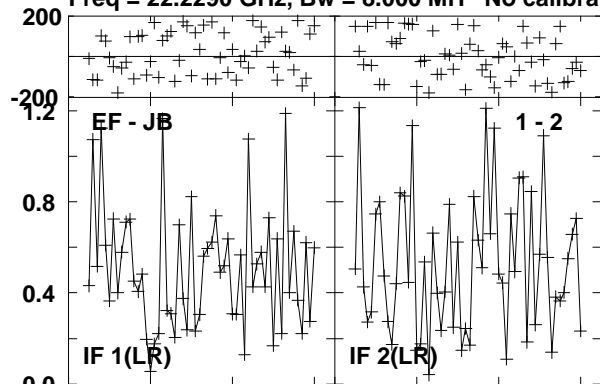

Channels
Lower frame: Milli Ampl Jy Top frame: Phas deg
Vector averaged cross-power spectrum Several baselines displayed
Timerange: 00/14:13:58 to 00/14:14:54

Plot file version 175 created 17-SEP-2012 12:09:09

J0529-0519 EE008D 1.UVDATA.1

Freq = 22.2290 GHz, Bw = 8.000 MH No calibration applied and no bandpass applied

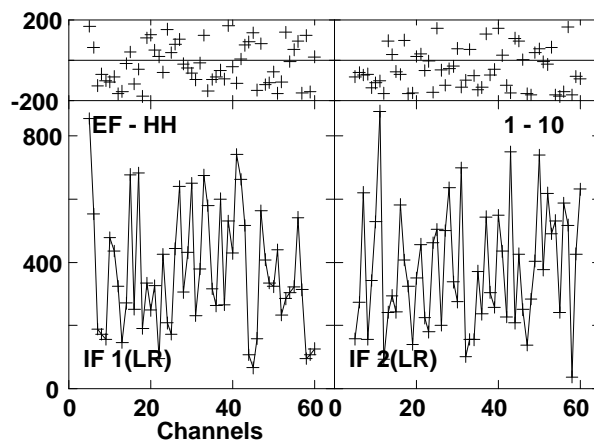
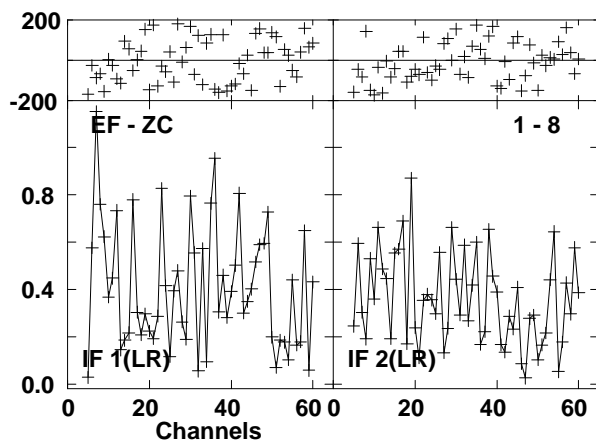
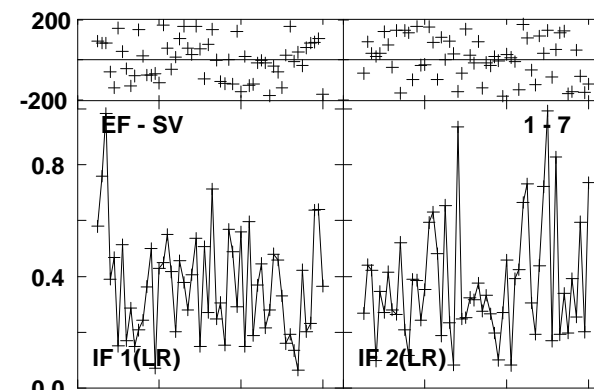
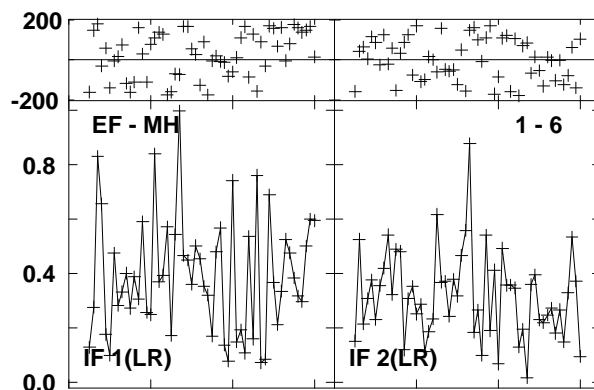
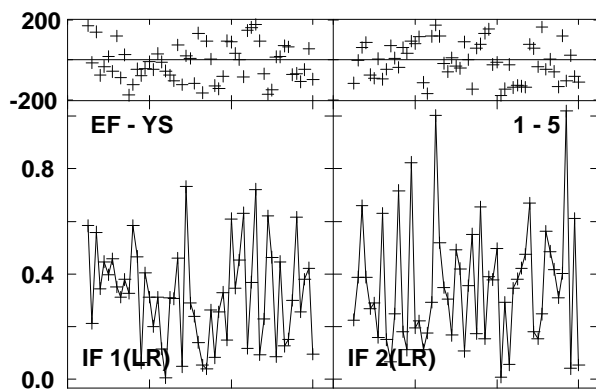
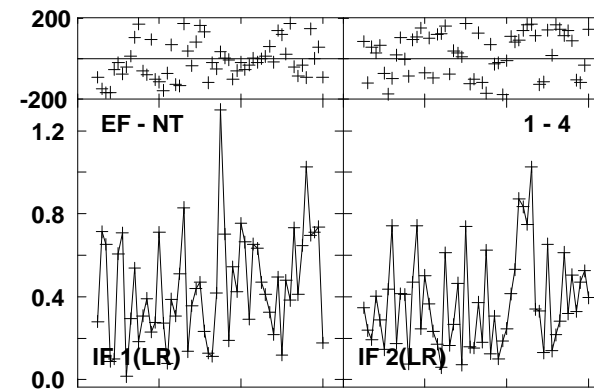
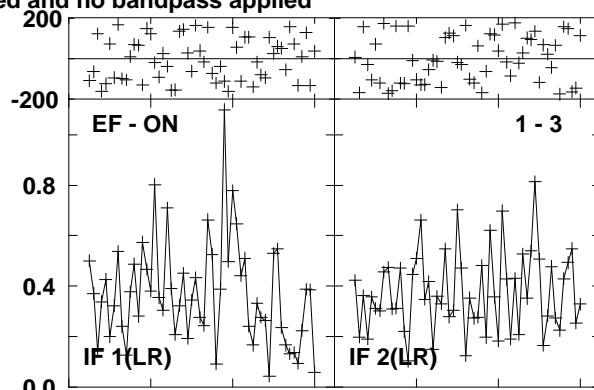
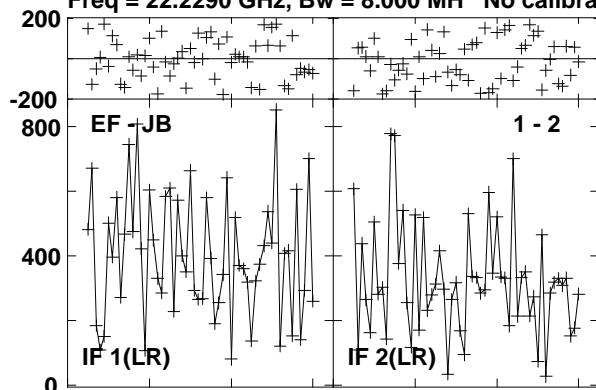

Lower frame: Micro Ampl Jy Top frame: Phas deg

Vector averaged cross-power spectrum Several baselines displayed

Timerange: 00/14:15:41 to 00/14:16:40

Plot file version 176 created 17-SEP-2012 12:09:12

ORIKL1 EE008D 1.UVDATA.1

Freq = 22.2290 GHz, Bw = 8.000 MH No calibration applied and no bandpass applied

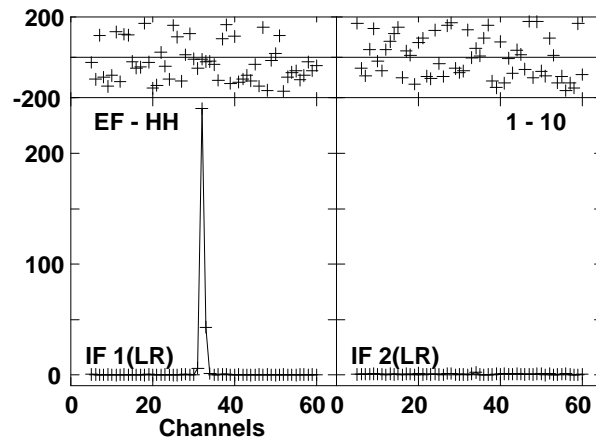
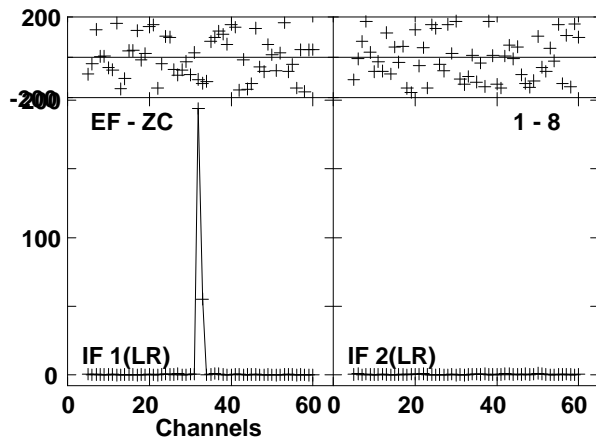
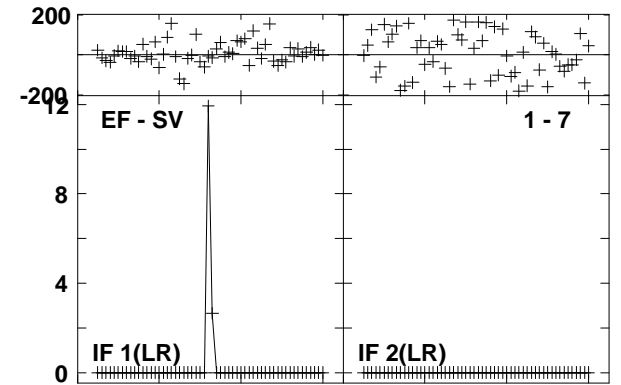
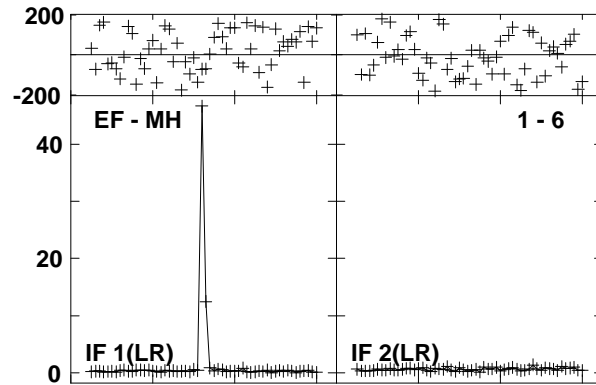
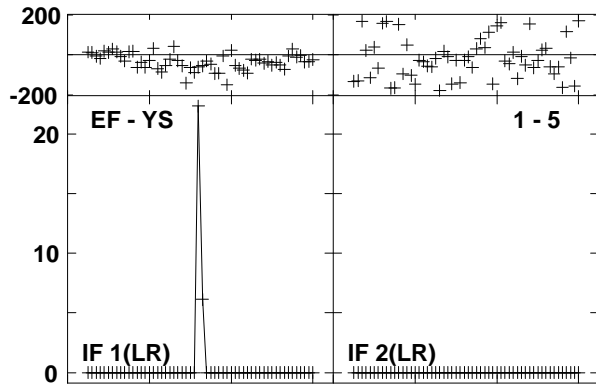
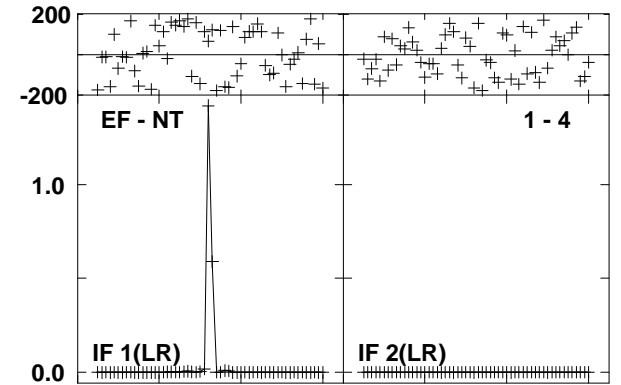
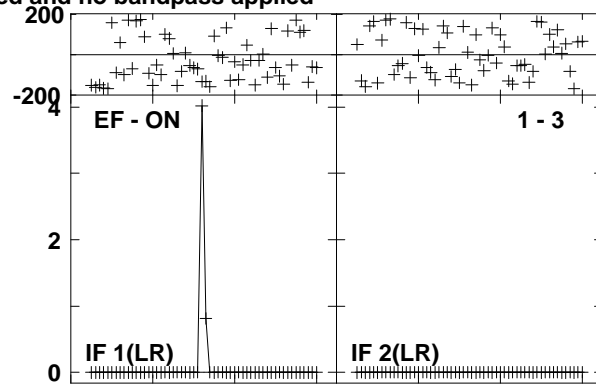
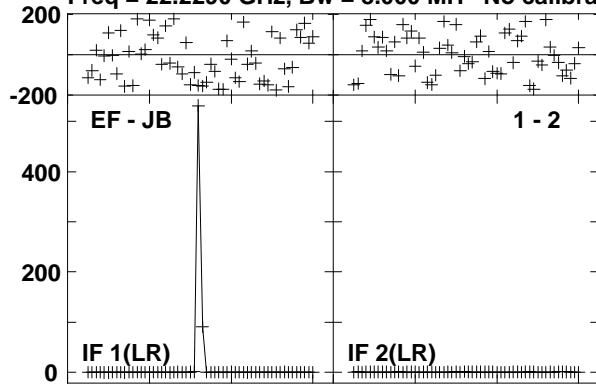

Lower frame: Milli Ampl Jy Top frame: Phas deg
Vector averaged cross-power spectrum Several baselines displayed
Timerange: 00/14:16:44 to 00/14:17:40

Plot file version 177 created 17-SEP-2012 12:09:14

J0529-0519 EE008D 1.UVDATA.1

Freq = 22.2290 GHz, Bw = 8.000 MH No calibration applied and no bandpass applied

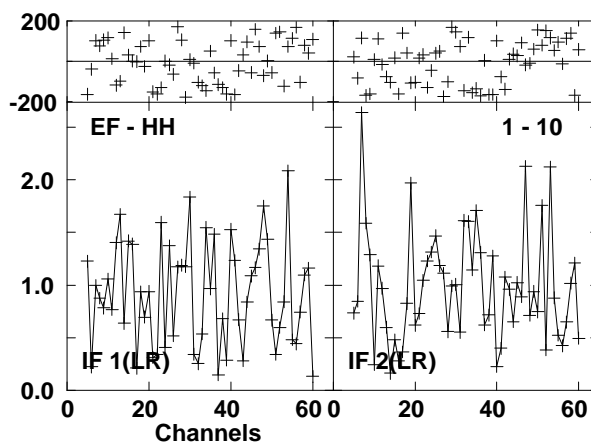
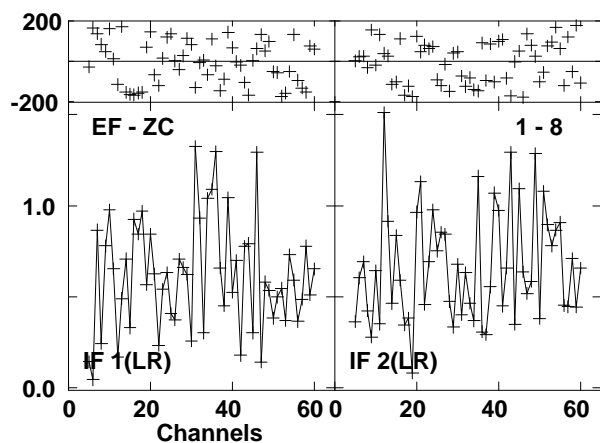
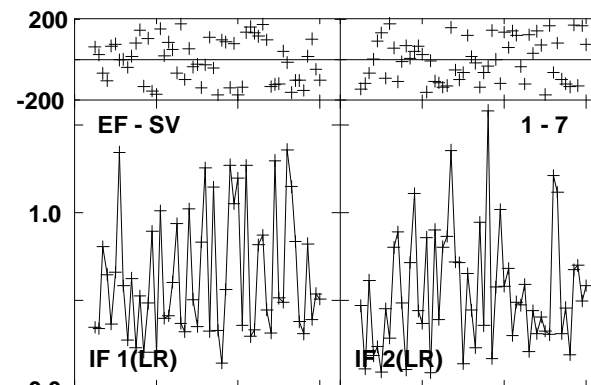
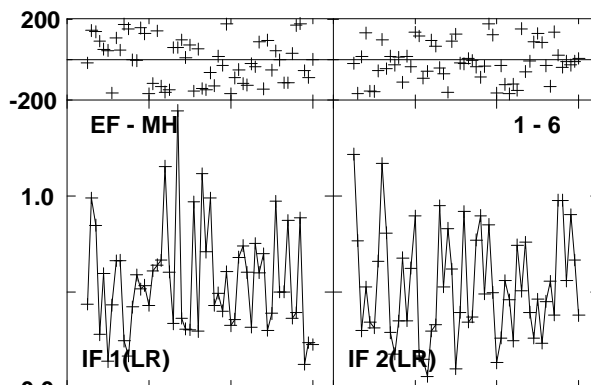
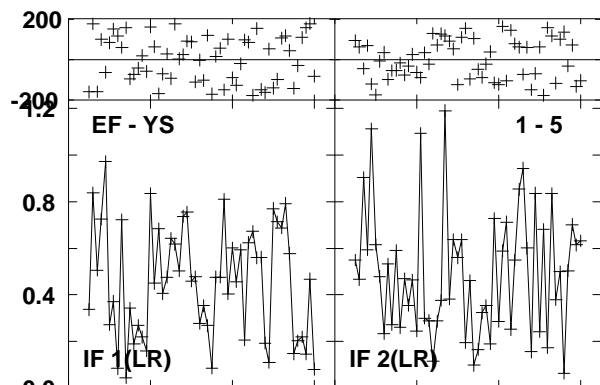
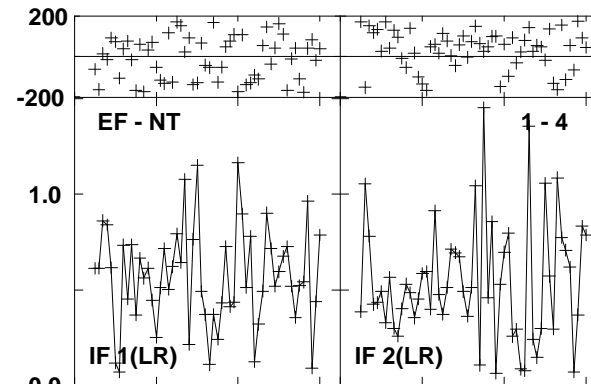
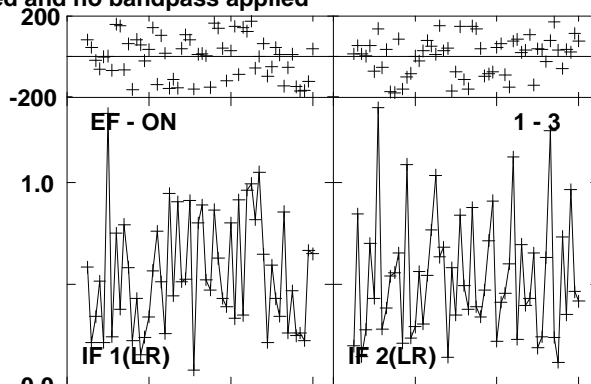
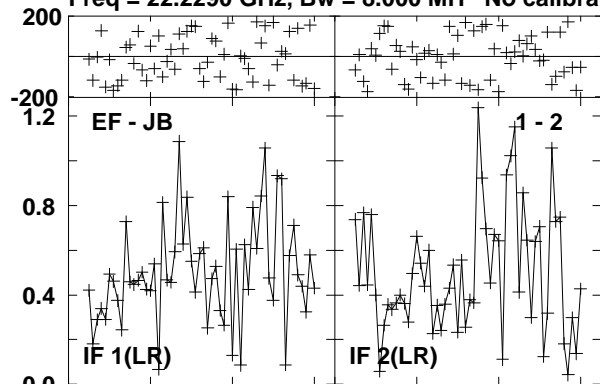

Lower frame: Milli Ampl Jy Top frame: Phas deg
Vector averaged cross-power spectrum Several baselines displayed
Timerange: 00/14:17:44 to 00/14:18:40

Plot file version 178 created 17-SEP-2012 12:09:16

ORIKL1 EE008D 1.UVDATA.1

Freq = 22.2290 GHz, Bw = 8.000 MH No calibration applied and no bandpass applied

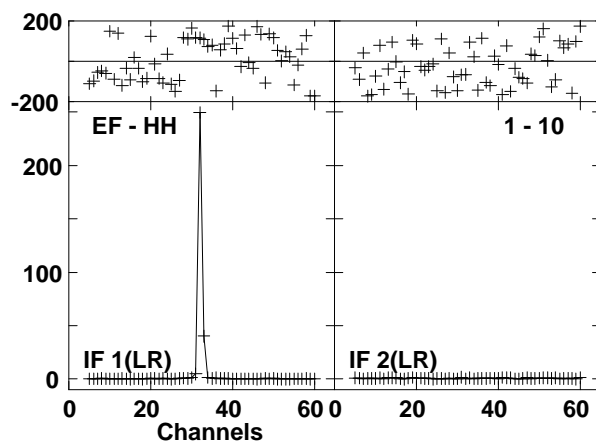
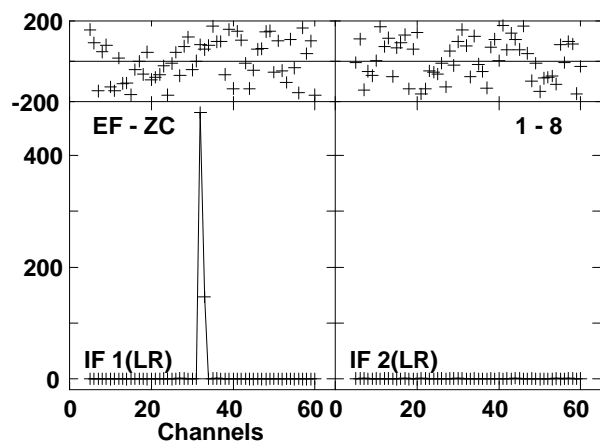
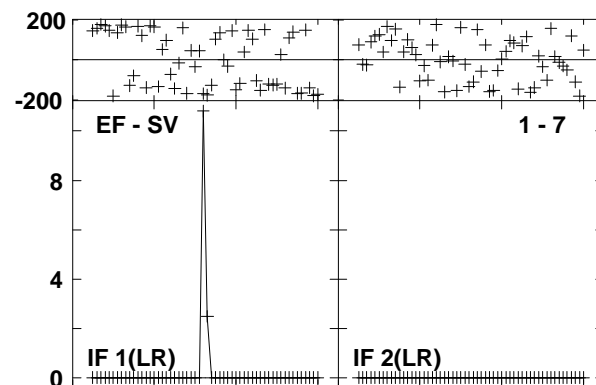
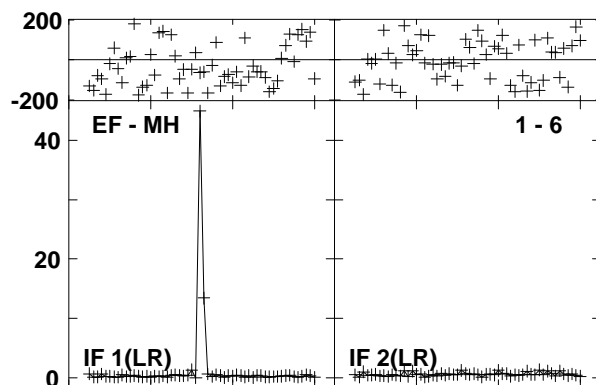
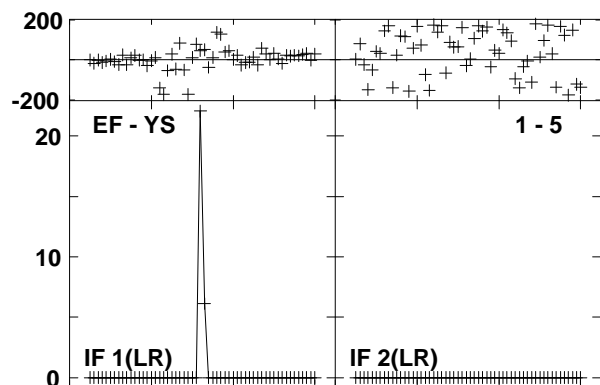
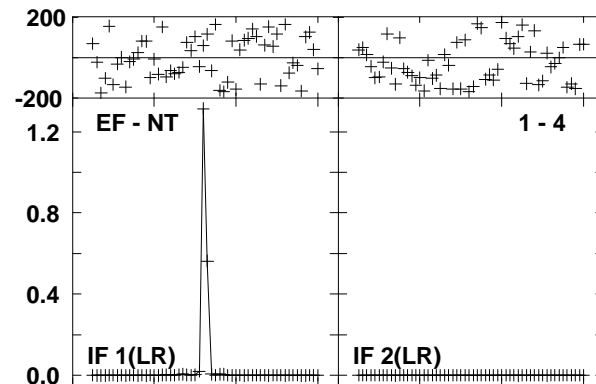
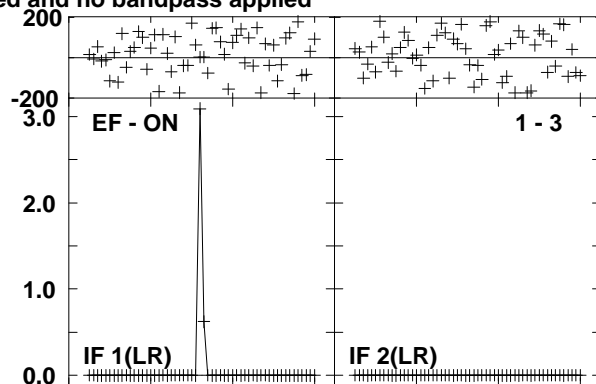
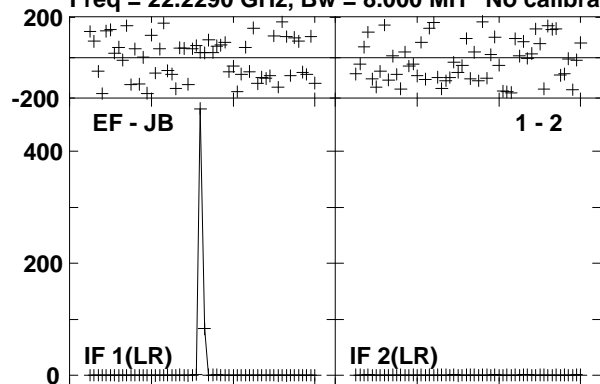

Lower frame: Milli Ampl Jy Top frame: Phas deg
Vector averaged cross-power spectrum Several baselines displayed
Timerange: 00/14:18:44 to 00/14:19:40

Plot file version 179 created 17-SEP-2012 12:09:18

J0529-0519 EE008D 1.UVDATA.1

Freq = 22.2290 GHz, Bw = 8.000 MH No calibration applied and no bandpass applied

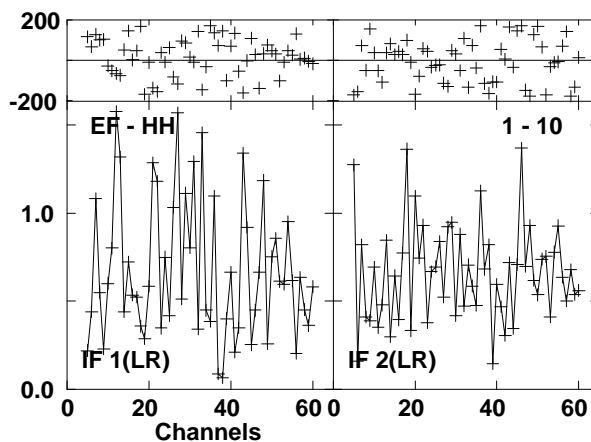
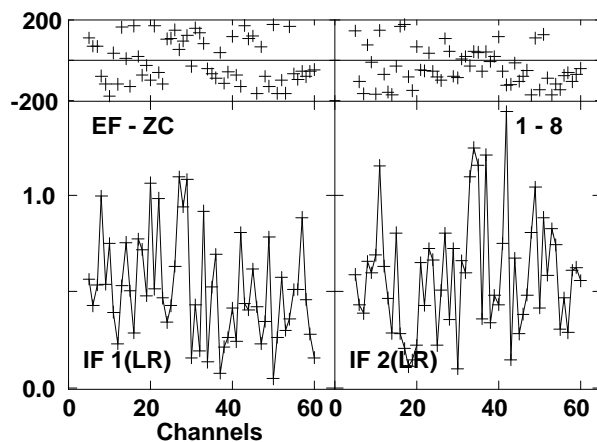
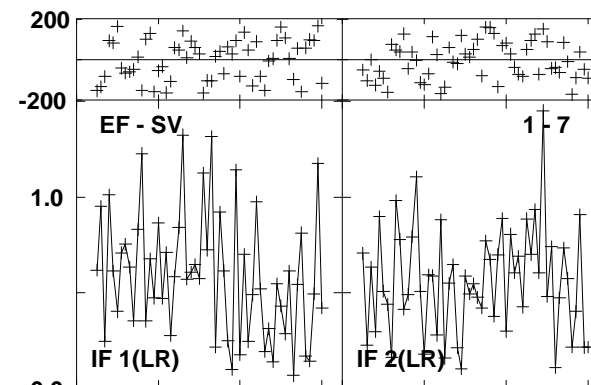
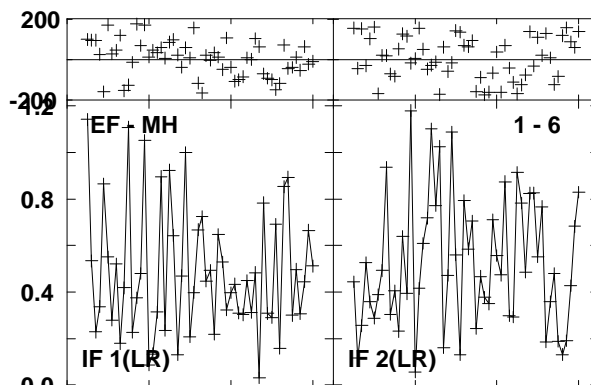
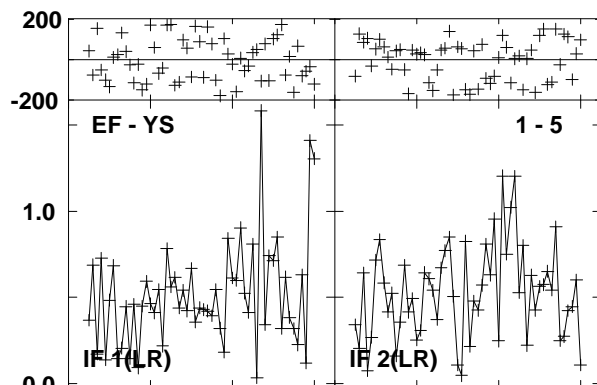
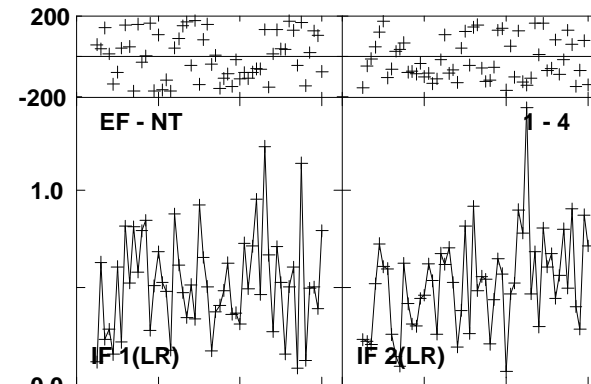
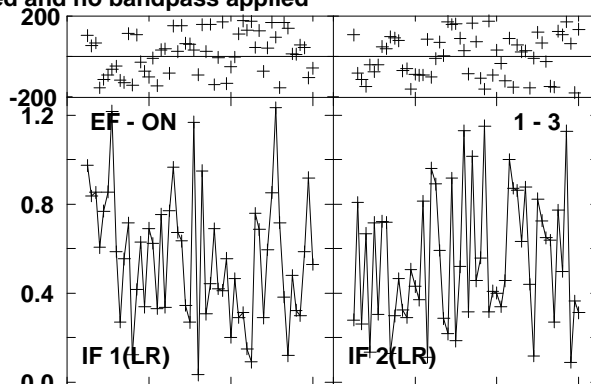
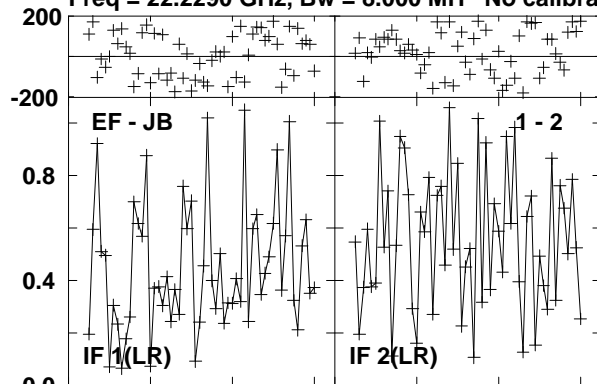

Lower frame: Milli Ampl Jy Top frame: Phas deg
Vector averaged cross-power spectrum Several baselines displayed
Timerange: 00/14:19:44 to 00/14:20:40

Plot file version 180 created 17-SEP-2012 12:09:20

J0541-0541 EE008D 1.UVDATA.1

Freq = 22.2290 GHz, Bw = 8.000 MH No calibration applied and no bandpass applied

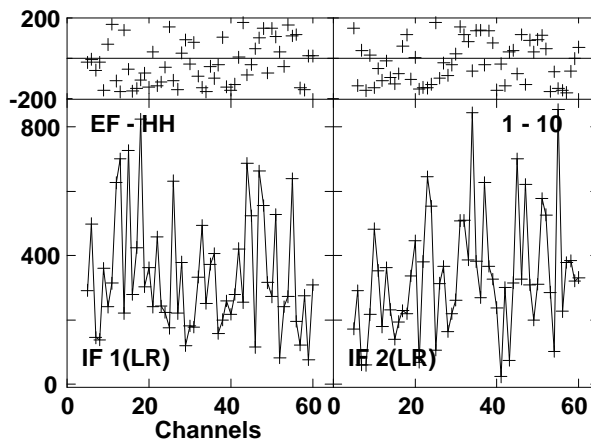
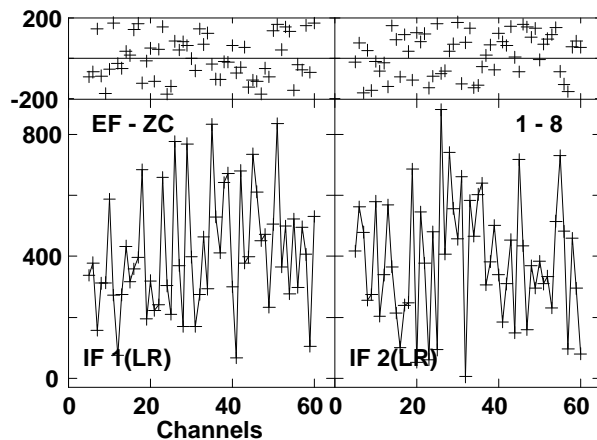
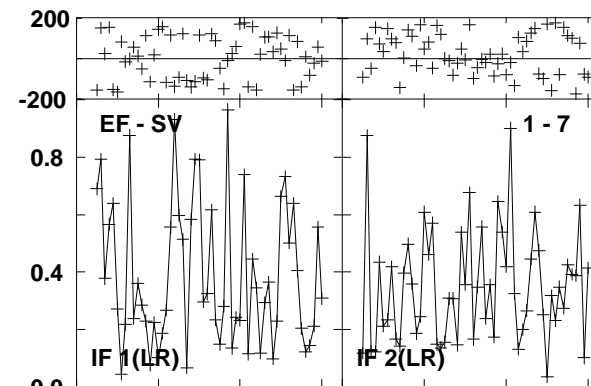
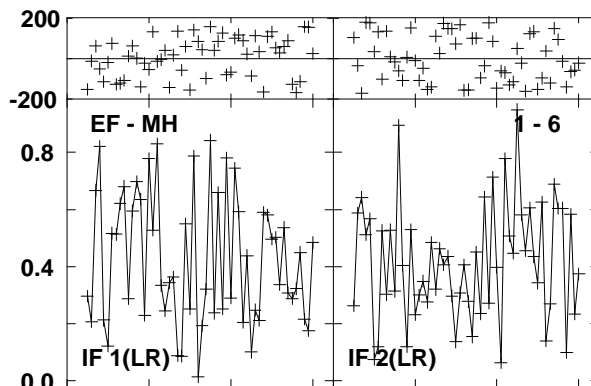
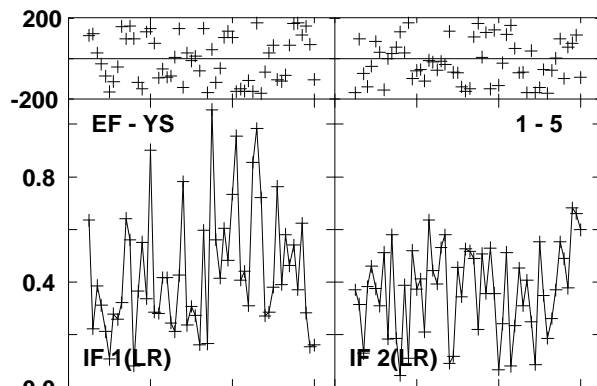
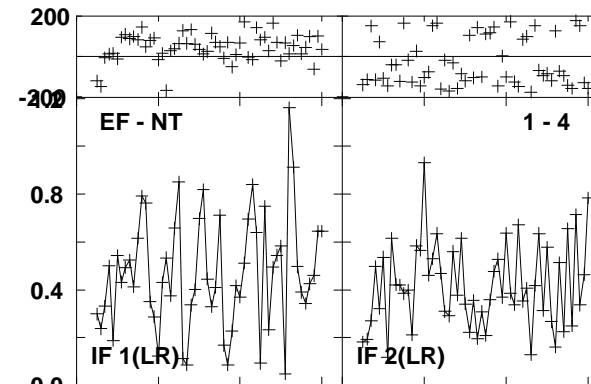
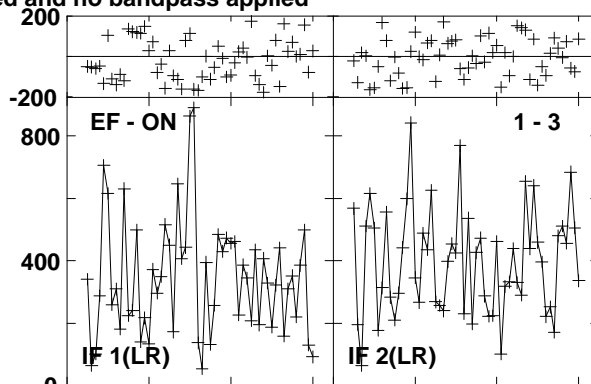
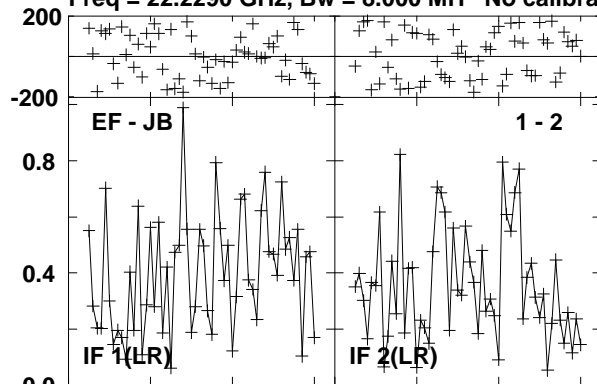

Lower frame: Milli Ampl Jy Top frame: Phas deg
Vector averaged cross-power spectrum Several baselines displayed
Timerange: 00/14:21:26 to 00/14:22:25

Plot file version 181 created 17-SEP-2012 12:09:23

ORIKL1 EE008D 1.UVDATA.1

Freq = 22.2290 GHz, Bw = 8.000 MH No calibration applied and no bandpass applied

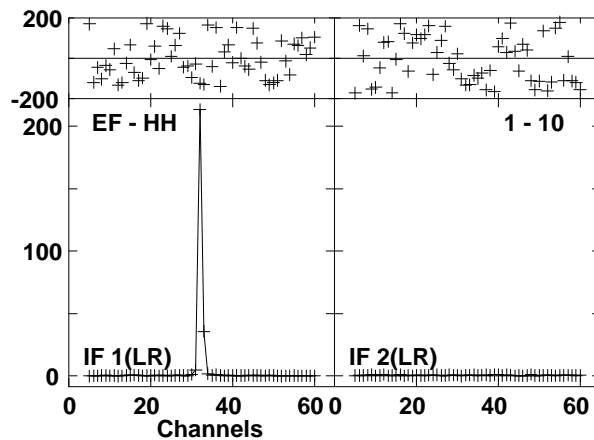
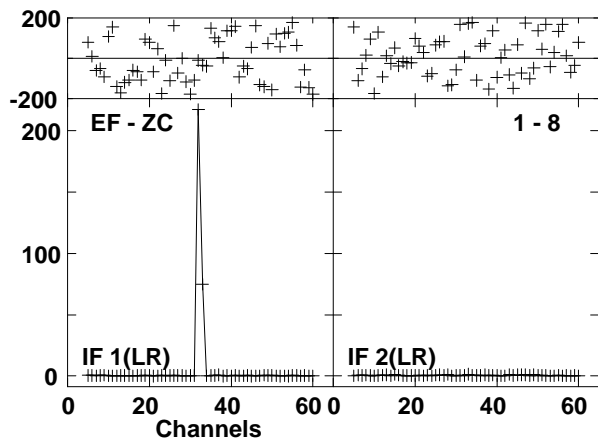
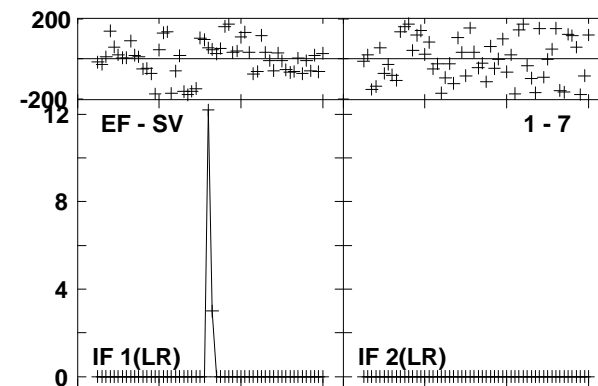
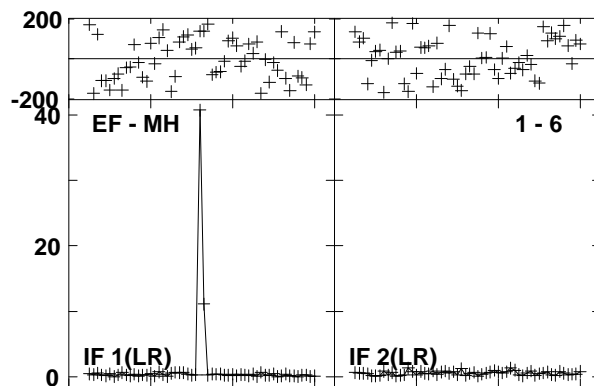
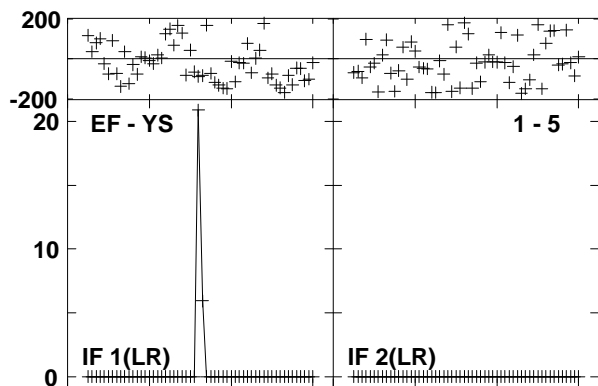
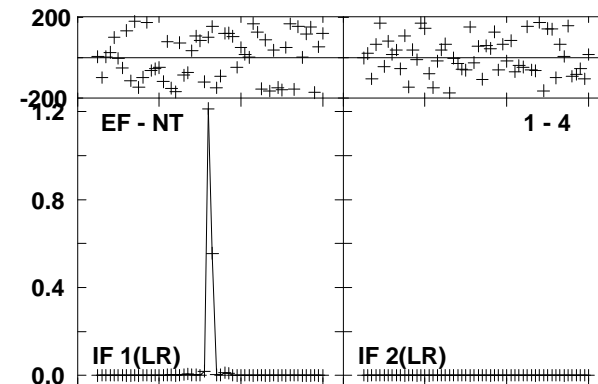
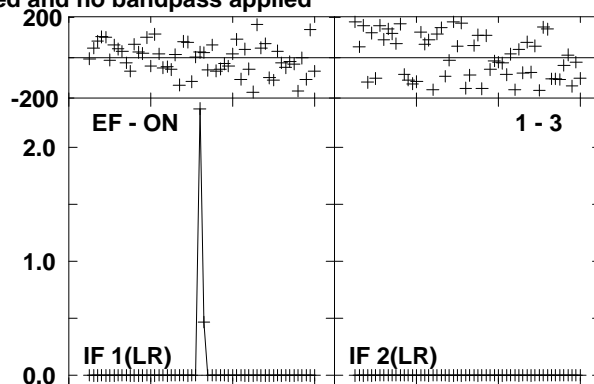
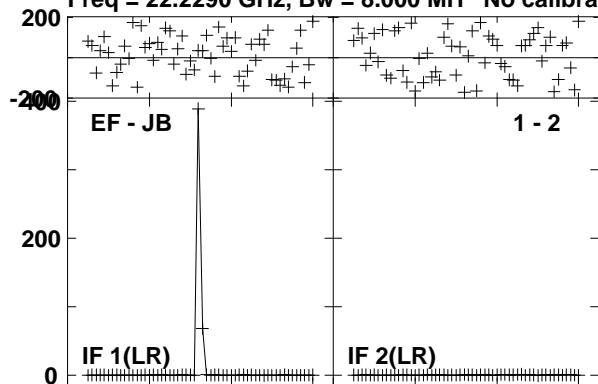

Lower frame: Milli Ampl Jy Top frame: Phas deg

Vector averaged cross-power spectrum Several baselines displayed

Timerange: 00/14:22:28 to 00/14:23:25

Plot file version 182 created 17-SEP-2012 12:09:25

J0541-0541 EE008D 1.UVDATA.1

Freq = 22.2290 GHz, Bw = 8.000 MH No calibration applied and no bandpass applied

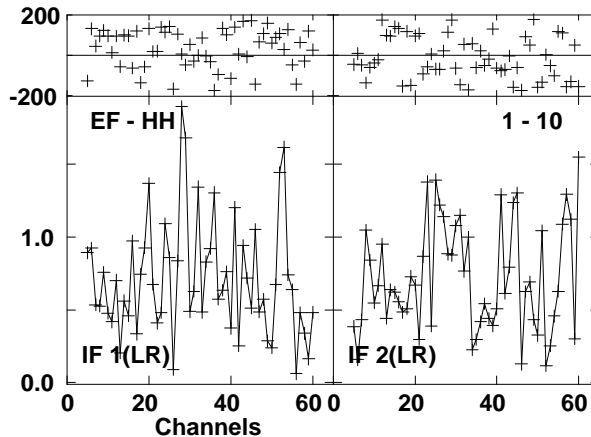
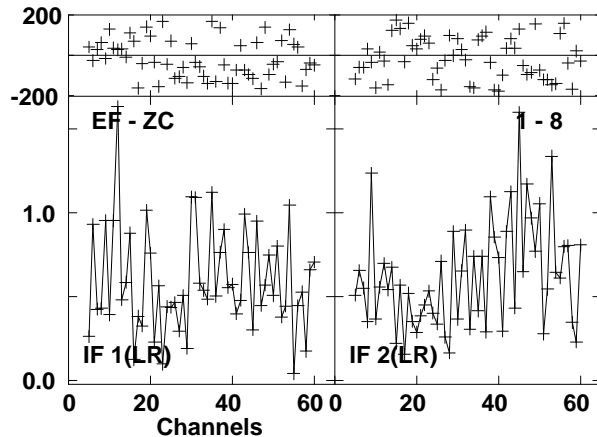
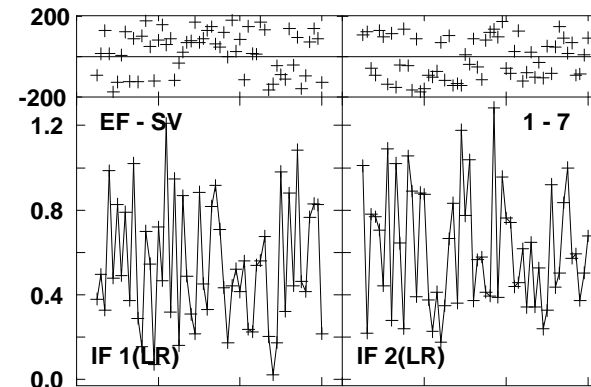
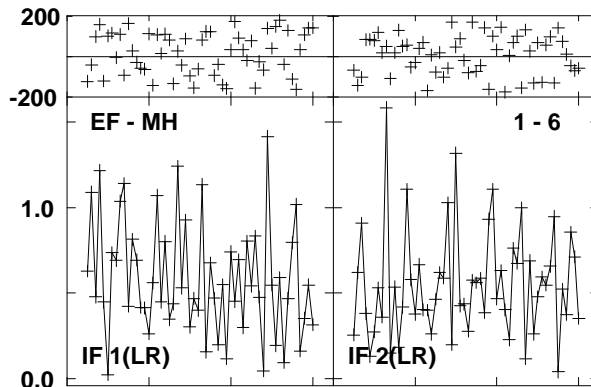
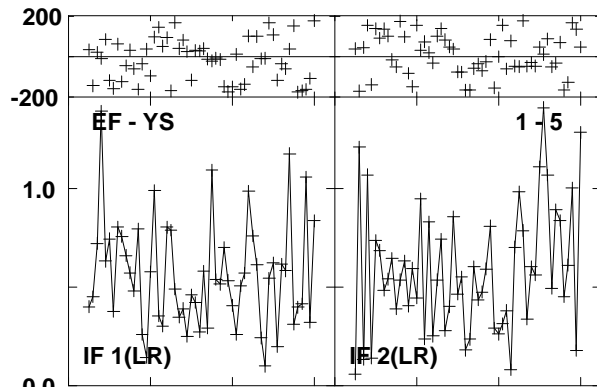
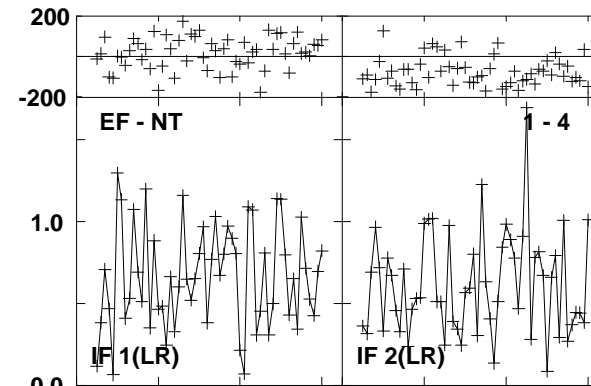
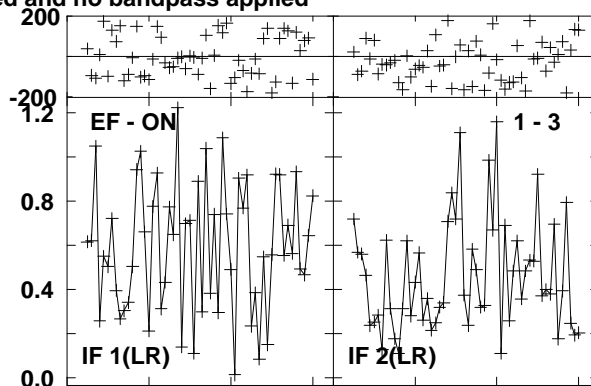
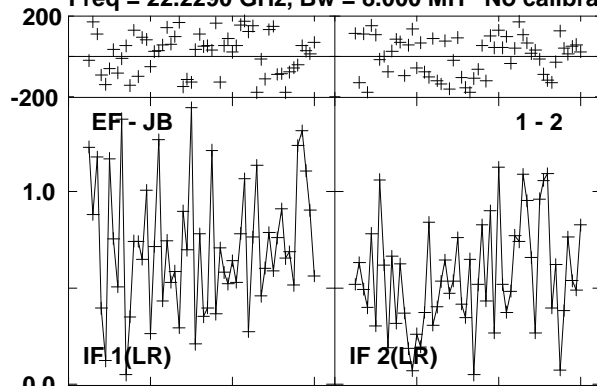

Lower frame: Milli Ampl Jy Top frame: Phas deg
Vector averaged cross-power spectrum Several baselines displayed
Timerange: 00/14:23:29 to 00/14:24:25

Plot file version 183 created 17-SEP-2012 12:09:27

ORIKL1 EE008D 1.UVDATA.1

Freq = 22.2290 GHz, Bw = 8.000 MH No calibration applied and no bandpass applied

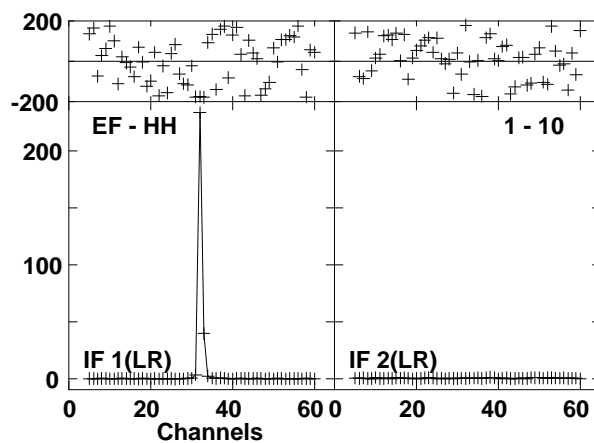
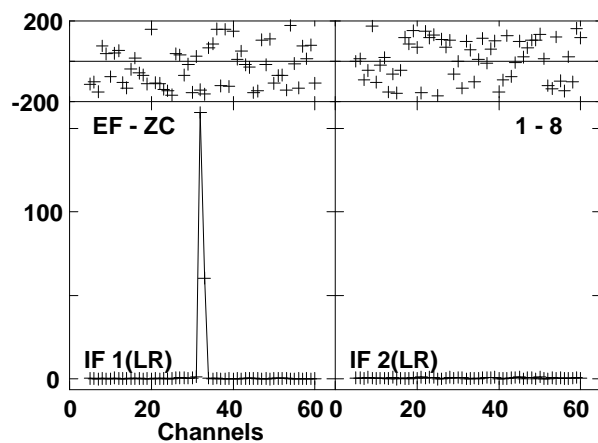
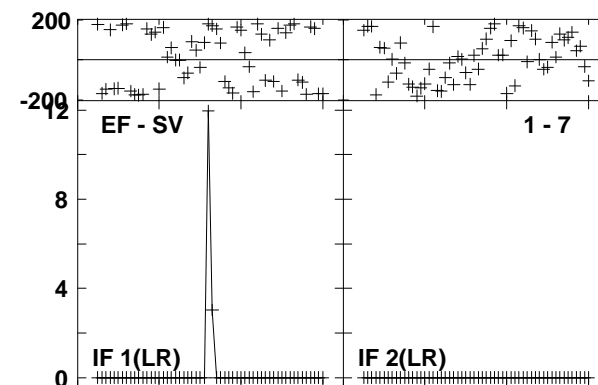
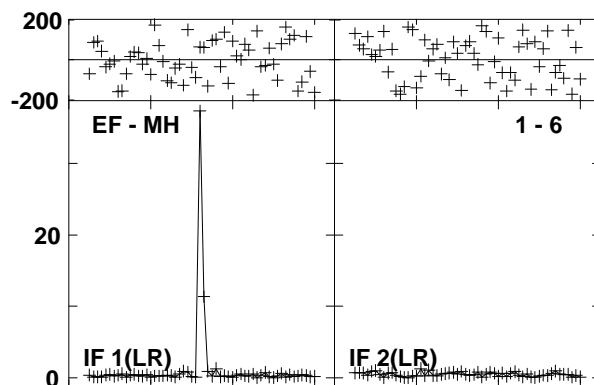
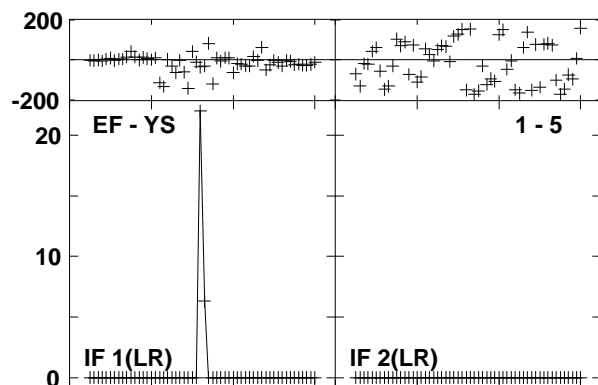
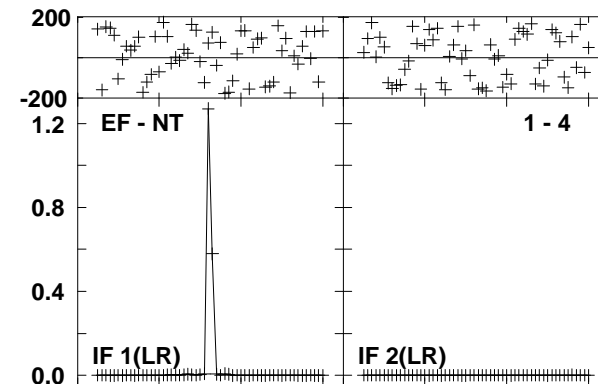
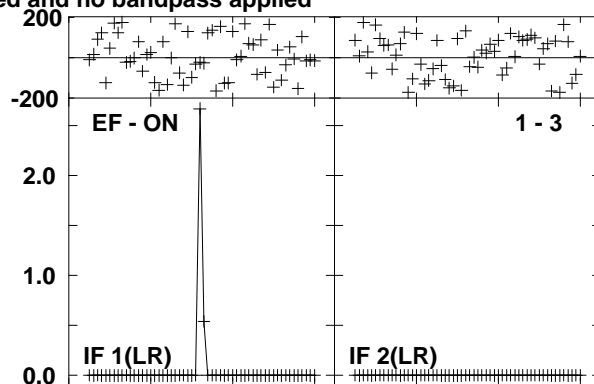
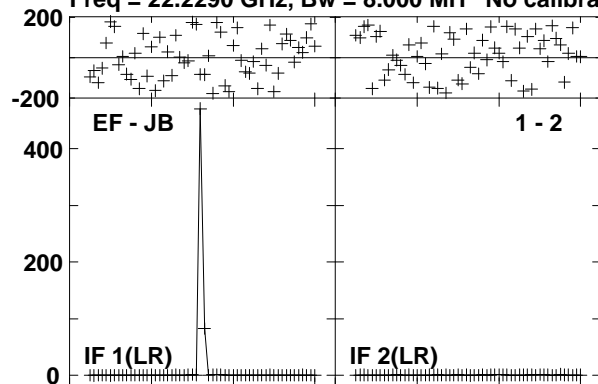

Lower frame: Milli Ampl Jy Top frame: Phas deg

Vector averaged cross-power spectrum Several baselines displayed

Timerange: 00/14:24:31 to 00/14:25:25

Plot file version 184 created 17-SEP-2012 12:09:28

J0541-0541 EE008D 1.UVDATA.1

Freq = 22.2290 GHz, Bw = 8.000 MH No calibration applied and no bandpass applied

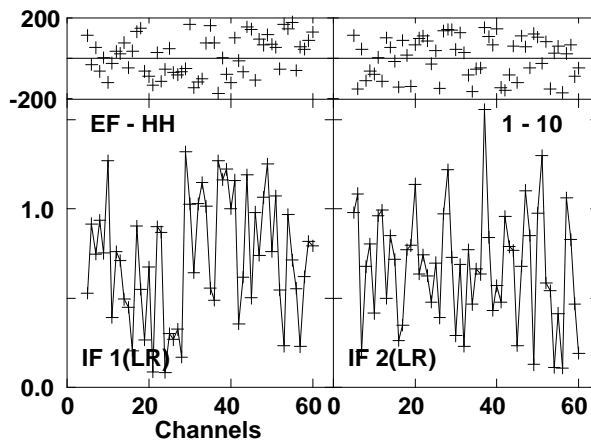
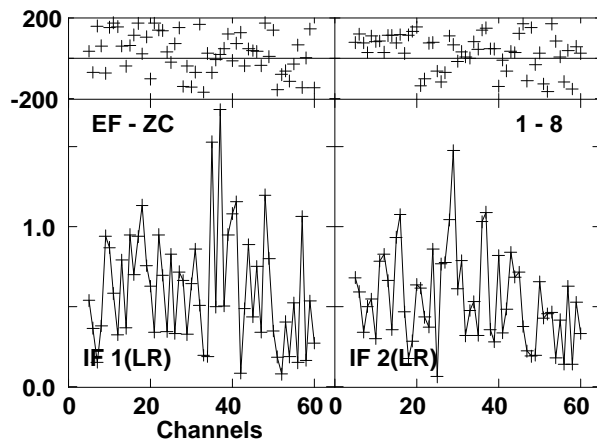
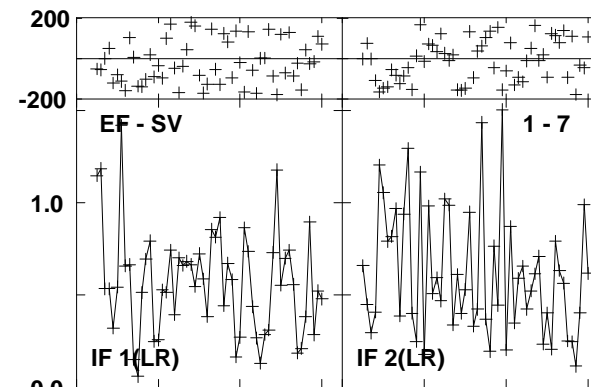
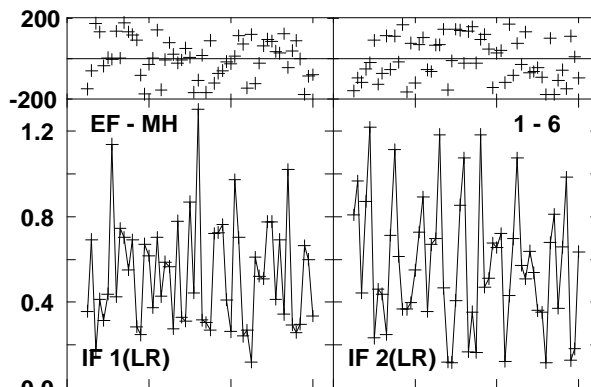
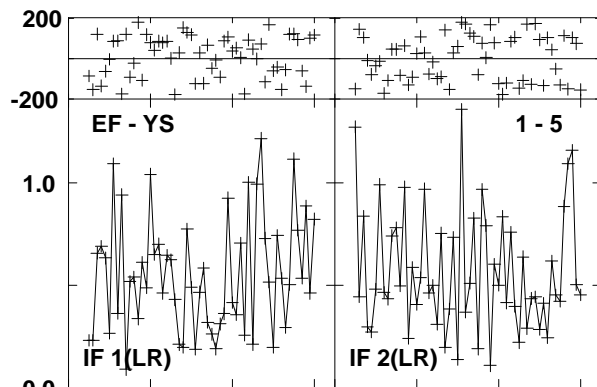
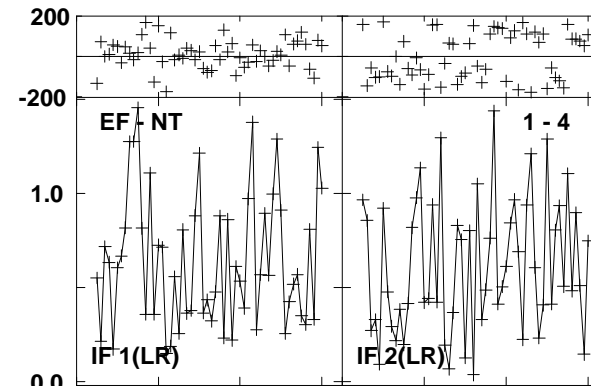
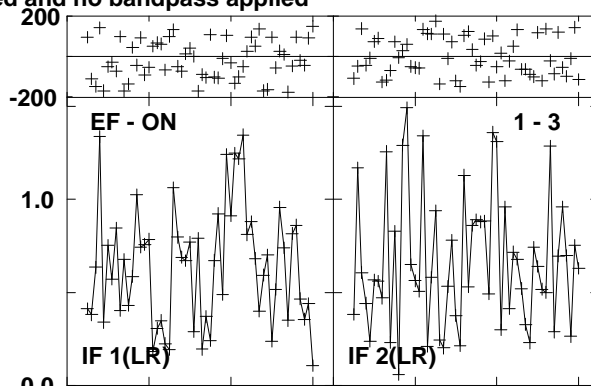
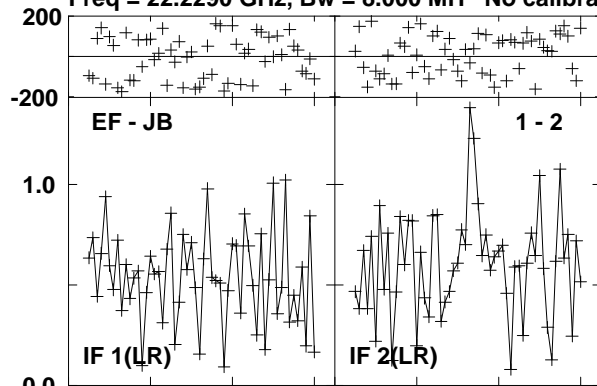

Lower frame: Milli Ampl Jy Top frame: Phas deg
Vector averaged cross-power spectrum Several baselines displayed
Timerange: 00/14:25:29 to 00/14:26:25

Plot file version 185 created 17-SEP-2012 12:09:31

J0529-0519 EE008D 1.UVDATA.1

Freq = 22.2290 GHz, Bw = 8.000 MH No calibration applied and no bandpass applied

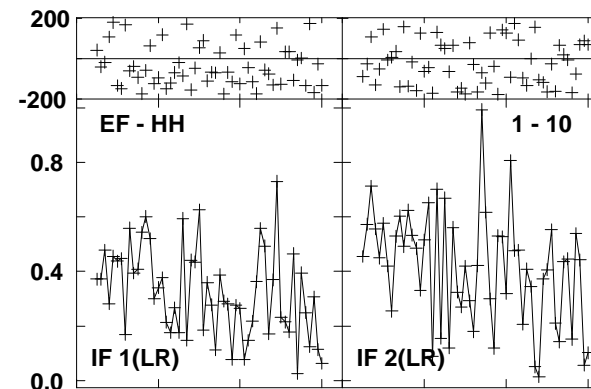
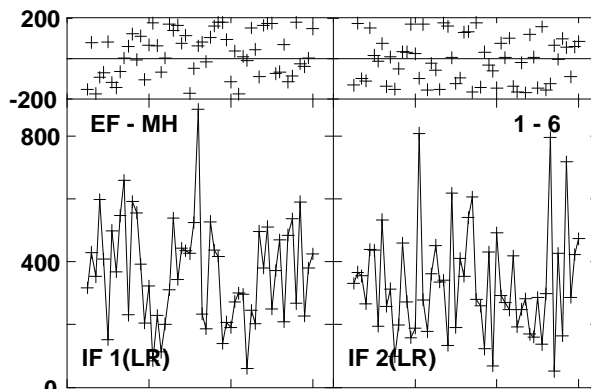
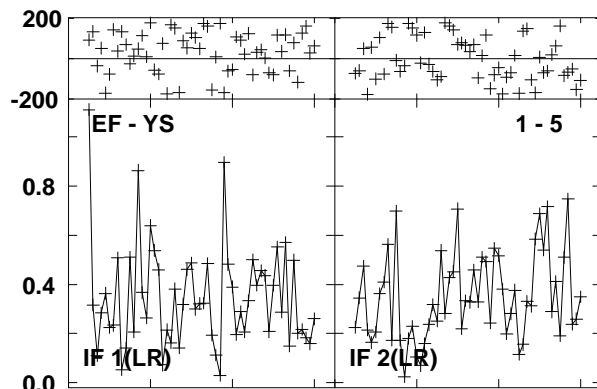
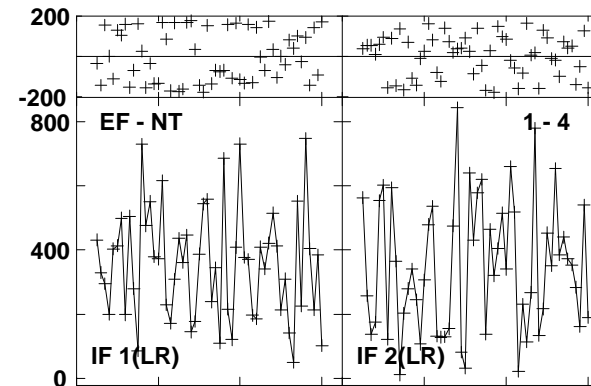
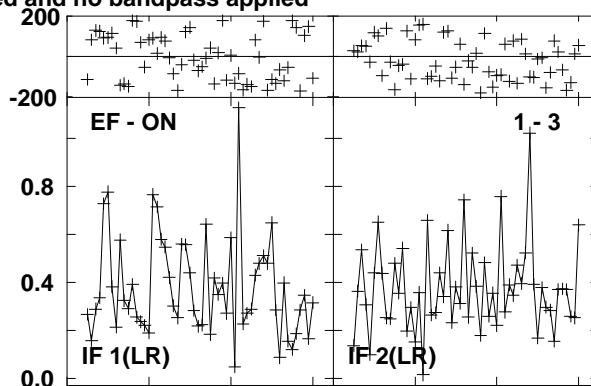
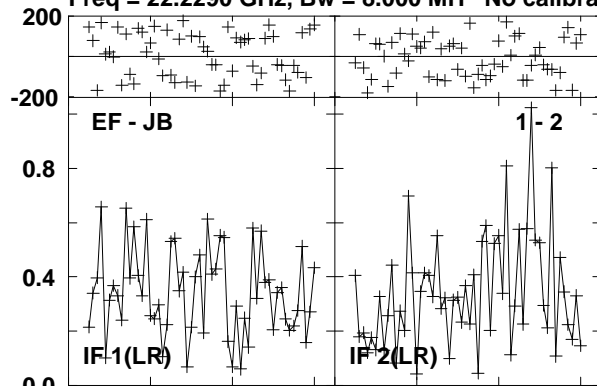

Lower frame: Milli Ampl Jy Top frame: Phas deg
Vector averaged cross-power spectrum Several baselines displayed
Timerange: 00/14:27:12 to 00/14:28:11

Plot file version 186 created 17-SEP-2012 12:09:32

ORIKL1 EE008D 1.UVDATA.1

Freq = 22.2290 GHz, Bw = 8.000 MH No calibration applied and no bandpass applied

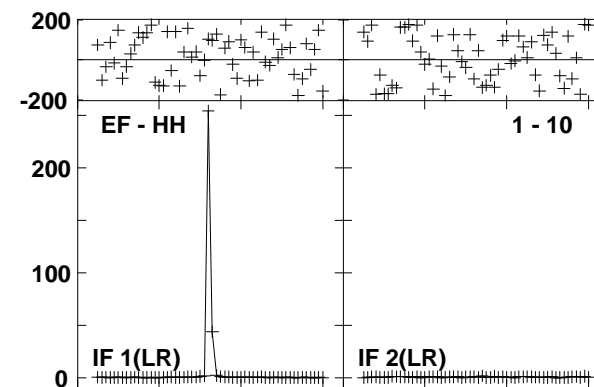
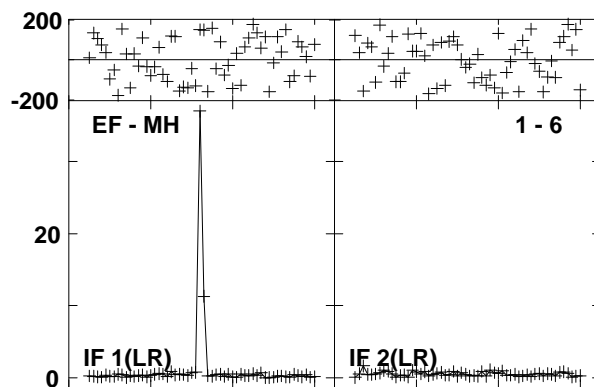
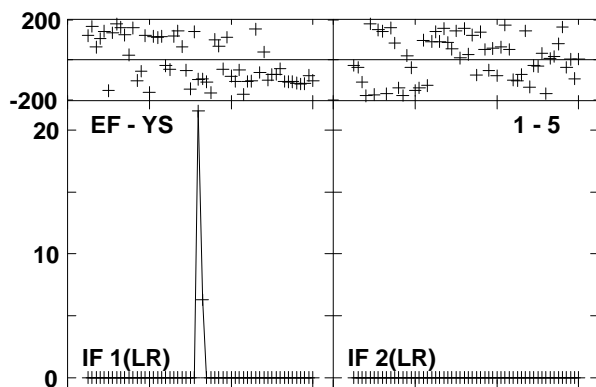
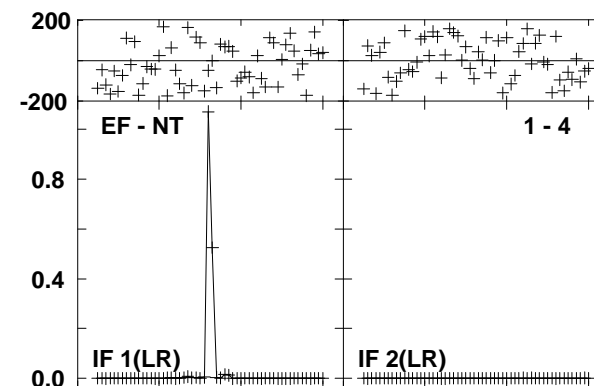
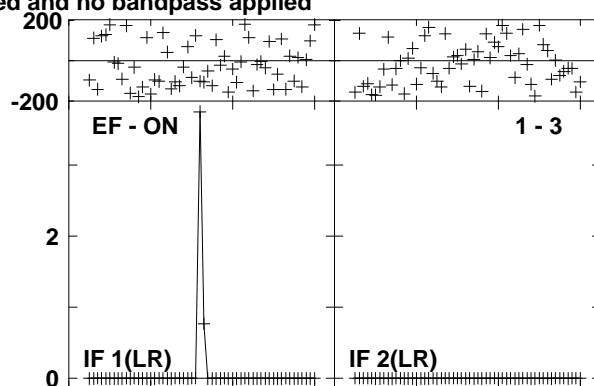
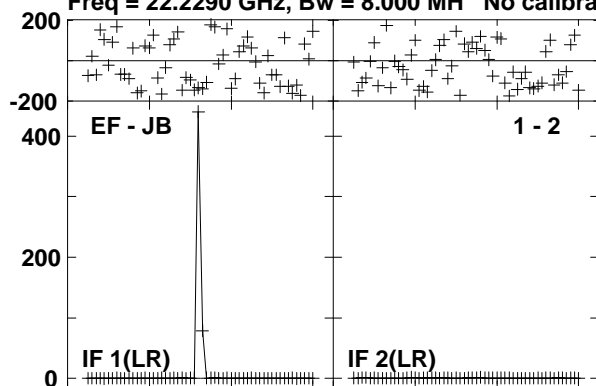

Lower frame: Milli Ampl Jy Top frame: Phas deg
Vector averaged cross-power spectrum Several baselines displayed
Timerange: 00/14:28:14 to 00/14:29:11

Plot file version 187 created 17-SEP-2012 12:09:33

J0529-0519 EE008D 1.UVDATA.1

Freq = 22.2290 GHz, Bw = 8.000 MH No calibration applied and no bandpass applied

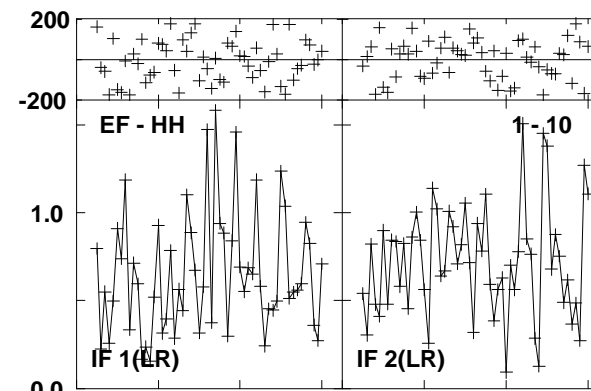
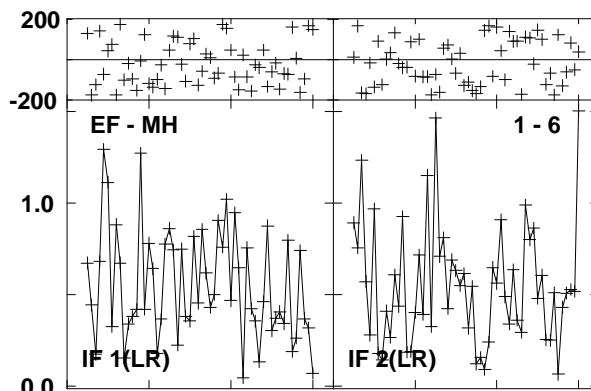
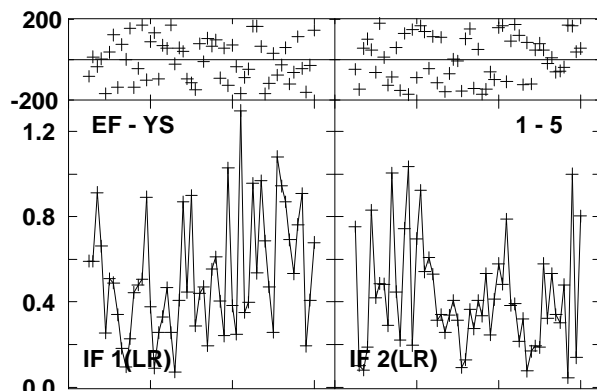
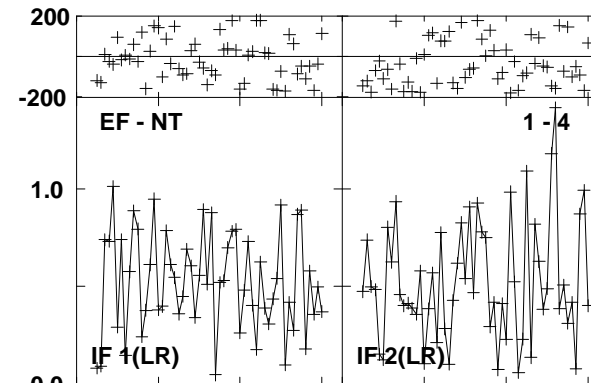
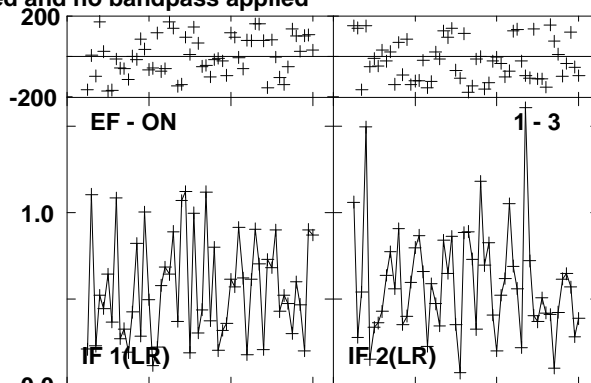
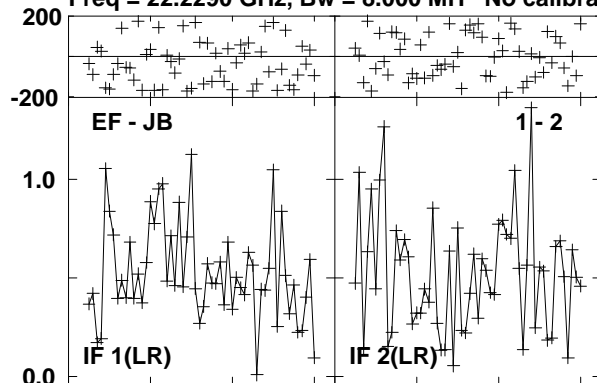

Lower frame: Milli Ampl Jy Top frame: Phas deg
Vector averaged cross-power spectrum Several baselines displayed
Timerange: 00/14:29:16 to 00/14:30:11

Plot file version 188 created 17-SEP-2012 12:09:35

ORIKL1 EE008D 1.UVDATA.1

Freq = 22.2290 GHz, Bw = 8.000 MH No calibration applied and no bandpass applied

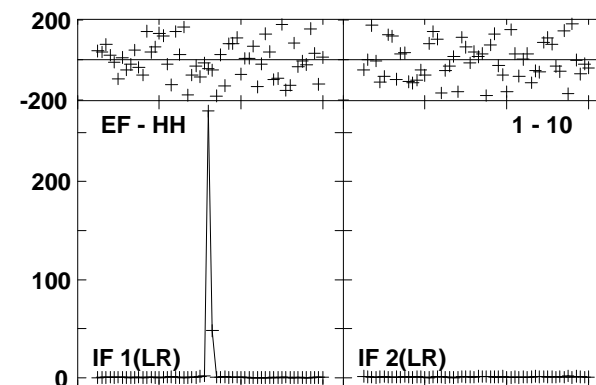
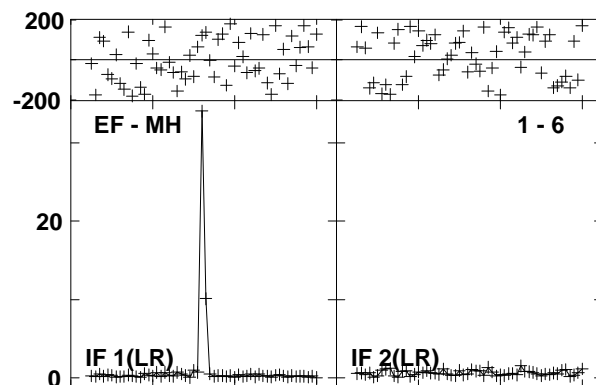
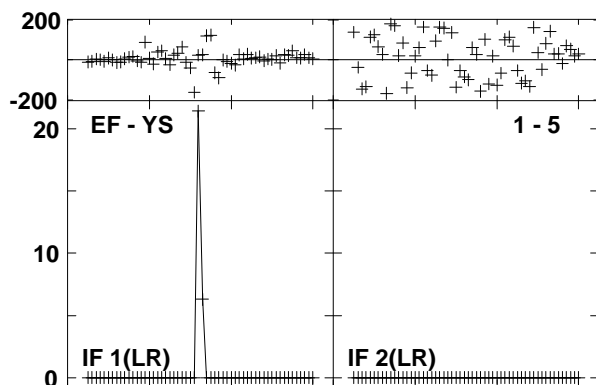
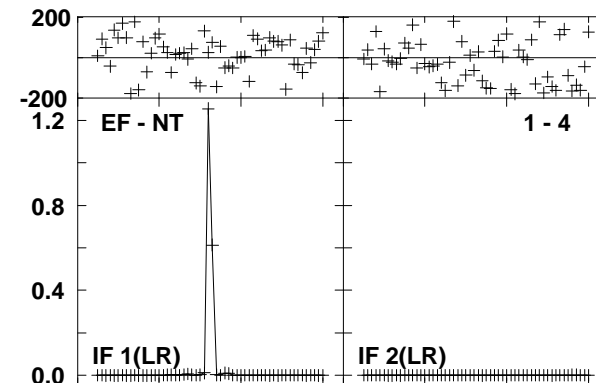
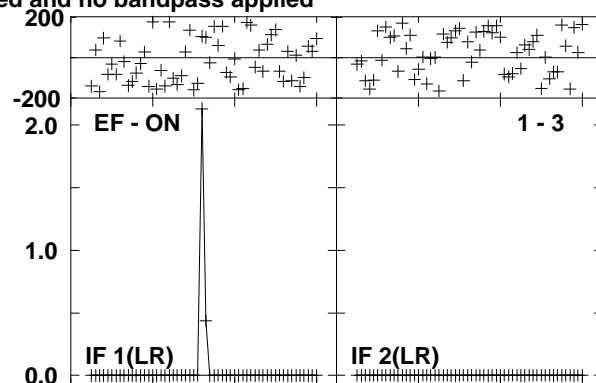
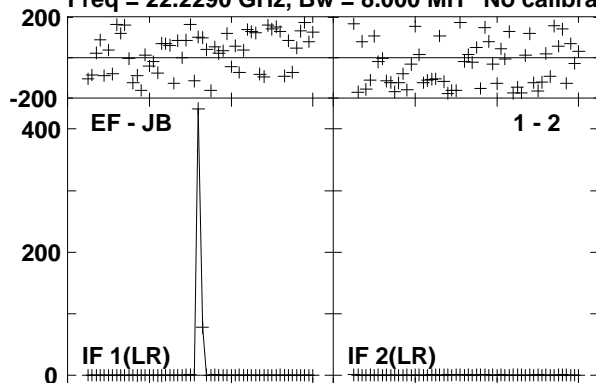

Lower frame: Milli Ampl Jy Top frame: Phas deg
Vector averaged cross-power spectrum Several baselines displayed
Timerange: 00/14:30:16 to 00/14:31:11

Plot file version 189 created 17-SEP-2012 12:09:36

J0529-0519 EE008D 1.UVDATA.1

Freq = 22.2290 GHz, Bw = 8.000 MH No calibration applied and no bandpass applied

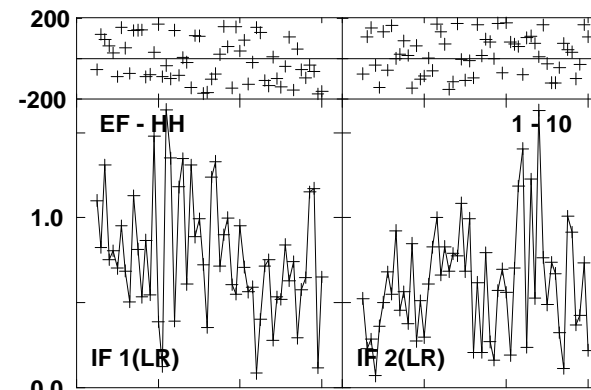
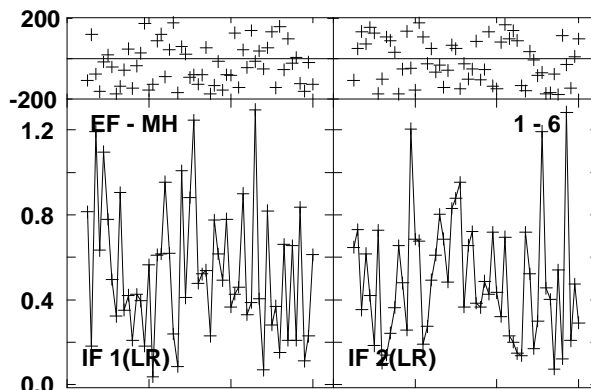
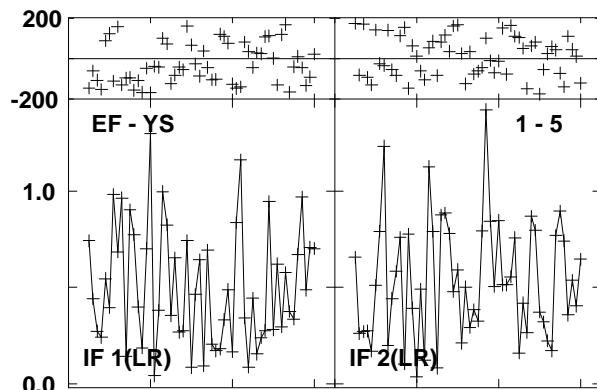
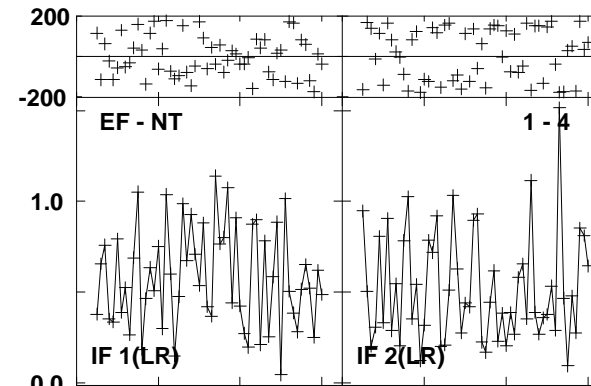
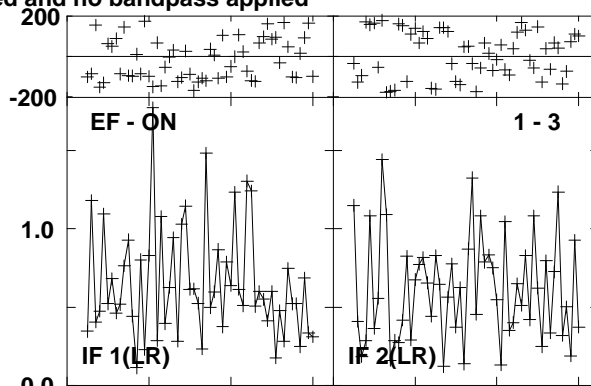
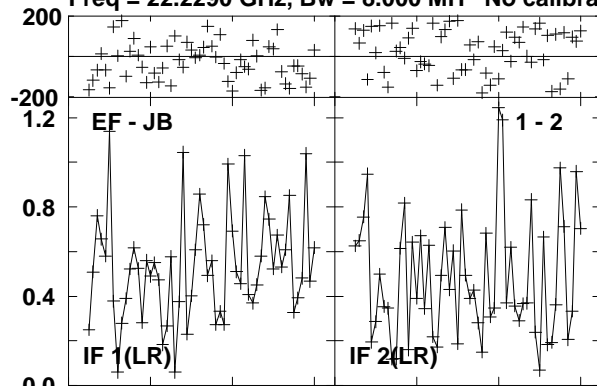

Lower frame: Milli Ampl Jy Top frame: Phas deg
Vector averaged cross-power spectrum Several baselines displayed
Timerange: 00/14:31:16 to 00/14:32:11

Plot file version 190 created 17-SEP-2012 12:09:37

J0541-0541 EE008D 1.UVDATA.1

Freq = 22.2290 GHz, Bw = 8.000 MH No calibration applied and no bandpass applied

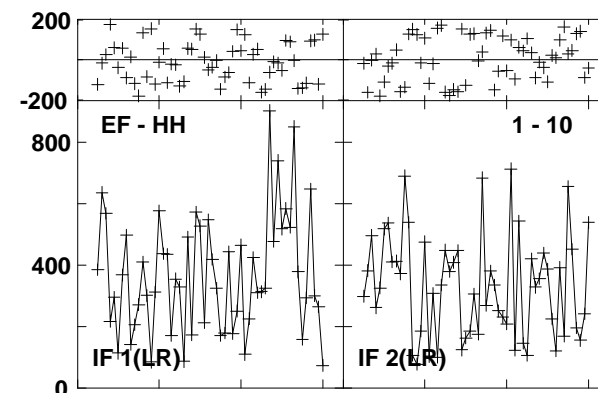
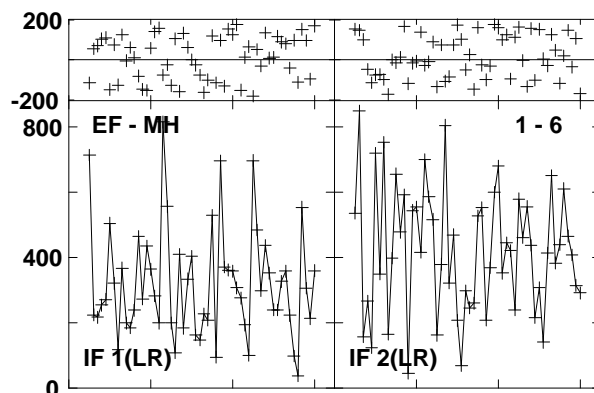
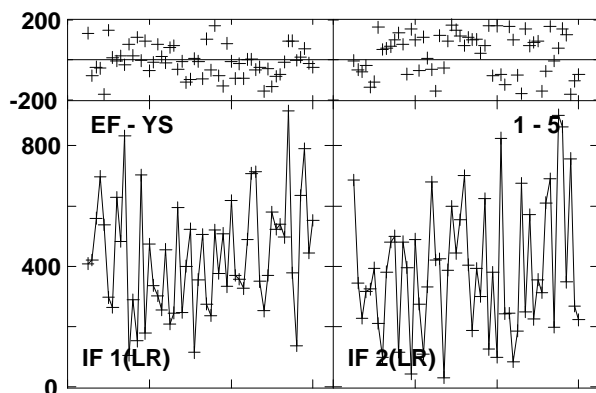
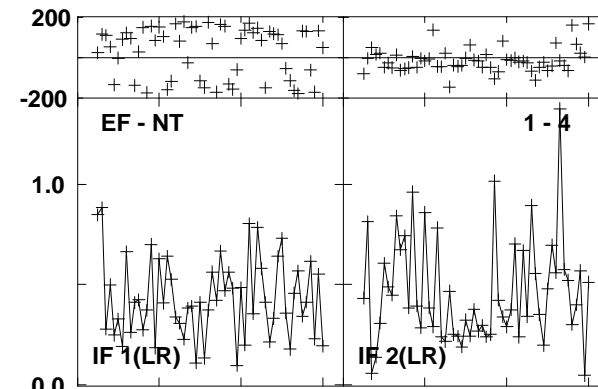
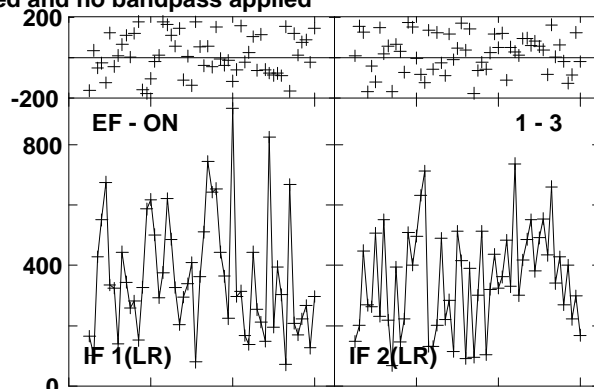
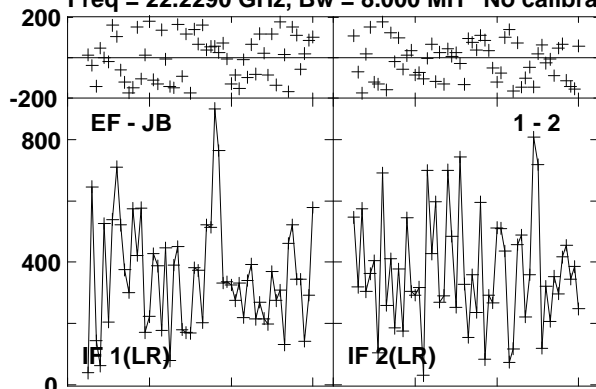

Lower frame: Micro Ampl Jy Top frame: Phas deg
Vector averaged cross-power spectrum Several baselines displayed
Timerange: 00/14:32:57 to 00/14:33:56

Plot file version 191 created 17-SEP-2012 12:09:39

ORIKL1 EE008D 1.UVDATA.1

Freq = 22.2290 GHz, Bw = 8.000 MH No calibration applied and no bandpass applied

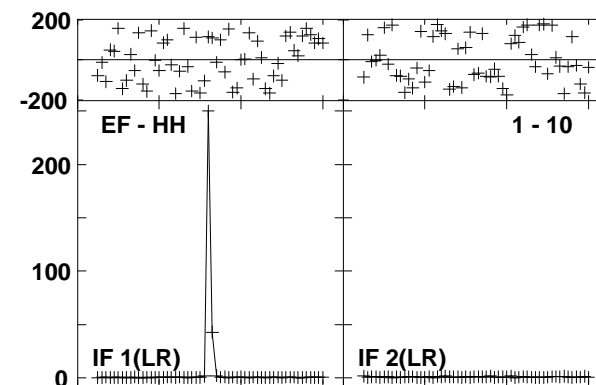
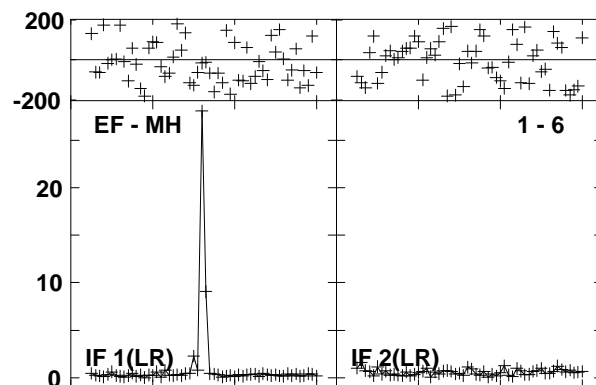
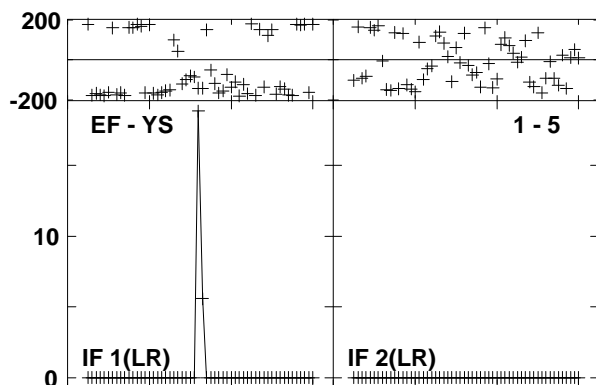
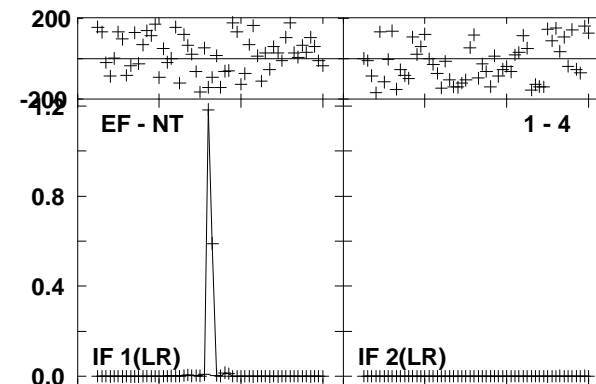
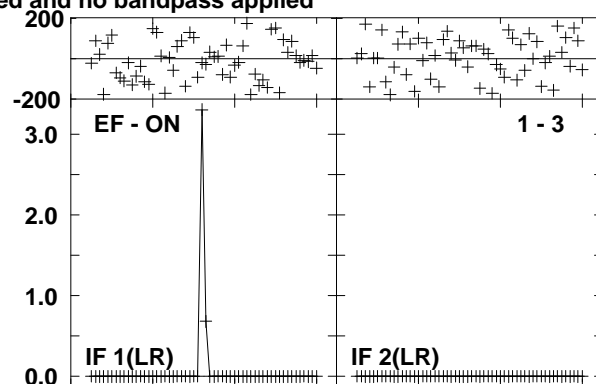
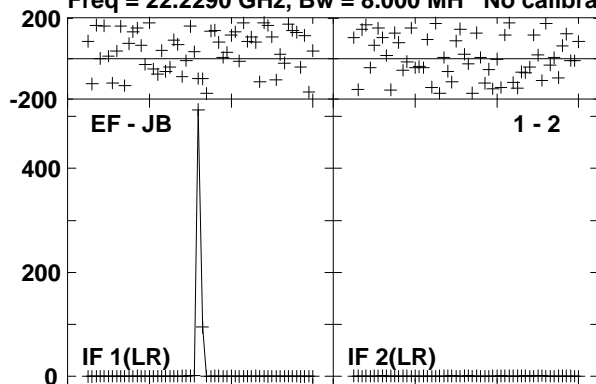

Lower frame: Milli Ampl Jy Top frame: Phas deg
Vector averaged cross-power spectrum Several baselines displayed
Timerange: 00/14:34:02 to 00/14:34:56

Plot file version 192 created 17-SEP-2012 12:09:40

J0541-0541 EE008D 1.UVDATA.1

Freq = 22.2290 GHz, Bw = 8.000 MH No calibration applied and no bandpass applied

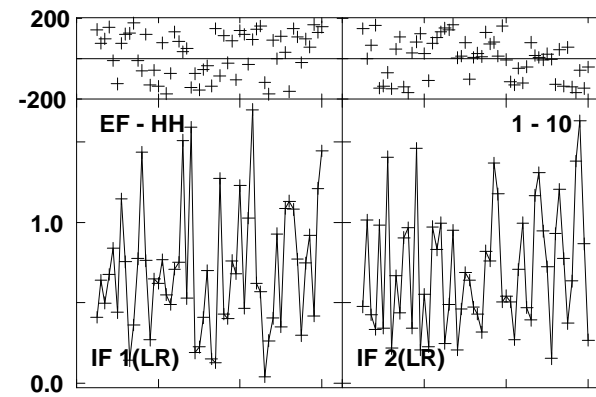
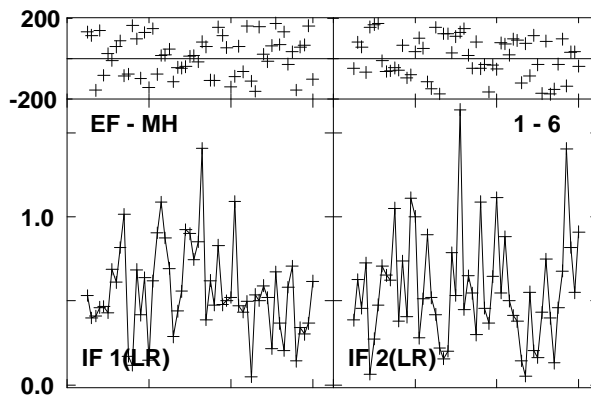
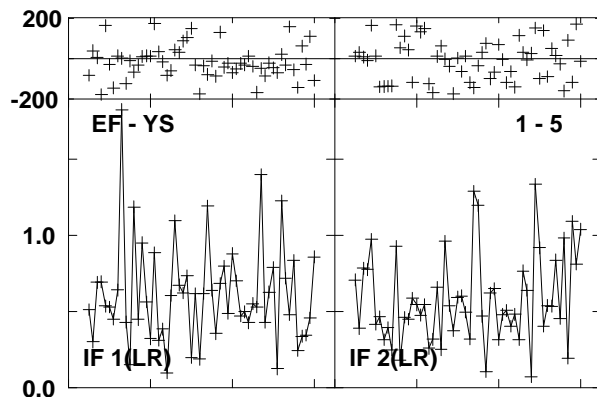
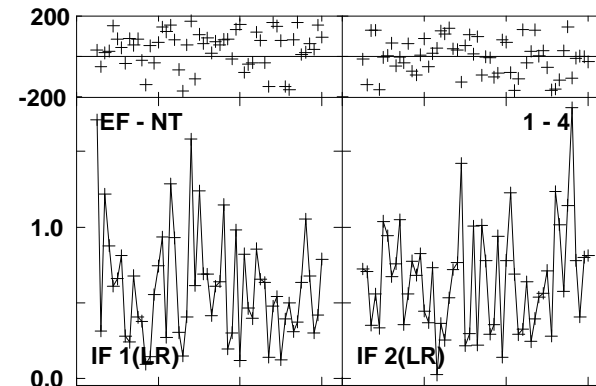
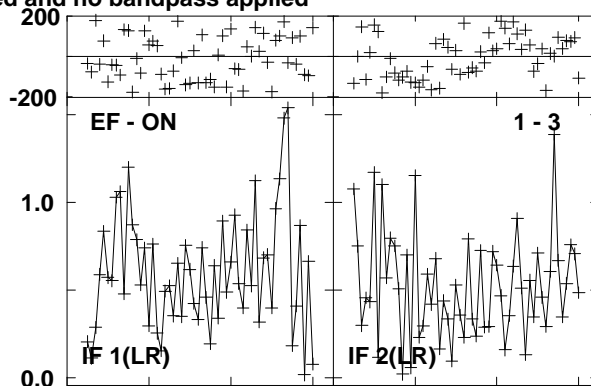
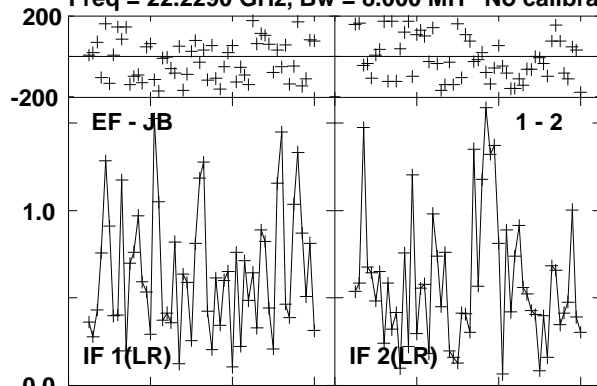

Lower frame: Milli Ampl Jy Top frame: Phas deg
Vector averaged cross-power spectrum Several baselines displayed
Timerange: 00/14:35:00 to 00/14:35:56

Plot file version 193 created 17-SEP-2012 12:09:41

ORIKL1 EE008D 1.UVDATA.1

Freq = 22.2290 GHz, Bw = 8.000 MH No calibration applied and no bandpass applied

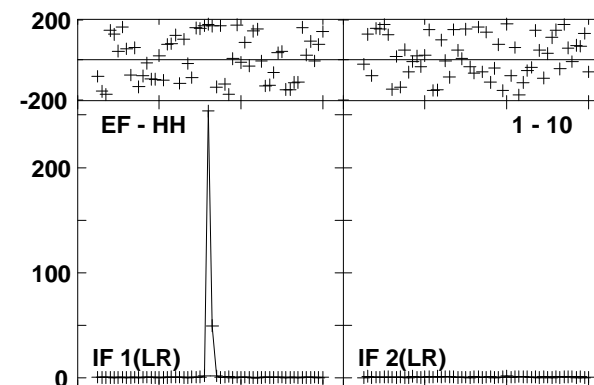
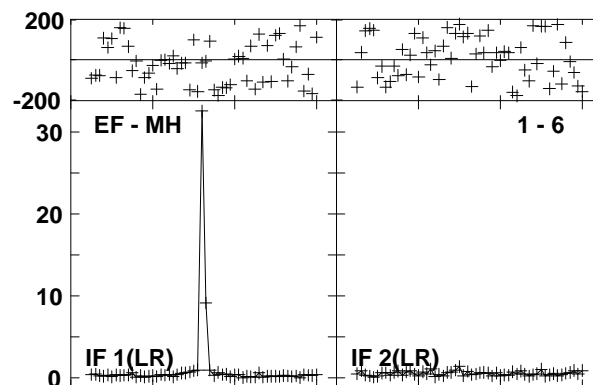
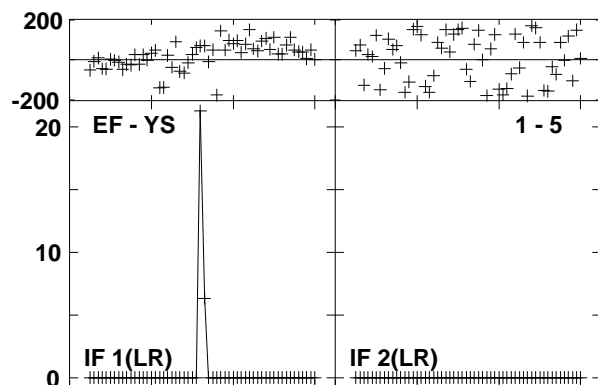
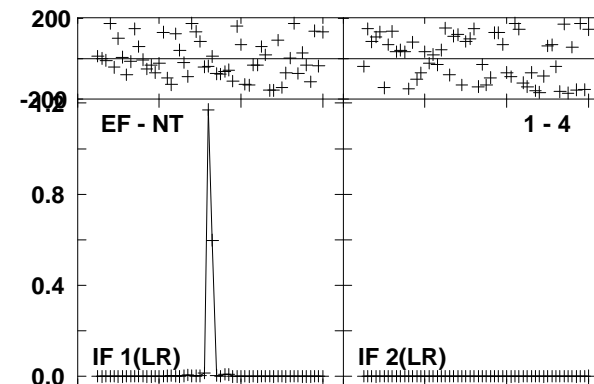
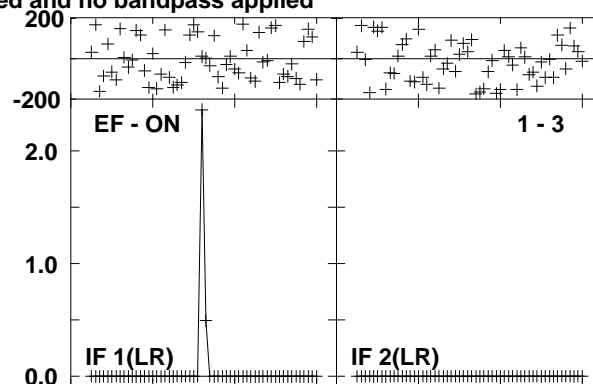
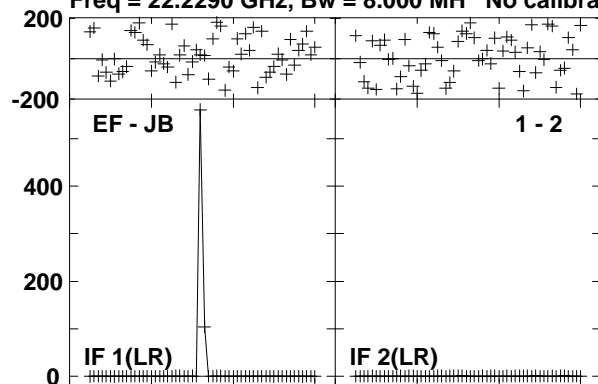

Lower frame: Milli Ampl Jy Top frame: Phas deg
Vector averaged cross-power spectrum Several baselines displayed
Timerange: 00/14:36:00 to 00/14:36:56

Plot file version 194 created 17-SEP-2012 12:09:42

J0541-0541 EE008D 1.UVDATA.1

Freq = 22.2290 GHz, Bw = 8.000 MH No calibration applied and no bandpass applied

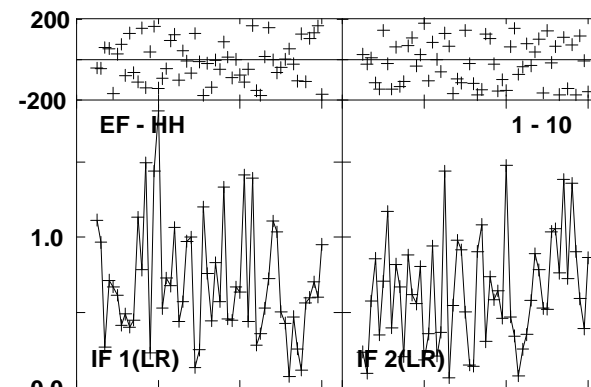
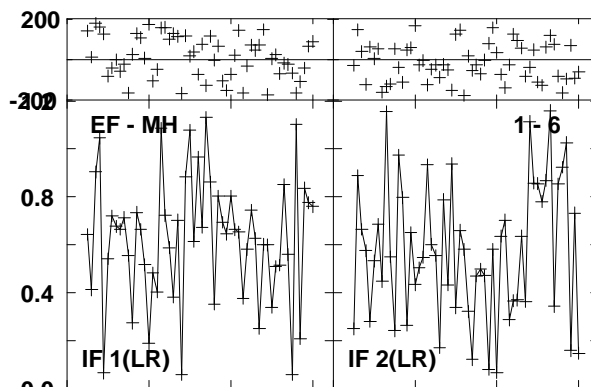
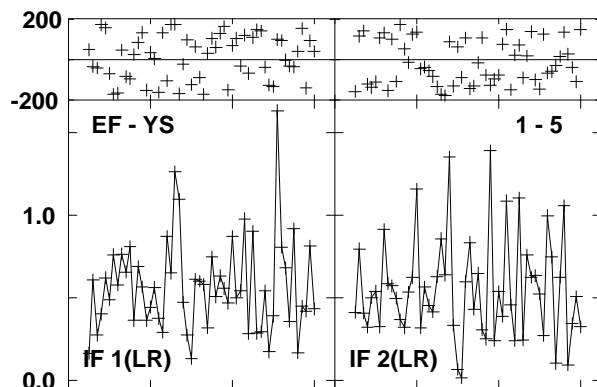
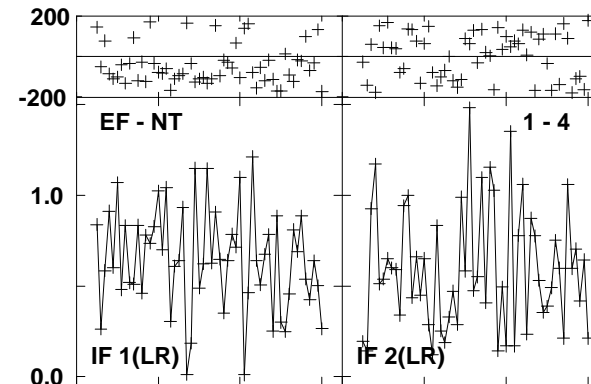
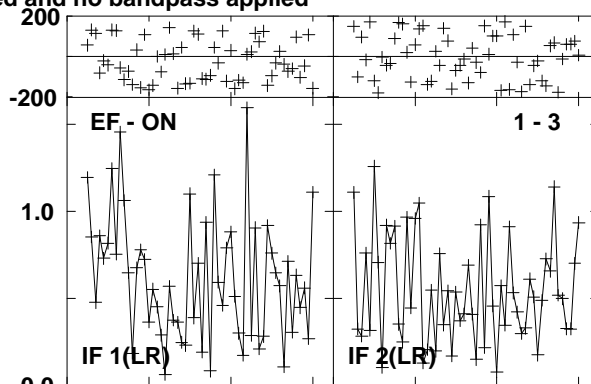
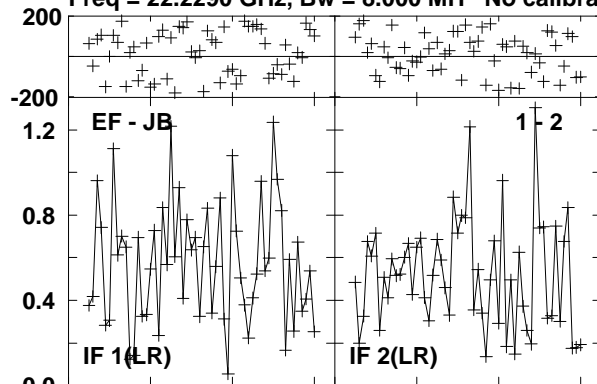

Lower frame: Milli Ampl Jy Top frame: Phas deg
Vector averaged cross-power spectrum Several baselines displayed
Timerange: 00/14:37:00 to 00/14:37:56

Plot file version 195 created 17-SEP-2012 12:09:44

J0529-0519 EE008D 1.UVDATA.1

Freq = 22.2290 GHz, Bw = 8.000 MH No calibration applied and no bandpass applied

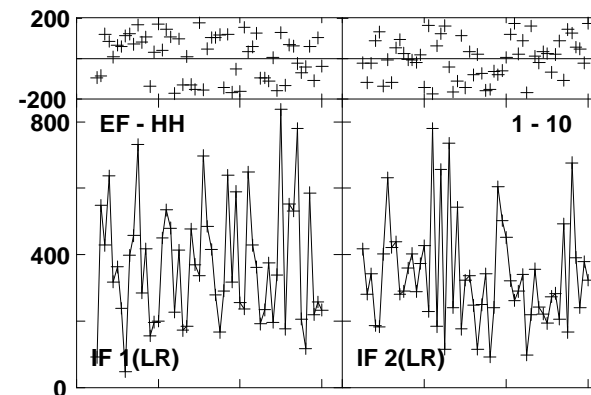
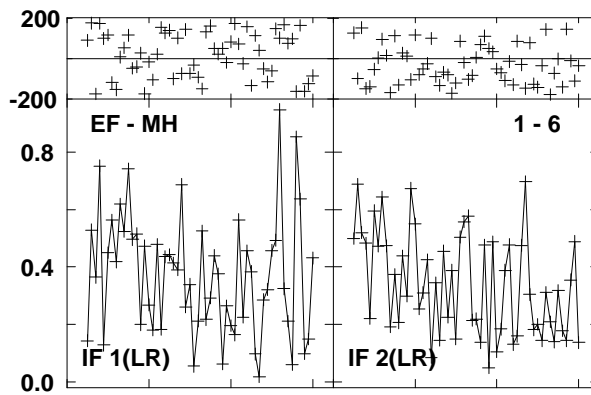
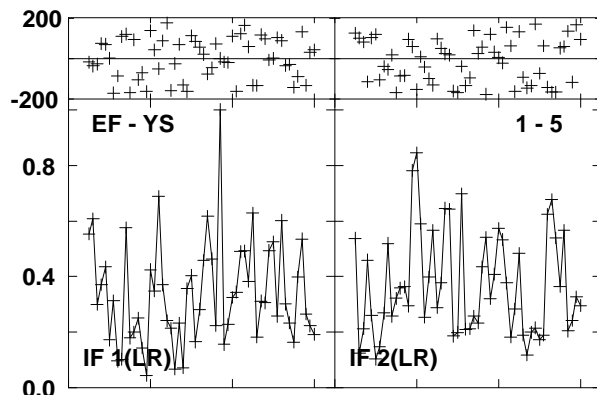
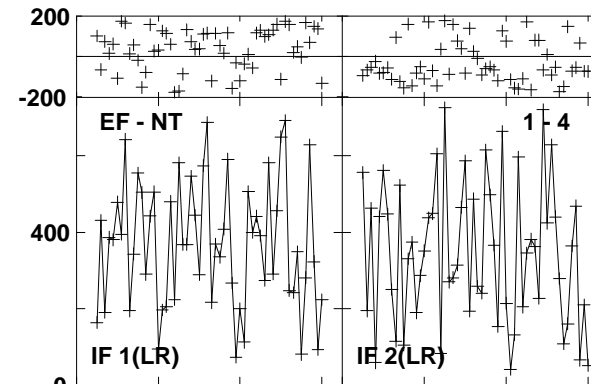
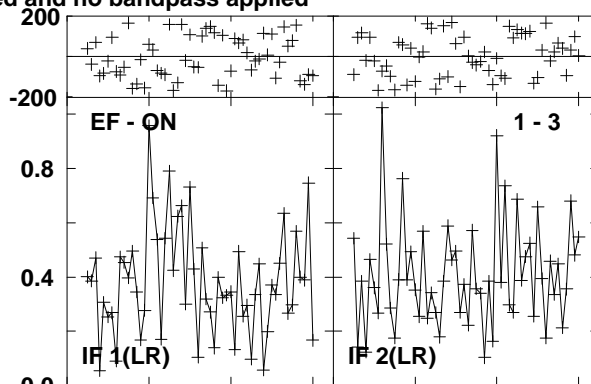
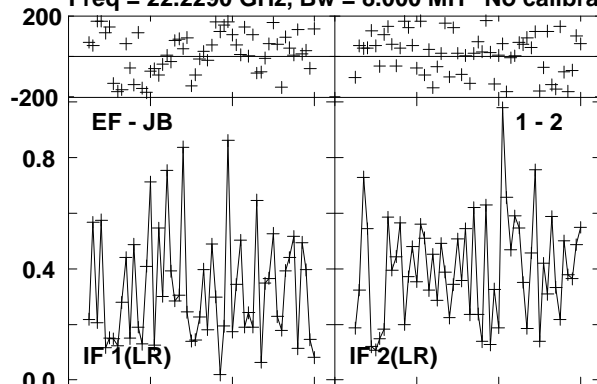

Lower frame: Milli Ampl Jy Top frame: Phas deg
Vector averaged cross-power spectrum Several baselines displayed
Timerange: 00/14:38:43 to 00/14:39:42

Plot file version 196 created 17-SEP-2012 12:09:45

ORIKL1 EE008D 1.UVDATA.1

Freq = 22.2290 GHz, Bw = 8.000 MH No calibration applied and no bandpass applied

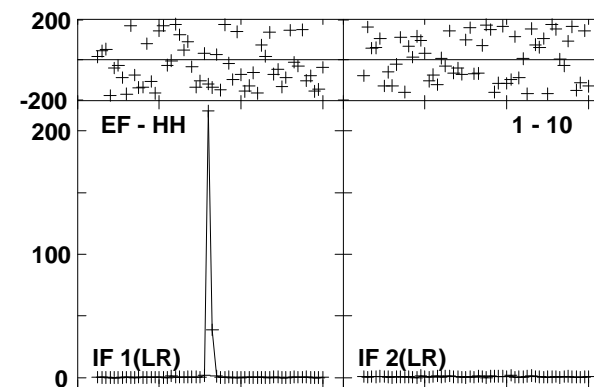
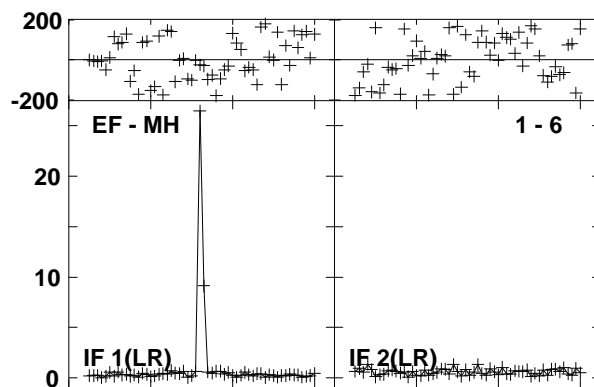
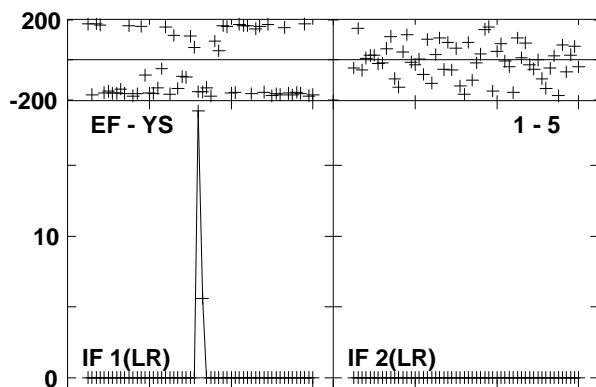
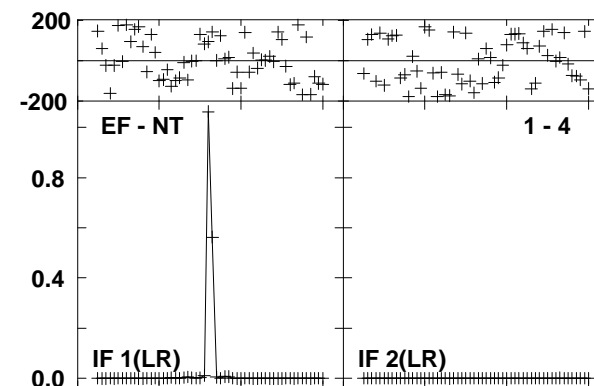
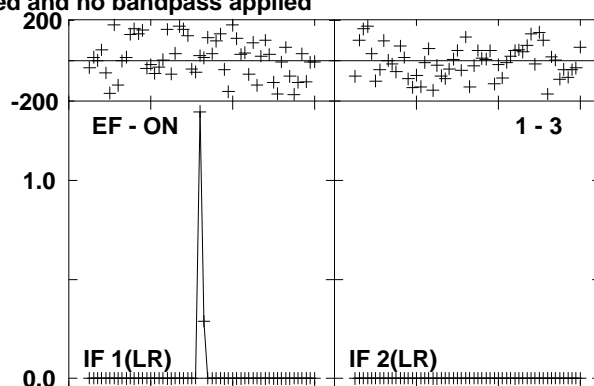
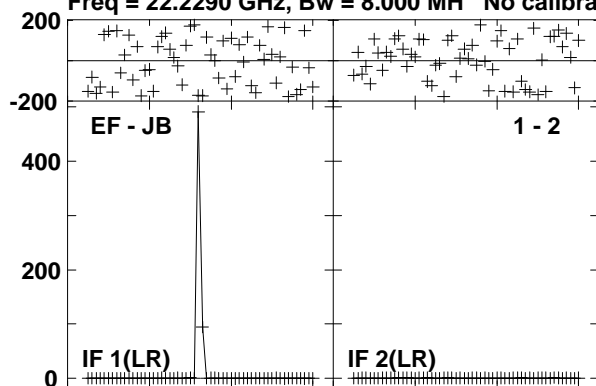

Lower frame: Milli Ampl Jy Top frame: Phas deg
Vector averaged cross-power spectrum Several baselines displayed
Timerange: 00/14:39:46 to 00/14:40:42

Plot file version 197 created 17-SEP-2012 12:09:46

J0529-0519 EE008D 1.UVDATA.1

Freq = 22.2290 GHz, Bw = 8.000 MH No calibration applied and no bandpass applied

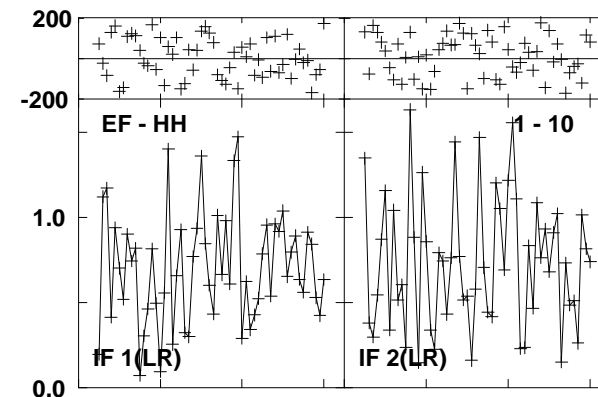
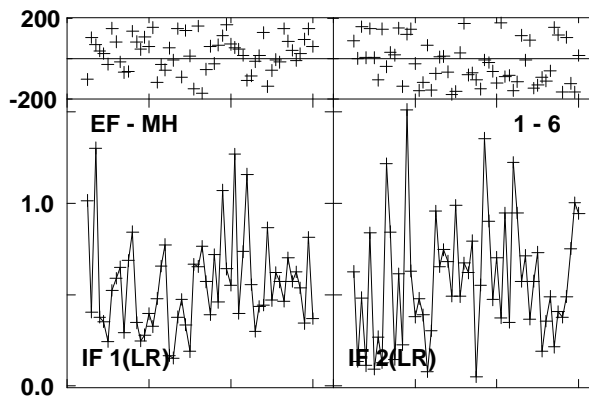
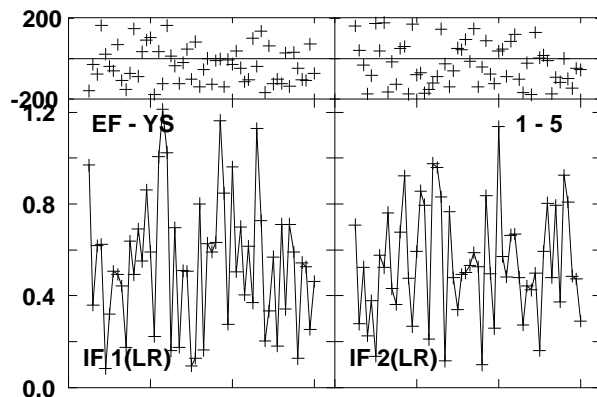
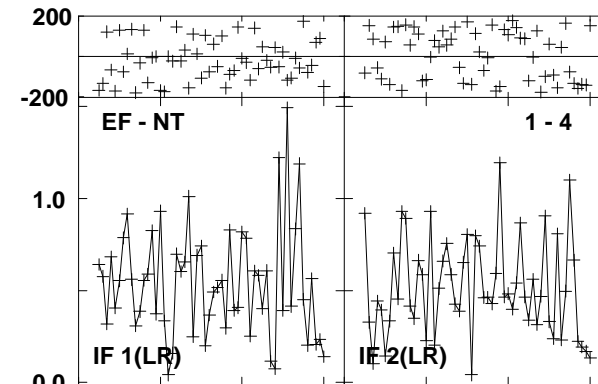
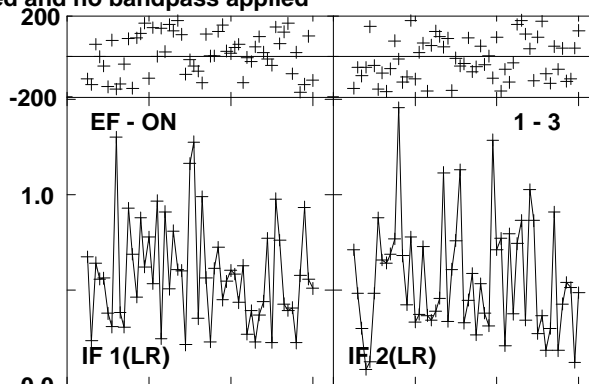
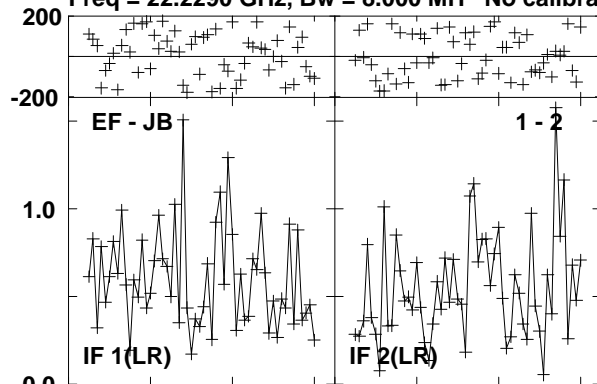

Lower frame: Milli Ampl Jy Top frame: Phas deg
Vector averaged cross-power spectrum Several baselines displayed
Timerange: 00/14:40:46 to 00/14:41:42

Plot file version 198 created 17-SEP-2012 12:09:48

ORIKL1 EE008D 1.UVDATA.1

Freq = 22.2290 GHz, Bw = 8.000 MH No calibration applied and no bandpass applied

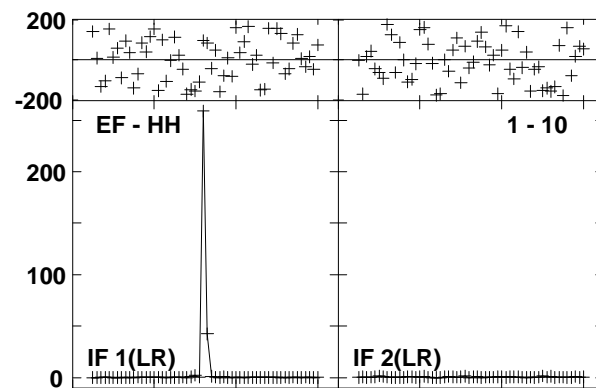
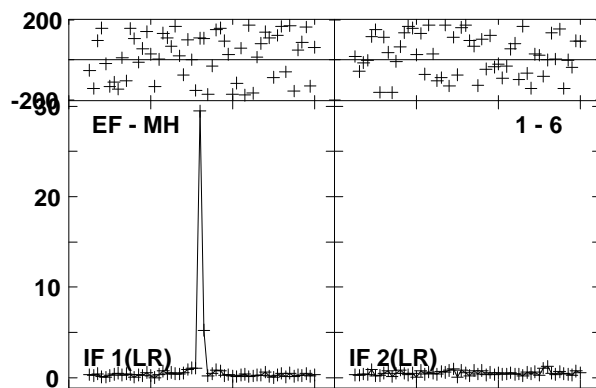
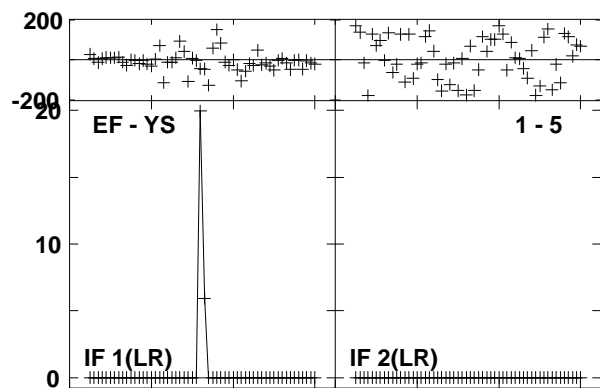
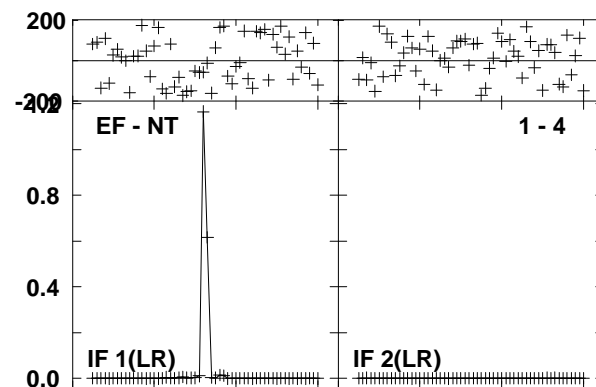
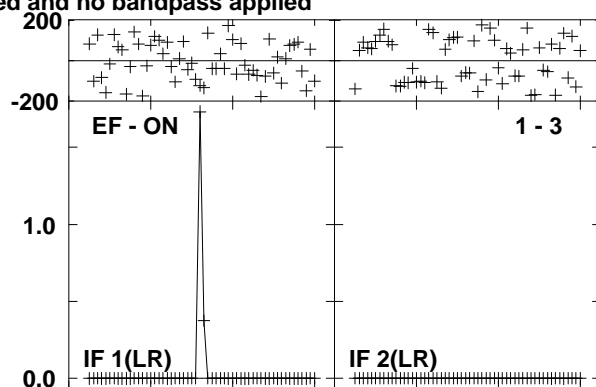
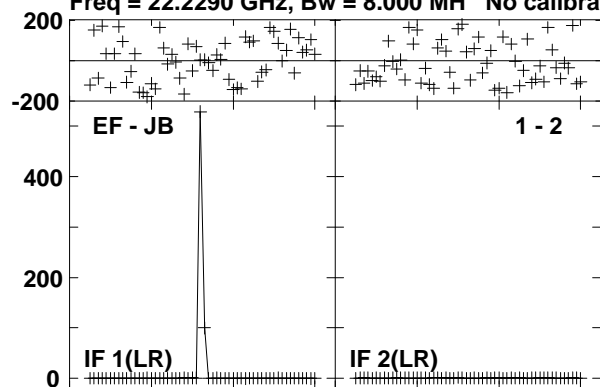

Lower frame: Milli Ampl Jy Top frame: Phas deg
Vector averaged cross-power spectrum Several baselines displayed
Timerange: 00/14:41:46 to 00/14:42:42

Plot file version 199 created 17-SEP-2012 12:09:49

J0529-0519 EE008D 1.UVDATA.1

Freq = 22.2290 GHz, Bw = 8.000 MH No calibration applied and no bandpass applied

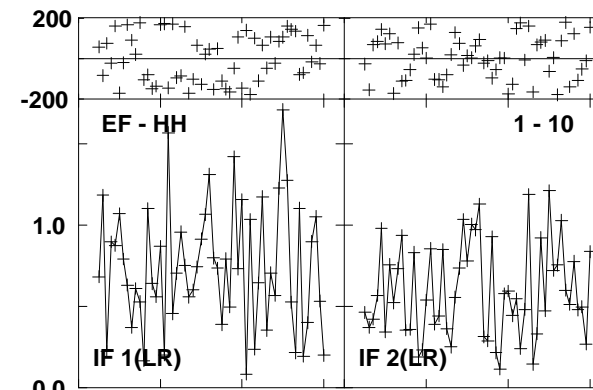
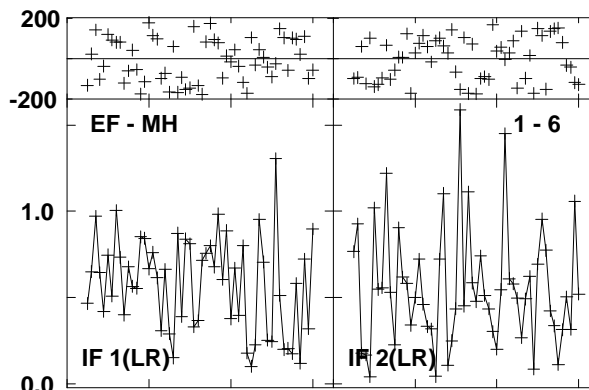
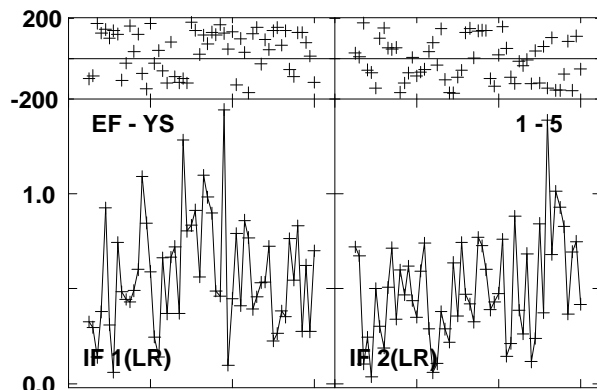
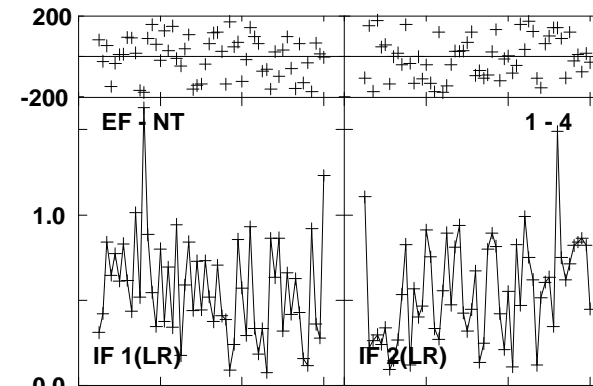
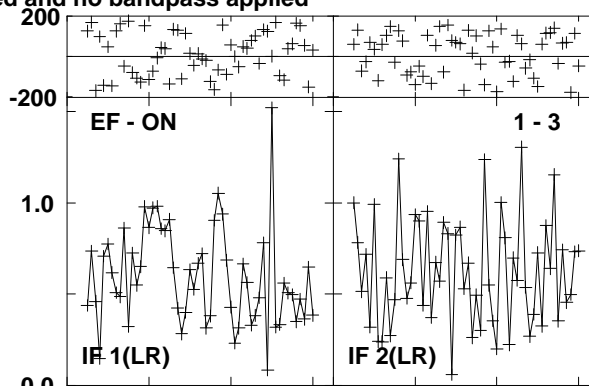
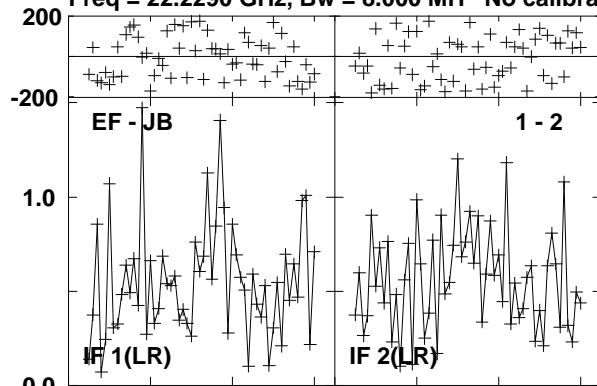

Lower frame: Milli Ampl Jy Top frame: Phas deg
Vector averaged cross-power spectrum Several baselines displayed
Timerange: 00/14:42:47 to 00/14:43:42

Plot file version 200 created 17-SEP-2012 12:09:50

J0541-0541 EE008D 1.UVDATA.1

Freq = 22.2290 GHz, Bw = 8.000 MH No calibration applied and no bandpass applied

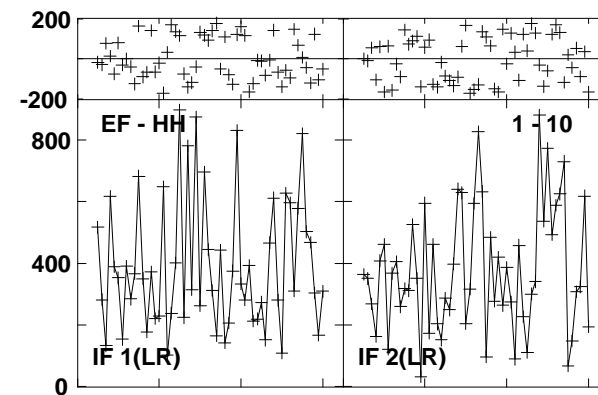
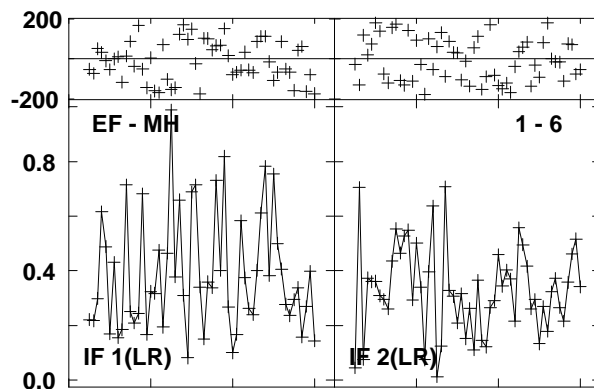
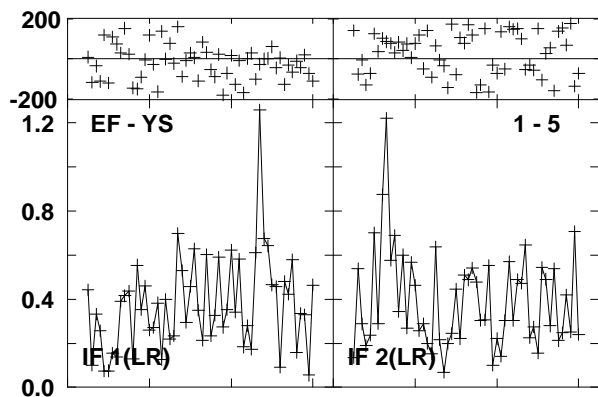
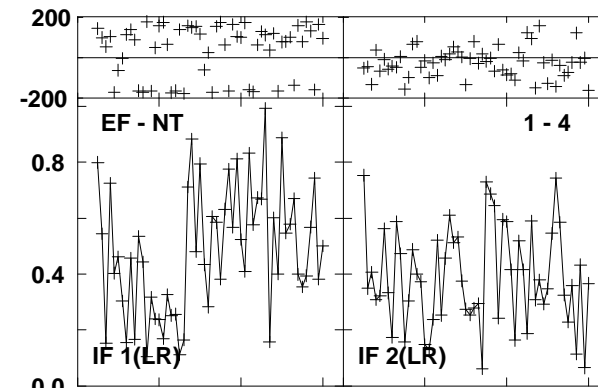
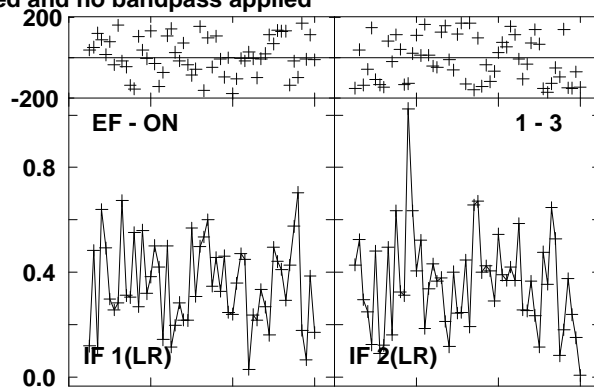
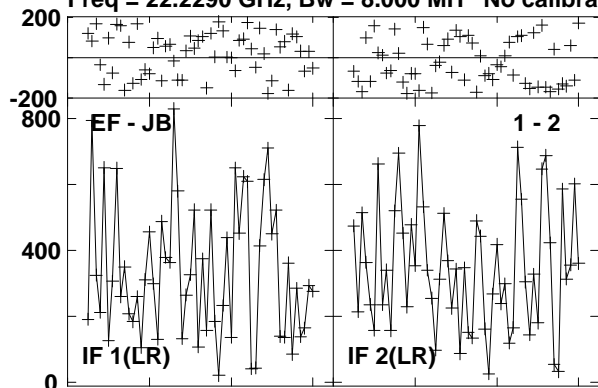

Lower frame: Micro Ampl Jy Top frame: Phas deg
Vector averaged cross-power spectrum Several baselines displayed
Timerange: 00/14:44:28 to 00/14:45:27

Plot file version 201 created 17-SEP-2012 12:09:52

ORIKL1 EE008D 1.UVDATA.1

Freq = 22.2290 GHz, Bw = 8.000 MH No calibration applied and no bandpass applied

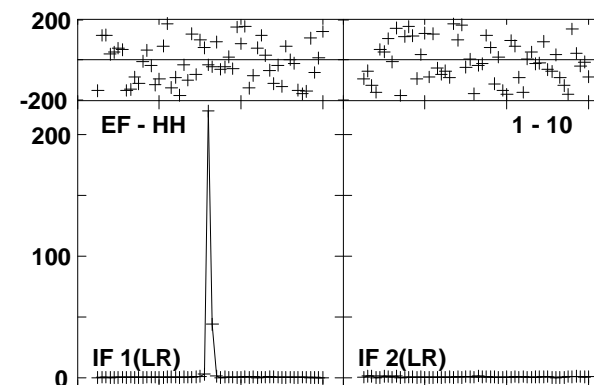
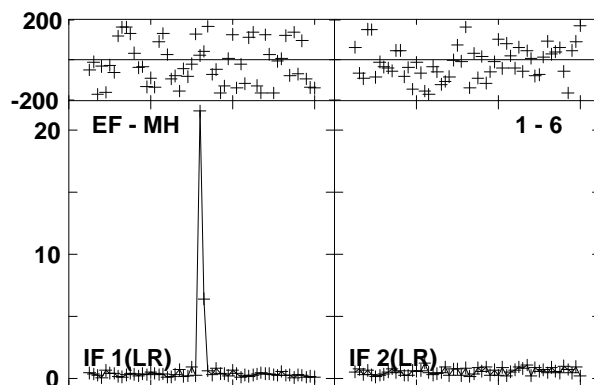
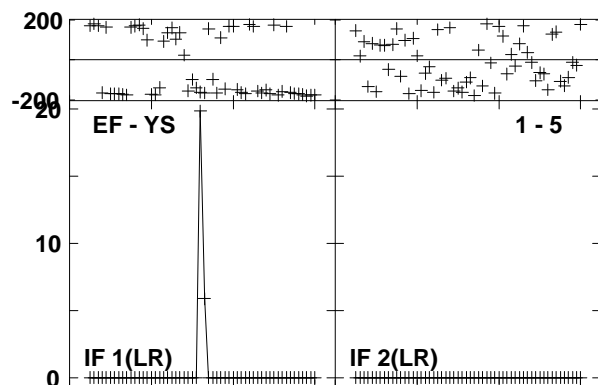
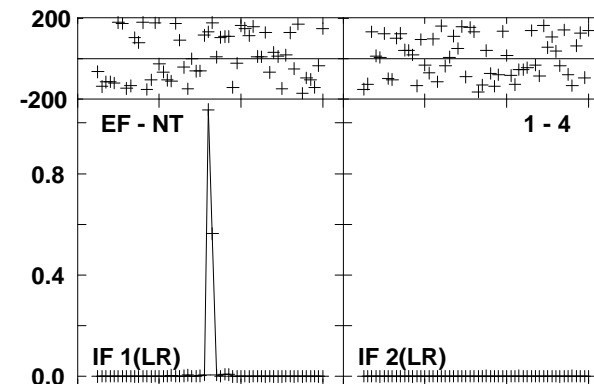
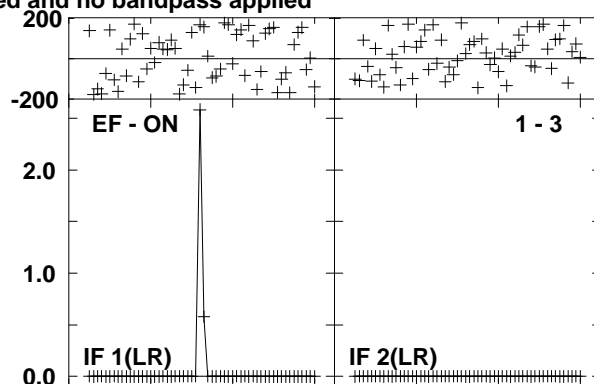
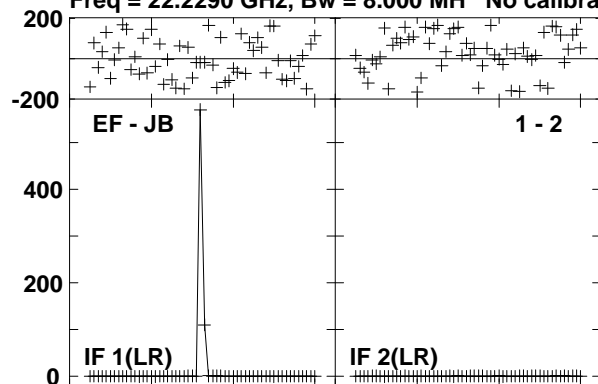

Lower frame: Milli Ampl Jy Top frame: Phas deg
Vector averaged cross-power spectrum Several baselines displayed
Timerange: 00/14:45:30 to 00/14:46:27

Plot file version 202 created 17-SEP-2012 12:09:53

J0541-0541 EE008D 1.UVDATA.1

Freq = 22.2290 GHz, Bw = 8.000 MH No calibration applied and no bandpass applied

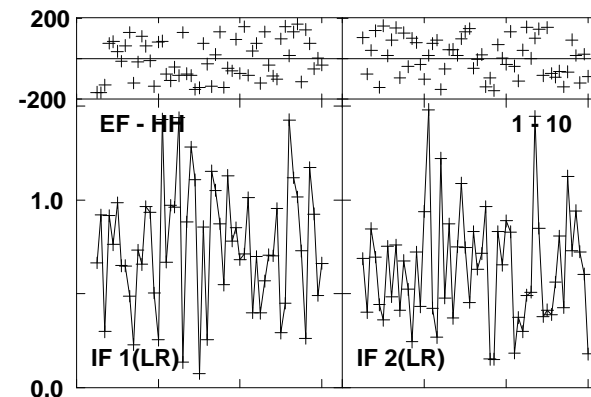
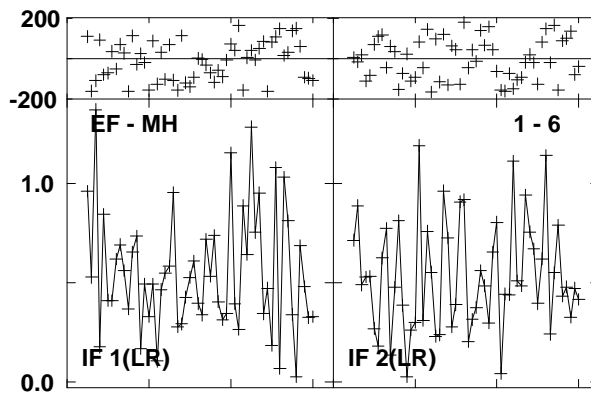
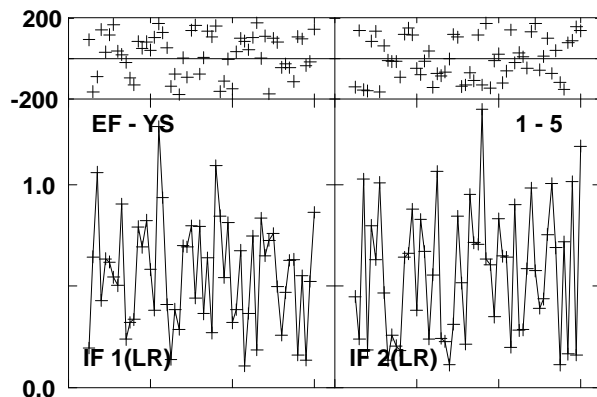
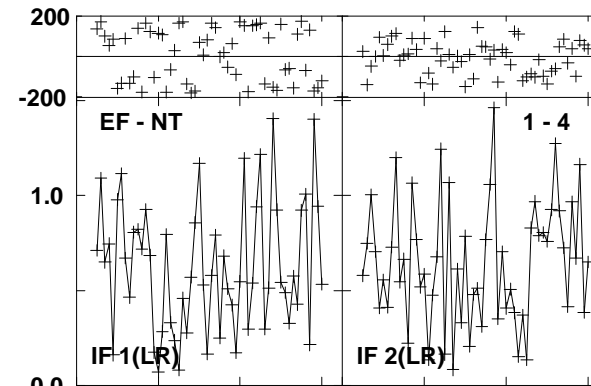
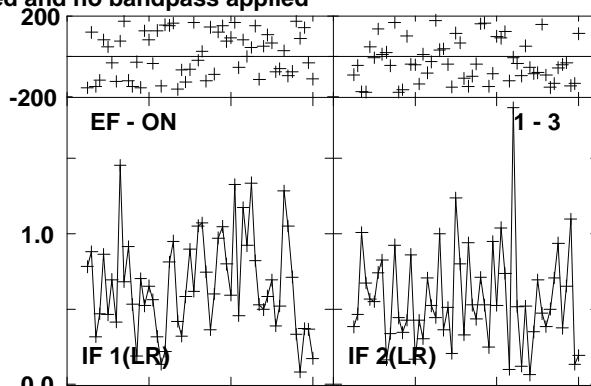
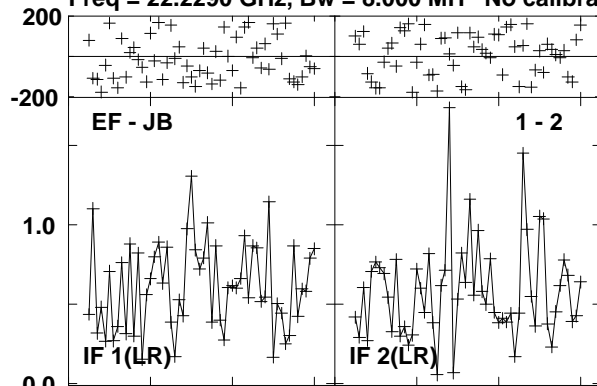

Lower frame: Milli Ampl Jy Top frame: Phas deg
Vector averaged cross-power spectrum Several baselines displayed
Timerange: 00/14:46:31 to 00/14:47:27

Plot file version 203 created 17-SEP-2012 12:09:54

ORIKL1 EE008D 1.UVDATA.1

Freq = 22.2290 GHz, Bw = 8.000 MH No calibration applied and no bandpass applied

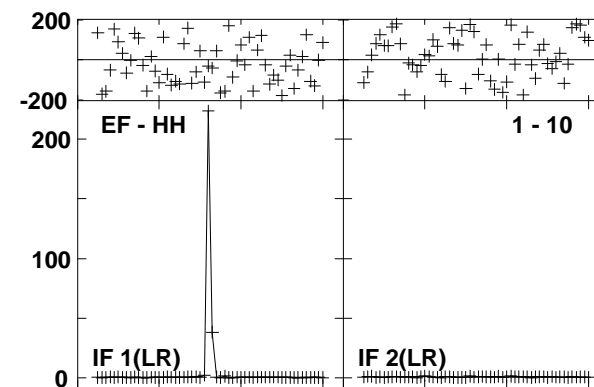
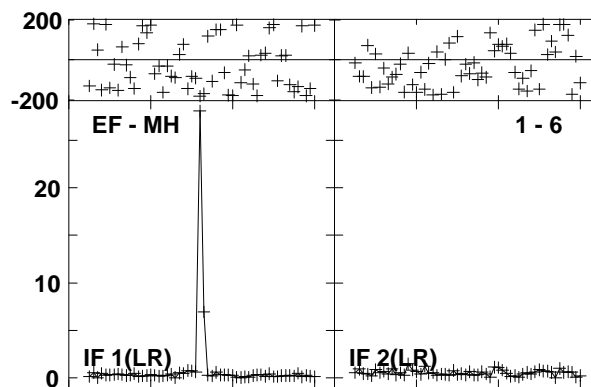
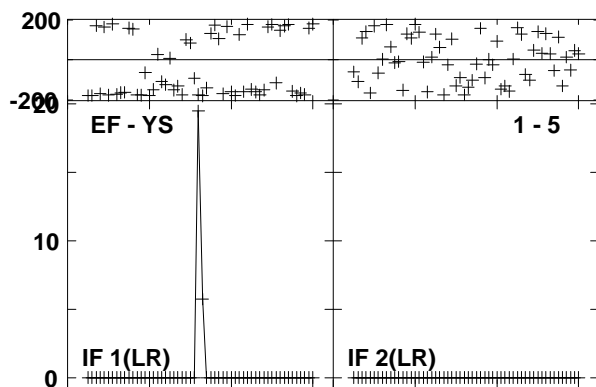
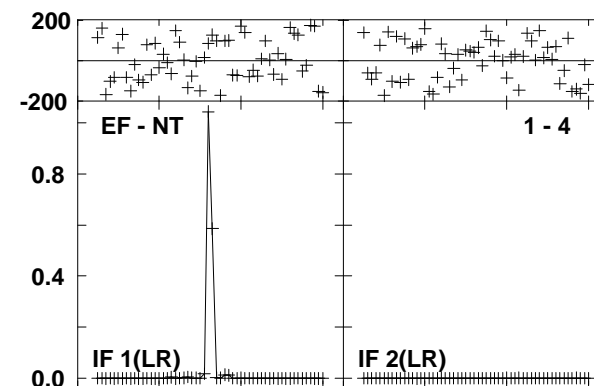
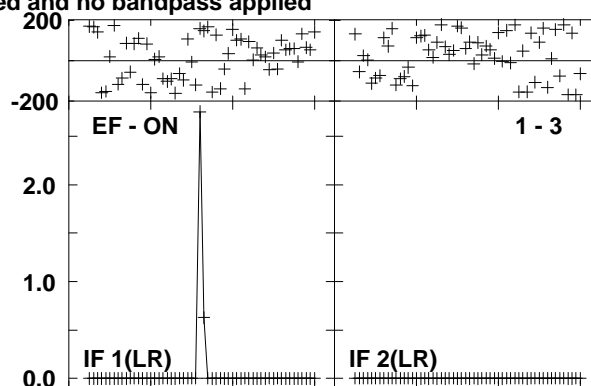
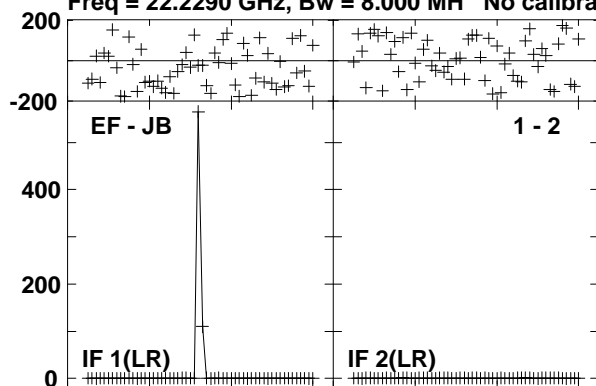

Lower frame: Milli Ampl Jy Top frame: Phas deg
Vector averaged cross-power spectrum Several baselines displayed
Timerange: 00/14:47:33 to 00/14:48:27

Plot file version 204 created 17-SEP-2012 12:09:55

J0541-0541 EE008D 1.UVDATA.1

Freq = 22.2290 GHz, Bw = 8.000 MH No calibration applied and no bandpass applied

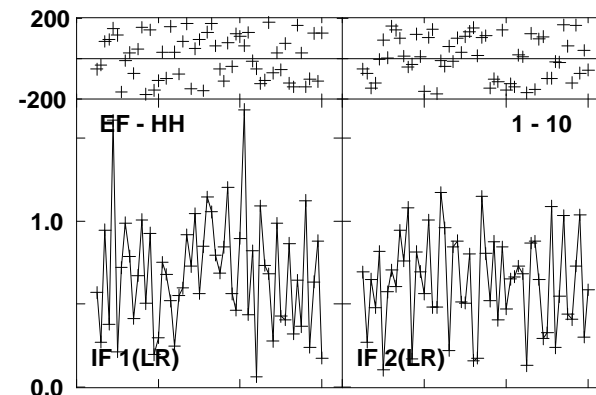
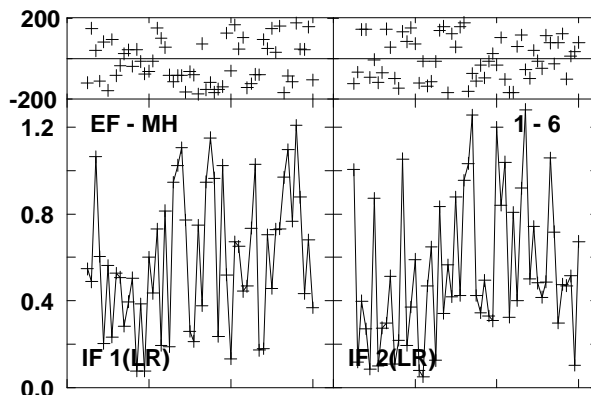
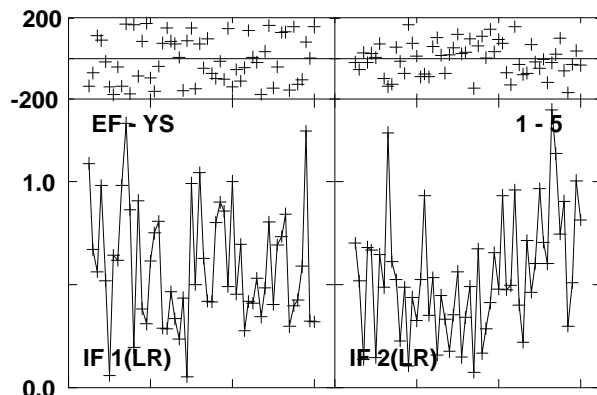
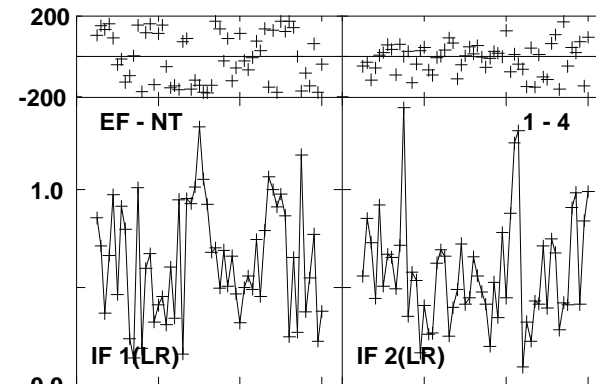
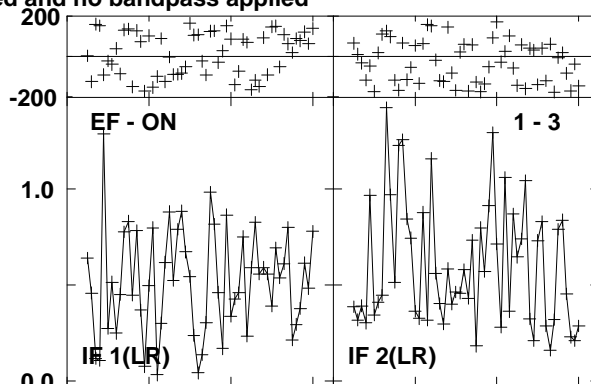
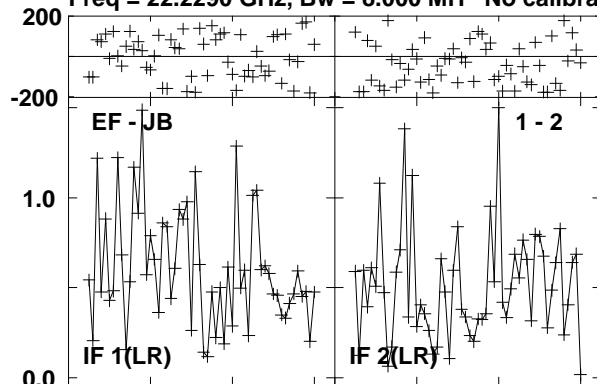

Lower frame: Milli Ampl Jy Top frame: Phas deg
Vector averaged cross-power spectrum Several baselines displayed
Timerange: 00/14:48:33 to 00/14:49:27

Plot file version 205 created 17-SEP-2012 12:09:56

J0529-0519 EE008D 1.UVDATA.1

Freq = 22.2290 GHz, Bw = 8.000 MH No calibration applied and no bandpass applied

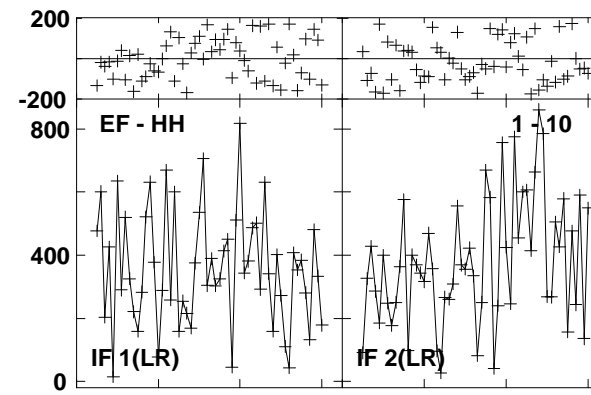
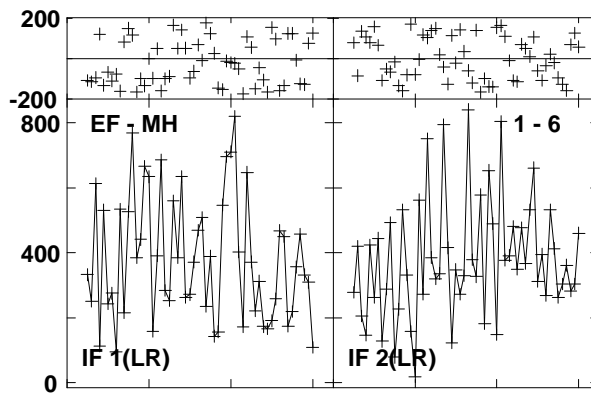
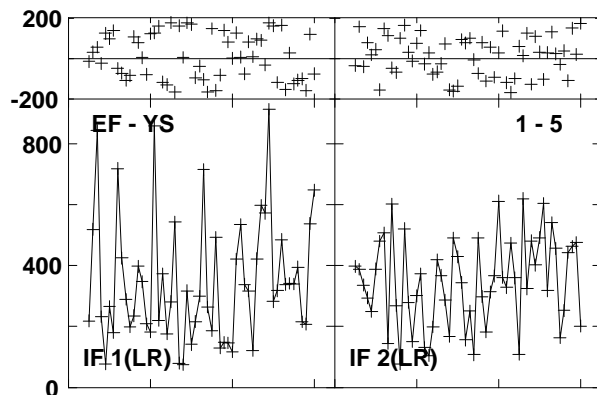
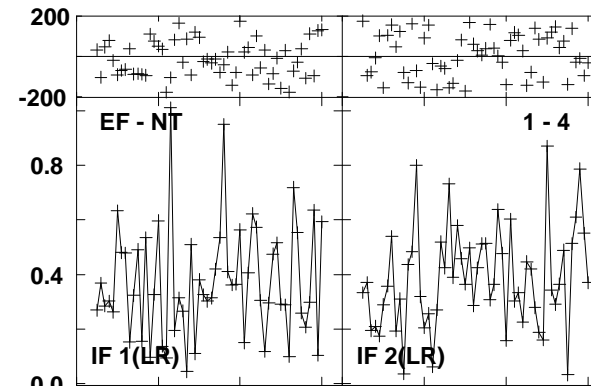
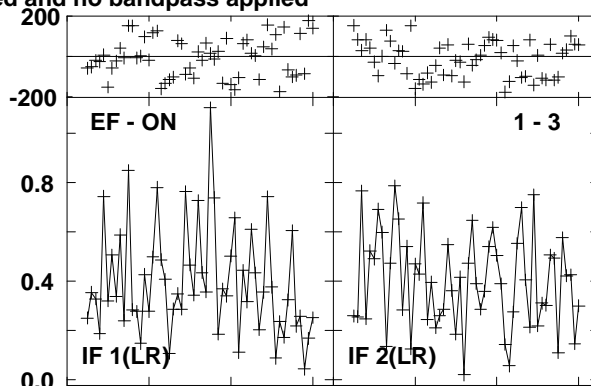
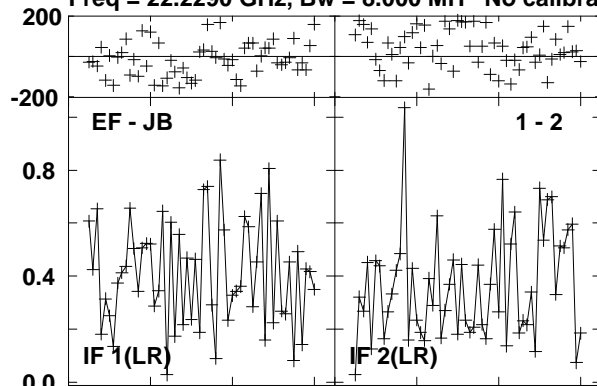

Lower frame: Milli Ampl Jy Top frame: Phas deg
Vector averaged cross-power spectrum Several baselines displayed
Timerange: 00/14:50:14 to 00/14:51:13

Plot file version 206 created 17-SEP-2012 12:09:58

ORIKL1 EE008D 1.UVDATA.1

Freq = 22.2290 GHz, Bw = 8.000 MH No calibration applied and no bandpass applied

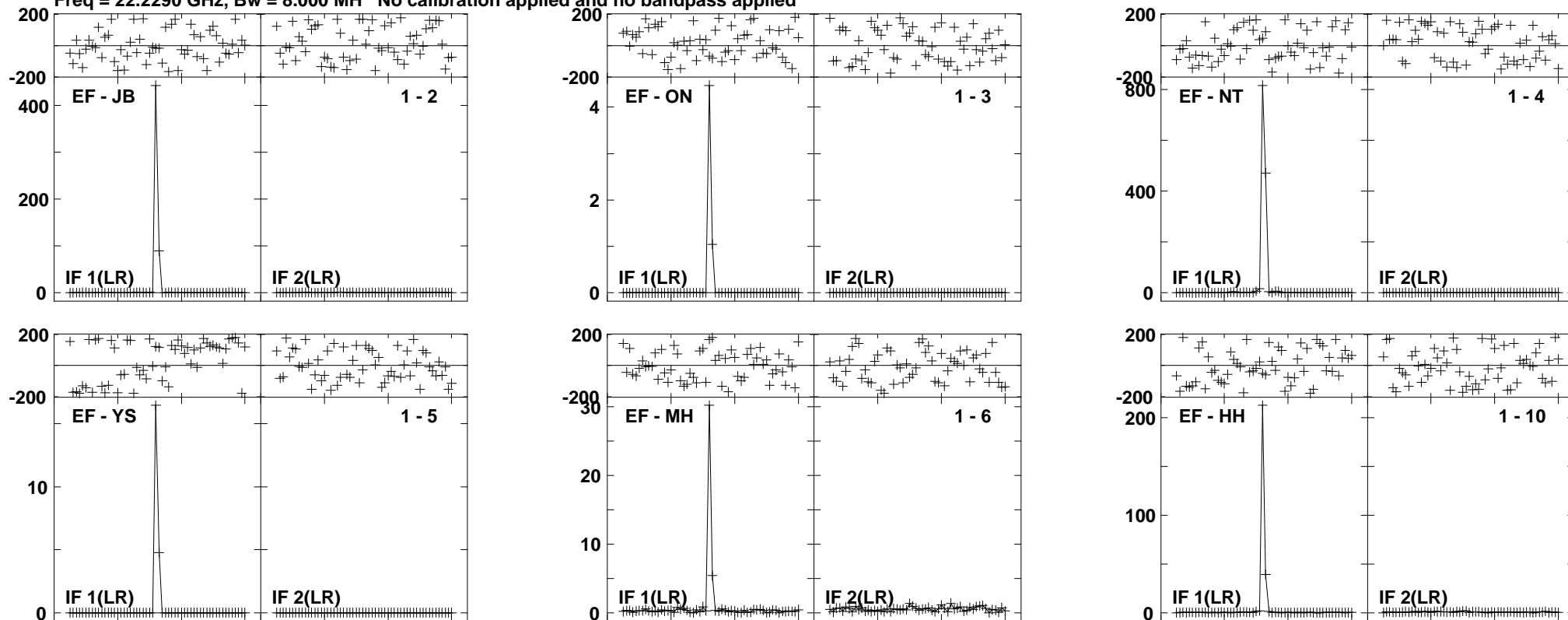

Lower frame: Milli Ampl Jy Top frame: Phas deg
Vector averaged cross-power spectrum Several baselines displayed
Timerange: 00/14:51:17 to 00/14:52:13

Plot file version 207 created 17-SEP-2012 12:09:59

J0529-0519 EE008D 1.UVDATA.1

Freq = 22.2290 GHz, Bw = 8.000 MH No calibration applied and no bandpass applied

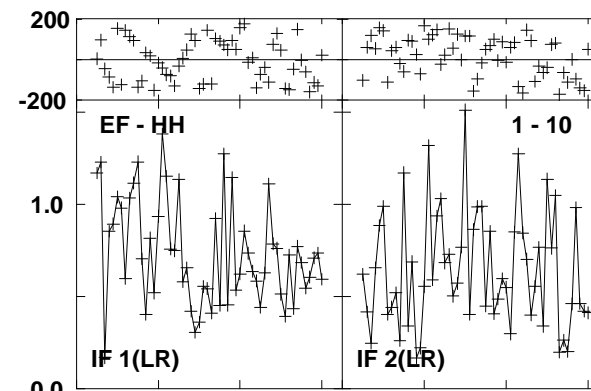
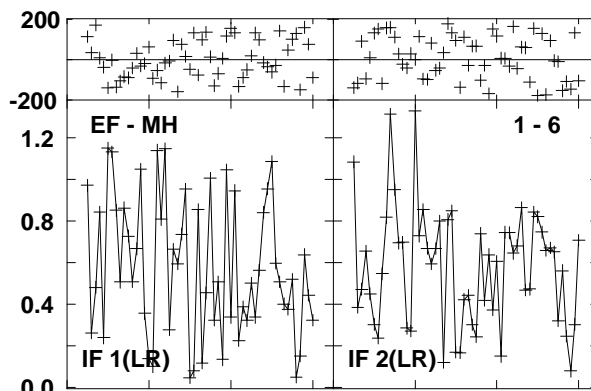
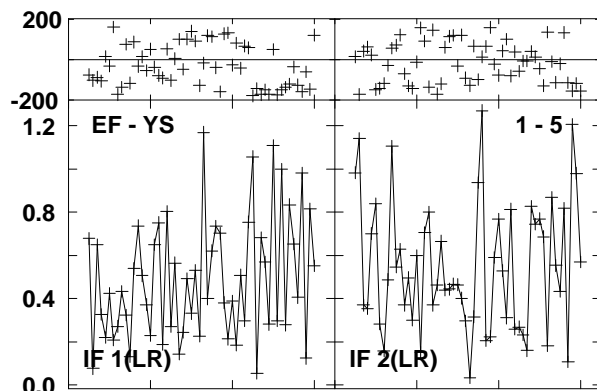
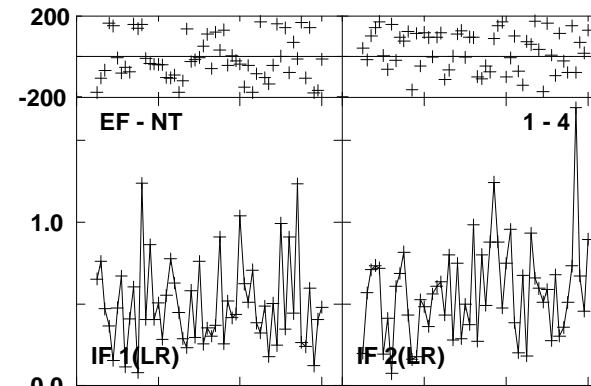
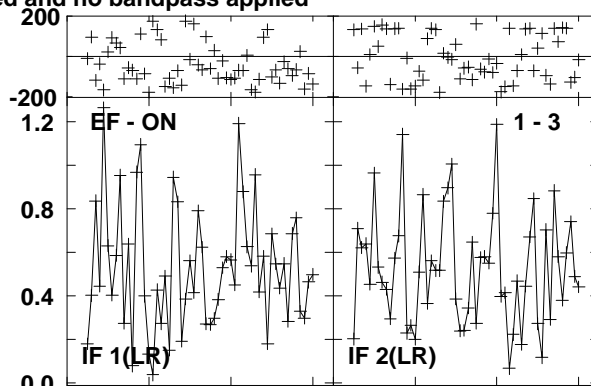
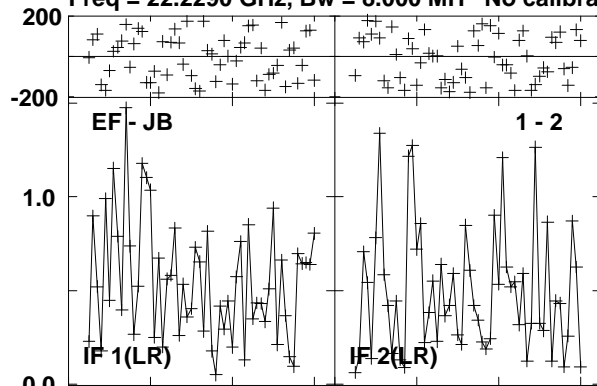

Lower frame: Milli Ampl Jy Top frame: Phas deg
Vector averaged cross-power spectrum Several baselines displayed
Timerange: 00/14:52:18 to 00/14:53:13

Plot file version 208 created 17-SEP-2012 12:10:01

ORIKL1 EE008D 1.UVDATA.1

Freq = 22.2290 GHz, Bw = 8.000 MH No calibration applied and no bandpass applied

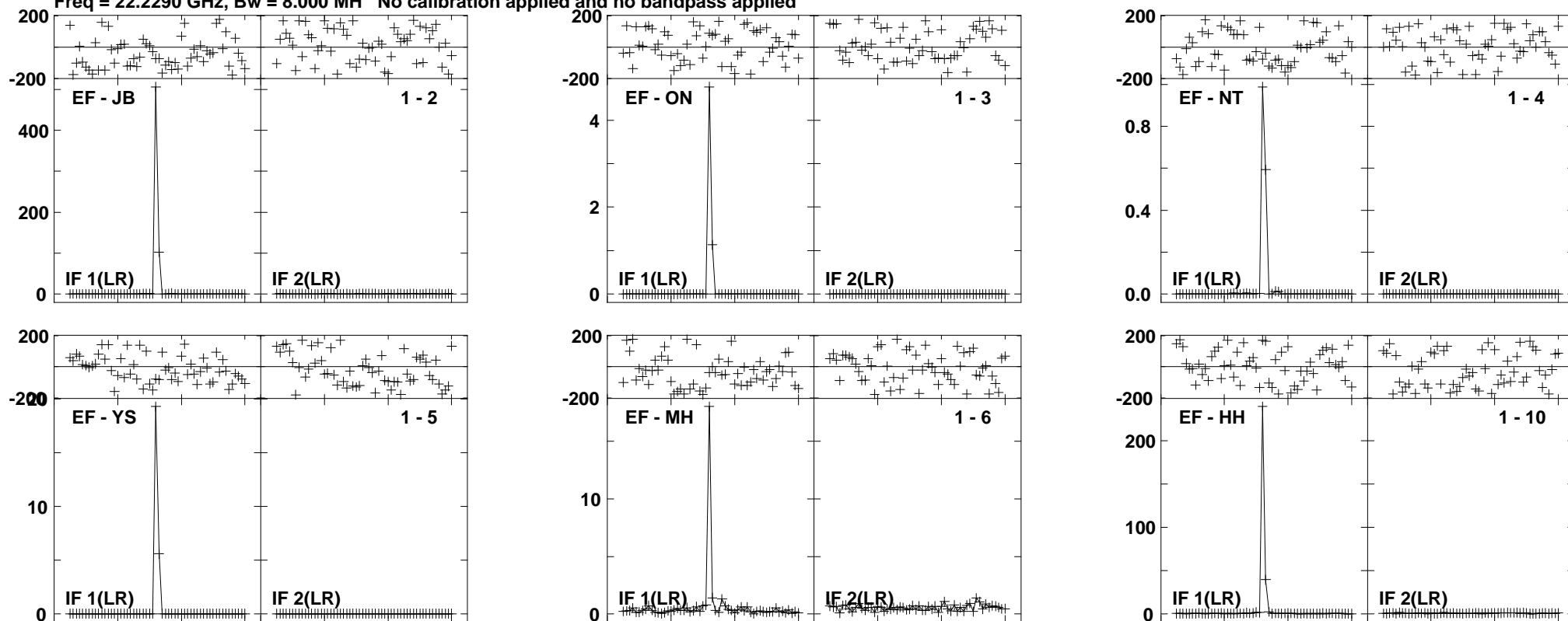

Lower frame: Milli Ampl Jy Top frame: Phas deg
Vector averaged cross-power spectrum Several baselines displayed
Timerange: 00/14:53:17 to 00/14:54:13

Plot file version 209 created 17-SEP-2012 12:10:02

J0529-0519 EE008D 1.UVDATA.1

Freq = 22.2290 GHz, Bw = 8.000 MH No calibration applied and no bandpass applied

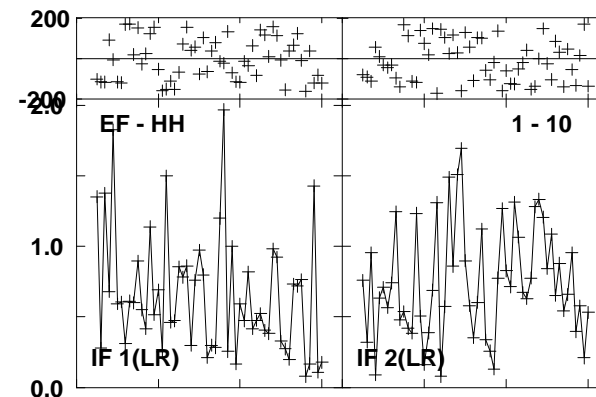
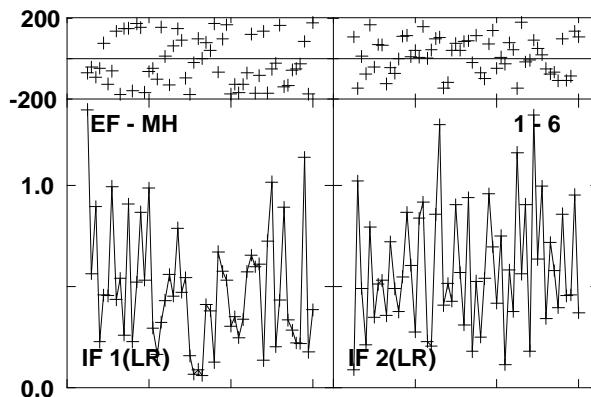
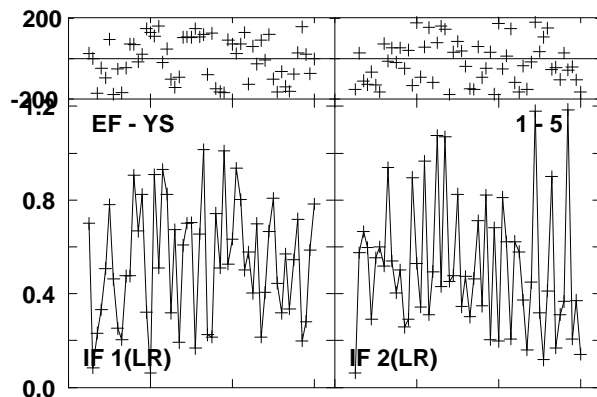
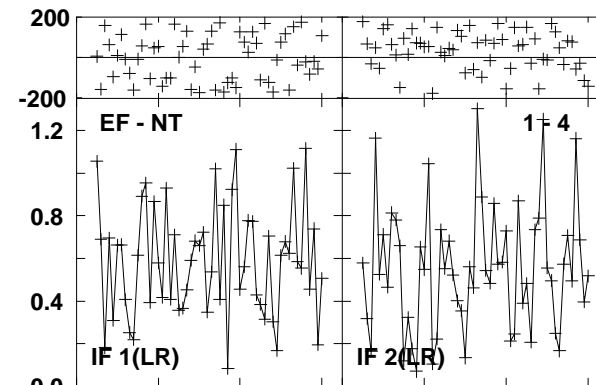
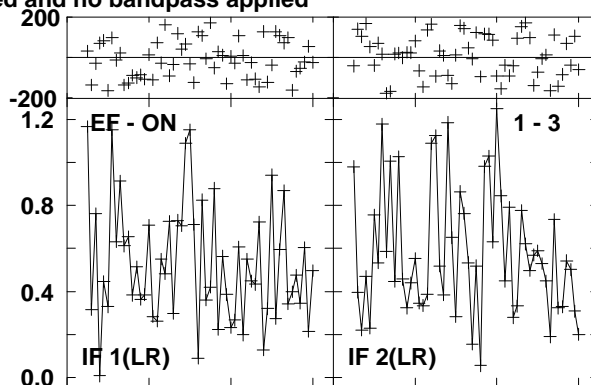
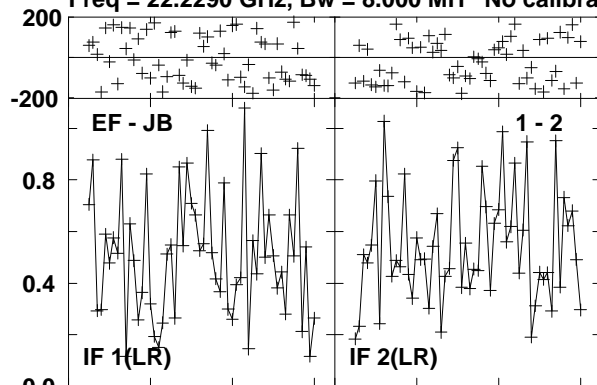

Lower frame: Milli Ampl Jy Top frame: Phas deg
Vector averaged cross-power spectrum Several baselines displayed
Timerange: 00/14:54:17 to 00/14:55:13

Plot file version 210 created 17-SEP-2012 12:10:03

J0541-0541 EE008D 1.UVDATA.1

Freq = 22.2290 GHz, Bw = 8.000 MH No calibration applied and no bandpass applied

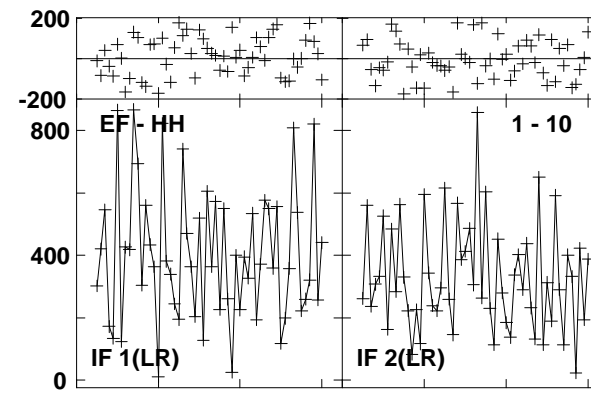
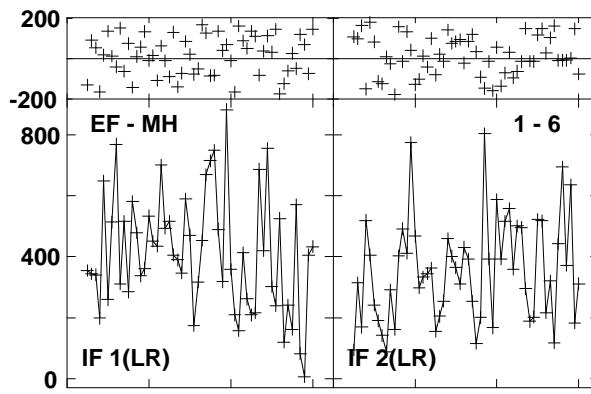
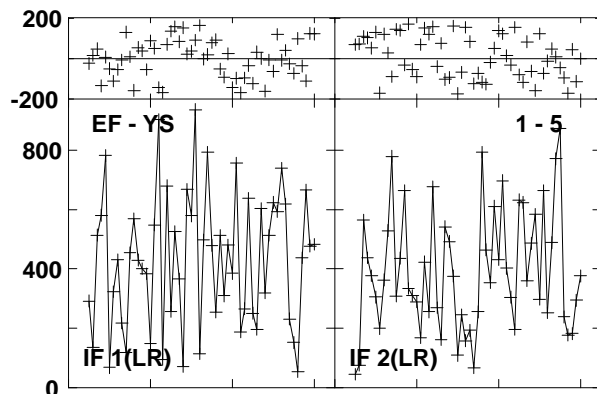
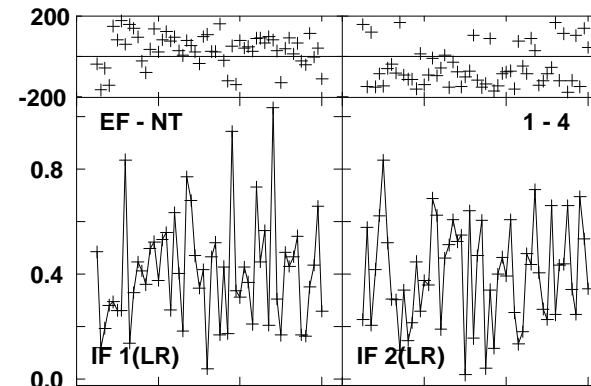
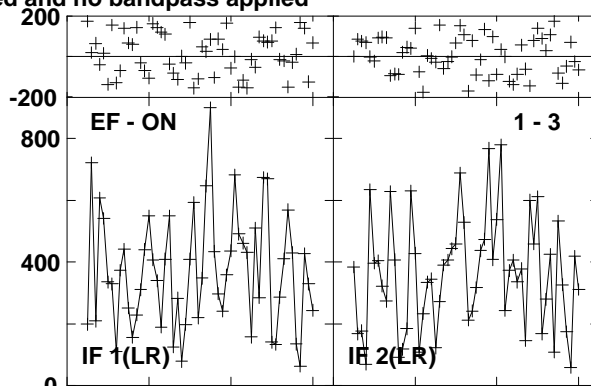
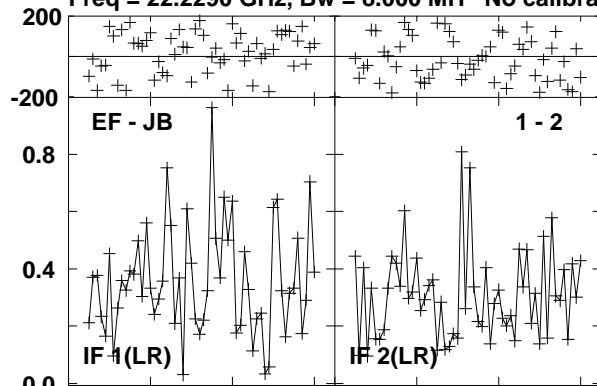

Lower frame: Milli Ampl Jy Top frame: Phas deg
Vector averaged cross-power spectrum Several baselines displayed
Timerange: 00/14:55:59 to 00/14:56:58

Plot file version 211 created 17-SEP-2012 12:10:05

ORIKL1 EE008D 1.UVDATA.1

Freq = 22.2290 GHz, Bw = 8.000 MH No calibration applied and no bandpass applied

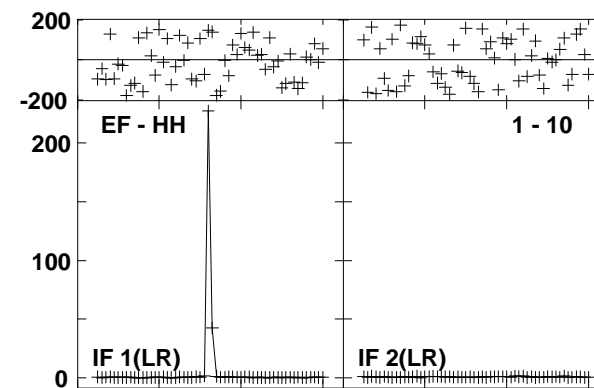
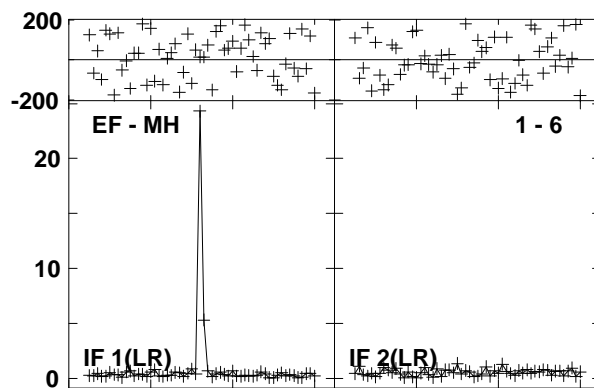
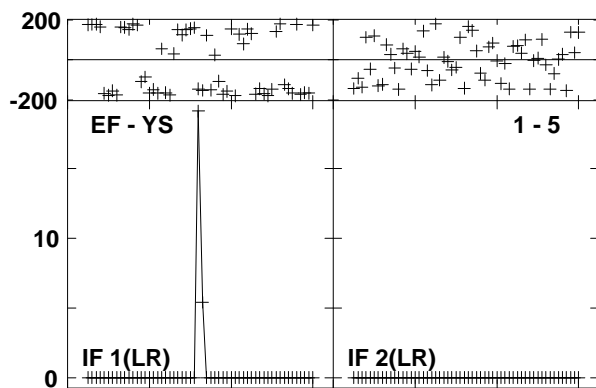
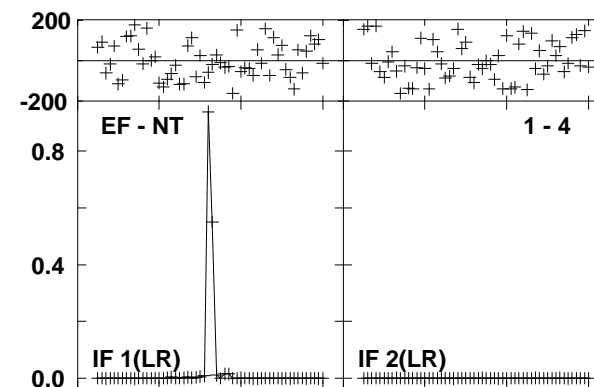
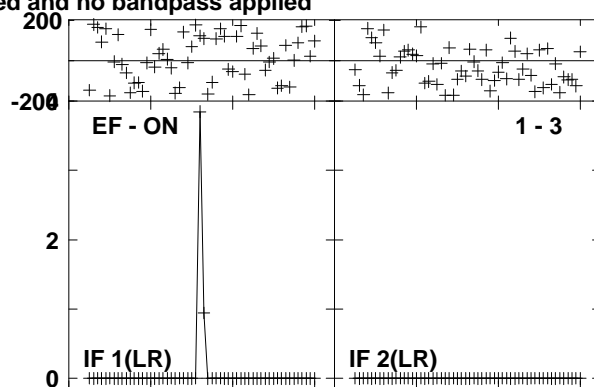
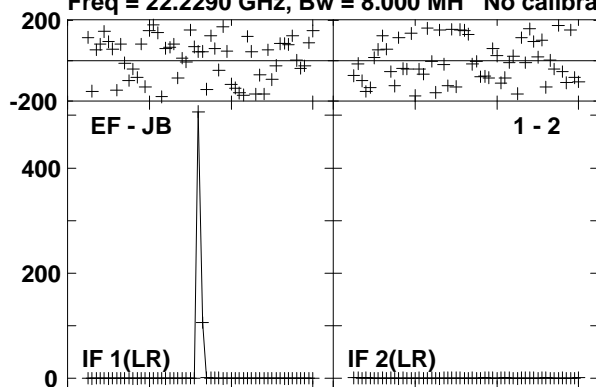

Lower frame: Milli Ampl Jy Top frame: Phas deg
Vector averaged cross-power spectrum Several baselines displayed
Timerange: 00/14:57:02 to 00/14:57:58

Plot file version 212 created 17-SEP-2012 12:10:06

J0541-0541 EE008D 1.UVDATA.1

Freq = 22.2290 GHz, Bw = 8.000 MH No calibration applied and no bandpass applied

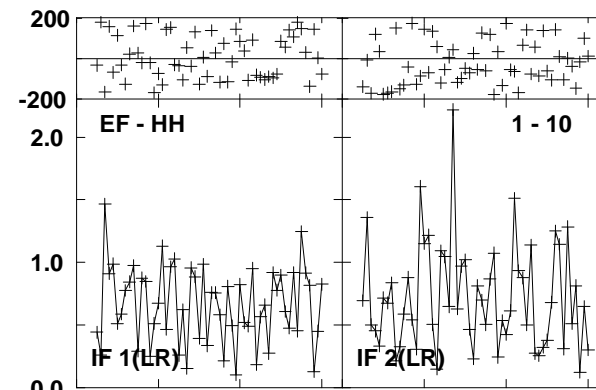
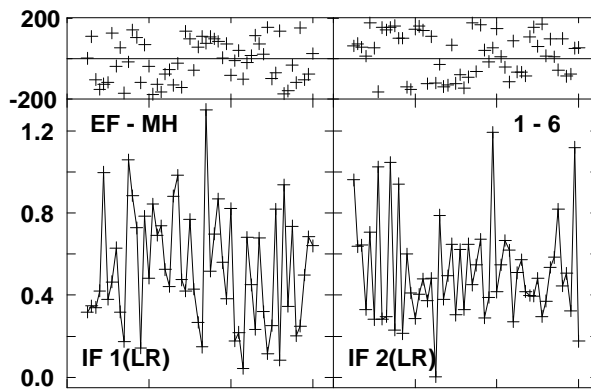
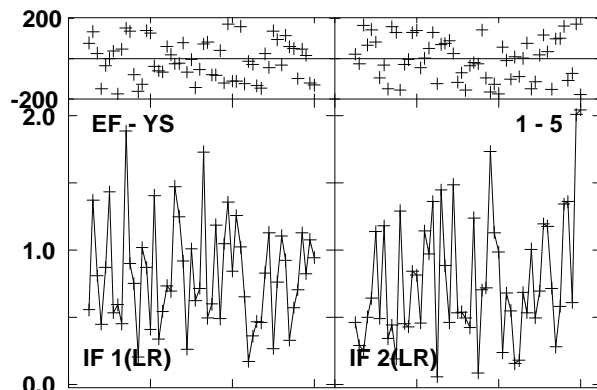
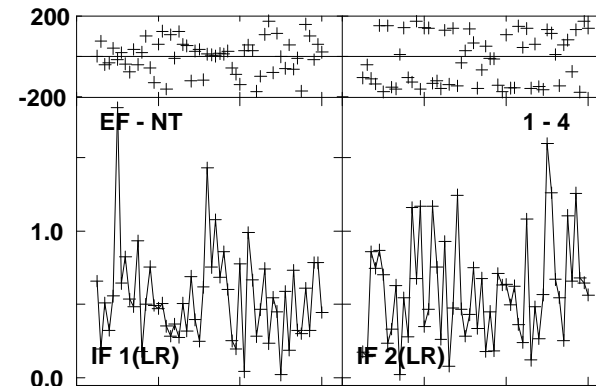
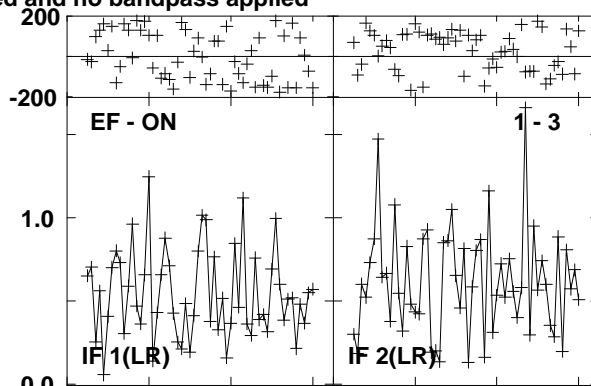
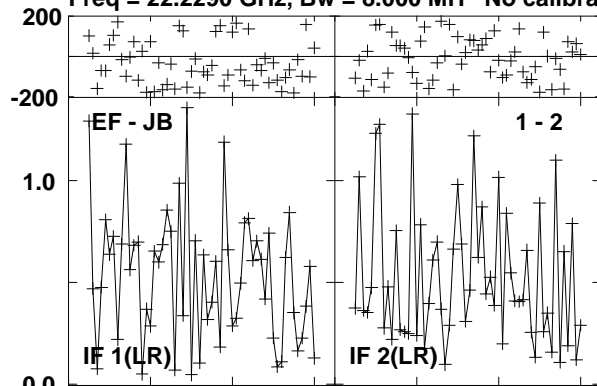

Lower frame: Milli Ampl Jy Top frame: Phas deg
Vector averaged cross-power spectrum Several baselines displayed
Timerange: 00/14:58:03 to 00/14:58:58

Plot file version 213 created 17-SEP-2012 12:10:07

ORIKL1 EE008D 1.UVDATA.1

Freq = 22.2290 GHz, Bw = 8.000 MH No calibration applied and no bandpass applied

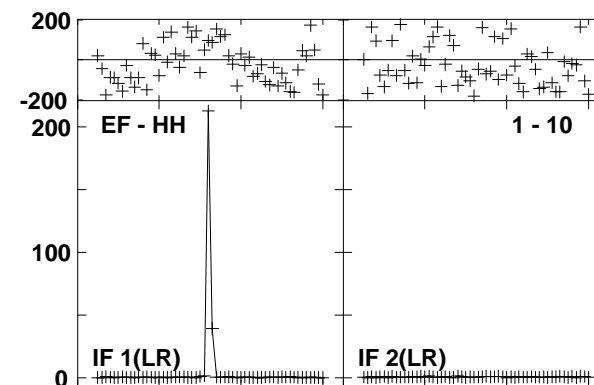
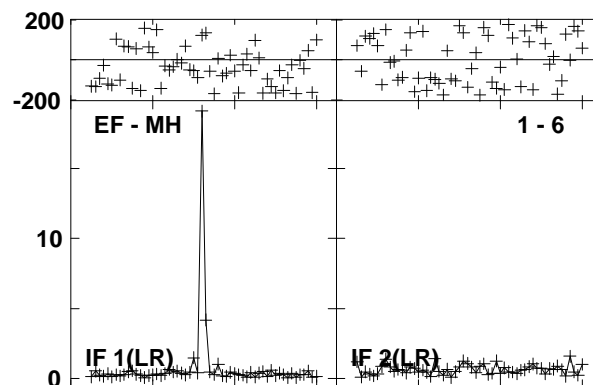
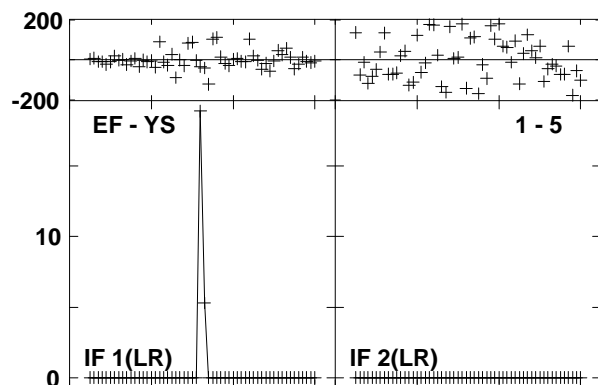
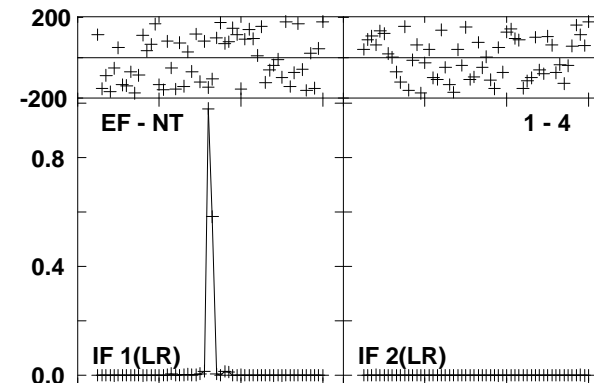
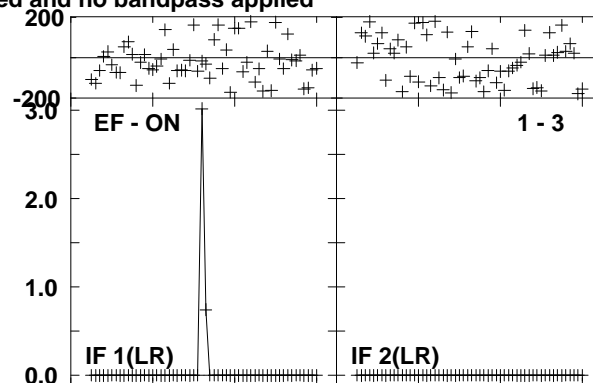
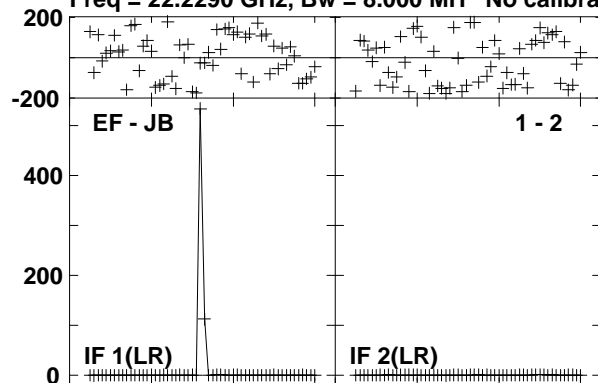

Lower frame: Milli Ampl Jy Top frame: Phas deg
Vector averaged cross-power spectrum Several baselines displayed
Timerange: 00/14:59:03 to 00/14:59:58

Plot file version 214 created 17-SEP-2012 12:10:08

J0541-0541 EE008D 1.UVDATA.1

Freq = 22.2290 GHz, Bw = 8.000 MH No calibration applied and no bandpass applied

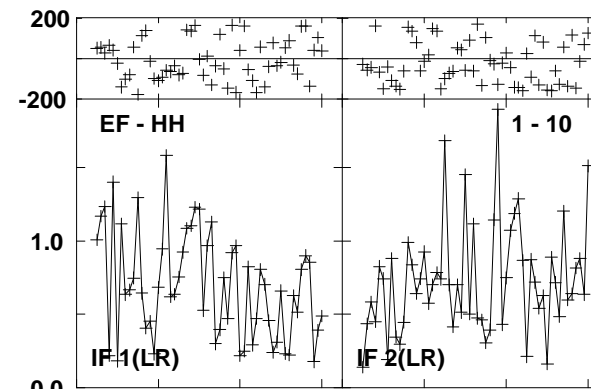
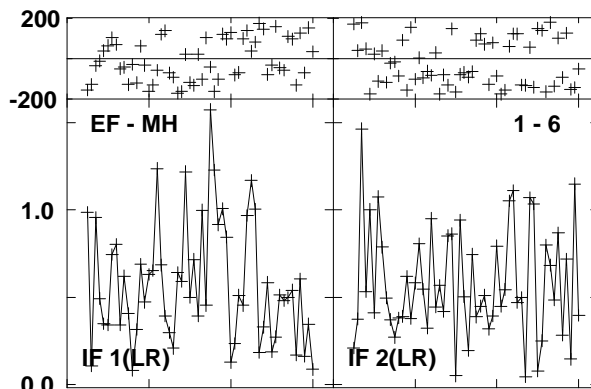
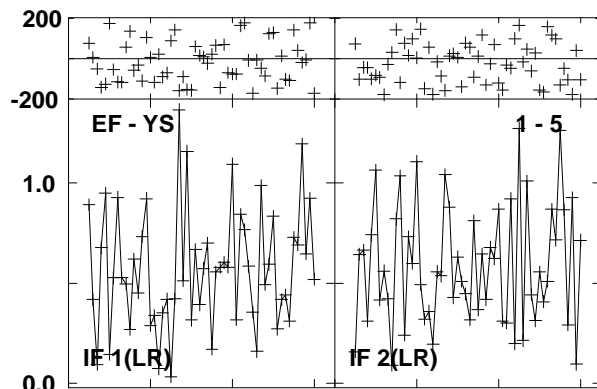
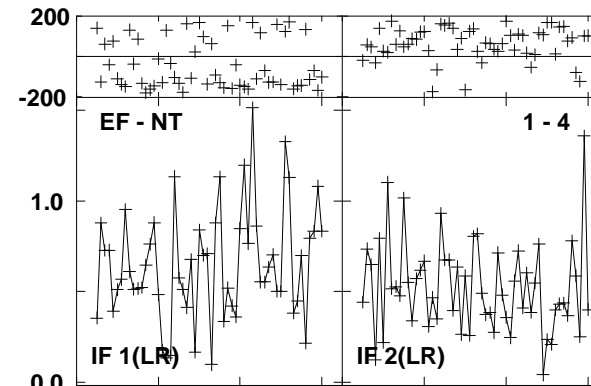
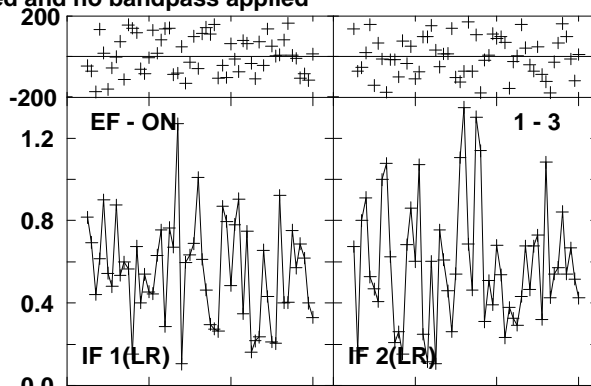
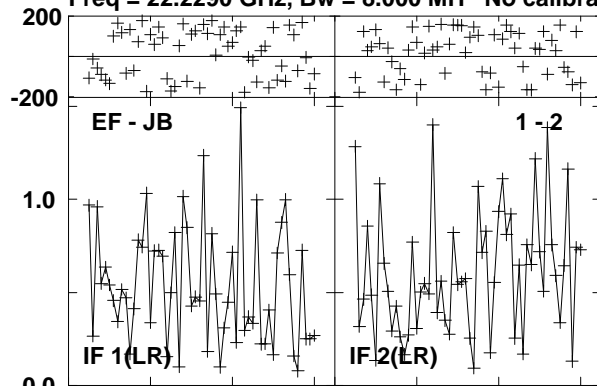

Lower frame: Milli Ampl Jy Top frame: Phas deg
Vector averaged cross-power spectrum Several baselines displayed
Timerange: 00/15:00:04 to 00/15:00:58

Plot file version 215 created 17-SEP-2012 12:10:10

J0529-0519 EE008D 1.UVDATA.1

Freq = 22.2290 GHz, Bw = 8.000 MH No calibration applied and no bandpass applied

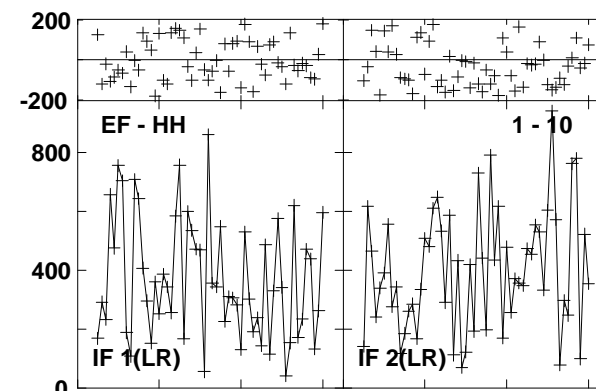
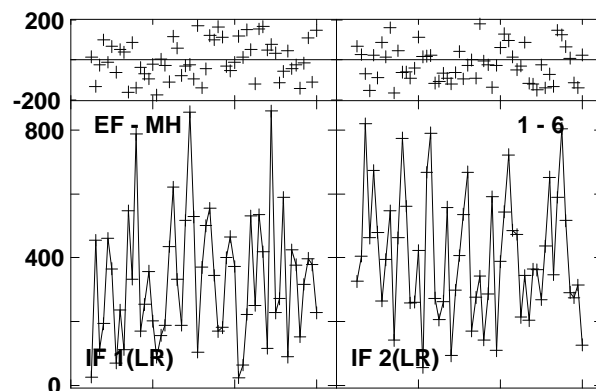
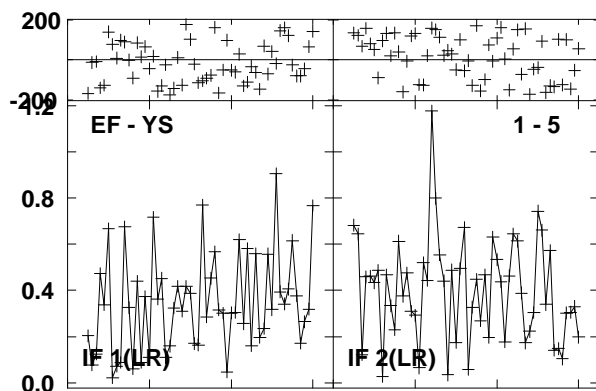
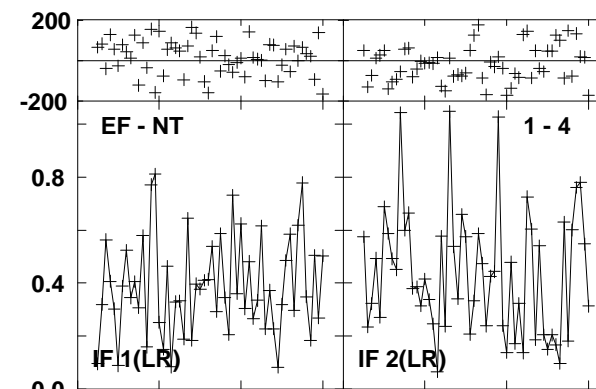
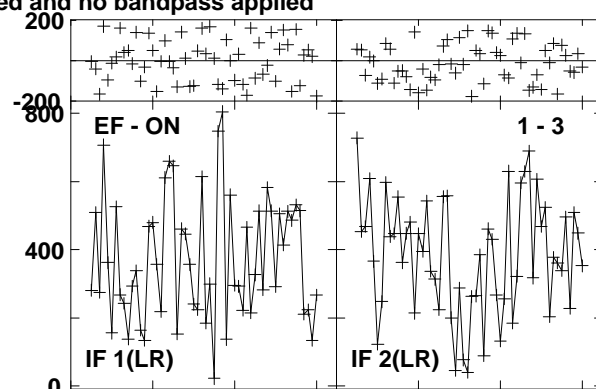
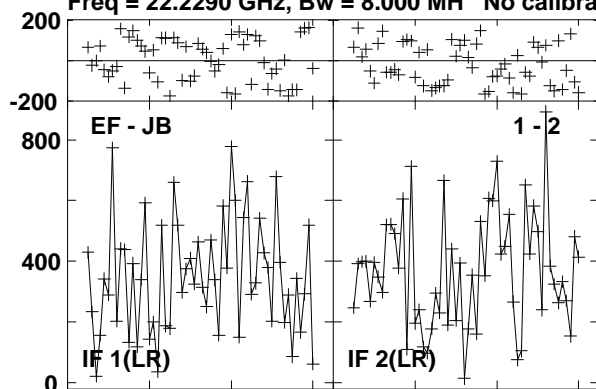

Lower frame: Micro Ampl Jy Top frame: Phas deg
Vector averaged cross-power spectrum Several baselines displayed
Timerange: 00/15:01:45 to 00/15:02:44

Plot file version 216 created 17-SEP-2012 12:10:11

ORIKL1 EE008D 1.UVDATA.1

Freq = 22.2290 GHz, Bw = 8.000 MH No calibration applied and no bandpass applied

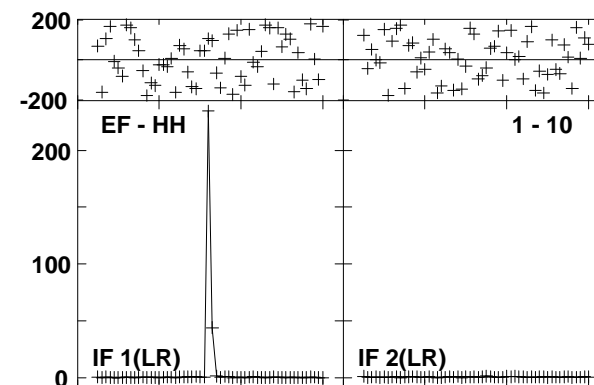
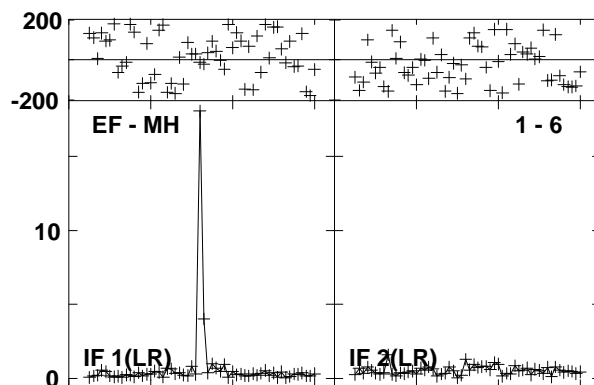
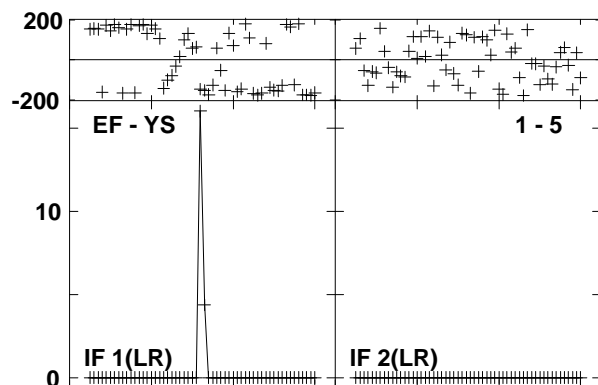
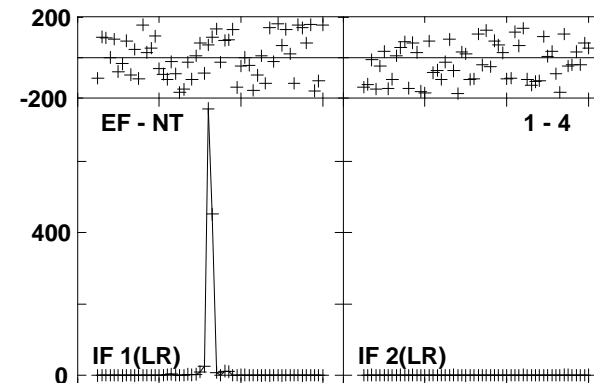
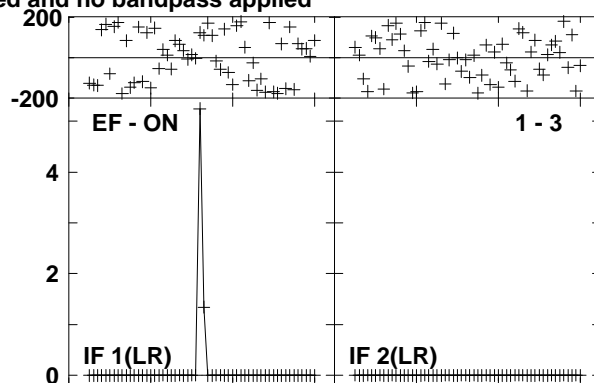
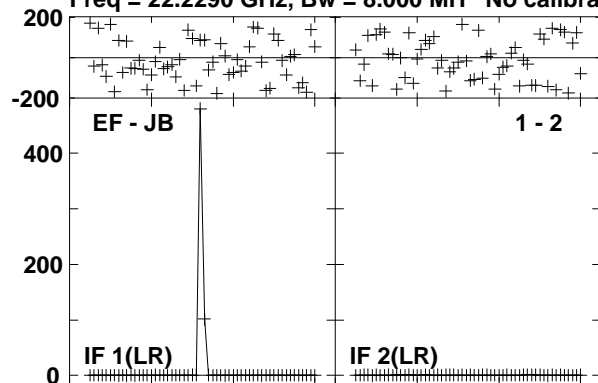

Lower frame: Milli Ampl Jy Top frame: Phas deg
Vector averaged cross-power spectrum Several baselines displayed
Timerange: 00/15:02:47 to 00/15:03:44

Plot file version 217 created 17-SEP-2012 12:10:12

J0529-0519 EE008D 1.UVDATA.1

Freq = 22.2290 GHz, Bw = 8.000 MH No calibration applied and no bandpass applied

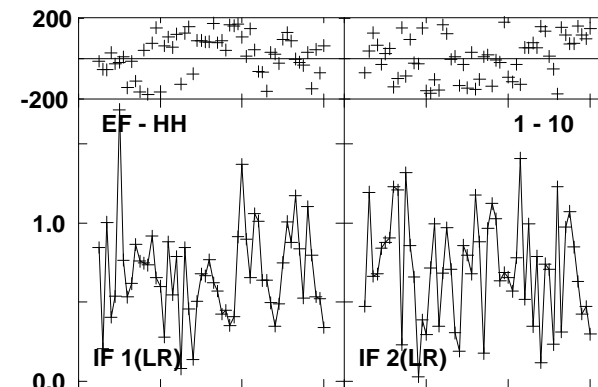
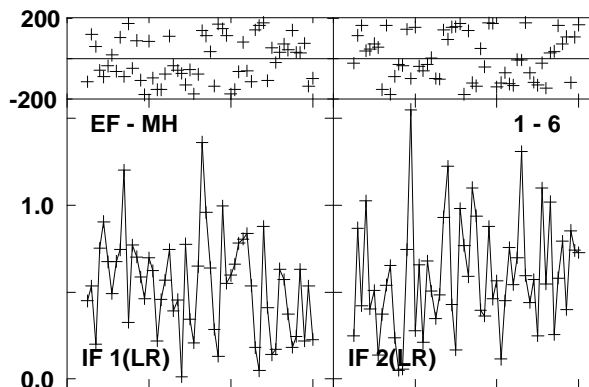
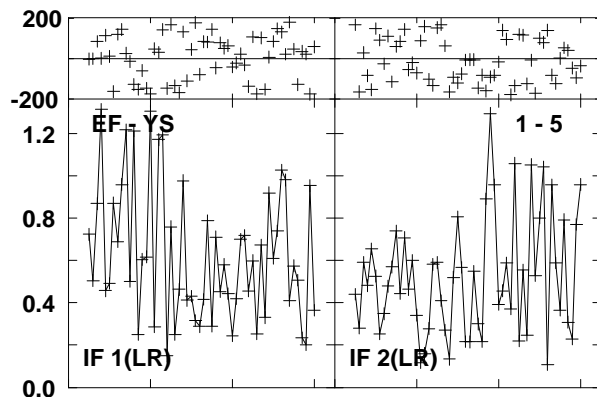
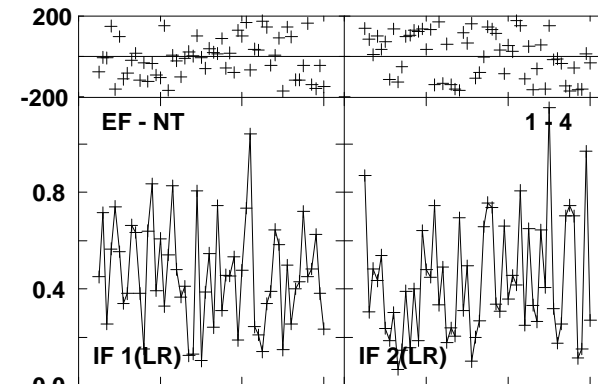
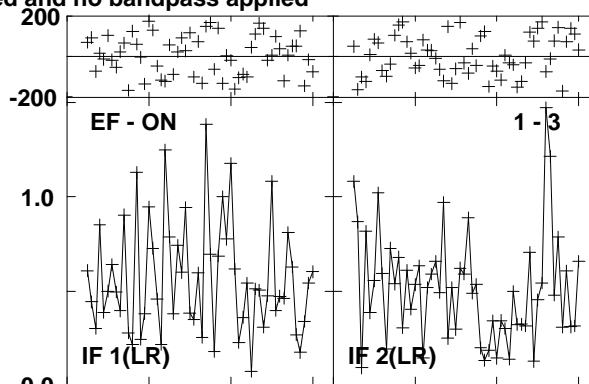
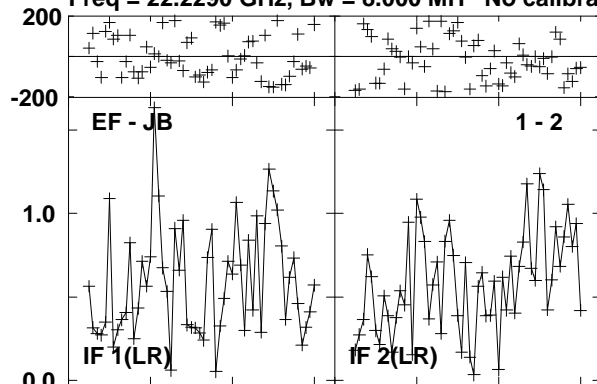

Lower frame: Milli Ampl Jy Top frame: Phas deg
Vector averaged cross-power spectrum Several baselines displayed
Timerange: 00/15:03:48 to 00/15:04:44

Plot file version 218 created 17-SEP-2012 12:10:14

ORIKL1 EE008D 1.UVDATA.1

Freq = 22.2290 GHz, Bw = 8.000 MH No calibration applied and no bandpass applied

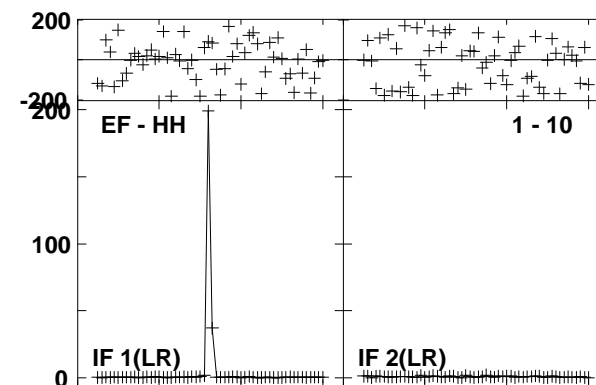
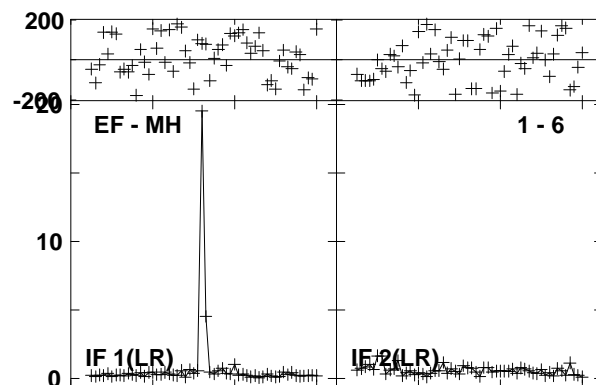
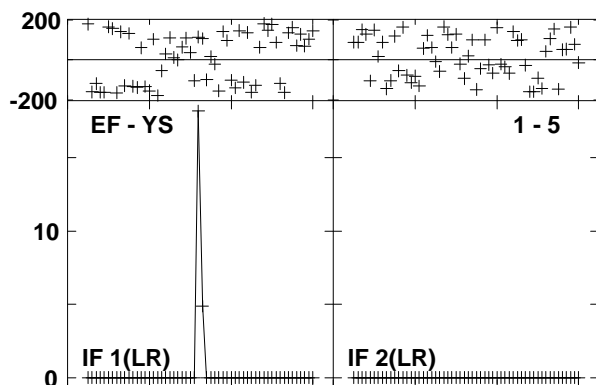
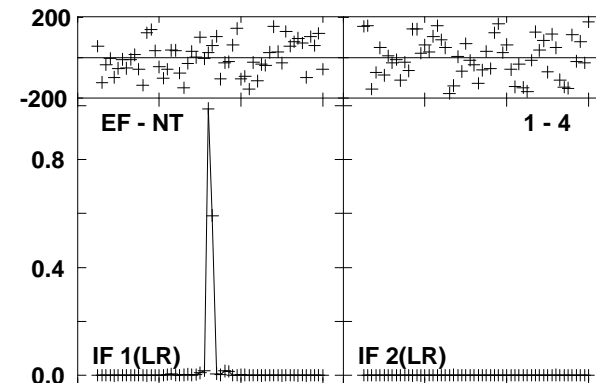
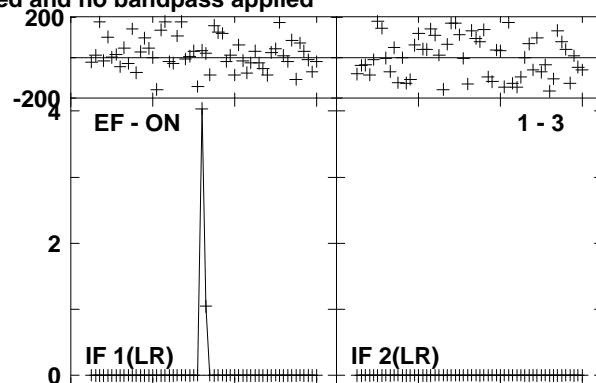
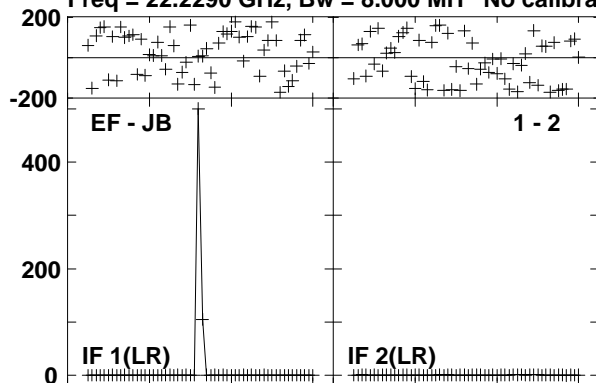

Lower frame: Milli Ampl Jy Top frame: Phas deg
Vector averaged cross-power spectrum Several baselines displayed
Timerange: 00/15:04:48 to 00/15:05:44

Plot file version 219 created 17-SEP-2012 12:10:15

J0529-0519 EE008D 1.UVDATA.1

Freq = 22.2290 GHz, Bw = 8.000 MH No calibration applied and no bandpass applied

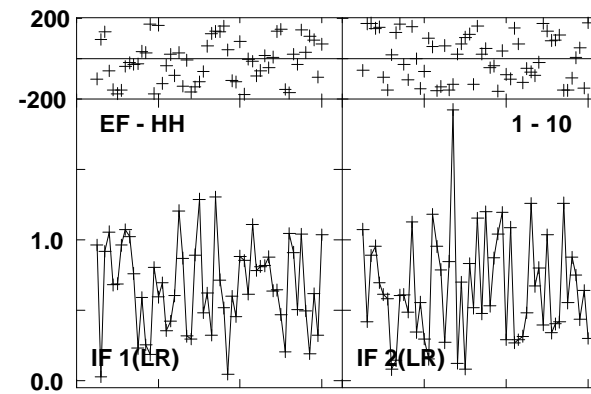
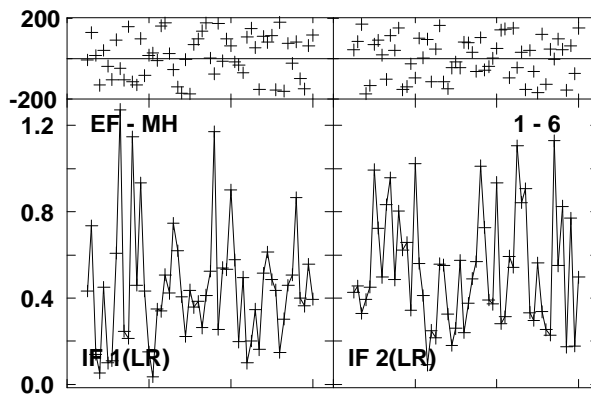
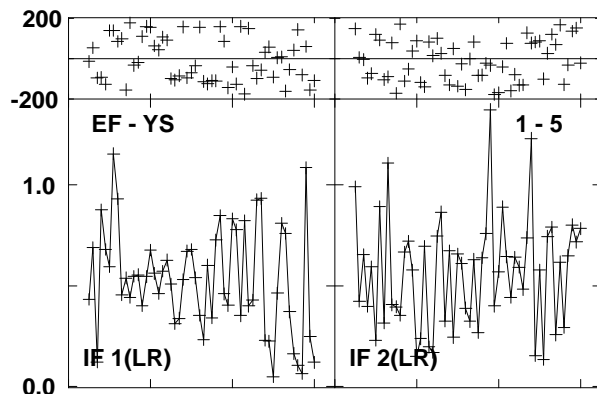
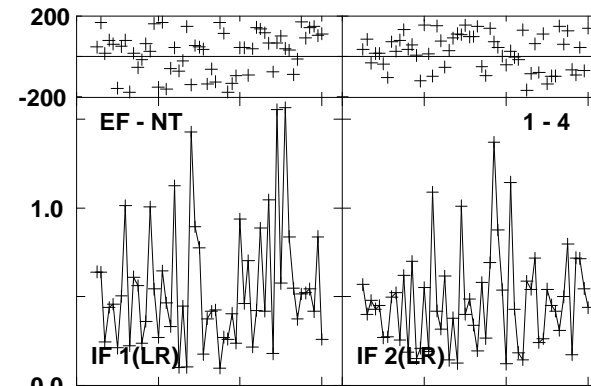
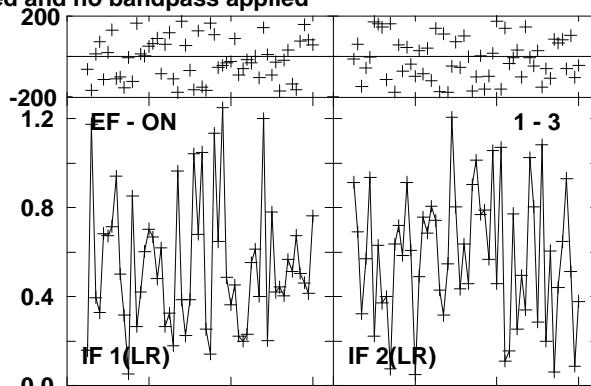
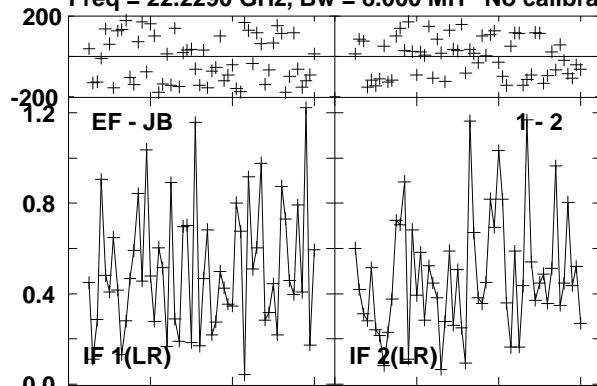

Lower frame: Milli Ampl Jy Top frame: Phas deg
Vector averaged cross-power spectrum Several baselines displayed
Timerange: 00/15:05:48 to 00/15:06:44

Plot file version 220 created 17-SEP-2012 12:10:16

J0541-0541 EE008D 1.UVDATA.1

Freq = 22.2290 GHz, Bw = 8.000 MH No calibration applied and no bandpass applied

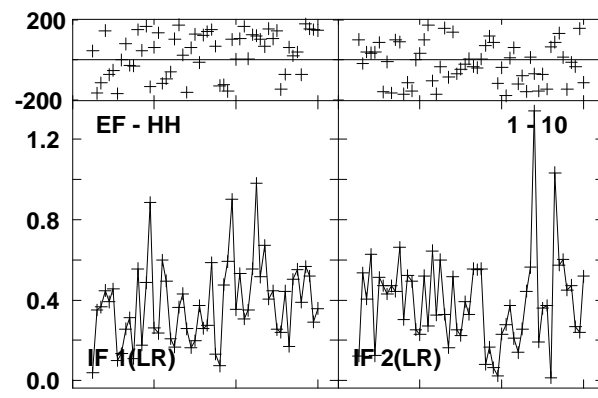
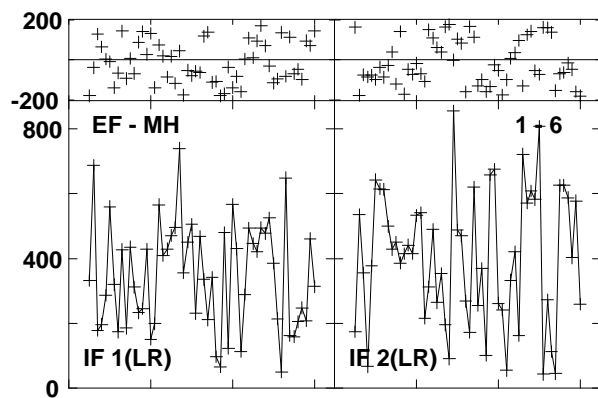
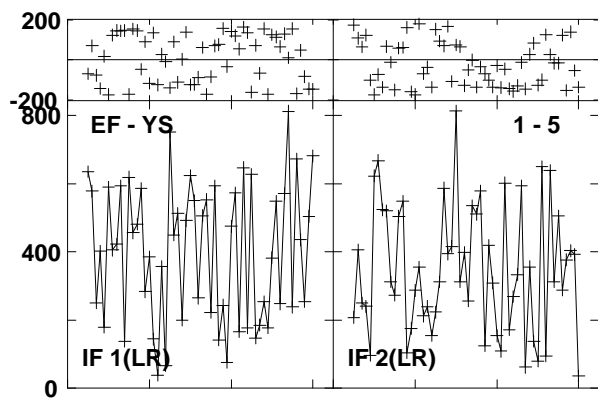
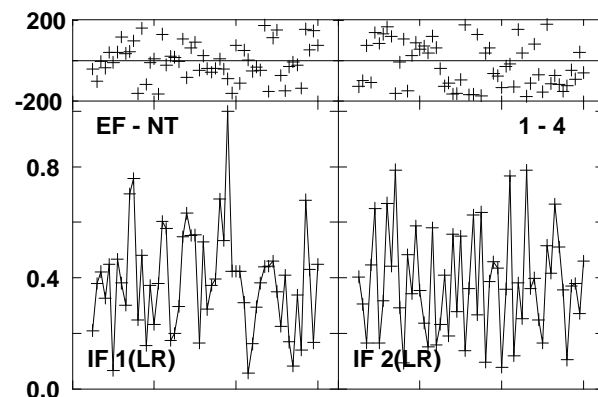
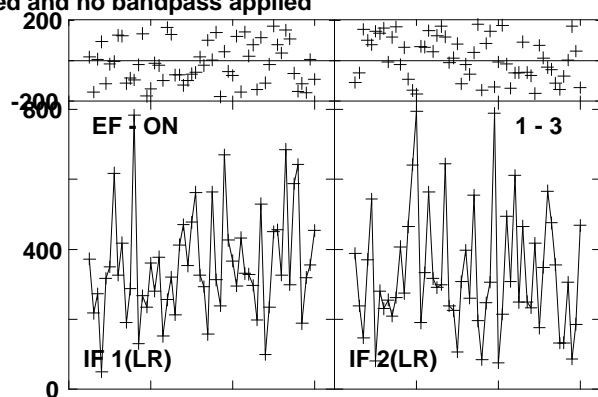
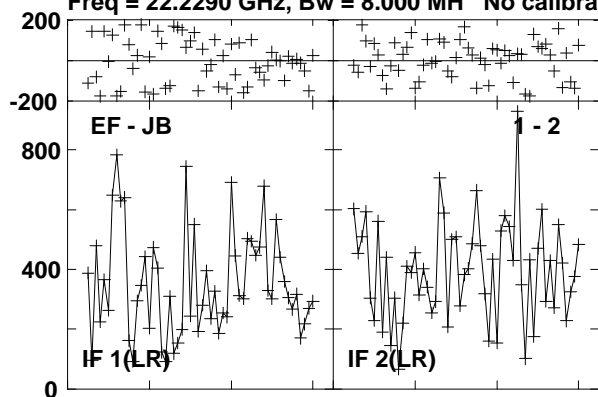

Lower frame: Micro Ampl Jy Top frame: Phas deg
Vector averaged cross-power spectrum Several baselines displayed
Timerange: 00/15:07:30 to 00/15:08:29

Plot file version 221 created 17-SEP-2012 12:10:18

ORIKL1 EE008D 1.UVDATA.1

Freq = 22.2290 GHz, Bw = 8.000 MH No calibration applied and no bandpass applied

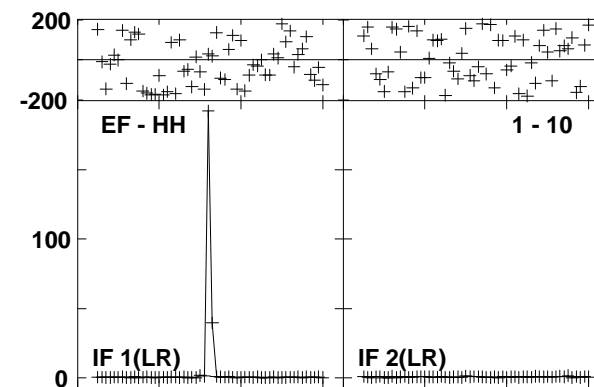
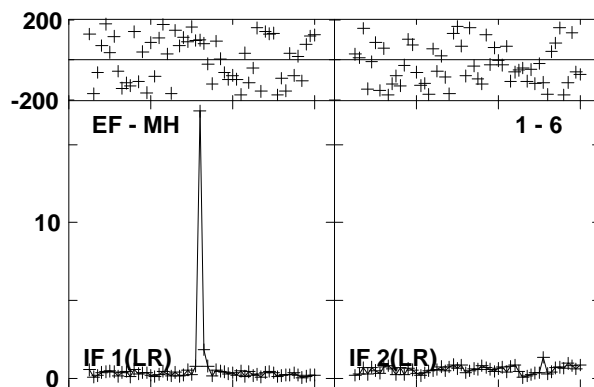
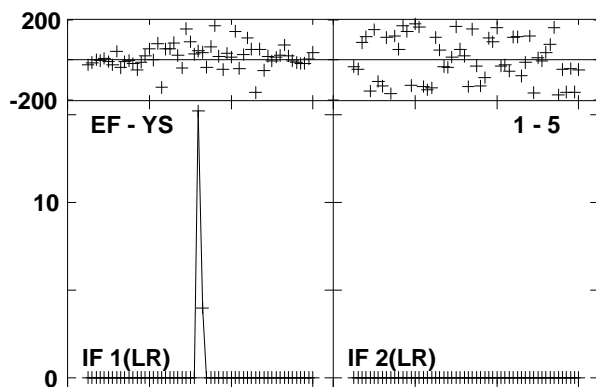
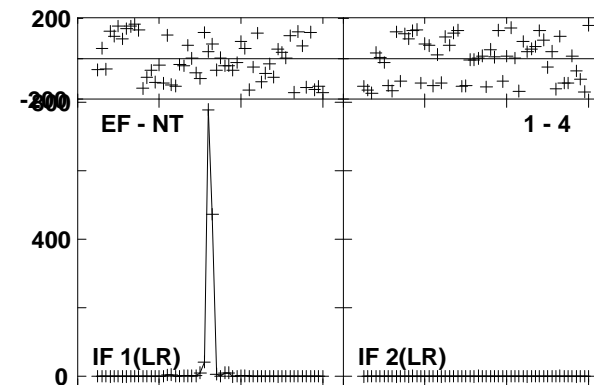
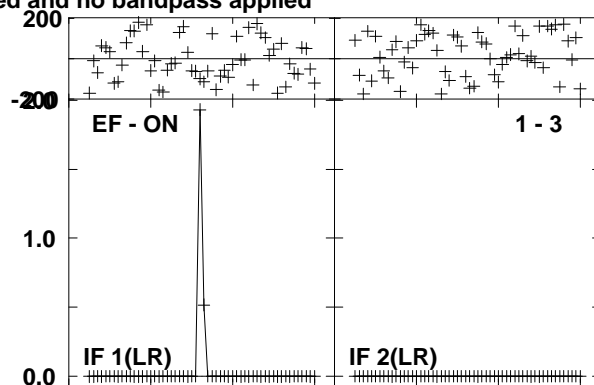
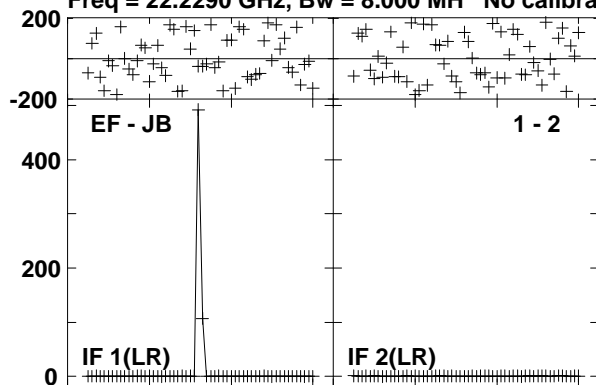

Lower frame: Milli Ampl Jy Top frame: Phas deg
Vector averaged cross-power spectrum Several baselines displayed
Timerange: 00/15:08:32 to 00/15:09:29

Plot file version 222 created 17-SEP-2012 12:10:19

J0541-0541 EE008D 1.UVDATA.1

Freq = 22.2290 GHz, Bw = 8.000 MH No calibration applied and no bandpass applied

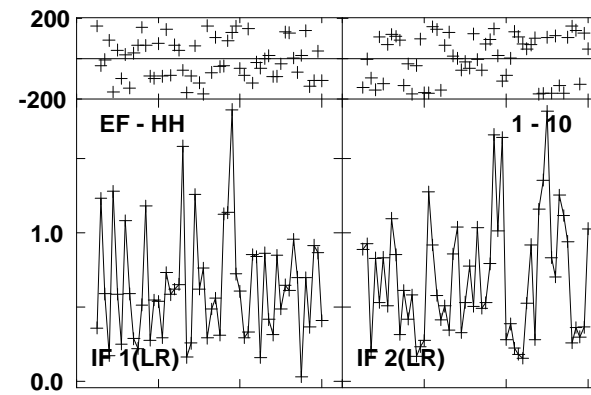
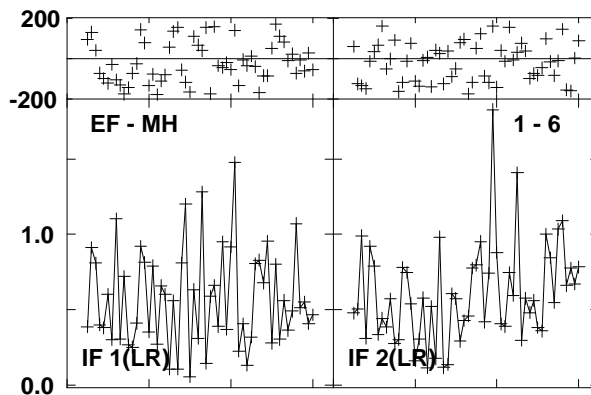
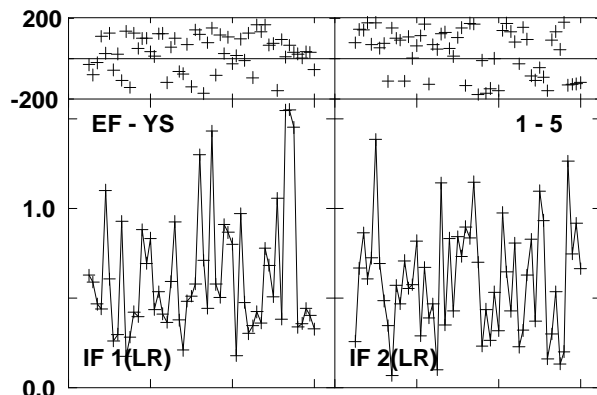
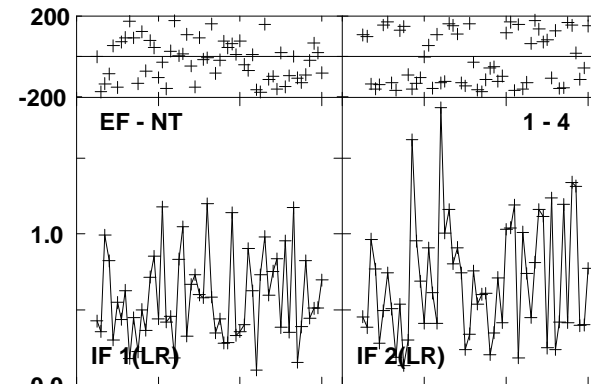
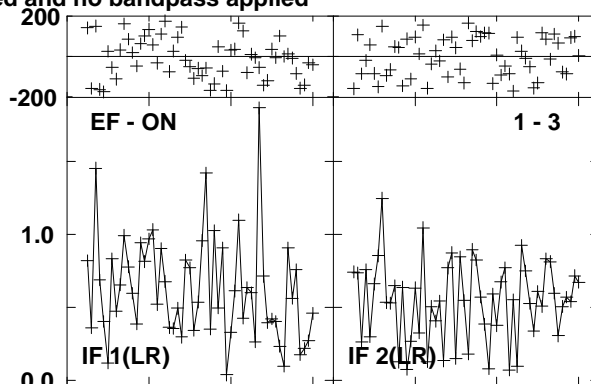
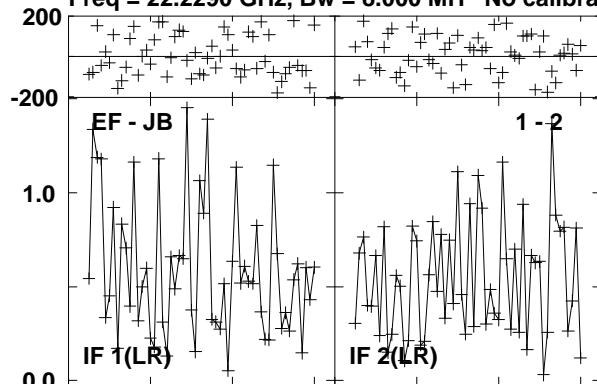

Lower frame: Milli Ampl Jy Top frame: Phas deg
Vector averaged cross-power spectrum Several baselines displayed
Timerange: 00/15:09:35 to 00/15:10:29

Plot file version 223 created 17-SEP-2012 12:10:20

ORIKL1 EE008D 1.UVDATA.1

Freq = 22.2290 GHz, Bw = 8.000 MH No calibration applied and no bandpass applied

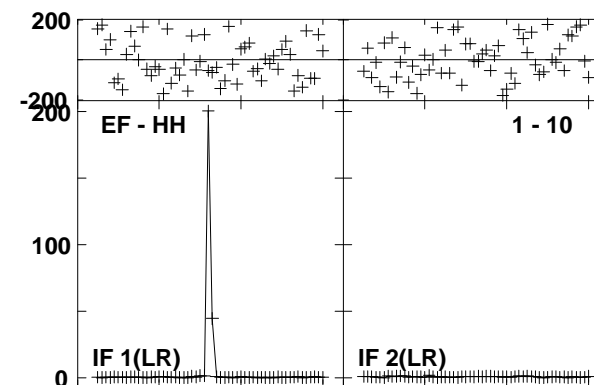
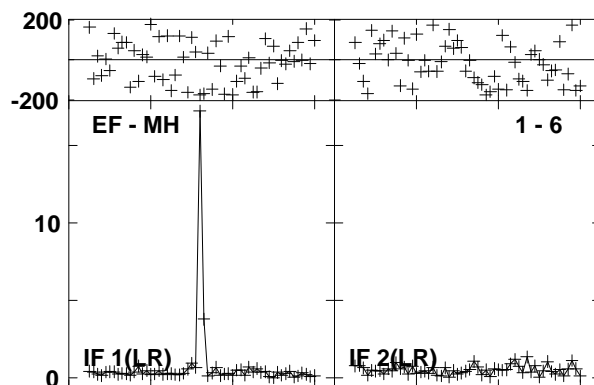
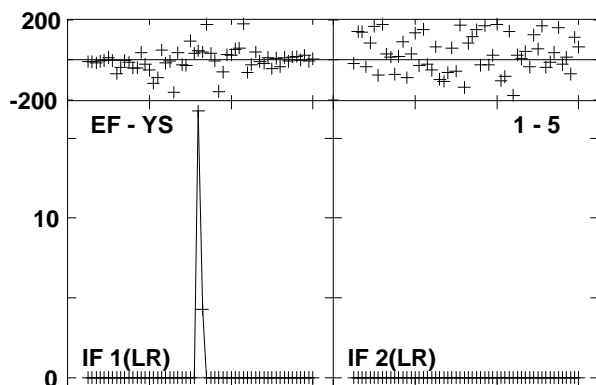
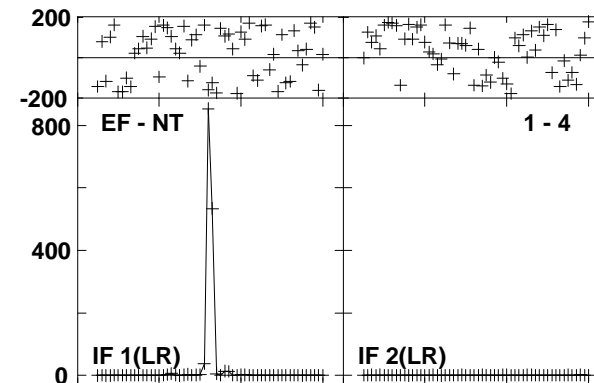
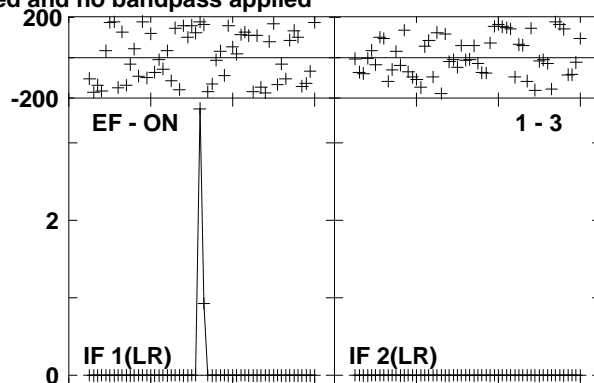
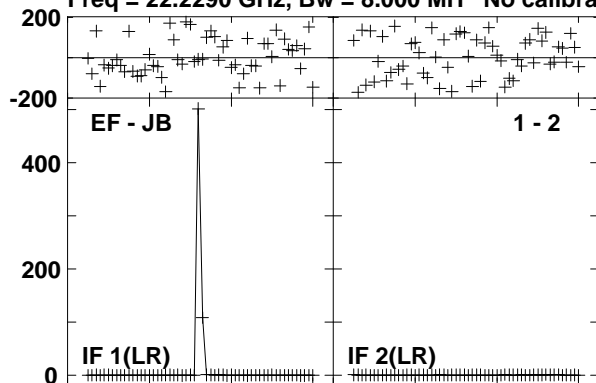

Lower frame: Milli Ampl Jy Top frame: Phas deg
Vector averaged cross-power spectrum Several baselines displayed
Timerange: 00/15:10:33 to 00/15:11:29

Plot file version 224 created 17-SEP-2012 12:10:21

J0541-0541 EE008D 1.UVDATA.1

Freq = 22.2290 GHz, Bw = 8.000 MH No calibration applied and no bandpass applied

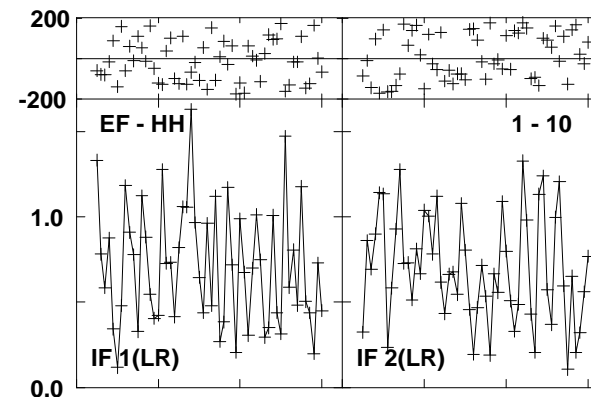
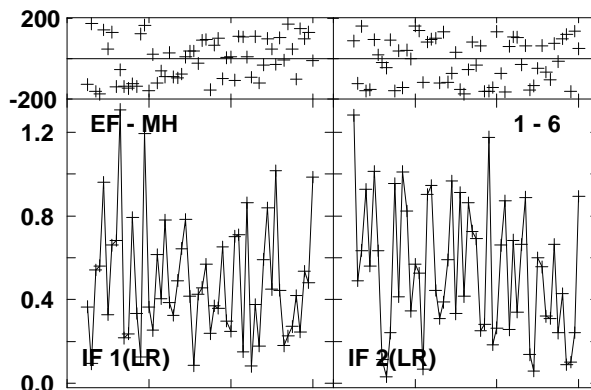
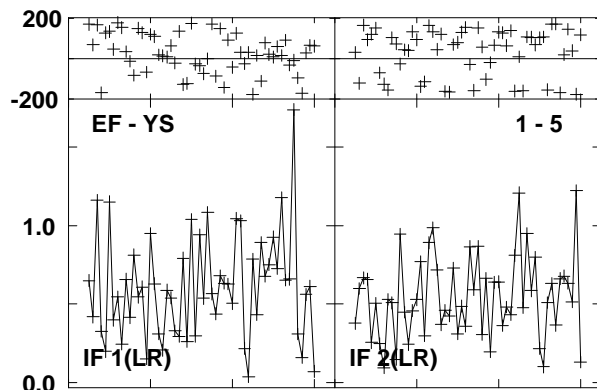
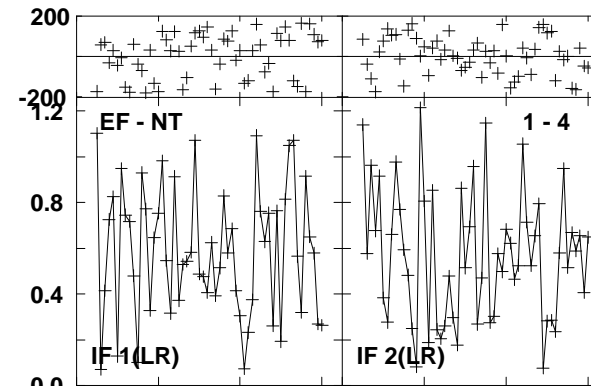
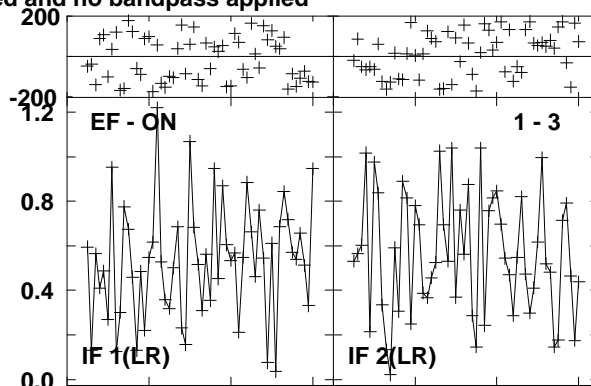
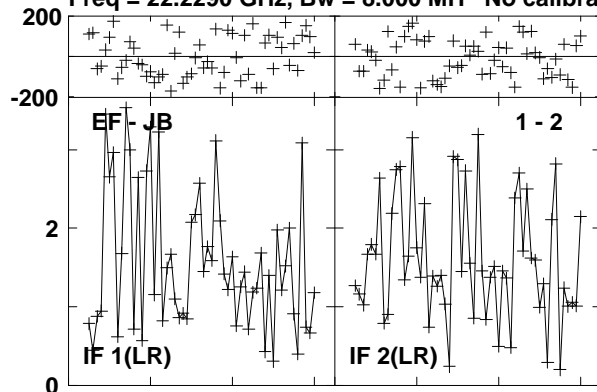

Lower frame: Milli Ampl Jy Top frame: Phas deg
Vector averaged cross-power spectrum Several baselines displayed
Timerange: 00/15:11:33 to 00/15:12:29

Plot file version 225 created 17-SEP-2012 12:10:22

J0529-0519 EE008D 1.UVDATA.1

Freq = 22.2290 GHz, Bw = 8.000 MH No calibration applied and no bandpass applied

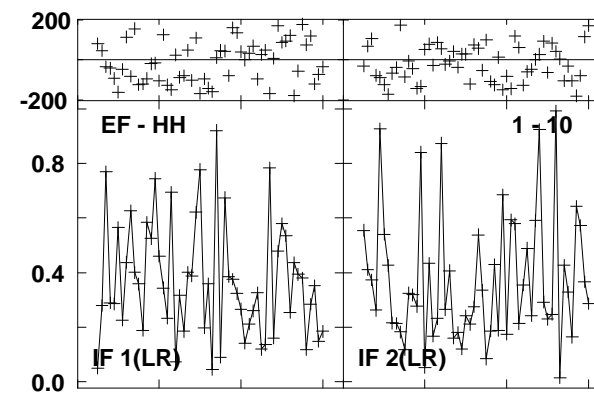
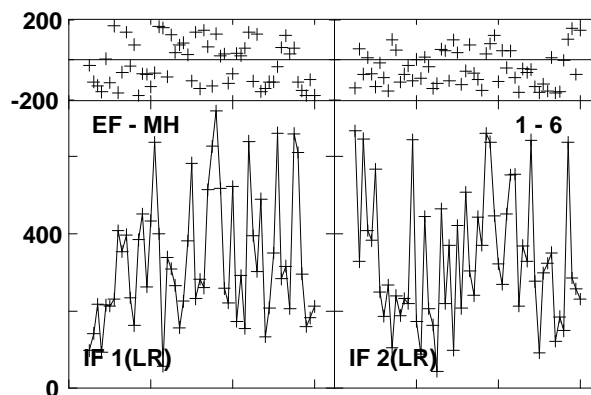
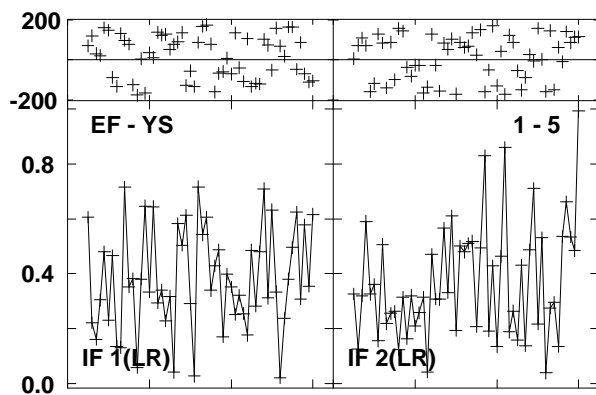
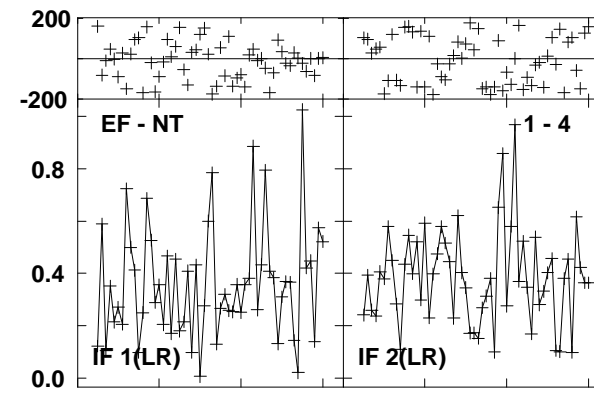
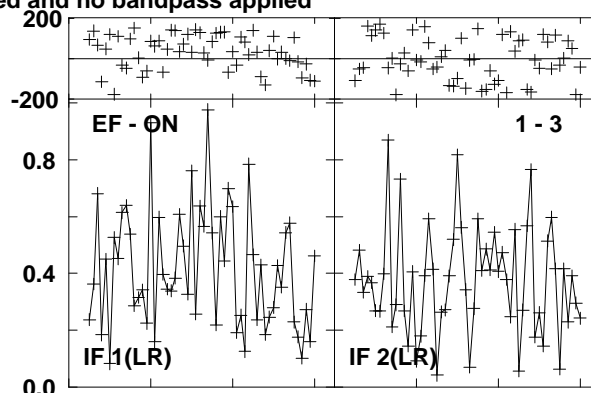
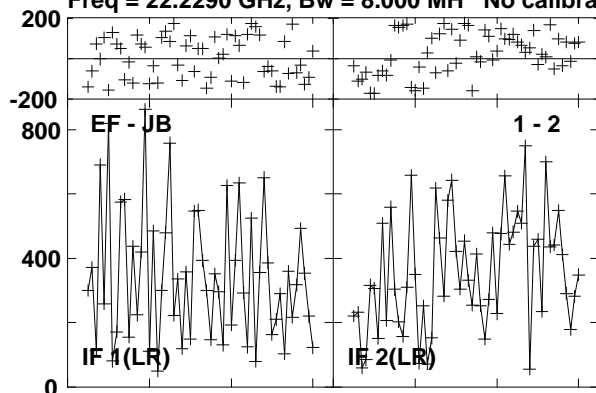

Lower frame: Micro Ampl Jy Top frame: Phas deg
Vector averaged cross-power spectrum Several baselines displayed
Timerange: 00/15:13:16 to 00/15:14:15

Plot file version 226 created 17-SEP-2012 12:10:24

ORIKL1 EE008D 1.UVDATA.1

Freq = 22.2290 GHz, Bw = 8.000 MH No calibration applied and no bandpass applied

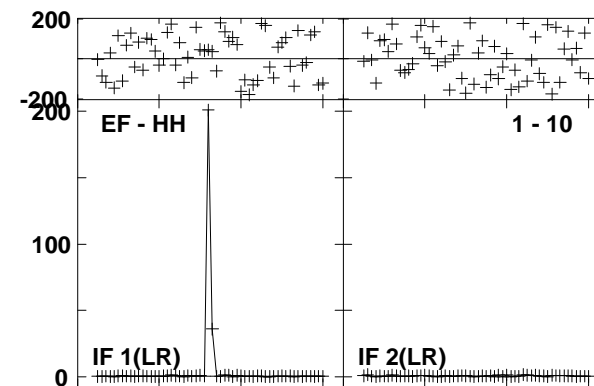
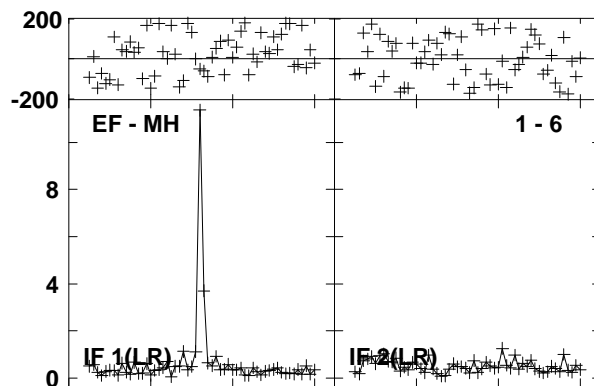
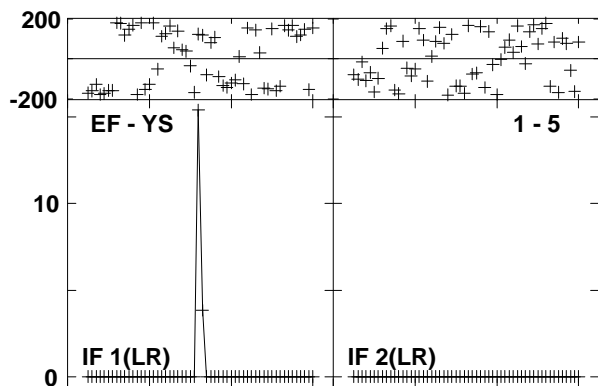
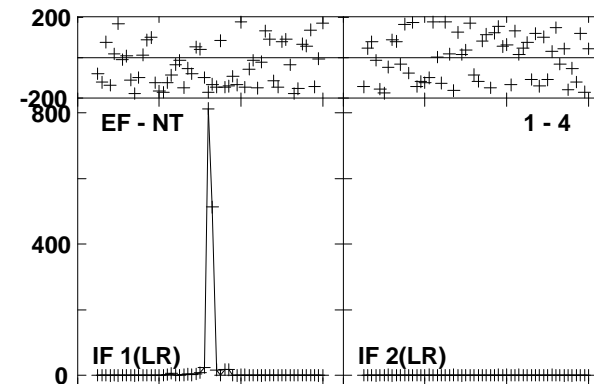
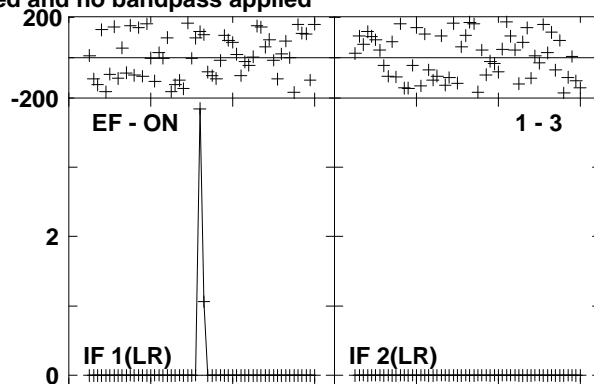
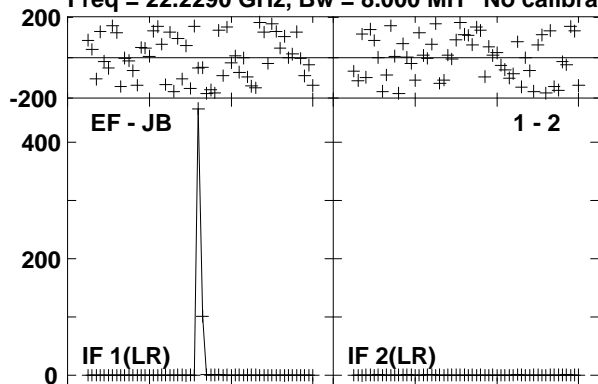

Lower frame: Milli Ampl Jy Top frame: Phas deg
Vector averaged cross-power spectrum Several baselines displayed
Timerange: 00/15:14:18 to 00/15:15:15

Plot file version 227 created 17-SEP-2012 12:10:25

J0529-0519 EE008D 1.UVDATA.1

Freq = 22.2290 GHz, Bw = 8.000 MH No calibration applied and no bandpass applied

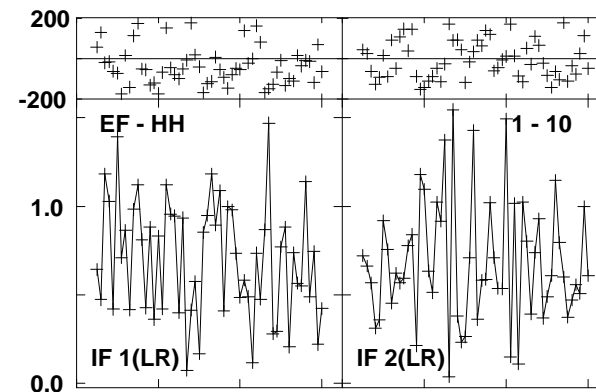
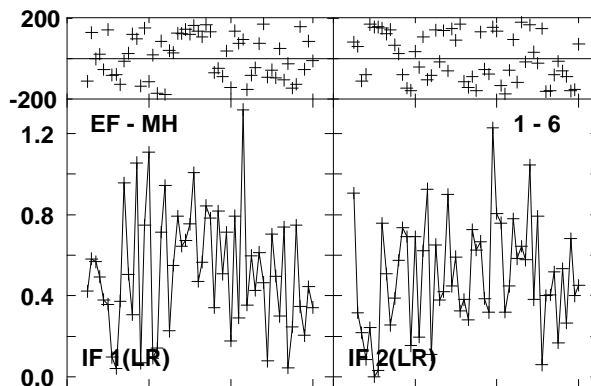
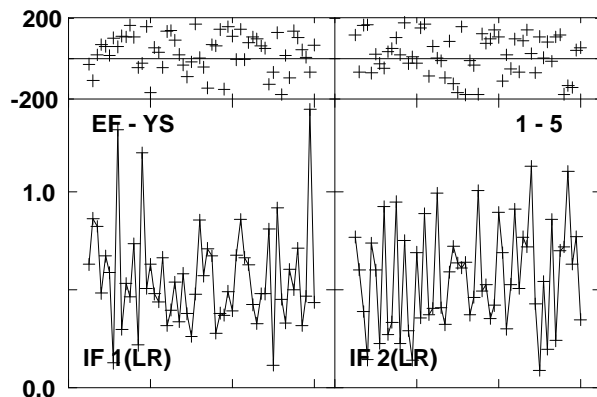
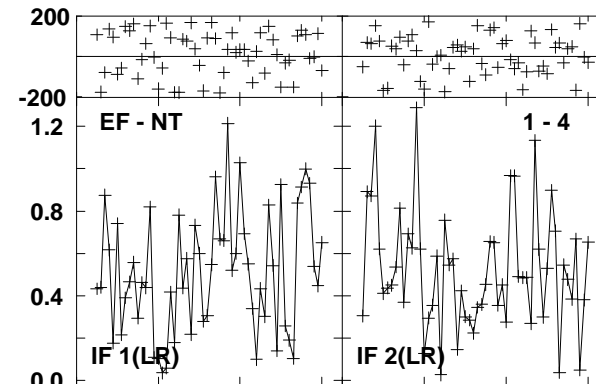
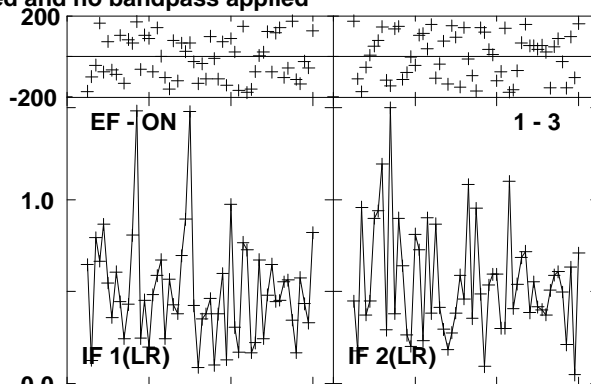
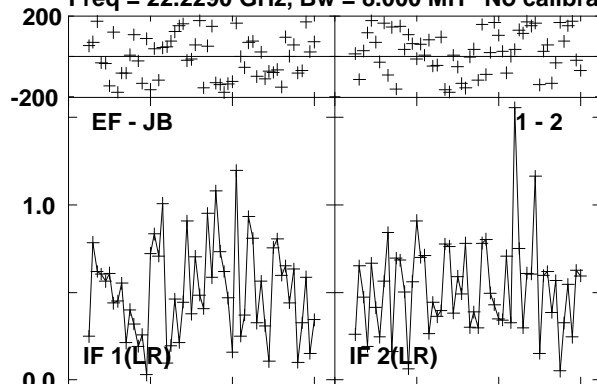

Lower frame: Milli Ampl Jy Top frame: Phas deg
Vector averaged cross-power spectrum Several baselines displayed
Timerange: 00/15:15:19 to 00/15:16:15

Plot file version 228 created 17-SEP-2012 12:10:26

ORIKL1 EE008D 1.UVDATA.1

Freq = 22.2290 GHz, Bw = 8.000 MH No calibration applied and no bandpass applied

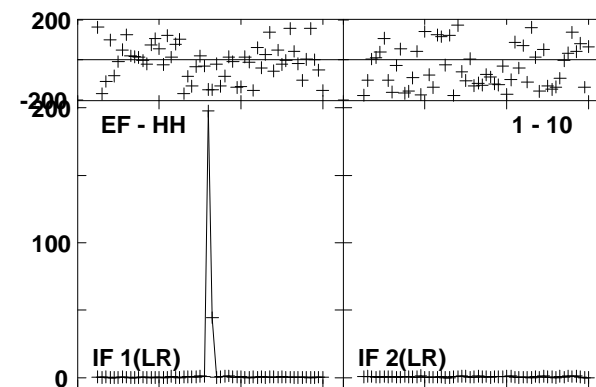
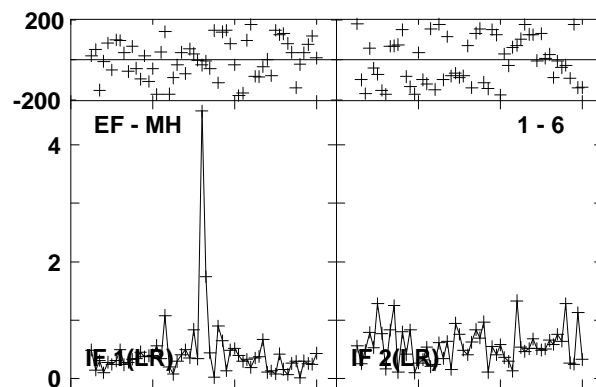
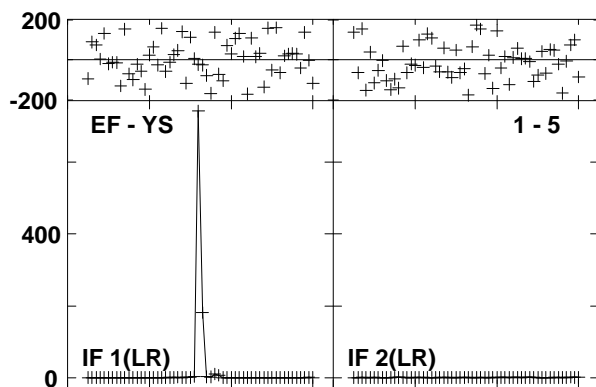
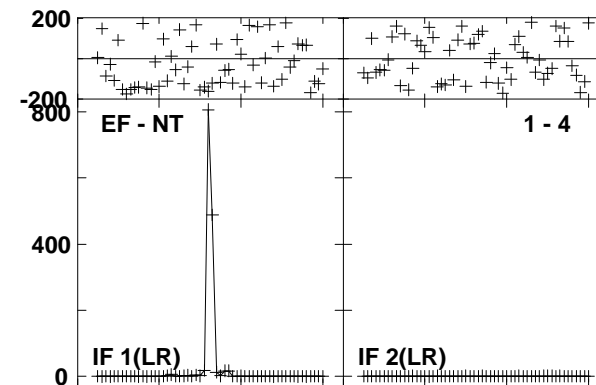
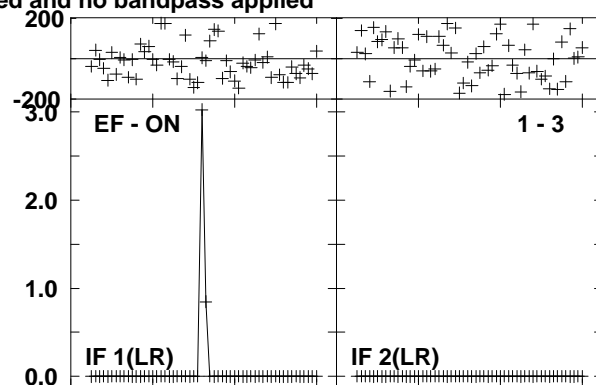
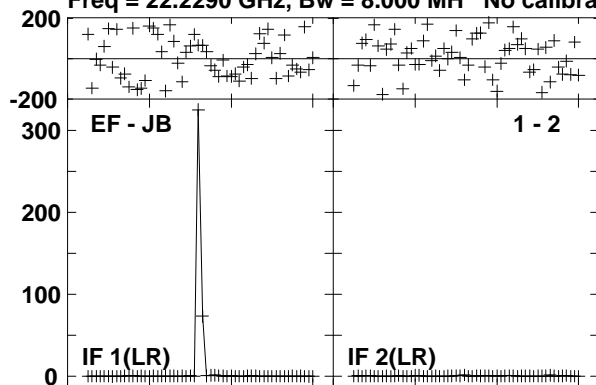

Lower frame: Milli Ampl Jy Top frame: Phas deg
Vector averaged cross-power spectrum Several baselines displayed
Timerange: 00/15:16:19 to 00/15:17:15

Plot file version 229 created 17-SEP-2012 12:10:27

J0529-0519 EE008D 1.UVDATA.1

Freq = 22.2290 GHz, Bw = 8.000 MH No calibration applied and no bandpass applied

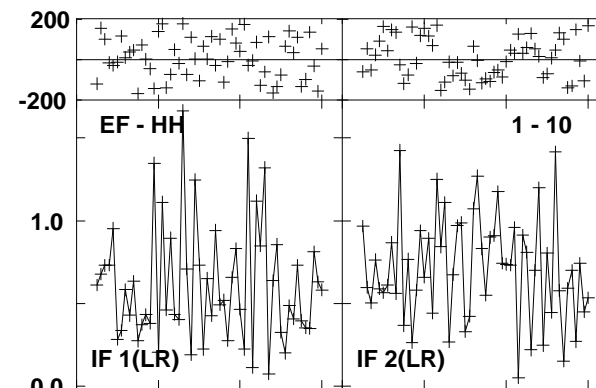
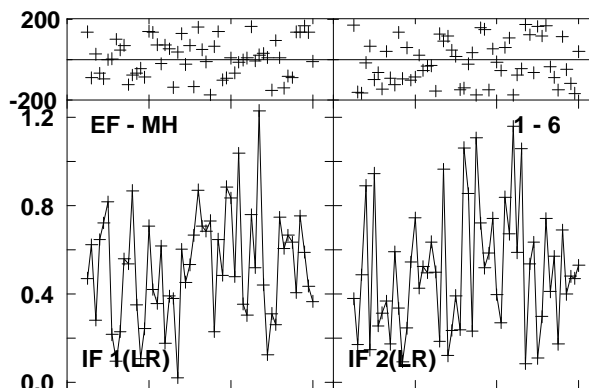
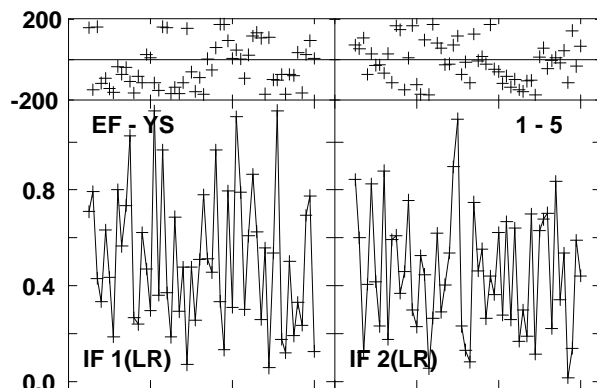
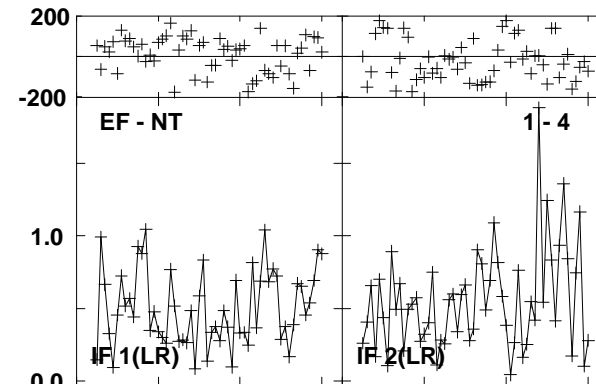
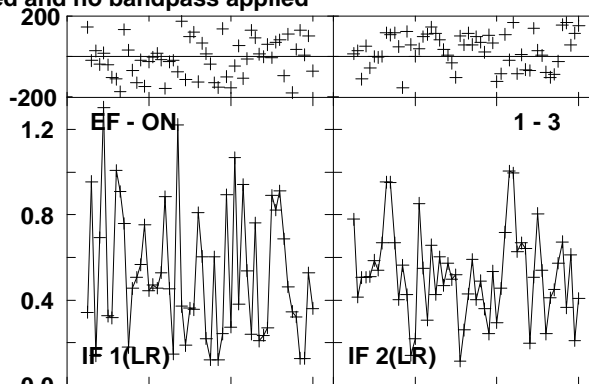
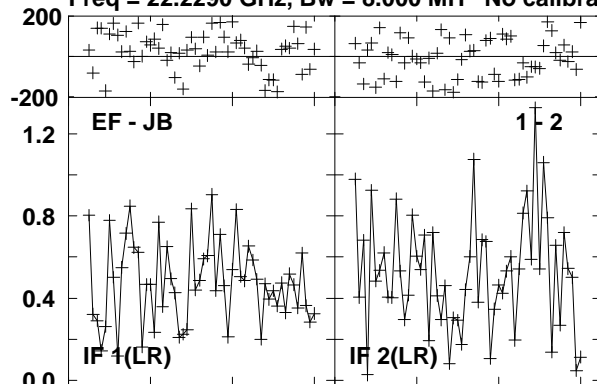

Lower frame: Milli Ampl Jy Top frame: Phas deg
Vector averaged cross-power spectrum Several baselines displayed
Timerange: 00/15:17:20 to 00/15:18:15

Plot file version 230 created 17-SEP-2012 12:10:29

J0541-0541 EE008D 1.UVDATA.1

Freq = 22.2290 GHz, Bw = 8.000 MH No calibration applied and no bandpass applied

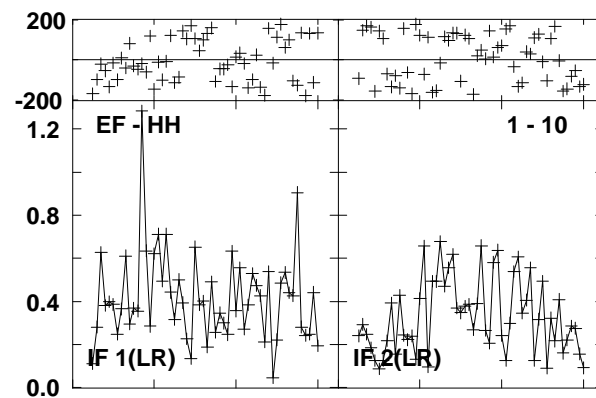
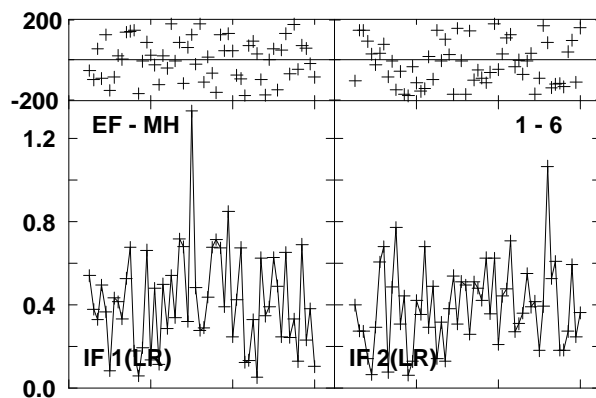
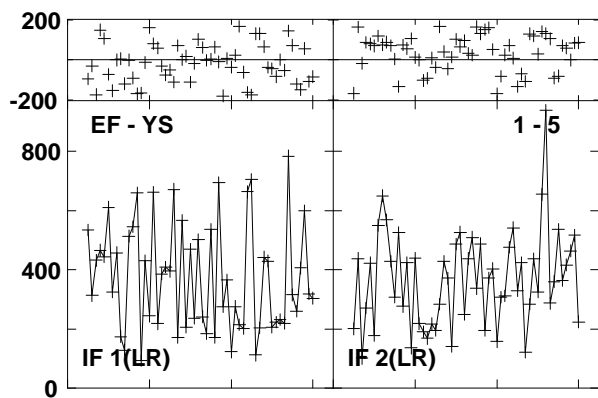
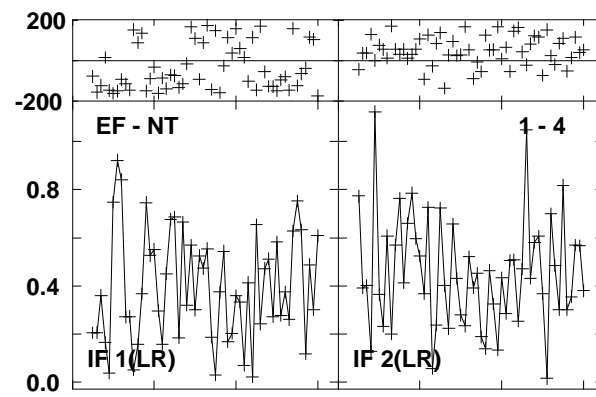
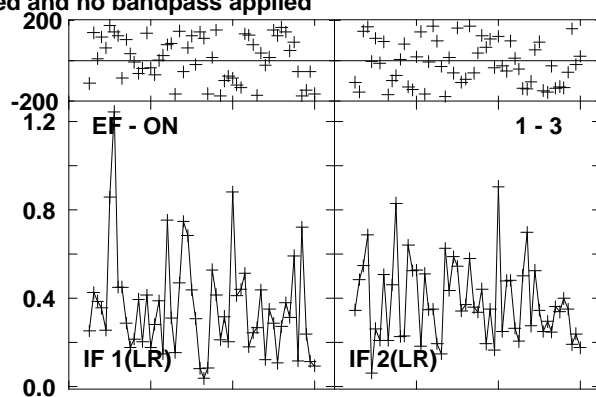
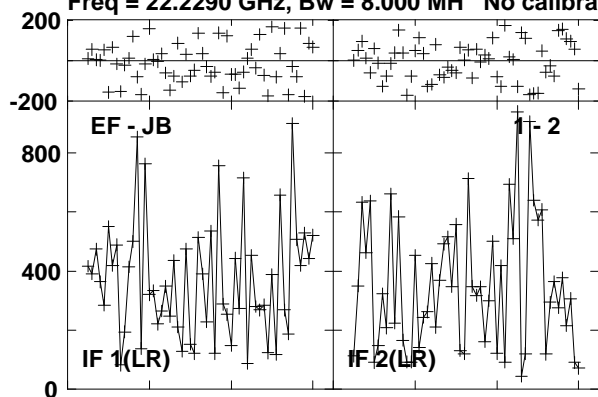

Lower frame: Micro Ampl Jy Top frame: Phas deg
Vector averaged cross-power spectrum Several baselines displayed
Timerange: 00/15:19:01 to 00/15:20:00

Plot file version 231 created 17-SEP-2012 12:10:30

ORIKL1 EE008D 1.UVDATA.1

Freq = 22.2290 GHz, Bw = 8.000 MH No calibration applied and no bandpass applied

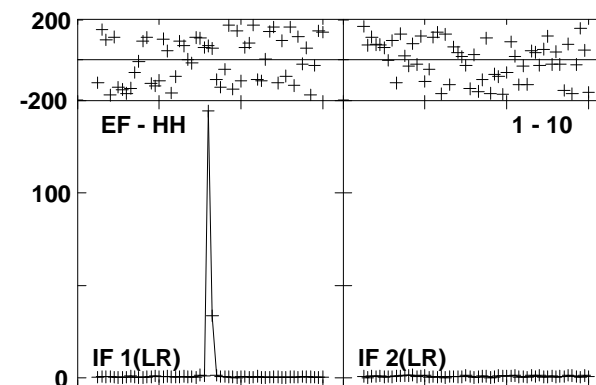
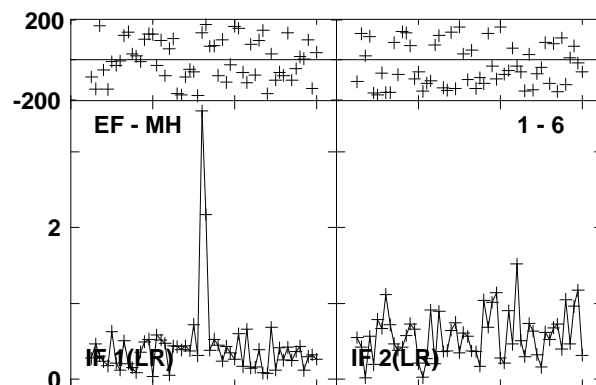
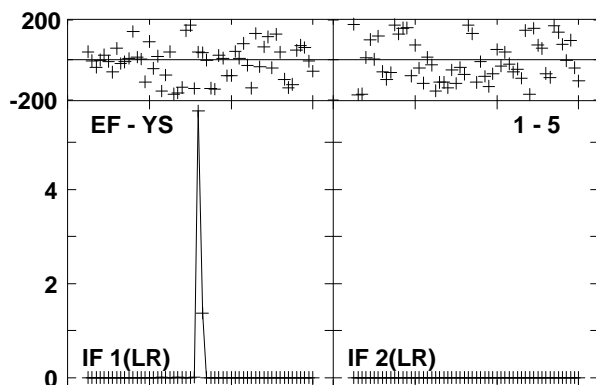
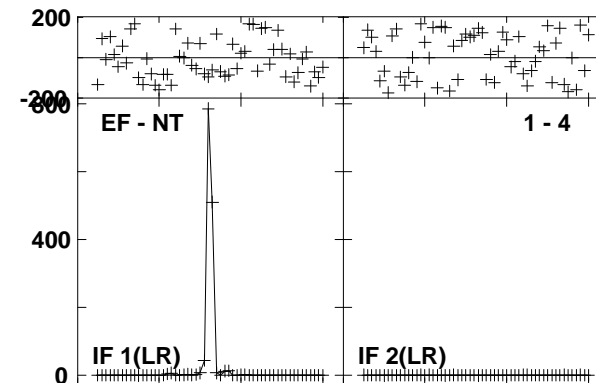
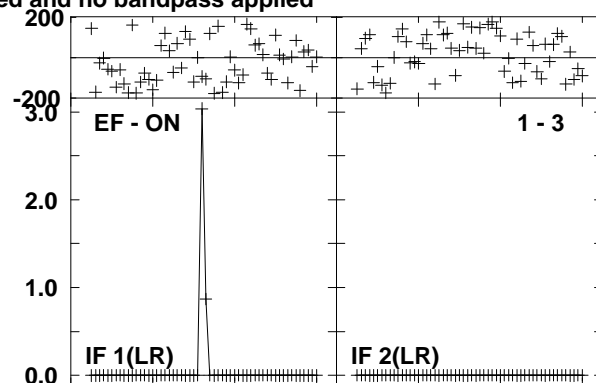
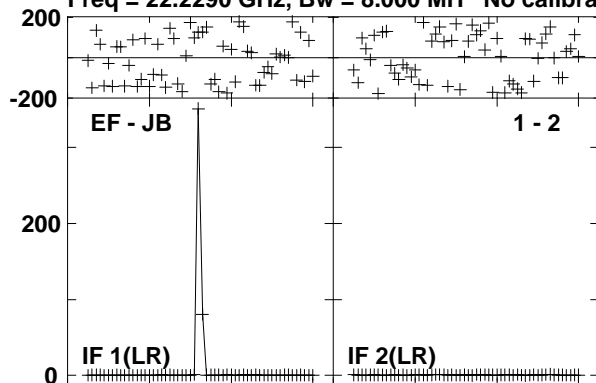

Lower frame: Milli Ampl Jy Top frame: Phas deg
Vector averaged cross-power spectrum Several baselines displayed
Timerange: 00/15:20:03 to 00/15:21:00

Plot file version 232 created 17-SEP-2012 12:10:31

J0541-0541 EE008D 1.UVDATA.1

Freq = 22.2290 GHz, Bw = 8.000 MH No calibration applied and no bandpass applied

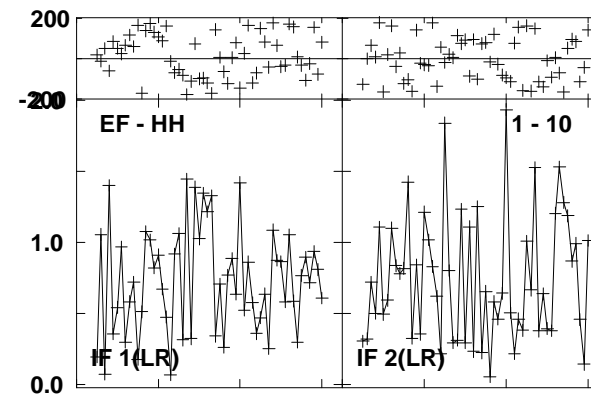
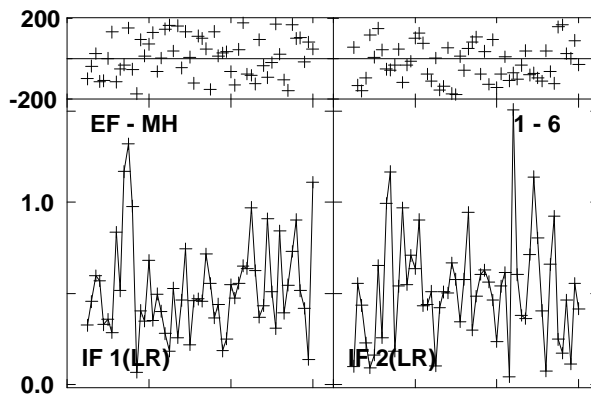
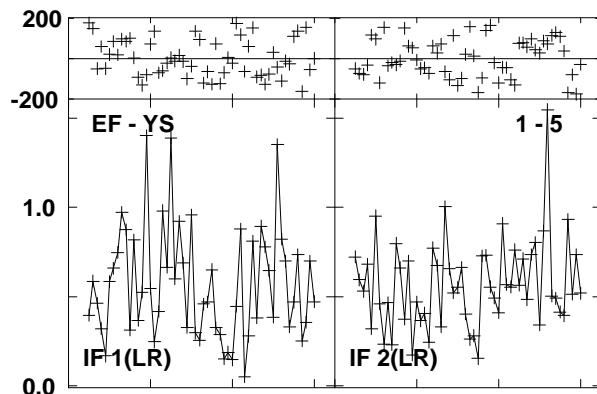
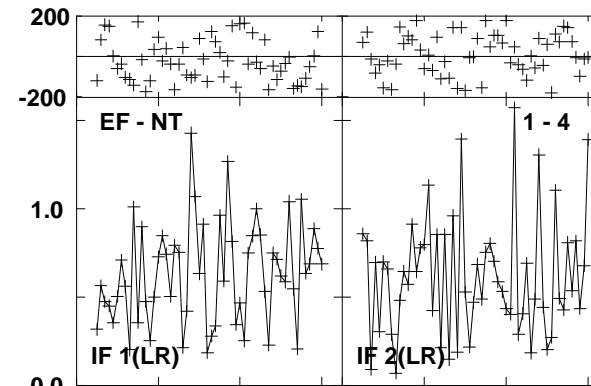
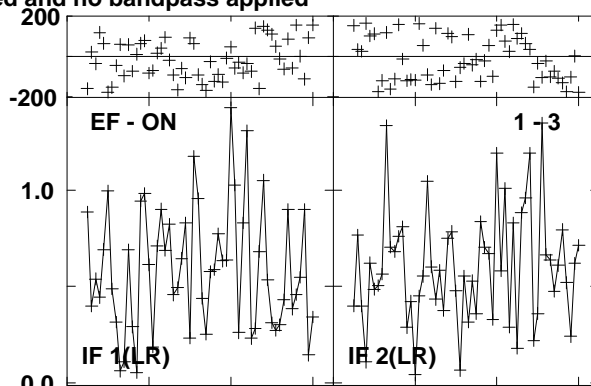
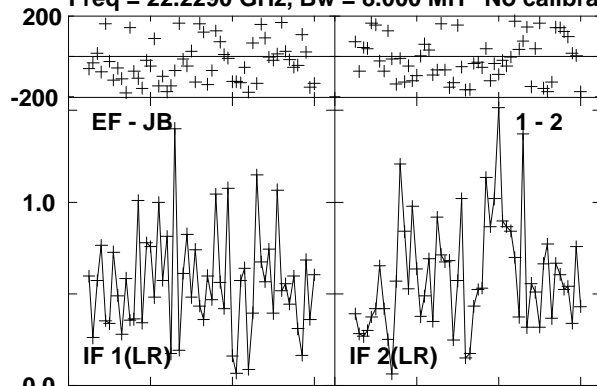

Lower frame: Milli Ampl Jy Top frame: Phas deg
Vector averaged cross-power spectrum Several baselines displayed
Timerange: 00/15:21:05 to 00/15:22:00

Plot file version 233 created 17-SEP-2012 12:10:32

ORIKL1 EE008D 1.UVDATA.1

Freq = 22.2290 GHz, Bw = 8.000 MH No calibration applied and no bandpass applied

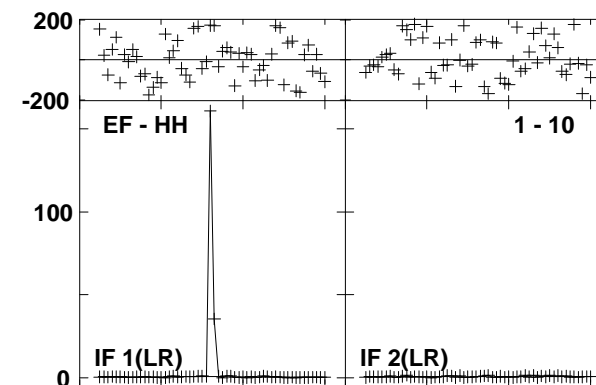
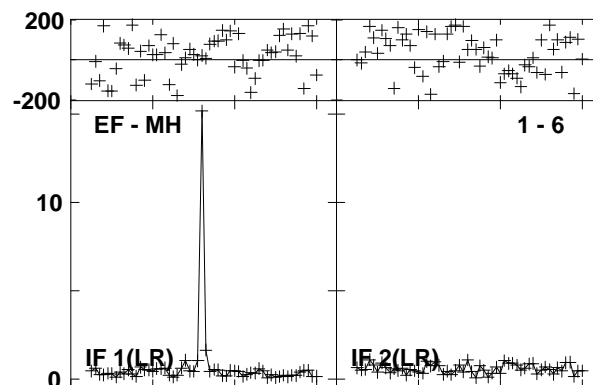
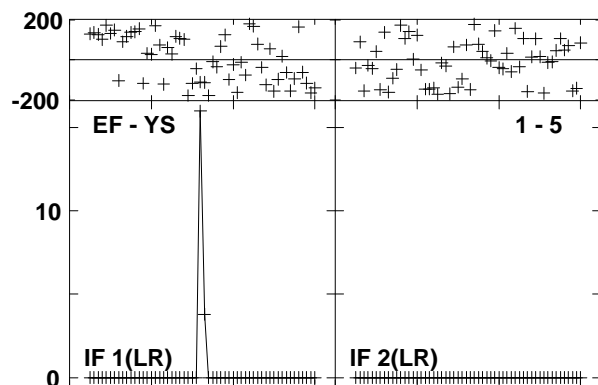
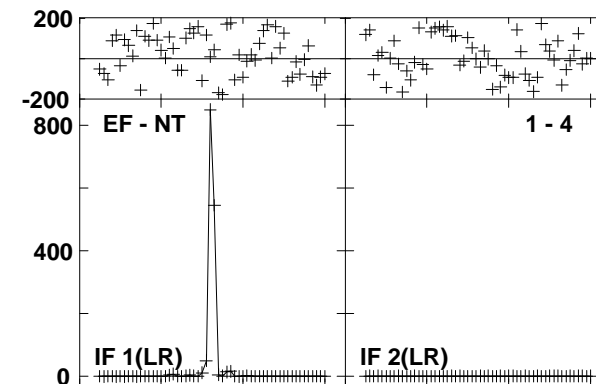
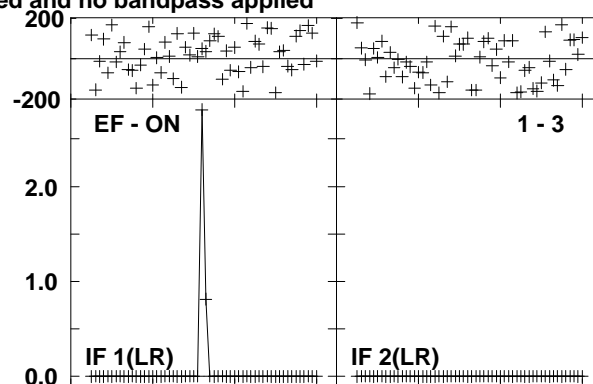
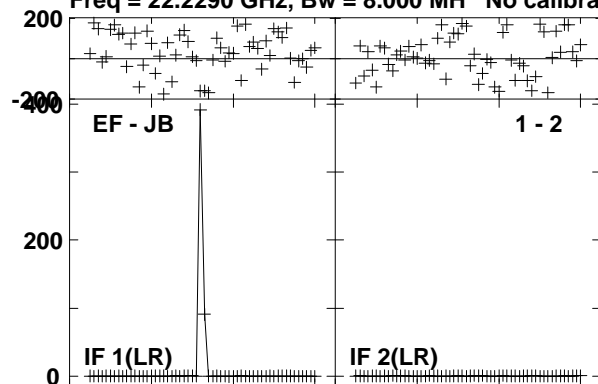

Lower frame: Milli Ampl Jy Top frame: Phas deg
Vector averaged cross-power spectrum Several baselines displayed
Timerange: 00/15:22:05 to 00/15:23:00

Plot file version 234 created 17-SEP-2012 12:10:34

J0541-0541 EE008D 1.UVDATA.1

Freq = 22.2290 GHz, Bw = 8.000 MH No calibration applied and no bandpass applied

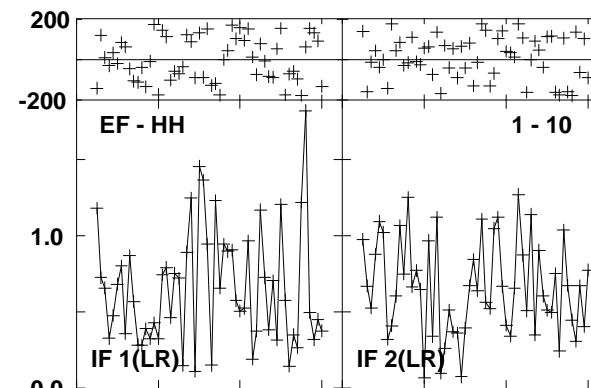
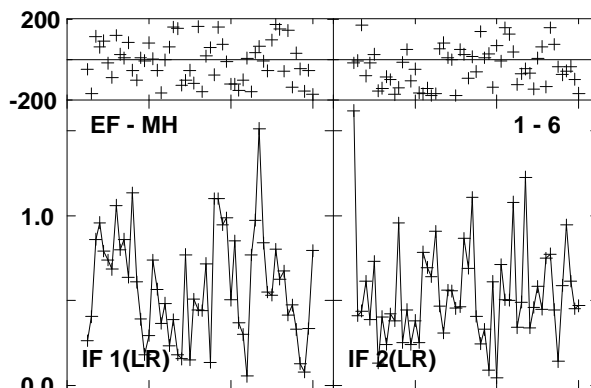
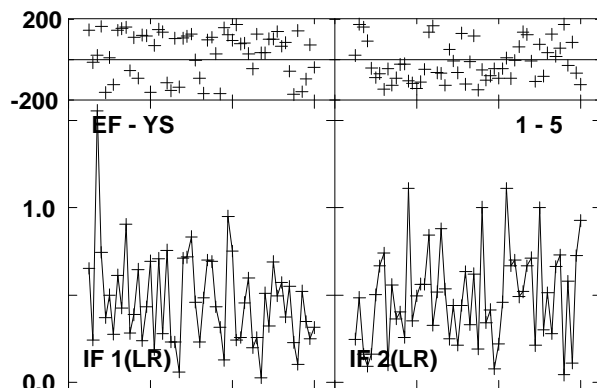
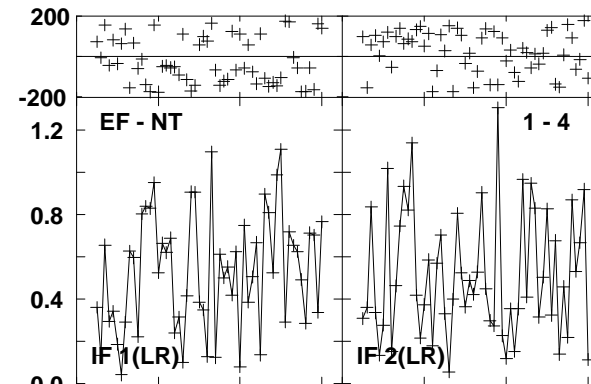
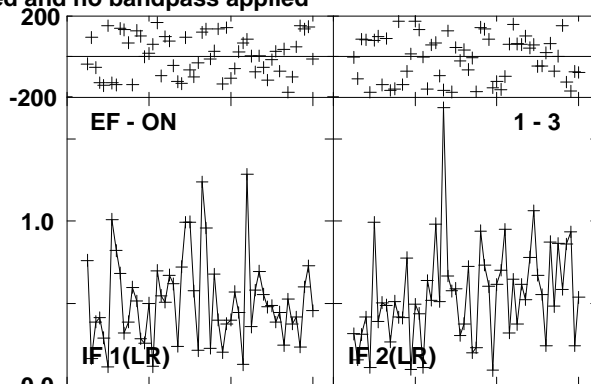
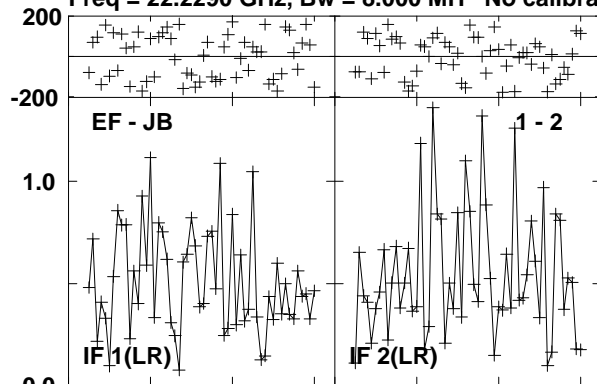

Lower frame: Milli Ampl Jy Top frame: Phas deg
Vector averaged cross-power spectrum Several baselines displayed
Timerange: 00/15:23:04 to 00/15:24:00

Plot file version 235 created 17-SEP-2012 12:10:35

J0529-0519 EE008D 1.UVDATA.1

Freq = 22.2290 GHz, Bw = 8.000 MH No calibration applied and no bandpass applied

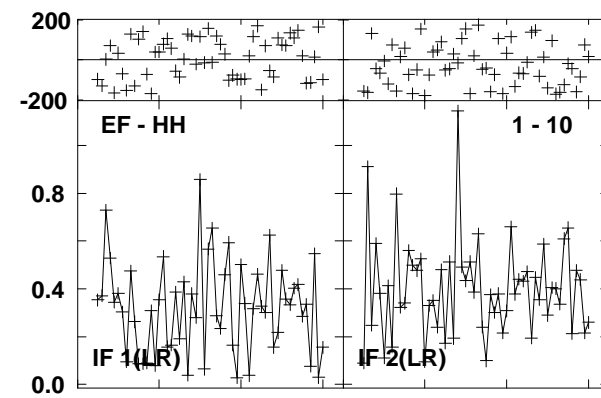
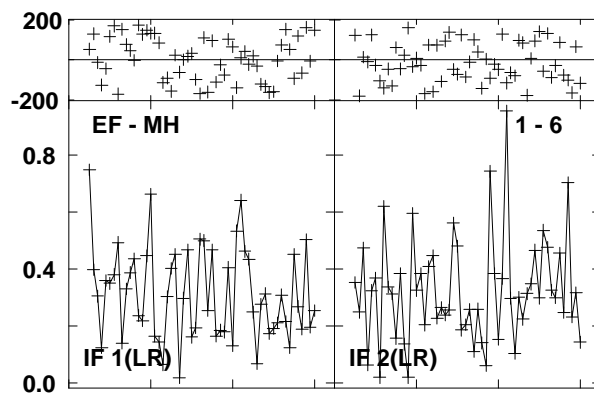
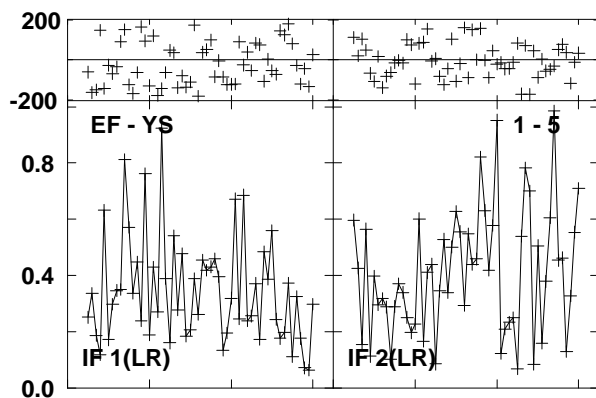
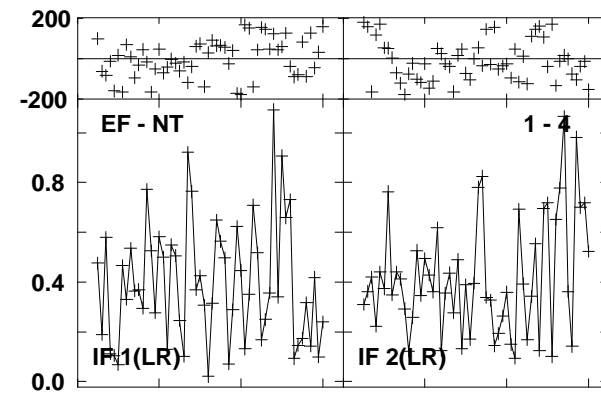
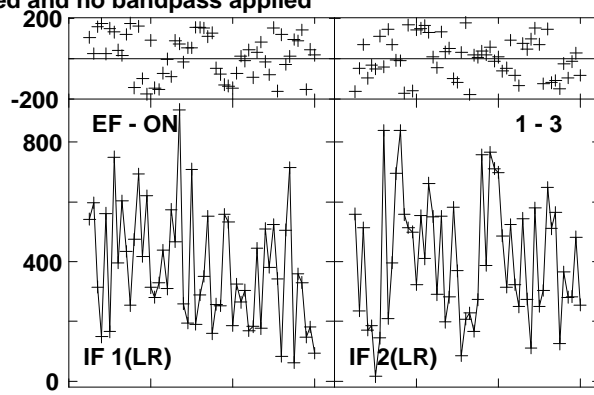
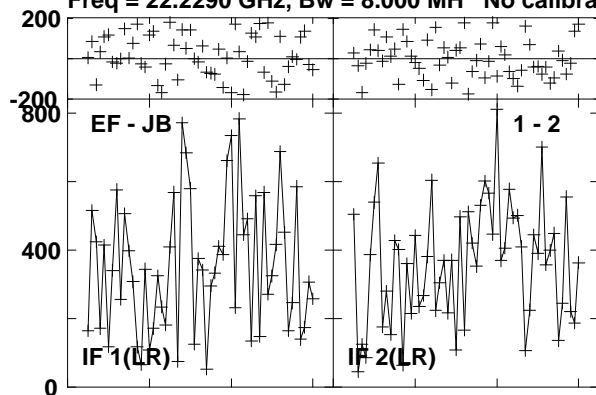

Lower frame: Micro Ampl Jy Top frame: Phas deg
Vector averaged cross-power spectrum Several baselines displayed
Timerange: 00/15:24:47 to 00/15:25:46

Plot file version 236 created 17-SEP-2012 12:10:36

ORIKL1 EE008D 1.UVDATA.1

Freq = 22.2290 GHz, Bw = 8.000 MH No calibration applied and no bandpass applied

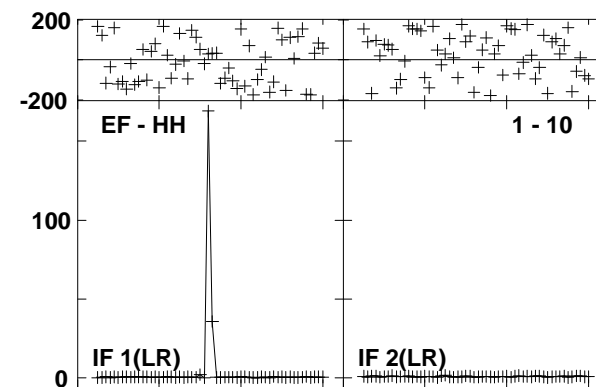
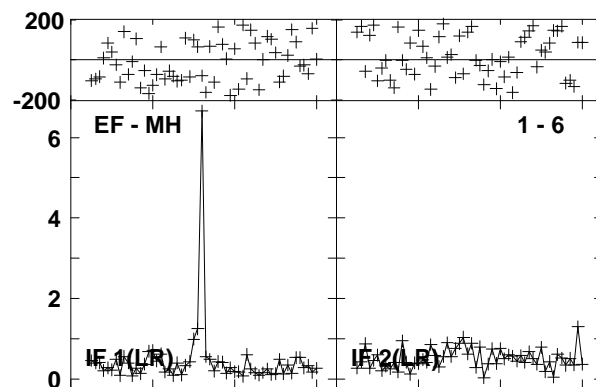
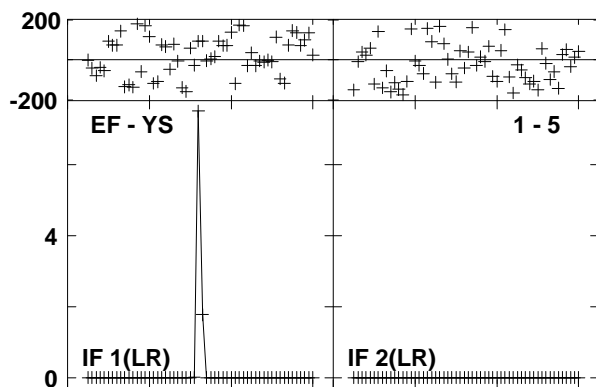
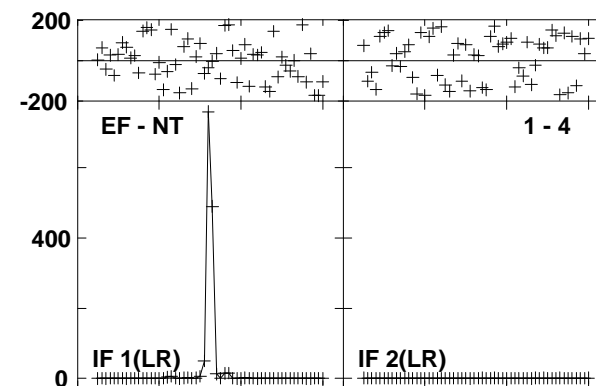
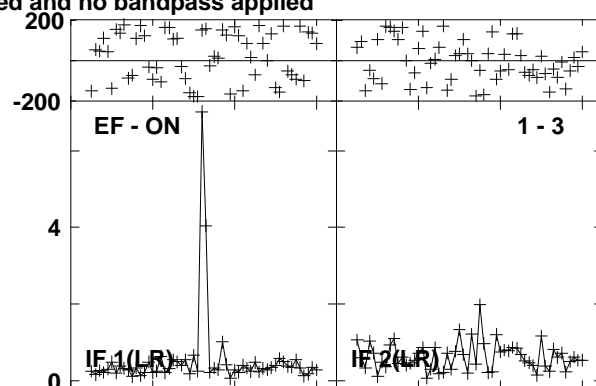
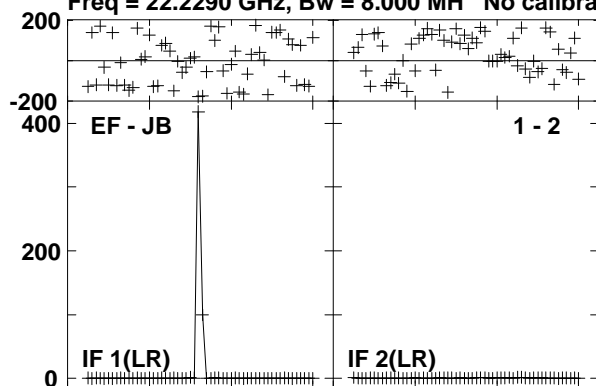

Lower frame: Milli Ampl Jy Top frame: Phas deg
Vector averaged cross-power spectrum Several baselines displayed
Timerange: 00/15:25:49 to 00/15:26:46

Plot file version 237 created 17-SEP-2012 12:10:38

J0529-0519 EE008D 1.UVDATA.1

Freq = 22.2290 GHz, Bw = 8.000 MH No calibration applied and no bandpass applied

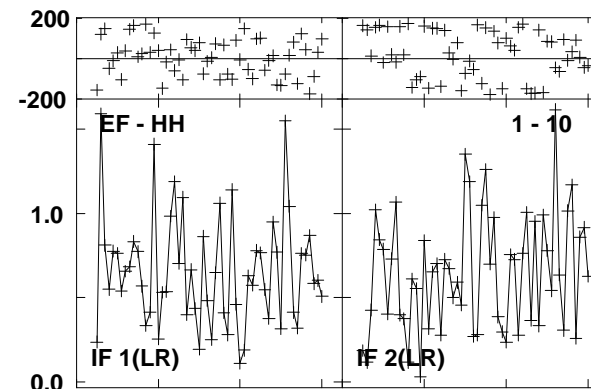
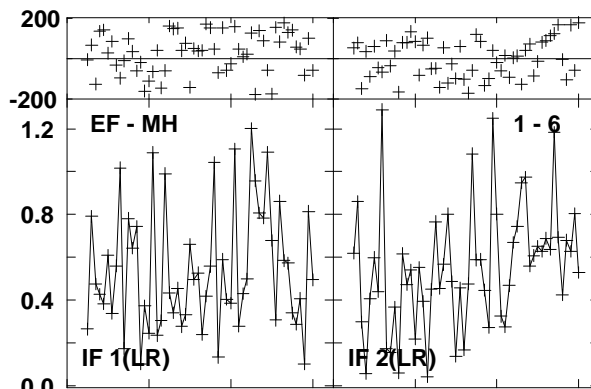
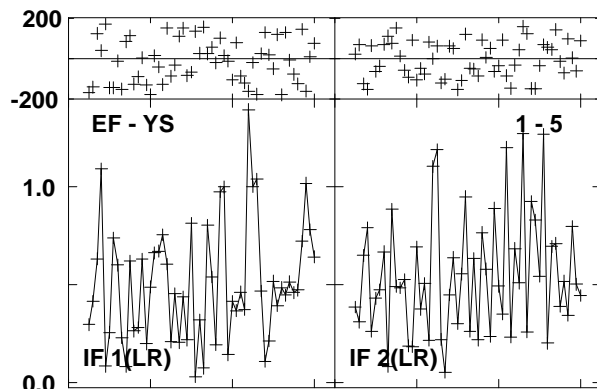
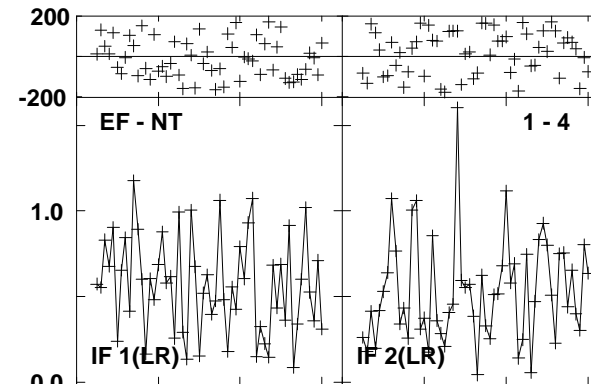
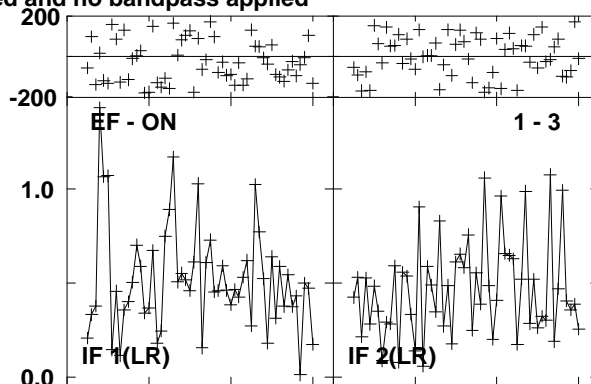
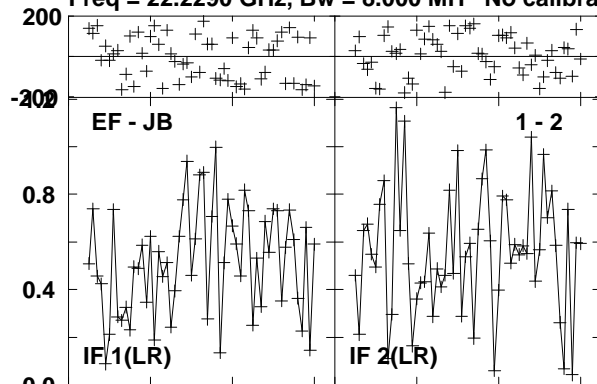

Lower frame: Milli Ampl Jy Top frame: Phas deg
Vector averaged cross-power spectrum Several baselines displayed
Timerange: 00/15:26:52 to 00/15:27:46

Plot file version 238 created 17-SEP-2012 12:10:39

ORIKL1 EE008D 1.UVDATA.1

Freq = 22.2290 GHz, Bw = 8.000 MH No calibration applied and no bandpass applied

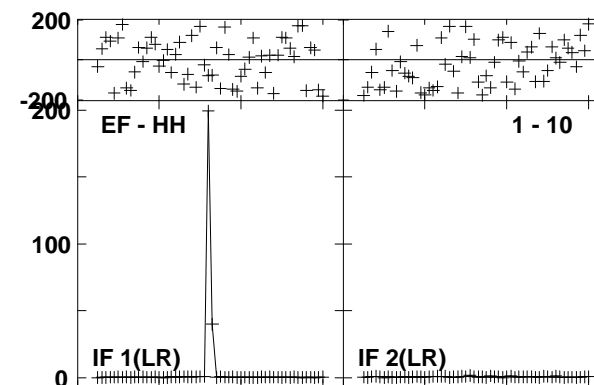
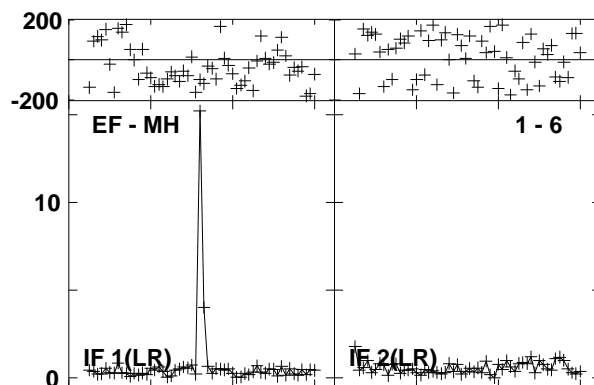
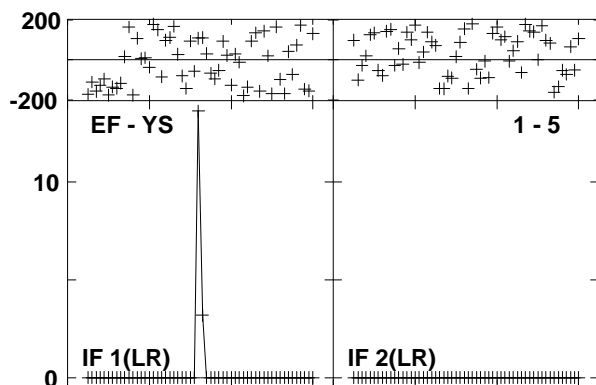
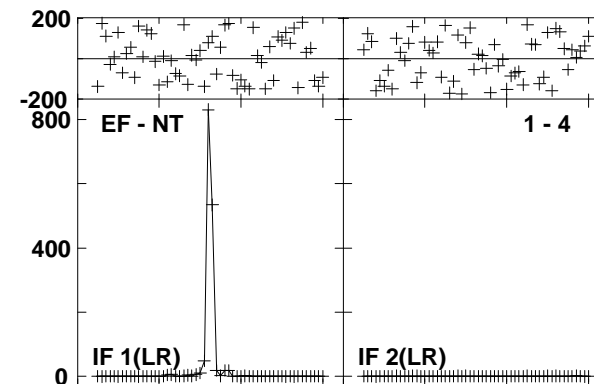
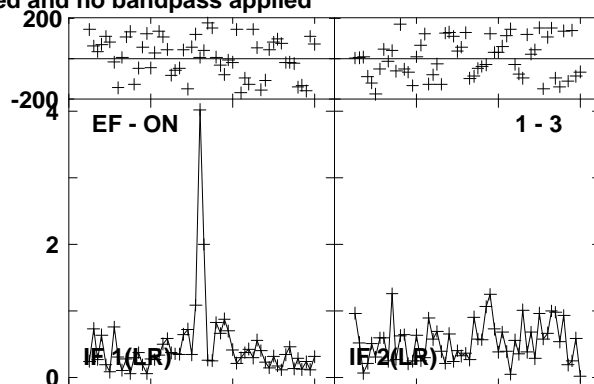
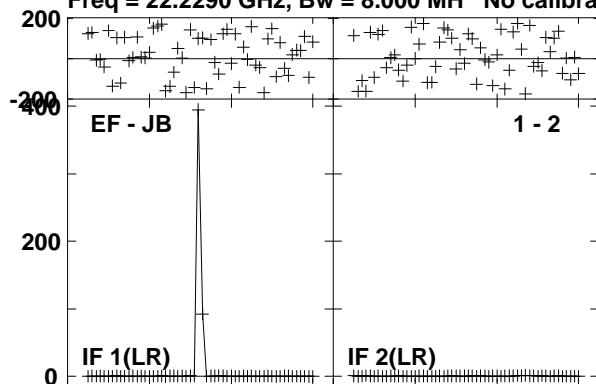

Lower frame: Milli Ampl Jy Top frame: Phas deg
Vector averaged cross-power spectrum Several baselines displayed
Timerange: 00/15:27:50 to 00/15:28:46

Plot file version 239 created 17-SEP-2012 12:10:41

J0529-0519 EE008D 1.UVDATA.1

Freq = 22.2290 GHz, Bw = 8.000 MH No calibration applied and no bandpass applied

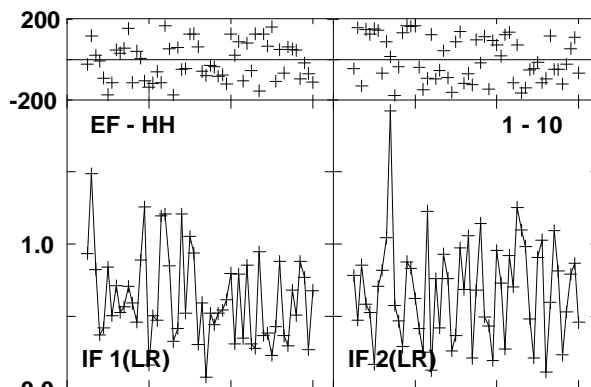
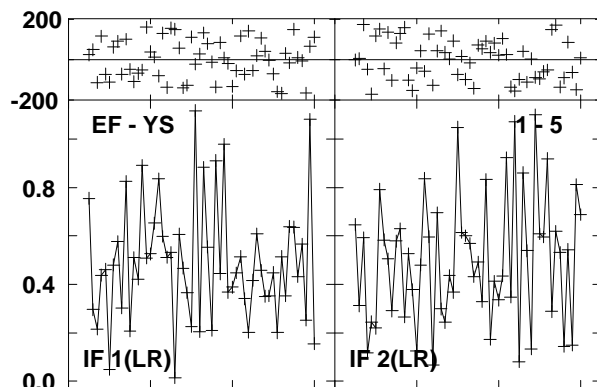
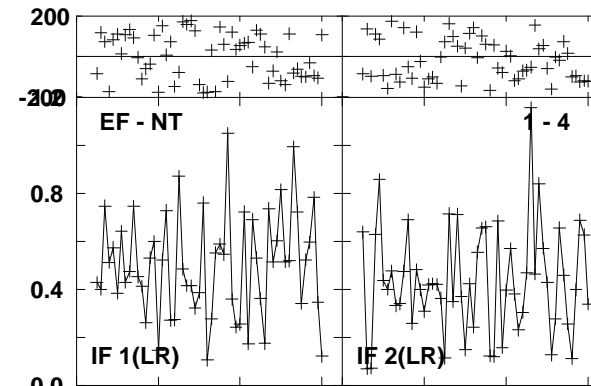
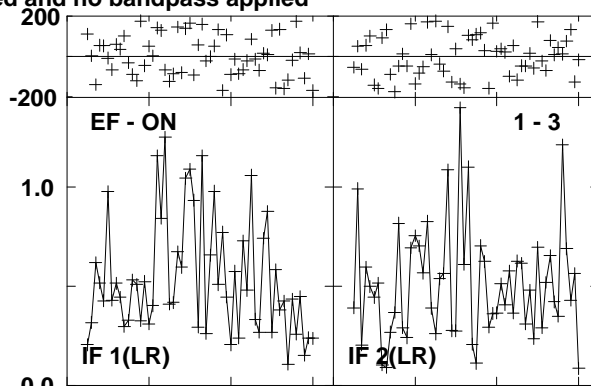
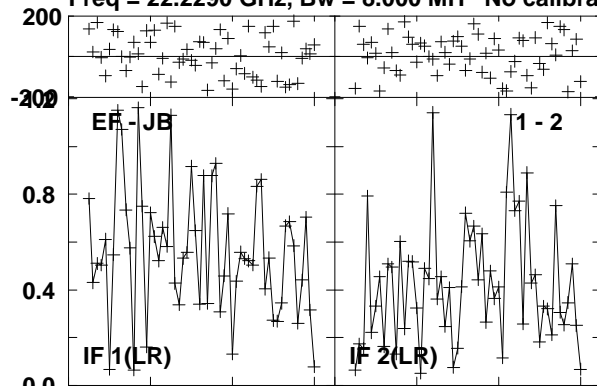

Lower frame: Milli Ampl Jy Top frame: Phas deg
Vector averaged cross-power spectrum Several baselines displayed
Timerange: 00/15:28:51 to 00/15:29:46

Plot file version 240 created 17-SEP-2012 12:10:45

4C39.25 EE008D 1.UVDATA.1

Freq = 22.2290 GHz, Bw = 8.000 MH No calibration applied and no bandpass applied

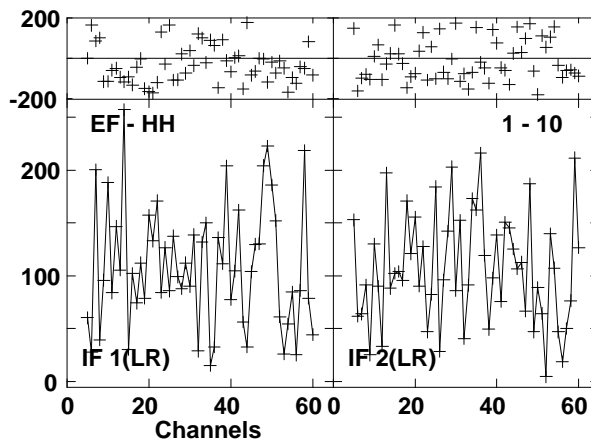
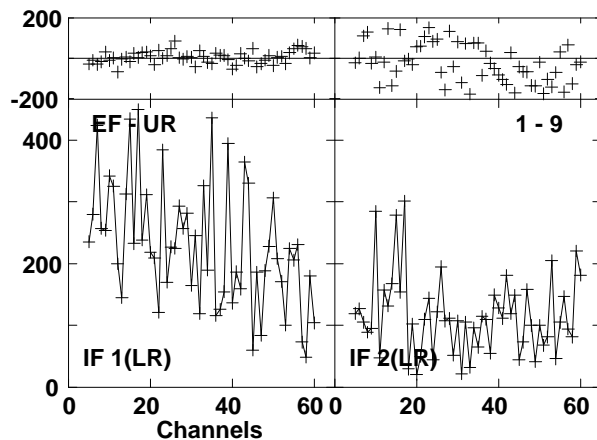
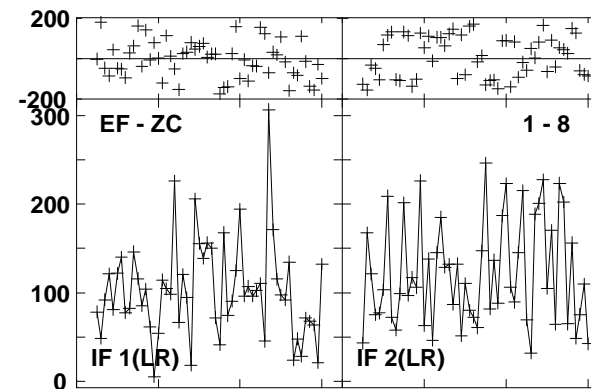
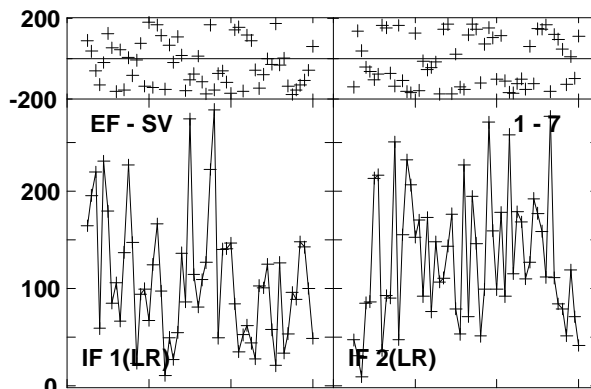
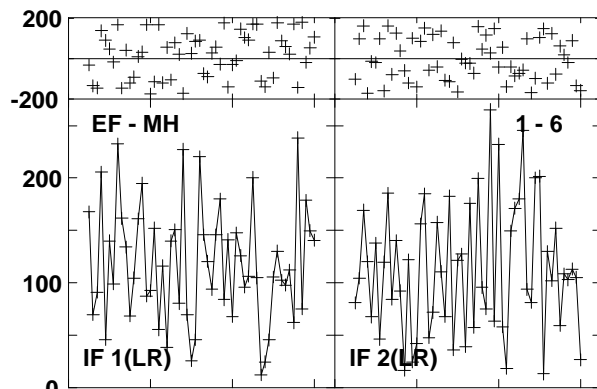
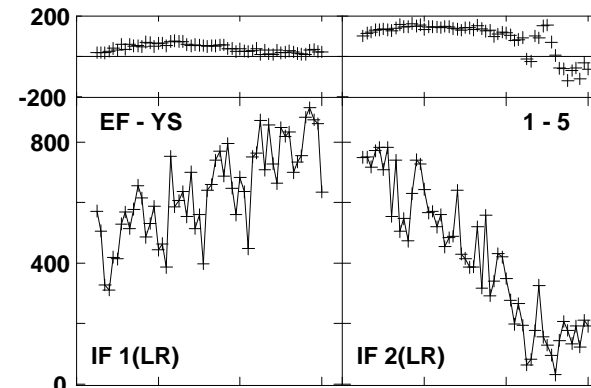
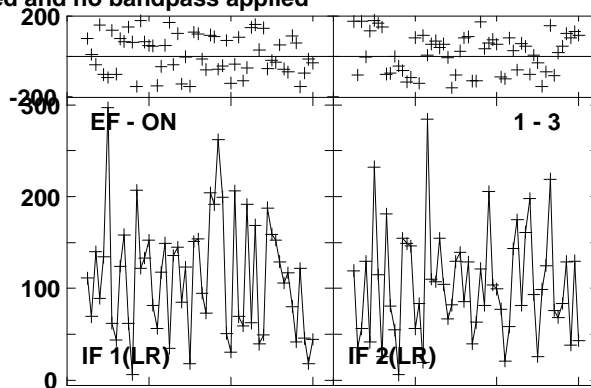
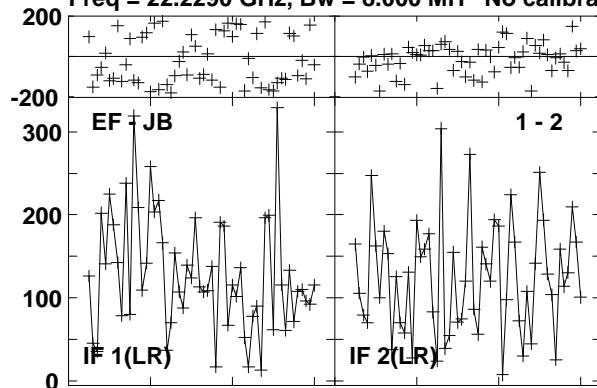

Lower frame: Micro Ampl Jy Top frame: Phas deg
Vector averaged cross-power spectrum Several baselines displayed
Timerange: 00/15:34:07 to 00/15:44:30

Plot file version 241 created 17-SEP-2012 12:11:13

4C39.25 EE008D 1.UVDATA.1

Freq = 22.2290 GHz, Bw = 8.000 MH No calibration applied and no bandpass applied

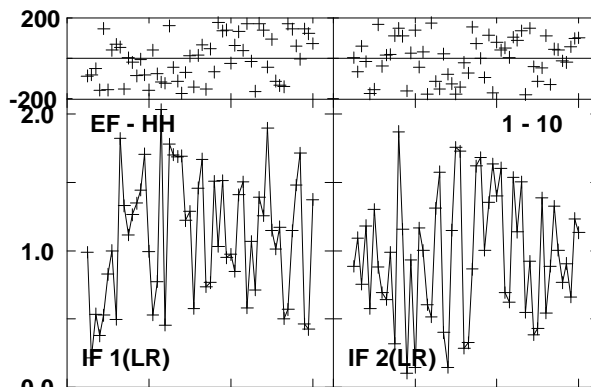
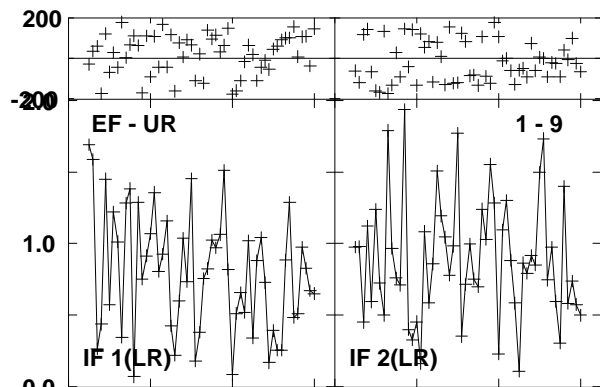
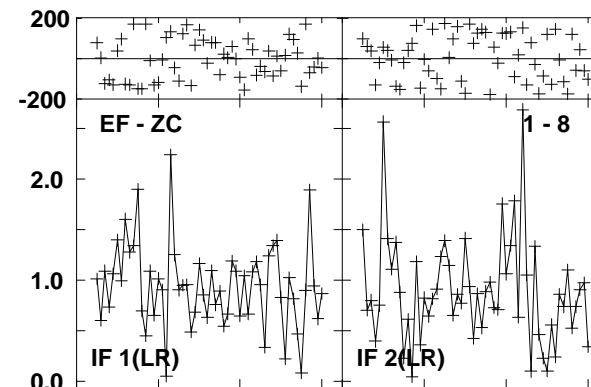
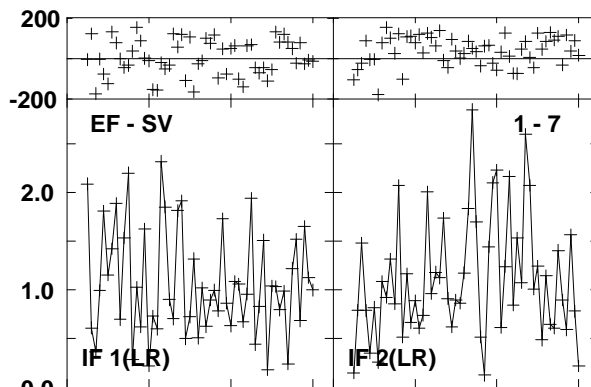
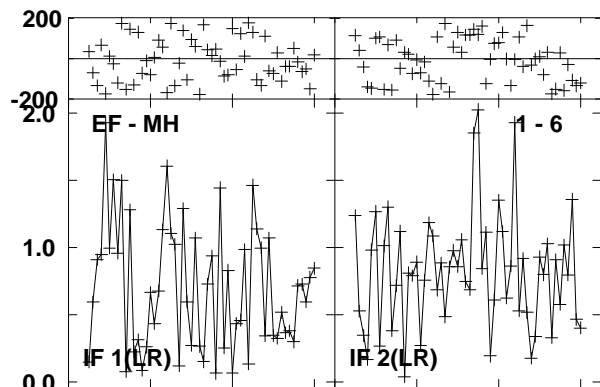
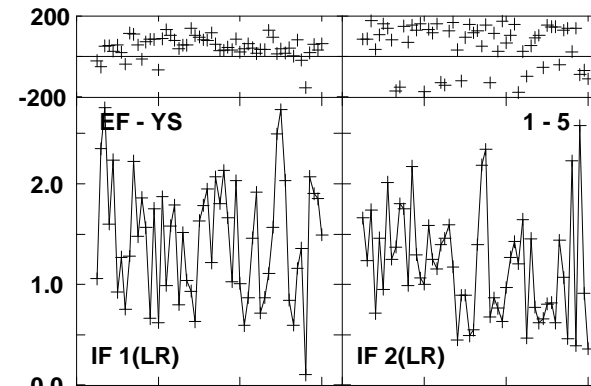
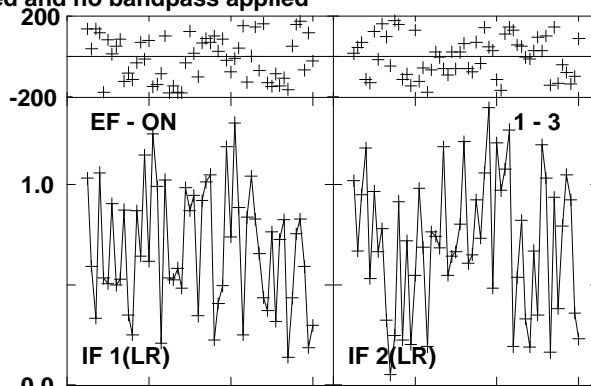
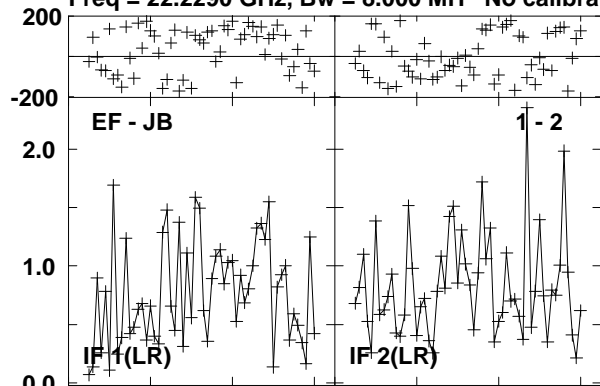

Lower frame: Milli Ampl Jy Top frame: Phas deg
Vector averaged cross-power spectrum Several baselines displayed
Timerange: 00/15:44:46 to 00/15:45:00

Plot file version 242 created 17-SEP-2012 12:11:18
3C286 EE008D 1.UVDATA.1

Freq = 22.2290 GHz, Bw = 8.000 MH No calibration applied and no bandpass applied

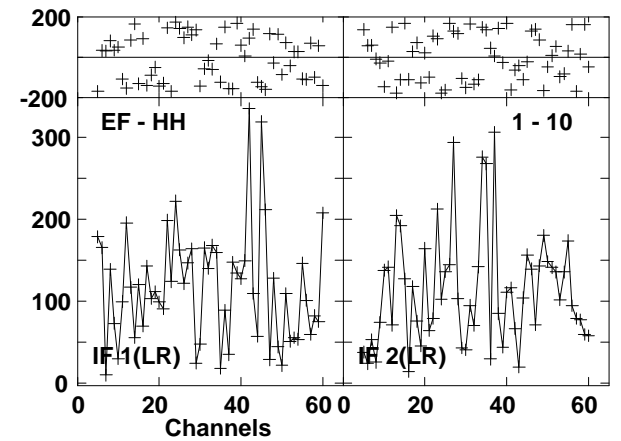
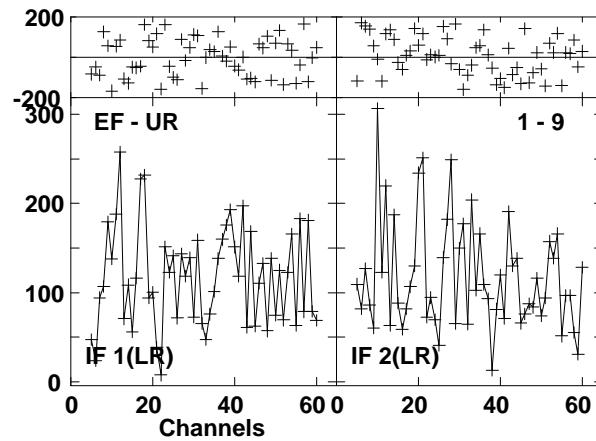
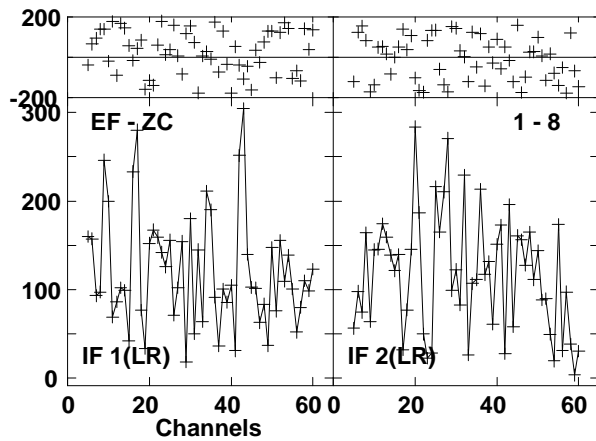
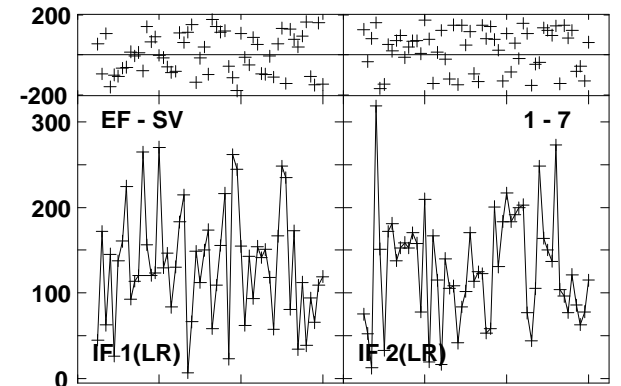
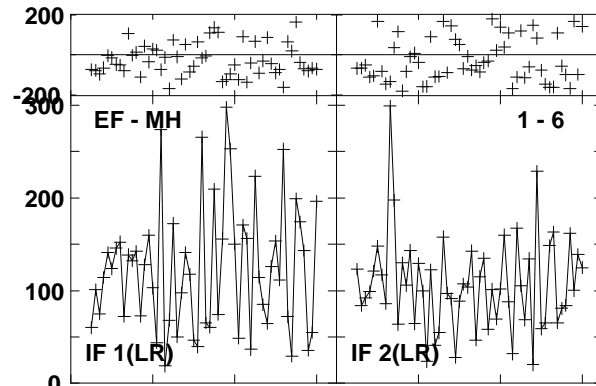
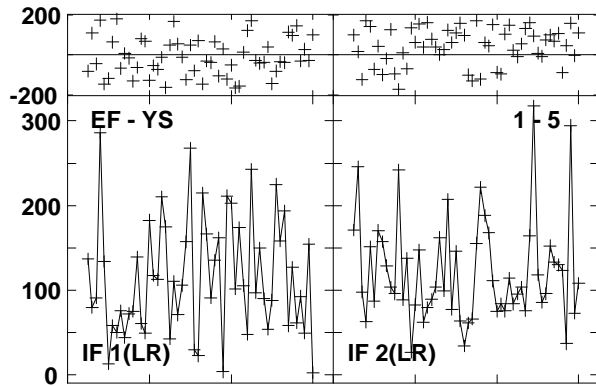
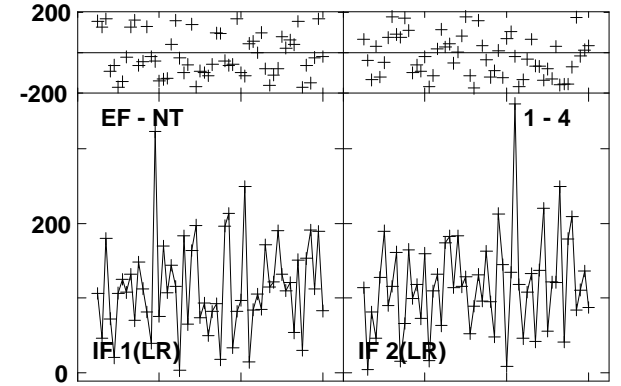
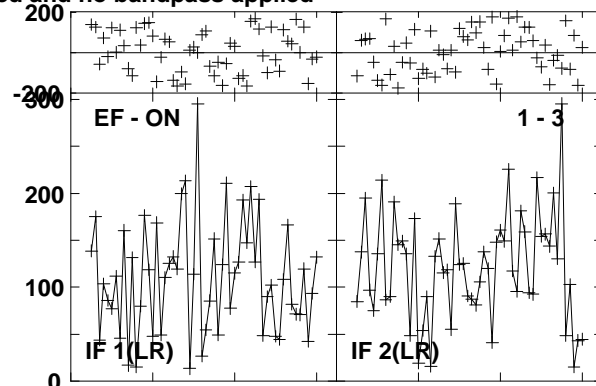
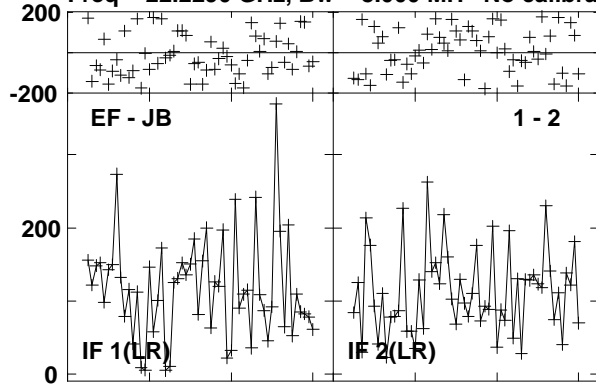

Lower frame: Micro Ampl Jy Top frame: Phas deg
Vector averaged cross-power spectrum Several baselines displayed
Timerange: 00/15:50:01 to 00/15:59:30

Plot file version 243 created 17-SEP-2012 12:11:48

3C286 EE008D 1.UVDATA.1

Freq = 22.2290 GHz, Bw = 8.000 MH No calibration applied and no bandpass applied

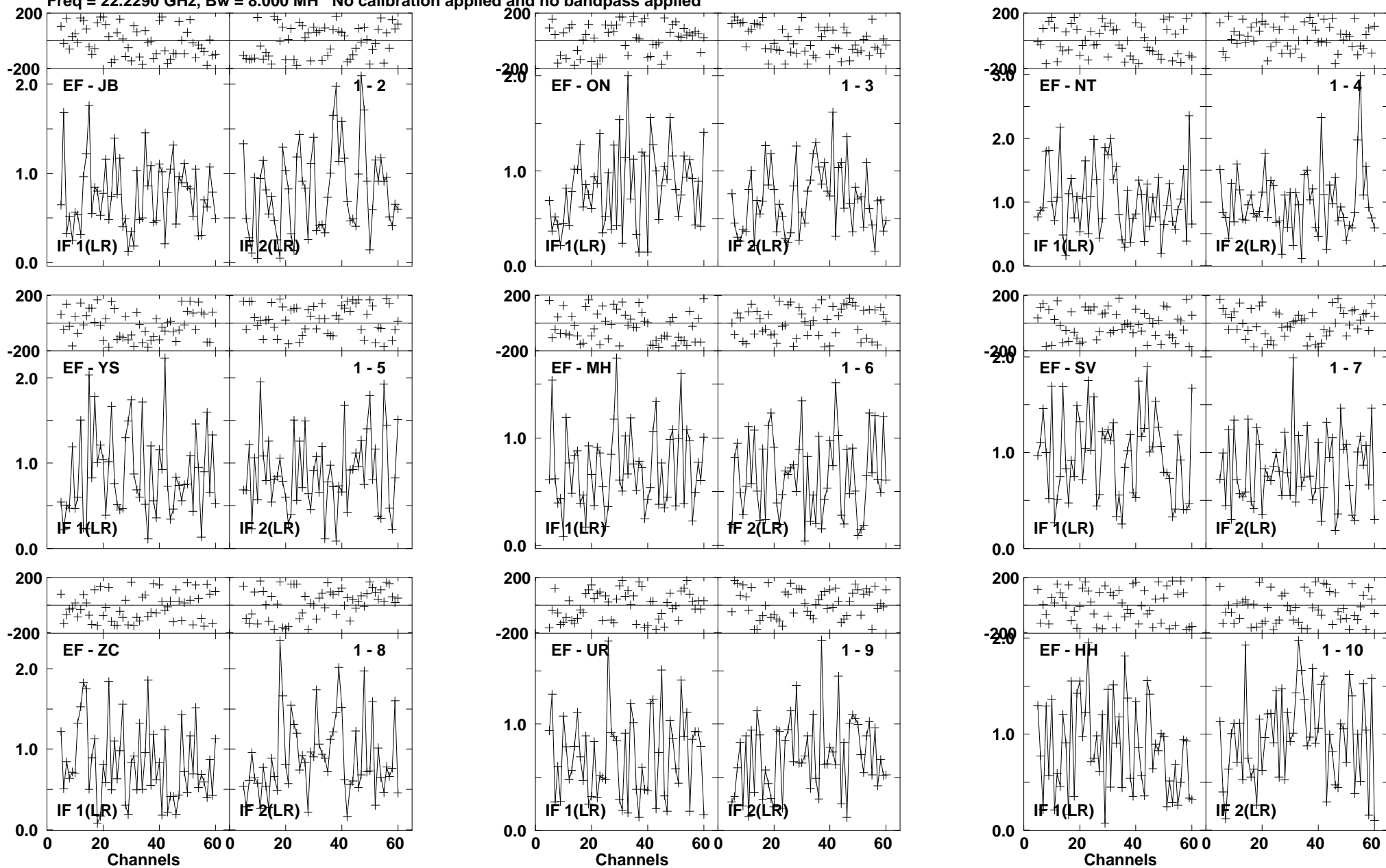

Lower frame: Milli Ampl Jy Top frame: Phas deg
Vector averaged cross-power spectrum Several baselines displayed
Timerange: 00/15:59:46 to 00/16:00:00