

Plot file version 1 created 20-AUG-2009 14:59:23

3C274 EG040B.UVDATA.1

Freq = 1.5955 GHz, Bw = 16.000 MH No calibration applied and no bandpass applied

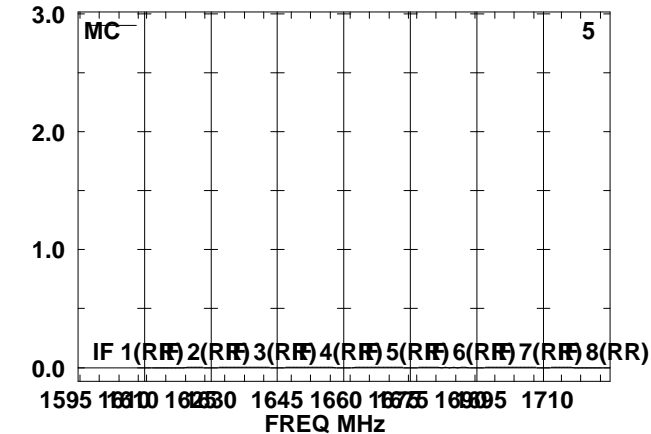
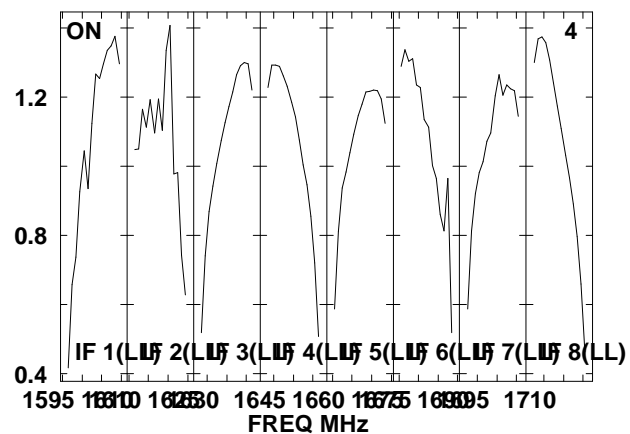
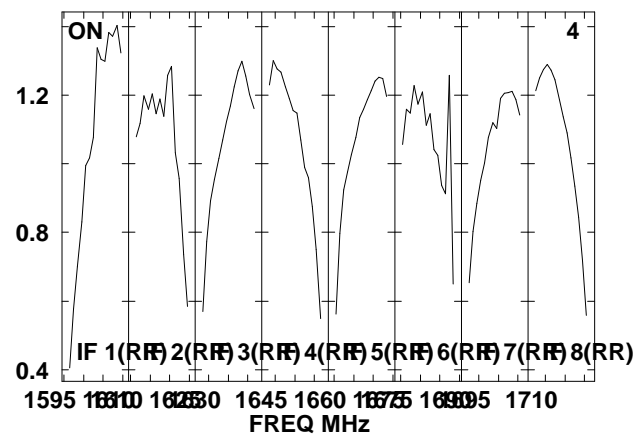
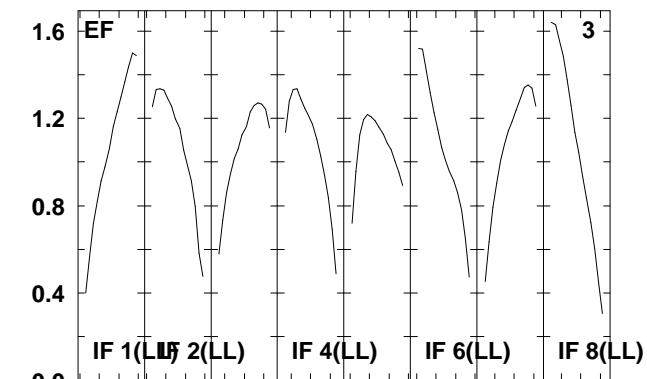
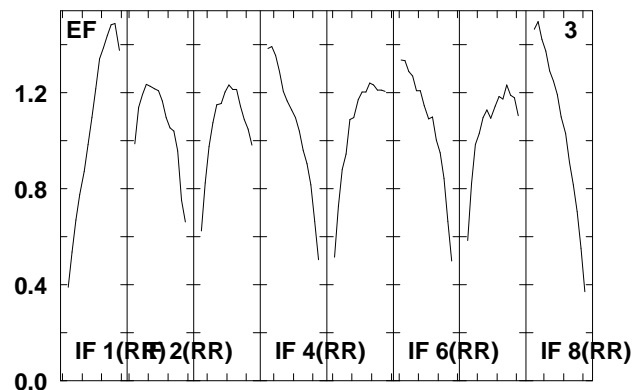
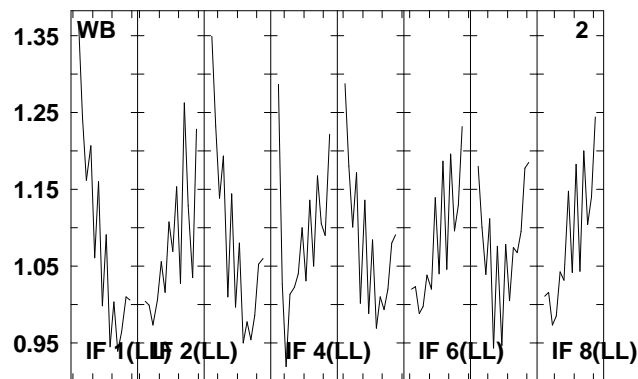
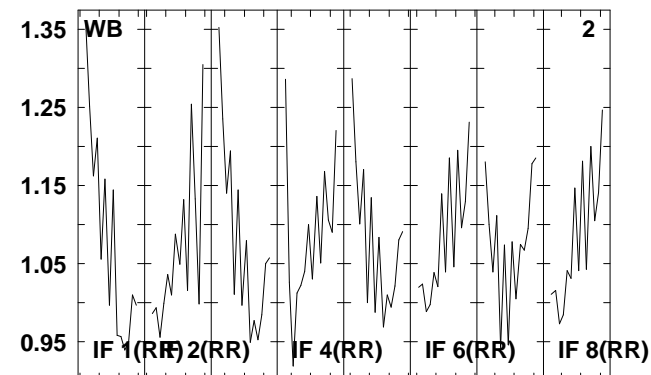
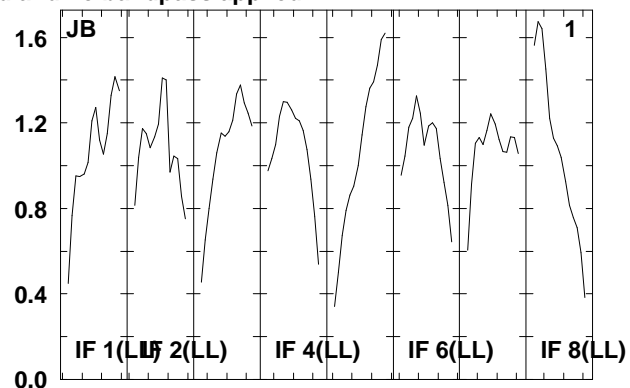
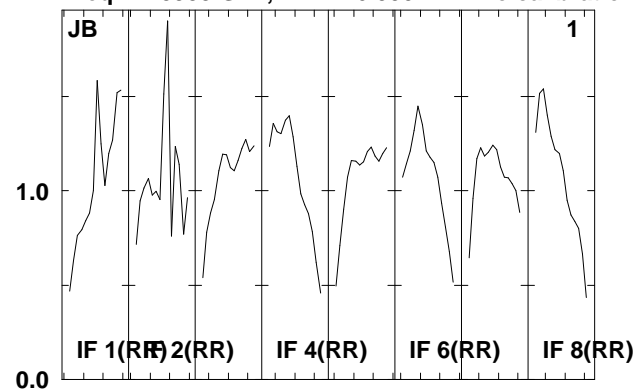

Lower frame: Real Jy  
Total-power spectrum Antenna: \*  
Timerange: 00/18:30:01 to 00/18:31:29

Plot file version 2 created 20-AUG-2009 14:59:23

3C274 EG040B.UVDATA.1

Freq = 1.5955 GHz, Bw = 16.000 MH No calibration applied and no bandpass applied

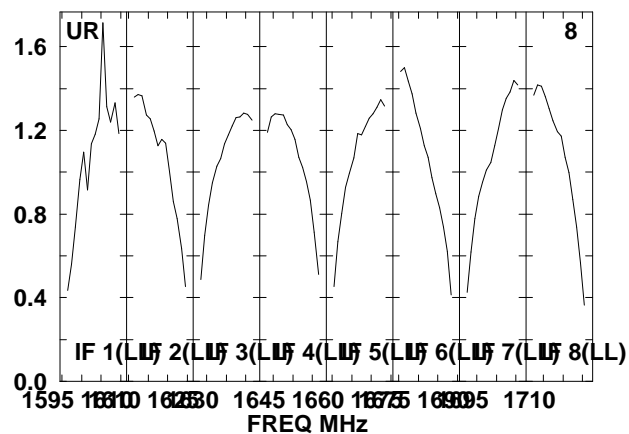
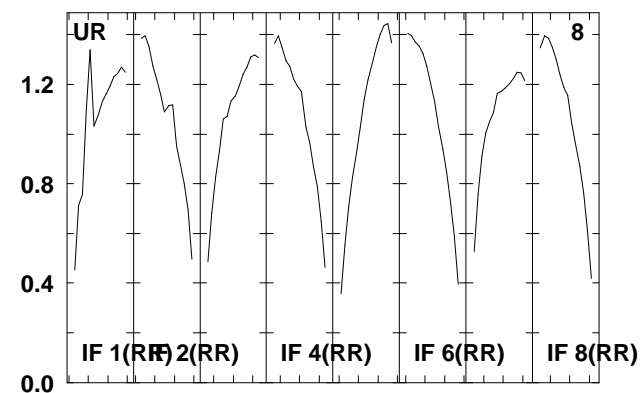
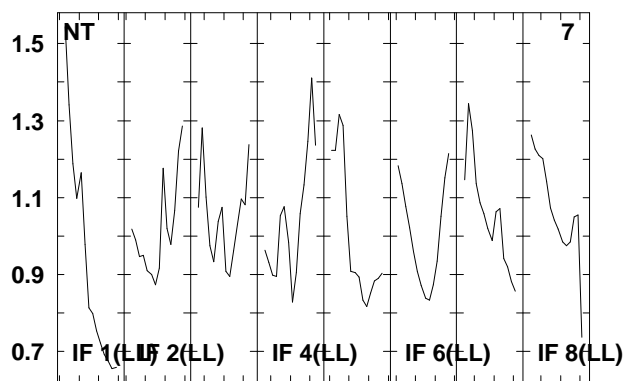
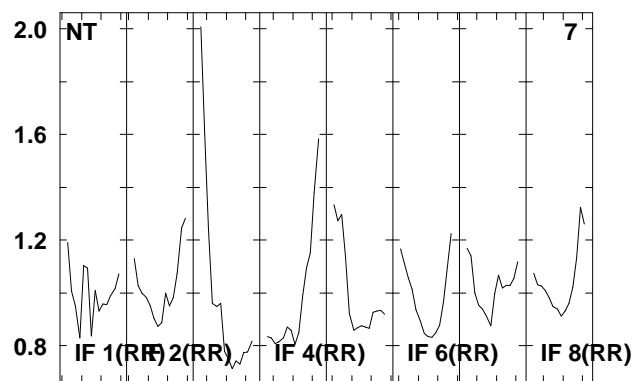
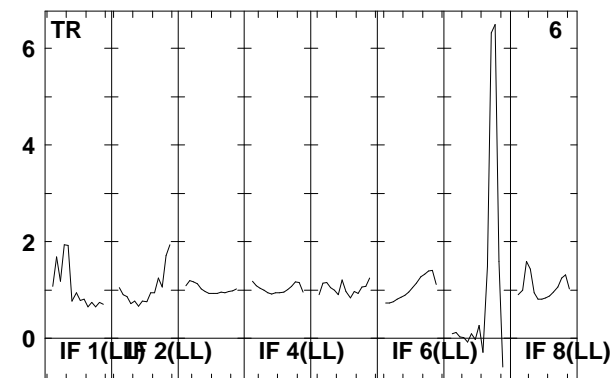
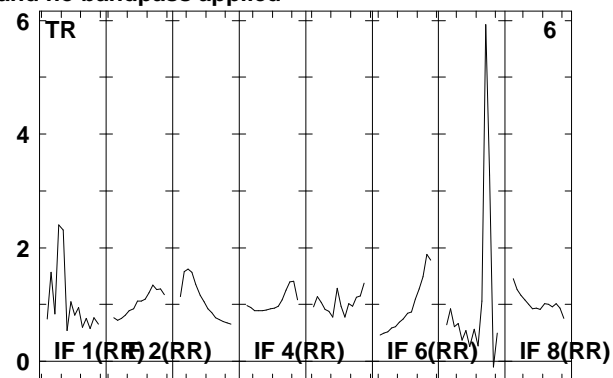
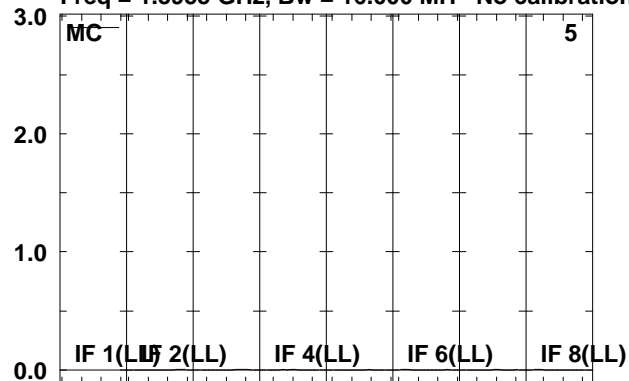

Lower frame: Kilo Real Jy

Total-power spectrum Antenna: \*

Timerange: 00/18:30:01 to 00/18:31:29

Plot file version 3 created 20-AUG-2009 14:59:23

NGC4639 EG040B.UVDATA.1

Freq = 1.5955 GHz, Bw = 16.000 MH No calibration applied and no bandpass applied

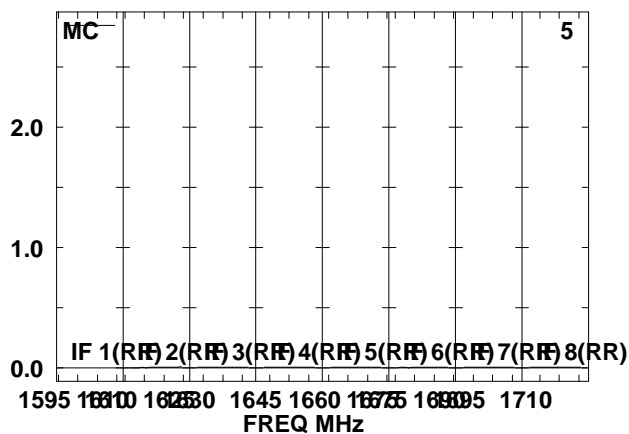
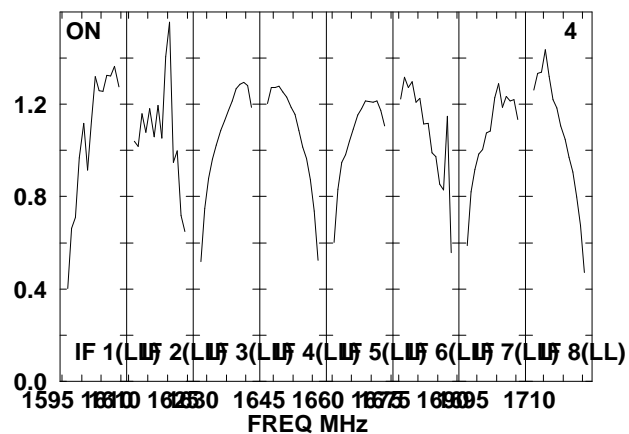
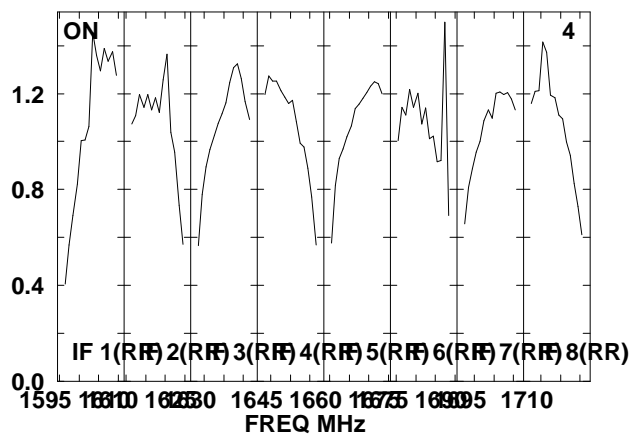
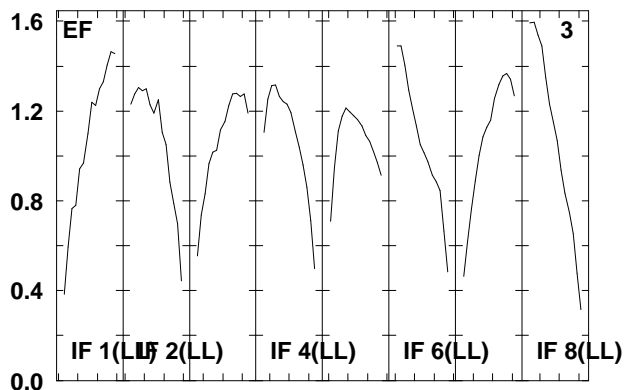
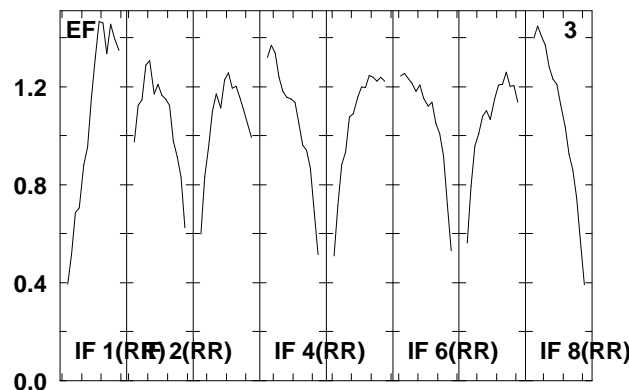
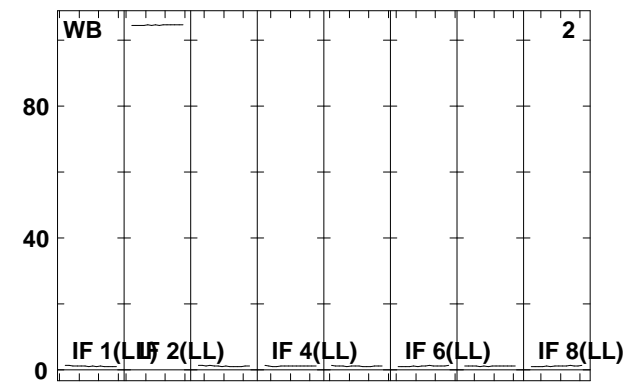
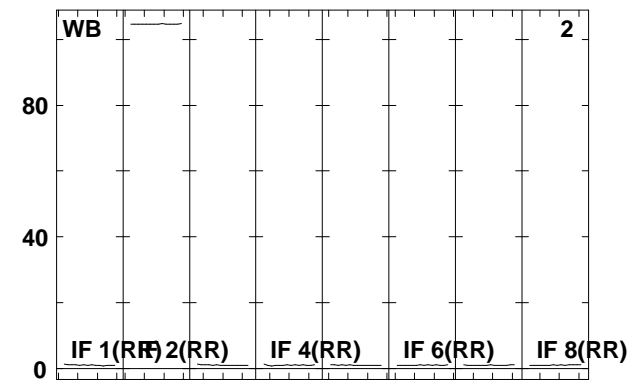
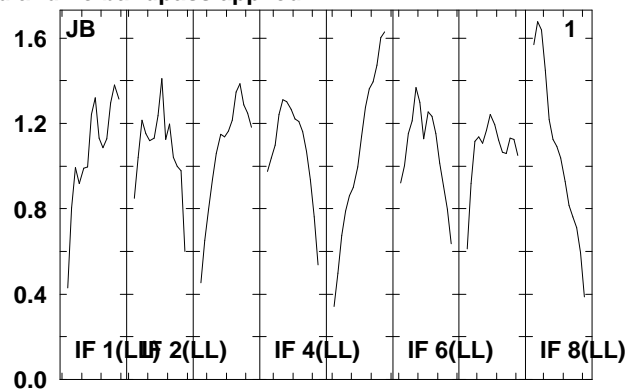
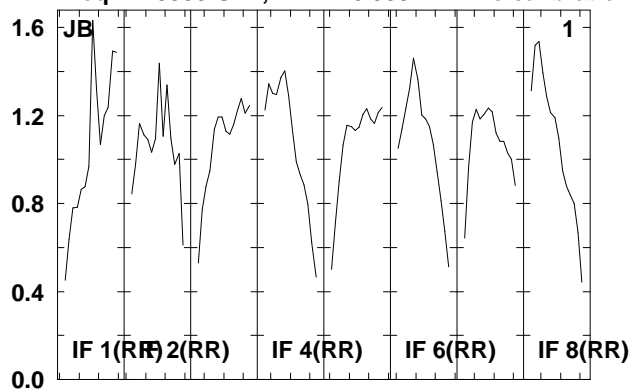

Lower frame: Real Jy  
Total-power spectrum Antenna: \*  
Timerange: 00/18:31:31 to 00/18:35:19

Plot file version 4 created 20-AUG-2009 14:59:24

NGC4639 EG040B.UVDATA.1

Freq = 1.5955 GHz, Bw = 16.000 MH No calibration applied and no bandpass applied

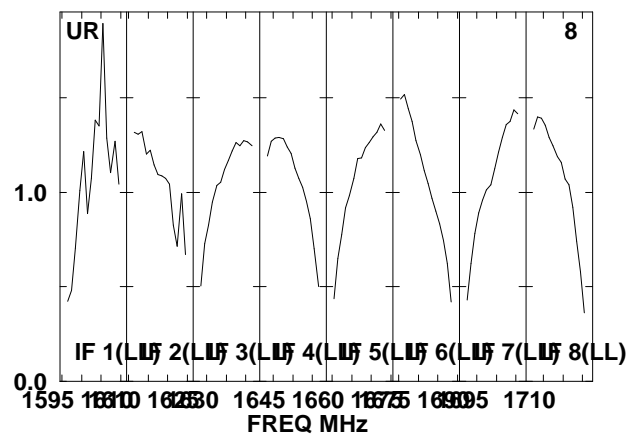
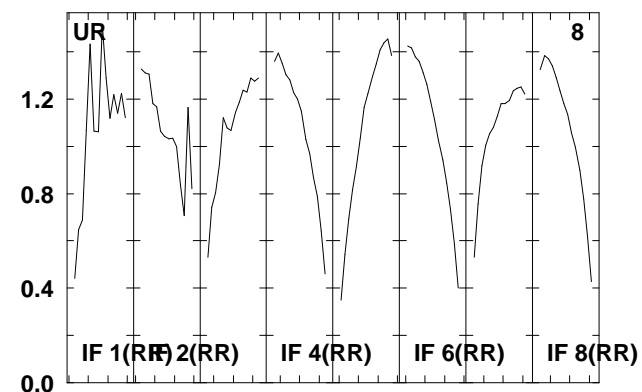
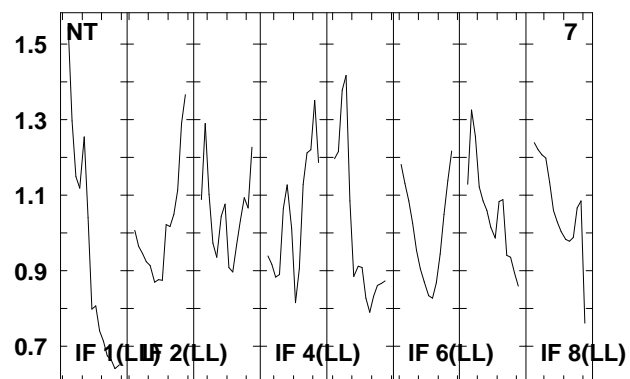
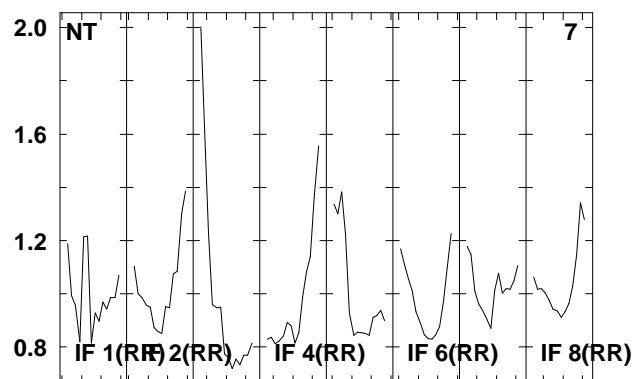
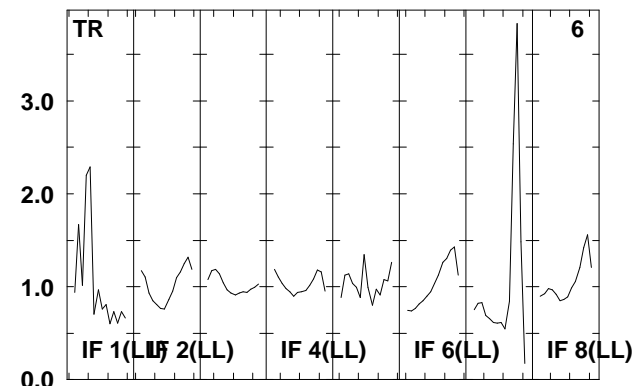
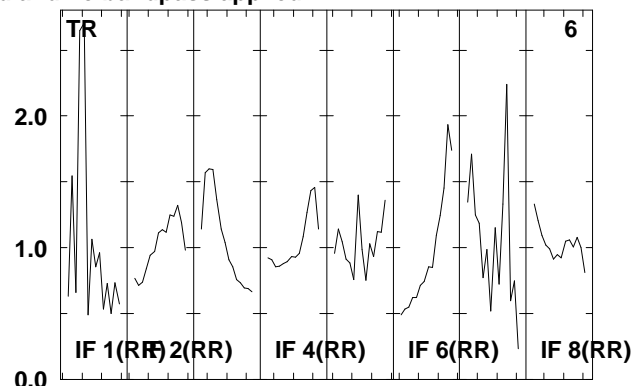
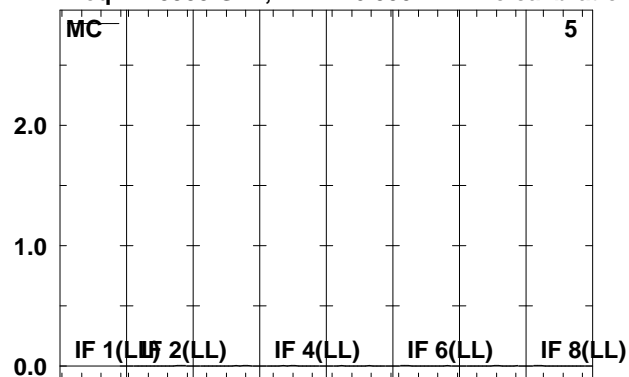

Lower frame: Kilo Real Jy

Total-power spectrum Antenna: \*

Timerange: 00/18:31:31 to 00/18:35:19

Plot file version 5 created 20-AUG-2009 14:59:24

3C274 EG040B.UVDATA.1

Freq = 1.5955 GHz, Bw = 16.000 MH No calibration applied and no bandpass applied

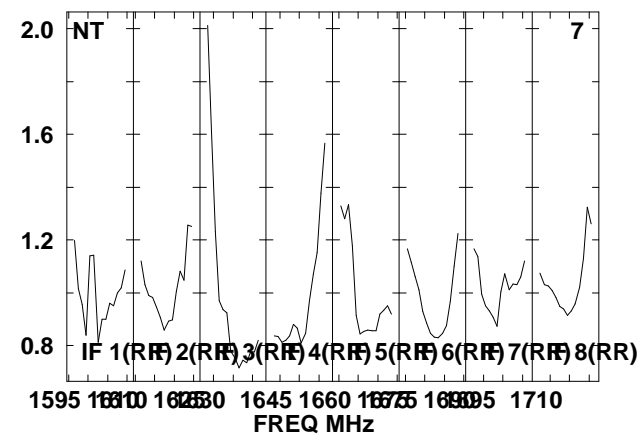
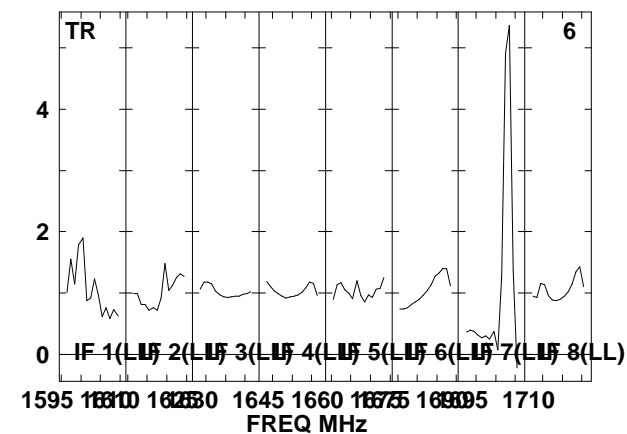
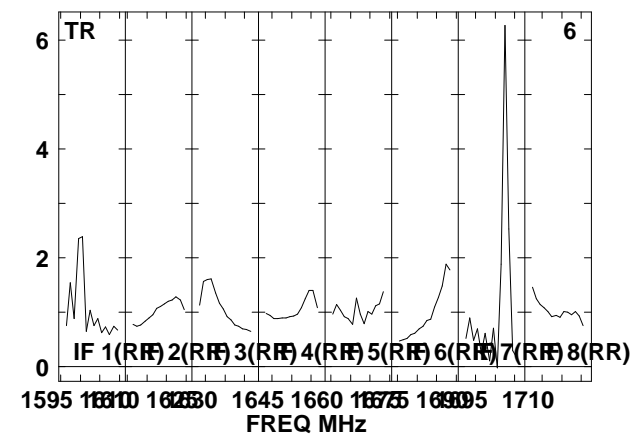
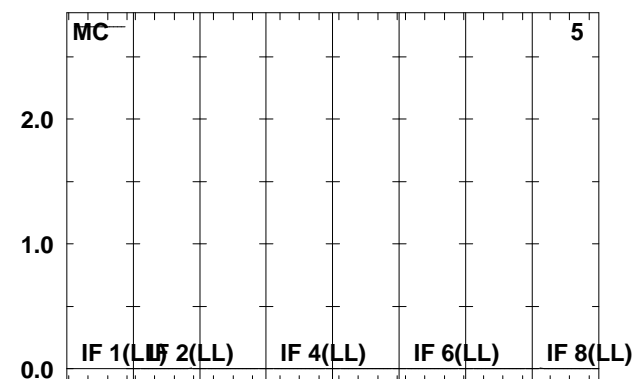
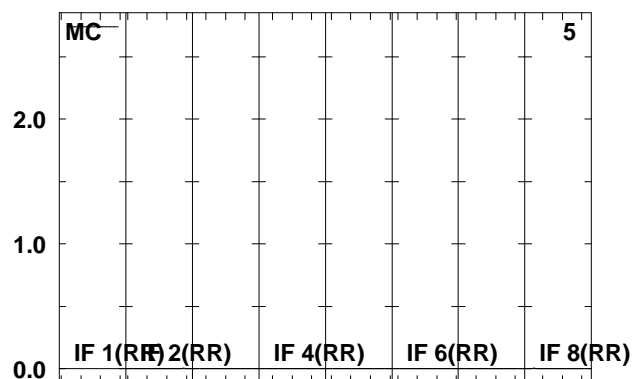
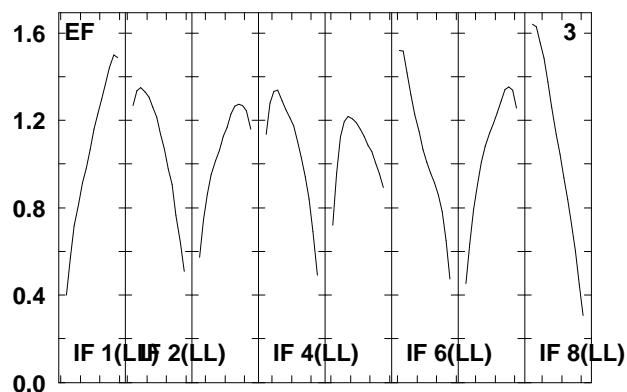
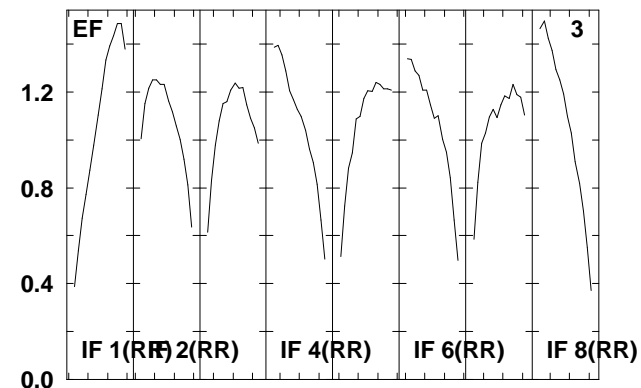
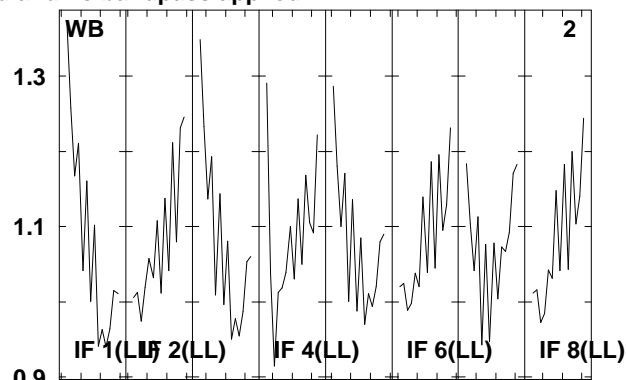
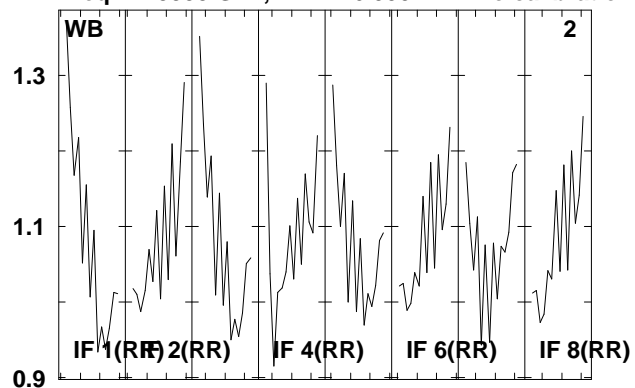

Lower frame: Real Jy  
Total-power spectrum Antenna: \*  
Timerange: 00/18:36:03 to 00/18:37:21

Plot file version 6 created 20-AUG-2009 14:59:24

3C274 EG040B.UVDATA.1

Freq = 1.5955 GHz, Bw = 16.000 MH No calibration applied and no bandpass applied

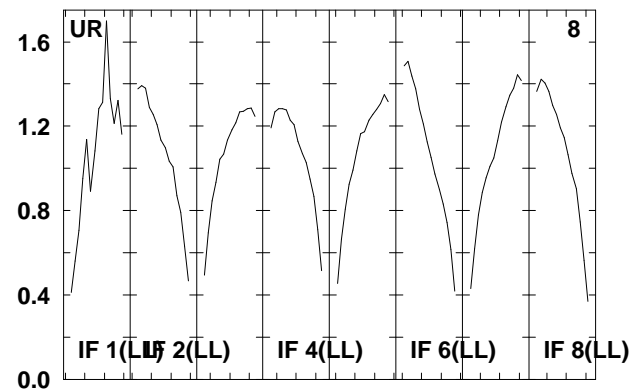
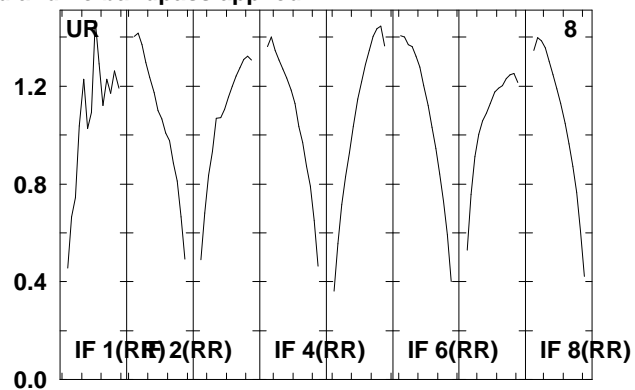
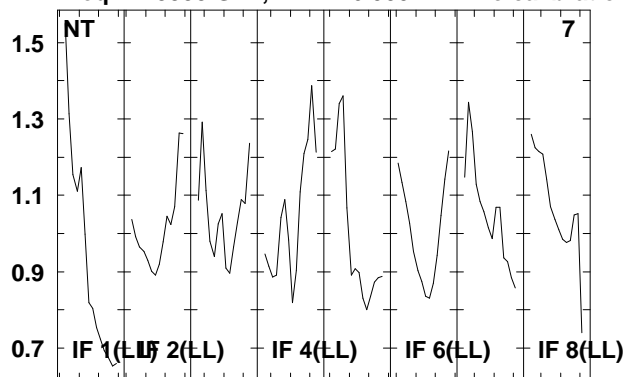

Lower frame: Real Jy  
Total-power spectrum Antenna: \*  
Timerange: 00/18:36:03 to 00/18:37:21

Plot file version 7 created 20-AUG-2009 14:59:25

NGC4639 EG040B.UVDATA.1

Freq = 1.5955 GHz, Bw = 16.000 MH No calibration applied and no bandpass applied

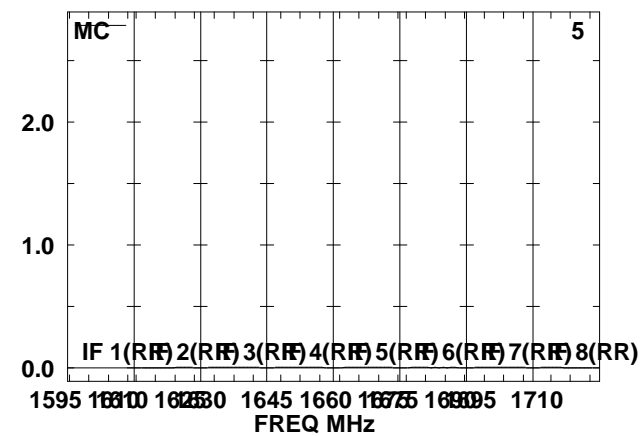
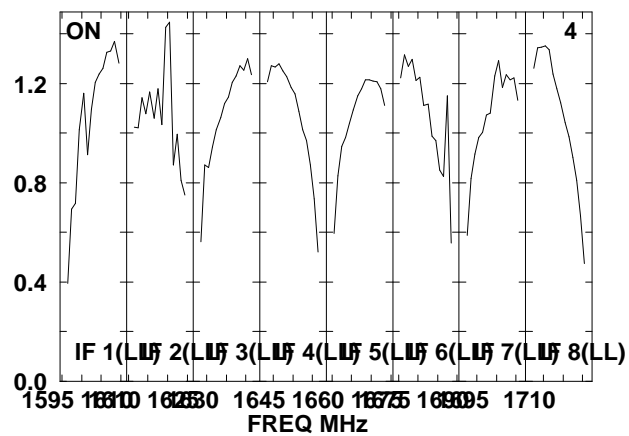
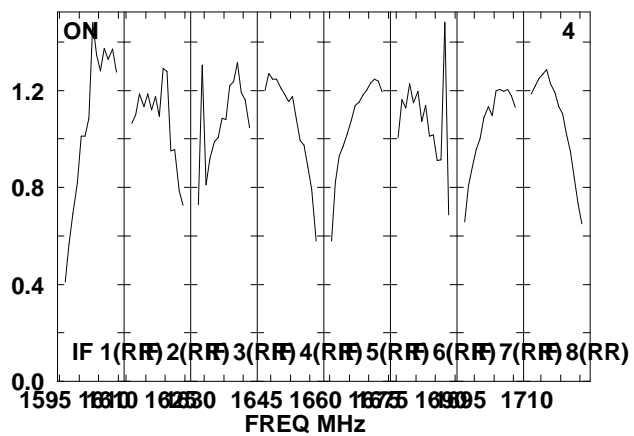
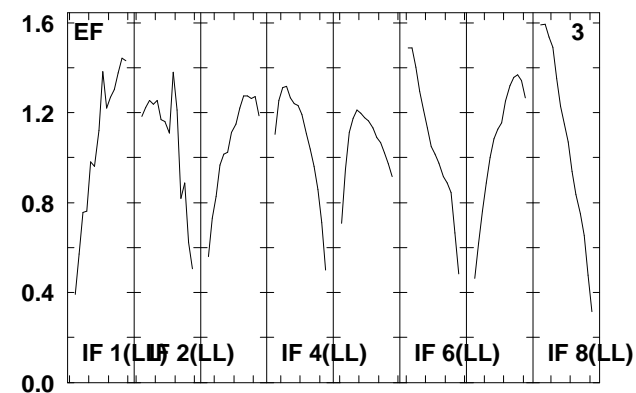
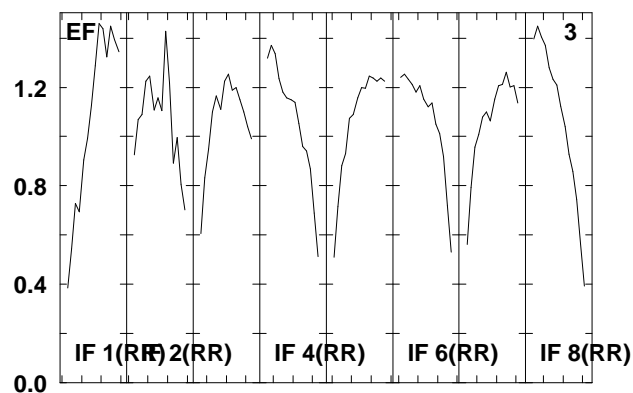
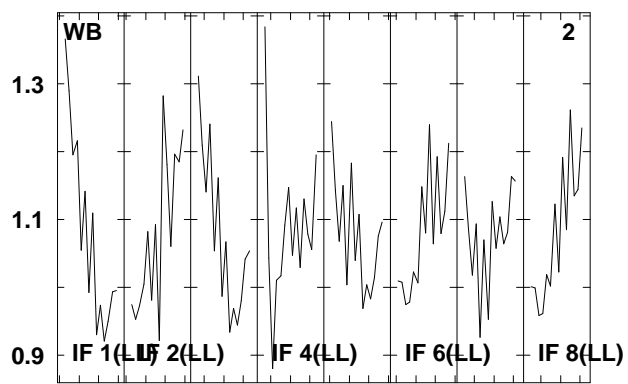
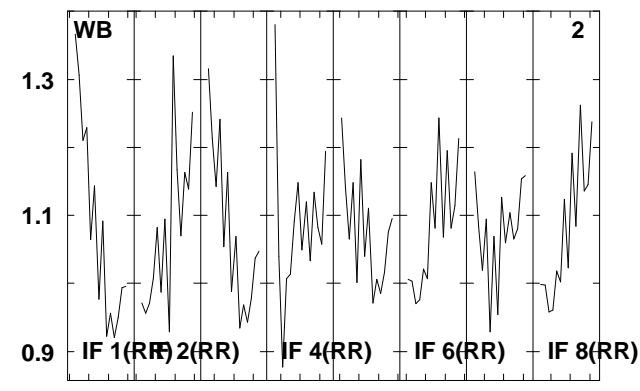
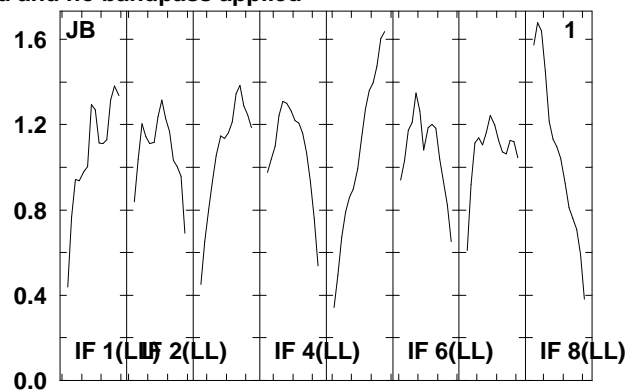
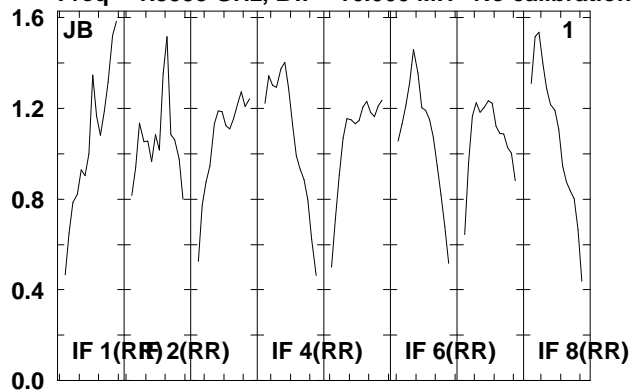

Lower frame: Real Jy  
Total-power spectrum Antenna: \*  
Timerange: 00/18:37:23 to 00/18:41:11

Plot file version 8 created 20-AUG-2009 14:59:25

NGC4639 EG040B.UVDATA.1

Freq = 1.5955 GHz, Bw = 16.000 MH No calibration applied and no bandpass applied

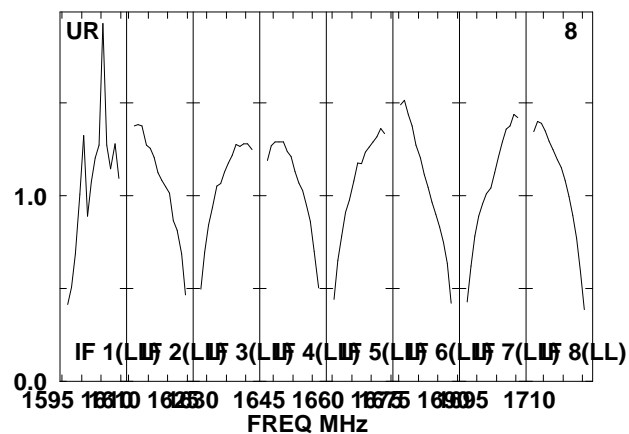
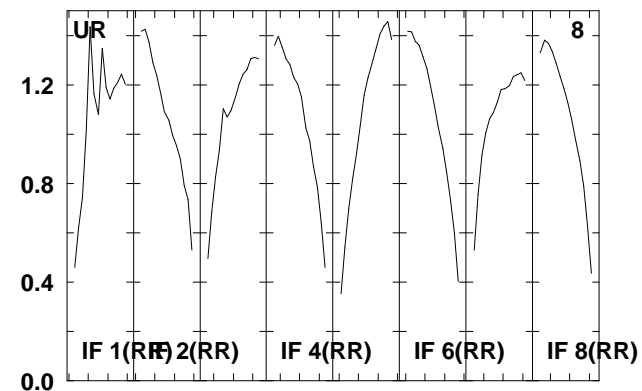
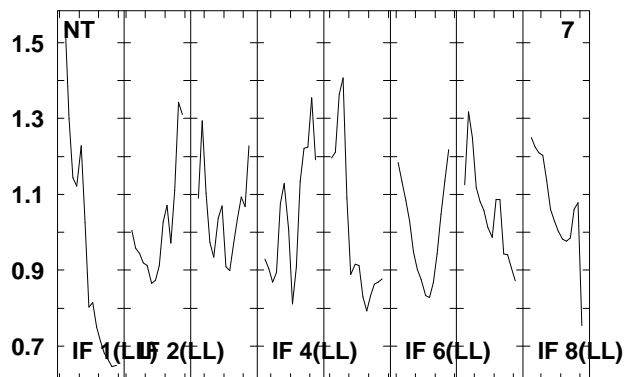
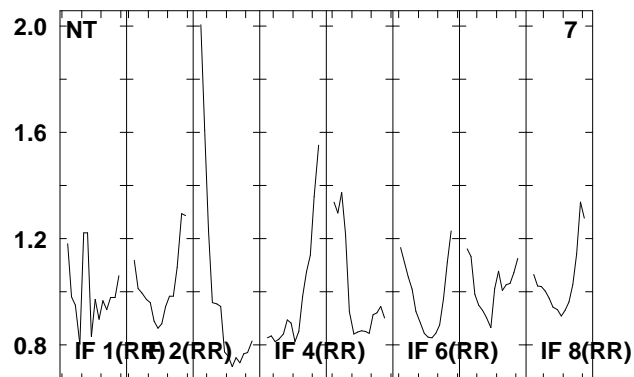
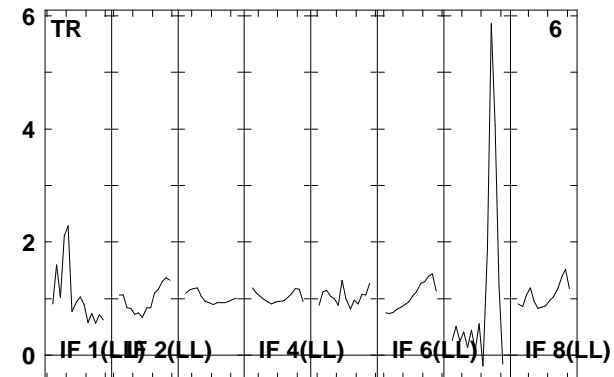
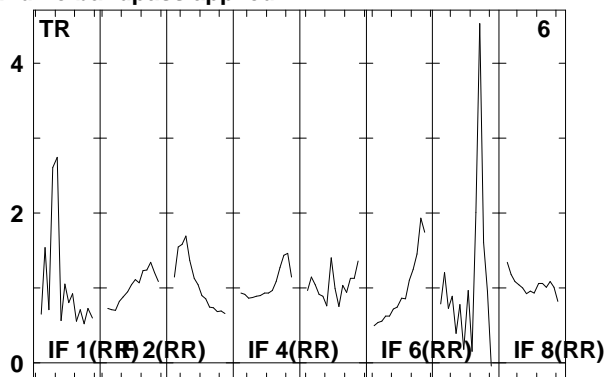
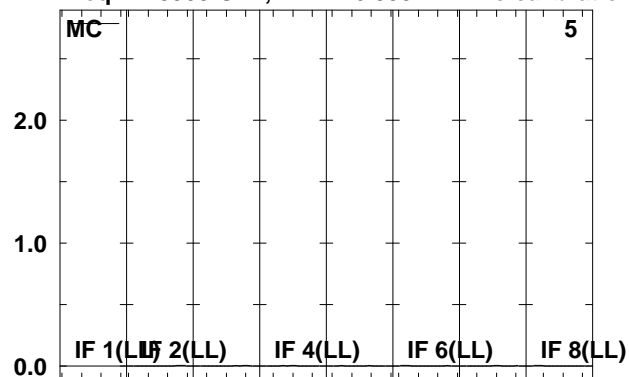

Lower frame: Kilo Real Jy

Total-power spectrum Antenna: \*

Timerange: 00/18:37:23 to 00/18:41:11



Plot file version 9 created 20-AUG-2009 14:59:25  
 3C274 EG040B.UVDATA.1  
 Freq = 1.5955 GHz, Bw = 16.000 MH No calibration applied and no bandpass applied

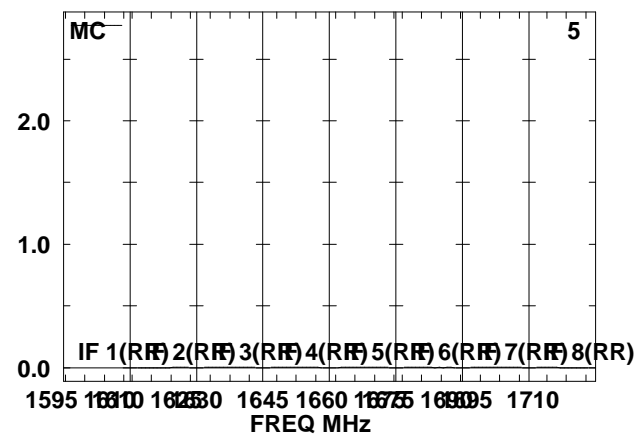
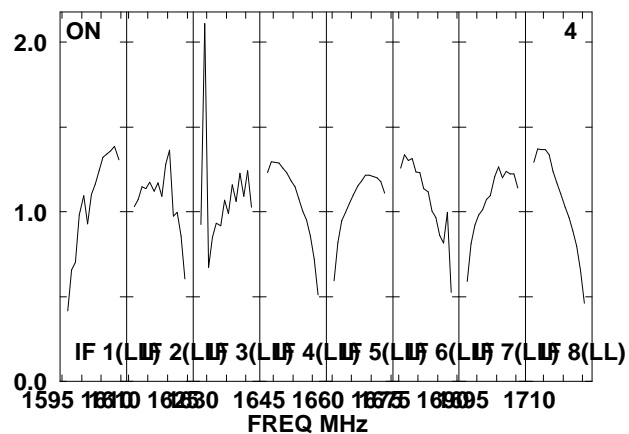
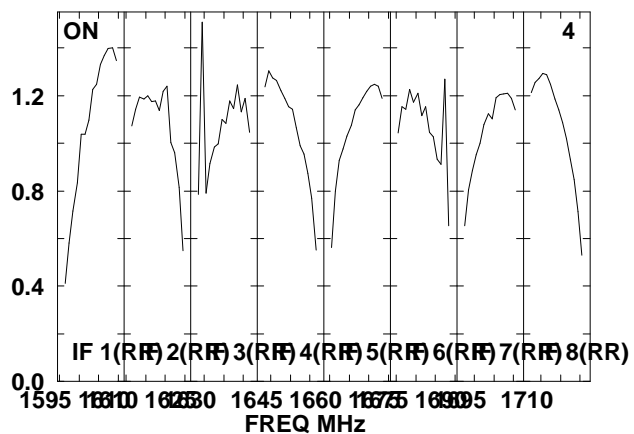
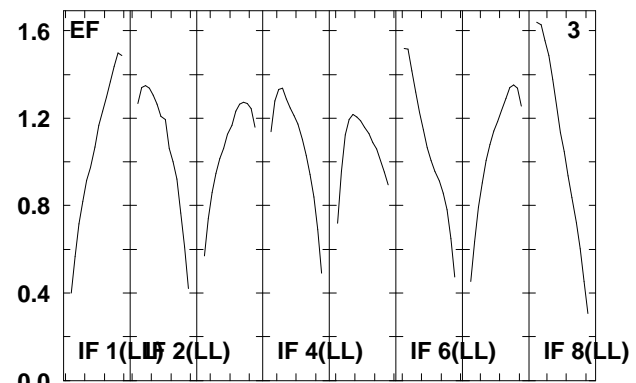
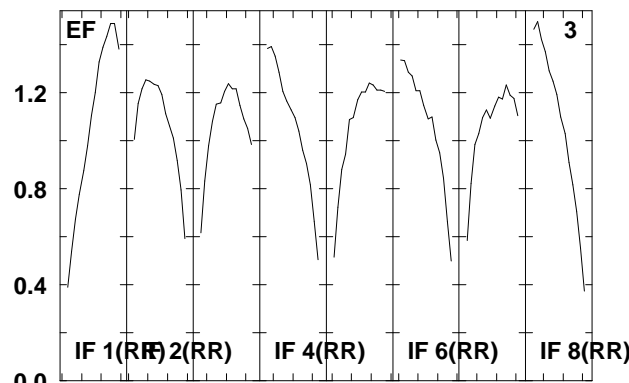
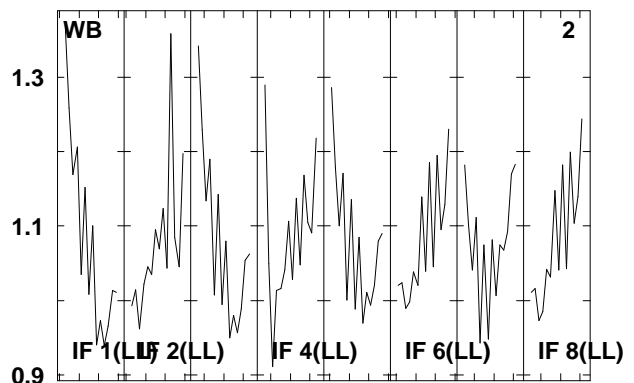
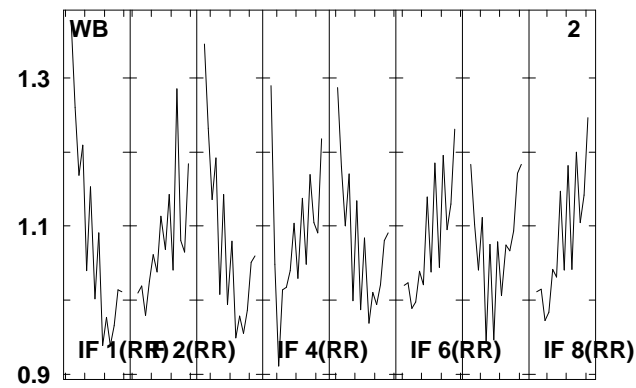
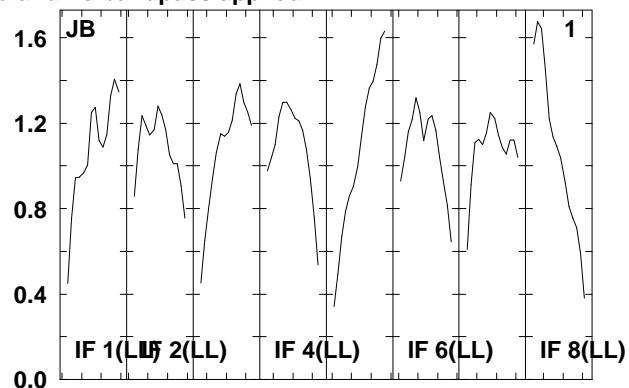
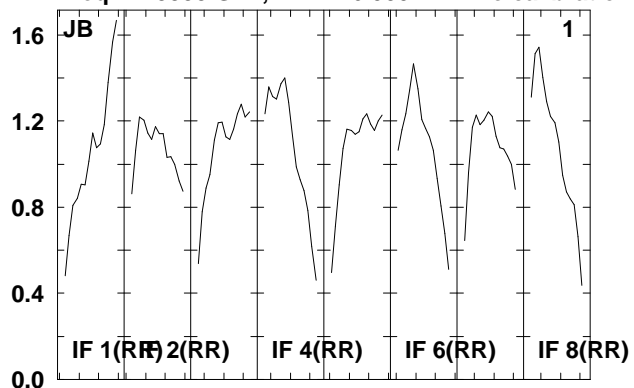

Lower frame: Real Jy  
 Total-power spectrum Antenna: \*  
 Timerange: 00/18:41:13 to 00/18:43:11

Plot file version 10 created 20-AUG-2009 14:59:26

3C274 EG040B.UVDATA.1

Freq = 1.5955 GHz, Bw = 16.000 MH No calibration applied and no bandpass applied

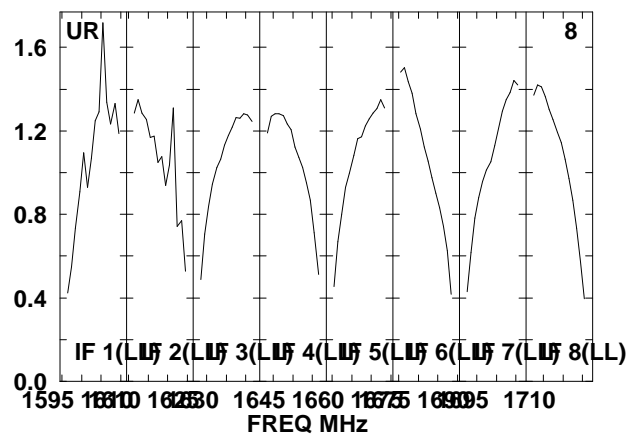
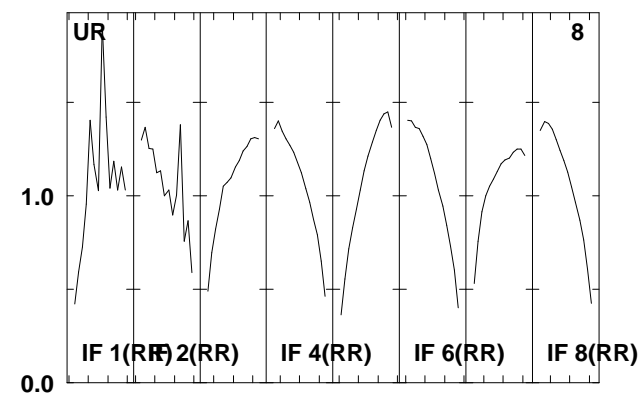
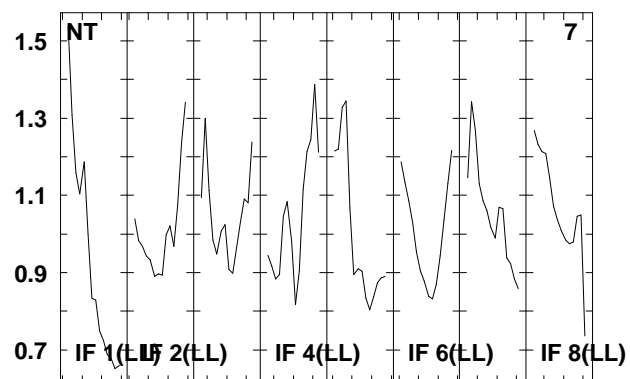
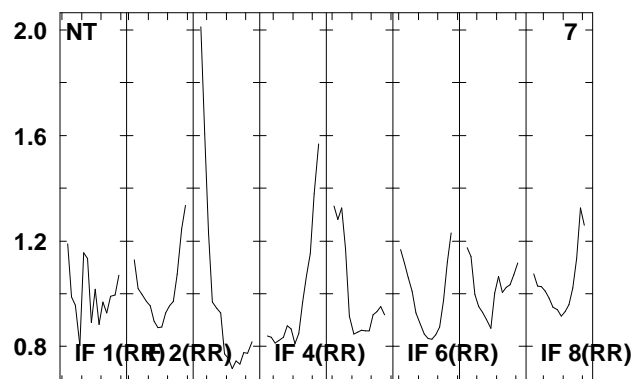
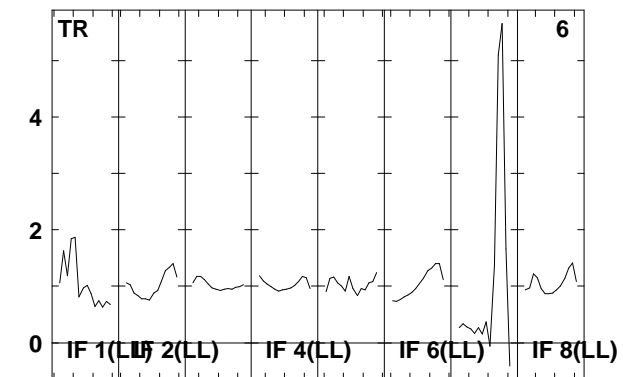
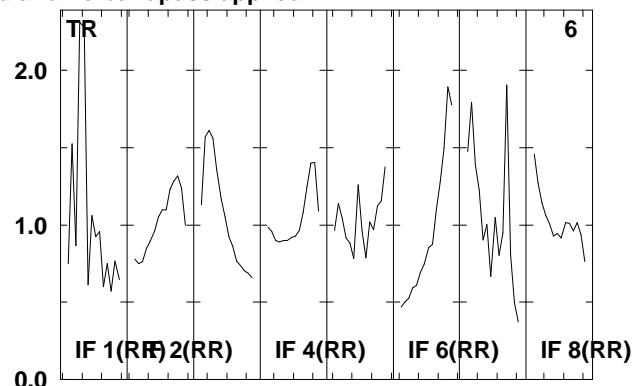
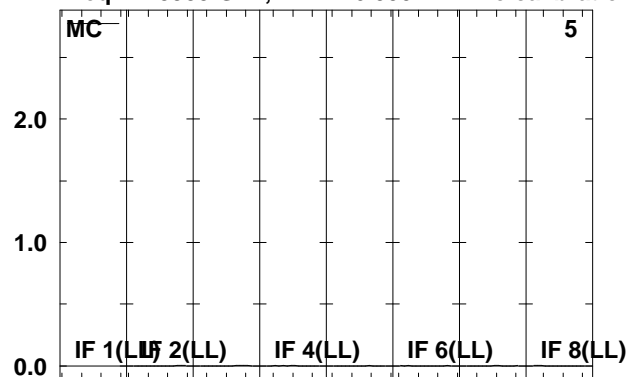

Lower frame: Kilo Real Jy

Total-power spectrum Antenna: \*

Timerange: 00/18:41:13 to 00/18:43:11

Plot file version 11 created 20-AUG-2009 14:59:26

NGC4639 EG040B.UVDATA.1

Freq = 1.5955 GHz, Bw = 16.000 MH No calibration applied and no bandpass applied

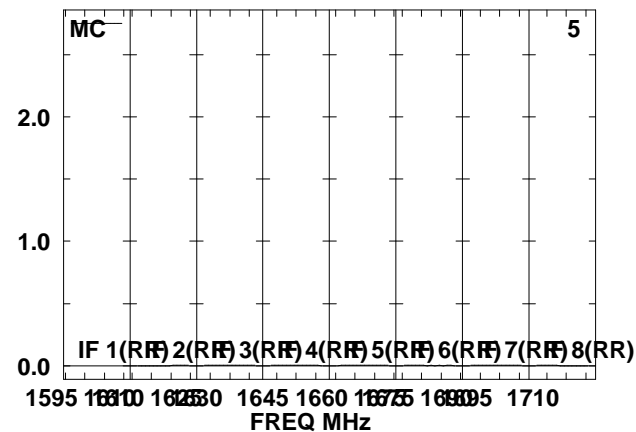
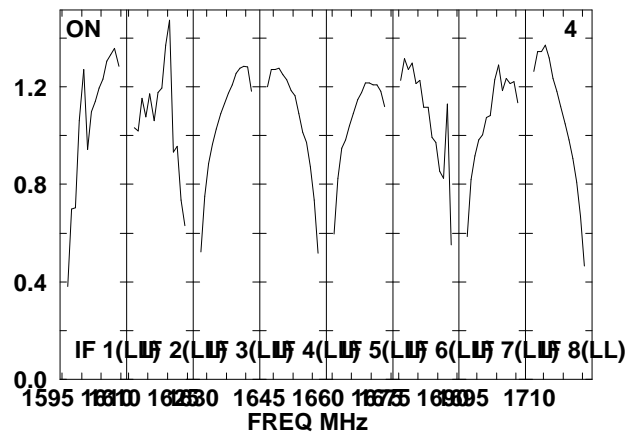
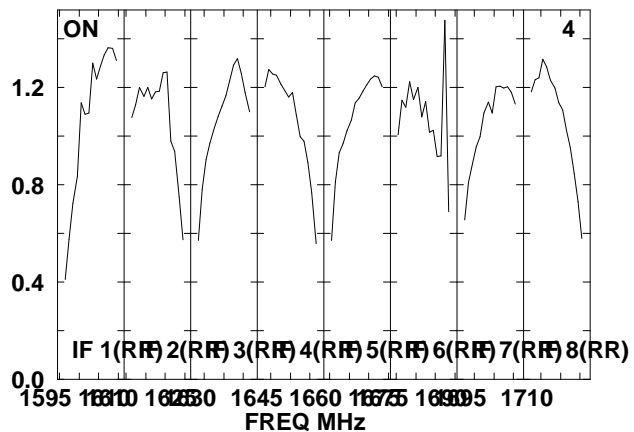
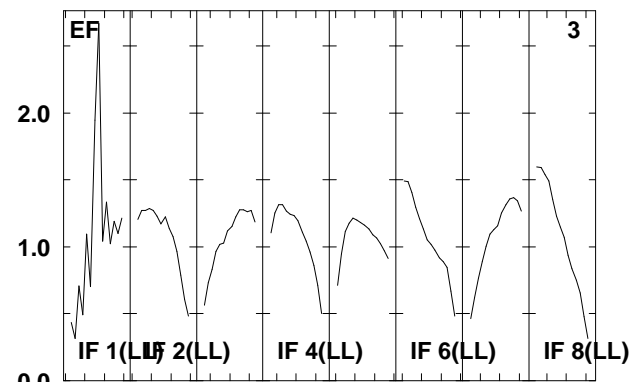
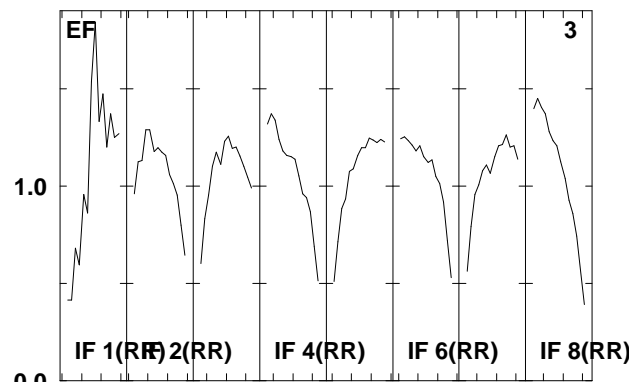
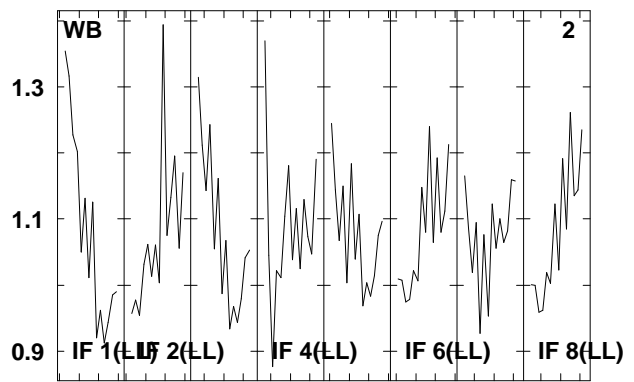
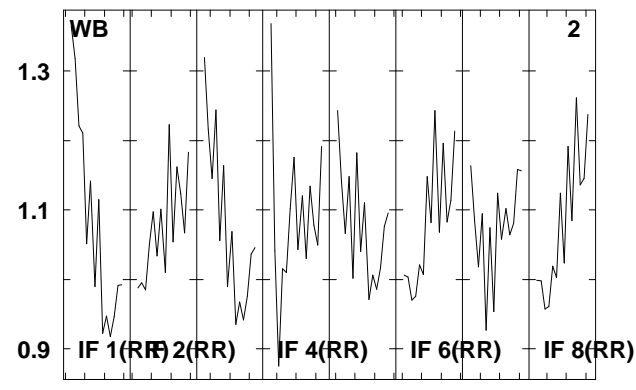
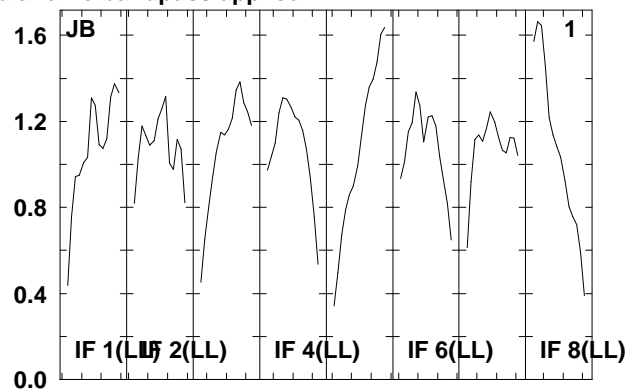
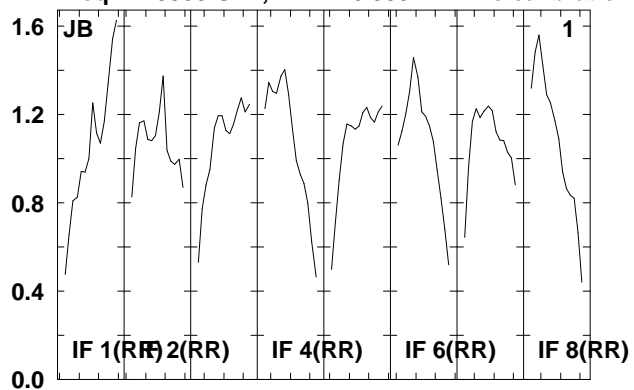

Lower frame: Real Jy  
Total-power spectrum Antenna: \*  
Timerange: 00/18:43:13 to 00/18:46:59

Plot file version 12 created 20-AUG-2009 14:59:26

NGC4639 EG040B.UVDATA.1

Freq = 1.5955 GHz, Bw = 16.000 MH No calibration applied and no bandpass applied

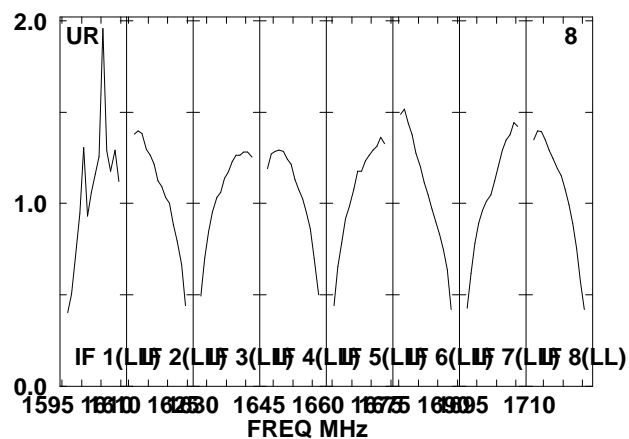
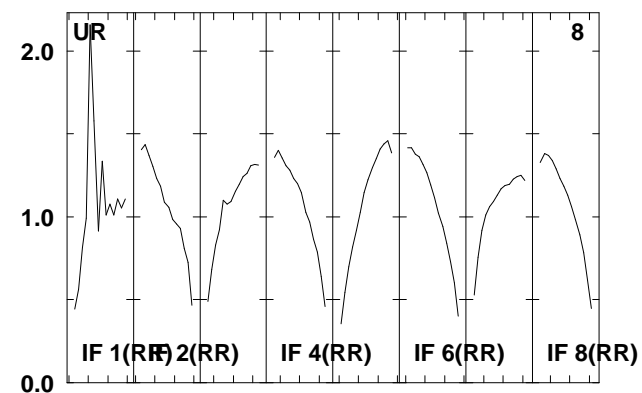
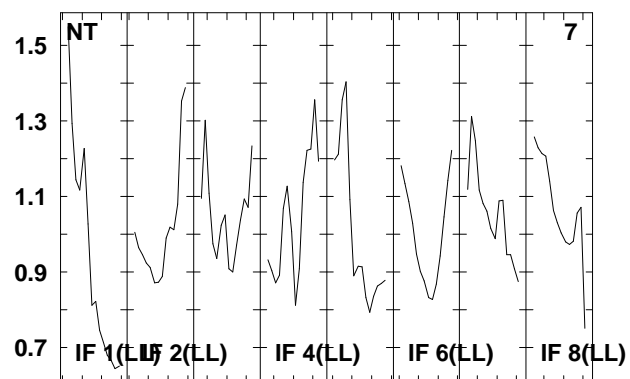
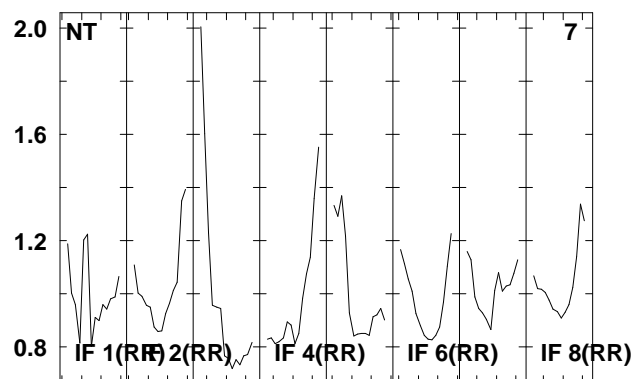
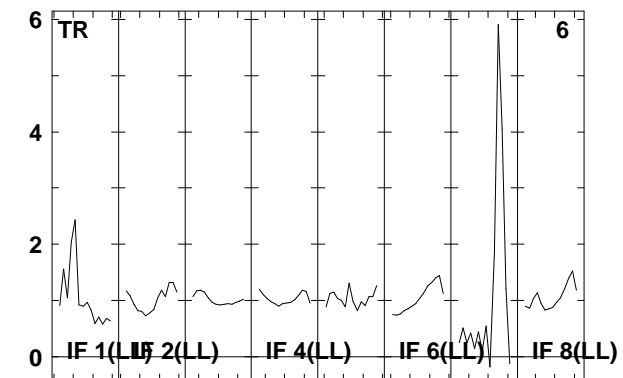
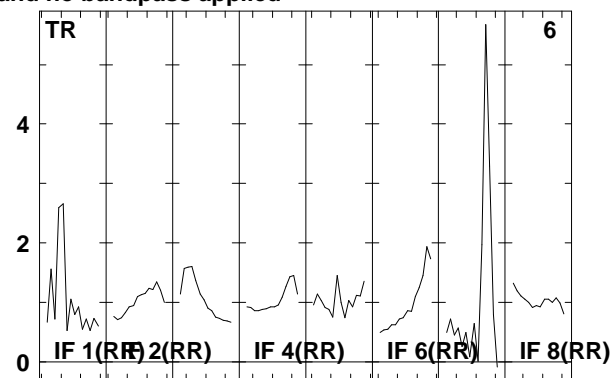
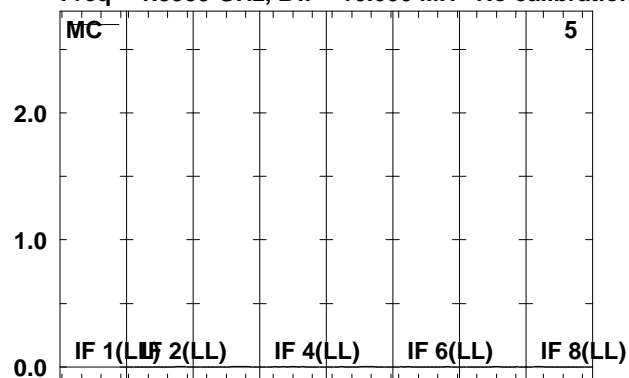

Lower frame: Kilo Real Jy

Total-power spectrum Antenna: \*

Timerange: 00/18:43:13 to 00/18:46:59

Plot file version 13 created 20-AUG-2009 14:59:27

3C274 EG040B.UVDATA.1

Freq = 1.5955 GHz, Bw = 16.000 MH No calibration applied and no bandpass applied

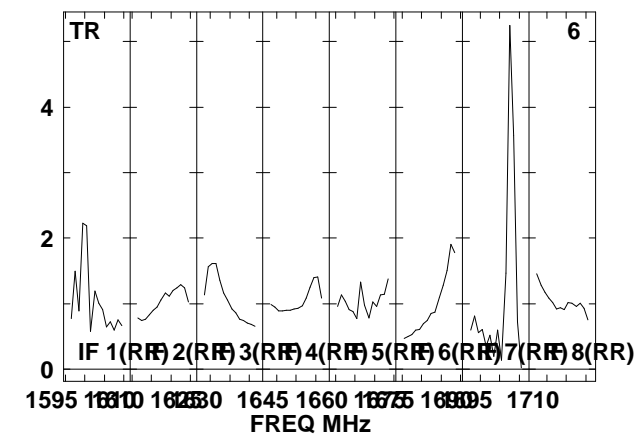
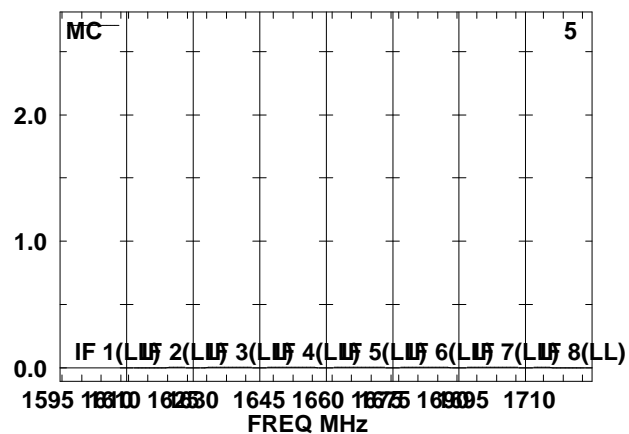
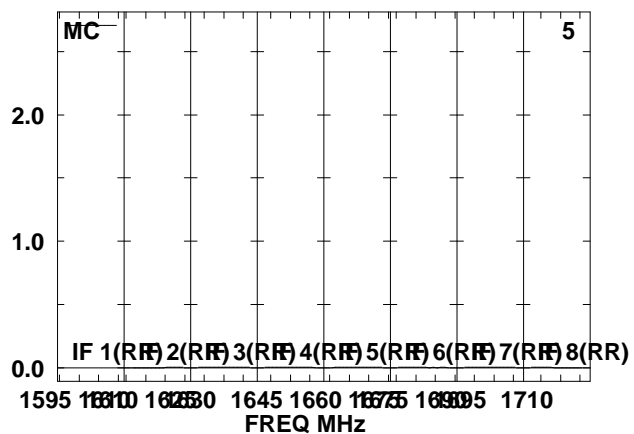
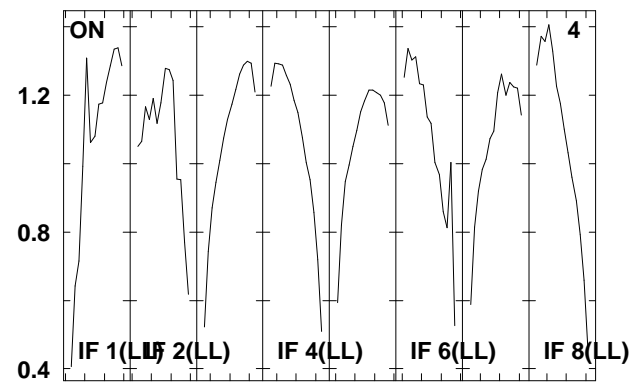
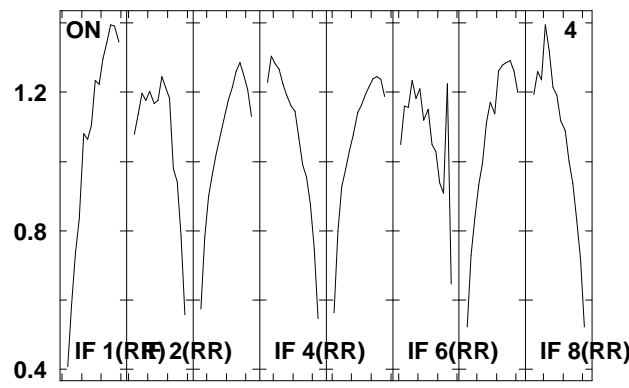
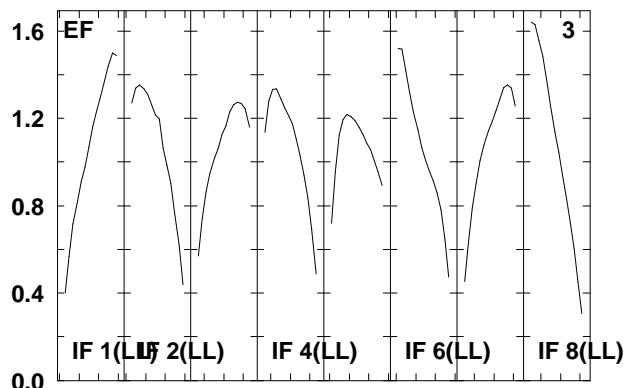
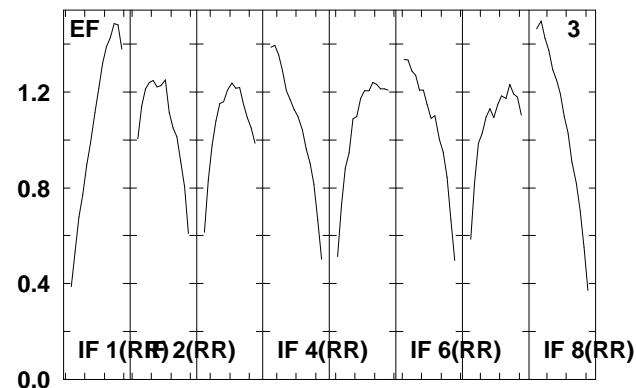
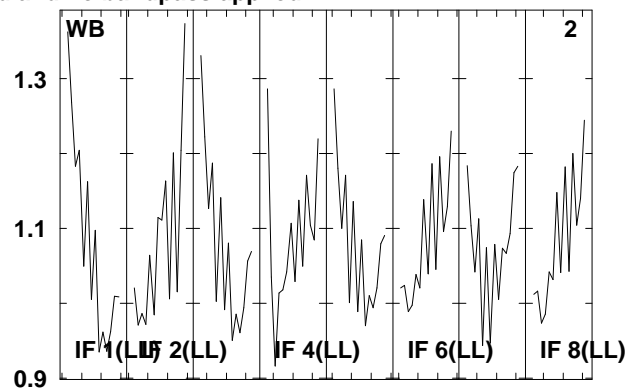
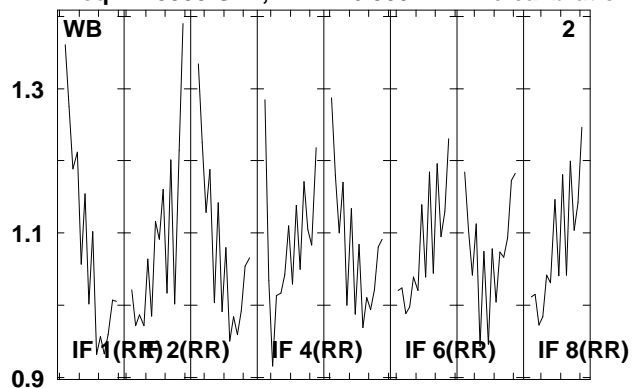

Lower frame: Real Jy  
Total-power spectrum Antenna: \*  
Timerange: 00/18:47:45 to 00/18:49:01

Plot file version 14 created 20-AUG-2009 14:59:27

3C274 EG040B.UVDATA.1

Freq = 1.5955 GHz, Bw = 16.000 MH No calibration applied and no bandpass applied

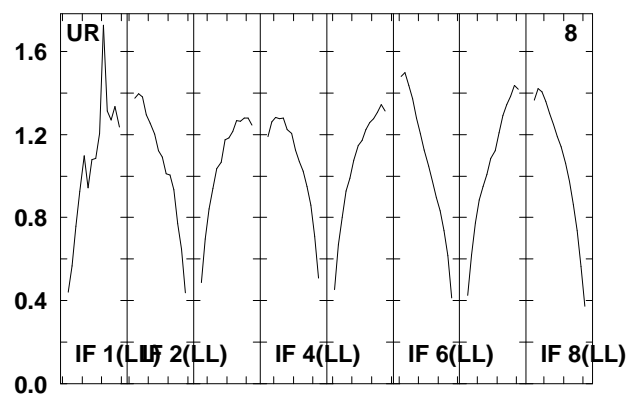
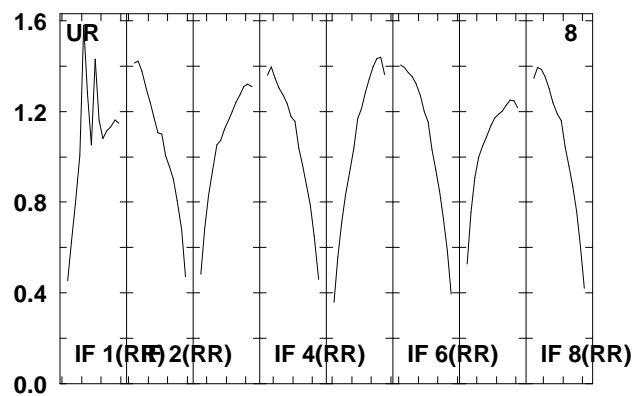
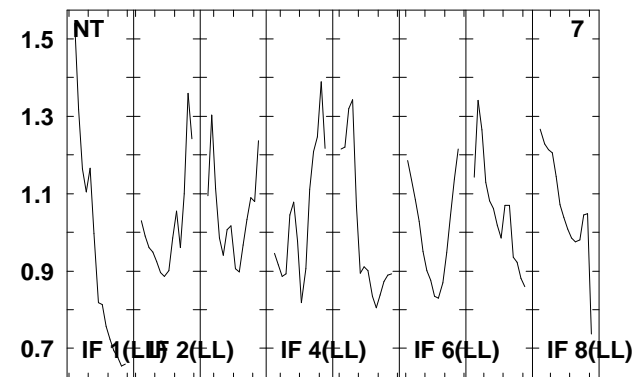
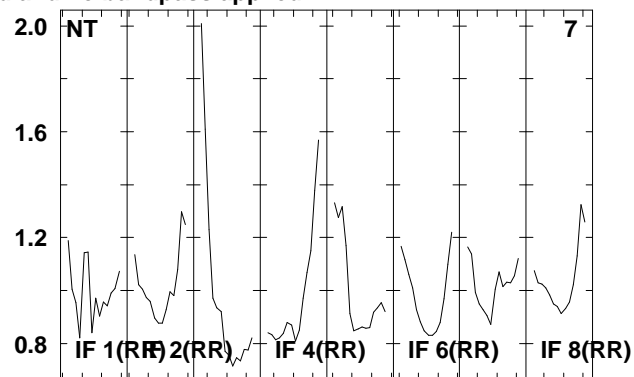
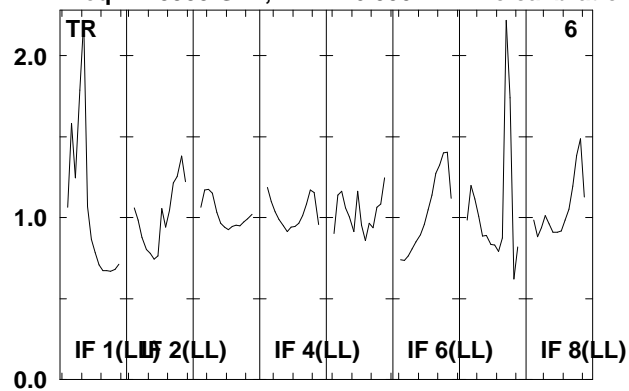

Lower frame: Real Jy  
Total-power spectrum Antenna: \*  
Timerange: 00/18:47:45 to 00/18:49:01

Plot file version 15 created 20-AUG-2009 14:59:27

NGC4639 EG040B.UVDATA.1

Freq = 1.5955 GHz, Bw = 16.000 MH No calibration applied and no bandpass applied

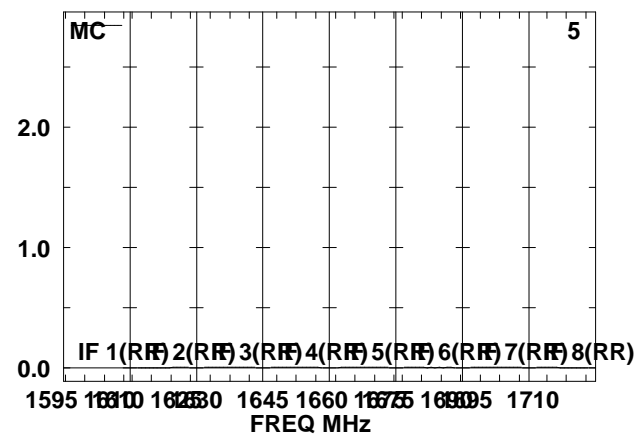
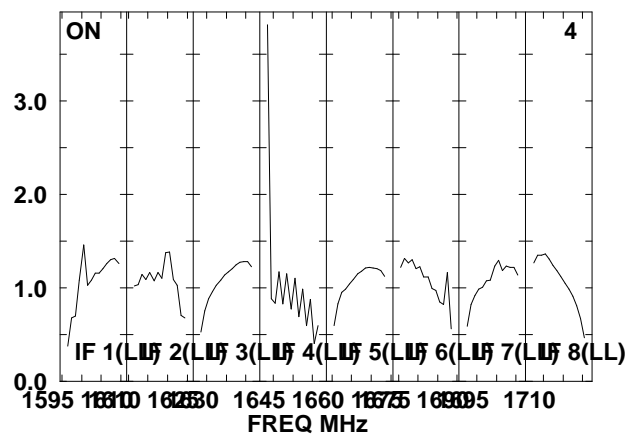
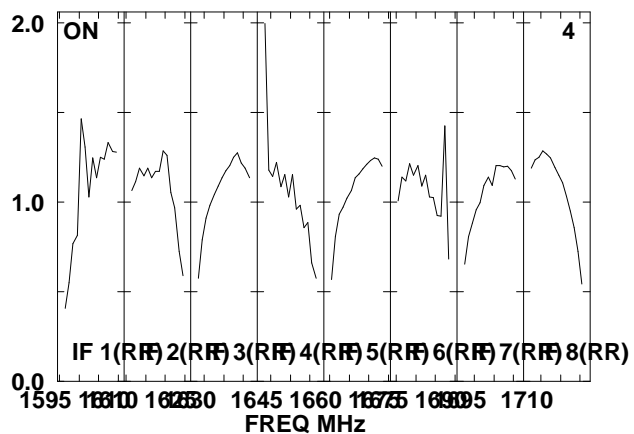
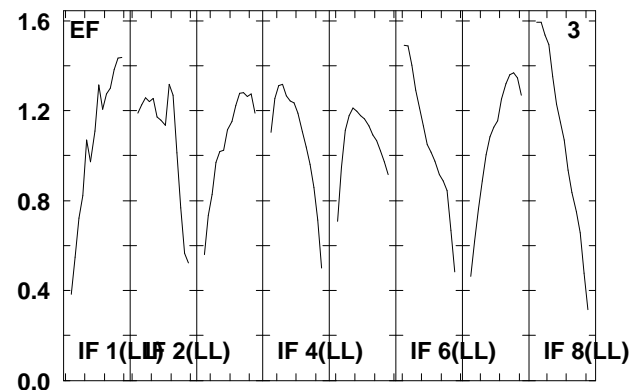
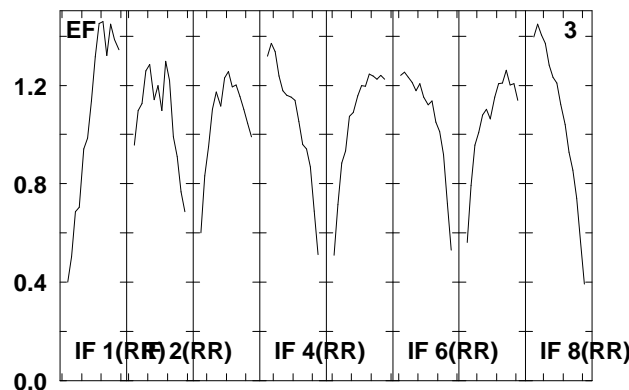
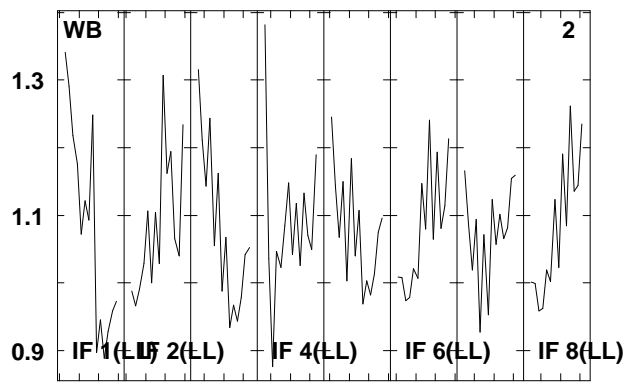
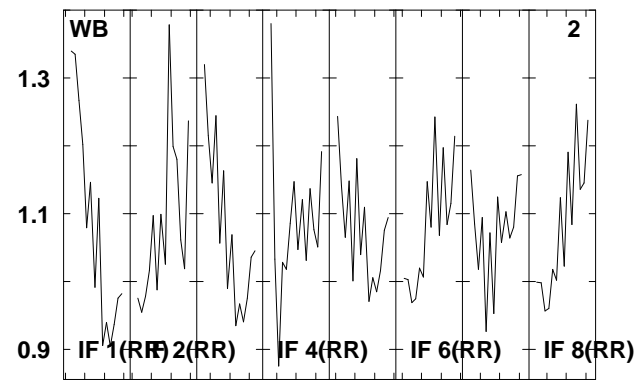
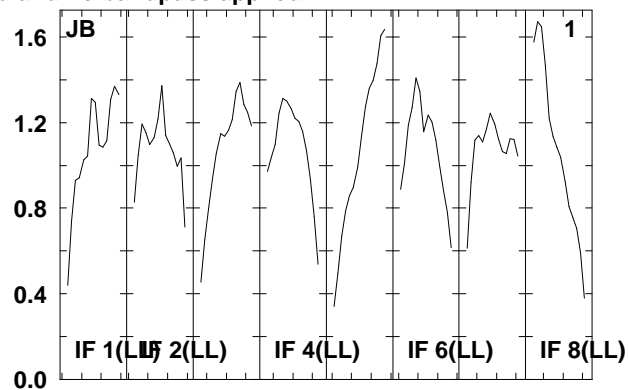
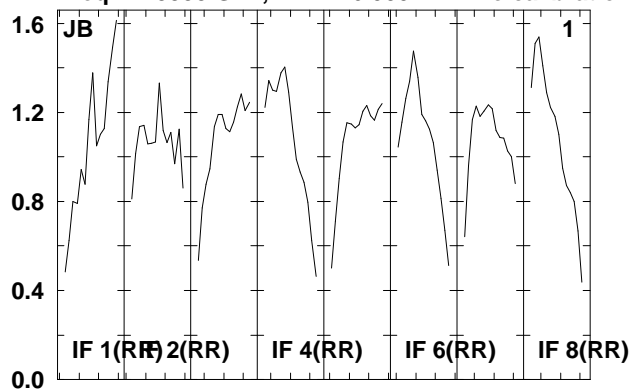

Lower frame: Real Jy  
Total-power spectrum Antenna: \*  
Timerange: 00/18:49:05 to 00/18:52:53

Plot file version 16 created 20-AUG-2009 14:59:28

NGC4639 EG040B.UVDATA.1

Freq = 1.5955 GHz, Bw = 16.000 MH No calibration applied and no bandpass applied

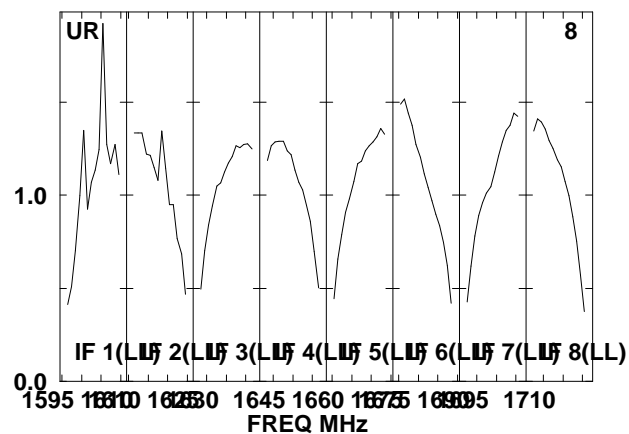
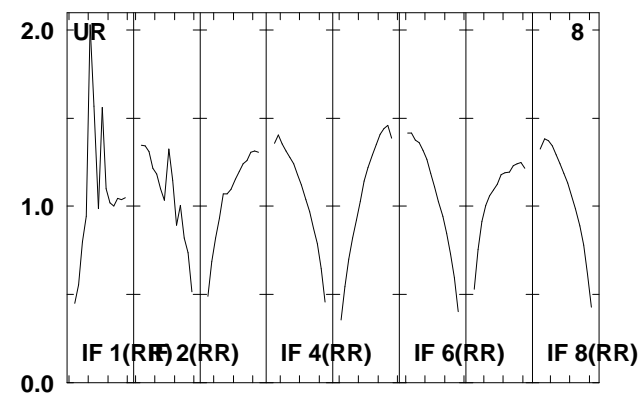
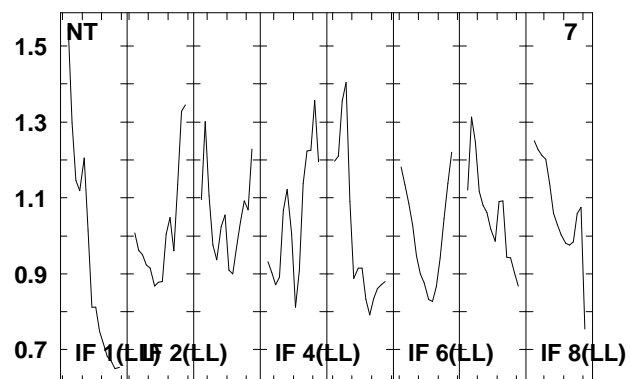
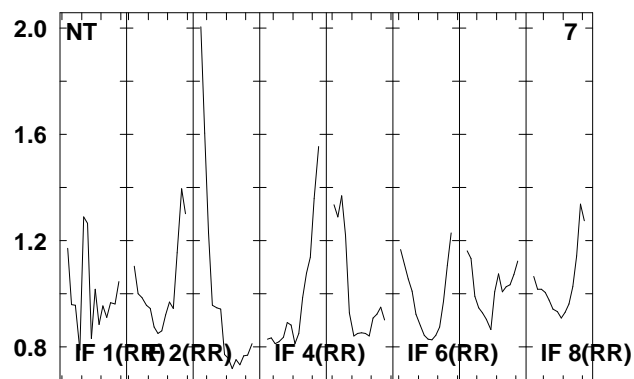
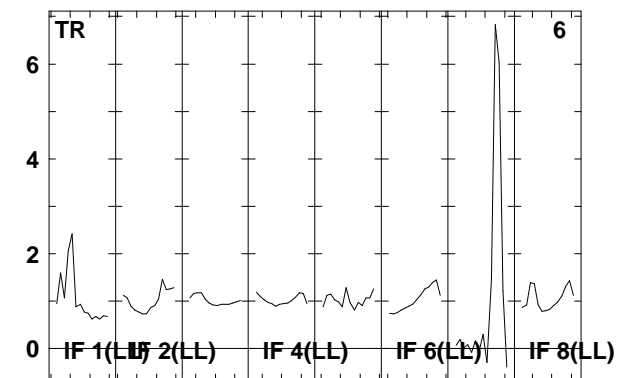
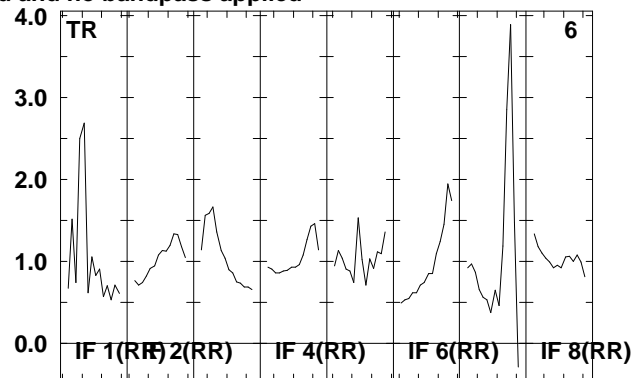
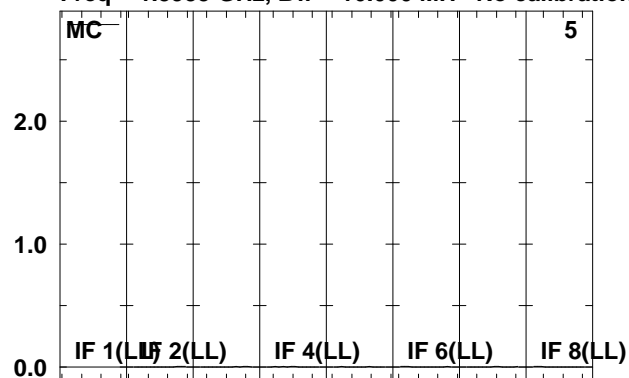

Lower frame: Kilo Real Jy

Total-power spectrum Antenna: \*

Timerange: 00/18:49:05 to 00/18:52:53



Plot file version 17 created 20-AUG-2009 14:59:28  
 3C274 EG040B.UVDATA.1  
 Freq = 1.5955 GHz, Bw = 16.000 MH No calibration applied and no bandpass applied

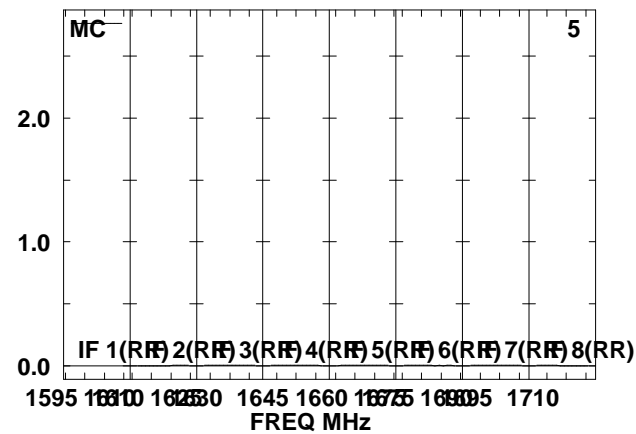
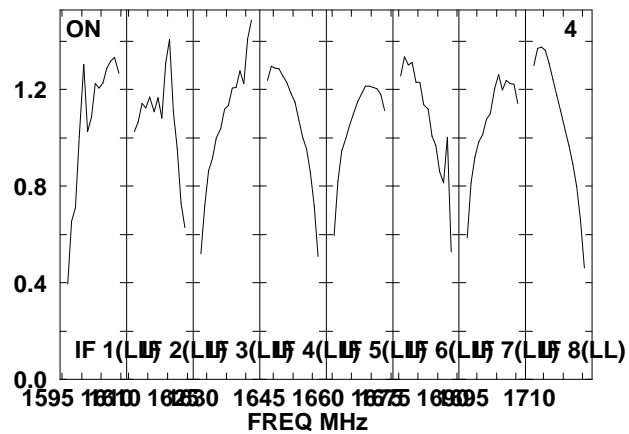
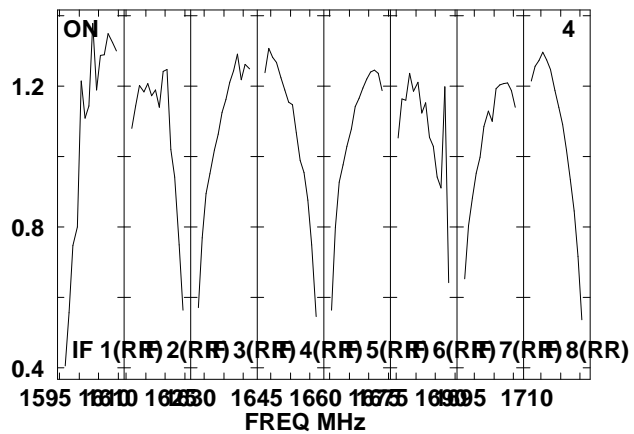
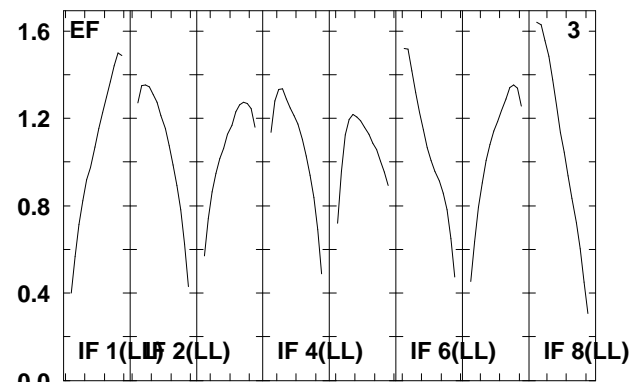
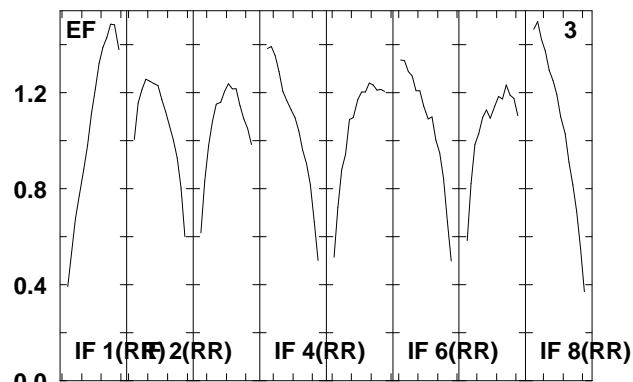
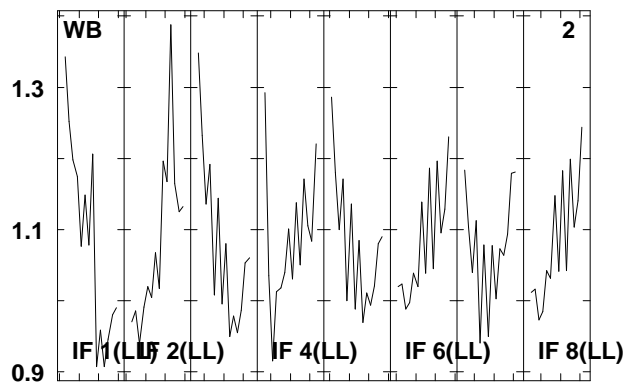
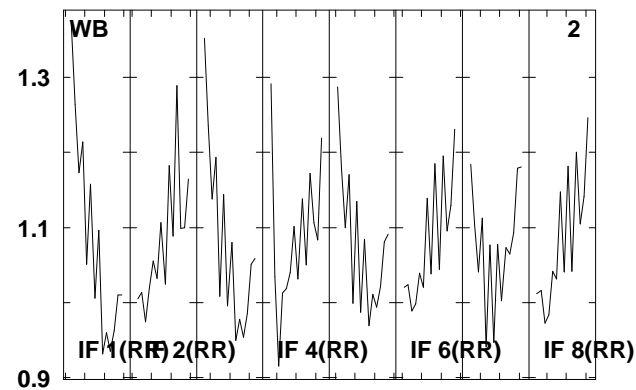
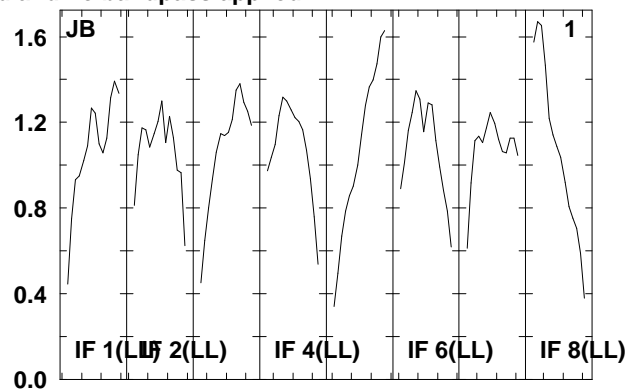
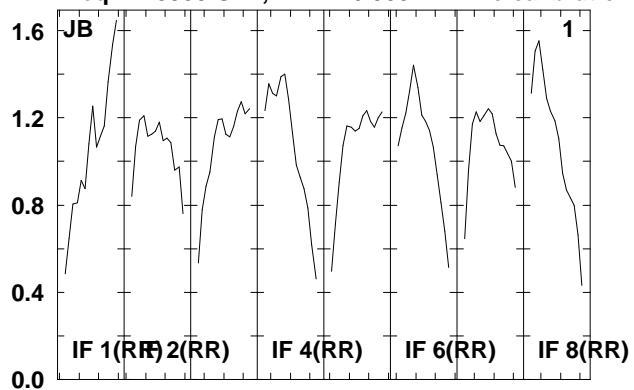

Lower frame: Real Jy  
 Total-power spectrum Antenna: \*  
 Timerange: 00/18:52:55 to 00/18:54:53

Plot file version 18 created 20-AUG-2009 14:59:28

3C274 EG040B.UVDATA.1

Freq = 1.5955 GHz, Bw = 16.000 MH No calibration applied and no bandpass applied

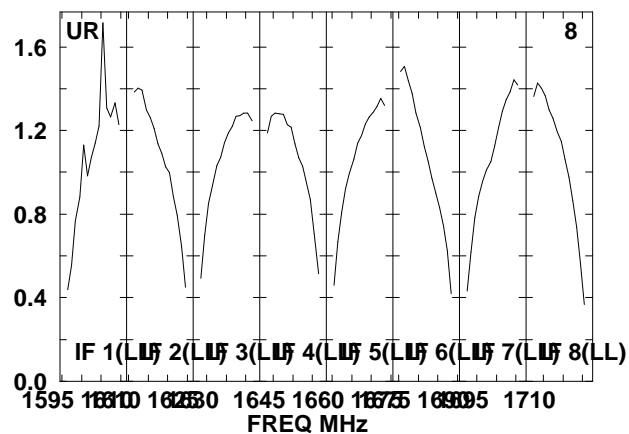
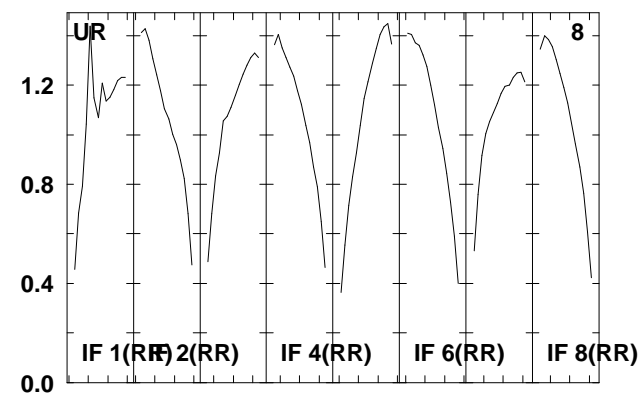
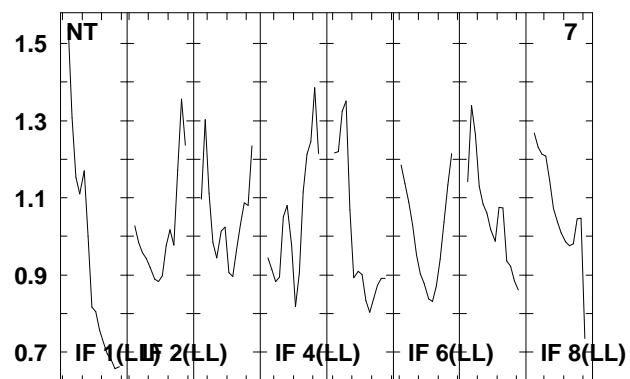
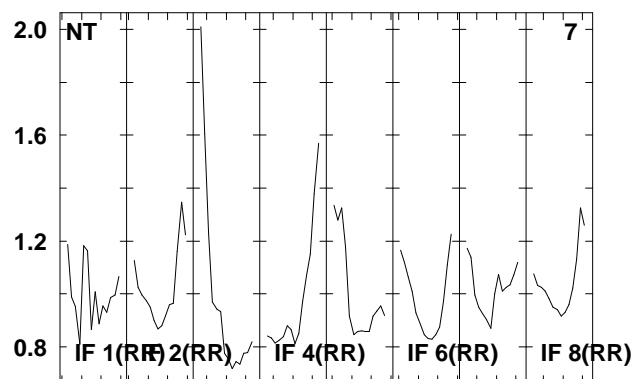
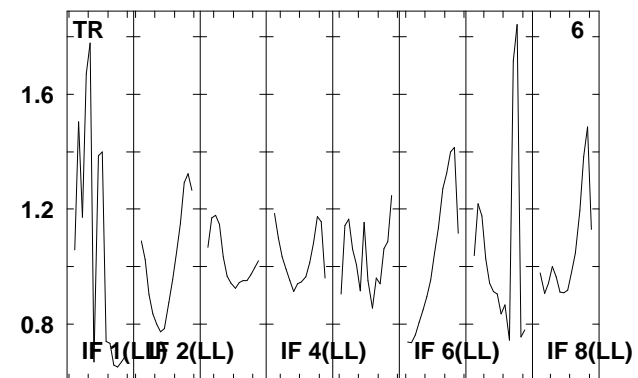
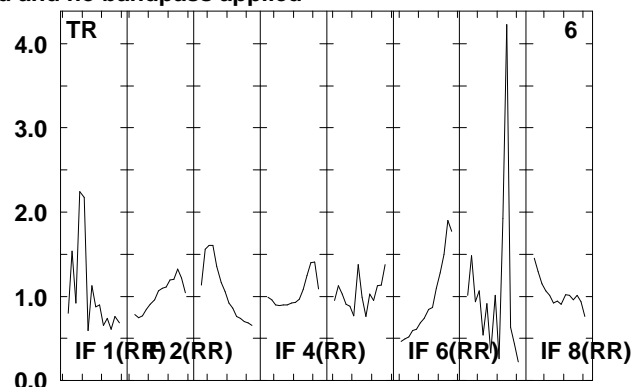
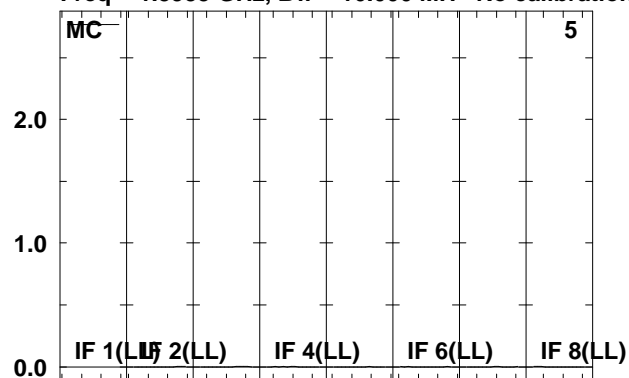

Lower frame: Kilo Real Jy

Total-power spectrum Antenna: \*

Timerange: 00/18:52:55 to 00/18:54:53

Plot file version 19 created 20-AUG-2009 14:59:29

NGC4639 EG040B.UVDATA.1

Freq = 1.5955 GHz, Bw = 16.000 MH No calibration applied and no bandpass applied

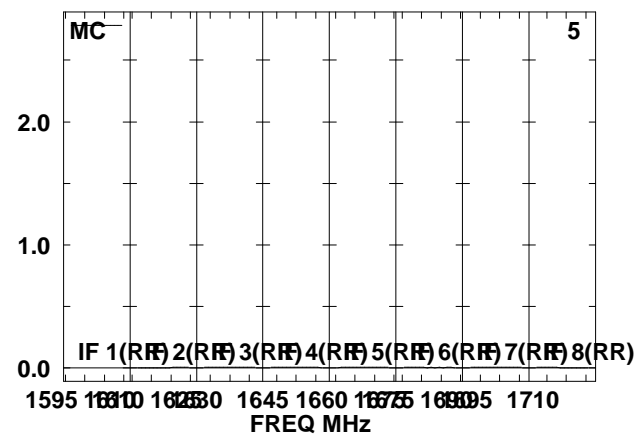
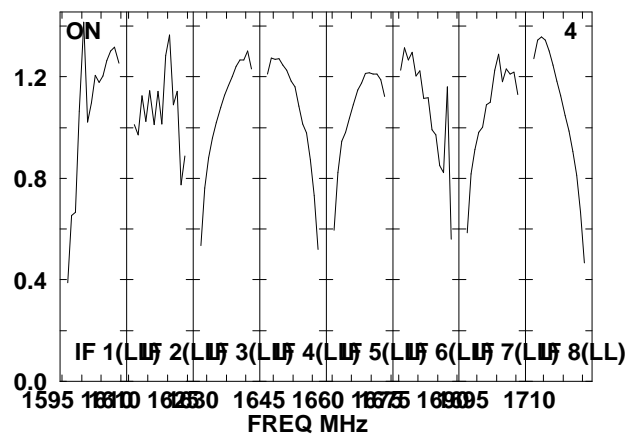
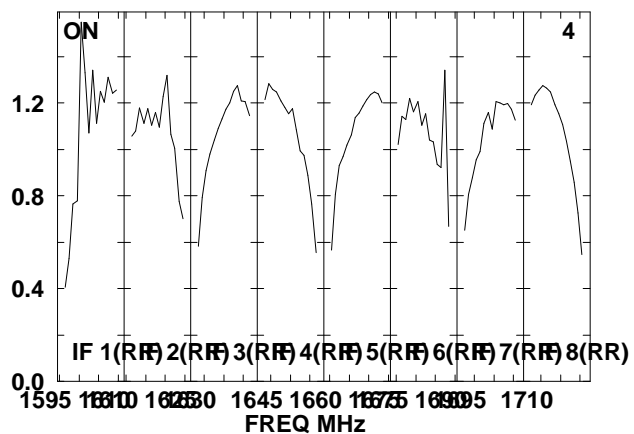
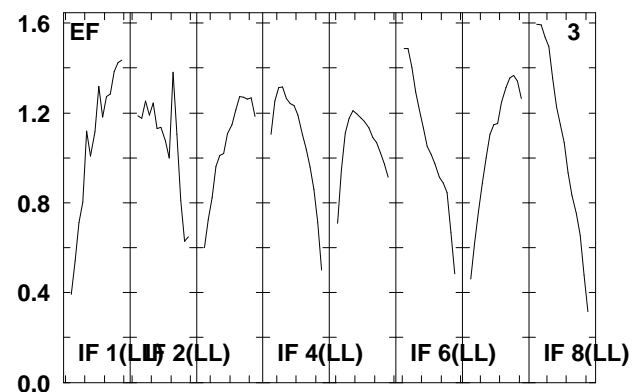
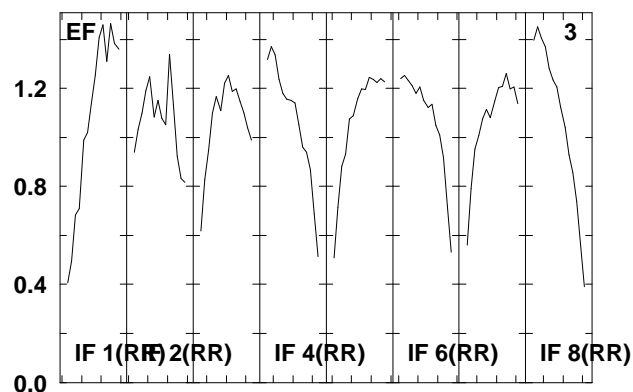
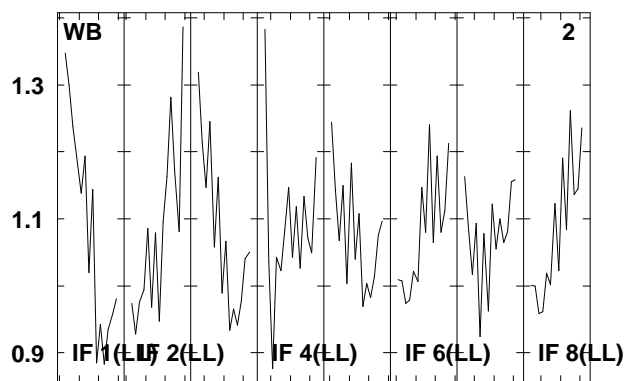
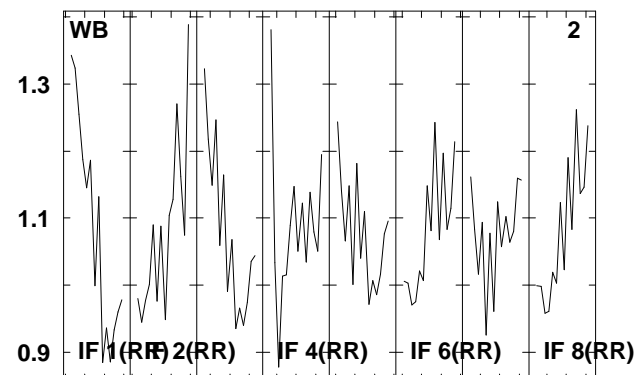
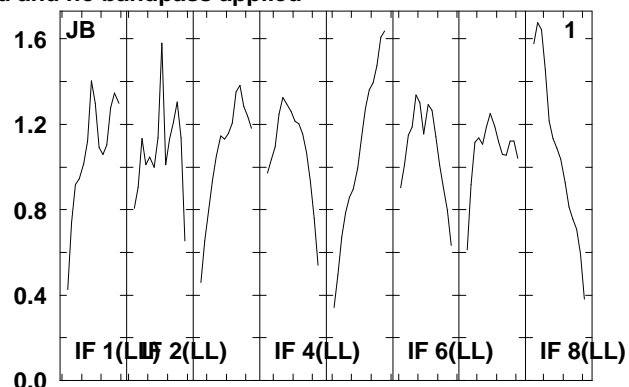
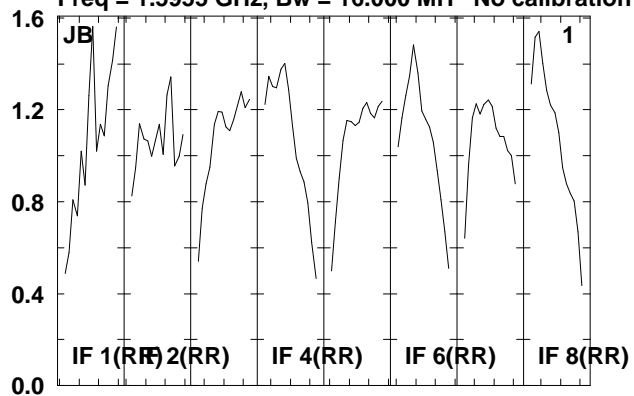

Lower frame: Real Jy

Total-power spectrum Antenna: \*

Timerange: 00/18:54:55 to 00/18:58:43

Plot file version 20 created 20-AUG-2009 14:59:29

NGC4639 EG040B.UVDATA.1

Freq = 1.5955 GHz, Bw = 16.000 MH No calibration applied and no bandpass applied

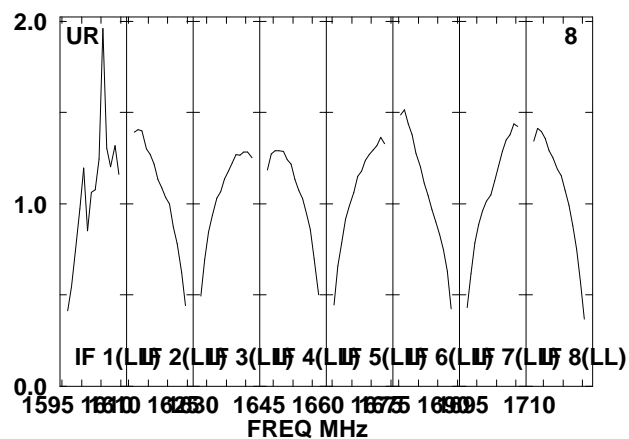
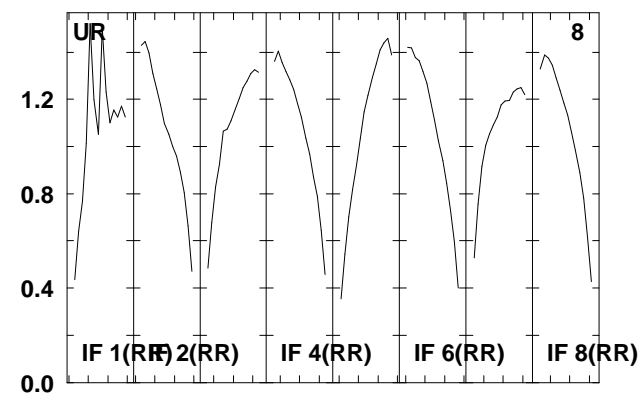
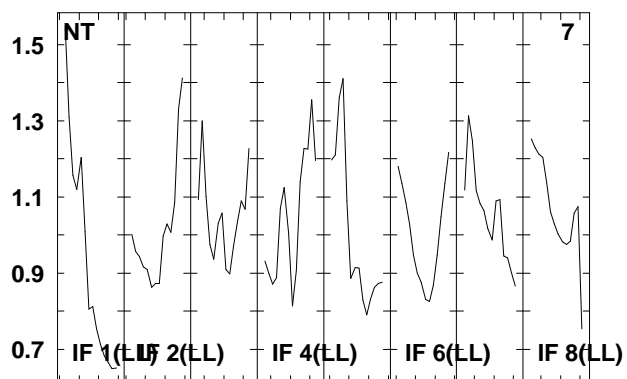
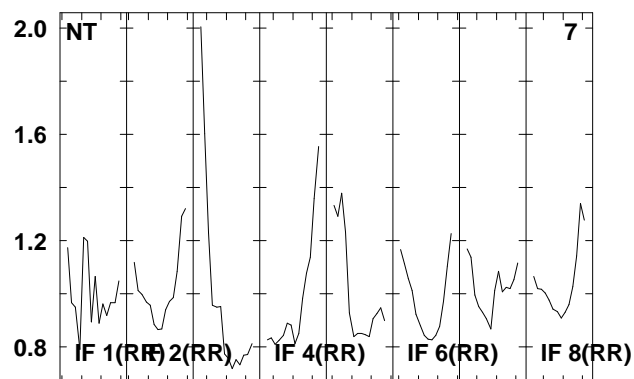
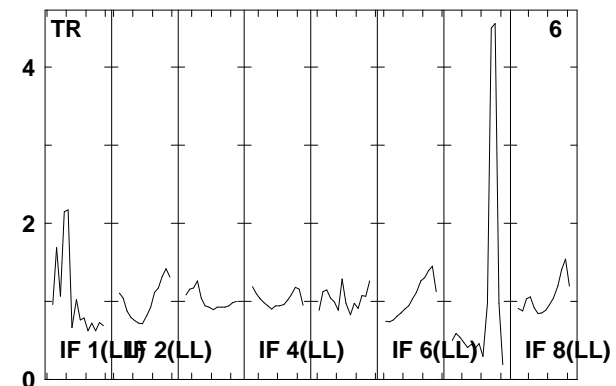
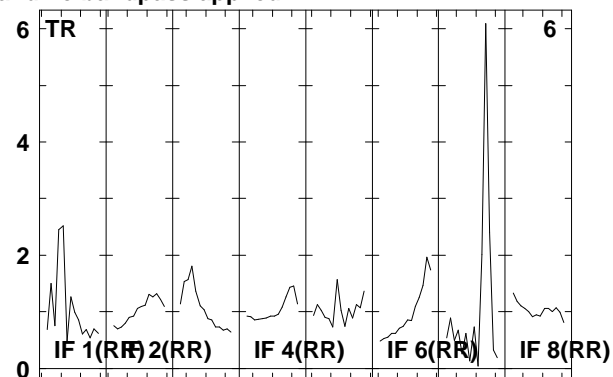
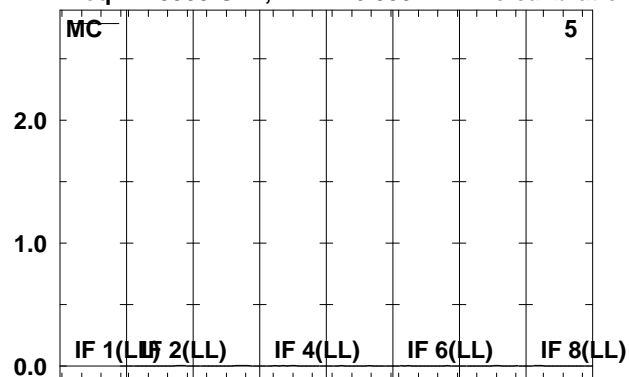

Lower frame: Kilo Real Jy

Total-power spectrum Antenna: \*

Timerange: 00/18:54:55 to 00/18:58:43

Plot file version 21 created 20-AUG-2009 14:59:29

3C274 EG040B.UVDATA.1

Freq = 1.5955 GHz, Bw = 16.000 MH No calibration applied and no bandpass applied

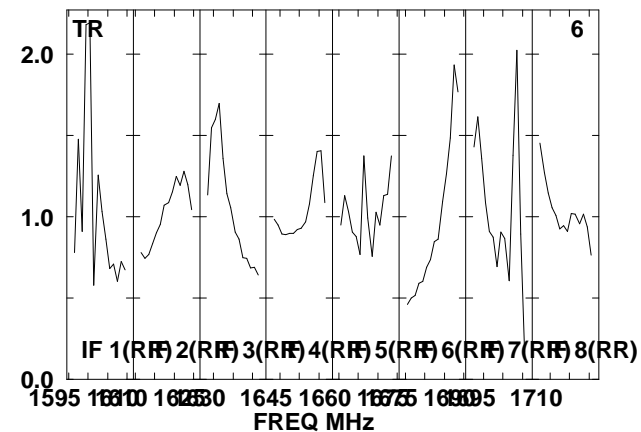
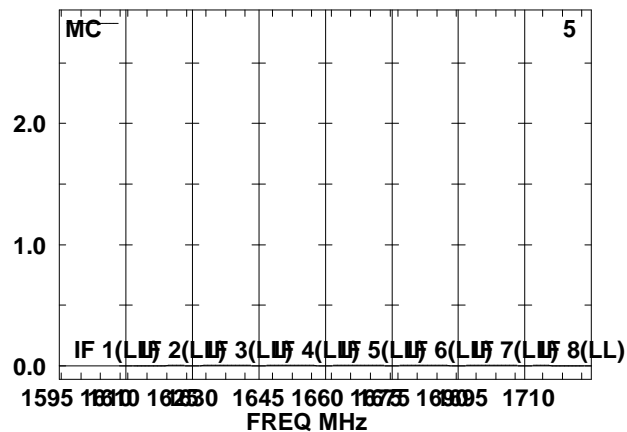
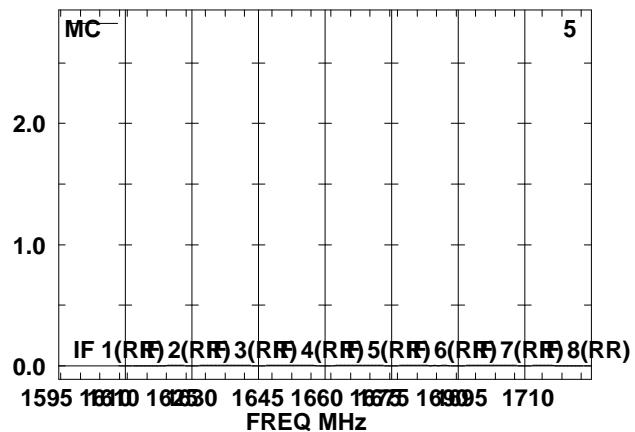
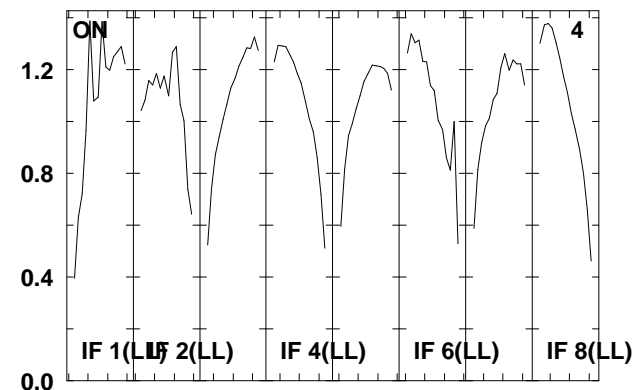
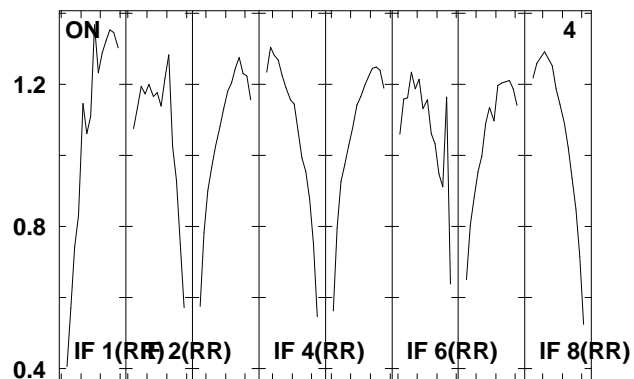
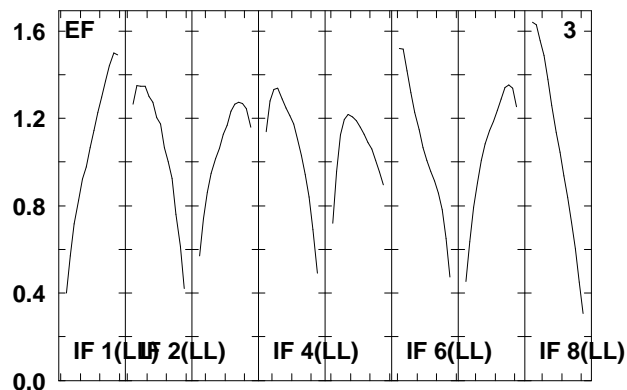
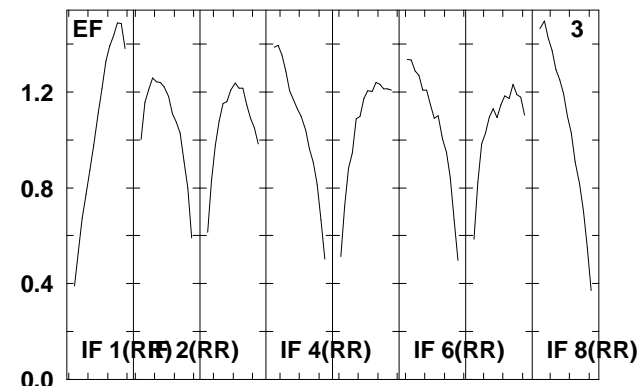
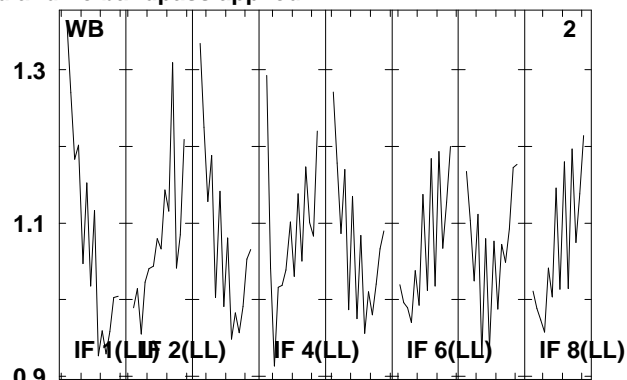
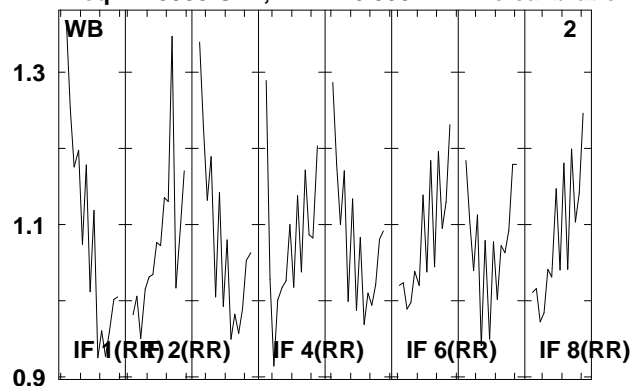

Lower frame: Real Jy

Total-power spectrum Antenna: \*

Timerange: 00/18:59:27 to 00/19:00:43

Plot file version 22 created 20-AUG-2009 14:59:30

3C274 EG040B.UVDATA.1

Freq = 1.5955 GHz, Bw = 16.000 MH No calibration applied and no bandpass applied

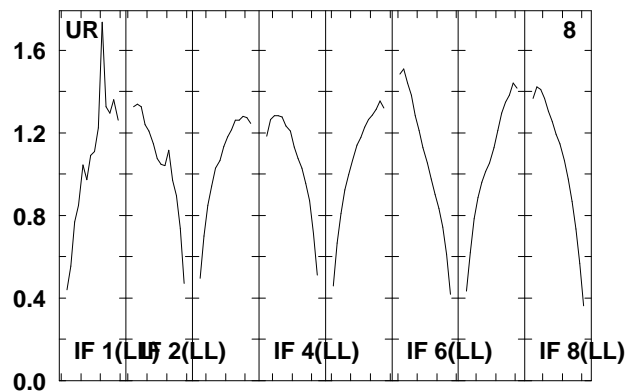
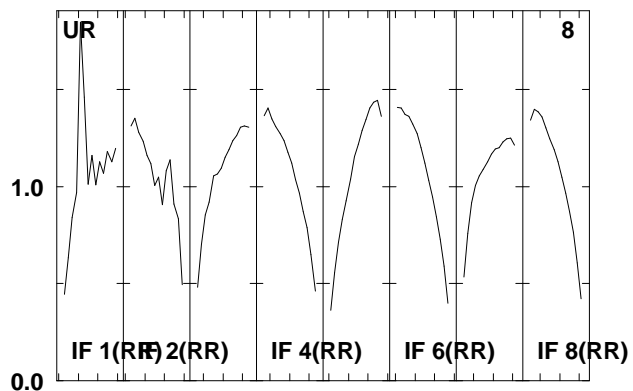
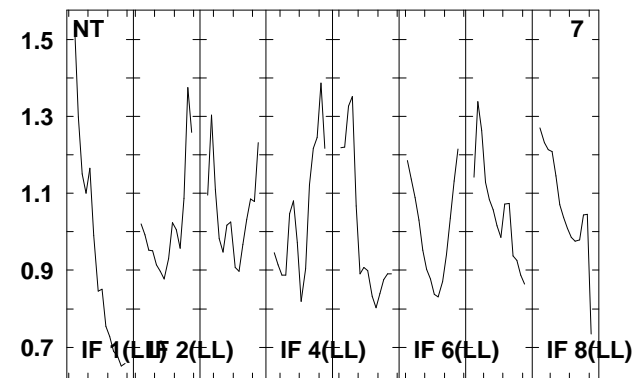
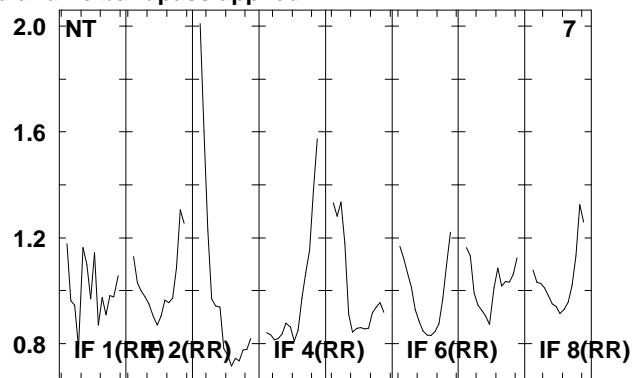
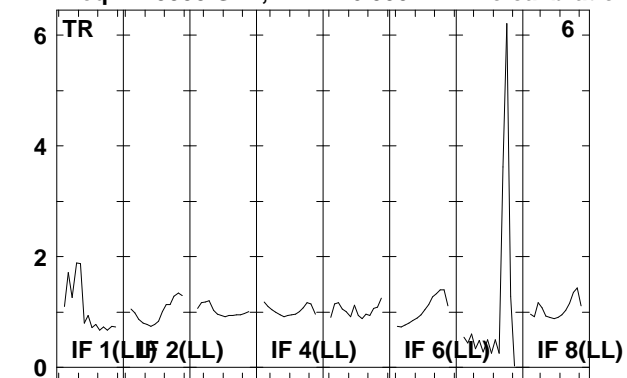

Lower frame: Real Jy  
Total-power spectrum Antenna: \*  
Timerange: 00/18:59:27 to 00/19:00:43

Plot file version 23 created 20-AUG-2009 14:59:30

NGC4639 EG040B.UVDATA.1

Freq = 1.5955 GHz, Bw = 16.000 MH No calibration applied and no bandpass applied

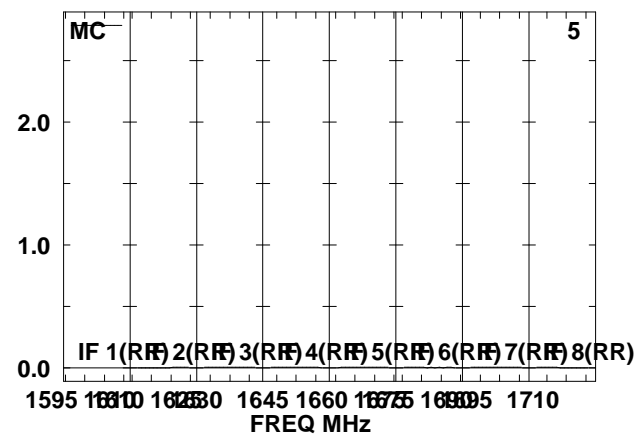
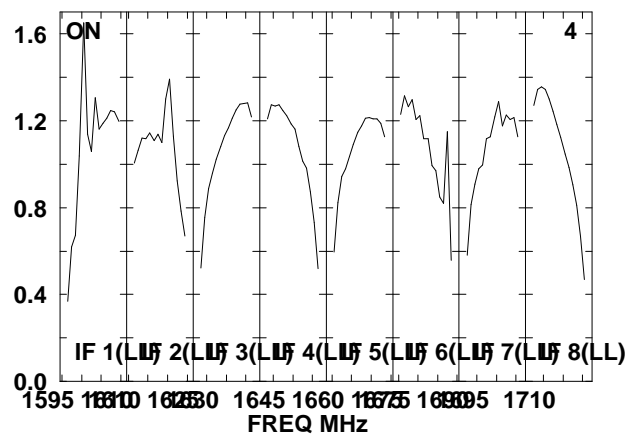
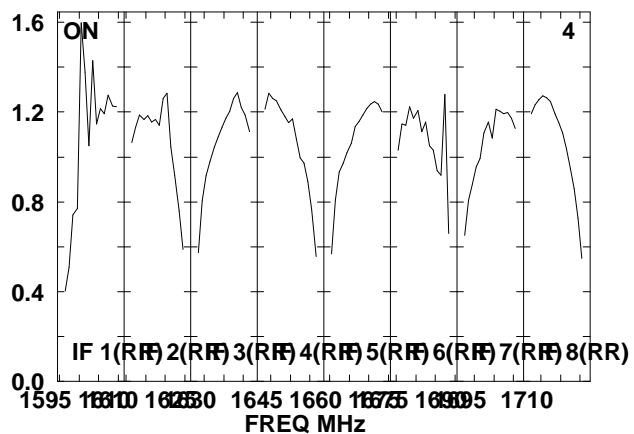
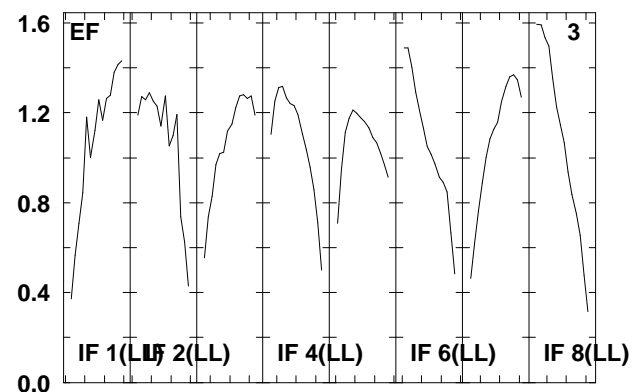
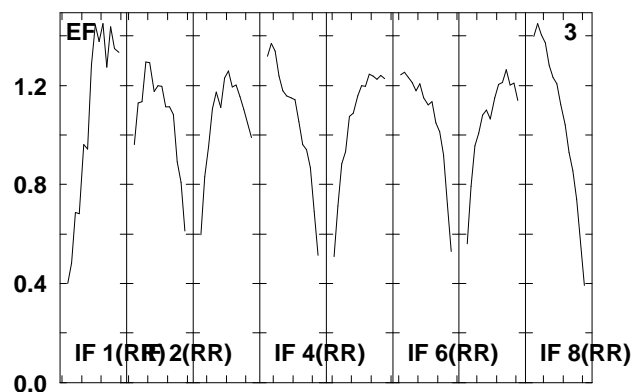
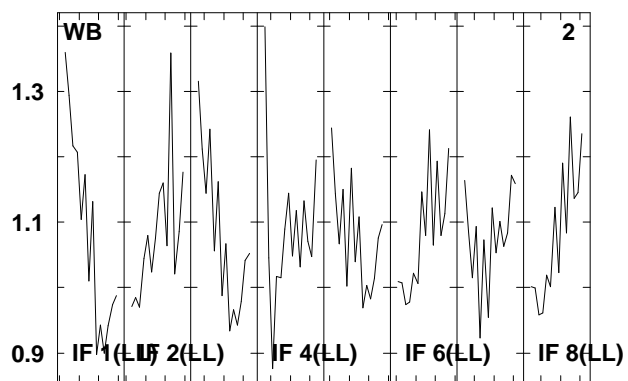
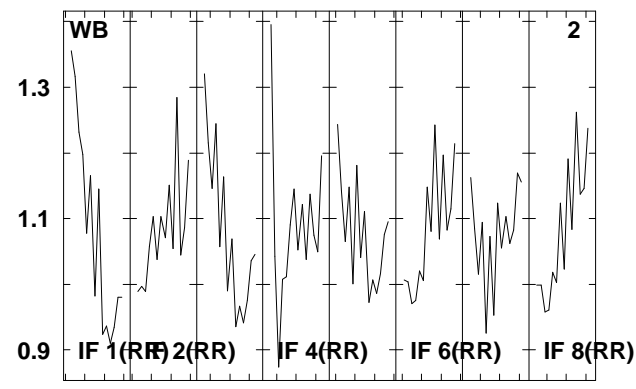
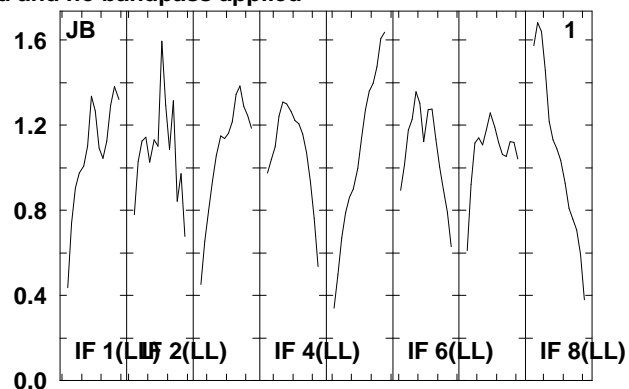
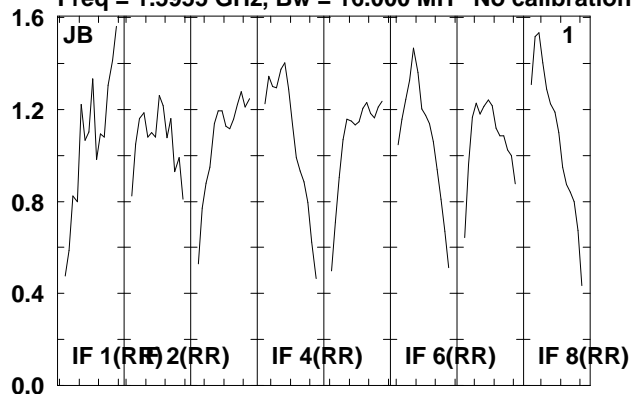

Lower frame: Real Jy  
Total-power spectrum Antenna: \*  
Timerange: 00/19:00:47 to 00/19:04:35

Plot file version 24 created 20-AUG-2009 14:59:30

NGC4639 EG040B.UVDATA.1

Freq = 1.5955 GHz, Bw = 16.000 MH No calibration applied and no bandpass applied

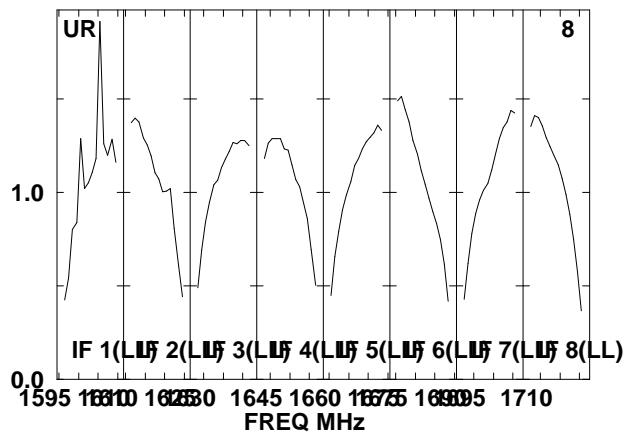
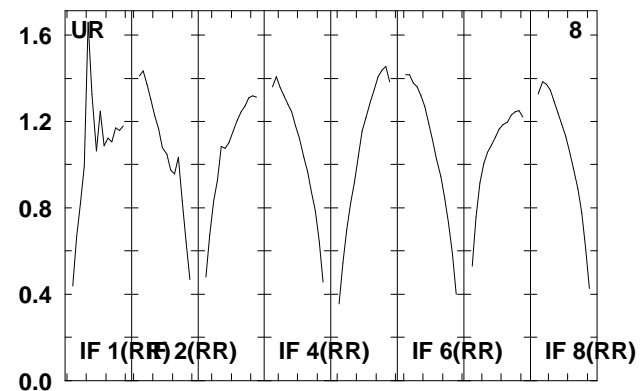
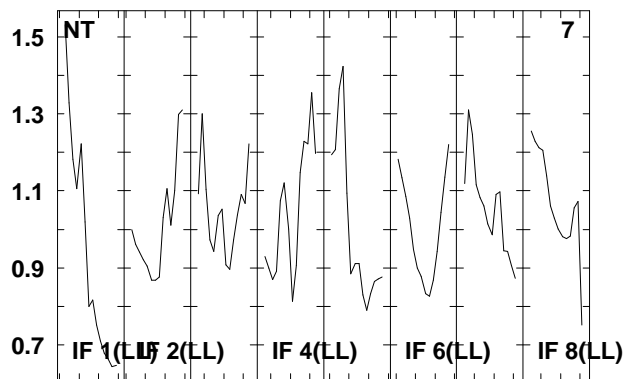
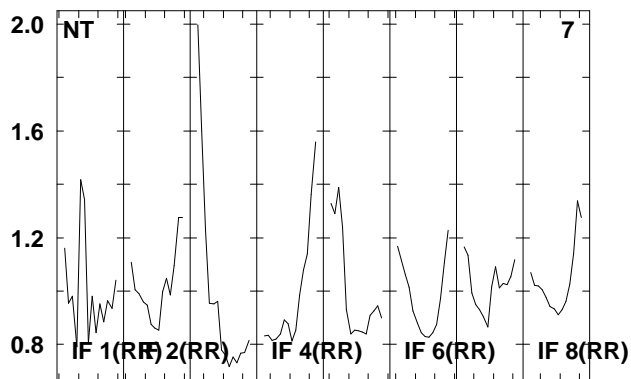
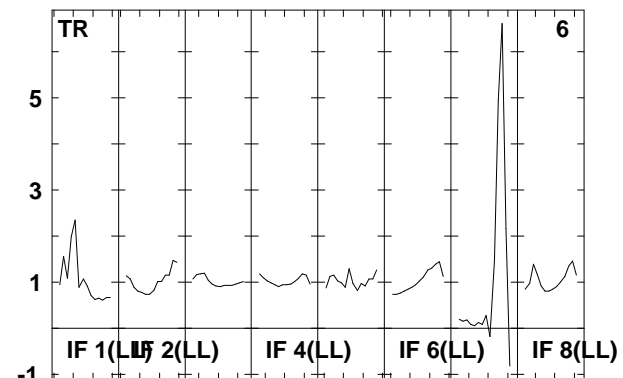
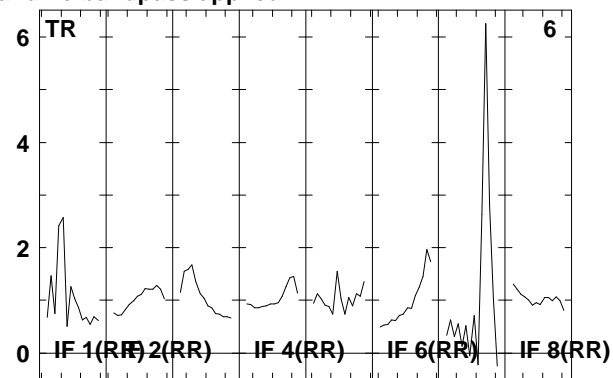
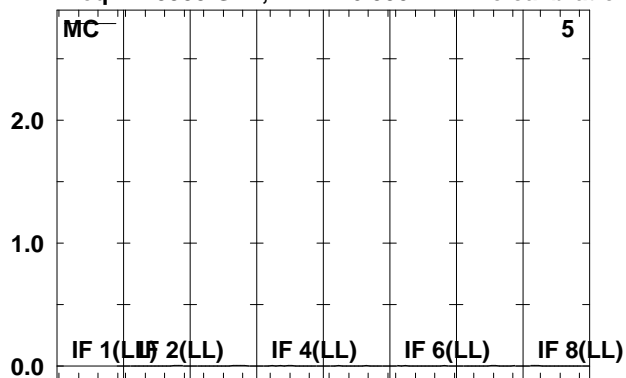

Lower frame: Kilo Real Jy

Total-power spectrum Antenna: \*

Timerange: 00/19:00:47 to 00/19:04:35



Plot file version 25 created 20-AUG-2009 14:59:31

3C274 EG040B.UVDATA.1

Freq = 1.5955 GHz, Bw = 16.000 MH No calibration applied and no bandpass applied

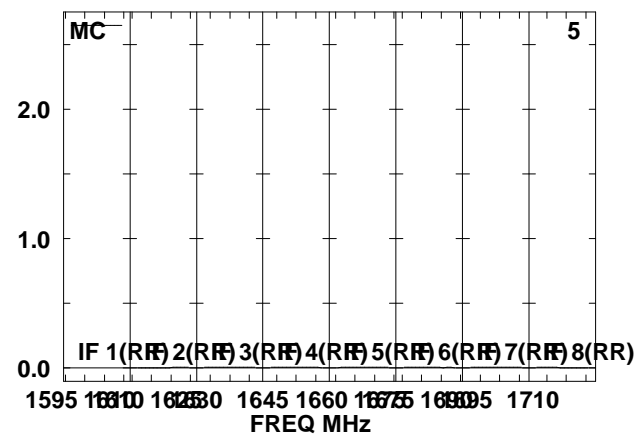
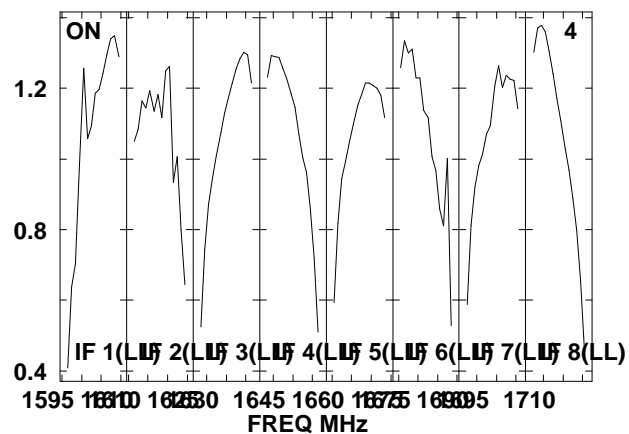
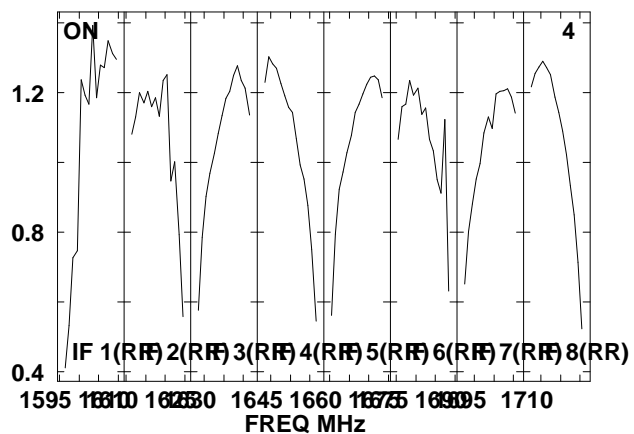
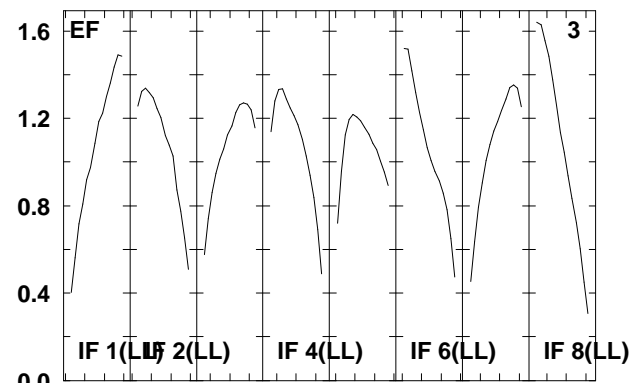
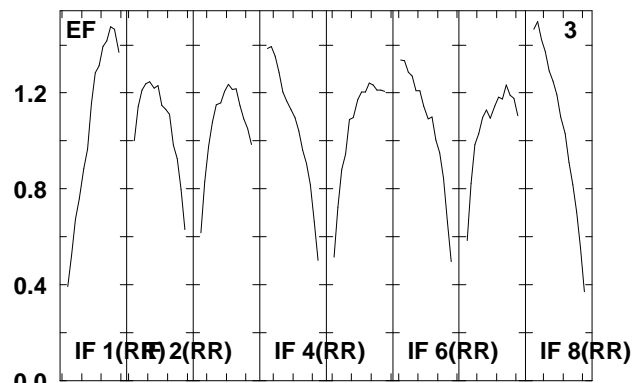
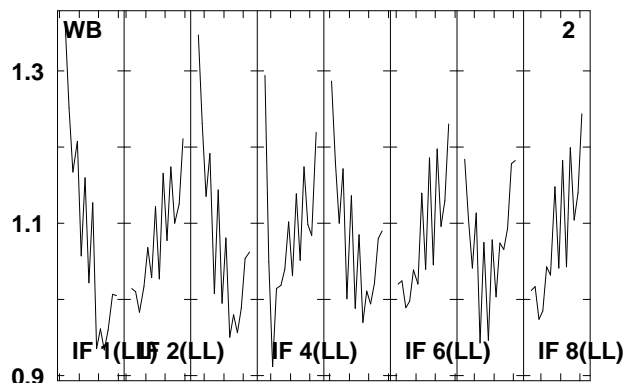
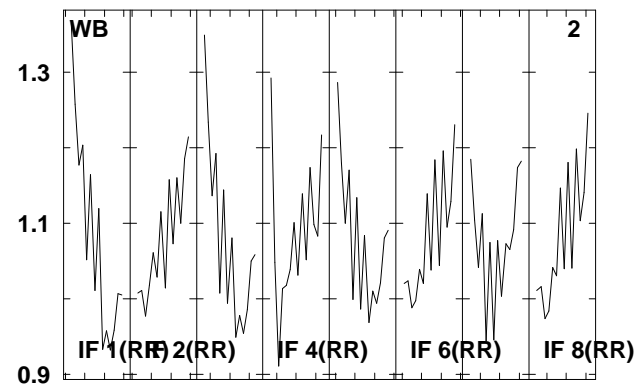
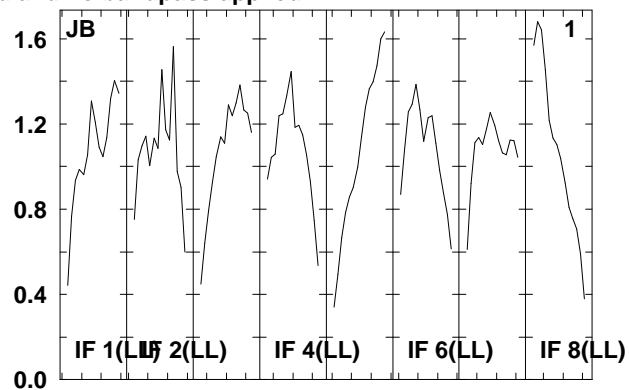
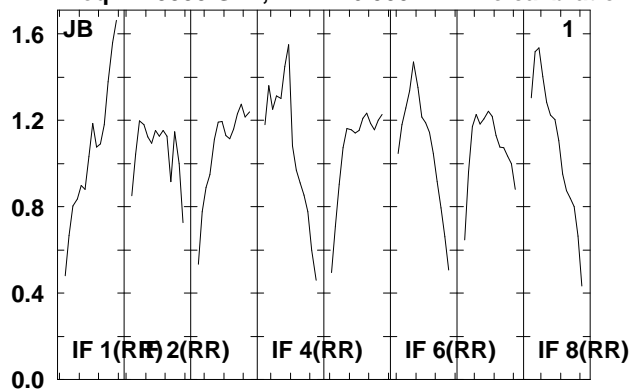

Lower frame: Real Jy  
Total-power spectrum Antenna: \*  
Timerange: 00/19:04:37 to 00/19:06:35

Plot file version 26 created 20-AUG-2009 14:59:31

3C274 EG040B.UVDATA.1

Freq = 1.5955 GHz, Bw = 16.000 MH No calibration applied and no bandpass applied

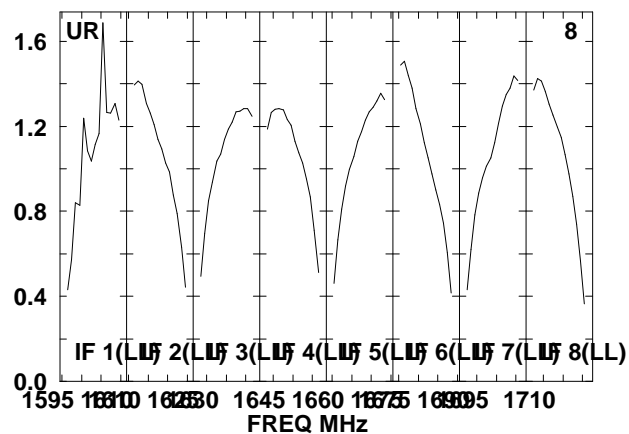
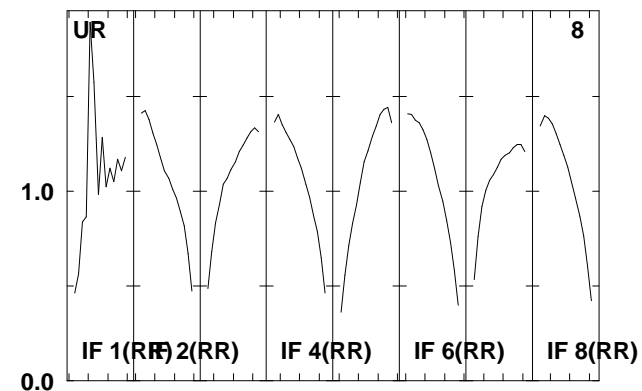
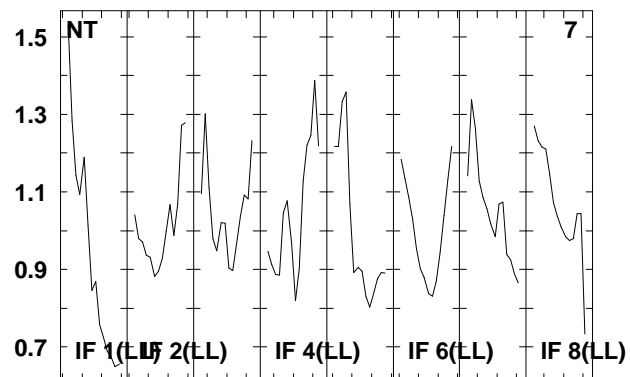
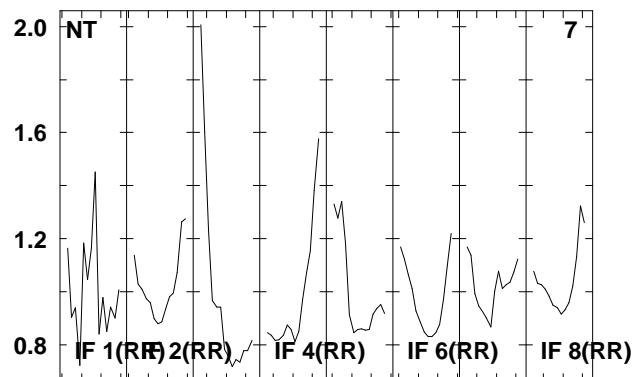
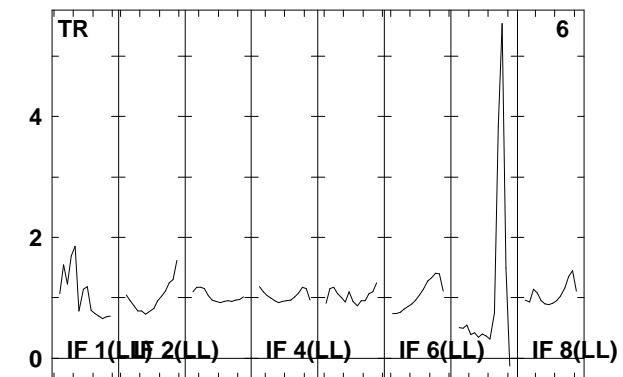
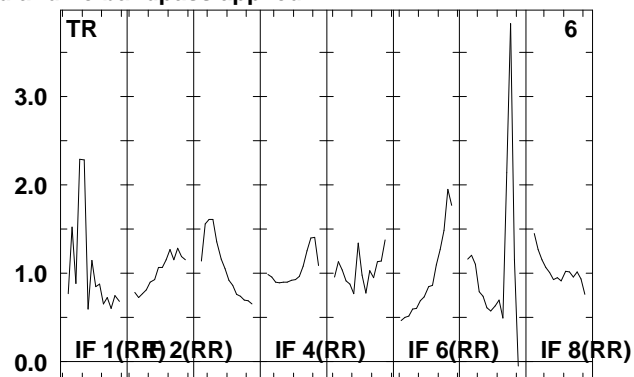
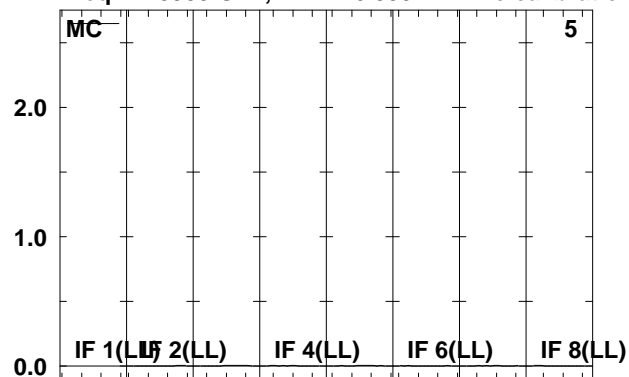

Lower frame: Kilo Real Jy

Total-power spectrum Antenna: \*

Timerange: 00/19:04:37 to 00/19:06:35

Plot file version 27 created 20-AUG-2009 14:59:31

NGC4639 EG040B.UVDATA.1

Freq = 1.5955 GHz, Bw = 16.000 MH No calibration applied and no bandpass applied

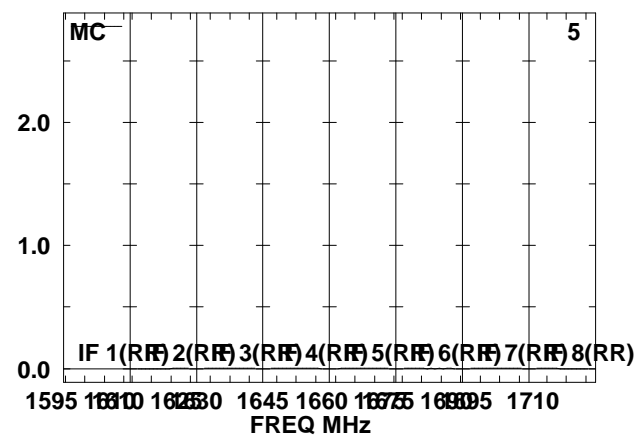
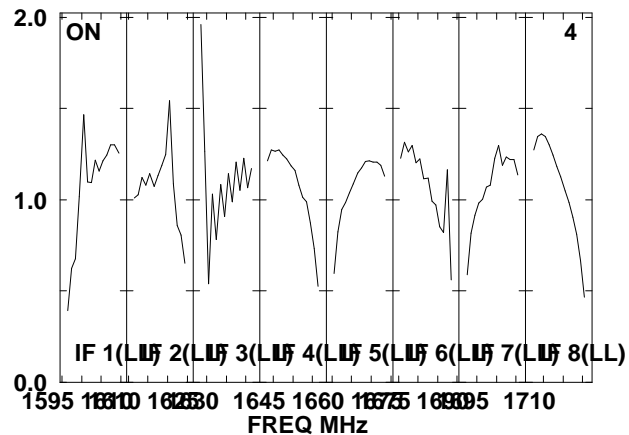
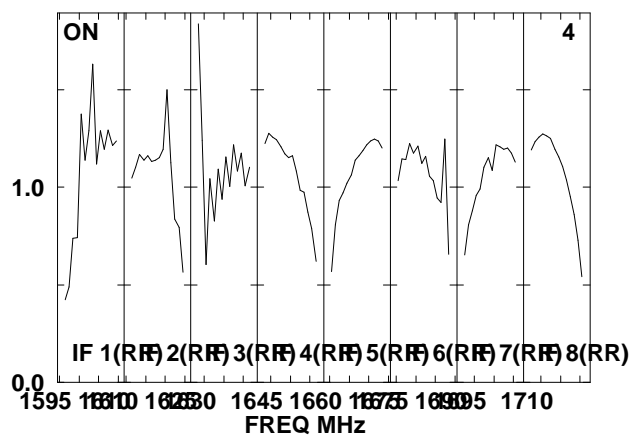
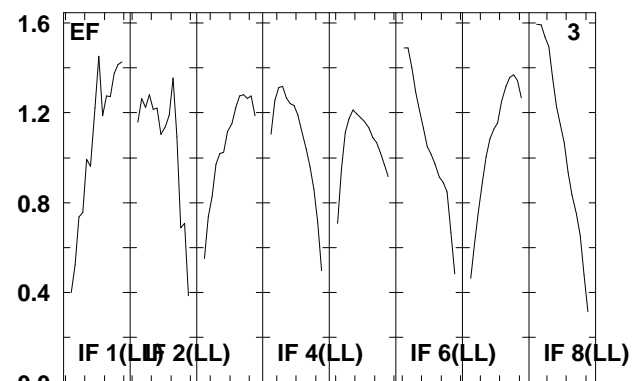
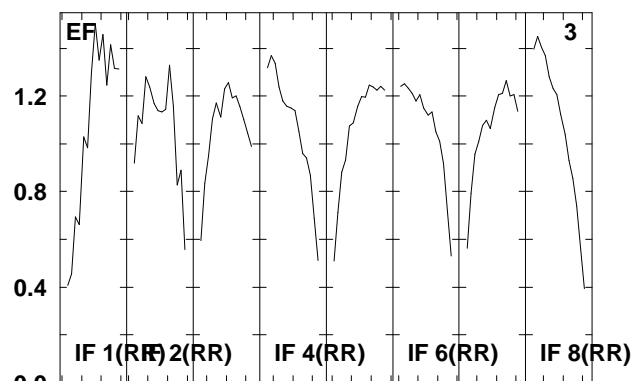
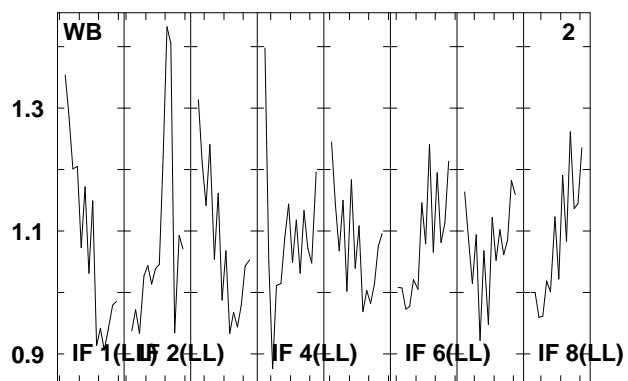
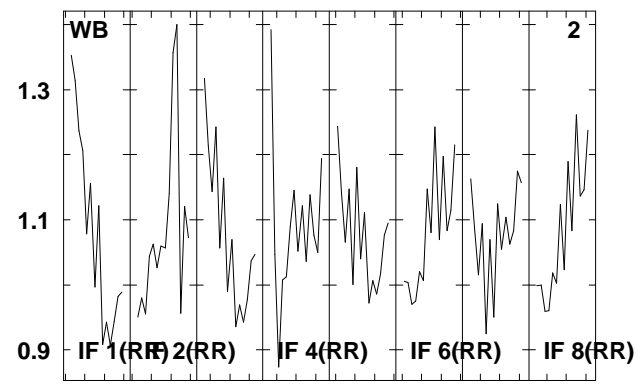
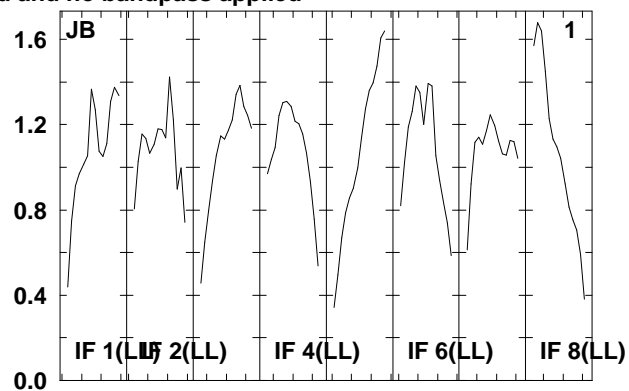
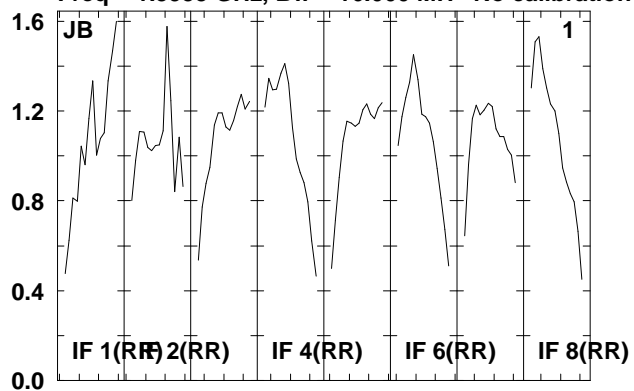

Lower frame: Real Jy  
Total-power spectrum Antenna: \*  
Timerange: 00/19:06:37 to 00/19:10:23

Plot file version 28 created 20-AUG-2009 14:59:32

NGC4639 EG040B.UVDATA.1

Freq = 1.5955 GHz, Bw = 16.000 MH No calibration applied and no bandpass applied

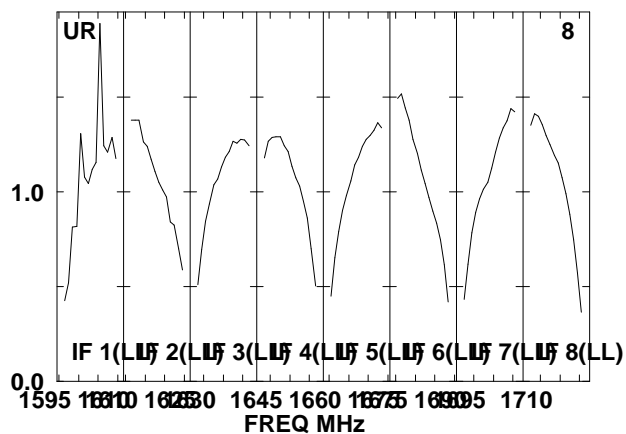
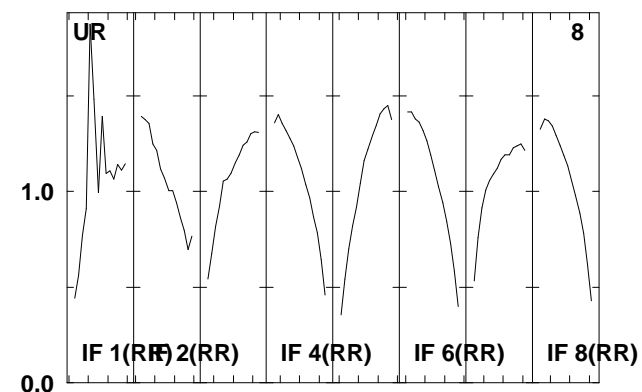
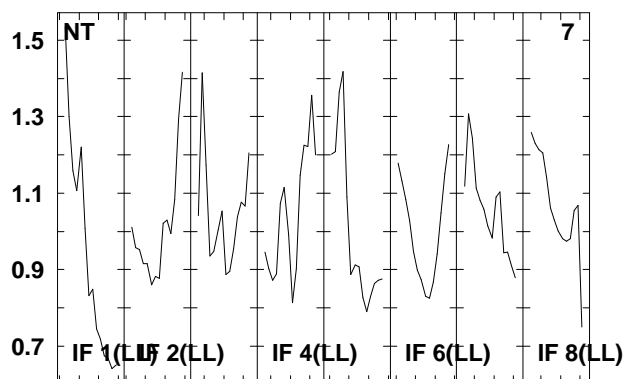
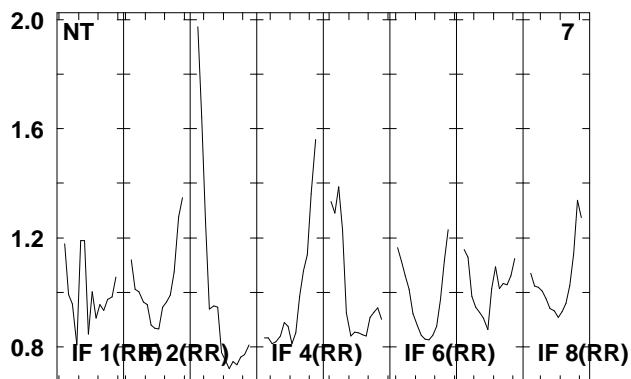
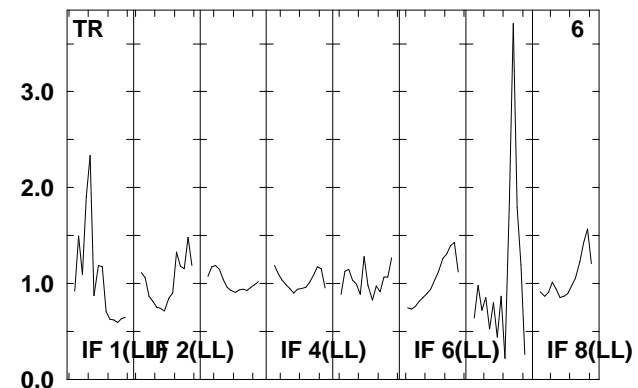
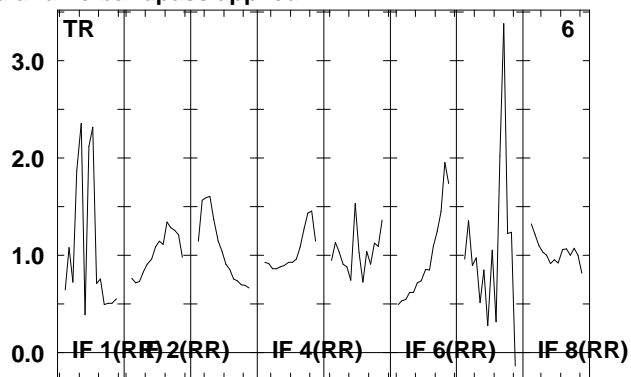
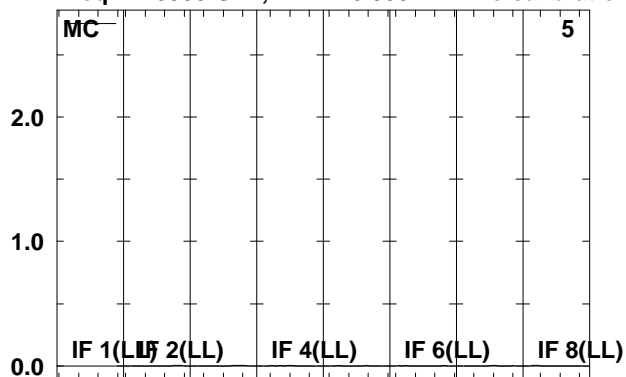

Lower frame: Kilo Real Jy

Total-power spectrum Antenna: \*

Timerange: 00/19:06:37 to 00/19:10:23

Plot file version 29 created 20-AUG-2009 14:59:32

3C274 EG040B.UVDATA.1

Freq = 1.5955 GHz, Bw = 16.000 MH No calibration applied and no bandpass applied

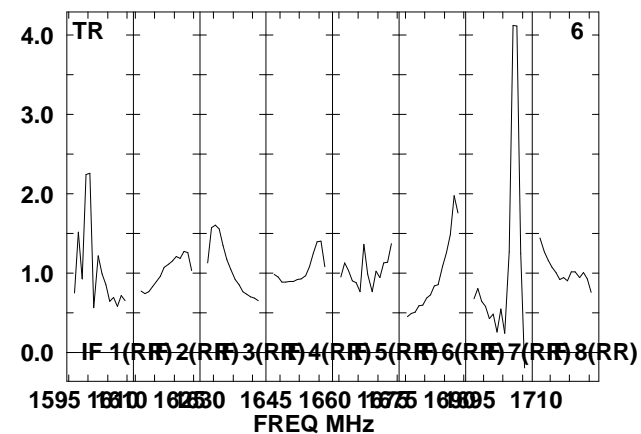
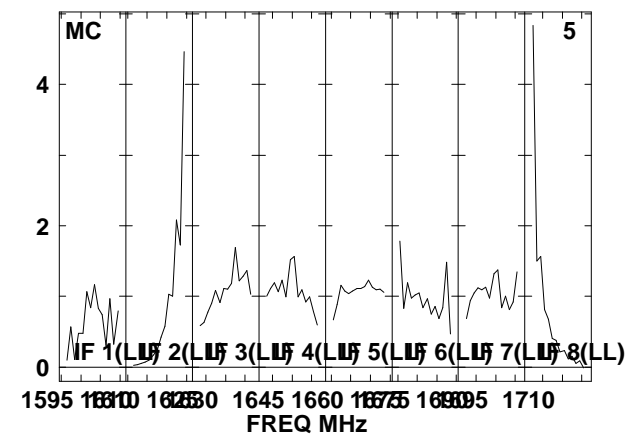
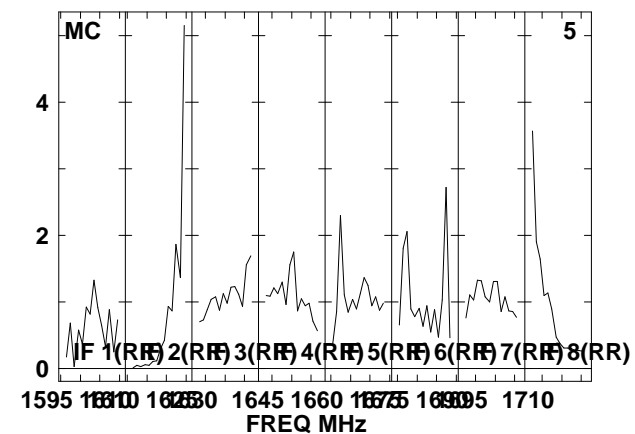
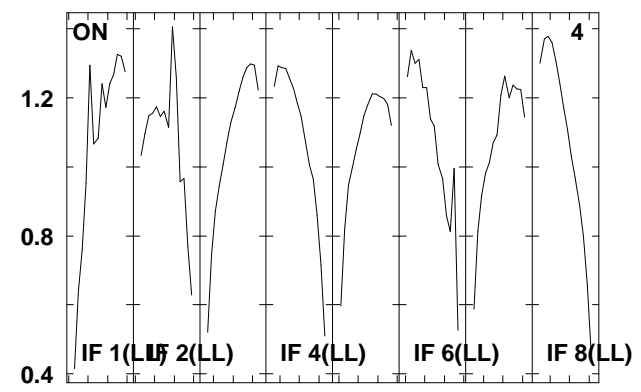
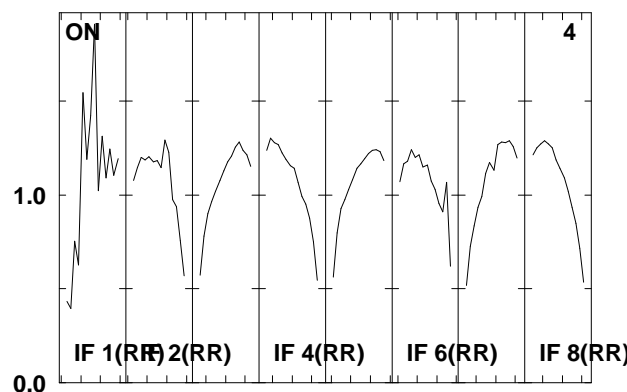
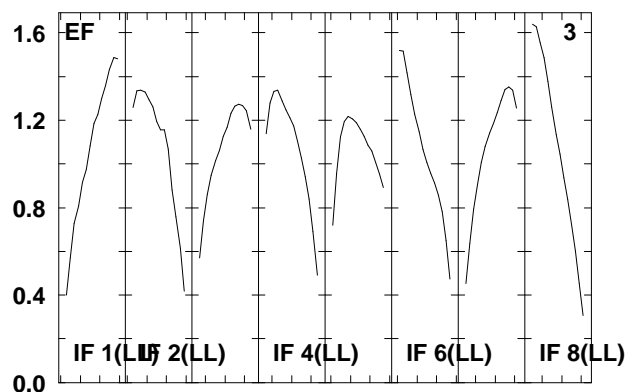
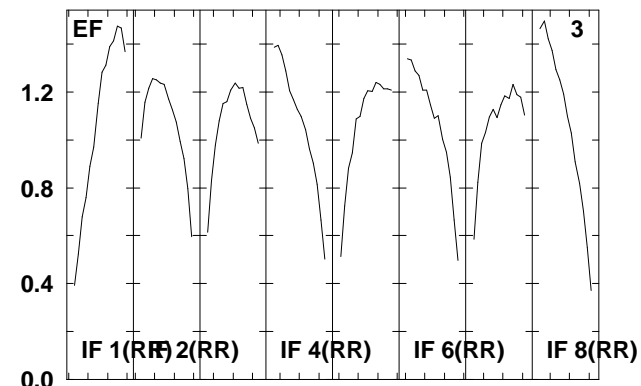
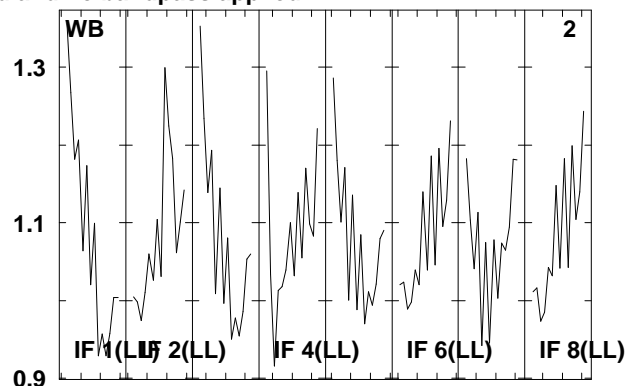
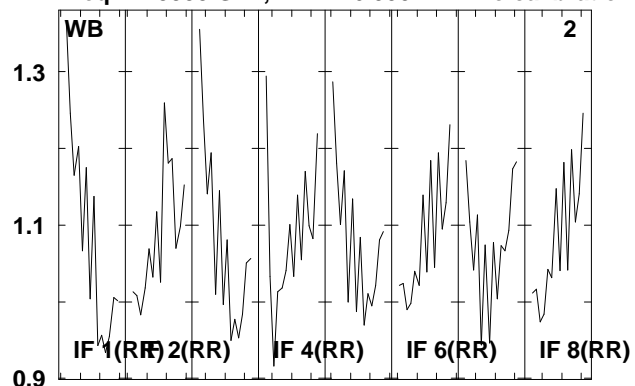

Lower frame: Real Jy

Total-power spectrum Antenna: \*

Timerange: 00/19:11:09 to 00/19:12:25

Plot file version 30 created 20-AUG-2009 14:59:32

3C274 EG040B.UVDATA.1

Freq = 1.5955 GHz, Bw = 16.000 MH No calibration applied and no bandpass applied

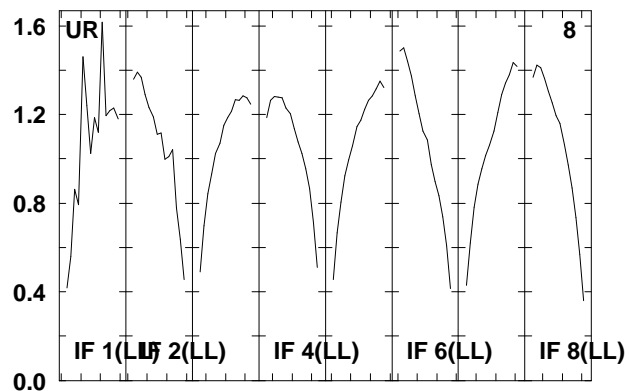
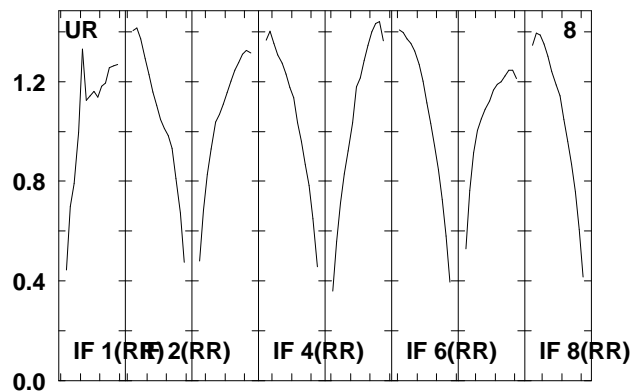
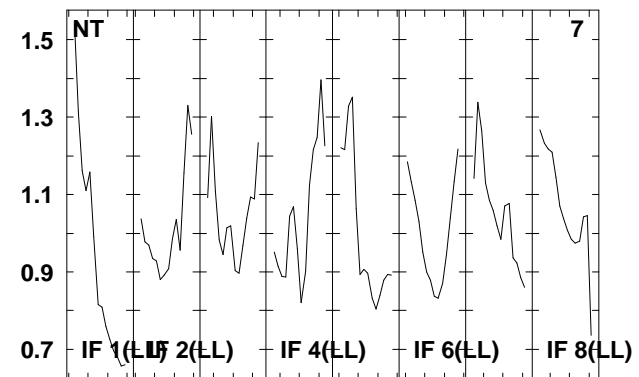
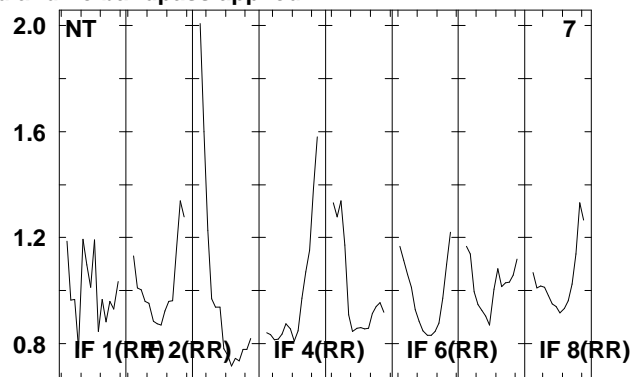
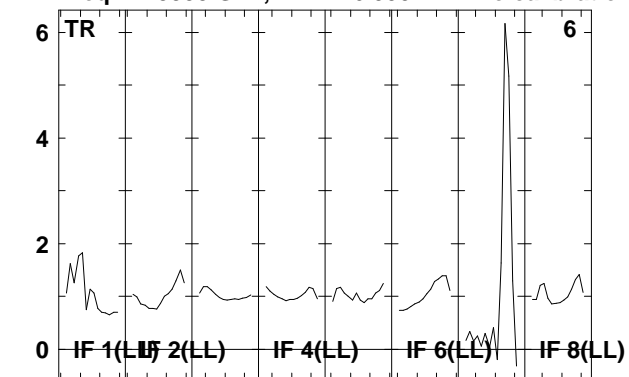

Lower frame: Real Jy  
Total-power spectrum Antenna: \*  
Timerange: 00/19:11:09 to 00/19:12:25

Plot file version 31 created 20-AUG-2009 14:59:32

NGC4639 EG040B.UVDATA.1

Freq = 1.5955 GHz, Bw = 16.000 MH No calibration applied and no bandpass applied

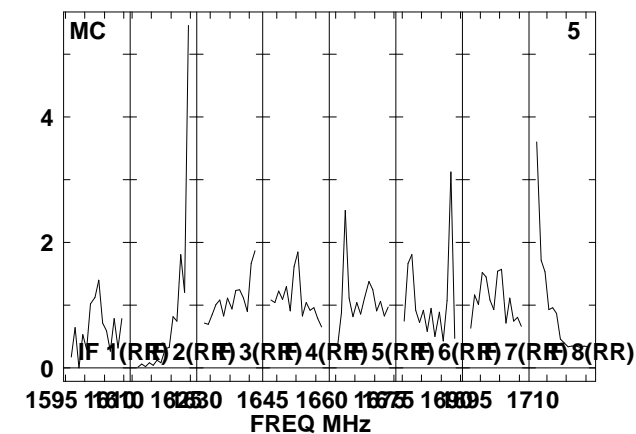
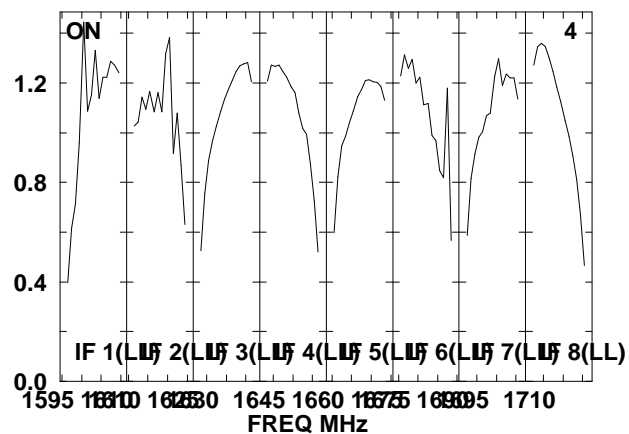
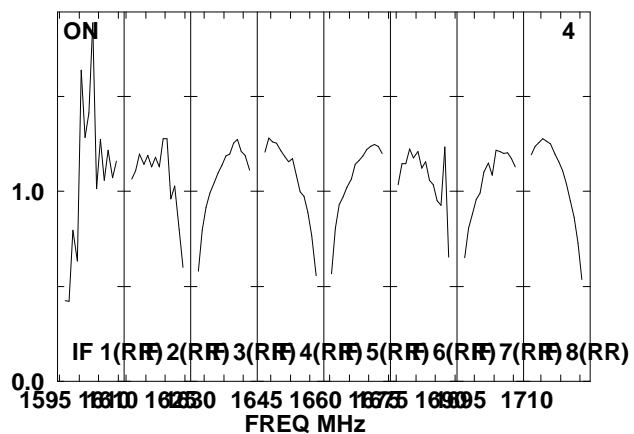
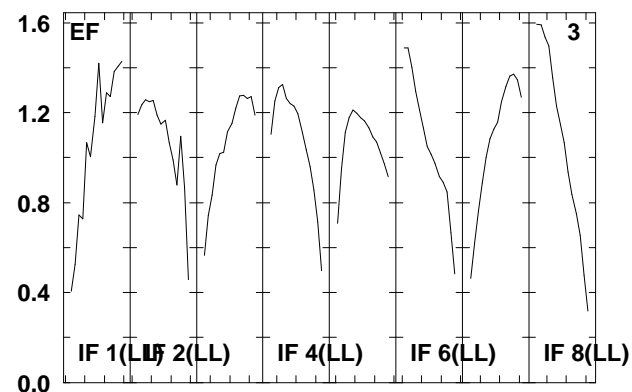
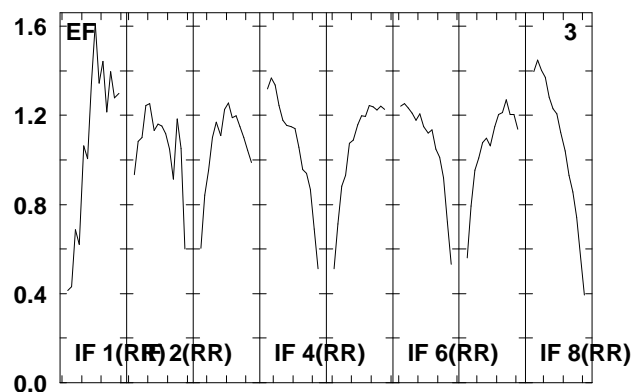
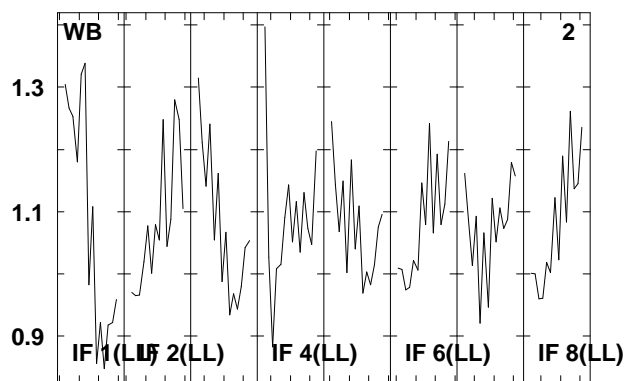
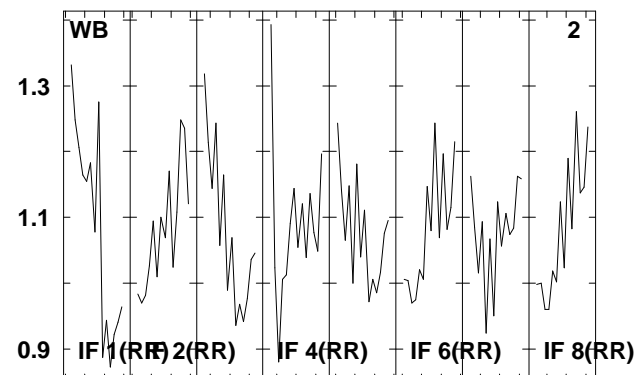
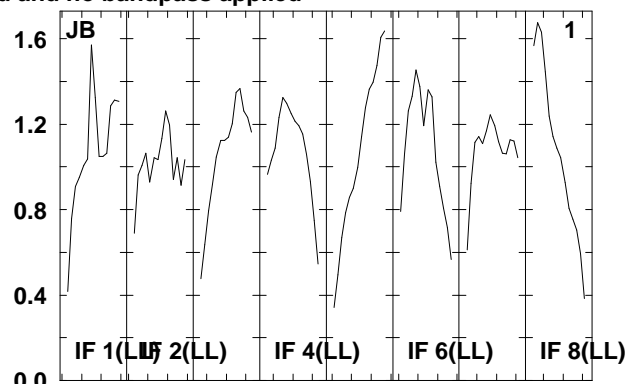
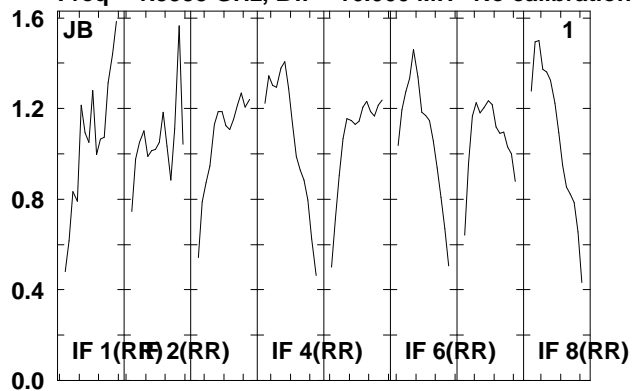

Lower frame: Real Jy

Total-power spectrum Antenna: \*

Timerange: 00/19:12:29 to 00/19:16:17

Plot file version 32 created 20-AUG-2009 14:59:33

NGC4639 EG040B.UVDATA.1

Freq = 1.5955 GHz, Bw = 16.000 MH No calibration applied and no bandpass applied

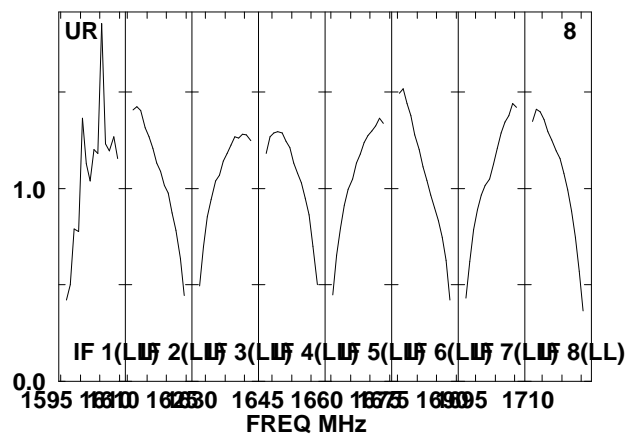
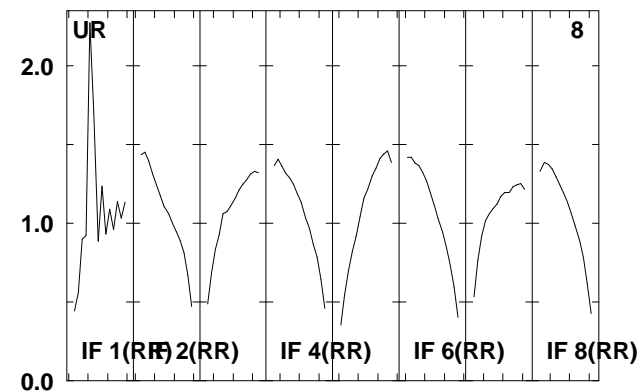
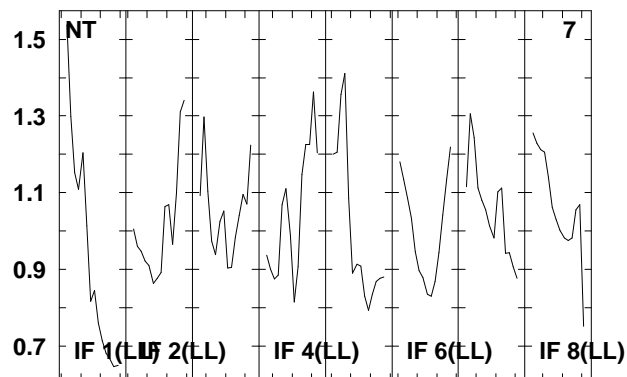
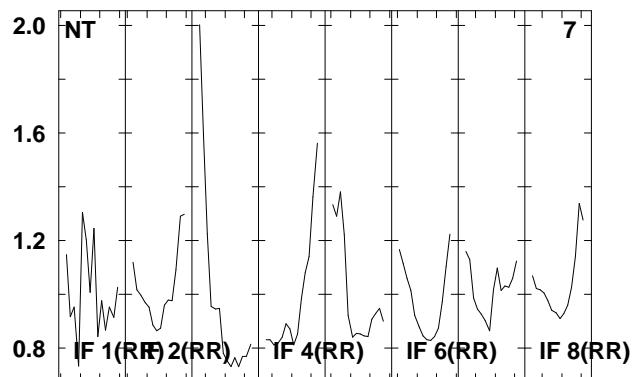
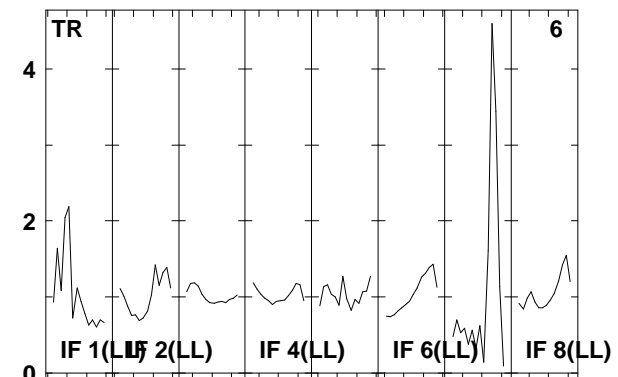
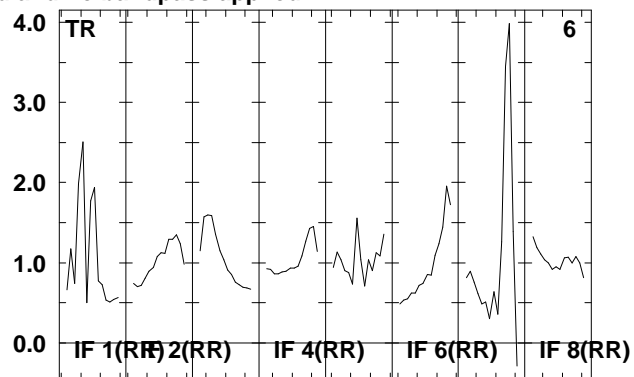
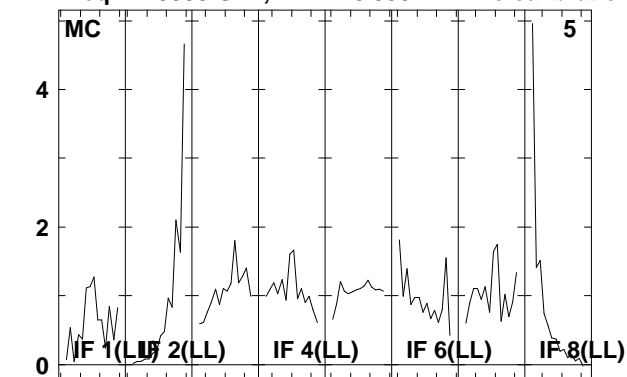

Lower frame: Real Jy

Total-power spectrum Antenna: \*

Timerange: 00/19:12:29 to 00/19:16:17



Plot file version 33 created 20-AUG-2009 14:59:33  
 3C274 EG040B.UVDATA.1  
 Freq = 1.5955 GHz, Bw = 16.000 MH No calibration applied and no bandpass applied

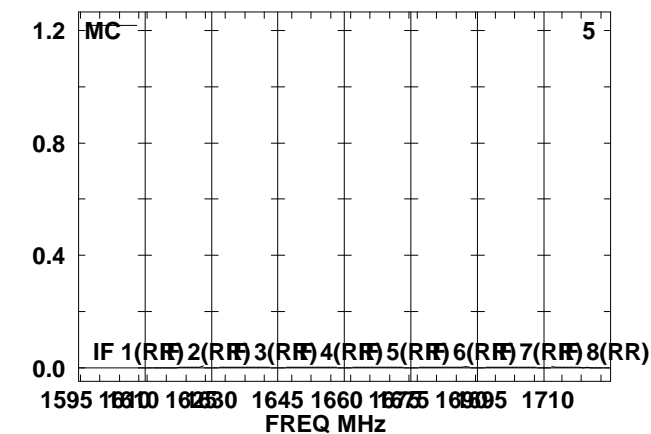
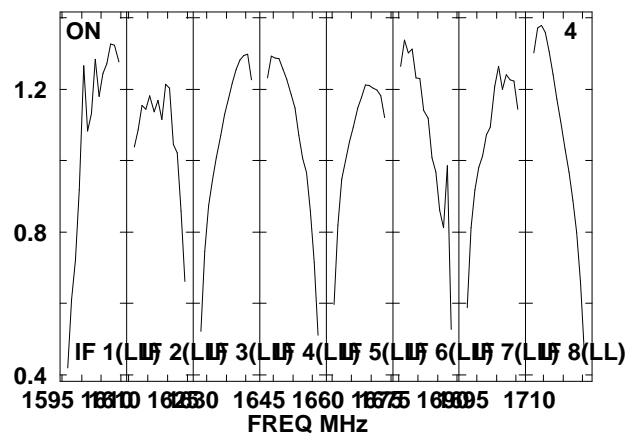
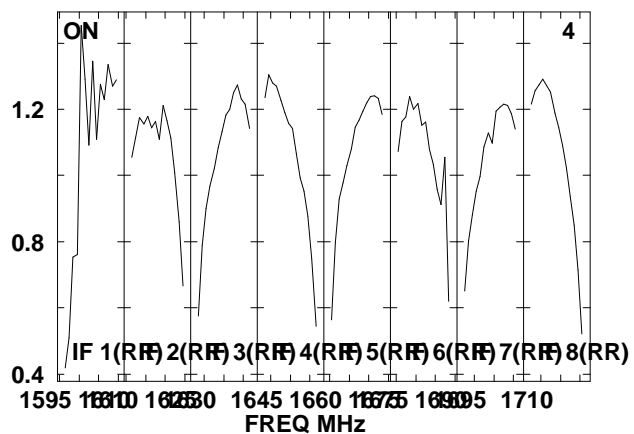
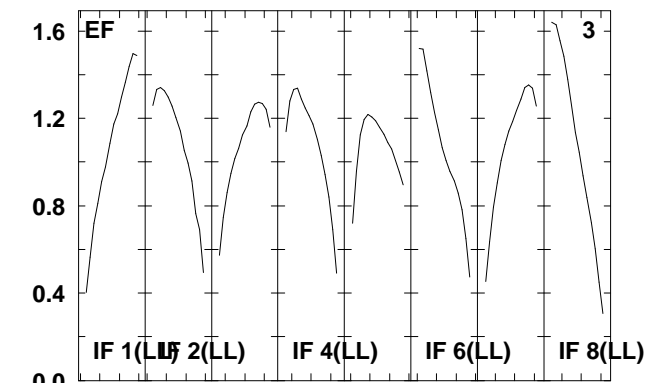
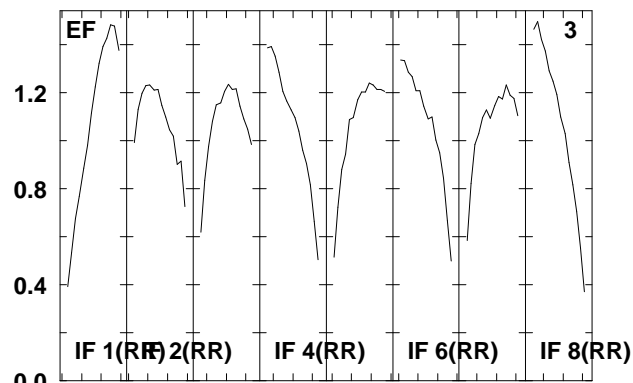
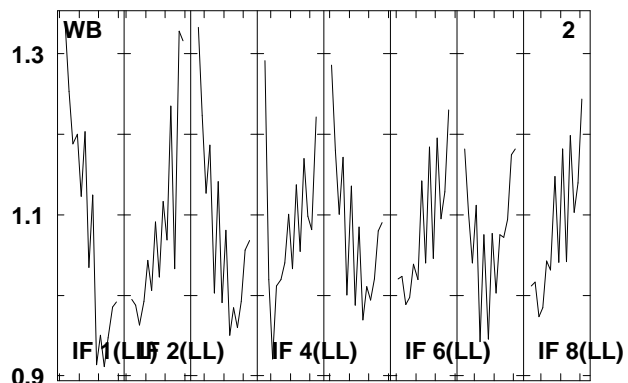
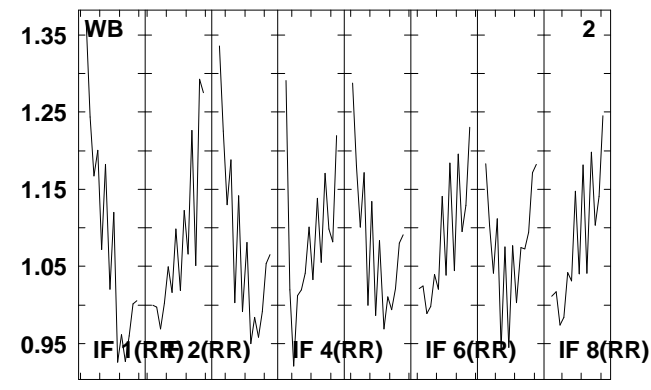
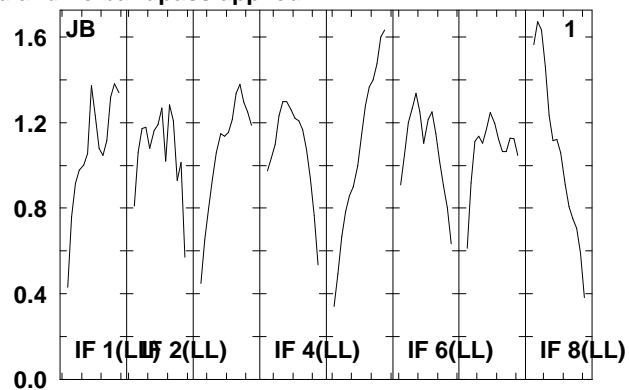
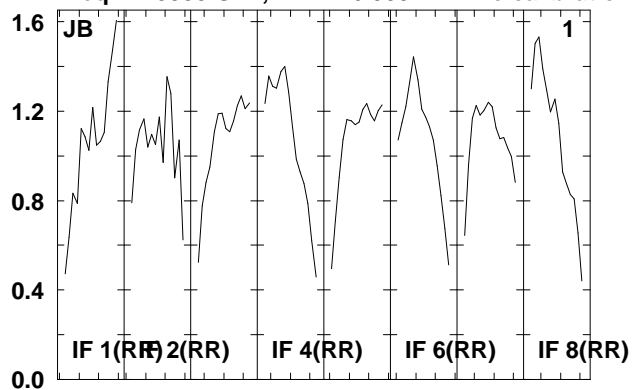

Lower frame: Real Jy  
 Total-power spectrum Antenna: \*  
 Timerange: 00/19:16:19 to 00/19:18:15

Plot file version 34 created 20-AUG-2009 14:59:33  
 3C274 EG040B.UVDATA.1  
 Freq = 1.5955 GHz, Bw = 16.000 MH No calibration applied and no bandpass applied

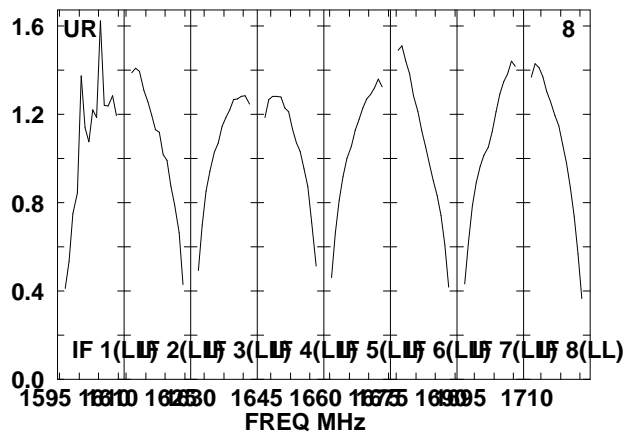
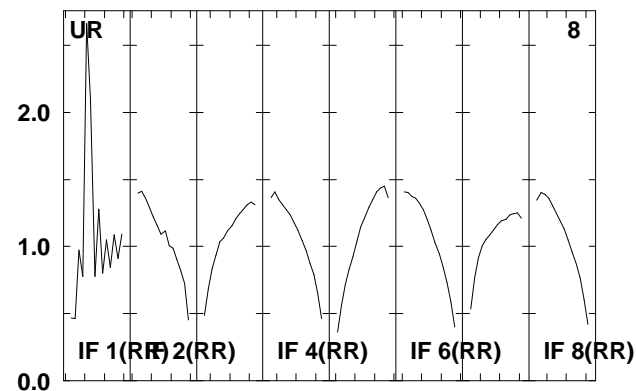
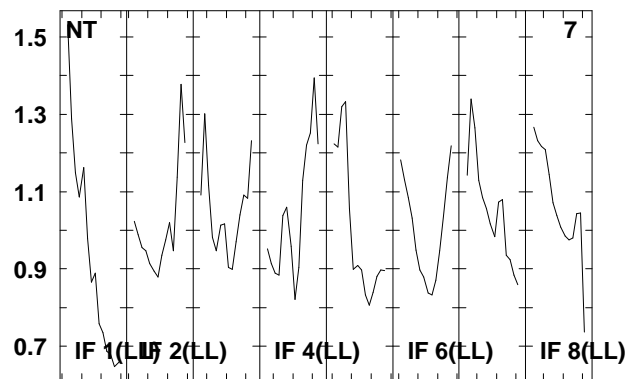
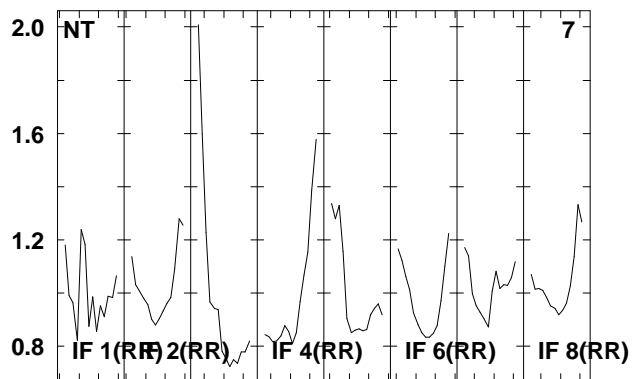
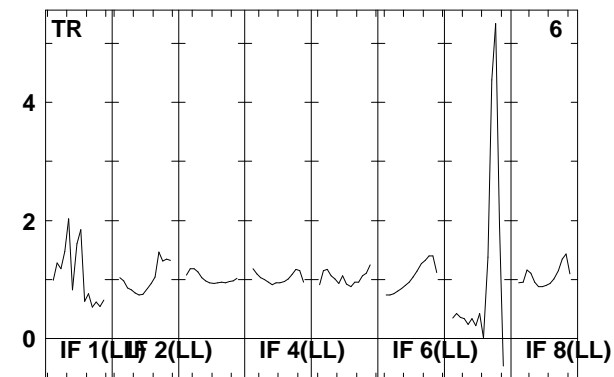
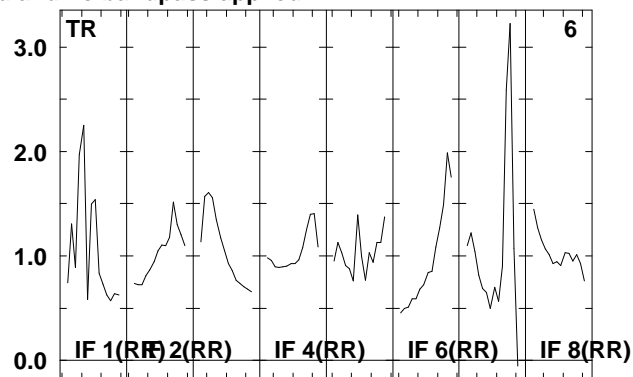
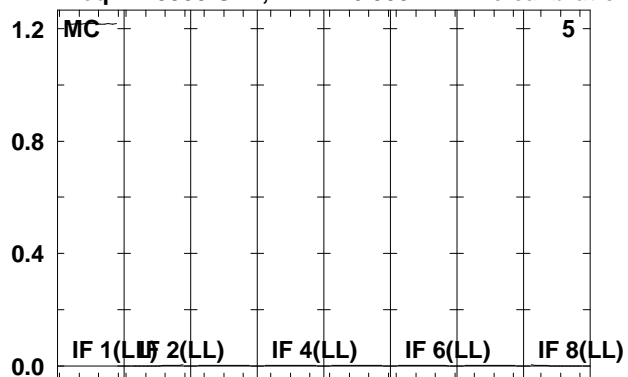

Lower frame: Kilo Real Jy  
 Total-power spectrum Antenna: \*  
 Timerange: 00/19:16:19 to 00/19:18:15

Plot file version 35 created 20-AUG-2009 14:59:34  
 3C345 EG040B.UVDATA.1  
 Freq = 1.5955 GHz, Bw = 16.000 MH No calibration applied and no bandpass applied

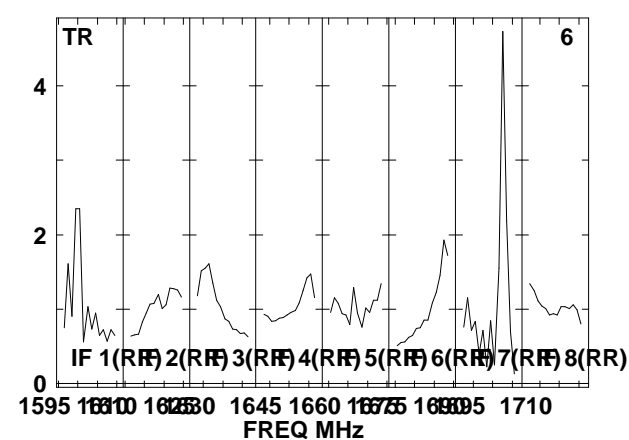
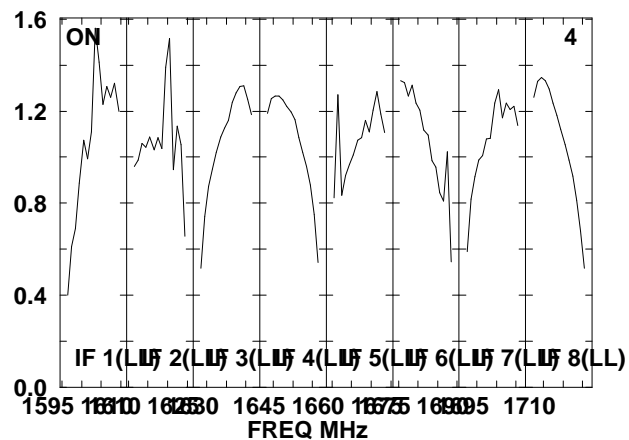
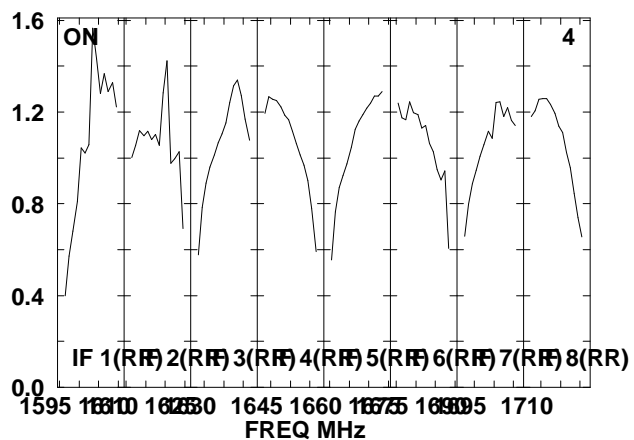
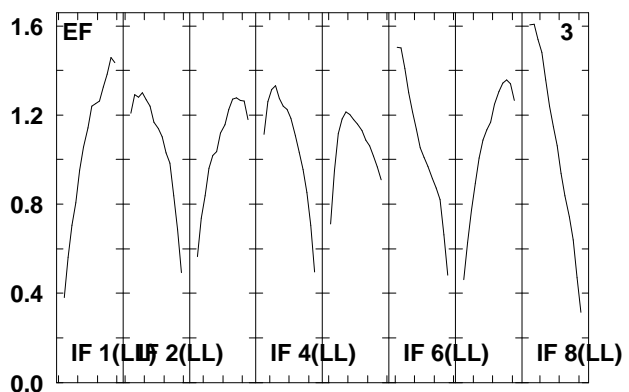
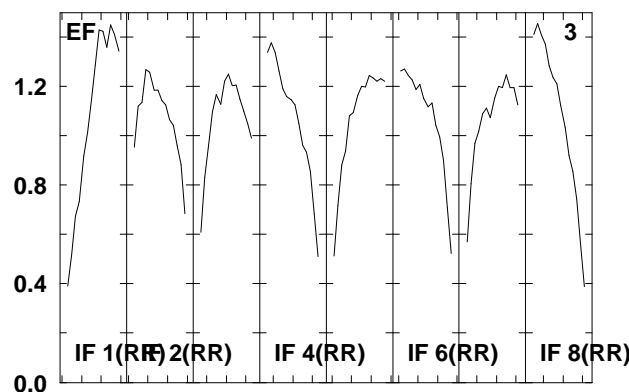
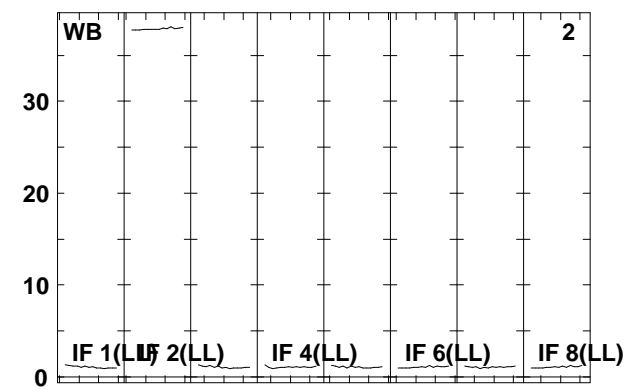
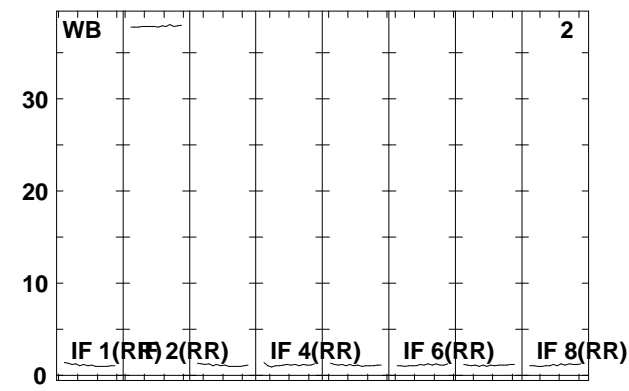
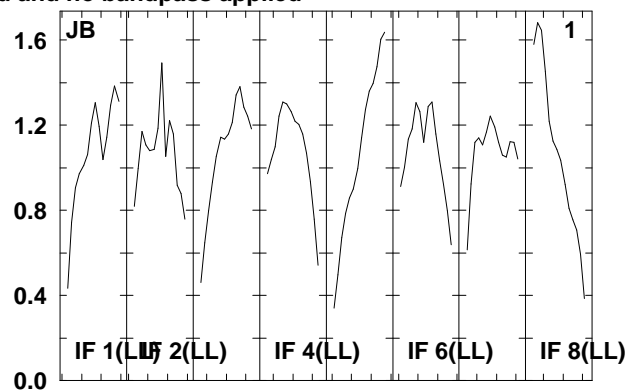
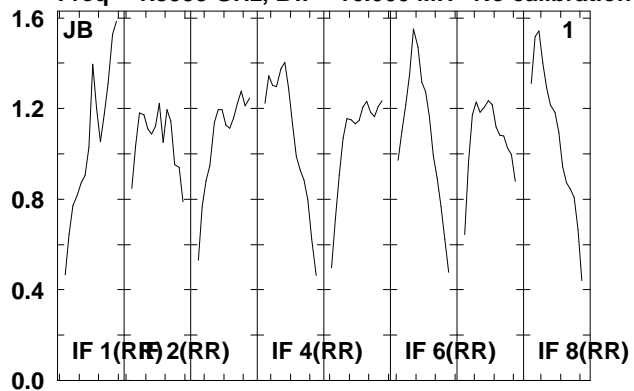

Lower frame: Real Jy  
 Total-power spectrum Antenna: \*  
 Timerange: 00/19:21:49 to 00/19:30:57

Plot file version 36 created 20-AUG-2009 14:59:35

3C345 EG040B.UVDATA.1

Freq = 1.5955 GHz, Bw = 16.000 MH No calibration applied and no bandpass applied

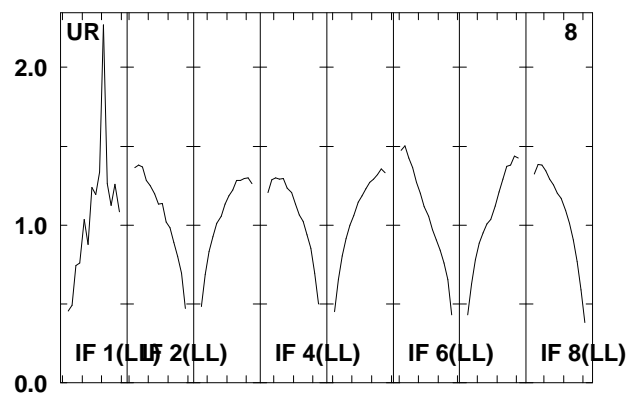
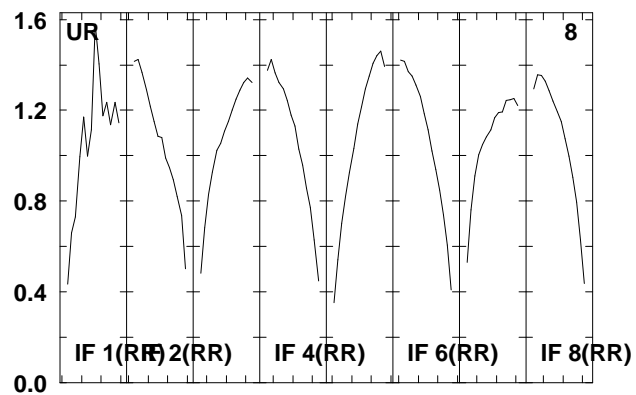
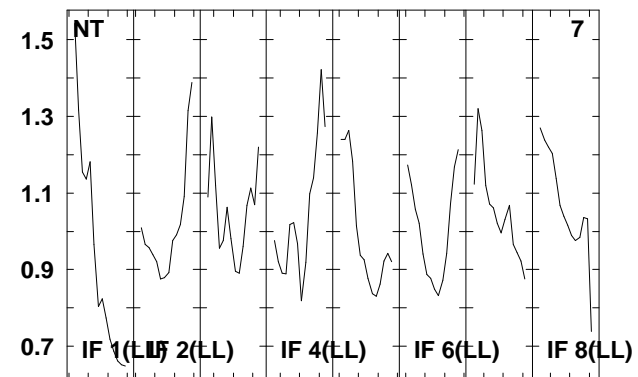
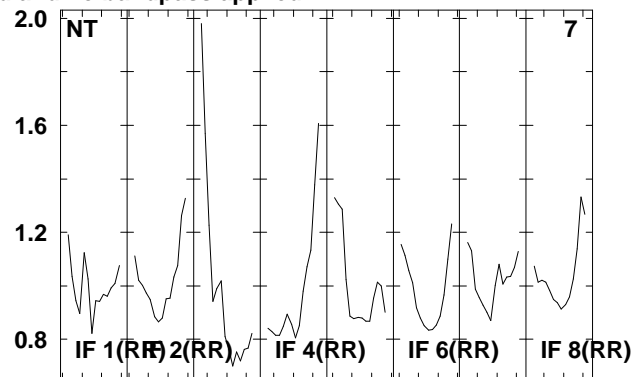
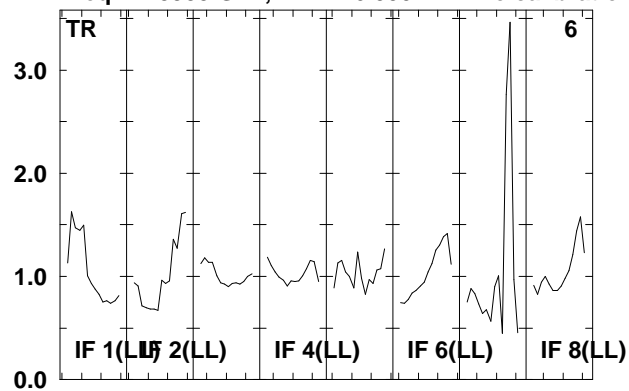

Lower frame: Real Jy  
Total-power spectrum Antenna: \*  
Timerange: 00/19:21:49 to 00/19:30:57

Plot file version 37 created 20-AUG-2009 14:59:35

J1016+20 EG040B.UVDATA.1

Freq = 1.5955 GHz, Bw = 16.000 MH No calibration applied and no bandpass applied

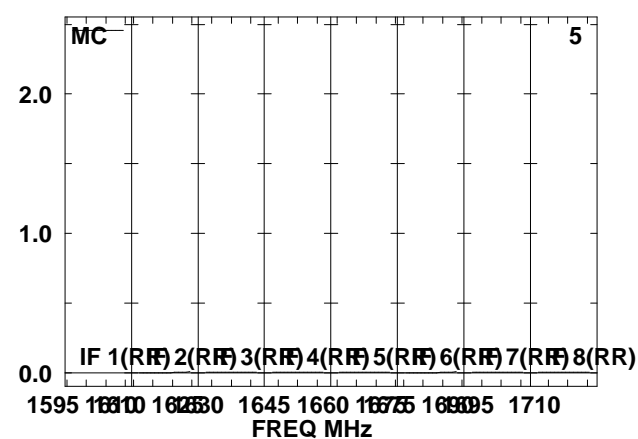
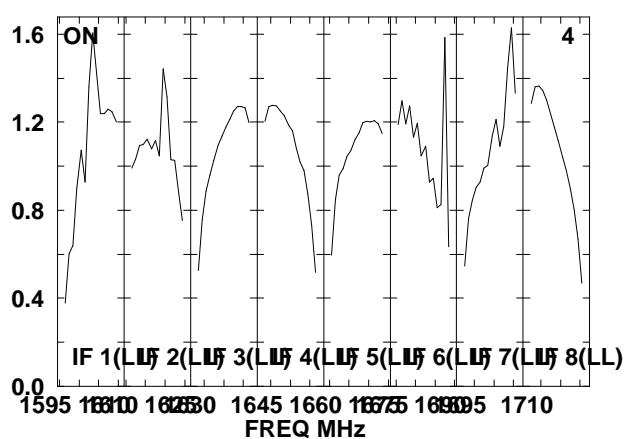
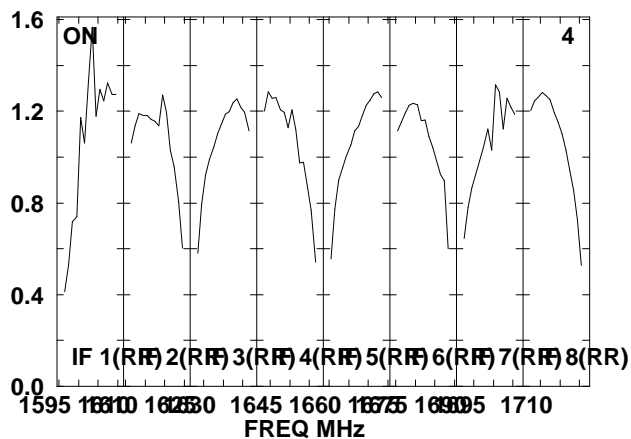
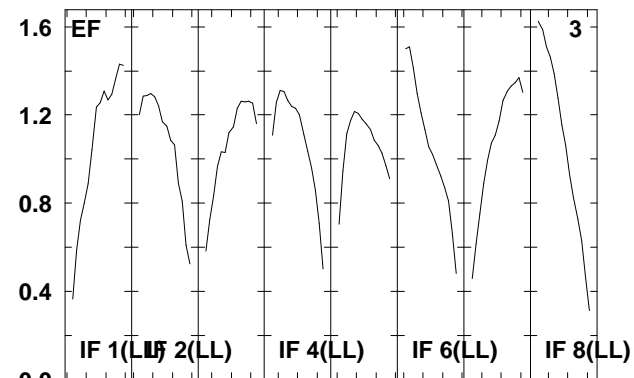
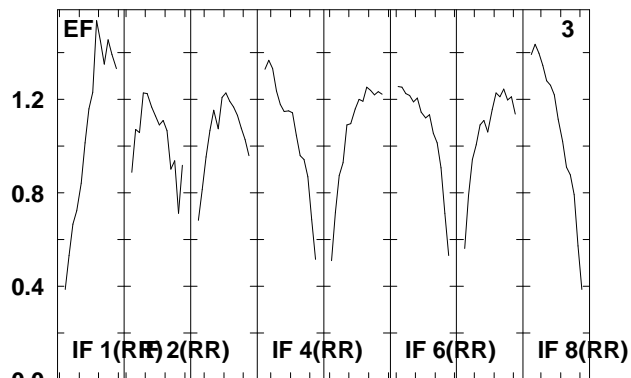
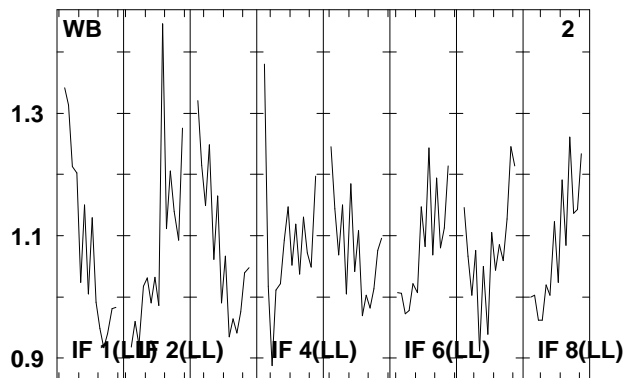
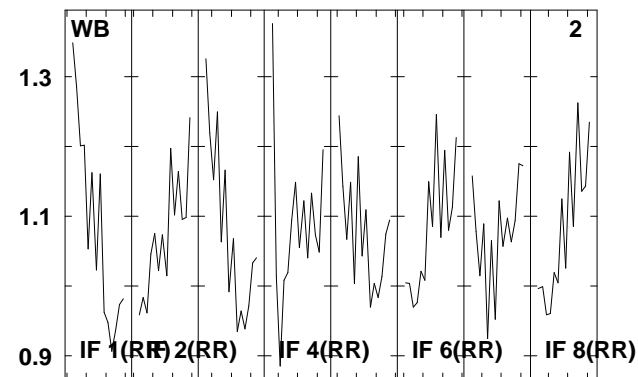
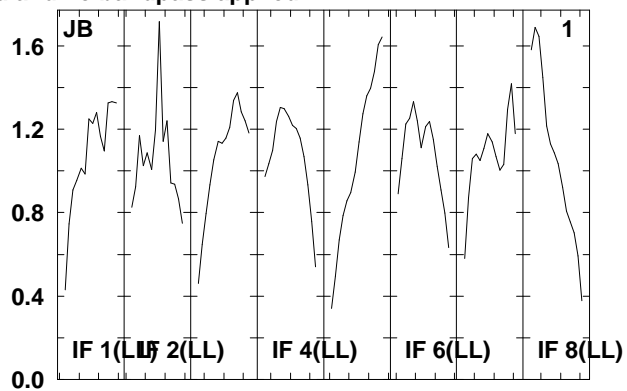
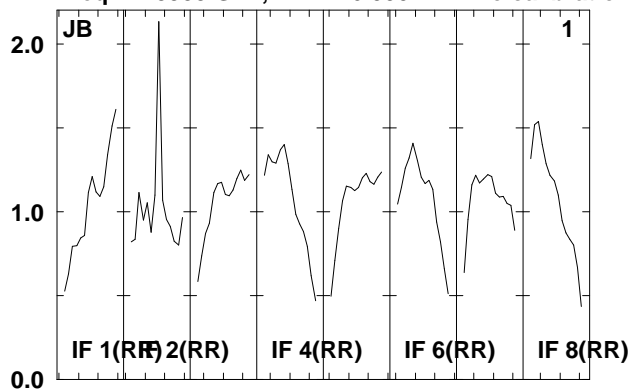

Lower frame: Real Jy  
Total-power spectrum Antenna: \*  
Timerange: 00/19:41:33 to 00/19:43:09

Plot file version 38 created 20-AUG-2009 14:59:35

J1016+20 EG040B.UVDATA.1

Freq = 1.5955 GHz, Bw = 16.000 MH No calibration applied and no bandpass applied

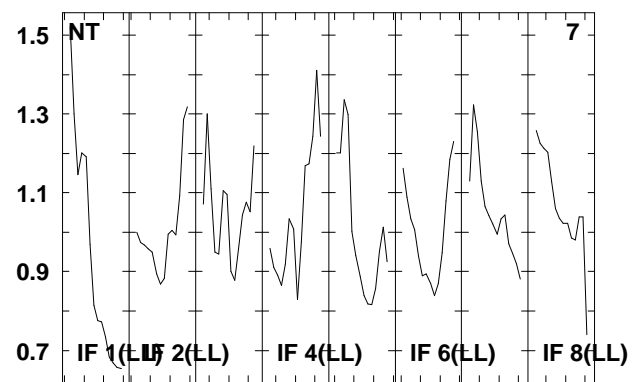
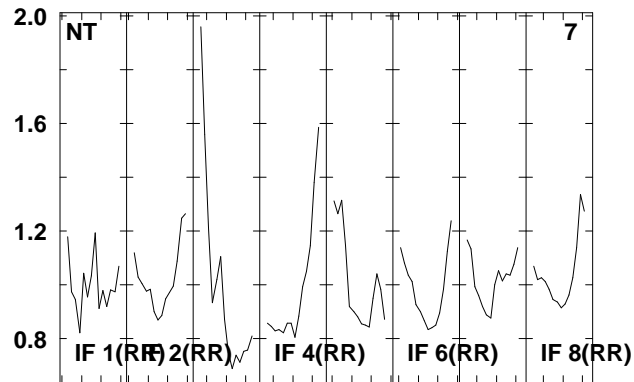
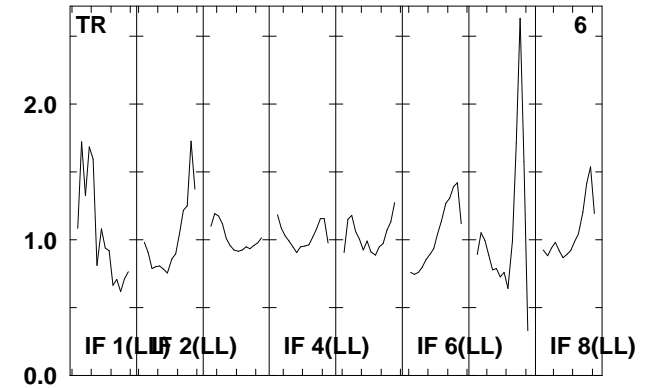
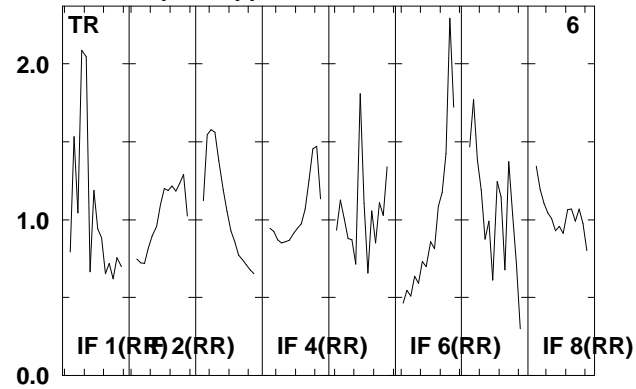
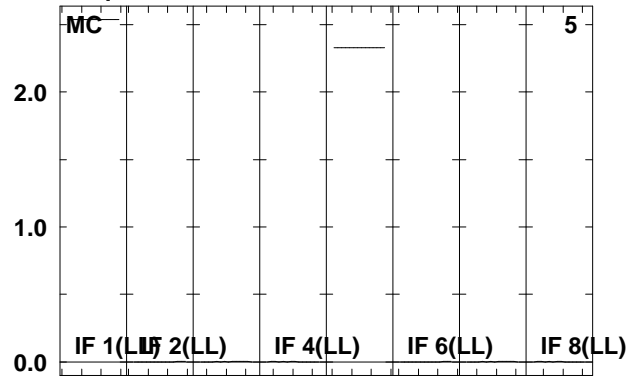

Lower frame: Kilo Real Jy  
Total-power spectrum Antenna: \*  
Timerange: 00/19:41:33 to 00/19:43:09

Plot file version 39 created 20-AUG-2009 14:59:36

NGC3227 EG040B.UVDATA.1

Freq = 1.5955 GHz, Bw = 16.000 MH No calibration applied and no bandpass applied

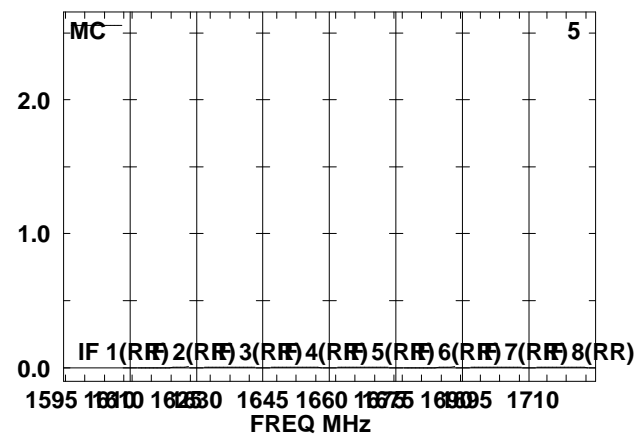
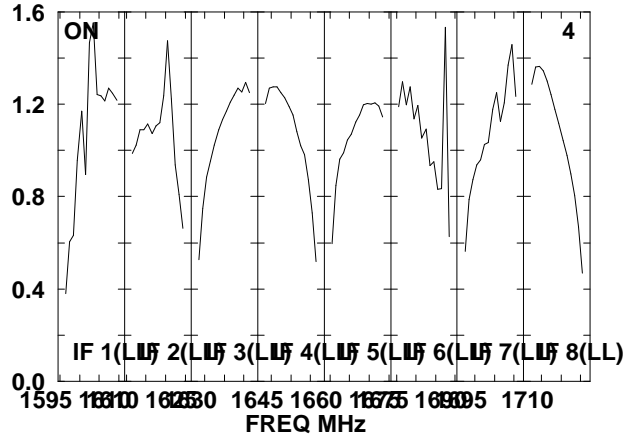
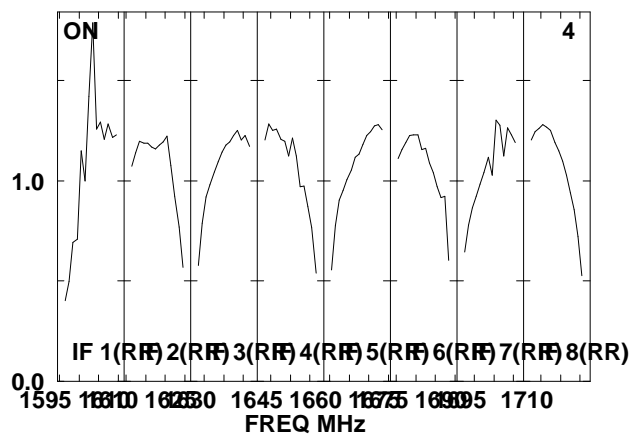
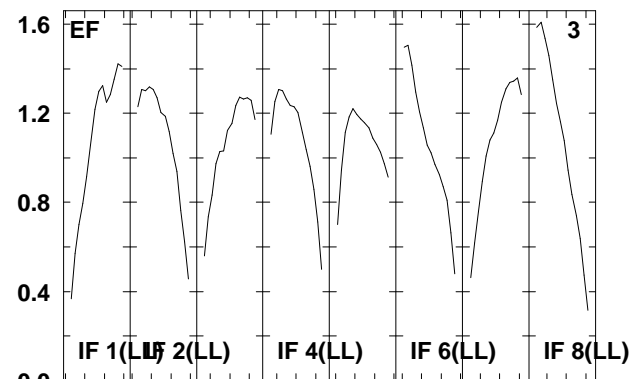
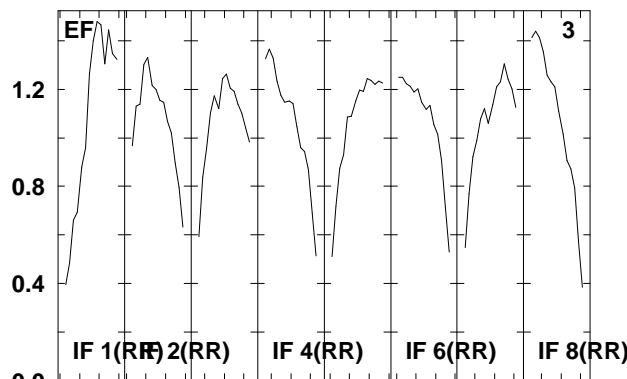
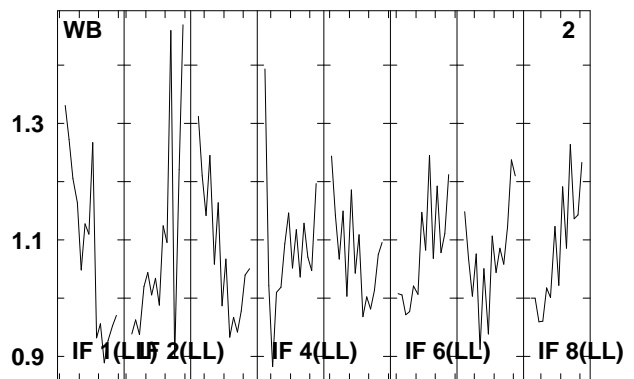
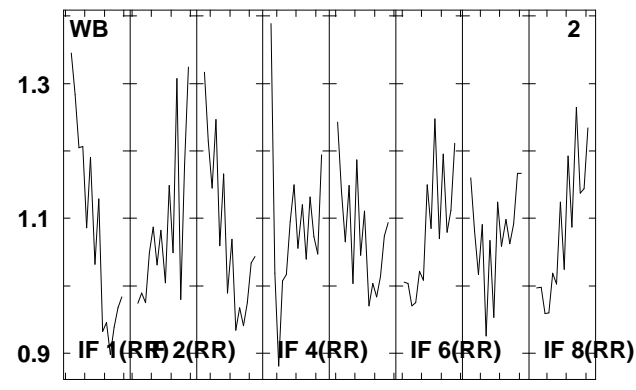
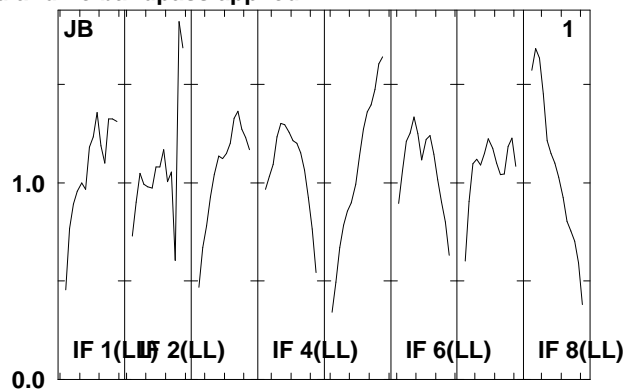
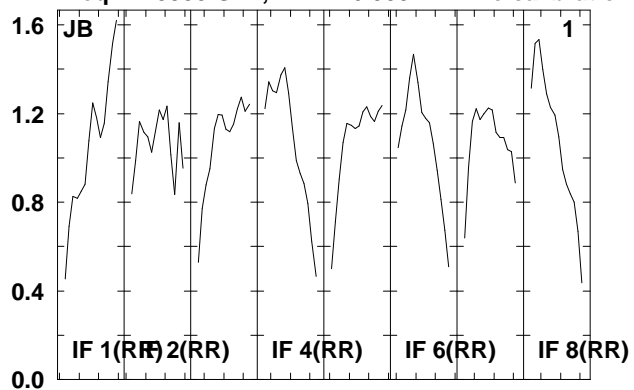

Lower frame: Real Jy  
Total-power spectrum Antenna: \*  
Timerange: 00/19:43:17 to 00/19:47:01

Plot file version 40 created 20-AUG-2009 14:59:36

NGC3227 EG040B.UVDATA.1

Freq = 1.5955 GHz, Bw = 16.000 MH No calibration applied and no bandpass applied

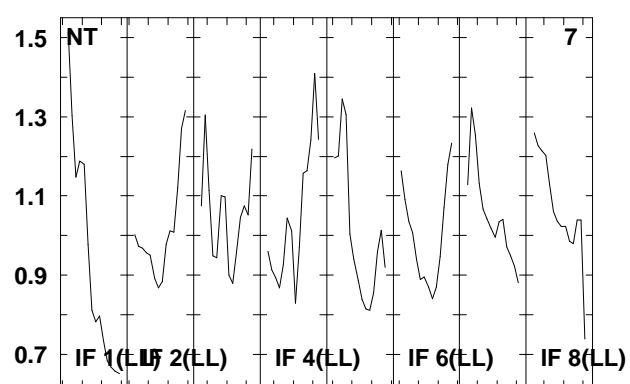
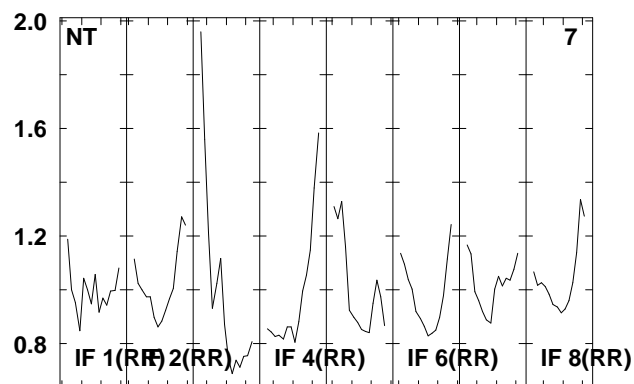
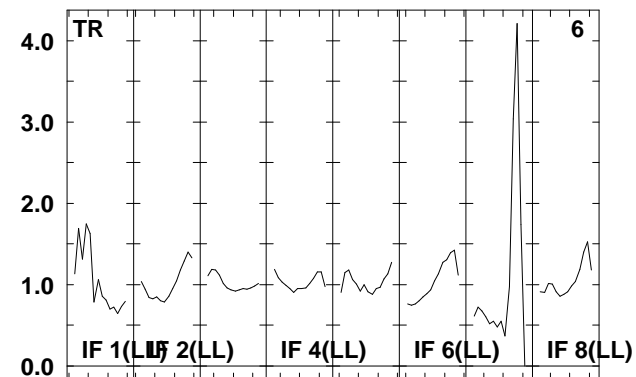
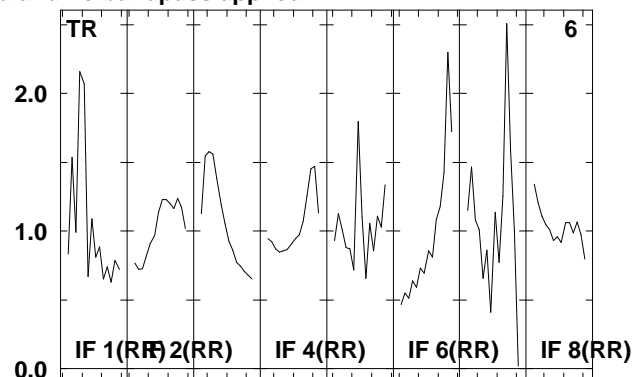
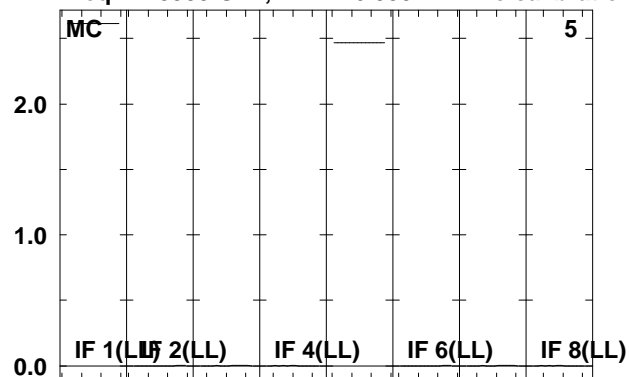

Lower frame: Kilo Real Jy  
Total-power spectrum Antenna: \*  
Timerange: 00/19:43:17 to 00/19:47:01



Plot file version 41 created 20-AUG-2009 14:59:36

J1016+20 EG040B.UVDATA.1

Freq = 1.5955 GHz, Bw = 16.000 MH No calibration applied and no bandpass applied

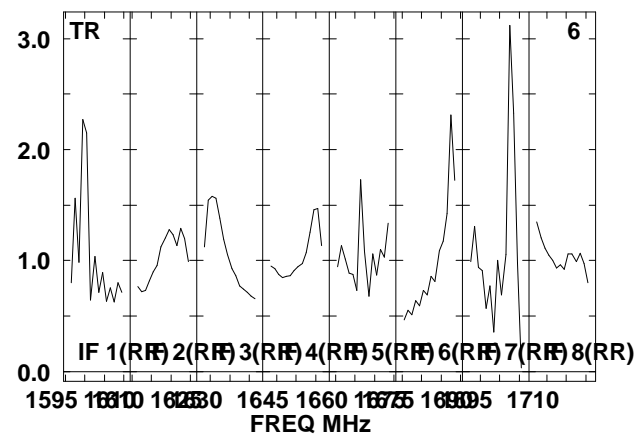
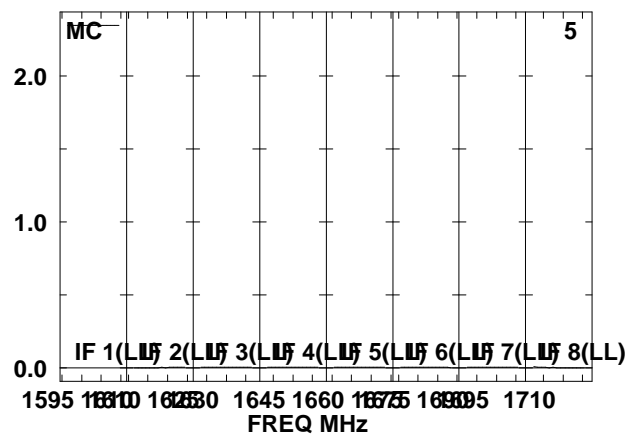
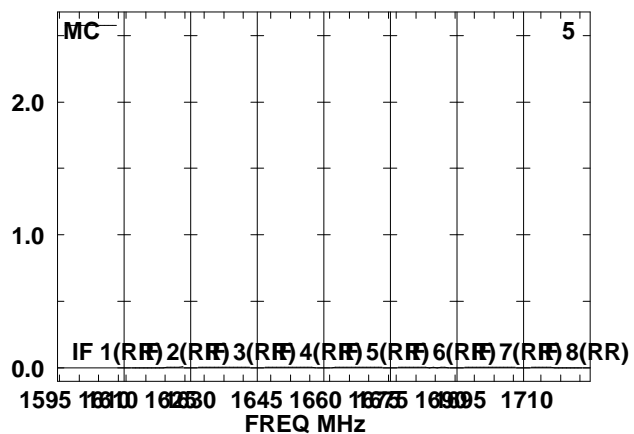
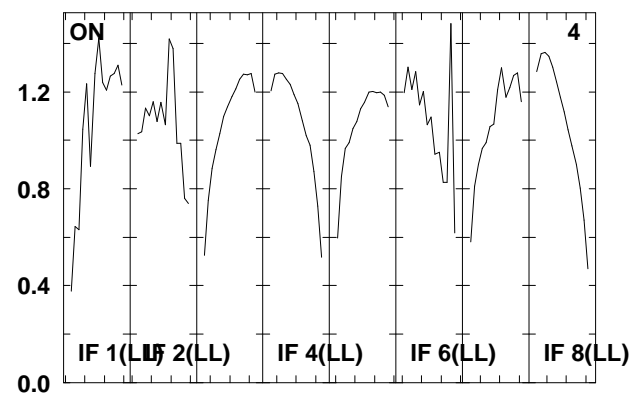
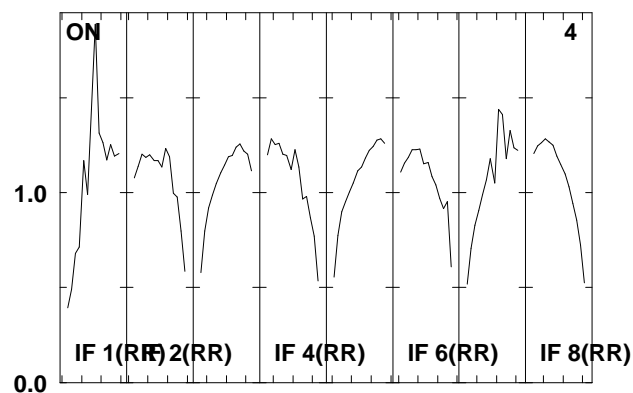
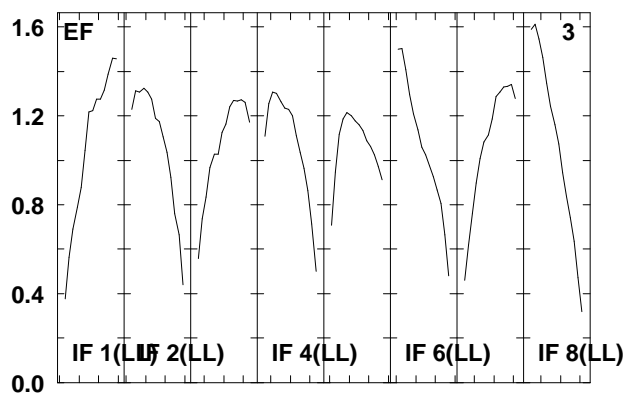
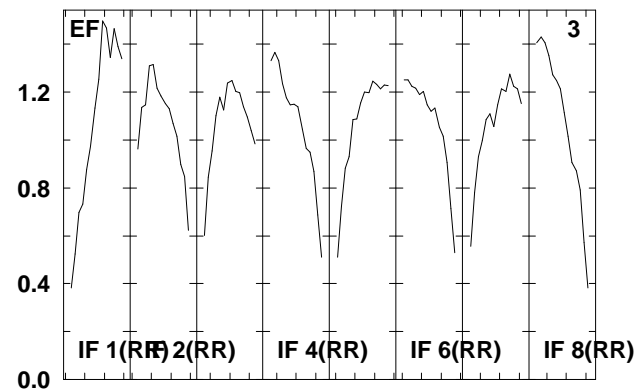
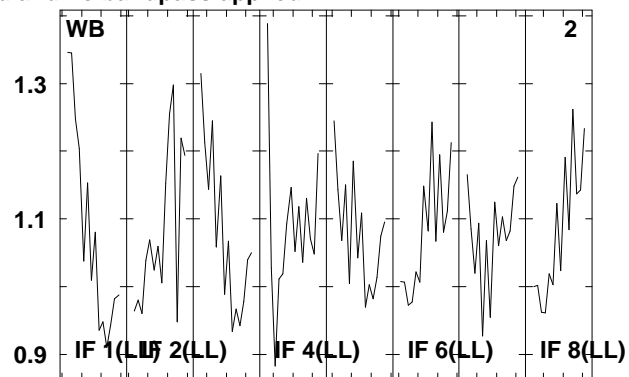
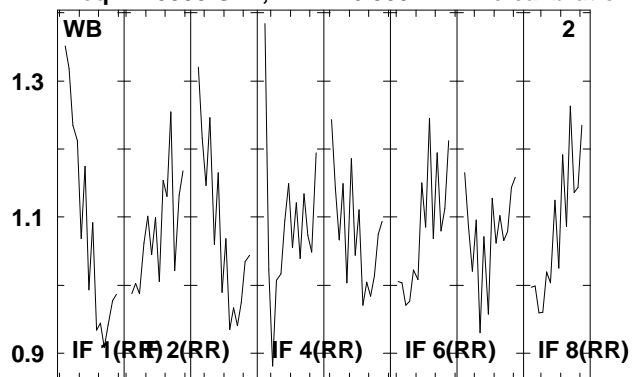

Lower frame: Real Jy  
Total-power spectrum Antenna: \*  
Timerange: 00/19:47:35 to 00/19:49:01

Plot file version 42 created 20-AUG-2009 14:59:37

J1016+20 EG040B.UVDATA.1

Freq = 1.5955 GHz, Bw = 16.000 MH No calibration applied and no bandpass applied

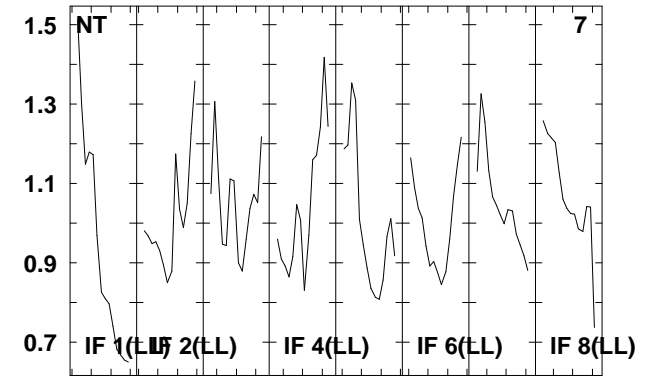
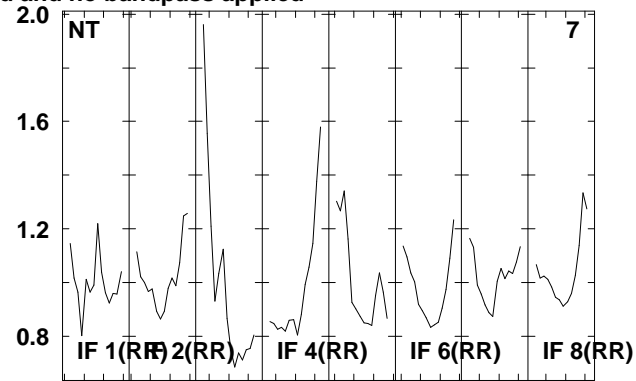
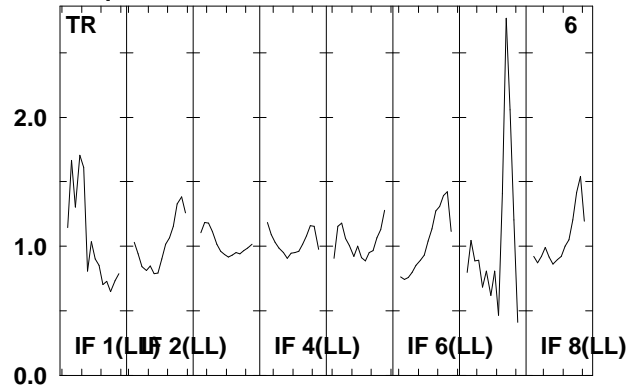

Lower frame: Real Jy  
Total-power spectrum Antenna: \*  
Timerange: 00/19:47:35 to 00/19:49:01

Plot file version 43 created 20-AUG-2009 14:59:37

NGC3227 EG040B.UVDATA.1

Freq = 1.5955 GHz, Bw = 16.000 MH No calibration applied and no bandpass applied

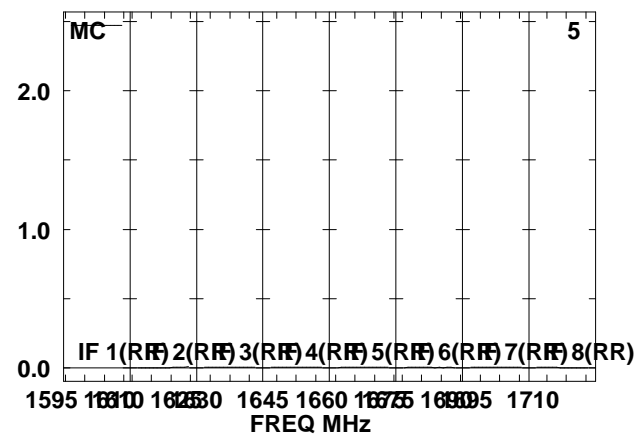
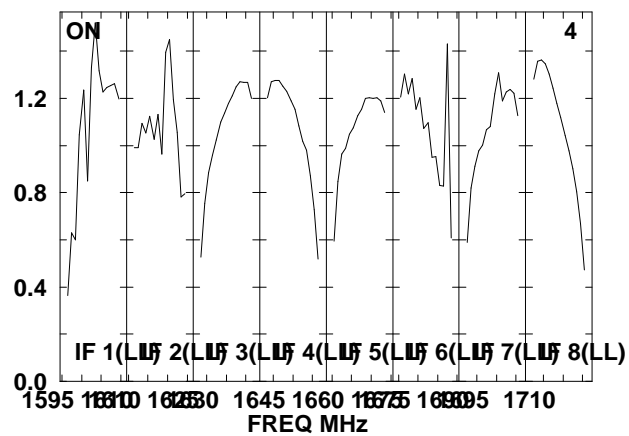
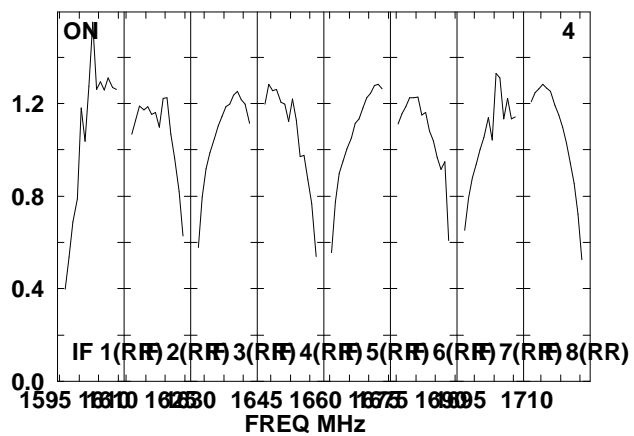
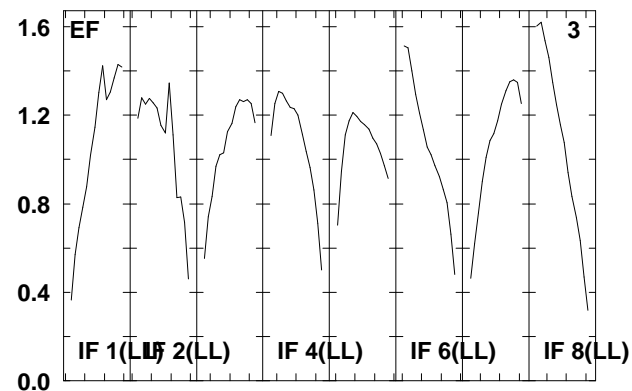
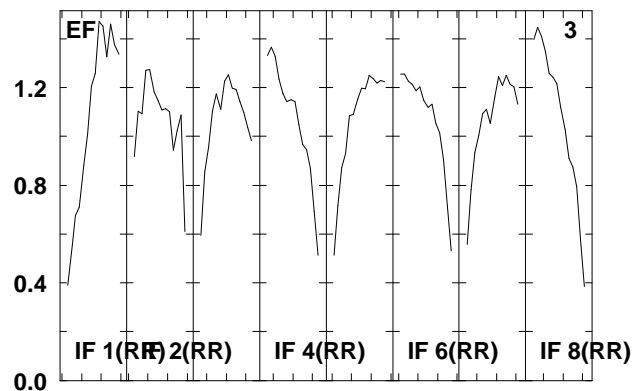
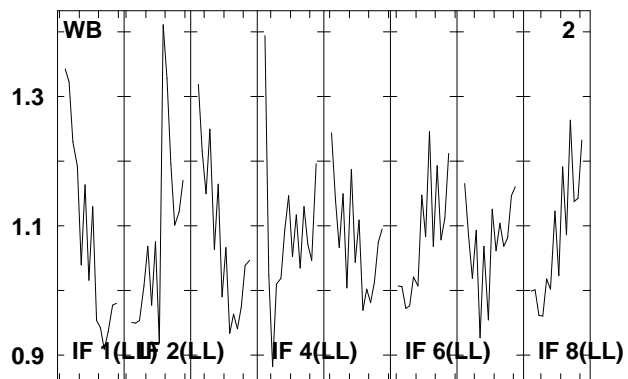
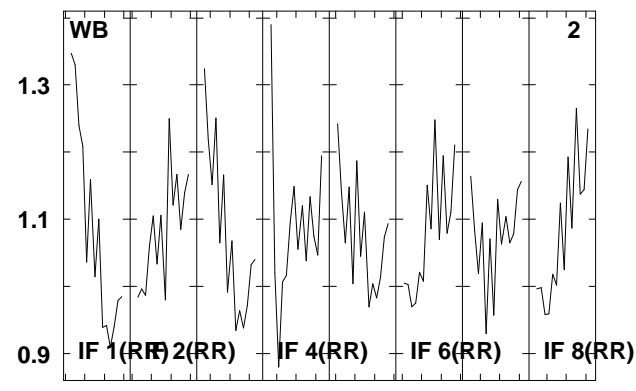
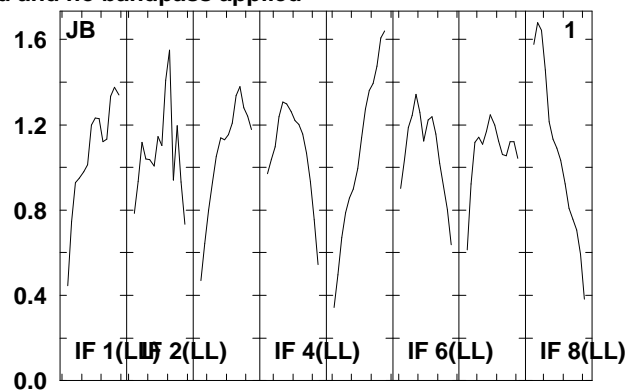
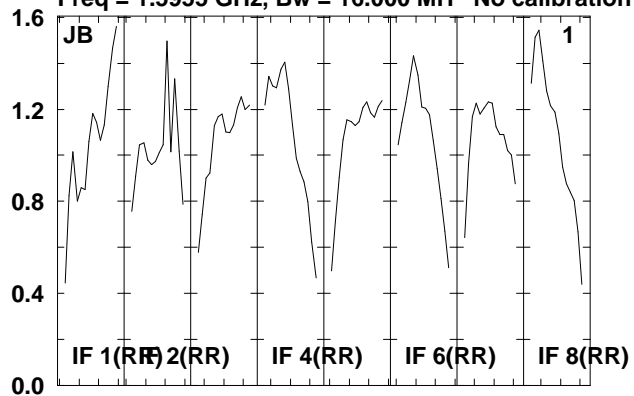

Lower frame: Real Jy  
Total-power spectrum Antenna: \*  
Timerange: 00/19:49:05 to 00/19:52:53

Plot file version 44 created 20-AUG-2009 14:59:37

NGC3227 EG040B.UVDATA.1

Freq = 1.5955 GHz, Bw = 16.000 MH No calibration applied and no bandpass applied

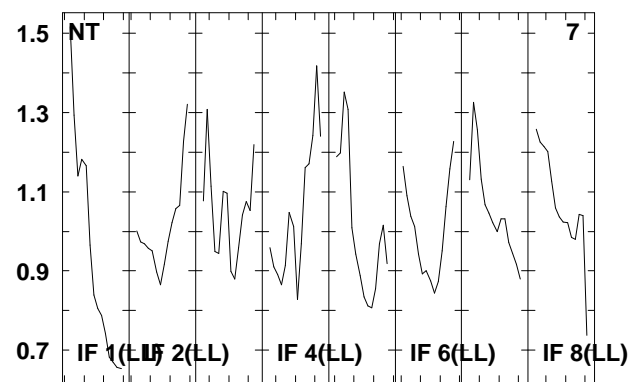
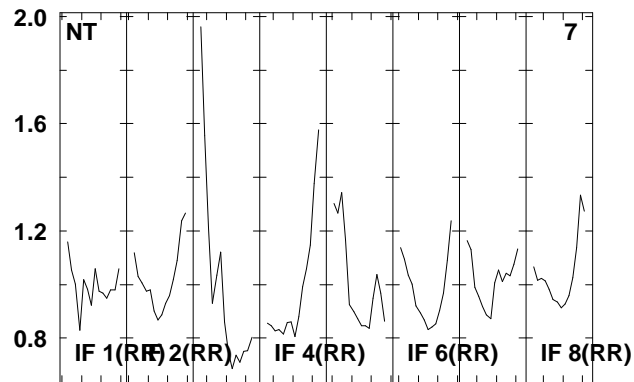
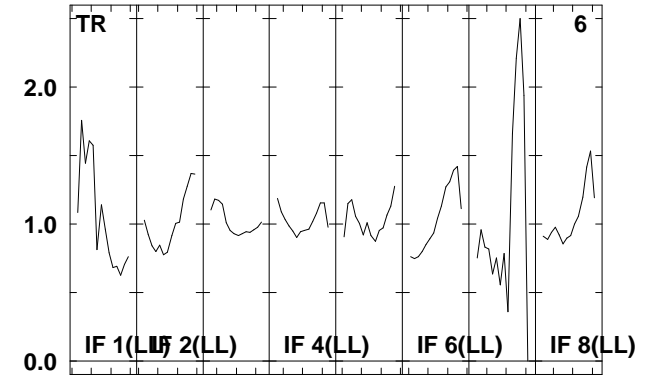
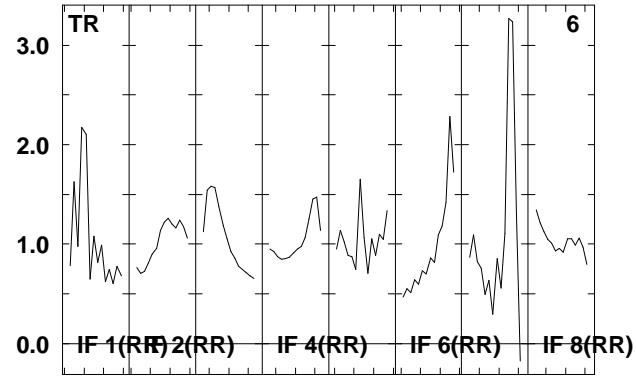
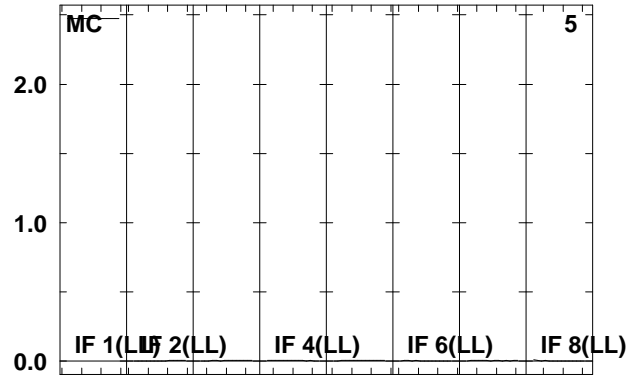

Lower frame: Kilo Real Jy  
Total-power spectrum Antenna: \*  
Timerange: 00/19:49:05 to 00/19:52:53

Plot file version 45 created 20-AUG-2009 14:59:37

J1016+20 EG040B.UVDATA.1

Freq = 1.5955 GHz, Bw = 16.000 MH No calibration applied and no bandpass applied

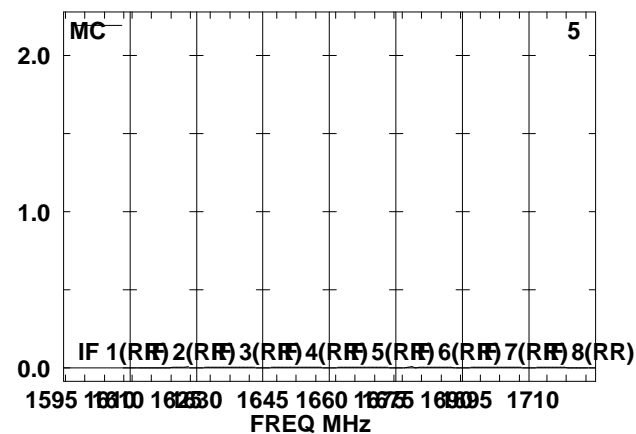
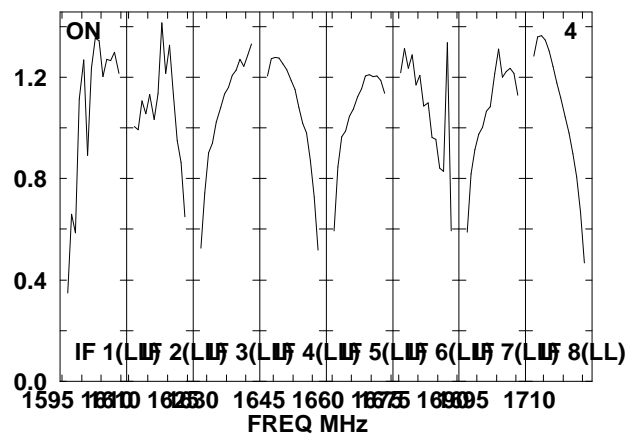
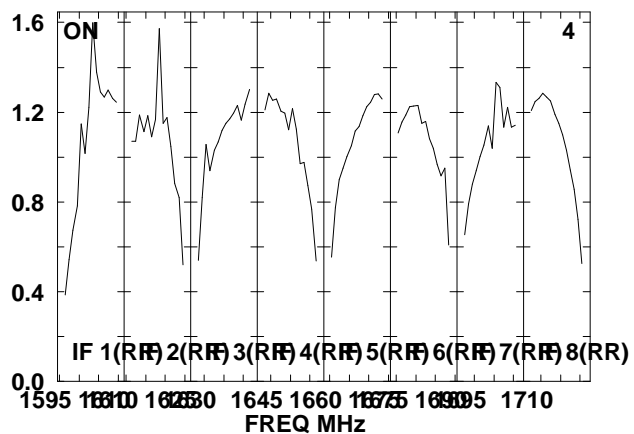
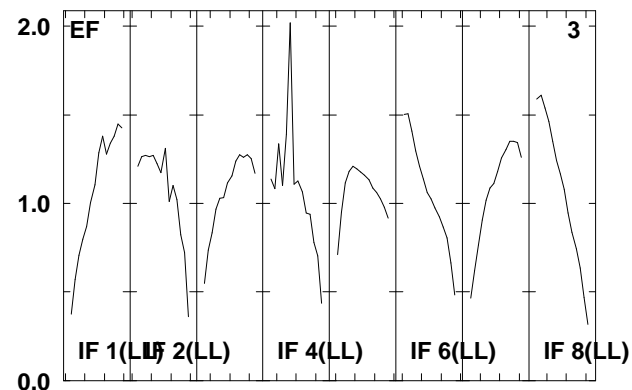
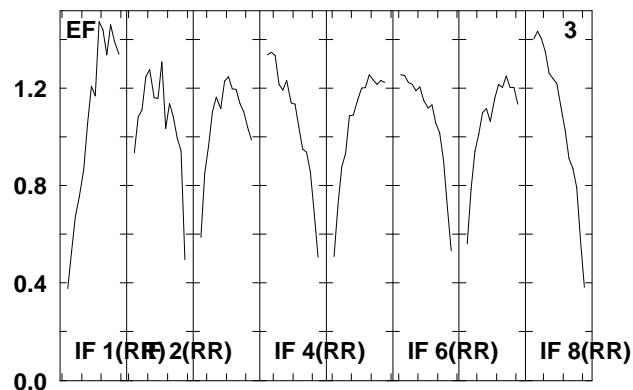
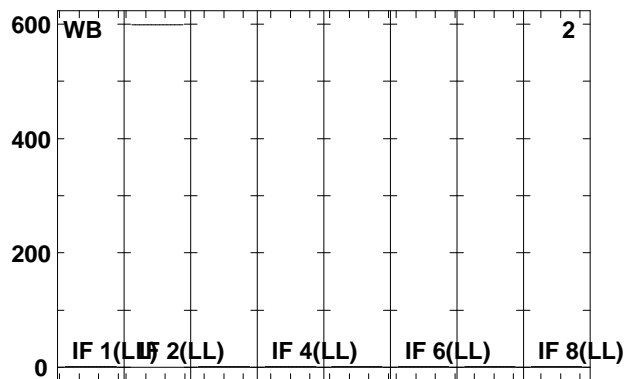
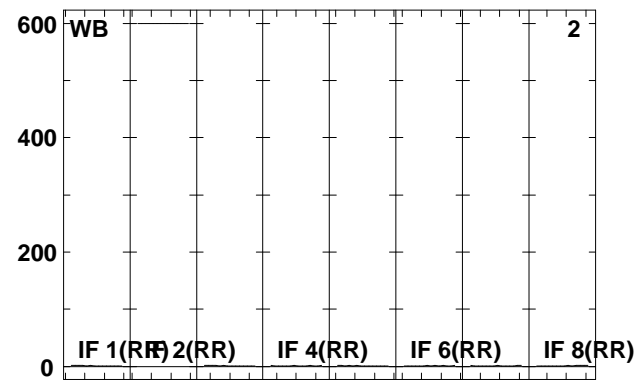
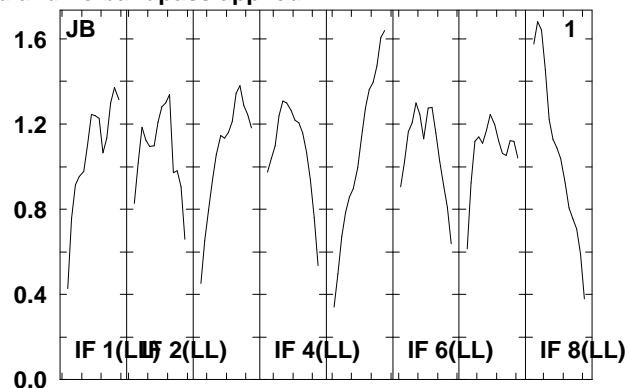
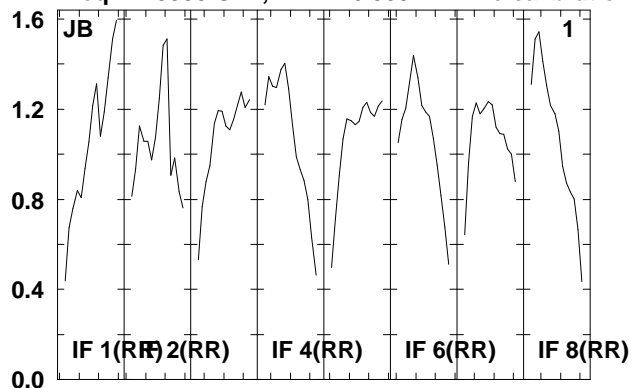

Lower frame: Real Jy  
Total-power spectrum Antenna: \*  
Timerange: 00/19:52:55 to 00/19:54:53

Plot file version 46 created 20-AUG-2009 14:59:38

J1016+20 EG040B.UVDATA.1

Freq = 1.5955 GHz, Bw = 16.000 MH No calibration applied and no bandpass applied

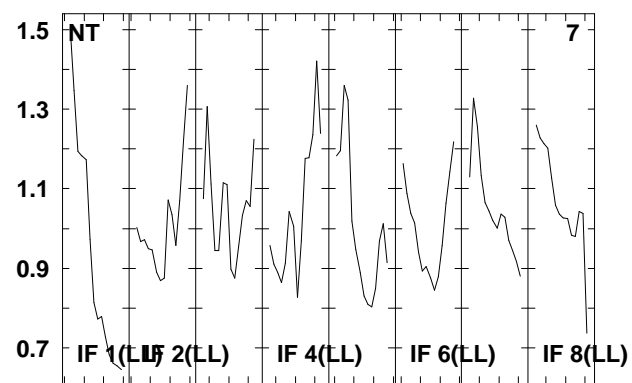
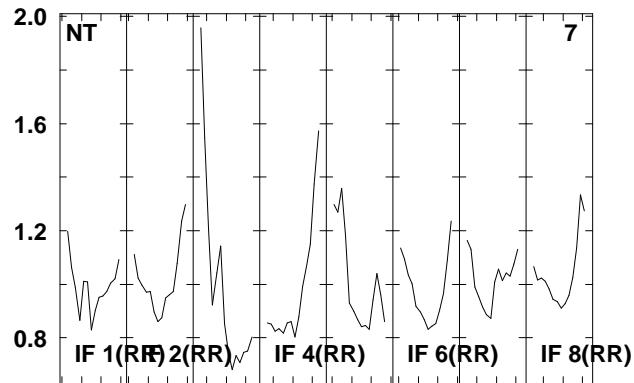
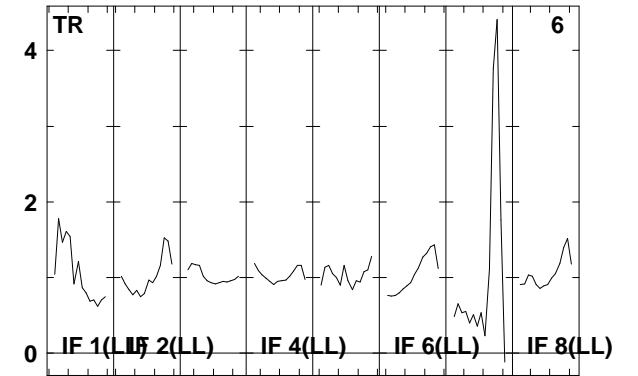
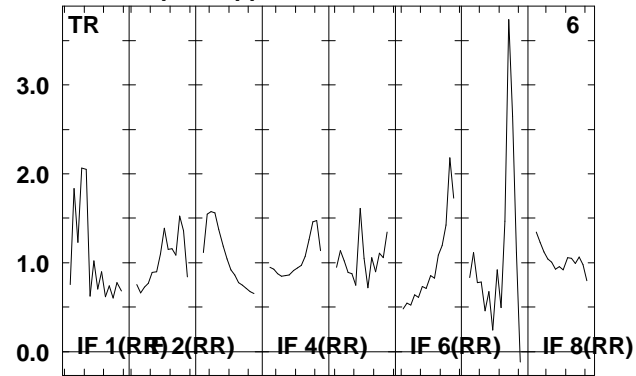
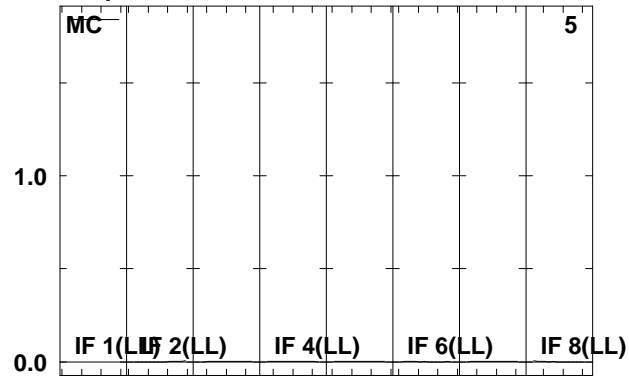

Lower frame: Kilo Real Jy  
Total-power spectrum Antenna: \*  
Timerange: 00/19:52:55 to 00/19:54:53

Plot file version 47 created 20-AUG-2009 14:59:38

NGC3227 EG040B.UVDATA.1

Freq = 1.5955 GHz, Bw = 16.000 MH No calibration applied and no bandpass applied

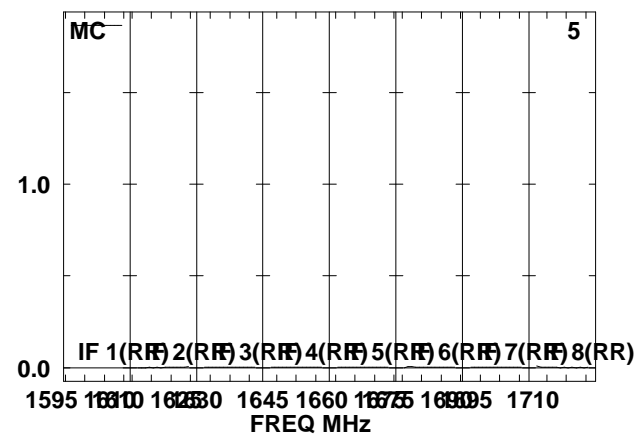
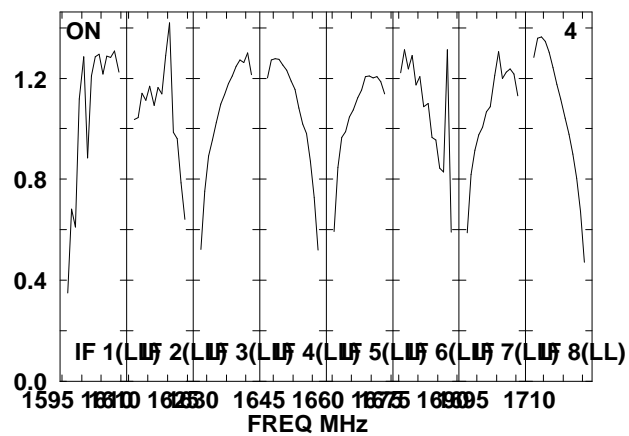
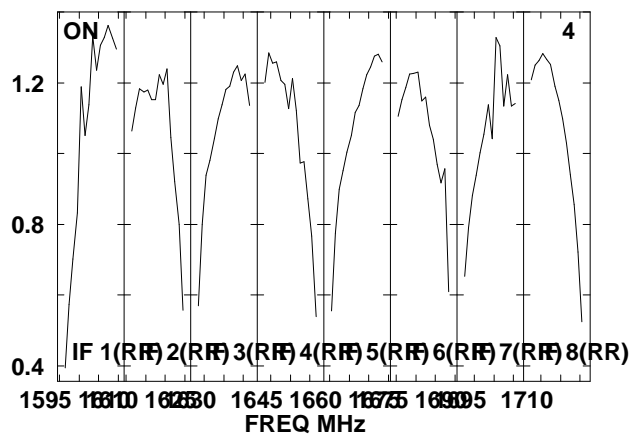
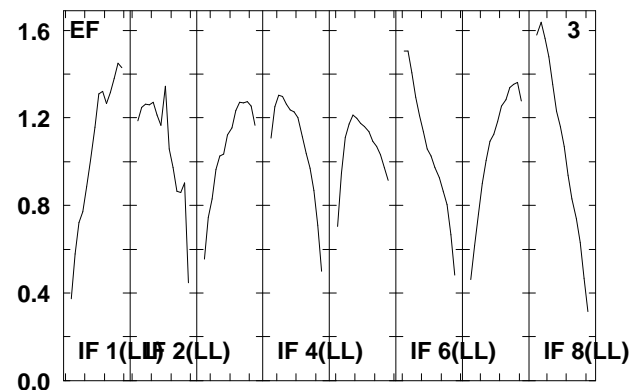
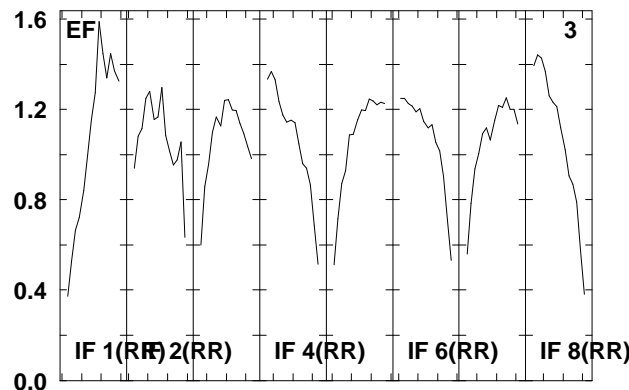
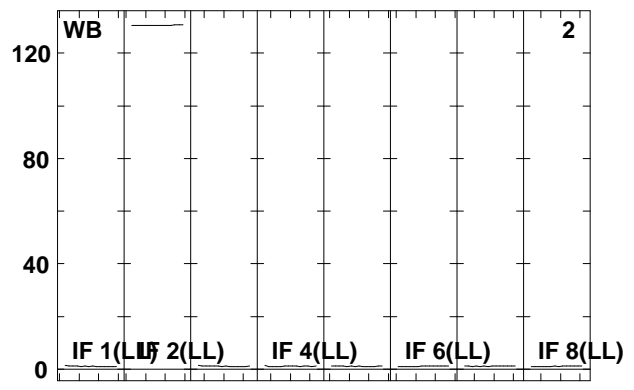
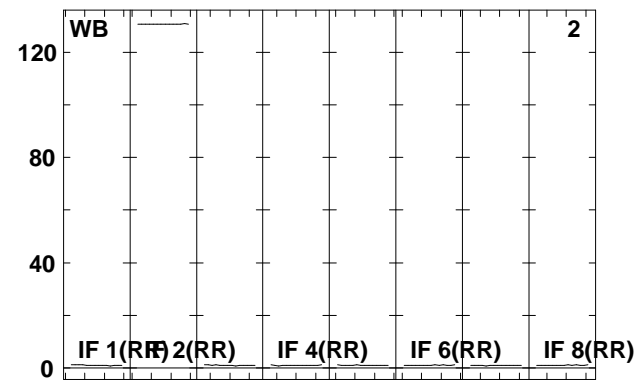
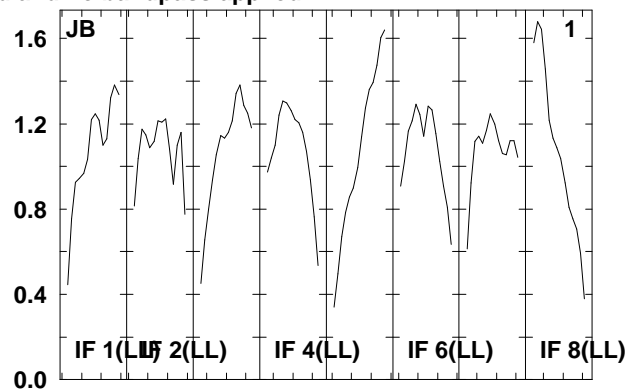
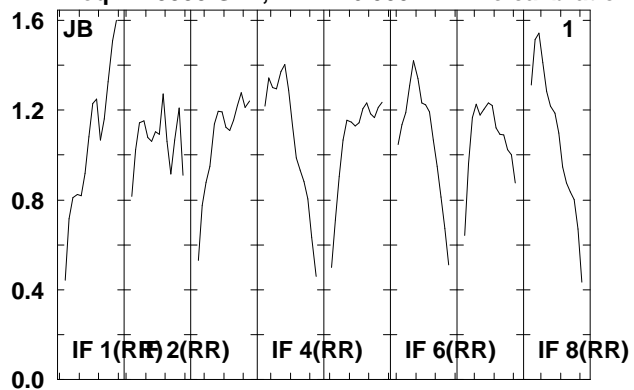

Lower frame: Real Jy  
Total-power spectrum Antenna: \*  
Timerange: 00/19:54:55 to 00/19:58:41

Plot file version 48 created 20-AUG-2009 14:59:38

NGC3227 EG040B.UVDATA.1

Freq = 1.5955 GHz, Bw = 16.000 MH No calibration applied and no bandpass applied

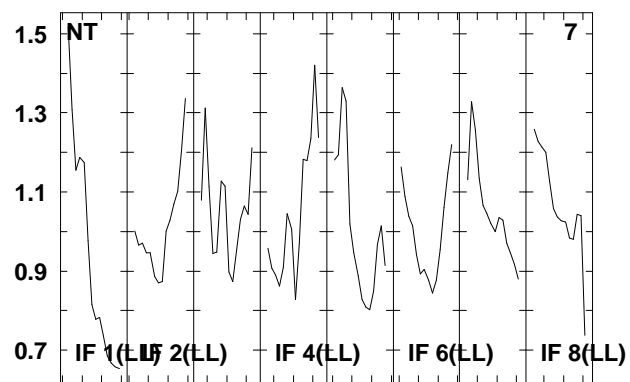
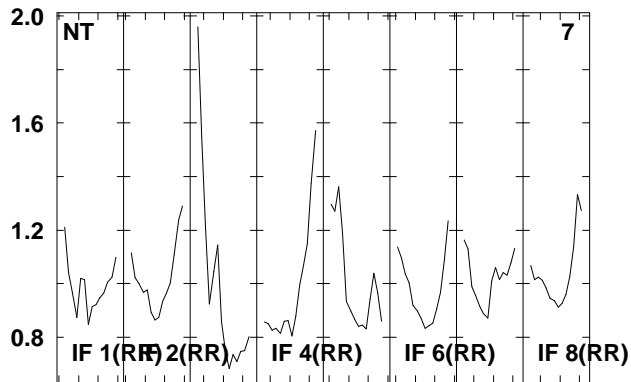
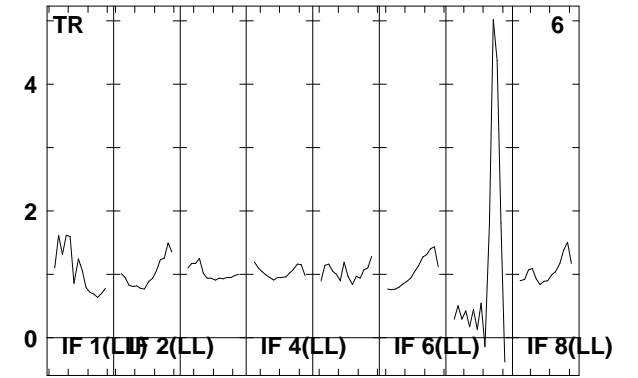
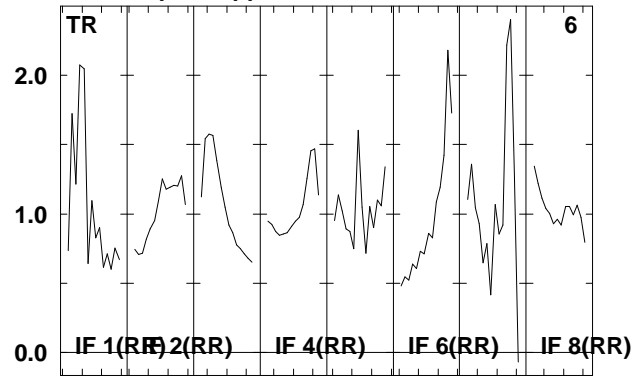
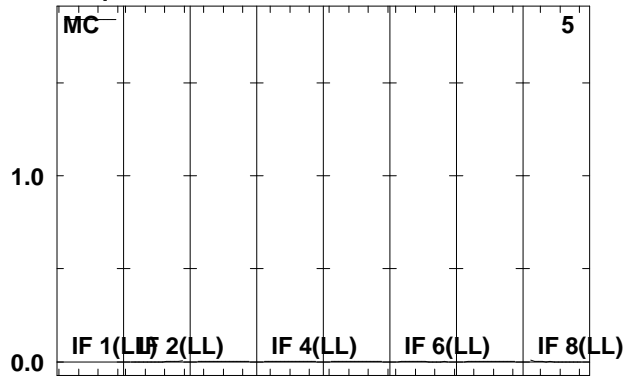

Lower frame: Kilo Real Jy  
Total-power spectrum Antenna: \*  
Timerange: 00/19:54:55 to 00/19:58:41



Plot file version 49 created 20-AUG-2009 14:59:39

J1016+20 EG040B.UVDATA.1

Freq = 1.5955 GHz, Bw = 16.000 MH No calibration applied and no bandpass applied

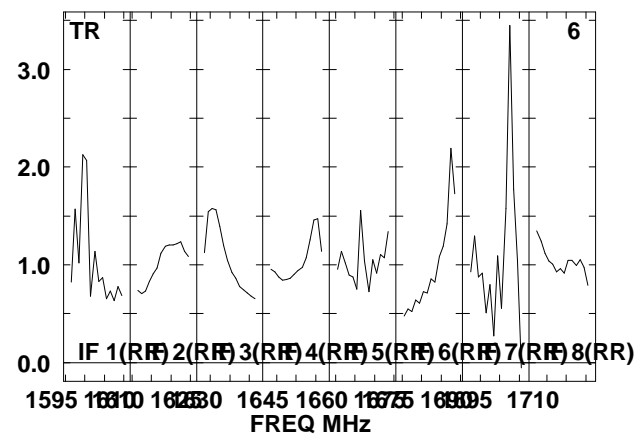
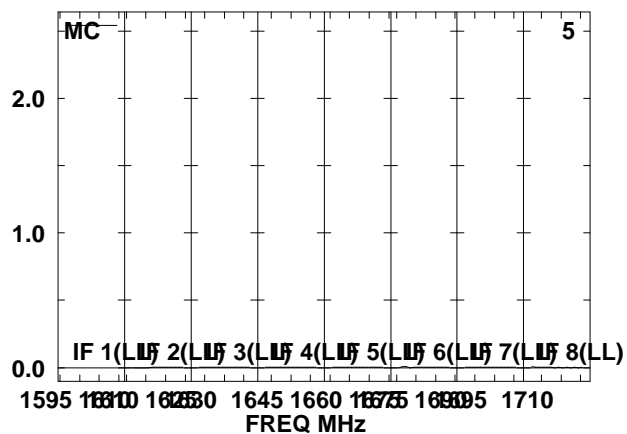
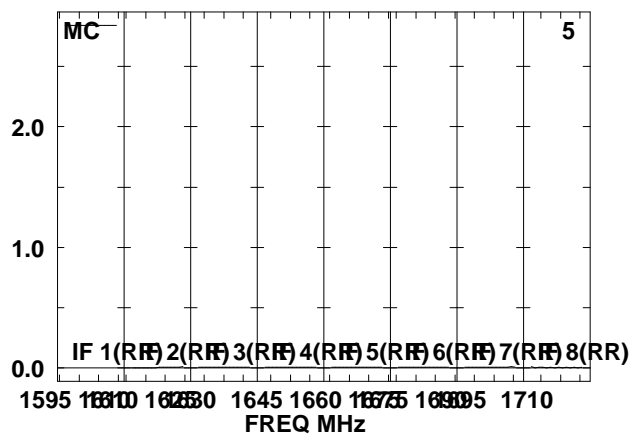
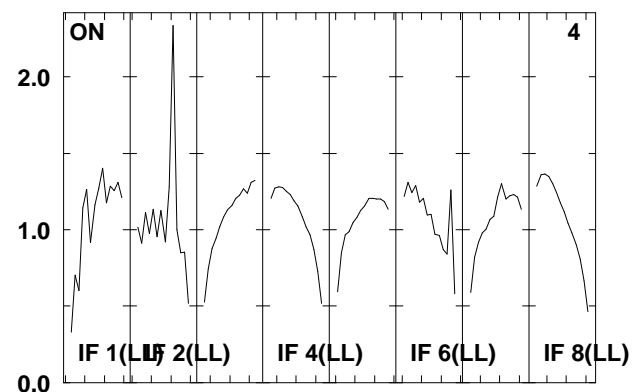
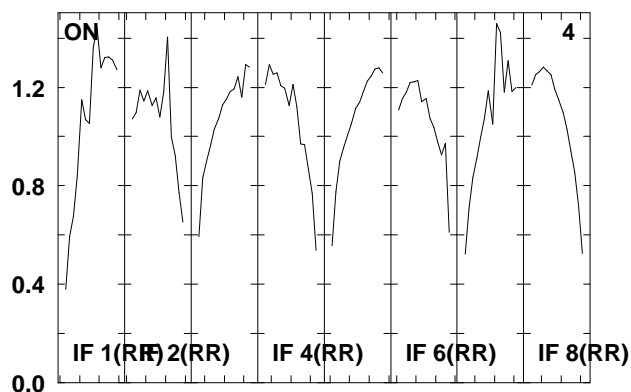
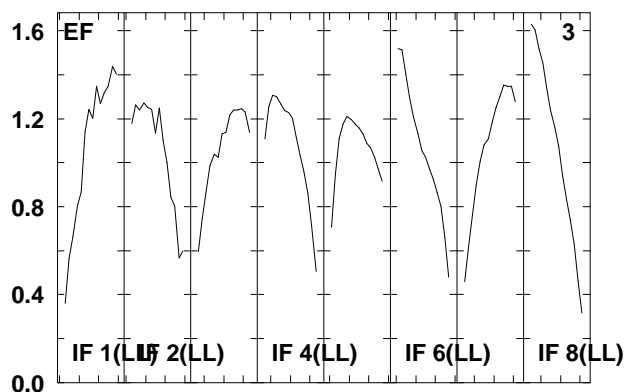
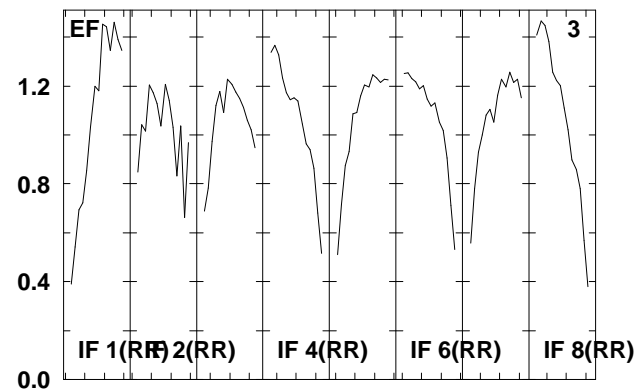
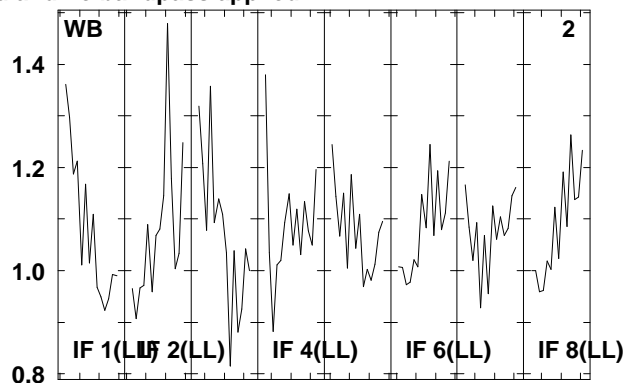
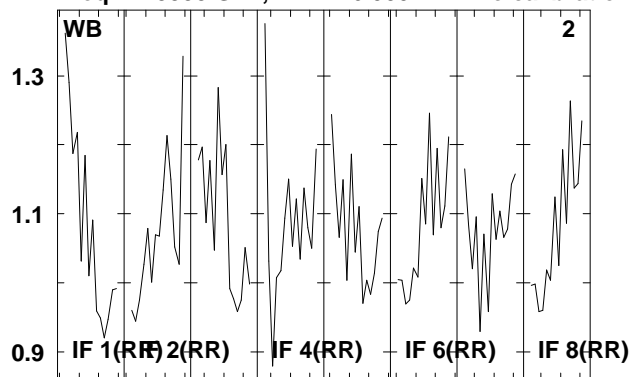

Lower frame: Real Jy  
Total-power spectrum Antenna: \*  
Timerange: 00/19:59:17 to 00/20:00:43

Plot file version 50 created 20-AUG-2009 14:59:39

J1016+20 EG040B.UVDATA.1

Freq = 1.5955 GHz, Bw = 16.000 MH No calibration applied and no bandpass applied

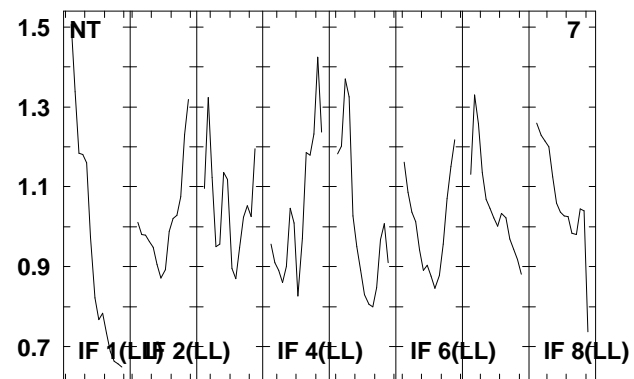
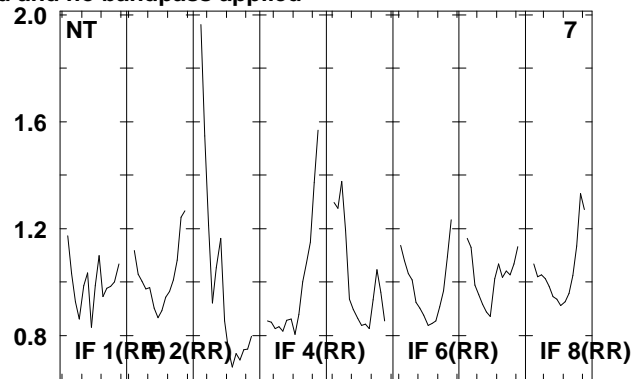
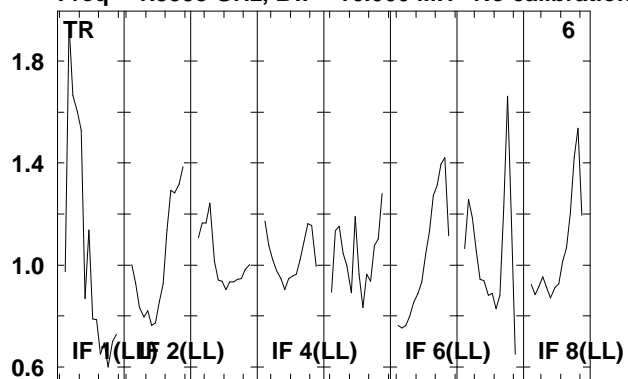

Lower frame: Real Jy  
Total-power spectrum Antenna: \*  
Timerange: 00/19:59:17 to 00/20:00:43

Plot file version 51 created 20-AUG-2009 14:59:39

NGC3227 EG040B.UVDATA.1

Freq = 1.5955 GHz, Bw = 16.000 MH No calibration applied and no bandpass applied

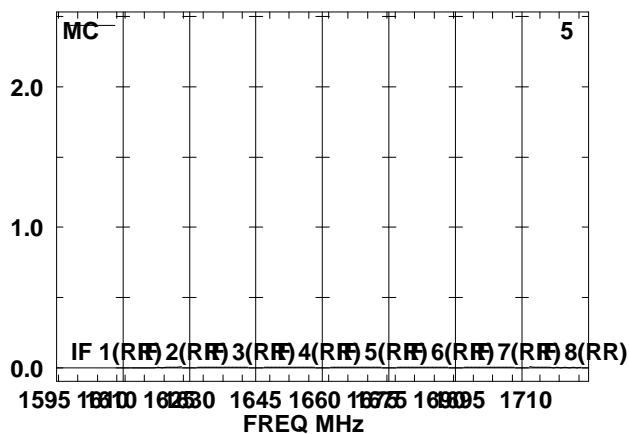
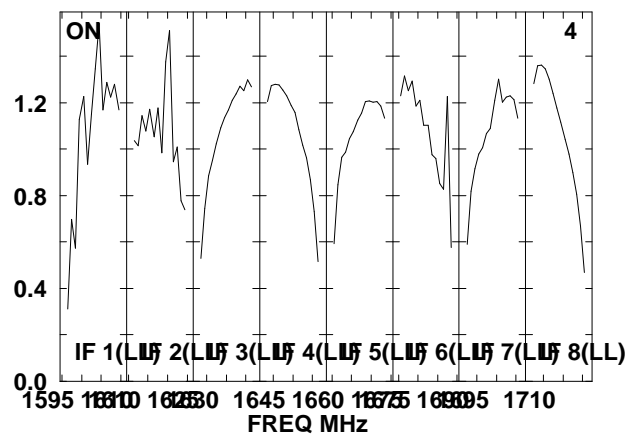
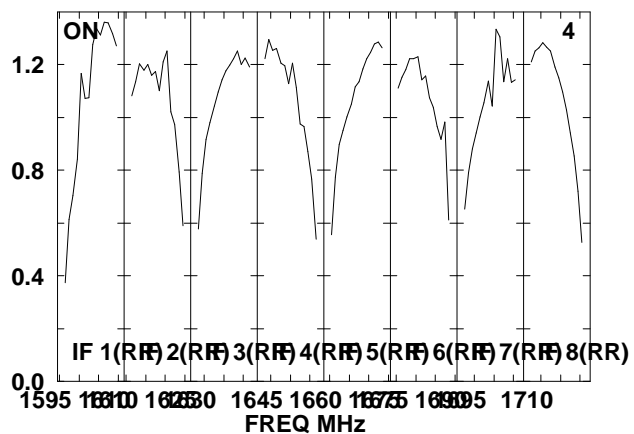
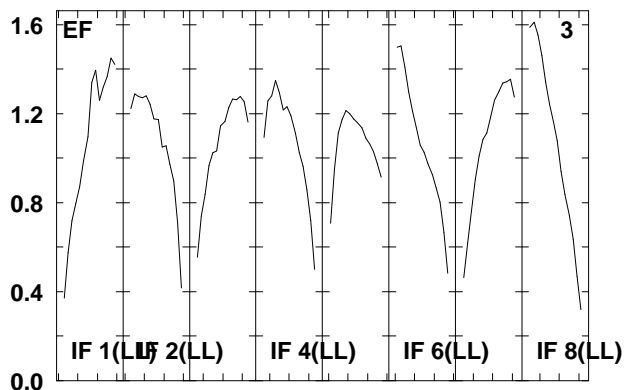
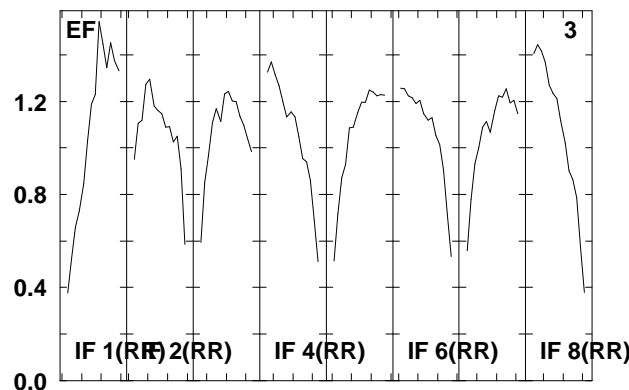
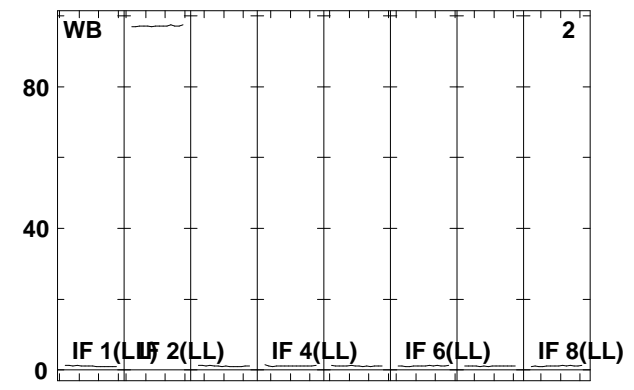
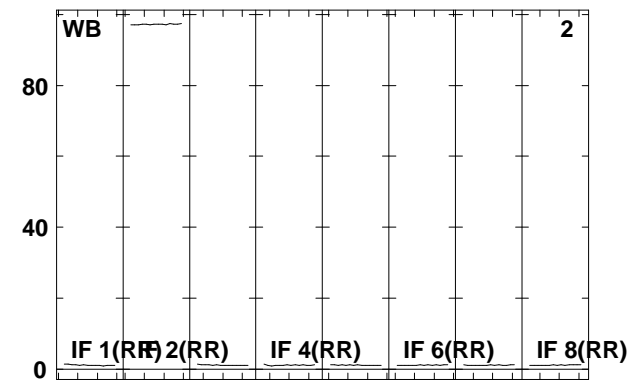
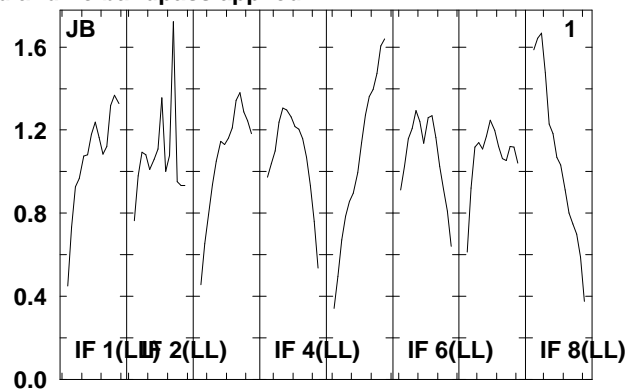
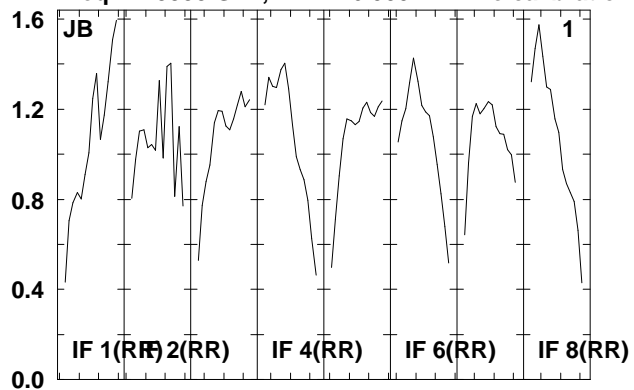

Lower frame: Real Jy  
Total-power spectrum Antenna: \*  
Timerange: 00/20:00:47 to 00/20:04:35

Plot file version 52 created 20-AUG-2009 14:59:39

NGC3227 EG040B.UVDATA.1

Freq = 1.5955 GHz, Bw = 16.000 MH No calibration applied and no bandpass applied

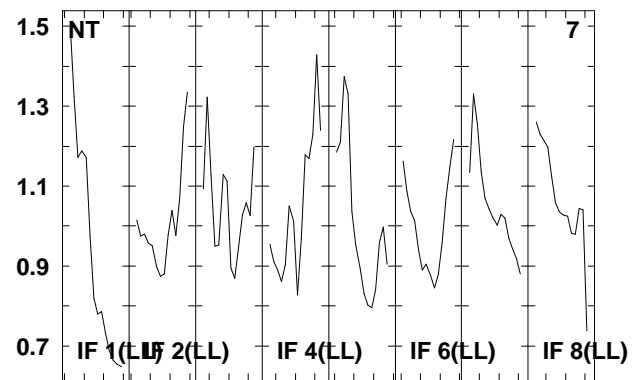
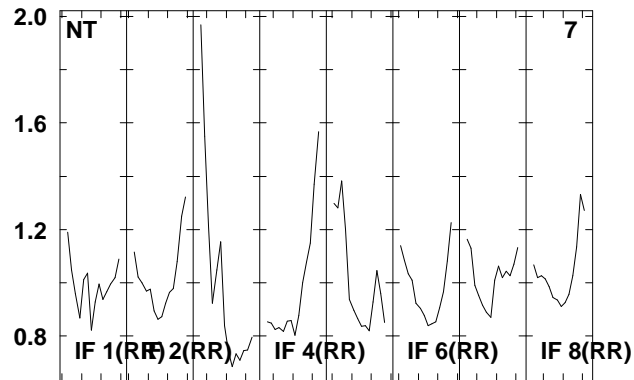
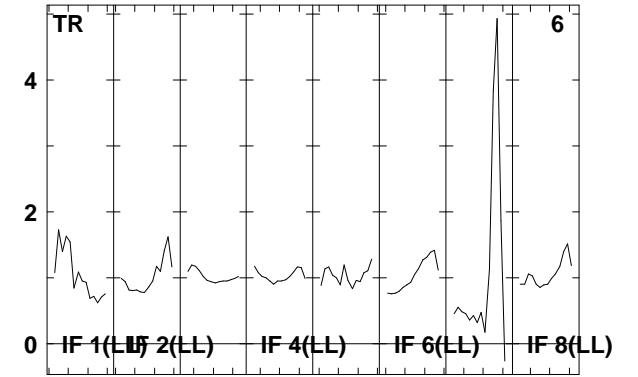
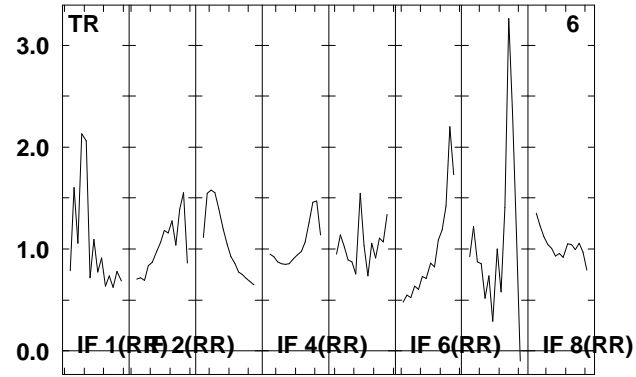
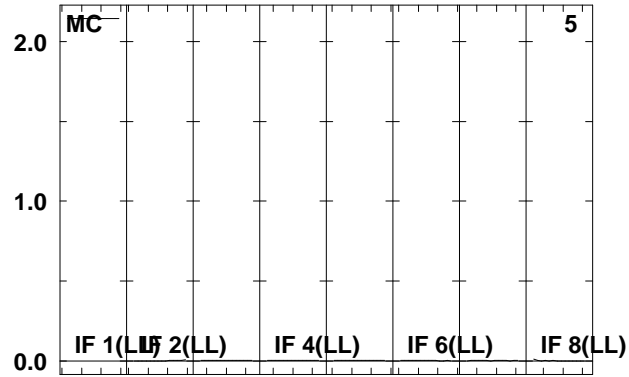

Lower frame: Kilo Real Jy  
Total-power spectrum Antenna: \*  
Timerange: 00/20:00:47 to 00/20:04:35

Plot file version 53 created 20-AUG-2009 14:59:40  
J1016+20 EG040B.UVDATA.1

Freq = 1.5955 GHz, Bw = 16.000 MH No calibration applied and no bandpass applied

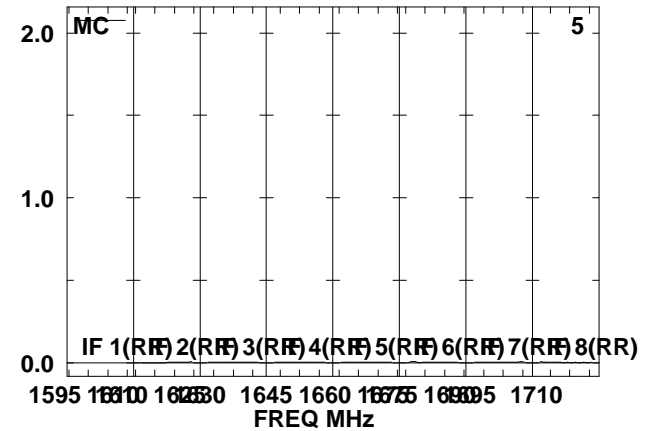
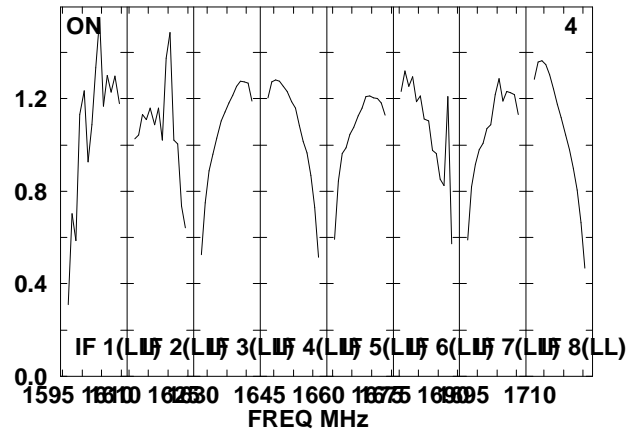
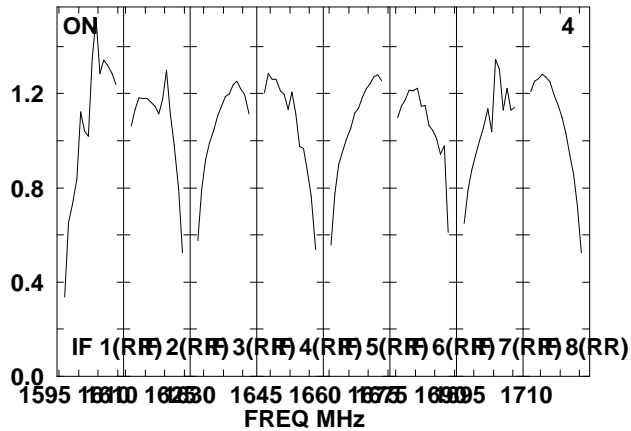
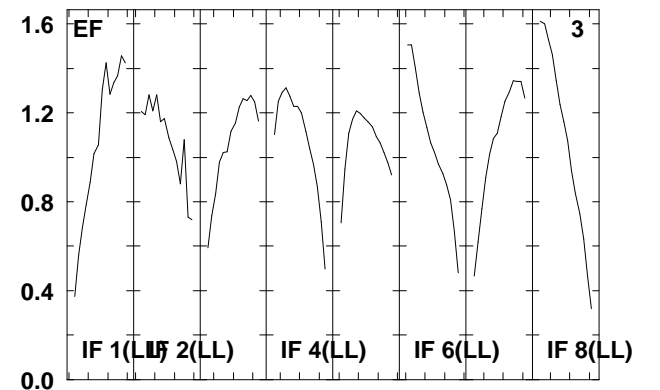
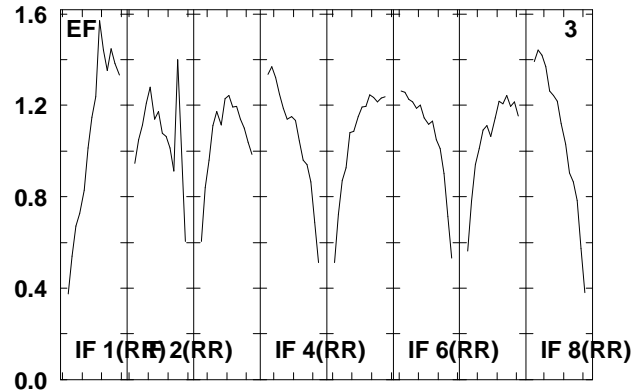
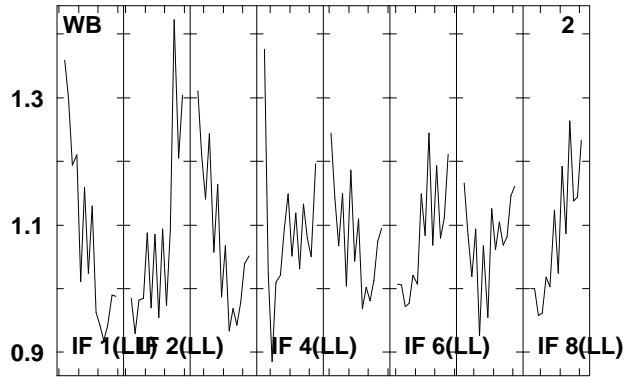
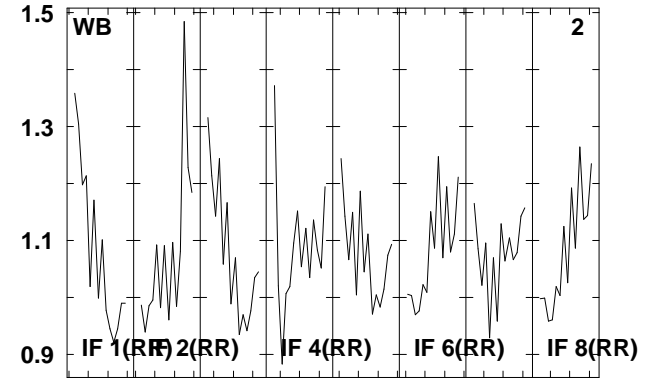
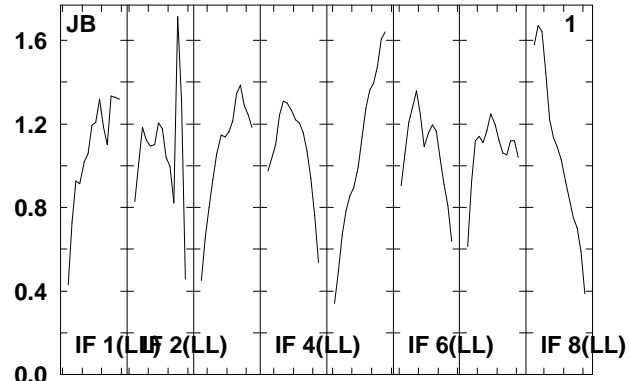
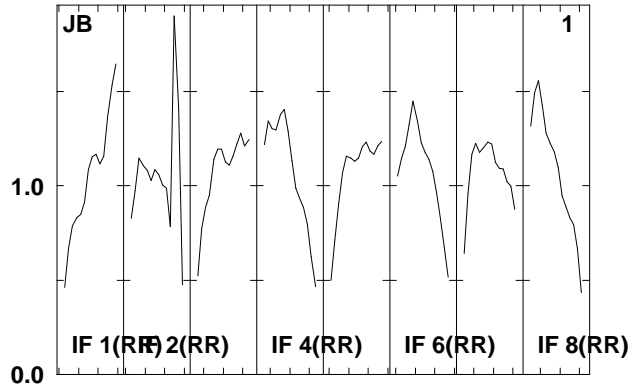

Lower frame: Real Jy  
Total-power spectrum Antenna: \*  
Timerange: 00/20:04:37 to 00/20:06:35

Plot file version 54 created 20-AUG-2009 14:59:40

J1016+20 EG040B.UVDATA.1

Freq = 1.5955 GHz, Bw = 16.000 MH No calibration applied and no bandpass applied

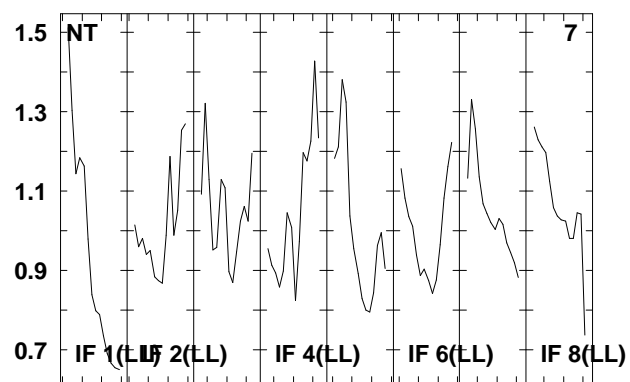
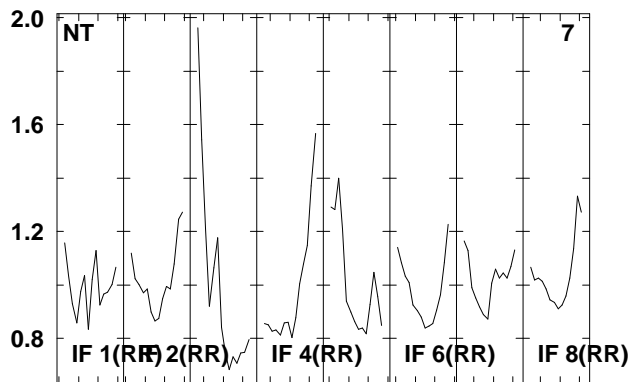
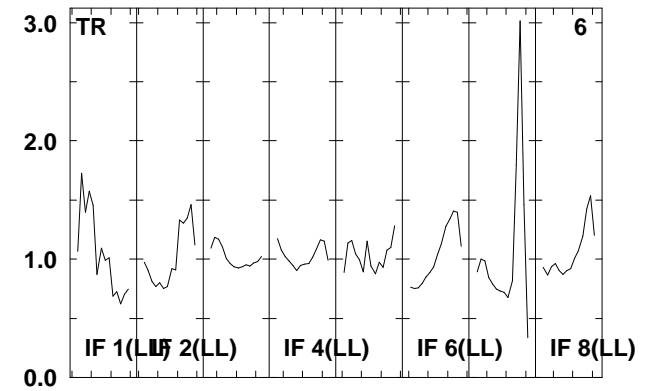
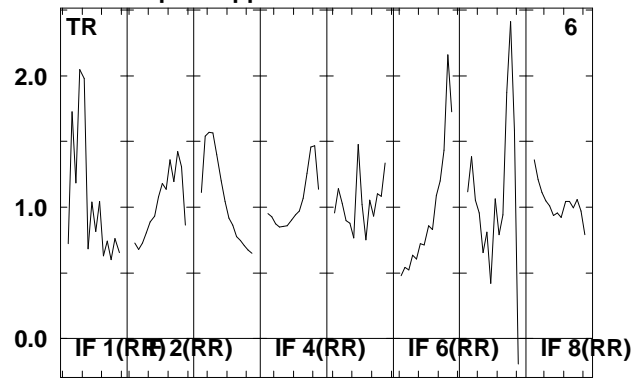
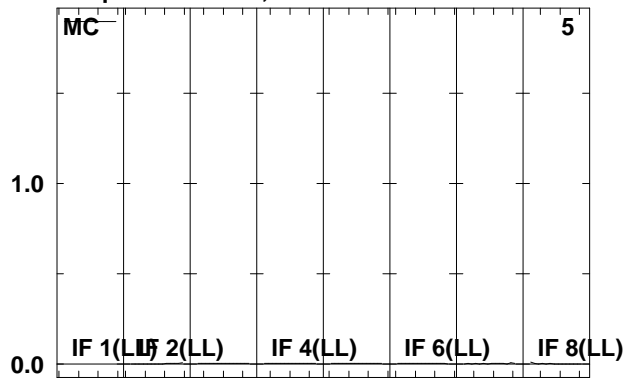

Lower frame: Kilo Real Jy  
Total-power spectrum Antenna: \*  
Timerange: 00/20:04:37 to 00/20:06:35

Plot file version 55 created 20-AUG-2009 14:59:40

NGC3227 EG040B.UVDATA.1

Freq = 1.5955 GHz, Bw = 16.000 MH No calibration applied and no bandpass applied

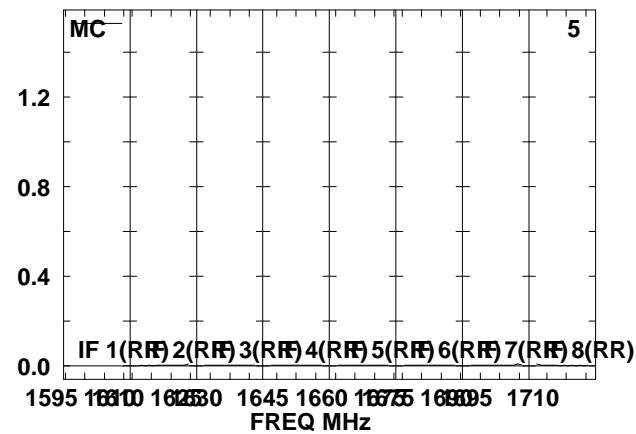
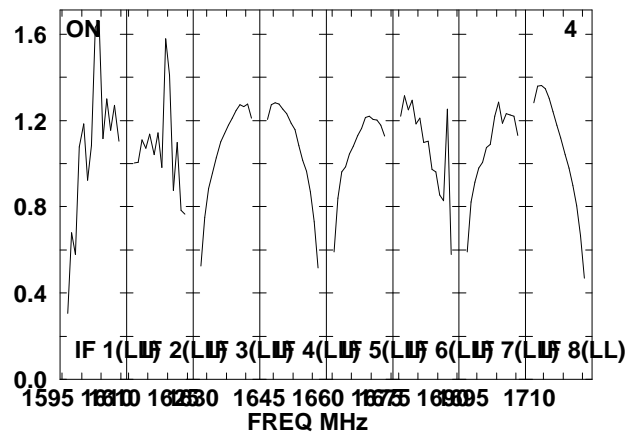
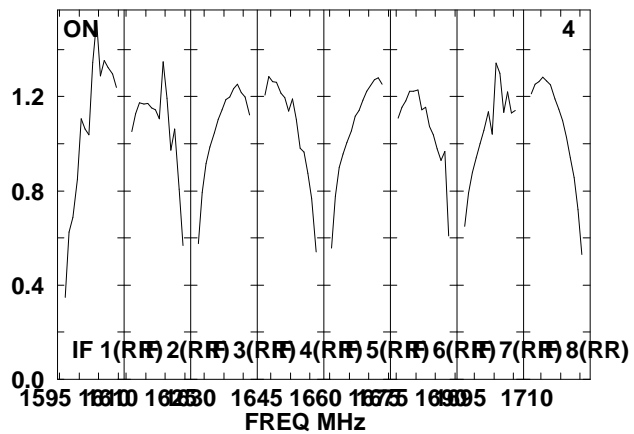
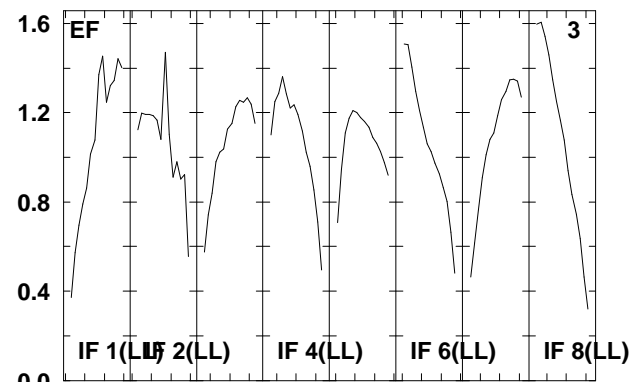
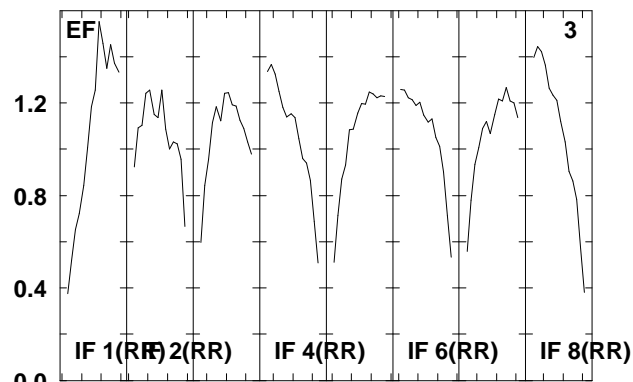
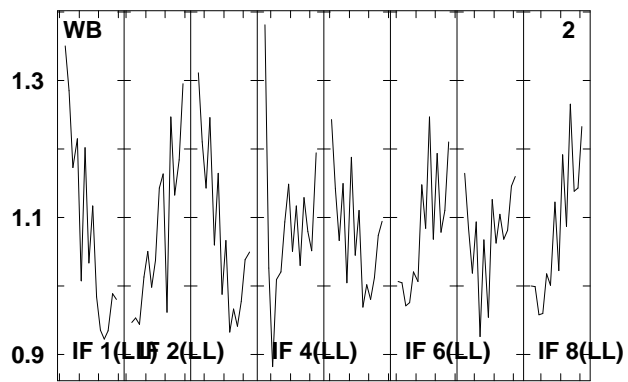
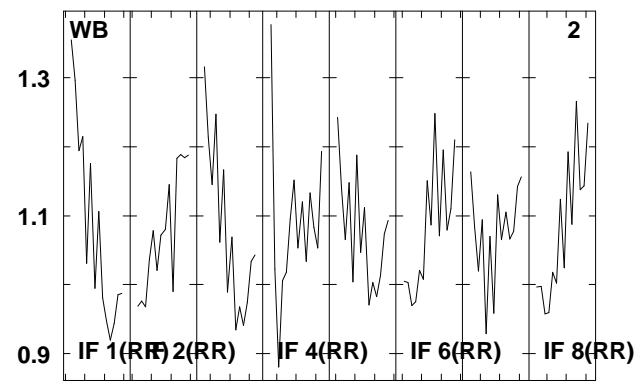
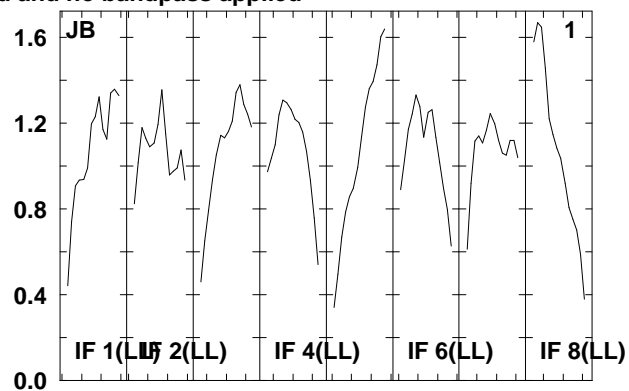
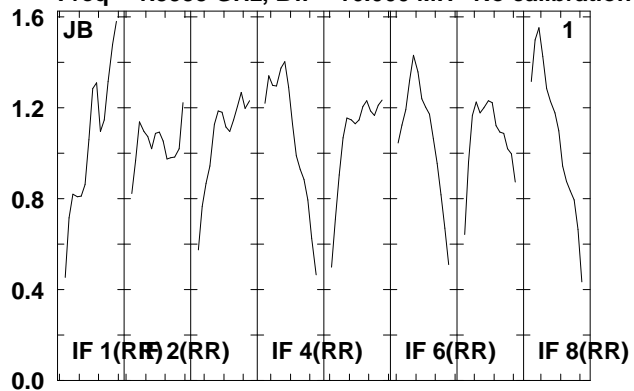

Lower frame: Real Jy  
Total-power spectrum Antenna: \*  
Timerange: 00/20:06:37 to 00/20:10:23

Plot file version 56 created 20-AUG-2009 14:59:40

NGC3227 EG040B.UVDATA.1

Freq = 1.5955 GHz, Bw = 16.000 MH No calibration applied and no bandpass applied

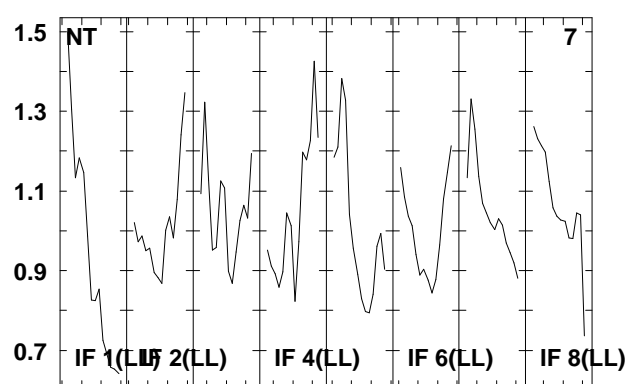
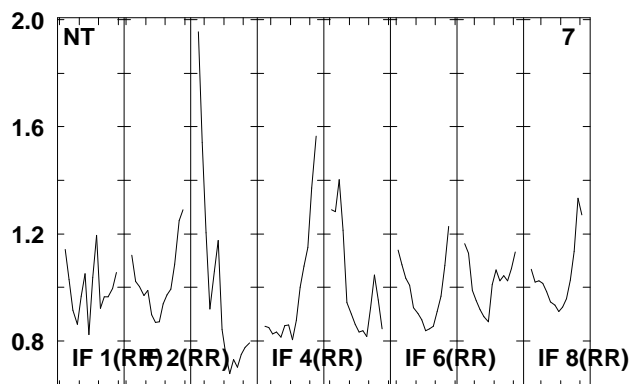
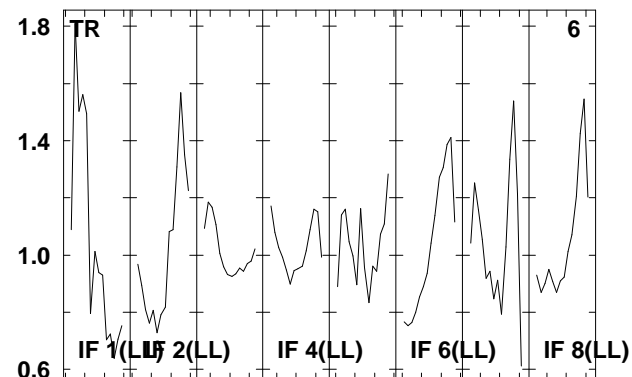
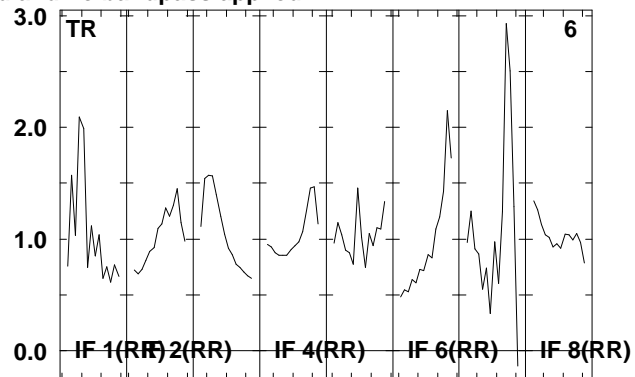
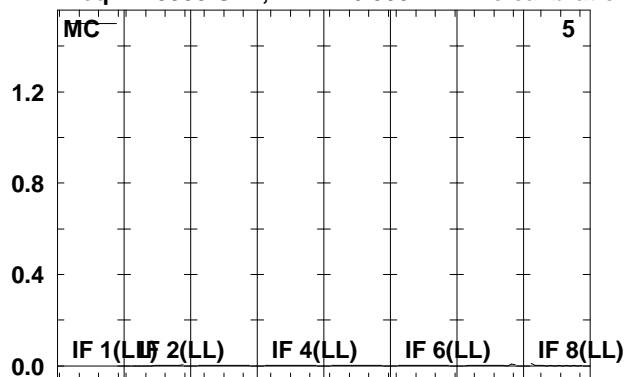

Lower frame: Kilo Real Jy  
Total-power spectrum Antenna: \*  
Timerange: 00/20:06:37 to 00/20:10:23



Plot file version 57 created 20-AUG-2009 14:59:41

J1016+20 EG040B.UVDATA.1

Freq = 1.5955 GHz, Bw = 16.000 MH No calibration applied and no bandpass applied

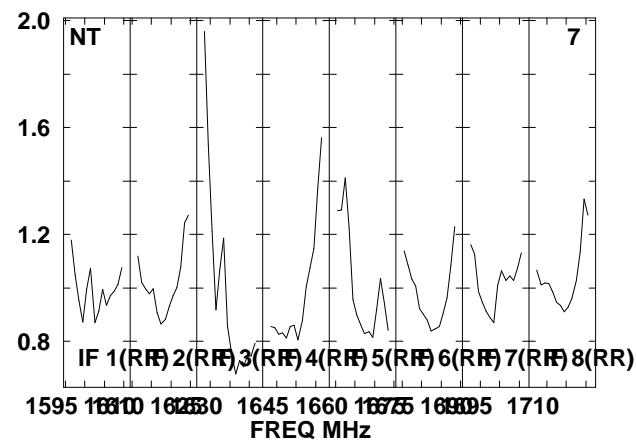
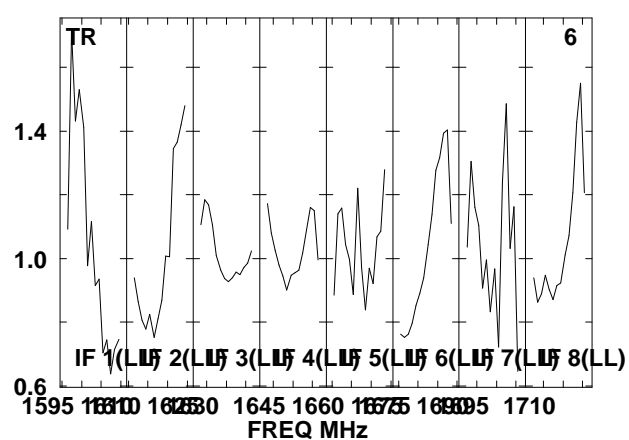
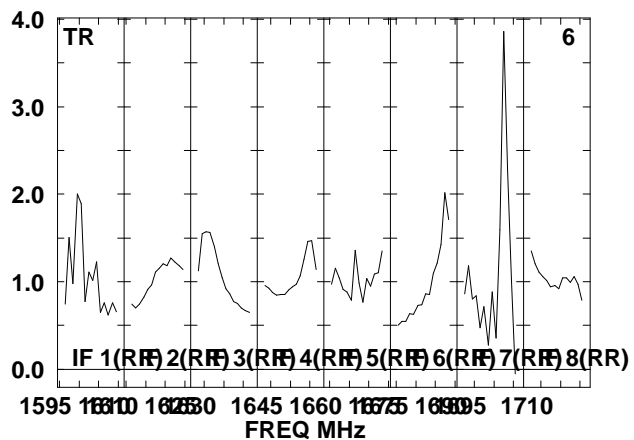
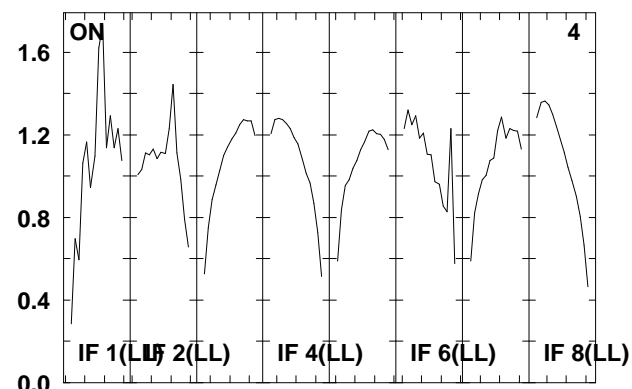
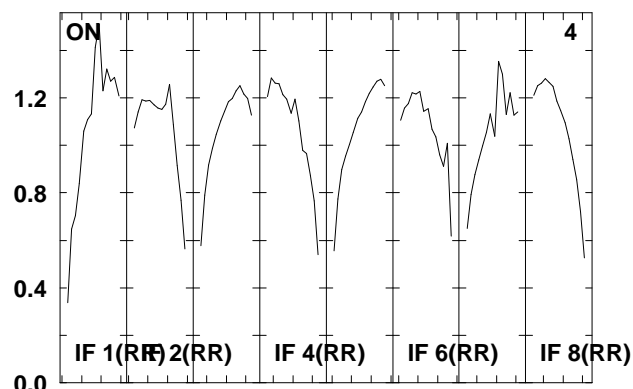
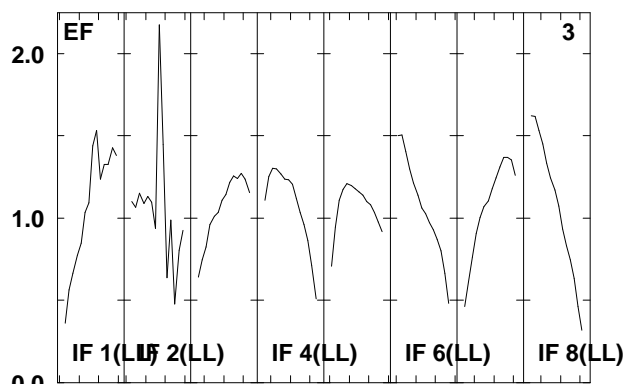
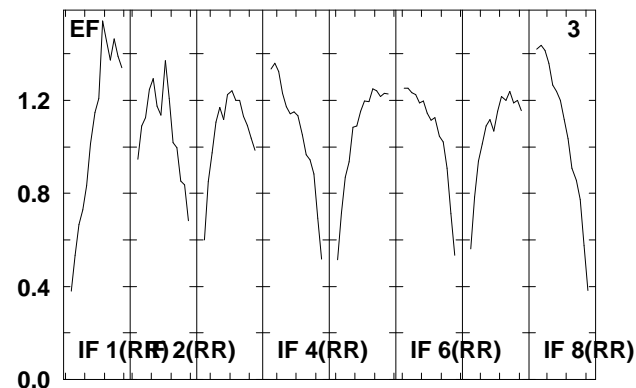
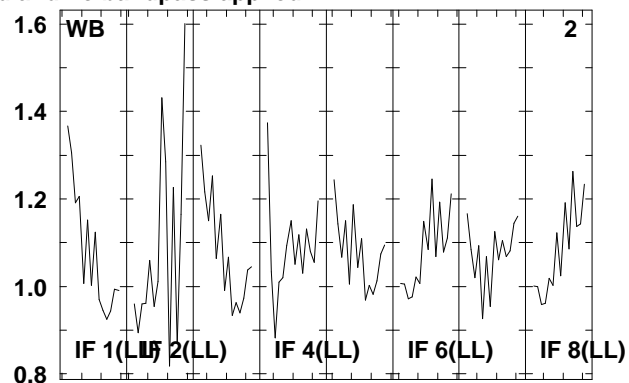
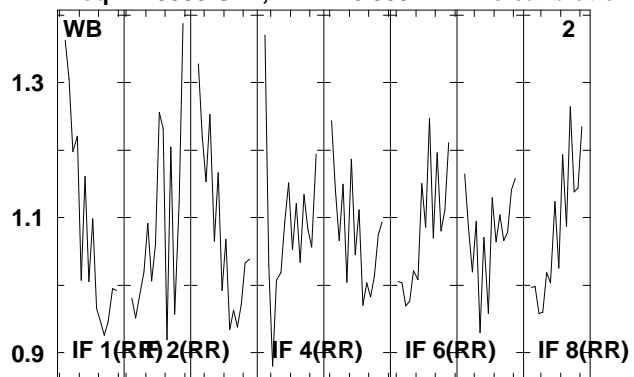

Lower frame: Real Jy  
Total-power spectrum Antenna: \*  
Timerange: 00/20:10:59 to 00/20:12:25

Plot file version 58 created 20-AUG-2009 14:59:41

J1016+20 EG040B.UVDATA.1

Freq = 1.5955 GHz, Bw = 16.000 MH No calibration applied and no bandpass applied

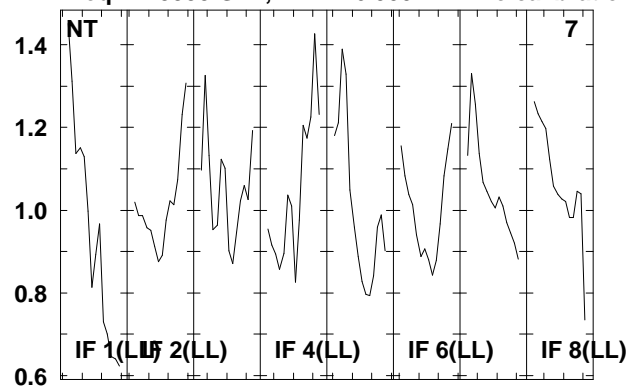

Lower frame: Real Jy  
Total-power spectrum Antenna: \*  
Timerange: 00/20:10:59 to 00/20:12:25

Plot file version 59 created 20-AUG-2009 14:59:41

NGC3227 EG040B.UVDATA.1

Freq = 1.5955 GHz, Bw = 16.000 MH No calibration applied and no bandpass applied

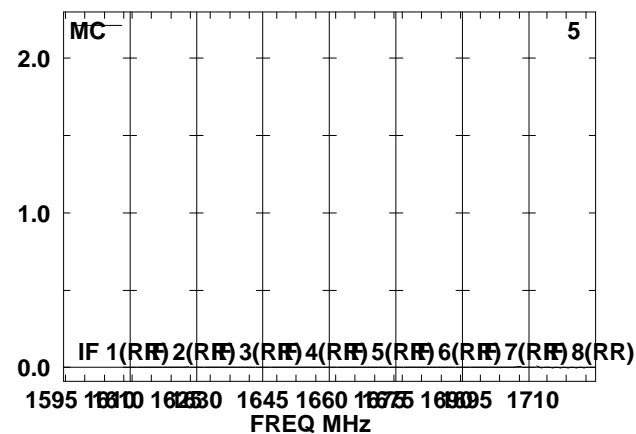
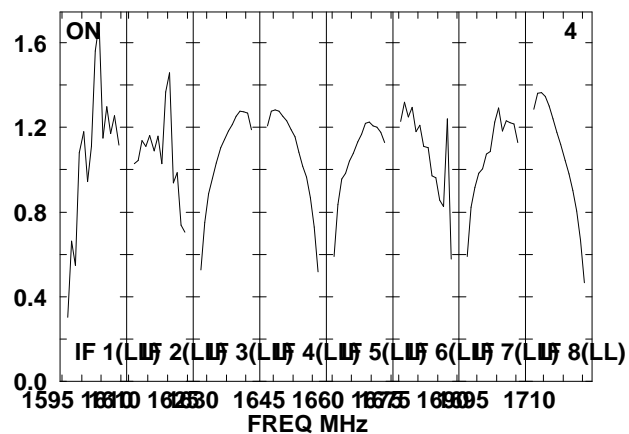
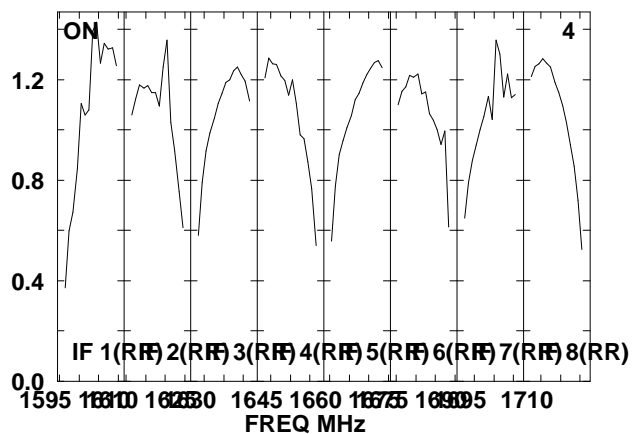
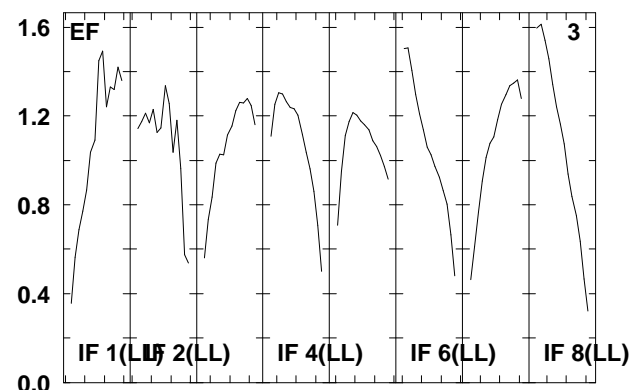
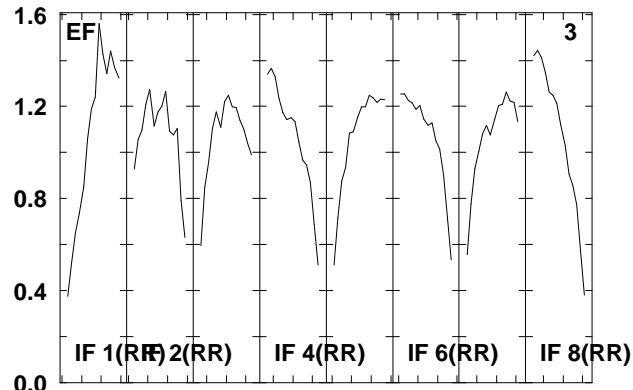
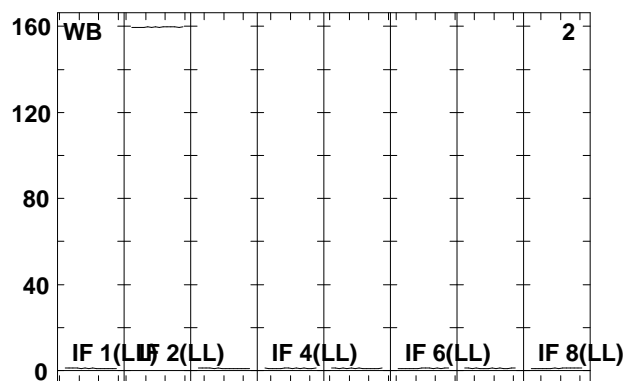
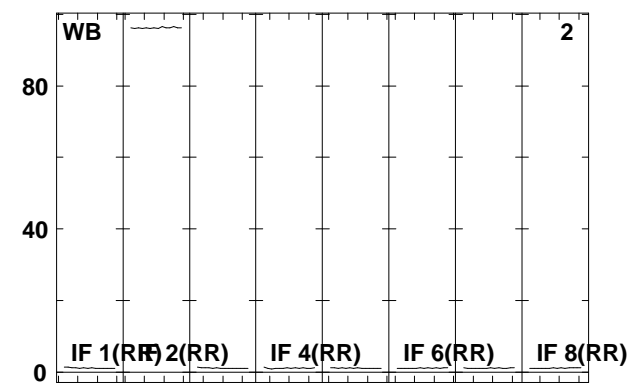
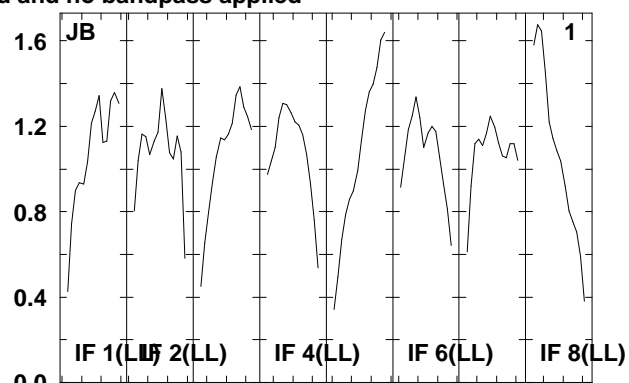
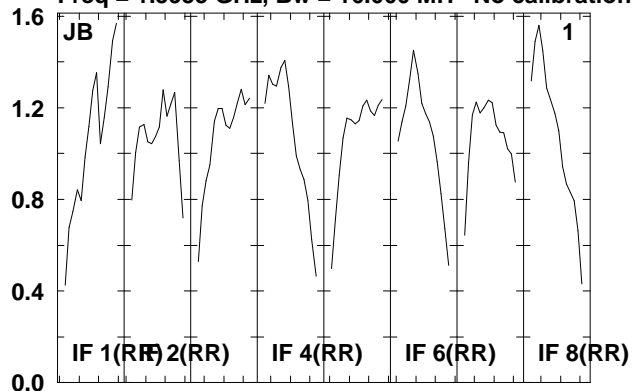

Lower frame: Real Jy  
Total-power spectrum Antenna: \*  
Timerange: 00/20:12:29 to 00/20:16:17

Plot file version 60 created 20-AUG-2009 14:59:41

NGC3227 EG040B.UVDATA.1

Freq = 1.5955 GHz, Bw = 16.000 MH No calibration applied and no bandpass applied

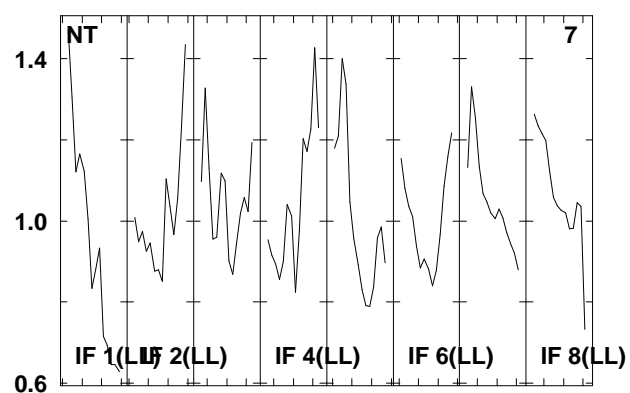
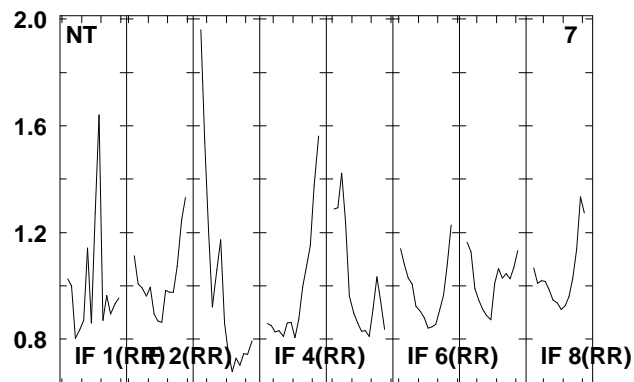
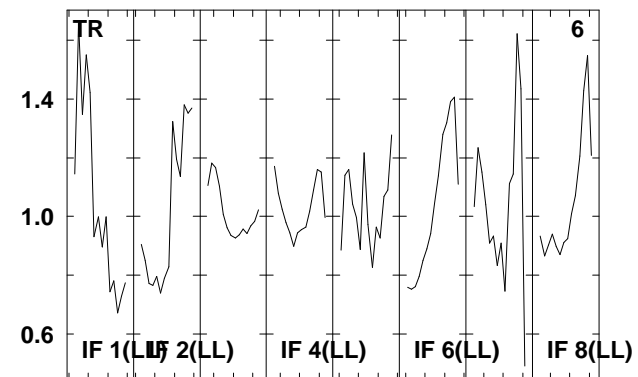
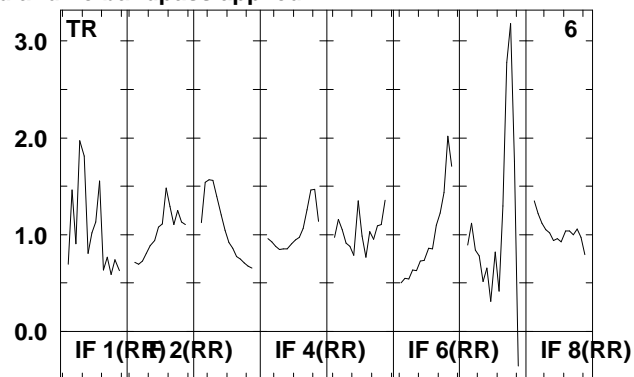
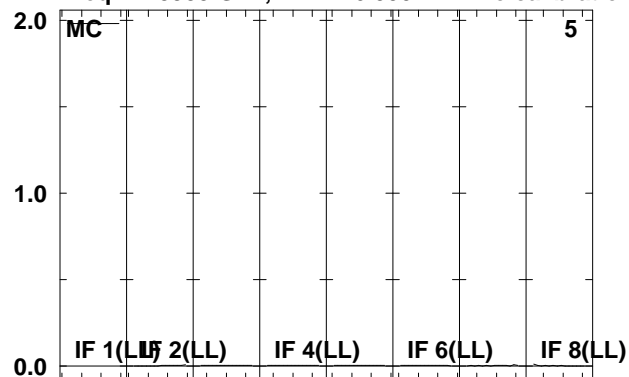

Lower frame: Kilo Real Jy  
Total-power spectrum Antenna: \*  
Timerange: 00/20:12:29 to 00/20:16:17

Plot file version 61 created 20-AUG-2009 14:59:42

J1016+20 EG040B.UVDATA.1

Freq = 1.5955 GHz, Bw = 16.000 MH No calibration applied and no bandpass applied

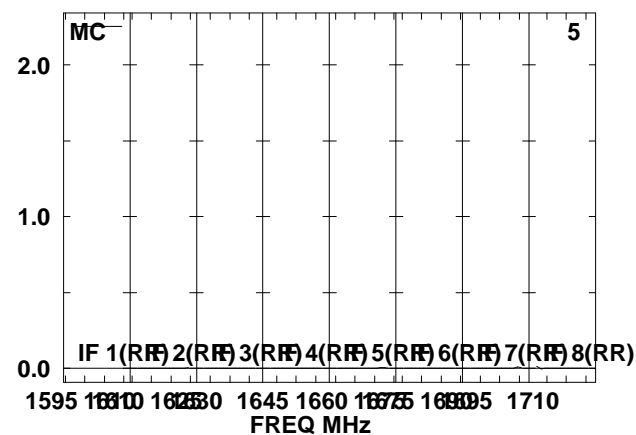
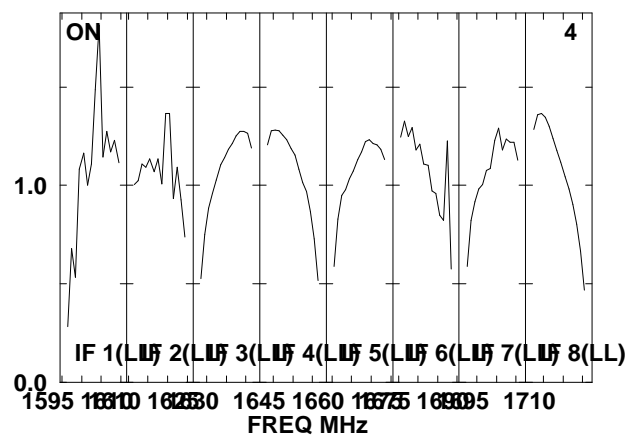
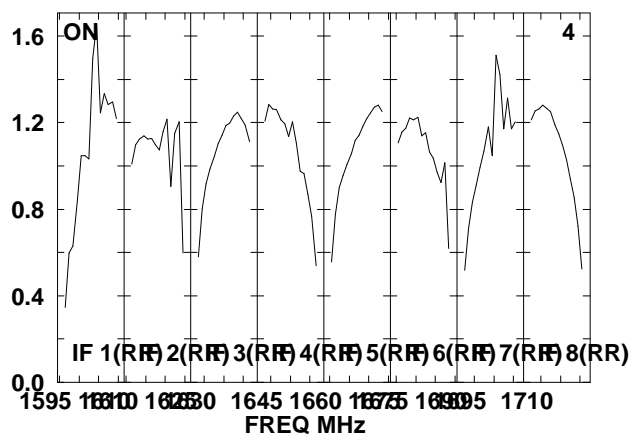
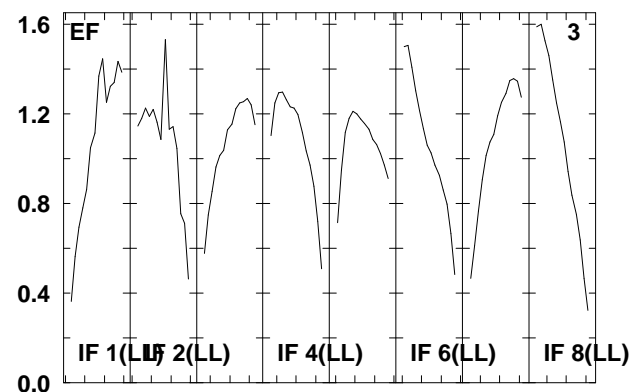
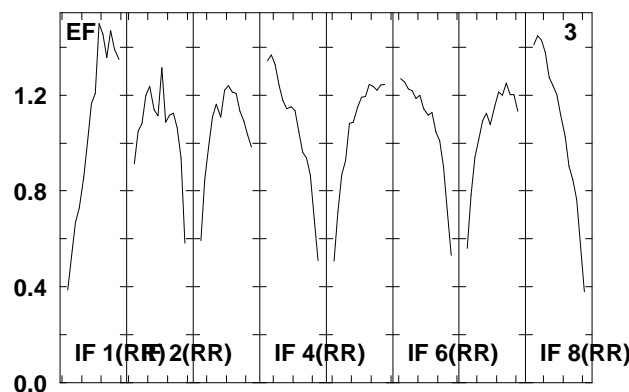
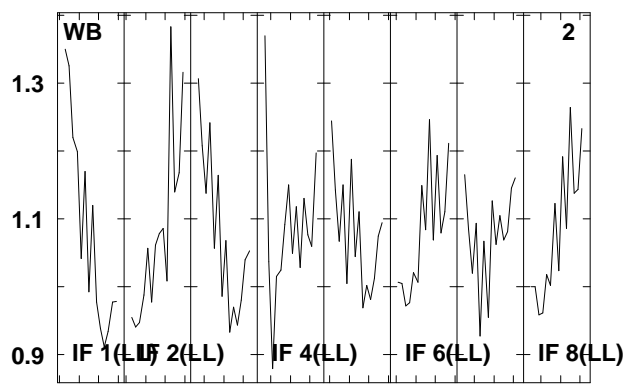
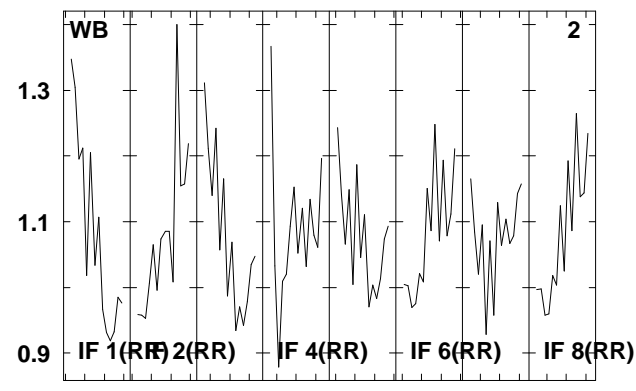
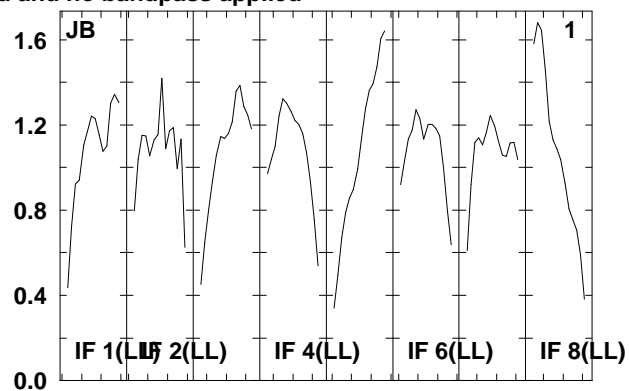
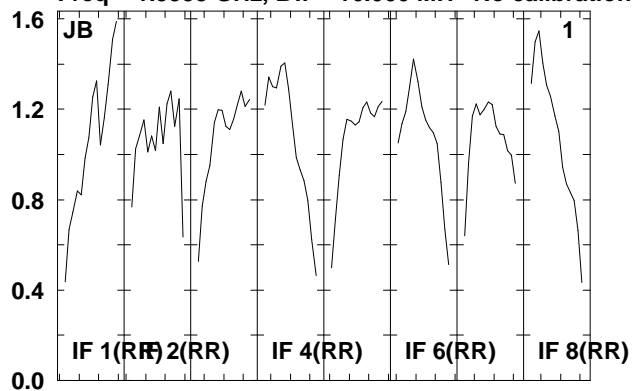

Lower frame: Real Jy  
Total-power spectrum Antenna: \*  
Timerange: 00/20:16:19 to 00/20:18:17

Plot file version 62 created 20-AUG-2009 14:59:42  
 J1016+20 EG040B.UVDATA.1  
 Freq = 1.5955 GHz, Bw = 16.000 MH No calibration applied and no bandpass applied

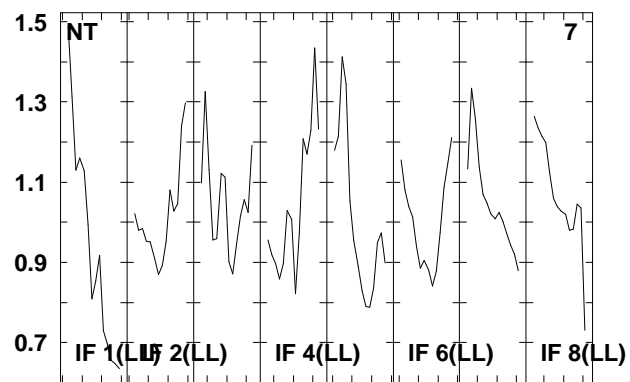
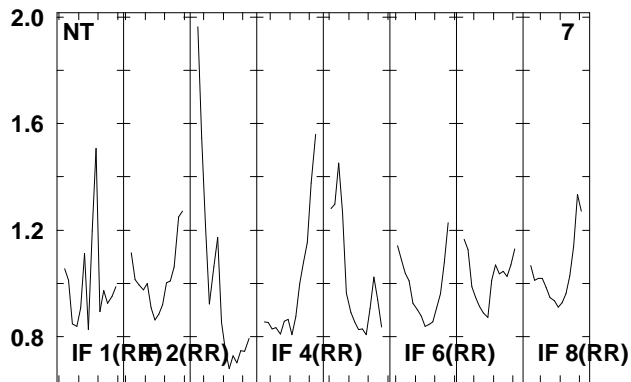
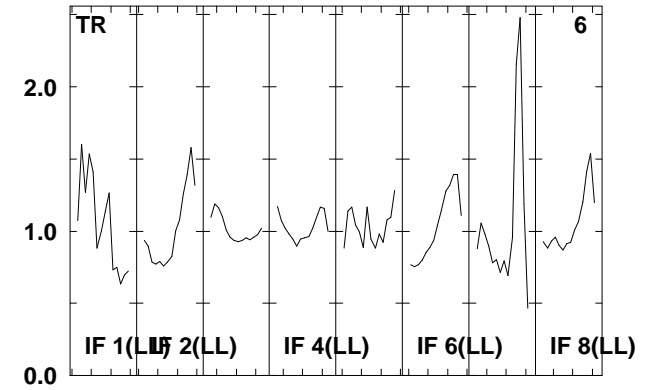
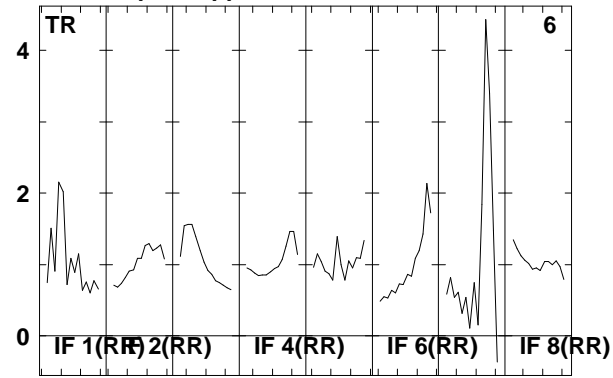
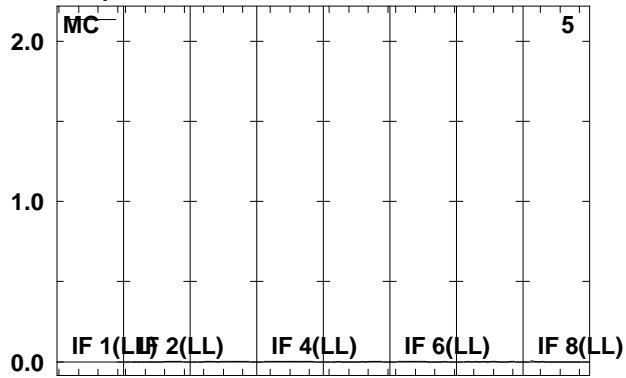

Lower frame: Kilo Real Jy  
 Total-power spectrum Antenna: \*  
 Timerange: 00/20:16:19 to 00/20:18:17

Plot file version 63 created 20-AUG-2009 14:59:43

NGC3227 EG040B.UVDATA.1

Freq = 1.5955 GHz, Bw = 16.000 MH No calibration applied and no bandpass applied

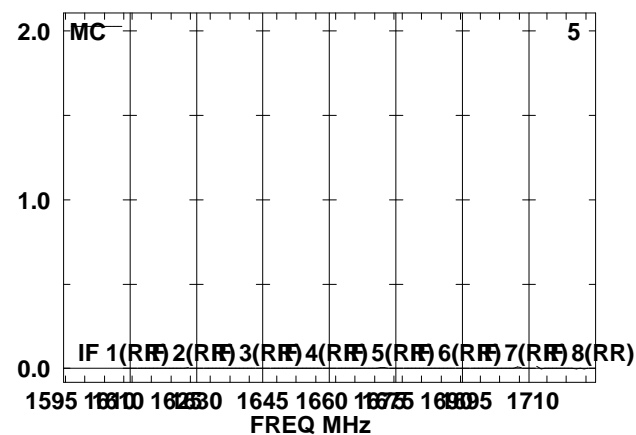
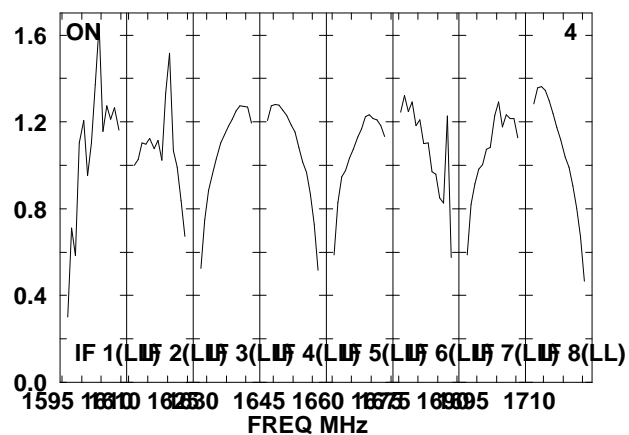
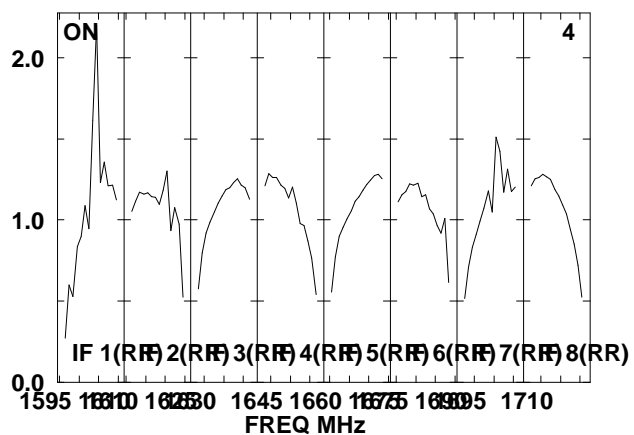
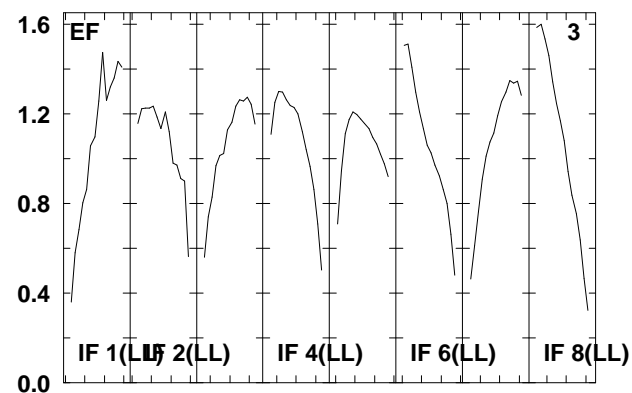
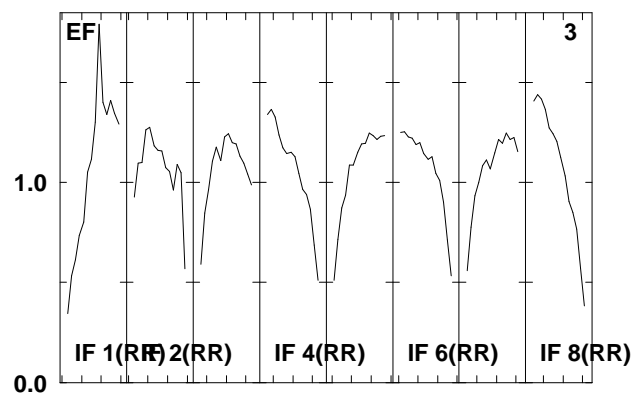
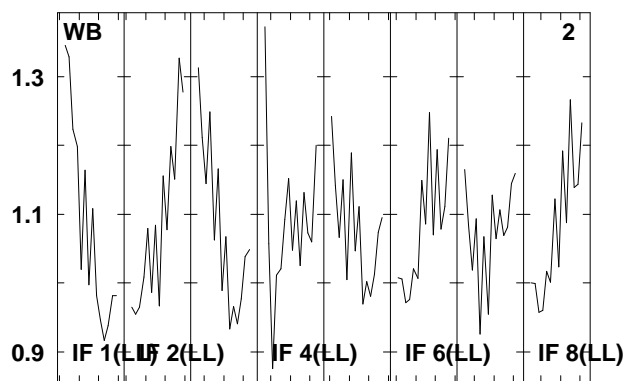
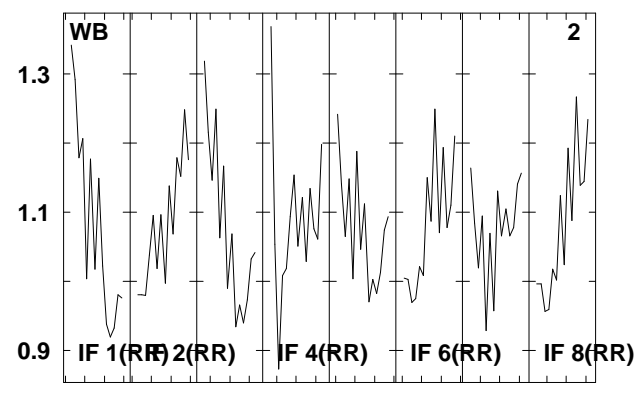
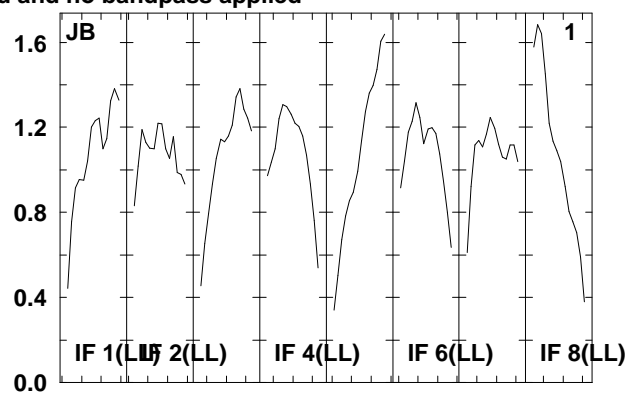
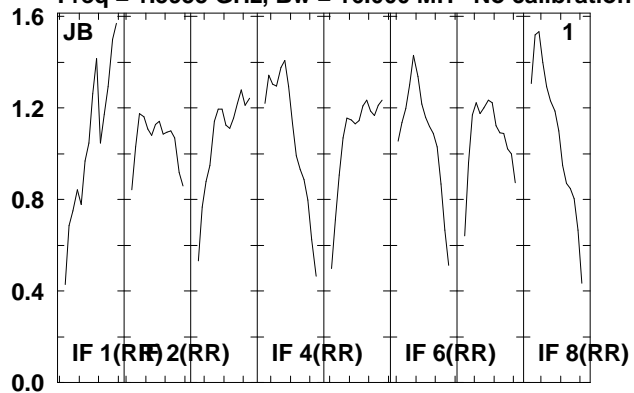

Lower frame: Real Jy  
Total-power spectrum Antenna: \*  
Timerange: 00/20:18:19 to 00/20:22:07

Plot file version 64 created 20-AUG-2009 14:59:43

NGC3227 EG040B.UVDATA.1

Freq = 1.5955 GHz, Bw = 16.000 MH No calibration applied and no bandpass applied

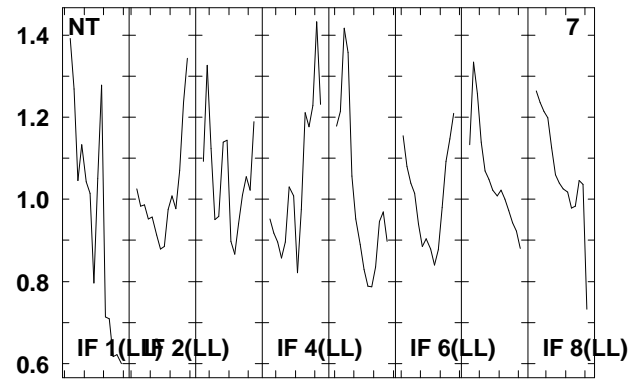
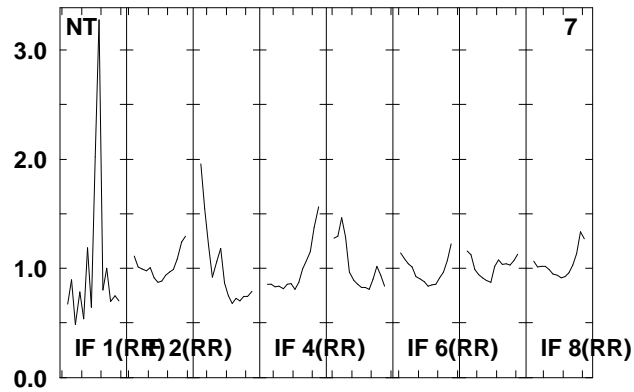
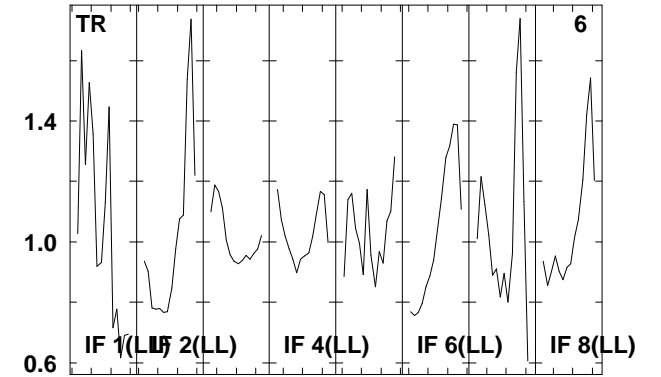
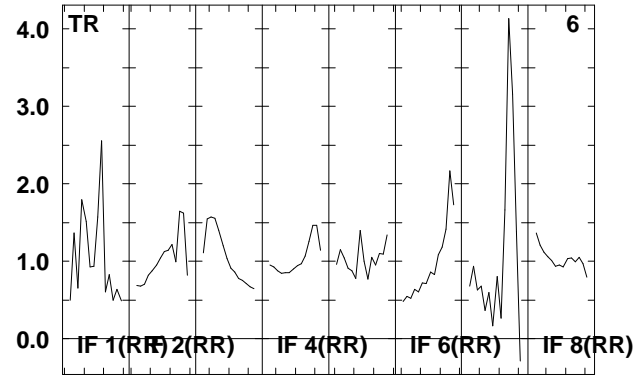
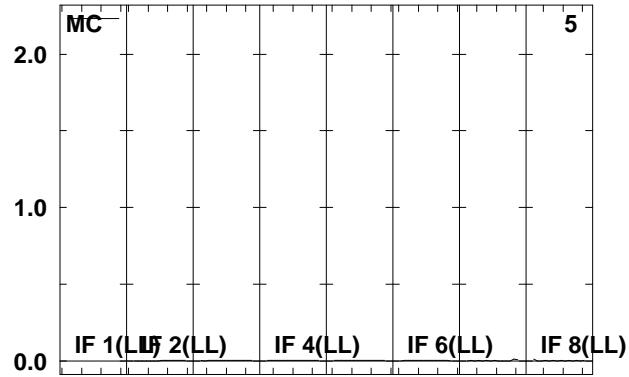

Lower frame: Kilo Real Jy  
Total-power spectrum Antenna: \*  
Timerange: 00/20:18:19 to 00/20:22:07



Plot file version 65 created 20-AUG-2009 14:59:43

J1016+20 EG040B.UVDATA.1

Freq = 1.5955 GHz, Bw = 16.000 MH No calibration applied and no bandpass applied

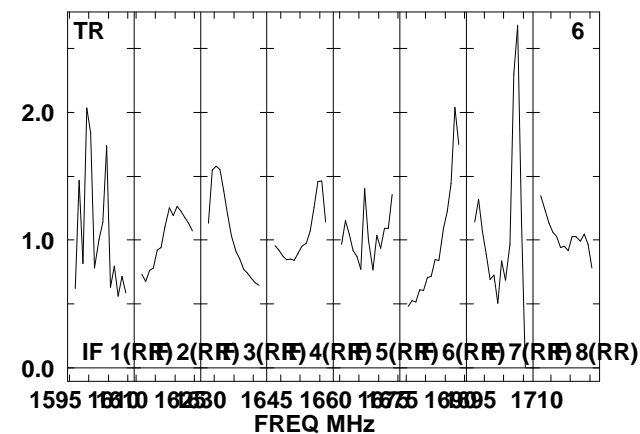
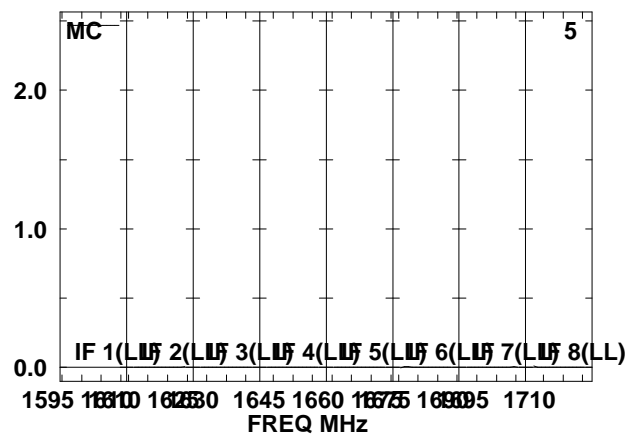
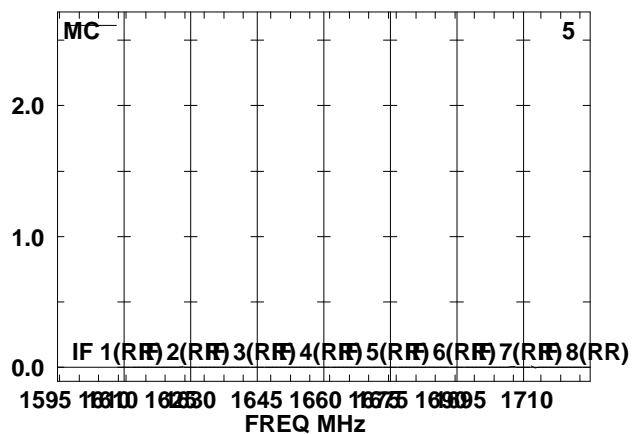
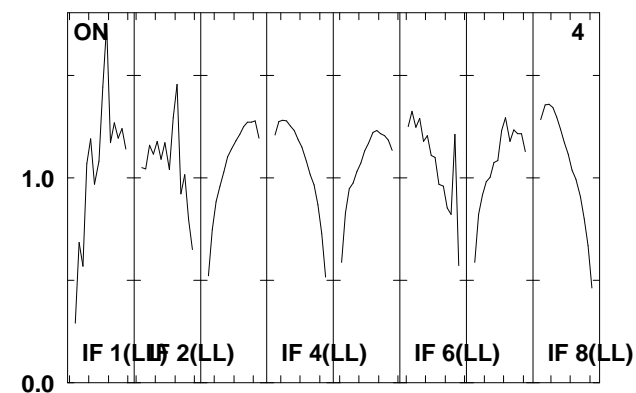
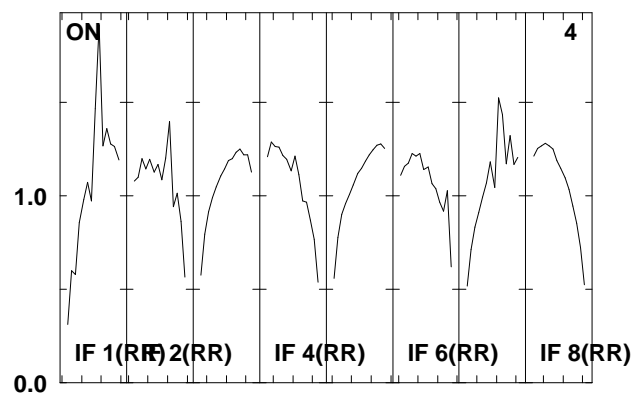
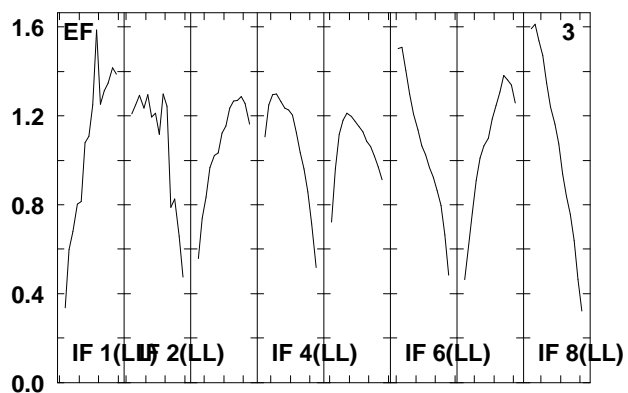
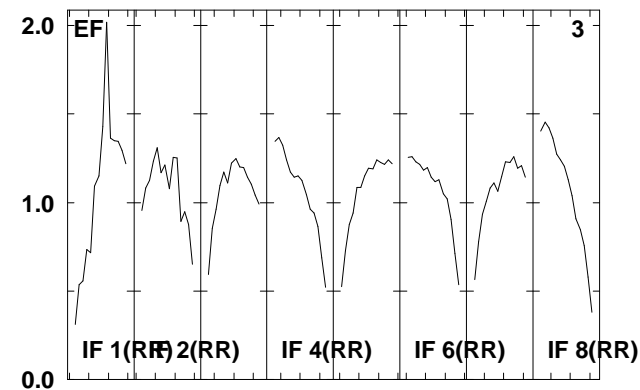
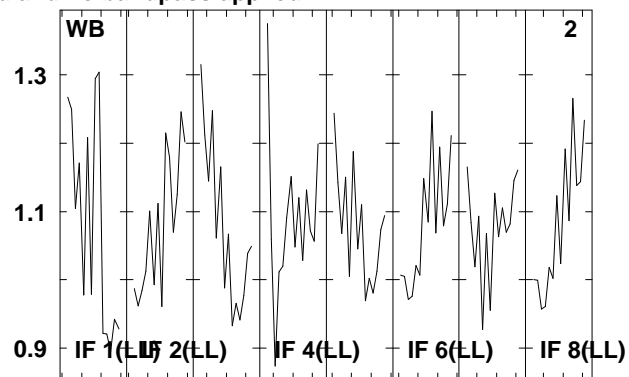
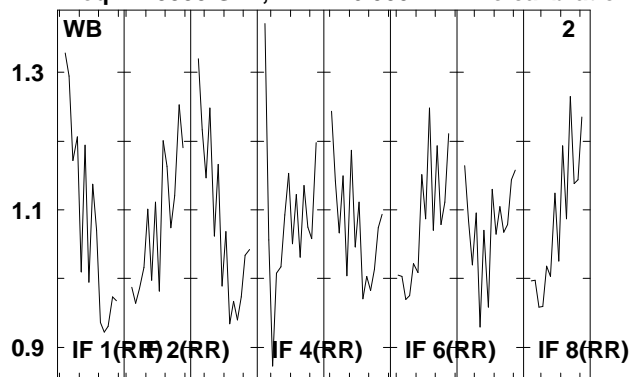

Lower frame: Real Jy  
Total-power spectrum Antenna: \*  
Timerange: 00/20:22:41 to 00/20:24:09

Plot file version 66 created 20-AUG-2009 14:59:43

J1016+20 EG040B.UVDATA.1

Freq = 1.5955 GHz, Bw = 16.000 MH No calibration applied and no bandpass applied

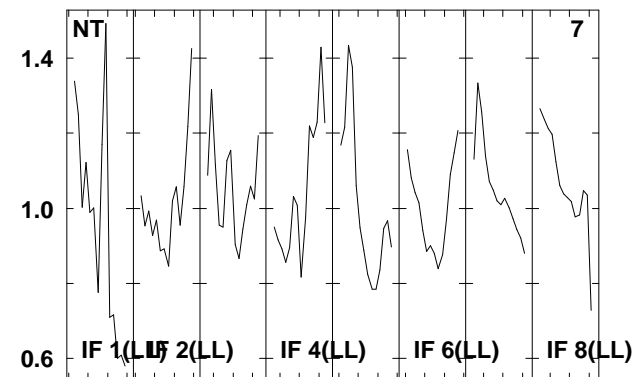
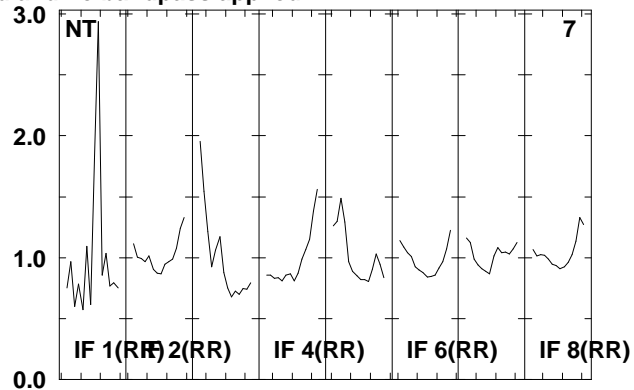
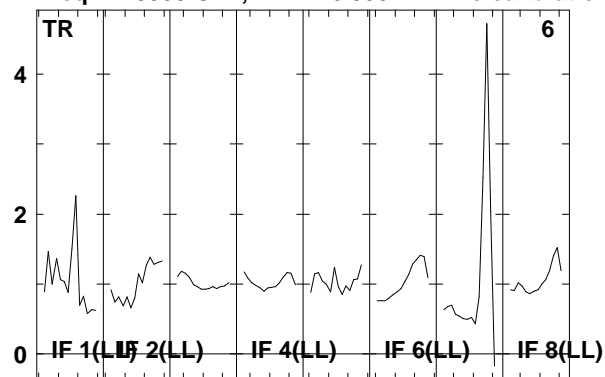

Lower frame: Real Jy  
Total-power spectrum Antenna: \*  
Timerange: 00/20:22:41 to 00/20:24:09

Plot file version 67 created 20-AUG-2009 14:59:44

NGC3227 EG040B.UVDATA.1

Freq = 1.5955 GHz, Bw = 16.000 MH No calibration applied and no bandpass applied

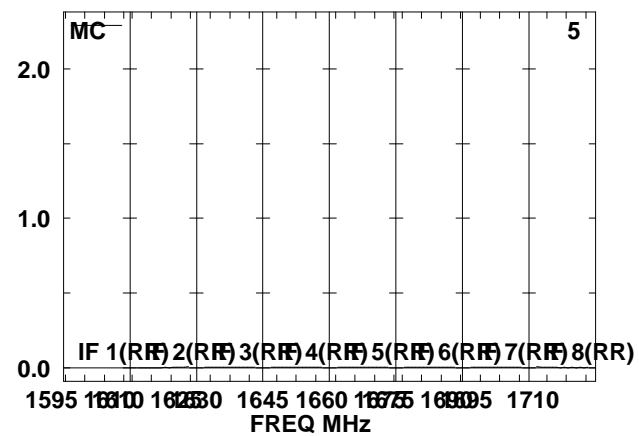
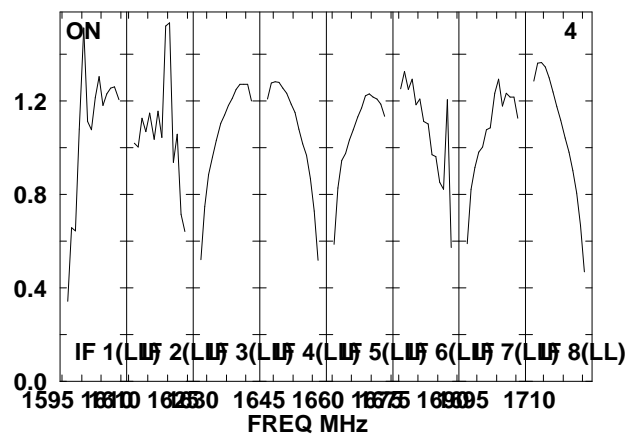
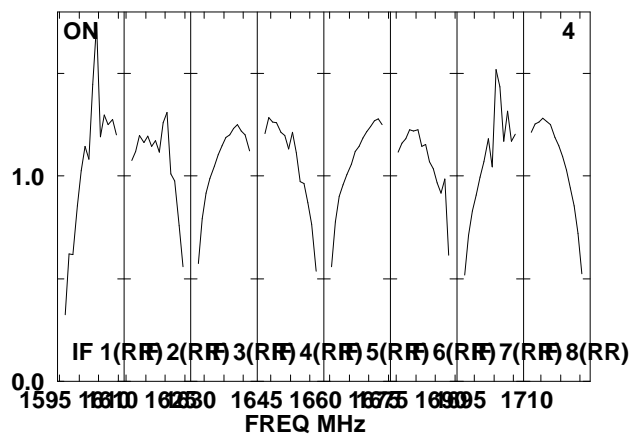
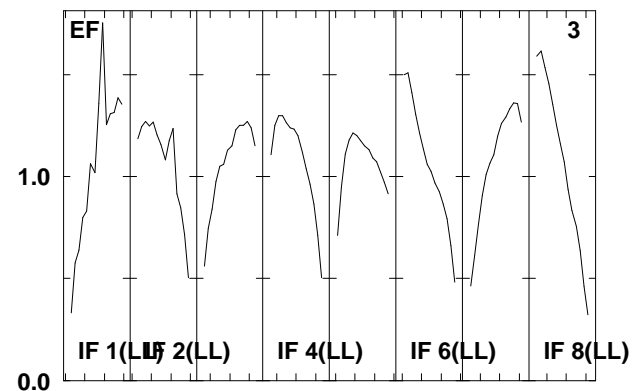
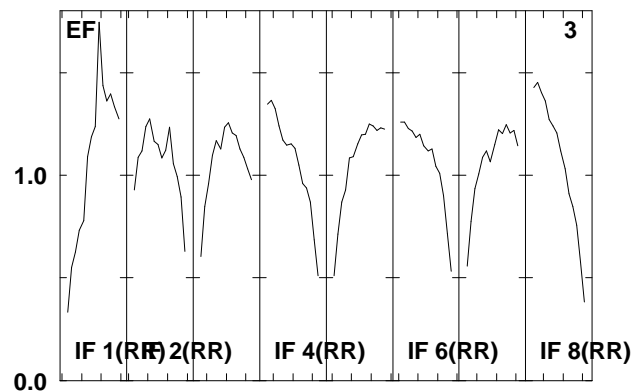
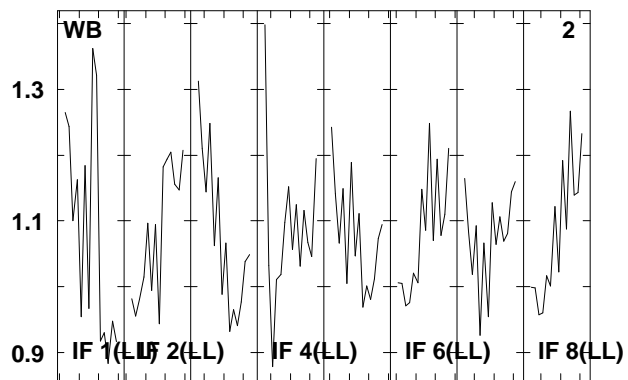
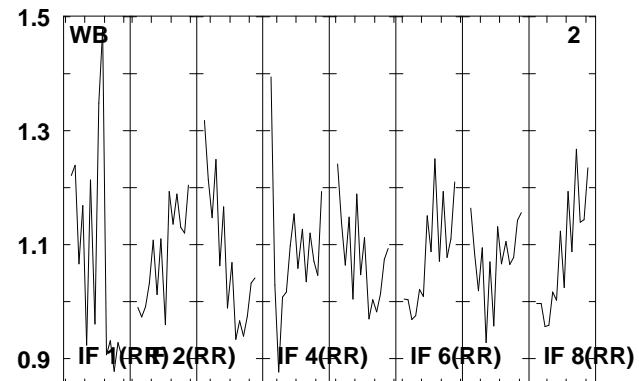
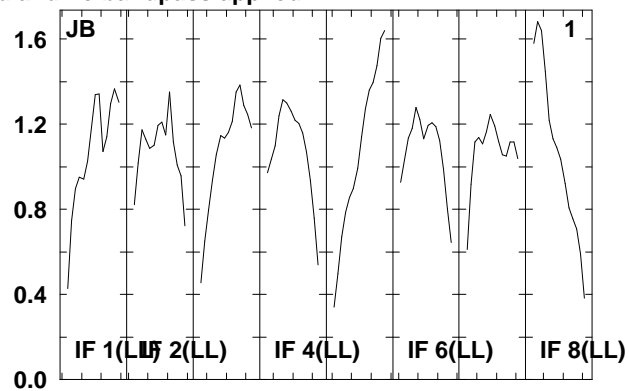
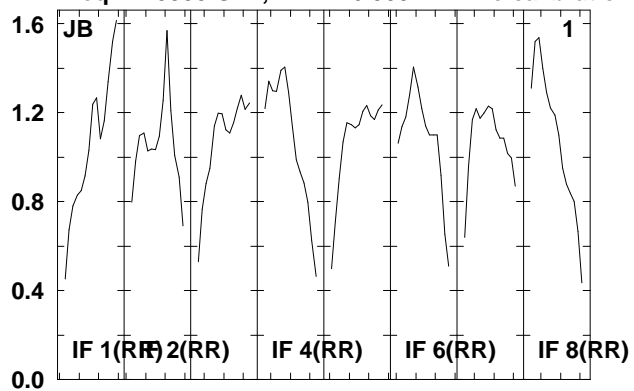

Lower frame: Real Jy  
Total-power spectrum Antenna: \*  
Timerange: 00/20:24:11 to 00/20:27:59

Plot file version 68 created 20-AUG-2009 14:59:44

NGC3227 EG040B.UVDATA.1

Freq = 1.5955 GHz, Bw = 16.000 MH No calibration applied and no bandpass applied

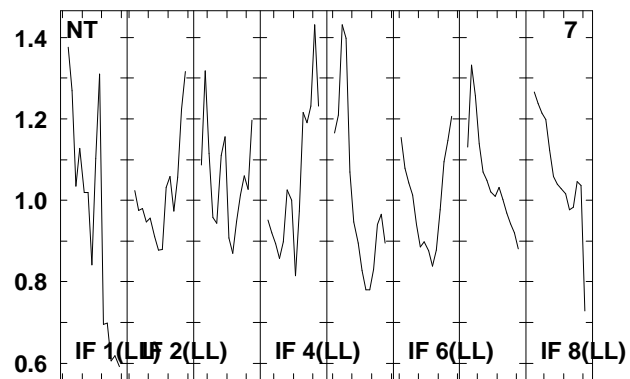
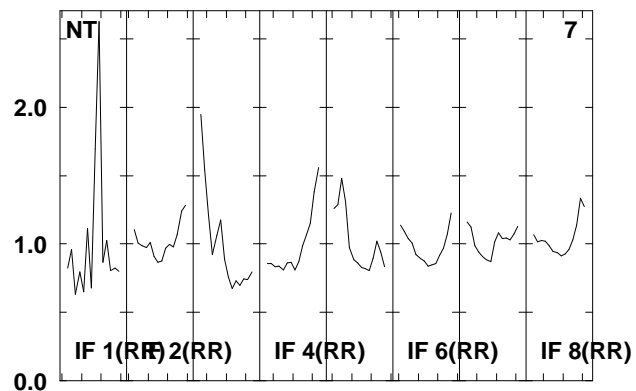
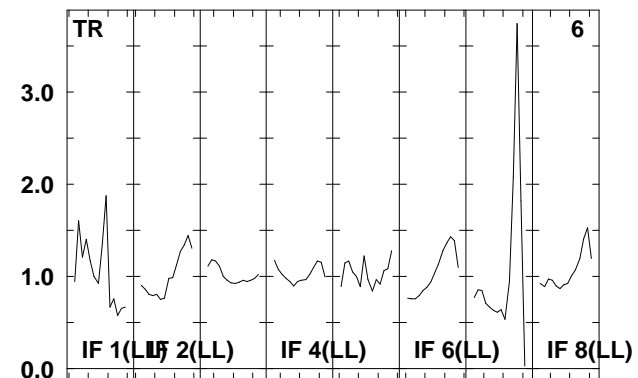
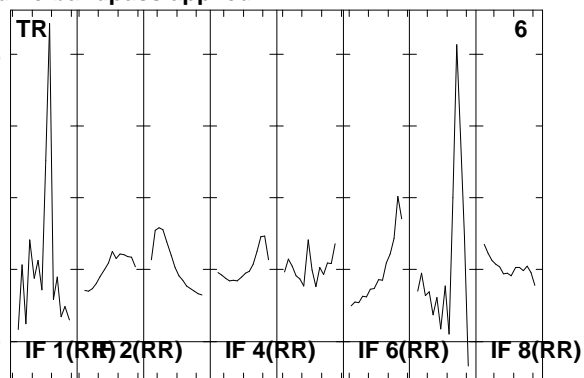
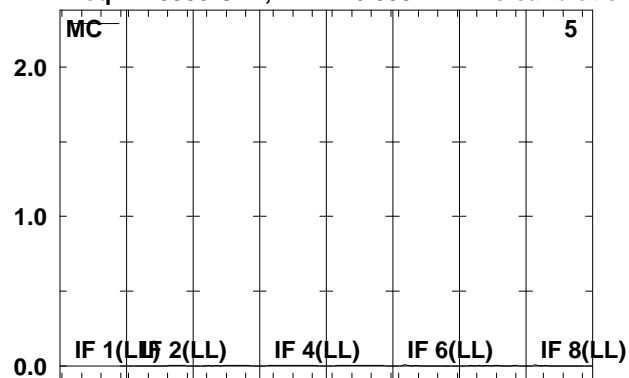

Lower frame: Kilo Real Jy  
Total-power spectrum Antenna: \*  
Timerange: 00/20:24:11 to 00/20:27:59

Plot file version 69 created 20-AUG-2009 14:59:44

J1016+20 EG040B.UVDATA.1

Freq = 1.5955 GHz, Bw = 16.000 MH No calibration applied and no bandpass applied

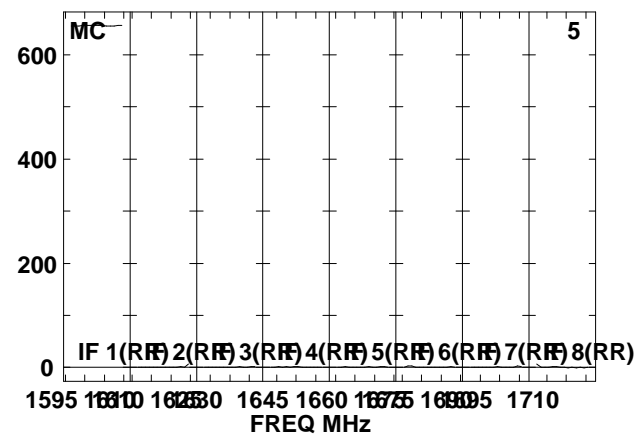
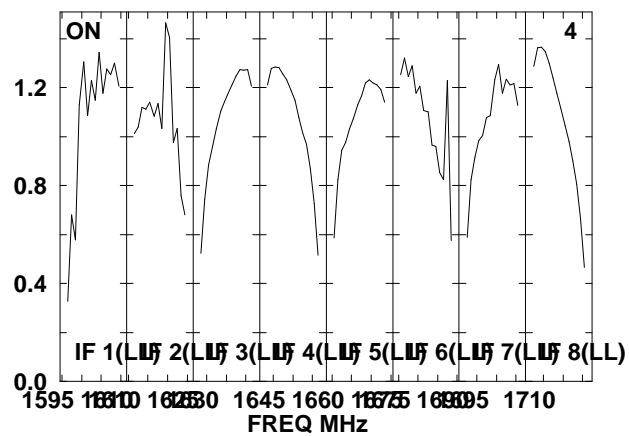
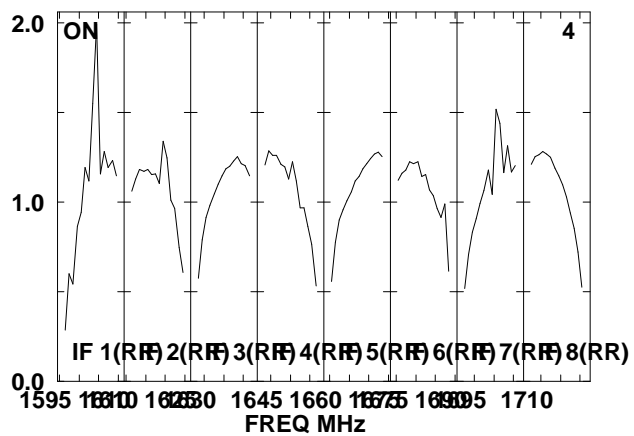
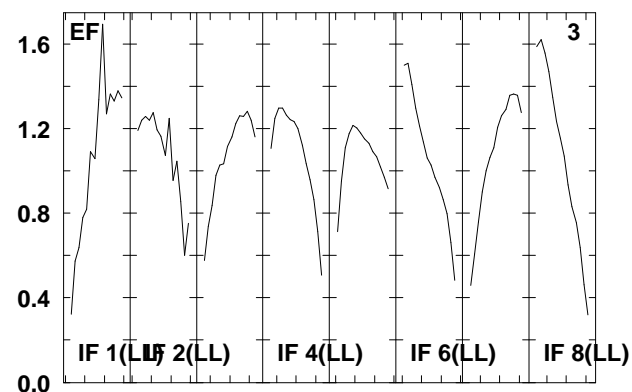
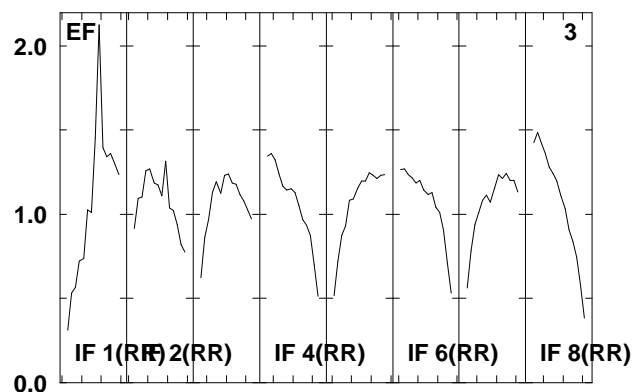
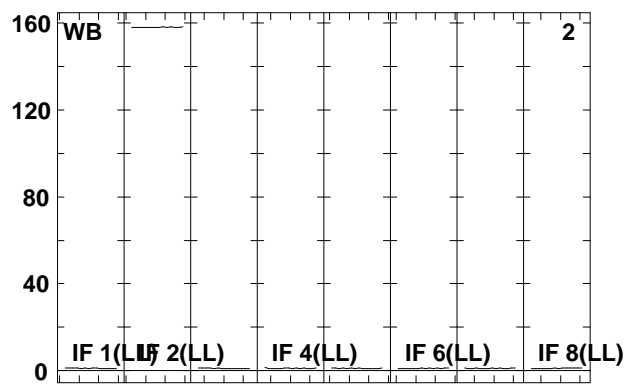
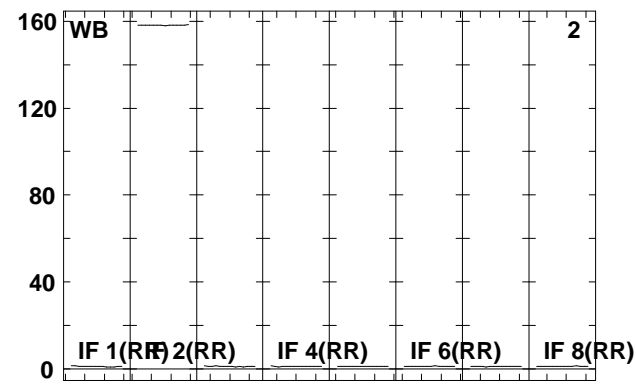
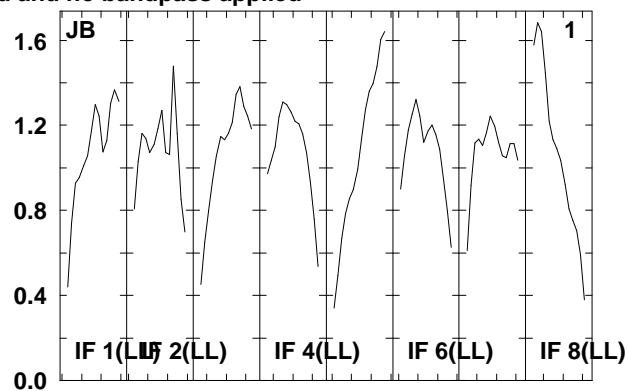
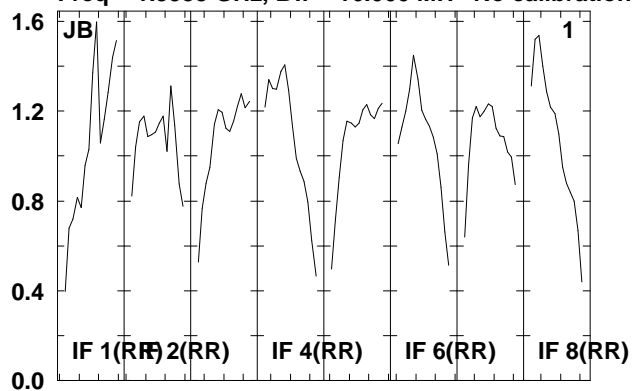

Lower frame: Real Jy  
Total-power spectrum Antenna: \*  
Timerange: 00/20:28:01 to 00/20:31:39

Plot file version 70 created 20-AUG-2009 14:59:45  
 J1016+20 EG040B.UVDATA.1  
 Freq = 1.5955 GHz, Bw = 16.000 MH No calibration applied and no bandpass applied

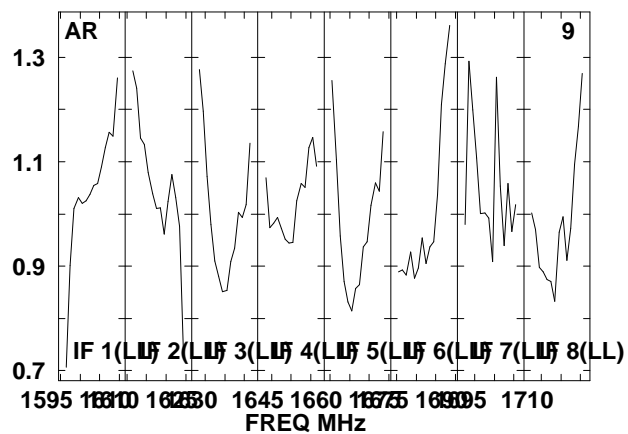
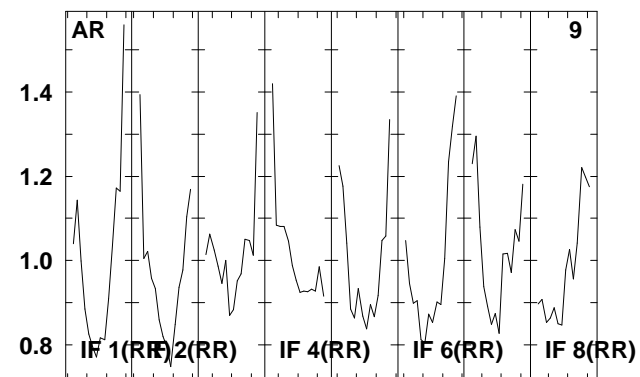
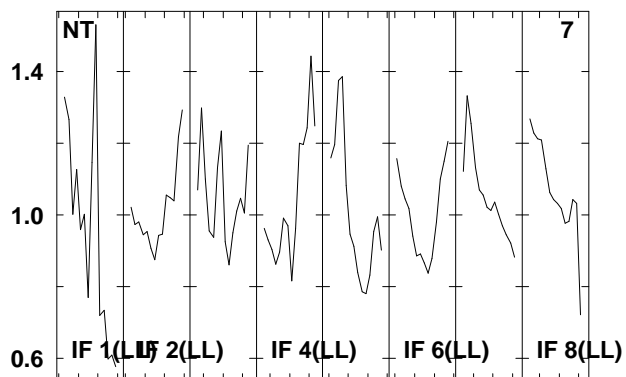
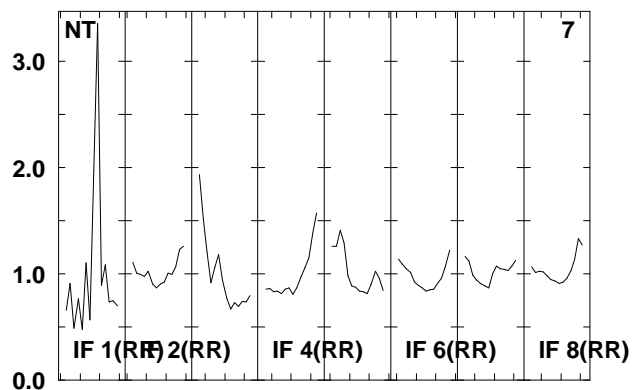
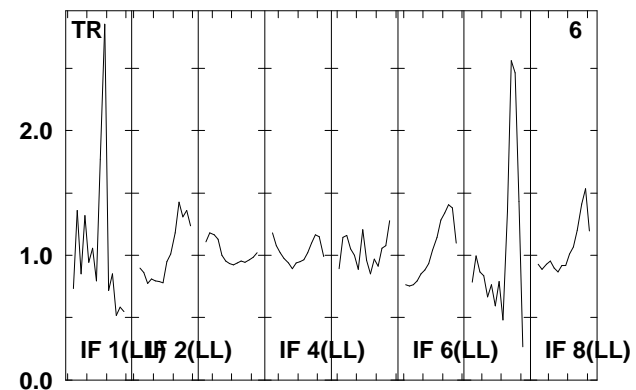
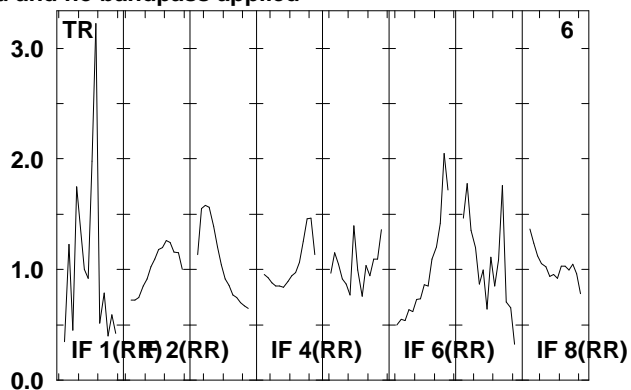
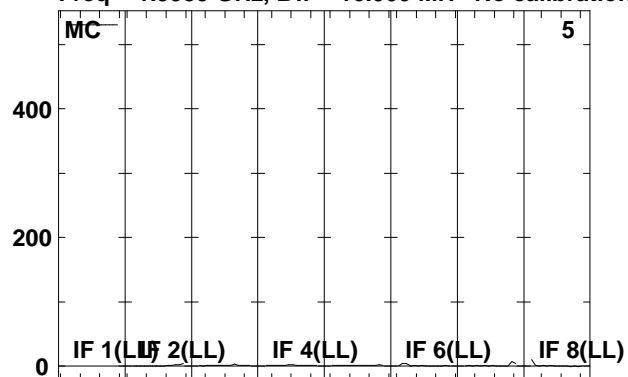

1595 1610 1625 1640 1655 1670 1685 1700 1715  
 FREQ MHz

Lower frame: Real Jy  
 Total-power spectrum Antenna: \*  
 Timerange: 00/20:28:01 to 00/20:31:39

Plot file version 71 created 20-AUG-2009 14:59:45

NGC3227 EG040B.UVDATA.1

Freq = 1.5955 GHz, Bw = 16.000 MH No calibration applied and no bandpass applied

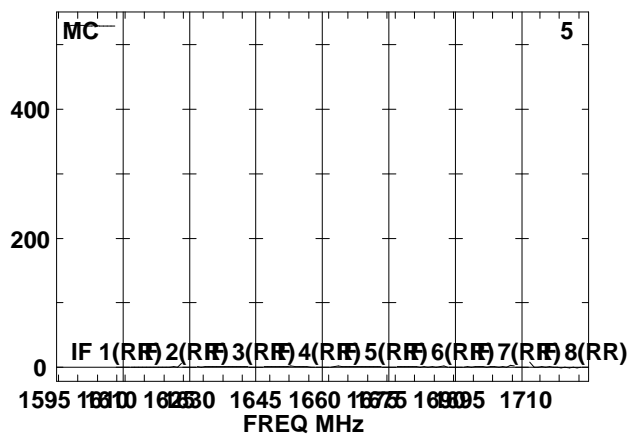
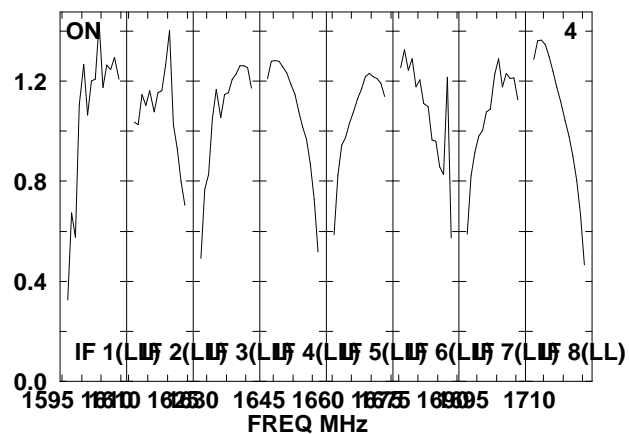
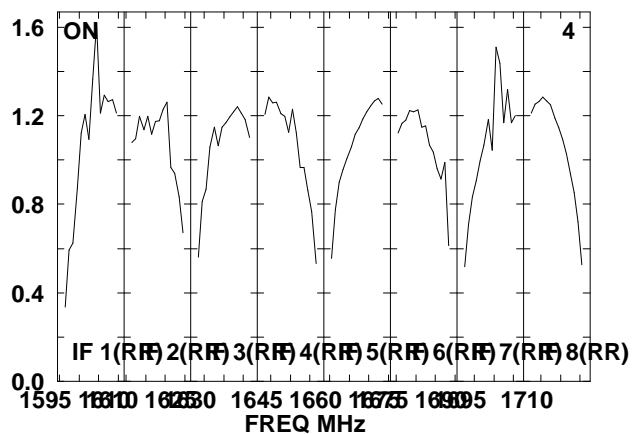
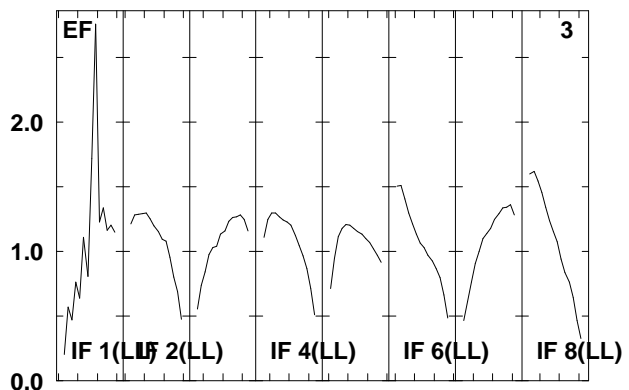
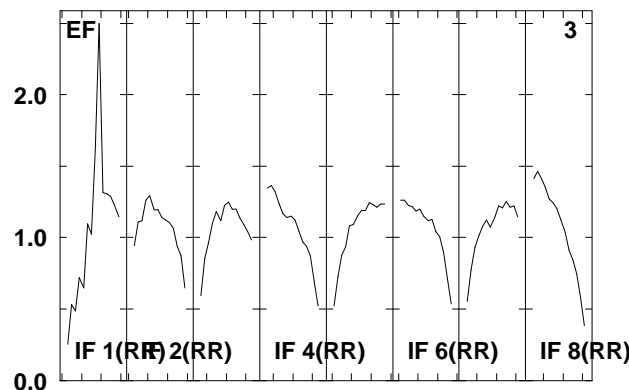
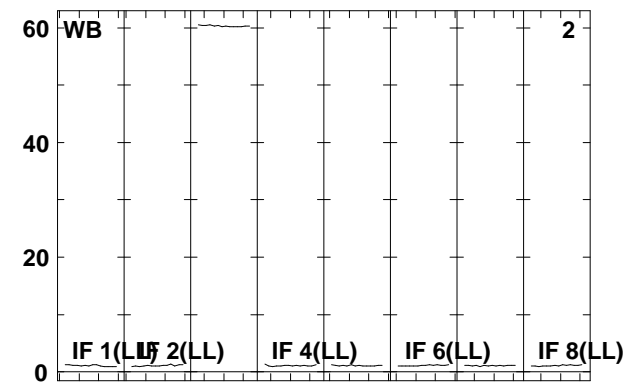
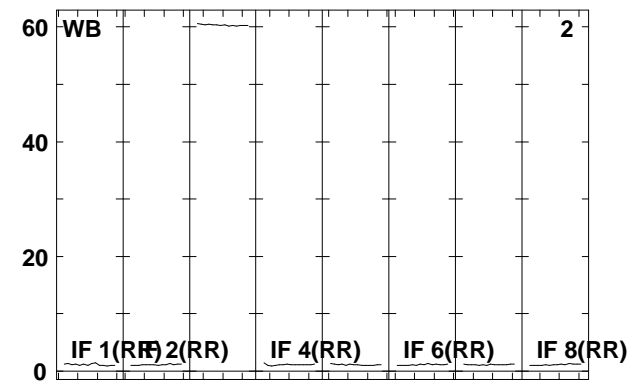
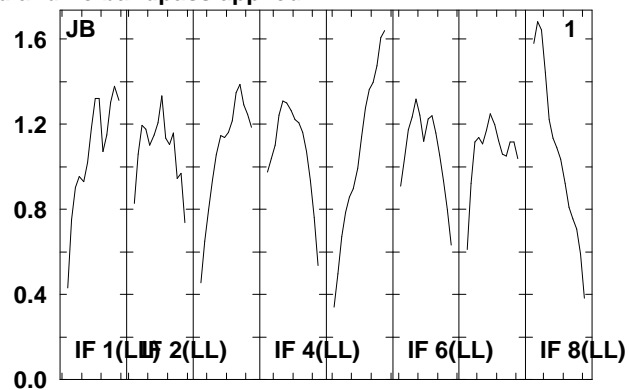
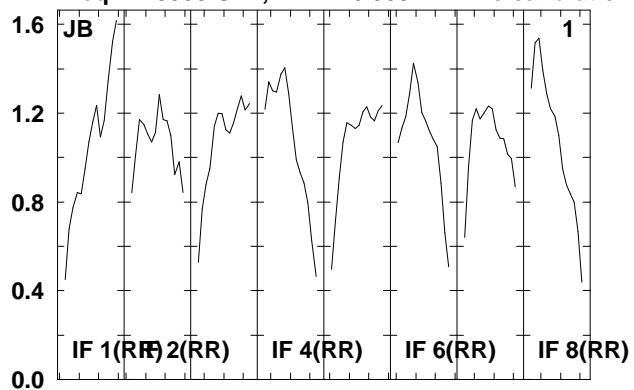

Lower frame: Real Jy  
Total-power spectrum Antenna: \*  
Timerange: 00/20:31:41 to 00/20:35:39

Plot file version 72 created 20-AUG-2009 14:59:46

NGC3227 EG040B.UVDATA.1

Freq = 1.5955 GHz, Bw = 16.000 MH No calibration applied and no bandpass applied

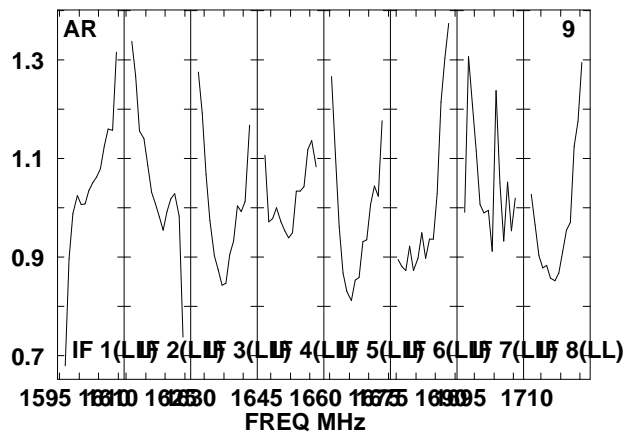
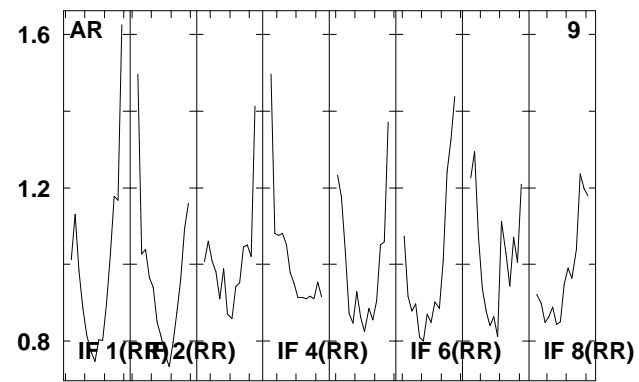
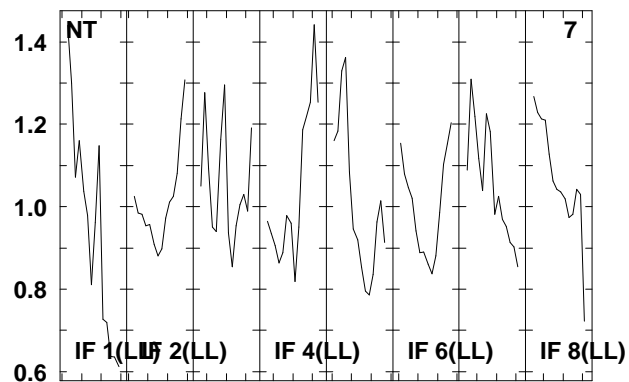
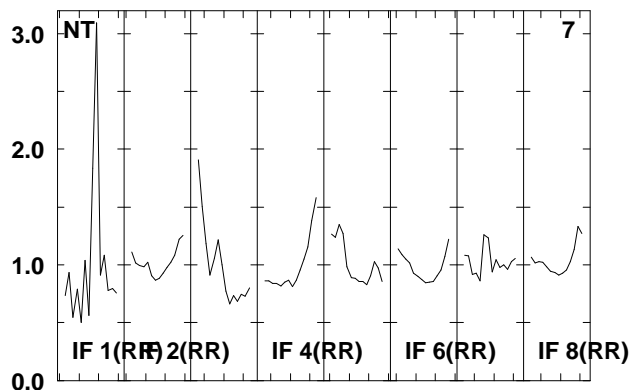
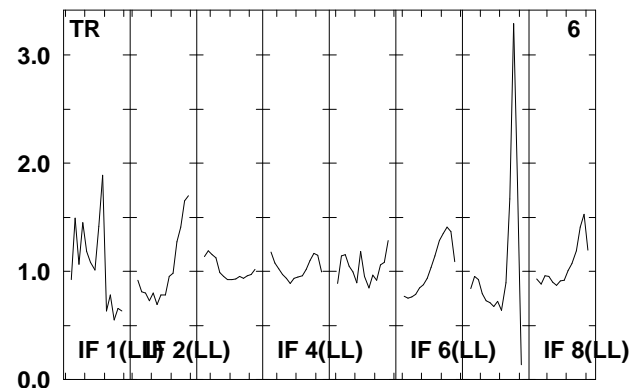
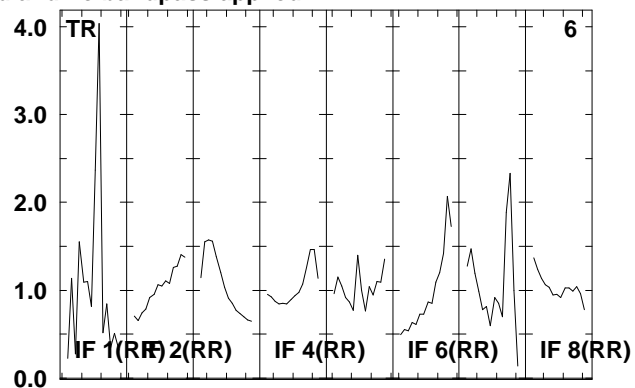
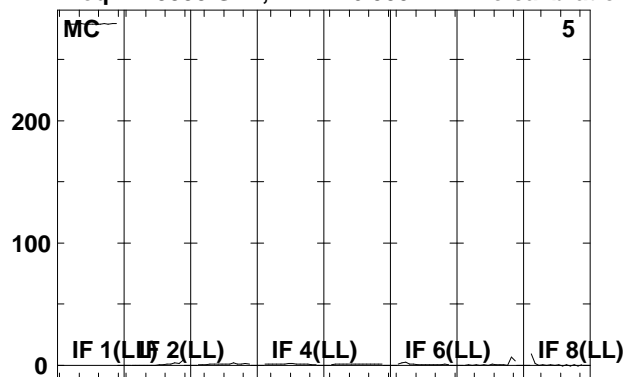

Lower frame: Real Jy

Total-power spectrum Antenna: \*

Timerange: 00/20:31:41 to 00/20:35:39



Plot file version 73 created 20-AUG-2009 14:59:46  
 J1016+20 EG040B.UVDATA.1  
 Freq = 1.5955 GHz, Bw = 16.000 MH No calibration applied and no bandpass applied

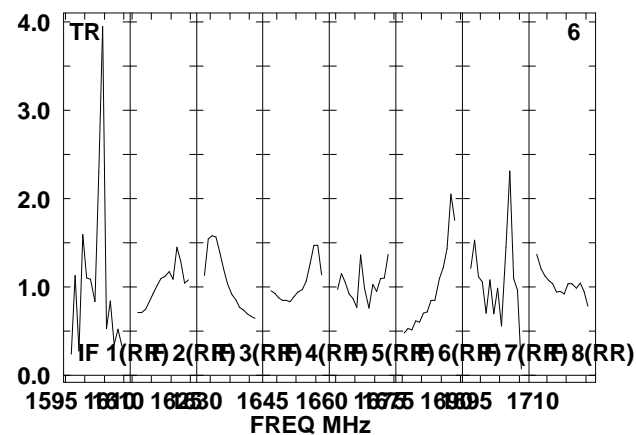
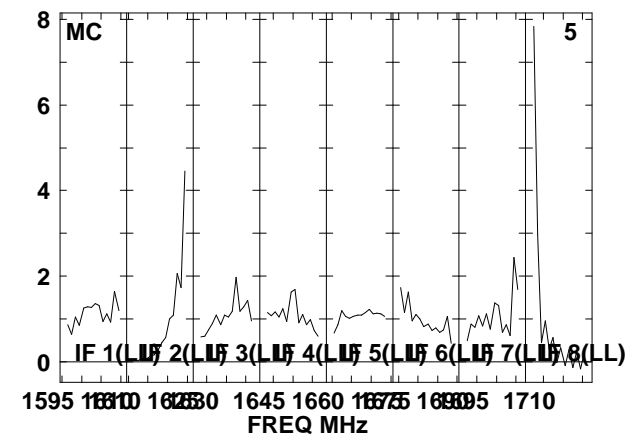
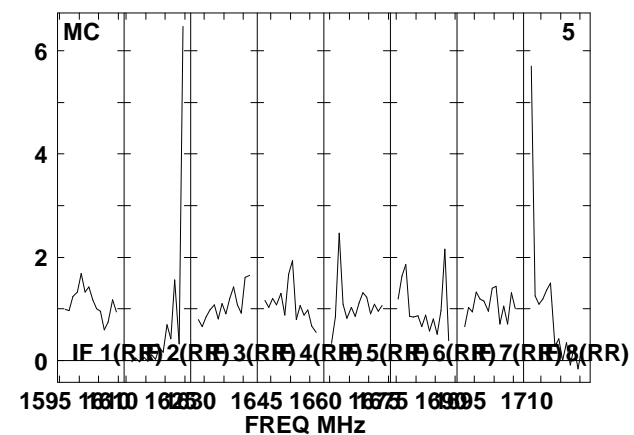
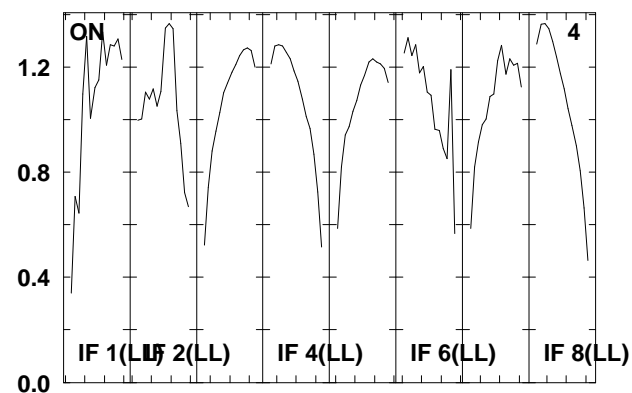
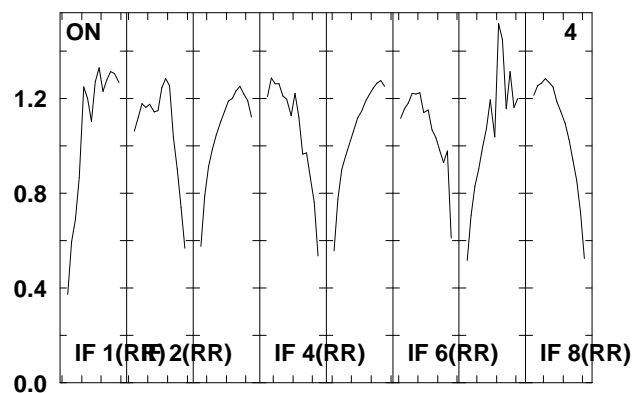
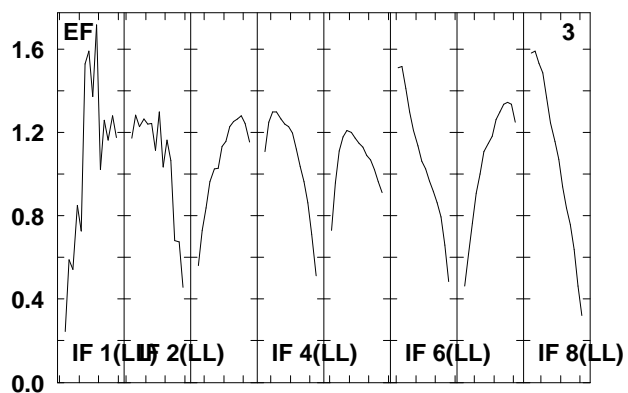
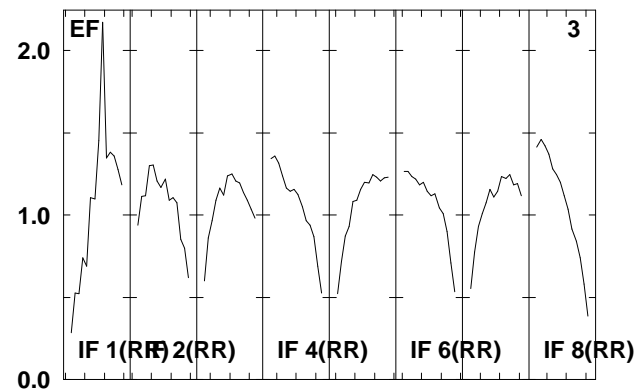
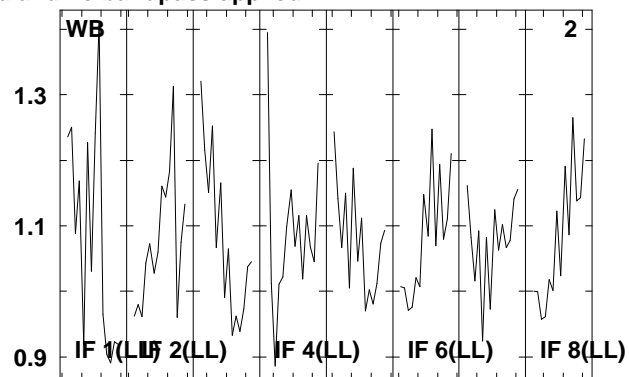
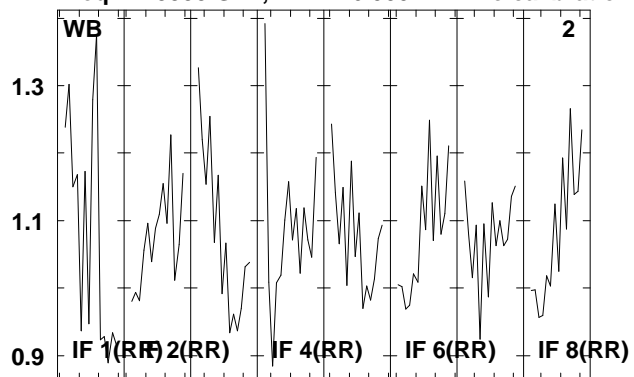

Lower frame: Real Jy  
 Total-power spectrum Antenna: \*  
 Timerange: 00/20:36:13 to 00/20:37:49

Plot file version 74 created 20-AUG-2009 14:59:46

J1016+20 EG040B.UVDATA.1

Freq = 1.5955 GHz, Bw = 16.000 MH No calibration applied and no bandpass applied

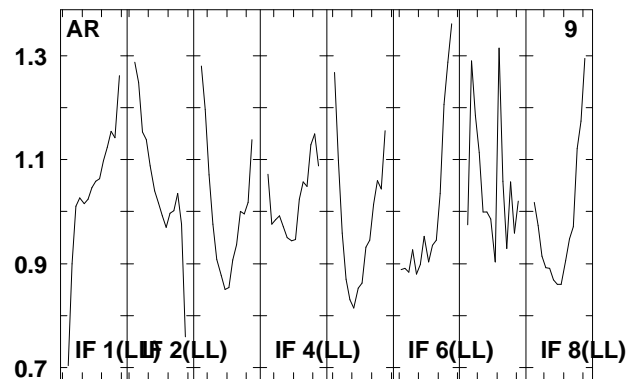
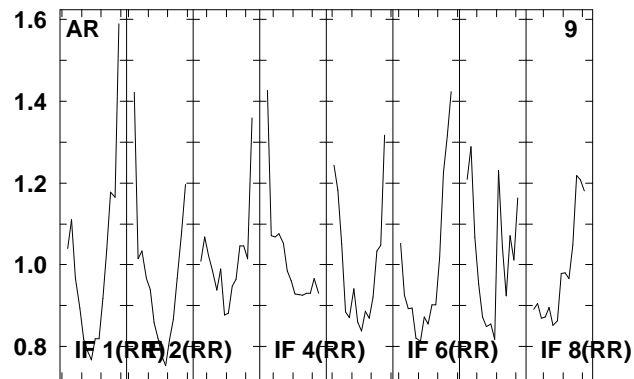
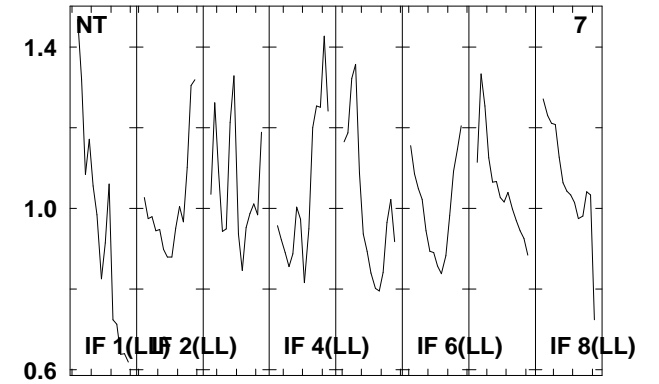
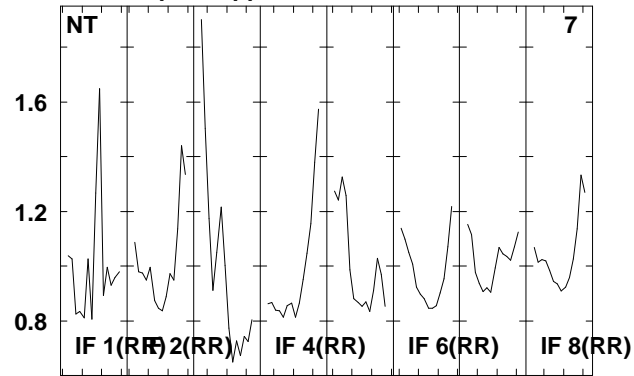
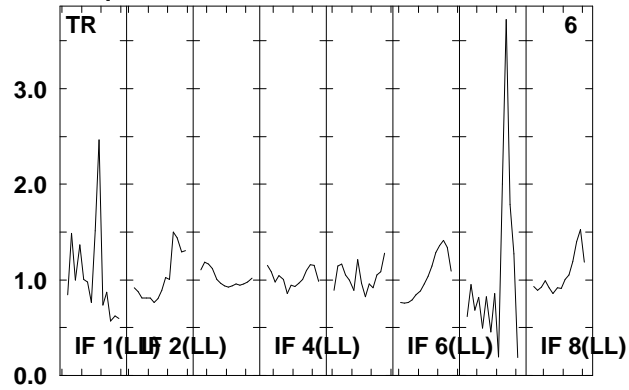

Lower frame: Real Jy  
Total-power spectrum Antenna: \*  
Timerange: 00/20:36:13 to 00/20:37:49

Plot file version 75 created 20-AUG-2009 14:59:47

NGC3227 EG040B.UVDATA.1

Freq = 1.5955 GHz, Bw = 16.000 MH No calibration applied and no bandpass applied

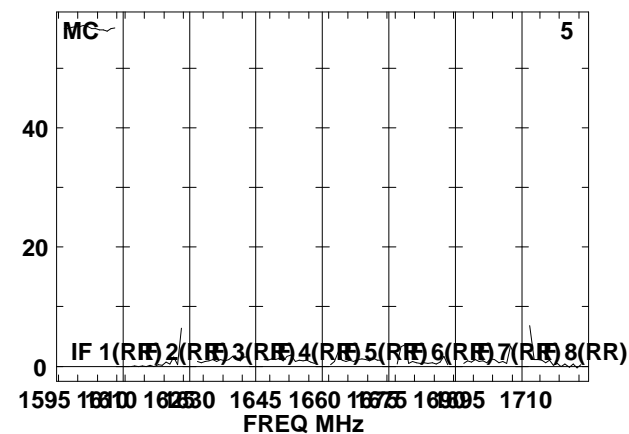
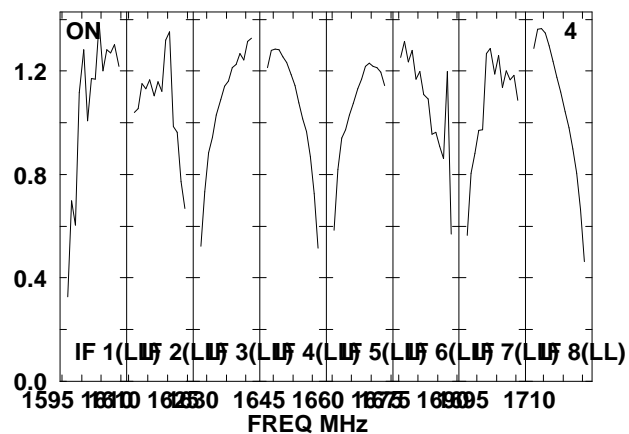
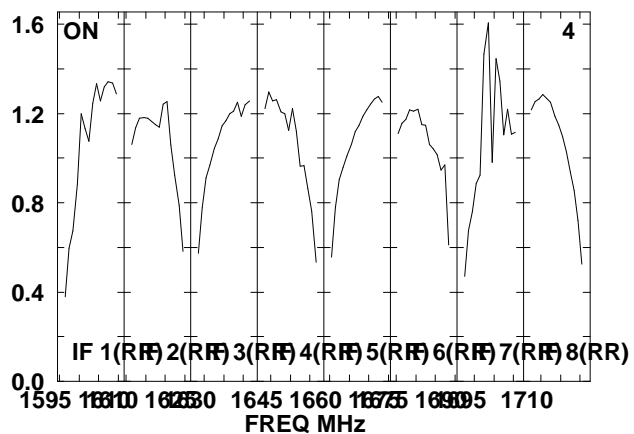
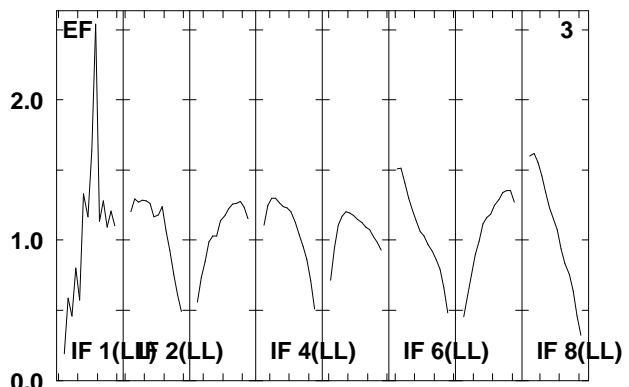
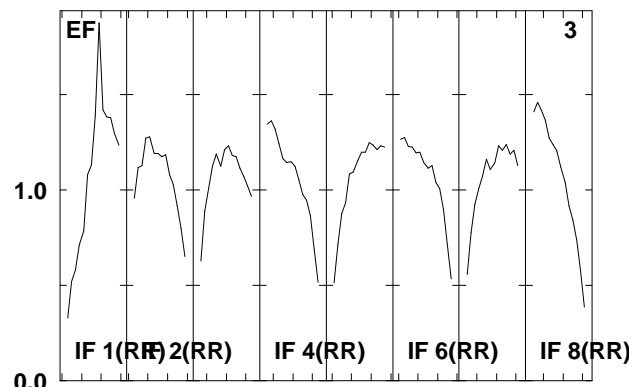
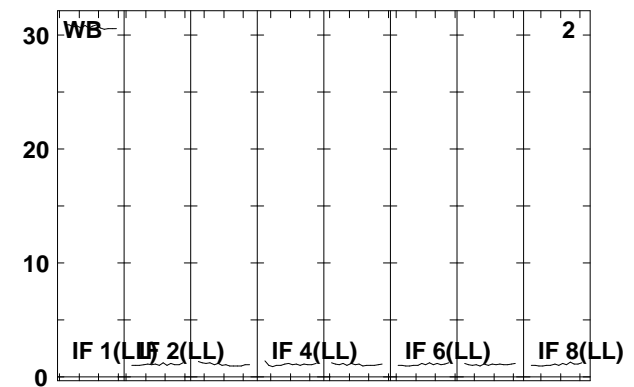
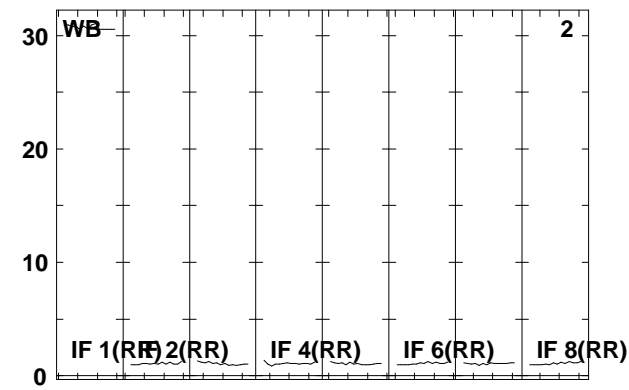
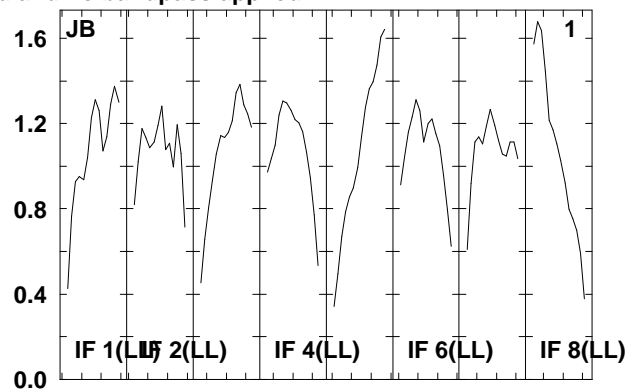
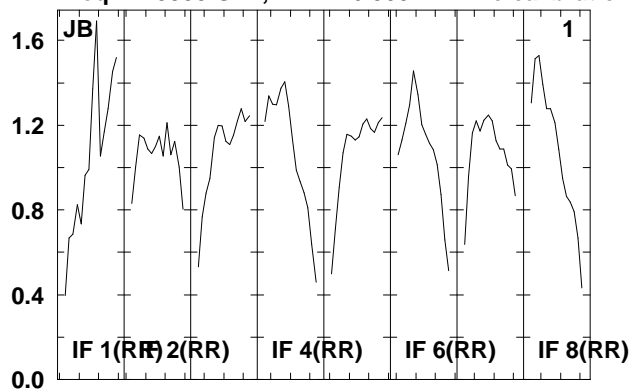

Lower frame: Real Jy  
Total-power spectrum Antenna: \*  
Timerange: 00/20:37:53 to 00/20:41:51

Plot file version 76 created 20-AUG-2009 14:59:47

NGC3227 EG040B.UVDATA.1

Freq = 1.5955 GHz, Bw = 16.000 MH No calibration applied and no bandpass applied

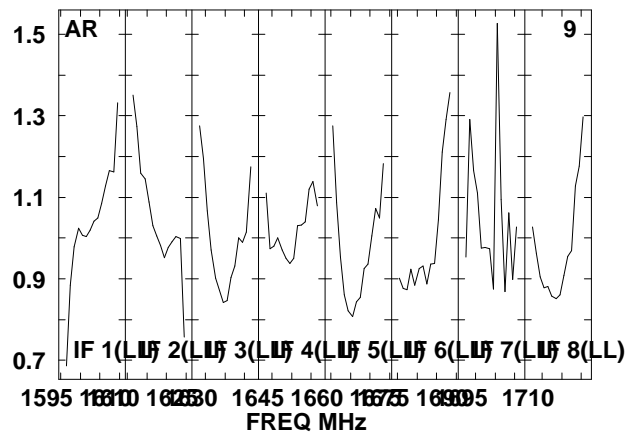
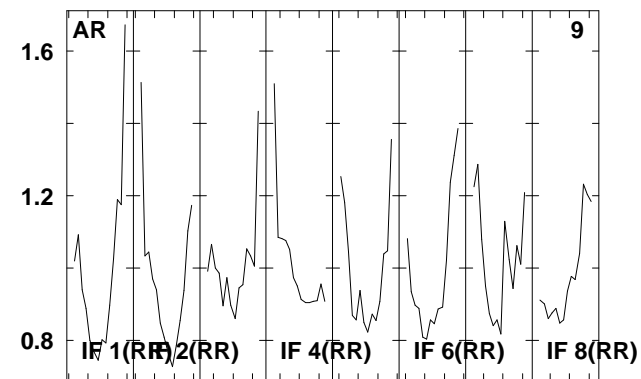
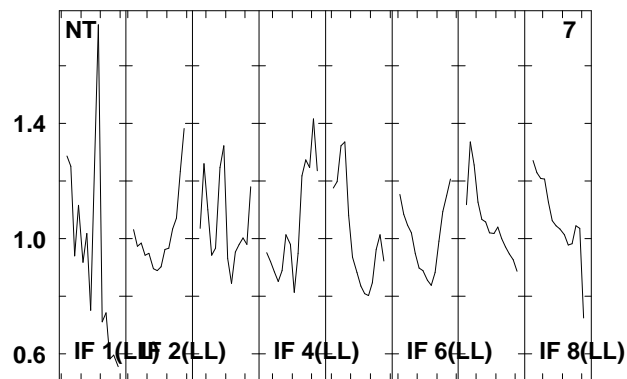
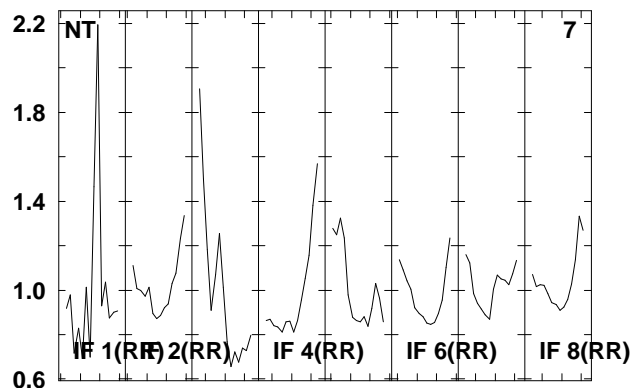
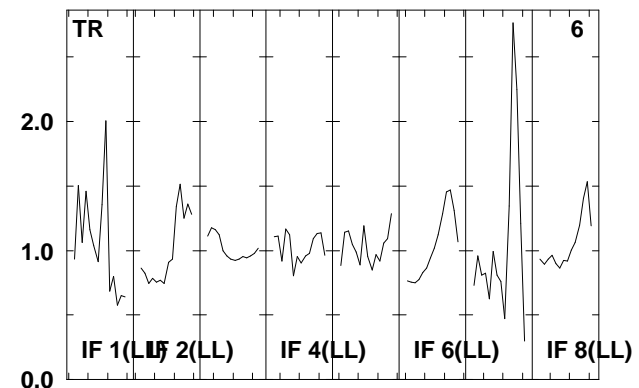
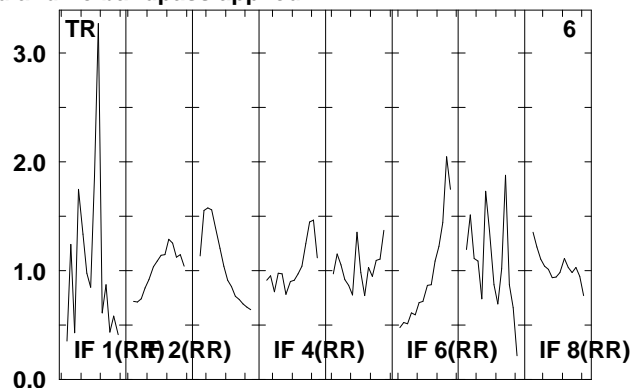
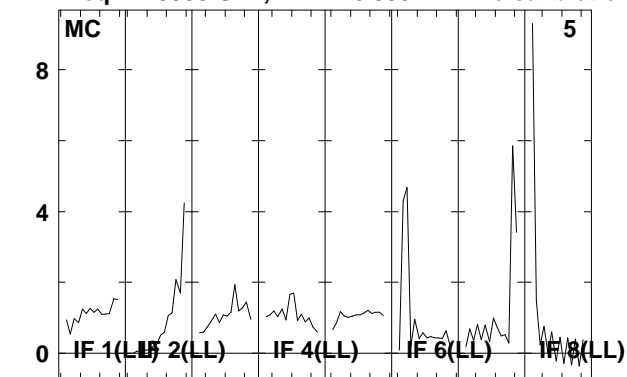

Lower frame: Real Jy

Total-power spectrum Antenna: \*

Timerange: 00/20:37:53 to 00/20:41:51

Plot file version 77 created 20-AUG-2009 14:59:48  
 J1016+20 EG040B.UVDATA.1  
 Freq = 1.5955 GHz, Bw = 16.000 MH No calibration applied and no bandpass applied

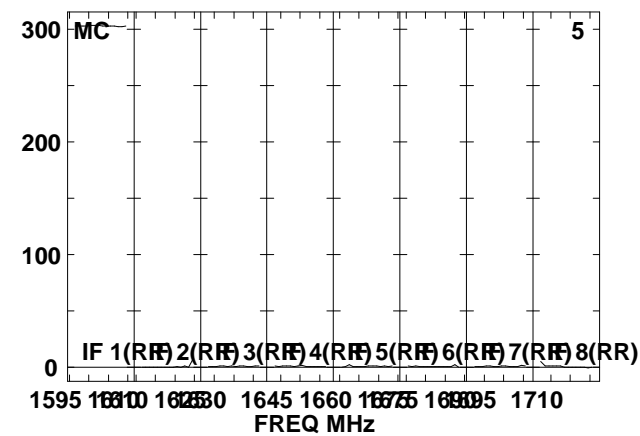
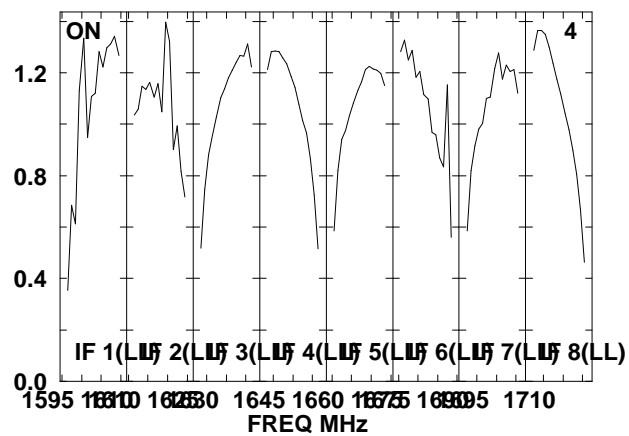
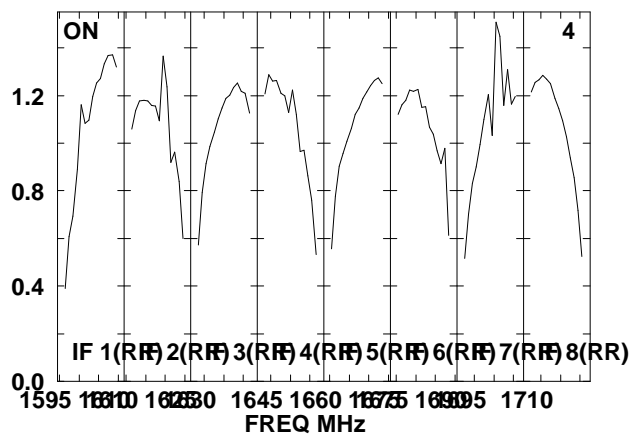
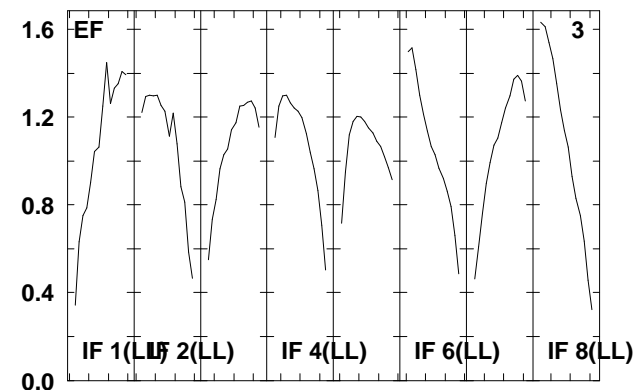
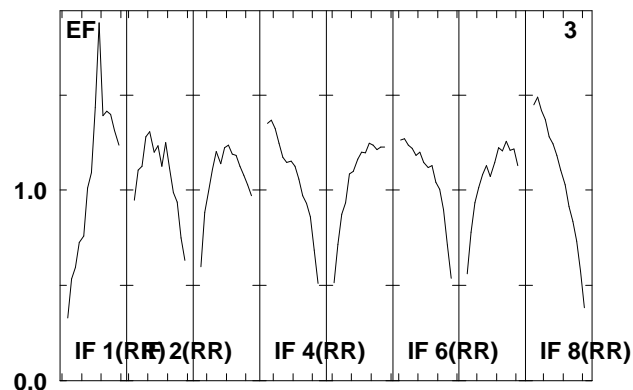
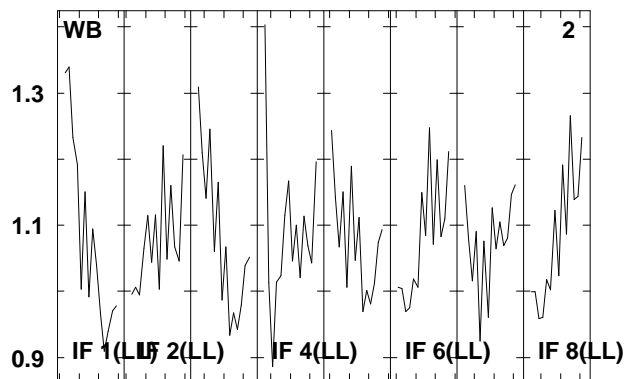
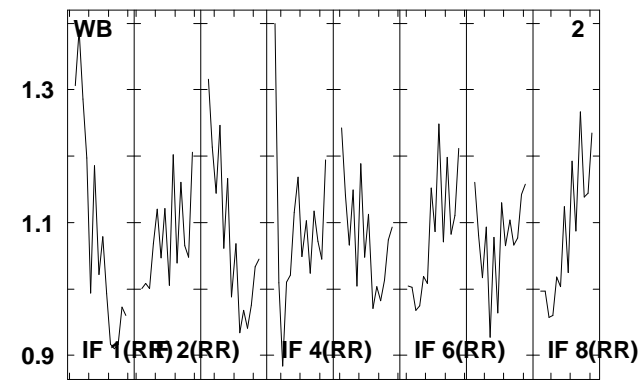
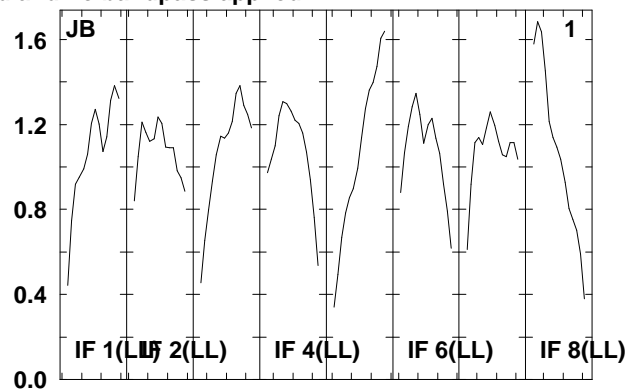
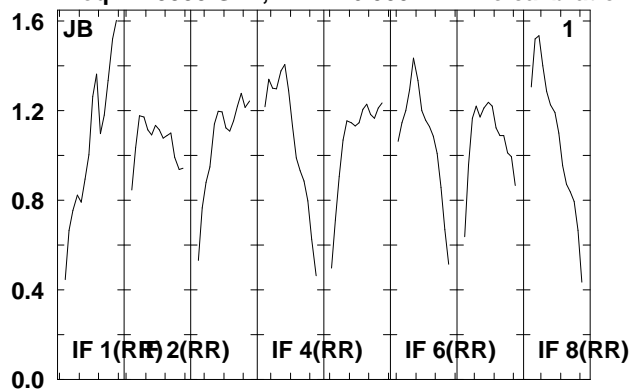

Lower frame: Real Jy  
 Total-power spectrum Antenna: \*  
 Timerange: 00/20:41:53 to 00/20:43:51

Plot file version 78 created 20-AUG-2009 14:59:48

J1016+20 EG040B.UVDATA.1

Freq = 1.5955 GHz, Bw = 16.000 MH No calibration applied and no bandpass applied

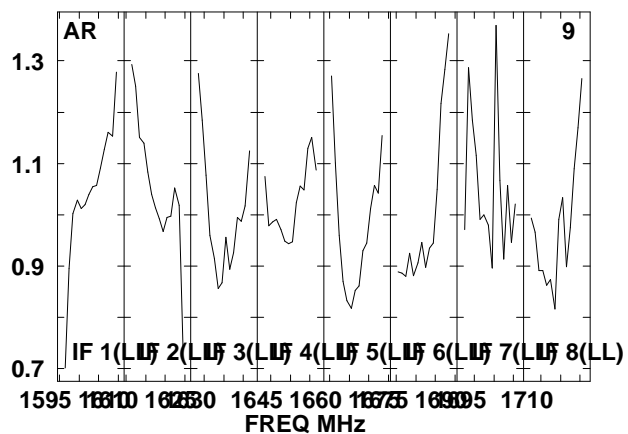
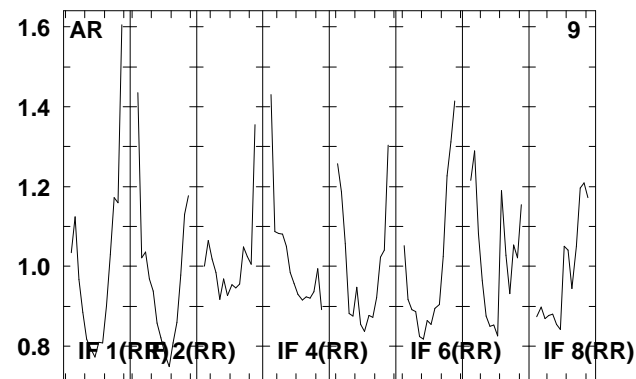
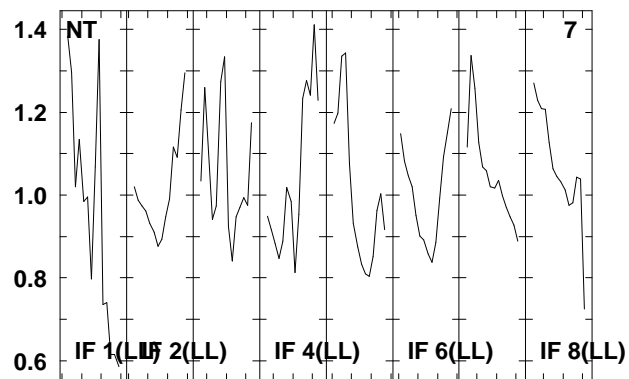
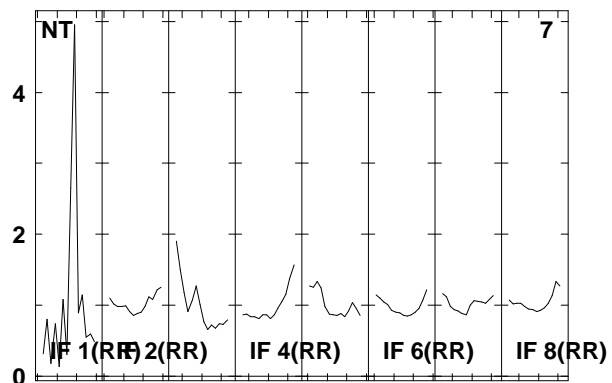
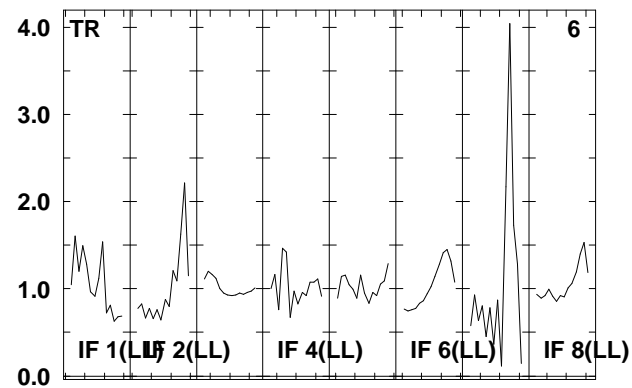
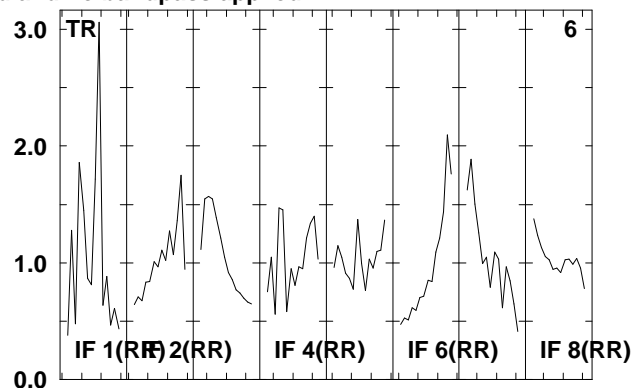
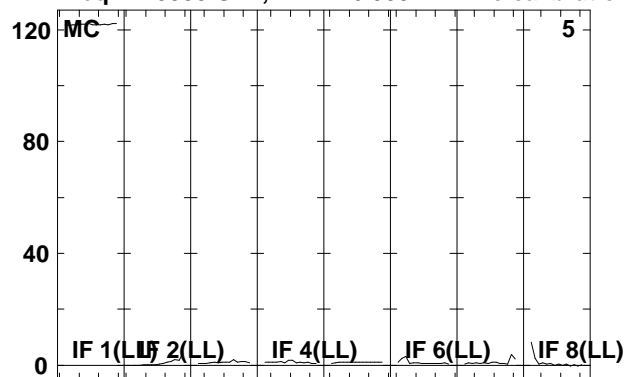

Lower frame: Real Jy

Total-power spectrum Antenna: \*

Timerange: 00/20:41:53 to 00/20:43:51

Plot file version 79 created 20-AUG-2009 14:59:48

NGC3227 EG040B.UVDATA.1

Freq = 1.5955 GHz, Bw = 16.000 MH No calibration applied and no bandpass applied

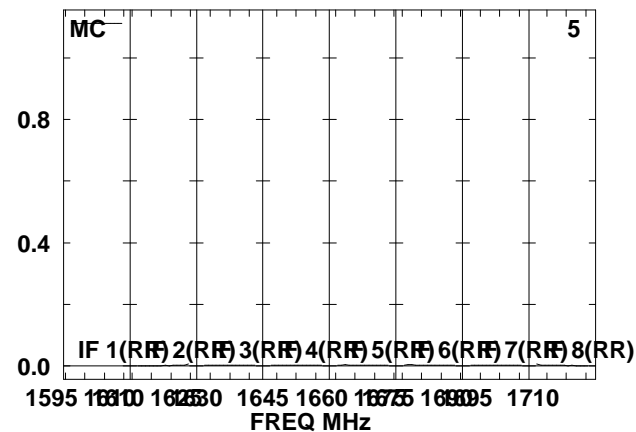
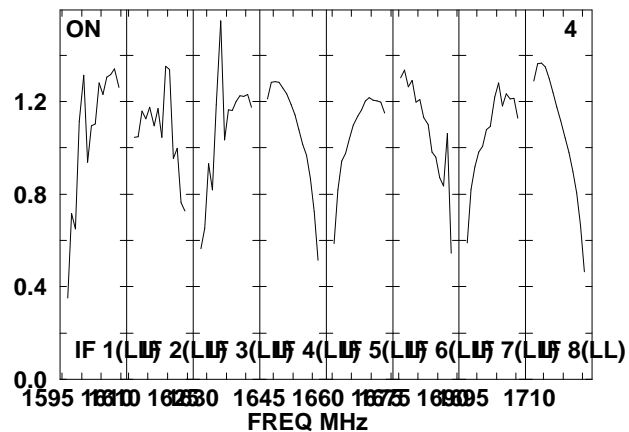
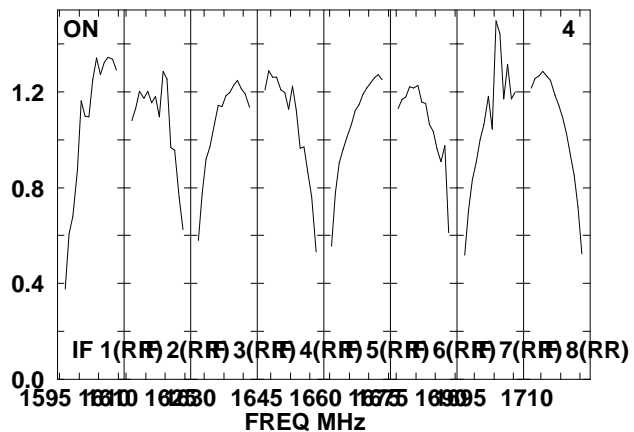
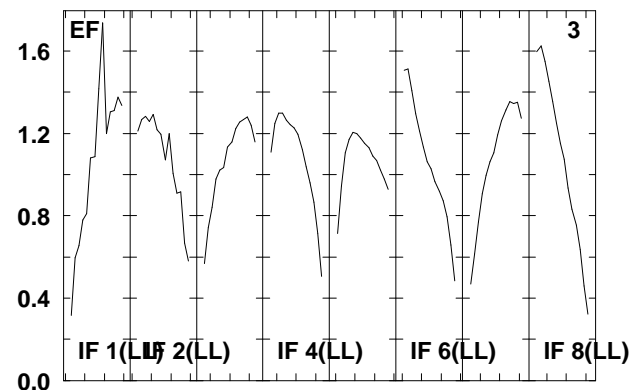
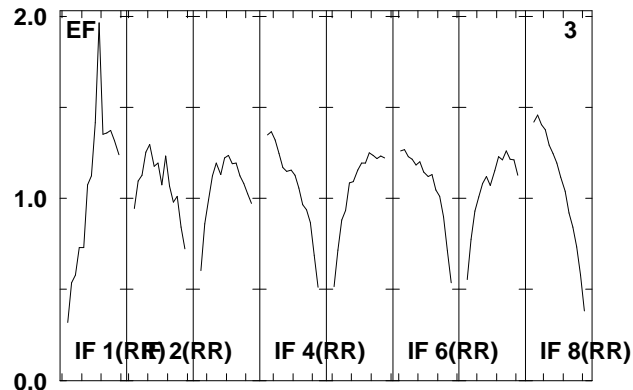
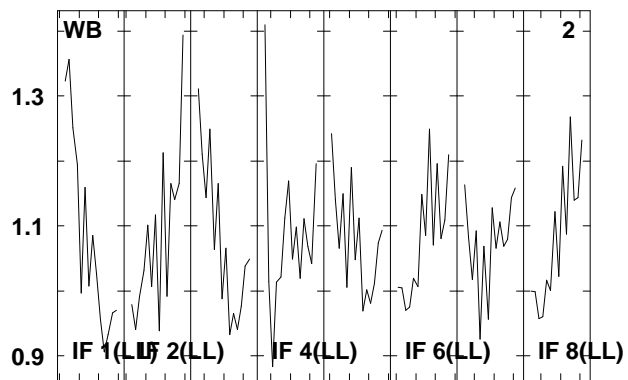
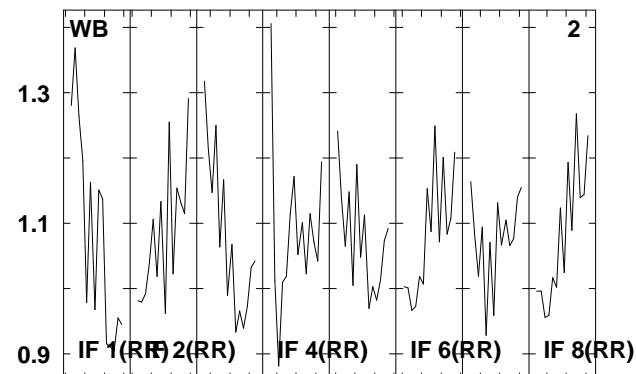
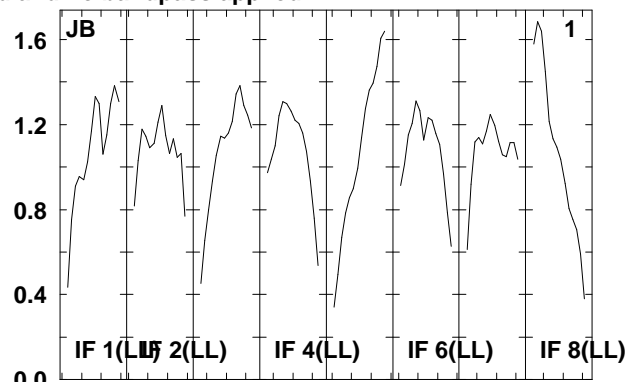
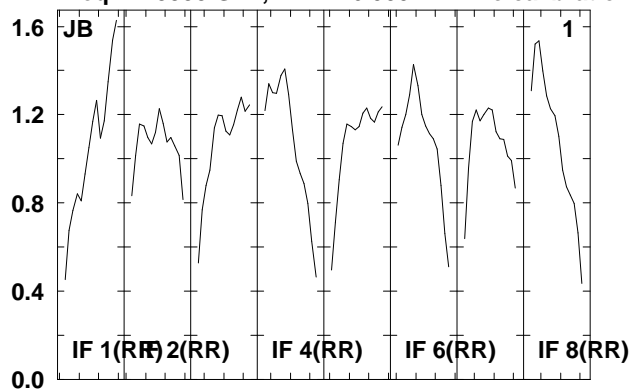

Lower frame: Real Jy  
Total-power spectrum Antenna: \*  
Timerange: 00/20:43:53 to 00/20:47:51

Plot file version 80 created 20-AUG-2009 14:59:49

NGC3227 EG040B.UVDATA.1

Freq = 1.5955 GHz, Bw = 16.000 MH No calibration applied and no bandpass applied

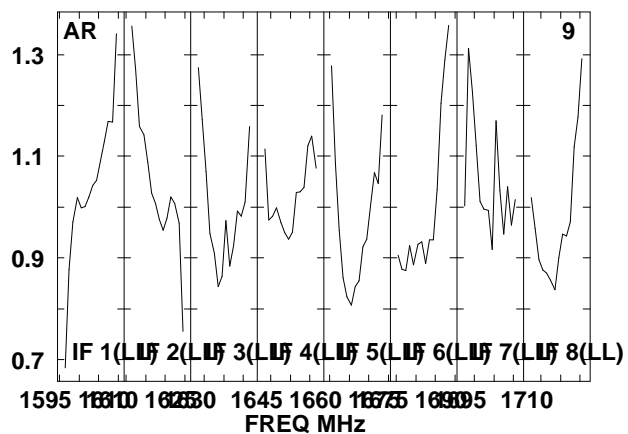
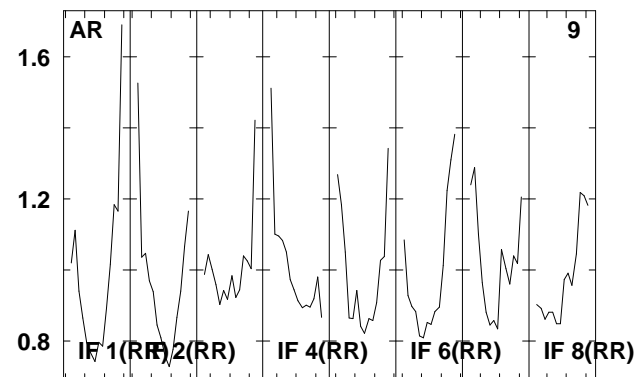
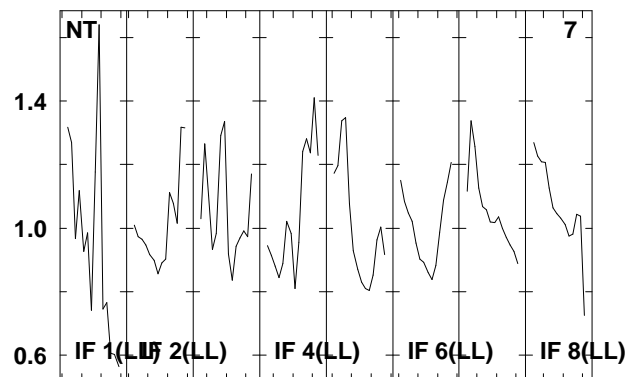
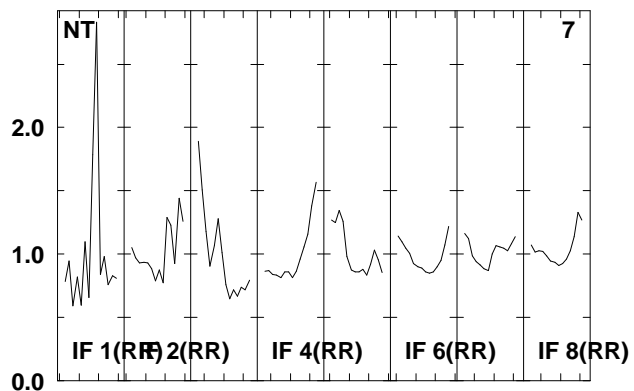
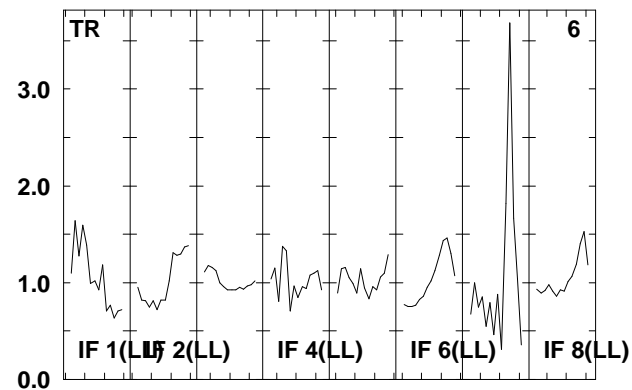
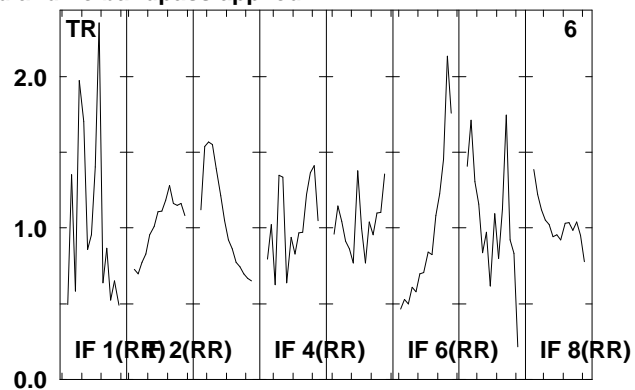
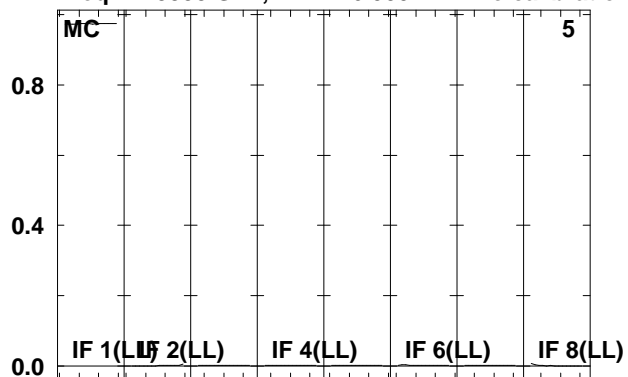

Lower frame: Kilo Real Jy

Total-power spectrum Antenna: \*

Timerange: 00/20:43:53 to 00/20:47:51



Plot file version 81 created 20-AUG-2009 14:59:49

J1016+20 EG040B.UVDATA.1

Freq = 1.5955 GHz, Bw = 16.000 MH No calibration applied and no bandpass applied

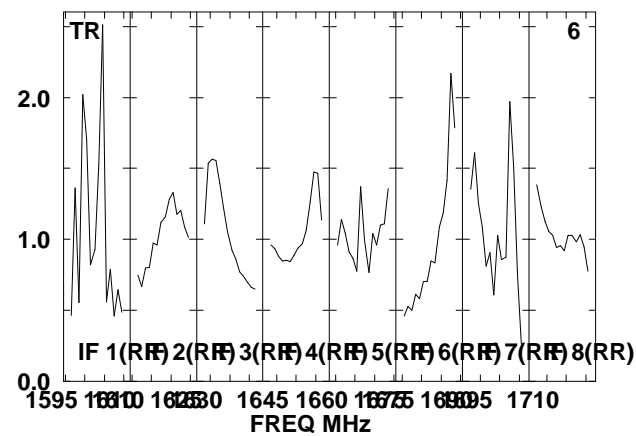
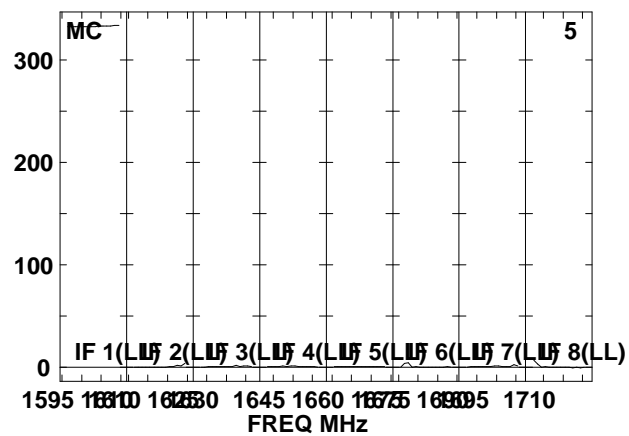
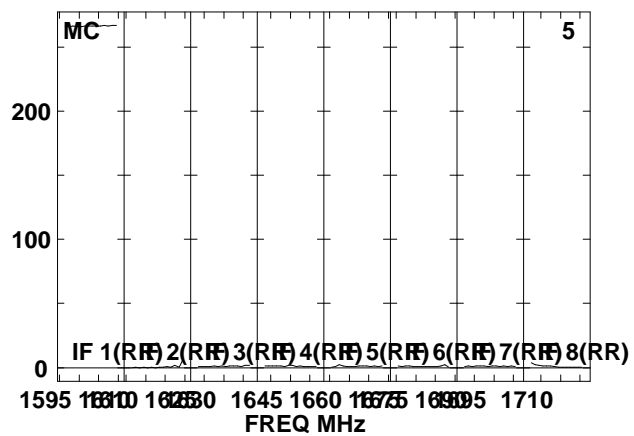
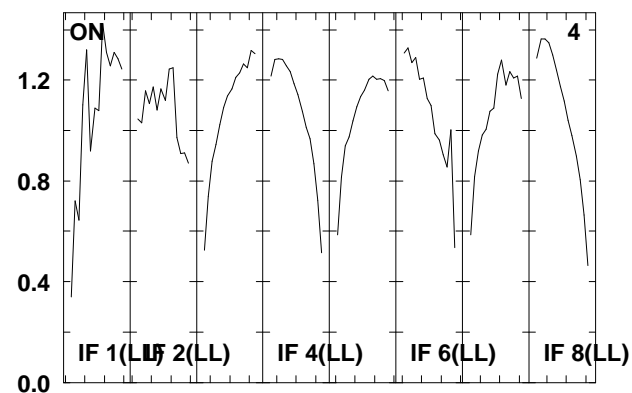
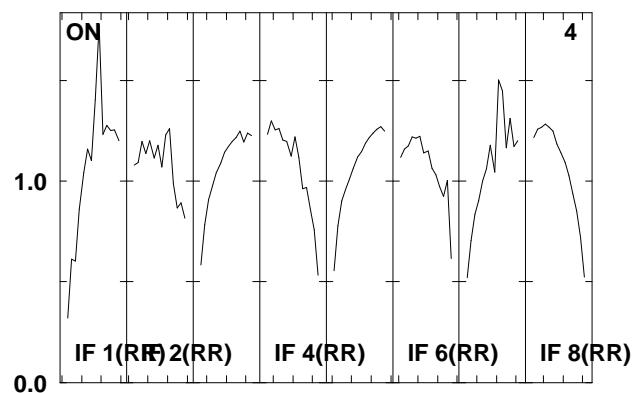
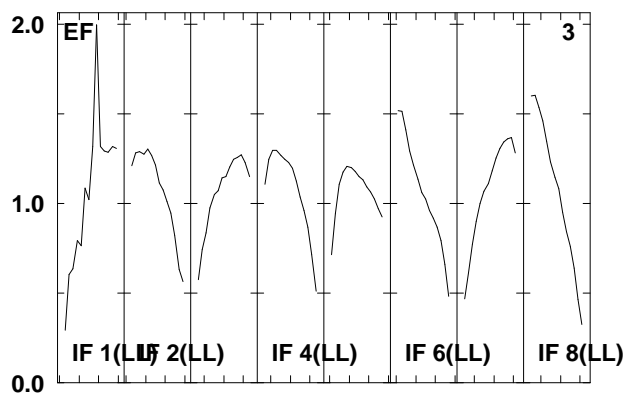
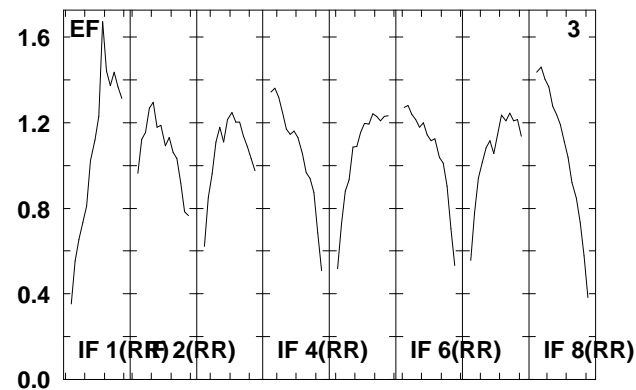
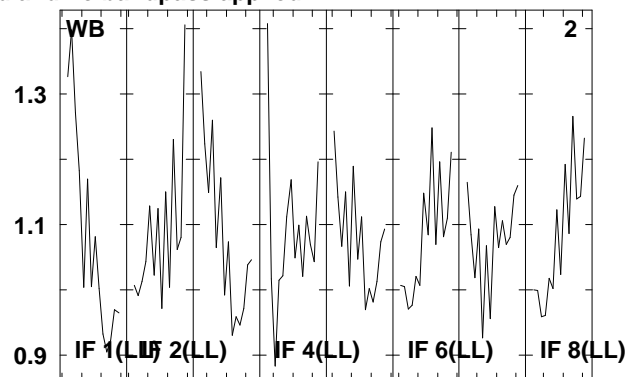
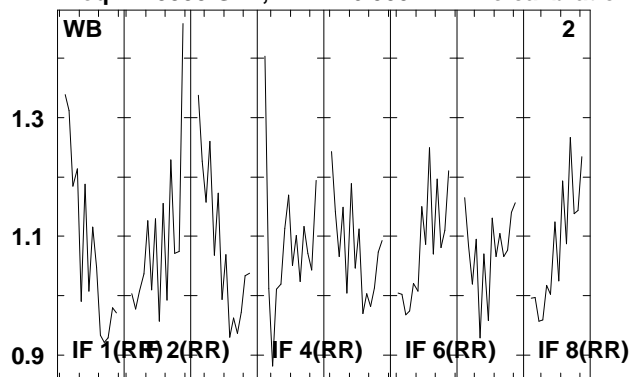

Lower frame: Real Jy

Total-power spectrum Antenna: \*

Timerange: 00/20:48:25 to 00/20:50:03

Plot file version 82 created 20-AUG-2009 14:59:49

J1016+20 EG040B.UVDATA.1

Freq = 1.5955 GHz, Bw = 16.000 MH No calibration applied and no bandpass applied

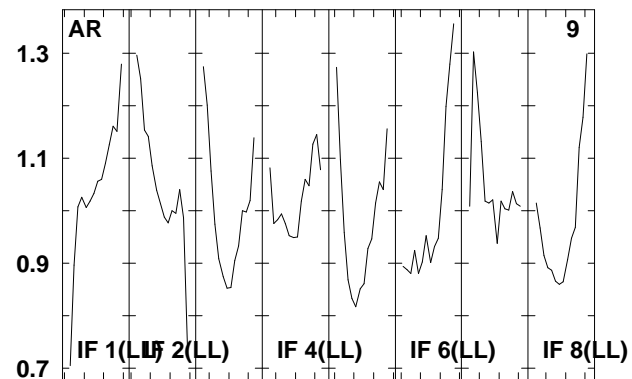
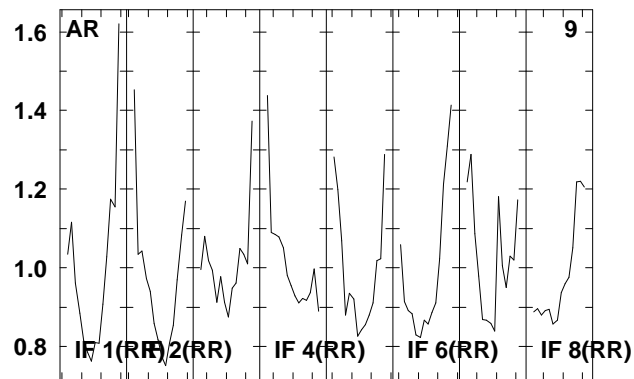
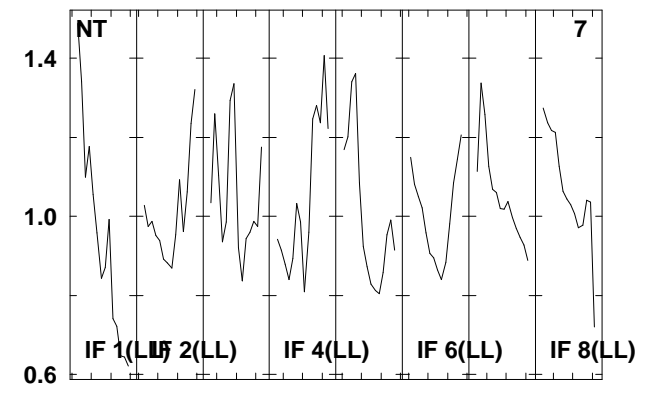
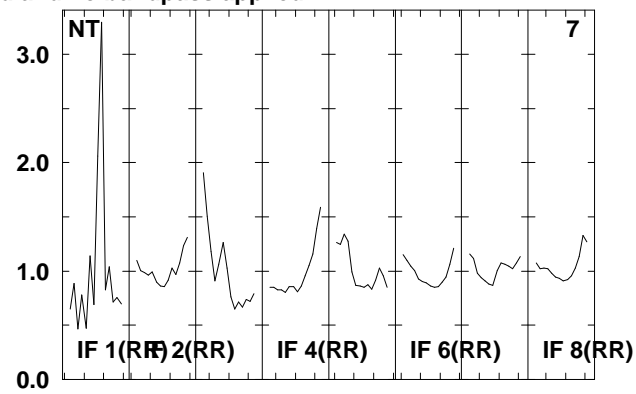
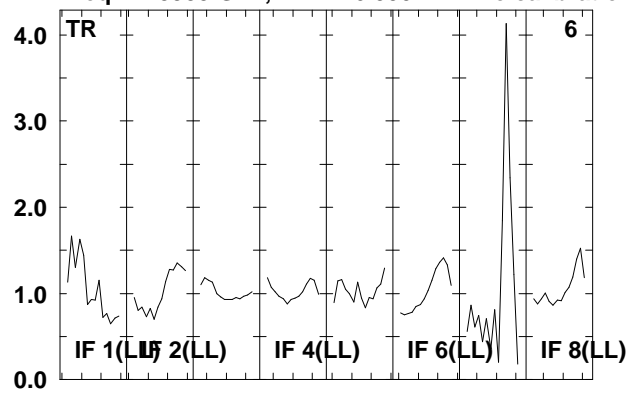

Lower frame: Real Jy  
Total-power spectrum Antenna: \*  
Timerange: 00/20:48:25 to 00/20:50:03

Plot file version 83 created 20-AUG-2009 14:59:50

NGC3227 EG040B.UVDATA.1

Freq = 1.5955 GHz, Bw = 16.000 MH No calibration applied and no bandpass applied

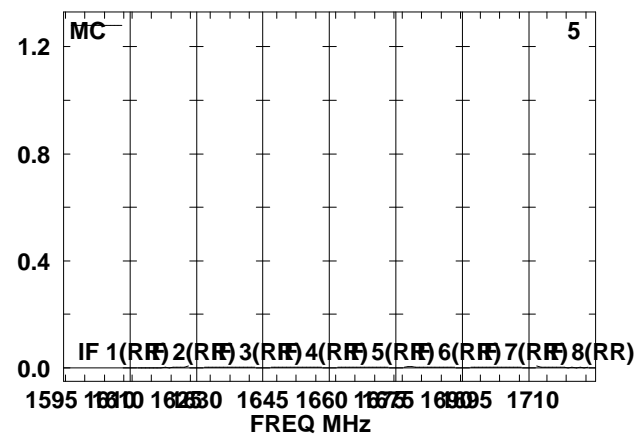
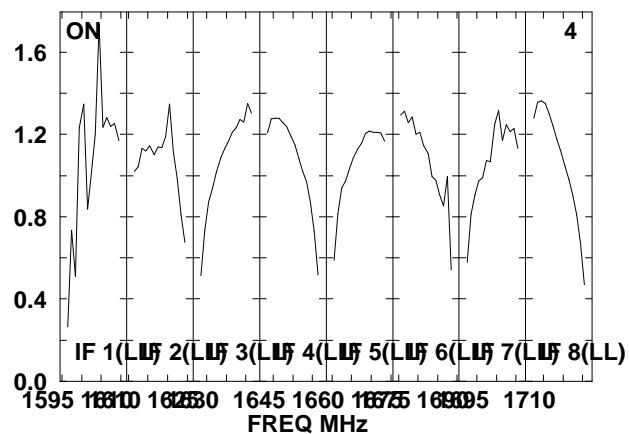
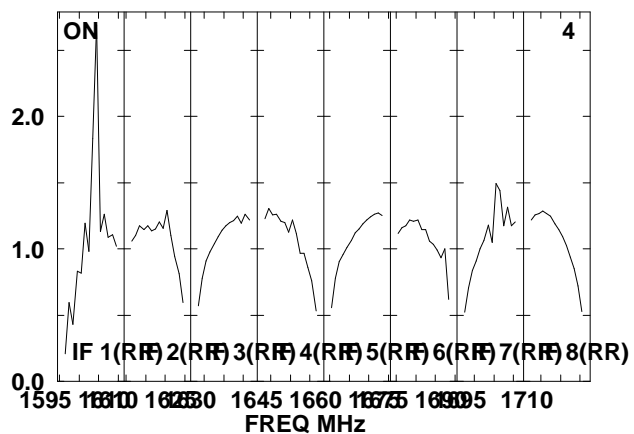
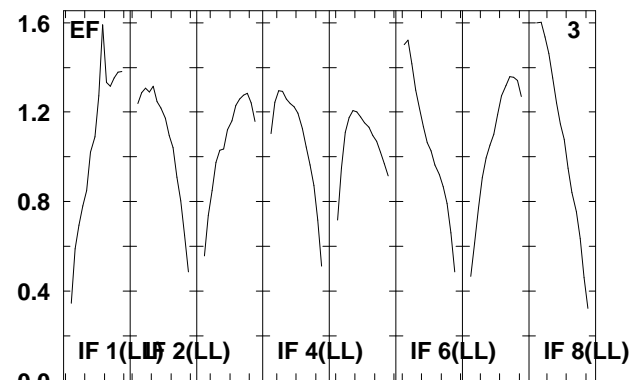
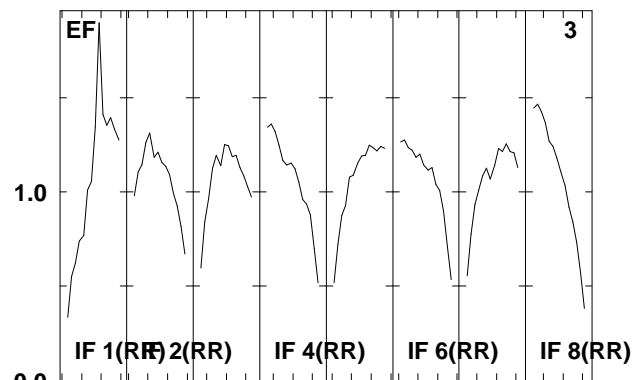
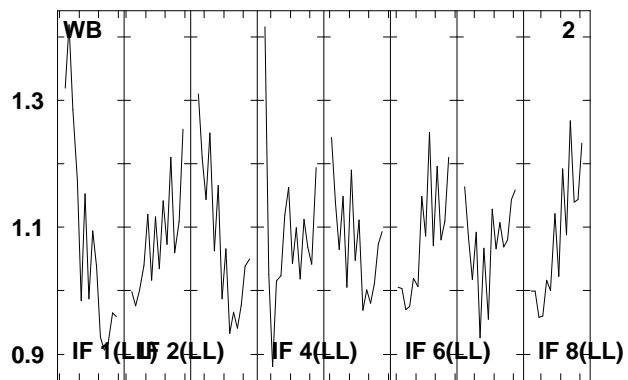
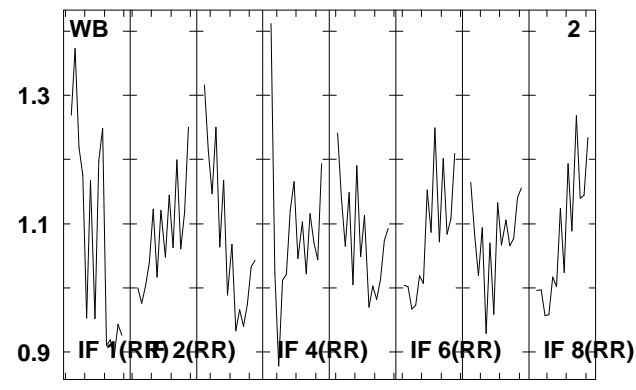
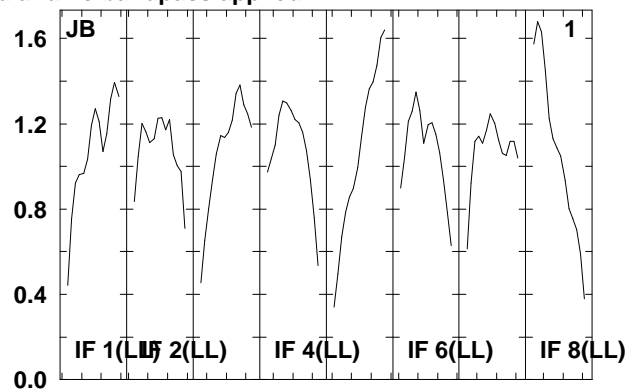
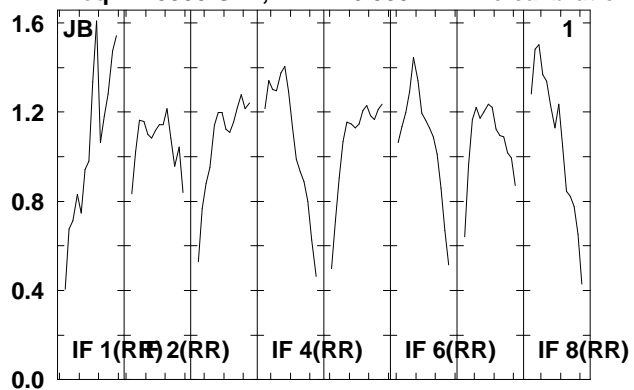

Lower frame: Real Jy  
Total-power spectrum Antenna: \*  
Timerange: 00/20:50:05 to 00/20:54:03

Plot file version 84 created 20-AUG-2009 14:59:50

NGC3227 EG040B.UVDATA.1

Freq = 1.5955 GHz, Bw = 16.000 MH No calibration applied and no bandpass applied

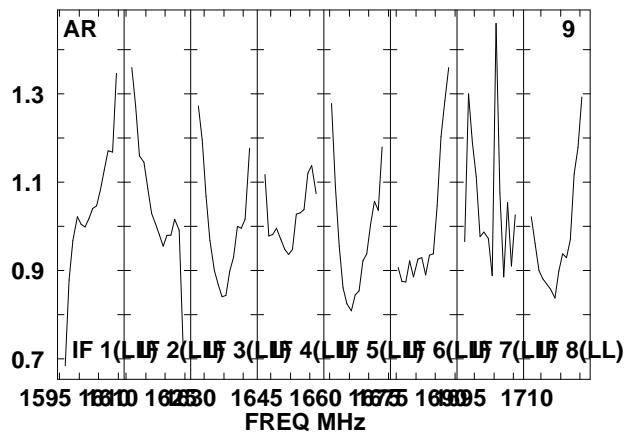
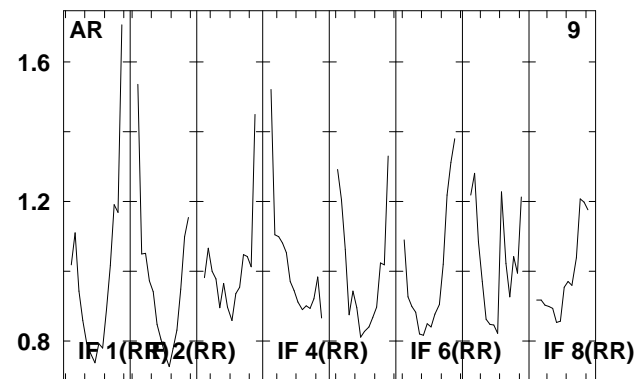
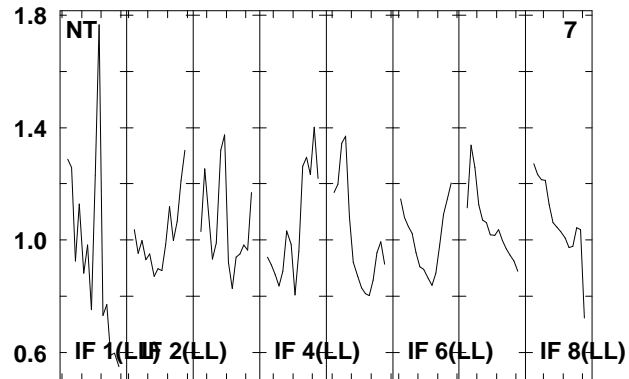
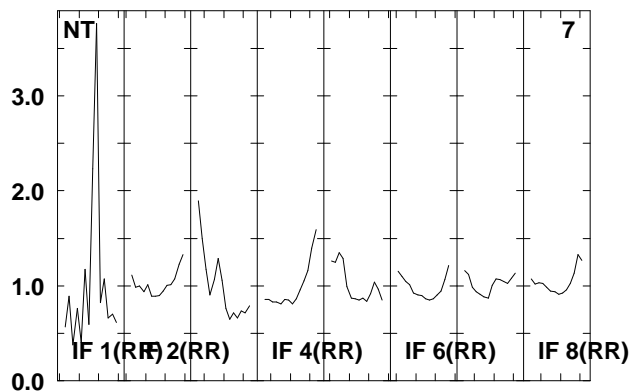
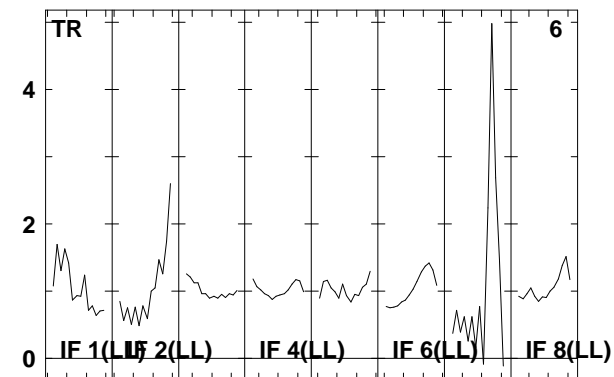
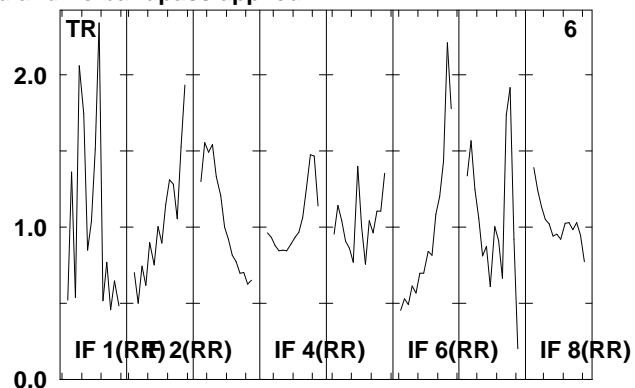
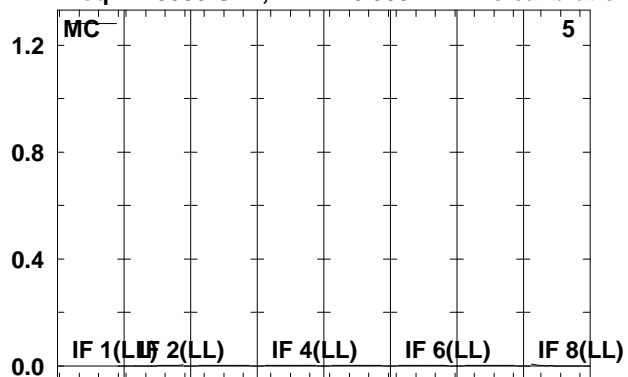

Lower frame: Kilo Real Jy

Total-power spectrum Antenna: \*

Timerange: 00/20:50:05 to 00/20:54:03

Plot file version 85 created 20-AUG-2009 14:59:51

J1016+20 EG040B.UVDATA.1

Freq = 1.5955 GHz, Bw = 16.000 MH No calibration applied and no bandpass applied

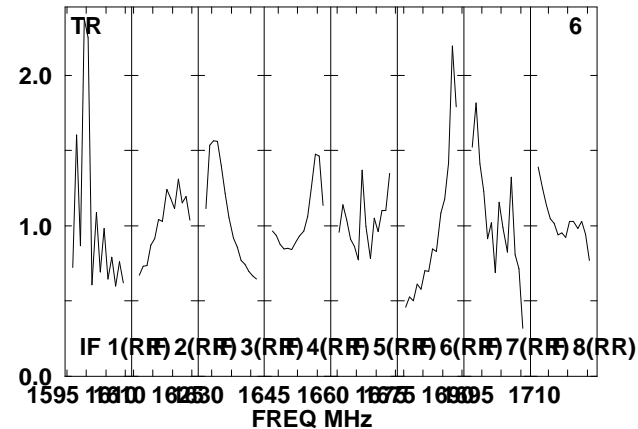
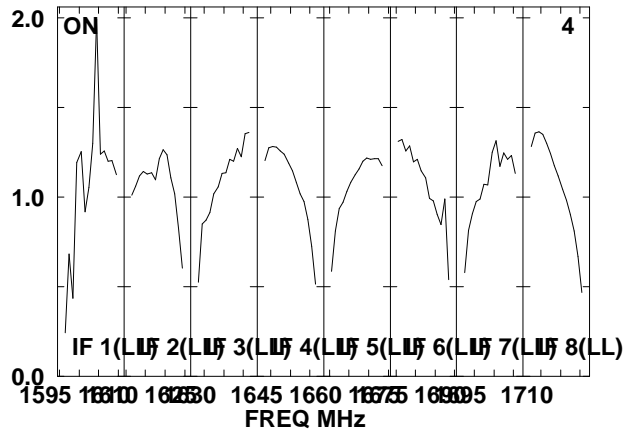
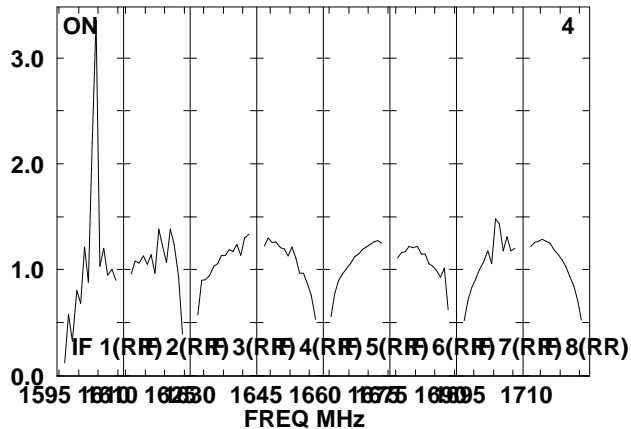
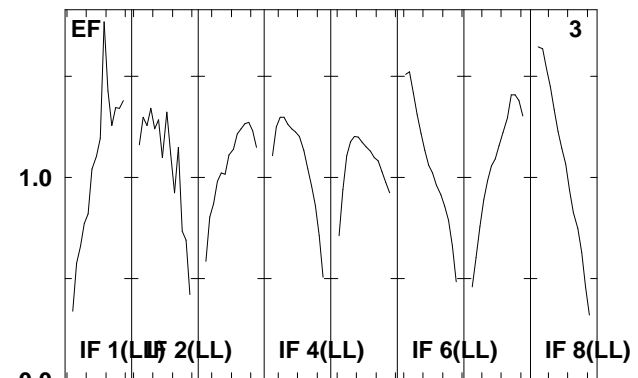
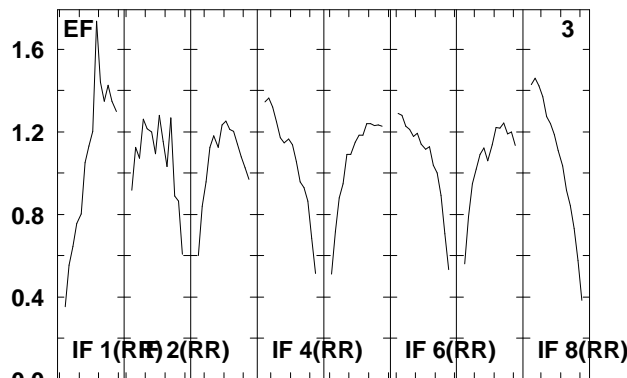
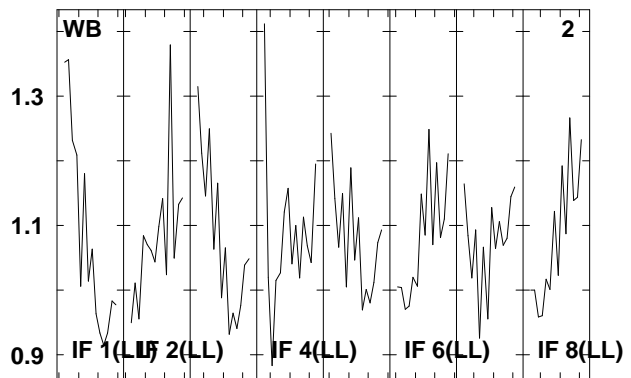
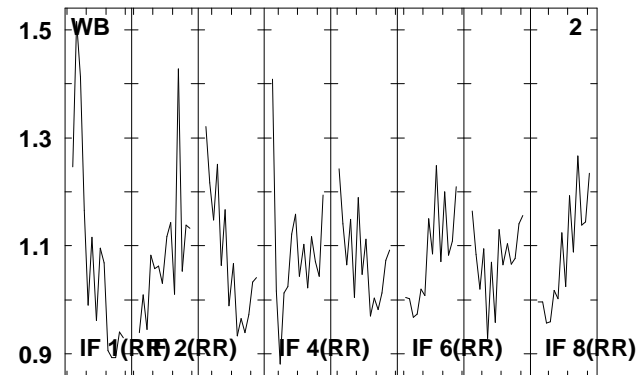
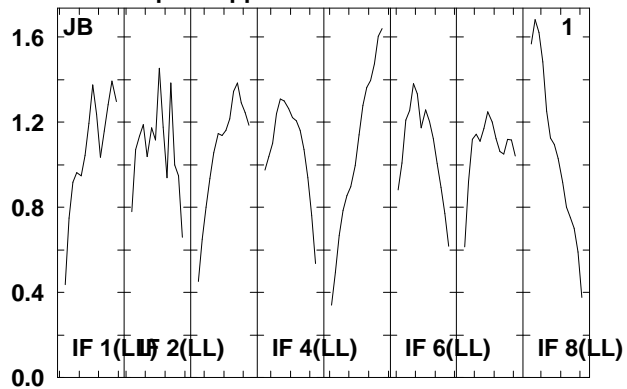
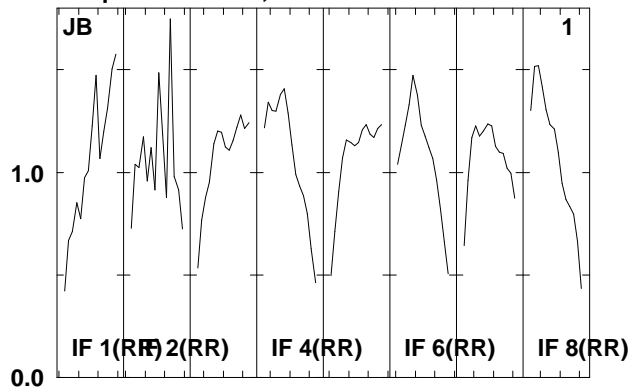

Lower frame: Real Jy  
Total-power spectrum Antenna: \*  
Timerange: 00/20:54:05 to 00/20:56:03

Plot file version 86 created 20-AUG-2009 14:59:51

J1016+20 EG040B.UVDATA.1

Freq = 1.5955 GHz, Bw = 16.000 MH No calibration applied and no bandpass applied

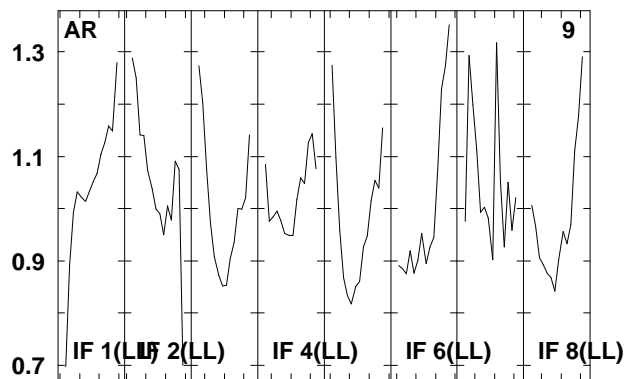
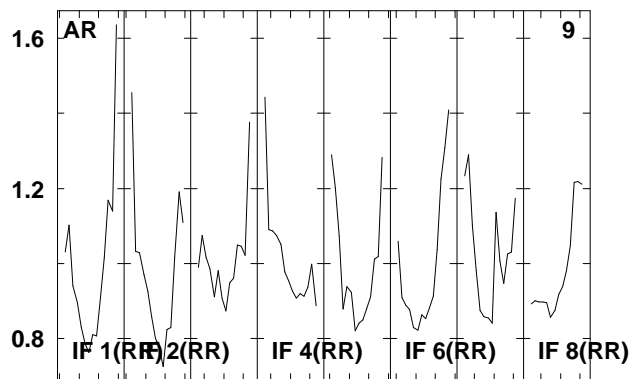
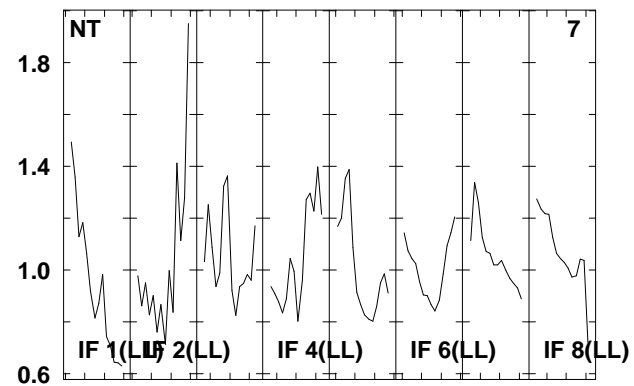
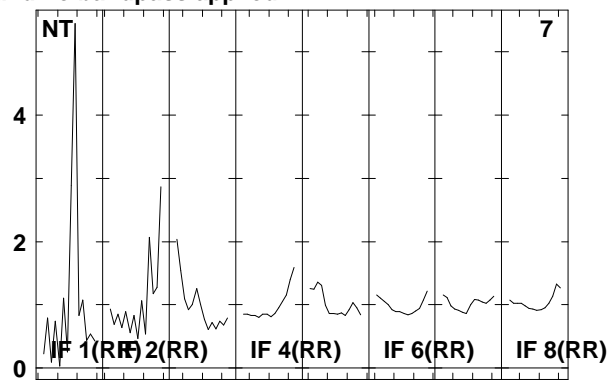
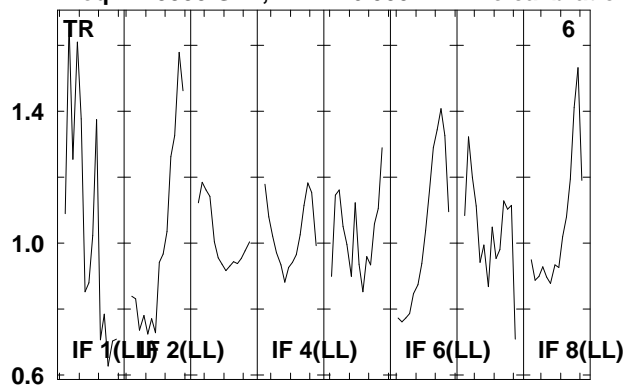

Lower frame: Real Jy  
Total-power spectrum Antenna: \*  
Timerange: 00/20:54:05 to 00/20:56:03

Plot file version 87 created 20-AUG-2009 14:59:51

NGC3227 EG040B.UVDATA.1

Freq = 1.5955 GHz, Bw = 16.000 MH No calibration applied and no bandpass applied

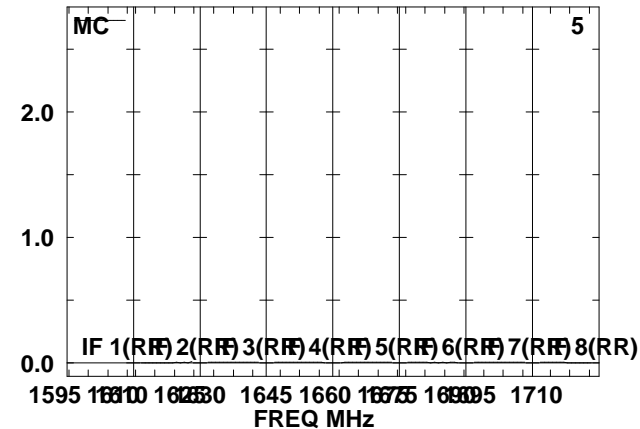
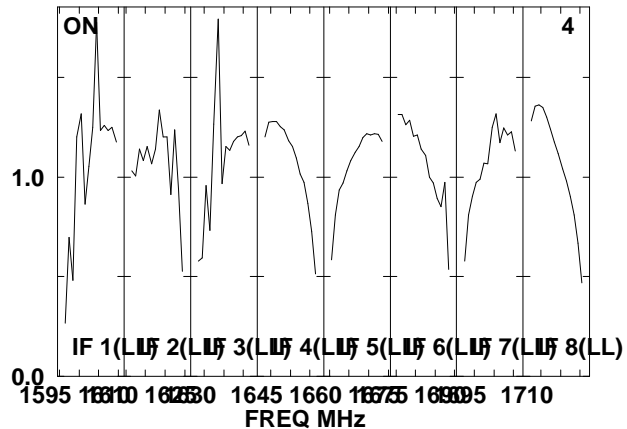
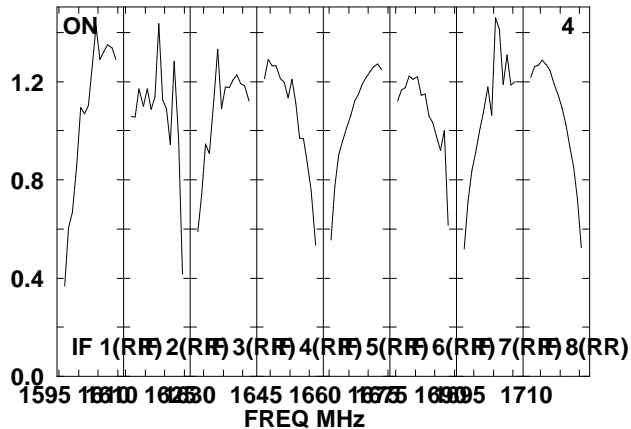
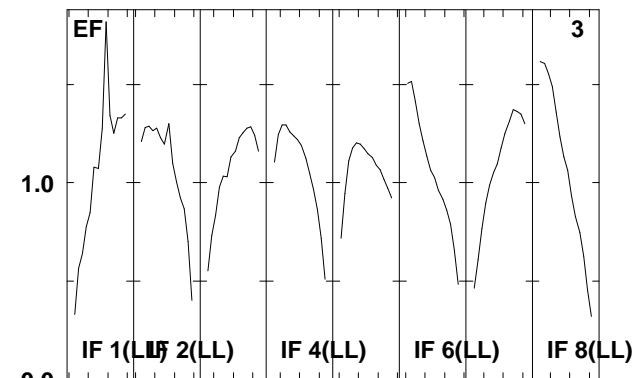
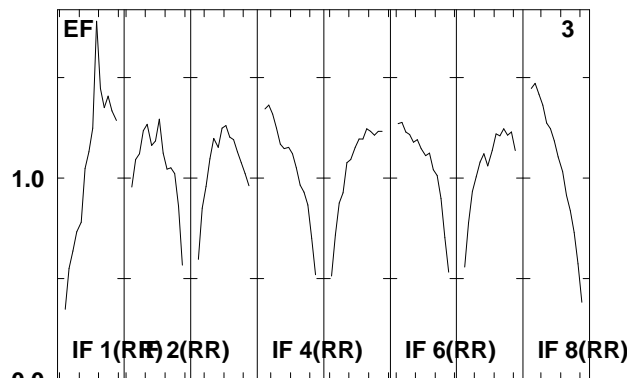
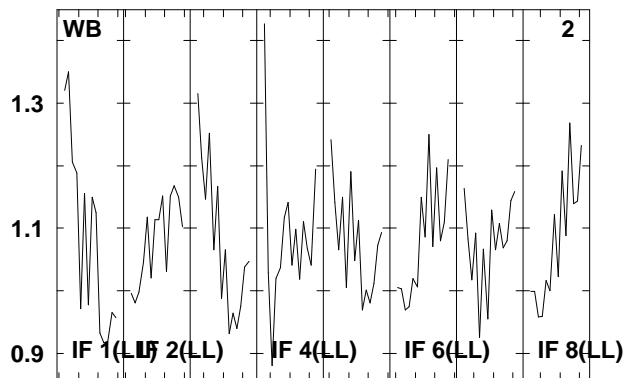
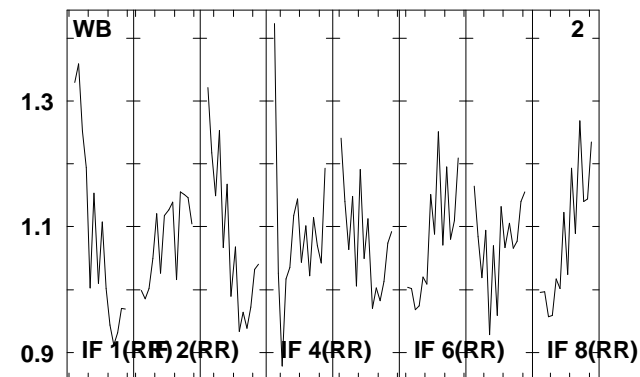
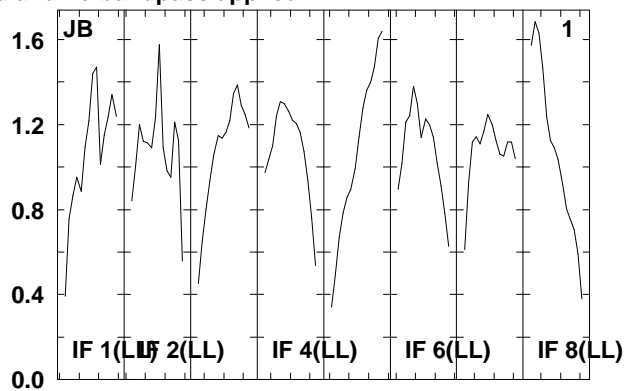
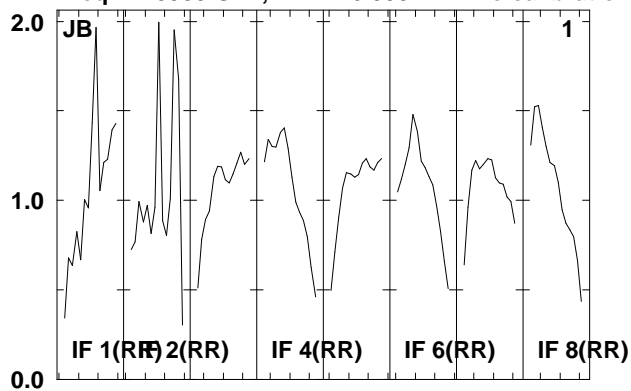

Lower frame: Real Jy  
Total-power spectrum Antenna: \*  
Timerange: 00/20:56:05 to 00/21:00:03

Plot file version 88 created 20-AUG-2009 14:59:52

NGC3227 EG040B.UVDATA.1

Freq = 1.5955 GHz, Bw = 16.000 MH No calibration applied and no bandpass applied

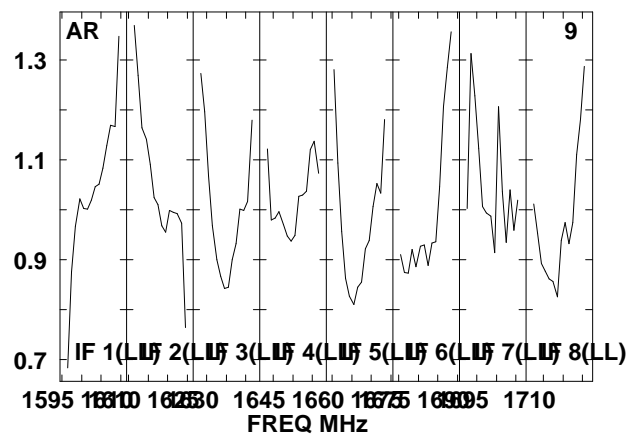
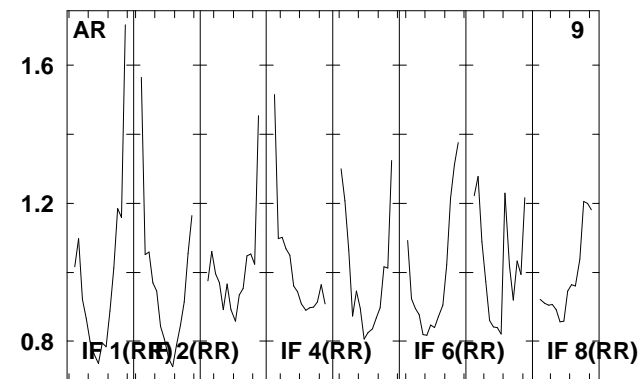
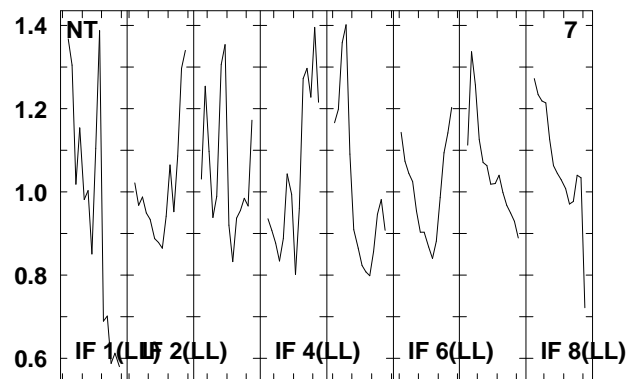
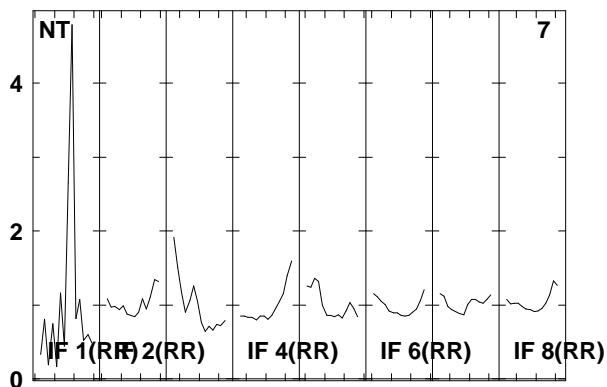
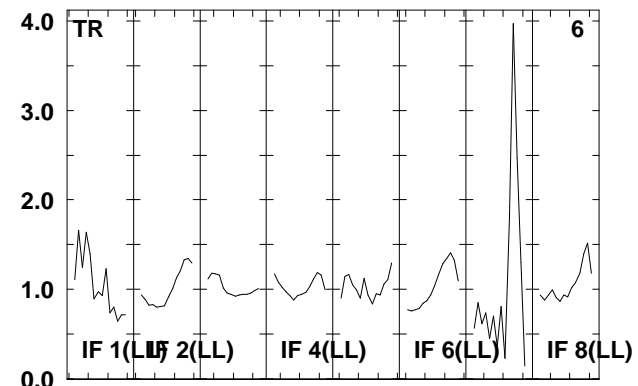
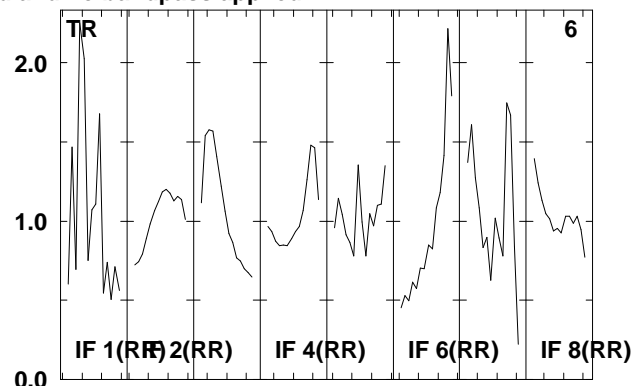
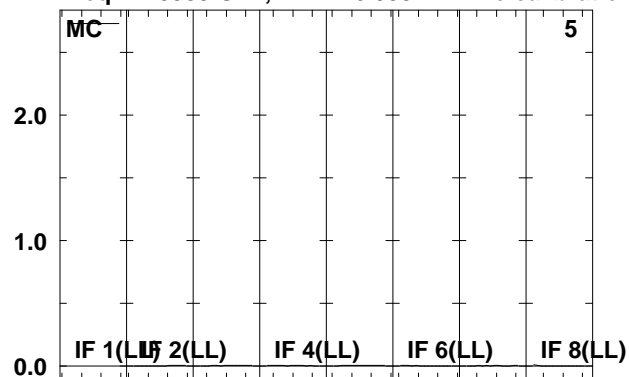

Lower frame: Kilo Real Jy

Total-power spectrum Antenna: \*

Timerange: 00/20:56:05 to 00/21:00:03



Plot file version 89 created 20-AUG-2009 14:59:52  
 J1016+20 EG040B.UVDATA.1  
 Freq = 1.5955 GHz, Bw = 16.000 MH No calibration applied and no bandpass applied

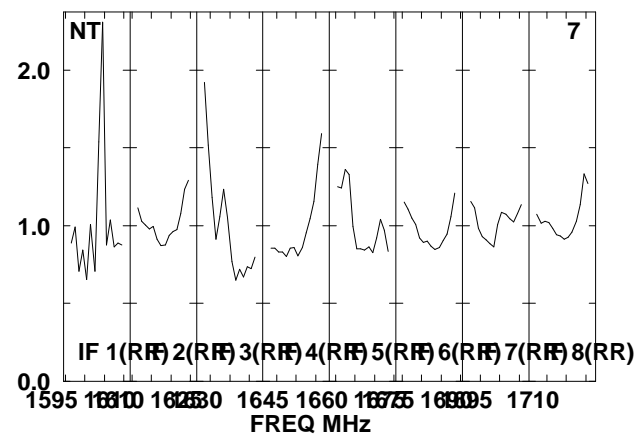
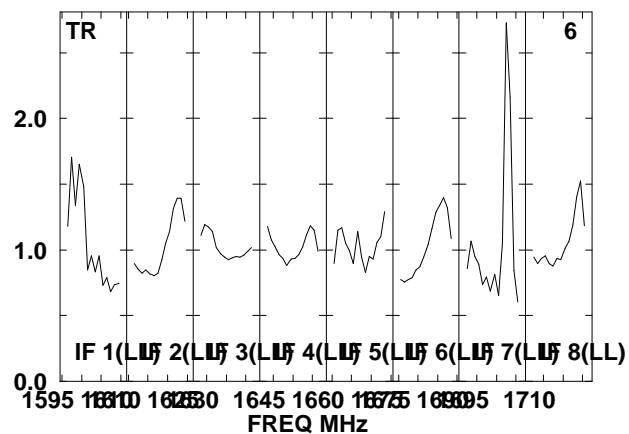
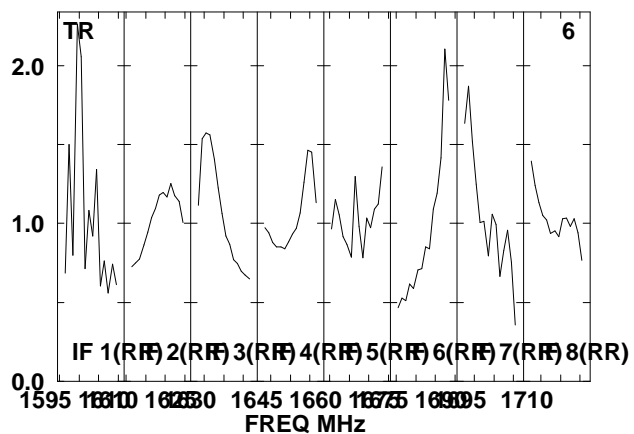
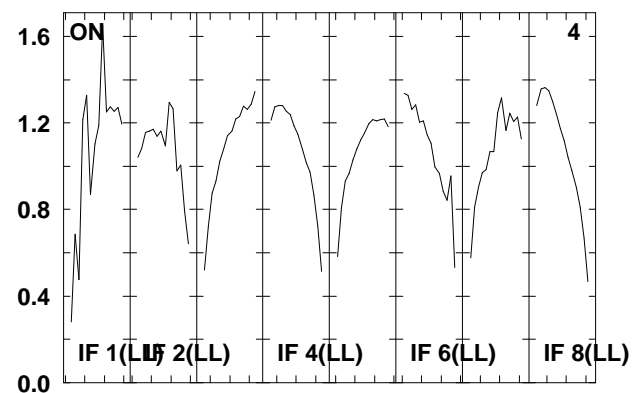
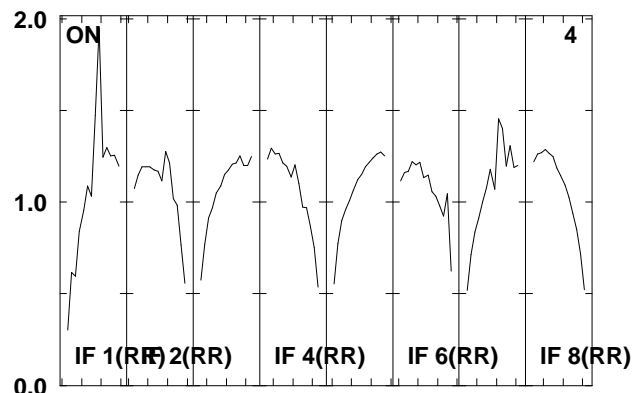
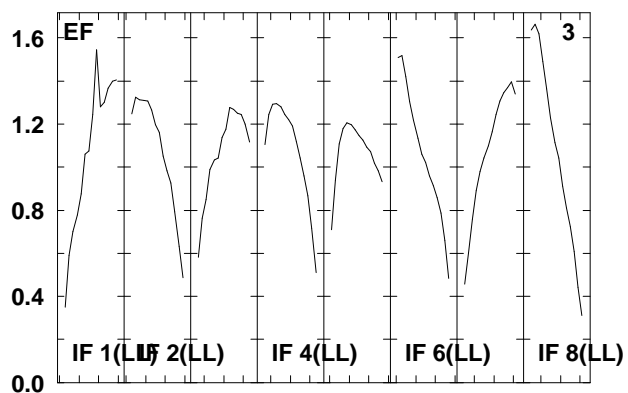
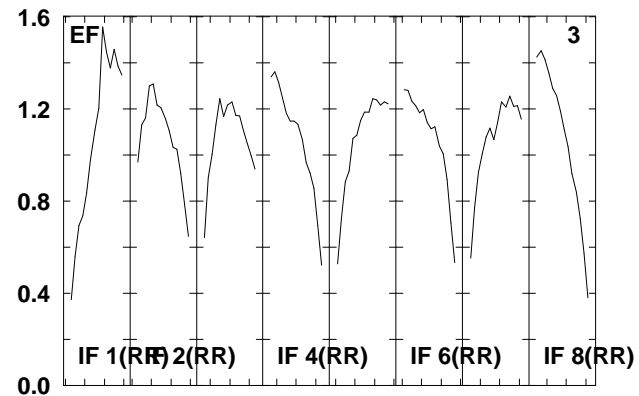
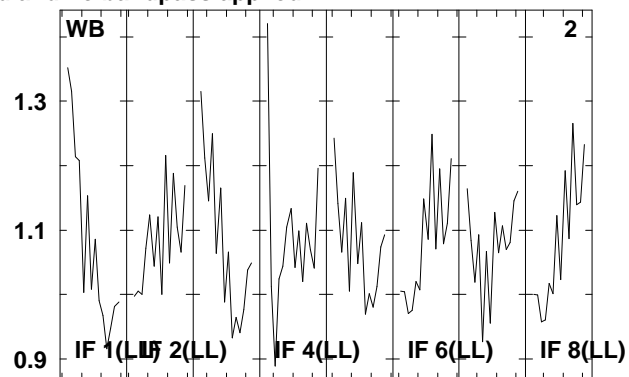
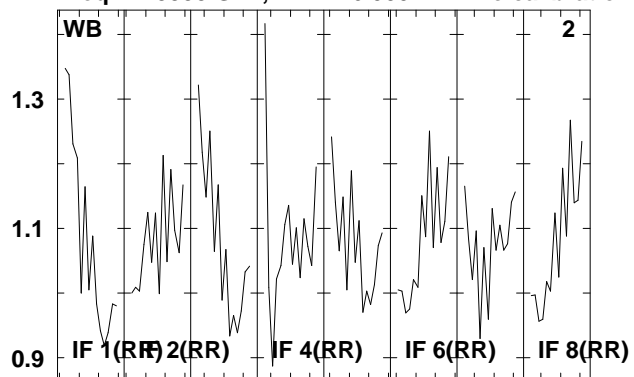

Lower frame: Real Jy  
 Total-power spectrum Antenna: \*  
 Timerange: 00/21:00:37 to 00/21:02:15

Plot file version 90 created 20-AUG-2009 14:59:52

J1016+20 EG040B.UVDATA.1

Freq = 1.5955 GHz, Bw = 16.000 MH No calibration applied and no bandpass applied

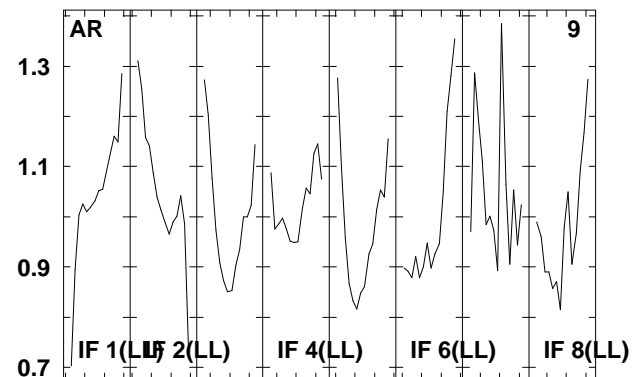
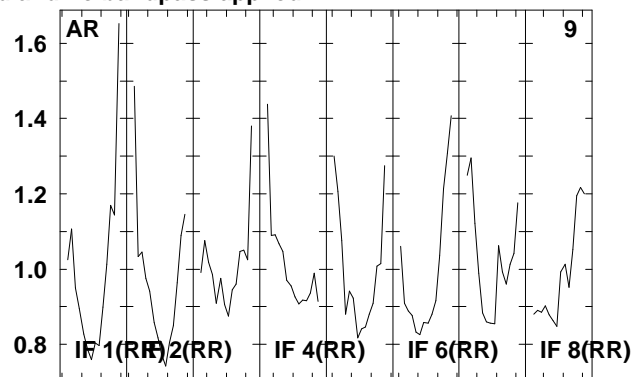
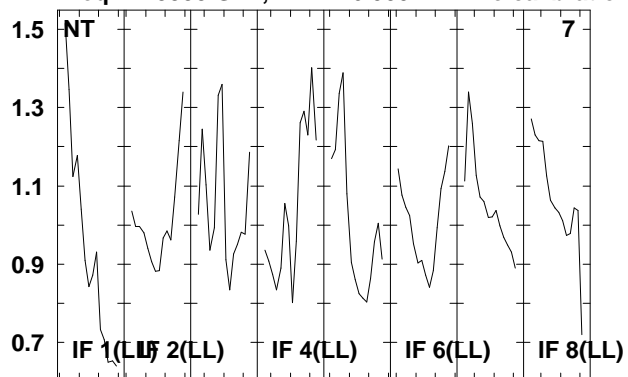

Lower frame: Real Jy  
Total-power spectrum Antenna: \*  
Timerange: 00/21:00:37 to 00/21:02:15

Plot file version 91 created 20-AUG-2009 14:59:53

NGC3227 EG040B.UVDATA.1

Freq = 1.5955 GHz, Bw = 16.000 MH No calibration applied and no bandpass applied

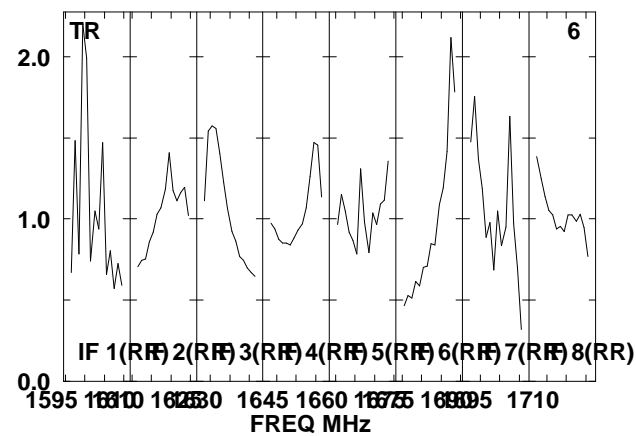
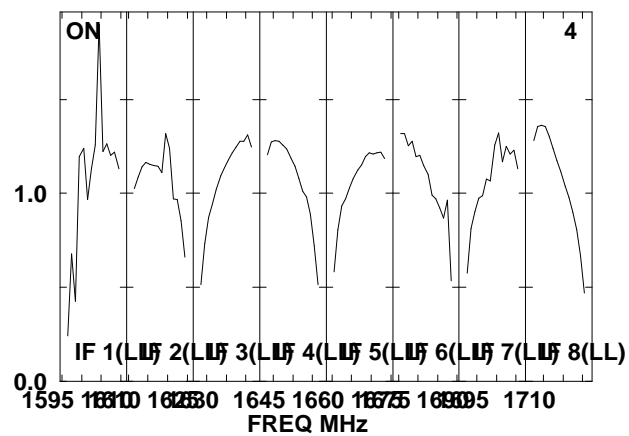
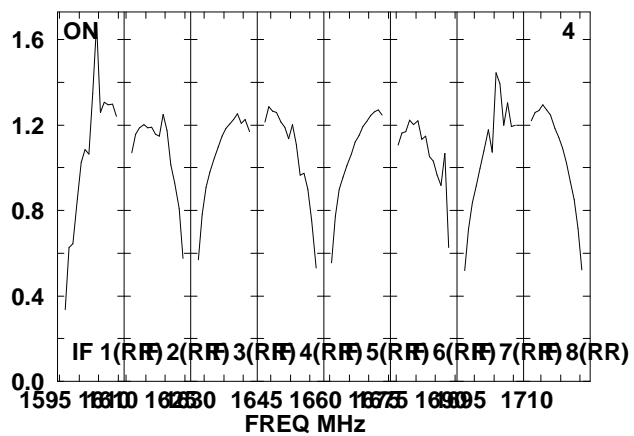
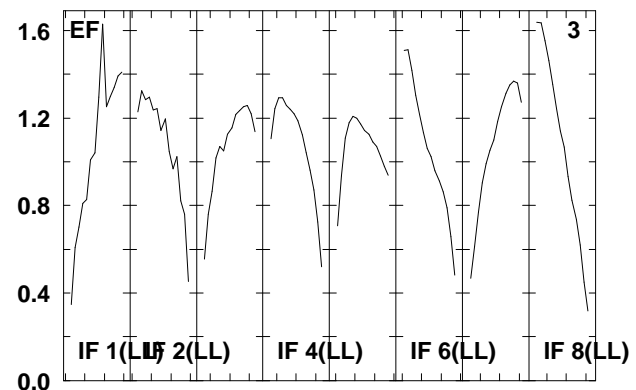
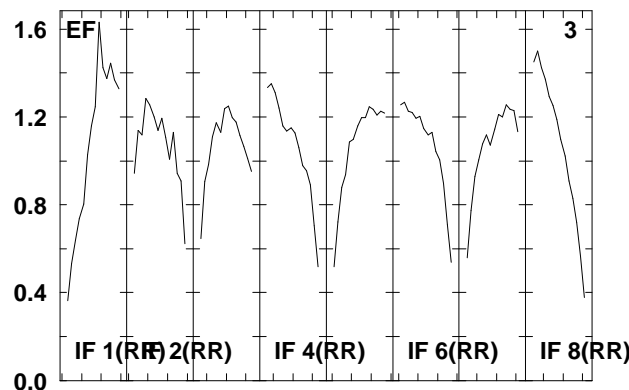
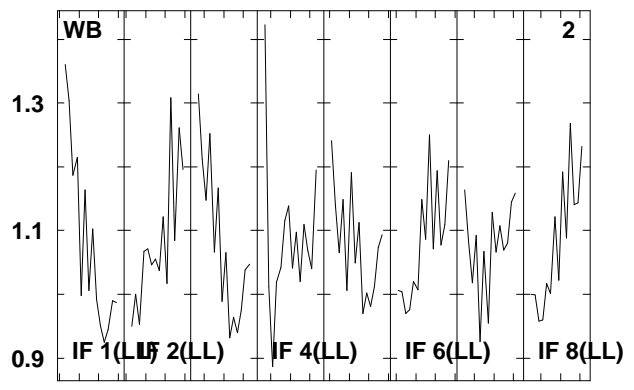
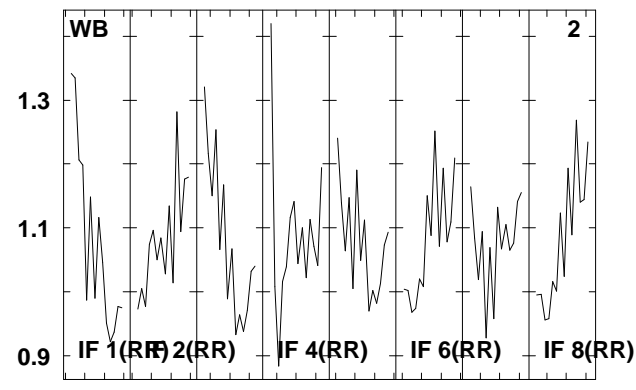
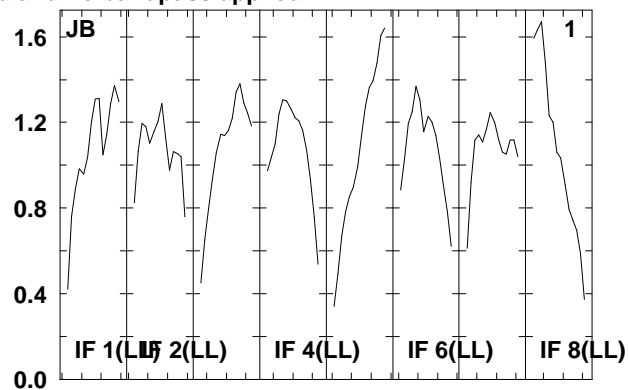
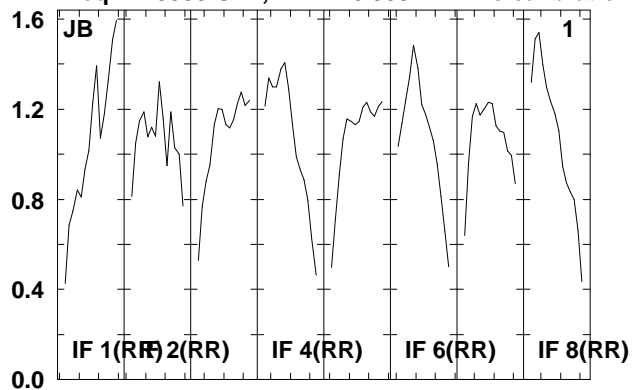

Lower frame: Real Jy  
Total-power spectrum Antenna: \*  
Timerange: 00/21:02:17 to 00/21:06:15

Plot file version 92 created 20-AUG-2009 14:59:53

NGC3227 EG040B.UVDATA.1

Freq = 1.5955 GHz, Bw = 16.000 MH No calibration applied and no bandpass applied

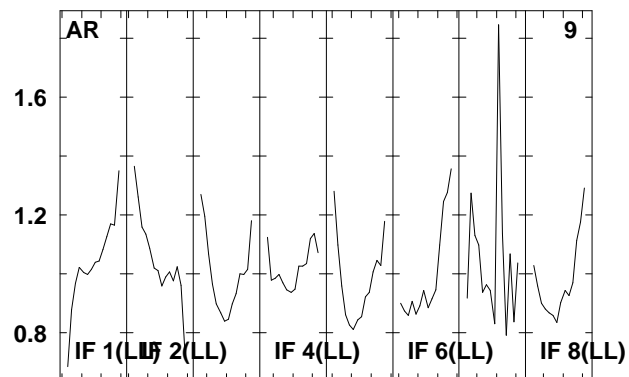
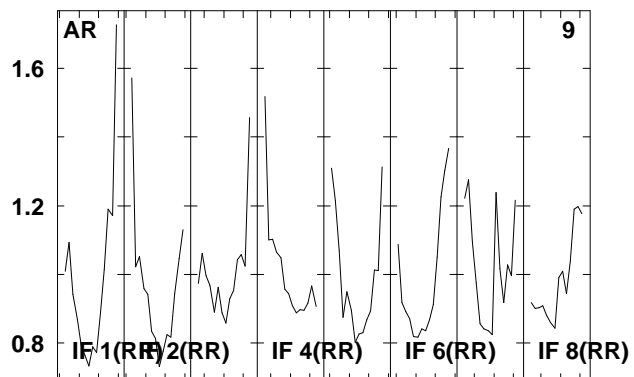
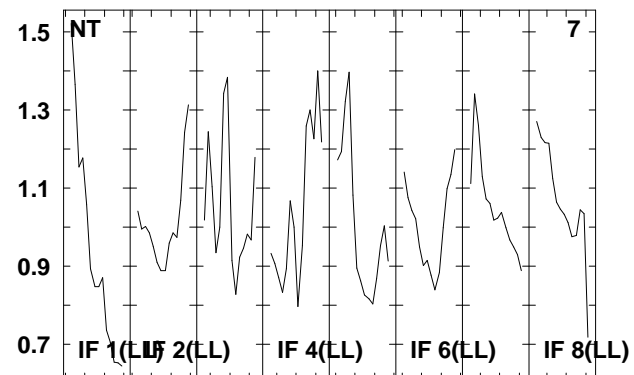
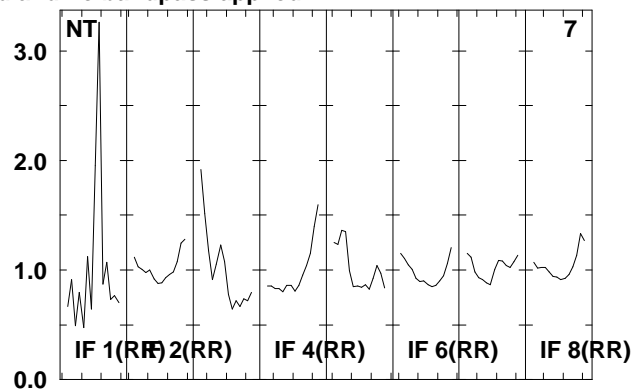
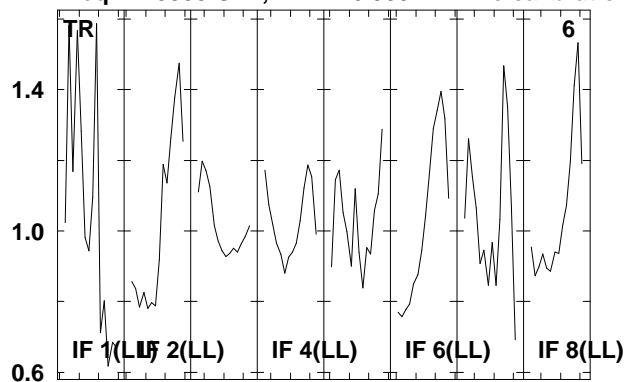

Lower frame: Real Jy  
Total-power spectrum Antenna: \*  
Timerange: 00/21:02:17 to 00/21:06:15

Plot file version 93 created 20-AUG-2009 14:59:53

J1016+20 EG040B.UVDATA.1

Freq = 1.5955 GHz, Bw = 16.000 MH No calibration applied and no bandpass applied

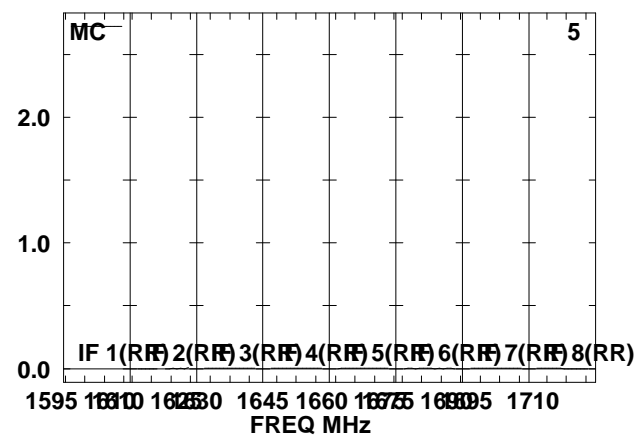
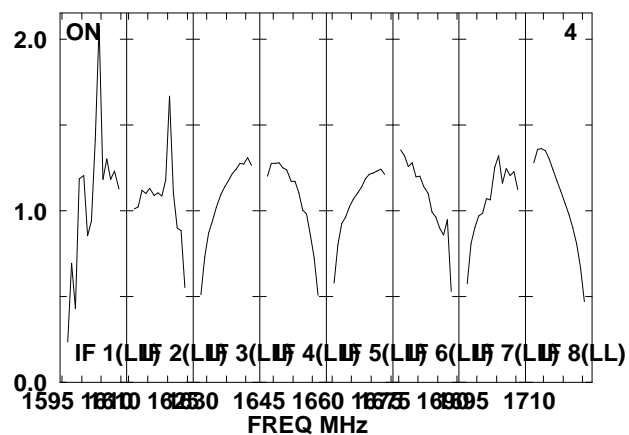
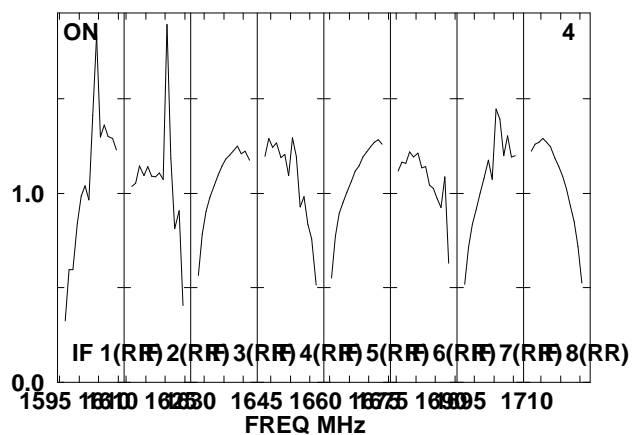
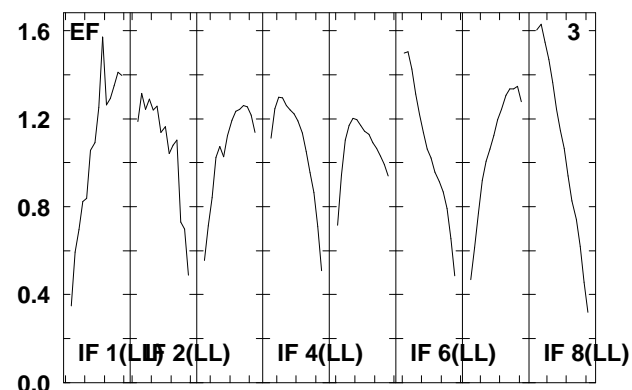
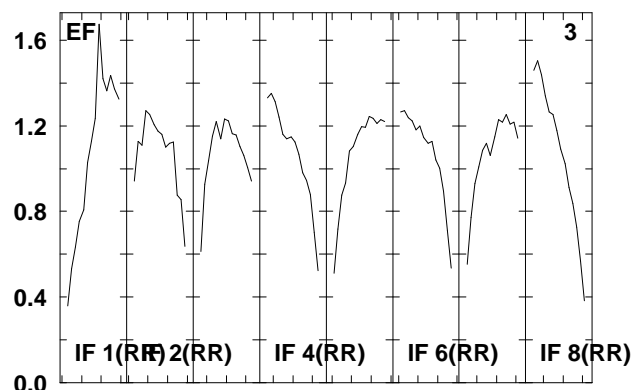
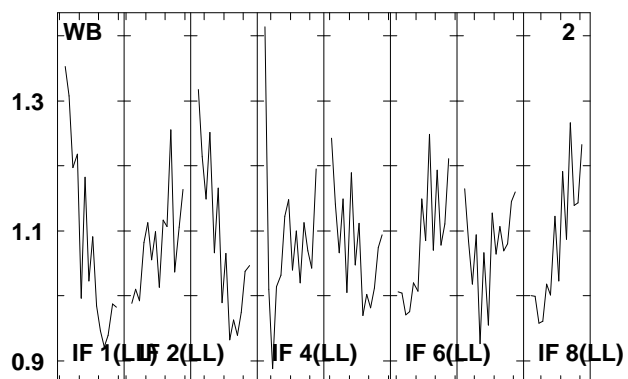
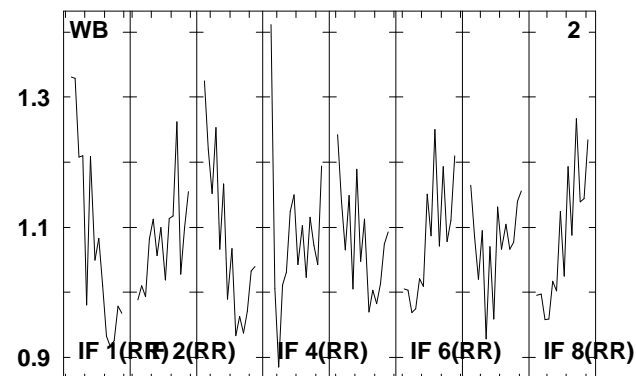
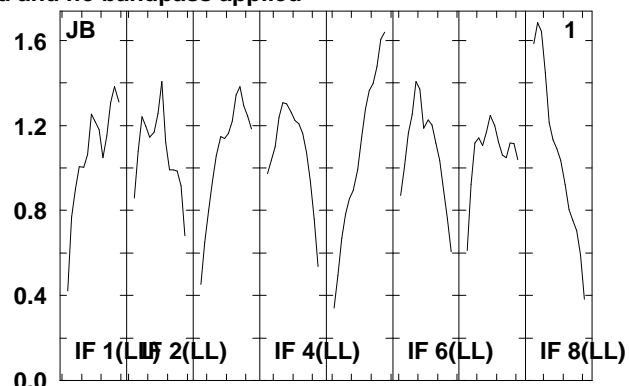
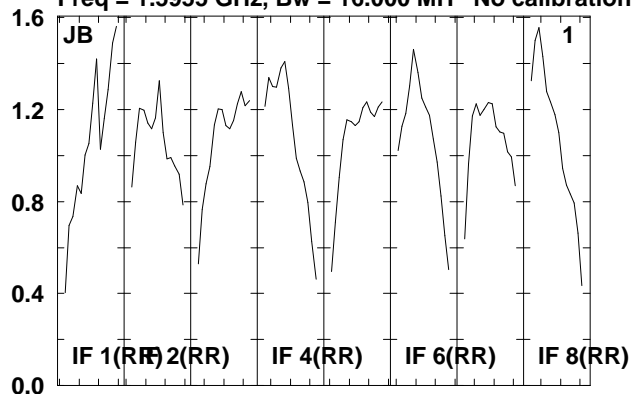

Lower frame: Real Jy

Total-power spectrum Antenna: \*

Timerange: 00/21:06:17 to 00/21:08:15

Plot file version 94 created 20-AUG-2009 14:59:54

J1016+20 EG040B.UVDATA.1

Freq = 1.5955 GHz, Bw = 16.000 MH No calibration applied and no bandpass applied

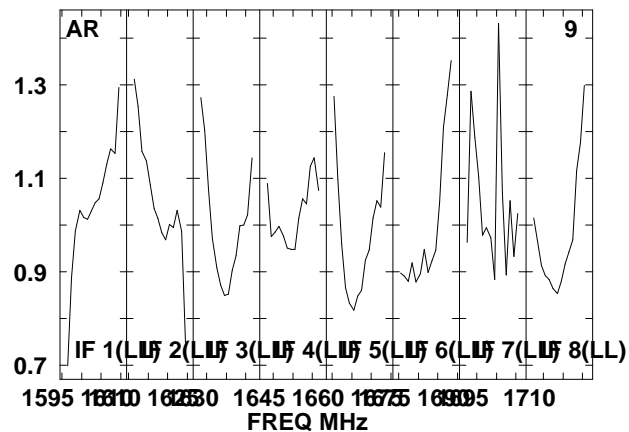
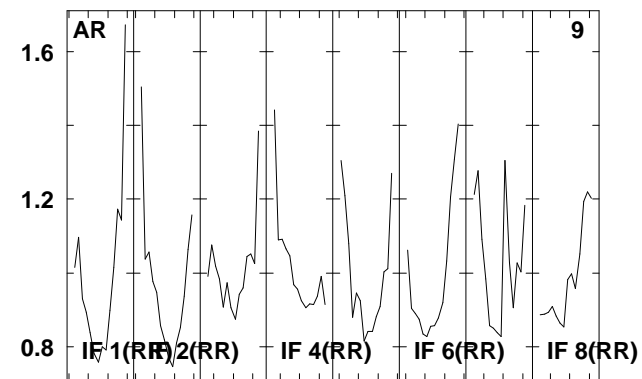
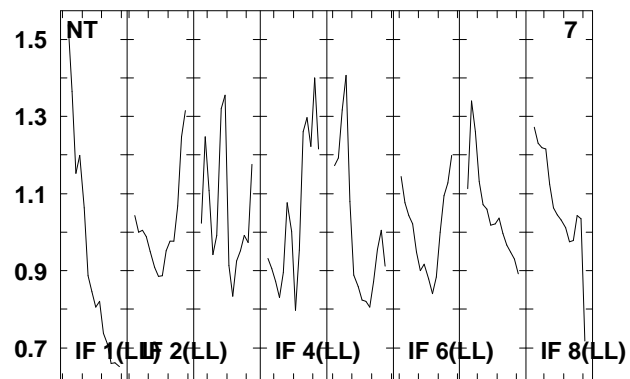
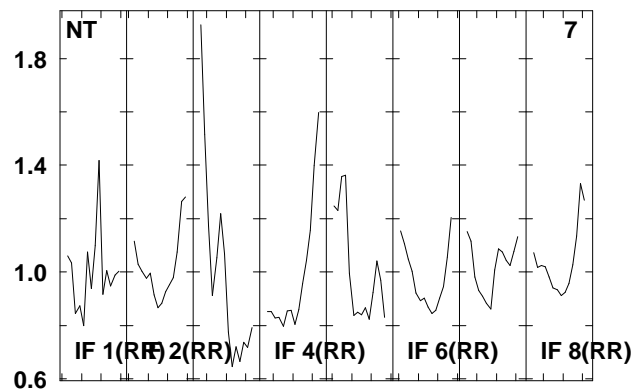
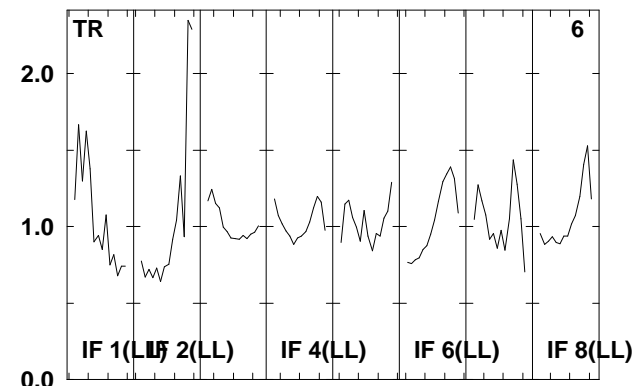
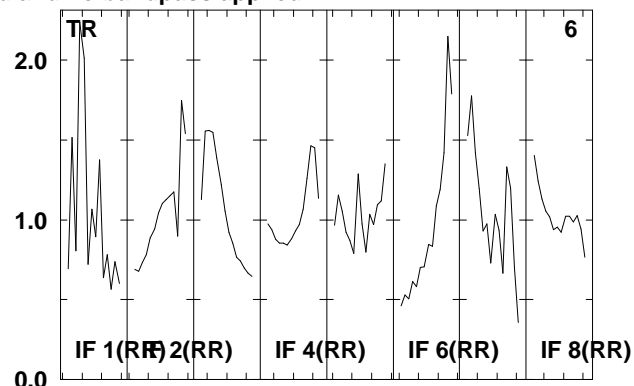
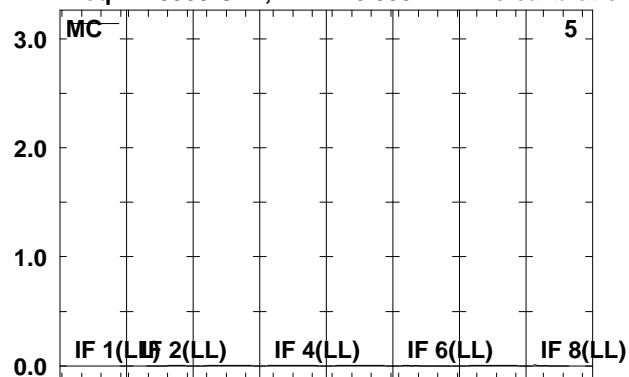

Lower frame: Kilo Real Jy

Total-power spectrum Antenna: \*

Timerange: 00/21:06:17 to 00/21:08:15

Plot file version 95 created 20-AUG-2009 14:59:54

NGC3227 EG040B.UVDATA.1

Freq = 1.5955 GHz, Bw = 16.000 MH No calibration applied and no bandpass applied

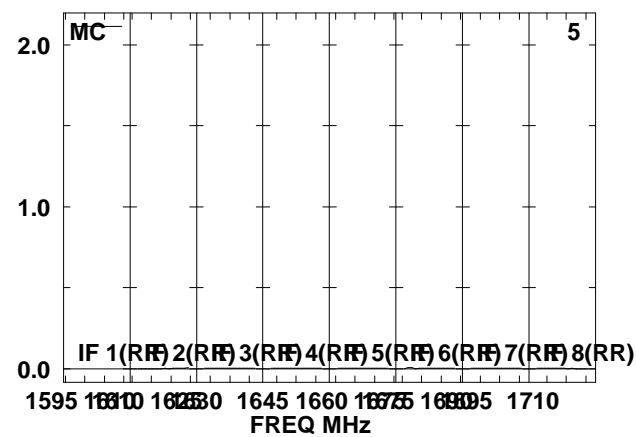
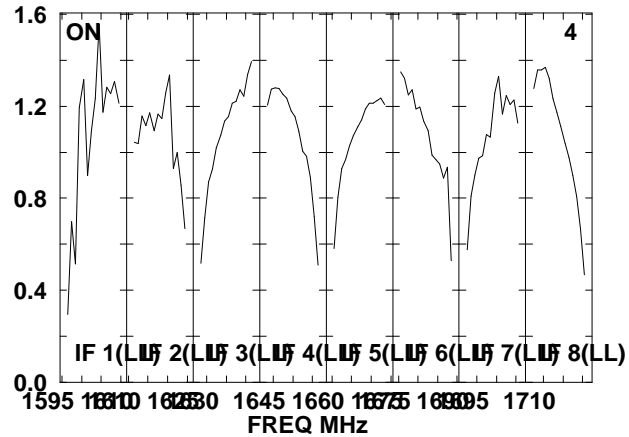
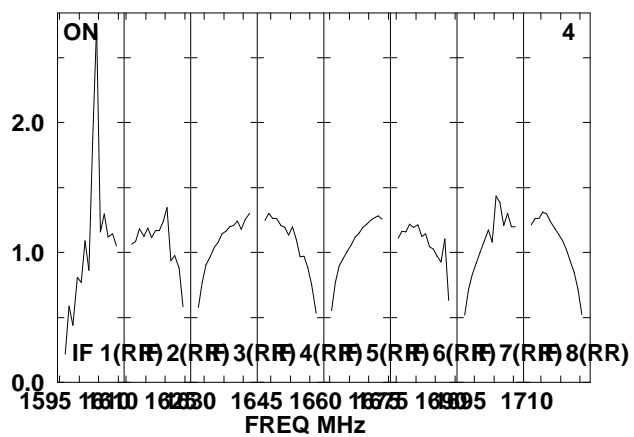
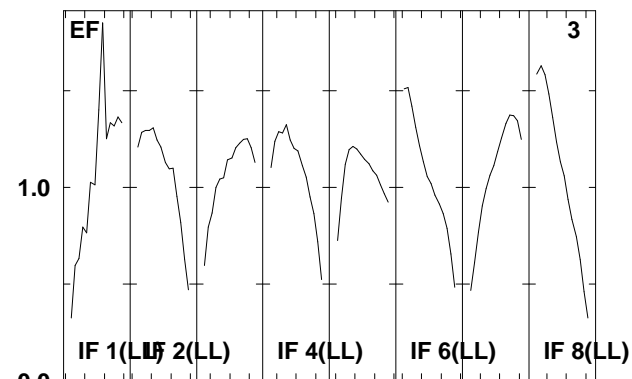
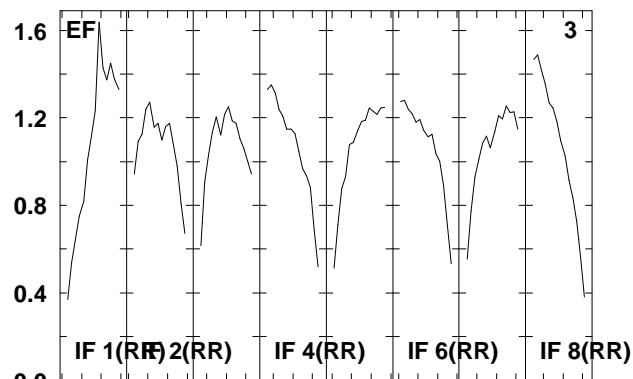
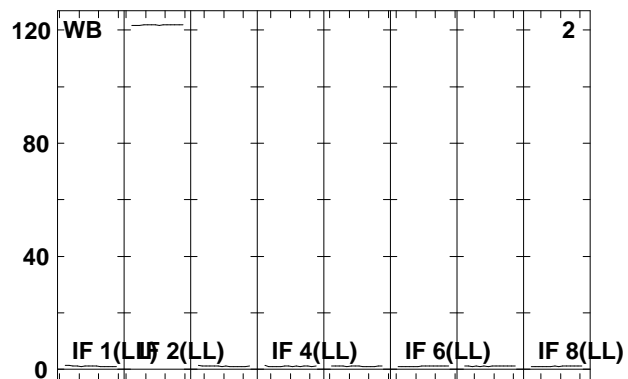
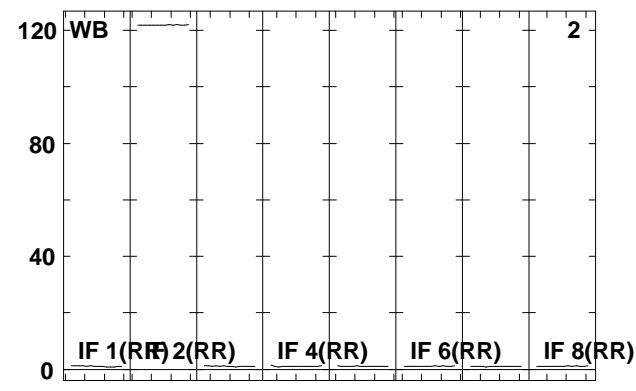
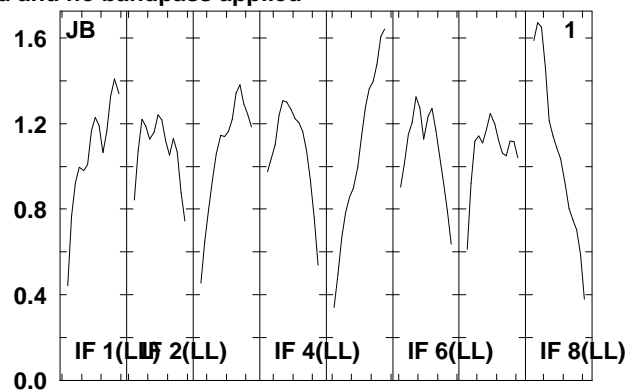
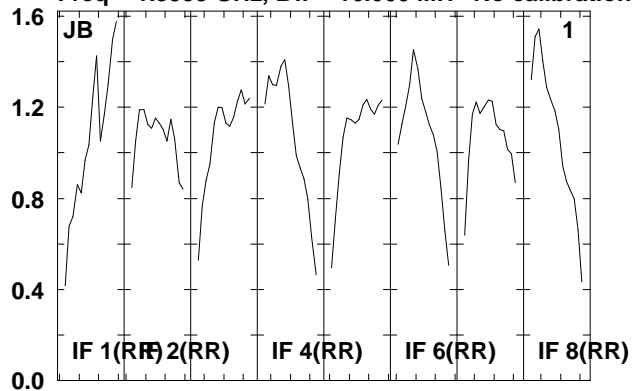

Lower frame: Real Jy  
Total-power spectrum Antenna: \*  
Timerange: 00/21:08:17 to 00/21:12:15

Plot file version 96 created 20-AUG-2009 14:59:54

NGC3227 EG040B.UVDATA.1

Freq = 1.5955 GHz, Bw = 16.000 MH No calibration applied and no bandpass applied

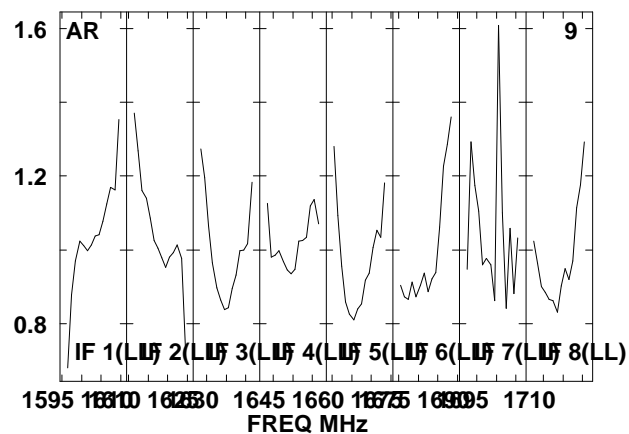
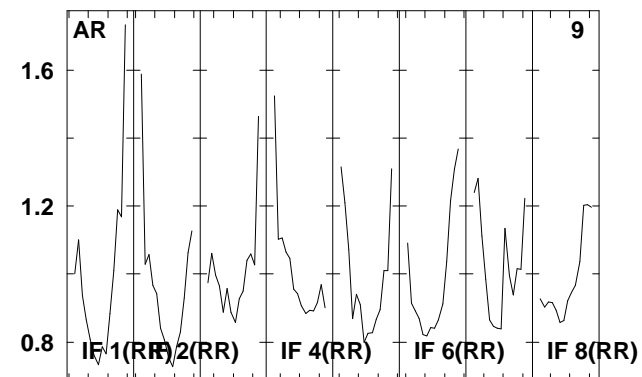
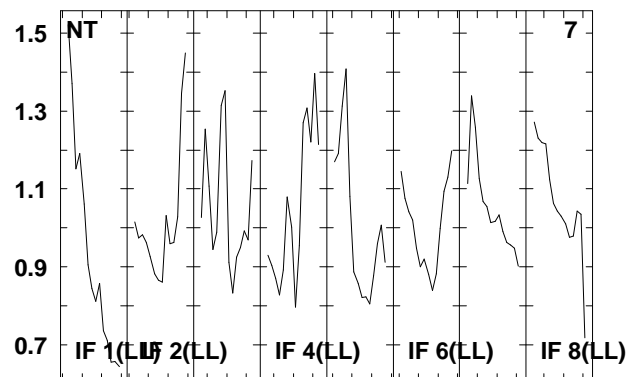
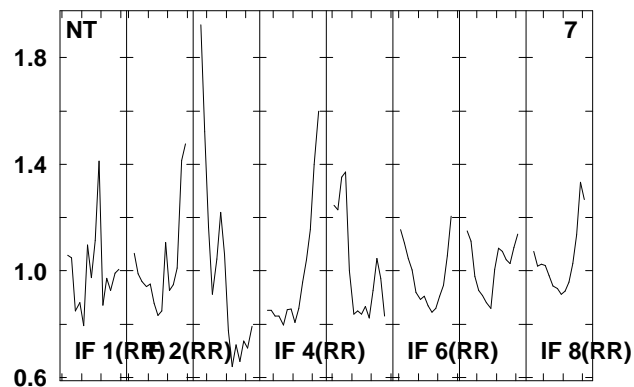
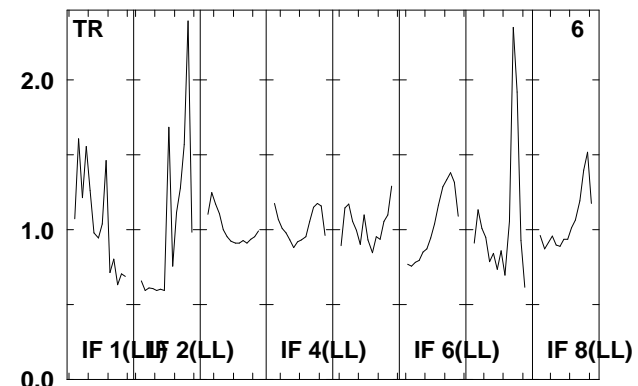
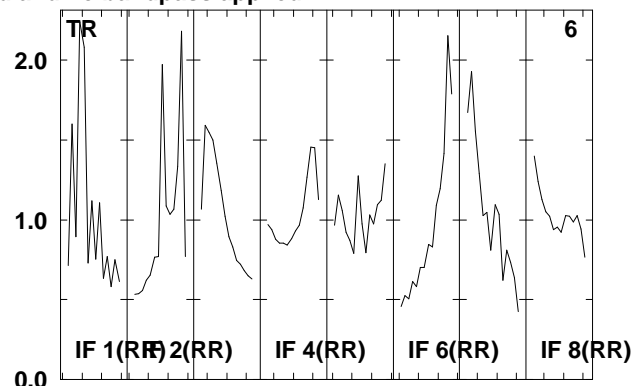
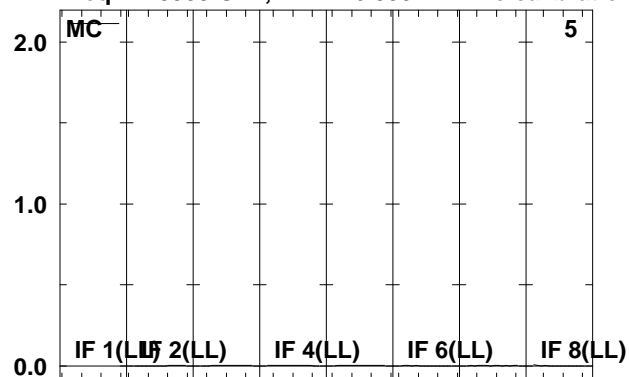

Lower frame: Kilo Real Jy

Total-power spectrum Antenna: \*

Timerange: 00/21:08:17 to 00/21:12:15



Plot file version 97 created 20-AUG-2009 14:59:55  
 J1016+20 EG040B.UVDATA.1  
 Freq = 1.5955 GHz, Bw = 16.000 MH No calibration applied and no bandpass applied

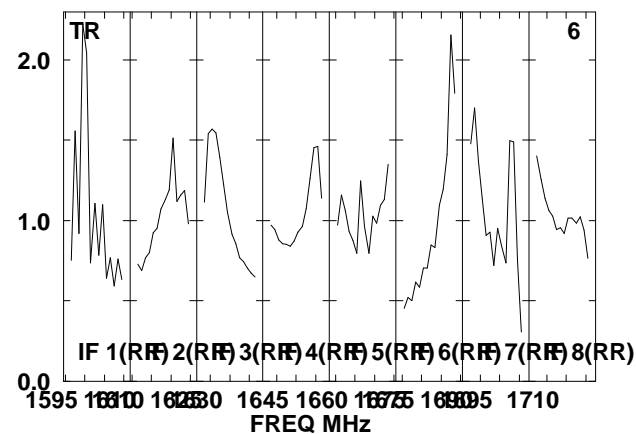
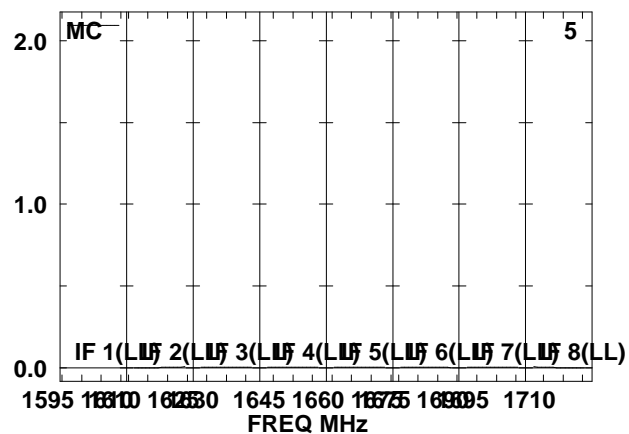
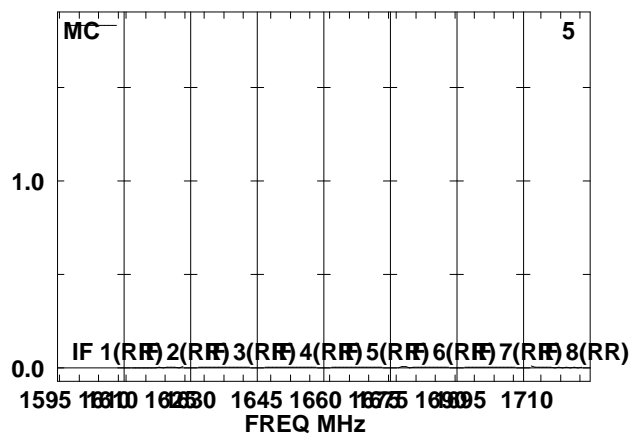
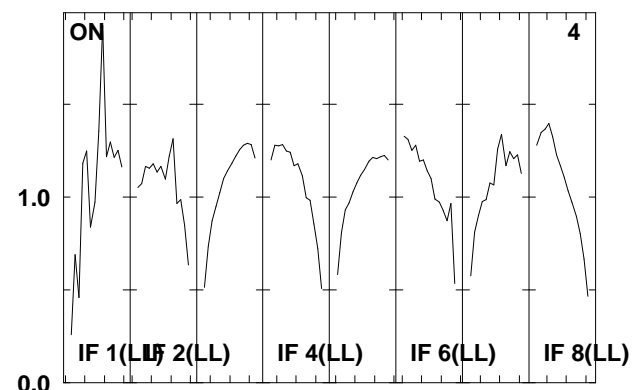
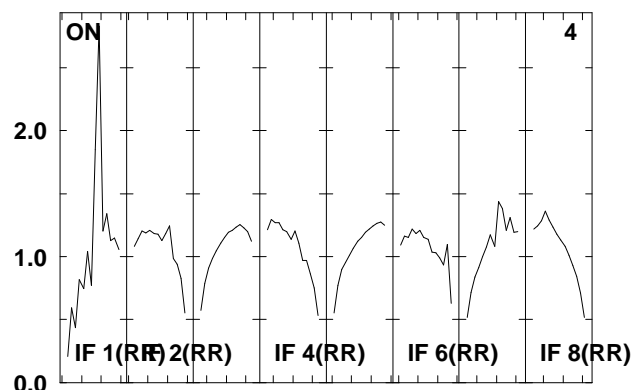
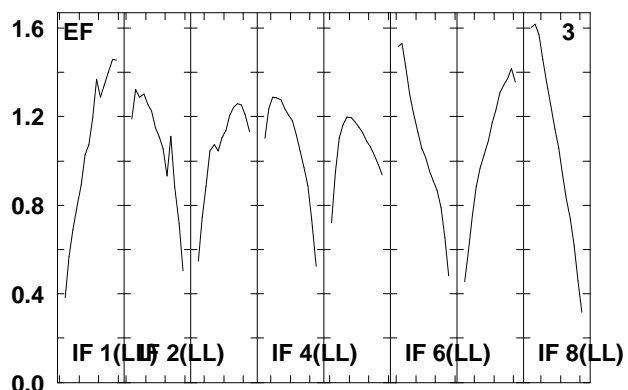
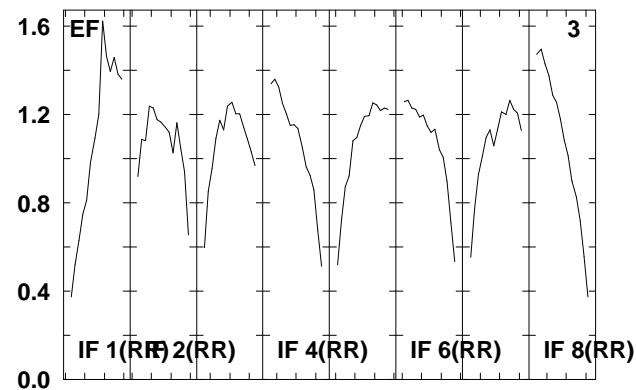
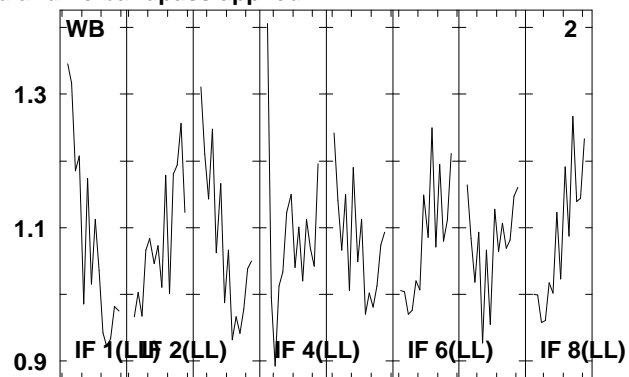
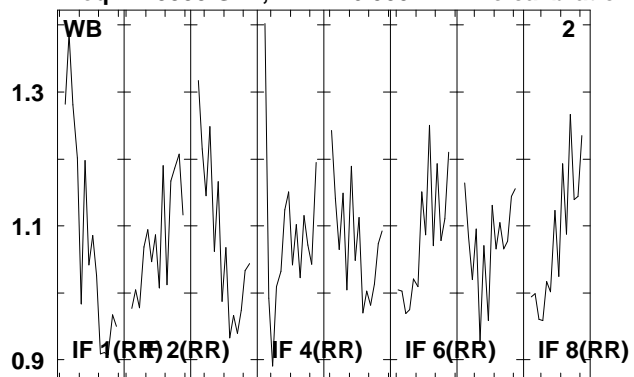

Lower frame: Real Jy  
 Total-power spectrum Antenna: \*  
 Timerange: 00/21:12:49 to 00/21:14:27

Plot file version 98 created 20-AUG-2009 14:59:55

J1016+20 EG040B.UVDATA.1

Freq = 1.5955 GHz, Bw = 16.000 MH No calibration applied and no bandpass applied

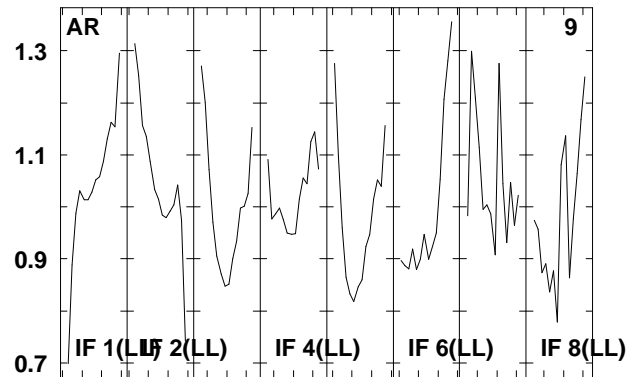
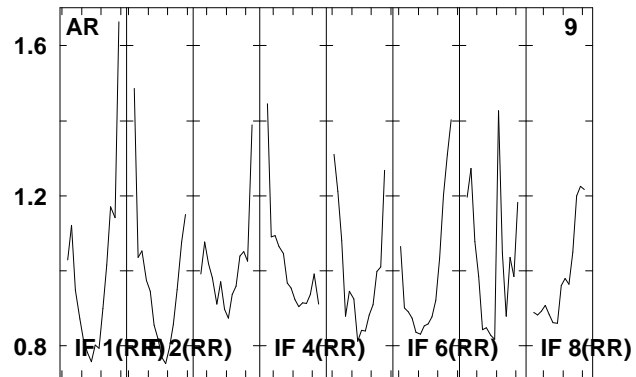
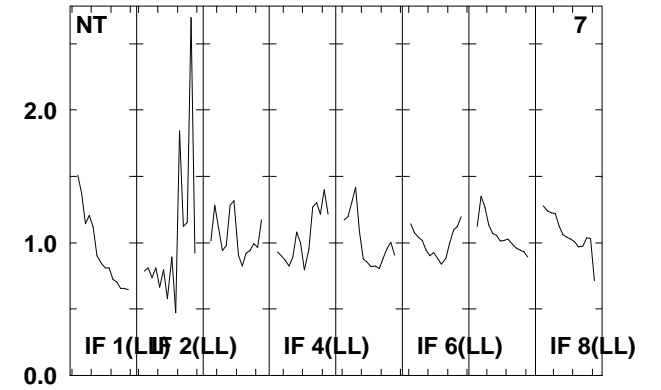
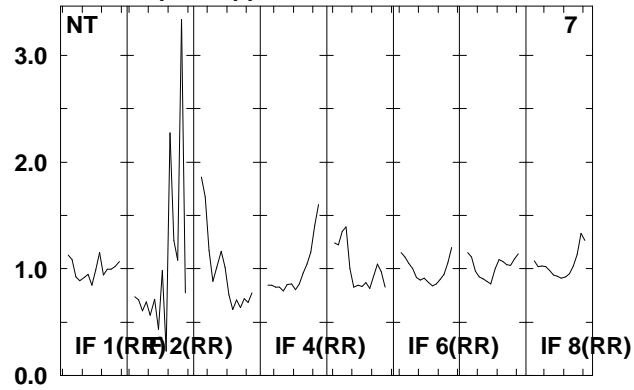
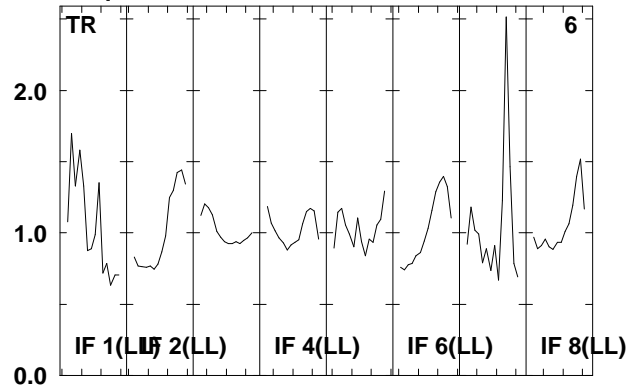

Lower frame: Real Jy  
Total-power spectrum Antenna: \*  
Timerange: 00/21:12:49 to 00/21:14:27

Plot file version 99 created 20-AUG-2009 14:59:55

NGC3227 EG040B.UVDATA.1

Freq = 1.5955 GHz, Bw = 16.000 MH No calibration applied and no bandpass applied

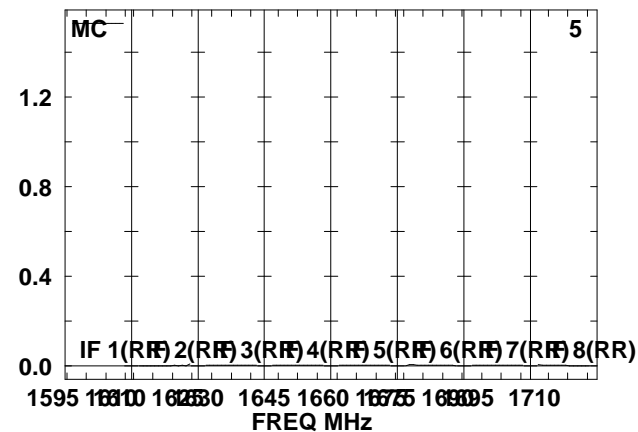
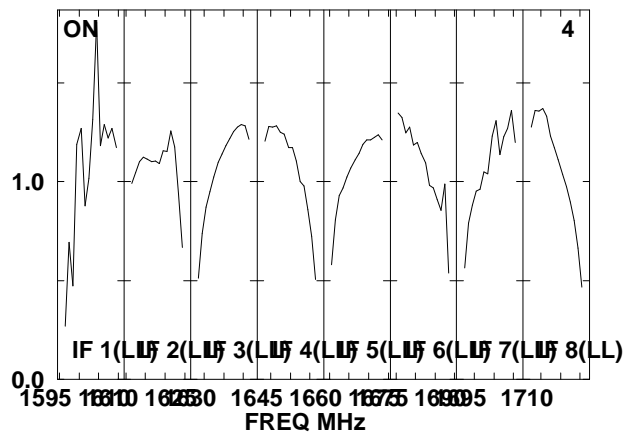
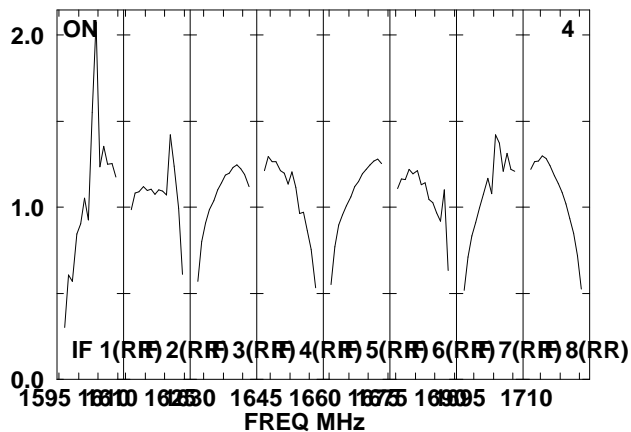
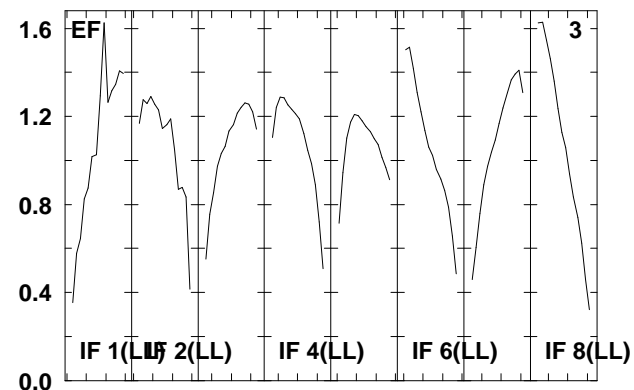
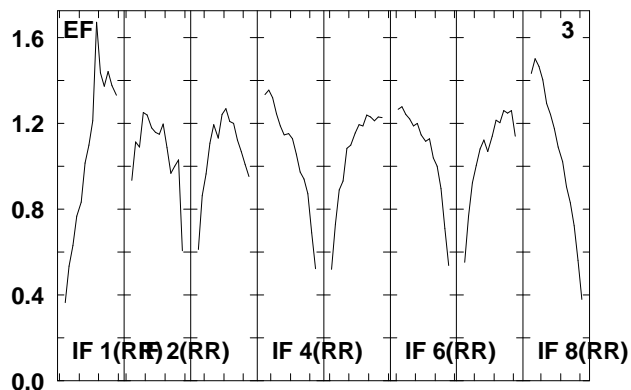
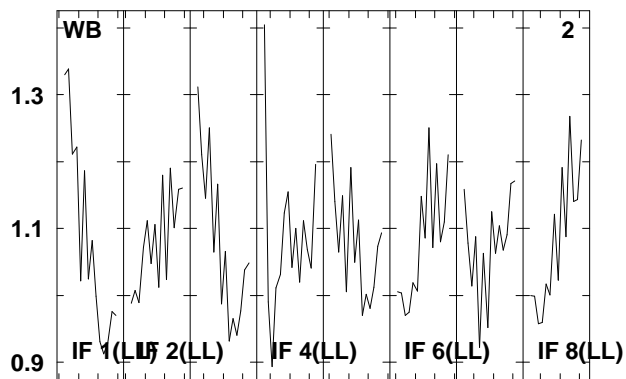
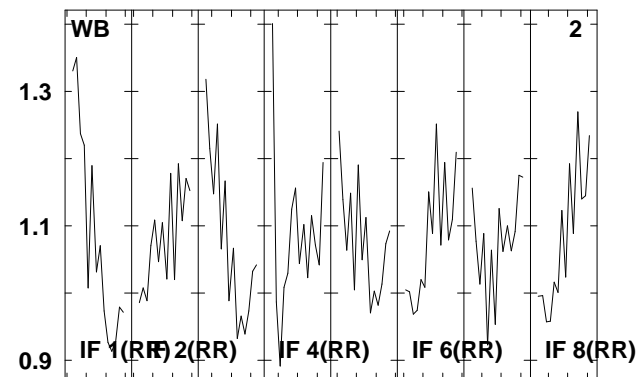
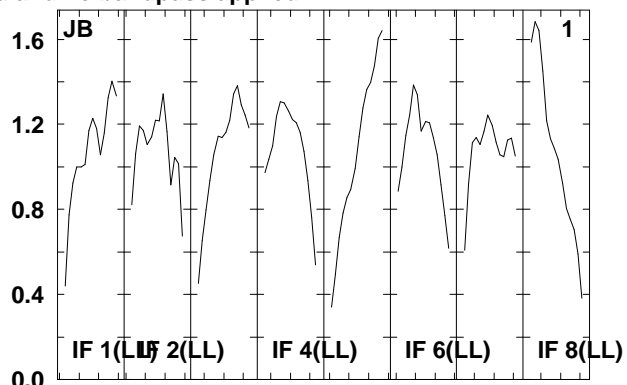
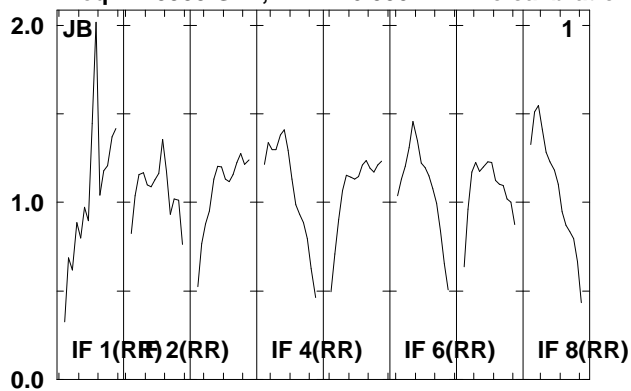

Lower frame: Real Jy

Total-power spectrum Antenna: \*

Timerange: 00/21:14:29 to 00/21:18:27

Plot file version 100 created 20-AUG-2009 14:59:56

NGC3227 EG040B.UVDATA.1

Freq = 1.5955 GHz, Bw = 16.000 MH No calibration applied and no bandpass applied

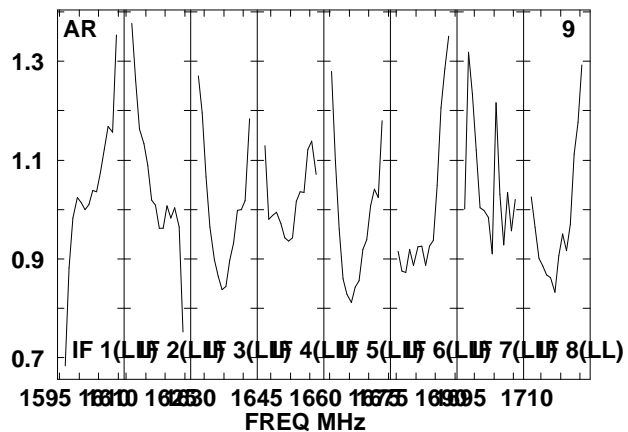
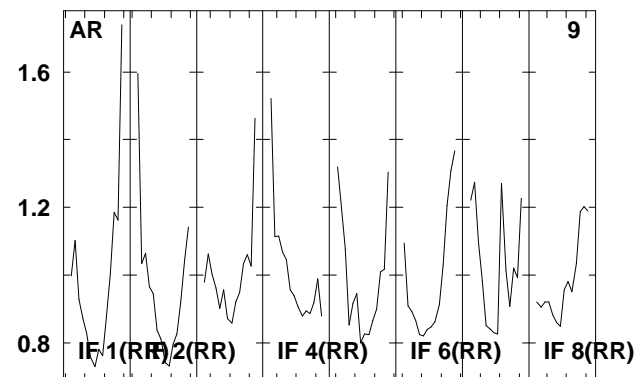
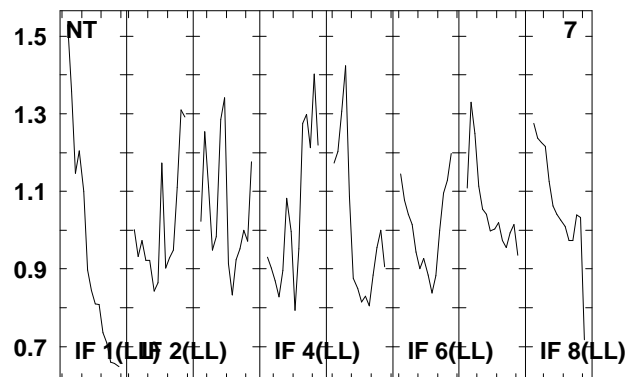
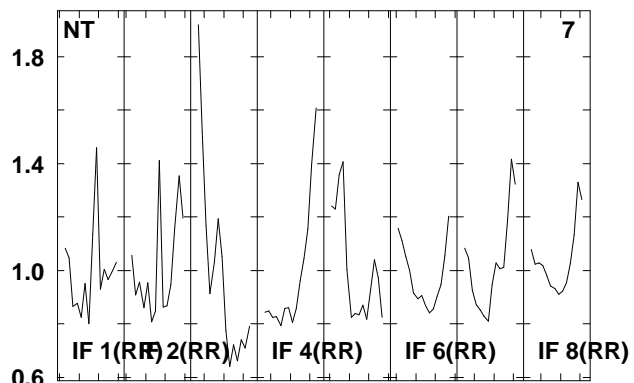
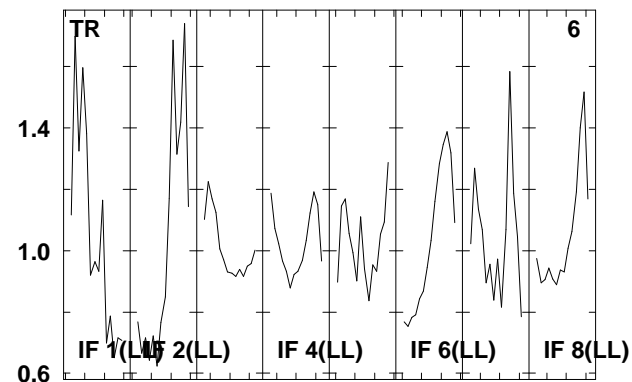
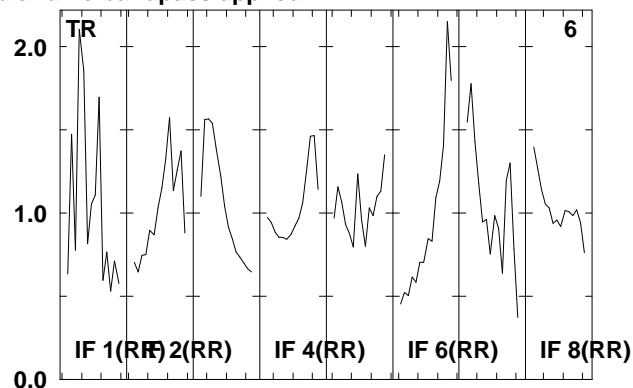
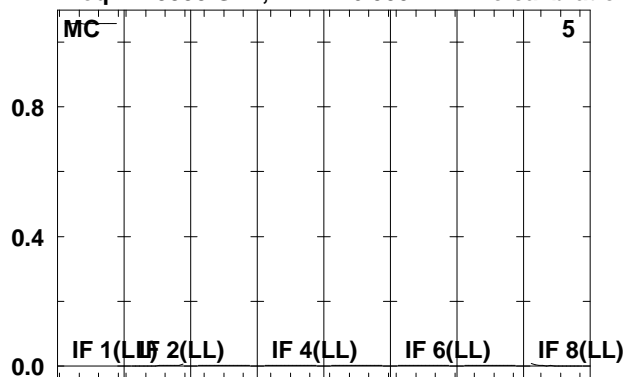

Lower frame: Kilo Real Jy  
Total-power spectrum Antenna: \*  
Timerange: 00/21:14:29 to 00/21:18:27

Plot file version 101 created 20-AUG-2009 14:59:56

J1016+20 EG040B.UVDATA.1

Freq = 1.5955 GHz, Bw = 16.000 MH No calibration applied and no bandpass applied

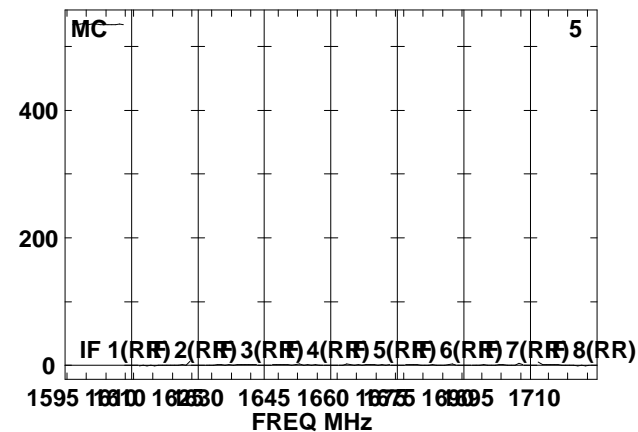
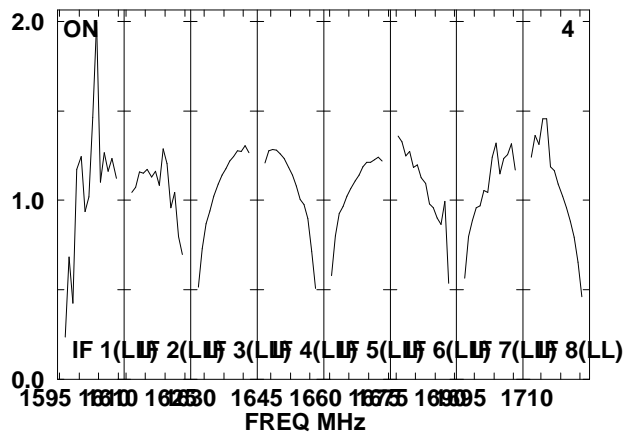
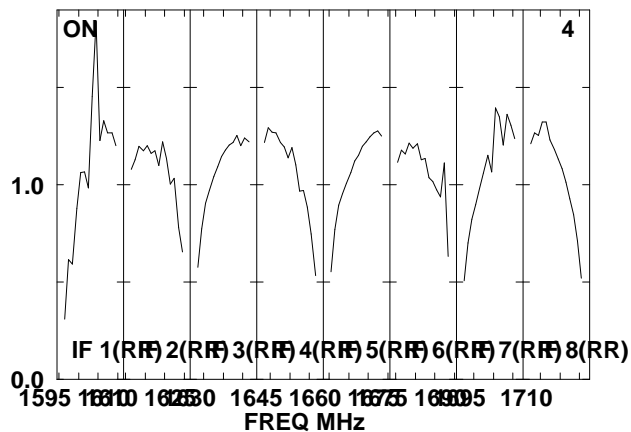
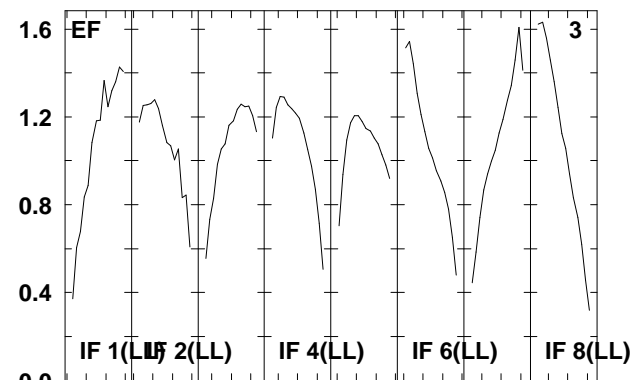
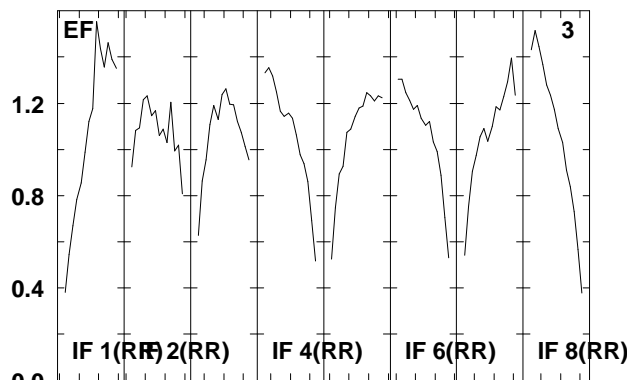
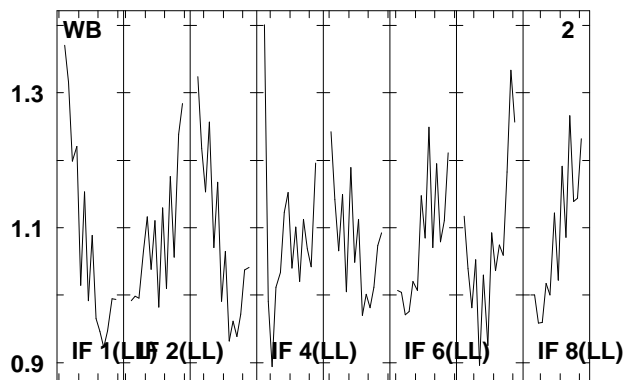
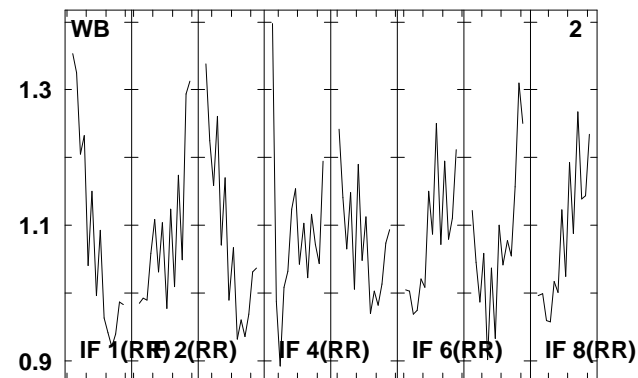
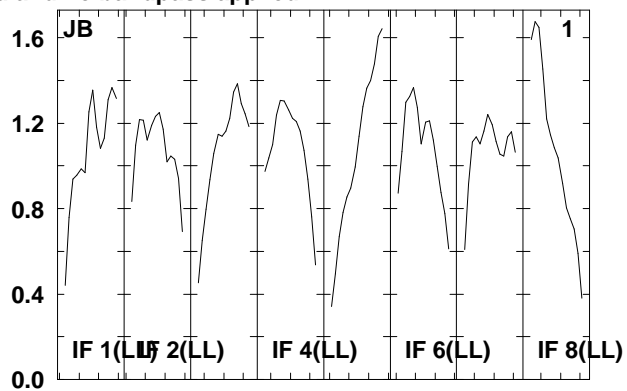
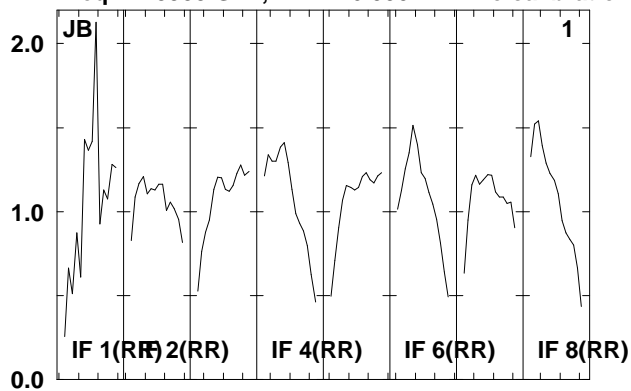

Lower frame: Real Jy  
Total-power spectrum Antenna: \*  
Timerange: 00/21:18:29 to 00/21:20:27

Plot file version 102 created 20-AUG-2009 14:59:56

J1016+20 EG040B.UVDATA.1

Freq = 1.5955 GHz, Bw = 16.000 MH No calibration applied and no bandpass applied

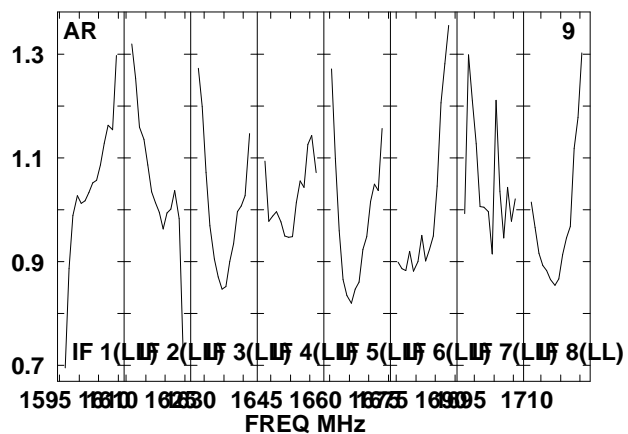
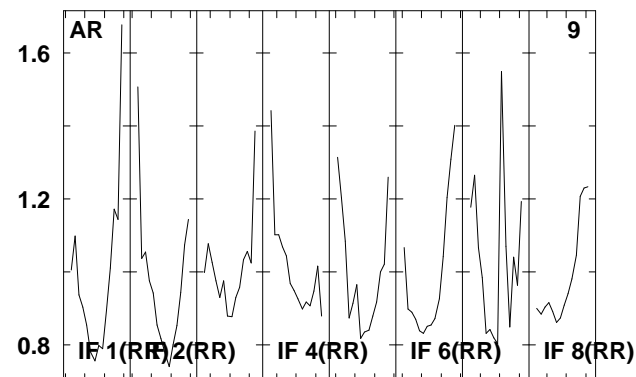
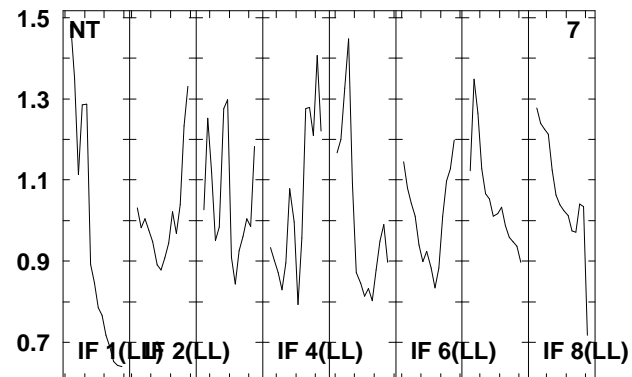
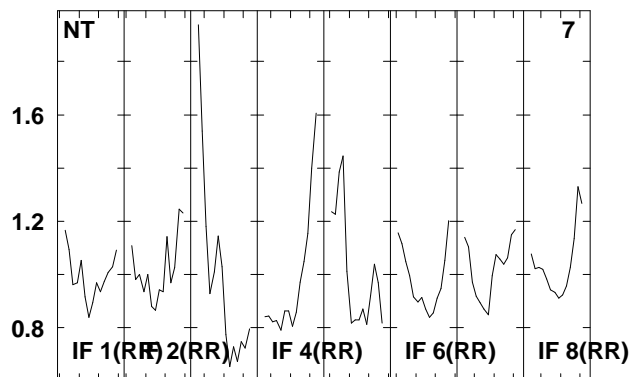
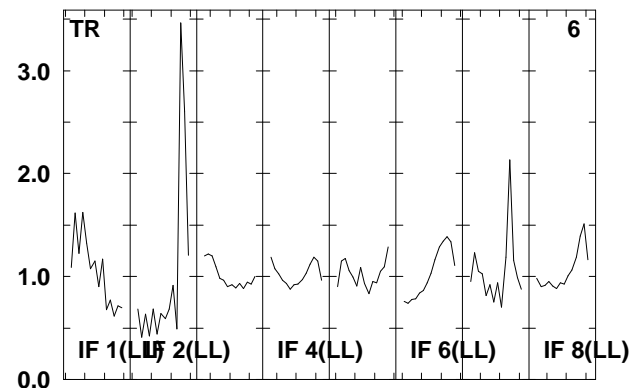
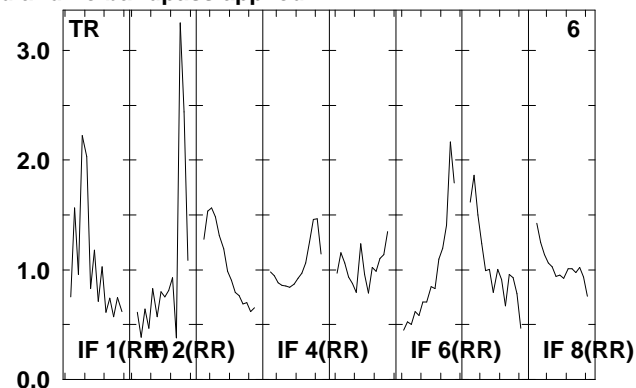
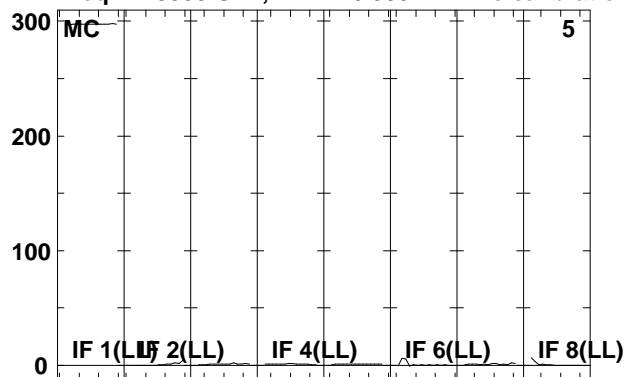

Lower frame: Real Jy

Total-power spectrum Antenna: \*

Timerange: 00/21:18:29 to 00/21:20:27

Plot file version 103 created 20-AUG-2009 14:59:57

NGC3227 EG040B.UVDATA.1

Freq = 1.5955 GHz, Bw = 16.000 MH No calibration applied and no bandpass applied

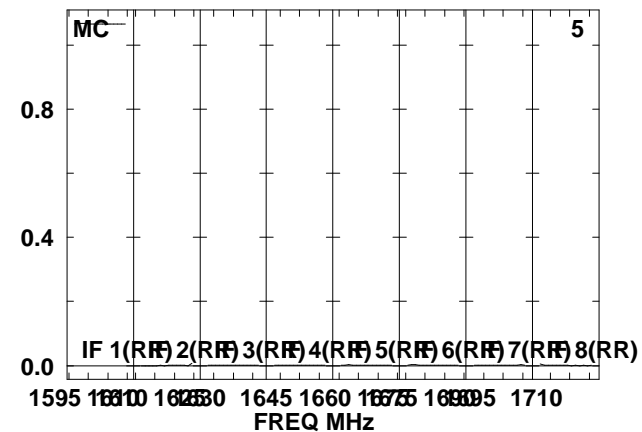
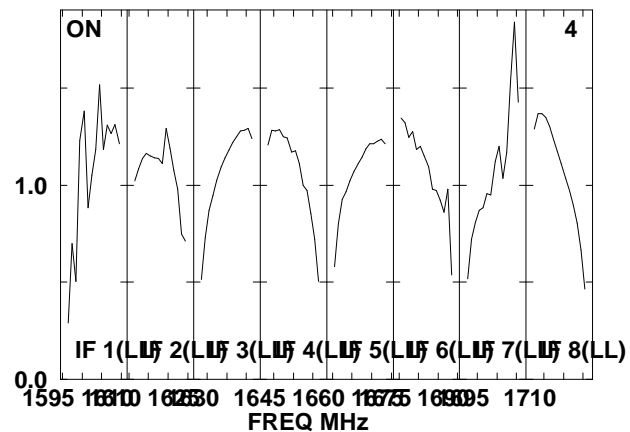
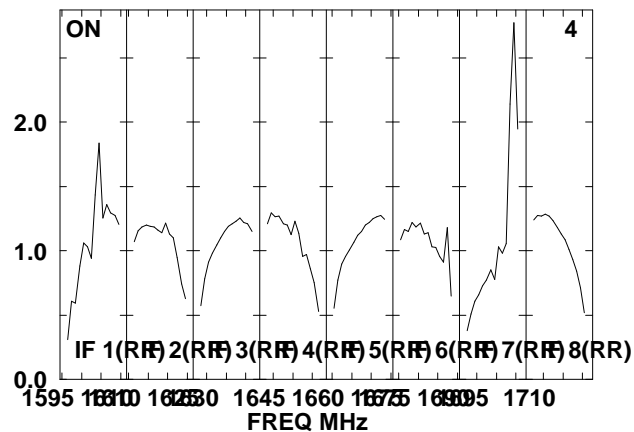
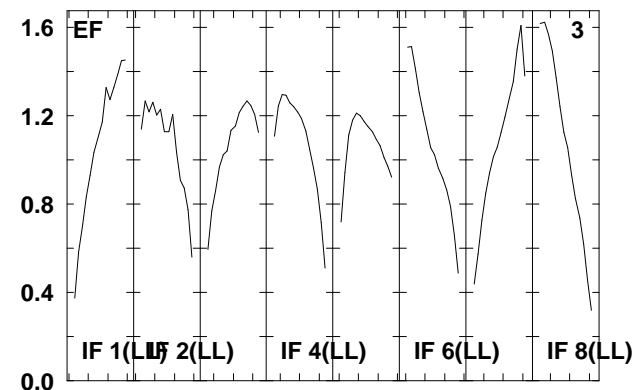
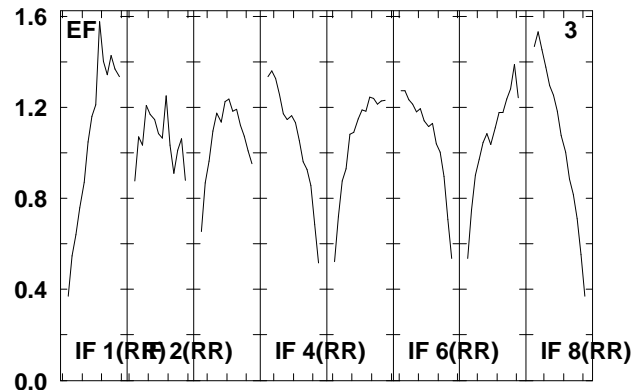
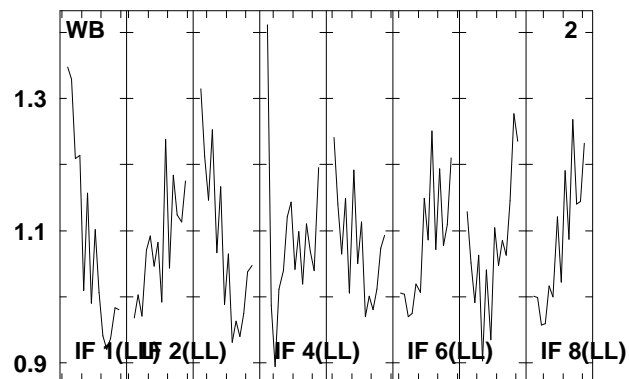
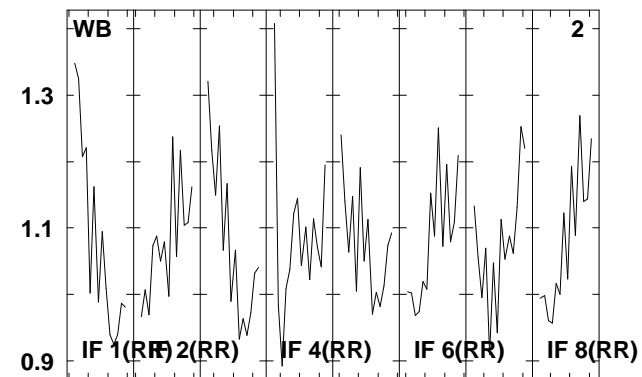
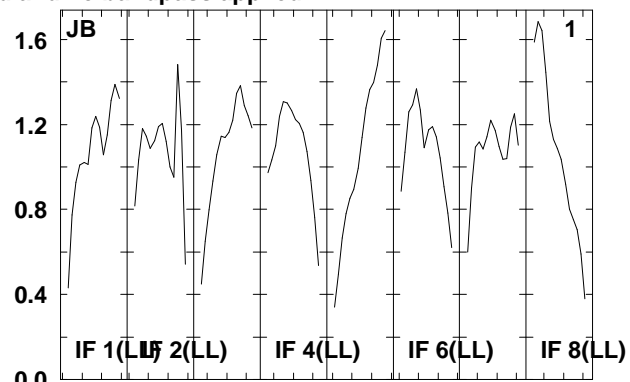
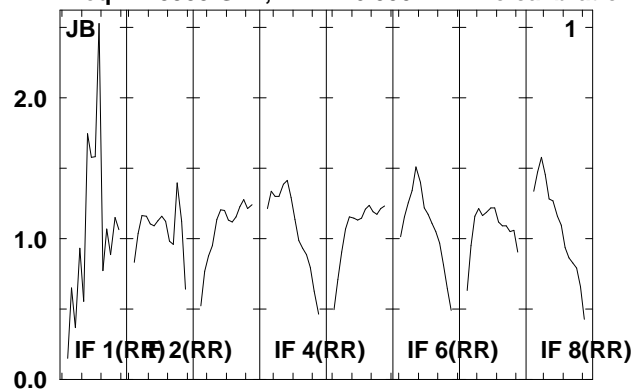

Lower frame: Real Jy  
Total-power spectrum Antenna: \*  
Timerange: 00/21:20:29 to 00/21:24:25

Plot file version 104 created 20-AUG-2009 14:59:57

NGC3227 EG040B.UVDATA.1

Freq = 1.5955 GHz, Bw = 16.000 MH No calibration applied and no bandpass applied

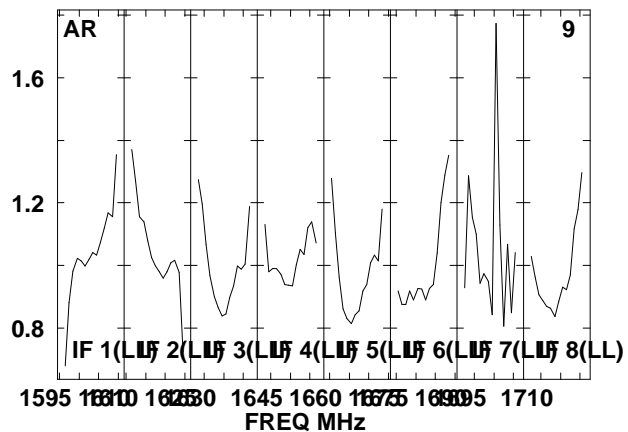
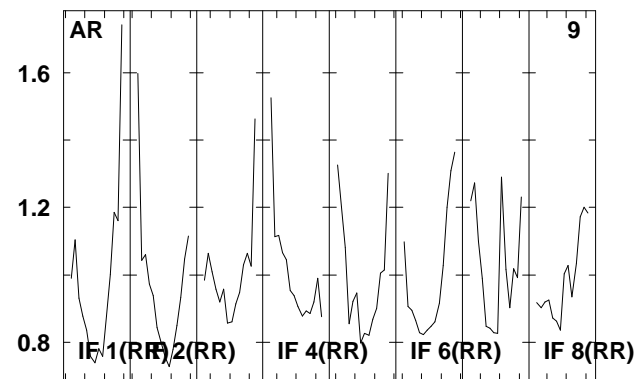
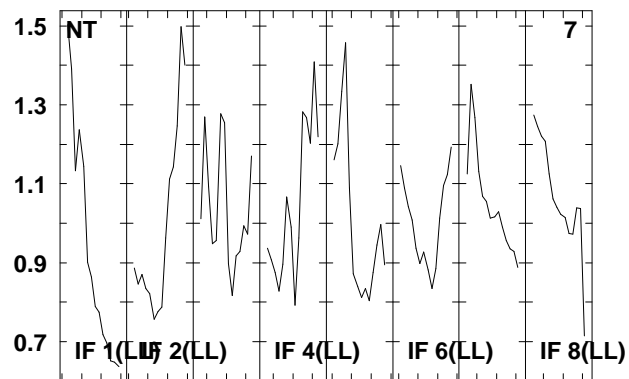
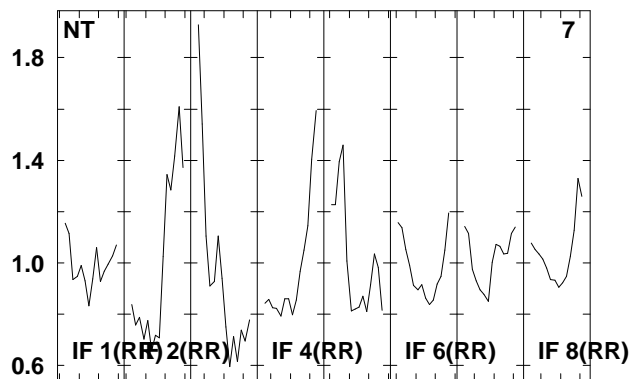
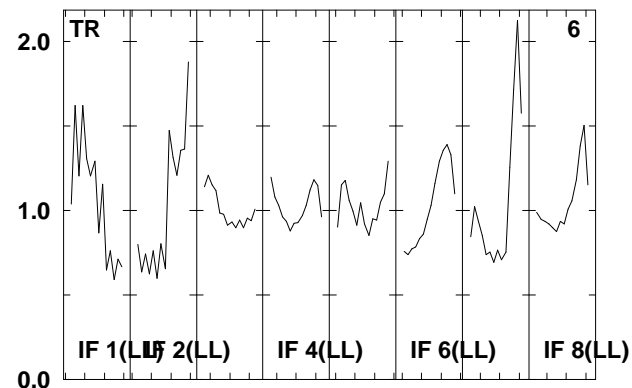
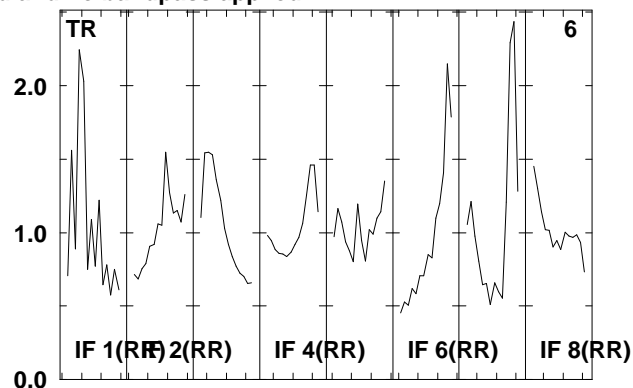
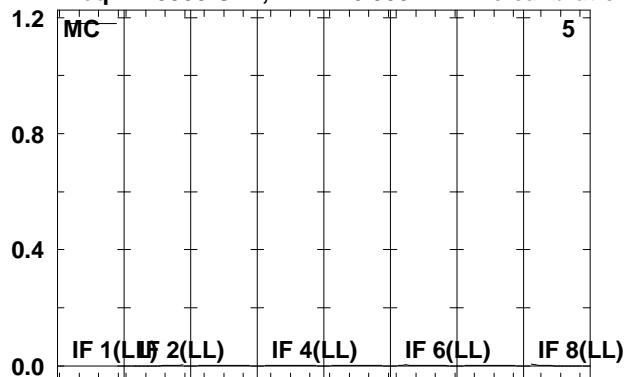

Lower frame: Kilo Real Jy  
Total-power spectrum Antenna: \*  
Timerange: 00/21:20:29 to 00/21:24:25



Plot file version 105 created 20-AUG-2009 14:59:58

J1016+20 EG040B.UVDATA.1

Freq = 1.5955 GHz, Bw = 16.000 MH No calibration applied and no bandpass applied

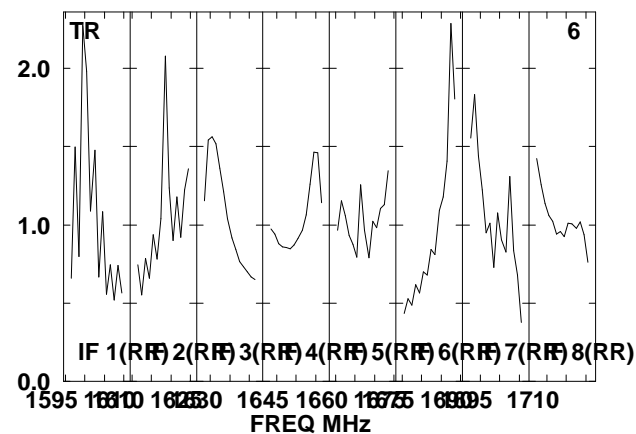
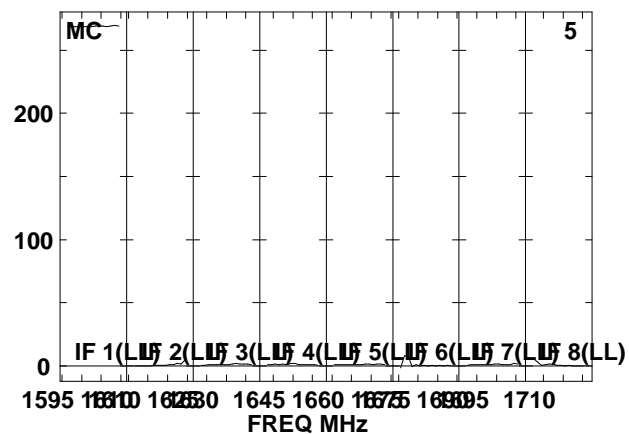
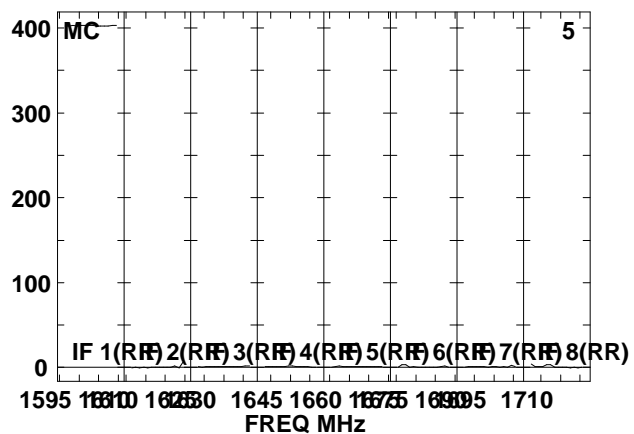
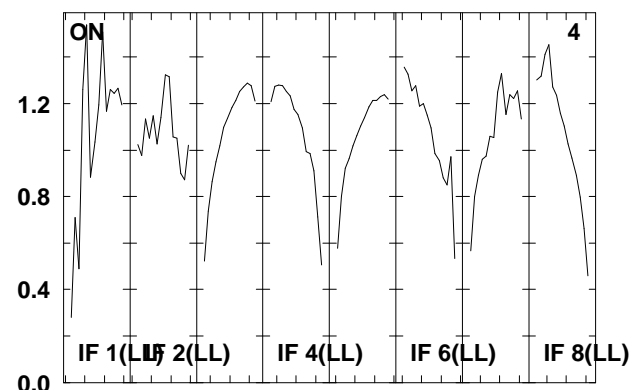
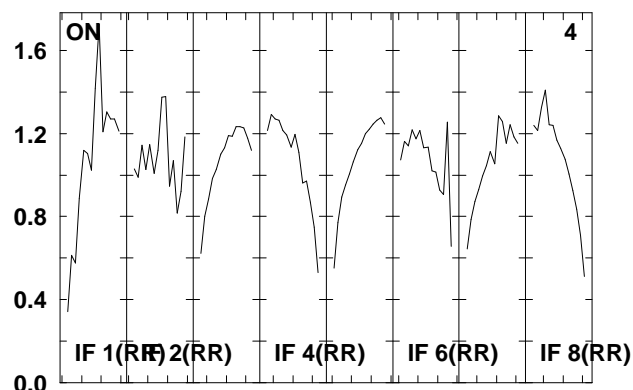
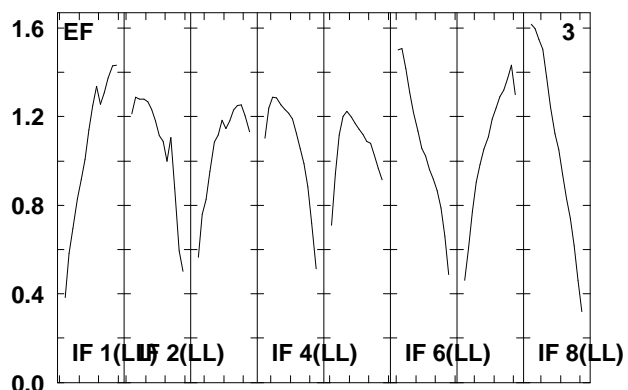
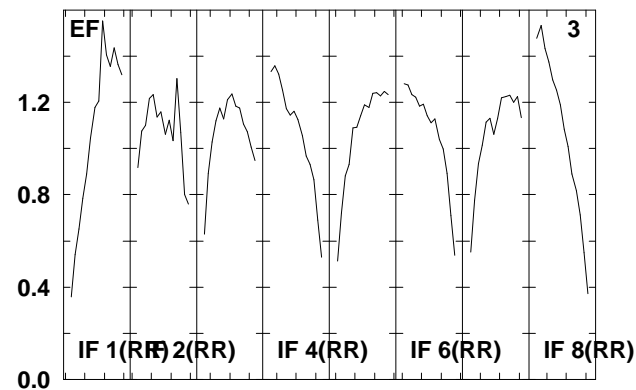
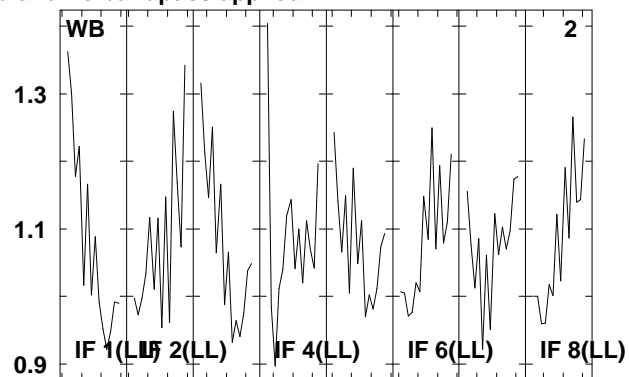
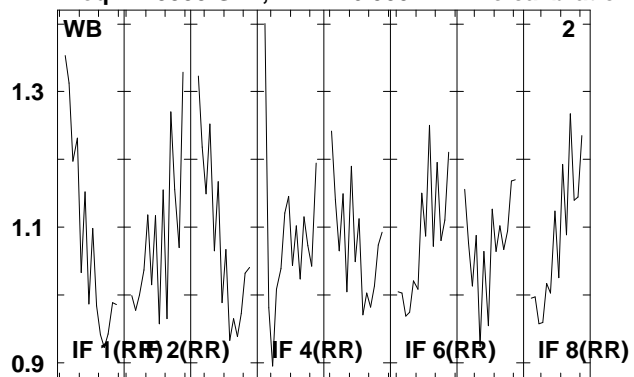

Lower frame: Real Jy  
Total-power spectrum Antenna: \*  
Timerange: 00/21:25:01 to 00/21:26:37

Plot file version 106 created 20-AUG-2009 14:59:58

J1016+20 EG040B.UVDATA.1

Freq = 1.5955 GHz, Bw = 16.000 MH No calibration applied and no bandpass applied

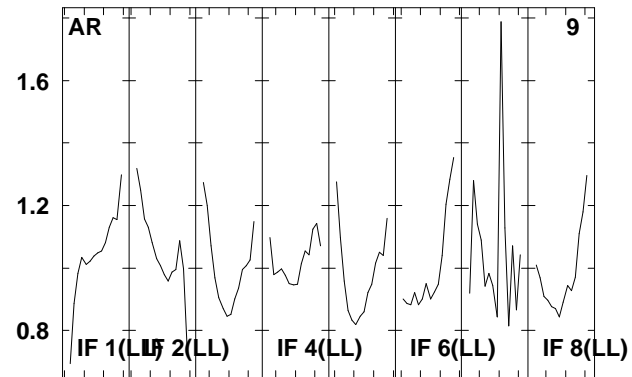
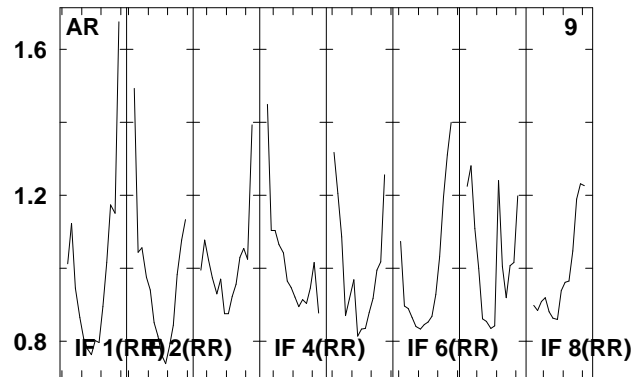
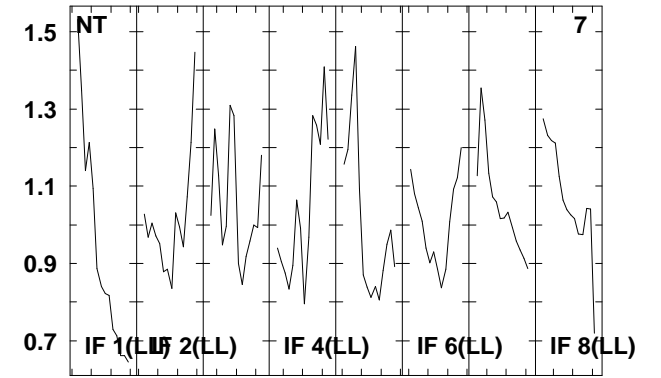
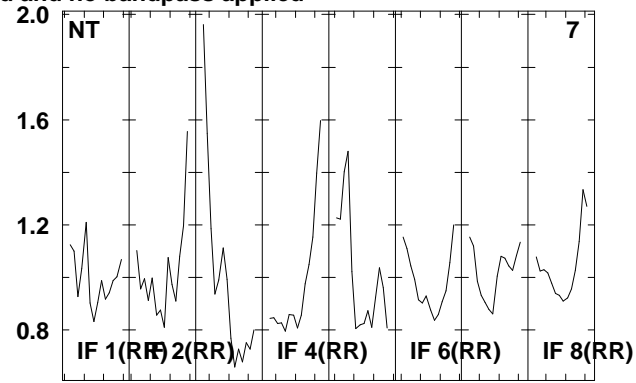
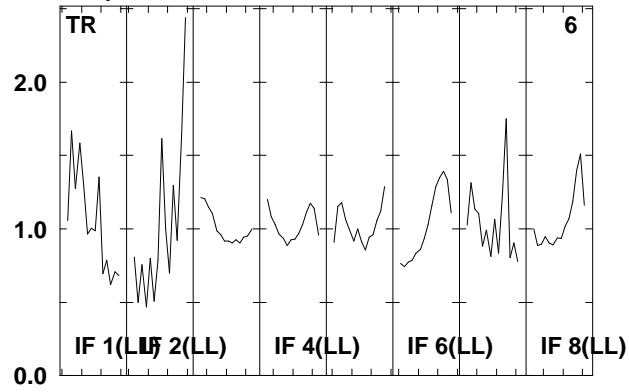

Lower frame: Real Jy  
Total-power spectrum Antenna: \*  
Timerange: 00/21:25:01 to 00/21:26:37

Plot file version 107 created 20-AUG-2009 14:59:58

NGC3227 EG040B.UVDATA.1

Freq = 1.5955 GHz, Bw = 16.000 MH No calibration applied and no bandpass applied

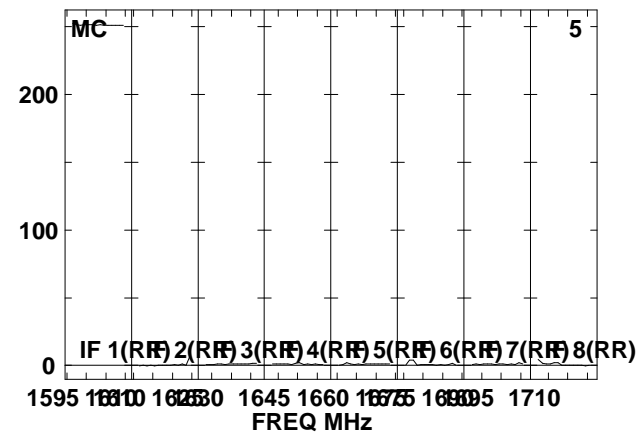
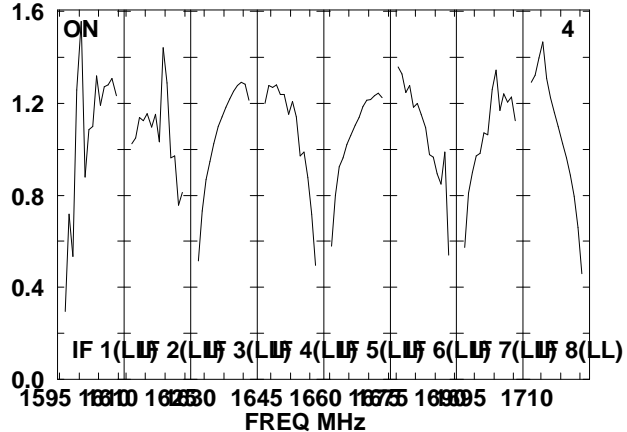
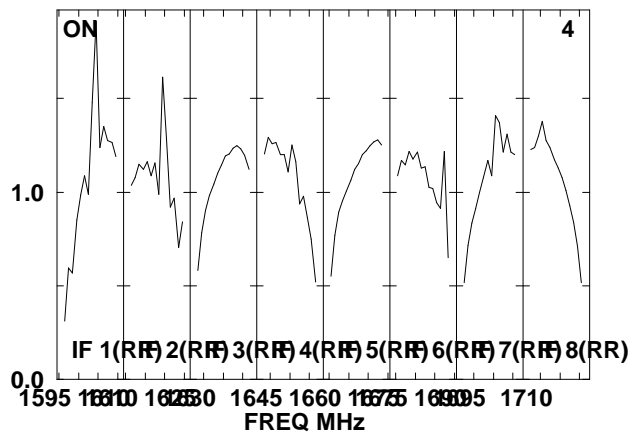
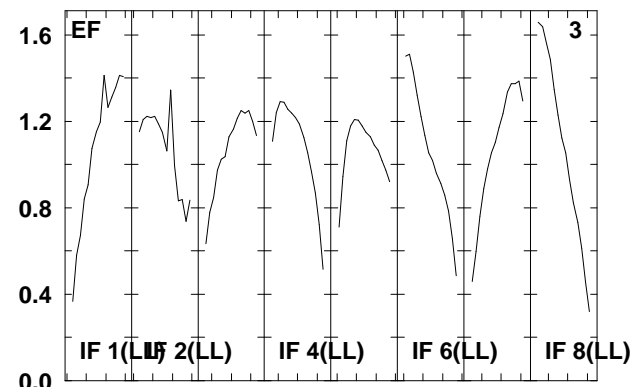
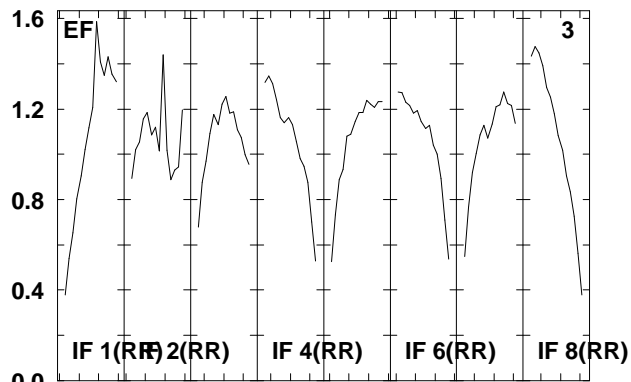
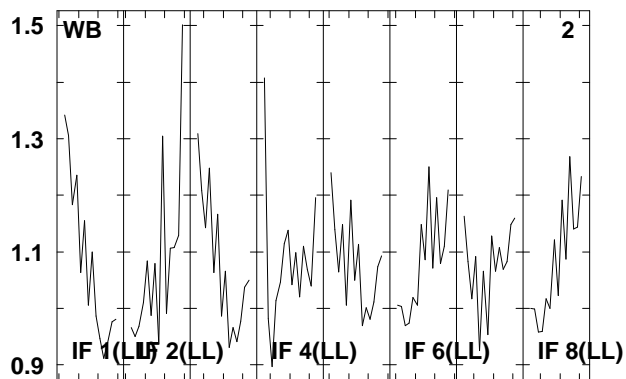
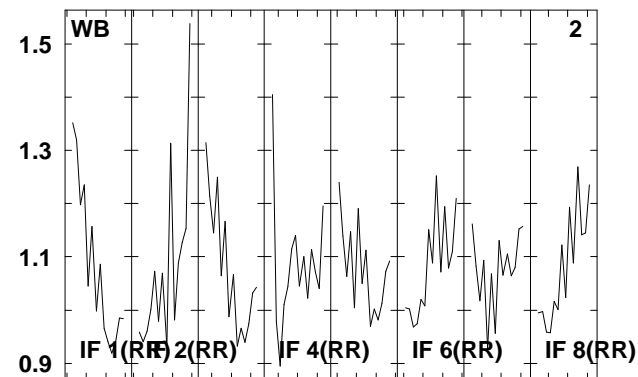
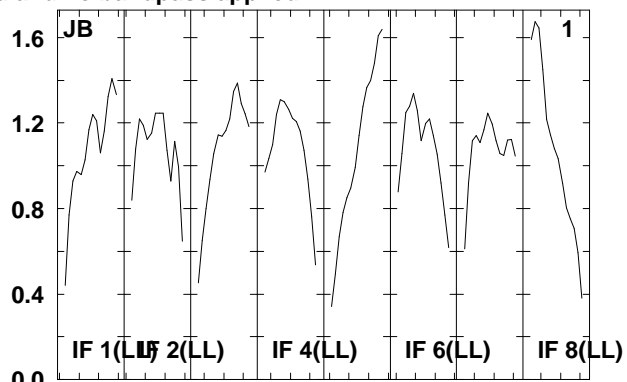
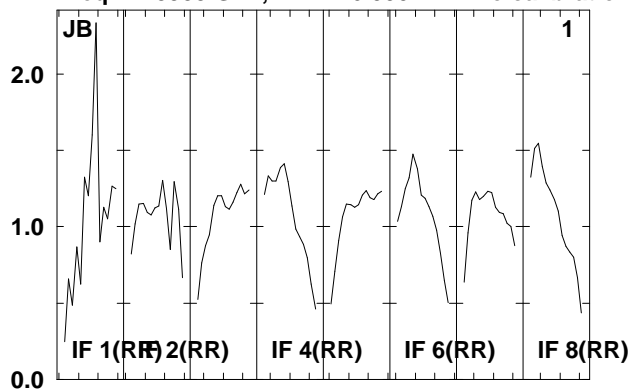

Lower frame: Real Jy  
Total-power spectrum Antenna: \*  
Timerange: 00/21:26:41 to 00/21:30:39

Plot file version 108 created 20-AUG-2009 14:59:59

NGC3227 EG040B.UVDATA.1

Freq = 1.5955 GHz, Bw = 16.000 MH No calibration applied and no bandpass applied

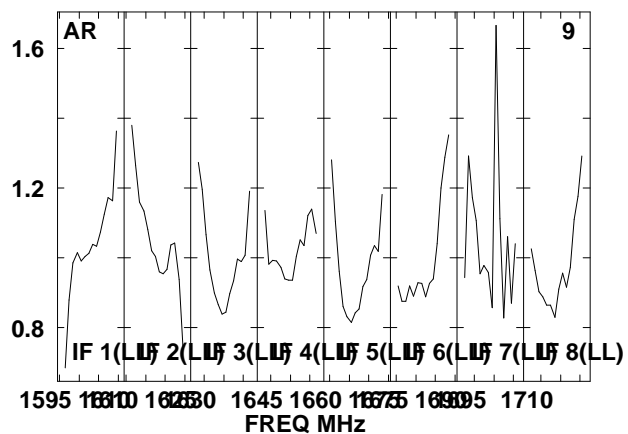
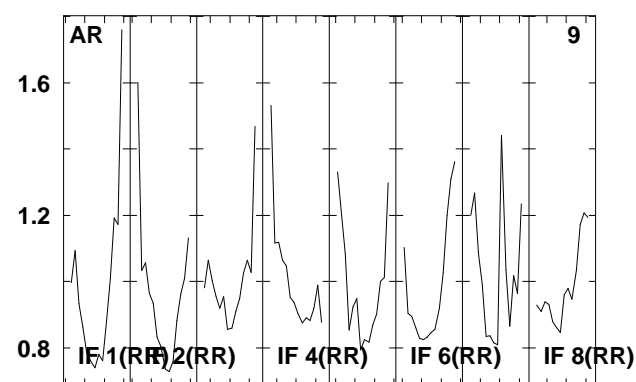
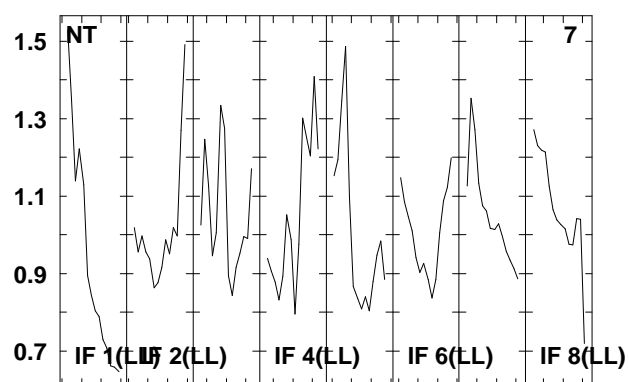
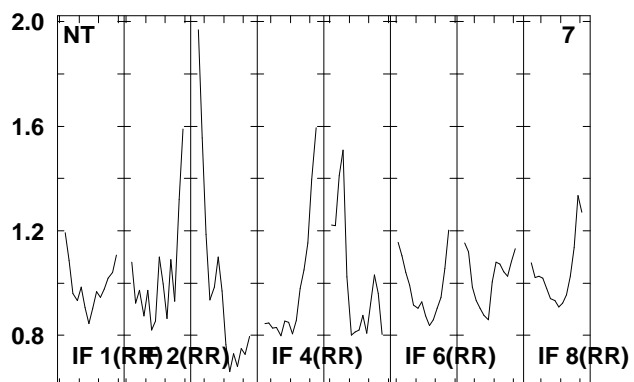
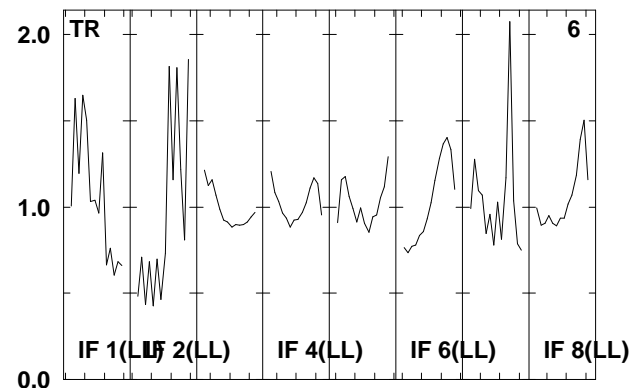
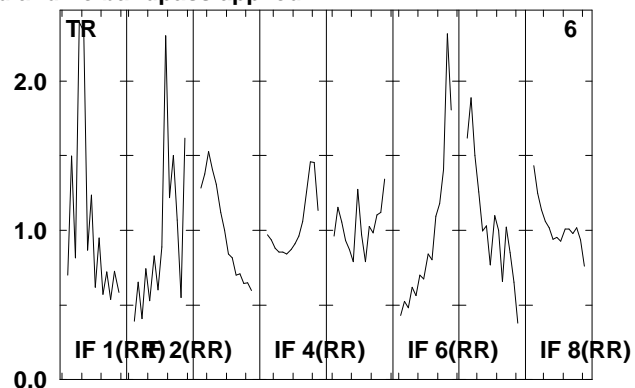
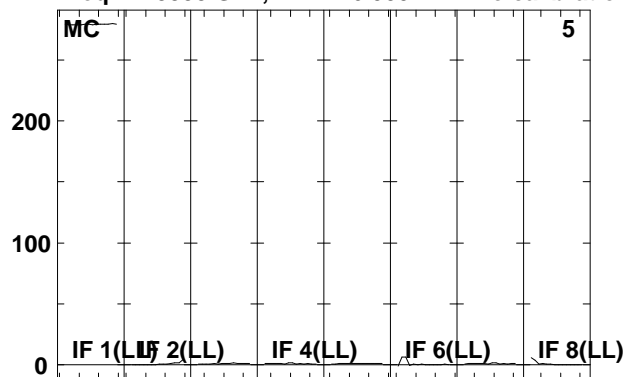

Lower frame: Real Jy

Total-power spectrum Antenna: \*

Timerange: 00/21:26:41 to 00/21:30:39

Plot file version 109 created 20-AUG-2009 14:59:59

J1016+20 EG040B.UVDATA.1

Freq = 1.5955 GHz, Bw = 16.000 MH No calibration applied and no bandpass applied

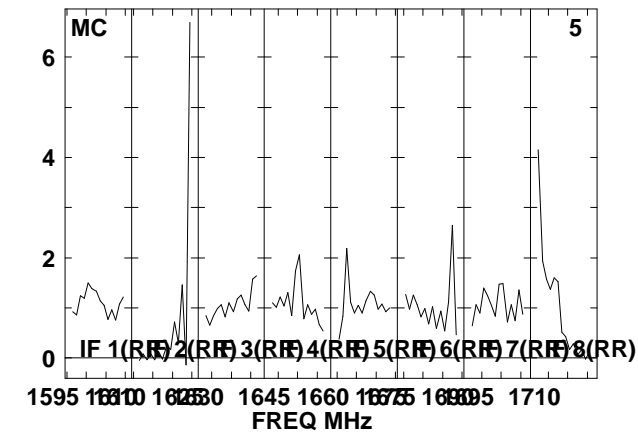
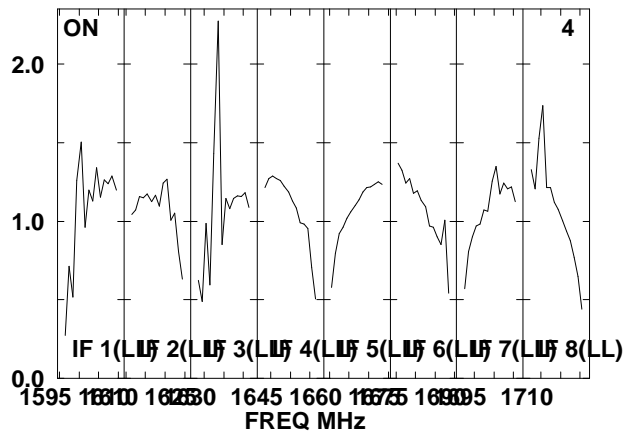
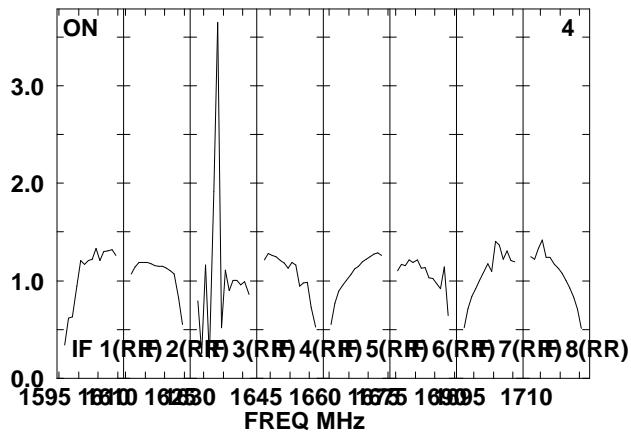
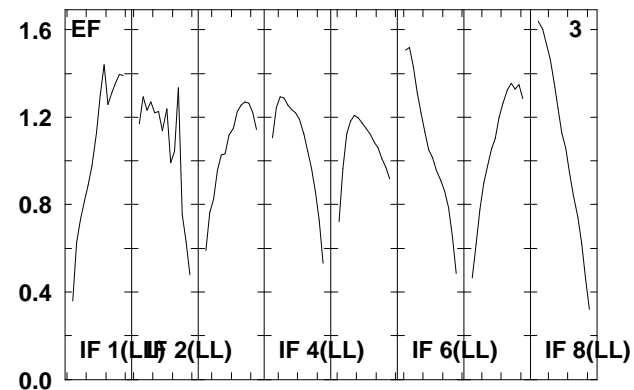
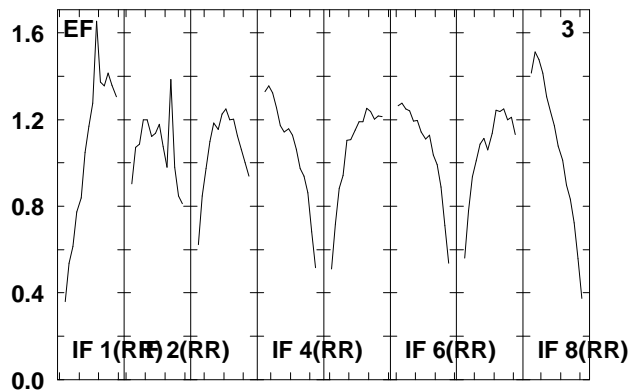
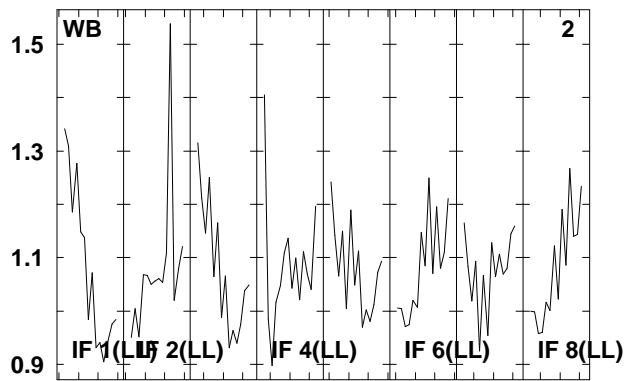
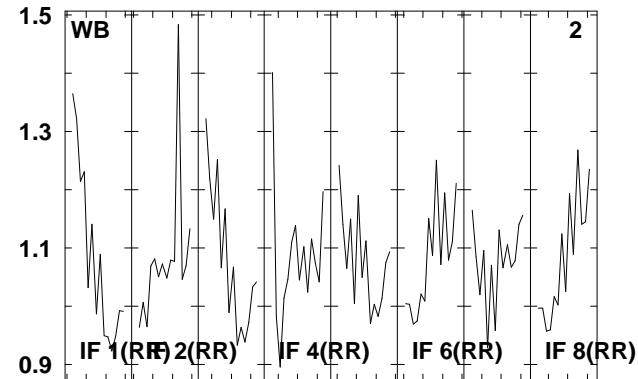
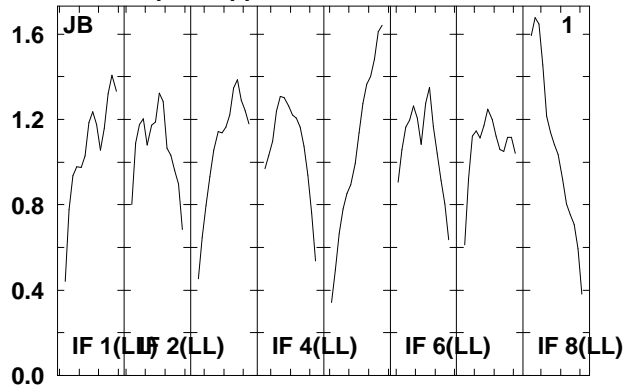
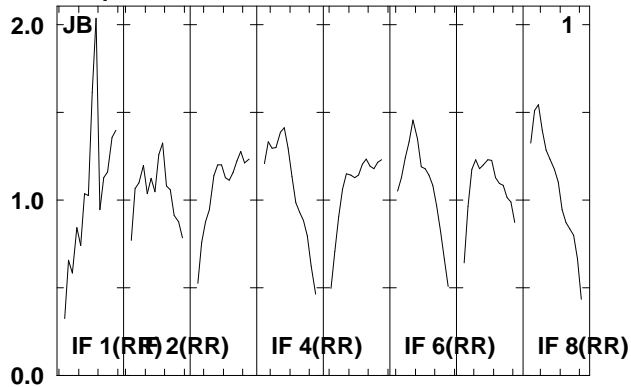

Lower frame: Real Jy  
Total-power spectrum Antenna: \*  
Timerange: 00/21:30:41 to 00/21:32:39

Plot file version 110 created 20-AUG-2009 14:59:59

J1016+20 EG040B.UVDATA.1

Freq = 1.5955 GHz, Bw = 16.000 MH No calibration applied and no bandpass applied

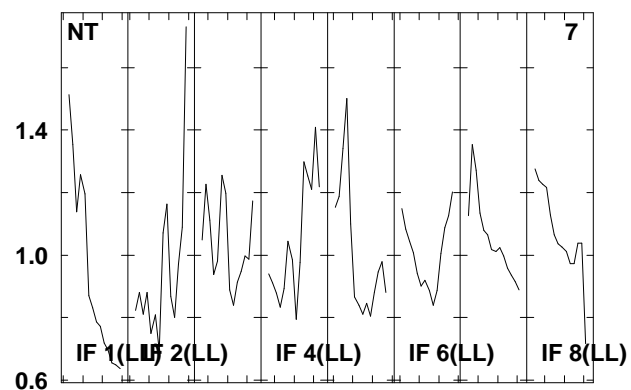
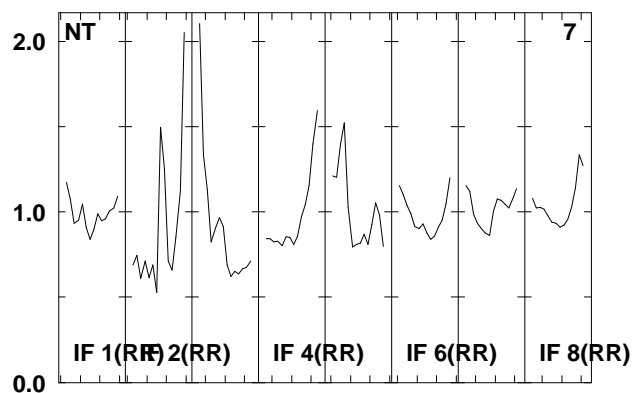
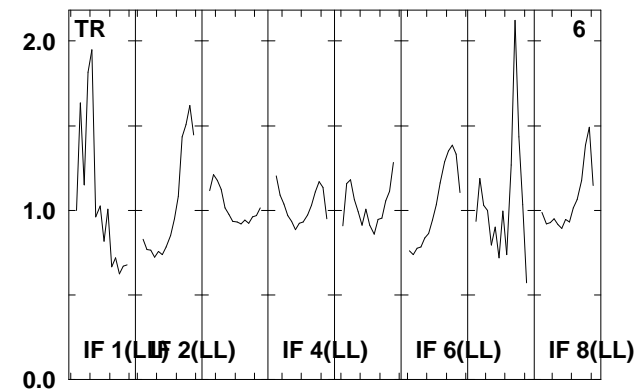
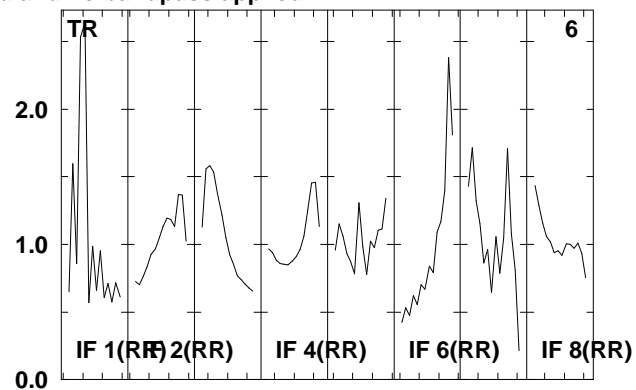
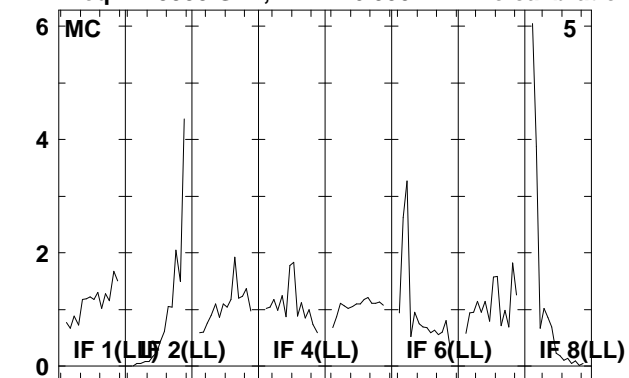

Lower frame: Real Jy  
Total-power spectrum Antenna: \*  
Timerange: 00/21:30:41 to 00/21:32:39

Plot file version 111 created 20-AUG-2009 15:00:00

NGC3227 EG040B.UVDATA.1

Freq = 1.5955 GHz, Bw = 16.000 MH No calibration applied and no bandpass applied

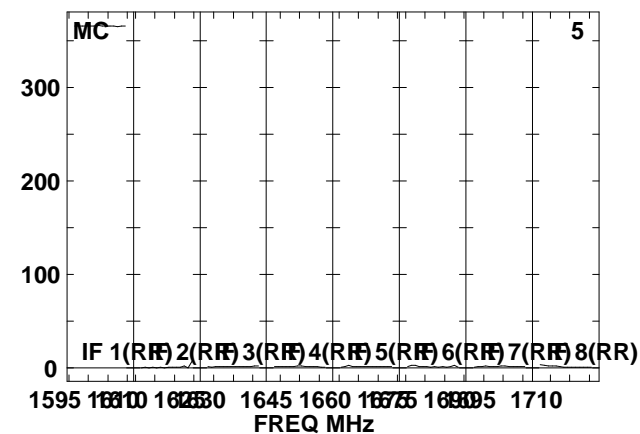
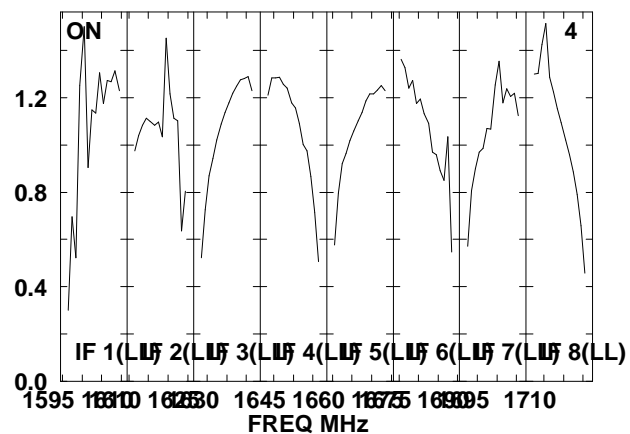
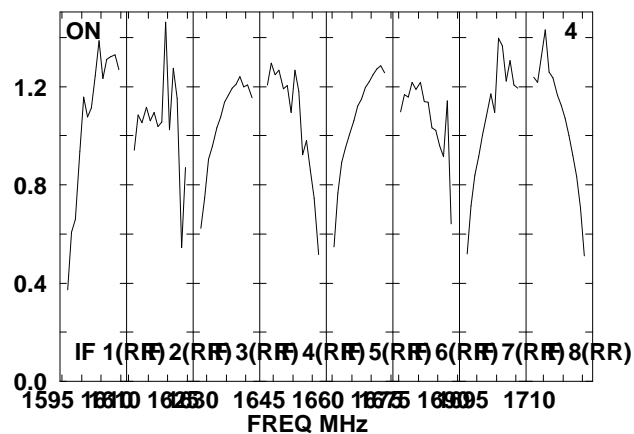
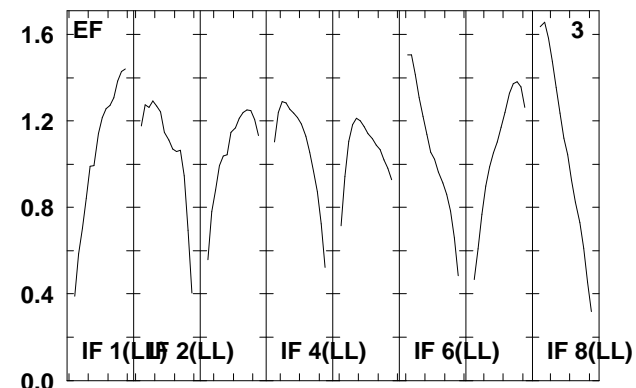
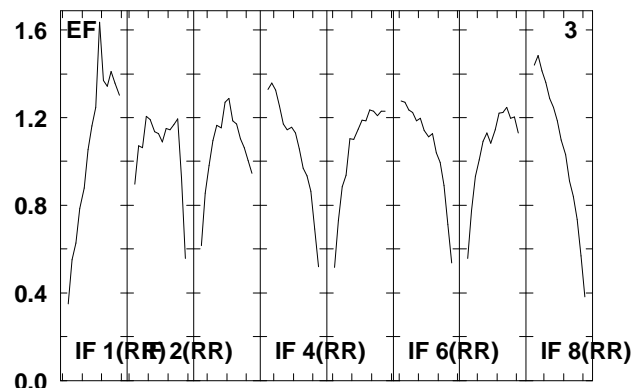
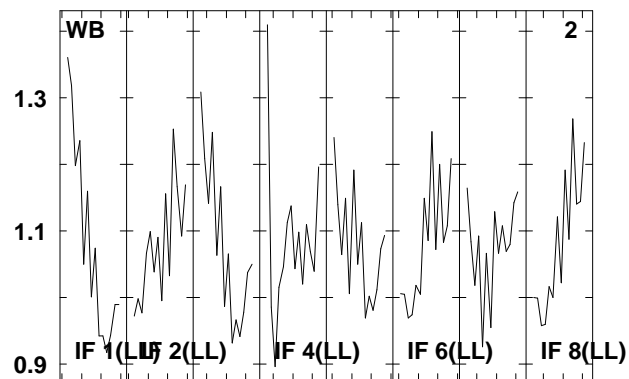
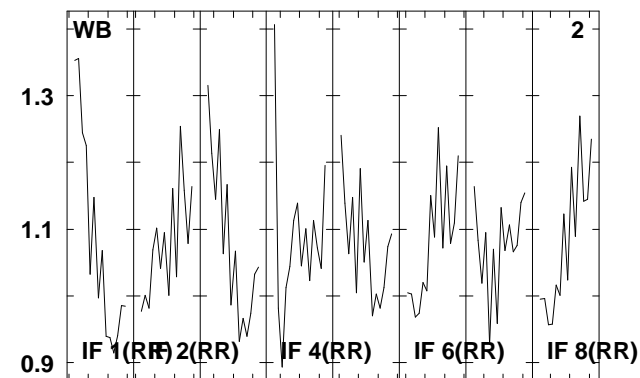
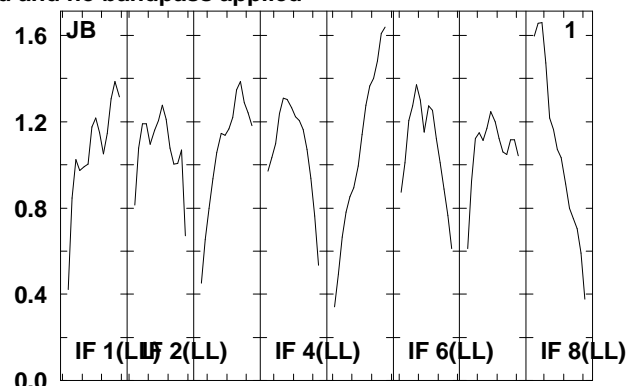
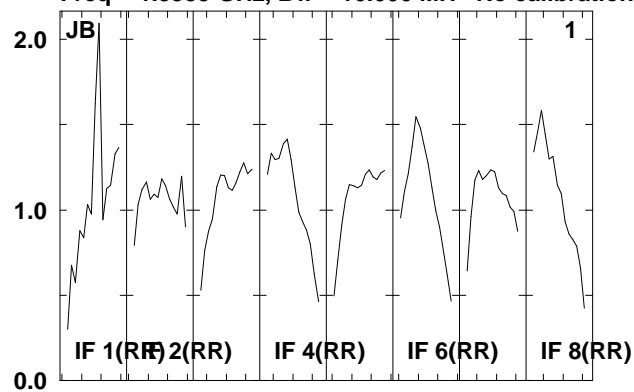

Lower frame: Real Jy  
Total-power spectrum Antenna: \*  
Timerange: 00/21:32:41 to 00/21:36:37

Plot file version 112 created 20-AUG-2009 15:00:00  
 NGC3227 EG040B.UVDATA.1  
 Freq = 1.5955 GHz, Bw = 16.000 MH No calibration applied and no bandpass applied

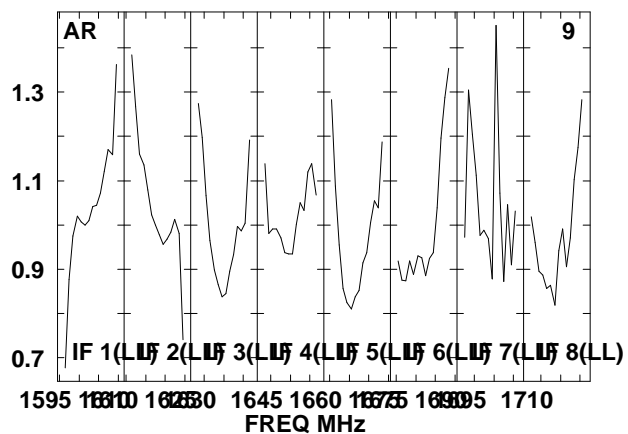
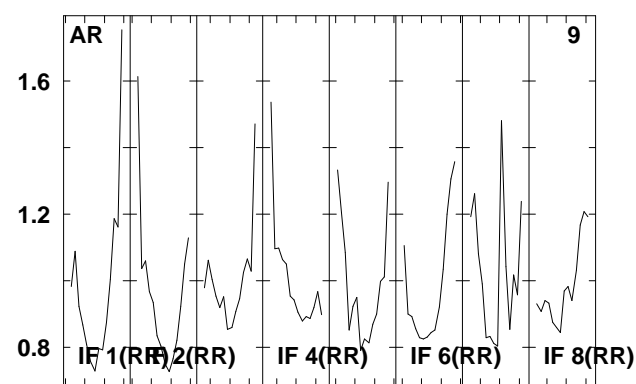
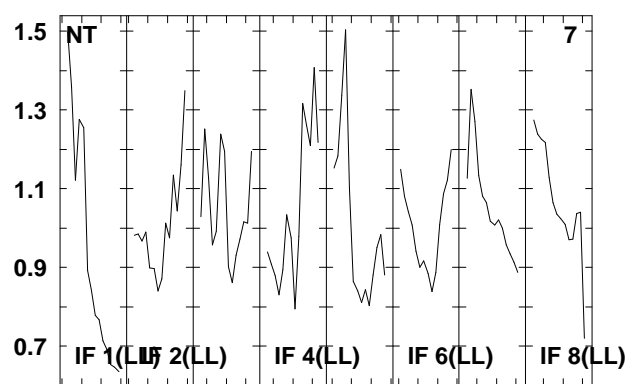
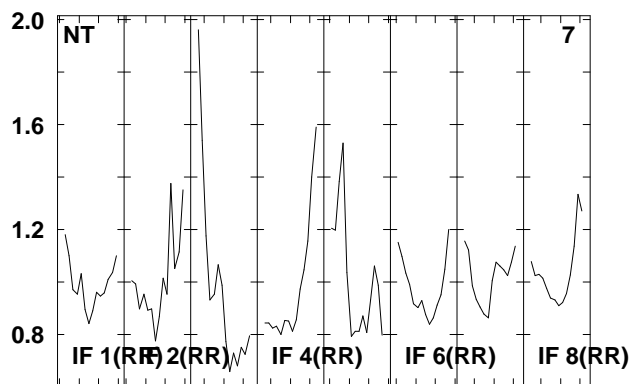
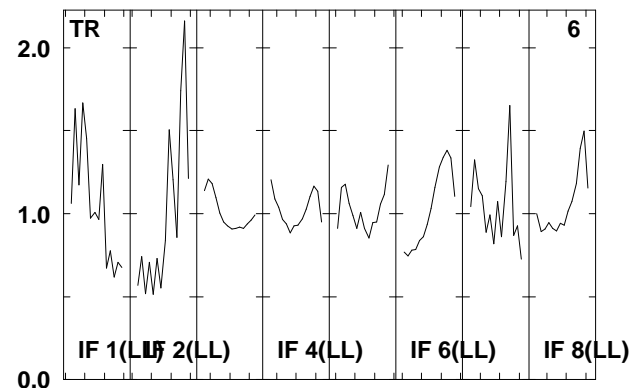
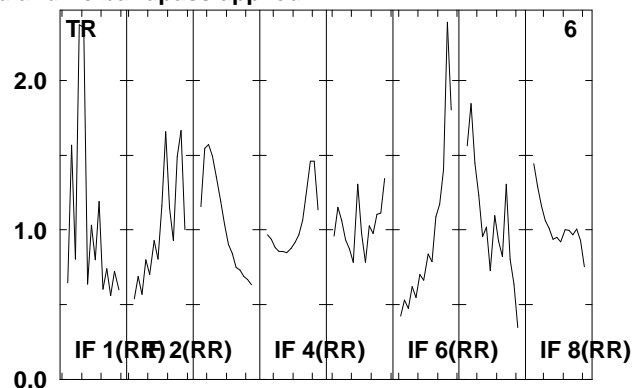
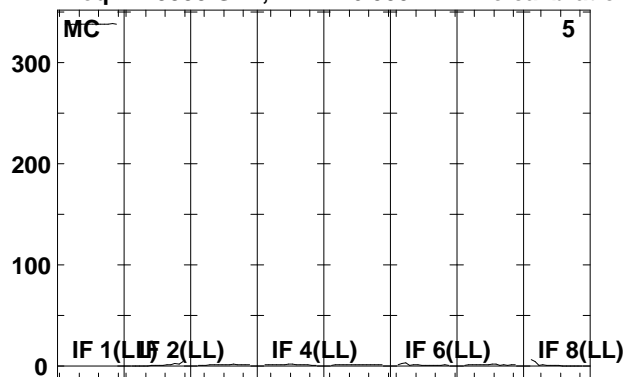

Lower frame: Real Jy  
 Total-power spectrum Antenna: \*  
 Timerange: 00/21:32:41 to 00/21:36:37



Plot file version 113 created 20-AUG-2009 15:00:00

J1016+20 EG040B.UVDATA.1

Freq = 1.5955 GHz, Bw = 16.000 MH No calibration applied and no bandpass applied

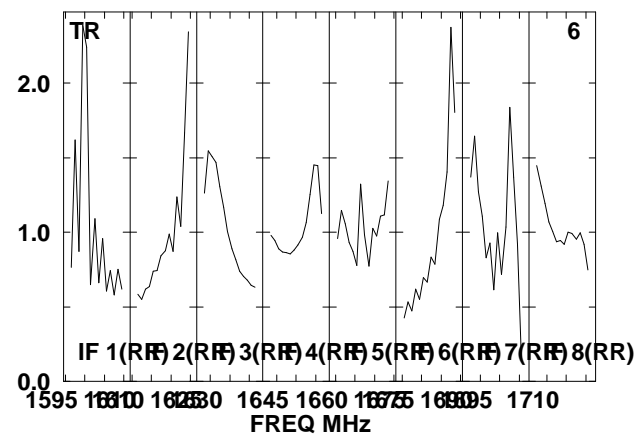
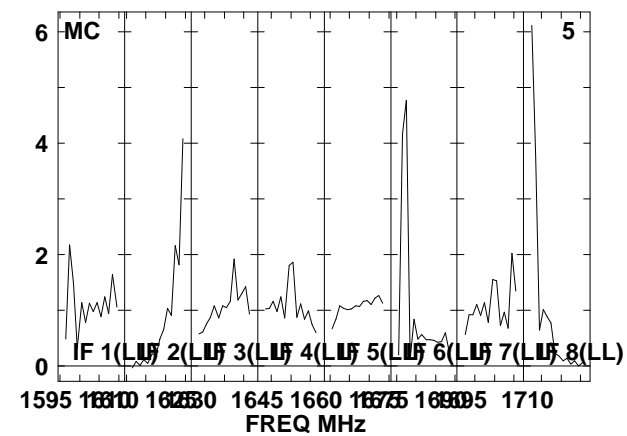
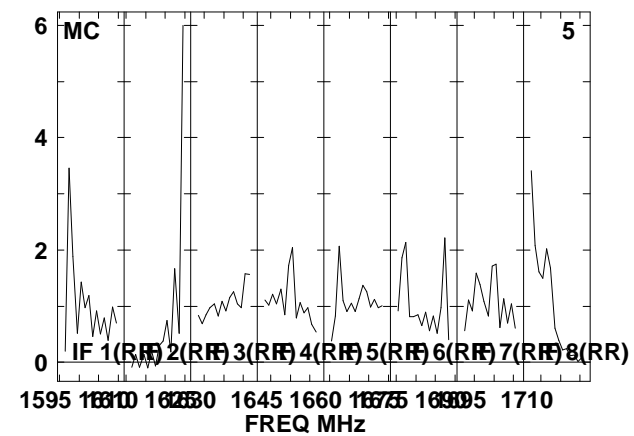
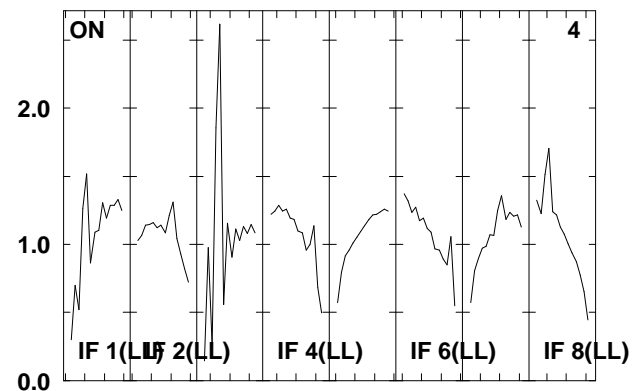
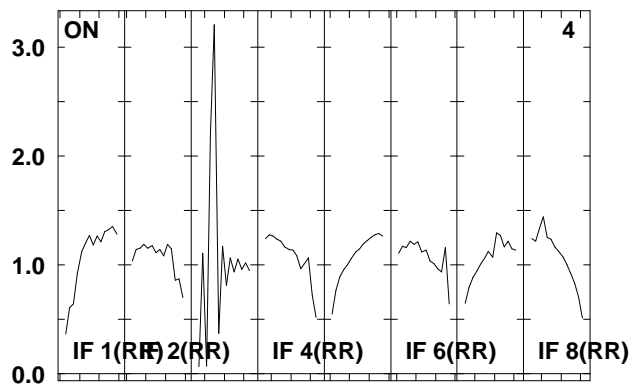
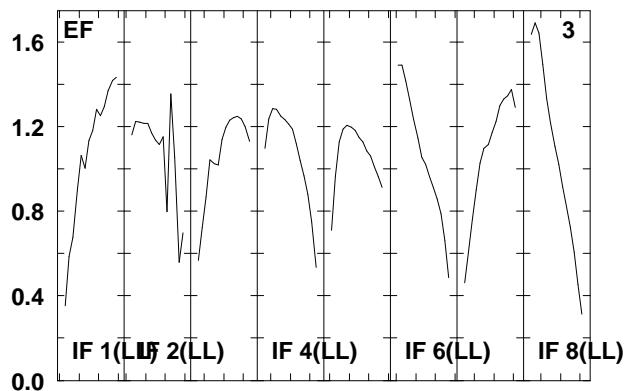
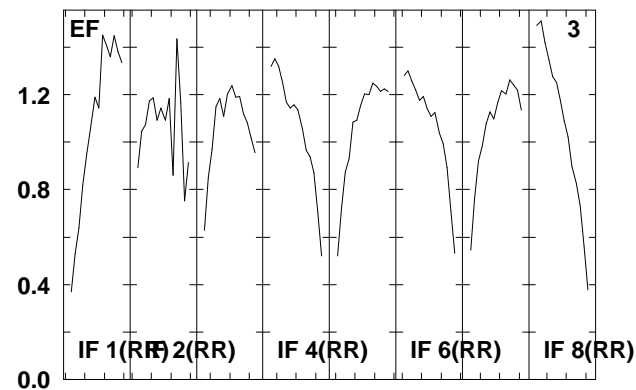
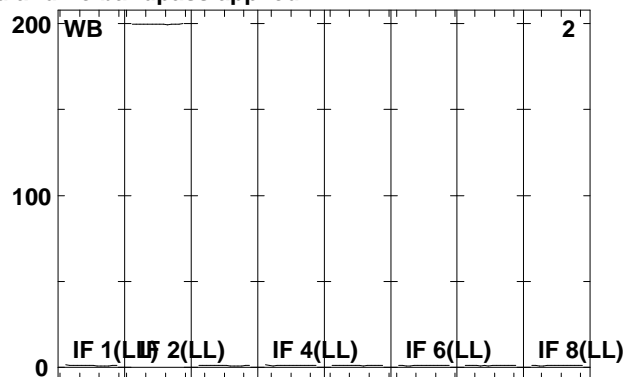
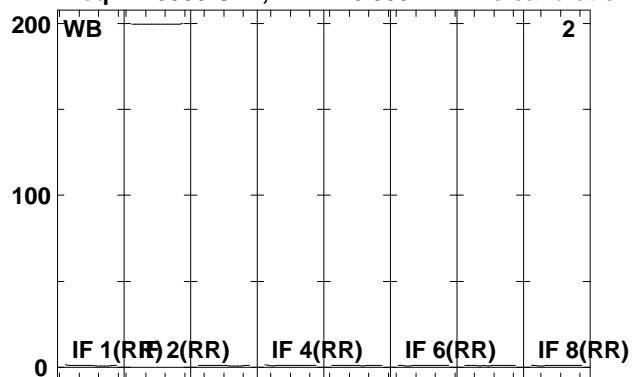

Lower frame: Real Jy  
Total-power spectrum Antenna: \*  
Timerange: 00/21:37:13 to 00/21:38:49

Plot file version 114 created 20-AUG-2009 15:00:01

J1016+20 EG040B.UVDATA.1

Freq = 1.5955 GHz, Bw = 16.000 MH No calibration applied and no bandpass applied

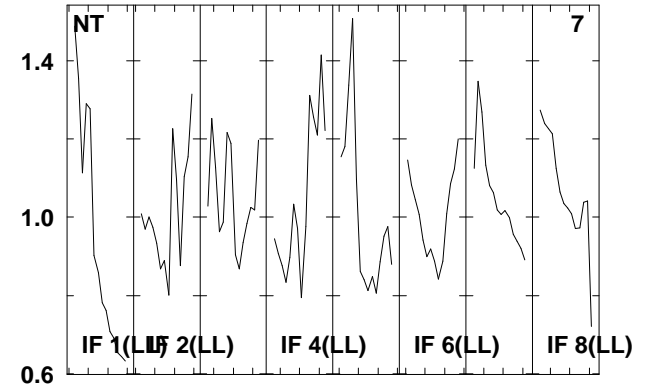
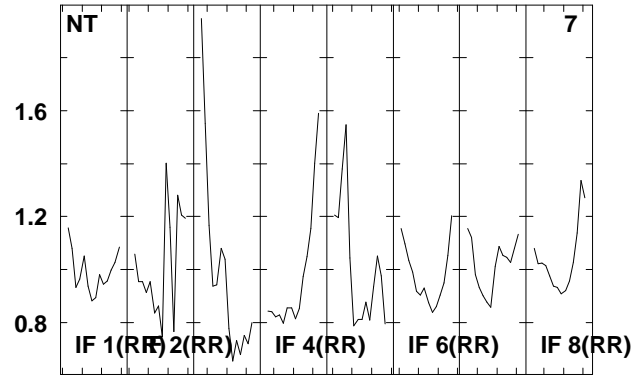
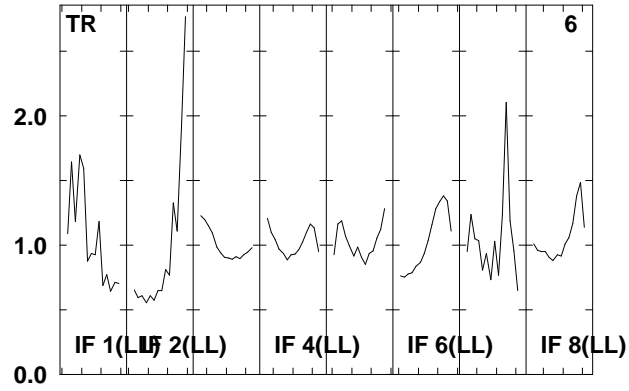

Lower frame: Real Jy  
Total-power spectrum Antenna: \*  
Timerange: 00/21:37:13 to 00/21:38:49

Plot file version 115 created 20-AUG-2009 15:00:01

NGC3227 EG040B.UVDATA.1

Freq = 1.5955 GHz, Bw = 16.000 MH No calibration applied and no bandpass applied

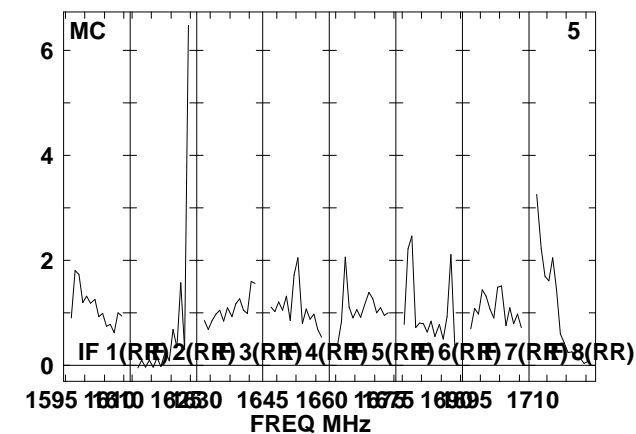
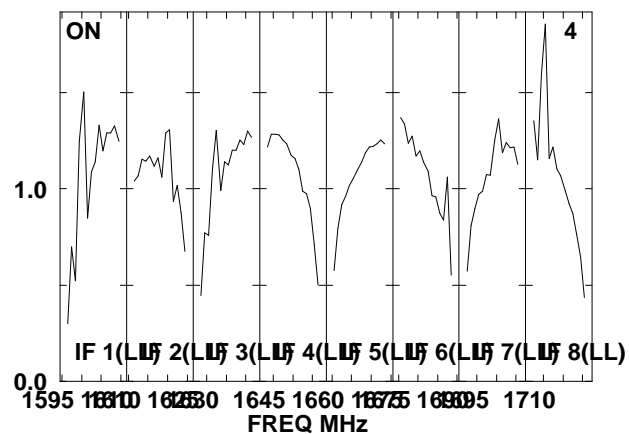
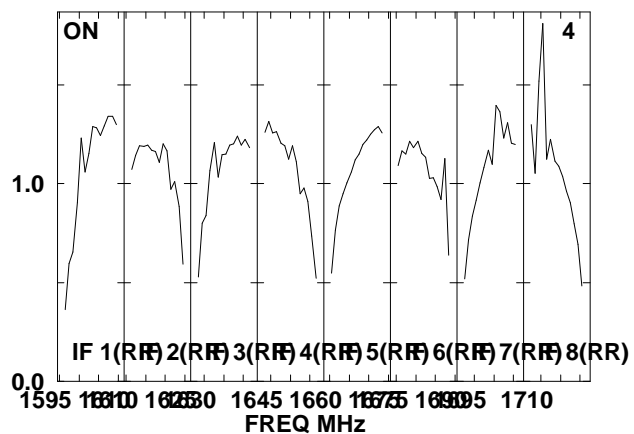
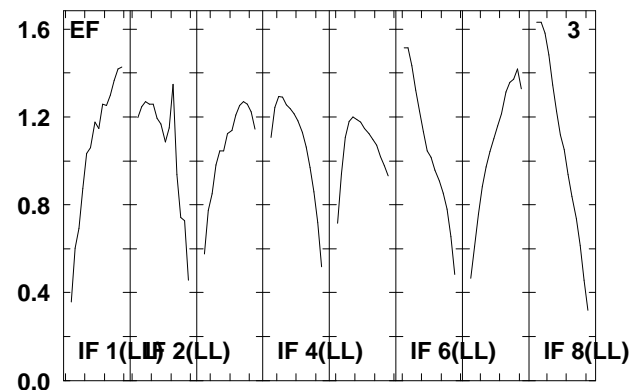
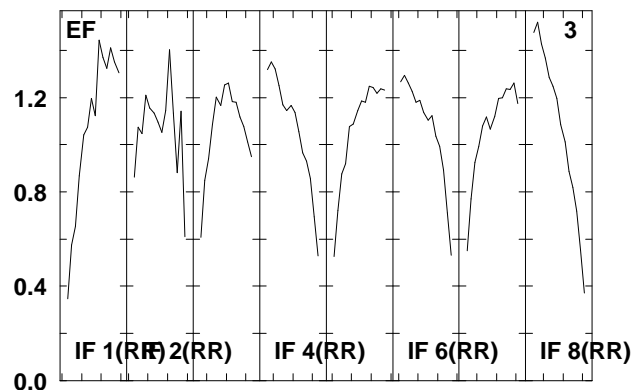
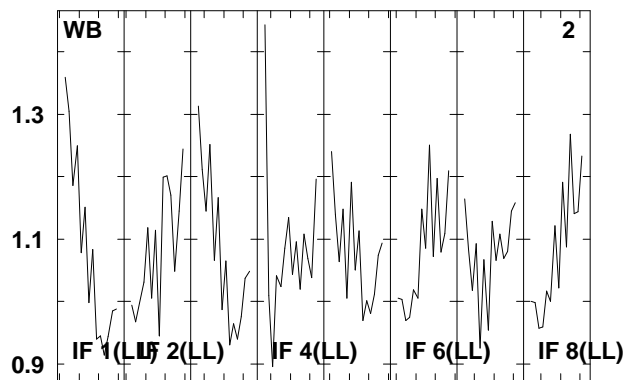
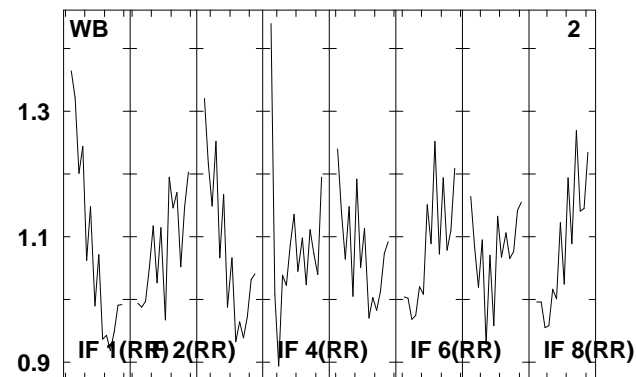
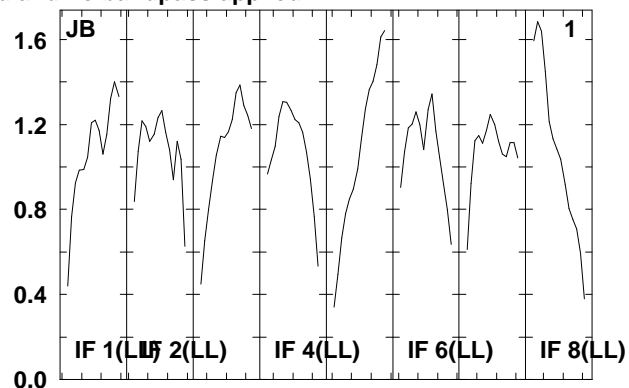
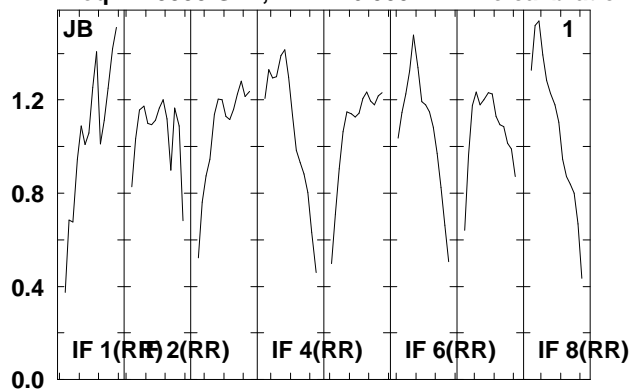

Lower frame: Real Jy

Total-power spectrum Antenna: \*

Timerange: 00/21:38:53 to 00/21:42:51

Plot file version 116 created 20-AUG-2009 15:00:01

NGC3227 EG040B.UVDATA.1

Freq = 1.5955 GHz, Bw = 16.000 MH No calibration applied and no bandpass applied

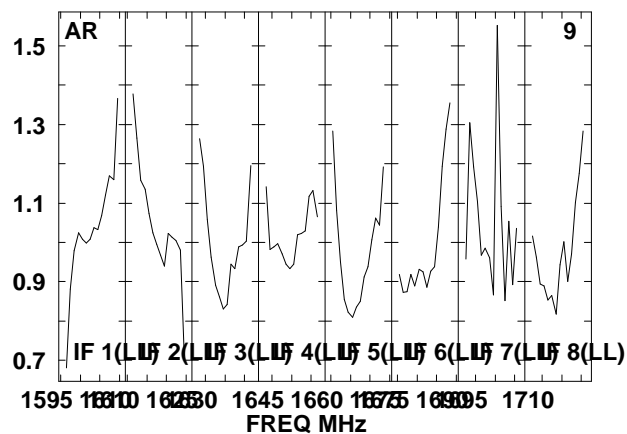
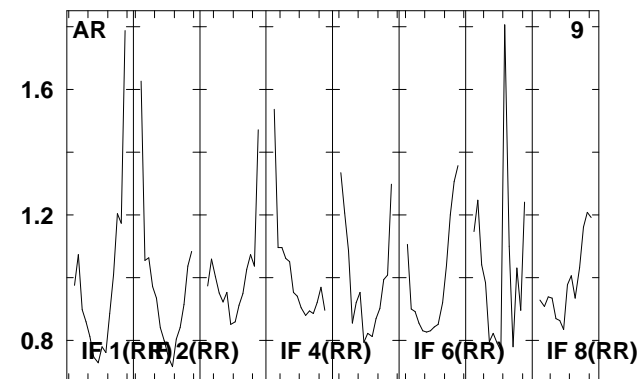
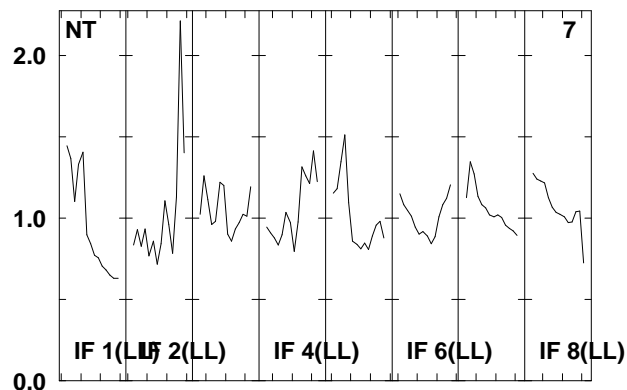
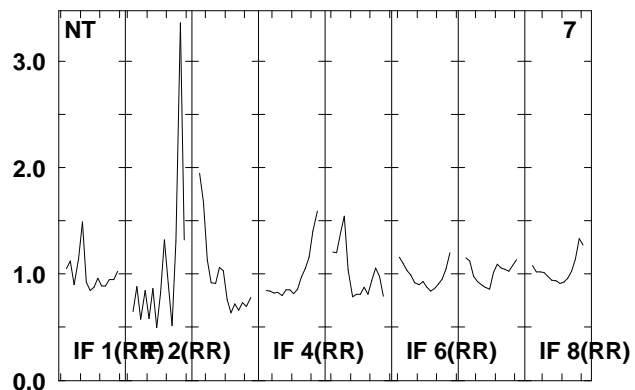
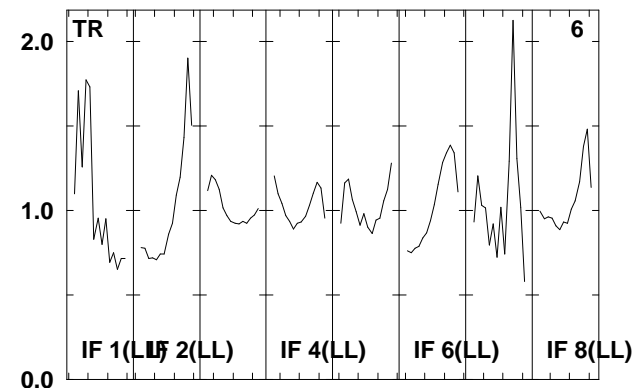
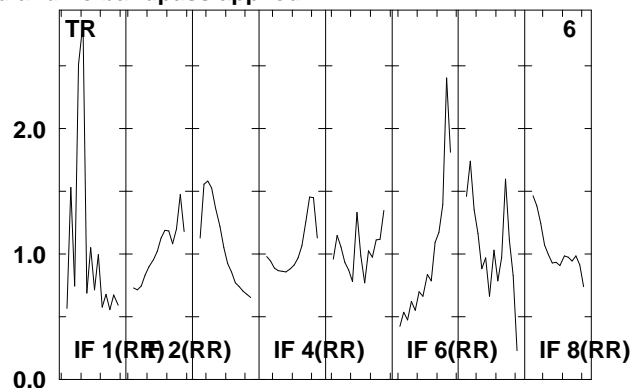
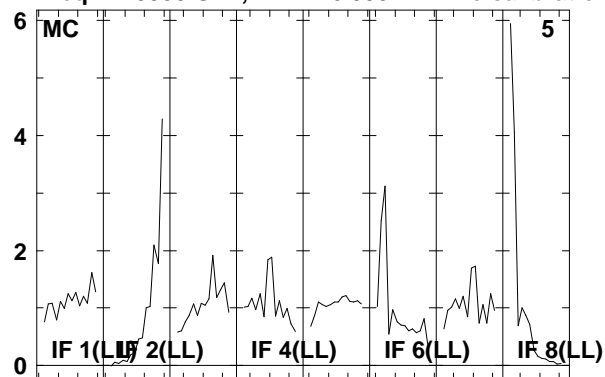

Lower frame: Real Jy

Total-power spectrum Antenna: \*

Timerange: 00/21:38:53 to 00/21:42:51

Plot file version 117 created 20-AUG-2009 15:00:02

J1016+20 EG040B.UVDATA.1

Freq = 1.5955 GHz, Bw = 16.000 MH No calibration applied and no bandpass applied

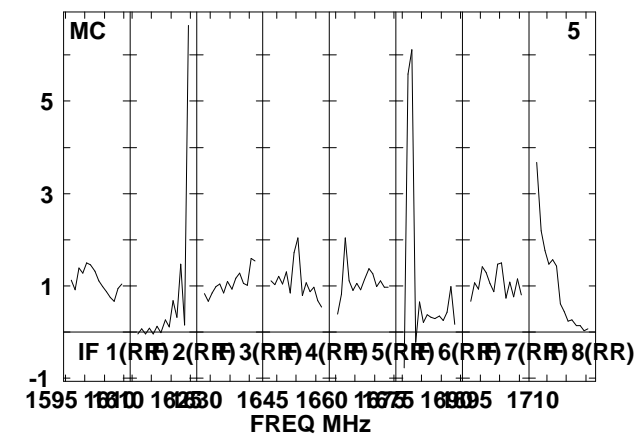
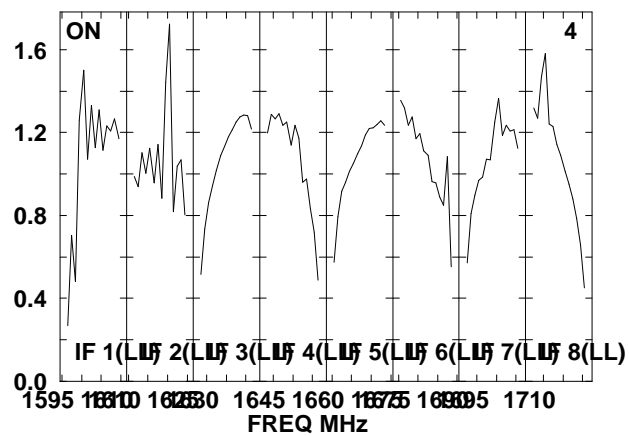
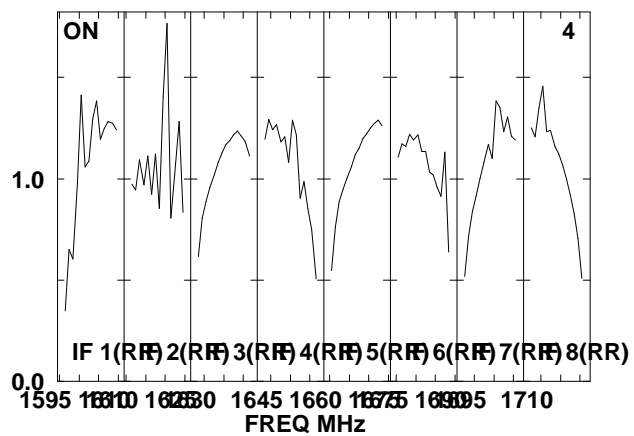
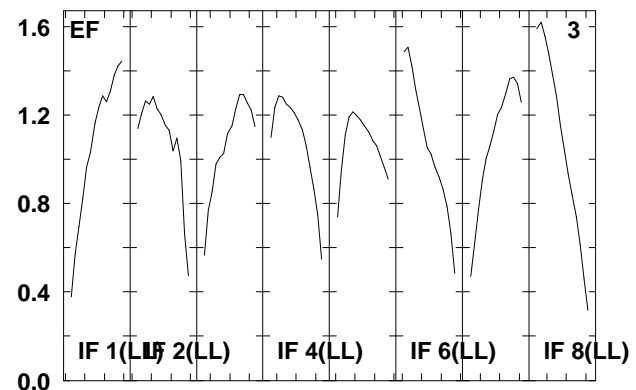
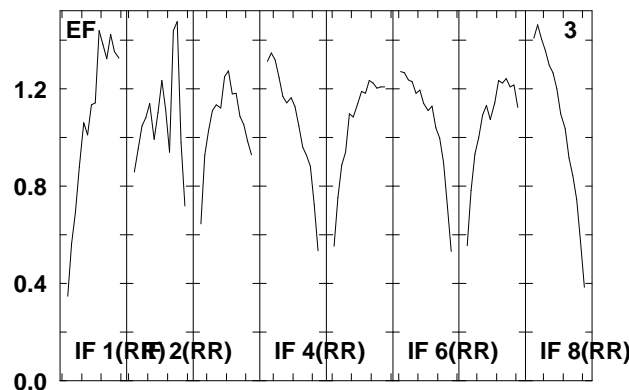
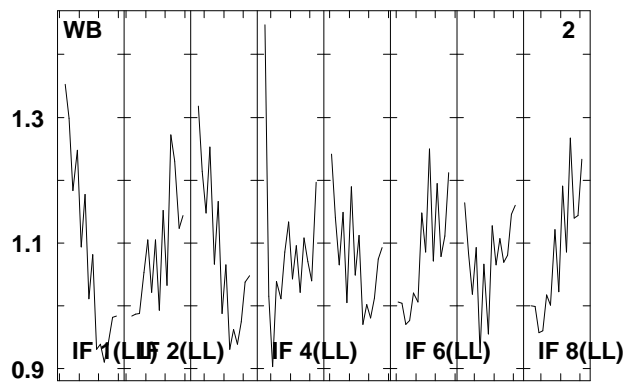
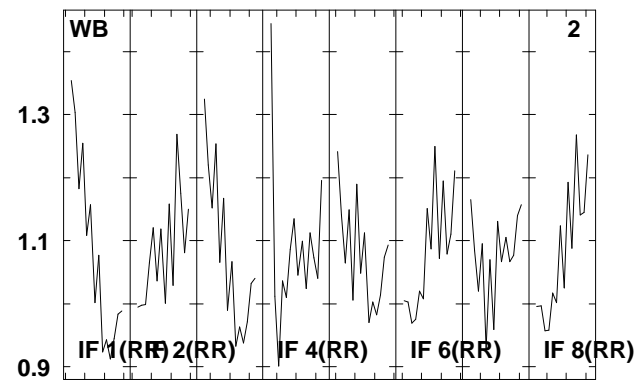
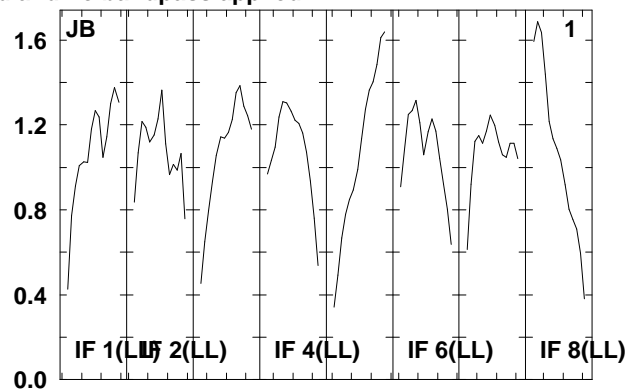
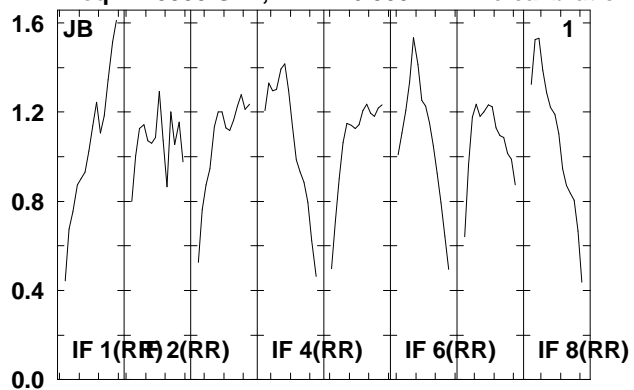

Lower frame: Real Jy  
Total-power spectrum Antenna: \*  
Timerange: 00/21:42:53 to 00/21:44:51

Plot file version 118 created 20-AUG-2009 15:00:02

J1016+20 EG040B.UVDATA.1

Freq = 1.5955 GHz, Bw = 16.000 MH No calibration applied and no bandpass applied

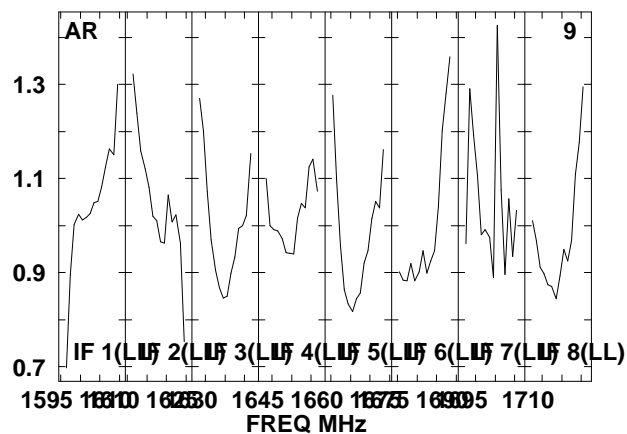
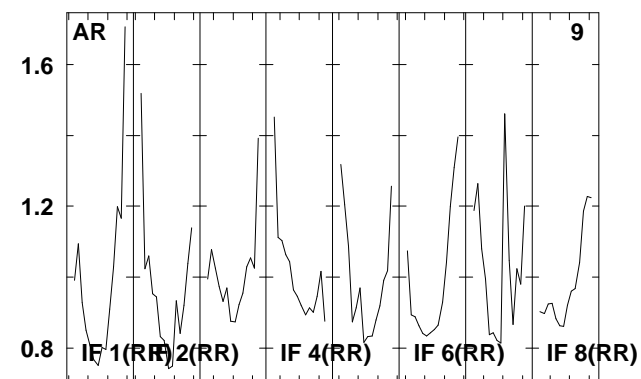
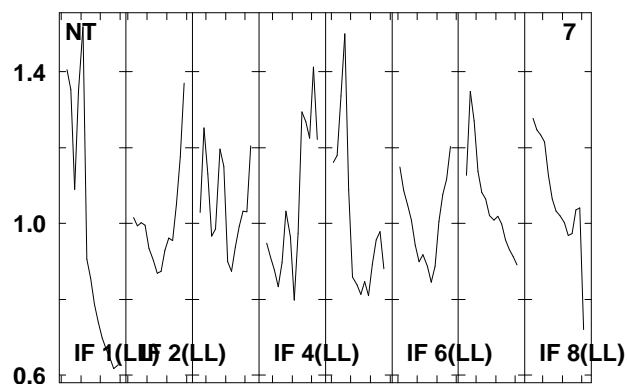
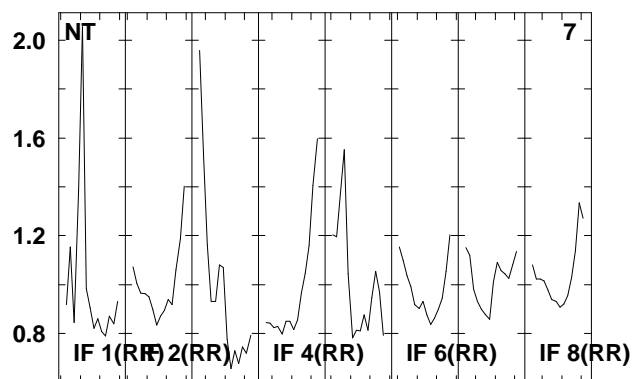
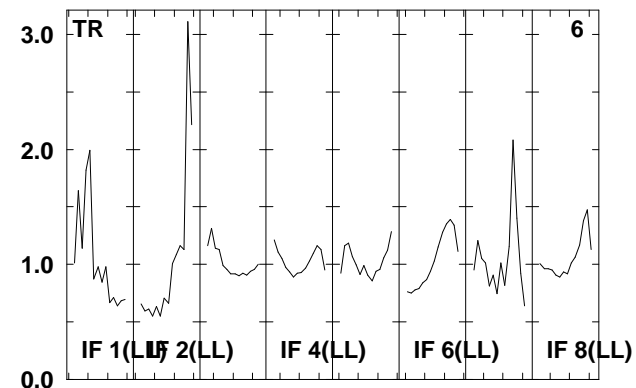
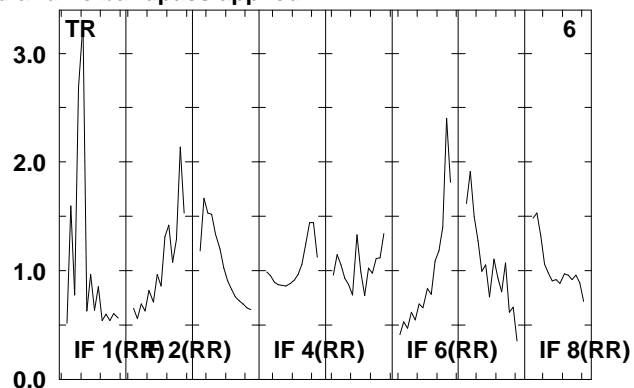
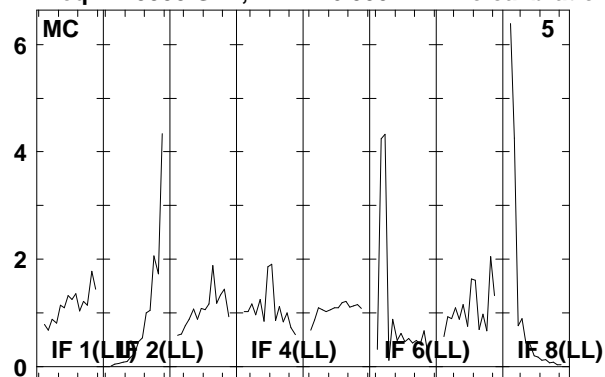

Lower frame: Real Jy

Total-power spectrum Antenna: \*

Timerange: 00/21:42:53 to 00/21:44:51

Plot file version 119 created 20-AUG-2009 15:00:02

NGC3227 EG040B.UVDATA.1

Freq = 1.5955 GHz, Bw = 16.000 MH No calibration applied and no bandpass applied

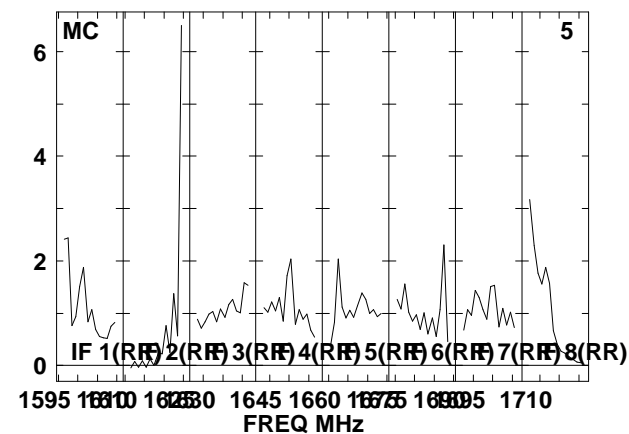
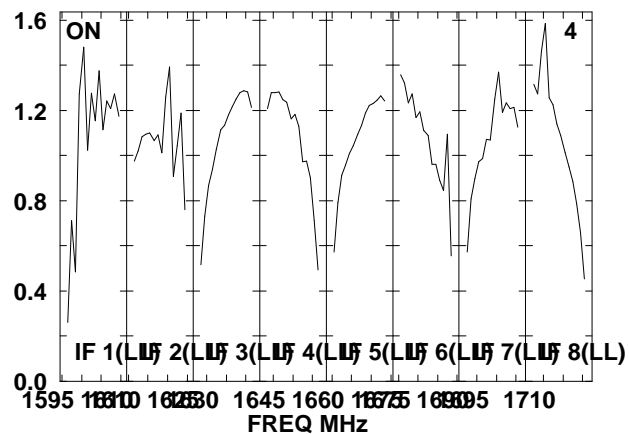
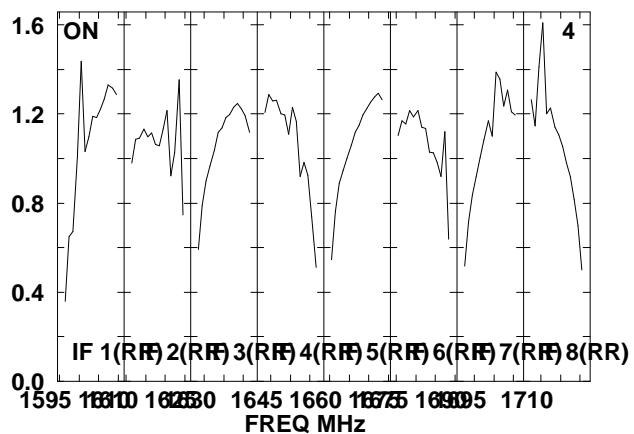
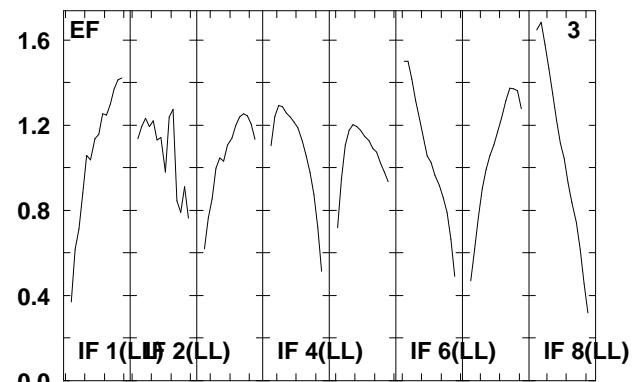
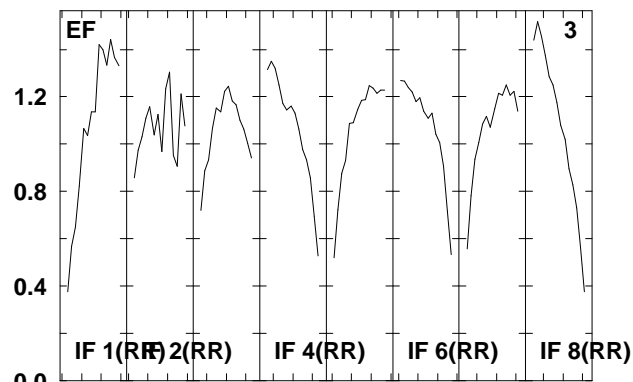
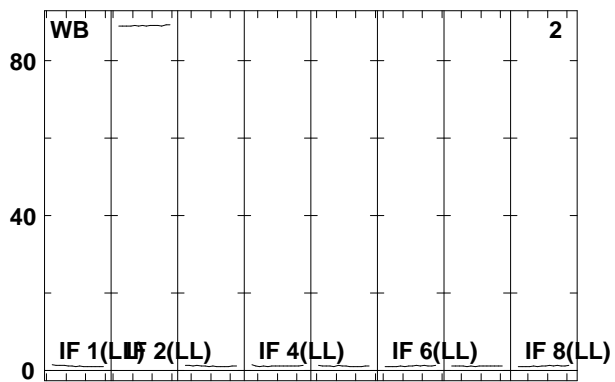
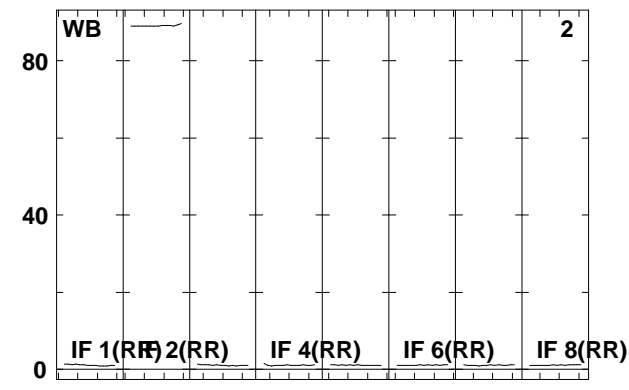
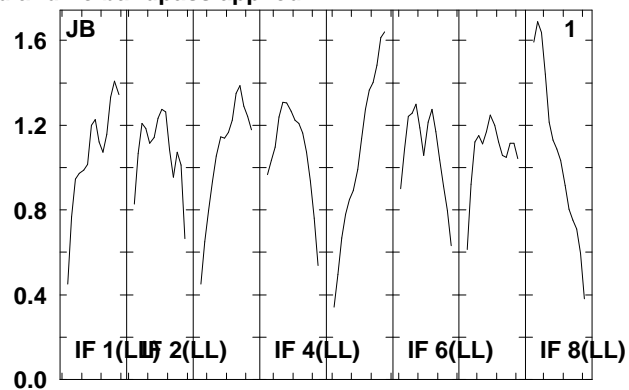
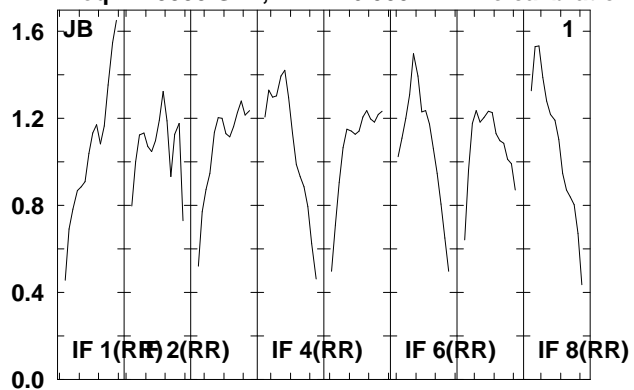

Lower frame: Real Jy  
Total-power spectrum Antenna: \*  
Timerange: 00/21:44:53 to 00/21:48:51

Plot file version 120 created 20-AUG-2009 15:00:03

NGC3227 EG040B.UVDATA.1

Freq = 1.5955 GHz, Bw = 16.000 MH No calibration applied and no bandpass applied

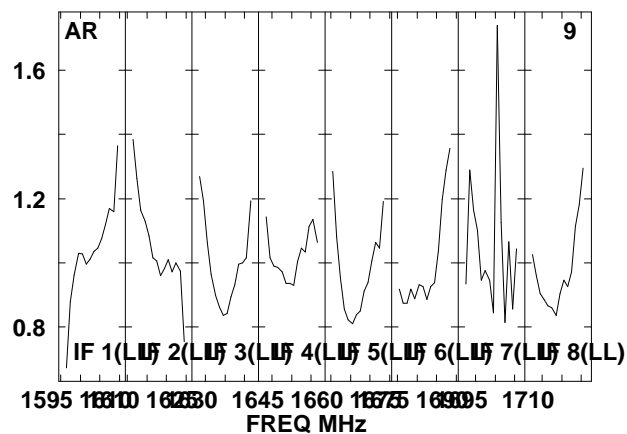
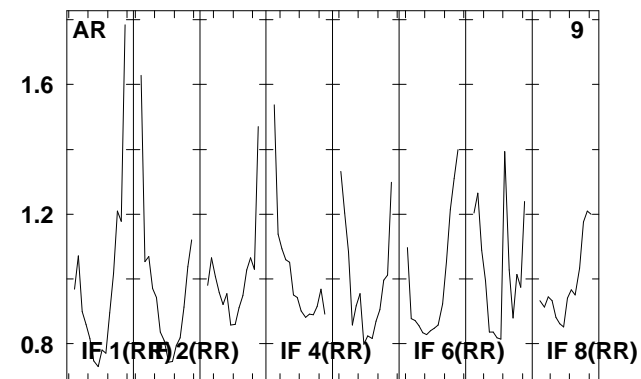
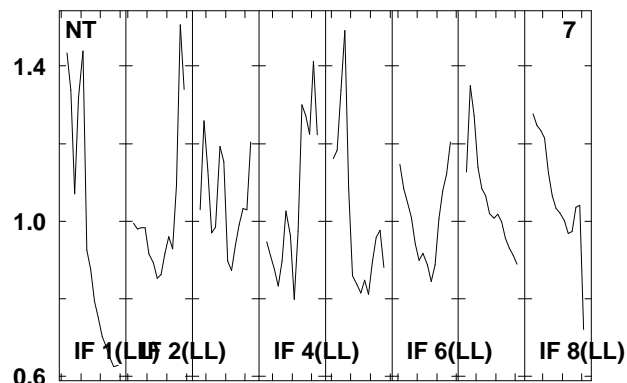
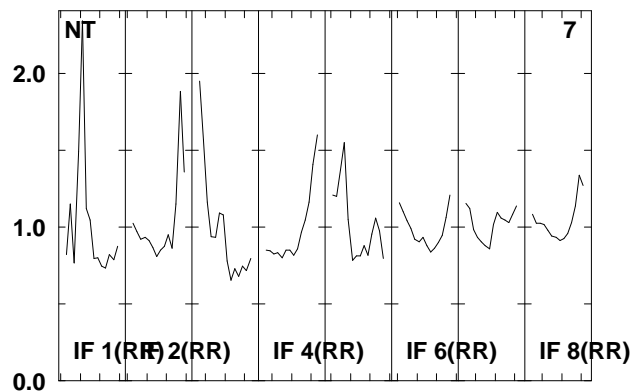
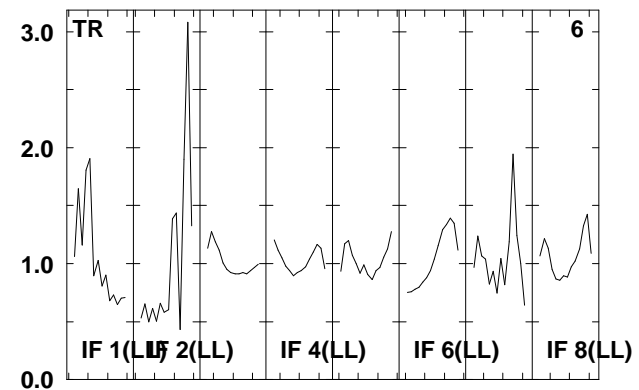
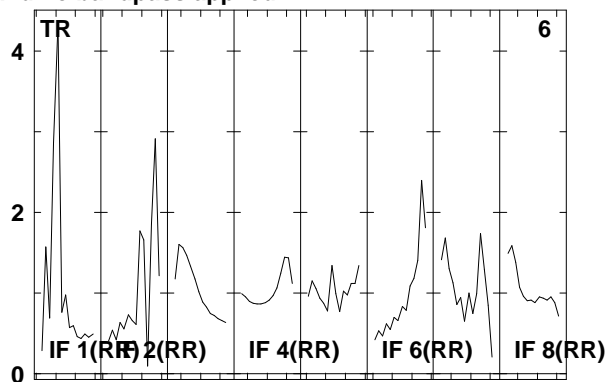
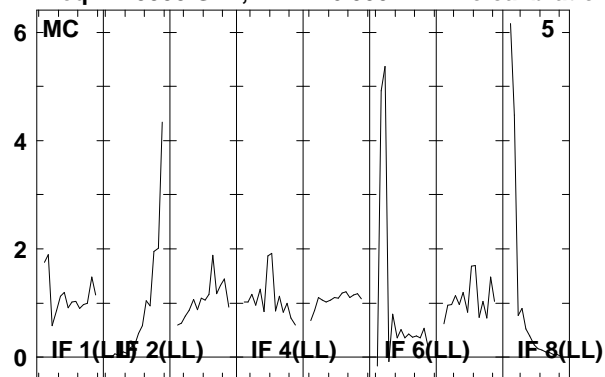

Lower frame: Real Jy

Total-power spectrum Antenna: \*

Timerange: 00/21:44:53 to 00/21:48:51



Plot file version 121 created 20-AUG-2009 15:00:03

J1016+20 EG040B.UVDATA.1

Freq = 1.5955 GHz, Bw = 16.000 MH No calibration applied and no bandpass applied

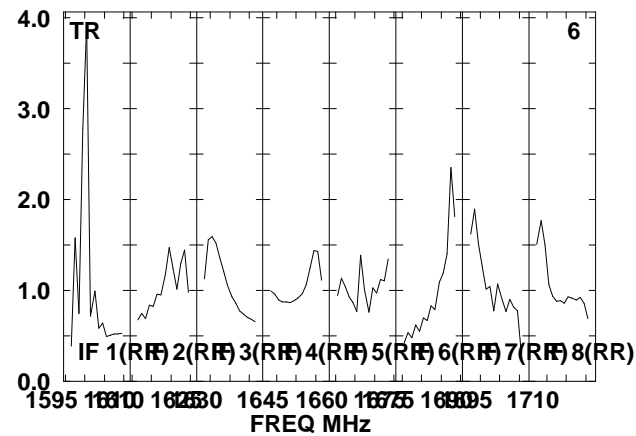
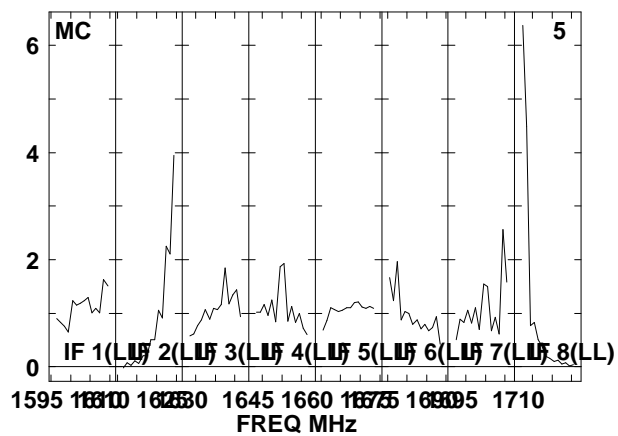
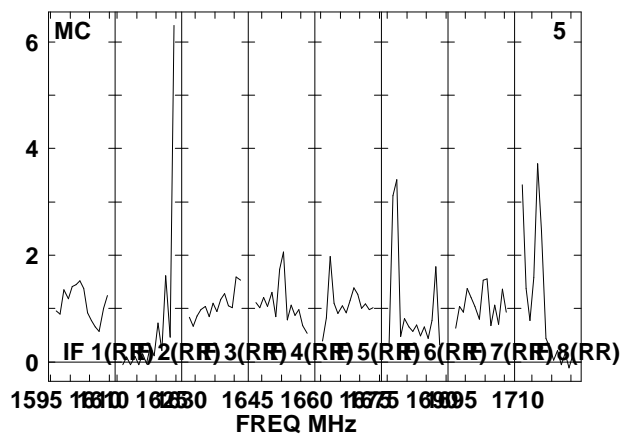
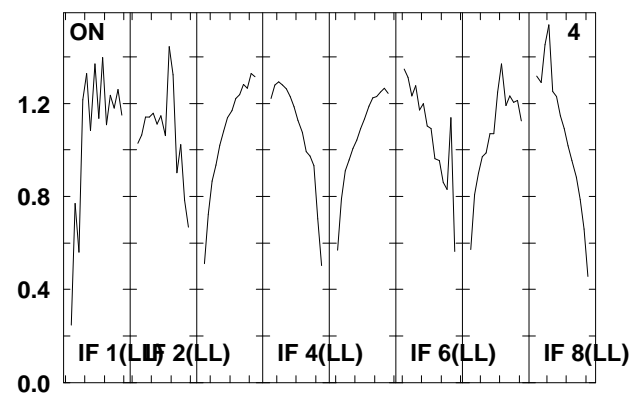
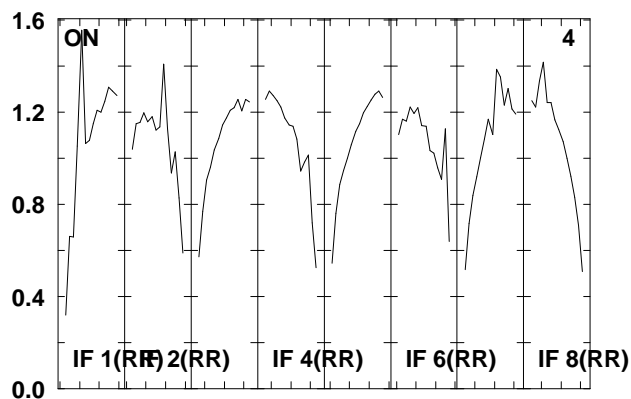
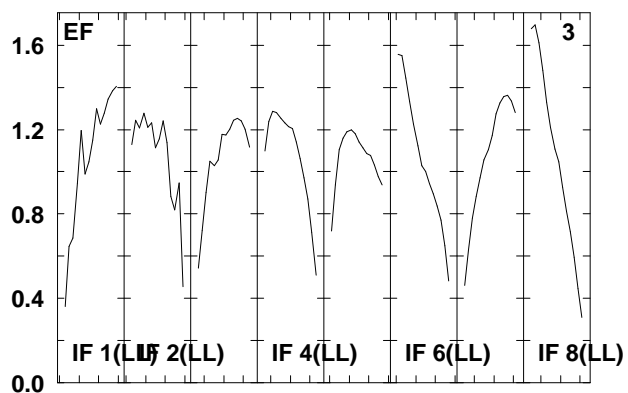
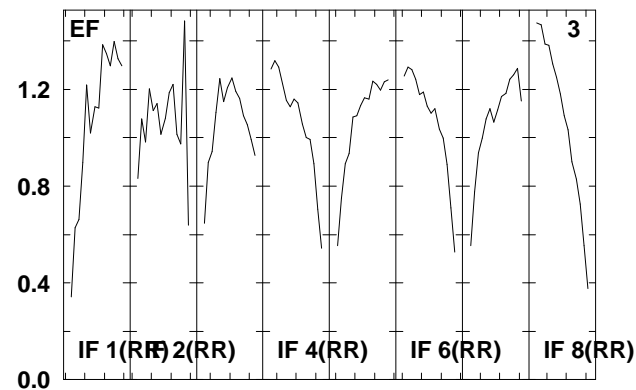
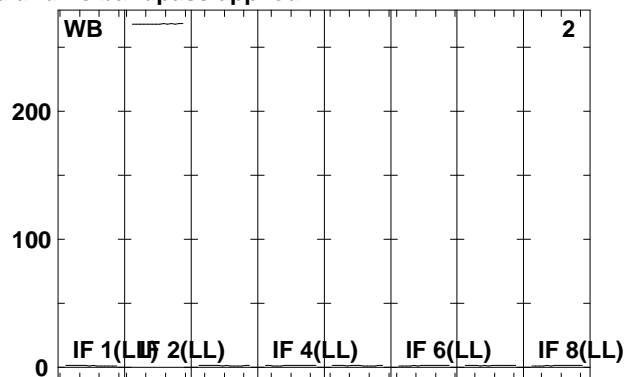
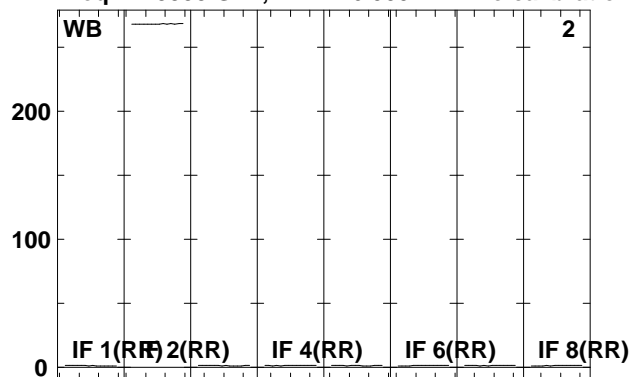

Lower frame: Real Jy  
Total-power spectrum Antenna: \*  
Timerange: 00/21:49:25 to 00/21:51:03

Plot file version 122 created 20-AUG-2009 15:00:03

J1016+20 EG040B.UVDATA.1

Freq = 1.5955 GHz, Bw = 16.000 MH No calibration applied and no bandpass applied

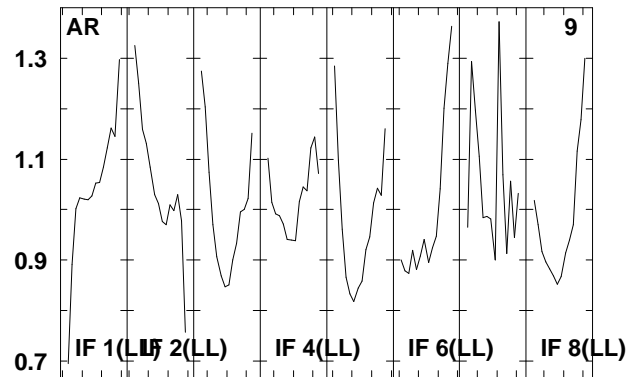
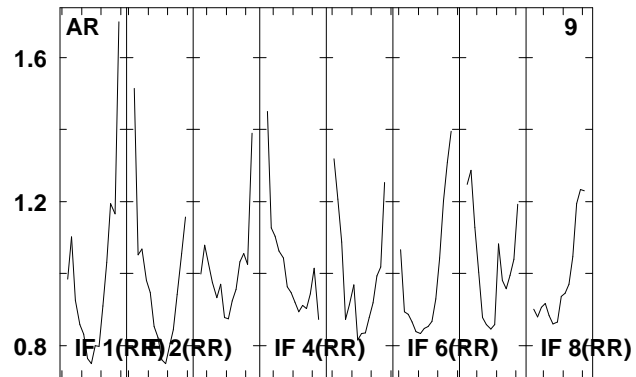
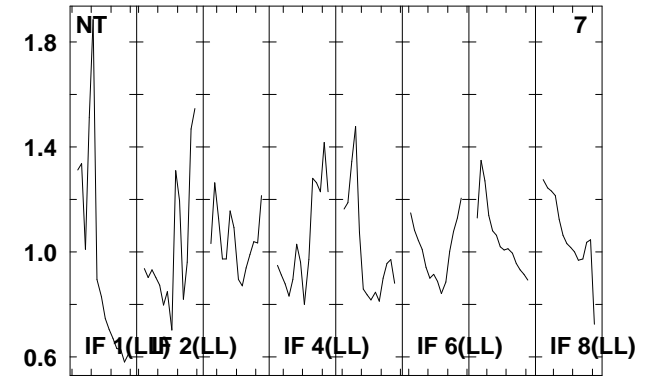
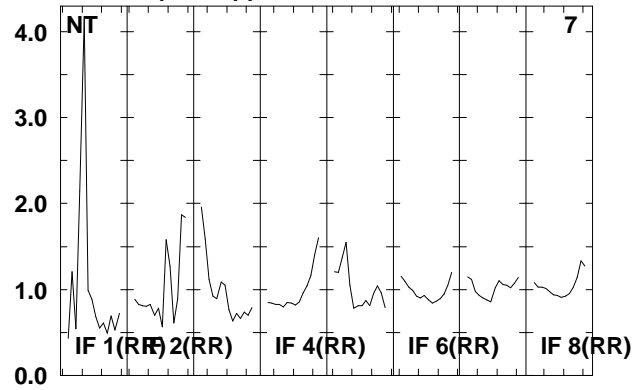
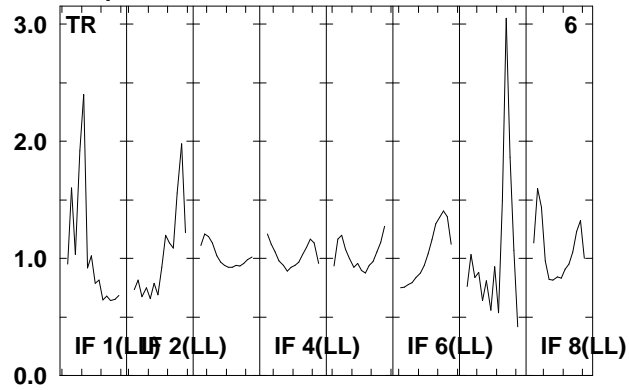

Lower frame: Real Jy  
Total-power spectrum Antenna: \*  
Timerange: 00/21:49:25 to 00/21:51:03

Plot file version 123 created 20-AUG-2009 15:00:04

NGC3227 EG040B.UVDATA.1

Freq = 1.5955 GHz, Bw = 16.000 MH No calibration applied and no bandpass applied

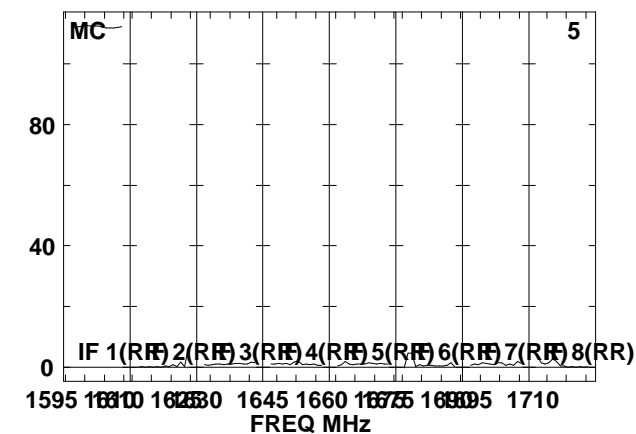
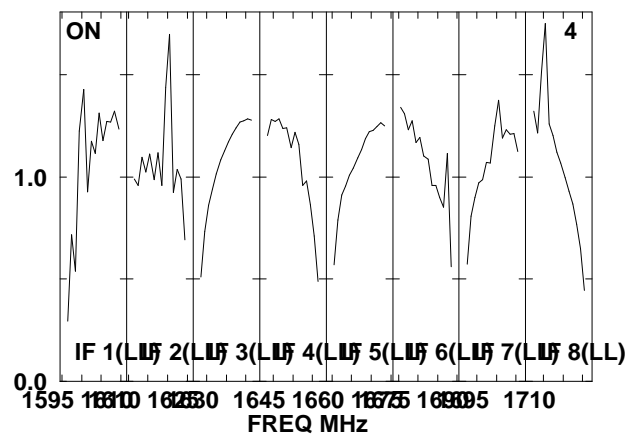
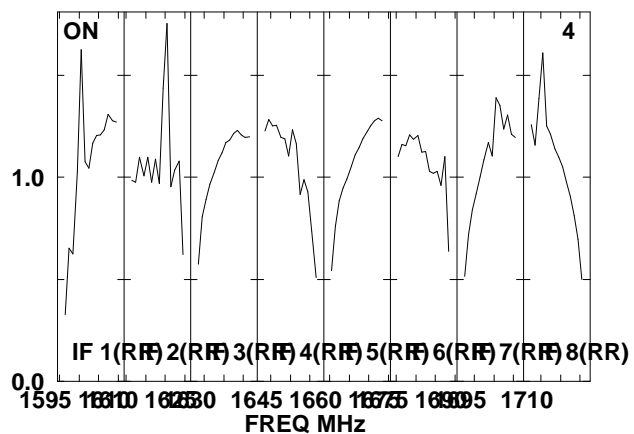
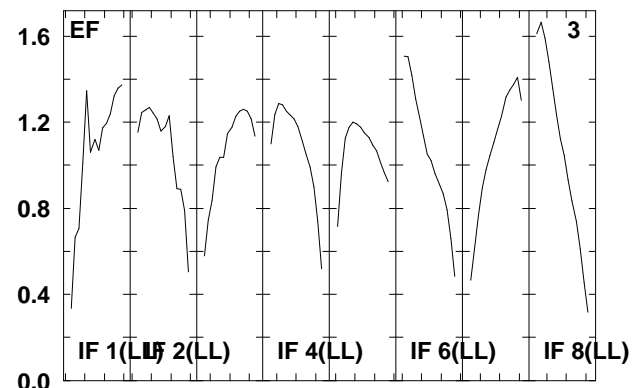
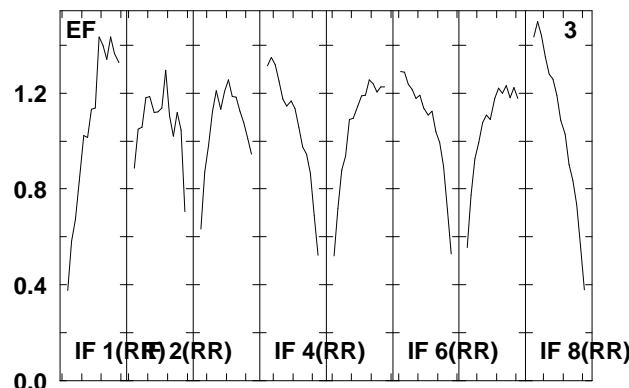
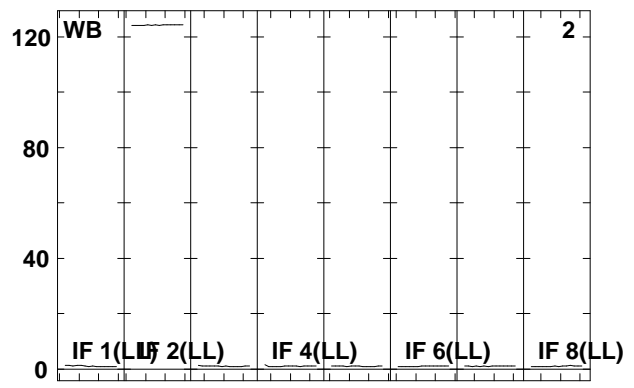
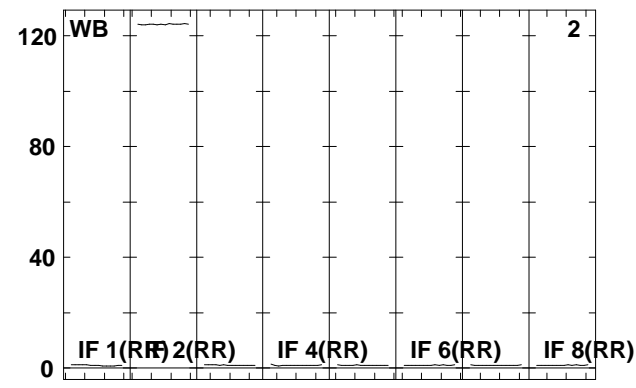
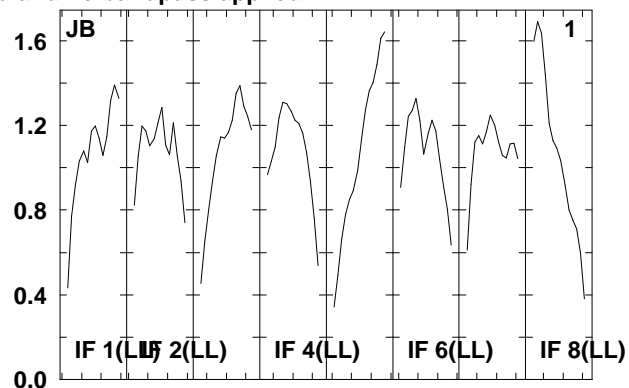
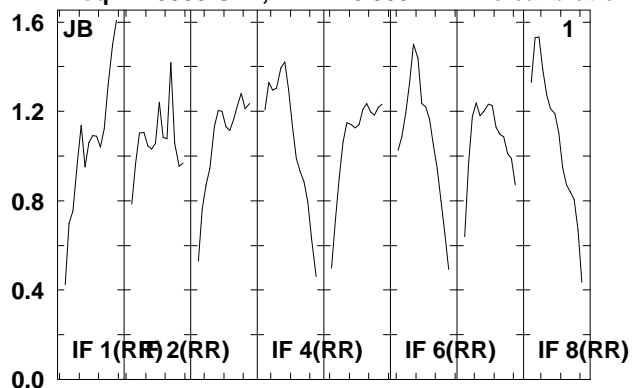

Lower frame: Real Jy  
Total-power spectrum Antenna: \*  
Timerange: 00/21:51:05 to 00/21:55:03

Plot file version 124 created 20-AUG-2009 15:00:04

NGC3227 EG040B.UVDATA.1

Freq = 1.5955 GHz, Bw = 16.000 MH No calibration applied and no bandpass applied

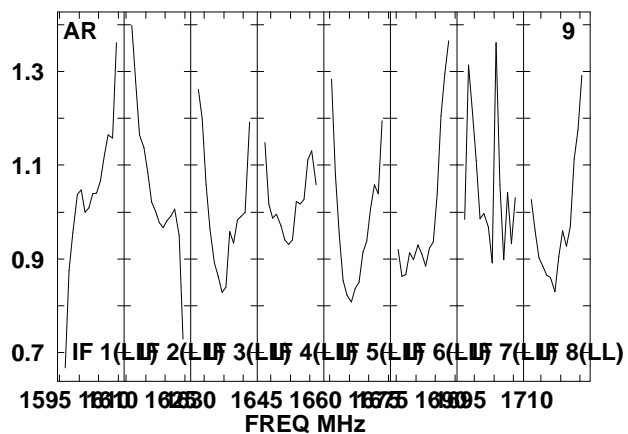
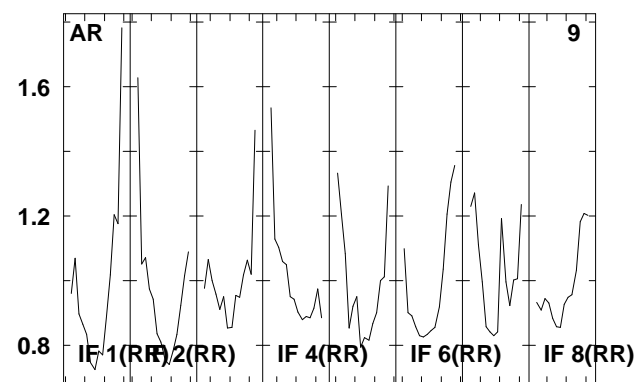
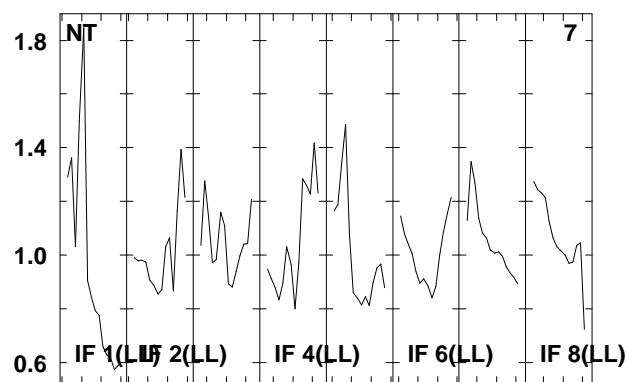
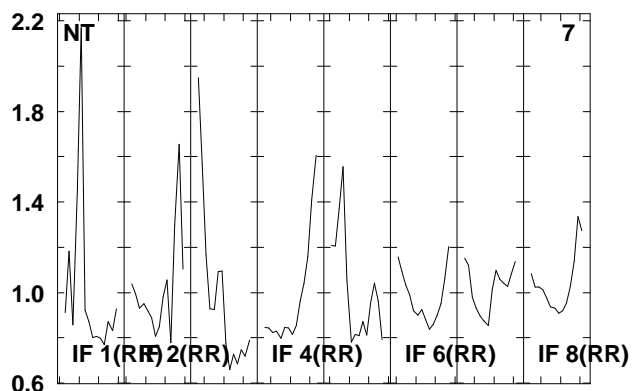
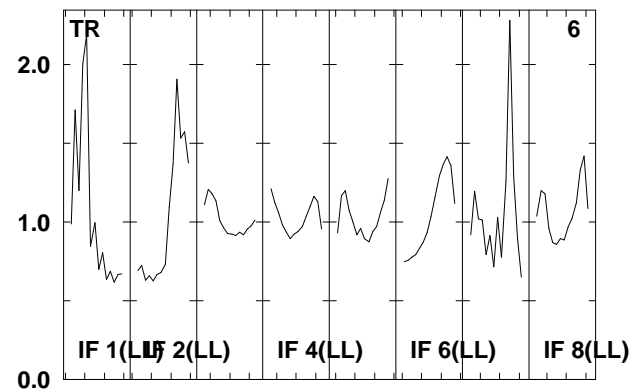
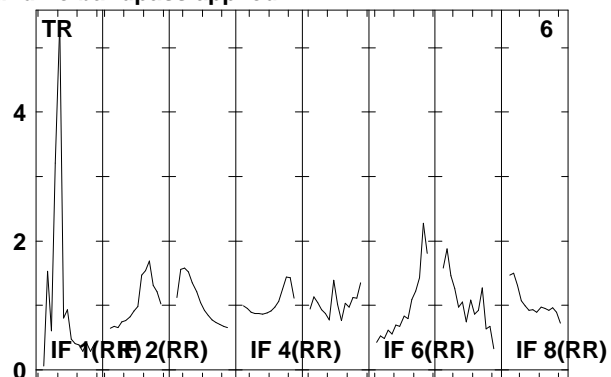
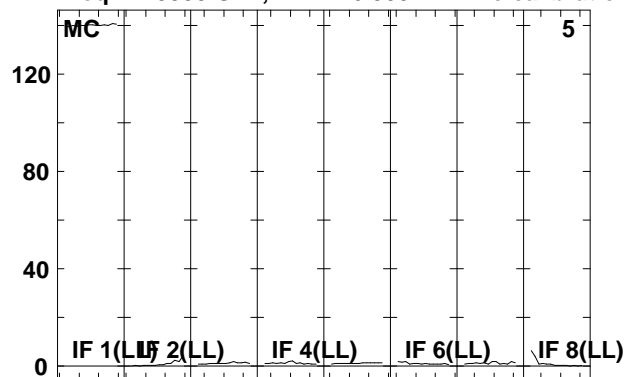

Lower frame: Real Jy

Total-power spectrum Antenna: \*

Timerange: 00/21:51:05 to 00/21:55:03

Plot file version 125 created 20-AUG-2009 15:00:04

J1016+20 EG040B.UVDATA.1

Freq = 1.5955 GHz, Bw = 16.000 MH No calibration applied and no bandpass applied

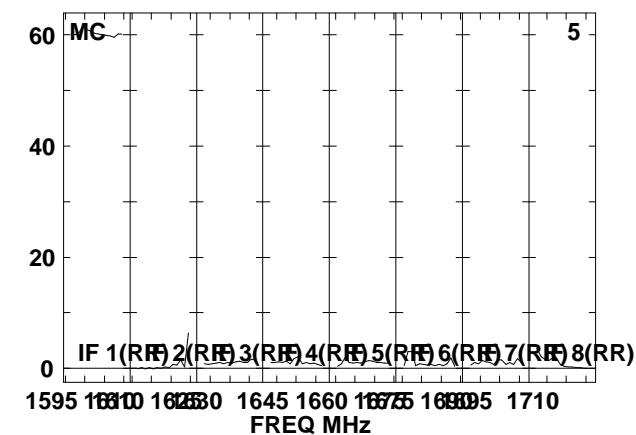
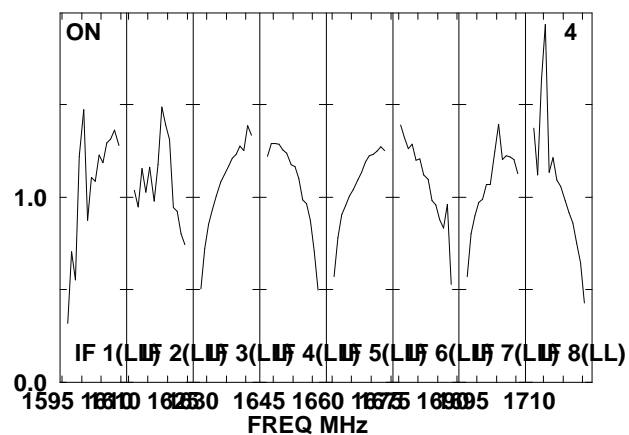
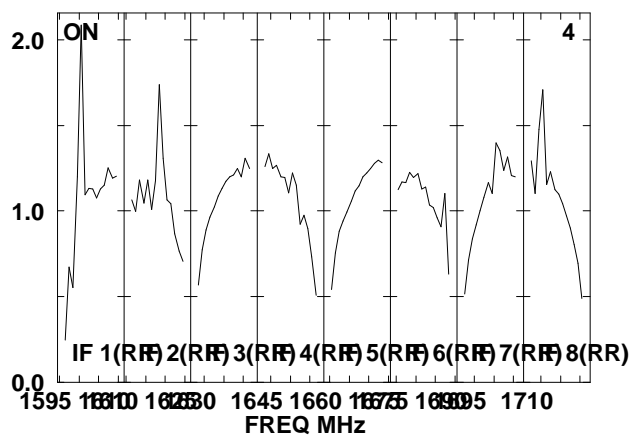
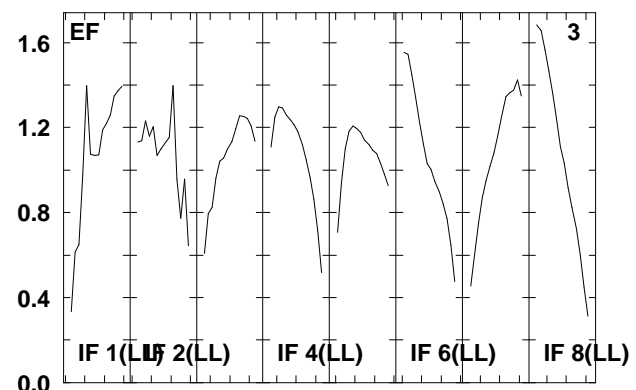
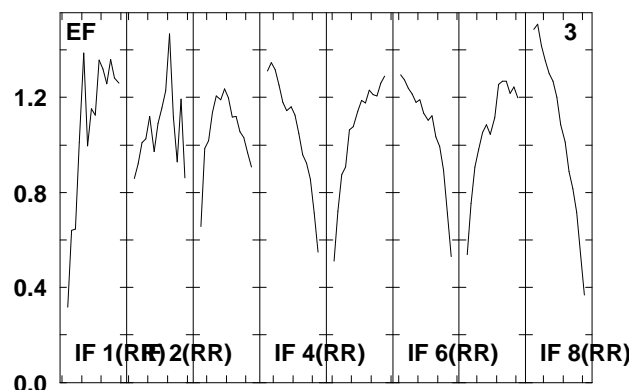
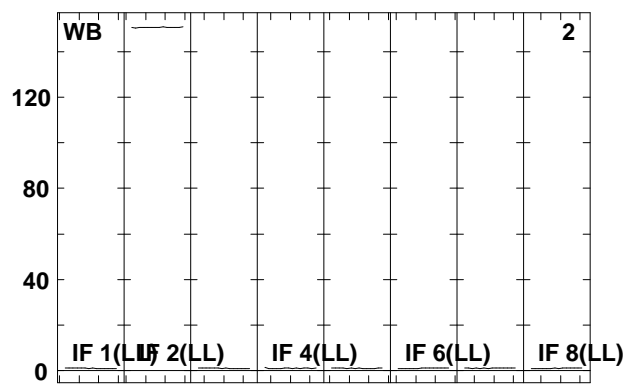
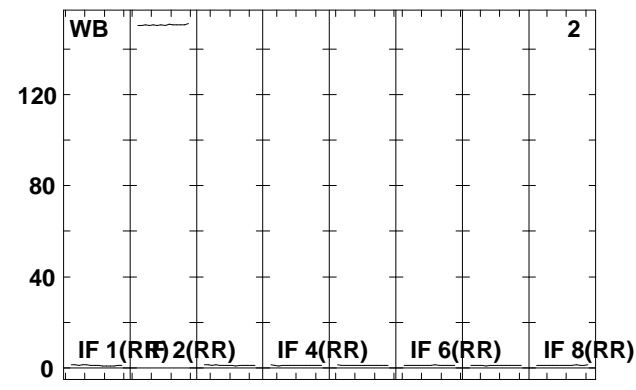
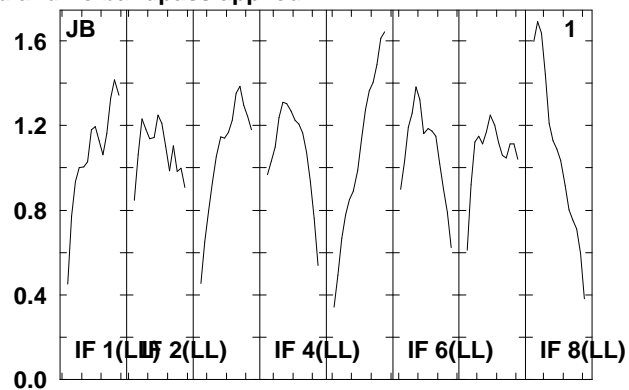
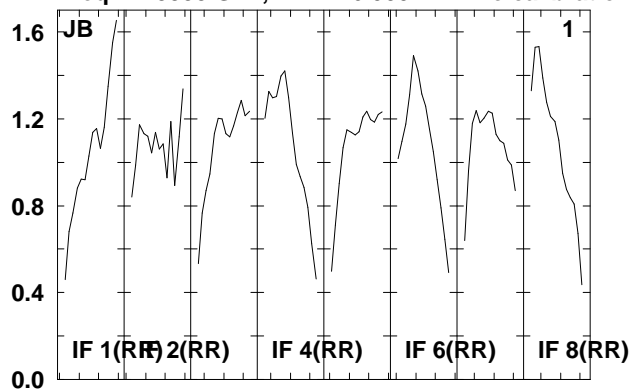

Lower frame: Real Jy  
Total-power spectrum Antenna: \*  
Timerange: 00/21:55:05 to 00/21:57:03

Plot file version 126 created 20-AUG-2009 15:00:05

J1016+20 EG040B.UVDATA.1

Freq = 1.5955 GHz, Bw = 16.000 MH No calibration applied and no bandpass applied

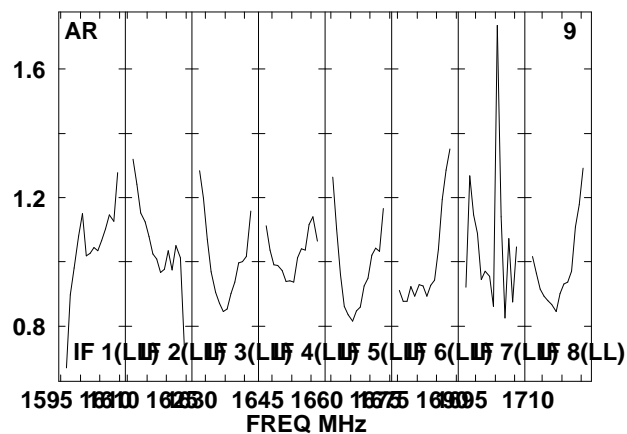
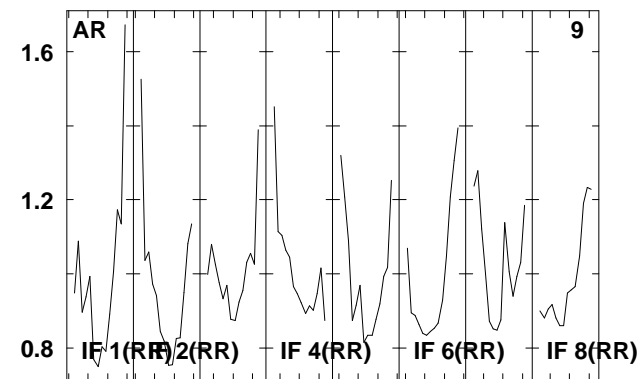
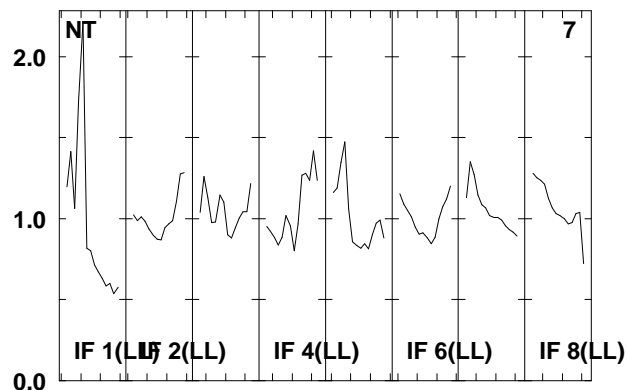
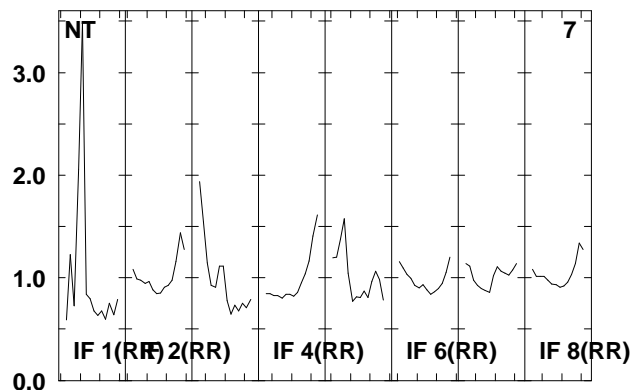
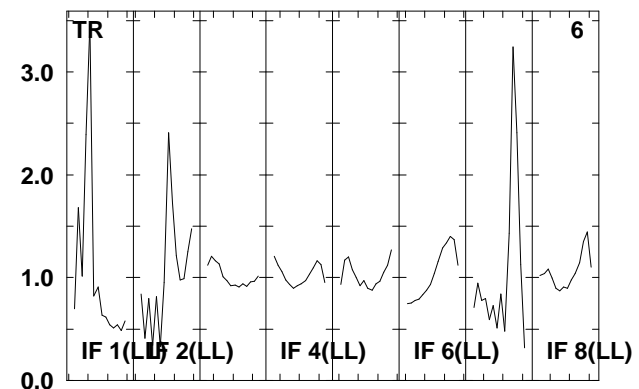
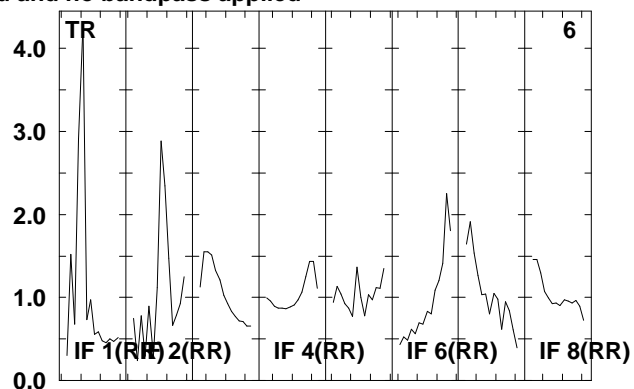
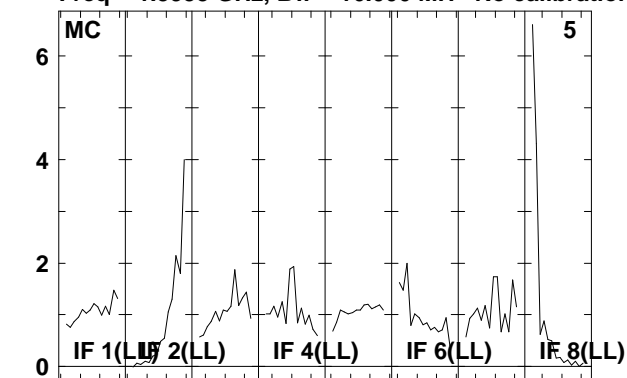

Lower frame: Real Jy

Total-power spectrum Antenna: \*

Timerange: 00/21:55:05 to 00/21:57:03

Plot file version 127 created 20-AUG-2009 15:00:05

NGC3227 EG040B.UVDATA.1

Freq = 1.5955 GHz, Bw = 16.000 MH No calibration applied and no bandpass applied

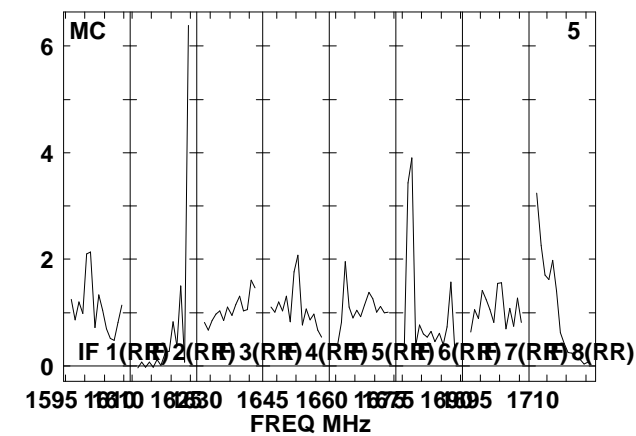
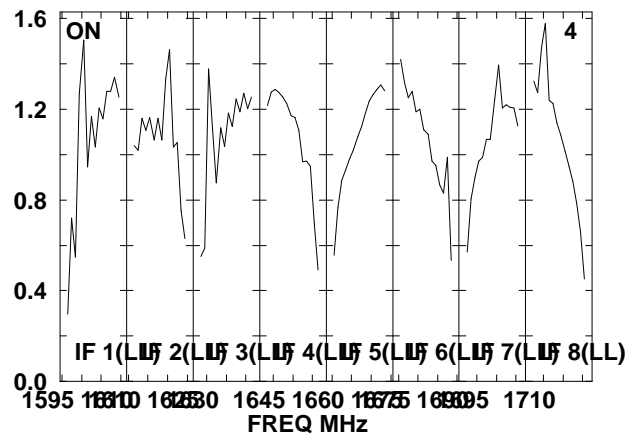
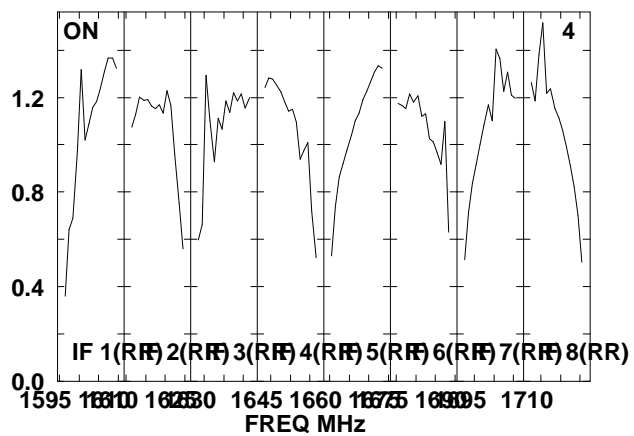
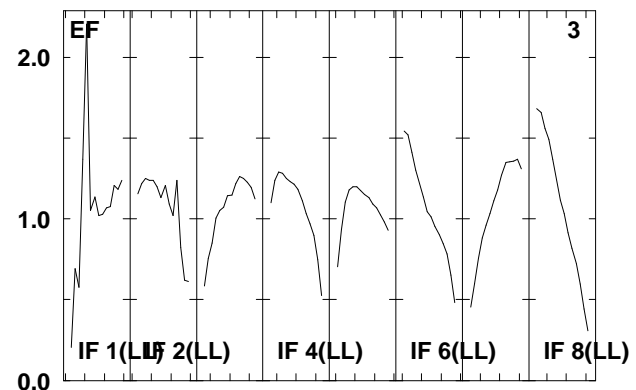
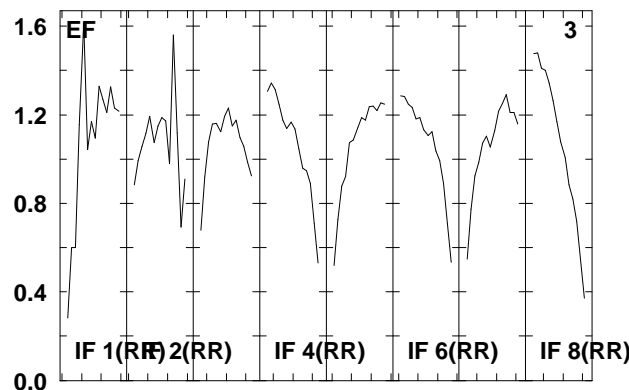
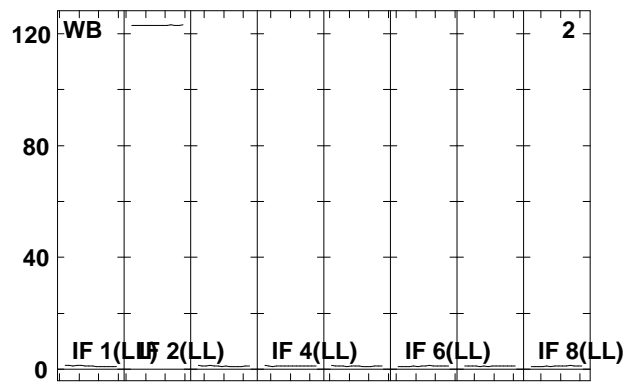
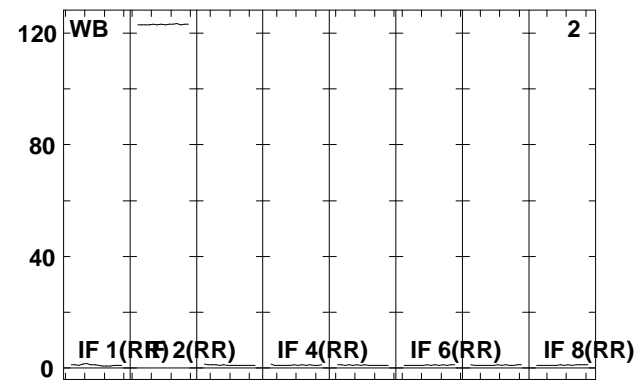
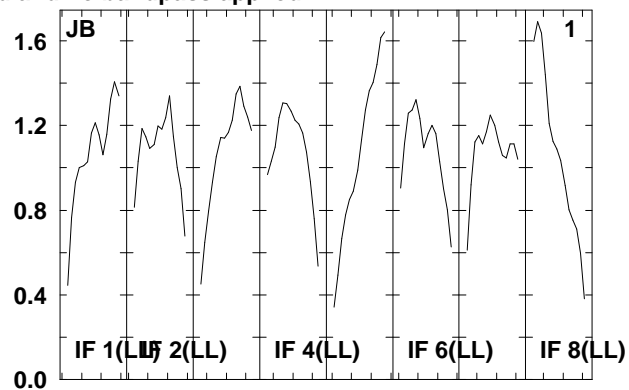
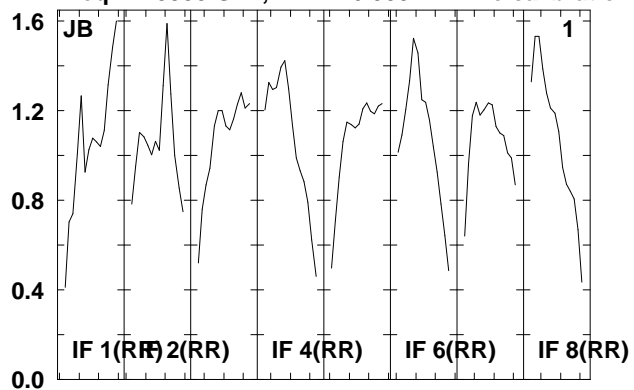

Lower frame: Real Jy  
Total-power spectrum Antenna: \*  
Timerange: 00/21:57:05 to 00/22:01:03

Plot file version 128 created 20-AUG-2009 15:00:05

NGC3227 EG040B.UVDATA.1

Freq = 1.5955 GHz, Bw = 16.000 MH No calibration applied and no bandpass applied

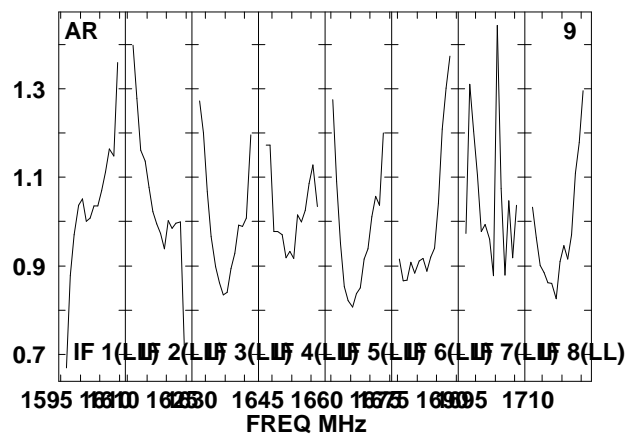
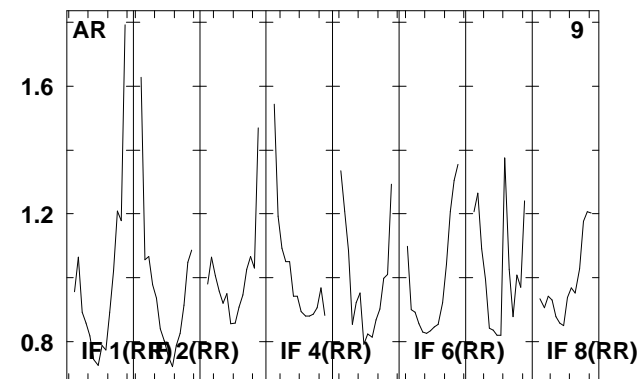
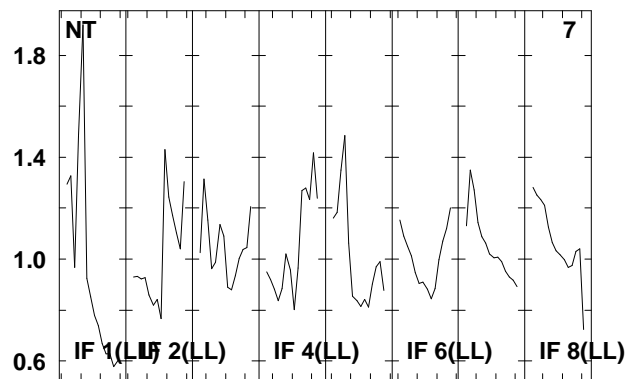
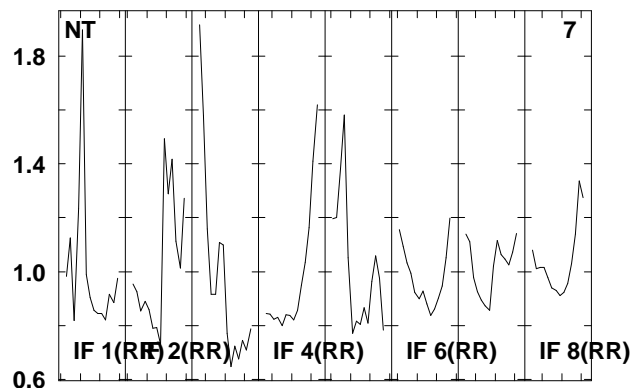
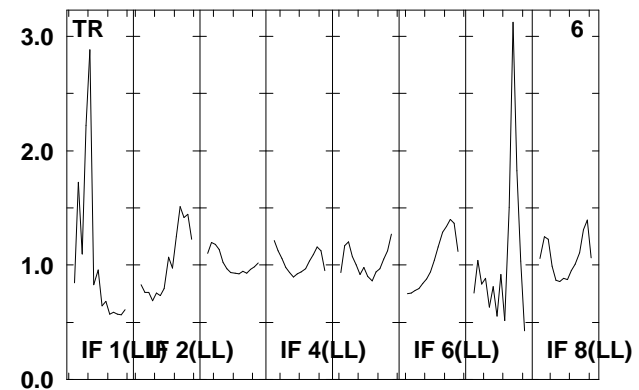
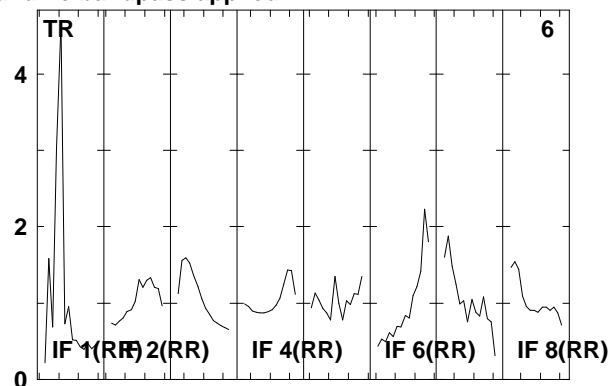
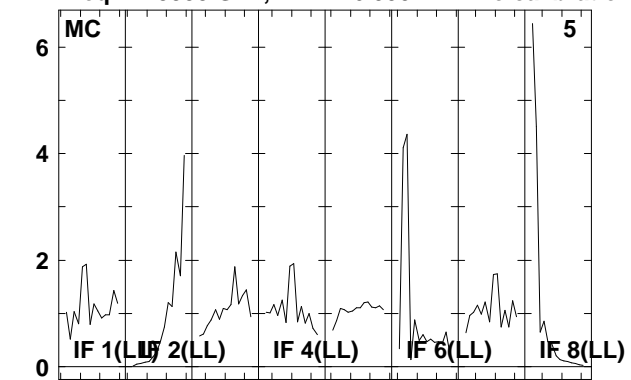

Lower frame: Real Jy

Total-power spectrum Antenna: \*

Timerange: 00/21:57:05 to 00/22:01:03



Plot file version 129 created 20-AUG-2009 15:00:06

J1016+20 EG040B.UVDATA.1

Freq = 1.5955 GHz, Bw = 16.000 MH No calibration applied and no bandpass applied

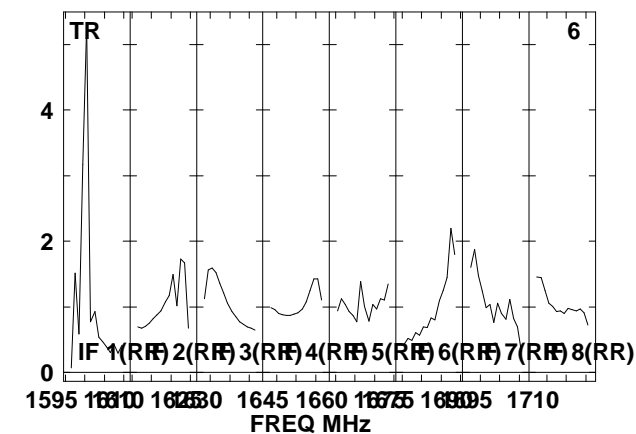
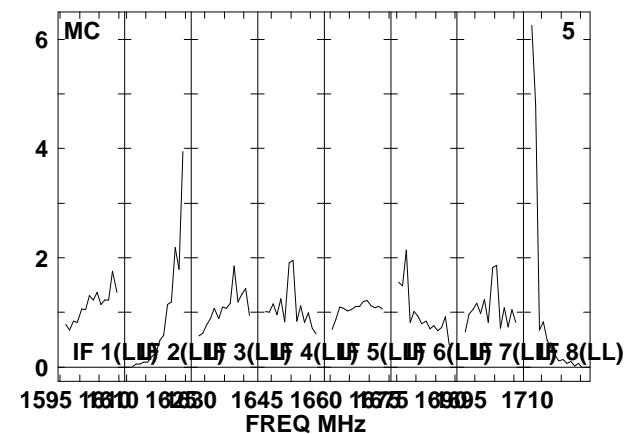
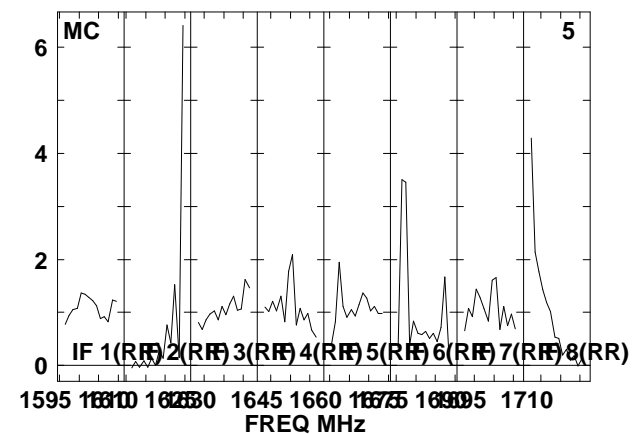
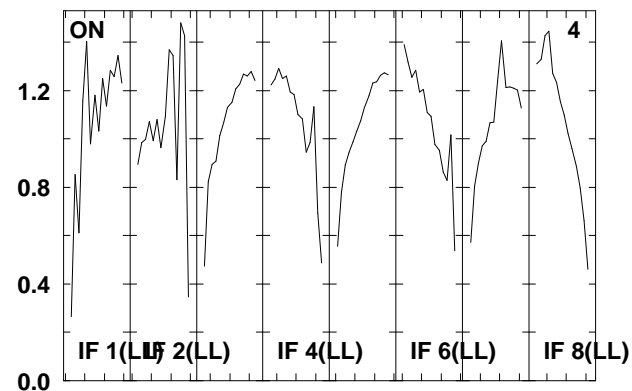
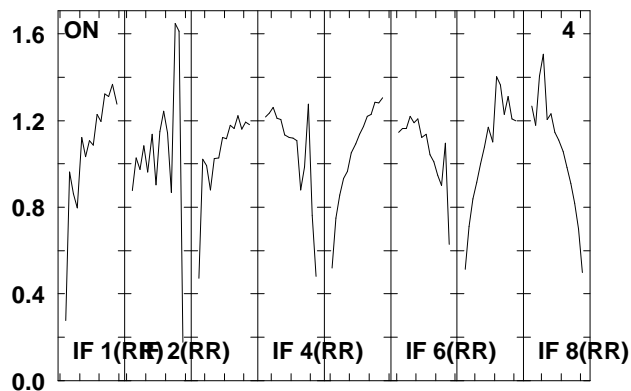
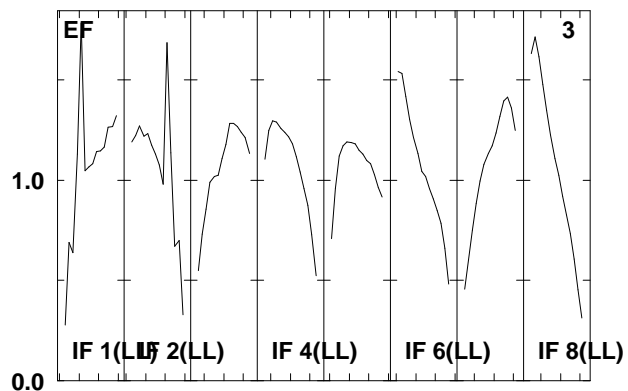
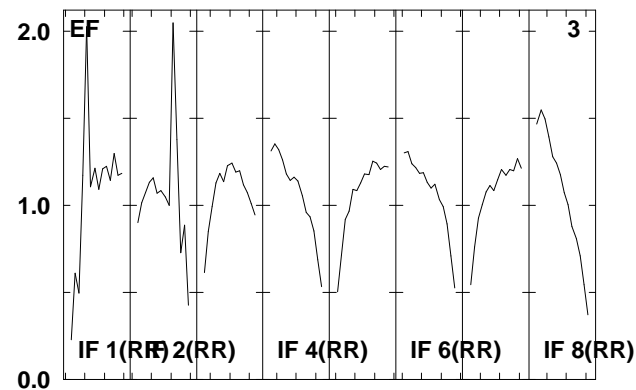
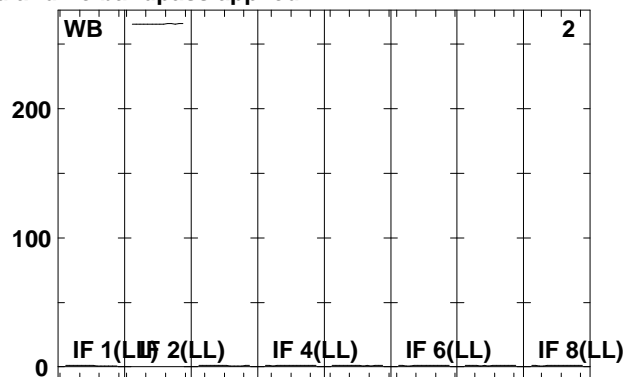
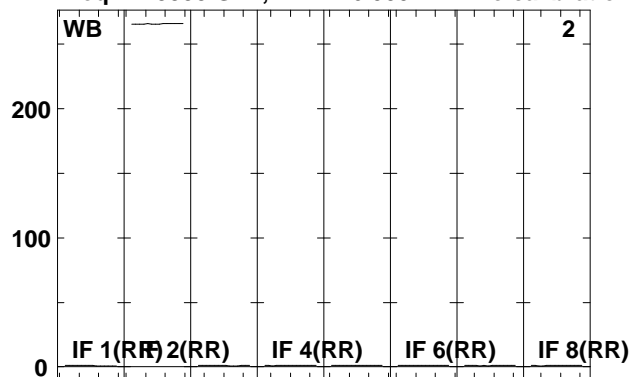

Lower frame: Real Jy  
Total-power spectrum Antenna: \*  
Timerange: 00/22:01:37 to 00/22:03:15

Plot file version 130 created 20-AUG-2009 15:00:06

J1016+20 EG040B.UVDATA.1

Freq = 1.5955 GHz, Bw = 16.000 MH No calibration applied and no bandpass applied

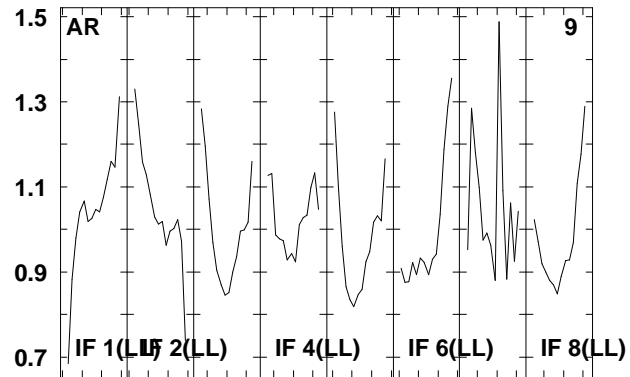
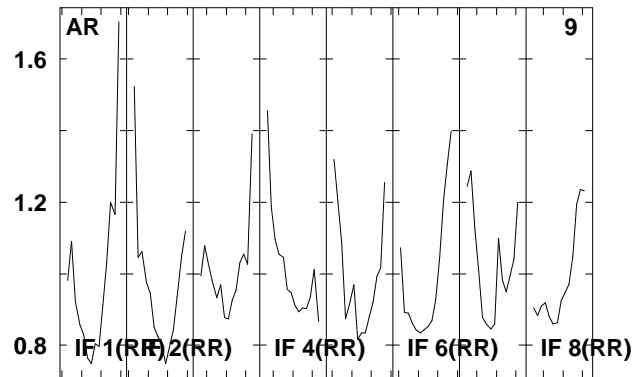
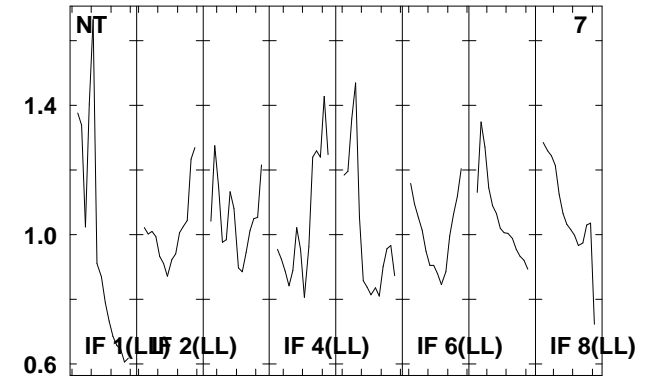
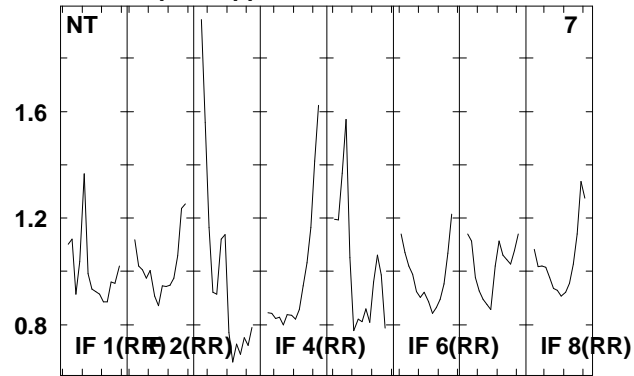
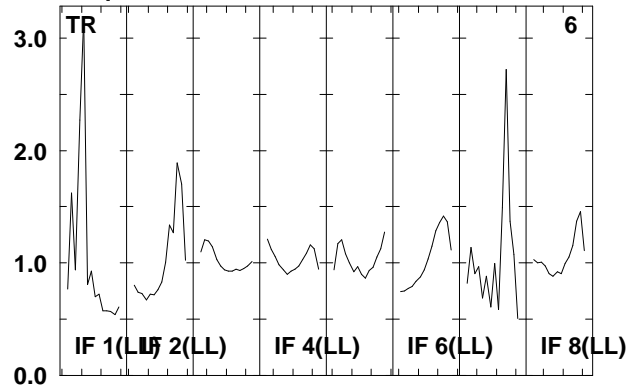

Lower frame: Real Jy  
Total-power spectrum Antenna: \*  
Timerange: 00/22:01:37 to 00/22:03:15

Plot file version 131 created 20-AUG-2009 15:00:06

NGC3227 EG040B.UVDATA.1

Freq = 1.5955 GHz, Bw = 16.000 MH No calibration applied and no bandpass applied

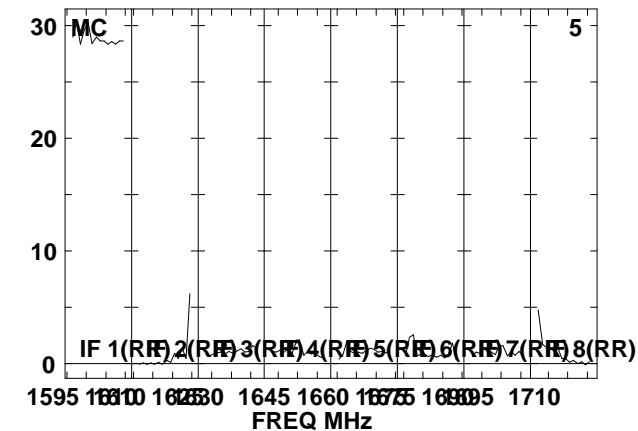
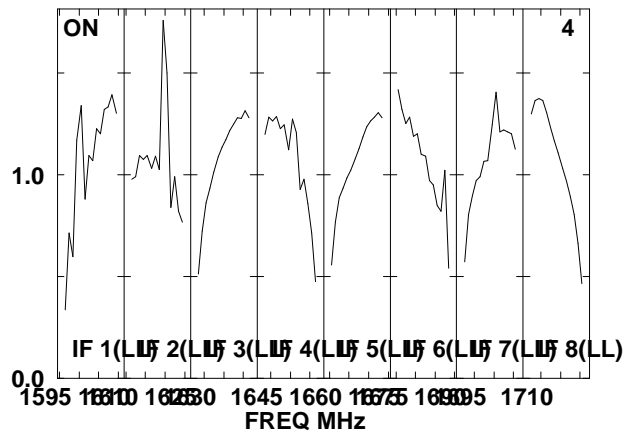
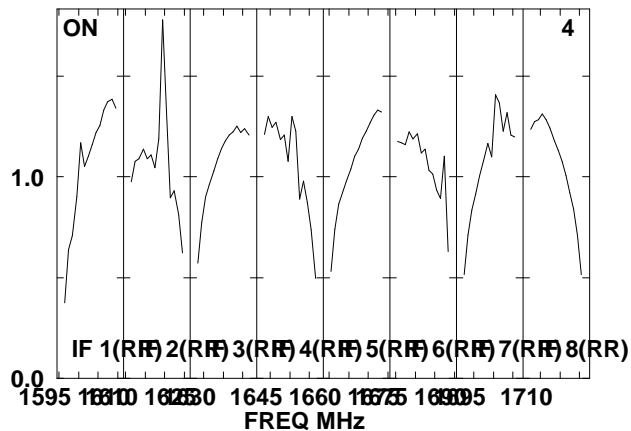
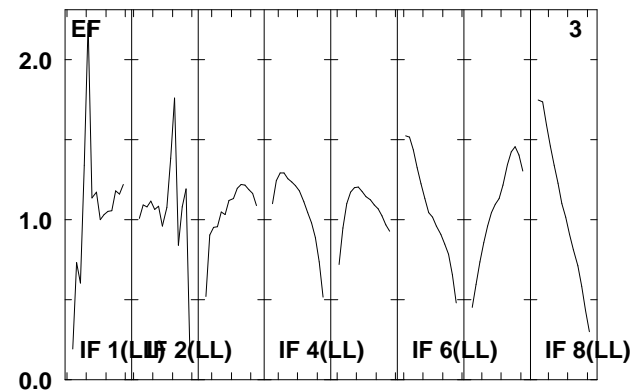
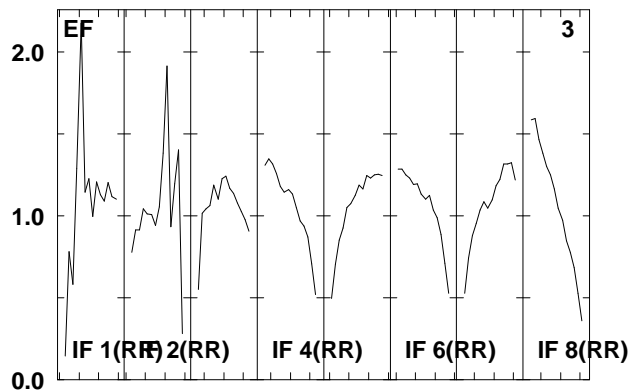
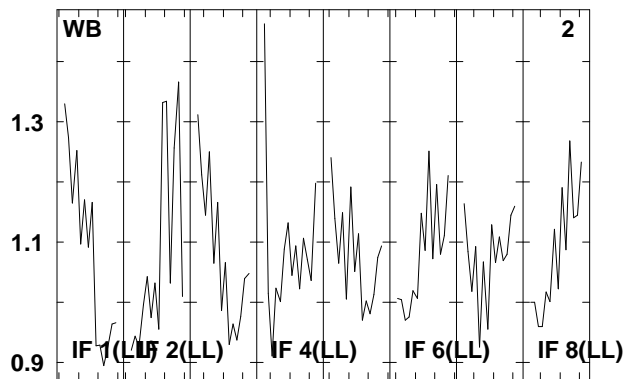
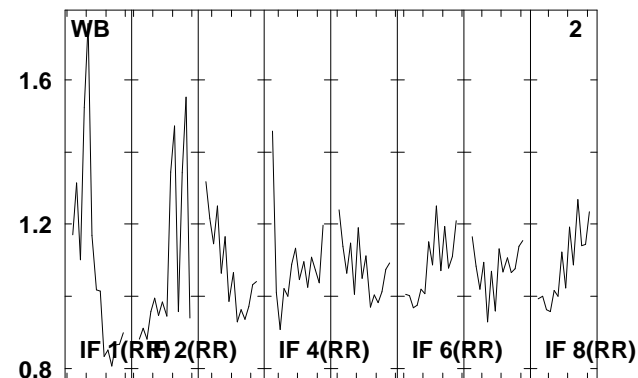
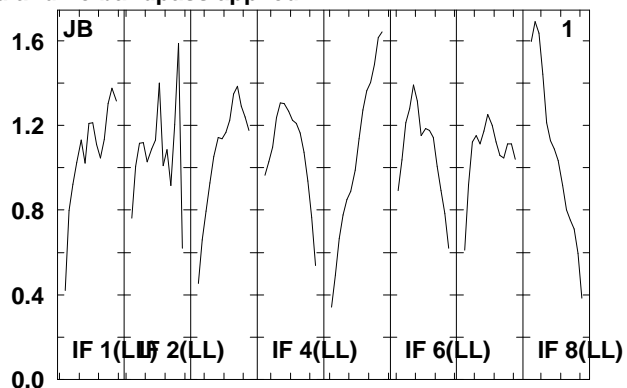
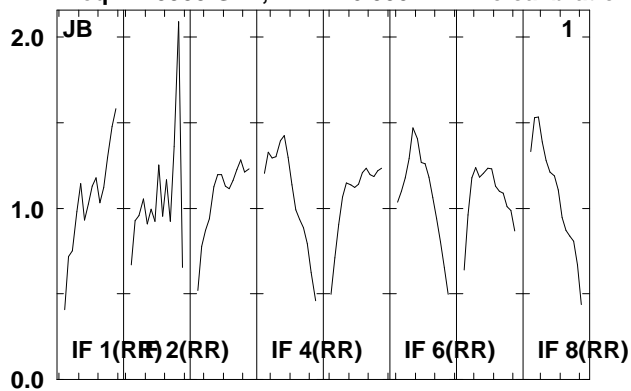

Lower frame: Real Jy  
Total-power spectrum Antenna: \*  
Timerange: 00/22:03:17 to 00/22:07:15

Plot file version 132 created 20-AUG-2009 15:00:07

NGC3227 EG040B.UVDATA.1

Freq = 1.5955 GHz, Bw = 16.000 MH No calibration applied and no bandpass applied

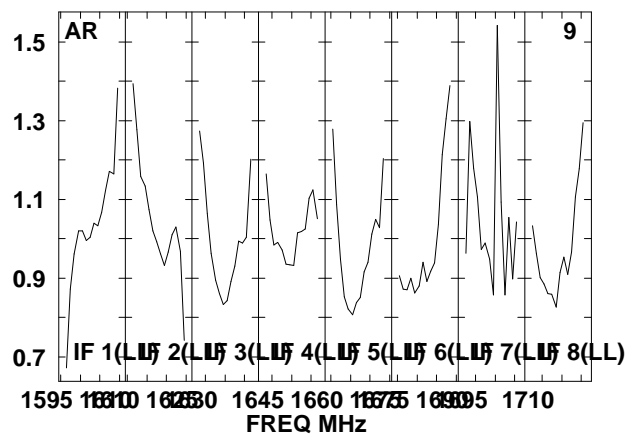
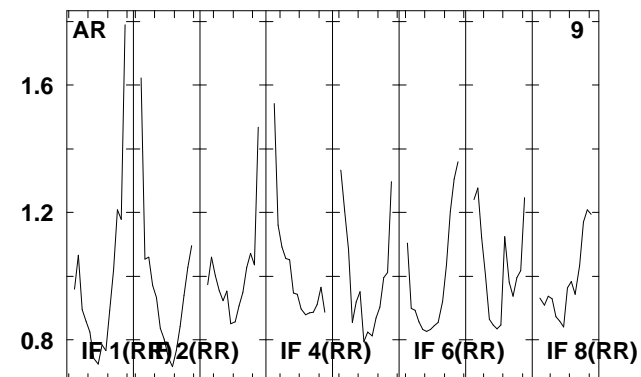
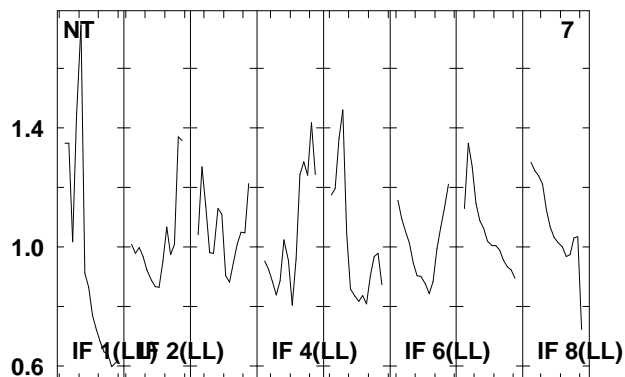
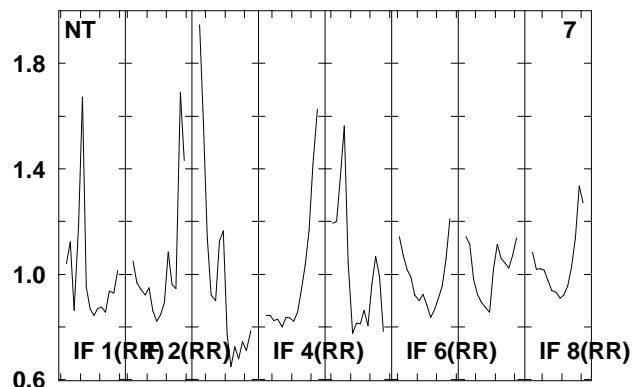
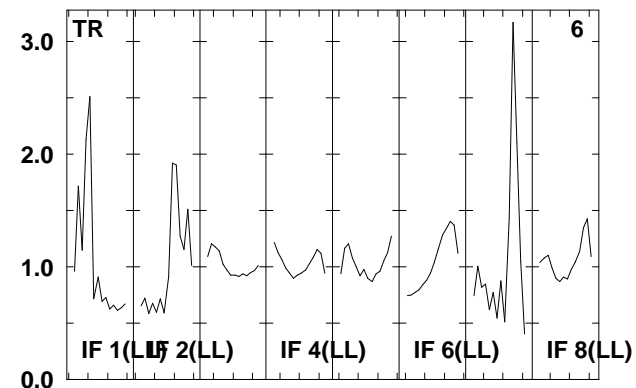
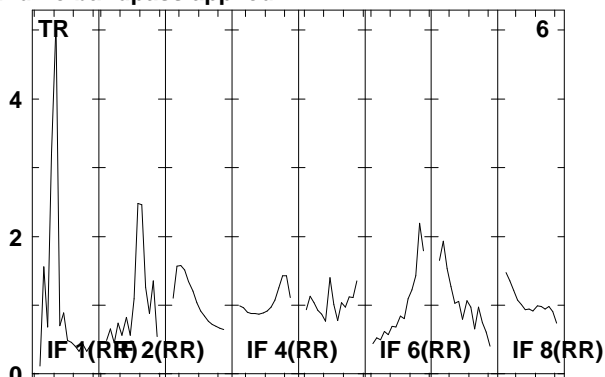
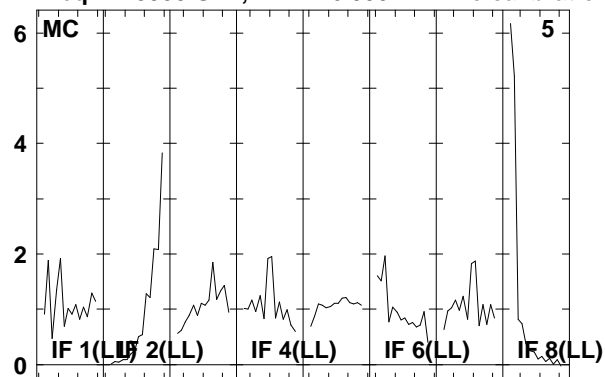

Lower frame: Real Jy

Total-power spectrum Antenna: \*

Timerange: 00/22:03:17 to 00/22:07:15

Plot file version 133 created 20-AUG-2009 15:00:07

J1016+20 EG040B.UVDATA.1

Freq = 1.5955 GHz, Bw = 16.000 MH No calibration applied and no bandpass applied

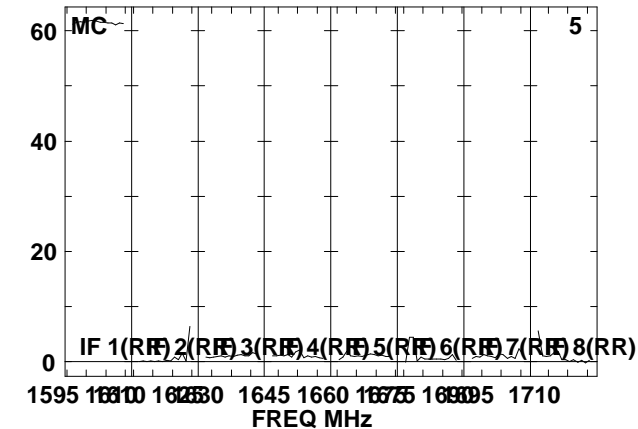
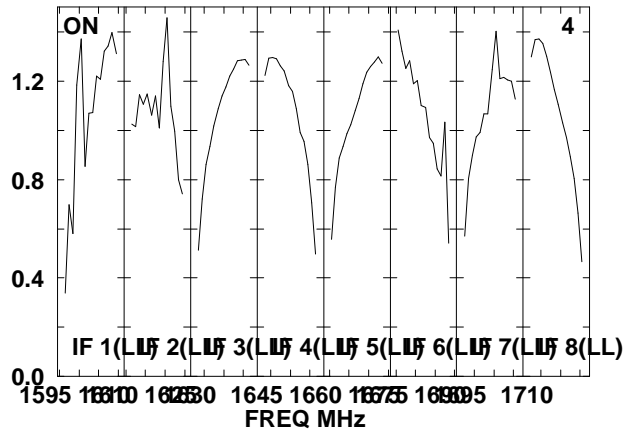
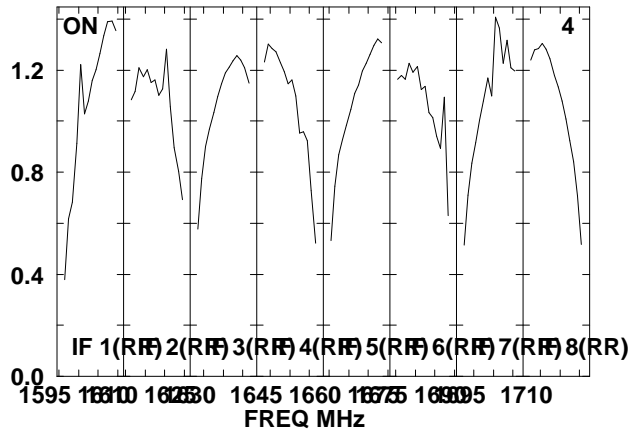
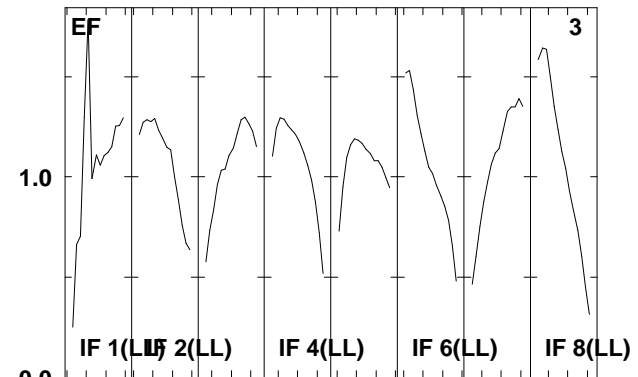
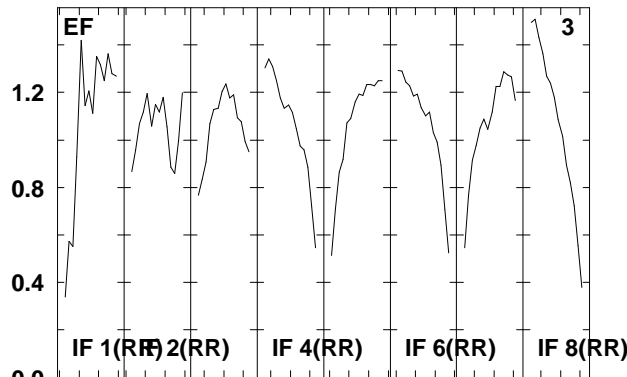
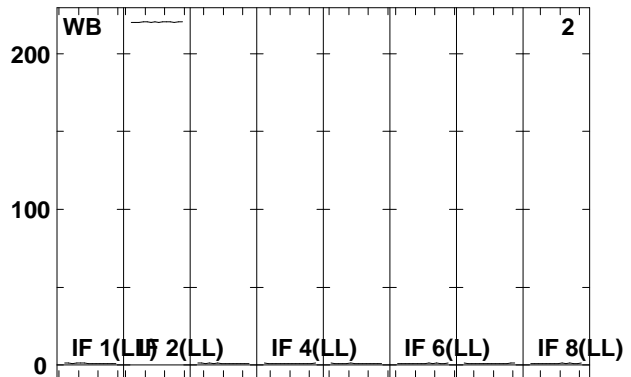
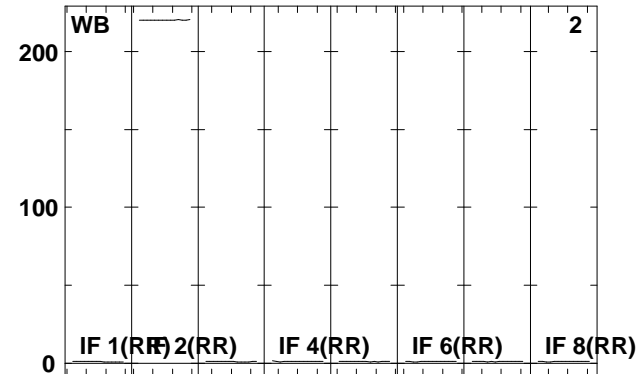
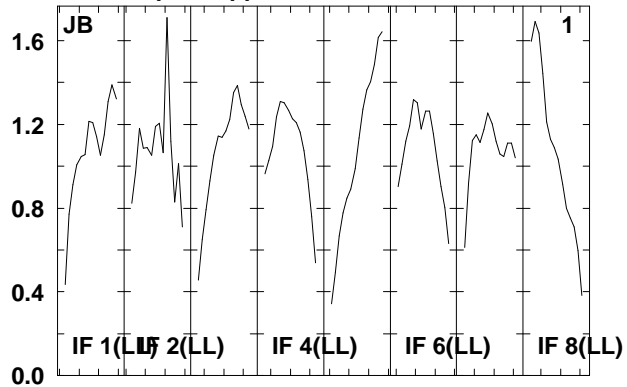
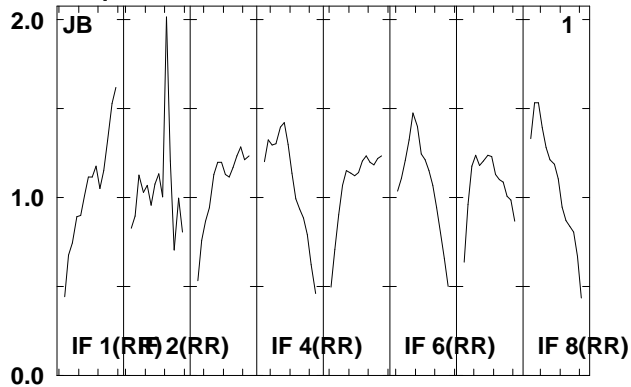

Lower frame: Real Jy  
Total-power spectrum Antenna: \*  
Timerange: 00/22:07:17 to 00/22:09:15

Plot file version 134 created 20-AUG-2009 15:00:08

J1016+20 EG040B.UVDATA.1

Freq = 1.5955 GHz, Bw = 16.000 MH No calibration applied and no bandpass applied

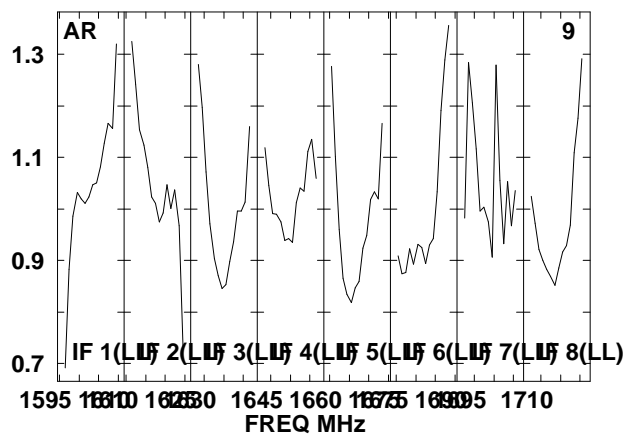
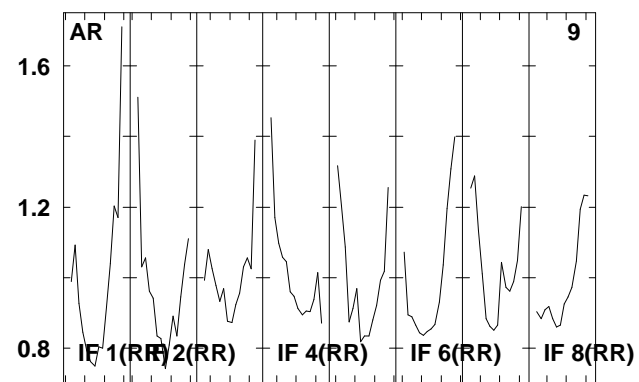
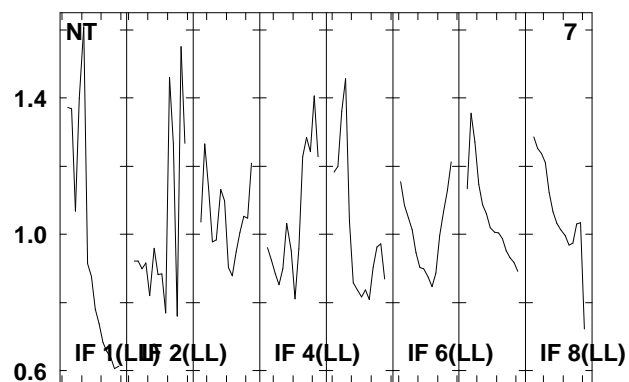
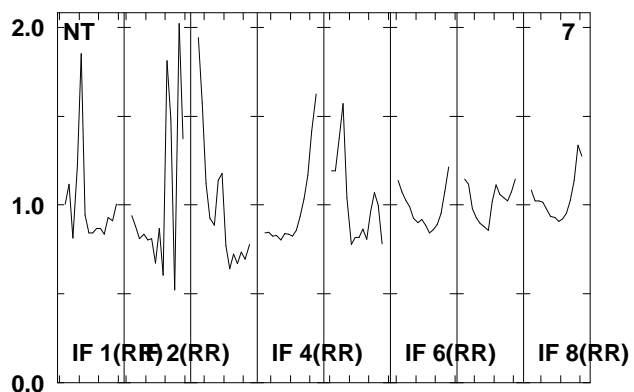
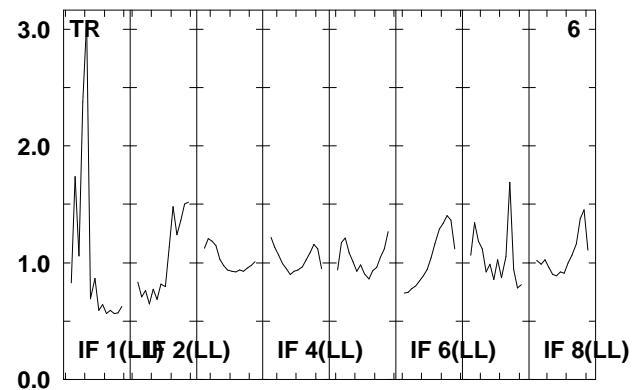
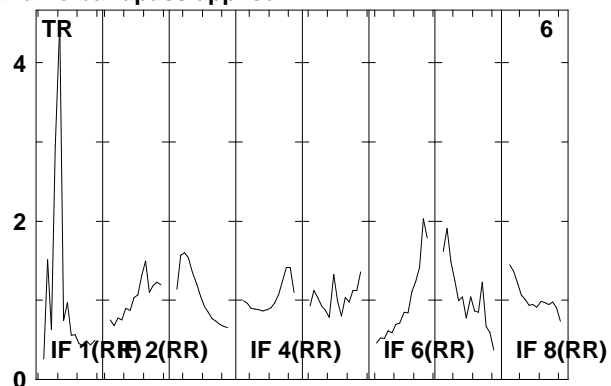
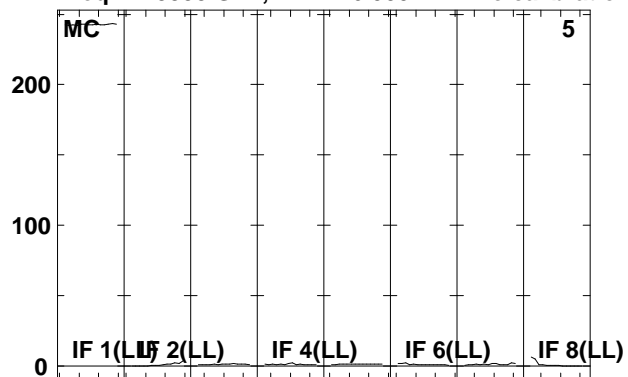

Lower frame: Real Jy

Total-power spectrum Antenna: \*

Timerange: 00/22:07:17 to 00/22:09:15

Plot file version 135 created 20-AUG-2009 15:00:08

NGC3227 EG040B.UVDATA.1

Freq = 1.5955 GHz, Bw = 16.000 MH No calibration applied and no bandpass applied

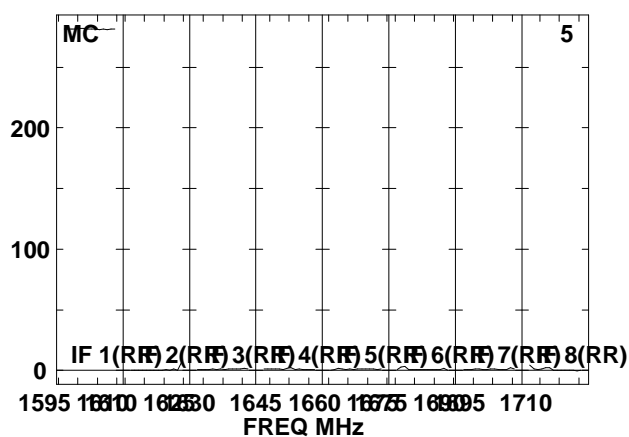
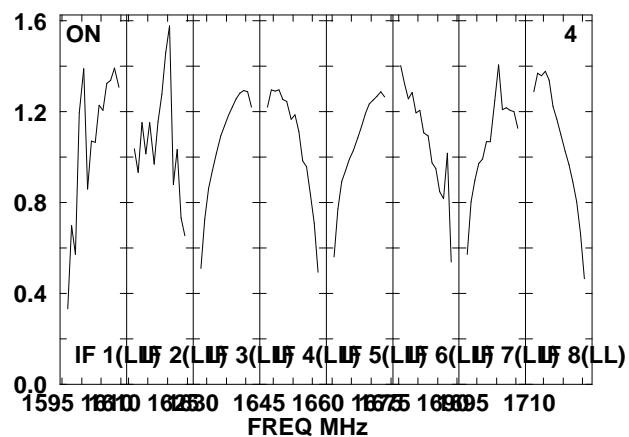
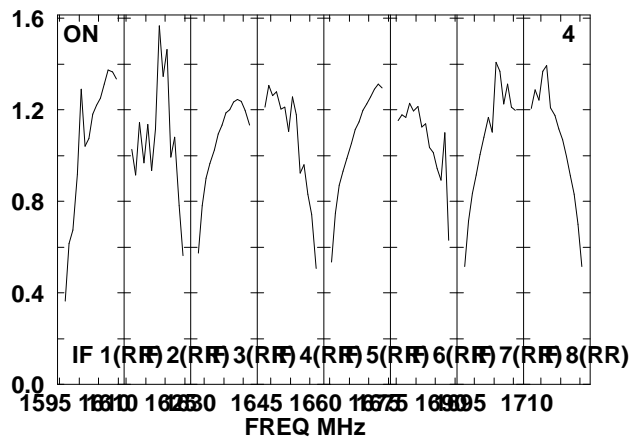
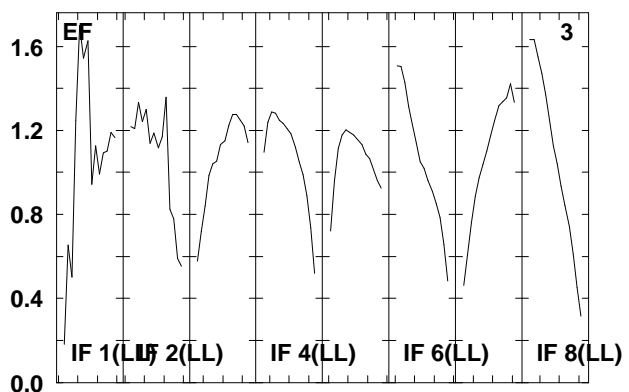
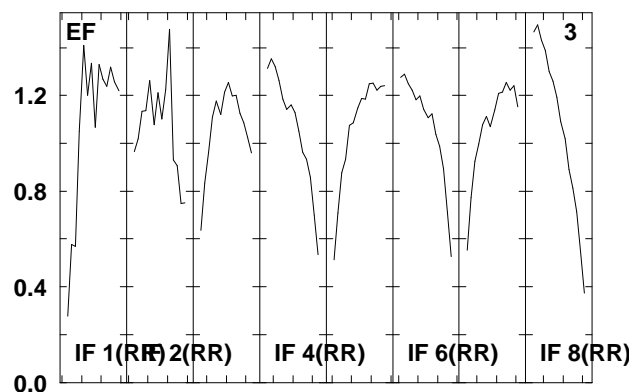
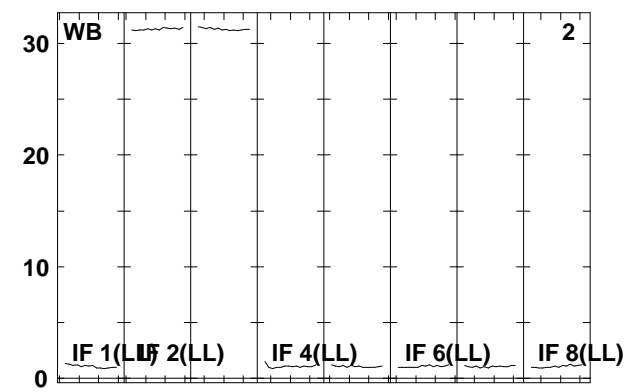
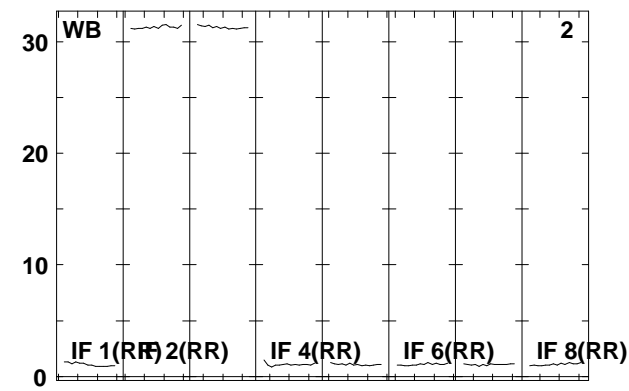
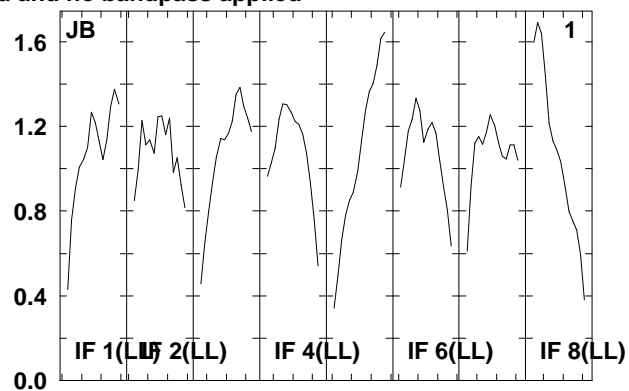
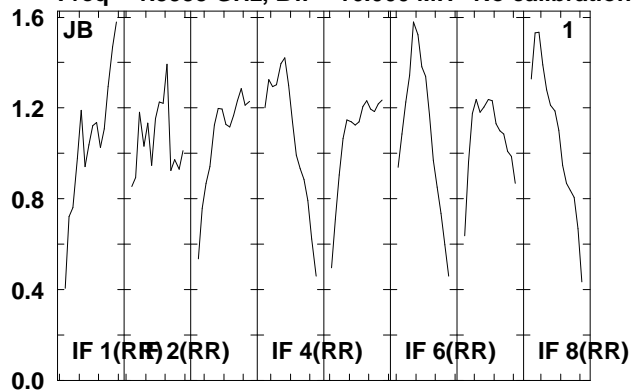

Lower frame: Real Jy  
Total-power spectrum Antenna: \*  
Timerange: 00/22:09:17 to 00/22:13:13

Plot file version 136 created 20-AUG-2009 15:00:08

NGC3227 EG040B.UVDATA.1

Freq = 1.5955 GHz, Bw = 16.000 MH No calibration applied and no bandpass applied

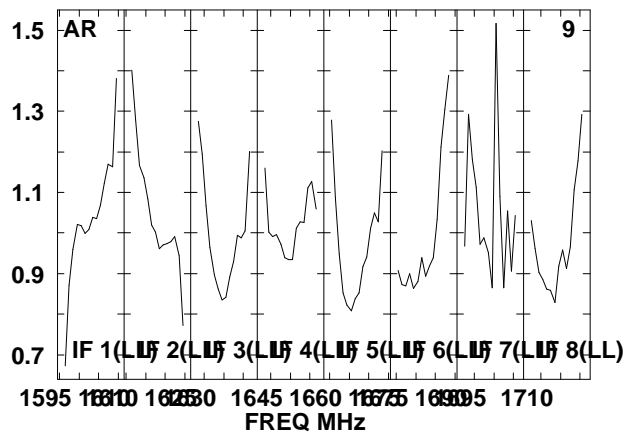
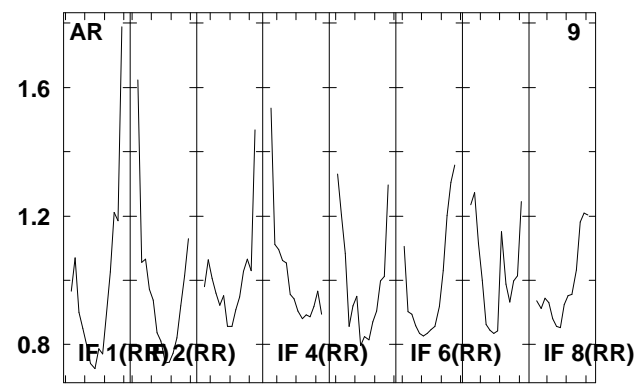
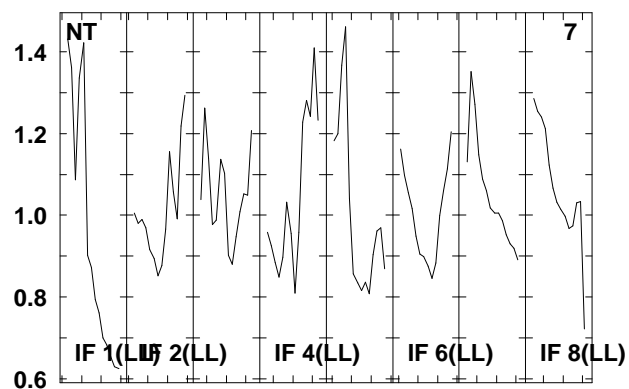
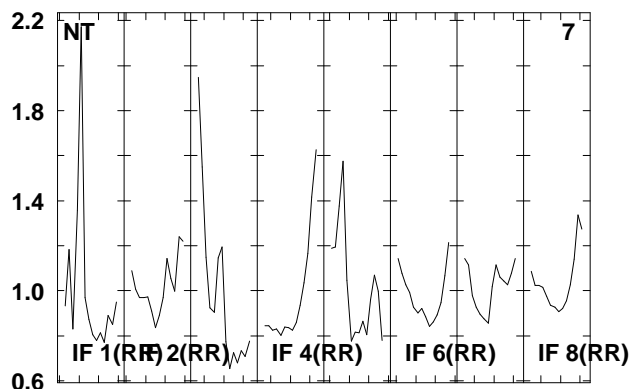
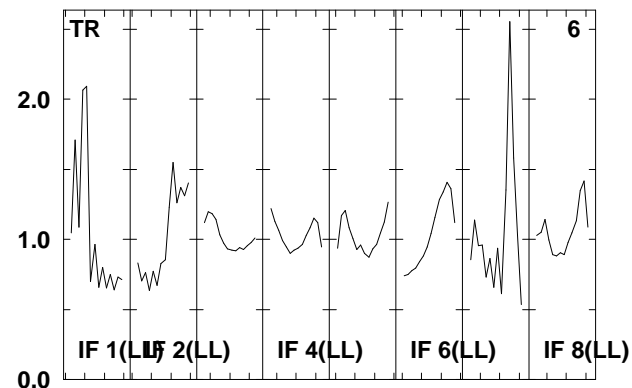
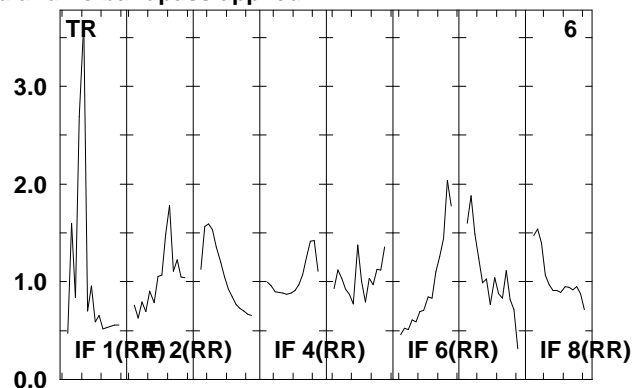
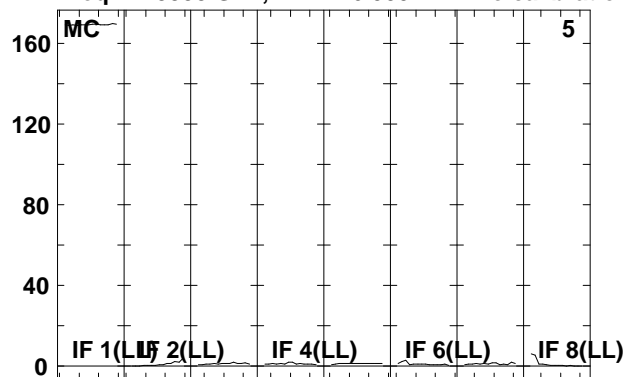

Lower frame: Real Jy

Total-power spectrum Antenna: \*

Timerange: 00/22:09:17 to 00/22:13:13



Plot file version 137 created 20-AUG-2009 15:00:09

J1016+20 EG040B.UVDATA.1

Freq = 1.5955 GHz, Bw = 16.000 MH No calibration applied and no bandpass applied

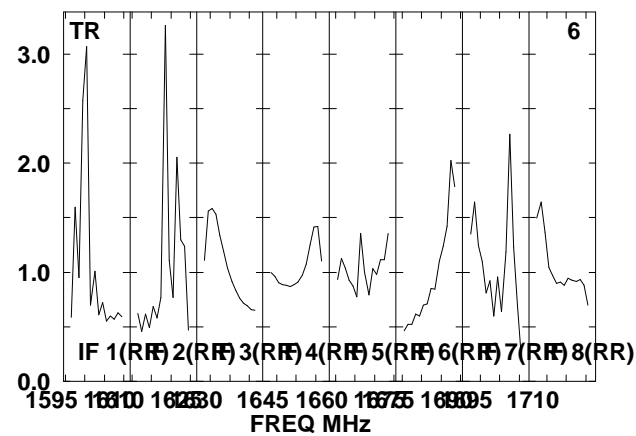
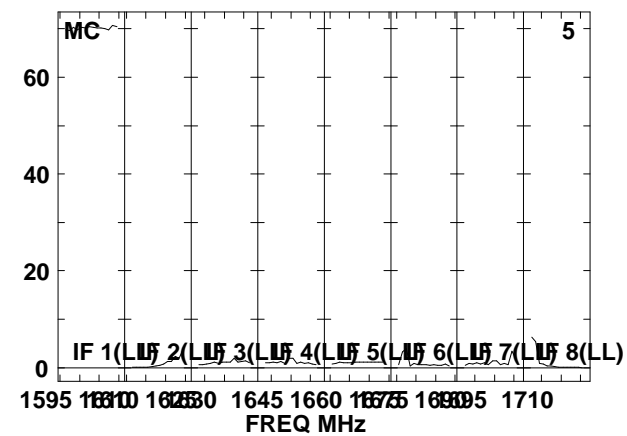
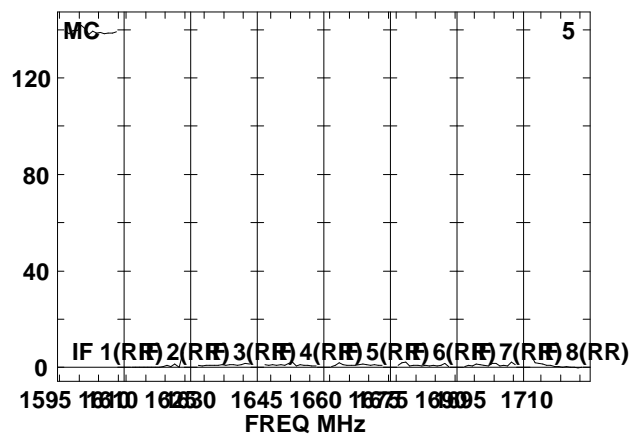
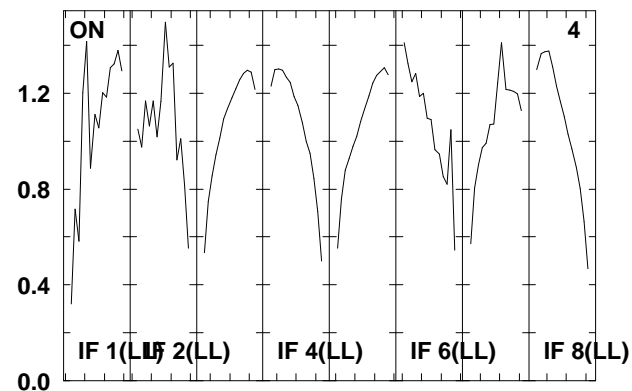
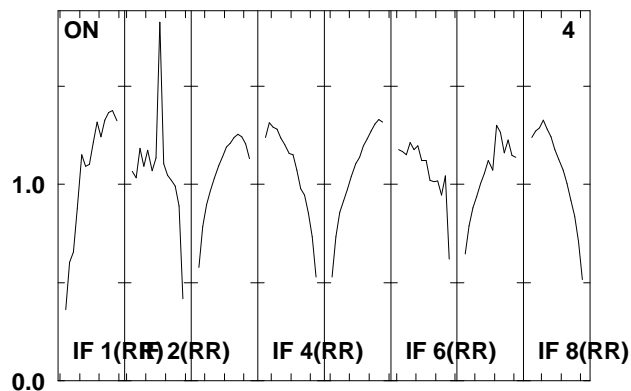
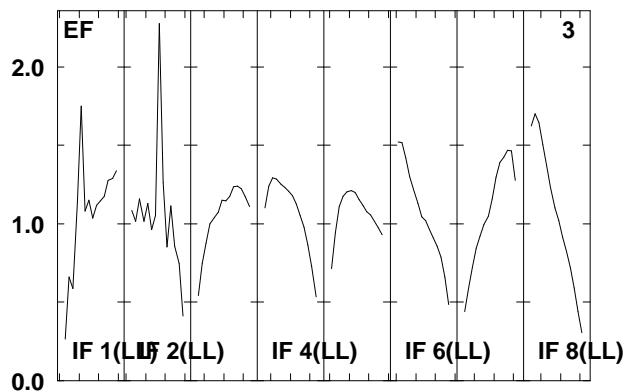
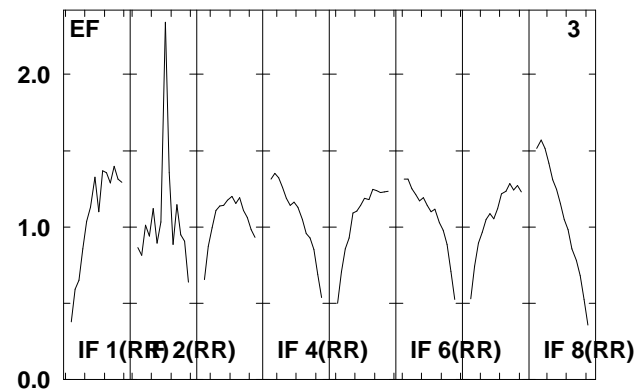
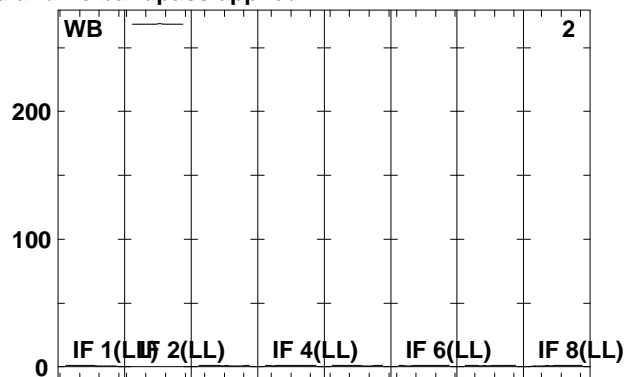
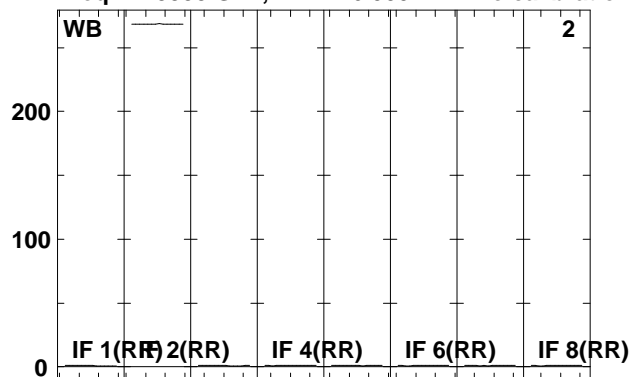

Lower frame: Real Jy

Total-power spectrum Antenna: \*

Timerange: 00/22:13:49 to 00/22:15:25

Plot file version 138 created 20-AUG-2009 15:00:09

J1016+20 EG040B.UVDATA.1

Freq = 1.5955 GHz, Bw = 16.000 MH No calibration applied and no bandpass applied

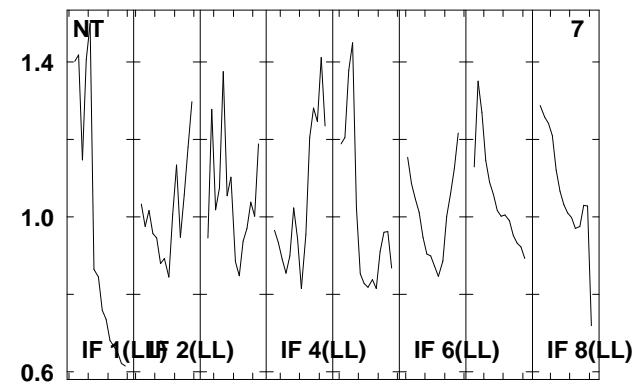
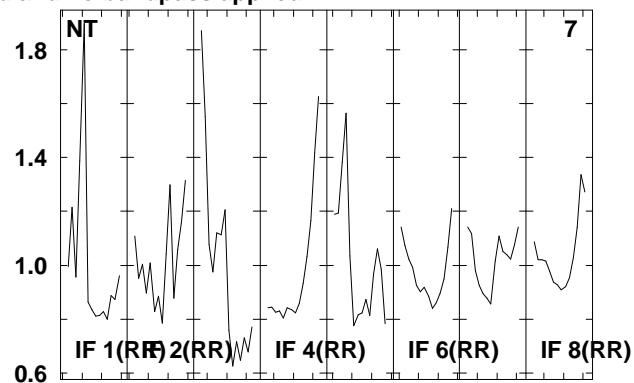
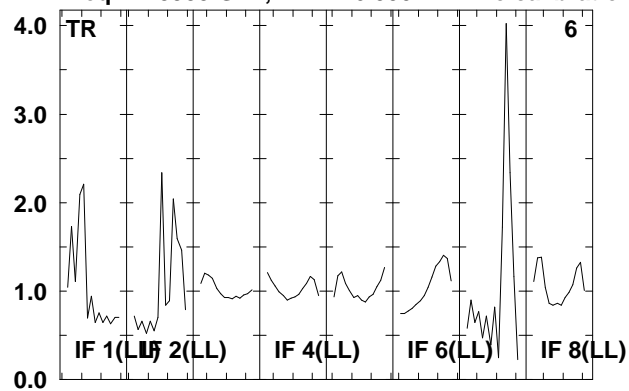

Lower frame: Real Jy  
Total-power spectrum Antenna: \*  
Timerange: 00/22:13:49 to 00/22:15:25

Plot file version 139 created 20-AUG-2009 15:00:09

NGC3227 EG040B.UVDATA.1

Freq = 1.5955 GHz, Bw = 16.000 MH No calibration applied and no bandpass applied

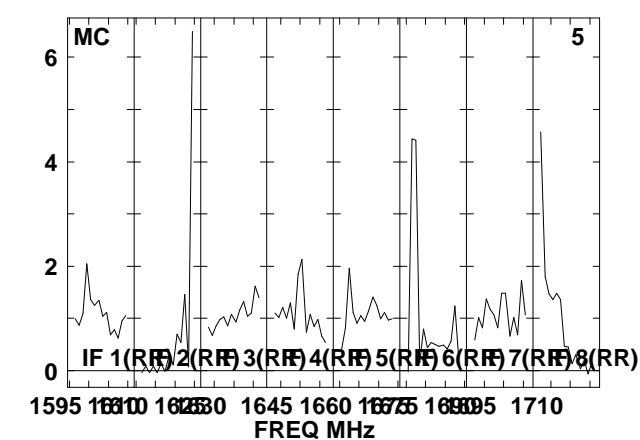
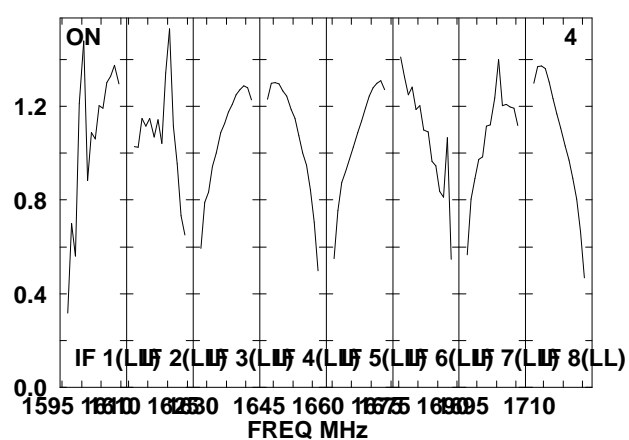
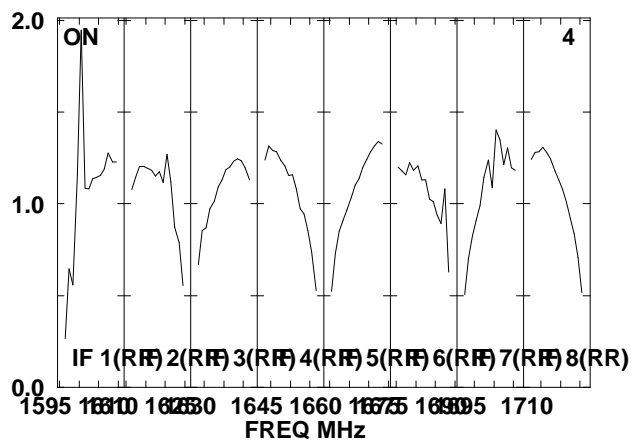
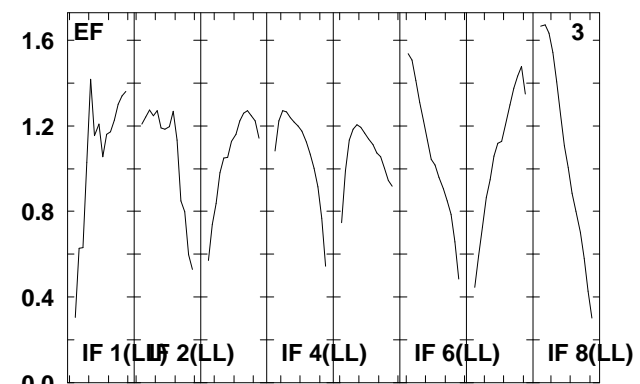
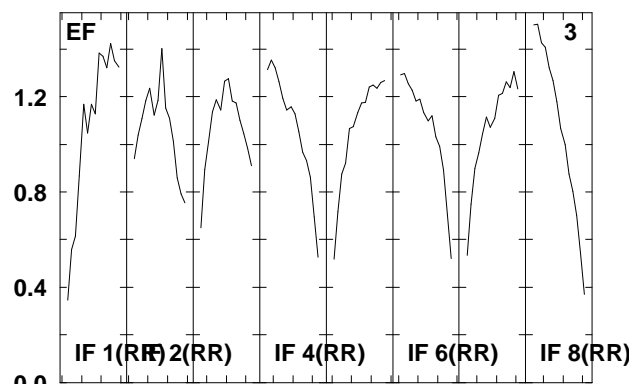
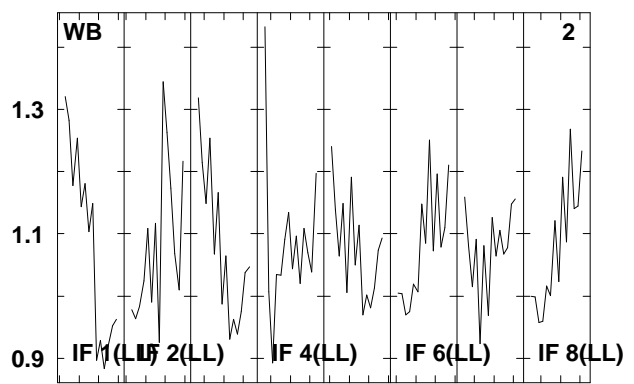
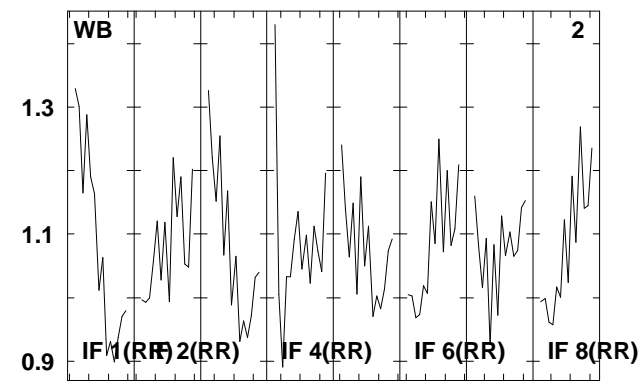
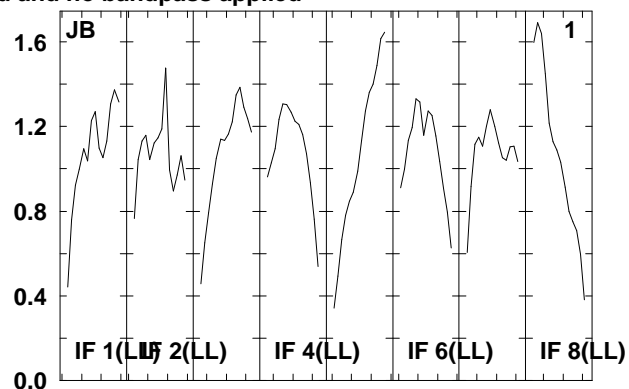
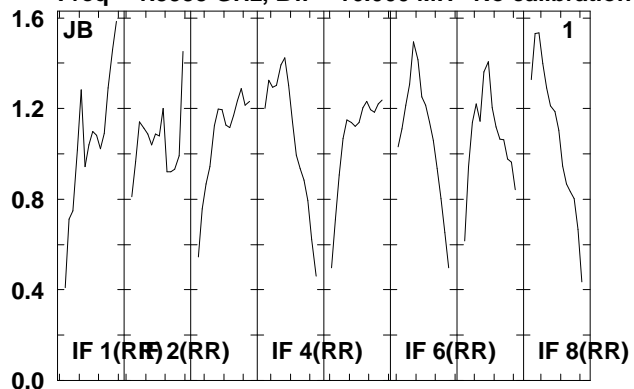

Lower frame: Real Jy  
Total-power spectrum Antenna: \*  
Timerange: 00/22:15:29 to 00/22:19:27

Plot file version 140 created 20-AUG-2009 15:00:09

NGC3227 EG040B.UVDATA.1

Freq = 1.5955 GHz, Bw = 16.000 MH No calibration applied and no bandpass applied

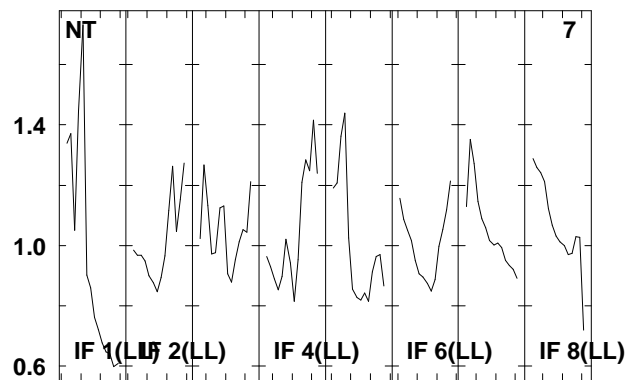
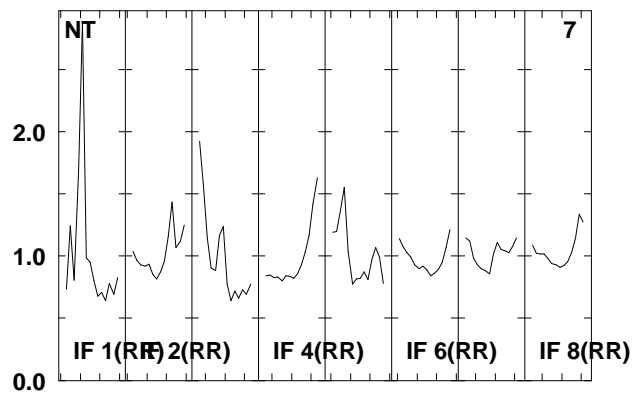
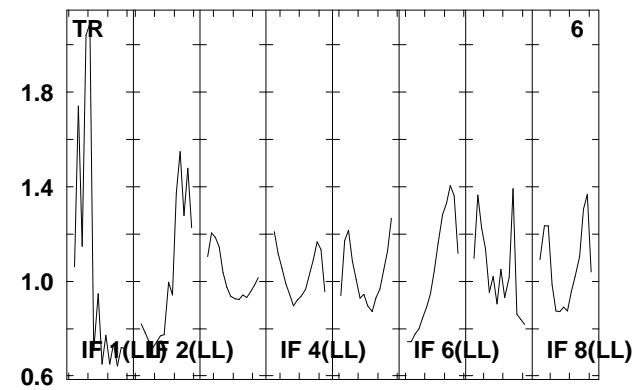
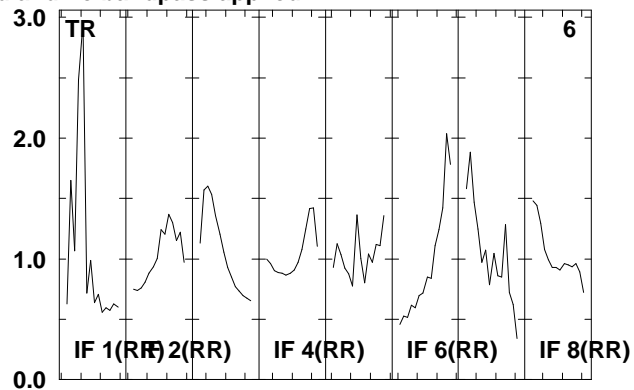
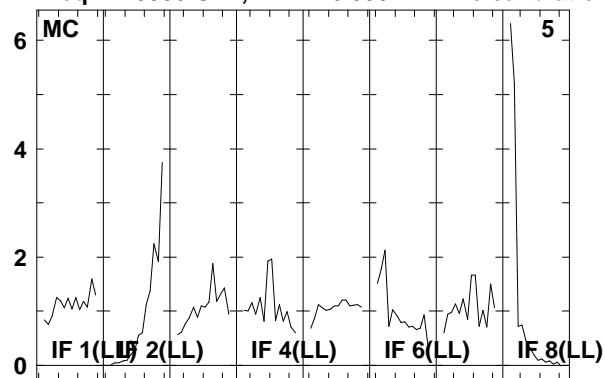

Lower frame: Real Jy  
Total-power spectrum Antenna: \*  
Timerange: 00/22:15:29 to 00/22:19:27

Plot file version 141 created 20-AUG-2009 15:00:10

J1016+20 EG040B.UVDATA.1

Freq = 1.5955 GHz, Bw = 16.000 MH No calibration applied and no bandpass applied

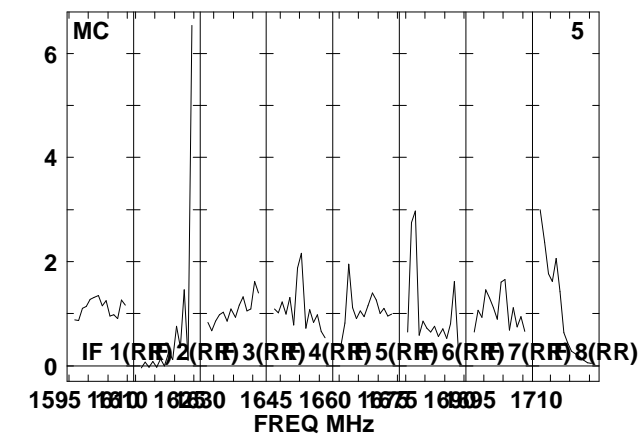
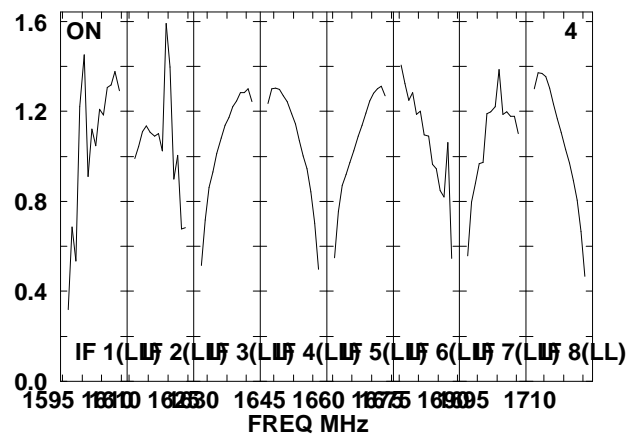
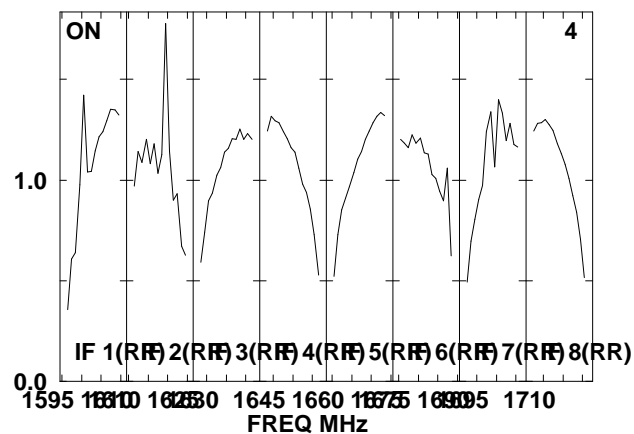
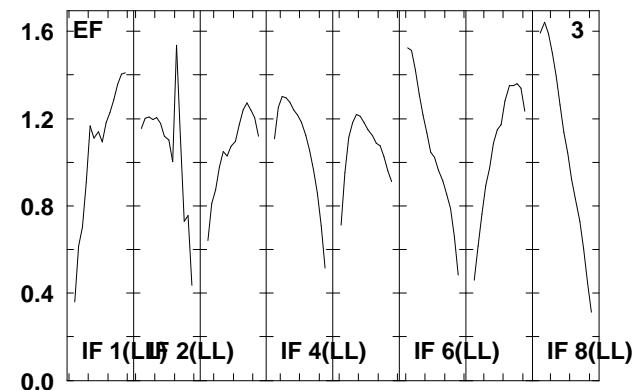
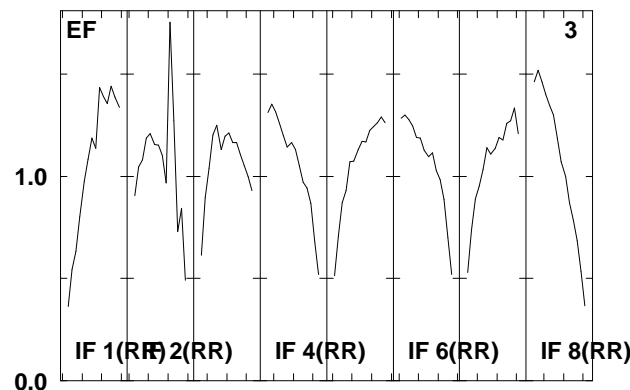
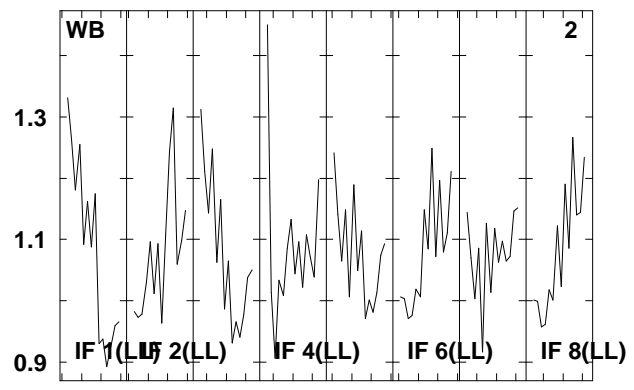
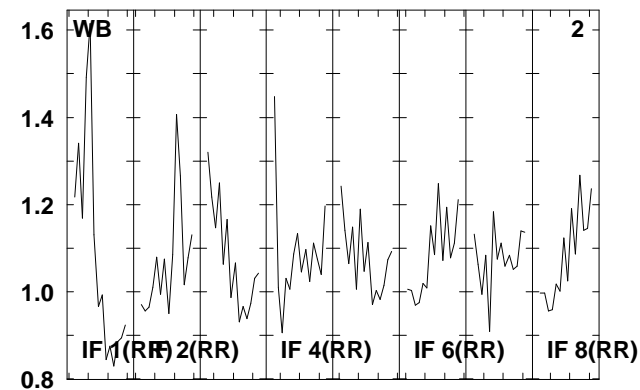
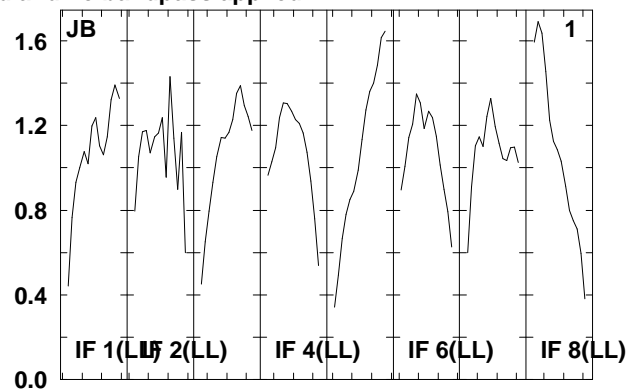
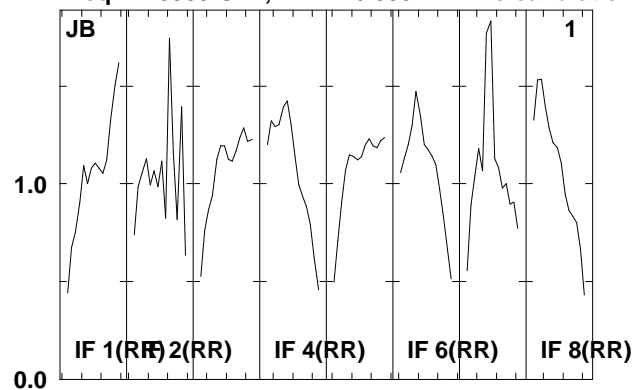

Lower frame: Real Jy  
Total-power spectrum Antenna: \*  
Timerange: 00/22:19:29 to 00/22:21:27

Plot file version 142 created 20-AUG-2009 15:00:10

J1016+20 EG040B.UVDATA.1

Freq = 1.5955 GHz, Bw = 16.000 MH No calibration applied and no bandpass applied

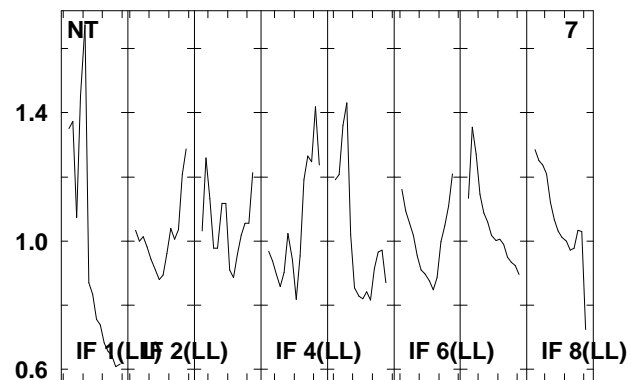
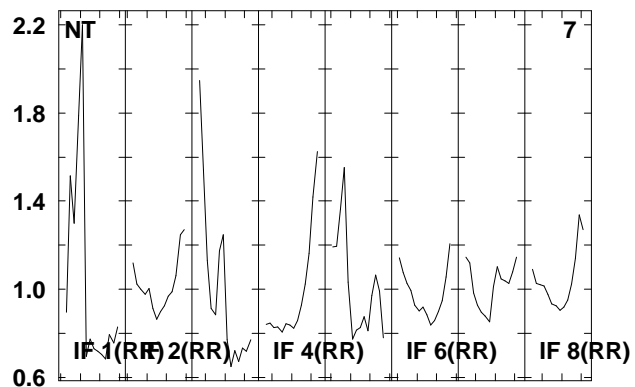
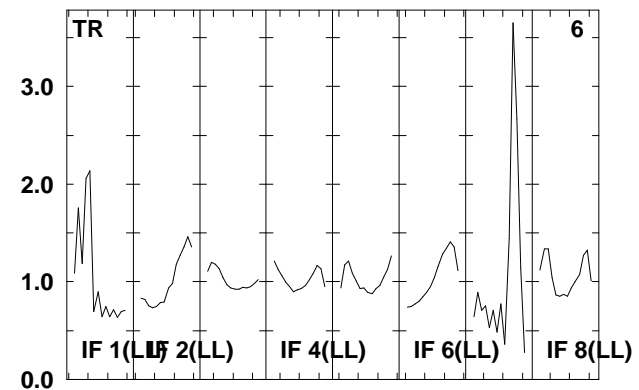
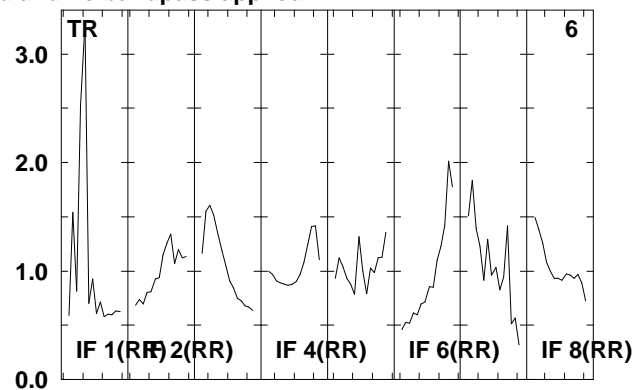
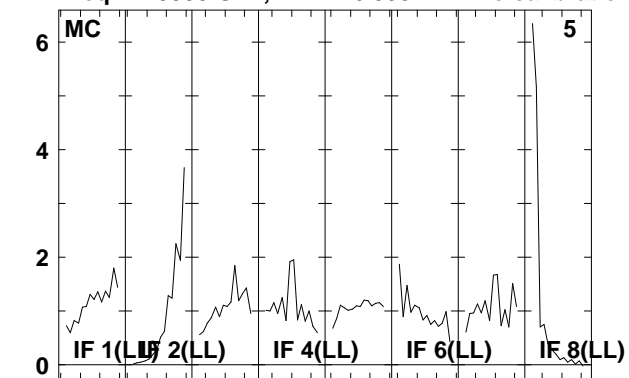

Lower frame: Real Jy  
Total-power spectrum Antenna: \*  
Timerange: 00/22:19:29 to 00/22:21:27

Plot file version 143 created 20-AUG-2009 15:00:10

NGC3227 EG040B.UVDATA.1

Freq = 1.5955 GHz, Bw = 16.000 MH No calibration applied and no bandpass applied

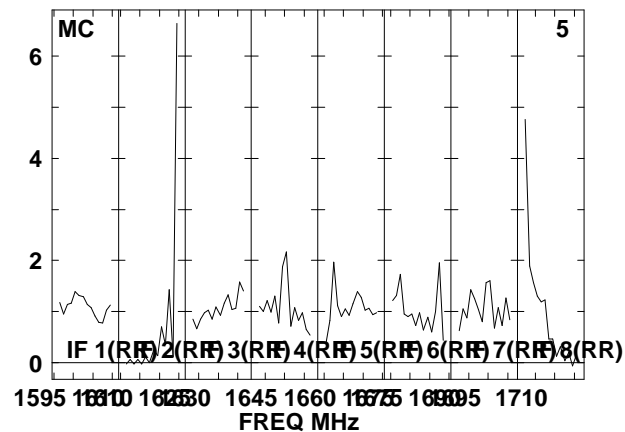
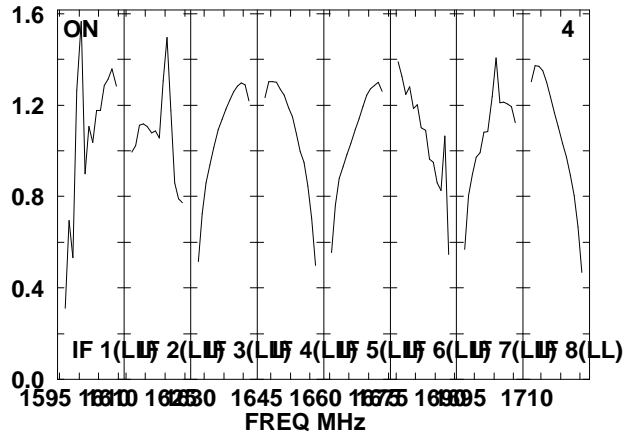
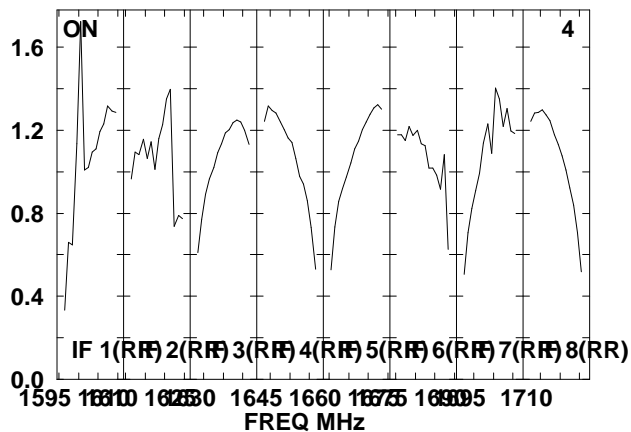
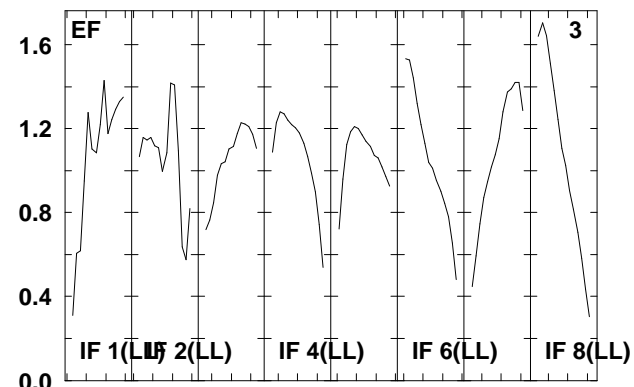
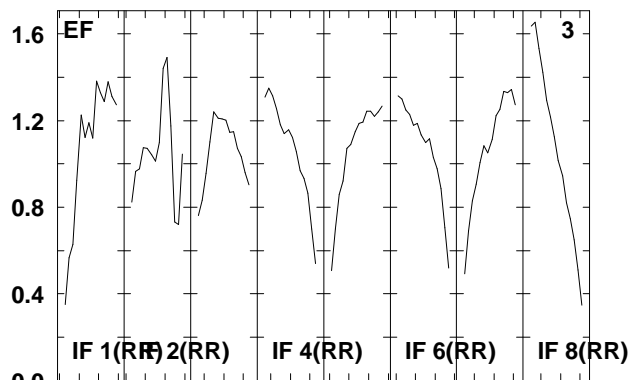
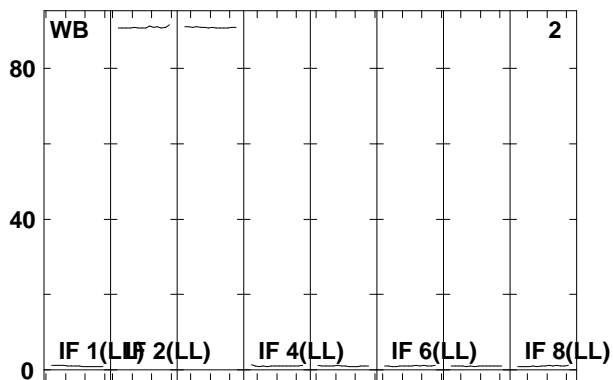
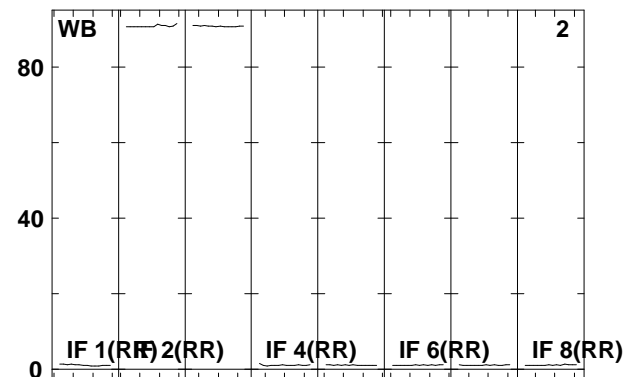
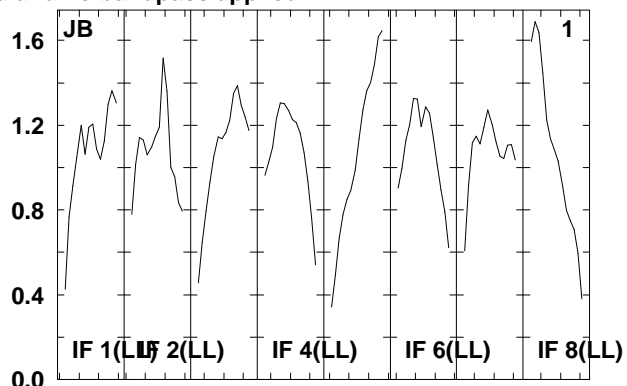
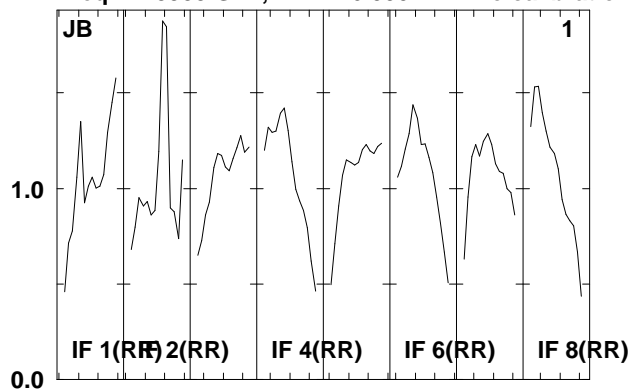

Lower frame: Real Jy  
Total-power spectrum Antenna: \*  
Timerange: 00/22:21:29 to 00/22:25:25

Plot file version 144 created 20-AUG-2009 15:00:11

NGC3227 EG040B.UVDATA.1

Freq = 1.5955 GHz, Bw = 16.000 MH No calibration applied and no bandpass applied

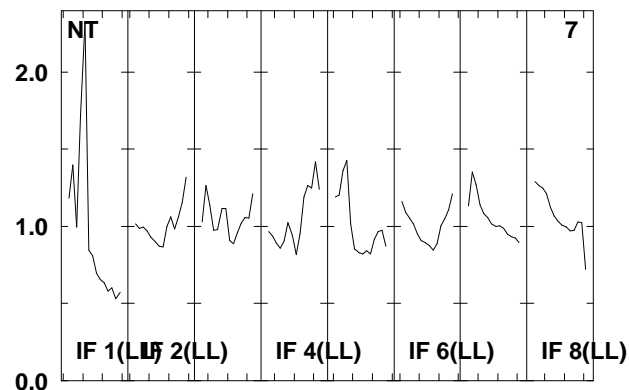
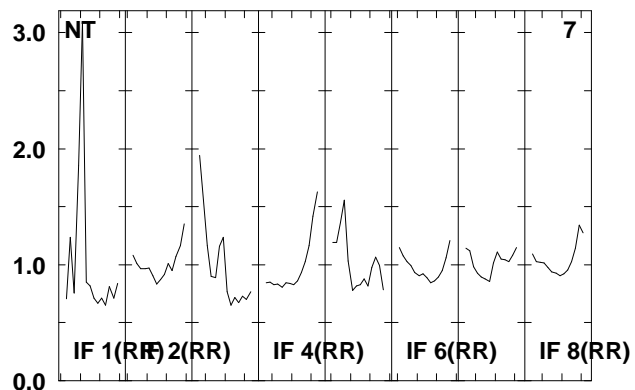
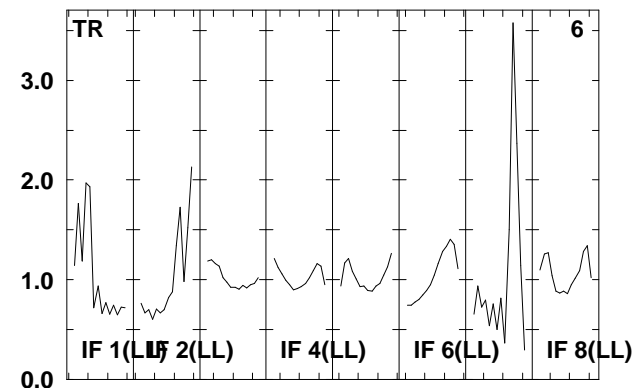
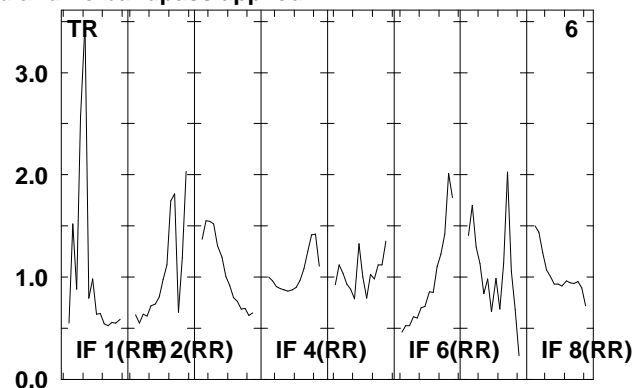
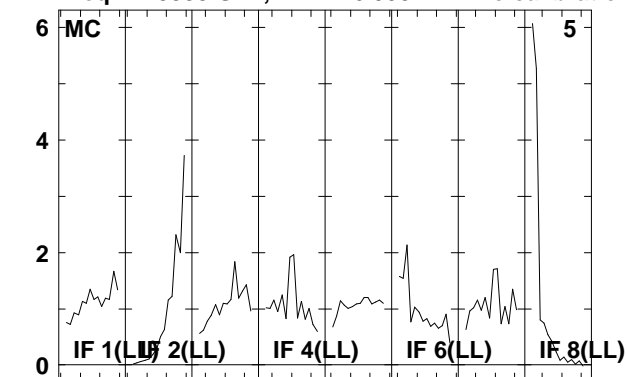

Lower frame: Real Jy  
Total-power spectrum Antenna: \*  
Timerange: 00/22:21:29 to 00/22:25:25



Plot file version 145 created 20-AUG-2009 15:00:11

J1016+20 EG040B.UVDATA.1

Freq = 1.5955 GHz, Bw = 16.000 MH No calibration applied and no bandpass applied

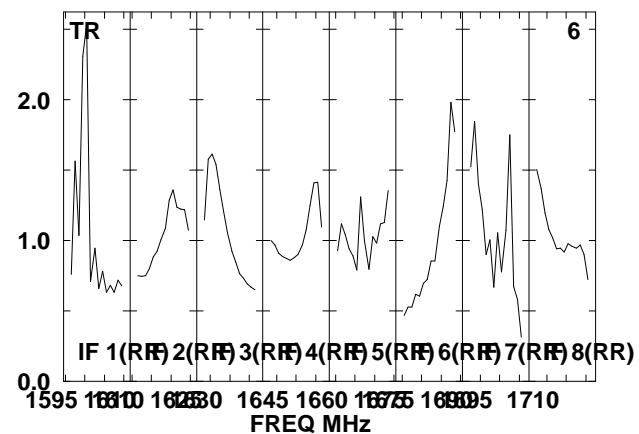
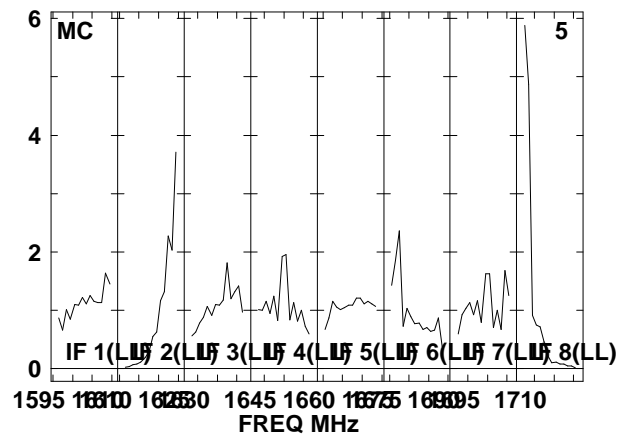
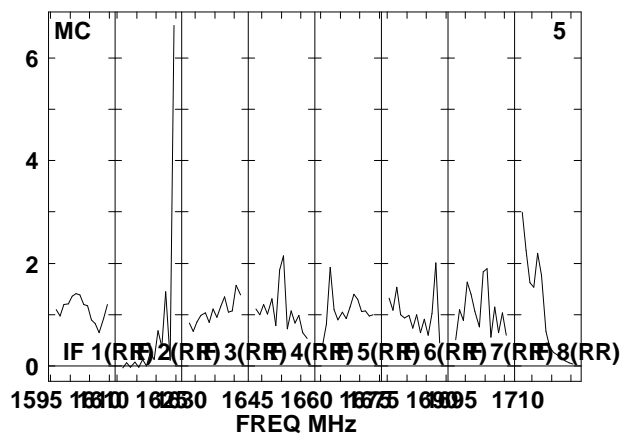
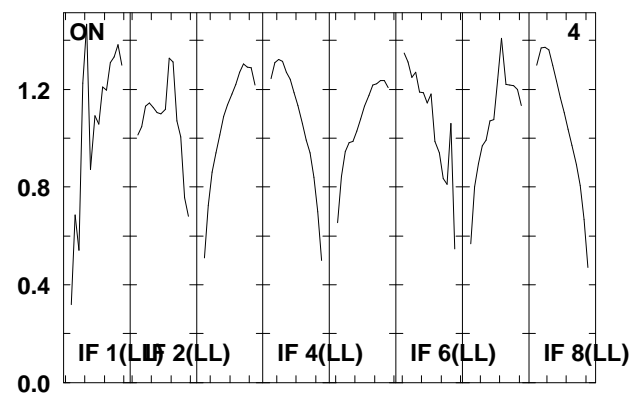
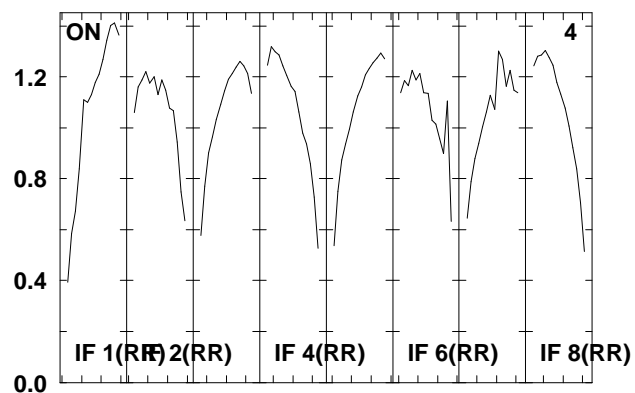
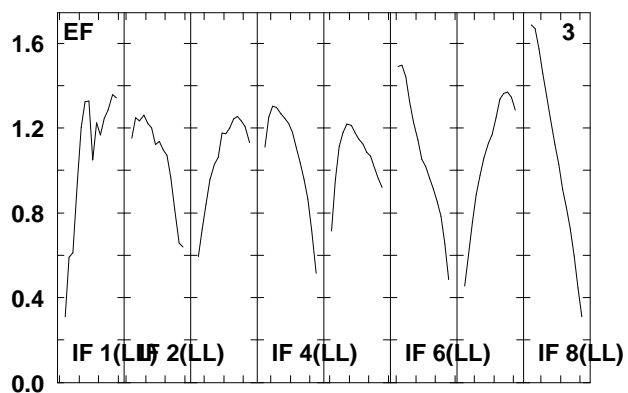
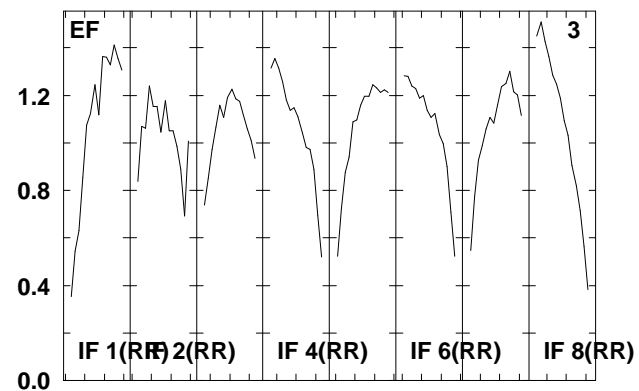
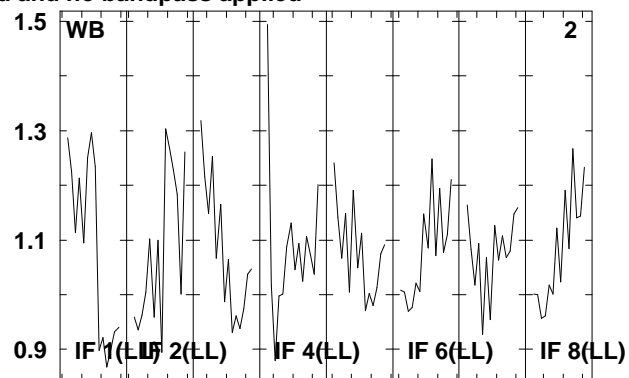
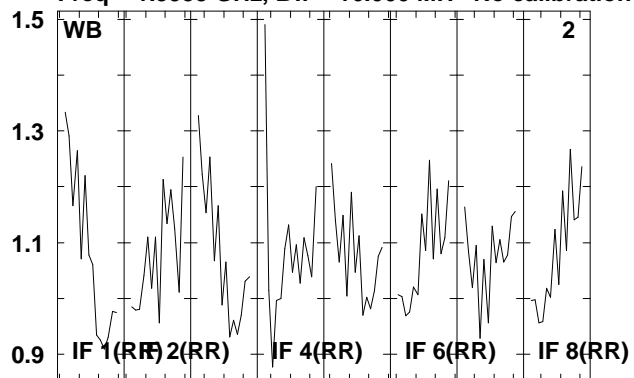

Lower frame: Real Jy  
Total-power spectrum Antenna: \*  
Timerange: 00/22:26:01 to 00/22:27:37

Plot file version 146 created 20-AUG-2009 15:00:11

J1016+20 EG040B.UVDATA.1

Freq = 1.5955 GHz, Bw = 16.000 MH No calibration applied and no bandpass applied

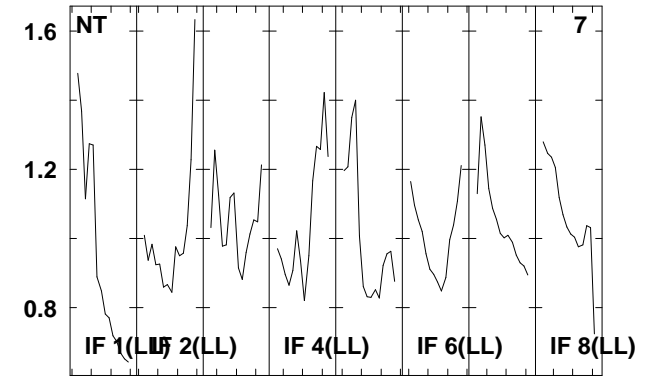
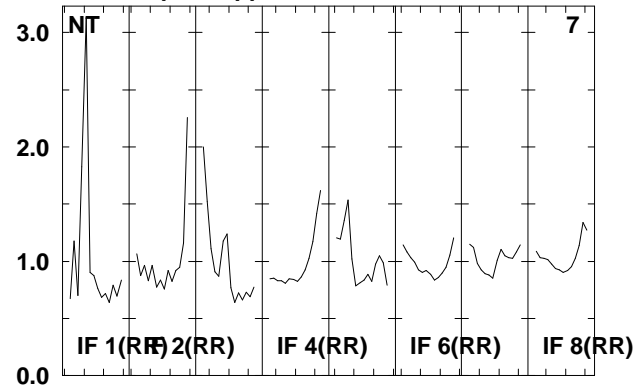
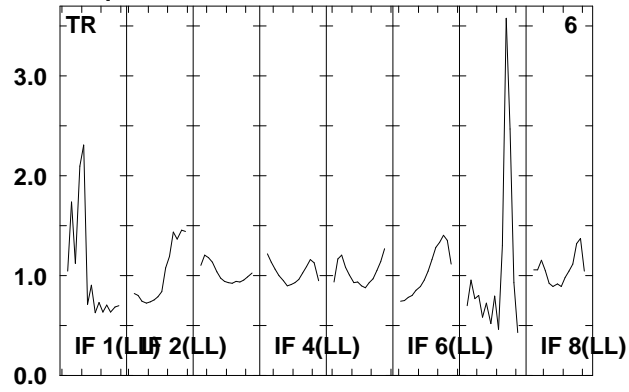

Lower frame: Real Jy  
Total-power spectrum Antenna: \*  
Timerange: 00/22:26:01 to 00/22:27:37

Plot file version 147 created 20-AUG-2009 15:00:11

NGC3227 EG040B.UVDATA.1

Freq = 1.5955 GHz, Bw = 16.000 MH No calibration applied and no bandpass applied

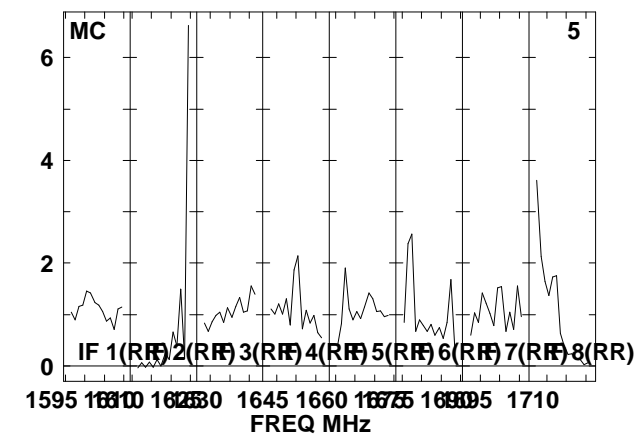
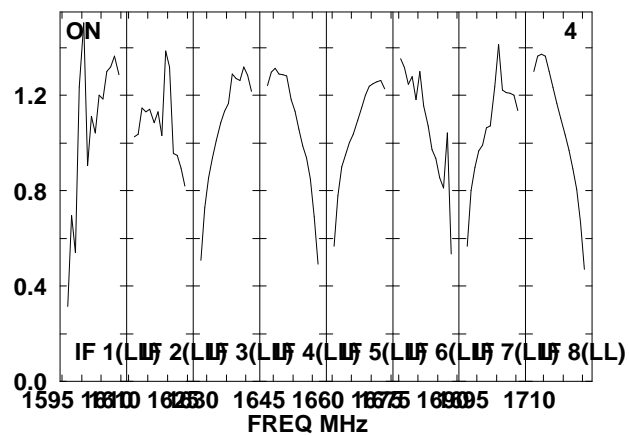
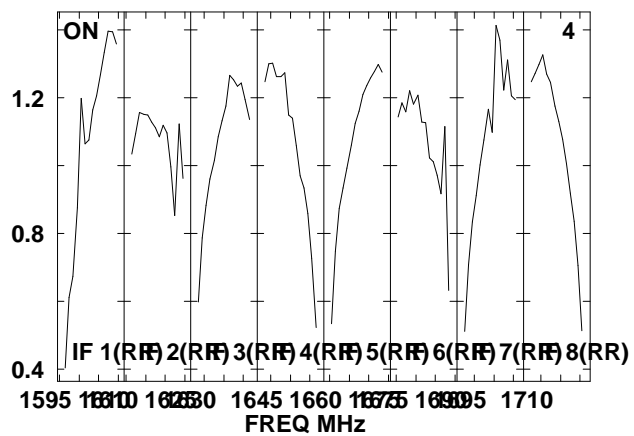
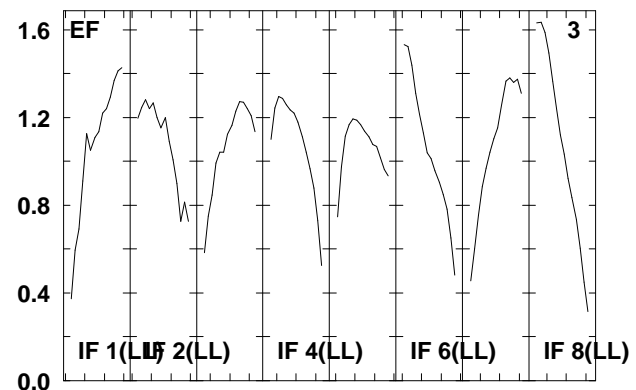
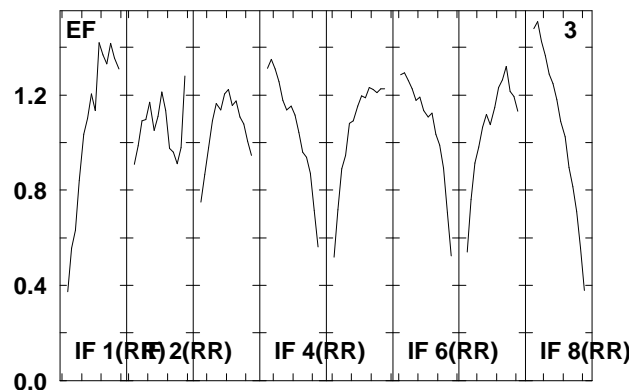
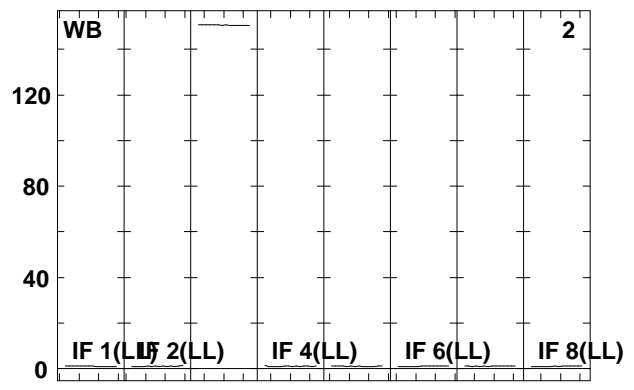
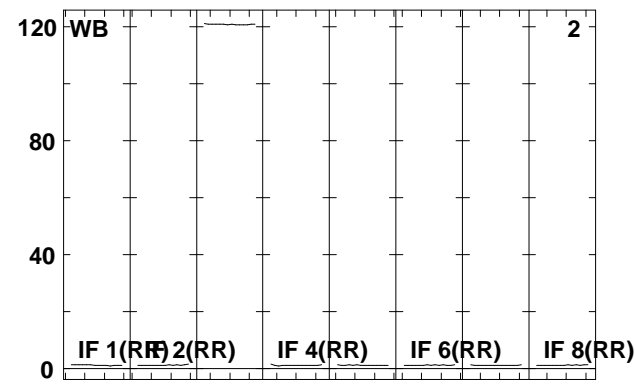
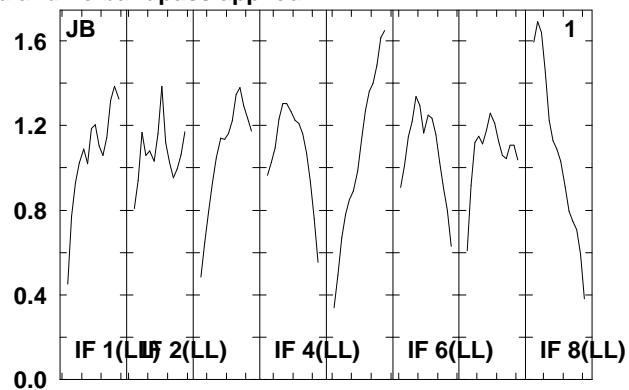
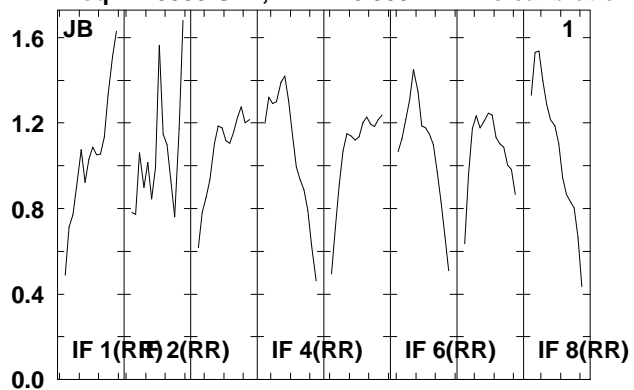

Lower frame: Real Jy  
Total-power spectrum Antenna: \*  
Timerange: 00/22:27:41 to 00/22:31:39

Plot file version 148 created 20-AUG-2009 15:00:12

NGC3227 EG040B.UVDATA.1

Freq = 1.5955 GHz, Bw = 16.000 MH No calibration applied and no bandpass applied

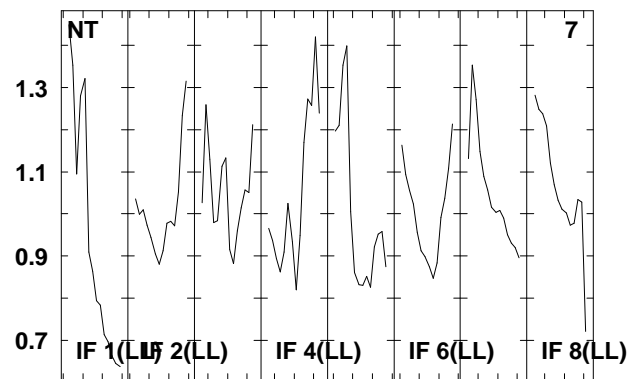
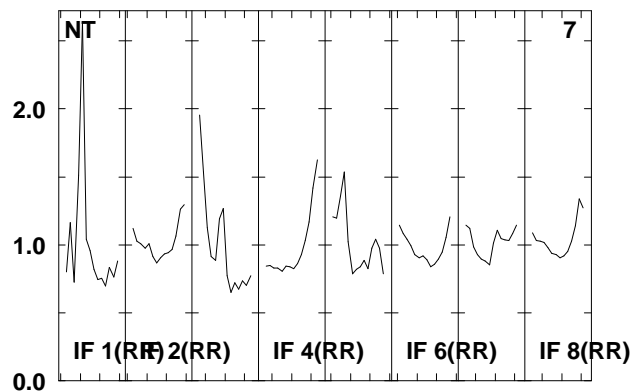
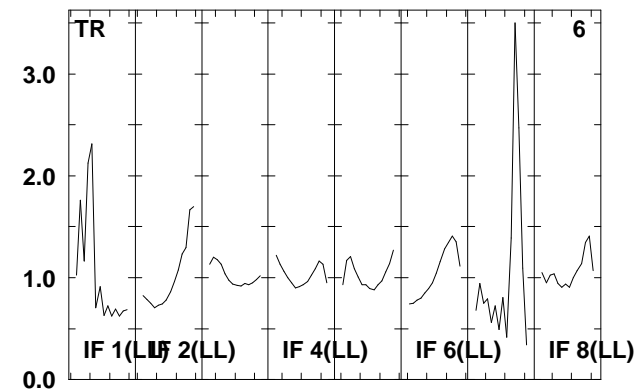
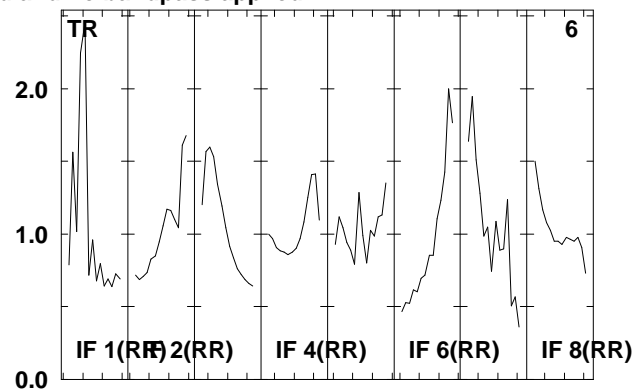
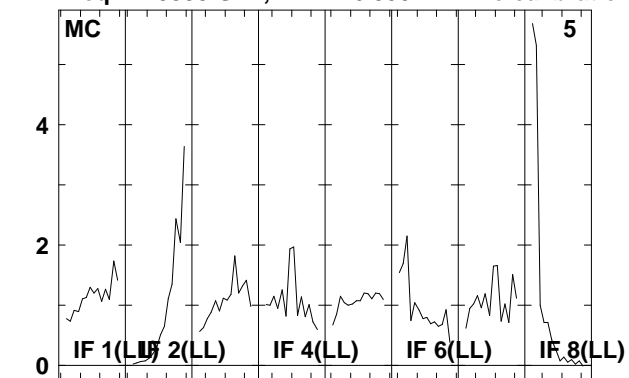

Lower frame: Real Jy  
Total-power spectrum Antenna: \*  
Timerange: 00/22:27:41 to 00/22:31:39

Plot file version 149 created 20-AUG-2009 15:00:12

J1016+20 EG040B.UVDATA.1

Freq = 1.5955 GHz, Bw = 16.000 MH No calibration applied and no bandpass applied

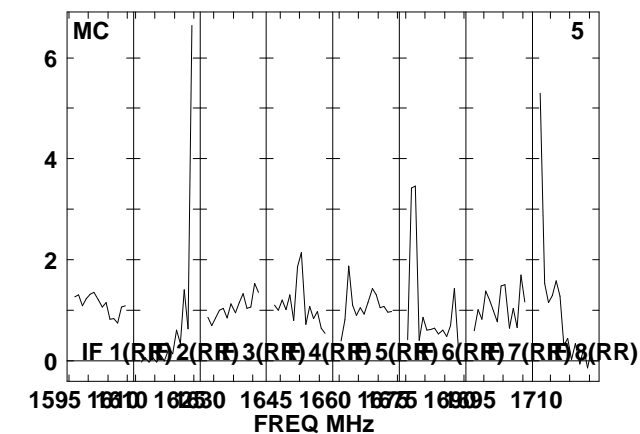
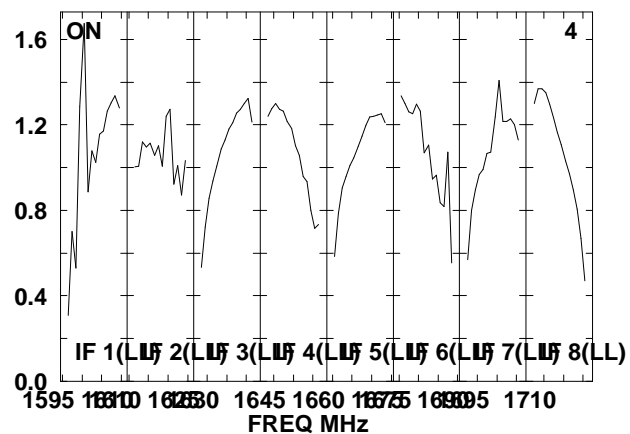
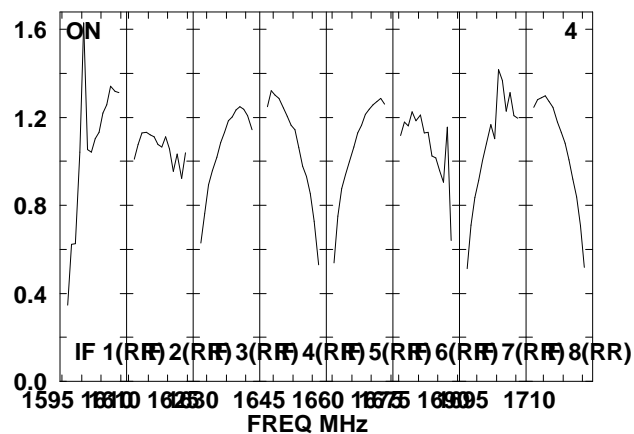
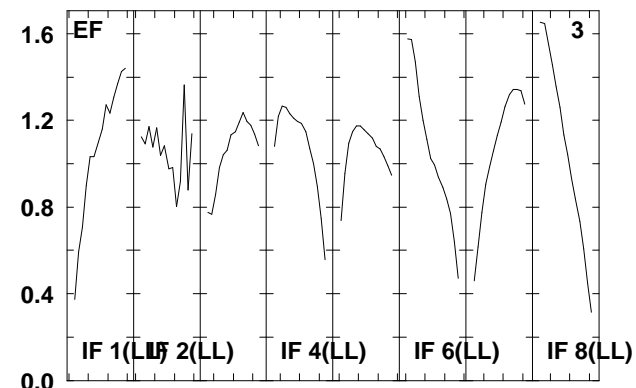
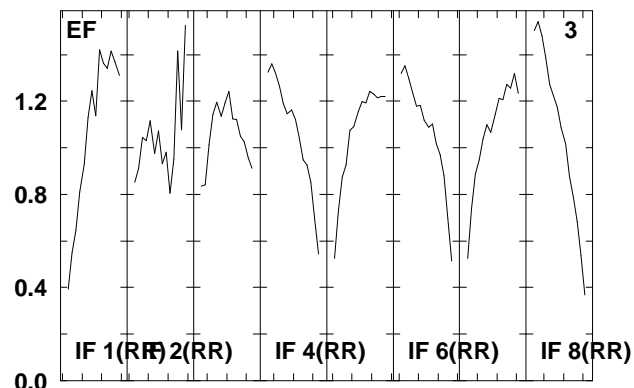
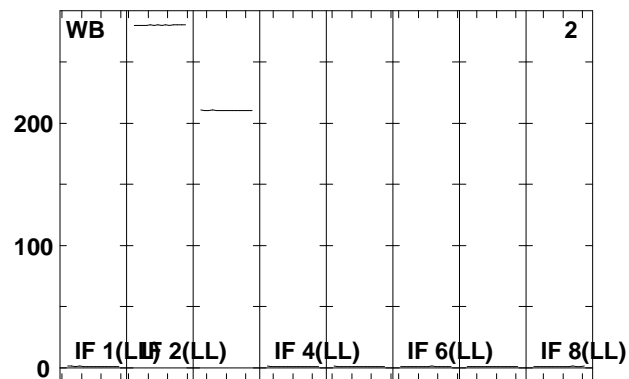
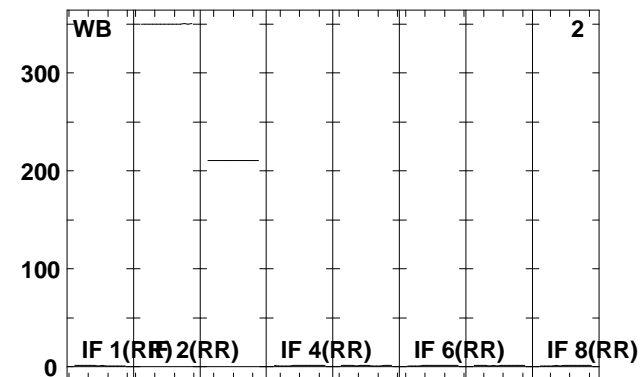
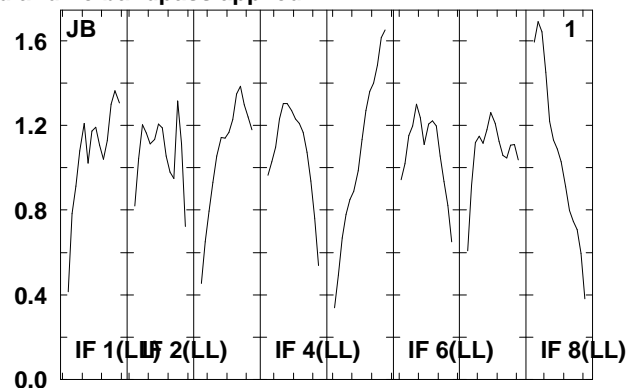
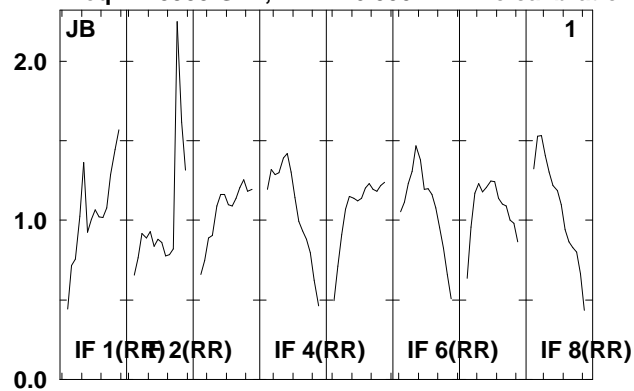

Lower frame: Real Jy  
Total-power spectrum Antenna: \*  
Timerange: 00/22:31:41 to 00/22:33:37

Plot file version 150 created 20-AUG-2009 15:00:12

J1016+20 EG040B.UVDATA.1

Freq = 1.5955 GHz, Bw = 16.000 MH No calibration applied and no bandpass applied

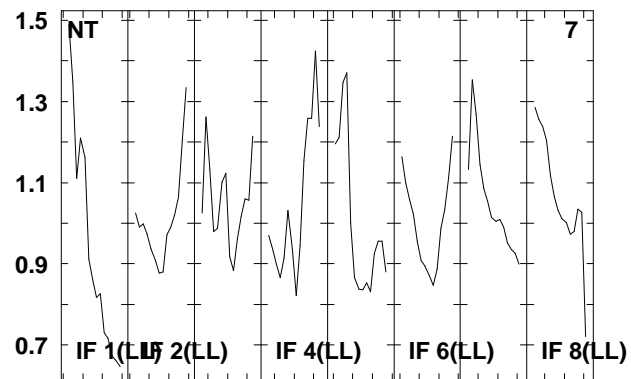
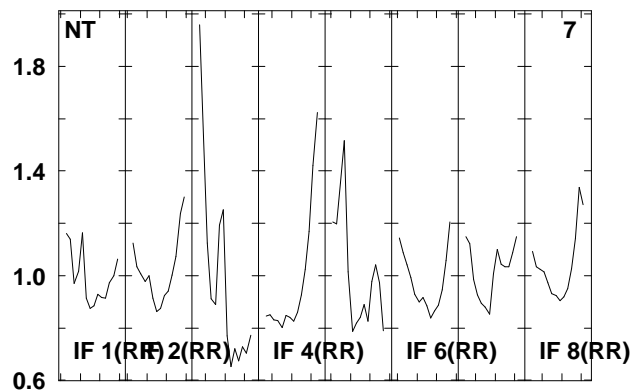
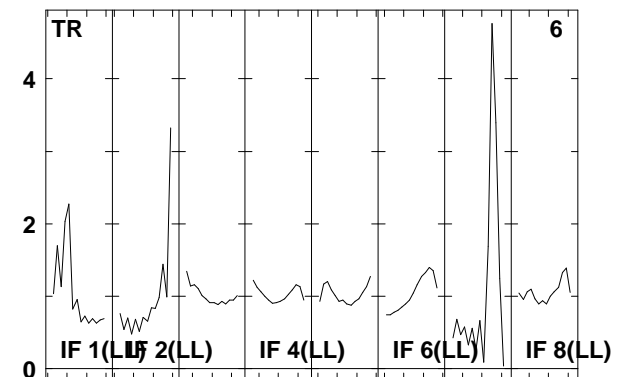
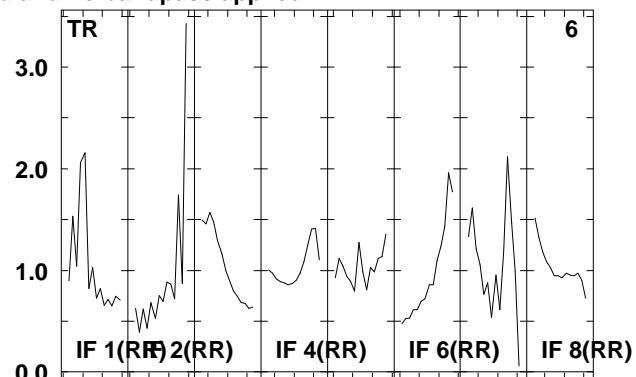
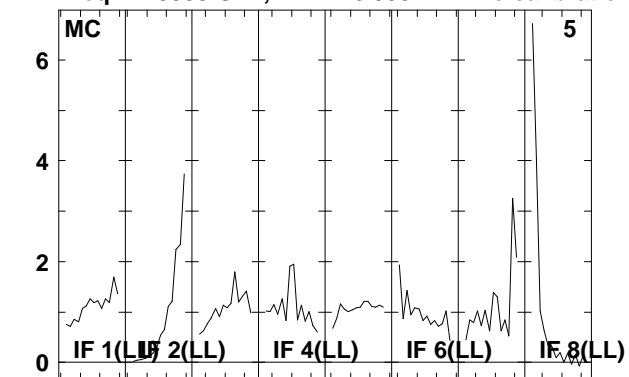

Lower frame: Real Jy  
Total-power spectrum Antenna: \*  
Timerange: 00/22:31:41 to 00/22:33:37

Plot file version 151 created 20-AUG-2009 15:00:13  
 3C274 EG040B.UVDATA.1  
 Freq = 1.5955 GHz, Bw = 16.000 MH No calibration applied and no bandpass applied

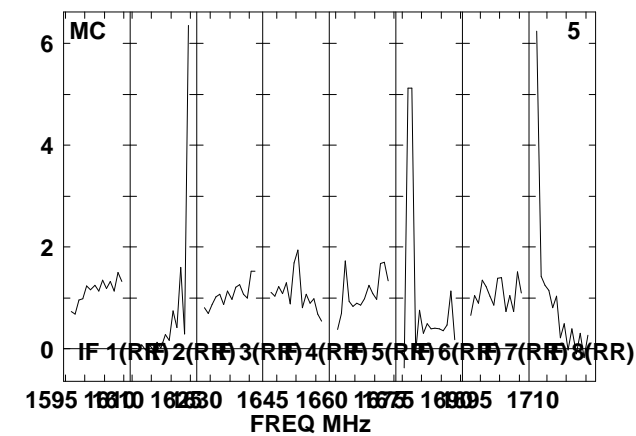
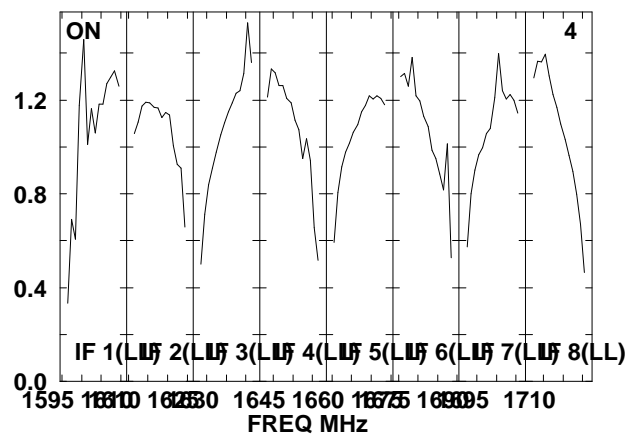
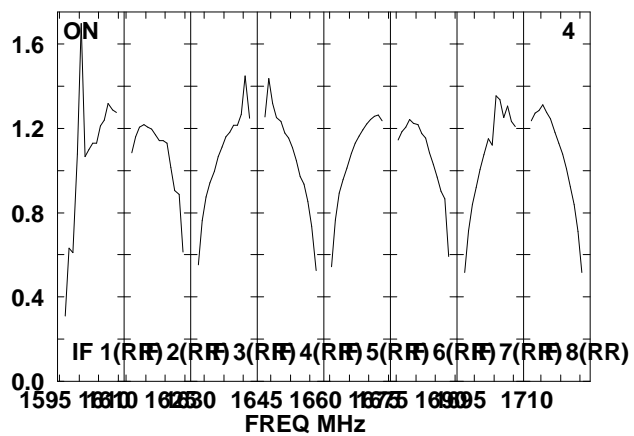
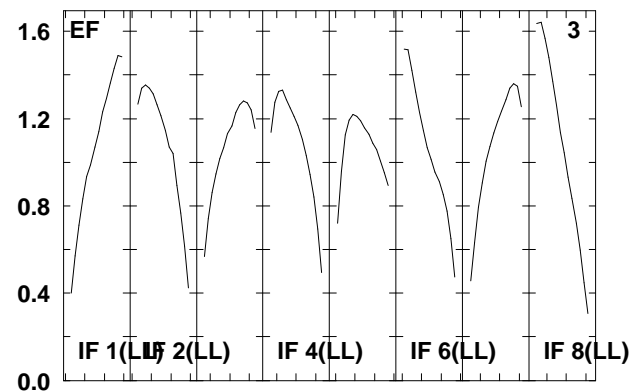
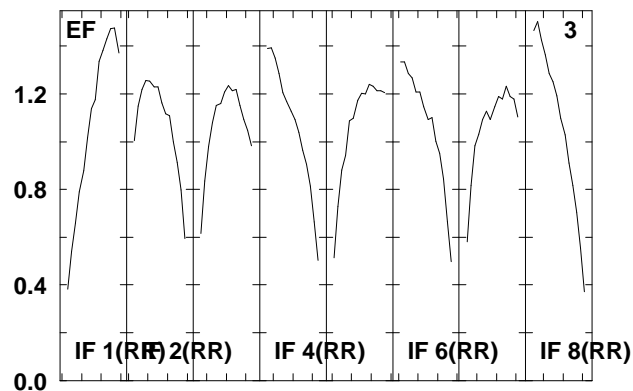
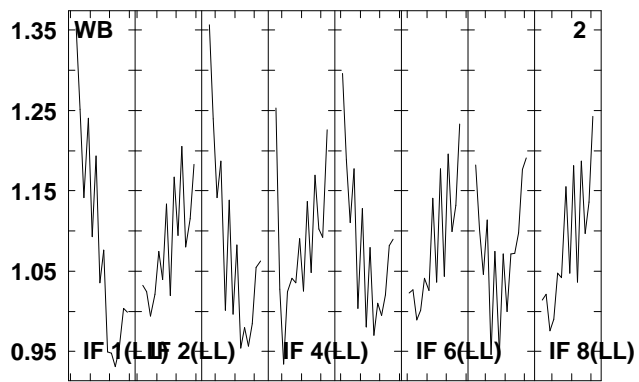
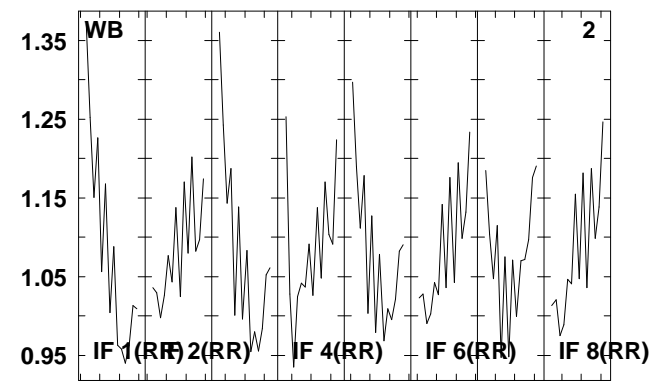
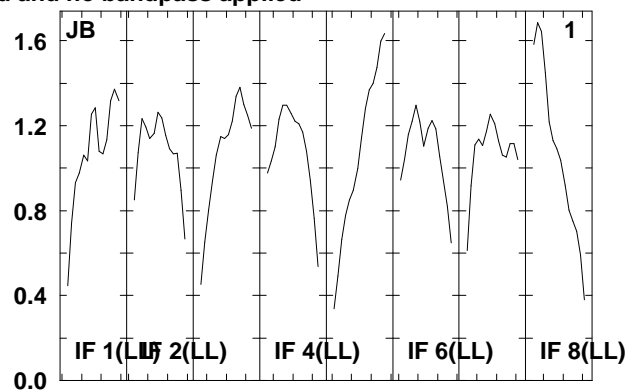
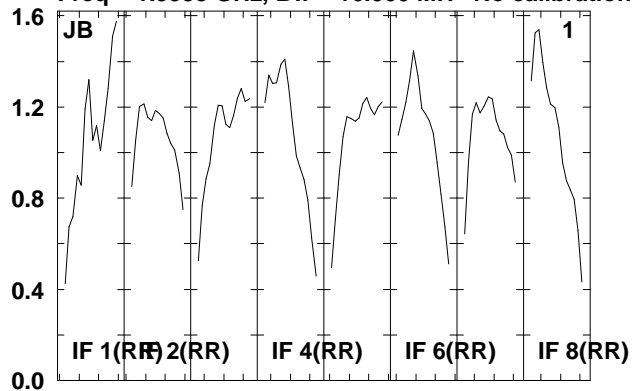

Lower frame: Real Jy  
 Total-power spectrum Antenna: \*  
 Timerange: 00/22:40:49 to 00/22:42:17

Plot file version 152 created 20-AUG-2009 15:00:13

3C274 EG040B.UVDATA.1

Freq = 1.5955 GHz, Bw = 16.000 MH No calibration applied and no bandpass applied

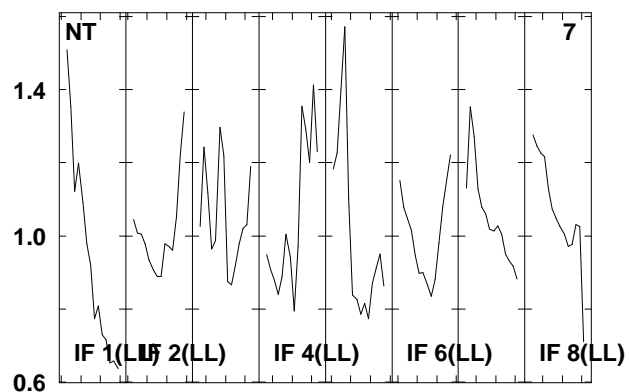
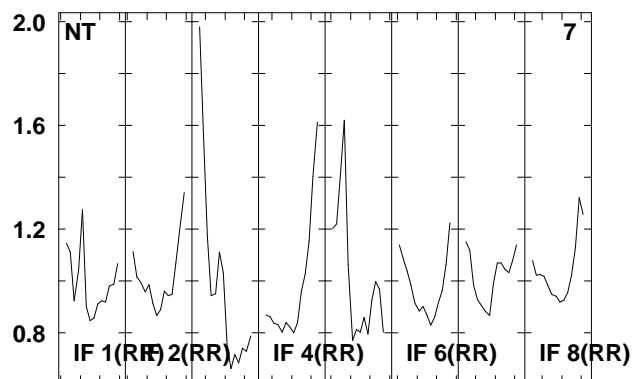
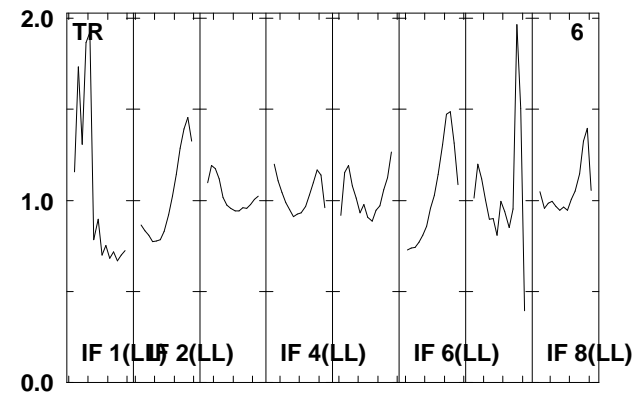
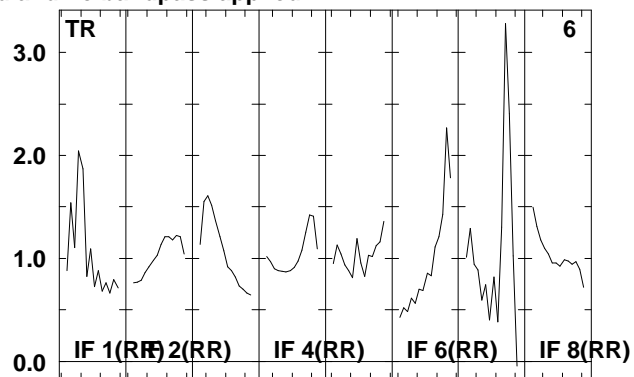
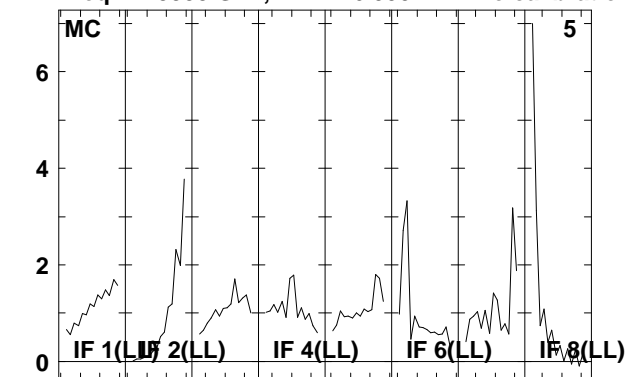

Lower frame: Real Jy  
Total-power spectrum Antenna: \*  
Timerange: 00/22:40:49 to 00/22:42:17



Plot file version 153 created 20-AUG-2009 15:00:13

NGC4639 EG040B.UVDATA.1

Freq = 1.5955 GHz, Bw = 16.000 MH No calibration applied and no bandpass applied

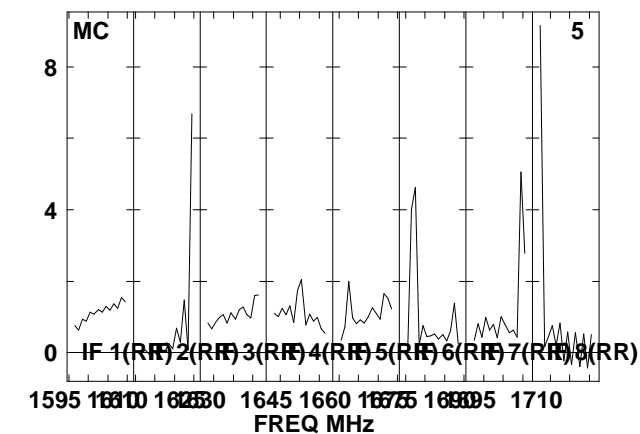
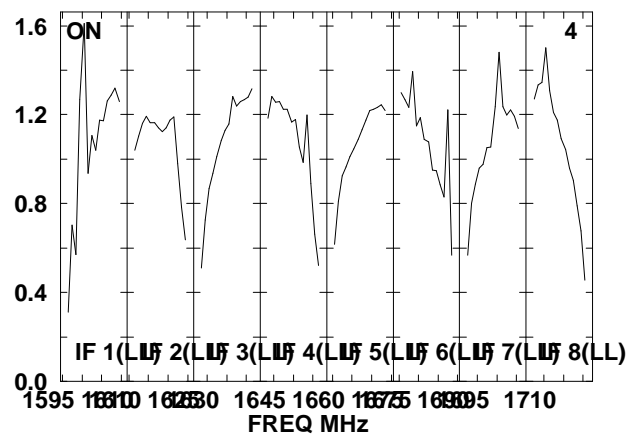
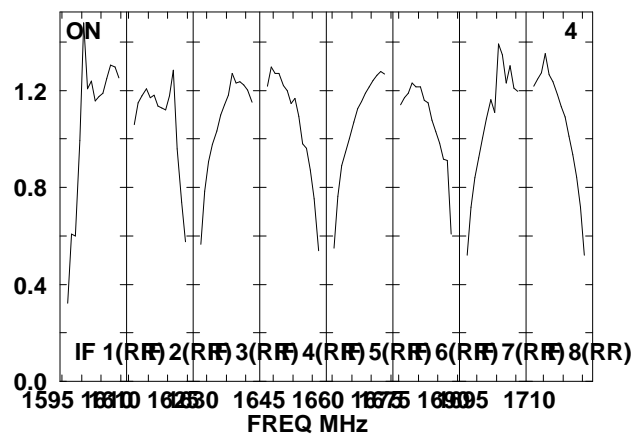
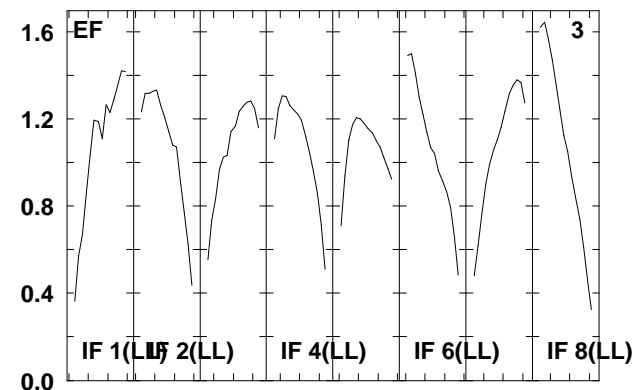
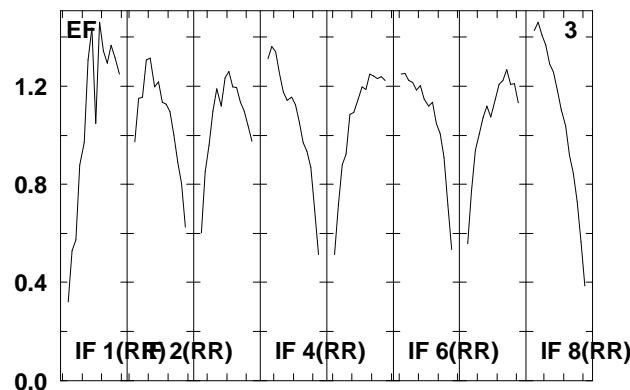
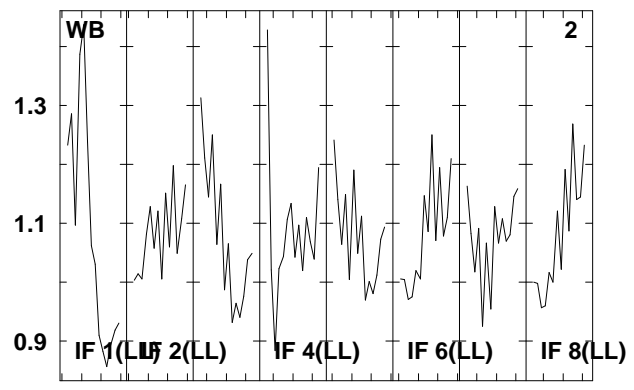
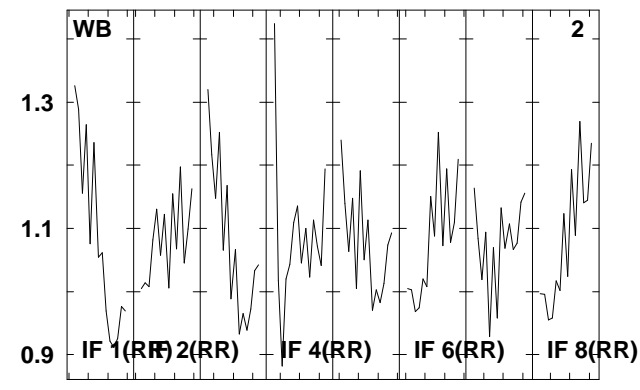
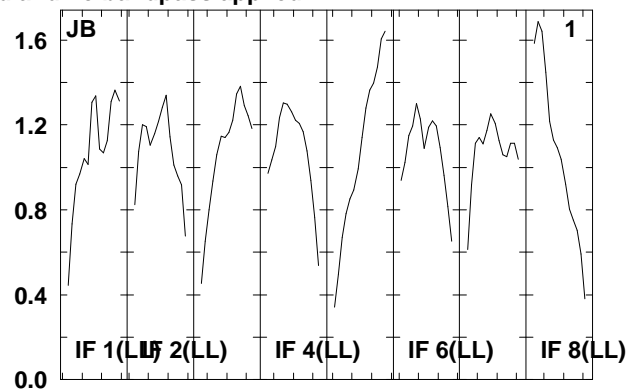
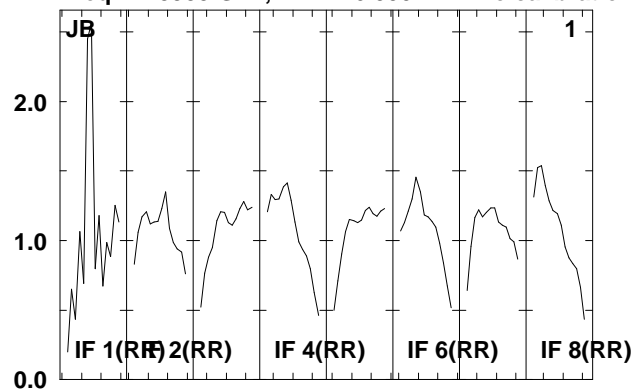

Lower frame: Real Jy  
Total-power spectrum Antenna: \*  
Timerange: 00/22:42:19 to 00/22:46:17

Plot file version 154 created 20-AUG-2009 15:00:13

NGC4639 EG040B.UVDATA.1

Freq = 1.5955 GHz, Bw = 16.000 MH No calibration applied and no bandpass applied

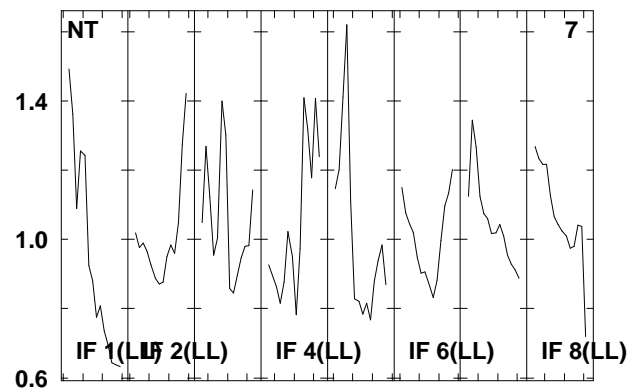
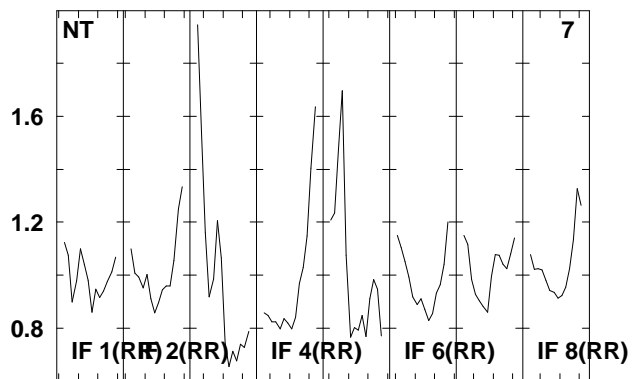
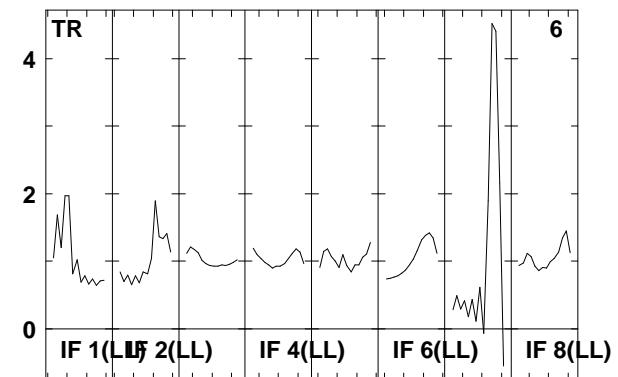
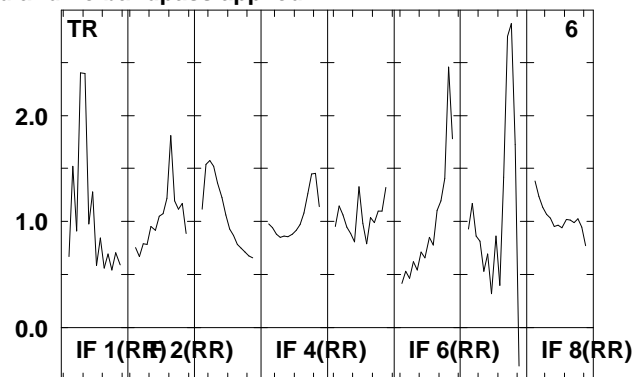
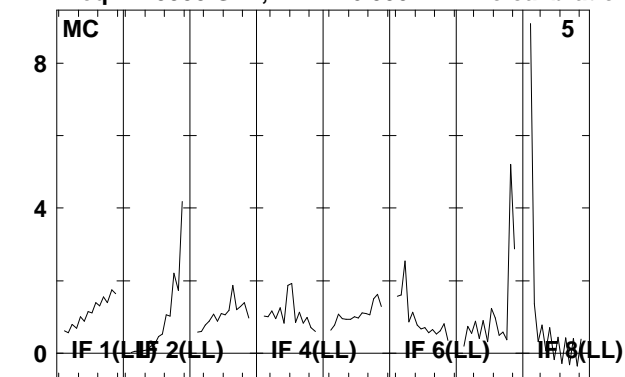

Lower frame: Real Jy  
Total-power spectrum Antenna: \*  
Timerange: 00/22:42:19 to 00/22:46:17

Plot file version 155 created 20-AUG-2009 15:00:14

3C274 EG040B.UVDATA.1

Freq = 1.5955 GHz, Bw = 16.000 MH No calibration applied and no bandpass applied

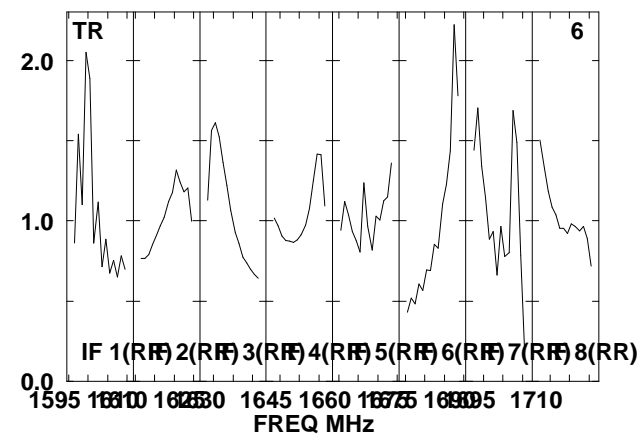
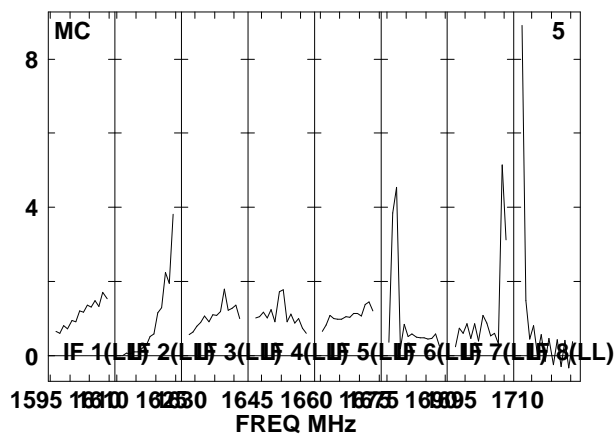
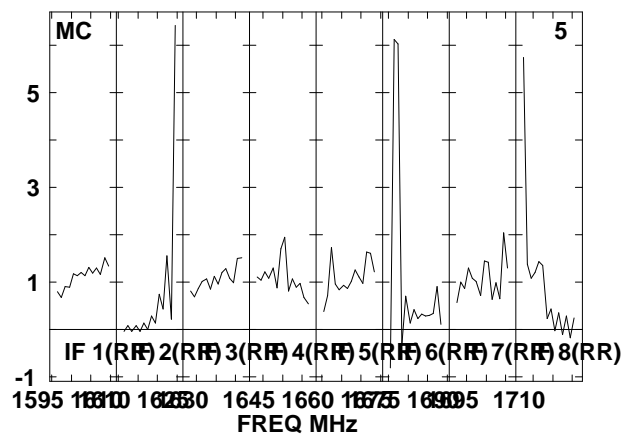
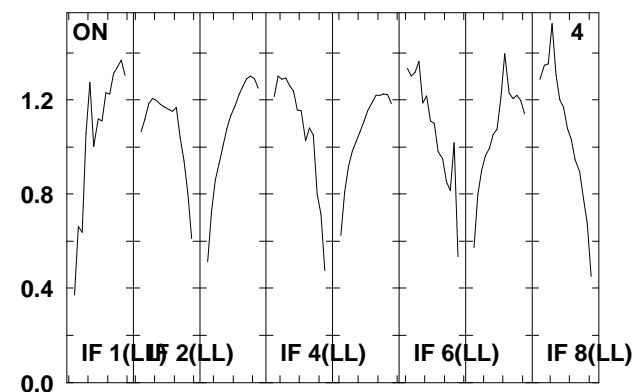
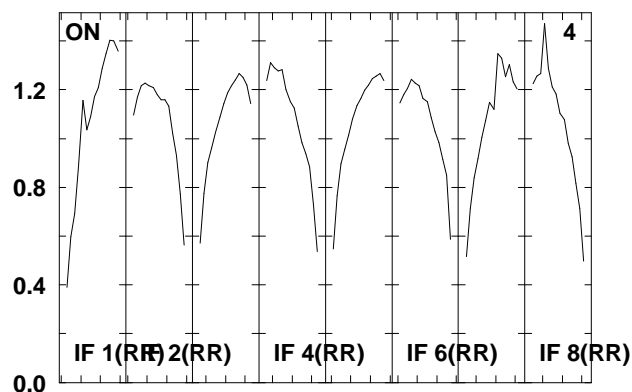
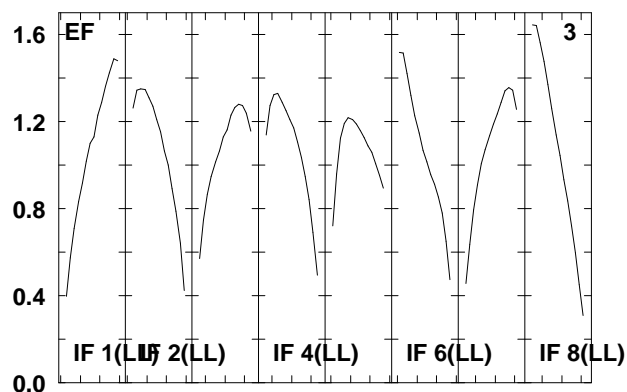
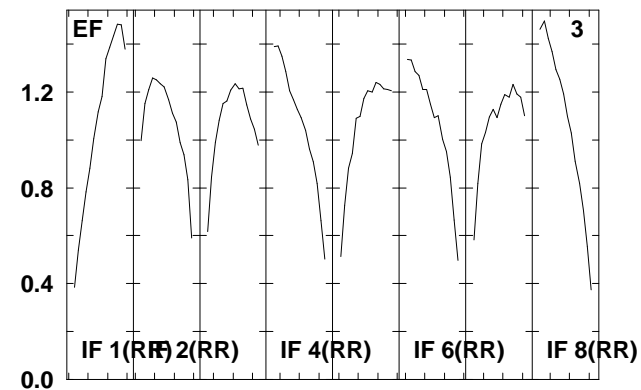
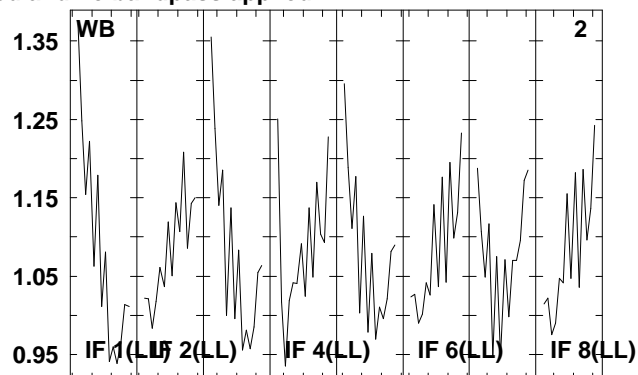
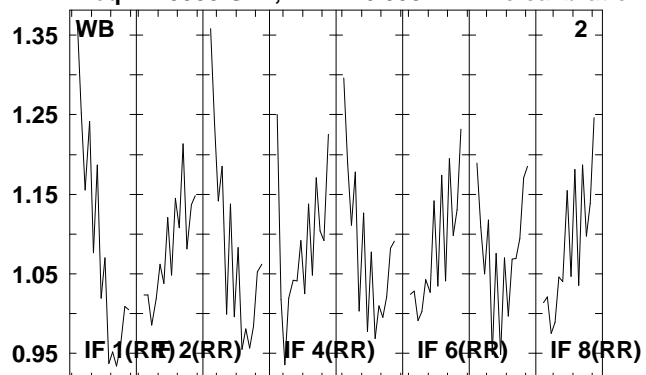

Lower frame: Real Jy  
Total-power spectrum Antenna: \*  
Timerange: 00/22:46:55 to 00/22:48:21

Plot file version 156 created 20-AUG-2009 15:00:14

3C274 EG040B.UVDATA.1

Freq = 1.5955 GHz, Bw = 16.000 MH No calibration applied and no bandpass applied

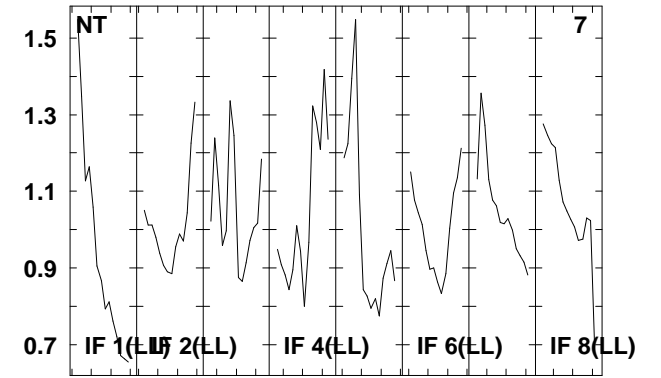
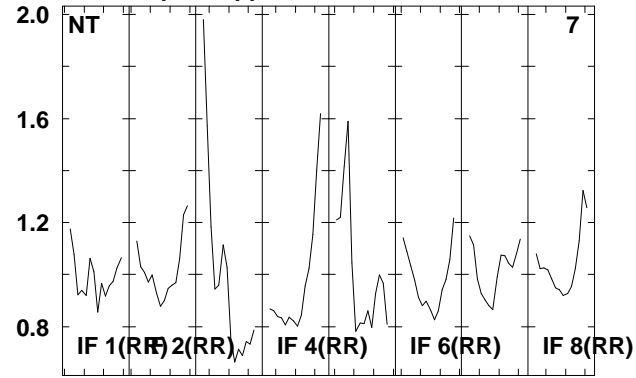
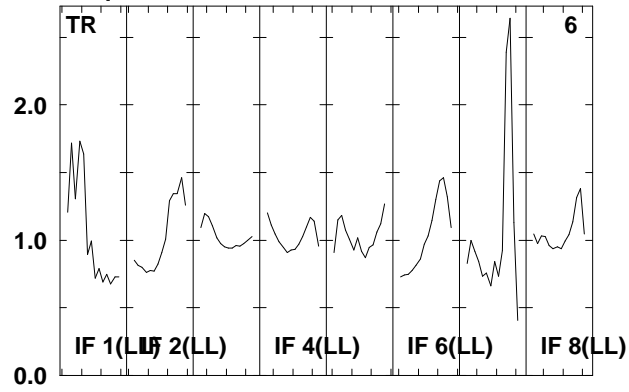

Lower frame: Real Jy  
Total-power spectrum Antenna: \*  
Timerange: 00/22:46:55 to 00/22:48:21

Plot file version 157 created 20-AUG-2009 15:00:14

NGC4639 EG040B.UVDATA.1

Freq = 1.5955 GHz, Bw = 16.000 MH No calibration applied and no bandpass applied

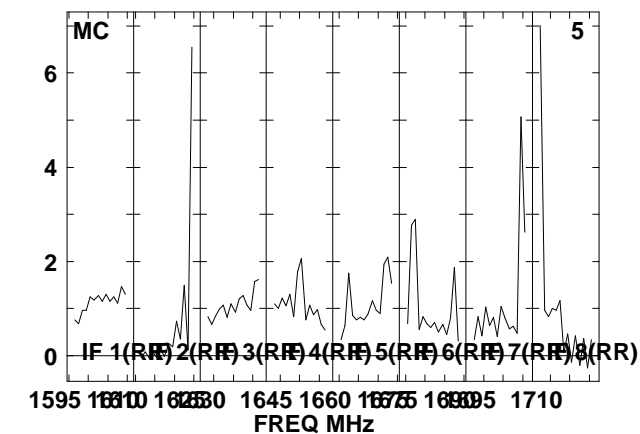
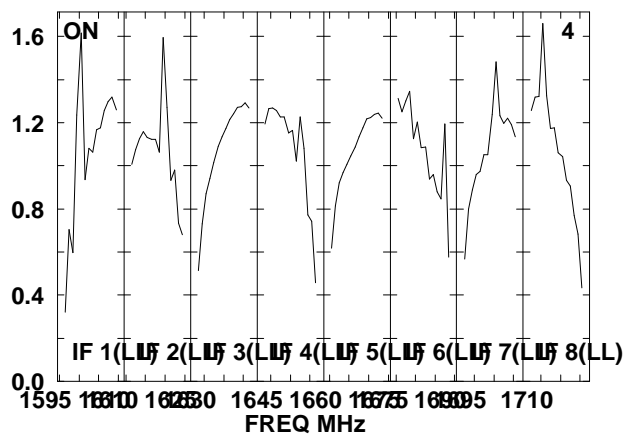
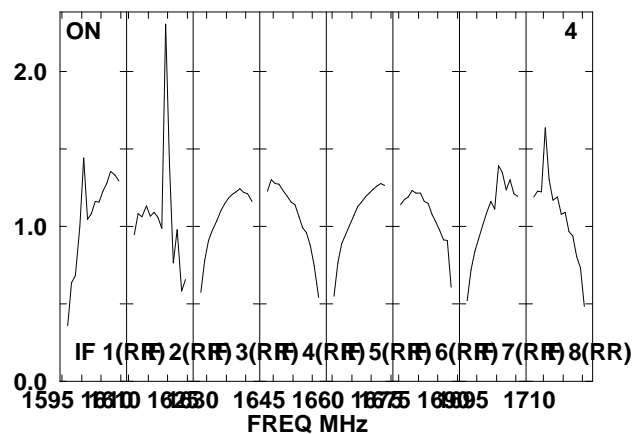
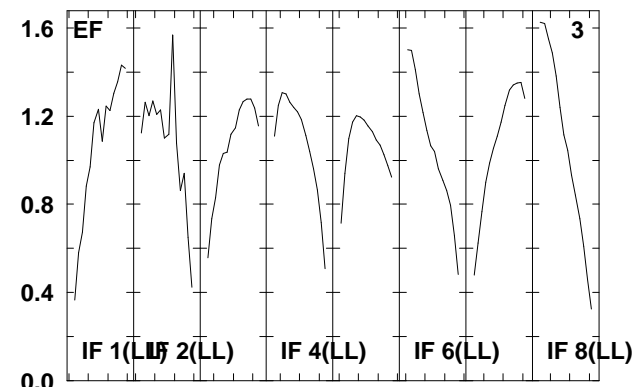
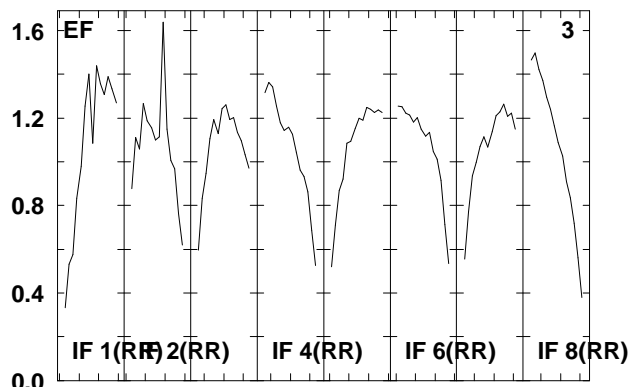
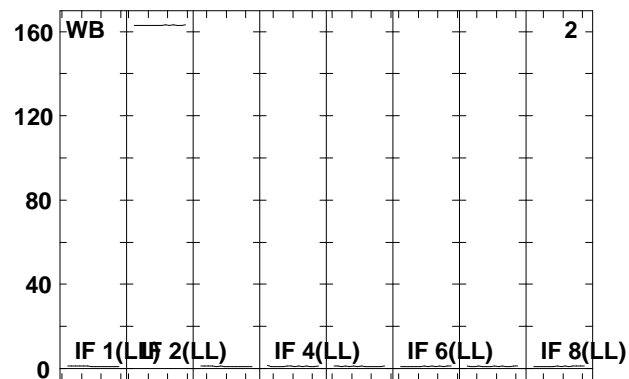
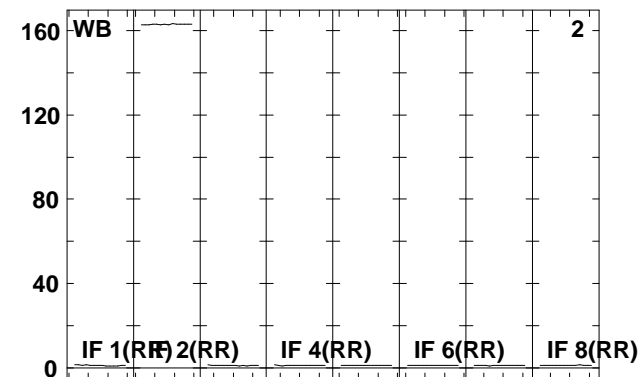
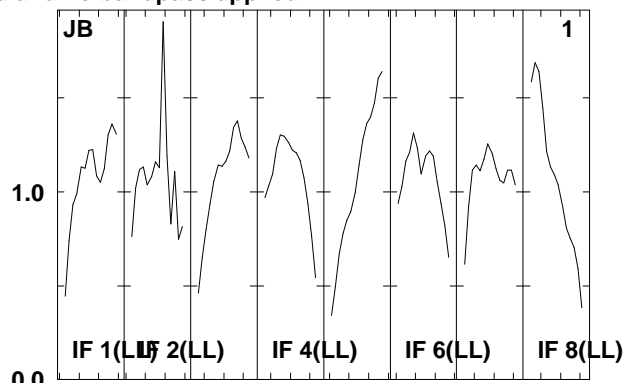
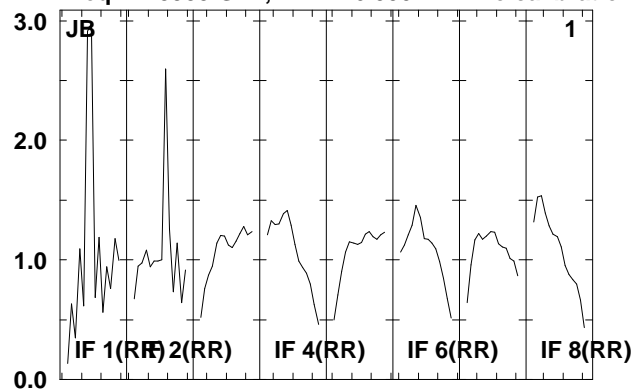

Lower frame: Real Jy

Total-power spectrum Antenna: \*

Timerange: 00/22:48:23 to 00/22:52:21

Plot file version 158 created 20-AUG-2009 15:00:15

NGC4639 EG040B.UVDATA.1

Freq = 1.5955 GHz, Bw = 16.000 MH No calibration applied and no bandpass applied

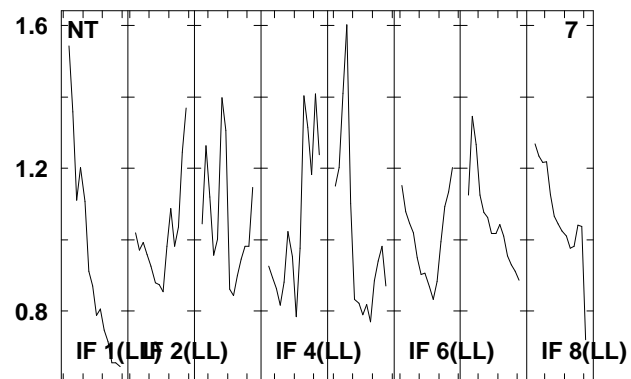
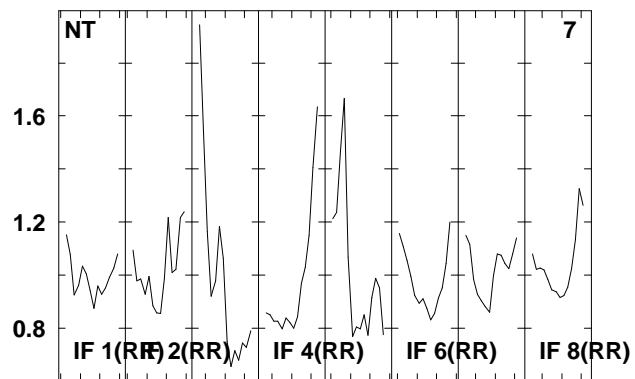
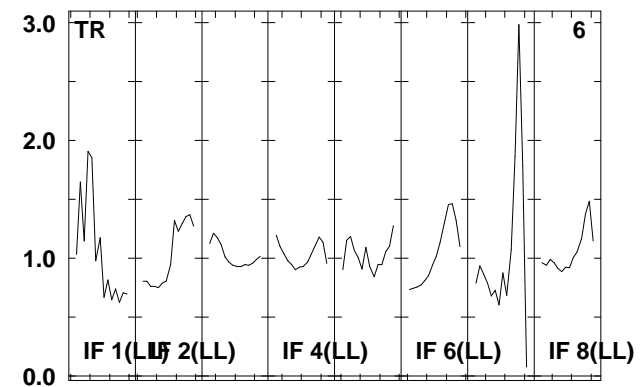
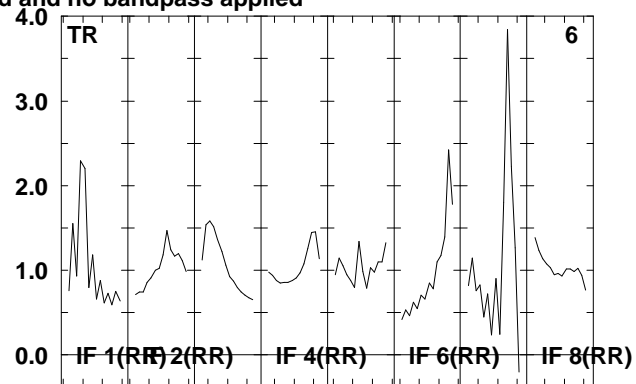
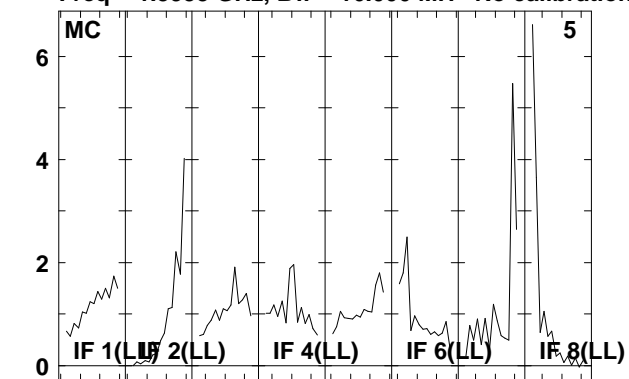

Lower frame: Real Jy  
Total-power spectrum Antenna: \*  
Timerange: 00/22:48:23 to 00/22:52:21

Plot file version 159 created 20-AUG-2009 15:00:15  
 3C274 EG040B.UVDATA.1  
 Freq = 1.5955 GHz, Bw = 16.000 MH No calibration applied and no bandpass applied

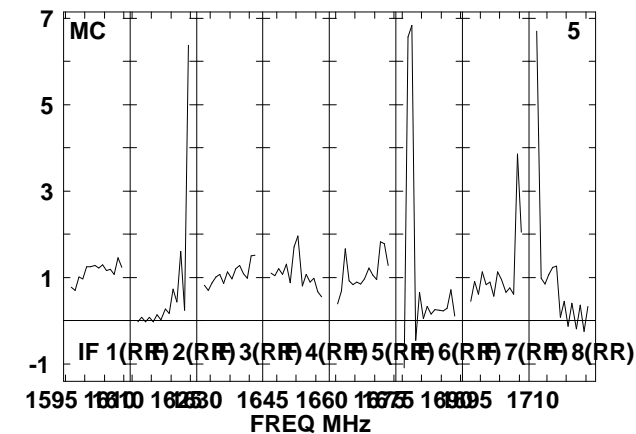
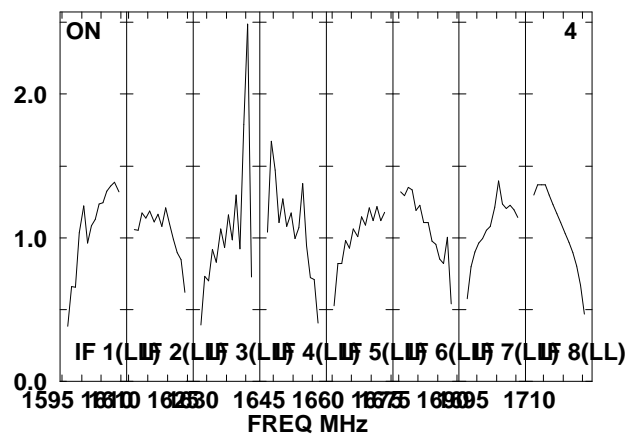
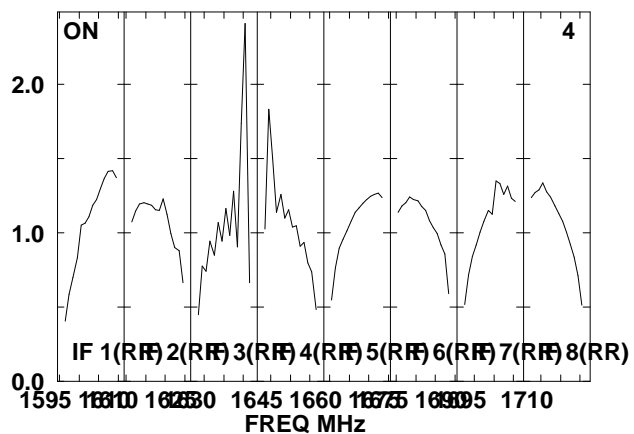
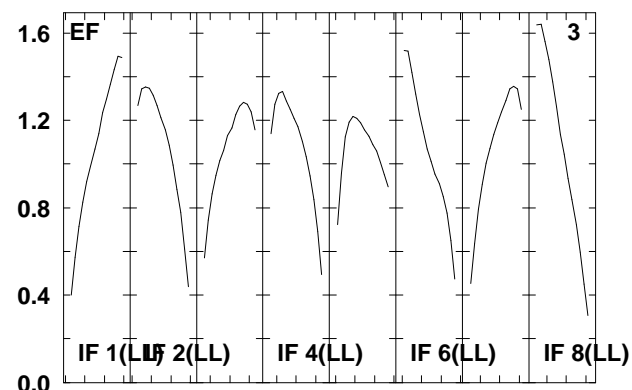
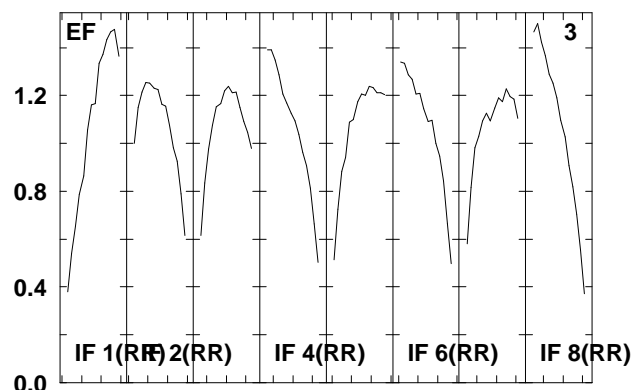
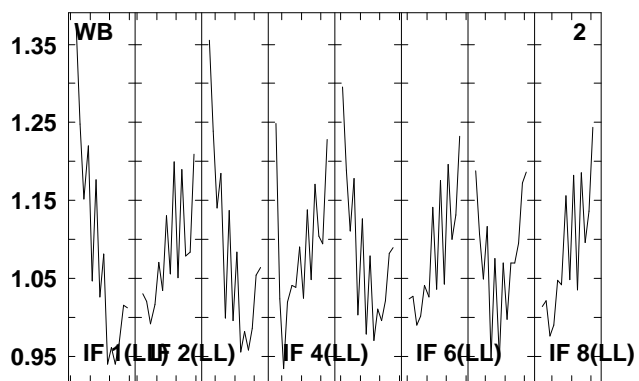
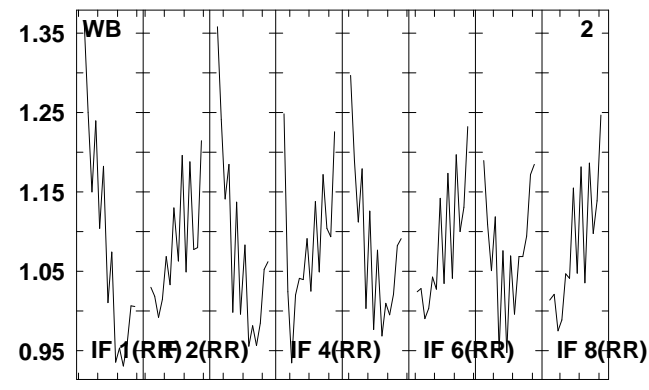
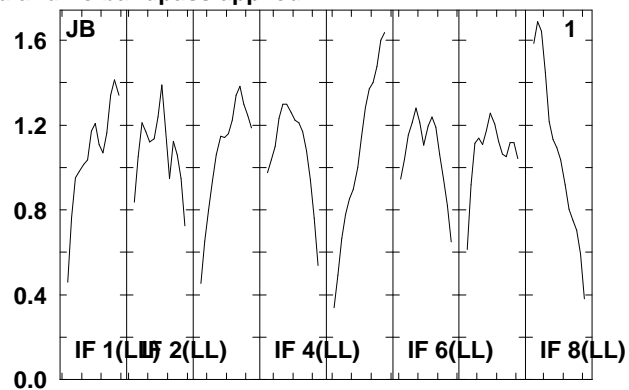
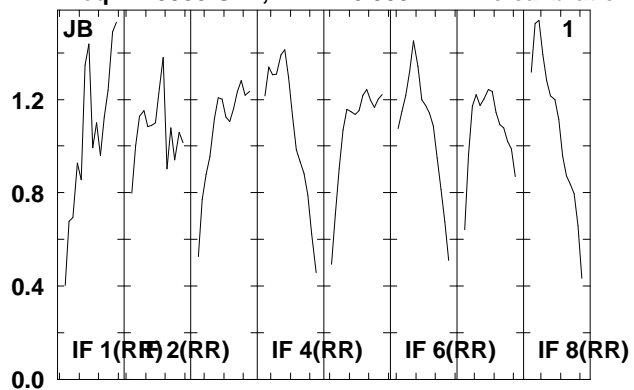

Lower frame: Real Jy  
 Total-power spectrum Antenna: \*  
 Timerange: 00/22:52:23 to 00/22:54:21

Plot file version 160 created 20-AUG-2009 15:00:15

3C274 EG040B.UVDATA.1

Freq = 1.5955 GHz, Bw = 16.000 MH No calibration applied and no bandpass applied

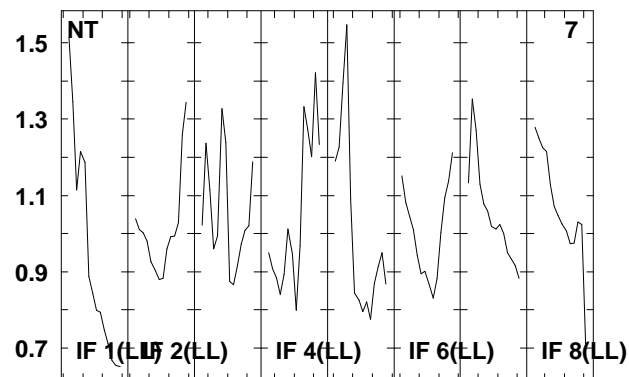
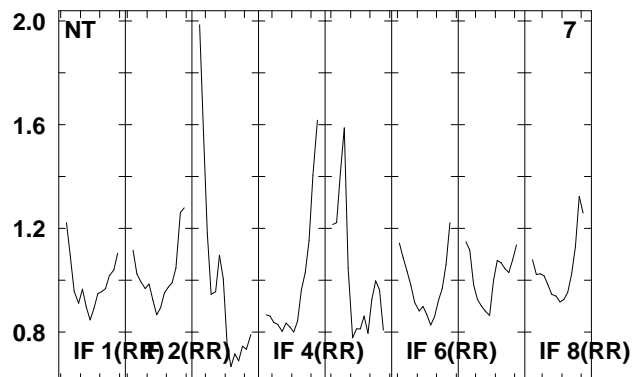
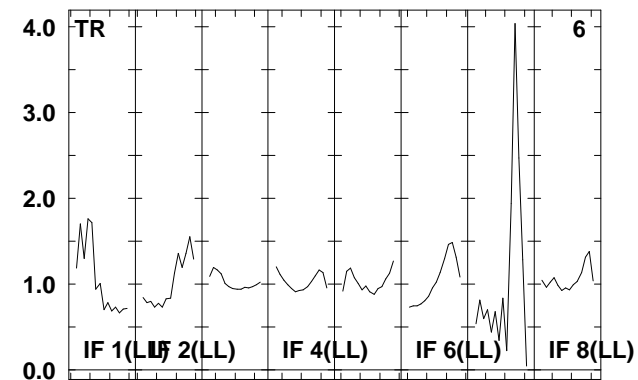
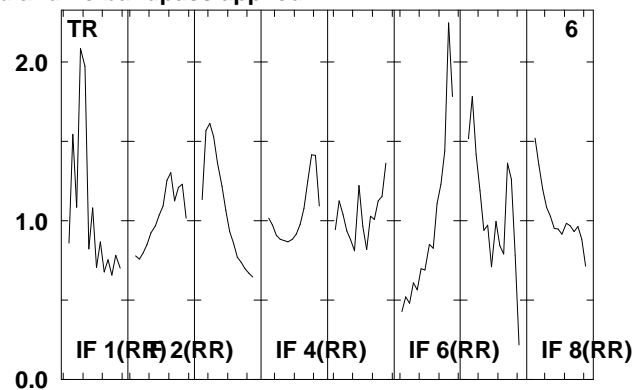
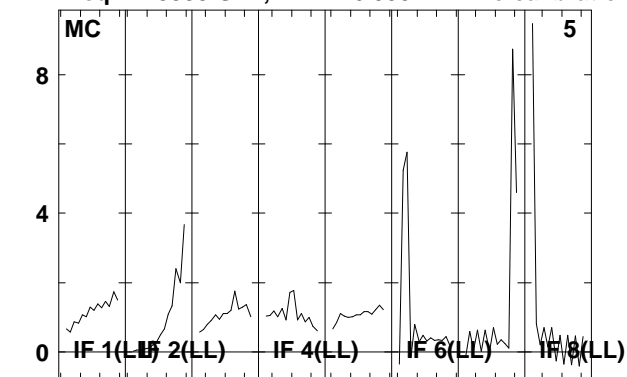

Lower frame: Real Jy  
Total-power spectrum Antenna: \*  
Timerange: 00/22:52:23 to 00/22:54:21



Plot file version 161 created 20-AUG-2009 15:00:15

NGC4639 EG040B.UVDATA.1

Freq = 1.5955 GHz, Bw = 16.000 MH No calibration applied and no bandpass applied

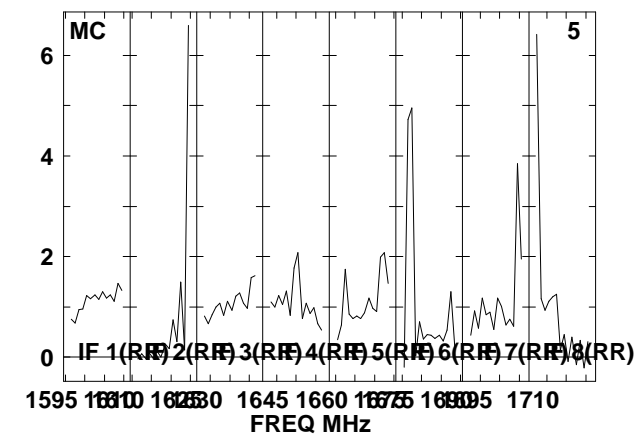
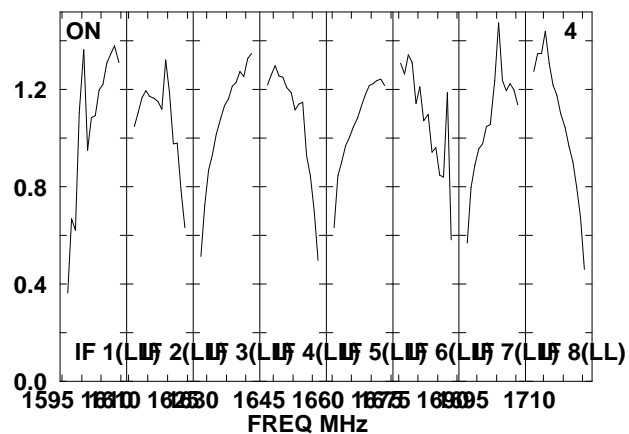
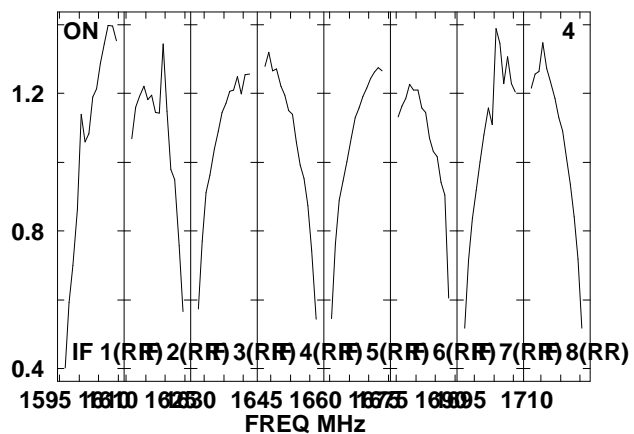
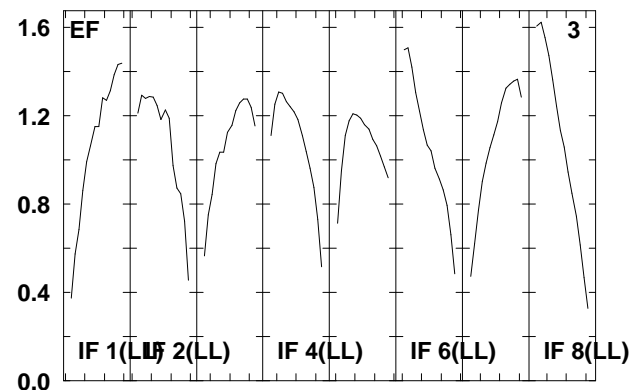
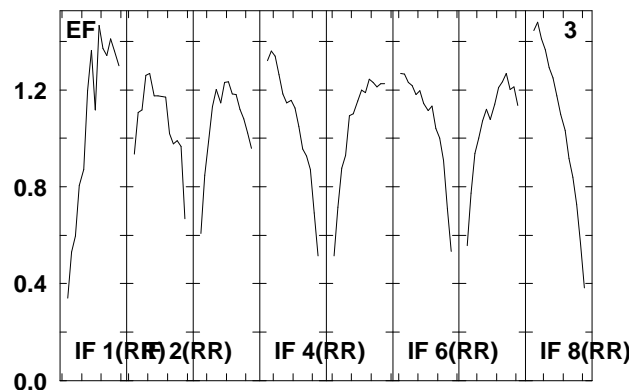
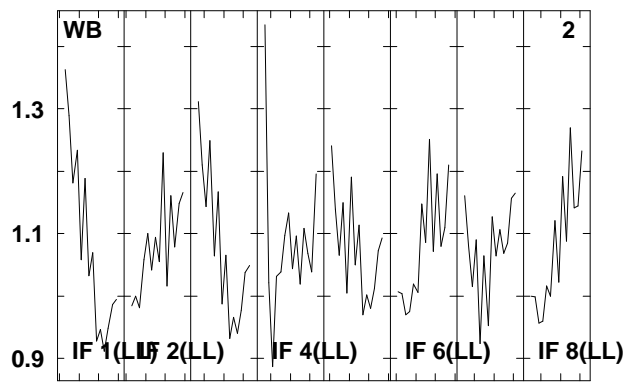
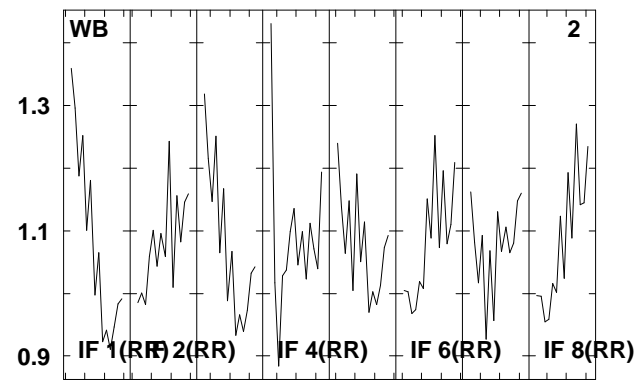
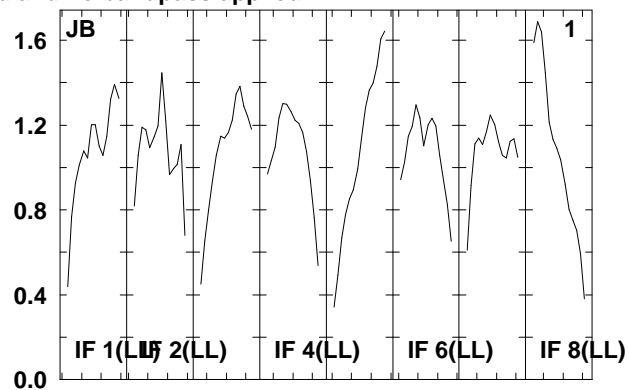
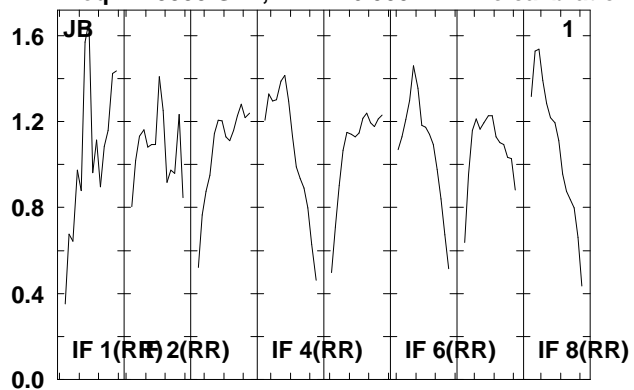

Lower frame: Real Jy  
Total-power spectrum Antenna: \*  
Timerange: 00/22:54:23 to 00/22:58:19

Plot file version 162 created 20-AUG-2009 15:00:16

NGC4639 EG040B.UVDATA.1

Freq = 1.5955 GHz, Bw = 16.000 MH No calibration applied and no bandpass applied

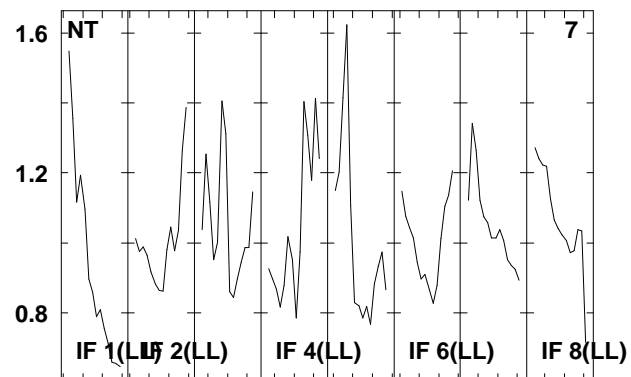
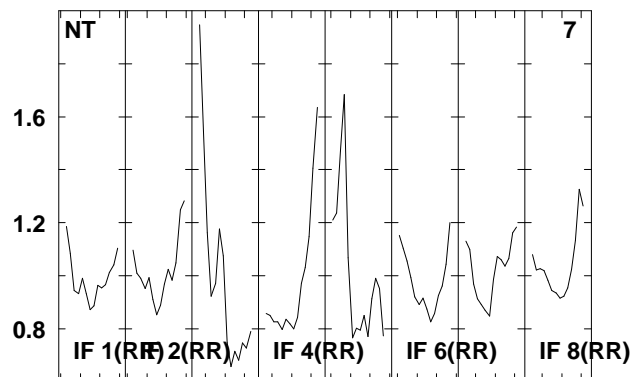
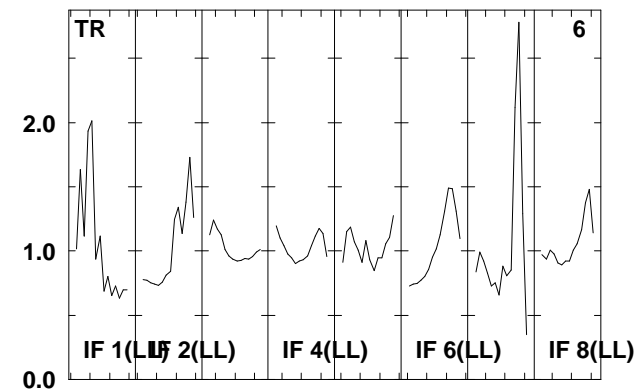
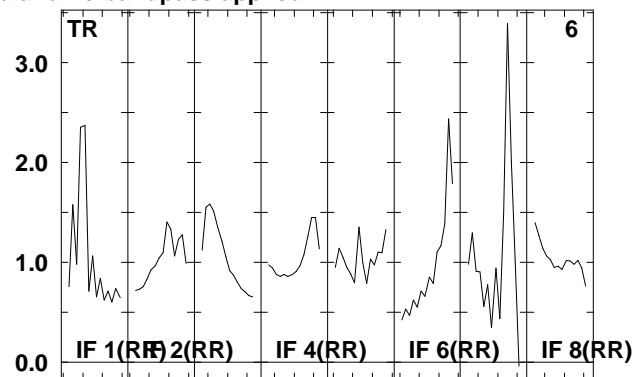
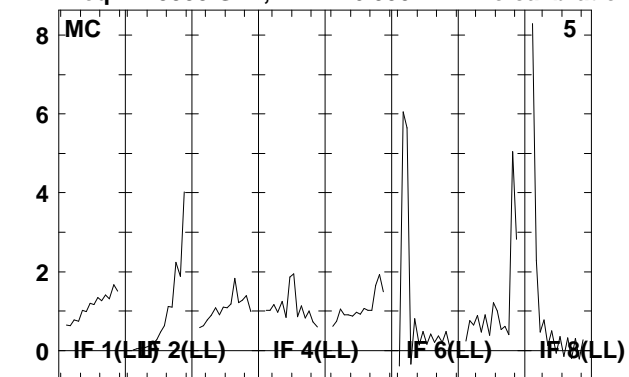

Lower frame: Real Jy

Total-power spectrum Antenna: \*

Timerange: 00/22:54:23 to 00/22:58:19

Plot file version 163 created 20-AUG-2009 15:00:16

3C274 EG040B.UVDATA.1

Freq = 1.5955 GHz, Bw = 16.000 MH No calibration applied and no bandpass applied

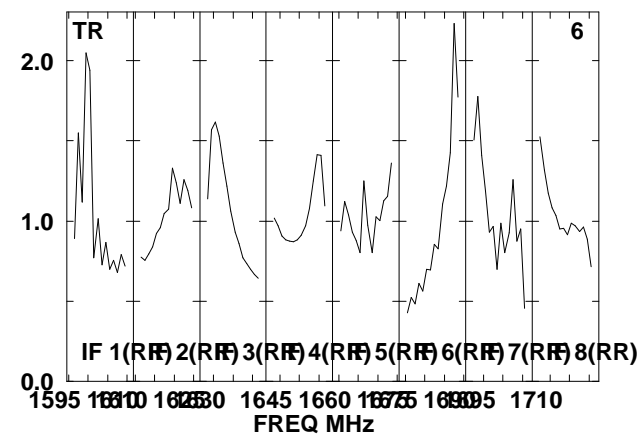
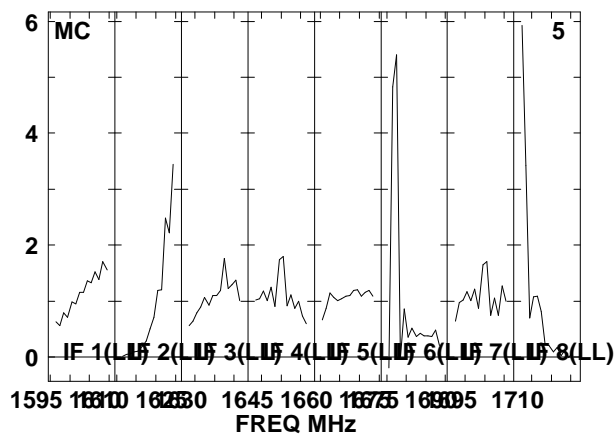
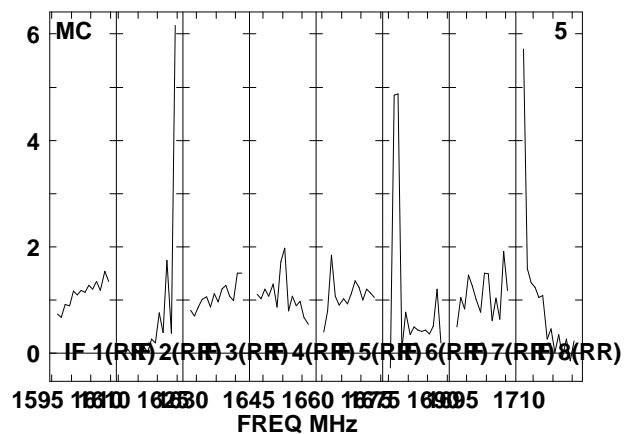
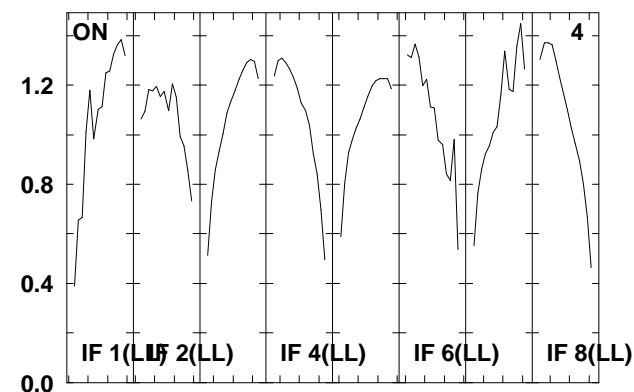
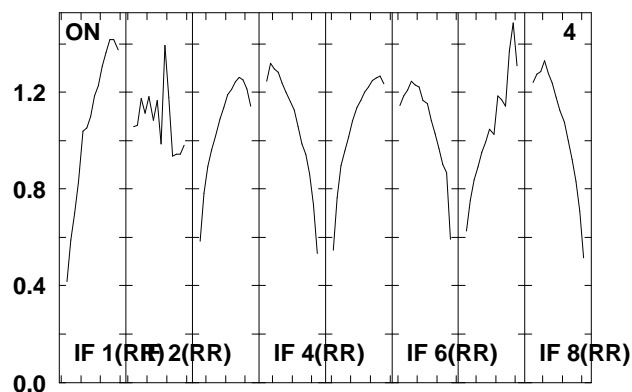
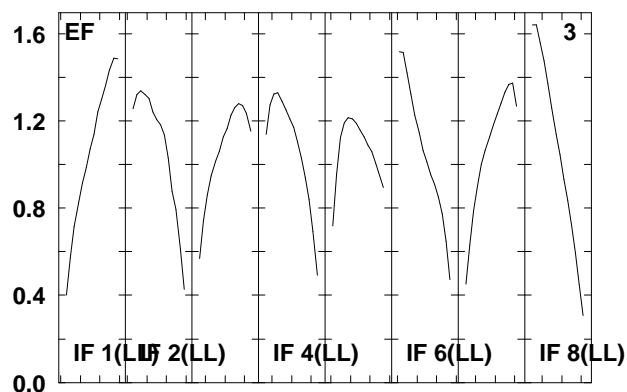
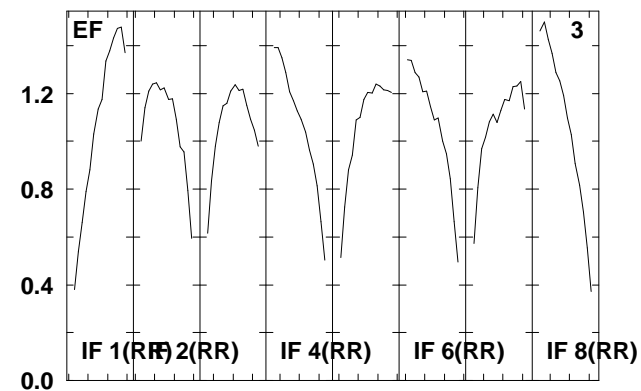
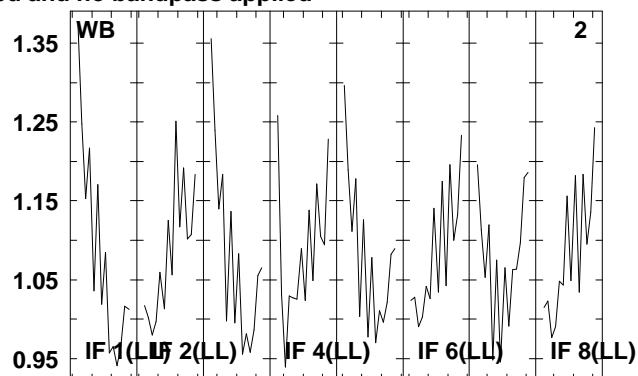
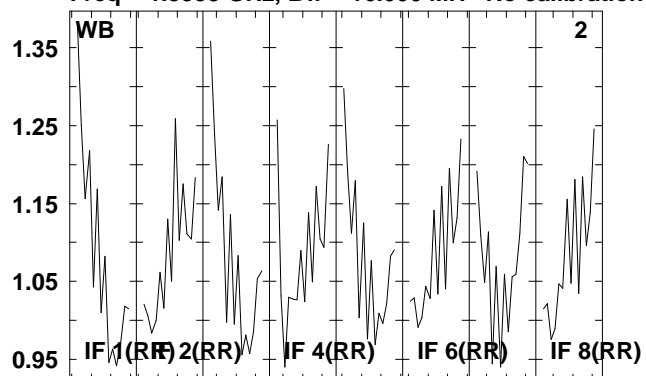

Lower frame: Real Jy

Total-power spectrum Antenna: \*

Timerange: 00/22:58:59 to 00/23:00:25

Plot file version 164 created 20-AUG-2009 15:00:16

3C274 EG040B.UVDATA.1

Freq = 1.5955 GHz, Bw = 16.000 MH No calibration applied and no bandpass applied

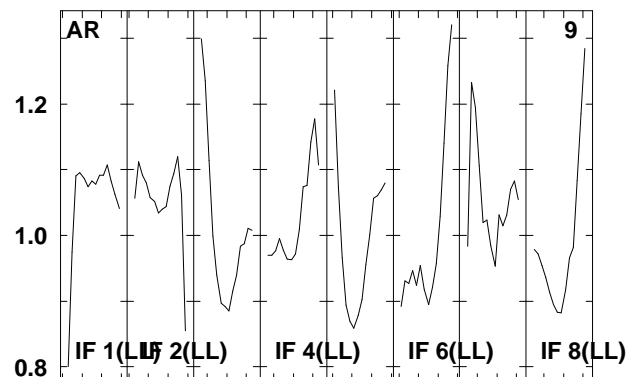
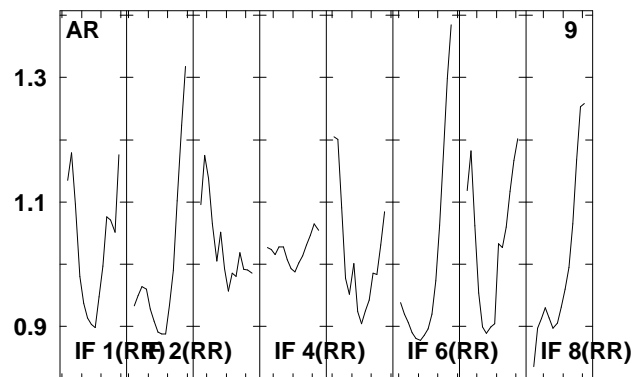
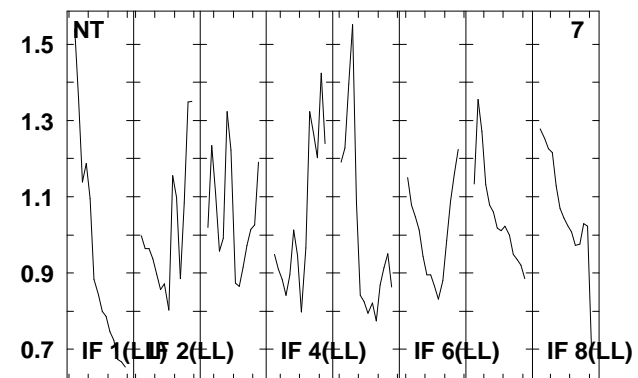
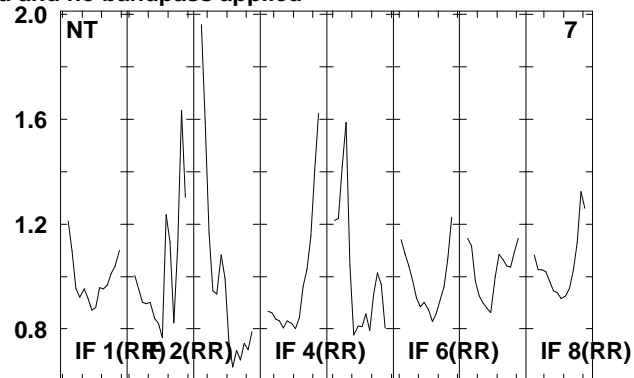
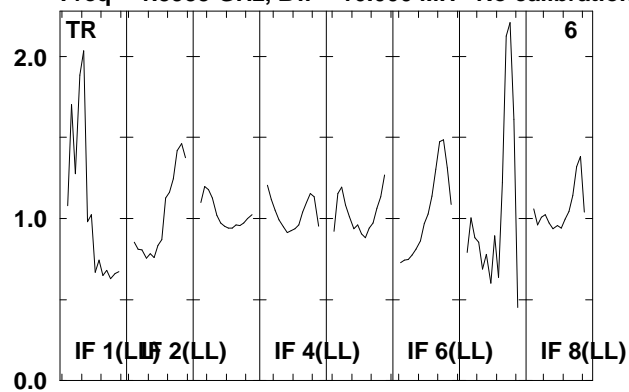

Lower frame: Real Jy  
Total-power spectrum Antenna: \*  
Timerange: 00/22:58:59 to 00/23:00:25

Plot file version 165 created 20-AUG-2009 15:00:17

NGC4639 EG040B.UVDATA.1

Freq = 1.5955 GHz, Bw = 16.000 MH No calibration applied and no bandpass applied

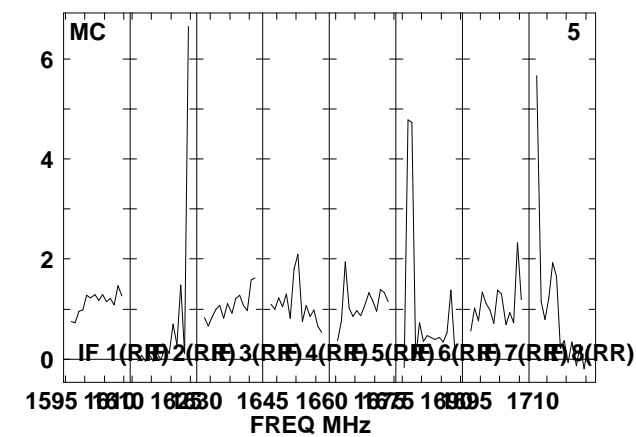
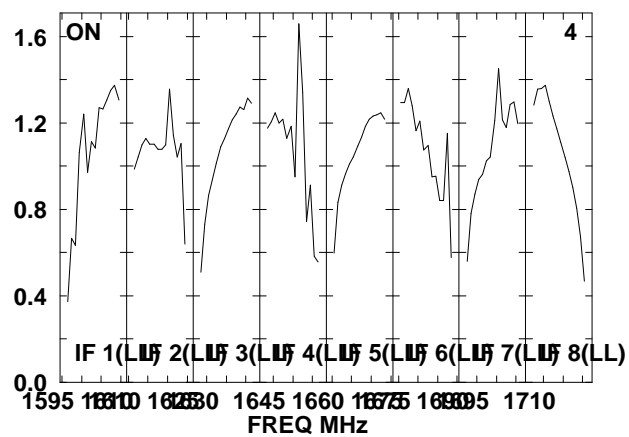
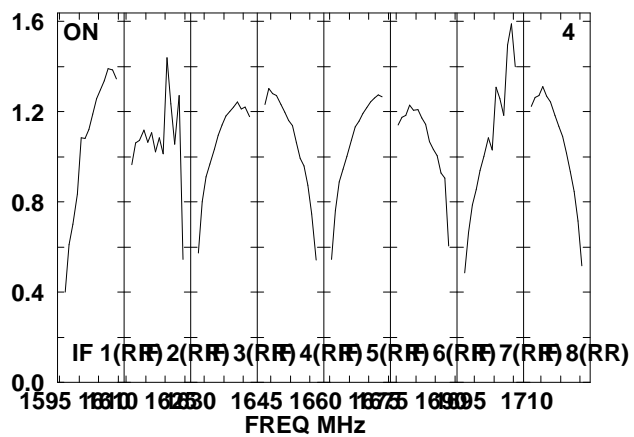
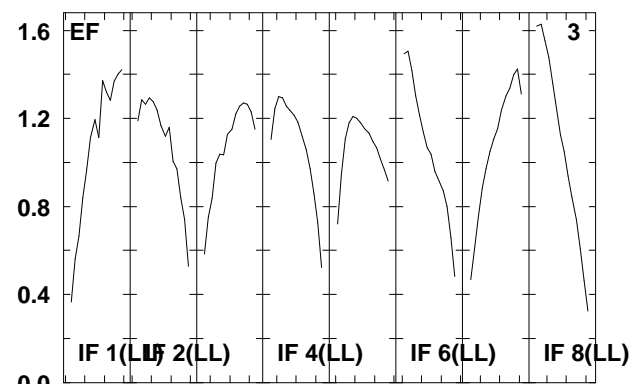
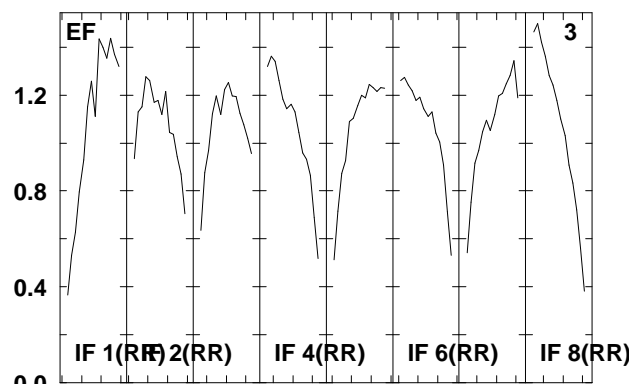
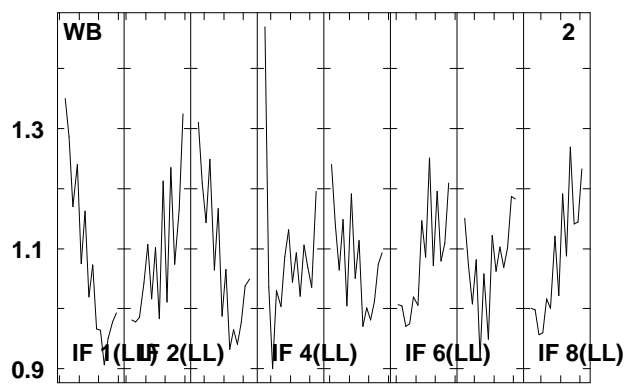
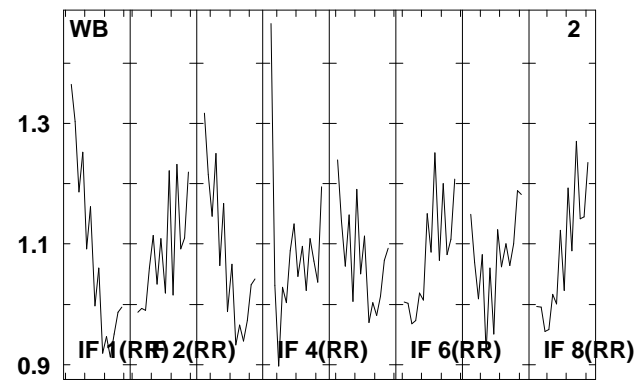
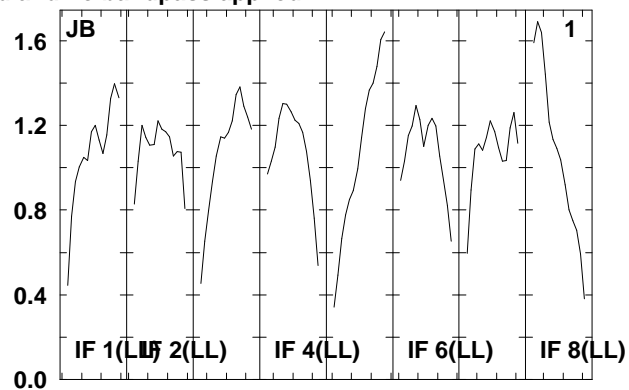
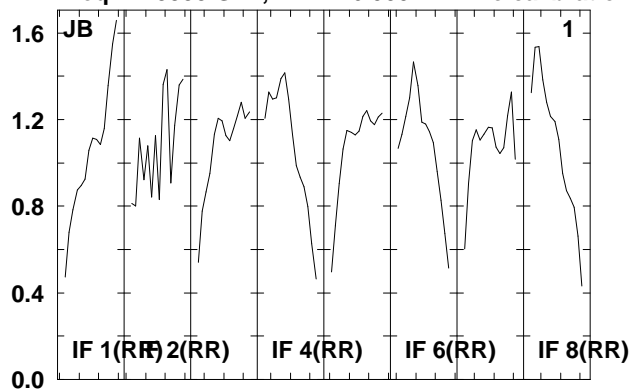

Lower frame: Real Jy  
Total-power spectrum Antenna: \*  
Timerange: 00/23:00:29 to 00/23:04:27

Plot file version 166 created 20-AUG-2009 15:00:17

NGC4639 EG040B.UVDATA.1

Freq = 1.5955 GHz, Bw = 16.000 MH No calibration applied and no bandpass applied

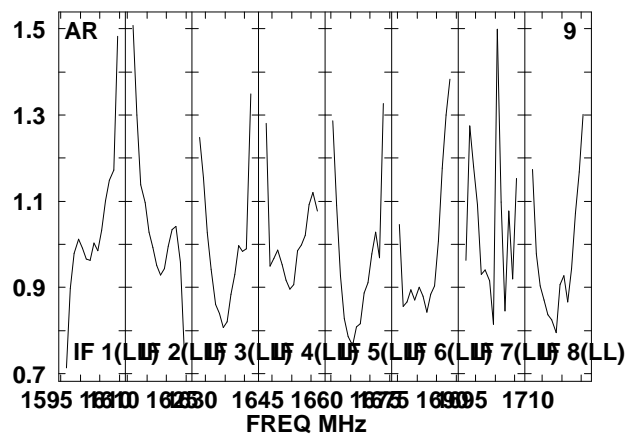
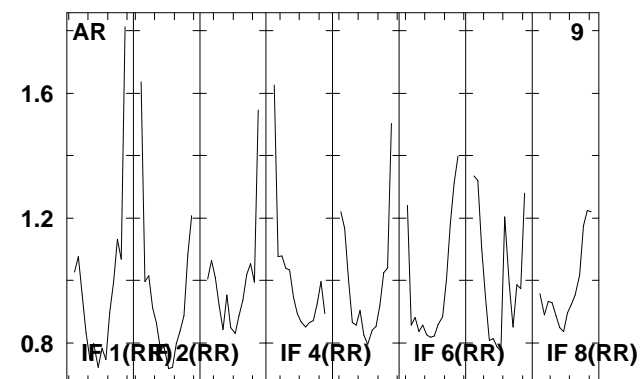
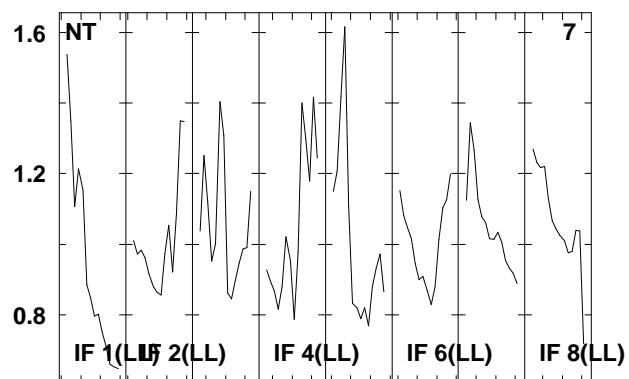
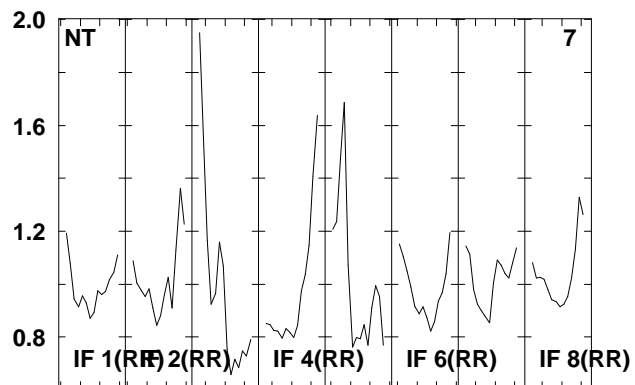
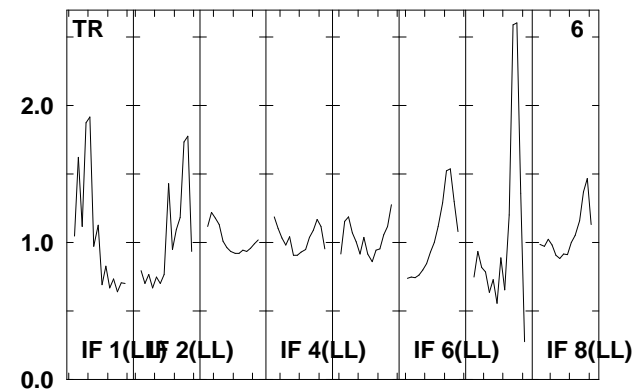
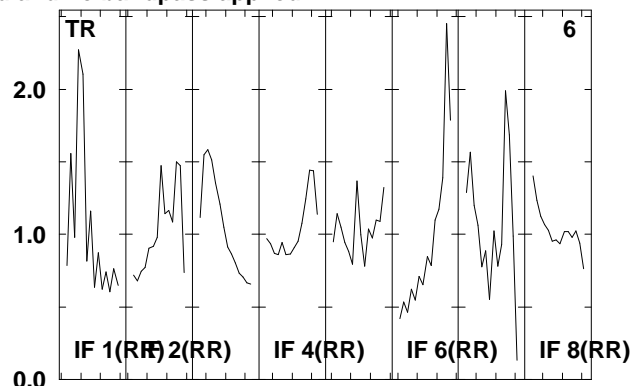
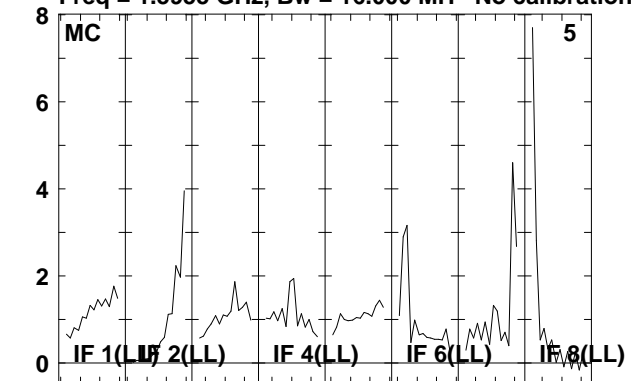

Lower frame: Real Jy

Total-power spectrum Antenna: \*

Timerange: 00/23:00:29 to 00/23:04:27

Plot file version 167 created 20-AUG-2009 15:00:17  
 3C274 EG040B.UVDATA.1  
 Freq = 1.5955 GHz, Bw = 16.000 MH No calibration applied and no bandpass applied

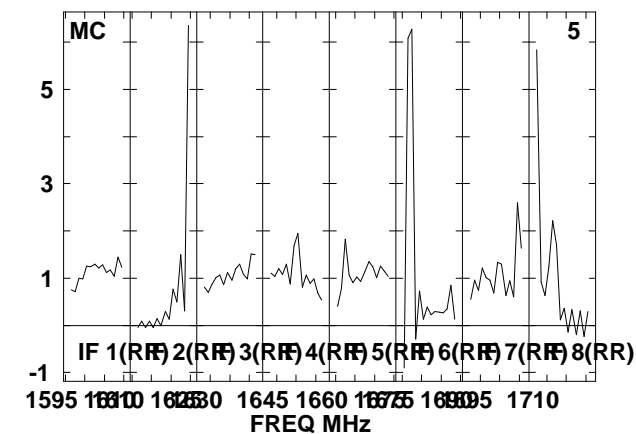
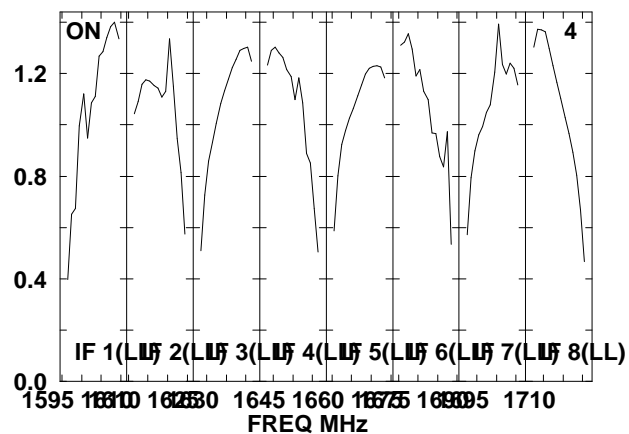
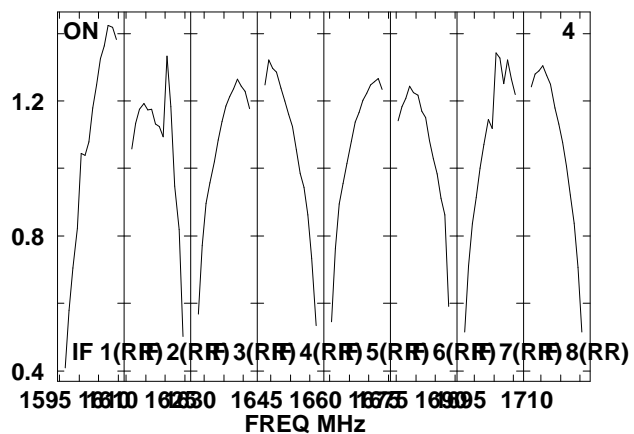
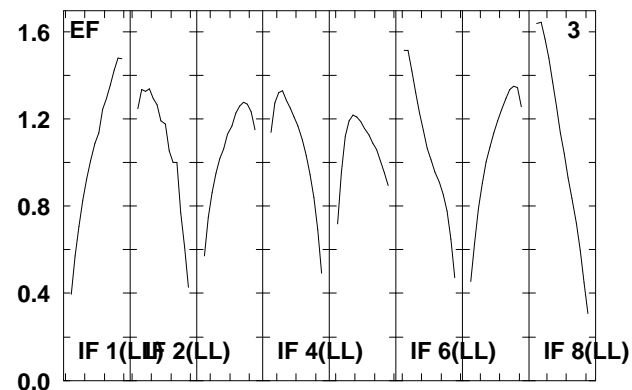
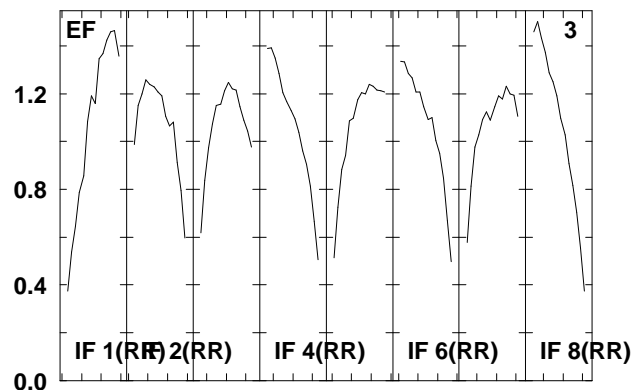
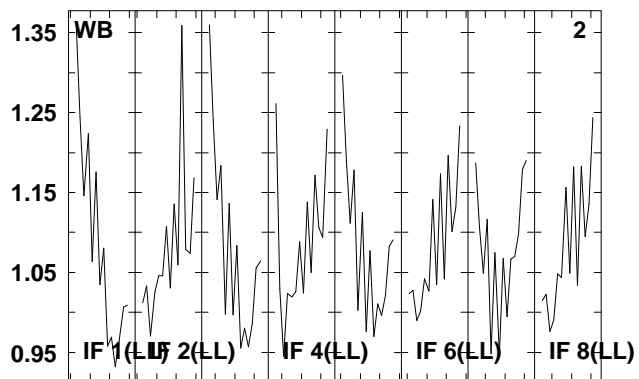
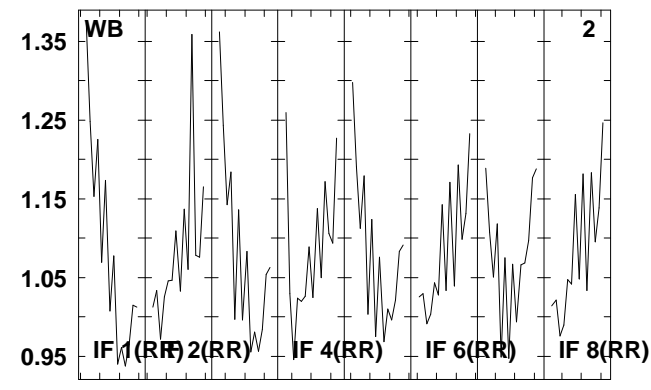
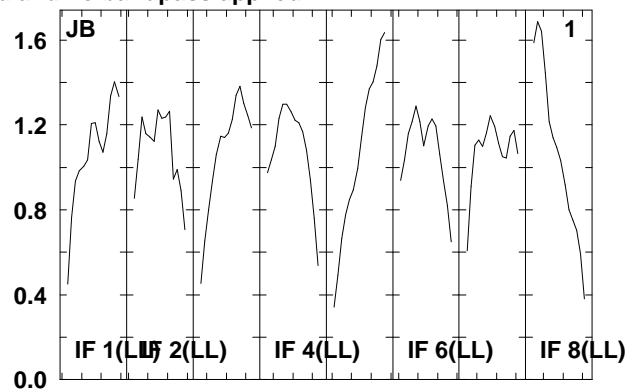
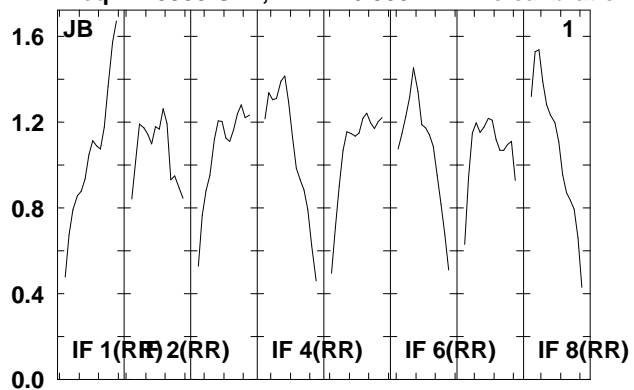

Lower frame: Real Jy  
 Total-power spectrum Antenna: \*  
 Timerange: 00/23:04:29 to 00/23:06:27

Plot file version 168 created 20-AUG-2009 15:00:18

3C274 EG040B.UVDATA.1

Freq = 1.5955 GHz, Bw = 16.000 MH No calibration applied and no bandpass applied

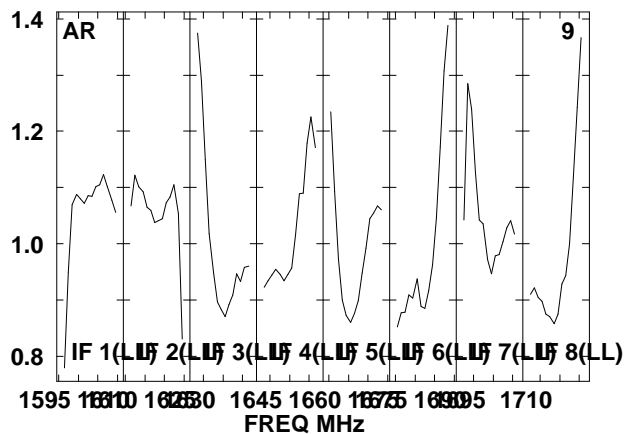
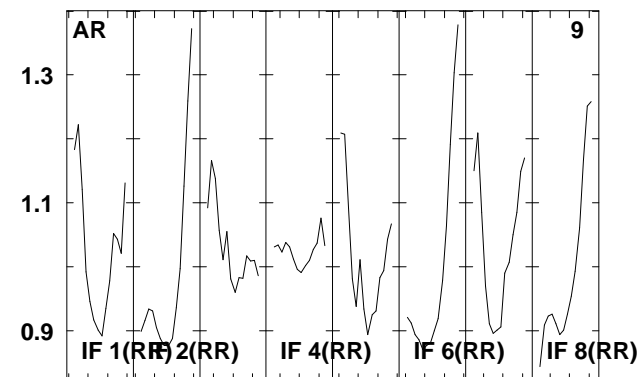
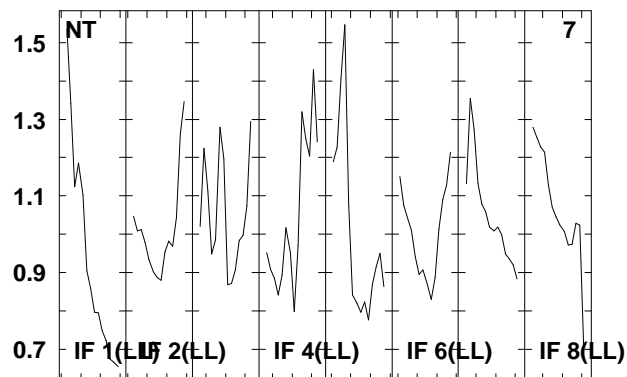
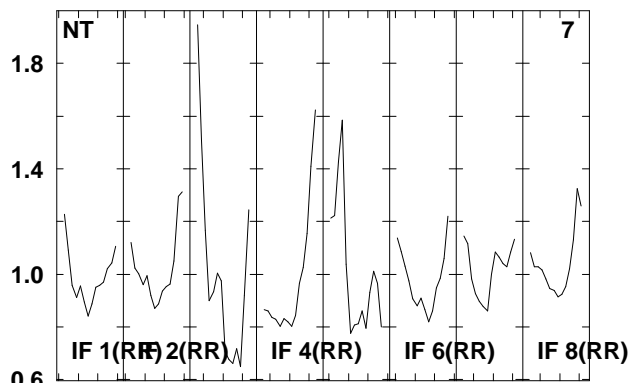
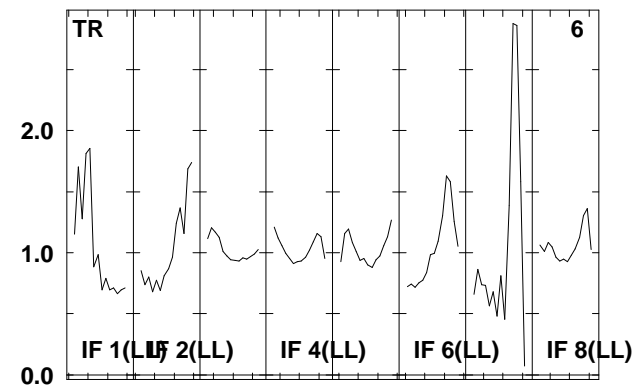
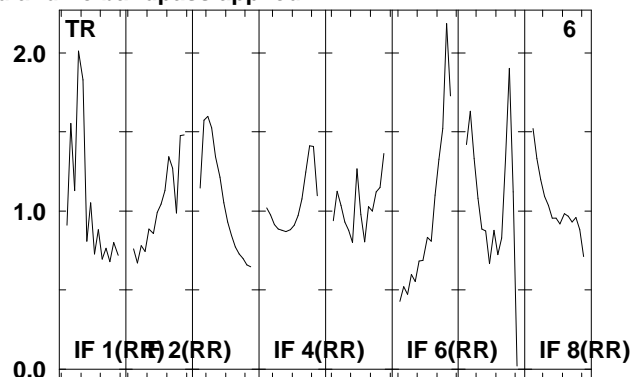
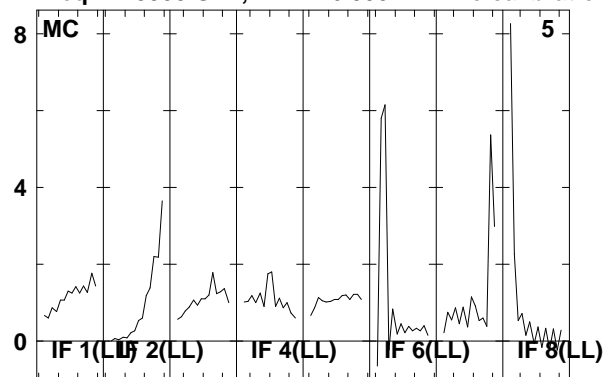

Lower frame: Real Jy

Total-power spectrum Antenna: \*

Timerange: 00/23:04:29 to 00/23:06:27



Plot file version 169 created 20-AUG-2009 15:00:18

NGC4639 EG040B.UVDATA.1

Freq = 1.5955 GHz, Bw = 16.000 MH No calibration applied and no bandpass applied

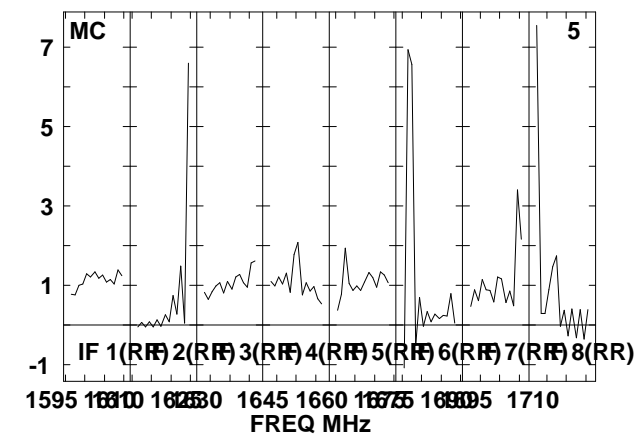
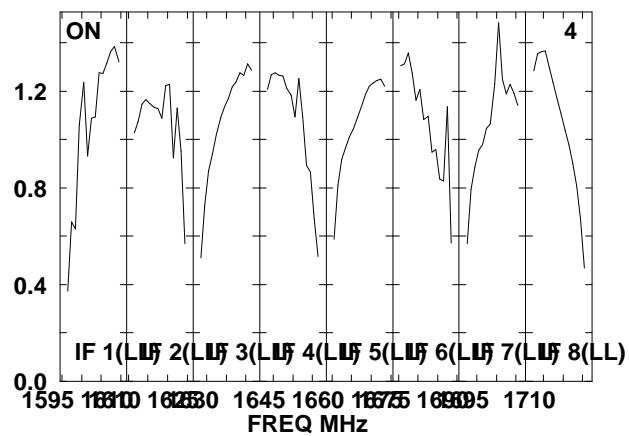
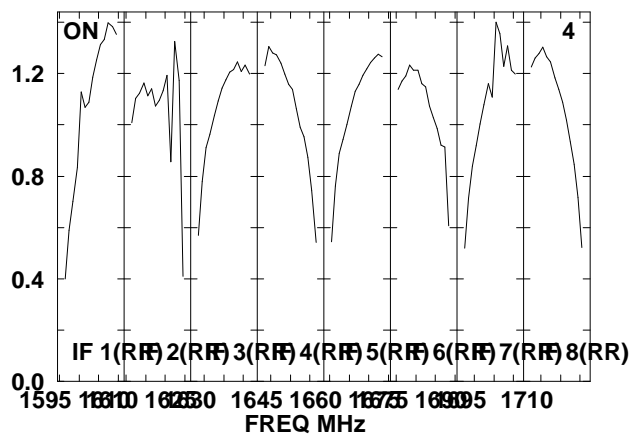
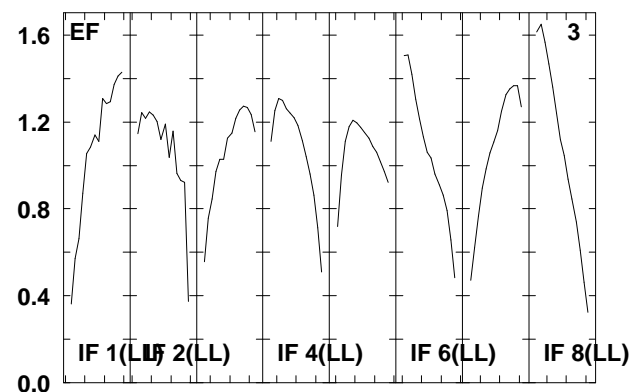
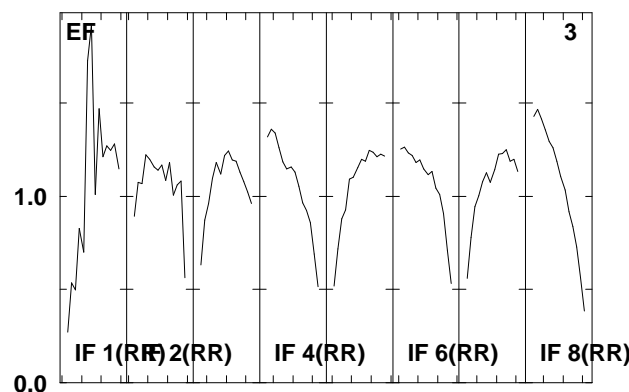
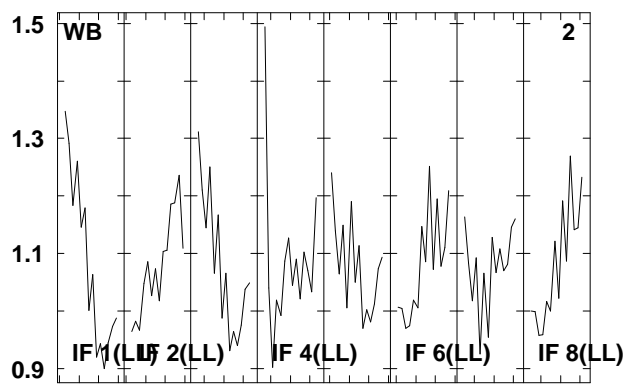
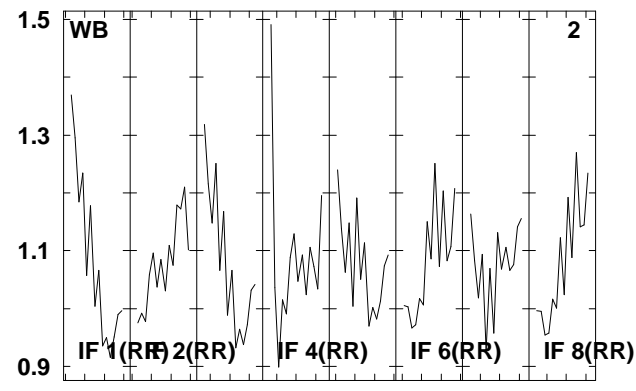
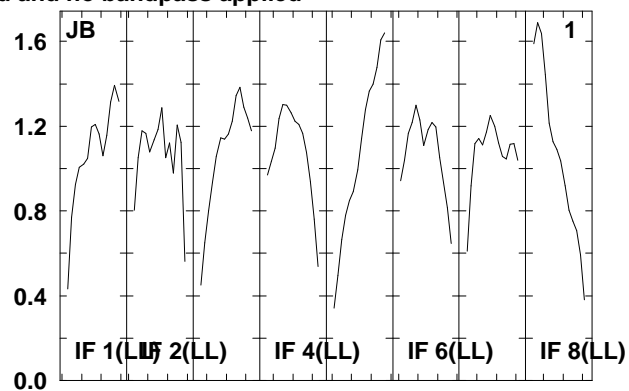
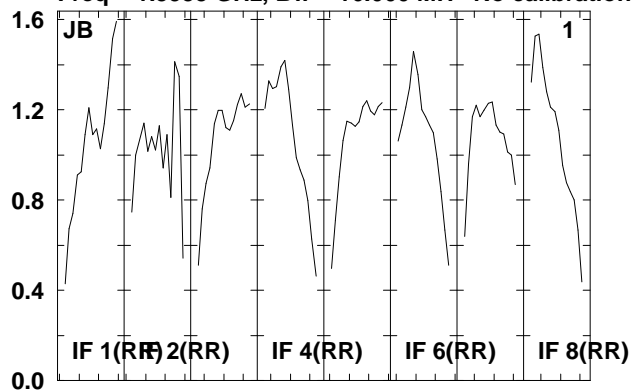

Lower frame: Real Jy  
Total-power spectrum Antenna: \*  
Timerange: 00/23:06:29 to 00/23:10:27

Plot file version 170 created 20-AUG-2009 15:00:18

NGC4639 EG040B.UVDATA.1

Freq = 1.5955 GHz, Bw = 16.000 MH No calibration applied and no bandpass applied

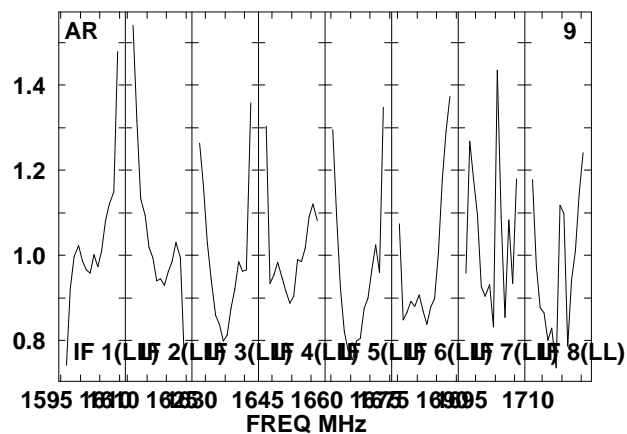
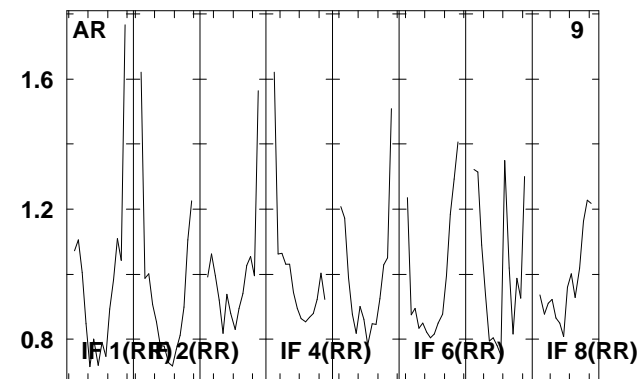
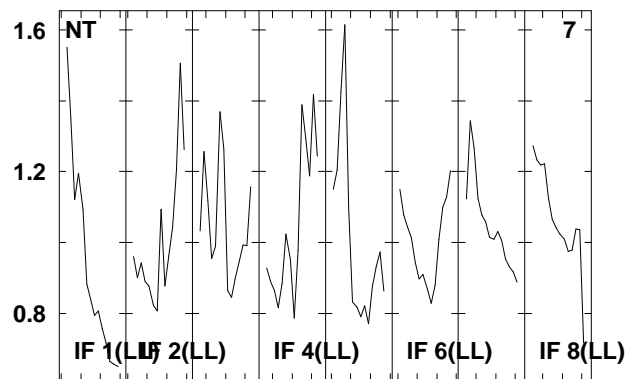
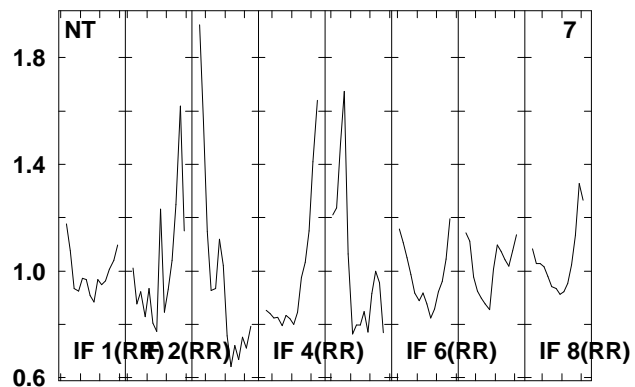
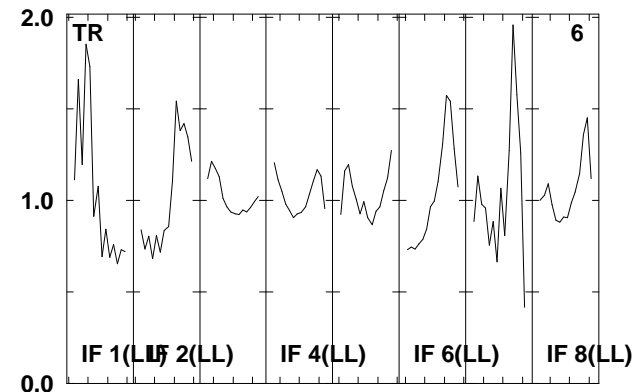
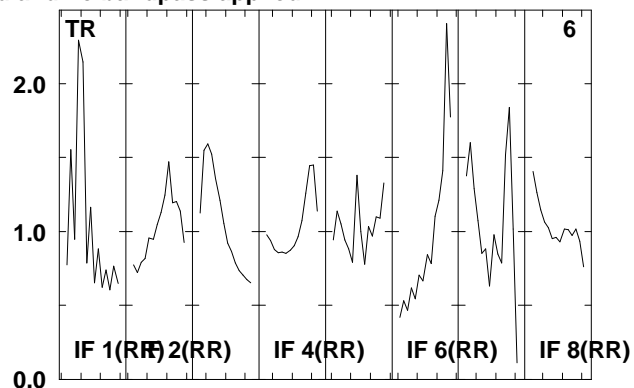
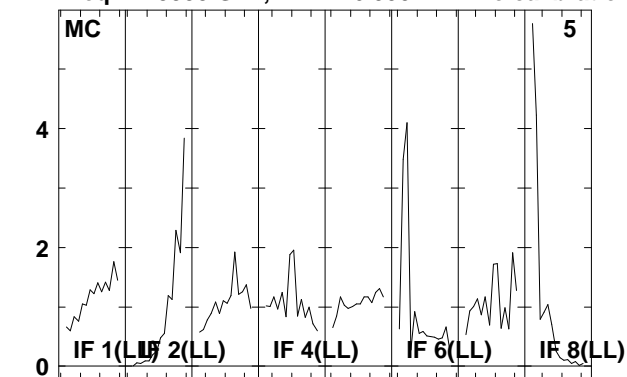

Lower frame: Real Jy

Total-power spectrum Antenna: \*

Timerange: 00/23:06:29 to 00/23:10:27

Plot file version 171 created 20-AUG-2009 15:00:19

3C274 EG040B.UVDATA.1

Freq = 1.5955 GHz, Bw = 16.000 MH No calibration applied and no bandpass applied

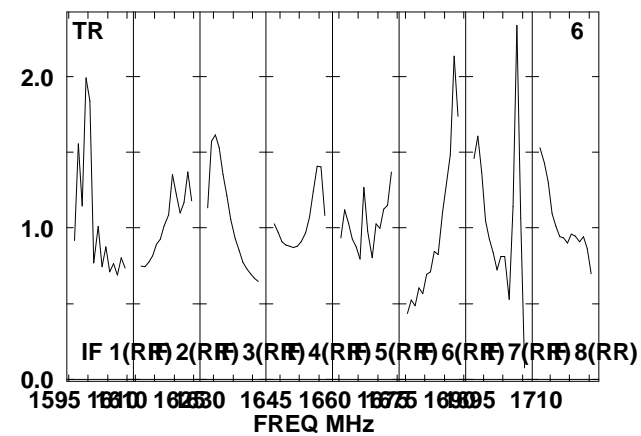
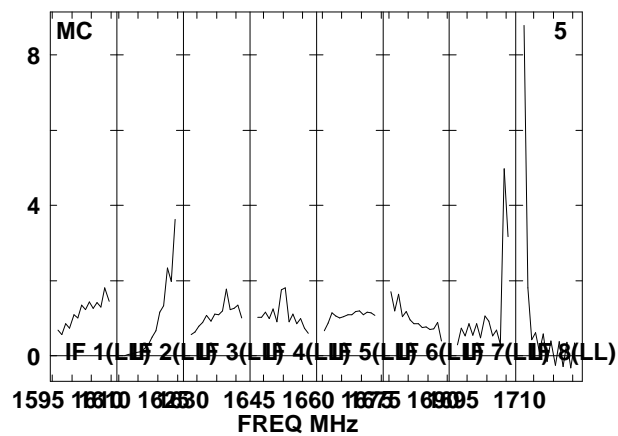
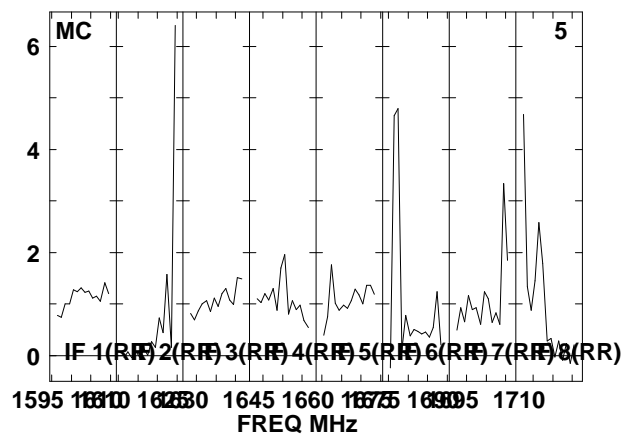
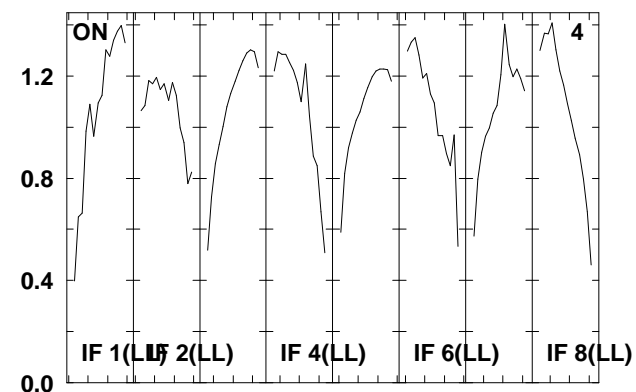
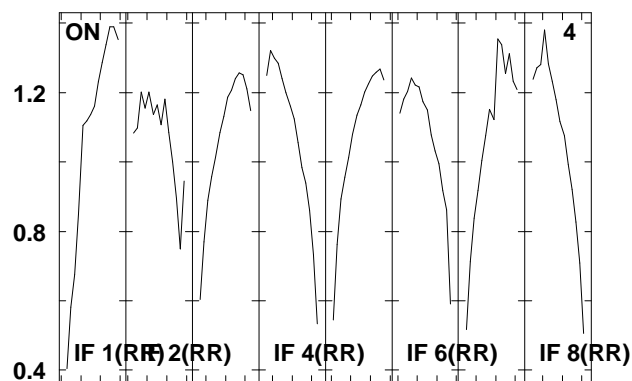
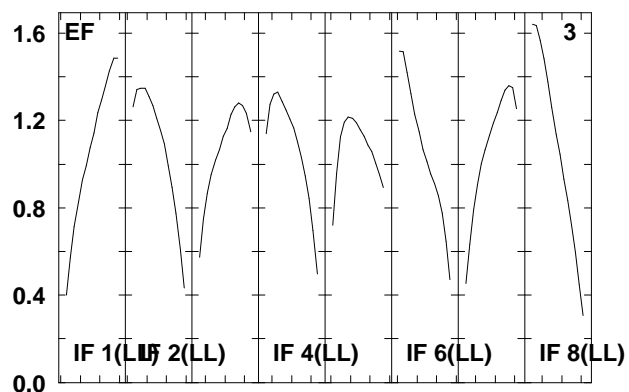
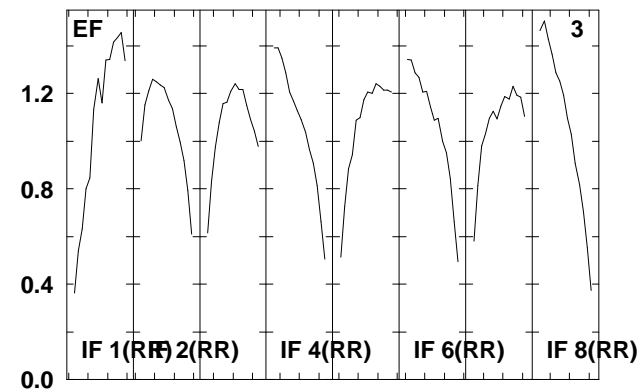
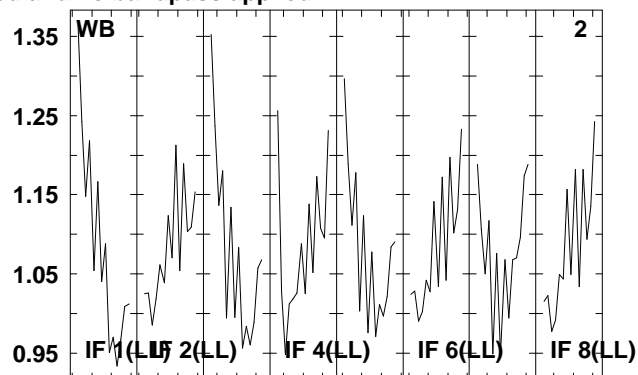
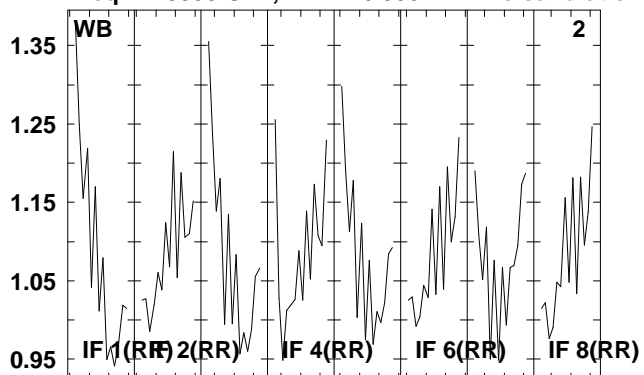

Lower frame: Real Jy

Total-power spectrum Antenna: \*

Timerange: 00/23:11:03 to 00/23:12:31

Plot file version 172 created 20-AUG-2009 15:00:19

3C274 EG040B.UVDATA.1

Freq = 1.5955 GHz, Bw = 16.000 MH No calibration applied and no bandpass applied

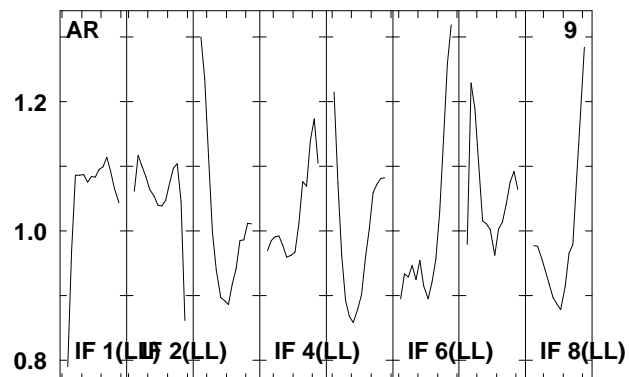
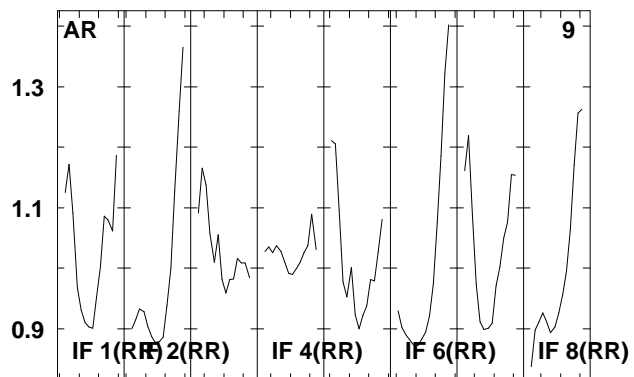
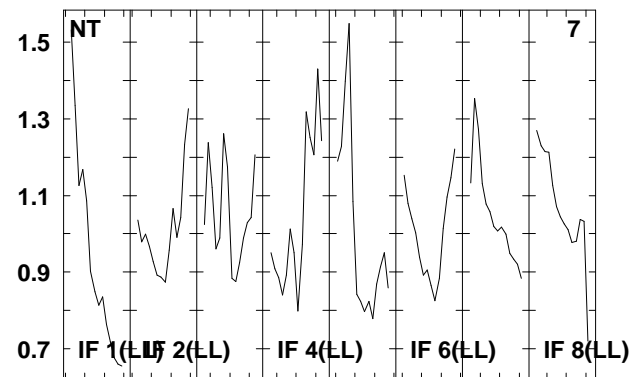
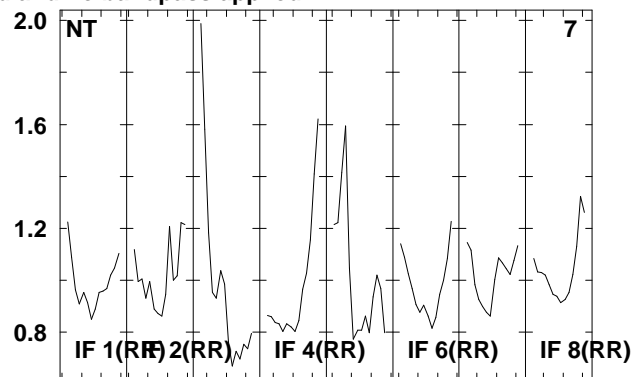
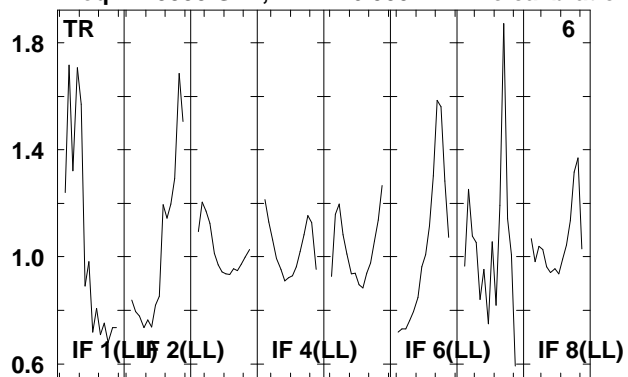

Lower frame: Real Jy  
Total-power spectrum Antenna: \*  
Timerange: 00/23:11:03 to 00/23:12:31

Plot file version 173 created 20-AUG-2009 15:00:19

NGC4639 EG040B.UVDATA.1

Freq = 1.5955 GHz, Bw = 16.000 MH No calibration applied and no bandpass applied

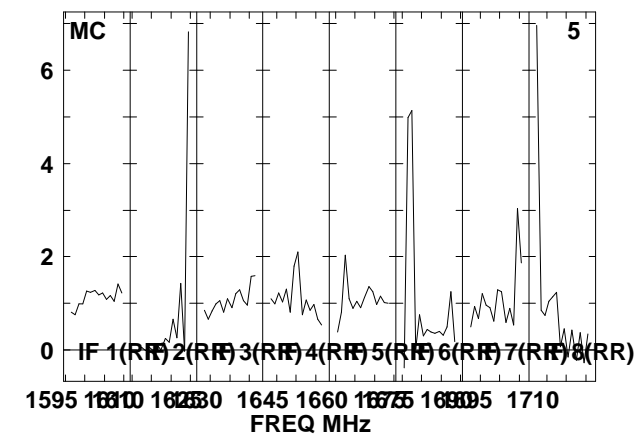
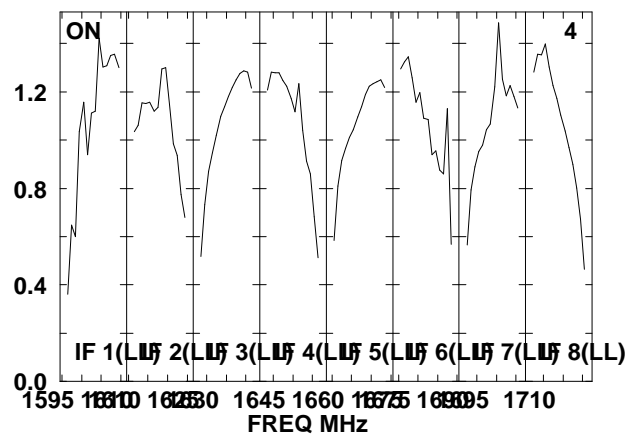
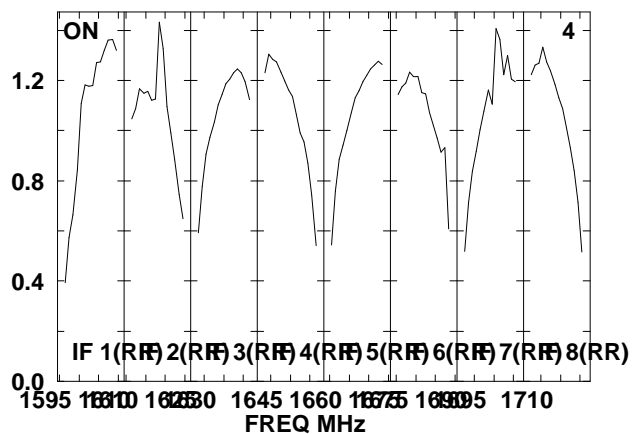
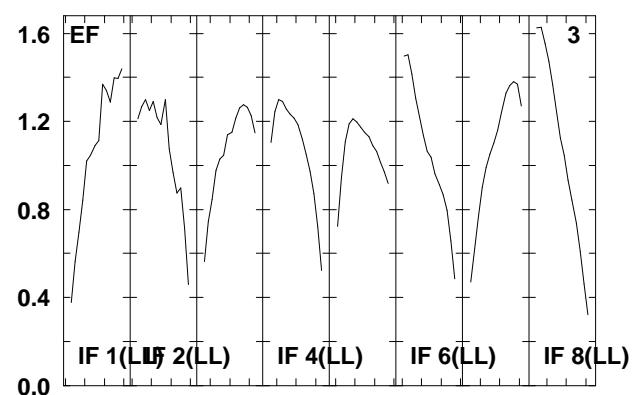
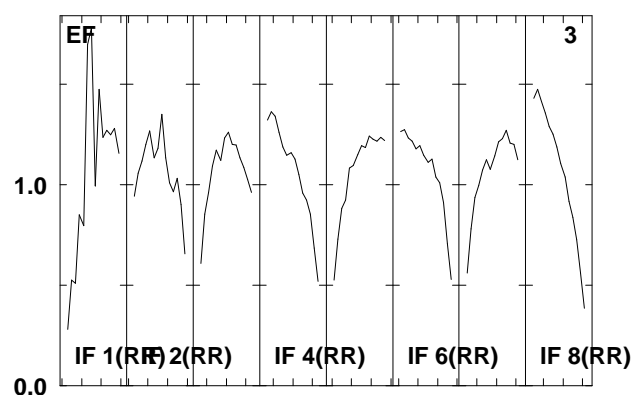
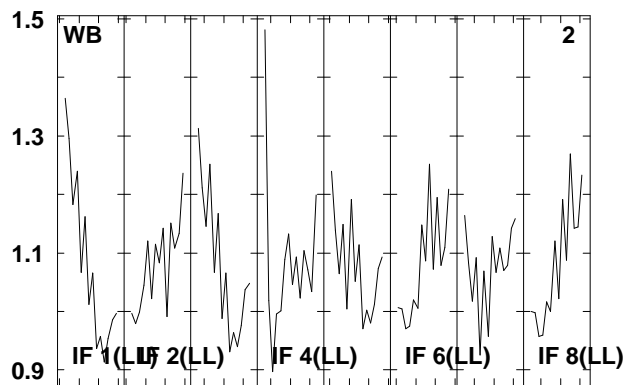
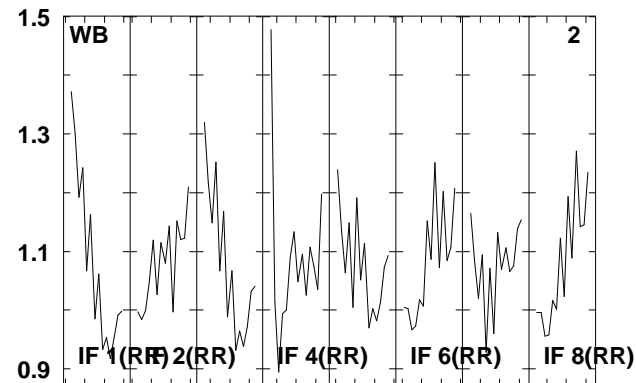
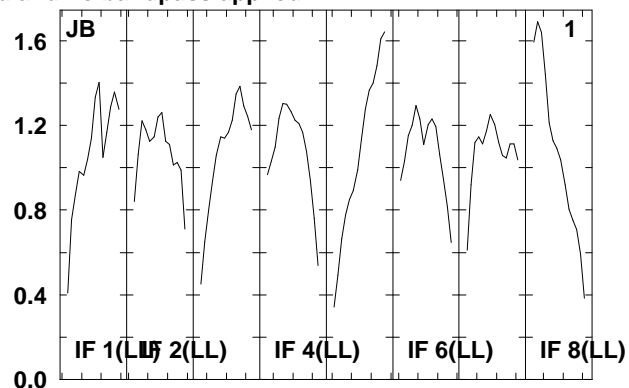
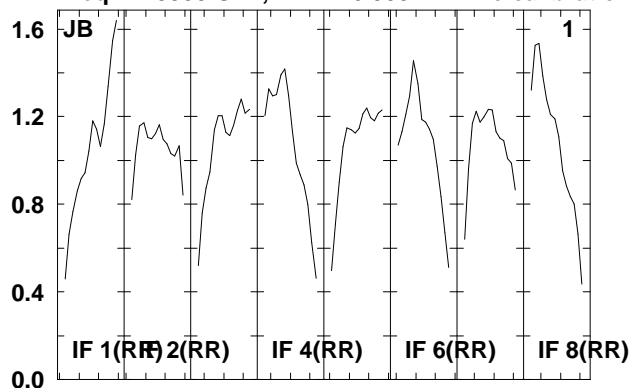

Lower frame: Real Jy  
Total-power spectrum Antenna: \*  
Timerange: 00/23:12:33 to 00/23:16:33

Plot file version 174 created 20-AUG-2009 15:00:20

NGC4639 EG040B.UVDATA.1

Freq = 1.5955 GHz, Bw = 16.000 MH No calibration applied and no bandpass applied

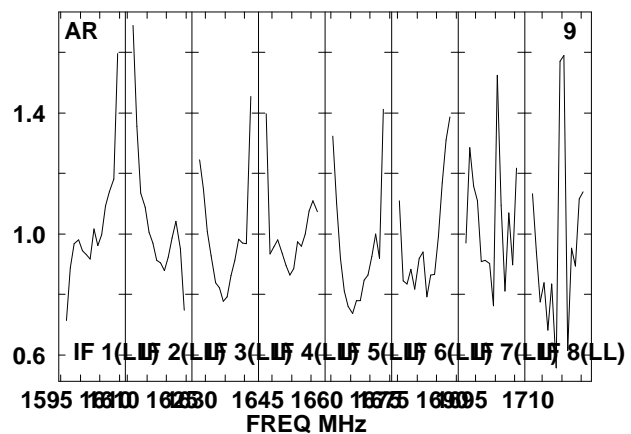
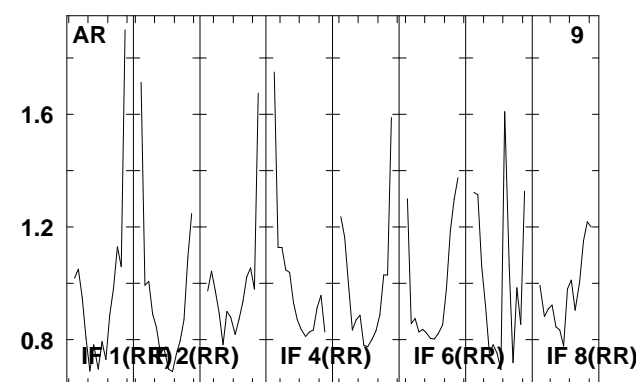
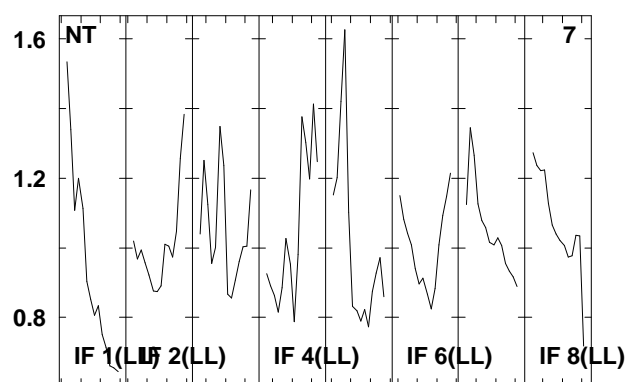
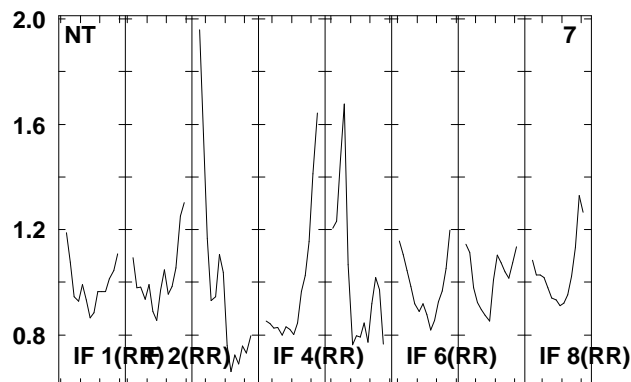
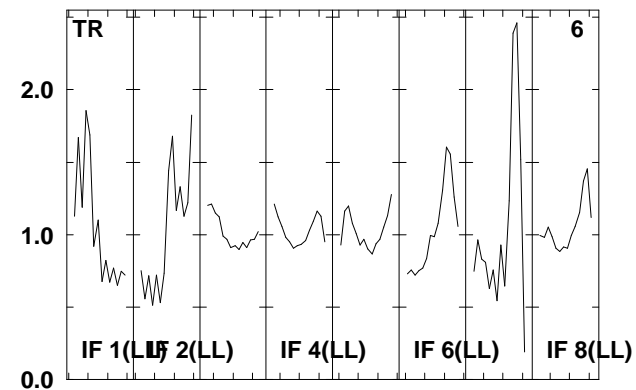
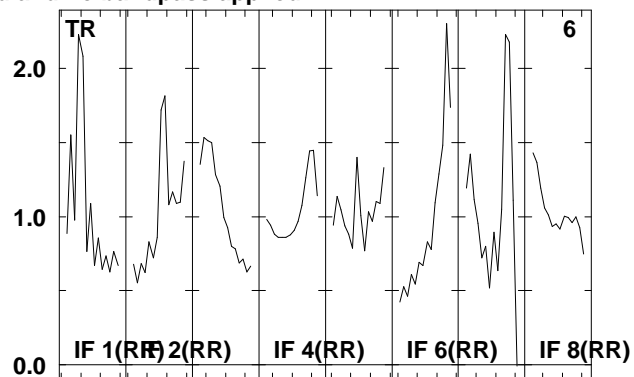
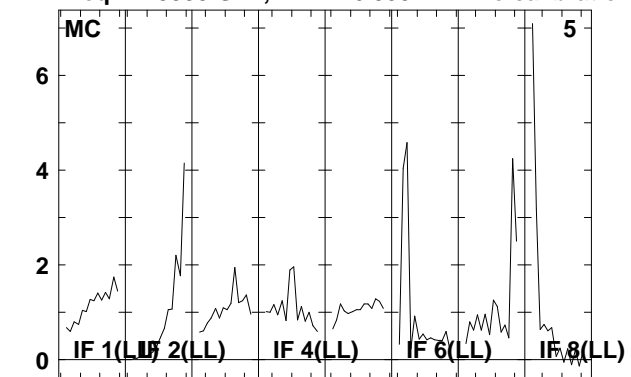

Lower frame: Real Jy

Total-power spectrum Antenna: \*

Timerange: 00/23:12:33 to 00/23:16:33

Plot file version 175 created 20-AUG-2009 15:00:20  
 3C274 EG040B.UVDATA.1  
 Freq = 1.5955 GHz, Bw = 16.000 MH No calibration applied and no bandpass applied

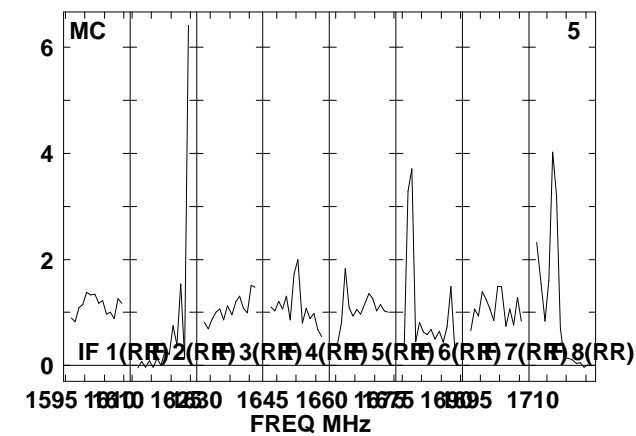
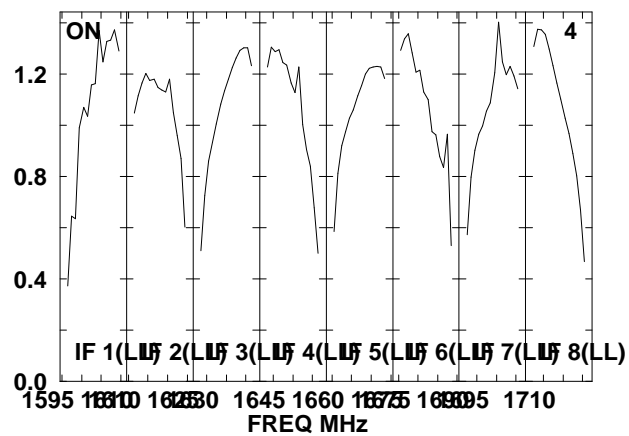
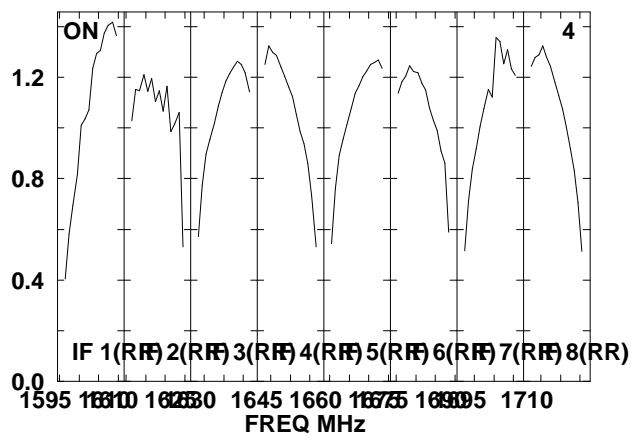
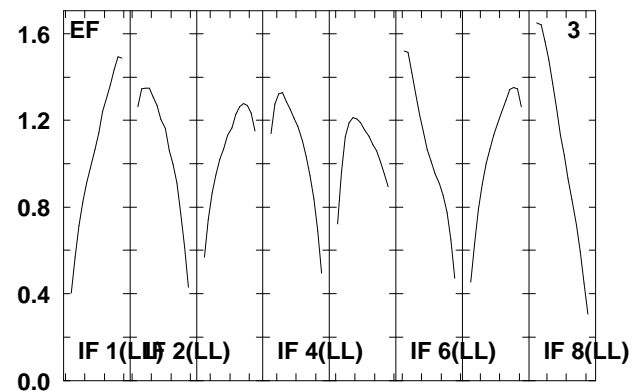
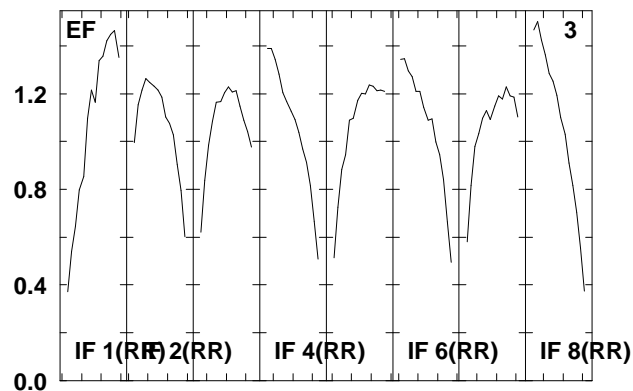
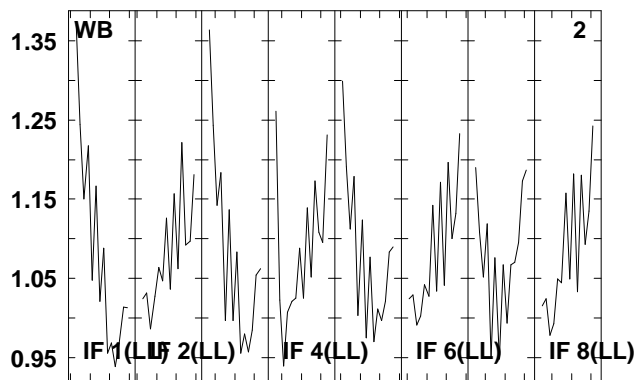
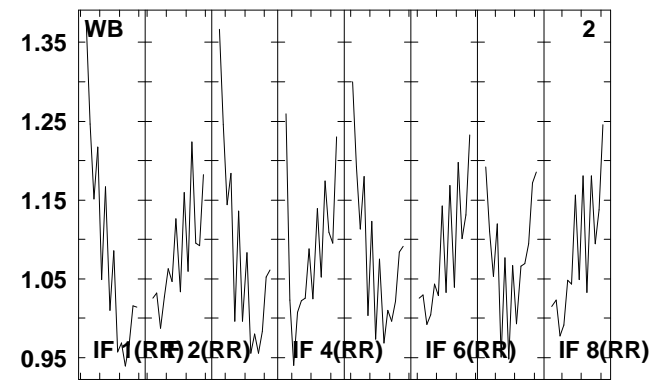
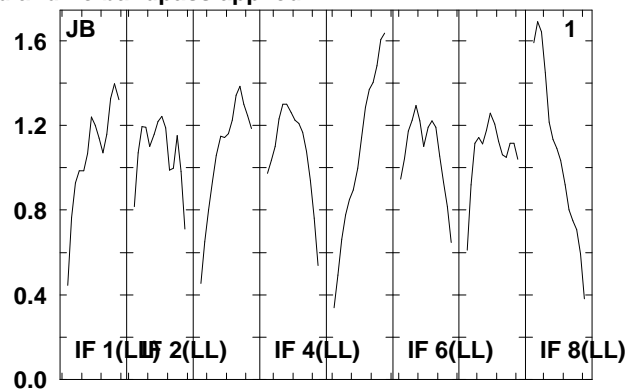
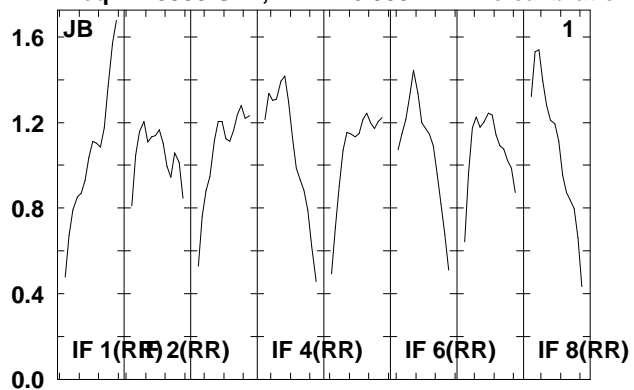

Lower frame: Real Jy  
 Total-power spectrum Antenna: \*  
 Timerange: 00/23:16:35 to 00/23:18:33

Plot file version 176 created 20-AUG-2009 15:00:20

3C274 EG040B.UVDATA.1

Freq = 1.5955 GHz, Bw = 16.000 MH No calibration applied and no bandpass applied

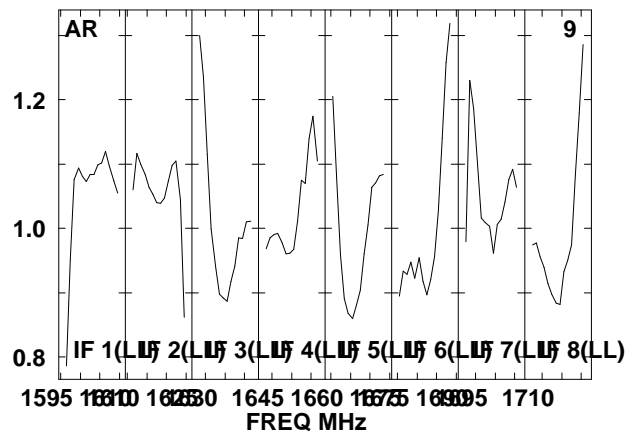
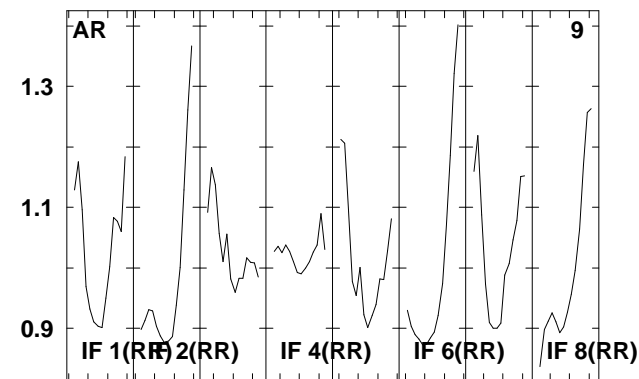
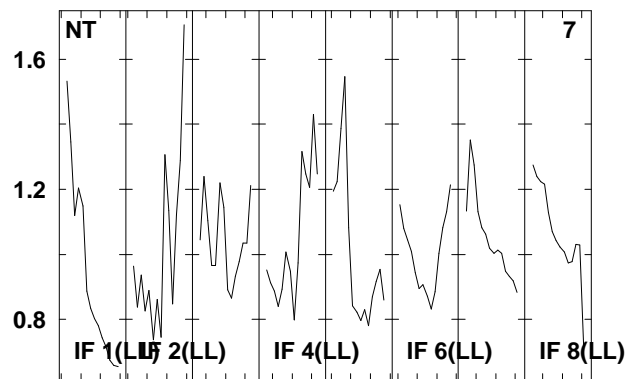
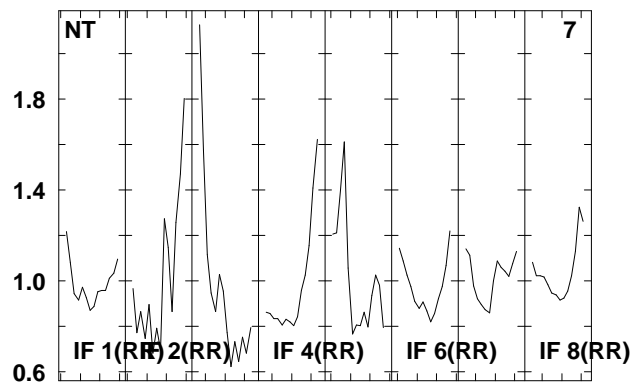
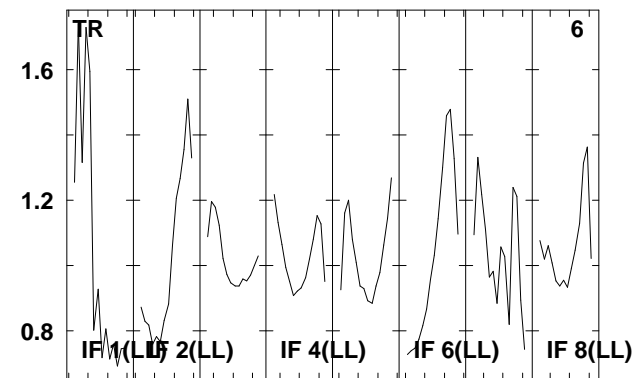
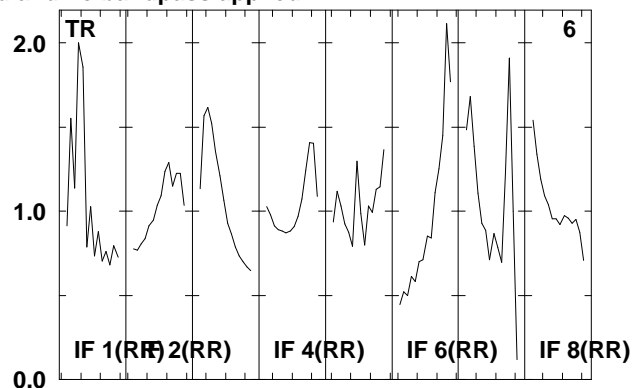
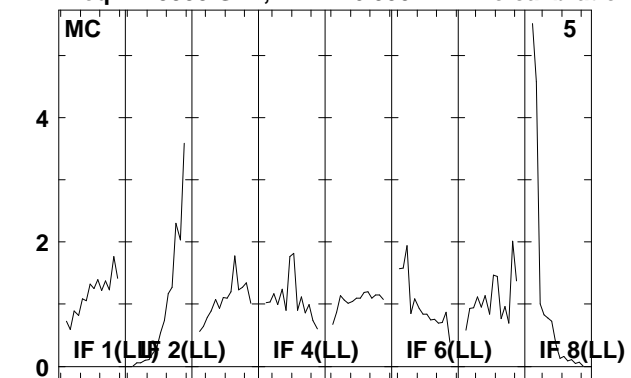

Lower frame: Real Jy

Total-power spectrum Antenna: \*

Timerange: 00/23:16:35 to 00/23:18:33



Plot file version 177 created 20-AUG-2009 15:00:21

NGC4639 EG040B.UVDATA.1

Freq = 1.5955 GHz, Bw = 16.000 MH No calibration applied and no bandpass applied

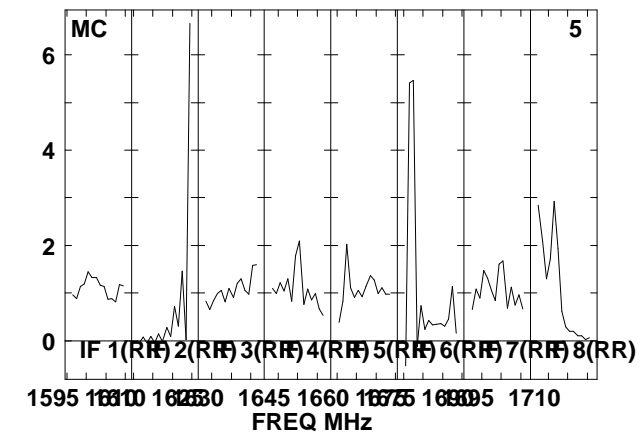
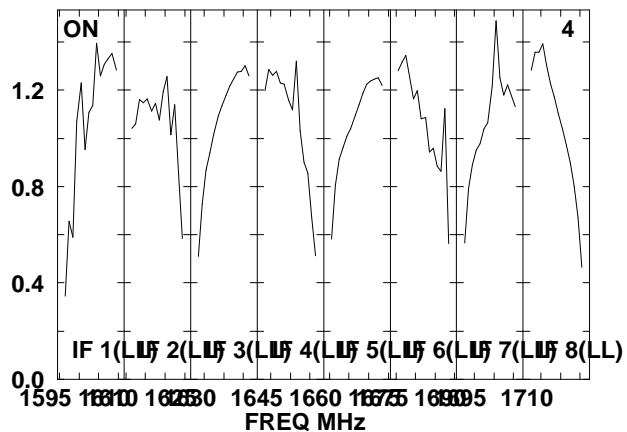
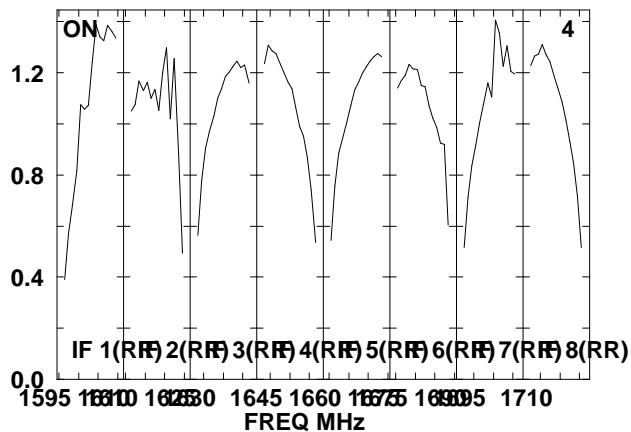
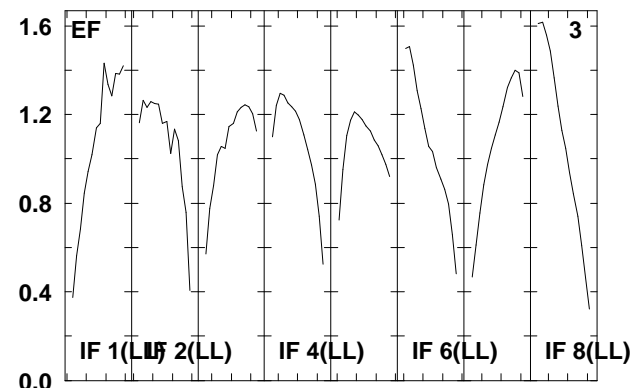
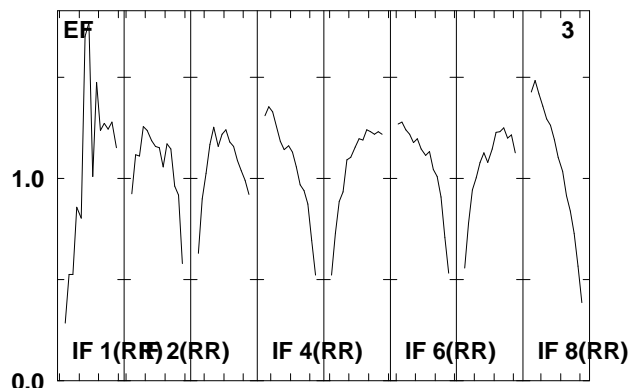
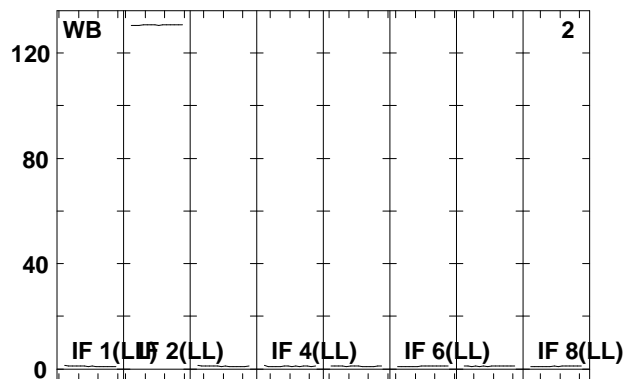
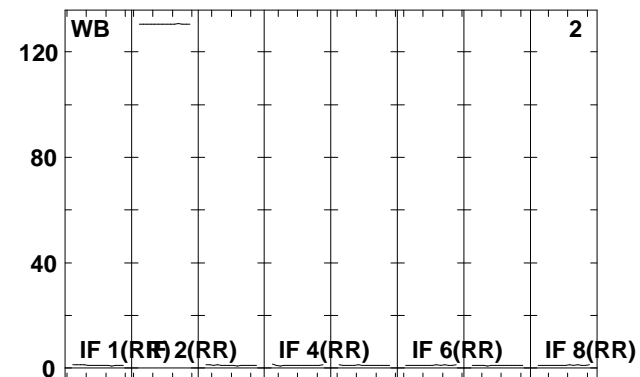
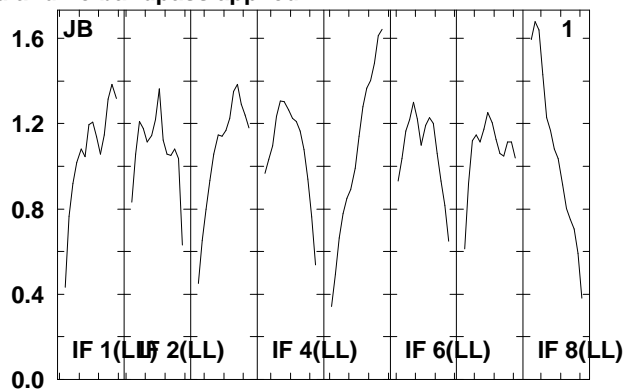
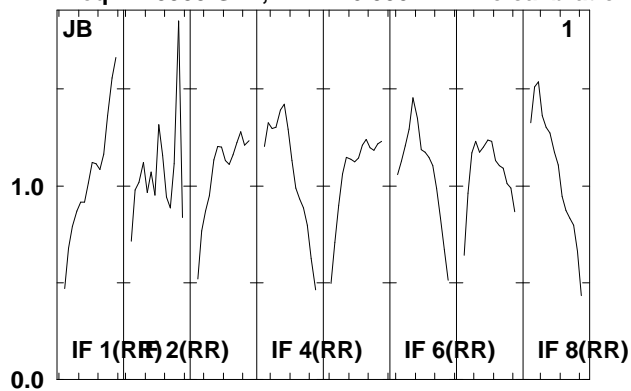

Lower frame: Real Jy  
Total-power spectrum Antenna: \*  
Timerange: 00/23:18:35 to 00/23:22:31

Plot file version 178 created 20-AUG-2009 15:00:21

NGC4639 EG040B.UVDATA.1

Freq = 1.5955 GHz, Bw = 16.000 MH No calibration applied and no bandpass applied

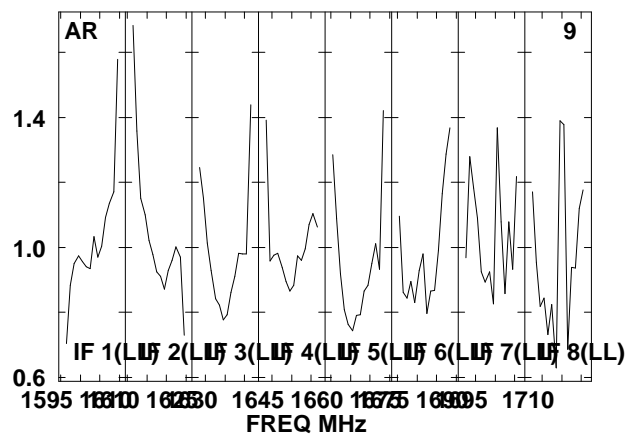
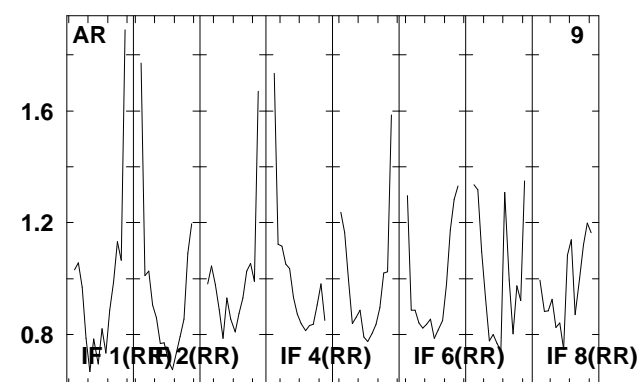
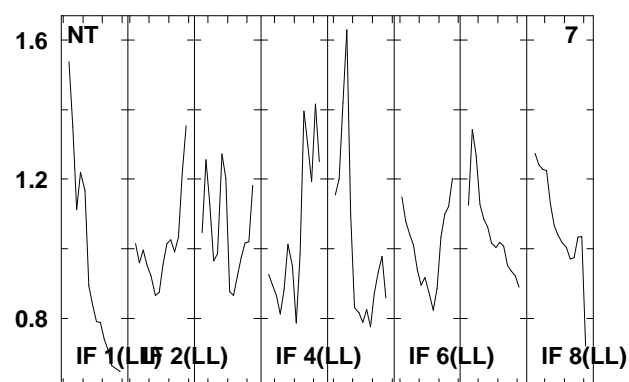
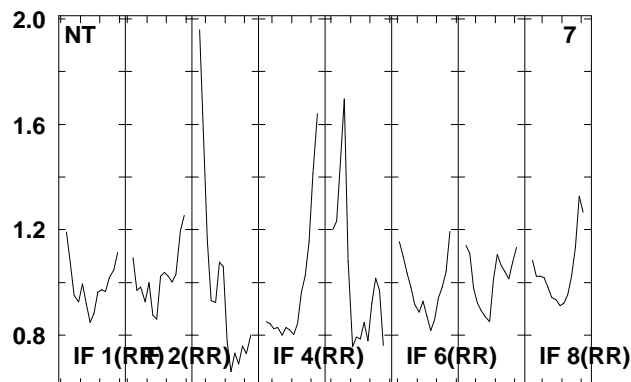
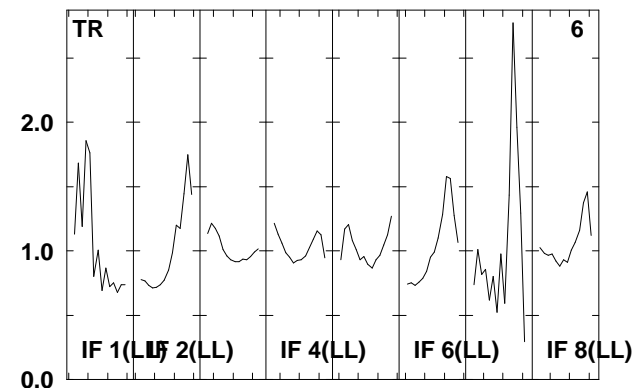
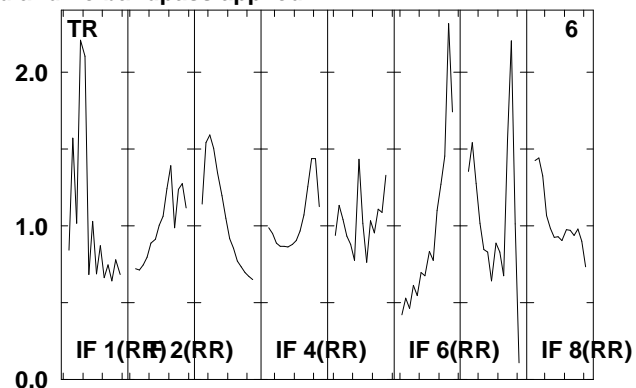
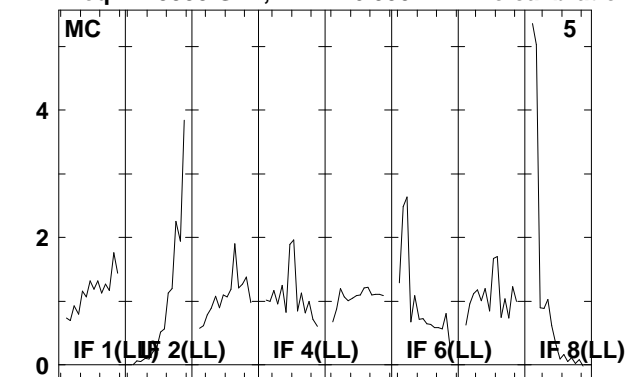

Lower frame: Real Jy

Total-power spectrum Antenna: \*

Timerange: 00/23:18:35 to 00/23:22:31

Plot file version 179 created 20-AUG-2009 15:00:22

3C274 EG040B.UVDATA.1

Freq = 1.5955 GHz, Bw = 16.000 MH No calibration applied and no bandpass applied

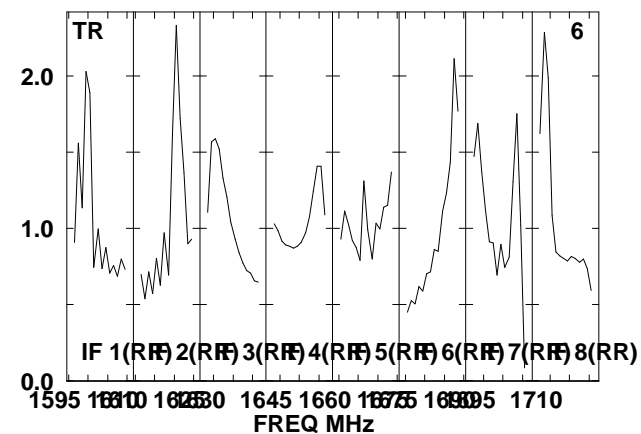
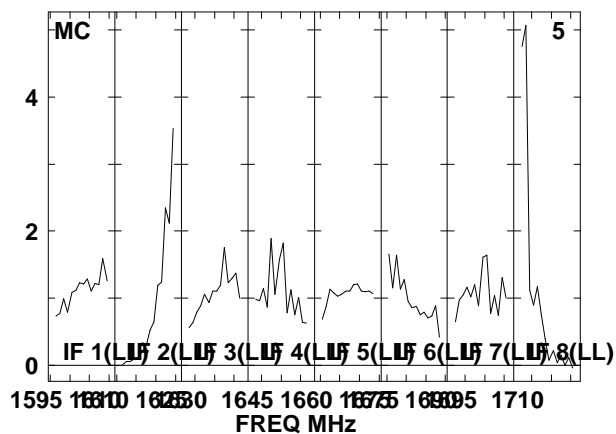
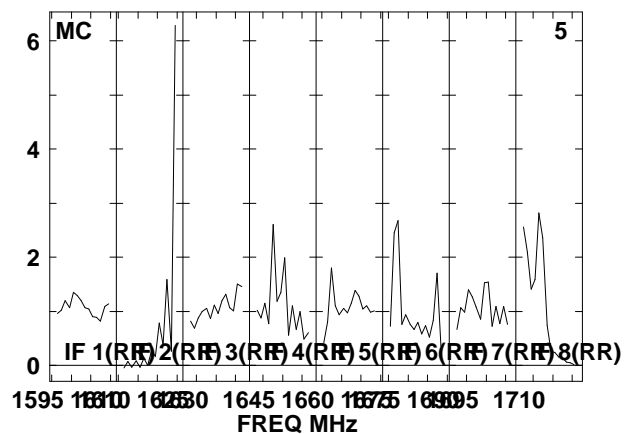
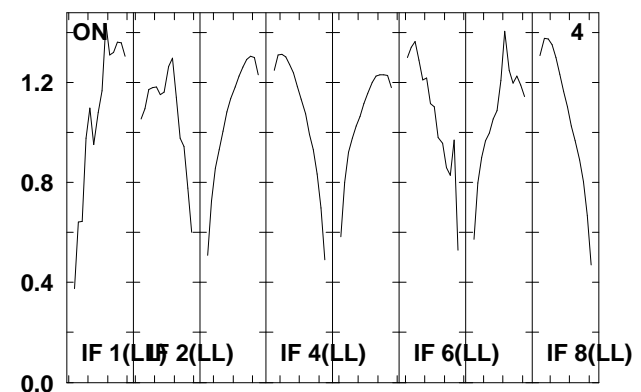
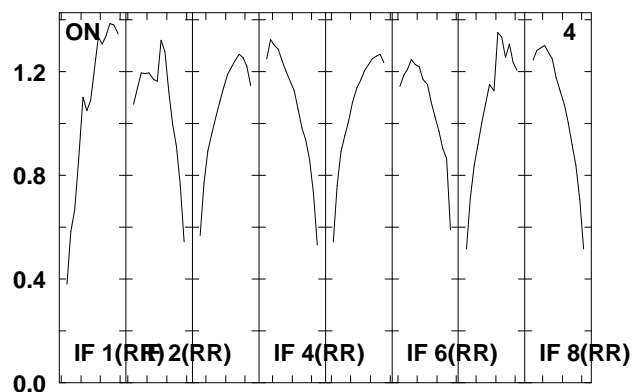
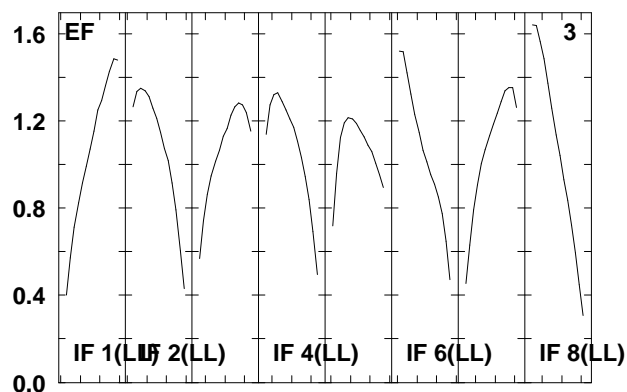
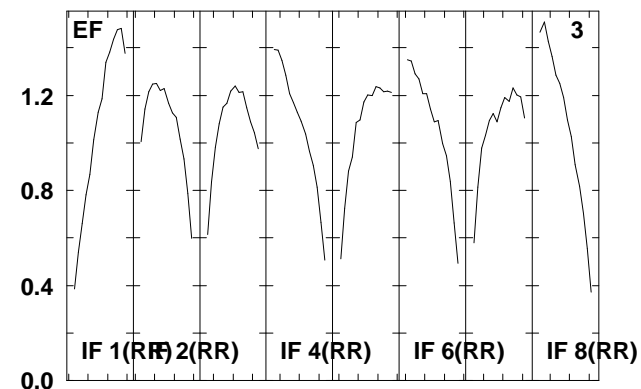
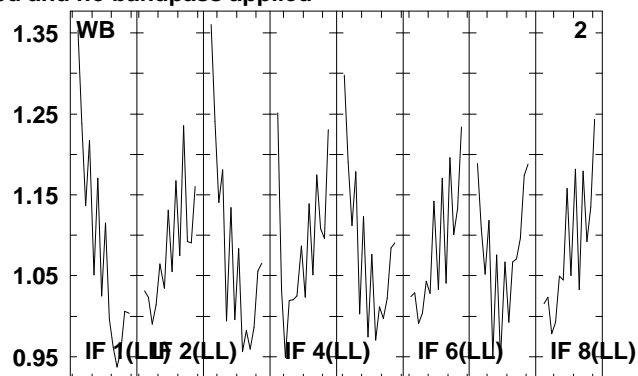
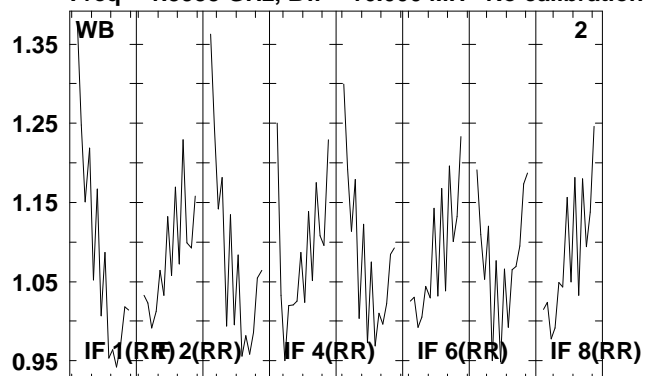

Lower frame: Real Jy

Total-power spectrum Antenna: \*

Timerange: 00/23:23:09 to 00/23:24:37

Plot file version 180 created 20-AUG-2009 15:00:22

3C274 EG040B.UVDATA.1

Freq = 1.5955 GHz, Bw = 16.000 MH No calibration applied and no bandpass applied

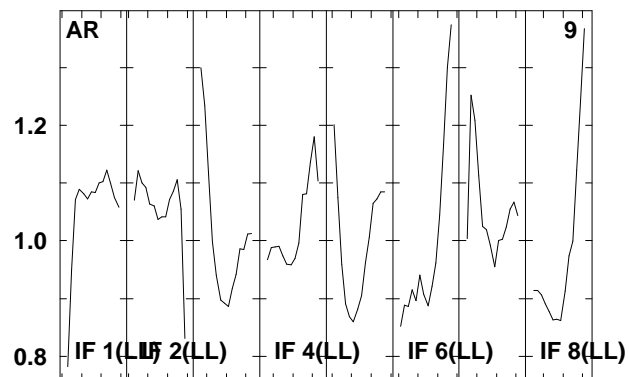
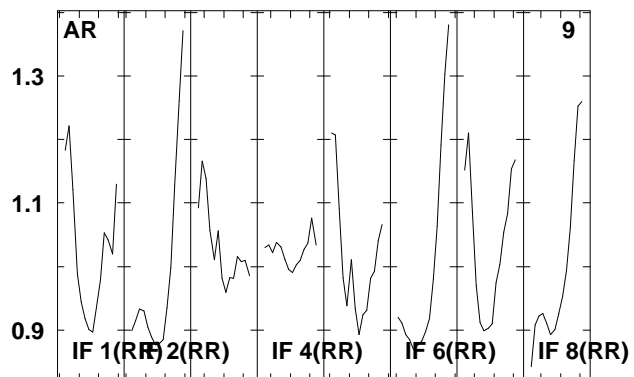
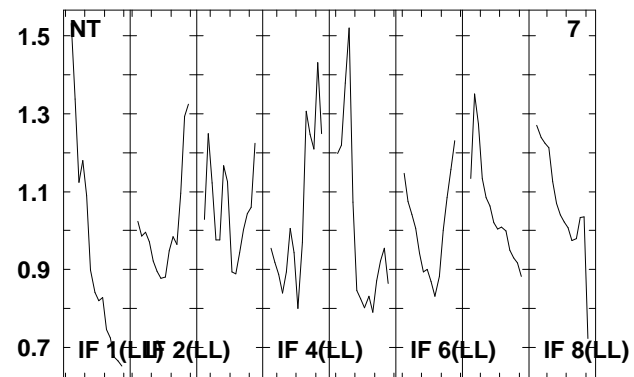
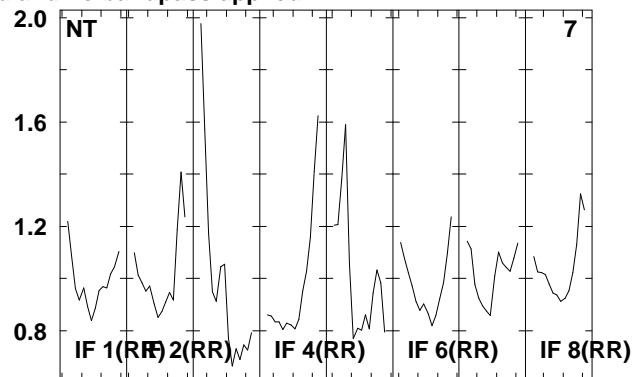
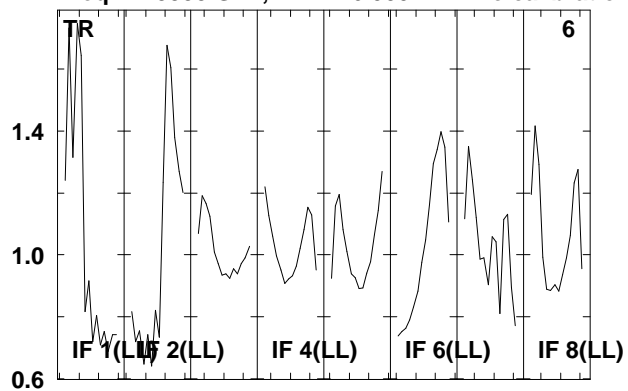

Lower frame: Real Jy  
Total-power spectrum Antenna: \*  
Timerange: 00/23:23:09 to 00/23:24:37

Plot file version 181 created 20-AUG-2009 15:00:22

NGC4639 EG040B.UVDATA.1

Freq = 1.5955 GHz, Bw = 16.000 MH No calibration applied and no bandpass applied

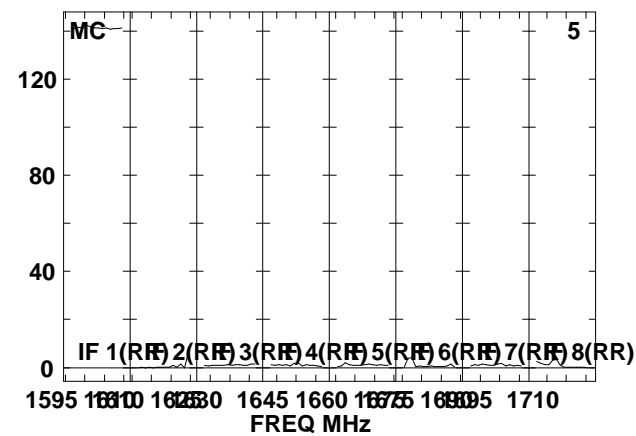
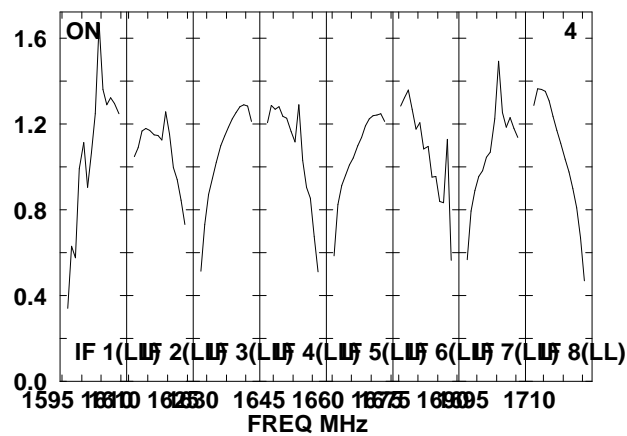
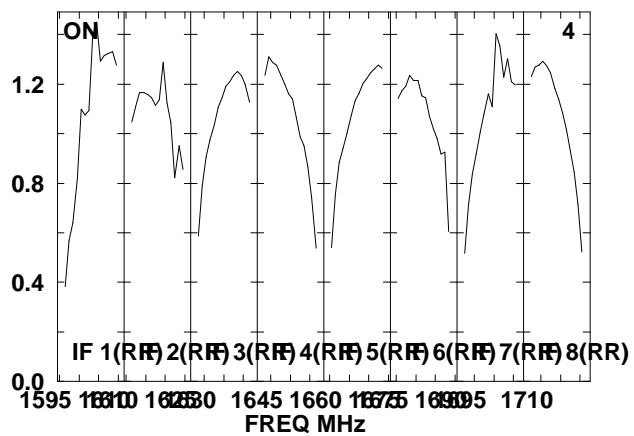
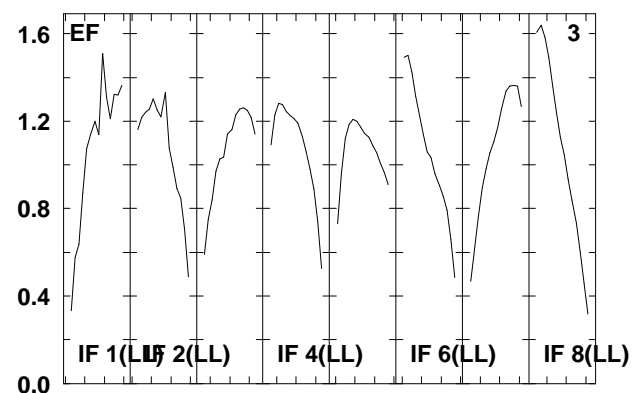
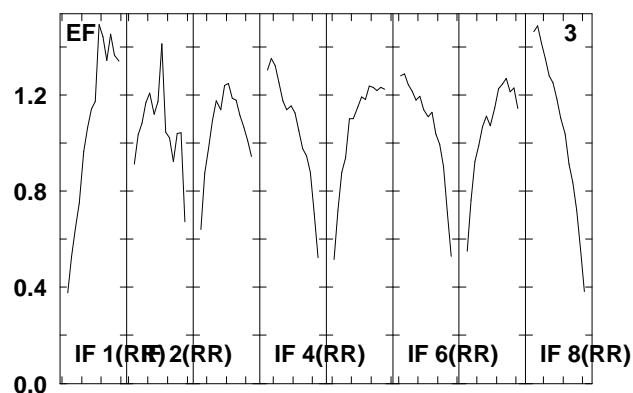
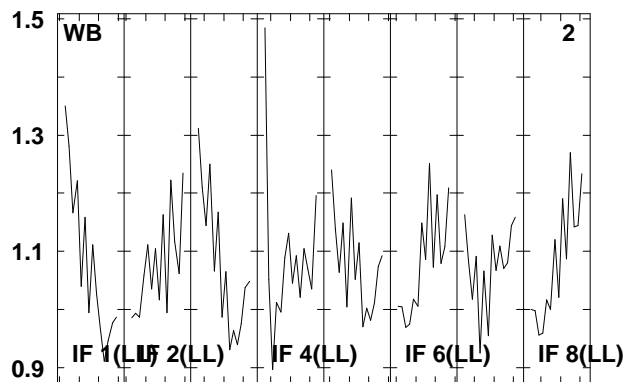
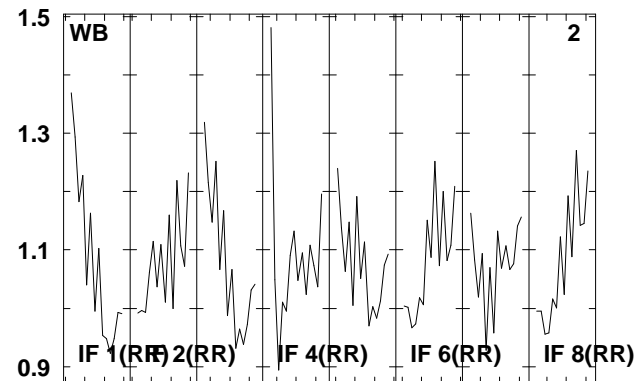
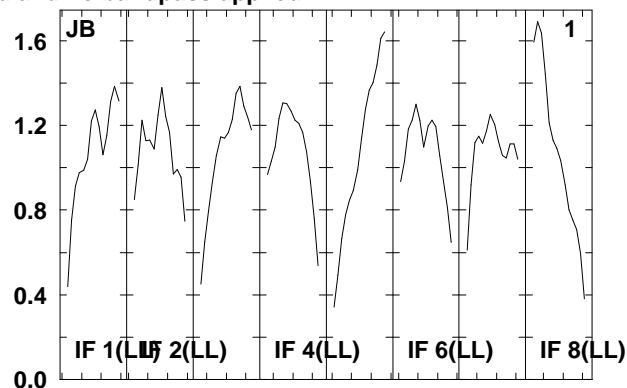
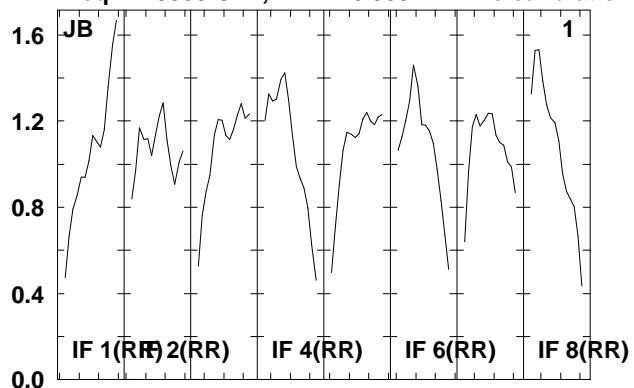

Lower frame: Real Jy  
Total-power spectrum Antenna: \*  
Timerange: 00/23:24:39 to 00/23:28:37

Plot file version 182 created 20-AUG-2009 15:00:22

NGC4639 EG040B.UVDATA.1

Freq = 1.5955 GHz, Bw = 16.000 MH No calibration applied and no bandpass applied

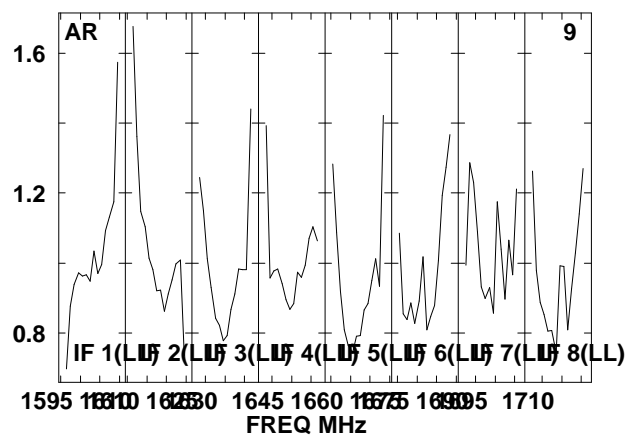
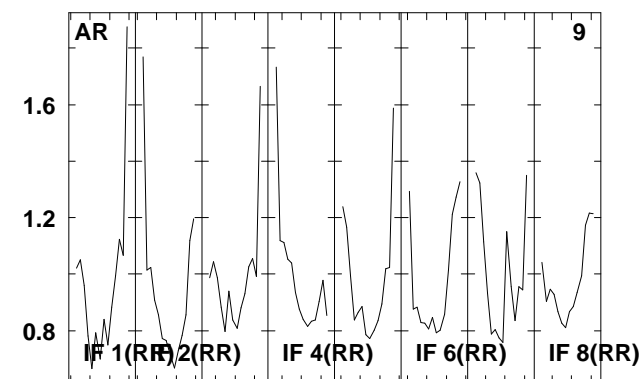
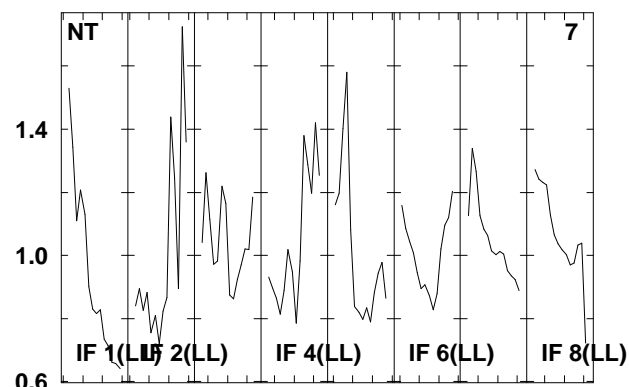
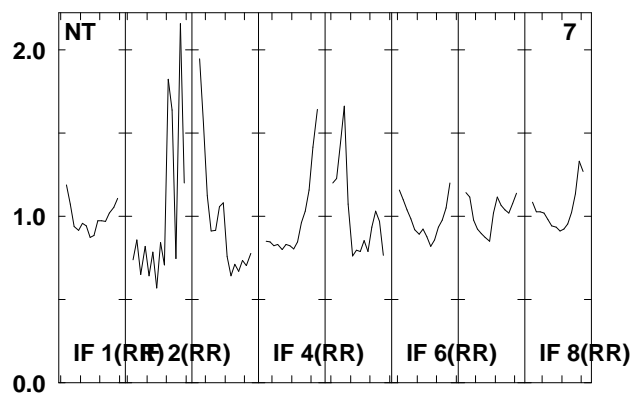
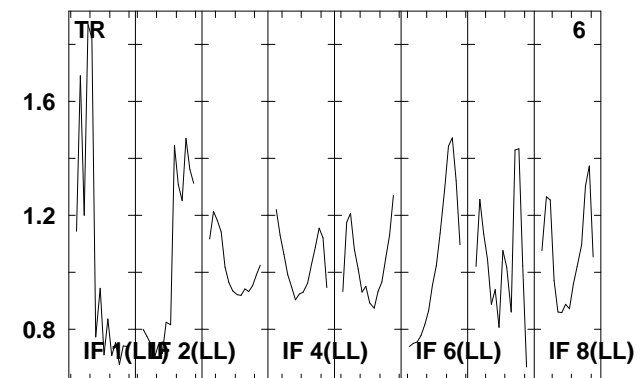
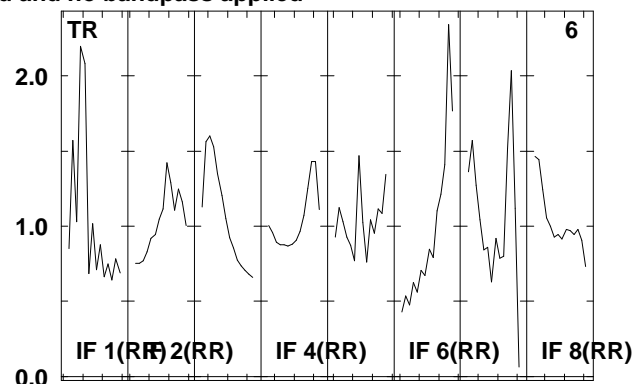
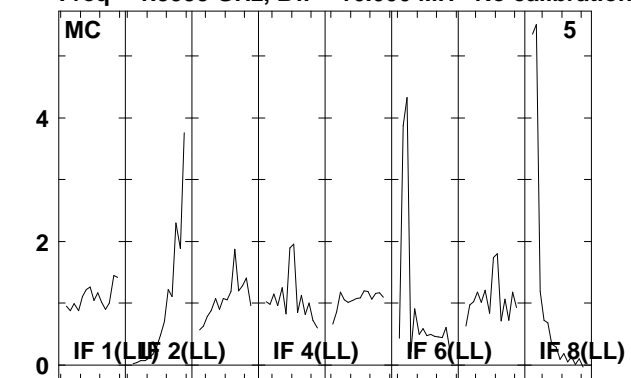

Lower frame: Real Jy

Total-power spectrum Antenna: \*

Timerange: 00/23:24:39 to 00/23:28:37

Plot file version 183 created 20-AUG-2009 15:00:23

3C274 EG040B.UVDATA.1

Freq = 1.5955 GHz, Bw = 16.000 MH No calibration applied and no bandpass applied

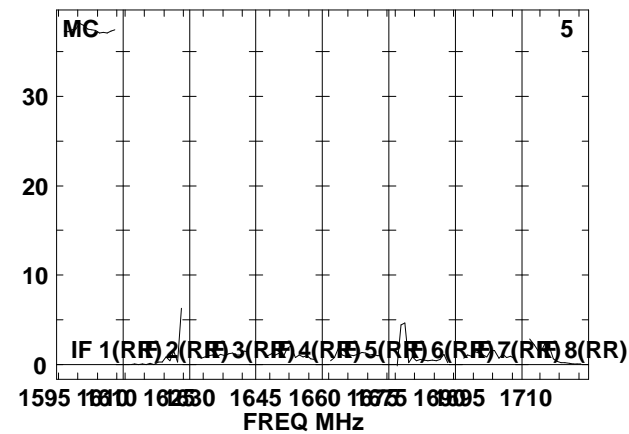
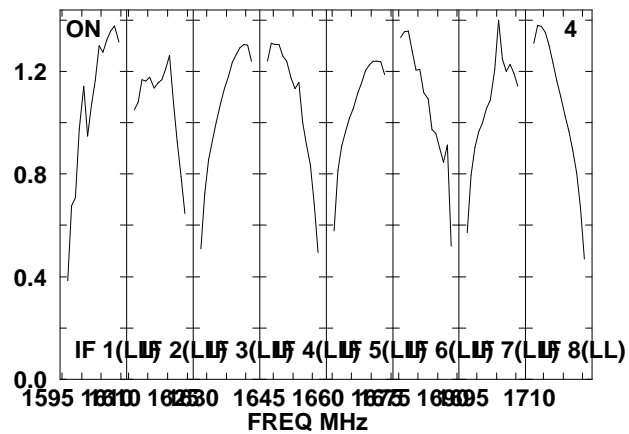
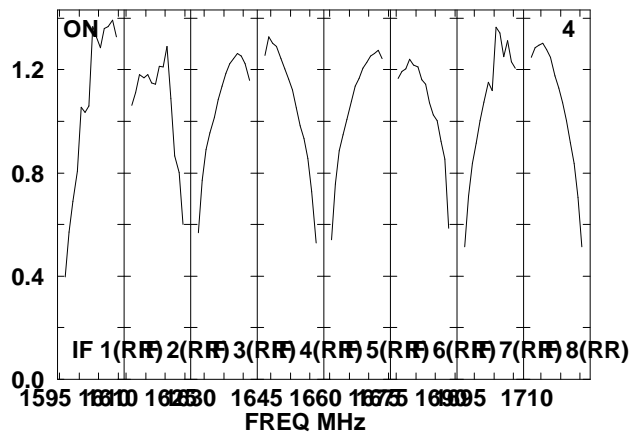
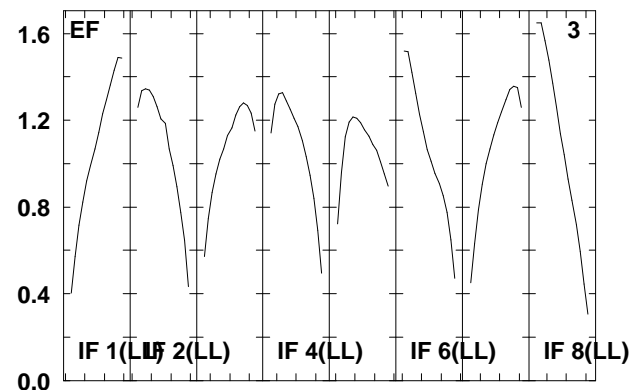
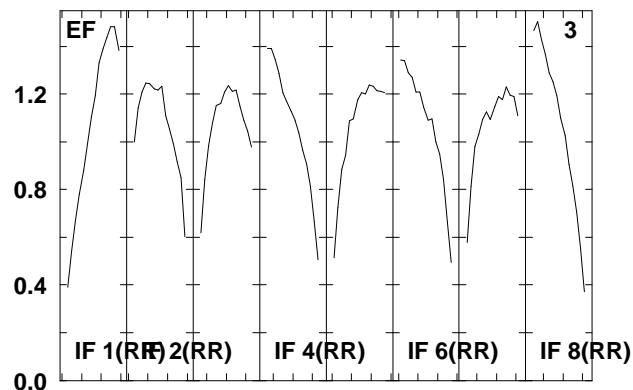
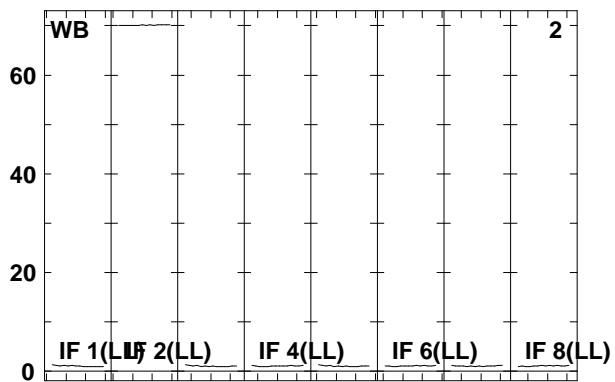
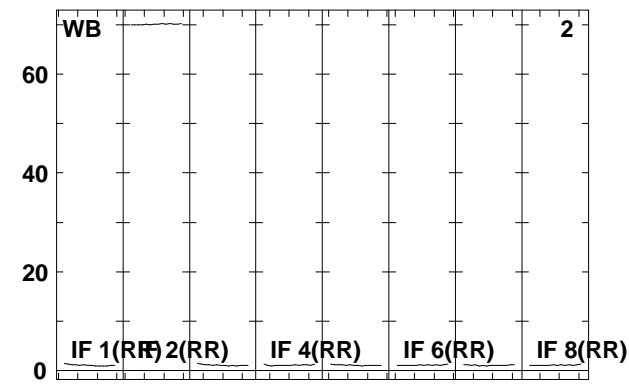
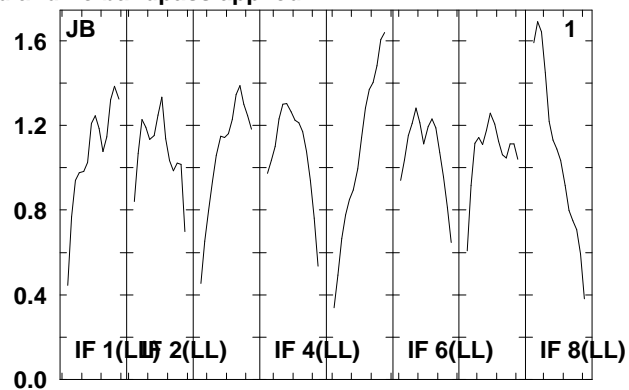
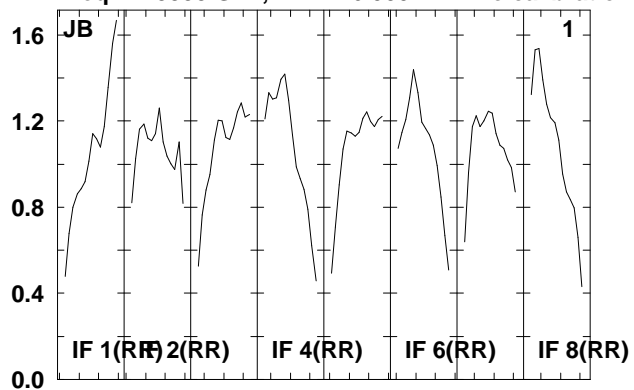

Lower frame: Real Jy  
Total-power spectrum Antenna: \*  
Timerange: 00/23:28:39 to 00/23:40:59

Plot file version 184 created 20-AUG-2009 15:00:24

3C274 EG040B.UVDATA.1

Freq = 1.5955 GHz, Bw = 16.000 MH No calibration applied and no bandpass applied

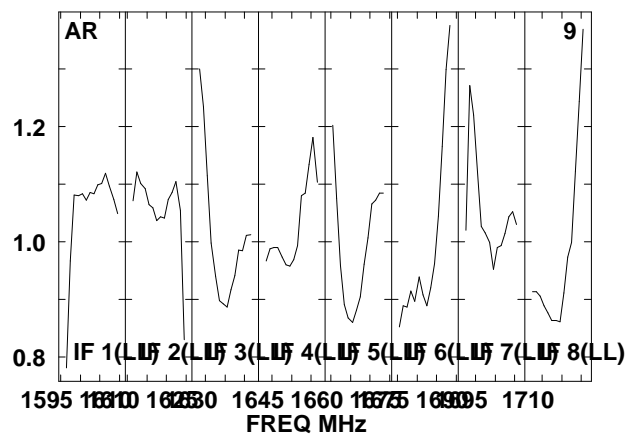
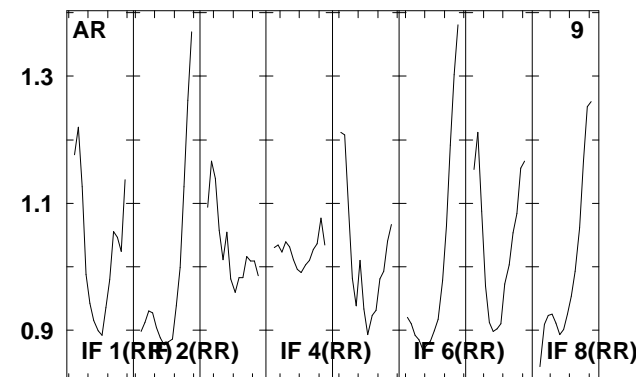
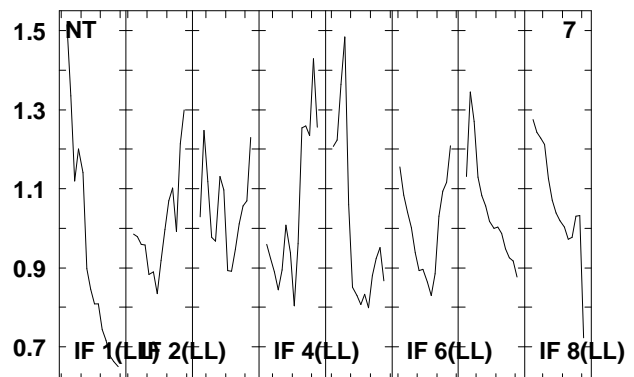
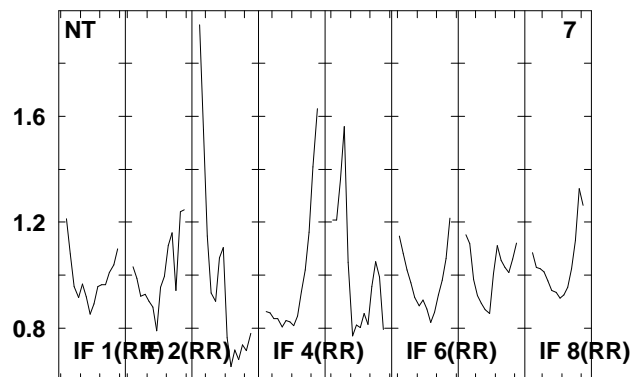
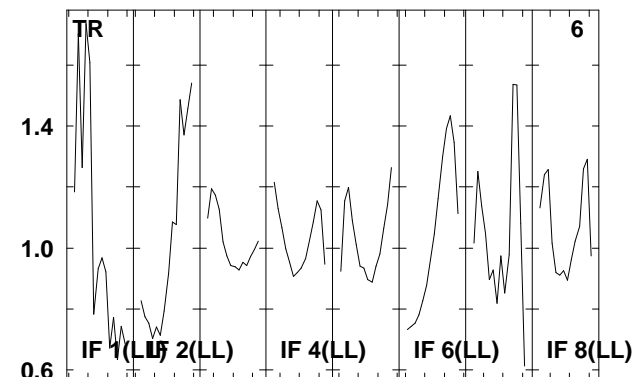
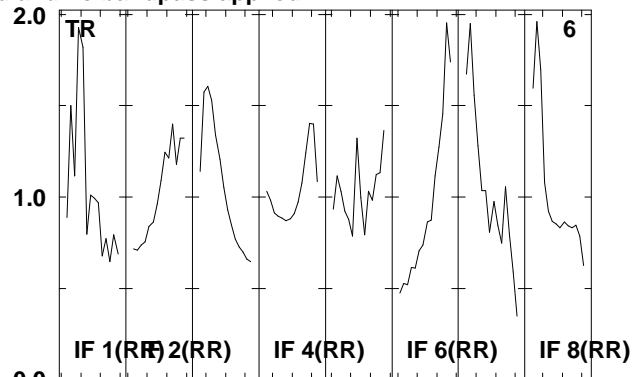
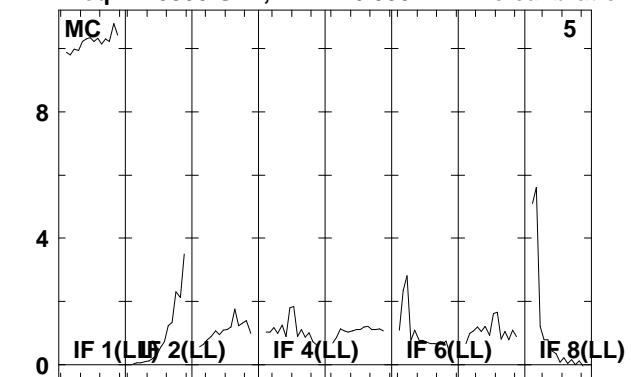

Lower frame: Real Jy

Total-power spectrum Antenna: \*

Timerange: 00/23:28:39 to 00/23:40:59



Plot file version 185 created 20-AUG-2009 15:00:26

NGC4639 EG040B.UVDATA.1

Freq = 1.5955 GHz, Bw = 16.000 MH No calibration applied and no bandpass applied

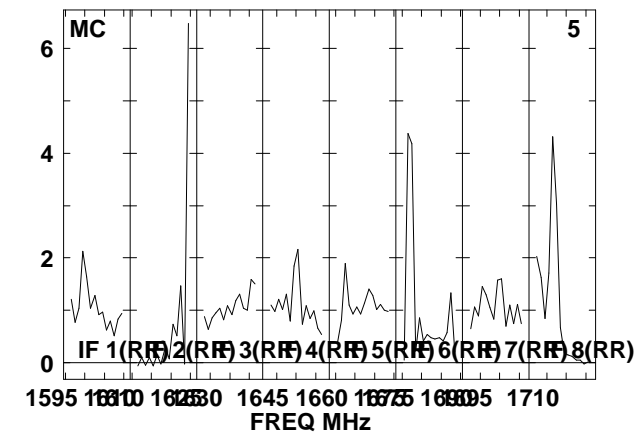
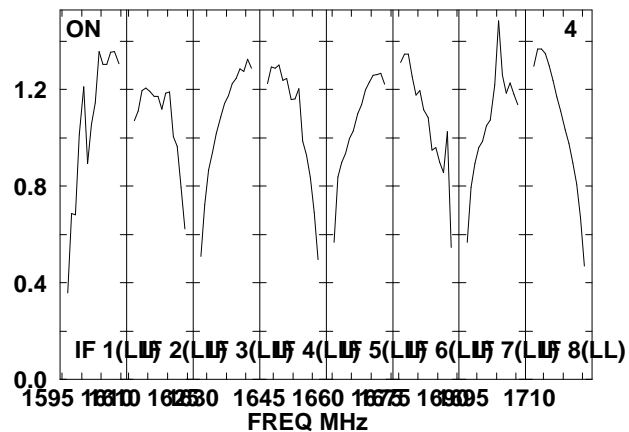
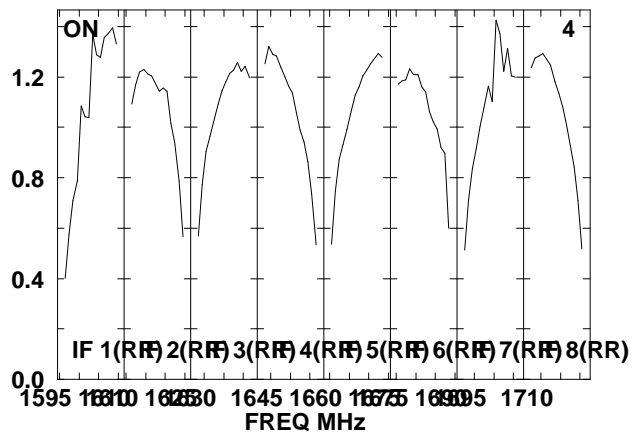
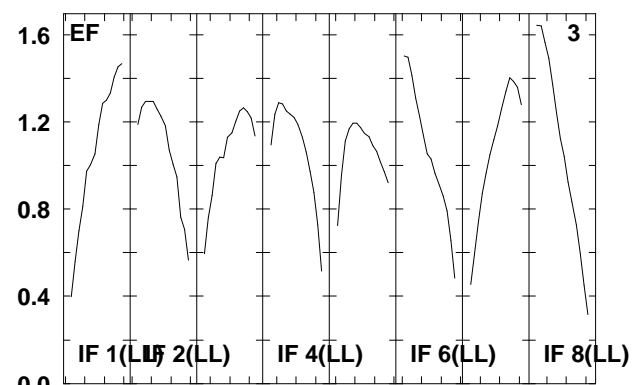
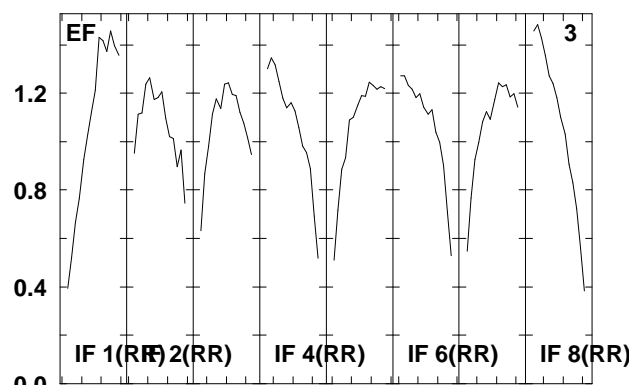
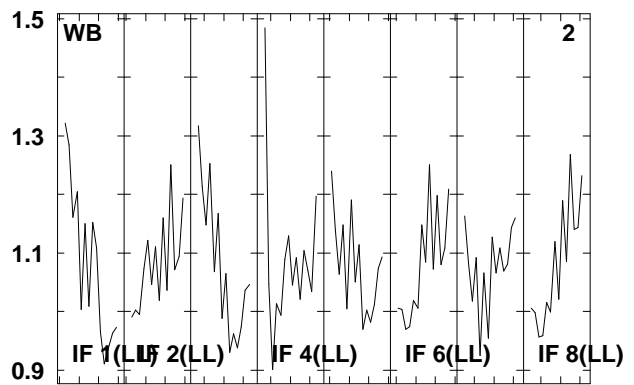
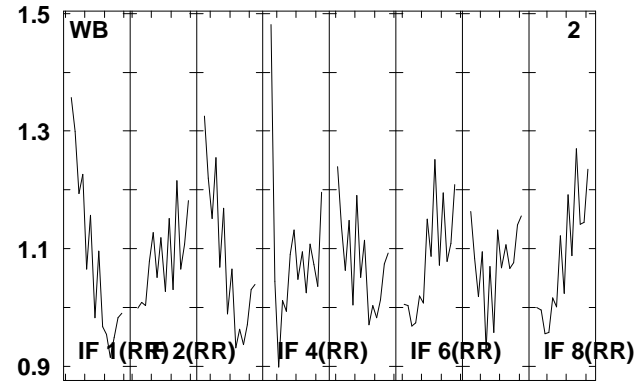
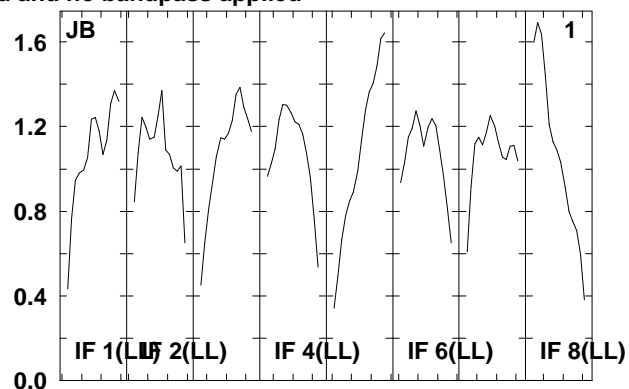
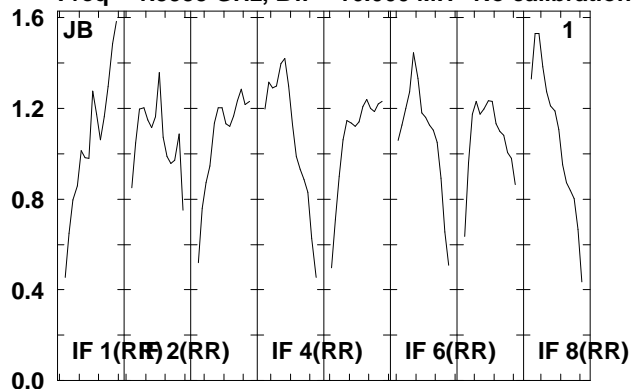

Lower frame: Real Jy  
Total-power spectrum Antenna: \*  
Timerange: 00/23:41:01 to 00/23:44:59

Plot file version 186 created 20-AUG-2009 15:00:26

NGC4639 EG040B.UVDATA.1

Freq = 1.5955 GHz, Bw = 16.000 MH No calibration applied and no bandpass applied

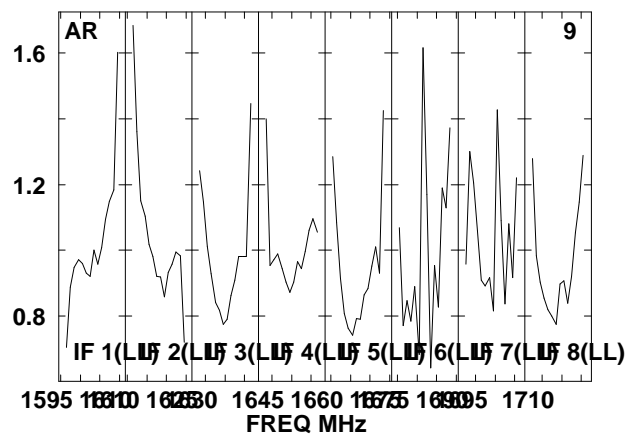
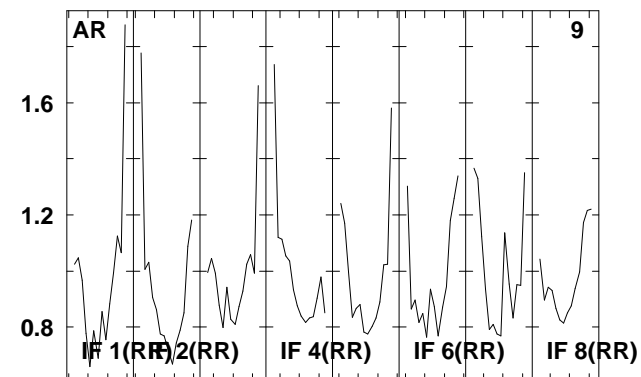
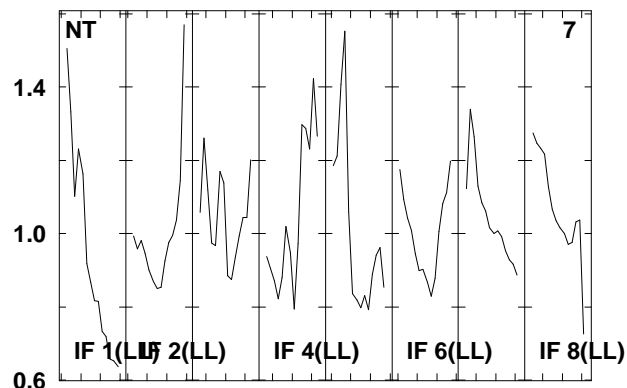
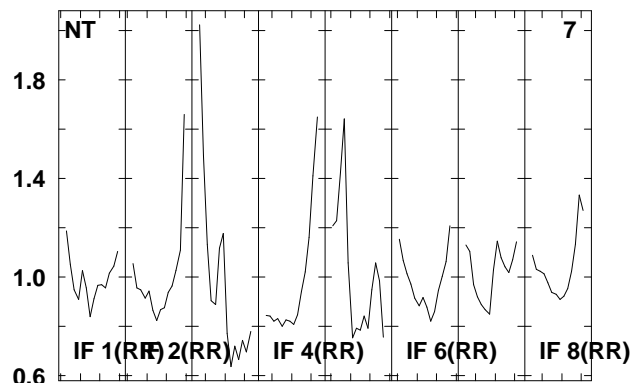
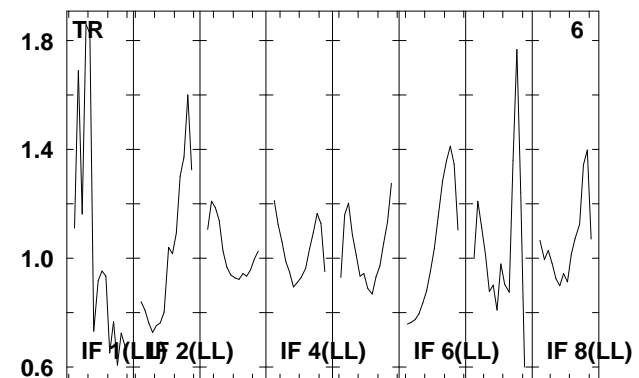
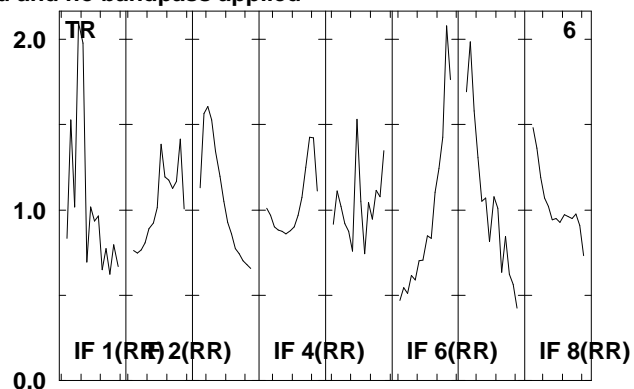
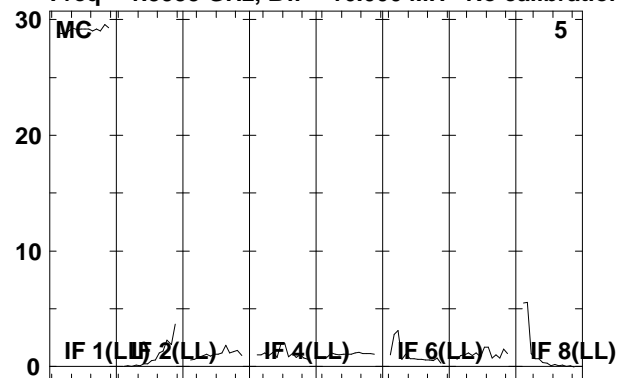

Lower frame: Real Jy

Total-power spectrum Antenna: \*

Timerange: 00/23:41:01 to 00/23:44:59

Plot file version 187 created 20-AUG-2009 15:00:27

3C274 EG040B.UVDATA.1

Freq = 1.5955 GHz, Bw = 16.000 MH No calibration applied and no bandpass applied

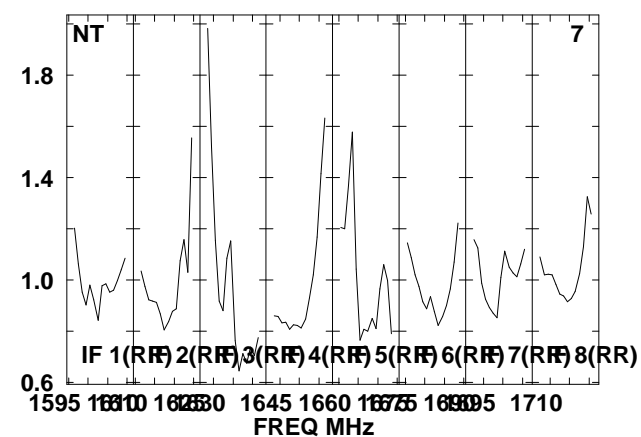
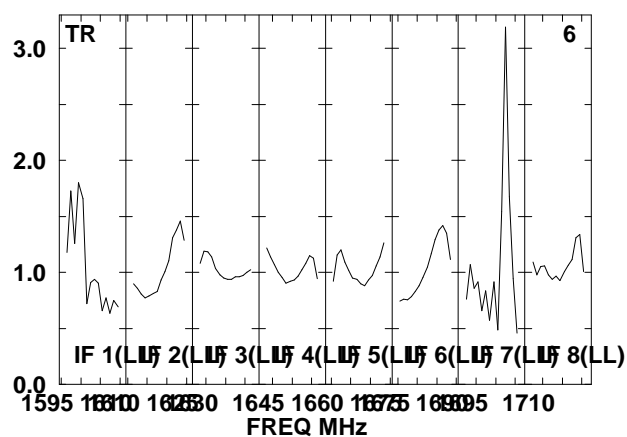
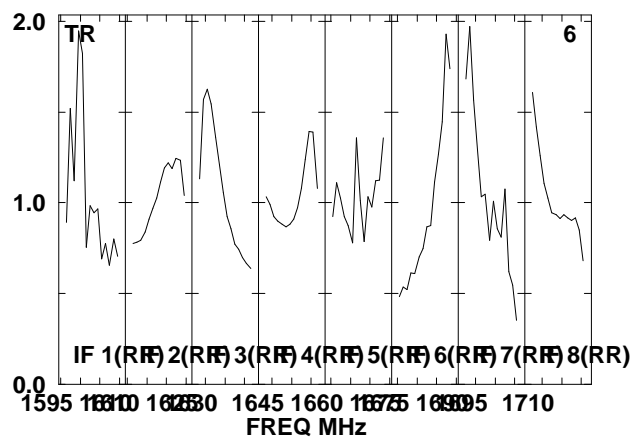
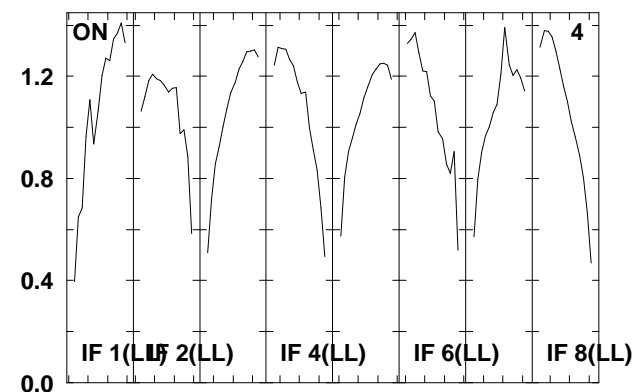
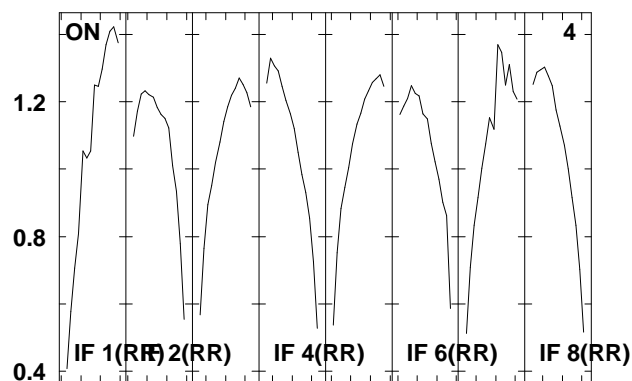
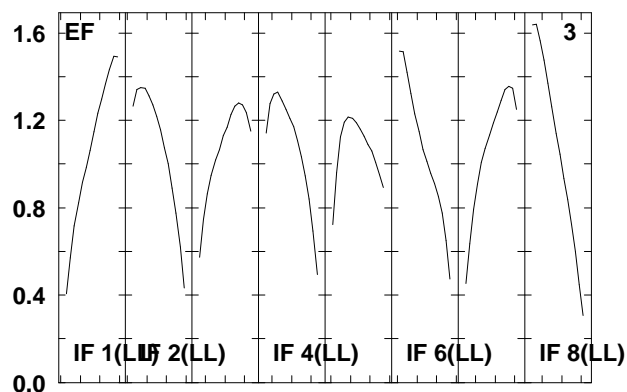
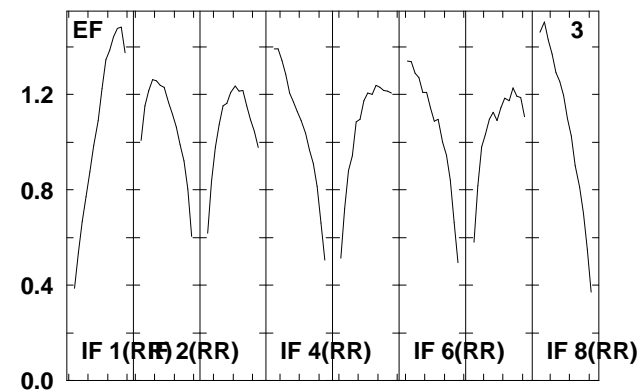
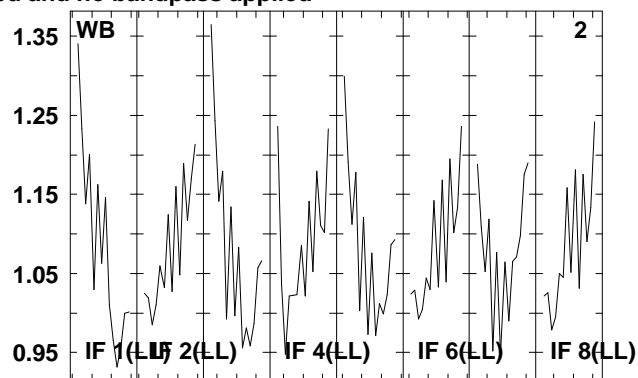
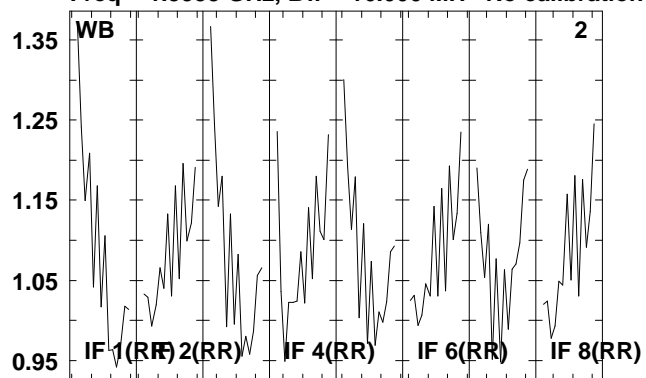

Lower frame: Real Jy

Total-power spectrum Antenna: \*

Timerange: 00/23:45:37 to 00/23:47:13

Plot file version 188 created 20-AUG-2009 15:00:27

3C274 EG040B.UVDATA.1

Freq = 1.5955 GHz, Bw = 16.000 MH No calibration applied and no bandpass applied

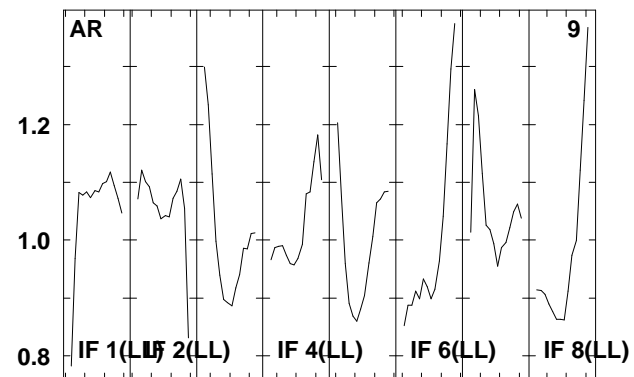
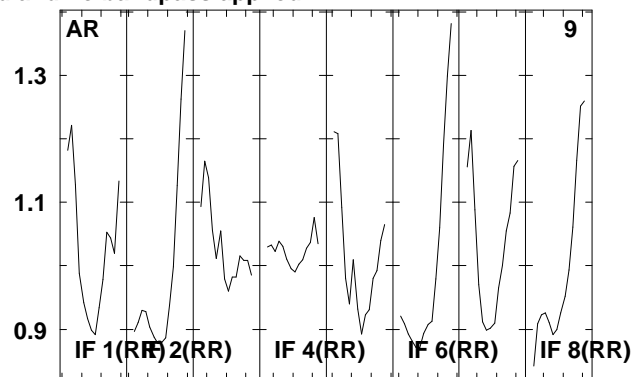
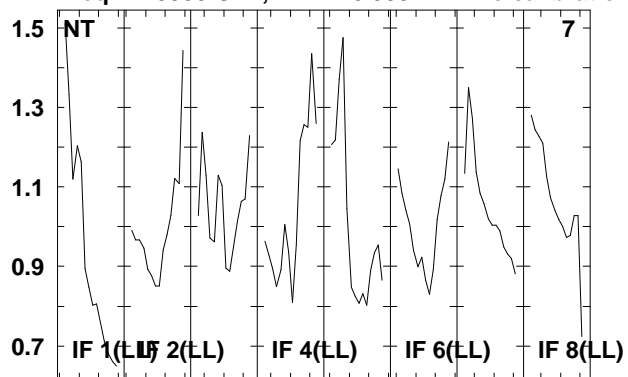

Lower frame: Real Jy  
Total-power spectrum Antenna: \*  
Timerange: 00/23:45:37 to 00/23:47:13

Plot file version 189 created 20-AUG-2009 15:00:27

NGC4639 EG040B.UVDATA.1

Freq = 1.5955 GHz, Bw = 16.000 MH No calibration applied and no bandpass applied

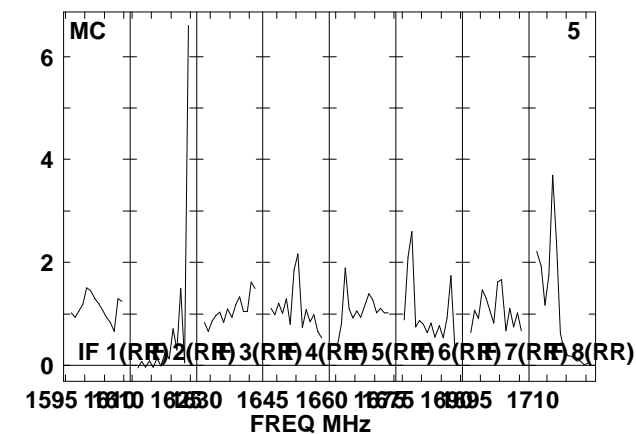
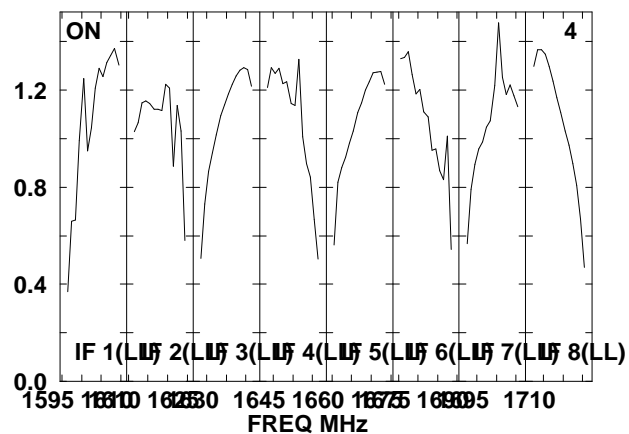
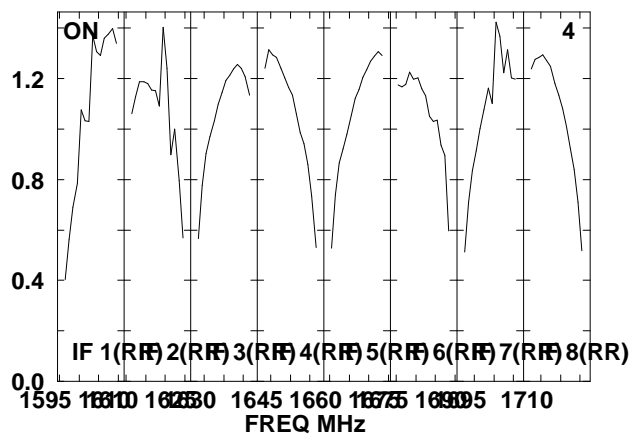
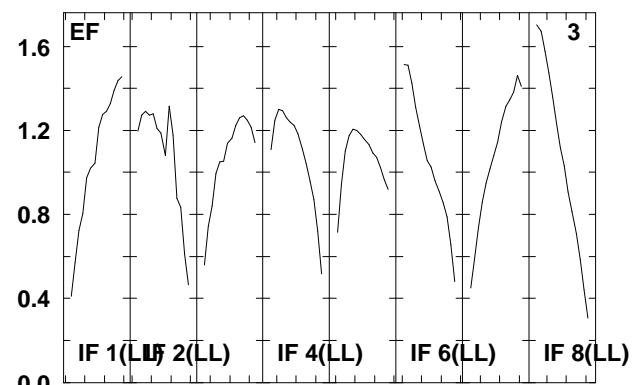
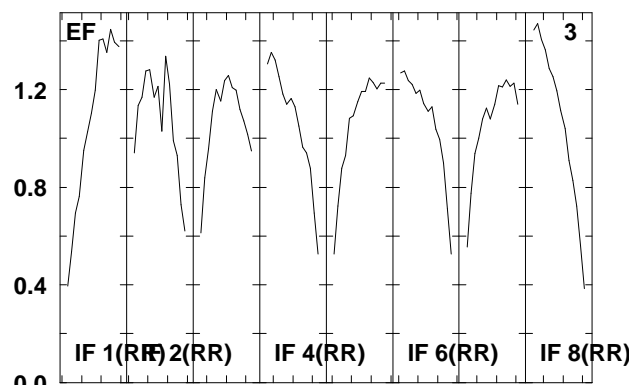
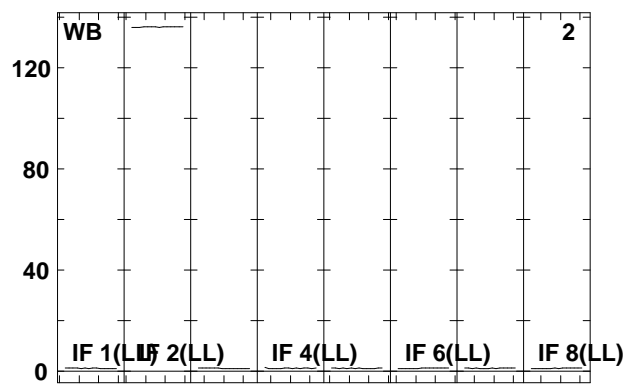
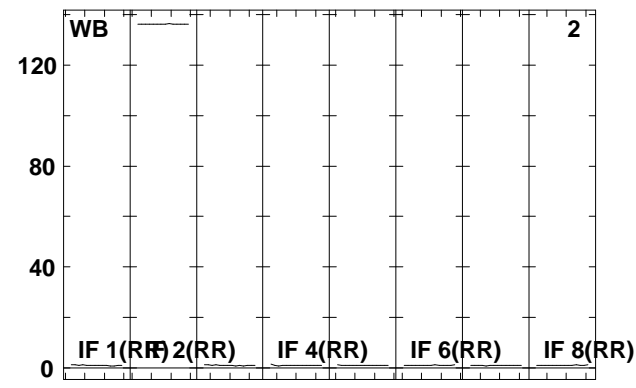
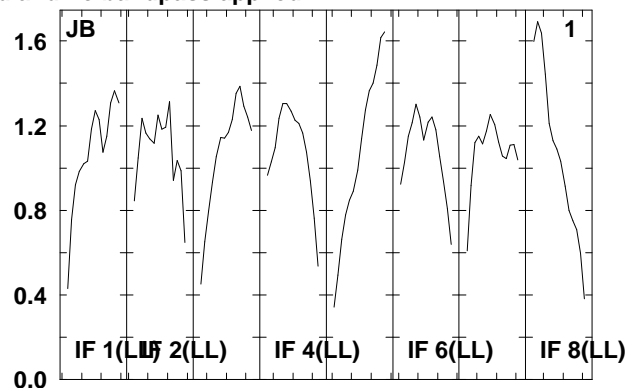
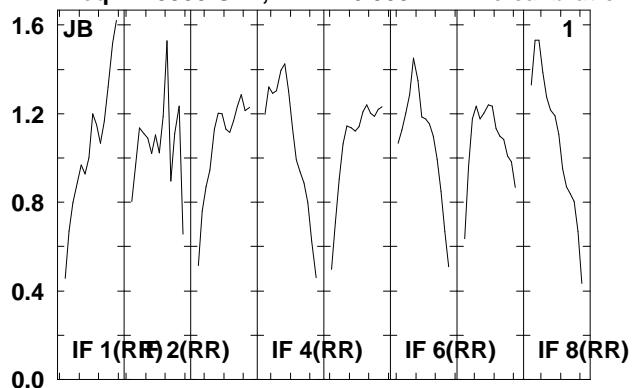

Lower frame: Real Jy  
Total-power spectrum Antenna: \*  
Timerange: 00/23:47:15 to 00/23:51:13

Plot file version 190 created 20-AUG-2009 15:00:27

NGC4639 EG040B.UVDATA.1

Freq = 1.5955 GHz, Bw = 16.000 MH No calibration applied and no bandpass applied

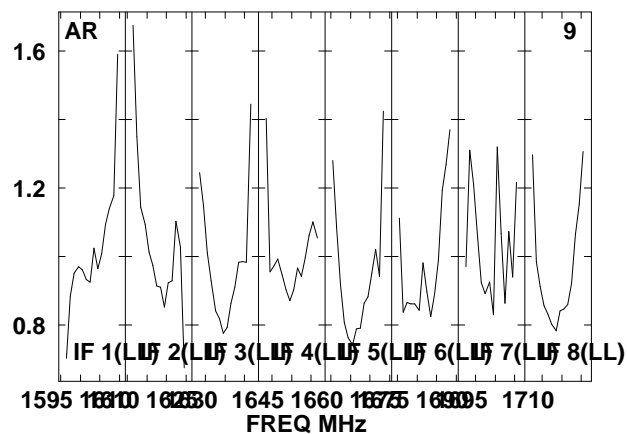
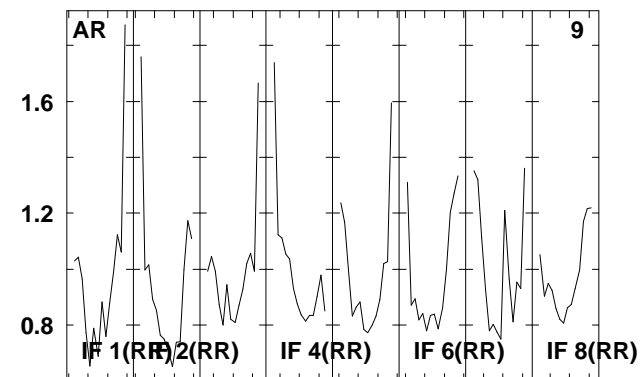
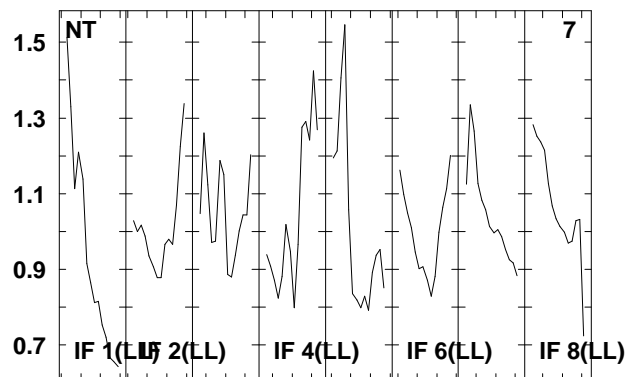
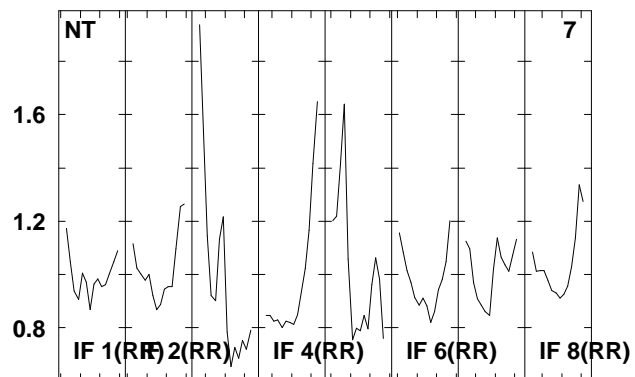
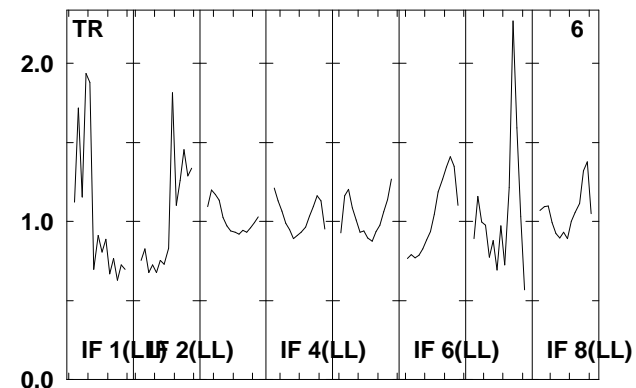
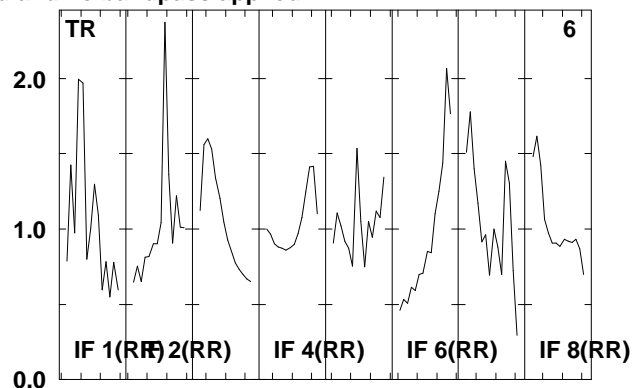
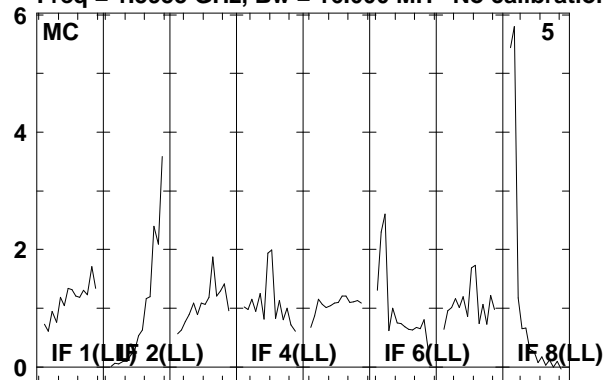

Lower frame: Real Jy

Total-power spectrum Antenna: \*

Timerange: 00/23:47:15 to 00/23:51:13

Plot file version 191 created 20-AUG-2009 15:00:28  
 3C274 EG040B.UVDATA.1  
 Freq = 1.5955 GHz, Bw = 16.000 MH No calibration applied and no bandpass applied

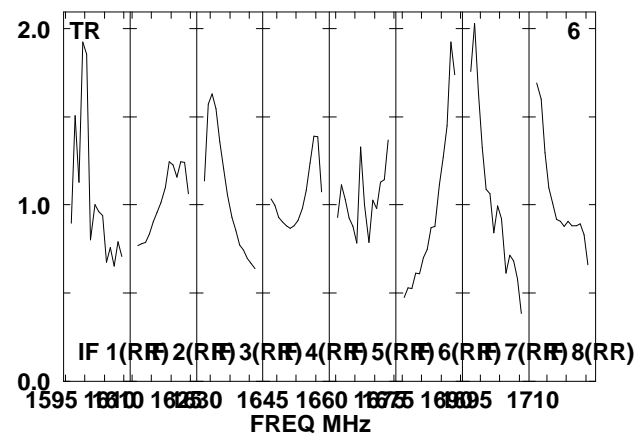
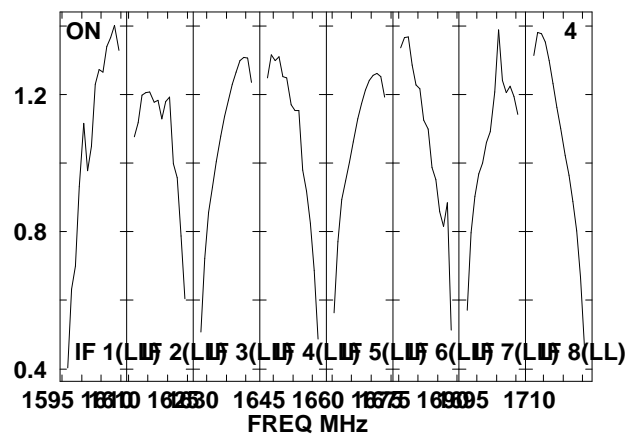
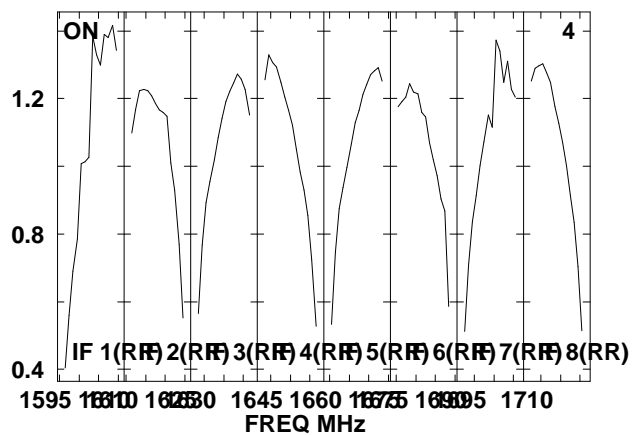
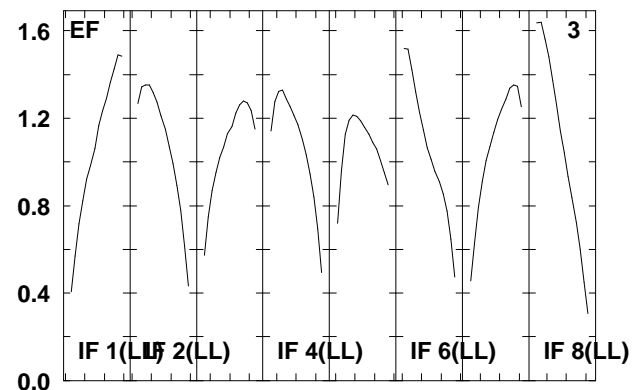
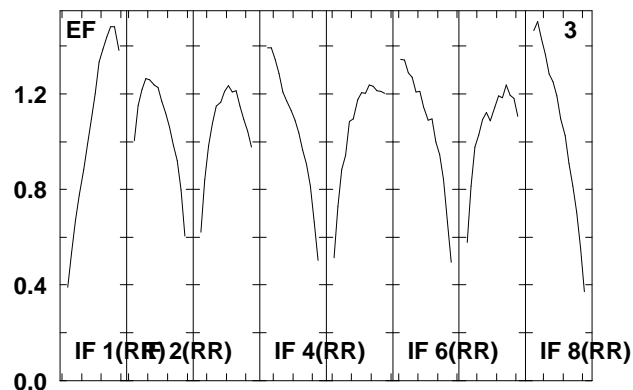
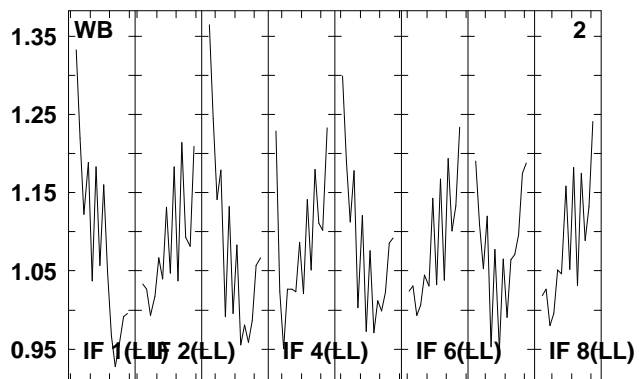
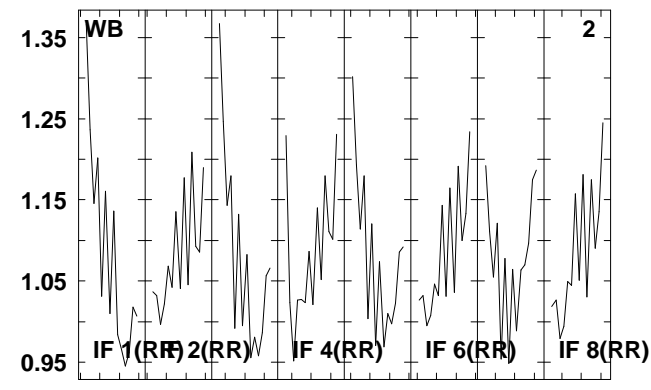
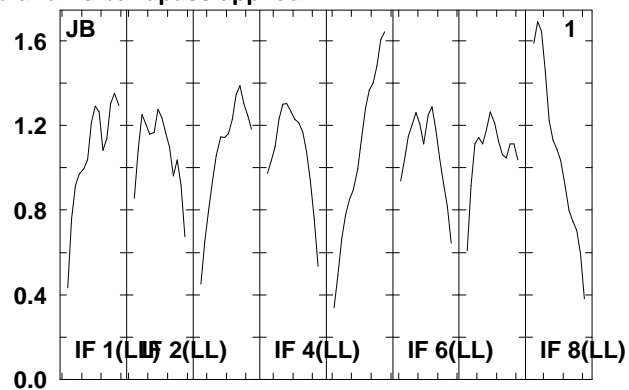
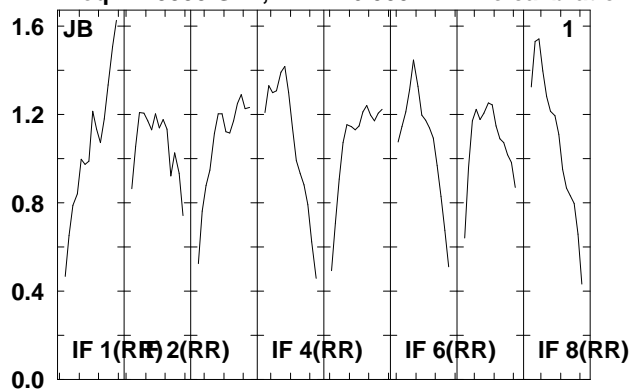

Lower frame: Real Jy  
 Total-power spectrum Antenna: \*  
 Timerange: 00/23:51:15 to 00/23:53:13

Plot file version 192 created 20-AUG-2009 15:00:28

3C274 EG040B.UVDATA.1

Freq = 1.5955 GHz, Bw = 16.000 MH No calibration applied and no bandpass applied

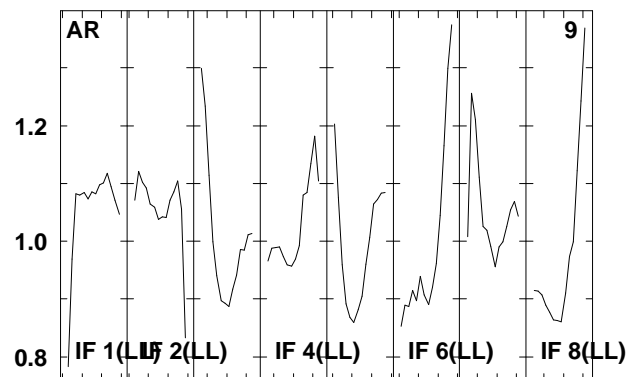
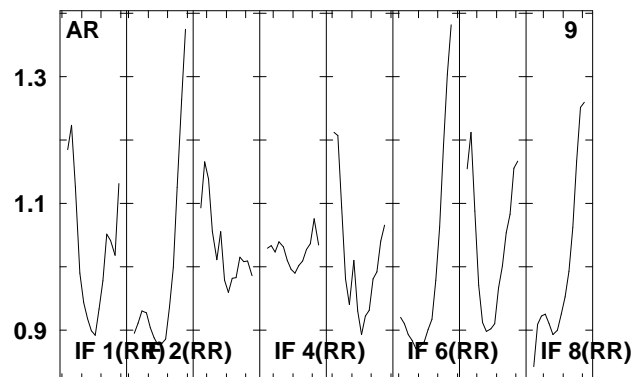
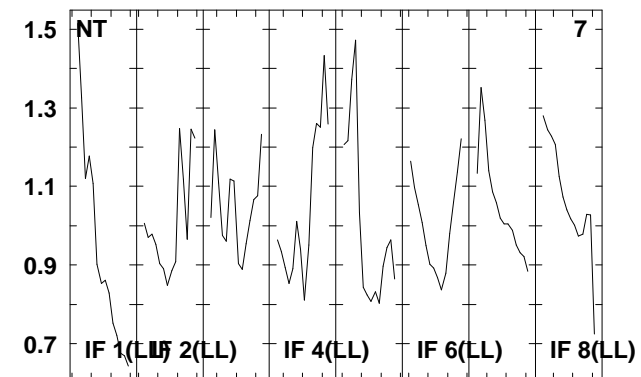
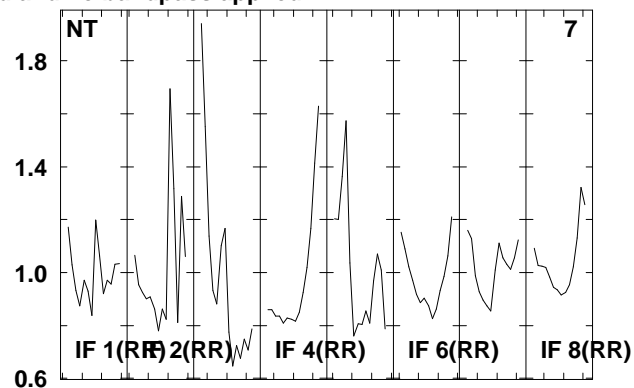
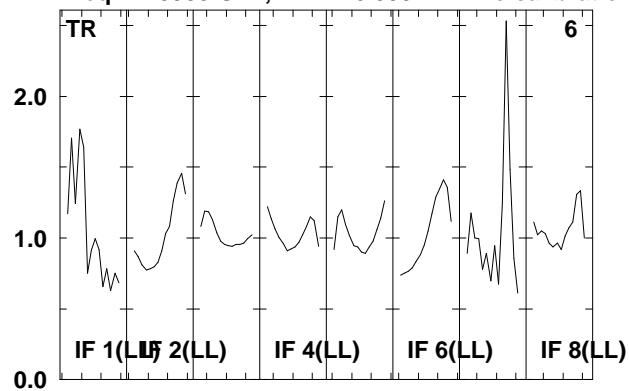

Lower frame: Real Jy  
Total-power spectrum Antenna: \*  
Timerange: 00/23:51:15 to 00/23:53:13



Plot file version 193 created 20-AUG-2009 15:00:28

NGC4639 EG040B.UVDATA.1

Freq = 1.5955 GHz, Bw = 16.000 MH No calibration applied and no bandpass applied

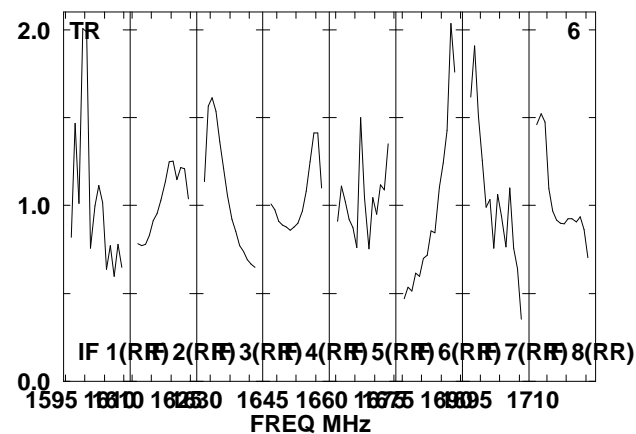
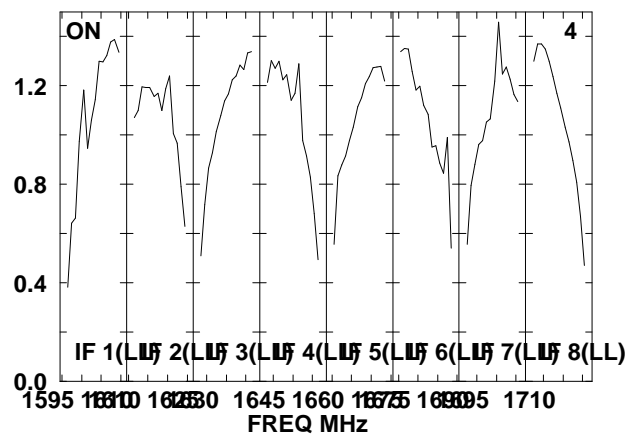
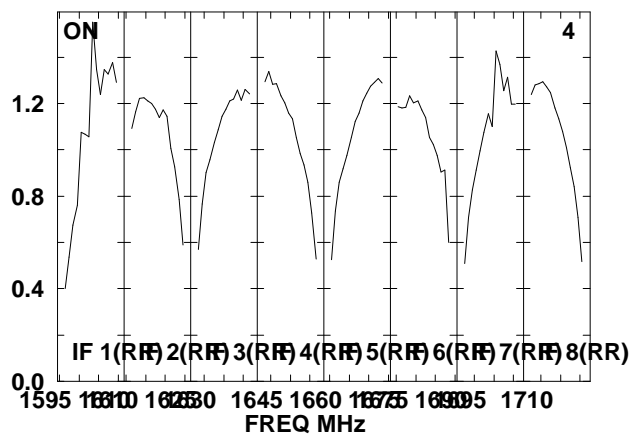
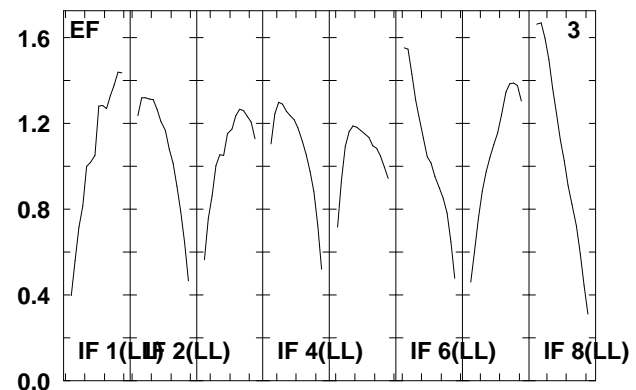
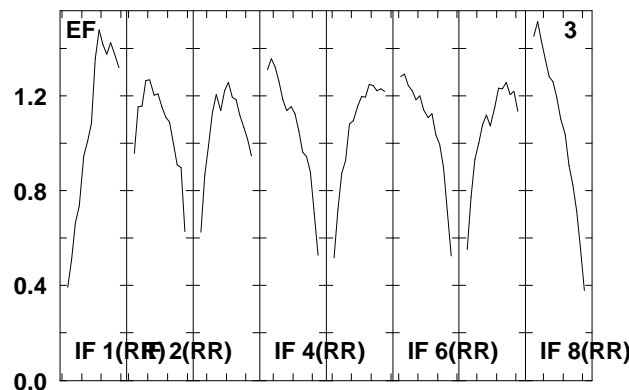
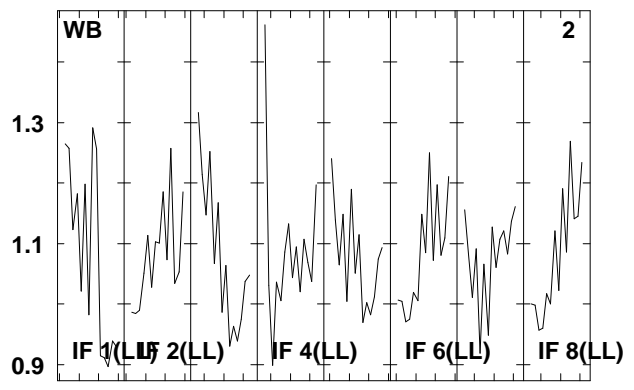
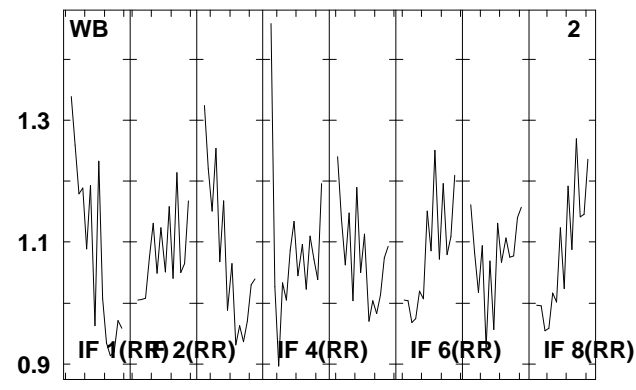
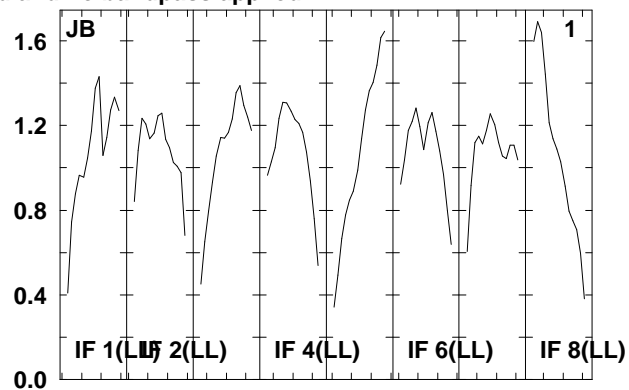
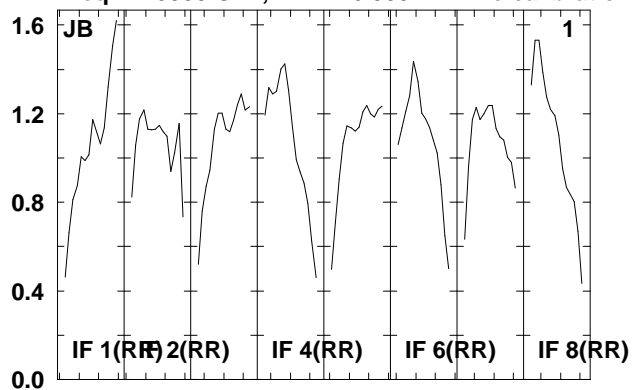

Lower frame: Real Jy  
Total-power spectrum Antenna: \*  
Timerange: 00/23:53:17 to 00/23:57:15

Plot file version 194 created 20-AUG-2009 15:00:29

NGC4639 EG040B.UVDATA.1

Freq = 1.5955 GHz, Bw = 16.000 MH No calibration applied and no bandpass applied

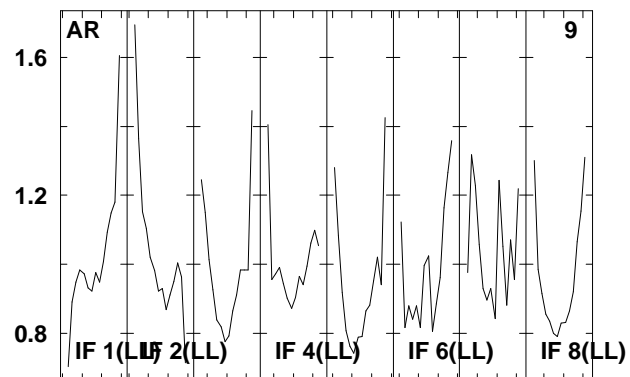
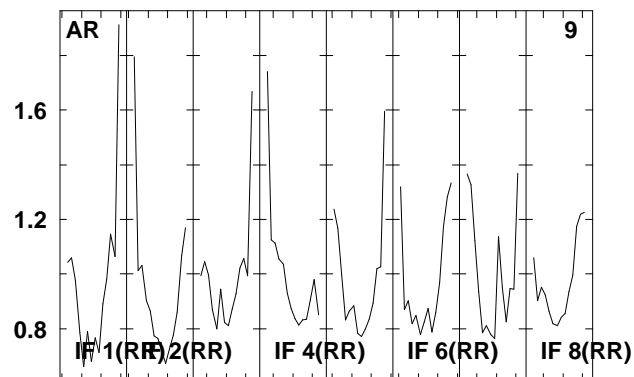
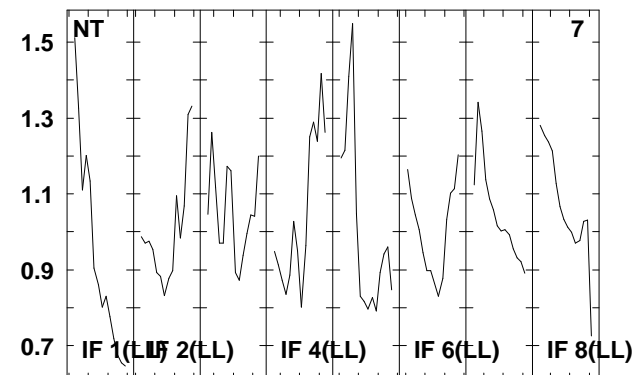
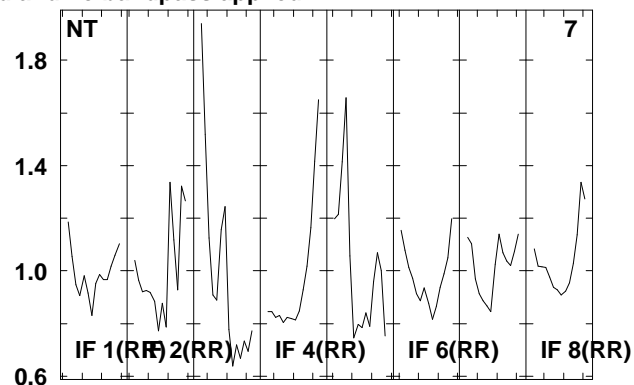
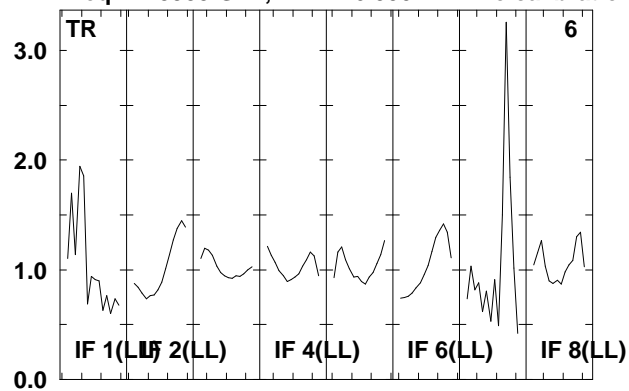

Lower frame: Real Jy  
Total-power spectrum Antenna: \*  
Timerange: 00/23:53:17 to 00/23:57:15

Plot file version 195 created 20-AUG-2009 15:00:29

3C274 EG040B.UVDATA.1

Freq = 1.5955 GHz, Bw = 16.000 MH No calibration applied and no bandpass applied

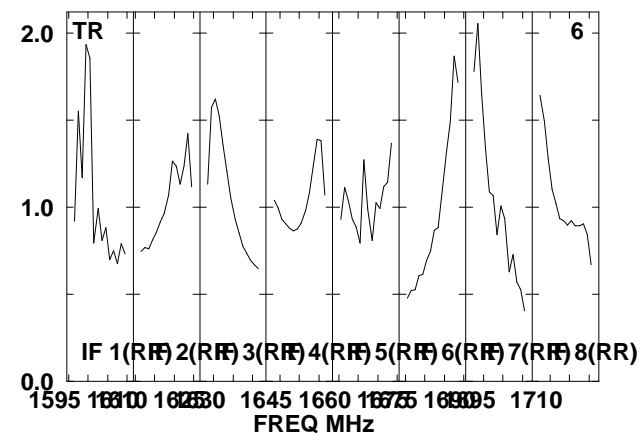
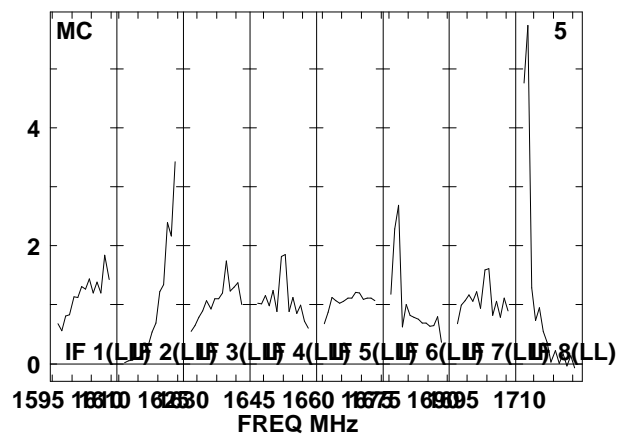
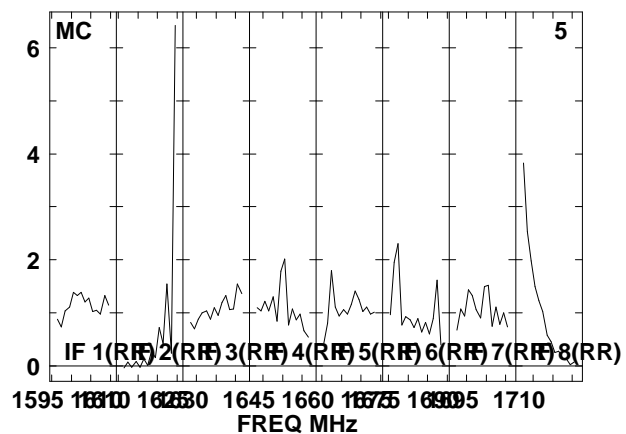
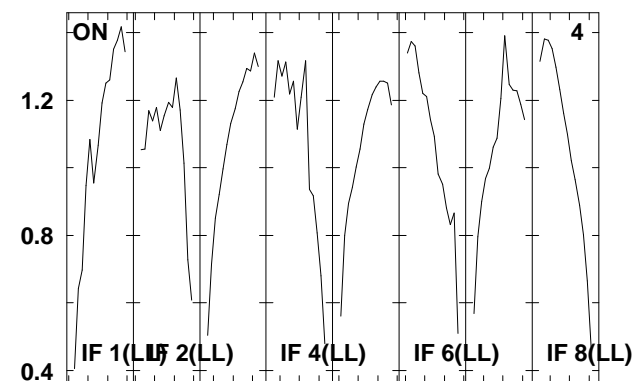
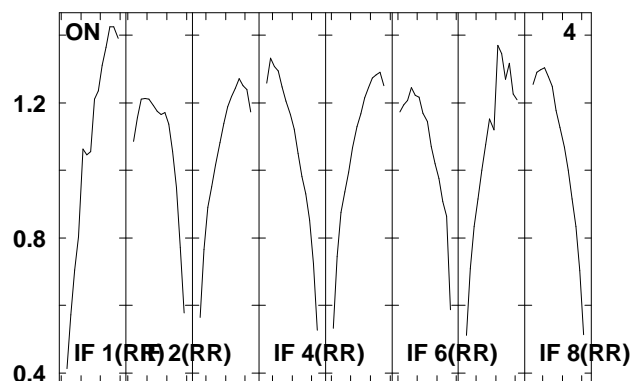
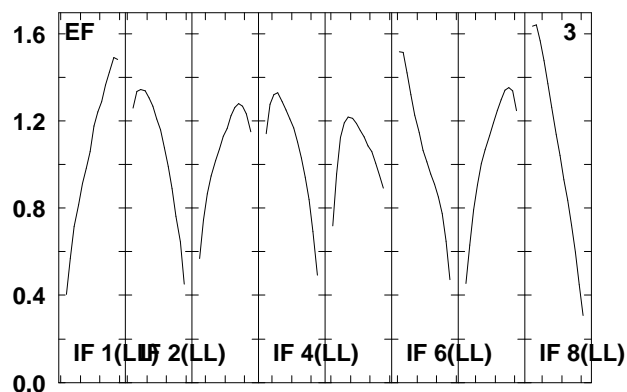
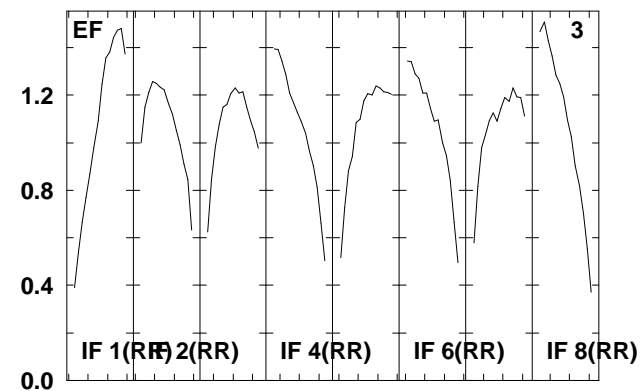
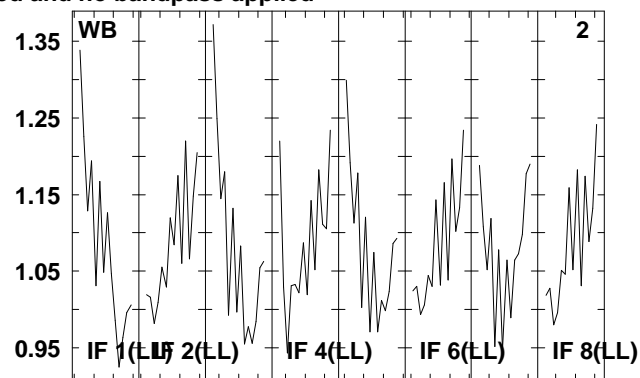
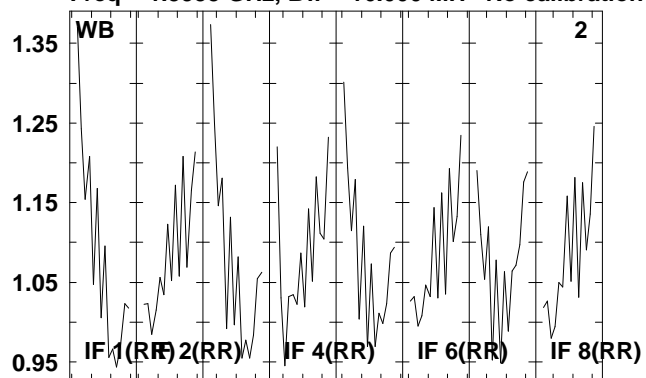

Lower frame: Real Jy

Total-power spectrum Antenna: \*

Timerange: 00/23:57:51 to 00/23:59:29

Plot file version 196 created 20-AUG-2009 15:00:29

3C274 EG040B.UVDATA.1

Freq = 1.5955 GHz, Bw = 16.000 MH No calibration applied and no bandpass applied

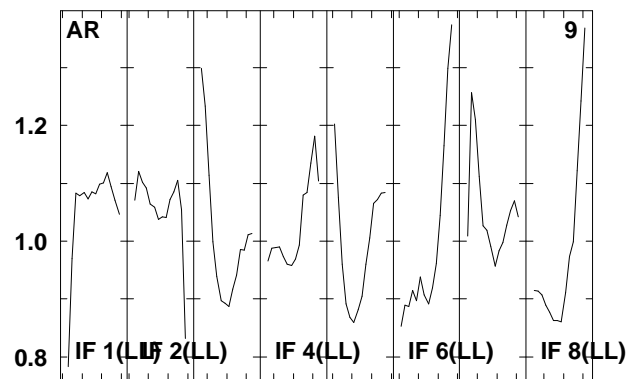
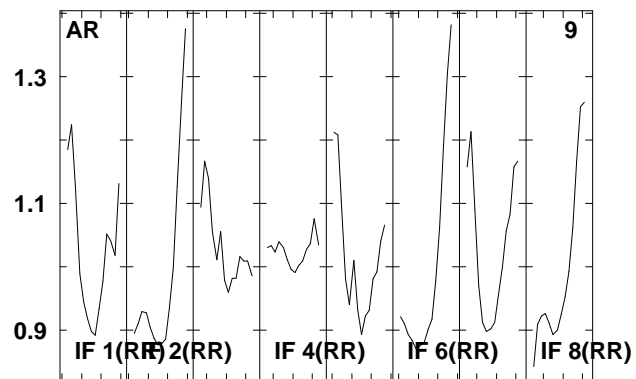
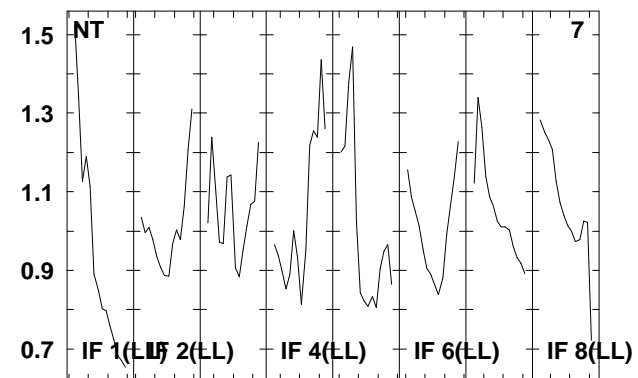
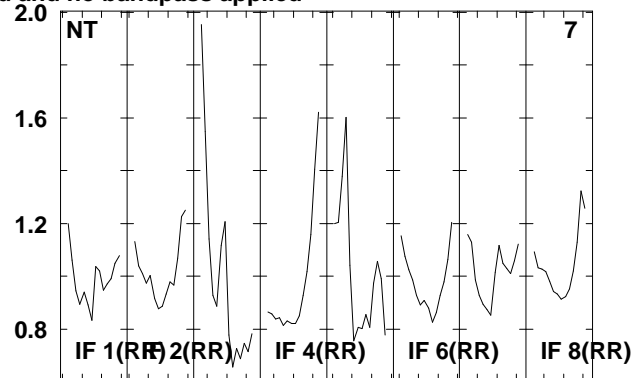
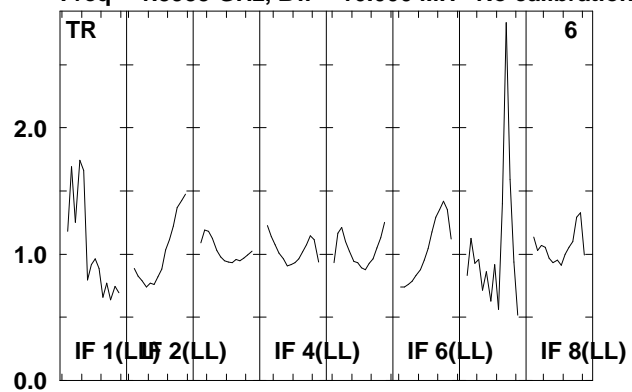

Lower frame: Real Jy  
Total-power spectrum Antenna: \*  
Timerange: 00/23:57:51 to 00/23:59:29

Plot file version 197 created 20-AUG-2009 15:00:30

NGC4639 EG040B.UVDATA.1

Freq = 1.5955 GHz, Bw = 16.000 MH No calibration applied and no bandpass applied

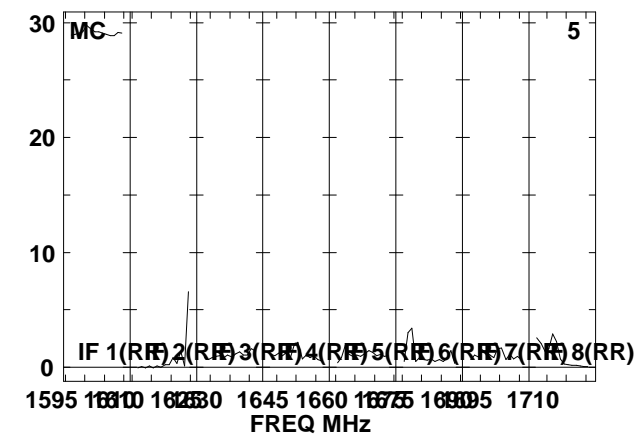
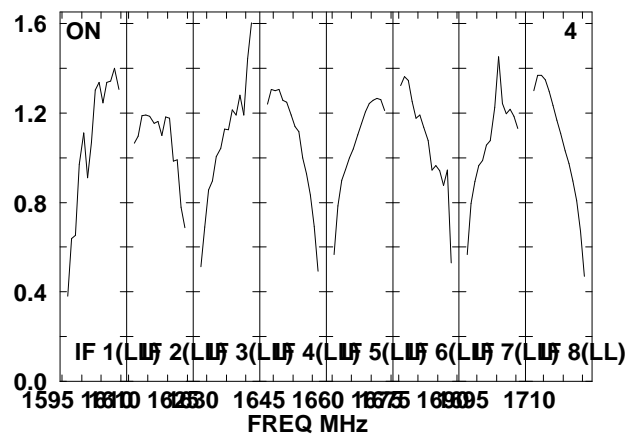
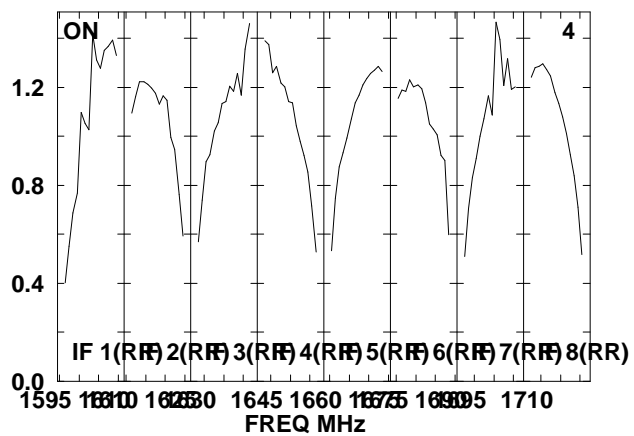
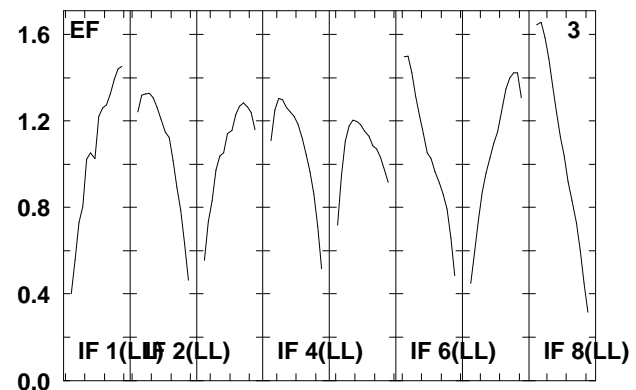
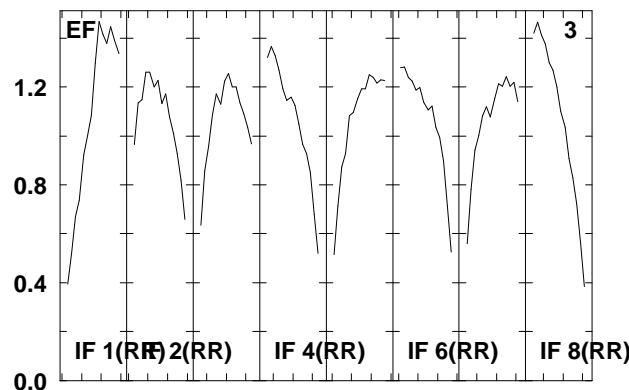
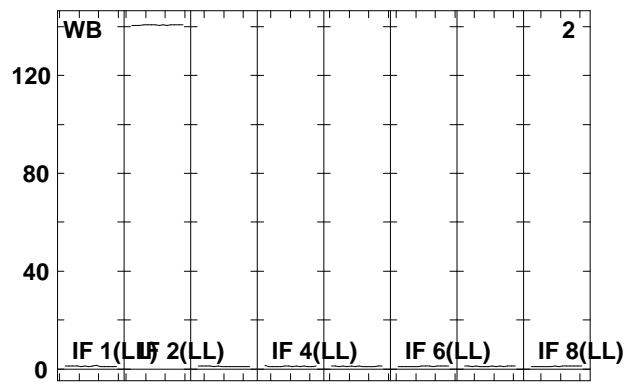
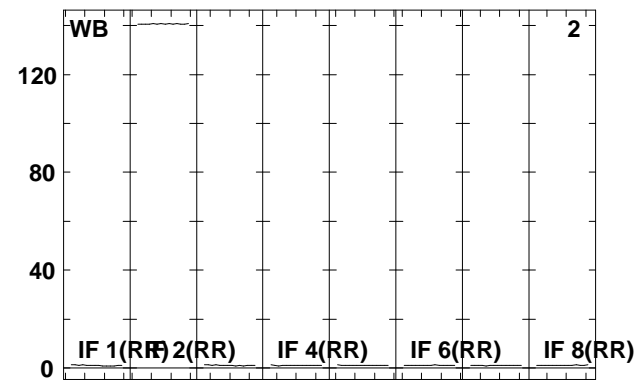
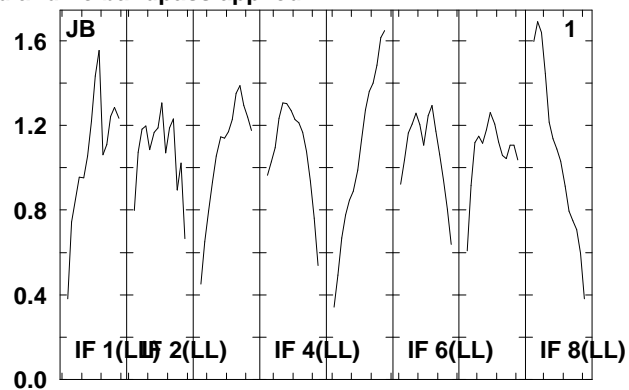
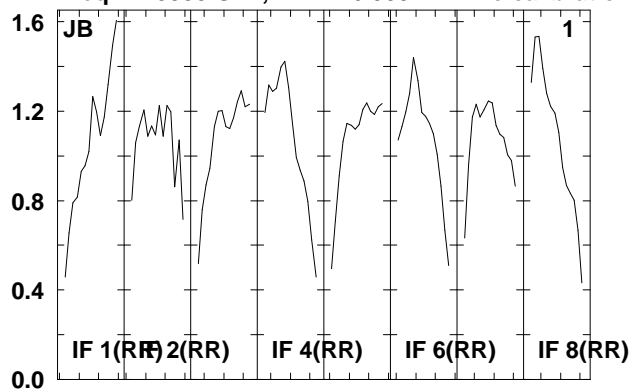

Lower frame: Real Jy  
Total-power spectrum Antenna: \*  
Timerange: 00/23:59:31 to 01/00:03:29

Plot file version 198 created 20-AUG-2009 15:00:30

NGC4639 EG040B.UVDATA.1

Freq = 1.5955 GHz, Bw = 16.000 MH No calibration applied and no bandpass applied

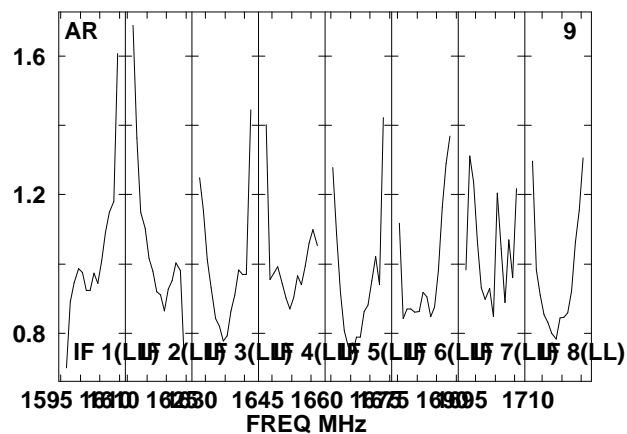
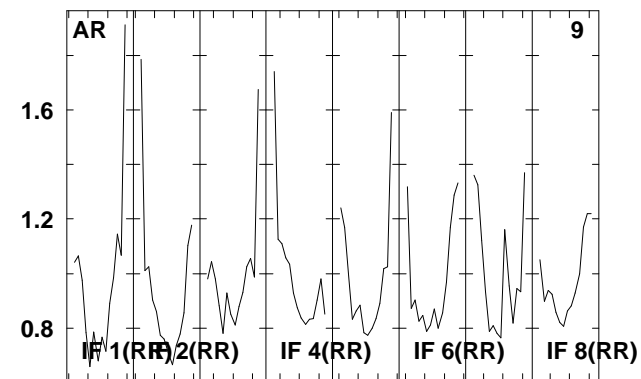
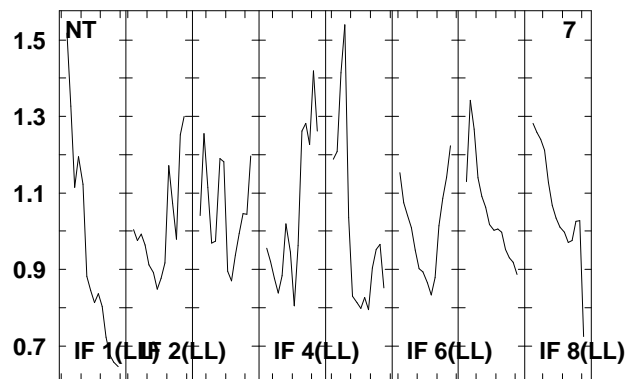
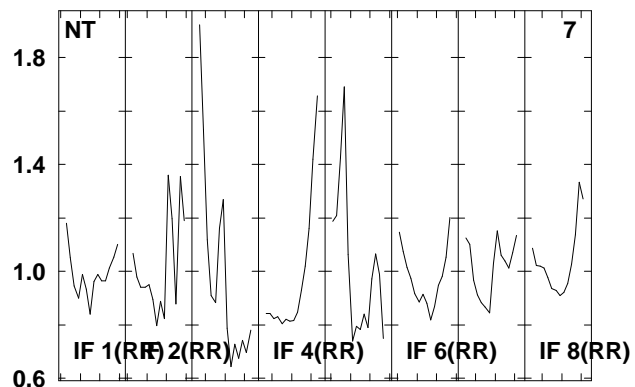
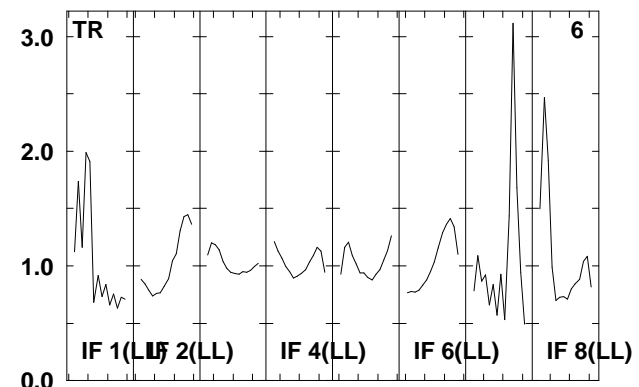
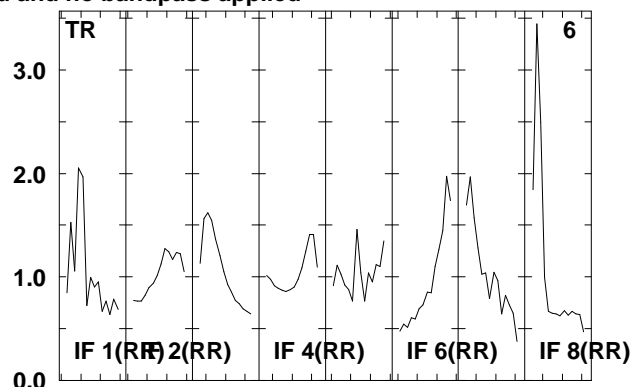
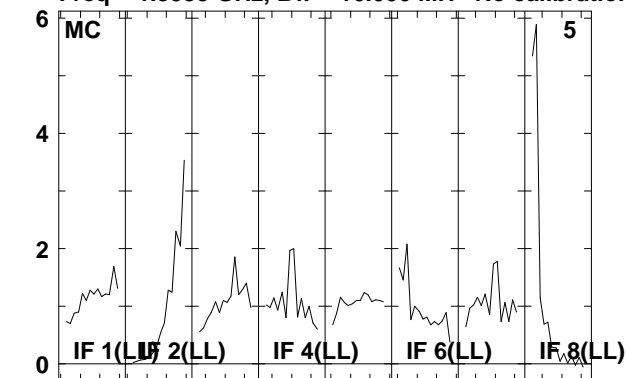

Lower frame: Real Jy

Total-power spectrum Antenna: \*

Timerange: 00/23:59:31 to 01/00:03:29

Plot file version 199 created 20-AUG-2009 15:00:31  
 3C274 EG040B.UVDATA.1  
 Freq = 1.5955 GHz, Bw = 16.000 MH No calibration applied and no bandpass applied

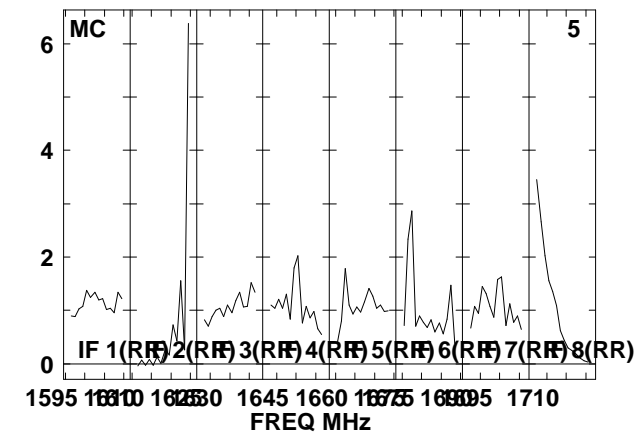
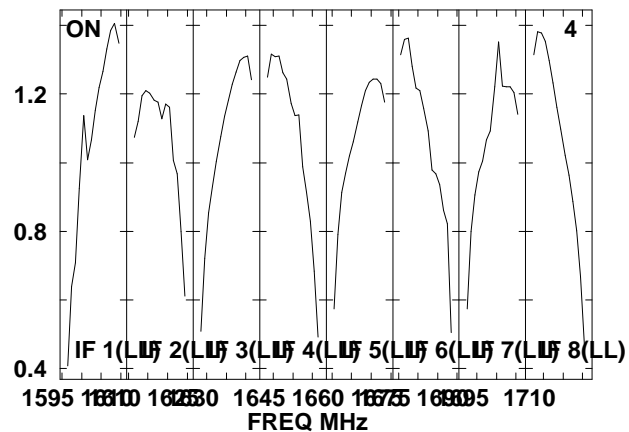
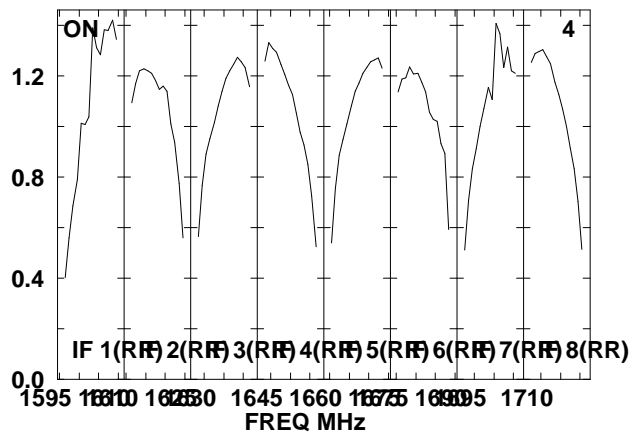
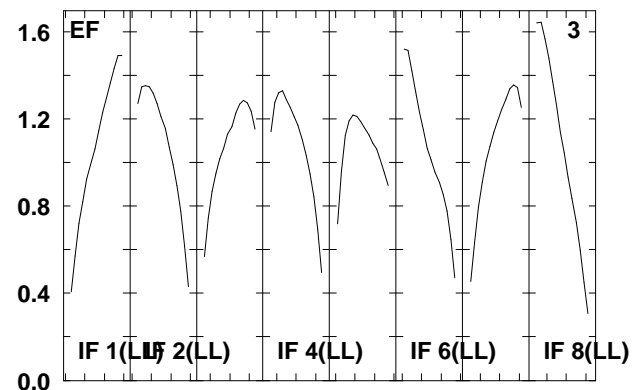
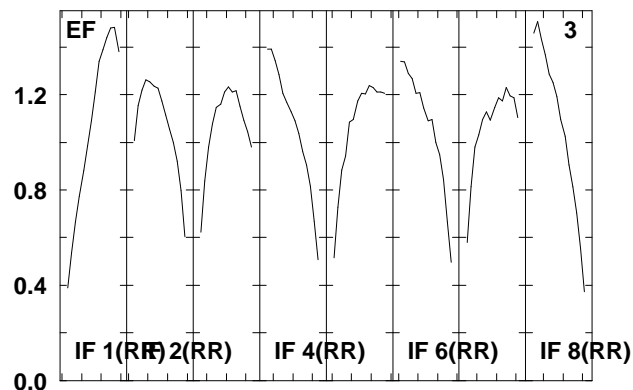
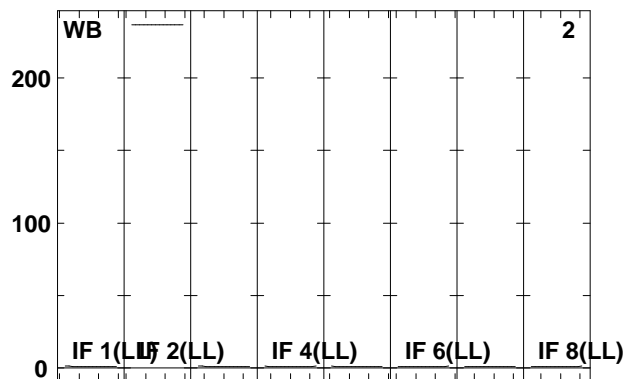
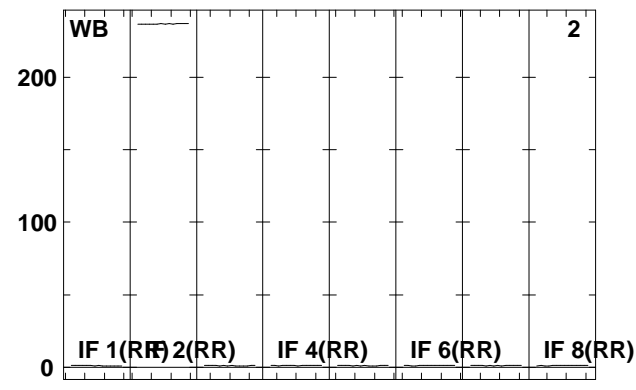
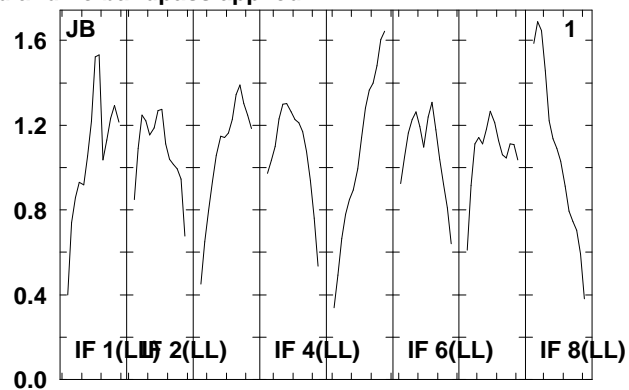
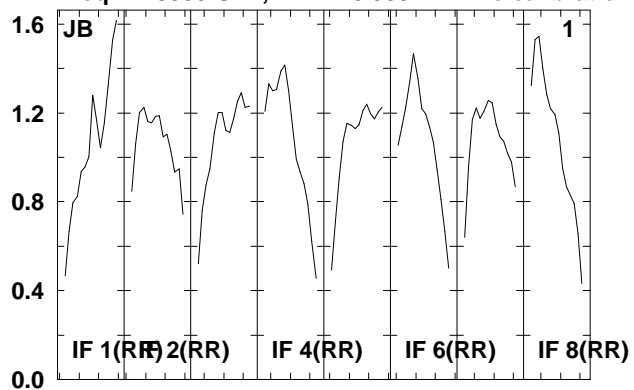

Lower frame: Real Jy  
 Total-power spectrum Antenna: \*  
 Timerange: 01/00:03:31 to 01/00:05:29

Plot file version 200 created 20-AUG-2009 15:00:31

3C274 EG040B.UVDATA.1

Freq = 1.5955 GHz, Bw = 16.000 MH No calibration applied and no bandpass applied

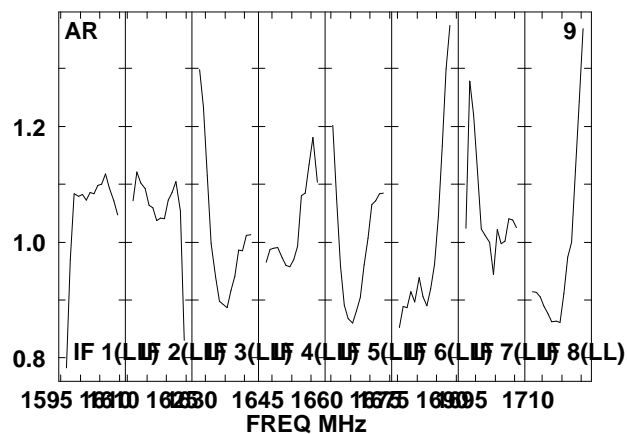
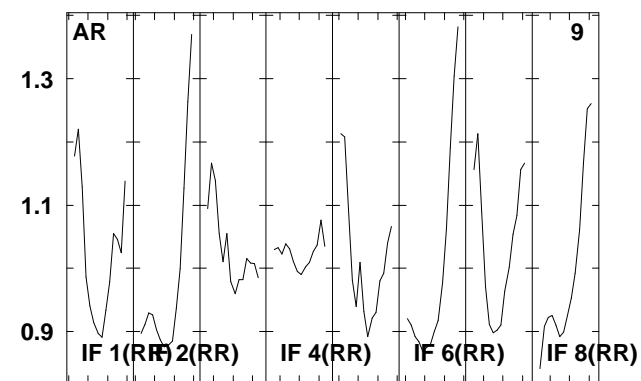
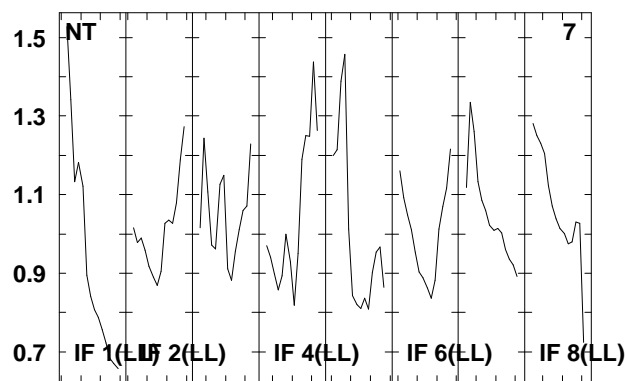
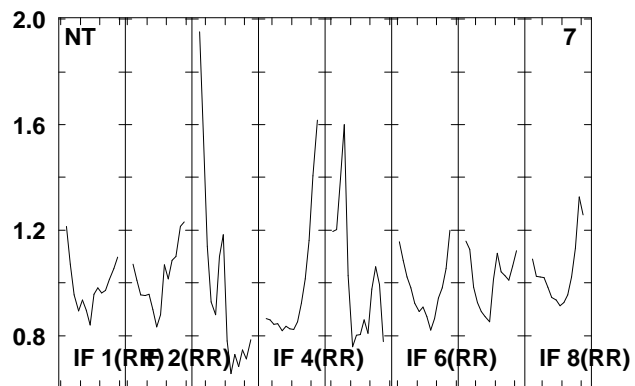
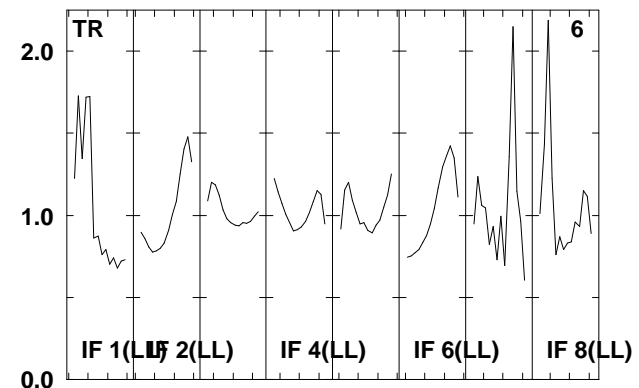
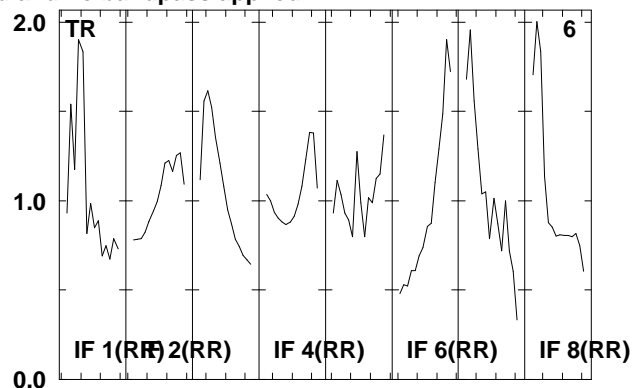
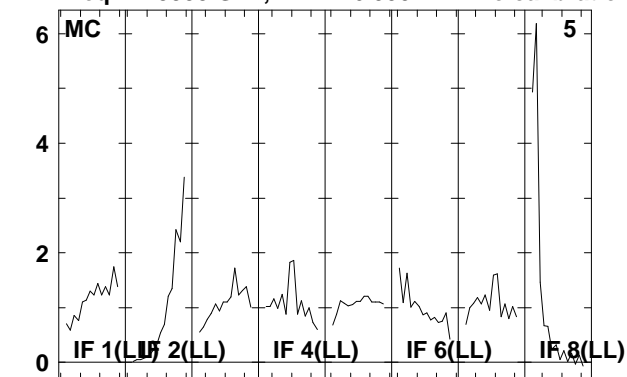

Lower frame: Real Jy

Total-power spectrum Antenna: \*

Timerange: 01/00:03:31 to 01/00:05:29



Plot file version 201 created 20-AUG-2009 15:00:31

NGC4639 EG040B.UVDATA.1

Freq = 1.5955 GHz, Bw = 16.000 MH No calibration applied and no bandpass applied

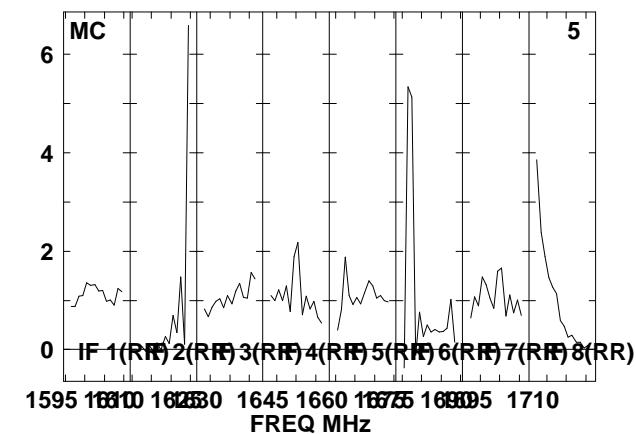
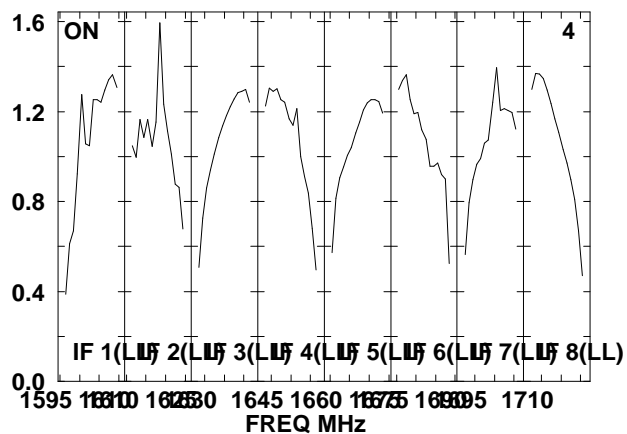
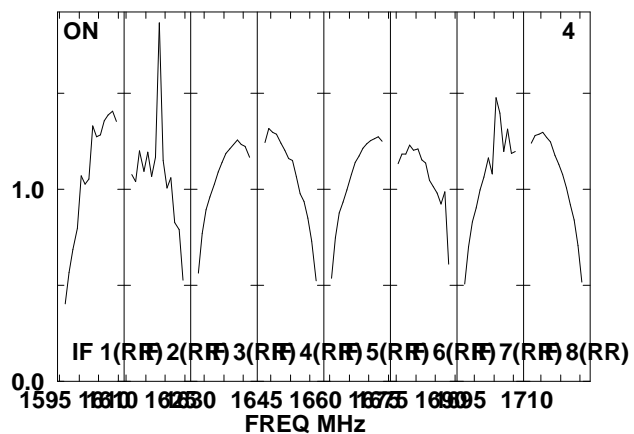
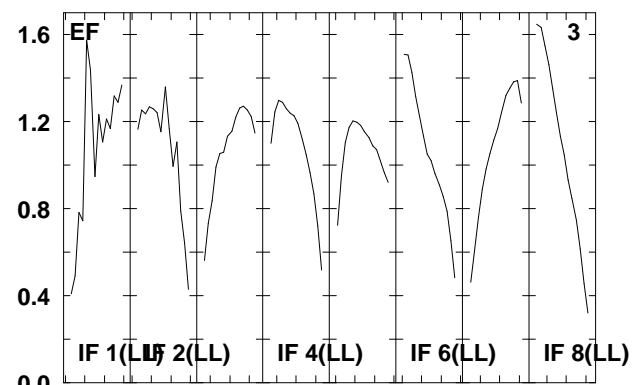
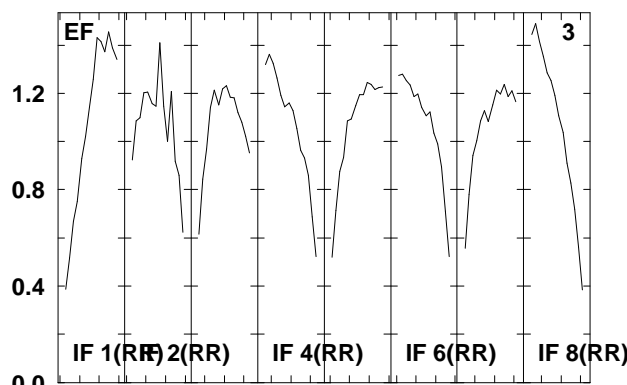
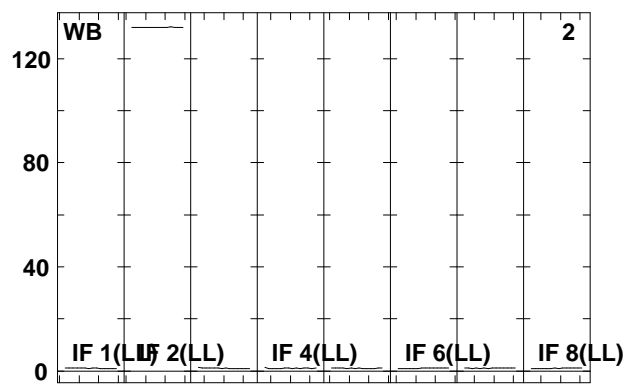
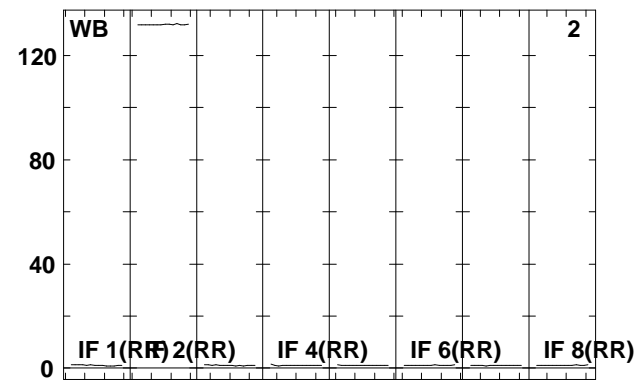
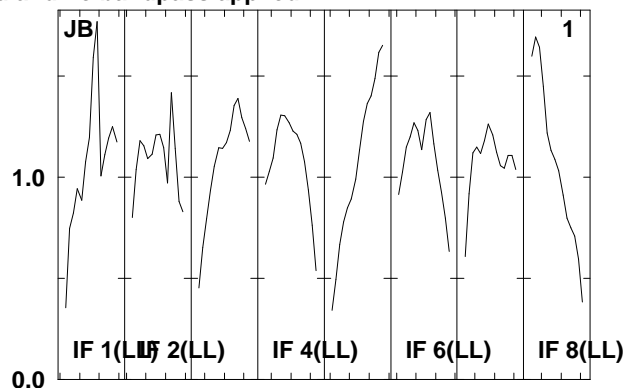
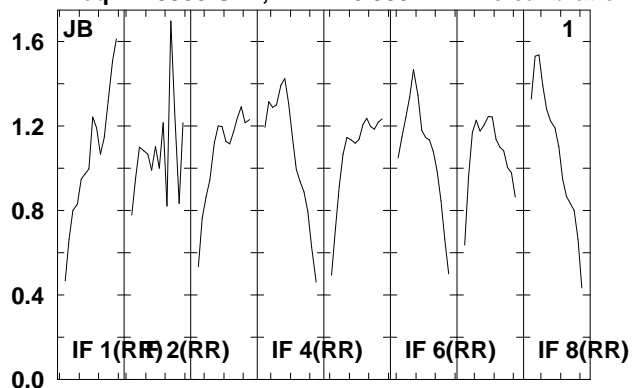

Lower frame: Real Jy  
Total-power spectrum Antenna: \*  
Timerange: 01/00:05:31 to 01/00:09:27

Plot file version 202 created 20-AUG-2009 15:00:32

NGC4639 EG040B.UVDATA.1

Freq = 1.5955 GHz, Bw = 16.000 MH No calibration applied and no bandpass applied

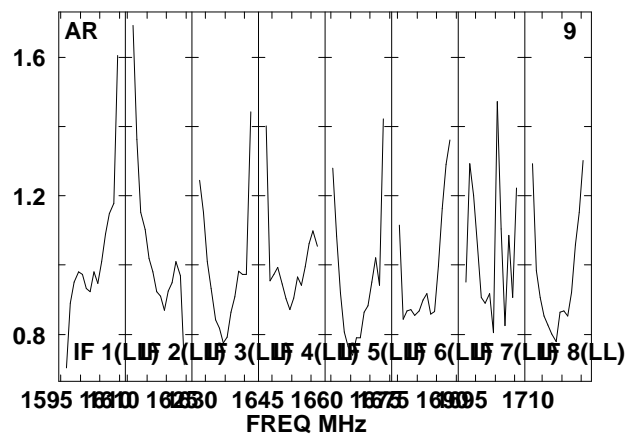
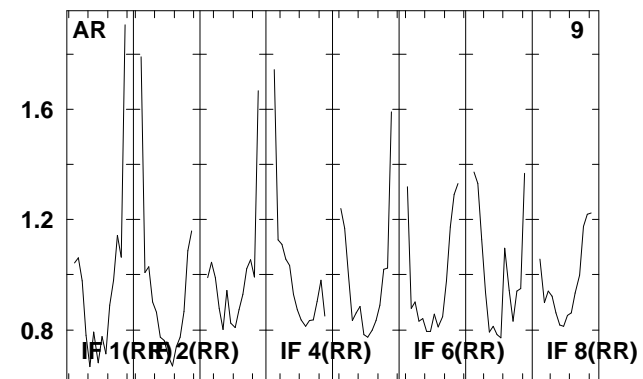
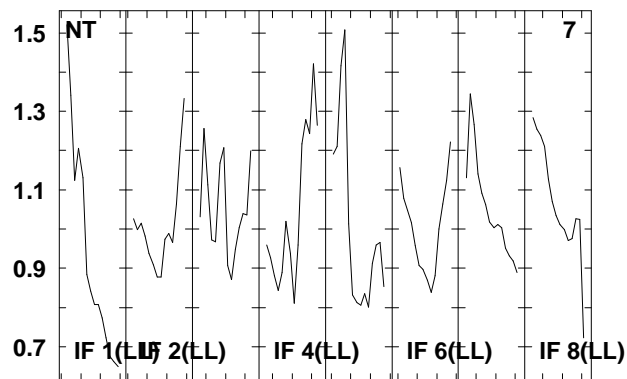
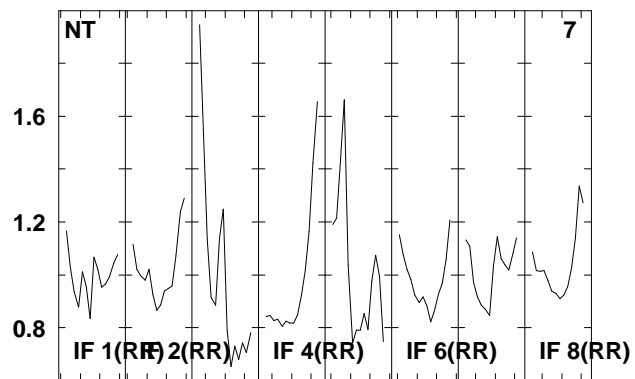
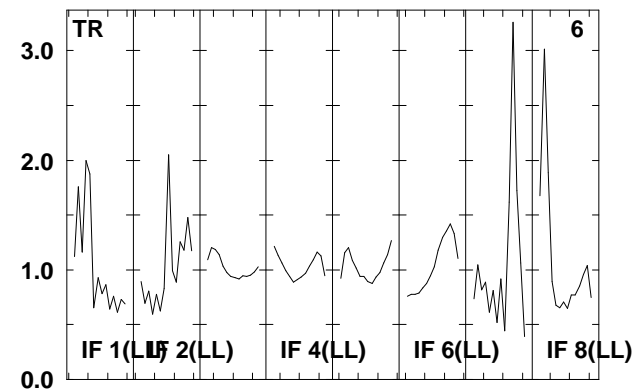
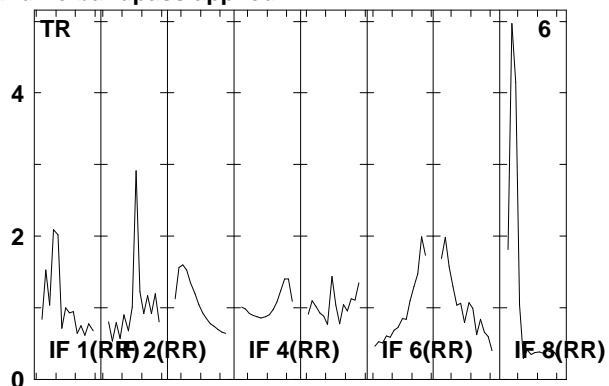
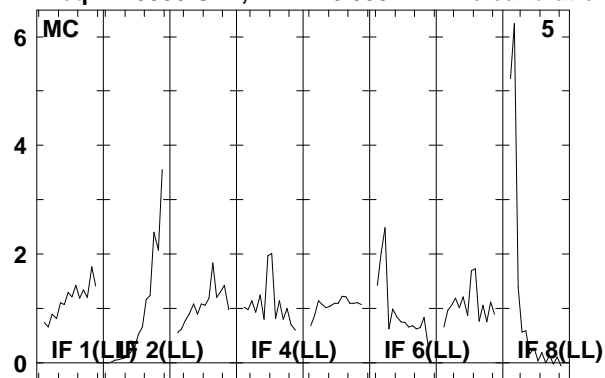

Lower frame: Real Jy

Total-power spectrum Antenna: \*

Timerange: 01/00:05:31 to 01/00:09:27

Plot file version 203 created 20-AUG-2009 15:00:32

3C274 EG040B.UVDATA.1

Freq = 1.5955 GHz, Bw = 16.000 MH No calibration applied and no bandpass applied

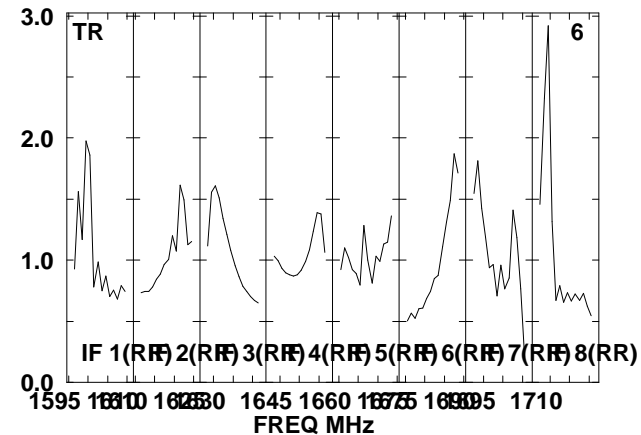
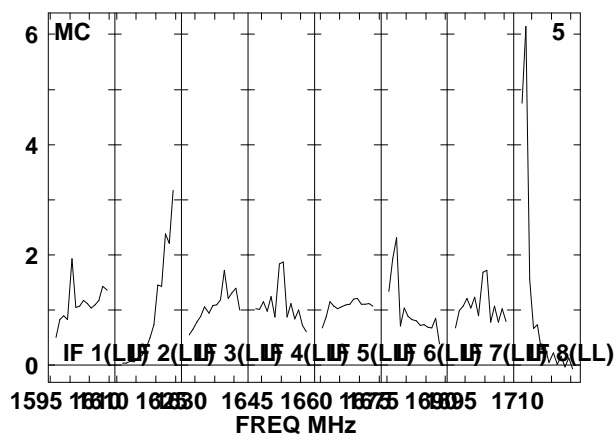
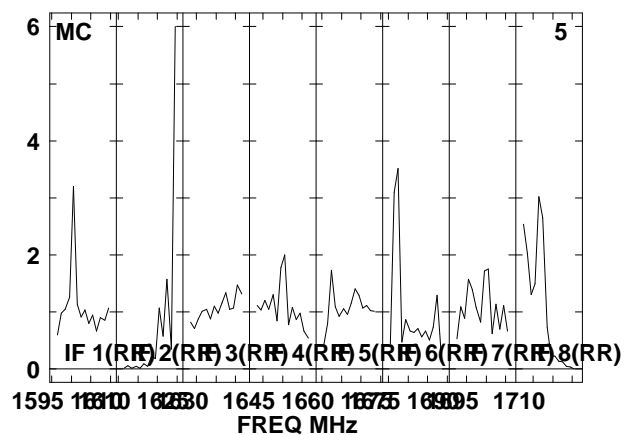
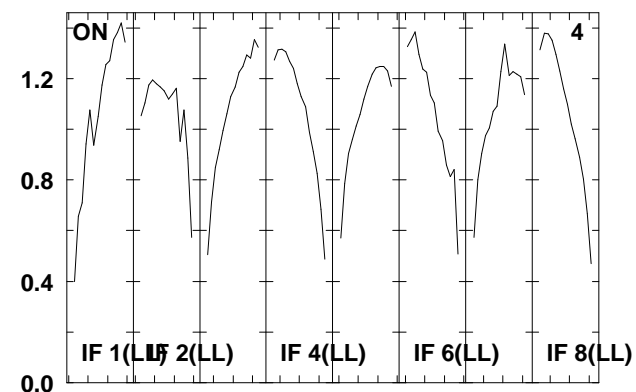
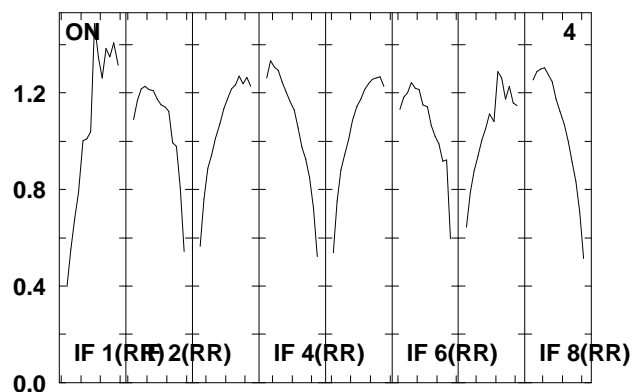
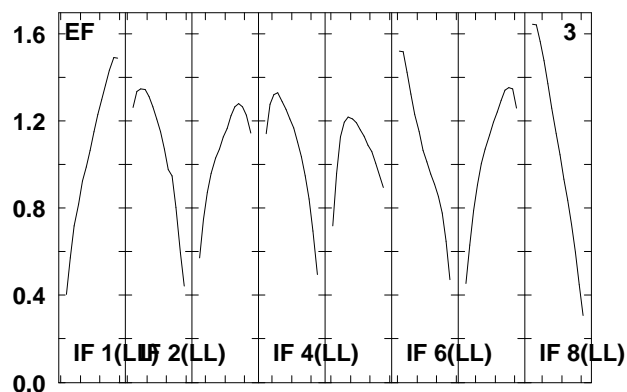
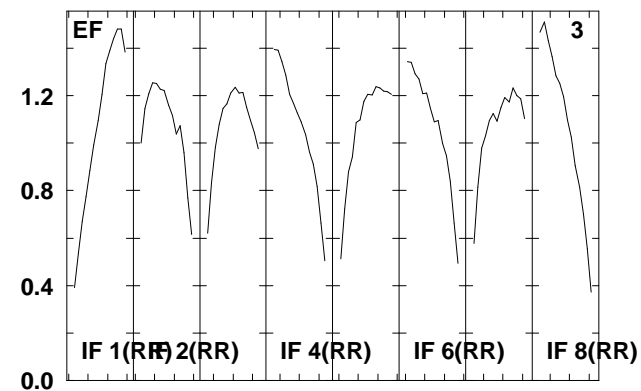
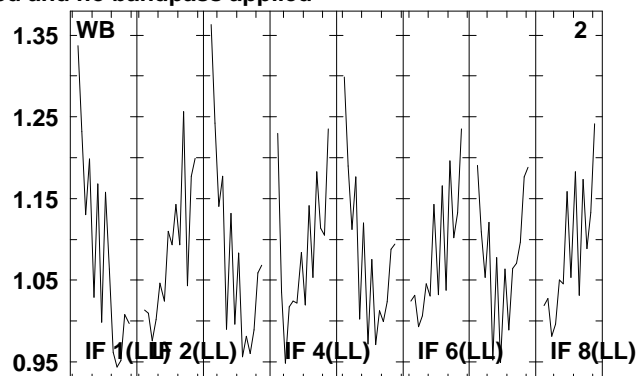
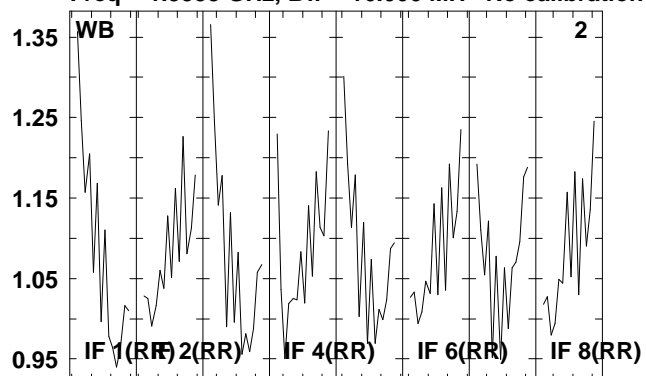

Lower frame: Real Jy

Total-power spectrum Antenna: \*

Timerange: 01/00:10:06 to 01/00:11:42

Plot file version 204 created 20-AUG-2009 15:00:32

3C274 EG040B.UVDATA.1

Freq = 1.5955 GHz, Bw = 16.000 MH No calibration applied and no bandpass applied

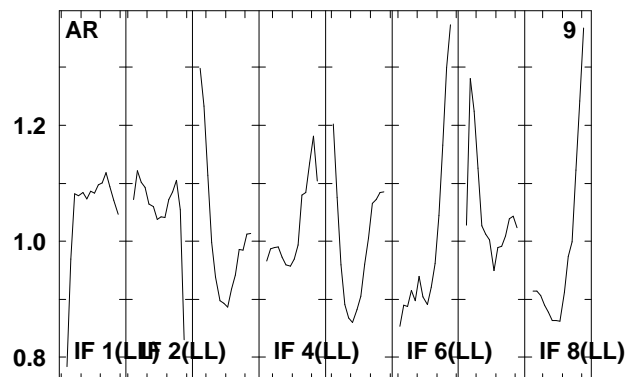
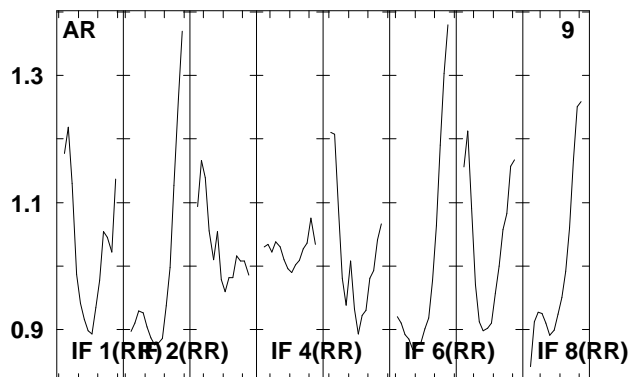
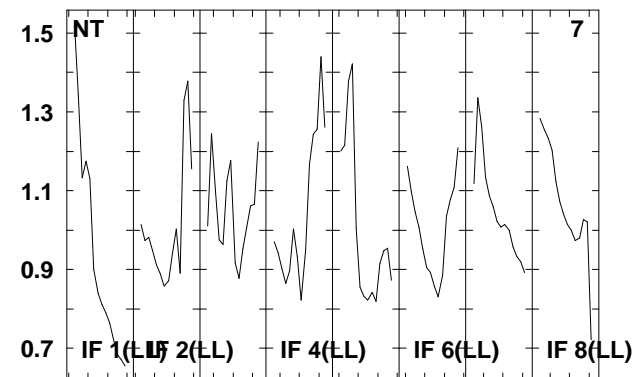
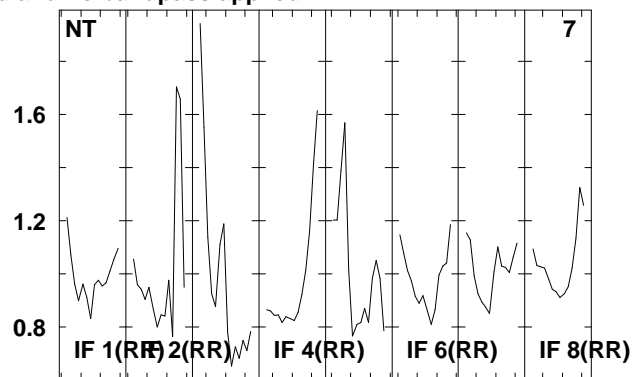
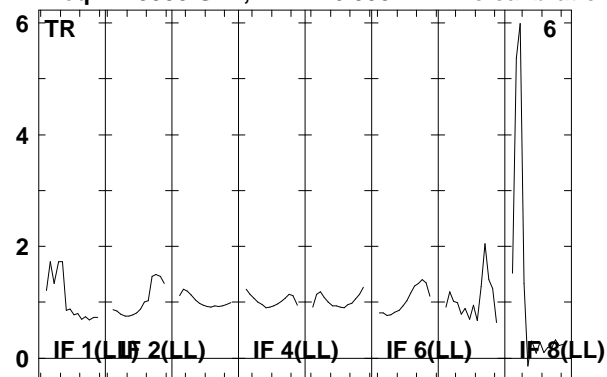

Lower frame: Real Jy  
Total-power spectrum Antenna: \*  
Timerange: 01/00:10:06 to 01/00:11:42

Plot file version 205 created 20-AUG-2009 15:00:33

NGC4639 EG040B.UVDATA.1

Freq = 1.5955 GHz, Bw = 16.000 MH No calibration applied and no bandpass applied

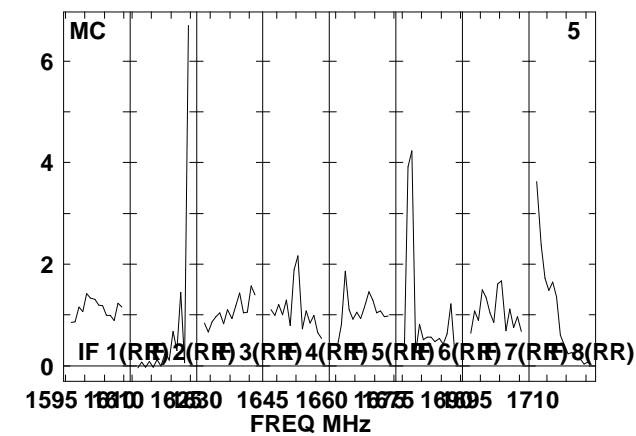
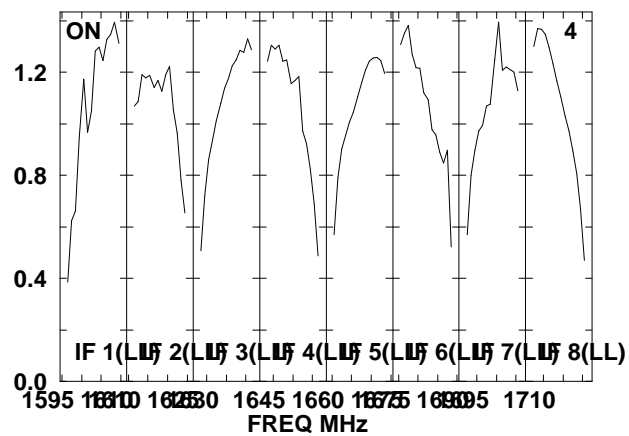
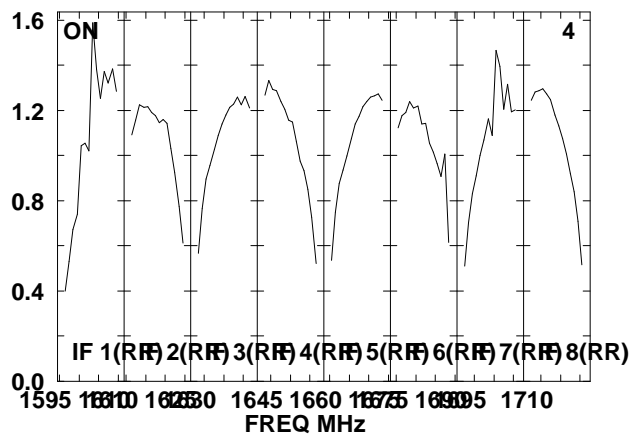
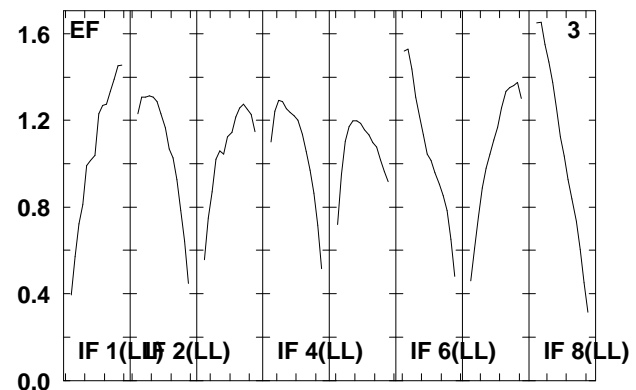
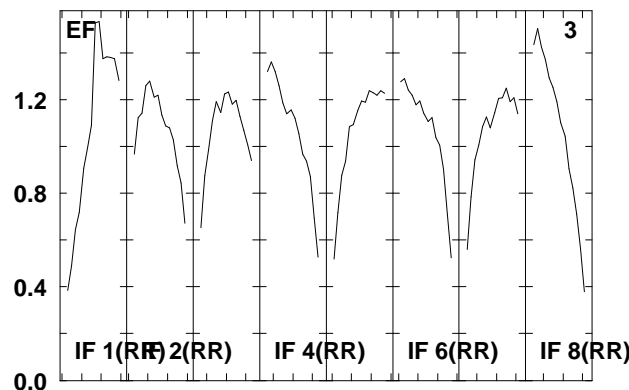
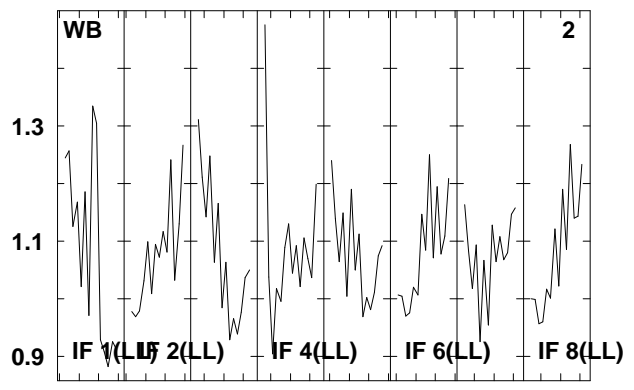
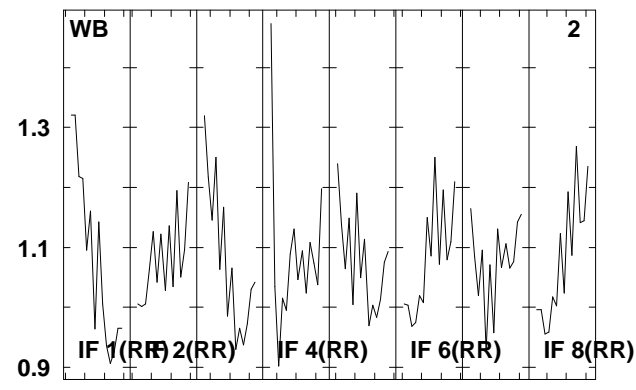
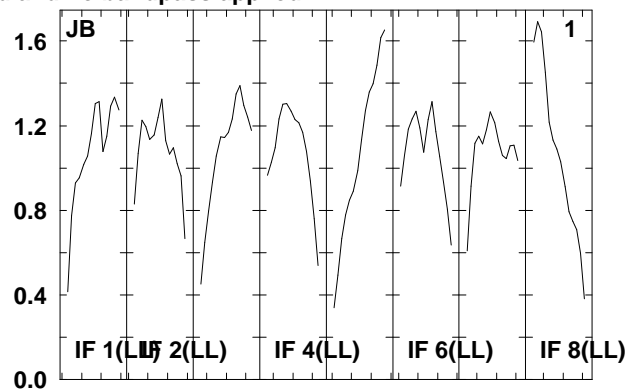
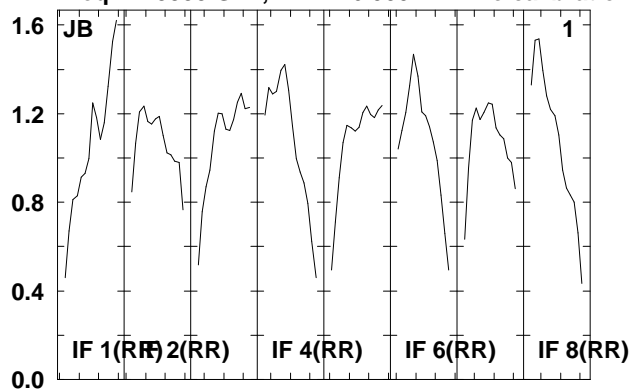

Lower frame: Real Jy  
Total-power spectrum Antenna: \*  
Timerange: 01/00:11:46 to 01/00:15:44

Plot file version 206 created 20-AUG-2009 15:00:33

NGC4639 EG040B.UVDATA.1

Freq = 1.5955 GHz, Bw = 16.000 MH No calibration applied and no bandpass applied

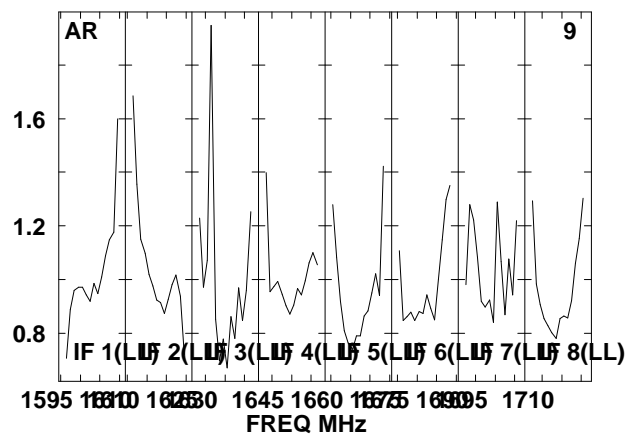
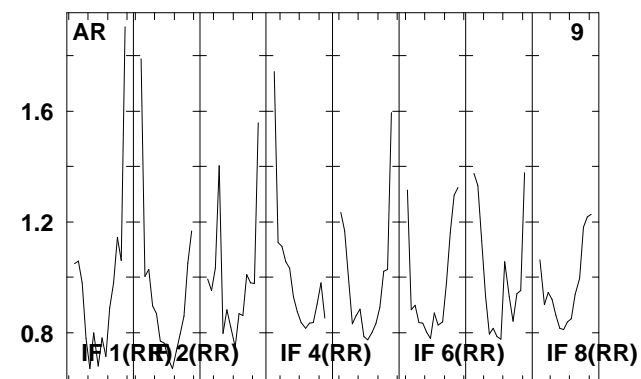
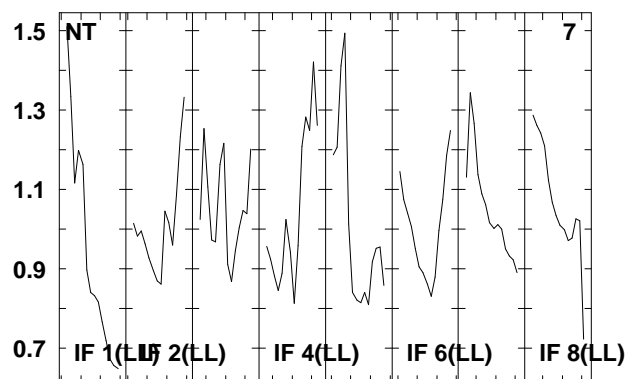
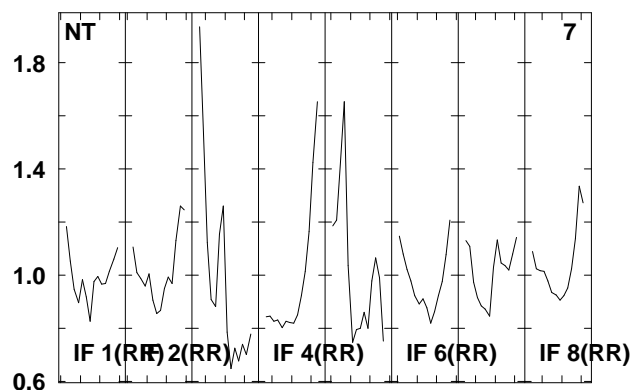
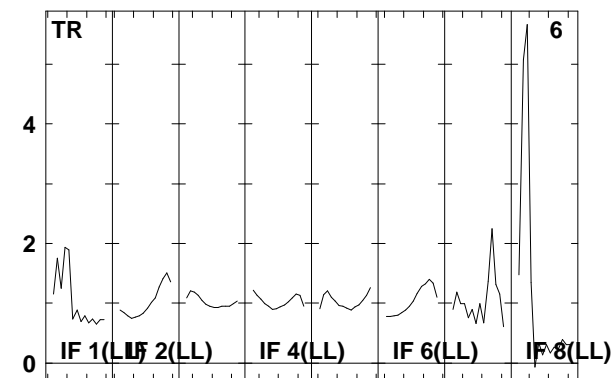
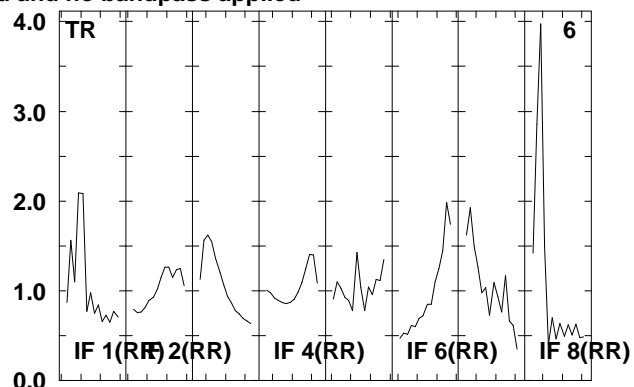
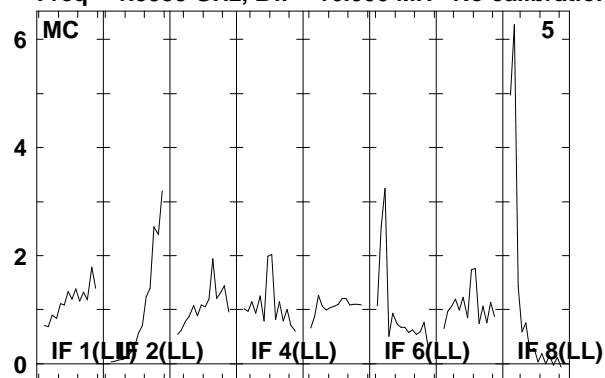

Lower frame: Real Jy

Total-power spectrum Antenna: \*

Timerange: 01/00:11:46 to 01/00:15:44

Plot file version 207 created 20-AUG-2009 15:00:33  
 3C274 EG040B.UVDATA.1  
 Freq = 1.5955 GHz, Bw = 16.000 MH No calibration applied and no bandpass applied

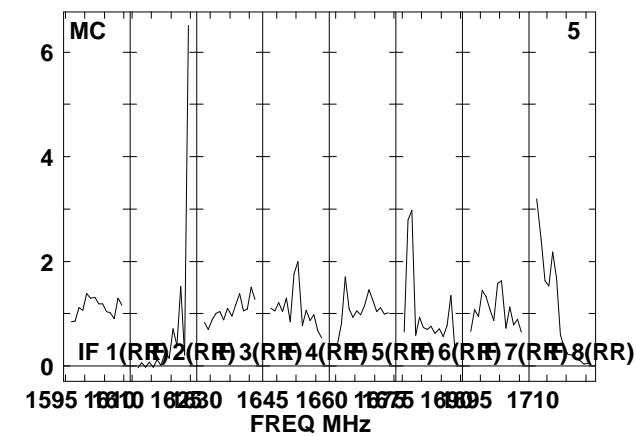
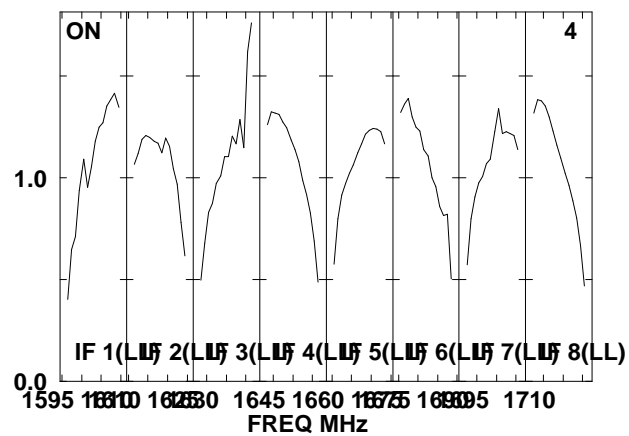
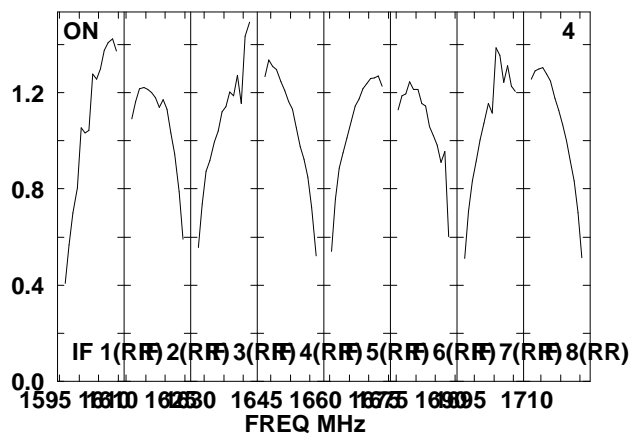
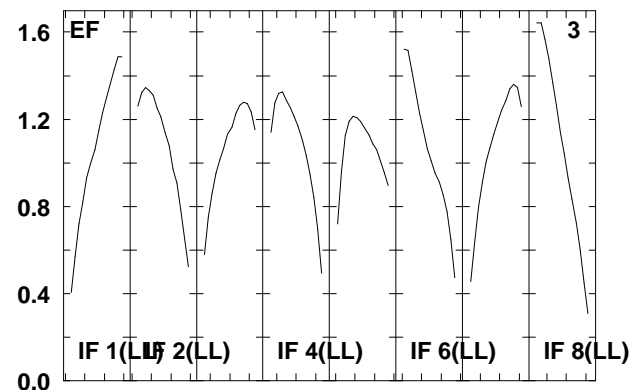
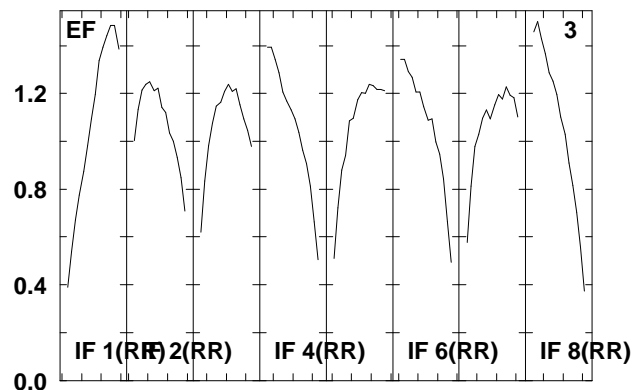
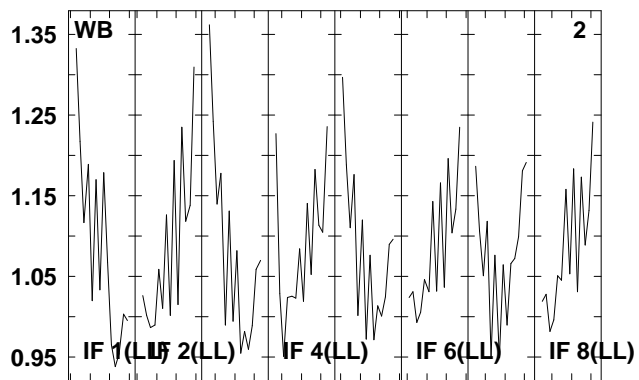
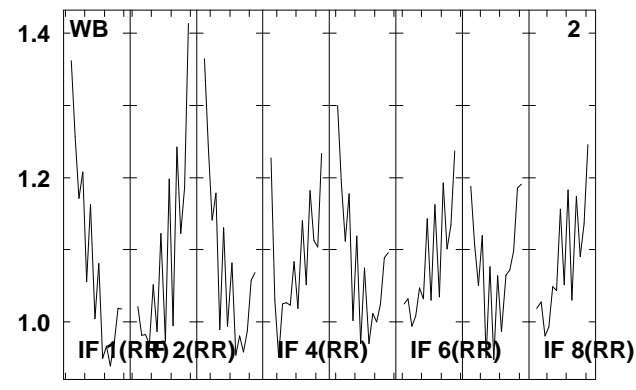
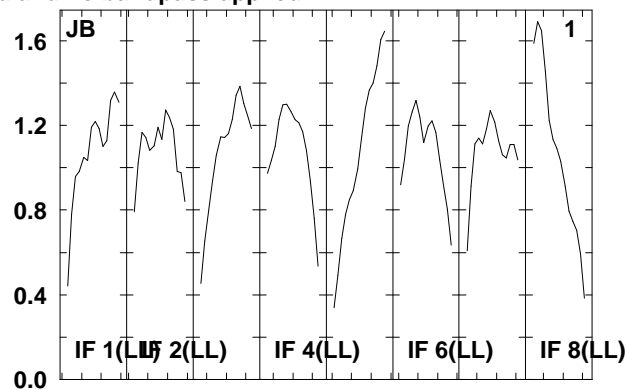
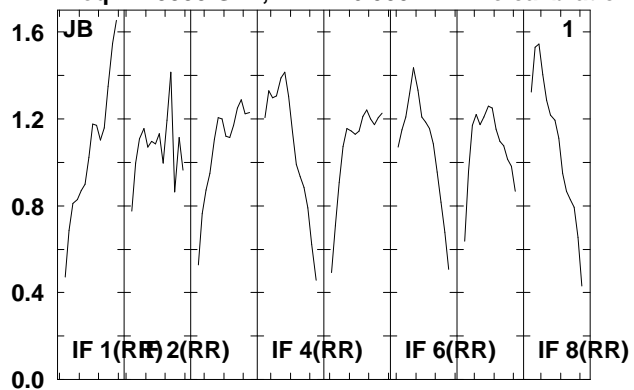

Lower frame: Real Jy  
 Total-power spectrum Antenna: \*  
 Timerange: 01/00:15:46 to 01/00:17:44

Plot file version 208 created 20-AUG-2009 15:00:34

3C274 EG040B.UVDATA.1

Freq = 1.5955 GHz, Bw = 16.000 MH No calibration applied and no bandpass applied

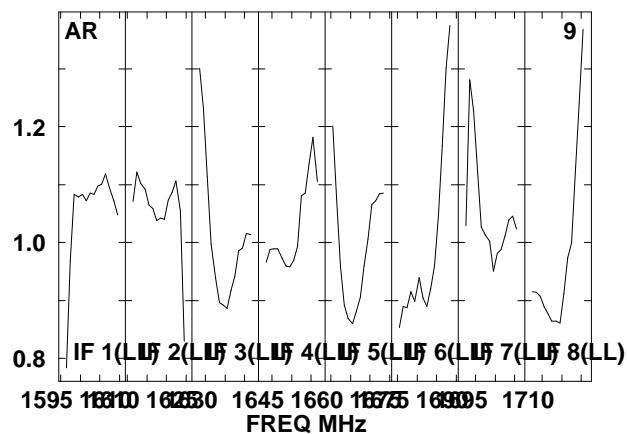
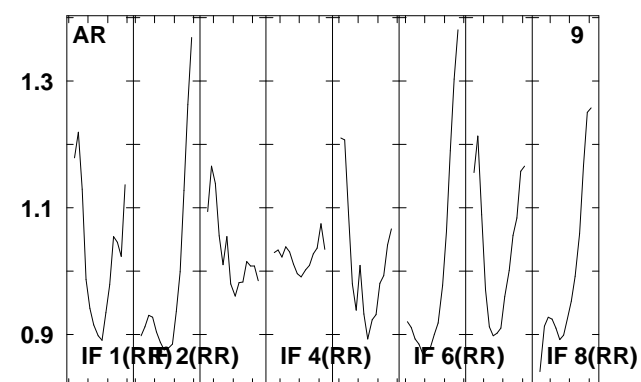
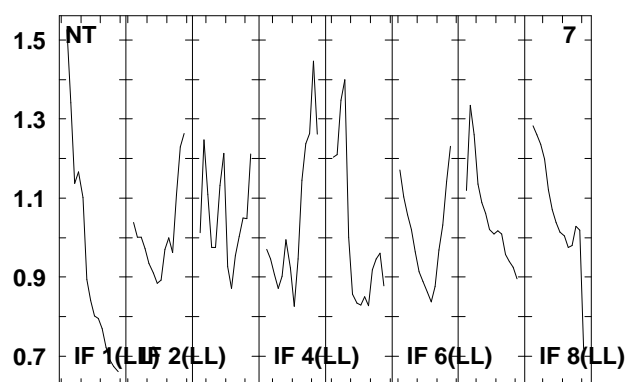
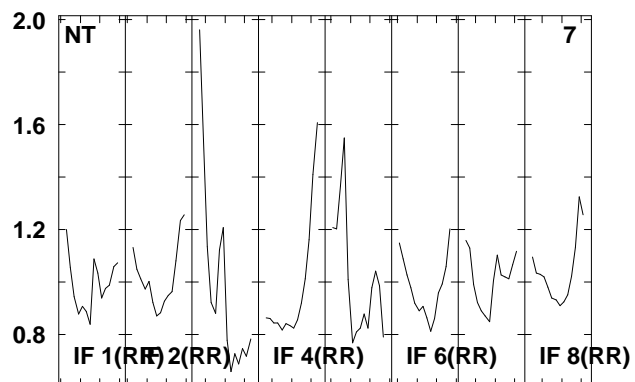
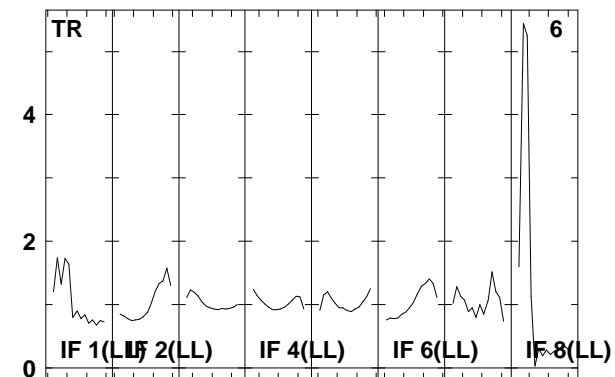
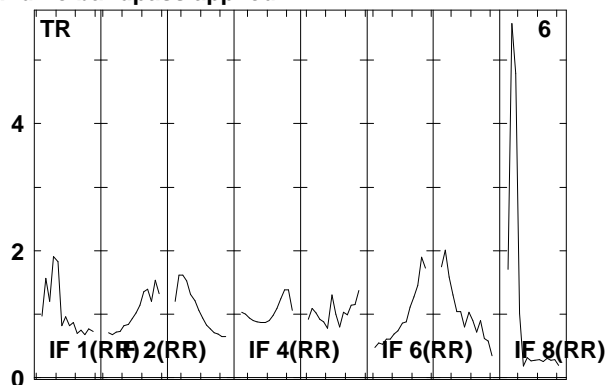
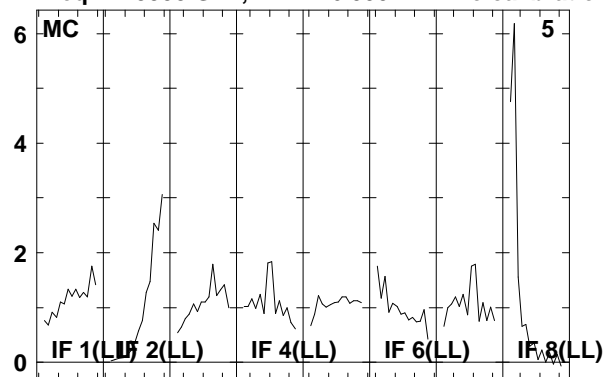

Lower frame: Real Jy

Total-power spectrum Antenna: \*

Timerange: 01/00:15:46 to 01/00:17:44



Plot file version 209 created 20-AUG-2009 15:00:34

NGC4639 EG040B.UVDATA.1

Freq = 1.5955 GHz, Bw = 16.000 MH No calibration applied and no bandpass applied

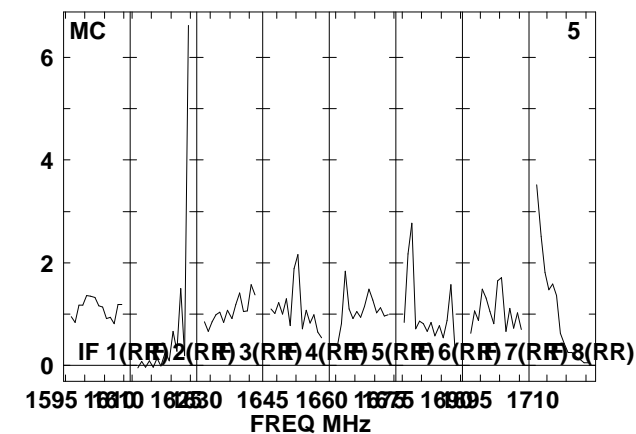
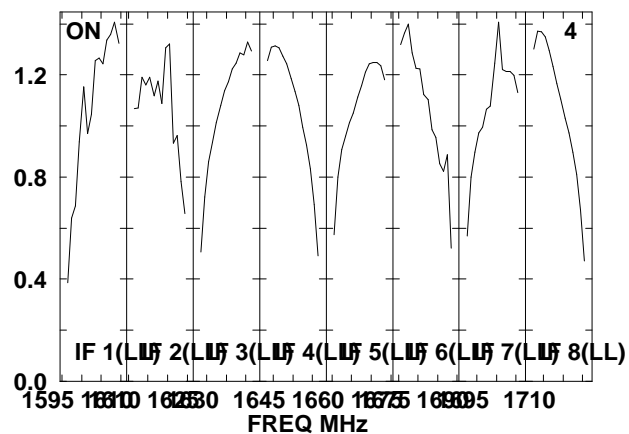
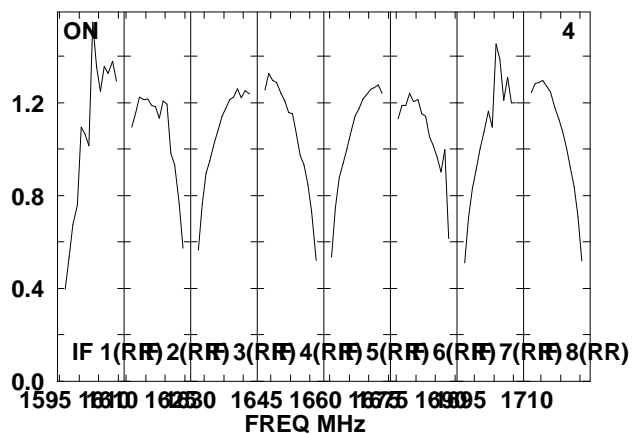
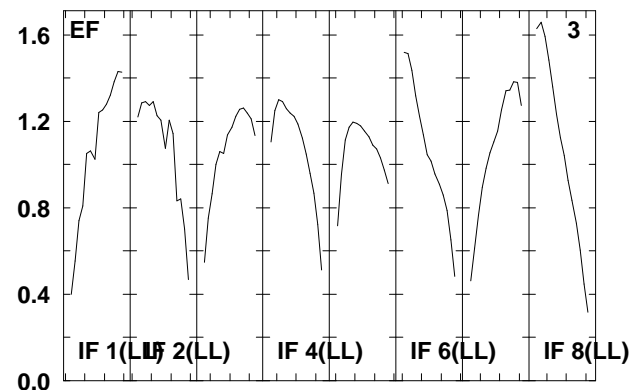
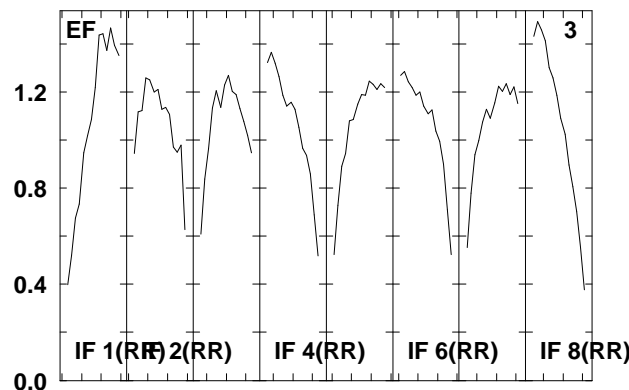
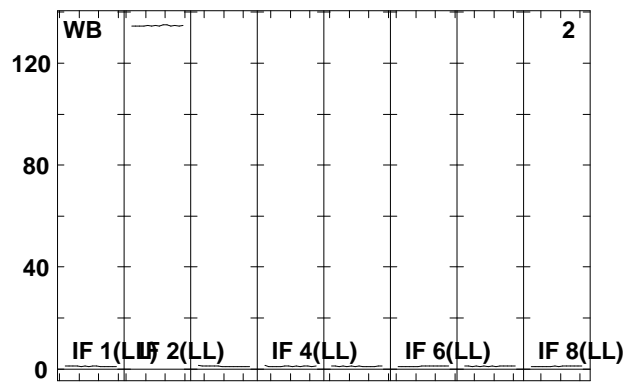
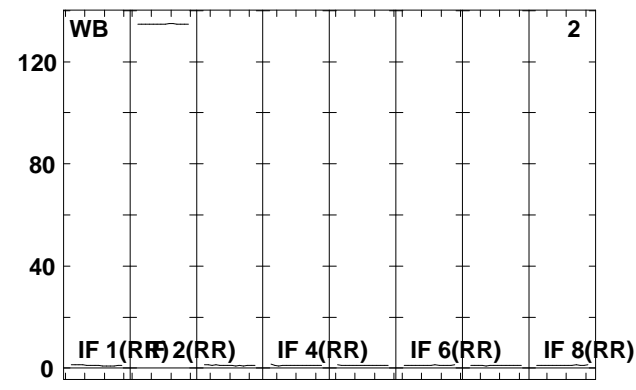
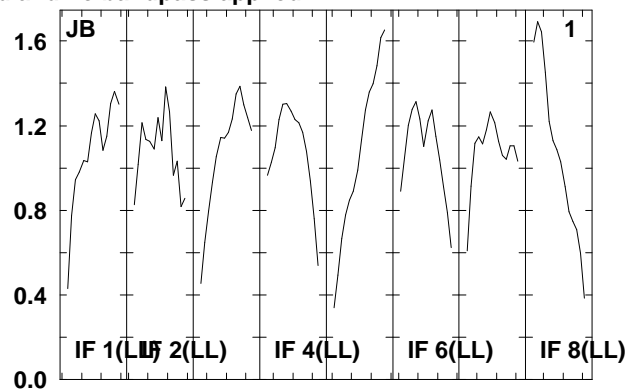
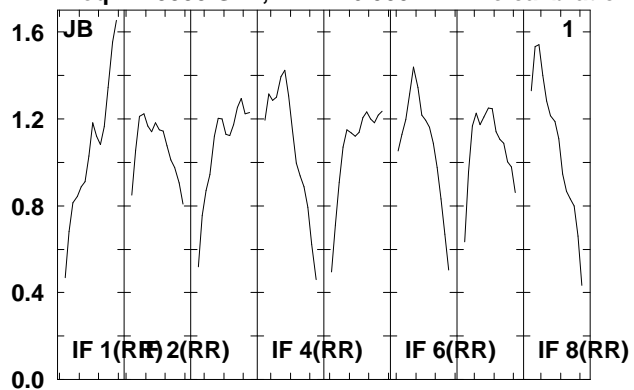

Lower frame: Real Jy  
Total-power spectrum Antenna: \*  
Timerange: 01/00:17:46 to 01/00:21:44

Plot file version 210 created 20-AUG-2009 15:00:34

NGC4639 EG040B.UVDATA.1

Freq = 1.5955 GHz, Bw = 16.000 MH No calibration applied and no bandpass applied

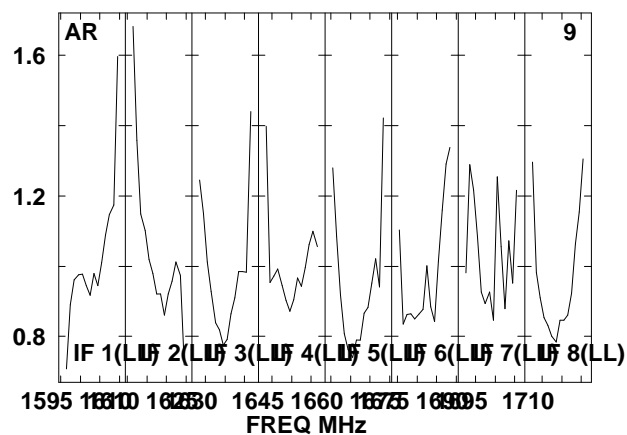
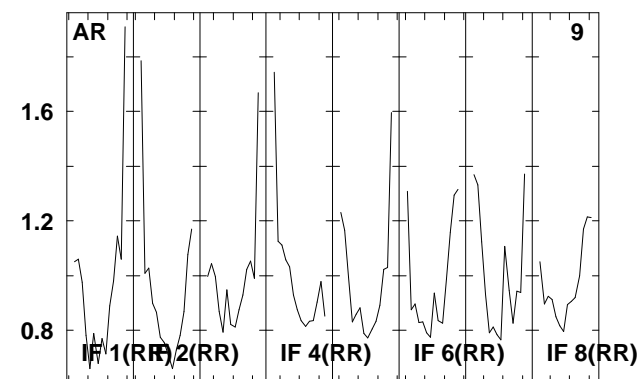
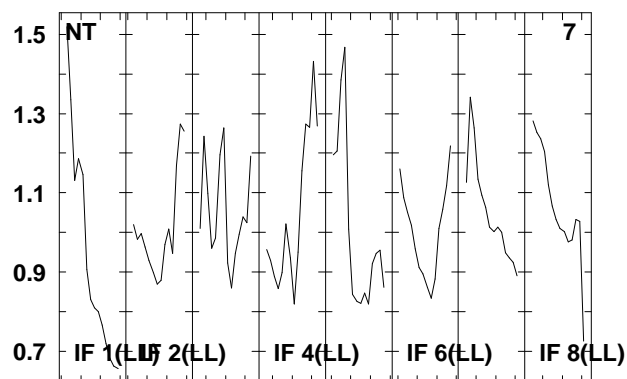
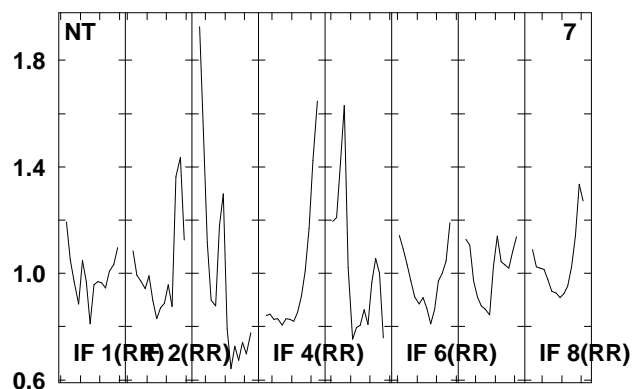
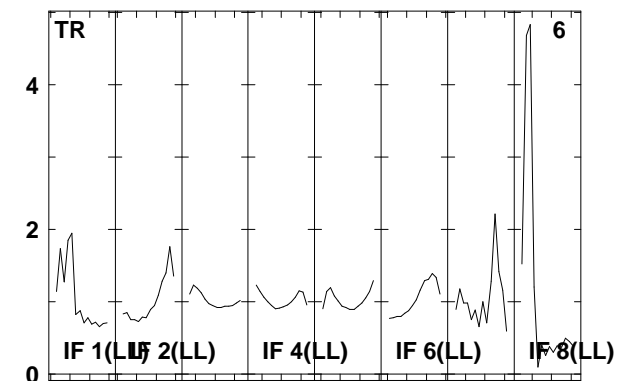
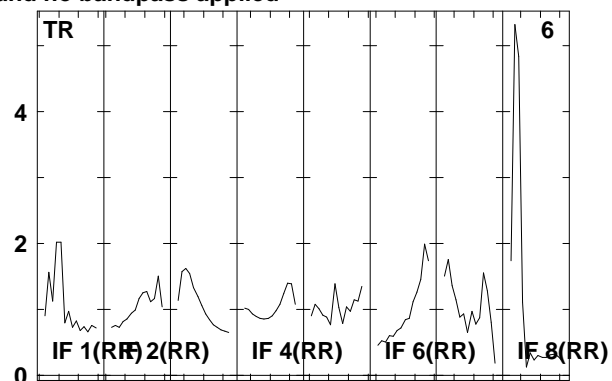
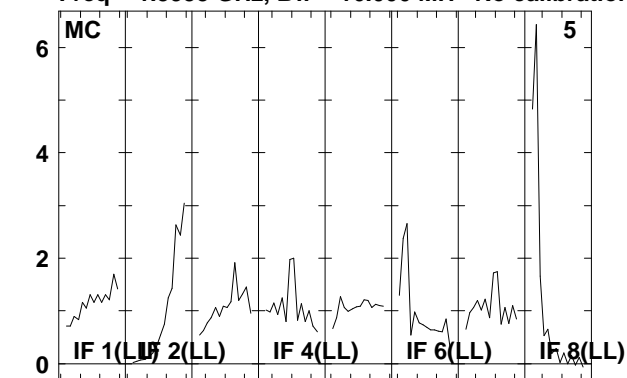

Lower frame: Real Jy

Total-power spectrum Antenna: \*

Timerange: 01/00:17:46 to 01/00:21:44

Plot file version 211 created 20-AUG-2009 15:00:35  
 3C274 EG040B.UVDATA.1  
 Freq = 1.5955 GHz, Bw = 16.000 MH No calibration applied and no bandpass applied

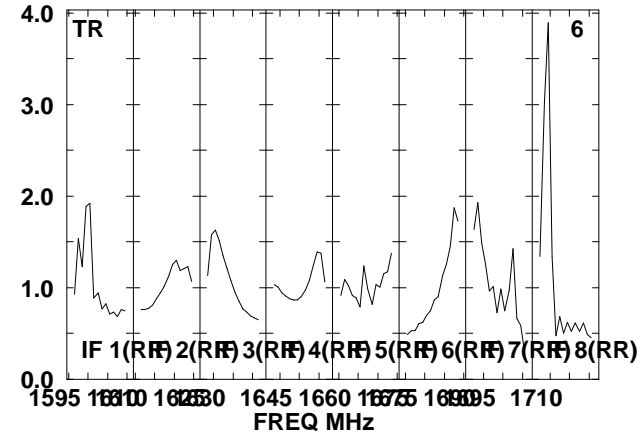
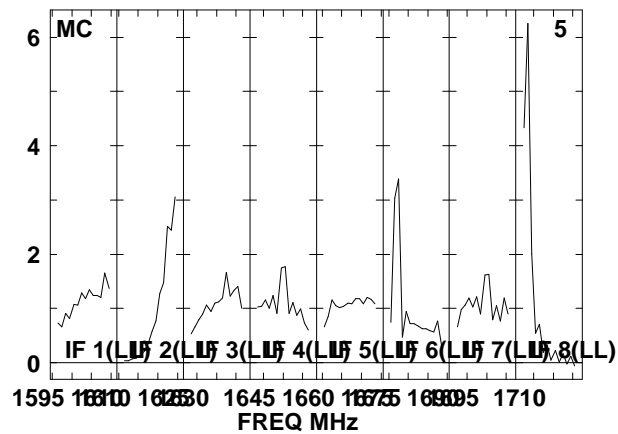
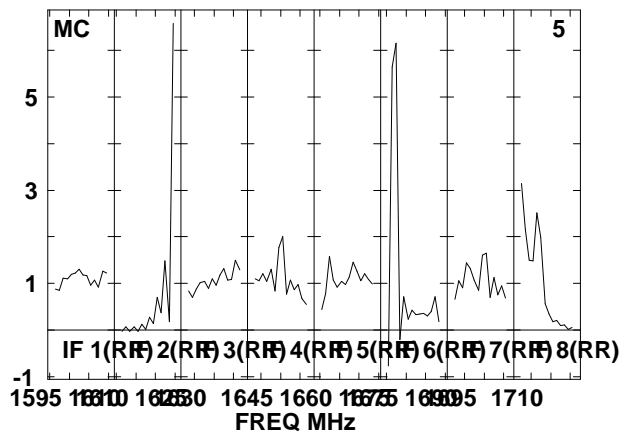
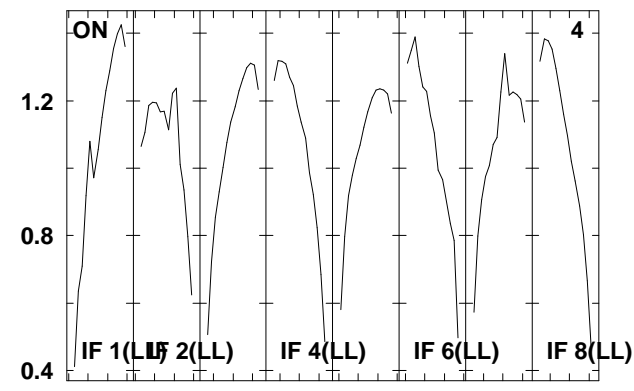
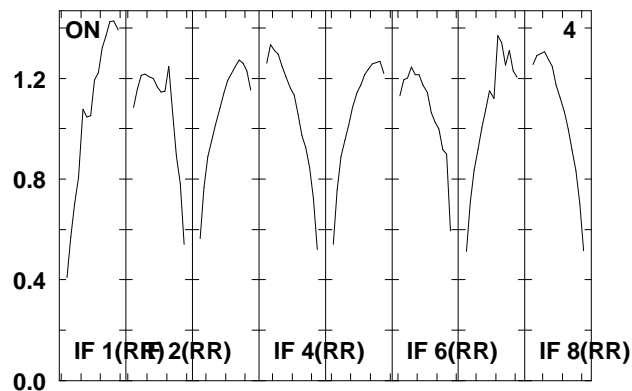
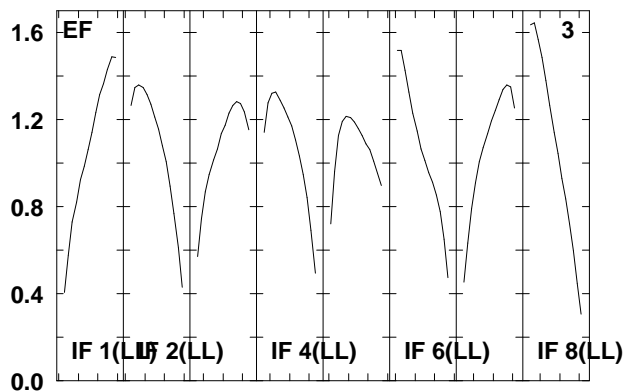
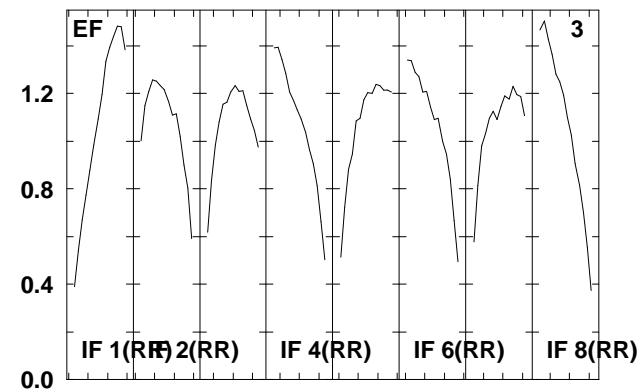
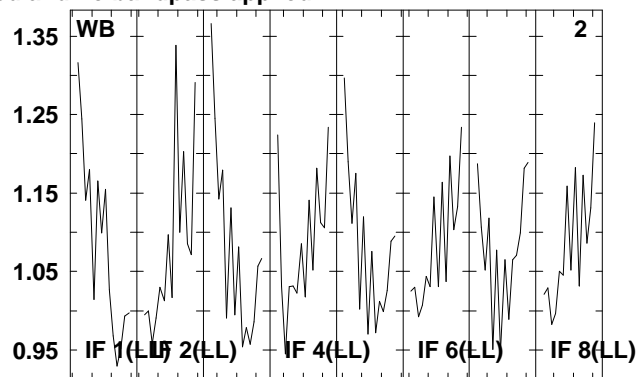
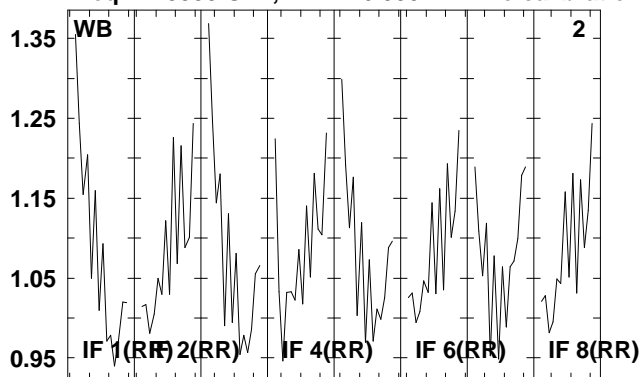

Lower frame: Real Jy  
 Total-power spectrum Antenna: \*  
 Timerange: 01/00:22:22 to 01/00:24:00

Plot file version 212 created 20-AUG-2009 15:00:35

3C274 EG040B.UVDATA.1

Freq = 1.5955 GHz, Bw = 16.000 MH No calibration applied and no bandpass applied

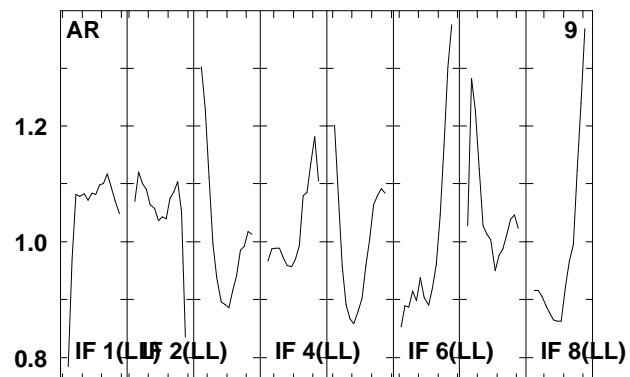
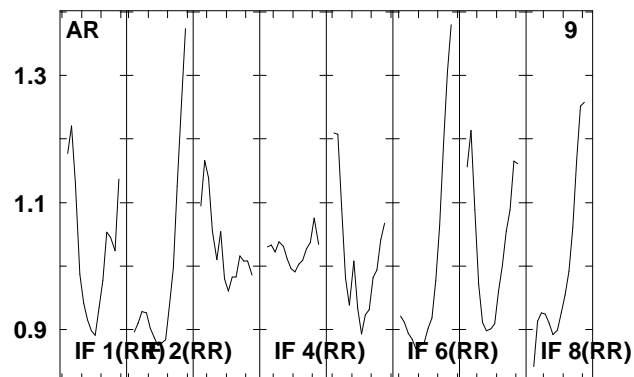
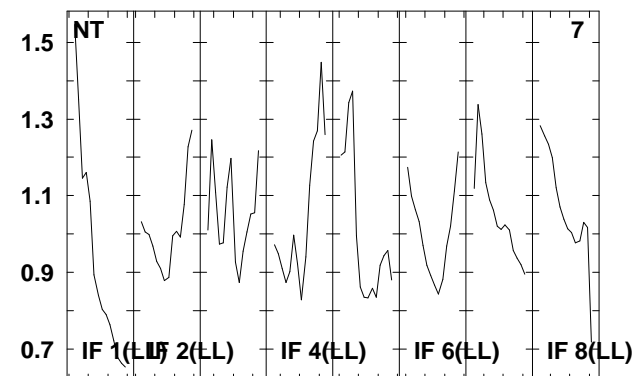
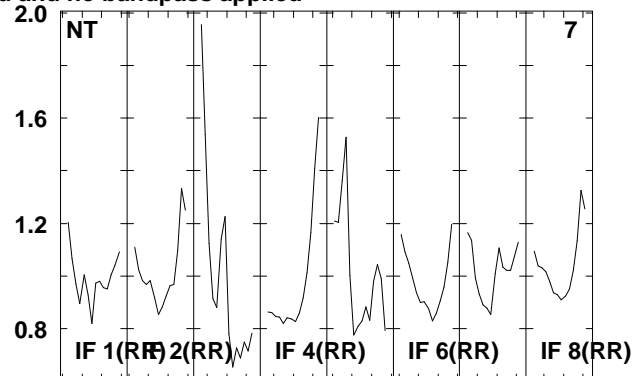
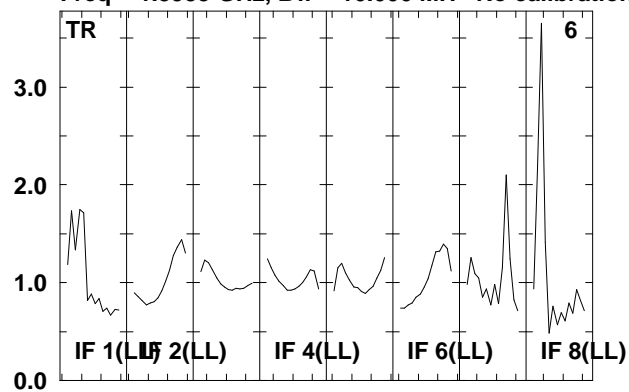

Lower frame: Real Jy  
Total-power spectrum Antenna: \*  
Timerange: 01/00:22:22 to 01/00:24:00

Plot file version 213 created 20-AUG-2009 15:00:35

NGC4639 EG040B.UVDATA.1

Freq = 1.5955 GHz, Bw = 16.000 MH No calibration applied and no bandpass applied

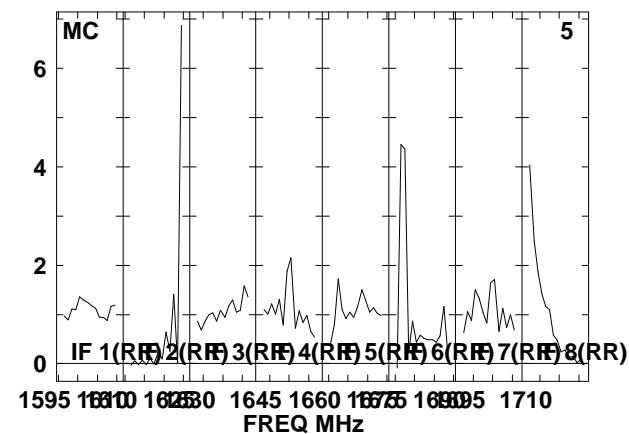
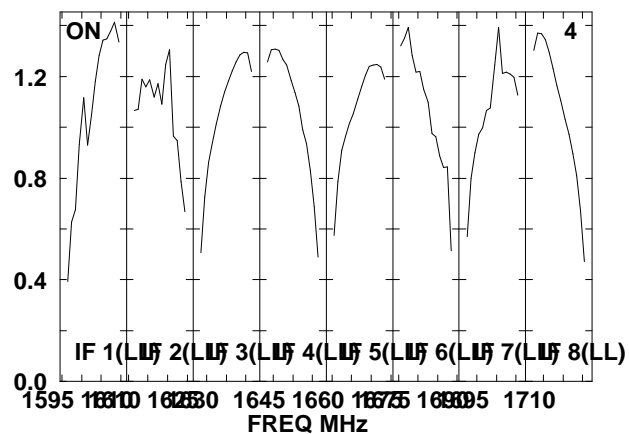
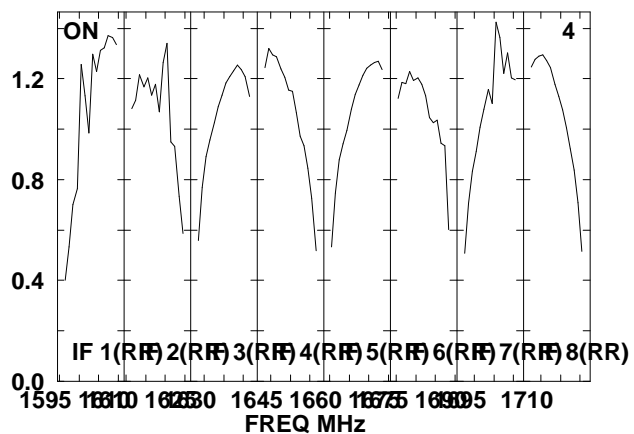
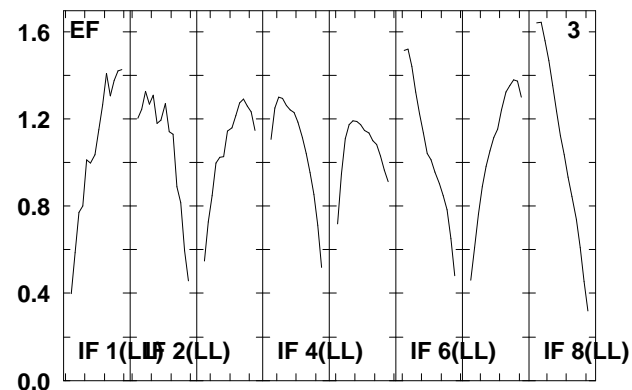
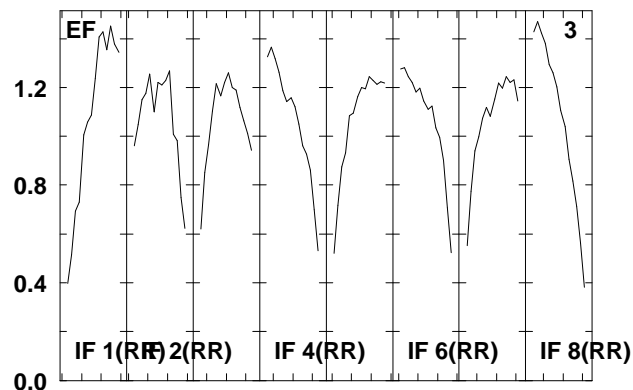
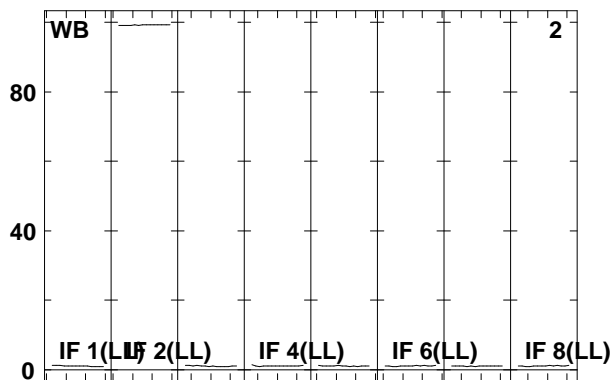
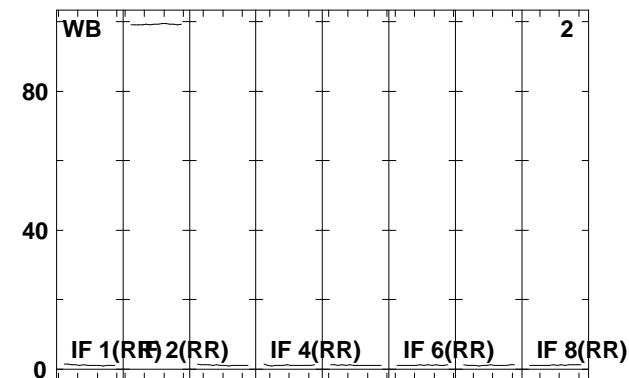
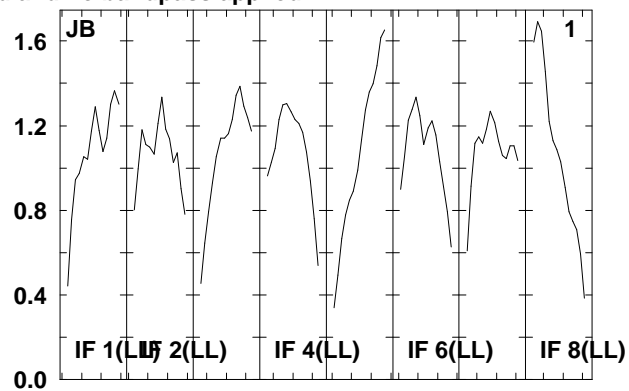
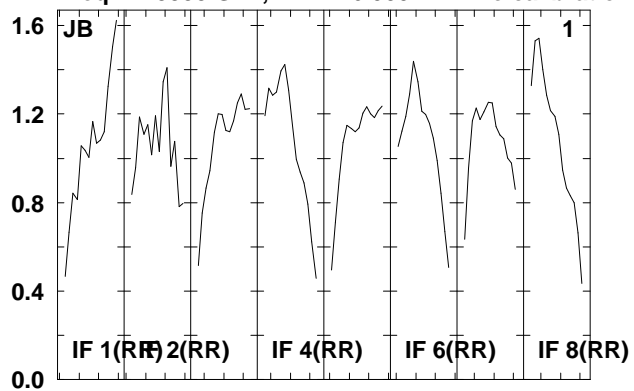

Lower frame: Real Jy  
Total-power spectrum Antenna: \*  
Timerange: 01/00:24:02 to 01/00:27:58

Plot file version 214 created 20-AUG-2009 15:00:36

NGC4639 EG040B.UVDATA.1

Freq = 1.5955 GHz, Bw = 16.000 MH No calibration applied and no bandpass applied

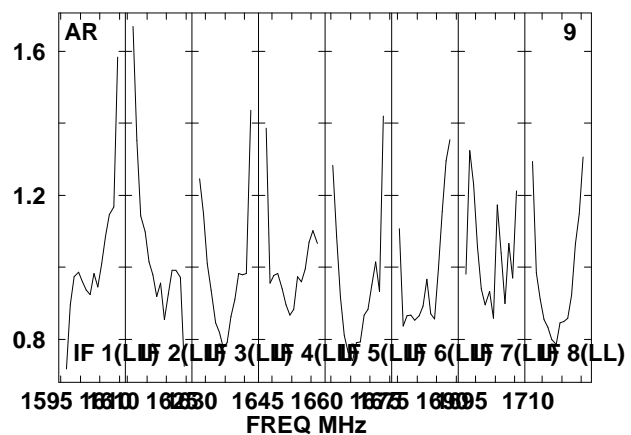
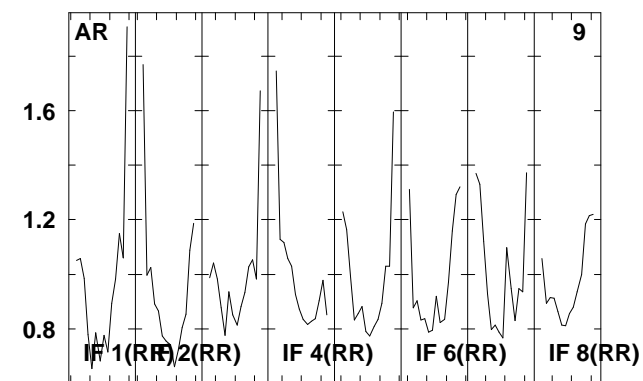
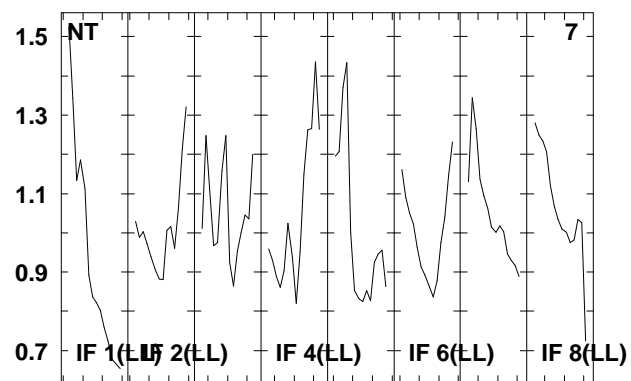
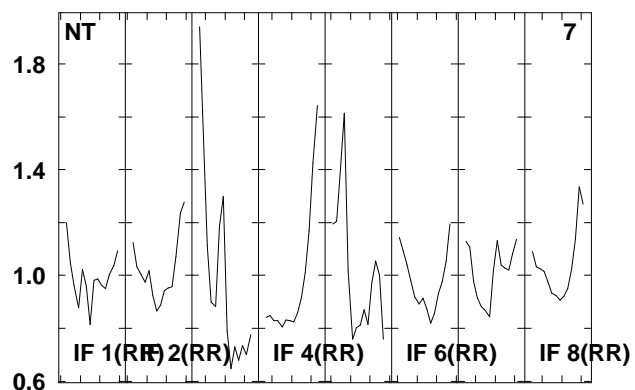
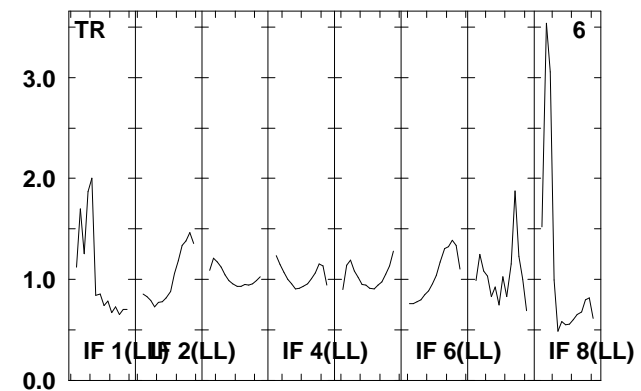
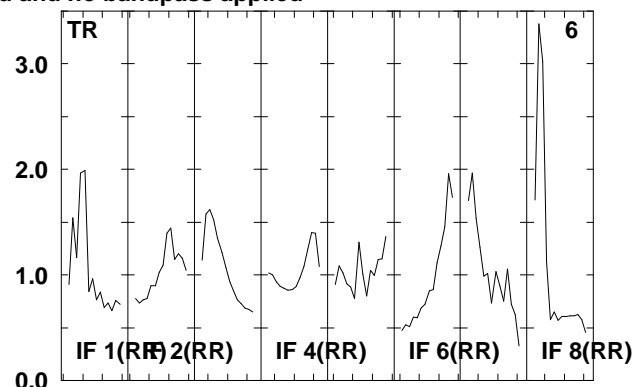
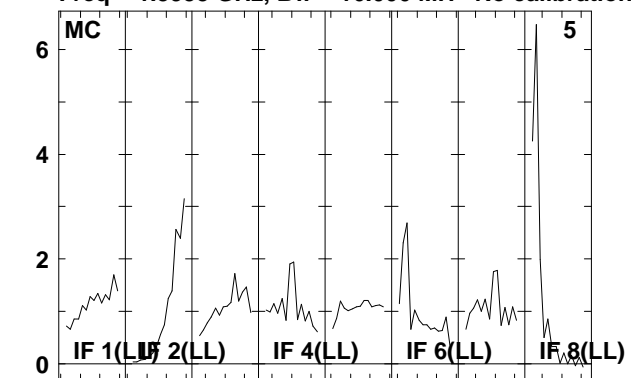

Lower frame: Real Jy

Total-power spectrum Antenna: \*

Timerange: 01/00:24:02 to 01/00:27:58

Plot file version 215 created 20-AUG-2009 15:00:36  
 3C274 EG040B.UVDATA.1  
 Freq = 1.5955 GHz, Bw = 16.000 MH No calibration applied and no bandpass applied

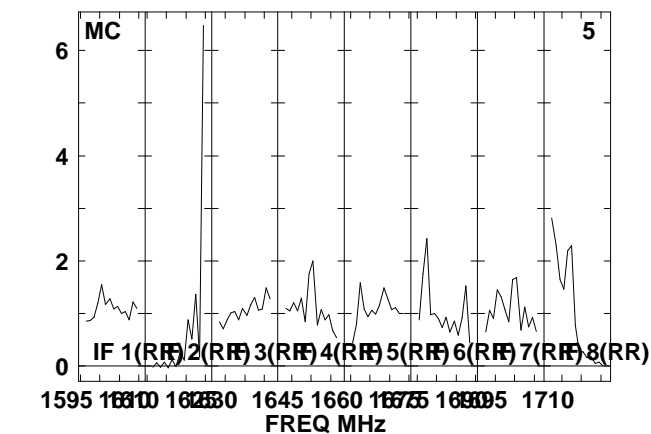
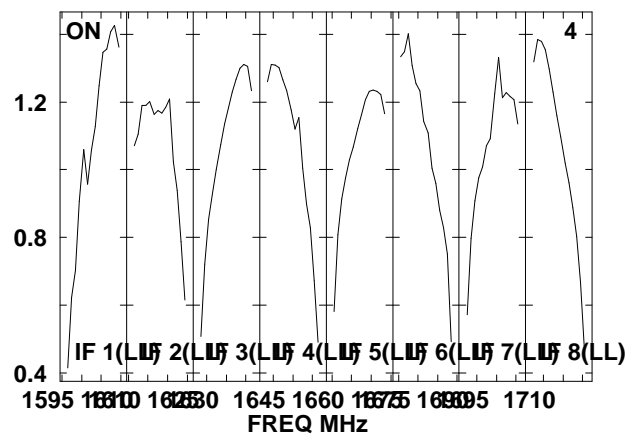
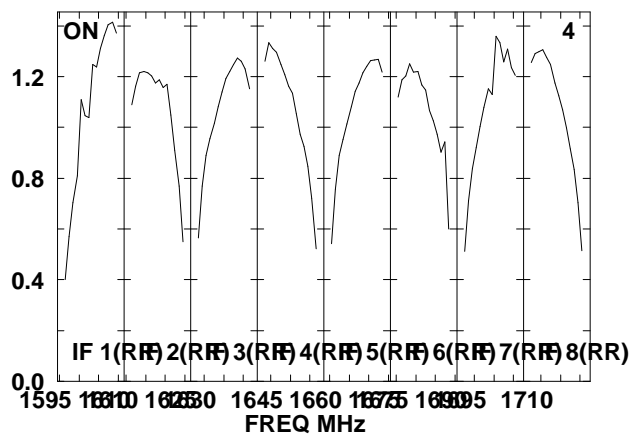
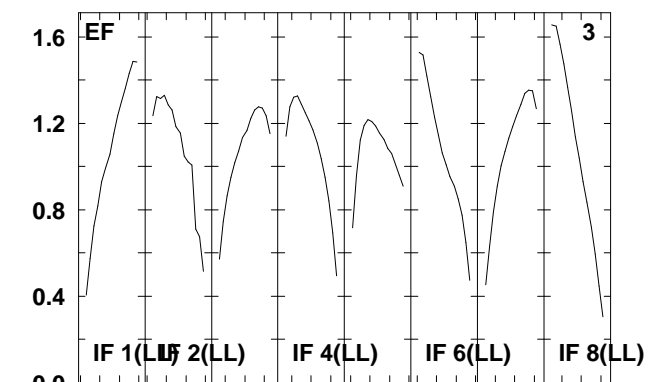
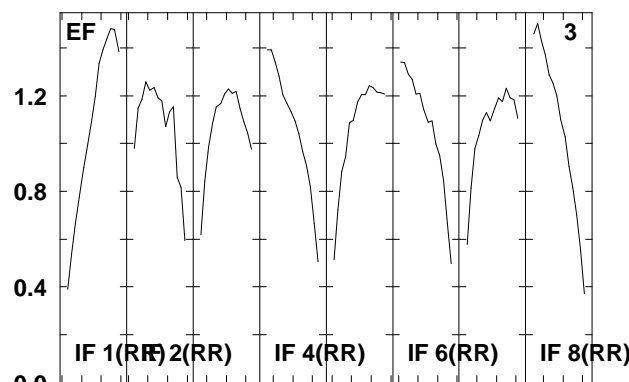
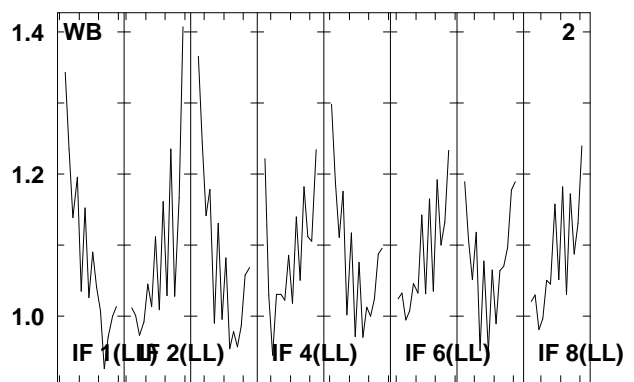
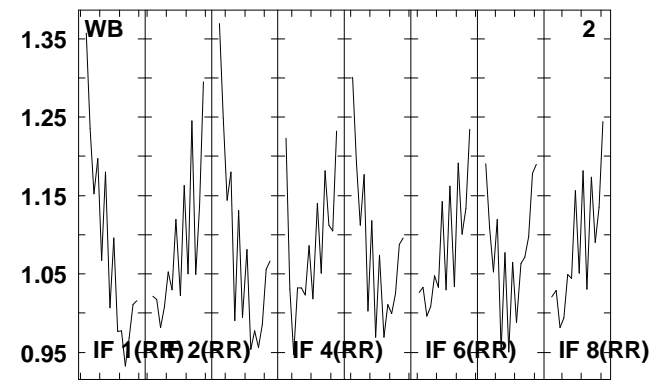
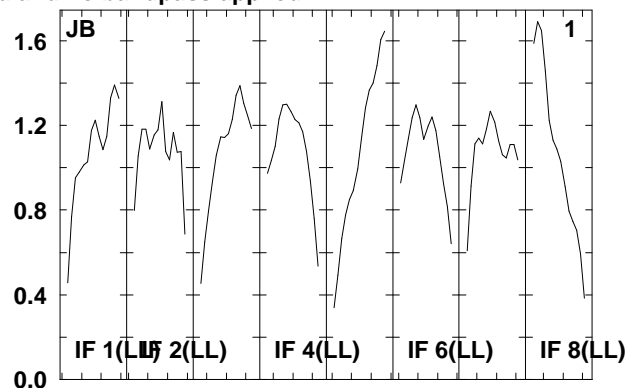
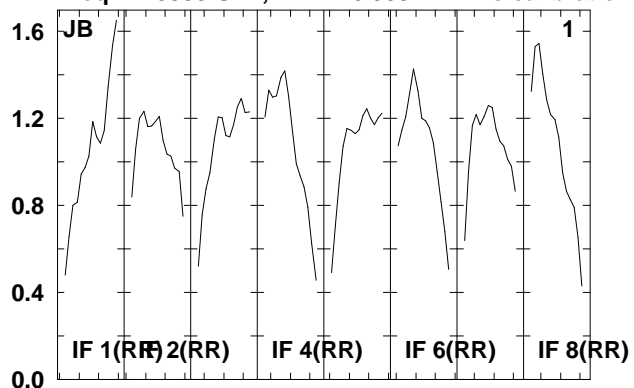

Lower frame: Real Jy  
 Total-power spectrum Antenna: \*  
 Timerange: 01/00:28:00 to 01/00:29:56

Plot file version 216 created 20-AUG-2009 15:00:36

3C274 EG040B.UVDATA.1

Freq = 1.5955 GHz, Bw = 16.000 MH No calibration applied and no bandpass applied

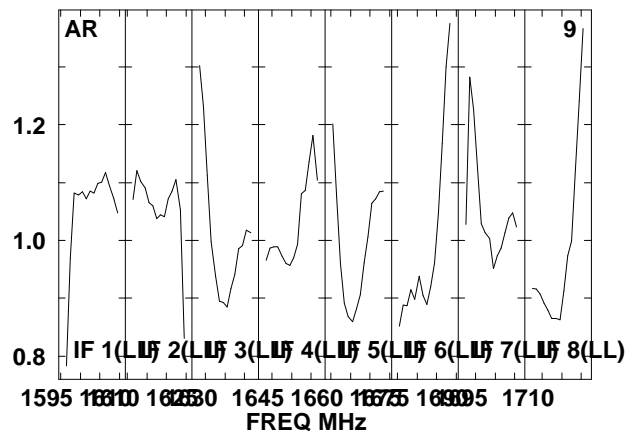
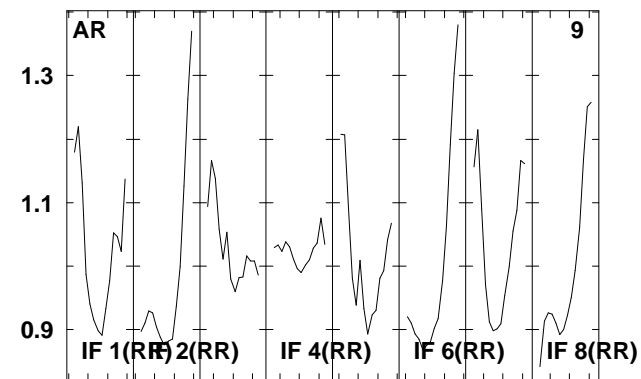
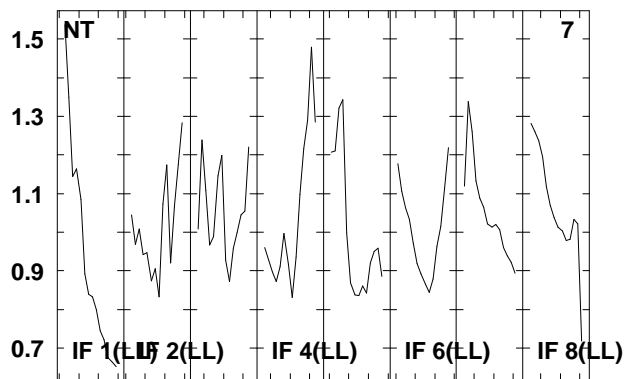
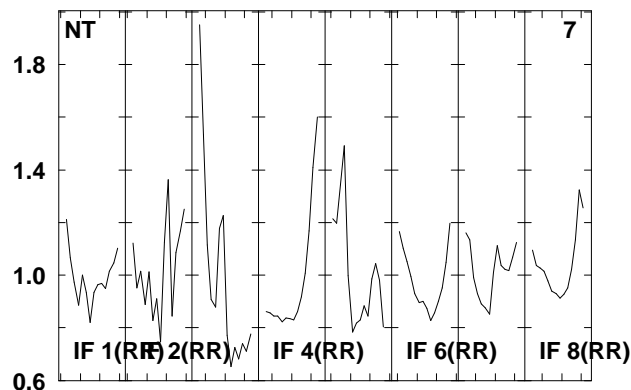
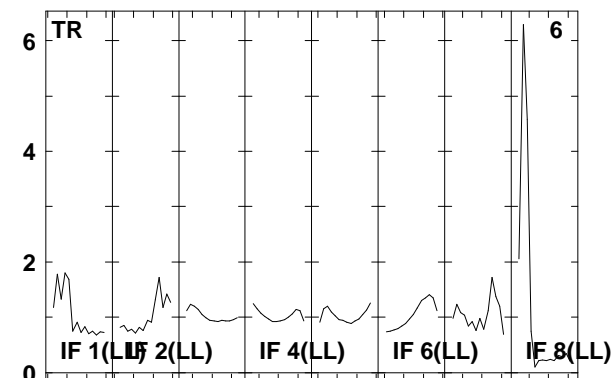
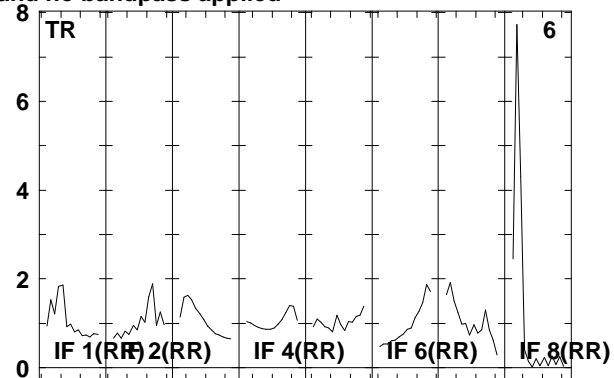
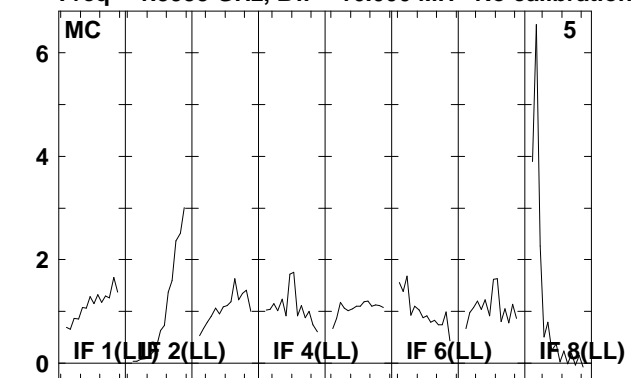

Lower frame: Real Jy

Total-power spectrum Antenna: \*

Timerange: 01/00:28:00 to 01/00:29:56