

Plot file version 1 created 26-MAR-2015 15:27:34

0528+134 EG082E.UVDATA.1

Freq = 4.9270 GHz, Bw = 16.000 MH No calibration applied and no bandpass applied

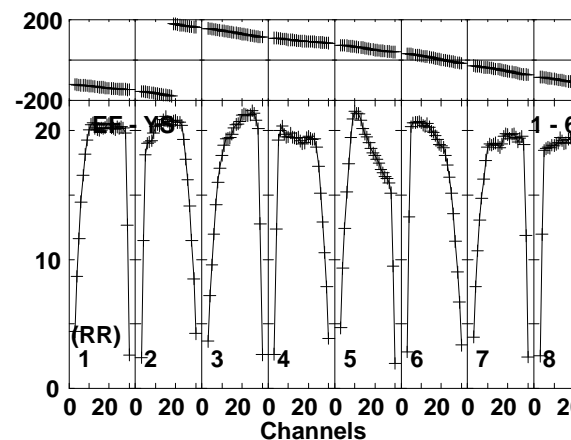
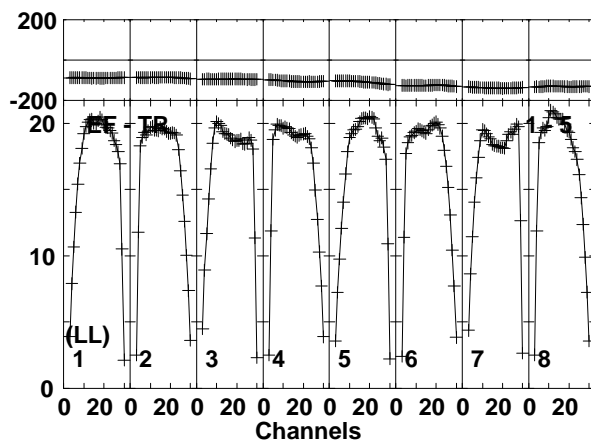
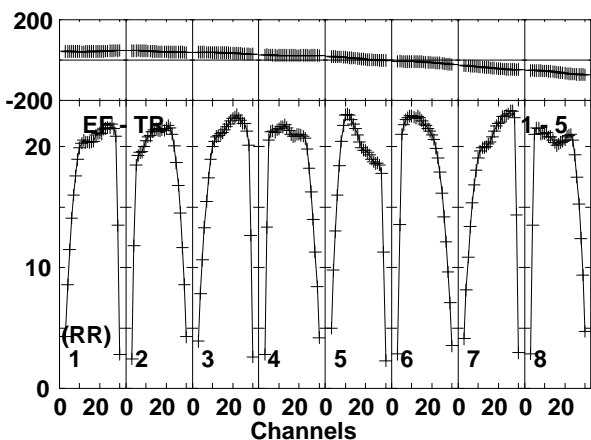
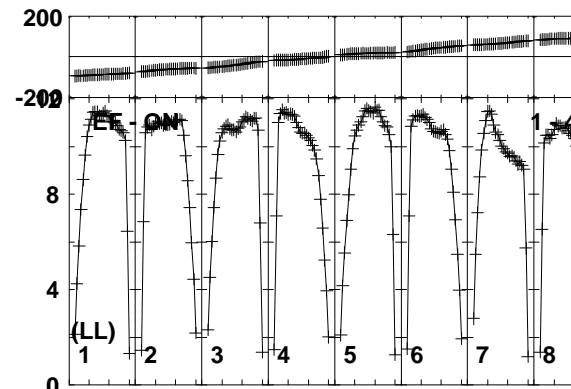
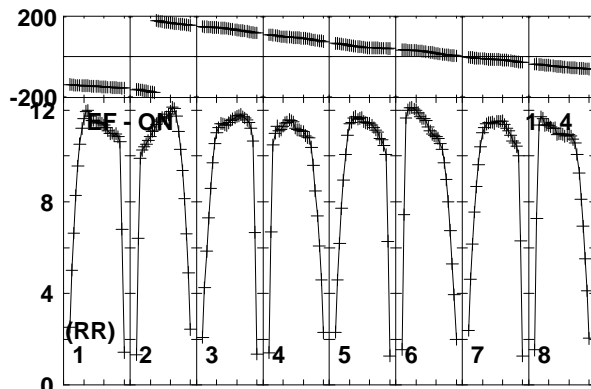
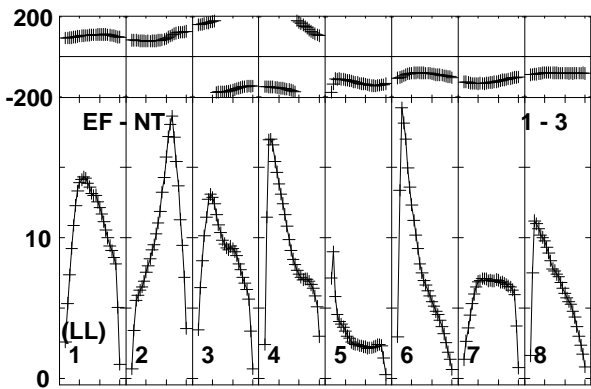
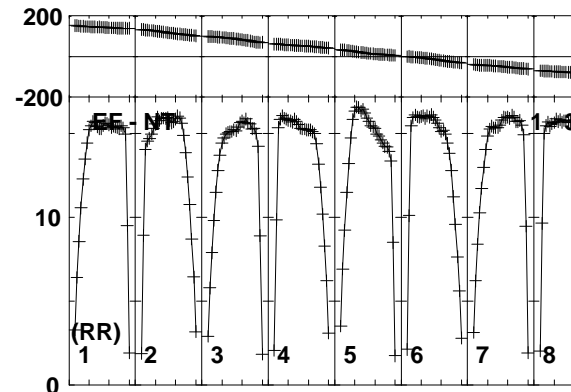
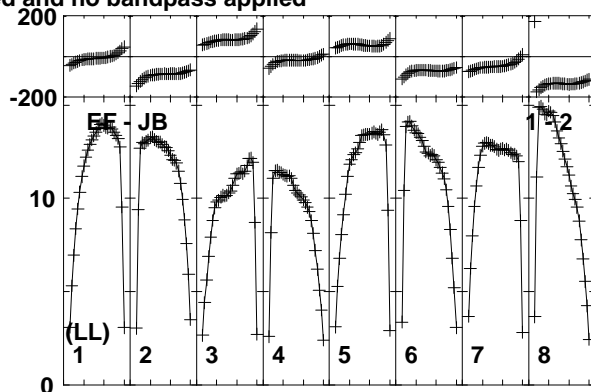
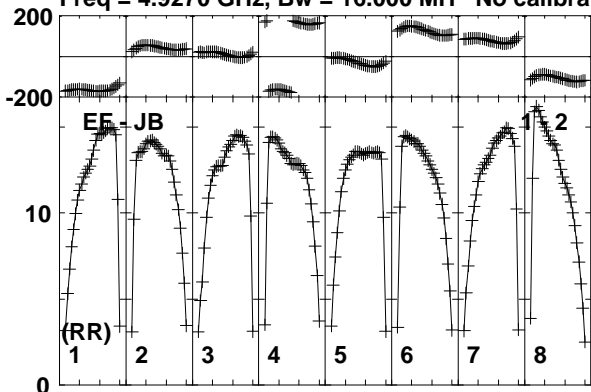

Lower frame: Milli Ampl Jy Top frame: Phas deg
Vector averaged cross-power spectrum Baseline: EF (01) - JB (02)
Timerange: 00/13:00:56 to 00/13:04:58

Plot file version 2 created 26-MAR-2015 15:27:34

0528+134 EG082E.UVDATA.1

Freq = 4.9270 GHz, Bw = 16.000 MH No calibration applied and no bandpass applied

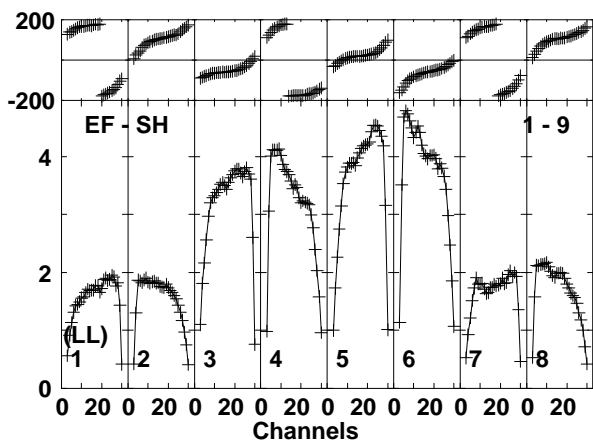
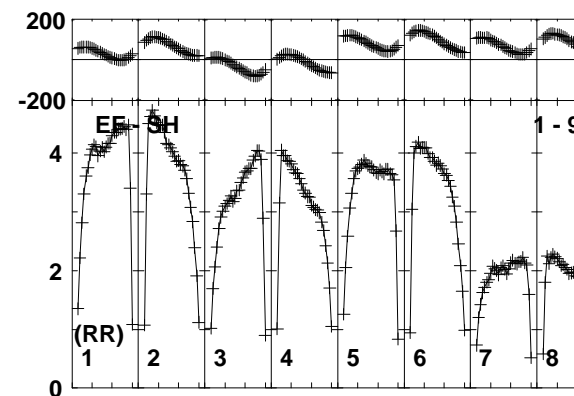
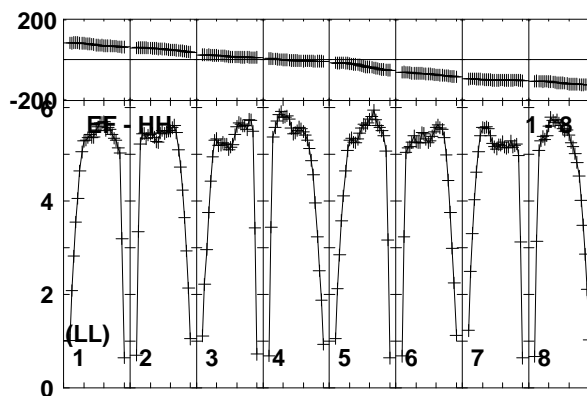
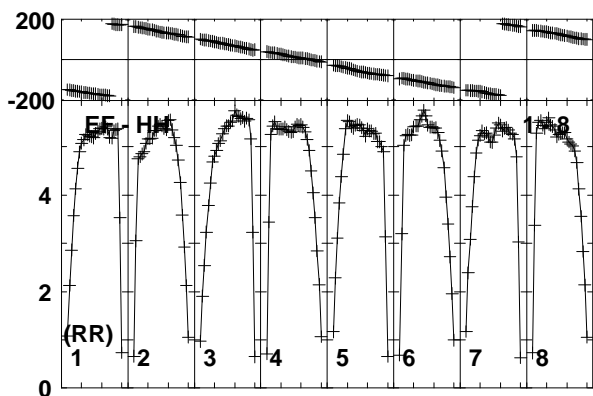
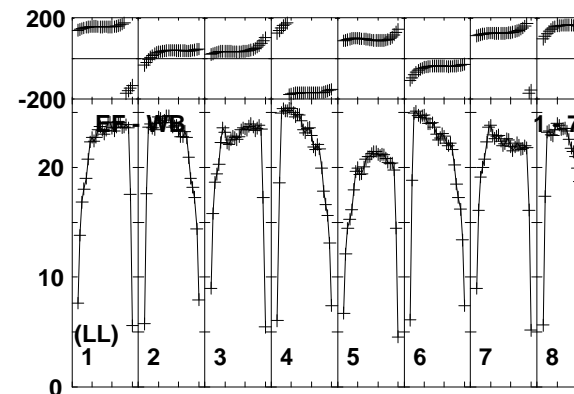
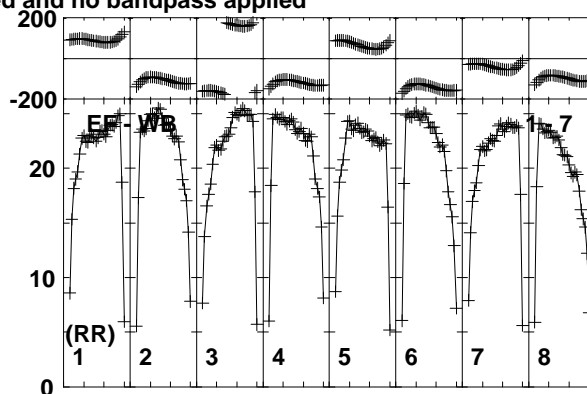
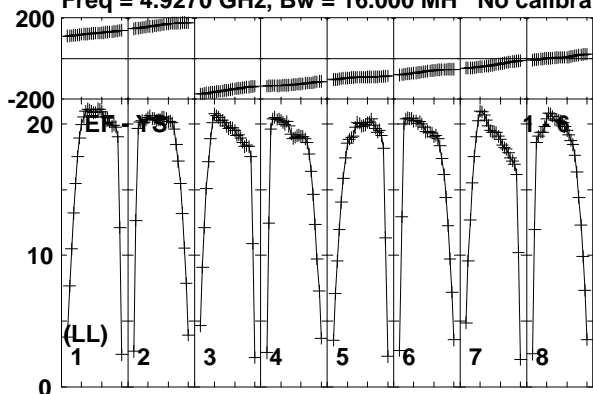

Lower frame: Milli Ampl Jy Top frame: Phas deg
Vector averaged cross-power spectrum Baseline: EF (01) - YS (06)
Timerange: 00:13:00:56 to 00:13:04:58

Plot file version 3 created 26-MAR-2015 15:27:34

J0519+0848 EG082E.UVDATA.1

Freq = 4.9270 GHz, Bw = 16.000 MH No calibration applied and no bandpass applied

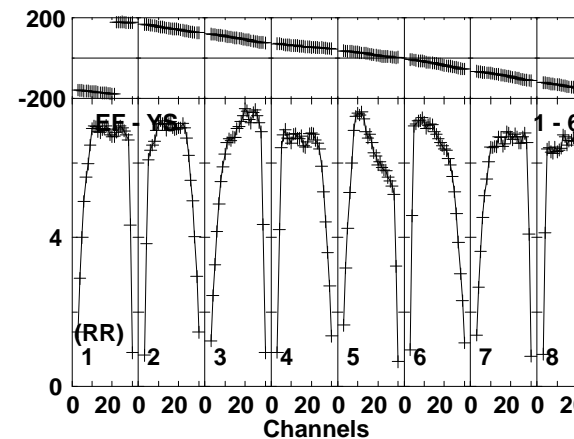
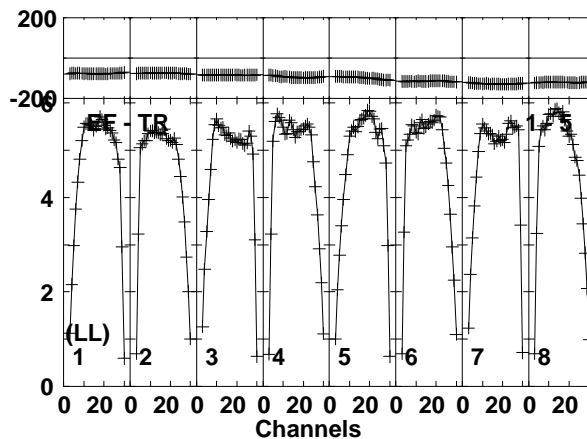
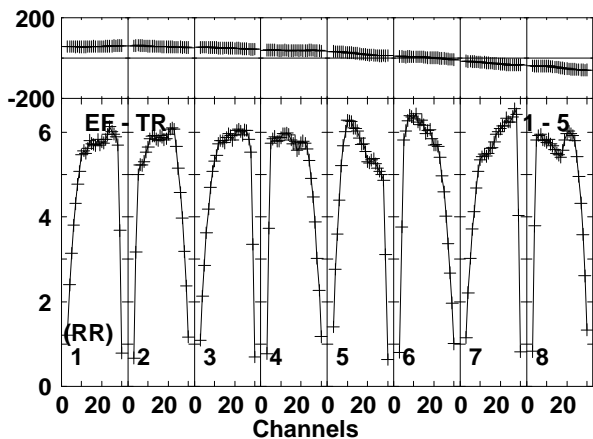
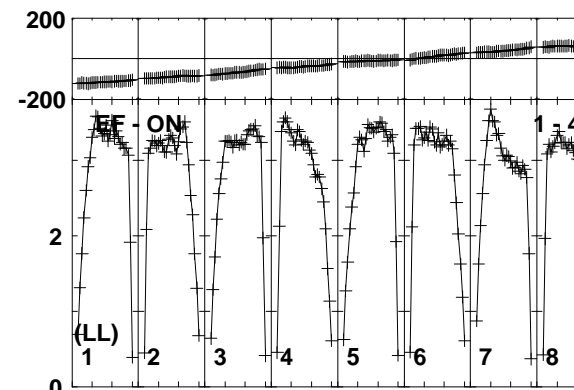
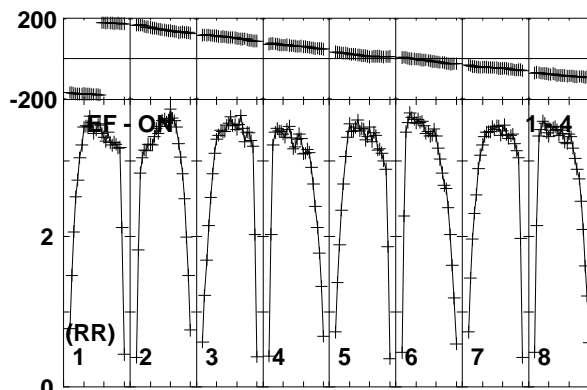
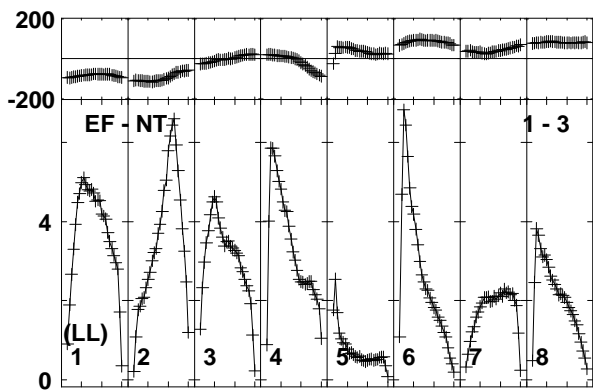
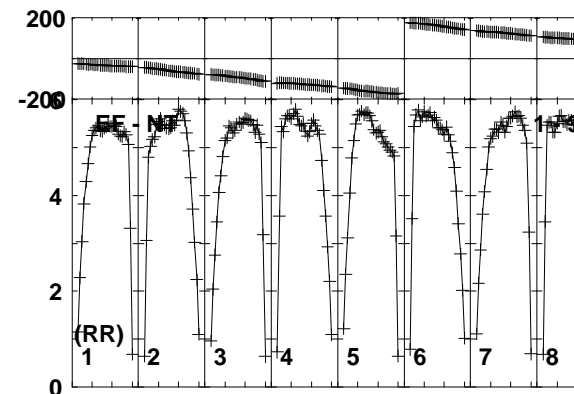
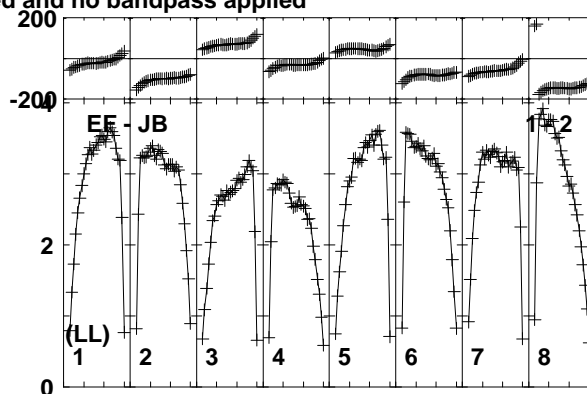
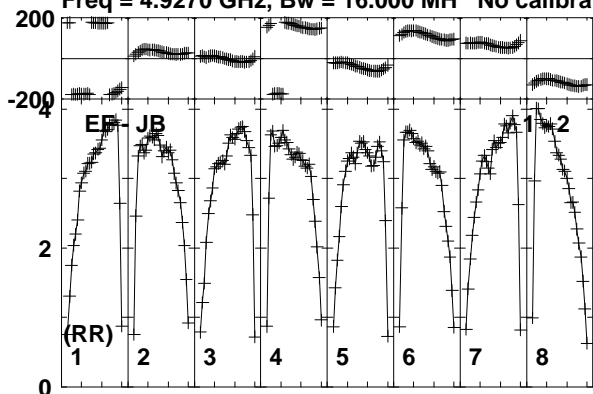

Lower frame: Milli Ampl Jy Top frame: Phas deg
Vector averaged cross-power spectrum Baseline: EF (01) - JB (02)
Timerange: 00/13:06:02 to 00/13:08:28

Plot file version 4 created 26-MAR-2015 15:27:34

J0519+0848 EG082E.UVDATA.1

Freq = 4.9270 GHz, Bw = 16.000 MH No calibration applied and no bandpass applied

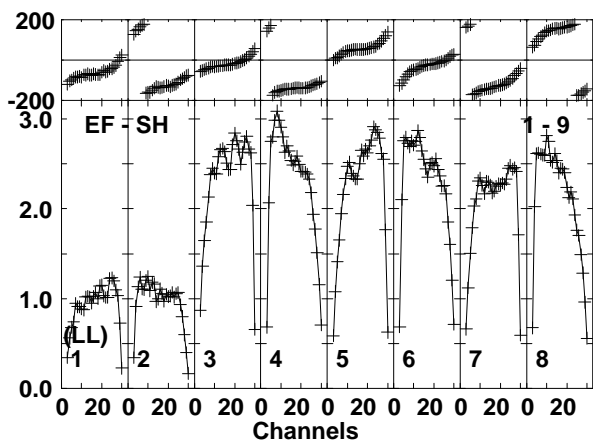
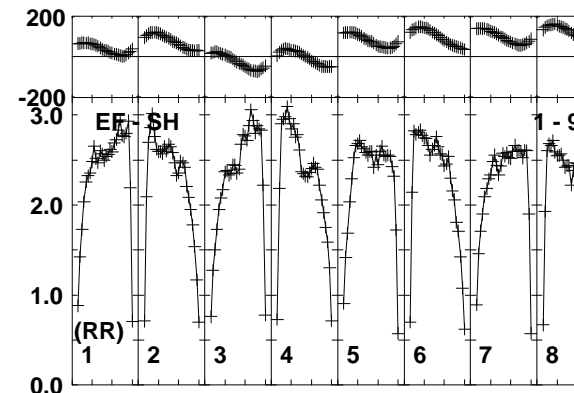
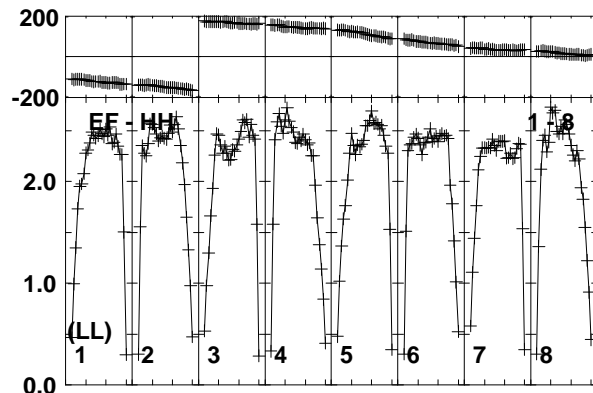
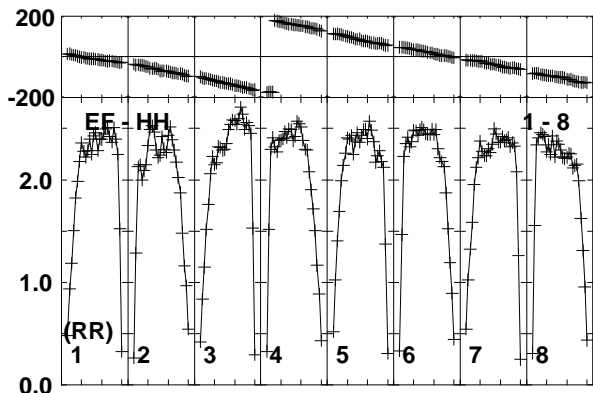
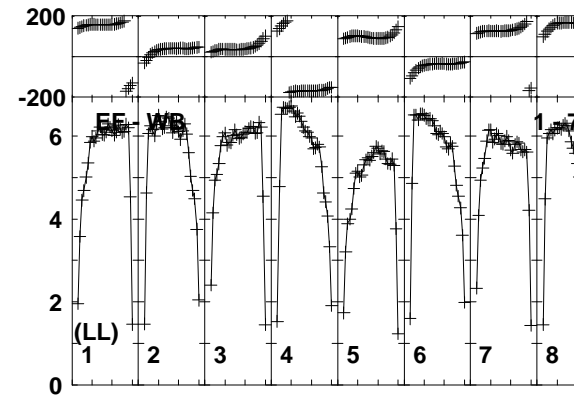
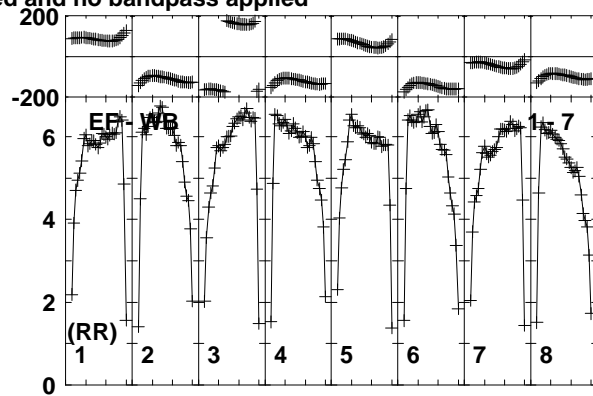
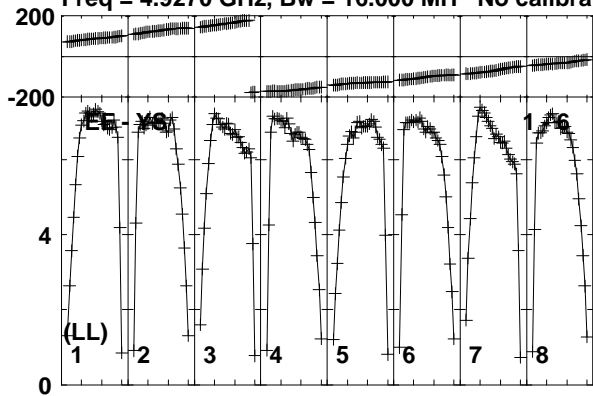

Lower frame: Milli Ampl Jy Top frame: Phas deg
Vector averaged cross-power spectrum Baseline: EF (01) - YS (06)
Timerange: 00:13:06:02 to 00:13:08:28

Plot file version 5 created 26-MAR-2015 15:27:34

J0525+0951 EG082E.UVDATA.1

Freq = 4.9270 GHz, Bw = 16.000 MH No calibration applied and no bandpass applied

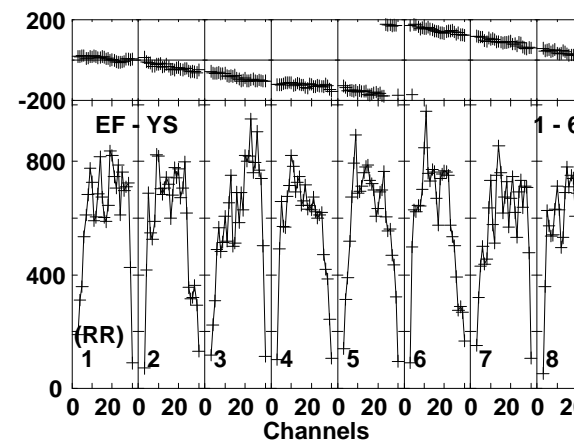
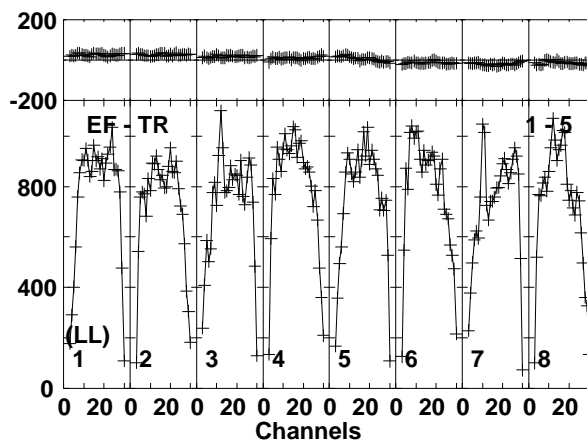
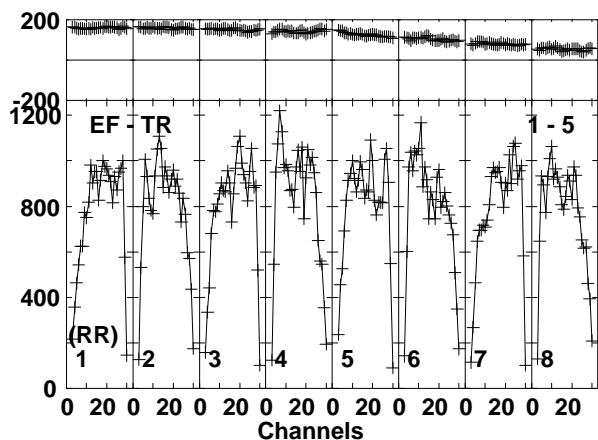
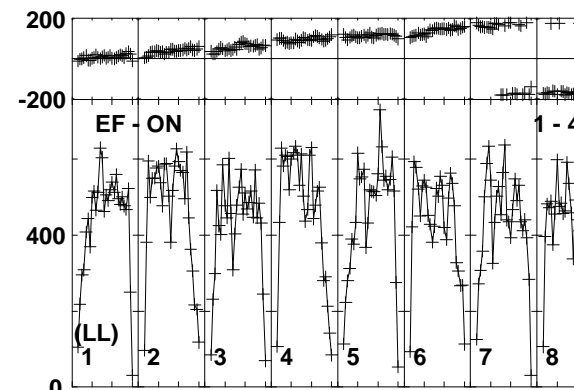
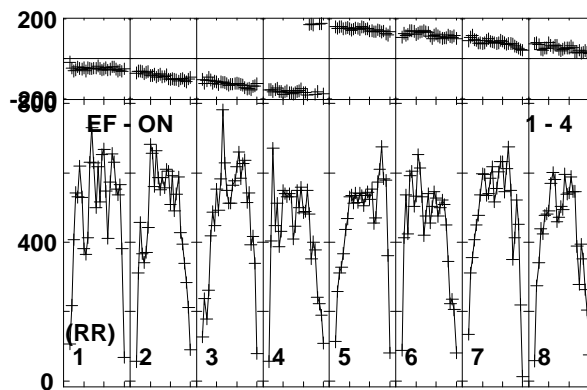
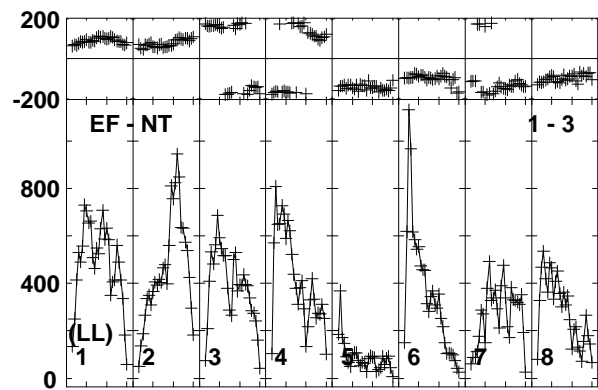
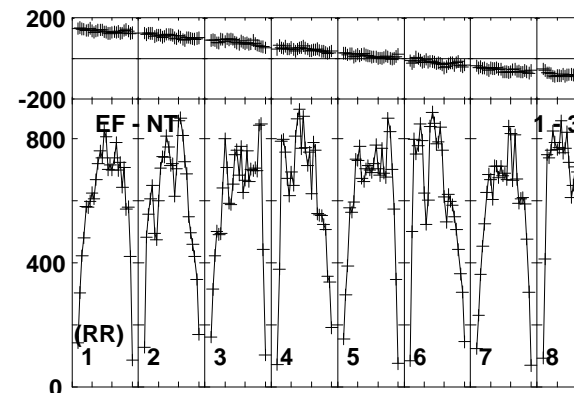
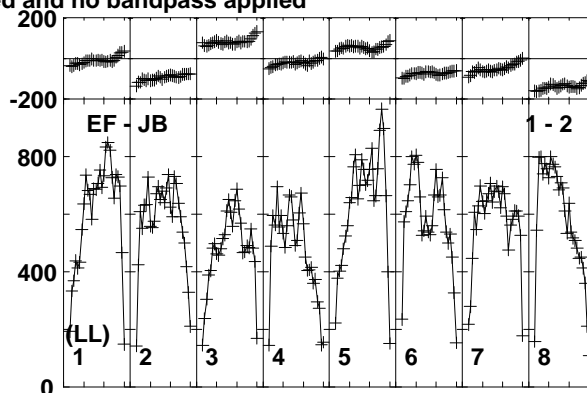
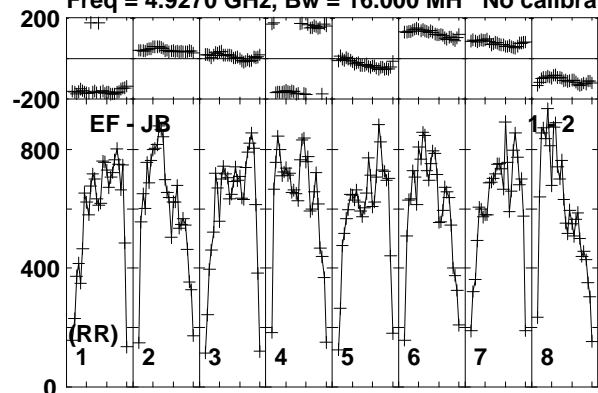

Lower frame: Micro Ampl Jy Top frame: Phas deg
Vector averaged cross-power spectrum Baseline: EF (01) - JB (02)
Timerange: 00/13:08:32 to 00/13:11:32

Plot file version 6 created 26-MAR-2015 15:27:34

J0525+0951 EG082E.UVDATA.1

Freq = 4.9270 GHz, Bw = 16.000 MH No calibration applied and no bandpass applied

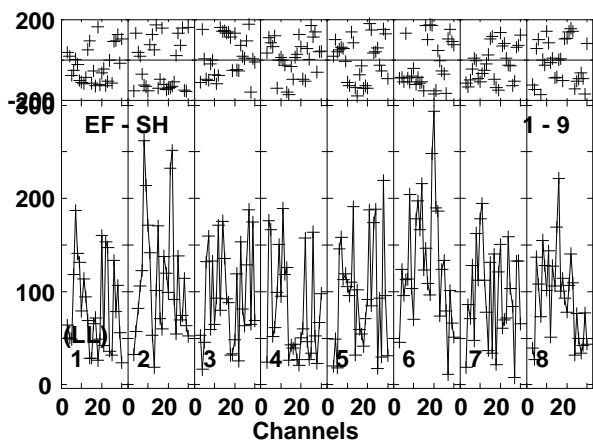
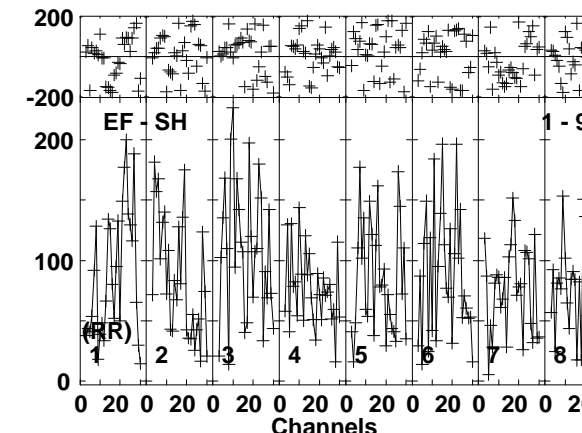
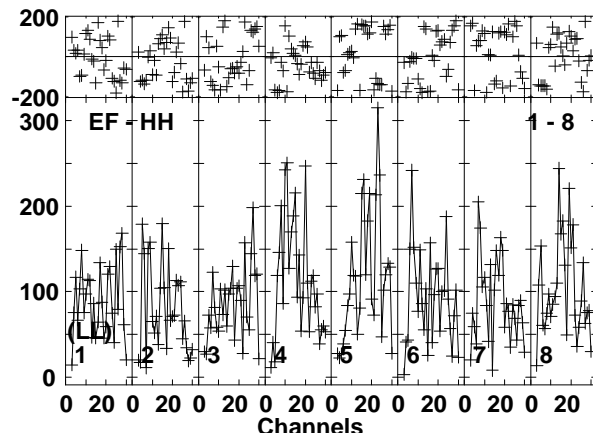
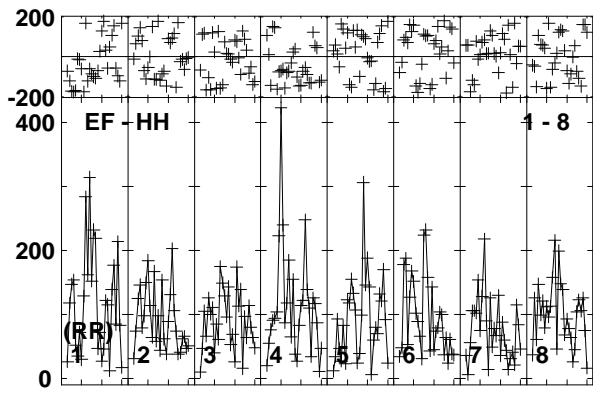
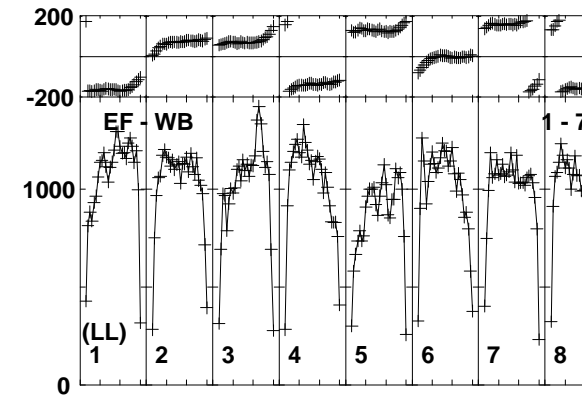
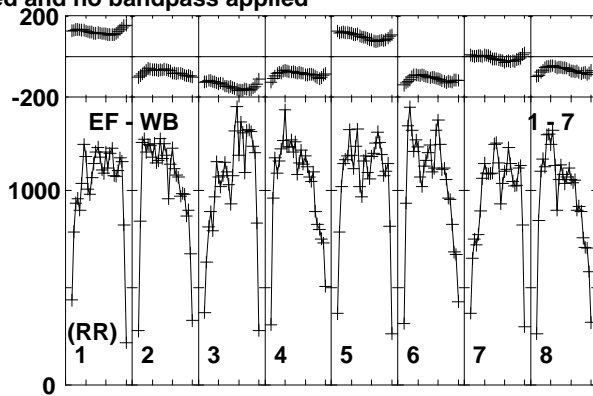
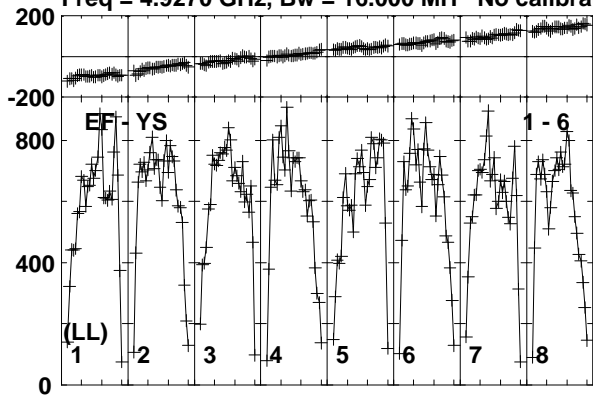

Lower frame: Micro Ampl Jy Top frame: Phas deg
Vector averaged cross-power spectrum Baseline: EF (01) - YS (06)
Timerange: 00/13:08:32 to 00/13:11:32

Plot file version 7 created 26-MAR-2015 15:27:34

V998ORI EG082E.UVDATA.1

Freq = 4.9270 GHz, Bw = 16.000 MH No calibration applied and no bandpass applied

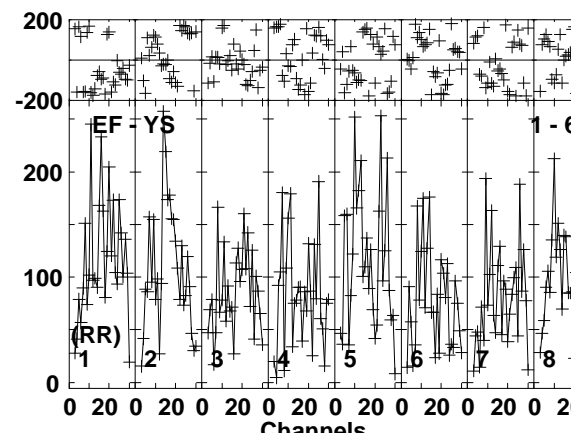
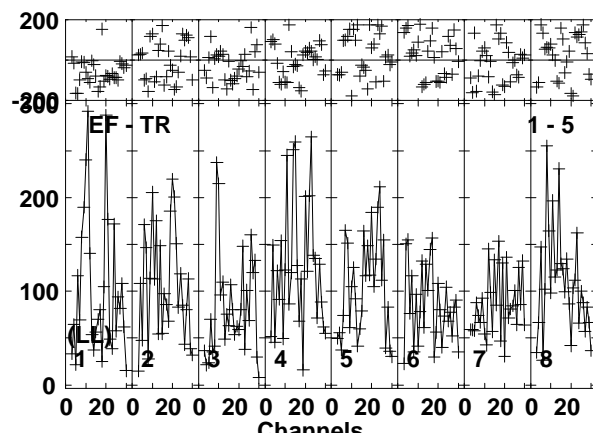
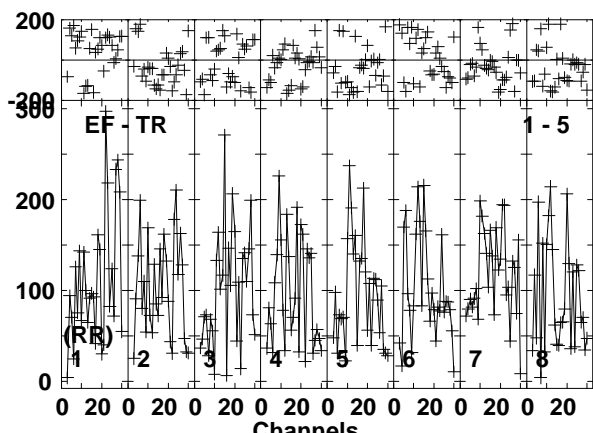
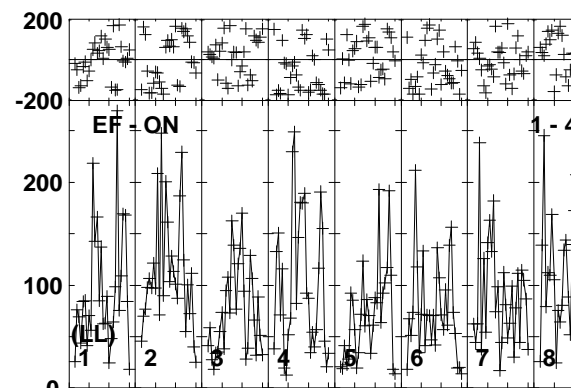
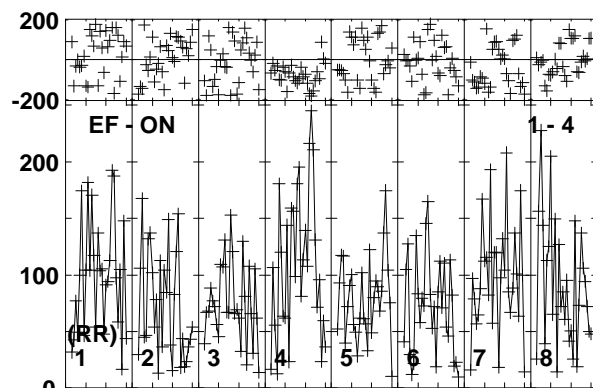
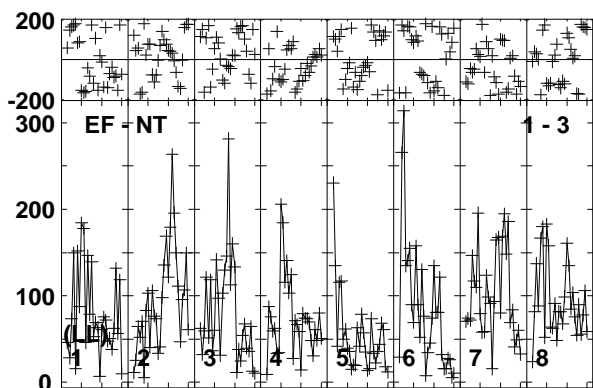
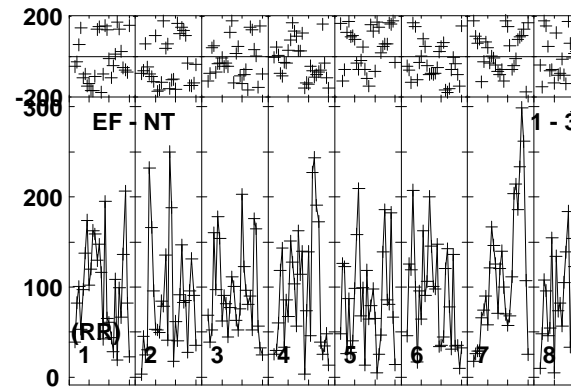
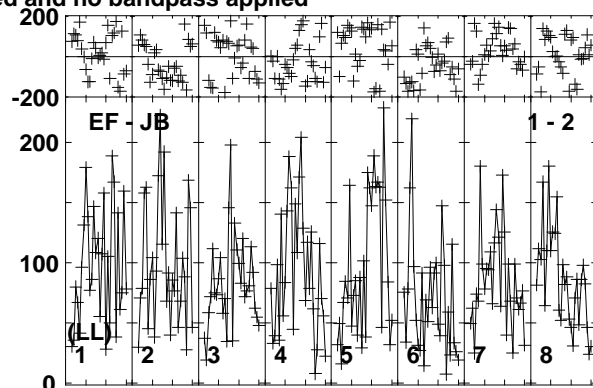
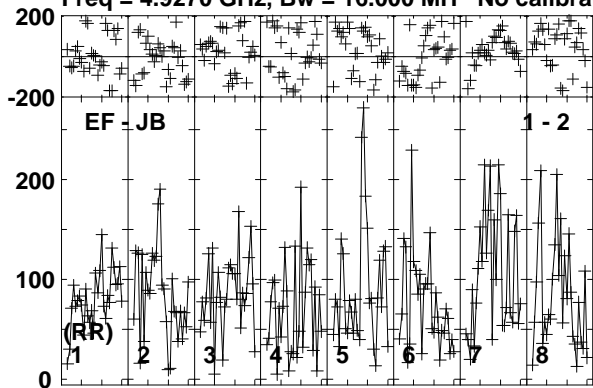

Lower frame: Micro Ampl Jy Top frame: Phas deg
Vector averaged cross-power spectrum Baseline: EF (01) - JB (02)
Timerange: 00/13:18:52 to 00/13:21:34

Plot file version 8 created 26-MAR-2015 15:27:34

V998ORI EG082E.UVDATA.1

Freq = 4.9270 GHz, Bw = 16.000 MH No calibration applied and no bandpass applied

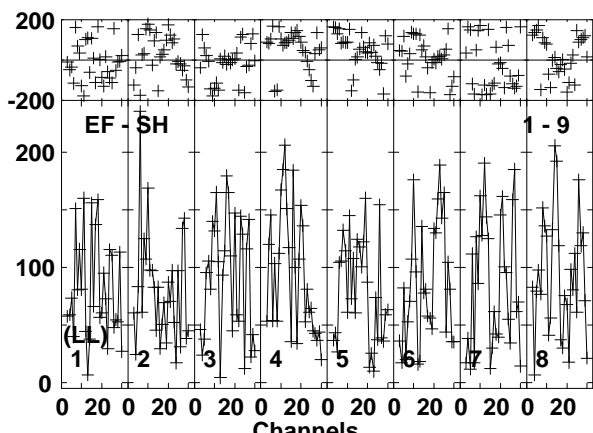
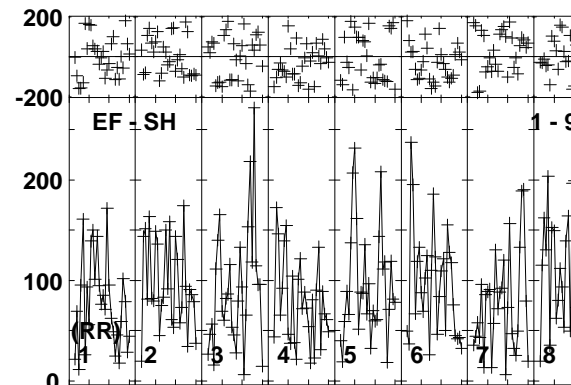
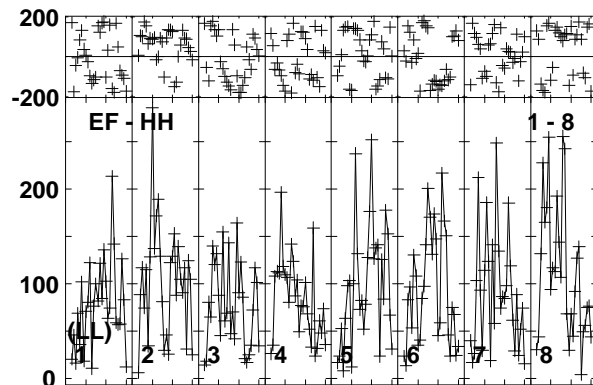
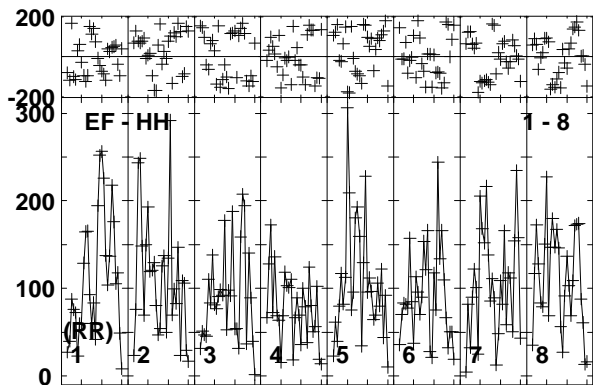
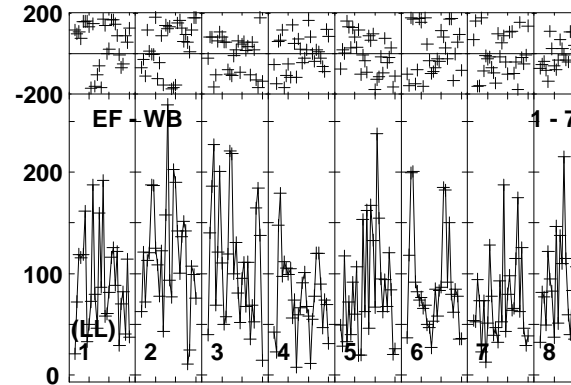
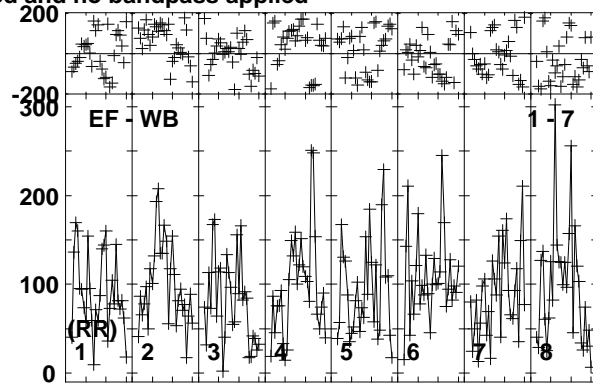
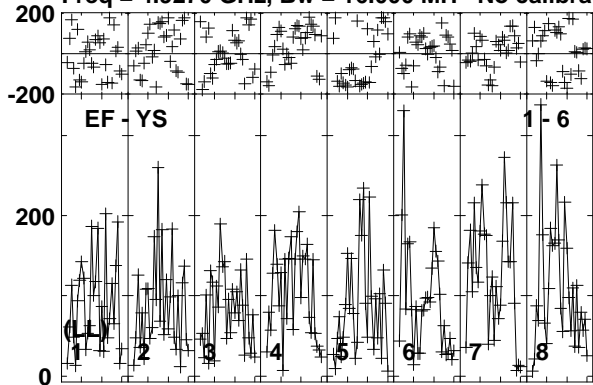

Lower frame: Micro Ampl Jy Top frame: Phas deg
Vector averaged cross-power spectrum Baseline: EF (01) - YS (06)
Timerange: 00/13:18:52 to 00/13:21:34

Plot file version 9 created 26-MAR-2015 15:27:34

V998ORI EG082E.UVDATA.1

Freq = 4.9270 GHz, Bw = 16.000 MH No calibration applied and no bandpass applied

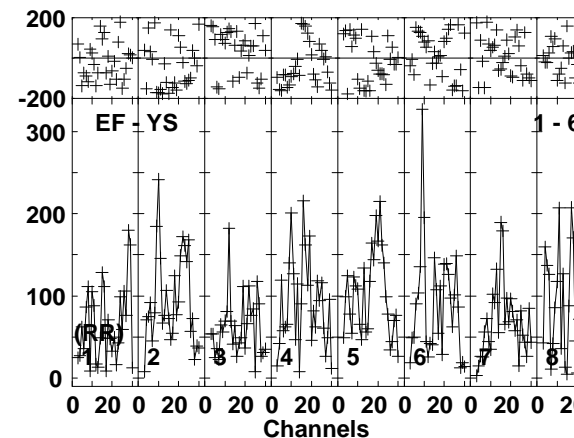
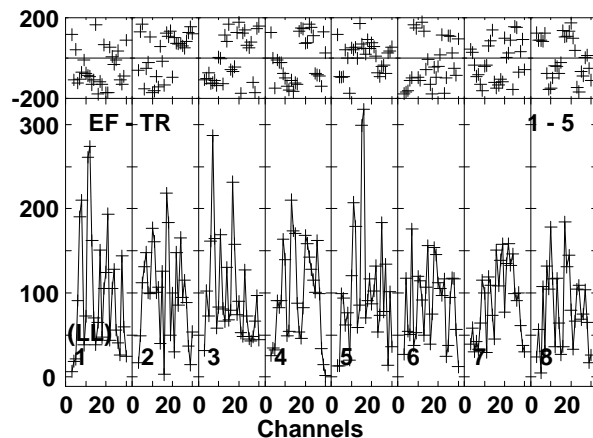
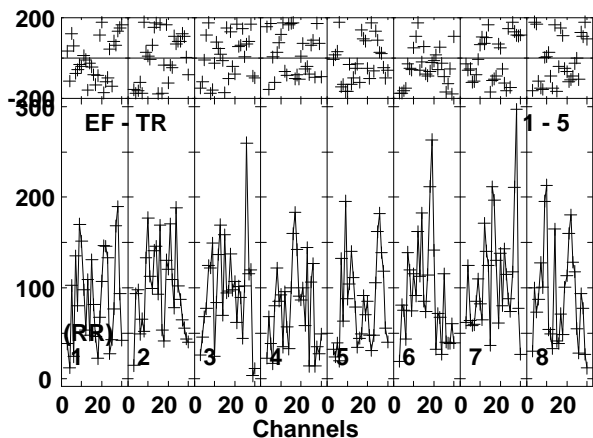
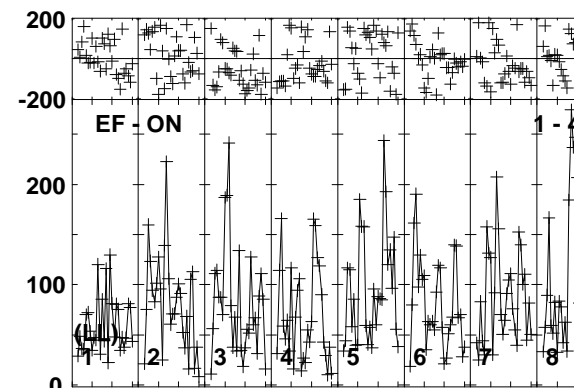
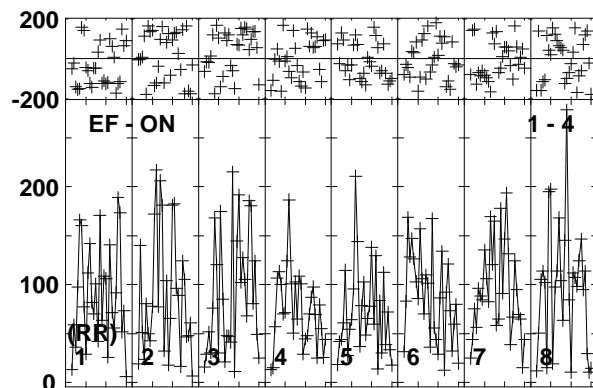
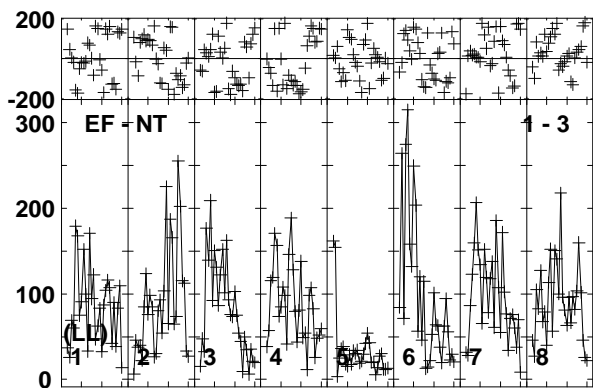
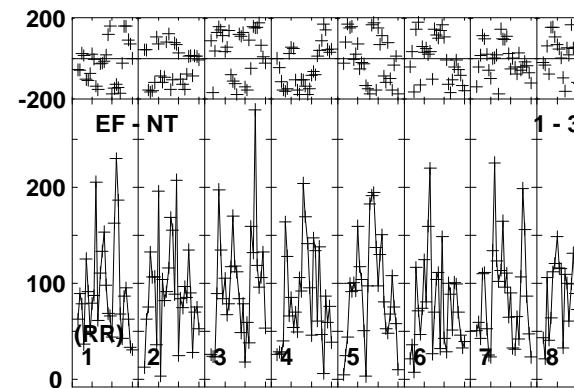
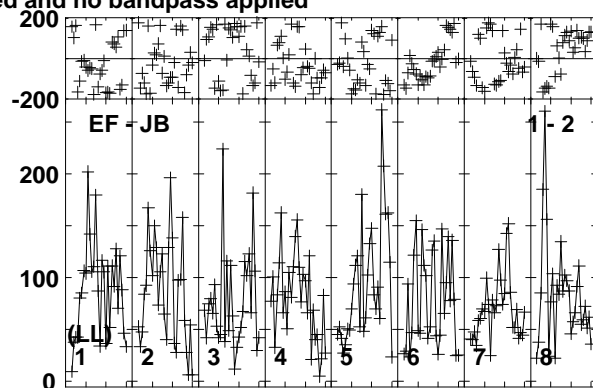
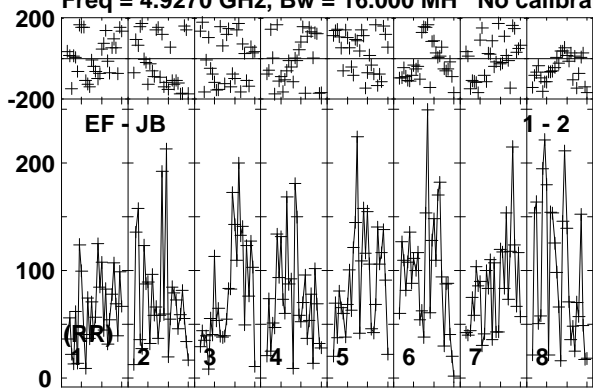

Lower frame: Micro Ampl Jy Top frame: Phas deg
Vector averaged cross-power spectrum Baseline: EF (01) - JB (02)
Timerange: 00/13:23:36 to 00/13:26:58

Plot file version 10 created 26-MAR-2015 15:27:34

V998ORI EG082E.UVDATA.1

Freq = 4.9270 GHz, Bw = 16.000 MH No calibration applied and no bandpass applied

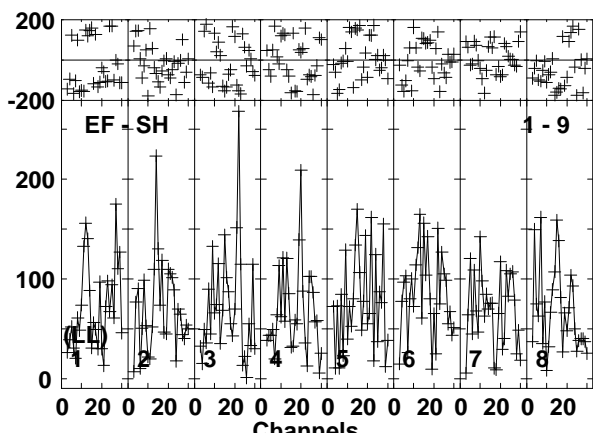
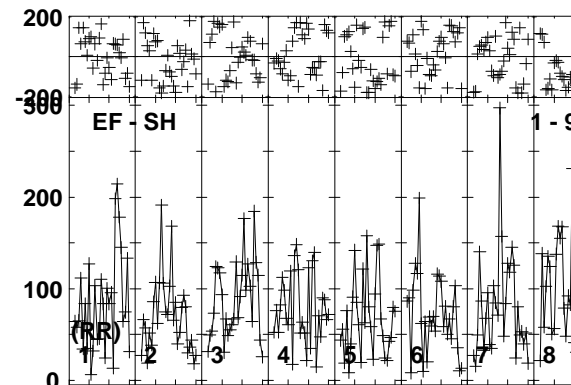
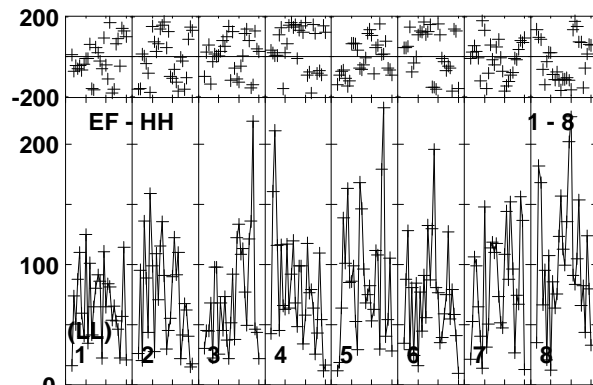
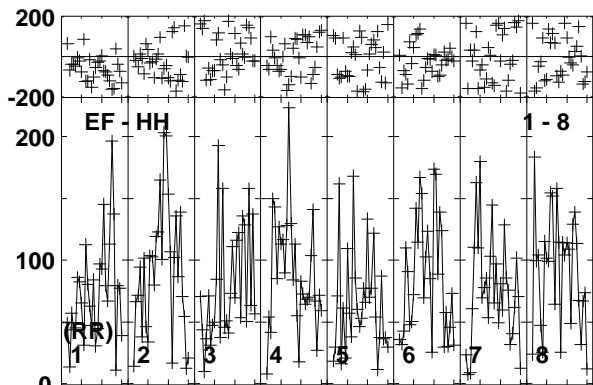
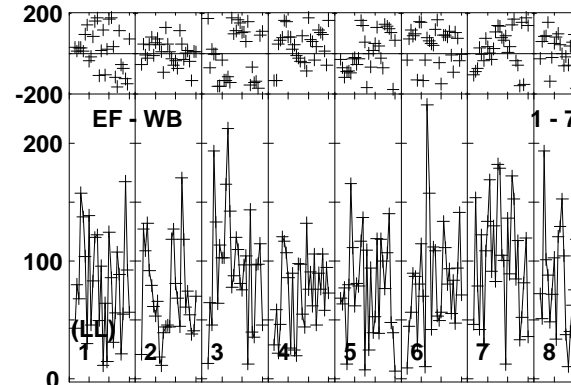
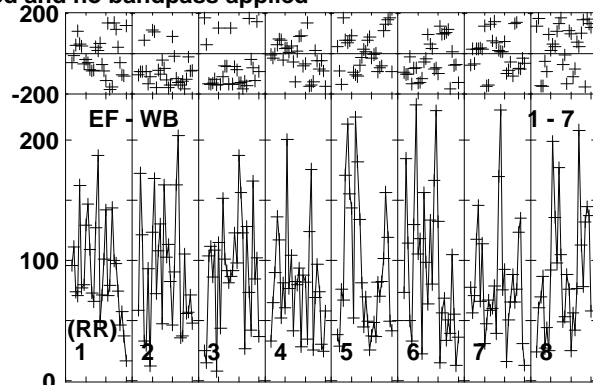
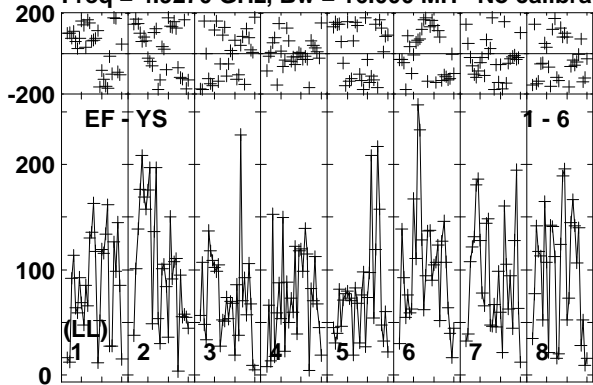

Lower frame: Micro Ampl Jy Top frame: Phas deg
Vector averaged cross-power spectrum Baseline: EF (01) - YS (06)
Timerange: 00/13:23:36 to 00/13:26:58

Plot file version 11 created 26-MAR-2015 15:27:34

J0519+0848 EG082E.UVDATA.1

Freq = 4.9270 GHz, Bw = 16.000 MH No calibration applied and no bandpass applied

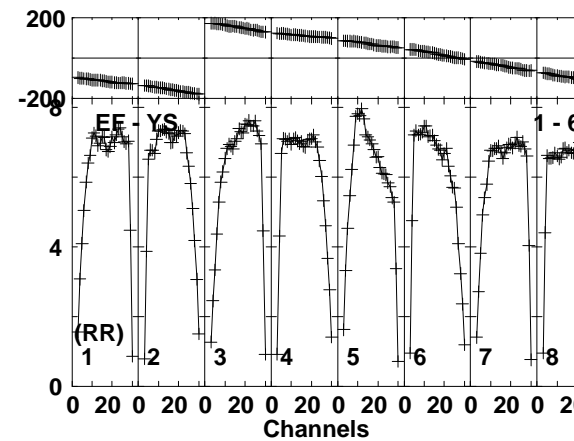
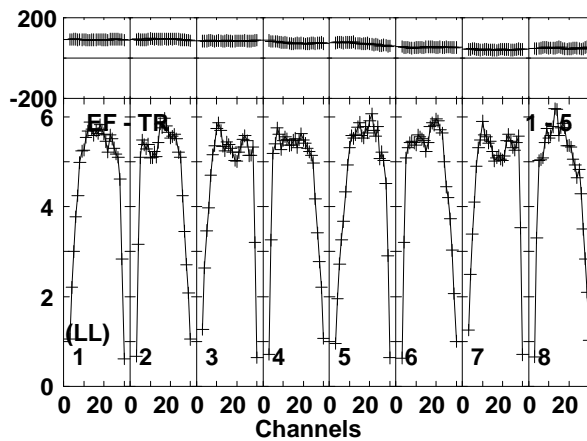
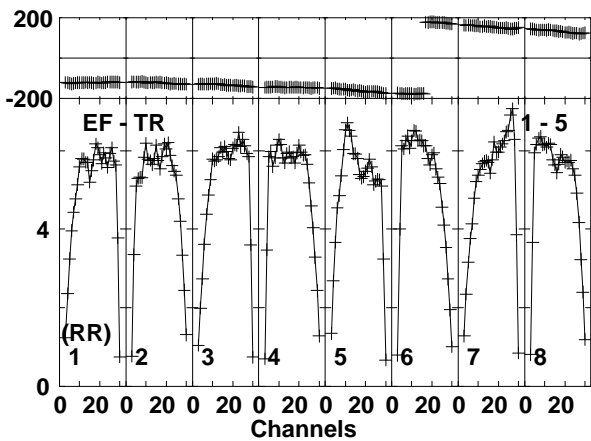
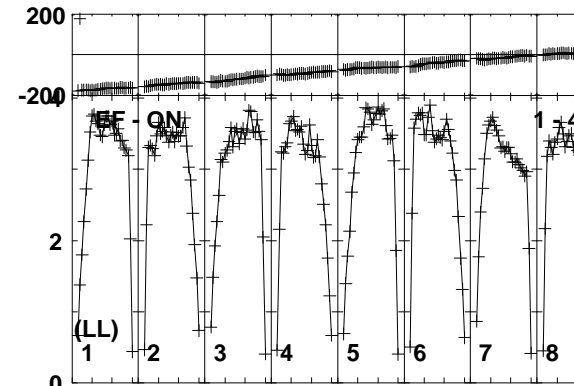
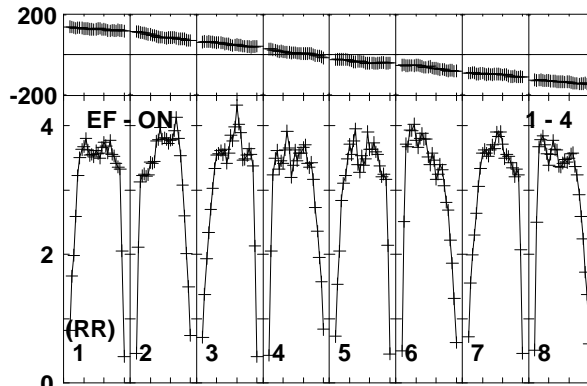
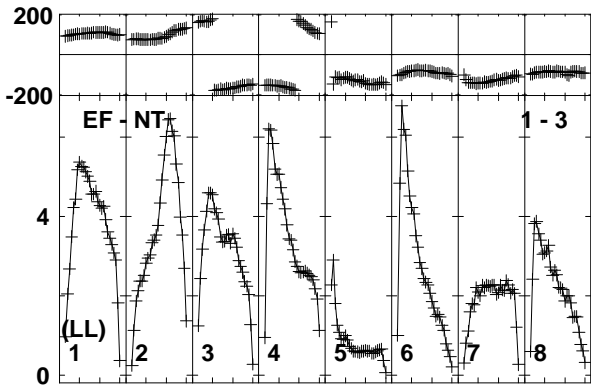
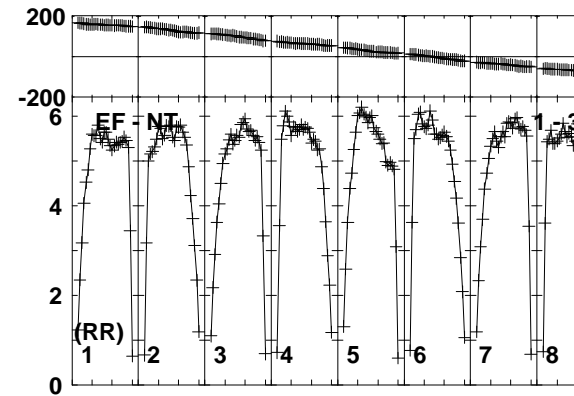
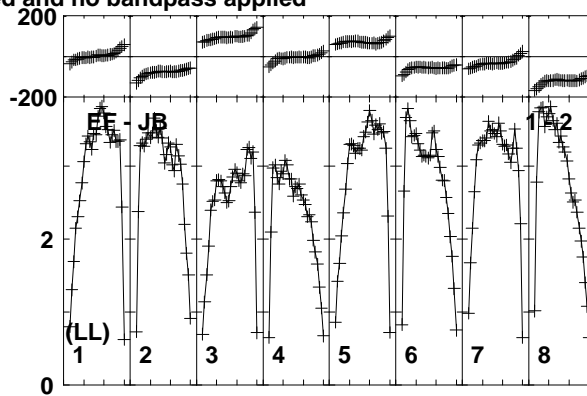
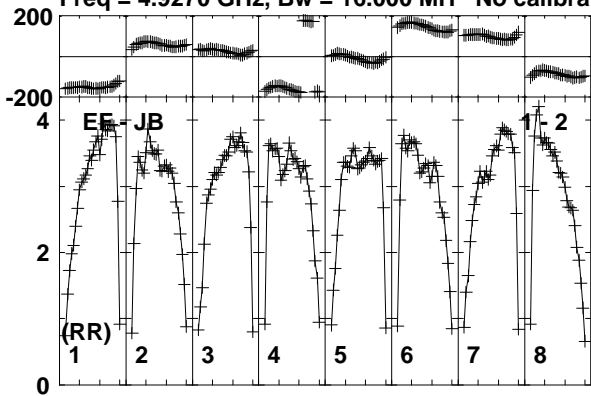

Lower frame: Milli Ampl Jy Top frame: Phas deg
Vector averaged cross-power spectrum Baseline: EF (01) - JB (02)
Timerange: 00:13:27:02 to 00:13:28:28

Plot file version 12 created 26-MAR-2015 15:27:34

J0519+0848 EG082E.UVDATA.1

Freq = 4.9270 GHz, Bw = 16.000 MH No calibration applied and no bandpass applied

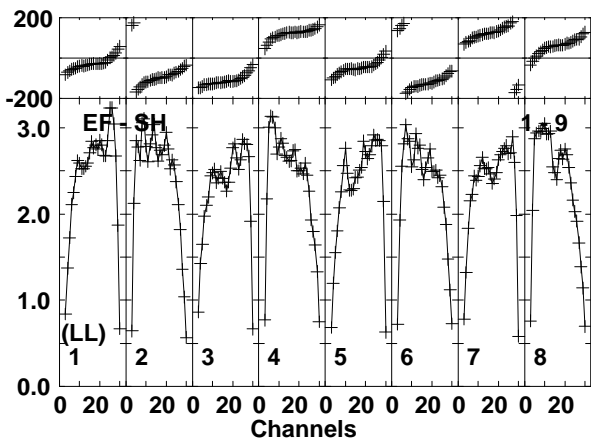
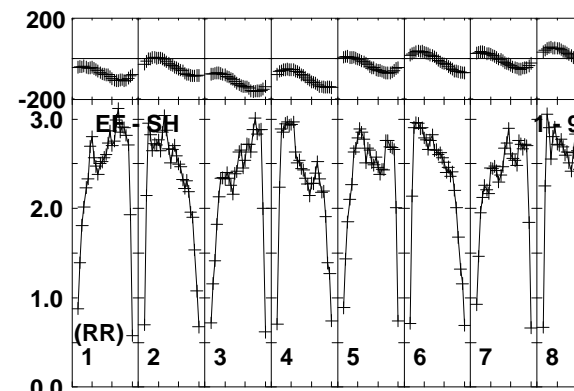
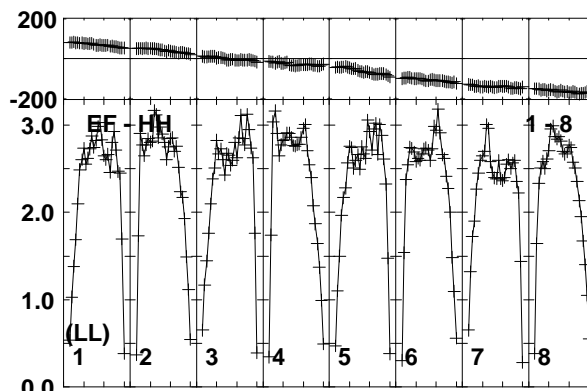
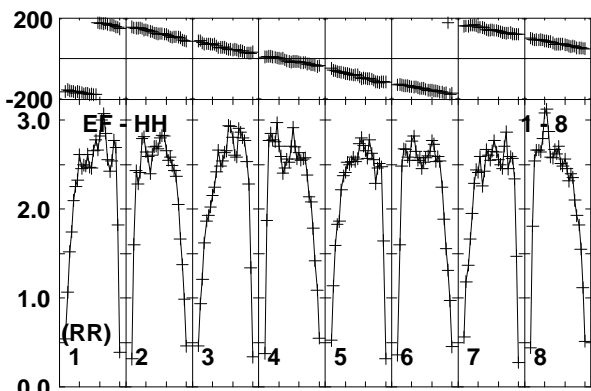
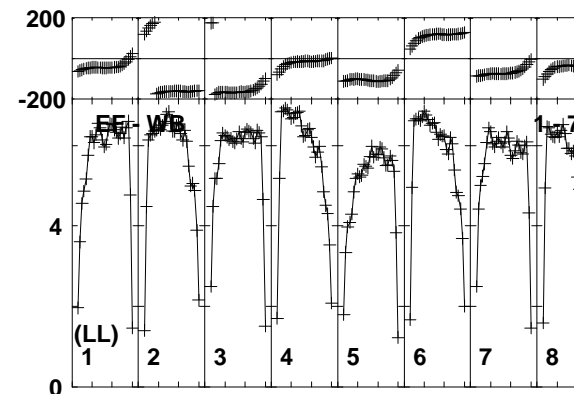
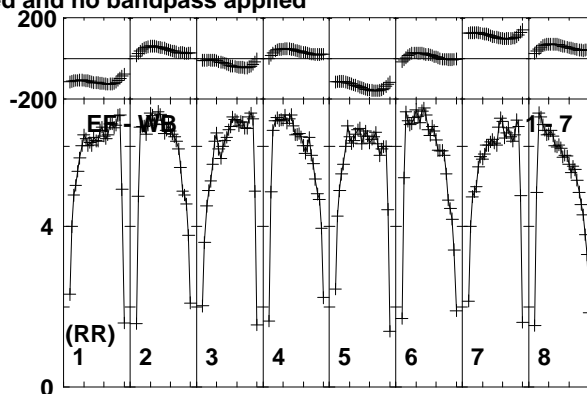
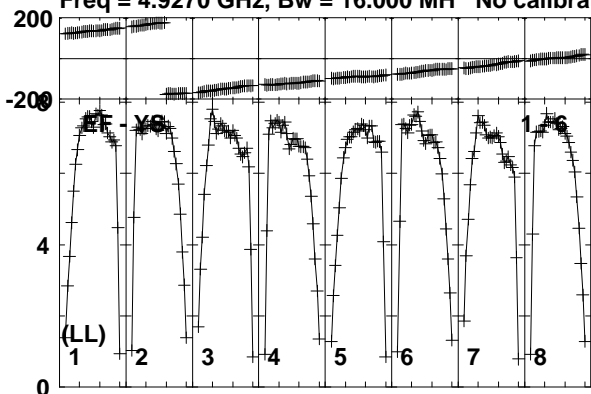

Lower frame: Milli Ampl Jy Top frame: Phas deg
Vector averaged cross-power spectrum Baseline: EF (01) - YS (06)
Timerange: 00:13:27:02 to 00:13:28:28

Plot file version 13 created 26-MAR-2015 15:27:34

V998ORI EG082E.UVDATA.1

Freq = 4.9270 GHz, Bw = 16.000 MH No calibration applied and no bandpass applied

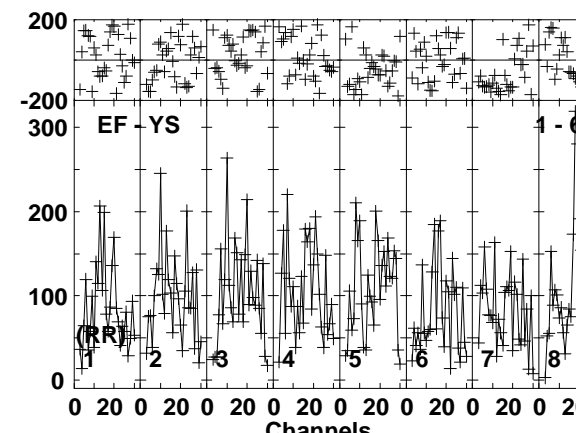
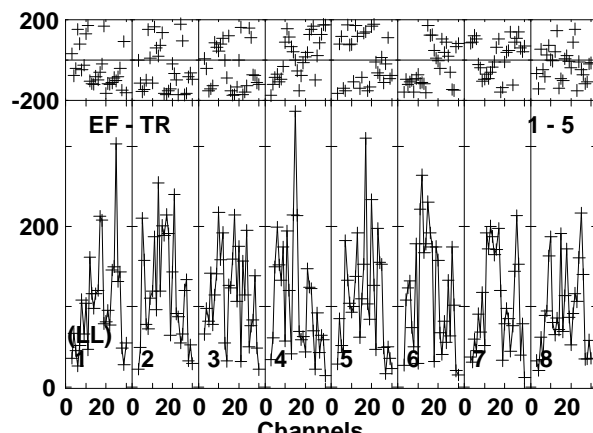
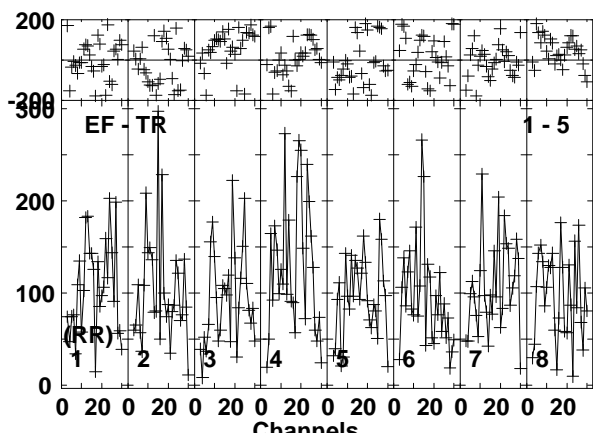
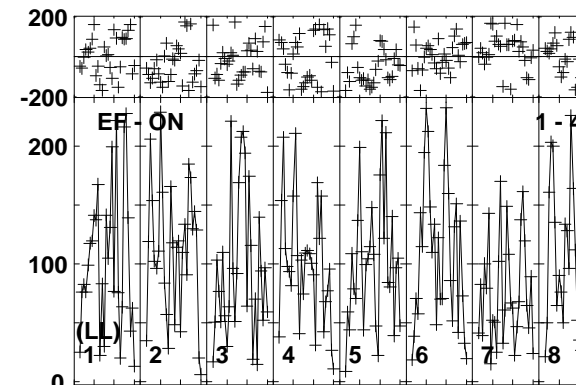
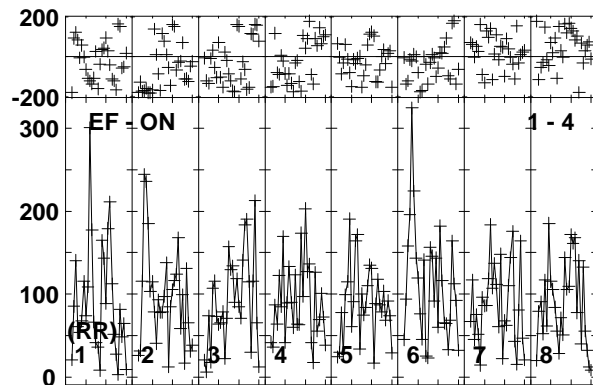
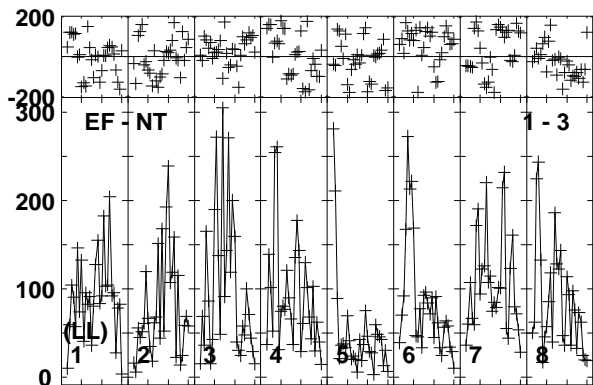
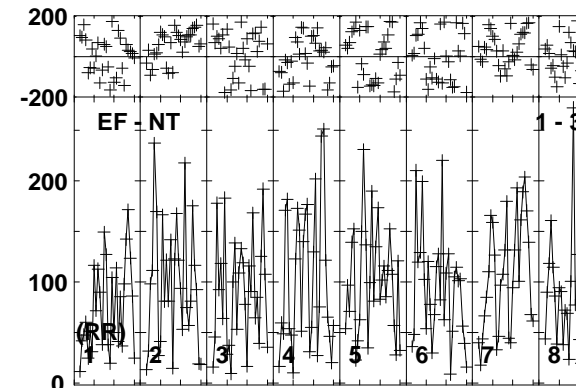
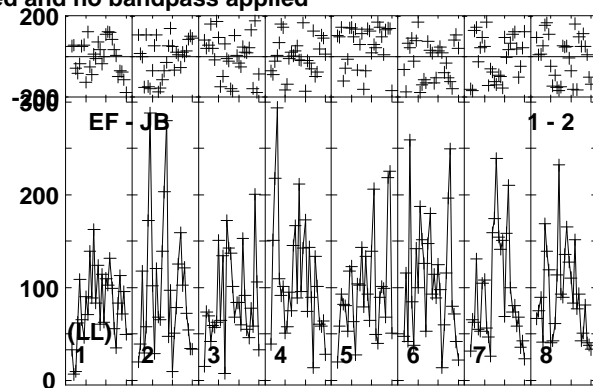
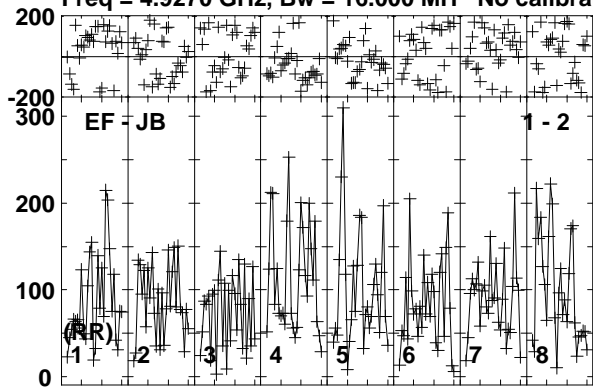

Lower frame: Micro Ampl Jy Top frame: Phas deg
Vector averaged cross-power spectrum Baseline: EF (01) - JB (02)
Timerange: 00/13:28:32 to 00/13:31:22

Plot file version 14 created 26-MAR-2015 15:27:35

V998ORI EG082E.UVDATA.1

Freq = 4.9270 GHz, Bw = 16.000 MH No calibration applied and no bandpass applied

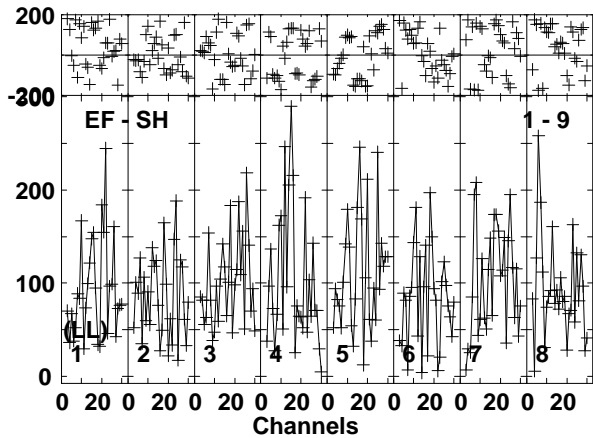
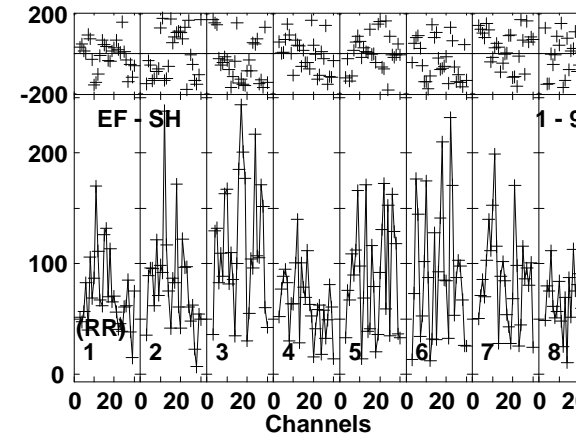
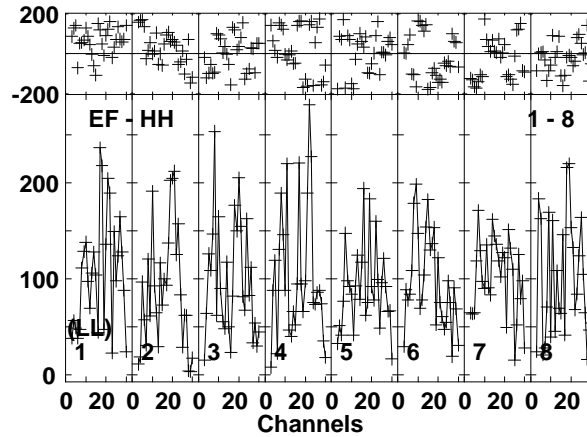
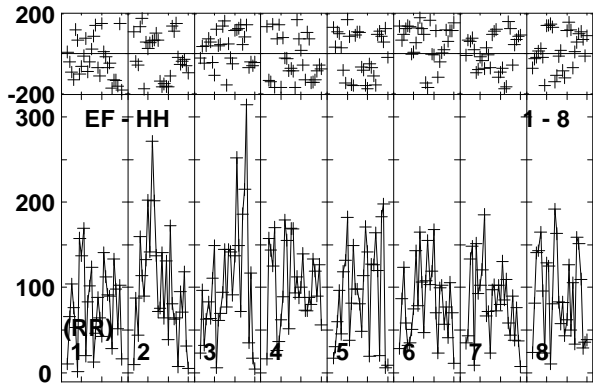
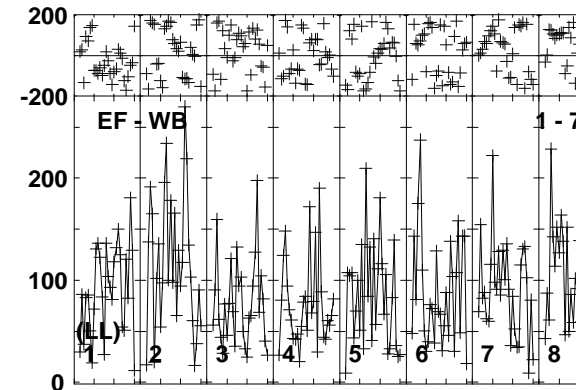
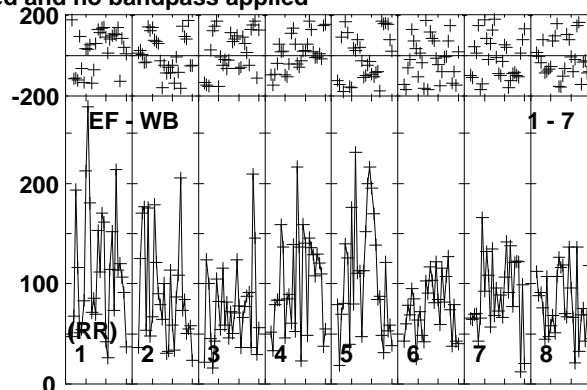
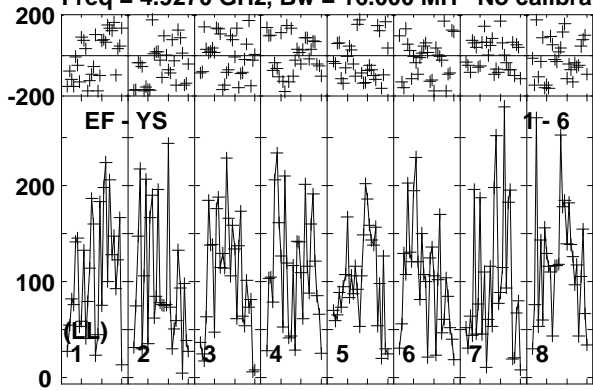

Lower frame: Micro Ampl Jy Top frame: Phas deg
Vector averaged cross-power spectrum Baseline: EF (01) - YS (06)
Timerange: 00/13:28:32 to 00/13:31:22

Plot file version 15 created 26-MAR-2015 15:27:35

V998ORI EG082E.UVDATA.1

Freq = 4.9270 GHz, Bw = 16.000 MH No calibration applied and no bandpass applied

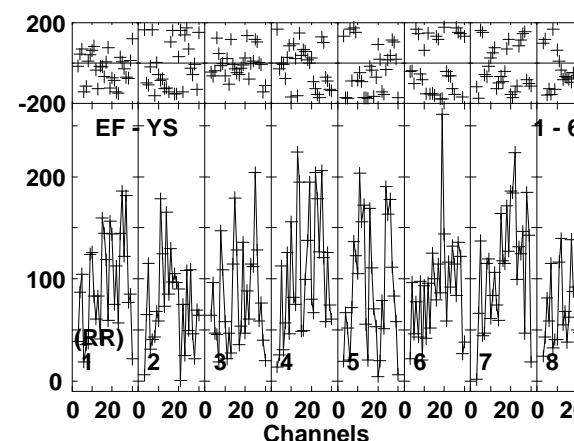
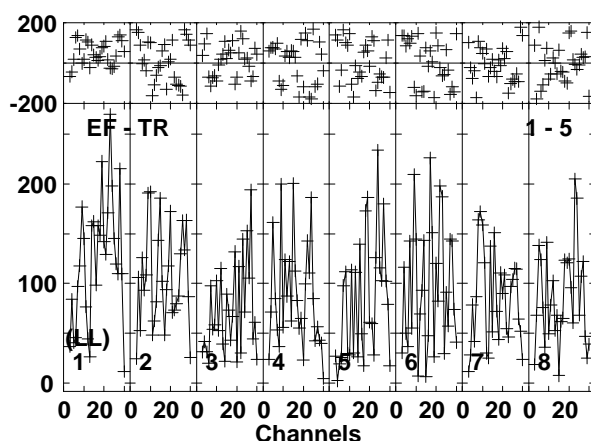
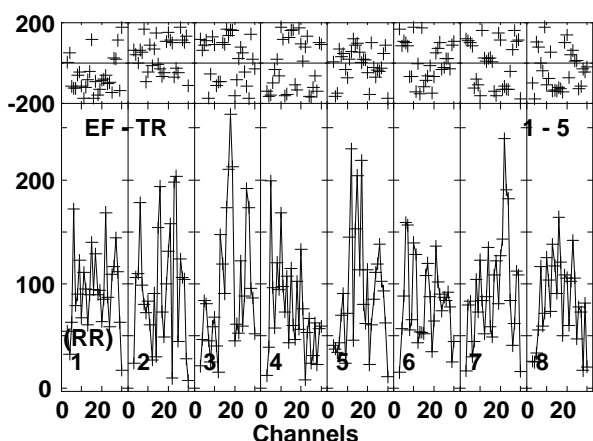
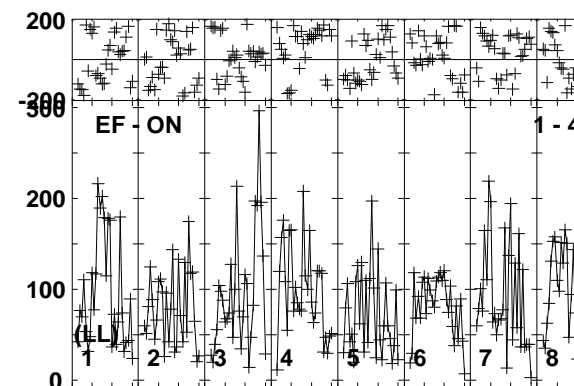
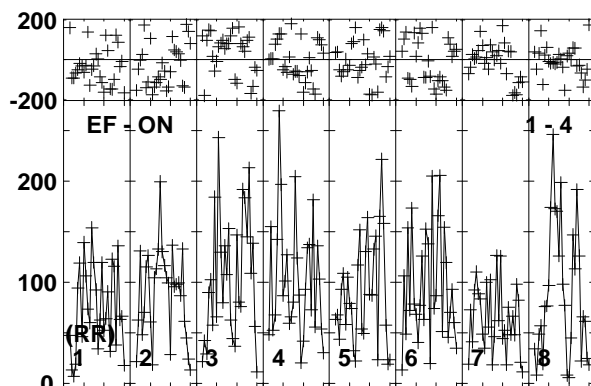
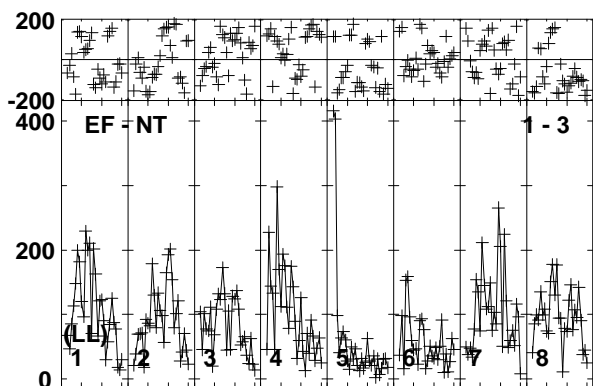
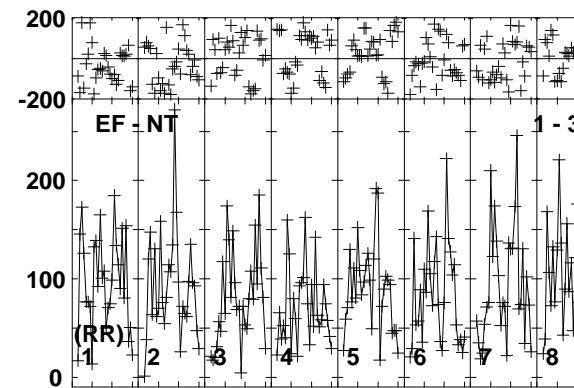
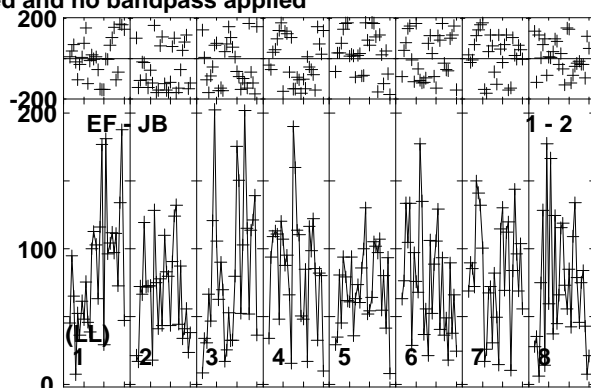
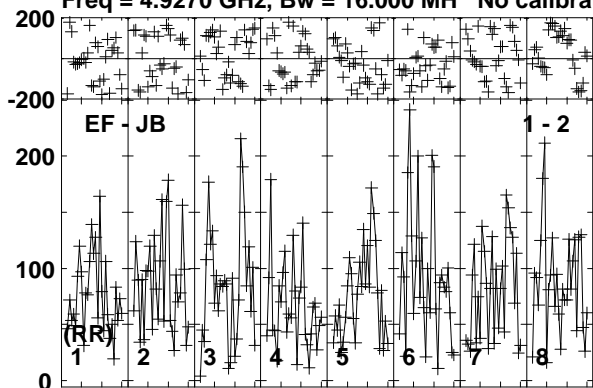

Lower frame: Micro Ampl Jy Top frame: Phas deg
Vector averaged cross-power spectrum Baseline: EF (01) - JB (02)
Timerange: 00/13:34:06 to 00/13:36:58

Plot file version 16 created 26-MAR-2015 15:27:35

V998ORI EG082E.UVDATA.1

Freq = 4.9270 GHz, Bw = 16.000 MH No calibration applied and no bandpass applied

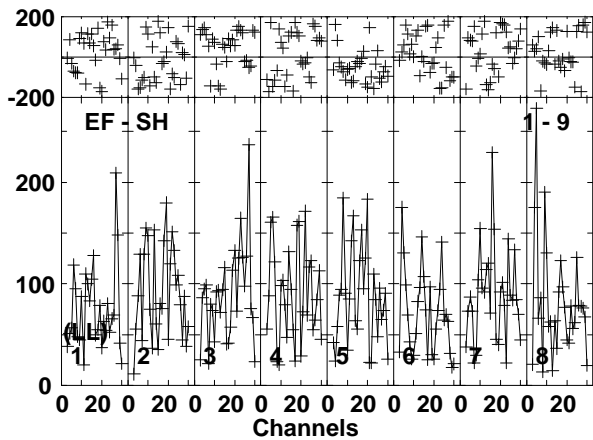
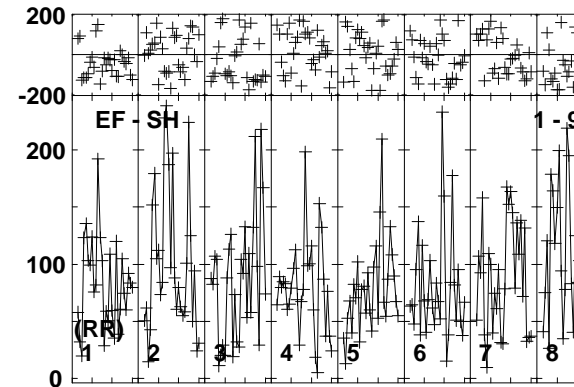
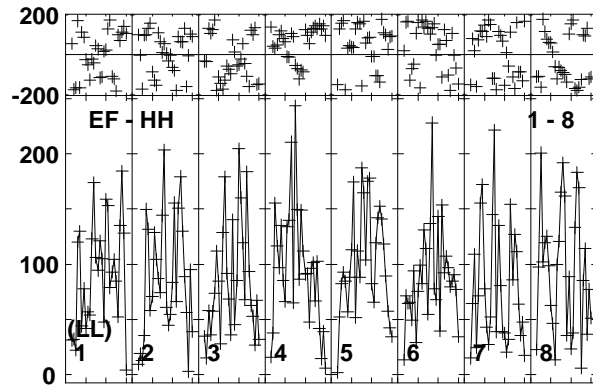
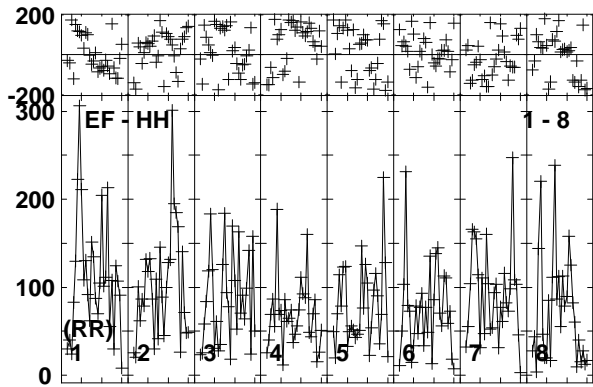
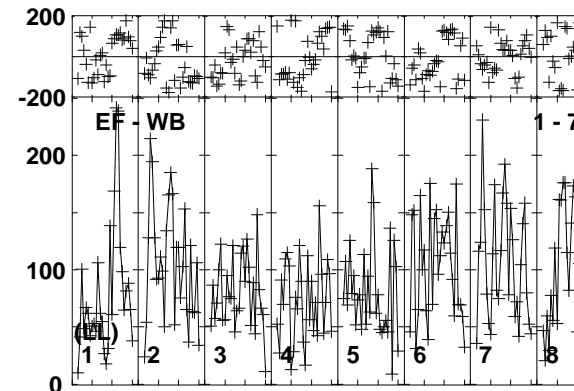
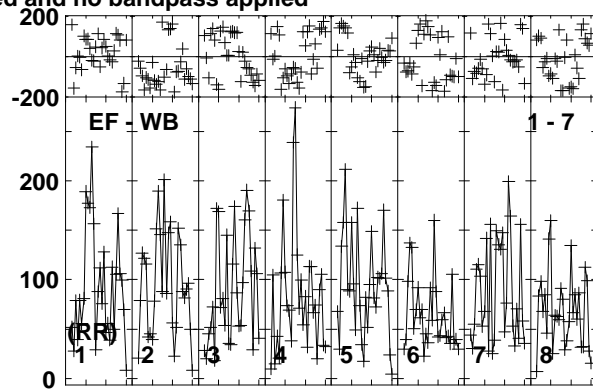
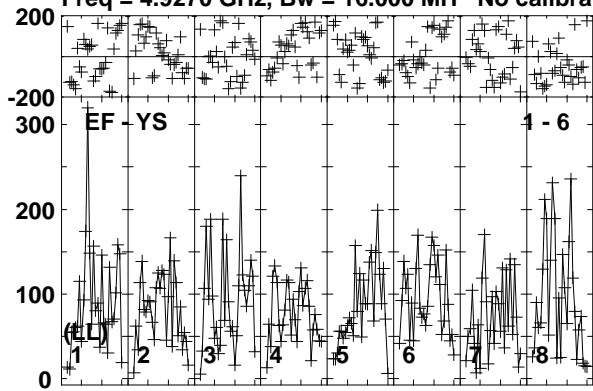

Lower frame: Micro Ampl Jy Top frame: Phas deg
Vector averaged cross-power spectrum Baseline: EF (01) - YS (06)
Timerange: 00/13:34:06 to 00/13:36:58

Plot file version 17 created 26-MAR-2015 15:27:35

J0519+0848 EG082E.UVDATA.1

Freq = 4.9270 GHz, Bw = 16.000 MH No calibration applied and no bandpass applied

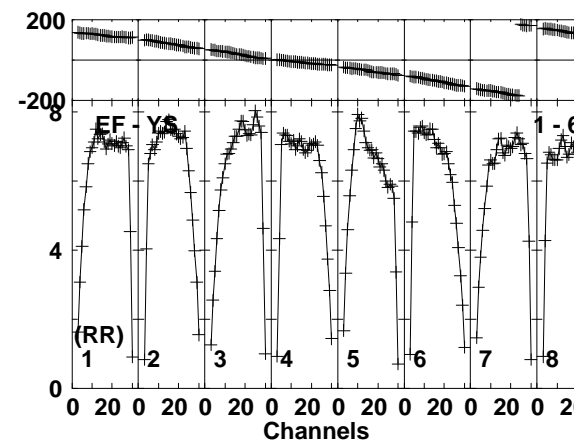
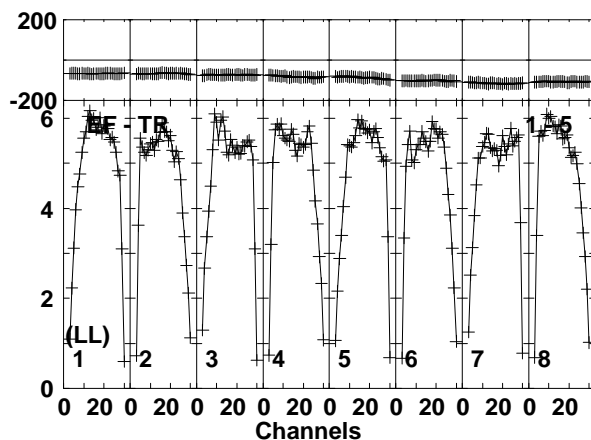
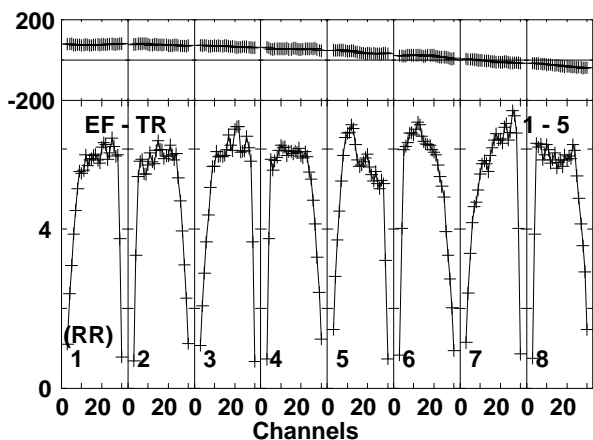
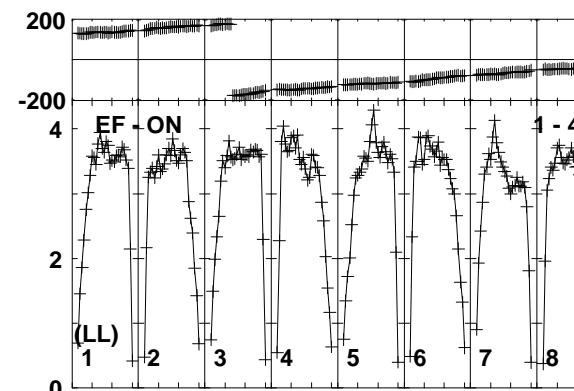
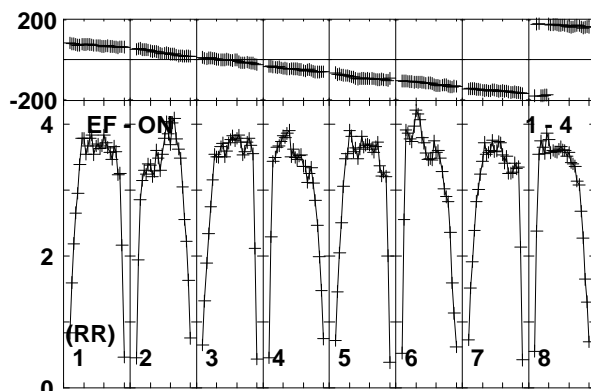
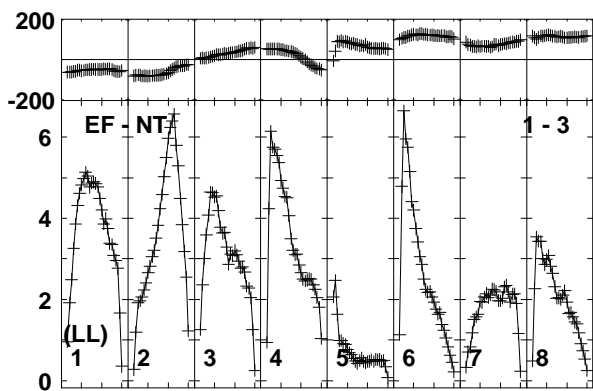
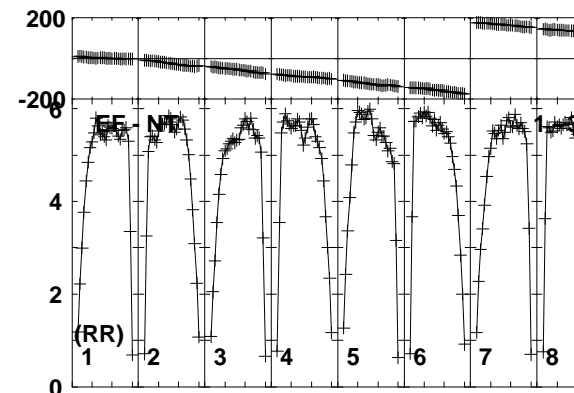
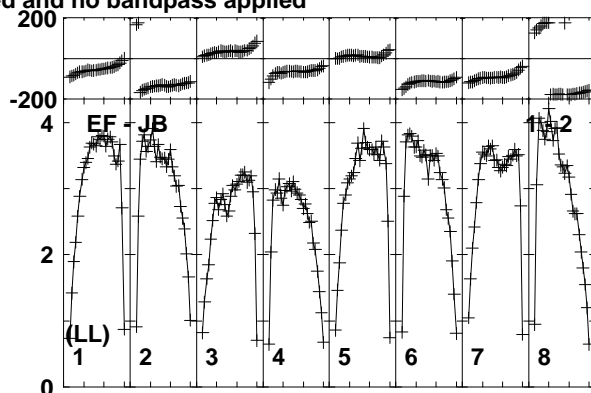
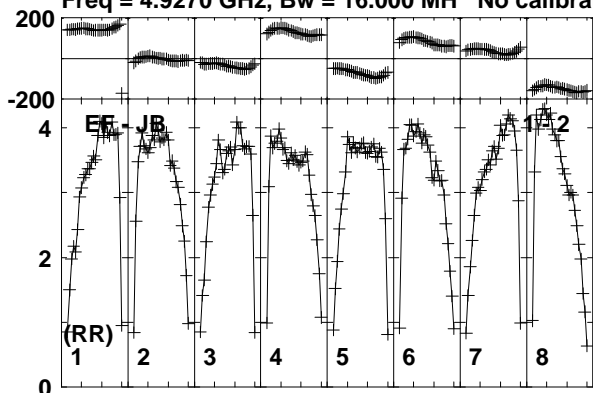

Lower frame: Milli Ampl Jy Top frame: Phas deg
Vector averaged cross-power spectrum Baseline: EF (01) - JB (02)
Timerange: 00:13:37:02 to 00:13:38:28

Plot file version 18 created 26-MAR-2015 15:27:35

J0519+0848 EG082E.UVDATA.1

Freq = 4.9270 GHz, Bw = 16.000 MH No calibration applied and no bandpass applied

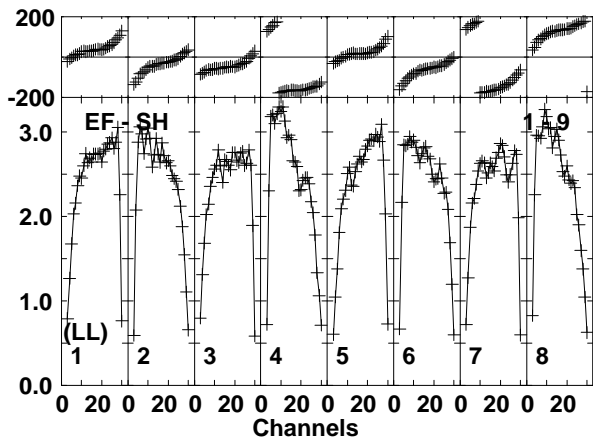
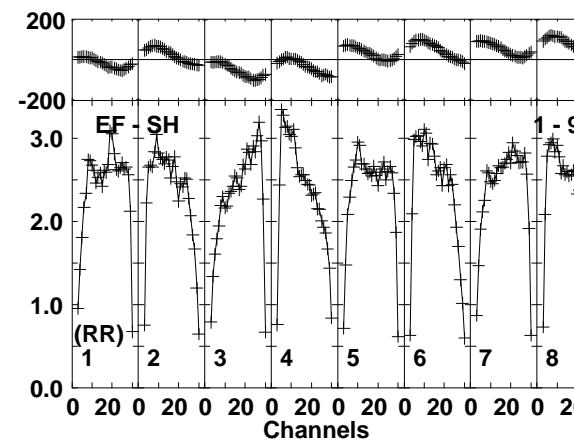
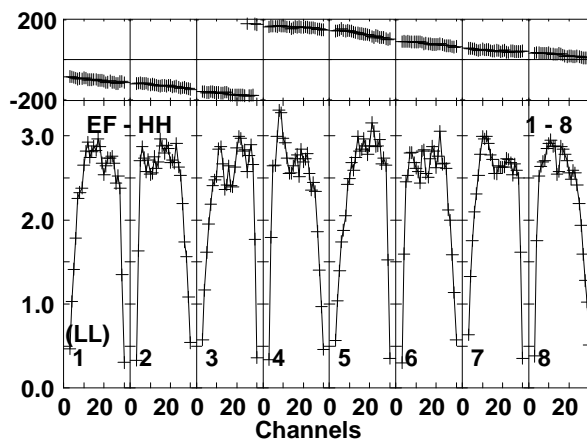
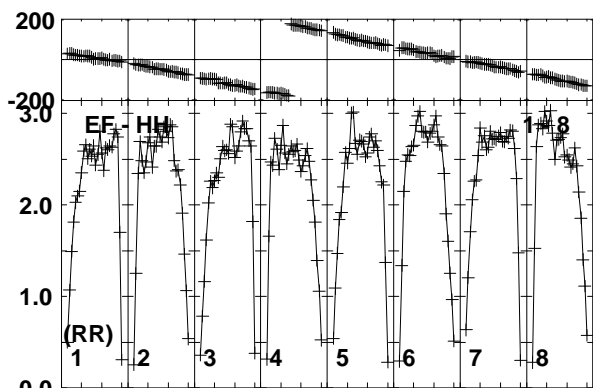
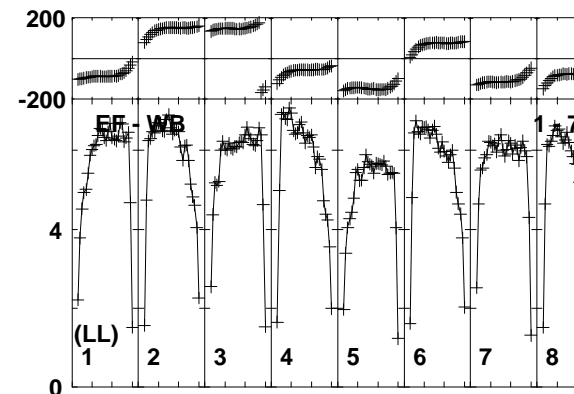
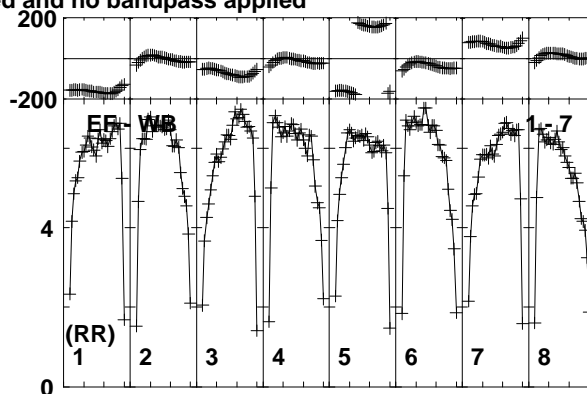
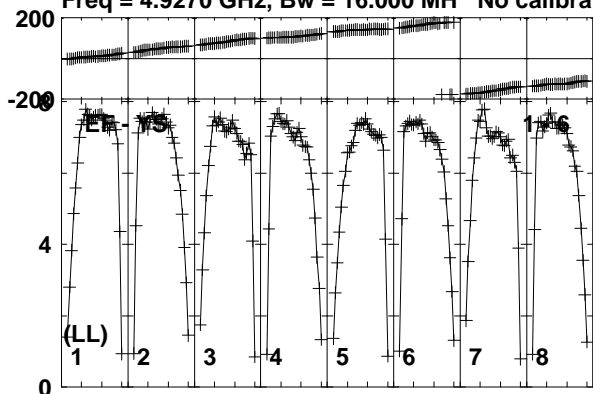

Lower frame: Milli Ampl Jy Top frame: Phas deg
Vector averaged cross-power spectrum Baseline: EF (01) - YS (06)
Timerange: 00:13:37:02 to 00:13:38:28

Plot file version 19 created 26-MAR-2015 15:27:35

J0525+0951 EG082E.UVDATA.1

Freq = 4.9270 GHz, Bw = 16.000 MH No calibration applied and no bandpass applied

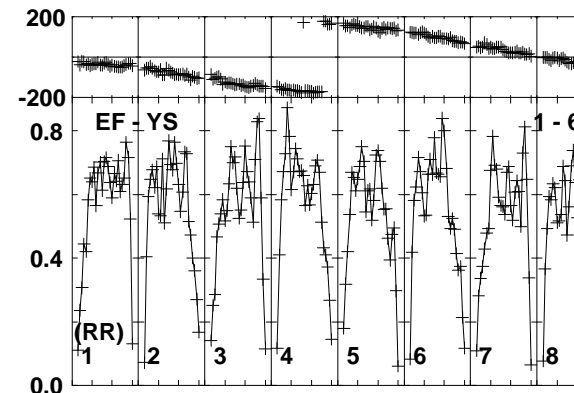
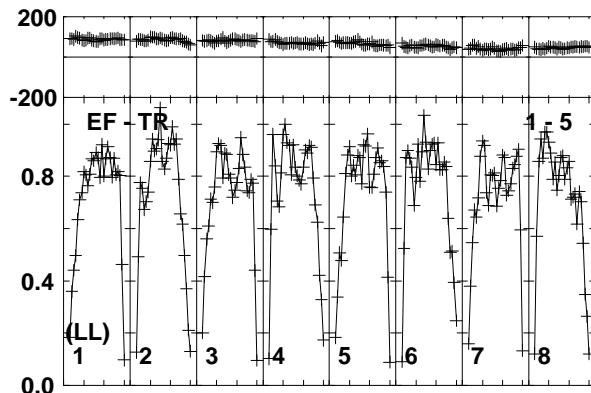
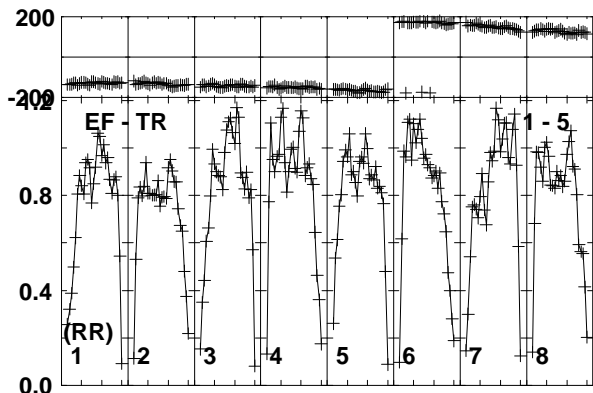
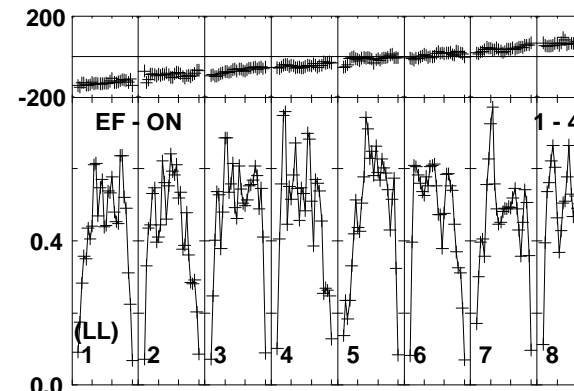
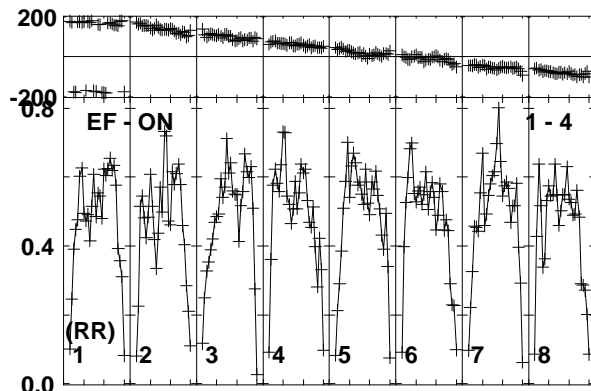
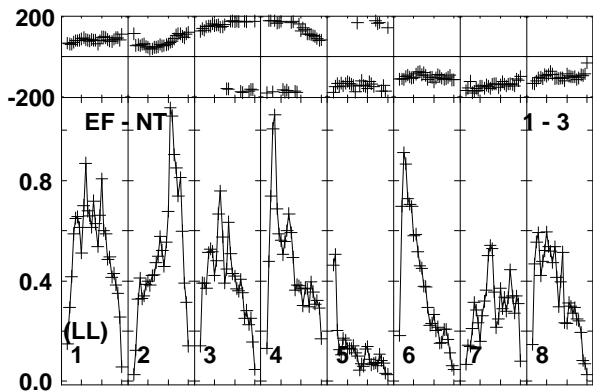
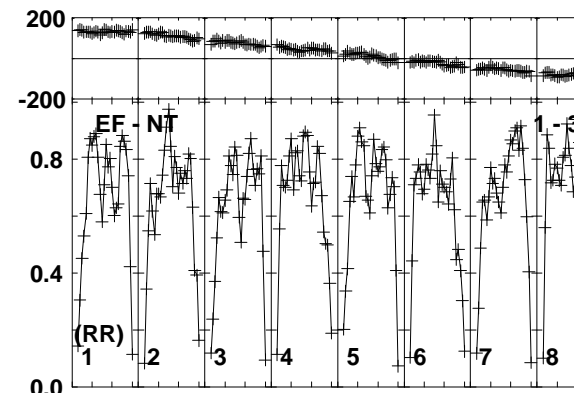
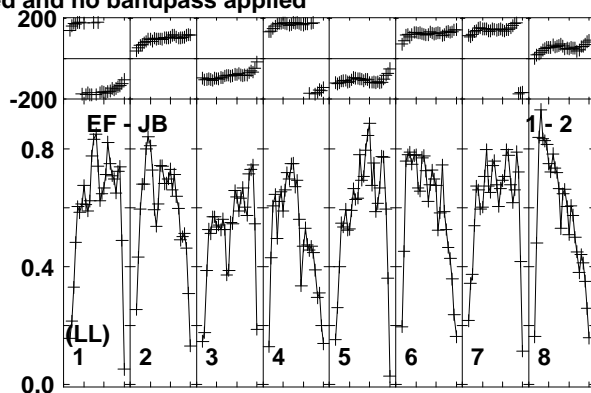
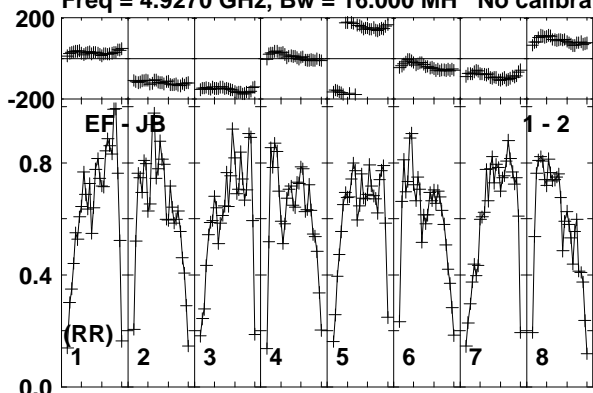

Lower frame: Milli Ampl Jy Top frame: Phas deg
Vector averaged cross-power spectrum Baseline: EF (01) - JB (02)
Timerange: 00/13:38:32 to 00/13:41:26

Plot file version 20 created 26-MAR-2015 15:27:35

J0525+0951 EG082E.UVDATA.1

Freq = 4.9270 GHz, Bw = 16.000 MH No calibration applied and no bandpass applied

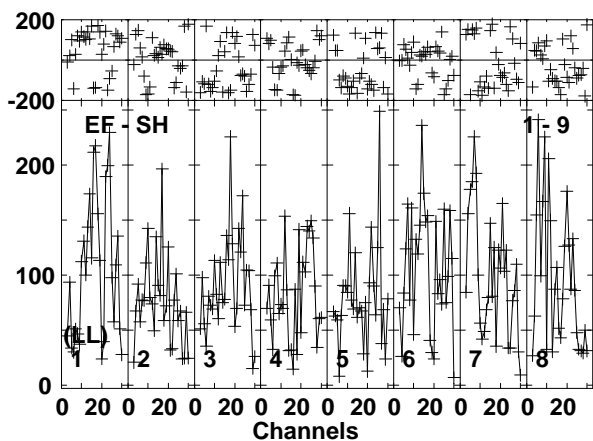
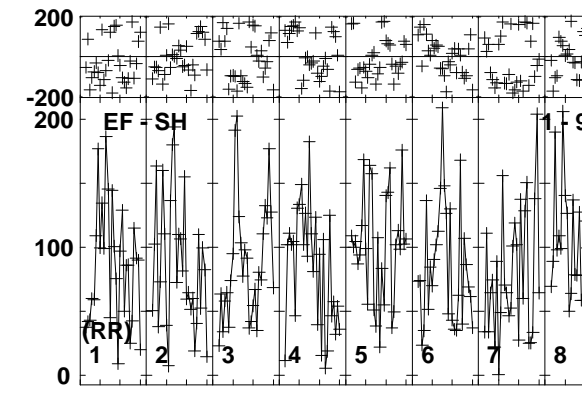
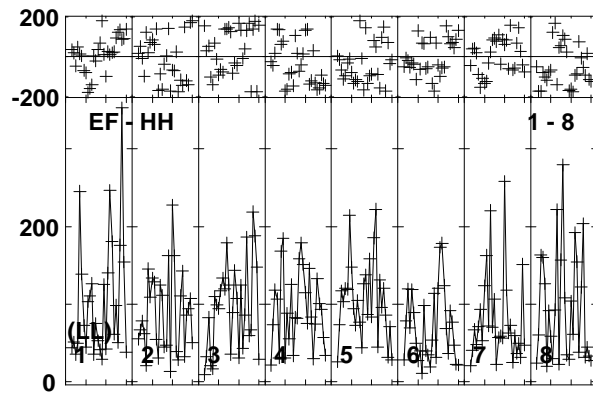
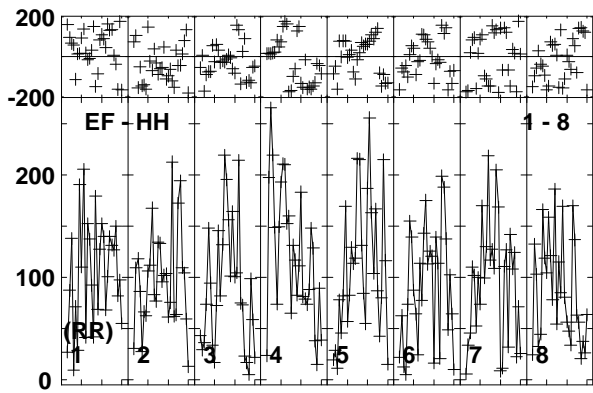
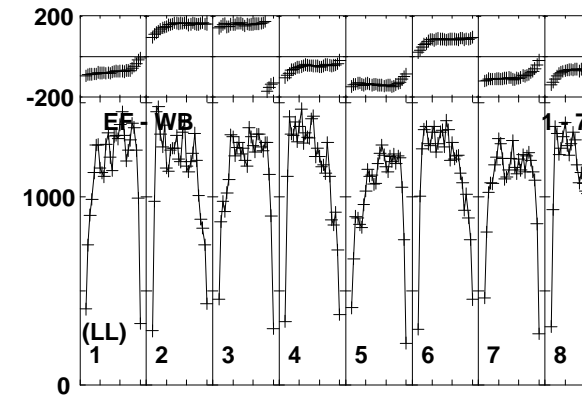
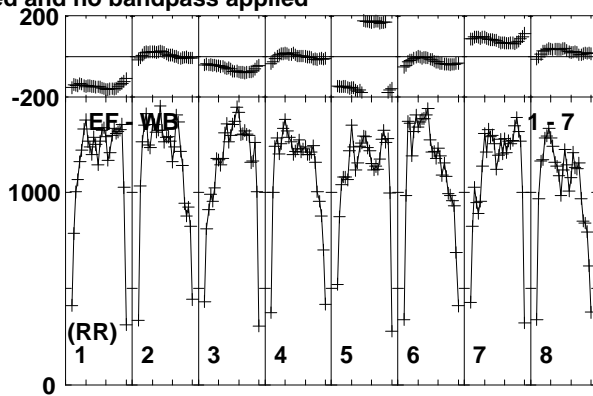
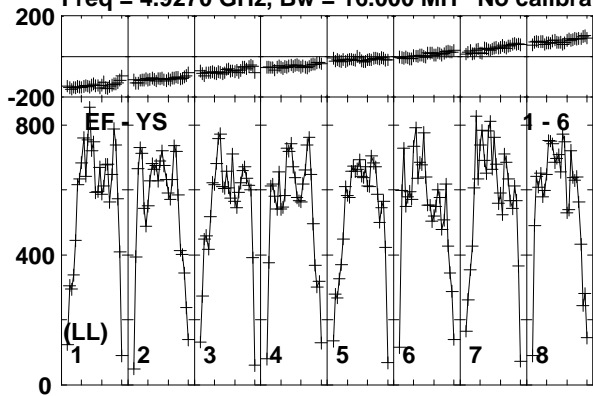

Lower frame: Micro Ampl Jy Top frame: Phas deg
Vector averaged cross-power spectrum Baseline: EF (01) - YS (06)
Timerange: 00:13:38:32 to 00:13:41:26

Plot file version 21 created 26-MAR-2015 15:27:35

V998ORI EG082E.UVDATA.1

Freq = 4.9270 GHz, Bw = 16.000 MH No calibration applied and no bandpass applied

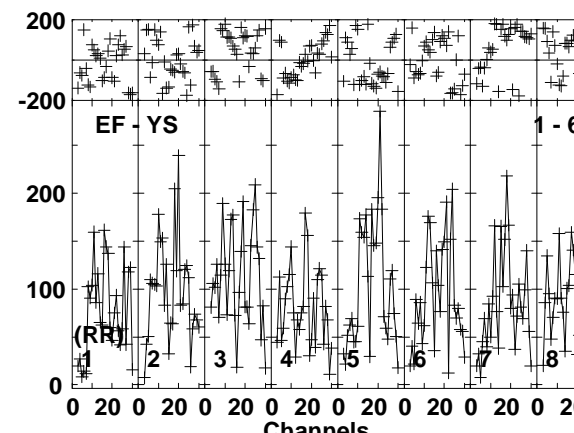
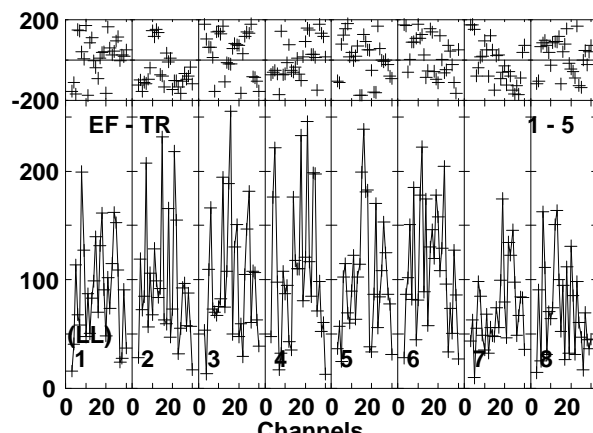
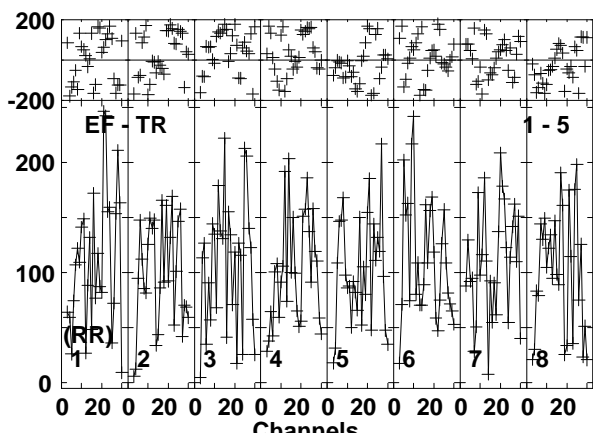
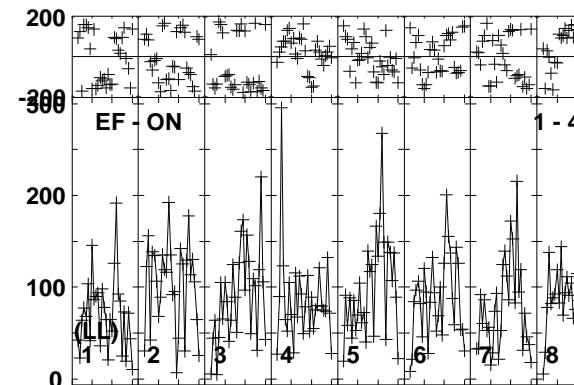
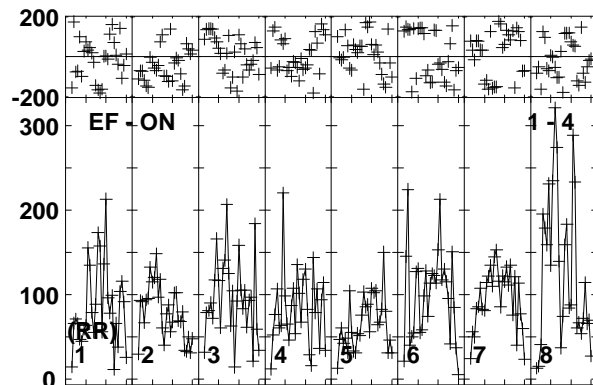
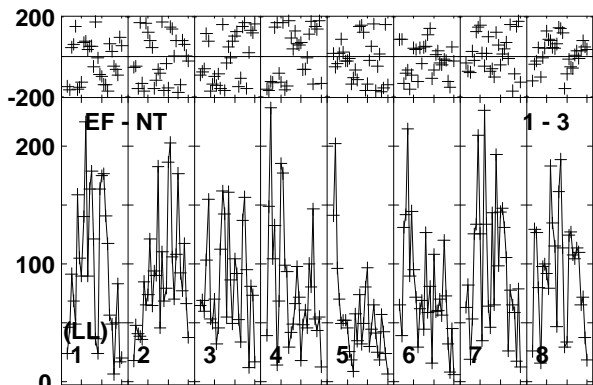
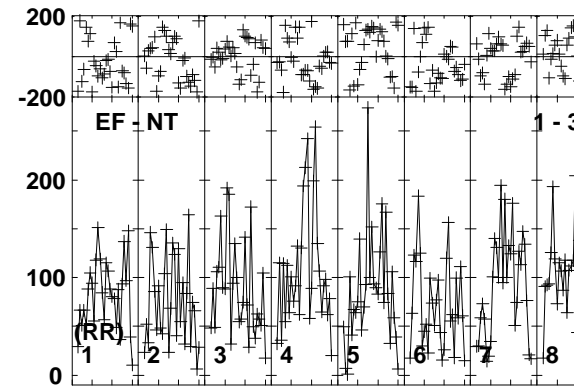
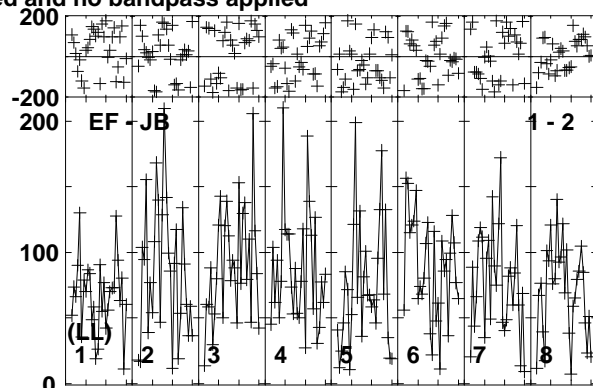
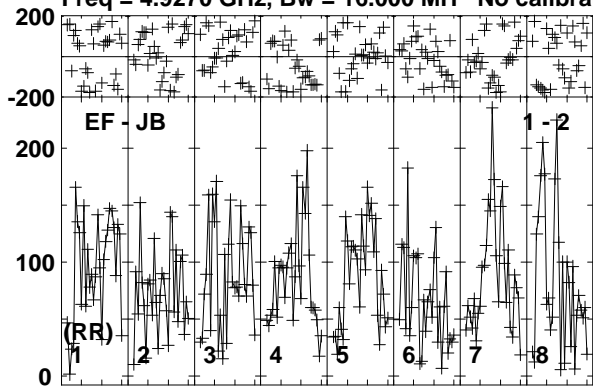

Lower frame: Micro Ampl Jy Top frame: Phas deg
Vector averaged cross-power spectrum Baseline: EF (01) - JB (02)
Timerange: 00/13:43:41 to 00/13:46:59

Plot file version 22 created 26-MAR-2015 15:27:35

V998ORI EG082E.UVDATA.1

Freq = 4.9270 GHz, Bw = 16.000 MH No calibration applied and no bandpass applied

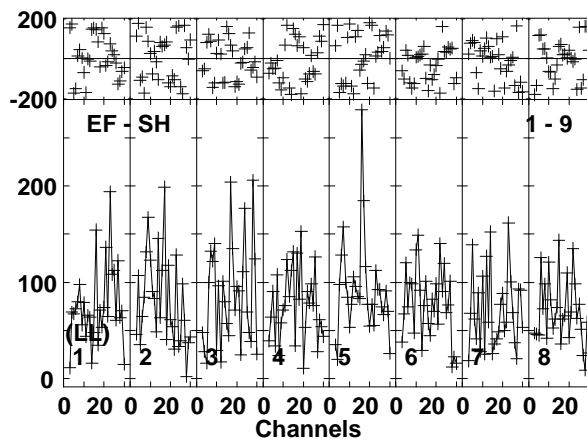
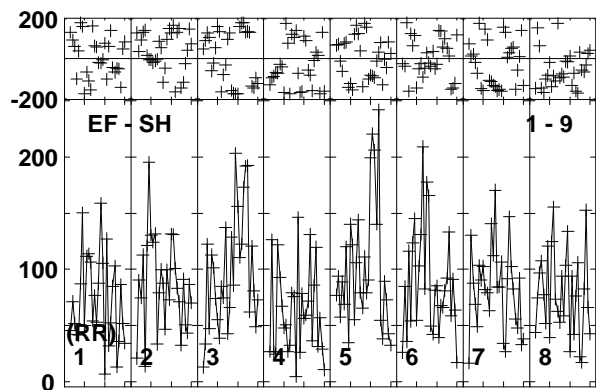
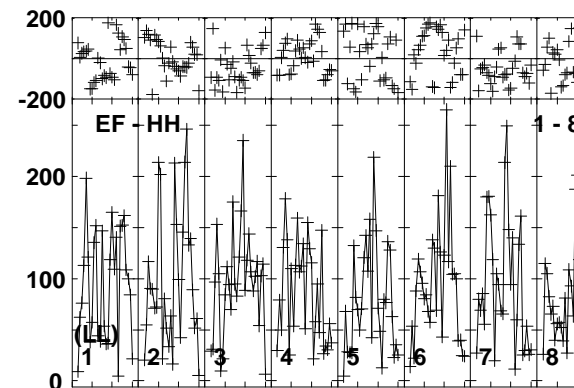
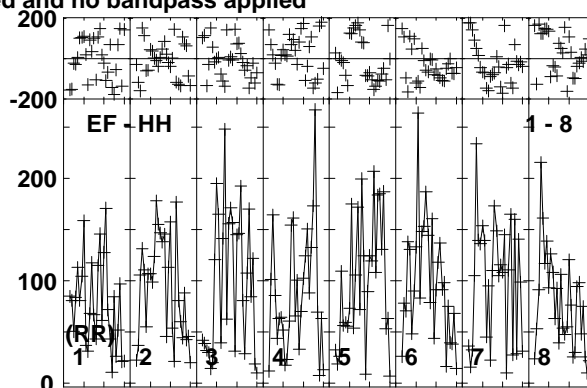
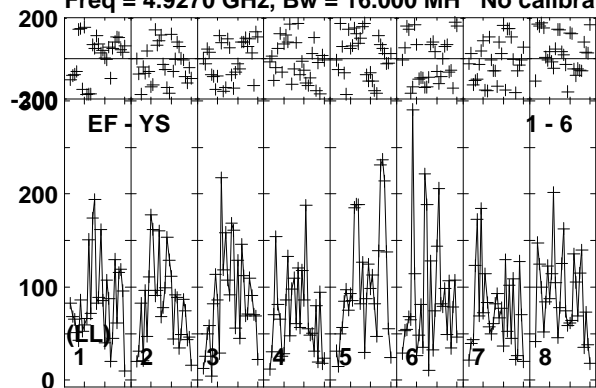

Lower frame: Micro Ampl Jy Top frame: Phas deg
Vector averaged cross-power spectrum Baseline: EF (01) - YS (06)
Timerange: 00:13:43:41 to 00:13:46:59

Plot file version 23 created 26-MAR-2015 15:27:35

J0519+0848 EG082E.UVDATA.1

Freq = 4.9270 GHz, Bw = 16.000 MH No calibration applied and no bandpass applied

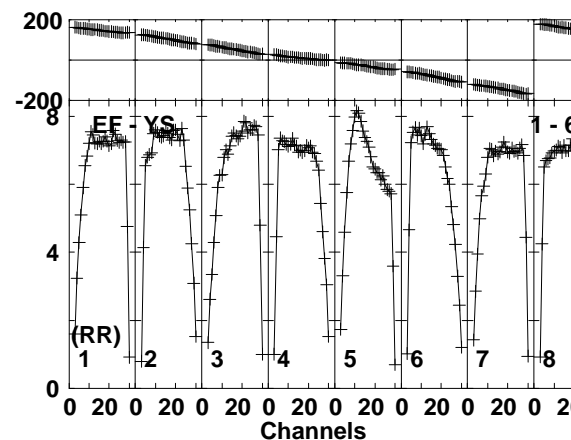
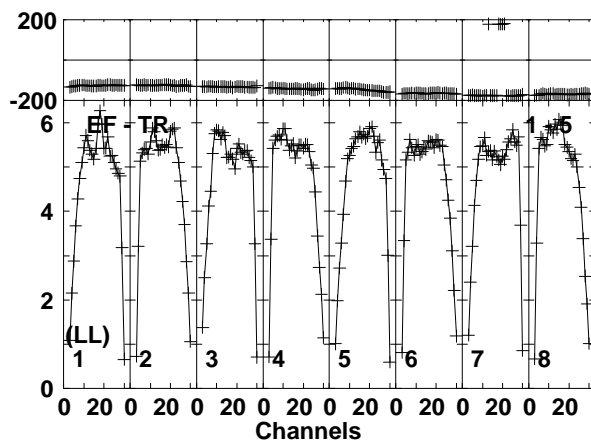
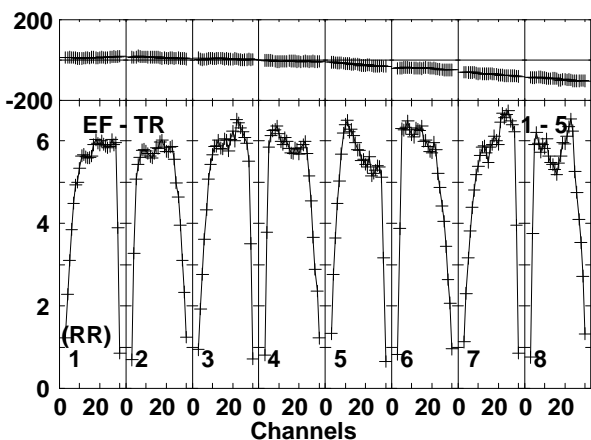
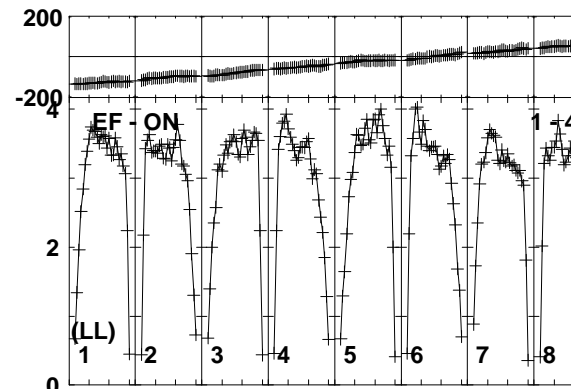
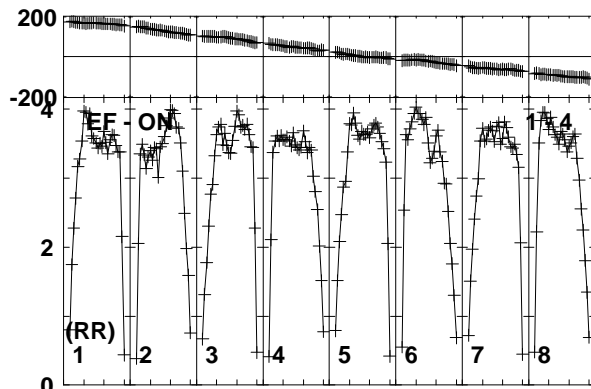
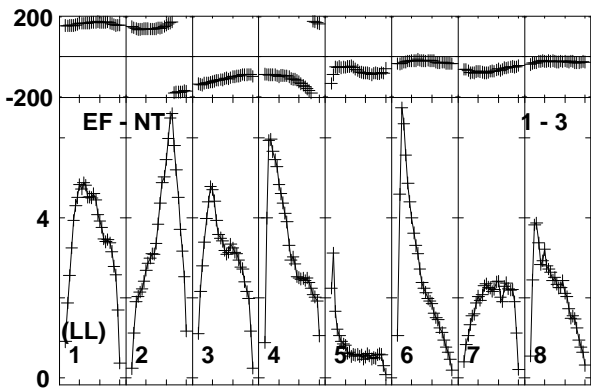
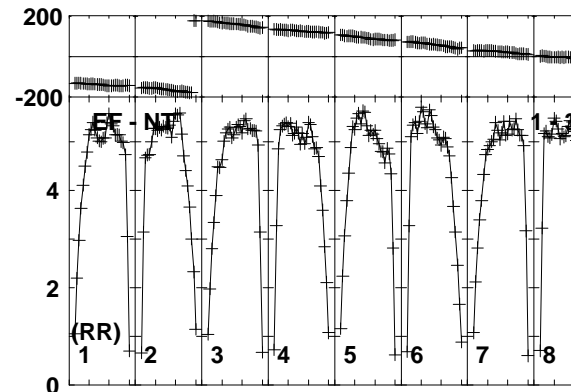
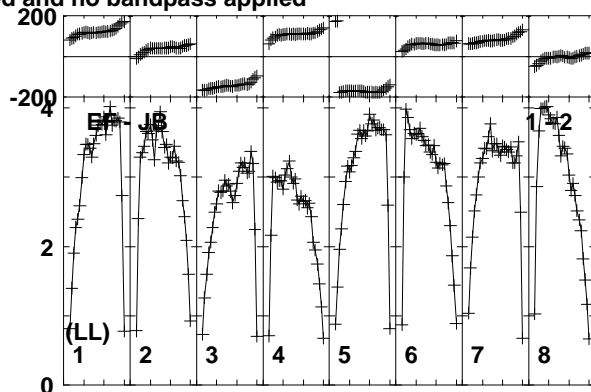
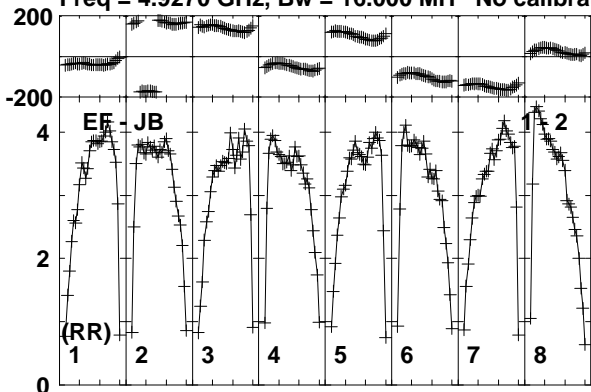

Lower frame: Milli Ampl Jy Top frame: Phas deg
Vector averaged cross-power spectrum Baseline: EF (01) - JB (02)
Timerange: 00:13:47:03 to 00:13:48:29

Plot file version 25 created 26-MAR-2015 15:27:35

V998ORI EG082E.UVDATA.1

Freq = 4.9270 GHz, Bw = 16.000 MH No calibration applied and no bandpass applied

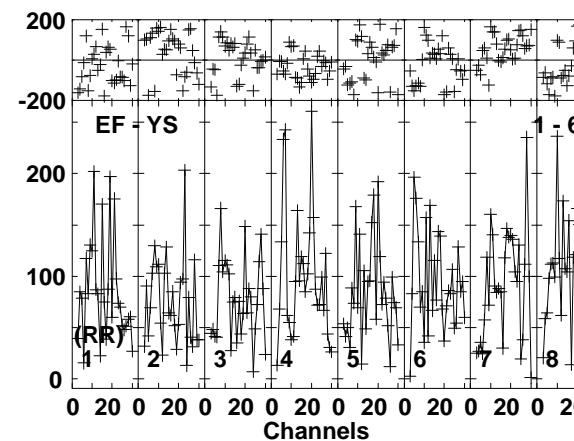
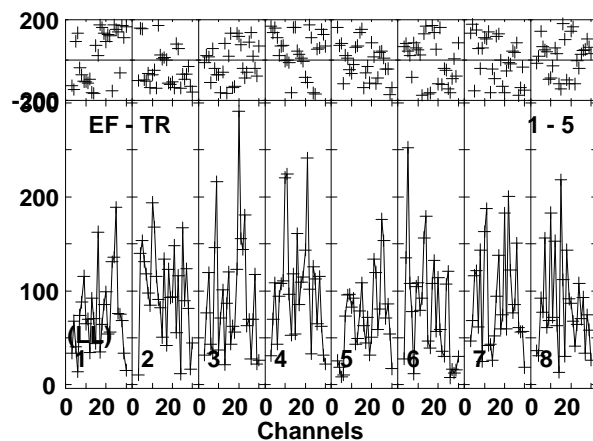
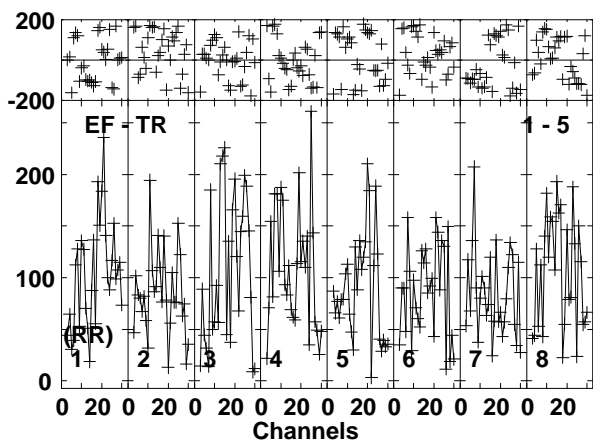
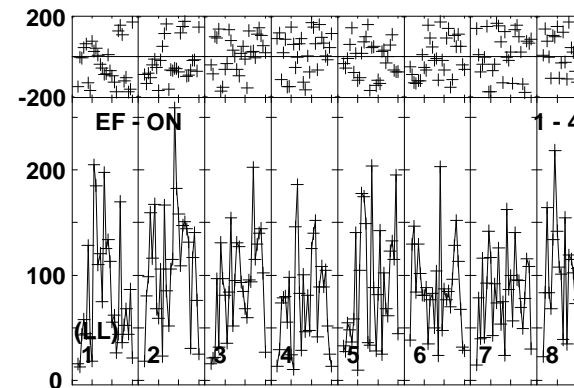
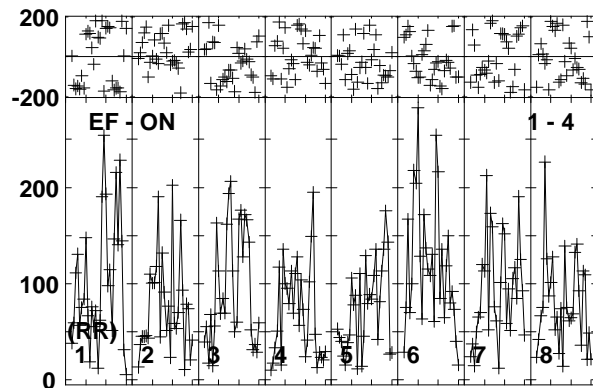
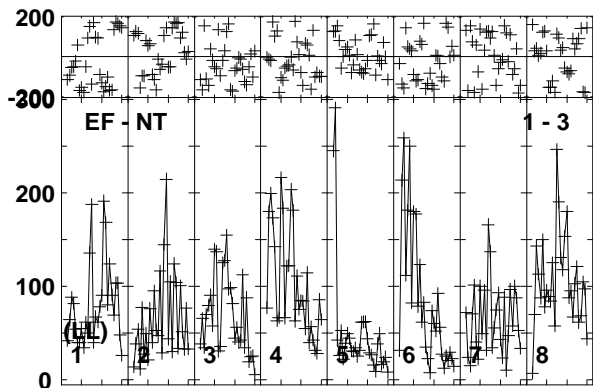
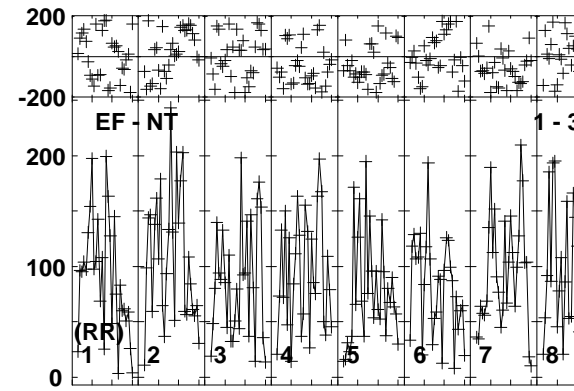
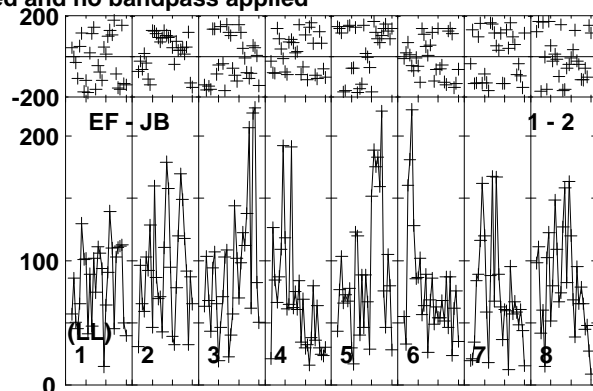
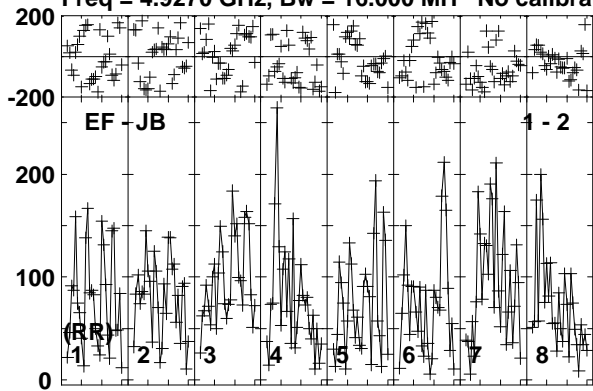

Lower frame: Micro Ampl Jy Top frame: Phas deg
Vector averaged cross-power spectrum Baseline: EF (01) - JB (02)
Timerange: 00/13:48:33 to 00/13:51:59

Plot file version 26 created 26-MAR-2015 15:27:36

V998ORI EG082E.UVDATA.1

Freq = 4.9270 GHz, Bw = 16.000 MH No calibration applied and no bandpass applied

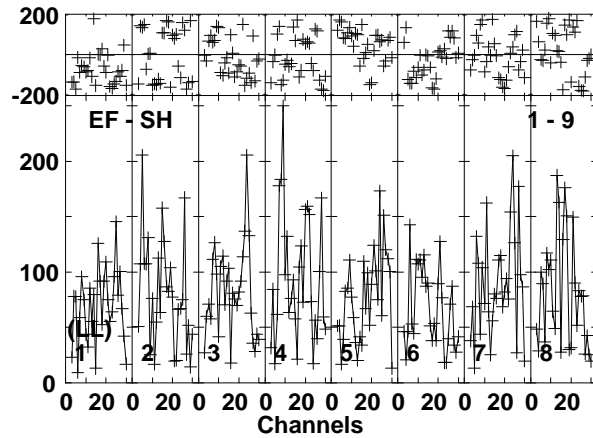
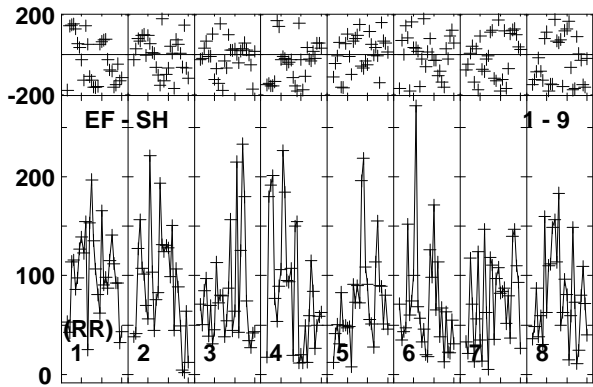
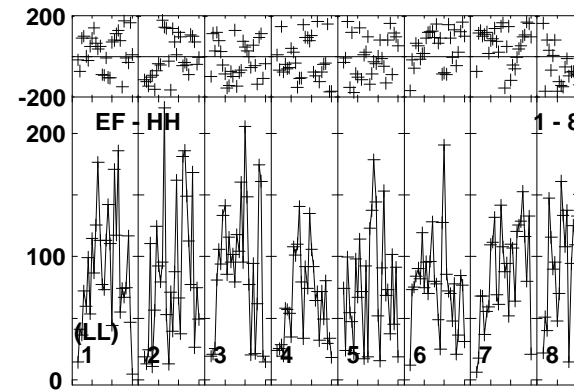
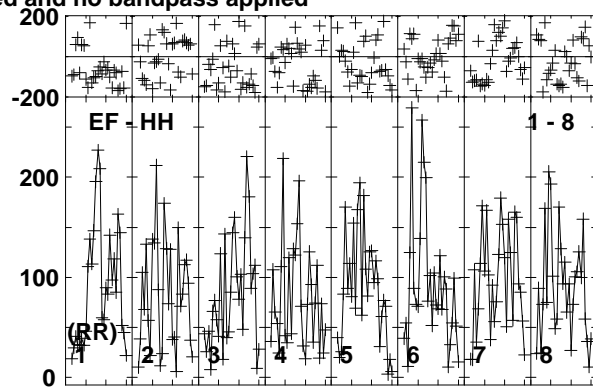
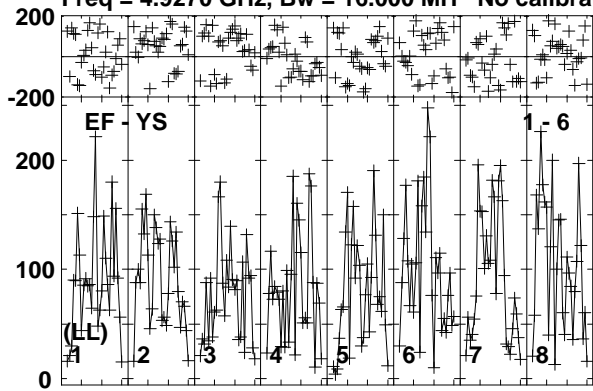

Lower frame: Micro Ampl Jy Top frame: Phas deg
Vector averaged cross-power spectrum Baseline: EF (01) - YS (06)
Timerange: 00/13:48:33 to 00/13:51:59

Plot file version 27 created 26-MAR-2015 15:27:36

J0519+0848 EG082E.UVDATA.1

Freq = 4.9270 GHz, Bw = 16.000 MH No calibration applied and no bandpass applied

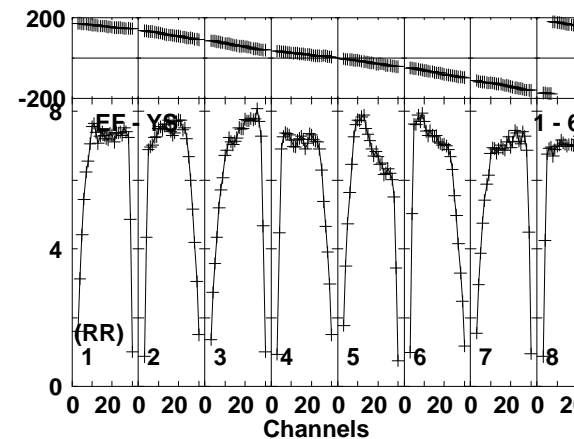
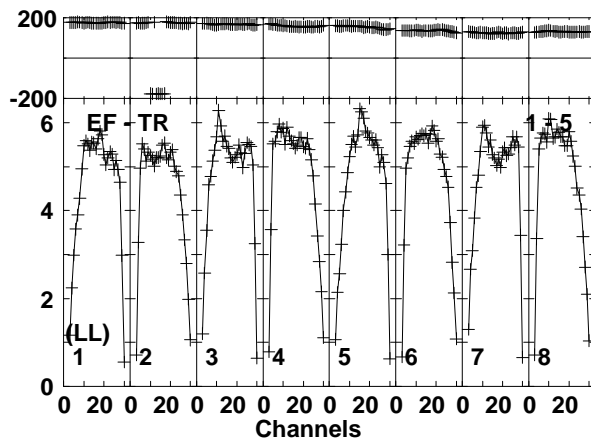
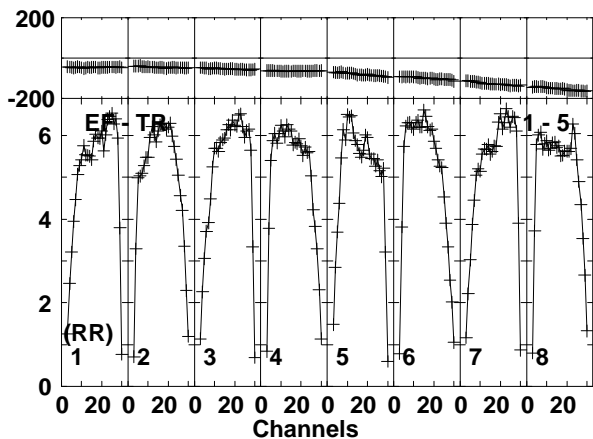
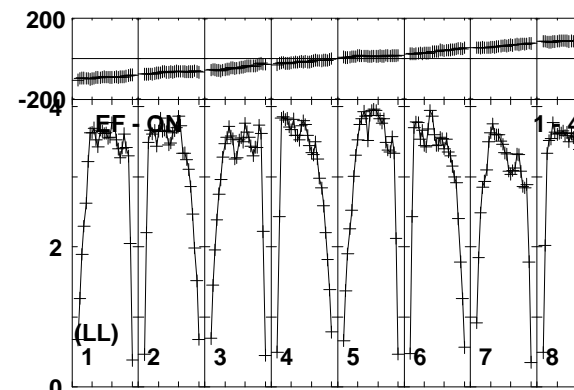
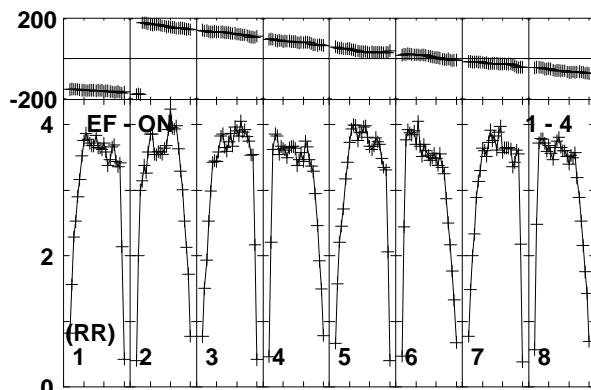
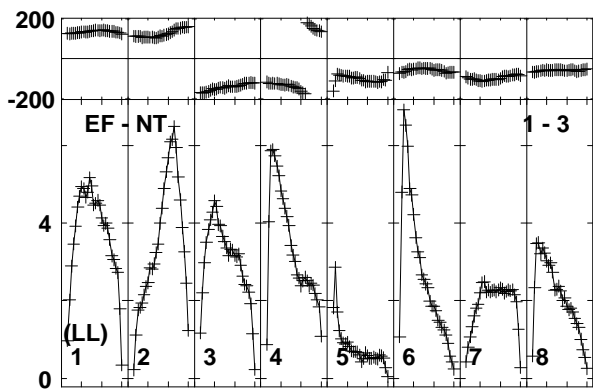
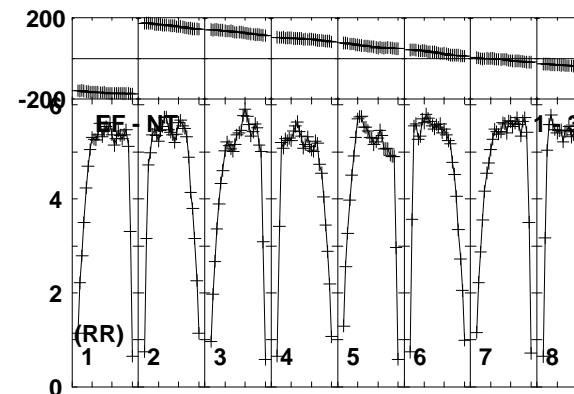
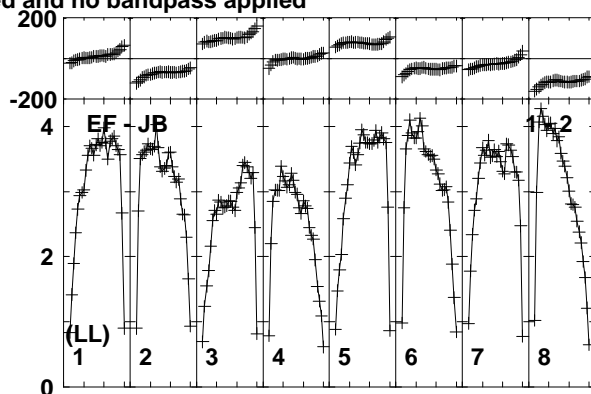
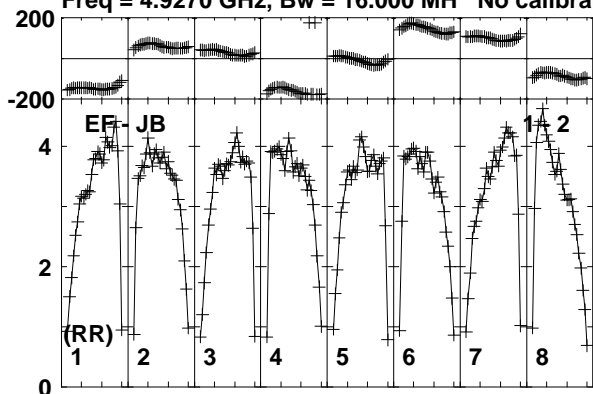

Lower frame: Milli Ampl Jy Top frame: Phas deg
Vector averaged cross-power spectrum Baseline: EF (01) - JB (02)
Timerange: 00:13:52:33 to 00:13:53:29

Plot file version 28 created 26-MAR-2015 15:27:36

J0519+0848 EG082E.UVDATA.1

Freq = 4.9270 GHz, Bw = 16.000 MH No calibration applied and no bandpass applied

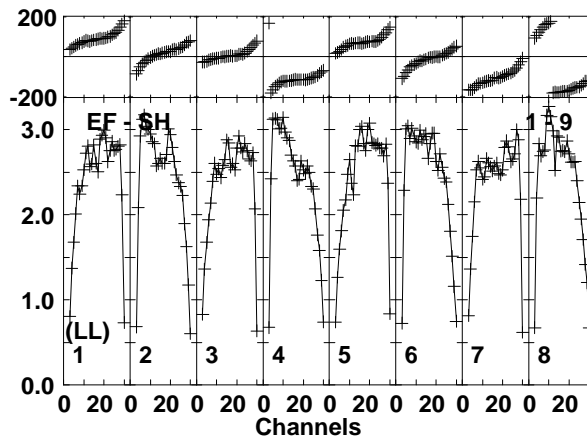
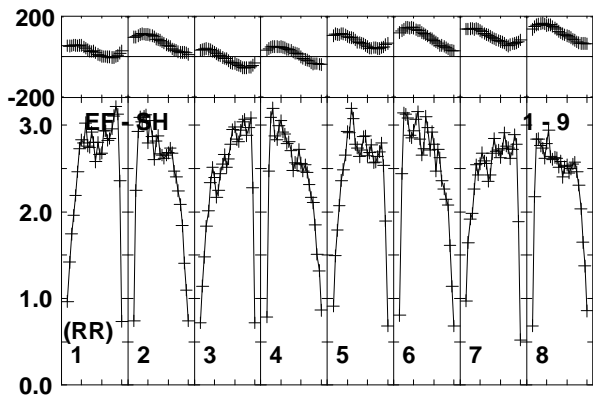
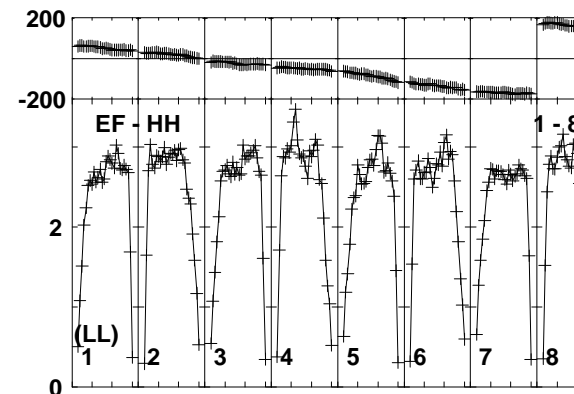
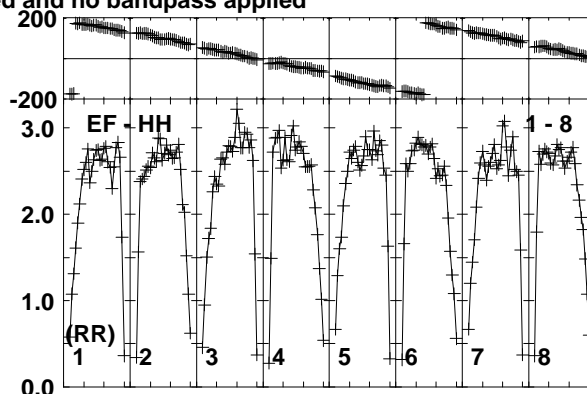
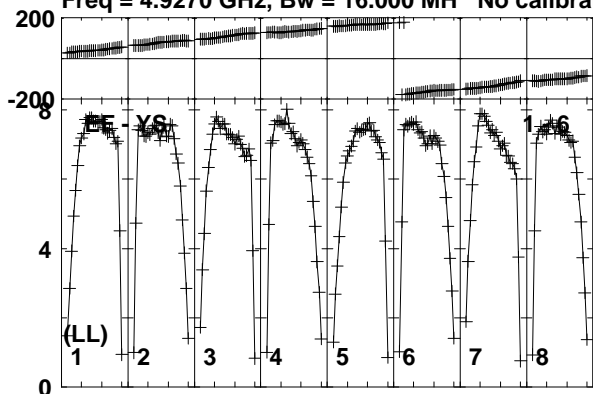

Lower frame: Milli Ampl Jy Top frame: Phas deg
Vector averaged cross-power spectrum Baseline: EF (01) - YS (06)
Timerange: 00/13:52:33 to 00/13:53:29

Plot file version 29 created 26-MAR-2015 15:27:36

V998ORI EG082E.UVDATA.1

Freq = 4.9270 GHz, Bw = 16.000 MH No calibration applied and no bandpass applied

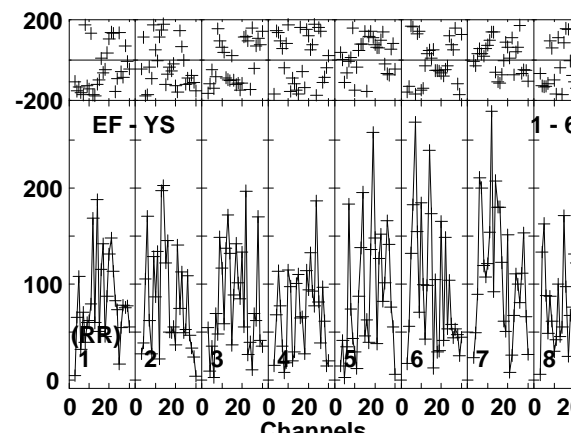
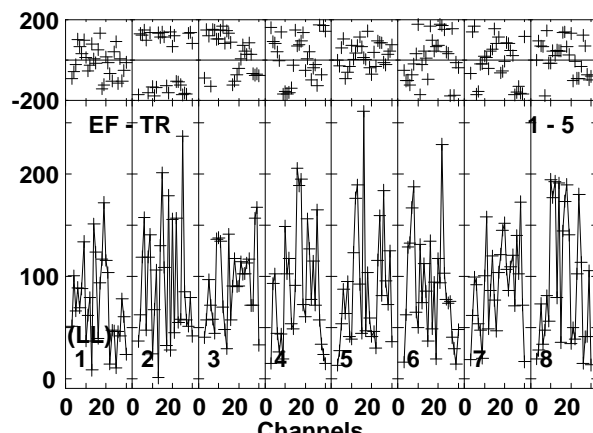
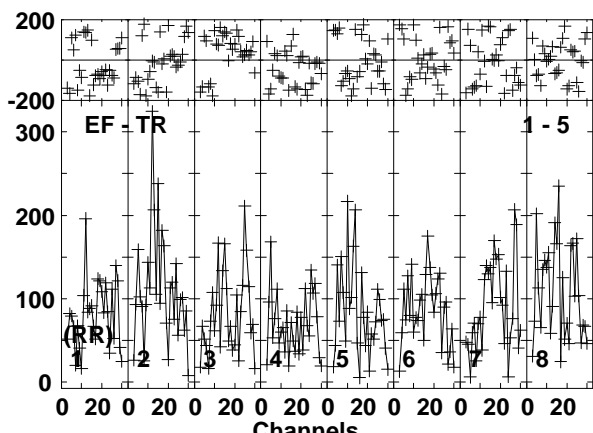
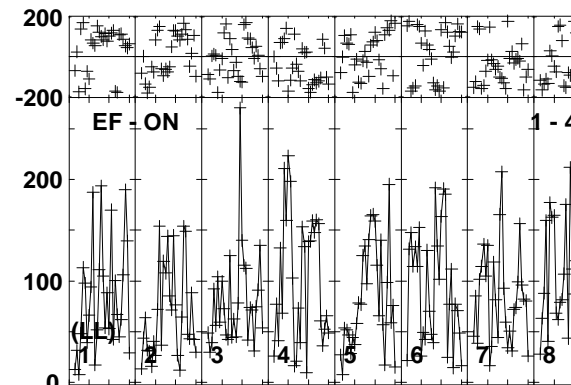
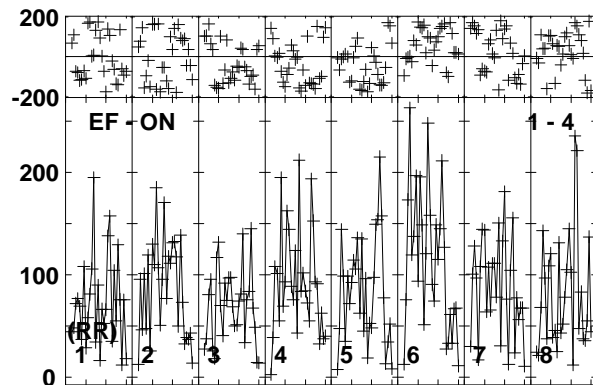
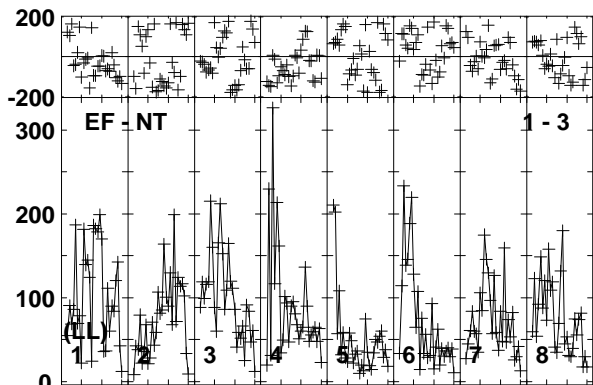
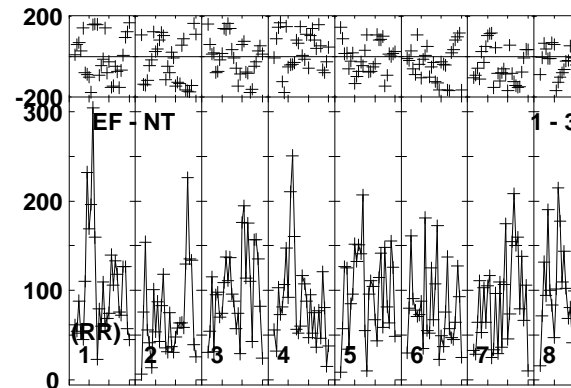
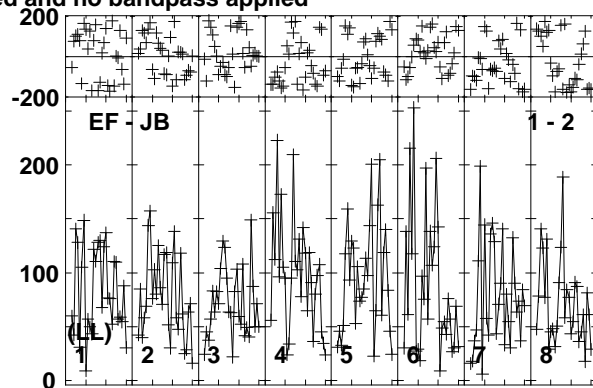
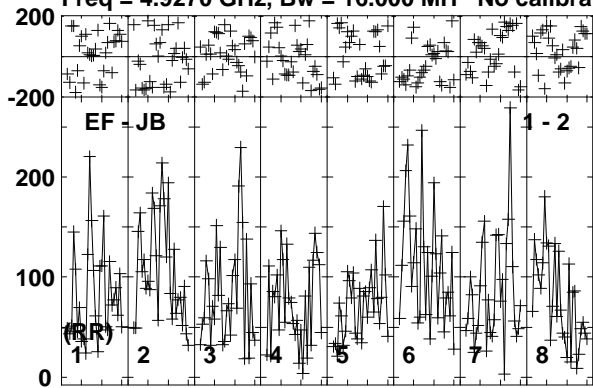

Lower frame: Micro Ampl Jy Top frame: Phas deg
Vector averaged cross-power spectrum Baseline: EF (01) - JB (02)
Timerange: 00/13:53:33 to 00/13:56:59

Plot file version 30 created 26-MAR-2015 15:27:36

V998ORI EG082E.UVDATA.1

Freq = 4.9270 GHz, Bw = 16.000 MH No calibration applied and no bandpass applied

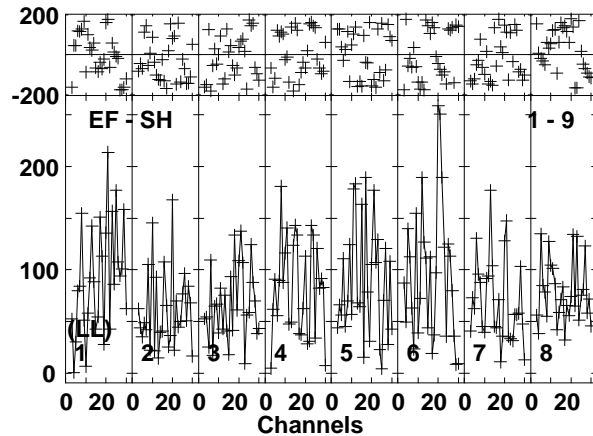
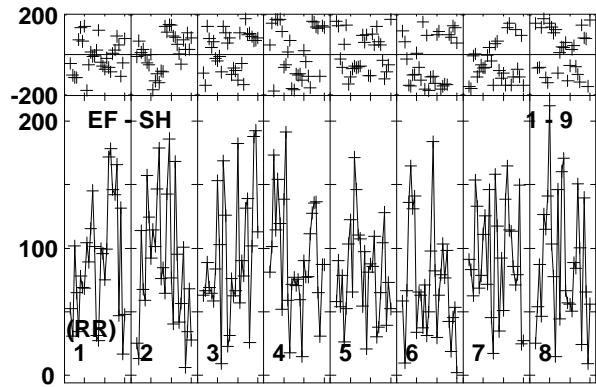
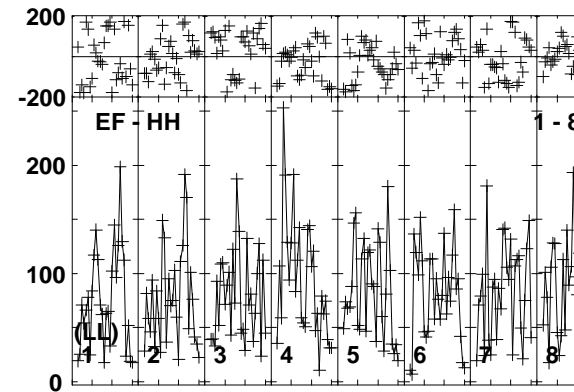
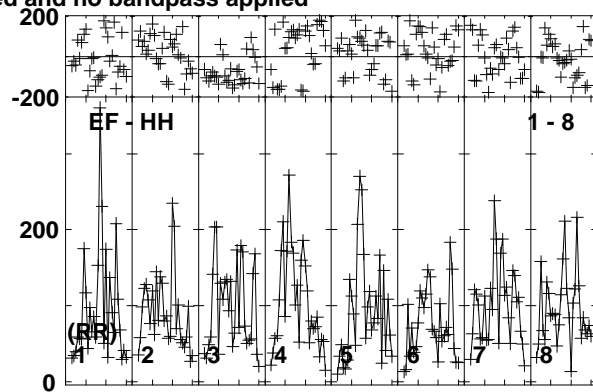
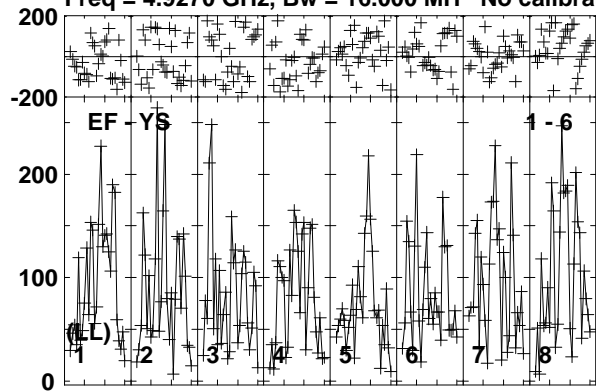

Lower frame: Micro Ampl Jy Top frame: Phas deg
Vector averaged cross-power spectrum Baseline: EF (01) - YS (06)
Timerange: 00/13:53:33 to 00/13:56:59

Plot file version 31 created 26-MAR-2015 15:27:36

J0519+0848 EG082E.UVDATA.1

Freq = 4.9270 GHz, Bw = 16.000 MH No calibration applied and no bandpass applied

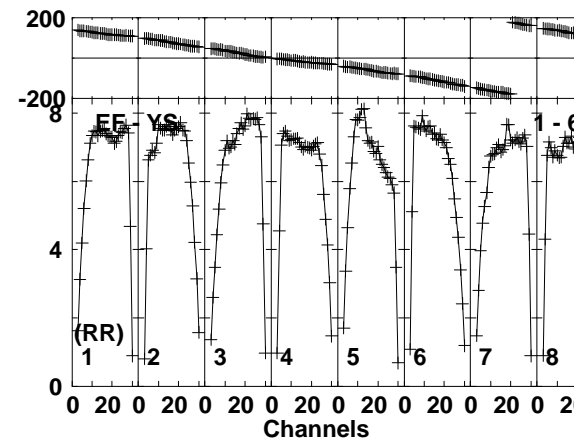
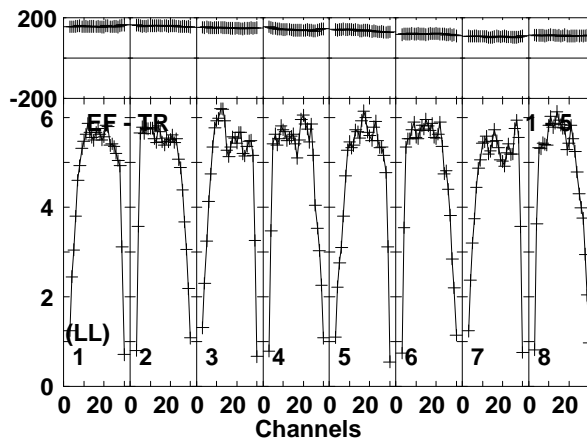
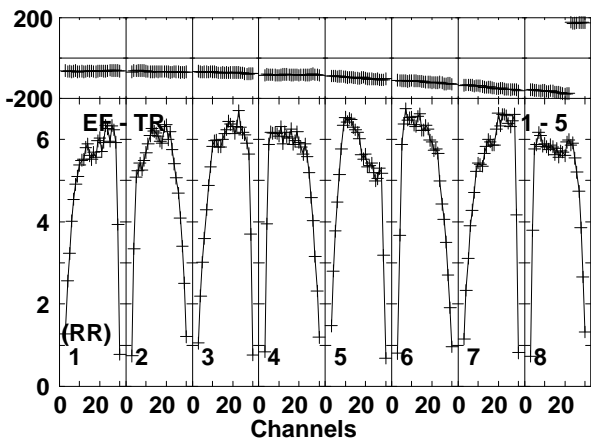
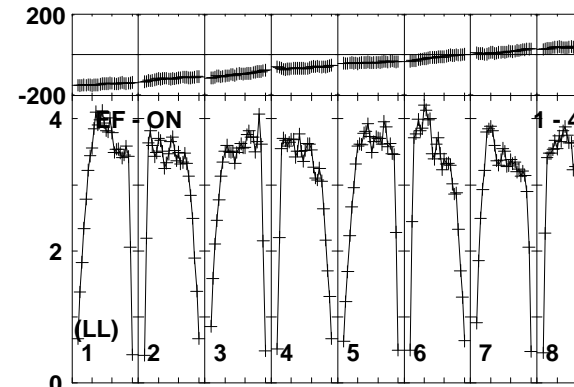
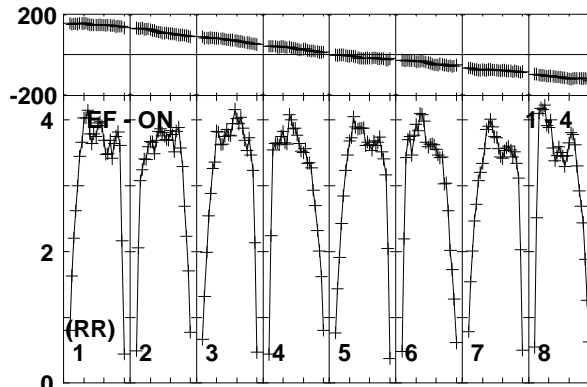
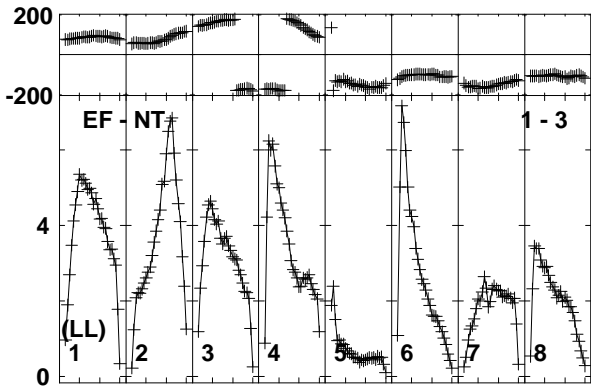
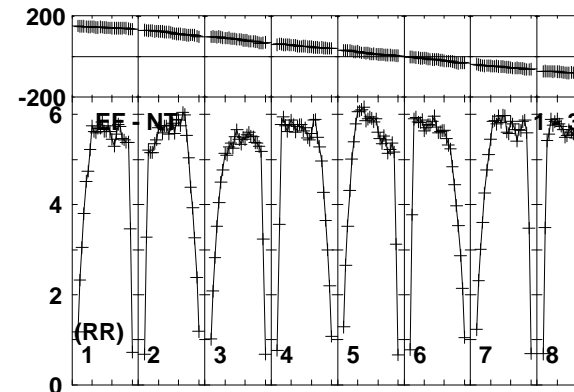
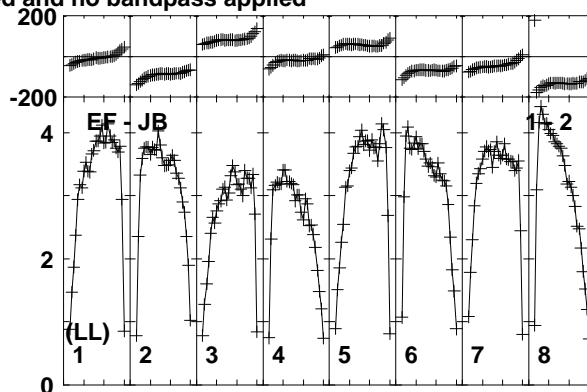
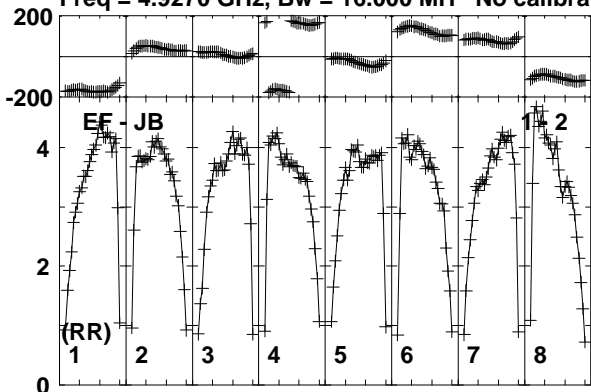

Lower frame: Milli Ampl Jy Top frame: Phas deg
Vector averaged cross-power spectrum Baseline: EF (01) - JB (02)
Timerange: 00/13:57:03 to 00/13:58:29

Plot file version 32 created 26-MAR-2015 15:27:36

J0519+0848 EG082E.UVDATA.1

Freq = 4.9270 GHz, Bw = 16.000 MH No calibration applied and no bandpass applied

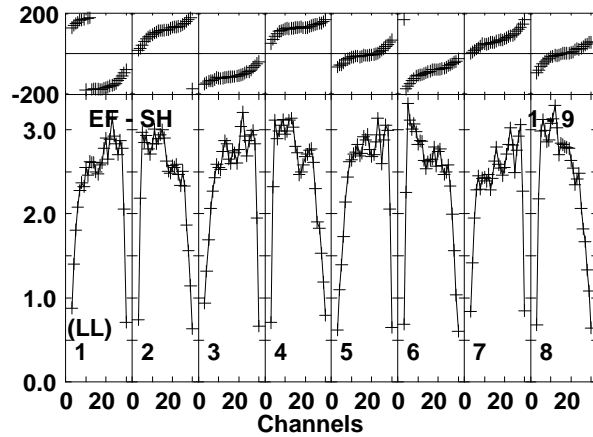
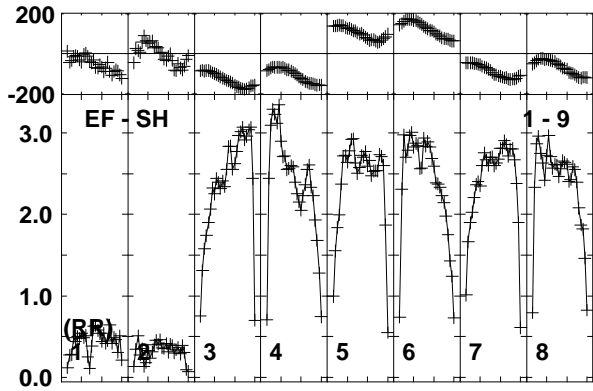
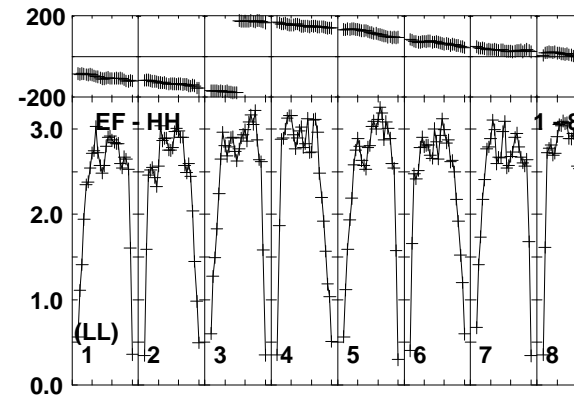
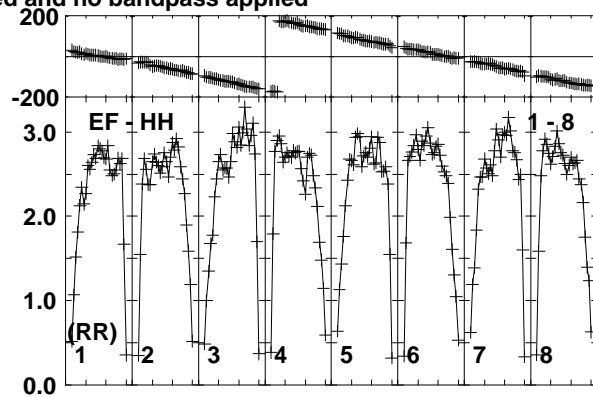
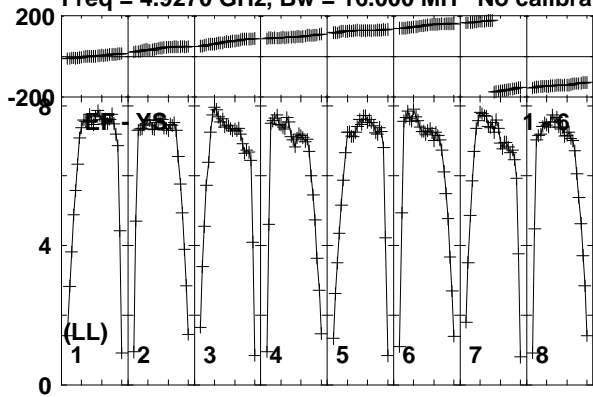

Lower frame: Milli Ampl Jy Top frame: Phas deg
Vector averaged cross-power spectrum Baseline: EF (01) - YS (06)
Timerange: 00/13:57:03 to 00/13:58:29

Plot file version 33 created 26-MAR-2015 15:27:36

V998ORI EG082E.UVDATA.1

Freq = 4.9270 GHz, Bw = 16.000 MH No calibration applied and no bandpass applied

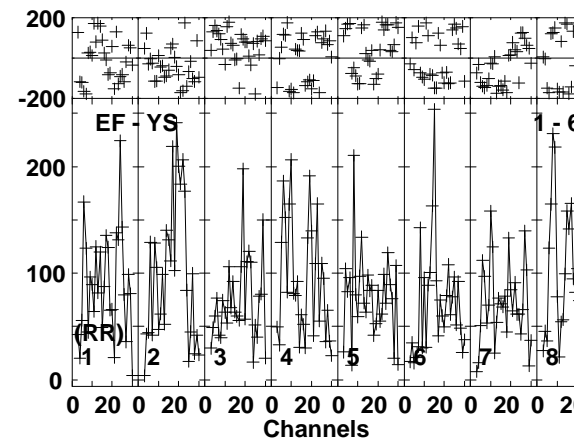
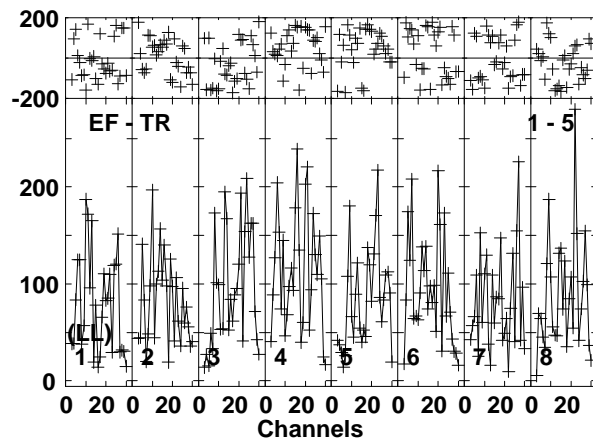
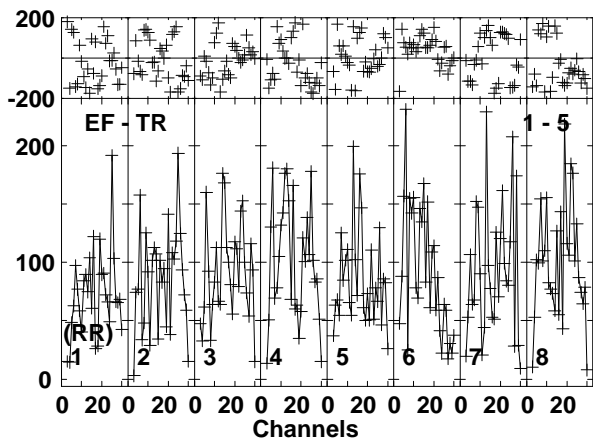
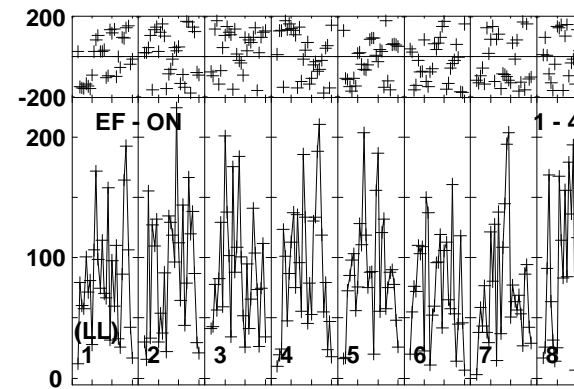
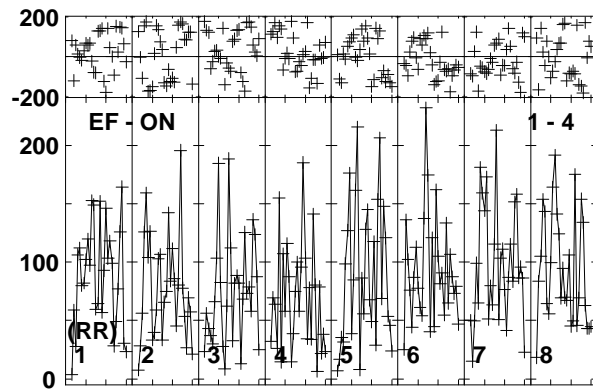
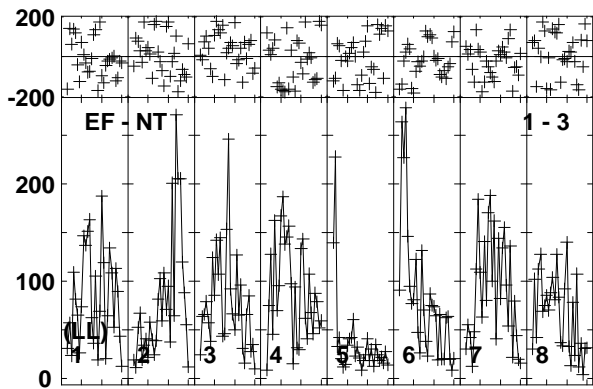
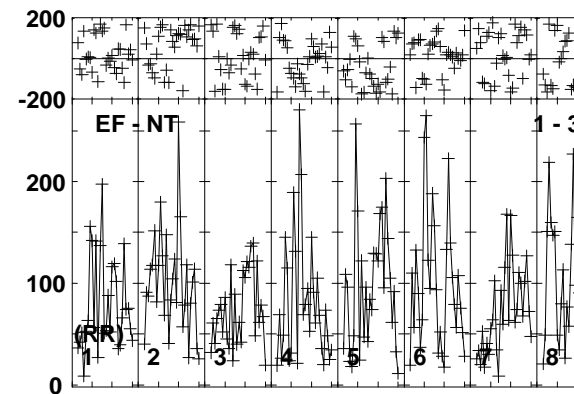
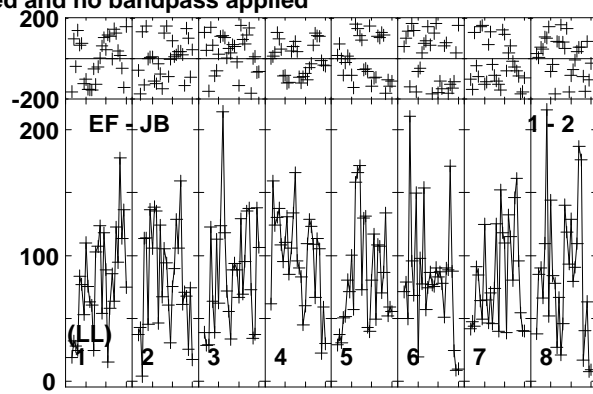
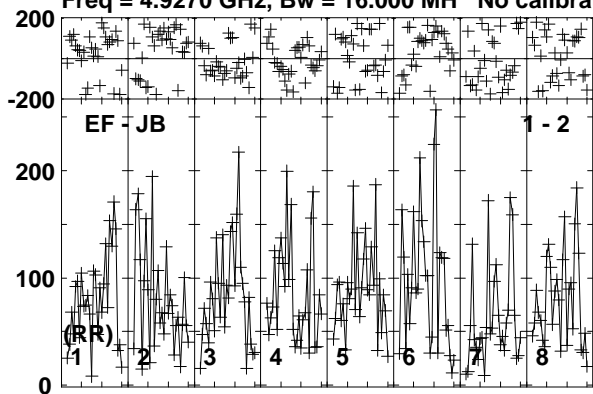

Lower frame: Micro Ampl Jy Top frame: Phas deg
Vector averaged cross-power spectrum Baseline: EF (01) - JB (02)
Timerange: 00/13:58:33 to 00/14:01:59

Plot file version 34 created 26-MAR-2015 15:27:36

V998ORI EG082E.UVDATA.1

Freq = 4.9270 GHz, Bw = 16.000 MH No calibration applied and no bandpass applied

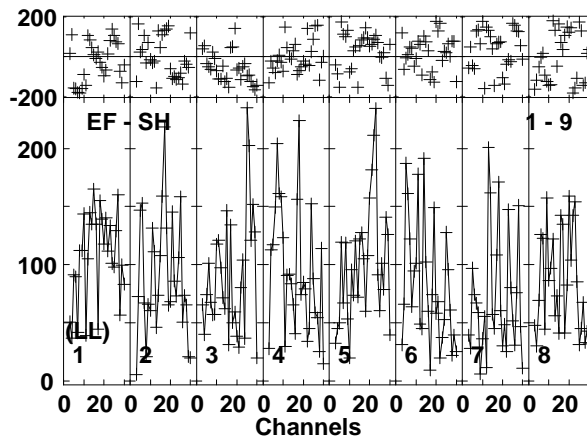
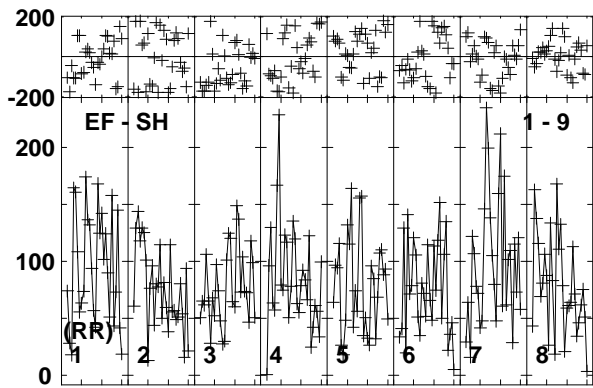
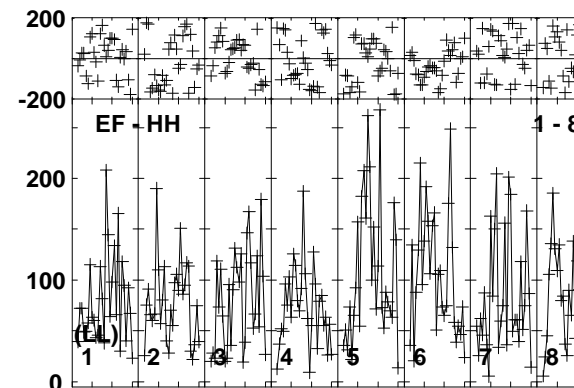
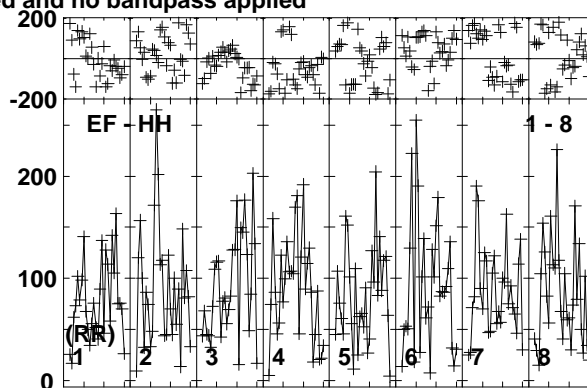
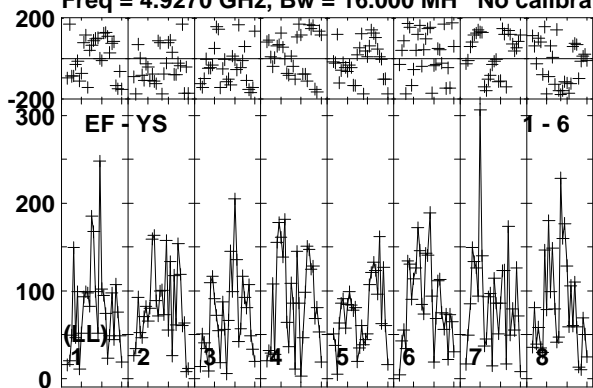

Lower frame: Micro Ampl Jy Top frame: Phas deg
Vector averaged cross-power spectrum Baseline: EF (01) - YS (06)
Timerange: 00/13:58:33 to 00/14:01:59

Plot file version 35 created 26-MAR-2015 15:27:36

J0519+0848 EG082E.UVDATA.1

Freq = 4.9270 GHz, Bw = 16.000 MH No calibration applied and no bandpass applied

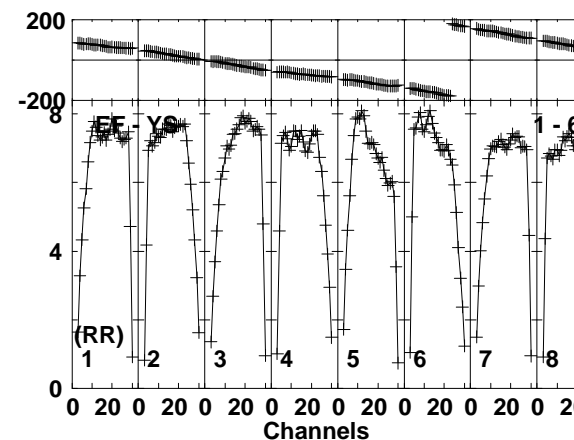
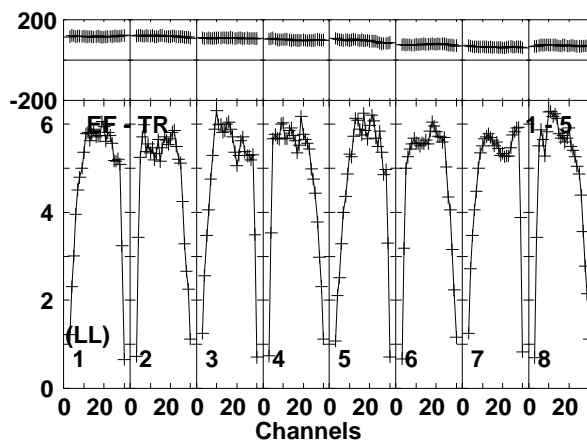
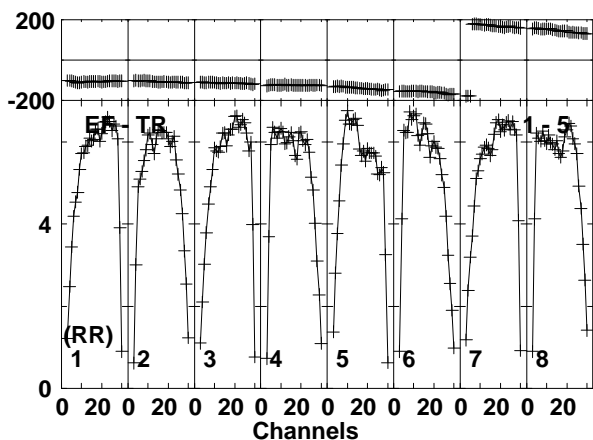
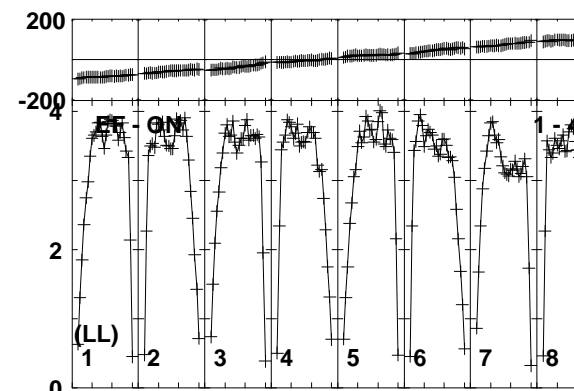
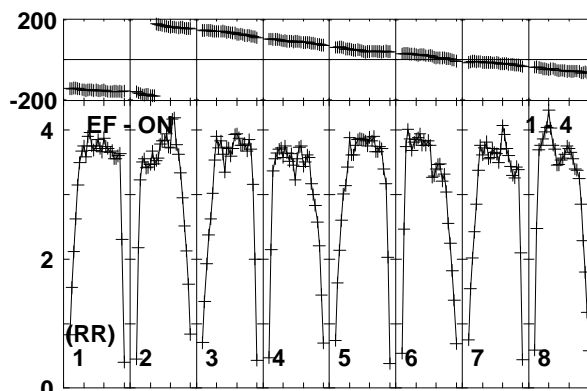
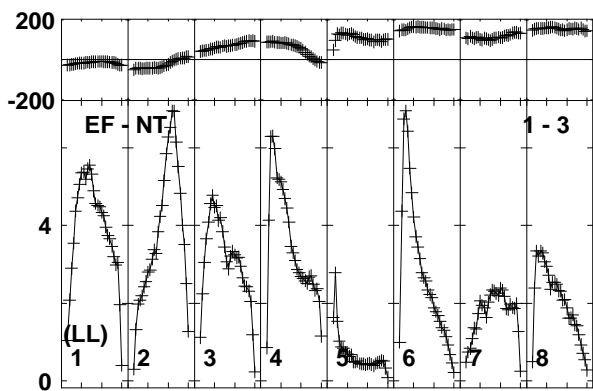
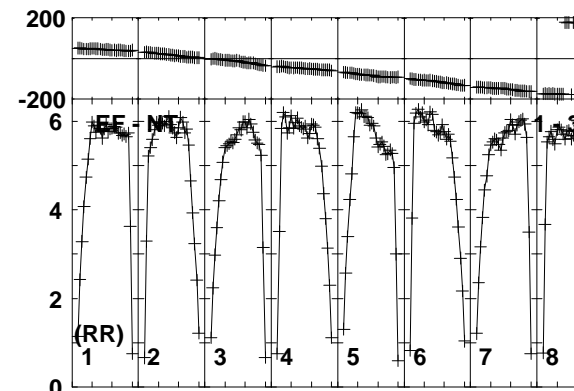
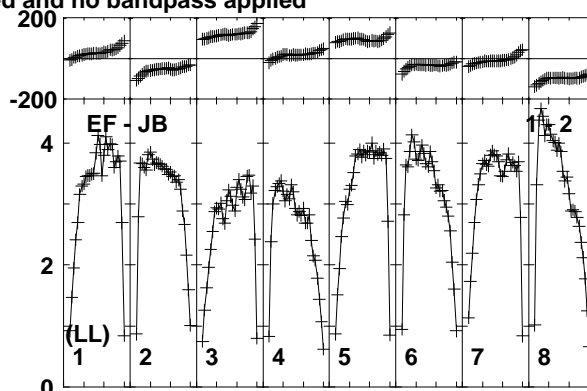
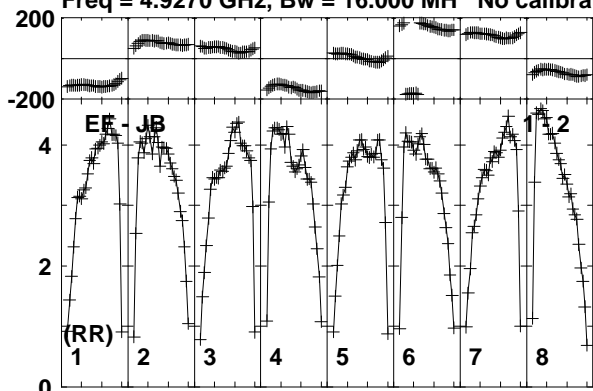

Lower frame: Milli Ampl Jy Top frame: Phas deg
Vector averaged cross-power spectrum Baseline: EF (01) - JB (02)
Timerange: 00/14:02:33 to 00/14:03:29

Plot file version 36 created 26-MAR-2015 15:27:36

J0519+0848 EG082E.UVDATA.1

Freq = 4.9270 GHz, Bw = 16.000 MH No calibration applied and no bandpass applied

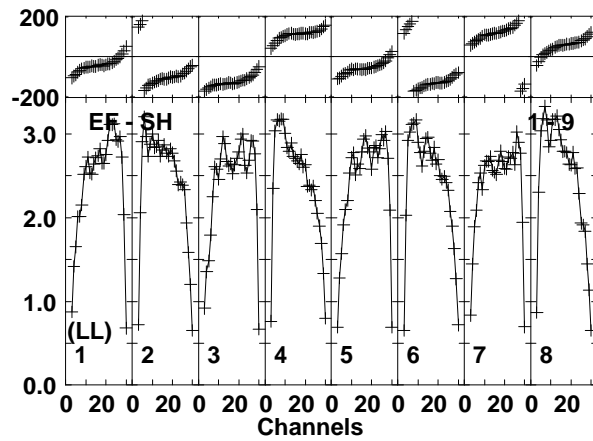
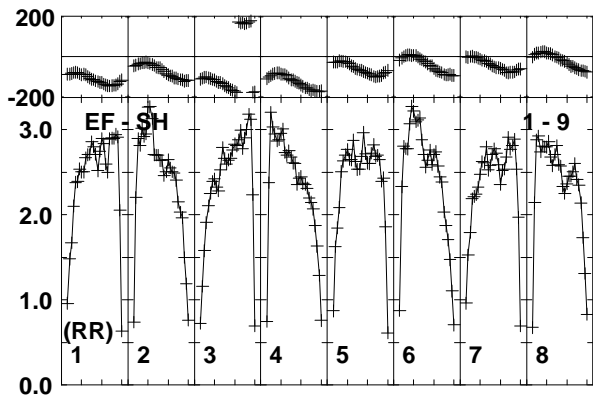
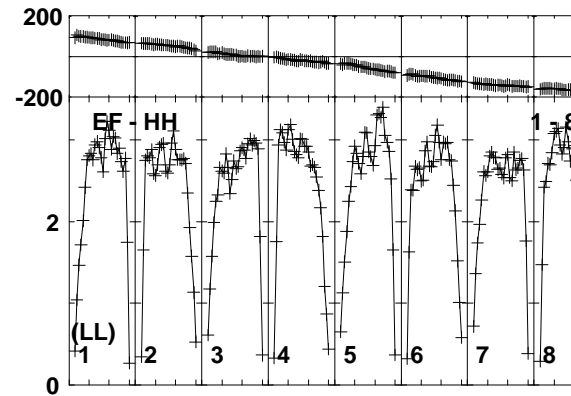
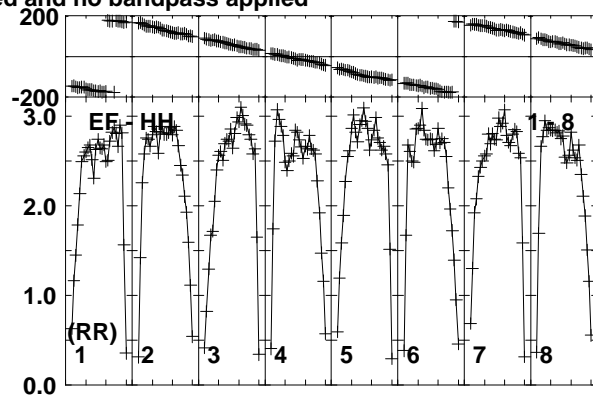
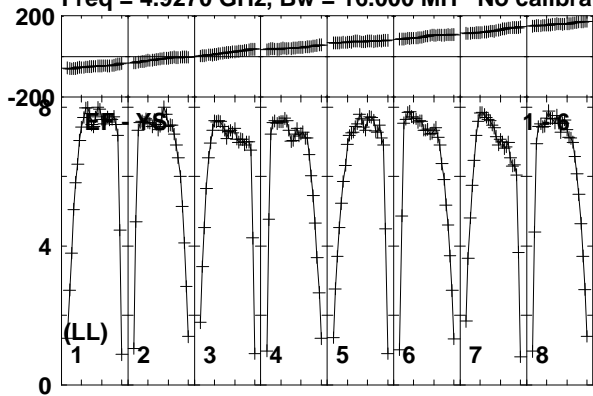

Lower frame: Milli Ampl Jy Top frame: Phas deg
Vector averaged cross-power spectrum Baseline: EF (01) - YS (06)
Timerange: 00/14:02:33 to 00/14:03:29

Plot file version 37 created 26-MAR-2015 15:27:36

V998ORI EG082E.UVDATA.1

Freq = 4.9270 GHz, Bw = 16.000 MH No calibration applied and no bandpass applied

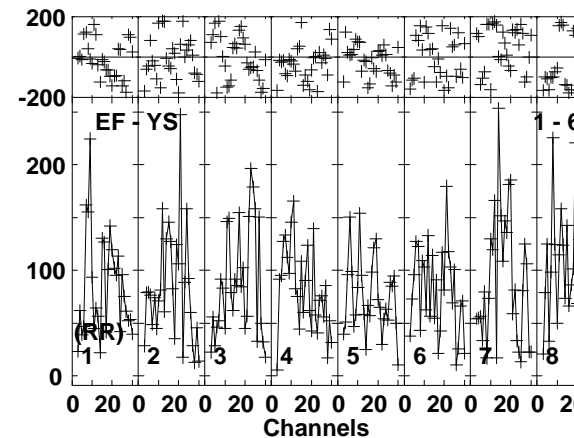
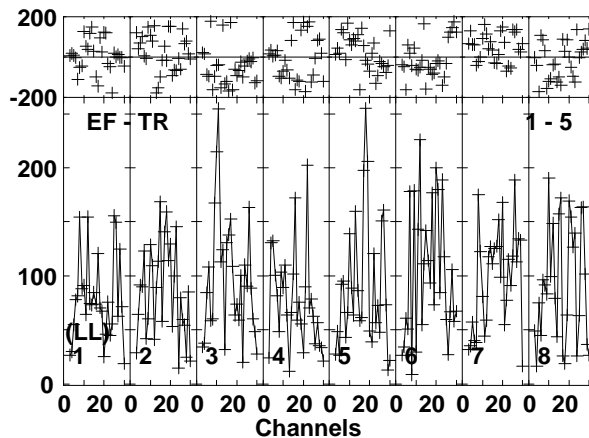
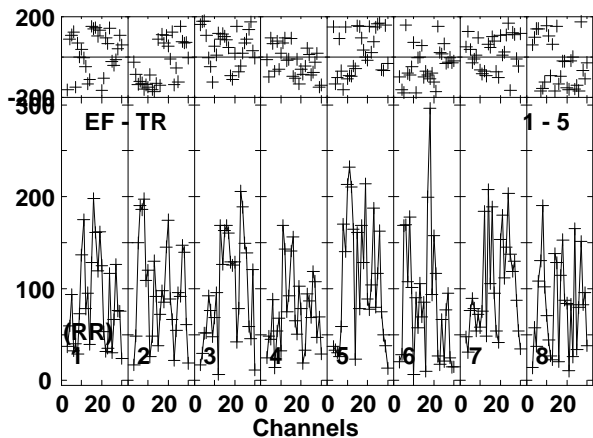
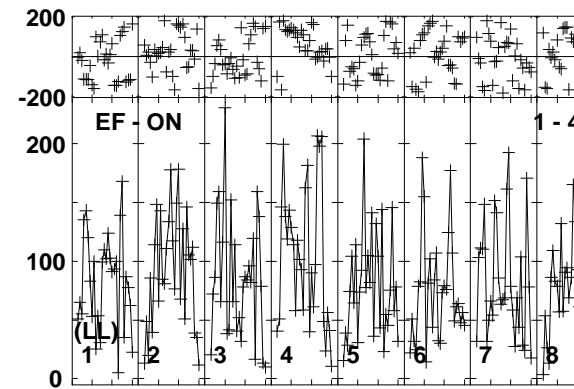
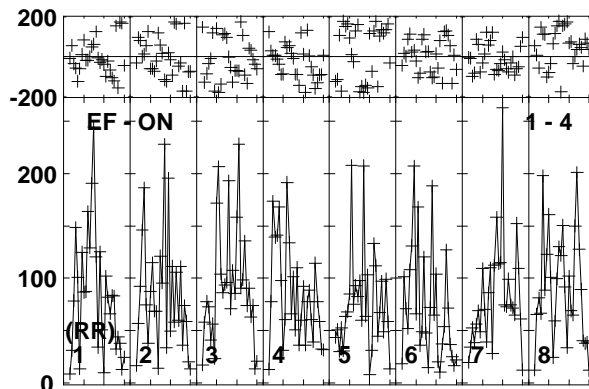
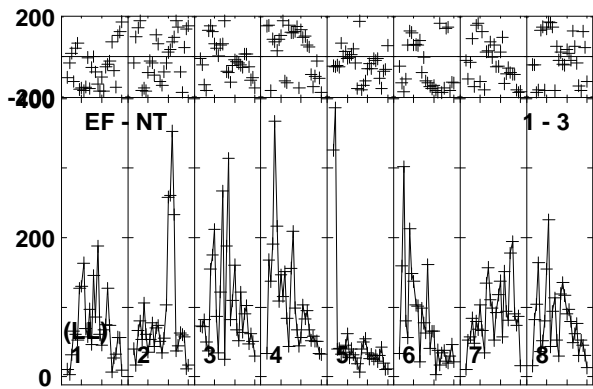
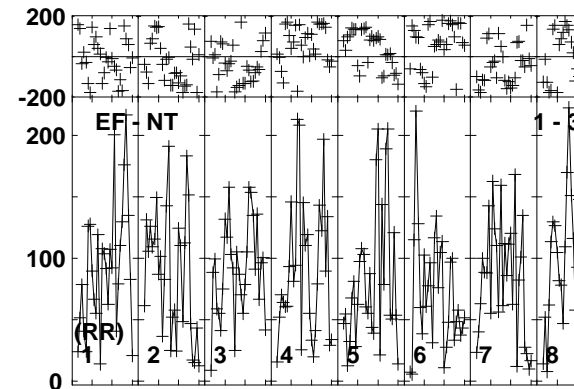
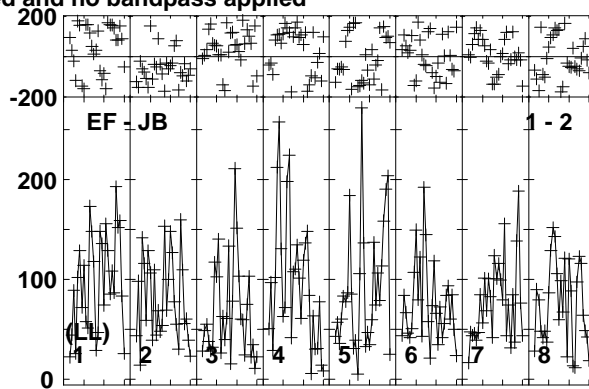
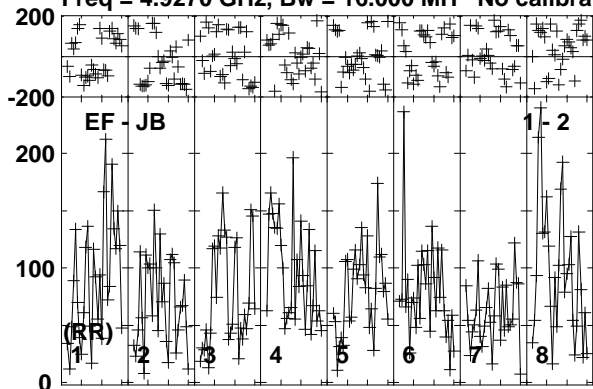

Lower frame: Micro Ampl Jy Top frame: Phas deg
Vector averaged cross-power spectrum Baseline: EF (01) - JB (02)
Timerange: 00/14:03:33 to 00/14:06:59

Plot file version 38 created 26-MAR-2015 15:27:36

V998ORI EG082E.UVDATA.1

Freq = 4.9270 GHz, Bw = 16.000 MH No calibration applied and no bandpass applied

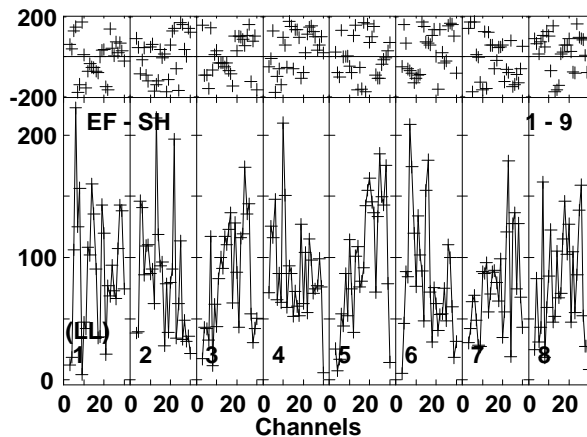
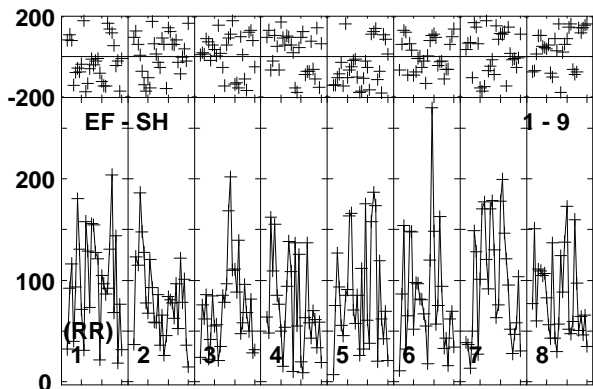
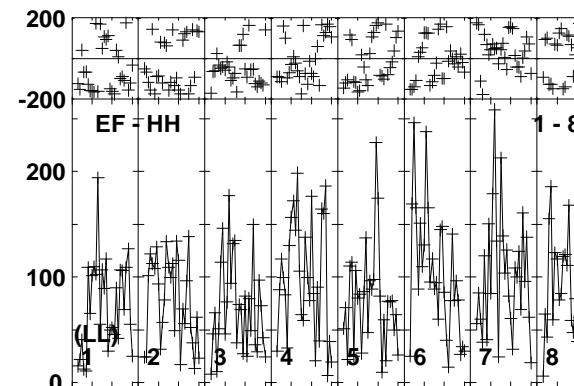
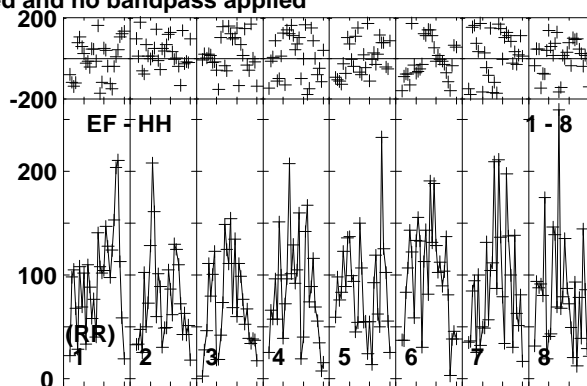
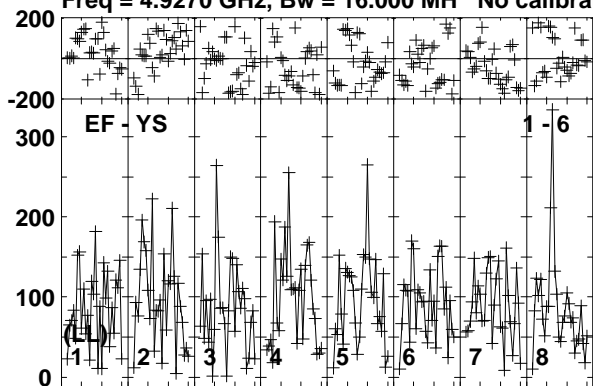

Lower frame: Micro Ampl Jy Top frame: Phas deg
Vector averaged cross-power spectrum Baseline: EF (01) - YS (06)
Timerange: 00/14:03:33 to 00/14:06:59

Plot file version 39 created 26-MAR-2015 15:27:36

J0519+0848 EG082E.UVDATA.1

Freq = 4.9270 GHz, Bw = 16.000 MH No calibration applied and no bandpass applied

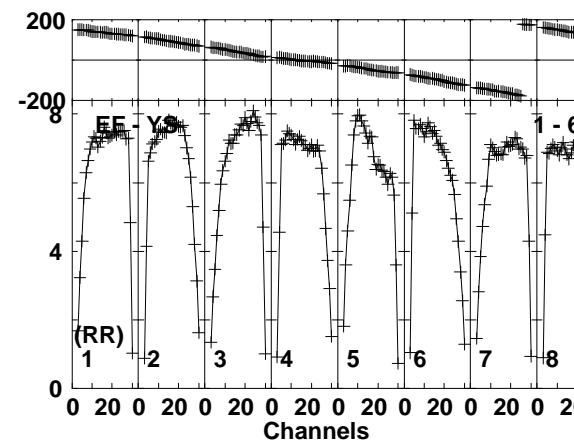
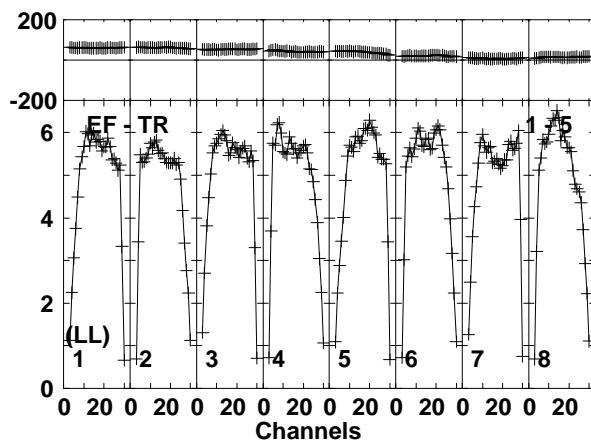
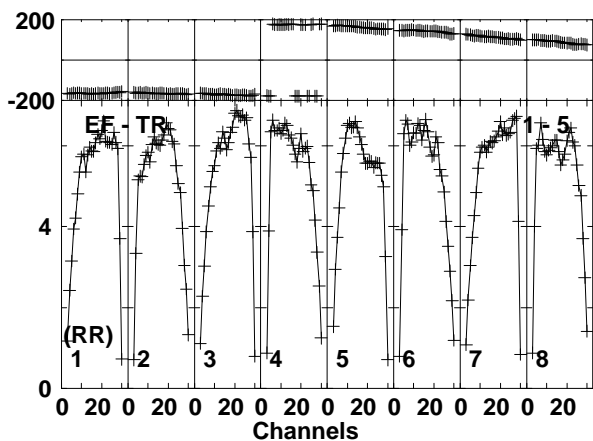
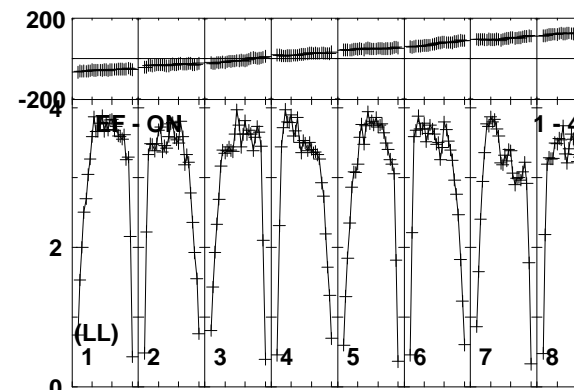
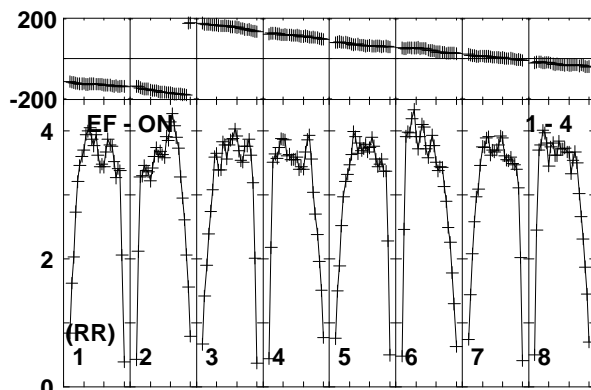
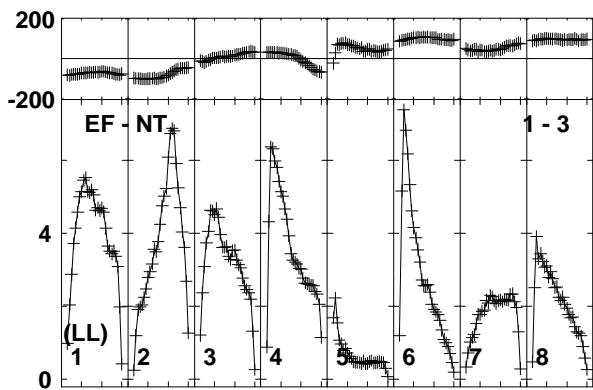
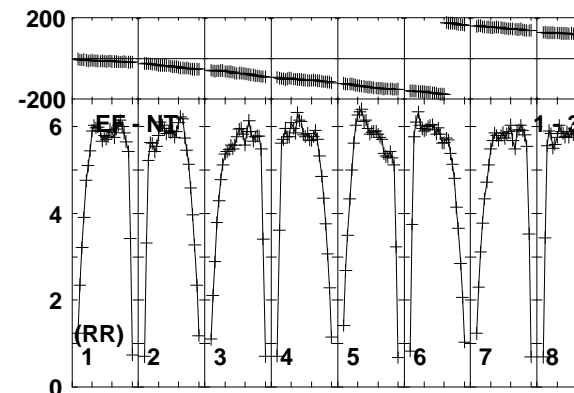
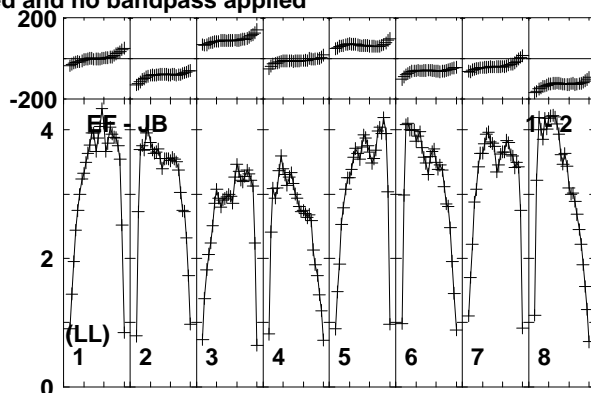
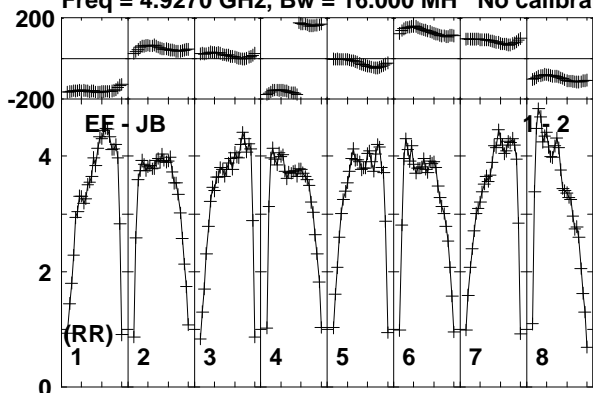

Lower frame: Milli Ampl Jy Top frame: Phas deg
Vector averaged cross-power spectrum Baseline: EF (01) - JB (02)
Timerange: 00/14:07:03 to 00/14:08:29

Plot file version 40 created 26-MAR-2015 15:27:36

J0519+0848 EG082E.UVDATA.1

Freq = 4.9270 GHz, Bw = 16.000 MH No calibration applied and no bandpass applied

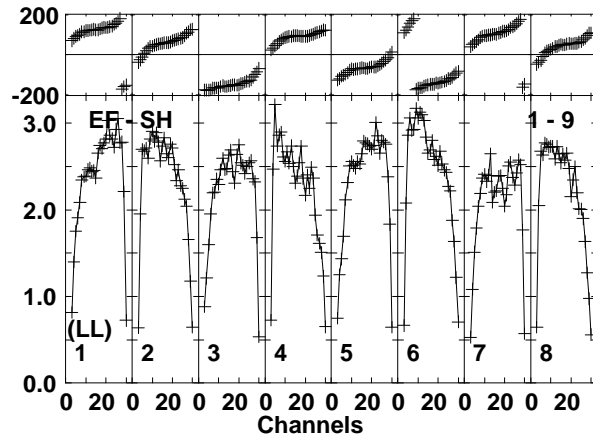
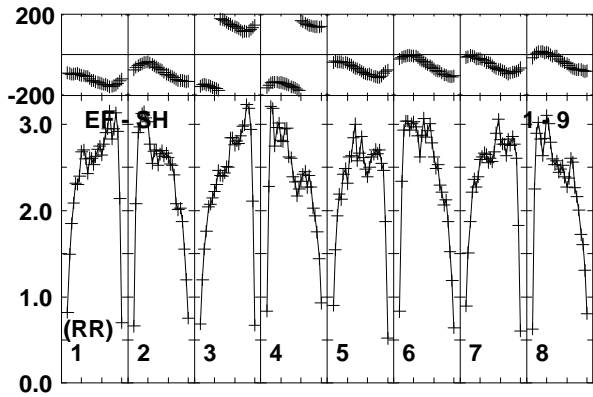
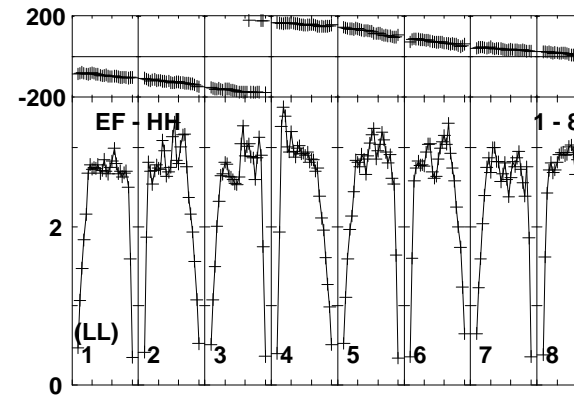
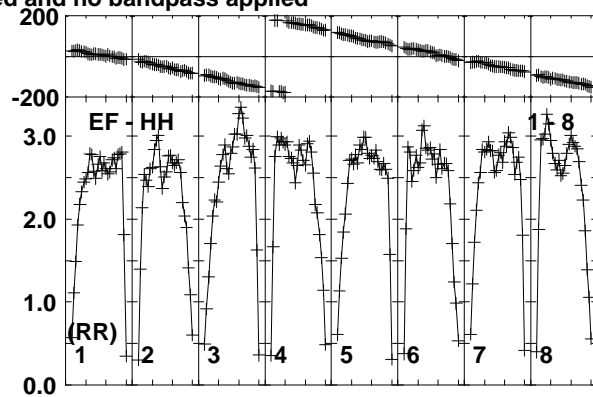
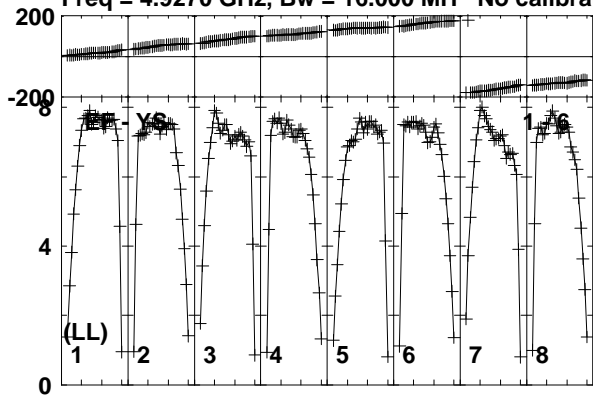

Lower frame: Milli Ampl Jy Top frame: Phas deg
Vector averaged cross-power spectrum Baseline: EF (01) - YS (06)
Timerange: 00/14:07:03 to 00/14:08:29

Plot file version 41 created 26-MAR-2015 15:27:37

J0525+0951 EG082E.UVDATA.1

Freq = 4.9270 GHz, Bw = 16.000 MH No calibration applied and no bandpass applied

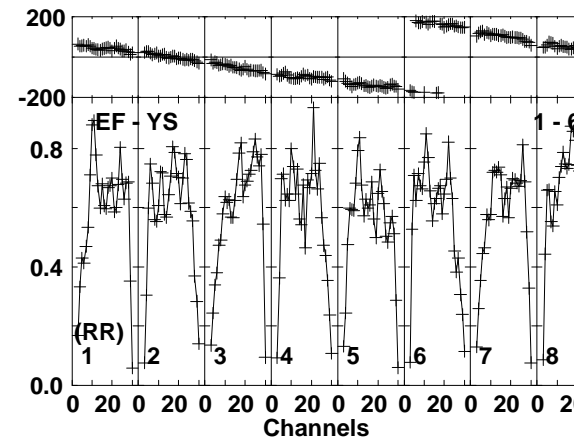
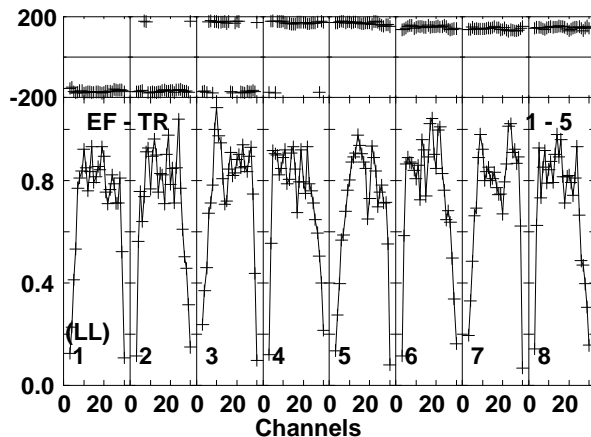
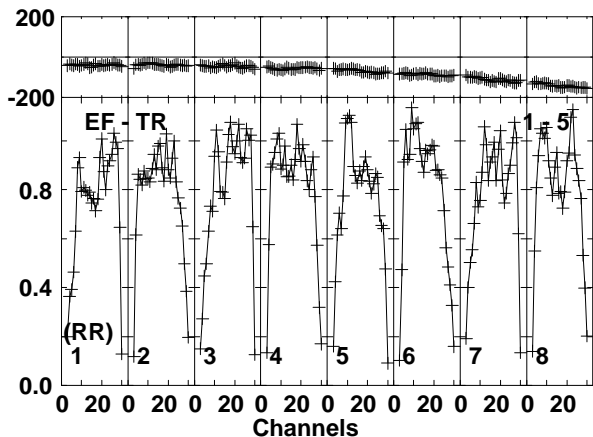
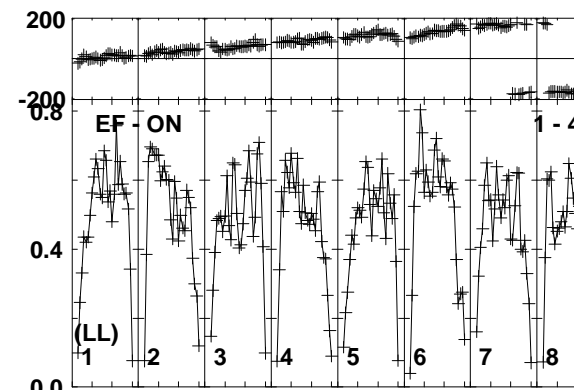
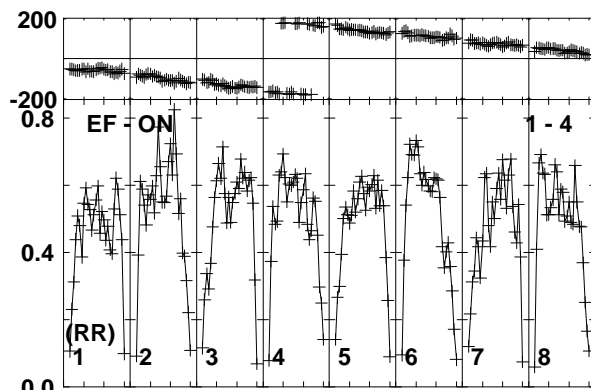
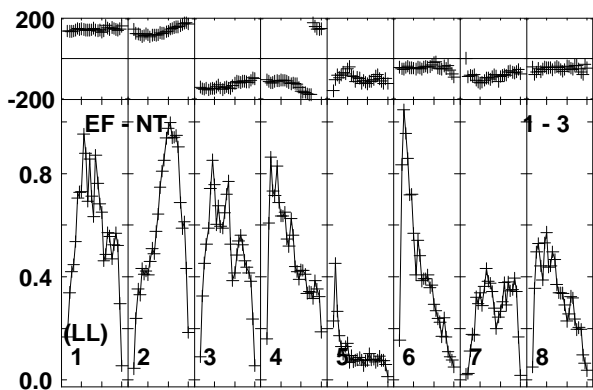
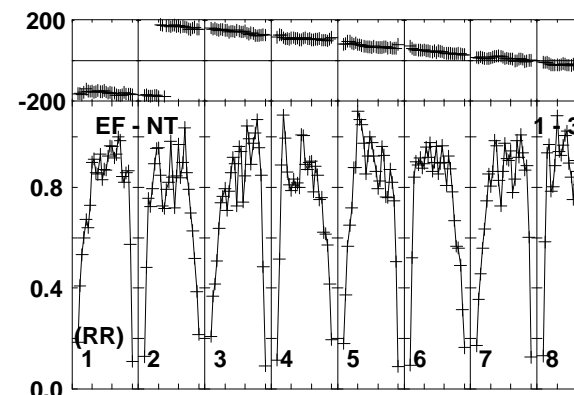
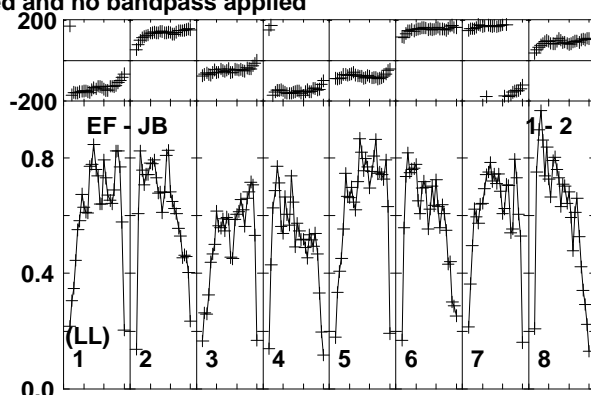
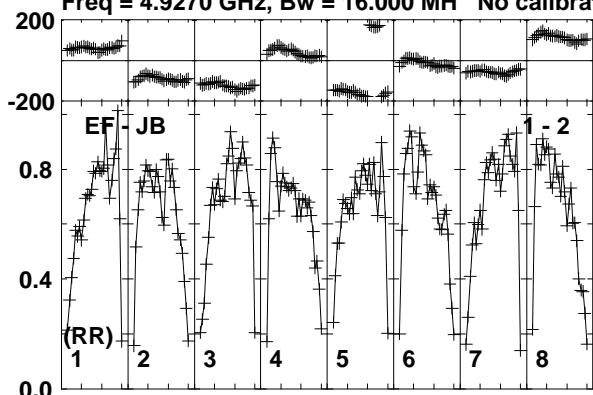

Lower frame: Milli Ampl Jy Top frame: Phas deg
Vector averaged cross-power spectrum Baseline: EF (01) - JB (02)
Timerange: 00/14:08:33 to 00/14:11:59

Plot file version 42 created 26-MAR-2015 15:27:37

J0525+0951 EG082E.UVDATA.1

Freq = 4.9270 GHz, Bw = 16.000 MH No calibration applied and no bandpass applied

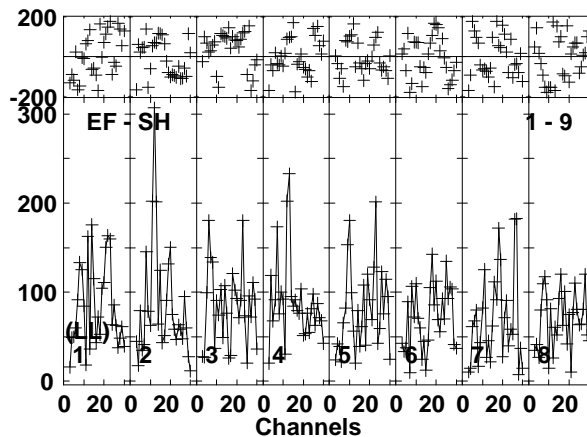
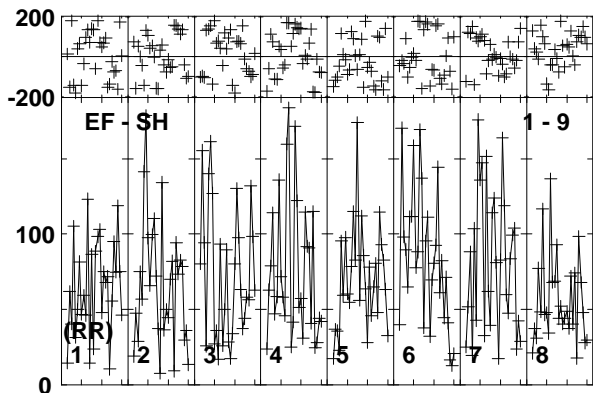
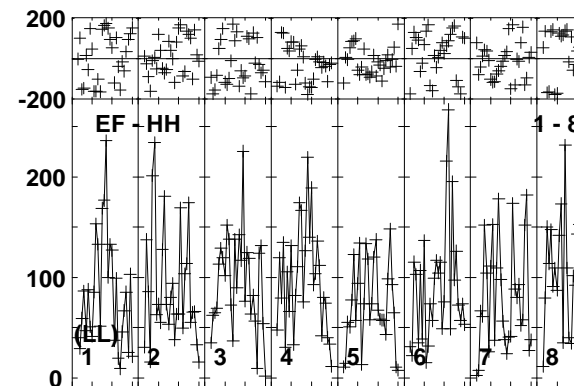
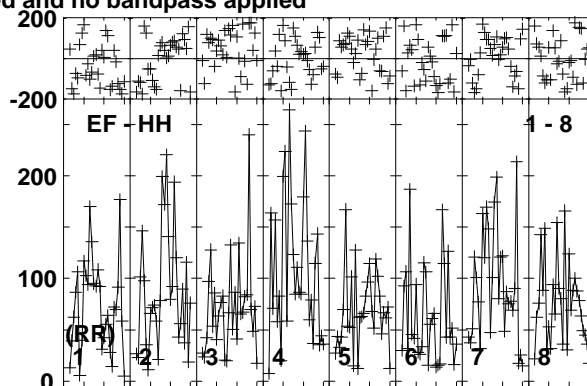
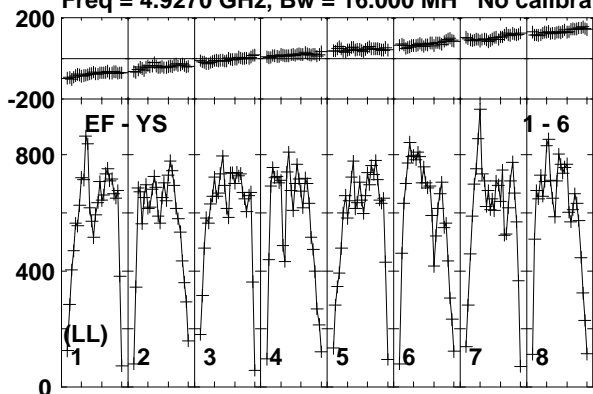

Lower frame: Micro Ampl Jy Top frame: Phas deg
Vector averaged cross-power spectrum Baseline: EF (01) - YS (06)
Timerange: 00/14:08:33 to 00/14:11:59

Plot file version 43 created 26-MAR-2015 15:27:37

J0519+0848 EG082E.UVDATA.1

Freq = 4.9270 GHz, Bw = 16.000 MH No calibration applied and no bandpass applied

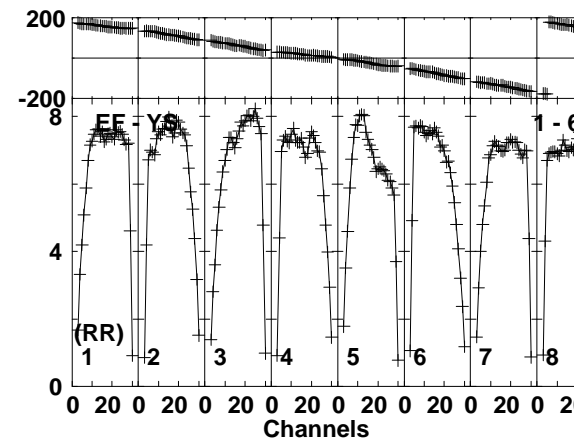
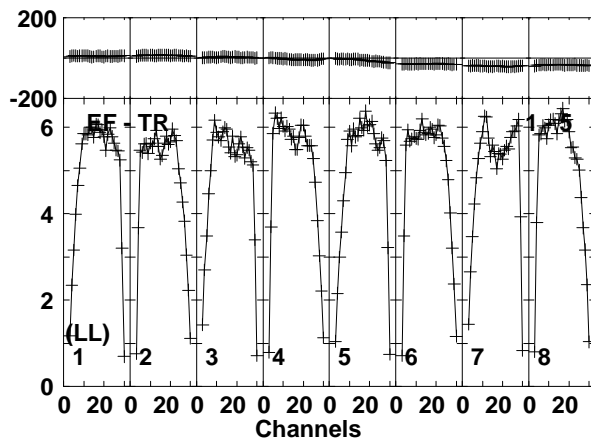
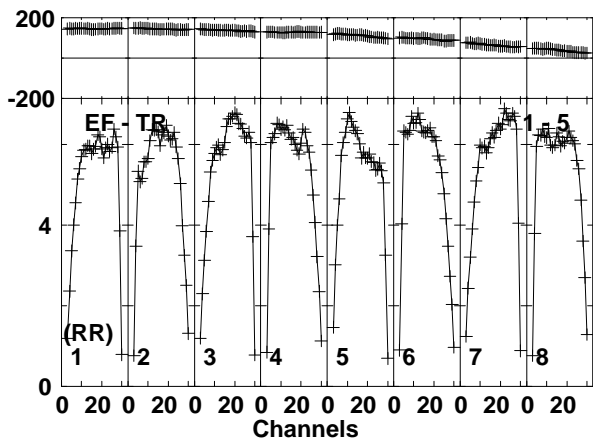
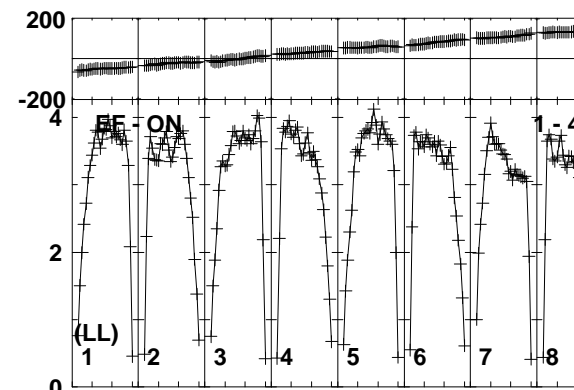
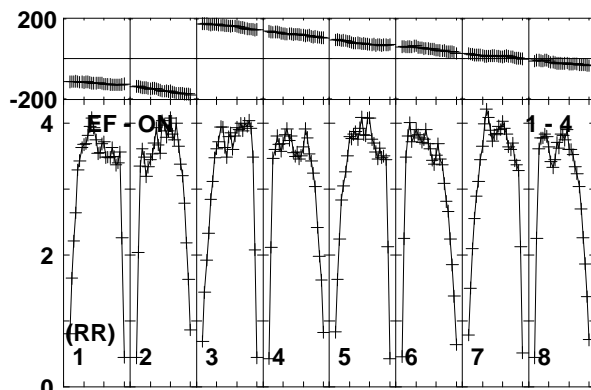
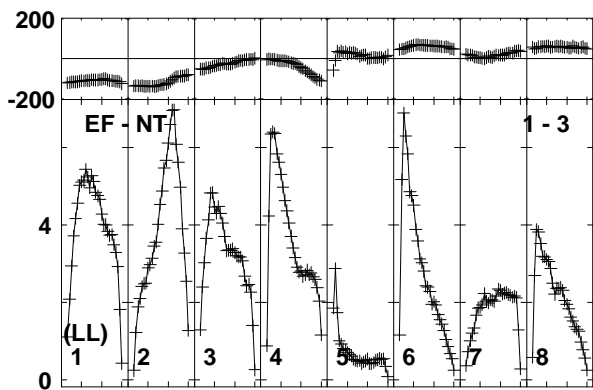
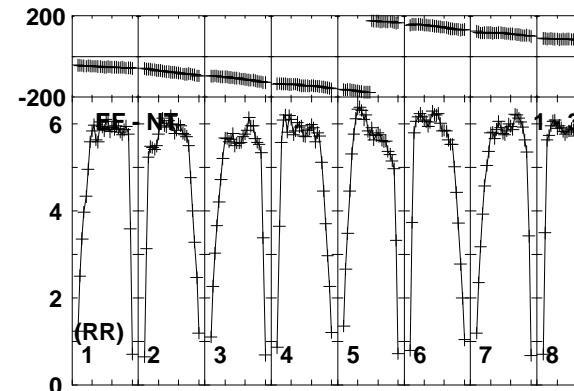
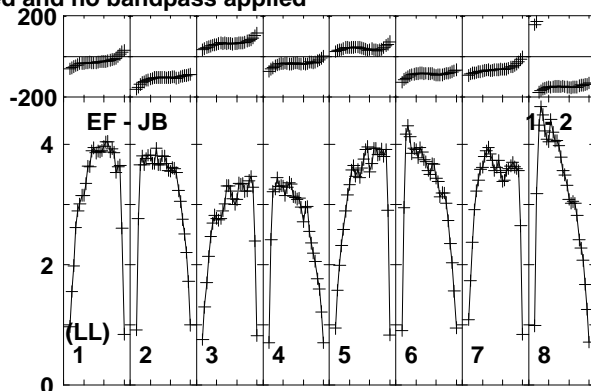
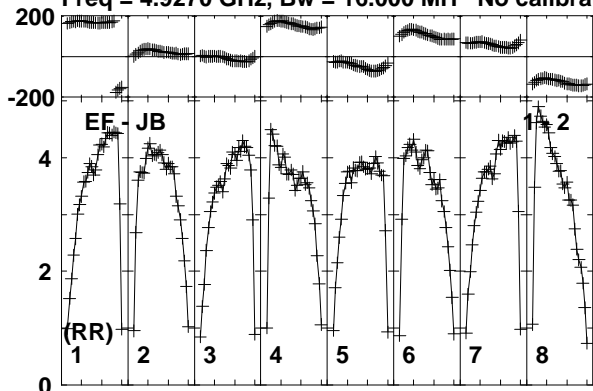

Lower frame: Milli Ampl Jy Top frame: Phas deg
Vector averaged cross-power spectrum Baseline: EF (01) - JB (02)
Timerange: 00/14:12:33 to 00/14:13:29

Plot file version 44 created 26-MAR-2015 15:27:37

J0519+0848 EG082E.UVDATA.1

Freq = 4.9270 GHz, Bw = 16.000 MH No calibration applied and no bandpass applied

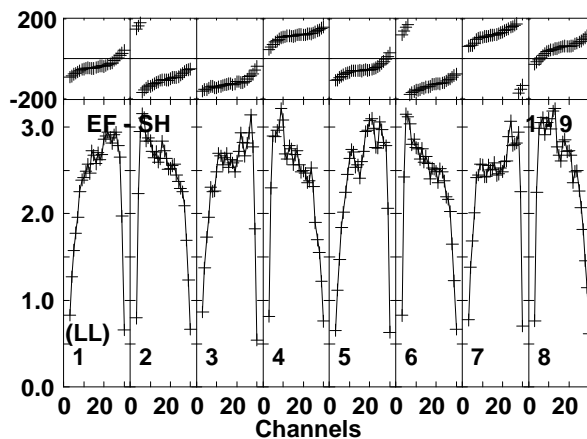
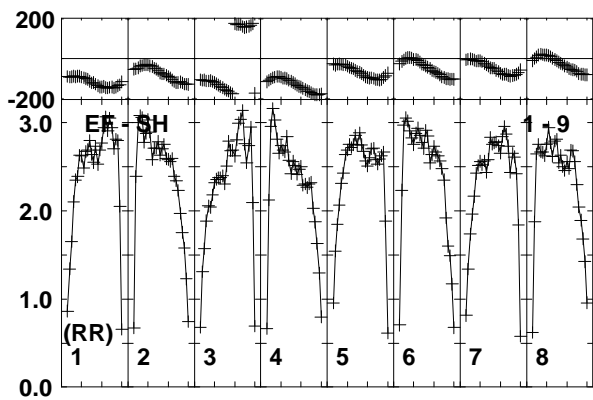
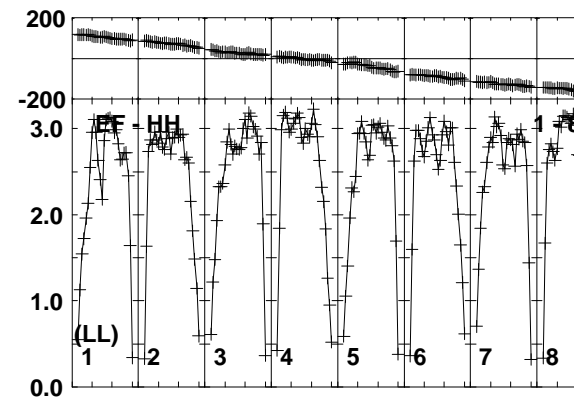
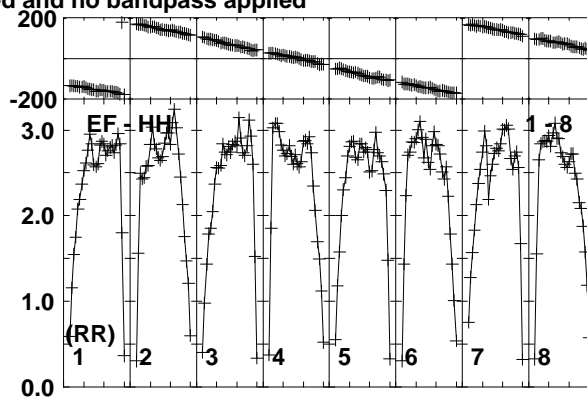
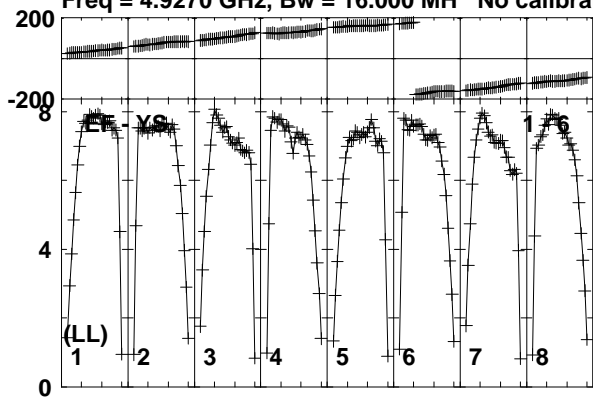

Lower frame: Milli Ampl Jy Top frame: Phas deg
Vector averaged cross-power spectrum Baseline: EF (01) - YS (06)
Timerange: 00/14:12:33 to 00/14:13:29

Plot file version 45 created 26-MAR-2015 15:27:37

V998ORI EG082E.UVDATA.1

Freq = 4.9270 GHz, Bw = 16.000 MH No calibration applied and no bandpass applied

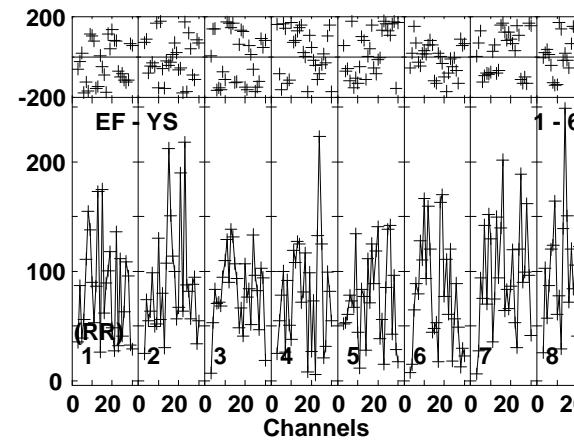
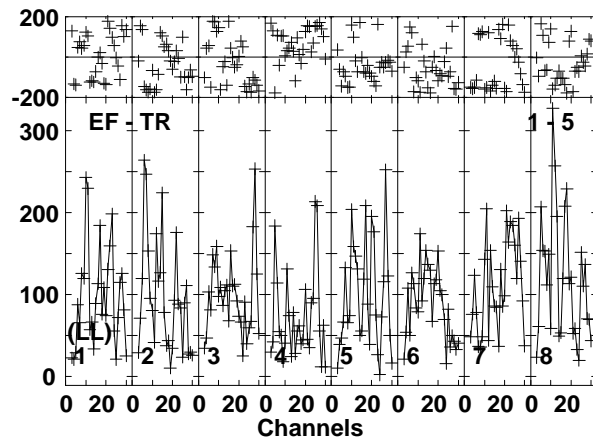
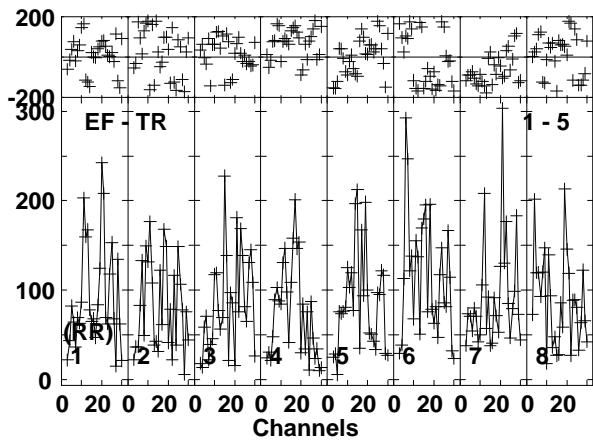
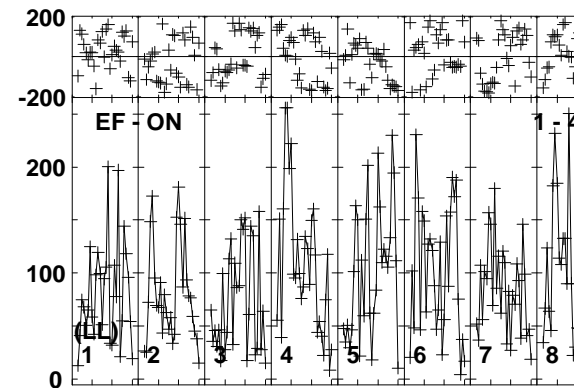
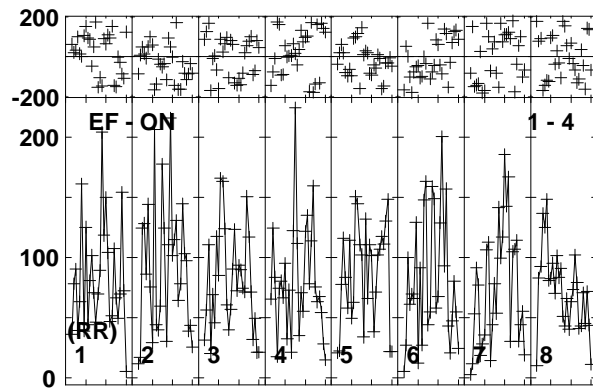
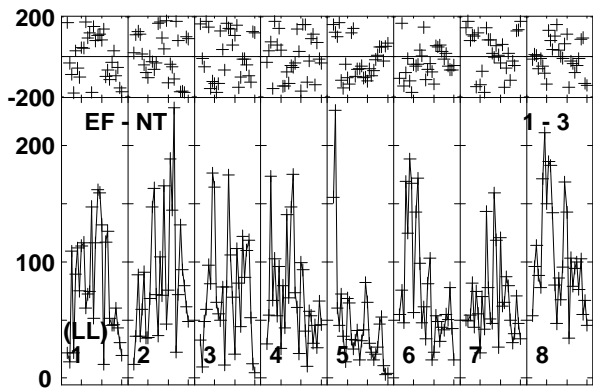
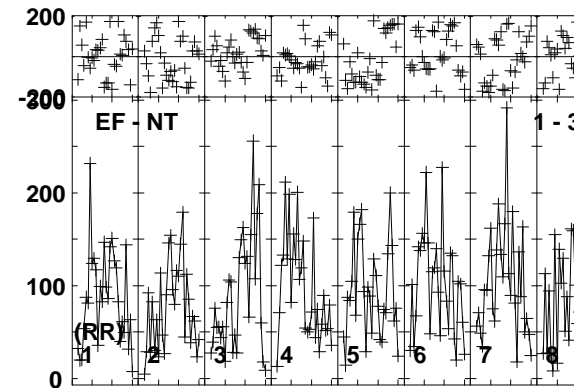
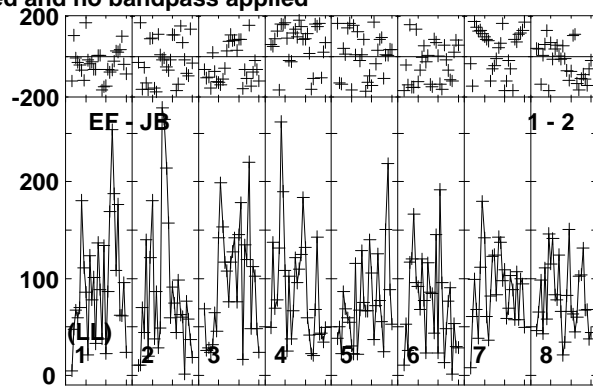
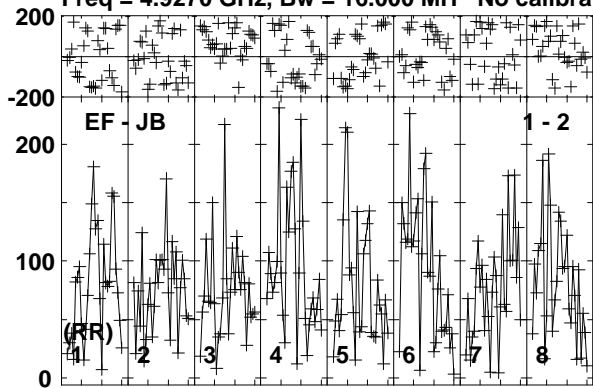

Lower frame: Micro Ampl Jy Top frame: Phas deg
Vector averaged cross-power spectrum Baseline: EF (01) - JB (02)
Timerange: 00/14:13:33 to 00/14:16:59

Plot file version 46 created 26-MAR-2015 15:27:37

V998ORI EG082E.UVDATA.1

Freq = 4.9270 GHz, Bw = 16.000 MH No calibration applied and no bandpass applied

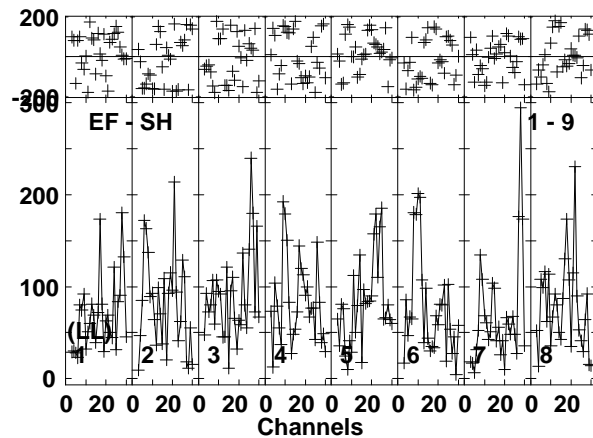
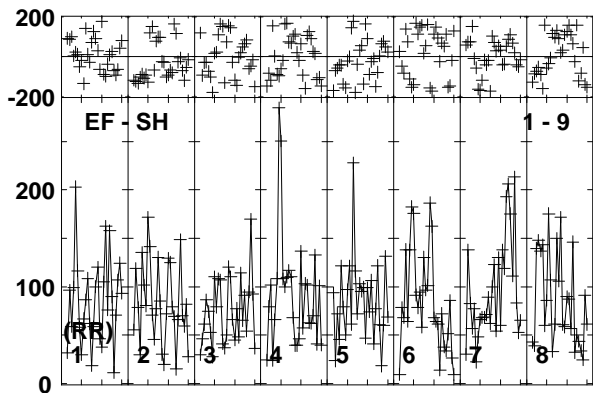
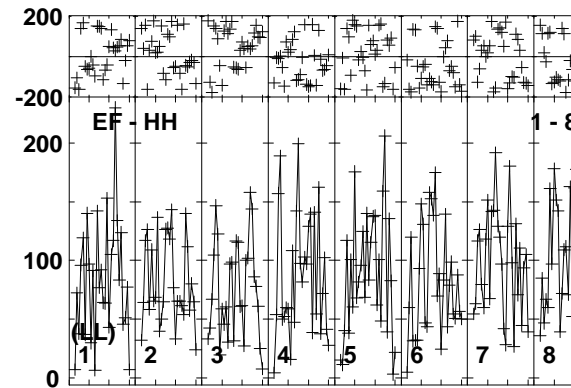
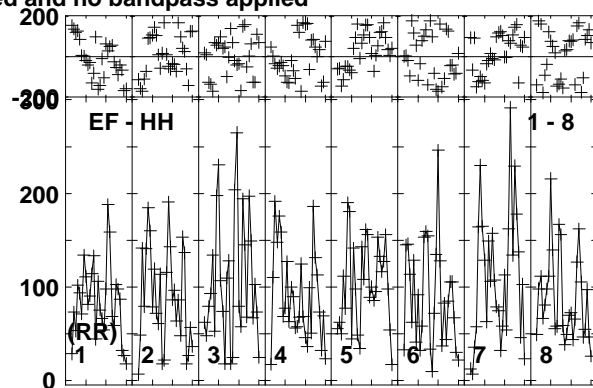
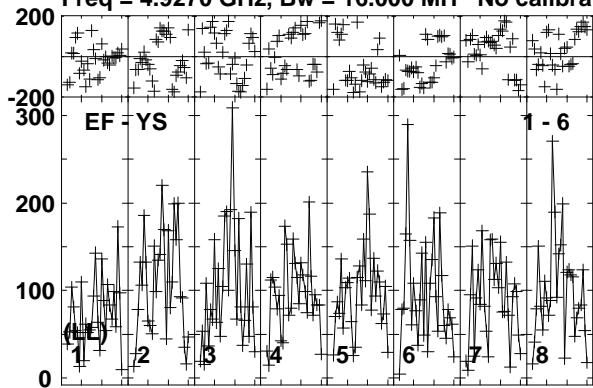

Lower frame: Micro Ampl Jy Top frame: Phas deg
Vector averaged cross-power spectrum Baseline: EF (01) - YS (06)
Timerange: 00/14:13:33 to 00/14:16:59

Plot file version 47 created 26-MAR-2015 15:27:37

J0519+0848 EG082E.UVDATA.1

Freq = 4.9270 GHz, Bw = 16.000 MH No calibration applied and no bandpass applied

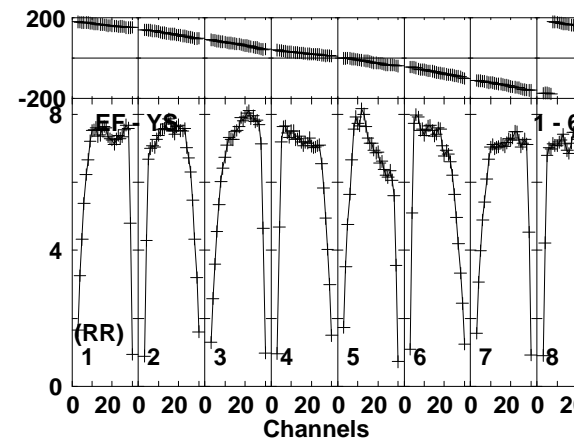
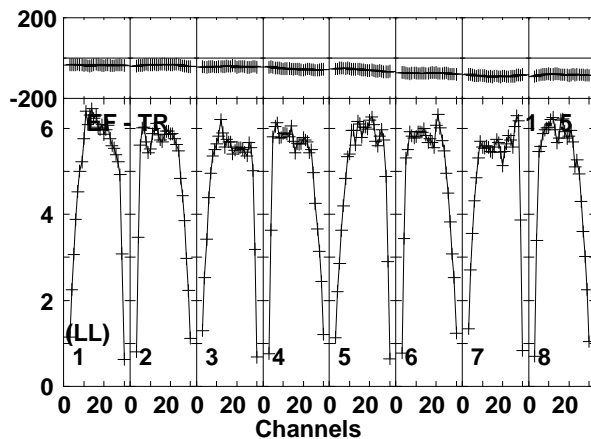
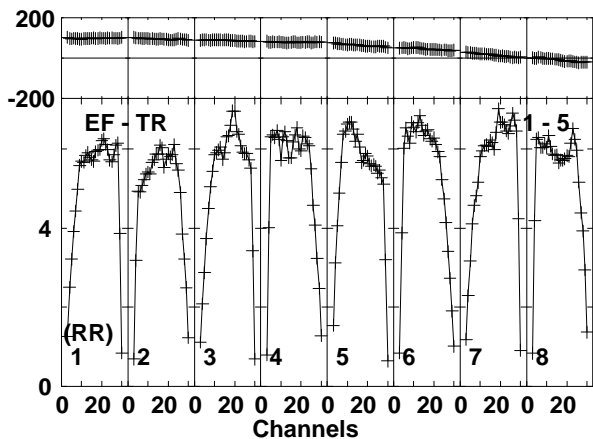
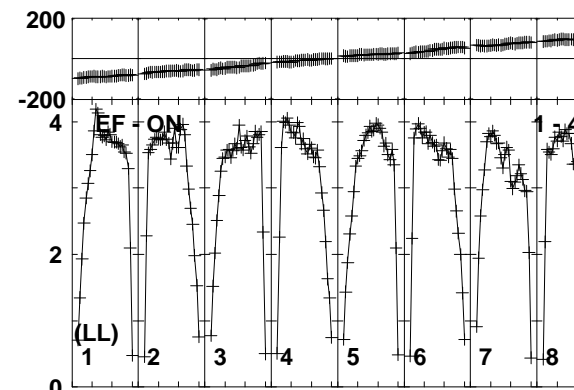
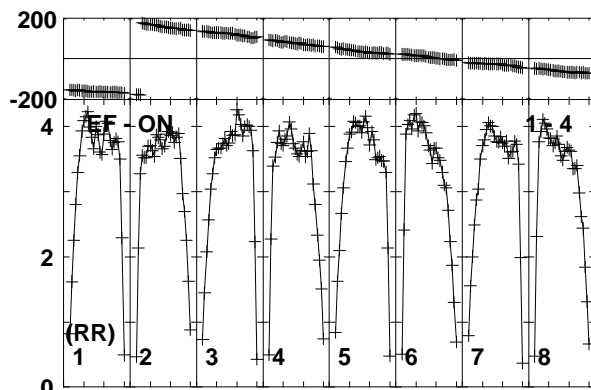
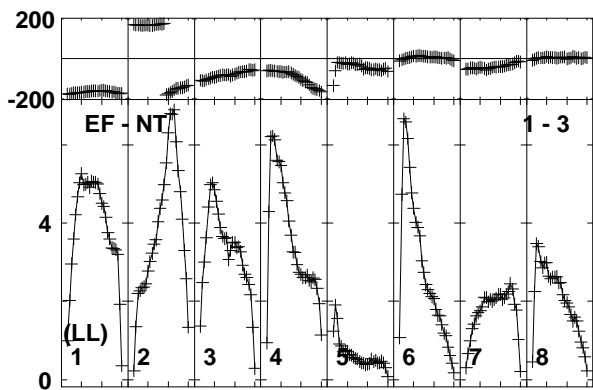
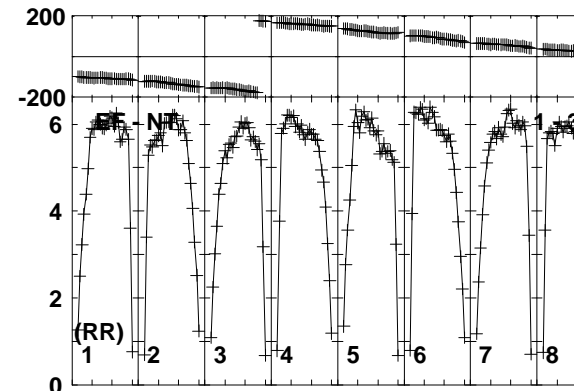
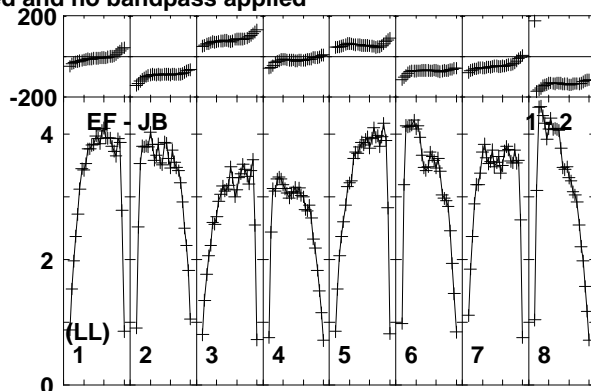
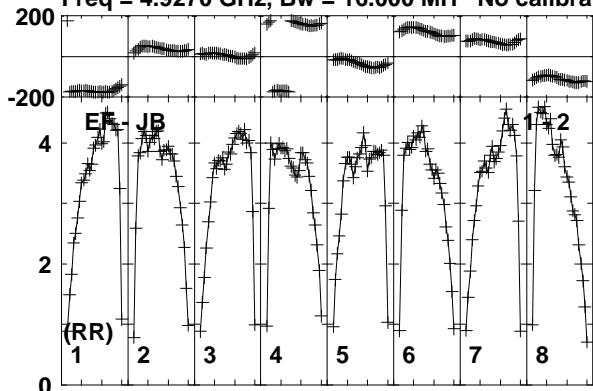

Lower frame: Milli Ampl Jy Top frame: Phas deg
Vector averaged cross-power spectrum Baseline: EF (01) - JB (02)
Timerange: 00/14:17:03 to 00/14:18:29

Plot file version 48 created 26-MAR-2015 15:27:37

J0519+0848 EG082E.UVDATA.1

Freq = 4.9270 GHz, Bw = 16.000 MH No calibration applied and no bandpass applied

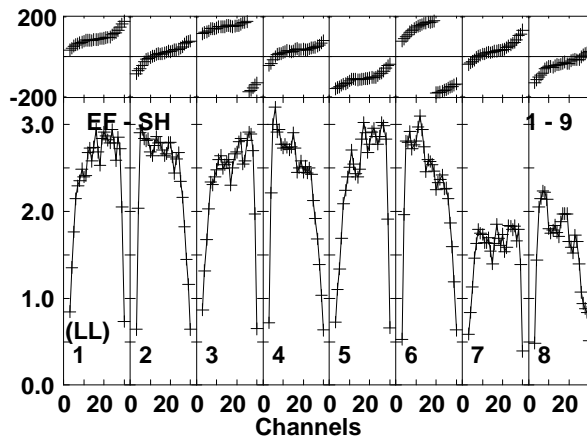
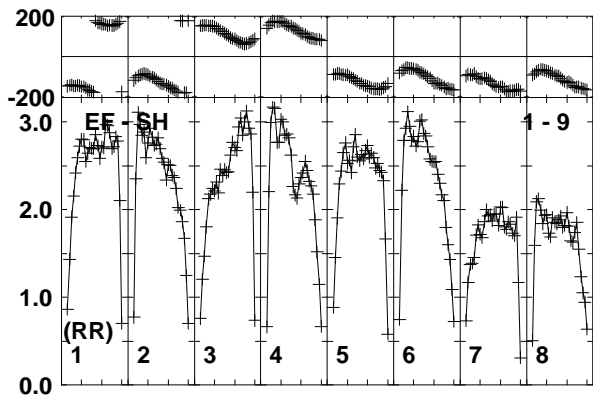
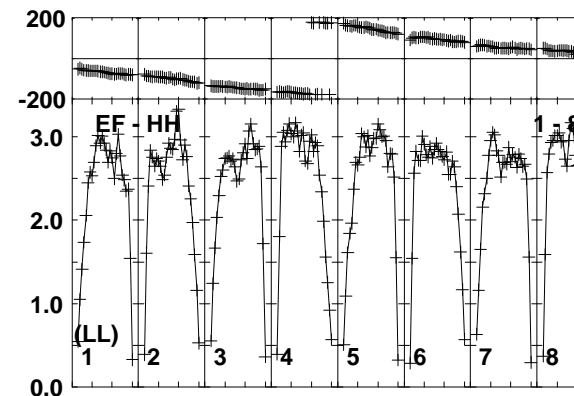
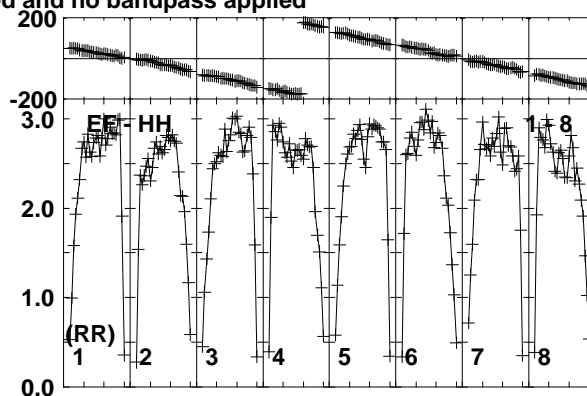
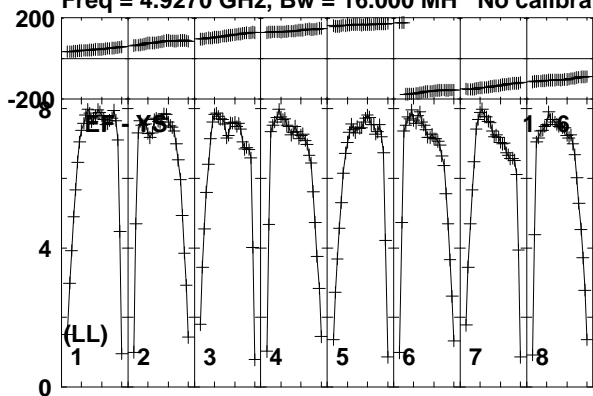

Lower frame: Milli Ampl Jy Top frame: Phas deg
Vector averaged cross-power spectrum Baseline: EF (01) - YS (06)
Timerange: 00/14:17:03 to 00/14:18:29

Plot file version 49 created 26-MAR-2015 15:27:37

V998ORI EG082E.UVDATA.1

Freq = 4.9270 GHz, Bw = 16.000 MH No calibration applied and no bandpass applied

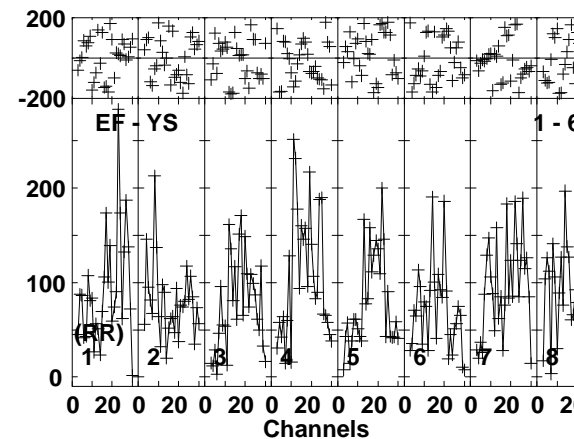
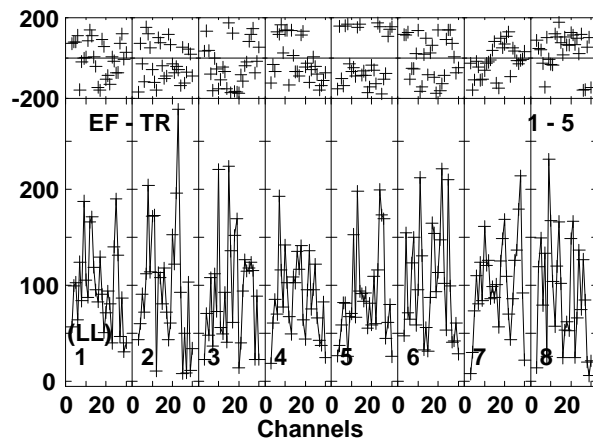
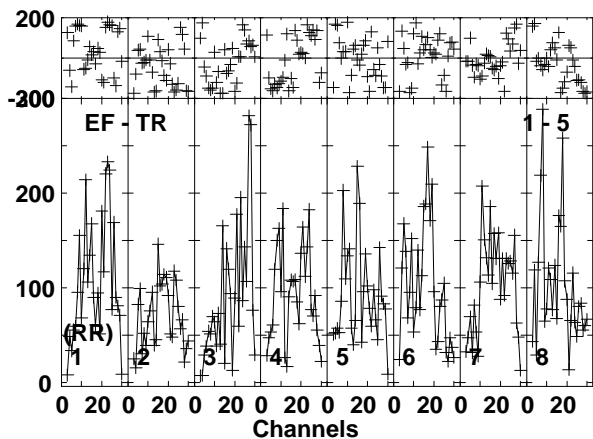
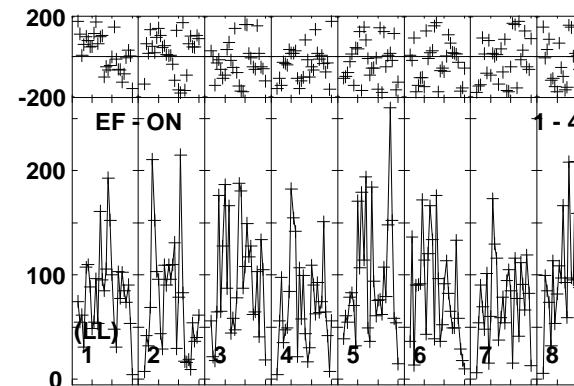
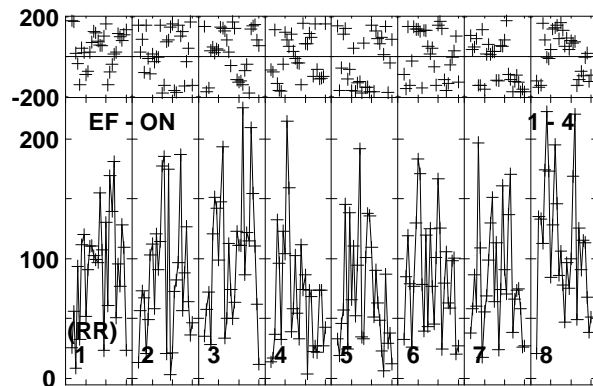
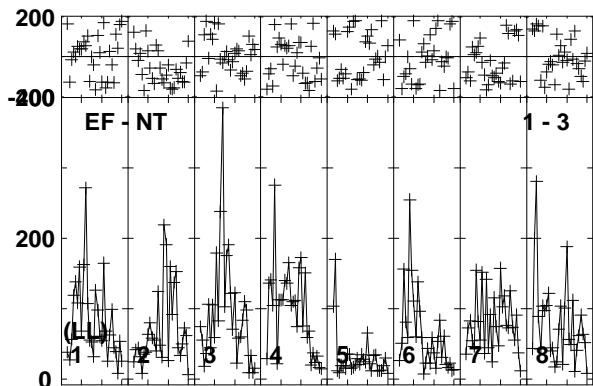
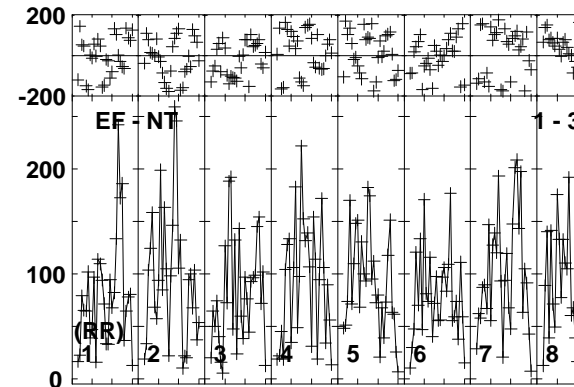
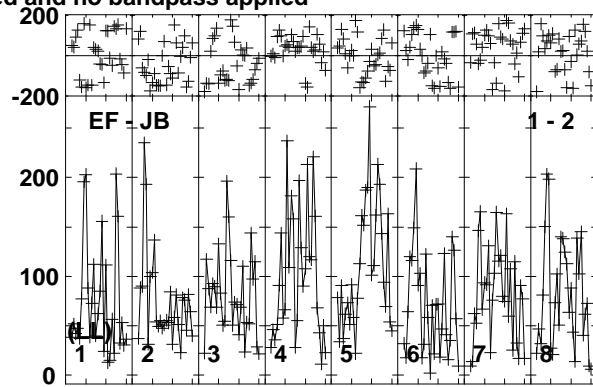
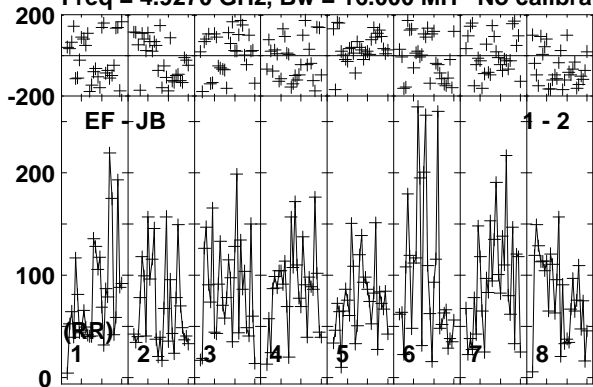

Lower frame: Micro Ampl Jy Top frame: Phas deg
Vector averaged cross-power spectrum Baseline: EF (01) - JB (02)
Timerange: 00/14:18:33 to 00/14:21:59

Plot file version 50 created 26-MAR-2015 15:27:37

V998ORI EG082E.UVDATA.1

Freq = 4.9270 GHz, Bw = 16.000 MH No calibration applied and no bandpass applied

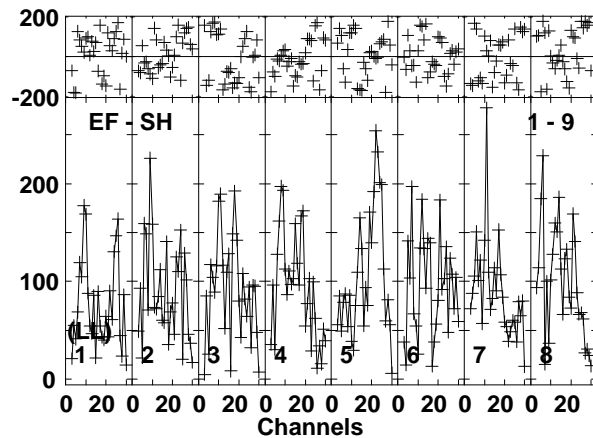
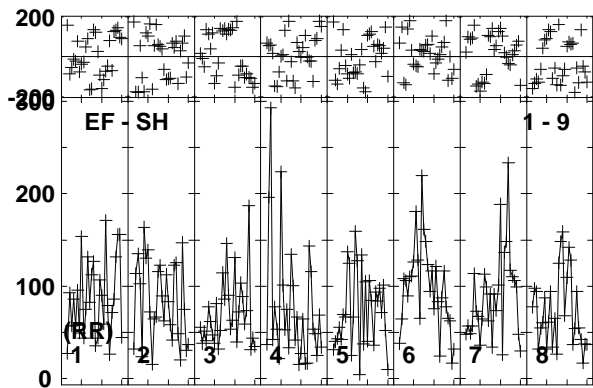
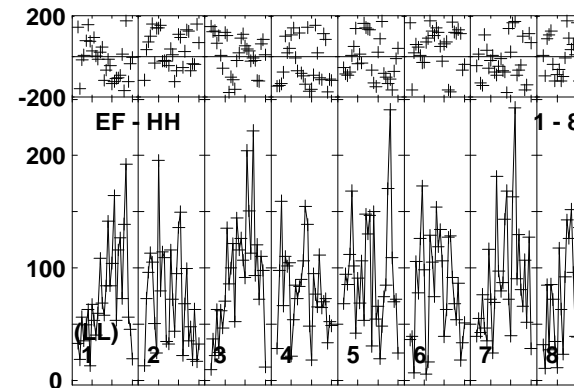
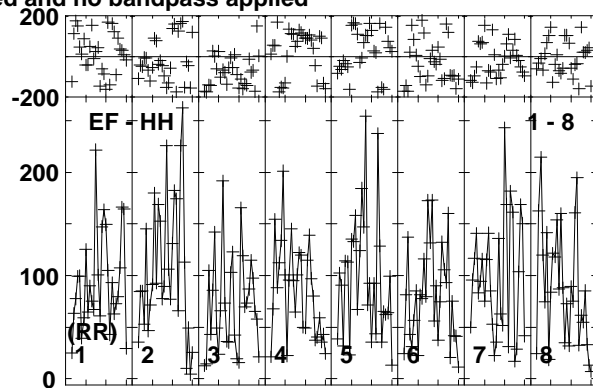
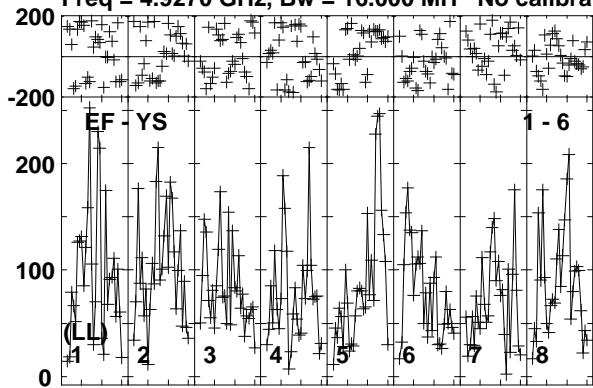

Lower frame: Micro Ampl Jy Top frame: Phas deg
Vector averaged cross-power spectrum Baseline: EF (01) - YS (06)
Timerange: 00/14:18:33 to 00/14:21:59

Plot file version 51 created 26-MAR-2015 15:27:37

J0519+0848 EG082E.UVDATA.1

Freq = 4.9270 GHz, Bw = 16.000 MH No calibration applied and no bandpass applied

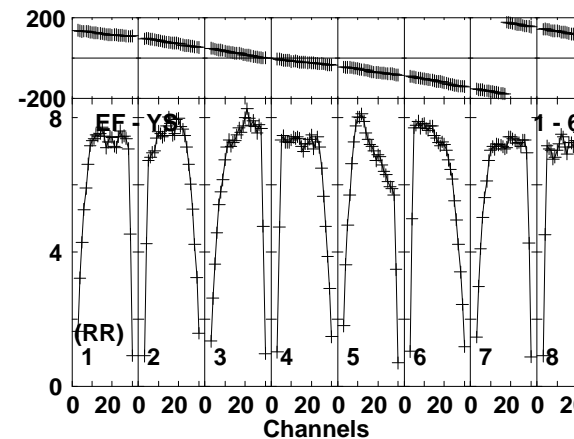
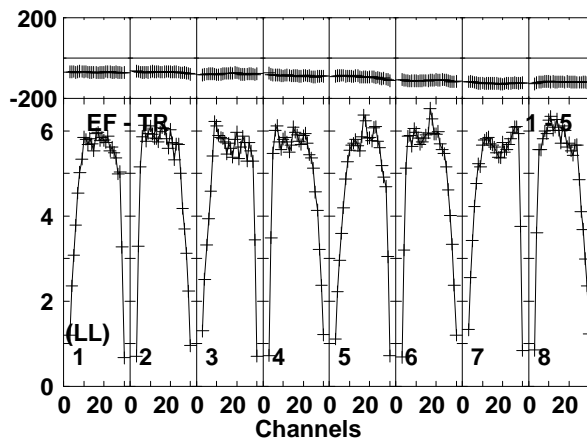
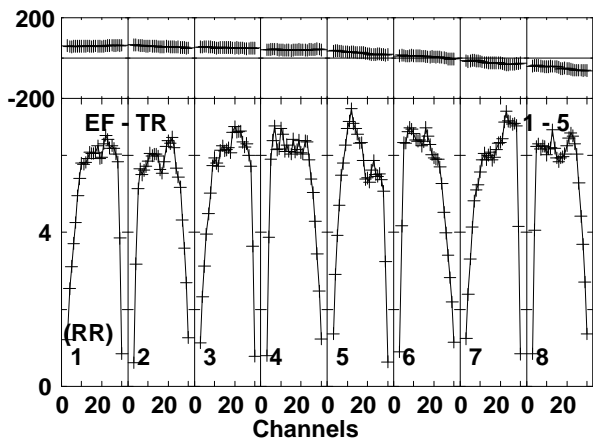
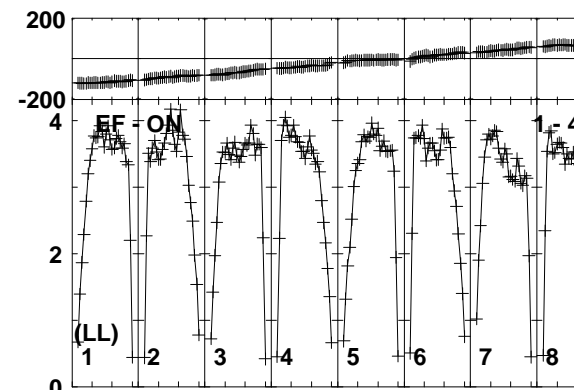
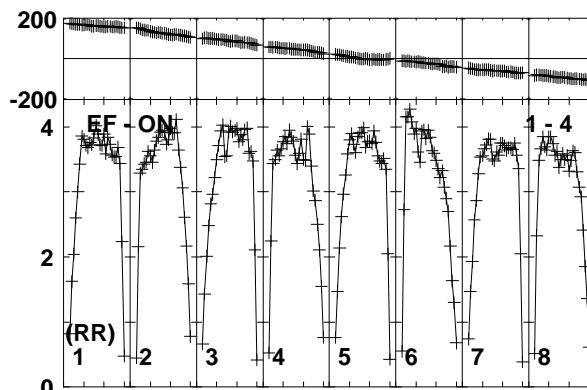
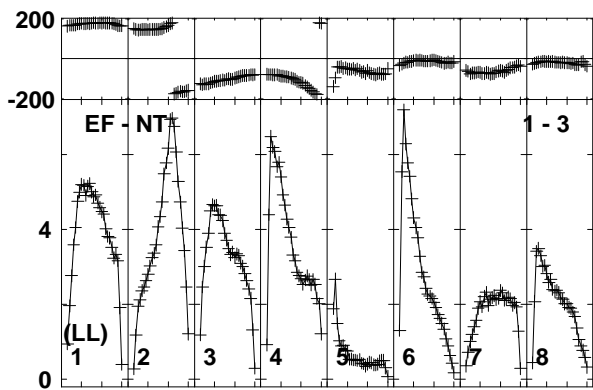
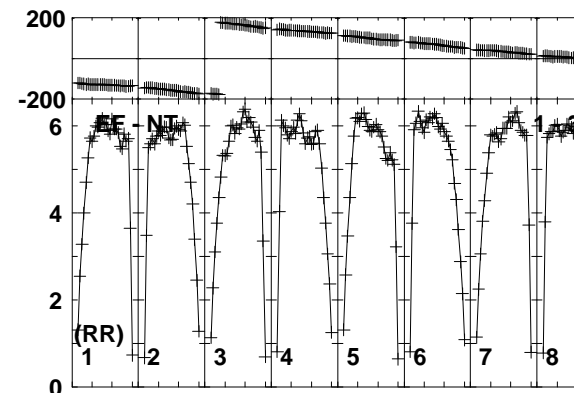
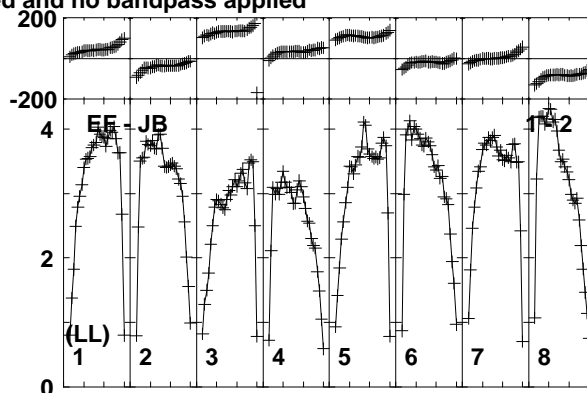
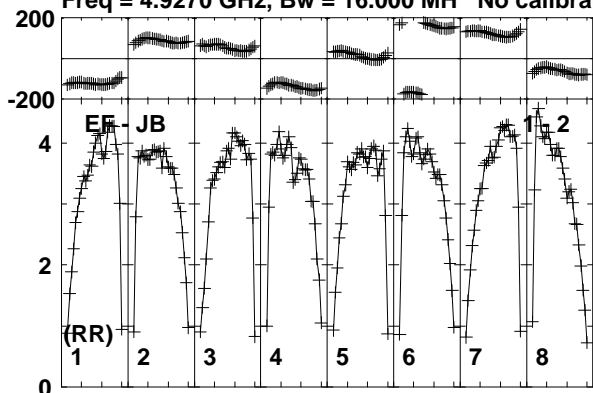

Lower frame: Milli Ampl Jy Top frame: Phas deg
Vector averaged cross-power spectrum Baseline: EF (01) - JB (02)
Timerange: 00/14:22:33 to 00/14:23:29

Plot file version 52 created 26-MAR-2015 15:27:37

J0519+0848 EG082E.UVDATA.1

Freq = 4.9270 GHz, Bw = 16.000 MH No calibration applied and no bandpass applied

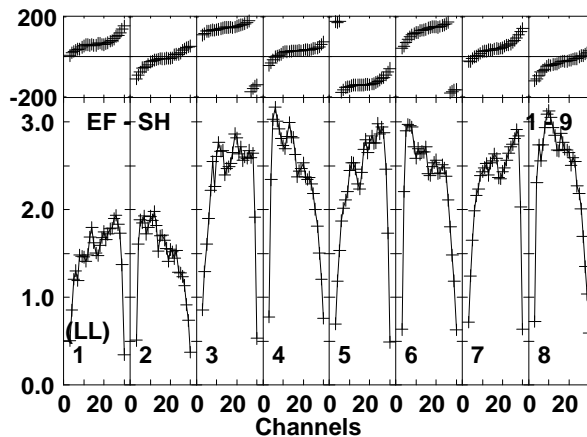
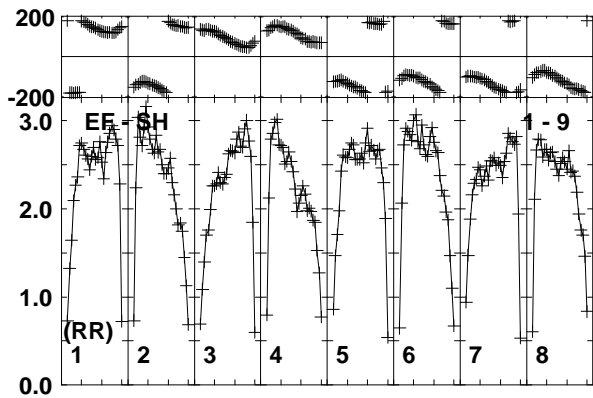
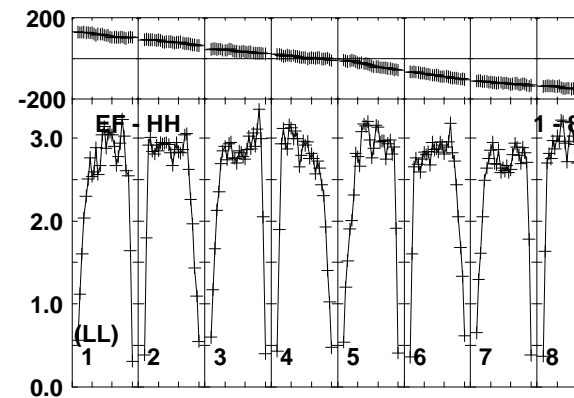
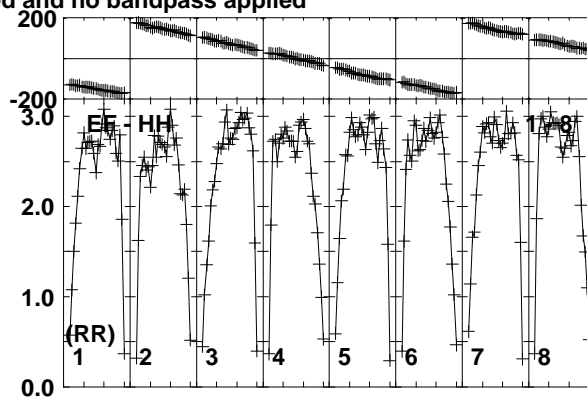
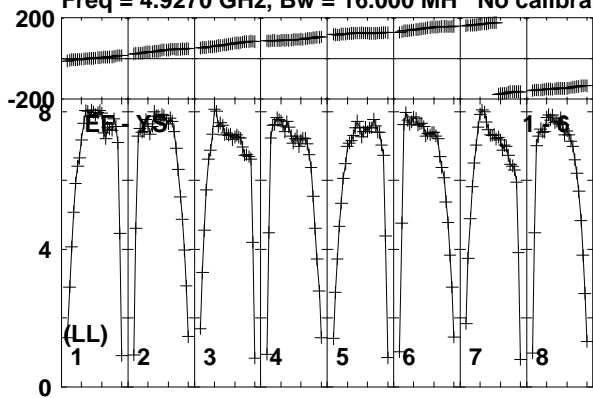

Lower frame: Milli Ampl Jy Top frame: Phas deg
Vector averaged cross-power spectrum Baseline: EF (01) - YS (06)
Timerange: 00/14:22:33 to 00/14:23:29

Plot file version 53 created 26-MAR-2015 15:27:37

V998ORI EG082E.UVDATA.1

Freq = 4.9270 GHz, Bw = 16.000 MH No calibration applied and no bandpass applied

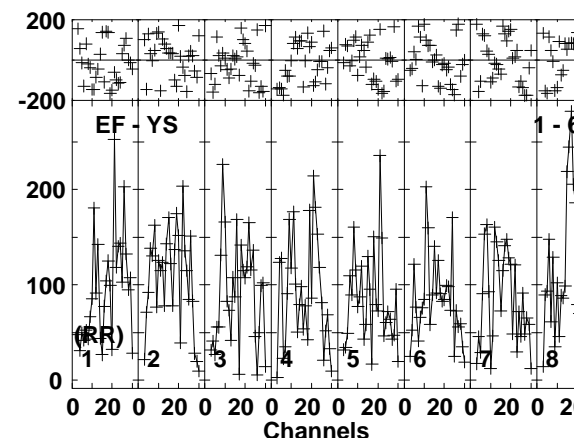
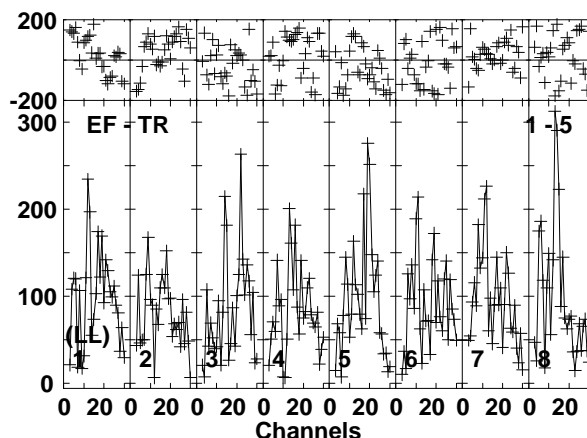
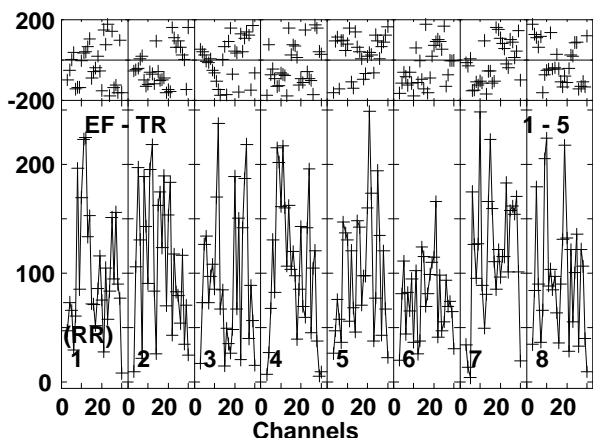
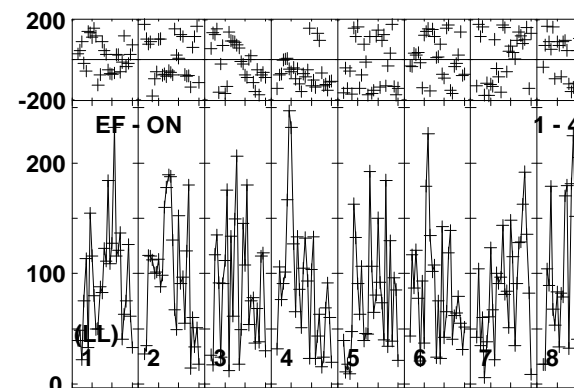
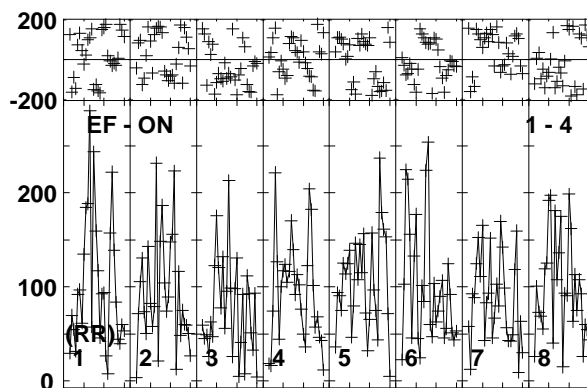
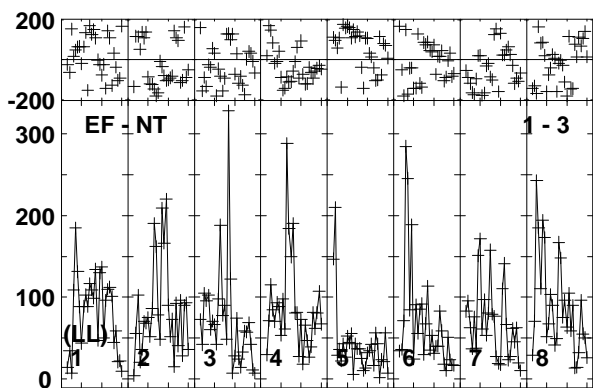
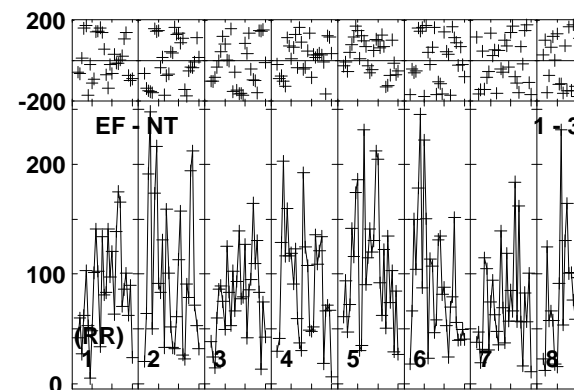
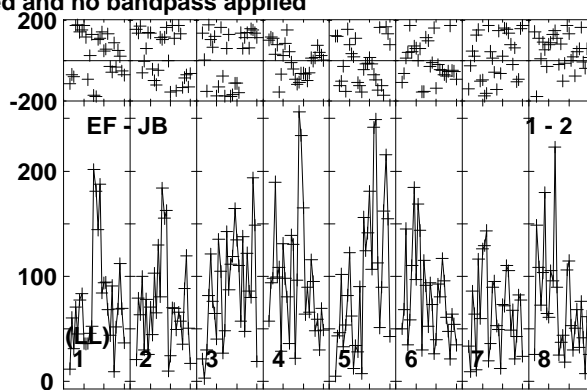
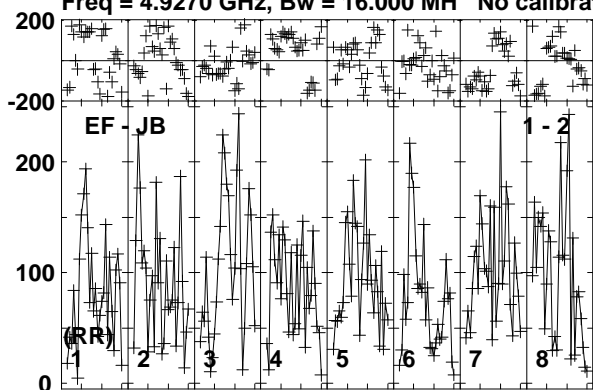

Lower frame: Micro Ampl Jy Top frame: Phas deg
Vector averaged cross-power spectrum Baseline: EF (01) - JB (02)
Timerange: 00/14:23:33 to 00/14:26:59

Plot file version 54 created 26-MAR-2015 15:27:37

V998ORI EG082E.UVDATA.1

Freq = 4.9270 GHz, Bw = 16.000 MH No calibration applied and no bandpass applied

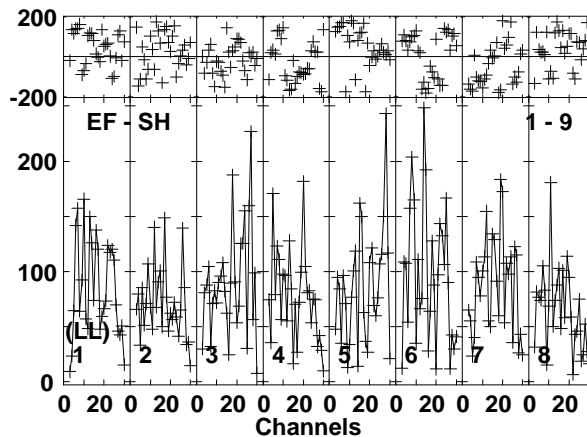
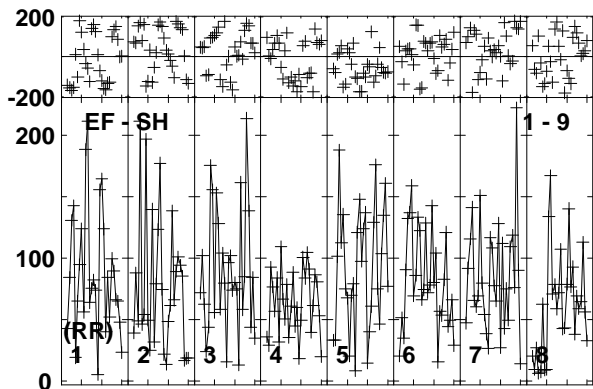
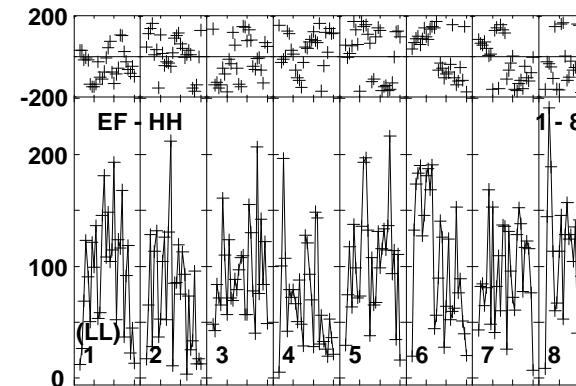
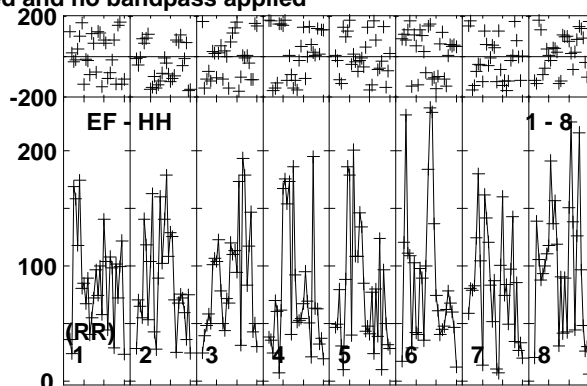
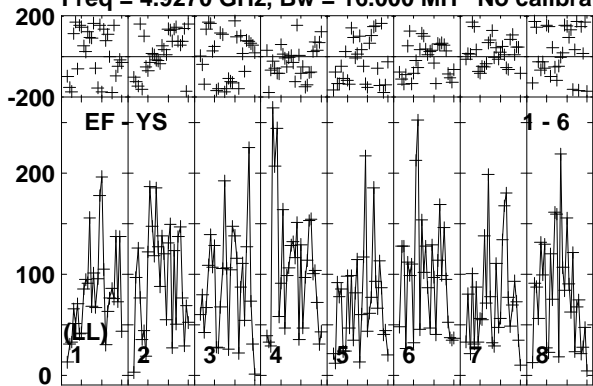

Lower frame: Micro Ampl Jy Top frame: Phas deg
Vector averaged cross-power spectrum Baseline: EF (01) - YS (06)
Timerange: 00/14:23:33 to 00/14:26:59

Plot file version 55 created 26-MAR-2015 15:27:38

J0519+0848 EG082E.UVDATA.1

Freq = 4.9270 GHz, Bw = 16.000 MH No calibration applied and no bandpass applied

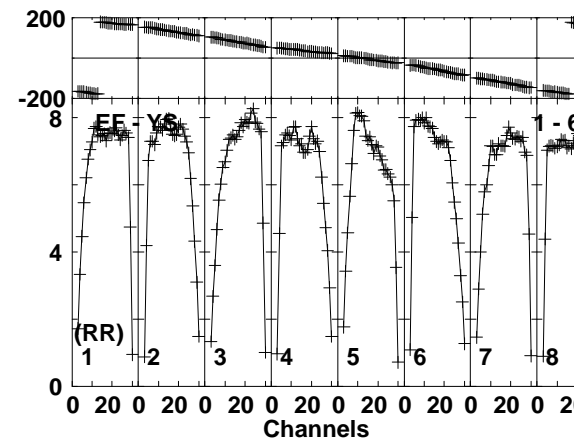
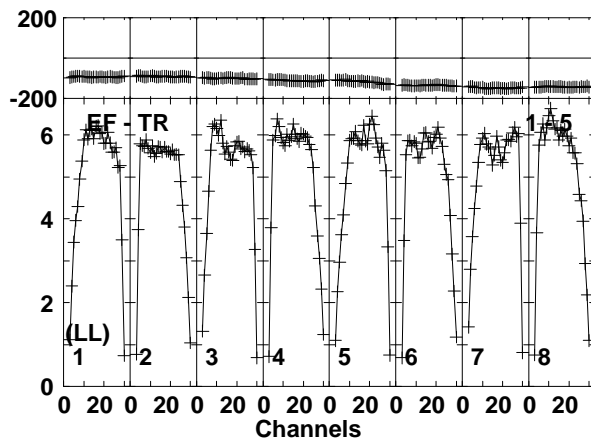
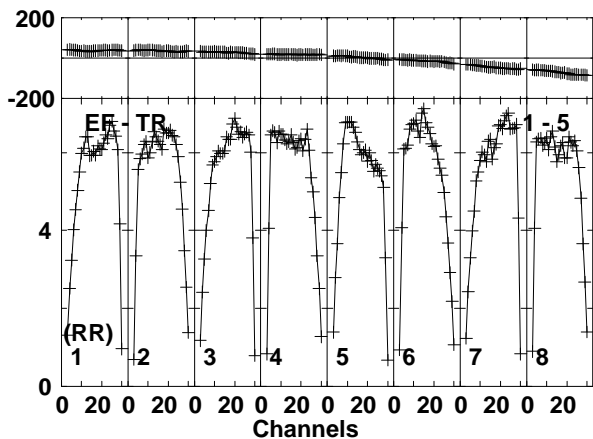
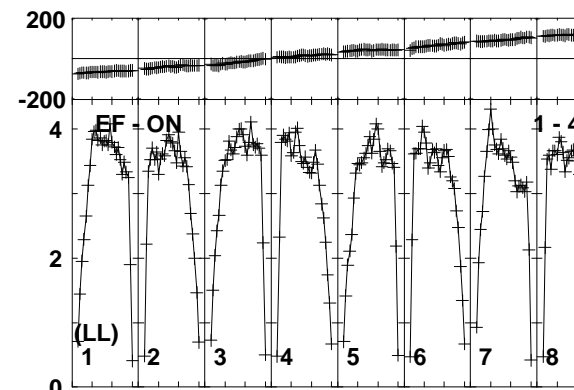
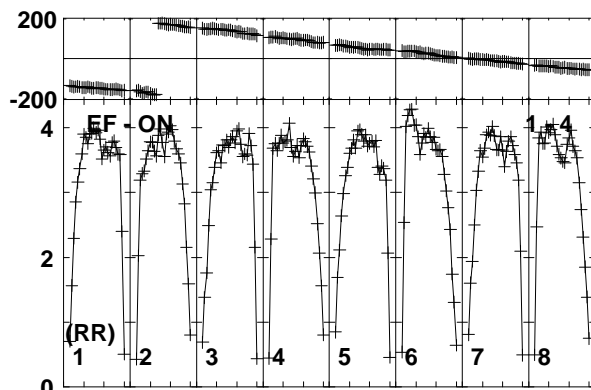
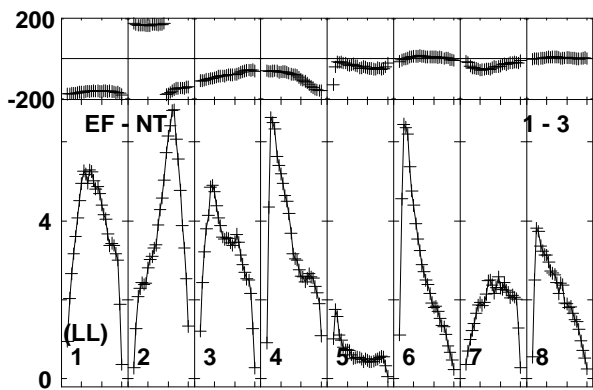
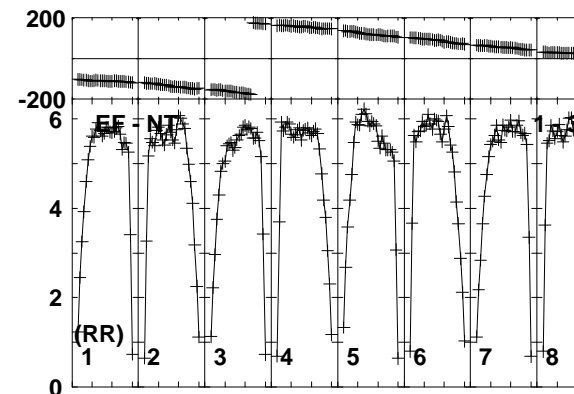
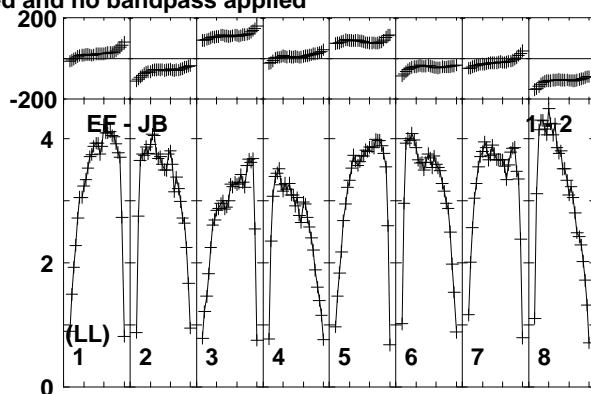
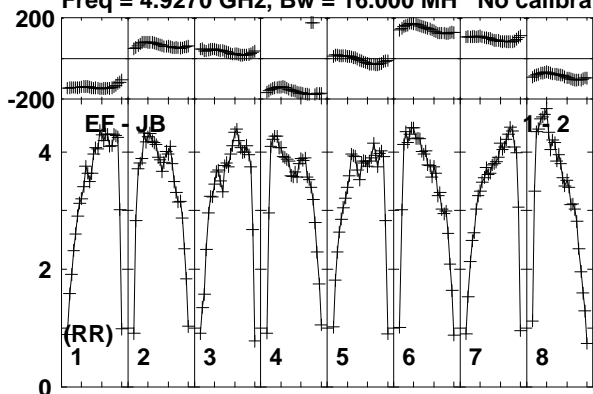

Lower frame: Milli Ampl Jy Top frame: Phas deg
Vector averaged cross-power spectrum Baseline: EF (01) - JB (02)
Timerange: 00/14:27:03 to 00/14:28:29

Plot file version 56 created 26-MAR-2015 15:27:38

J0519+0848 EG082E.UVDATA.1

Freq = 4.9270 GHz, Bw = 16.000 MH No calibration applied and no bandpass applied

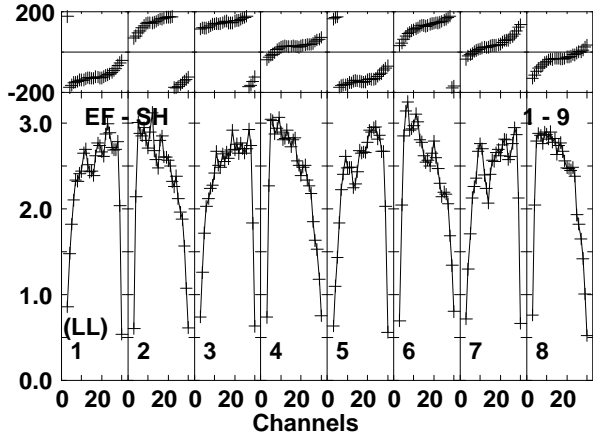
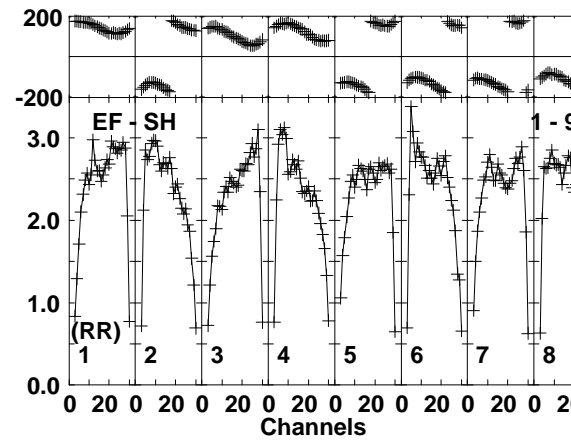
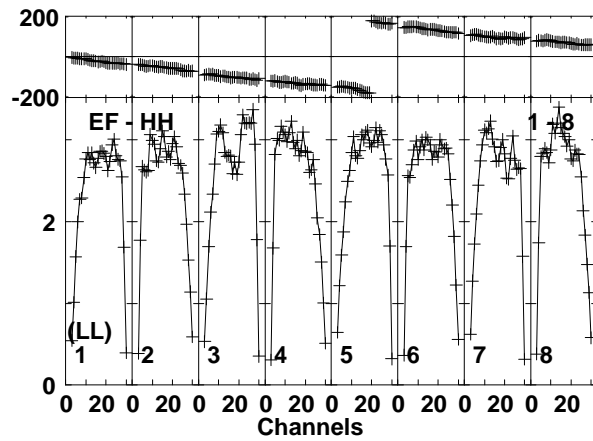
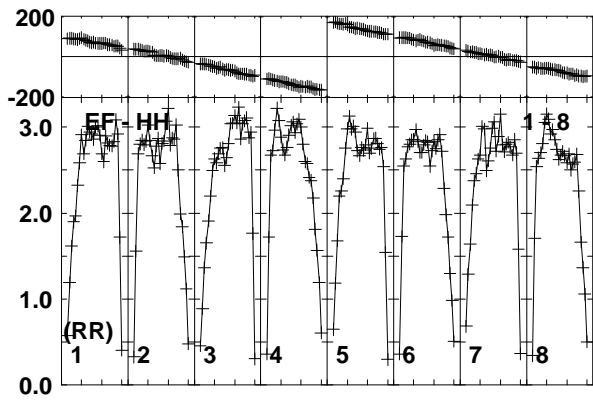
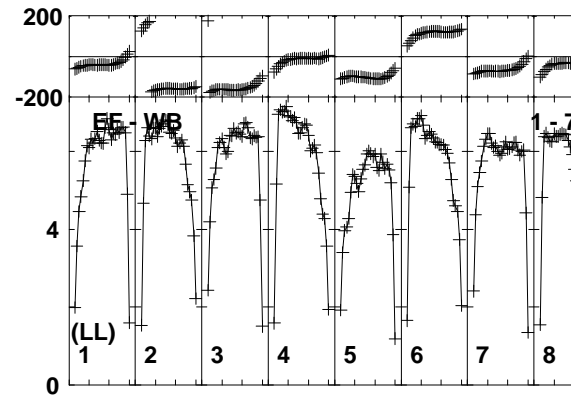
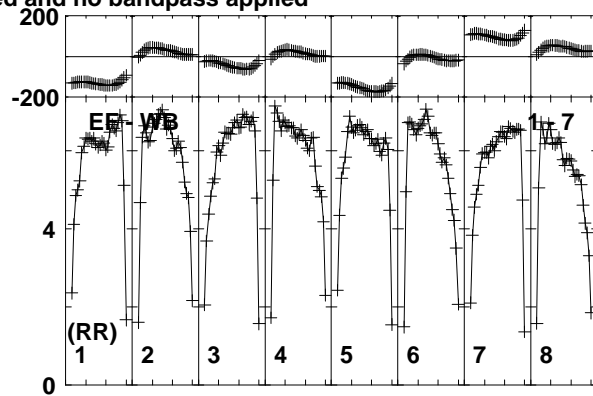
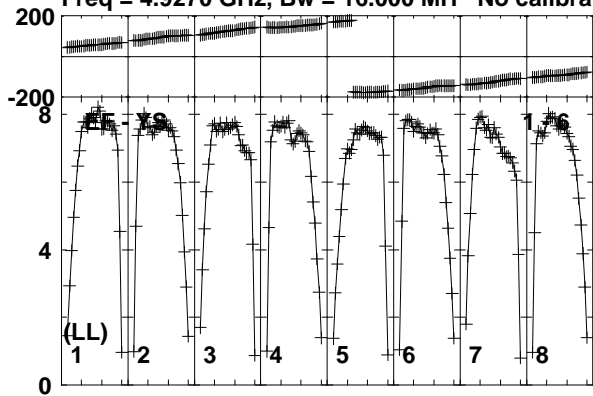

Lower frame: Milli Ampl Jy Top frame: Phas deg
Vector averaged cross-power spectrum Baseline: EF (01) - YS (06)
Timerange: 00/14:27:03 to 00/14:28:29

Plot file version 57 created 26-MAR-2015 15:27:38

V998ORI EG082E.UVDATA.1

Freq = 4.9270 GHz, Bw = 16.000 MH No calibration applied and no bandpass applied

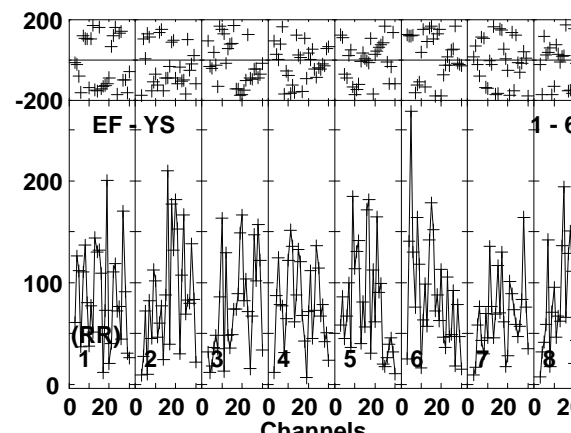
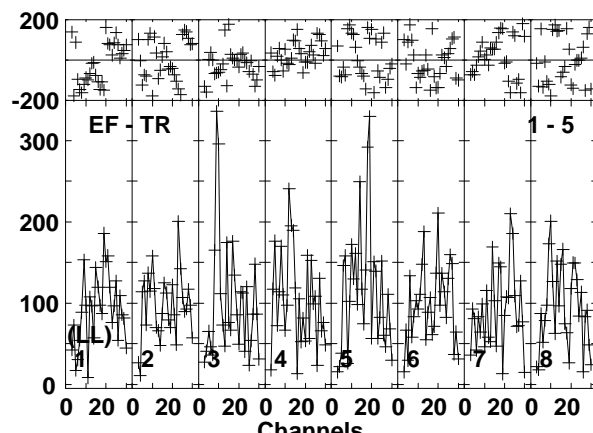
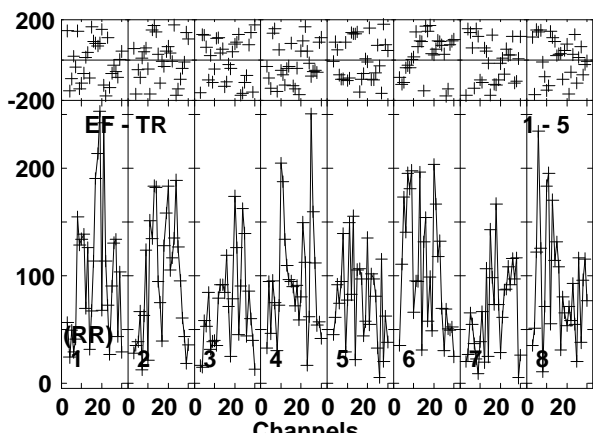
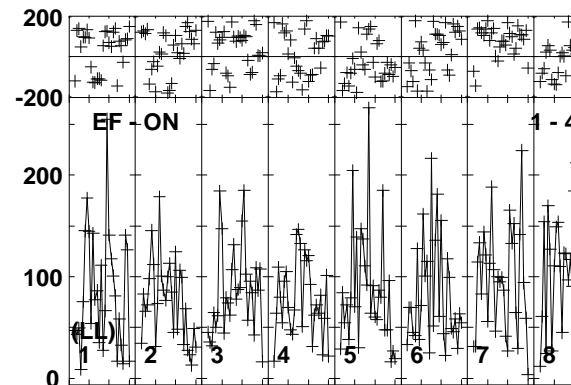
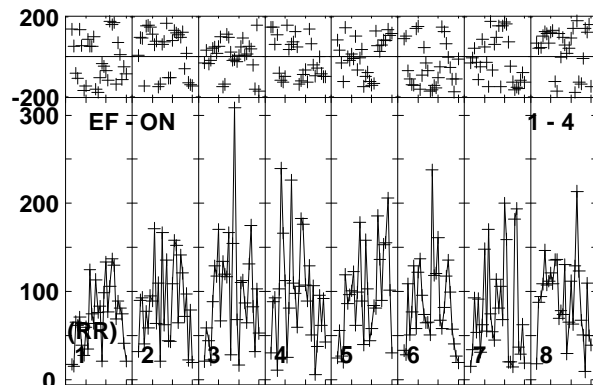
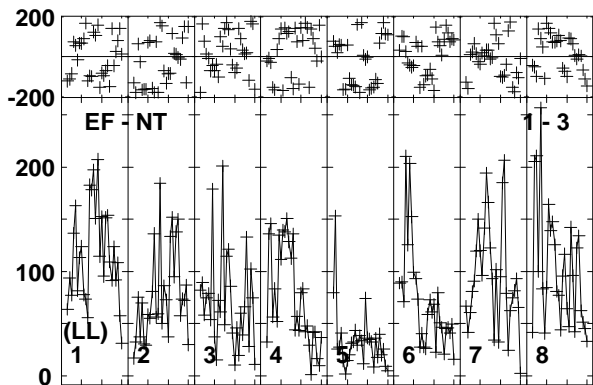
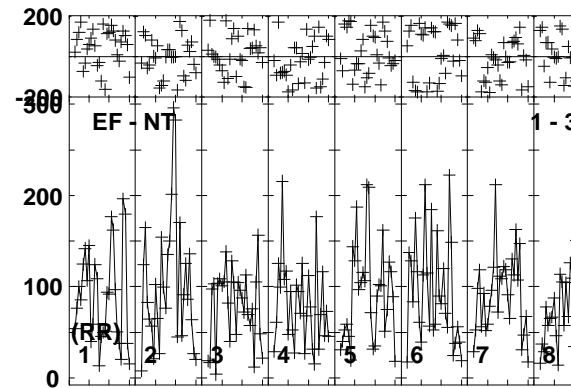
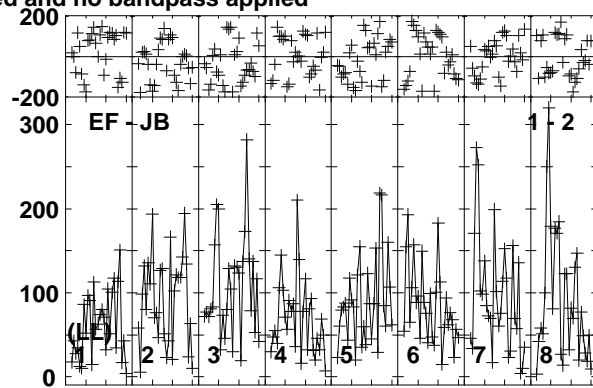
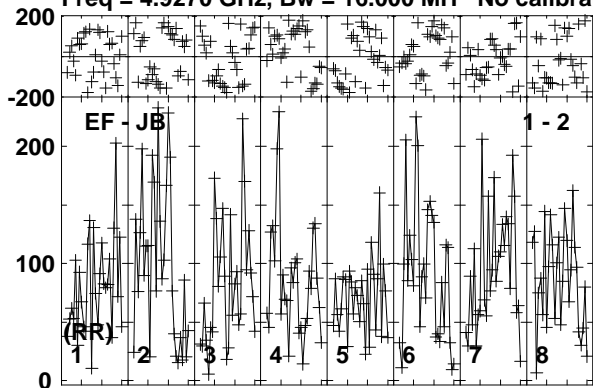

Lower frame: Micro Ampl Jy Top frame: Phas deg
Vector averaged cross-power spectrum Baseline: EF (01) - JB (02)
Timerange: 00/14:28:33 to 00/14:31:59

Plot file version 58 created 26-MAR-2015 15:27:38

V998ORI EG082E.UVDATA.1

Freq = 4.9270 GHz, Bw = 16.000 MH No calibration applied and no bandpass applied

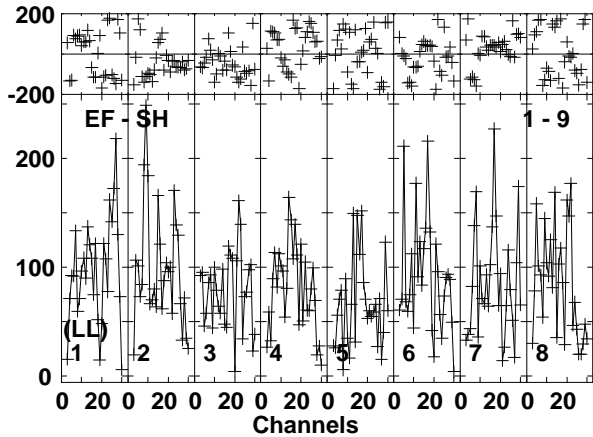
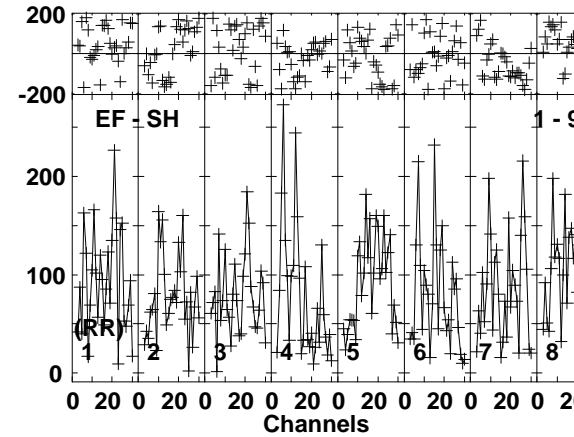
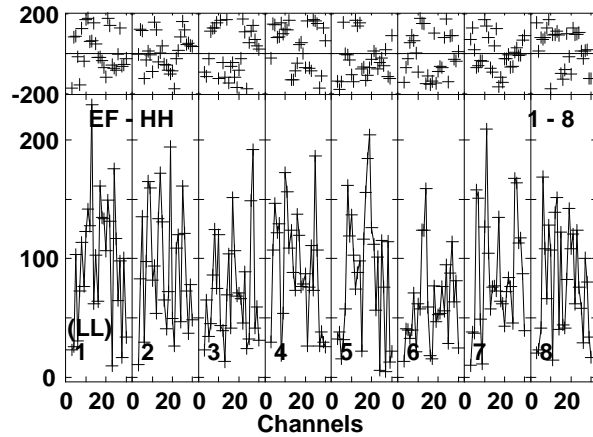
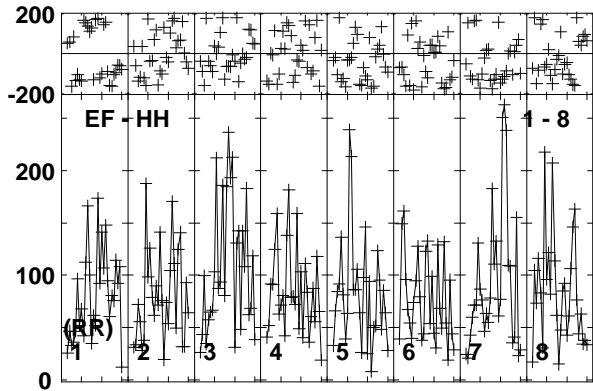
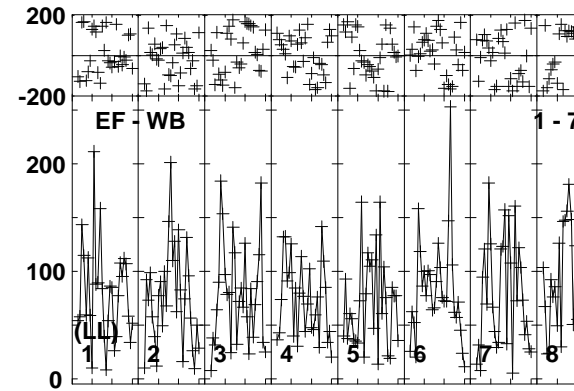
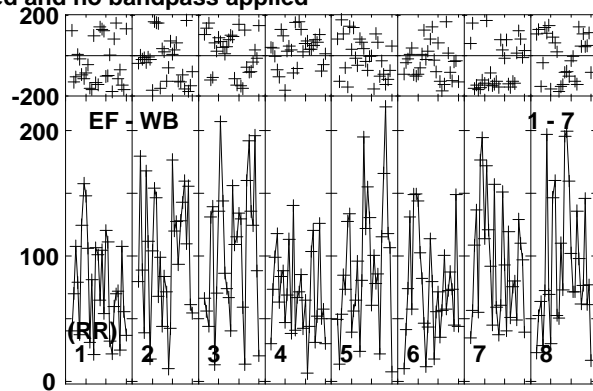
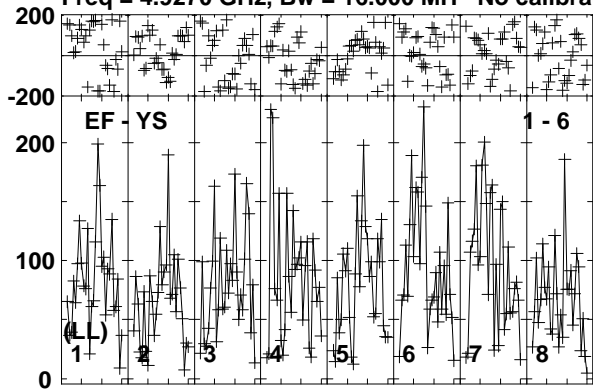

Lower frame: Micro Ampl Jy Top frame: Phas deg
Vector averaged cross-power spectrum Baseline: EF (01) - YS (06)
Timerange: 00/14:28:33 to 00/14:31:59

Plot file version 59 created 26-MAR-2015 15:27:38

J0519+0848 EG082E.UVDATA.1

Freq = 4.9270 GHz, Bw = 16.000 MH No calibration applied and no bandpass applied

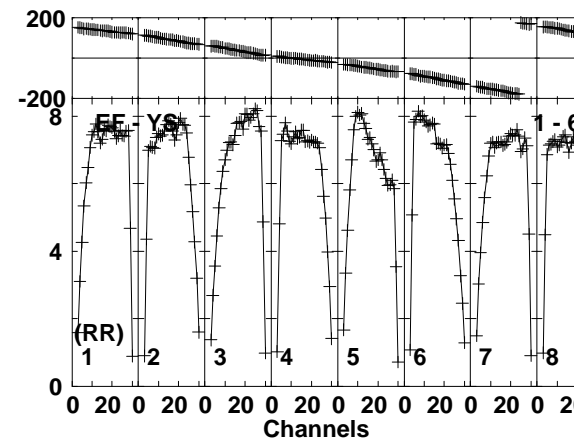
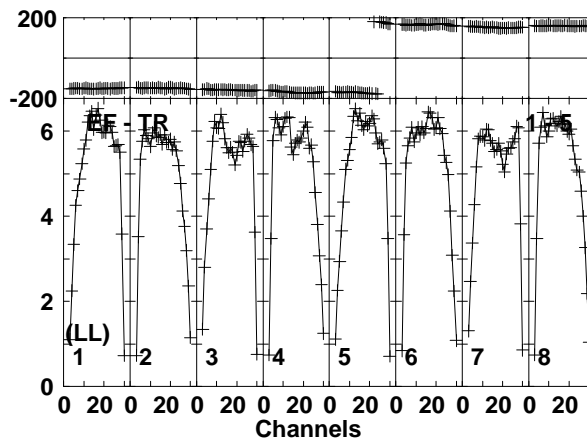
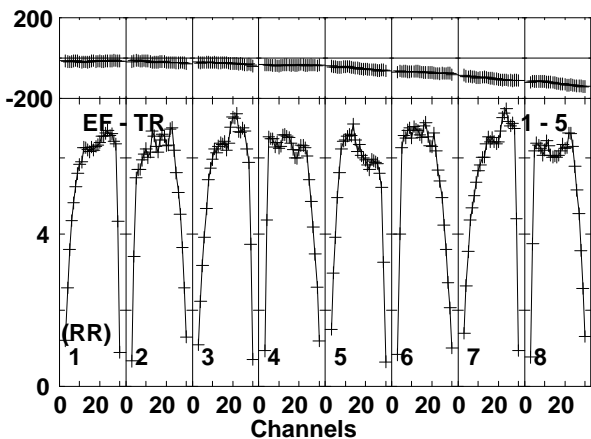
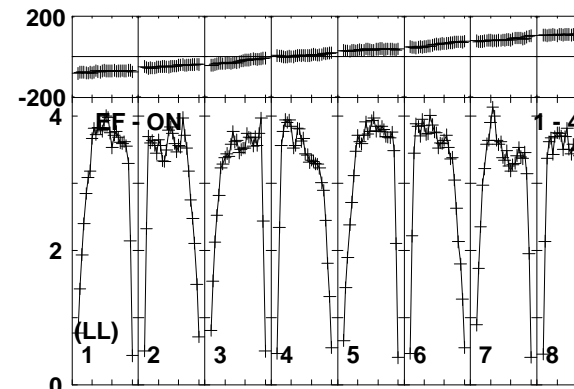
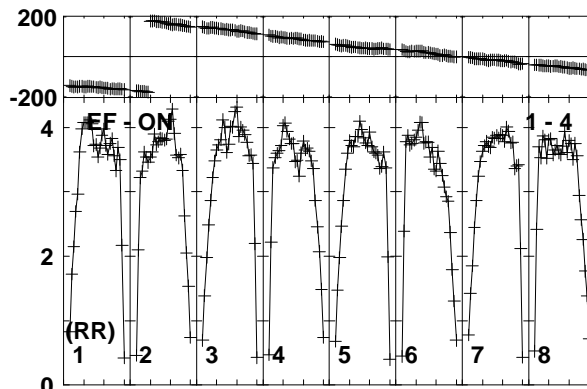
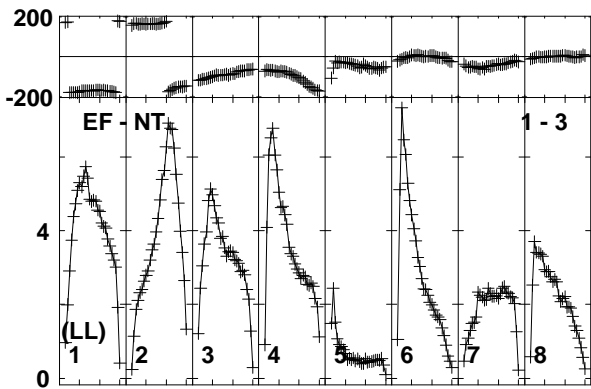
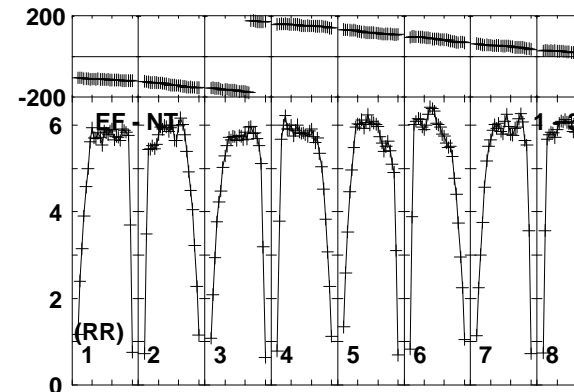
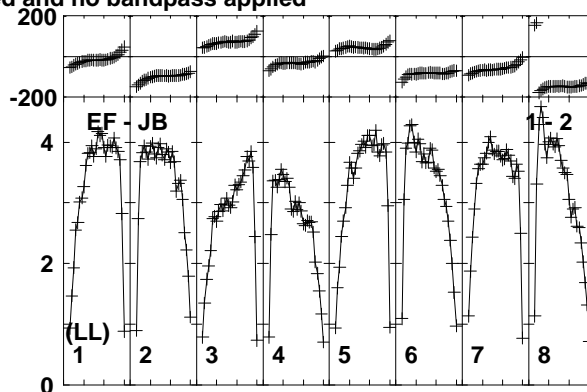
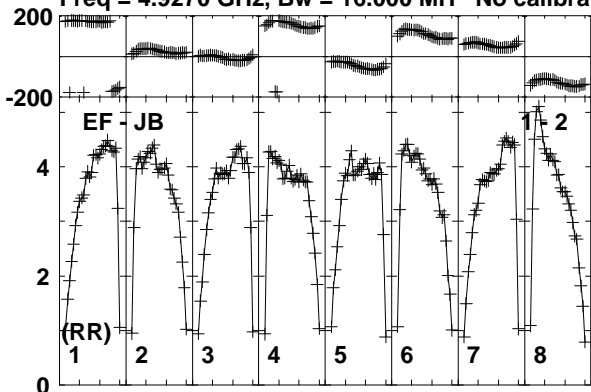

Lower frame: Milli Ampl Jy Top frame: Phas deg
Vector averaged cross-power spectrum Baseline: EF (01) - JB (02)
Timerange: 00/14:32:33 to 00/14:33:29

Plot file version 60 created 26-MAR-2015 15:27:38

J0519+0848 EG082E.UVDATA.1

Freq = 4.9270 GHz, Bw = 16.000 MH No calibration applied and no bandpass applied

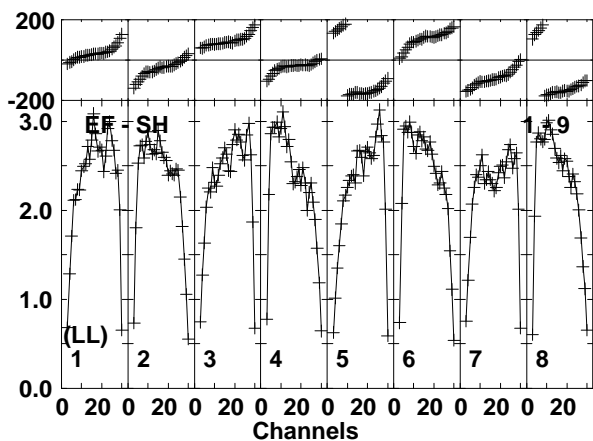
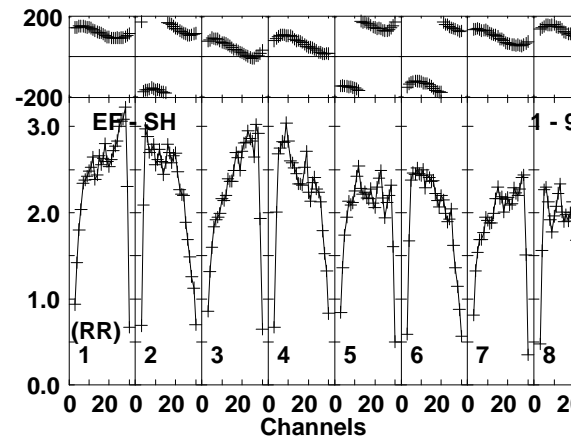
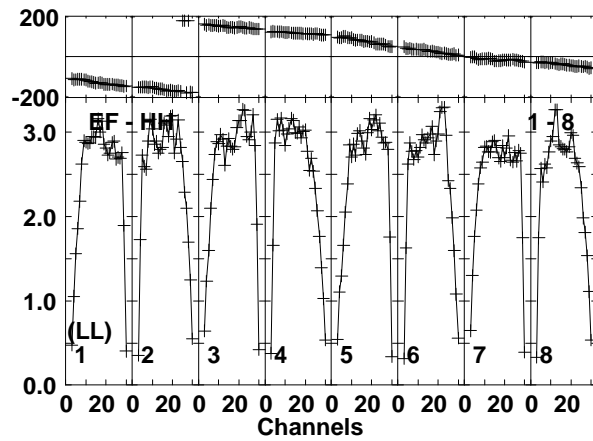
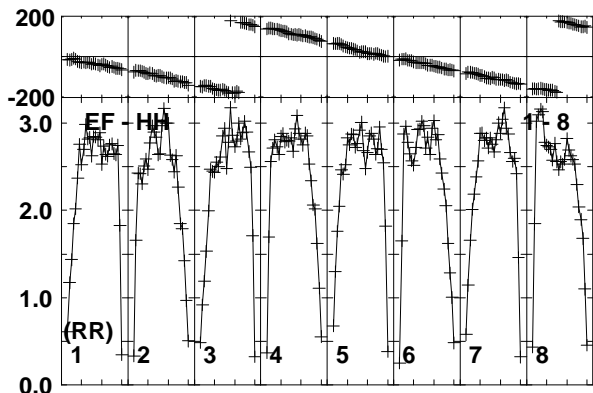
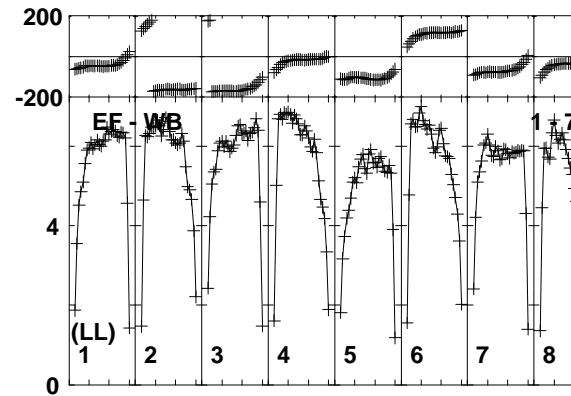
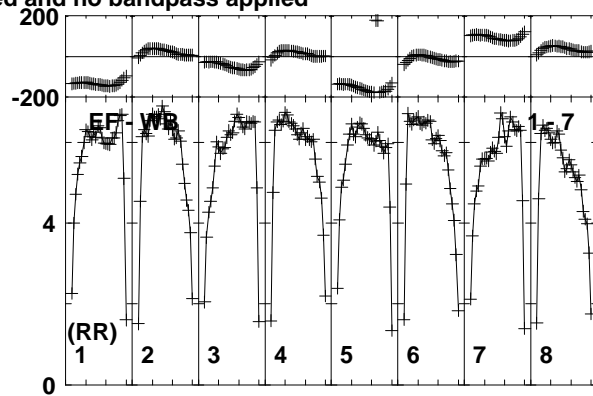
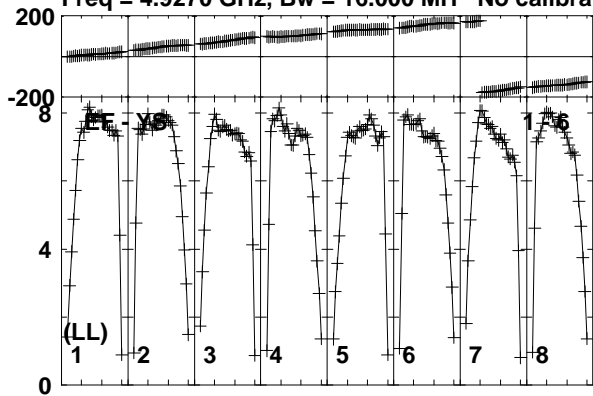

Lower frame: Milli Ampl Jy Top frame: Phas deg
Vector averaged cross-power spectrum Baseline: EF (01) - YS (06)
Timerange: 00/14:32:33 to 00/14:33:29

Plot file version 61 created 26-MAR-2015 15:27:38

V998ORI EG082E.UVDATA.1

Freq = 4.9270 GHz, Bw = 16.000 MH No calibration applied and no bandpass applied

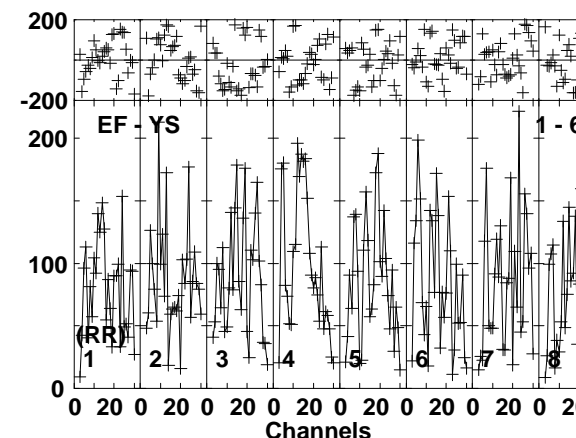
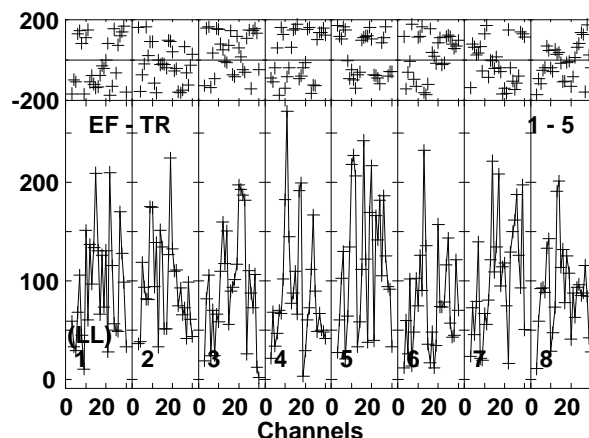
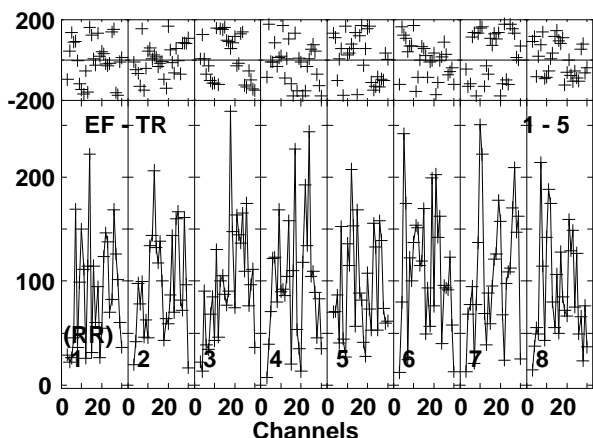
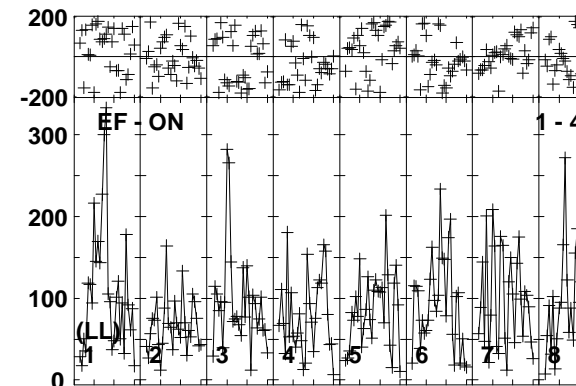
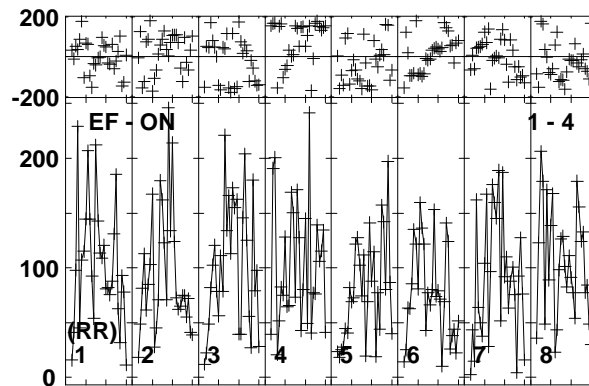
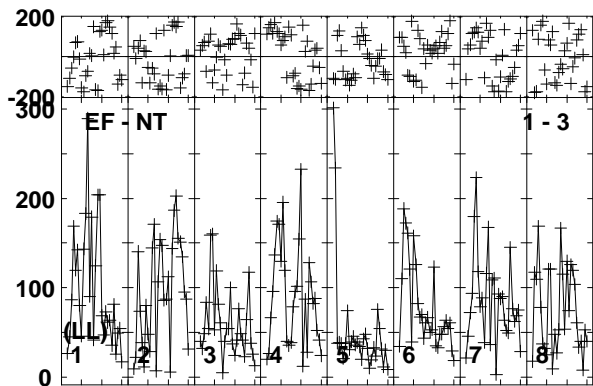
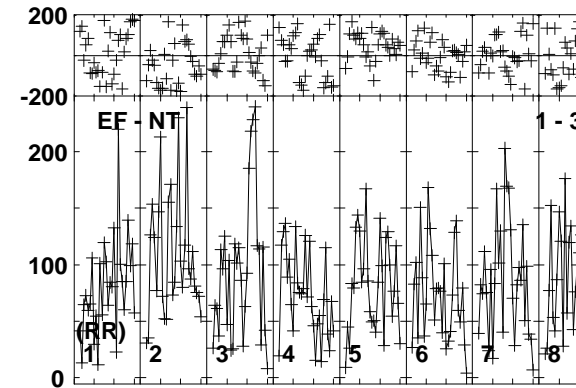
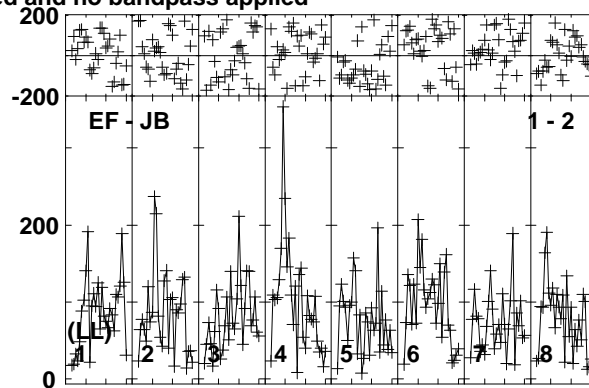
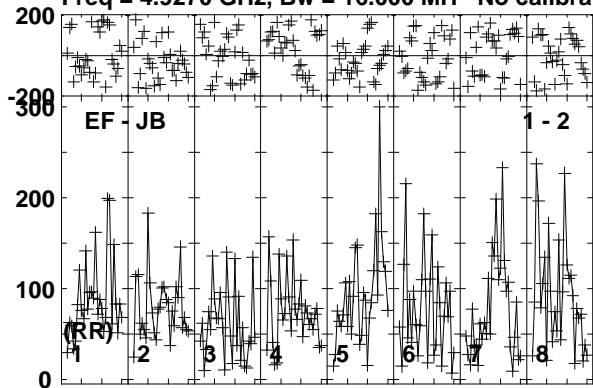

Lower frame: Micro Ampl Jy Top frame: Phas deg
Vector averaged cross-power spectrum Baseline: EF (01) - JB (02)
Timerange: 00/14:33:33 to 00/14:36:59

Plot file version 63 created 26-MAR-2015 15:27:38

J0519+0848 EG082E.UVDATA.1

Freq = 4.9270 GHz, Bw = 16.000 MH No calibration applied and no bandpass applied

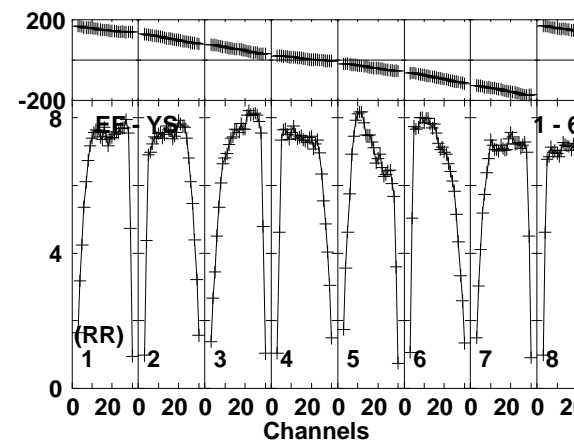
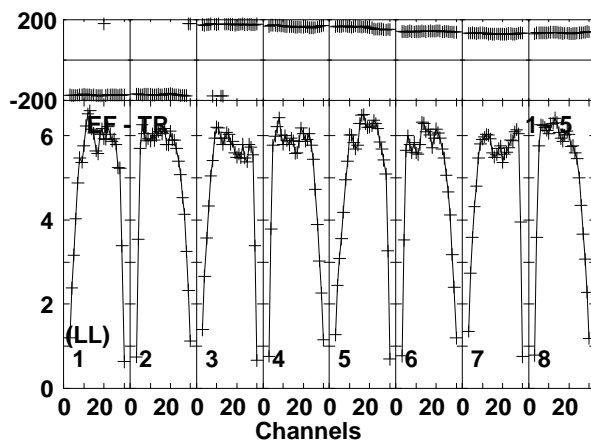
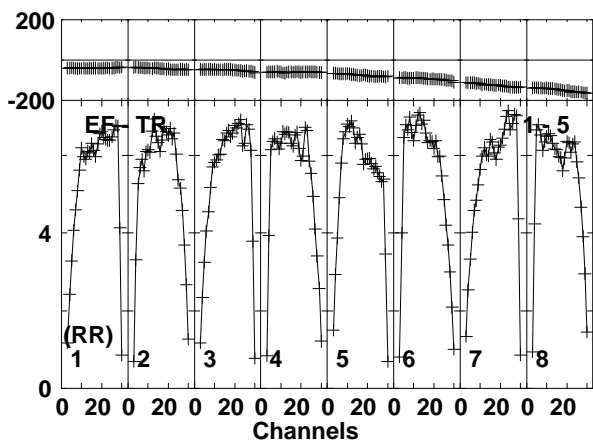
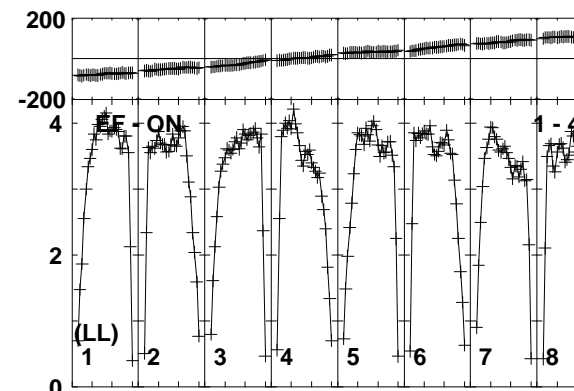
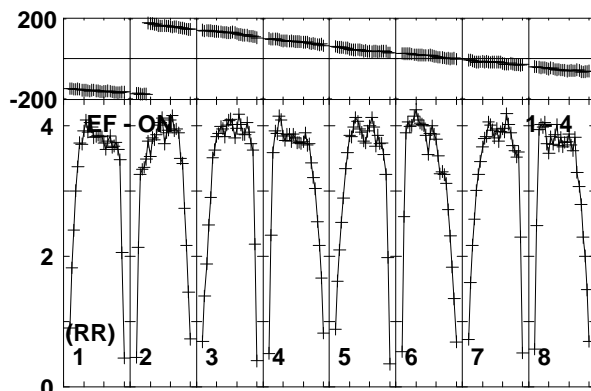
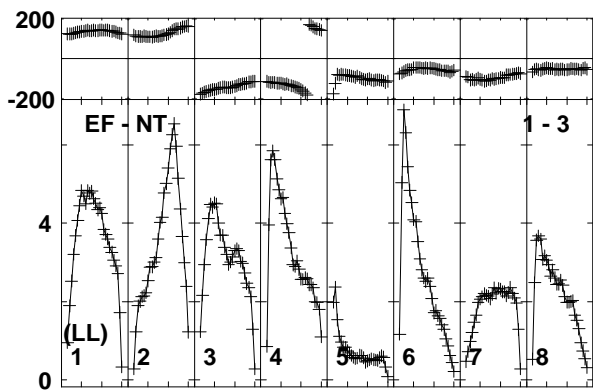
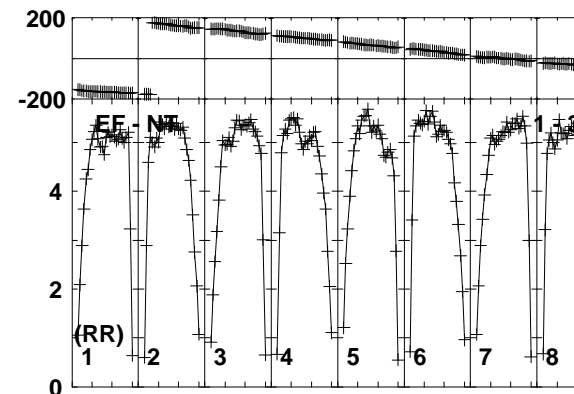
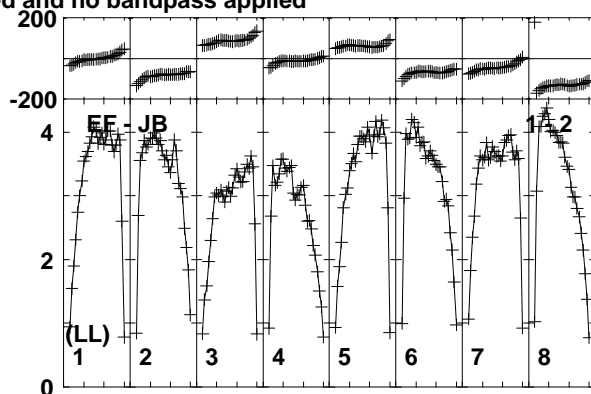
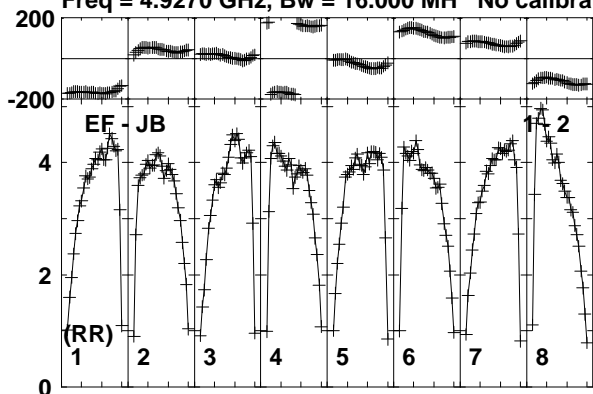

Lower frame: Milli Ampl Jy Top frame: Phas deg
Vector averaged cross-power spectrum Baseline: EF (01) - JB (02)
Timerange: 00/14:37:03 to 00/14:38:29

Plot file version 64 created 26-MAR-2015 15:27:38

J0519+0848 EG082E.UVDATA.1

Freq = 4.9270 GHz, Bw = 16.000 MH No calibration applied and no bandpass applied

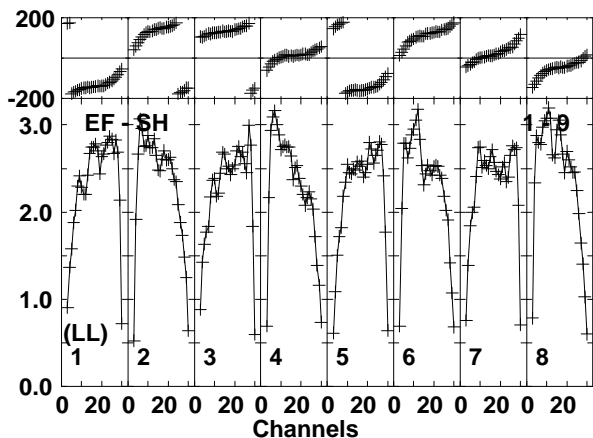
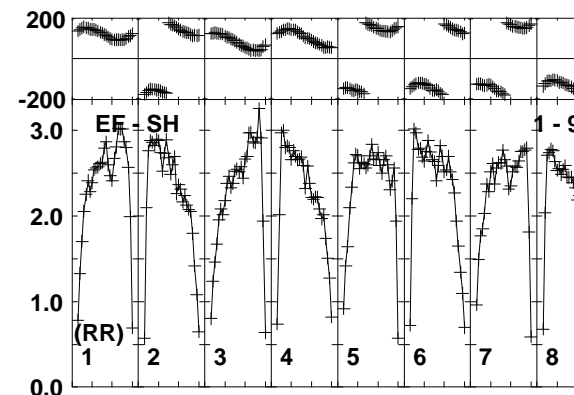
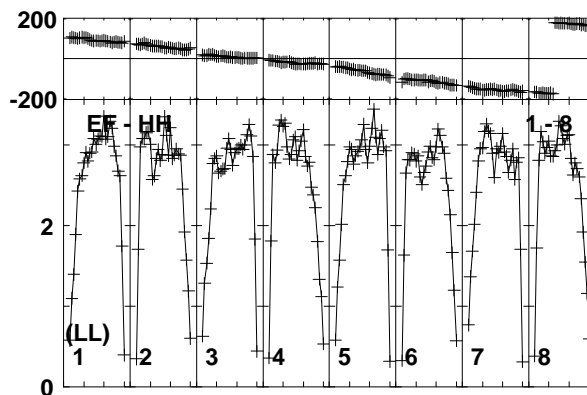
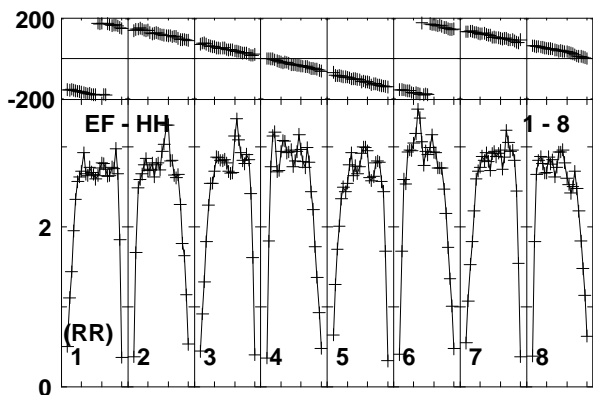
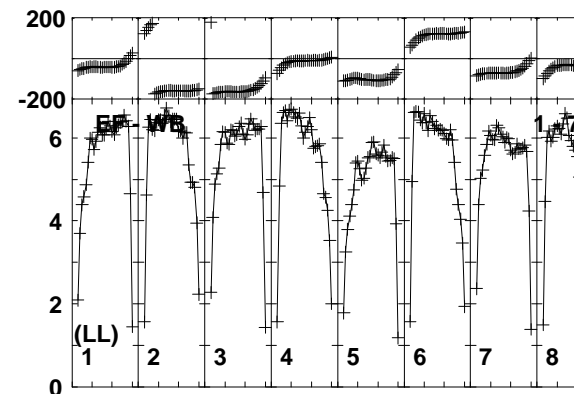
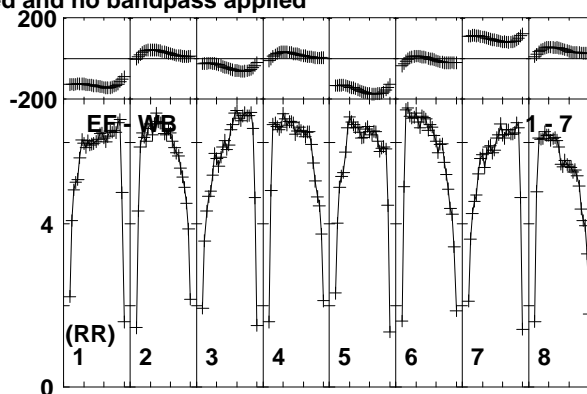
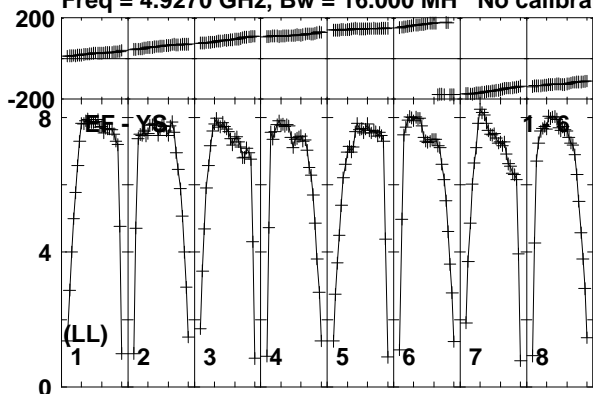

Lower frame: Milli Ampl Jy Top frame: Phas deg
Vector averaged cross-power spectrum Baseline: EF (01) - YS (06)
Timerange: 00/14:37:03 to 00/14:38:29

Plot file version 65 created 26-MAR-2015 15:27:38

J0525+0951 EG082E.UVDATA.1

Freq = 4.9270 GHz, Bw = 16.000 MH No calibration applied and no bandpass applied

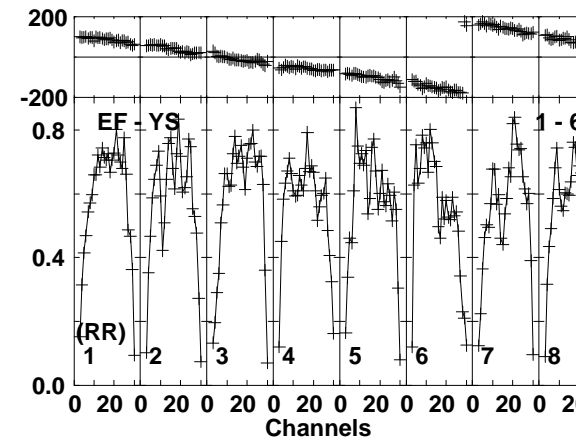
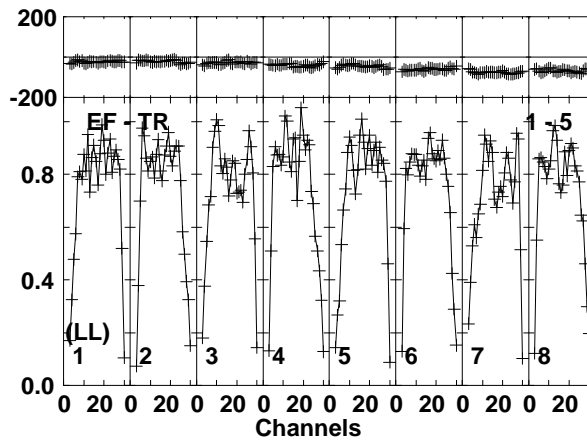
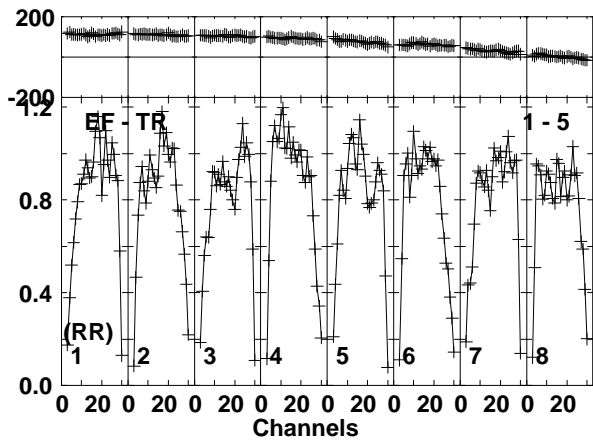
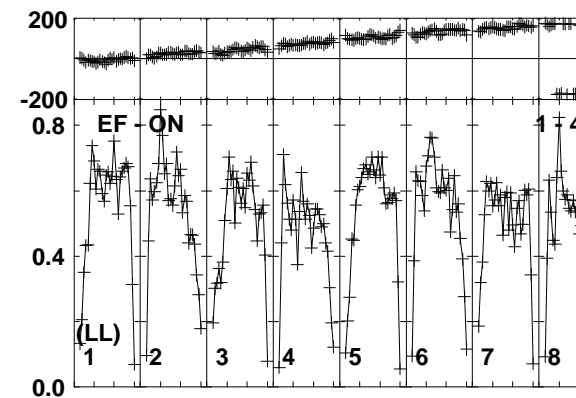
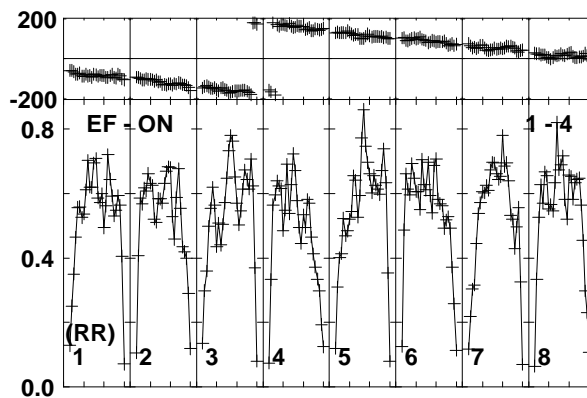
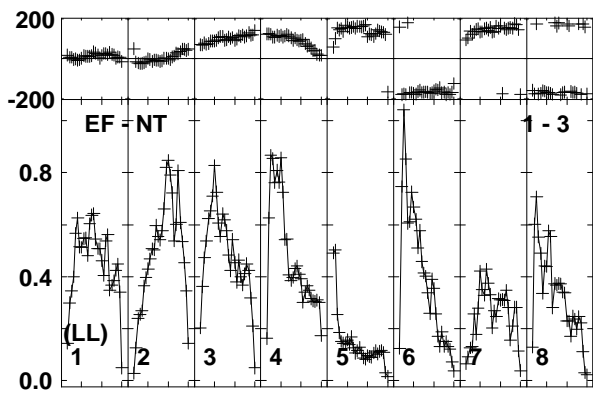
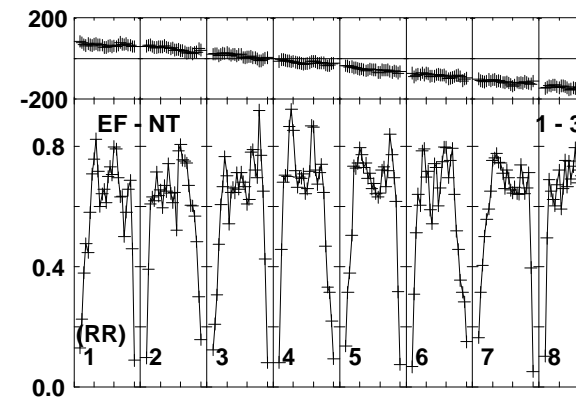
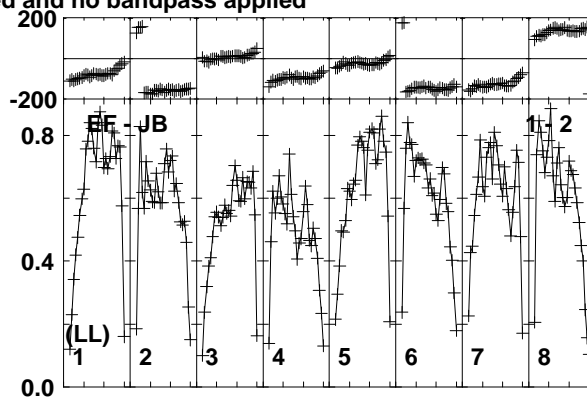
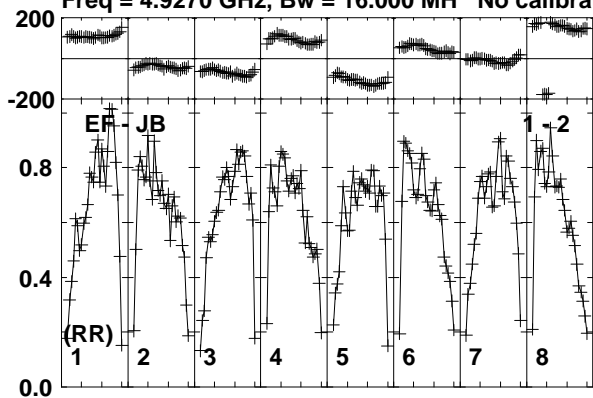

Lower frame: Milli Ampl Jy Top frame: Phas deg
Vector averaged cross-power spectrum Baseline: EF (01) - JB (02)
Timerange: 00/14:38:33 to 00/14:41:59

Plot file version 66 created 26-MAR-2015 15:27:38

J0525+0951 EG082E.UVDATA.1

Freq = 4.9270 GHz, Bw = 16.000 MH No calibration applied and no bandpass applied

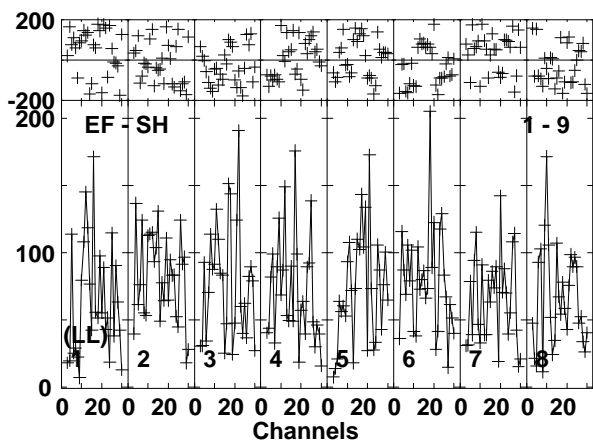
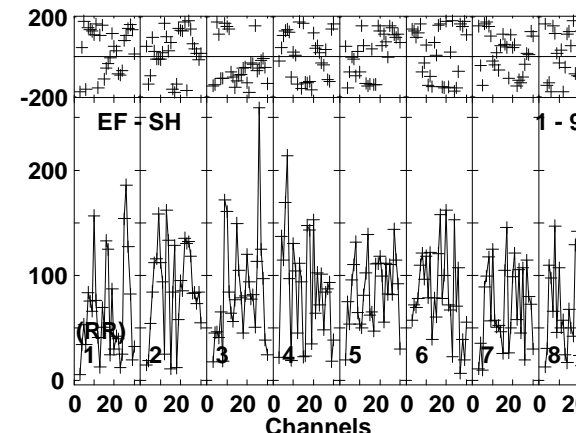
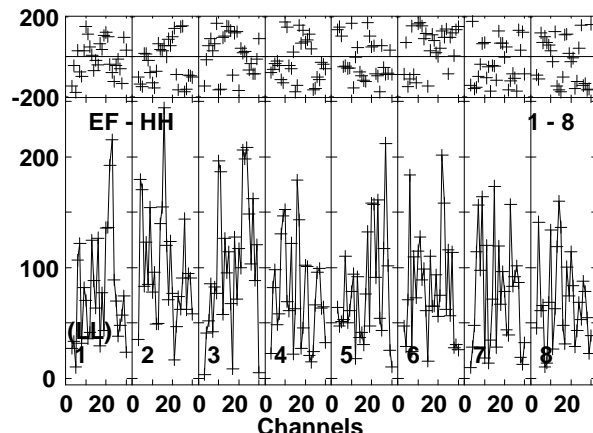
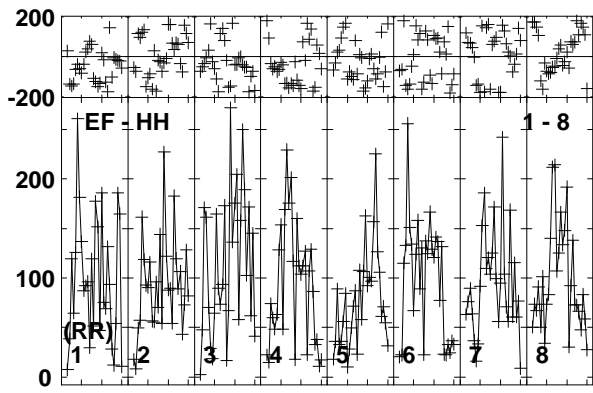
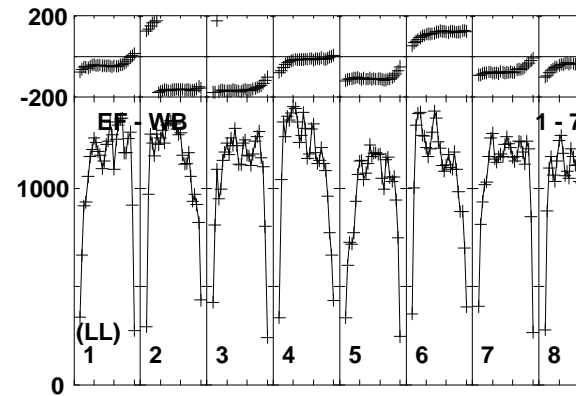
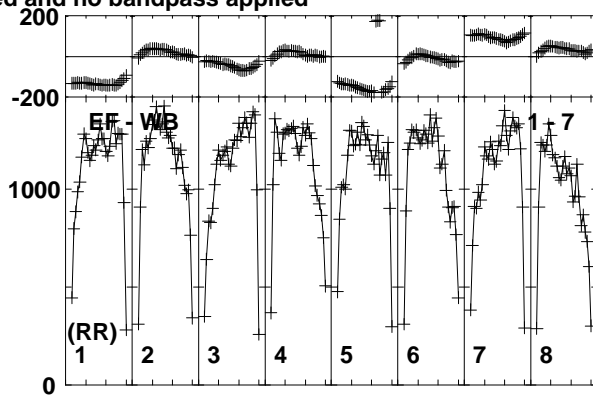
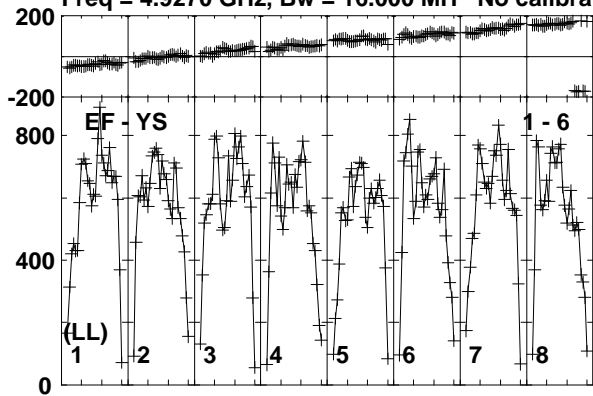

Lower frame: Micro Ampl Jy Top frame: Phas deg
Vector averaged cross-power spectrum Baseline: EF (01) - YS (06)
Timerange: 00/14:38:33 to 00/14:41:59

Plot file version 67 created 26-MAR-2015 15:27:38

J0519+0848 EG082E.UVDATA.1

Freq = 4.9270 GHz, Bw = 16.000 MH No calibration applied and no bandpass applied

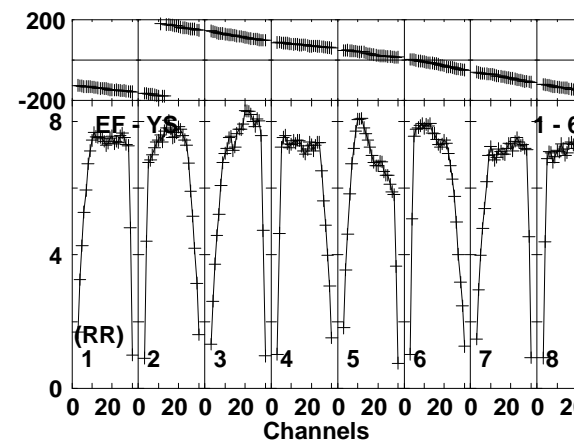
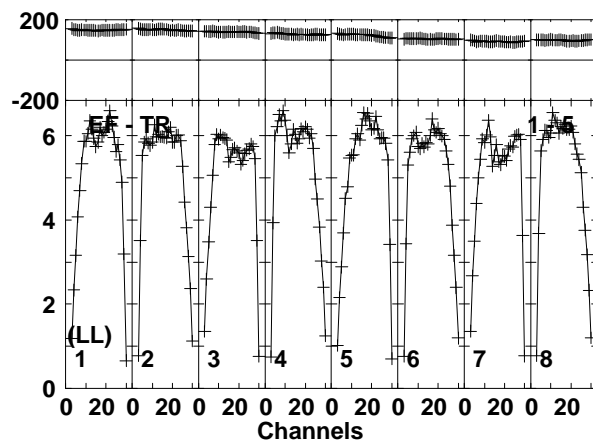
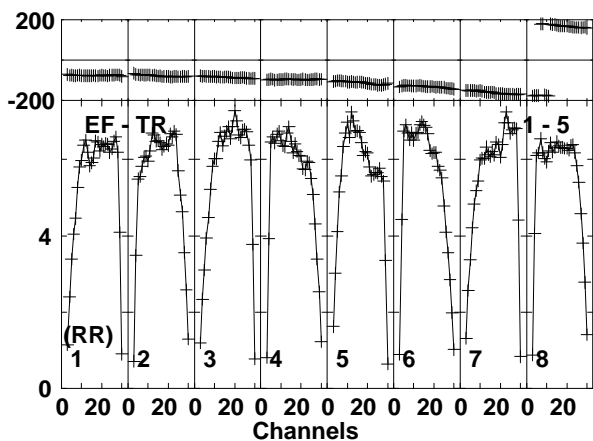
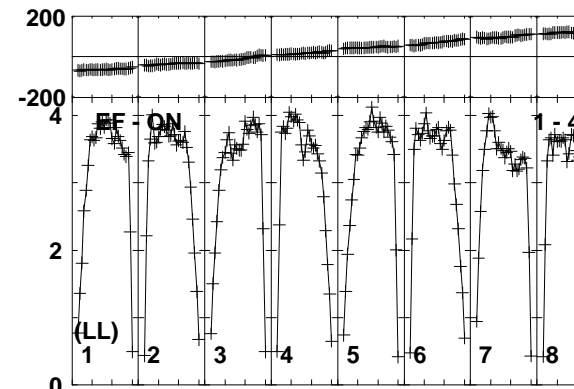
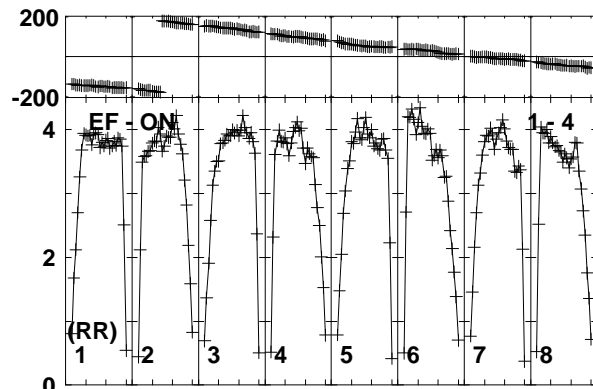
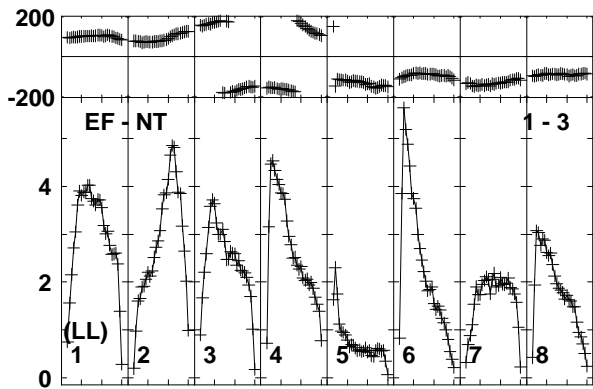
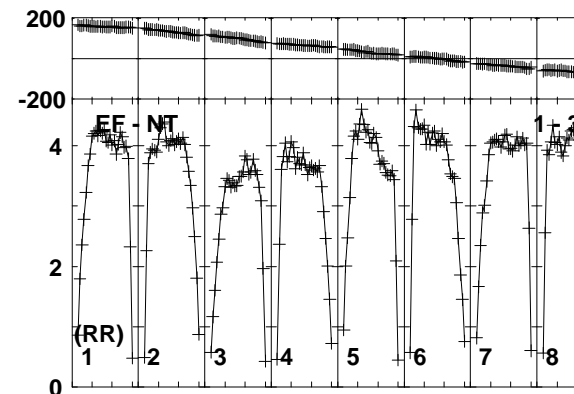
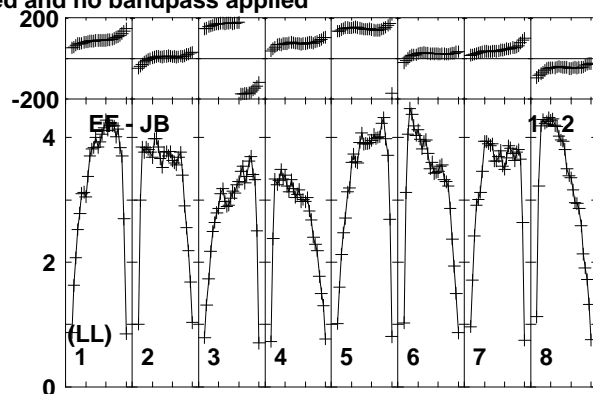
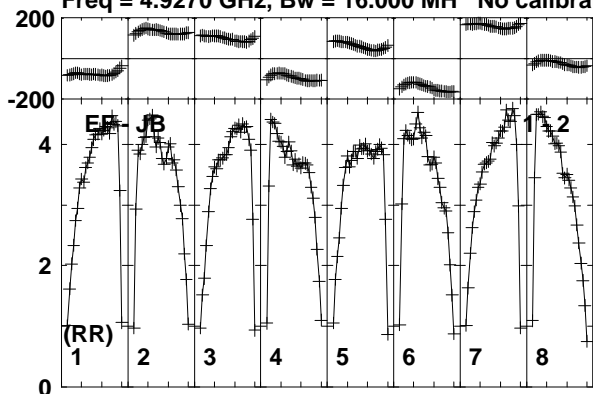

Lower frame: Milli Ampl Jy Top frame: Phas deg
Vector averaged cross-power spectrum Baseline: EF (01) - JB (02)
Timerange: 00/14:42:33 to 00/14:43:29

Plot file version 68 created 26-MAR-2015 15:27:38

J0519+0848 EG082E.UVDATA.1

Freq = 4.9270 GHz, Bw = 16.000 MH No calibration applied and no bandpass applied

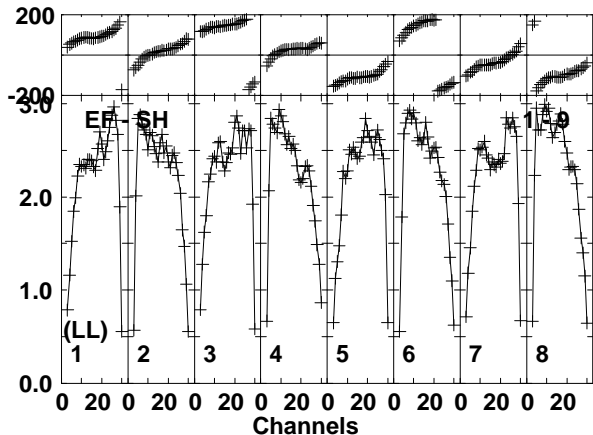
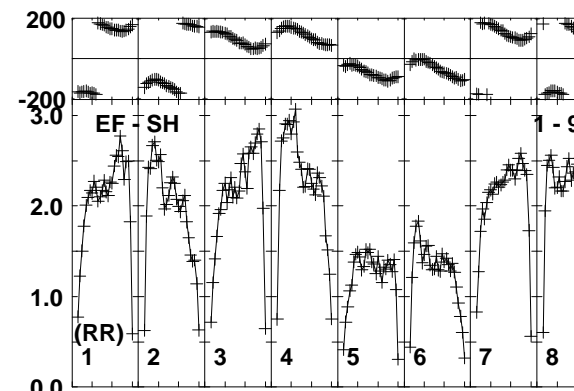
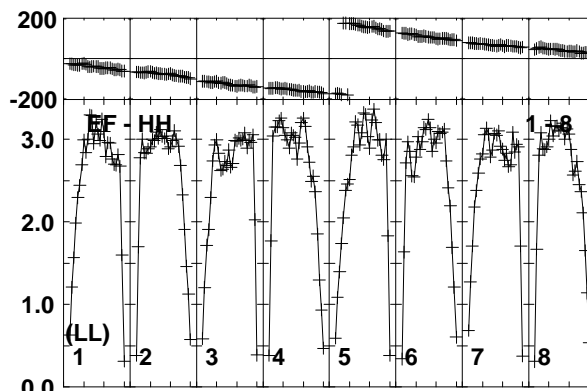
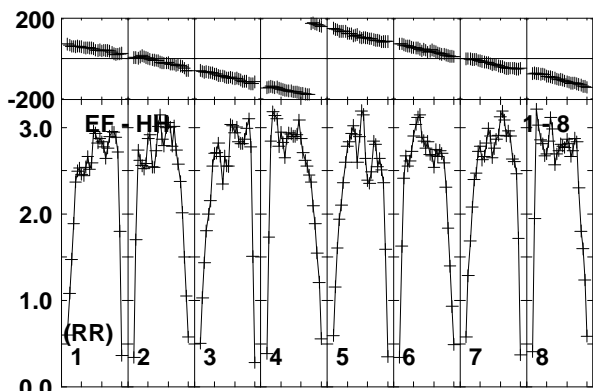
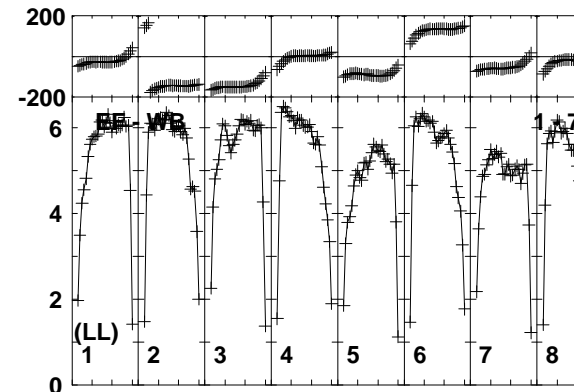
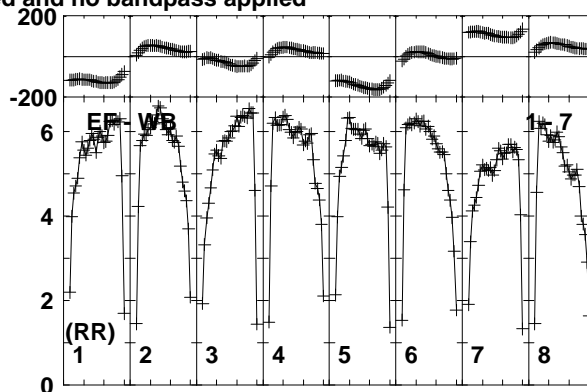
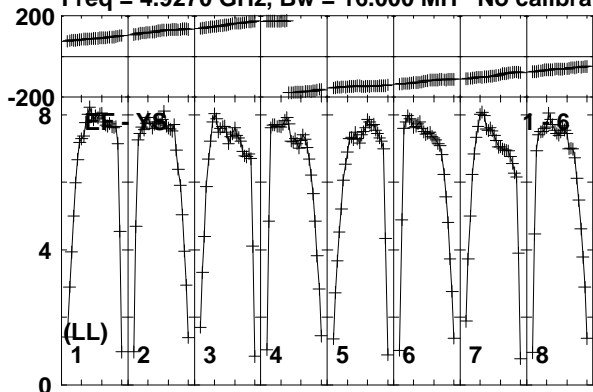

Lower frame: Milli Ampl Jy Top frame: Phas deg
Vector averaged cross-power spectrum Baseline: EF (01) - YS (06)
Timerange: 00/14:42:33 to 00/14:43:29

Plot file version 69 created 26-MAR-2015 15:27:38

V998ORI EG082E.UVDATA.1

Freq = 4.9270 GHz, Bw = 16.000 MH No calibration applied and no bandpass applied

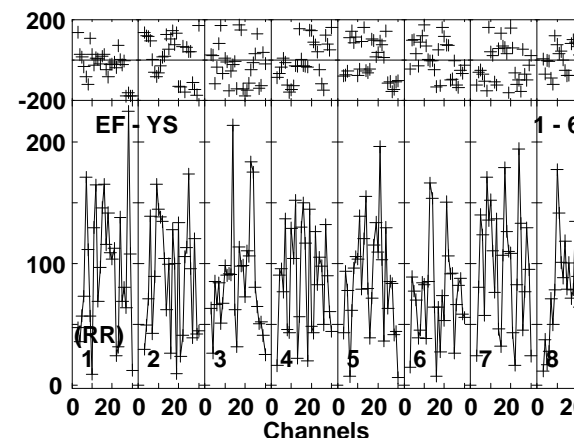
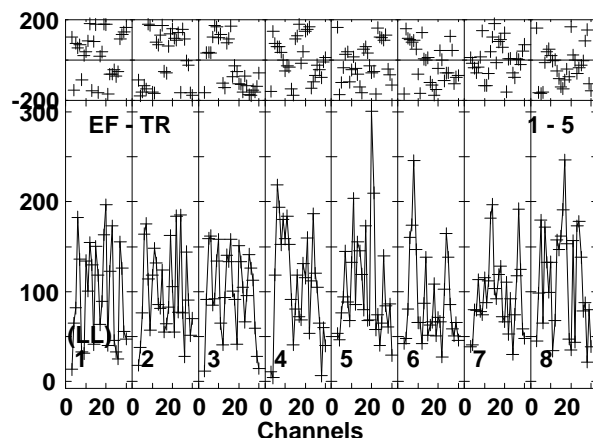
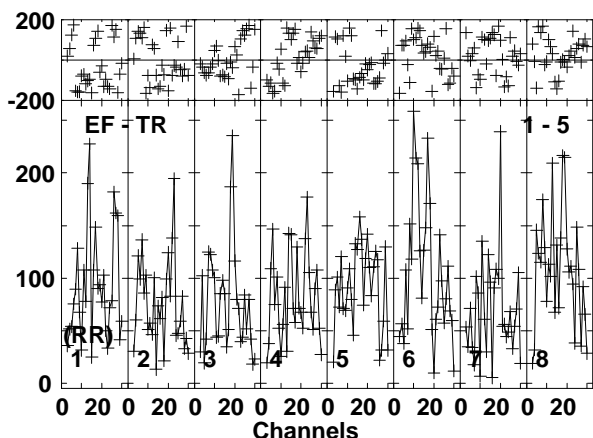
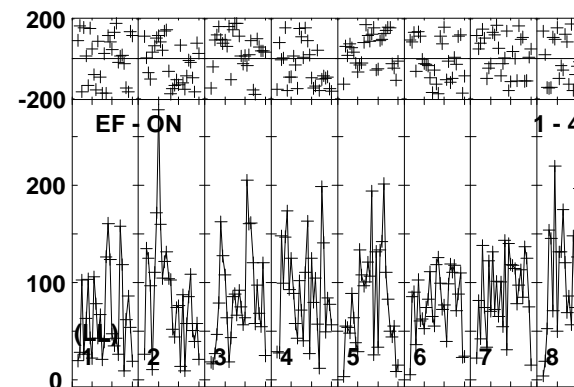
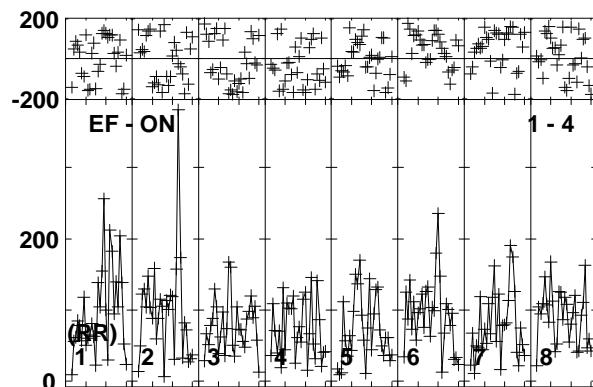
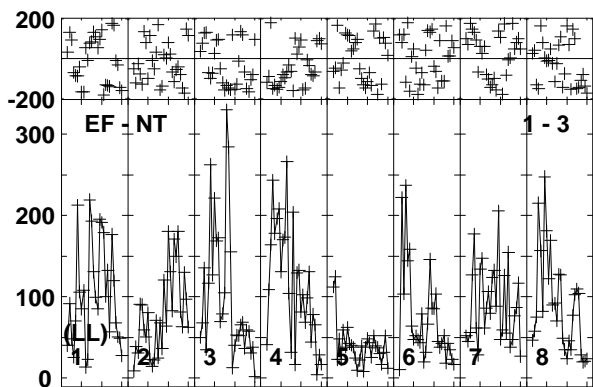
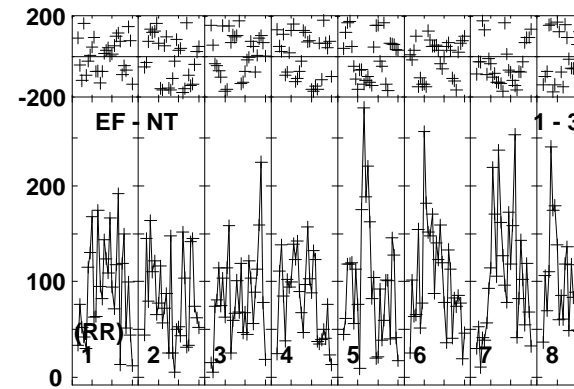
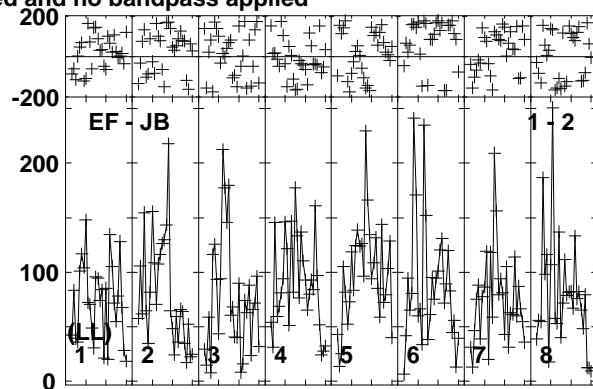
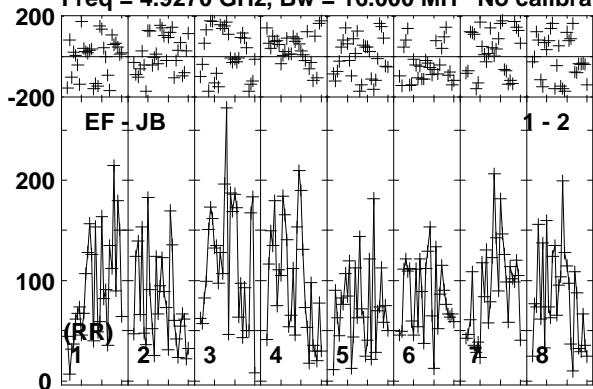

Lower frame: Micro Ampl Jy Top frame: Phas deg
Vector averaged cross-power spectrum Baseline: EF (01) - JB (02)
Timerange: 00/14:43:33 to 00/14:46:59

Plot file version 70 created 26-MAR-2015 15:27:38

V998ORI EG082E.UVDATA.1

Freq = 4.9270 GHz, Bw = 16.000 MH No calibration applied and no bandpass applied

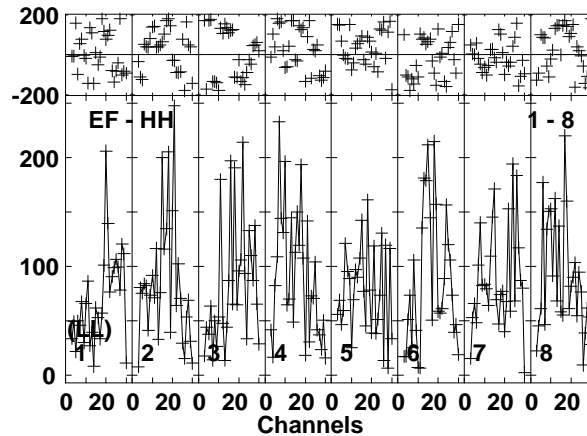
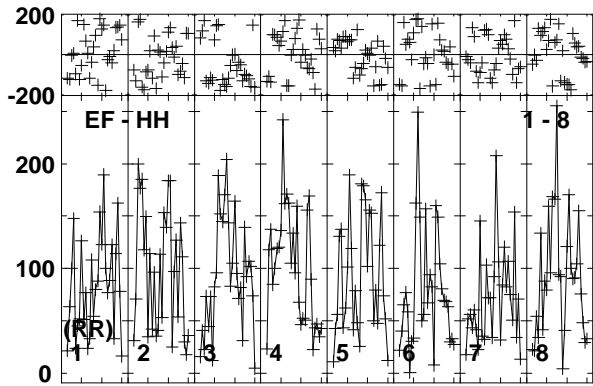
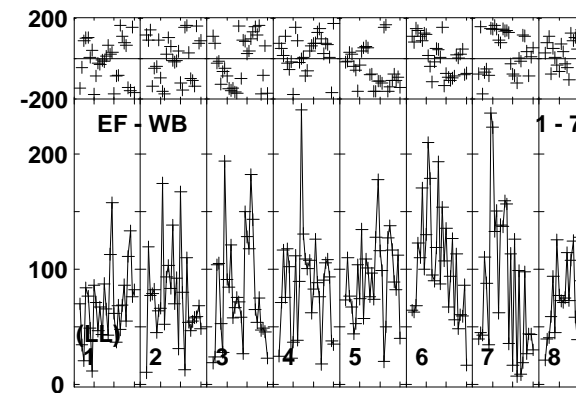
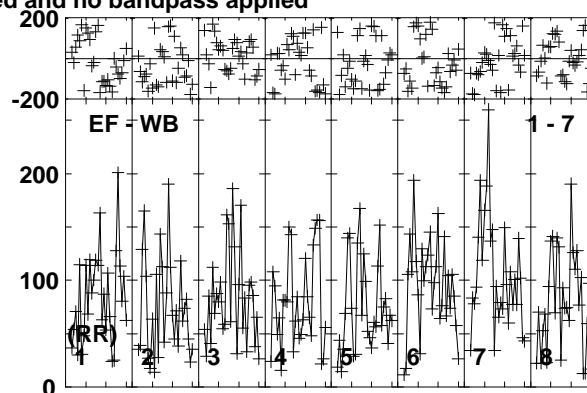
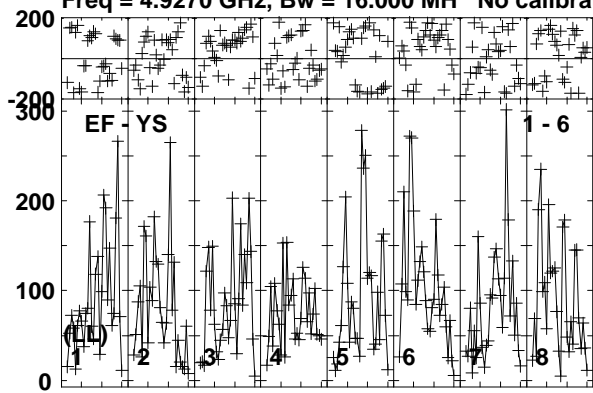

Lower frame: Micro Ampl Jy Top frame: Phas deg
Vector averaged cross-power spectrum Baseline: EF (01) - YS (06)
Timerange: 00/14:43:33 to 00/14:46:59

Plot file version 71 created 26-MAR-2015 15:27:39

J0519+0848 EG082E.UVDATA.1

Freq = 4.9270 GHz, Bw = 16.000 MH No calibration applied and no bandpass applied

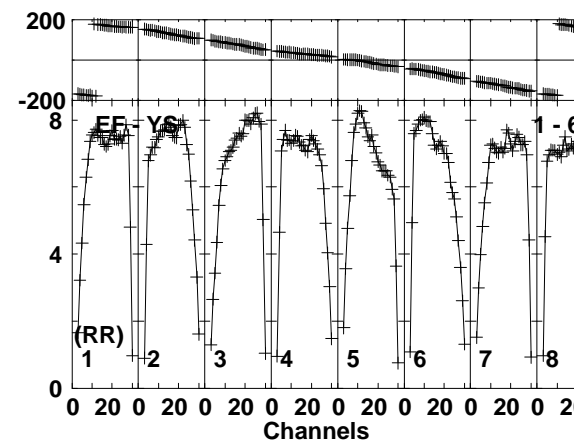
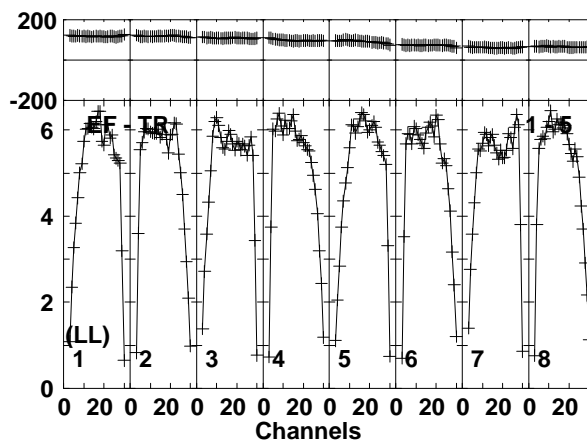
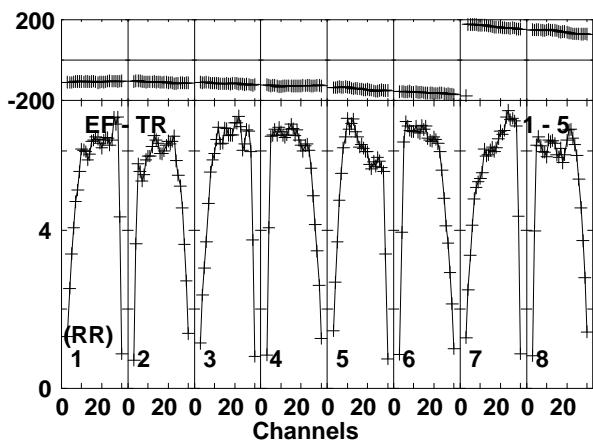
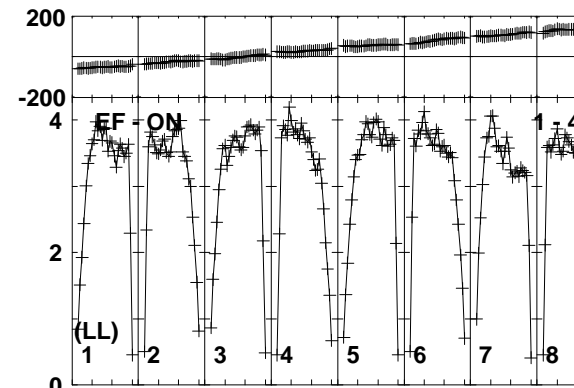
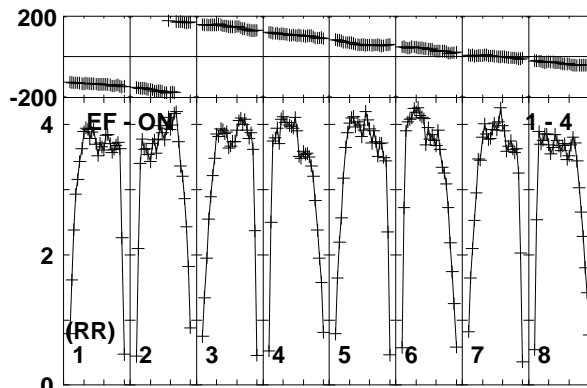
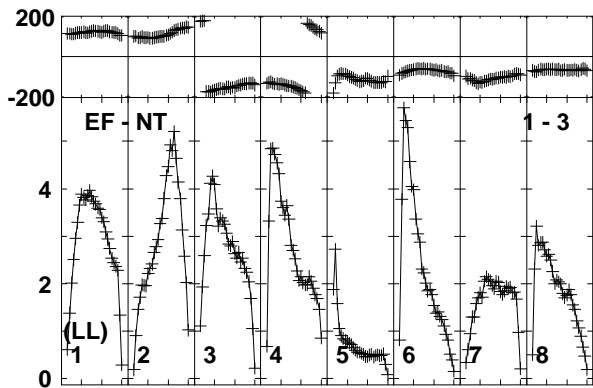
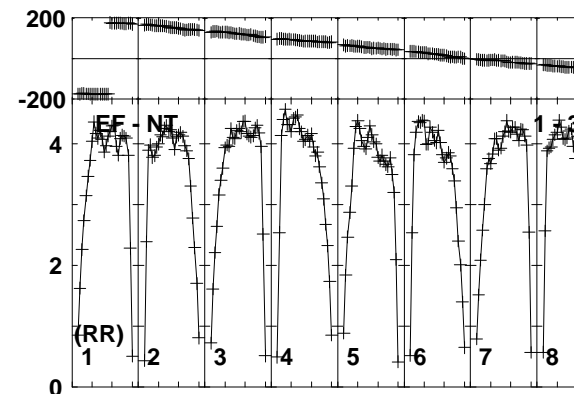
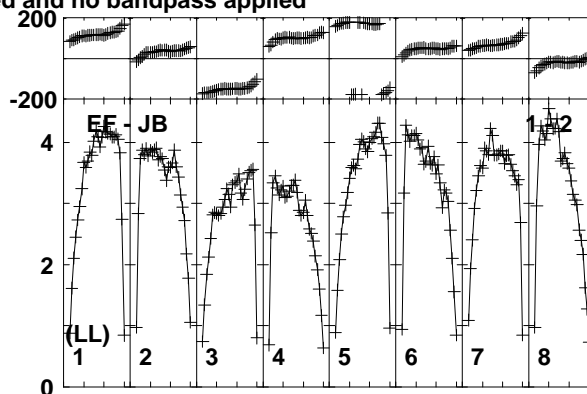
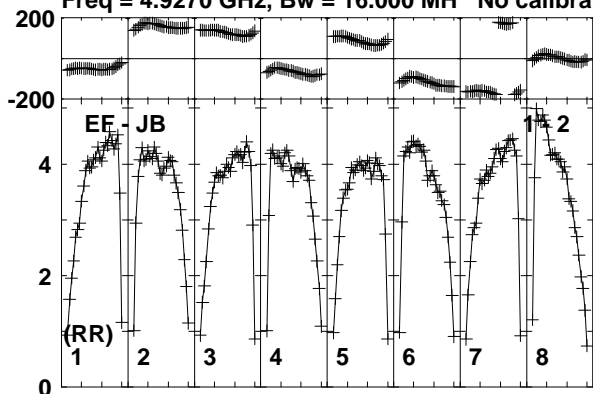

Lower frame: Milli Ampl Jy Top frame: Phas deg
Vector averaged cross-power spectrum Baseline: EF (01) - JB (02)
Timerange: 00/14:47:03 to 00/14:48:29

Plot file version 72 created 26-MAR-2015 15:27:39

J0519+0848 EG082E.UVDATA.1

Freq = 4.9270 GHz, Bw = 16.000 MH No calibration applied and no bandpass applied

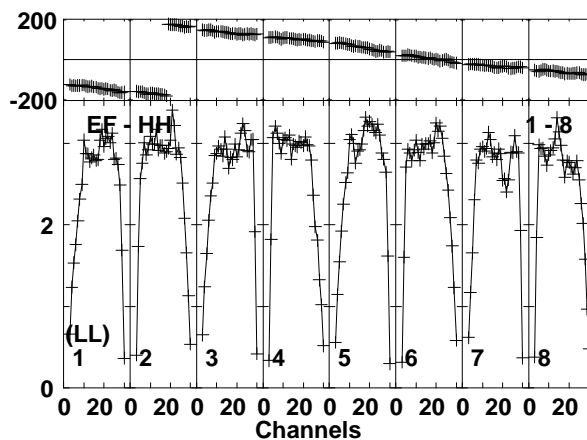
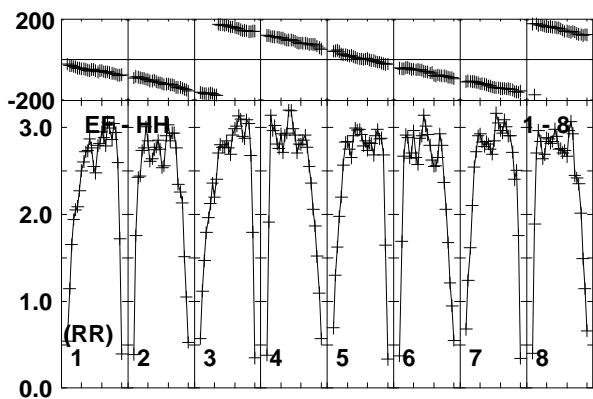
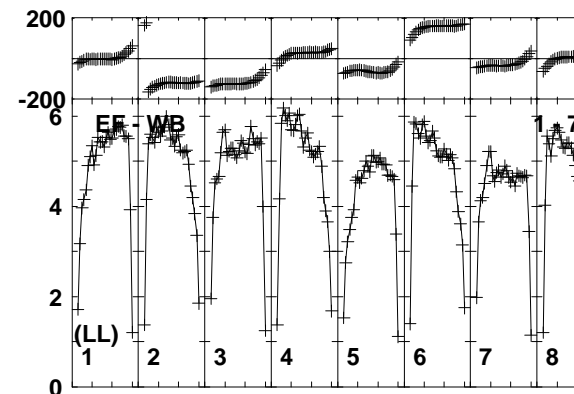
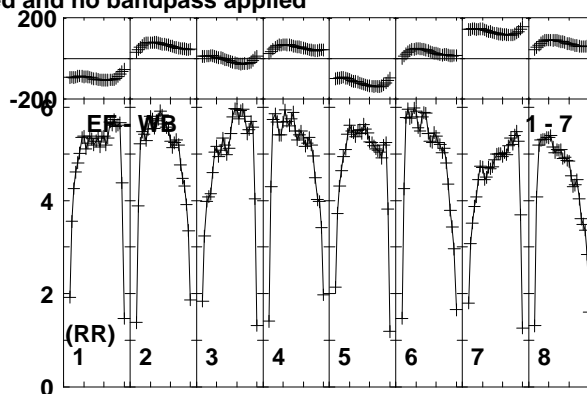
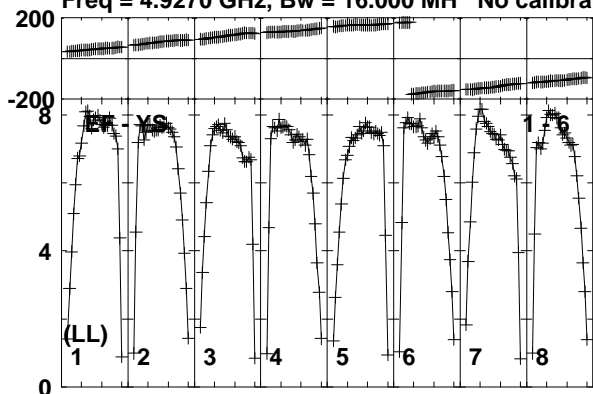

Lower frame: Milli Ampl Jy Top frame: Phas deg
Vector averaged cross-power spectrum Baseline: EF (01) - YS (06)
Timerange: 00/14:47:03 to 00/14:48:29

Plot file version 73 created 26-MAR-2015 15:27:39

V998ORI EG082E.UVDATA.1

Freq = 4.9270 GHz, Bw = 16.000 MH No calibration applied and no bandpass applied

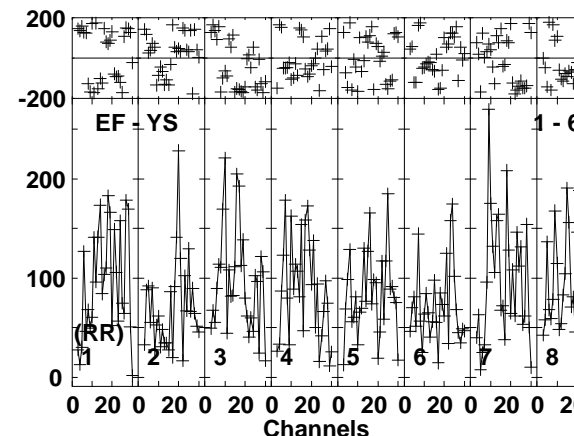
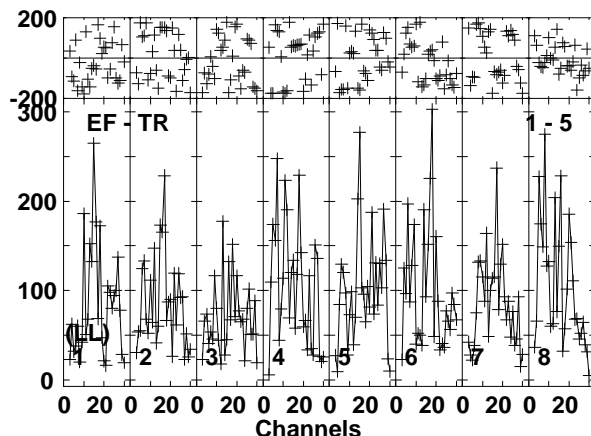
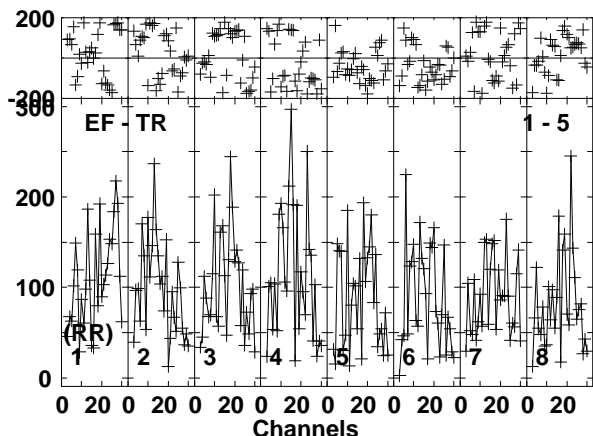
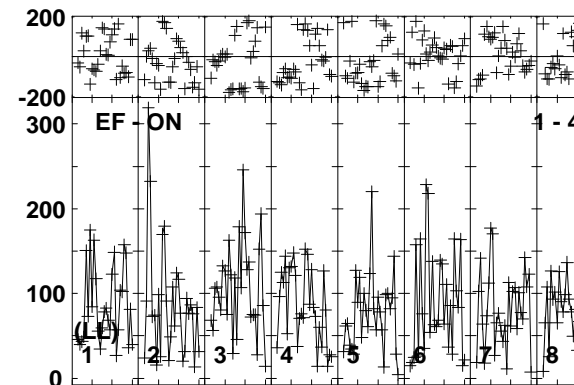
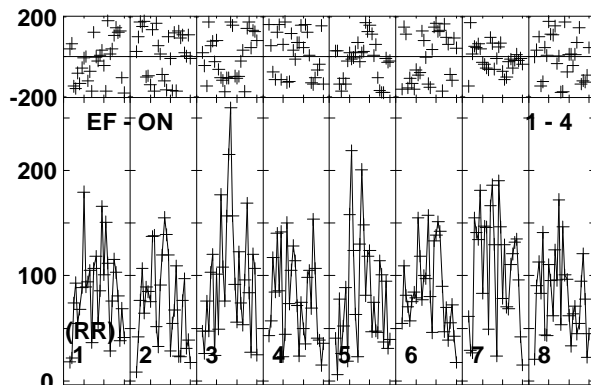
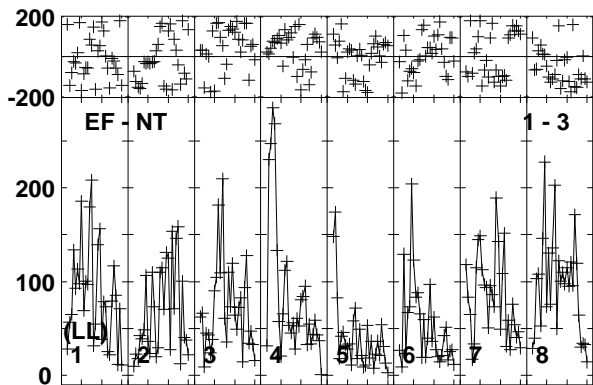
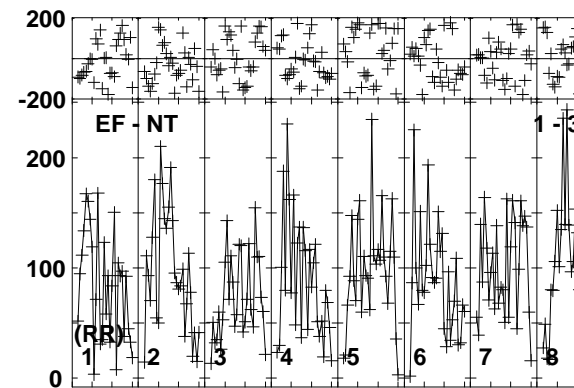
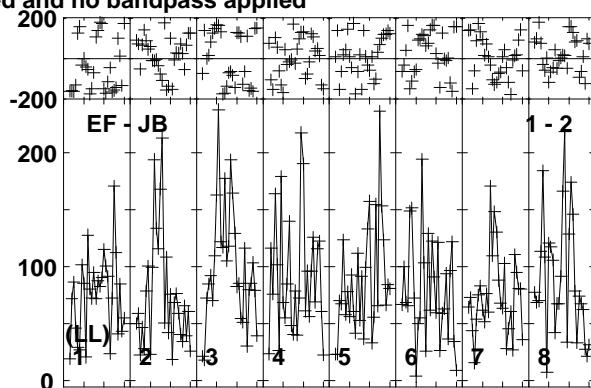
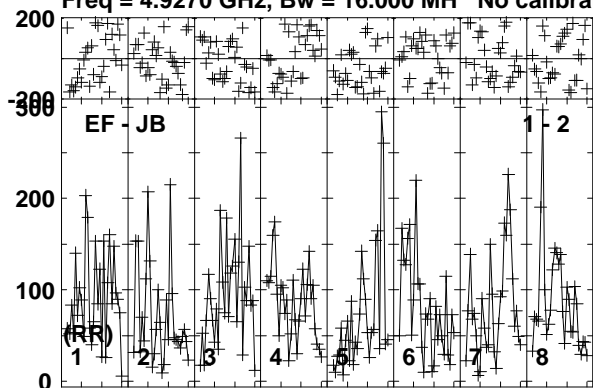

Lower frame: Micro Ampl Jy Top frame: Phas deg
Vector averaged cross-power spectrum Baseline: EF (01) - JB (02)
Timerange: 00/14:48:33 to 00/14:51:59

Plot file version 74 created 26-MAR-2015 15:27:39

V998ORI EG082E.UVDATA.1

Freq = 4.9270 GHz, Bw = 16.000 MH No calibration applied and no bandpass applied

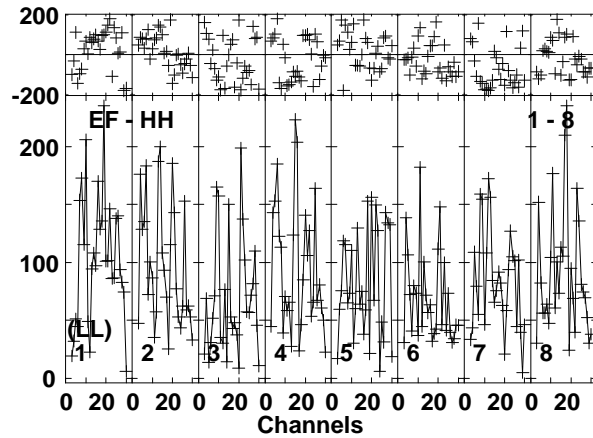
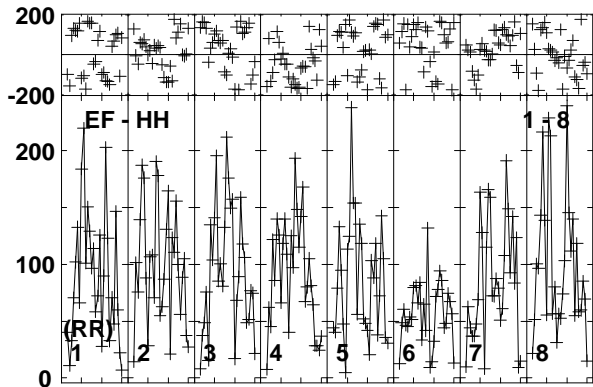
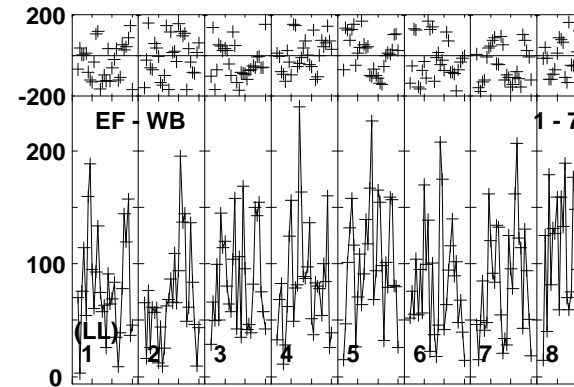
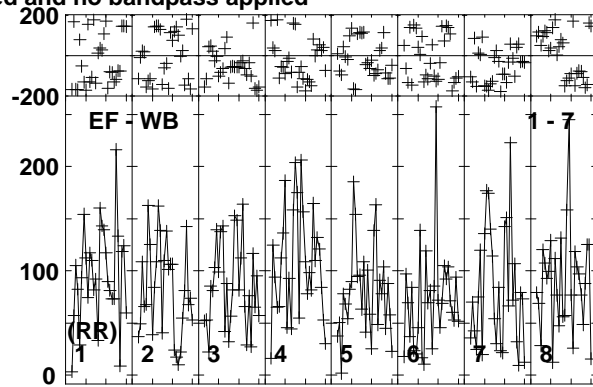
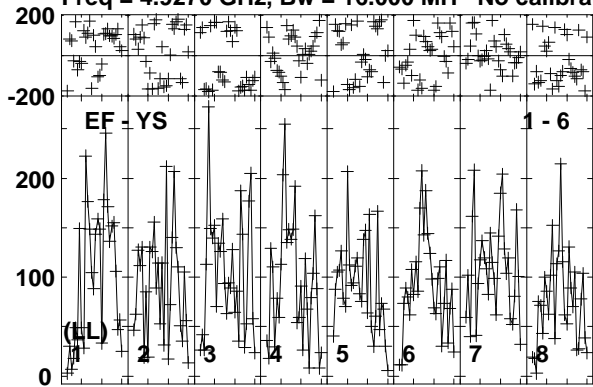

Lower frame: Micro Ampl Jy Top frame: Phas deg
Vector averaged cross-power spectrum Baseline: EF (01) - YS (06)
Timerange: 00/14:48:33 to 00/14:51:59

Plot file version 75 created 26-MAR-2015 15:27:39

J0519+0848 EG082E.UVDATA.1

Freq = 4.9270 GHz, Bw = 16.000 MH No calibration applied and no bandpass applied

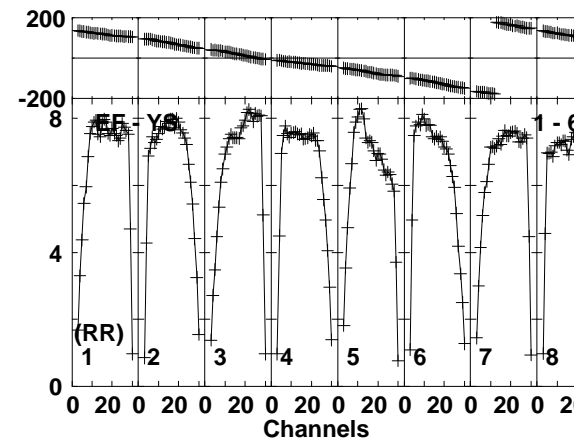
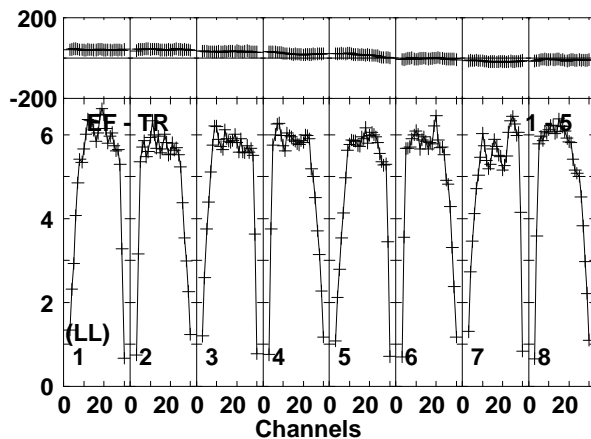
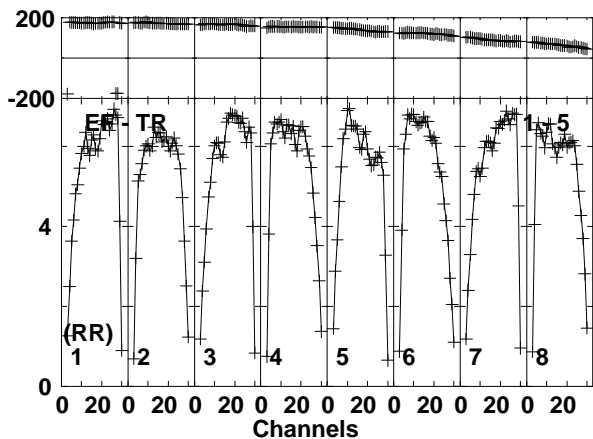
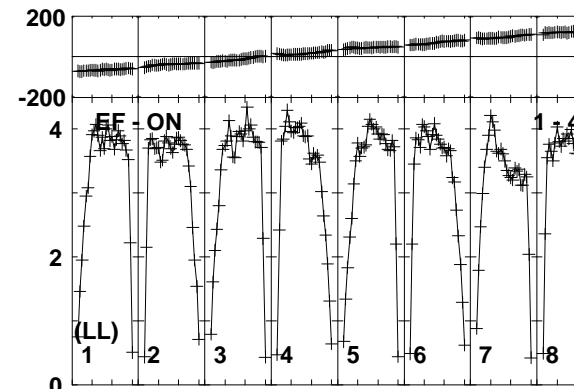
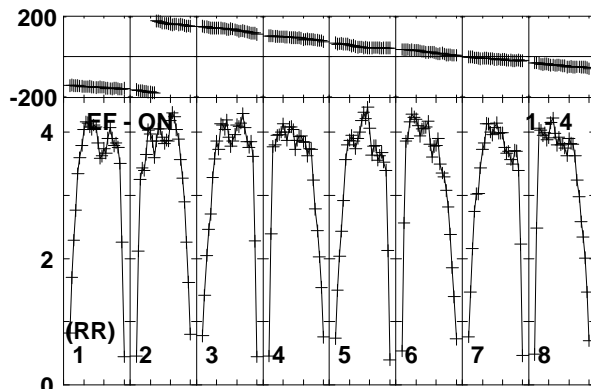
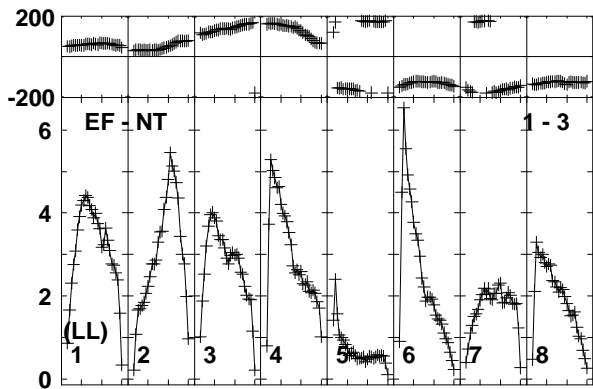
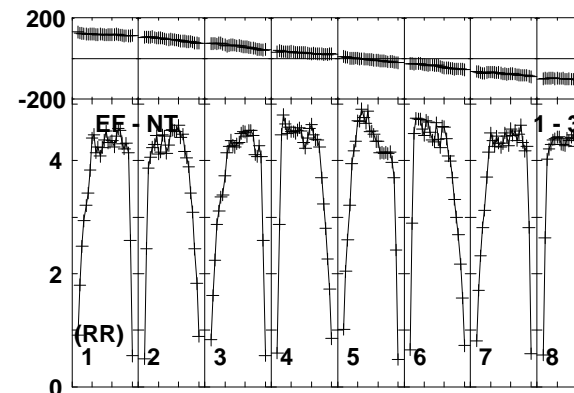
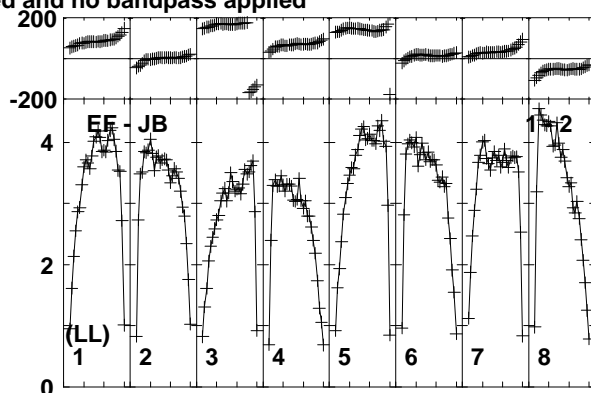
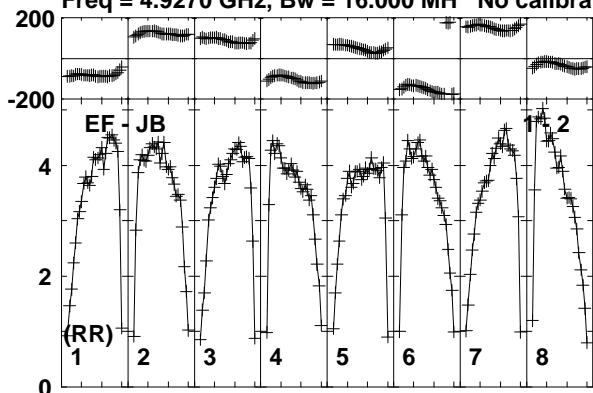

Lower frame: Milli Ampl Jy Top frame: Phas deg
Vector averaged cross-power spectrum Baseline: EF (01) - JB (02)
Timerange: 00/14:52:33 to 00/14:53:29

Plot file version 76 created 26-MAR-2015 15:27:39

J0519+0848 EG082E.UVDATA.1

Freq = 4.9270 GHz, Bw = 16.000 MH No calibration applied and no bandpass applied

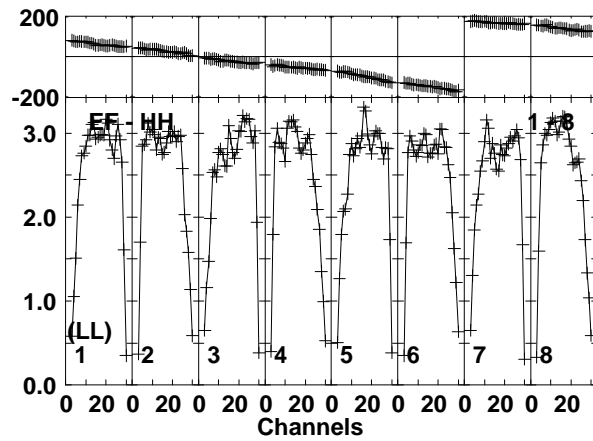
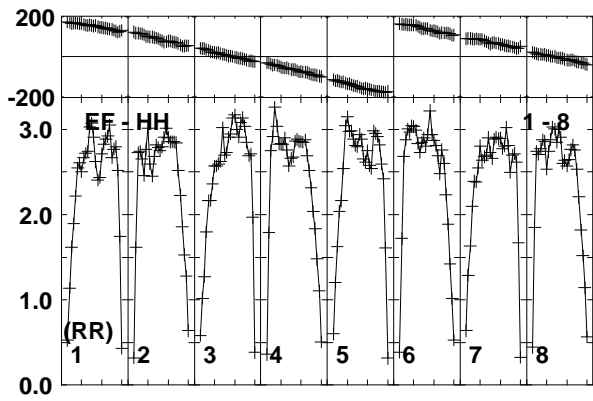
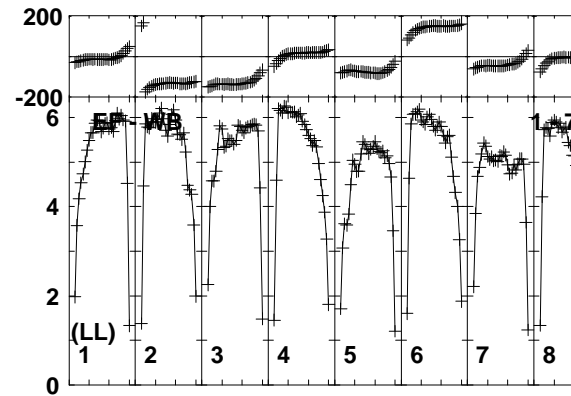
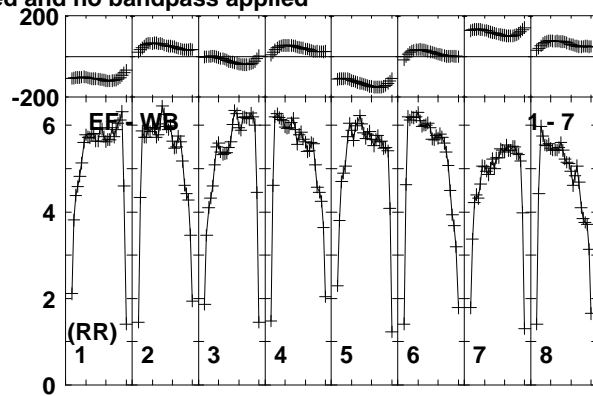
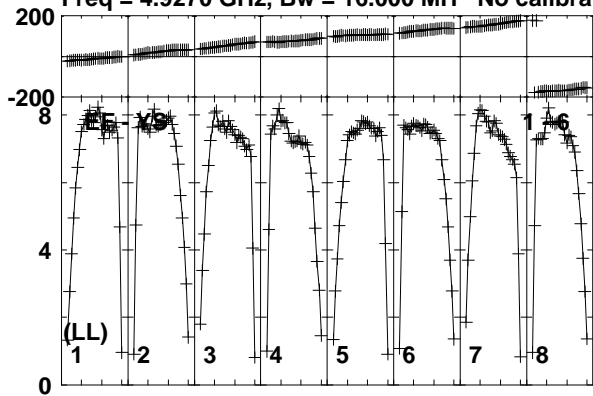

Lower frame: Milli Ampl Jy Top frame: Phas deg
Vector averaged cross-power spectrum Baseline: EF (01) - YS (06)
Timerange: 00/14:52:33 to 00/14:53:29

Plot file version 77 created 26-MAR-2015 15:27:39

V998ORI EG082E.UVDATA.1

Freq = 4.9270 GHz, Bw = 16.000 MH No calibration applied and no bandpass applied

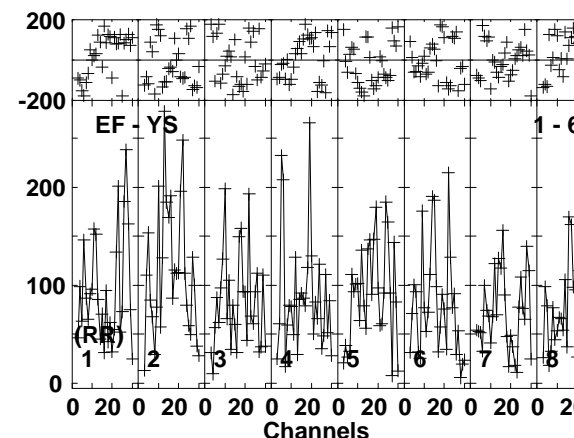
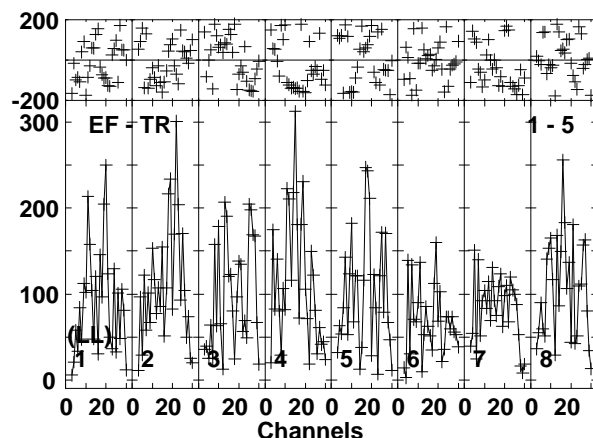
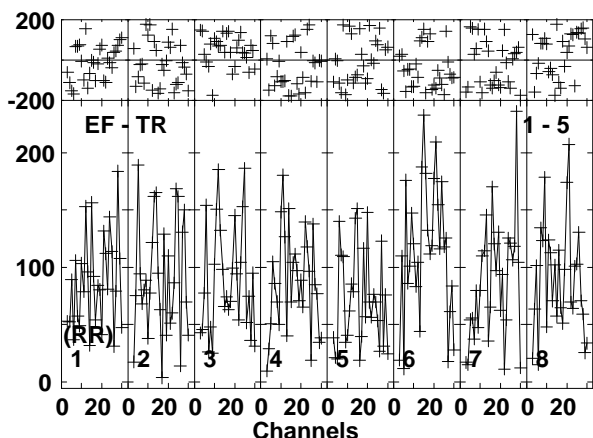
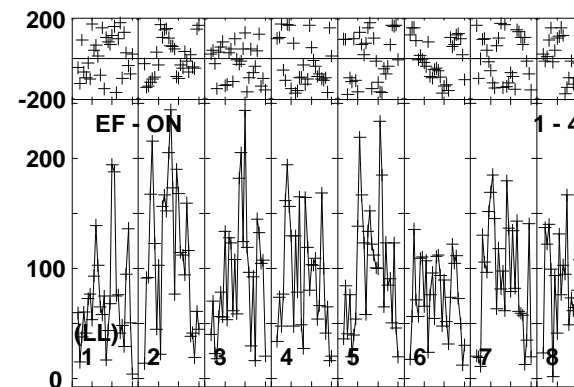
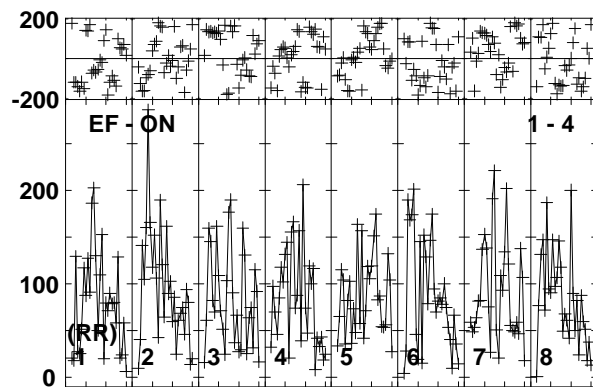
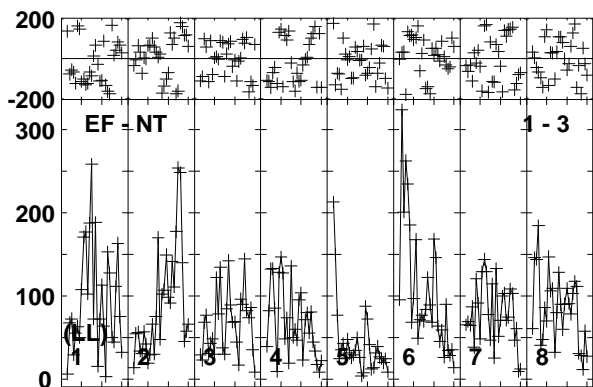
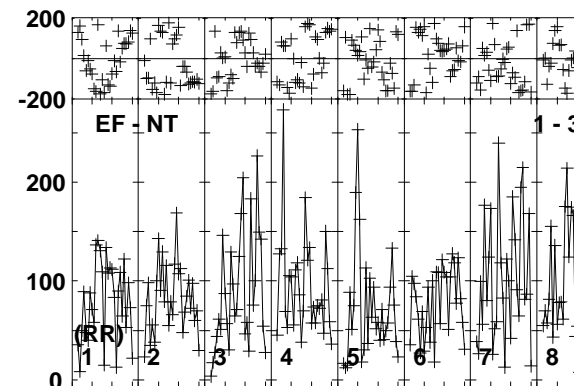
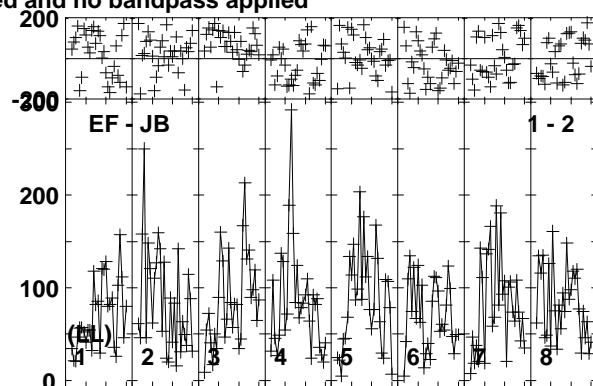
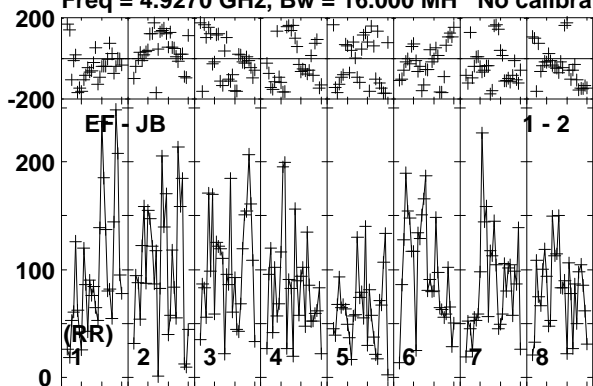

Lower frame: Micro Ampl Jy Top frame: Phas deg
Vector averaged cross-power spectrum Baseline: EF (01) - JB (02)
Timerange: 00/14:53:33 to 00/14:56:59

Plot file version 78 created 26-MAR-2015 15:27:39

V998ORI EG082E.UVDATA.1

Freq = 4.9270 GHz, Bw = 16.000 MH No calibration applied and no bandpass applied

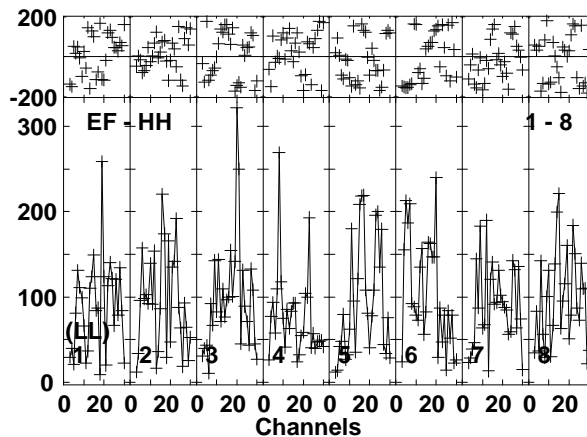
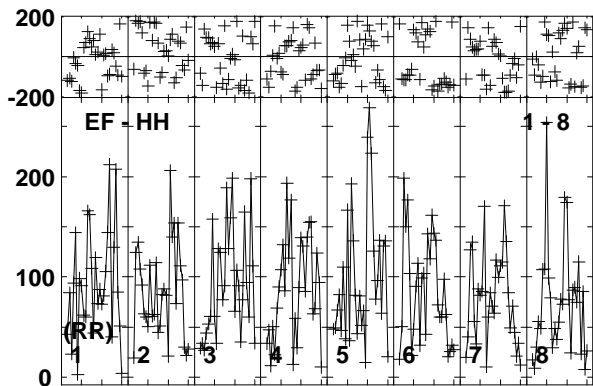
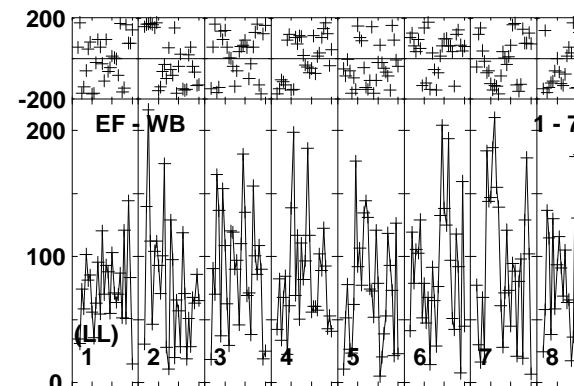
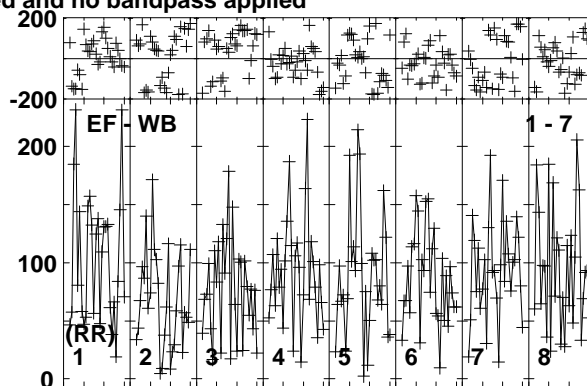
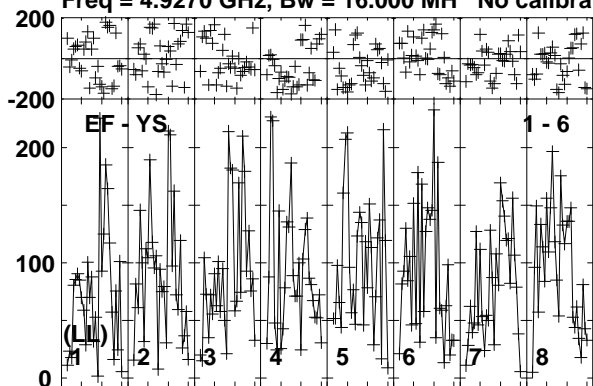

Lower frame: Micro Ampl Jy Top frame: Phas deg
Vector averaged cross-power spectrum Baseline: EF (01) - YS (06)
Timerange: 00/14:53:33 to 00/14:56:59

Plot file version 79 created 26-MAR-2015 15:27:39

J0519+0848 EG082E.UVDATA.1

Freq = 4.9270 GHz, Bw = 16.000 MH No calibration applied and no bandpass applied

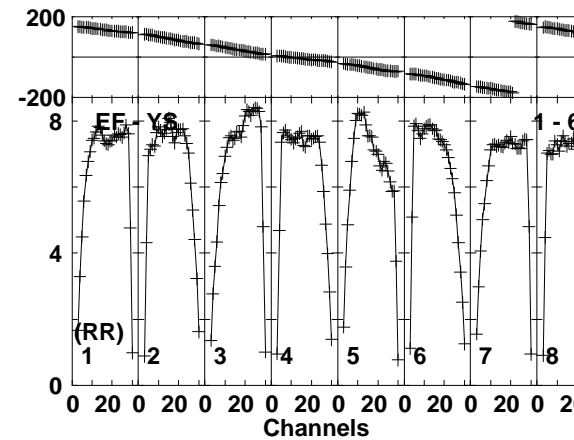
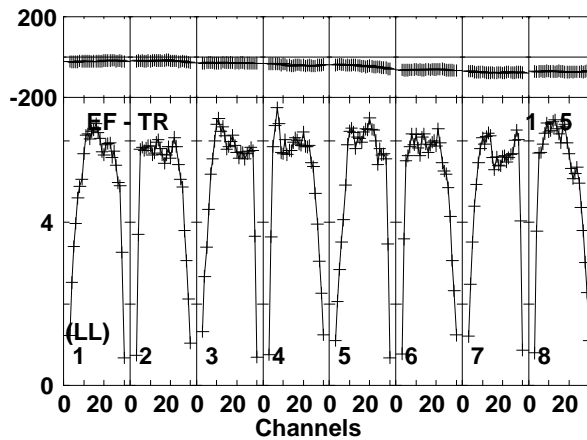
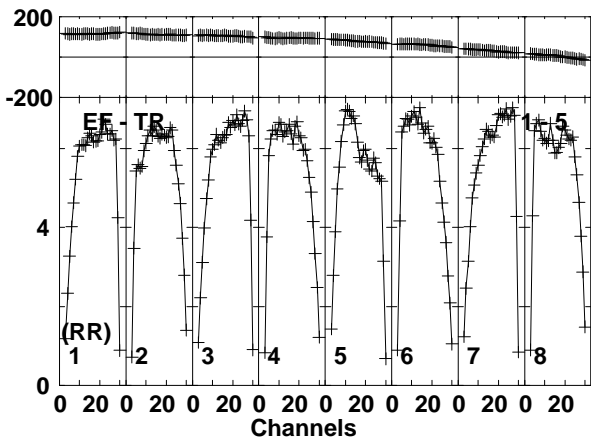
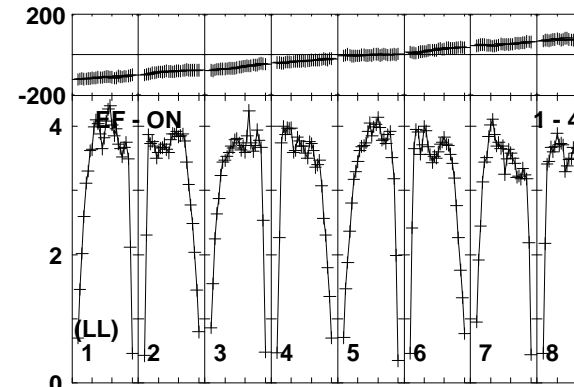
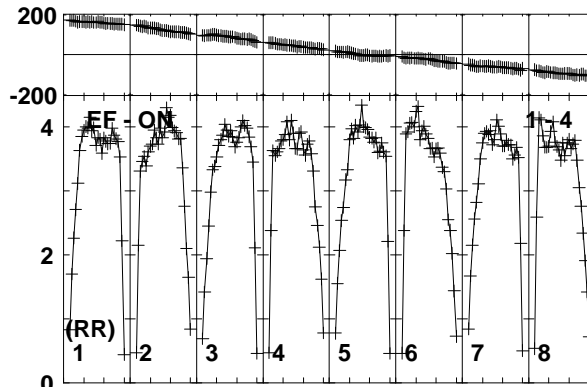
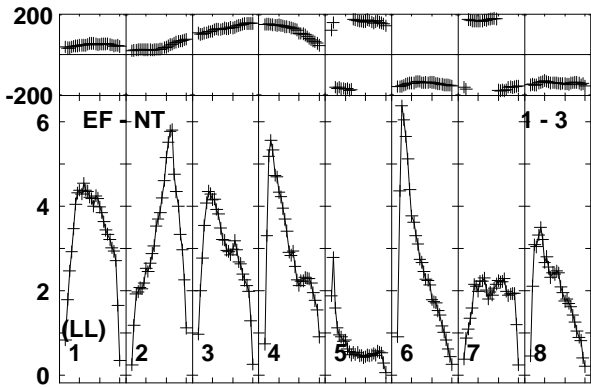
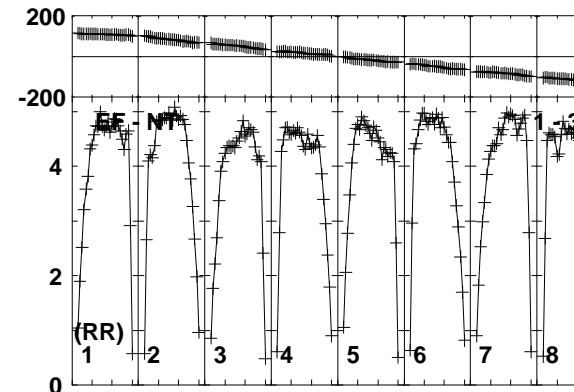
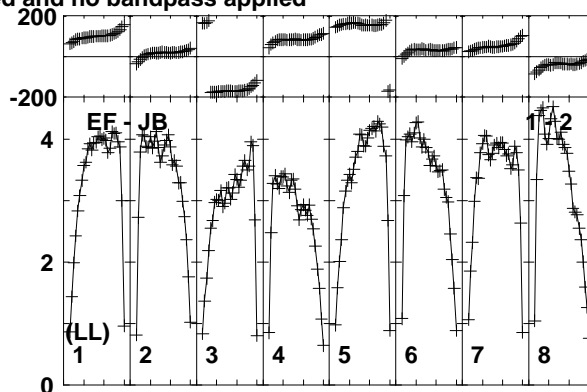
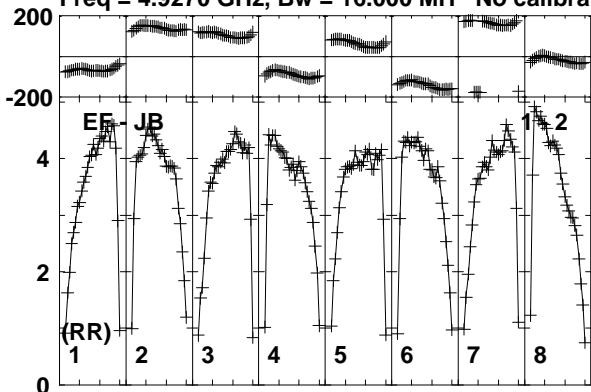

Lower frame: Milli Ampl Jy Top frame: Phas deg
Vector averaged cross-power spectrum Baseline: EF (01) - JB (02)
Timerange: 00/14:57:03 to 00/14:58:29

Plot file version 80 created 26-MAR-2015 15:27:39

J0519+0848 EG082E.UVDATA.1

Freq = 4.9270 GHz, Bw = 16.000 MH No calibration applied and no bandpass applied

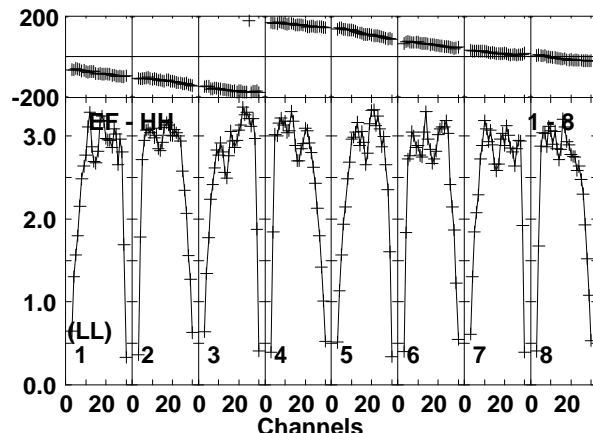
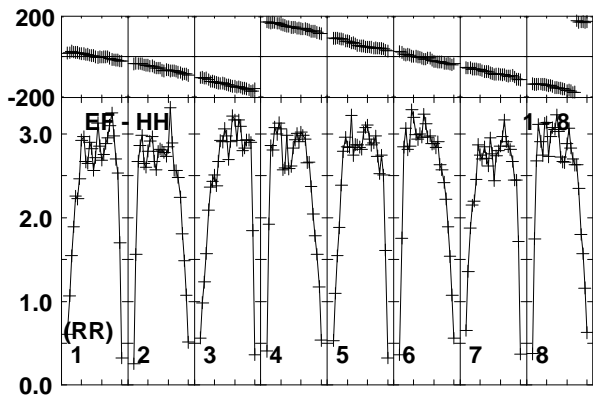
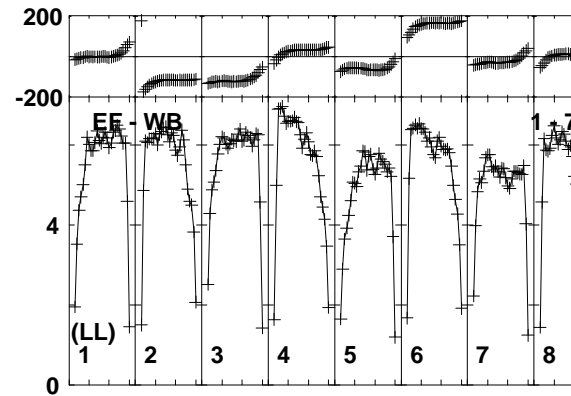
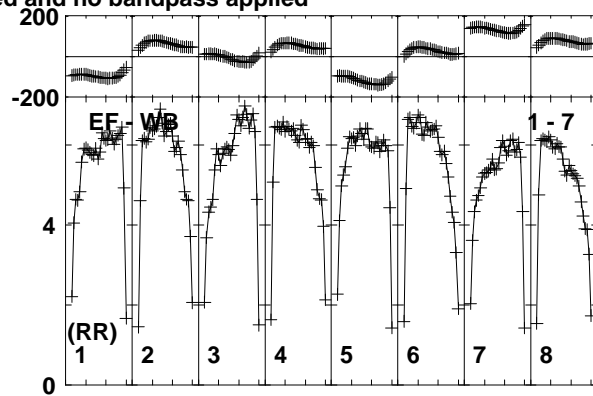
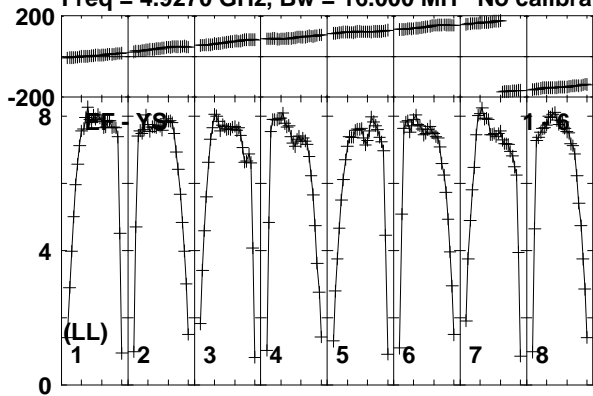

Lower frame: Milli Ampl Jy Top frame: Phas deg
Vector averaged cross-power spectrum Baseline: EF (01) - YS (06)
Timerange: 00/14:57:03 to 00/14:58:29

Plot file version 81 created 26-MAR-2015 15:27:39

V998ORI EG082E.UVDATA.1

Freq = 4.9270 GHz, Bw = 16.000 MH No calibration applied and no bandpass applied

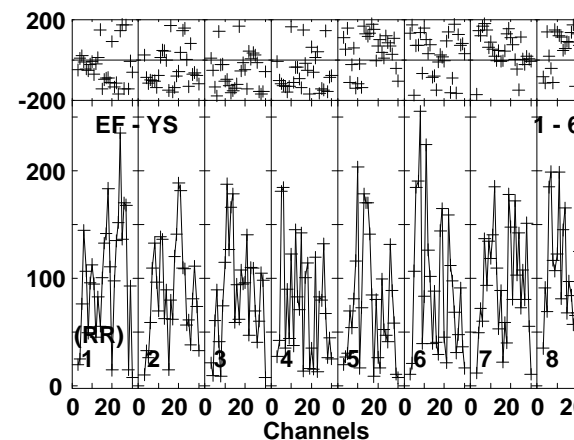
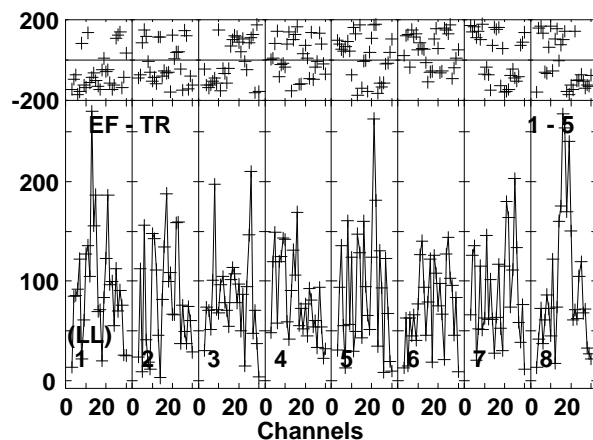
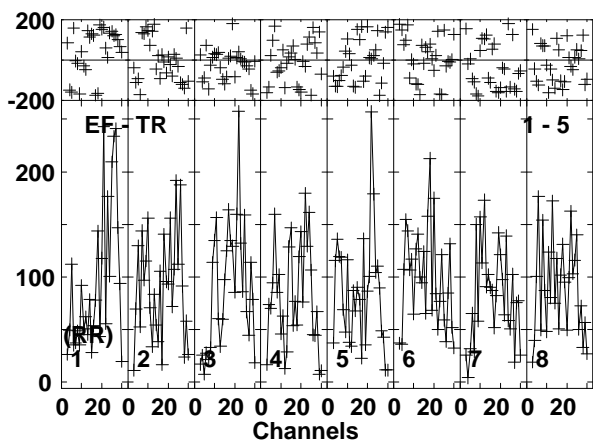
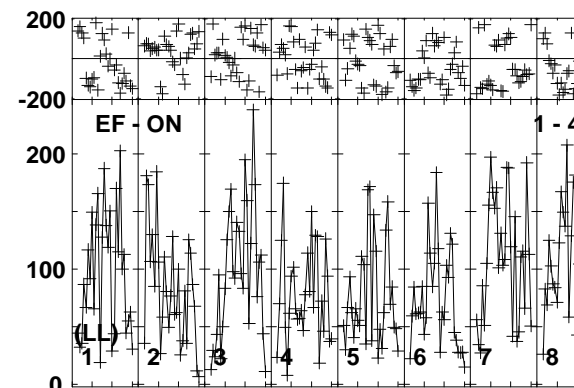
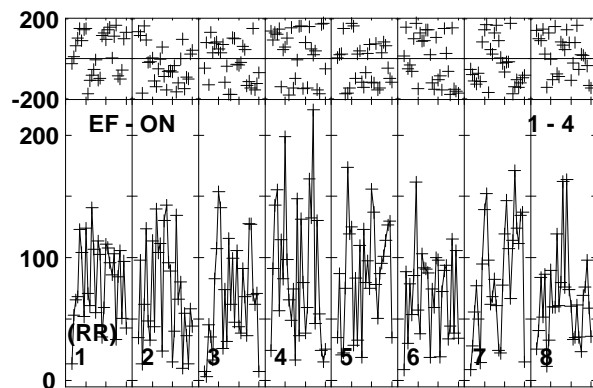
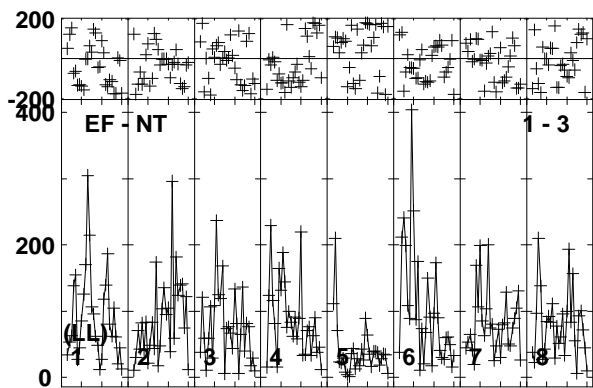
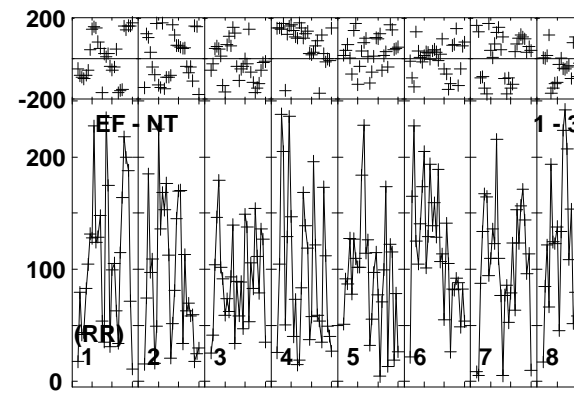
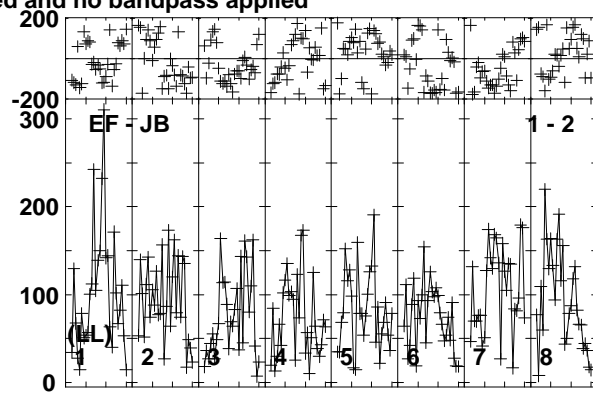
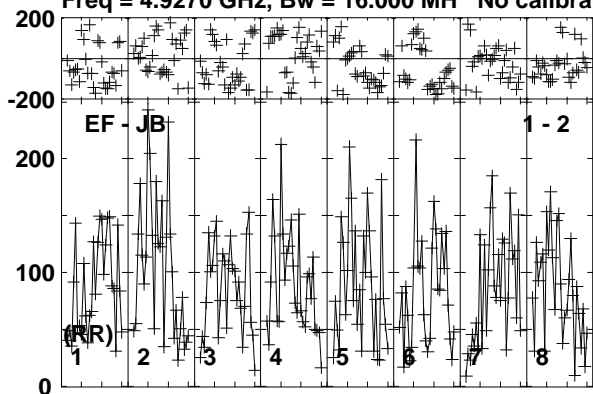

Lower frame: Micro Ampl Jy Top frame: Phas deg
Vector averaged cross-power spectrum Baseline: EF (01) - JB (02)
Timerange: 00/14:58:33 to 00/15:01:59

Plot file version 82 created 26-MAR-2015 15:27:39

V998ORI EG082E.UVDATA.1

Freq = 4.9270 GHz, Bw = 16.000 MH No calibration applied and no bandpass applied

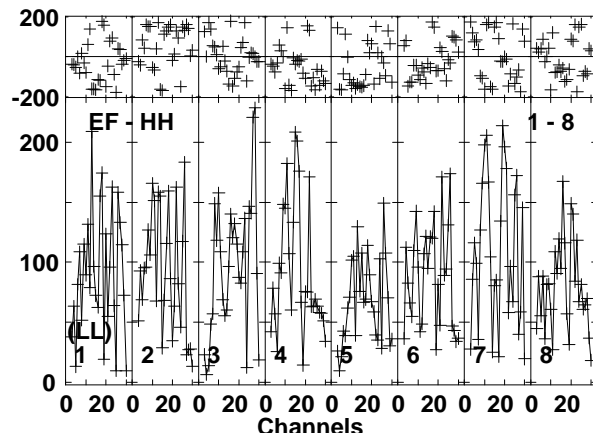
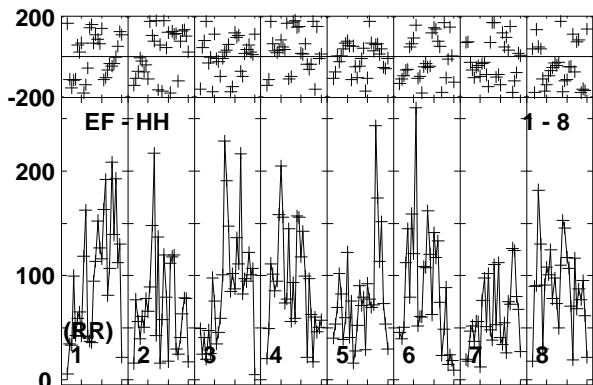
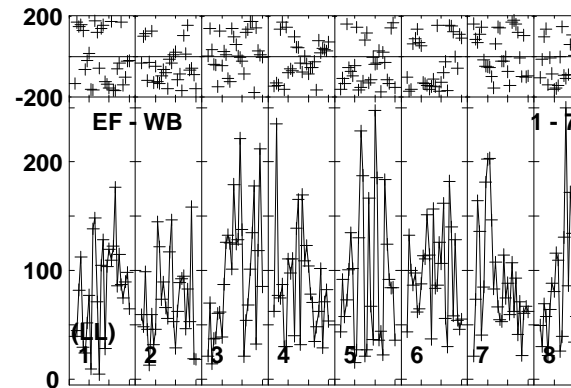
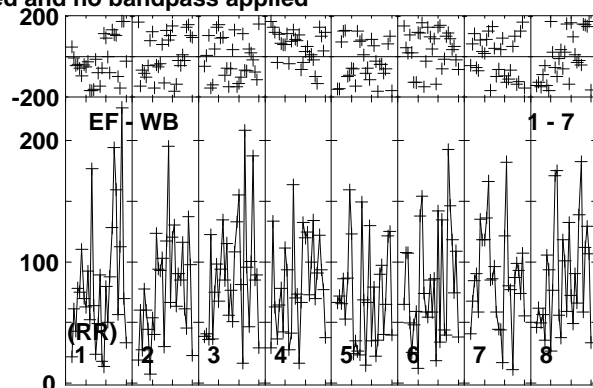
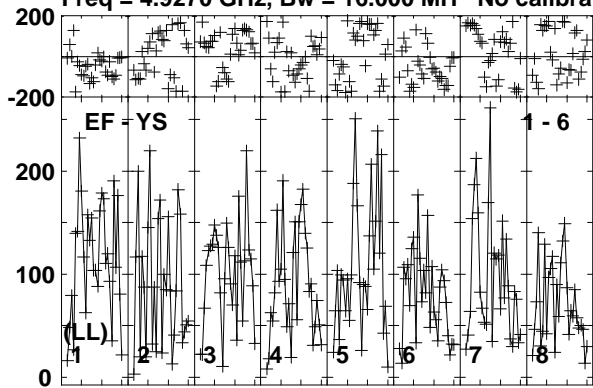

Lower frame: Micro Ampl Jy Top frame: Phas deg
Vector averaged cross-power spectrum Baseline: EF (01) - YS (06)
Timerange: 00/14:58:33 to 00/15:01:59

Plot file version 83 created 26-MAR-2015 15:27:39

J0519+0848 EG082E.UVDATA.1

Freq = 4.9270 GHz, Bw = 16.000 MH No calibration applied and no bandpass applied

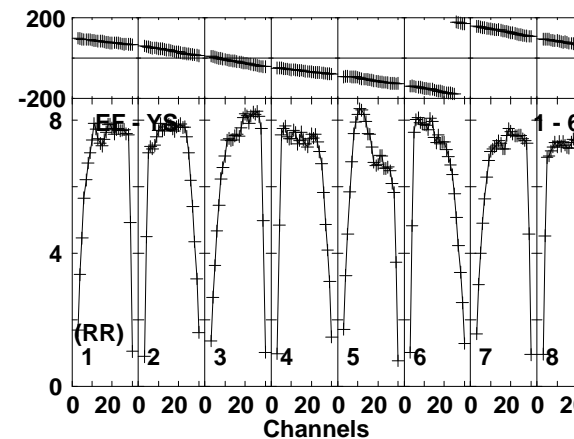
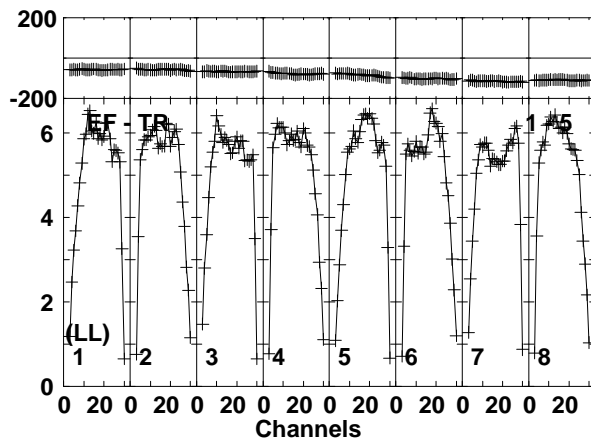
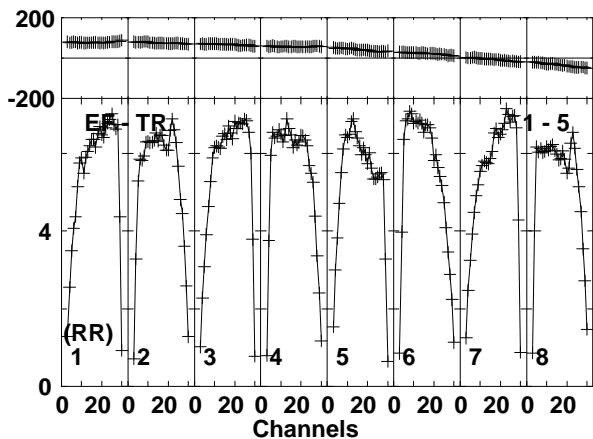
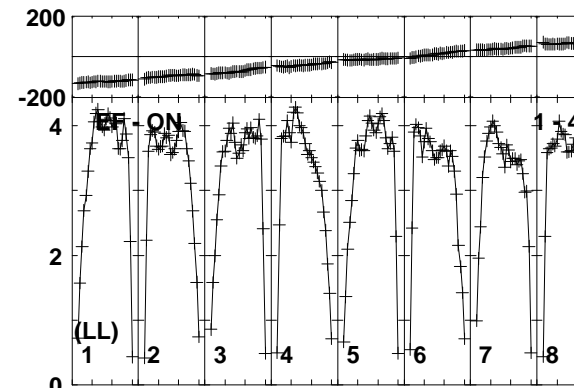
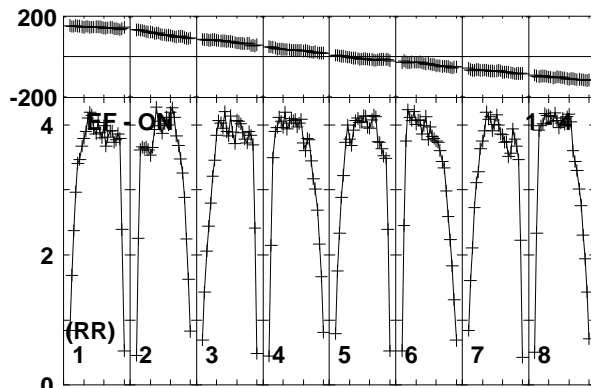
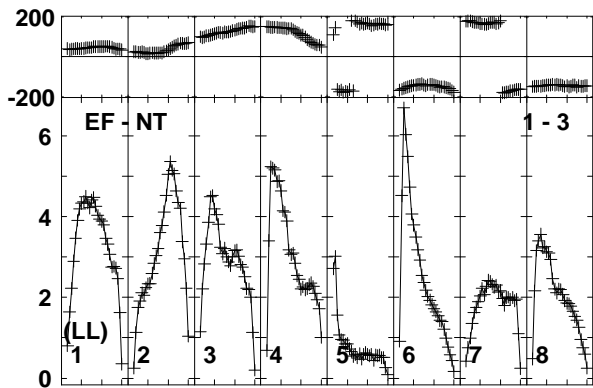
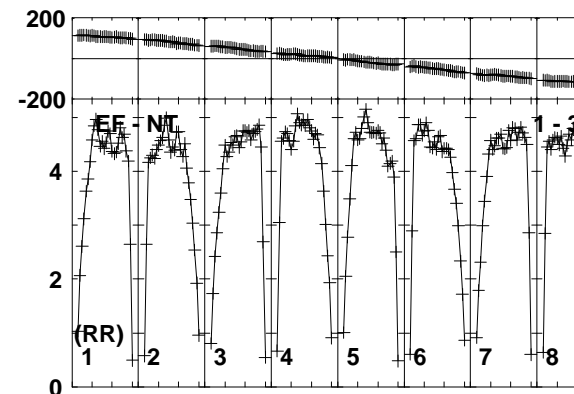
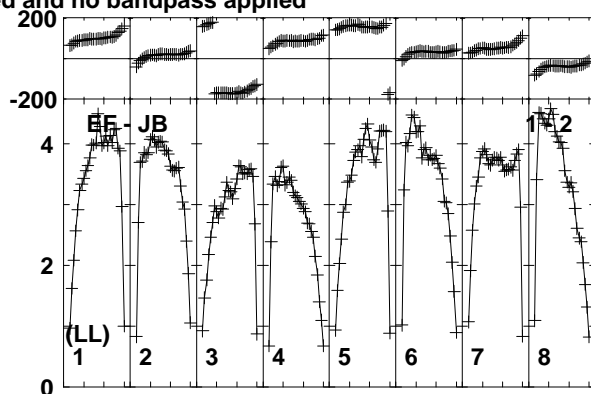
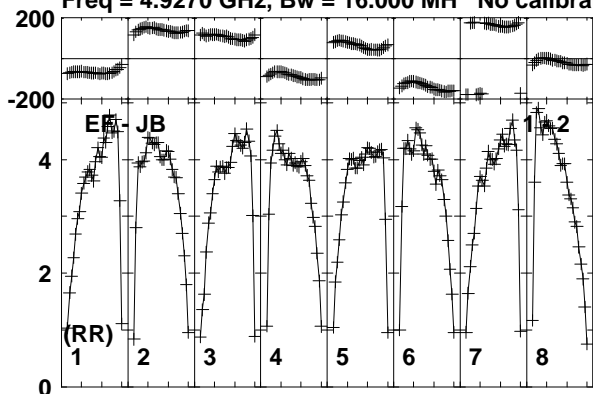

Lower frame: Milli Ampl Jy Top frame: Phas deg
Vector averaged cross-power spectrum Baseline: EF (01) - JB (02)
Timerange: 00:15:02:33 to 00:15:03:29

Plot file version 84 created 26-MAR-2015 15:27:39

J0519+0848 EG082E.UVDATA.1

Freq = 4.9270 GHz, Bw = 16.000 MH No calibration applied and no bandpass applied

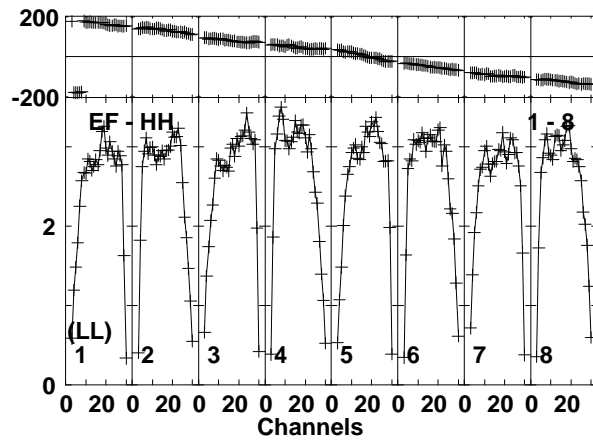
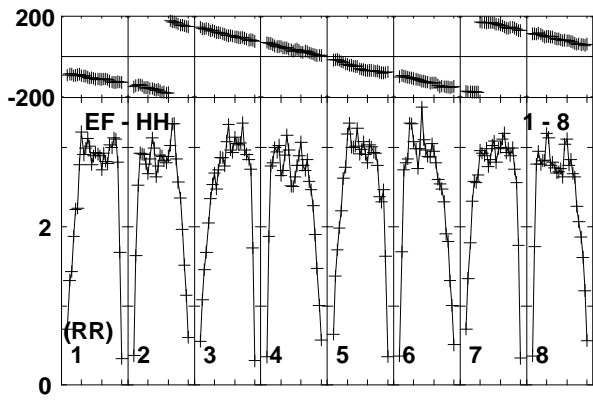
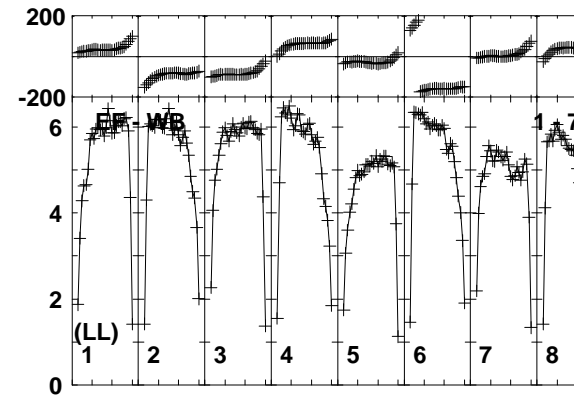
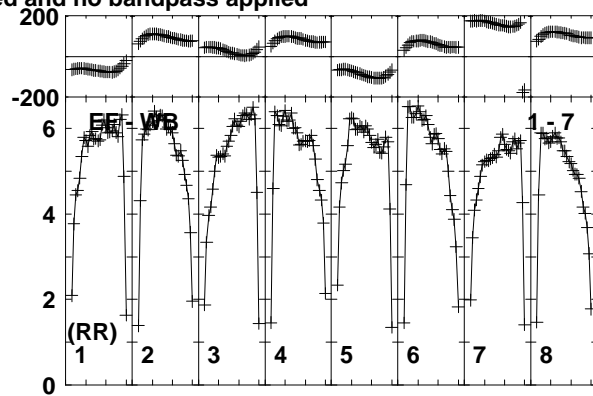
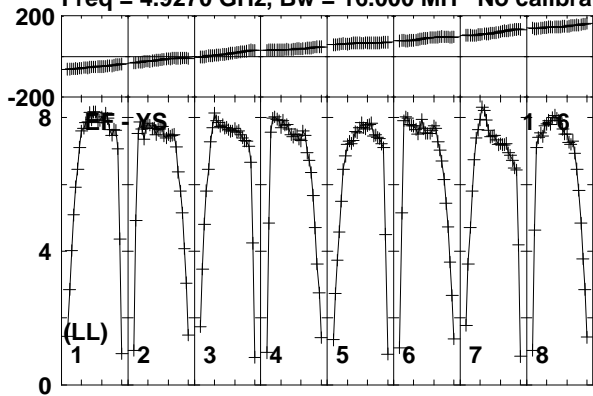

Lower frame: Milli Ampl Jy Top frame: Phas deg
Vector averaged cross-power spectrum Baseline: EF (01) - YS (06)
Timerange: 00/15:02:33 to 00/15:03:29

Plot file version 85 created 26-MAR-2015 15:27:39

V998ORI EG082E.UVDATA.1

Freq = 4.9270 GHz, Bw = 16.000 MH No calibration applied and no bandpass applied

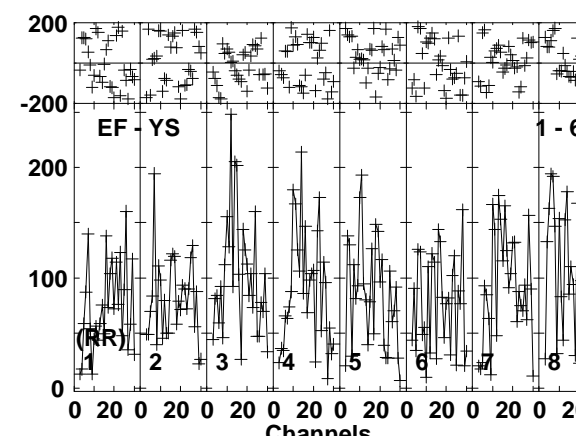
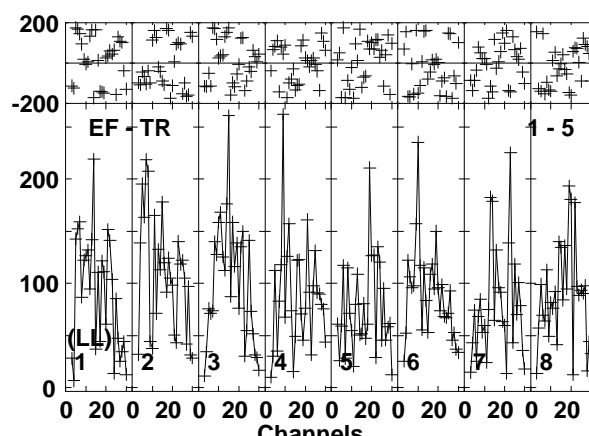
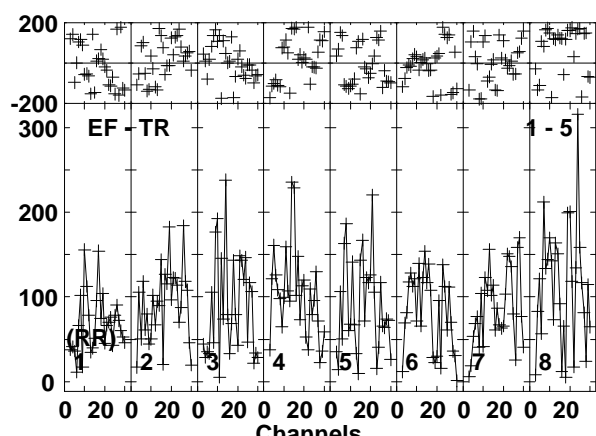
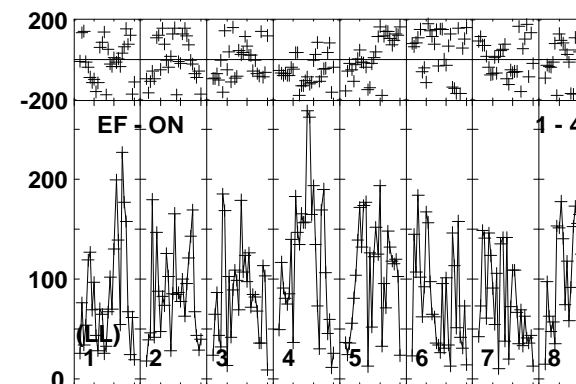
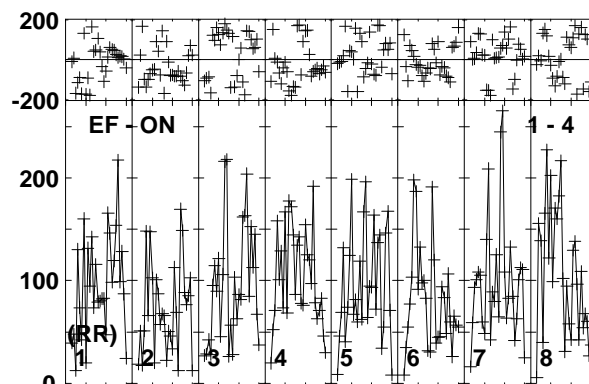
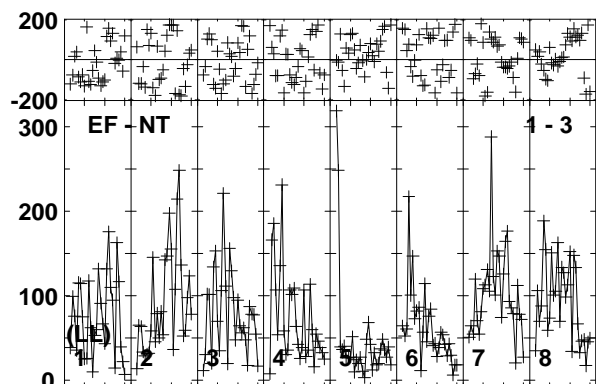
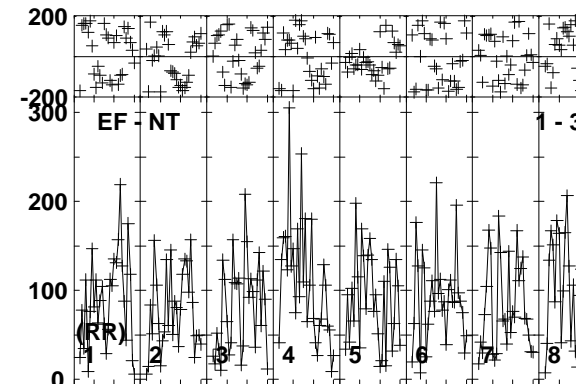
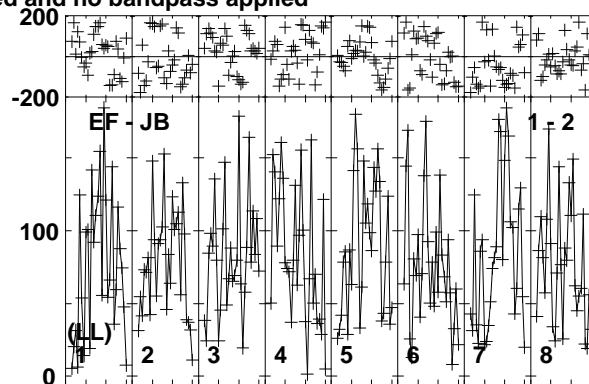
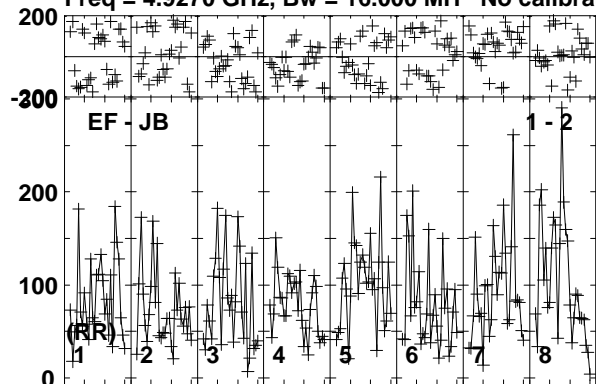

Lower frame: Micro Ampl Jy Top frame: Phas deg
Vector averaged cross-power spectrum Baseline: EF (01) - JB (02)
Timerange: 00/15:03:33 to 00/15:06:59

Plot file version 86 created 26-MAR-2015 15:27:39

V998ORI EG082E.UVDATA.1

Freq = 4.9270 GHz, Bw = 16.000 MH No calibration applied and no bandpass applied

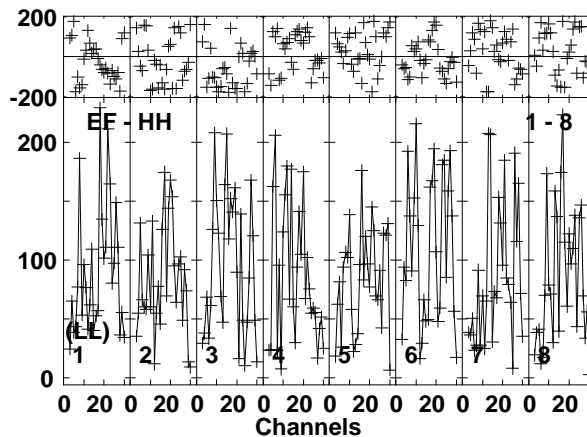
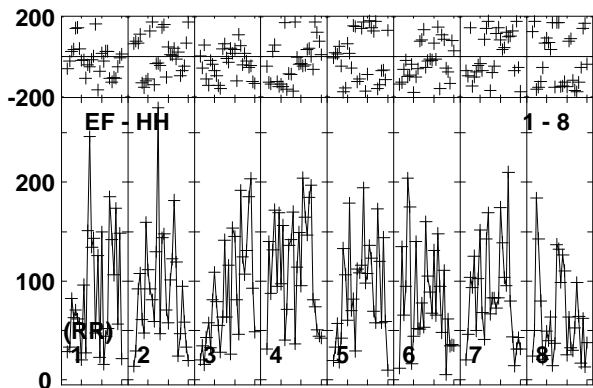
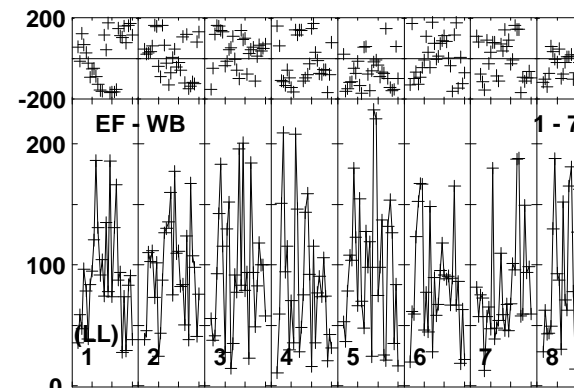
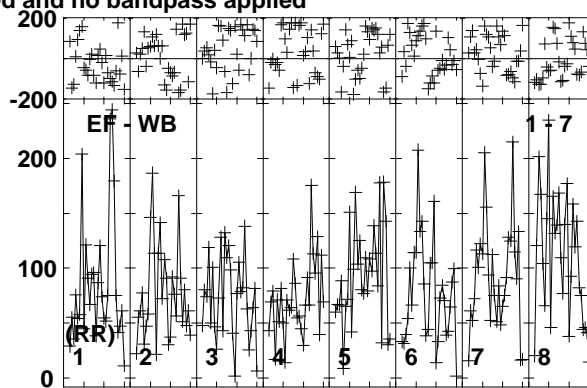
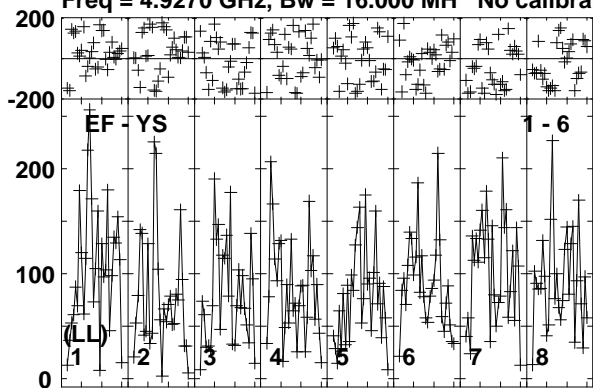

Lower frame: Micro Ampl Jy Top frame: Phas deg
Vector averaged cross-power spectrum Baseline: EF (01) - YS (06)
Timerange: 00/15:03:33 to 00/15:06:59

Plot file version 87 created 26-MAR-2015 15:27:39

J0519+0848 EG082E.UVDATA.1

Freq = 4.9270 GHz, Bw = 16.000 MH No calibration applied and no bandpass applied

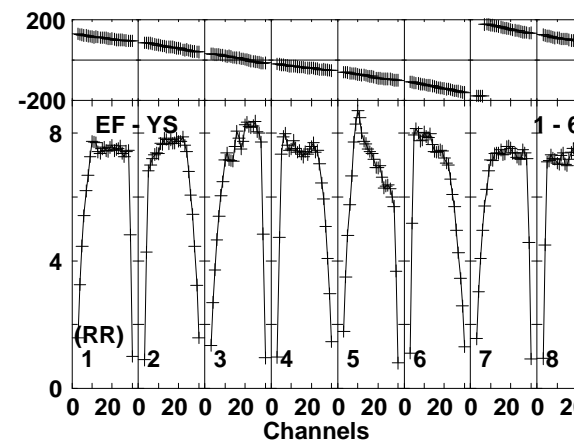
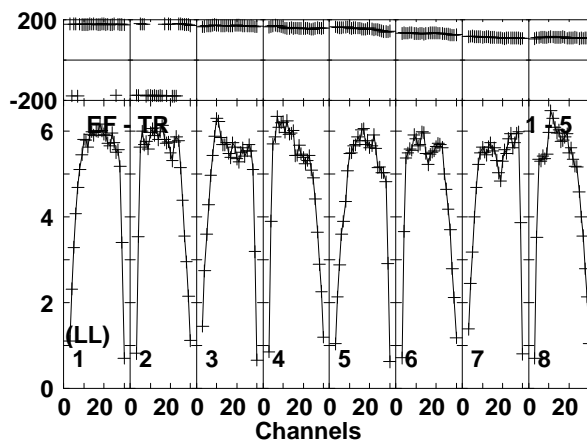
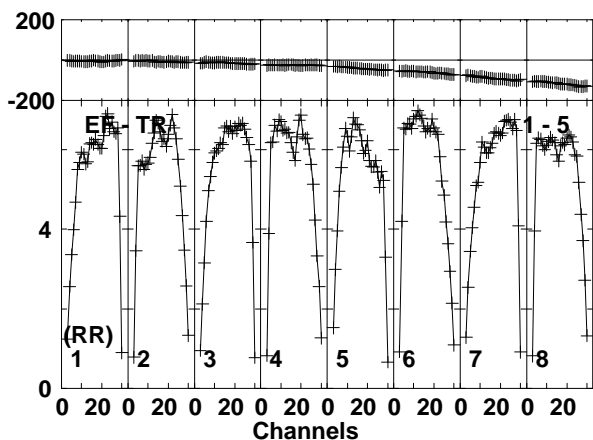
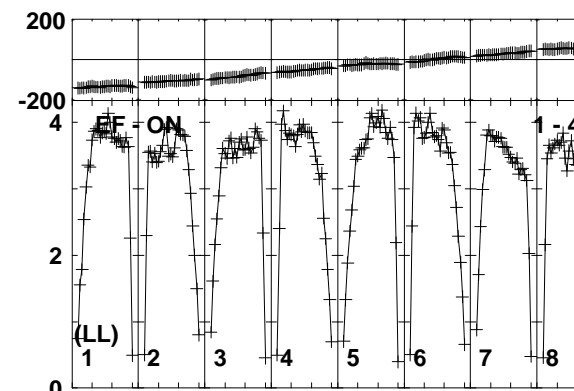
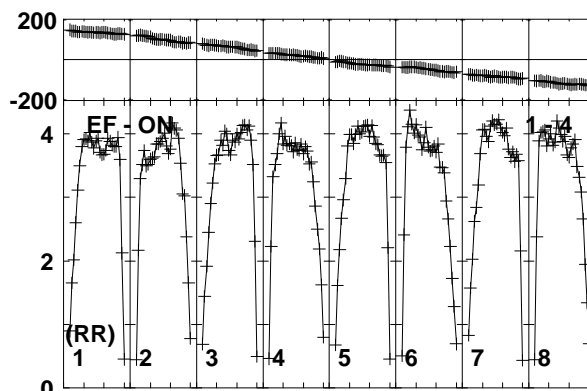
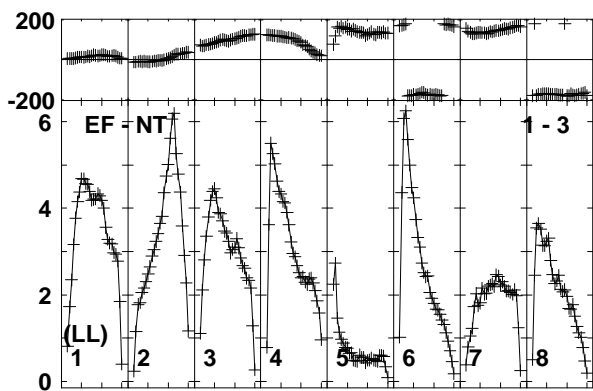
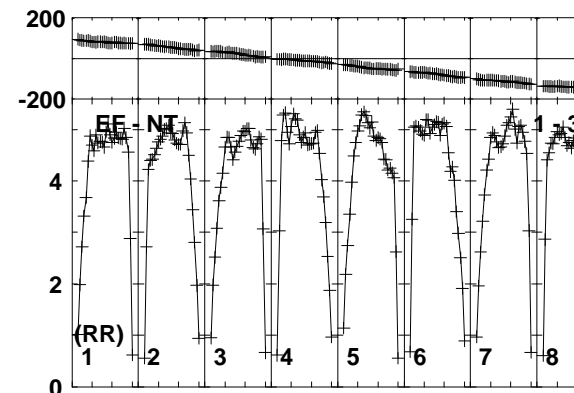
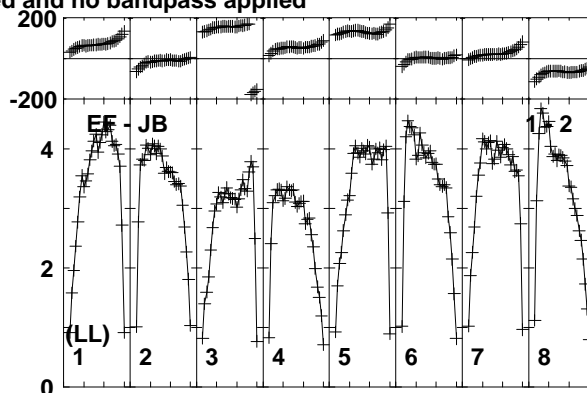
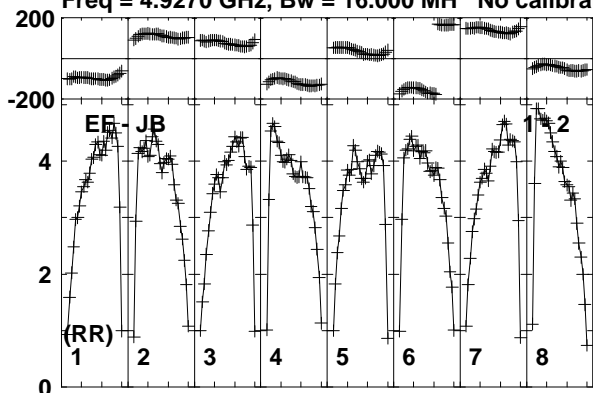

Lower frame: Milli Ampl Jy Top frame: Phas deg
Vector averaged cross-power spectrum Baseline: EF (01) - JB (02)
Timerange: 00:15:07:03 to 00:15:08:29

Plot file version 88 created 26-MAR-2015 15:27:39

J0519+0848 EG082E.UVDATA.1

Freq = 4.9270 GHz, Bw = 16.000 MH No calibration applied and no bandpass applied

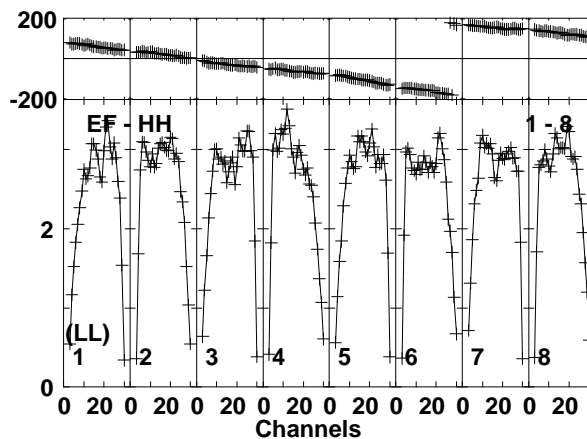
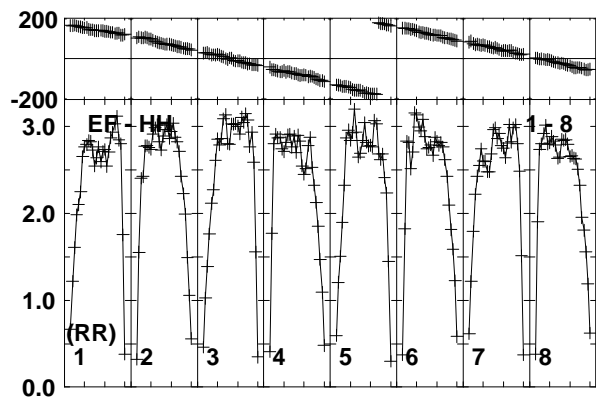
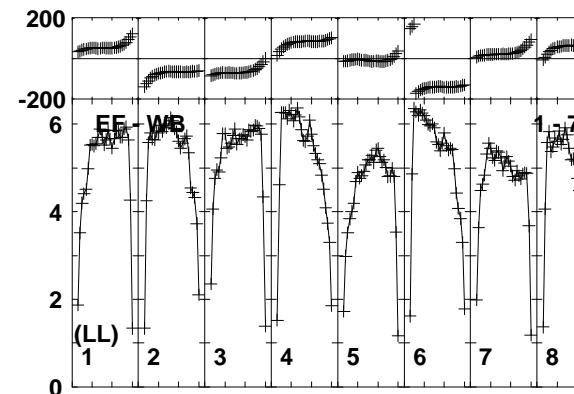
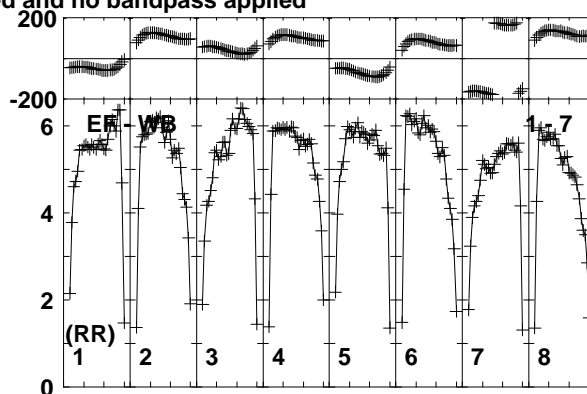
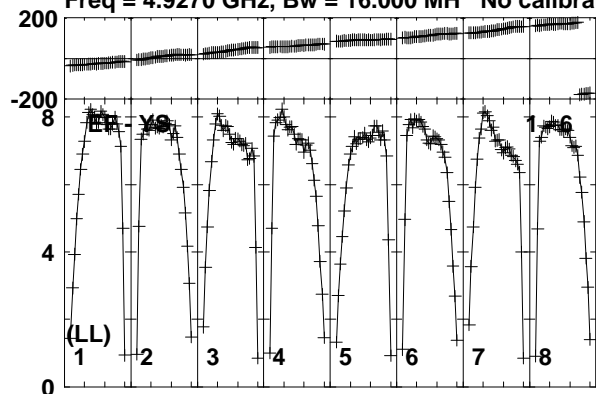

Lower frame: Milli Ampl Jy Top frame: Phas deg
Vector averaged cross-power spectrum Baseline: EF (01) - YS (06)
Timerange: 00/15:07:03 to 00/15:08:29

Plot file version 89 created 26-MAR-2015 15:27:40

J0525+0951 EG082E.UVDATA.1

Freq = 4.9270 GHz, Bw = 16.000 MH No calibration applied and no bandpass applied

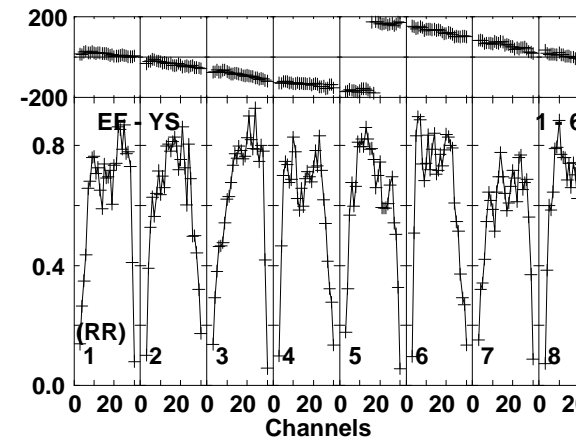
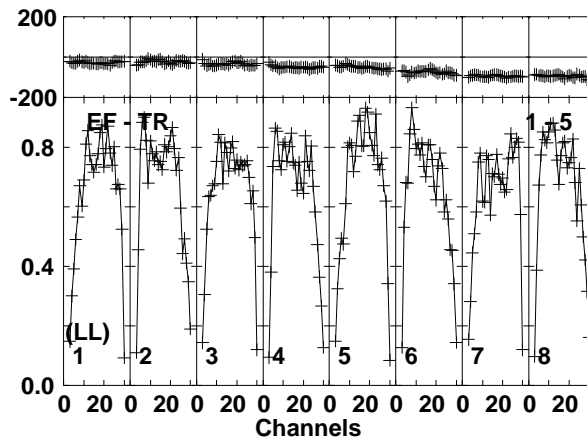
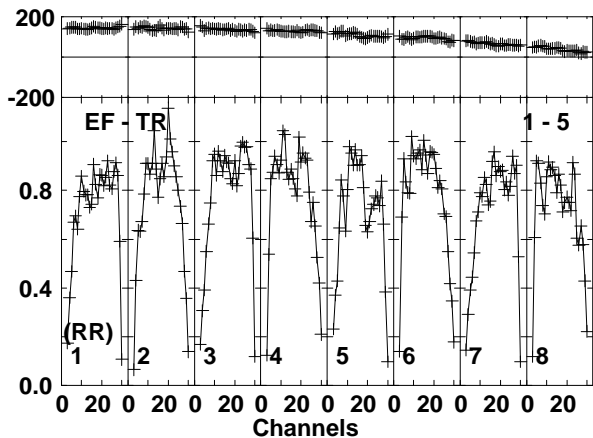
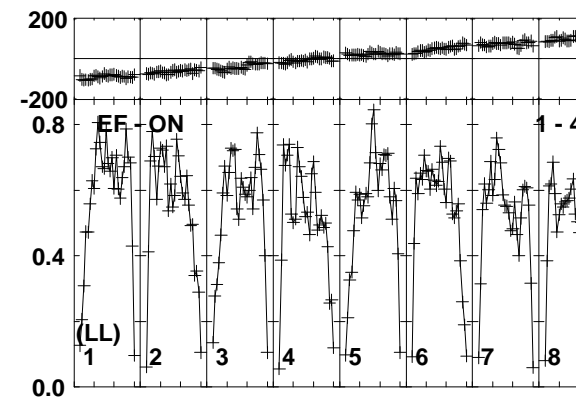
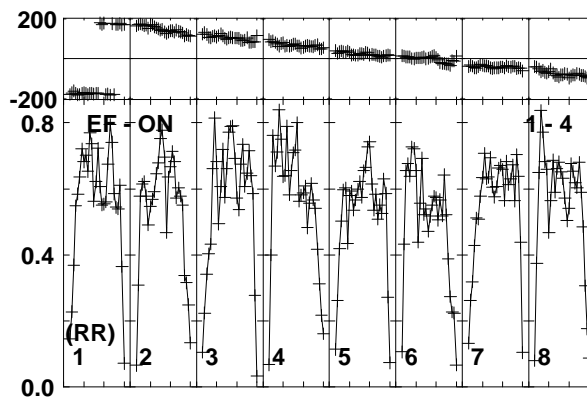
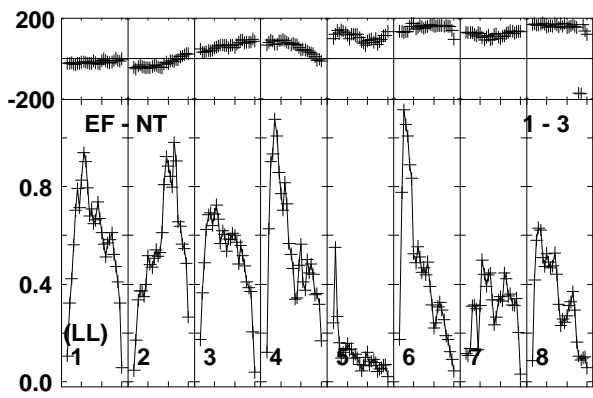
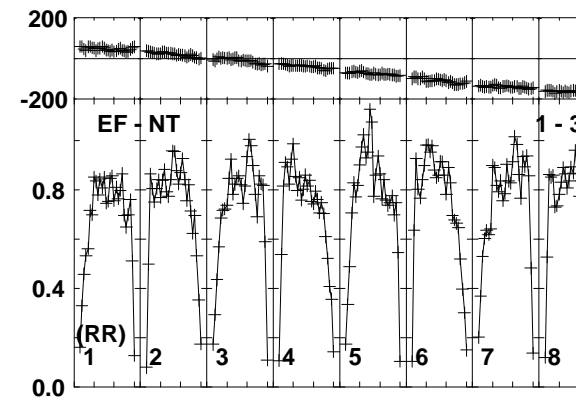
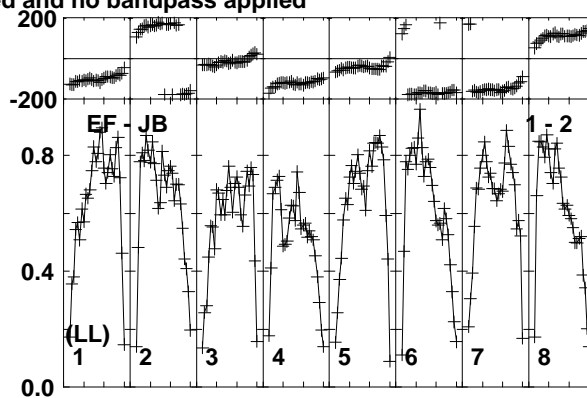
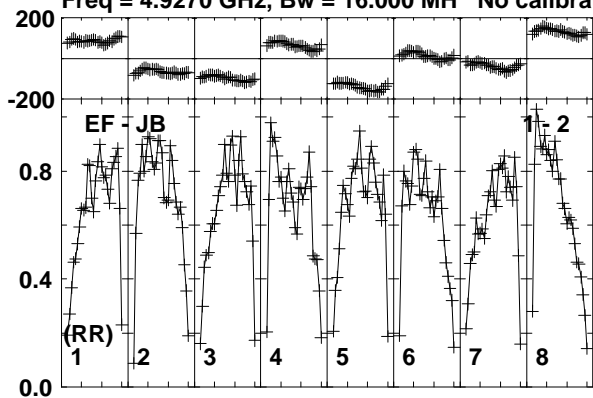

Lower frame: Milli Ampl Jy Top frame: Phas deg
Vector averaged cross-power spectrum Baseline: EF (01) - JB (02)
Timerange: 00/15:08:33 to 00/15:11:59

Plot file version 90 created 26-MAR-2015 15:27:40

J0525+0951 EG082E.UVDATA.1

Freq = 4.9270 GHz, Bw = 16.000 MH No calibration applied and no bandpass applied

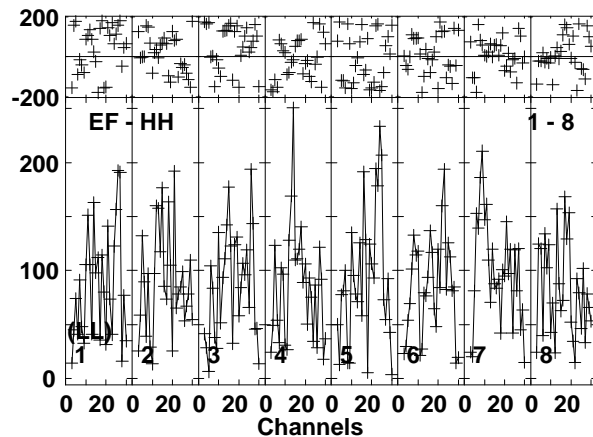
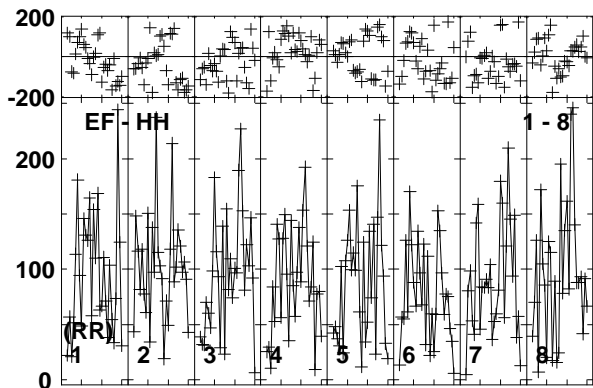
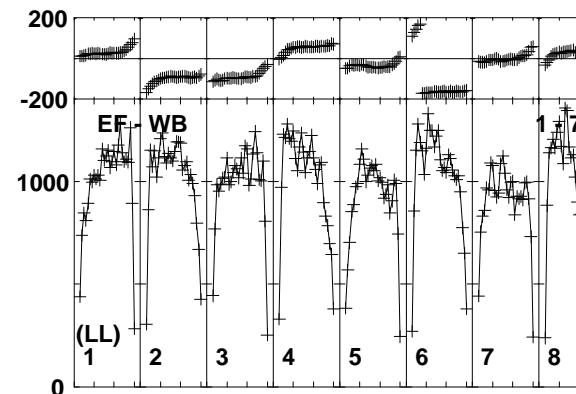
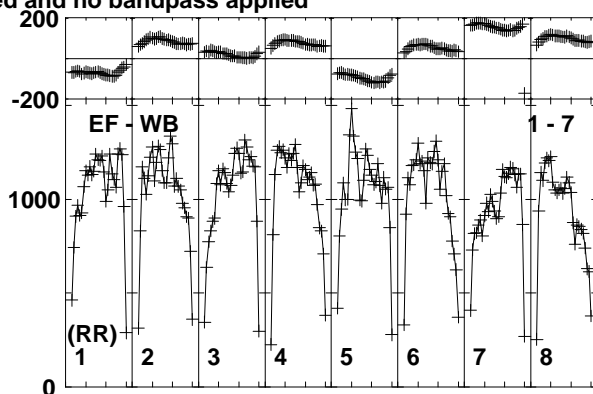
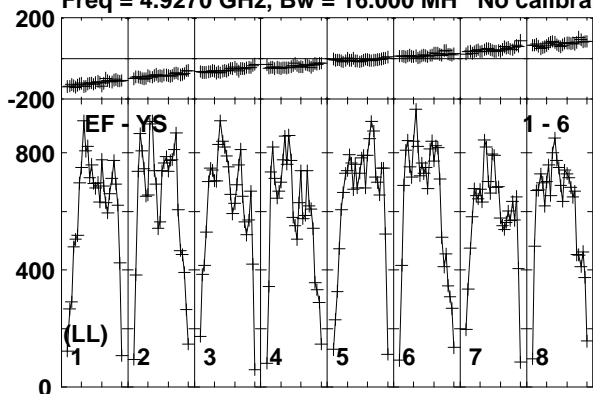

Lower frame: Micro Ampl Jy Top frame: Phas deg
Vector averaged cross-power spectrum Baseline: EF (01) - YS (06)
Timerange: 00/15:08:33 to 00/15:11:59

Plot file version 91 created 26-MAR-2015 15:27:40

J0519+0848 EG082E.UVDATA.1

Freq = 4.9270 GHz, Bw = 16.000 MH No calibration applied and no bandpass applied

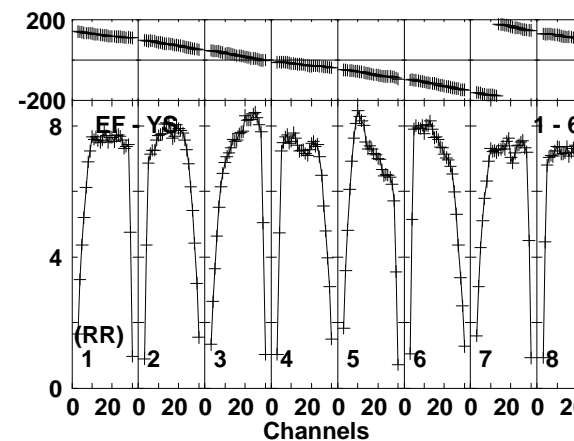
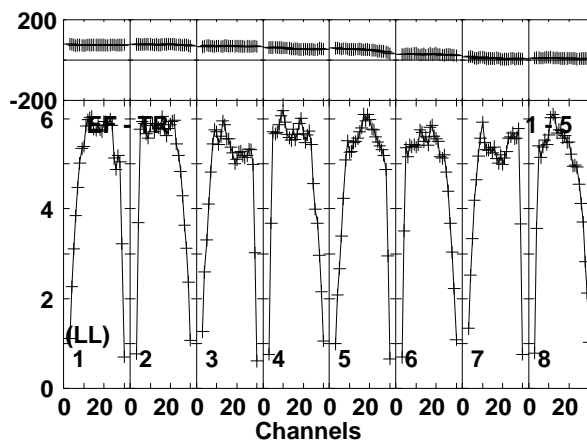
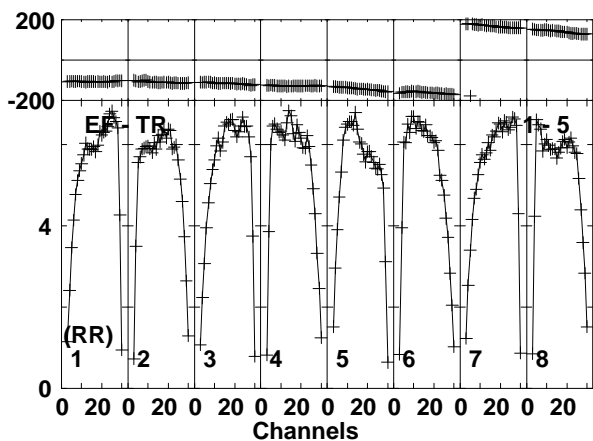
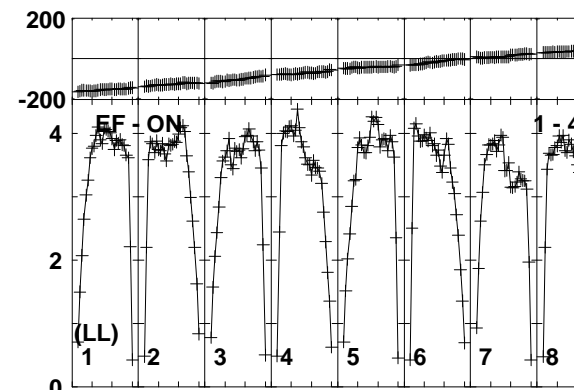
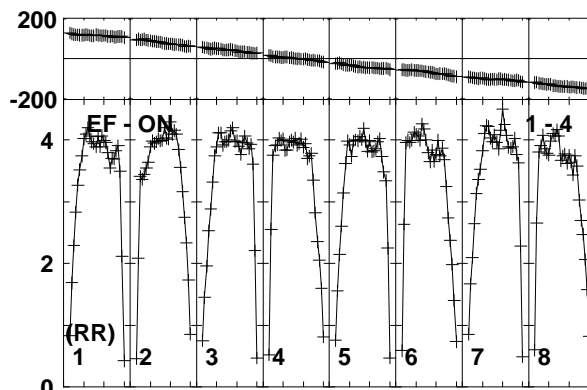
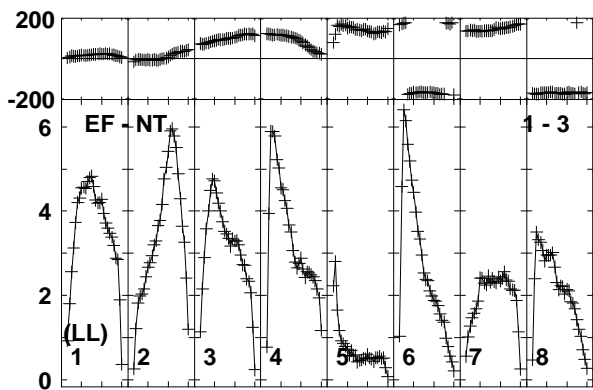
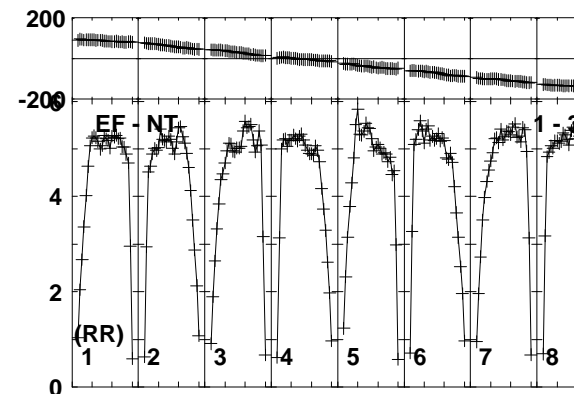
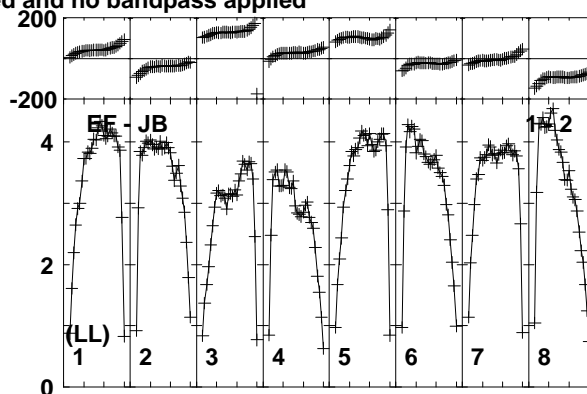
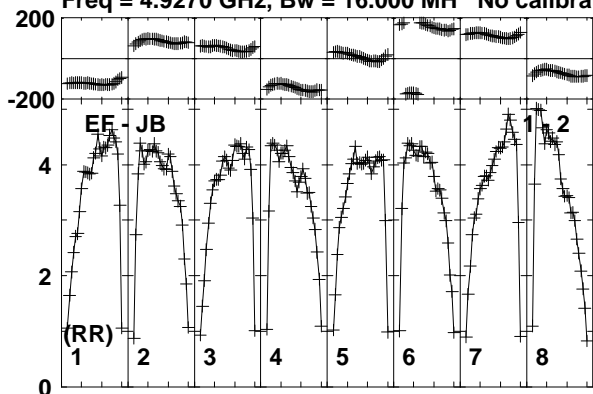

Lower frame: Milli Ampl Jy Top frame: Phas deg
Vector averaged cross-power spectrum Baseline: EF (01) - JB (02)
Timerange: 00/15:12:33 to 00/15:13:29

Plot file version 92 created 26-MAR-2015 15:27:40

J0519+0848 EG082E.UVDATA.1

Freq = 4.9270 GHz, Bw = 16.000 MH No calibration applied and no bandpass applied

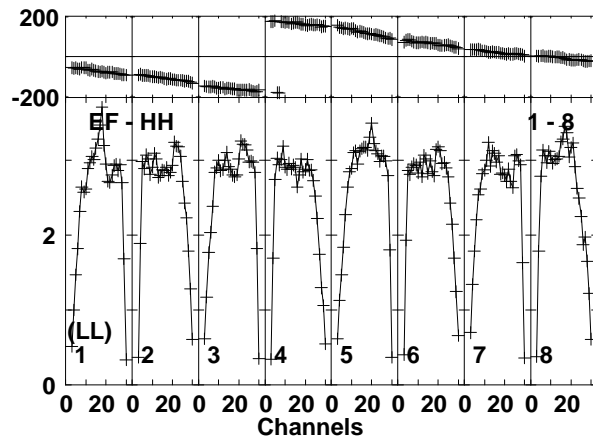
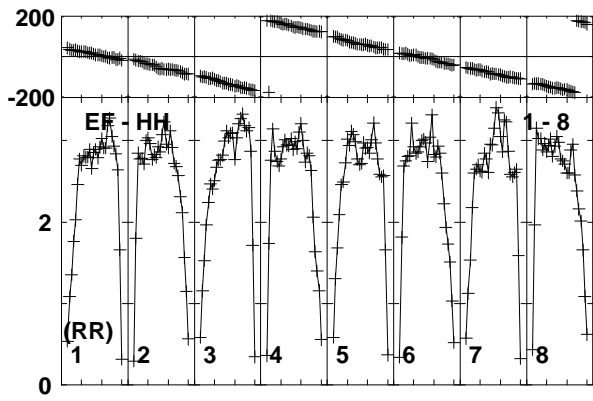
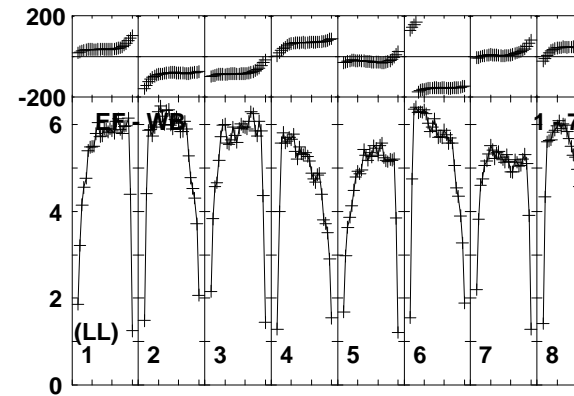
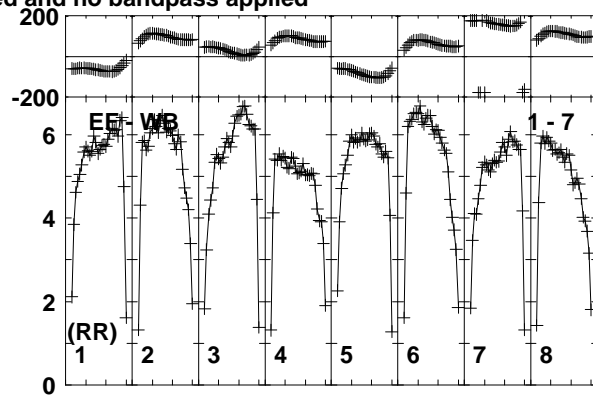
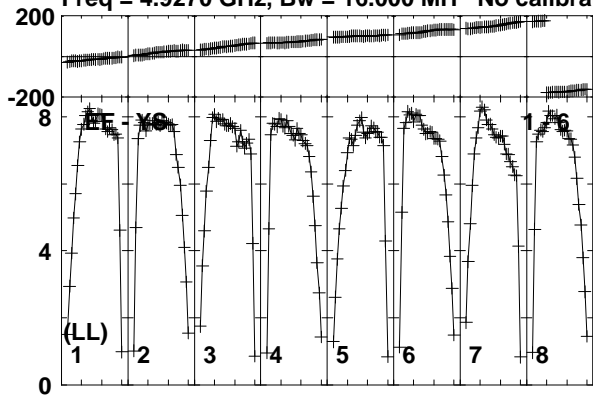

Lower frame: Milli Ampl Jy Top frame: Phas deg
Vector averaged cross-power spectrum Baseline: EF (01) - YS (06)
Timerange: 00/15:12:33 to 00/15:13:29

Plot file version 93 created 26-MAR-2015 15:27:40

V998ORI EG082E.UVDATA.1

Freq = 4.9270 GHz, Bw = 16.000 MH No calibration applied and no bandpass applied

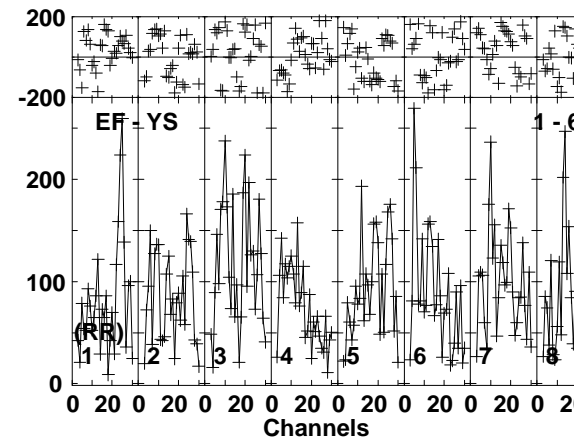
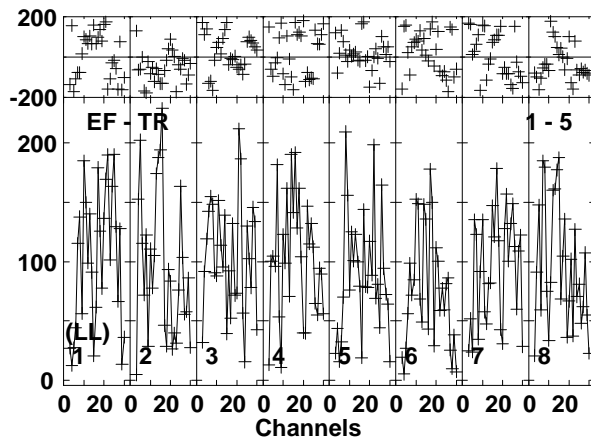
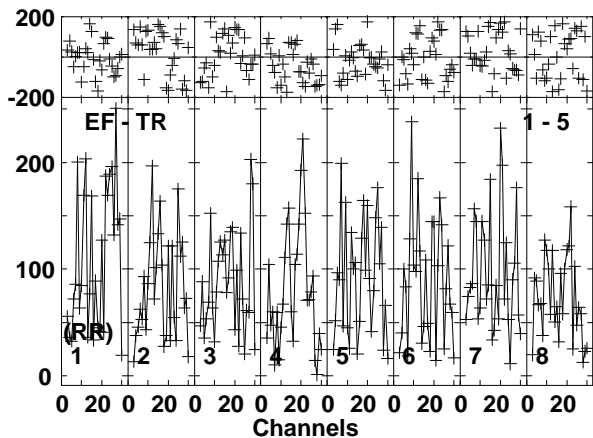
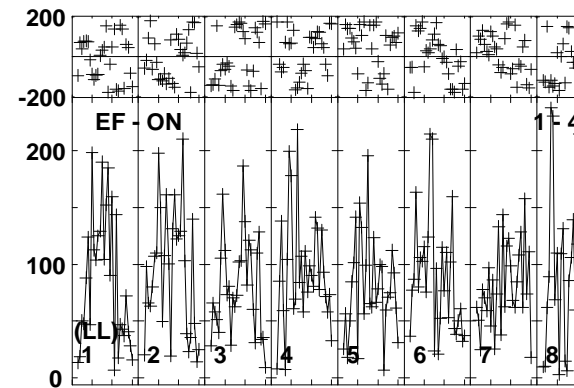
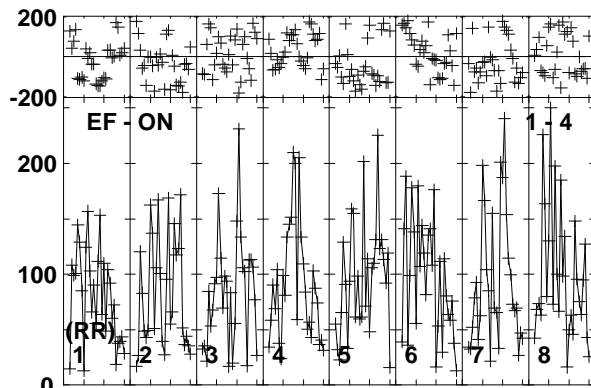
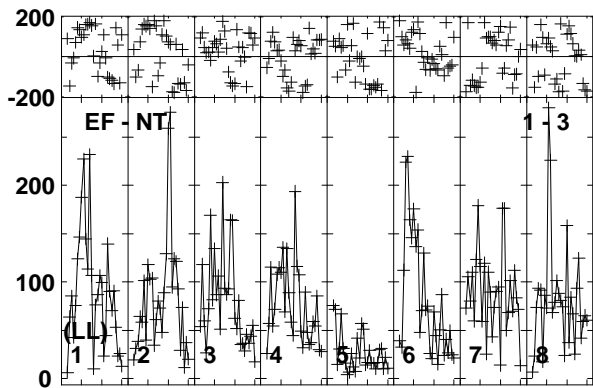
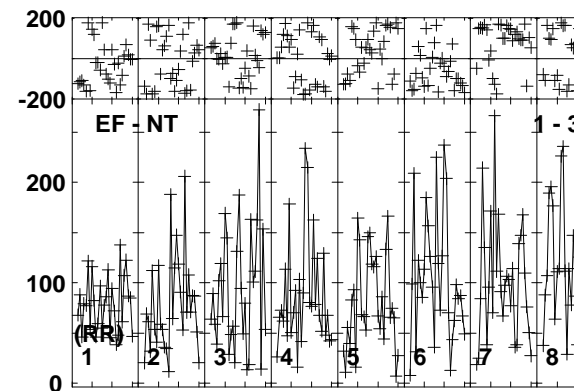
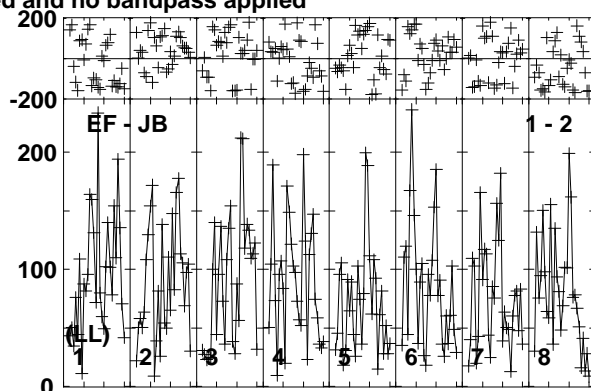
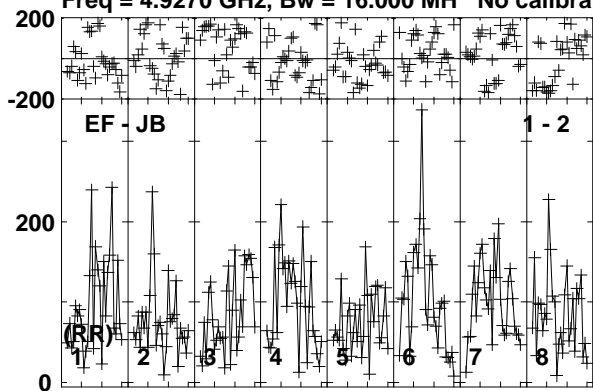

Lower frame: Micro Ampl Jy Top frame: Phas deg
Vector averaged cross-power spectrum Baseline: EF (01) - JB (02)
Timerange: 00/15:13:33 to 00/15:16:59

Plot file version 94 created 26-MAR-2015 15:27:40

V998ORI EG082E.UVDATA.1

Freq = 4.9270 GHz, Bw = 16.000 MH No calibration applied and no bandpass applied

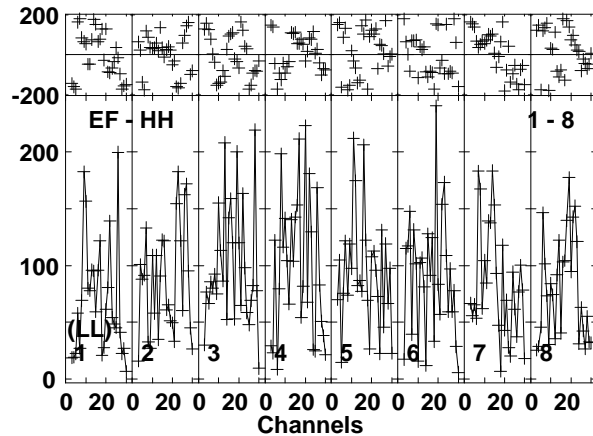
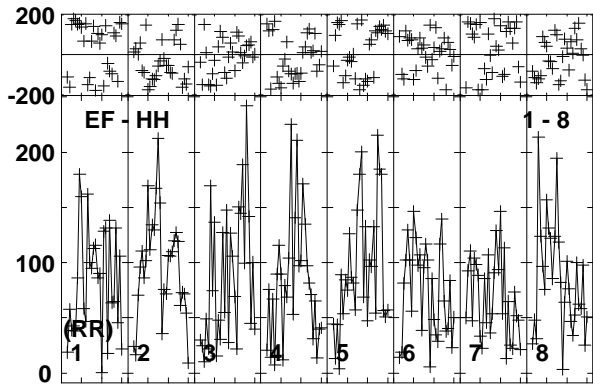
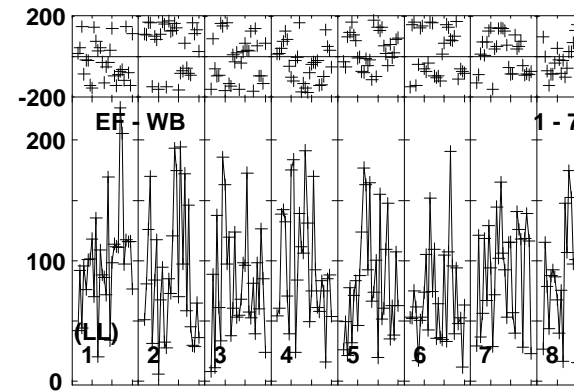
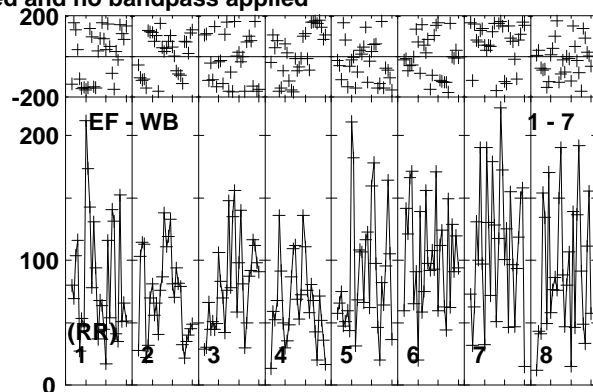
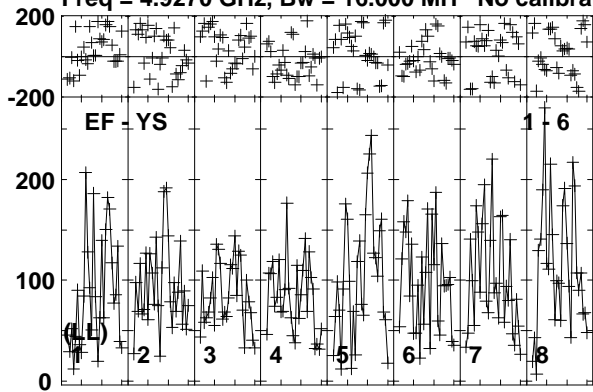

Lower frame: Micro Ampl Jy Top frame: Phas deg
Vector averaged cross-power spectrum Baseline: EF (01) - YS (06)
Timerange: 00/15:13:33 to 00/15:16:59

Plot file version 95 created 26-MAR-2015 15:27:40

J0519+0848 EG082E.UVDATA.1

Freq = 4.9270 GHz, Bw = 16.000 MH No calibration applied and no bandpass applied

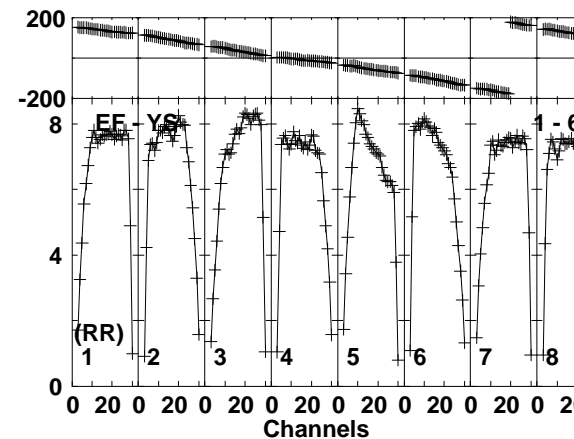
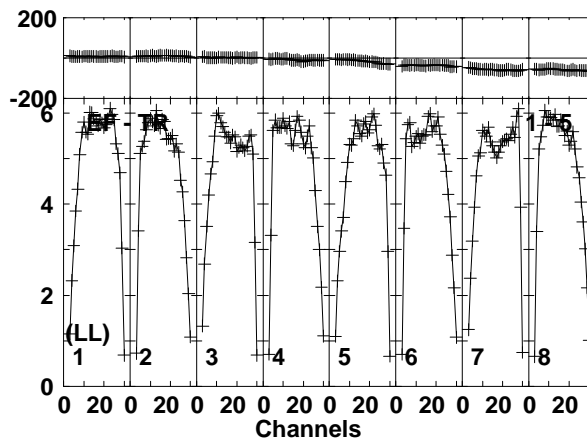
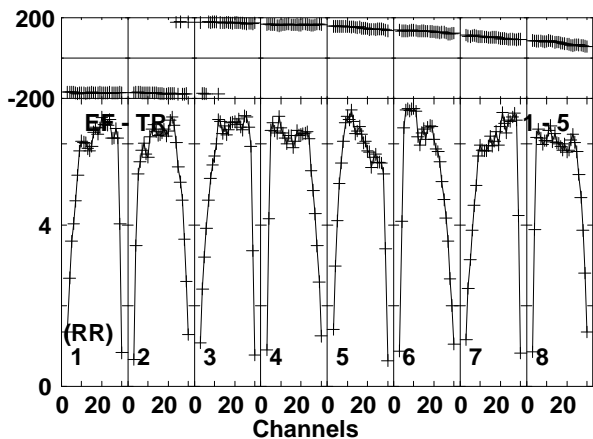
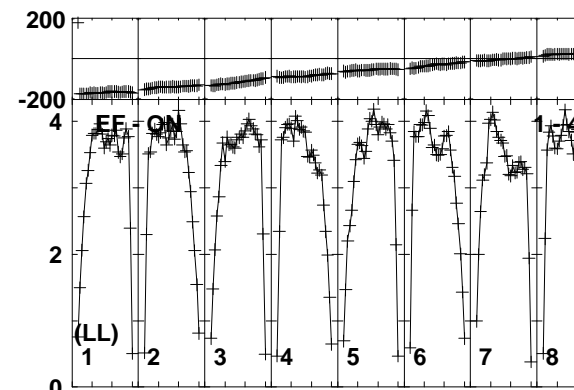
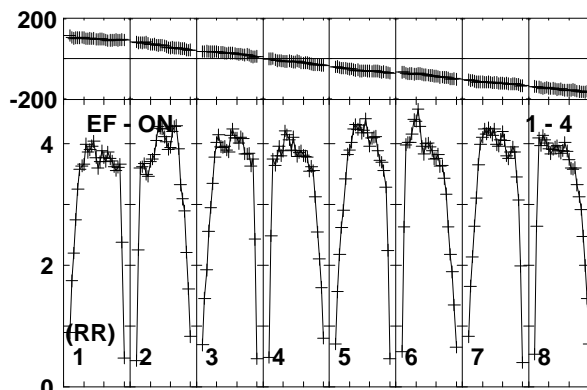
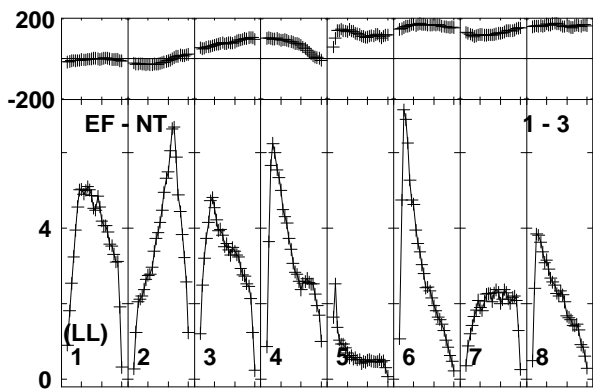
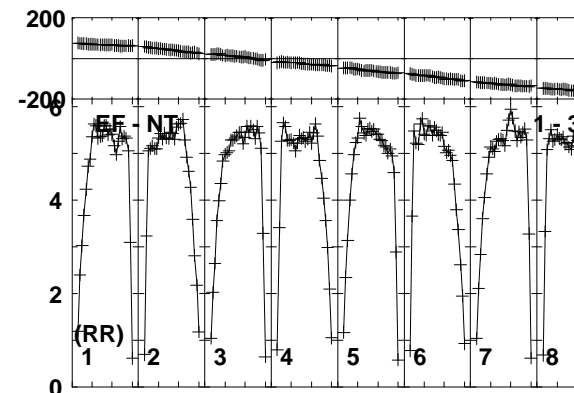
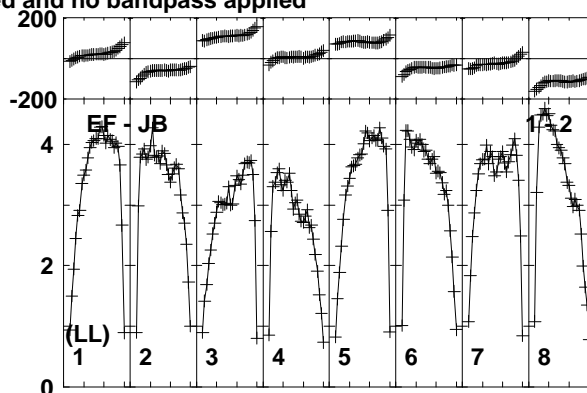
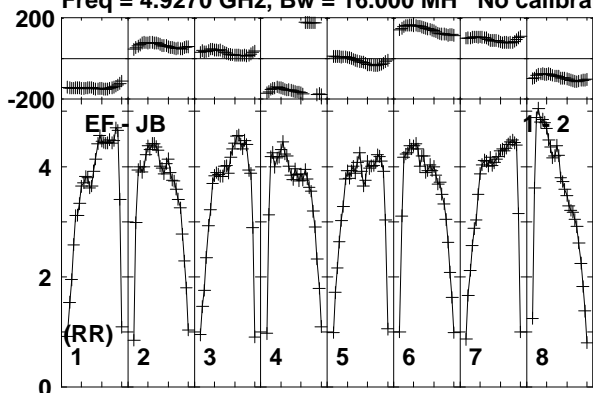

Lower frame: Milli Ampl Jy Top frame: Phas deg
Vector averaged cross-power spectrum Baseline: EF (01) - JB (02)
Timerange: 00:15:17:03 to 00:15:18:29

Plot file version 96 created 26-MAR-2015 15:27:40

J0519+0848 EG082E.UVDATA.1

Freq = 4.9270 GHz, Bw = 16.000 MH No calibration applied and no bandpass applied

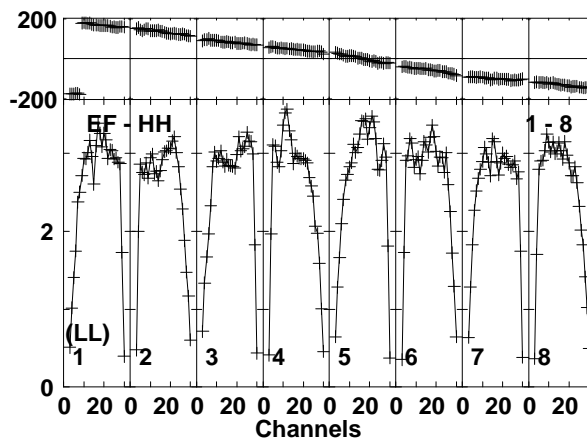
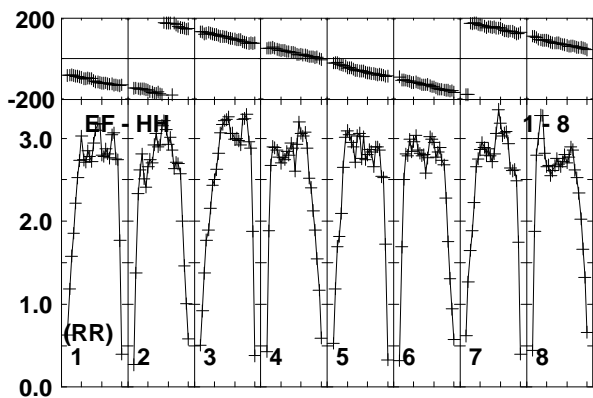
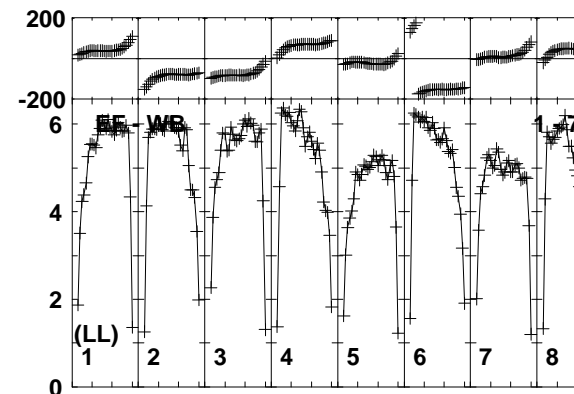
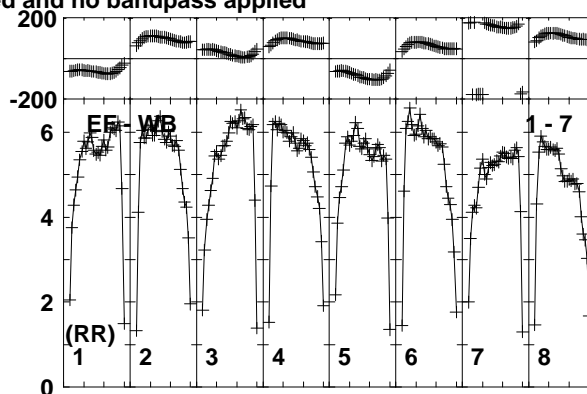
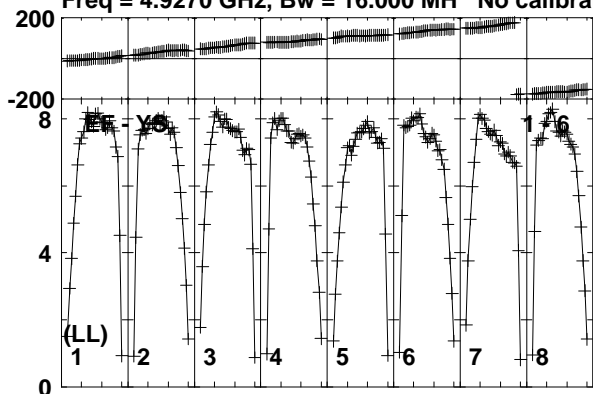

Lower frame: Milli Ampl Jy Top frame: Phas deg
Vector averaged cross-power spectrum Baseline: EF (01) - YS (06)
Timerange: 00/15:17:03 to 00/15:18:29

Plot file version 97 created 26-MAR-2015 15:27:40

V998ORI EG082E.UVDATA.1

Freq = 4.9270 GHz, Bw = 16.000 MH No calibration applied and no bandpass applied

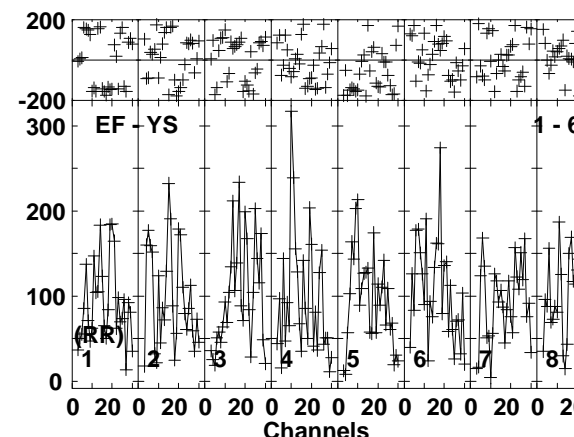
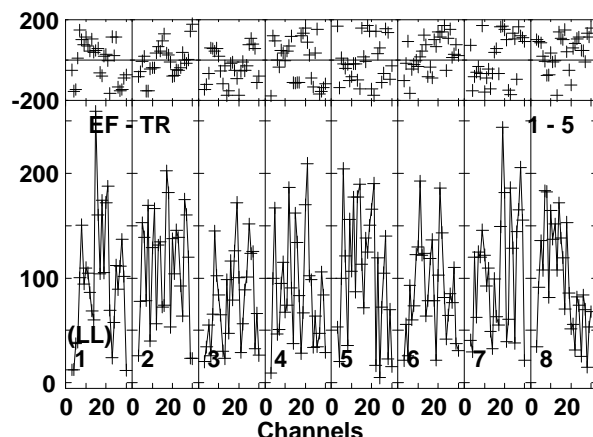
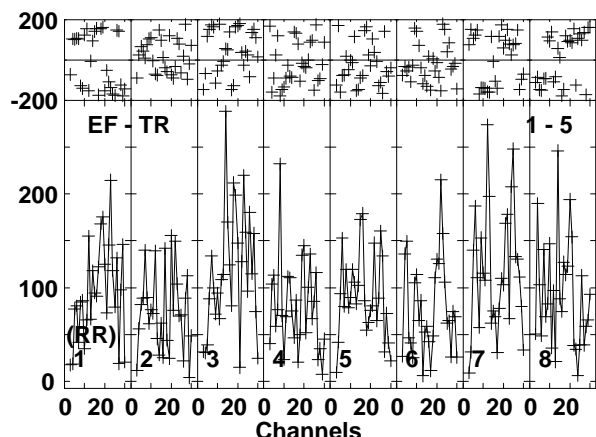
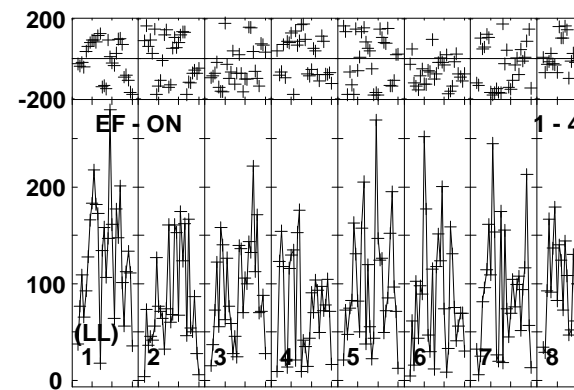
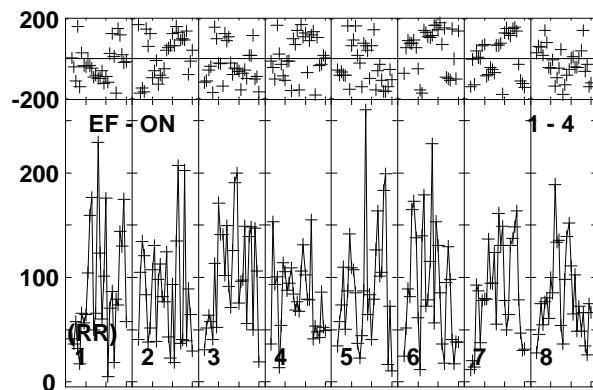
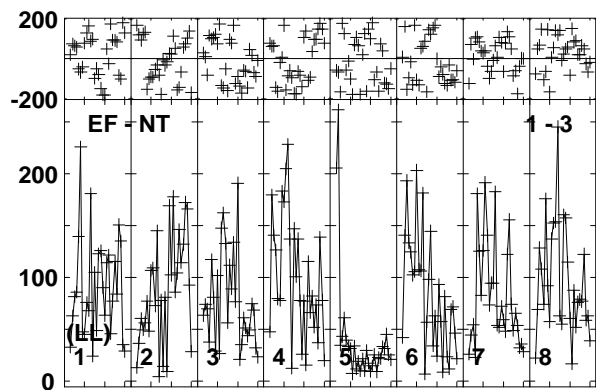
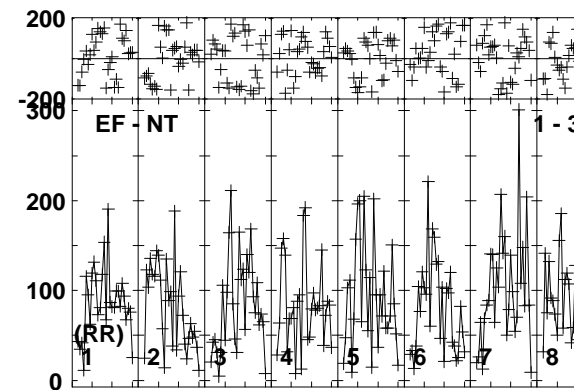
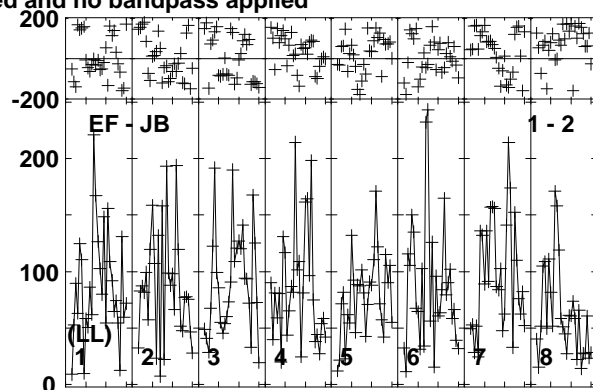
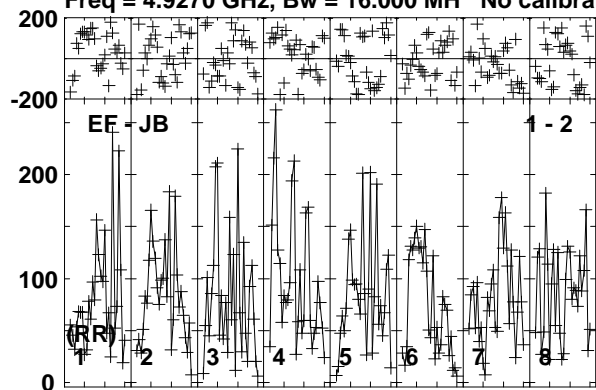

Lower frame: Micro Ampl Jy Top frame: Phas deg
Vector averaged cross-power spectrum Baseline: EF (01) - JB (02)
Timerange: 00/15:18:33 to 00/15:21:59

Plot file version 98 created 26-MAR-2015 15:27:40

V998ORI EG082E.UVDATA.1

Freq = 4.9270 GHz, Bw = 16.000 MH No calibration applied and no bandpass applied

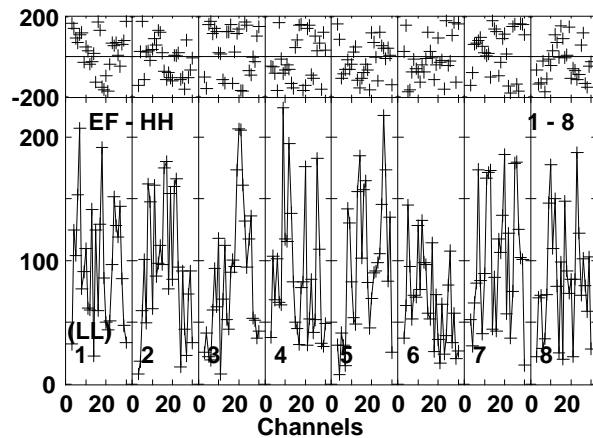
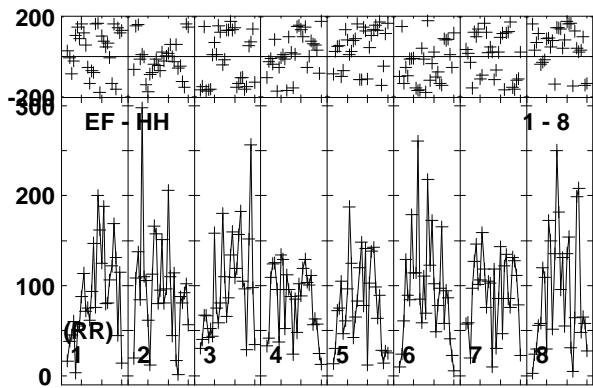
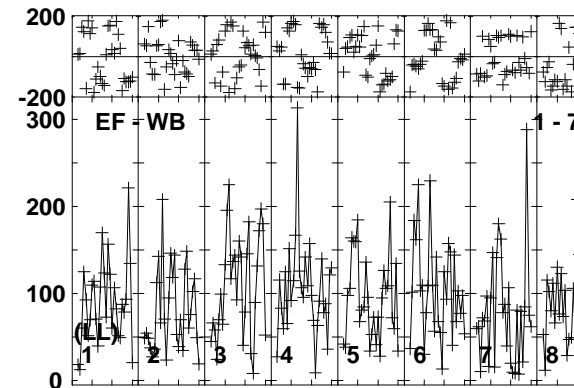
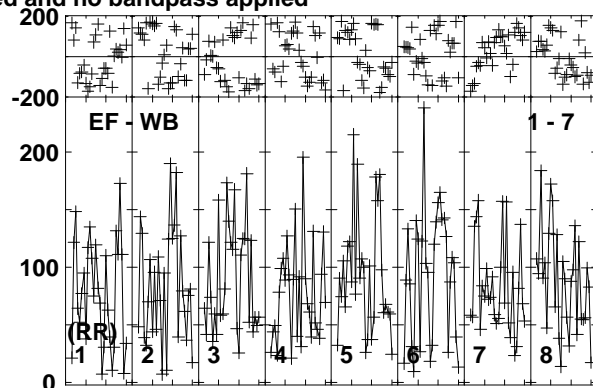
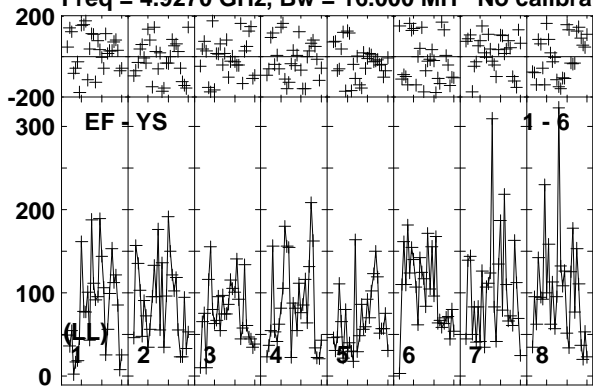

Lower frame: Micro Ampl Jy Top frame: Phas deg
Vector averaged cross-power spectrum Baseline: EF (01) - YS (06)
Timerange: 00/15:18:33 to 00/15:21:59

Plot file version 99 created 26-MAR-2015 15:27:40

J0519+0848 EG082E.UVDATA.1

Freq = 4.9270 GHz, Bw = 16.000 MH No calibration applied and no bandpass applied

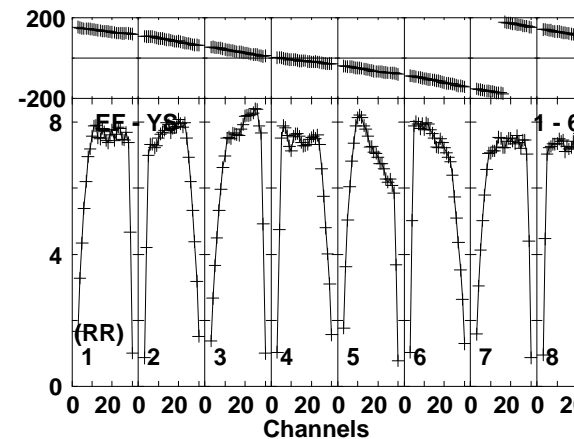
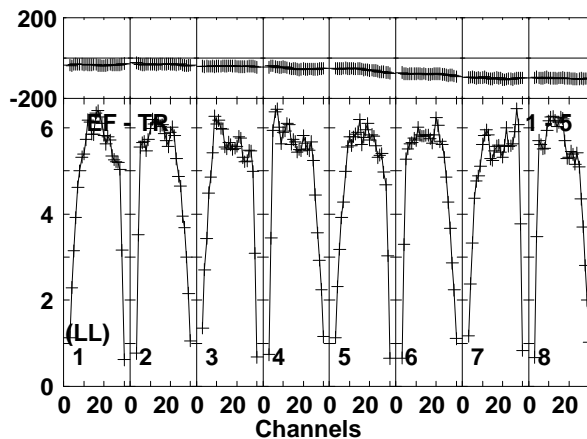
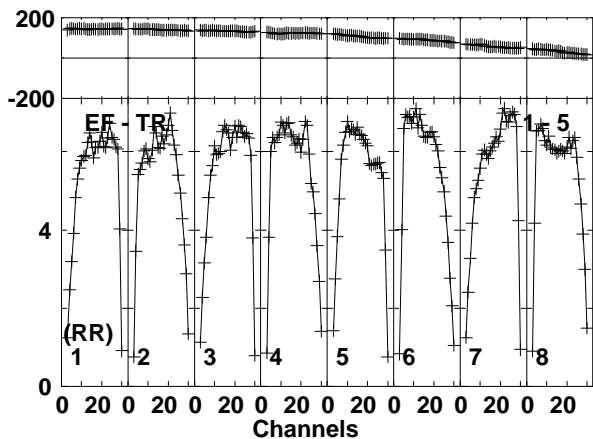
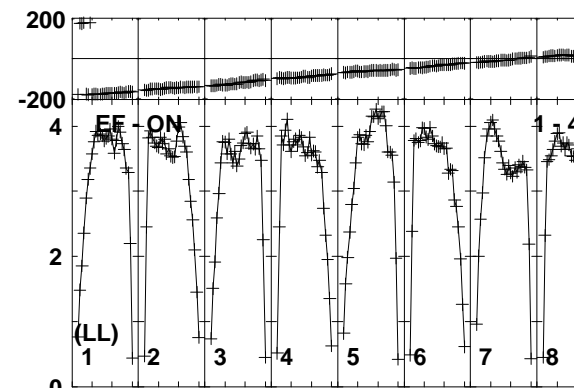
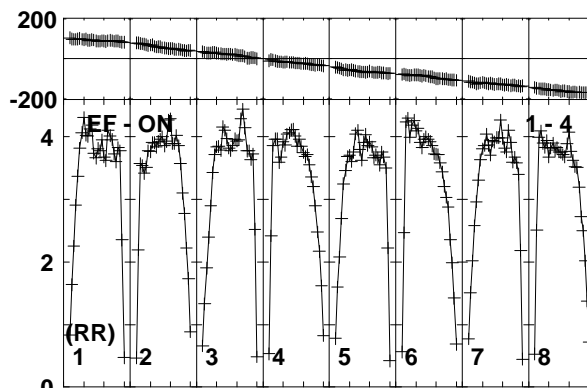
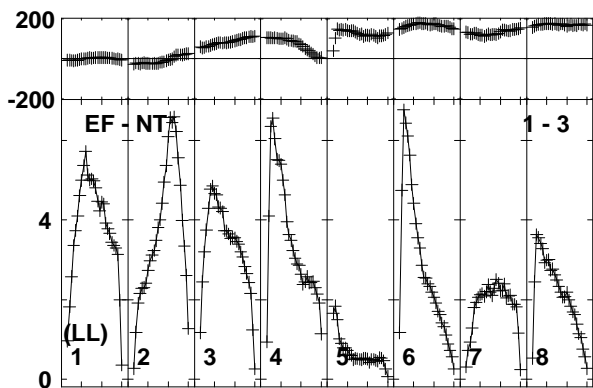
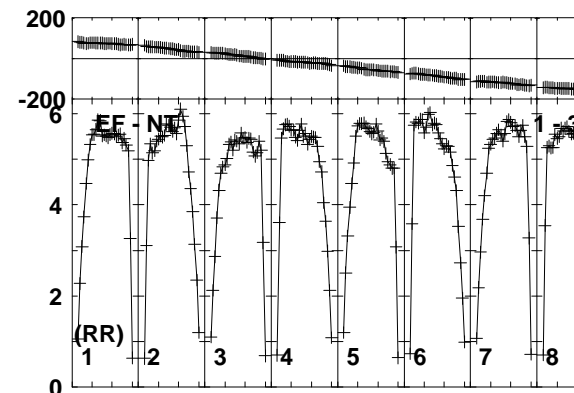
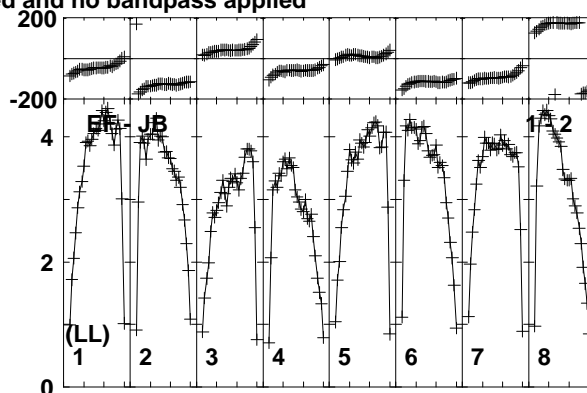
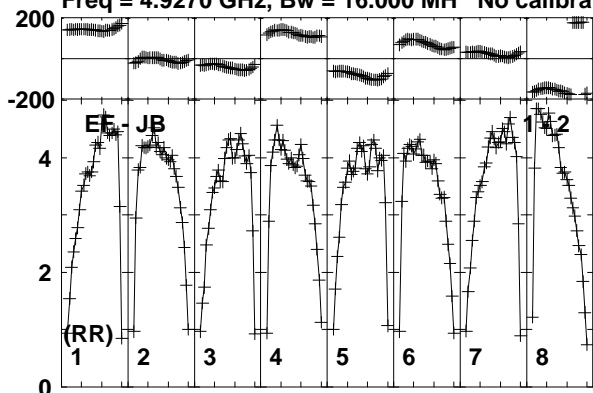

Lower frame: Milli Ampl Jy Top frame: Phas deg
Vector averaged cross-power spectrum Baseline: EF (01) - JB (02)
Timerange: 00/15:22:33 to 00/15:23:29

Plot file version 100 created 26-MAR-2015 15:27:40

J0519+0848 EG082E.UVDATA.1

Freq = 4.9270 GHz, Bw = 16.000 MH No calibration applied and no bandpass applied

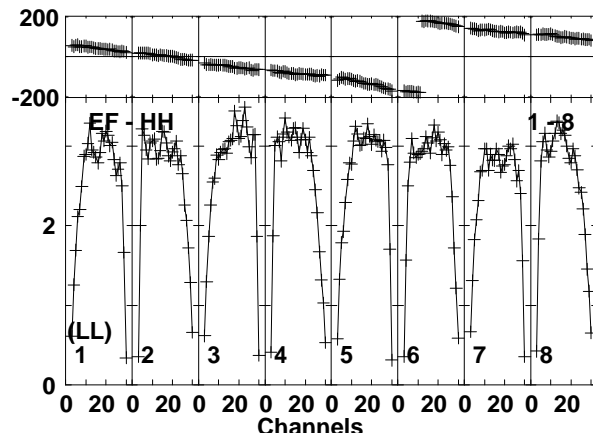
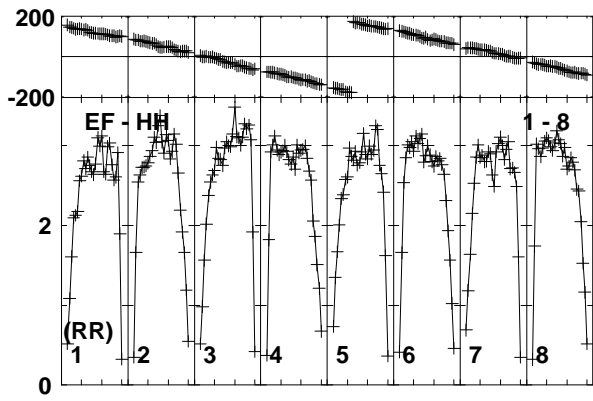
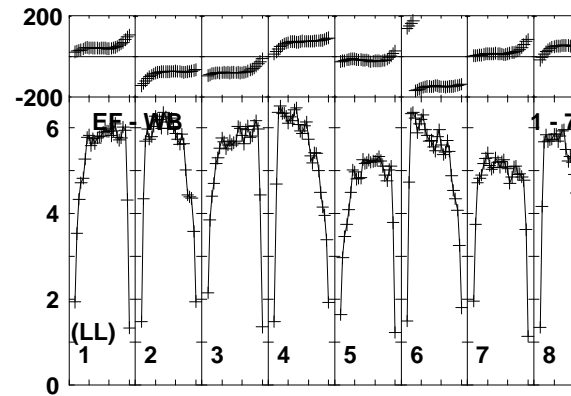
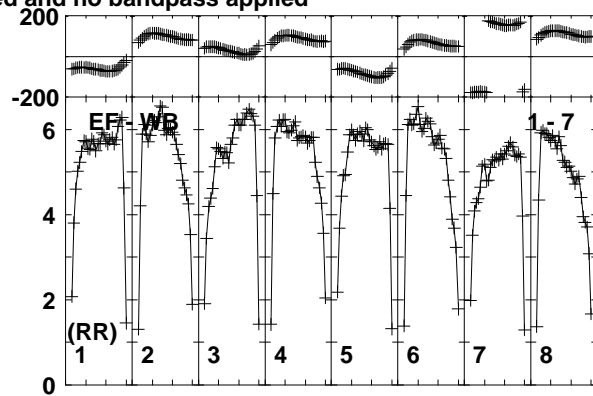
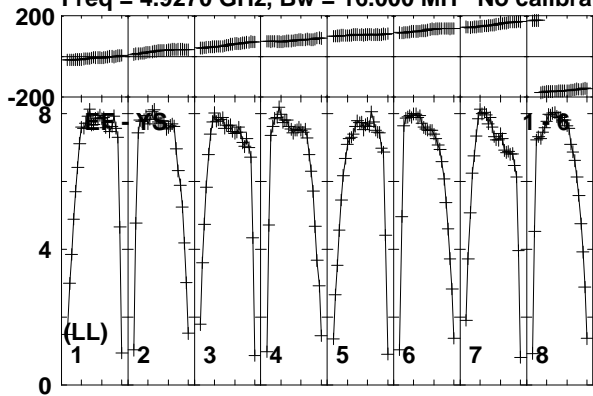

Lower frame: Milli Ampl Jy Top frame: Phas deg
Vector averaged cross-power spectrum Baseline: EF (01) - YS (06)
Timerange: 00:15:22:33 to 00:15:23:29

Plot file version 101 created 26-MAR-2015 15:27:40

V998ORI EG082E.UVDATA.1

Freq = 4.9270 GHz, Bw = 16.000 MH No calibration applied and no bandpass applied

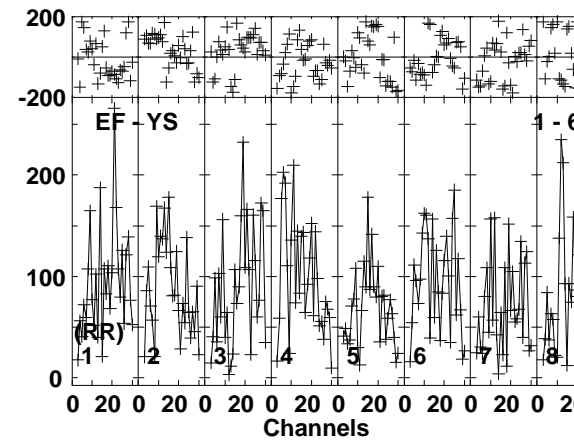
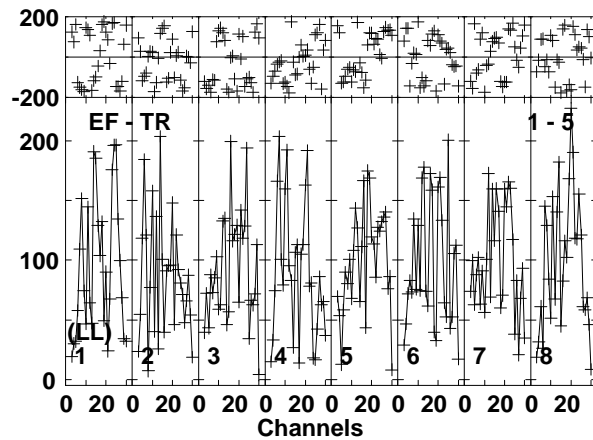
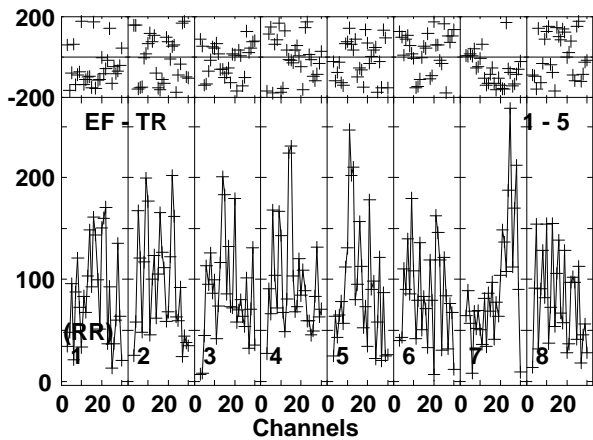
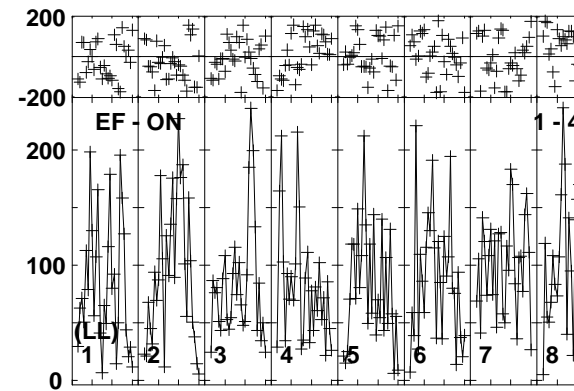
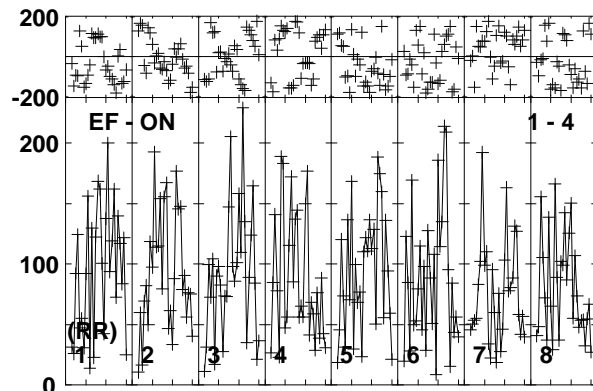
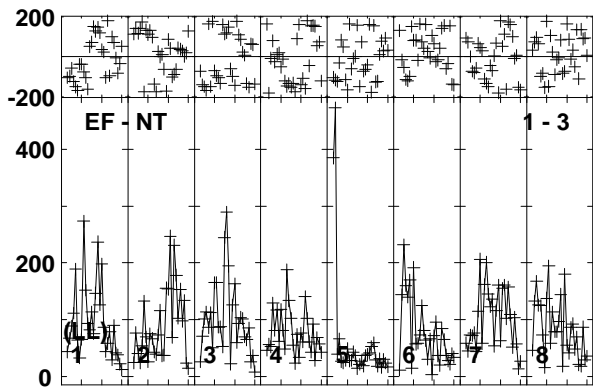
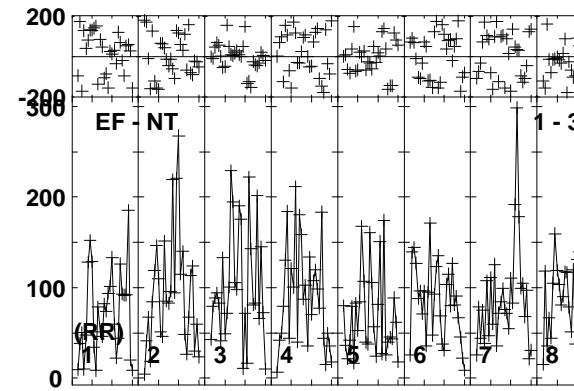
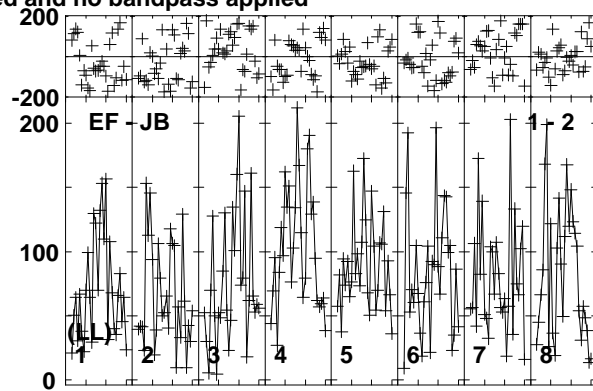
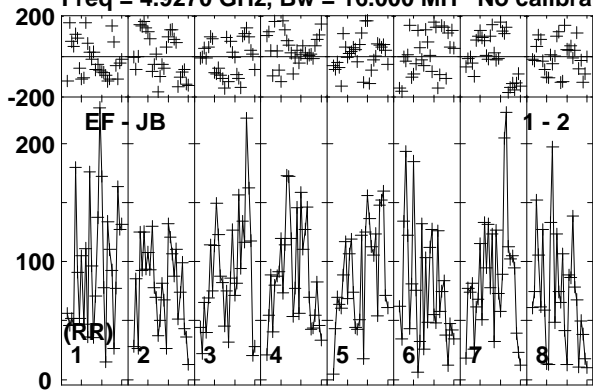

Lower frame: Micro Ampl Jy Top frame: Phas deg
Vector averaged cross-power spectrum Baseline: EF (01) - JB (02)
Timerange: 00/15:23:33 to 00/15:26:59

Plot file version 102 created 26-MAR-2015 15:27:40

V998ORI EG082E.UVDATA.1

Freq = 4.9270 GHz, Bw = 16.000 MH No calibration applied and no bandpass applied

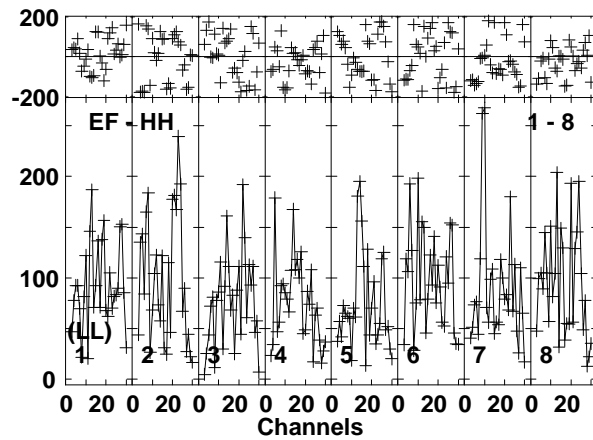
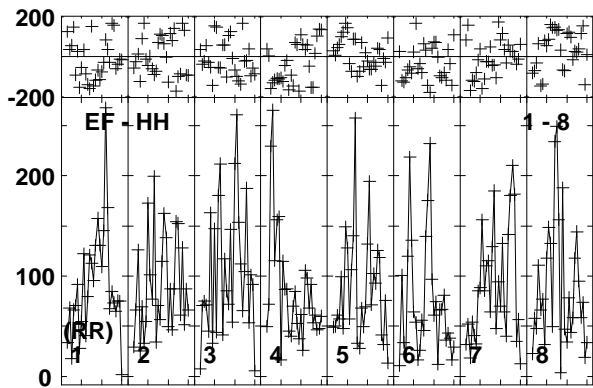
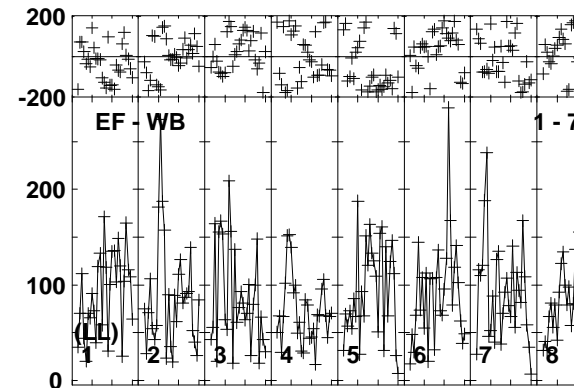
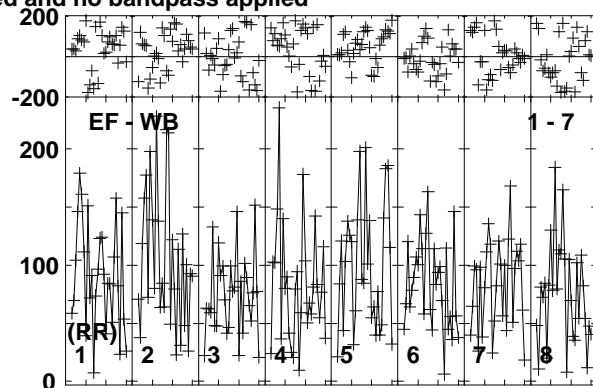
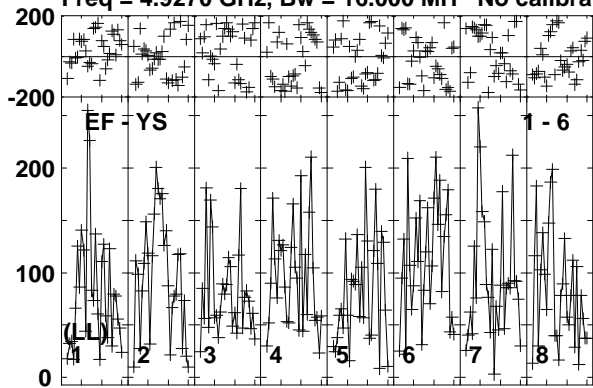

Lower frame: Micro Ampl Jy Top frame: Phas deg
Vector averaged cross-power spectrum Baseline: EF (01) - YS (06)
Timerange: 00:15:23:33 to 00:15:26:59

Plot file version 103 created 26-MAR-2015 15:27:40

J0519+0848 EG082E.UVDATA.1

Freq = 4.9270 GHz, Bw = 16.000 MH No calibration applied and no bandpass applied

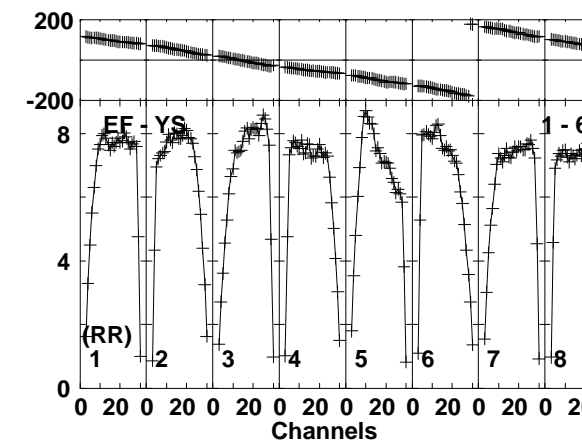
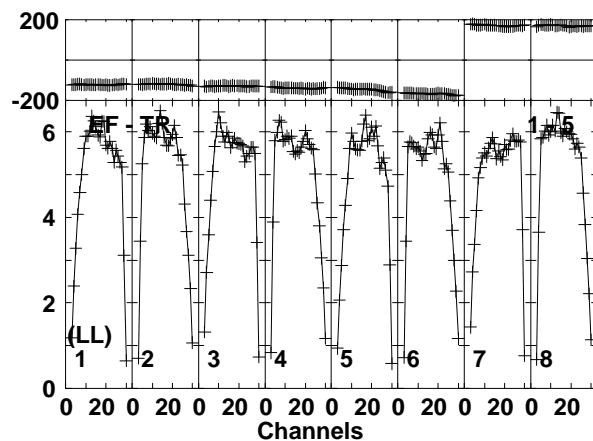
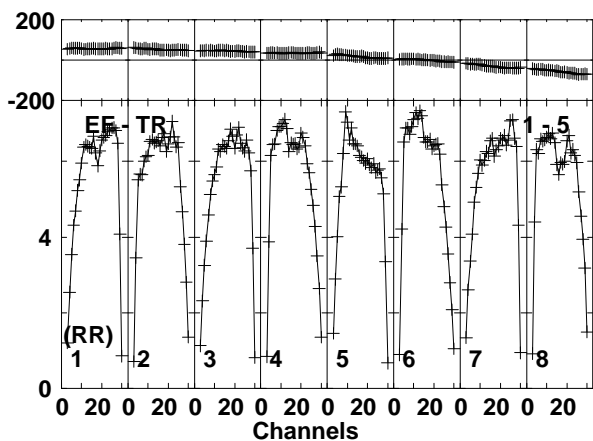
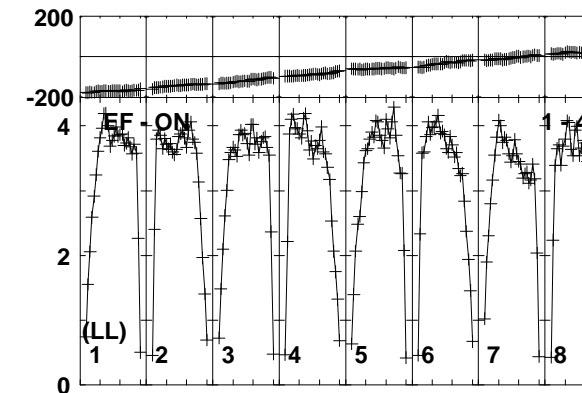
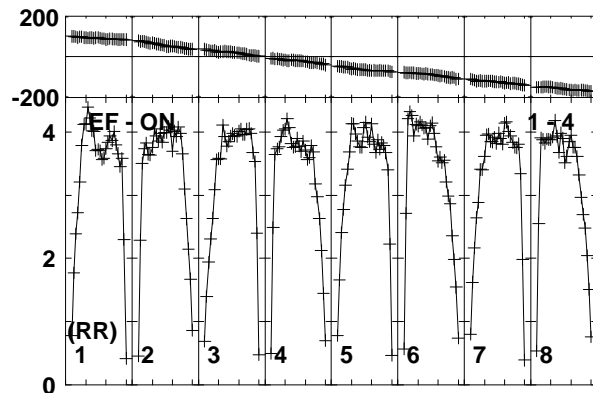
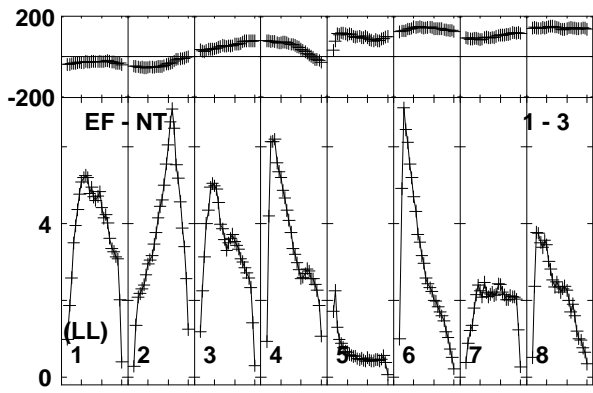
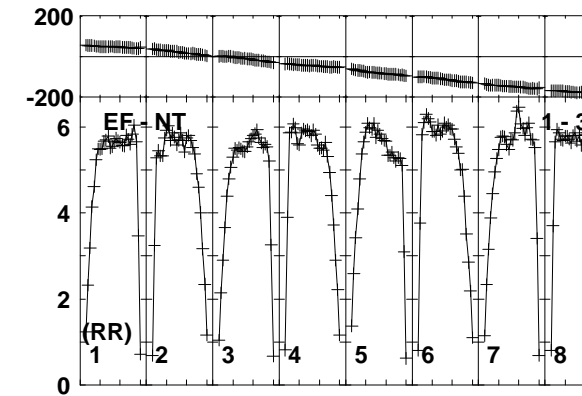
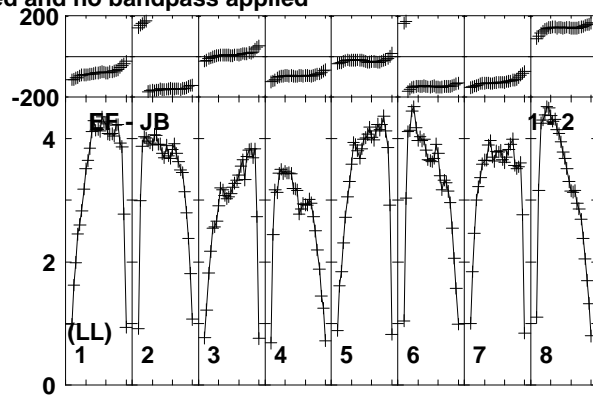
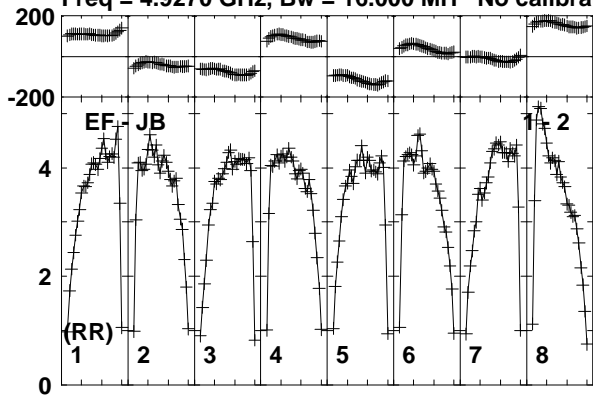

Lower frame: Milli Ampl Jy Top frame: Phas deg
Vector averaged cross-power spectrum Baseline: EF (01) - JB (02)
Timerange: 00/15:27:03 to 00/15:28:29

Plot file version 104 created 26-MAR-2015 15:27:40

J0519+0848 EG082E.UVDATA.1

Freq = 4.9270 GHz, Bw = 16.000 MH No calibration applied and no bandpass applied

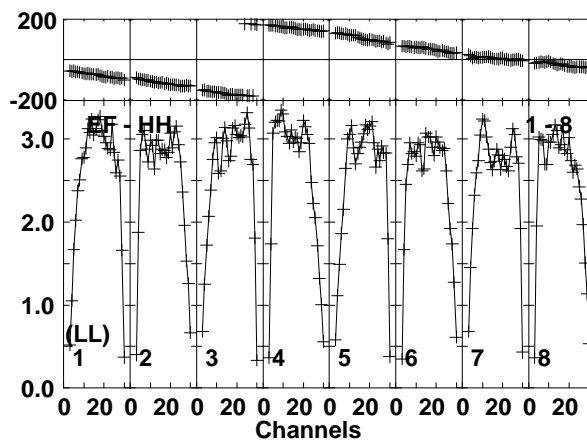
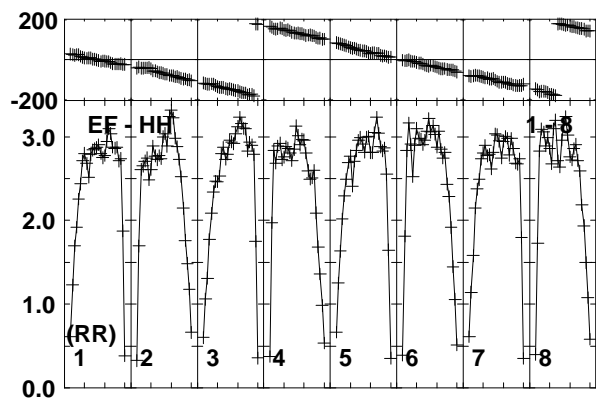
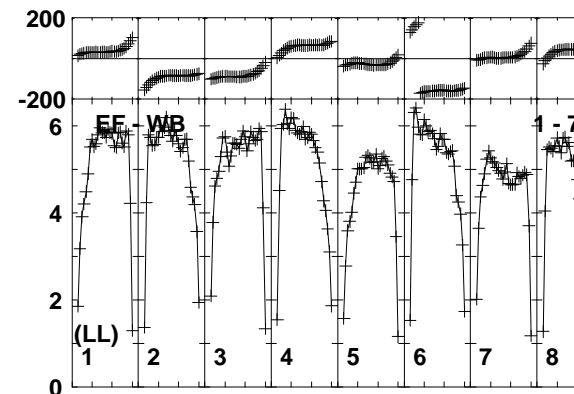
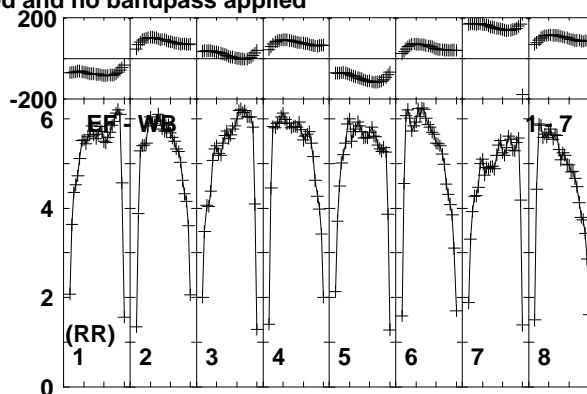
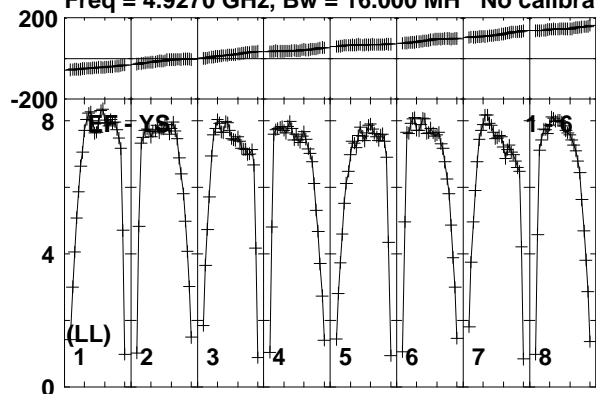

Lower frame: Milli Ampl Jy Top frame: Phas deg
Vector averaged cross-power spectrum Baseline: EF (01) - YS (06)
Timerange: 00/15:27:03 to 00/15:28:29

Plot file version 105 created 26-MAR-2015 15:27:40

V998ORI EG082E.UVDATA.1

Freq = 4.9270 GHz, Bw = 16.000 MH No calibration applied and no bandpass applied

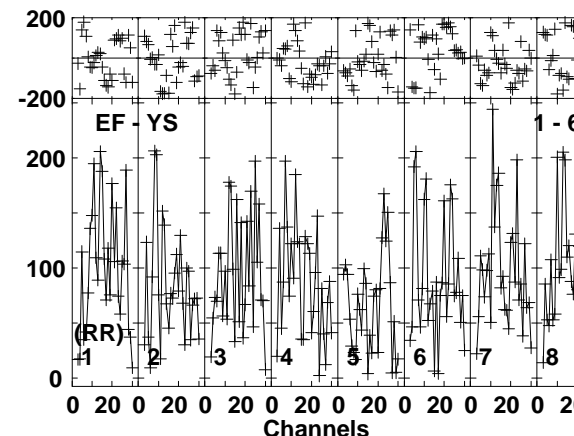
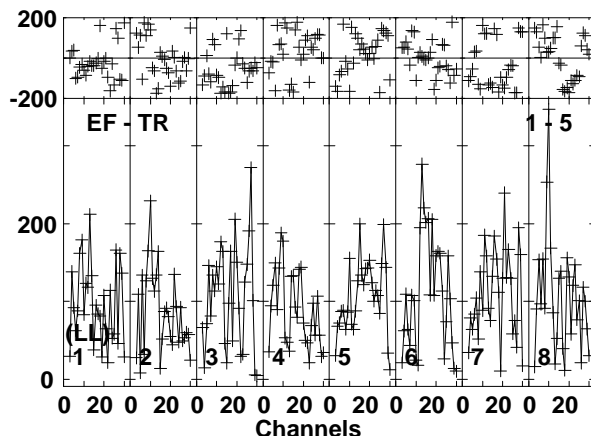
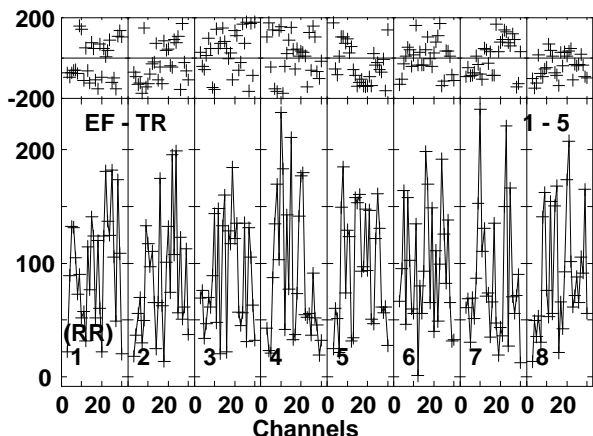
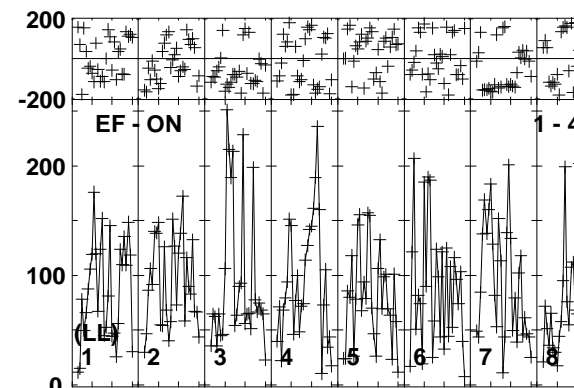
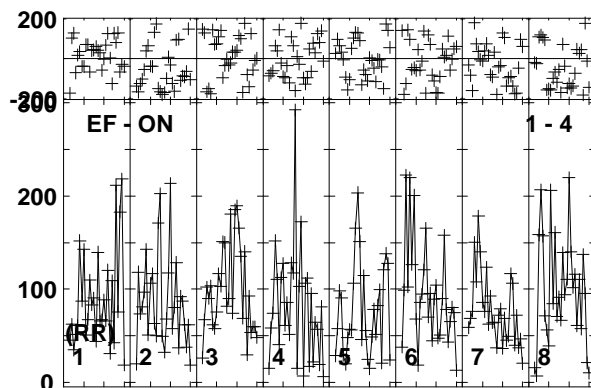
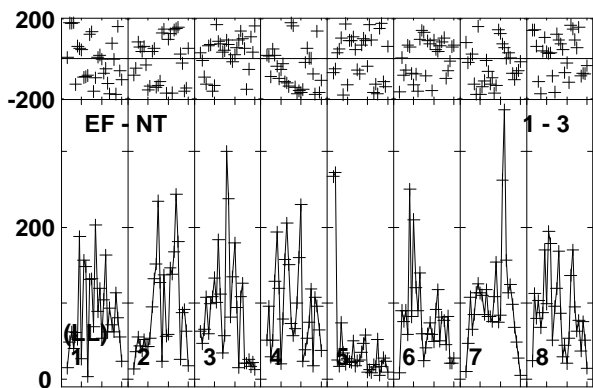
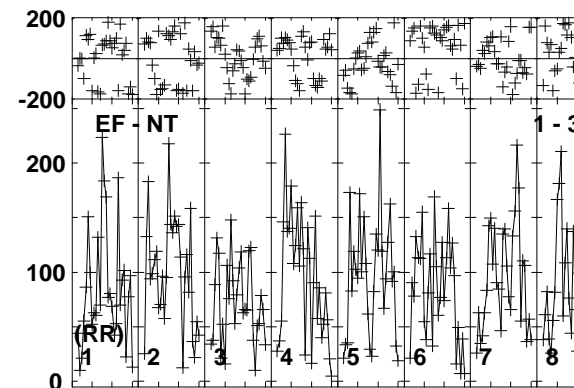
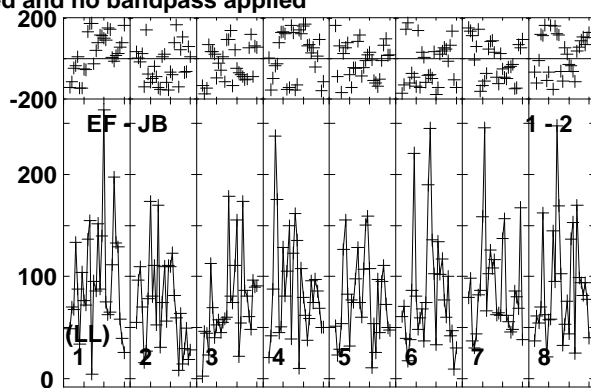
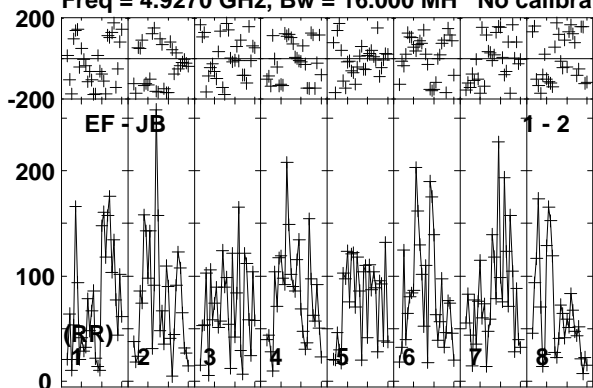

Lower frame: Micro Ampl Jy Top frame: Phas deg
Vector averaged cross-power spectrum Baseline: EF (01) - JB (02)
Timerange: 00:15:28:33 to 00:15:31:59

Plot file version 106 created 26-MAR-2015 15:27:40

V998ORI EG082E.UVDATA.1

Freq = 4.9270 GHz, Bw = 16.000 MH No calibration applied and no bandpass applied

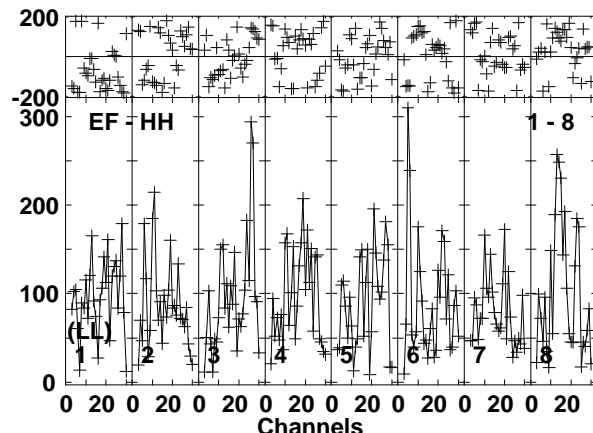
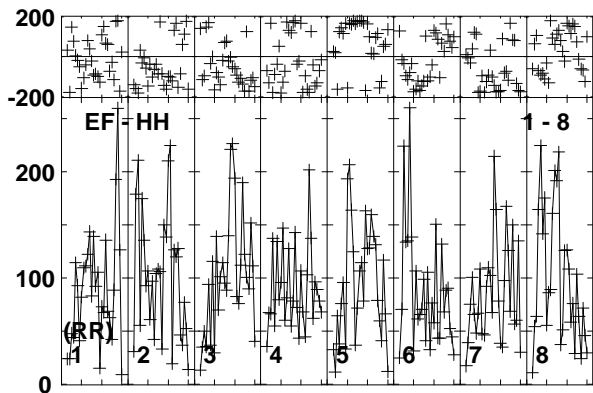
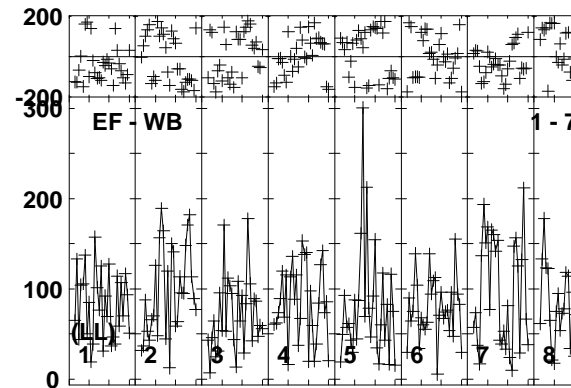
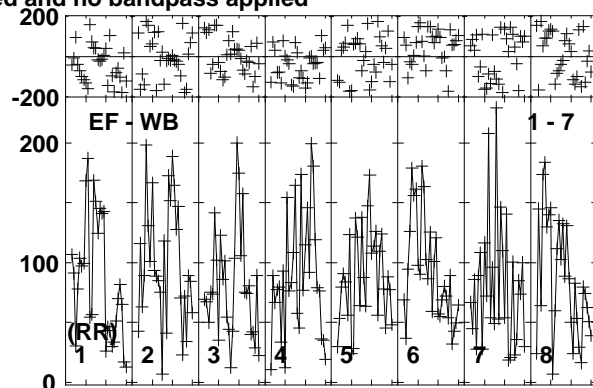
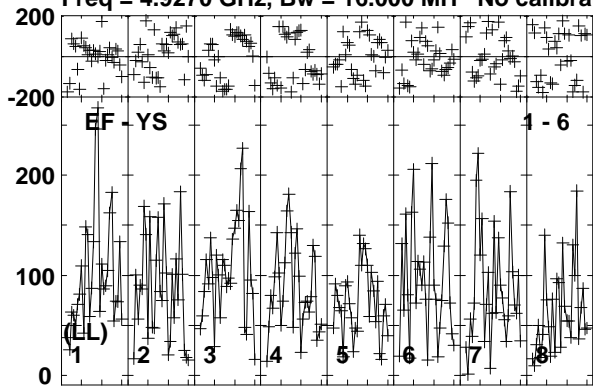

Lower frame: Micro Ampl Jy Top frame: Phas deg
Vector averaged cross-power spectrum Baseline: EF (01) - YS (06)
Timerange: 00/15:28:33 to 00/15:31:59

Plot file version 107 created 26-MAR-2015 15:27:41

J0519+0848 EG082E.UVDATA.1

Freq = 4.9270 GHz, Bw = 16.000 MH No calibration applied and no bandpass applied

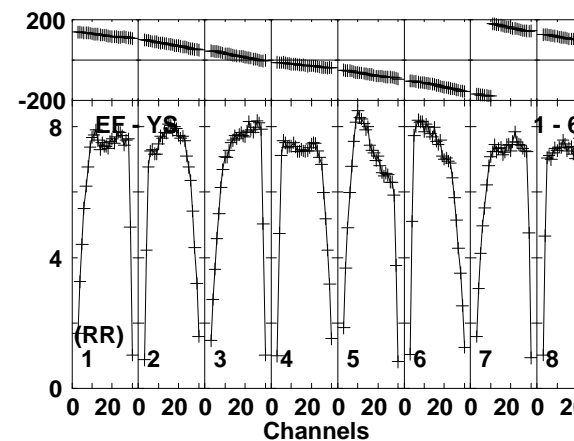
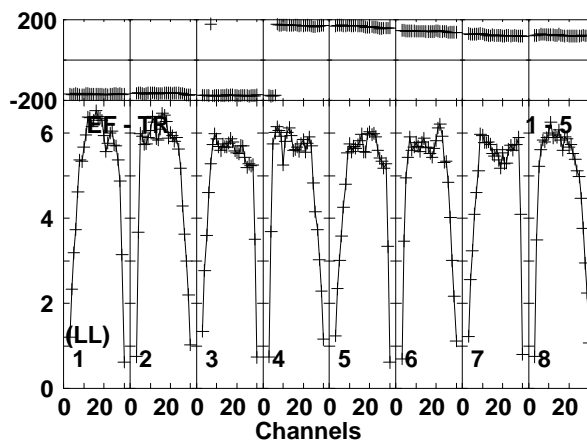
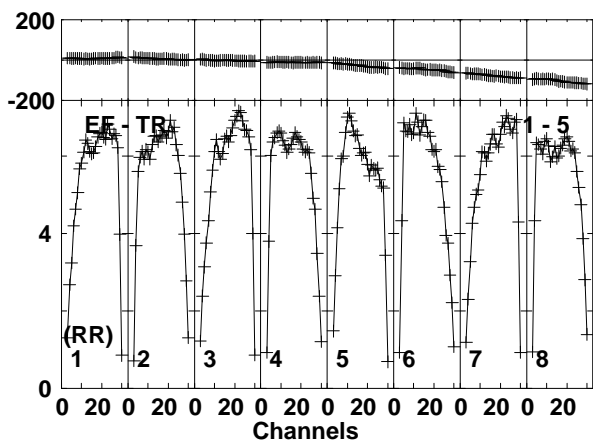
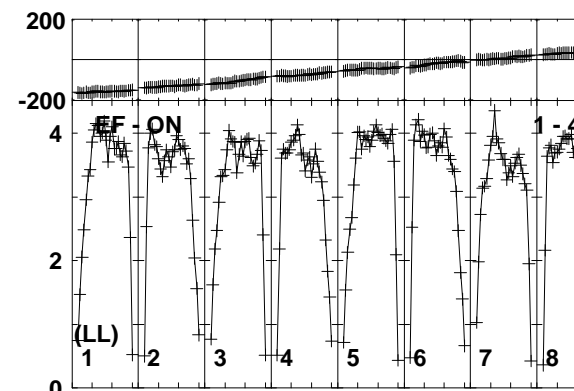
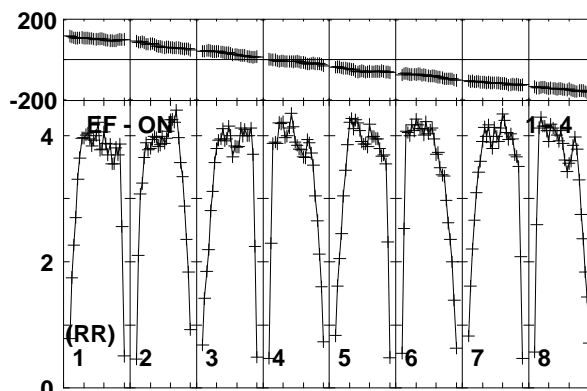
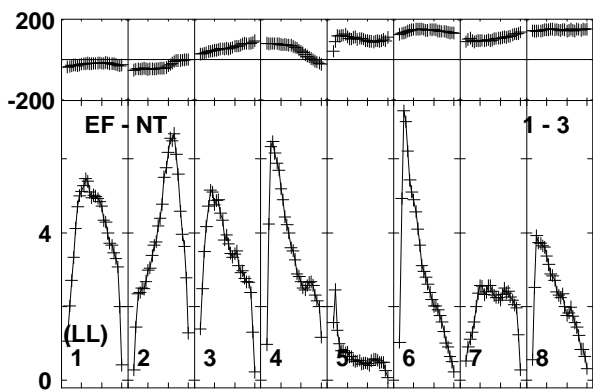
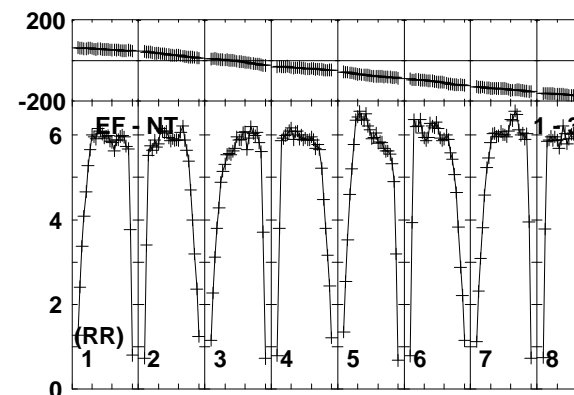
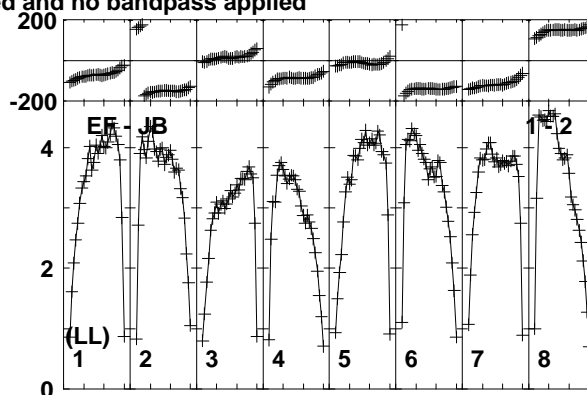
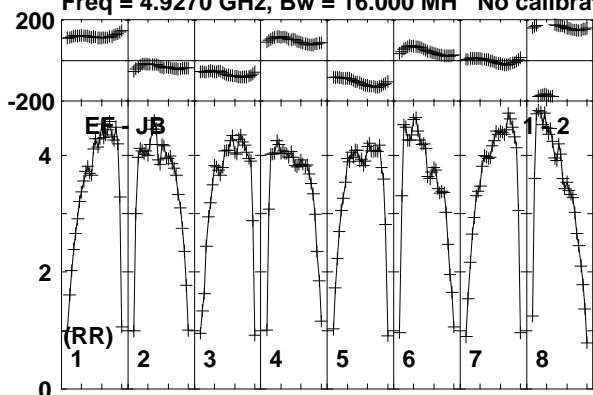

Lower frame: Milli Ampl Jy Top frame: Phas deg
Vector averaged cross-power spectrum Baseline: EF (01) - JB (02)
Timerange: 00/15:32:33 to 00/15:33:29

Plot file version 108 created 26-MAR-2015 15:27:41

J0519+0848 EG082E.UVDATA.1

Freq = 4.9270 GHz, Bw = 16.000 MH No calibration applied and no bandpass applied

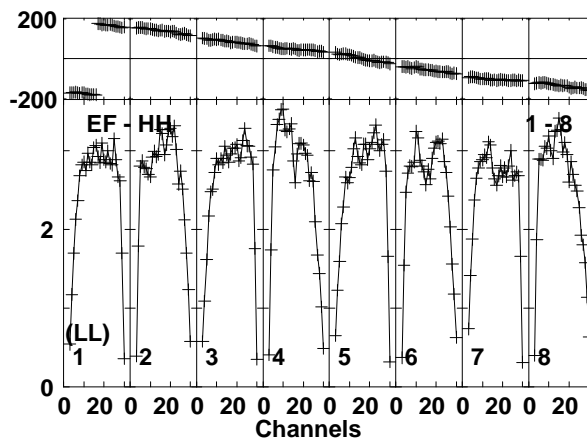
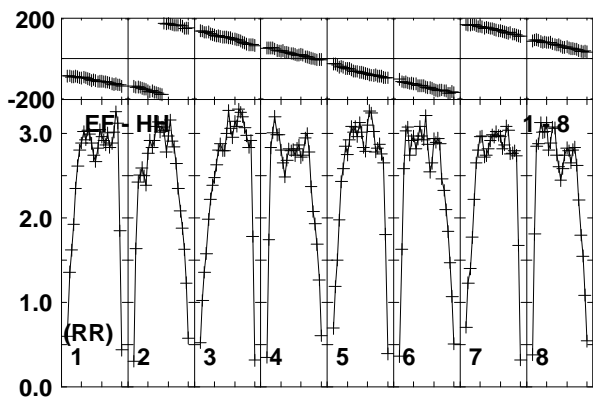
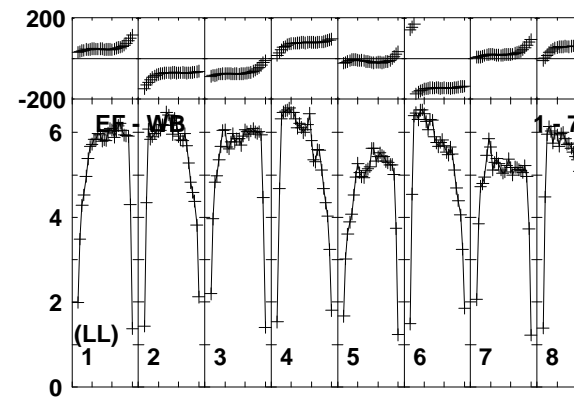
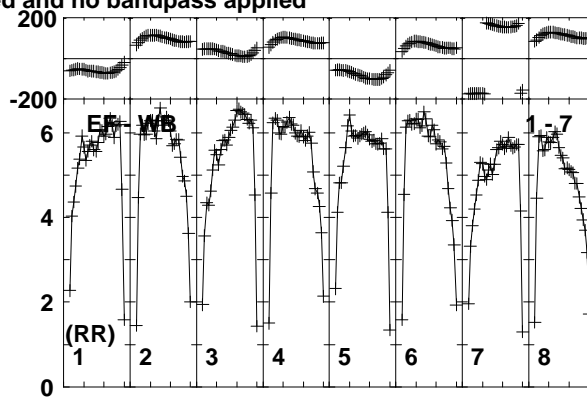
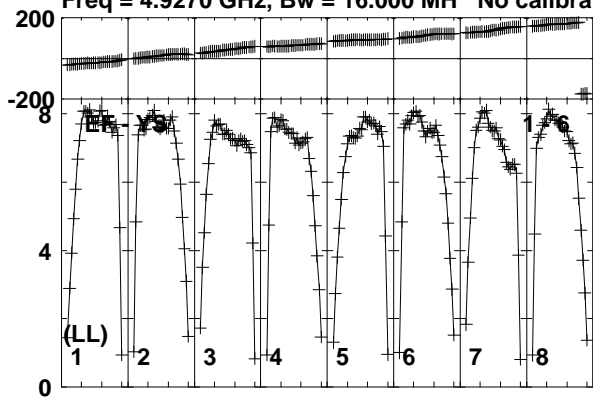

Lower frame: Milli Ampl Jy Top frame: Phas deg
Vector averaged cross-power spectrum Baseline: EF (01) - YS (06)
Timerange: 00/15:32:33 to 00/15:33:29

Plot file version 109 created 26-MAR-2015 15:27:41

V998ORI EG082E.UVDATA.1

Freq = 4.9270 GHz, Bw = 16.000 MH No calibration applied and no bandpass applied

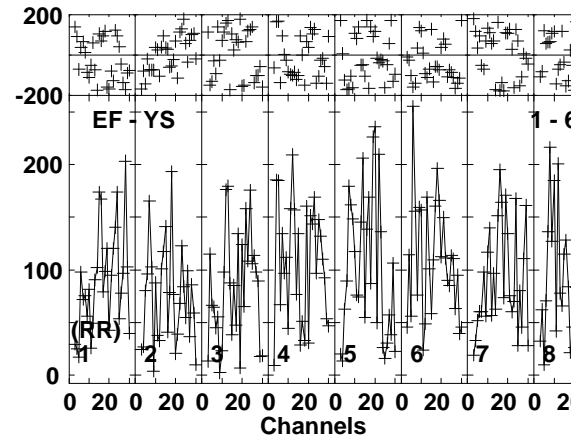
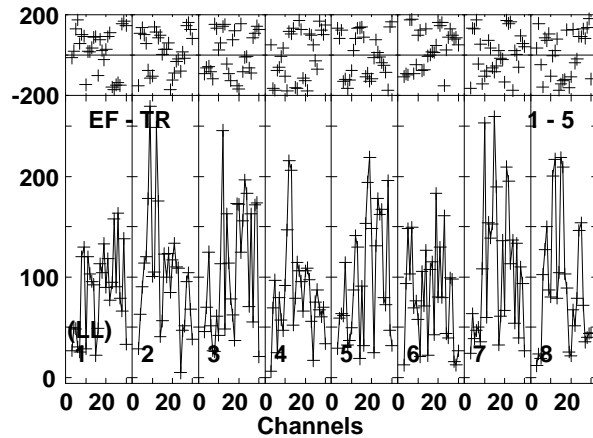
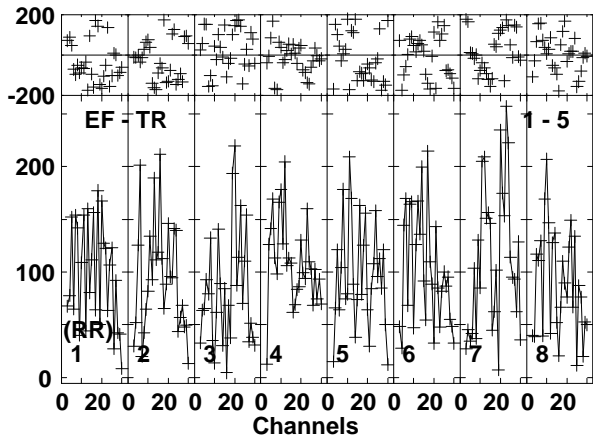
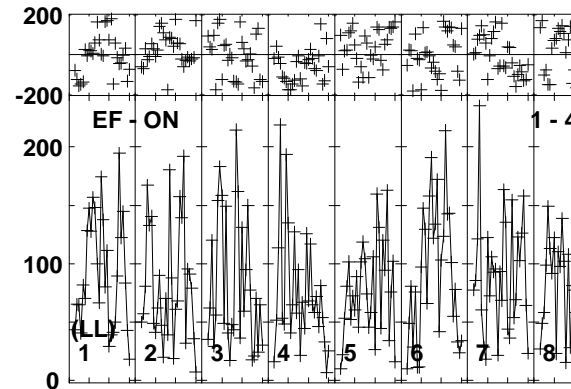
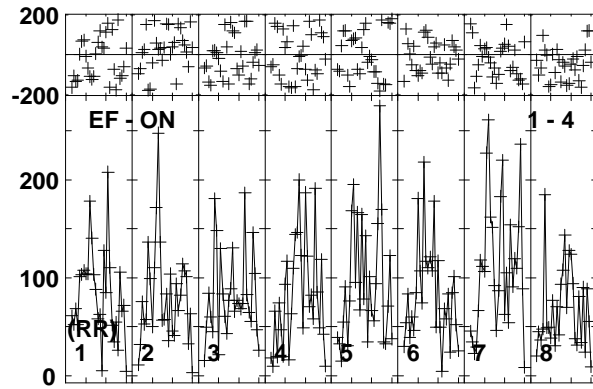
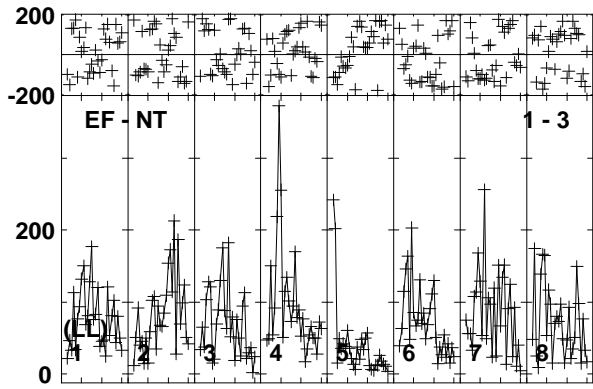
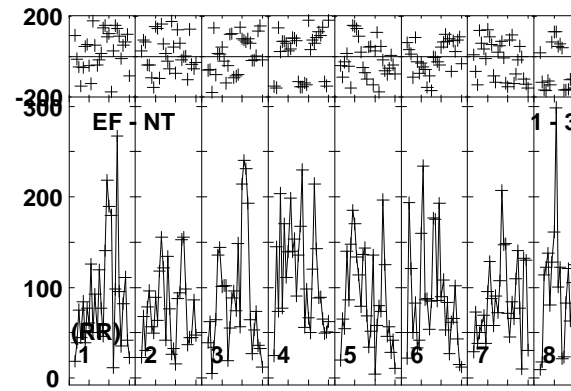
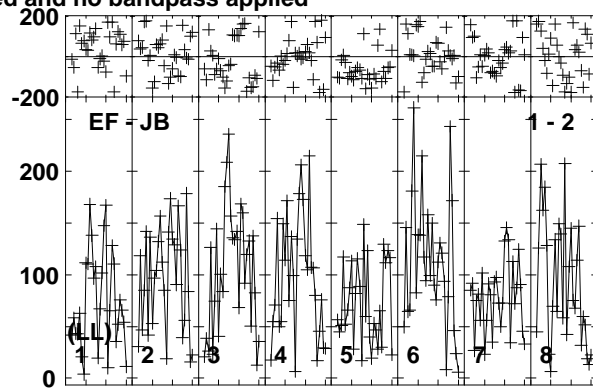
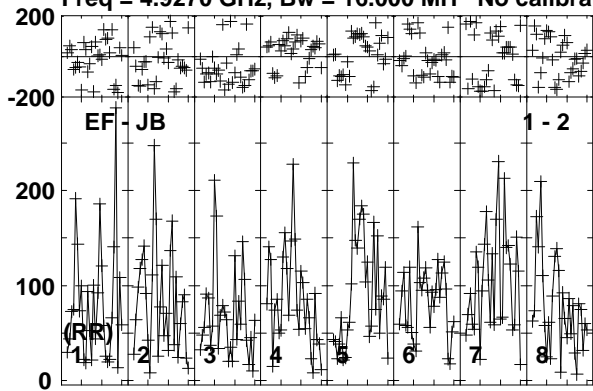

Lower frame: Micro Ampl Jy Top frame: Phas deg
Vector averaged cross-power spectrum Baseline: EF (01) - JB (02)
Timerange: 00:15:33:33 to 00:15:36:59

Plot file version 110 created 26-MAR-2015 15:27:41

V998ORI EG082E.UVDATA.1

Freq = 4.9270 GHz, Bw = 16.000 MH No calibration applied and no bandpass applied

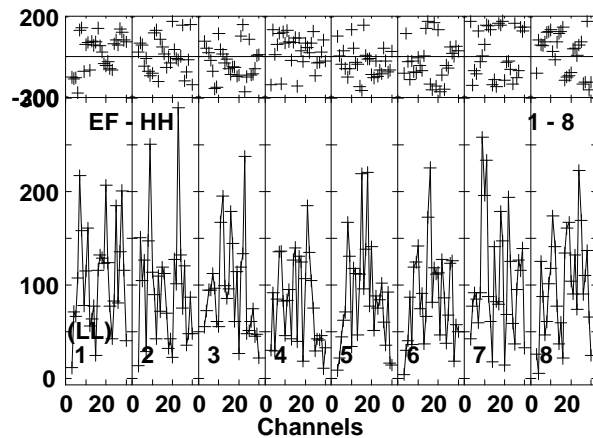
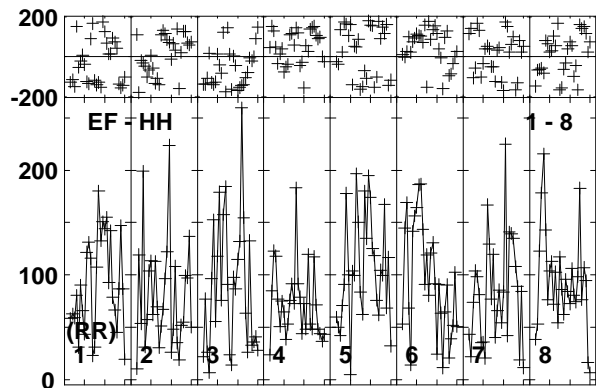
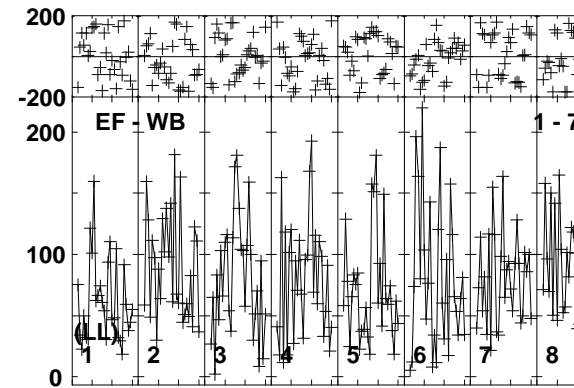
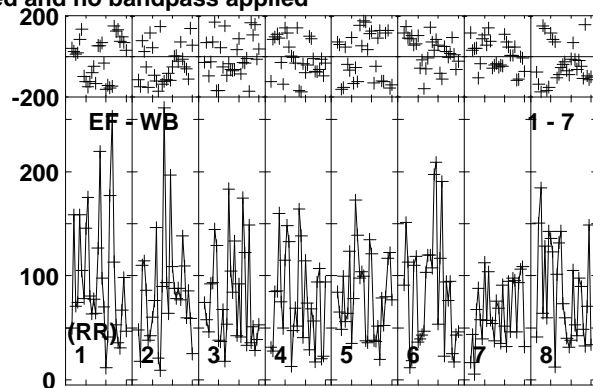
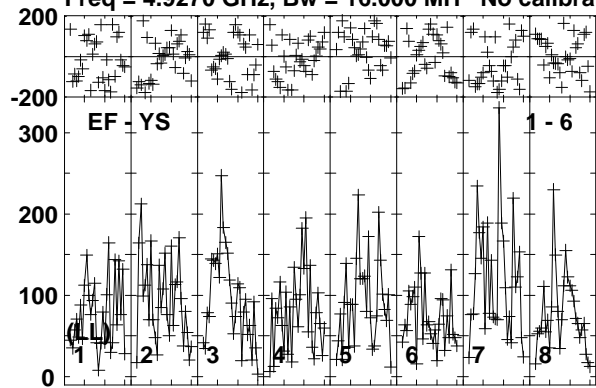

Lower frame: Micro Ampl Jy Top frame: Phas deg
Vector averaged cross-power spectrum Baseline: EF (01) - YS (06)
Timerange: 00/15:33:33 to 00/15:36:59

Plot file version 111 created 26-MAR-2015 15:27:41

J0519+0848 EG082E.UVDATA.1

Freq = 4.9270 GHz, Bw = 16.000 MH No calibration applied and no bandpass applied

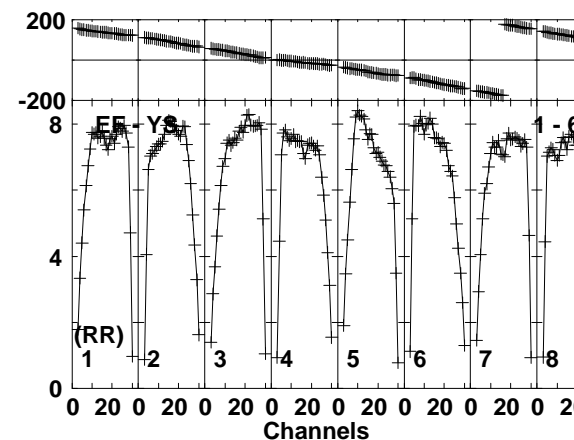
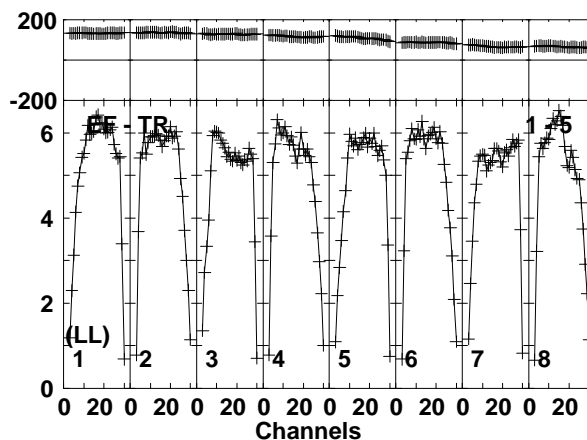
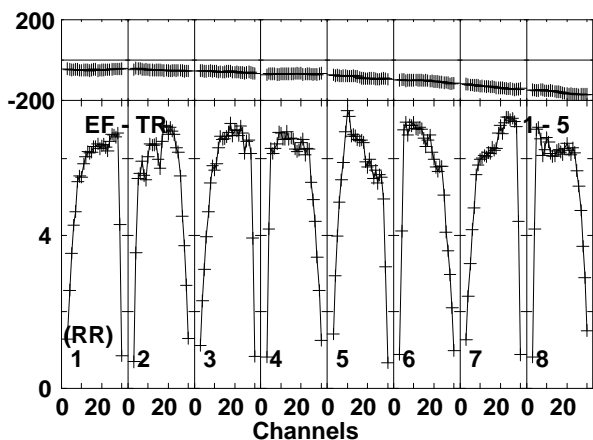
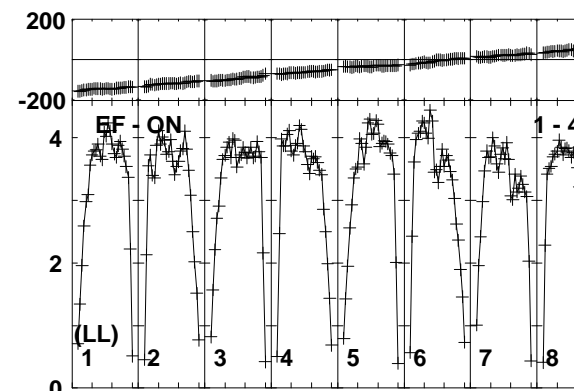
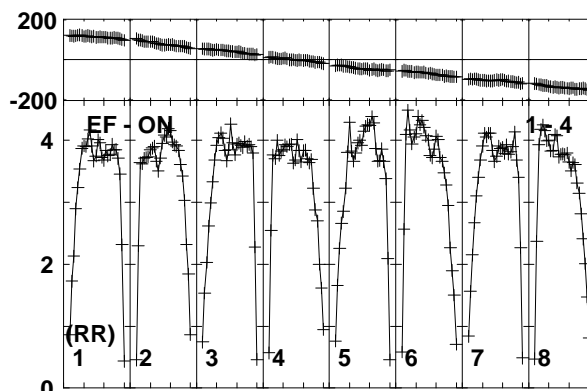
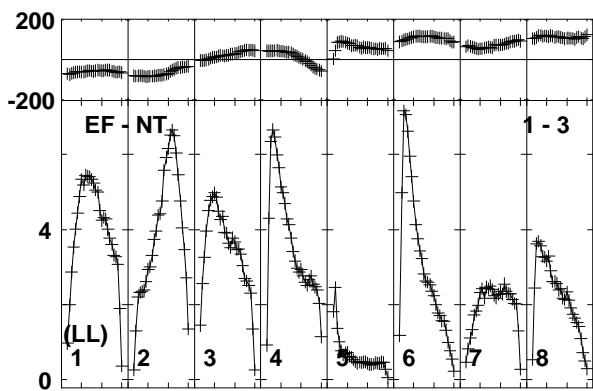
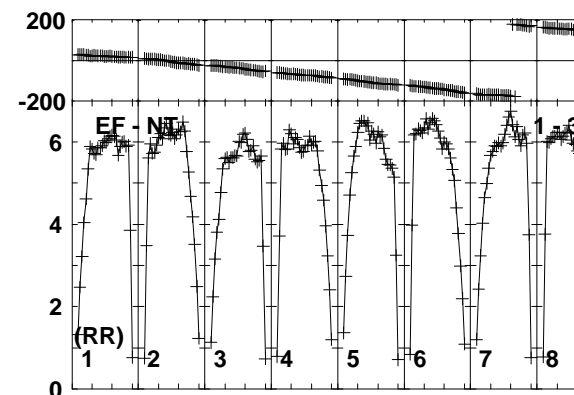
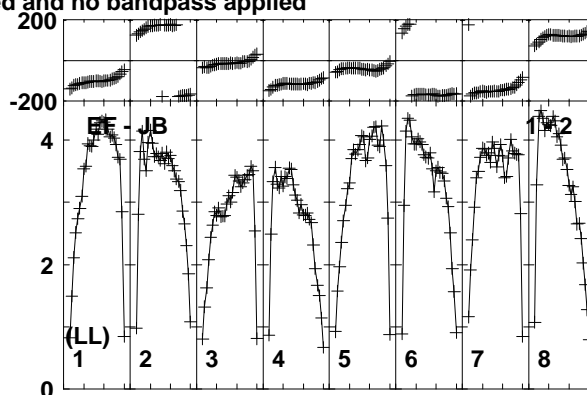
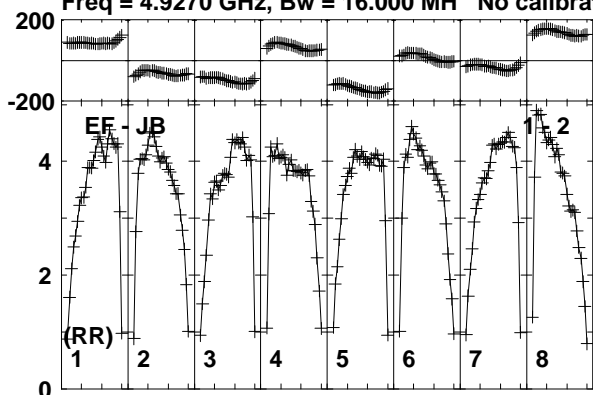

Lower frame: Milli Ampl Jy Top frame: Phas deg
Vector averaged cross-power spectrum Baseline: EF (01) - JB (02)
Timerange: 00:15:37:03 to 00:15:38:29

Plot file version 112 created 26-MAR-2015 15:27:41

J0519+0848 EG082E.UVDATA.1

Freq = 4.9270 GHz, Bw = 16.000 MH No calibration applied and no bandpass applied

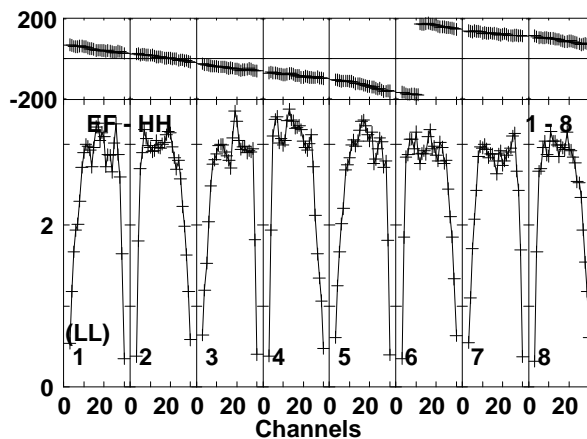
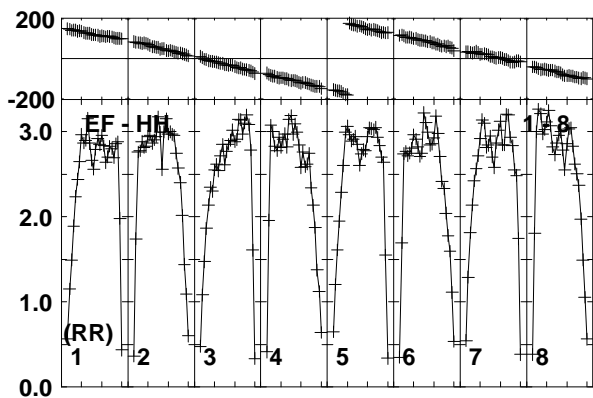
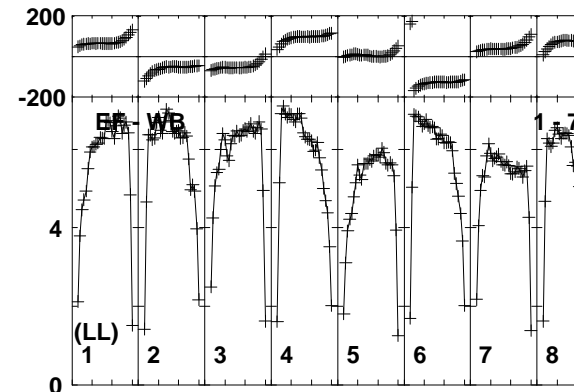
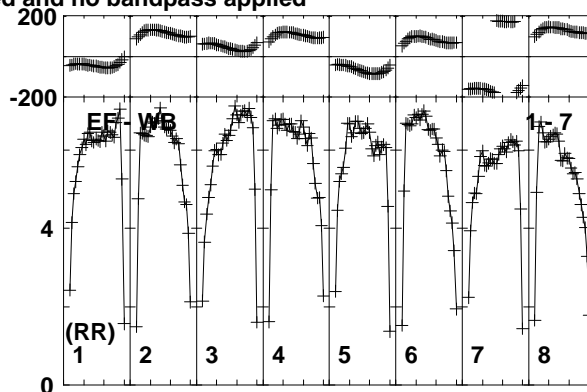
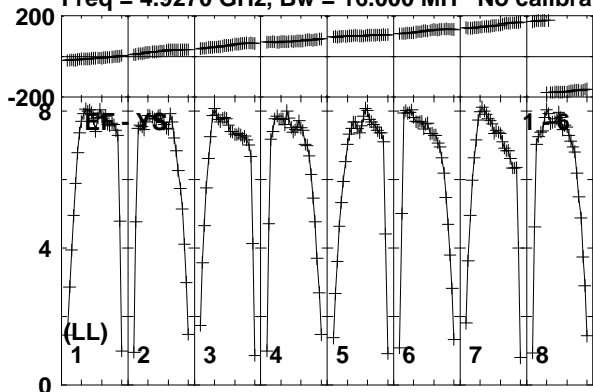

Lower frame: Milli Ampl Jy Top frame: Phas deg
Vector averaged cross-power spectrum Baseline: EF (01) - YS (06)
Timerange: 00/15:37:03 to 00/15:38:29

Plot file version 113 created 26-MAR-2015 15:27:41

J0525+0951 EG082E.UVDATA.1

Freq = 4.9270 GHz, Bw = 16.000 MH No calibration applied and no bandpass applied

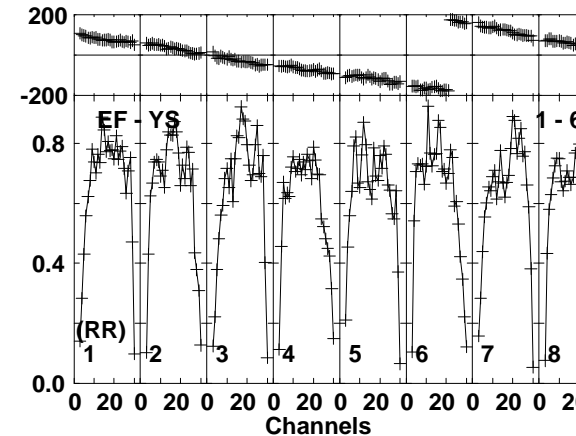
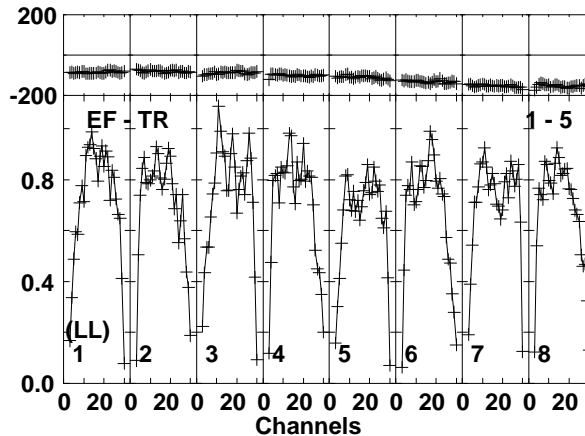
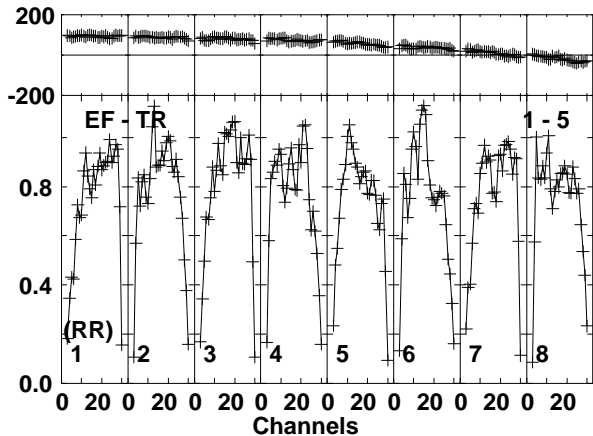
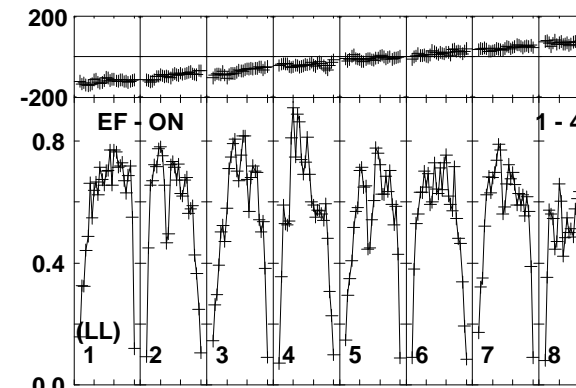
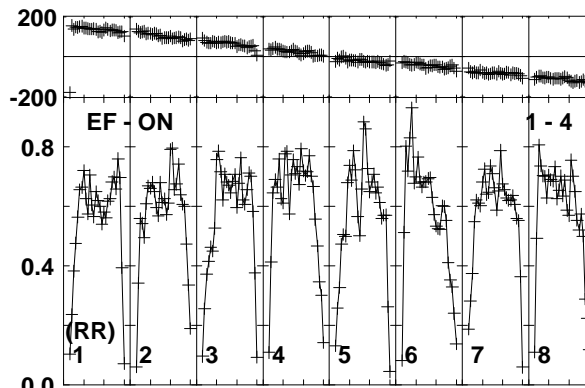
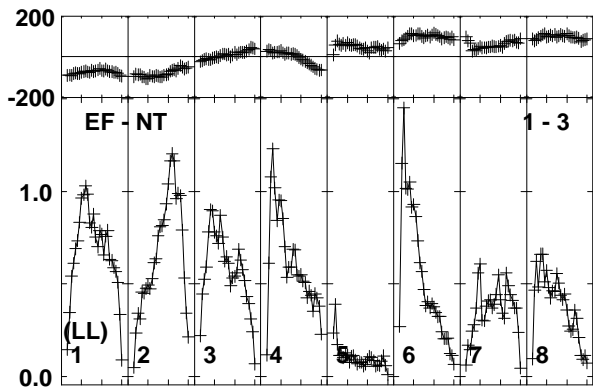
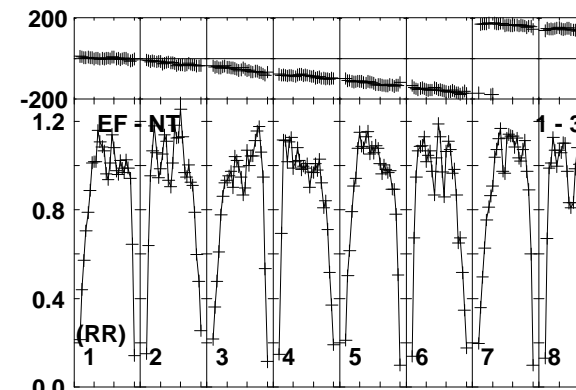
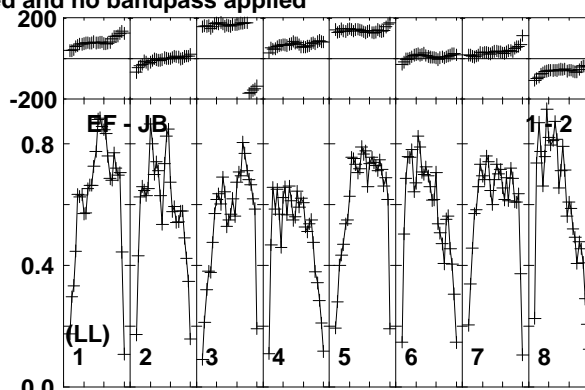
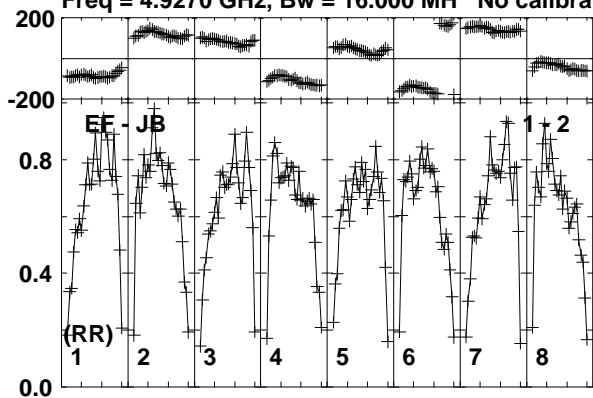

Lower frame: Milli Ampl Jy Top frame: Phas deg
Vector averaged cross-power spectrum Baseline: EF (01) - JB (02)
Timerange: 00/15:38:33 to 00/15:41:59

Plot file version 114 created 26-MAR-2015 15:27:41

J0525+0951 EG082E.UVDATA.1

Freq = 4.9270 GHz, Bw = 16.000 MH No calibration applied and no bandpass applied

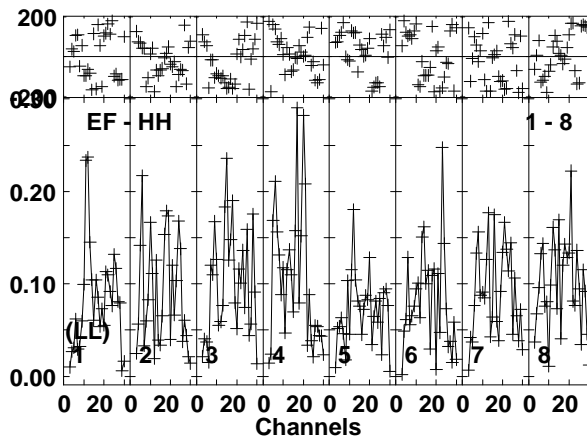
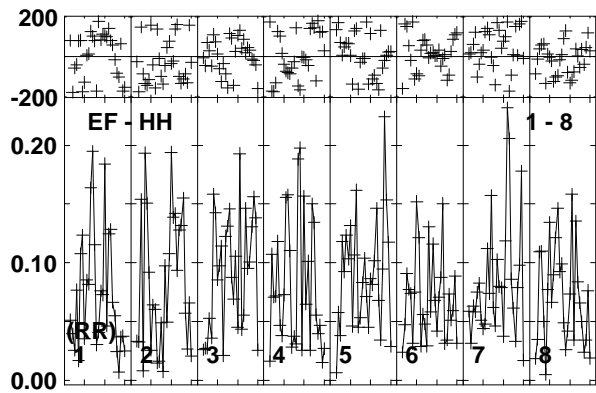
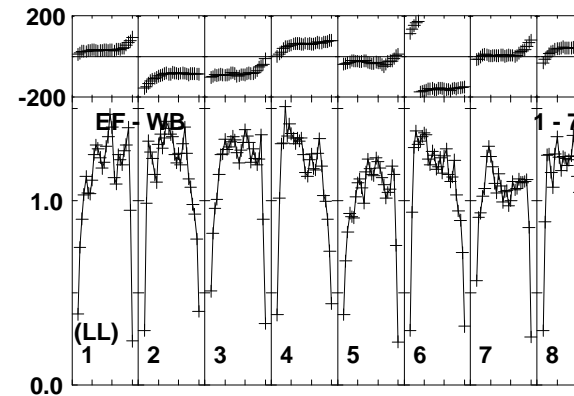
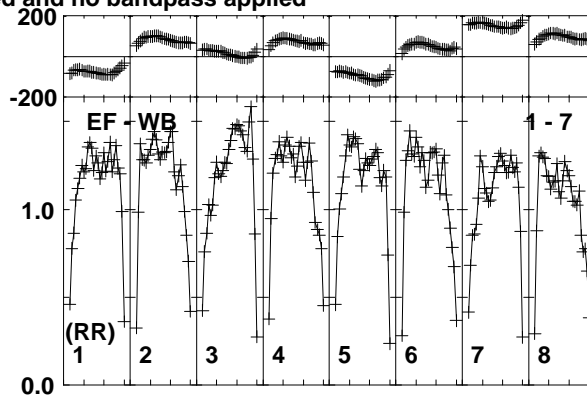
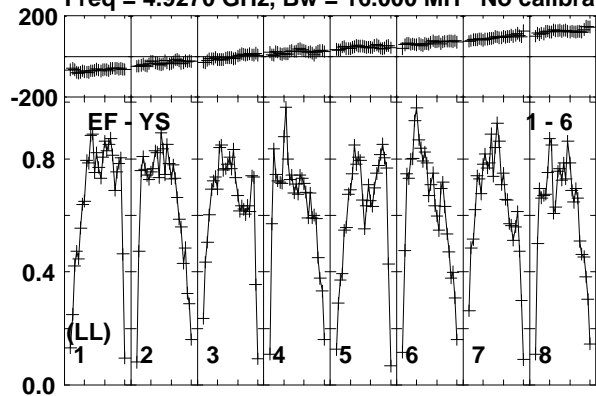

Lower frame: Milli Ampl Jy Top frame: Phas deg
Vector averaged cross-power spectrum Baseline: EF (01) - YS (06)
Timerange: 00/15:38:33 to 00/15:41:59

Plot file version 115 created 26-MAR-2015 15:27:41

J0519+0848 EG082E.UVDATA.1

Freq = 4.9270 GHz, Bw = 16.000 MH No calibration applied and no bandpass applied

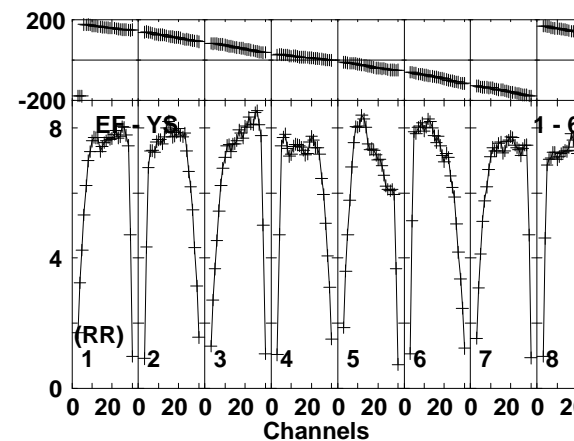
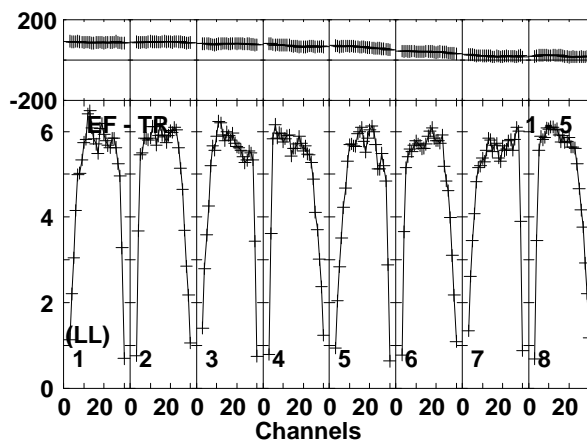
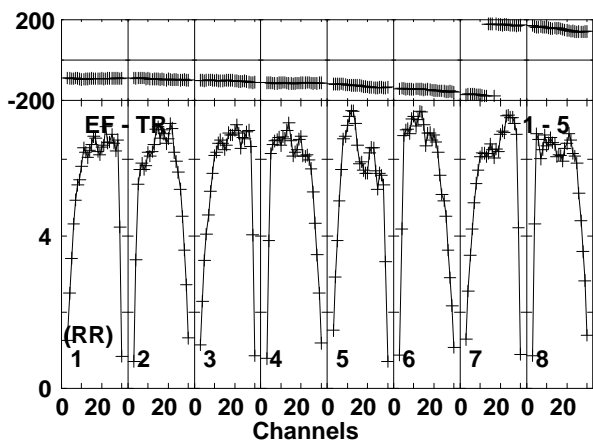
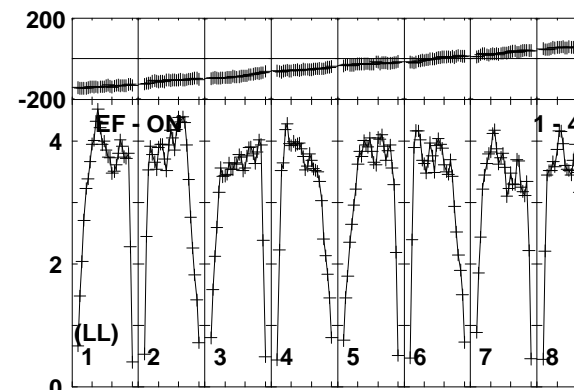
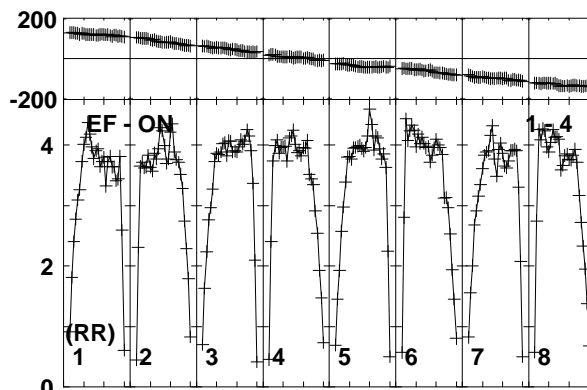
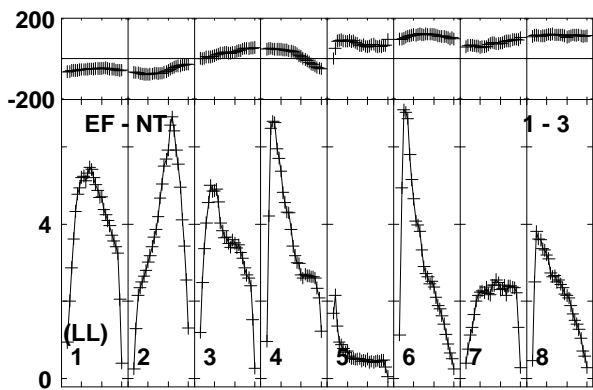
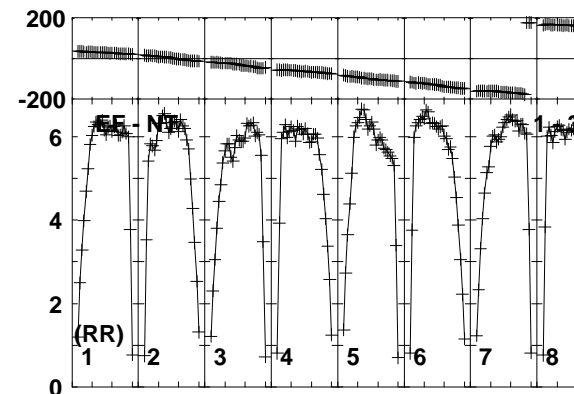
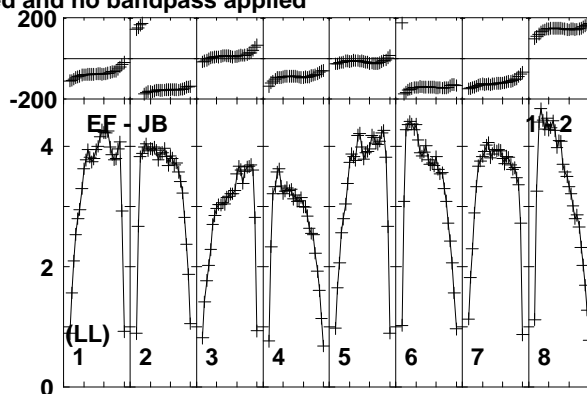
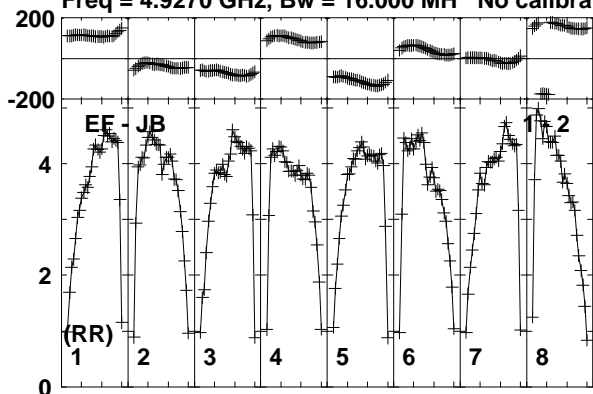

Lower frame: Milli Ampl Jy Top frame: Phas deg
Vector averaged cross-power spectrum Baseline: EF (01) - JB (02)
Timerange: 00/15:42:33 to 00/15:43:29

Plot file version 116 created 26-MAR-2015 15:27:41

J0519+0848 EG082E.UVDATA.1

Freq = 4.9270 GHz, Bw = 16.000 MH No calibration applied and no bandpass applied

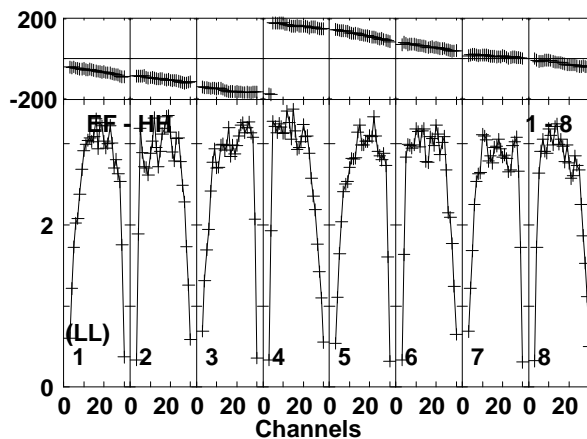
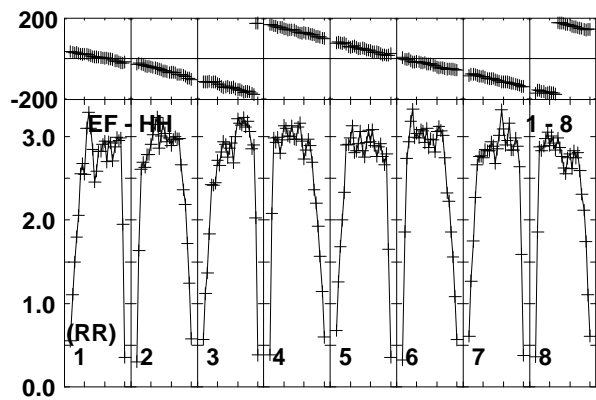
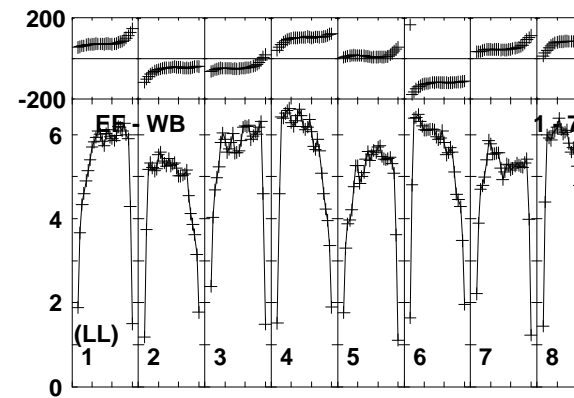
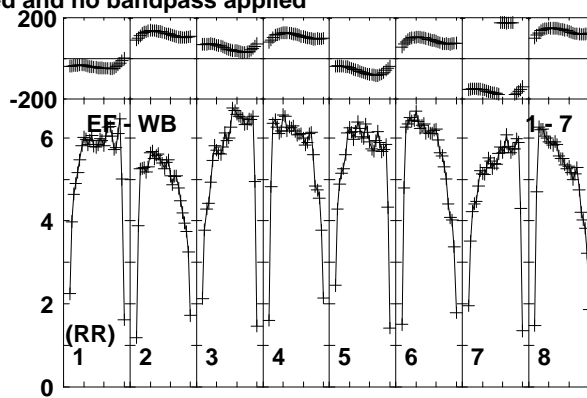
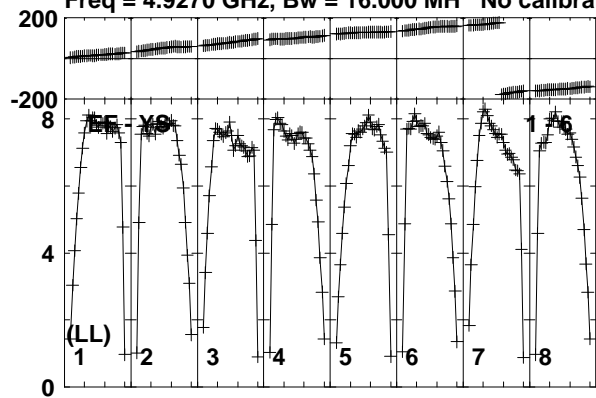

Lower frame: Milli Ampl Jy Top frame: Phas deg
Vector averaged cross-power spectrum Baseline: EF (01) - YS (06)
Timerange: 00/15:42:33 to 00/15:43:29

Plot file version 117 created 26-MAR-2015 15:27:41

J1038+0512 EG082E.UVDATA.1

Freq = 4.9270 GHz, Bw = 16.000 MH No calibration applied and no bandpass applied

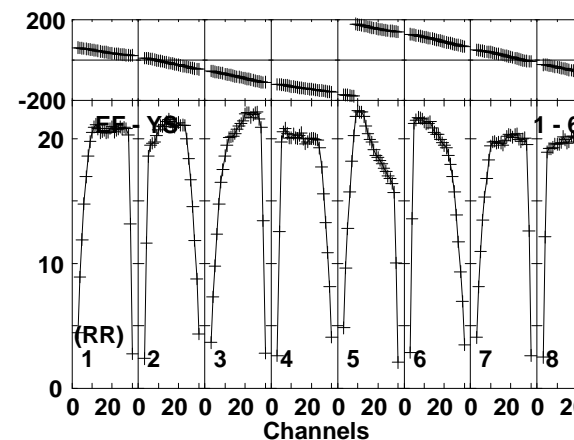
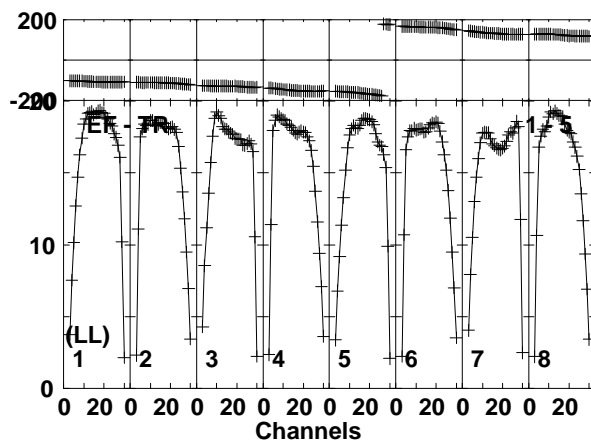
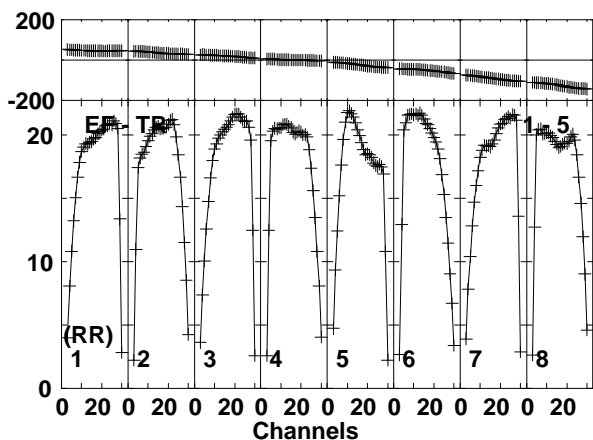
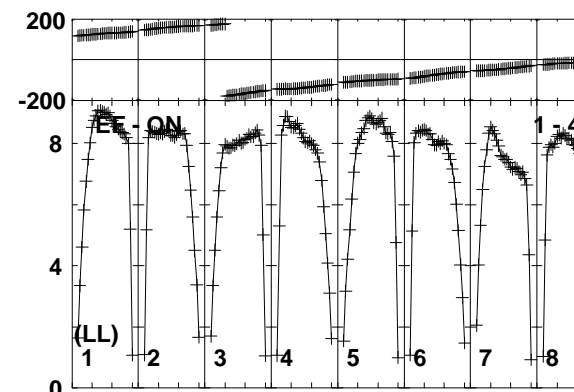
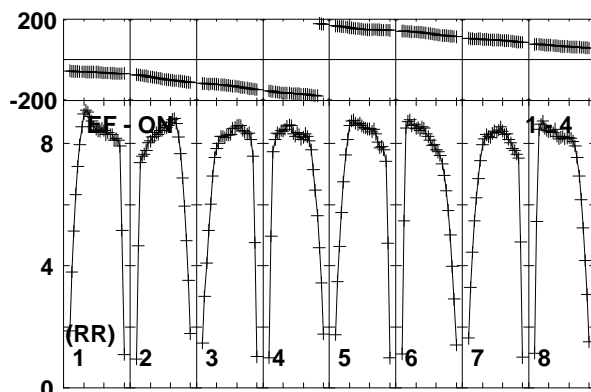
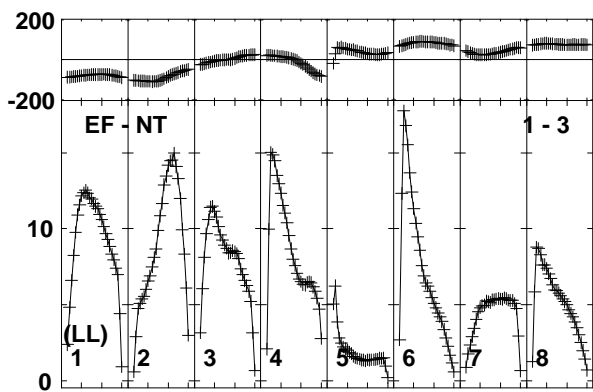
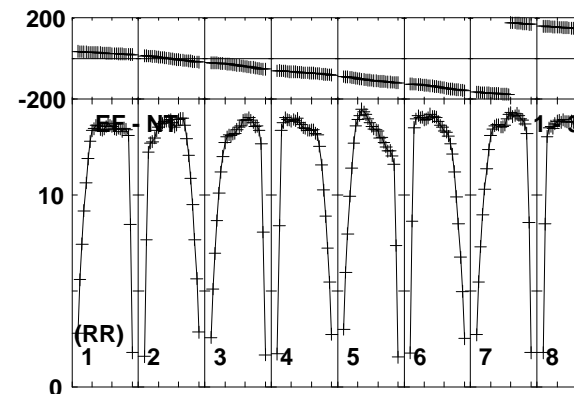
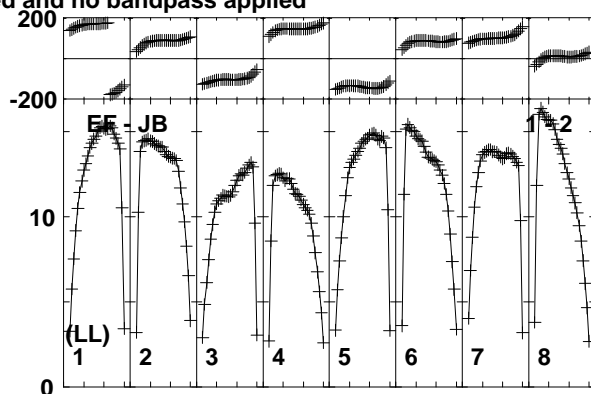
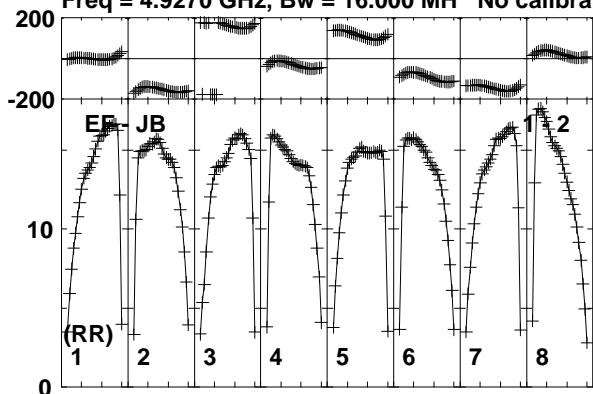

Lower frame: Milli Ampl Jy Top frame: Phas deg
Vector averaged cross-power spectrum Baseline: EF (01) - JB (02)
Timerange: 01/00:30:13 to 01/00:33:59

Plot file version 118 created 26-MAR-2015 15:27:41

J1038+0512 EG082E.UVDATA.1

Freq = 4.9270 GHz, Bw = 16.000 MH No calibration applied and no bandpass applied

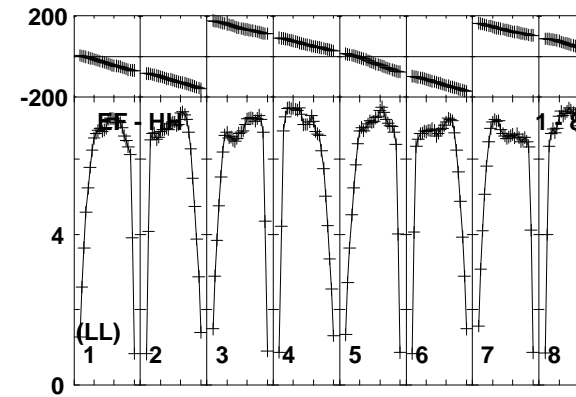
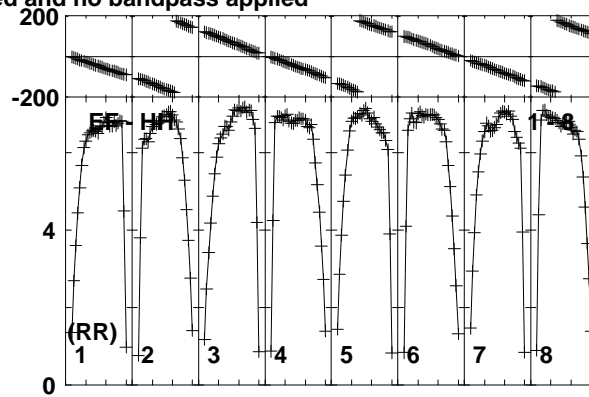
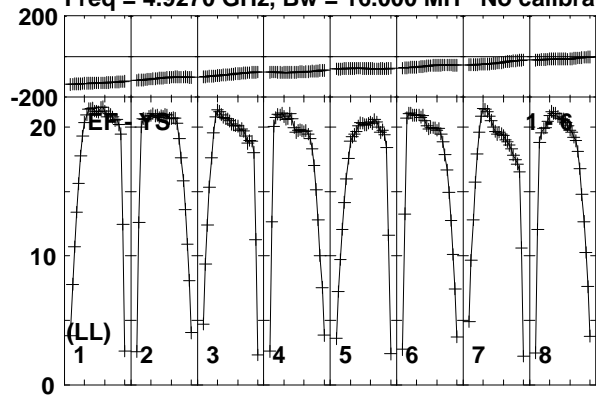

Lower frame: Milli Ampl Jy Top frame: Phas deg
Vector averaged cross-power spectrum Baseline: EF (01) - YS (06)
Timerange: 01/00:30:13 to 01/00:33:59

Plot file version 119 created 26-MAR-2015 15:27:41

J1035+0522 EG082E.UVDATA.1

Freq = 4.9270 GHz, Bw = 16.000 MH No calibration applied and no bandpass applied

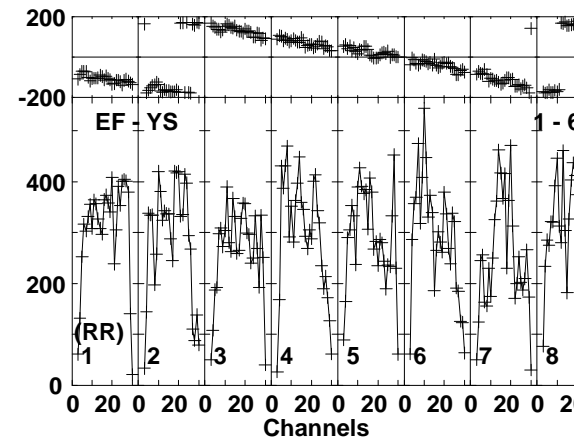
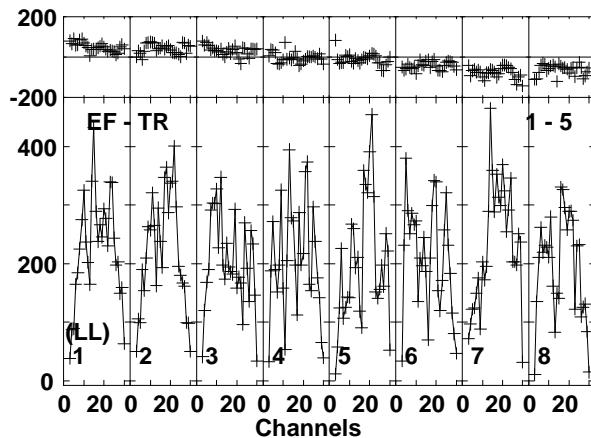
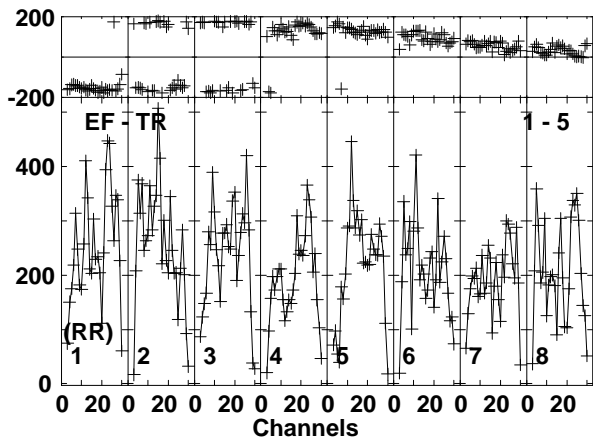
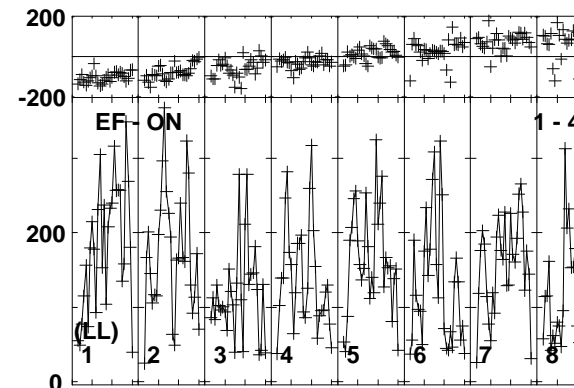
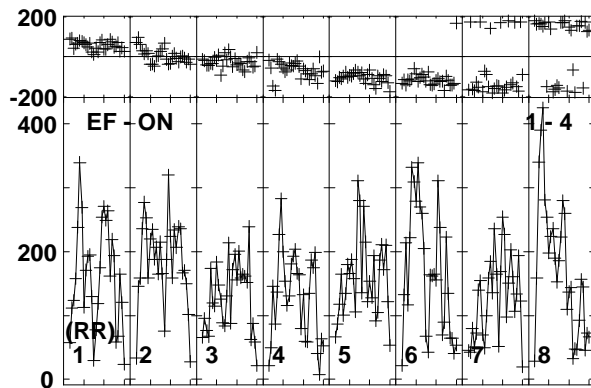
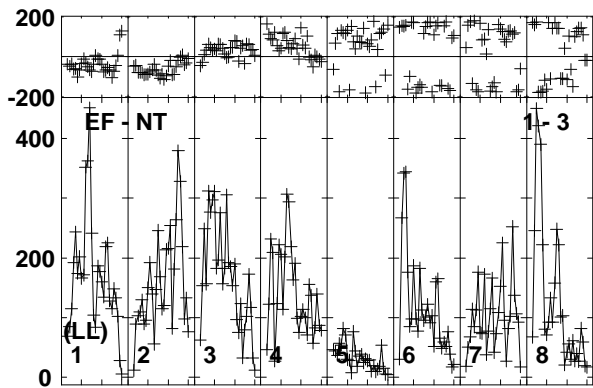
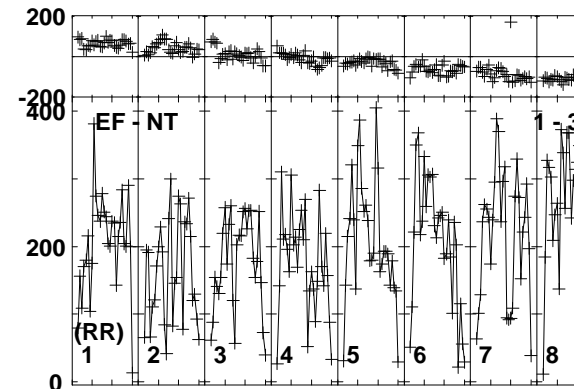
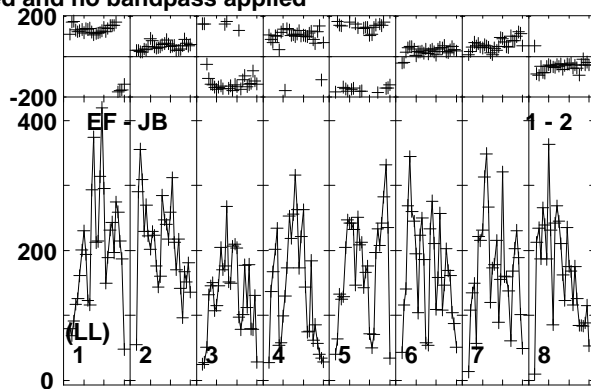
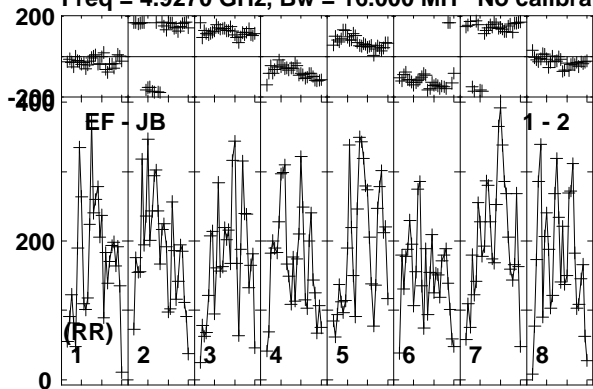

Lower frame: Micro Ampl Jy Top frame: Phas deg
Vector averaged cross-power spectrum Baseline: EF (01) - JB (02)
Timerange: 01/00:34:03 to 01/00:37:29

Plot file version 120 created 26-MAR-2015 15:27:41

J1035+0522 EG082E.UVDATA.1

Freq = 4.9270 GHz, Bw = 16.000 MH No calibration applied and no bandpass applied

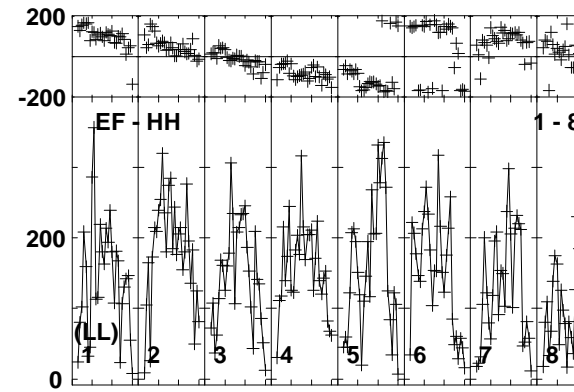
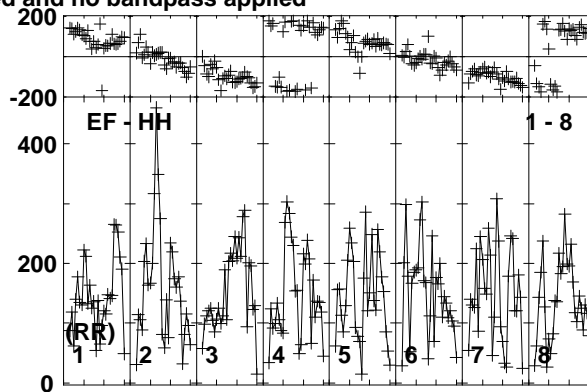
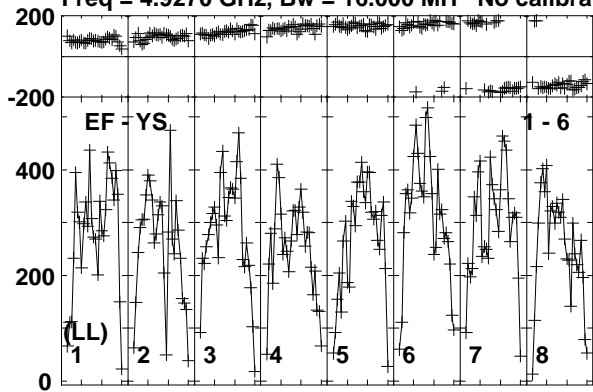

Lower frame: Micro Ampl Jy Top frame: Phas deg
Vector averaged cross-power spectrum Baseline: EF (01) - YS (06)
Timerange: 01/00:34:03 to 01/00:37:29

Plot file version 121 created 26-MAR-2015 15:27:41

J1038+0512 EG082E.UVDATA.1

Freq = 4.9270 GHz, Bw = 16.000 MH No calibration applied and no bandpass applied

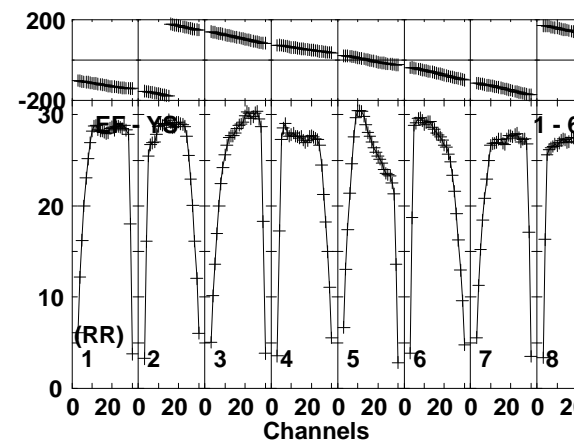
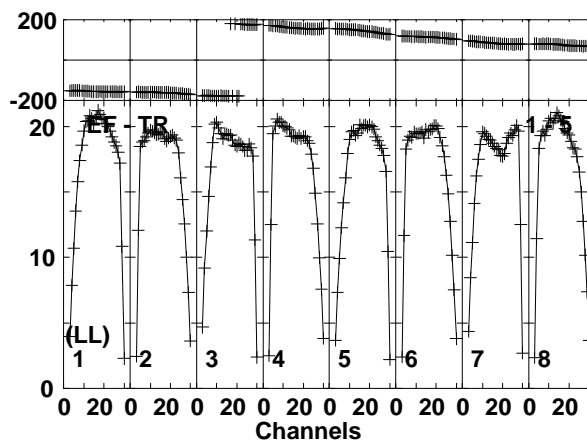
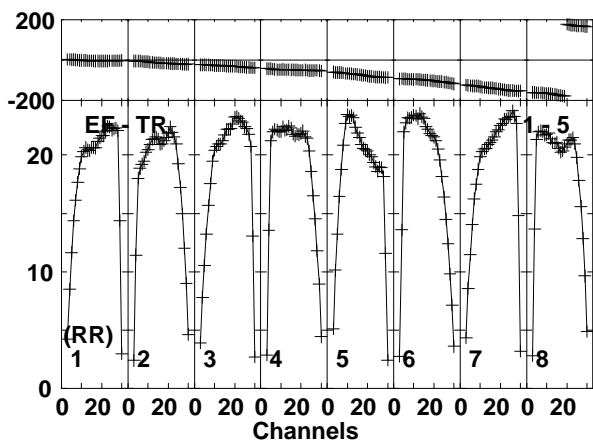
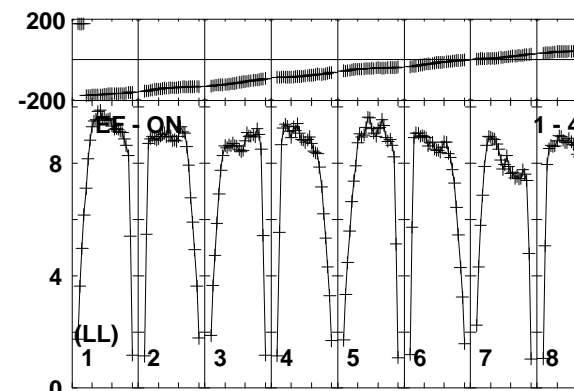
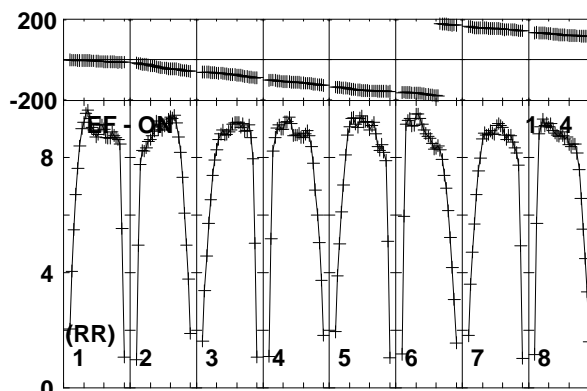
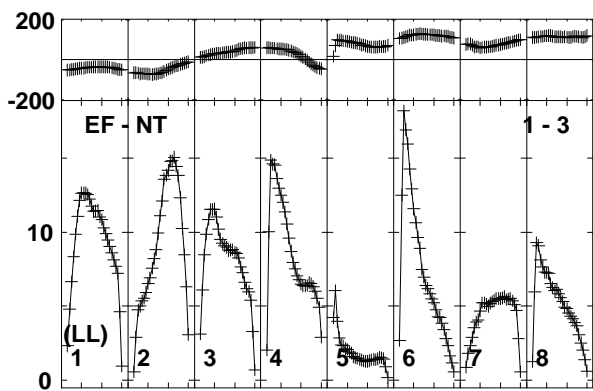
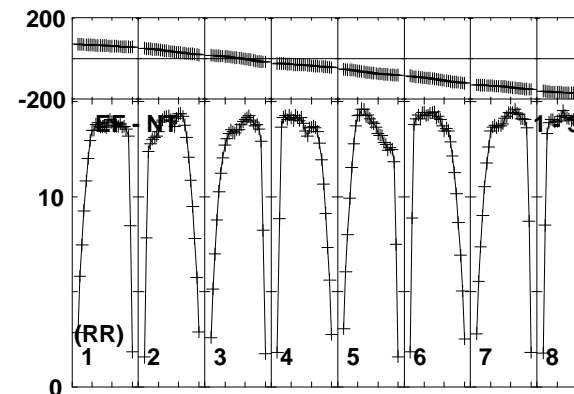
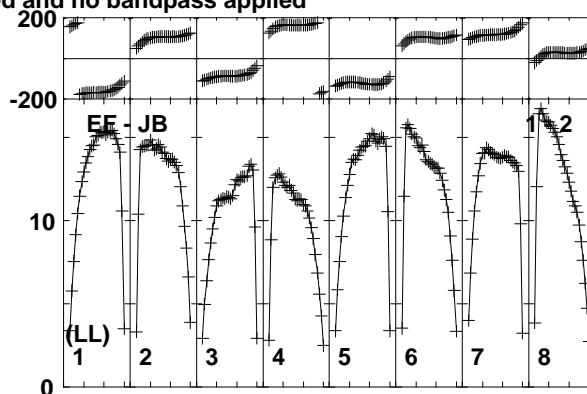
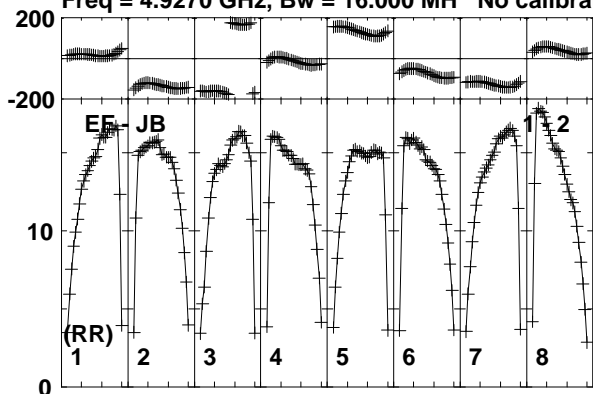

Lower frame: Milli Ampl Jy Top frame: Phas deg
Vector averaged cross-power spectrum Baseline: EF (01) - JB (02)
Timerange: 01/00:38:03 to 01/00:38:59

Plot file version 122 created 26-MAR-2015 15:27:41

J1038+0512 EG082E.UVDATA.1

Freq = 4.9270 GHz, Bw = 16.000 MH No calibration applied and no bandpass applied

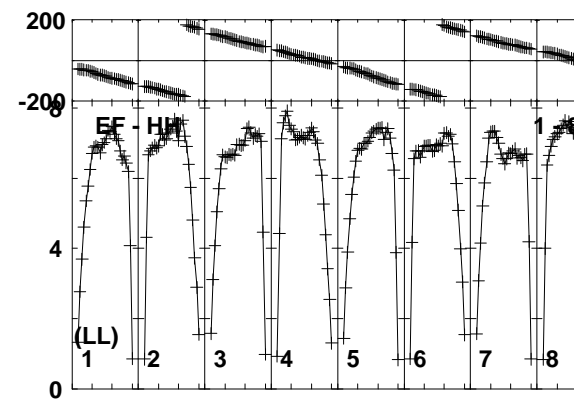
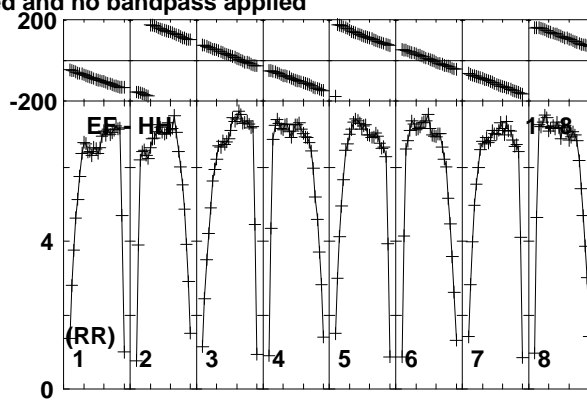
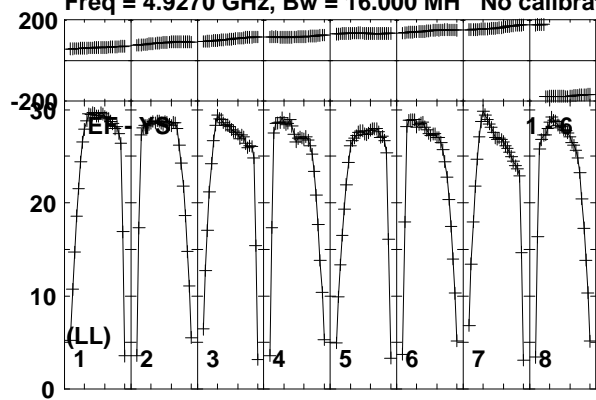

Lower frame: Milli Ampl Jy Top frame: Phas deg
Vector averaged cross-power spectrum Baseline: EF (01) - YS (06)
Timerange: 01/00:38:03 to 01/00:38:59

Plot file version 123 created 26-MAR-2015 15:27:42

RYSEX EG082E.UVDATA.1

Freq = 4.9270 GHz, Bw = 16.000 MH No calibration applied and no bandpass applied

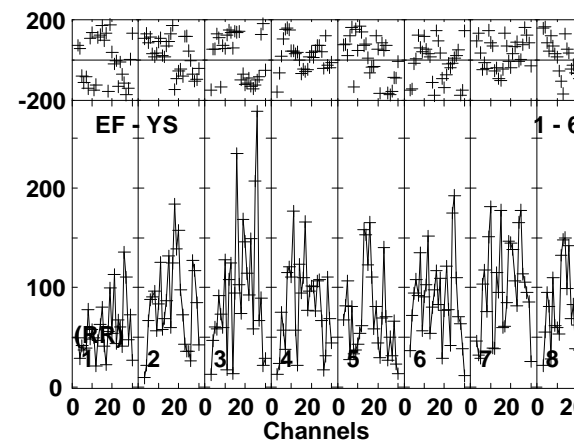
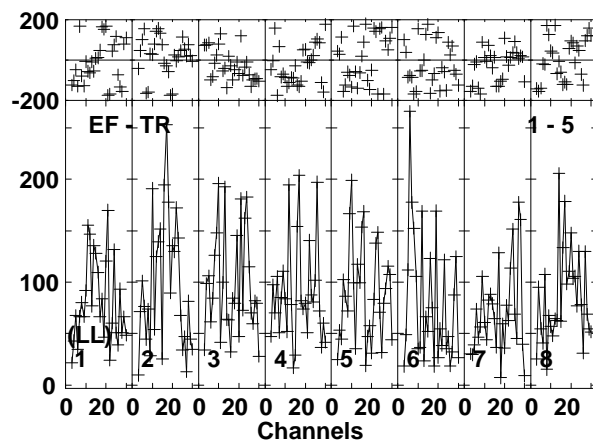
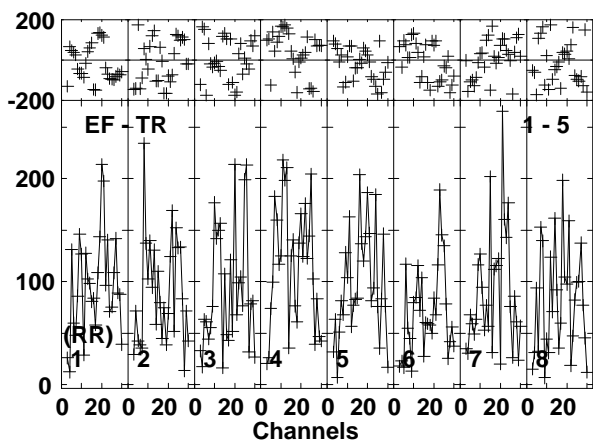
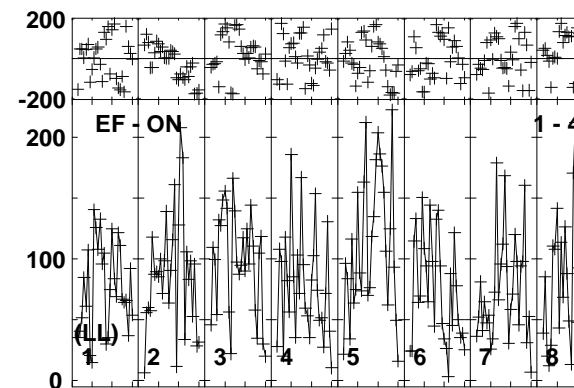
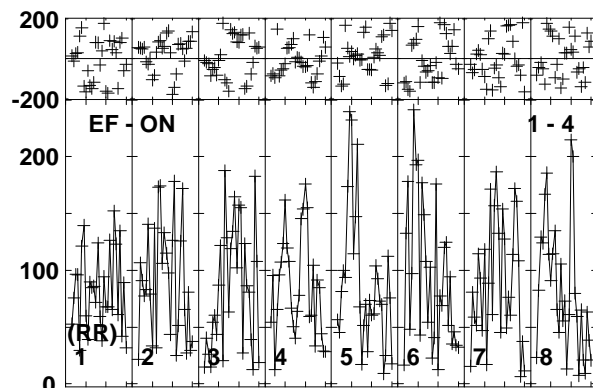
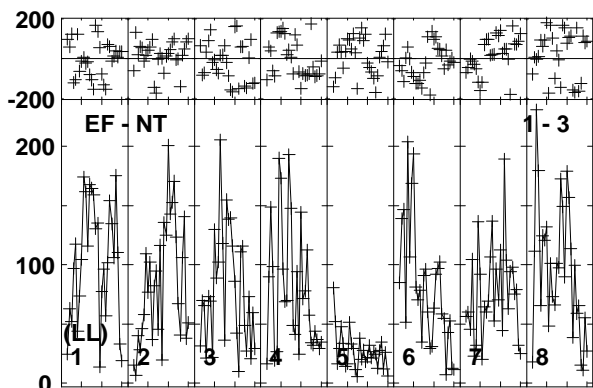
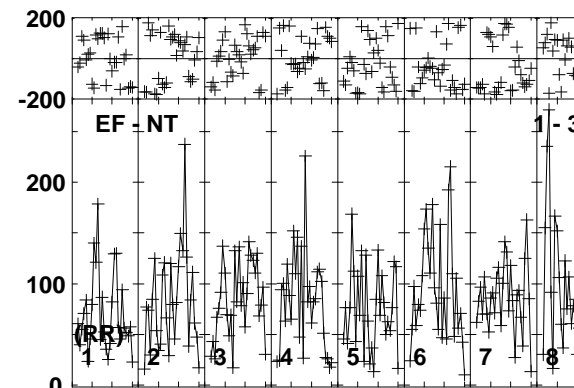
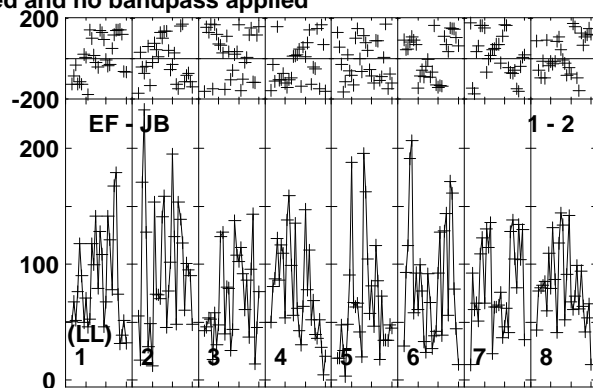
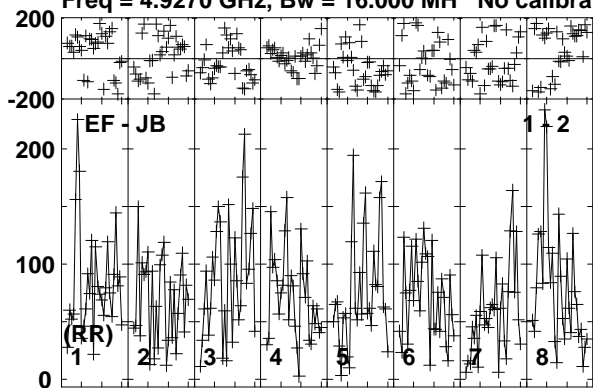

Lower frame: Micro Ampl Jy Top frame: Phas deg
Vector averaged cross-power spectrum Baseline: EF (01) - JB (02)
Timerange: 01/00:39:03 to 01/00:42:29

Plot file version 124 created 26-MAR-2015 15:27:42

RYSEX EG082E.UVDATA.1

Freq = 4.9270 GHz, Bw = 16.000 MH No calibration applied and no bandpass applied

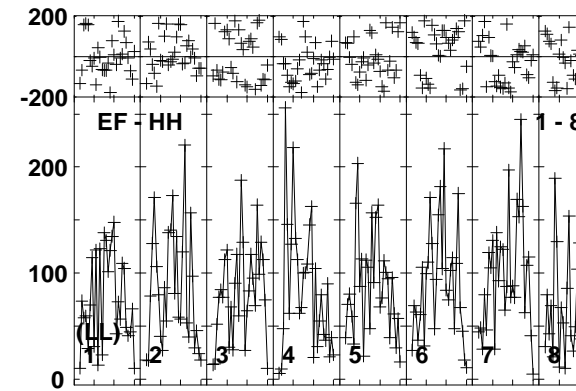
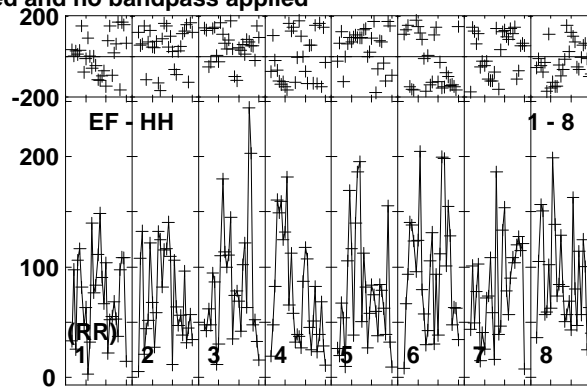
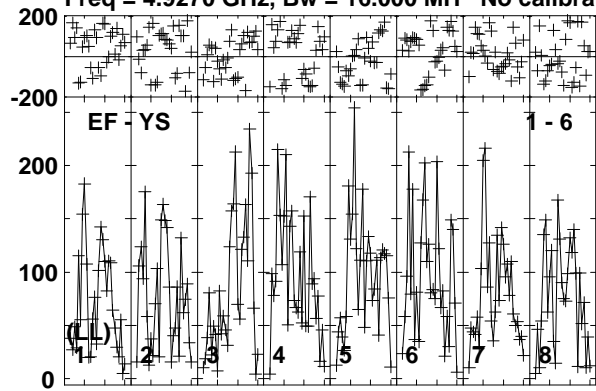

Lower frame: Micro Ampl Jy Top frame: Phas deg
Vector averaged cross-power spectrum Baseline: EF (01) - YS (06)
Timerange: 01/00:39:03 to 01/00:42:29

Plot file version 125 created 26-MAR-2015 15:27:42

J1038+0512 EG082E.UVDATA.1

Freq = 4.9270 GHz, Bw = 16.000 MH No calibration applied and no bandpass applied

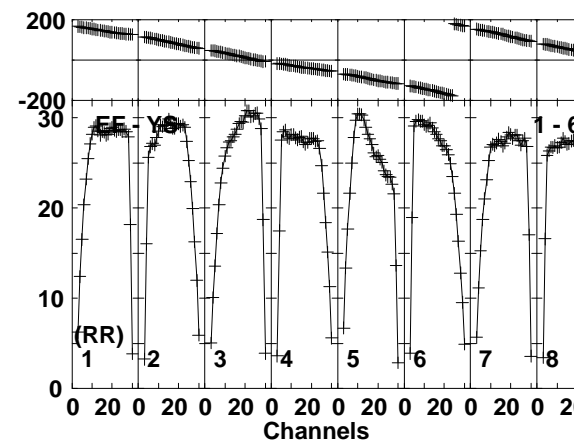
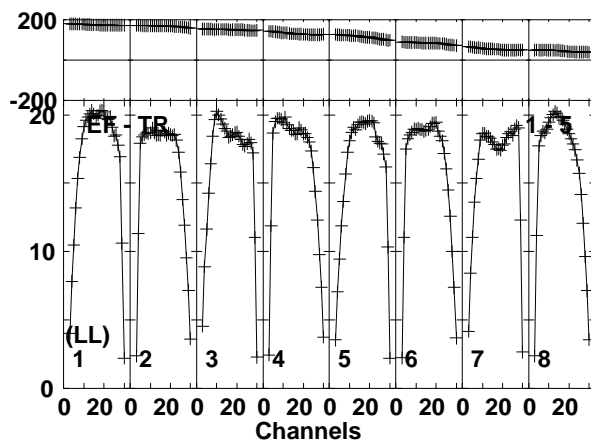
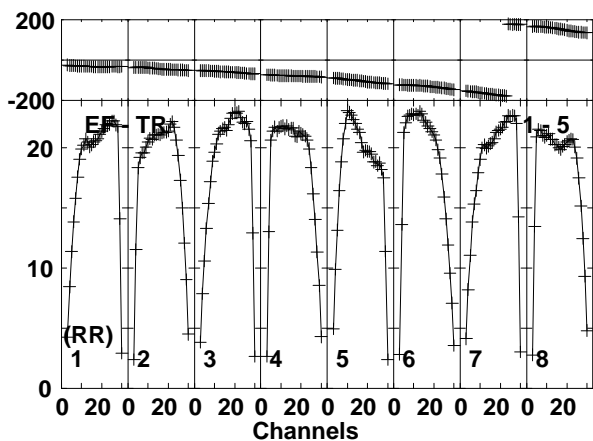
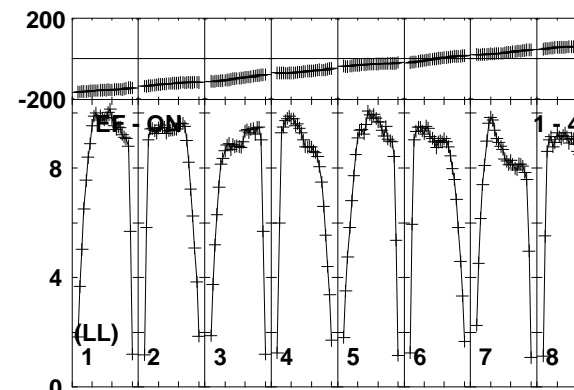
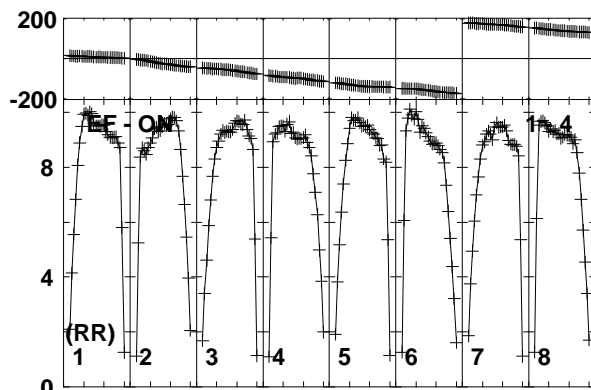
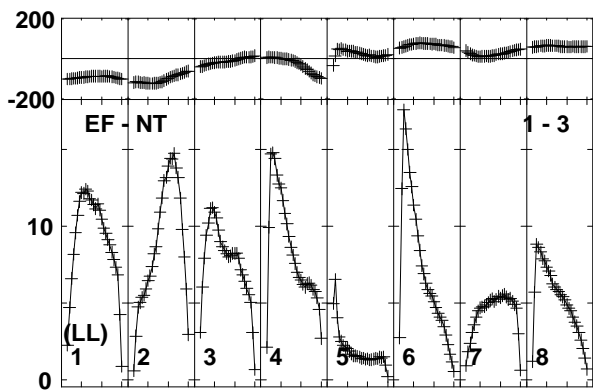
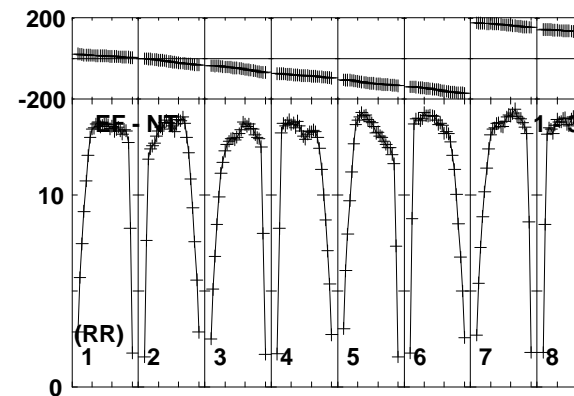
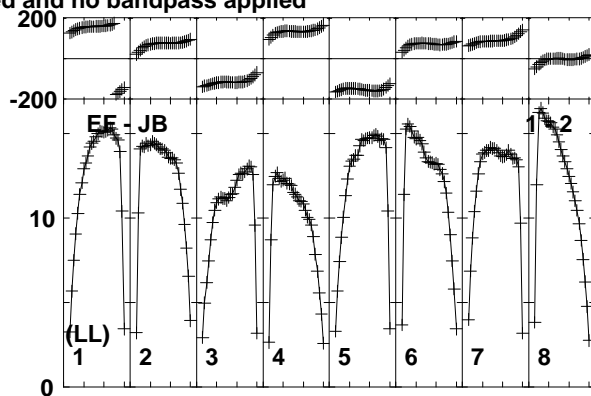
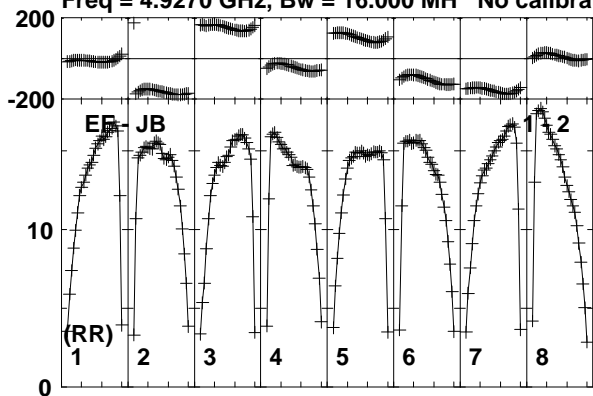

Lower frame: Milli Ampl Jy Top frame: Phas deg
Vector averaged cross-power spectrum Baseline: EF (01) - JB (02)
Timerange: 01/00:42:33 to 01/00:43:59

Plot file version 126 created 26-MAR-2015 15:27:42

J1038+0512 EG082E.UVDATA.1

Freq = 4.9270 GHz, Bw = 16.000 MH No calibration applied and no bandpass applied

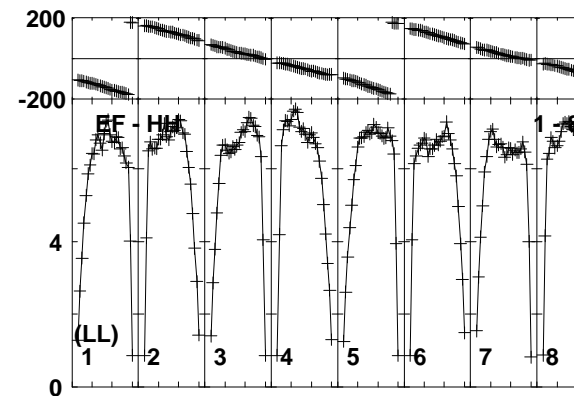
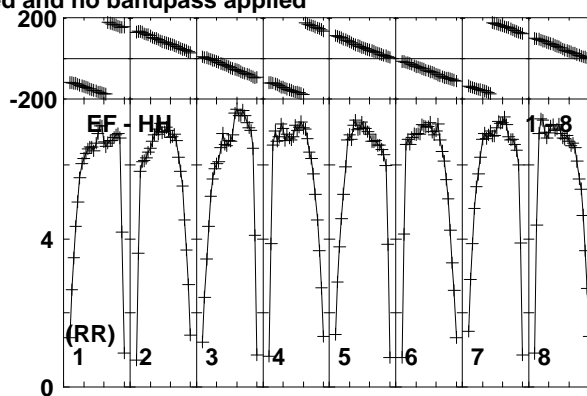
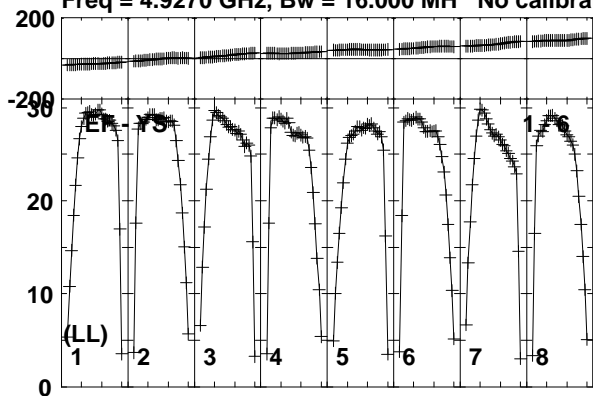

Lower frame: Milli Ampl Jy Top frame: Phas deg
Vector averaged cross-power spectrum Baseline: EF (01) - YS (06)
Timerange: 01/00:42:33 to 01/00:43:59

Plot file version 127 created 26-MAR-2015 15:27:42

RYSEX EG082E.UVDATA.1

Freq = 4.9270 GHz, Bw = 16.000 MH No calibration applied and no bandpass applied

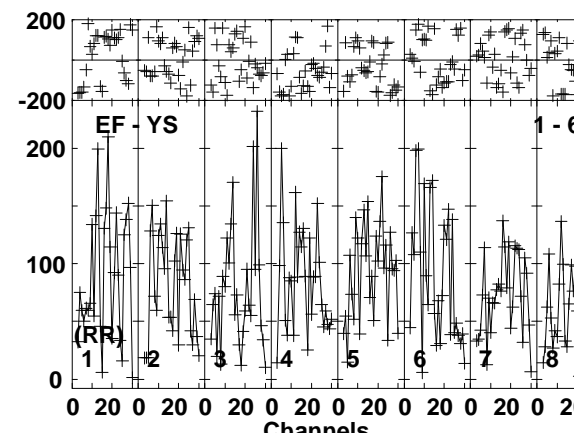
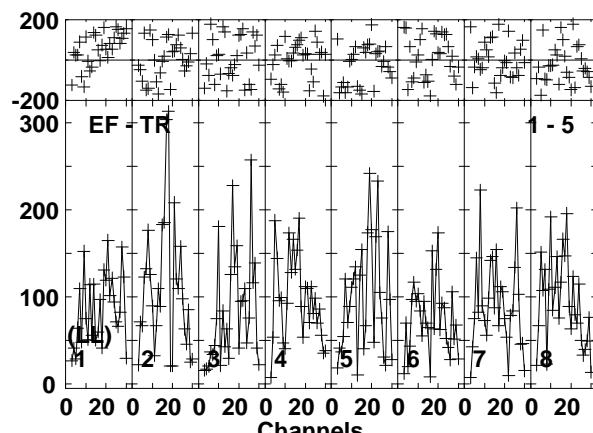
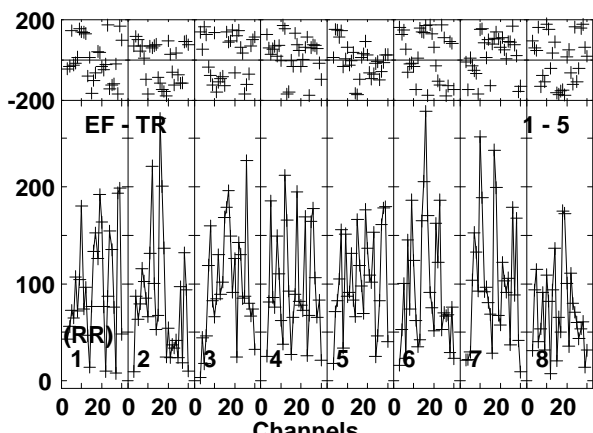
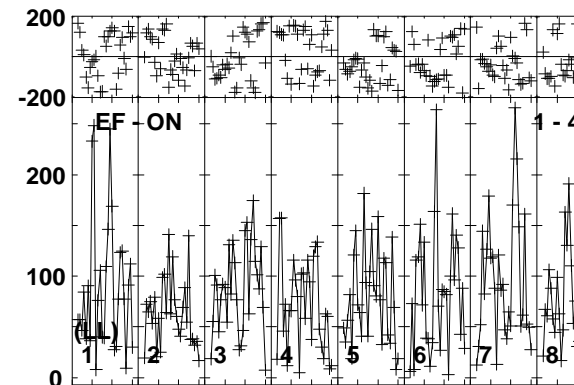
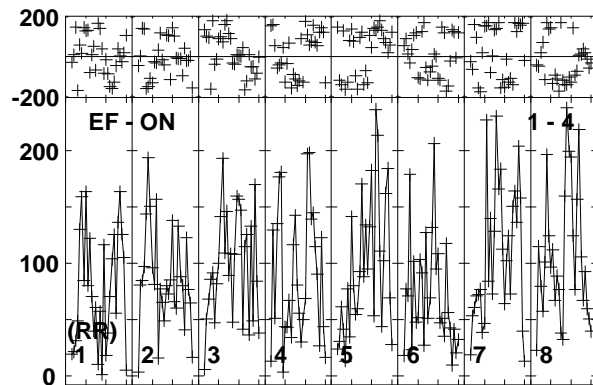
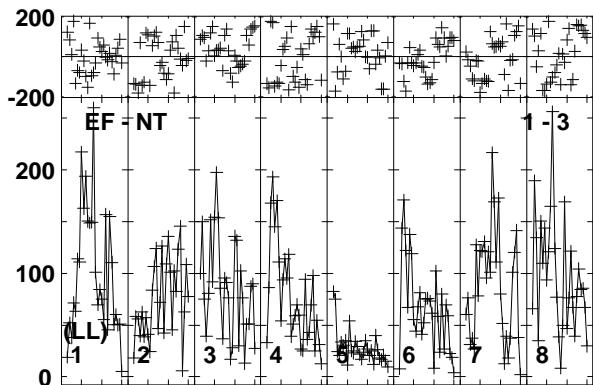
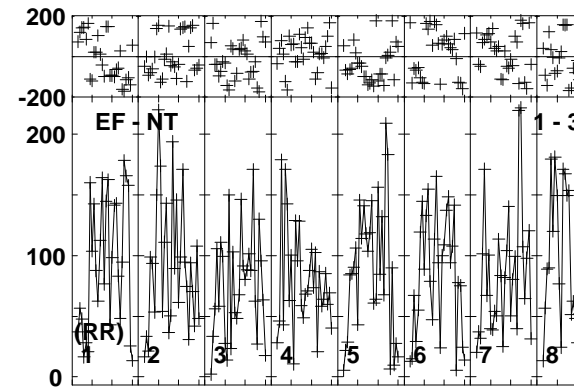
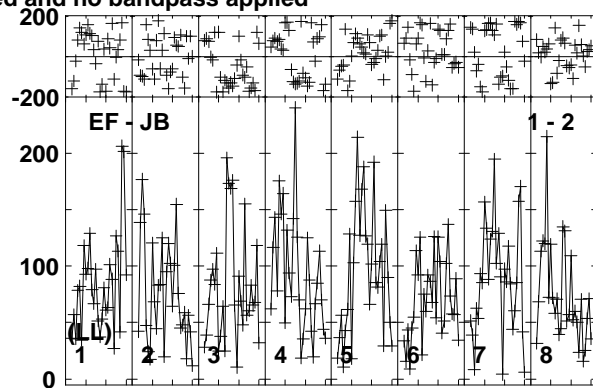
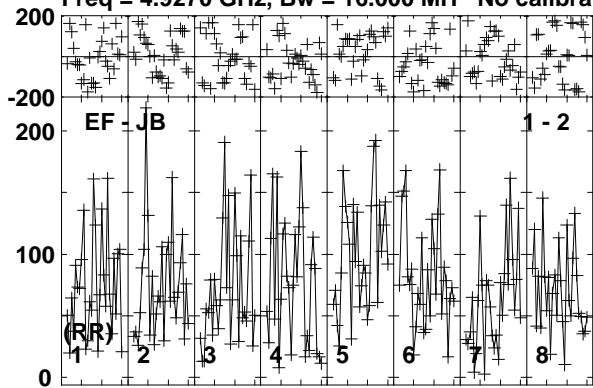

Lower frame: Micro Ampl Jy Top frame: Phas deg
Vector averaged cross-power spectrum Baseline: EF (01) - JB (02)
Timerange: 01/00:44:03 to 01/00:47:29

Plot file version 128 created 26-MAR-2015 15:27:42

RYSEX EG082E.UVDATA.1

Freq = 4.9270 GHz, Bw = 16.000 MH No calibration applied and no bandpass applied

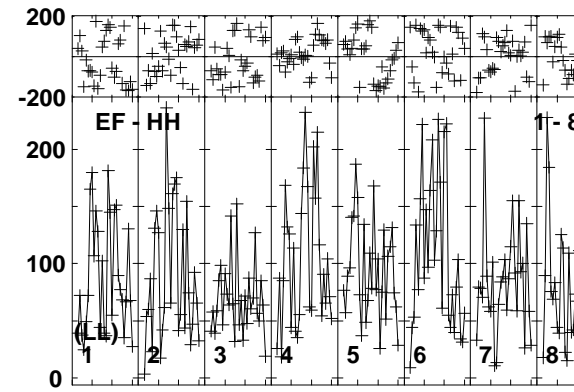
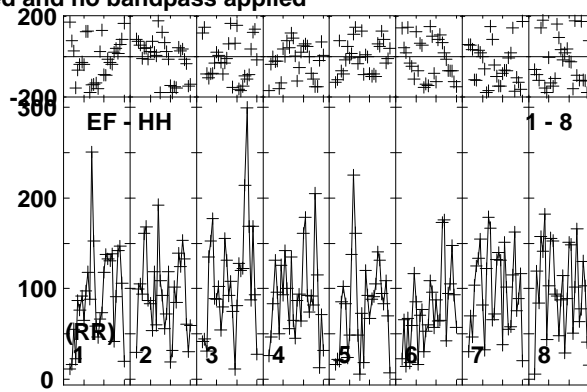
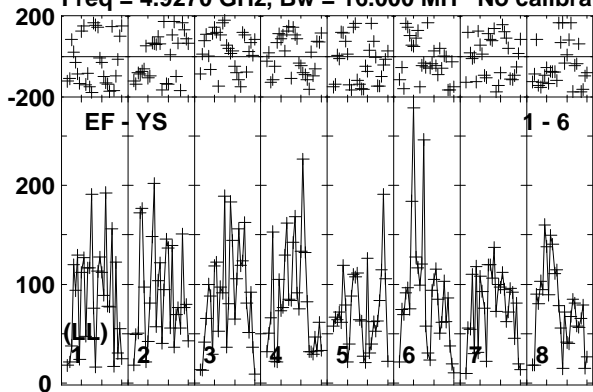

Lower frame: Micro Ampl Jy Top frame: Phas deg
Vector averaged cross-power spectrum Baseline: EF (01) - YS (06)
Timerange: 01/00:44:03 to 01/00:47:29

Plot file version 129 created 26-MAR-2015 15:27:42

J1038+0512 EG082E.UVDATA.1

Freq = 4.9270 GHz, Bw = 16.000 MH No calibration applied and no bandpass applied

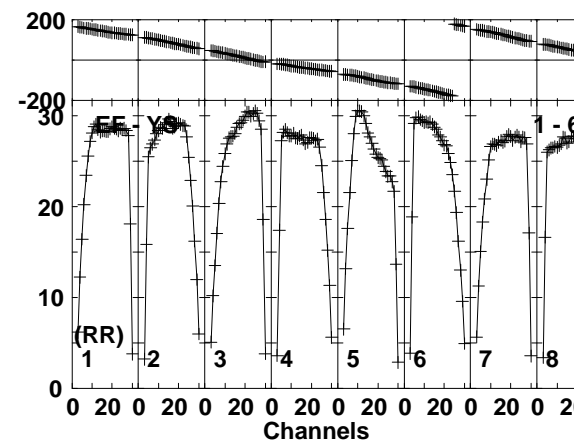
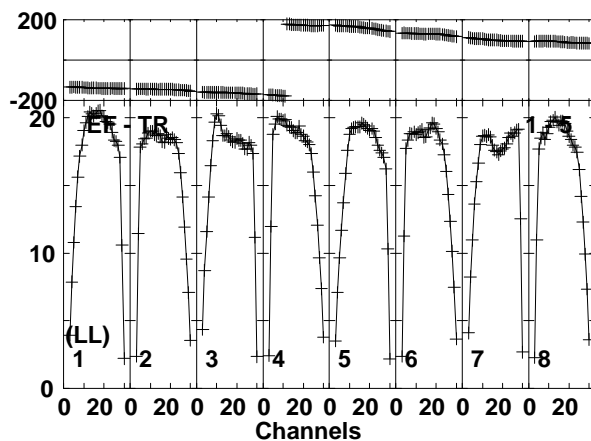
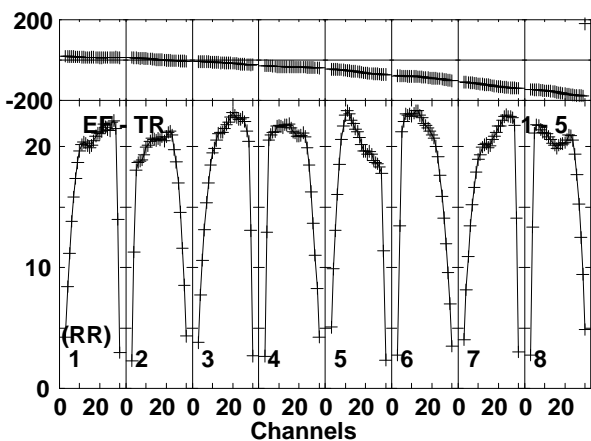
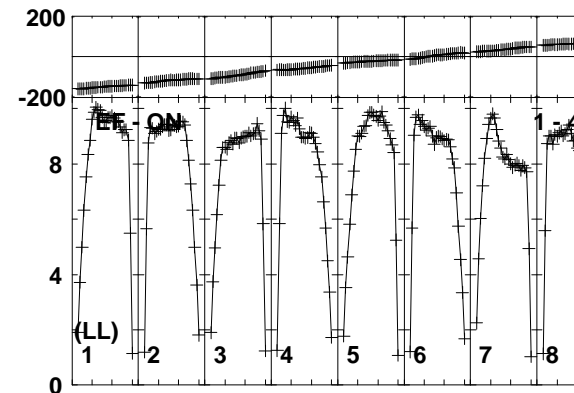
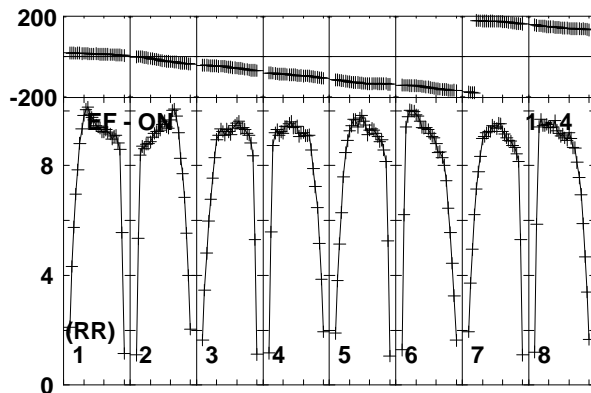
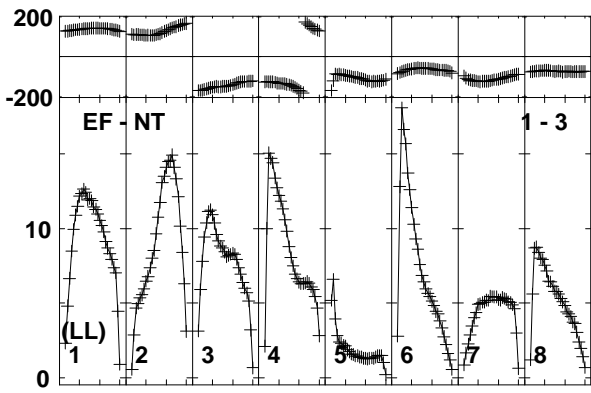
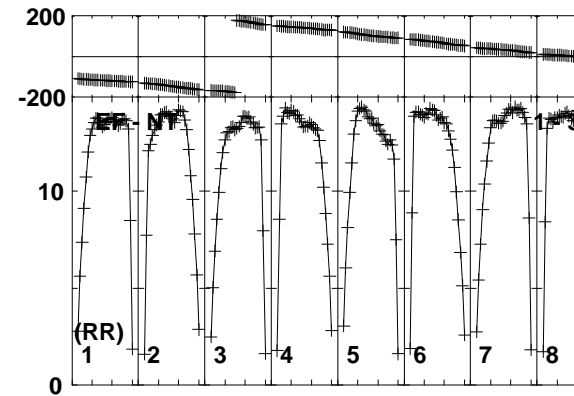
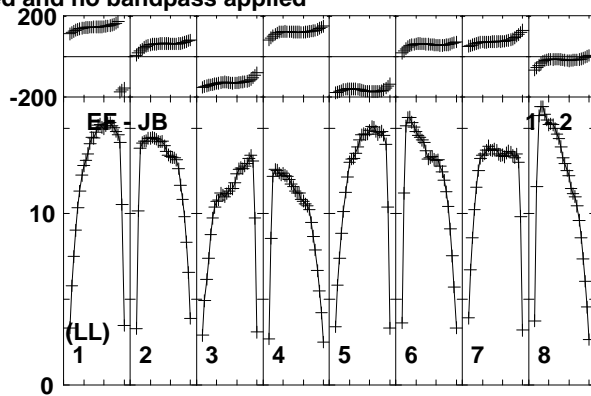
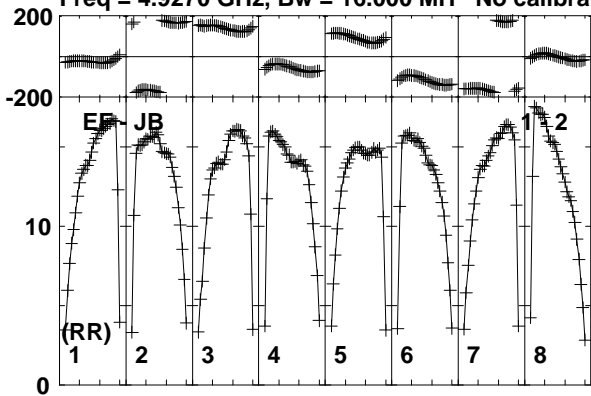

Lower frame: Milli Ampl Jy Top frame: Phas deg
Vector averaged cross-power spectrum Baseline: EF (01) - JB (02)
Timerange: 01/00:48:03 to 01/00:48:59

Plot file version 130 created 26-MAR-2015 15:27:42

J1038+0512 EG082E.UVDATA.1

Freq = 4.9270 GHz, Bw = 16.000 MH No calibration applied and no bandpass applied

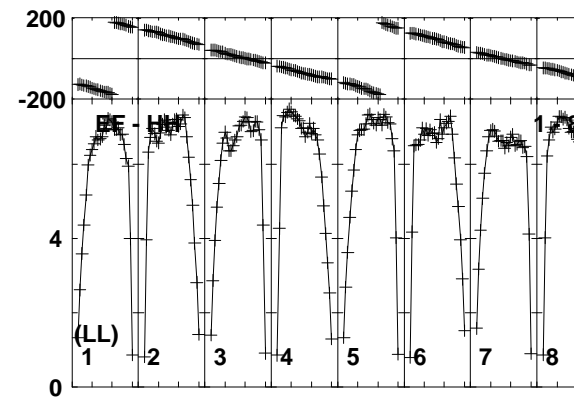
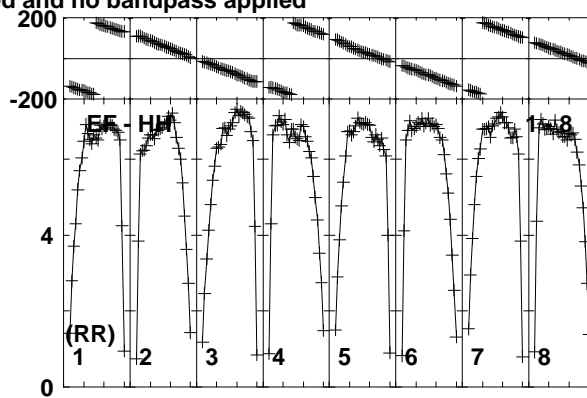
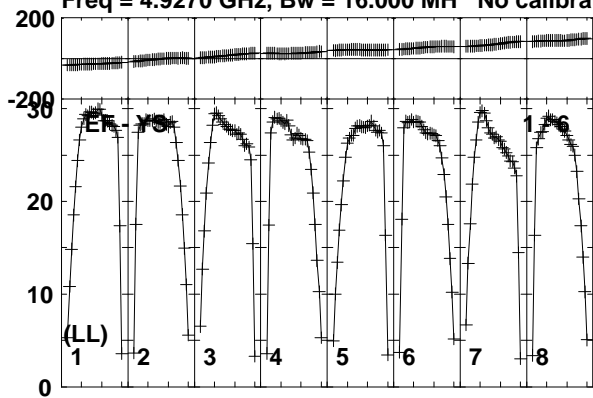

Lower frame: Milli Ampl Jy Top frame: Phas deg
Vector averaged cross-power spectrum Baseline: EF (01) - YS (06)
Timerange: 01/00:48:03 to 01/00:48:59

Plot file version 131 created 26-MAR-2015 15:27:42

RYSEX EG082E.UVDATA.1

Freq = 4.9270 GHz, Bw = 16.000 MH No calibration applied and no bandpass applied

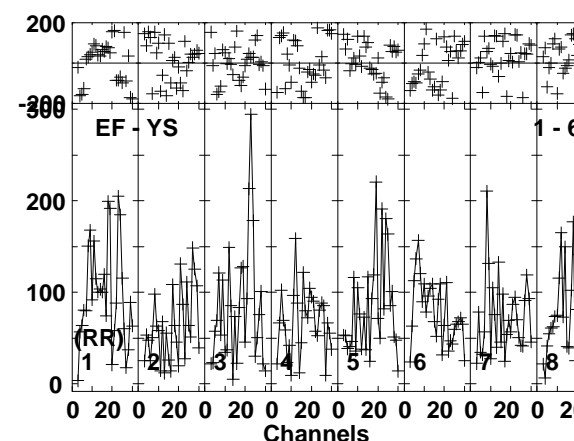
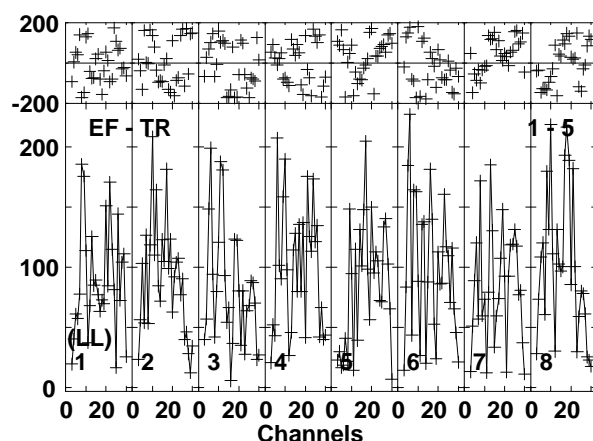
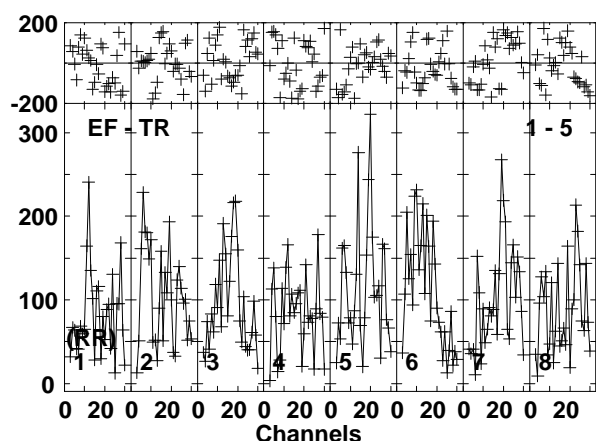
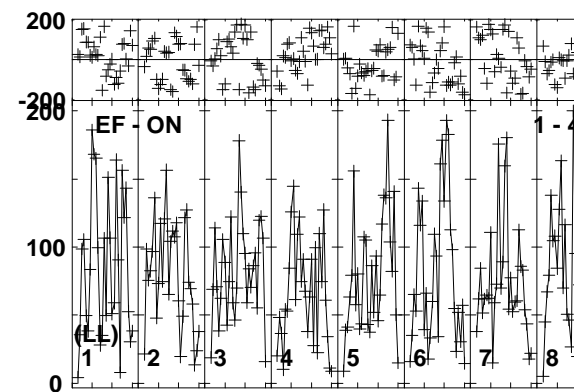
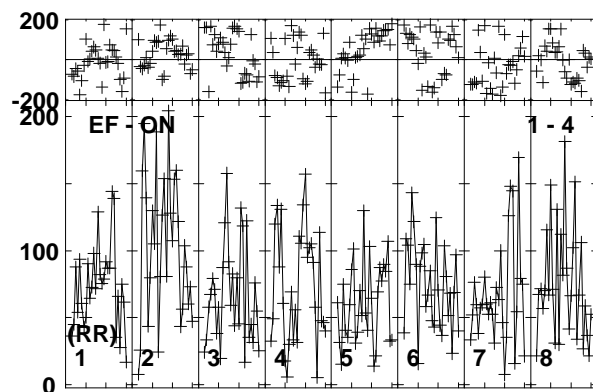
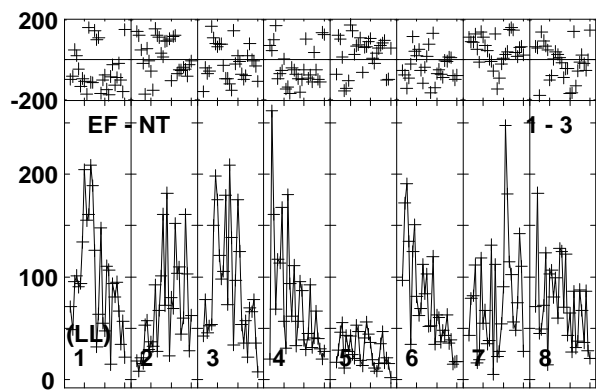
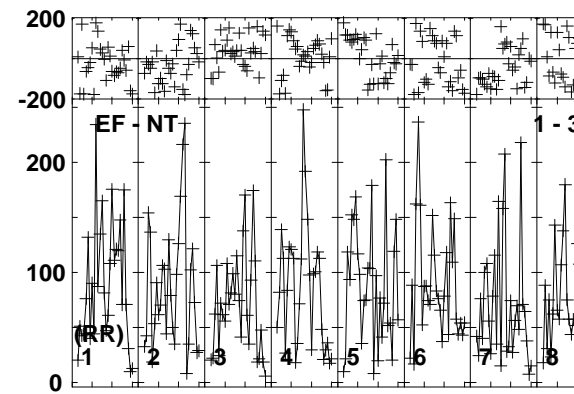
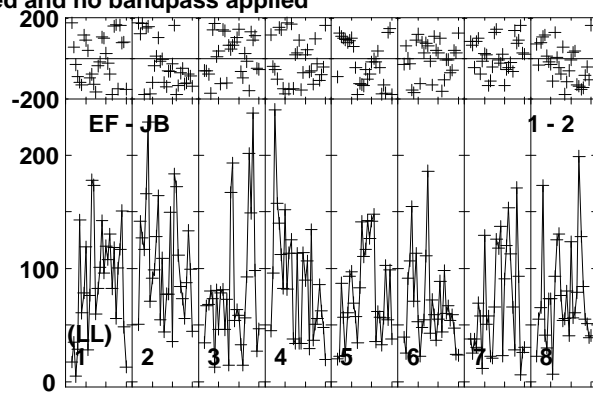
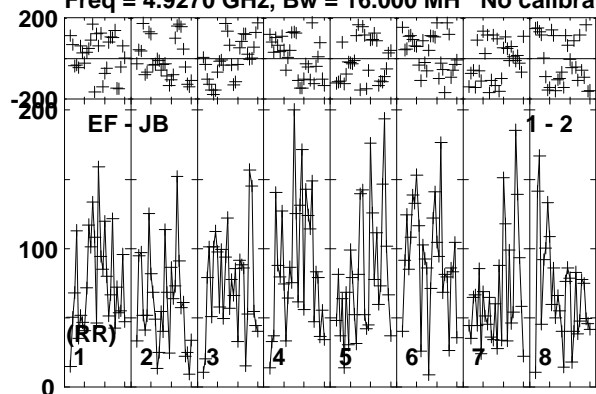

Lower frame: Micro Ampl Jy Top frame: Phas deg
Vector averaged cross-power spectrum Baseline: EF (01) - JB (02)
Timerange: 01/00:49:03 to 01/00:52:29

Plot file version 132 created 26-MAR-2015 15:27:42

RYSEX EG082E.UVDATA.1

Freq = 4.9270 GHz, Bw = 16.000 MH No calibration applied and no bandpass applied

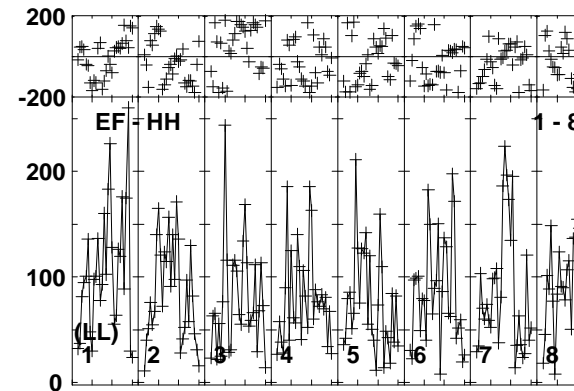
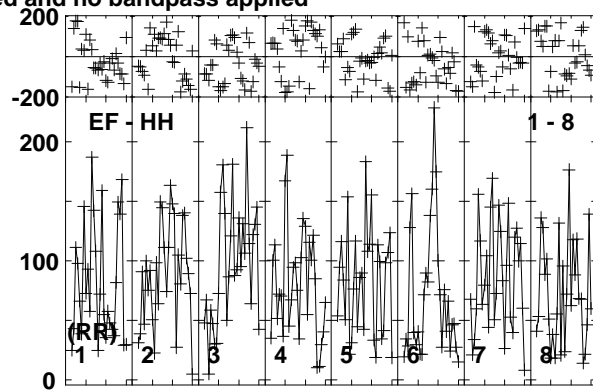
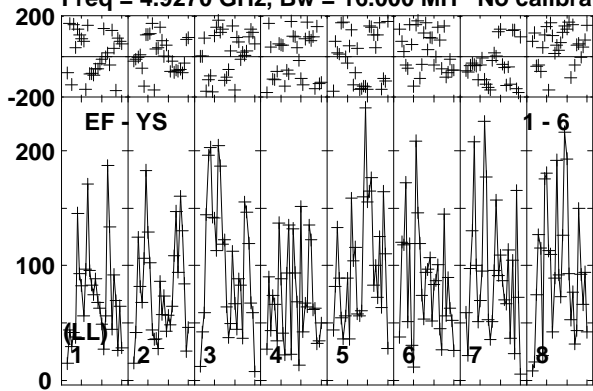

Lower frame: Micro Ampl Jy Top frame: Phas deg
Vector averaged cross-power spectrum Baseline: EF (01) - YS (06)
Timerange: 01/00:49:03 to 01/00:52:29

Plot file version 133 created 26-MAR-2015 15:27:42

J1038+0512 EG082E.UVDATA.1

Freq = 4.9270 GHz, Bw = 16.000 MH No calibration applied and no bandpass applied

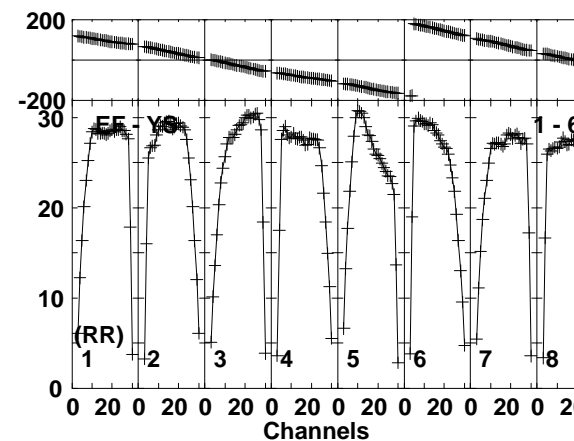
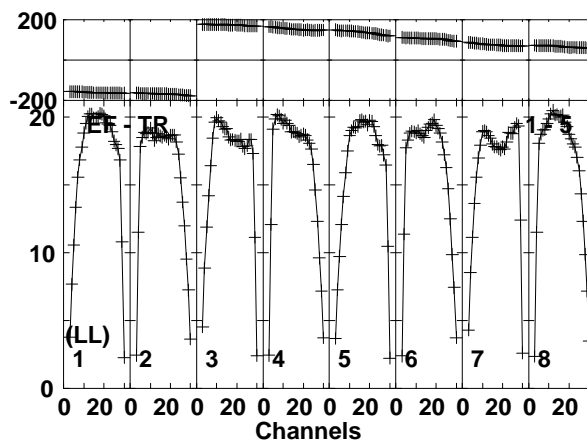
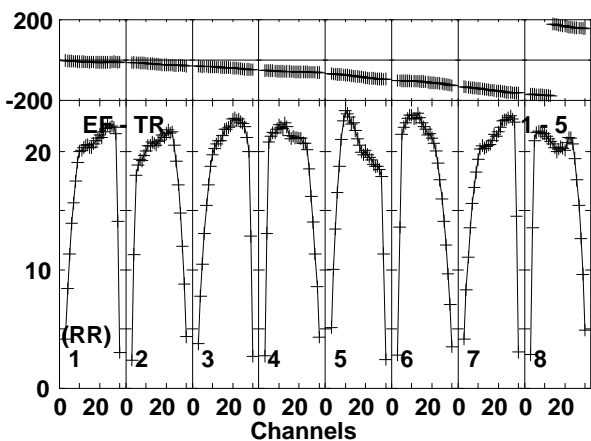
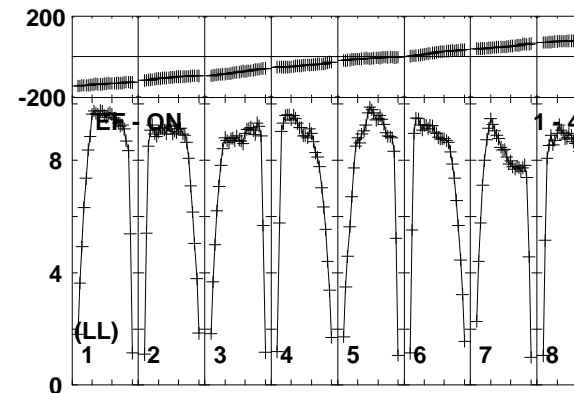
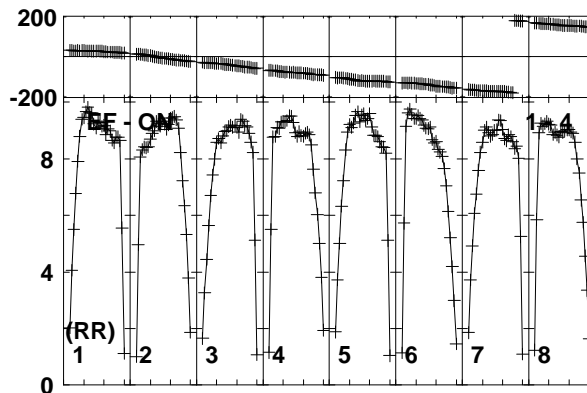
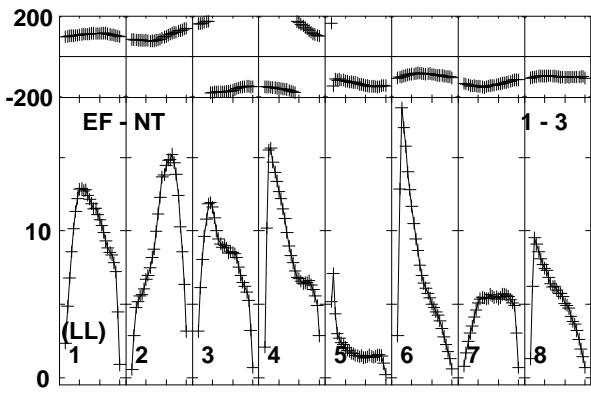
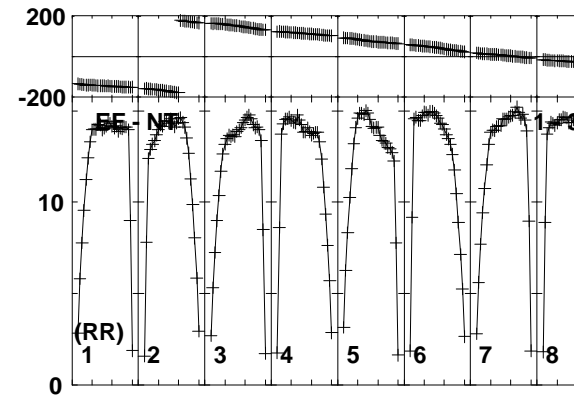
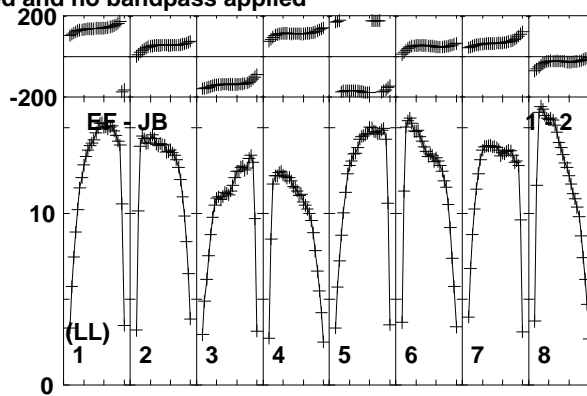
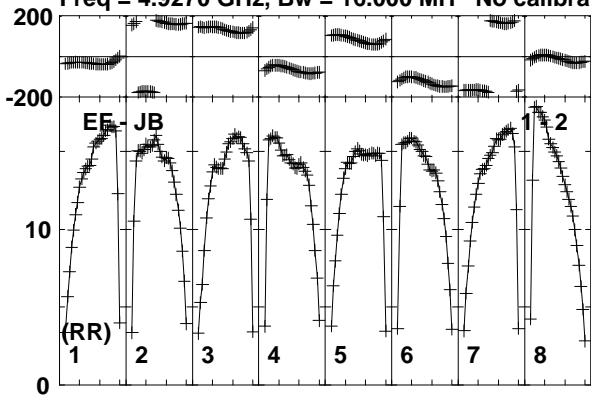

Lower frame: Milli Ampl Jy Top frame: Phas deg
Vector averaged cross-power spectrum Baseline: EF (01) - JB (02)
Timerange: 01/00:52:33 to 01/00:53:59

Plot file version 134 created 26-MAR-2015 15:27:42

J1038+0512 EG082E.UVDATA.1

Freq = 4.9270 GHz, Bw = 16.000 MH No calibration applied and no bandpass applied

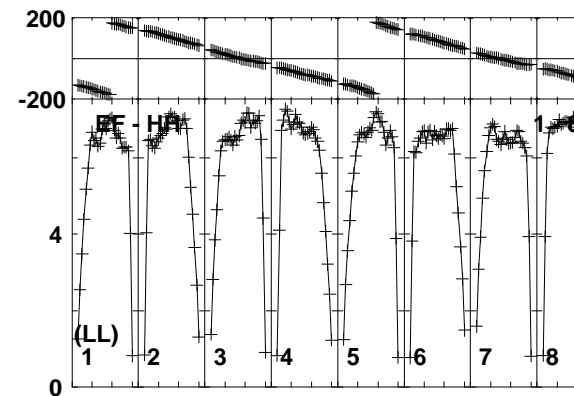
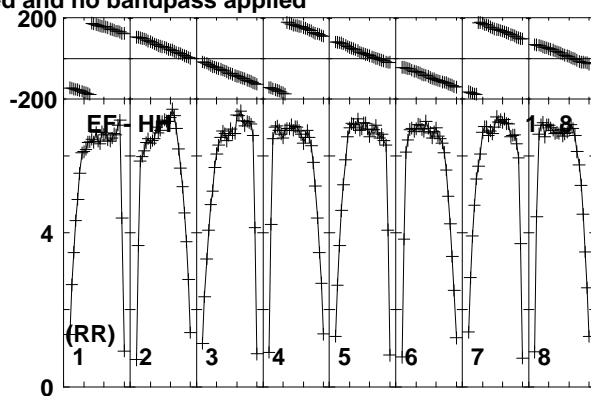
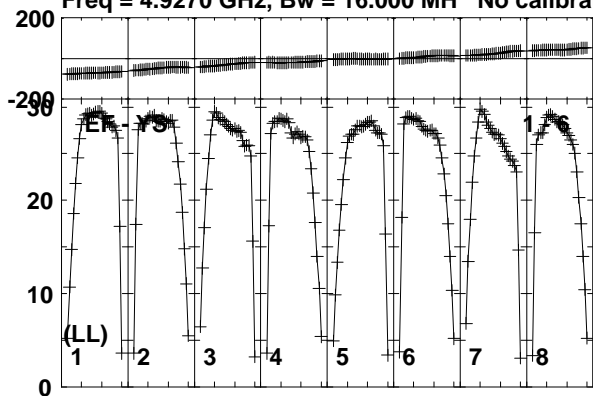

Lower frame: Milli Ampl Jy Top frame: Phas deg
Vector averaged cross-power spectrum Baseline: EF (01) - YS (06)
Timerange: 01/00:52:33 to 01/00:53:59

Plot file version 135 created 26-MAR-2015 15:27:42

RYSEX EG082E.UVDATA.1

Freq = 4.9270 GHz, Bw = 16.000 MH No calibration applied and no bandpass applied

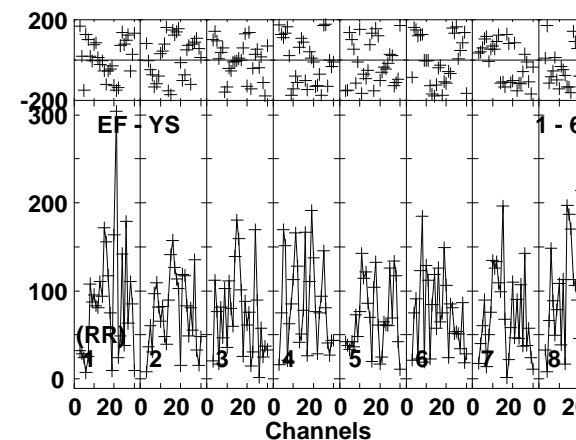
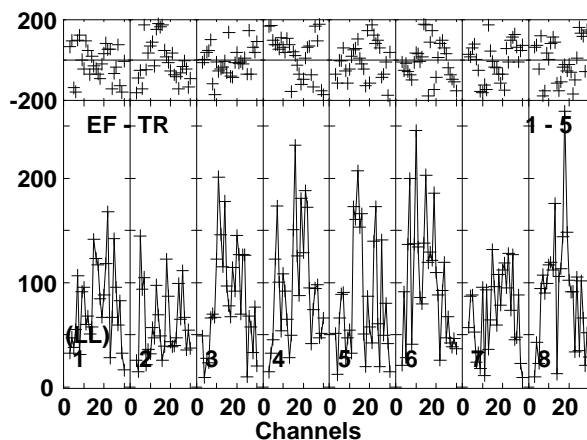
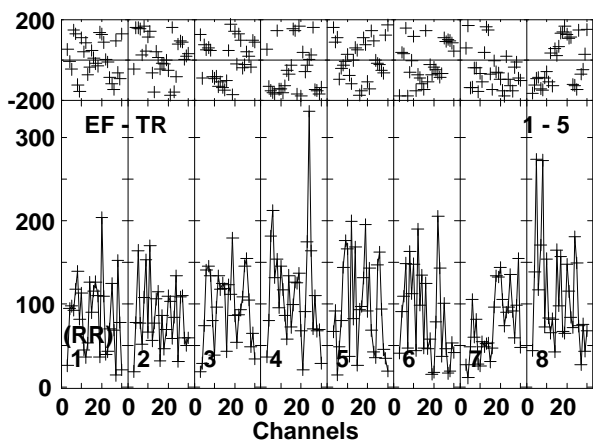
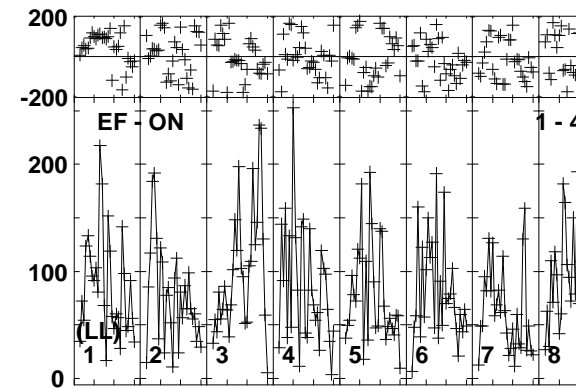
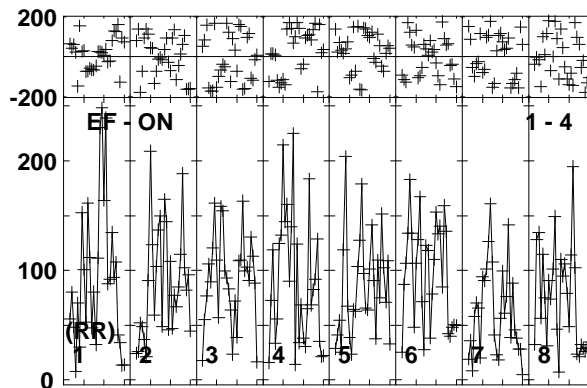
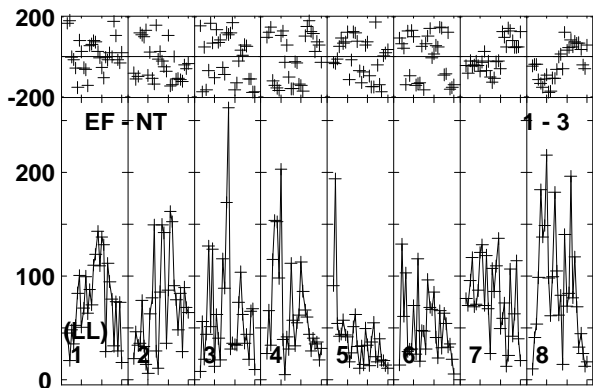
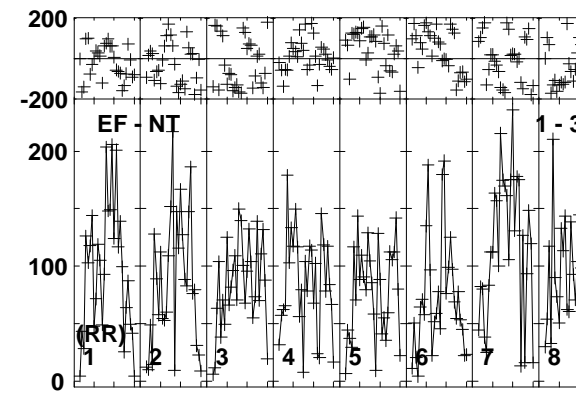
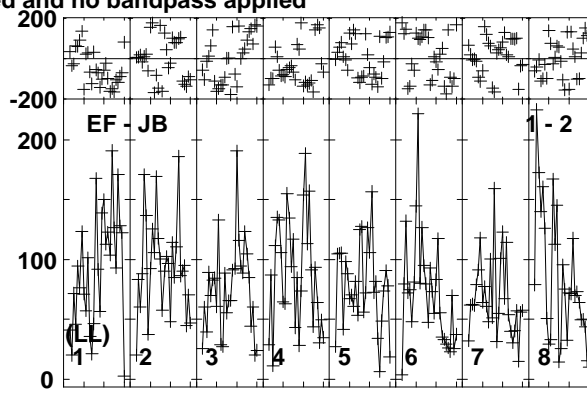
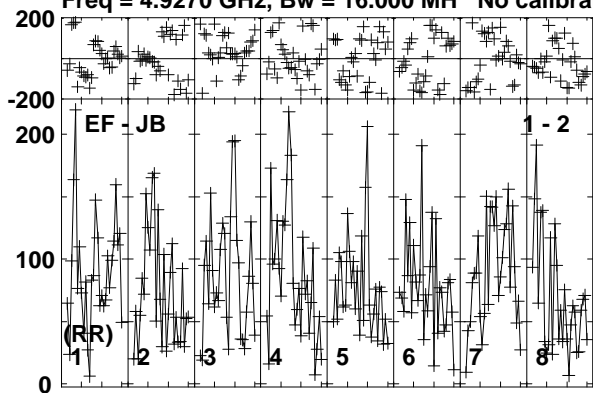

Lower frame: Micro Ampl Jy Top frame: Phas deg
Vector averaged cross-power spectrum Baseline: EF (01) - JB (02)
Timerange: 01/00:54:03 to 01/00:57:29

Plot file version 136 created 26-MAR-2015 15:27:42

RYSEX EG082E.UVDATA.1

Freq = 4.9270 GHz, Bw = 16.000 MH No calibration applied and no bandpass applied

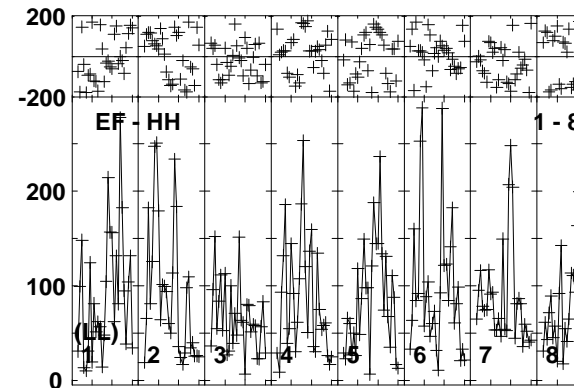
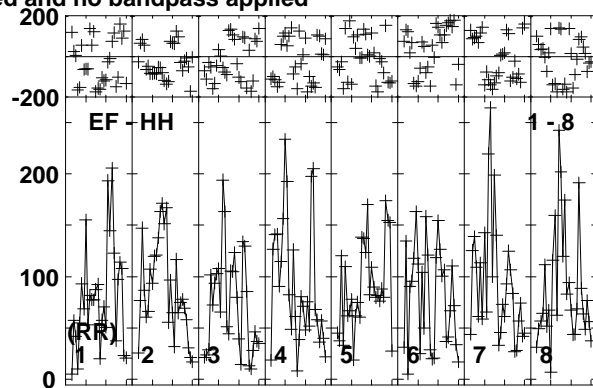
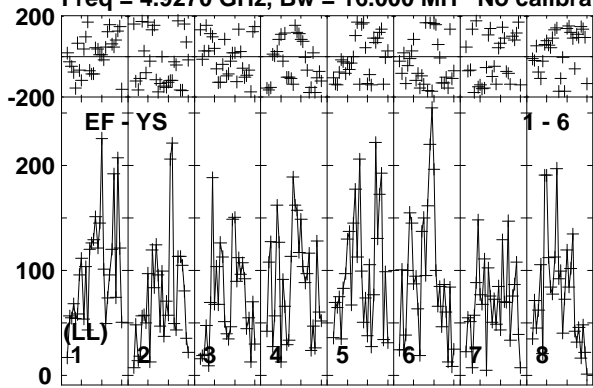

Lower frame: Micro Ampl Jy Top frame: Phas deg
Vector averaged cross-power spectrum Baseline: EF (01) - YS (06)
Timerange: 01/00:54:03 to 01/00:57:29

Plot file version 137 created 26-MAR-2015 15:27:42

J1038+0512 EG082E.UVDATA.1

Freq = 4.9270 GHz, Bw = 16.000 MH No calibration applied and no bandpass applied

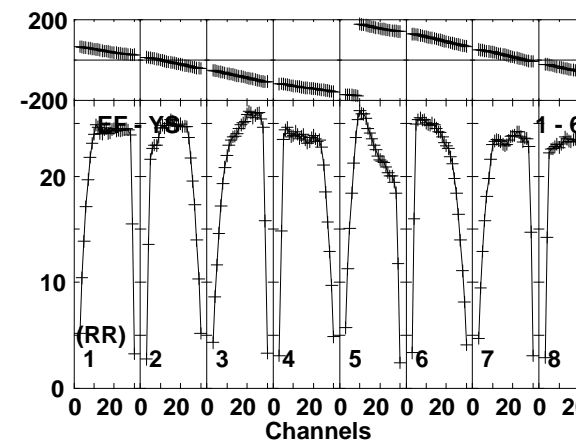
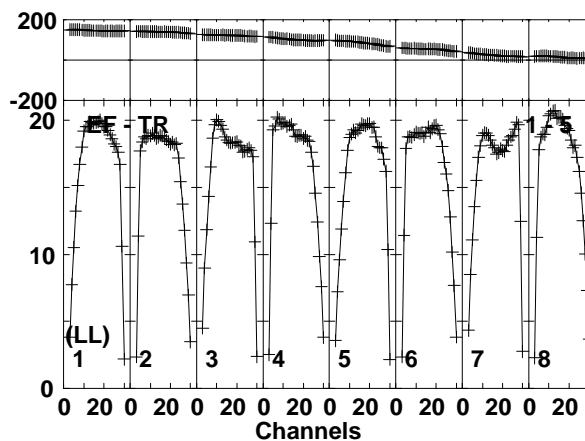
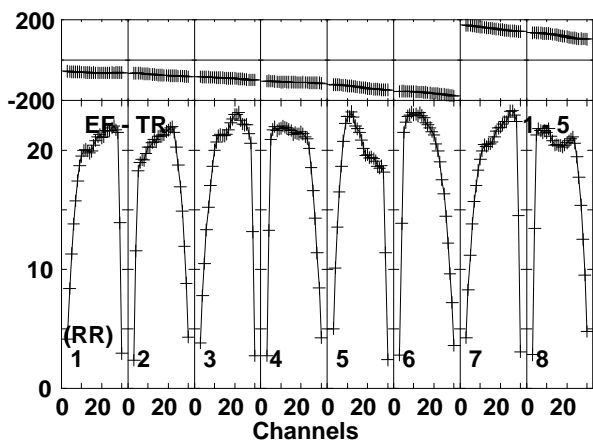
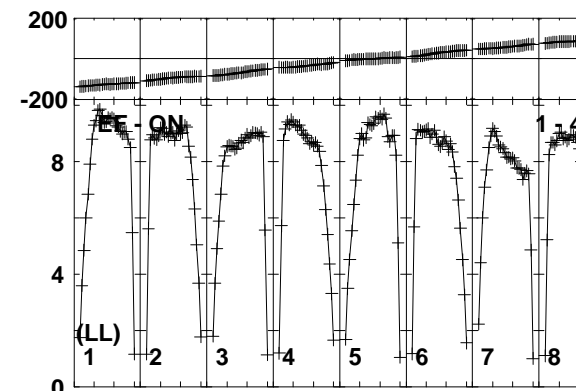
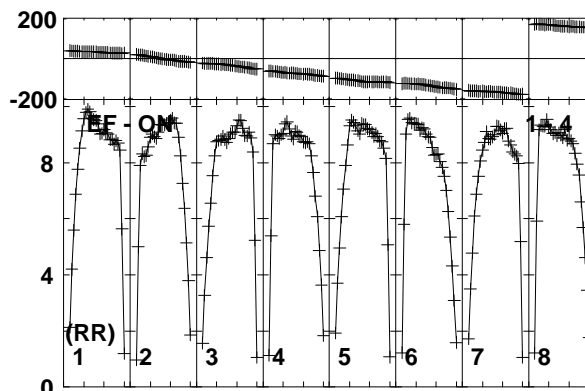
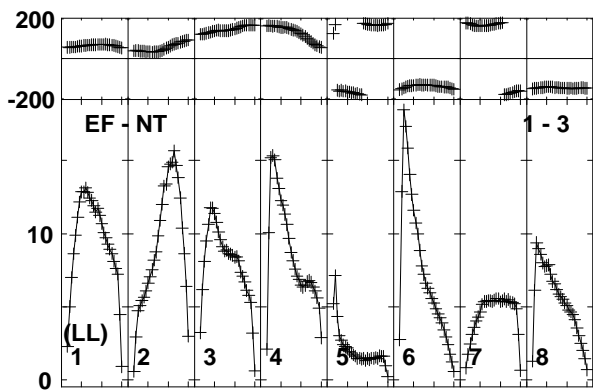
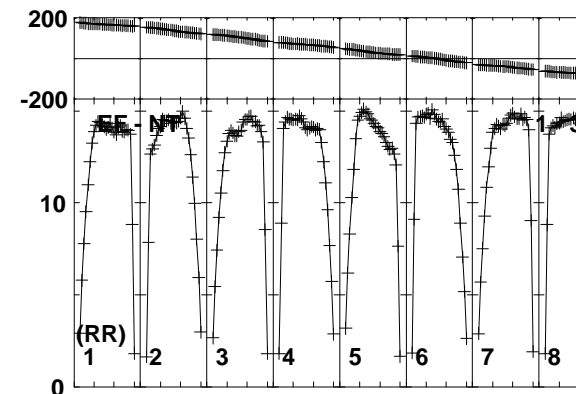
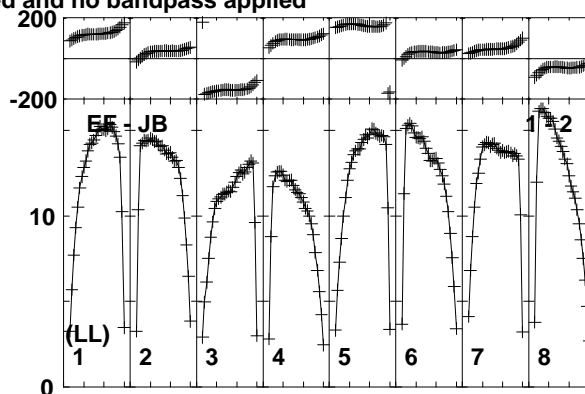
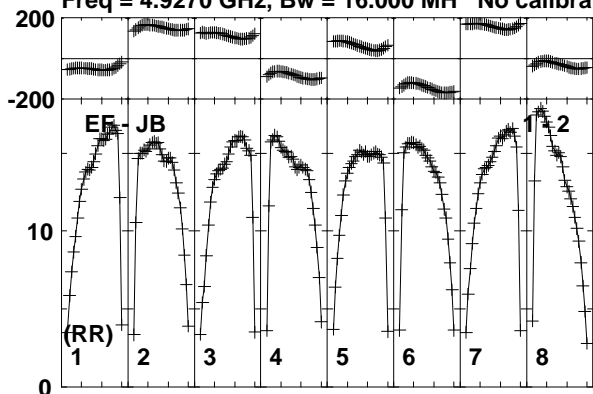

Lower frame: Milli Ampl Jy Top frame: Phas deg
Vector averaged cross-power spectrum Baseline: EF (01) - JB (02)
Timerange: 01/00:58:03 to 01/00:58:59

Plot file version 138 created 26-MAR-2015 15:27:42

J1038+0512 EG082E.UVDATA.1

Freq = 4.9270 GHz, Bw = 16.000 MH No calibration applied and no bandpass applied

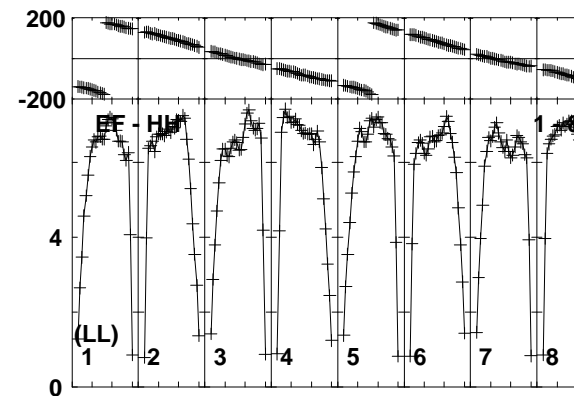
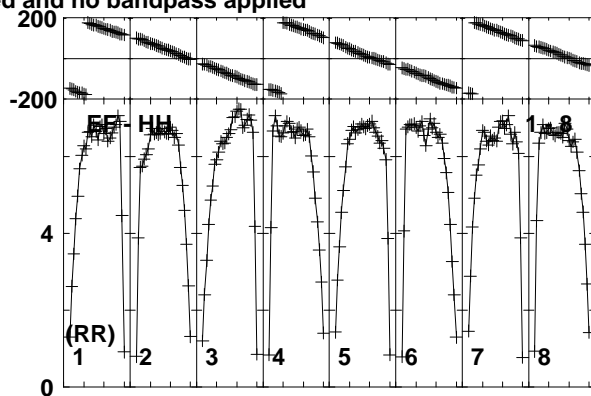
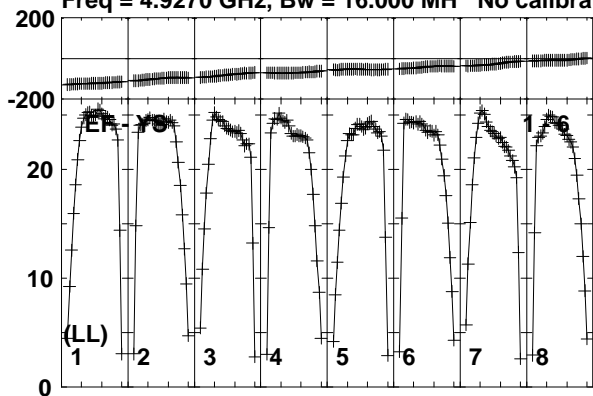

Lower frame: Milli Ampl Jy Top frame: Phas deg
Vector averaged cross-power spectrum Baseline: EF (01) - YS (06)
Timerange: 01/00:58:03 to 01/00:58:59

Plot file version 139 created 26-MAR-2015 15:27:42

RYSEX EG082E.UVDATA.1

Freq = 4.9270 GHz, Bw = 16.000 MH No calibration applied and no bandpass applied

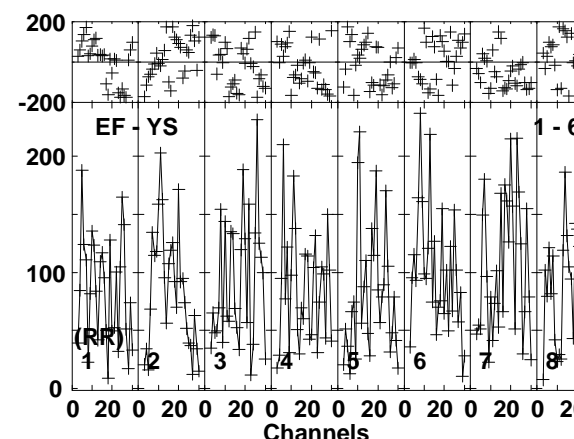
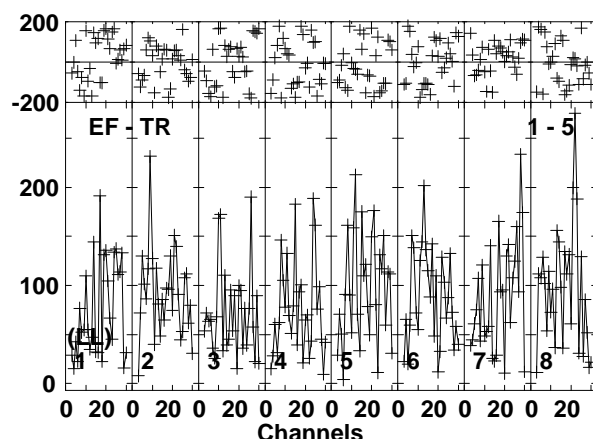
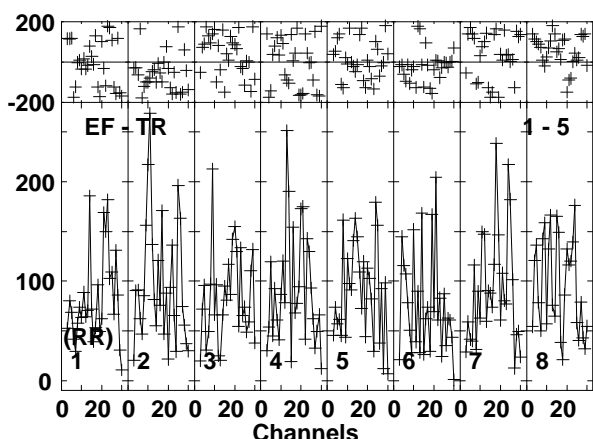
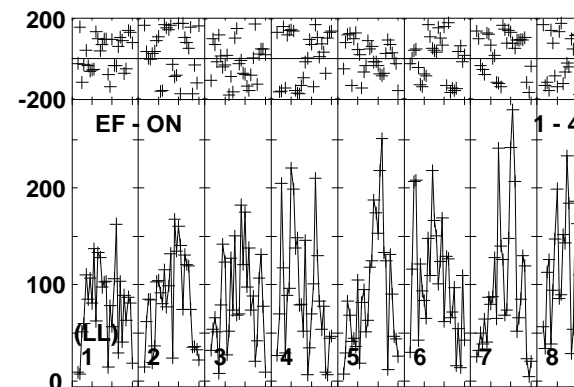
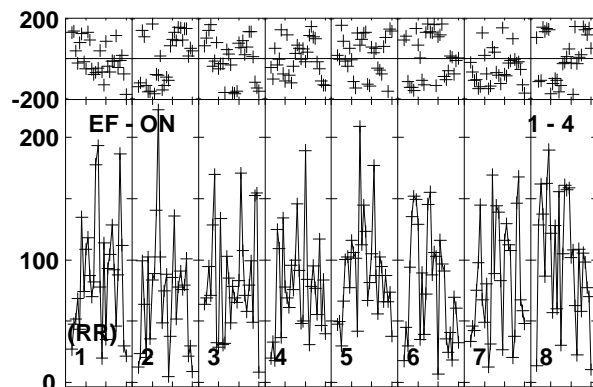
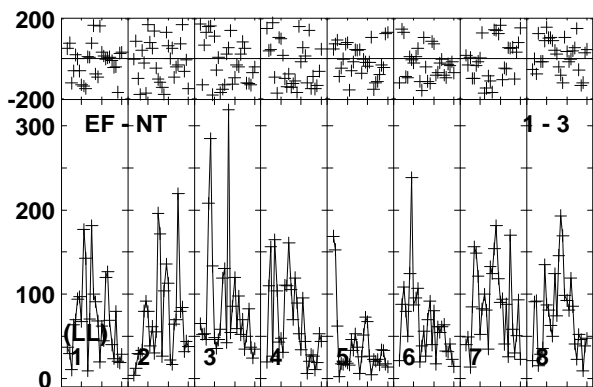
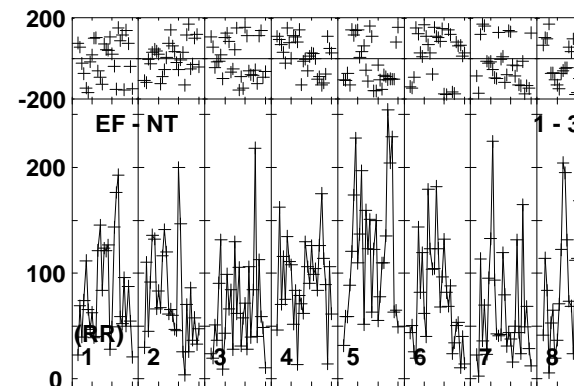
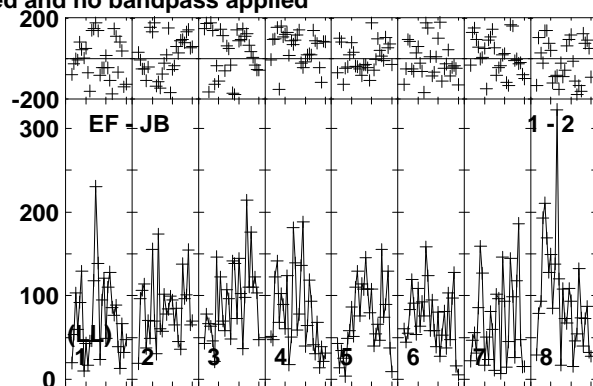
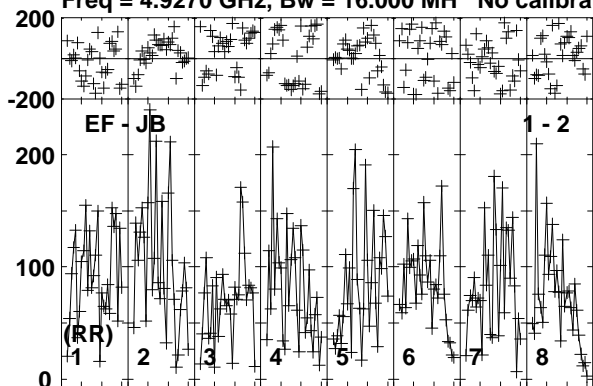

Lower frame: Micro Ampl Jy Top frame: Phas deg
Vector averaged cross-power spectrum Baseline: EF (01) - JB (02)
Timerange: 01/00:59:03 to 01/01:02:29

Plot file version 140 created 26-MAR-2015 15:27:43

RYSEX EG082E.UVDATA.1

Freq = 4.9270 GHz, Bw = 16.000 MH No calibration applied and no bandpass applied

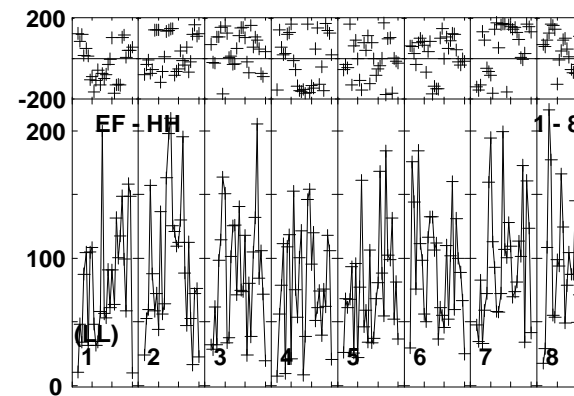
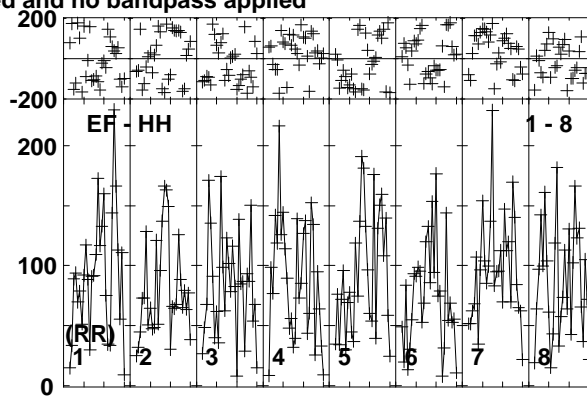
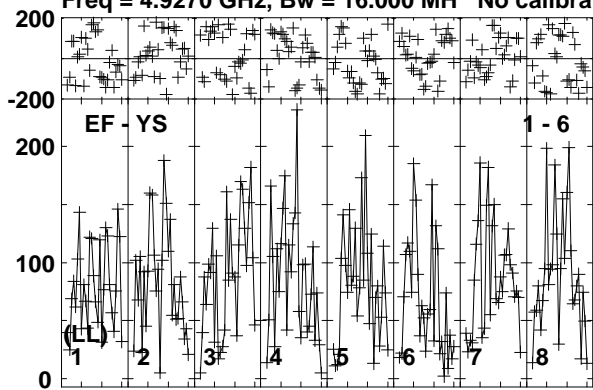

Lower frame: Micro Ampl Jy Top frame: Phas deg
Vector averaged cross-power spectrum Baseline: EF (01) - YS (06)
Timerange: 01/00:59:03 to 01/01:02:29

Plot file version 141 created 26-MAR-2015 15:27:43

J1038+0512 EG082E.UVDATA.1

Freq = 4.9270 GHz, Bw = 16.000 MH No calibration applied and no bandpass applied

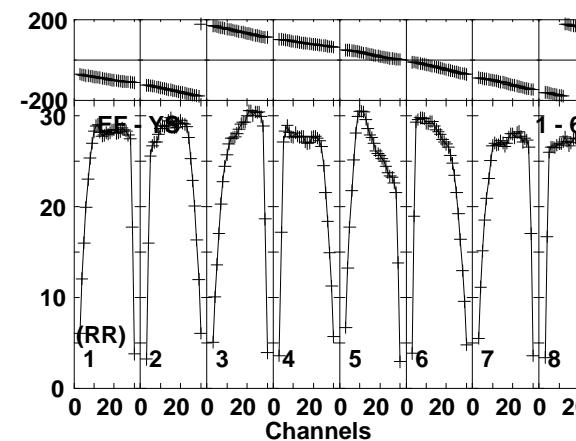
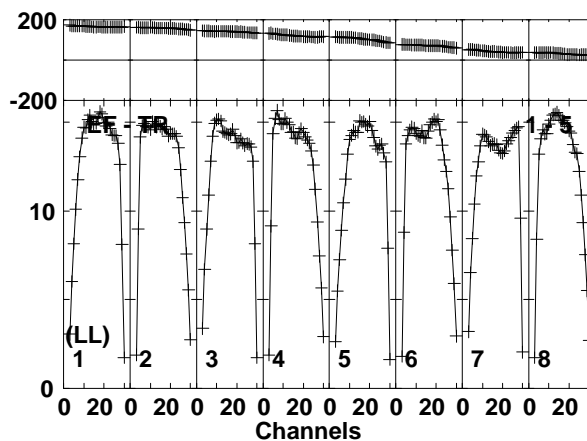
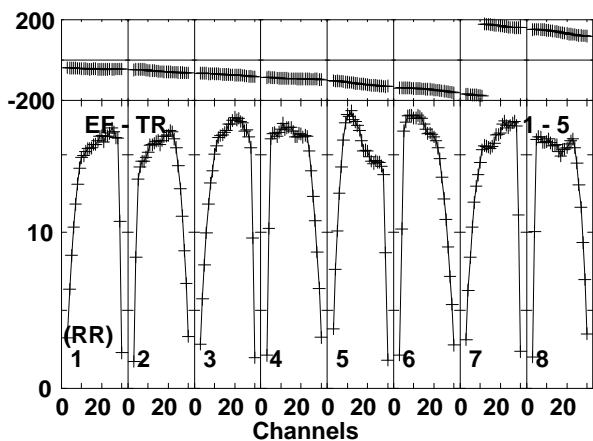
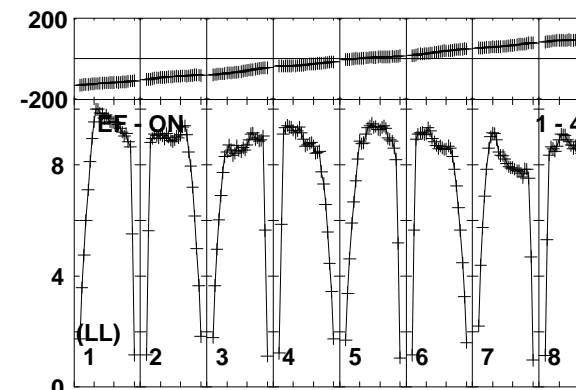
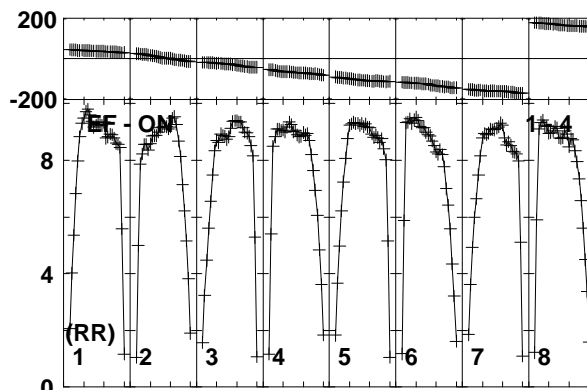
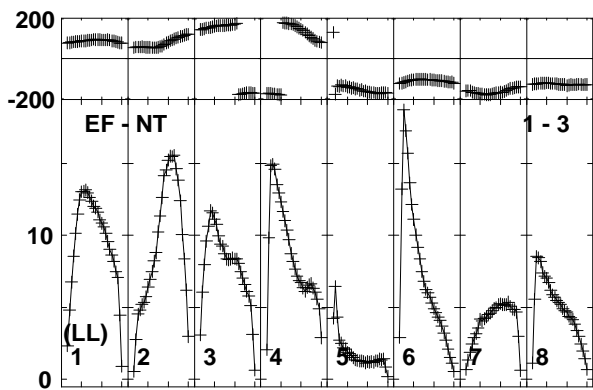
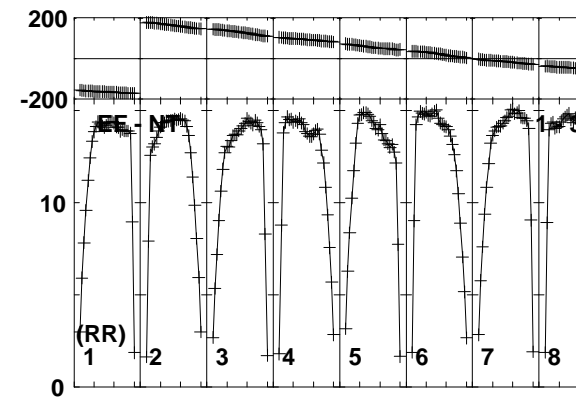
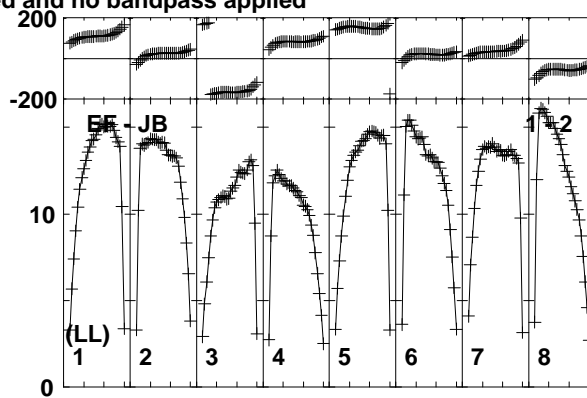
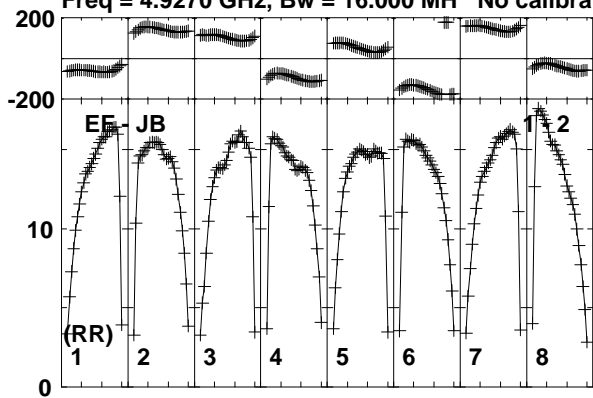

Lower frame: Milli Ampl Jy Top frame: Phas deg
Vector averaged cross-power spectrum Baseline: EF (01) - JB (02)
Timerange: 01/01:02:33 to 01/01:03:59

Plot file version 142 created 26-MAR-2015 15:27:43

J1038+0512 EG082E.UVDATA.1

Freq = 4.9270 GHz, Bw = 16.000 MH No calibration applied and no bandpass applied

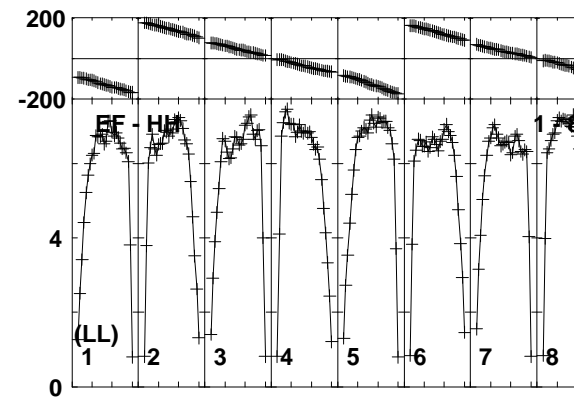
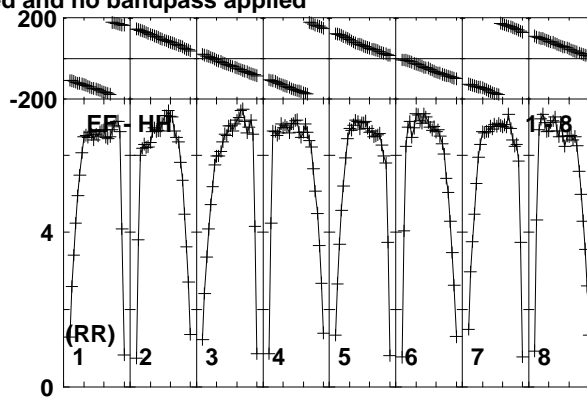
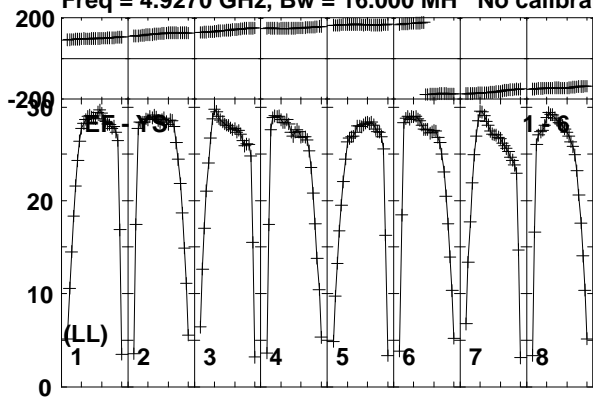

Lower frame: Milli Ampl Jy Top frame: Phas deg
Vector averaged cross-power spectrum Baseline: EF (01) - YS (06)
Timerange: 01/01:02:33 to 01/01:03:59

Plot file version 143 created 26-MAR-2015 15:27:43

J1035+0522 EG082E.UVDATA.1

Freq = 4.9270 GHz, Bw = 16.000 MH No calibration applied and no bandpass applied

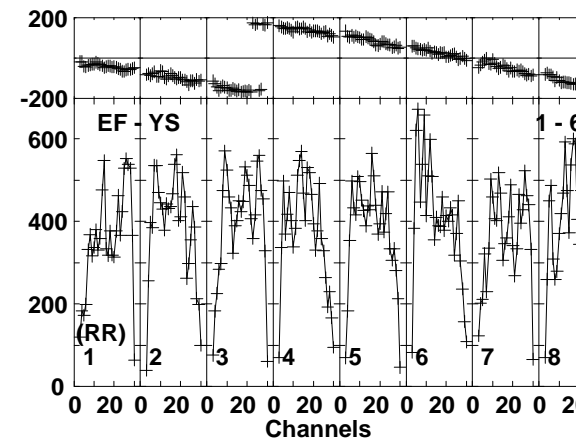
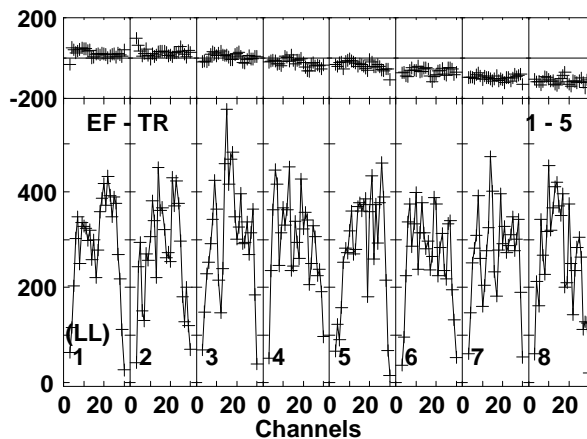
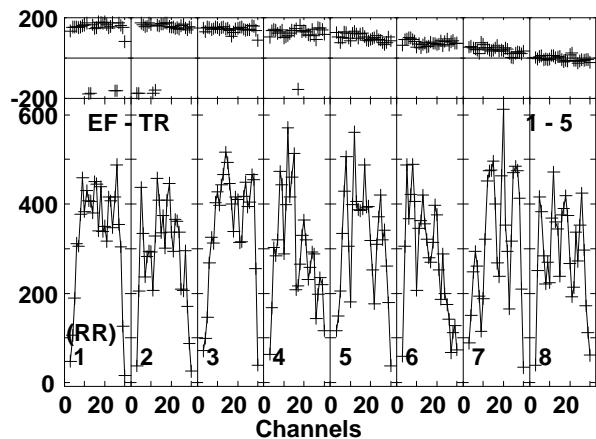
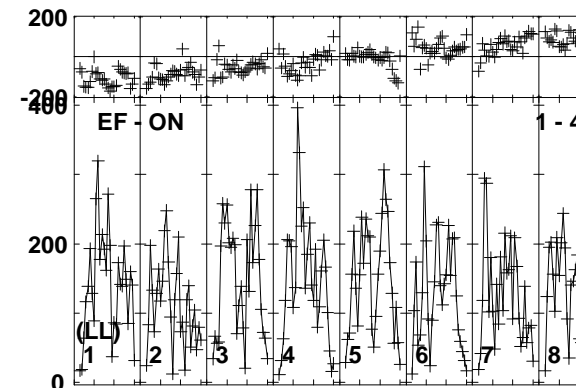
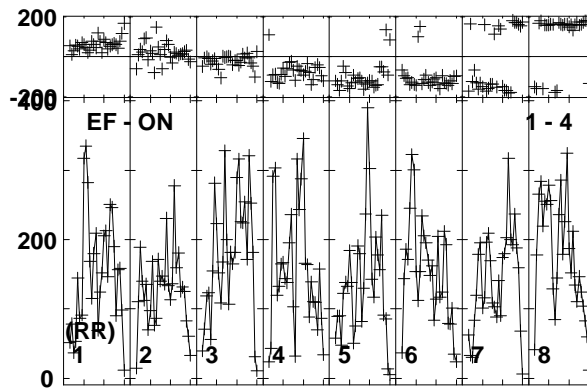
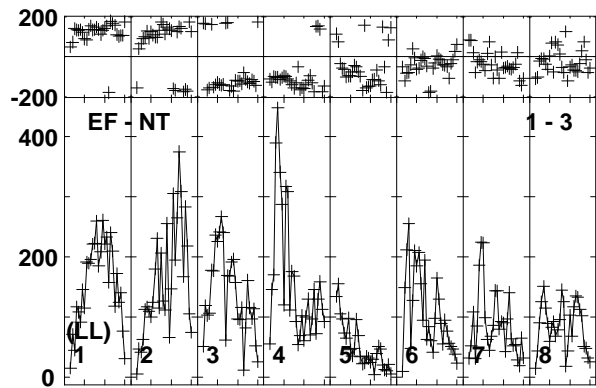
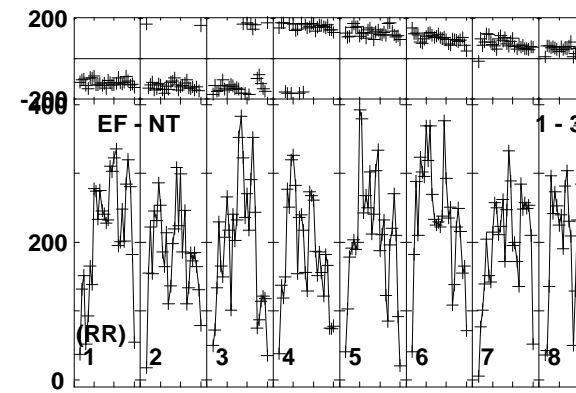
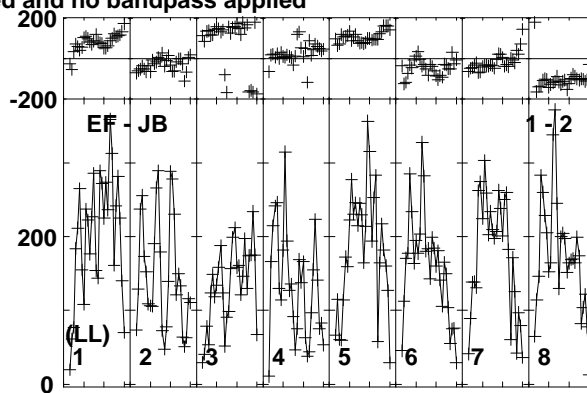
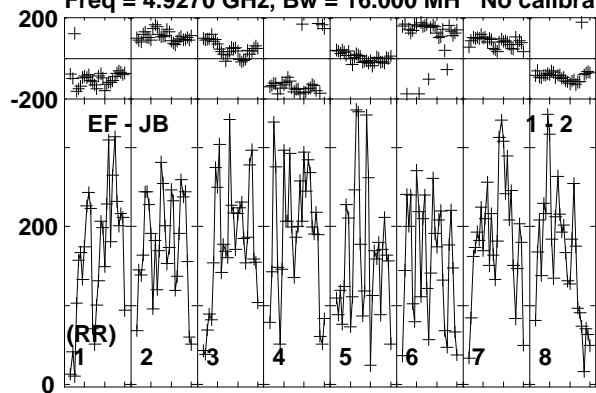

Lower frame: Micro Ampl Jy Top frame: Phas deg
Vector averaged cross-power spectrum Baseline: EF (01) - JB (02)
Timerange: 01/01:04:03 to 01/01:07:29

Plot file version 144 created 26-MAR-2015 15:27:43

J1035+0522 EG082E.UVDATA.1

Freq = 4.9270 GHz, Bw = 16.000 MH No calibration applied and no bandpass applied

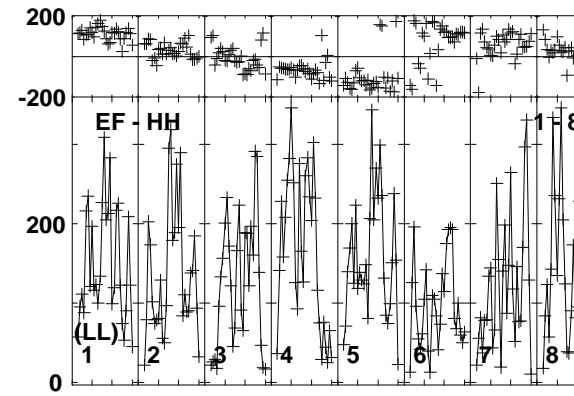
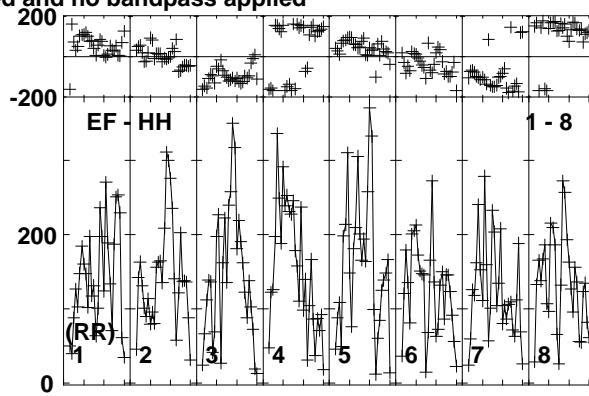
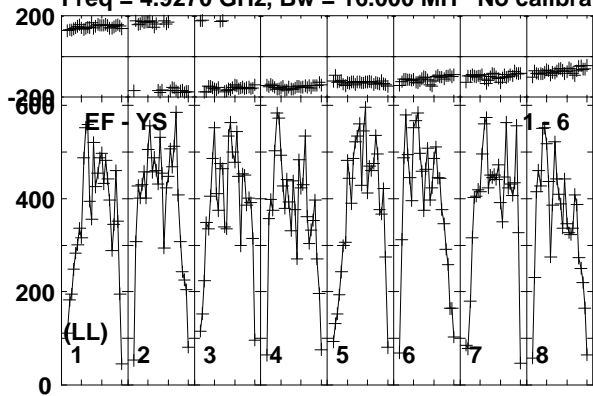

Lower frame: Micro Ampl Jy Top frame: Phas deg
Vector averaged cross-power spectrum Baseline: EF (01) - YS (06)
Timerange: 01/01:04:03 to 01/01:07:29

Plot file version 145 created 26-MAR-2015 15:27:43

J1038+0512 EG082E.UVDATA.1

Freq = 4.9270 GHz, Bw = 16.000 MH No calibration applied and no bandpass applied

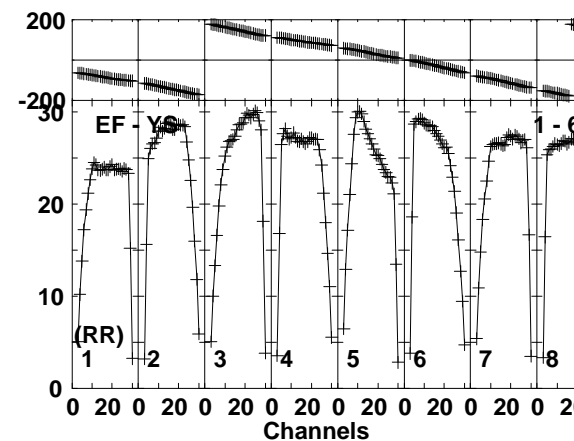
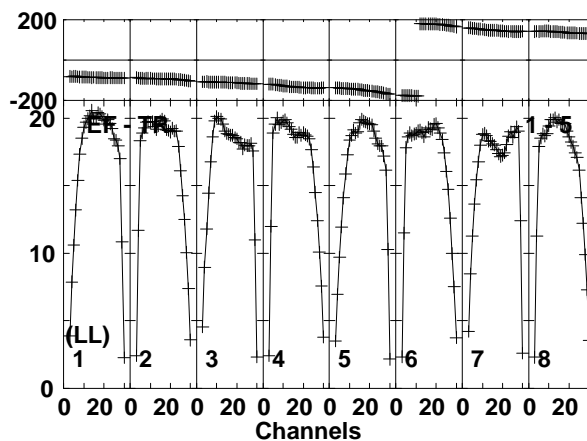
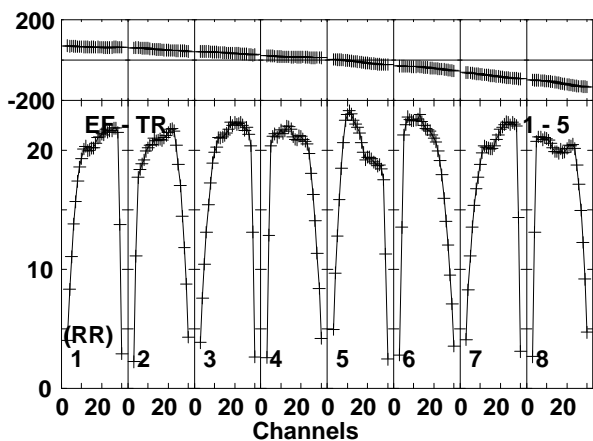
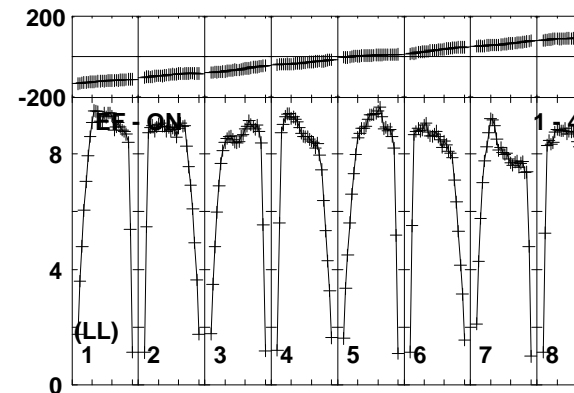
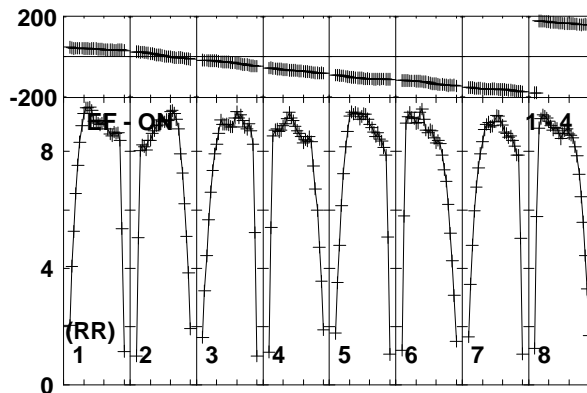
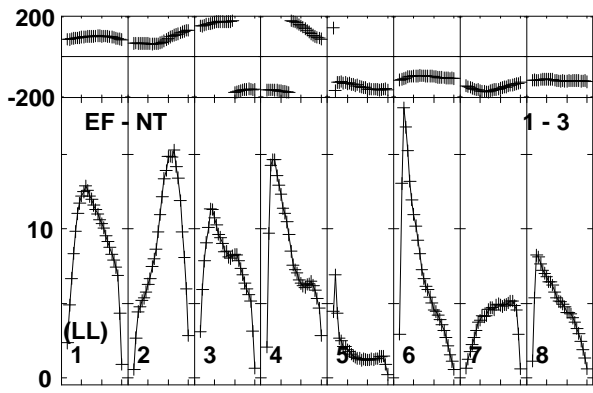
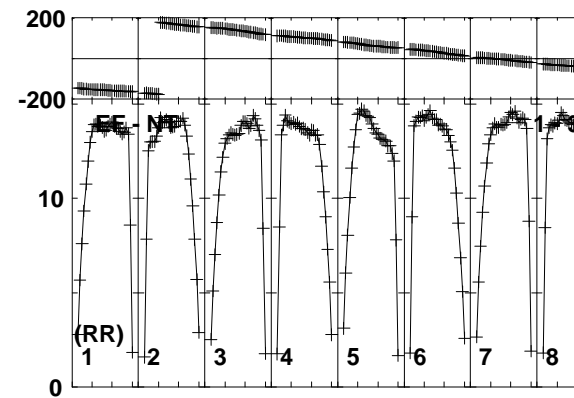
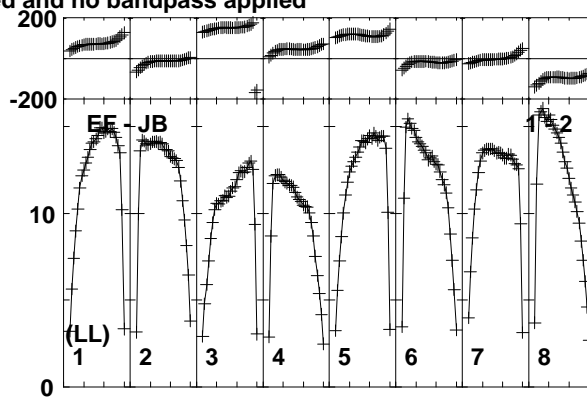
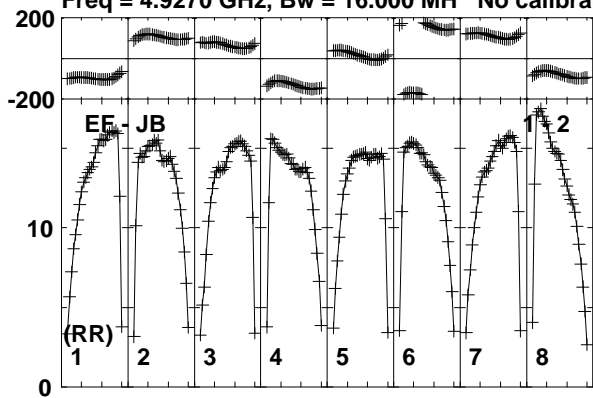

Lower frame: Milli Ampl Jy Top frame: Phas deg
Vector averaged cross-power spectrum Baseline: EF (01) - JB (02)
Timerange: 01/01:08:03 to 01/01:08:59

Plot file version 146 created 26-MAR-2015 15:27:43

J1038+0512 EG082E.UVDATA.1

Freq = 4.9270 GHz, Bw = 16.000 MH No calibration applied and no bandpass applied

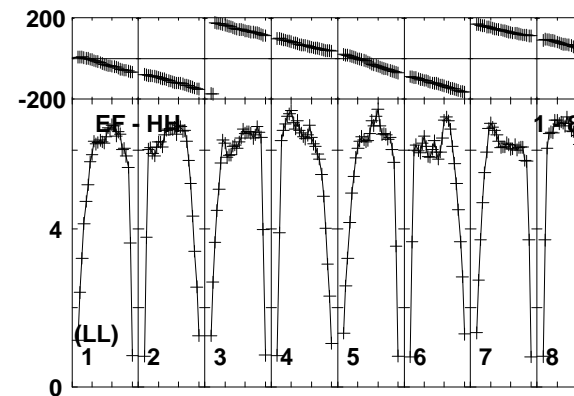
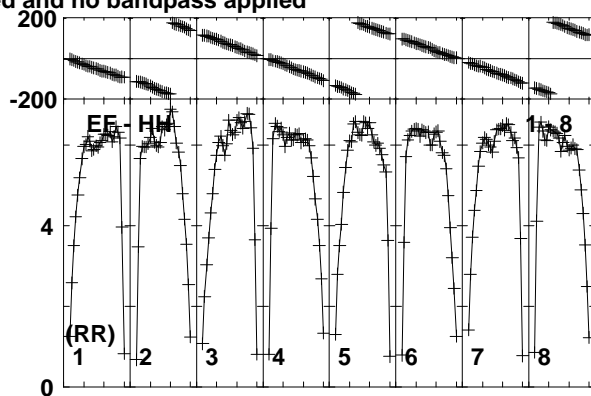
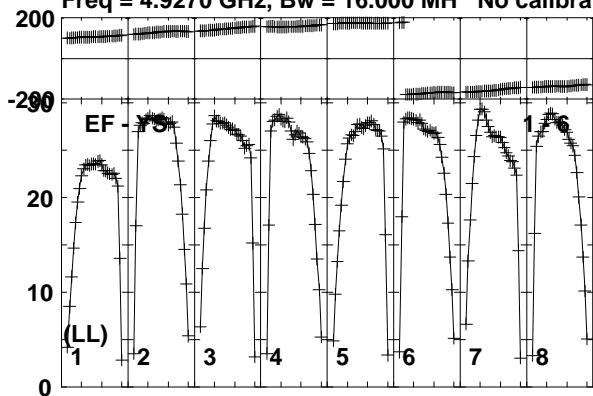

Lower frame: Milli Ampl Jy Top frame: Phas deg
Vector averaged cross-power spectrum Baseline: EF (01) - YS (06)
Timerange: 01/01:08:03 to 01/01:08:59

Plot file version 147 created 26-MAR-2015 15:27:43

RYSEX EG082E.UVDATA.1

Freq = 4.9270 GHz, Bw = 16.000 MH No calibration applied and no bandpass applied

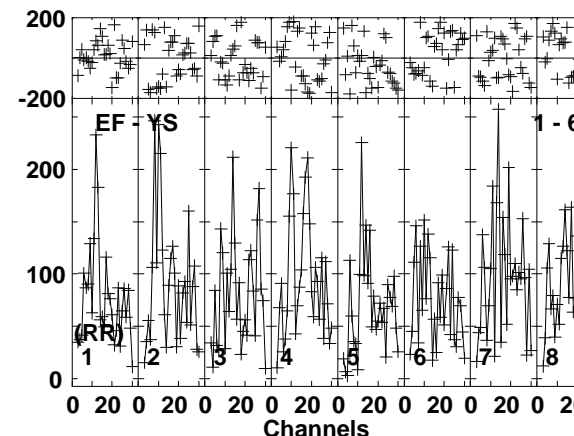
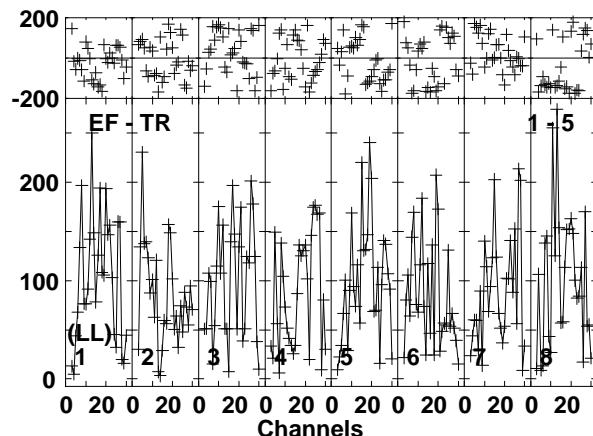
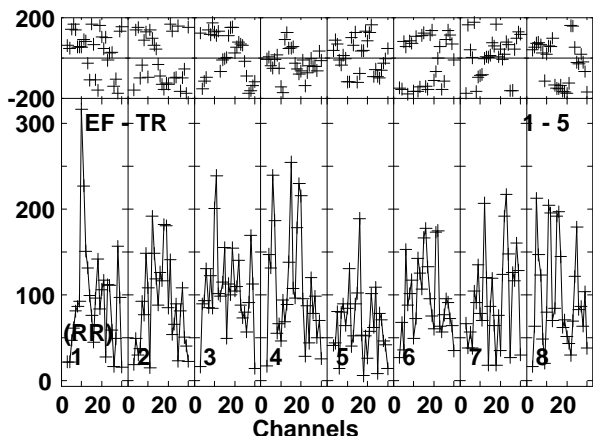
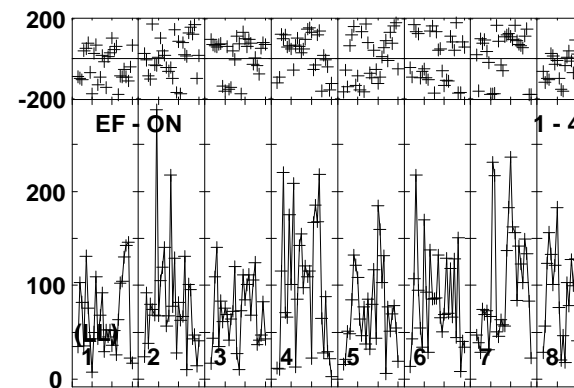
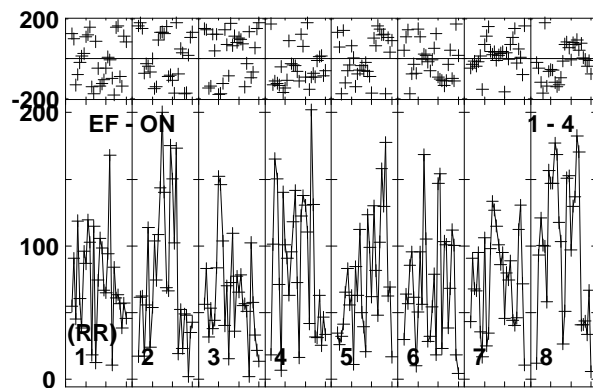
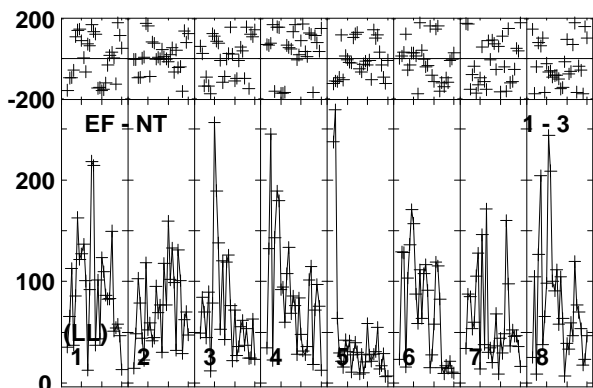
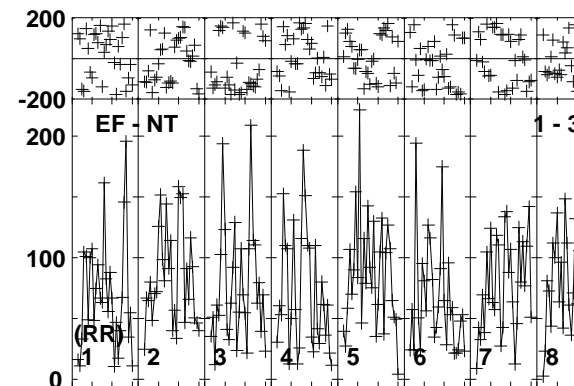
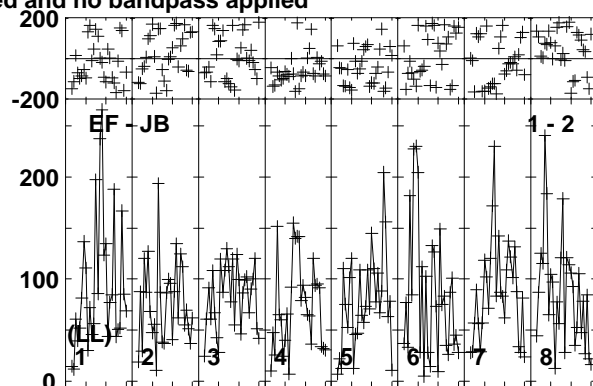
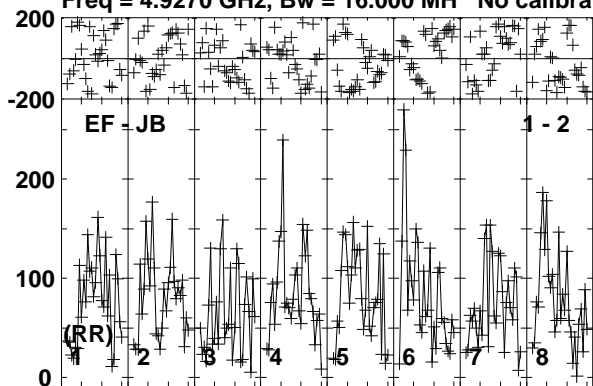

Lower frame: Micro Ampl Jy Top frame: Phas deg
Vector averaged cross-power spectrum Baseline: EF (01) - JB (02)
Timerange: 01/01:09:03 to 01/01:12:29

Plot file version 148 created 26-MAR-2015 15:27:43

RYSEX EG082E.UVDATA.1

Freq = 4.9270 GHz, Bw = 16.000 MH No calibration applied and no bandpass applied

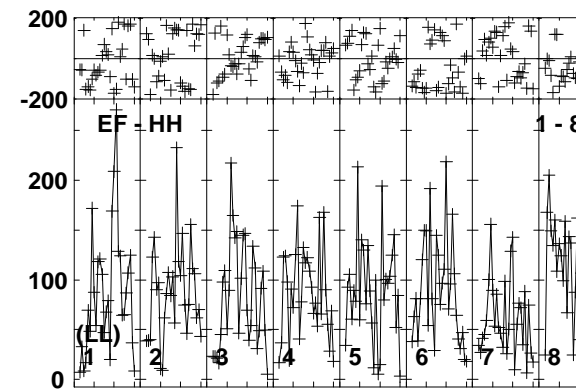
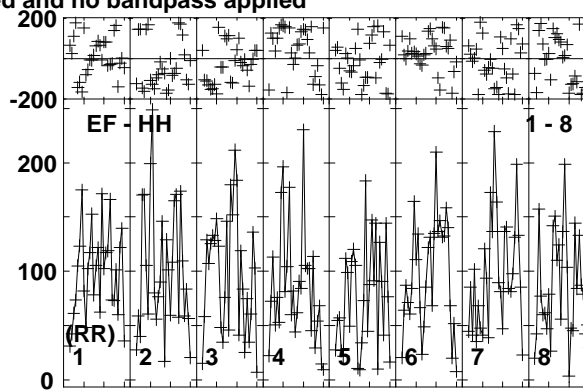
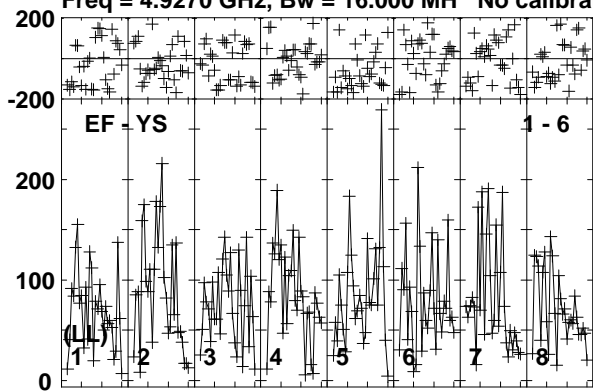

Lower frame: Micro Ampl Jy Top frame: Phas deg
Vector averaged cross-power spectrum Baseline: EF (01) - YS (06)
Timerange: 01/01:09:03 to 01/01:12:29

Plot file version 149 created 26-MAR-2015 15:27:43

J1038+0512 EG082E.UVDATA.1

Freq = 4.9270 GHz, Bw = 16.000 MH No calibration applied and no bandpass applied

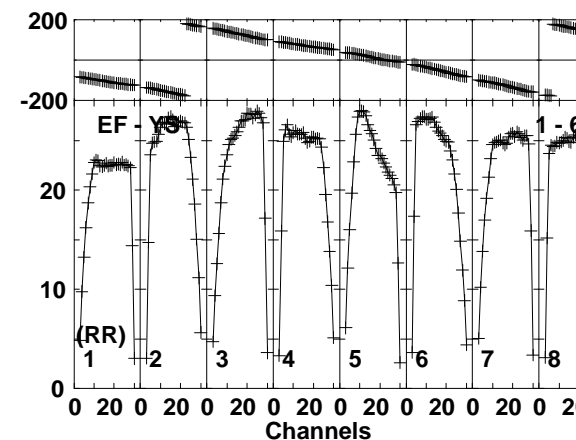
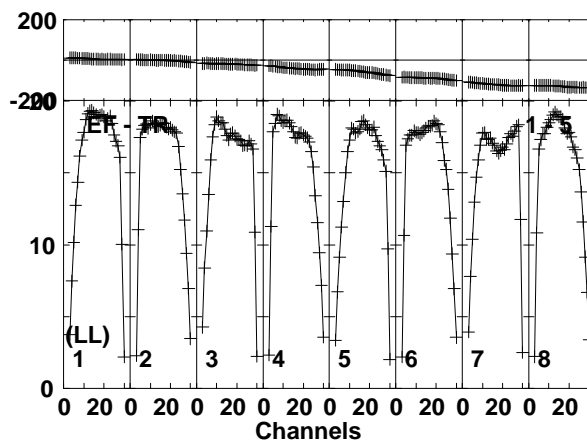
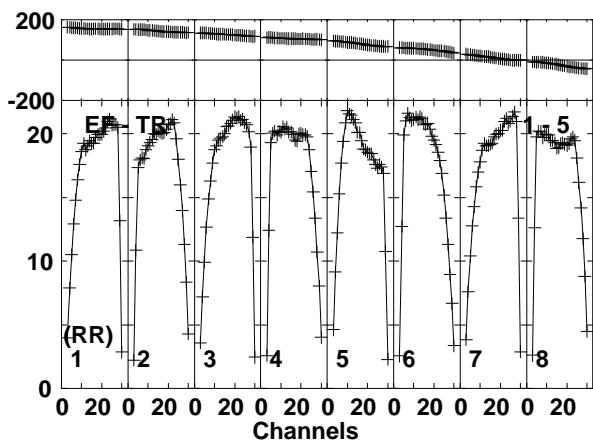
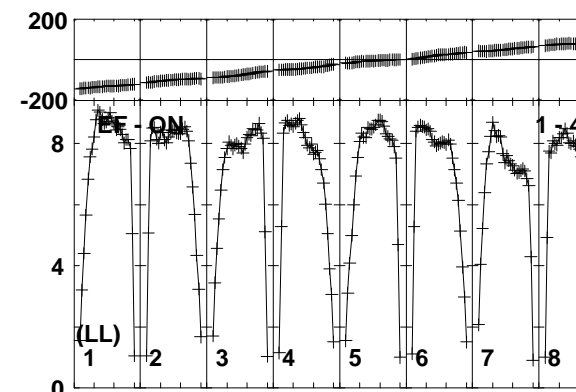
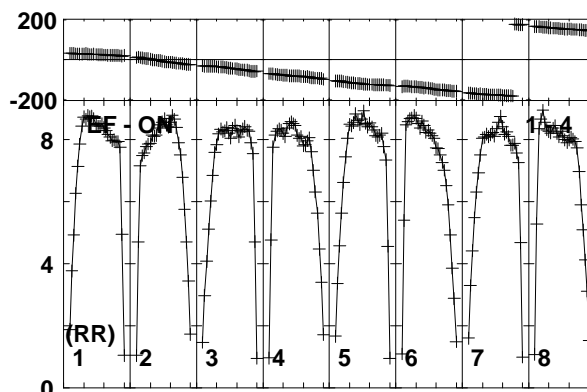
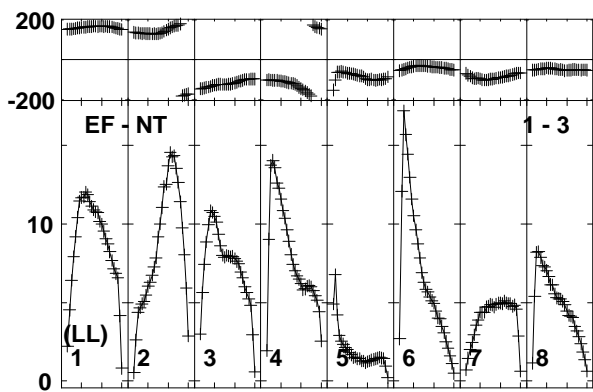
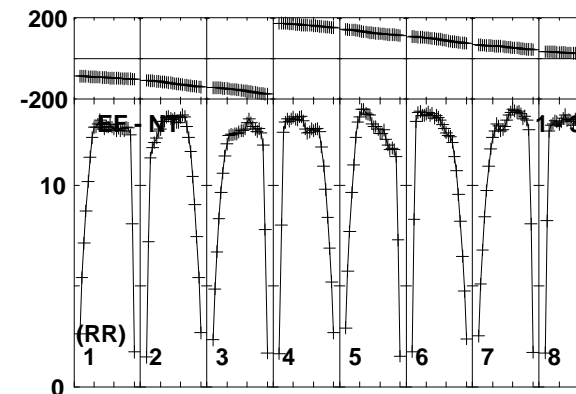
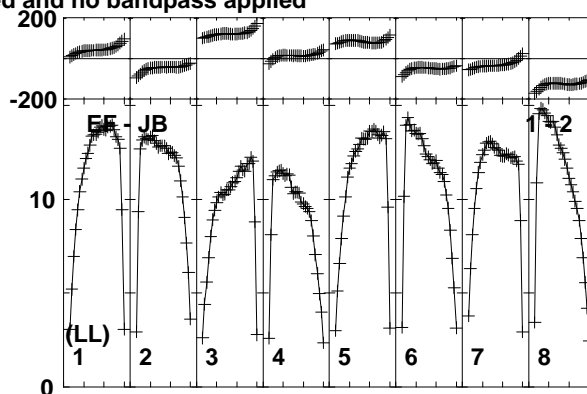
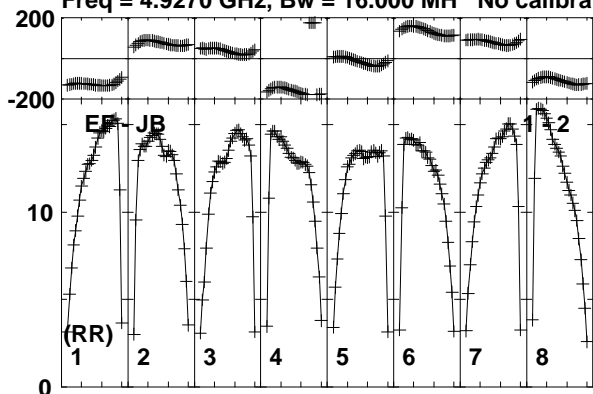

Lower frame: Milli Ampl Jy Top frame: Phas deg
Vector averaged cross-power spectrum Baseline: EF (01) - JB (02)
Timerange: 01/01:12:33 to 01/01:13:59

Plot file version 150 created 26-MAR-2015 15:27:43

J1038+0512 EG082E.UVDATA.1

Freq = 4.9270 GHz, Bw = 16.000 MH No calibration applied and no bandpass applied

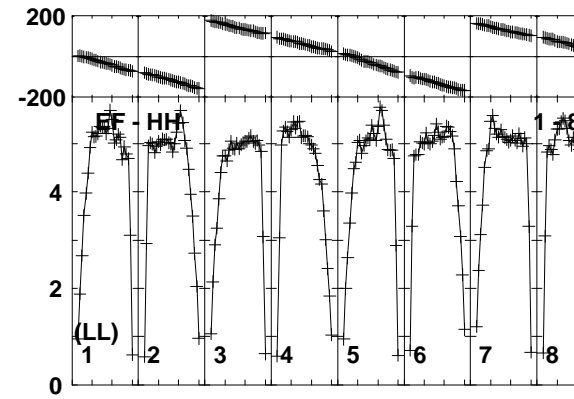
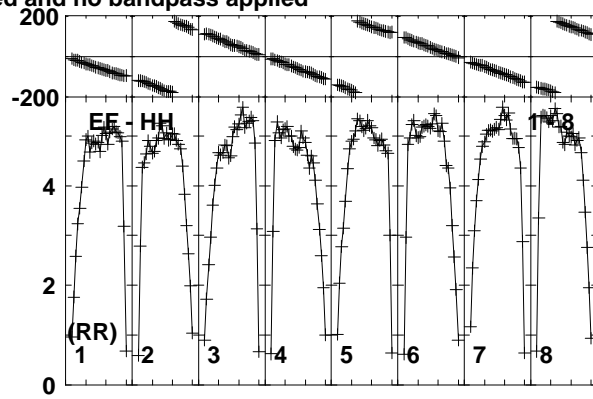
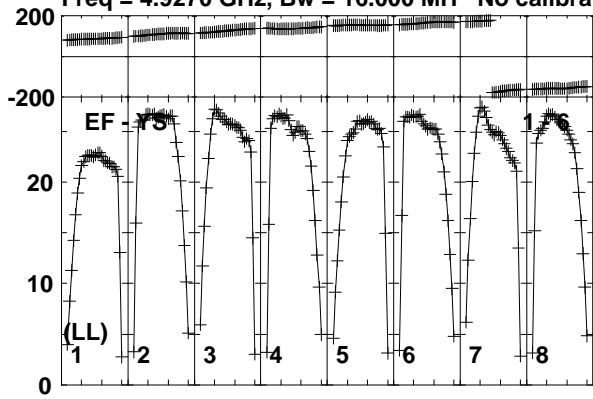

Lower frame: Milli Ampl Jy Top frame: Phas deg
Vector averaged cross-power spectrum Baseline: EF (01) - YS (06)
Timerange: 01/01:12:33 to 01/01:13:59

Plot file version 151 created 26-MAR-2015 15:27:43

RYSEX EG082E.UVDATA.1

Freq = 4.9270 GHz, Bw = 16.000 MH No calibration applied and no bandpass applied

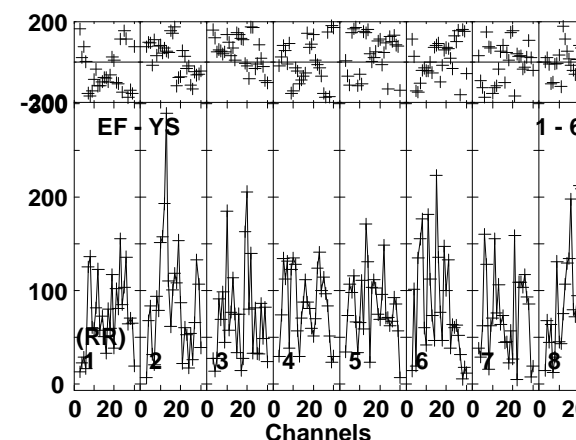
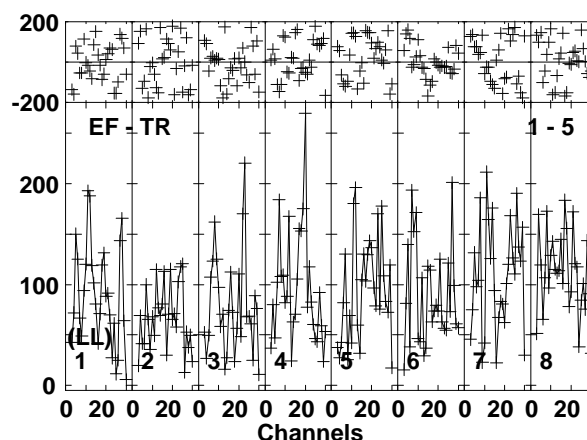
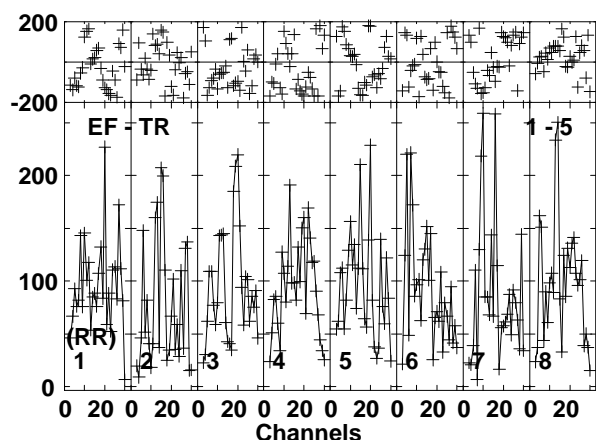
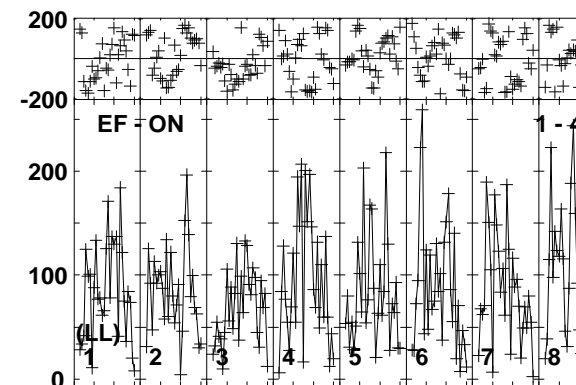
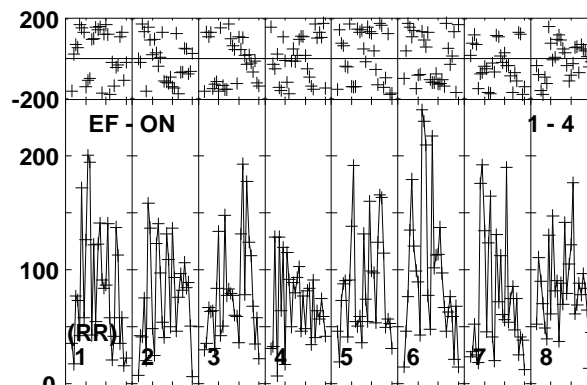
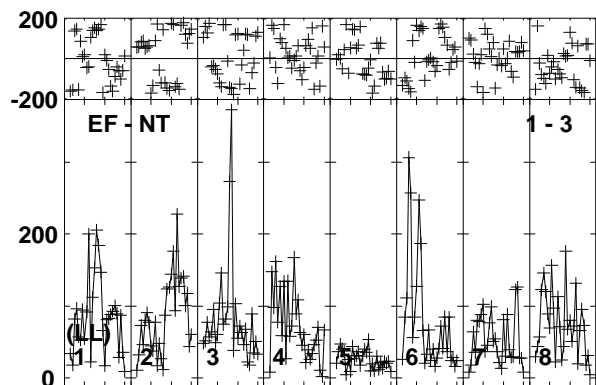
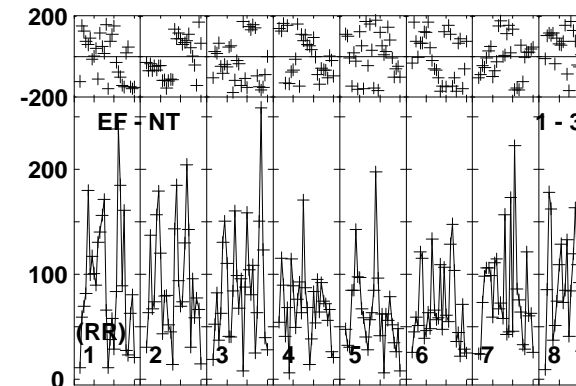
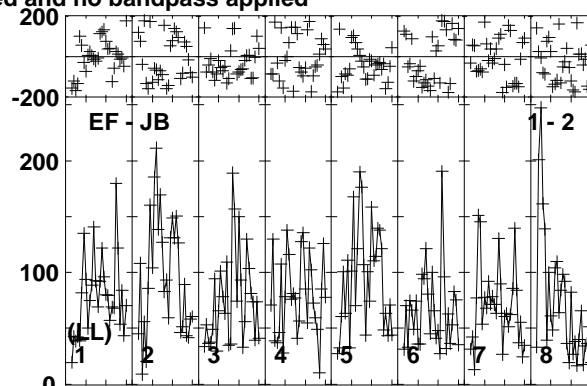
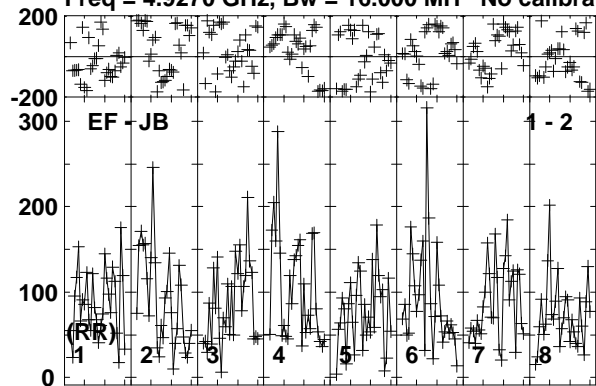

Lower frame: Micro Ampl Jy Top frame: Phas deg
Vector averaged cross-power spectrum Baseline: EF (01) - JB (02)
Timerange: 01/01:14:03 to 01/01:17:29

Plot file version 152 created 26-MAR-2015 15:27:43

RYSEX EG082E.UVDATA.1

Freq = 4.9270 GHz, Bw = 16.000 MH No calibration applied and no bandpass applied

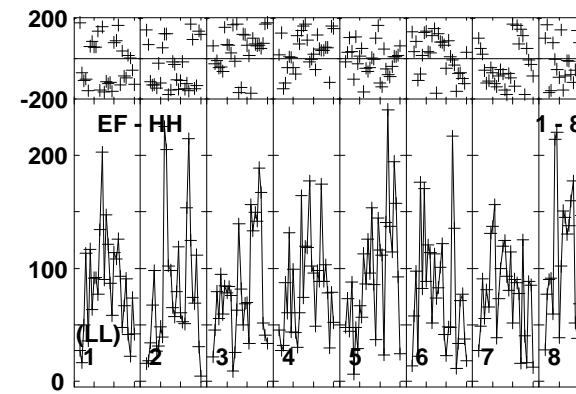
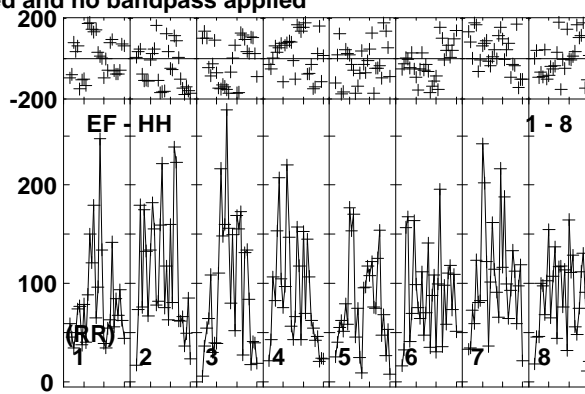
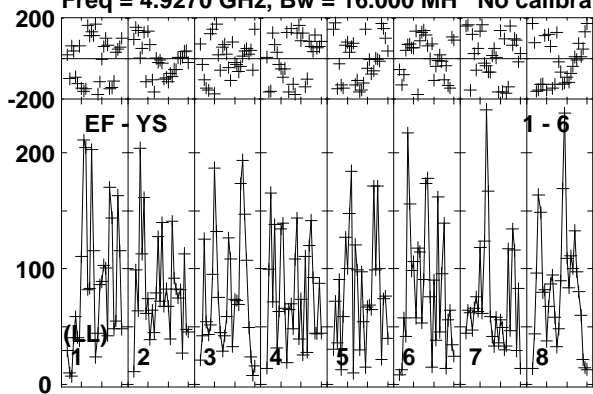

Lower frame: Micro Ampl Jy Top frame: Phas deg
Vector averaged cross-power spectrum Baseline: EF (01) - YS (06)
Timerange: 01/01:14:03 to 01/01:17:29

Plot file version 153 created 26-MAR-2015 15:27:43

J1038+0512 EG082E.UVDATA.1

Freq = 4.9270 GHz, Bw = 16.000 MH No calibration applied and no bandpass applied

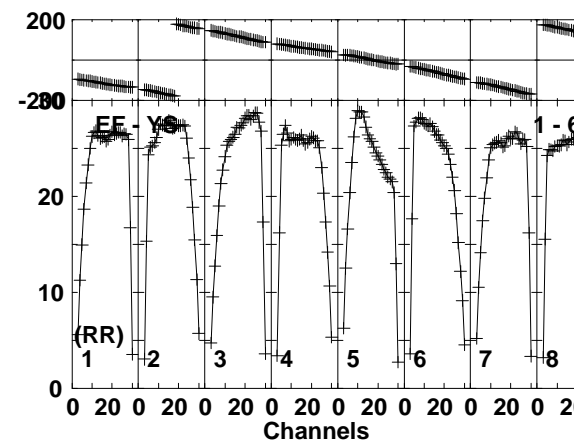
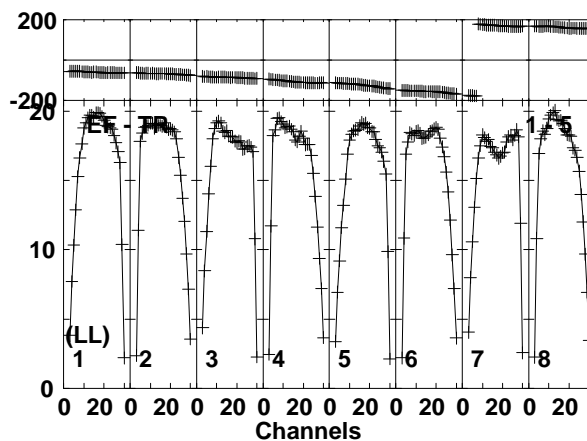
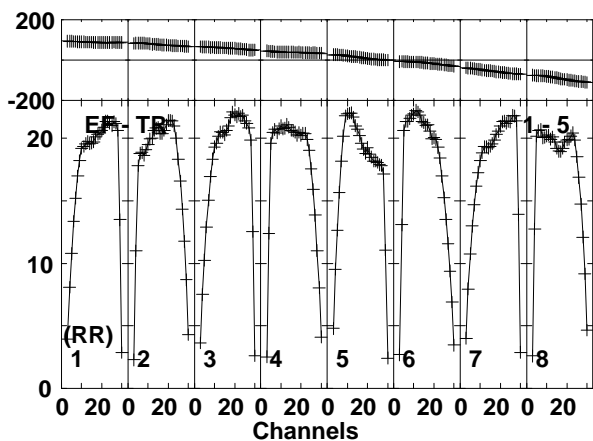
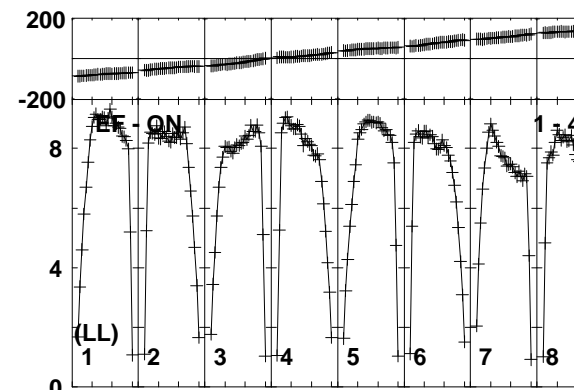
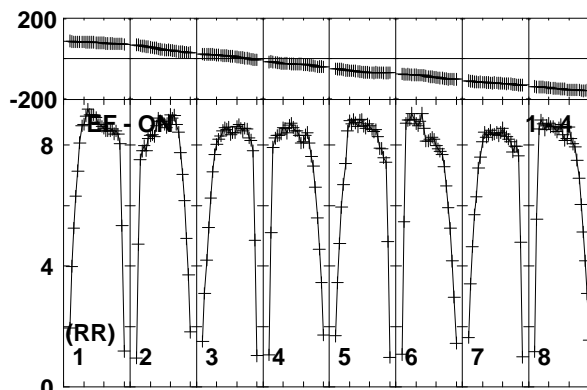
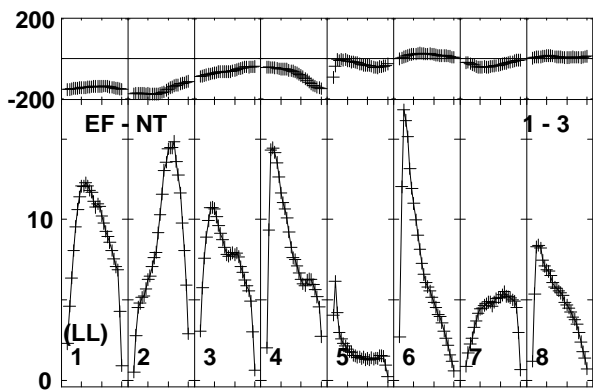
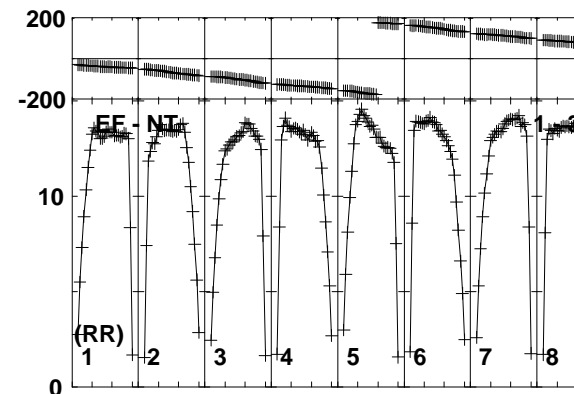
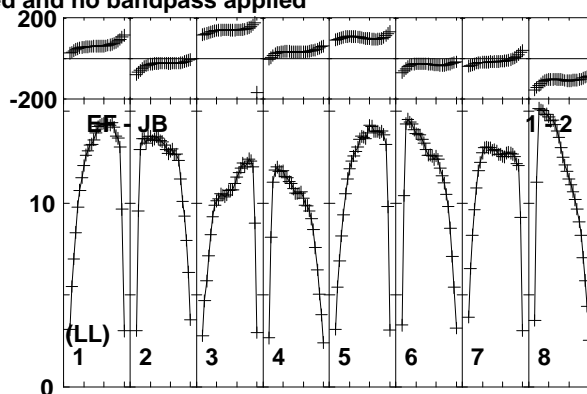
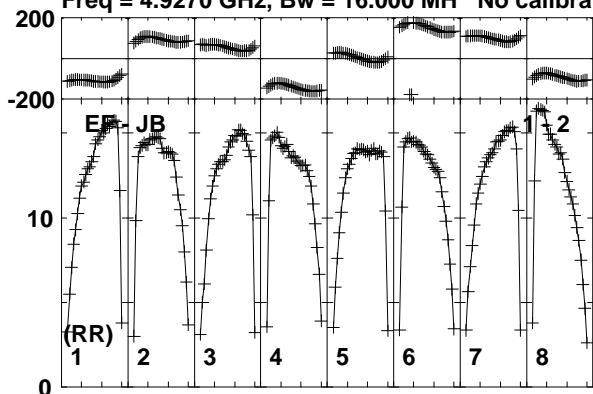

Lower frame: Milli Ampl Jy Top frame: Phas deg
Vector averaged cross-power spectrum Baseline: EF (01) - JB (02)
Timerange: 01/01:18:03 to 01/01:18:59

Plot file version 154 created 26-MAR-2015 15:27:43

J1038+0512 EG082E.UVDATA.1

Freq = 4.9270 GHz, Bw = 16.000 MH No calibration applied and no bandpass applied

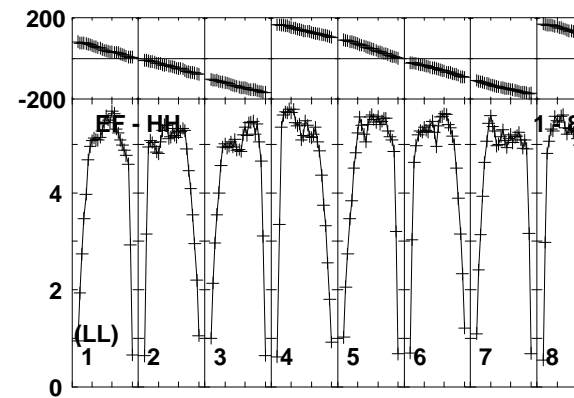
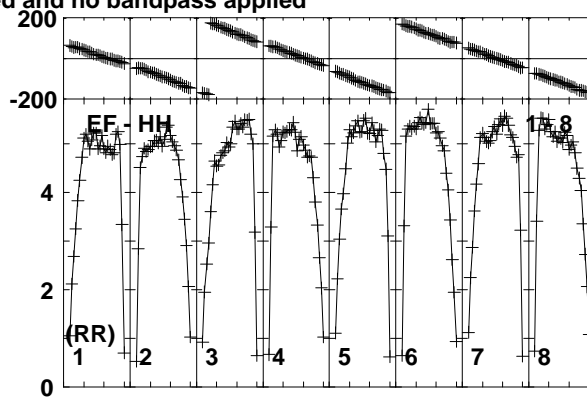
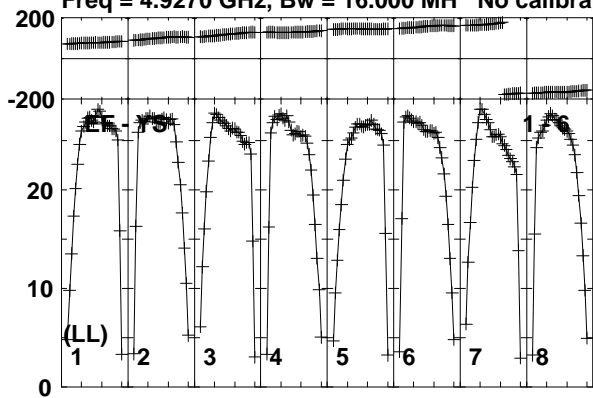

Lower frame: Milli Ampl Jy Top frame: Phas deg
Vector averaged cross-power spectrum Baseline: EF (01) - YS (06)
Timerange: 01/01:18:03 to 01/01:18:59

Plot file version 155 created 26-MAR-2015 15:27:43

RYSEX EG082E.UVDATA.1

Freq = 4.9270 GHz, Bw = 16.000 MH No calibration applied and no bandpass applied

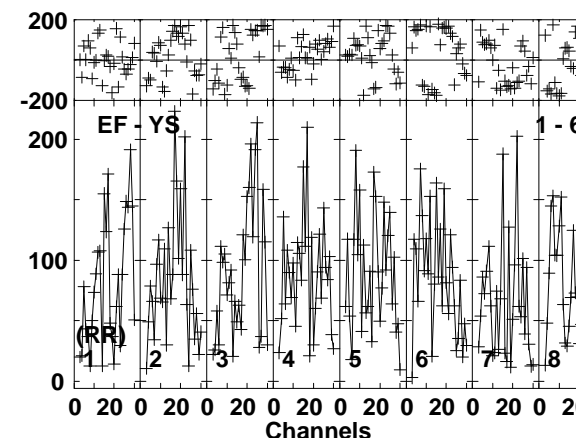
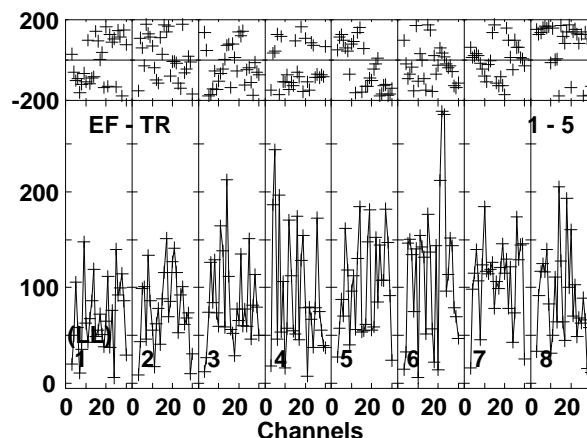
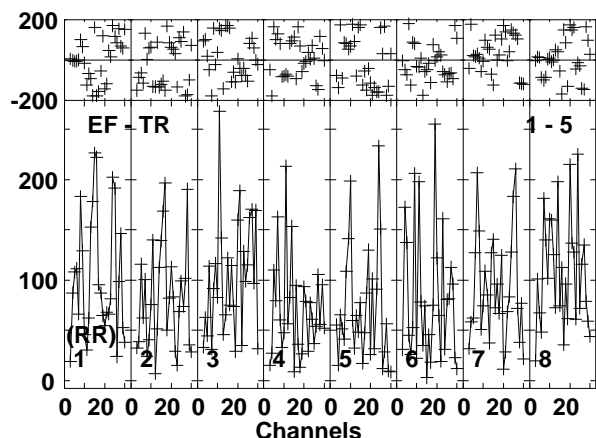
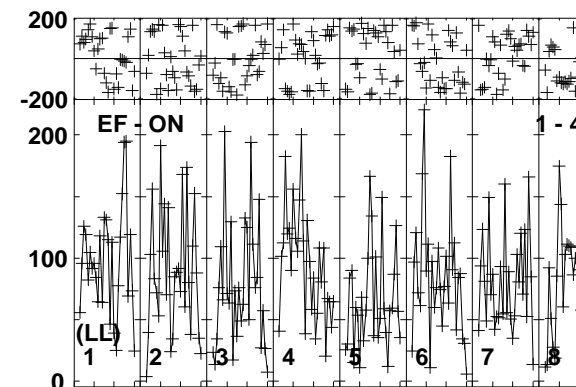
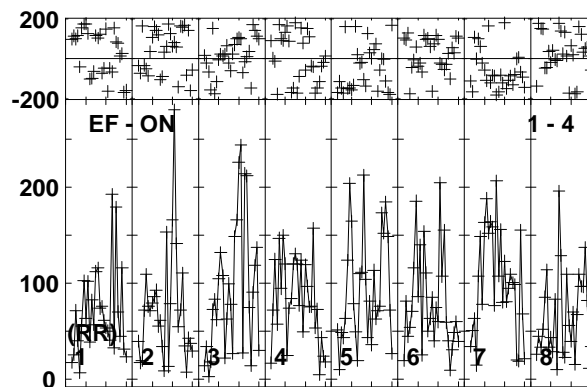
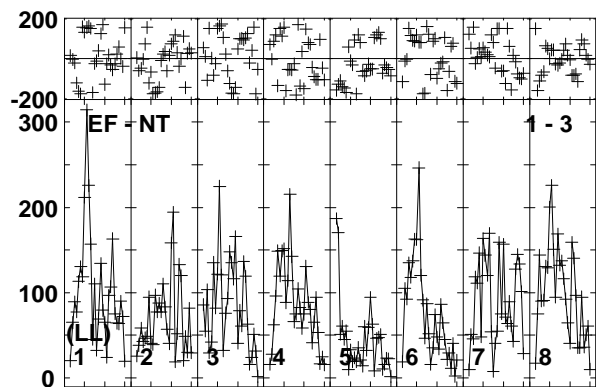
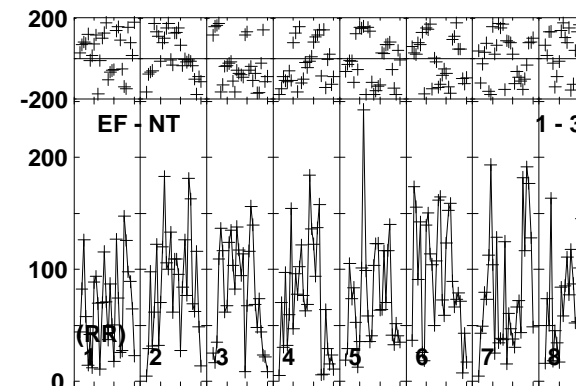
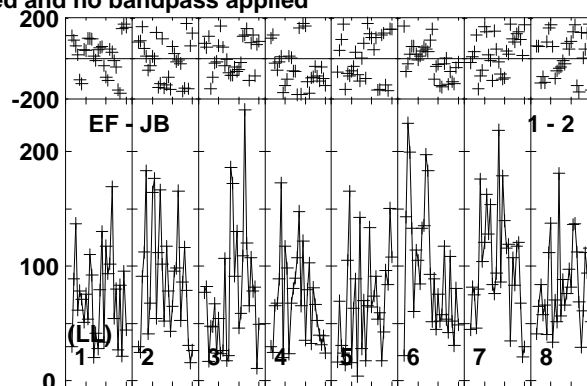
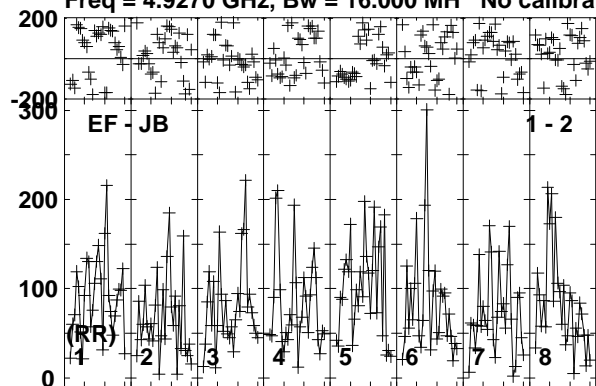

Lower frame: Micro Ampl Jy Top frame: Phas deg
Vector averaged cross-power spectrum Baseline: EF (01) - JB (02)
Timerange: 01/01:19:03 to 01/01:22:29

Plot file version 156 created 26-MAR-2015 15:27:44

RYSEX EG082E.UVDATA.1

Freq = 4.9270 GHz, Bw = 16.000 MH No calibration applied and no bandpass applied

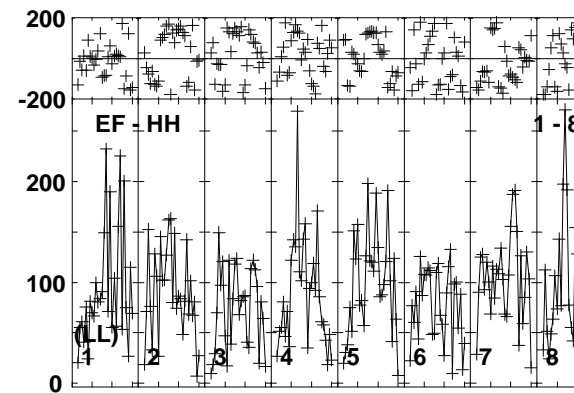
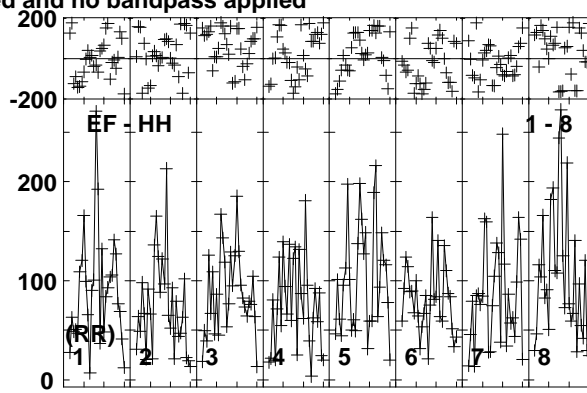
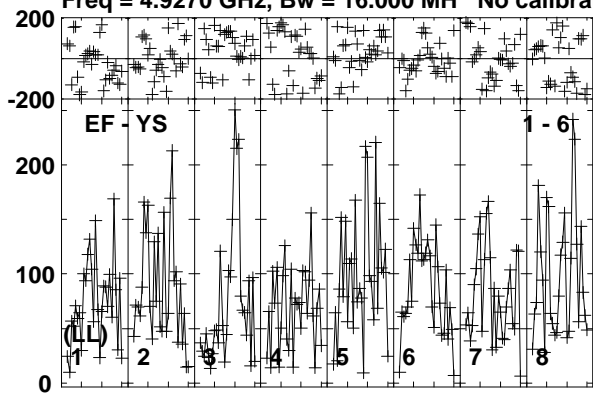

Lower frame: Micro Ampl Jy Top frame: Phas deg
Vector averaged cross-power spectrum Baseline: EF (01) - YS (06)
Timerange: 01/01:19:03 to 01/01:22:29

Plot file version 157 created 26-MAR-2015 15:27:44

J1038+0512 EG082E.UVDATA.1

Freq = 4.9270 GHz, Bw = 16.000 MH No calibration applied and no bandpass applied

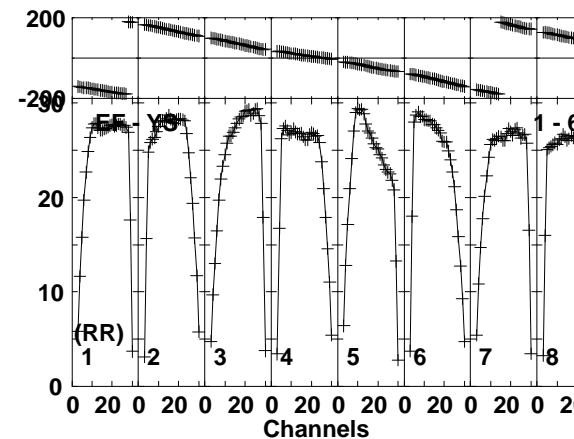
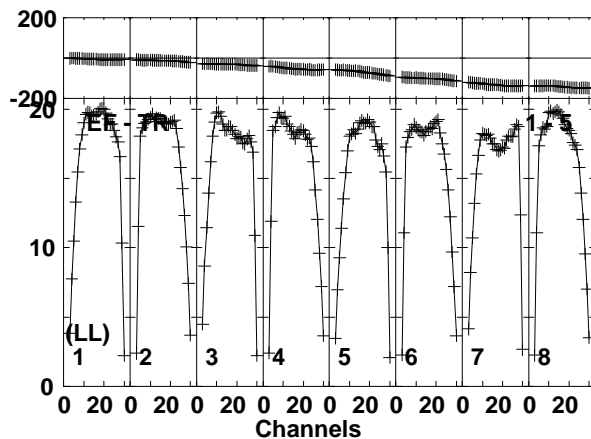
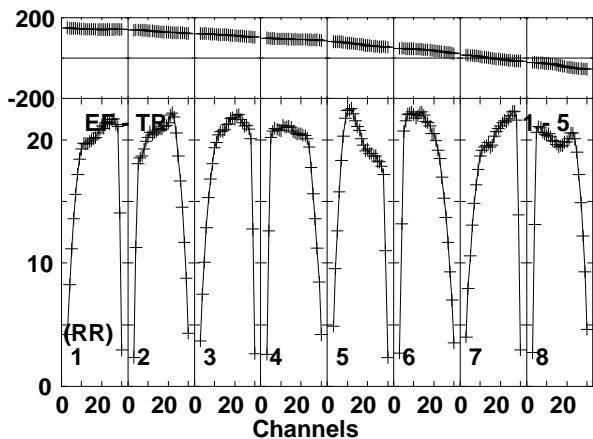
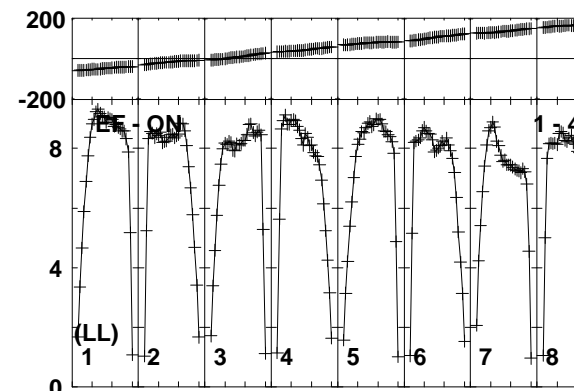
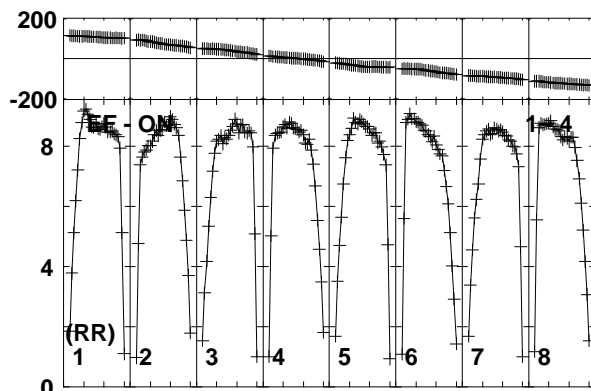
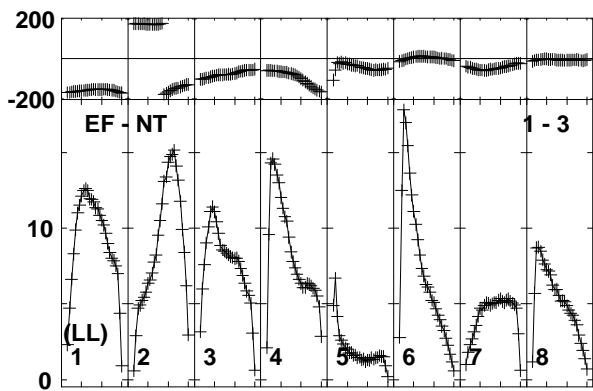
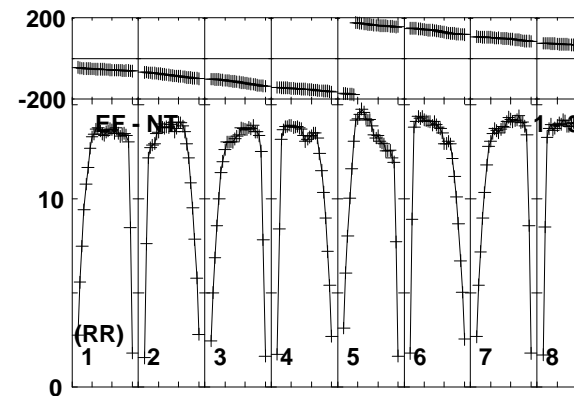
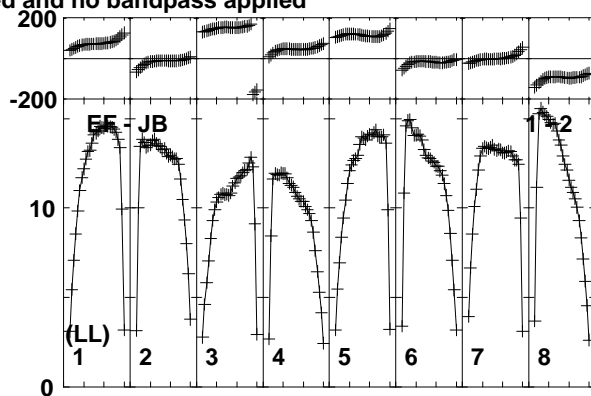
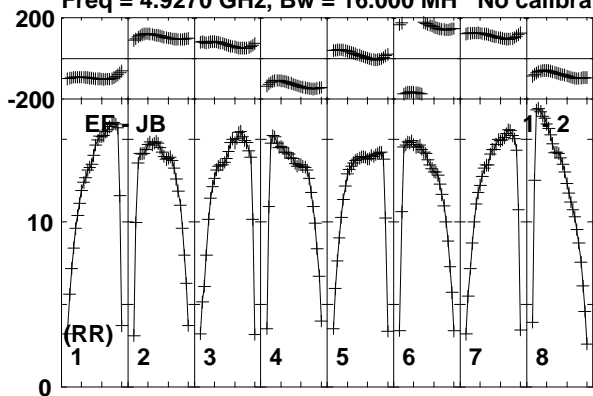

Lower frame: Milli Ampl Jy Top frame: Phas deg
Vector averaged cross-power spectrum Baseline: EF (01) - JB (02)
Timerange: 01/01:22:33 to 01/01:23:59

Plot file version 158 created 26-MAR-2015 15:27:44

J1038+0512 EG082E.UVDATA.1

Freq = 4.9270 GHz, Bw = 16.000 MH No calibration applied and no bandpass applied

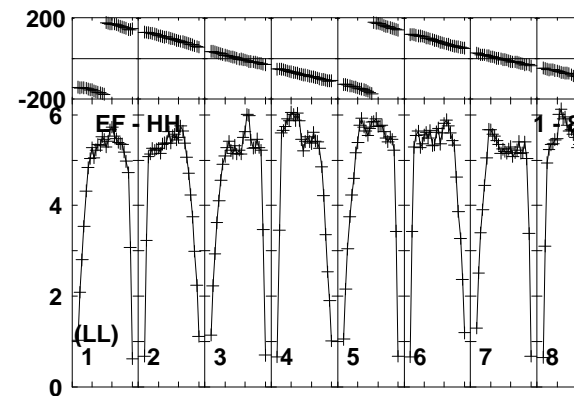
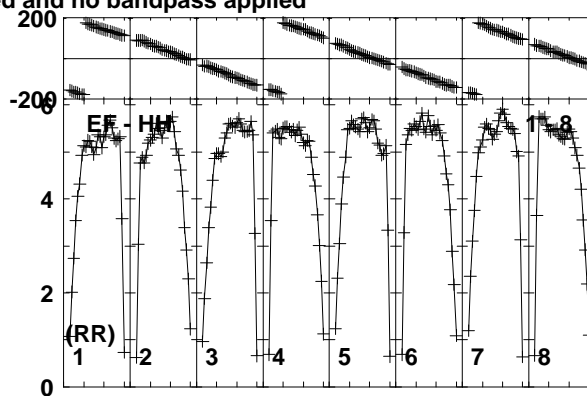
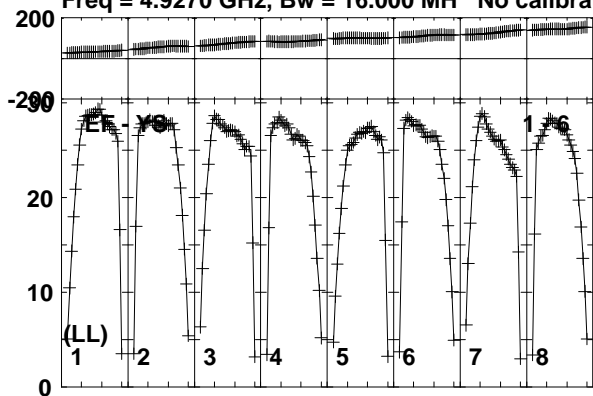

Lower frame: Milli Ampl Jy Top frame: Phas deg
Vector averaged cross-power spectrum Baseline: EF (01) - YS (06)
Timerange: 01/01:22:33 to 01/01:23:59

Plot file version 160 created 26-MAR-2015 15:27:44

RYSEX EG082E.UVDATA.1

Freq = 4.9270 GHz, Bw = 16.000 MH No calibration applied and no bandpass applied

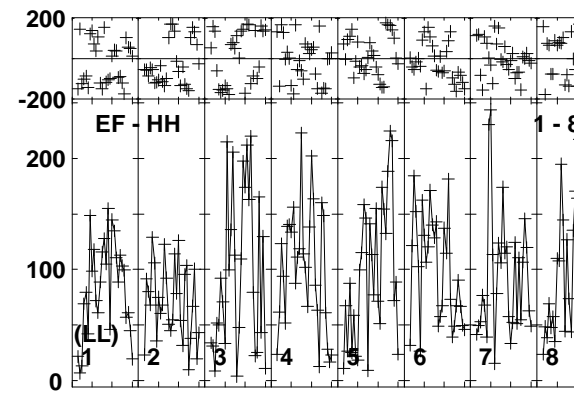
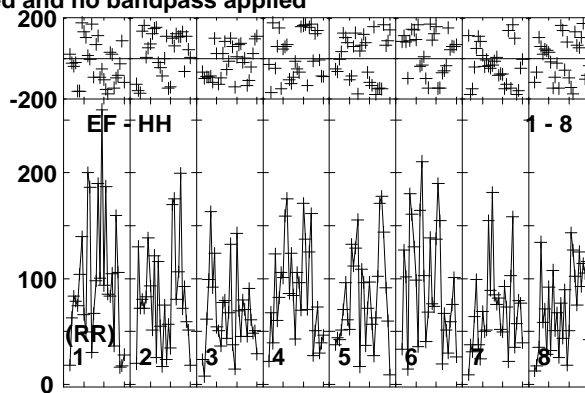
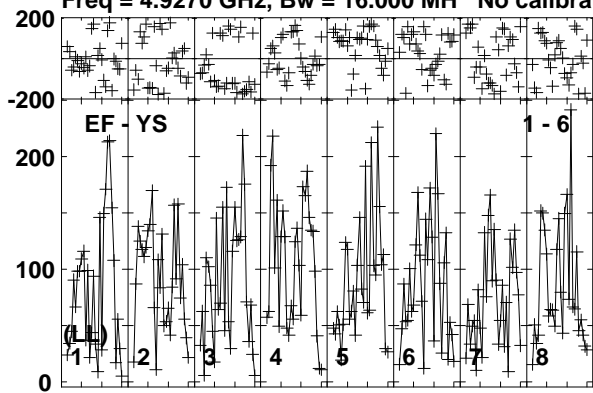

Lower frame: Micro Ampl Jy Top frame: Phas deg
Vector averaged cross-power spectrum Baseline: EF (01) - YS (06)
Timerange: 01/01:24:03 to 01/01:27:29

Plot file version 161 created 26-MAR-2015 15:27:44

J1038+0512 EG082E.UVDATA.1

Freq = 4.9270 GHz, Bw = 16.000 MH No calibration applied and no bandpass applied

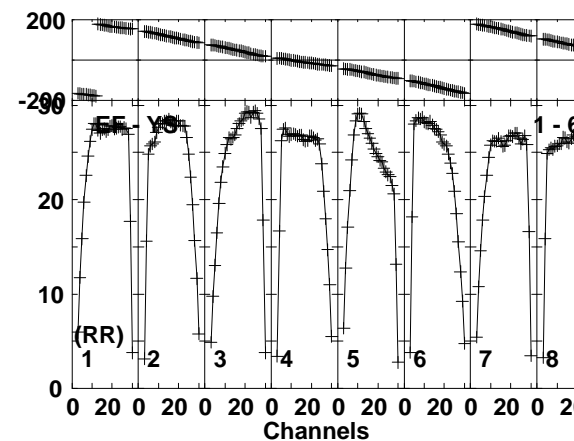
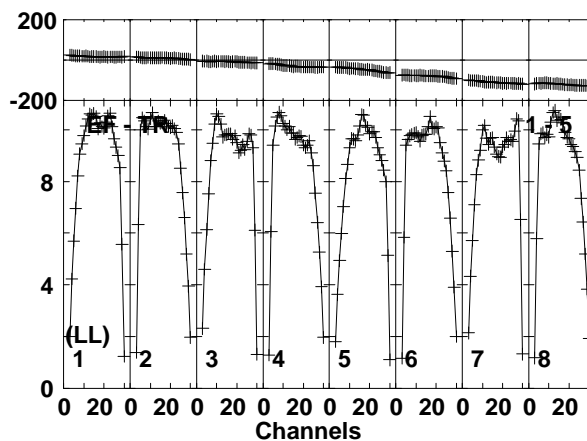
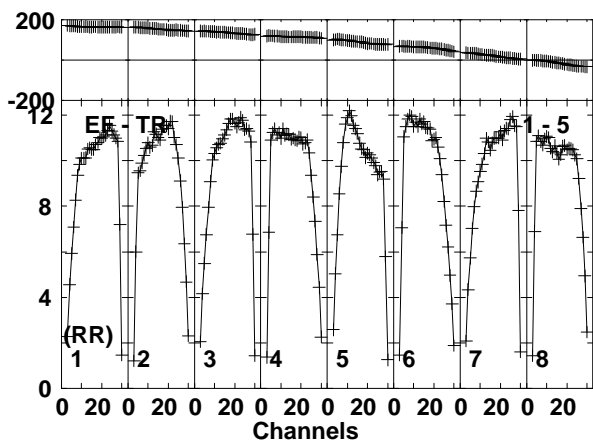
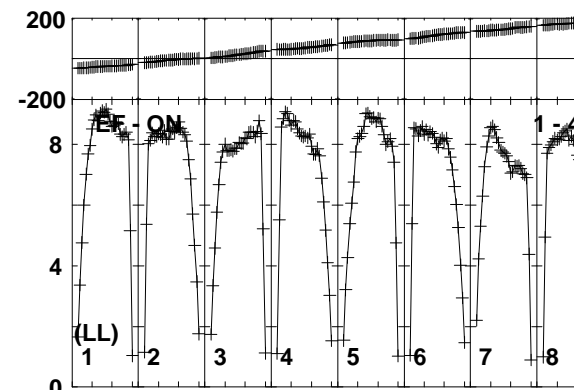
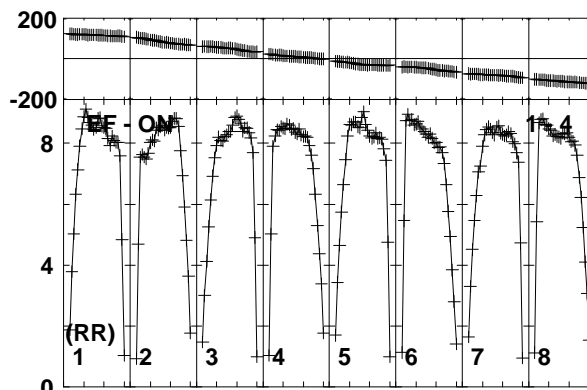
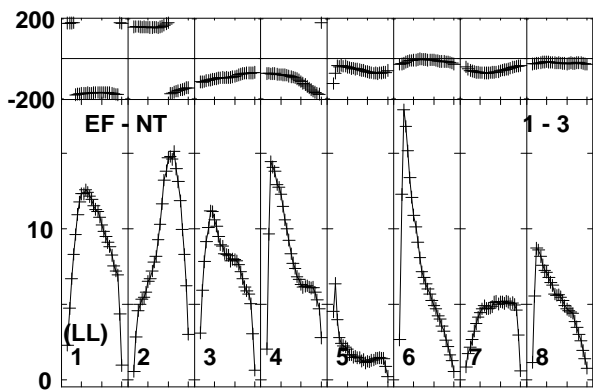
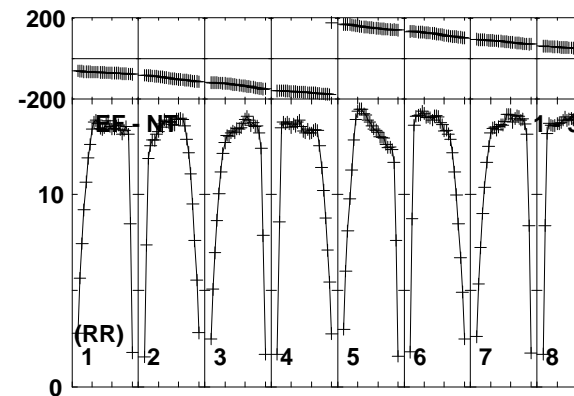
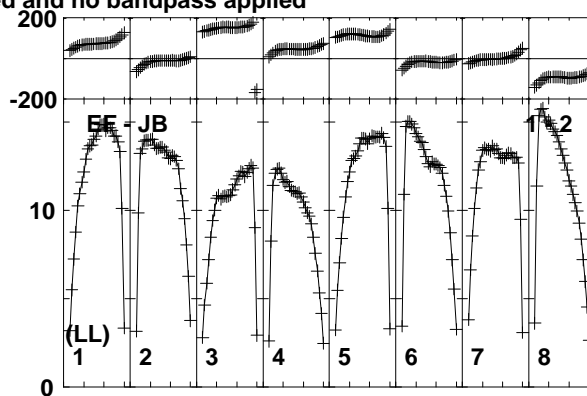
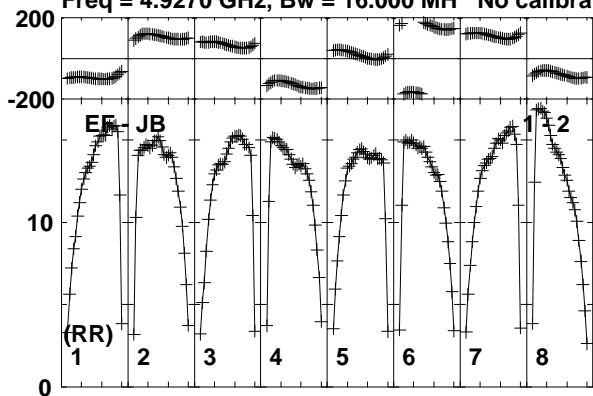

Lower frame: Milli Ampl Jy Top frame: Phas deg
Vector averaged cross-power spectrum Baseline: EF (01) - JB (02)
Timerange: 01/01:28:03 to 01/01:28:59

Plot file version 162 created 26-MAR-2015 15:27:44

J1038+0512 EG082E.UVDATA.1

Freq = 4.9270 GHz, Bw = 16.000 MH No calibration applied and no bandpass applied

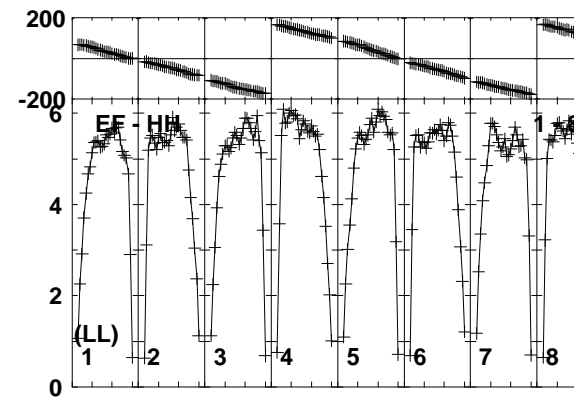
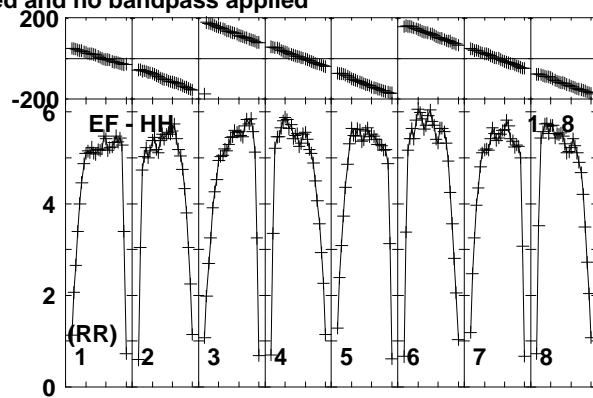
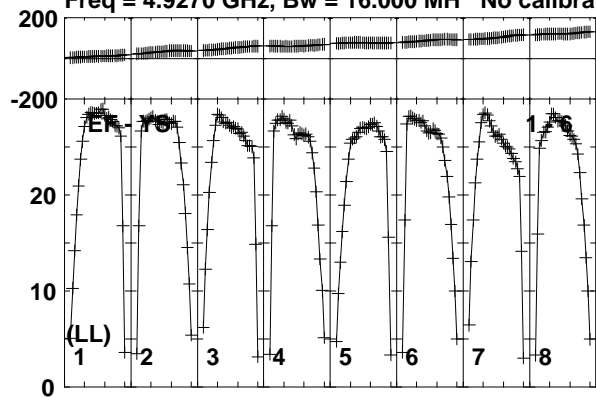

Lower frame: Milli Ampl Jy Top frame: Phas deg
Vector averaged cross-power spectrum Baseline: EF (01) - YS (06)
Timerange: 01/01:28:03 to 01/01:28:59

Plot file version 163 created 26-MAR-2015 15:27:44

RYSEX EG082E.UVDATA.1

Freq = 4.9270 GHz, Bw = 16.000 MH No calibration applied and no bandpass applied

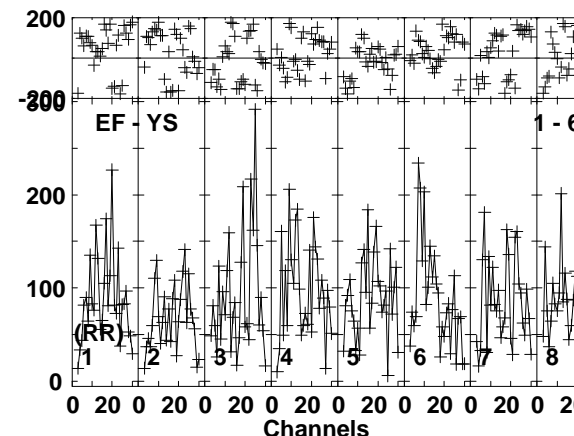
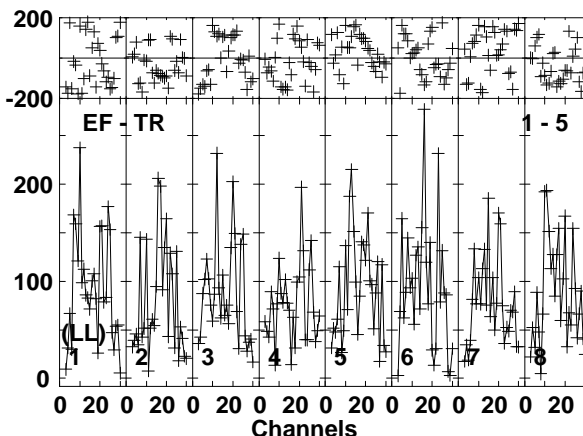
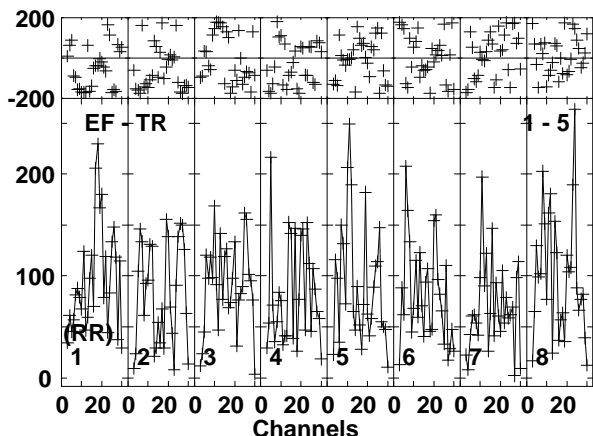
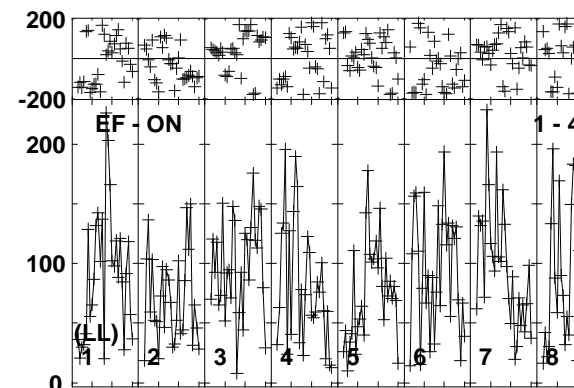
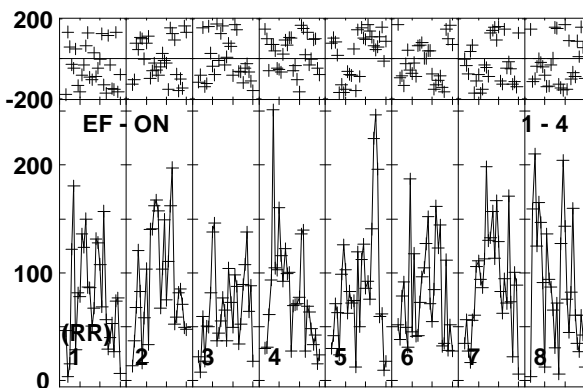
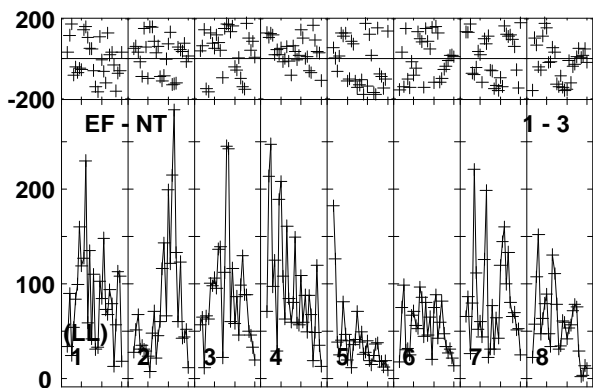
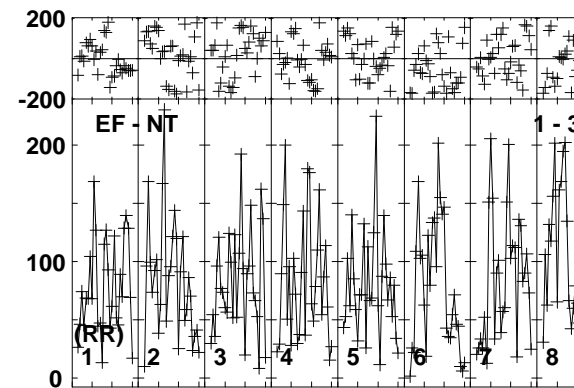
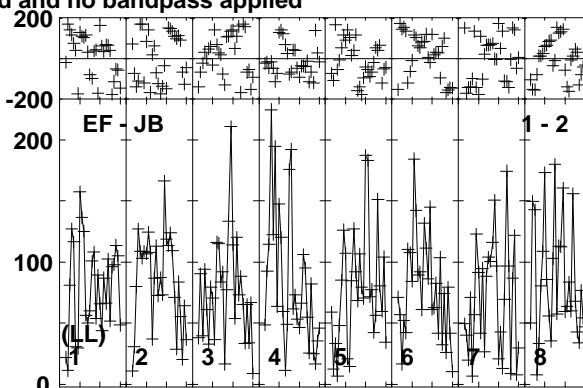
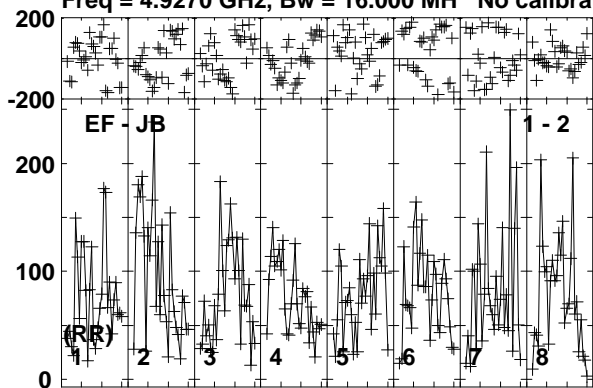

Lower frame: Micro Ampl Jy Top frame: Phas deg
Vector averaged cross-power spectrum Baseline: EF (01) - JB (02)
Timerange: 01/01:29:03 to 01/01:32:29

Plot file version 164 created 26-MAR-2015 15:27:44

RYSEX EG082E.UVDATA.1

Freq = 4.9270 GHz, Bw = 16.000 MH No calibration applied and no bandpass applied

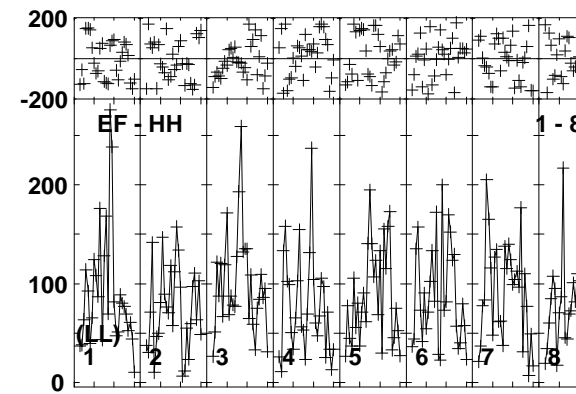
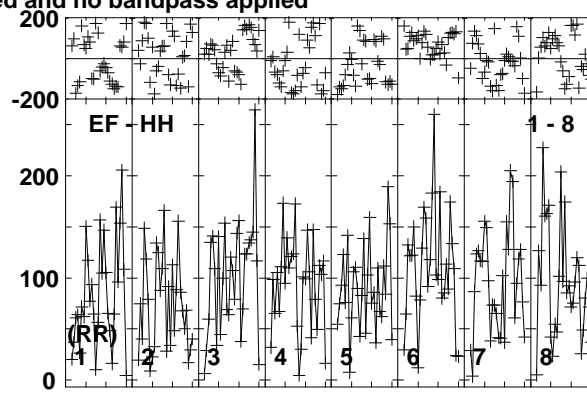
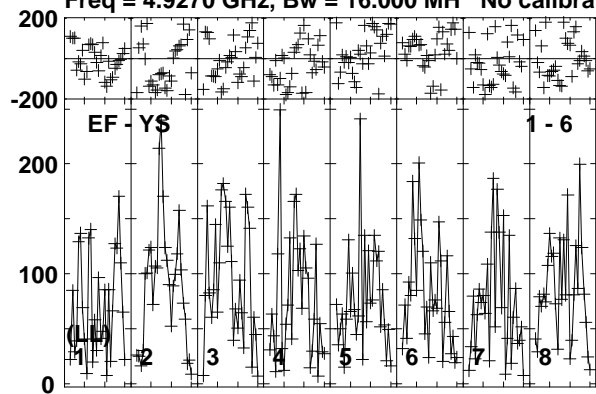

Lower frame: Micro Ampl Jy Top frame: Phas deg
Vector averaged cross-power spectrum Baseline: EF (01) - YS (06)
Timerange: 01/01:29:03 to 01/01:32:29

Plot file version 165 created 26-MAR-2015 15:27:44

J1038+0512 EG082E.UVDATA.1

Freq = 4.9270 GHz, Bw = 16.000 MH No calibration applied and no bandpass applied

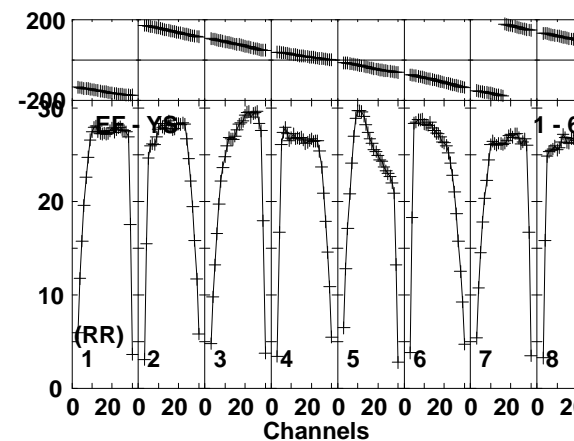
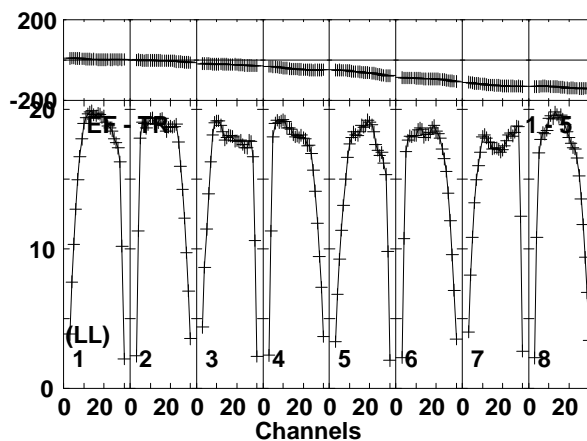
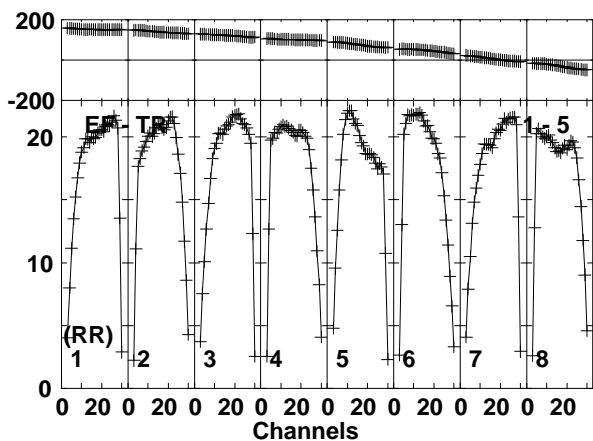
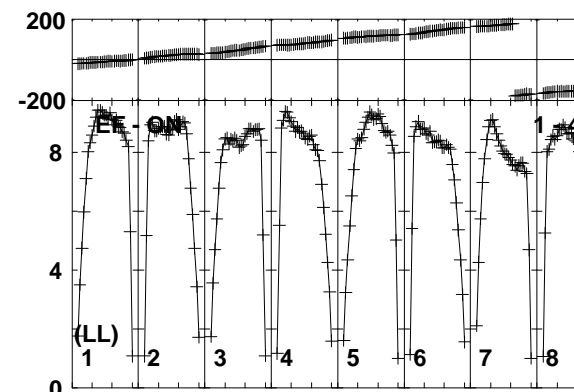
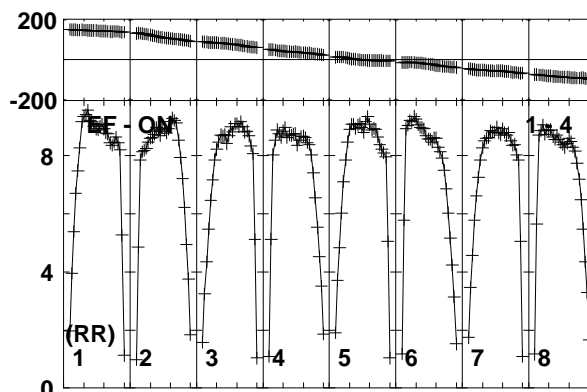
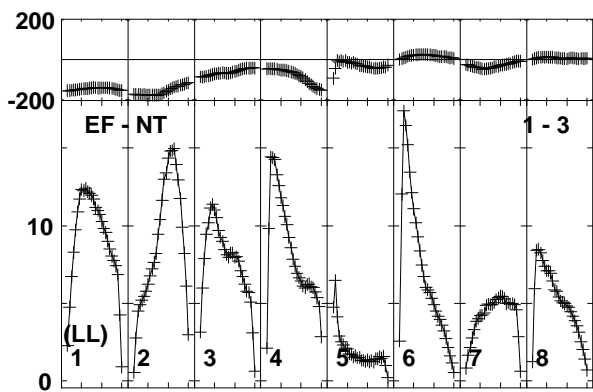
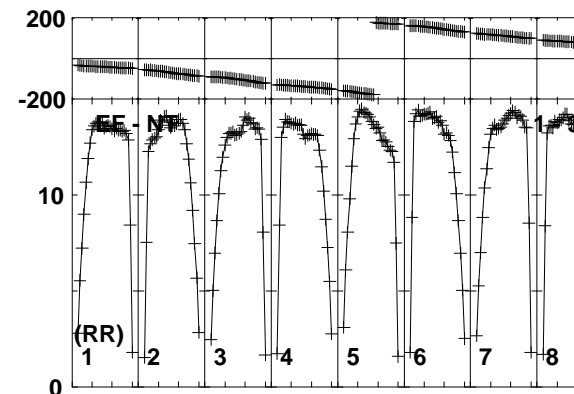
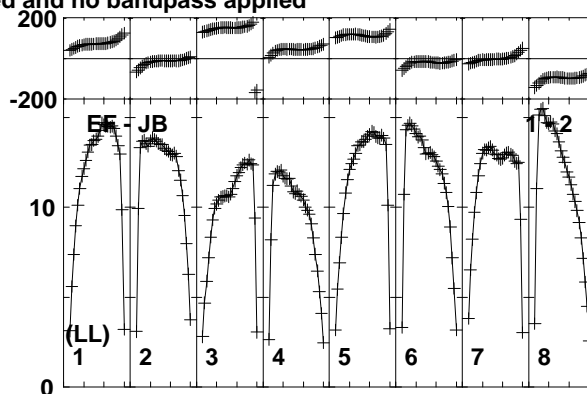
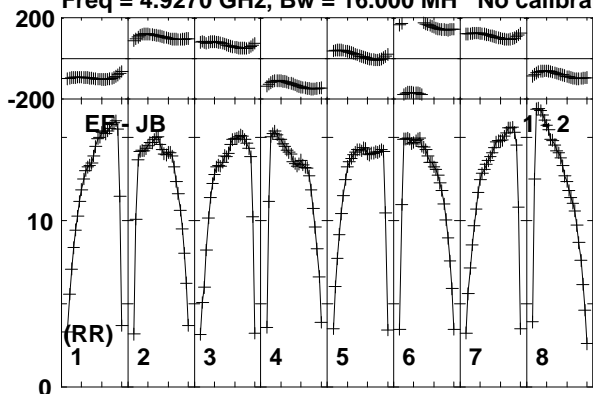

Lower frame: Milli Ampl Jy Top frame: Phas deg
Vector averaged cross-power spectrum Baseline: EF (01) - JB (02)
Timerange: 01/01:32:33 to 01/01:33:59

Plot file version 166 created 26-MAR-2015 15:27:44

J1038+0512 EG082E.UVDATA.1

Freq = 4.9270 GHz, Bw = 16.000 MH No calibration applied and no bandpass applied

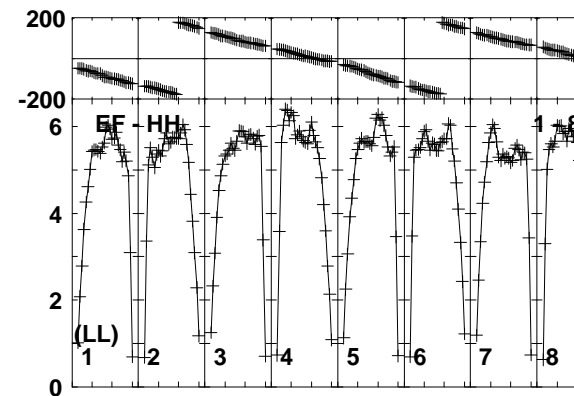
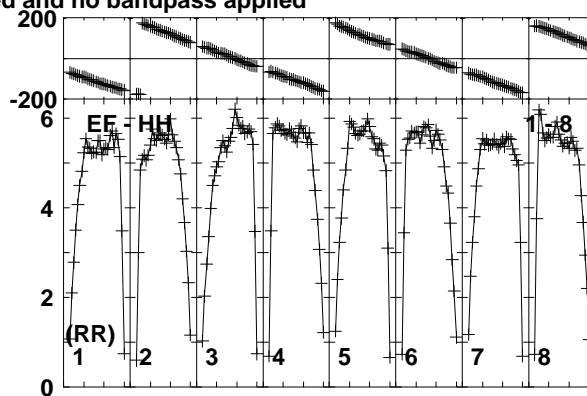
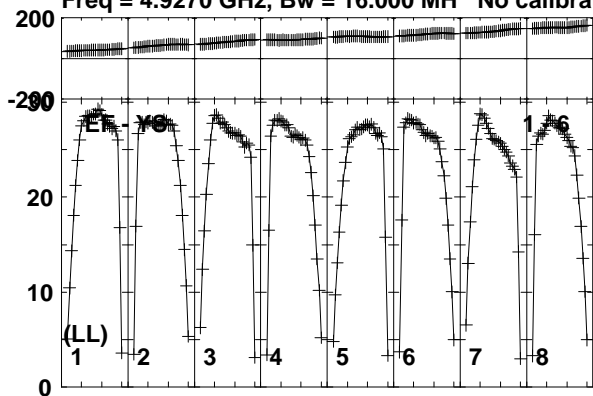

Lower frame: Milli Ampl Jy Top frame: Phas deg
Vector averaged cross-power spectrum Baseline: EF (01) - YS (06)
Timerange: 01/01:32:33 to 01/01:33:59

Plot file version 167 created 26-MAR-2015 15:27:44

J1035+0522 EG082E.UVDATA.1

Freq = 4.9270 GHz, Bw = 16.000 MH No calibration applied and no bandpass applied

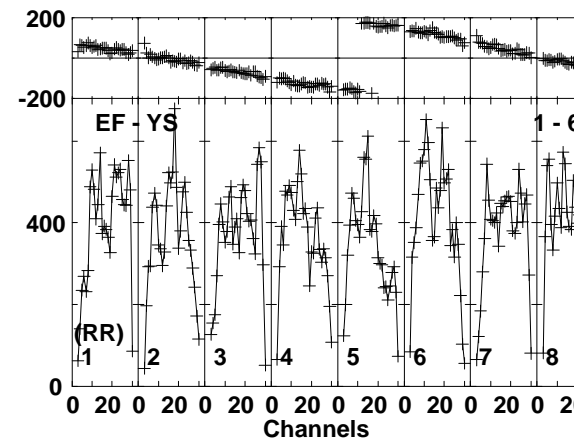
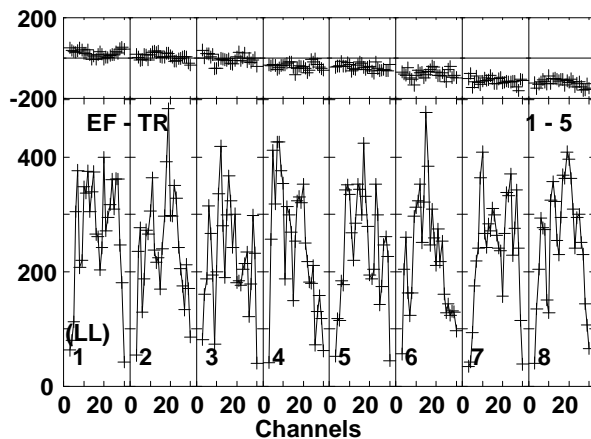
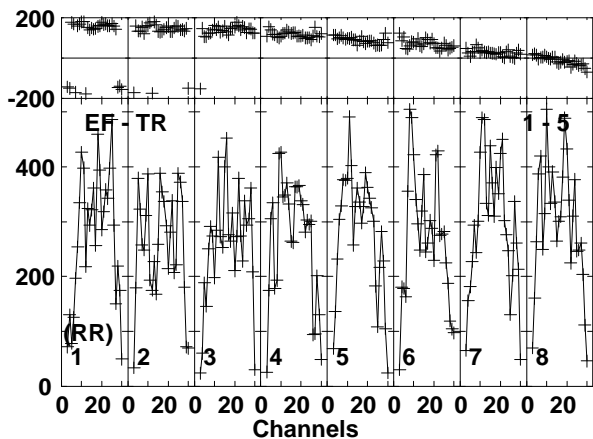
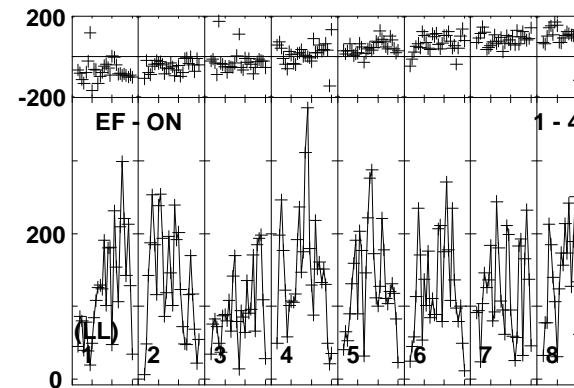
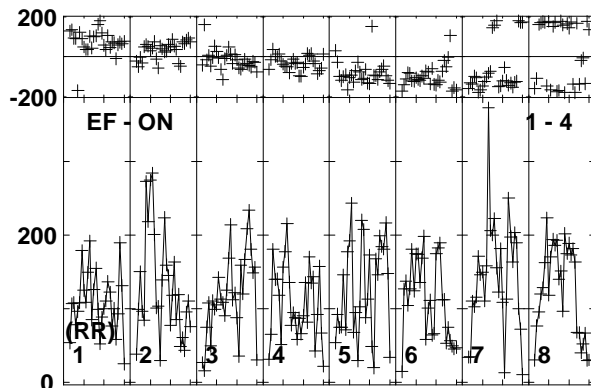
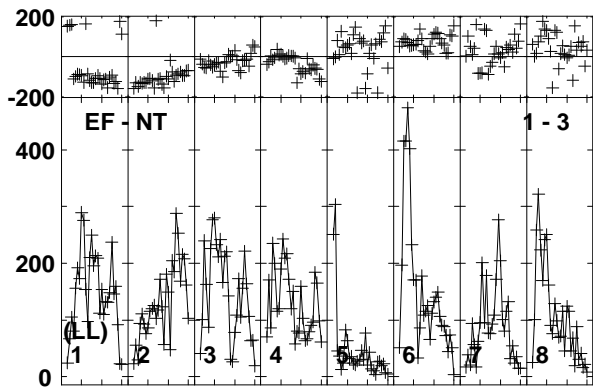
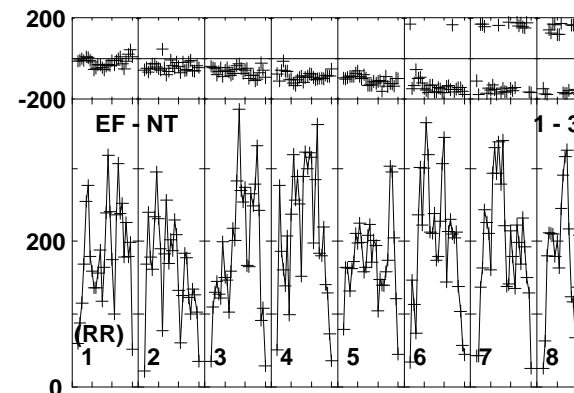
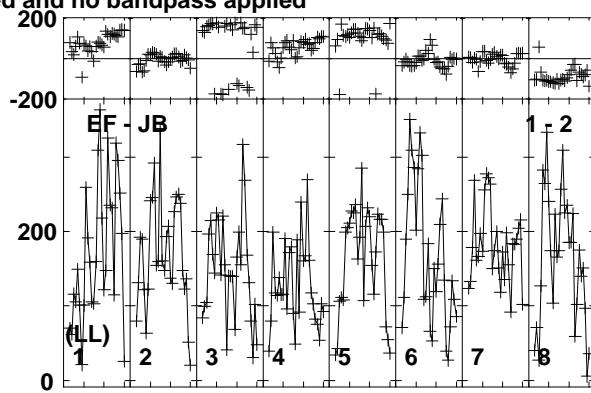
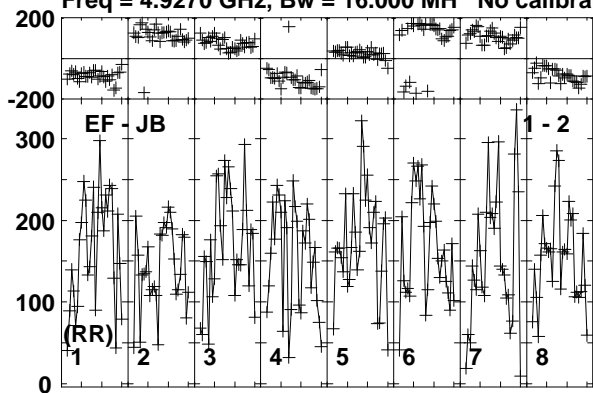

Lower frame: Micro Ampl Jy Top frame: Phas deg
Vector averaged cross-power spectrum Baseline: EF (01) - JB (02)
Timerange: 01/01:34:03 to 01/01:37:29

Plot file version 168 created 26-MAR-2015 15:27:44

J1035+0522 EG082E.UVDATA.1

Freq = 4.9270 GHz, Bw = 16.000 MH No calibration applied and no bandpass applied

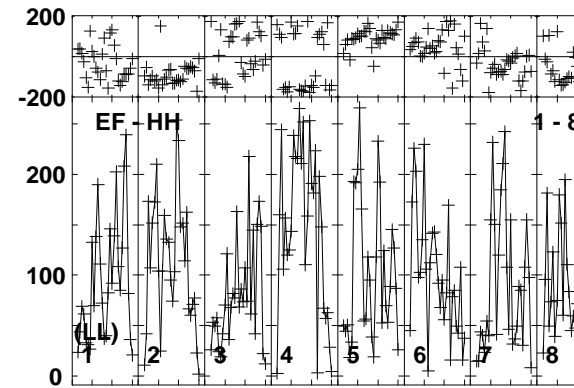
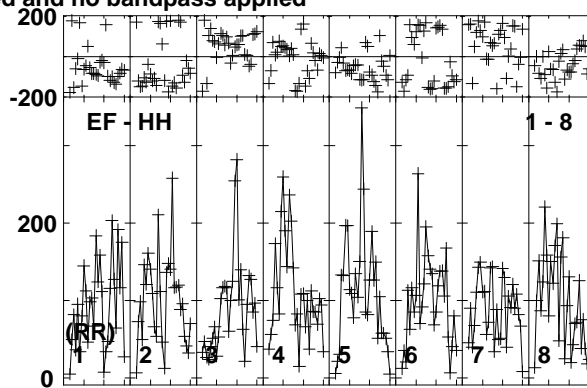
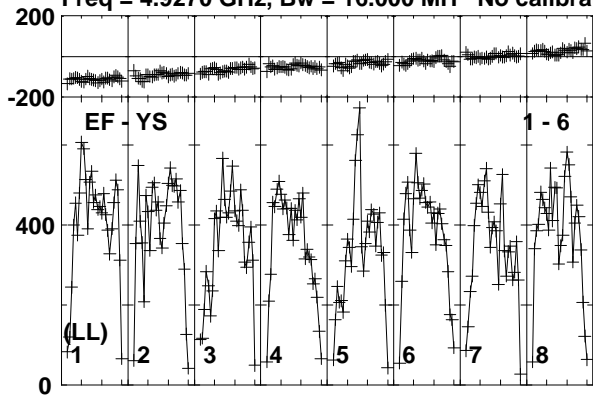

Lower frame: Micro Ampl Jy Top frame: Phas deg
Vector averaged cross-power spectrum Baseline: EF (01) - YS (06)
Timerange: 01/01:34:03 to 01/01:37:29

Plot file version 169 created 26-MAR-2015 15:27:44

J1038+0512 EG082E.UVDATA.1

Freq = 4.9270 GHz, Bw = 16.000 MH No calibration applied and no bandpass applied

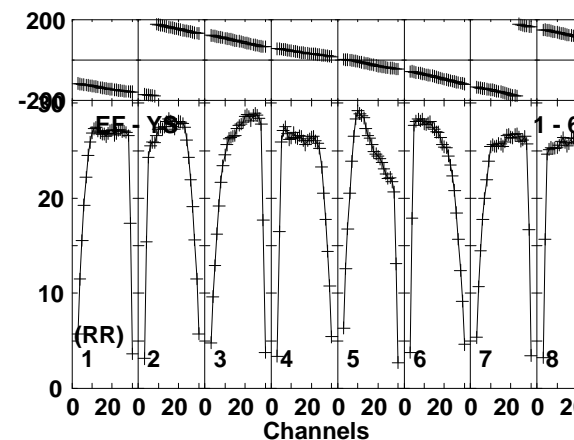
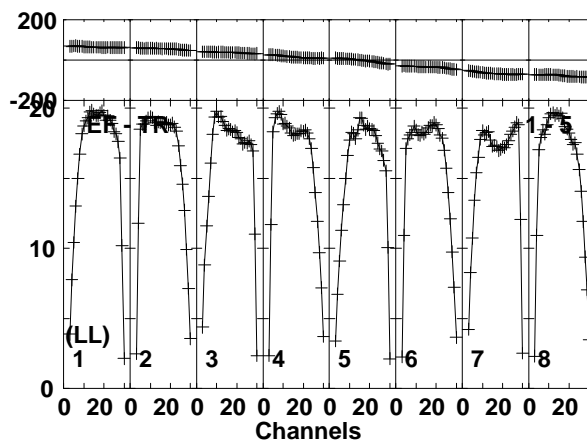
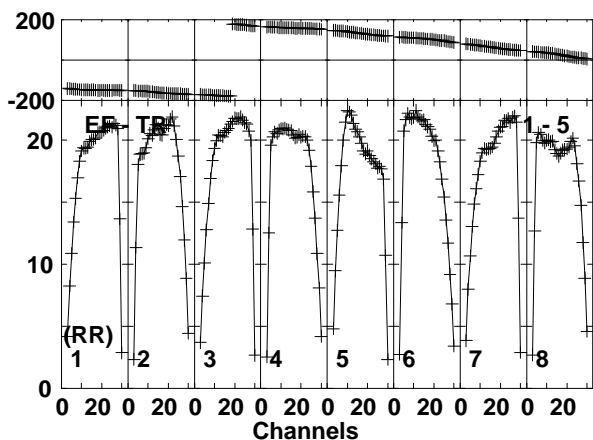
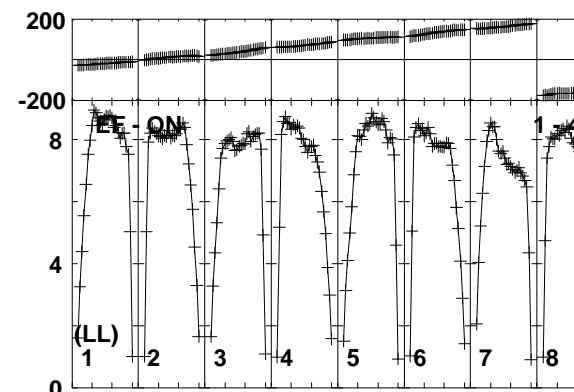
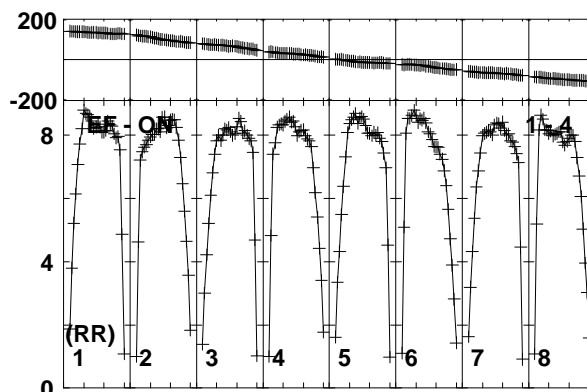
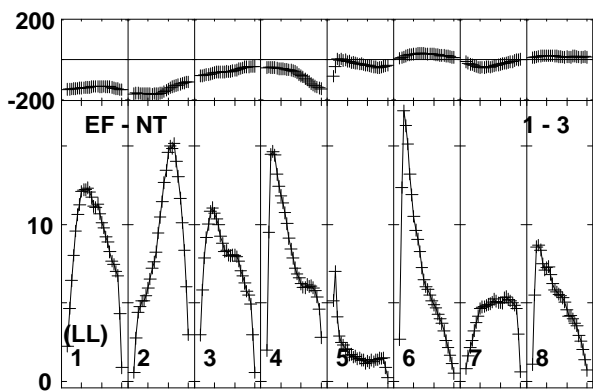
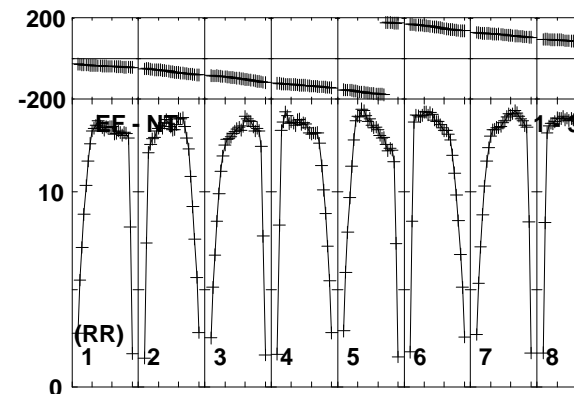
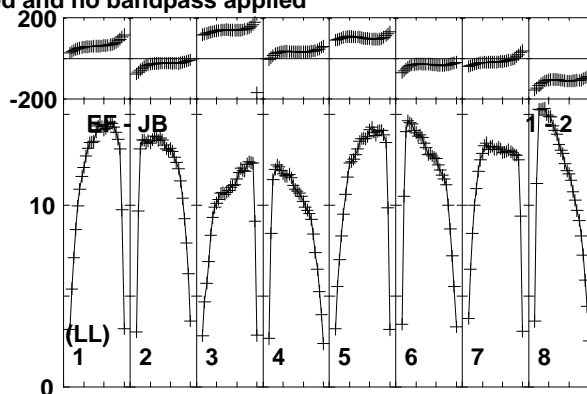
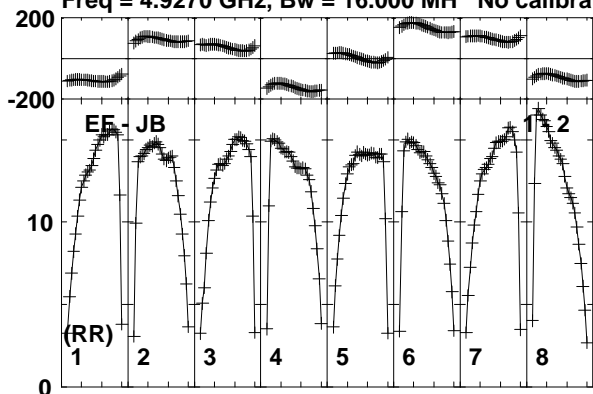

Lower frame: Milli Ampl Jy Top frame: Phas deg
Vector averaged cross-power spectrum Baseline: EF (01) - JB (02)
Timerange: 01/01:38:03 to 01/01:38:59

Plot file version 170 created 26-MAR-2015 15:27:44

J1038+0512 EG082E.UVDATA.1

Freq = 4.9270 GHz, Bw = 16.000 MH No calibration applied and no bandpass applied

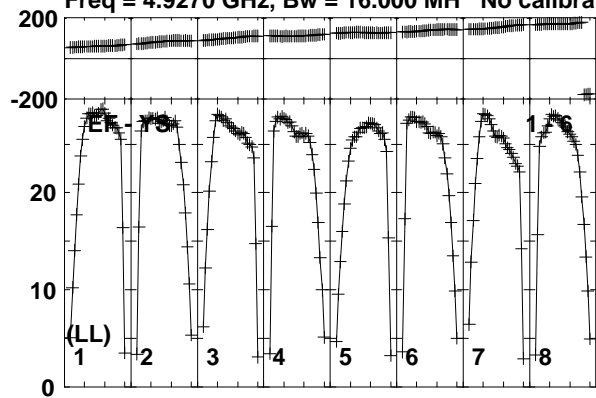

Lower frame: Milli Ampl Jy Top frame: Phas deg
Vector averaged cross-power spectrum Baseline: EF (01) - YS (06)
Timerange: 01/01:38:03 to 01/01:38:59

Plot file version 171 created 26-MAR-2015 15:27:44

RYSEX EG082E.UVDATA.1

Freq = 4.9270 GHz, Bw = 16.000 MH No calibration applied and no bandpass applied

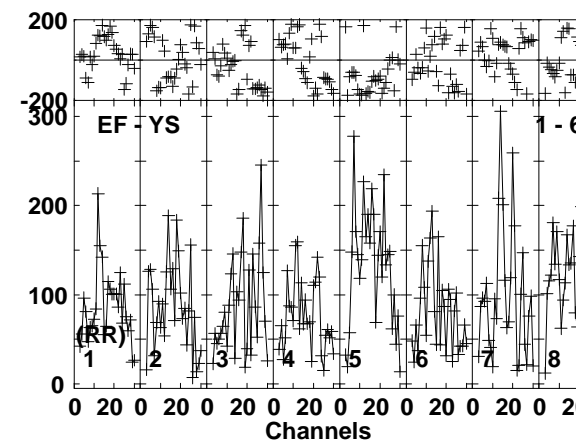
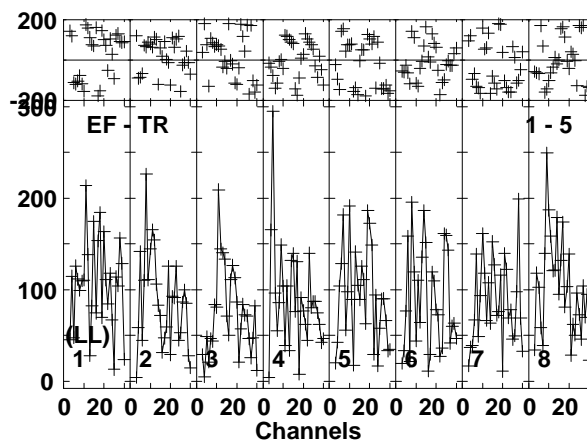
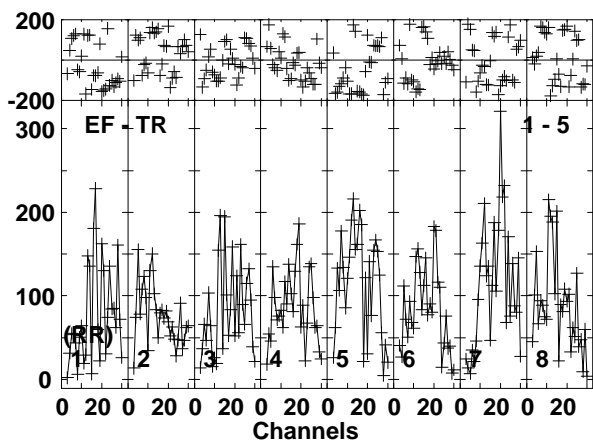
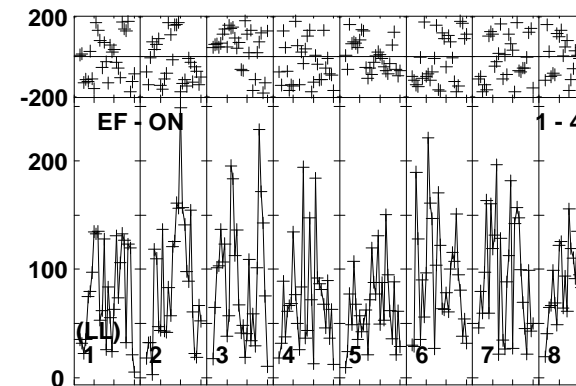
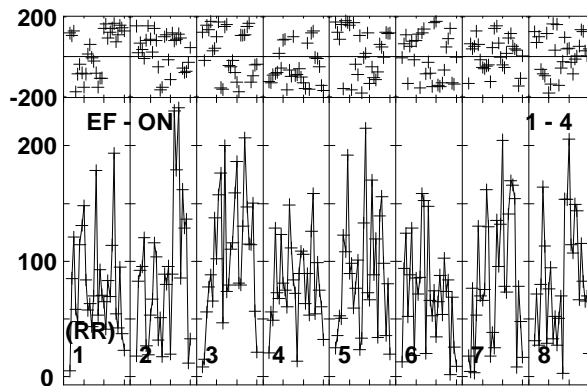
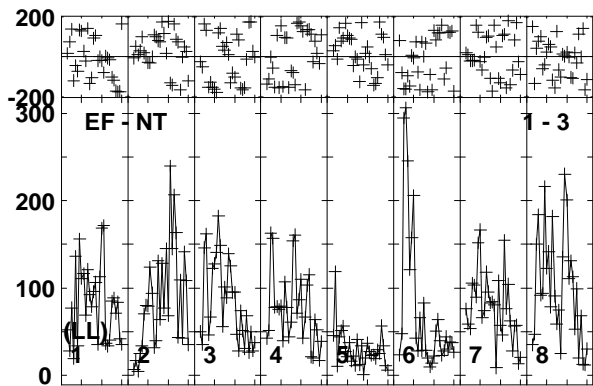
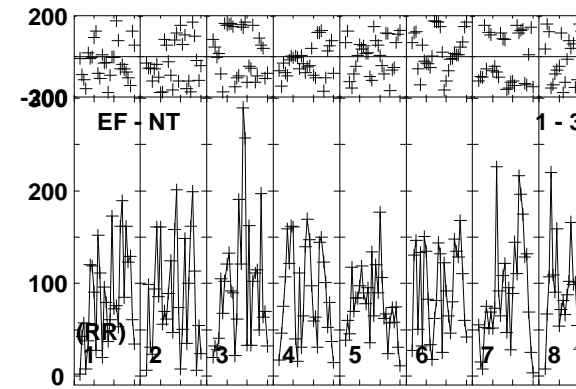
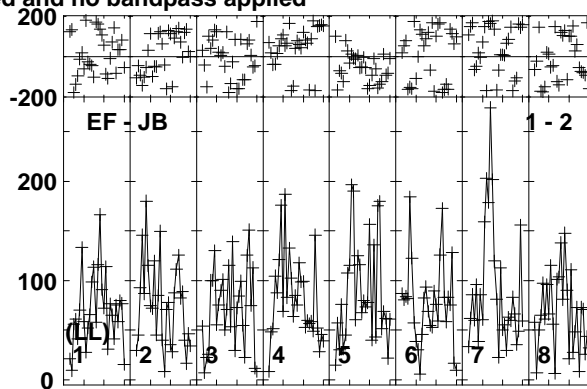
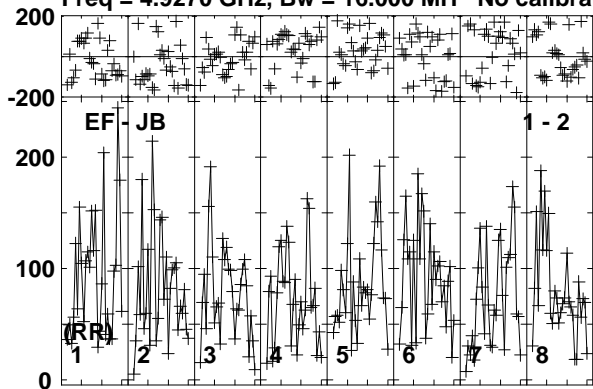

Lower frame: Micro Ampl Jy Top frame: Phas deg
Vector averaged cross-power spectrum Baseline: EF (01) - JB (02)
Timerange: 01/01:39:03 to 01/01:42:29

Plot file version 172 created 26-MAR-2015 15:27:45

RYSEX EG082E.UVDATA.1

Freq = 4.9270 GHz, Bw = 16.000 MH No calibration applied and no bandpass applied

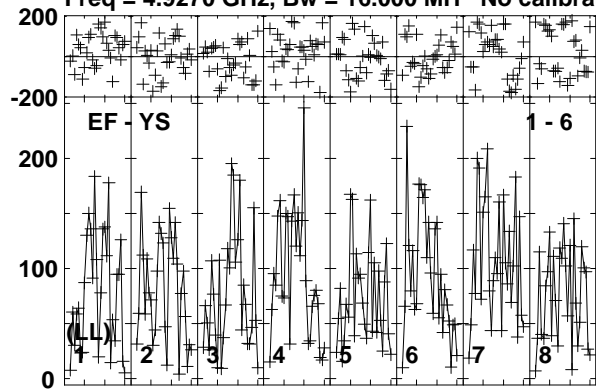

Lower frame: Micro Ampl Jy Top frame: Phas deg
Vector averaged cross-power spectrum Baseline: EF (01) - YS (06)
Timerange: 01/01:39:03 to 01/01:42:29

Plot file version 173 created 26-MAR-2015 15:27:45

J1038+0512 EG082E.UVDATA.1

Freq = 4.9270 GHz, Bw = 16.000 MH No calibration applied and no bandpass applied

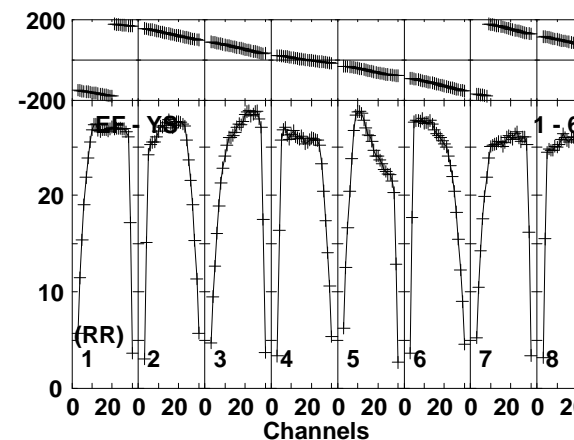
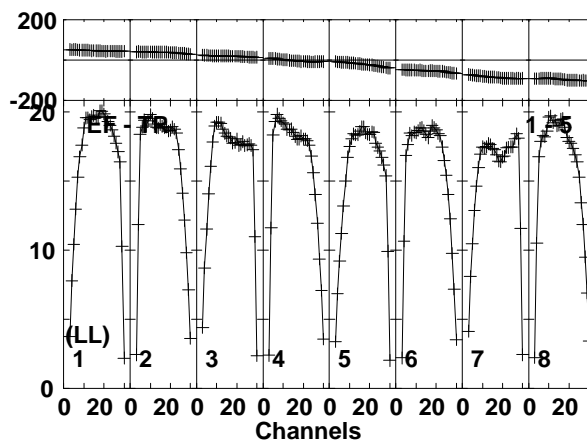
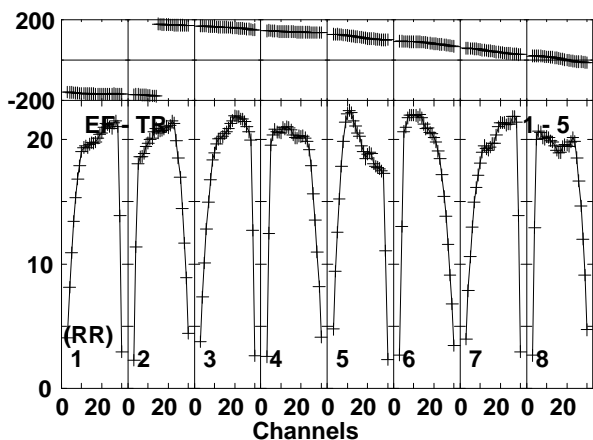
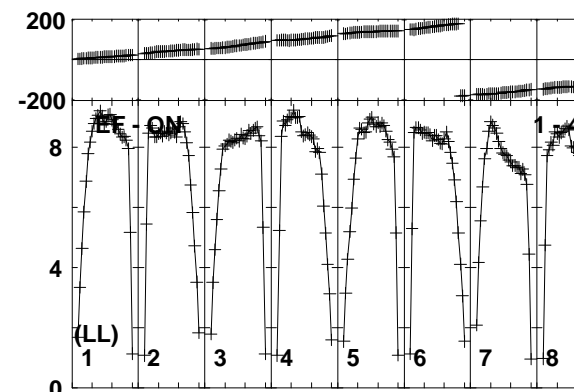
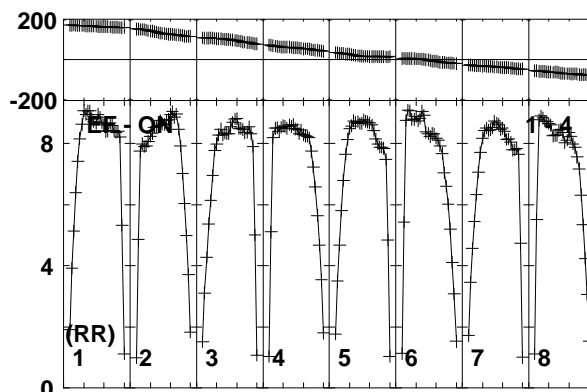
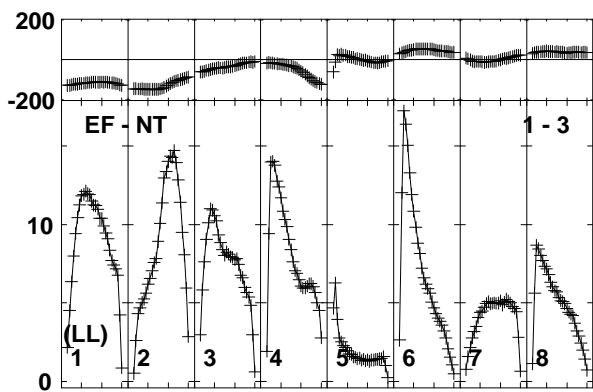
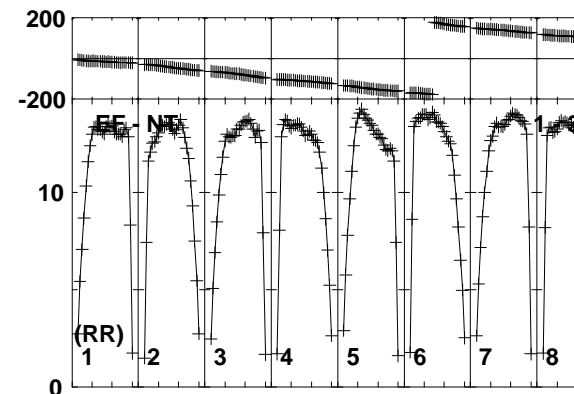
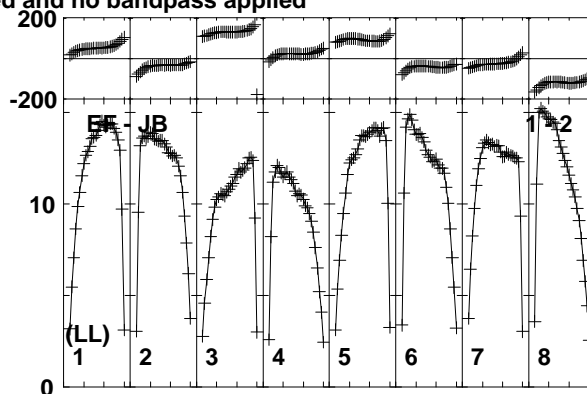
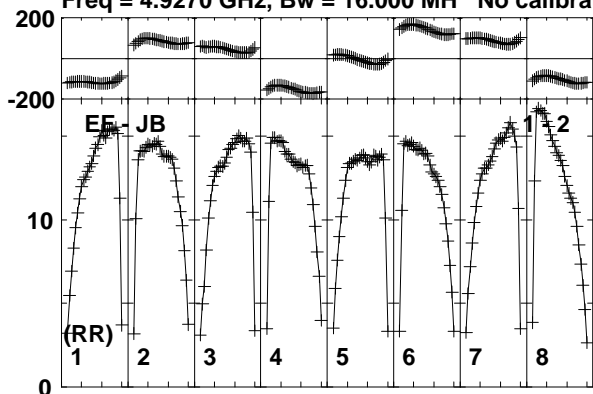

Lower frame: Milli Ampl Jy Top frame: Phas deg
Vector averaged cross-power spectrum Baseline: EF (01) - JB (02)
Timerange: 01/01:42:33 to 01/01:43:59

Plot file version 174 created 26-MAR-2015 15:27:45

J1038+0512 EG082E.UVDATA.1

Freq = 4.9270 GHz, Bw = 16.000 MH No calibration applied and no bandpass applied

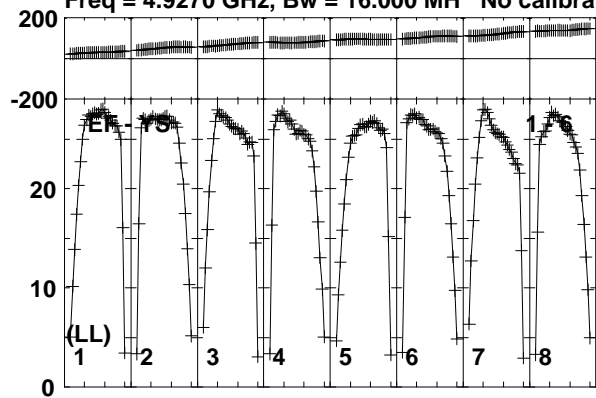

Lower frame: Milli Ampl Jy Top frame: Phas deg
Vector averaged cross-power spectrum Baseline: EF (01) - YS (06)
Timerange: 01/01:42:33 to 01/01:43:59

Plot file version 175 created 26-MAR-2015 15:27:45

RYSEX EG082E.UVDATA.1

Freq = 4.9270 GHz, Bw = 16.000 MH No calibration applied and no bandpass applied

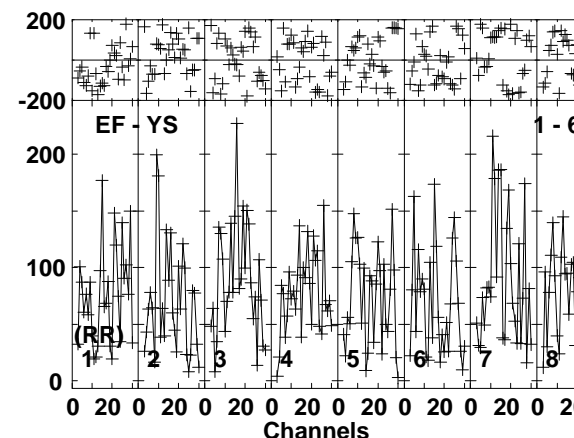
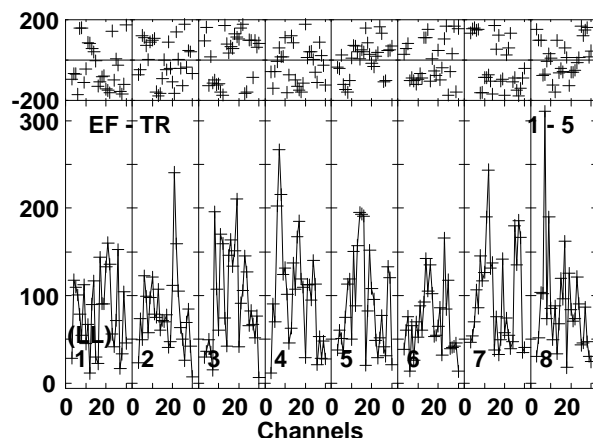
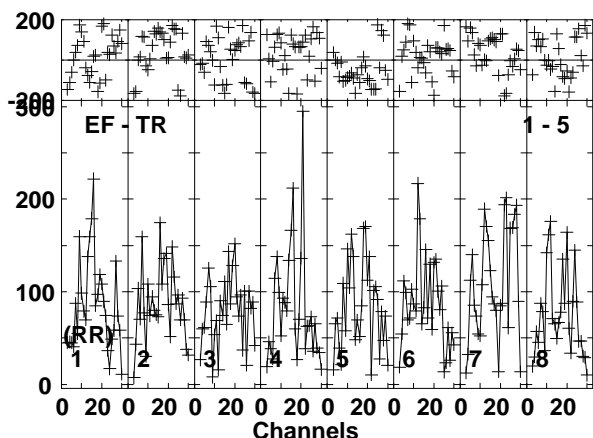
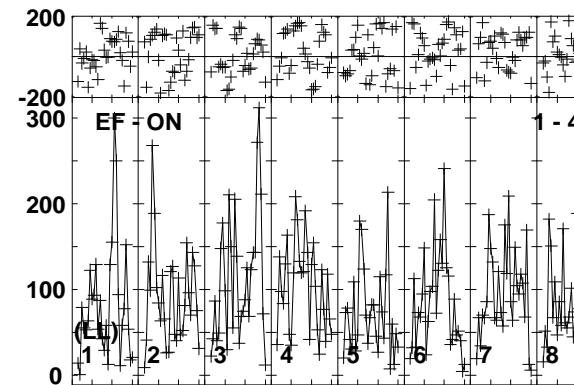
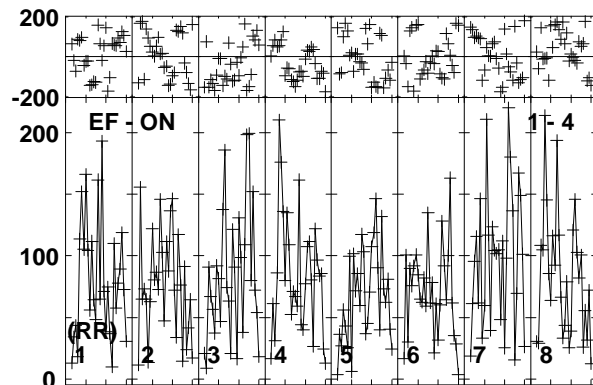
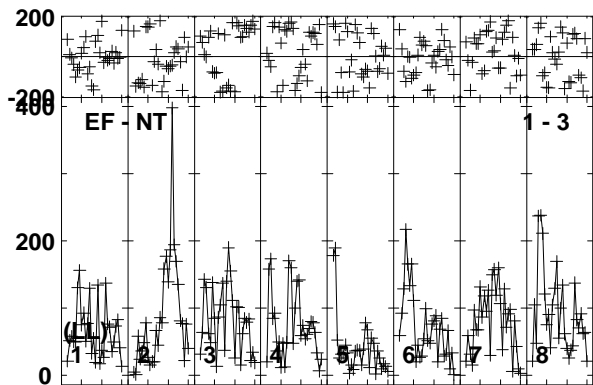
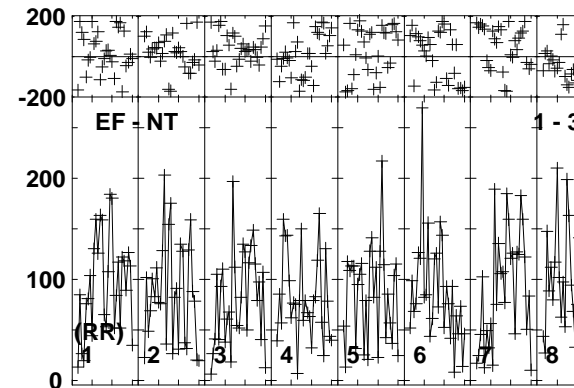
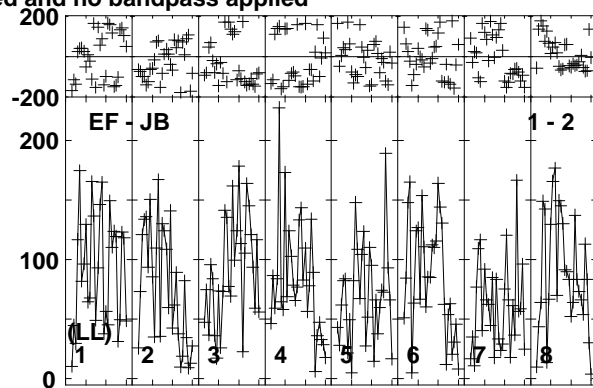
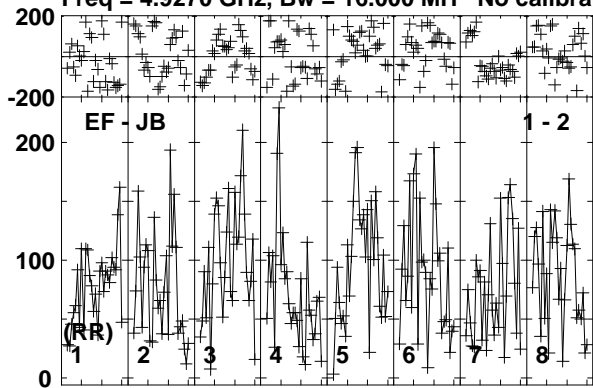

Lower frame: Micro Ampl Jy Top frame: Phas deg
Vector averaged cross-power spectrum Baseline: EF (01) - JB (02)
Timerange: 01/01:44:03 to 01/01:47:29

Plot file version 176 created 26-MAR-2015 15:27:45

RYSEX EG082E.UVDATA.1

Freq = 4.9270 GHz, Bw = 16.000 MH No calibration applied and no bandpass applied

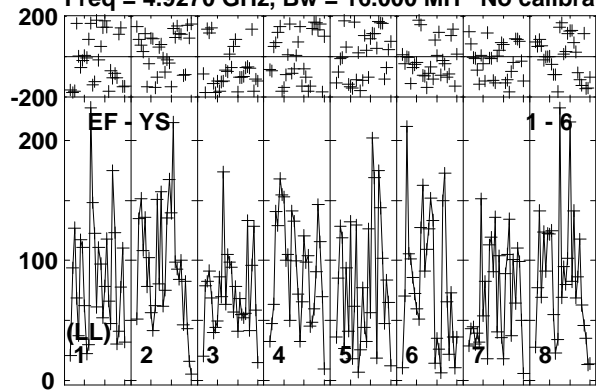

Lower frame: Micro Ampl Jy Top frame: Phas deg
Vector averaged cross-power spectrum Baseline: EF (01) - YS (06)
Timerange: 01/01:44:03 to 01/01:47:29

Plot file version 177 created 26-MAR-2015 15:27:45

J1038+0512 EG082E.UVDATA.1

Freq = 4.9270 GHz, Bw = 16.000 MH No calibration applied and no bandpass applied

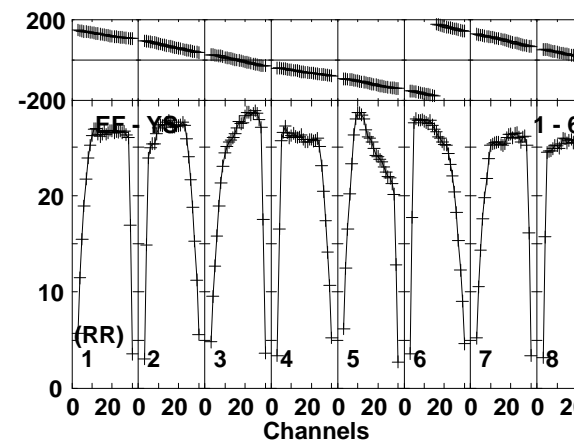
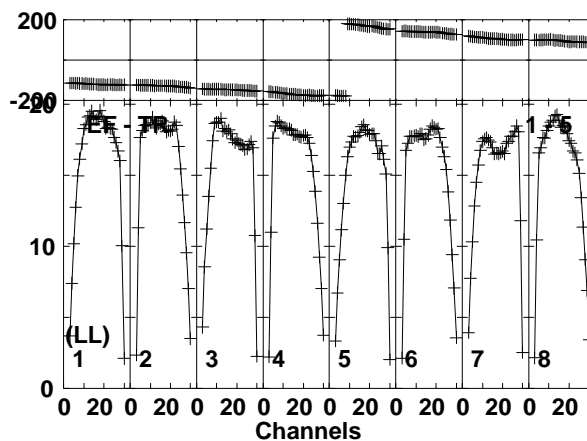
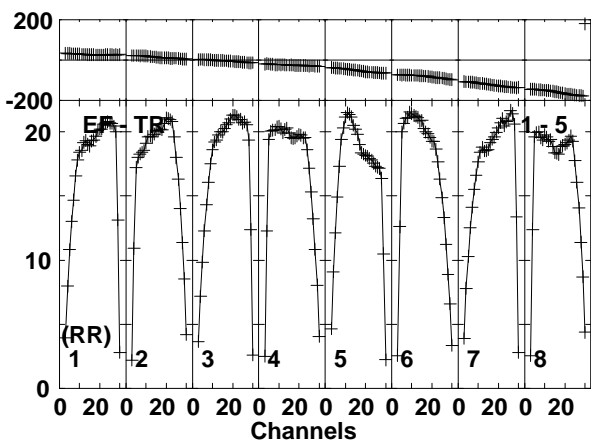
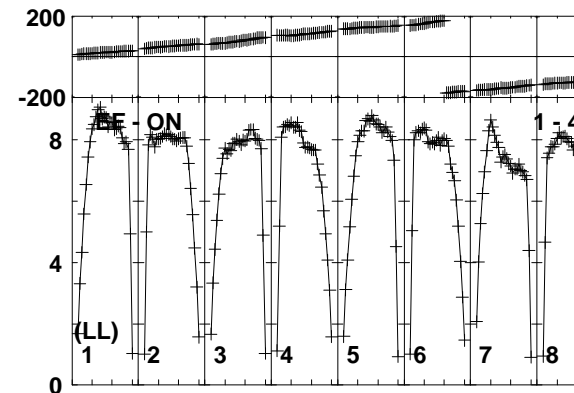
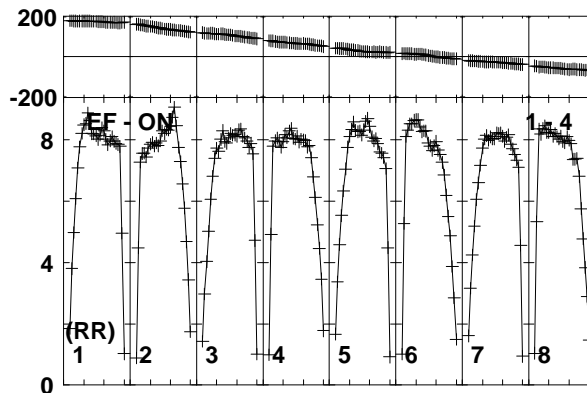
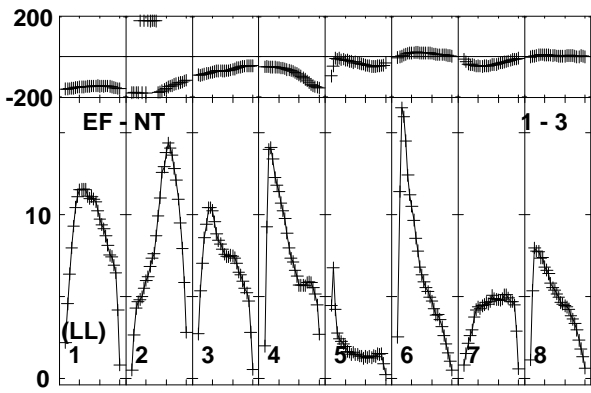
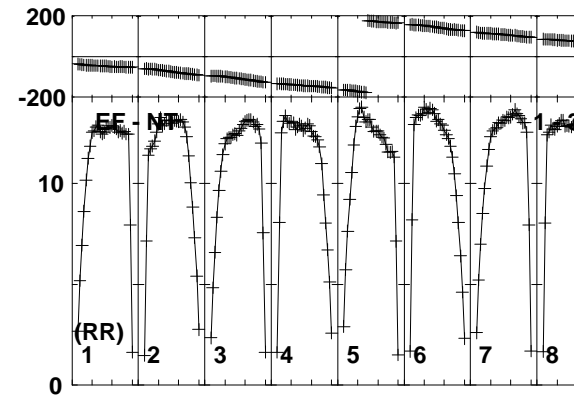
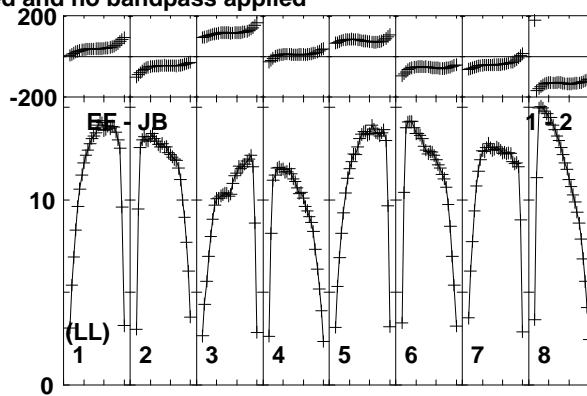
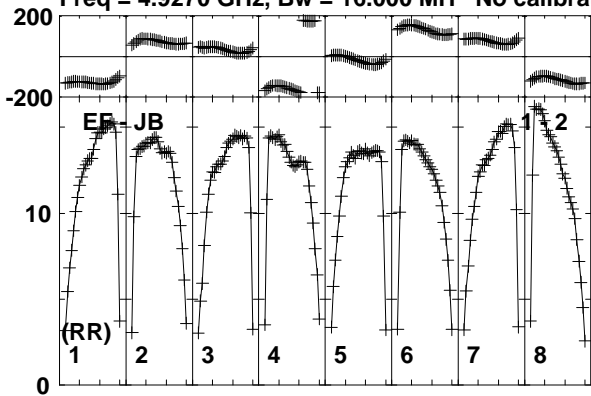

Lower frame: Milli Ampl Jy Top frame: Phas deg
Vector averaged cross-power spectrum Baseline: EF (01) - JB (02)
Timerange: 01/01:48:03 to 01/01:48:59

Plot file version 178 created 26-MAR-2015 15:27:45

J1038+0512 EG082E.UVDATA.1

Freq = 4.9270 GHz, Bw = 16.000 MH No calibration applied and no bandpass applied

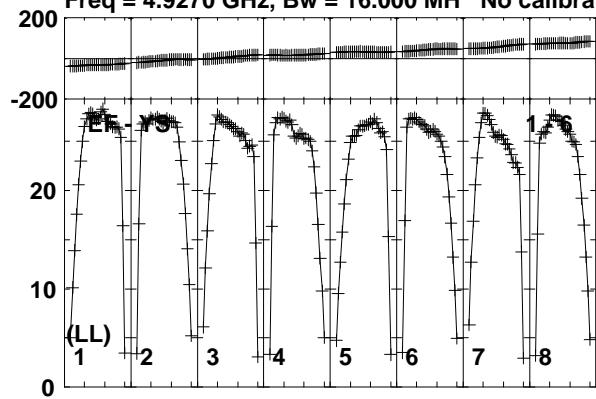

Lower frame: Milli Ampl Jy Top frame: Phas deg
Vector averaged cross-power spectrum Baseline: EF (01) - YS (06)
Timerange: 01/01:48:03 to 01/01:48:59

Plot file version 179 created 26-MAR-2015 15:27:45

RYSEX EG082E.UVDATA.1

Freq = 4.9270 GHz, Bw = 16.000 MH No calibration applied and no bandpass applied

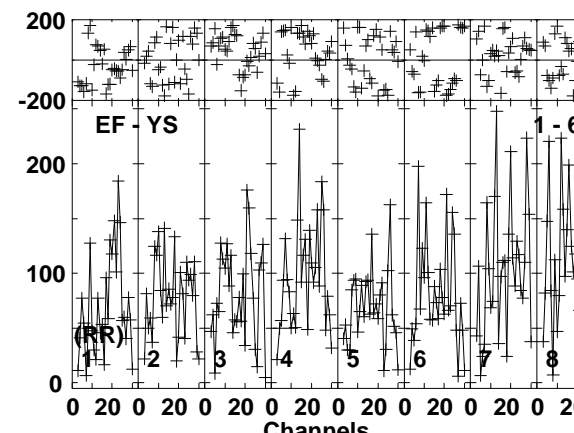
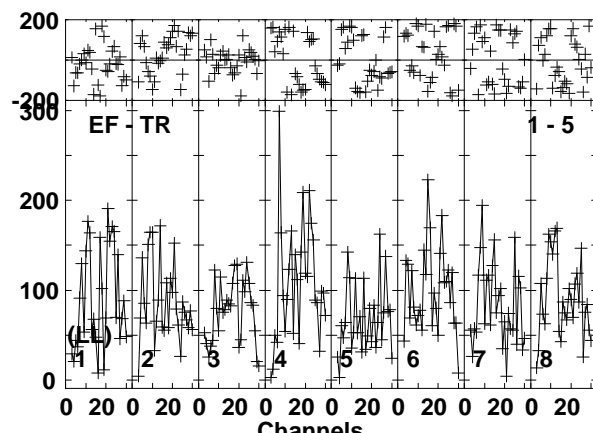
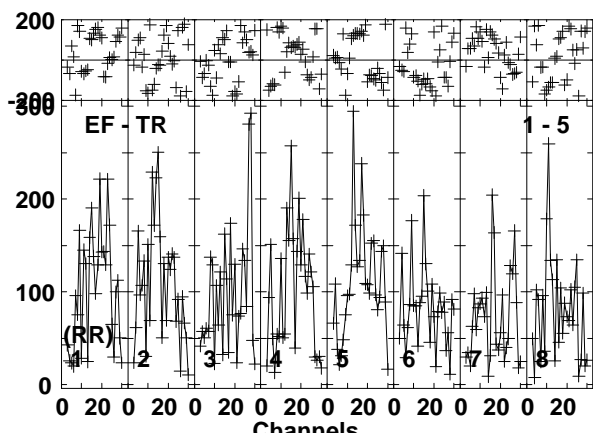
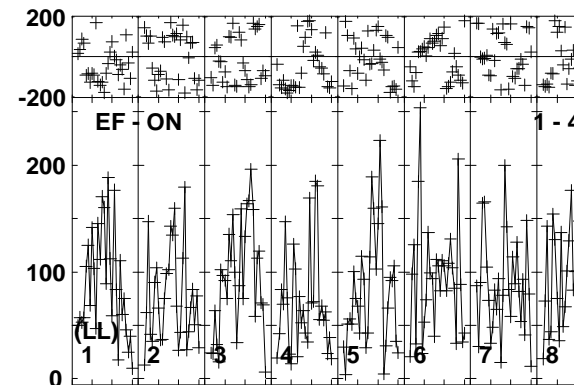
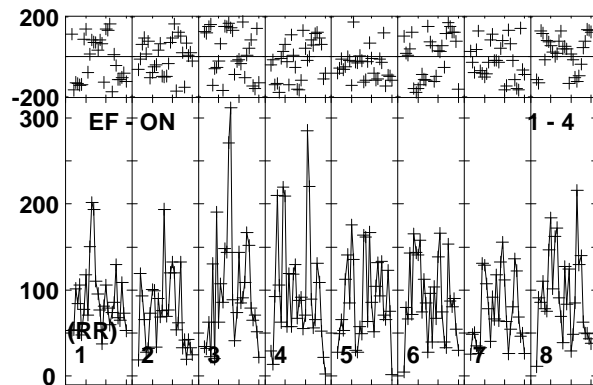
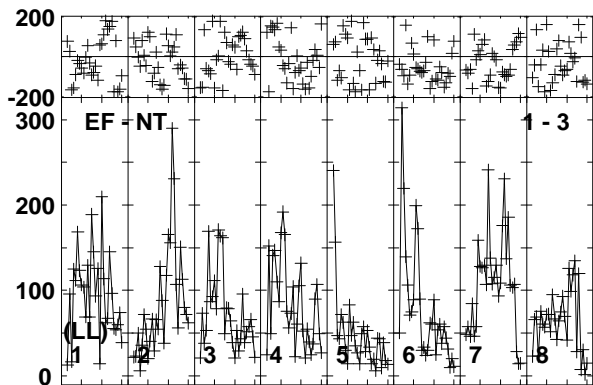
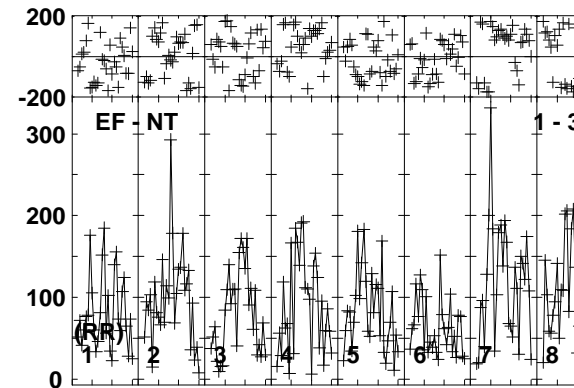
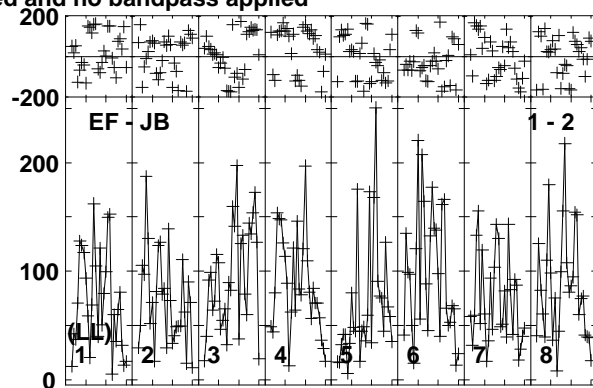
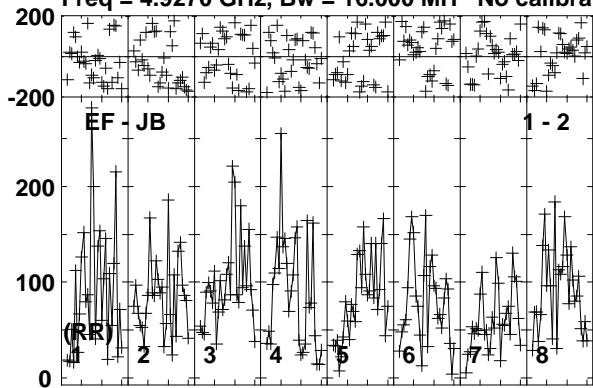

Lower frame: Micro Ampl Jy Top frame: Phas deg
Vector averaged cross-power spectrum Baseline: EF (01) - JB (02)
Timerange: 01/01:49:03 to 01/01:52:29

Plot file version 180 created 26-MAR-2015 15:27:45

RYSEX EG082E.UVDATA.1

Freq = 4.9270 GHz, Bw = 16.000 MH No calibration applied and no bandpass applied

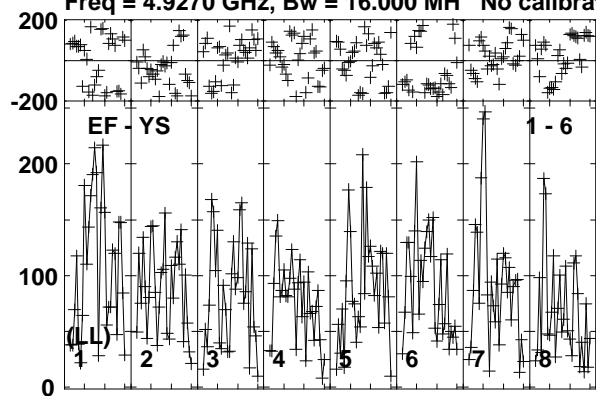

Lower frame: Micro Ampl Jy Top frame: Phas deg
Vector averaged cross-power spectrum Baseline: EF (01) - YS (06)
Timerange: 01/01:49:03 to 01/01:52:29

Plot file version 181 created 26-MAR-2015 15:27:45

J1038+0512 EG082E.UVDATA.1

Freq = 4.9270 GHz, Bw = 16.000 MH No calibration applied and no bandpass applied

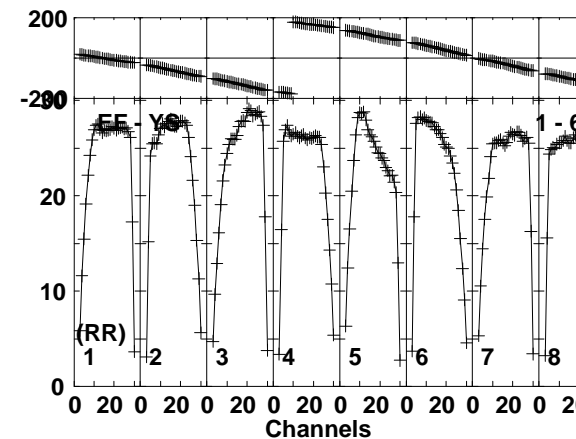
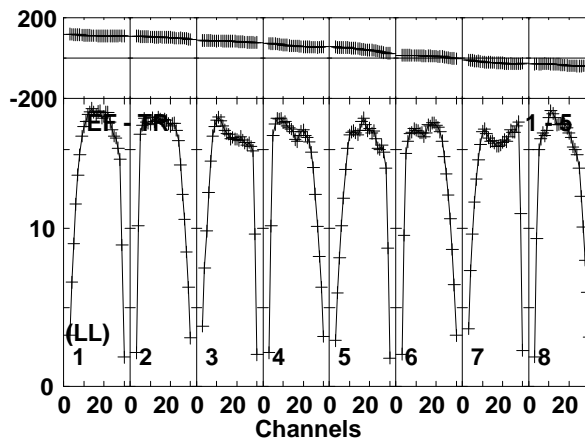
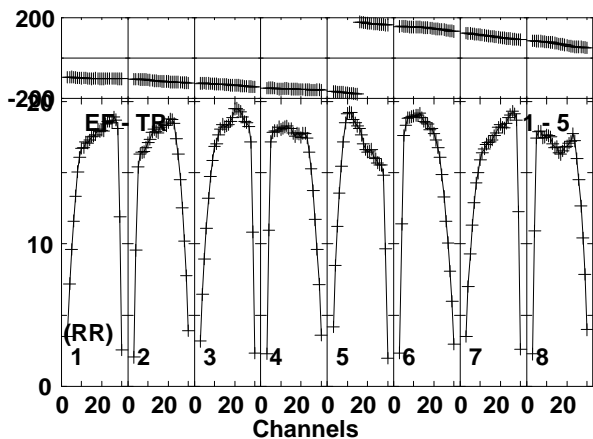
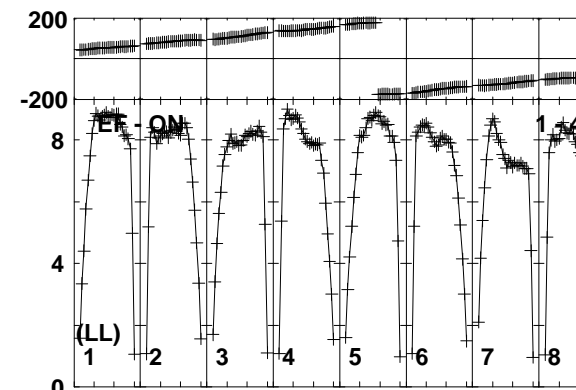
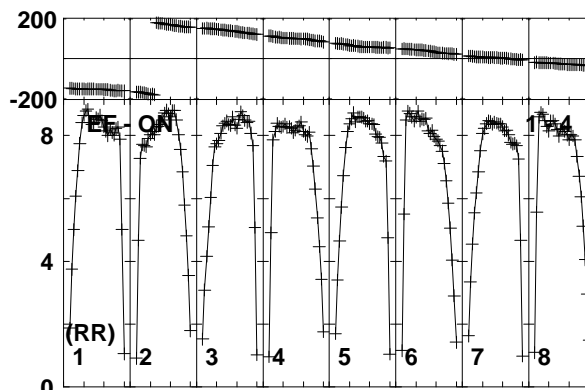
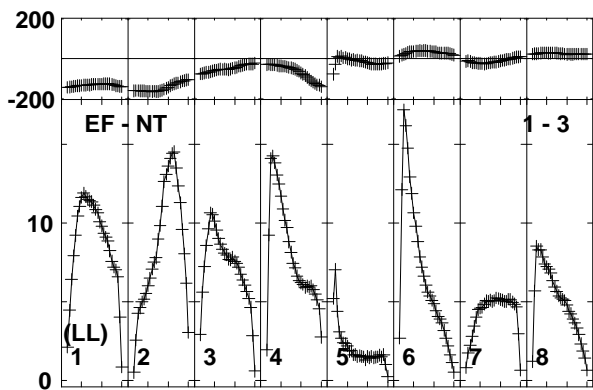
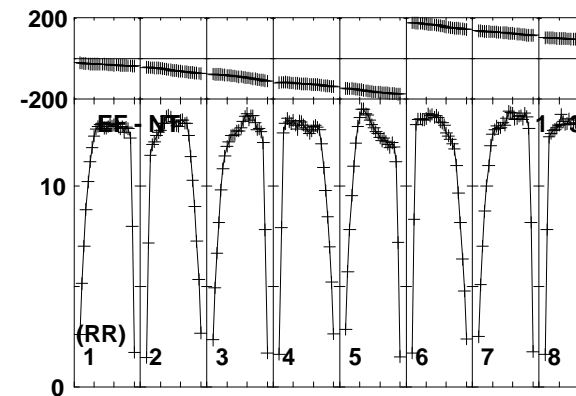
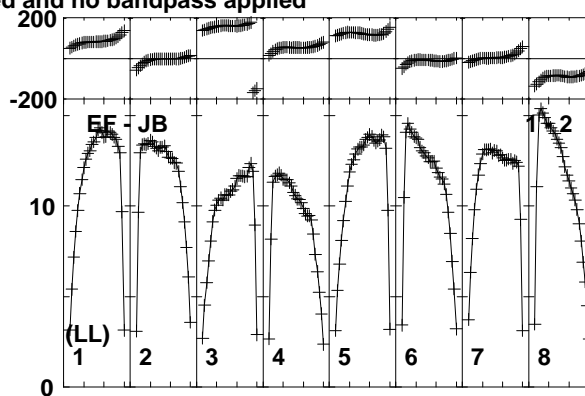
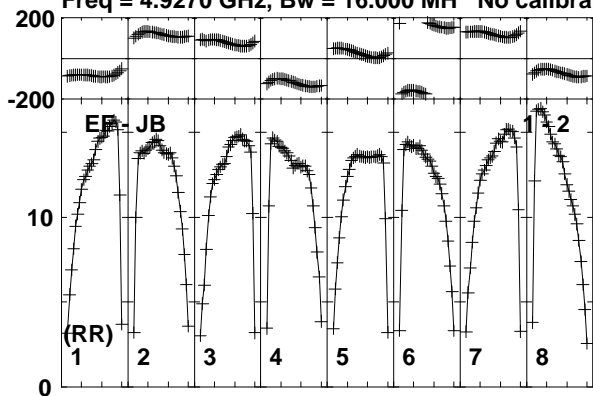

Lower frame: Milli Ampl Jy Top frame: Phas deg
Vector averaged cross-power spectrum Baseline: EF (01) - JB (02)
Timerange: 01/01:52:33 to 01/01:53:59

Plot file version 182 created 26-MAR-2015 15:27:45

J1038+0512 EG082E.UVDATA.1

Freq = 4.9270 GHz, Bw = 16.000 MH No calibration applied and no bandpass applied

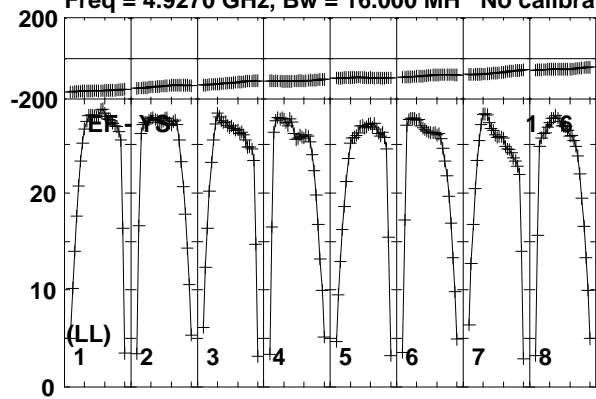

Lower frame: Milli Ampl Jy Top frame: Phas deg
Vector averaged cross-power spectrum Baseline: EF (01) - YS (06)
Timerange: 01/01:52:33 to 01/01:53:59

Plot file version 183 created 26-MAR-2015 15:27:45

RYSEX EG082E.UVDATA.1

Freq = 4.9270 GHz, Bw = 16.000 MH No calibration applied and no bandpass applied

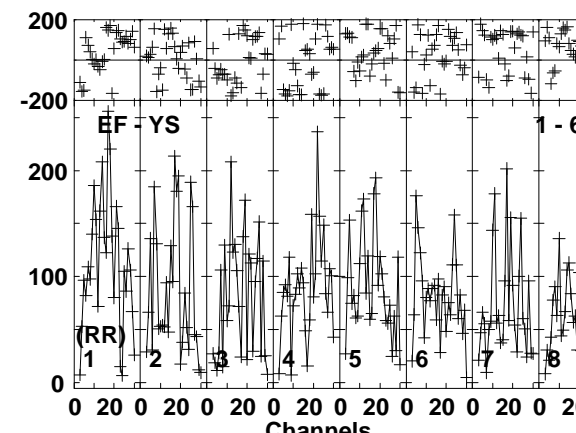
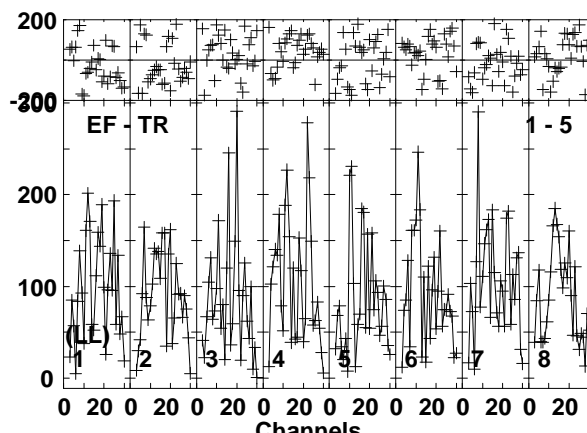
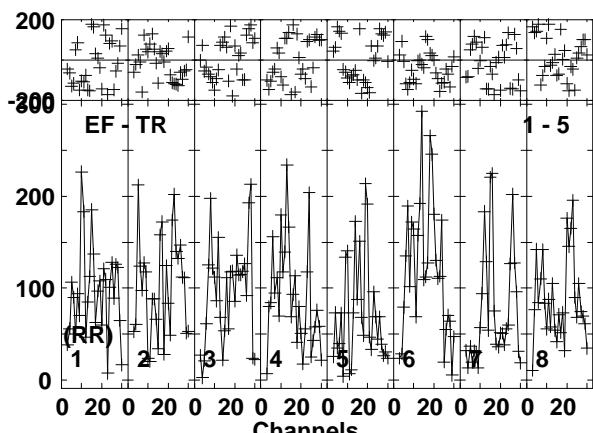
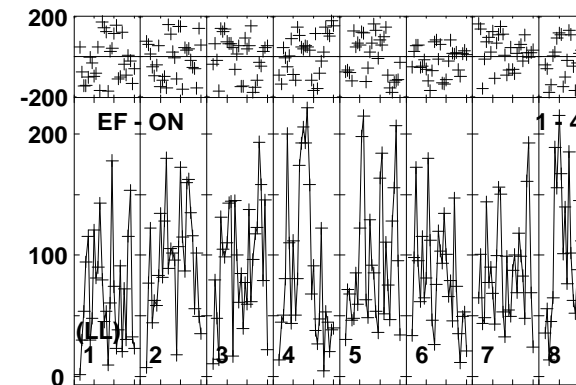
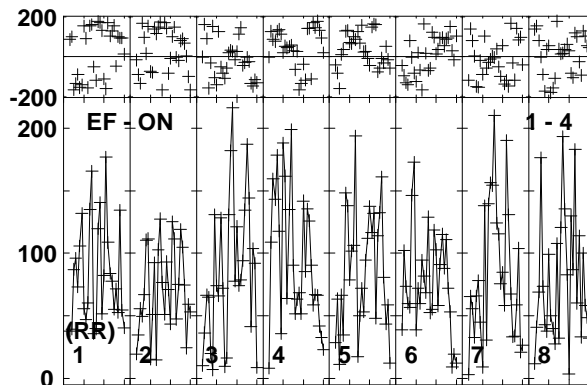
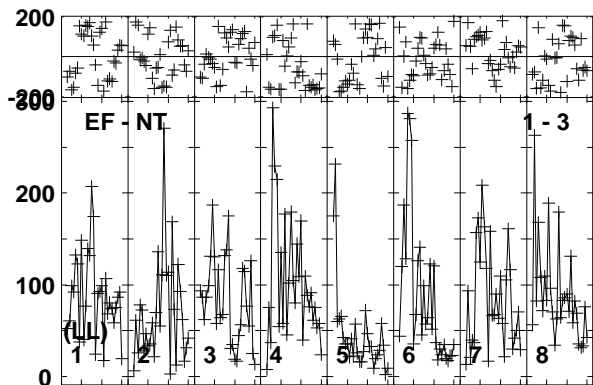
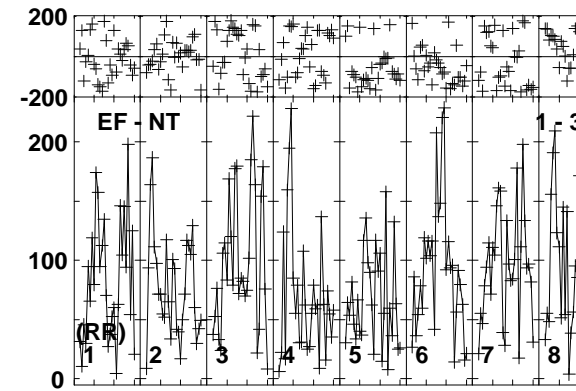
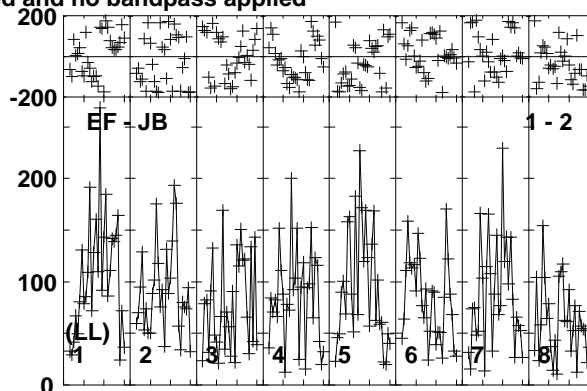
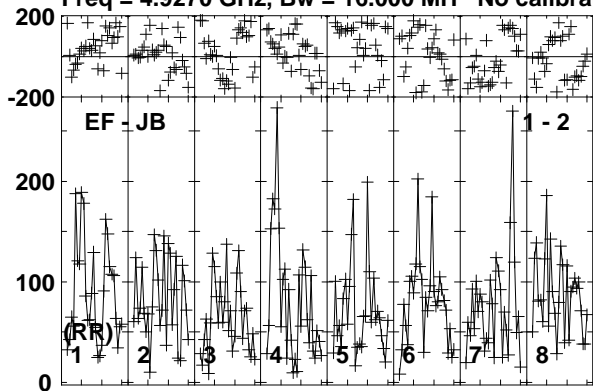

Lower frame: Micro Ampl Jy Top frame: Phas deg
Vector averaged cross-power spectrum Baseline: EF (01) - JB (02)
Timerange: 01/01:54:03 to 01/01:57:29

Plot file version 184 created 26-MAR-2015 15:27:45

RYSEX EG082E.UVDATA.1

Freq = 4.9270 GHz, Bw = 16.000 MH No calibration applied and no bandpass applied

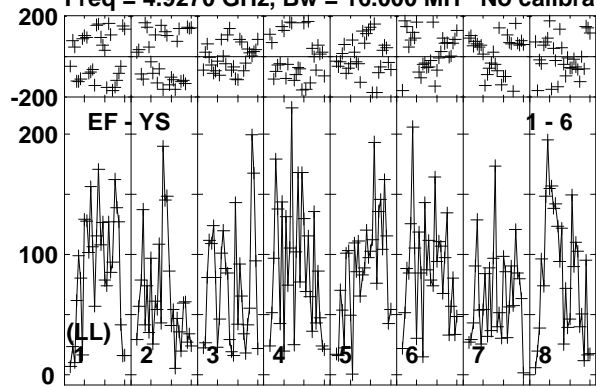

Lower frame: Micro Ampl Jy Top frame: Phas deg
Vector averaged cross-power spectrum Baseline: EF (01) - YS (06)
Timerange: 01/01:54:03 to 01/01:57:29

Plot file version 185 created 26-MAR-2015 15:27:45

J1038+0512 EG082E.UVDATA.1

Freq = 4.9270 GHz, Bw = 16.000 MH No calibration applied and no bandpass applied

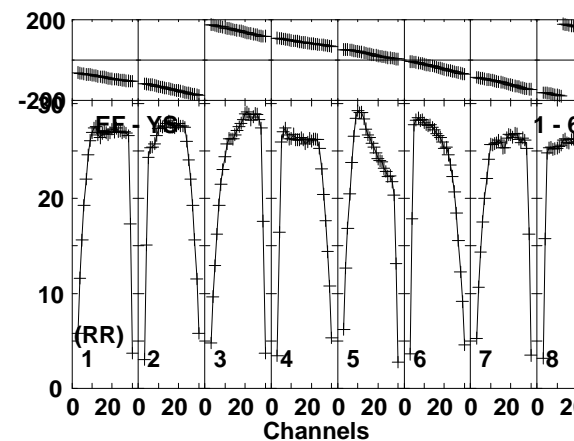
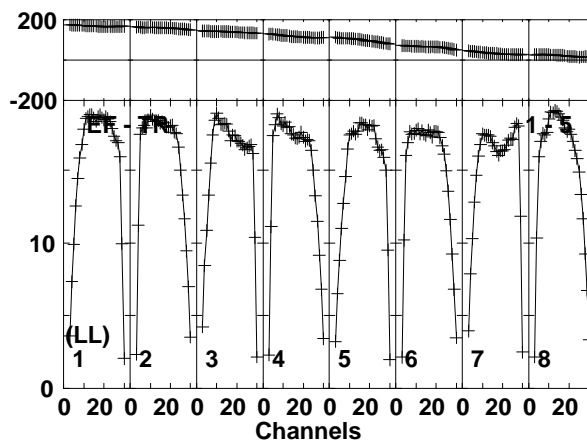
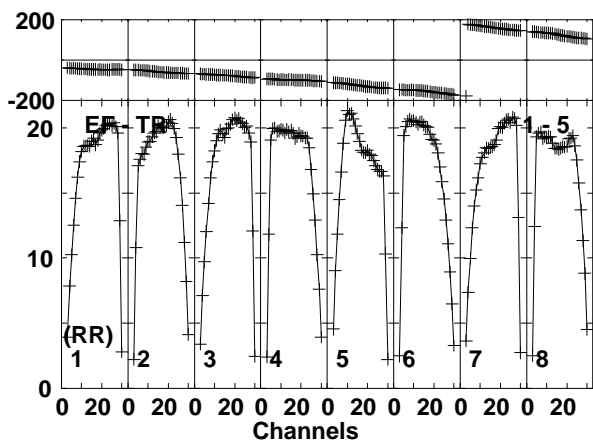
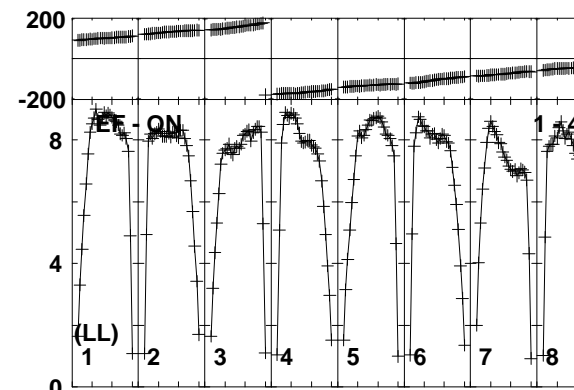
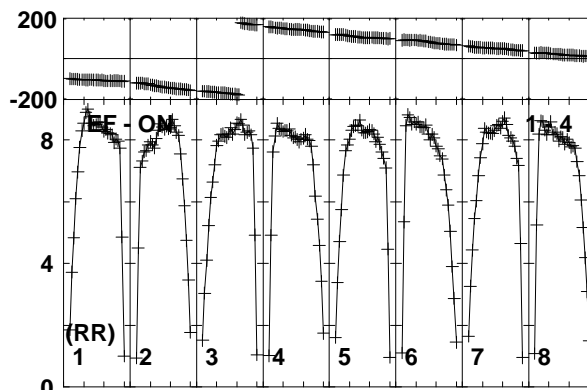
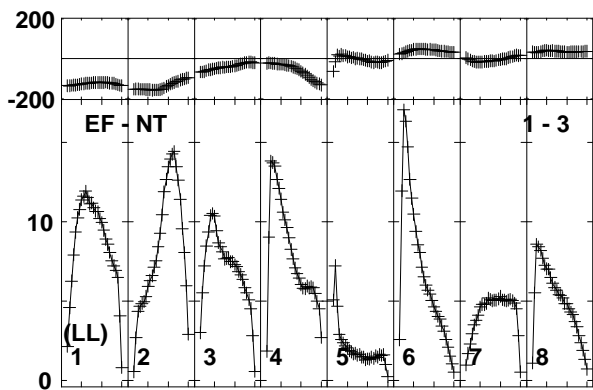
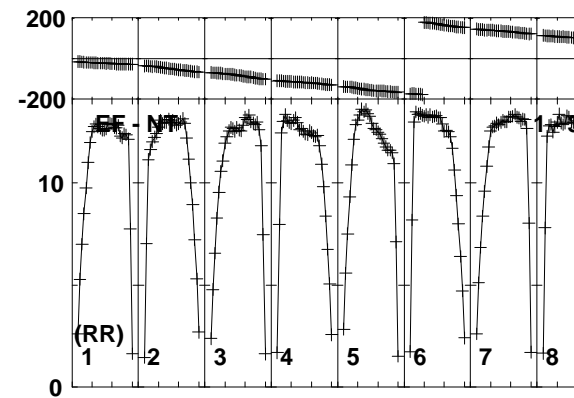
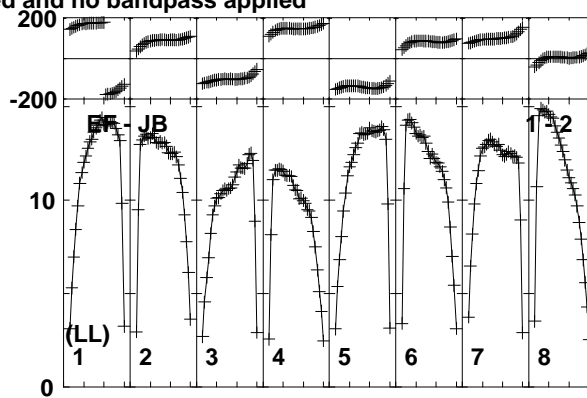
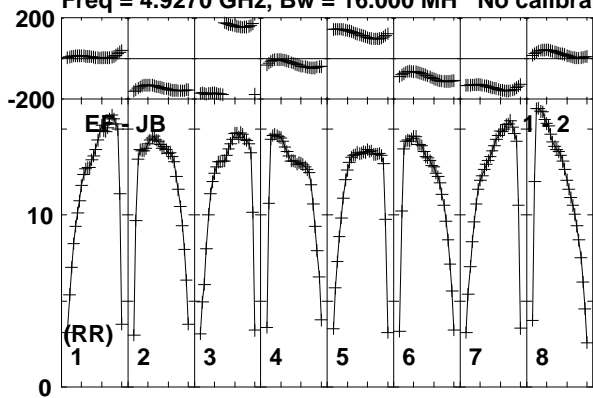

Lower frame: Milli Ampl Jy Top frame: Phas deg
Vector averaged cross-power spectrum Baseline: EF (01) - JB (02)
Timerange: 01/01:58:03 to 01/01:58:59

Plot file version 186 created 26-MAR-2015 15:27:45

J1038+0512 EG082E.UVDATA.1

Freq = 4.9270 GHz, Bw = 16.000 MH No calibration applied and no bandpass applied

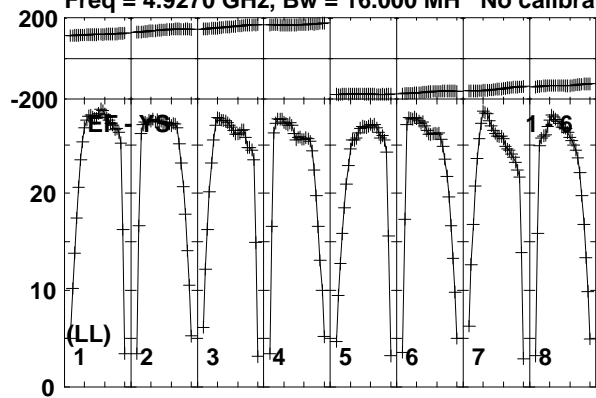

Lower frame: Milli Ampl Jy Top frame: Phas deg
Vector averaged cross-power spectrum Baseline: EF (01) - YS (06)
Timerange: 01/01:58:03 to 01/01:58:59

Plot file version 187 created 26-MAR-2015 15:27:45

RYSEX EG082E.UVDATA.1

Freq = 4.9270 GHz, Bw = 16.000 MH No calibration applied and no bandpass applied

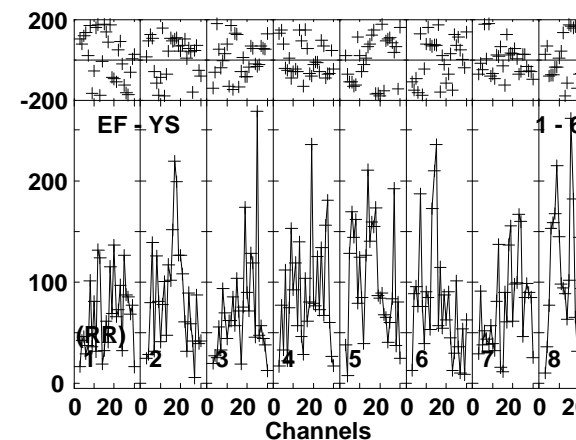
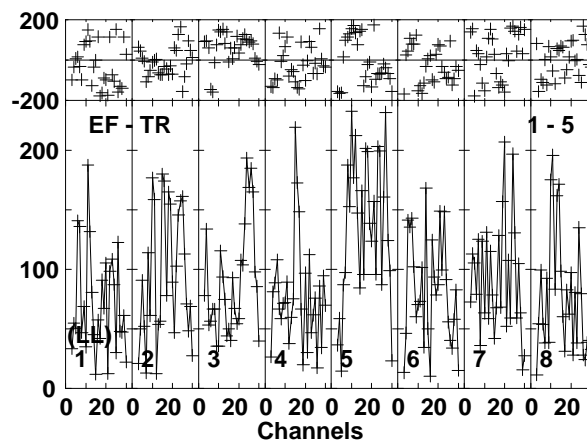
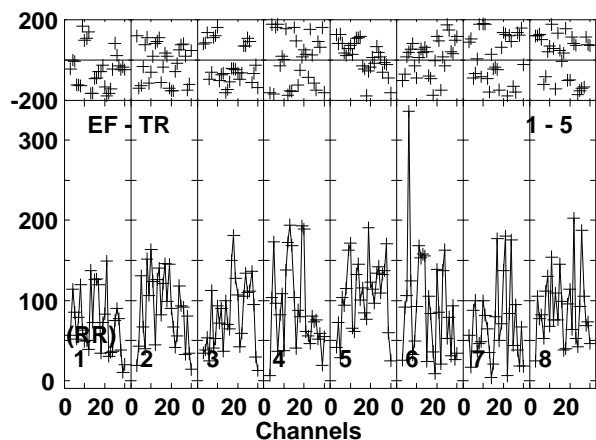
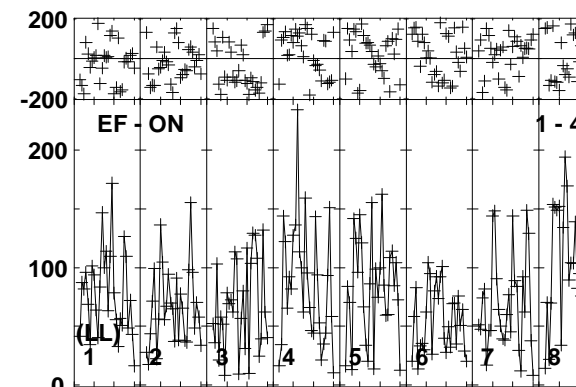
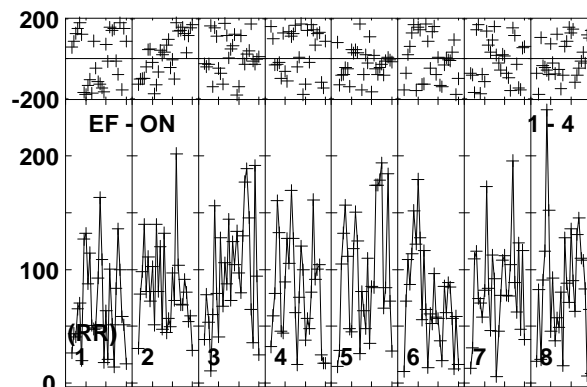
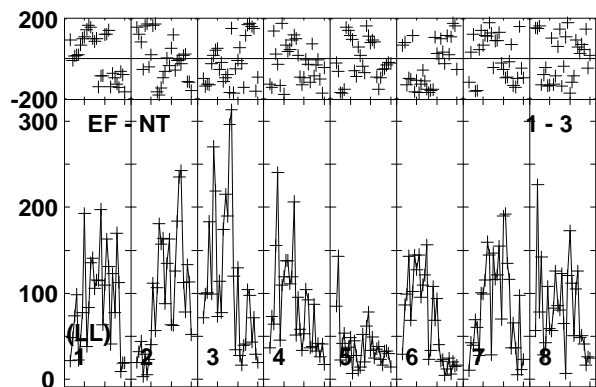
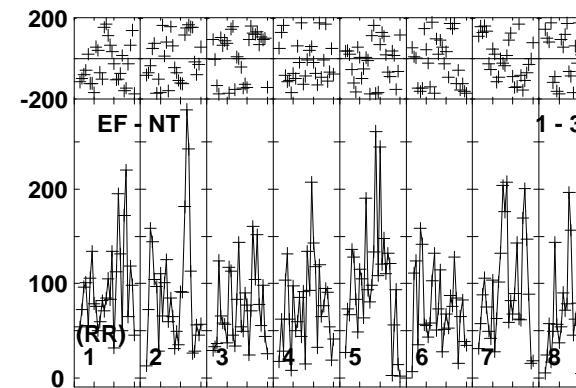
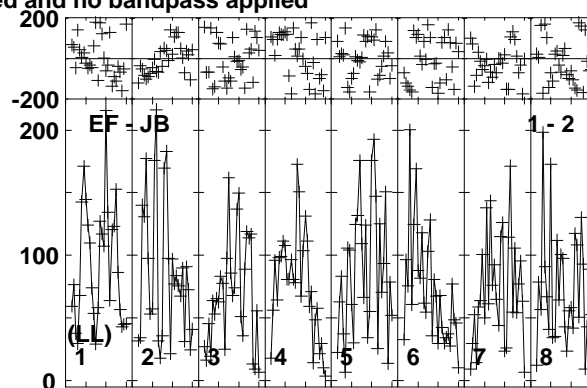
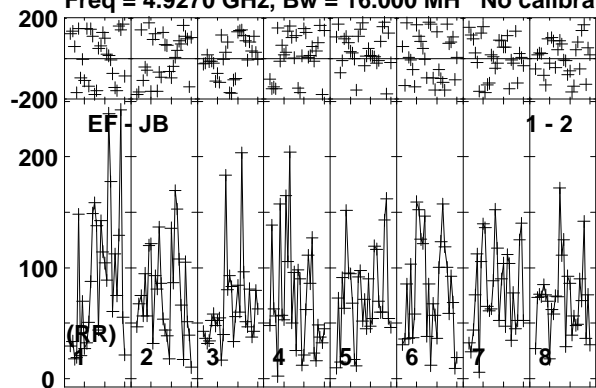

Lower frame: Micro Ampl Jy Top frame: Phas deg
Vector averaged cross-power spectrum Baseline: EF (01) - JB (02)
Timerange: 01/01:59:03 to 01/02:02:29

Plot file version 188 created 26-MAR-2015 15:27:45

RYSEX EG082E.UVDATA.1

Freq = 4.9270 GHz, Bw = 16.000 MH No calibration applied and no bandpass applied

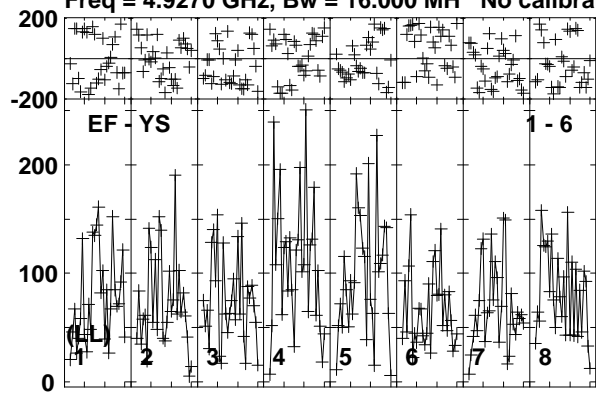

Lower frame: Micro Ampl Jy Top frame: Phas deg
Vector averaged cross-power spectrum Baseline: EF (01) - YS (06)
Timerange: 01/01:59:03 to 01/02:02:29

Plot file version 189 created 26-MAR-2015 15:27:45

J1038+0512 EG082E.UVDATA.1

Freq = 4.9270 GHz, Bw = 16.000 MH No calibration applied and no bandpass applied

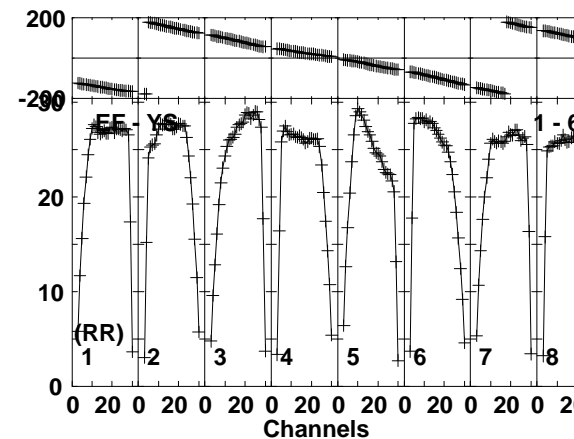
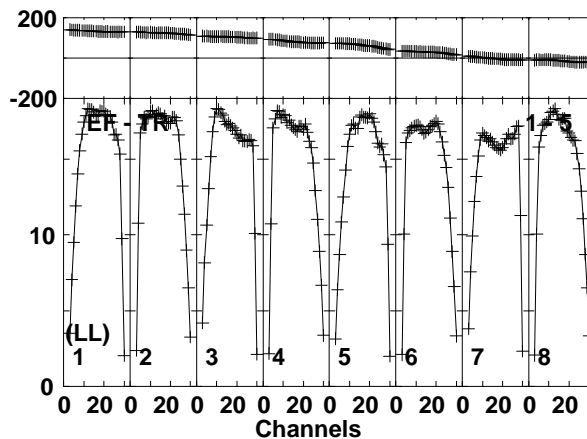
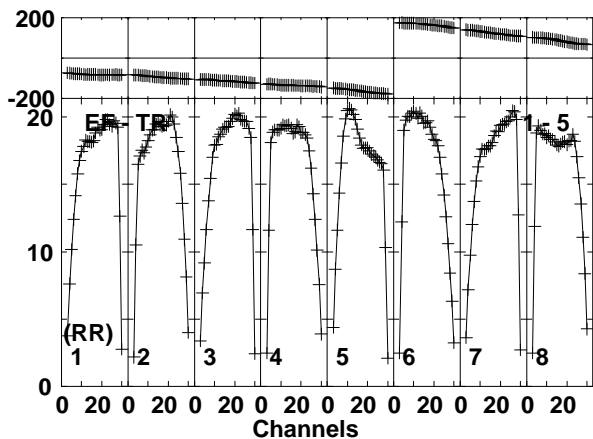
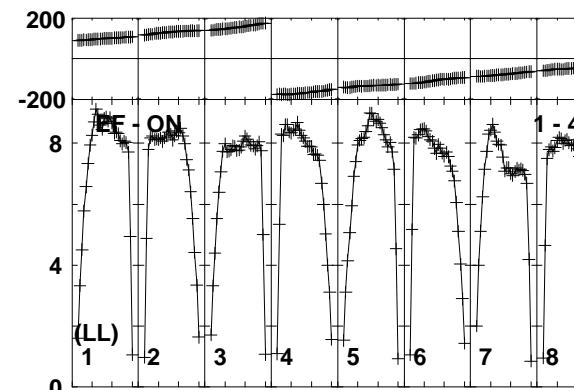
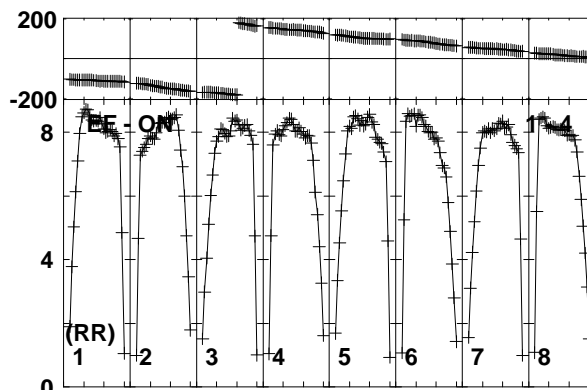
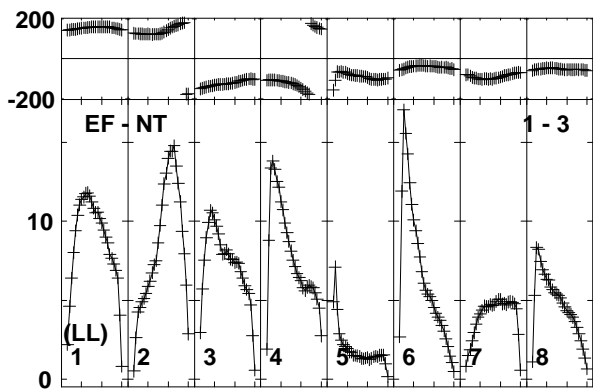
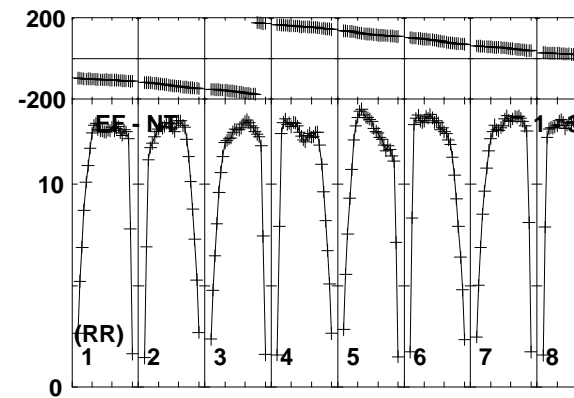
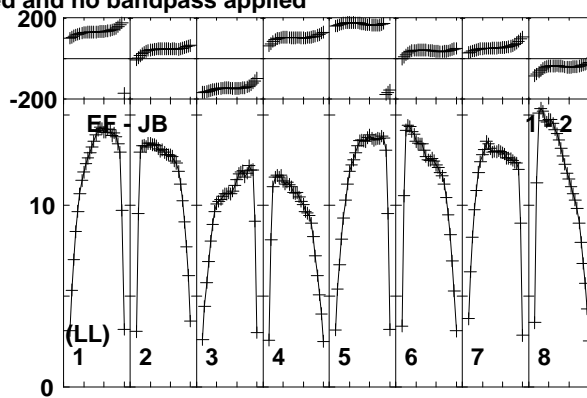
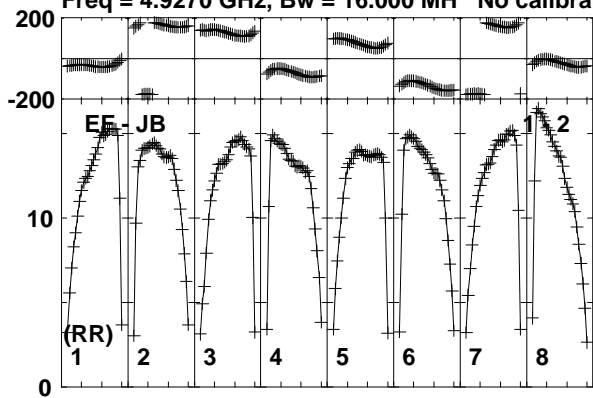

Lower frame: Milli Ampl Jy Top frame: Phas deg
Vector averaged cross-power spectrum Baseline: EF (01) - JB (02)
Timerange: 01/02:02:33 to 01/02:03:59

Plot file version 190 created 26-MAR-2015 15:27:45

J1038+0512 EG082E.UVDATA.1

Freq = 4.9270 GHz, Bw = 16.000 MH No calibration applied and no bandpass applied

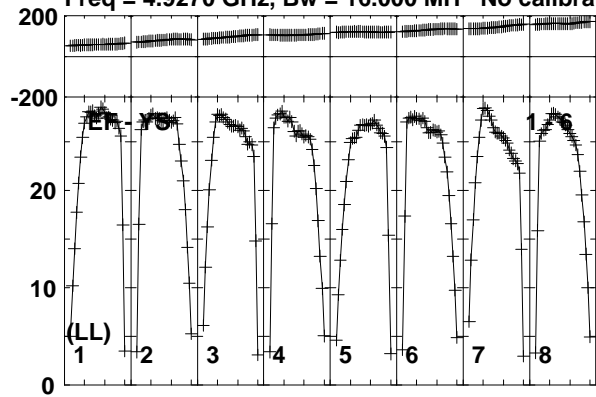

Lower frame: Milli Ampl Jy Top frame: Phas deg
Vector averaged cross-power spectrum Baseline: EF (01) - YS (06)
Timerange: 01/02:02:33 to 01/02:03:59

Plot file version 191 created 26-MAR-2015 15:27:45

J1035+0522 EG082E.UVDATA.1

Freq = 4.9270 GHz, Bw = 16.000 MH No calibration applied and no bandpass applied

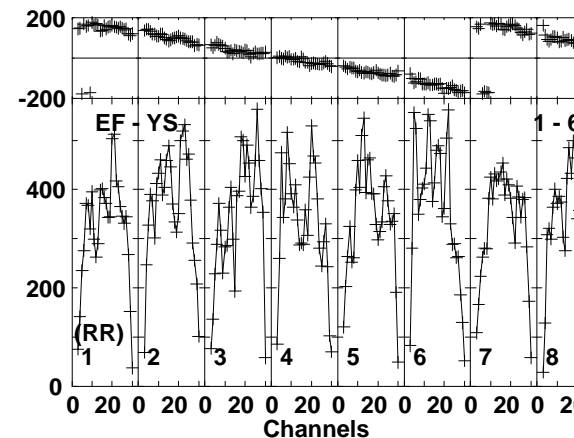
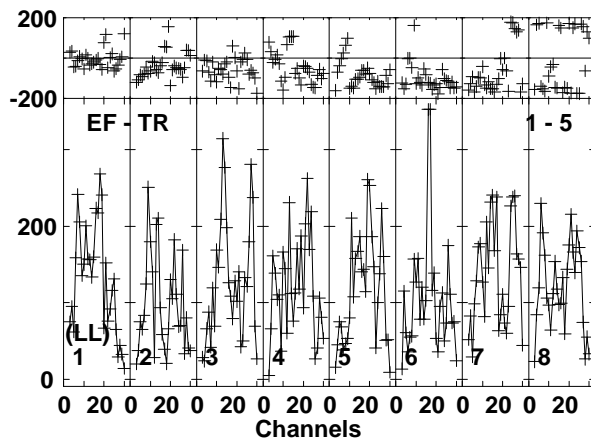
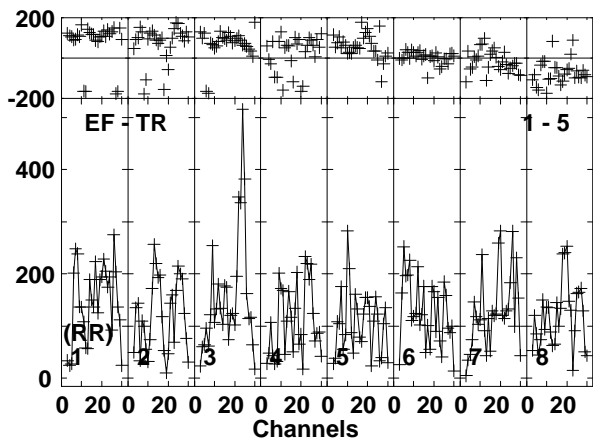
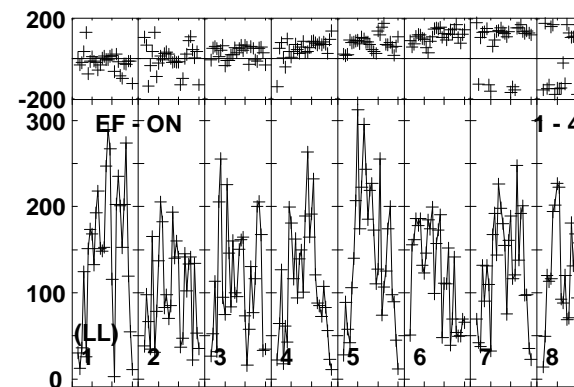
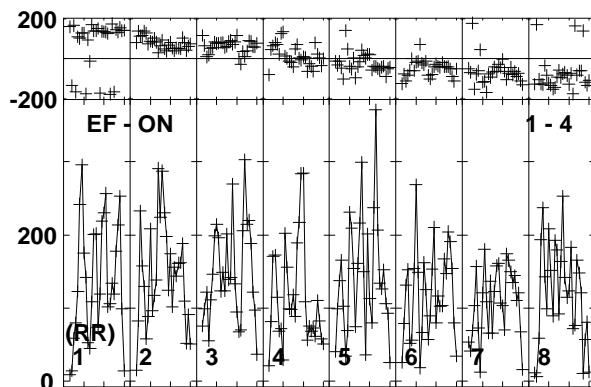
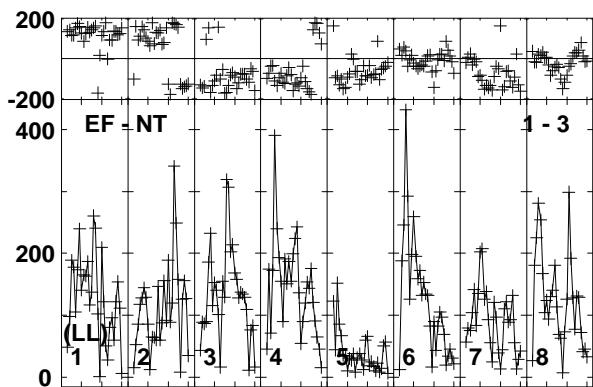
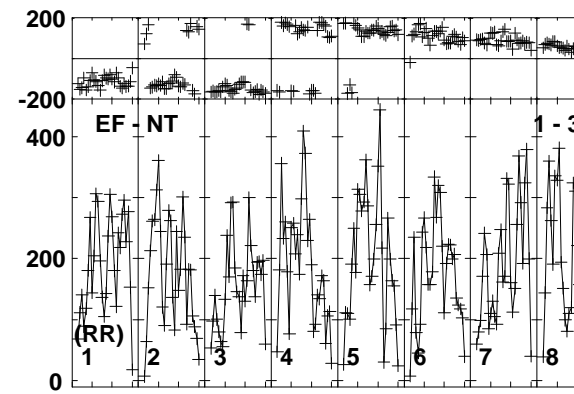
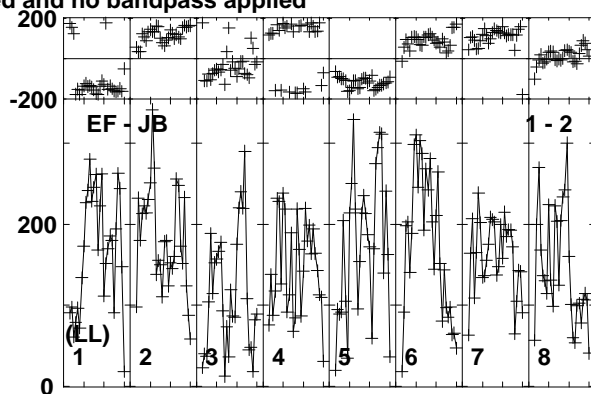
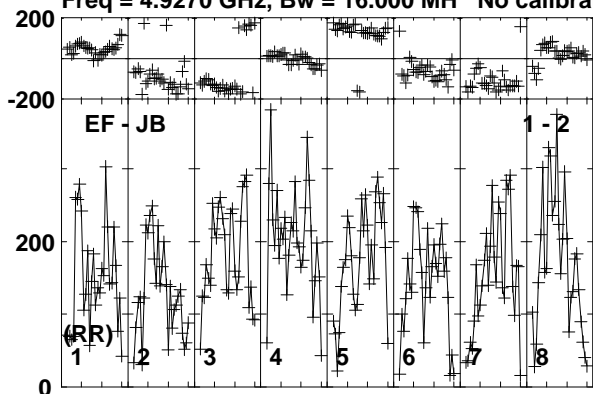

Lower frame: Micro Ampl Jy Top frame: Phas deg
Vector averaged cross-power spectrum Baseline: EF (01) - JB (02)
Timerange: 01/02:04:03 to 01/02:07:29

Plot file version 192 created 26-MAR-2015 15:27:46

J1035+0522 EG082E.UVDATA.1

Freq = 4.9270 GHz, Bw = 16.000 MH No calibration applied and no bandpass applied

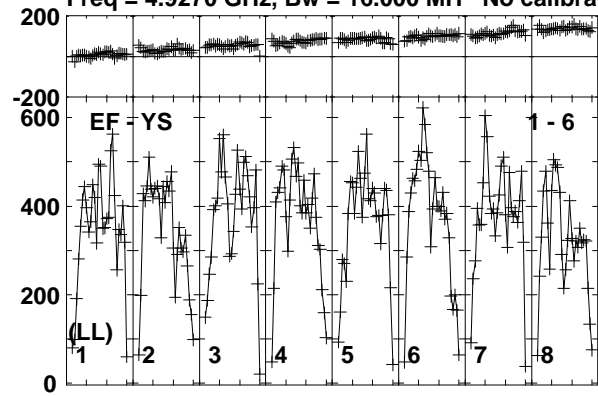

Lower frame: Micro Ampl Jy Top frame: Phas deg
Vector averaged cross-power spectrum Baseline: EF (01) - YS (06)
Timerange: 01/02:04:03 to 01/02:07:29

Plot file version 193 created 26-MAR-2015 15:27:46

J1038+0512 EG082E.UVDATA.1

Freq = 4.9270 GHz, Bw = 16.000 MH No calibration applied and no bandpass applied

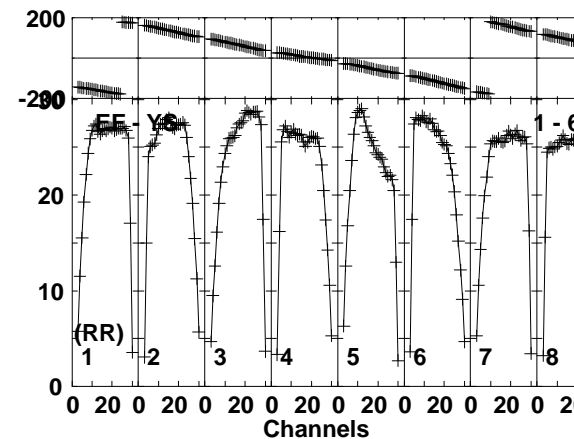
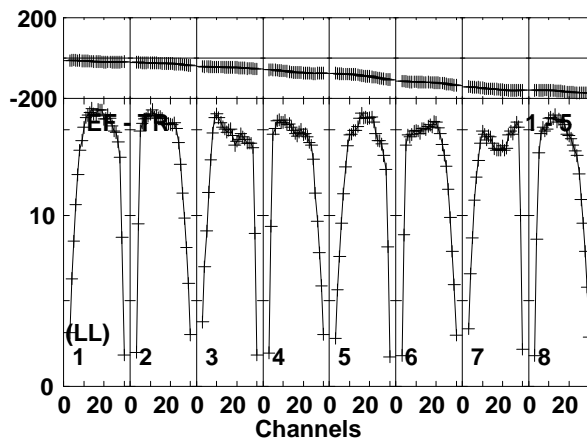
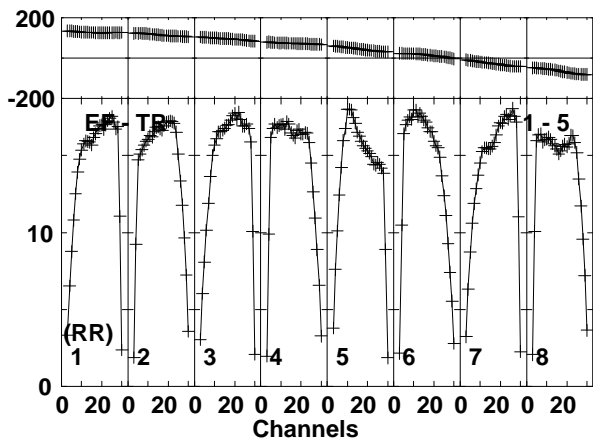
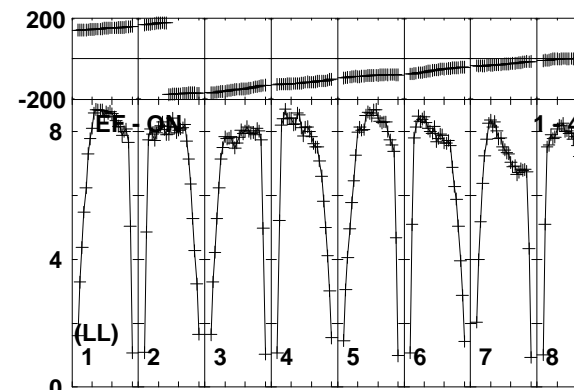
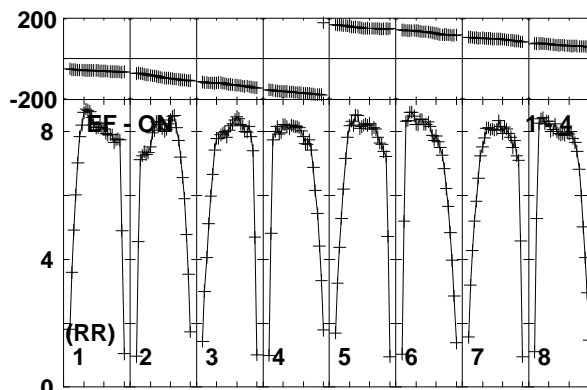
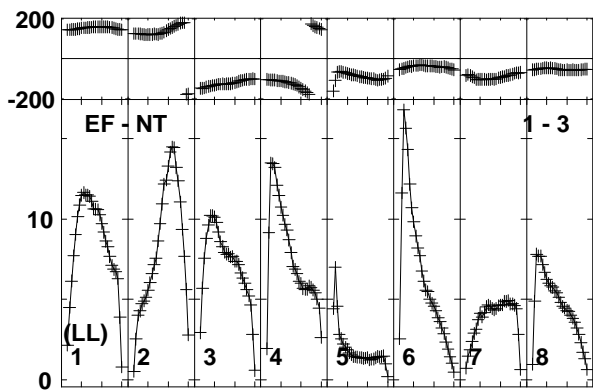
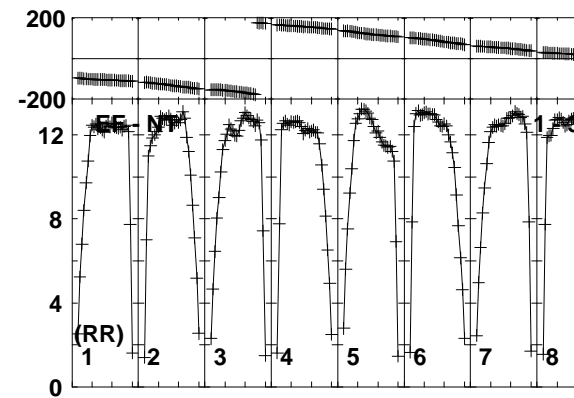
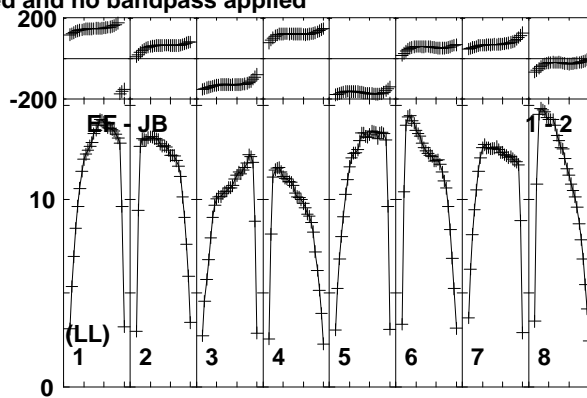
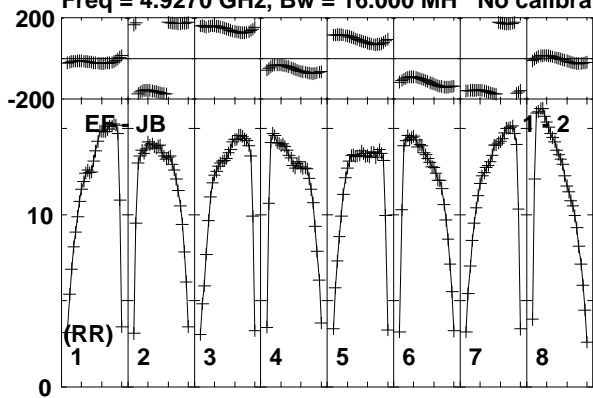

Lower frame: Milli Ampl Jy Top frame: Phas deg
Vector averaged cross-power spectrum Baseline: EF (01) - JB (02)
Timerange: 01/02:08:03 to 01/02:08:59

Plot file version 194 created 26-MAR-2015 15:27:46
J1038+0512 EG082E.UVDATA.1
Freq = 4.9270 GHz, Bw = 16.000 MH No calibration applied and no bandpass applied

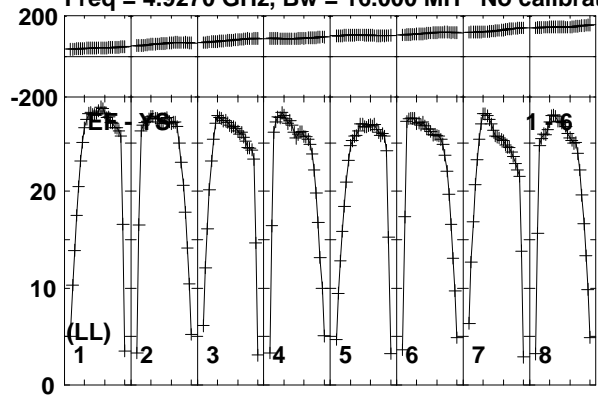

Lower frame: Milli Ampl Jy Top frame: Phas deg
Vector averaged cross-power spectrum Baseline: EF (01) - YS (06)
Timerange: 01/02:08:03 to 01/02:08:59

Plot file version 195 created 26-MAR-2015 15:27:46

RYSEX EG082E.UVDATA.1

Freq = 4.9270 GHz, Bw = 16.000 MH No calibration applied and no bandpass applied

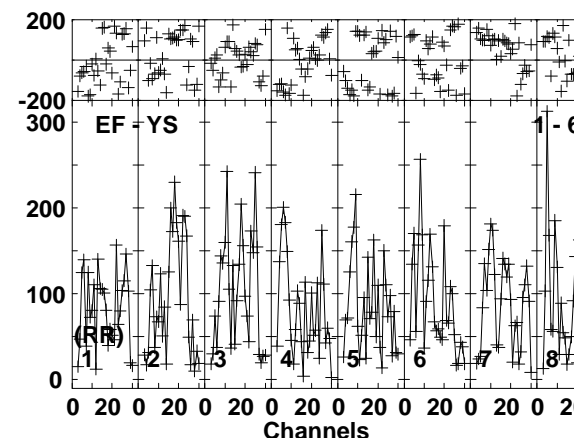
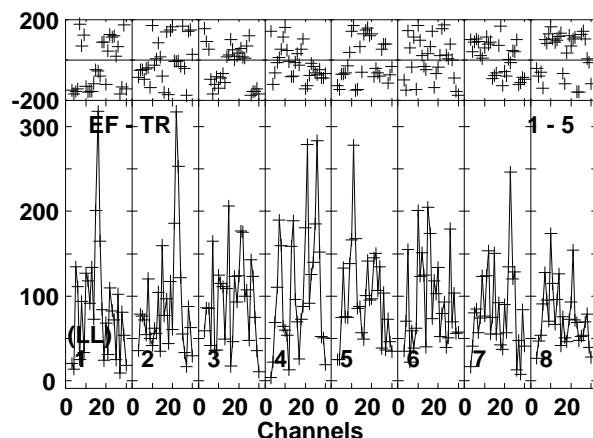
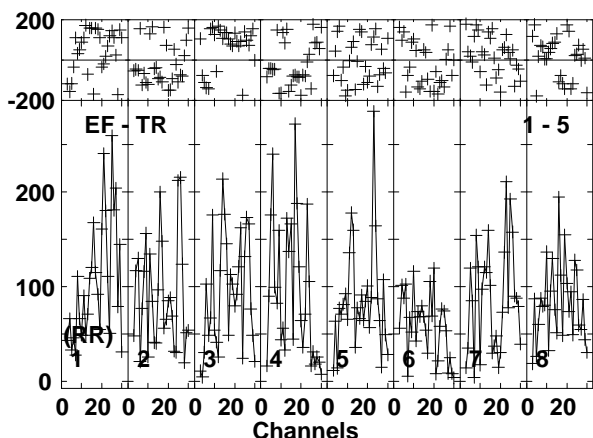
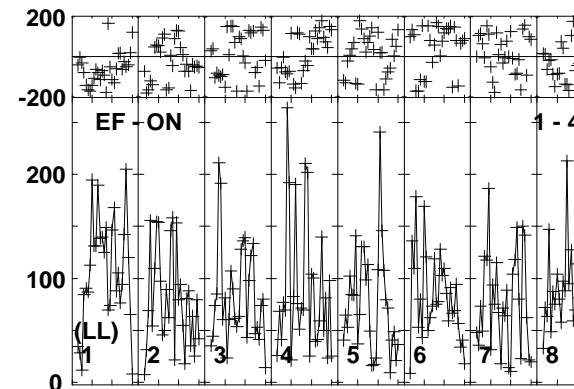
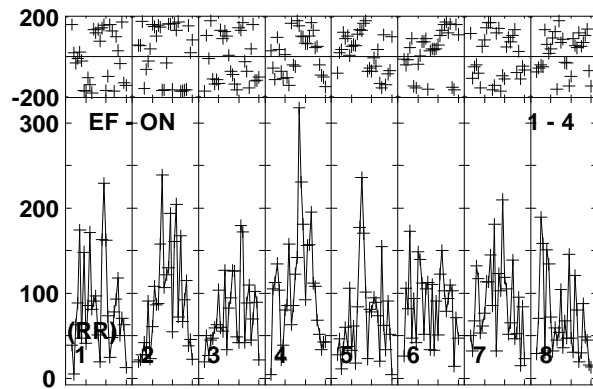
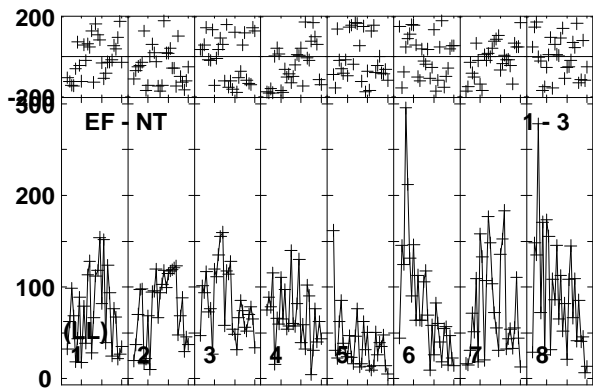
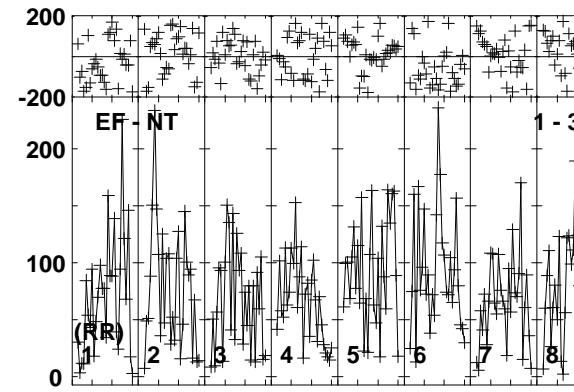
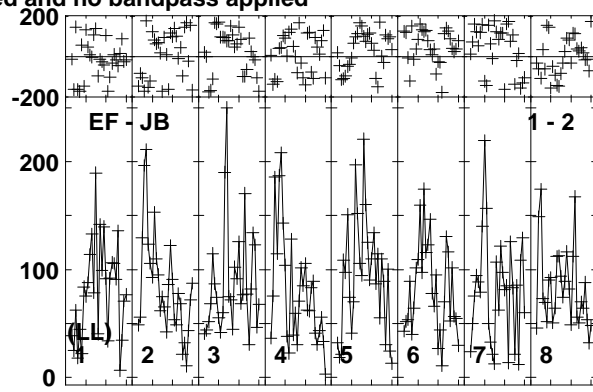
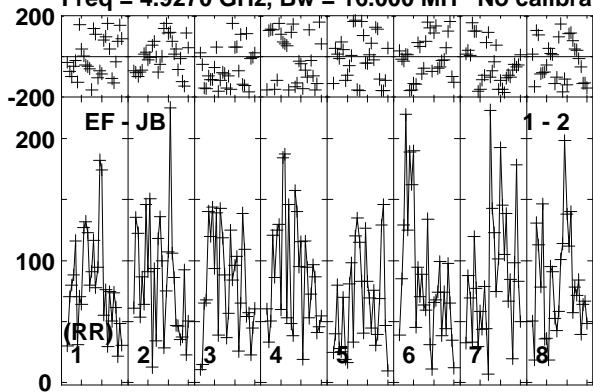

Lower frame: Micro Ampl Jy Top frame: Phas deg
Vector averaged cross-power spectrum Baseline: EF (01) - JB (02)
Timerange: 01/02:09:03 to 01/02:12:29

Plot file version 196 created 26-MAR-2015 15:27:46

RYSEX EG082E.UVDATA.1

Freq = 4.9270 GHz, Bw = 16.000 MH No calibration applied and no bandpass applied

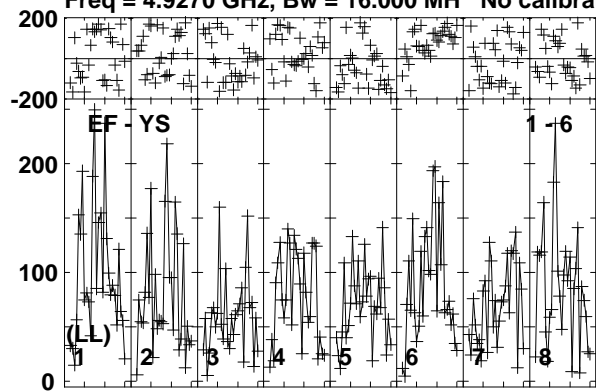

Lower frame: Micro Ampl Jy Top frame: Phas deg
Vector averaged cross-power spectrum Baseline: EF (01) - YS (06)
Timerange: 01/02:09:03 to 01/02:12:29

Plot file version 197 created 26-MAR-2015 15:27:46

J1038+0512 EG082E.UVDATA.1

Freq = 4.9270 GHz, Bw = 16.000 MH No calibration applied and no bandpass applied

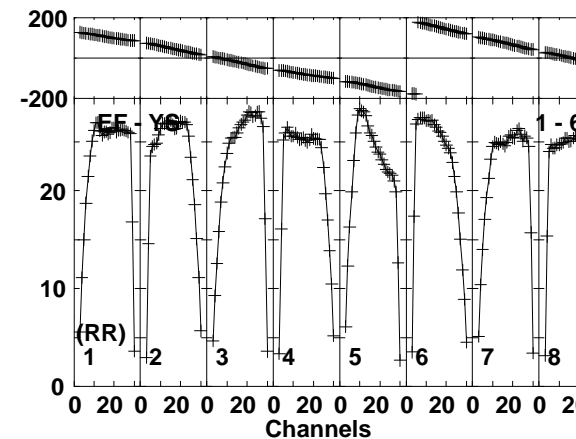
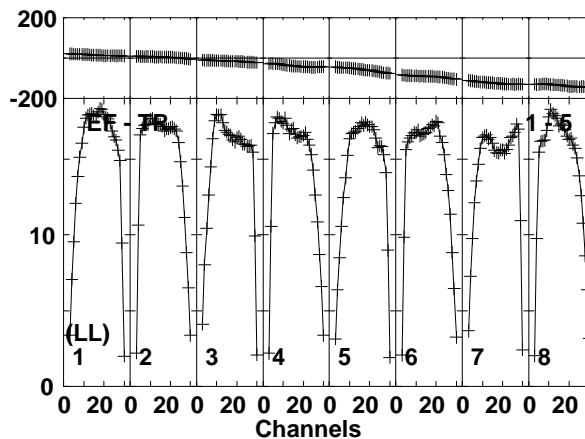
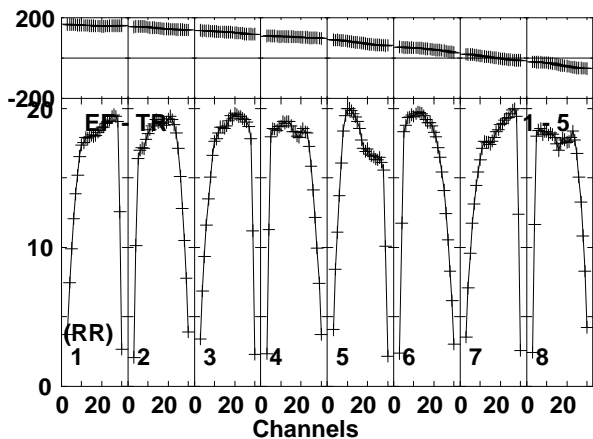
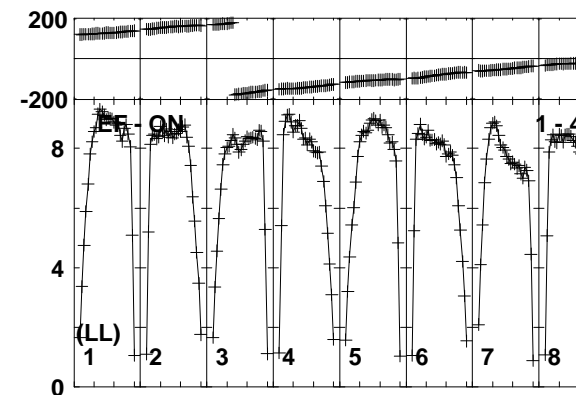
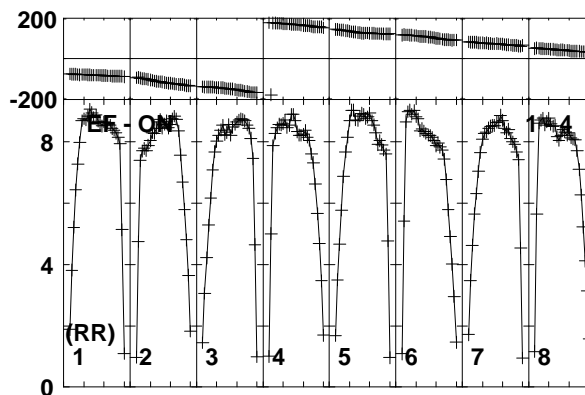
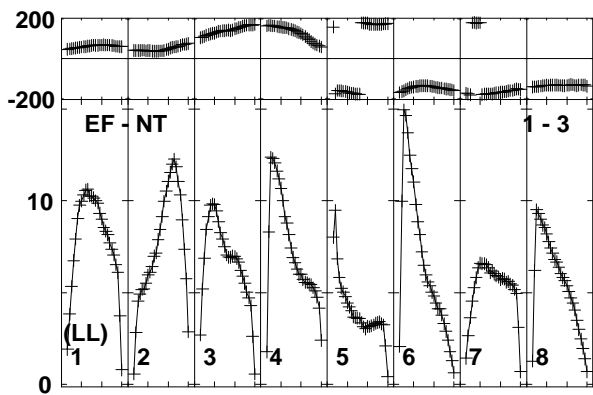
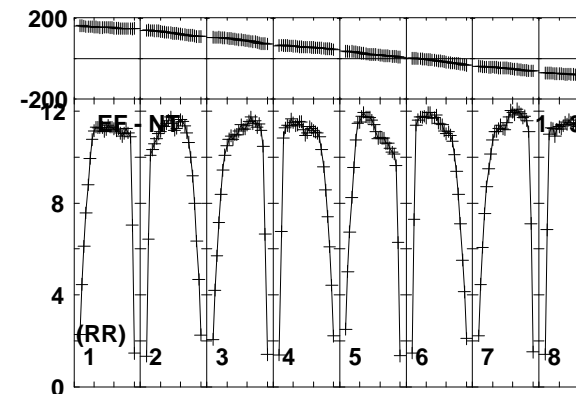
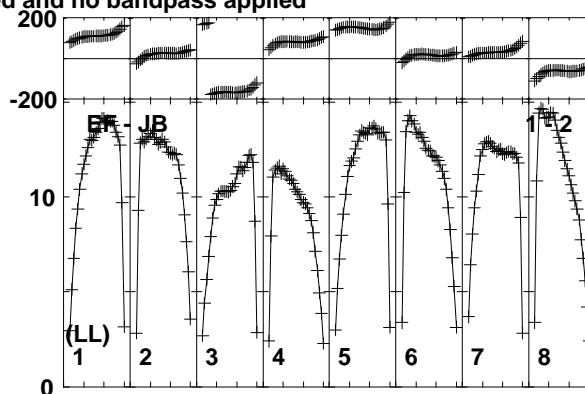
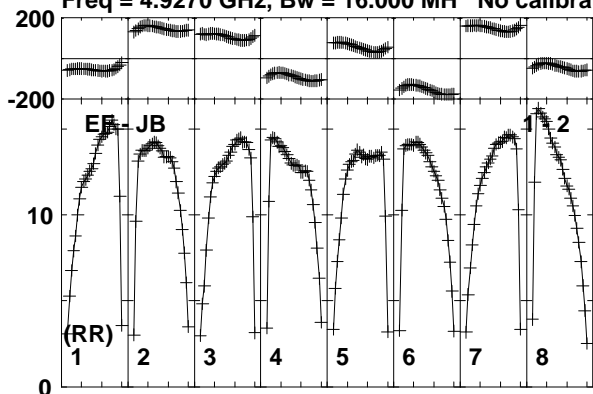

Lower frame: Milli Ampl Jy Top frame: Phas deg
Vector averaged cross-power spectrum Baseline: EF (01) - JB (02)
Timerange: 01/02:12:33 to 01/02:13:59

Plot file version 198 created 26-MAR-2015 15:27:46
J1038+0512 EG082E.UVDATA.1
Freq = 4.9270 GHz, Bw = 16.000 MH No calibration applied and no bandpass applied

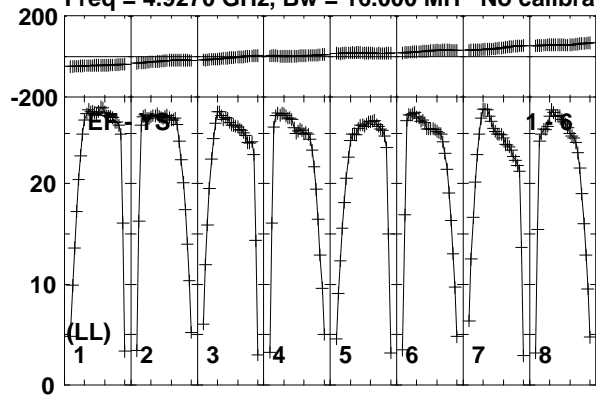

Lower frame: Milli Ampl Jy Top frame: Phas deg
Vector averaged cross-power spectrum Baseline: EF (01) - YS (06)
Timerange: 01/02:12:33 to 01/02:13:59

Plot file version 200 created 26-MAR-2015 15:27:46

RYSEX EG082E.UVDATA.1

Freq = 4.9270 GHz, Bw = 16.000 MH No calibration applied and no bandpass applied

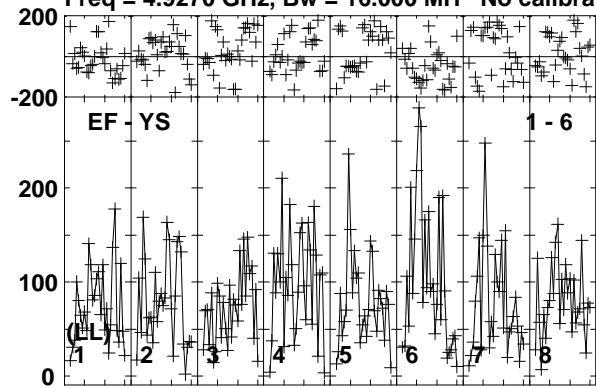

Lower frame: Micro Ampl Jy Top frame: Phas deg
Vector averaged cross-power spectrum Baseline: EF (01) - YS (06)
Timerange: 01/02:14:03 to 01/02:17:29

Plot file version 201 created 26-MAR-2015 15:27:46

J1038+0512 EG082E.UVDATA.1

Freq = 4.9270 GHz, Bw = 16.000 MH No calibration applied and no bandpass applied

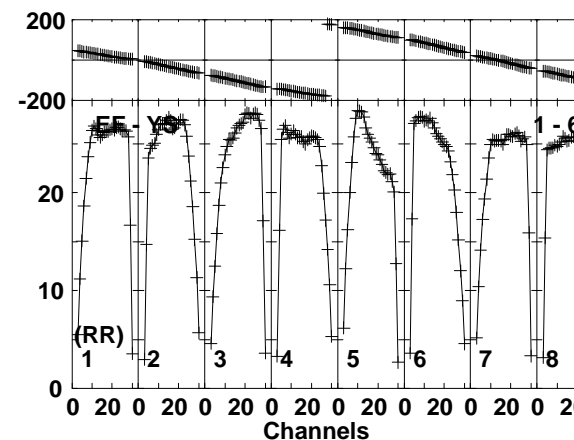
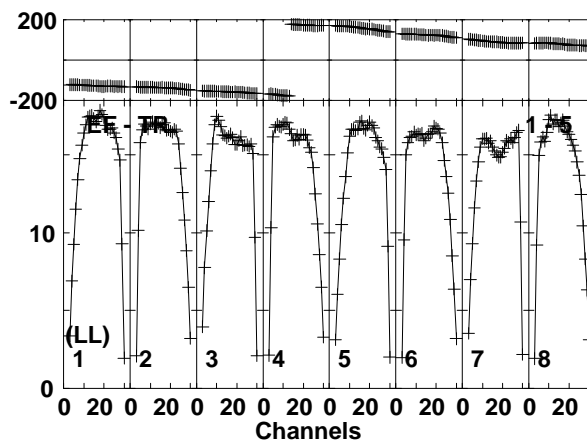
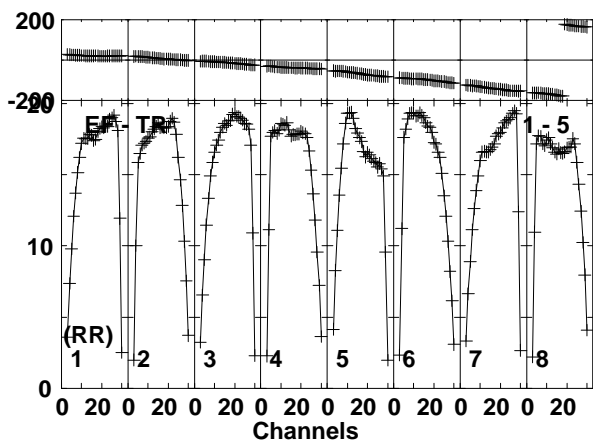
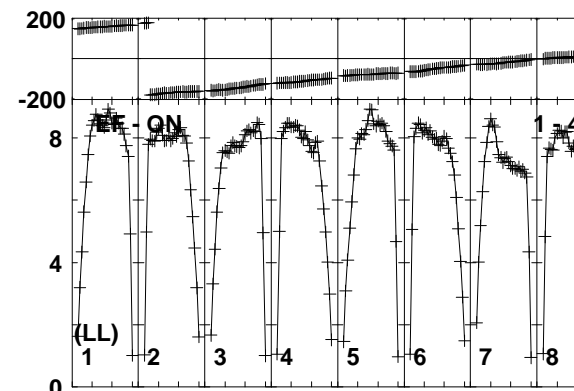
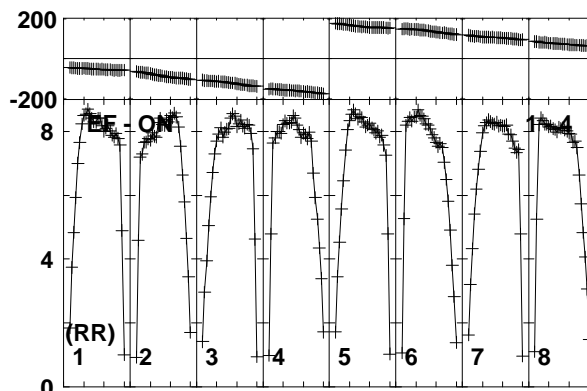
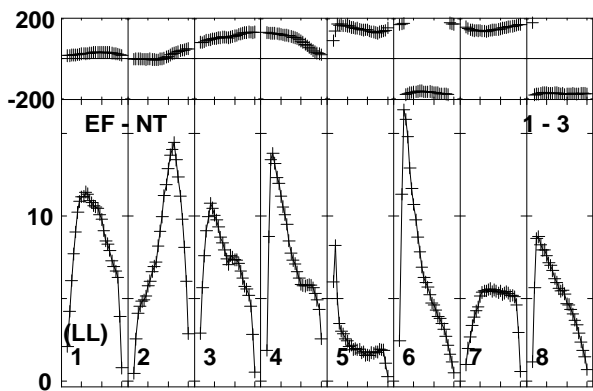
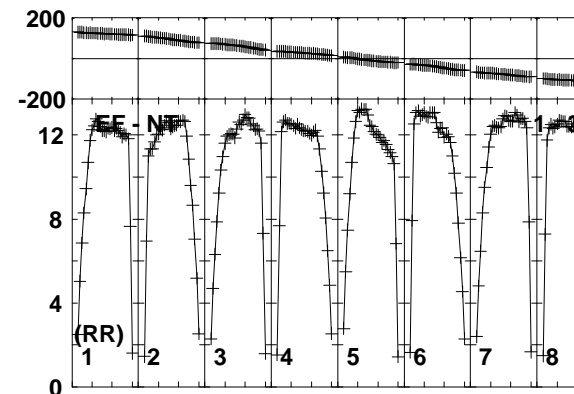
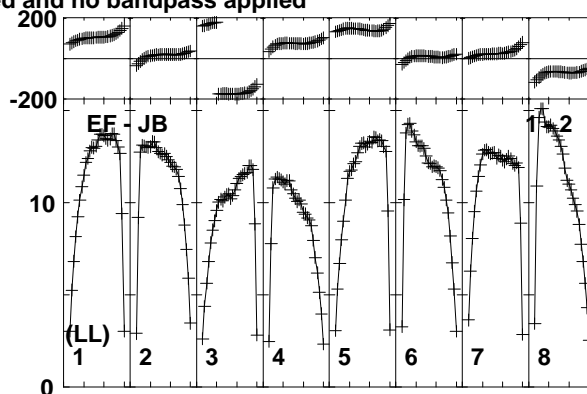
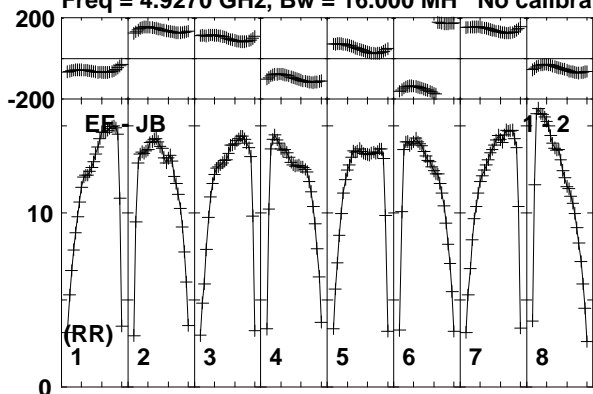

Lower frame: Milli Ampl Jy Top frame: Phas deg
Vector averaged cross-power spectrum Baseline: EF (01) - JB (02)
Timerange: 01/02:18:03 to 01/02:18:59

Plot file version 202 created 26-MAR-2015 15:27:46
J1038+0512 EG082E.UVDATA.1
Freq = 4.9270 GHz, Bw = 16.000 MH No calibration applied and no bandpass applied

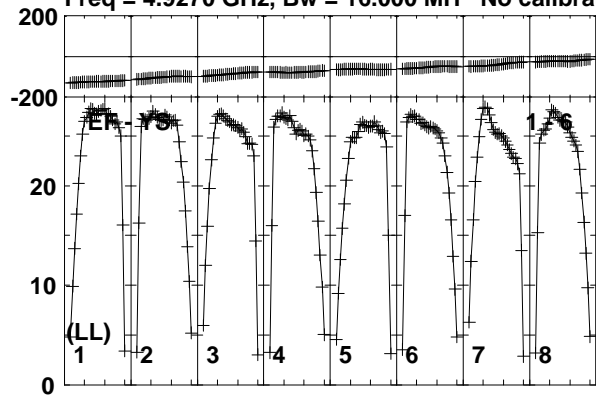

Lower frame: Milli Ampl Jy Top frame: Phas deg
Vector averaged cross-power spectrum Baseline: EF (01) - YS (06)
Timerange: 01/02:18:03 to 01/02:18:59

Plot file version 203 created 26-MAR-2015 15:27:46

RYSEX EG082E.UVDATA.1

Freq = 4.9270 GHz, Bw = 16.000 MH No calibration applied and no bandpass applied

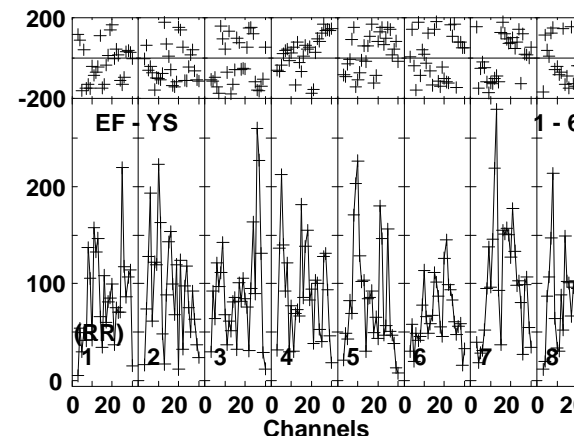
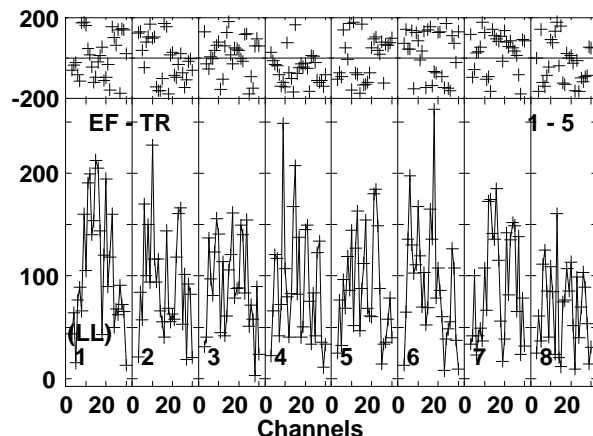
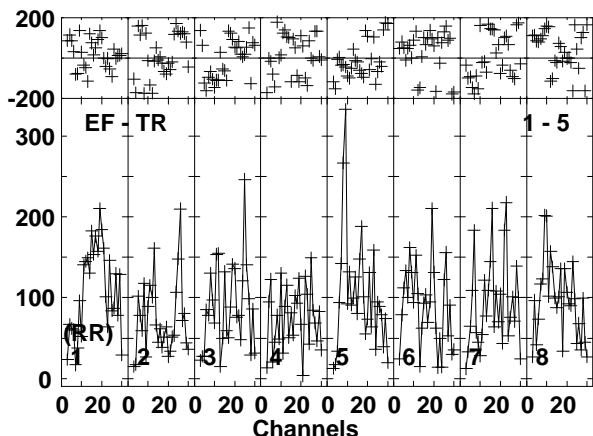
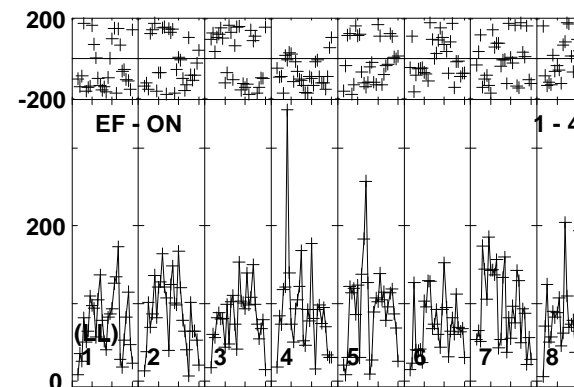
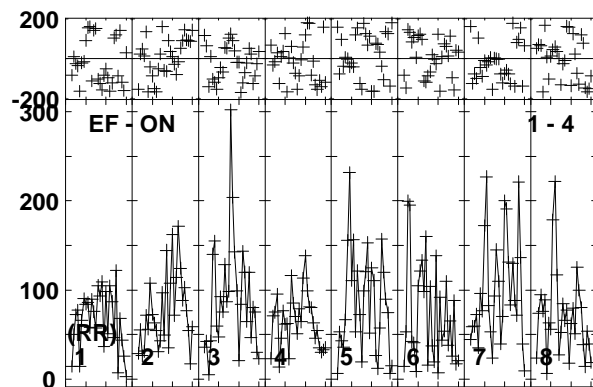
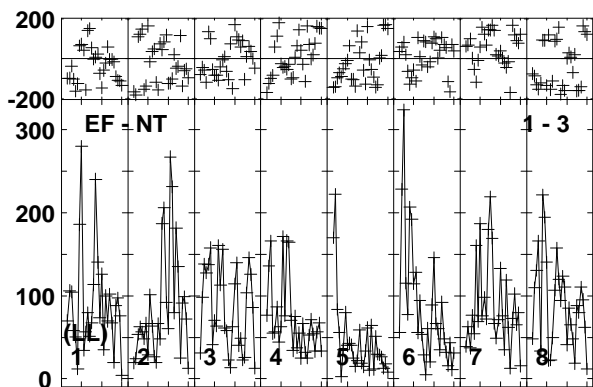
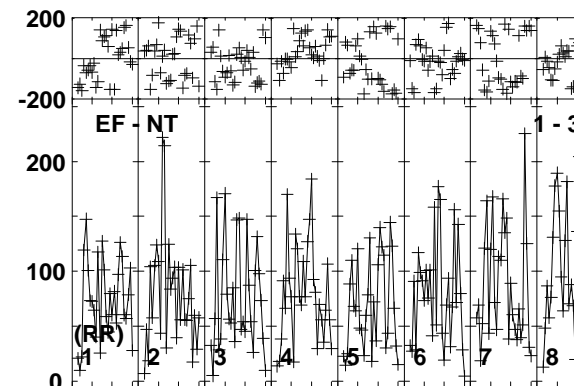
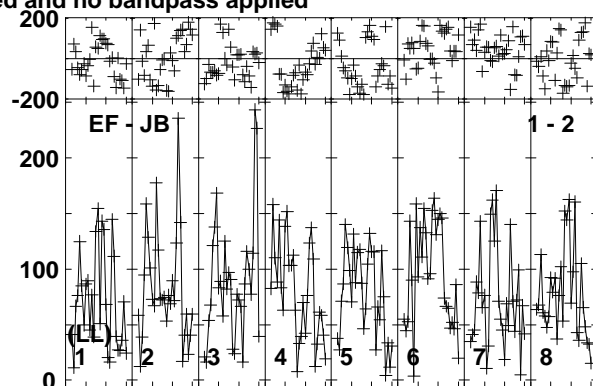
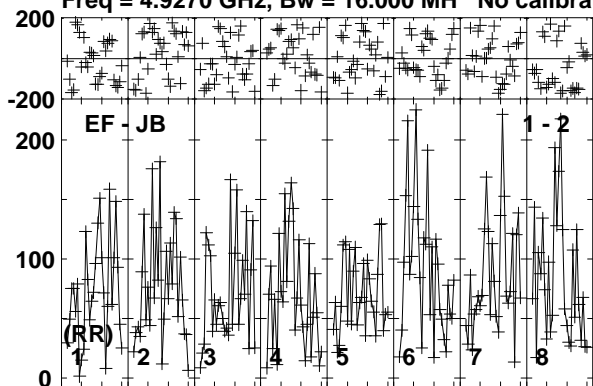

Lower frame: Micro Ampl Jy Top frame: Phas deg
Vector averaged cross-power spectrum Baseline: EF (01) - JB (02)
Timerange: 01/02:19:03 to 01/02:22:29

Plot file version 204 created 26-MAR-2015 15:27:46

RYSEX EG082E.UVDATA.1

Freq = 4.9270 GHz, Bw = 16.000 MH No calibration applied and no bandpass applied

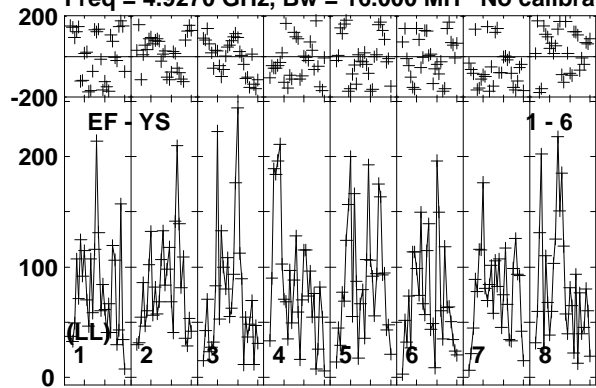

Lower frame: Micro Ampl Jy Top frame: Phas deg
Vector averaged cross-power spectrum Baseline: EF (01) - YS (06)
Timerange: 01/02:19:03 to 01/02:22:29

Plot file version 205 created 26-MAR-2015 15:27:46

J1038+0512 EG082E.UVDATA.1

Freq = 4.9270 GHz, Bw = 16.000 MH No calibration applied and no bandpass applied

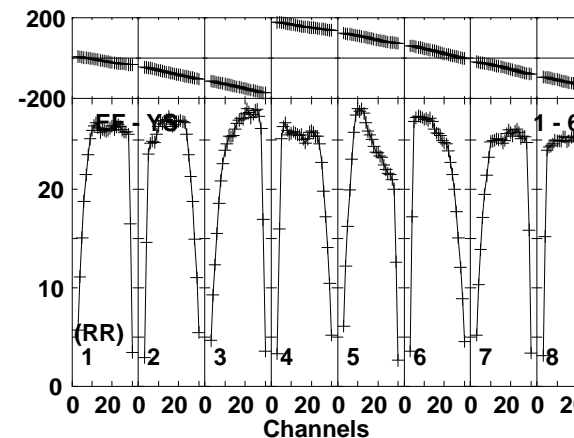
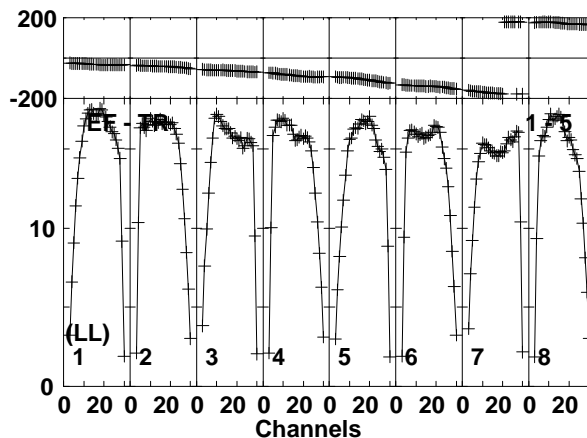
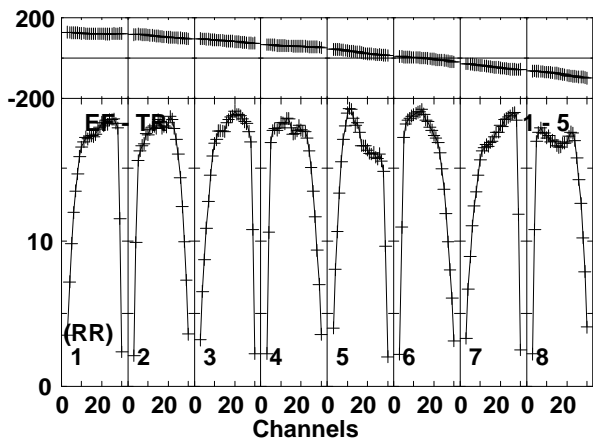
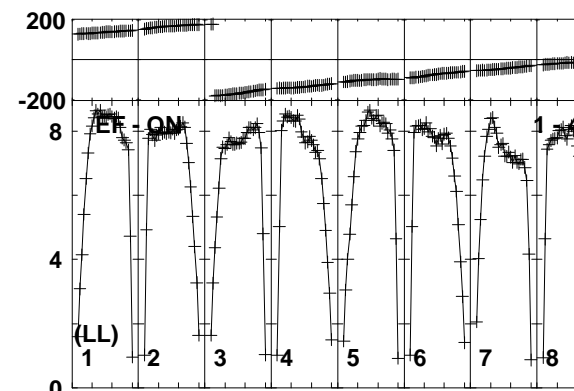
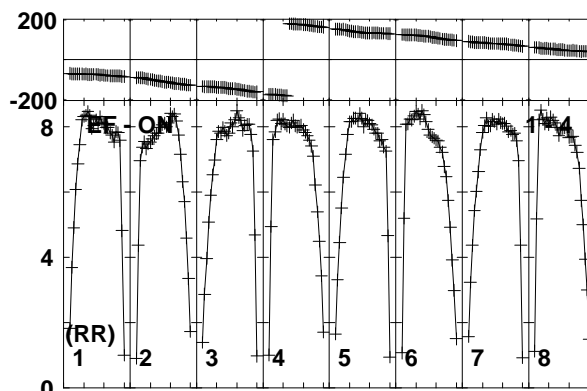
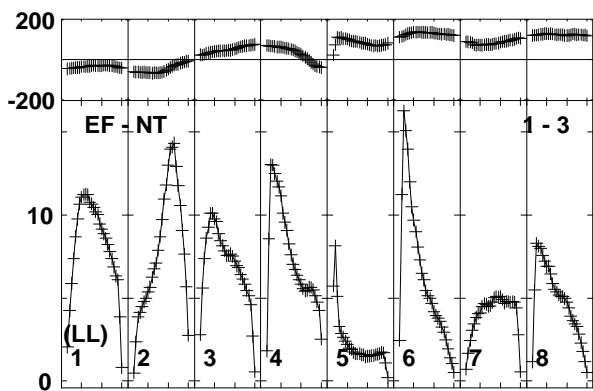
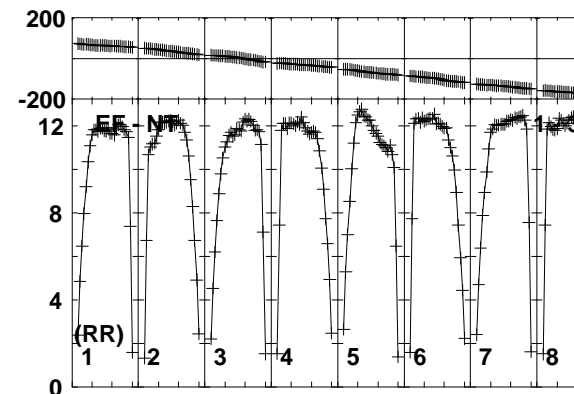
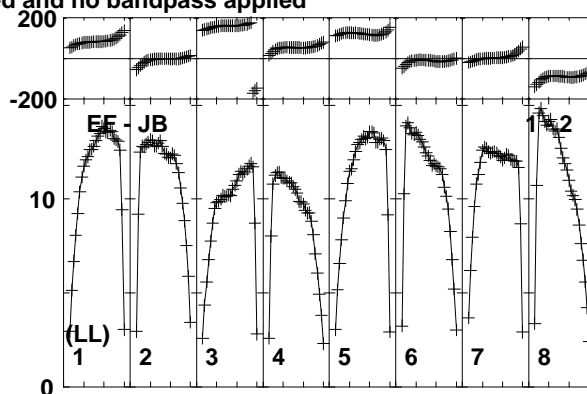
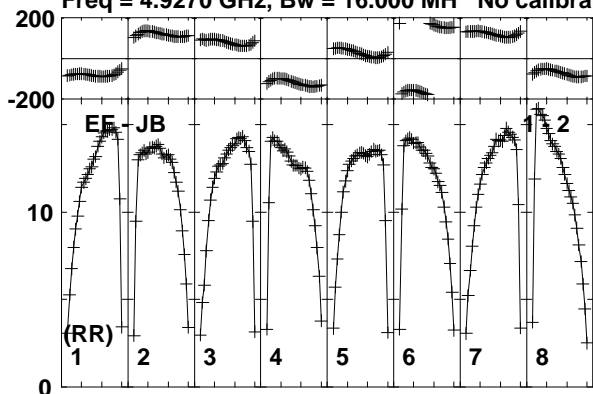

Lower frame: Milli Ampl Jy Top frame: Phas deg
Vector averaged cross-power spectrum Baseline: EF (01) - JB (02)
Timerange: 01/02:22:33 to 01/02:23:59

Plot file version 206 created 26-MAR-2015 15:27:46

J1038+0512 EG082E.UVDATA.1

Freq = 4.9270 GHz, Bw = 16.000 MH No calibration applied and no bandpass applied

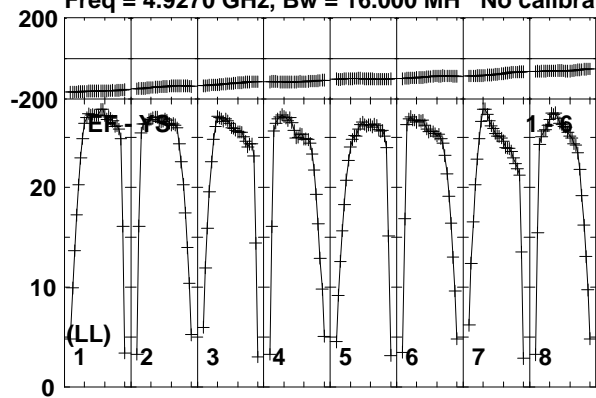

Lower frame: Milli Ampl Jy Top frame: Phas deg
Vector averaged cross-power spectrum Baseline: EF (01) - YS (06)
Timerange: 01/02:22:33 to 01/02:23:59

Plot file version 207 created 26-MAR-2015 15:27:46

RYSEX EG082E.UVDATA.1

Freq = 4.9270 GHz, Bw = 16.000 MH No calibration applied and no bandpass applied

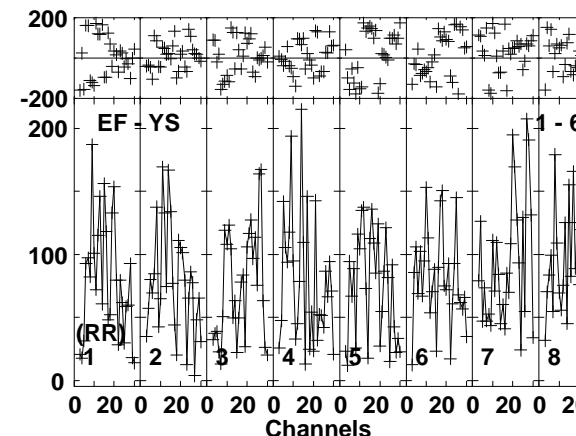
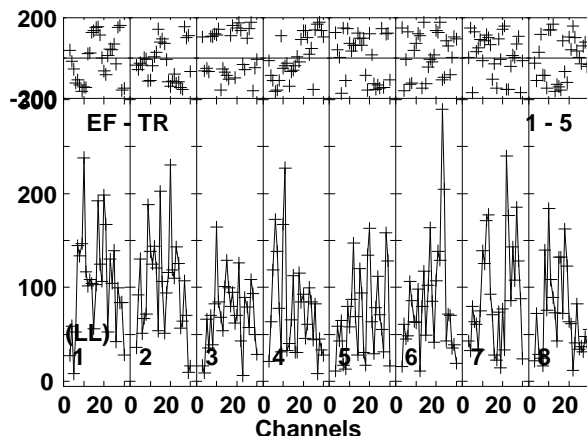
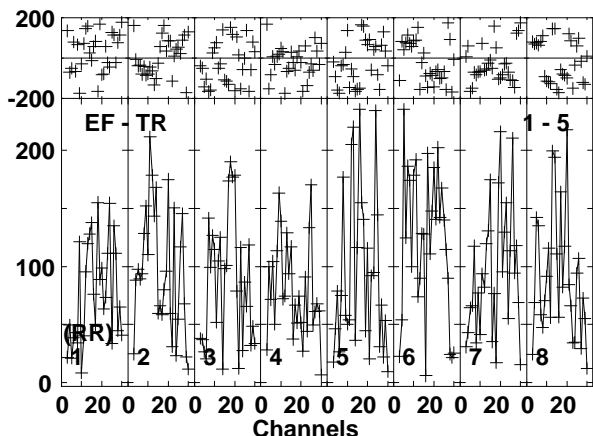
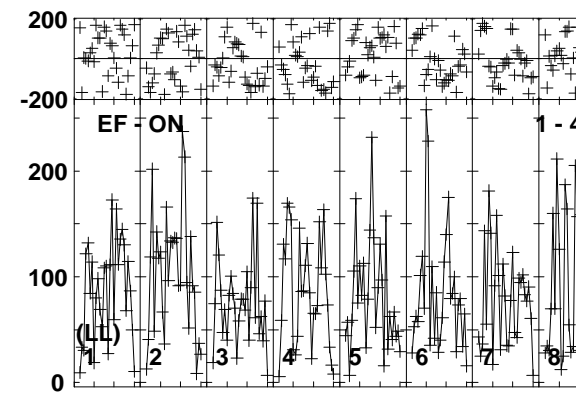
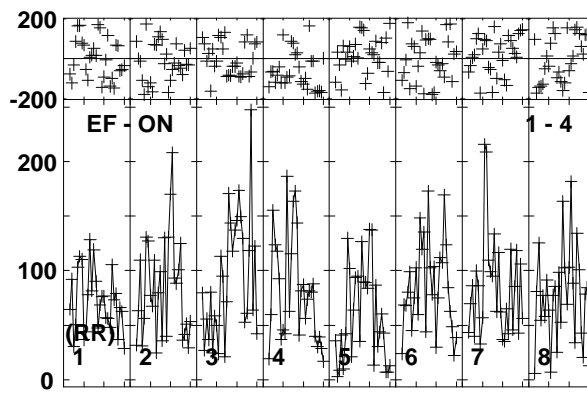
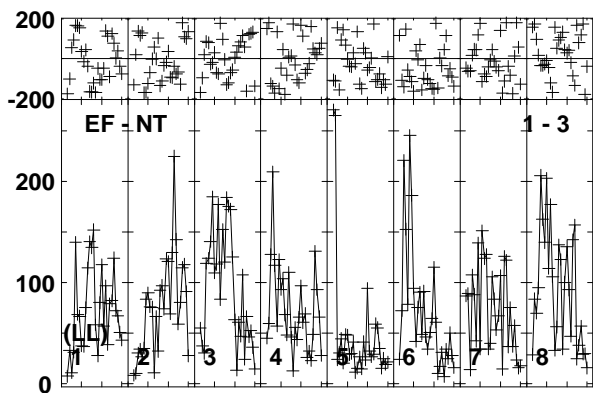
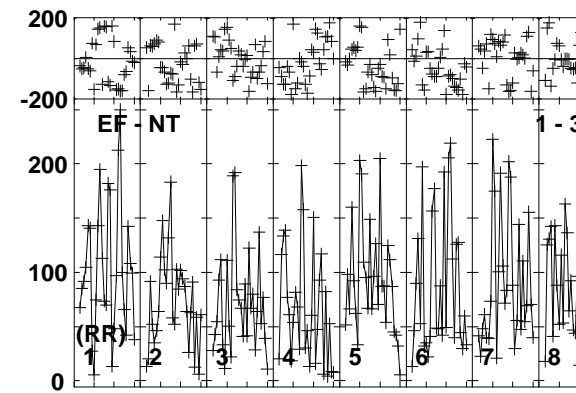
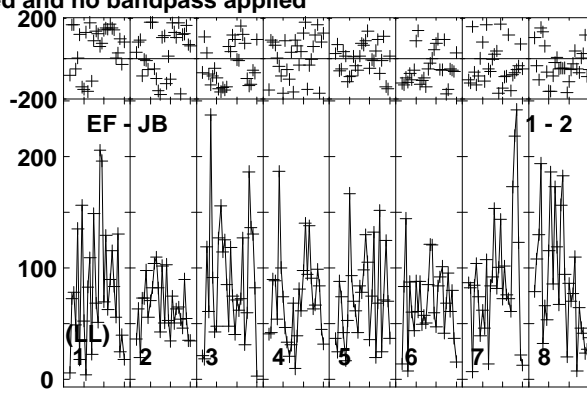
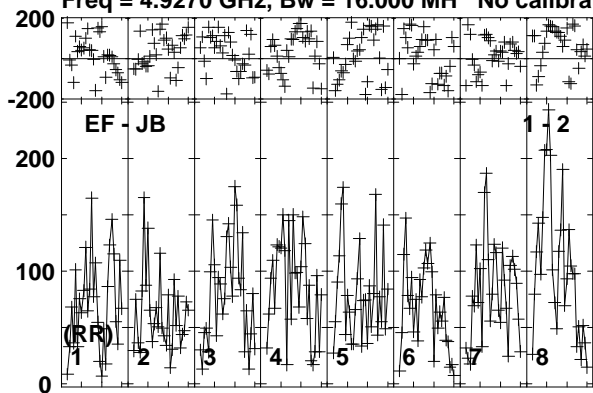

Lower frame: Micro Ampl Jy Top frame: Phas deg
Vector averaged cross-power spectrum Baseline: EF (01) - JB (02)
Timerange: 01/02:24:03 to 01/02:27:29

Plot file version 208 created 26-MAR-2015 15:27:46

RYSEX EG082E.UVDATA.1

Freq = 4.9270 GHz, Bw = 16.000 MH No calibration applied and no bandpass applied

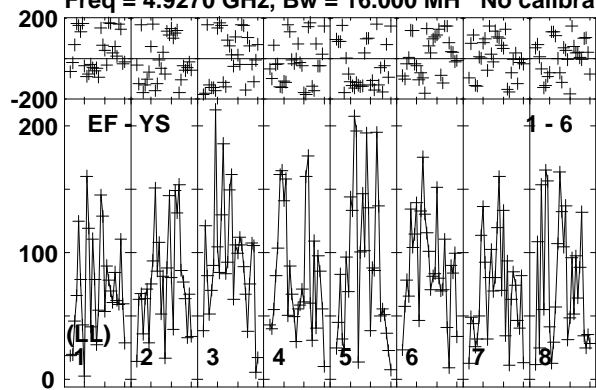

Lower frame: Micro Ampl Jy Top frame: Phas deg
Vector averaged cross-power spectrum Baseline: EF (01) - YS (06)
Timerange: 01/02:24:03 to 01/02:27:29

Plot file version 209 created 26-MAR-2015 15:27:46

J1038+0512 EG082E.UVDATA.1

Freq = 4.9270 GHz, Bw = 16.000 MH No calibration applied and no bandpass applied

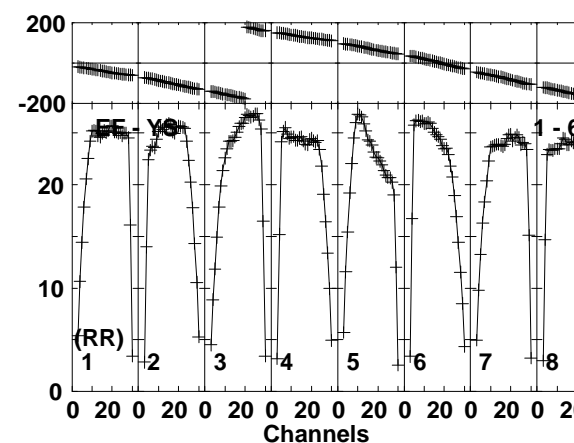
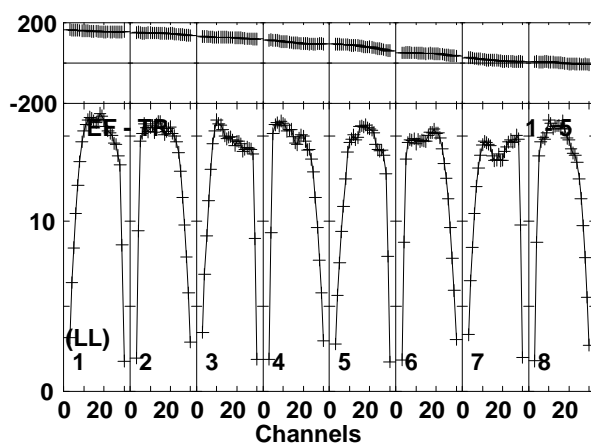
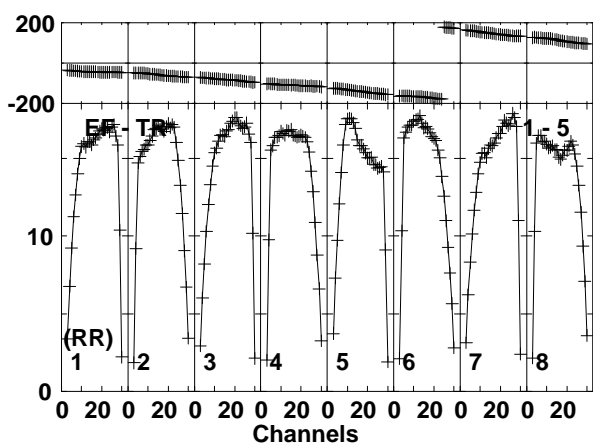
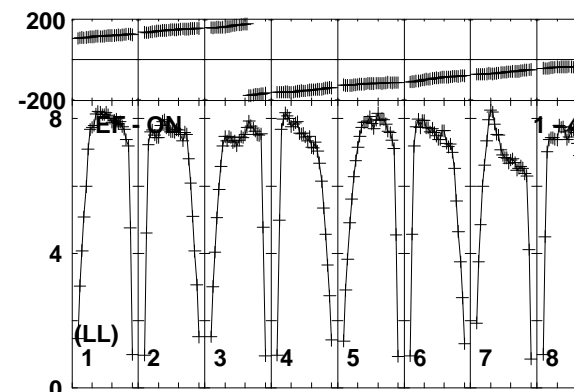
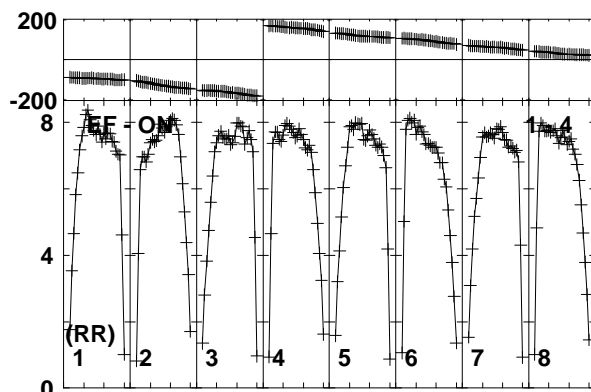
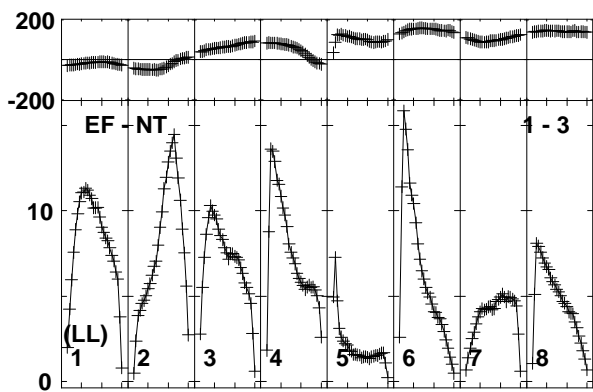
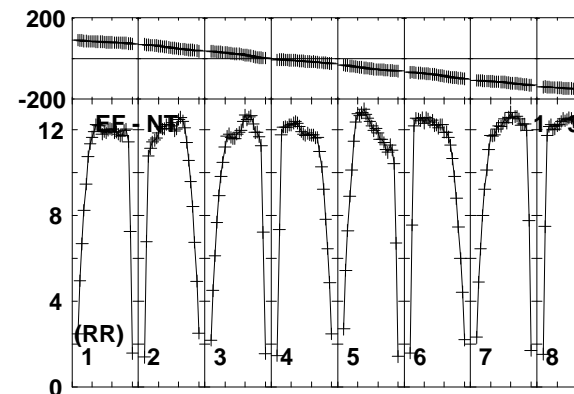
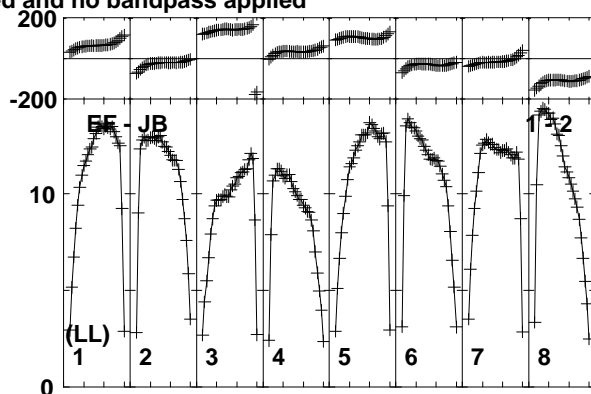
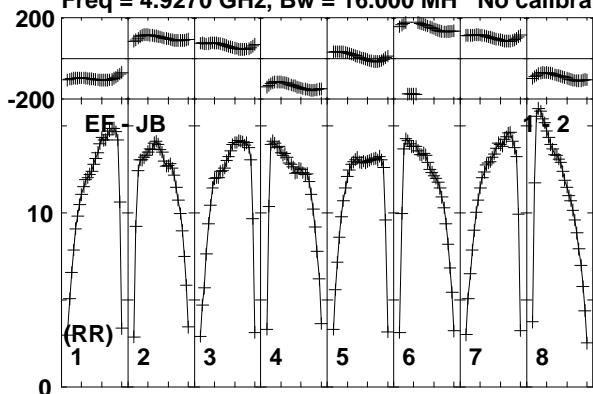

Lower frame: Milli Ampl Jy Top frame: Phas deg
Vector averaged cross-power spectrum Baseline: EF (01) - JB (02)
Timerange: 01/02:28:03 to 01/02:28:59

Plot file version 210 created 26-MAR-2015 15:27:46

J1038+0512 EG082E.UVDATA.1

Freq = 4.9270 GHz, Bw = 16.000 MH No calibration applied and no bandpass applied

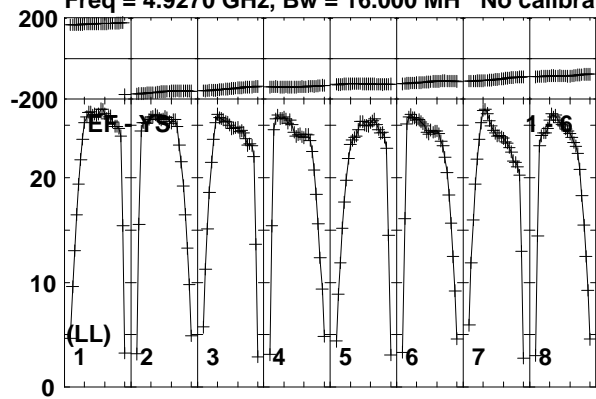

Lower frame: Milli Ampl Jy Top frame: Phas deg
Vector averaged cross-power spectrum Baseline: EF (01) - YS (06)
Timerange: 01/02:28:03 to 01/02:28:59

Plot file version 211 created 26-MAR-2015 15:27:46

RYSEX EG082E.UVDATA.1

Freq = 4.9270 GHz, Bw = 16.000 MH No calibration applied and no bandpass applied

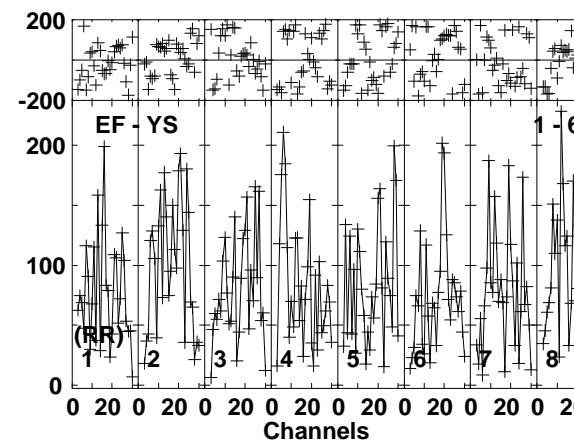
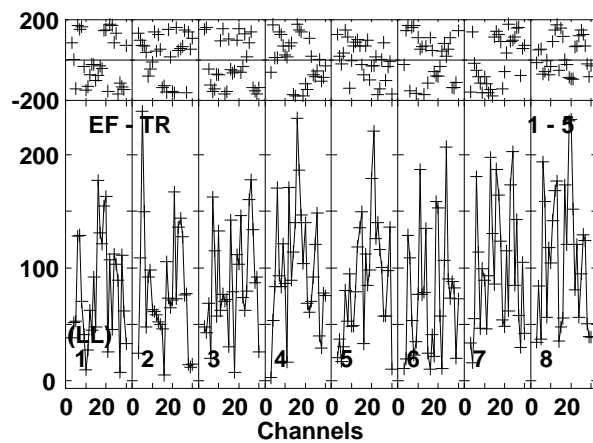
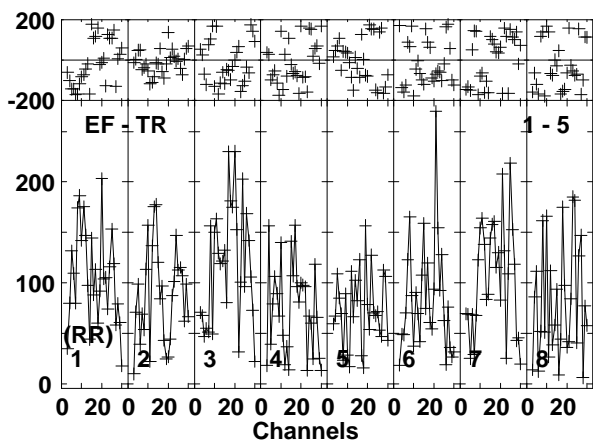
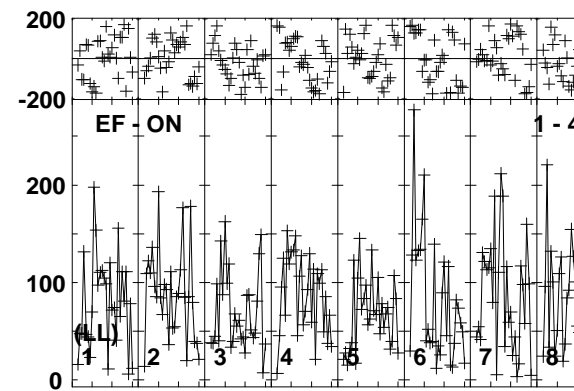
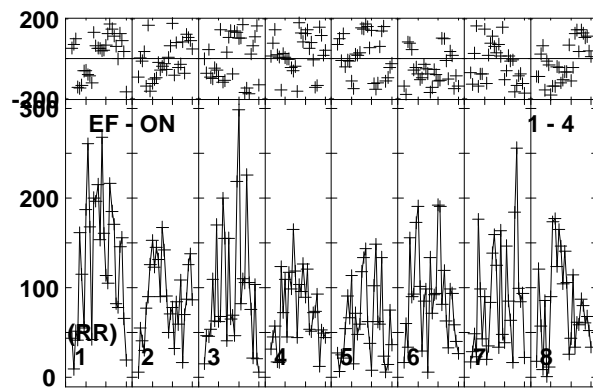
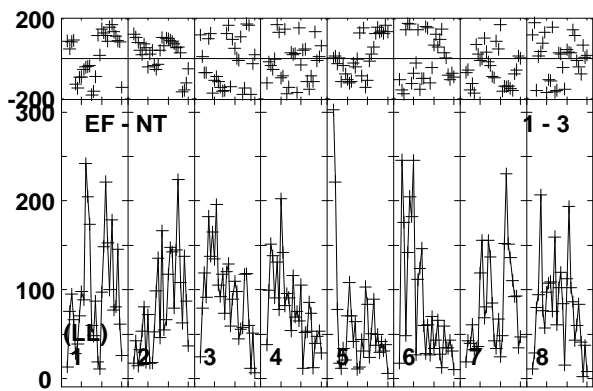
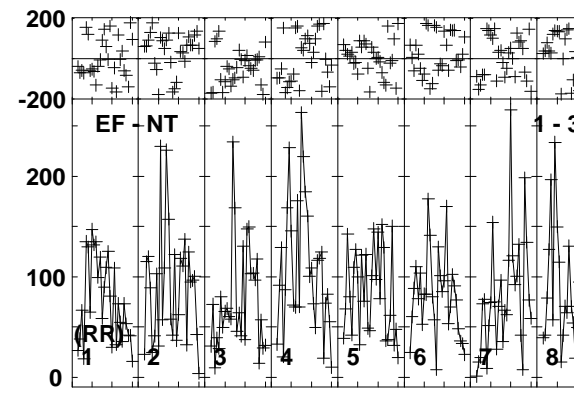
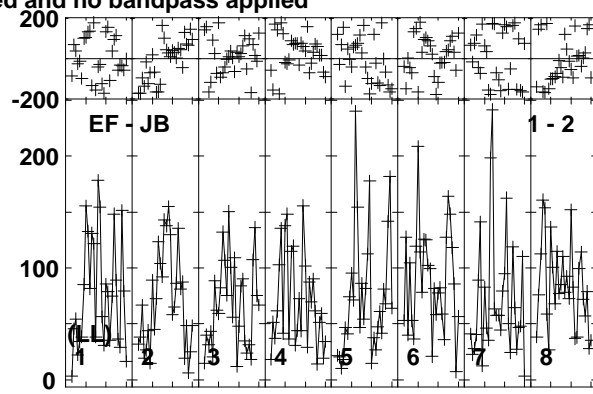
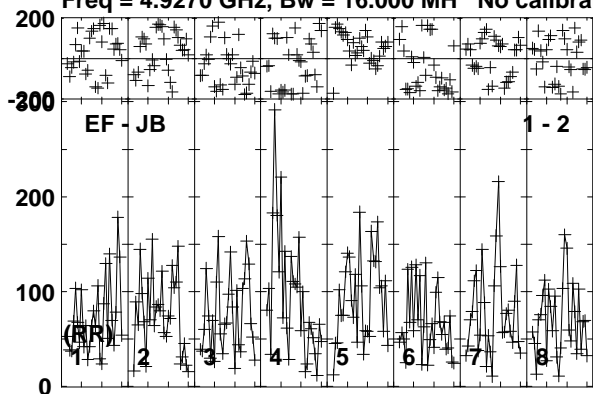

Lower frame: Micro Ampl Jy Top frame: Phas deg
Vector averaged cross-power spectrum Baseline: EF (01) - JB (02)
Timerange: 01/02:29:03 to 01/02:32:29

Plot file version 212 created 26-MAR-2015 15:27:46

RYSEX EG082E.UVDATA.1

Freq = 4.9270 GHz, Bw = 16.000 MH No calibration applied and no bandpass applied

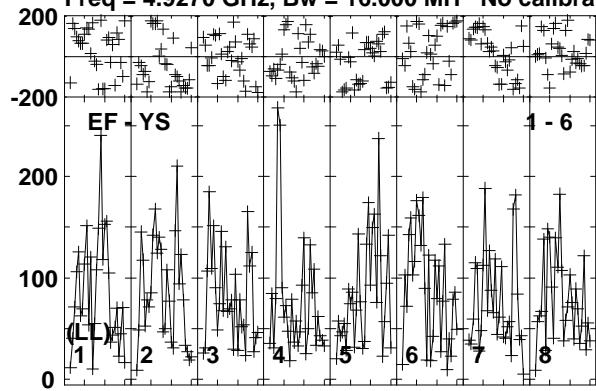

Lower frame: Micro Ampl Jy Top frame: Phas deg
Vector averaged cross-power spectrum Baseline: EF (01) - YS (06)
Timerange: 01/02:29:03 to 01/02:32:29

Plot file version 213 created 26-MAR-2015 15:27:47

J1038+0512 EG082E.UVDATA.1

Freq = 4.9270 GHz, Bw = 16.000 MH No calibration applied and no bandpass applied

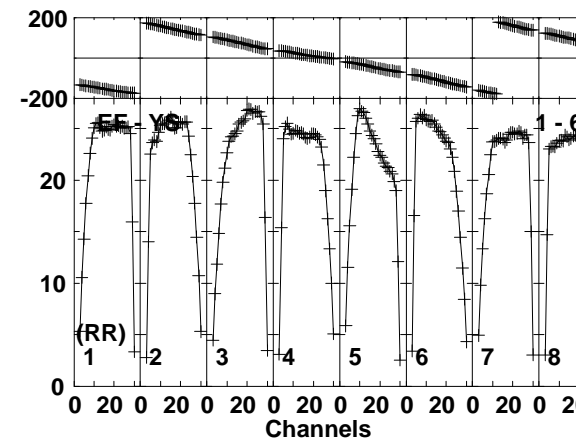
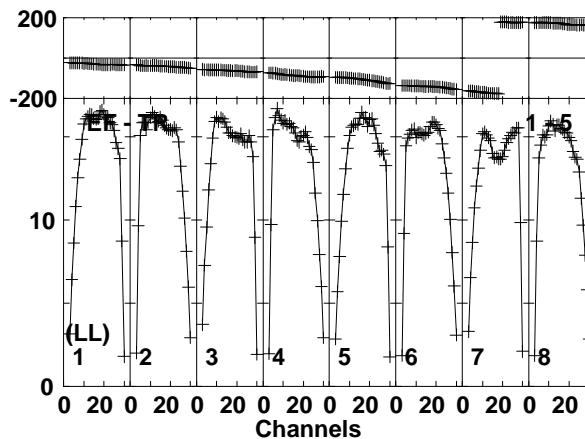
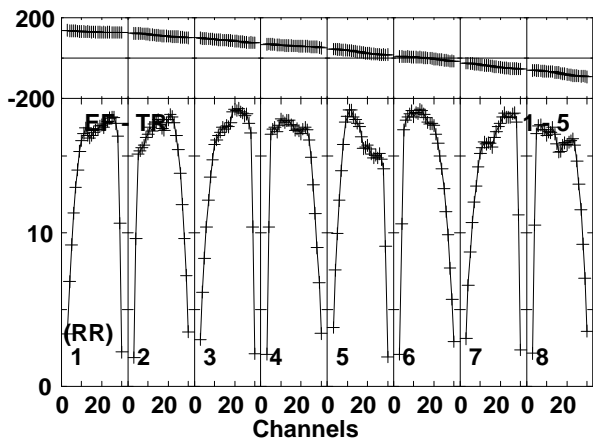
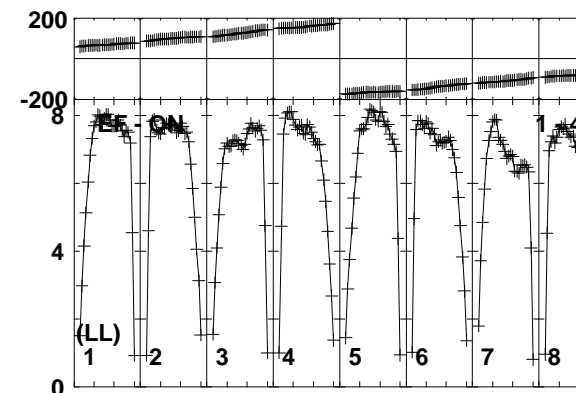
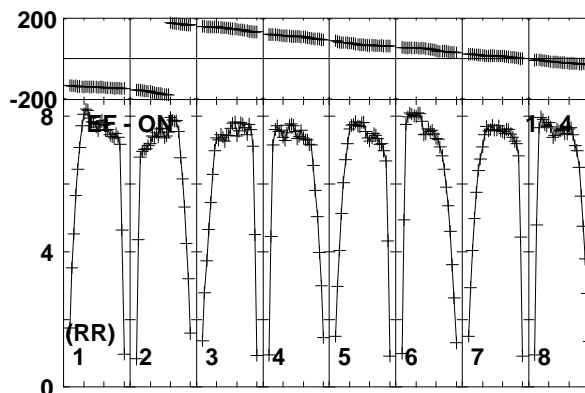
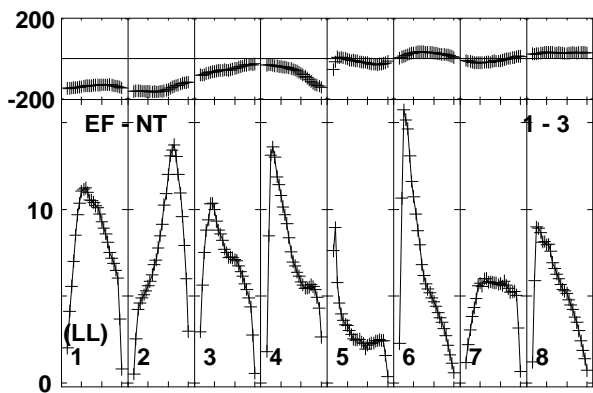
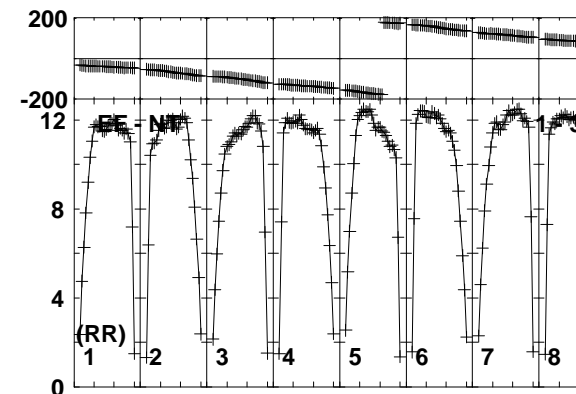
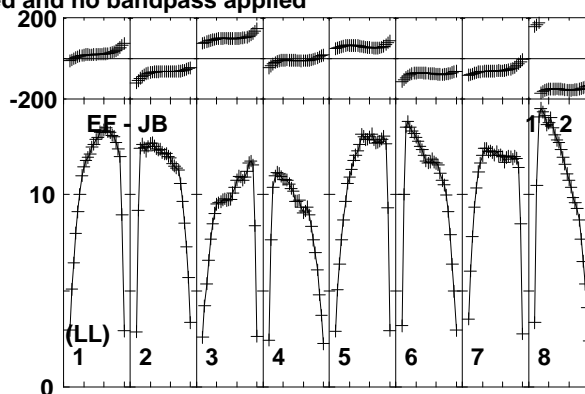
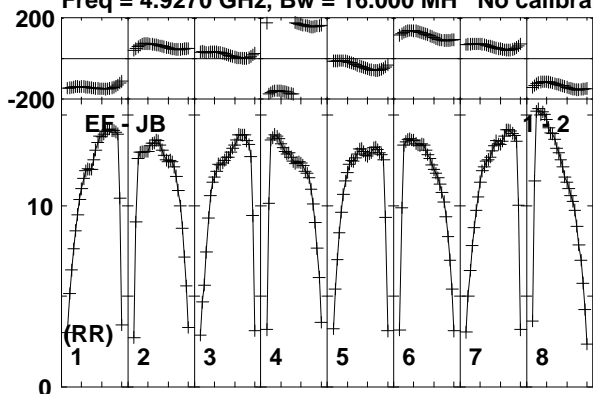

Lower frame: Milli Ampl Jy Top frame: Phas deg
Vector averaged cross-power spectrum Baseline: EF (01) - JB (02)
Timerange: 01/02:32:33 to 01/02:33:59

Plot file version 214 created 26-MAR-2015 15:27:47

J1038+0512 EG082E.UVDATA.1

Freq = 4.9270 GHz, Bw = 16.000 MH No calibration applied and no bandpass applied

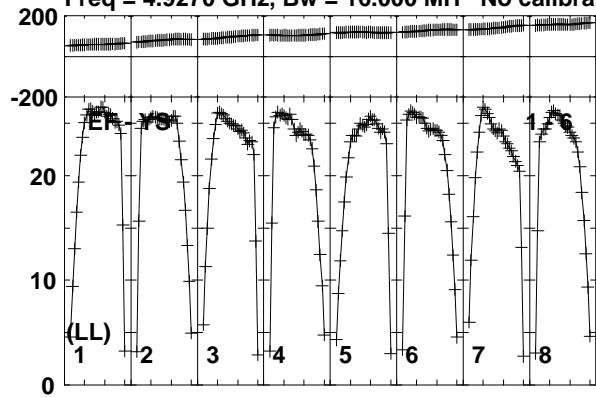

Lower frame: Milli Ampl Jy Top frame: Phas deg
Vector averaged cross-power spectrum Baseline: EF (01) - YS (06)
Timerange: 01/02:32:33 to 01/02:33:59

Plot file version 215 created 26-MAR-2015 15:27:47

J1035+0522 EG082E.UVDATA.1

Freq = 4.9270 GHz, Bw = 16.000 MH No calibration applied and no bandpass applied

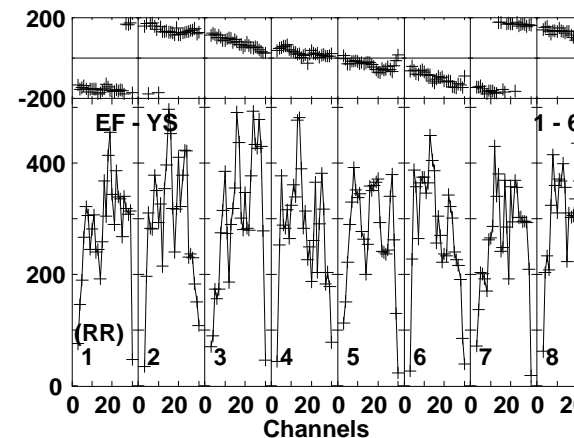
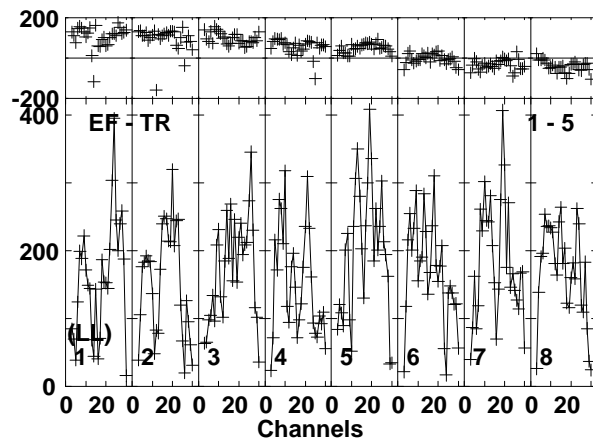
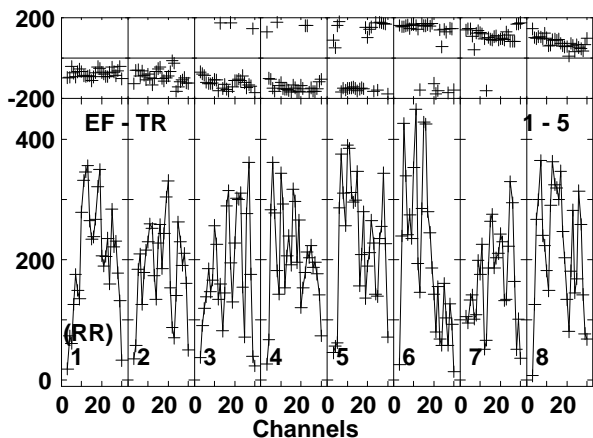
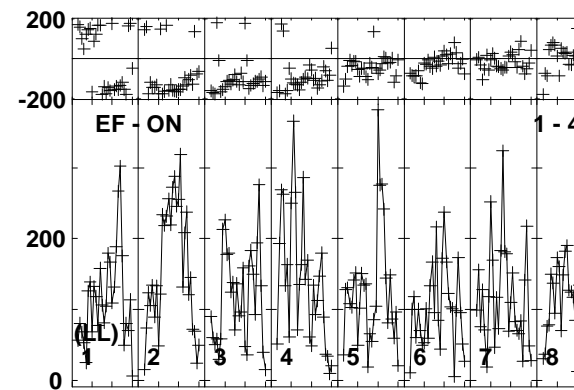
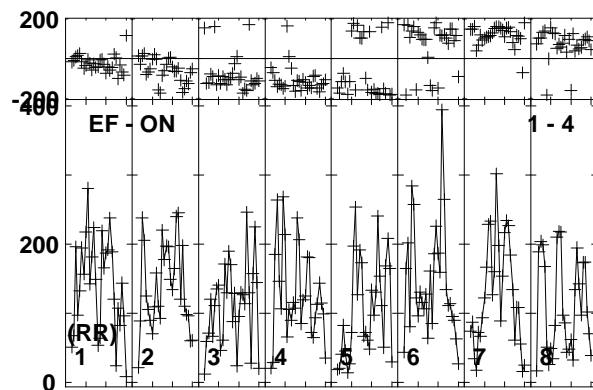
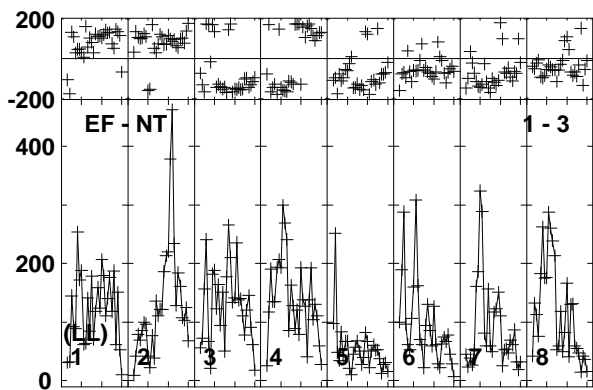
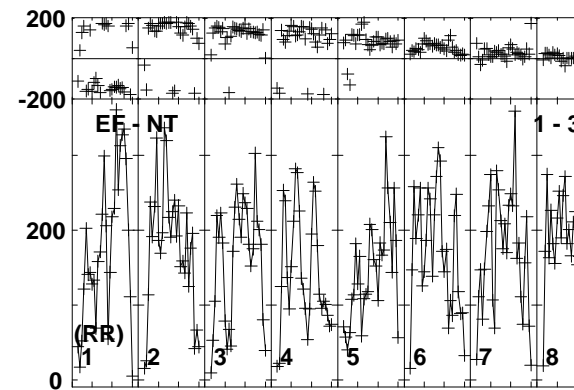
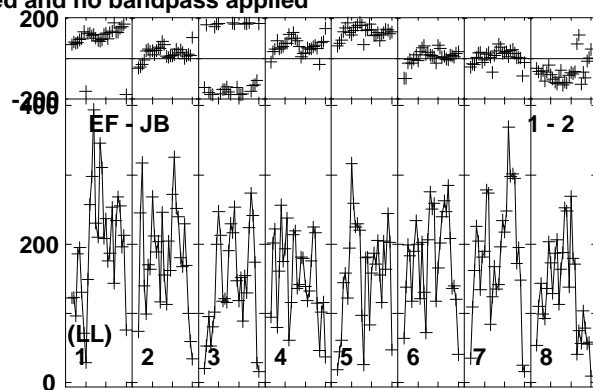
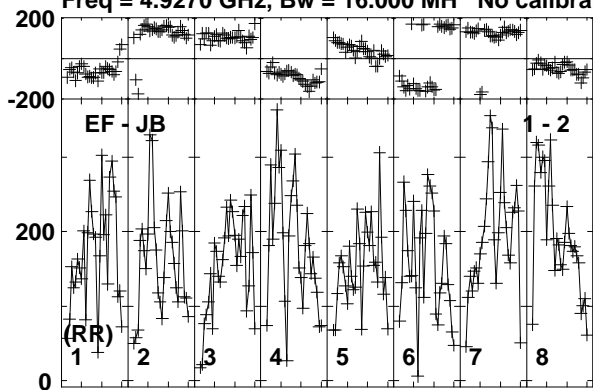

Lower frame: Micro Ampl Jy Top frame: Phas deg
Vector averaged cross-power spectrum Baseline: EF (01) - JB (02)
Timerange: 01/02:34:03 to 01/02:37:29

Plot file version 216 created 26-MAR-2015 15:27:47

J1035+0522 EG082E.UVDATA.1

Freq = 4.9270 GHz, Bw = 16.000 MH No calibration applied and no bandpass applied

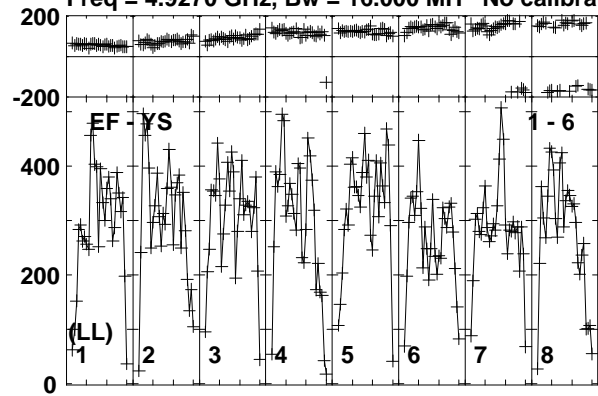

Lower frame: Micro Ampl Jy Top frame: Phas deg
Vector averaged cross-power spectrum Baseline: EF (01) - YS (06)
Timerange: 01/02:34:03 to 01/02:37:29

Plot file version 217 created 26-MAR-2015 15:27:47

J1038+0512 EG082E.UVDATA.1

Freq = 4.9270 GHz, Bw = 16.000 MH No calibration applied and no bandpass applied

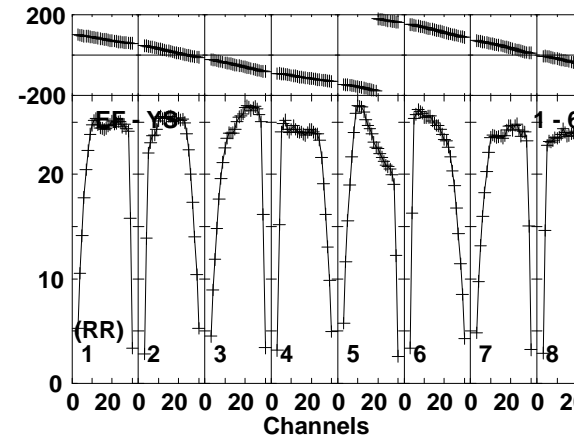
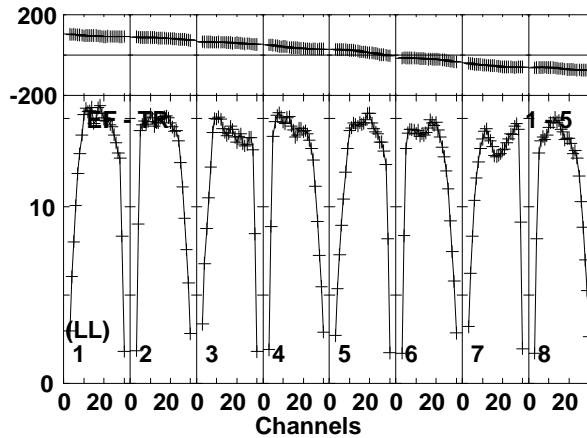
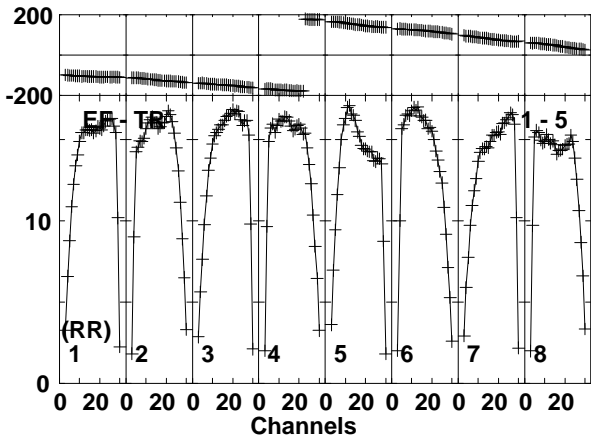
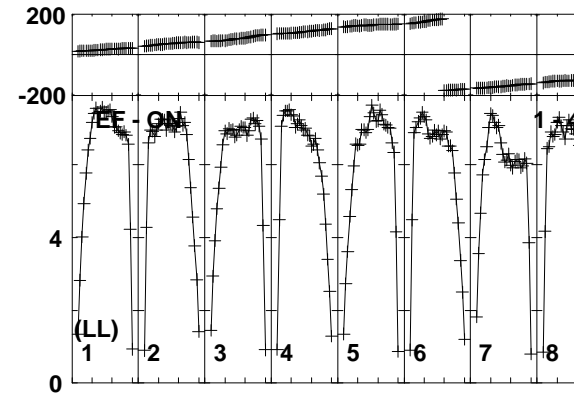
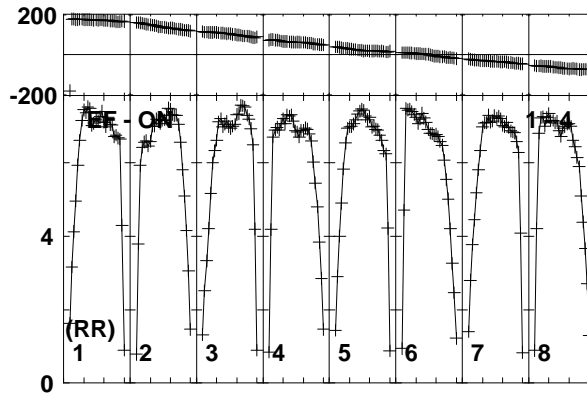
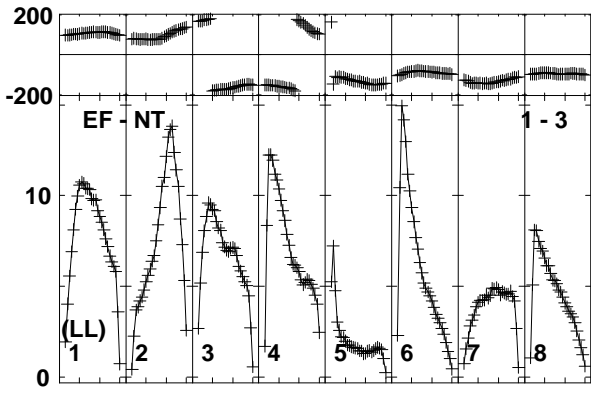
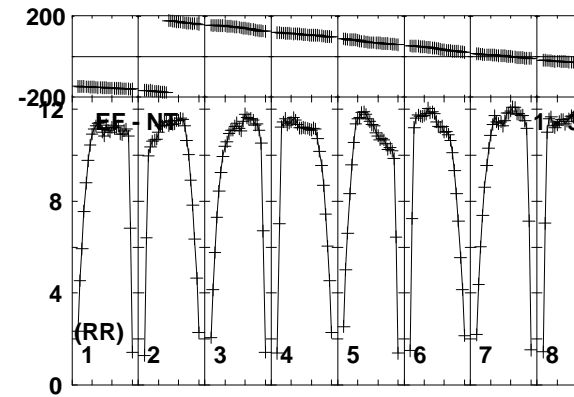
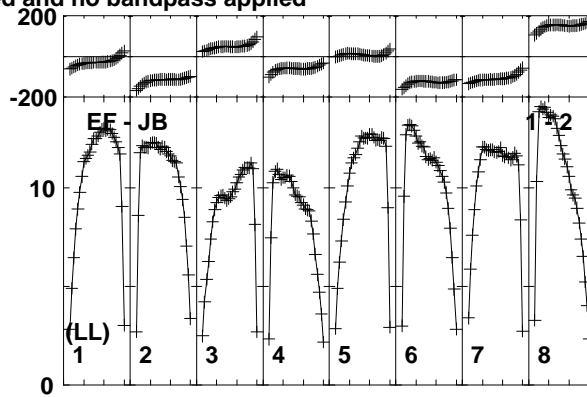
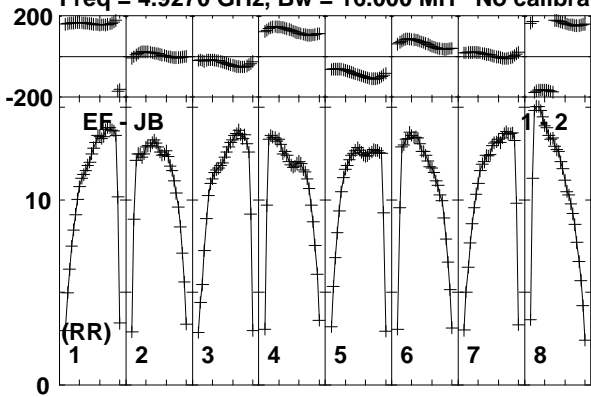

Lower frame: Milli Ampl Jy Top frame: Phas deg
Vector averaged cross-power spectrum Baseline: EF (01) - JB (02)
Timerange: 01/02:38:03 to 01/02:38:59

Plot file version 218 created 26-MAR-2015 15:27:47

J1038+0512 EG082E.UVDATA.1

Freq = 4.9270 GHz, Bw = 16.000 MH No calibration applied and no bandpass applied

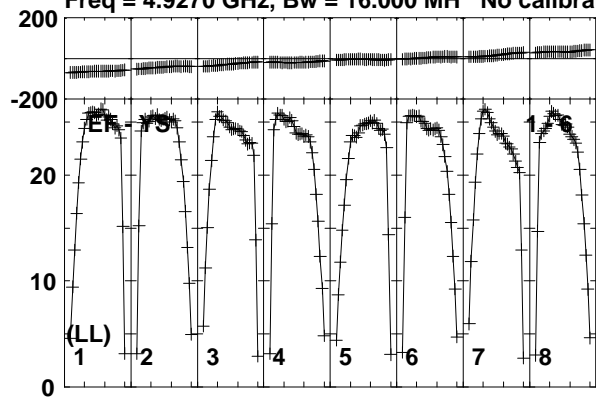

Lower frame: Milli Ampl Jy Top frame: Phas deg
Vector averaged cross-power spectrum Baseline: EF (01) - YS (06)
Timerange: 01/02:38:03 to 01/02:38:59

Plot file version 219 created 26-MAR-2015 15:27:47

RYSEX EG082E.UVDATA.1

Freq = 4.9270 GHz, Bw = 16.000 MH No calibration applied and no bandpass applied

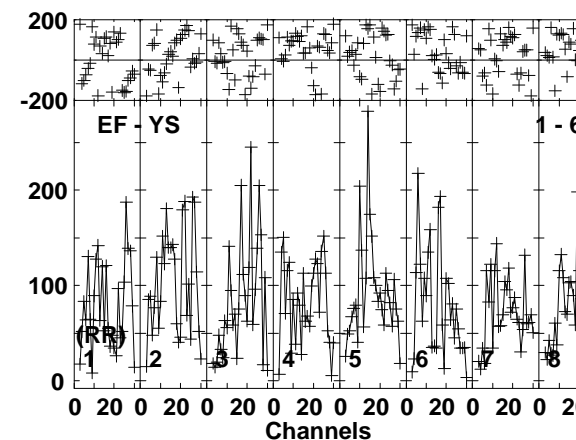
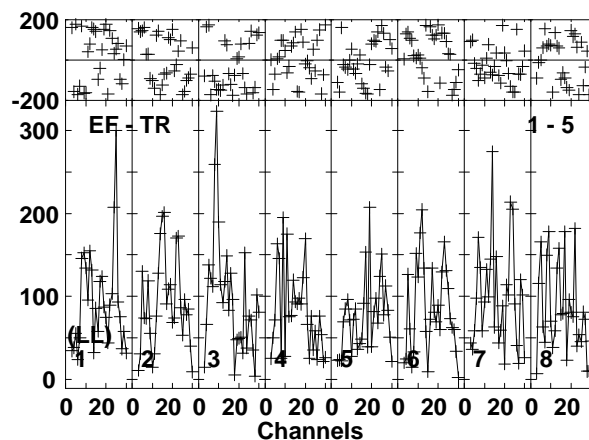
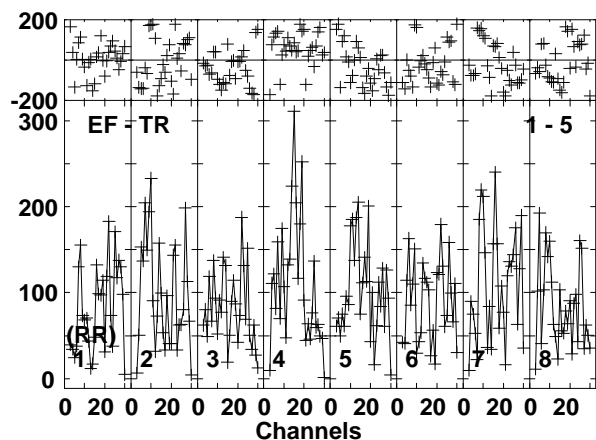
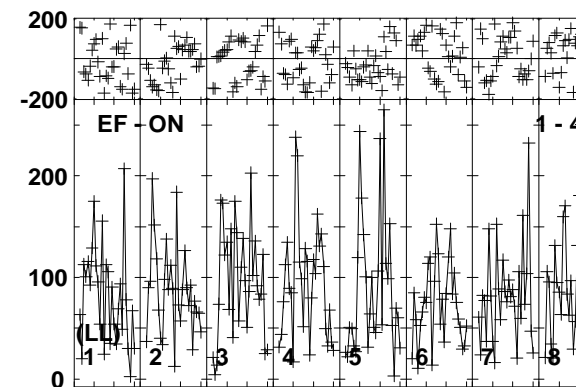
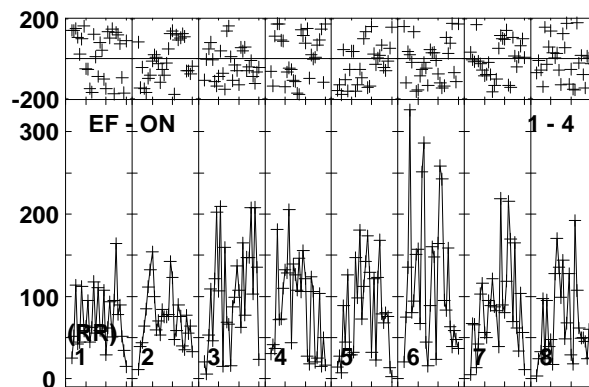
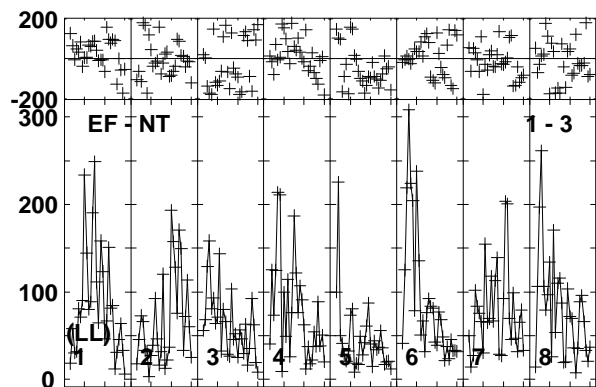
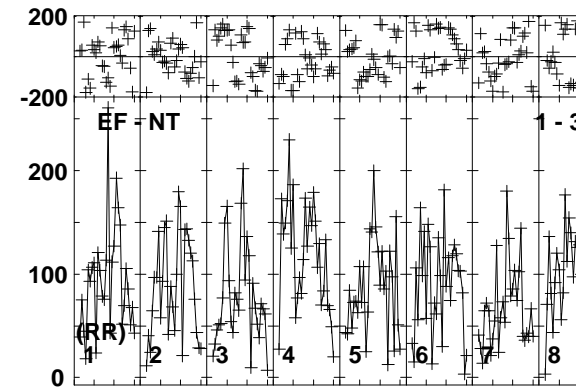
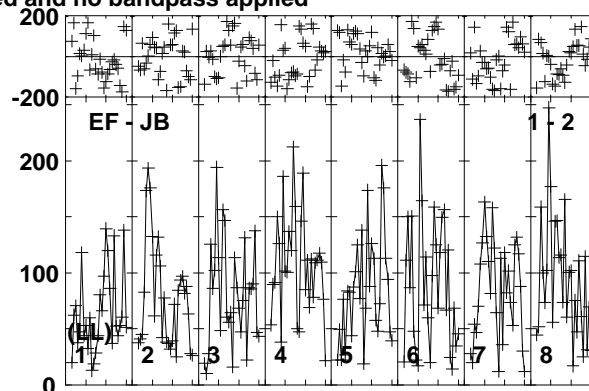
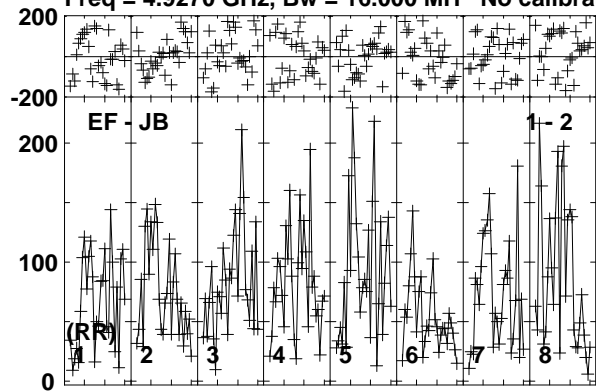

Lower frame: Micro Ampl Jy Top frame: Phas deg
Vector averaged cross-power spectrum Baseline: EF (01) - JB (02)
Timerange: 01/02:39:03 to 01/02:42:29

Plot file version 220 created 26-MAR-2015 15:27:47

RYSEX EG082E.UVDATA.1

Freq = 4.9270 GHz, Bw = 16.000 MH No calibration applied and no bandpass applied

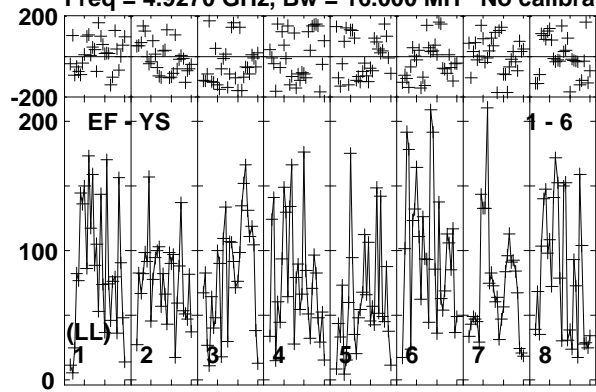

Lower frame: Micro Ampl Jy Top frame: Phas deg
Vector averaged cross-power spectrum Baseline: EF (01) - YS (06)
Timerange: 01/02:39:03 to 01/02:42:29

Plot file version 221 created 26-MAR-2015 15:27:47

J1038+0512 EG082E.UVDATA.1

Freq = 4.9270 GHz, Bw = 16.000 MH No calibration applied and no bandpass applied

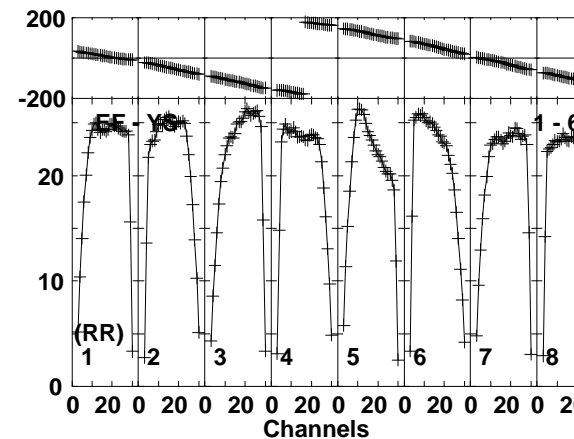
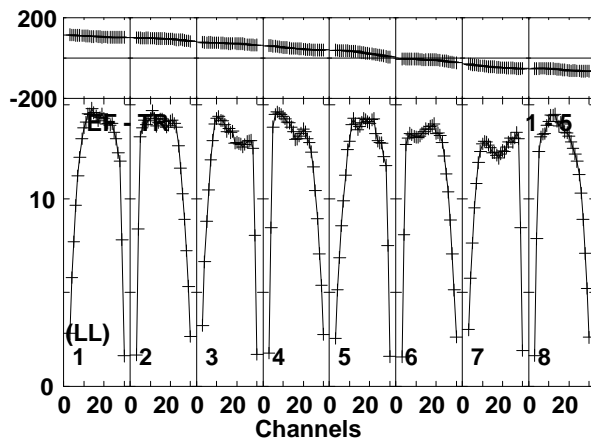
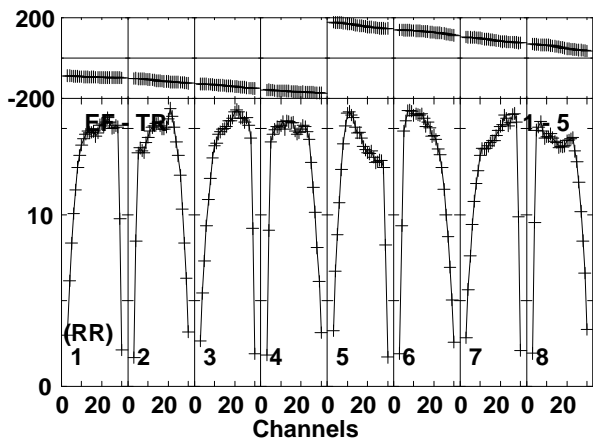
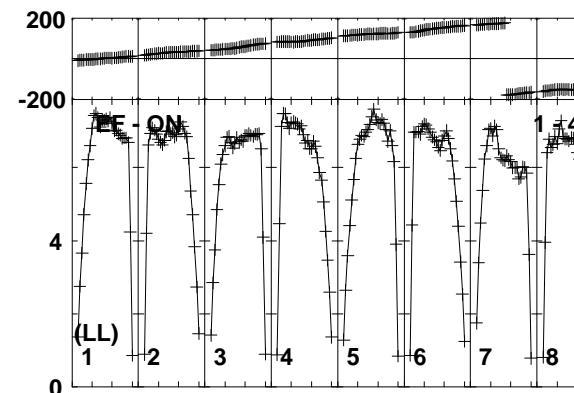
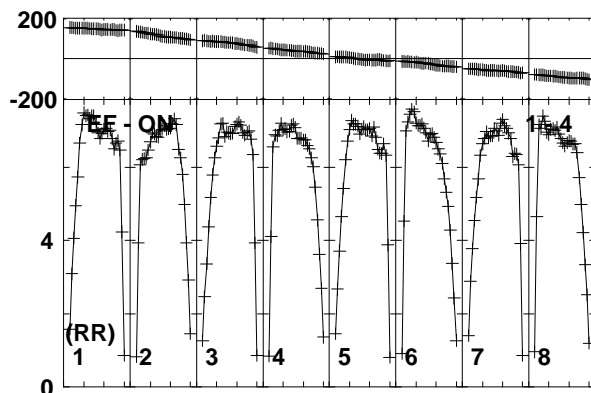
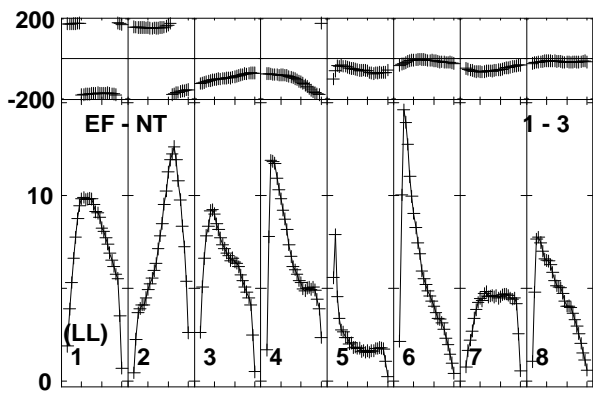
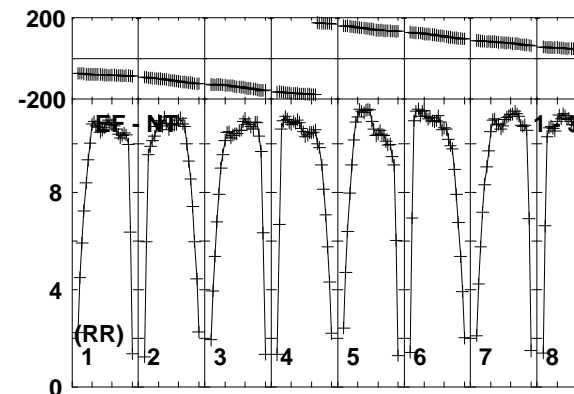
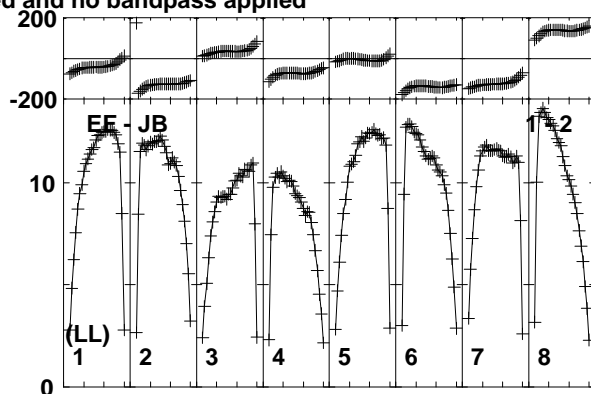
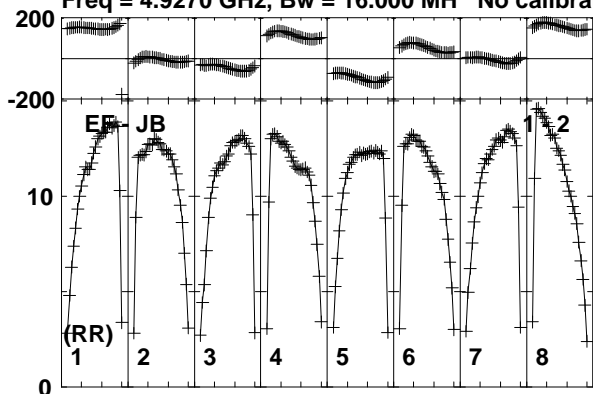

Lower frame: Milli Ampl Jy Top frame: Phas deg
Vector averaged cross-power spectrum Baseline: EF (01) - JB (02)
Timerange: 01/02:43:03 to 01/02:43:59

Plot file version 222 created 26-MAR-2015 15:27:47

J1038+0512 EG082E.UVDATA.1

Freq = 4.9270 GHz, Bw = 16.000 MH No calibration applied and no bandpass applied

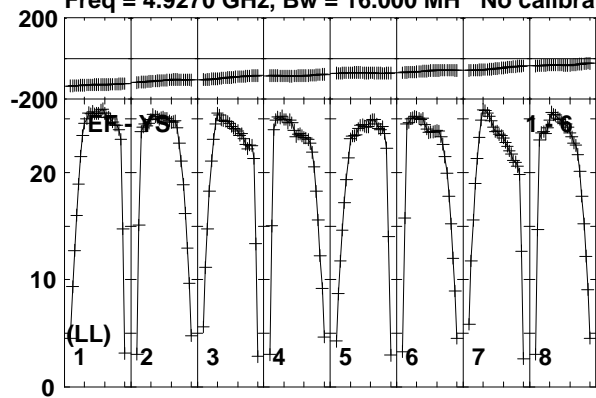

Lower frame: Milli Ampl Jy Top frame: Phas deg
Vector averaged cross-power spectrum Baseline: EF (01) - YS (06)
Timerange: 01/02:43:03 to 01/02:43:59

Plot file version 224 created 26-MAR-2015 15:27:47

RYSEX EG082E.UVDATA.1

Freq = 4.9270 GHz, Bw = 16.000 MH No calibration applied and no bandpass applied

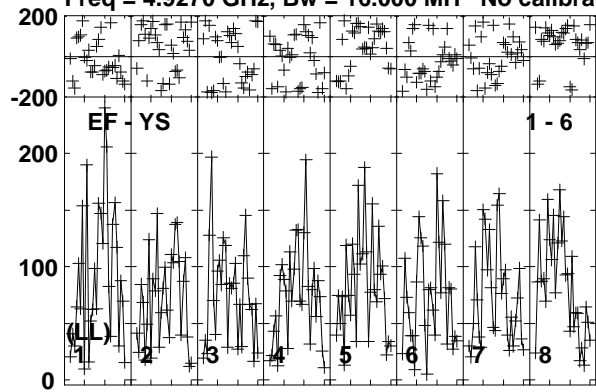

Lower frame: Micro Ampl Jy Top frame: Phas deg
Vector averaged cross-power spectrum Baseline: EF (01) - YS (06)
Timerange: 01/02:44:03 to 01/02:47:29

Plot file version 225 created 26-MAR-2015 15:27:47

J1038+0512 EG082E.UVDATA.1

Freq = 4.9270 GHz, Bw = 16.000 MH No calibration applied and no bandpass applied

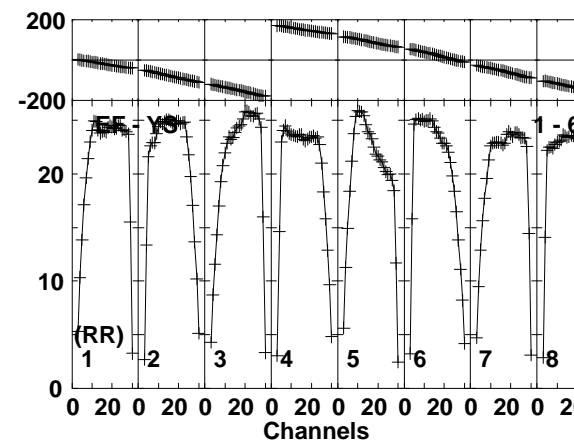
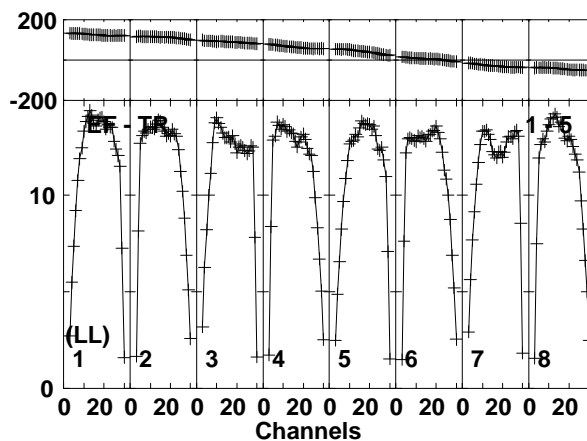
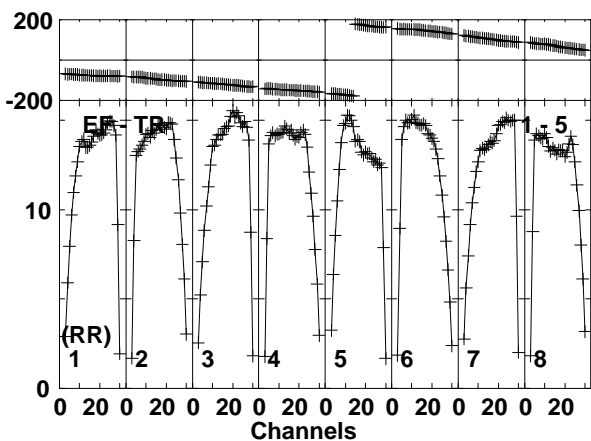
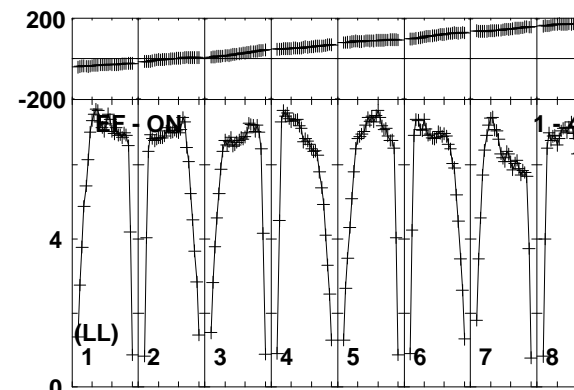
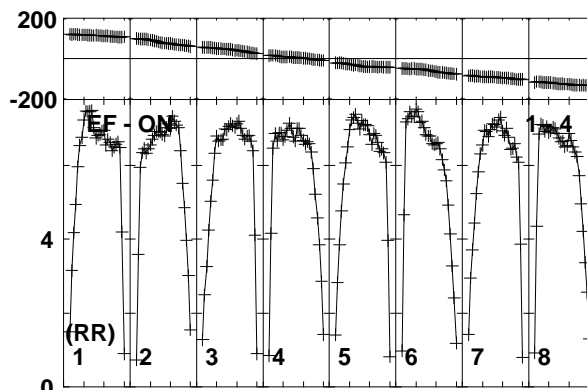
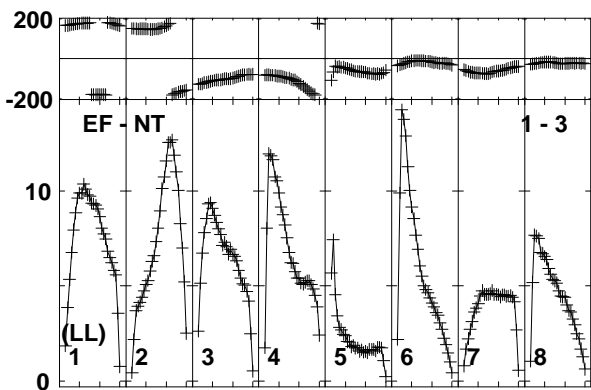
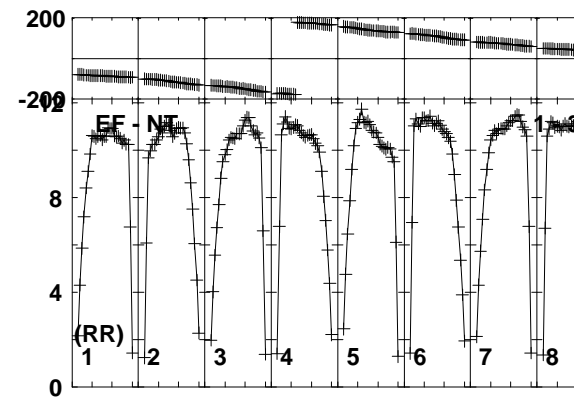
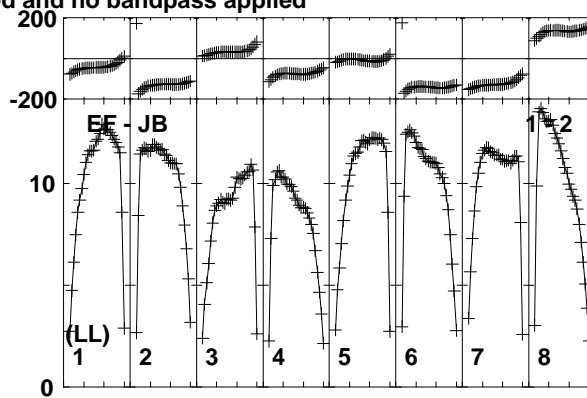
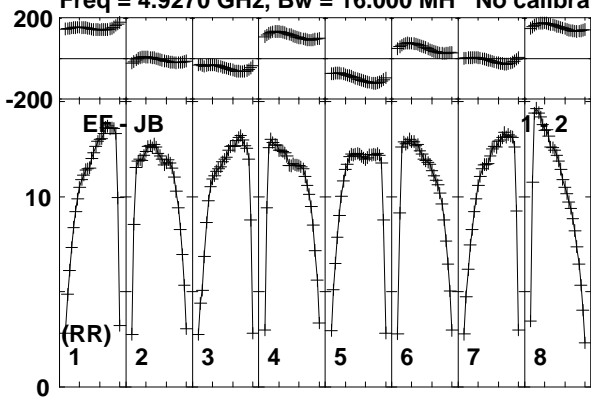

Lower frame: Milli Ampl Jy Top frame: Phas deg
Vector averaged cross-power spectrum Baseline: EF (01) - JB (02)
Timerange: 01/02:47:33 to 01/02:48:59

Plot file version 226 created 26-MAR-2015 15:27:47

J1038+0512 EG082E.UVDATA.1

Freq = 4.9270 GHz, Bw = 16.000 MH No calibration applied and no bandpass applied

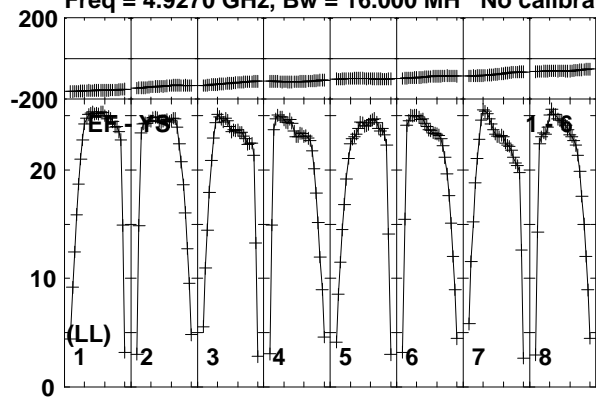

Lower frame: Milli Ampl Jy Top frame: Phas deg
Vector averaged cross-power spectrum Baseline: EF (01) - YS (06)
Timerange: 01/02:47:33 to 01/02:48:59

Plot file version 227 created 26-MAR-2015 15:27:47

RYSEX EG082E.UVDATA.1

Freq = 4.9270 GHz, Bw = 16.000 MH No calibration applied and no bandpass applied

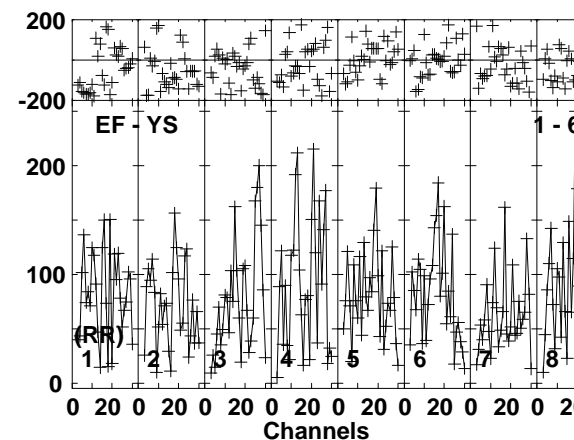
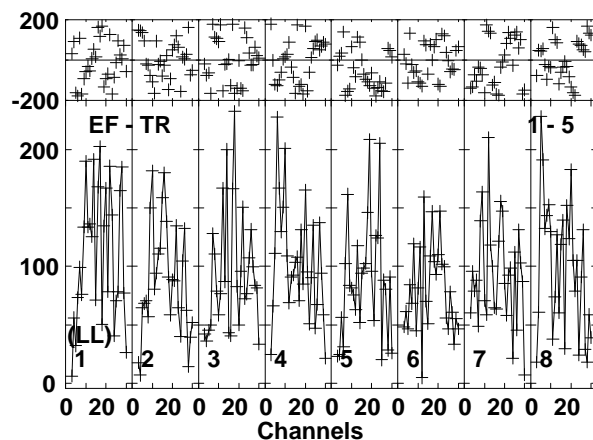
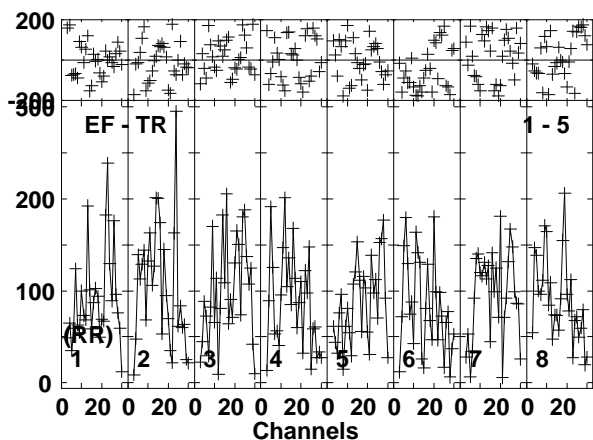
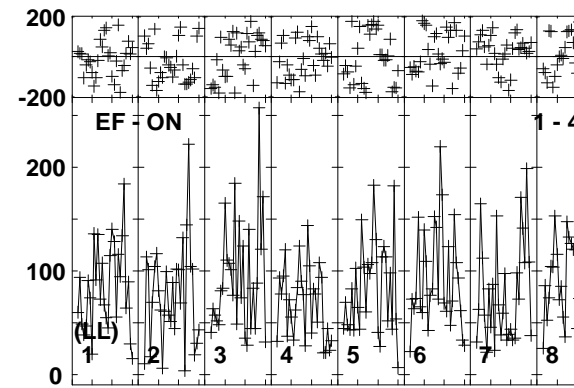
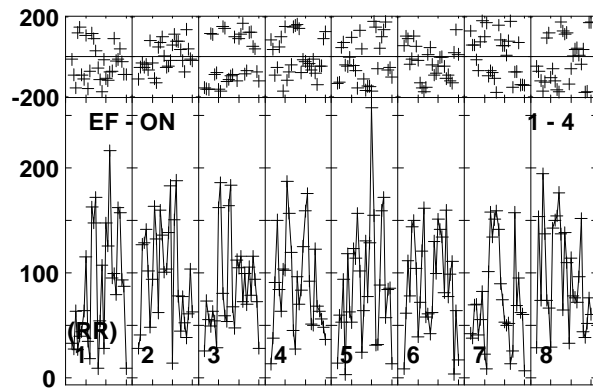
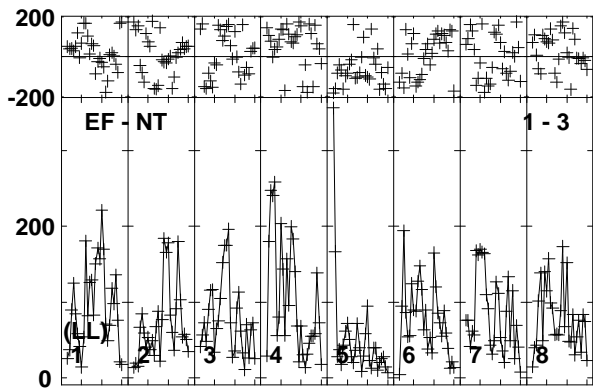
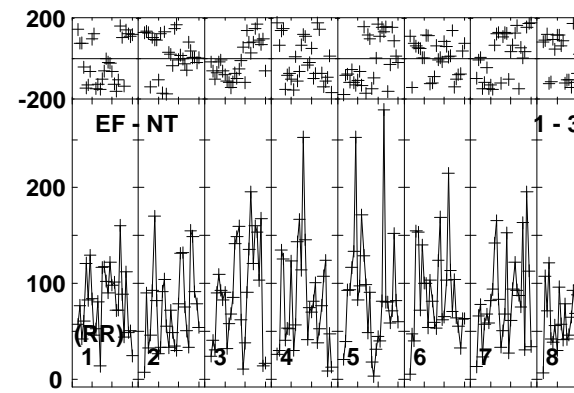
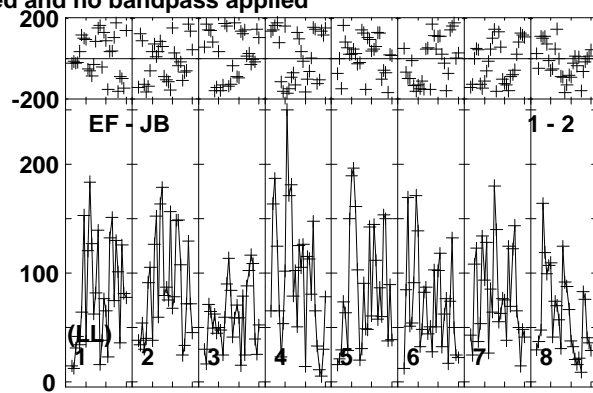
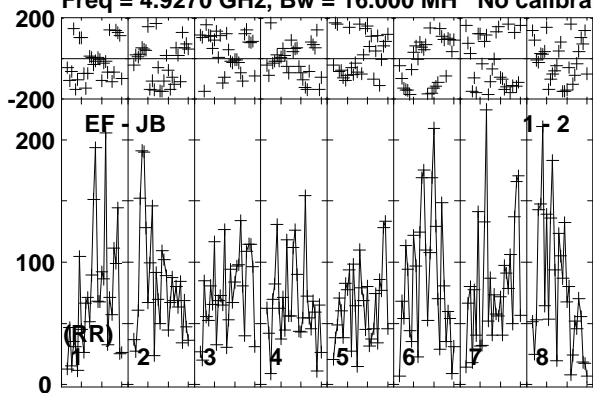

Lower frame: Micro Ampl Jy Top frame: Phas deg
Vector averaged cross-power spectrum Baseline: EF (01) - JB (02)
Timerange: 01/02:49:03 to 01/02:52:29

Plot file version 228 created 26-MAR-2015 15:27:47

RYSEX EG082E.UVDATA.1

Freq = 4.9270 GHz, Bw = 16.000 MH No calibration applied and no bandpass applied

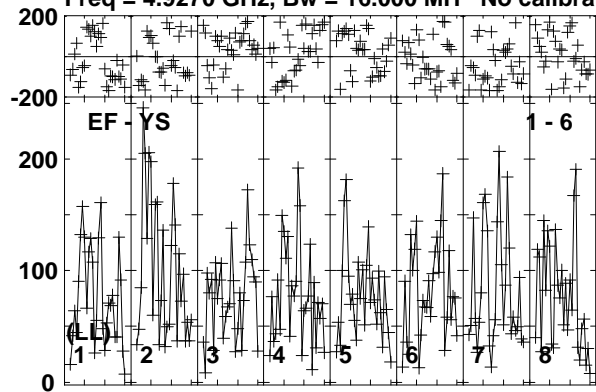

Lower frame: Micro Ampl Jy Top frame: Phas deg
Vector averaged cross-power spectrum Baseline: EF (01) - YS (06)
Timerange: 01/02:49:03 to 01/02:52:29

Plot file version 229 created 26-MAR-2015 15:27:47

J1038+0512 EG082E.UVDATA.1

Freq = 4.9270 GHz, Bw = 16.000 MH No calibration applied and no bandpass applied

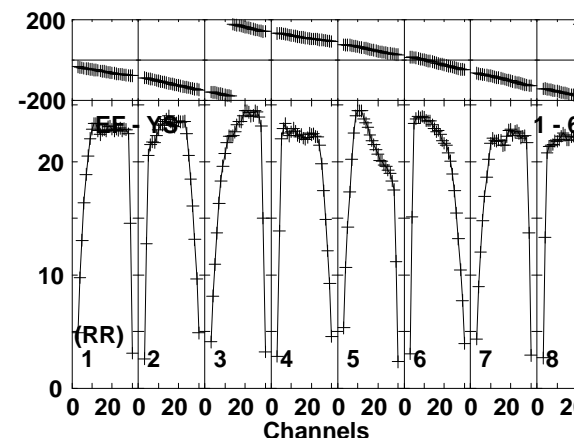
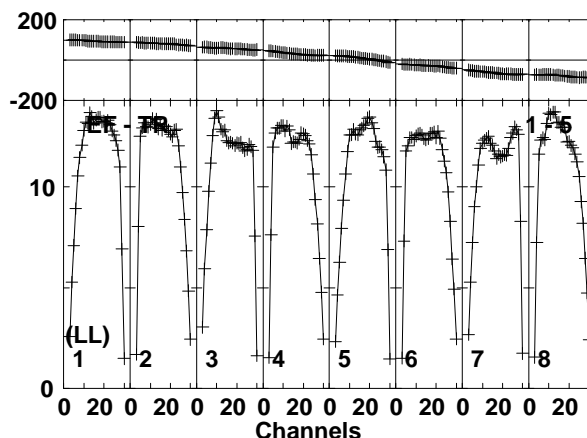
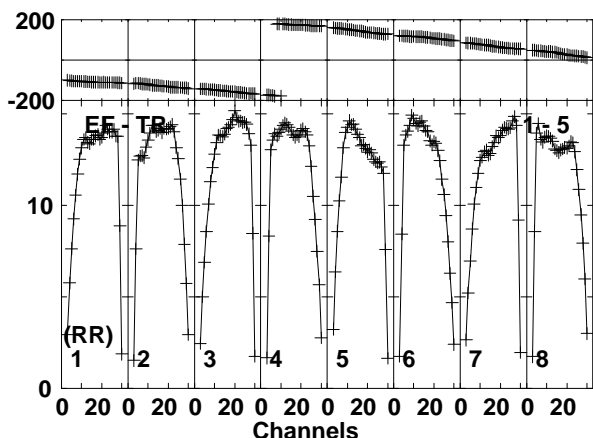
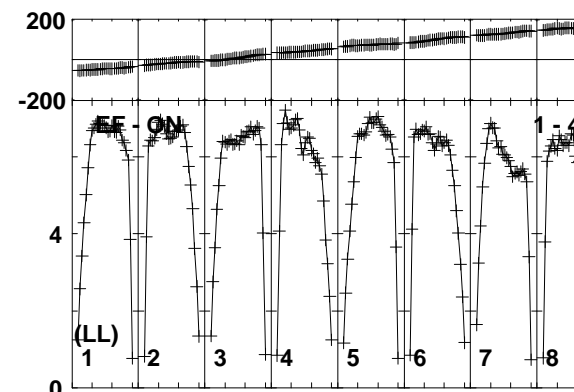
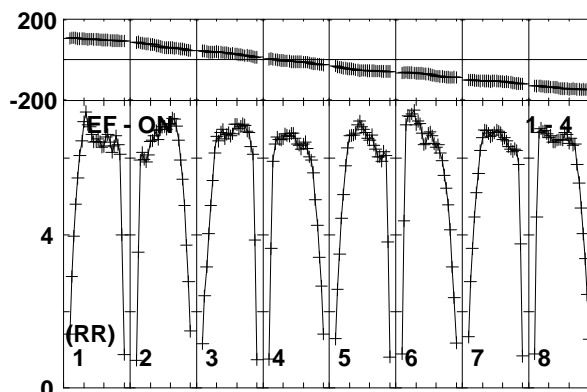
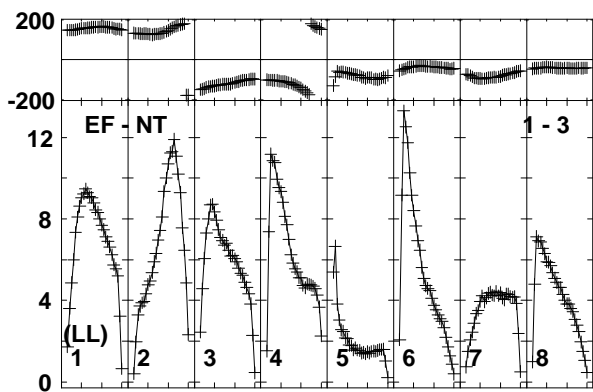
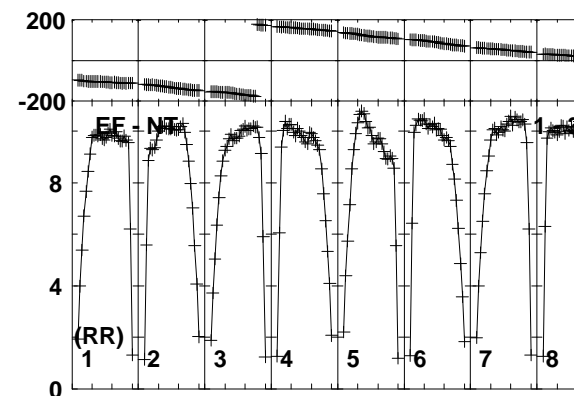
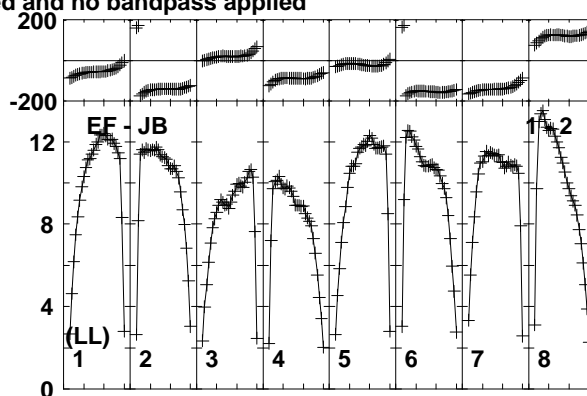
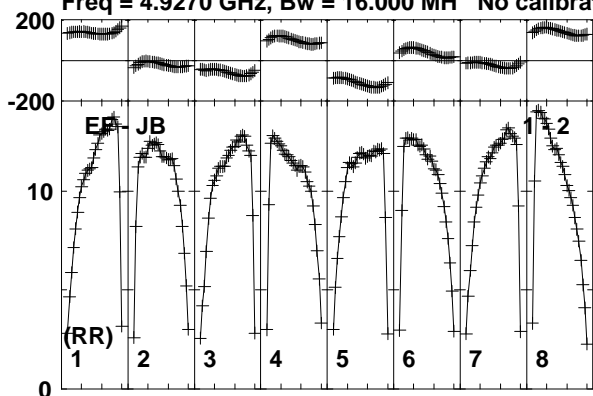

Lower frame: Milli Ampl Jy Top frame: Phas deg
Vector averaged cross-power spectrum Baseline: EF (01) - JB (02)
Timerange: 01/02:52:33 to 01/02:53:59

Plot file version 230 created 26-MAR-2015 15:27:47

J1038+0512 EG082E.UVDATA.1

Freq = 4.9270 GHz, Bw = 16.000 MH No calibration applied and no bandpass applied

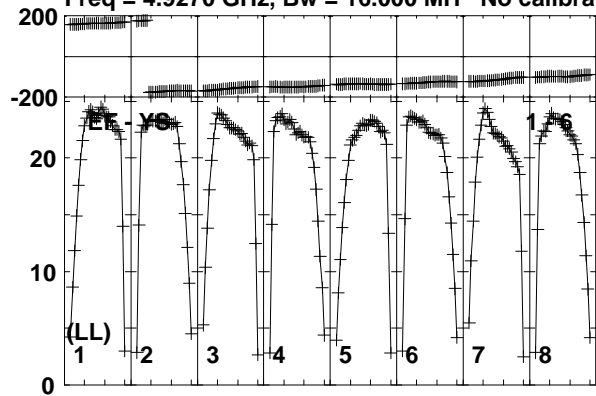

Lower frame: Milli Ampl Jy Top frame: Phas deg
Vector averaged cross-power spectrum Baseline: EF (01) - YS (06)
Timerange: 01/02:52:33 to 01/02:53:59

Plot file version 231 created 26-MAR-2015 15:27:47

J1035+0522 EG082E.UVDATA.1

Freq = 4.9270 GHz, Bw = 16.000 MH No calibration applied and no bandpass applied

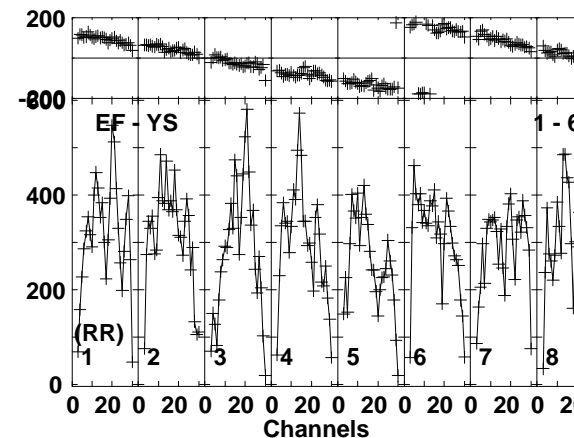
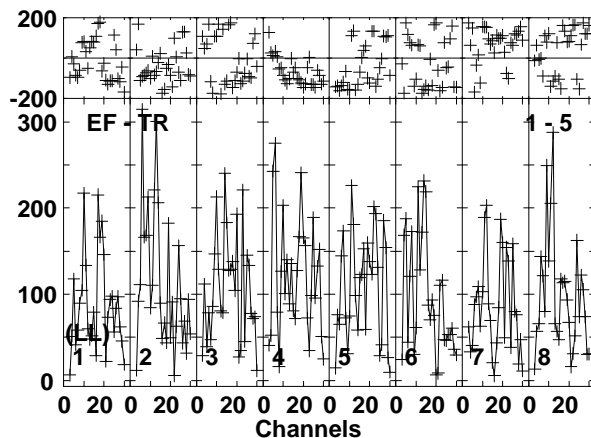
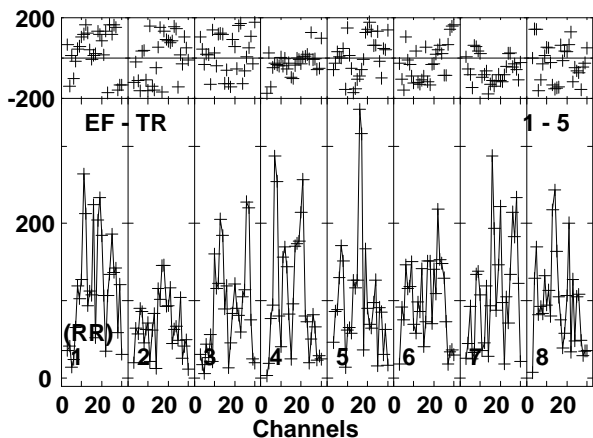
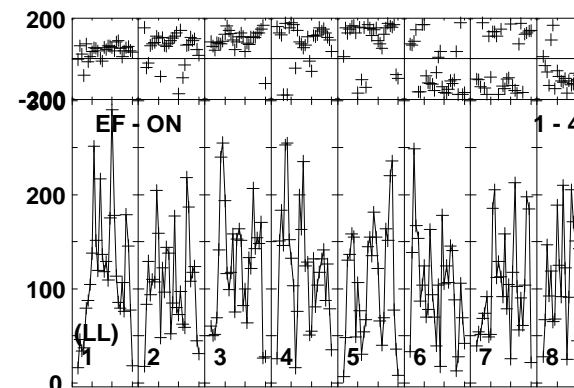
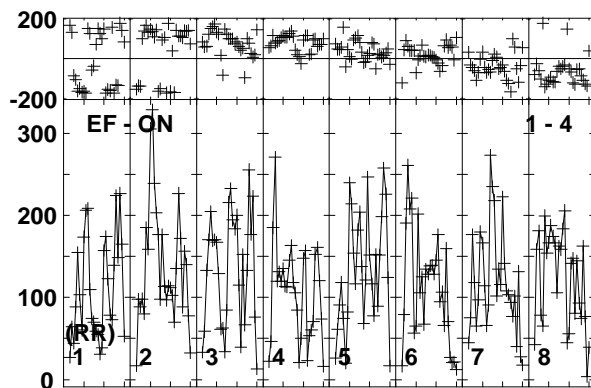
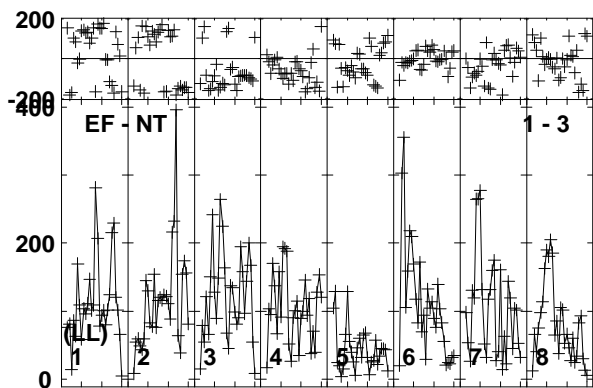
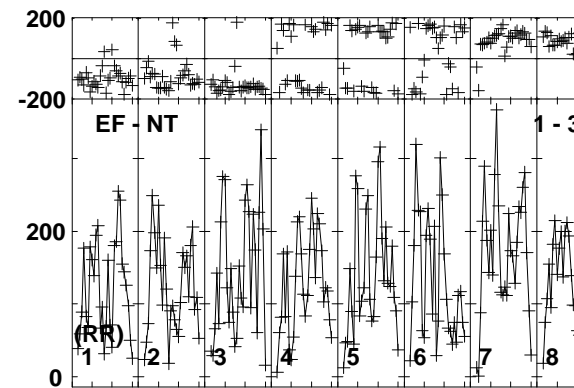
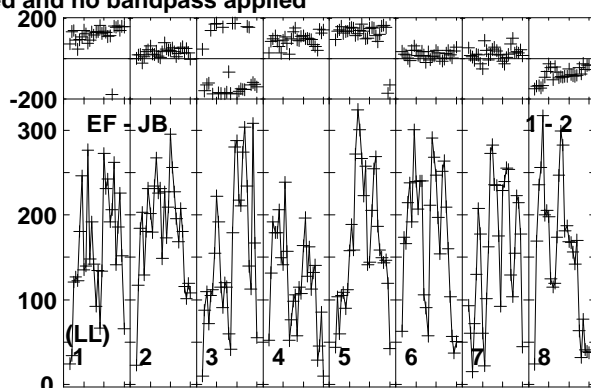
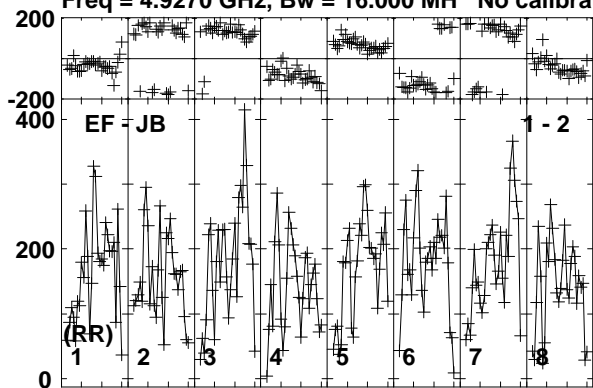

Lower frame: Micro Ampl Jy Top frame: Phas deg
Vector averaged cross-power spectrum Baseline: EF (01) - JB (02)
Timerange: 01/02:54:03 to 01/02:57:29

Plot file version 232 created 26-MAR-2015 15:27:47

J1035+0522 EG082E.UVDATA.1

Freq = 4.9270 GHz, Bw = 16.000 MH No calibration applied and no bandpass applied

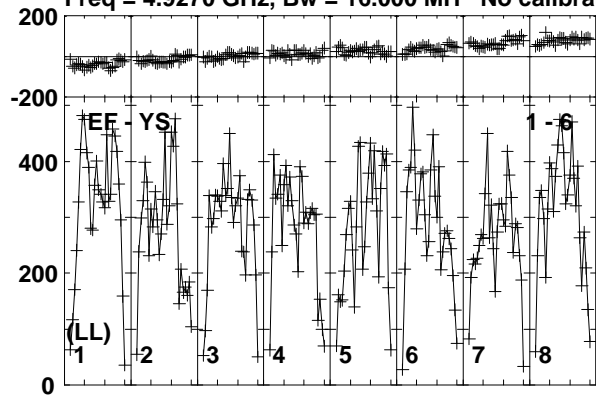

Lower frame: Micro Ampl Jy Top frame: Phas deg
Vector averaged cross-power spectrum Baseline: EF (01) - YS (06)
Timerange: 01/02:54:03 to 01/02:57:29

Plot file version 233 created 26-MAR-2015 15:27:47

J1038+0512 EG082E.UVDATA.1

Freq = 4.9270 GHz, Bw = 16.000 MH No calibration applied and no bandpass applied

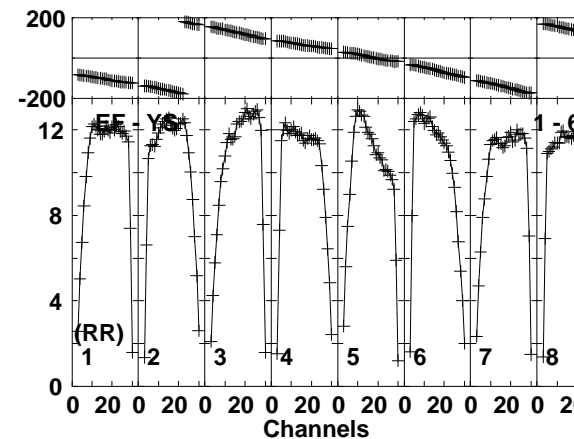
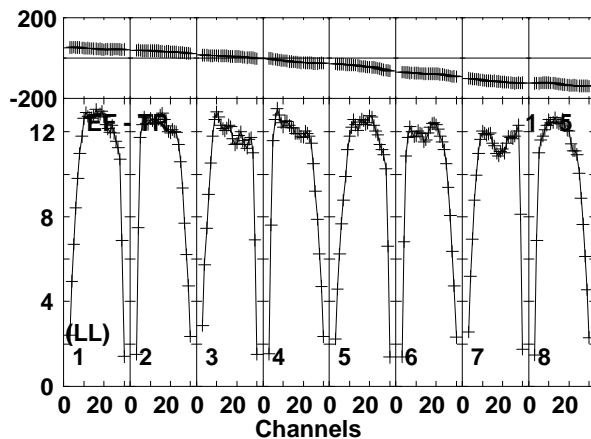
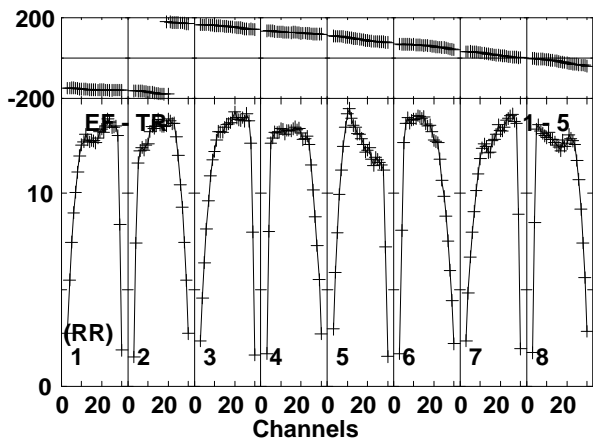
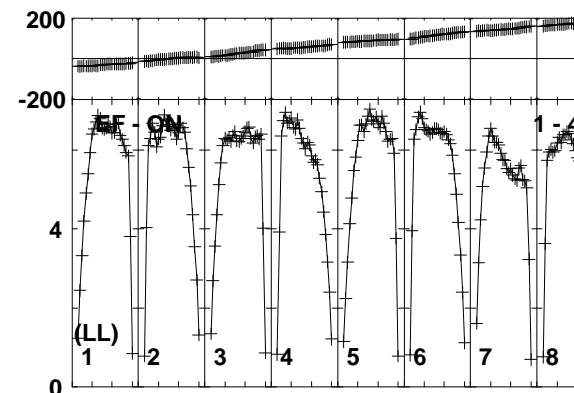
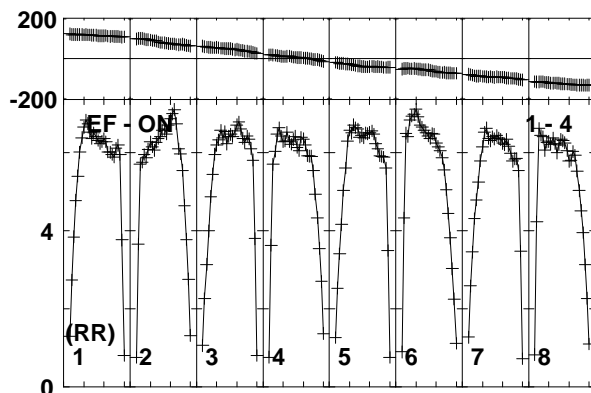
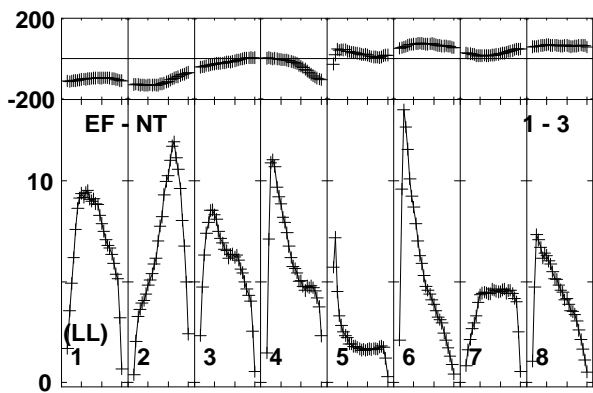
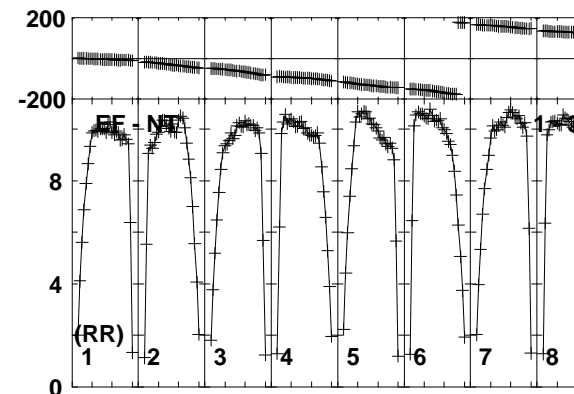
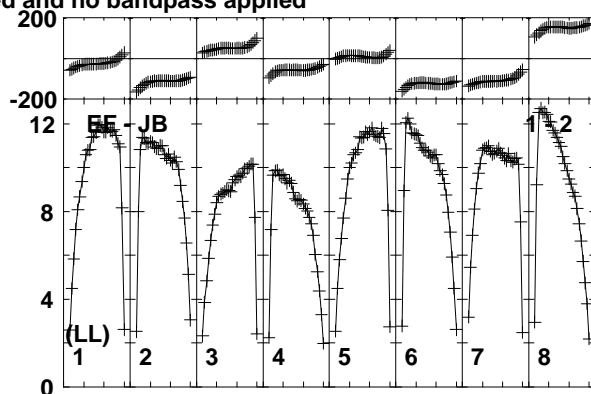
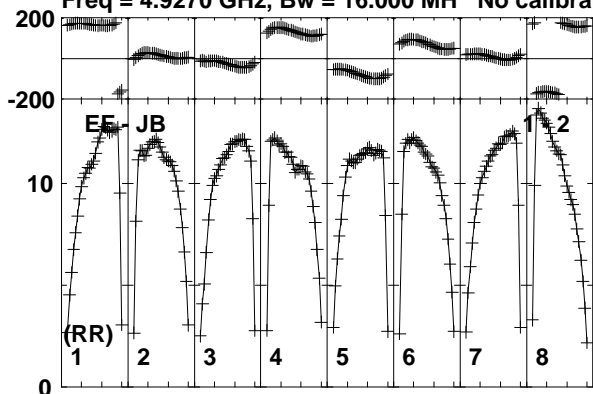

Lower frame: Milli Ampl Jy Top frame: Phas deg
Vector averaged cross-power spectrum Baseline: EF (01) - JB (02)
Timerange: 01/02:58:03 to 01/02:58:59

Plot file version 234 created 26-MAR-2015 15:27:48

J1038+0512 EG082E.UVDATA.1

Freq = 4.9270 GHz, Bw = 16.000 MH No calibration applied and no bandpass applied

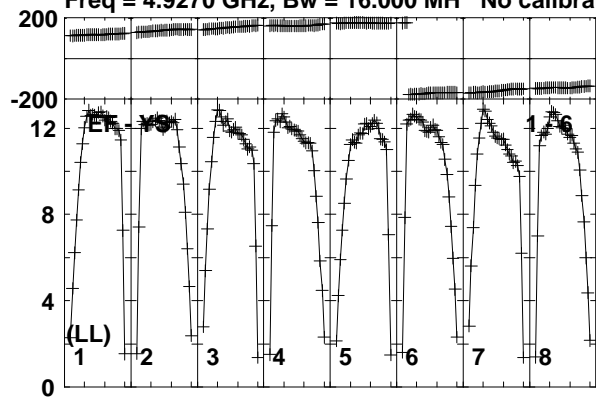

Lower frame: Milli Ampl Jy Top frame: Phas deg
Vector averaged cross-power spectrum Baseline: EF (01) - YS (06)
Timerange: 01/02:58:03 to 01/02:58:59

Plot file version 235 created 26-MAR-2015 15:27:48

J2113+4012 EG082E.UVDATA.1

Freq = 4.9270 GHz, Bw = 16.000 MH No calibration applied and no bandpass applied

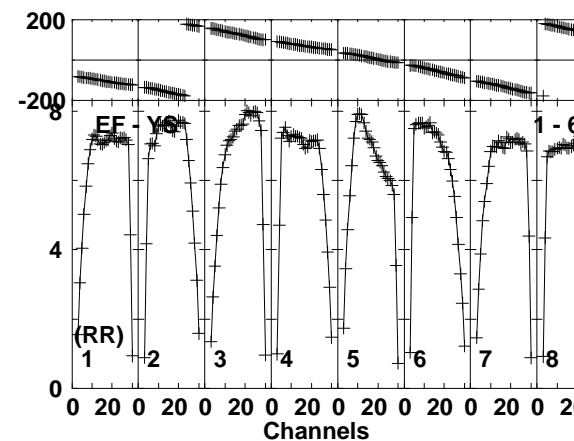
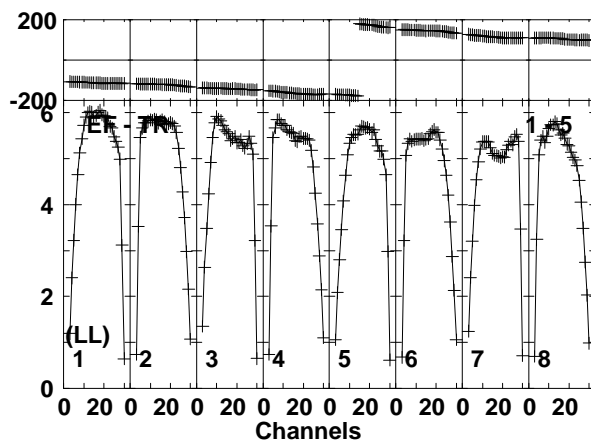
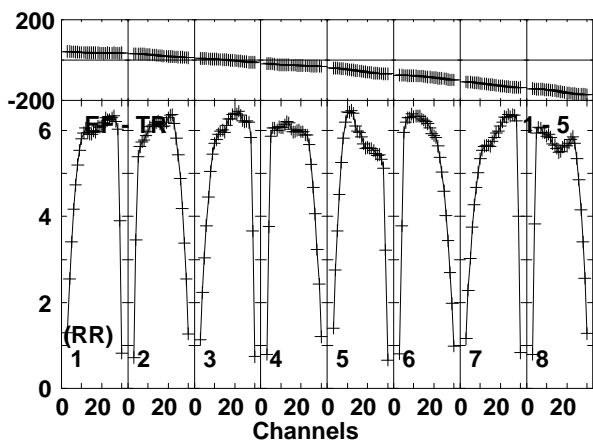
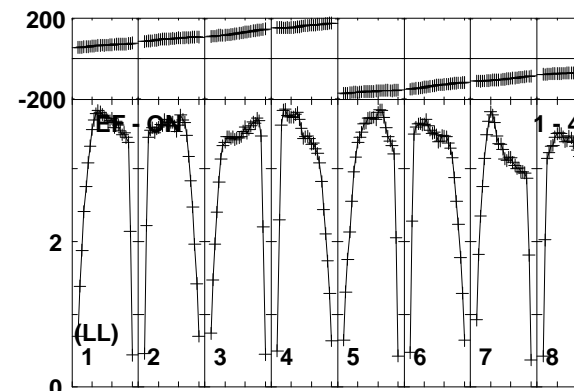
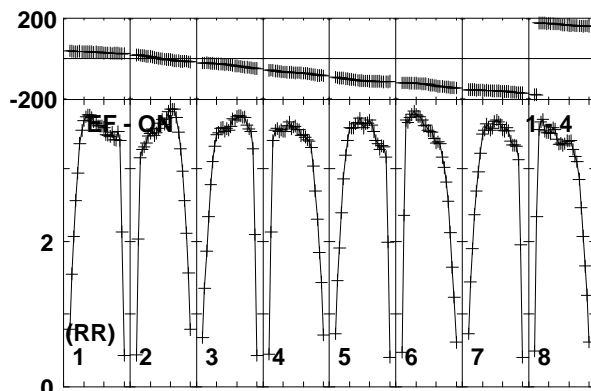
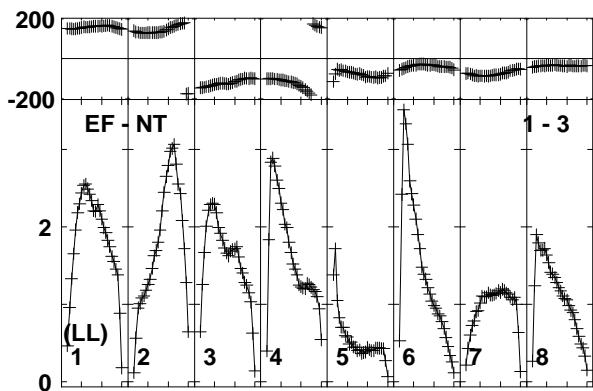
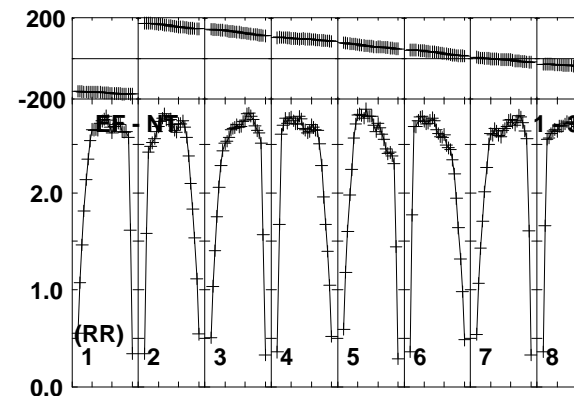
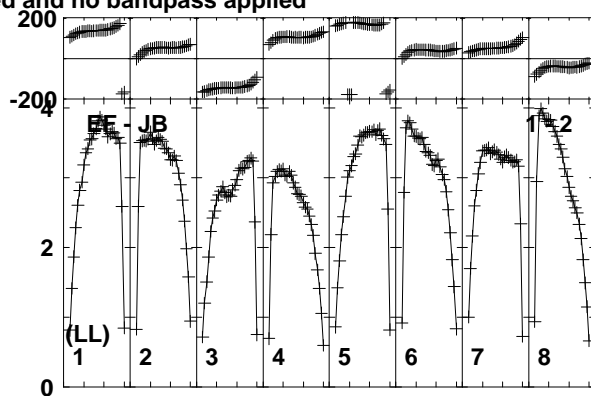
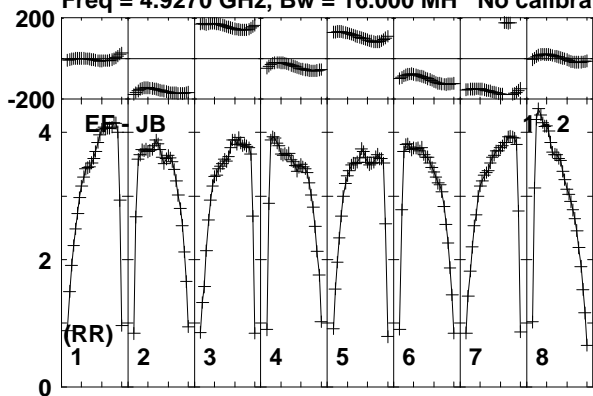

Lower frame: Milli Ampl Jy Top frame: Phas deg
Vector averaged cross-power spectrum Baseline: EF (01) - JB (02)
Timerange: 01/03:05:03 to 01/03:17:09

Plot file version 236 created 26-MAR-2015 15:27:48

J2113+4012 EG082E.UVDATA.1

Freq = 4.9270 GHz, Bw = 16.000 MH No calibration applied and no bandpass applied

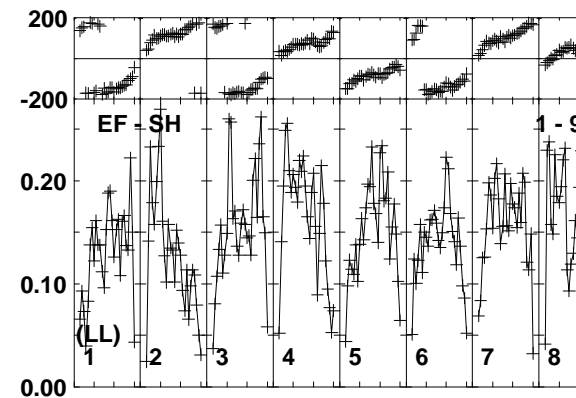
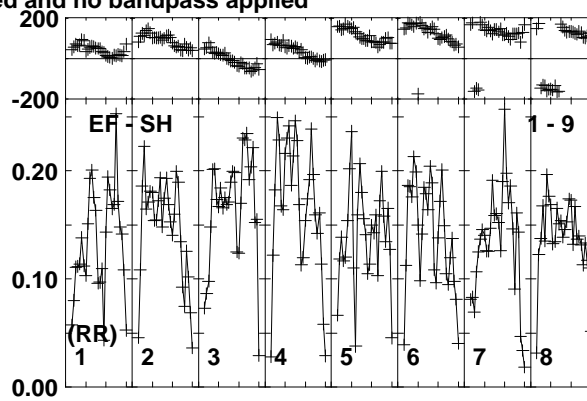
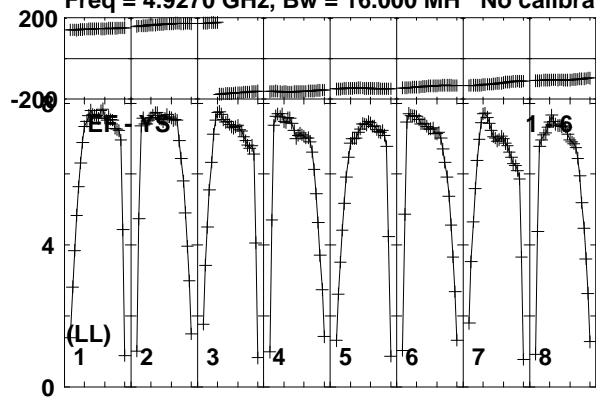

Lower frame: Milli Ampl Jy Top frame: Phas deg
Vector averaged cross-power spectrum Baseline: EF (01) - YS (06)
Timerange: 01/03:05:03 to 01/03:17:09

Plot file version 237 created 26-MAR-2015 15:27:48

J2115+3742 EG082E.UVDATA.1

Freq = 4.9270 GHz, Bw = 16.000 MH No calibration applied and no bandpass applied

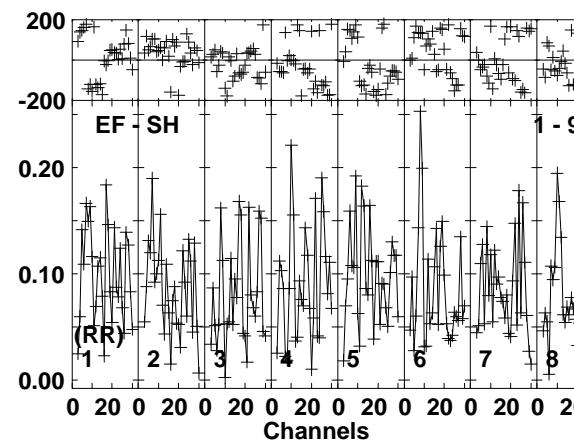
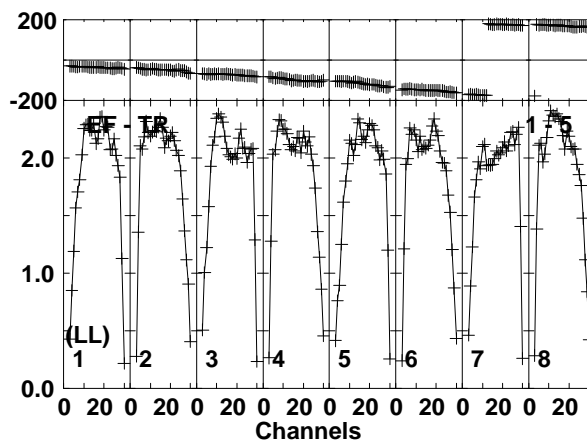
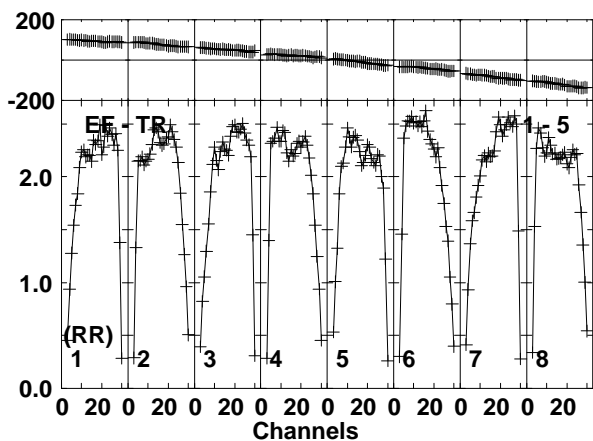
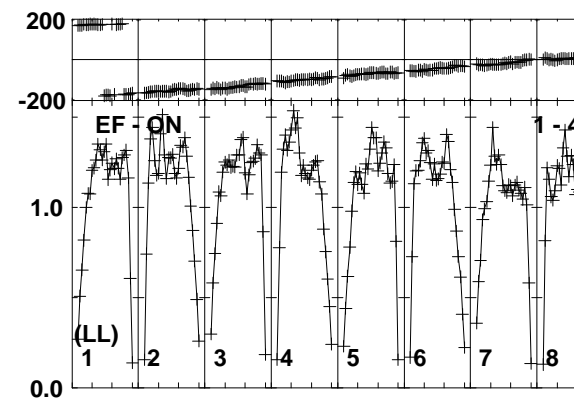
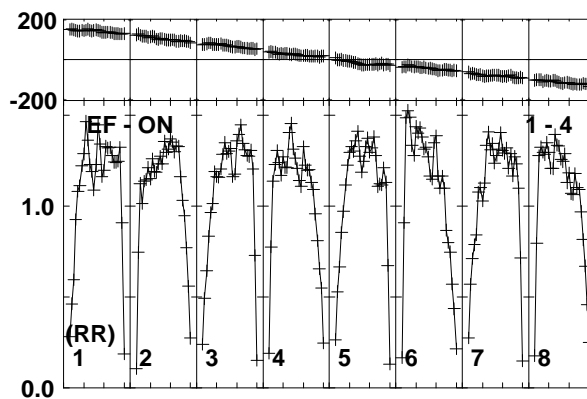
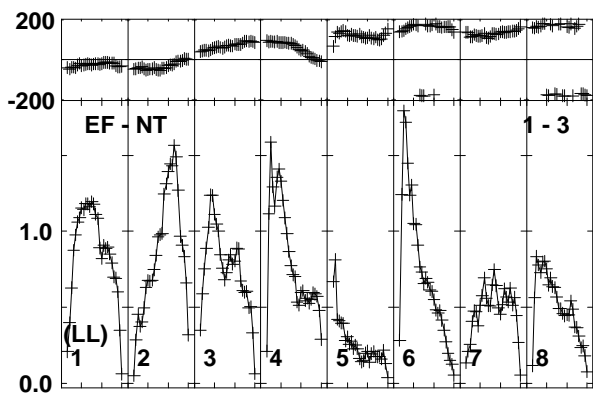
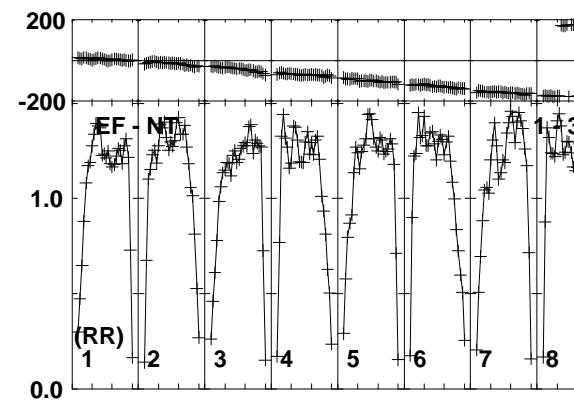
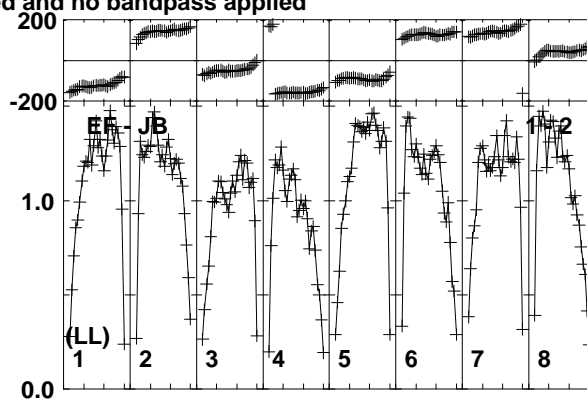
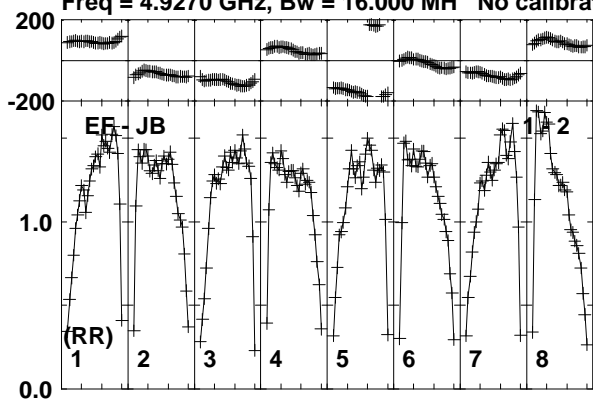

Lower frame: Milli Ampl Jy Top frame: Phas deg
Vector averaged cross-power spectrum Baseline: EF (01) - JB (02)
Timerange: 01/03:17:13 to 01/03:20:39

Plot file version 238 created 26-MAR-2015 15:27:48

J2115+3742 EG082E.UVDATA.1

Freq = 4.9270 GHz, Bw = 16.000 MH No calibration applied and no bandpass applied

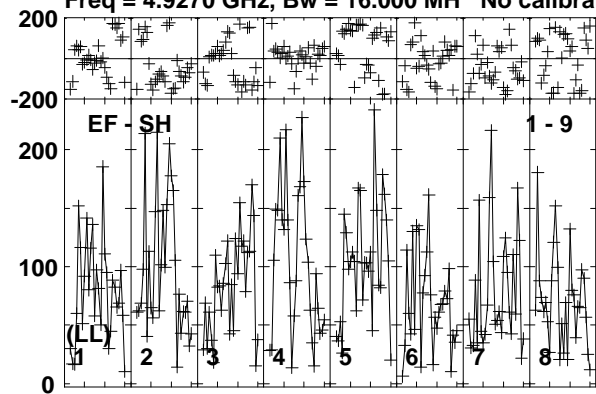

Lower frame: Micro Ampl Jy Top frame: Phas deg
Vector averaged cross-power spectrum Baseline: EF (01) - SH (09)
Timerange: 01/03:17:13 to 01/03:20:39

Plot file version 239 created 26-MAR-2015 15:27:48

J2113+4012 EG082E.UVDATA.1

Freq = 4.9270 GHz, Bw = 16.000 MH No calibration applied and no bandpass applied

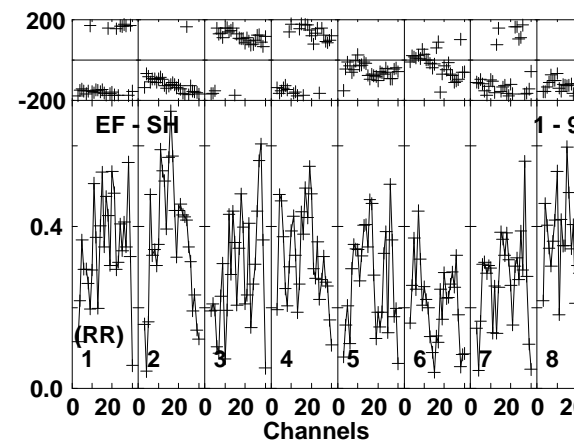
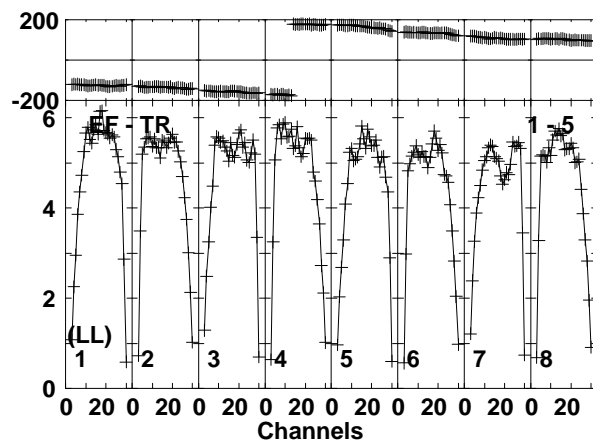
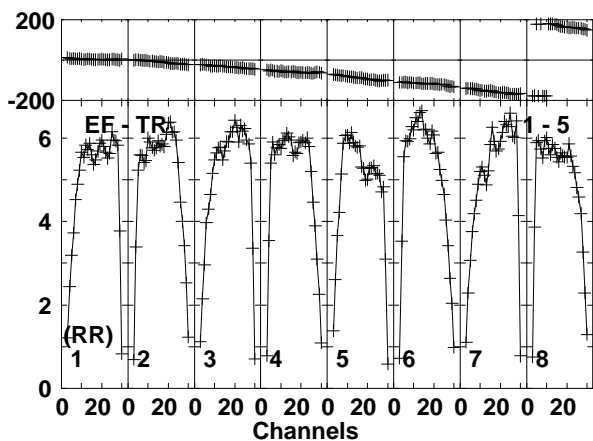
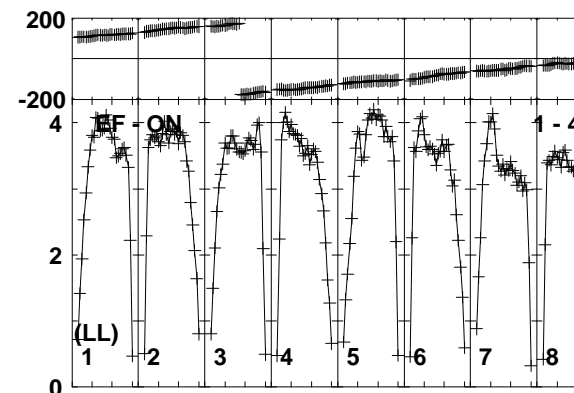
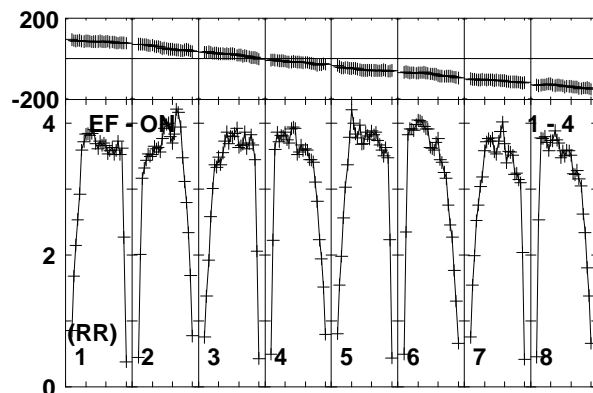
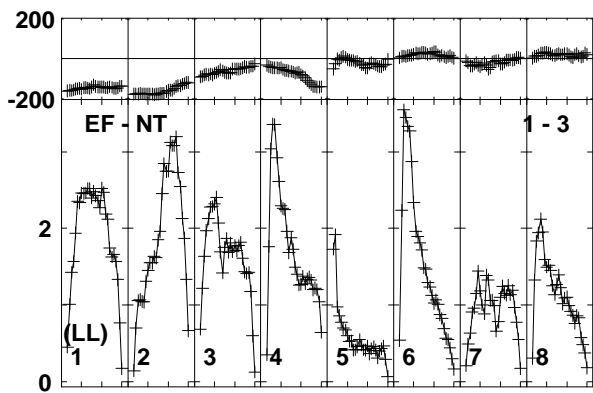
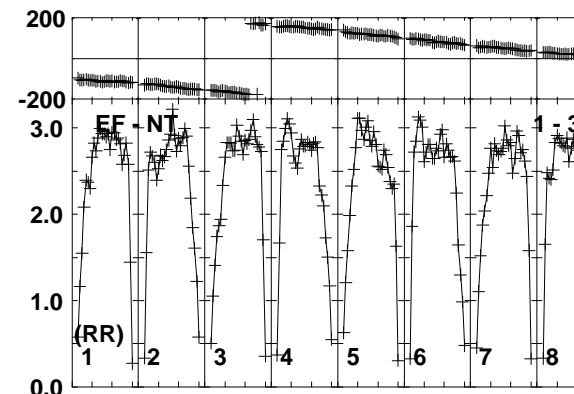
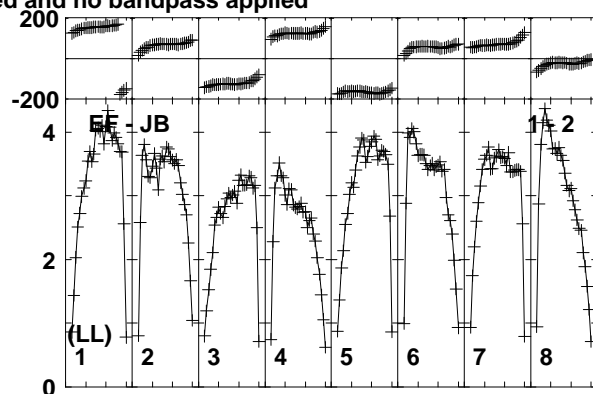
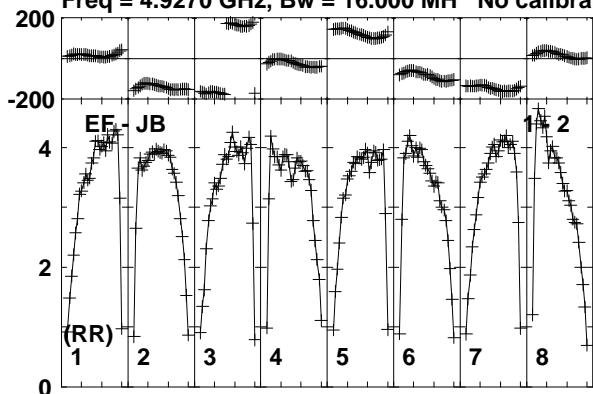

Lower frame: Milli Ampl Jy Top frame: Phas deg
Vector averaged cross-power spectrum Baseline: EF (01) - JB (02)
Timerange: 01/03:21:13 to 01/03:22:09

Plot file version 240 created 26-MAR-2015 15:27:48

J2113+4012 EG082E.UVDATA.1

Freq = 4.9270 GHz, Bw = 16.000 MH No calibration applied and no bandpass applied

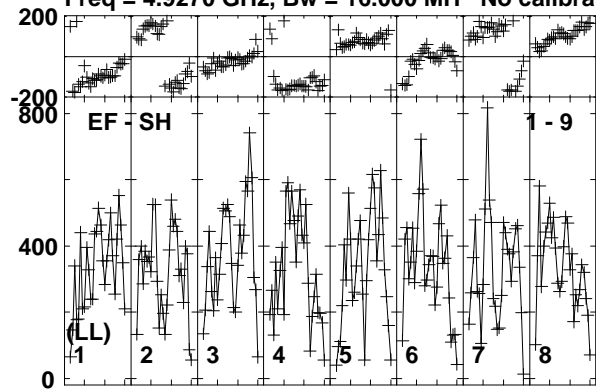

Lower frame: Micro Ampl Jy Top frame: Phas deg
Vector averaged cross-power spectrum Baseline: EF (01) - SH (09)
Timerange: 01/03:21:13 to 01/03:22:09

Plot file version 241 created 26-MAR-2015 15:27:48

V1396CYG EG082E.UVDATA.1

Freq = 4.9270 GHz, Bw = 16.000 MH No calibration applied and no bandpass applied

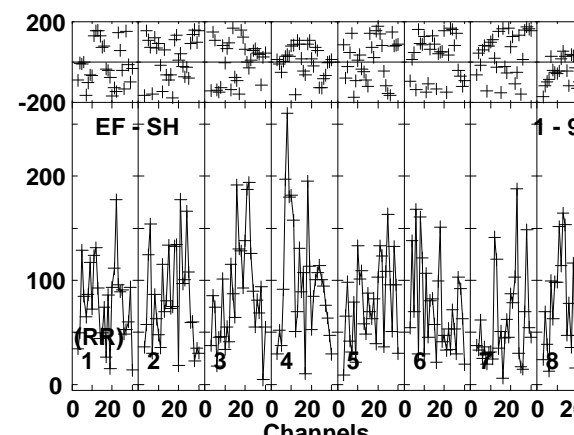
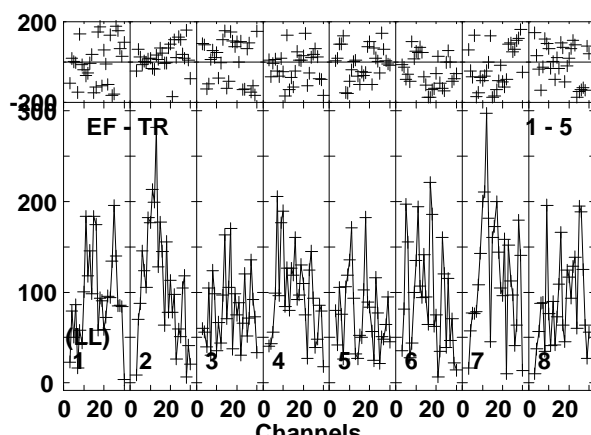
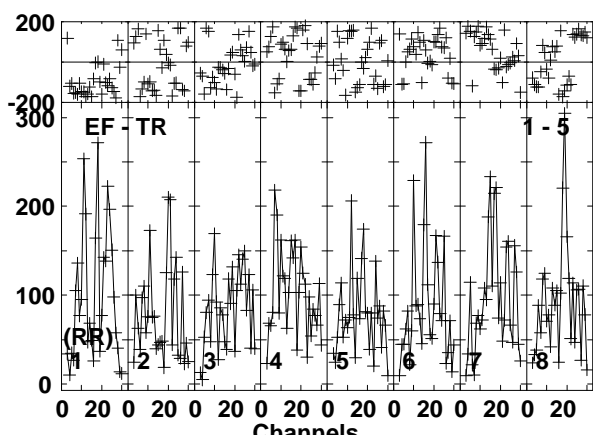
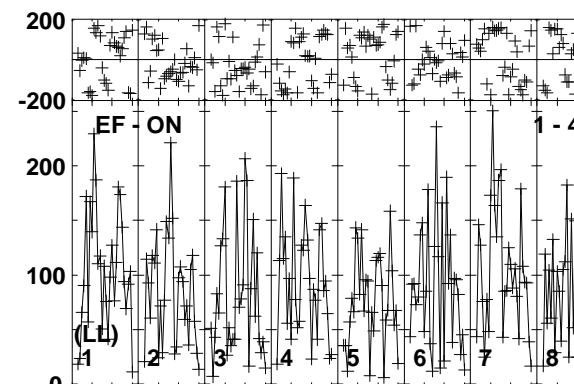
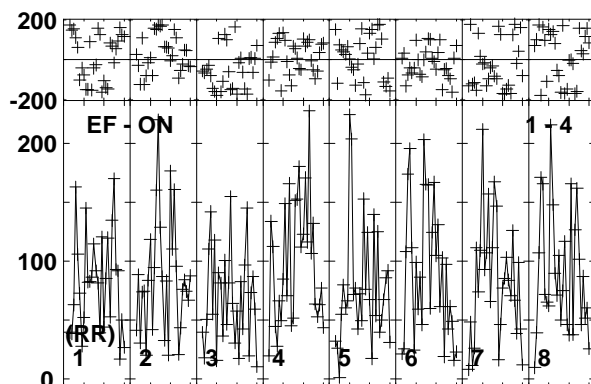
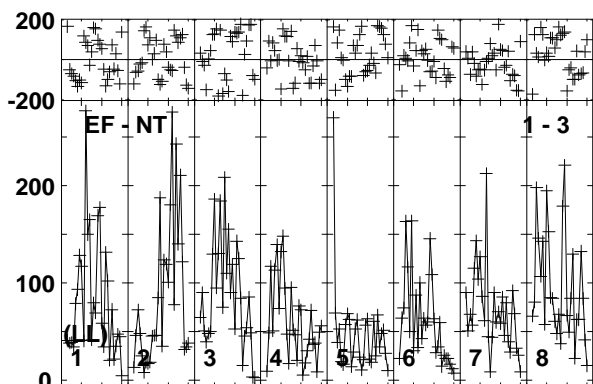
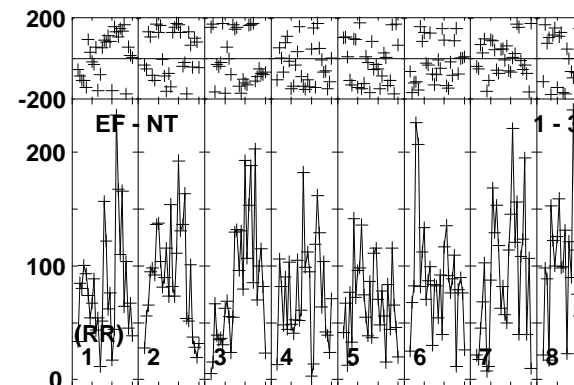
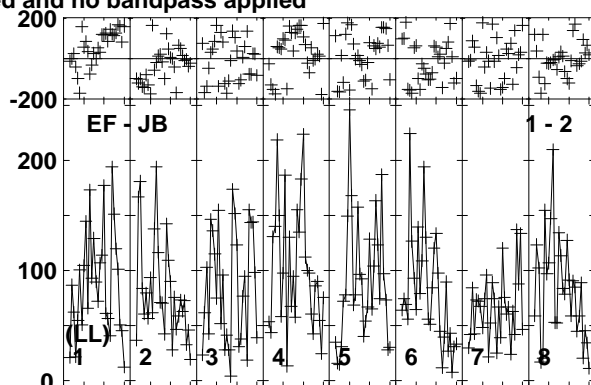
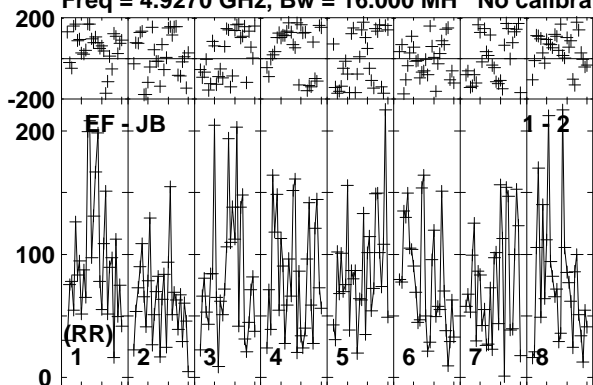

Lower frame: Micro Ampl Jy Top frame: Phas deg
Vector averaged cross-power spectrum Baseline: EF (01) - JB (02)
Timerange: 01/03:22:13 to 01/03:25:39

Plot file version 242 created 26-MAR-2015 15:27:48

V1396CYG EG082E.UVDATA.1

Freq = 4.9270 GHz, Bw = 16.000 MH No calibration applied and no bandpass applied

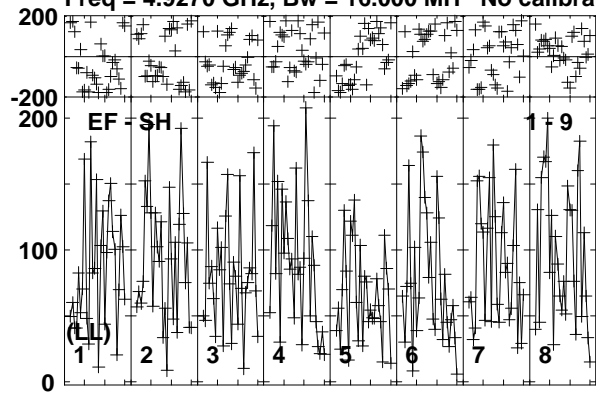

Lower frame: Micro Ampl Jy Top frame: Phas deg
Vector averaged cross-power spectrum Baseline: EF (01) - SH (09)
Timerange: 01/03:22:13 to 01/03:25:39

Plot file version 243 created 26-MAR-2015 15:27:48

J2113+4012 EG082E.UVDATA.1

Freq = 4.9270 GHz, Bw = 16.000 MH No calibration applied and no bandpass applied

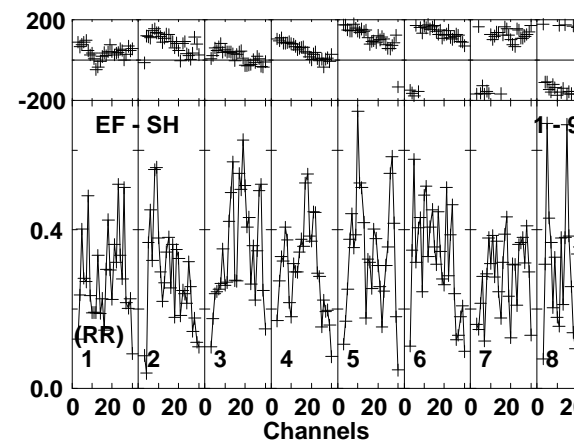
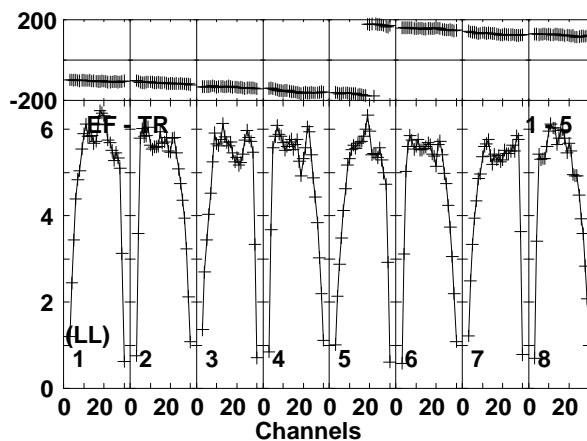
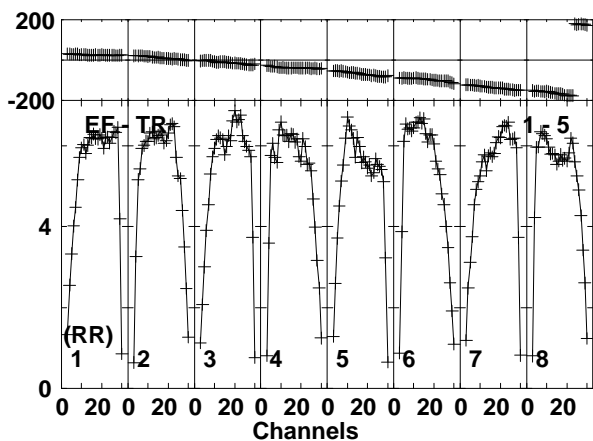
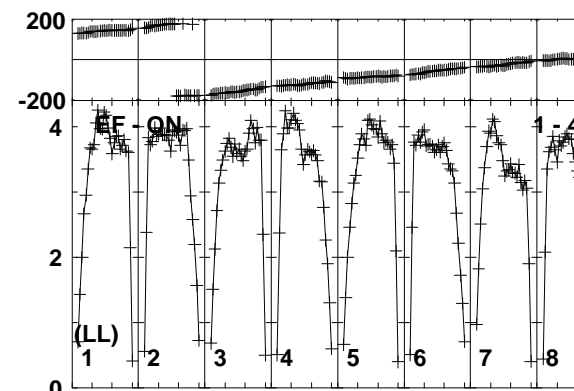
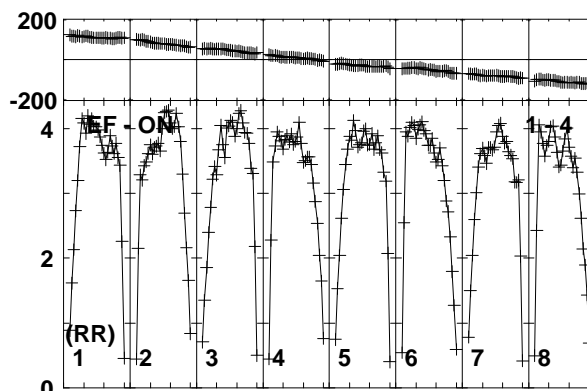
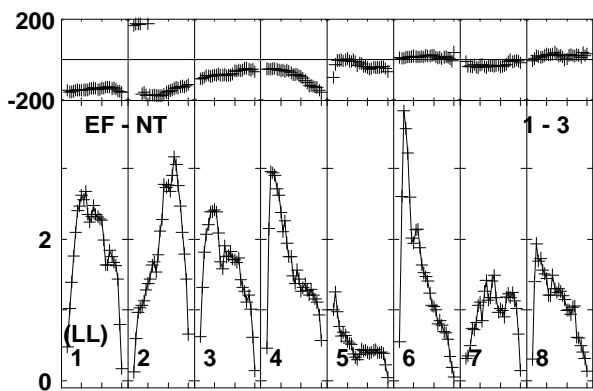
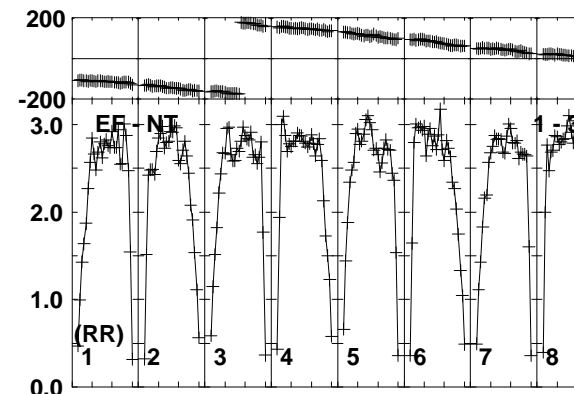
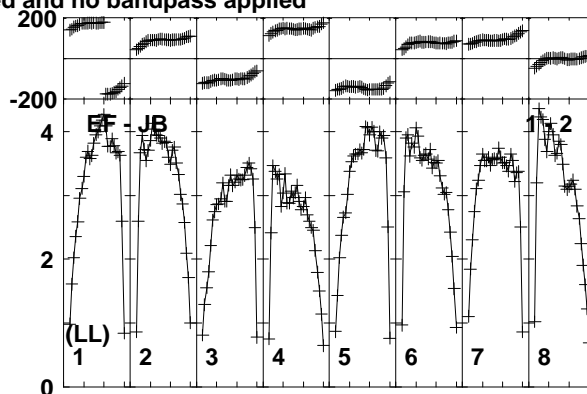
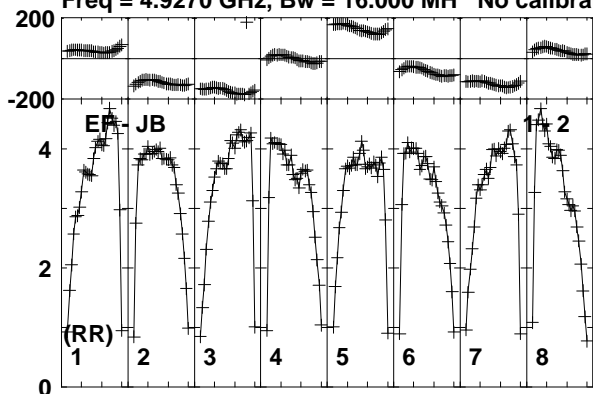

Lower frame: Milli Ampl Jy Top frame: Phas deg
Vector averaged cross-power spectrum Baseline: EF (01) - JB (02)
Timerange: 01/03:25:43 to 01/03:27:09

Plot file version 244 created 26-MAR-2015 15:27:48

J2113+4012 EG082E.UVDATA.1

Freq = 4.9270 GHz, Bw = 16.000 MH No calibration applied and no bandpass applied

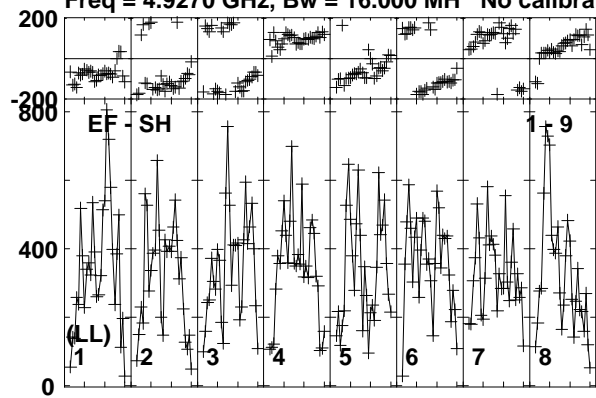

Lower frame: Micro Ampl Jy Top frame: Phas deg
Vector averaged cross-power spectrum Baseline: EF (01) - SH (09)
Timerange: 01/03:25:43 to 01/03:27:09

Plot file version 246 created 26-MAR-2015 15:27:49

V1396CYG EG082E.UVDATA.1

Freq = 4.9270 GHz, Bw = 16.000 MH No calibration applied and no bandpass applied

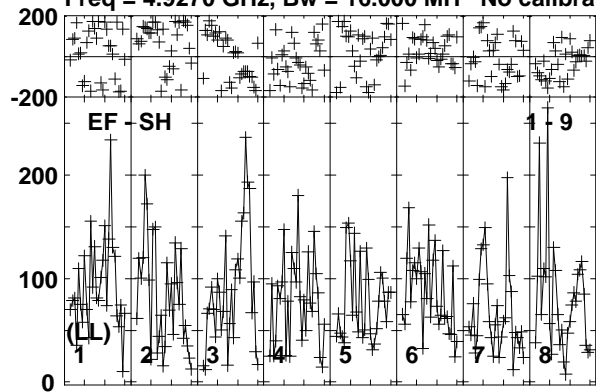

Lower frame: Micro Ampl Jy Top frame: Phas deg
Vector averaged cross-power spectrum Baseline: EF (01) - SH (09)
Timerange: 01/03:27:13 to 01/03:30:39

Plot file version 247 created 26-MAR-2015 15:27:49

J2113+4012 EG082E.UVDATA.1

Freq = 4.9270 GHz, Bw = 16.000 MH No calibration applied and no bandpass applied

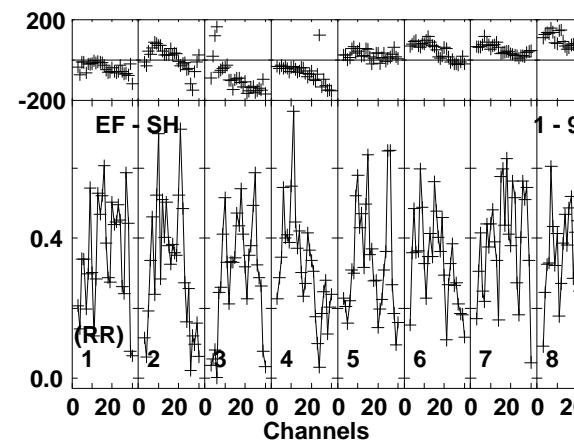
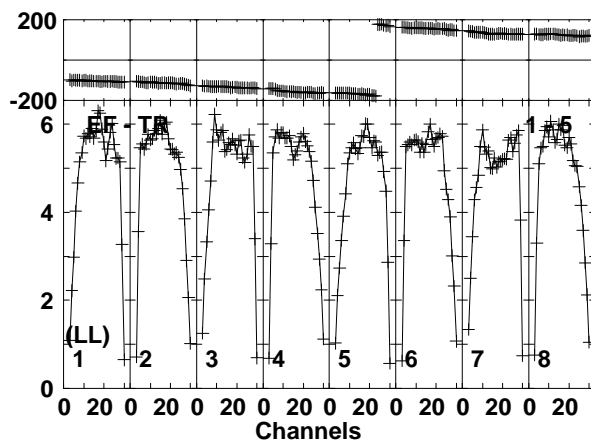
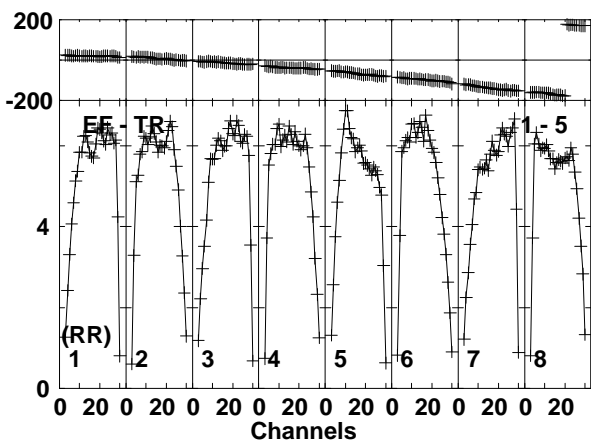
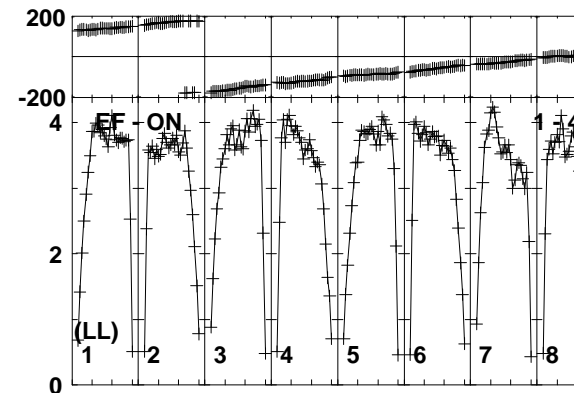
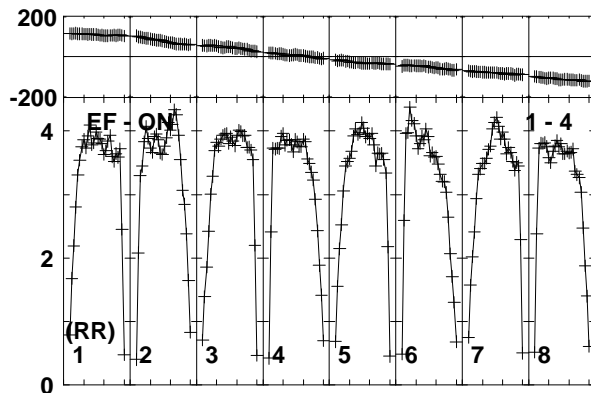
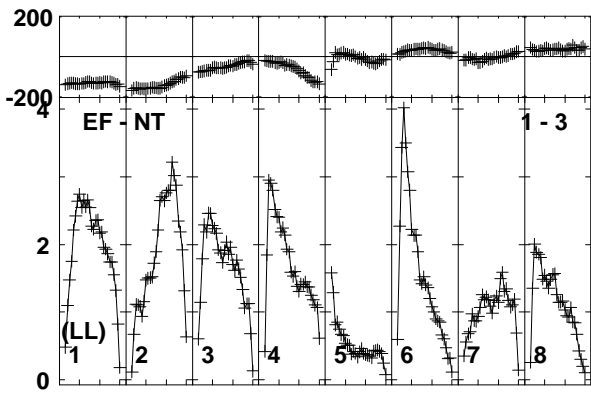
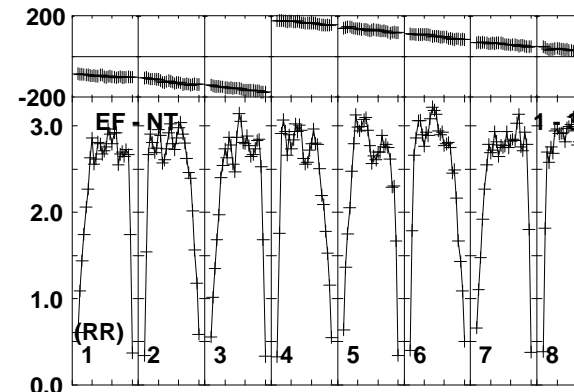
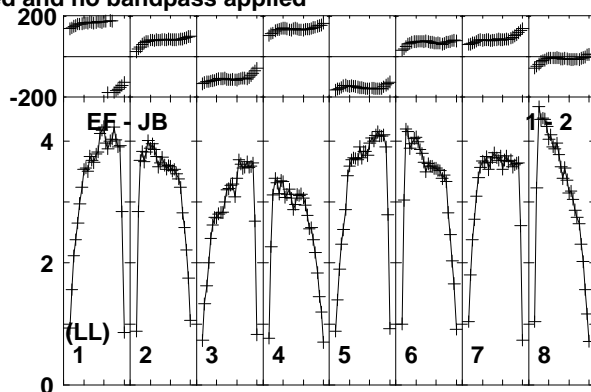
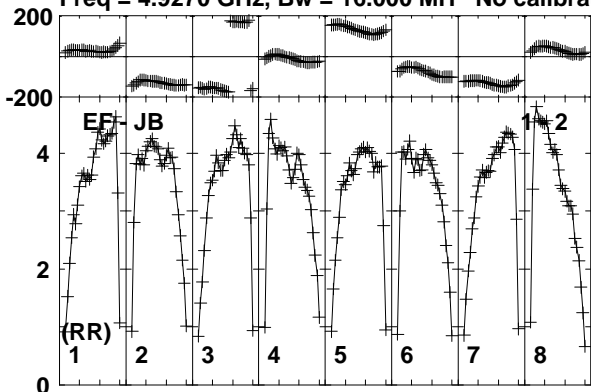

Lower frame: Milli Ampl Jy Top frame: Phas deg
Vector averaged cross-power spectrum Baseline: EF (01) - JB (02)
Timerange: 01/03:31:13 to 01/03:32:09

Plot file version 248 created 26-MAR-2015 15:27:49

J2113+4012 EG082E.UVDATA.1

Freq = 4.9270 GHz, Bw = 16.000 MH No calibration applied and no bandpass applied

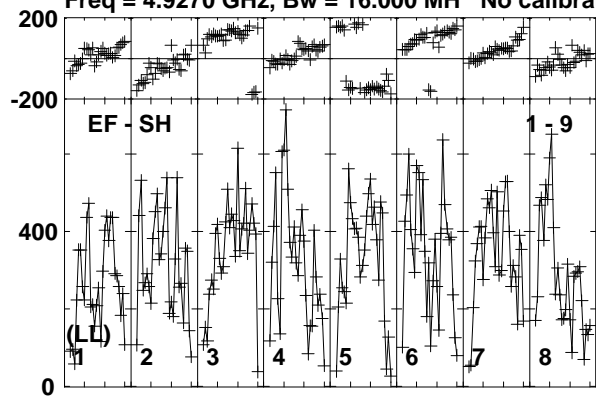

Lower frame: Micro Ampl Jy Top frame: Phas deg
Vector averaged cross-power spectrum Baseline: EF (01) - SH (09)
Timerange: 01/03:31:13 to 01/03:32:09

Plot file version 249 created 26-MAR-2015 15:27:49

V1396CYG EG082E.UVDATA.1

Freq = 4.9270 GHz, Bw = 16.000 MH No calibration applied and no bandpass applied

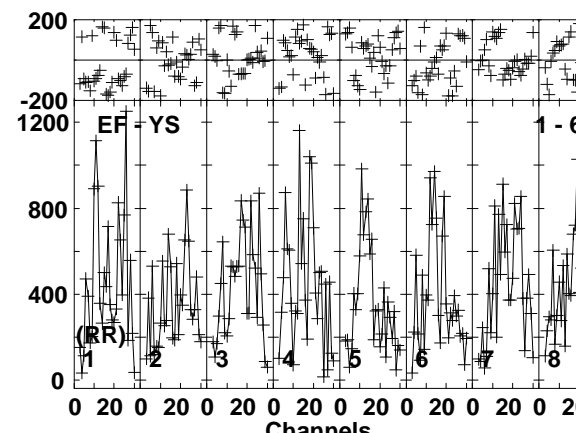
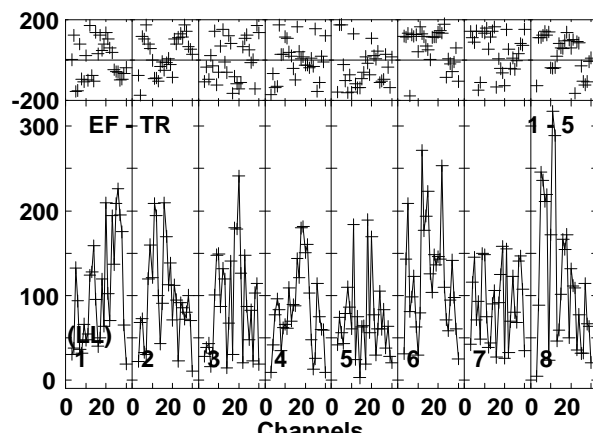
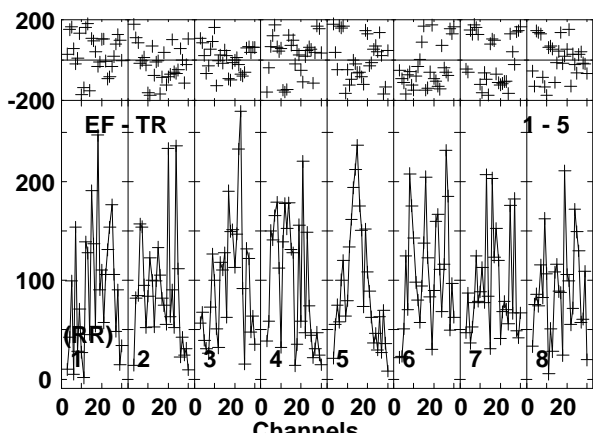
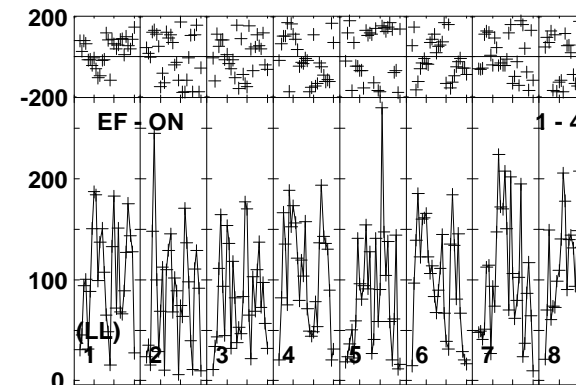
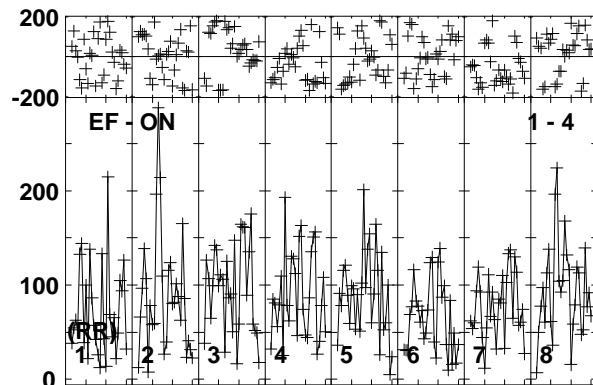
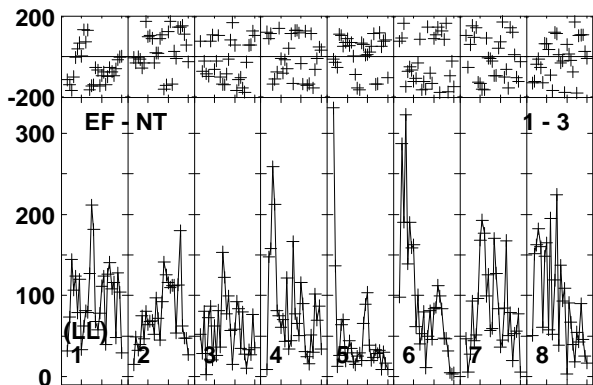
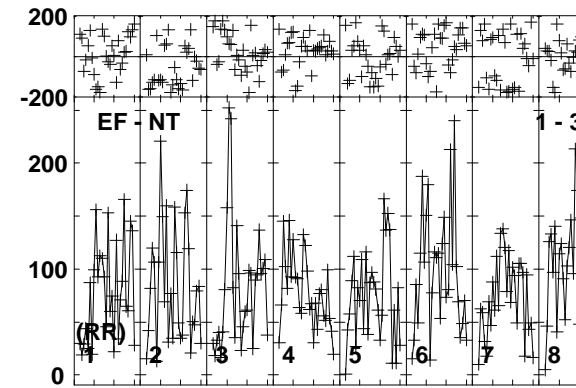
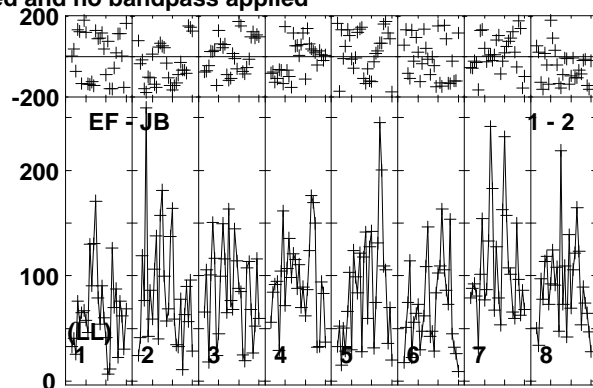
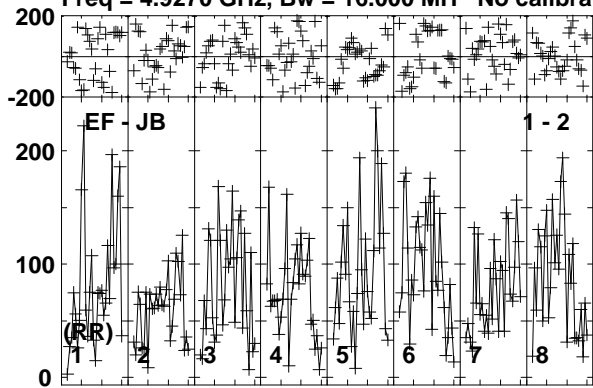

Lower frame: Micro Ampl Jy Top frame: Phas deg
Vector averaged cross-power spectrum Baseline: EF (01) - JB (02)
Timerange: 01/03/32:13 to 01/03/35:39

Plot file version 250 created 26-MAR-2015 15:27:49

V1396CYG EG082E.UVDATA.1

Freq = 4.9270 GHz, Bw = 16.000 MH No calibration applied and no bandpass applied

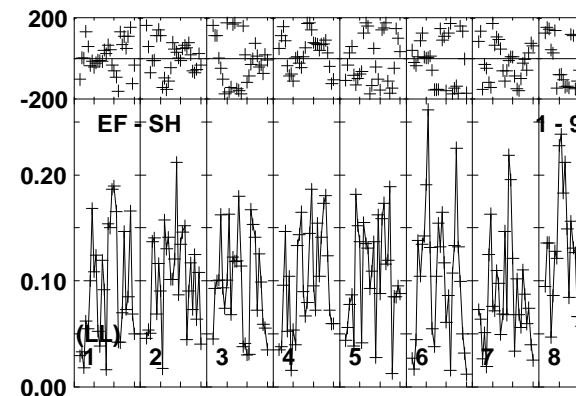
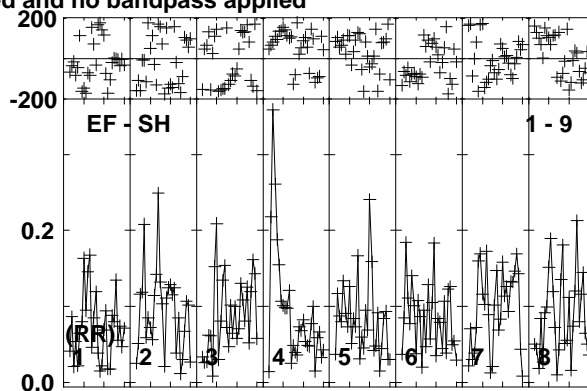
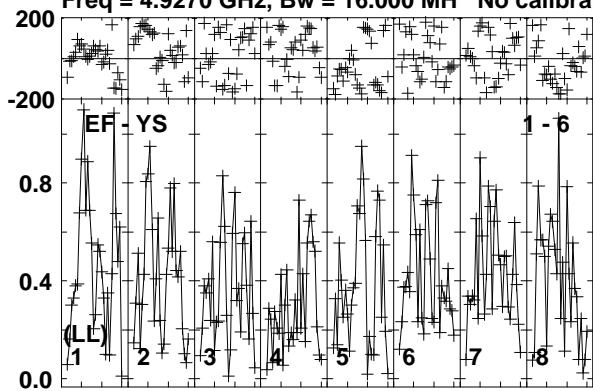

Lower frame: Milli Ampl Jy Top frame: Phas deg
Vector averaged cross-power spectrum Baseline: EF (01) - YS (06)
Timerange: 01/03:32:13 to 01/03:35:39

Plot file version 251 created 26-MAR-2015 15:27:49

J2113+4012 EG082E.UVDATA.1

Freq = 4.9270 GHz, Bw = 16.000 MH No calibration applied and no bandpass applied

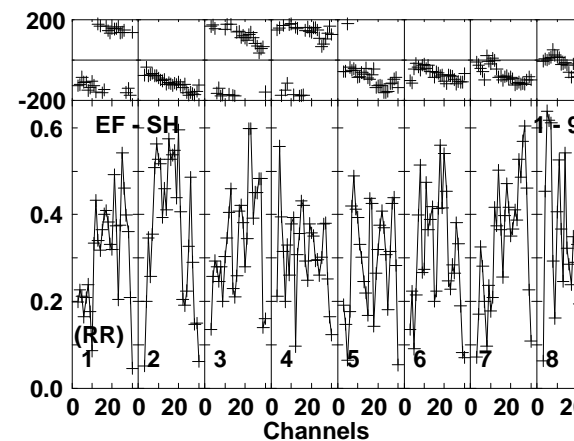
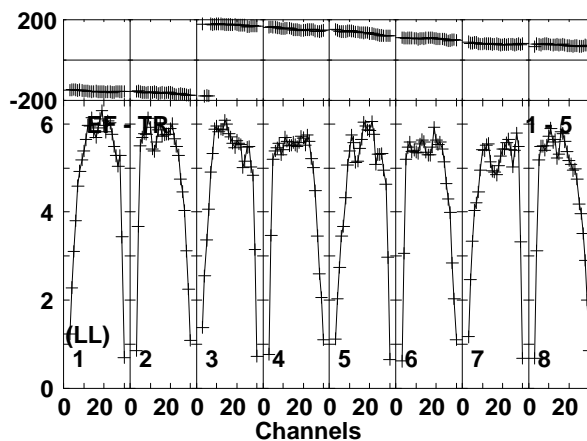
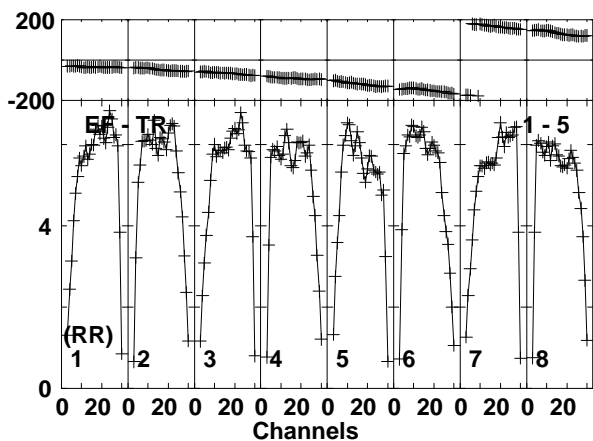
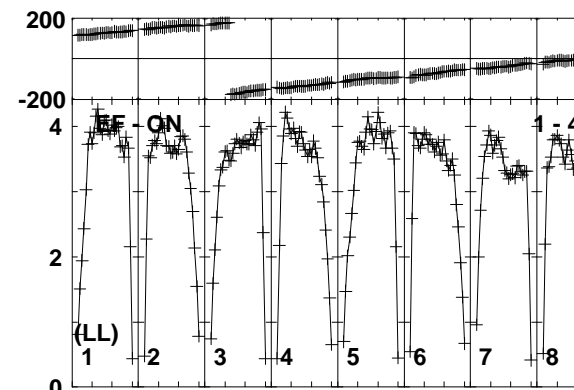
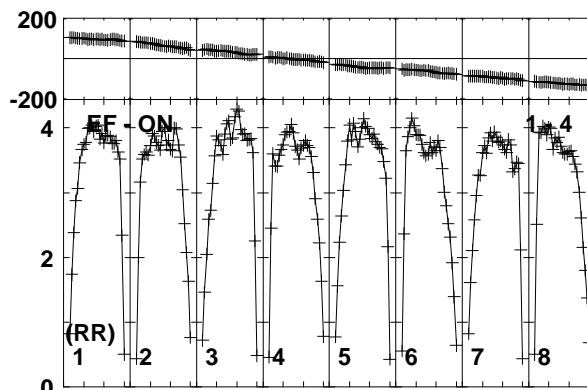
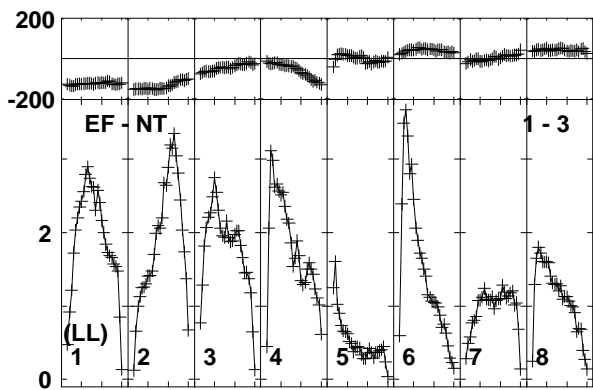
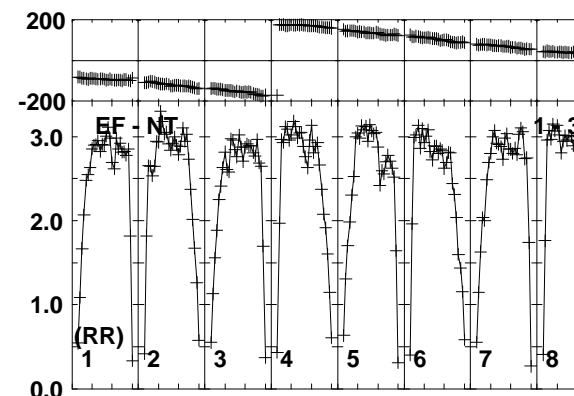
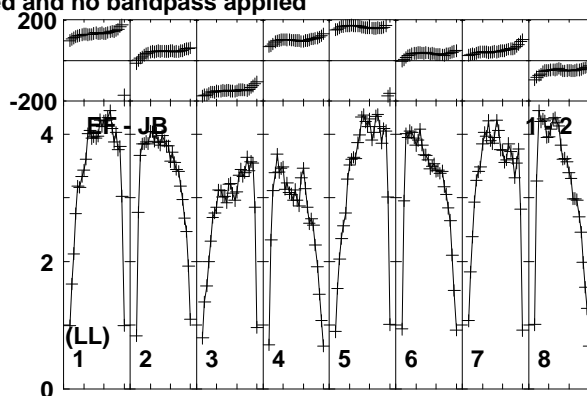
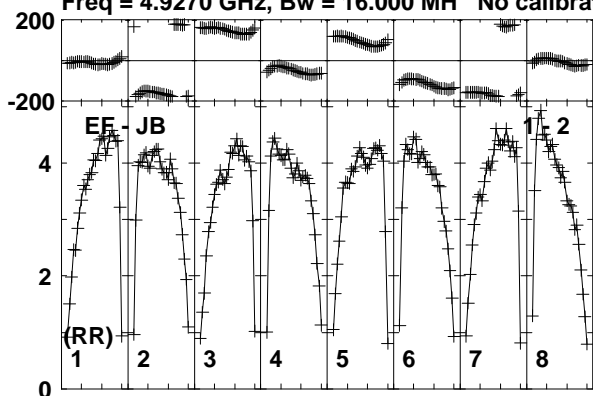

Lower frame: Milli Ampl Jy Top frame: Phas deg
Vector averaged cross-power spectrum Baseline: EF (01) - JB (02)
Timerange: 01/03:35:43 to 01/03:37:09

Plot file version 252 created 26-MAR-2015 15:27:49

J2113+4012 EG082E.UVDATA.1

Freq = 4.9270 GHz, Bw = 16.000 MH No calibration applied and no bandpass applied

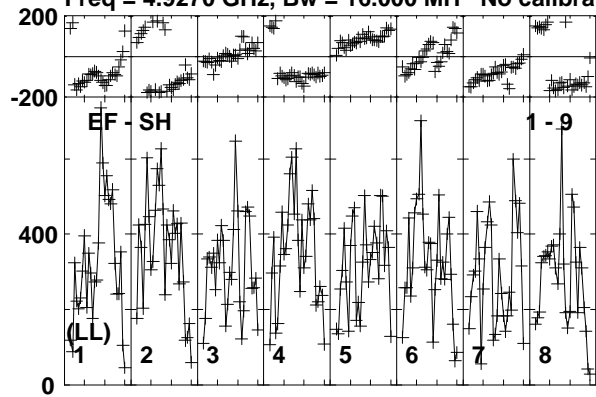

Lower frame: Micro Ampl Jy Top frame: Phas deg
Vector averaged cross-power spectrum Baseline: EF (01) - SH (09)
Timerange: 01/03:35:43 to 01/03:37:09

Plot file version 253 created 26-MAR-2015 15:27:49

V1396CYG EG082E.UVDATA.1

Freq = 4.9270 GHz, Bw = 16.000 MH No calibration applied and no bandpass applied

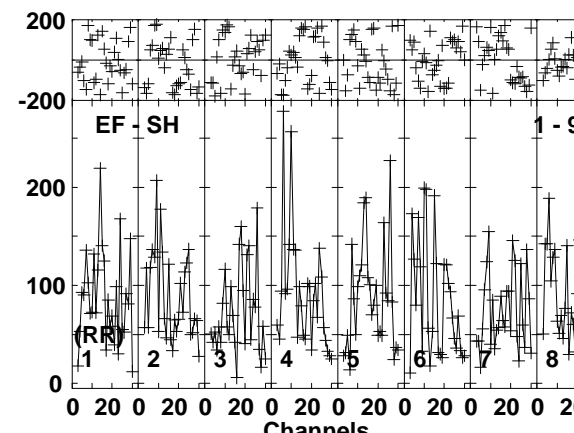
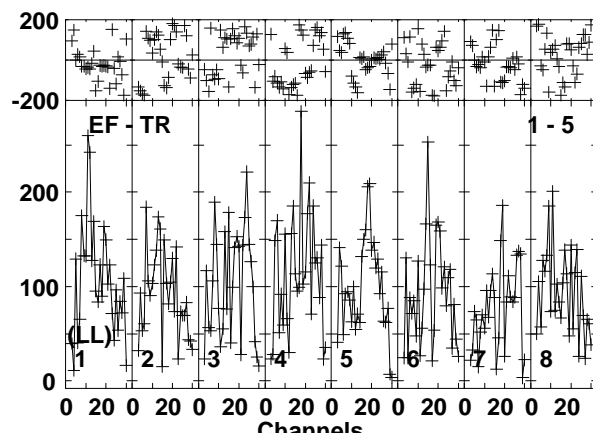
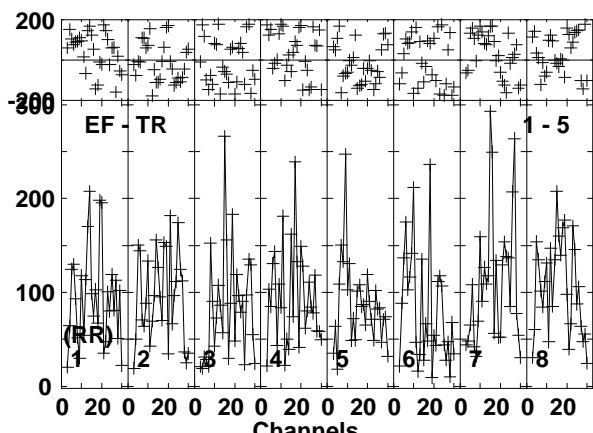
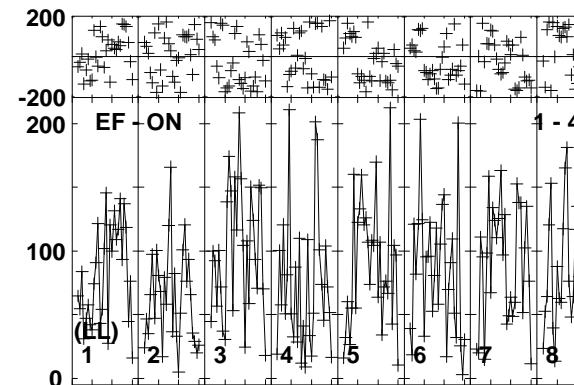
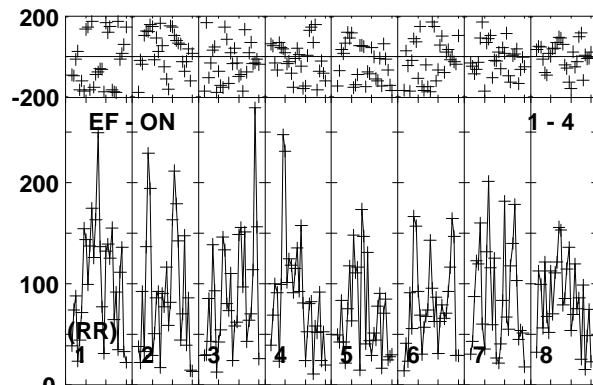
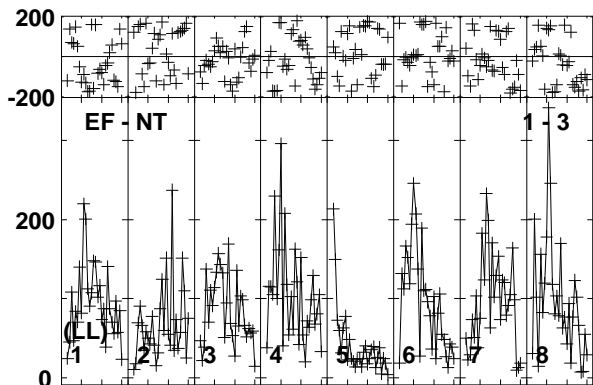
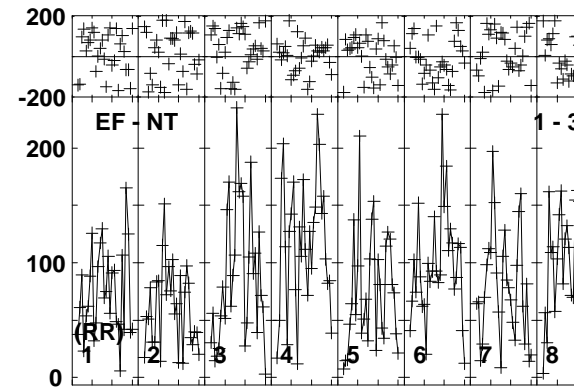
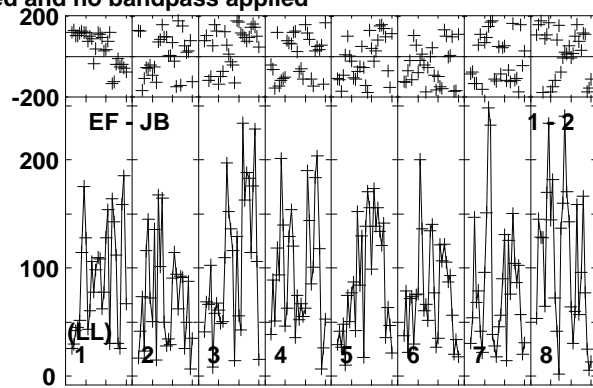
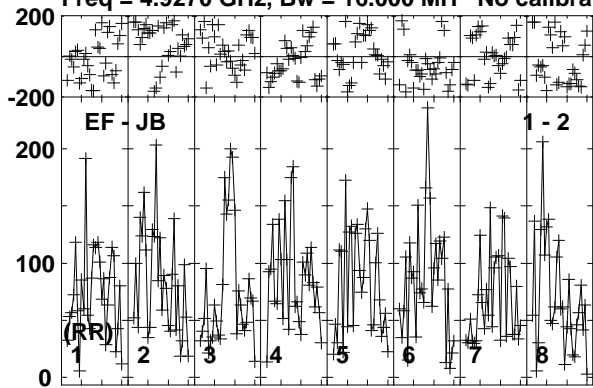

Lower frame: Micro Ampl Jy Top frame: Phas deg
Vector averaged cross-power spectrum Baseline: EF (01) - JB (02)
Timerange: 01/03:37:13 to 01/03:40:39

Plot file version 254 created 26-MAR-2015 15:27:49

V1396CYG EG082E.UVDATA.1

Freq = 4.9270 GHz, Bw = 16.000 MH No calibration applied and no bandpass applied

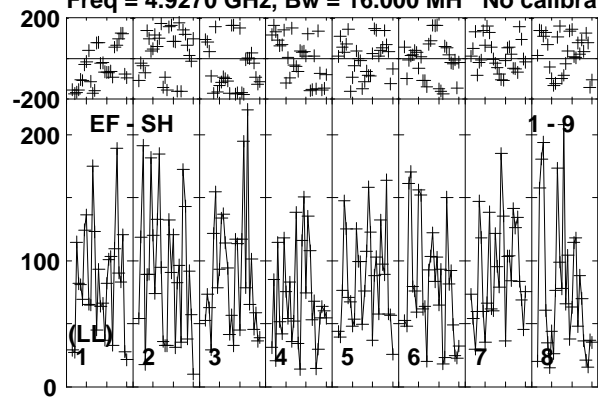

Lower frame: Micro Ampl Jy Top frame: Phas deg
Vector averaged cross-power spectrum Baseline: EF (01) - SH (09)
Timerange: 01/03:37:13 to 01/03:40:39

Plot file version 255 created 26-MAR-2015 15:27:49

J2113+4012 EG082E.UVDATA.1

Freq = 4.9270 GHz, Bw = 16.000 MH No calibration applied and no bandpass applied

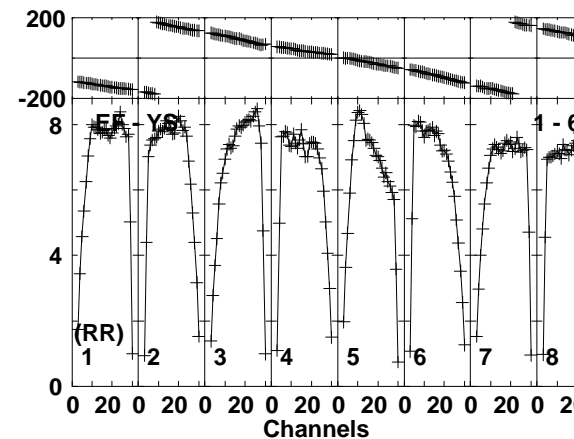
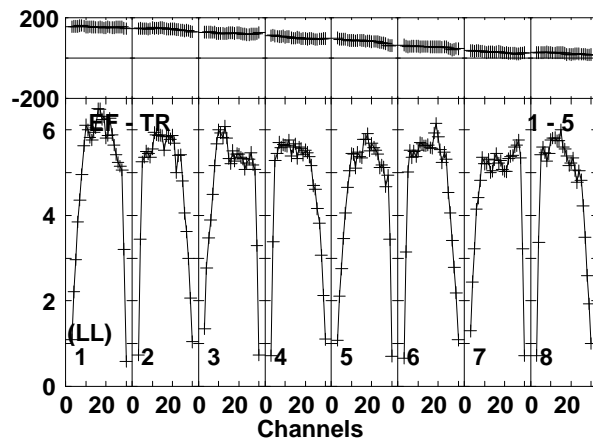
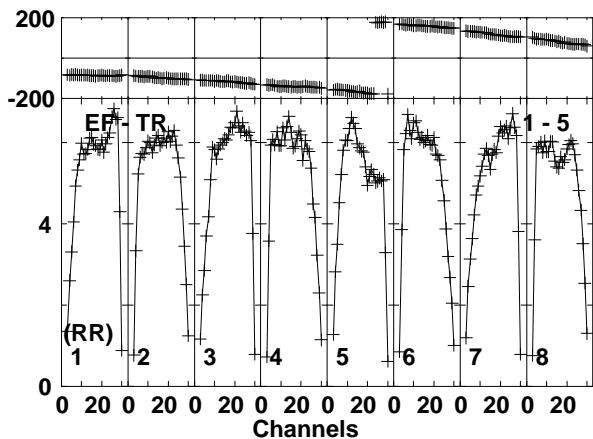
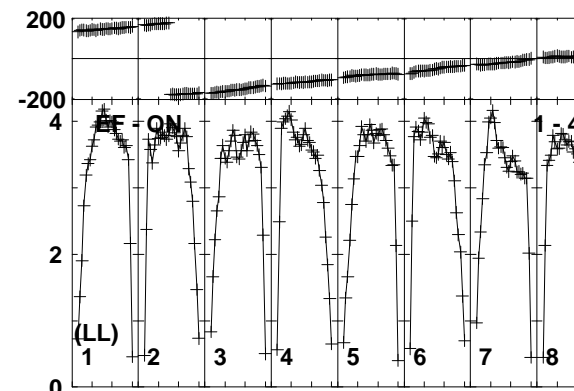
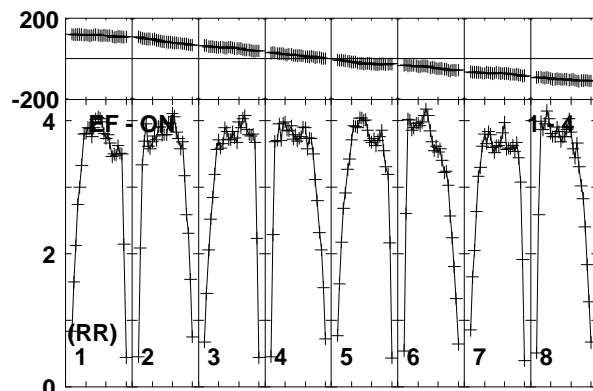
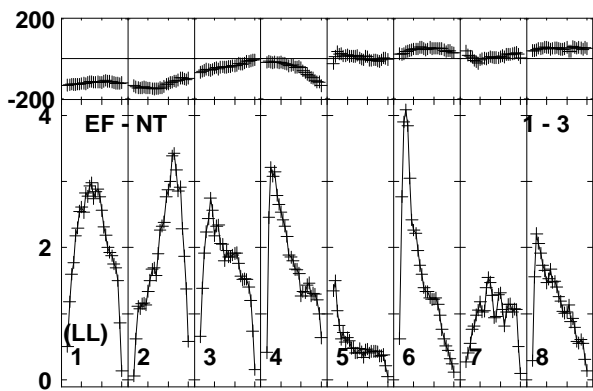
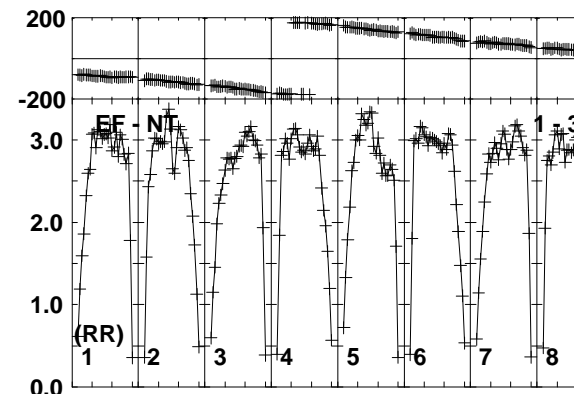
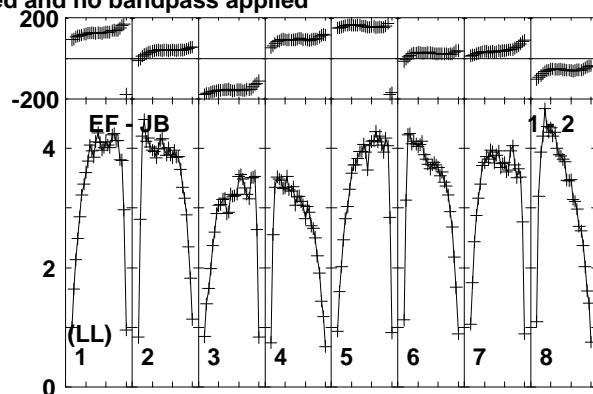
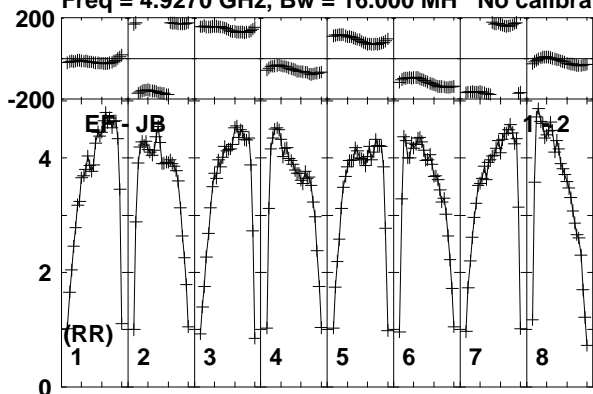

Lower frame: Milli Ampl Jy Top frame: Phas deg
Vector averaged cross-power spectrum Baseline: EF (01) - JB (02)
Timerange: 01/03:41:13 to 01/03:42:09

Plot file version 256 created 26-MAR-2015 15:27:49

J2113+4012 EG082E.UVDATA.1

Freq = 4.9270 GHz, Bw = 16.000 MH No calibration applied and no bandpass applied

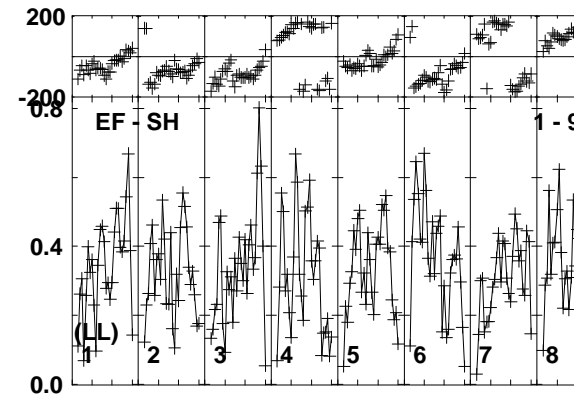
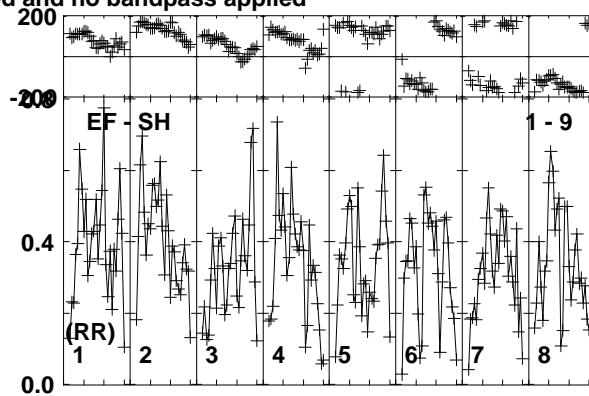
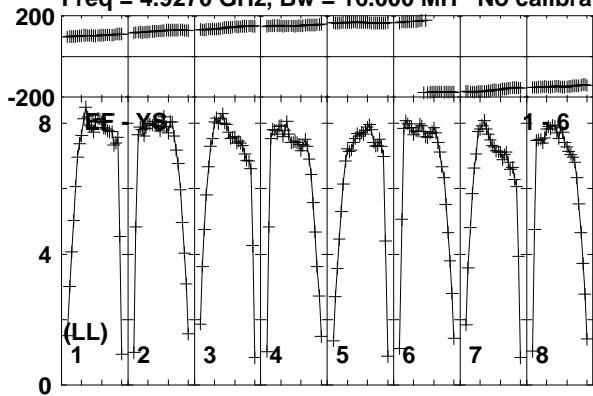

Lower frame: Milli Ampl Jy Top frame: Phas deg
Vector averaged cross-power spectrum Baseline: EF (01) - YS (06)
Timerange: 01/03:41:13 to 01/03:42:09

Plot file version 257 created 26-MAR-2015 15:27:49

V1396CYG EG082E.UVDATA.1

Freq = 4.9270 GHz, Bw = 16.000 MH No calibration applied and no bandpass applied

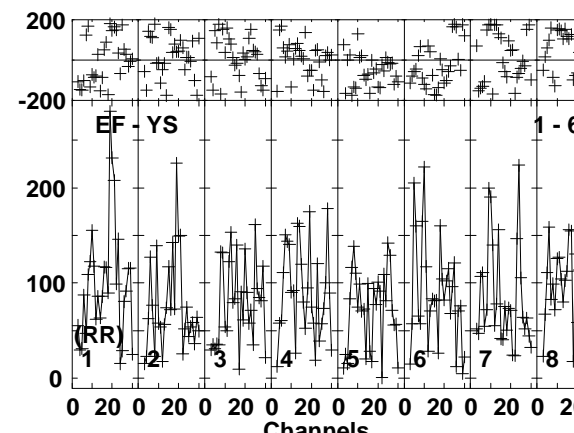
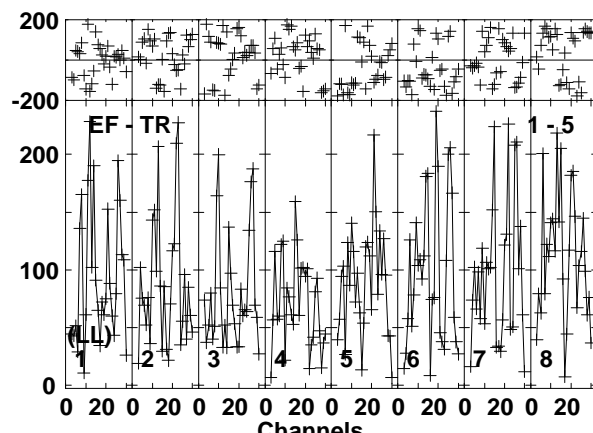
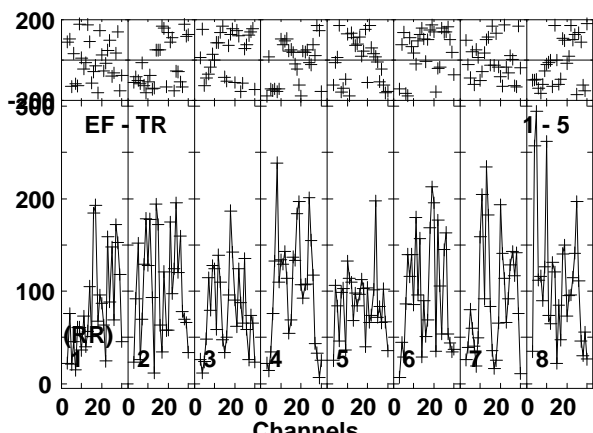
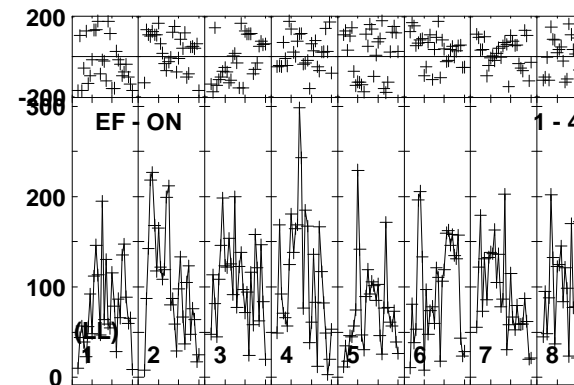
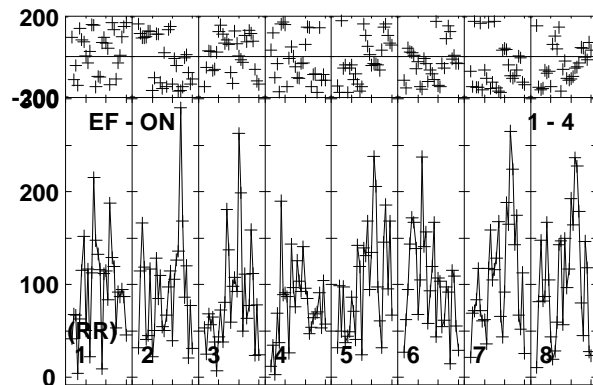
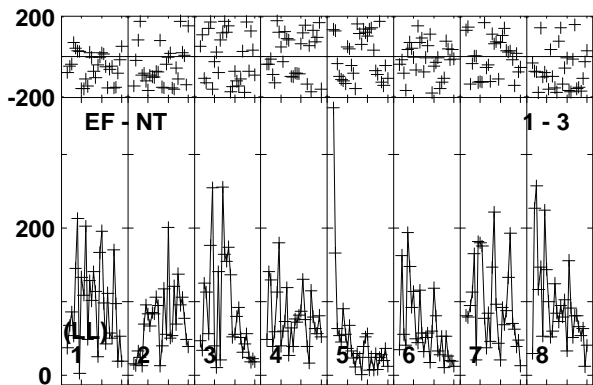
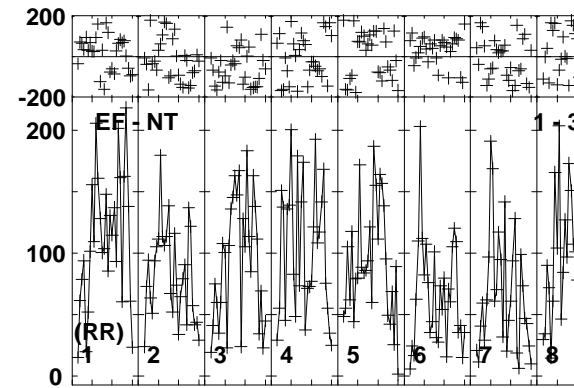
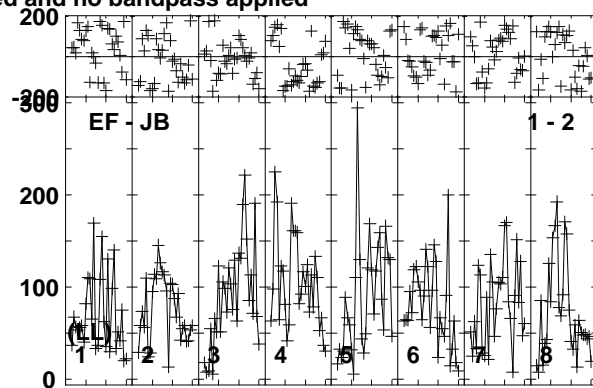
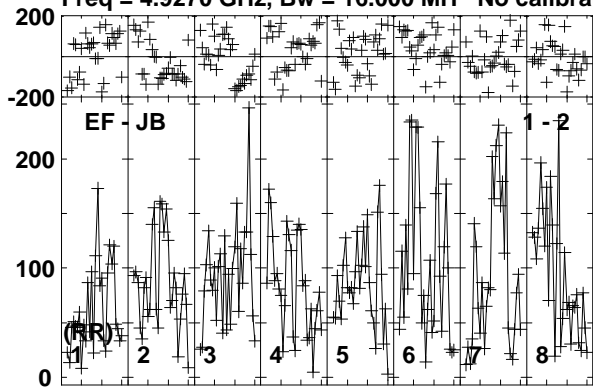

Lower frame: Micro Ampl Jy Top frame: Phas deg
Vector averaged cross-power spectrum Baseline: EF (01) - JB (02)
Timerange: 01/03:42:13 to 01/03:45:39

Plot file version 258 created 26-MAR-2015 15:27:49

V1396CYG EG082E.UVDATA.1

Freq = 4.9270 GHz, Bw = 16.000 MH No calibration applied and no bandpass applied

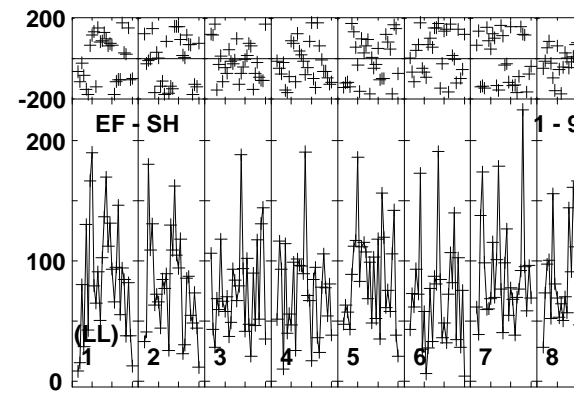
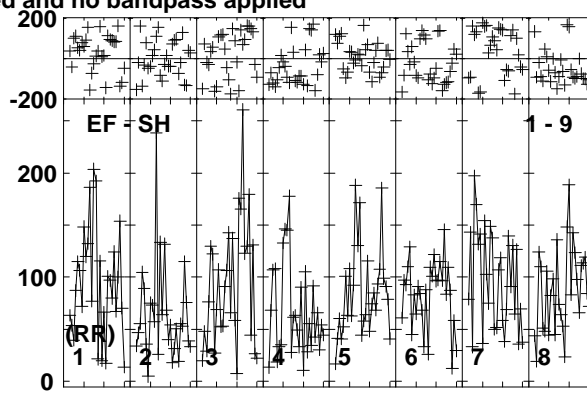
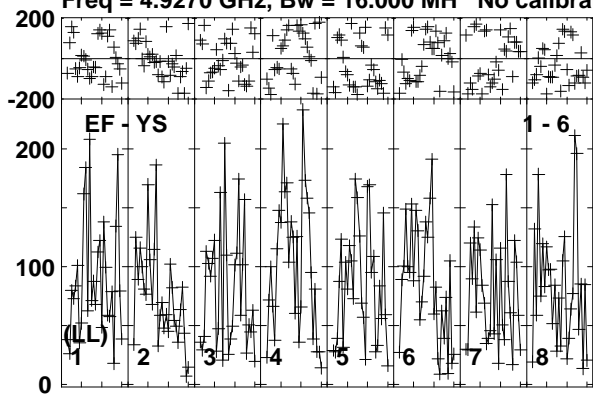

Lower frame: Micro Ampl Jy Top frame: Phas deg
Vector averaged cross-power spectrum Baseline: EF (01) - YS (06)
Timerange: 01/03:42:13 to 01/03:45:39

Plot file version 259 created 26-MAR-2015 15:27:49

J2113+4012 EG082E.UVDATA.1

Freq = 4.9270 GHz, Bw = 16.000 MH No calibration applied and no bandpass applied

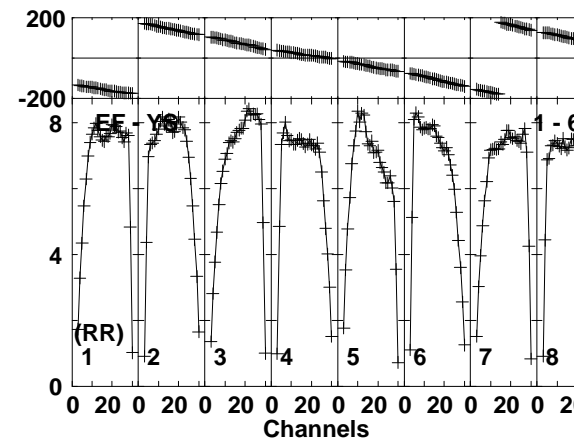
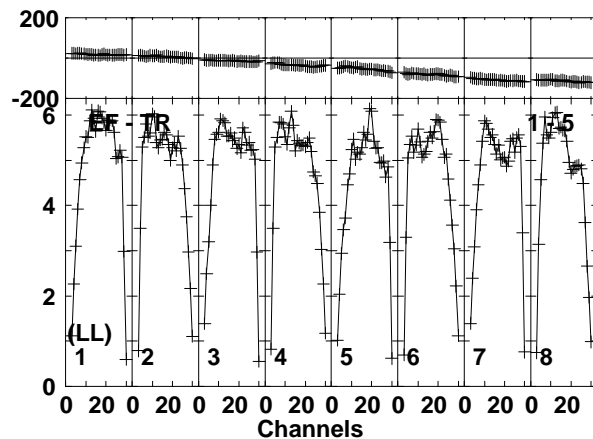
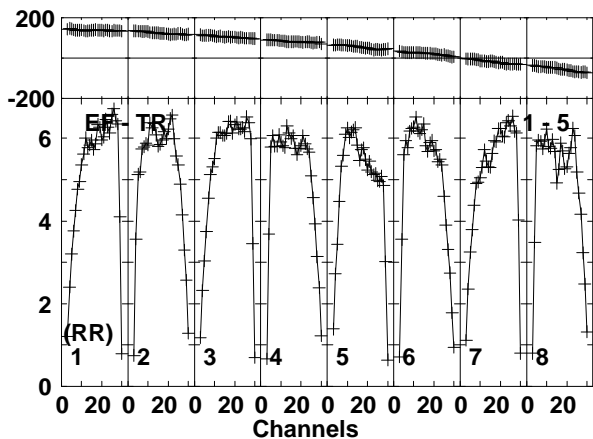
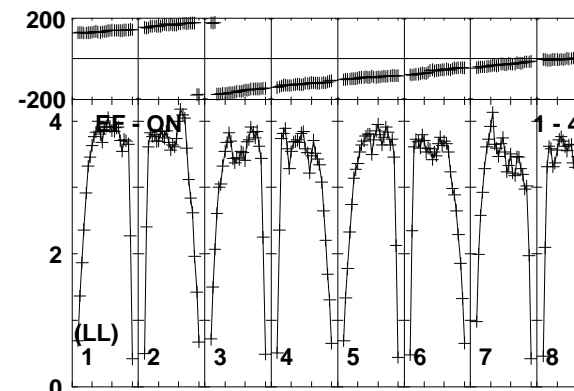
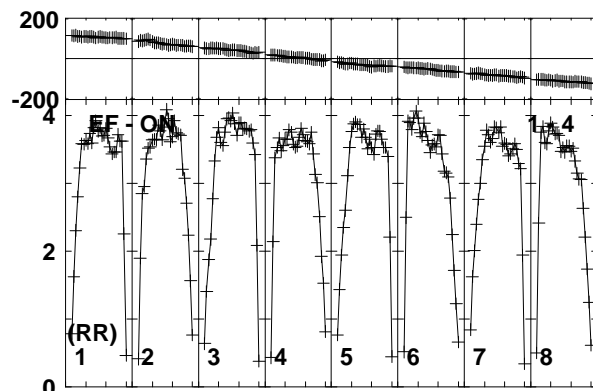
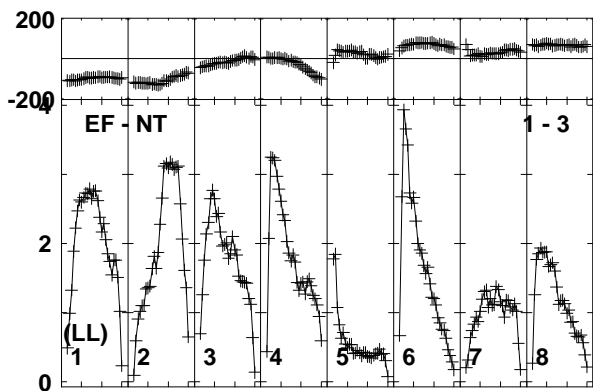
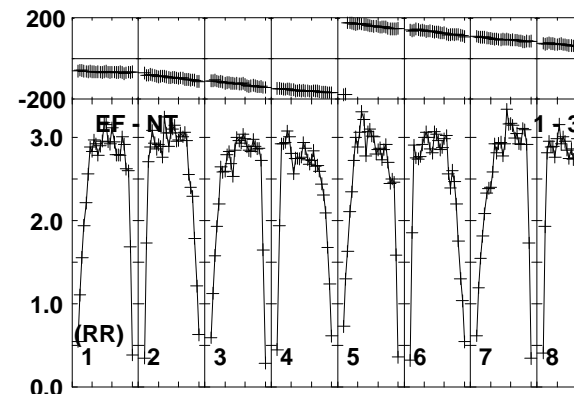
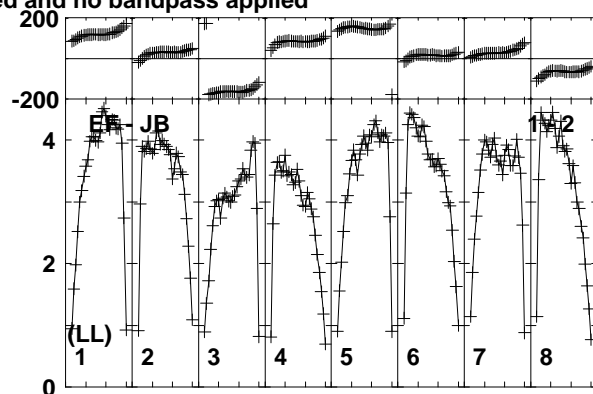
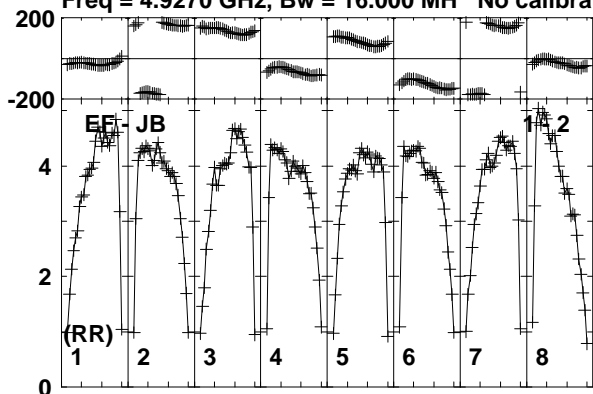

Lower frame: Milli Ampl Jy Top frame: Phas deg
Vector averaged cross-power spectrum Baseline: EF (01) - JB (02)
Timerange: 01/03:45:43 to 01/03:47:09

Plot file version 260 created 26-MAR-2015 15:27:49

J2113+4012 EG082E.UVDATA.1

Freq = 4.9270 GHz, Bw = 16.000 MH No calibration applied and no bandpass applied

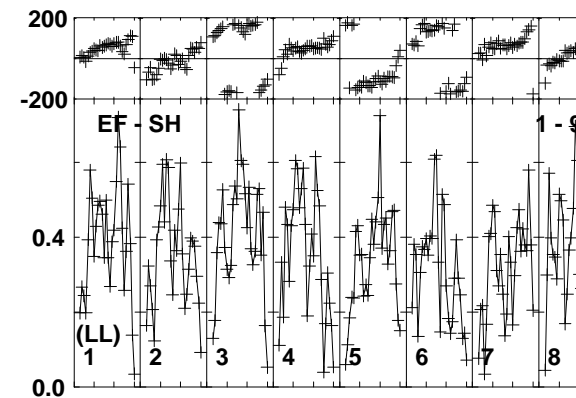
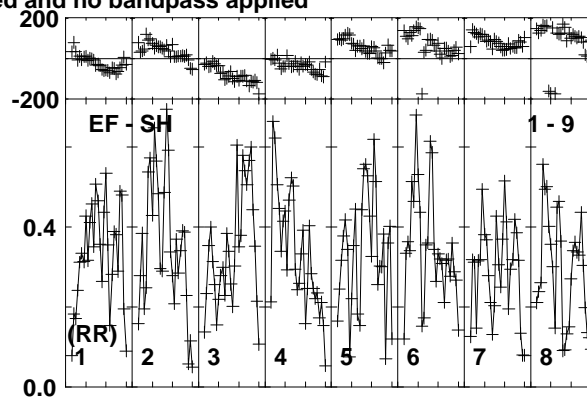
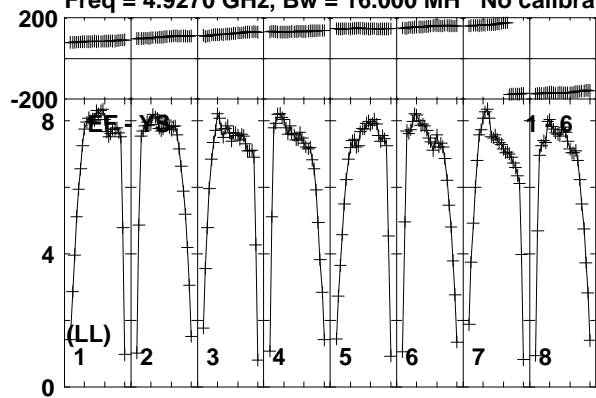

Lower frame: Milli Ampl Jy Top frame: Phas deg
Vector averaged cross-power spectrum Baseline: EF (01) - YS (06)
Timerange: 01/03:45:43 to 01/03:47:09

Plot file version 261 created 26-MAR-2015 15:27:49

J2115+3742 EG082E.UVDATA.1

Freq = 4.9270 GHz, Bw = 16.000 MH No calibration applied and no bandpass applied

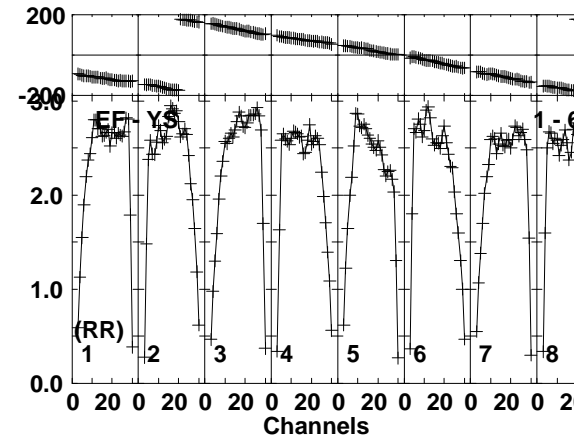
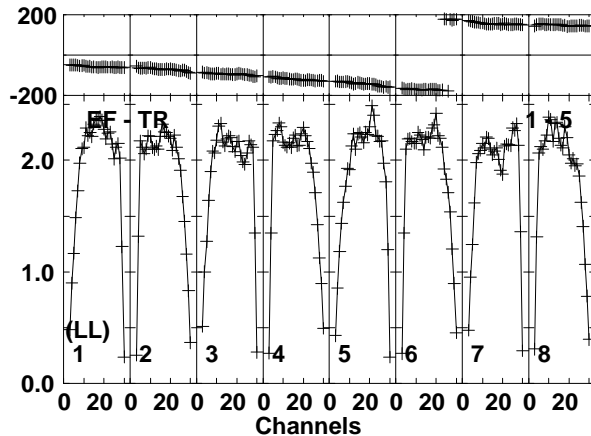
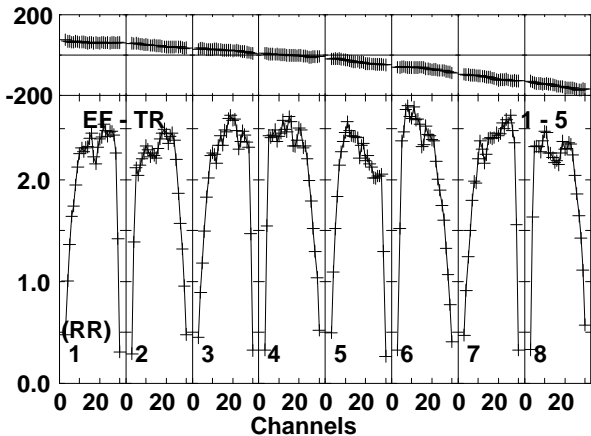
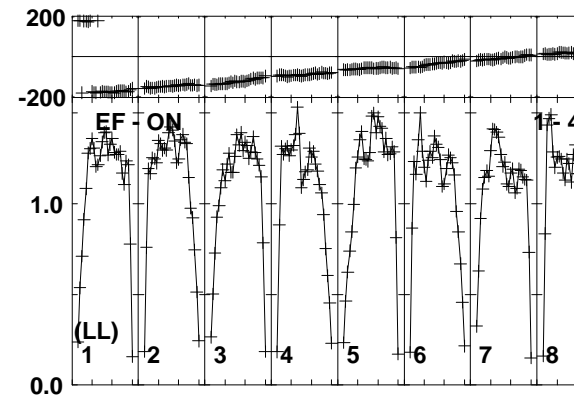
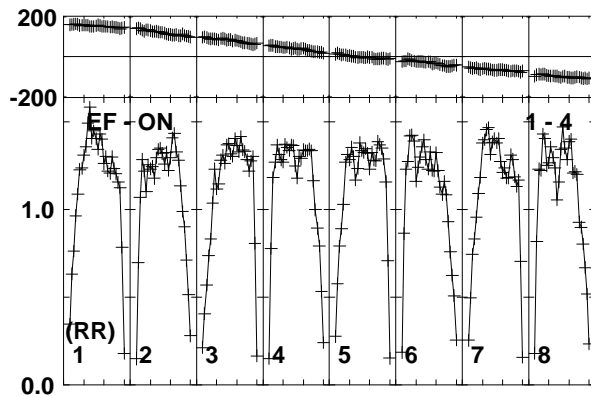
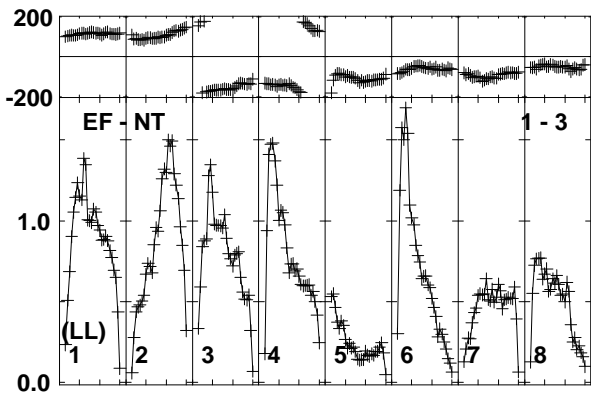
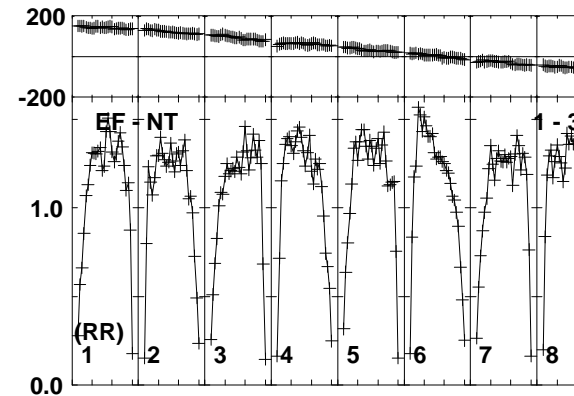
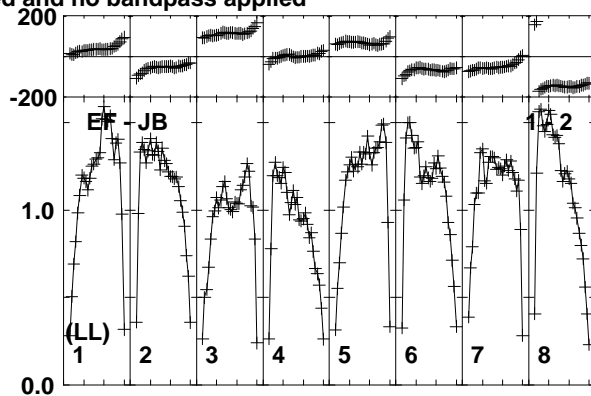
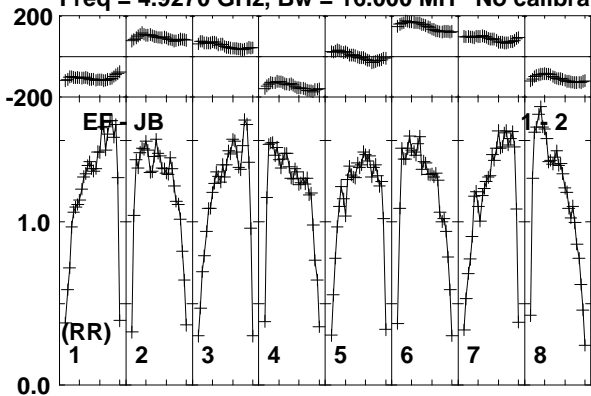

Lower frame: Milli Ampl Jy Top frame: Phas deg
Vector averaged cross-power spectrum Baseline: EF (01) - JB (02)
Timerange: 01/03:47:13 to 01/03:50:39

Plot file version 262 created 26-MAR-2015 15:27:49

J2115+3742 EG082E.UVDATA.1

Freq = 4.9270 GHz, Bw = 16.000 MH No calibration applied and no bandpass applied

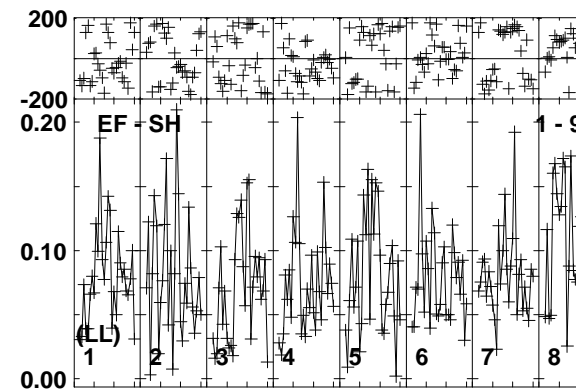
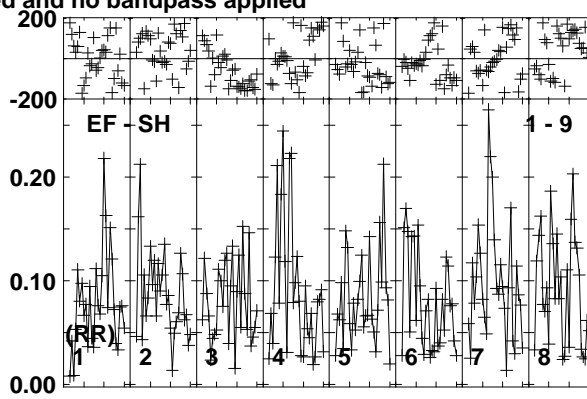
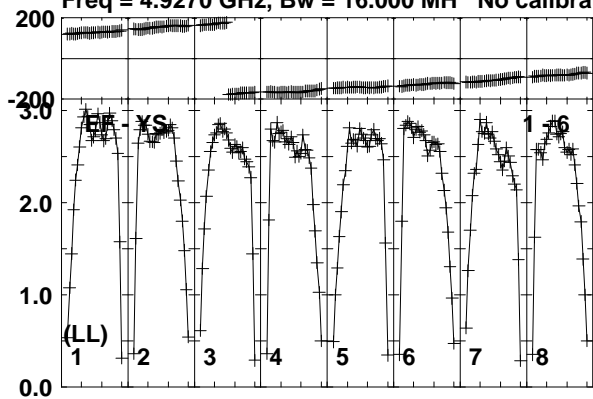

Lower frame: Milli Ampl Jy Top frame: Phas deg
Vector averaged cross-power spectrum Baseline: EF (01) - YS (06)
Timerange: 01/03:47:13 to 01/03:50:39

Plot file version 263 created 26-MAR-2015 15:27:50

J2113+4012 EG082E.UVDATA.1

Freq = 4.9270 GHz, Bw = 16.000 MH No calibration applied and no bandpass applied

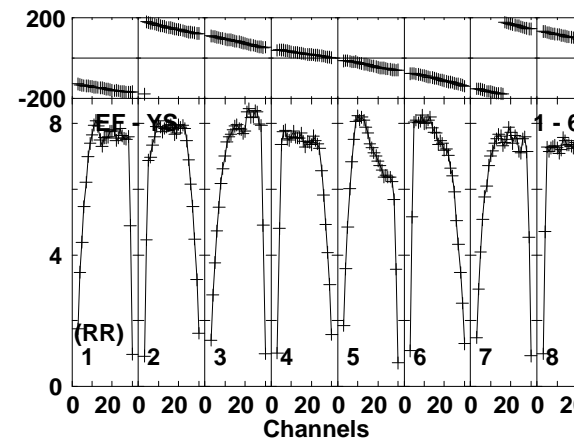
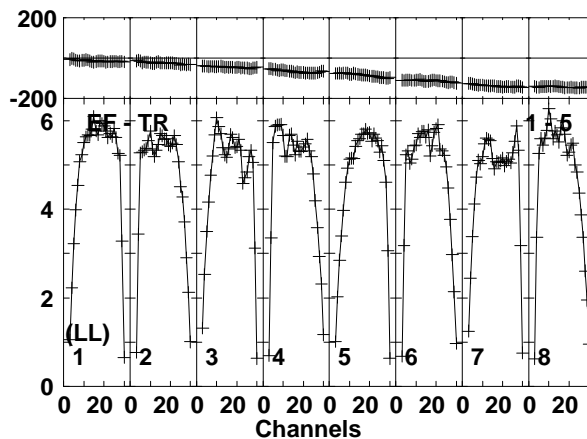
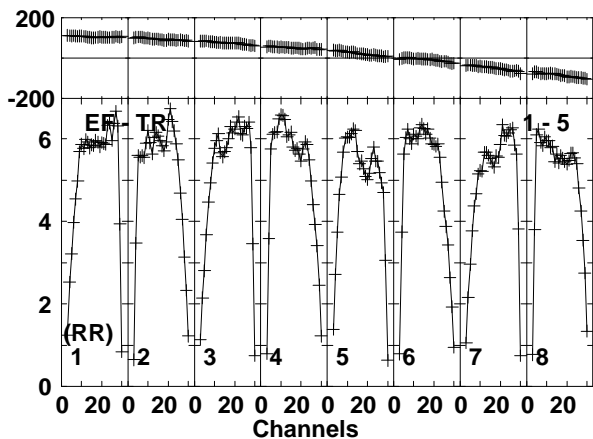
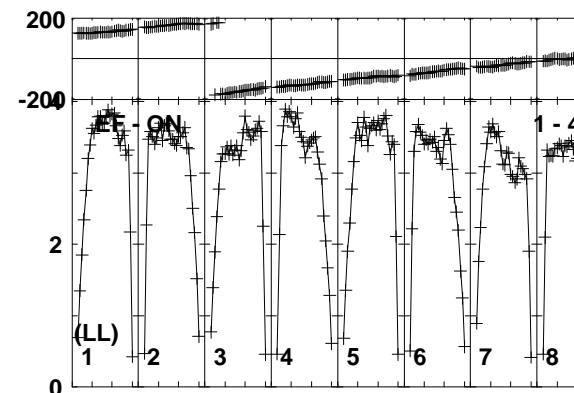
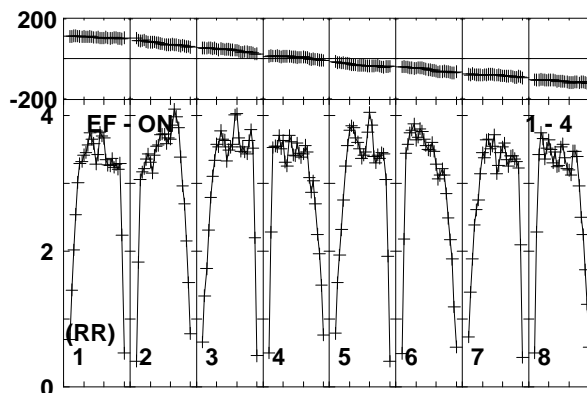
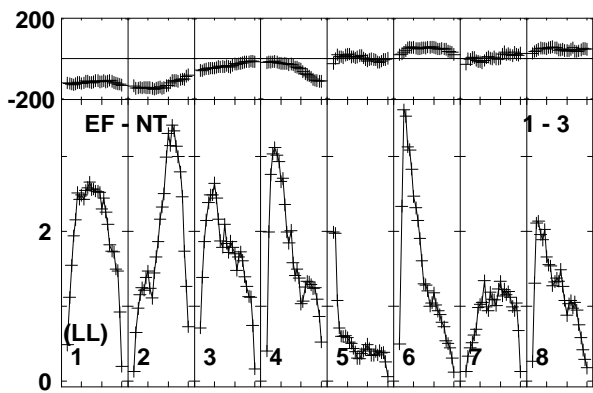
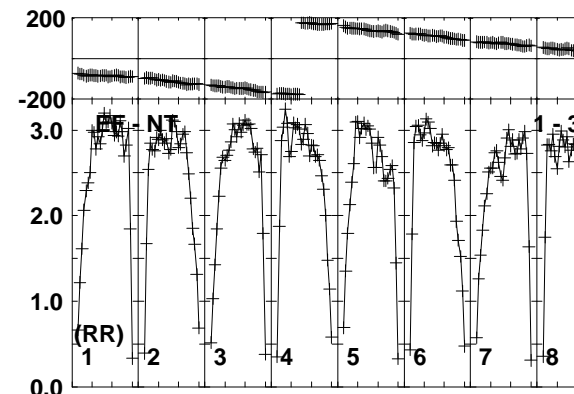
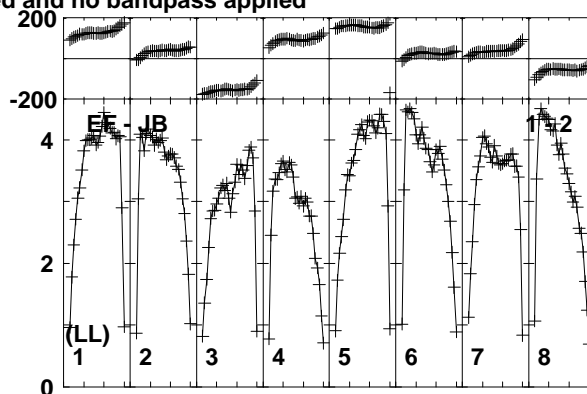
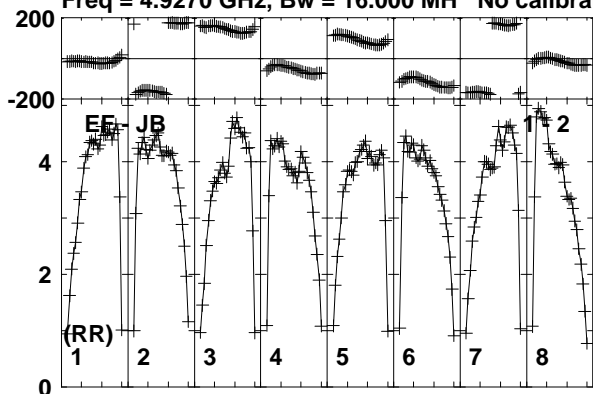

Lower frame: Milli Ampl Jy Top frame: Phas deg
Vector averaged cross-power spectrum Baseline: EF (01) - JB (02)
Timerange: 01/03:51:13 to 01/03:52:09

Plot file version 264 created 26-MAR-2015 15:27:50

J2113+4012 EG082E.UVDATA.1

Freq = 4.9270 GHz, Bw = 16.000 MH No calibration applied and no bandpass applied

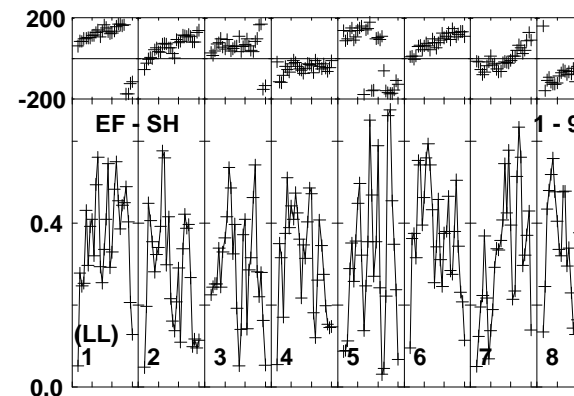
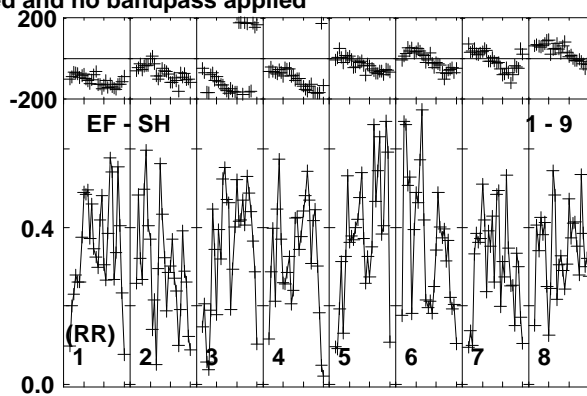
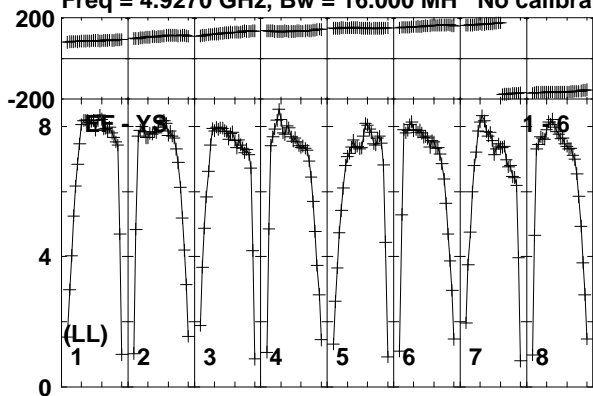

Lower frame: Milli Ampl Jy Top frame: Phas deg
Vector averaged cross-power spectrum Baseline: EF (01) - YS (06)
Timerange: 01/03:51:13 to 01/03:52:09

Plot file version 265 created 26-MAR-2015 15:27:50

V1396CYG EG082E.UVDATA.1

Freq = 4.9270 GHz, Bw = 16.000 MH No calibration applied and no bandpass applied

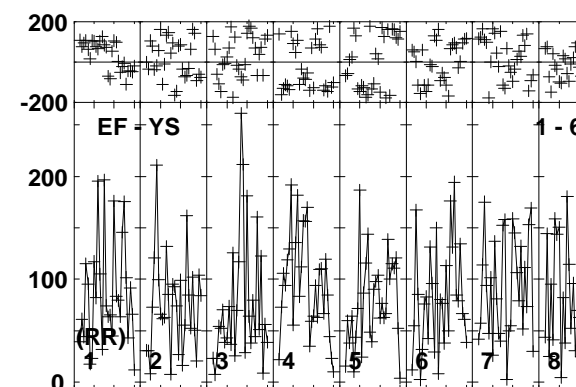
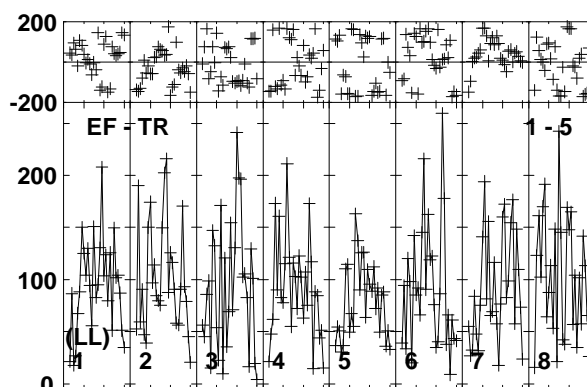
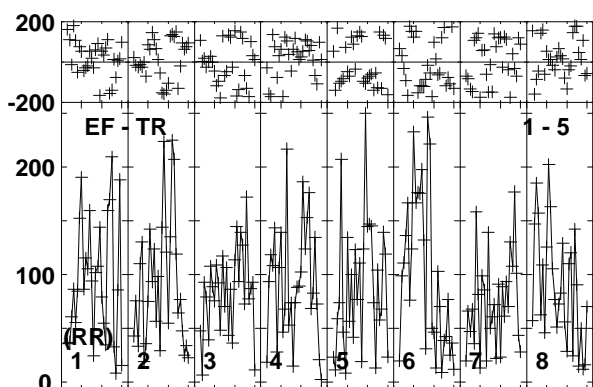
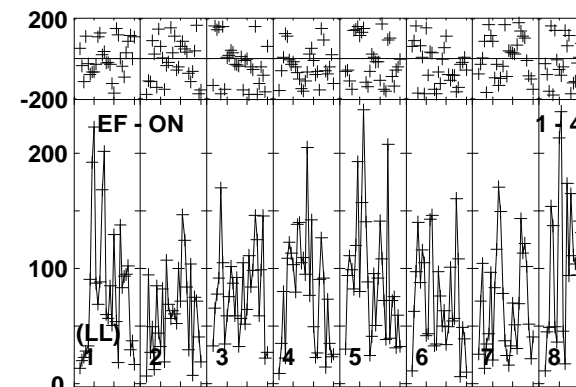
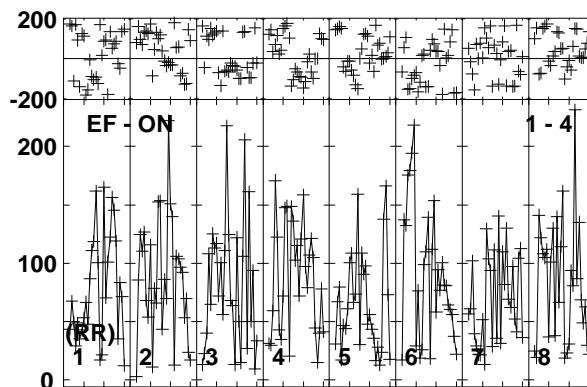
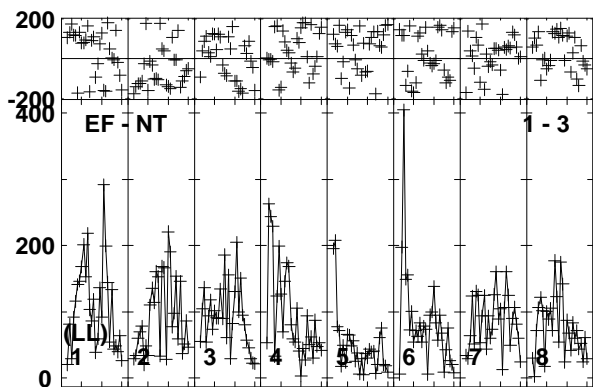
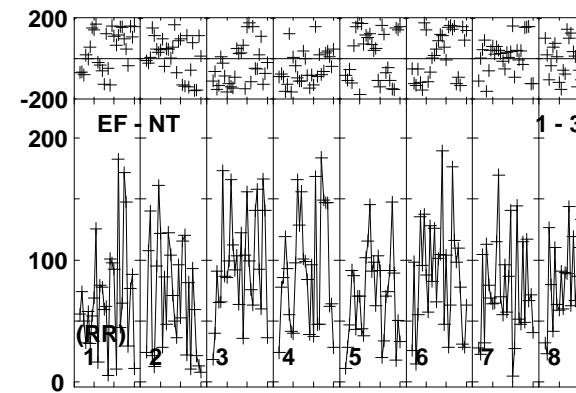
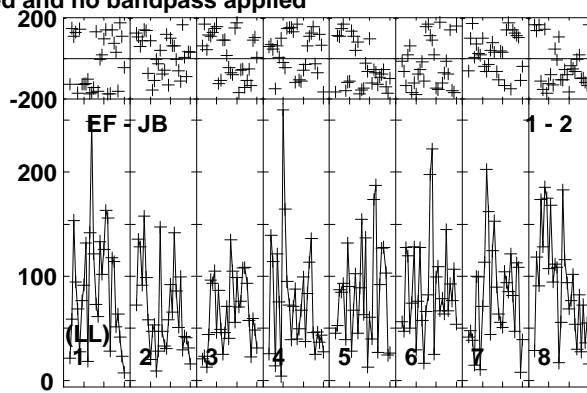
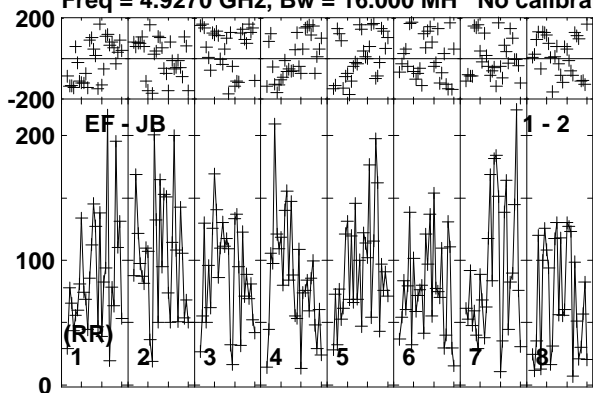

Lower frame: Micro Ampl Jy Top frame: Phas deg
Vector averaged cross-power spectrum Baseline: EF (01) - JB (02)
Timerange: 01/03:52:13 to 01/03:55:39

Plot file version 266 created 26-MAR-2015 15:27:50
V1396CYG EG082E.UVDATA.1

Freq = 4.9270 GHz, Bw = 16.000 MH No calibration applied and no bandpass applied

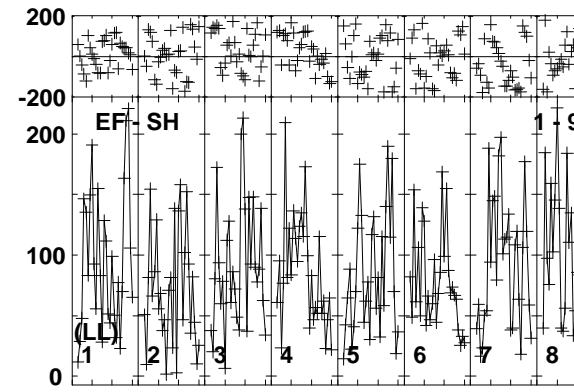
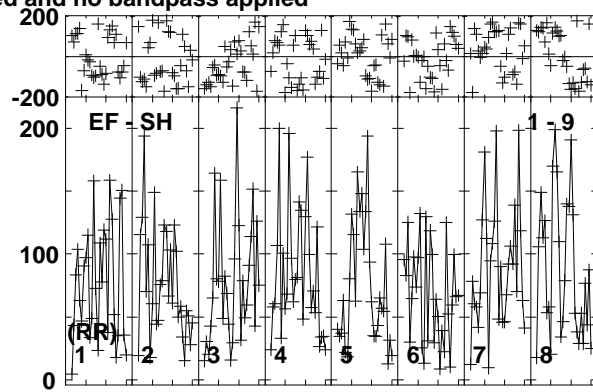
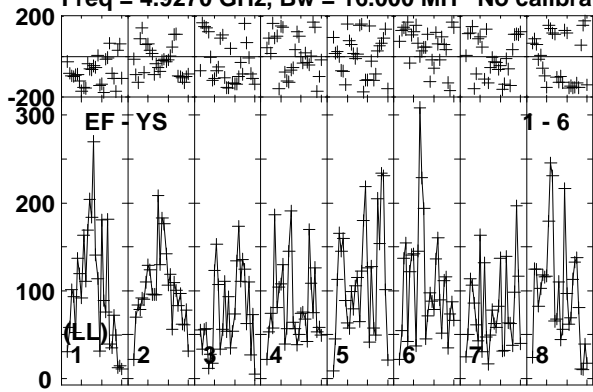

Lower frame: Micro Ampl Jy Top frame: Phas deg
Vector averaged cross-power spectrum Baseline: EF (01) - YS (06)
Timerange: 01/03:52:13 to 01/03:55:39

Plot file version 267 created 26-MAR-2015 15:27:50

J2113+4012 EG082E.UVDATA.1

Freq = 4.9270 GHz, Bw = 16.000 MH No calibration applied and no bandpass applied

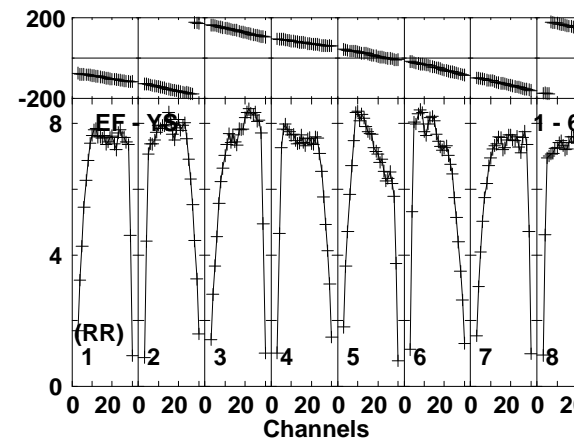
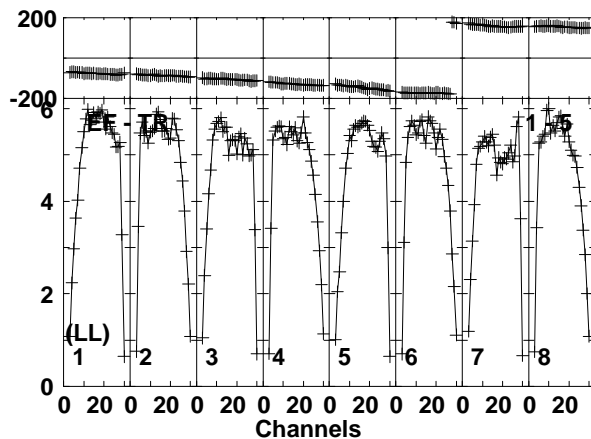
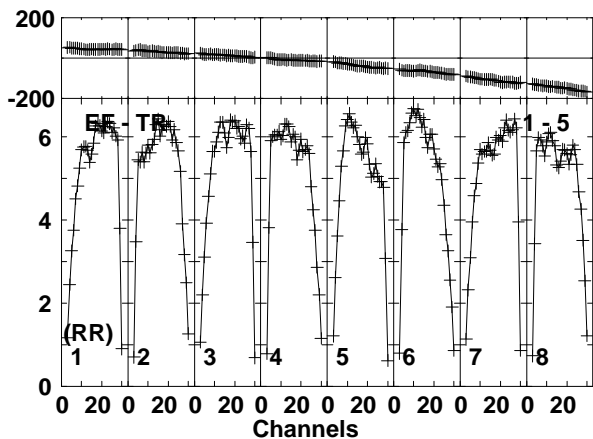
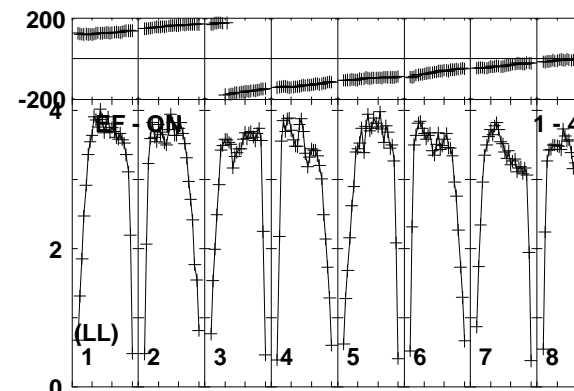
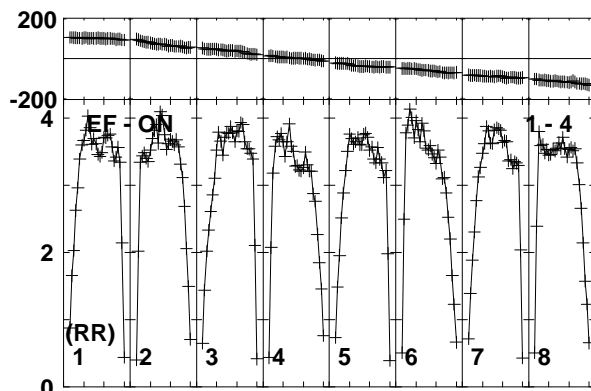
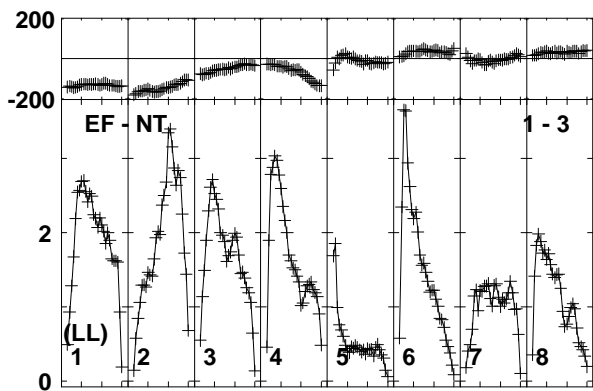
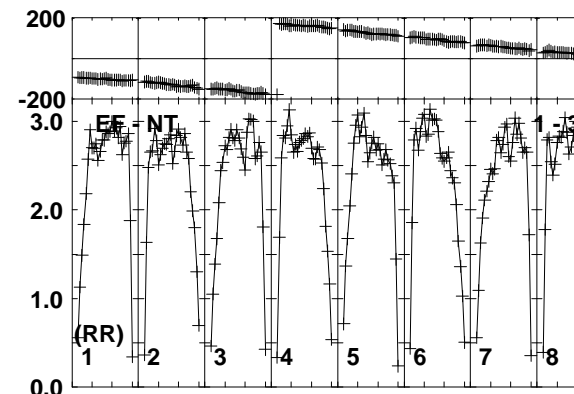
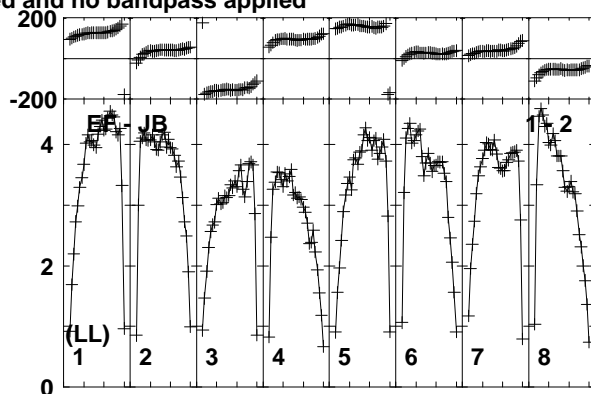
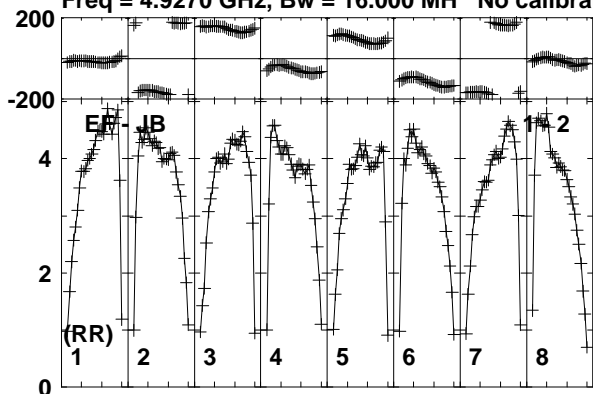

Lower frame: Milli Ampl Jy Top frame: Phas deg
Vector averaged cross-power spectrum Baseline: EF (01) - JB (02)
Timerange: 01/03:55:43 to 01/03:57:09

Plot file version 268 created 26-MAR-2015 15:27:50

J2113+4012 EG082E.UVDATA.1

Freq = 4.9270 GHz, Bw = 16.000 MH No calibration applied and no bandpass applied

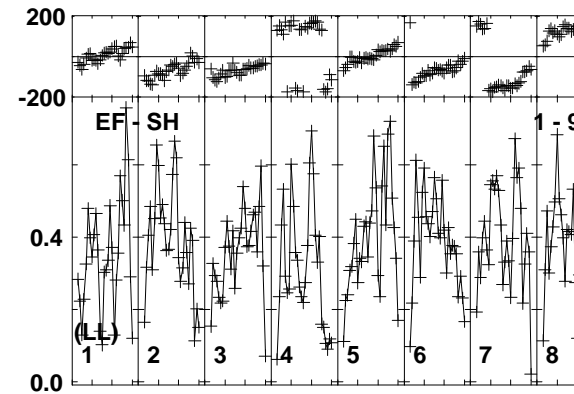
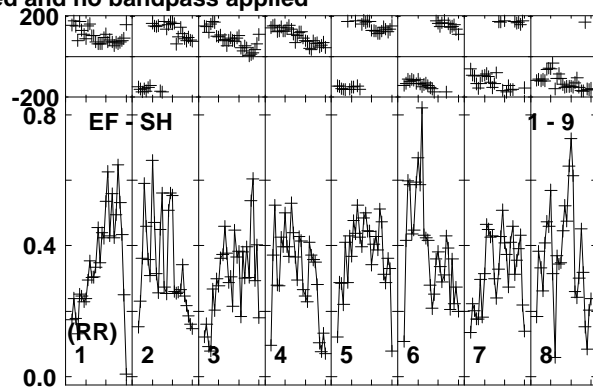
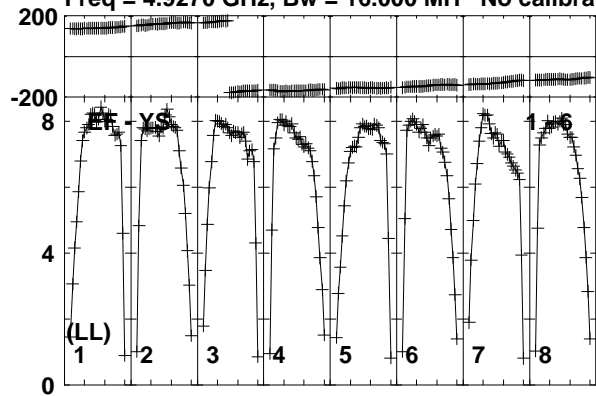

Lower frame: Milli Ampl Jy Top frame: Phas deg
Vector averaged cross-power spectrum Baseline: EF (01) - YS (06)
Timerange: 01/03:55:43 to 01/03:57:09

Plot file version 269 created 26-MAR-2015 15:27:50

V1396CYG EG082E.UVDATA.1

Freq = 4.9270 GHz, Bw = 16.000 MH No calibration applied and no bandpass applied

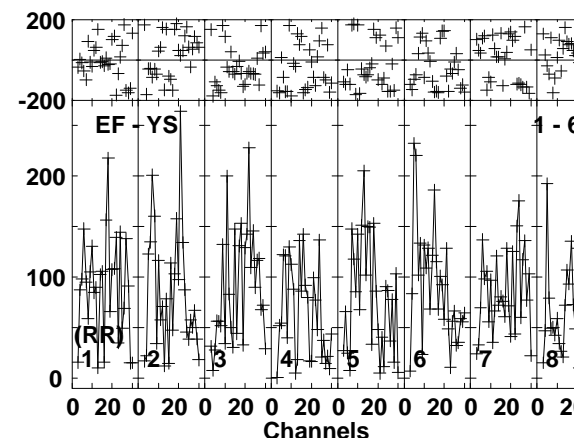
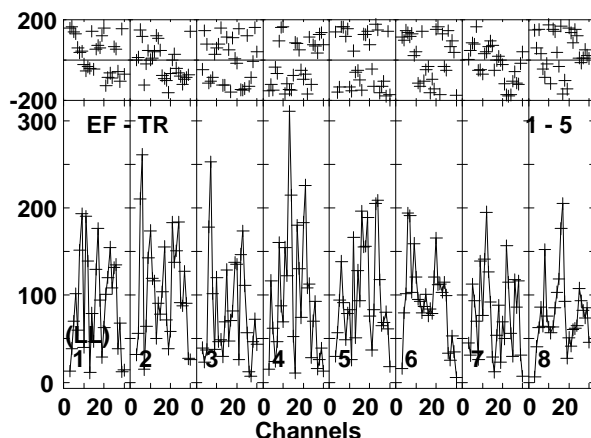
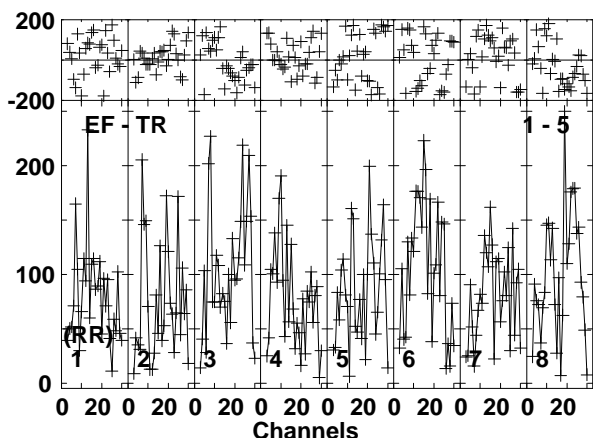
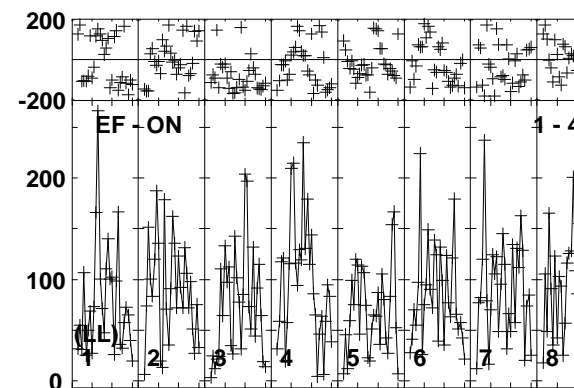
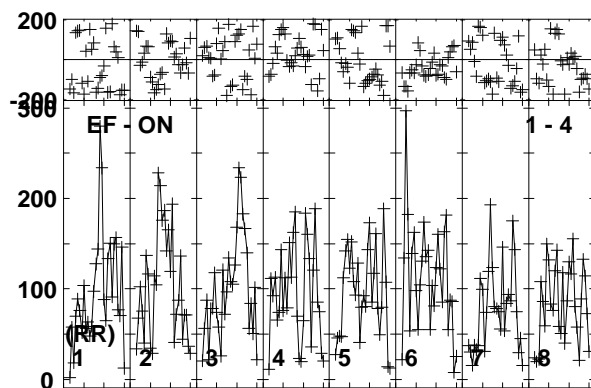
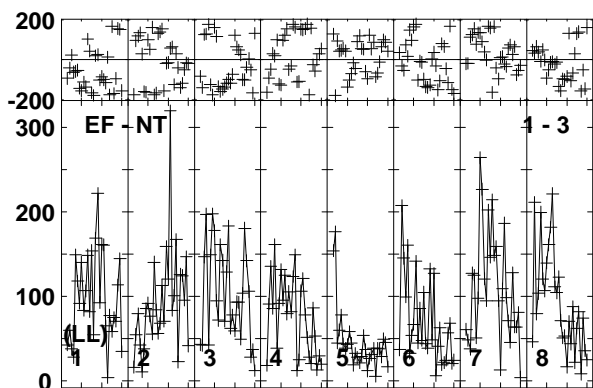
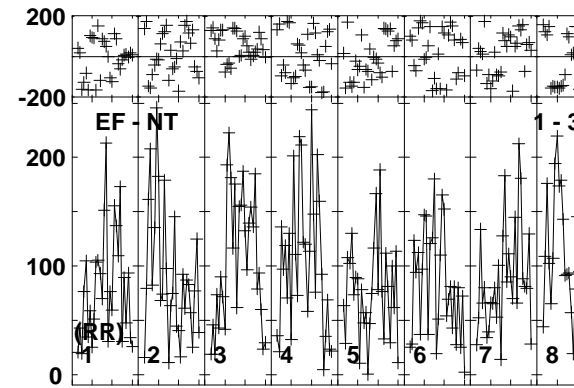
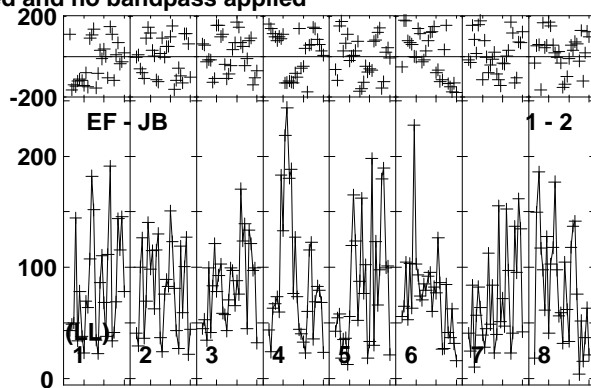
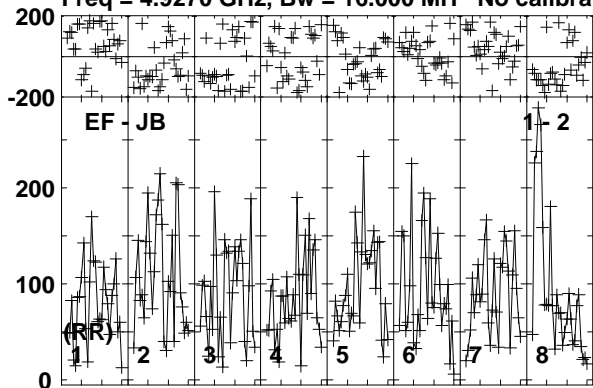

Lower frame: Micro Ampl Jy Top frame: Phas deg
Vector averaged cross-power spectrum Baseline: EF (01) - JB (02)
Timerange: 01/03:57:13 to 01/04:00:39

Plot file version 270 created 26-MAR-2015 15:27:50

V1396CYG EG082E.UVDATA.1

Freq = 4.9270 GHz, Bw = 16.000 MH No calibration applied and no bandpass applied

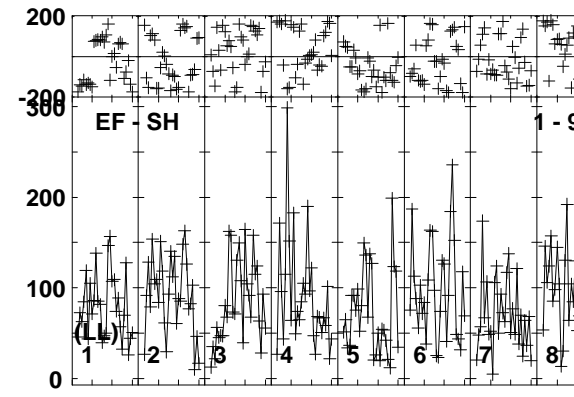
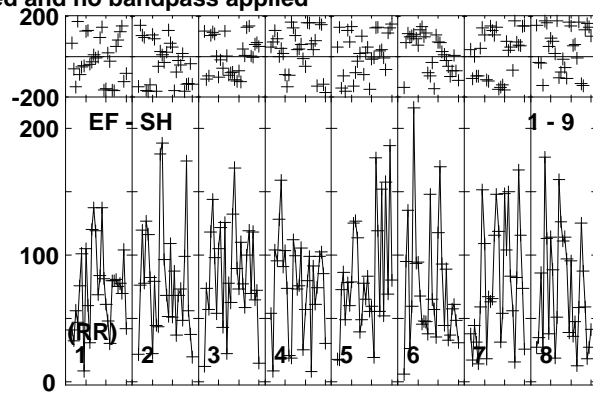
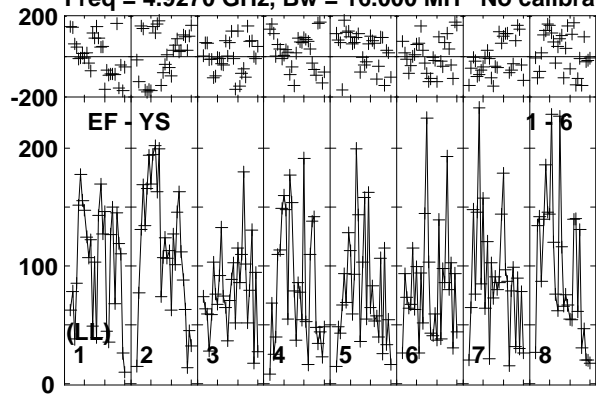

Lower frame: Micro Ampl Jy Top frame: Phas deg
Vector averaged cross-power spectrum Baseline: EF (01) - YS (06)
Timerange: 01/03:57:13 to 01/04:00:39

Plot file version 271 created 26-MAR-2015 15:27:50

J2113+4012 EG082E.UVDATA.1

Freq = 4.9270 GHz, Bw = 16.000 MH No calibration applied and no bandpass applied

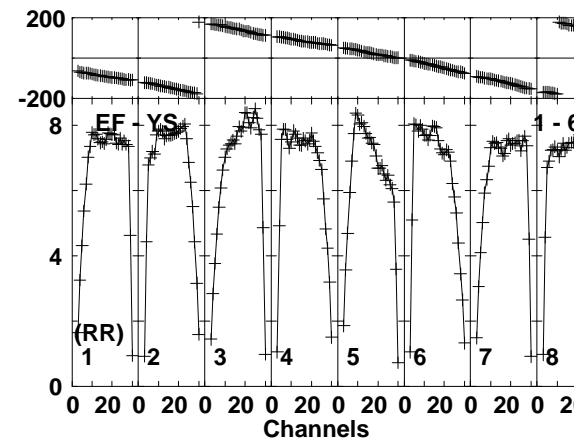
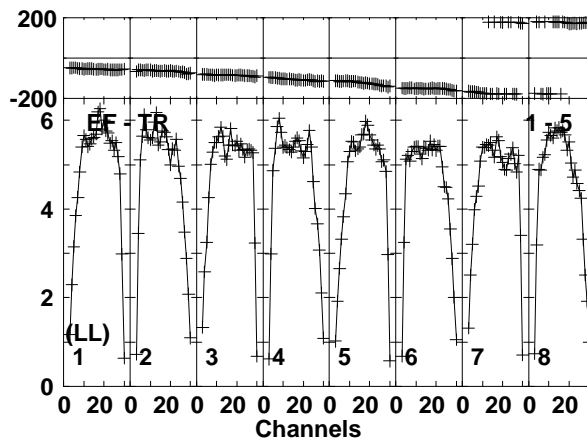
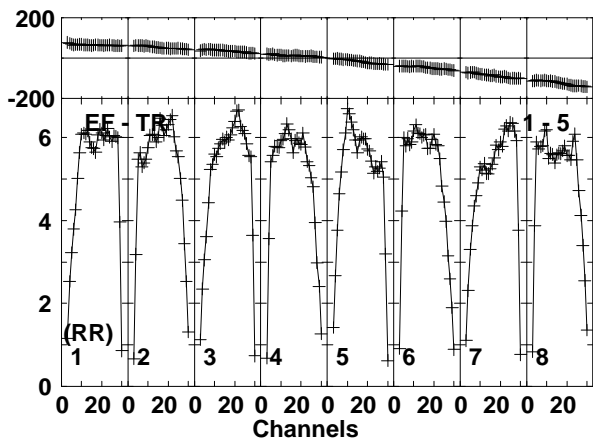
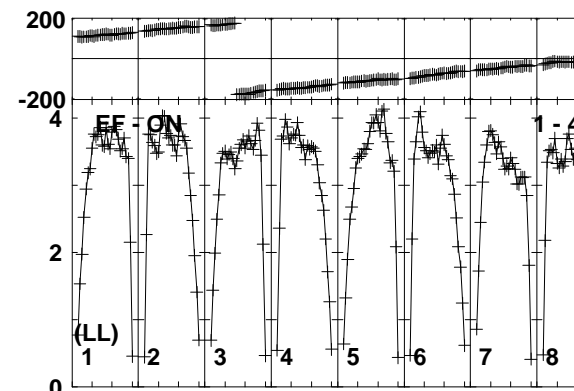
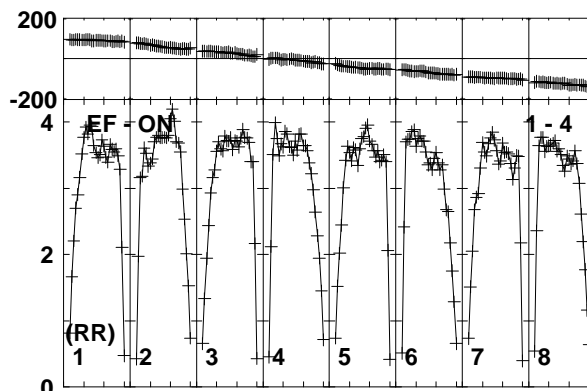
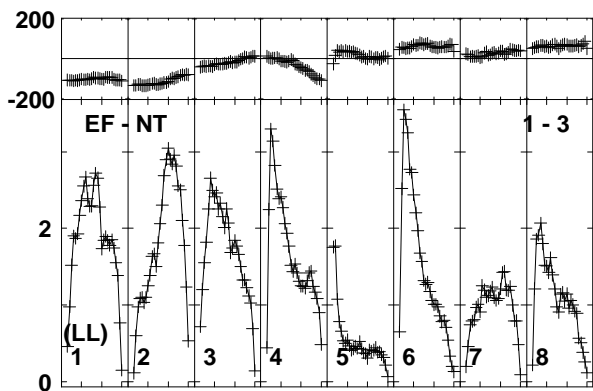
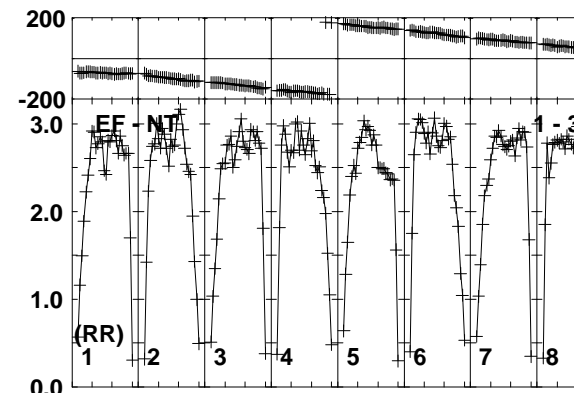
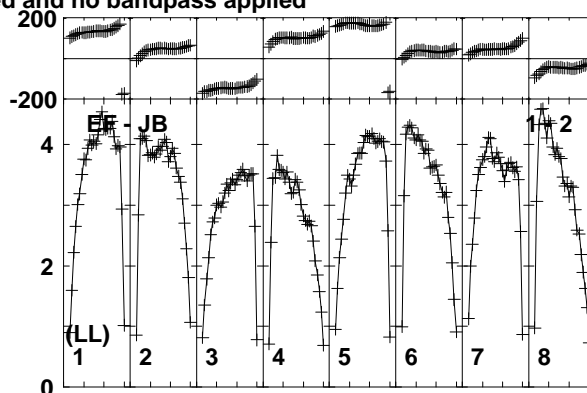
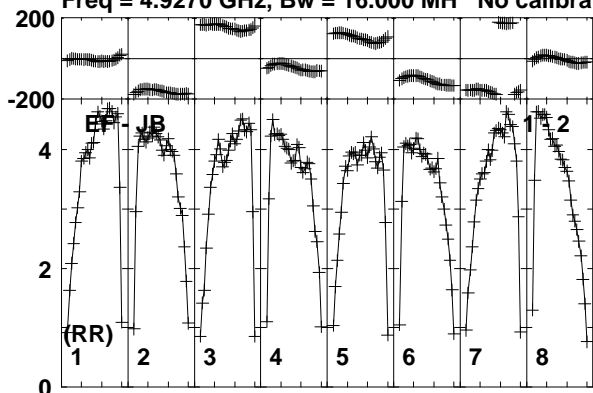

Lower frame: Milli Ampl Jy Top frame: Phas deg
Vector averaged cross-power spectrum Baseline: EF (01) - JB (02)
Timerange: 01/04:01:13 to 01/04:02:09

Plot file version 272 created 26-MAR-2015 15:27:50

J2113+4012 EG082E.UVDATA.1

Freq = 4.9270 GHz, Bw = 16.000 MH No calibration applied and no bandpass applied

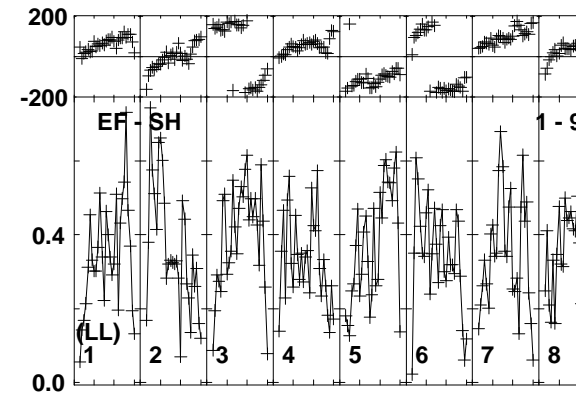
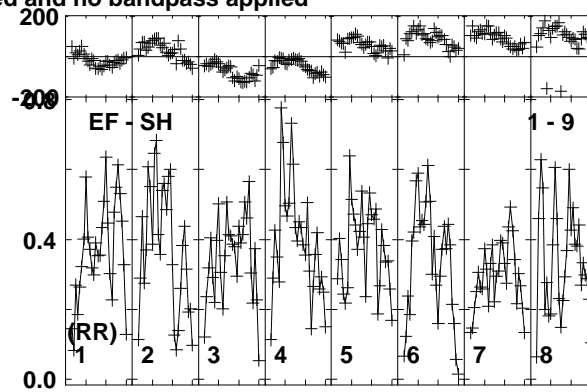
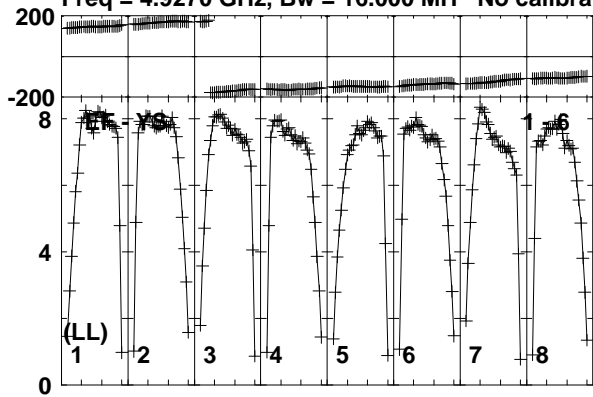

Lower frame: Milli Ampl Jy Top frame: Phas deg
Vector averaged cross-power spectrum Baseline: EF (01) - YS (06)
Timerange: 01/04:01:13 to 01/04:02:09

Plot file version 273 created 26-MAR-2015 15:27:50

V1396CYG EG082E.UVDATA.1

Freq = 4.9270 GHz, Bw = 16.000 MH No calibration applied and no bandpass applied

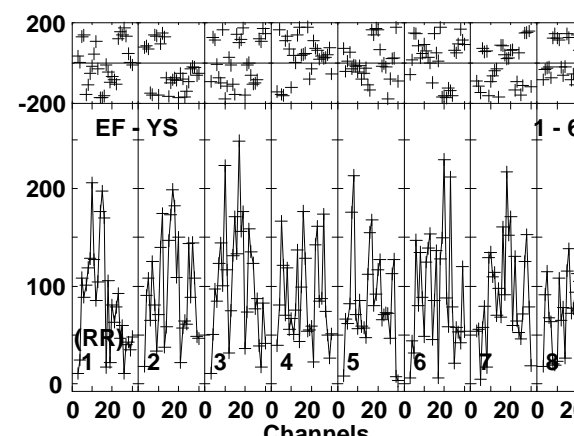
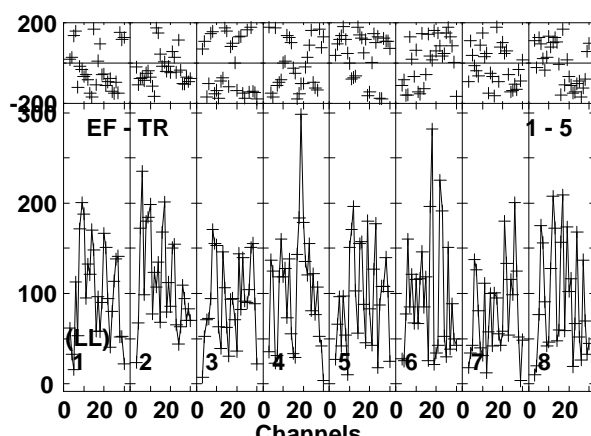
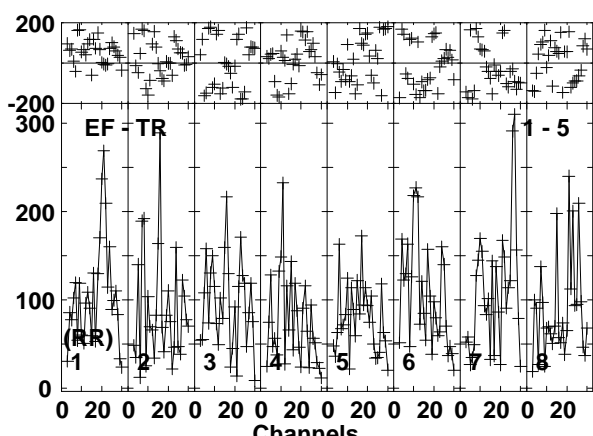
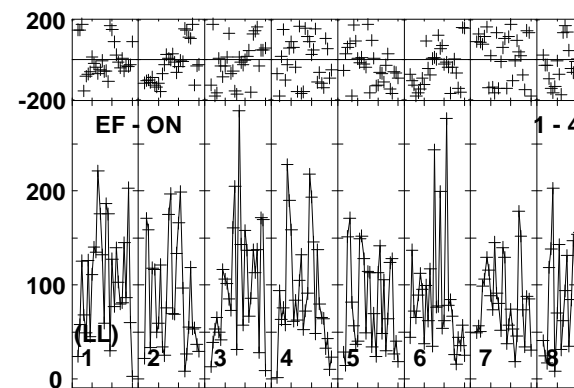
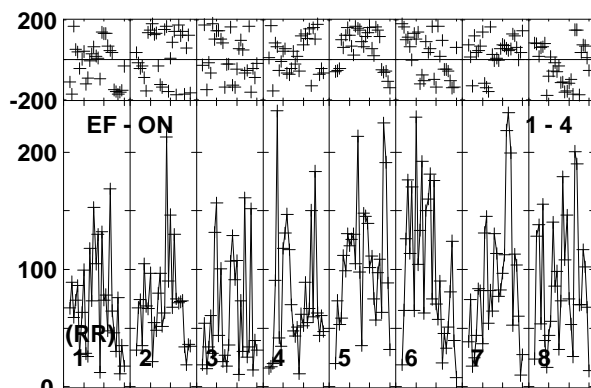
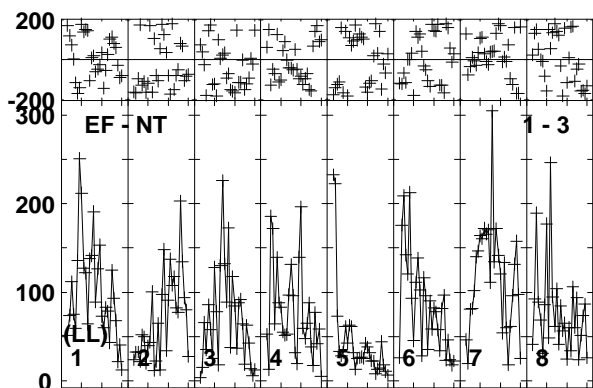
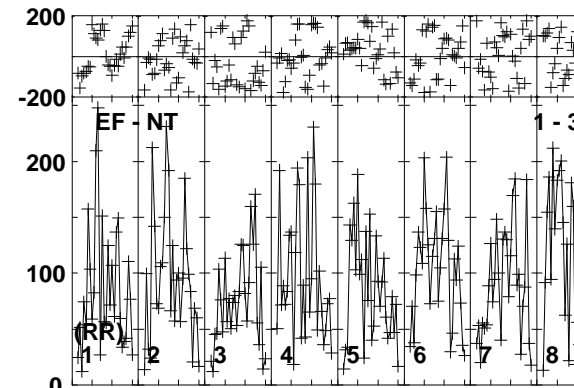
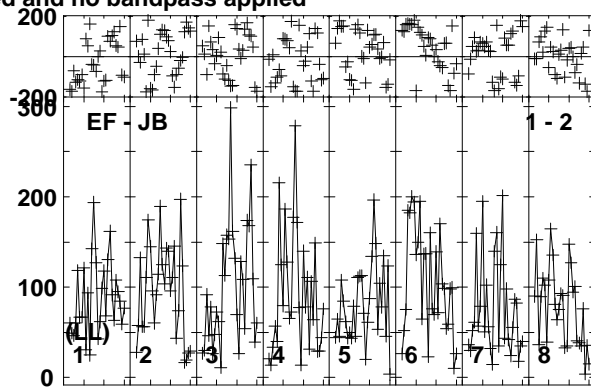
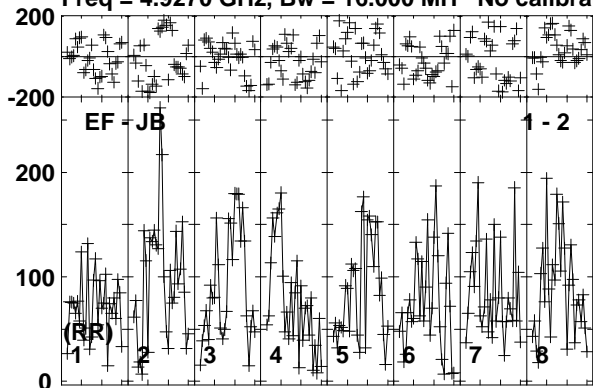

Lower frame: Micro Ampl Jy Top frame: Phas deg
Vector averaged cross-power spectrum Baseline: EF (01) - JB (02)
Timerange: 01/04:02:13 to 01/04:05:39

Plot file version 274 created 26-MAR-2015 15:27:50

V1396CYG EG082E.UVDATA.1

Freq = 4.9270 GHz, Bw = 16.000 MH No calibration applied and no bandpass applied

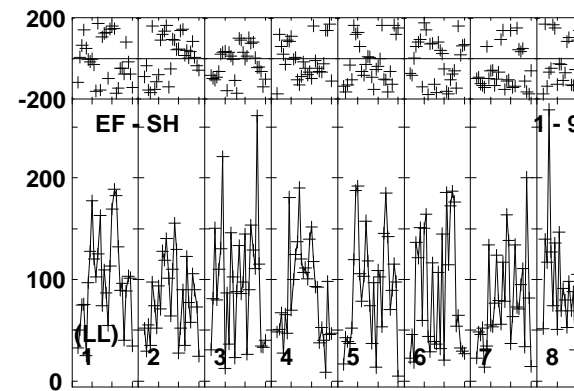
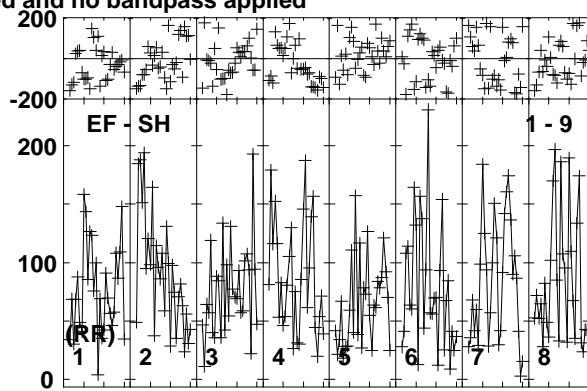
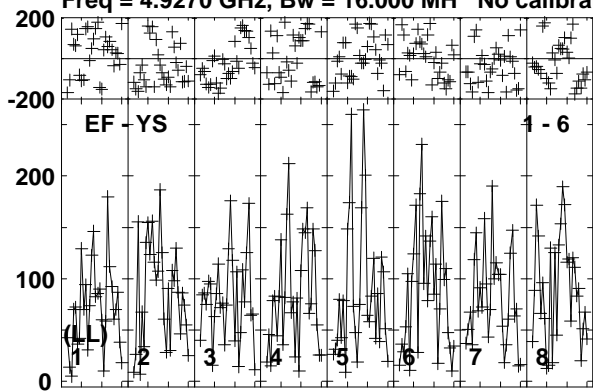

Lower frame: Micro Ampl Jy Top frame: Phas deg
Vector averaged cross-power spectrum Baseline: EF (01) - YS (06)
Timerange: 01/04:02:13 to 01/04:05:39

Plot file version 275 created 26-MAR-2015 15:27:50

J2113+4012 EG082E.UVDATA.1

Freq = 4.9270 GHz, Bw = 16.000 MH No calibration applied and no bandpass applied

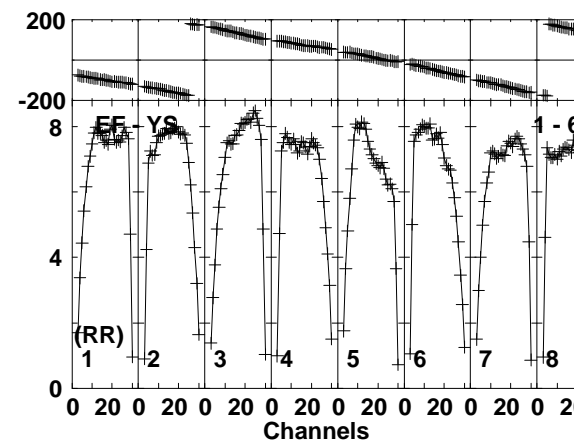
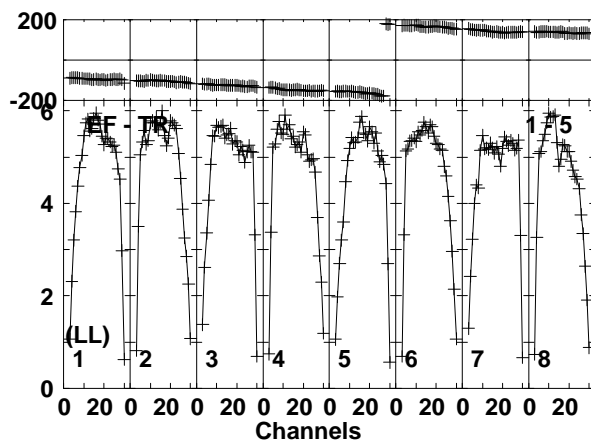
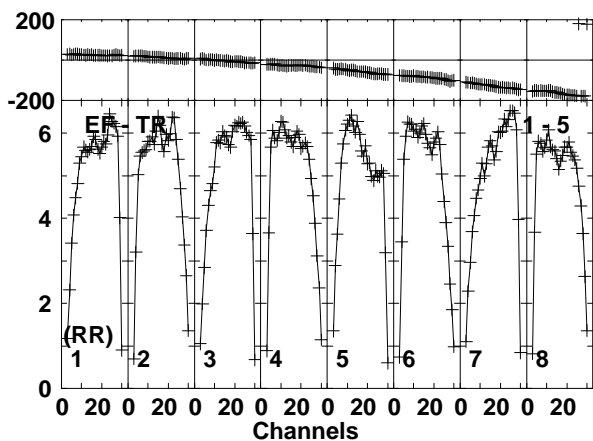
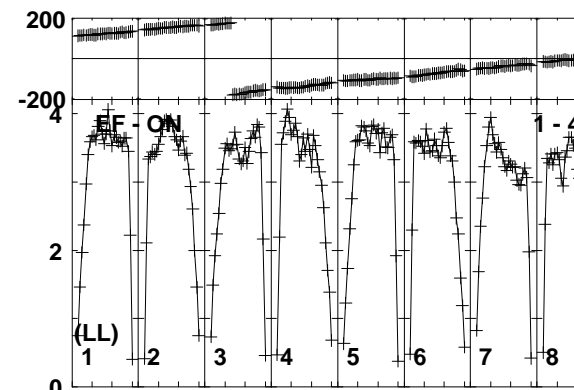
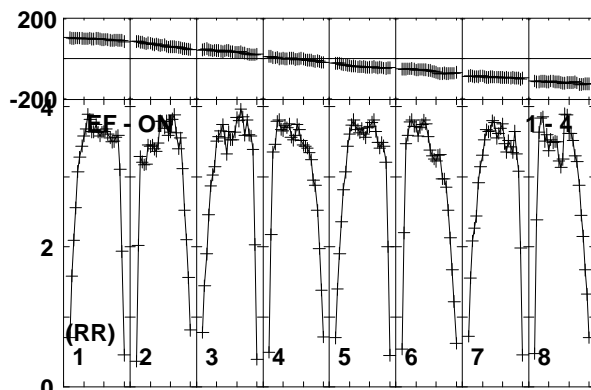
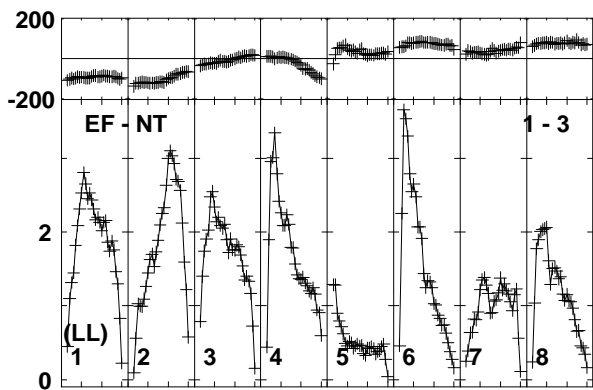
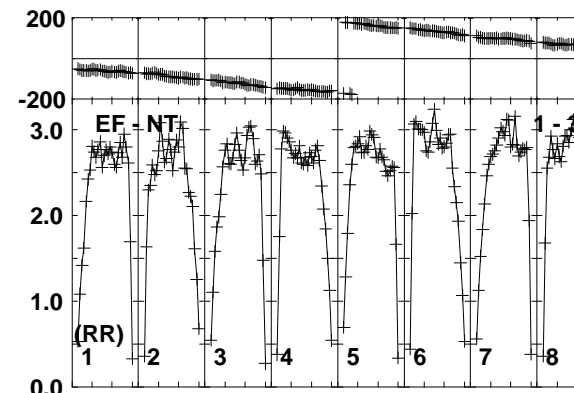
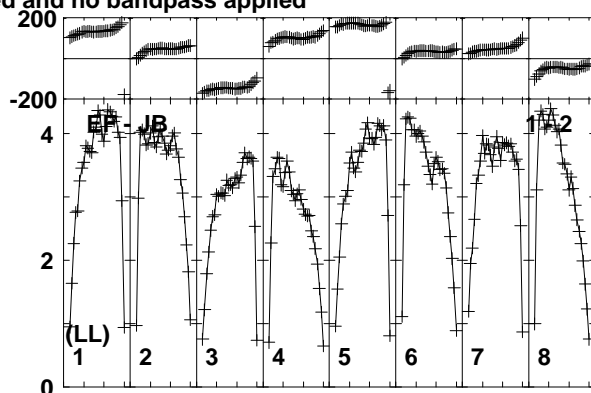
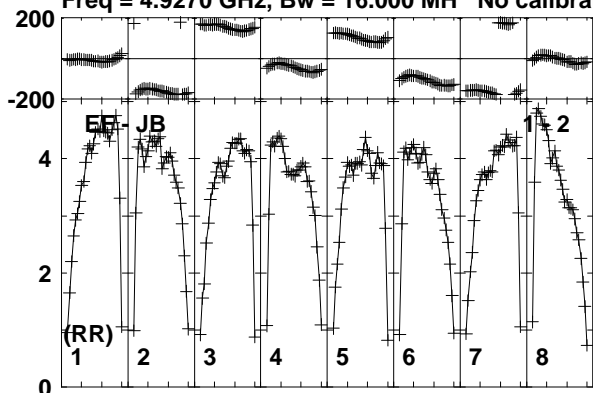

Lower frame: Milli Ampl Jy Top frame: Phas deg
Vector averaged cross-power spectrum Baseline: EF (01) - JB (02)
Timerange: 01/04:05:43 to 01/04:07:09

Plot file version 276 created 26-MAR-2015 15:27:50

J2113+4012 EG082E.UVDATA.1

Freq = 4.9270 GHz, Bw = 16.000 MH No calibration applied and no bandpass applied

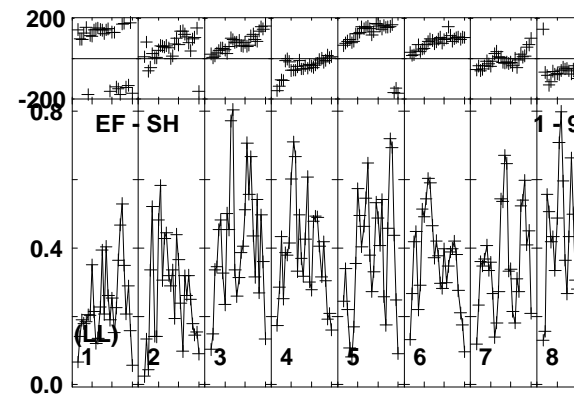
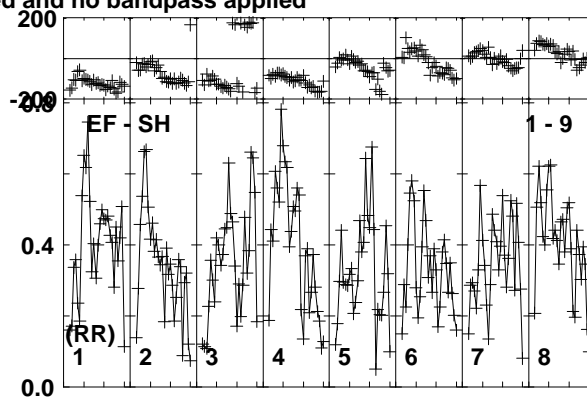
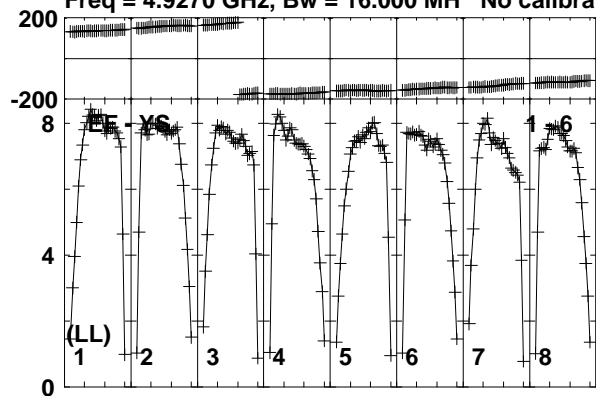

Lower frame: Milli Ampl Jy Top frame: Phas deg
Vector averaged cross-power spectrum Baseline: EF (01) - YS (06)
Timerange: 01/04:05:43 to 01/04:07:09

Plot file version 277 created 26-MAR-2015 15:27:50

V1396CYG EG082E.UVDATA.1

Freq = 4.9270 GHz, Bw = 16.000 MH No calibration applied and no bandpass applied

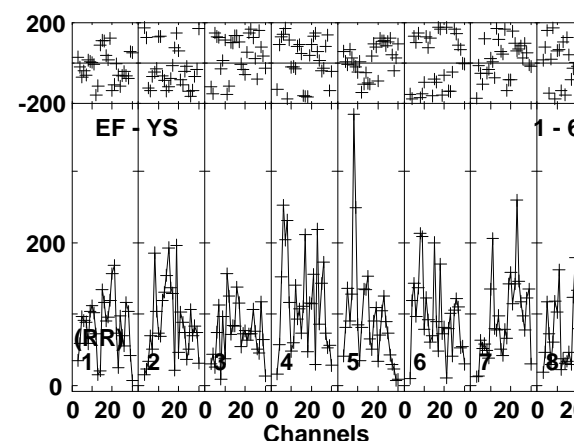
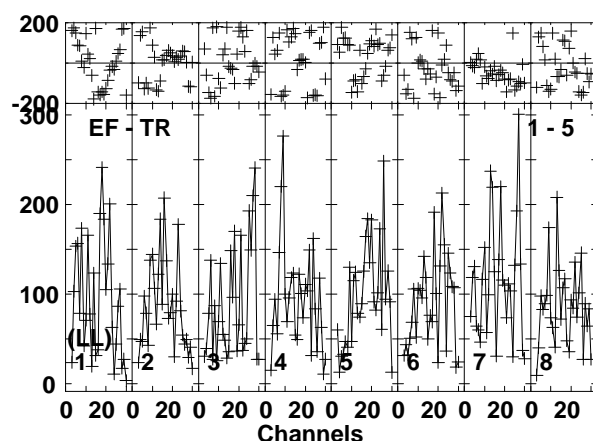
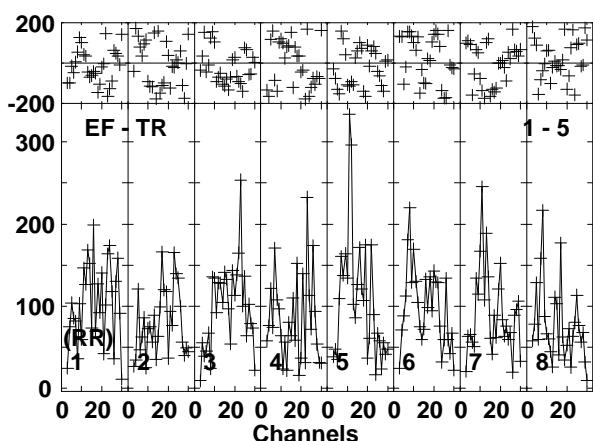
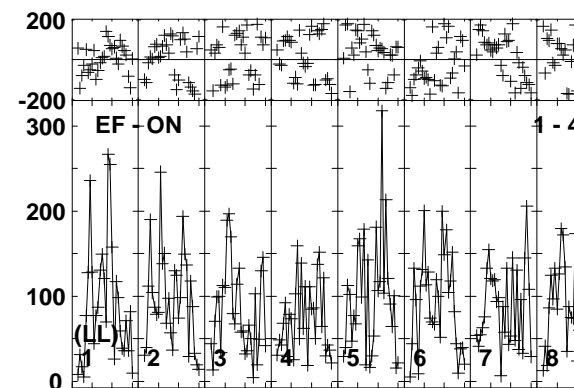
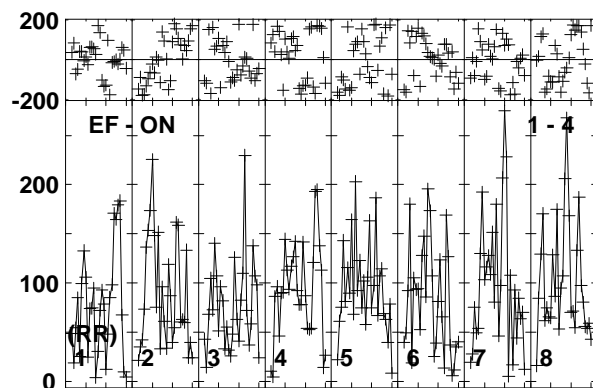
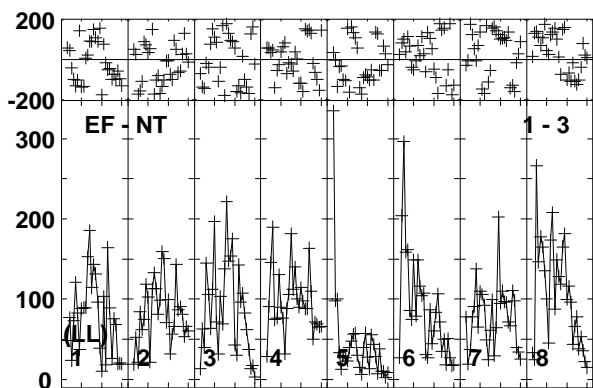
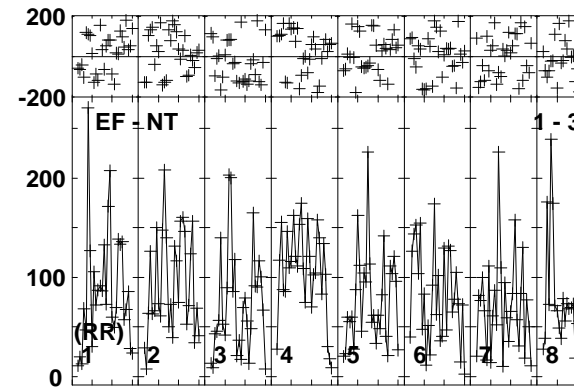
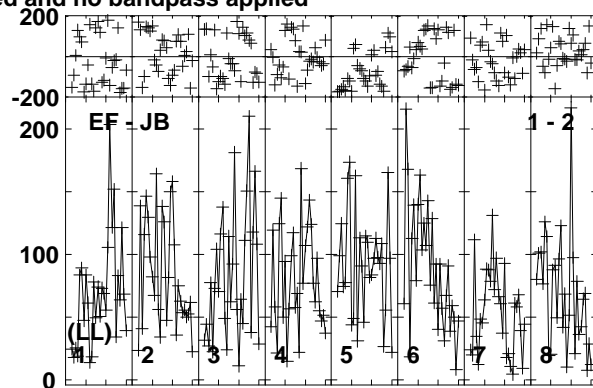
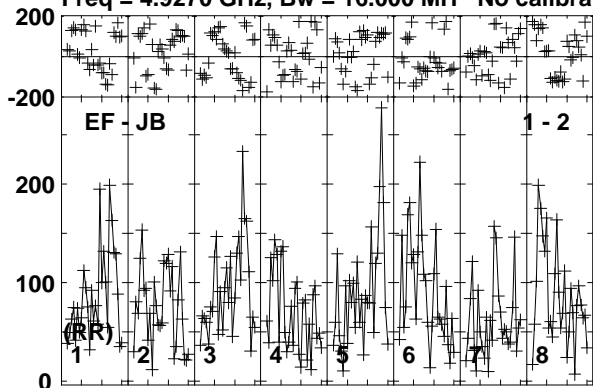

Lower frame: Micro Ampl Jy Top frame: Phas deg
Vector averaged cross-power spectrum Baseline: EF (01) - JB (02)
Timerange: 01/04:07:13 to 01/04:10:39

Plot file version 278 created 26-MAR-2015 15:27:50

V1396CYG EG082E.UVDATA.1

Freq = 4.9270 GHz, Bw = 16.000 MH No calibration applied and no bandpass applied

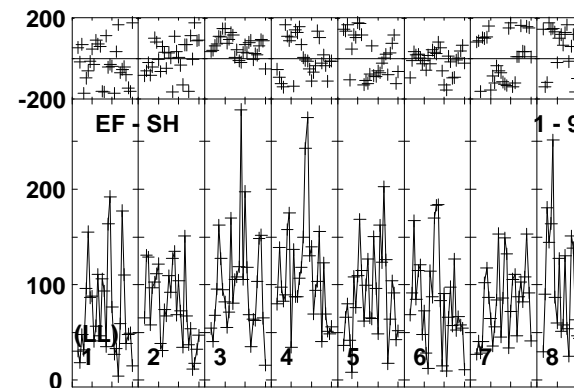
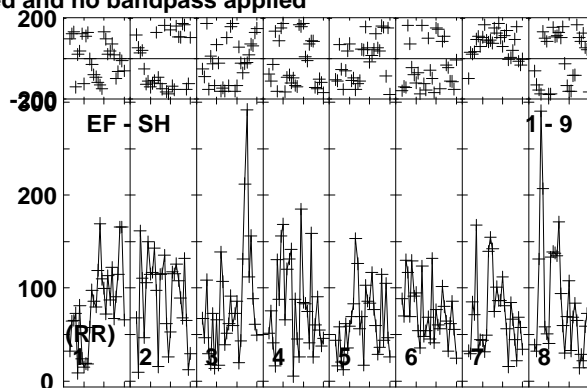
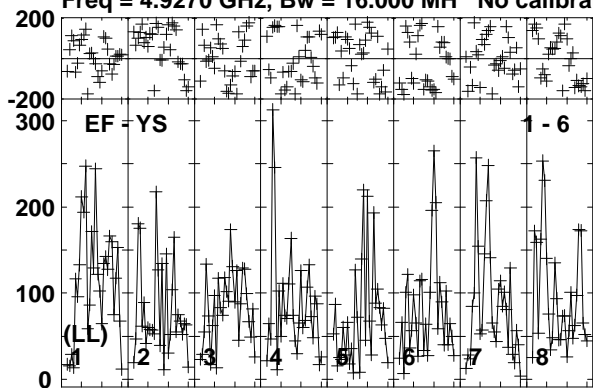

Lower frame: Micro Ampl Jy Top frame: Phas deg
Vector averaged cross-power spectrum Baseline: EF (01) - YS (06)
Timerange: 01/04:07:13 to 01/04:10:39

Plot file version 279 created 26-MAR-2015 15:27:51

J2113+4012 EG082E.UVDATA.1

Freq = 4.9270 GHz, Bw = 16.000 MH No calibration applied and no bandpass applied

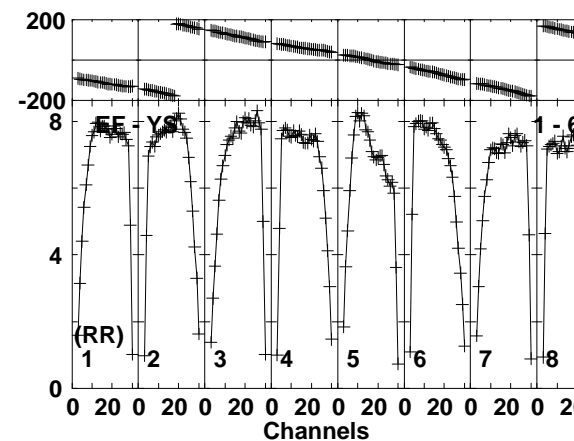
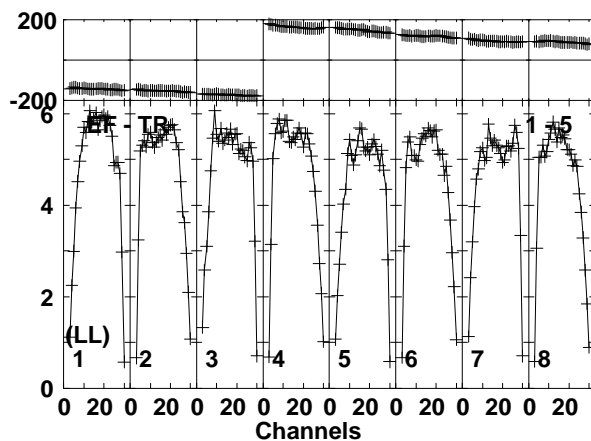
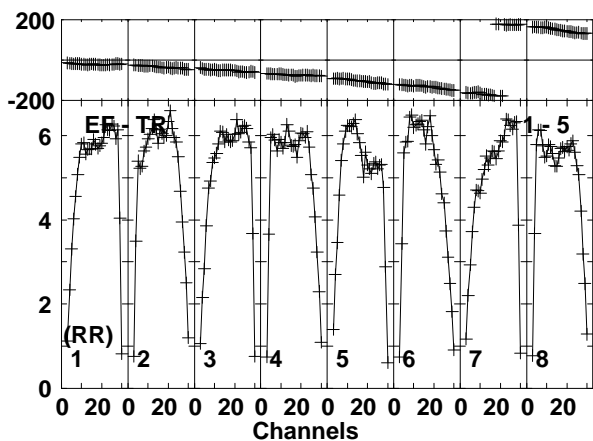
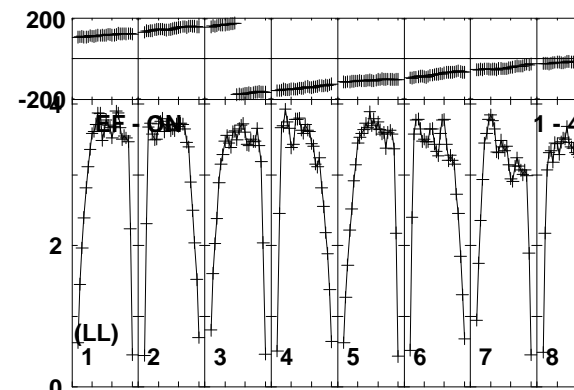
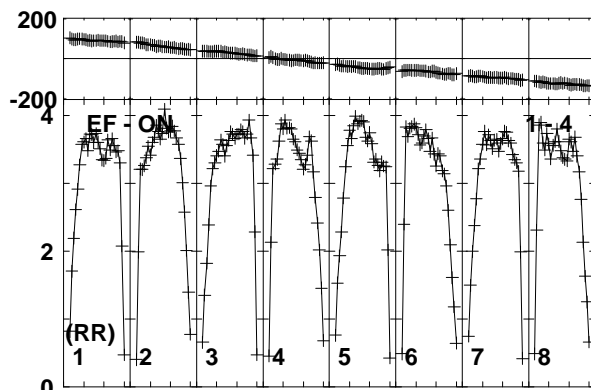
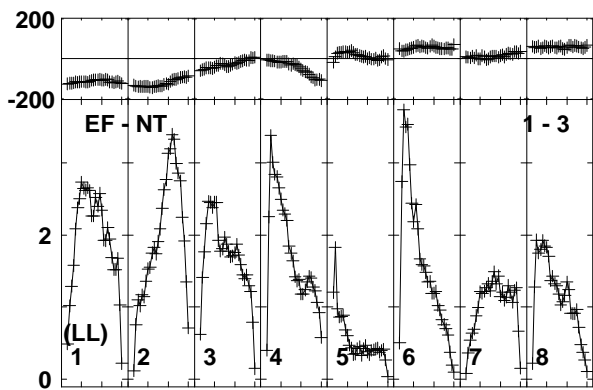
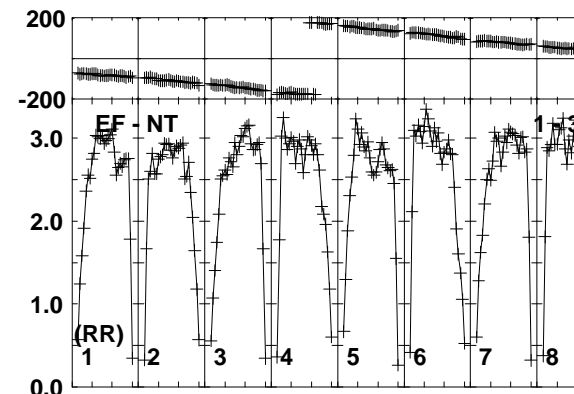
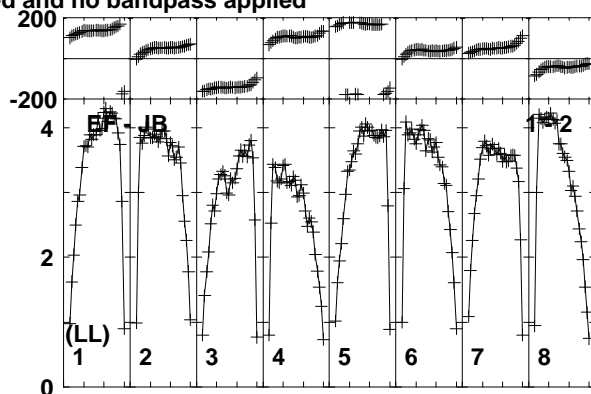
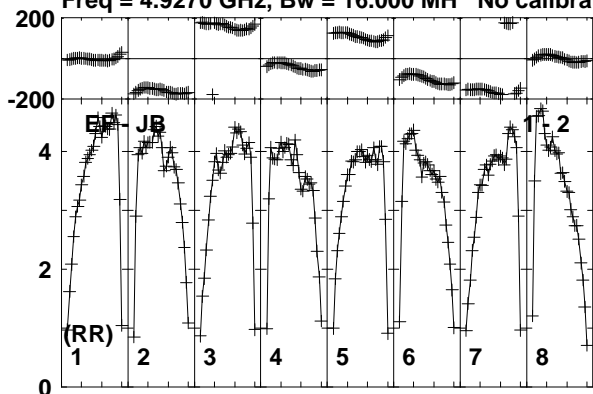

Lower frame: Milli Ampl Jy Top frame: Phas deg
Vector averaged cross-power spectrum Baseline: EF (01) - JB (02)
Timerange: 01/04:11:13 to 01/04:12:09

Plot file version 280 created 26-MAR-2015 15:27:51

J2113+4012 EG082E.UVDATA.1

Freq = 4.9270 GHz, Bw = 16.000 MH No calibration applied and no bandpass applied

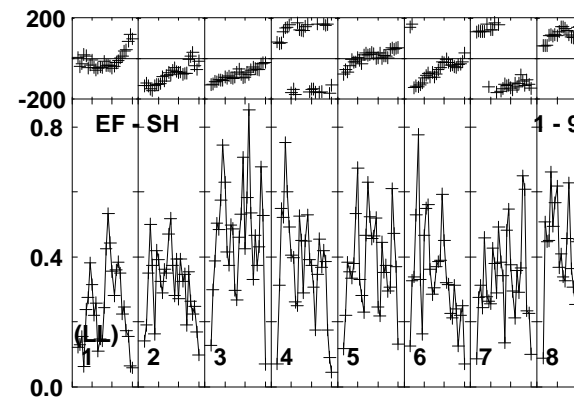
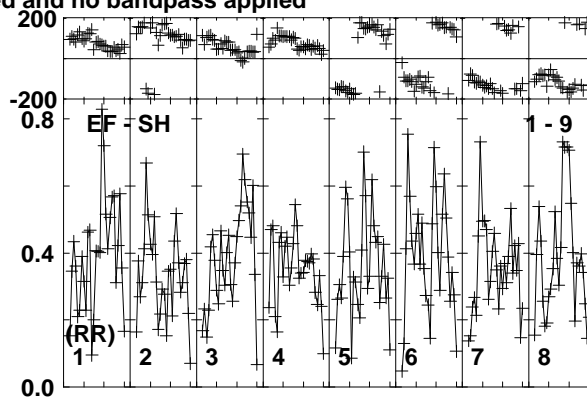
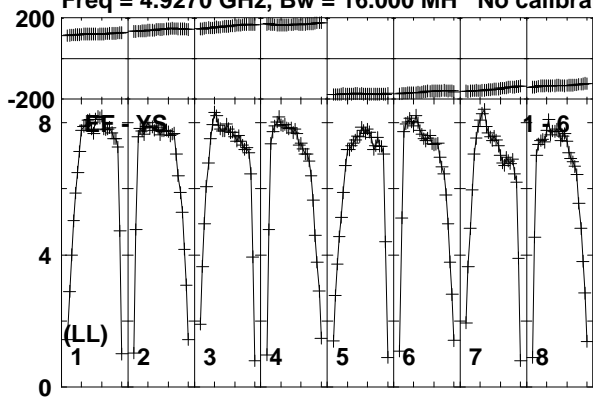

Lower frame: Milli Ampl Jy Top frame: Phas deg
Vector averaged cross-power spectrum Baseline: EF (01) - YS (06)
Timerange: 01/04:11:13 to 01/04:12:09

Plot file version 281 created 26-MAR-2015 15:27:51

V1396CYG EG082E.UVDATA.1

Freq = 4.9270 GHz, Bw = 16.000 MH No calibration applied and no bandpass applied

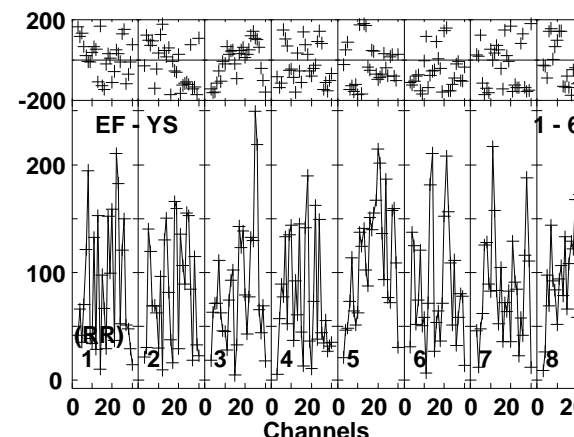
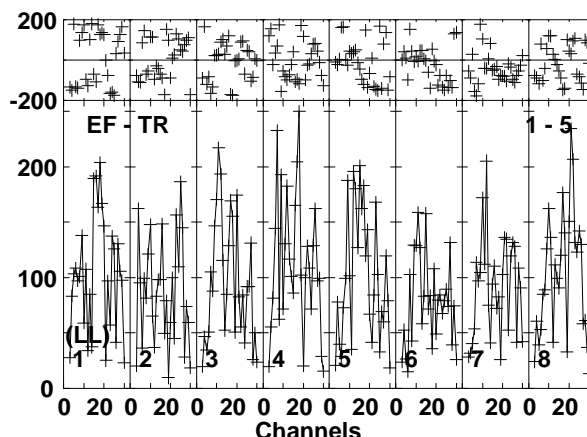
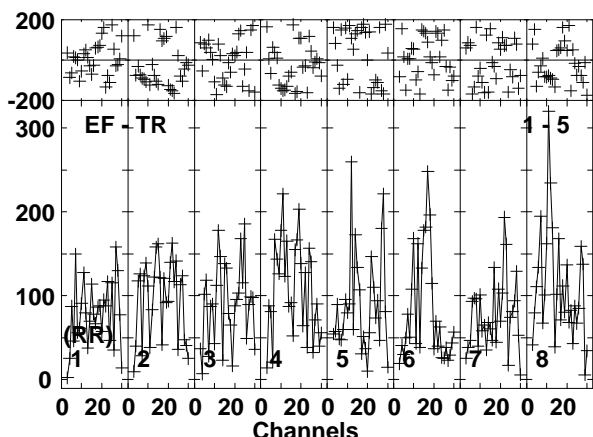
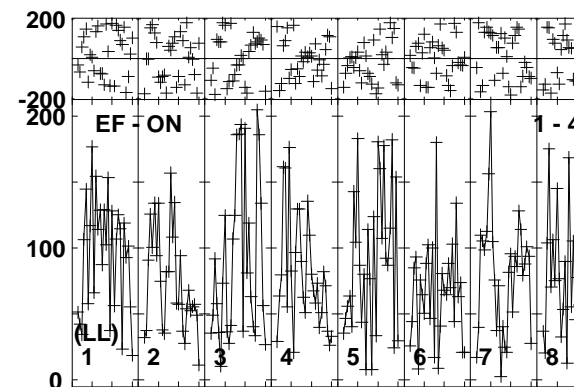
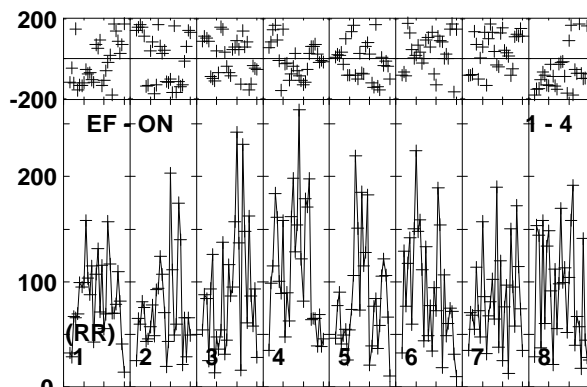
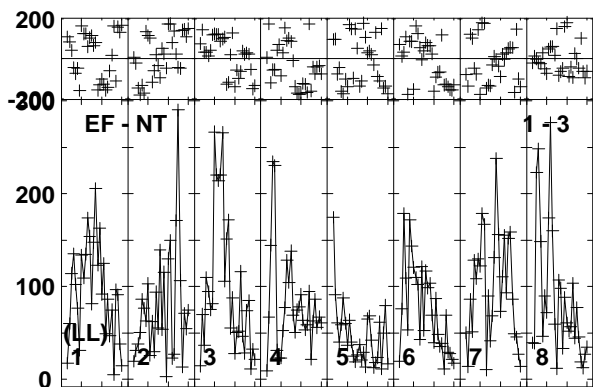
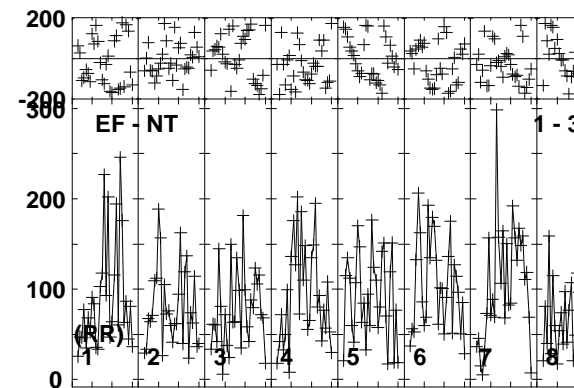
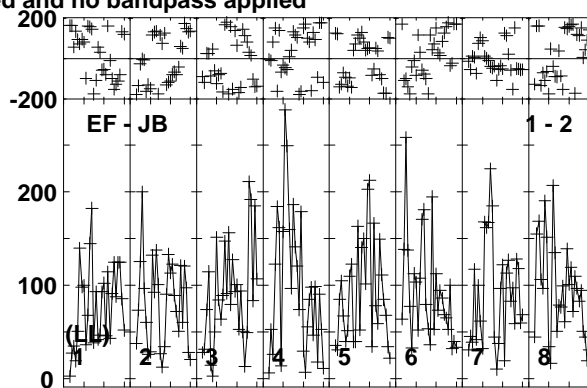
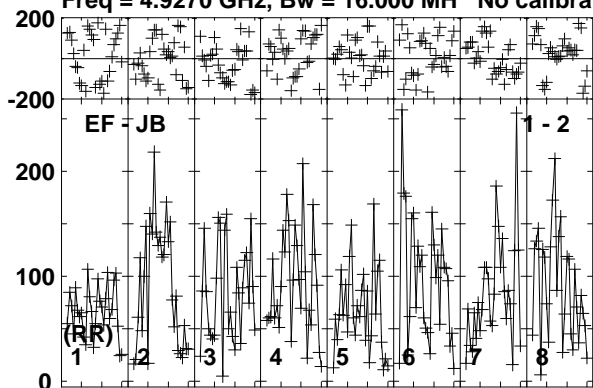

Lower frame: Micro Ampl Jy Top frame: Phas deg
Vector averaged cross-power spectrum Baseline: EF (01) - JB (02)
Timerange: 01/04:12:13 to 01/04:15:39

Plot file version 282 created 26-MAR-2015 15:27:51

V1396CYG EG082E.UVDATA.1

Freq = 4.9270 GHz, Bw = 16.000 MH No calibration applied and no bandpass applied

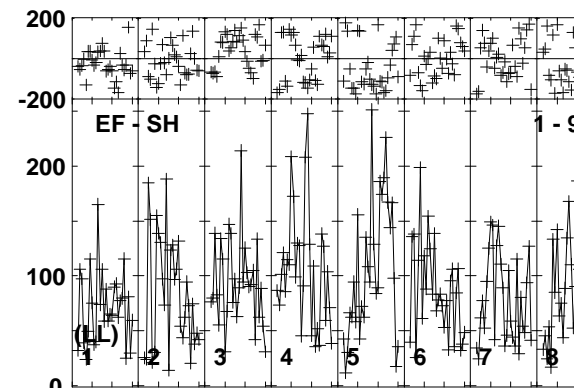
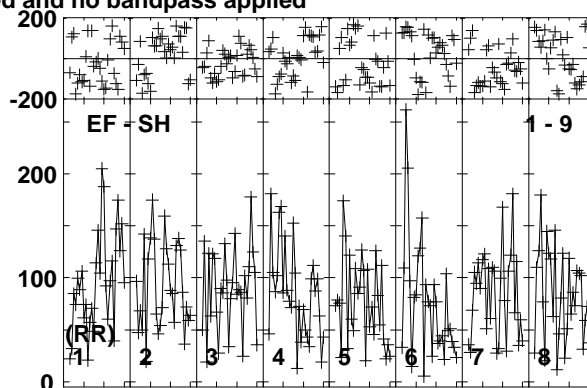
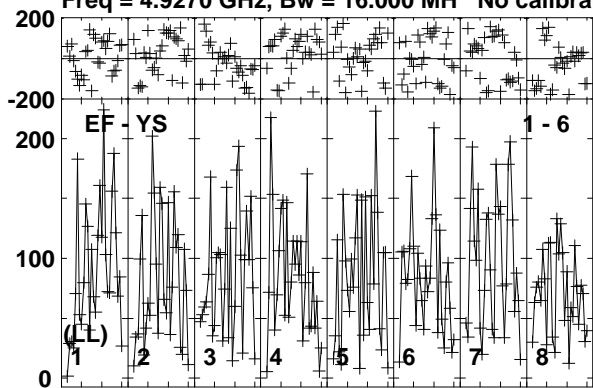

Lower frame: Micro Ampl Jy Top frame: Phas deg
Vector averaged cross-power spectrum Baseline: EF (01) - YS (06)
Timerange: 01/04:12:13 to 01/04:15:39

Plot file version 283 created 26-MAR-2015 15:27:51

J2113+4012 EG082E.UVDATA.1

Freq = 4.9270 GHz, Bw = 16.000 MH No calibration applied and no bandpass applied

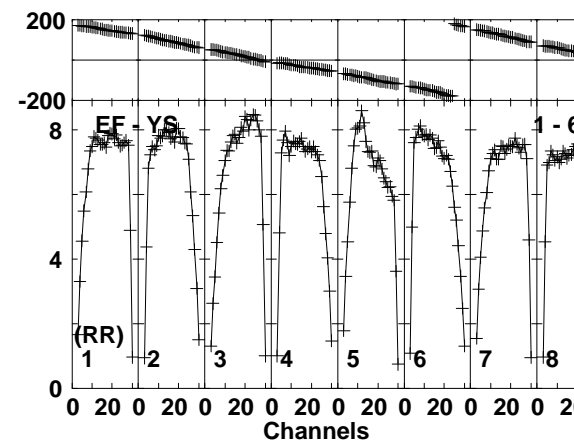
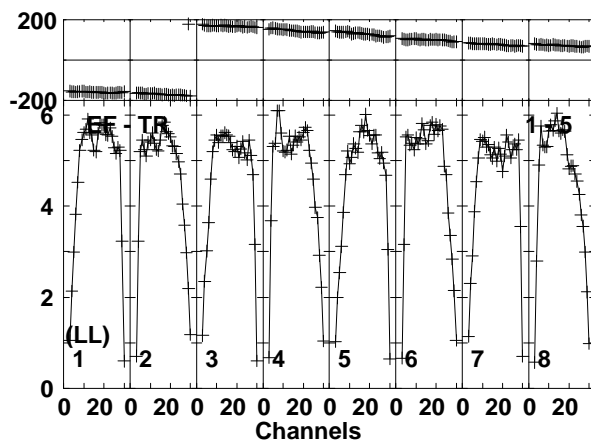
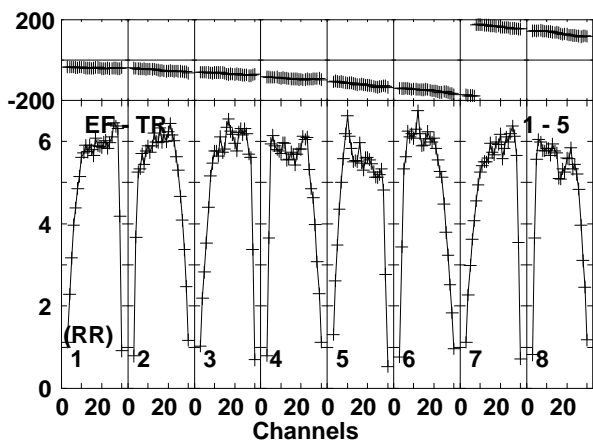
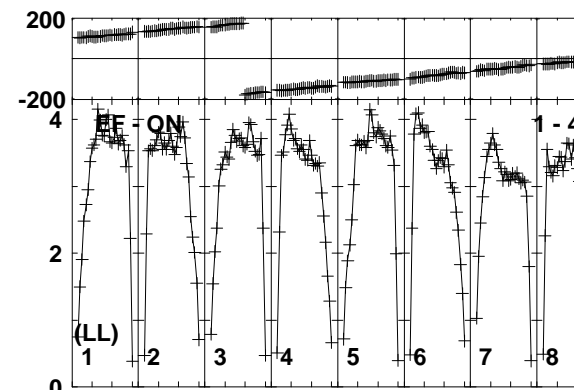
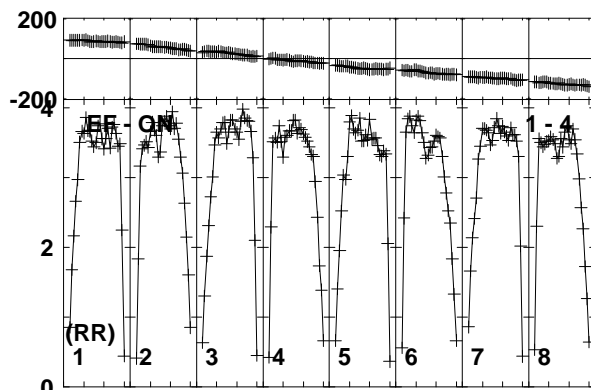
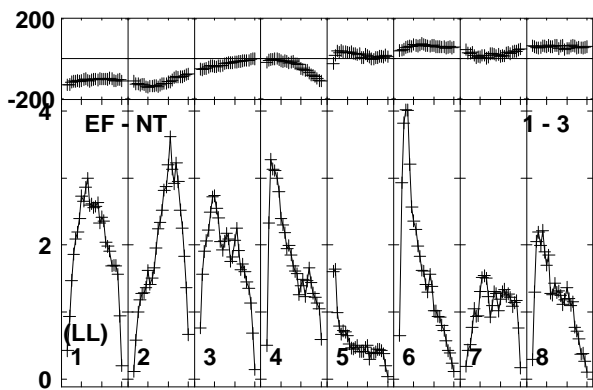
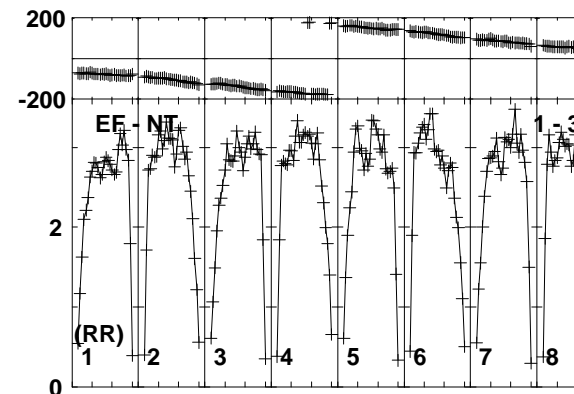
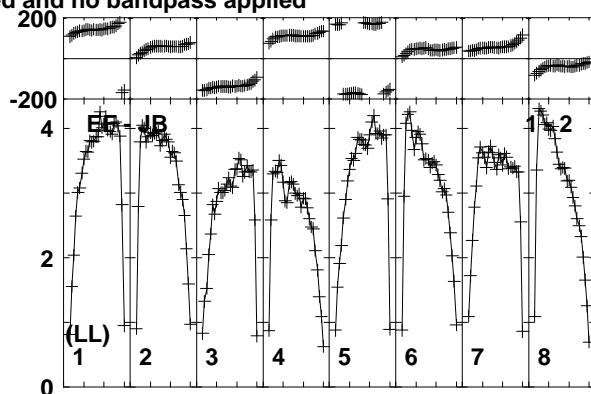
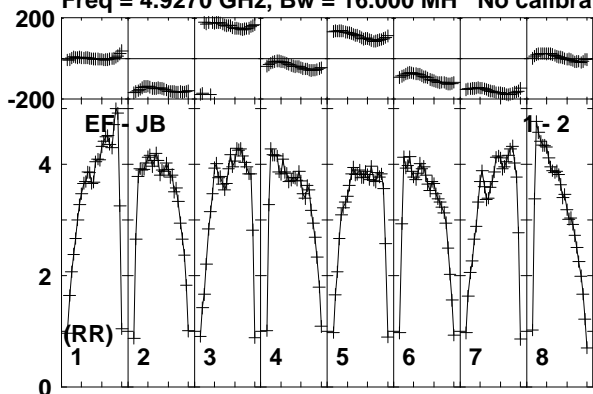

Lower frame: Milli Ampl Jy Top frame: Phas deg
Vector averaged cross-power spectrum Baseline: EF (01) - JB (02)
Timerange: 01/04:15:43 to 01/04:17:09

Plot file version 284 created 26-MAR-2015 15:27:51

J2113+4012 EG082E.UVDATA.1

Freq = 4.9270 GHz, Bw = 16.000 MH No calibration applied and no bandpass applied

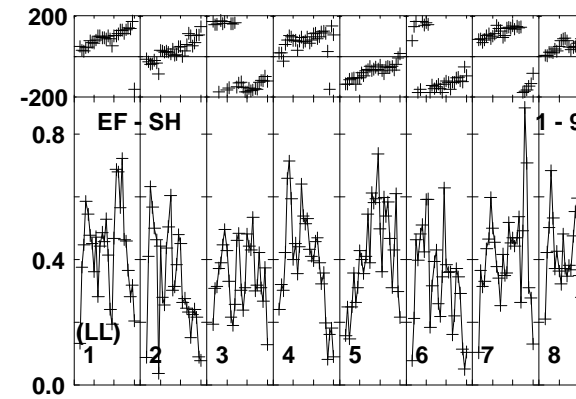
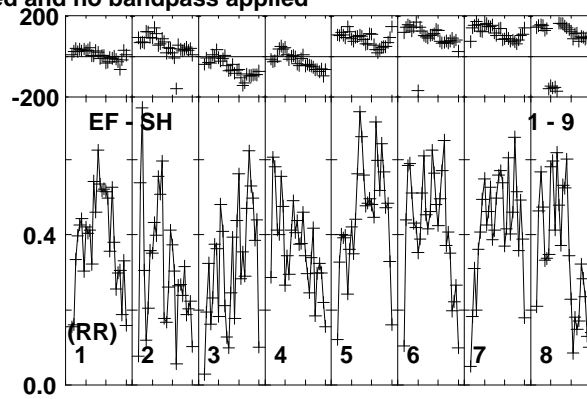
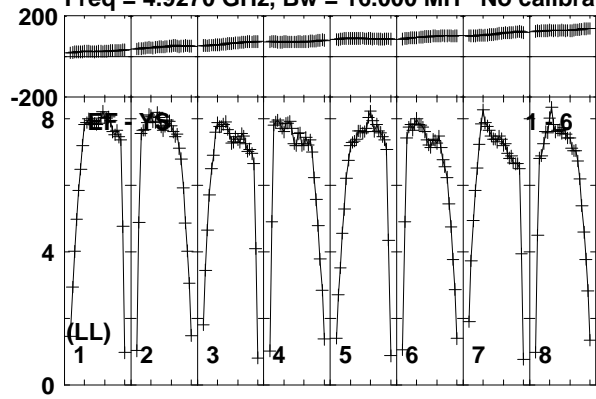

Lower frame: Milli Ampl Jy Top frame: Phas deg
Vector averaged cross-power spectrum Baseline: EF (01) - YS (06)
Timerange: 01/04:15:43 to 01/04:17:09

Plot file version 285 created 26-MAR-2015 15:27:51

J2115+3742 EG082E.UVDATA.1

Freq = 4.9270 GHz, Bw = 16.000 MH No calibration applied and no bandpass applied

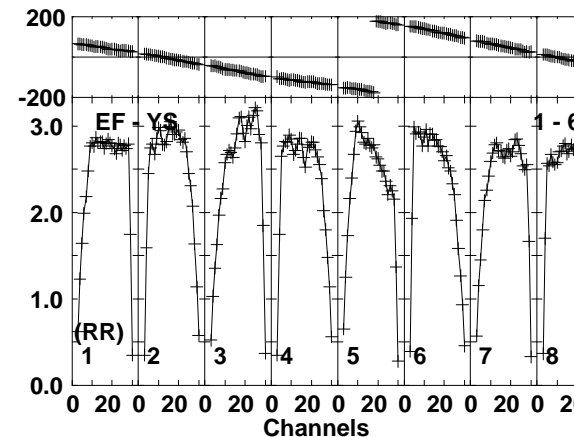
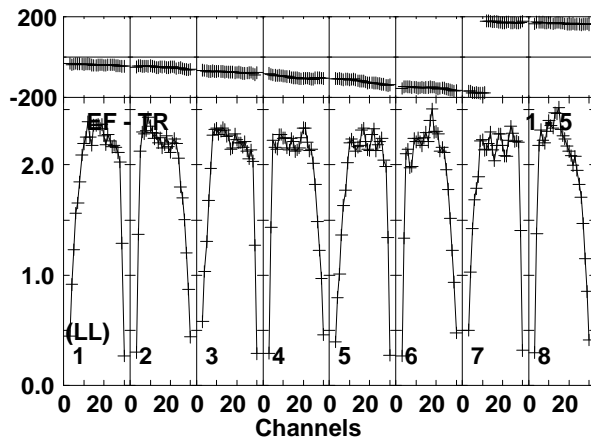
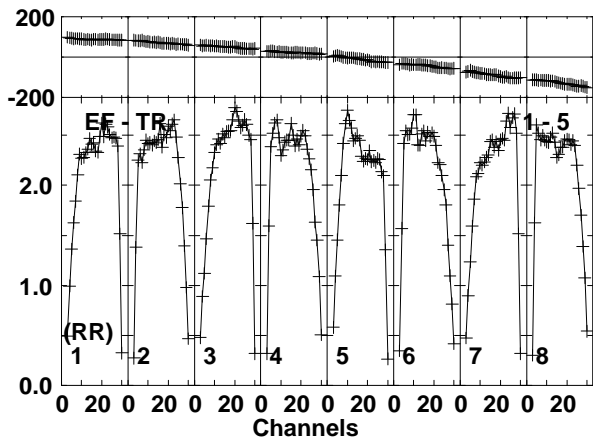
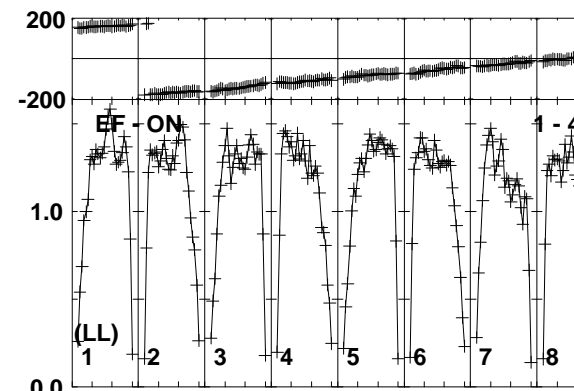
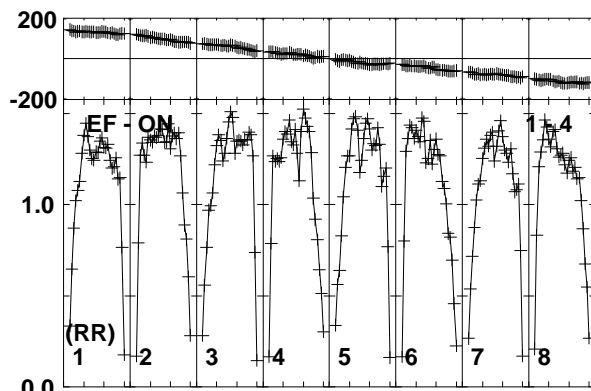
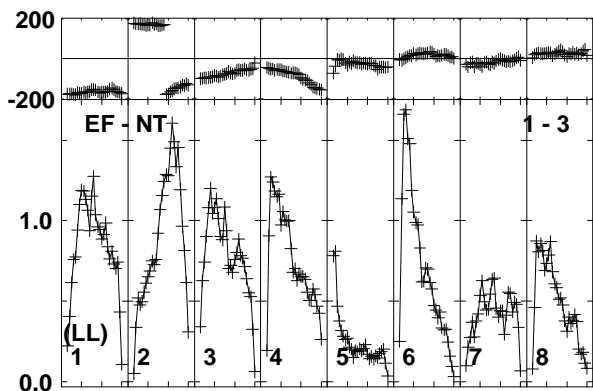
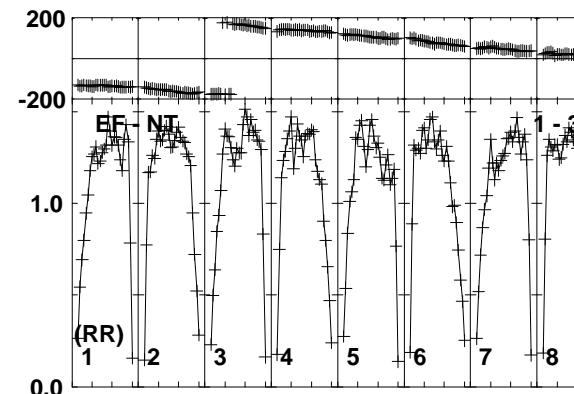
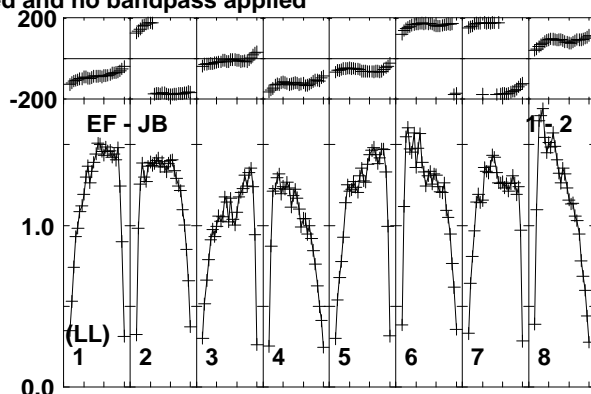
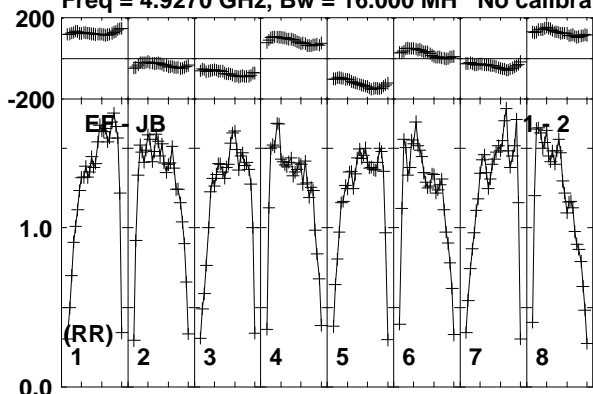

Lower frame: Milli Ampl Jy Top frame: Phas deg
Vector averaged cross-power spectrum Baseline: EF (01) - JB (02)
Timerange: 01/04:17:13 to 01/04:20:39

Plot file version 286 created 26-MAR-2015 15:27:51

J2115+3742 EG082E.UVDATA.1

Freq = 4.9270 GHz, Bw = 16.000 MH No calibration applied and no bandpass applied

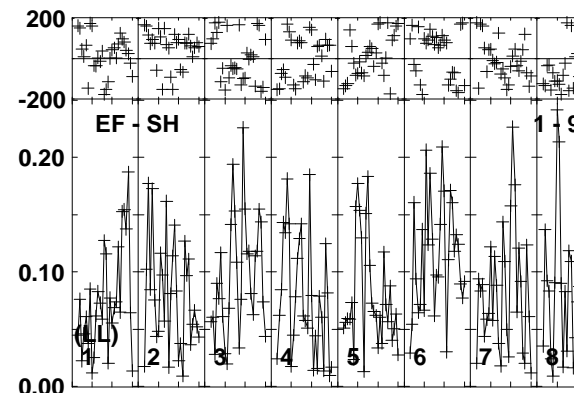
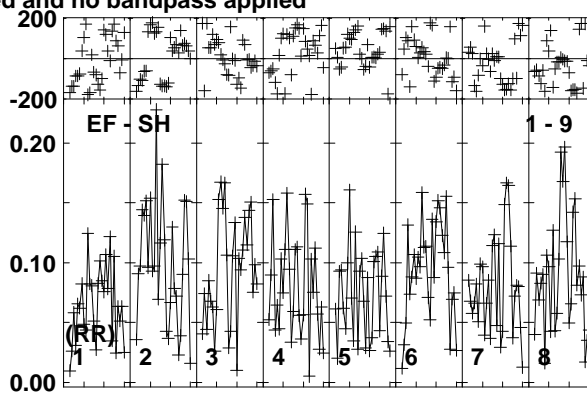
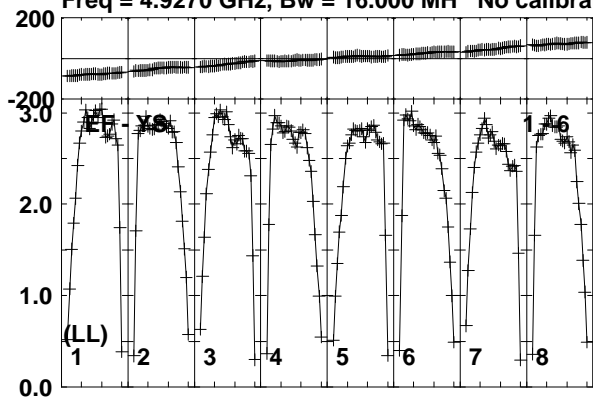

Lower frame: Milli Ampl Jy Top frame: Phas deg
Vector averaged cross-power spectrum Baseline: EF (01) - YS (06)
Timerange: 01/04:17:13 to 01/04:20:39

Plot file version 287 created 26-MAR-2015 15:27:51

J2113+4012 EG082E.UVDATA.1

Freq = 4.9270 GHz, Bw = 16.000 MH No calibration applied and no bandpass applied

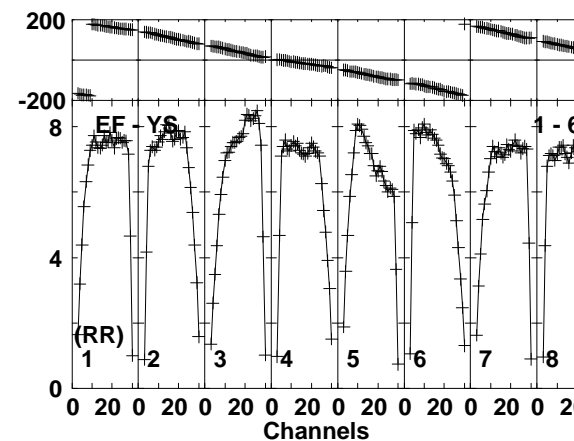
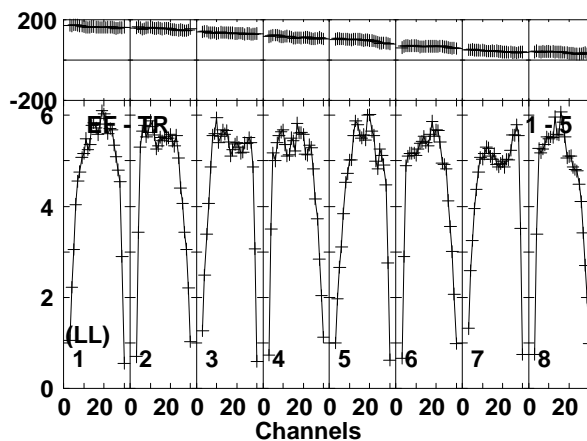
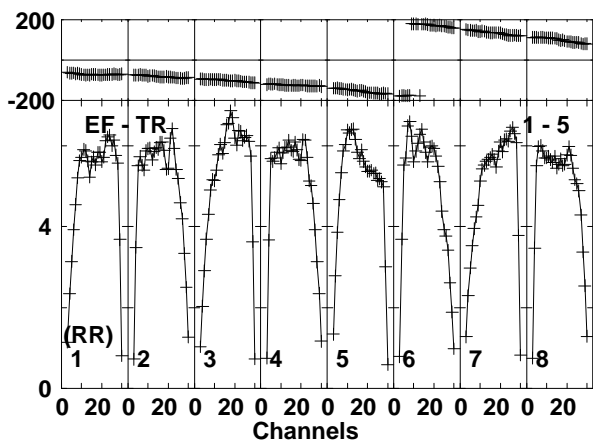
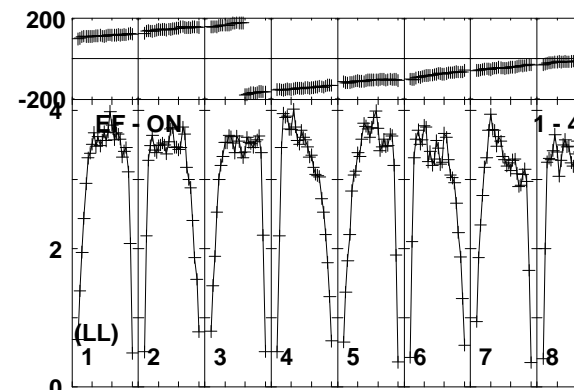
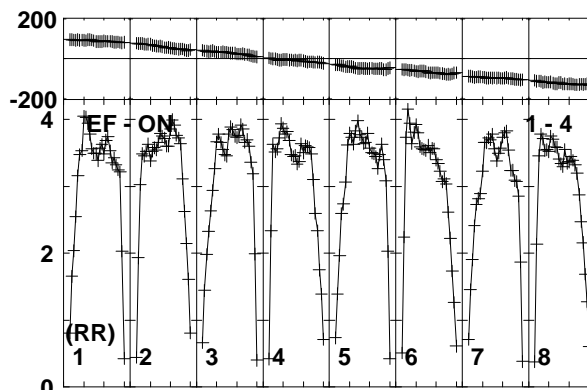
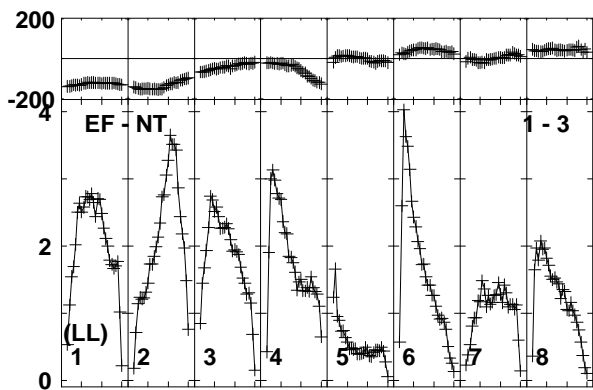
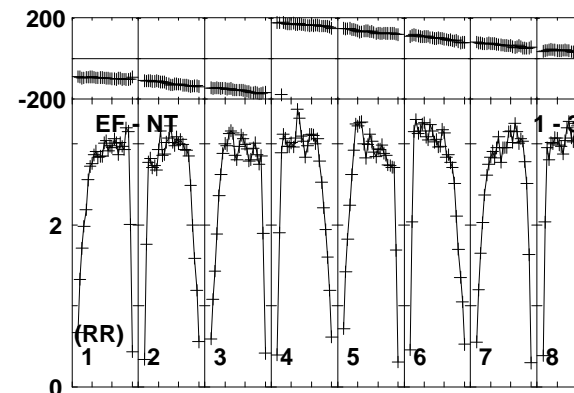
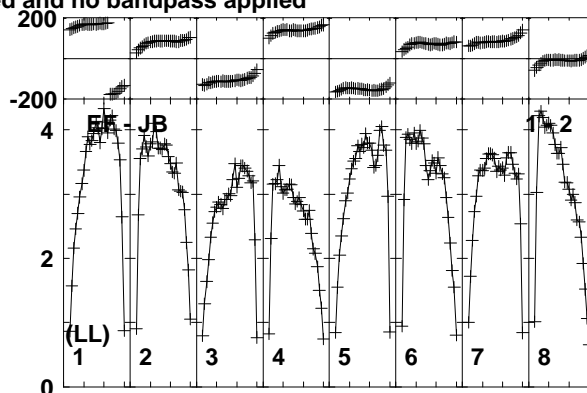
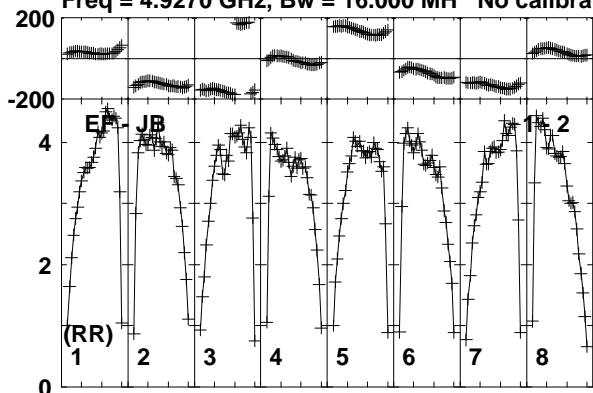

Lower frame: Milli Ampl Jy Top frame: Phas deg
Vector averaged cross-power spectrum Baseline: EF (01) - JB (02)
Timerange: 01/04:21:13 to 01/04:22:09

Plot file version 289 created 26-MAR-2015 15:27:51

V1396CYG EG082E.UVDATA.1

Freq = 4.9270 GHz, Bw = 16.000 MH No calibration applied and no bandpass applied

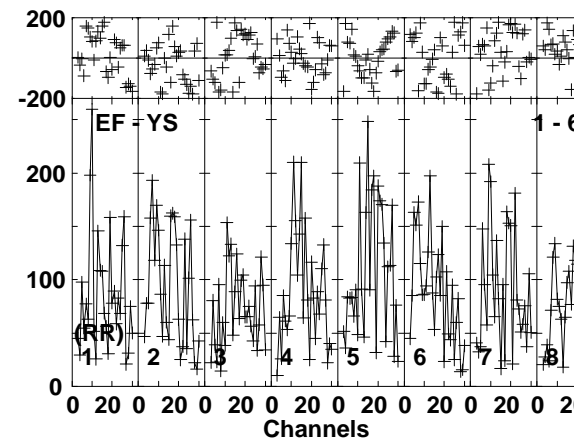
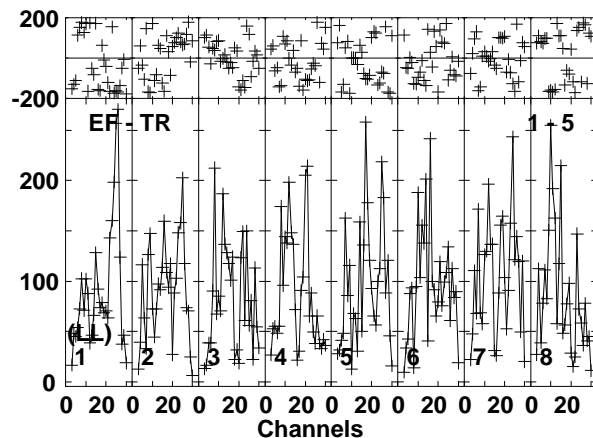
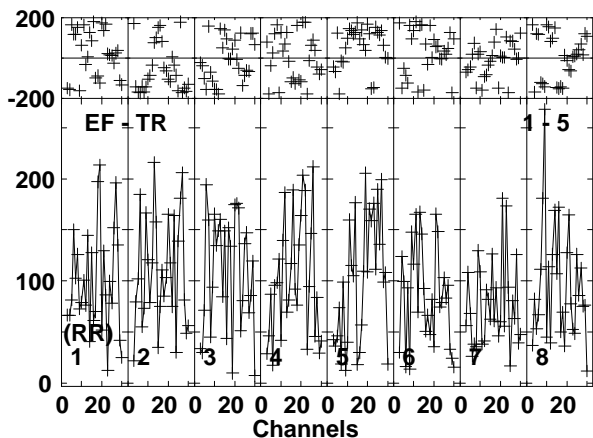
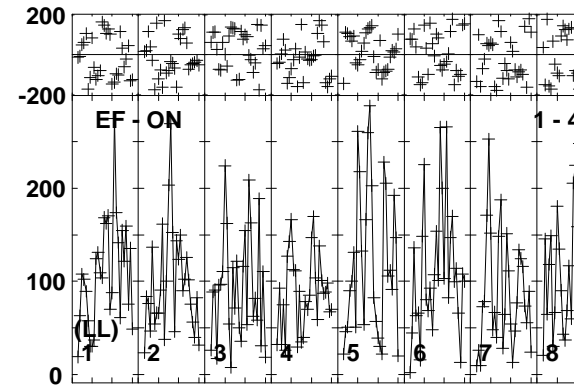
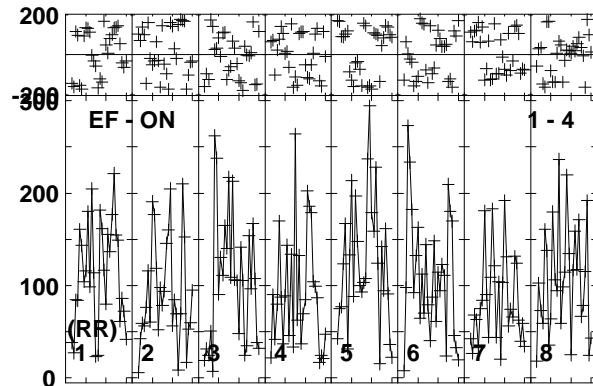
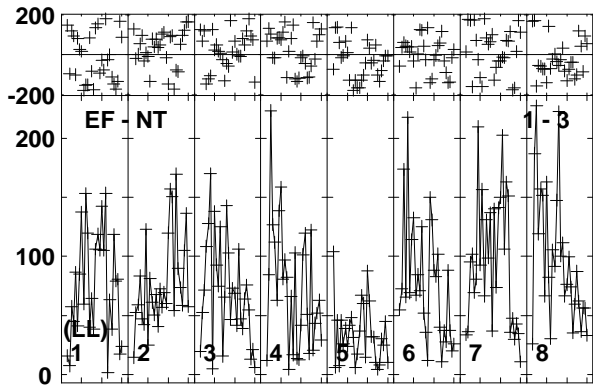
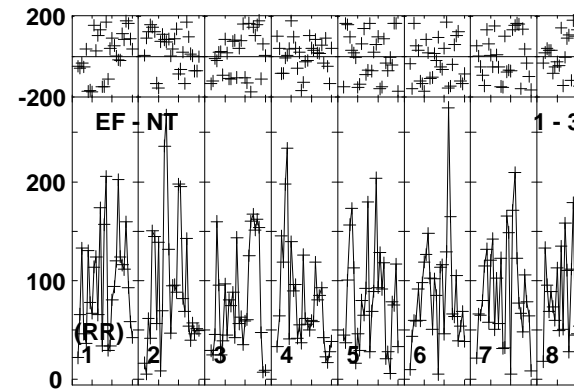
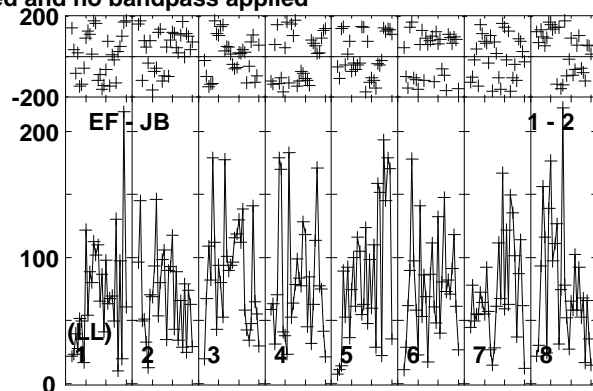
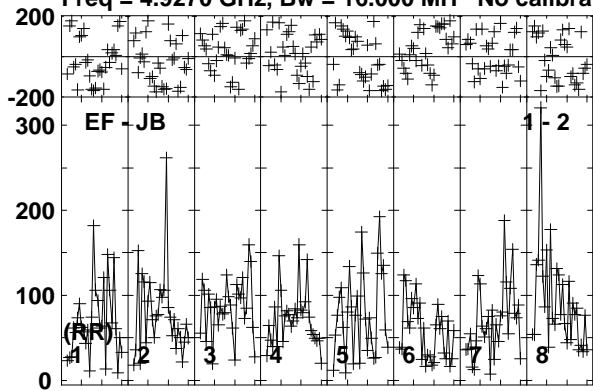

Lower frame: Micro Ampl Jy Top frame: Phas deg
Vector averaged cross-power spectrum Baseline: EF (01) - JB (02)
Timerange: 01/04:22:13 to 01/04:25:39

Plot file version 290 created 26-MAR-2015 15:27:51

V1396CYG EG082E.UVDATA.1

Freq = 4.9270 GHz, Bw = 16.000 MH No calibration applied and no bandpass applied

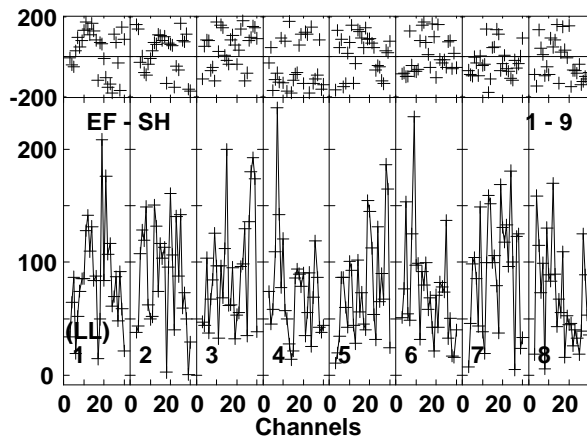
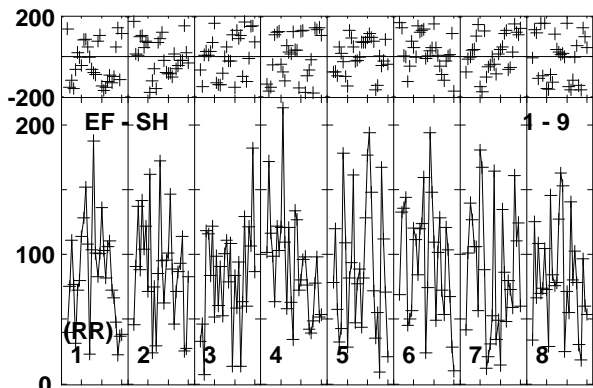
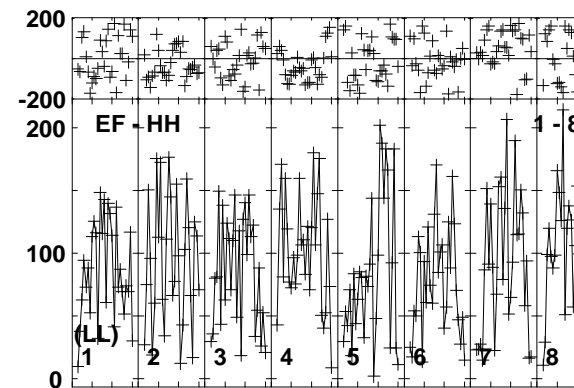
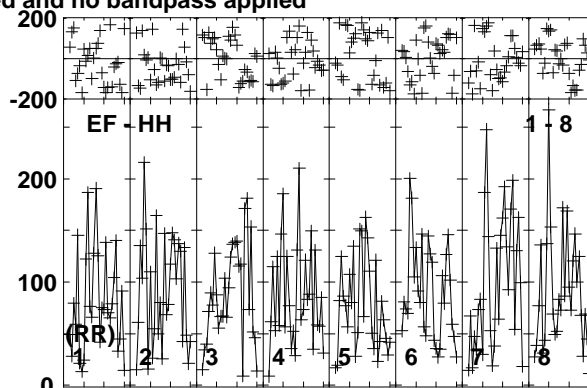
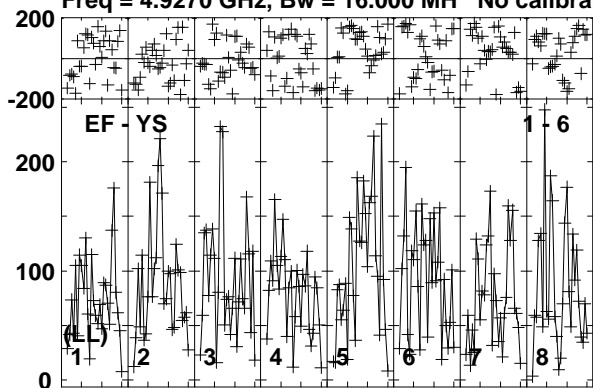

Lower frame: Micro Ampl Jy Top frame: Phas deg
Vector averaged cross-power spectrum Baseline: EF (01) - YS (06)
Timerange: 01/04:22:13 to 01/04:25:39

Plot file version 291 created 26-MAR-2015 15:27:51

J2113+4012 EG082E.UVDATA.1

Freq = 4.9270 GHz, Bw = 16.000 MH No calibration applied and no bandpass applied

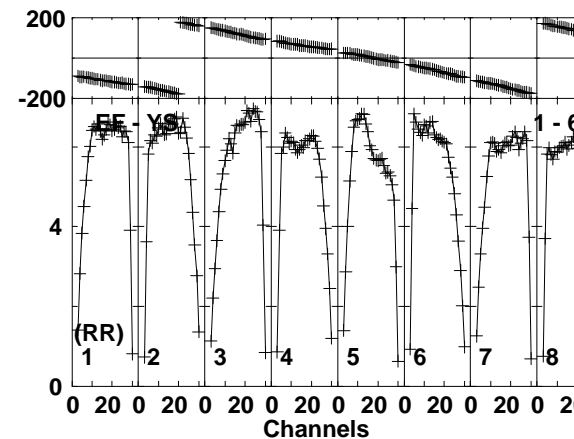
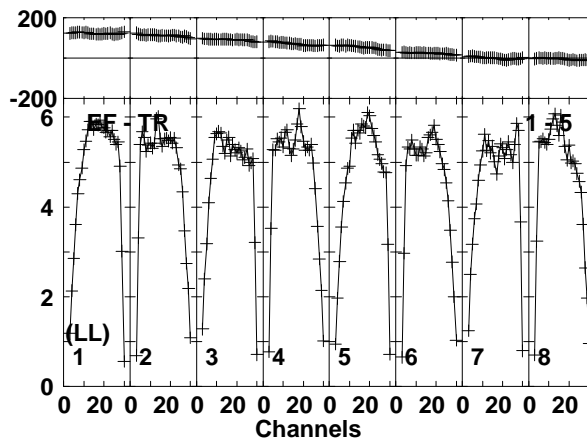
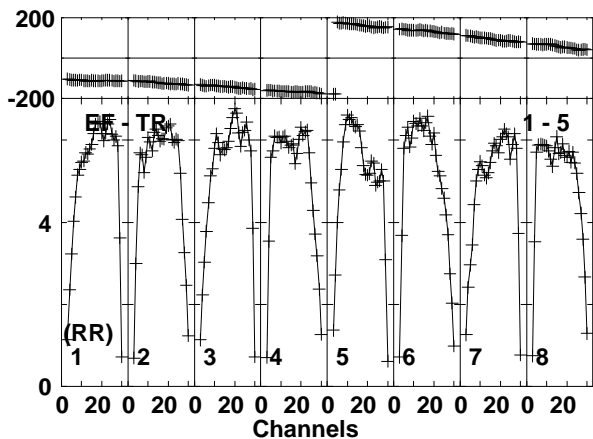
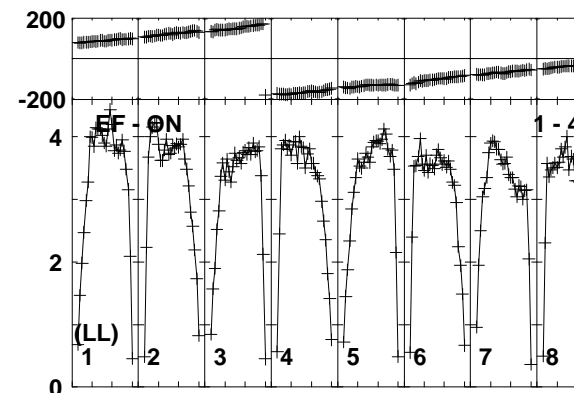
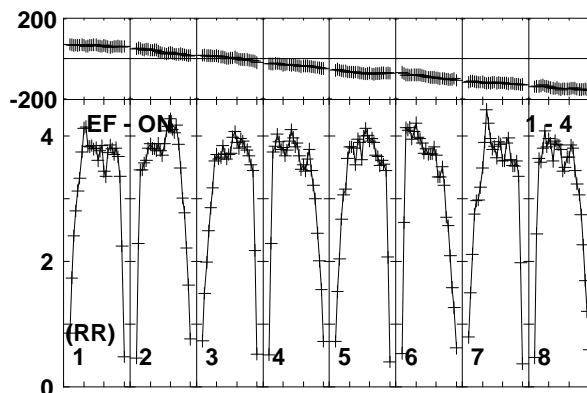
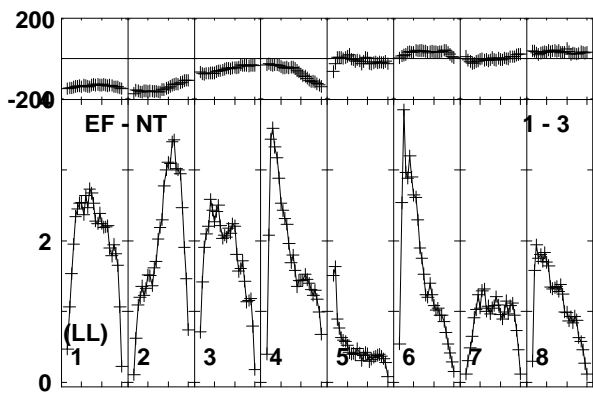
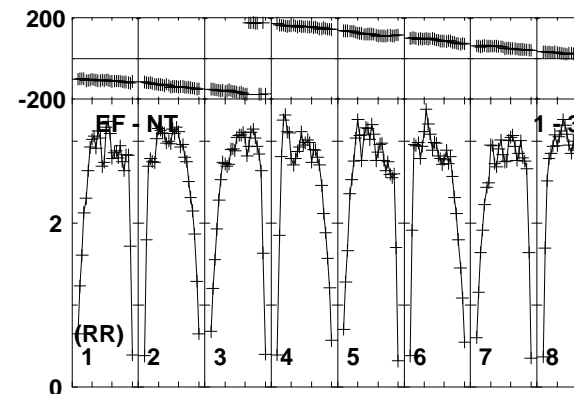
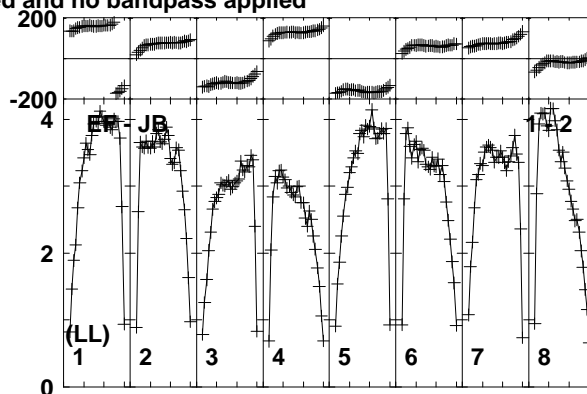
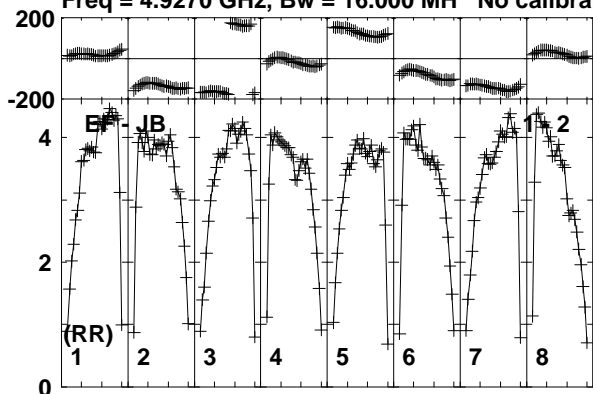

Lower frame: Milli Ampl Jy Top frame: Phas deg
Vector averaged cross-power spectrum Baseline: EF (01) - JB (02)
Timerange: 01/04:25:43 to 01/04:27:09

Plot file version 292 created 26-MAR-2015 15:27:51

J2113+4012 EG082E.UVDATA.1

Freq = 4.9270 GHz, Bw = 16.000 MH No calibration applied and no bandpass applied

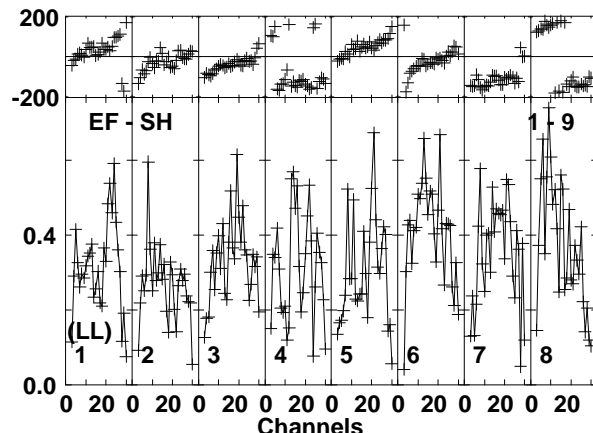
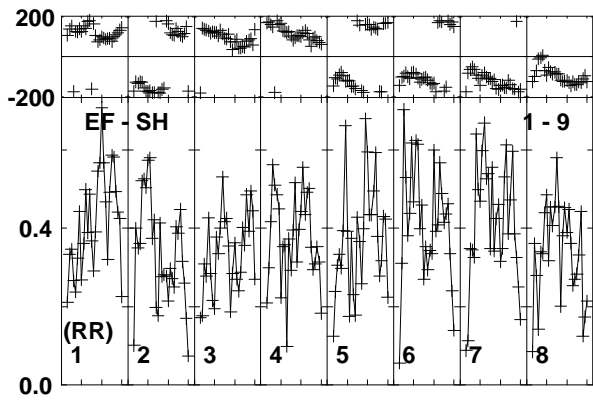
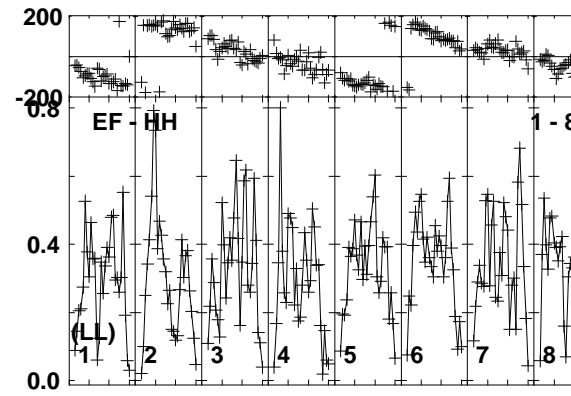
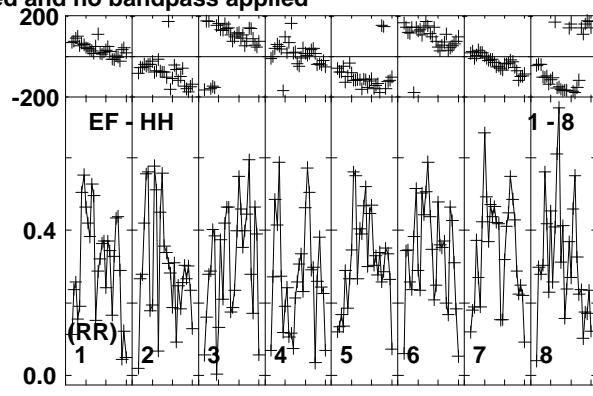
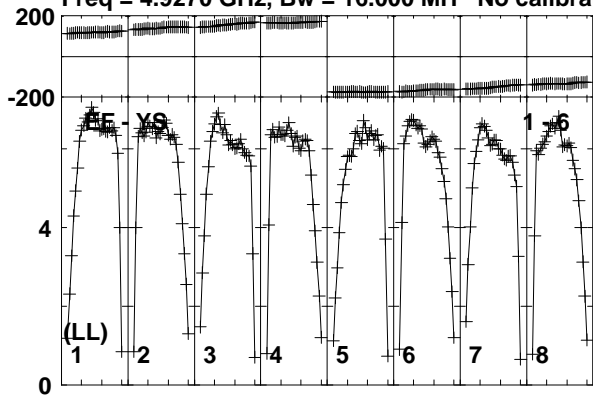

Lower frame: Milli Ampl Jy Top frame: Phas deg
Vector averaged cross-power spectrum Baseline: EF (01) - YS (06)
Timerange: 01/04:25:43 to 01/04:27:09

Plot file version 293 created 26-MAR-2015 15:27:51

V1396CYG EG082E.UVDATA.1

Freq = 4.9270 GHz, Bw = 16.000 MH No calibration applied and no bandpass applied

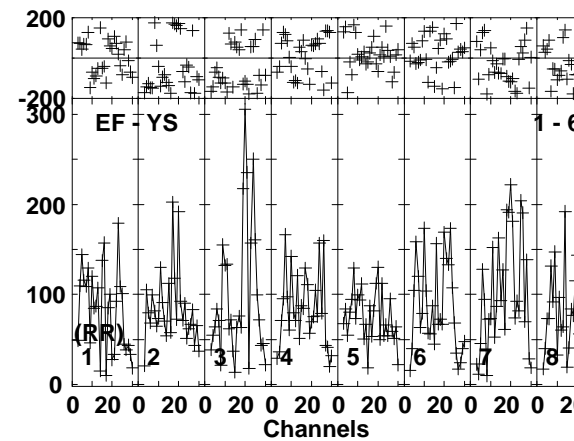
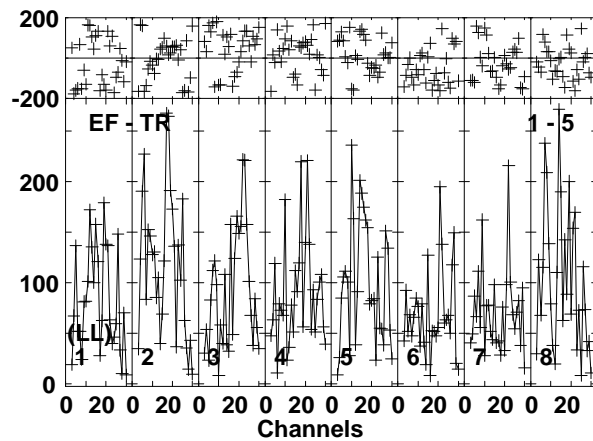
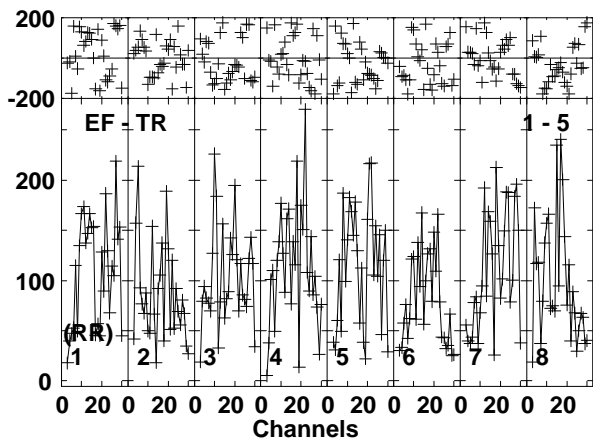
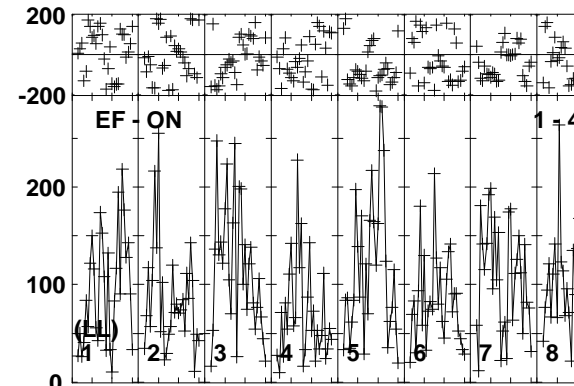
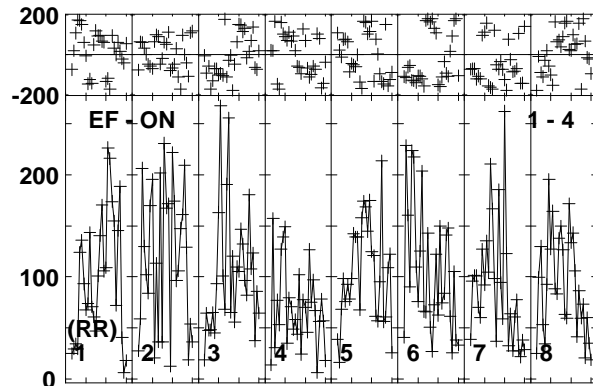
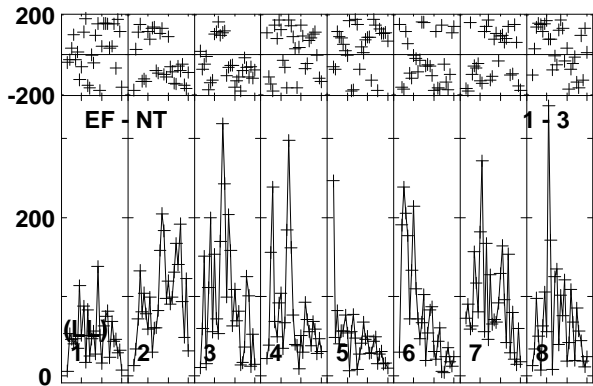
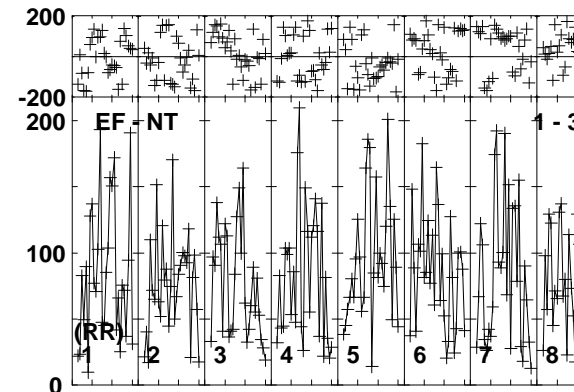
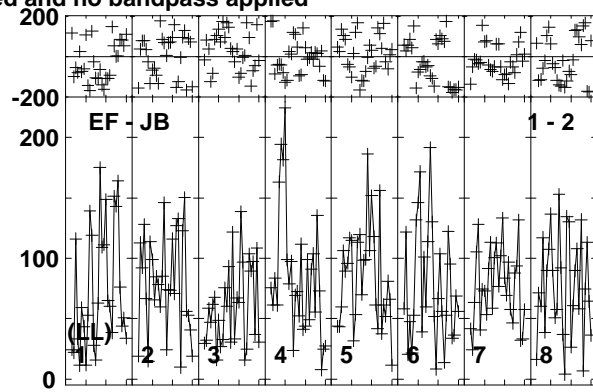
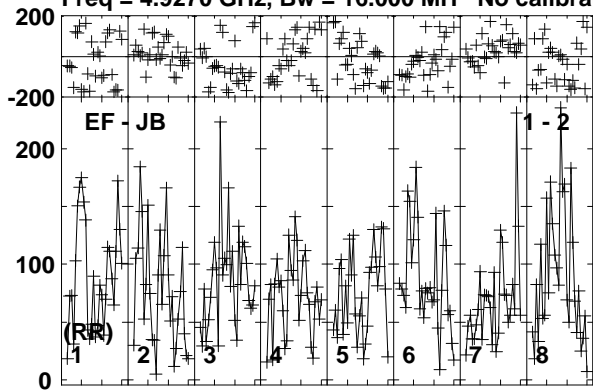

Lower frame: Micro Ampl Jy Top frame: Phas deg
Vector averaged cross-power spectrum Baseline: EF (01) - JB (02)
Timerange: 01/04:27:13 to 01/04:30:39

Plot file version 294 created 26-MAR-2015 15:27:52

V1396CYG EG082E.UVDATA.1

Freq = 4.9270 GHz, Bw = 16.000 MH No calibration applied and no bandpass applied

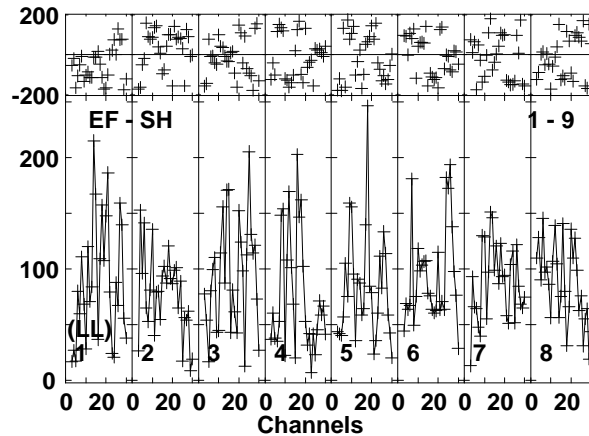
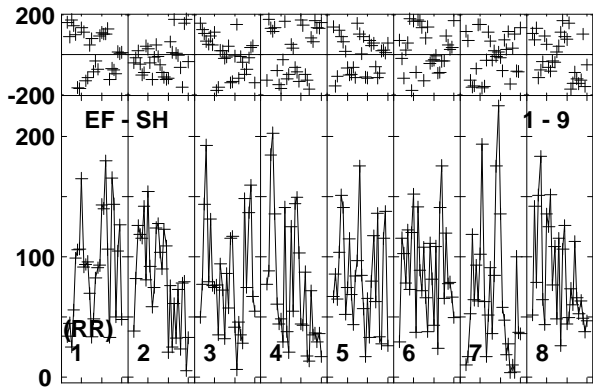
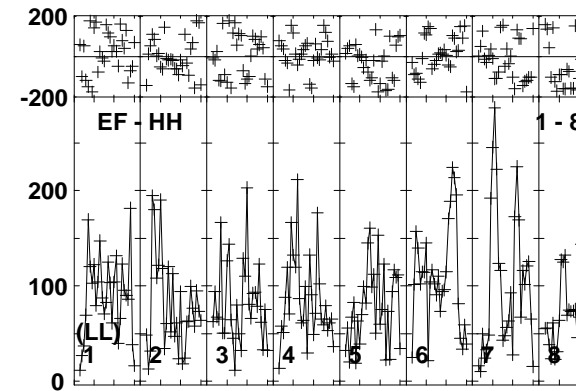
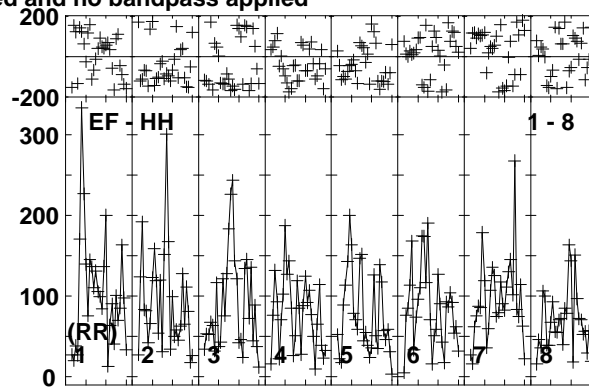
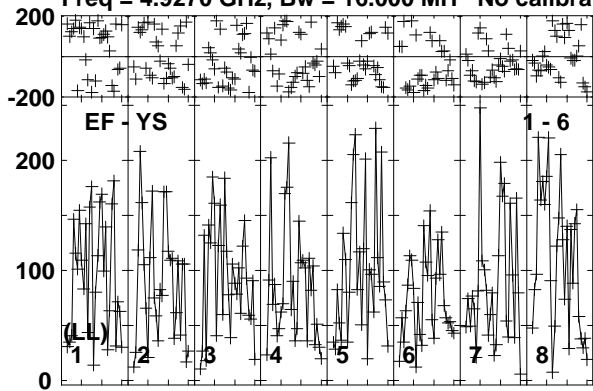

Lower frame: Micro Ampl Jy Top frame: Phas deg
Vector averaged cross-power spectrum Baseline: EF (01) - YS (06)
Timerange: 01/04:27:13 to 01/04:30:39

Plot file version 295 created 26-MAR-2015 15:27:52

J2113+4012 EG082E.UVDATA.1

Freq = 4.9270 GHz, Bw = 16.000 MH No calibration applied and no bandpass applied

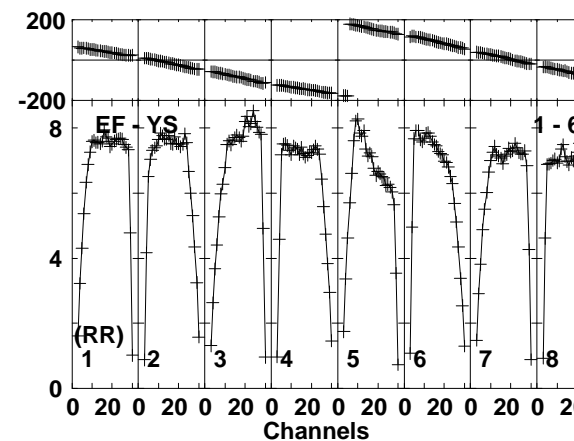
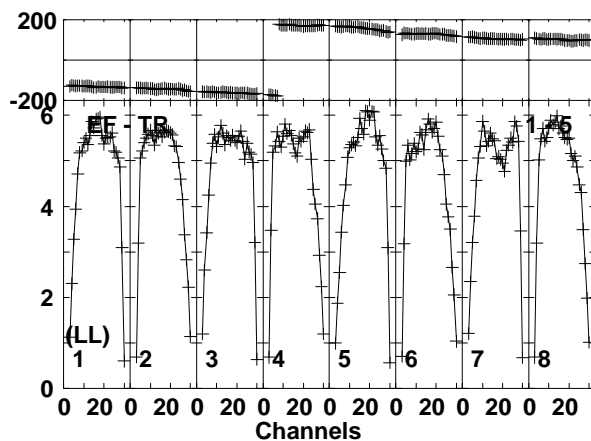
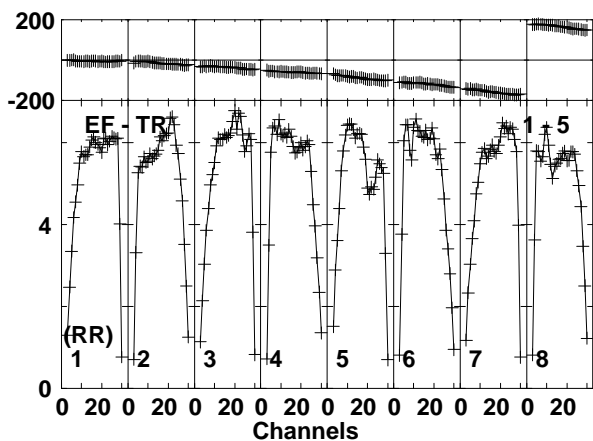
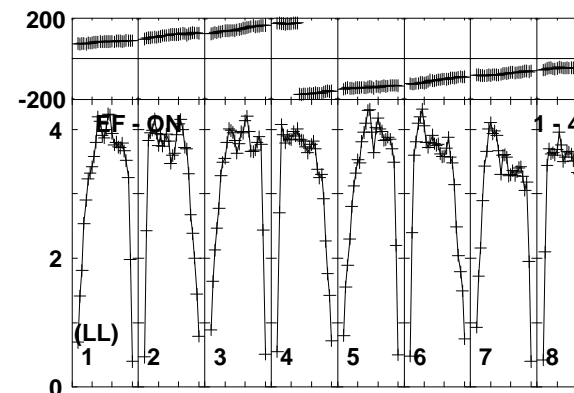
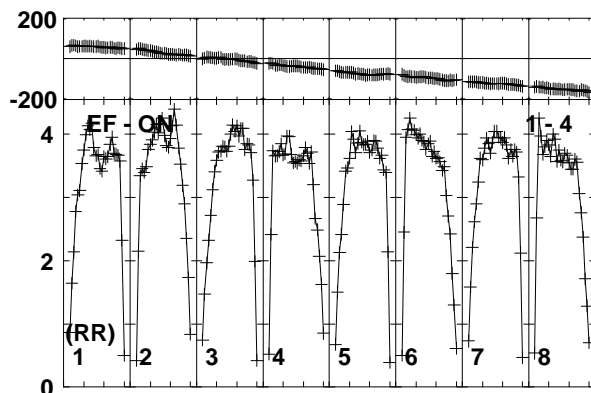
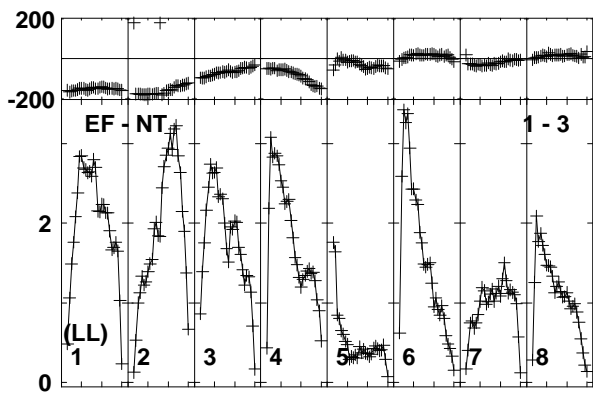
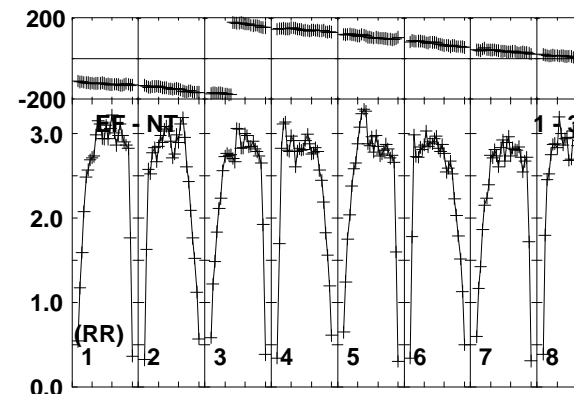
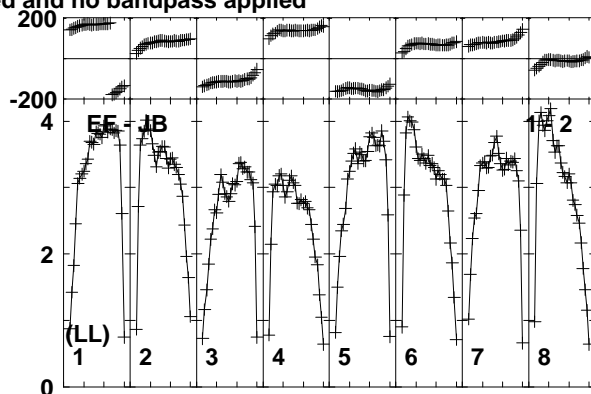
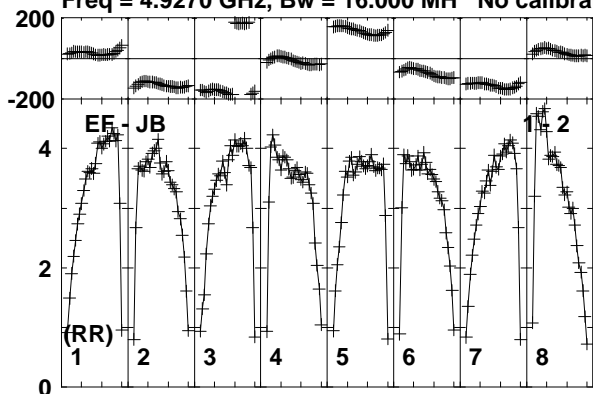

Lower frame: Milli Ampl Jy Top frame: Phas deg
Vector averaged cross-power spectrum Baseline: EF (01) - JB (02)
Timerange: 01/04:31:13 to 01/04:32:09

Plot file version 296 created 26-MAR-2015 15:27:52

J2113+4012 EG082E.UVDATA.1

Freq = 4.9270 GHz, Bw = 16.000 MH No calibration applied and no bandpass applied

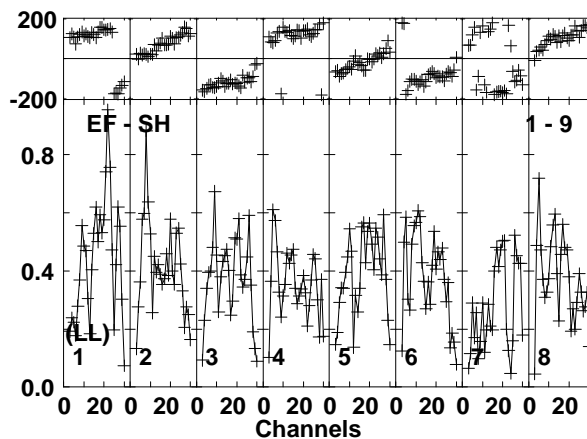
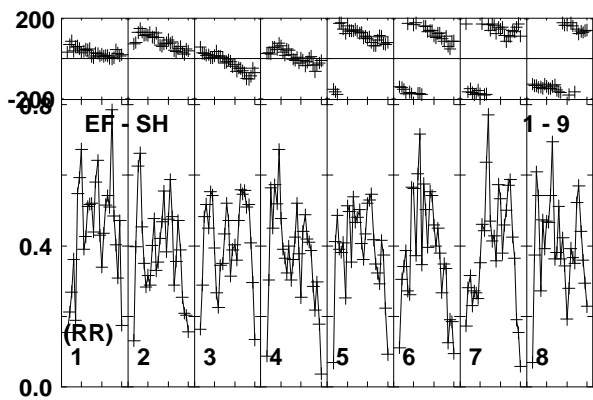
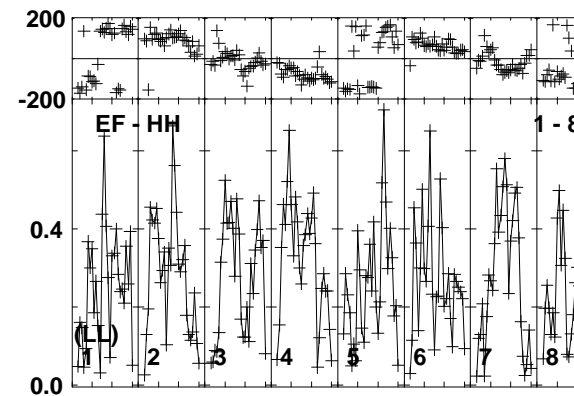
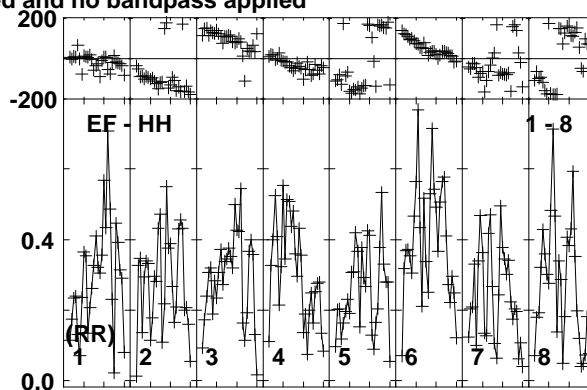
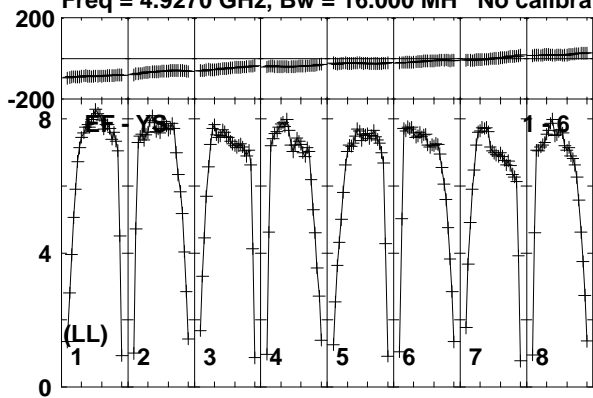

Lower frame: Milli Ampl Jy Top frame: Phas deg
Vector averaged cross-power spectrum Baseline: EF (01) - YS (06)
Timerange: 01/04:31:13 to 01/04:32:09

Plot file version 297 created 26-MAR-2015 15:27:52

V1396CYG EG082E.UVDATA.1

Freq = 4.9270 GHz, Bw = 16.000 MH No calibration applied and no bandpass applied

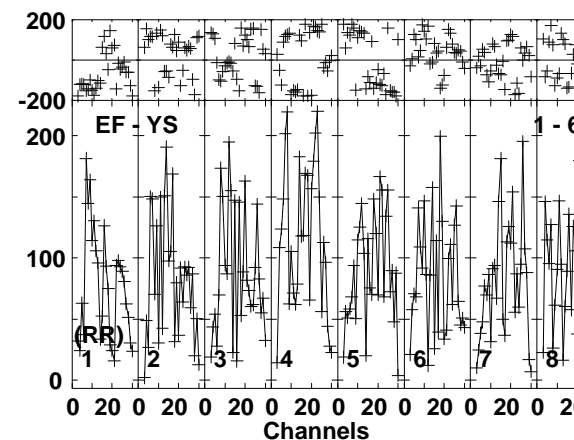
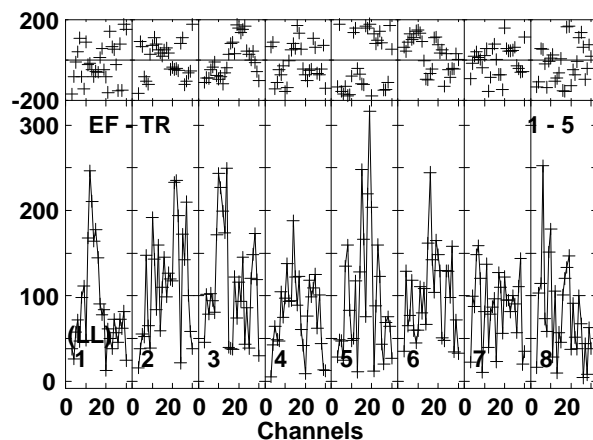
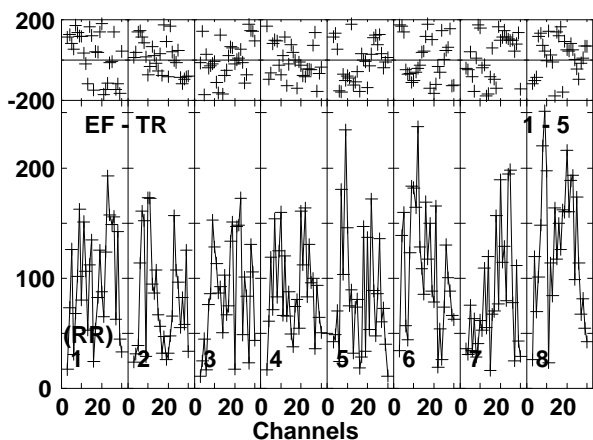
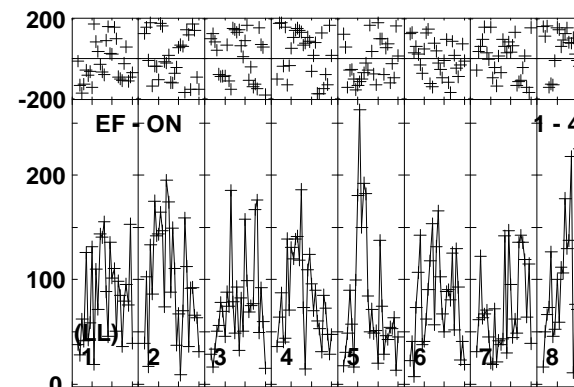
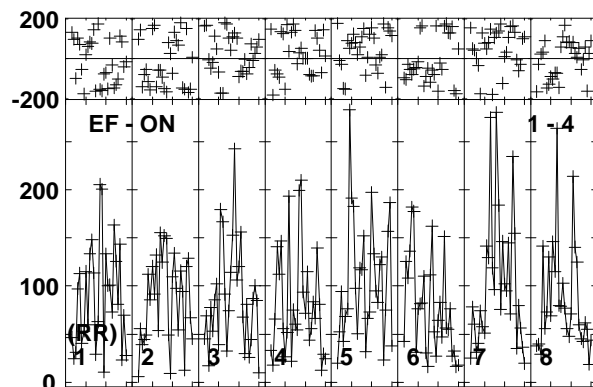
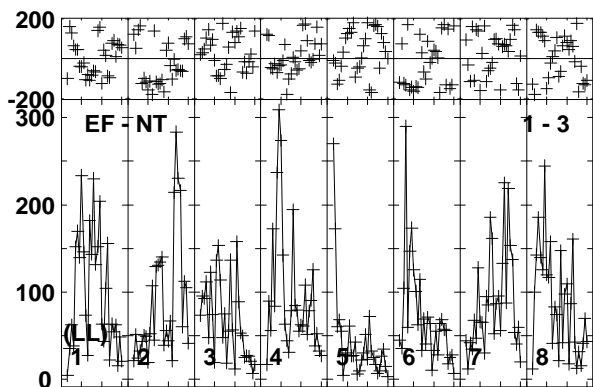
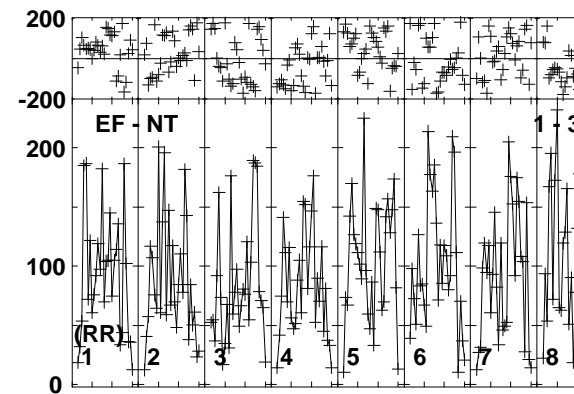
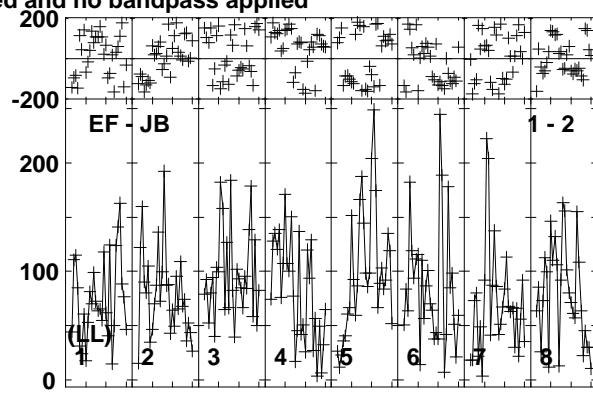
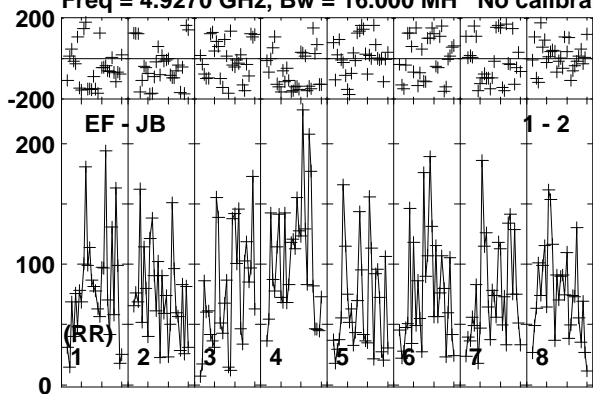

Lower frame: Micro Ampl Jy Top frame: Phas deg
Vector averaged cross-power spectrum Baseline: EF (01) - JB (02)
Timerange: 01/04:32:13 to 01/04:35:39

Plot file version 298 created 26-MAR-2015 15:27:52

V1396CYG EG082E.UVDATA.1

Freq = 4.9270 GHz, Bw = 16.000 MH No calibration applied and no bandpass applied

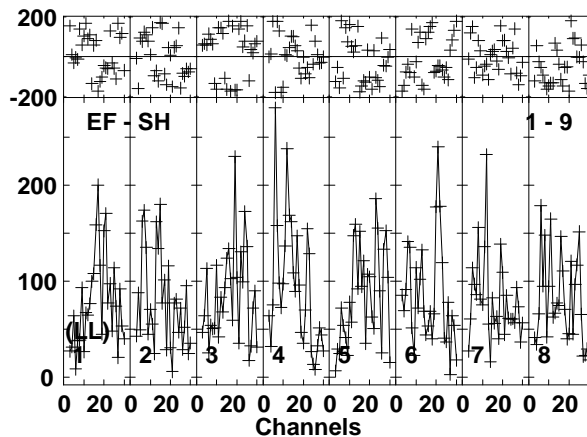
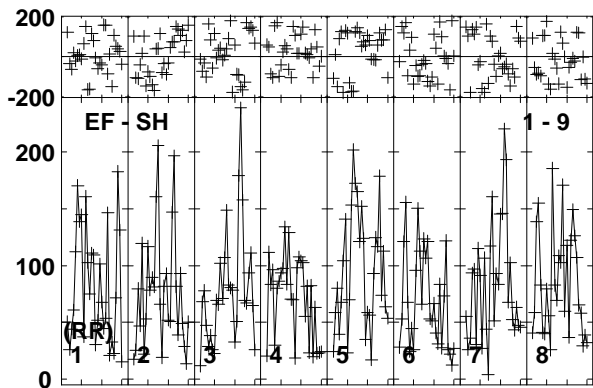
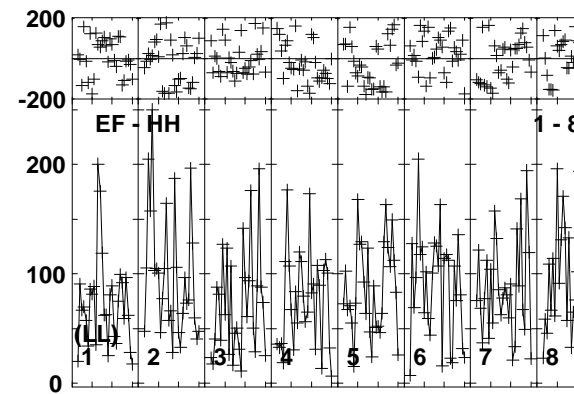
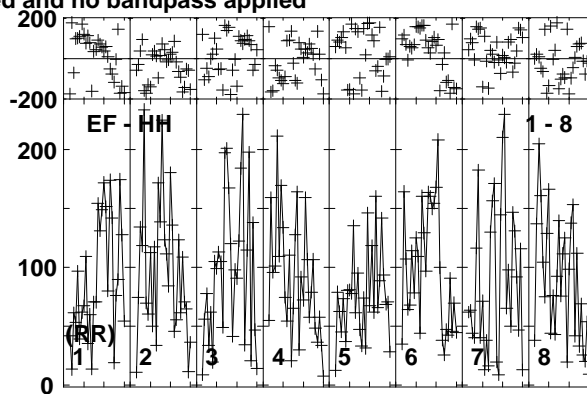
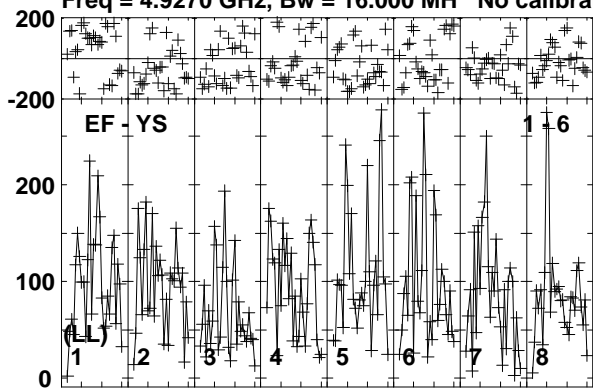

Lower frame: Micro Ampl Jy Top frame: Phas deg
Vector averaged cross-power spectrum Baseline: EF (01) - YS (06)
Timerange: 01/04:32:13 to 01/04:35:39

Plot file version 299 created 26-MAR-2015 15:27:52

J2113+4012 EG082E.UVDATA.1

Freq = 4.9270 GHz, Bw = 16.000 MH No calibration applied and no bandpass applied

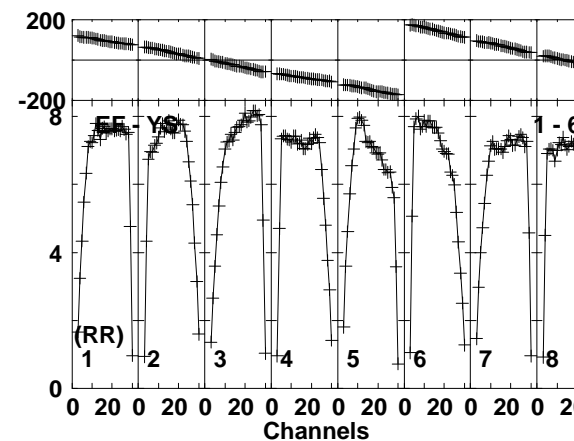
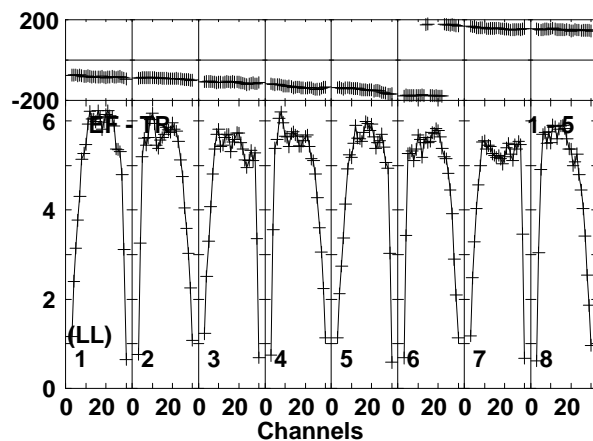
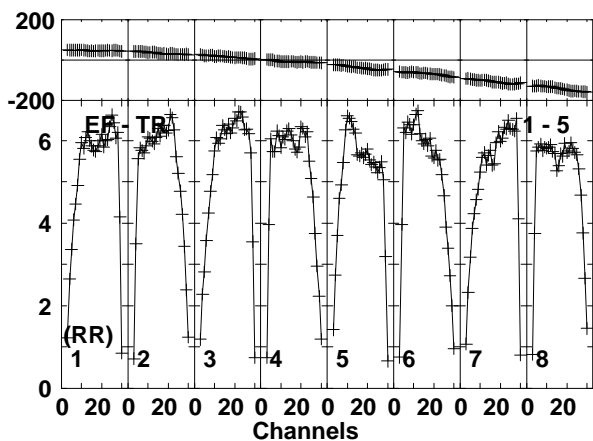
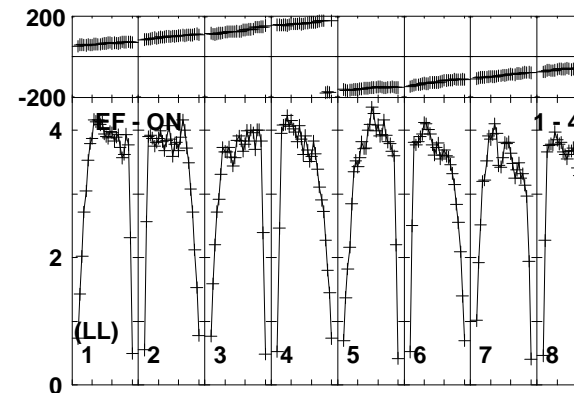
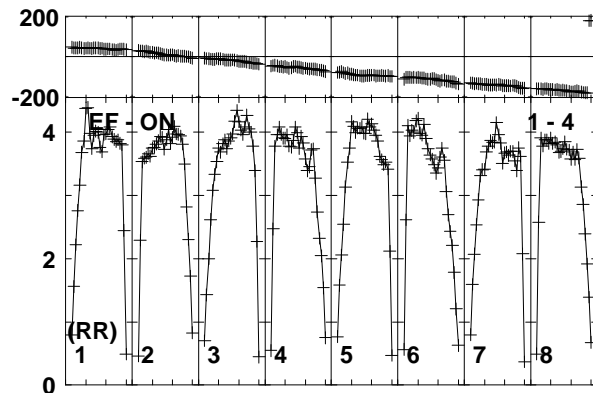
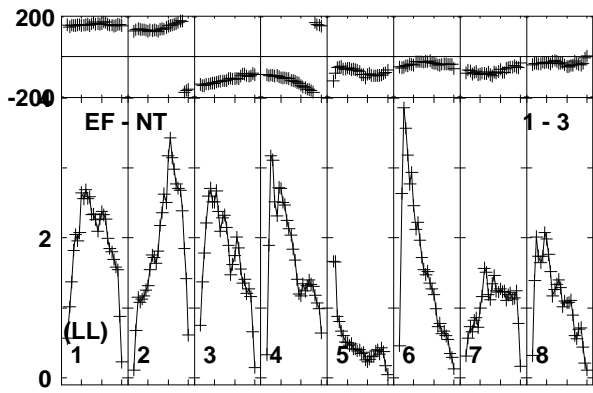
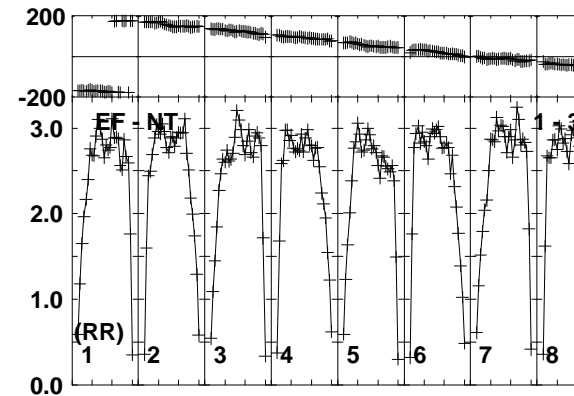
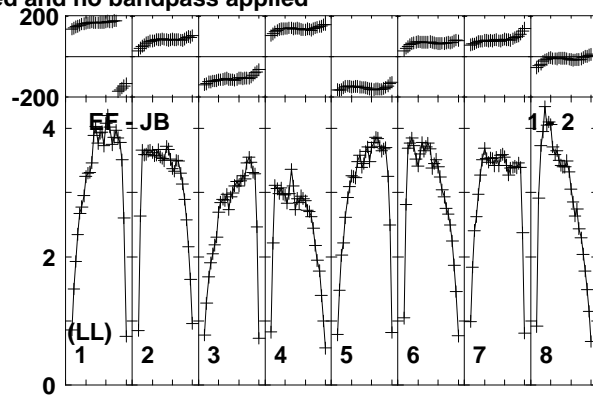
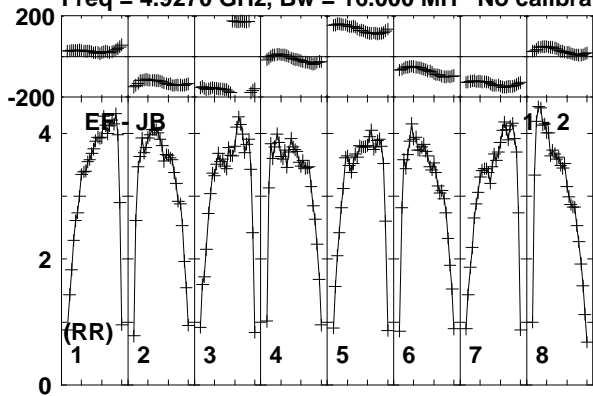

Lower frame: Milli Ampl Jy Top frame: Phas deg
Vector averaged cross-power spectrum Baseline: EF (01) - JB (02)
Timerange: 01/04:35:43 to 01/04:37:09

Plot file version 300 created 26-MAR-2015 15:27:52

J2113+4012 EG082E.UVDATA.1

Freq = 4.9270 GHz, Bw = 16.000 MH No calibration applied and no bandpass applied

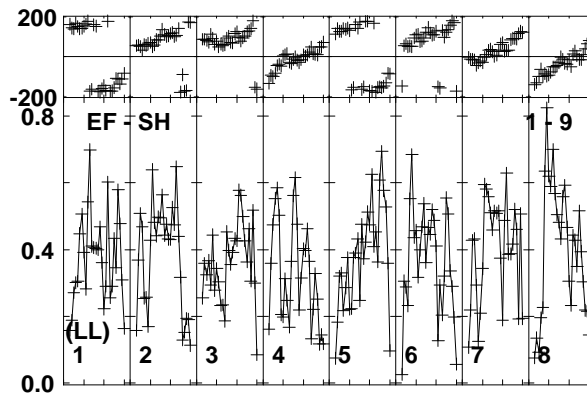
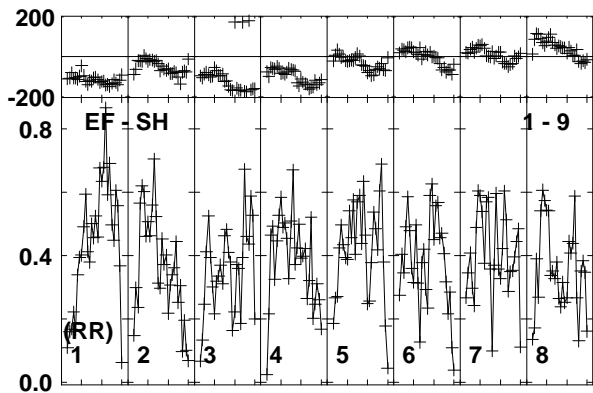
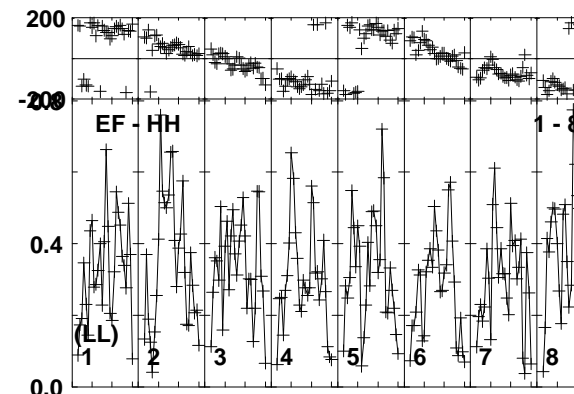
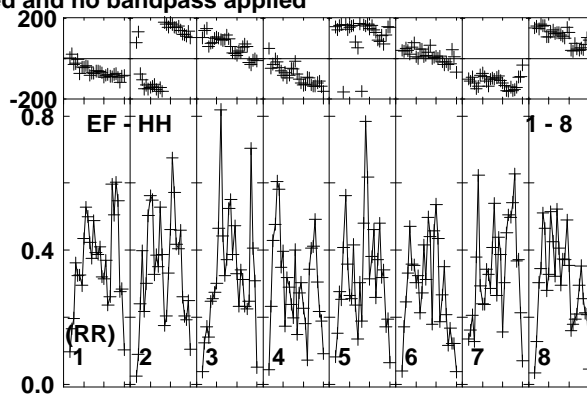
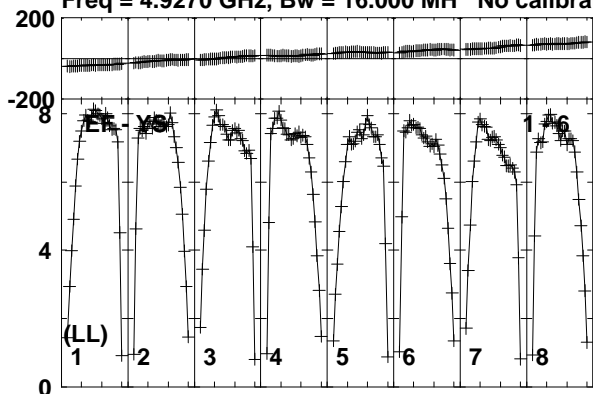

Channels

Lower frame: Milli Ampl Jy Top frame: Phas deg
Vector averaged cross-power spectrum Baseline: EF (01) - YS (06)
Timerange: 01/04:35:43 to 01/04:37:09

Plot file version 301 created 26-MAR-2015 15:27:52

V1396CYG EG082E.UVDATA.1

Freq = 4.9270 GHz, Bw = 16.000 MH No calibration applied and no bandpass applied

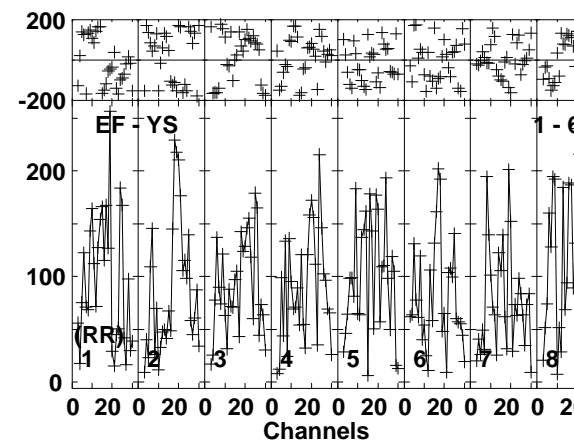
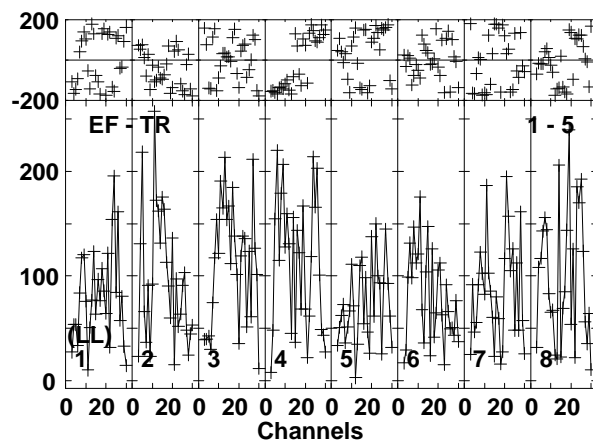
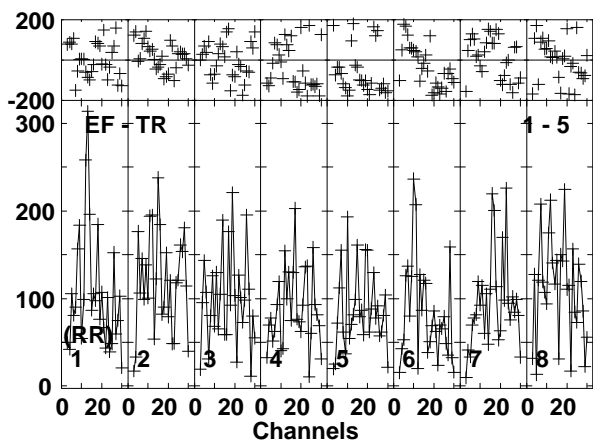
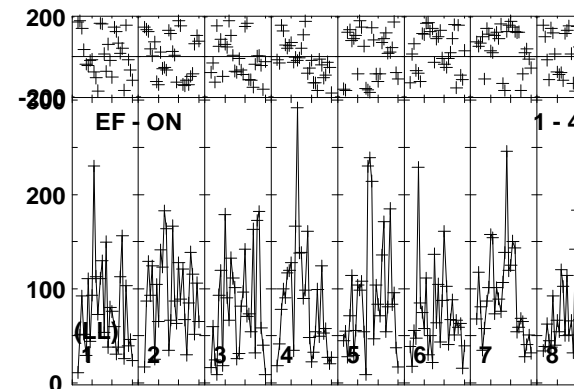
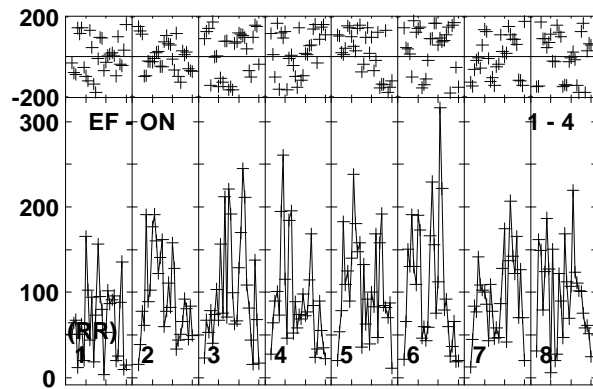
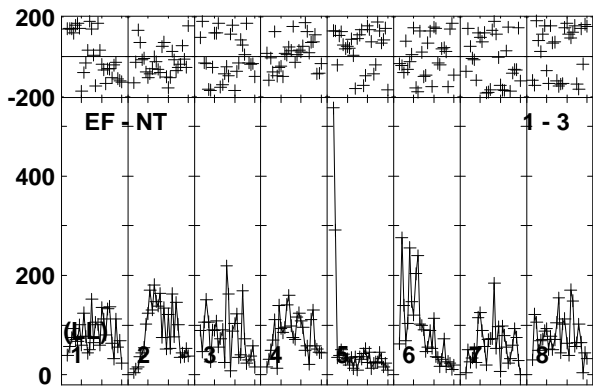
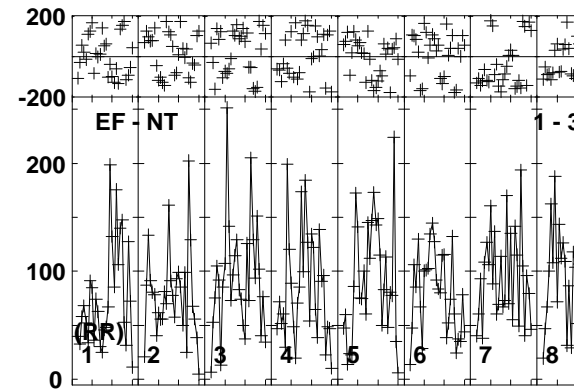
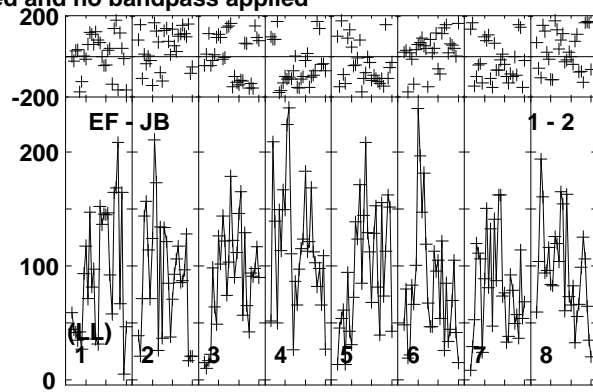
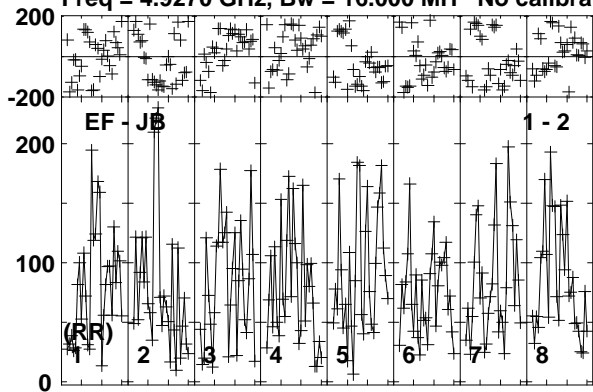

Lower frame: Micro Ampl Jy Top frame: Phas deg
Vector averaged cross-power spectrum Baseline: EF (01) - JB (02)
Timerange: 01/04:37:13 to 01/04:40:39

Plot file version 302 created 26-MAR-2015 15:27:52

V1396CYG EG082E.UVDATA.1

Freq = 4.9270 GHz, Bw = 16.000 MH No calibration applied and no bandpass applied

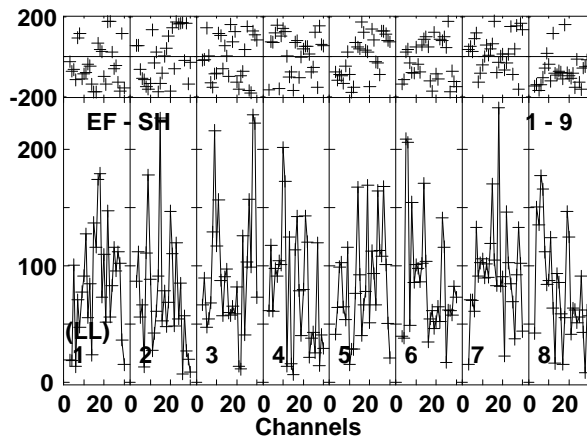
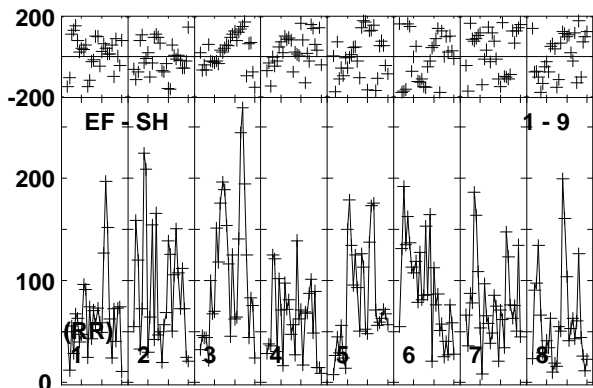
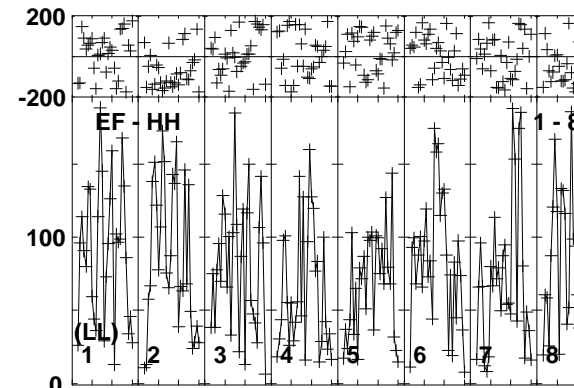
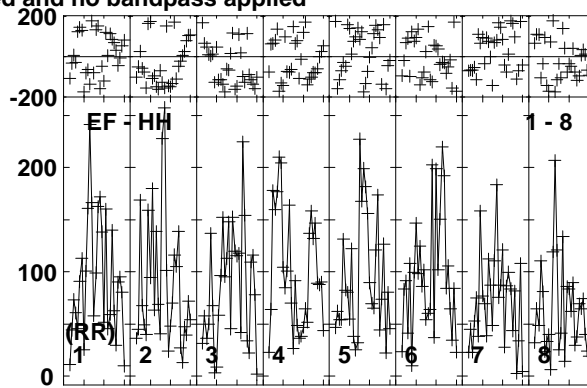
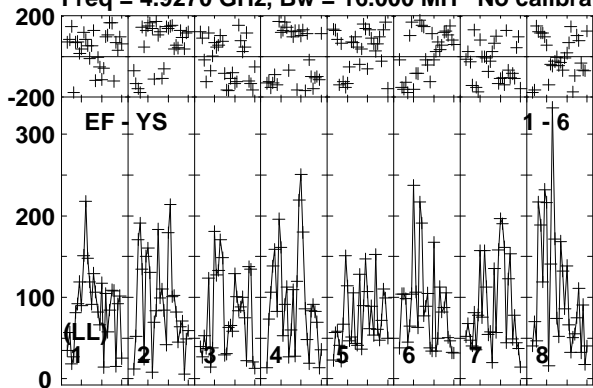

Lower frame: Micro Ampl Jy Top frame: Phas deg
Vector averaged cross-power spectrum Baseline: EF (01) - YS (06)
Timerange: 01/04:37:13 to 01/04:40:39

Plot file version 303 created 26-MAR-2015 15:27:52

J2113+4012 EG082E.UVDATA.1

Freq = 4.9270 GHz, Bw = 16.000 MH No calibration applied and no bandpass applied

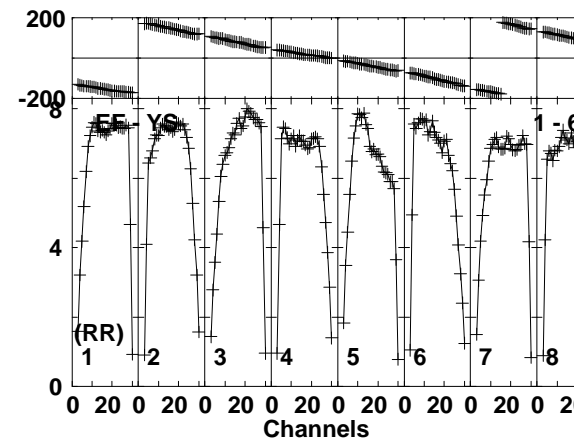
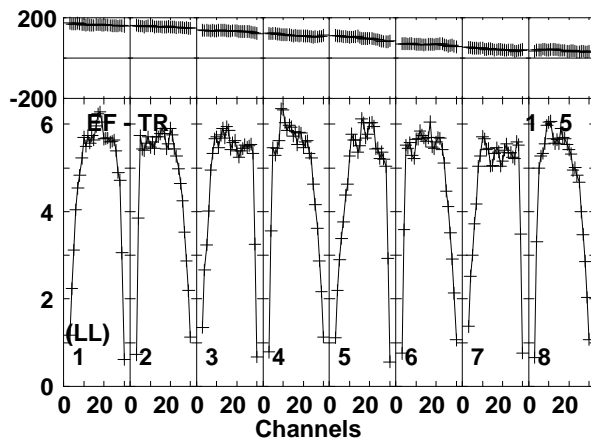
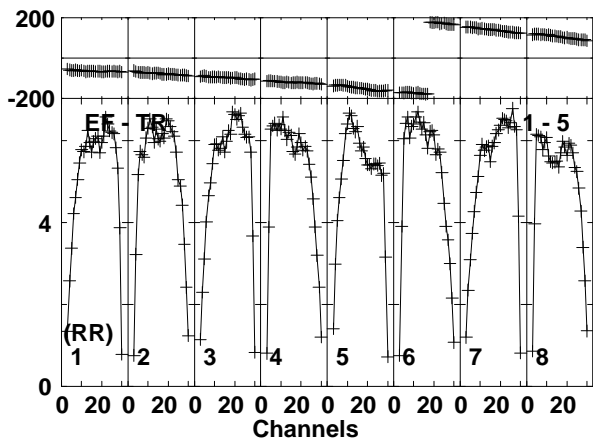
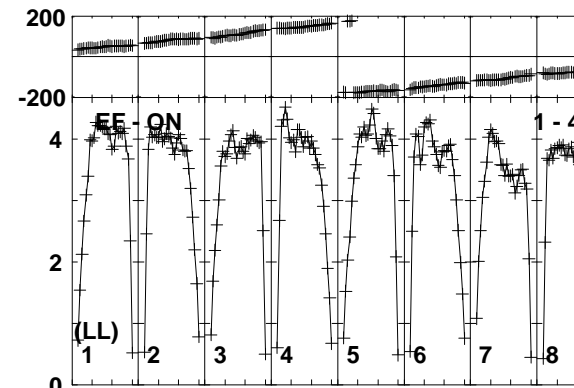
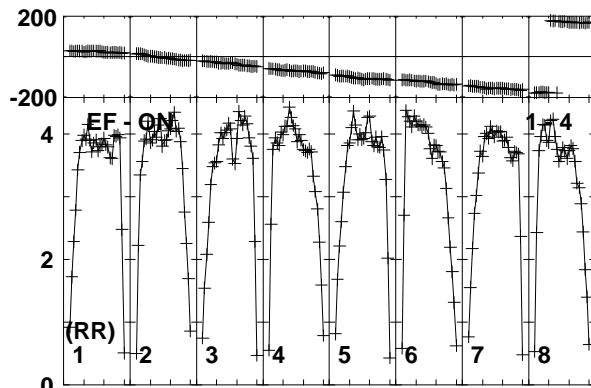
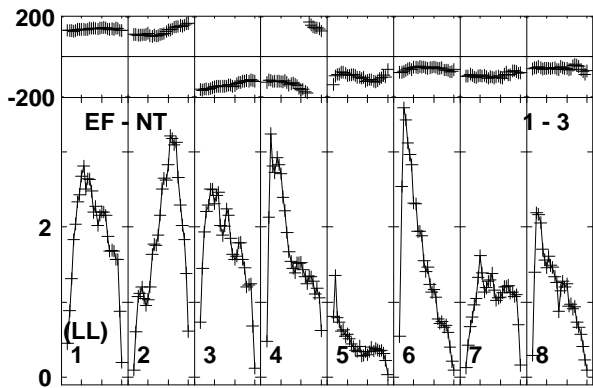
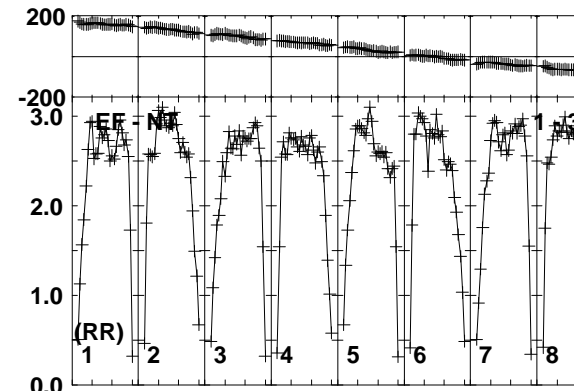
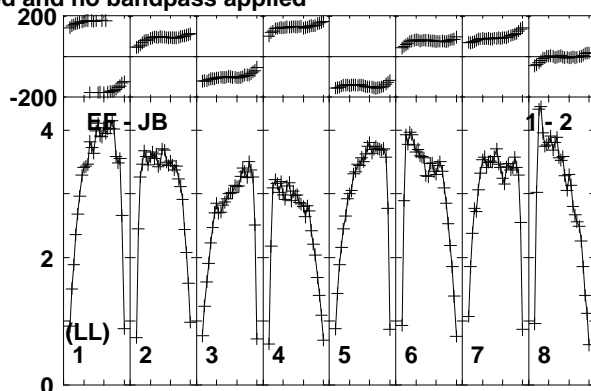
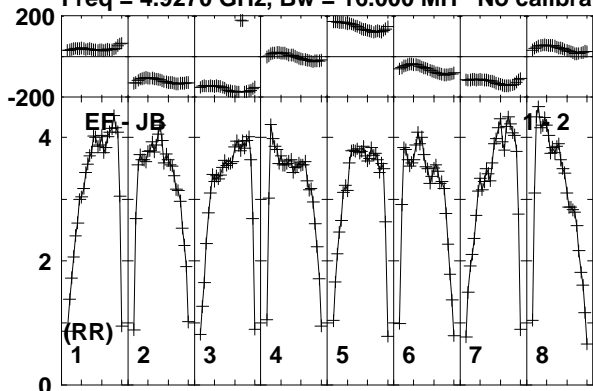

Lower frame: Milli Ampl Jy Top frame: Phas deg
Vector averaged cross-power spectrum Baseline: EF (01) - JB (02)
Timerange: 01/04:41:13 to 01/04:42:09

Plot file version 304 created 26-MAR-2015 15:27:52

J2113+4012 EG082E.UVDATA.1

Freq = 4.9270 GHz, Bw = 16.000 MH No calibration applied and no bandpass applied

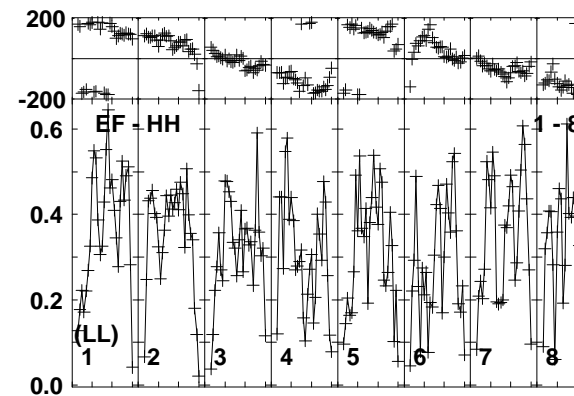
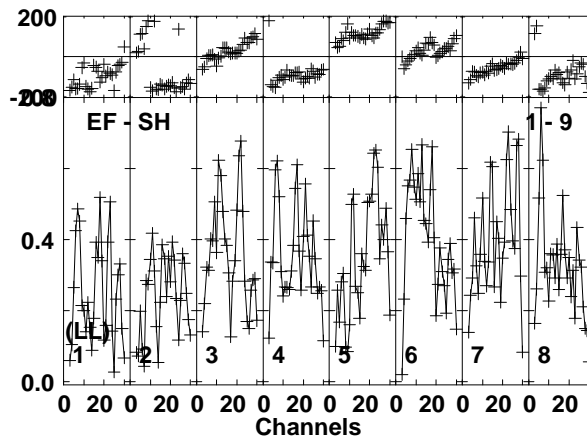
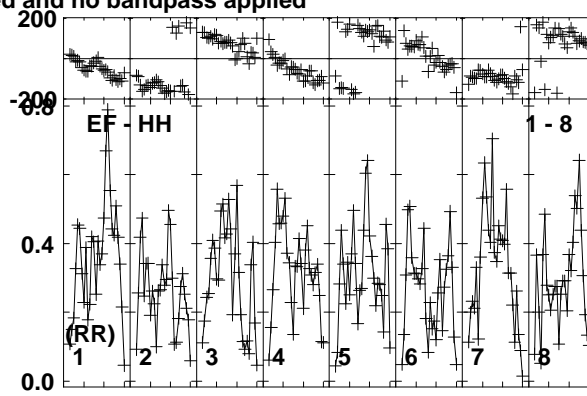
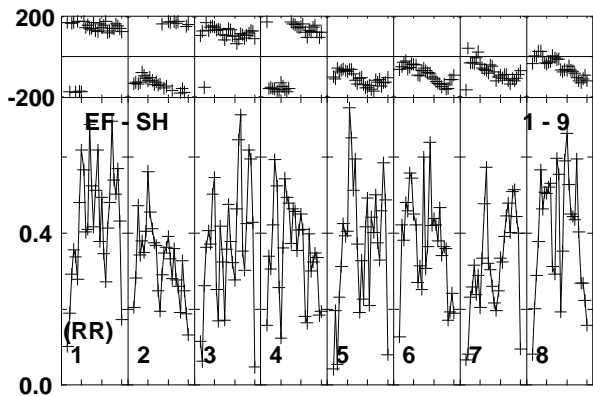
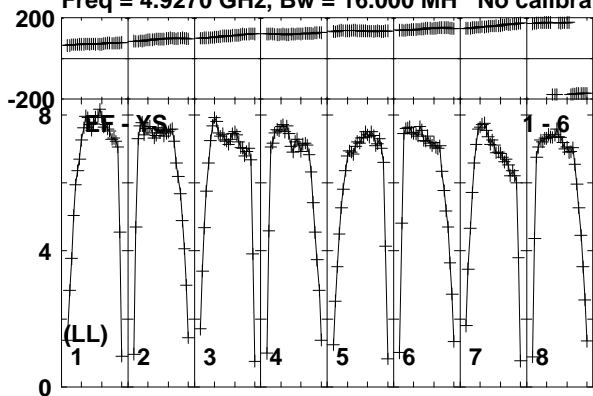

Lower frame: Milli Ampl Jy Top frame: Phas deg
Vector averaged cross-power spectrum Baseline: EF (01) - YS (06)
Timerange: 01/04:41:13 to 01/04:42:09

Plot file version 305 created 26-MAR-2015 15:27:52

V1396CYG EG082E.UVDATA.1

Freq = 4.9270 GHz, Bw = 16.000 MH No calibration applied and no bandpass applied

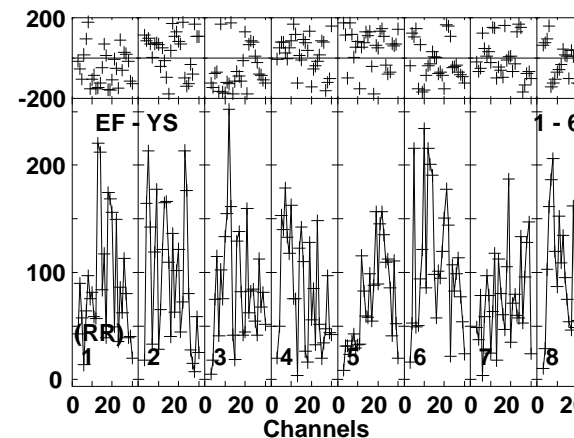
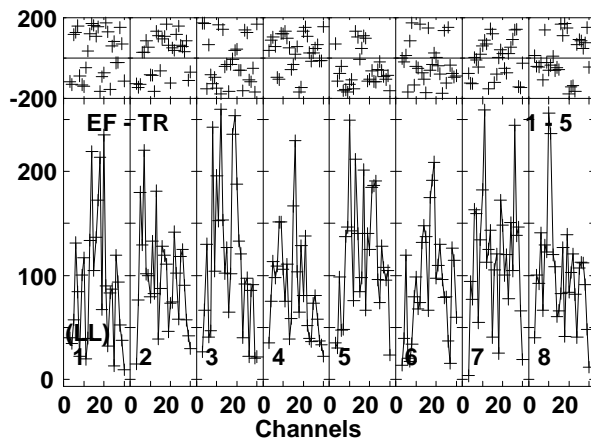
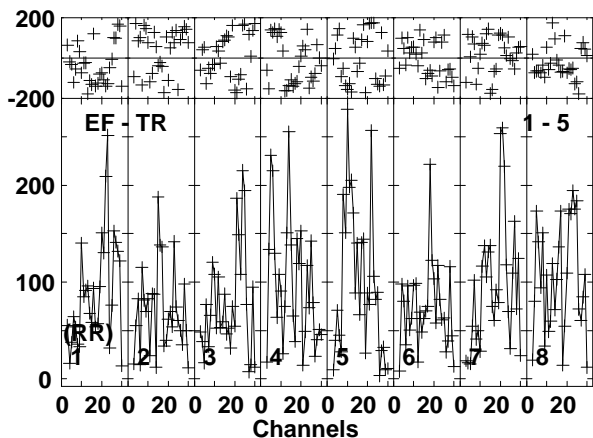
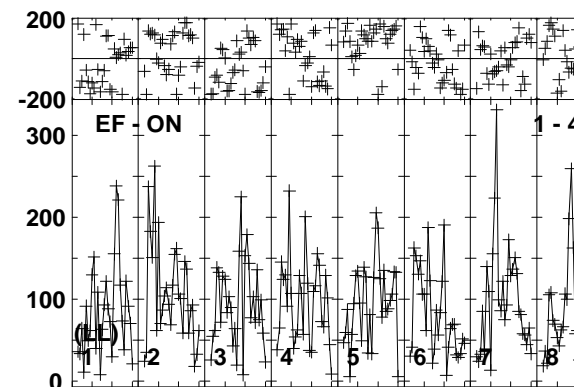
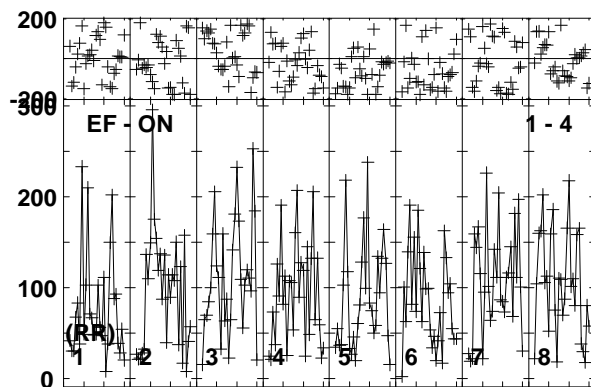
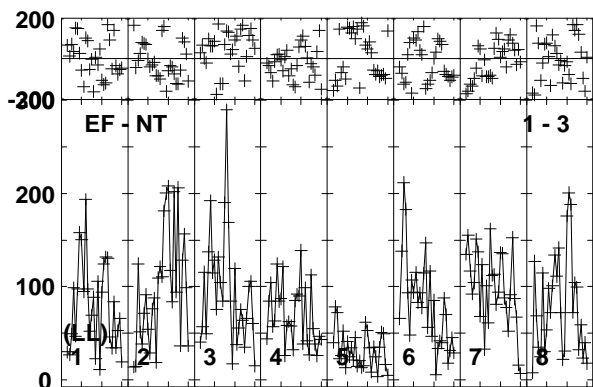
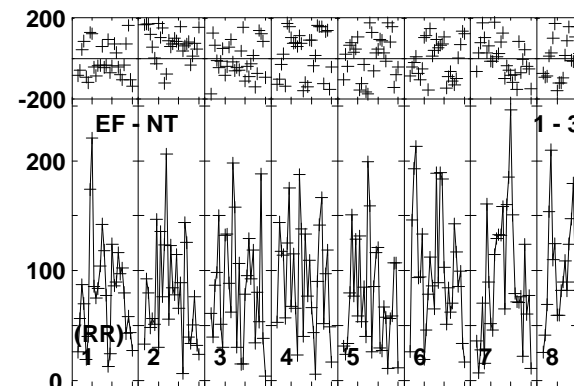
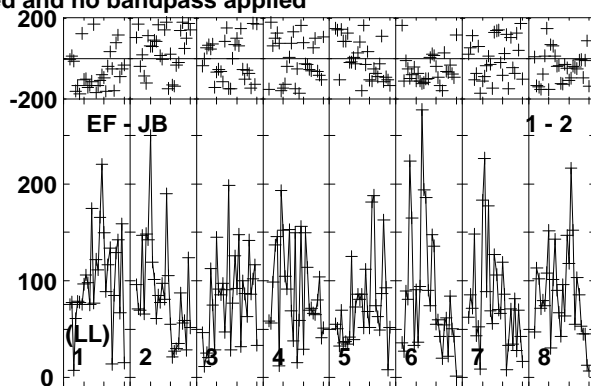
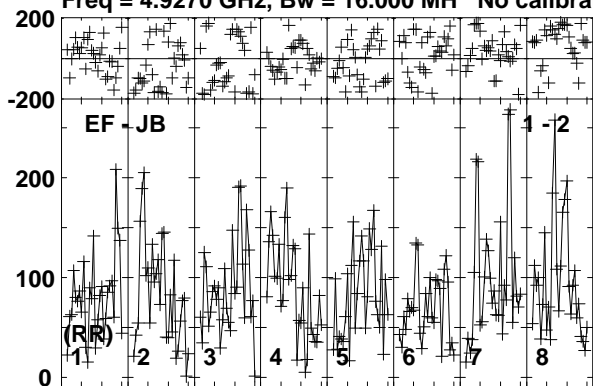

Lower frame: Micro Ampl Jy Top frame: Phas deg
Vector averaged cross-power spectrum Baseline: EF (01) - JB (02)
Timerange: 01/04:42:13 to 01/04:45:39

Plot file version 306 created 26-MAR-2015 15:27:52

V1396CYG EG082E.UVDATA.1

Freq = 4.9270 GHz, Bw = 16.000 MH No calibration applied and no bandpass applied

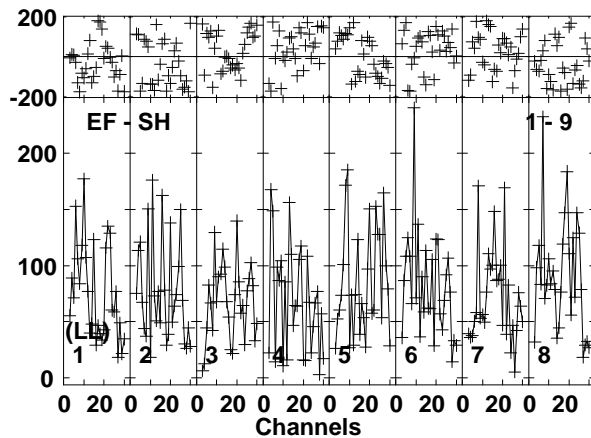
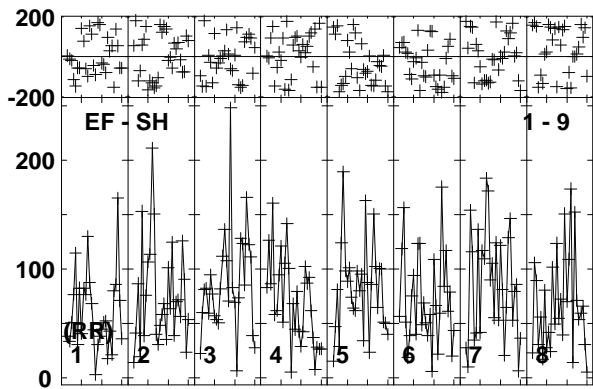
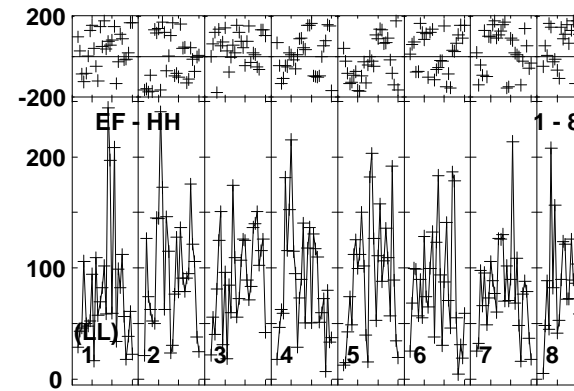
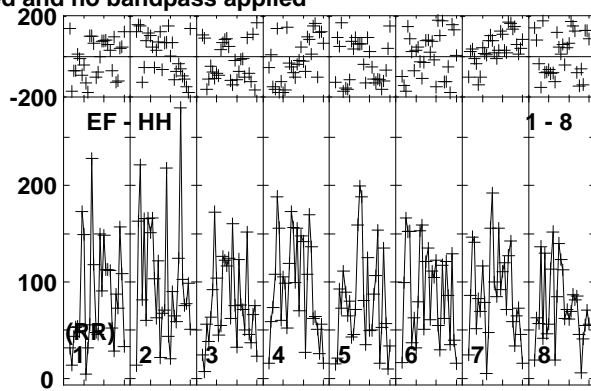
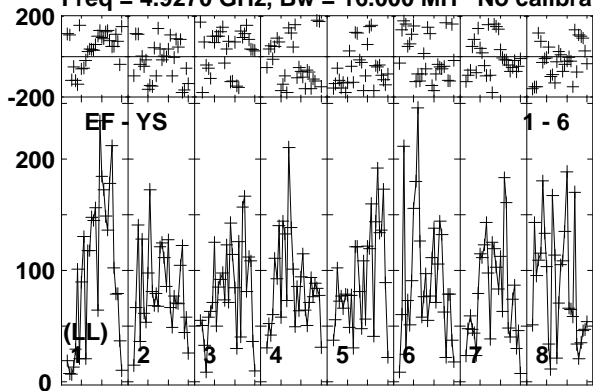

Lower frame: Micro Ampl Jy Top frame: Phas deg
Vector averaged cross-power spectrum Baseline: EF (01) - YS (06)
Timerange: 01/04:42:13 to 01/04:45:39

Plot file version 307 created 26-MAR-2015 15:27:53

J2113+4012 EG082E.UVDATA.1

Freq = 4.9270 GHz, Bw = 16.000 MH No calibration applied and no bandpass applied

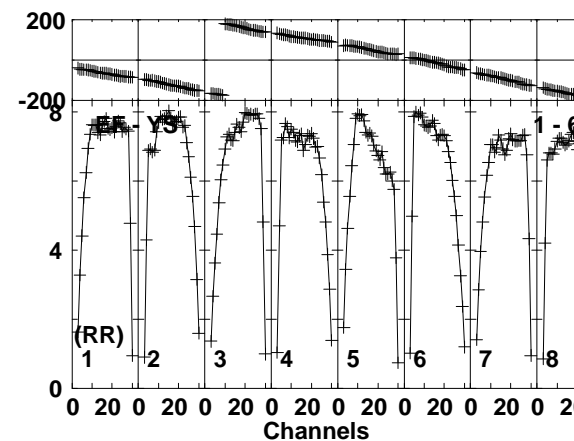
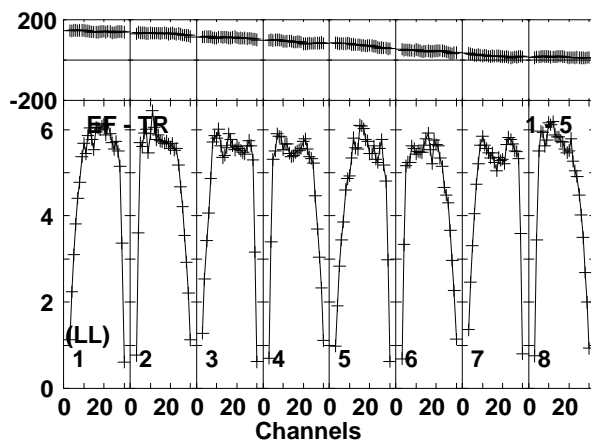
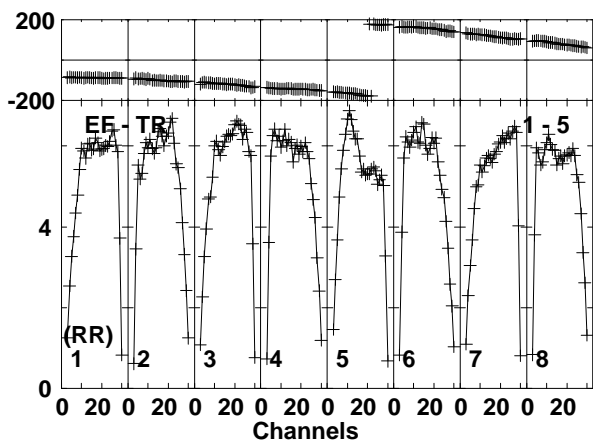
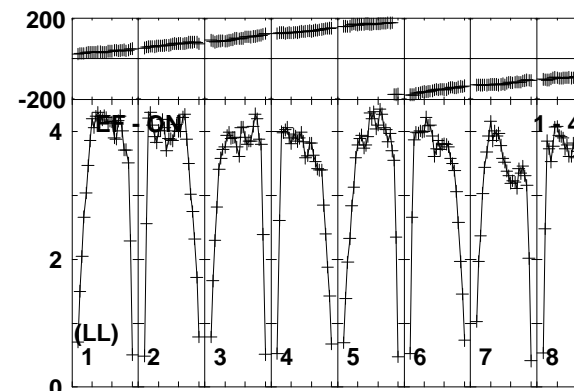
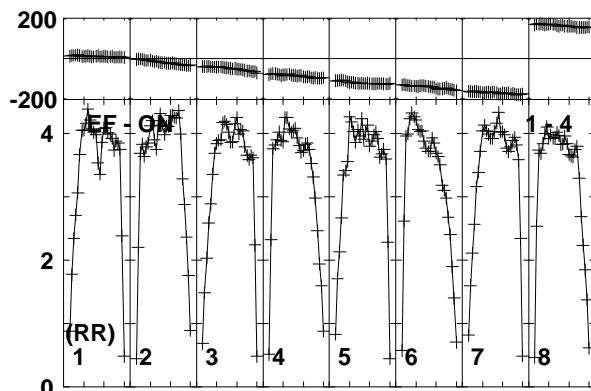
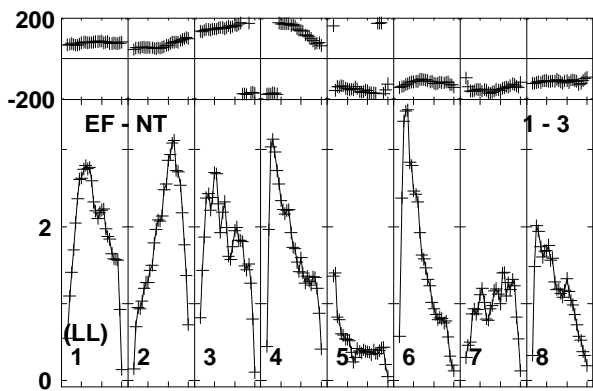
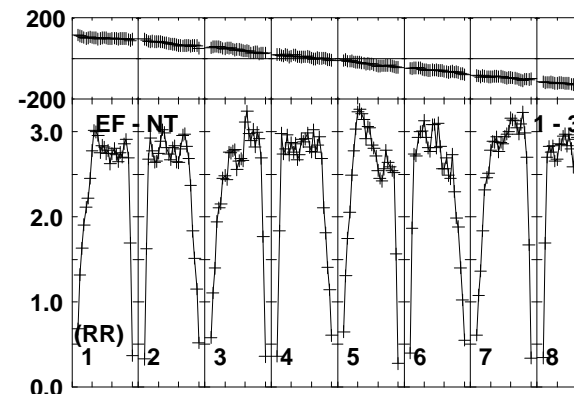
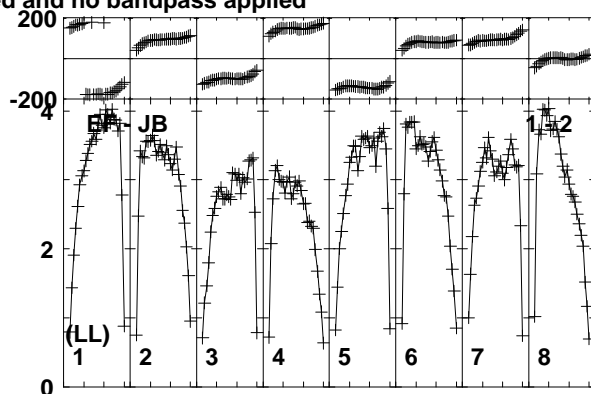
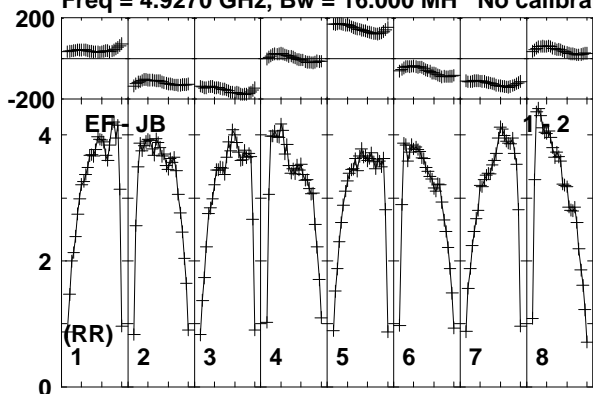

Lower frame: Milli Ampl Jy Top frame: Phas deg
Vector averaged cross-power spectrum Baseline: EF (01) - JB (02)
Timerange: 01/04:45:43 to 01/04:47:09

Plot file version 308 created 26-MAR-2015 15:27:53

J2113+4012 EG082E.UVDATA.1

Freq = 4.9270 GHz, Bw = 16.000 MH No calibration applied and no bandpass applied

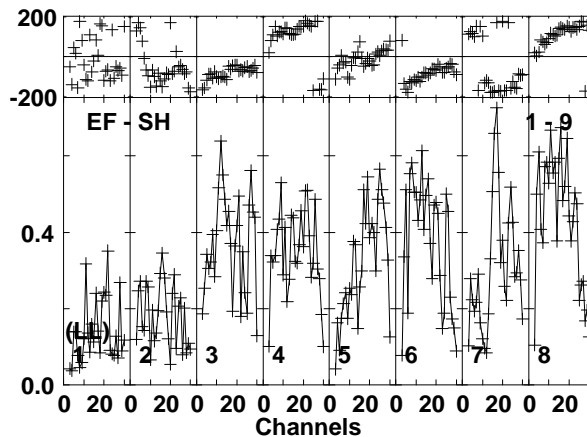
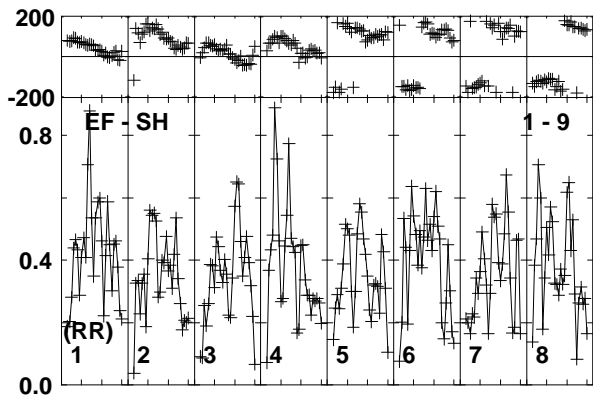
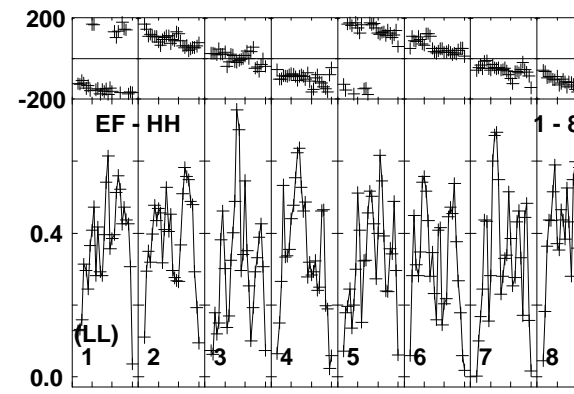
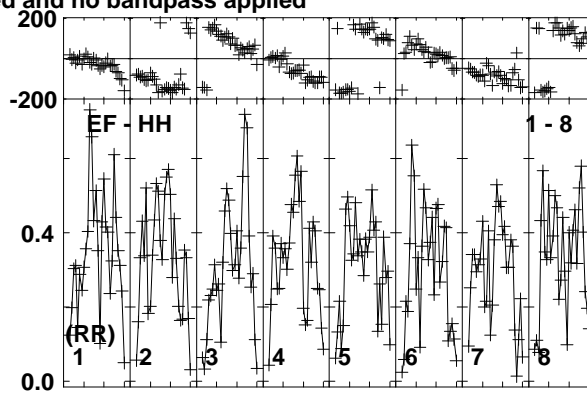
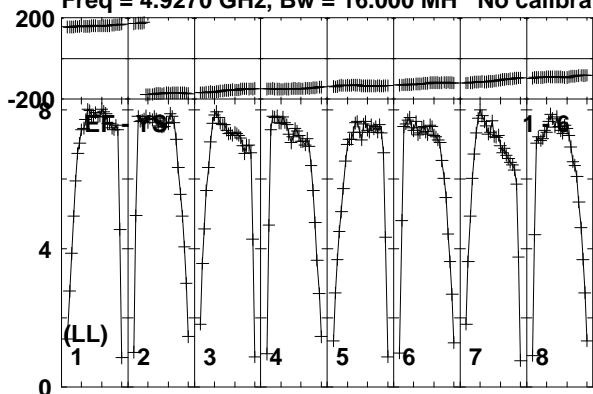

Lower frame: Milli Ampl Jy Top frame: Phas deg
Vector averaged cross-power spectrum Baseline: EF (01) - YS (06)
Timerange: 01/04:45:43 to 01/04:47:09

Plot file version 309 created 26-MAR-2015 15:27:53

J2115+3742 EG082E.UVDATA.1

Freq = 4.9270 GHz, Bw = 16.000 MH No calibration applied and no bandpass applied

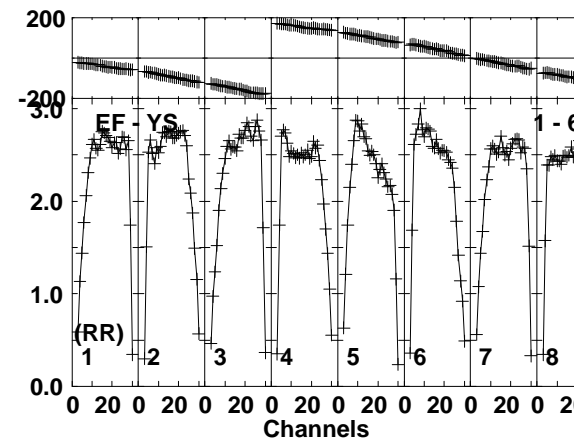
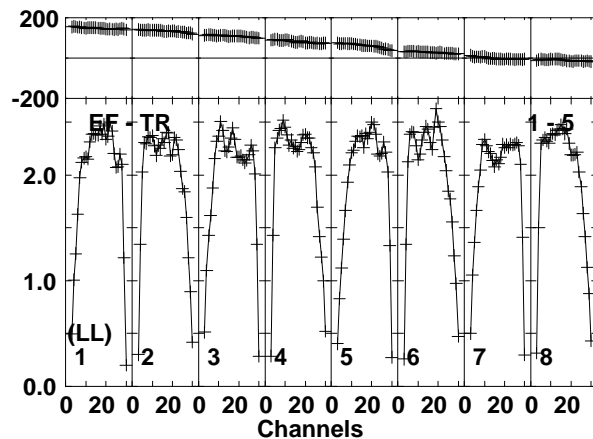
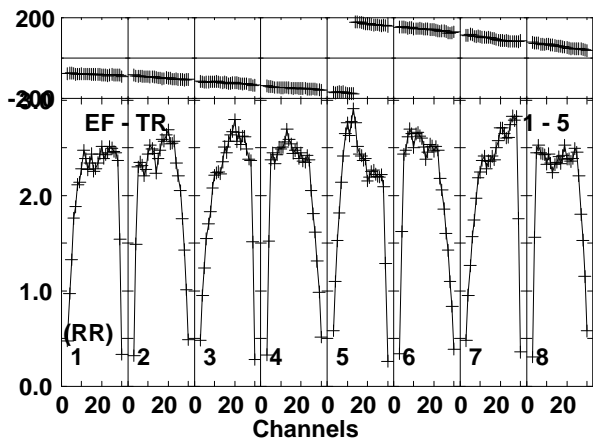
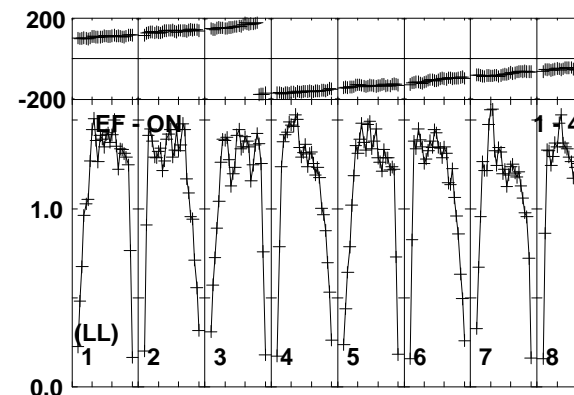
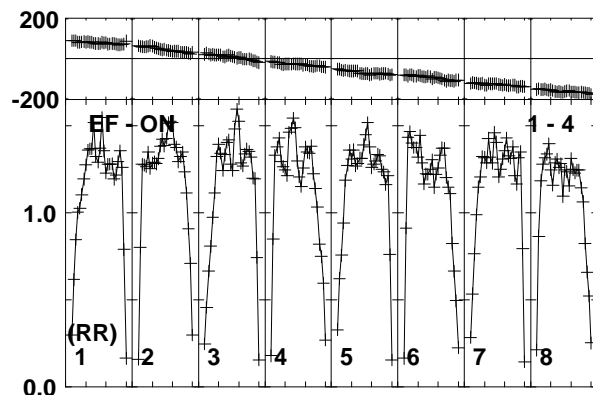
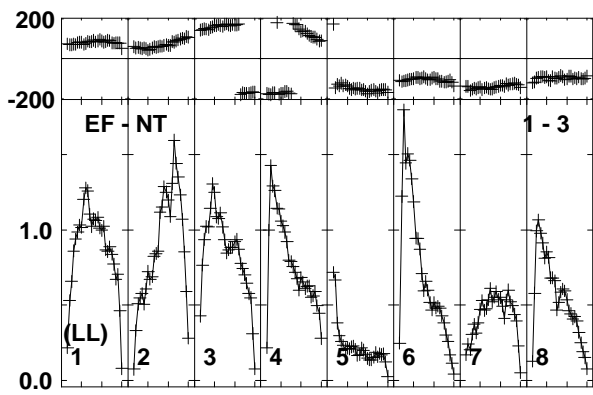
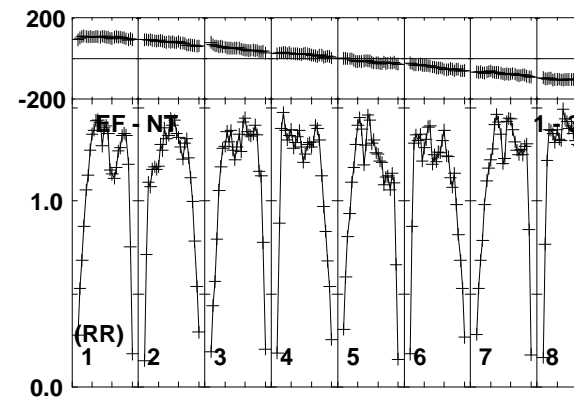
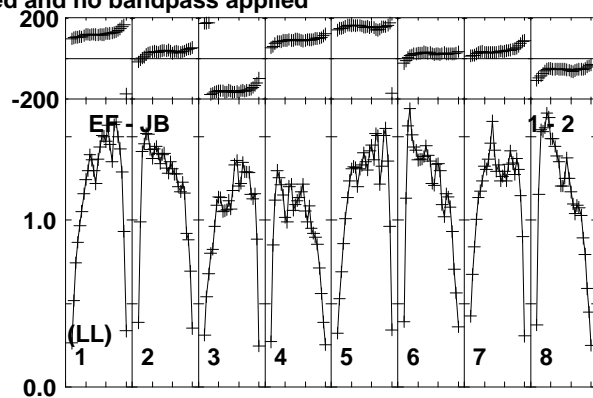
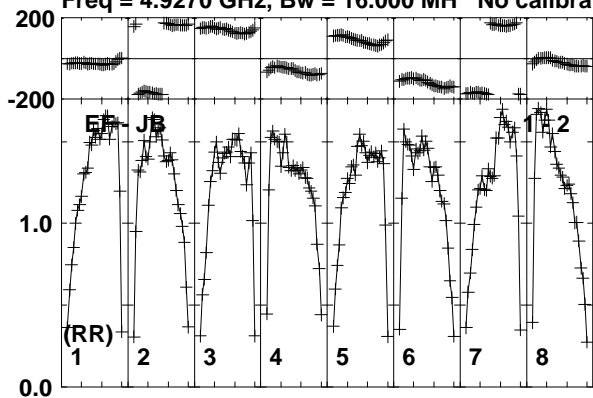

Lower frame: Milli Ampl Jy Top frame: Phas deg
Vector averaged cross-power spectrum Baseline: EF (01) - JB (02)
Timerange: 01/04:47:13 to 01/04:50:39

Plot file version 310 created 26-MAR-2015 15:27:53

J2115+3742 EG082E.UVDATA.1

Freq = 4.9270 GHz, Bw = 16.000 MH No calibration applied and no bandpass applied

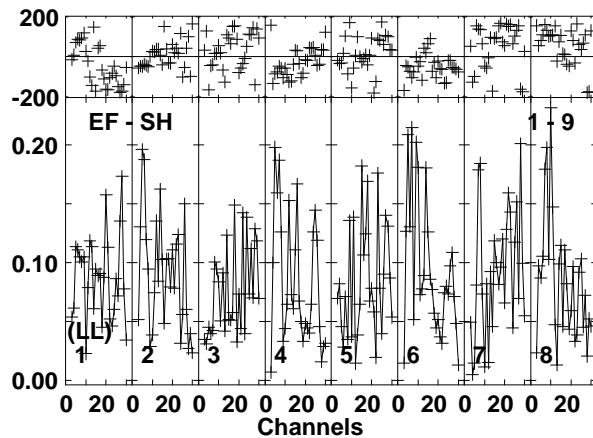
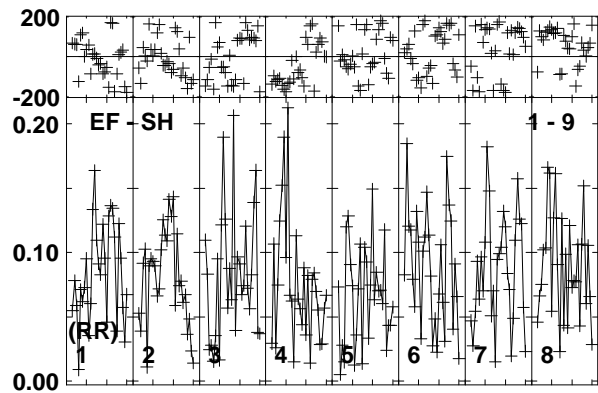
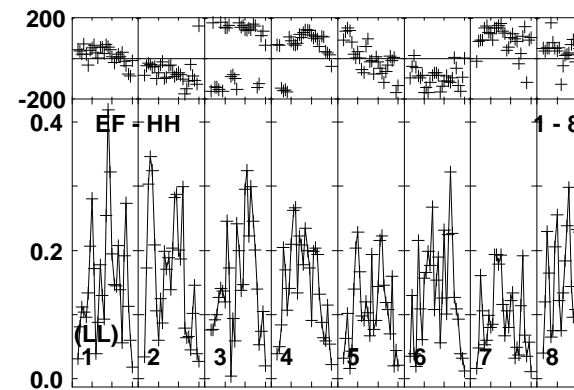
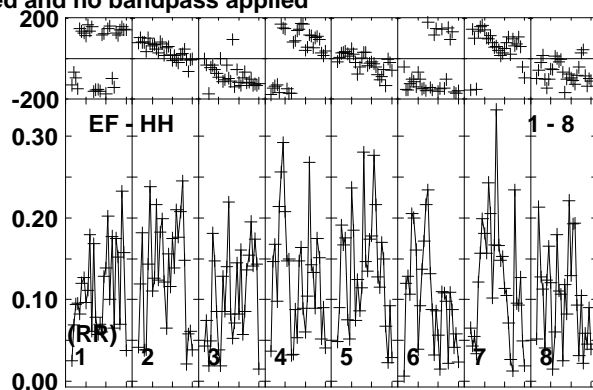
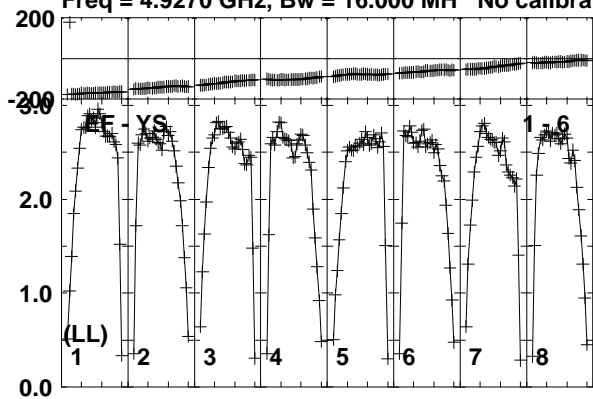

Lower frame: Milli Ampl Jy Top frame: Phas deg
Vector averaged cross-power spectrum Baseline: EF (01) - YS (06)
Timerange: 01/04:47:13 to 01/04:50:39

Plot file version 311 created 26-MAR-2015 15:27:53

J2113+4012 EG082E.UVDATA.1

Freq = 4.9270 GHz, Bw = 16.000 MH No calibration applied and no bandpass applied

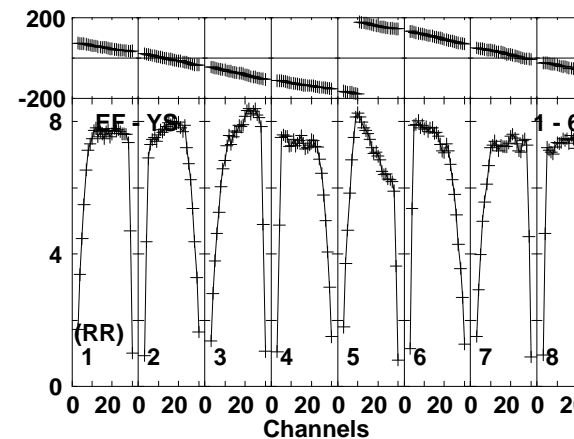
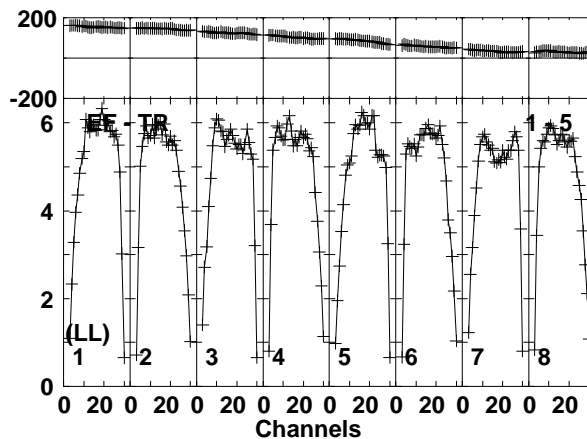
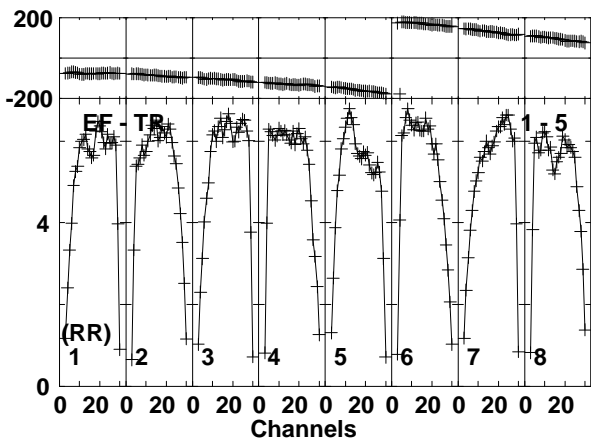
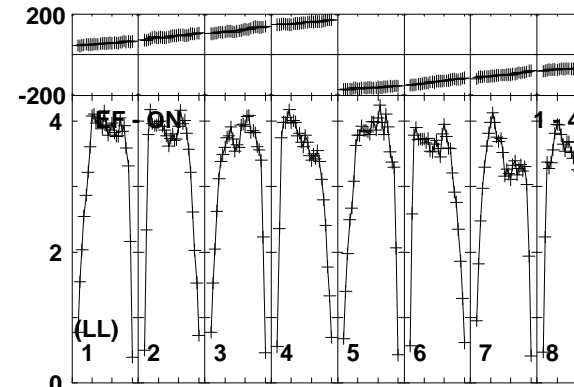
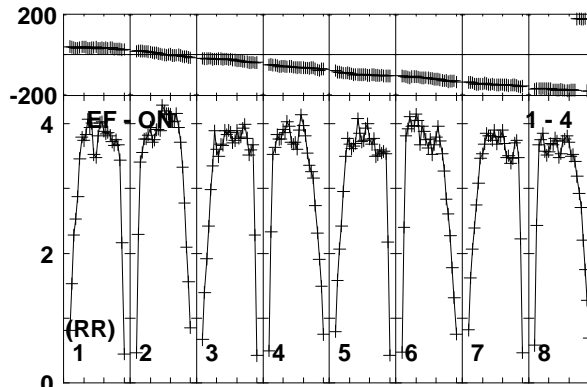
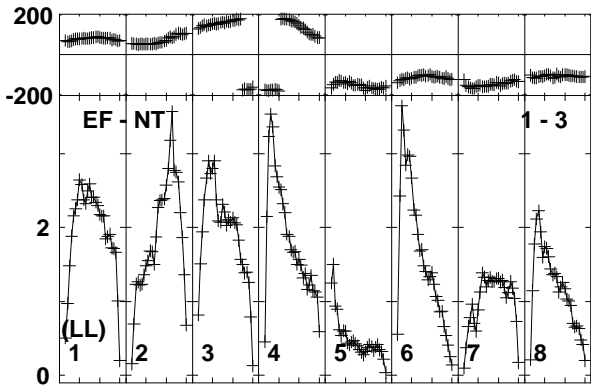
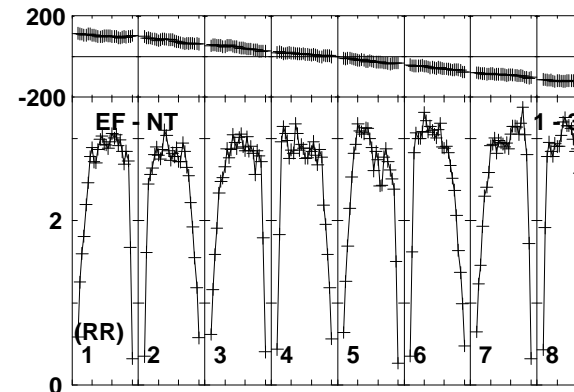
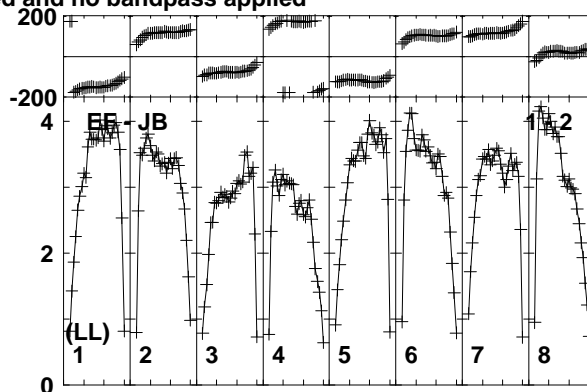
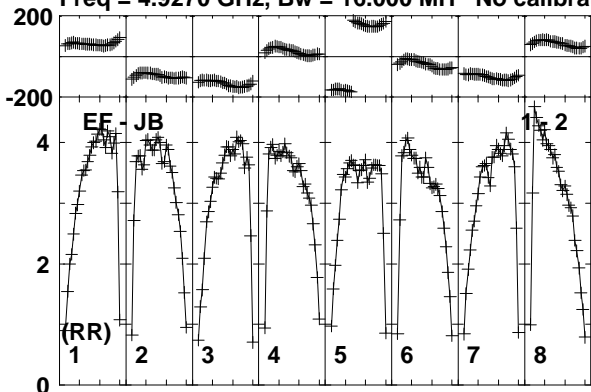

Lower frame: Milli Ampl Jy Top frame: Phas deg
Vector averaged cross-power spectrum Baseline: EF (01) - JB (02)
Timerange: 01/04:51:13 to 01/04:52:09

Plot file version 312 created 26-MAR-2015 15:27:53

J2113+4012 EG082E.UVDATA.1

Freq = 4.9270 GHz, Bw = 16.000 MH No calibration applied and no bandpass applied

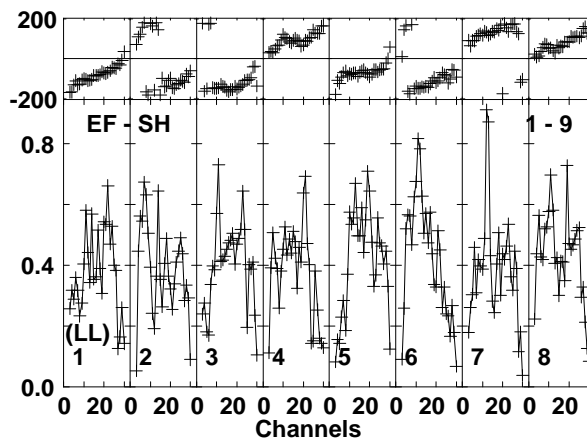
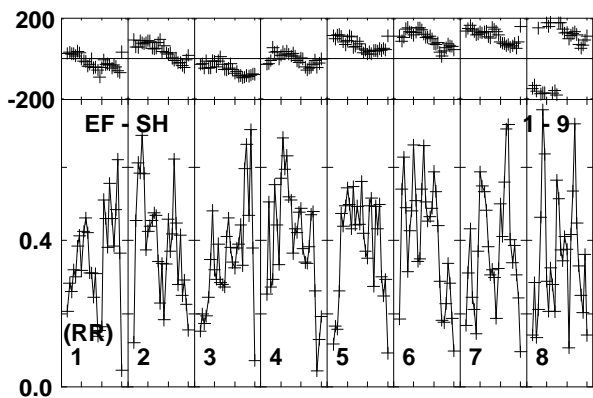
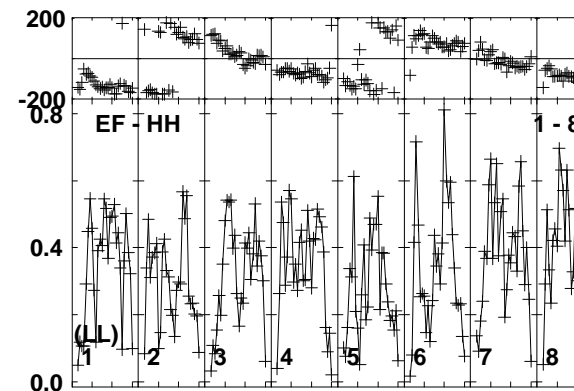
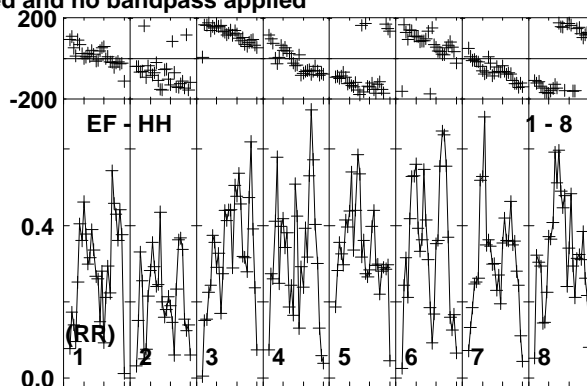
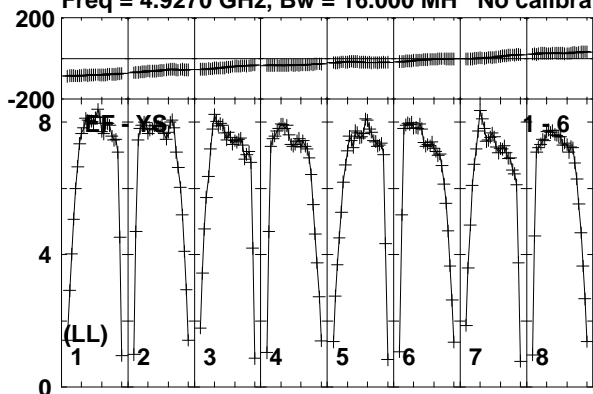

Lower frame: Milli Ampl Jy Top frame: Phas deg
Vector averaged cross-power spectrum Baseline: EF (01) - YS (06)
Timerange: 01/04:51:13 to 01/04:52:09

Plot file version 313 created 26-MAR-2015 15:27:53

V1396CYG EG082E.UVDATA.1

Freq = 4.9270 GHz, Bw = 16.000 MH No calibration applied and no bandpass applied

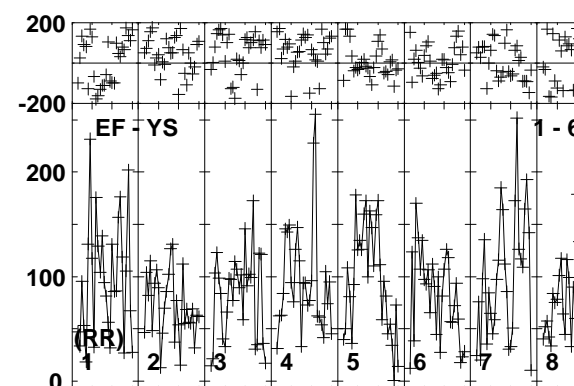
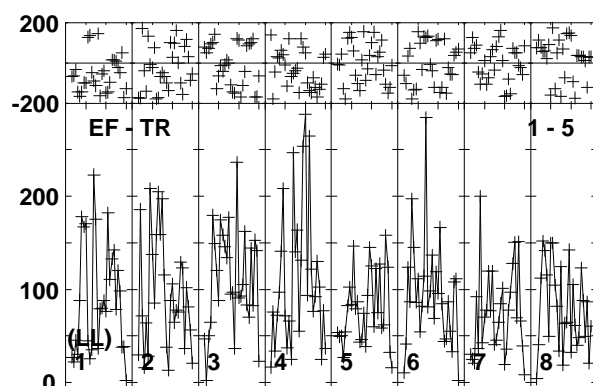
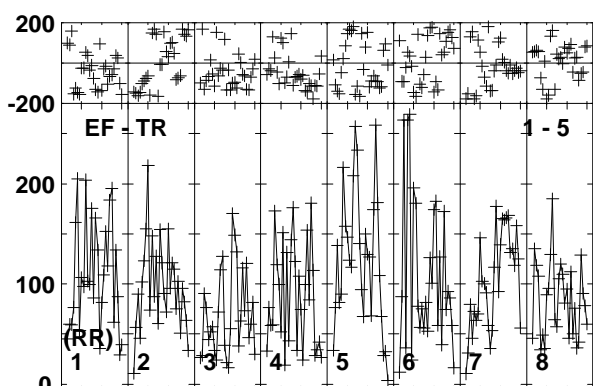
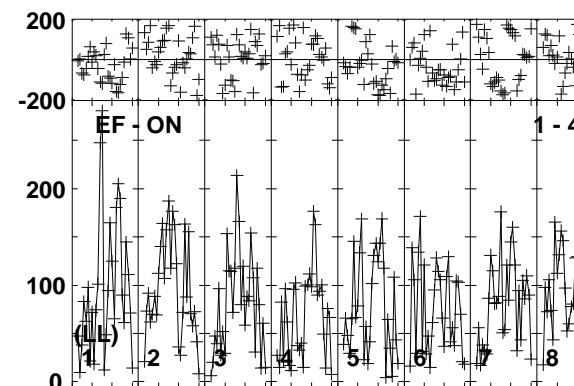
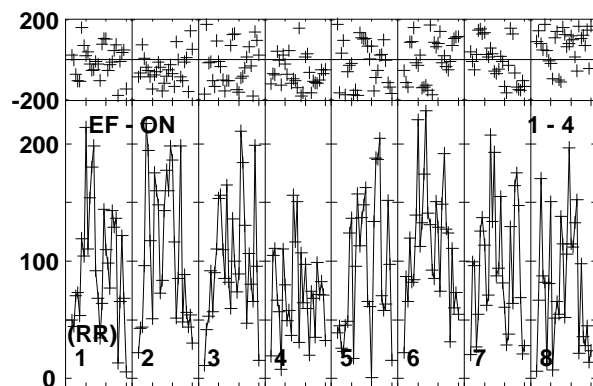
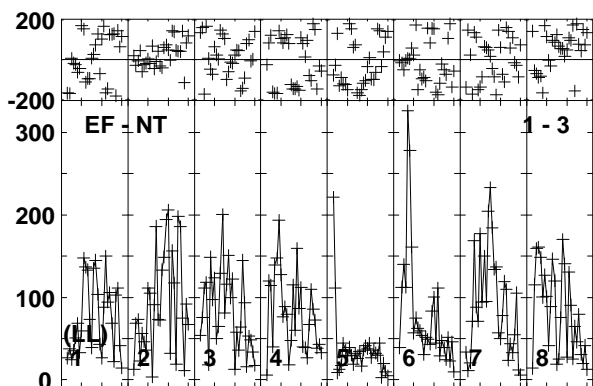
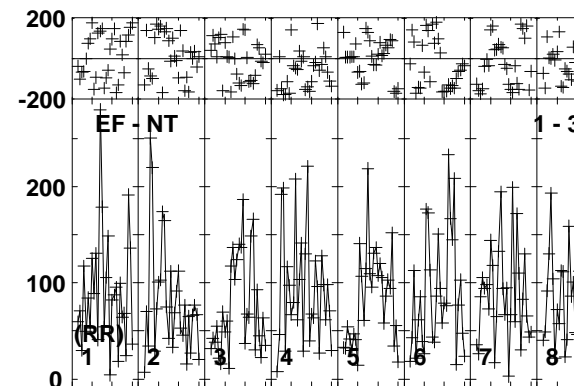
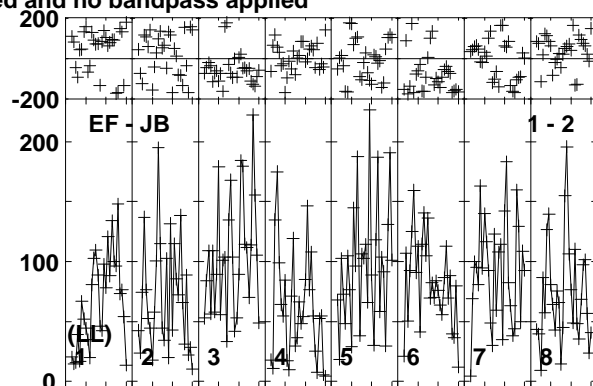
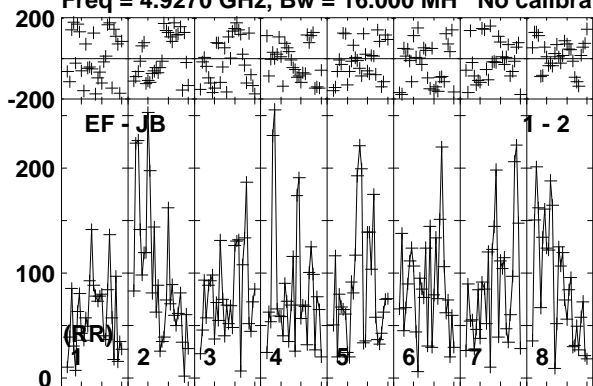

Lower frame: Micro Ampl Jy Top frame: Phas deg
Vector averaged cross-power spectrum Baseline: EF (01) - JB (02)
Timerange: 01/04:52:13 to 01/04:55:39

Plot file version 314 created 26-MAR-2015 15:27:53

V1396CYG EG082E.UVDATA.1

Freq = 4.9270 GHz, Bw = 16.000 MH No calibration applied and no bandpass applied

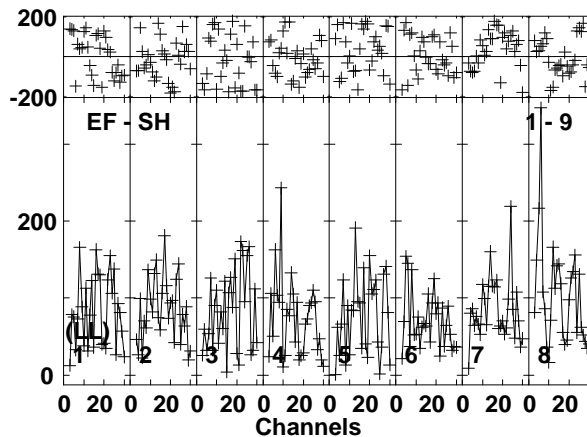
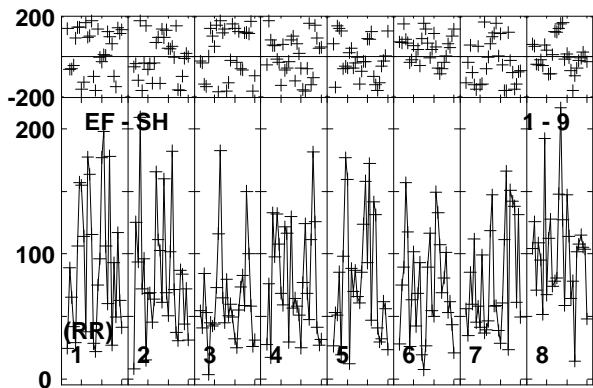
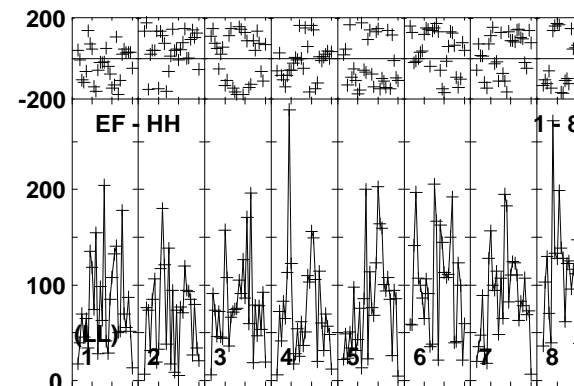
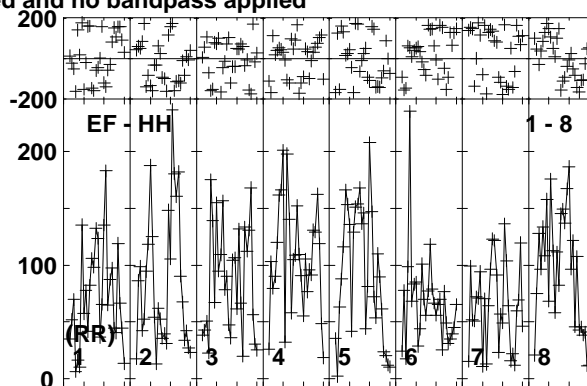
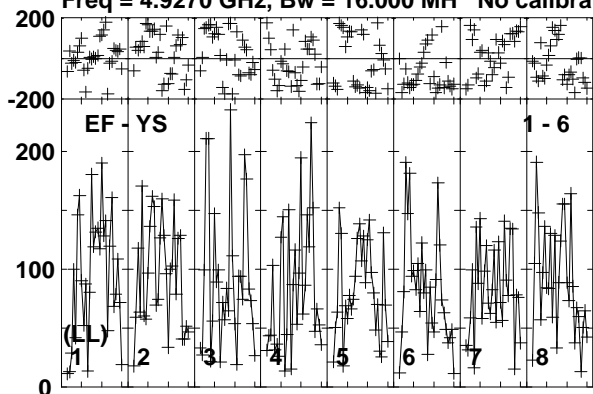

Lower frame: Micro Ampl Jy Top frame: Phas deg
Vector averaged cross-power spectrum Baseline: EF (01) - YS (06)
Timerange: 01/04:52:13 to 01/04:55:39

Plot file version 315 created 26-MAR-2015 15:27:53

J2113+4012 EG082E.UVDATA.1

Freq = 4.9270 GHz, Bw = 16.000 MH No calibration applied and no bandpass applied

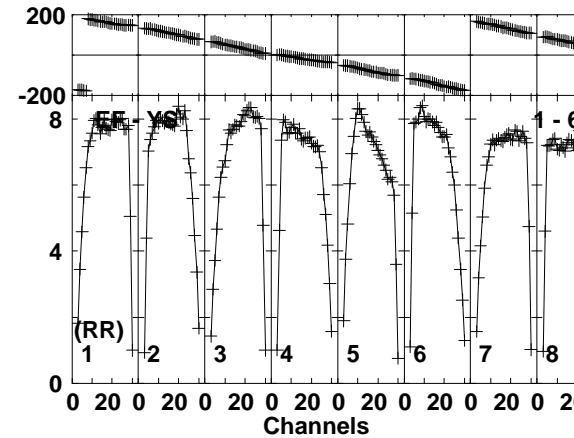
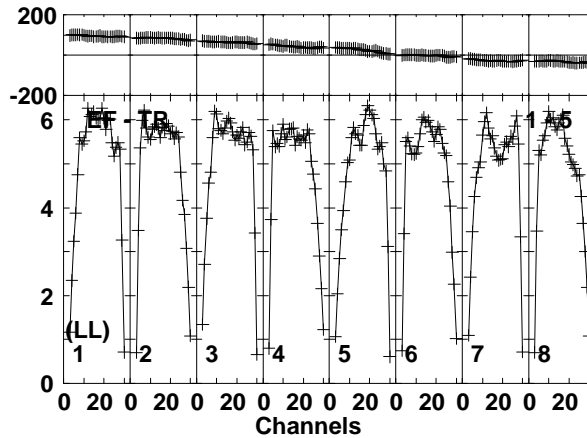
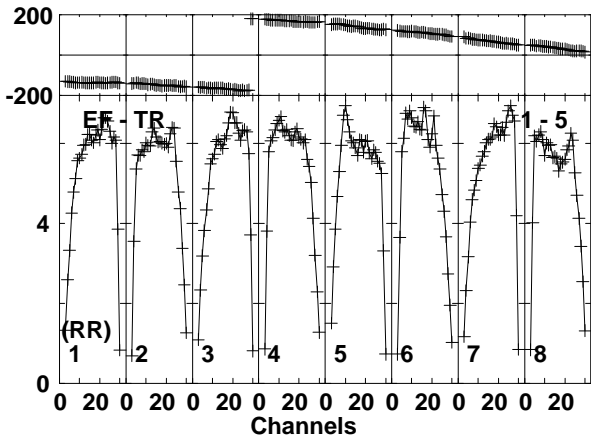
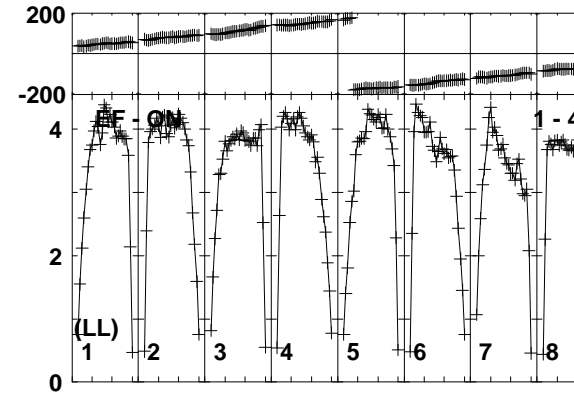
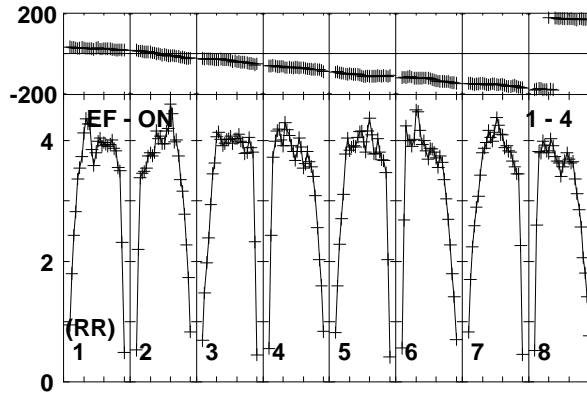
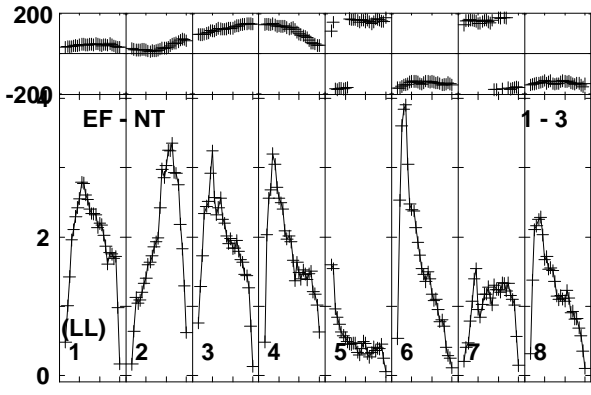
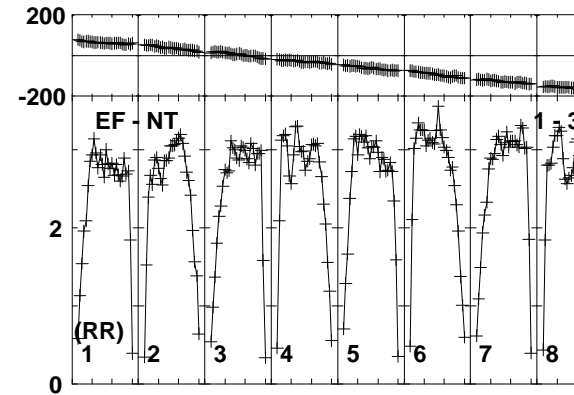
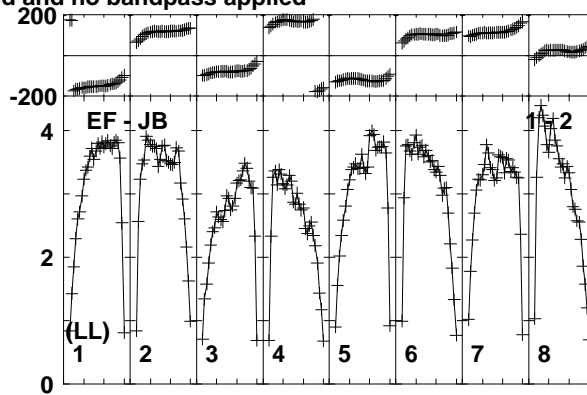
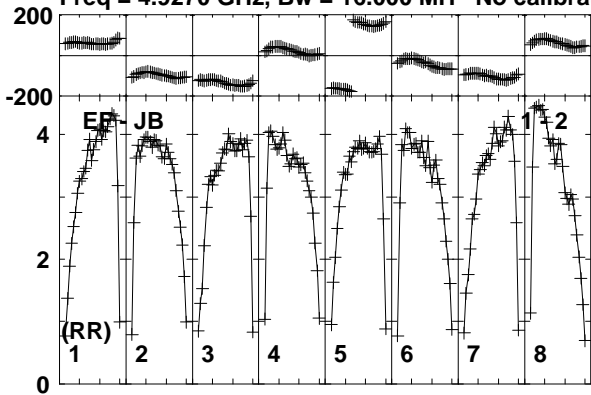

Lower frame: Milli Ampl Jy Top frame: Phas deg
Vector averaged cross-power spectrum Baseline: EF (01) - JB (02)
Timerange: 01/04:55:43 to 01/04:57:09

Plot file version 316 created 26-MAR-2015 15:27:53

J2113+4012 EG082E.UVDATA.1

Freq = 4.9270 GHz, Bw = 16.000 MH No calibration applied and no bandpass applied

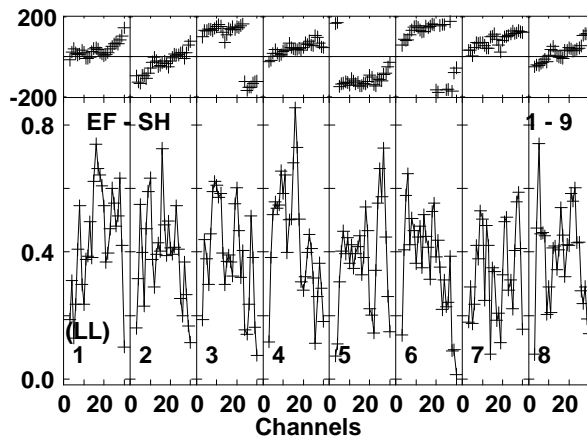
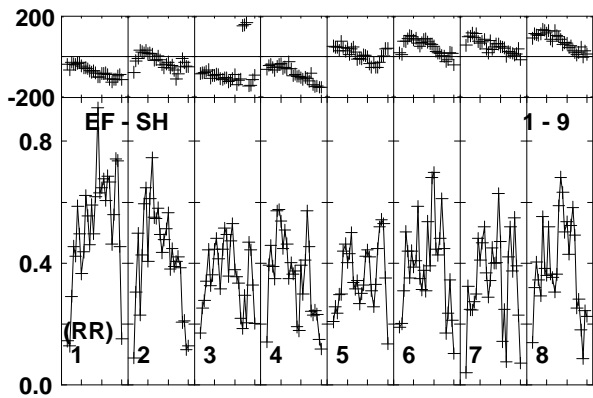
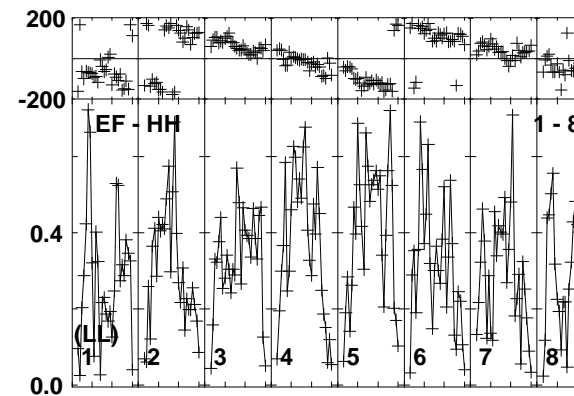
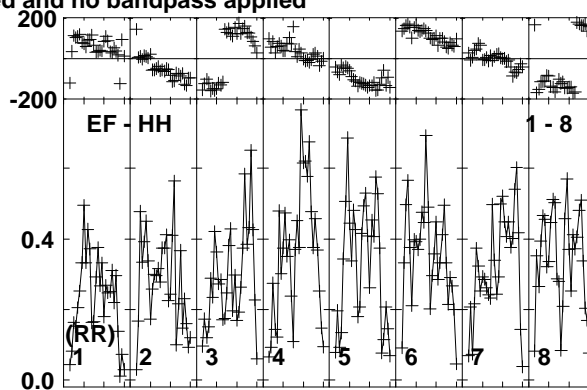
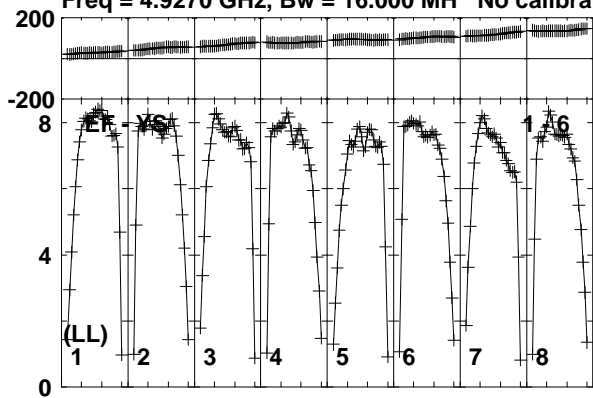

Lower frame: Milli Ampl Jy Top frame: Phas deg
Vector averaged cross-power spectrum Baseline: EF (01) - YS (06)
Timerange: 01/04:55:43 to 01/04:57:09

Plot file version 317 created 26-MAR-2015 15:27:53

V1396CYG EG082E.UVDATA.1

Freq = 4.9270 GHz, Bw = 16.000 MH No calibration applied and no bandpass applied

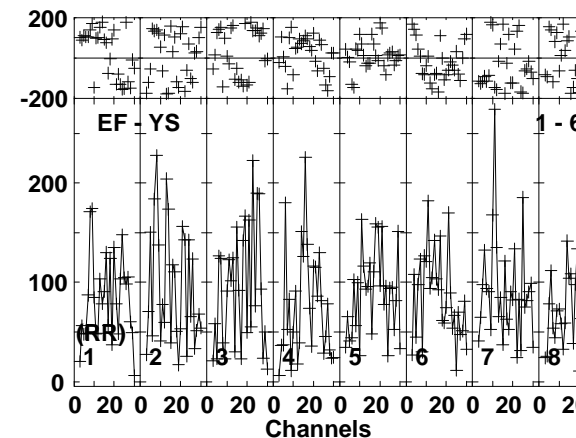
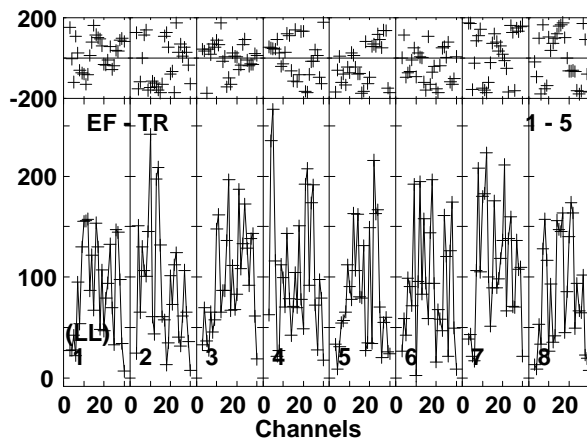
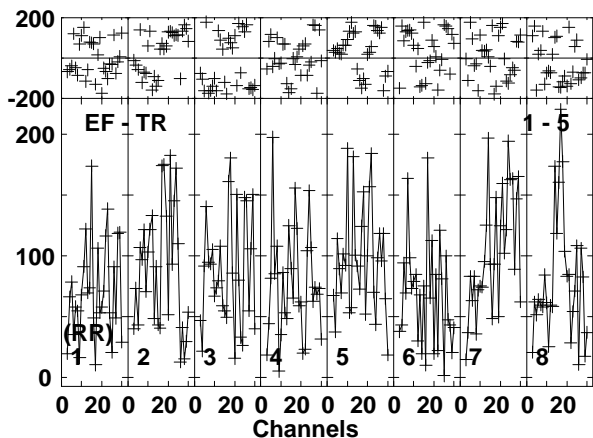
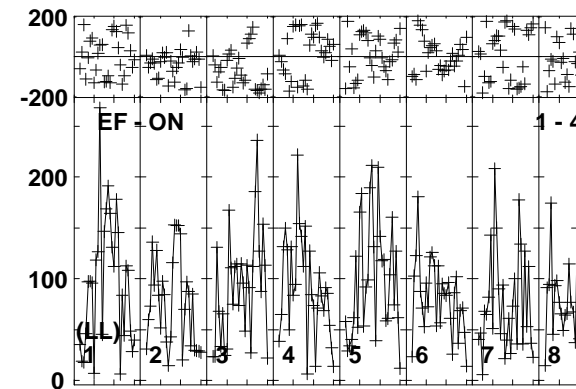
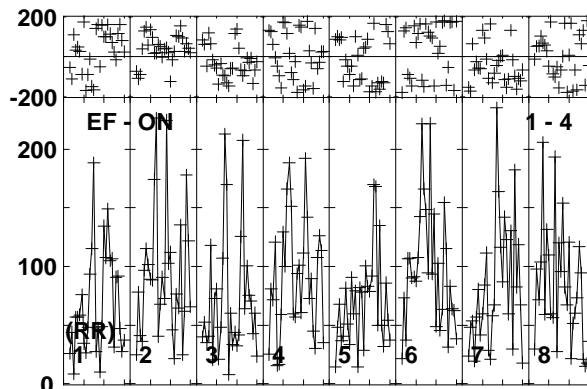
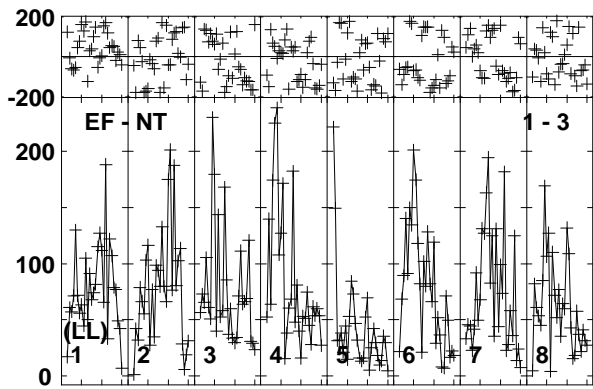
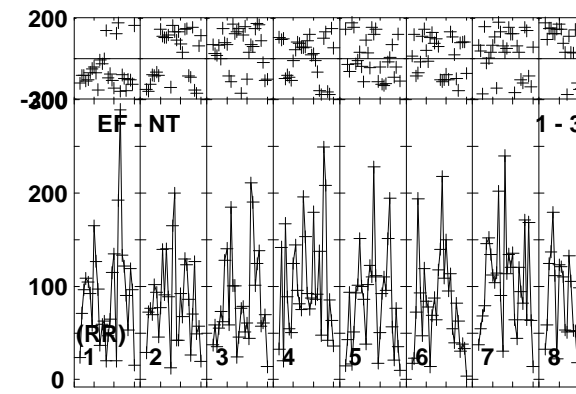
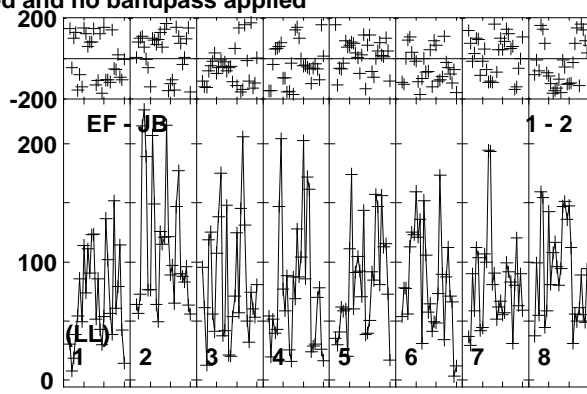
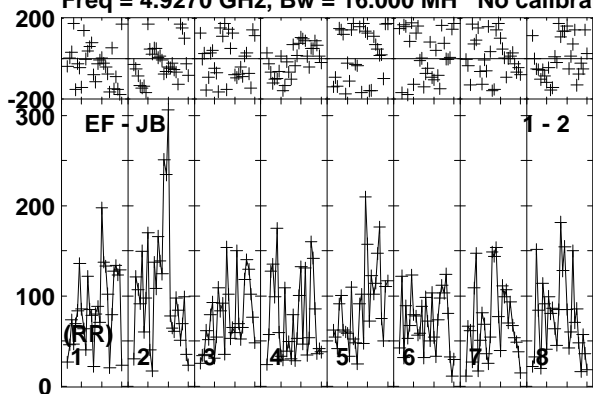

Lower frame: Micro Ampl Jy Top frame: Phas deg
Vector averaged cross-power spectrum Baseline: EF (01) - JB (02)
Timerange: 01/04:57:13 to 01/05:00:39

Plot file version 318 created 26-MAR-2015 15:27:53

V1396CYG EG082E.UVDATA.1

Freq = 4.9270 GHz, Bw = 16.000 MH No calibration applied and no bandpass applied

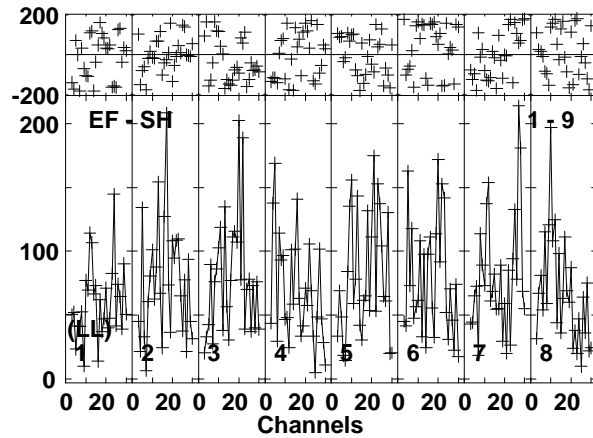
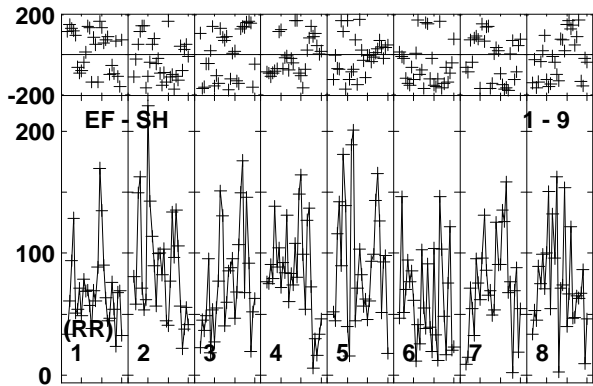
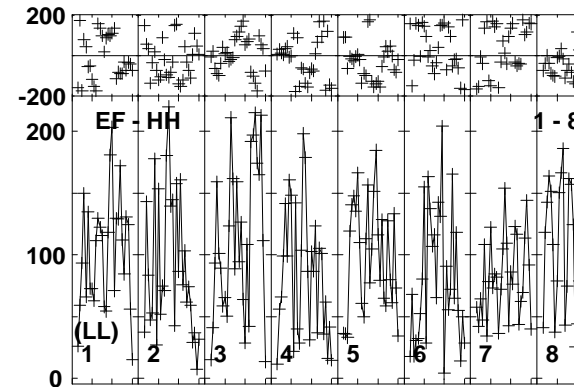
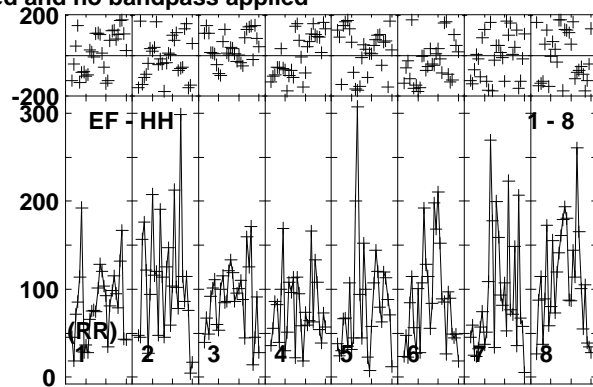
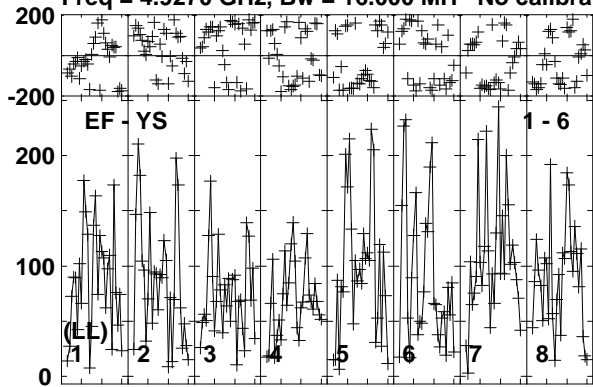

Lower frame: Micro Ampl Jy Top frame: Phas deg
Vector averaged cross-power spectrum Baseline: EF (01) - YS (06)
Timerange: 01/04:57:13 to 01/05:00:39

Plot file version 319 created 26-MAR-2015 15:27:53

J2113+4012 EG082E.UVDATA.1

Freq = 4.9270 GHz, Bw = 16.000 MH No calibration applied and no bandpass applied

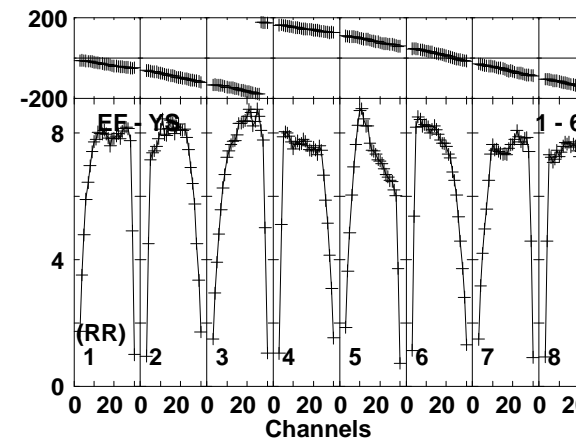
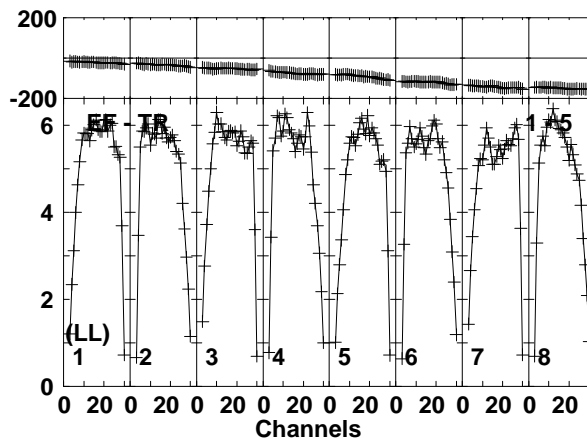
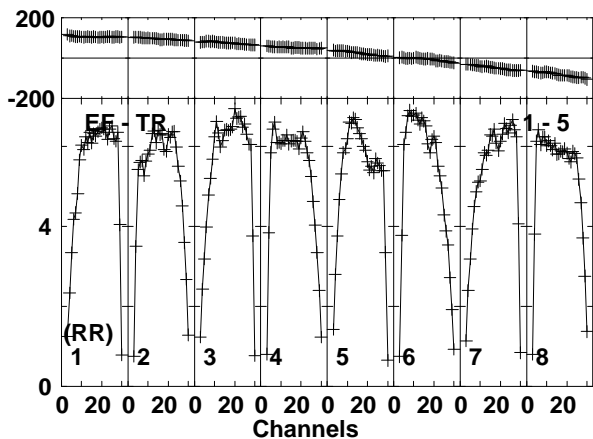
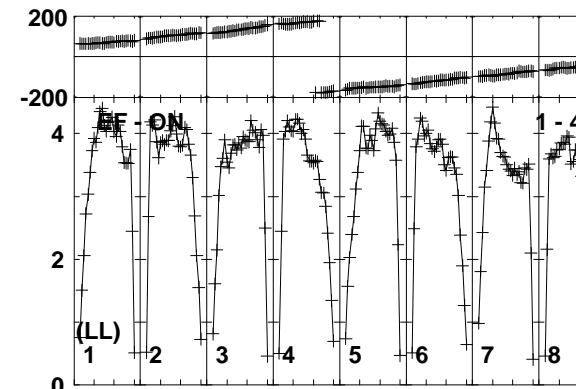
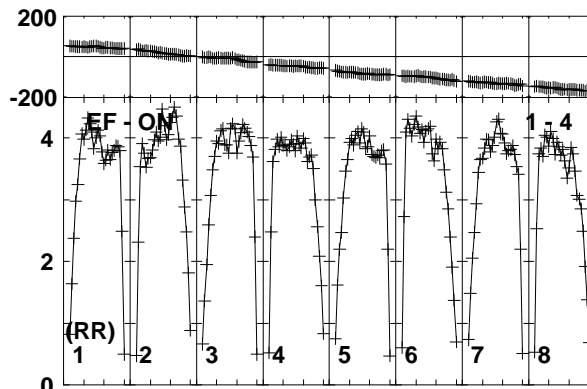
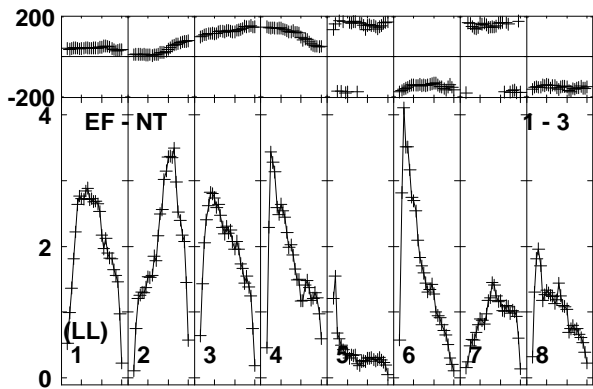
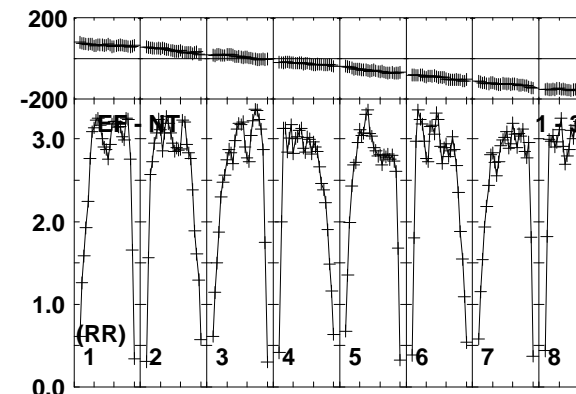
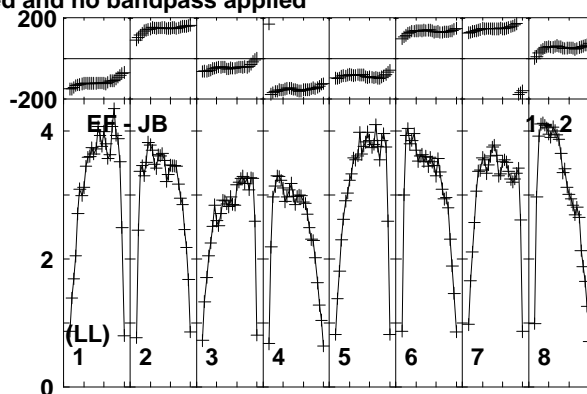
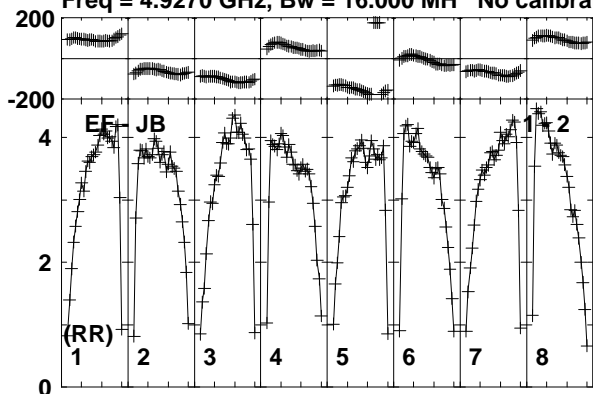

Lower frame: Milli Ampl Jy Top frame: Phas deg
Vector averaged cross-power spectrum Baseline: EF (01) - JB (02)
Timerange: 01/05:01:13 to 01/05:02:09

Plot file version 320 created 26-MAR-2015 15:27:53

J2113+4012 EG082E.UVDATA.1

Freq = 4.9270 GHz, Bw = 16.000 MH No calibration applied and no bandpass applied

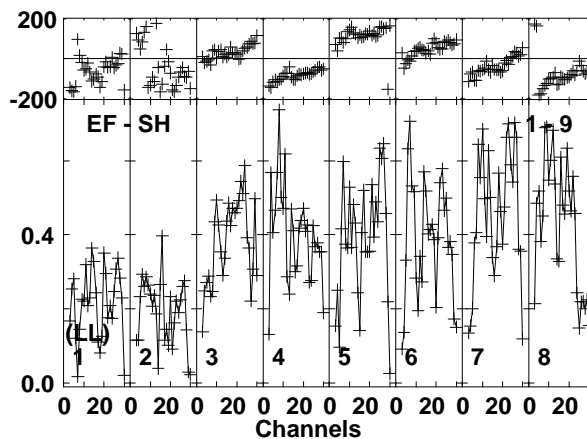
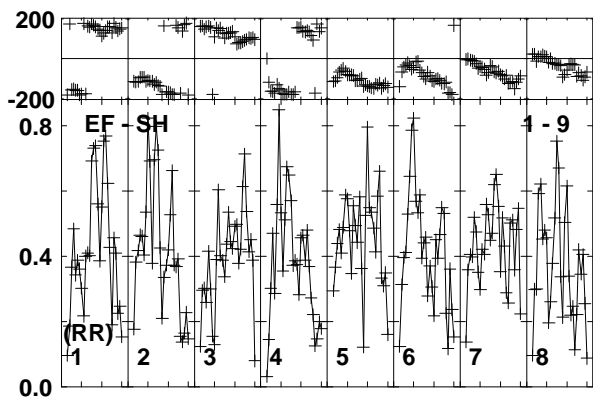
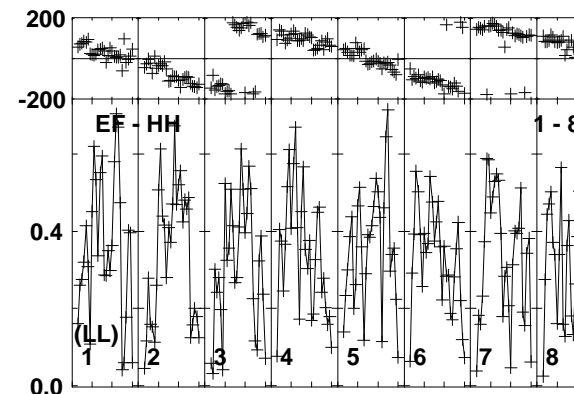
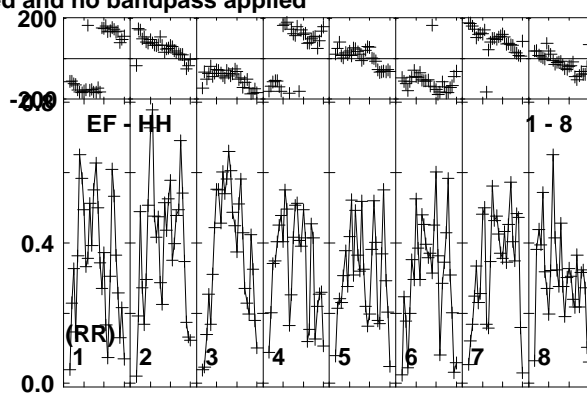
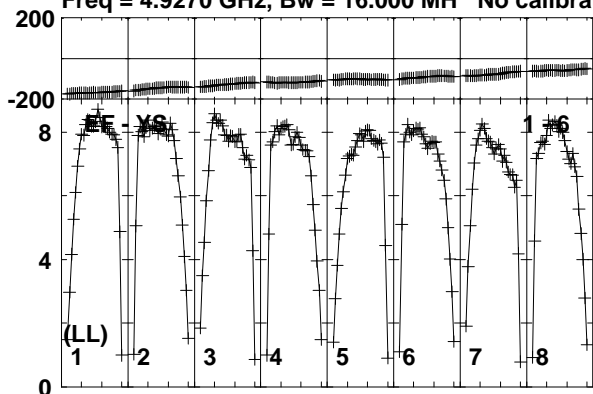

Lower frame: Milli Ampl Jy Top frame: Phas deg
Vector averaged cross-power spectrum Baseline: EF (01) - YS (06)
Timerange: 01/05:01:13 to 01/05:02:09

Plot file version 321 created 26-MAR-2015 15:27:54

V1396CYG EG082E.UVDATA.1

Freq = 4.9270 GHz, Bw = 16.000 MH No calibration applied and no bandpass applied

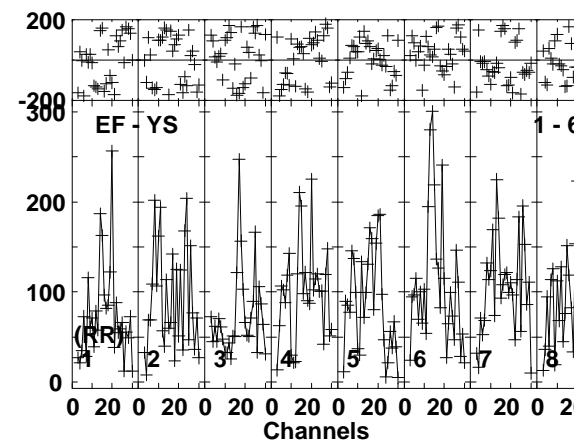
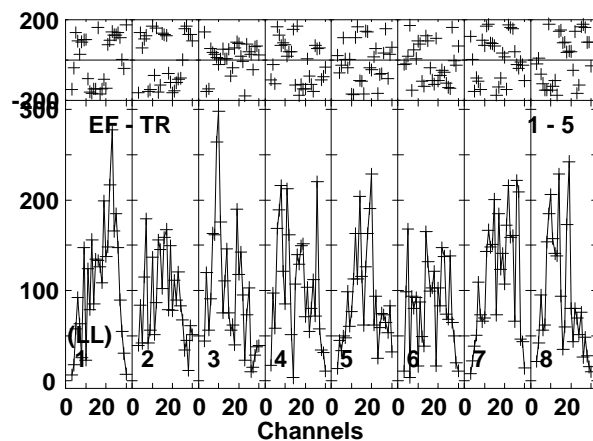
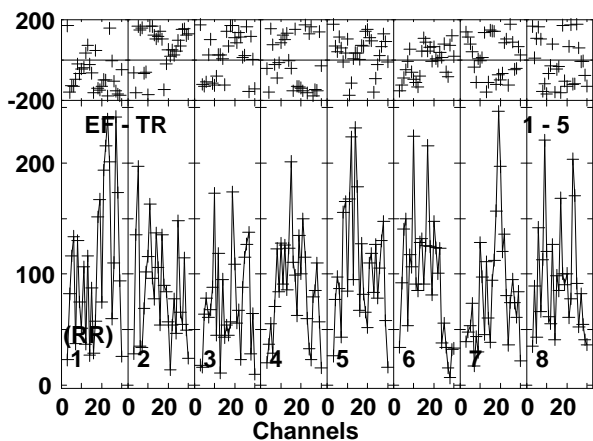
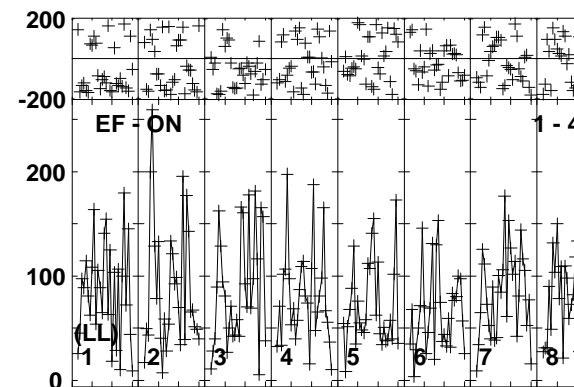
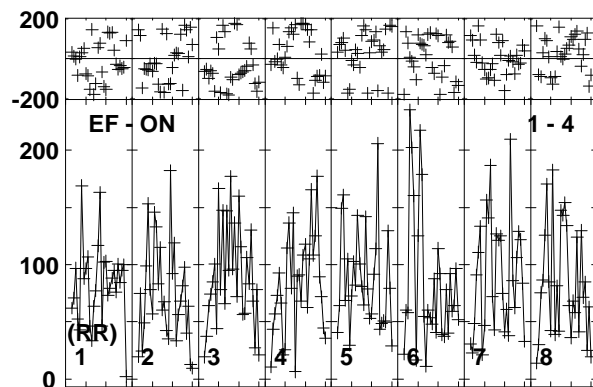
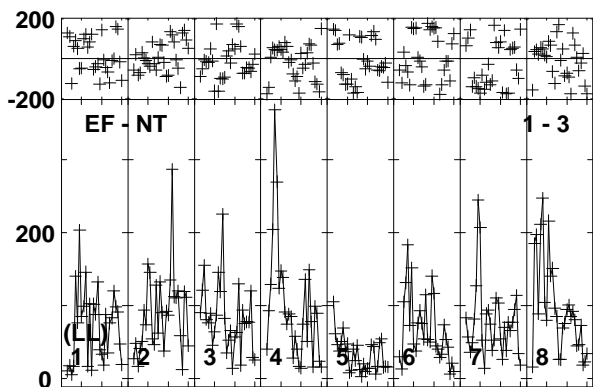
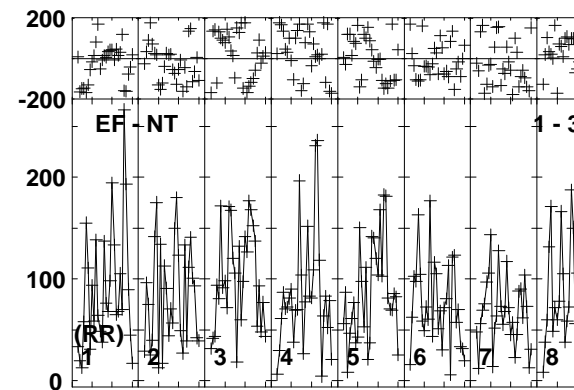
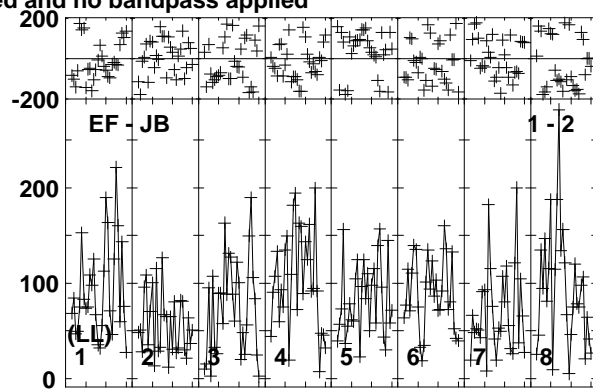
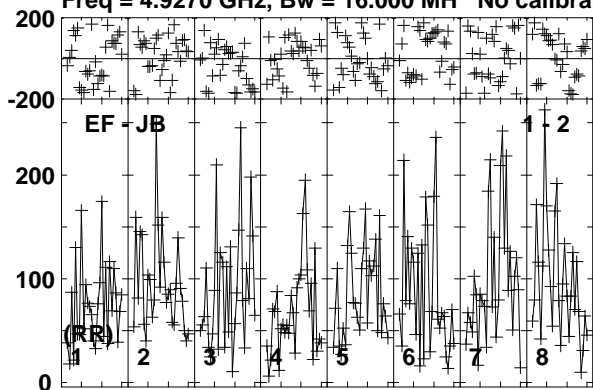

Lower frame: Micro Ampl Jy Top frame: Phas deg
Vector averaged cross-power spectrum Baseline: EF (01) - JB (02)
Timerange: 01/05:02:13 to 01/05:05:39

Plot file version 322 created 26-MAR-2015 15:27:54

V1396CYG EG082E.UVDATA.1

Freq = 4.9270 GHz, Bw = 16.000 MH No calibration applied and no bandpass applied

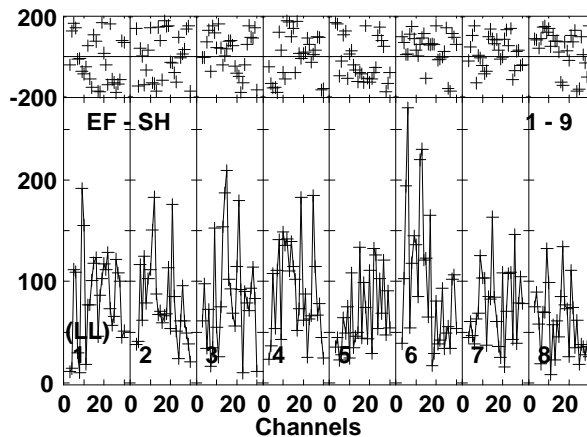
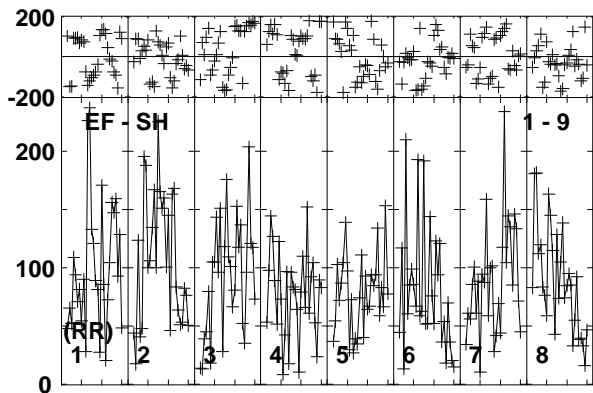
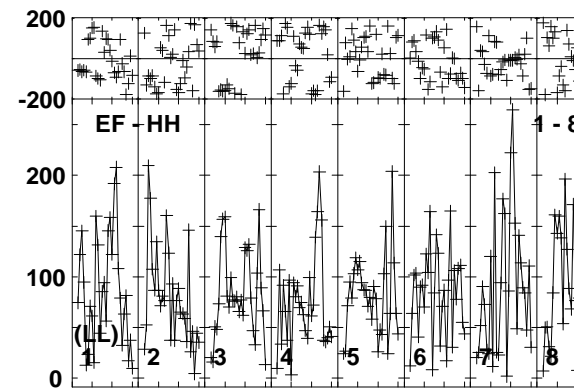
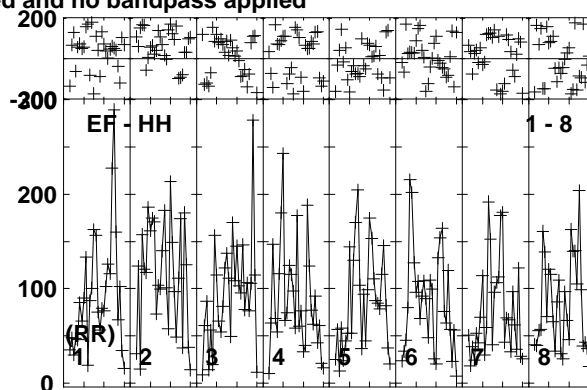
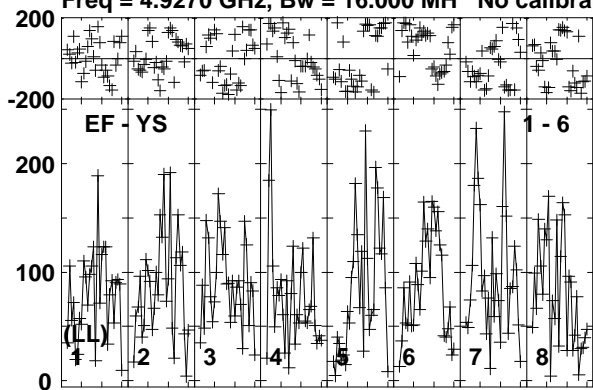

Lower frame: Micro Ampl Jy Top frame: Phas deg
Vector averaged cross-power spectrum Baseline: EF (01) - YS (06)
Timerange: 01/05:02:13 to 01/05:05:39

Plot file version 323 created 26-MAR-2015 15:27:54

J2113+4012 EG082E.UVDATA.1

Freq = 4.9270 GHz, Bw = 16.000 MH No calibration applied and no bandpass applied

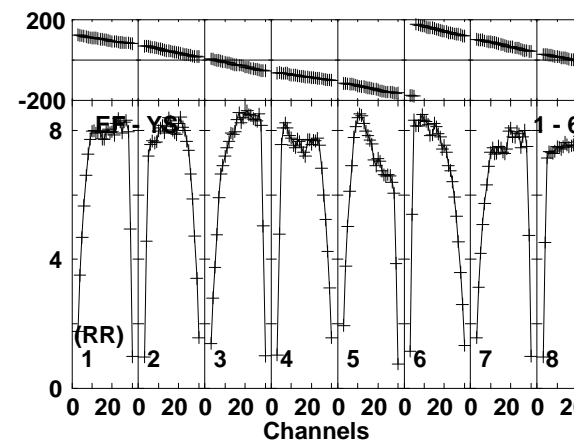
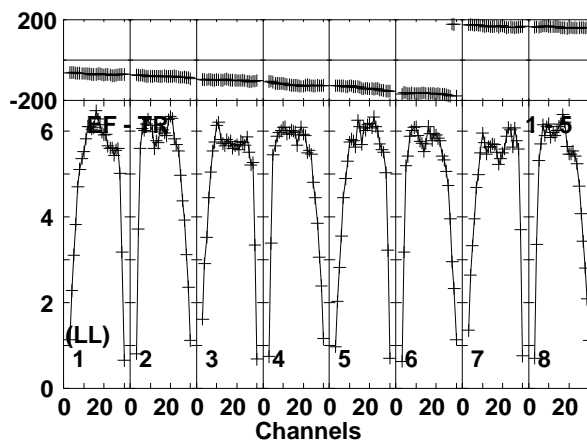
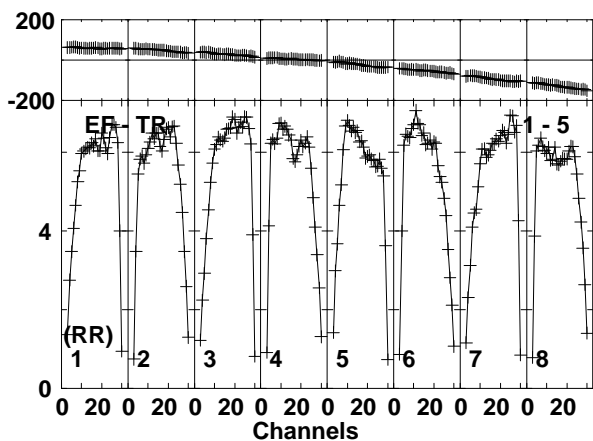
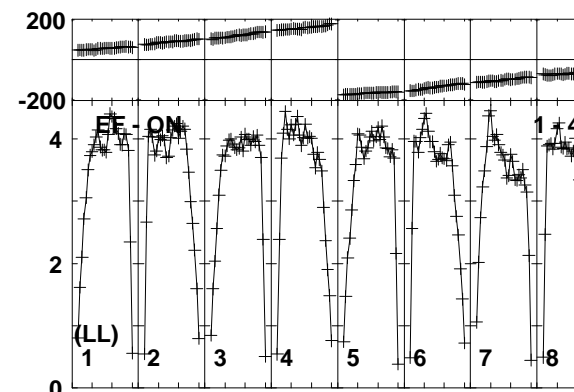
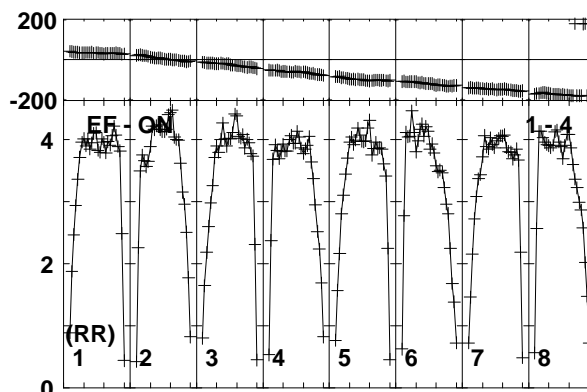
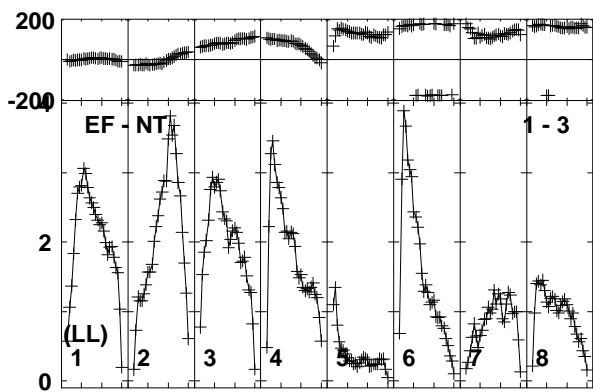
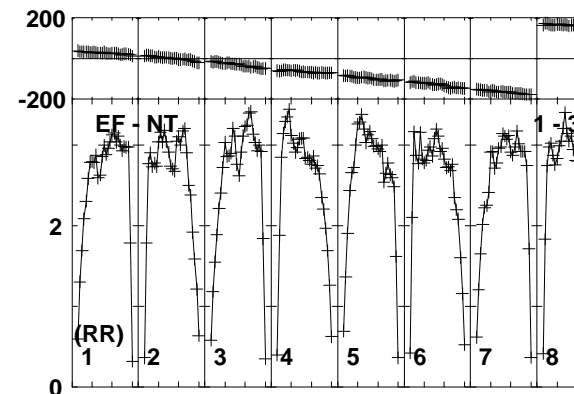
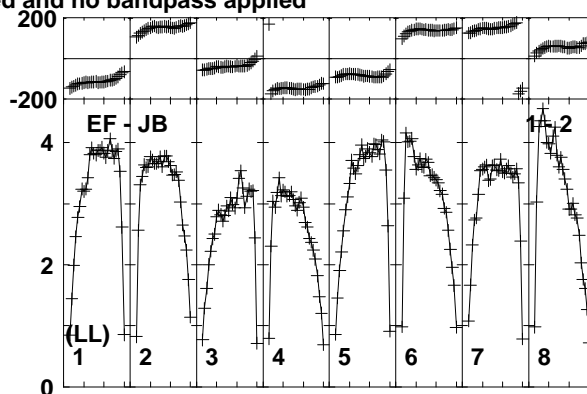
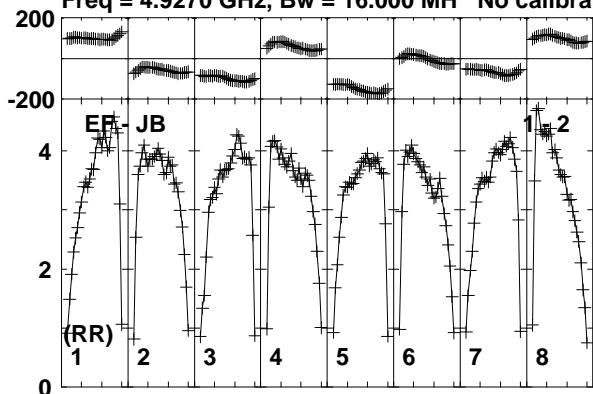

Lower frame: Milli Ampl Jy Top frame: Phas deg
Vector averaged cross-power spectrum Baseline: EF (01) - JB (02)
Timerange: 01/05:05:43 to 01/05:07:09

Plot file version 324 created 26-MAR-2015 15:27:54

J2113+4012 EG082E.UVDATA.1

Freq = 4.9270 GHz, Bw = 16.000 MH No calibration applied and no bandpass applied

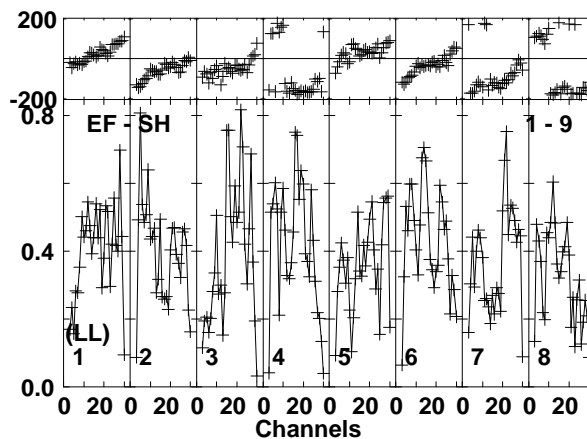
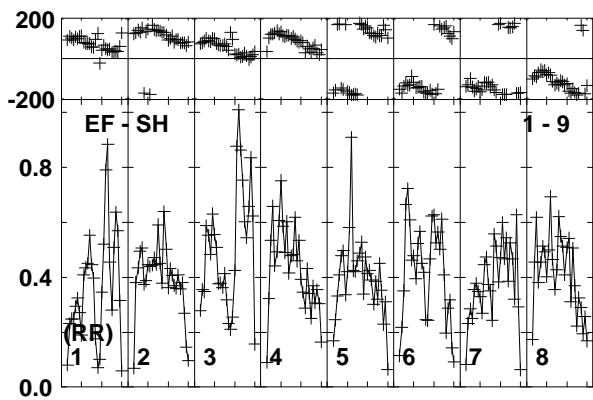
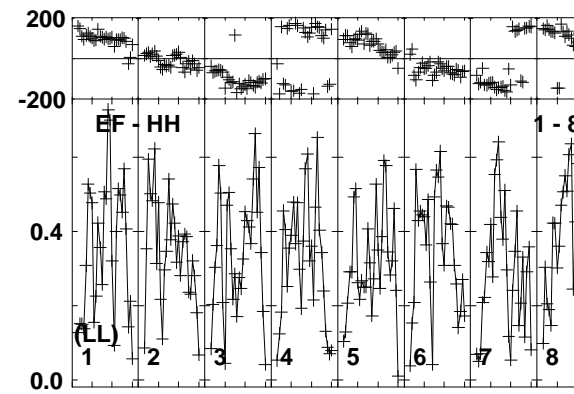
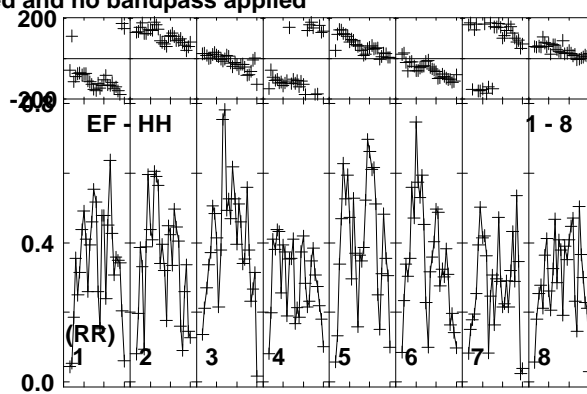
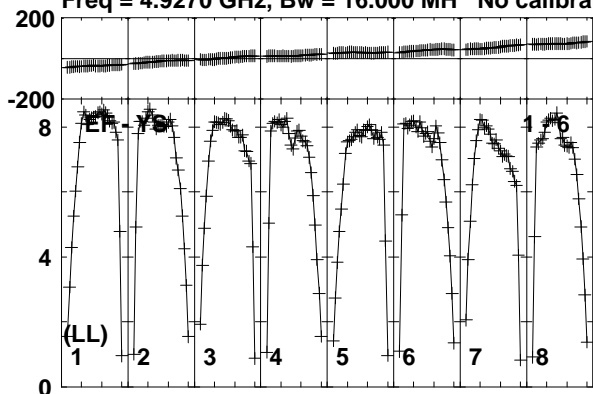

Lower frame: Milli Ampl Jy Top frame: Phas deg
Vector averaged cross-power spectrum Baseline: EF (01) - YS (06)
Timerange: 01/05:05:43 to 01/05:07:09

Plot file version 326 created 26-MAR-2015 15:27:54

V1396CYG EG082E.UVDATA.1

Freq = 4.9270 GHz, Bw = 16.000 MH No calibration applied and no bandpass applied

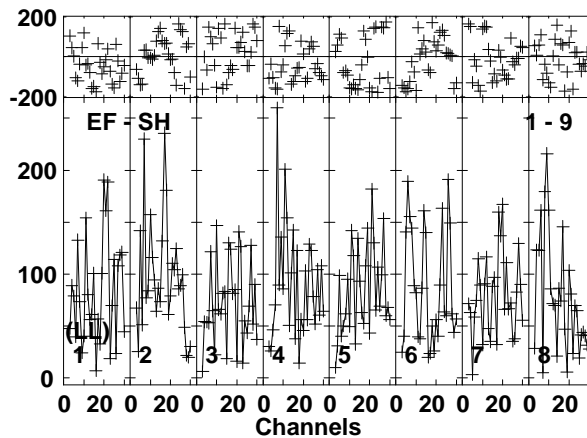
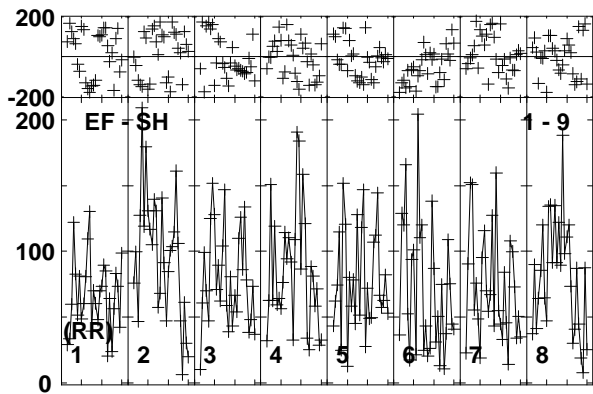
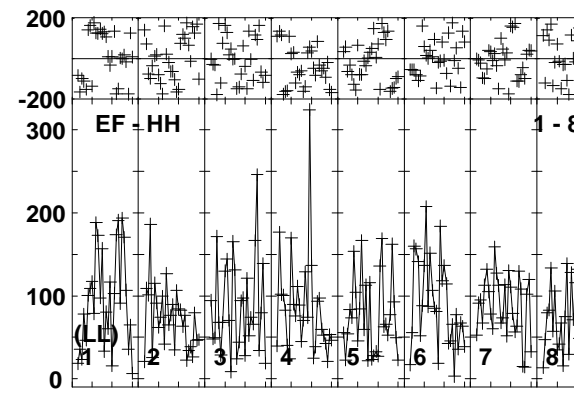
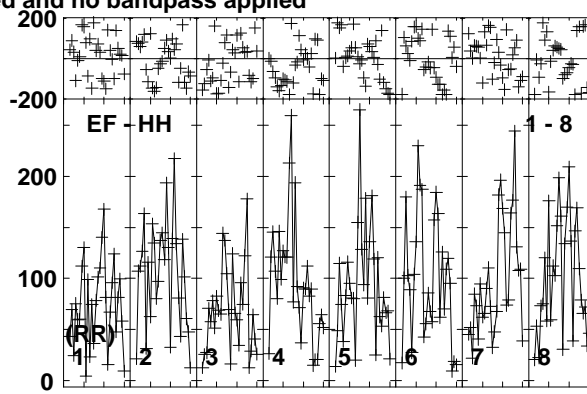
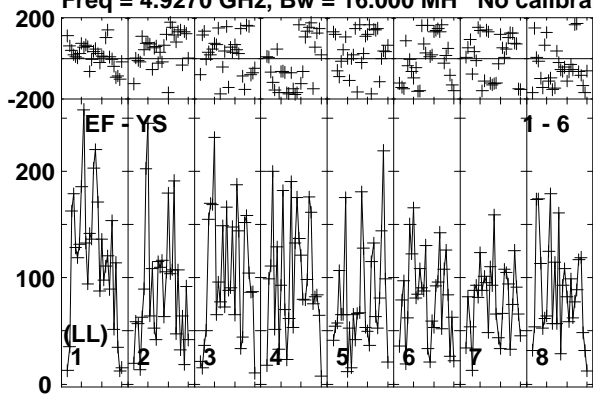

Lower frame: Micro Ampl Jy Top frame: Phas deg
Vector averaged cross-power spectrum Baseline: EF (01) - YS (06)
Timerange: 01/05:07:13 to 01/05:10:39

Plot file version 327 created 26-MAR-2015 15:27:54

J2113+4012 EG082E.UVDATA.1

Freq = 4.9270 GHz, Bw = 16.000 MH No calibration applied and no bandpass applied

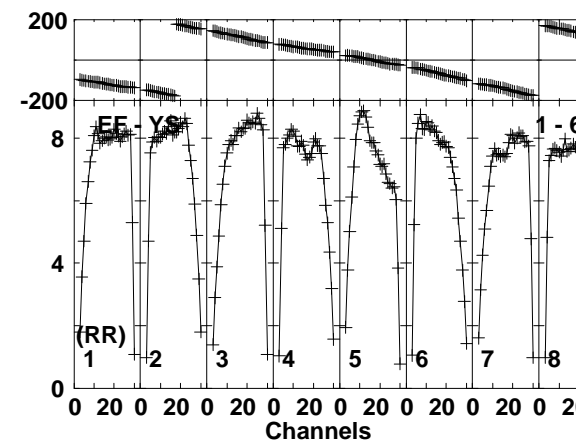
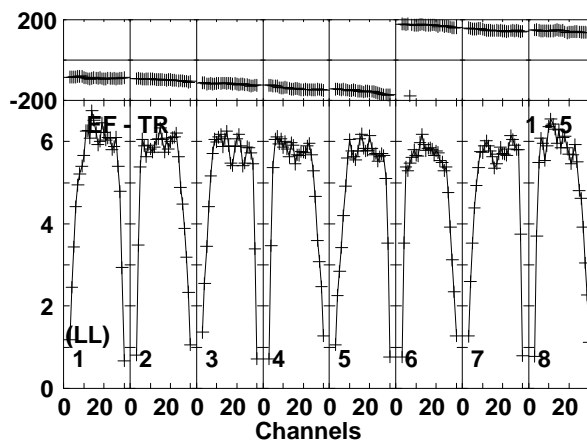
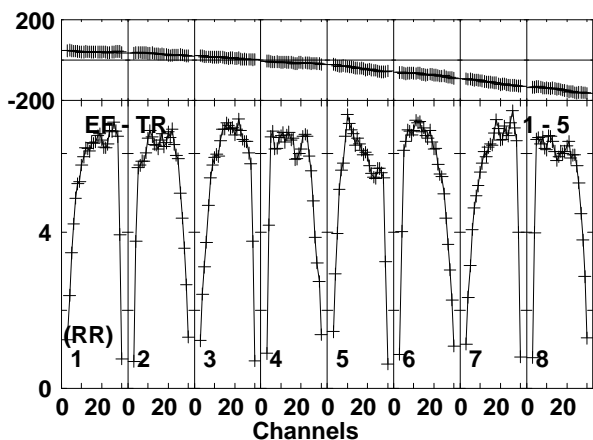
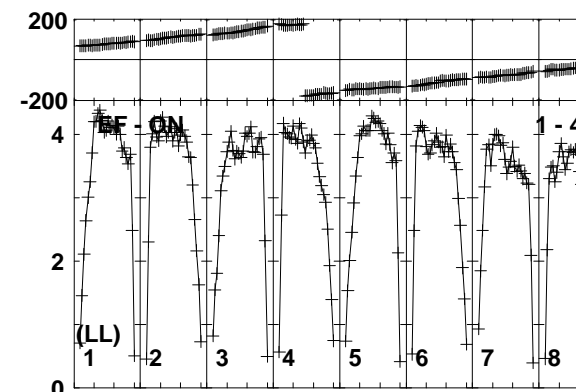
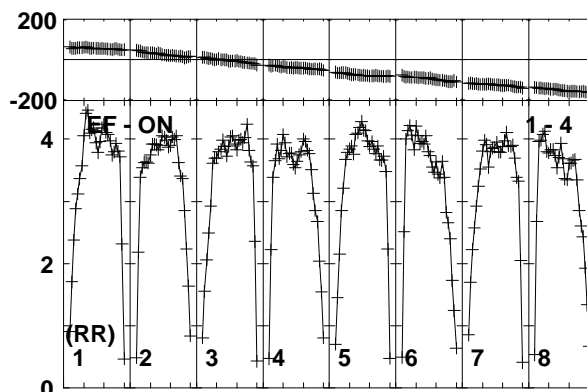
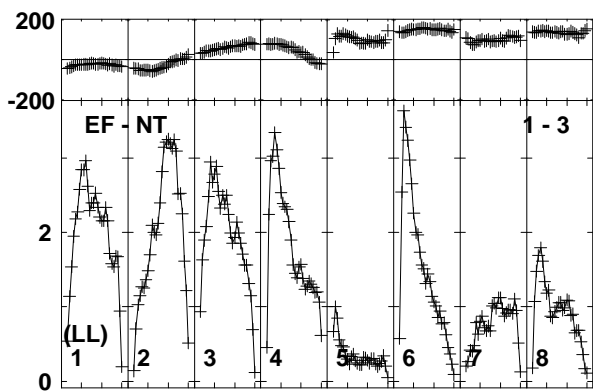
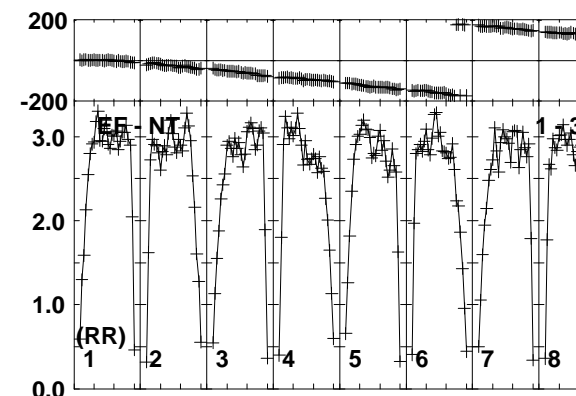
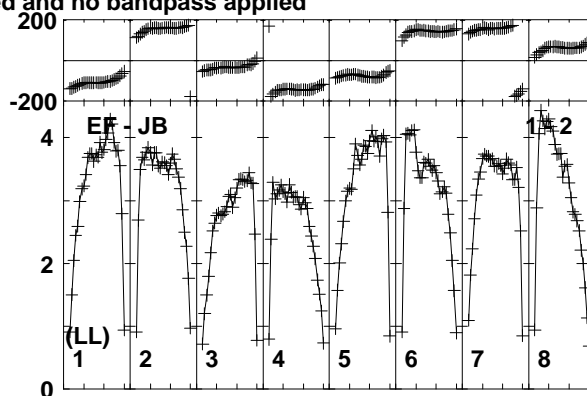
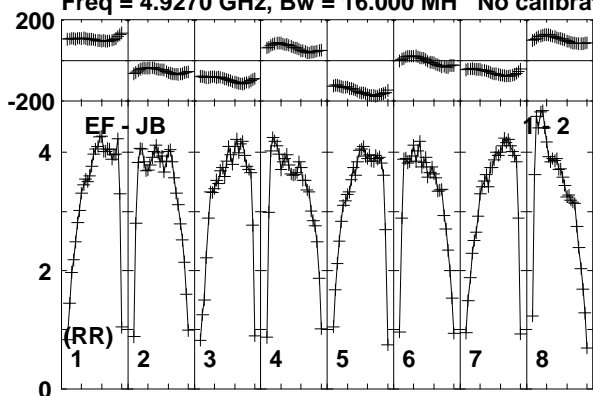

Lower frame: Milli Ampl Jy Top frame: Phas deg
Vector averaged cross-power spectrum Baseline: EF (01) - JB (02)
Timerange: 01/05:11:13 to 01/05:12:09

Plot file version 328 created 26-MAR-2015 15:27:54

J2113+4012 EG082E.UVDATA.1

Freq = 4.9270 GHz, Bw = 16.000 MH No calibration applied and no bandpass applied

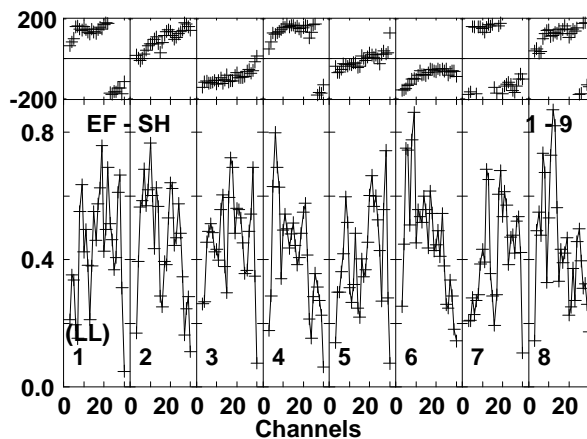
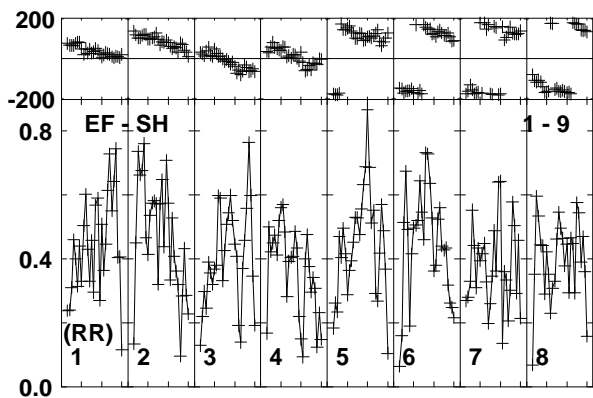
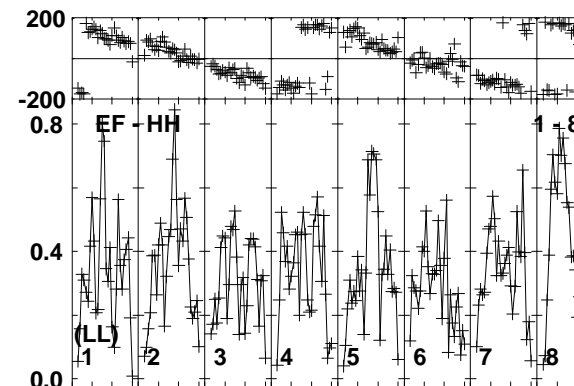
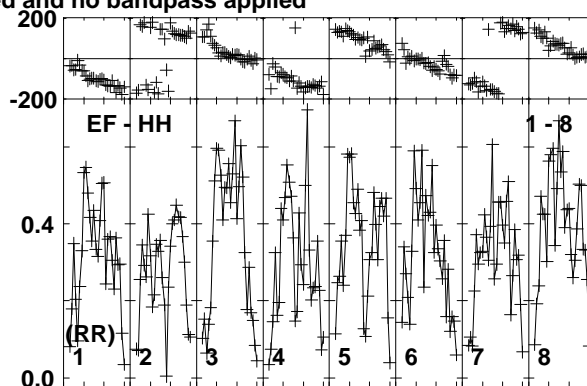
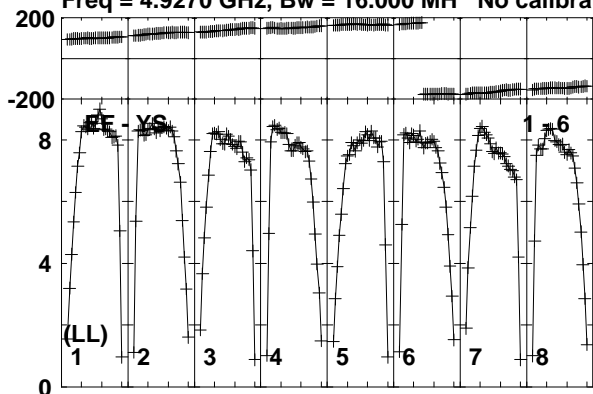

Lower frame: Milli Ampl Jy Top frame: Phas deg
Vector averaged cross-power spectrum Baseline: EF (01) - YS (06)
Timerange: 01/05:11:13 to 01/05:12:09

Plot file version 330 created 26-MAR-2015 15:27:54

V1396CYG EG082E.UVDATA.1

Freq = 4.9270 GHz, Bw = 16.000 MH No calibration applied and no bandpass applied

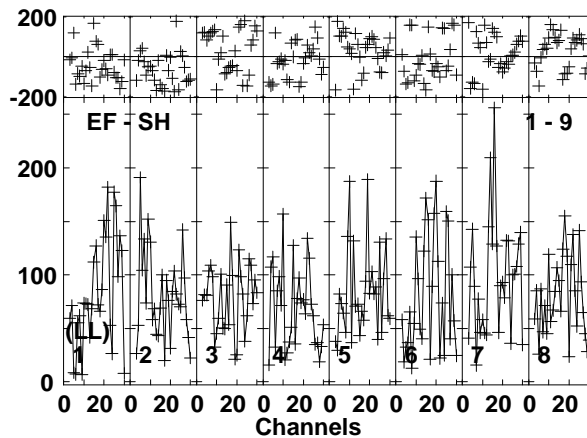
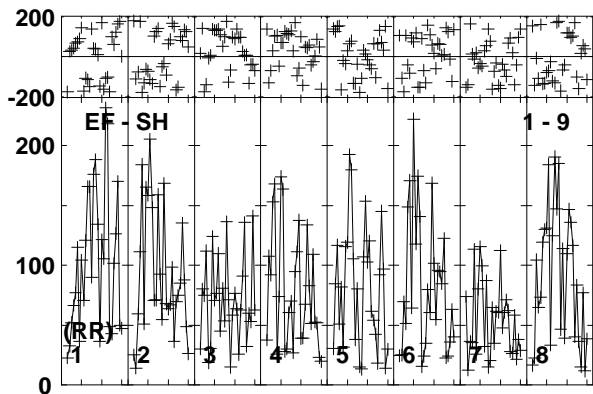
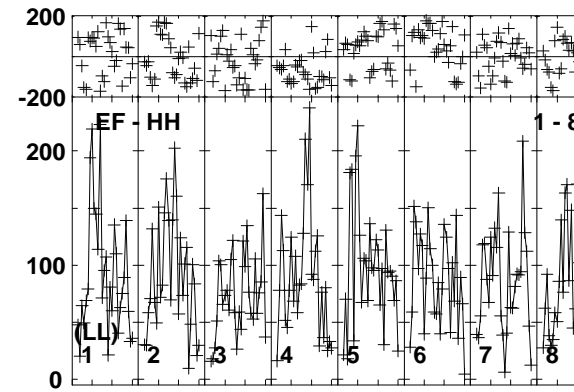
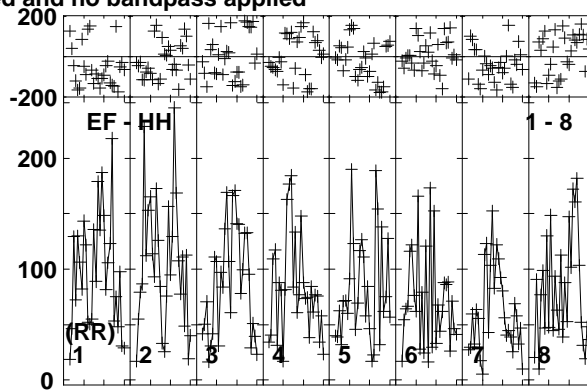
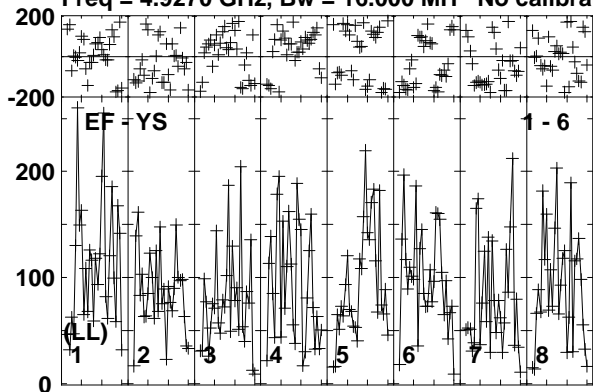

Lower frame: Micro Ampl Jy Top frame: Phas deg
Vector averaged cross-power spectrum Baseline: EF (01) - YS (06)
Timerange: 01/05:12:13 to 01/05:15:39

Plot file version 331 created 26-MAR-2015 15:27:54

J2113+4012 EG082E.UVDATA.1

Freq = 4.9270 GHz, Bw = 16.000 MH No calibration applied and no bandpass applied

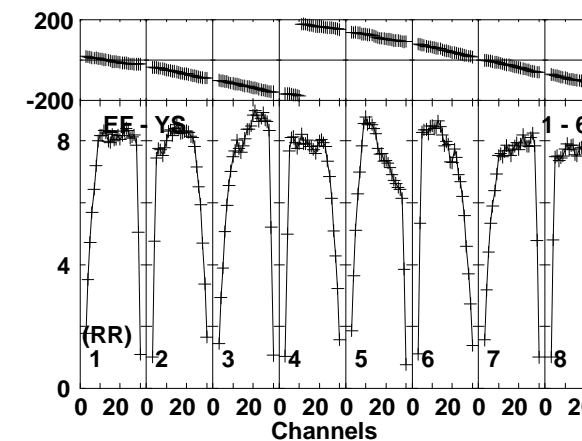
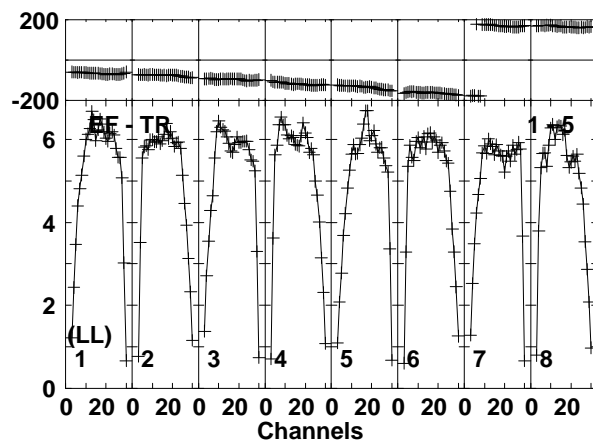
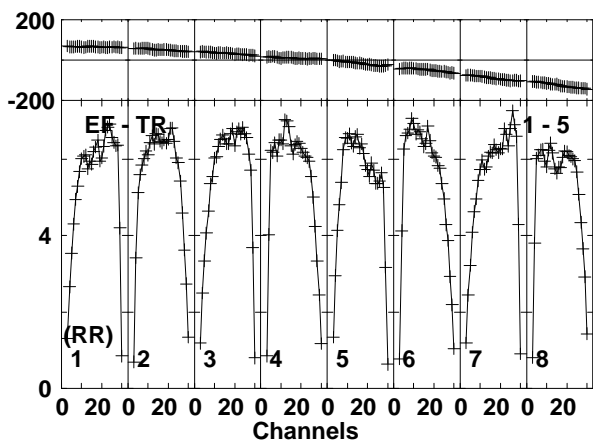
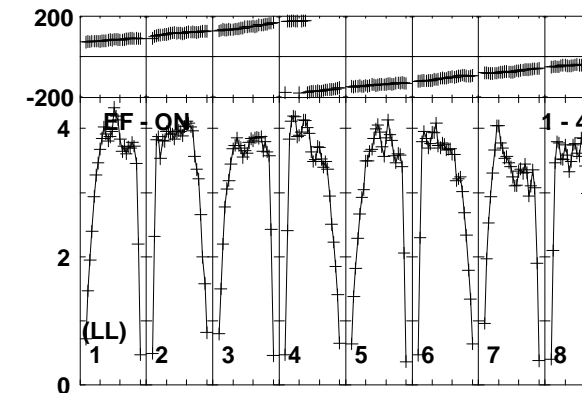
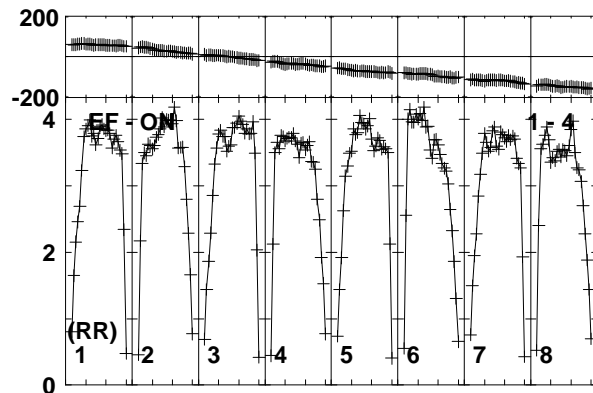
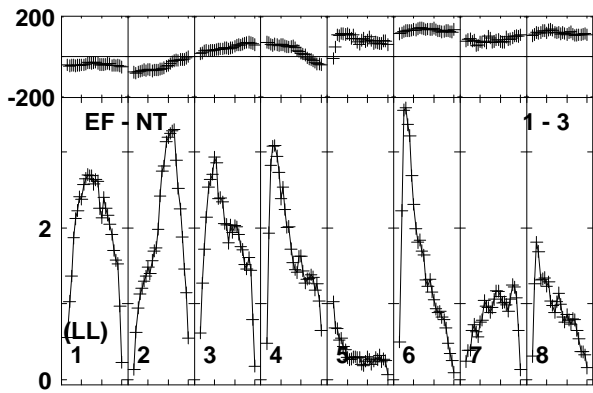
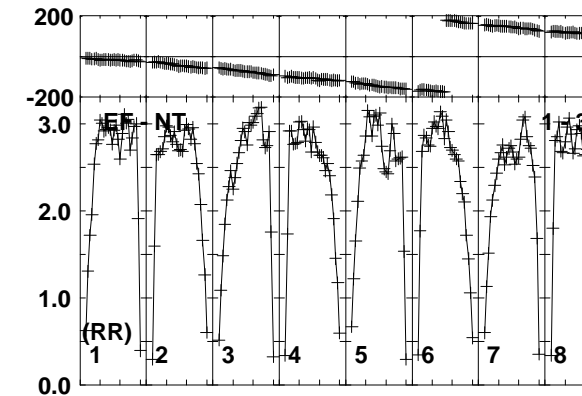
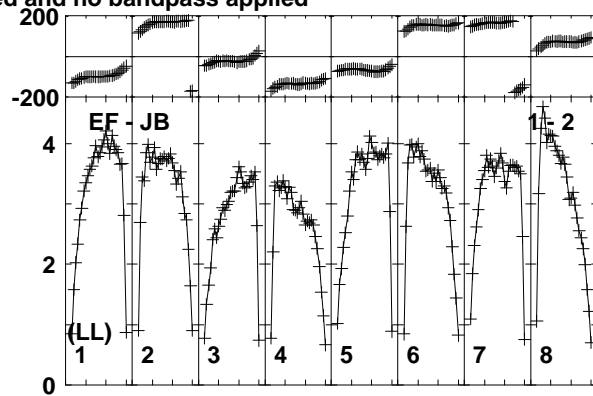
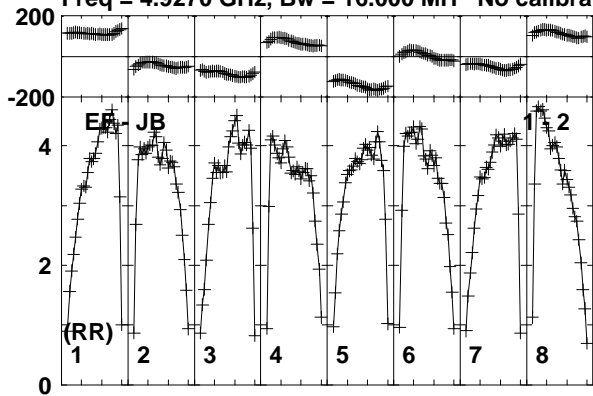

Lower frame: Milli Ampl Jy Top frame: Phas deg
Vector averaged cross-power spectrum Baseline: EF (01) - JB (02)
Timerange: 01/05:15:43 to 01/05:17:09

Plot file version 332 created 26-MAR-2015 15:27:54

J2113+4012 EG082E.UVDATA.1

Freq = 4.9270 GHz, Bw = 16.000 MH No calibration applied and no bandpass applied

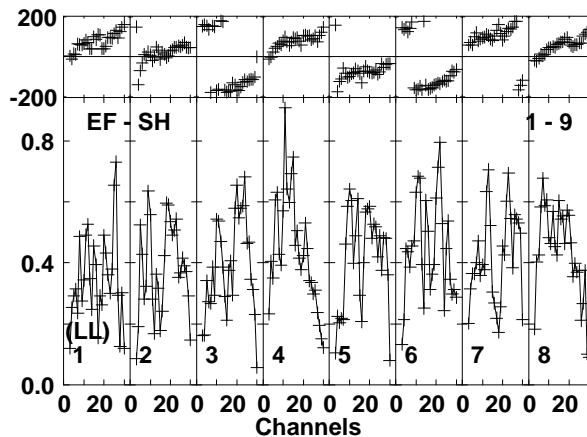
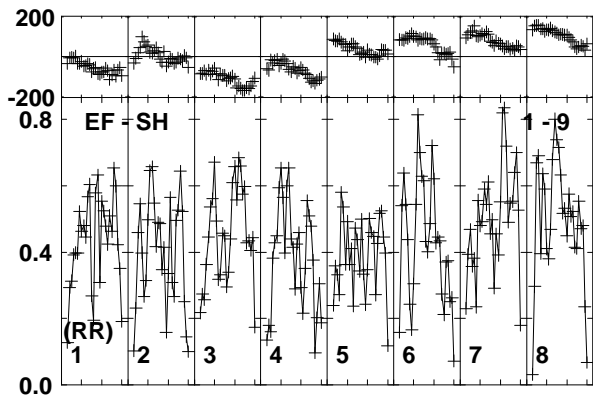
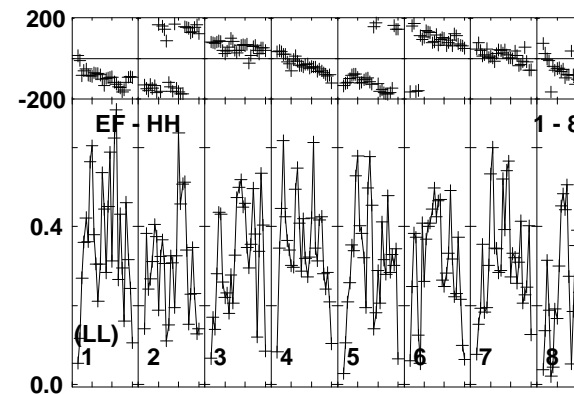
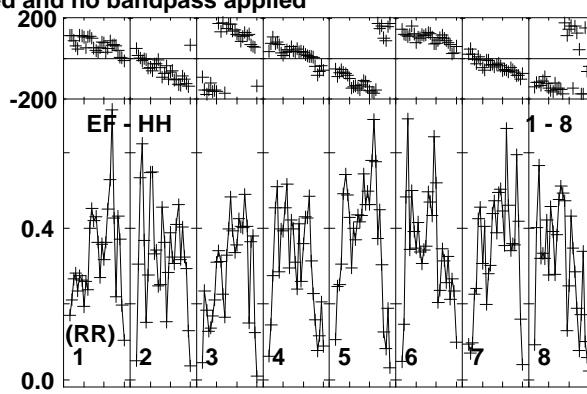
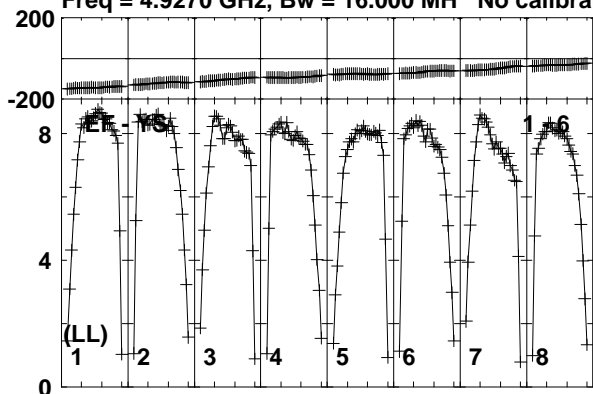

Lower frame: Milli Ampl Jy Top frame: Phas deg
Vector averaged cross-power spectrum Baseline: EF (01) - YS (06)
Timerange: 01/05:15:43 to 01/05:17:09

Plot file version 333 created 26-MAR-2015 15:27:54

J2115+3742 EG082E.UVDATA.1

Freq = 4.9270 GHz, Bw = 16.000 MH No calibration applied and no bandpass applied

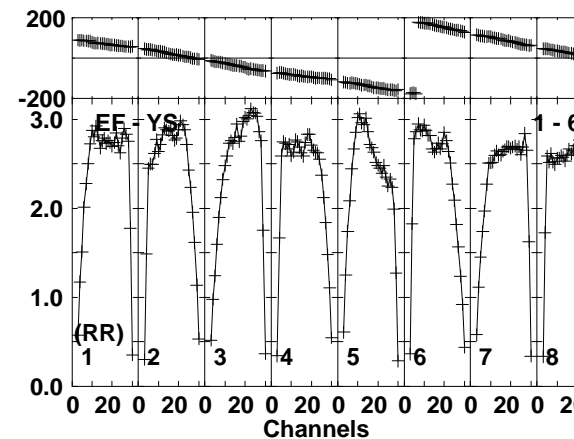
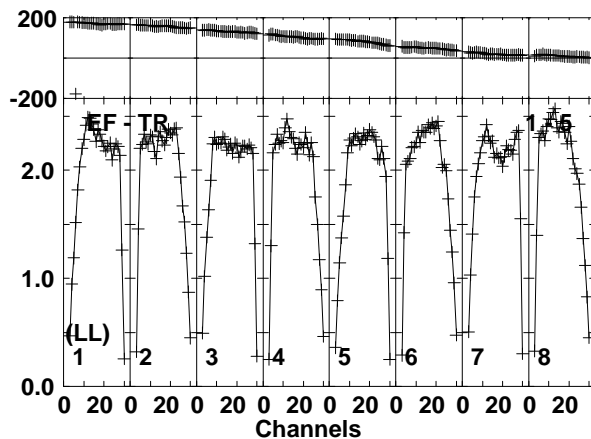
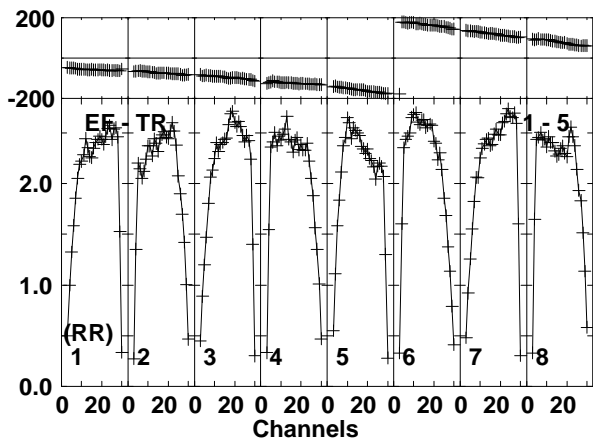
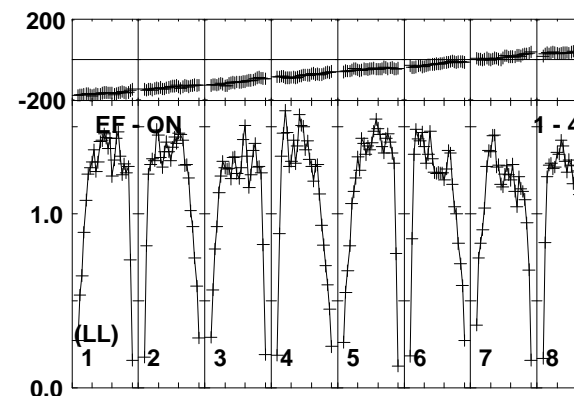
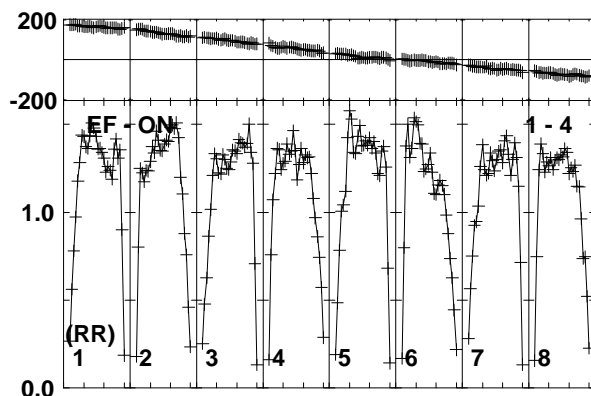
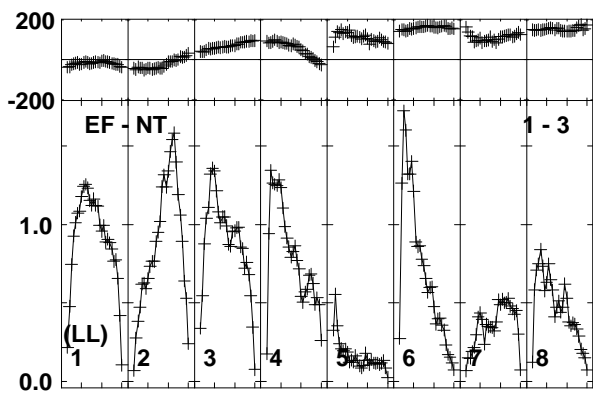
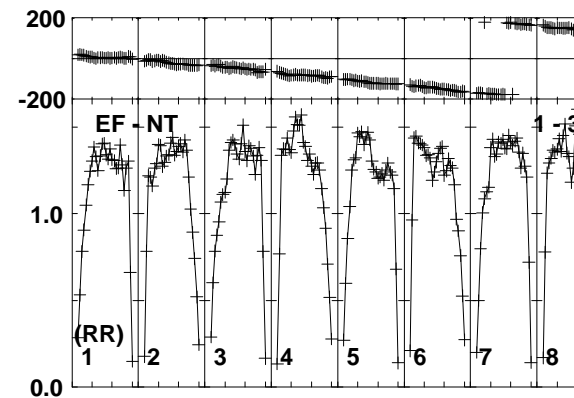
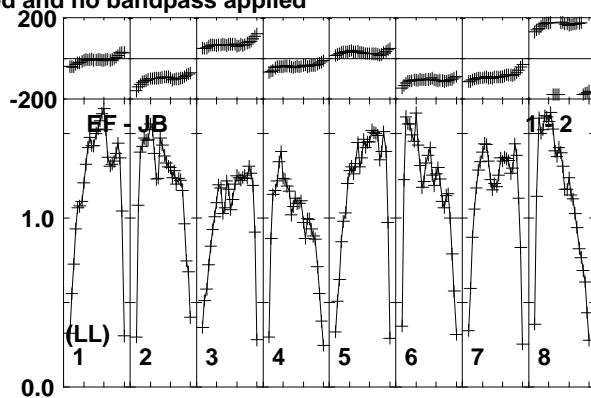
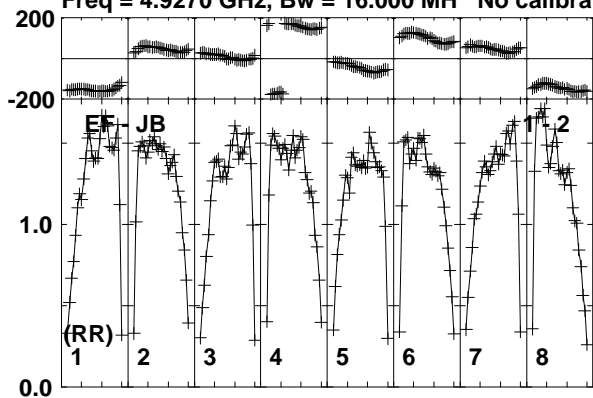

Lower frame: Milli Ampl Jy Top frame: Phas deg
Vector averaged cross-power spectrum Baseline: EF (01) - JB (02)
Timerange: 01/05:17:13 to 01/05:20:39

Plot file version 334 created 26-MAR-2015 15:27:55

J2115+3742 EG082E.UVDATA.1

Freq = 4.9270 GHz, Bw = 16.000 MH No calibration applied and no bandpass applied

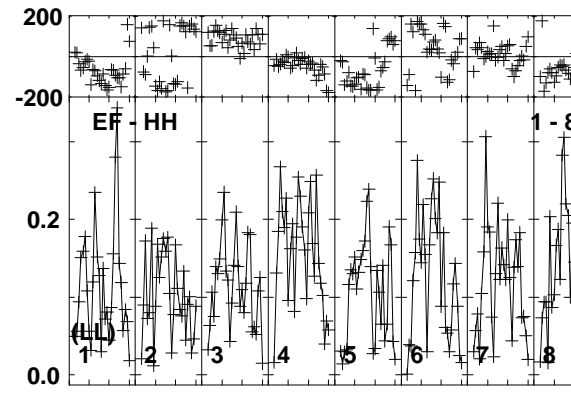
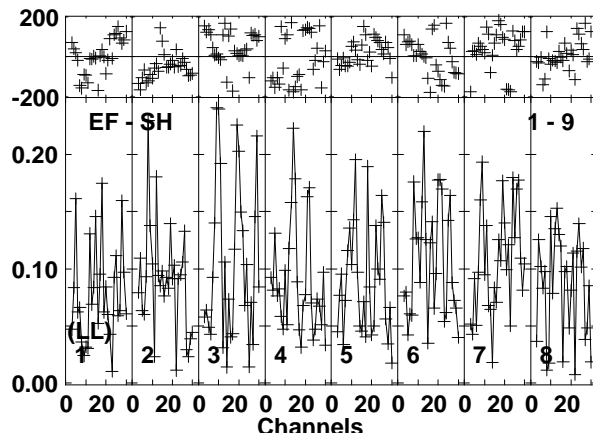
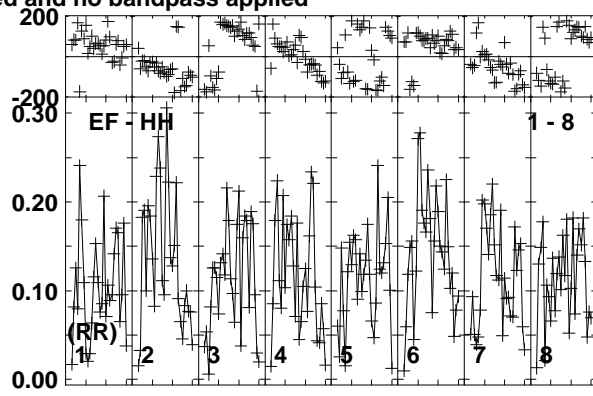
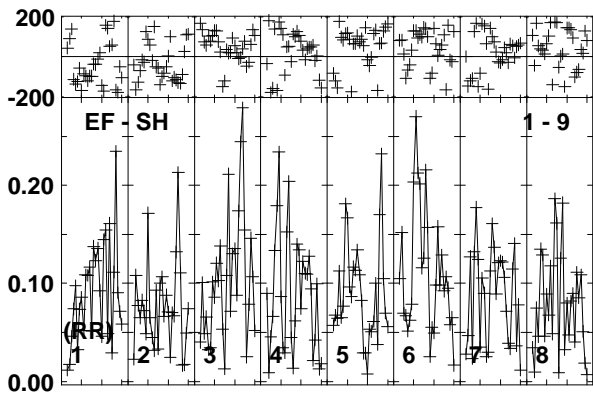
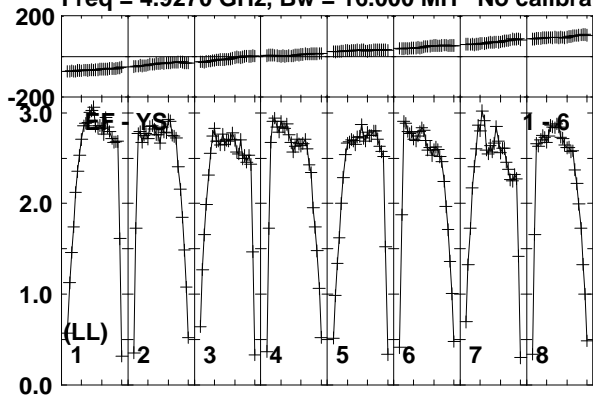

Lower frame: Milli Ampl Jy Top frame: Phas deg
Vector averaged cross-power spectrum Baseline: EF (01) - YS (06)
Timerange: 01/05:17:13 to 01/05:20:39

Plot file version 335 created 26-MAR-2015 15:27:55

J2113+4012 EG082E.UVDATA.1

Freq = 4.9270 GHz, Bw = 16.000 MH No calibration applied and no bandpass applied

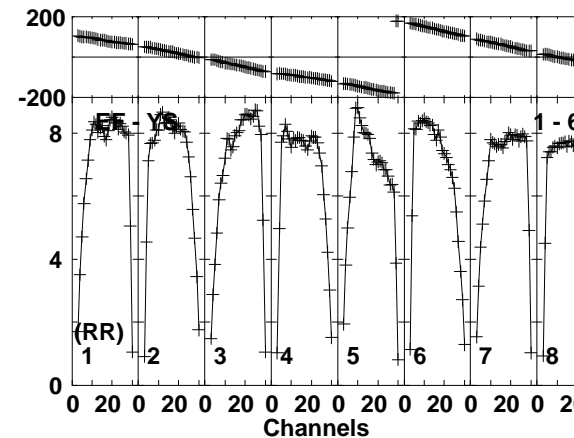
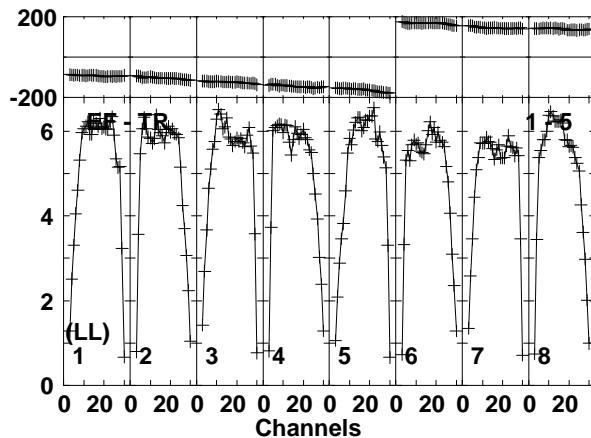
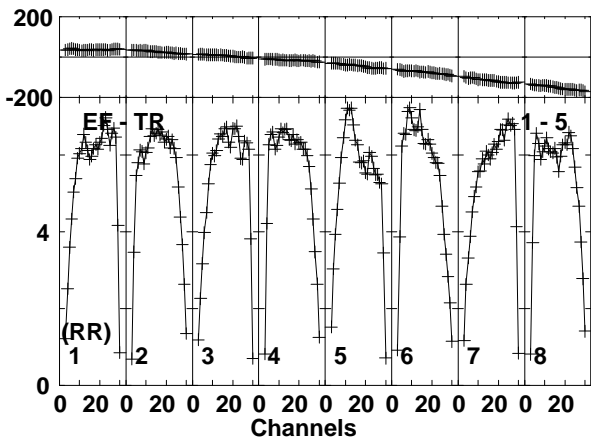
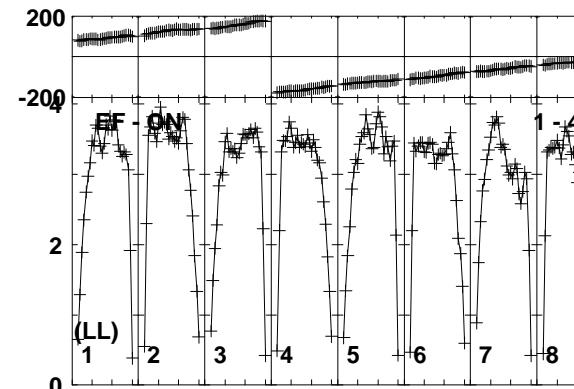
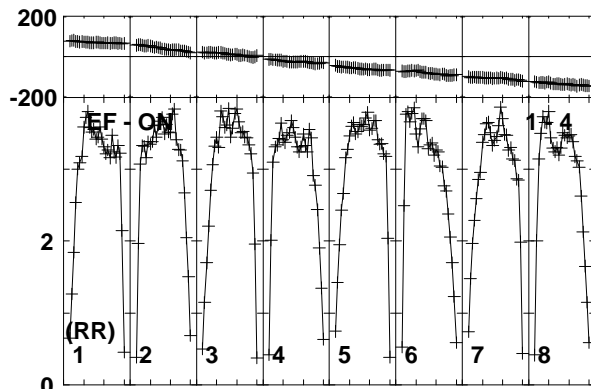
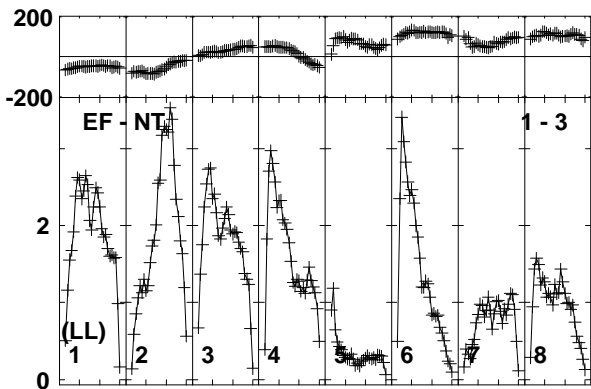
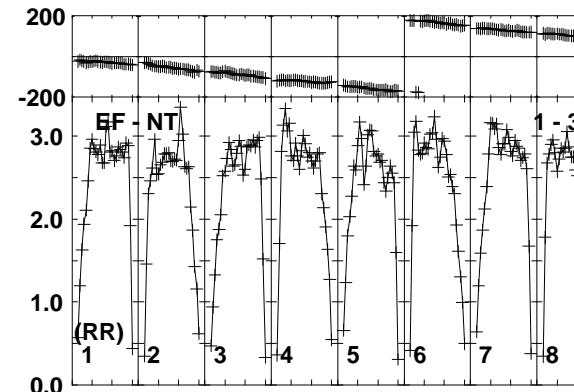
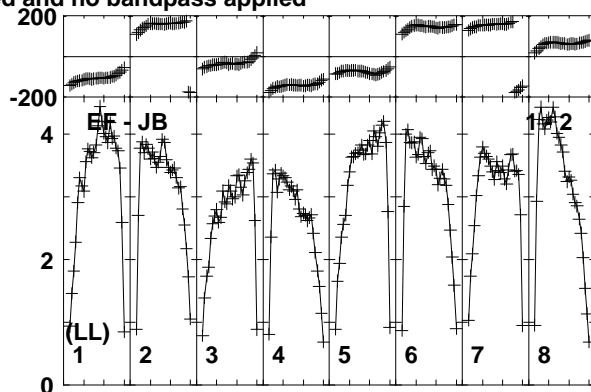
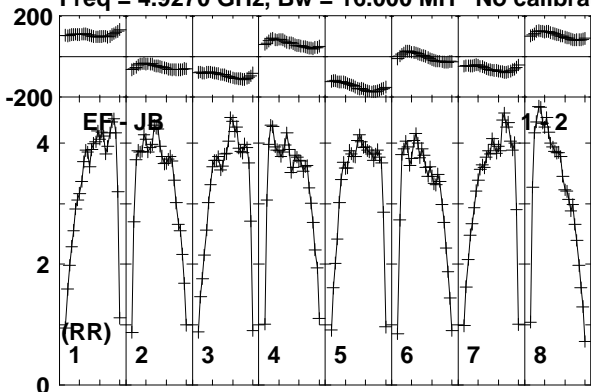

Lower frame: Milli Ampl Jy Top frame: Phas deg
Vector averaged cross-power spectrum Baseline: EF (01) - JB (02)
Timerange: 01/05:21:13 to 01/05:22:09

Plot file version 336 created 26-MAR-2015 15:27:55

J2113+4012 EG082E.UVDATA.1

Freq = 4.9270 GHz, Bw = 16.000 MH No calibration applied and no bandpass applied

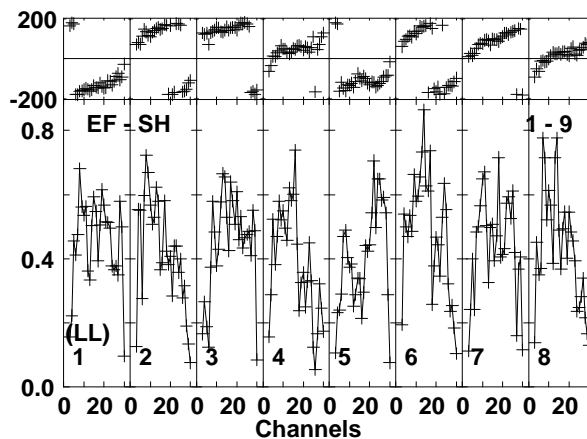
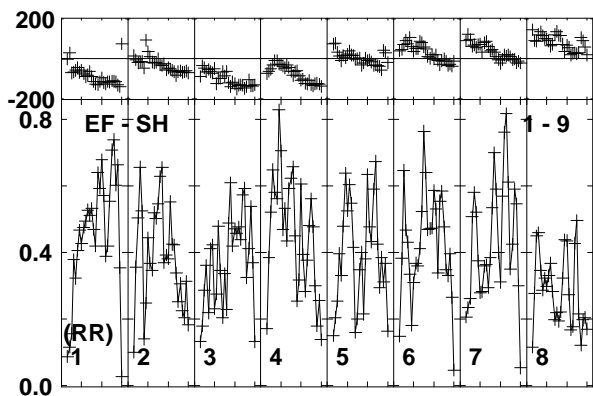
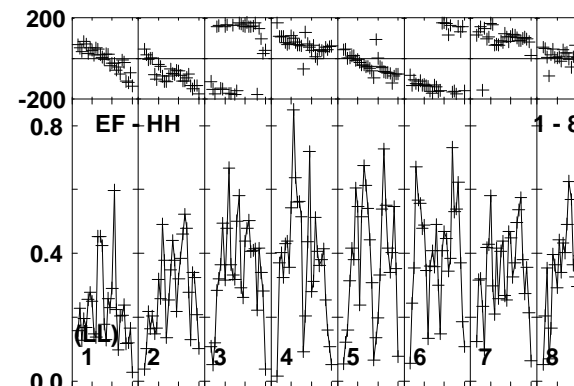
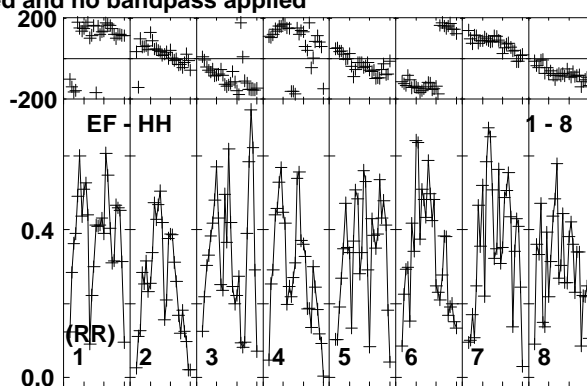
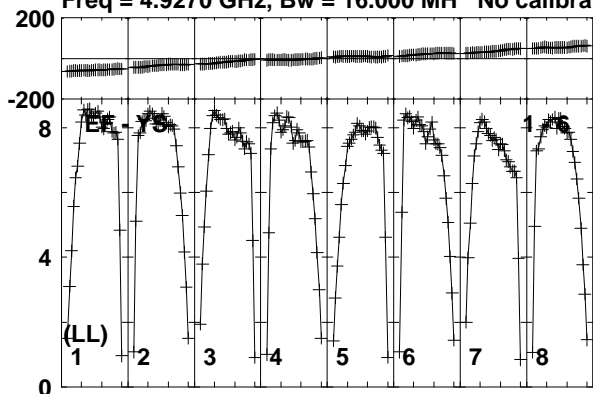

Lower frame: Milli Ampl Jy Top frame: Phas deg
Vector averaged cross-power spectrum Baseline: EF (01) - YS (06)
Timerange: 01/05:21:13 to 01/05:22:09

Plot file version 337 created 26-MAR-2015 15:27:55

V1396CYG EG082E.UVDATA.1

Freq = 4.9270 GHz, Bw = 16.000 MH No calibration applied and no bandpass applied

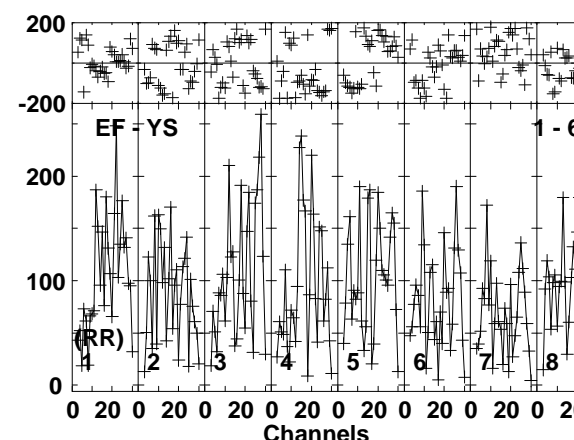
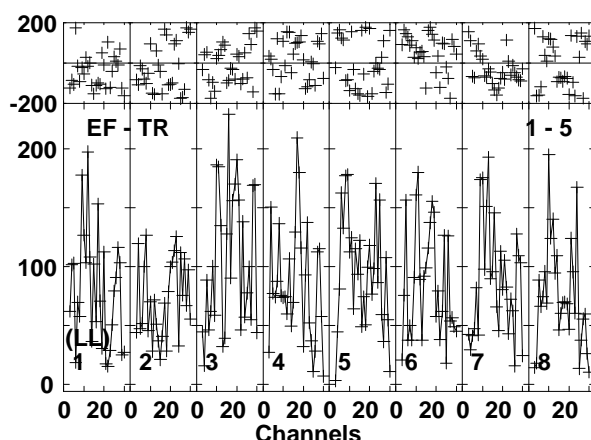
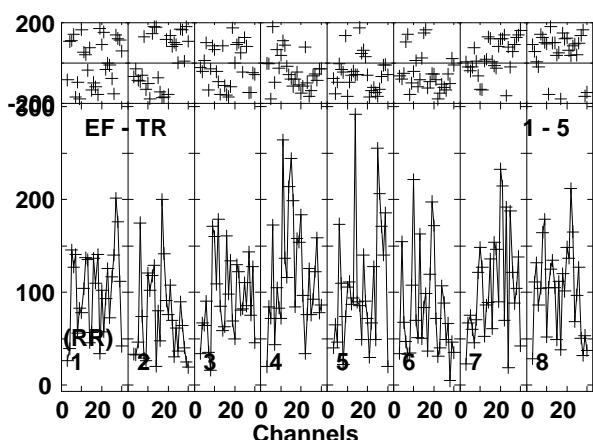
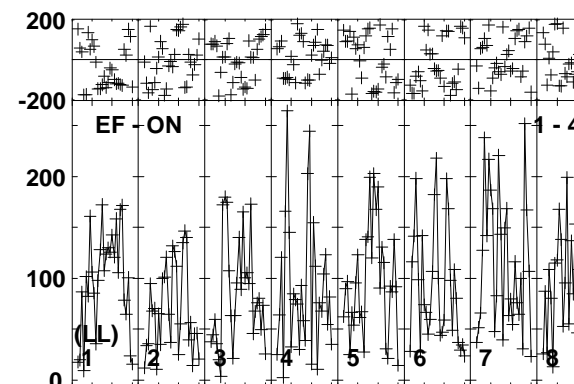
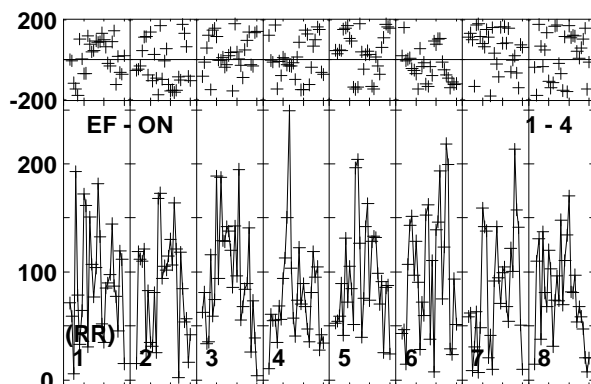
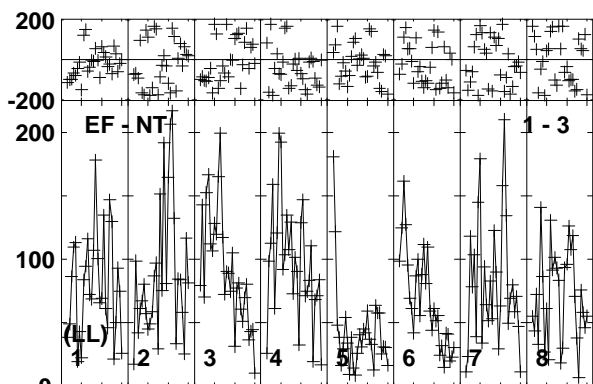
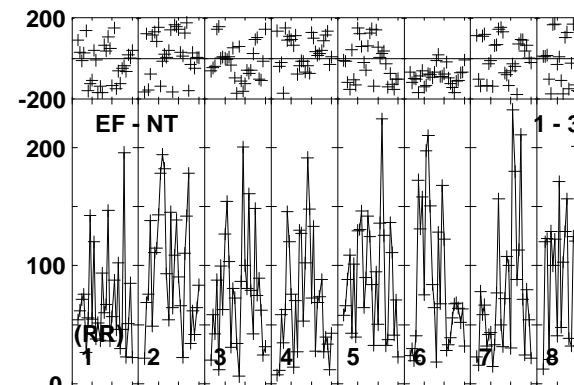
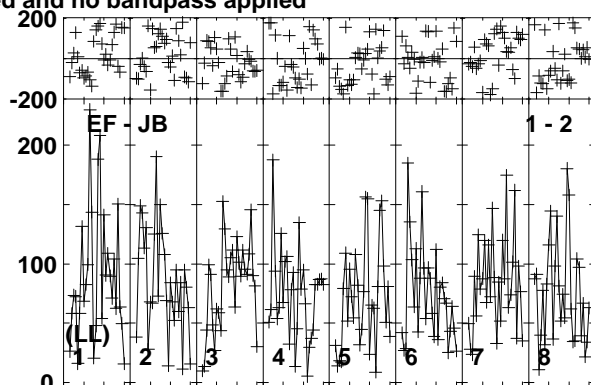
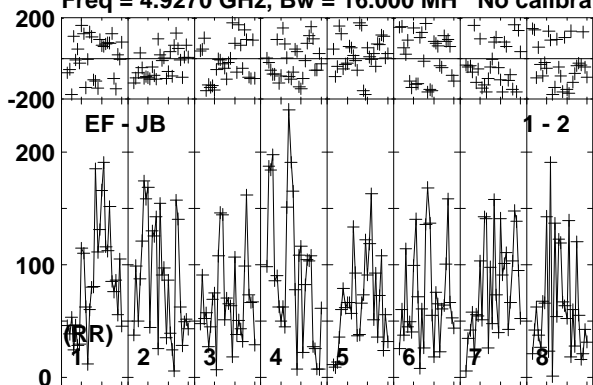

Lower frame: Micro Ampl Jy Top frame: Phas deg
Vector averaged cross-power spectrum Baseline: EF (01) - JB (02)
Timerange: 01/05:22:13 to 01/05:25:39

Plot file version 338 created 26-MAR-2015 15:27:55

V1396CYG EG082E.UVDATA.1

Freq = 4.9270 GHz, Bw = 16.000 MH No calibration applied and no bandpass applied

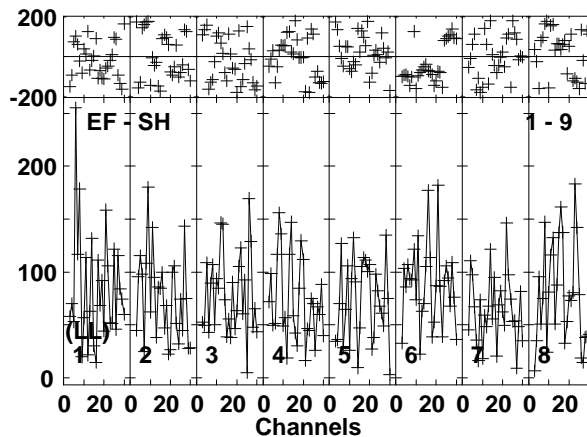
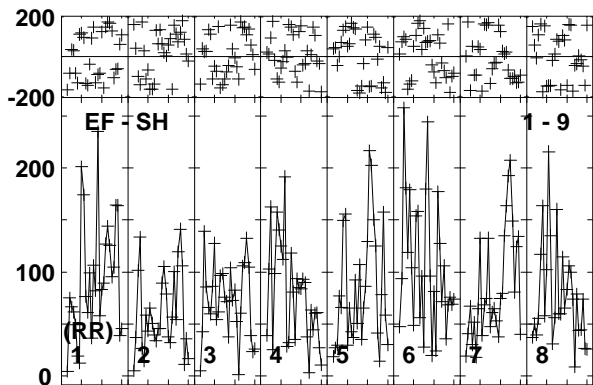
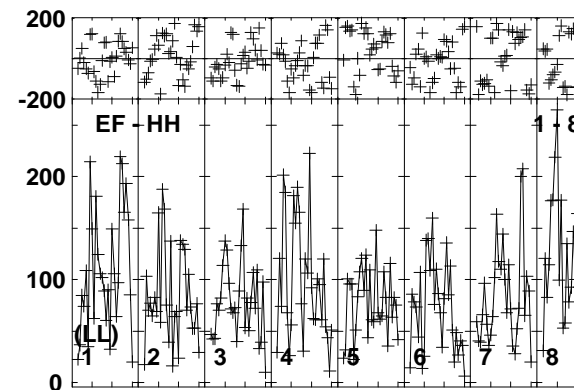
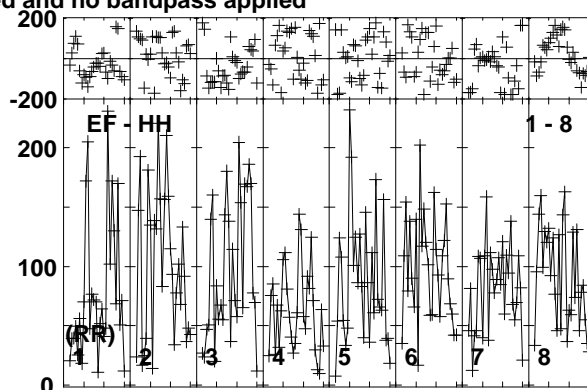
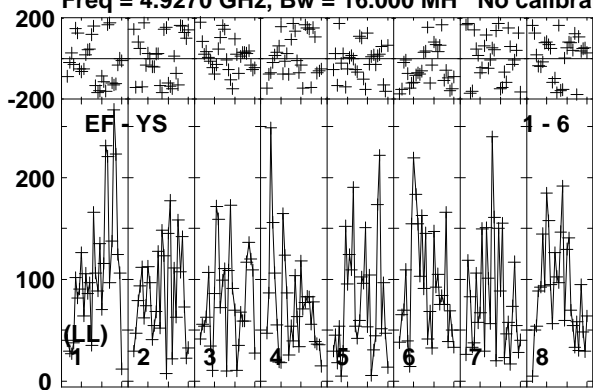

Lower frame: Micro Ampl Jy Top frame: Phas deg
Vector averaged cross-power spectrum Baseline: EF (01) - YS (06)
Timerange: 01/05:22:13 to 01/05:25:39

Plot file version 339 created 26-MAR-2015 15:27:55

J2113+4012 EG082E.UVDATA.1

Freq = 4.9270 GHz, Bw = 16.000 MH No calibration applied and no bandpass applied

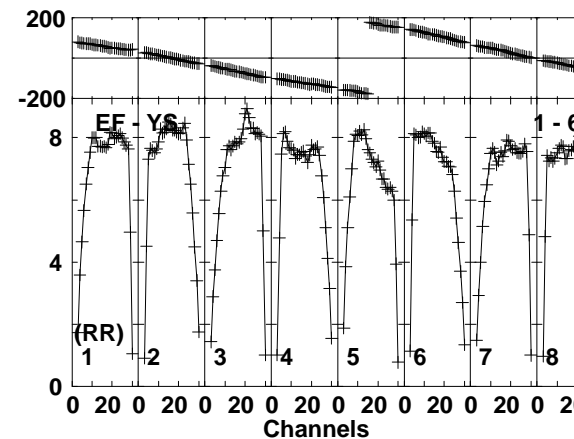
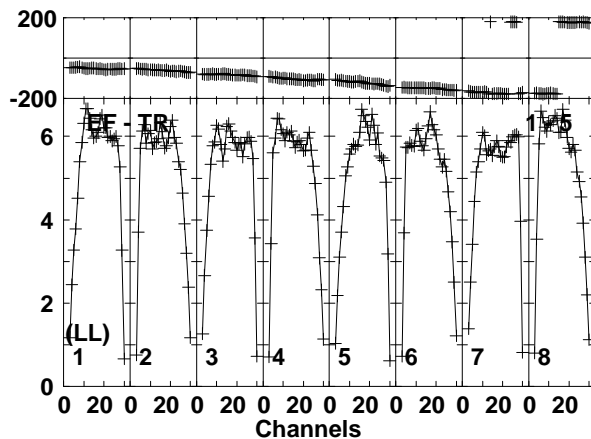
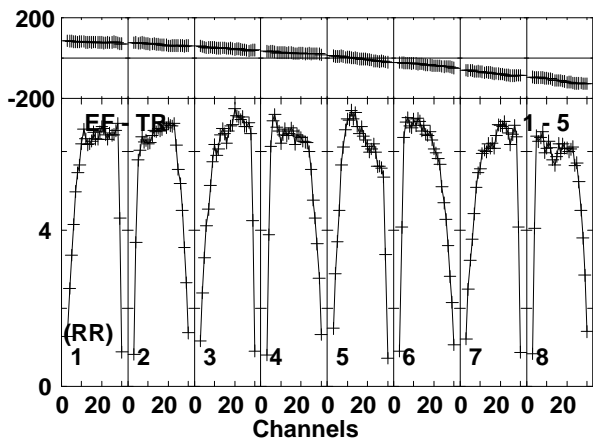
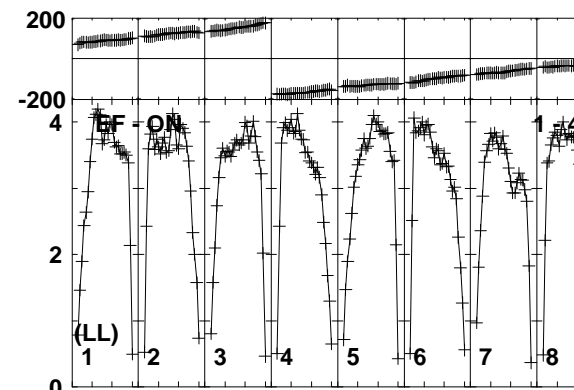
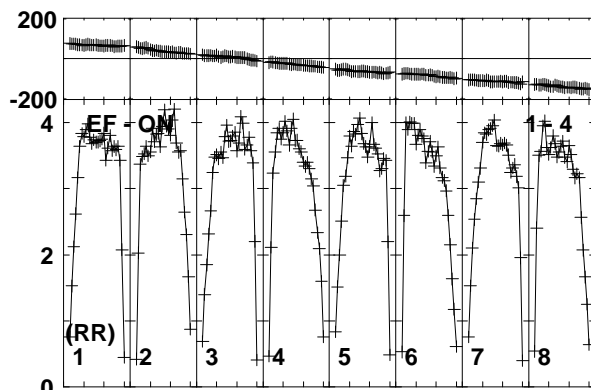
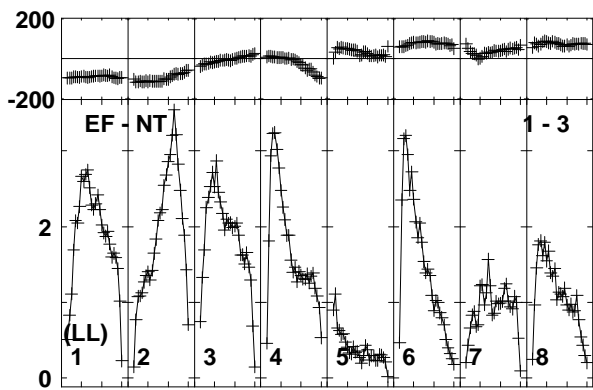
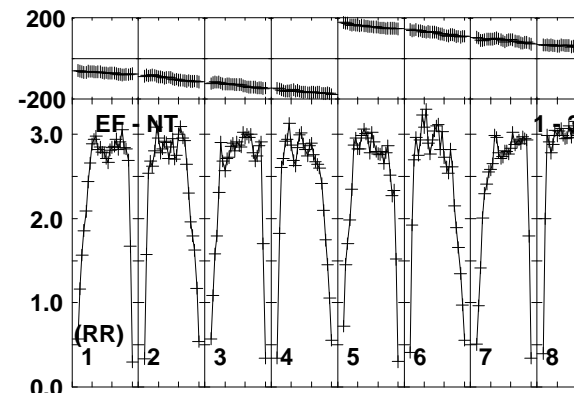
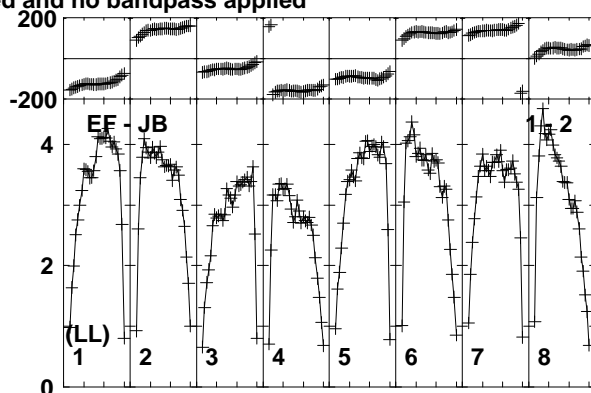
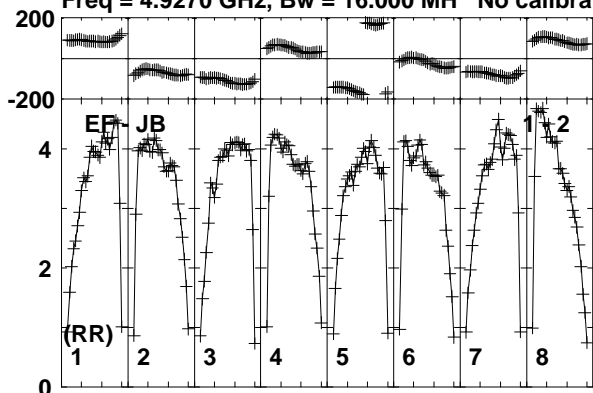

Lower frame: Milli Ampl Jy Top frame: Phas deg
Vector averaged cross-power spectrum Baseline: EF (01) - JB (02)
Timerange: 01/05:25:43 to 01/05:27:09

Plot file version 340 created 26-MAR-2015 15:27:55

J2113+4012 EG082E.UVDATA.1

Freq = 4.9270 GHz, Bw = 16.000 MH No calibration applied and no bandpass applied

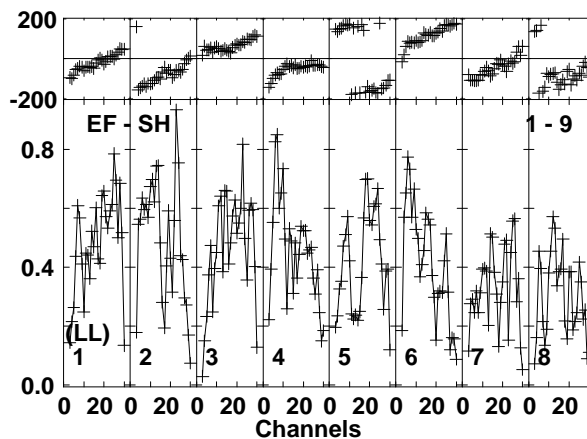
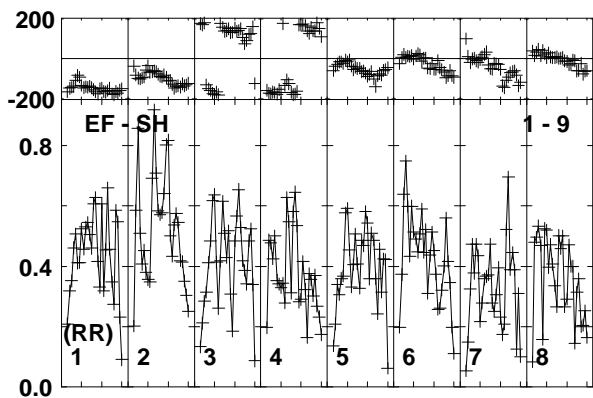
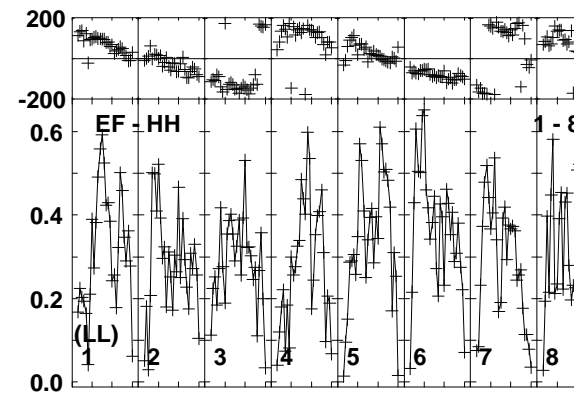
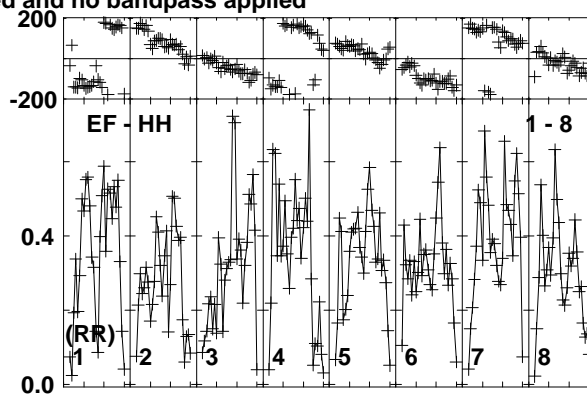
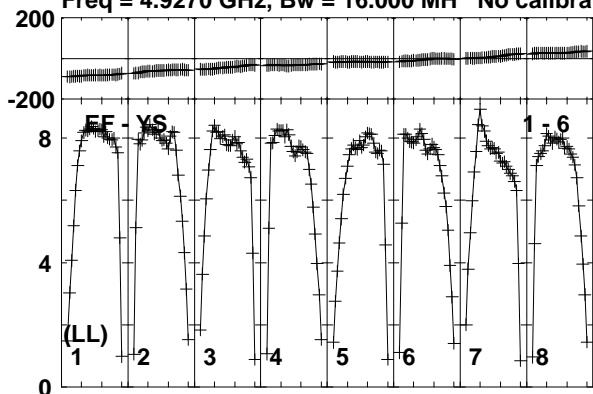

Lower frame: Milli Ampl Jy Top frame: Phas deg
Vector averaged cross-power spectrum Baseline: EF (01) - YS (06)
Timerange: 01/05:25:43 to 01/05:27:09

Plot file version 341 created 26-MAR-2015 15:27:55

V1396CYG EG082E.UVDATA.1

Freq = 4.9270 GHz, Bw = 16.000 MH No calibration applied and no bandpass applied

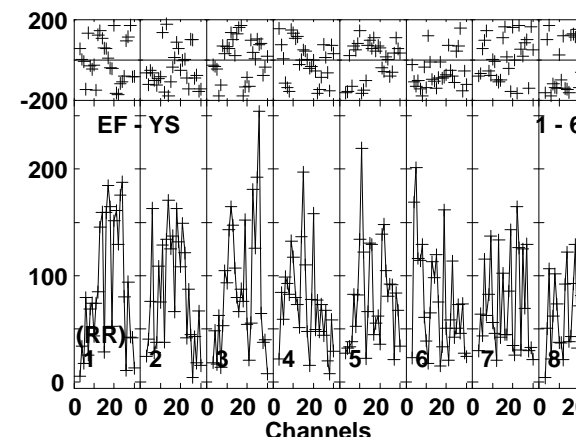
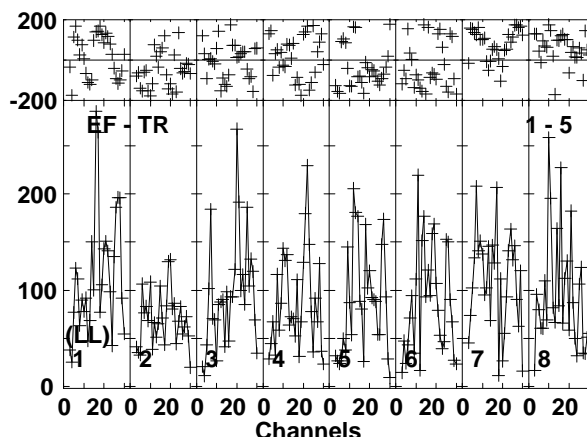
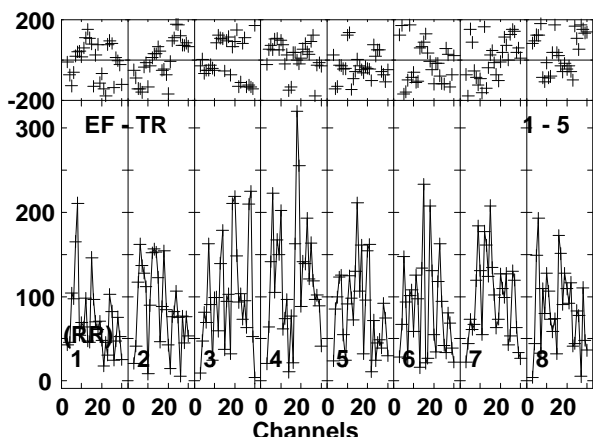
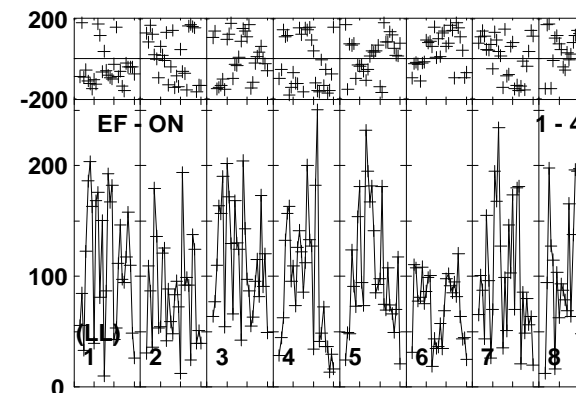
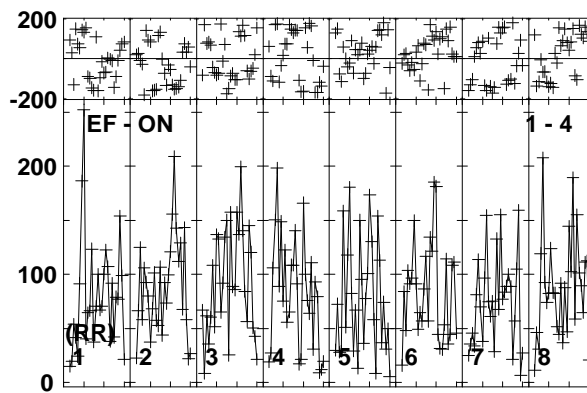
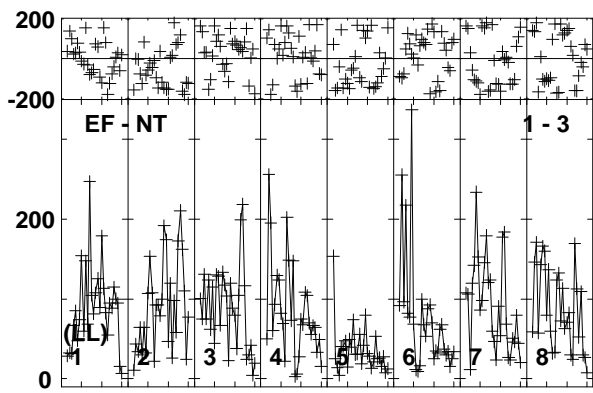
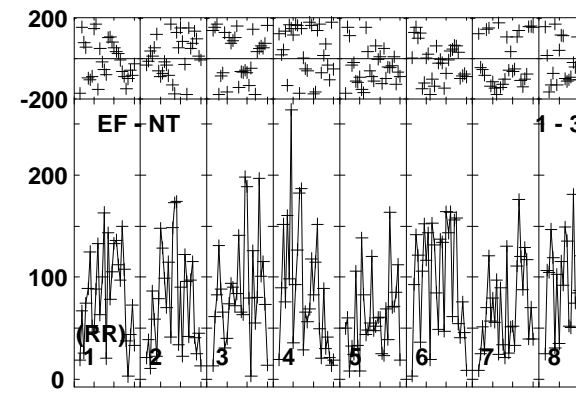
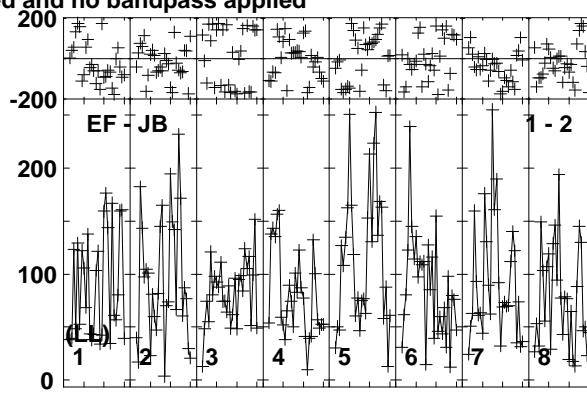
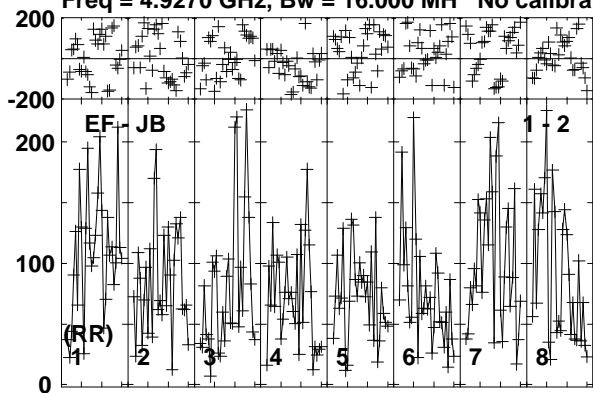

Lower frame: Micro Ampl Jy Top frame: Phas deg
Vector averaged cross-power spectrum Baseline: EF (01) - JB (02)
Timerange: 01/05:27:13 to 01/05:30:39

Plot file version 342 created 26-MAR-2015 15:27:55

V1396CYG EG082E.UVDATA.1

Freq = 4.9270 GHz, Bw = 16.000 MH No calibration applied and no bandpass applied

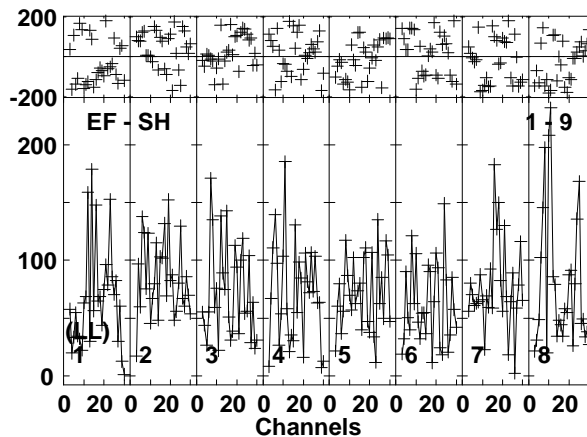
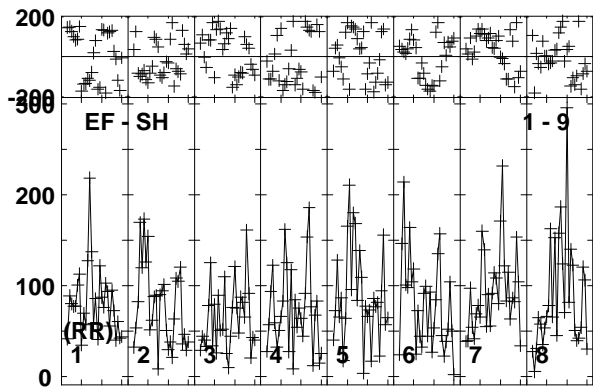
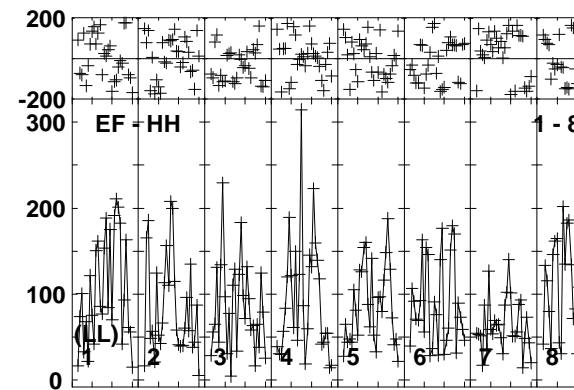
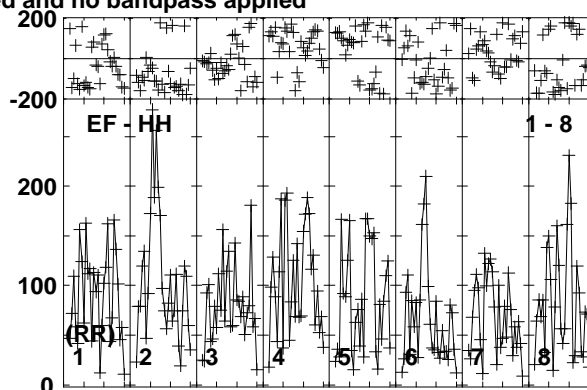
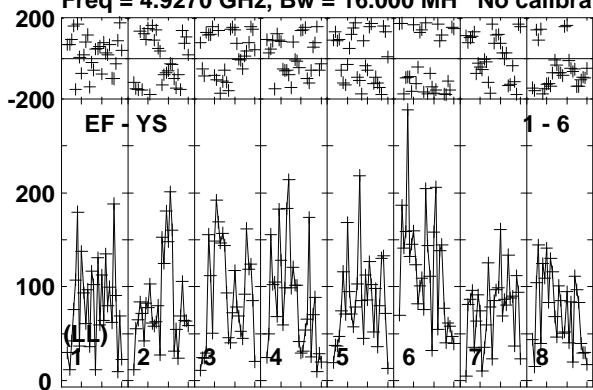

Lower frame: Micro Ampl Jy Top frame: Phas deg
Vector averaged cross-power spectrum Baseline: EF (01) - YS (06)
Timerange: 01/05:27:13 to 01/05:30:39

Plot file version 343 created 26-MAR-2015 15:27:55

J2113+4012 EG082E.UVDATA.1

Freq = 4.9270 GHz, Bw = 16.000 MH No calibration applied and no bandpass applied

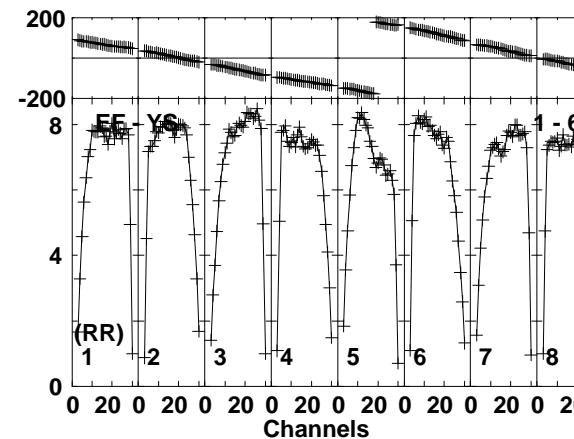
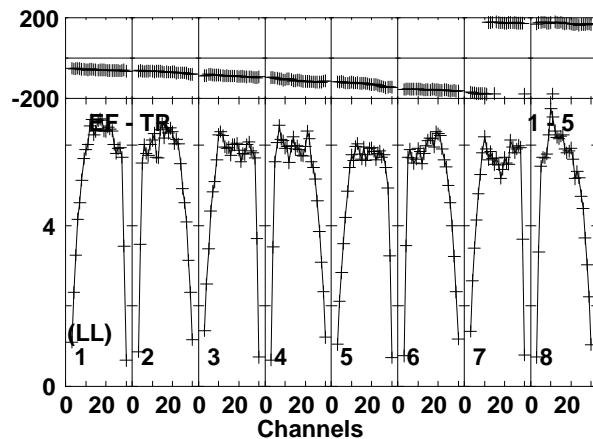
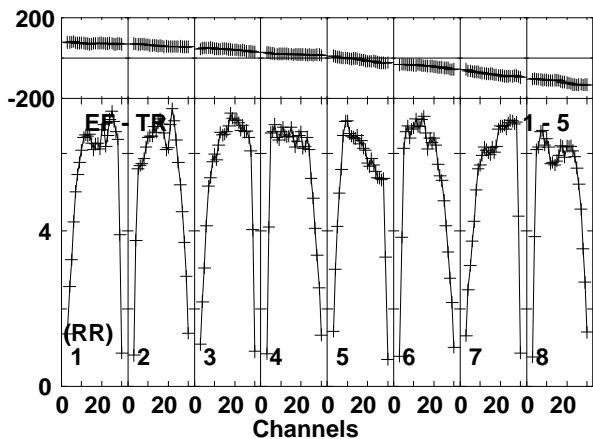
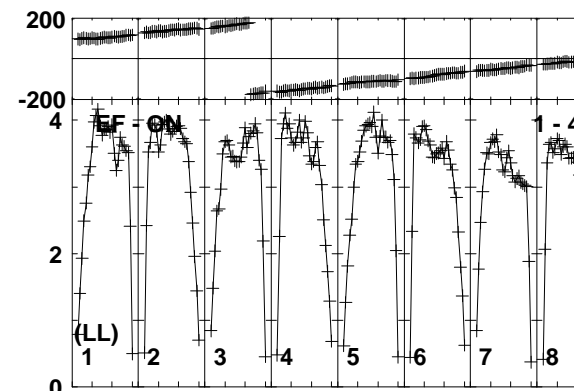
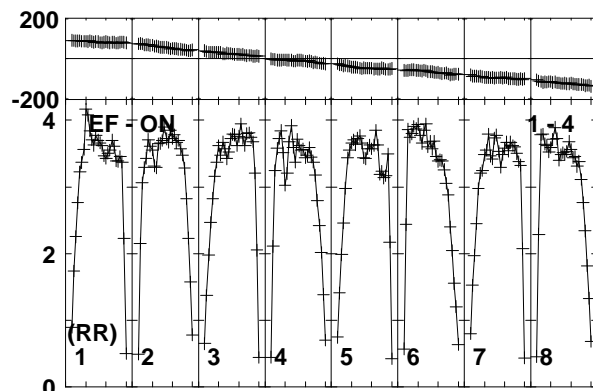
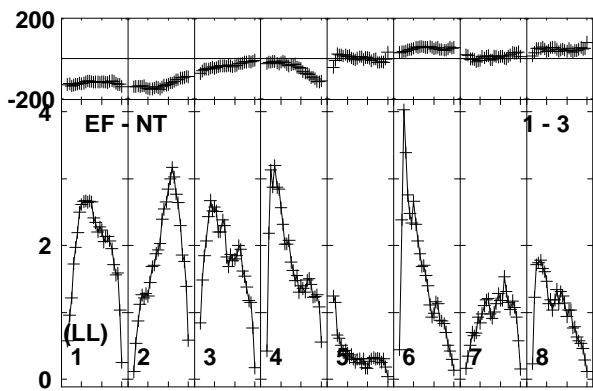
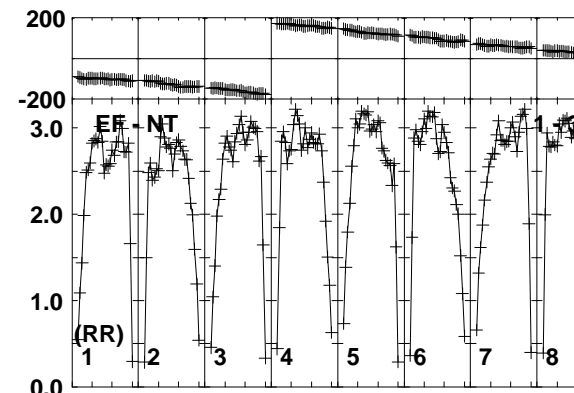
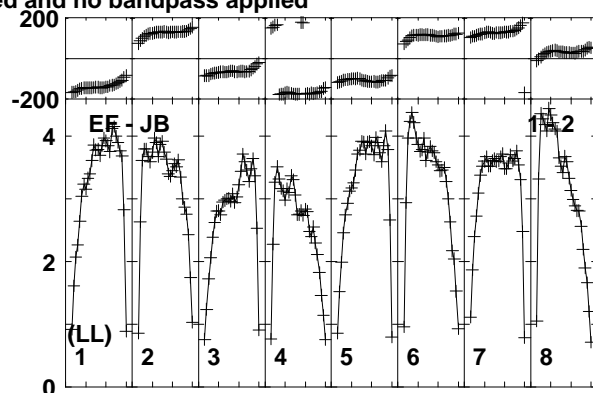
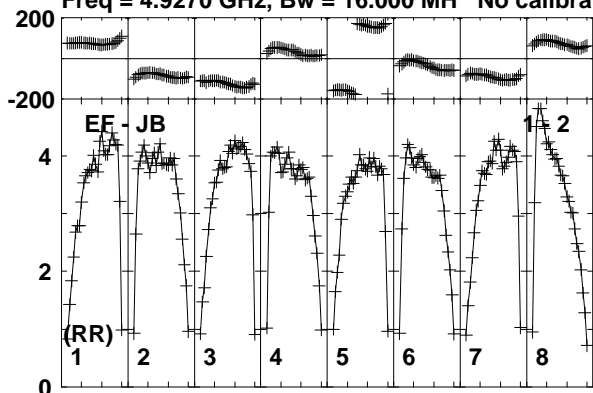

Lower frame: Milli Ampl Jy Top frame: Phas deg
Vector averaged cross-power spectrum Baseline: EF (01) - JB (02)
Timerange: 01/05:31:13 to 01/05:32:09

Plot file version 344 created 26-MAR-2015 15:27:55

J2113+4012 EG082E.UVDATA.1

Freq = 4.9270 GHz, Bw = 16.000 MH No calibration applied and no bandpass applied

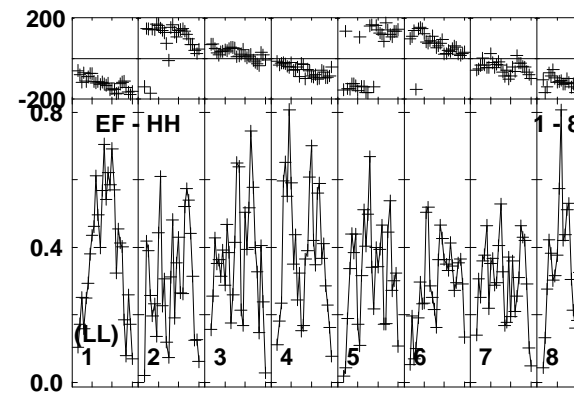
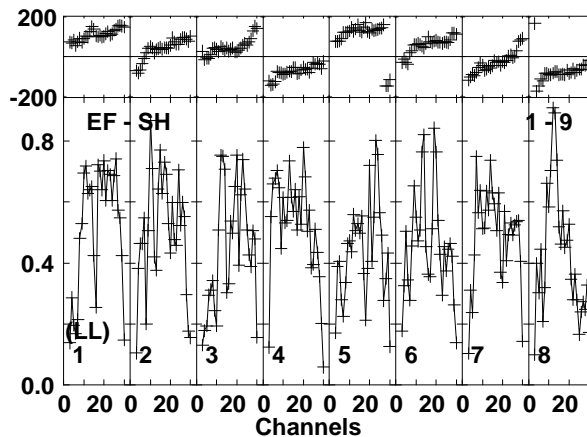
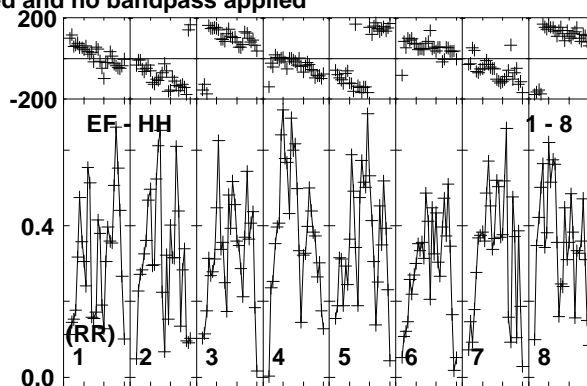
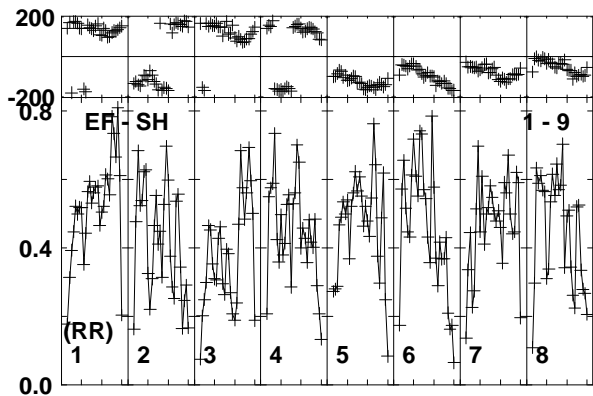
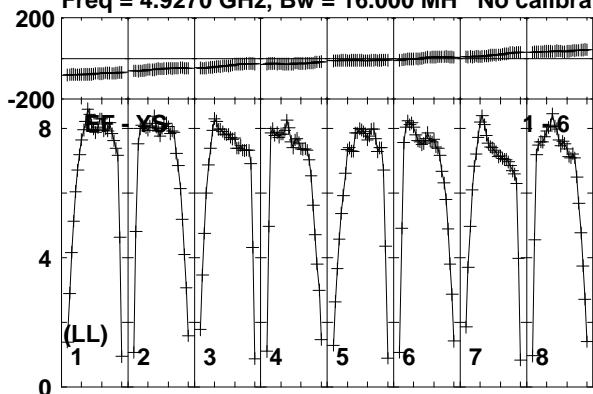

Lower frame: Milli Ampl Jy Top frame: Phas deg
Vector averaged cross-power spectrum Baseline: EF (01) - YS (06)
Timerange: 01/05:31:13 to 01/05:32:09

Plot file version 345 created 26-MAR-2015 15:27:55

J2115+3742 EG082E.UVDATA.1

Freq = 4.9270 GHz, Bw = 16.000 MH No calibration applied and no bandpass applied

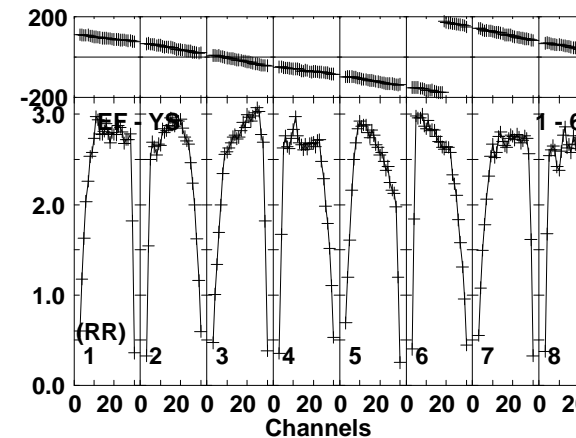
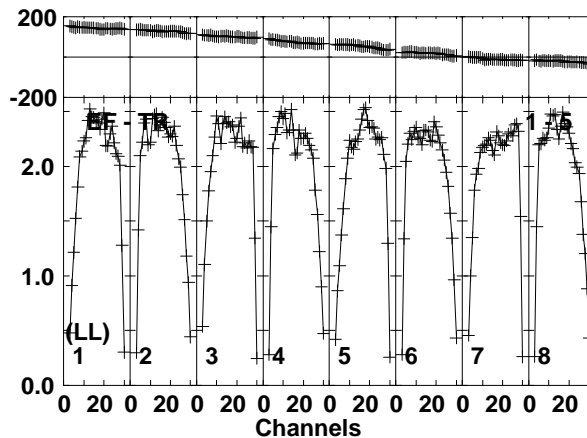
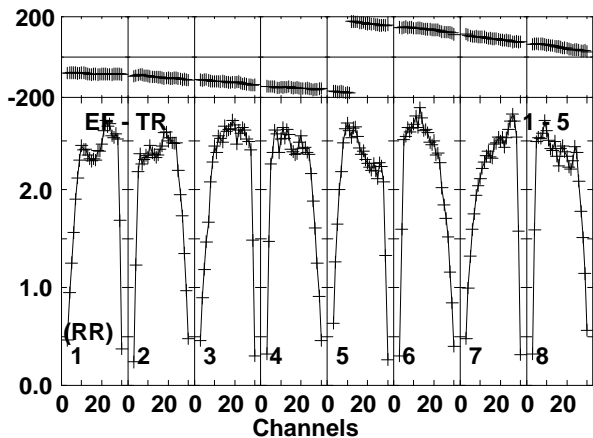
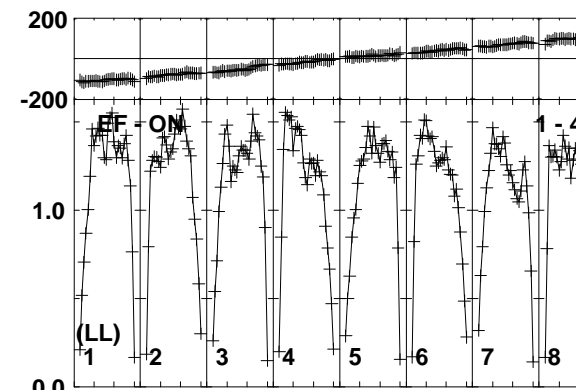
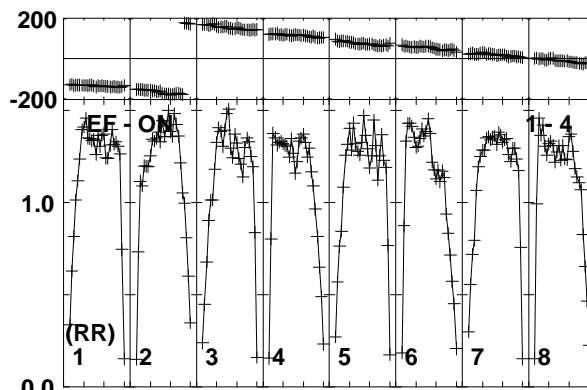
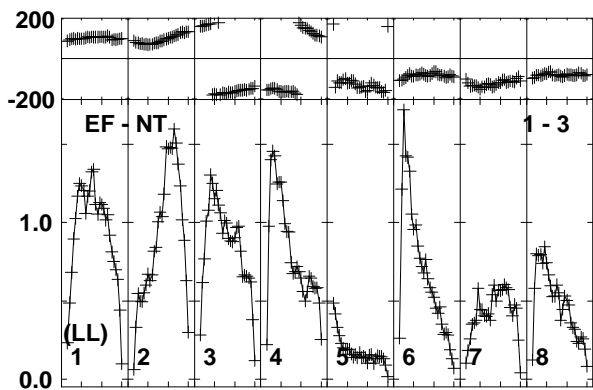
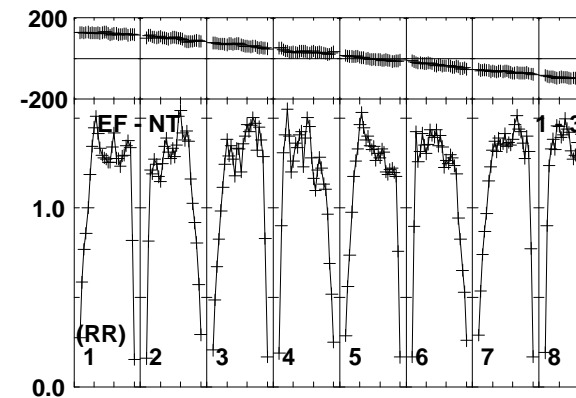
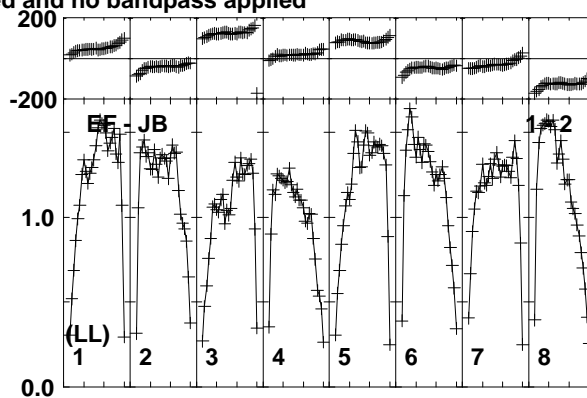
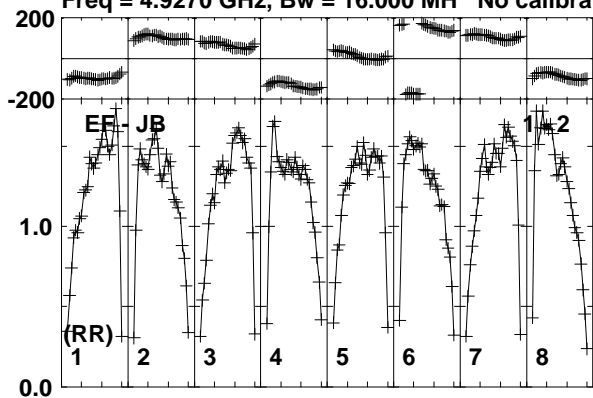

Lower frame: Milli Ampl Jy Top frame: Phas deg
Vector averaged cross-power spectrum Baseline: EF (01) - JB (02)
Timerange: 01/05:32:13 to 01/05:35:39

Plot file version 346 created 26-MAR-2015 15:27:55

J2115+3742 EG082E.UVDATA.1

Freq = 4.9270 GHz, Bw = 16.000 MH No calibration applied and no bandpass applied

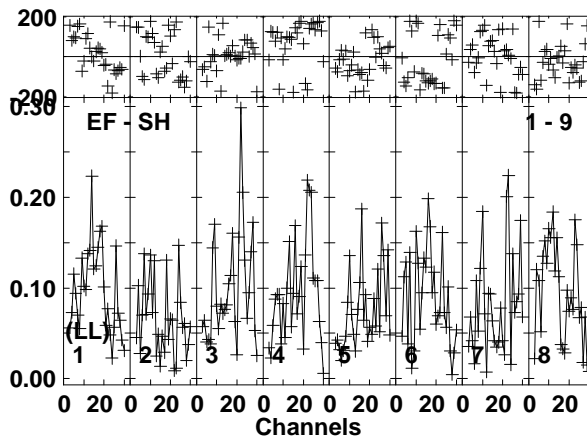
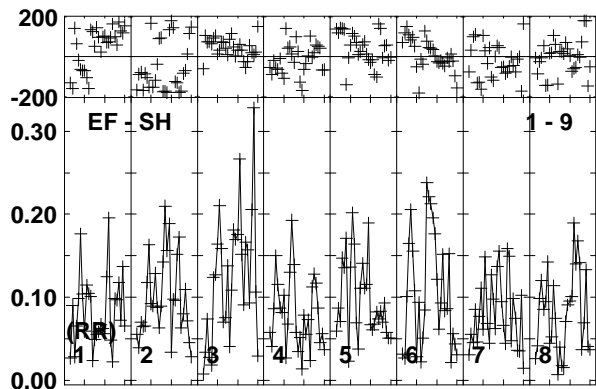
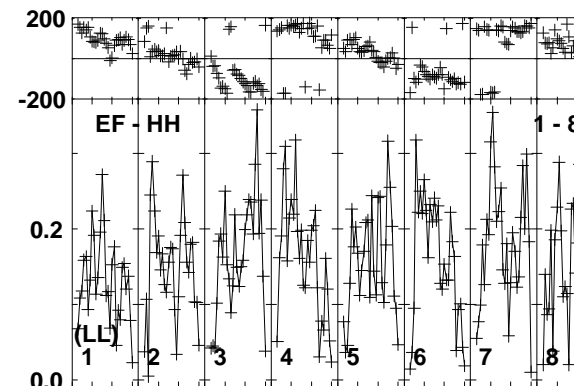
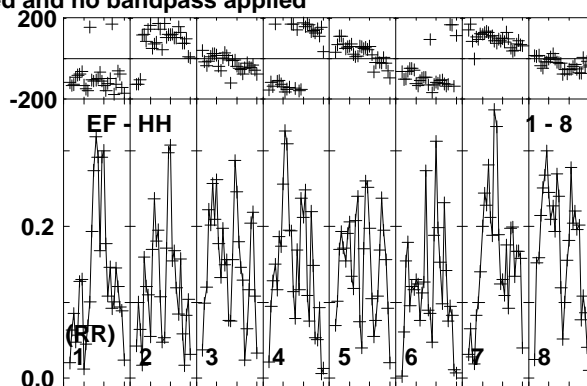
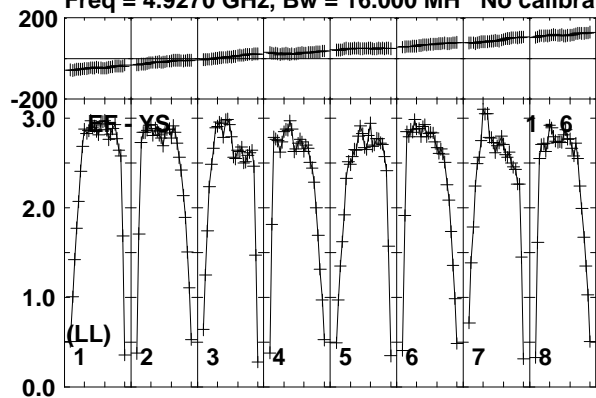

Lower frame: Milli Ampl Jy Top frame: Phas deg
Vector averaged cross-power spectrum Baseline: EF (01) - YS (06)
Timerange: 01/05:32:13 to 01/05:35:39

Plot file version 347 created 26-MAR-2015 15:27:55

J2113+4012 EG082E.UVDATA.1

Freq = 4.9270 GHz, Bw = 16.000 MH No calibration applied and no bandpass applied

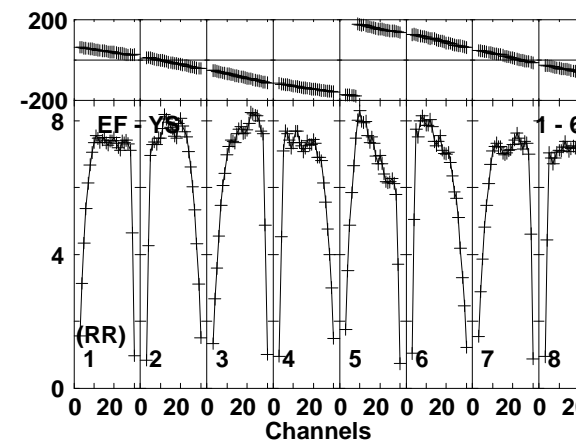
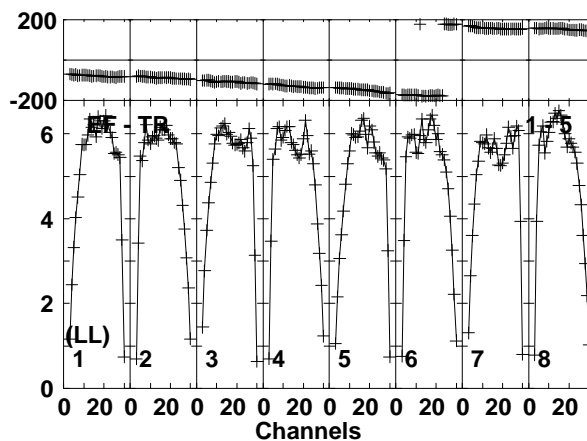
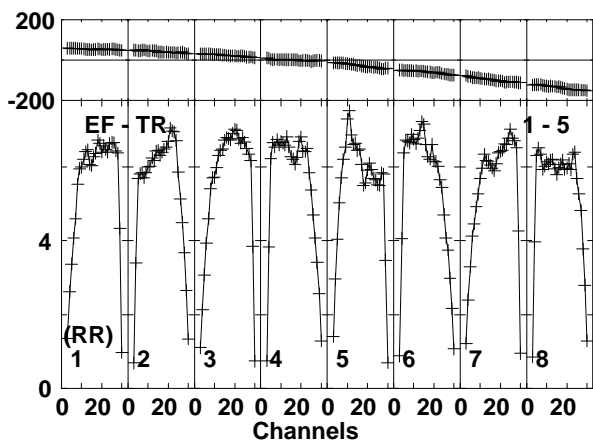
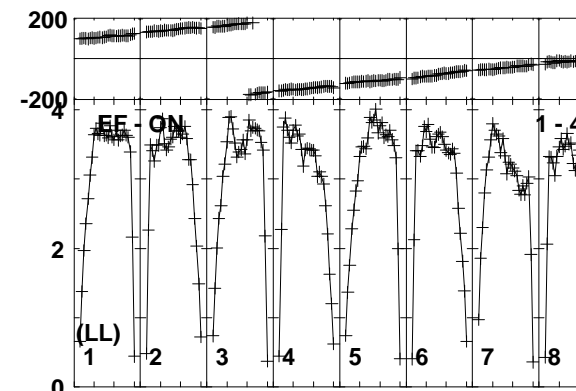
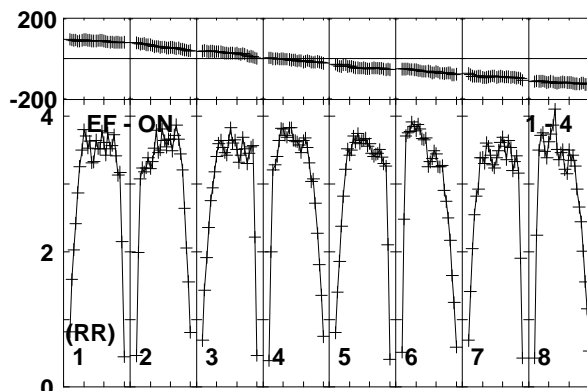
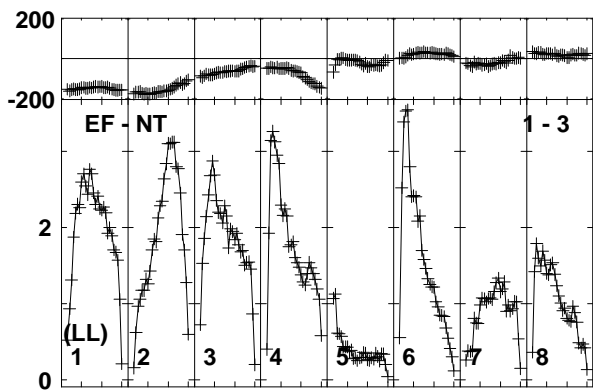
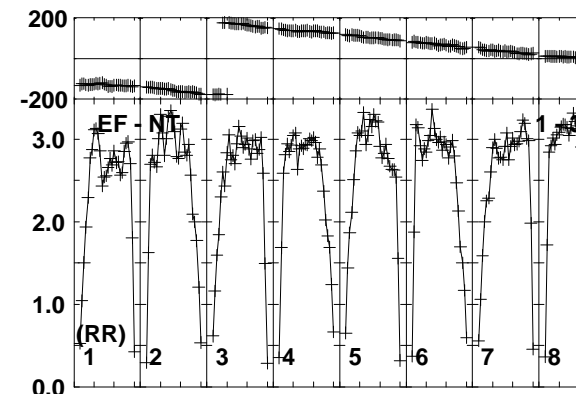
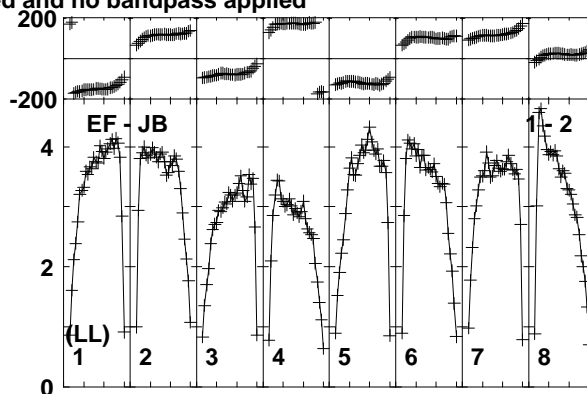
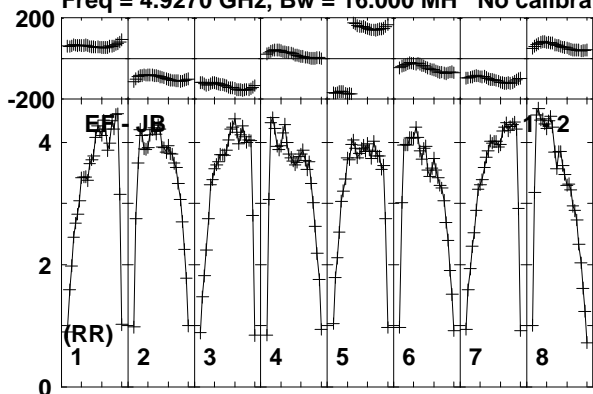

Lower frame: Milli Ampl Jy Top frame: Phas deg
Vector averaged cross-power spectrum Baseline: EF (01) - JB (02)
Timerange: 01/05:35:43 to 01/05:37:09

Plot file version 348 created 26-MAR-2015 15:27:56

J2113+4012 EG082E.UVDATA.1

Freq = 4.9270 GHz, Bw = 16.000 MH No calibration applied and no bandpass applied

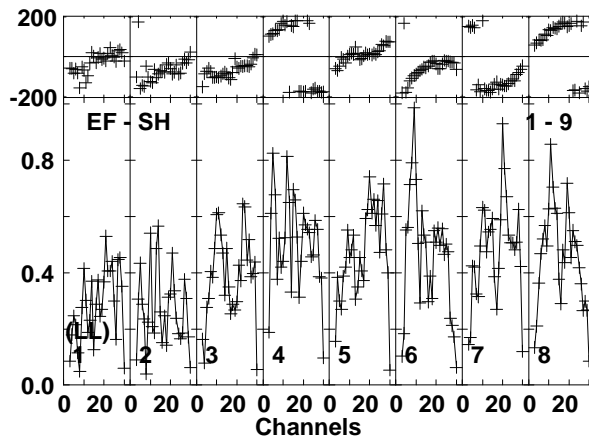
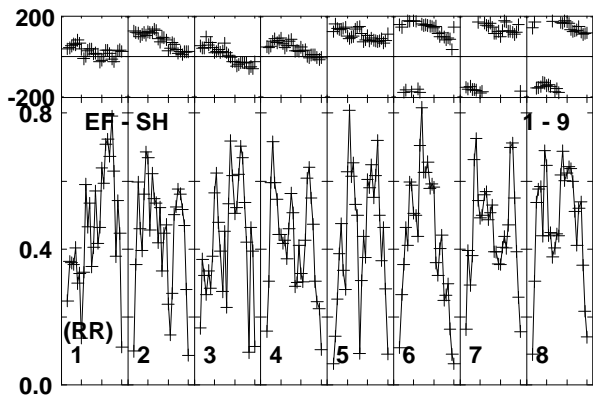
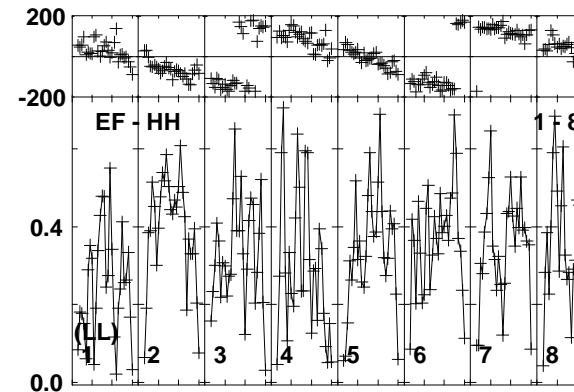
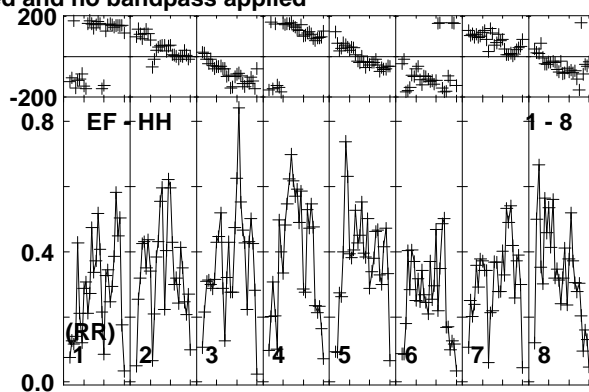
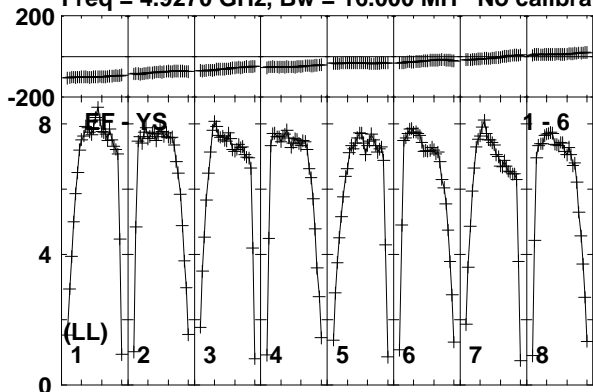

Lower frame: Milli Ampl Jy Top frame: Phas deg
Vector averaged cross-power spectrum Baseline: EF (01) - YS (06)
Timerange: 01/05:35:43 to 01/05:37:09

Plot file version 349 created 26-MAR-2015 15:27:56

J2202+4216 EG082E.UVDATA.1

Freq = 4.9270 GHz, Bw = 16.000 MH No calibration applied and no bandpass applied

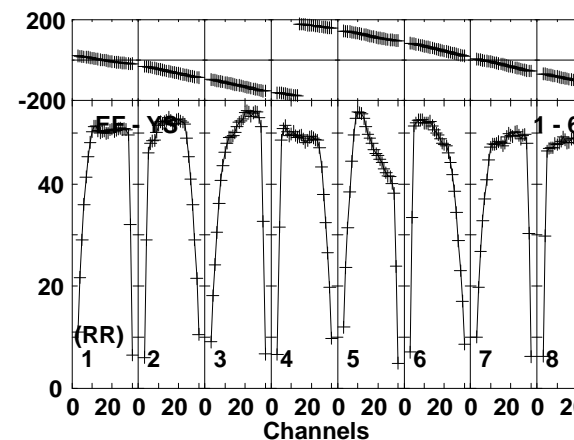
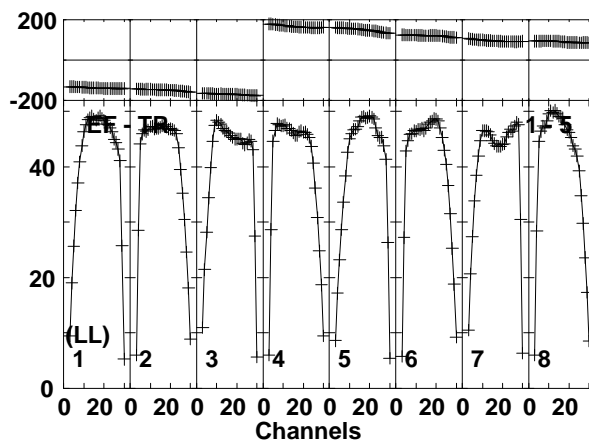
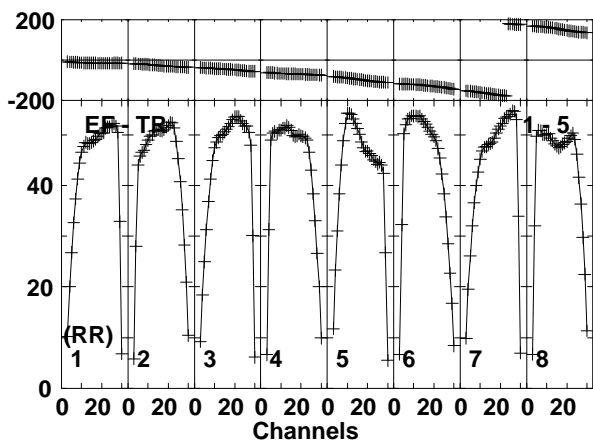
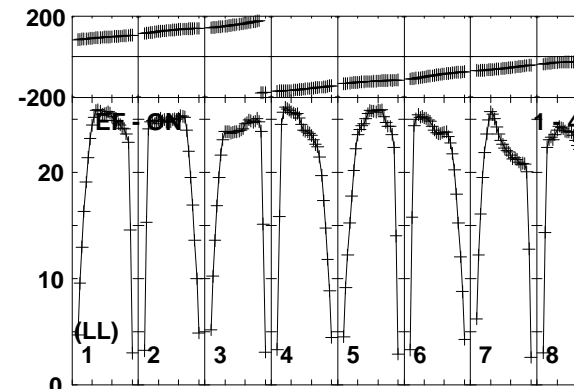
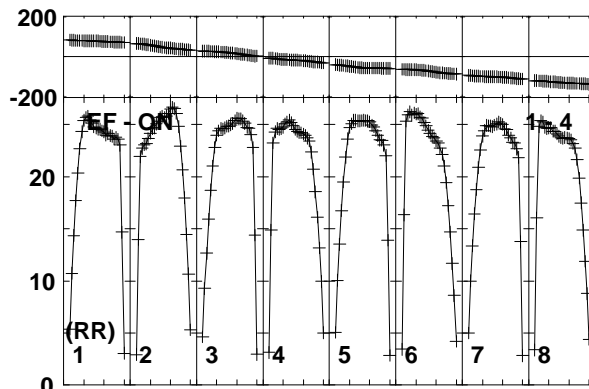
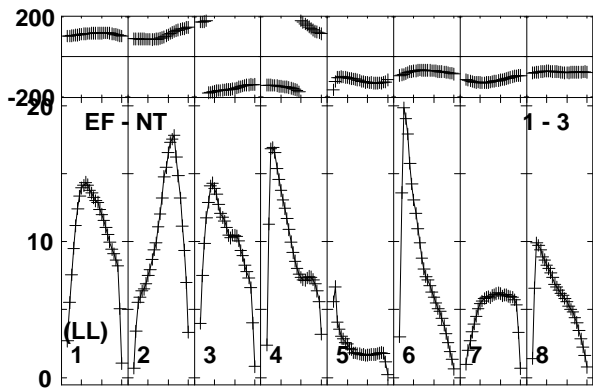
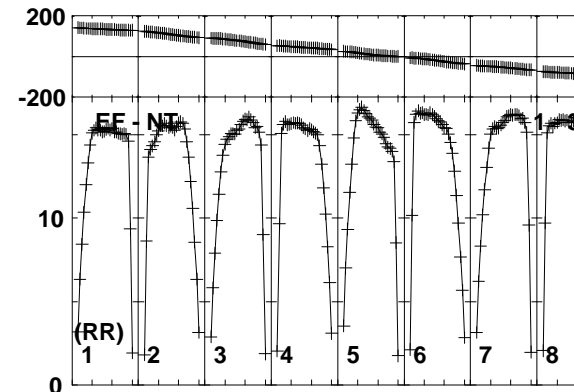
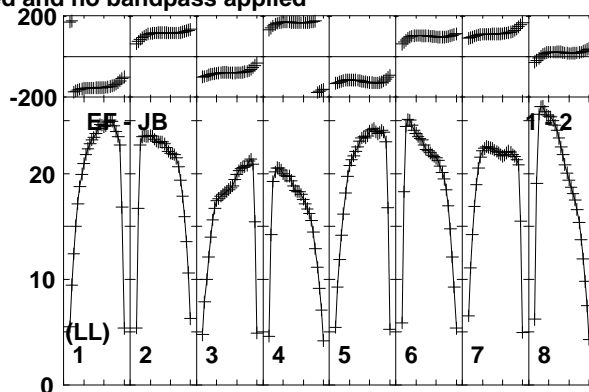
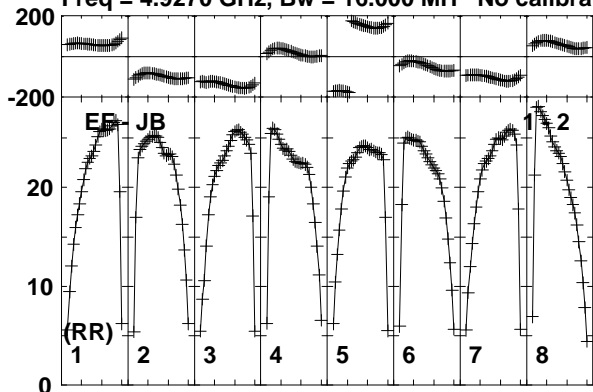

Lower frame: Milli Ampl Jy Top frame: Phas deg
Vector averaged cross-power spectrum Baseline: EF (01) - JB (02)
Timerange: 01/05:38:23 to 01/05:43:19

Plot file version 350 created 26-MAR-2015 15:27:56

J2202+4216 EG082E.UVDATA.1

Freq = 4.9270 GHz, Bw = 16.000 MH No calibration applied and no bandpass applied

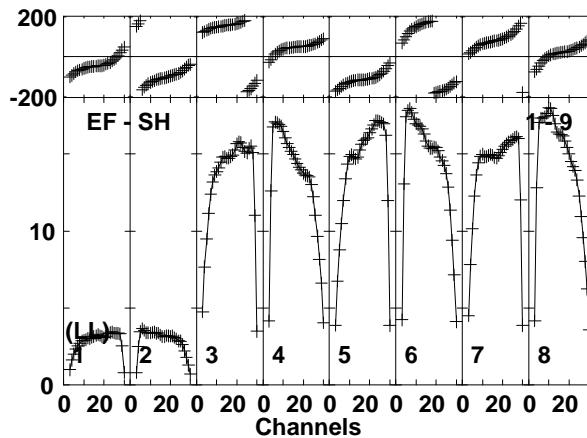
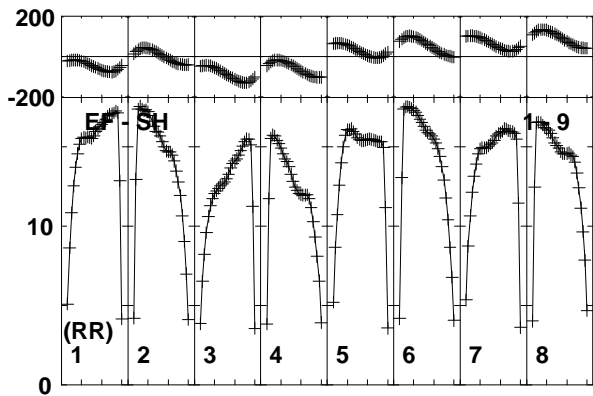
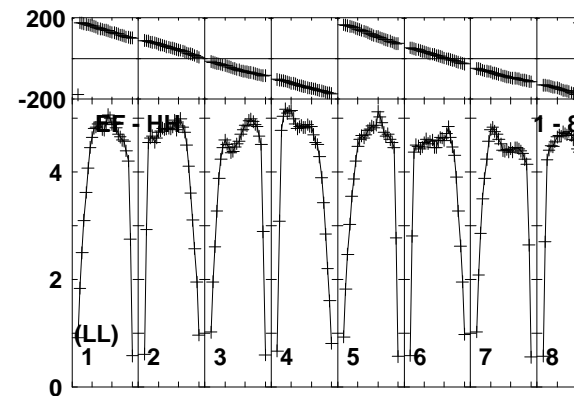
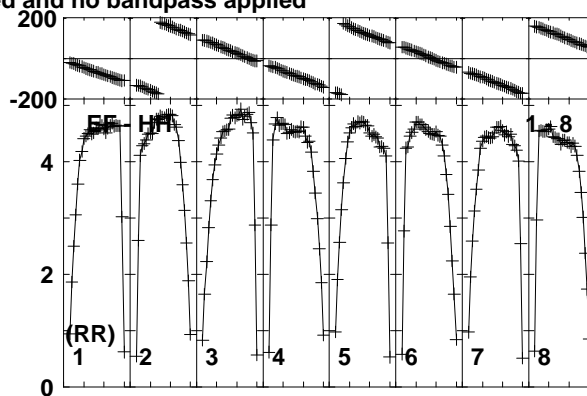
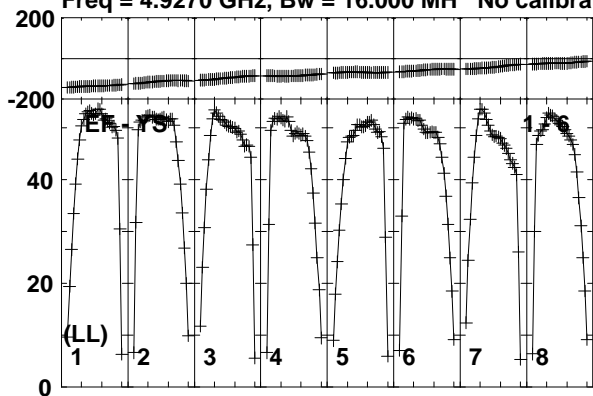

Lower frame: Milli Ampl Jy Top frame: Phas deg
Vector averaged cross-power spectrum Baseline: EF (01) - YS (06)
Timerange: 01/05:38:23 to 01/05:43:19

Plot file version 351 created 26-MAR-2015 15:27:56

J1504+1029 EG082E.UVDATA.1

Freq = 4.9270 GHz, Bw = 16.000 MH No calibration applied and no bandpass applied

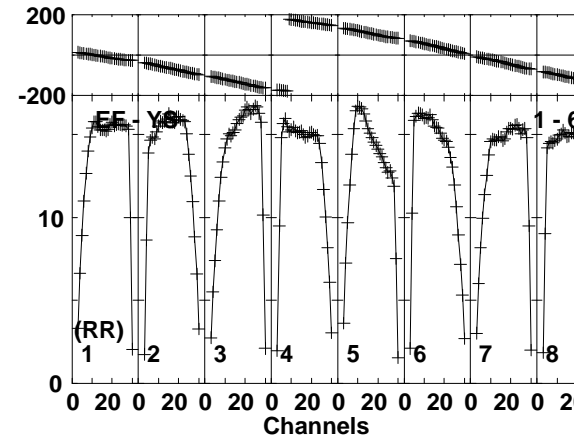
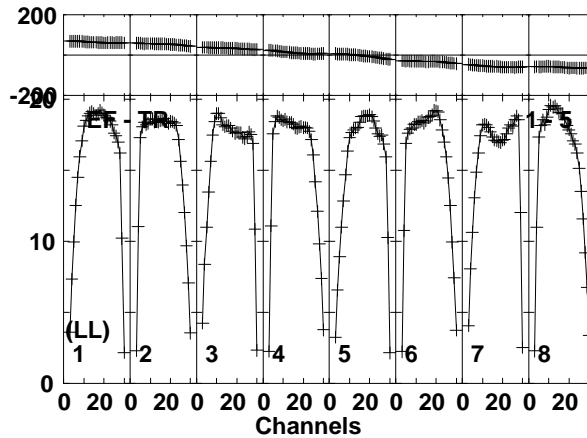
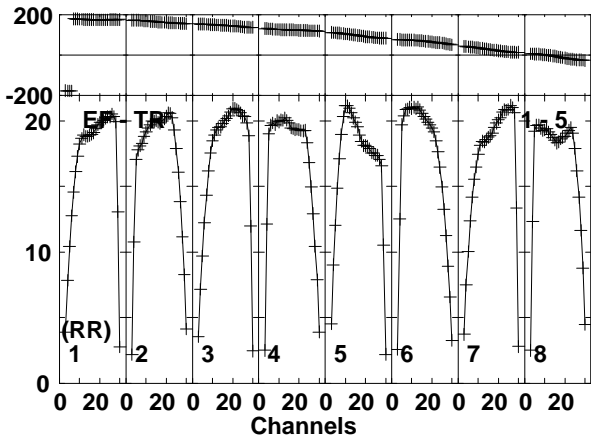
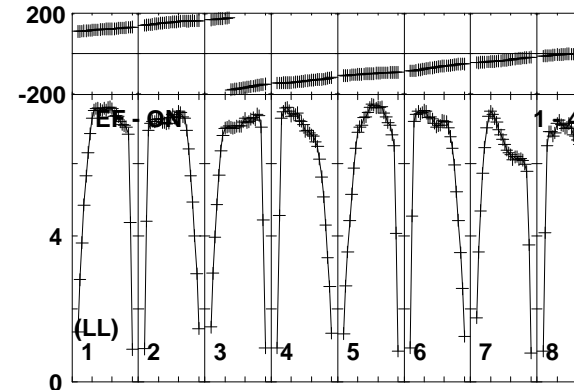
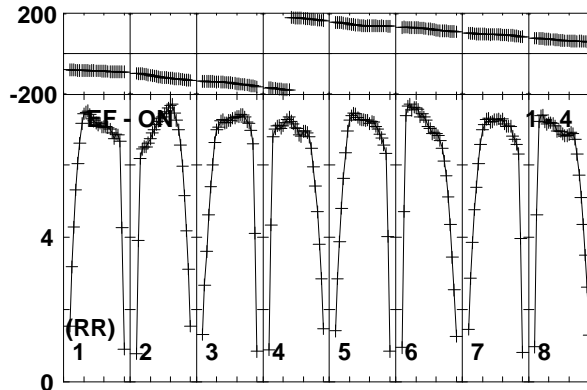
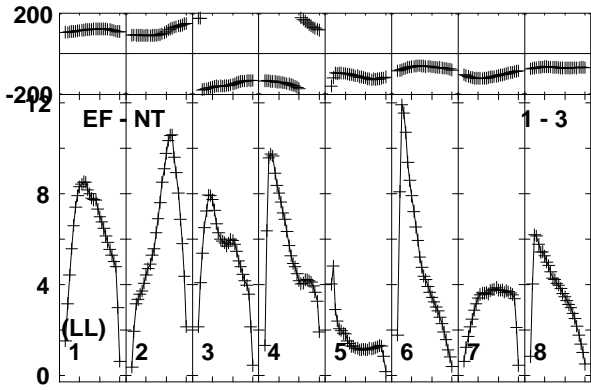
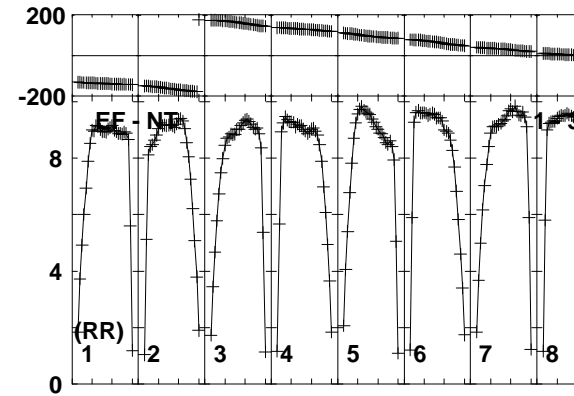
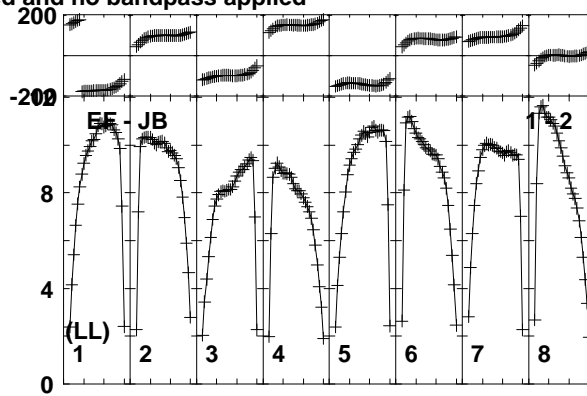
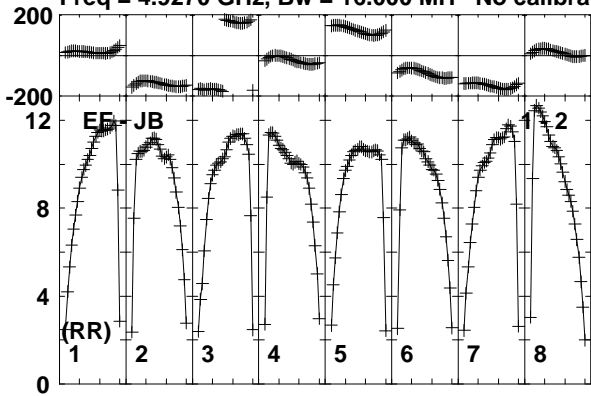

Lower frame: Milli Ampl Jy Top frame: Phas deg
Vector averaged cross-power spectrum Baseline: EF (01) - JB (02)
Timerange: 01/05:51:29 to 01/05:56:29

Plot file version 352 created 26-MAR-2015 15:27:56

J1504+1029 EG082E.UVDATA.1

Freq = 4.9270 GHz, Bw = 16.000 MH No calibration applied and no bandpass applied

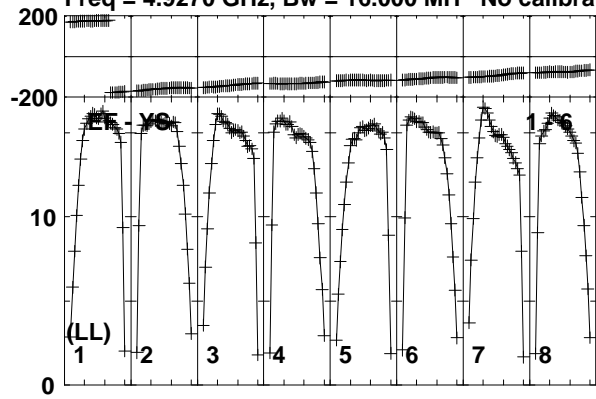

Lower frame: Milli Ampl Jy Top frame: Phas deg
Vector averaged cross-power spectrum Baseline: EF (01) - YS (06)
Timerange: 01/05:51:29 to 01/05:56:29

Plot file version 353 created 26-MAR-2015 15:27:56

J1455+2131 EG082E.UVDATA.1

Freq = 4.9270 GHz, Bw = 16.000 MH No calibration applied and no bandpass applied

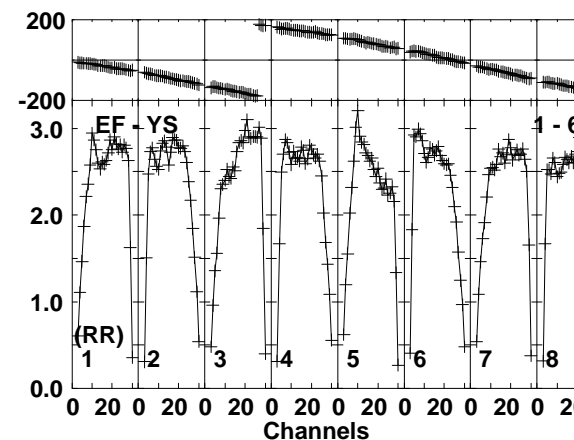
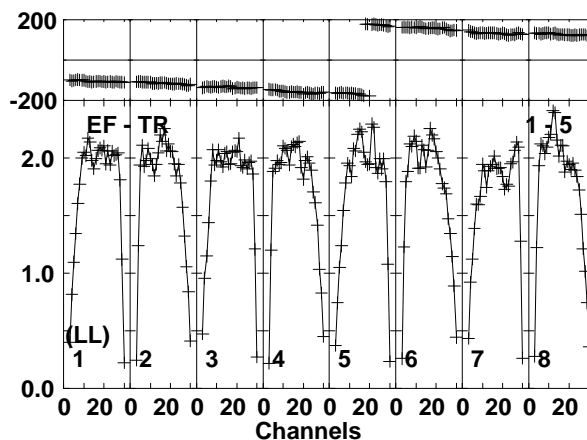
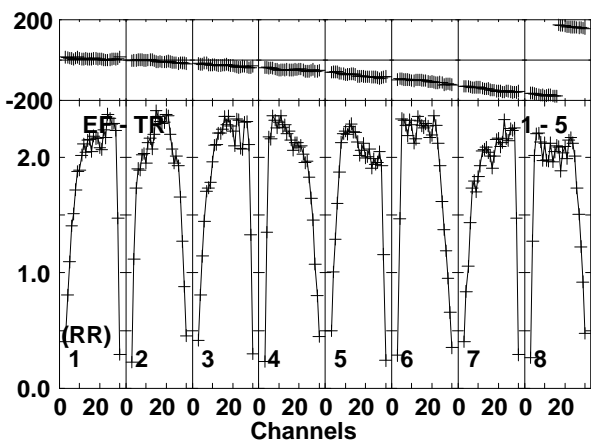
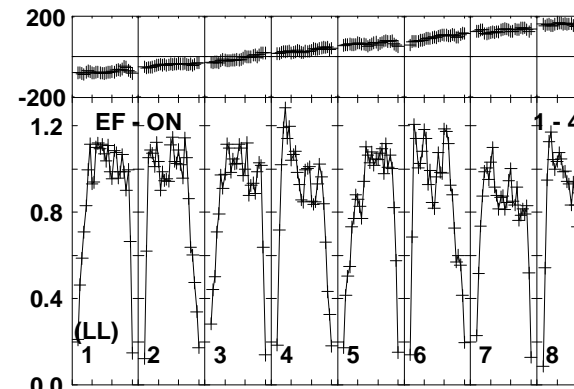
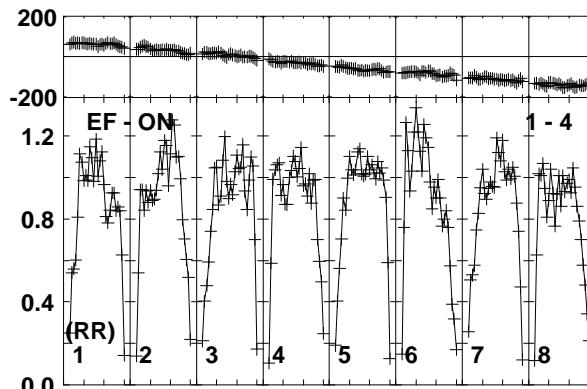
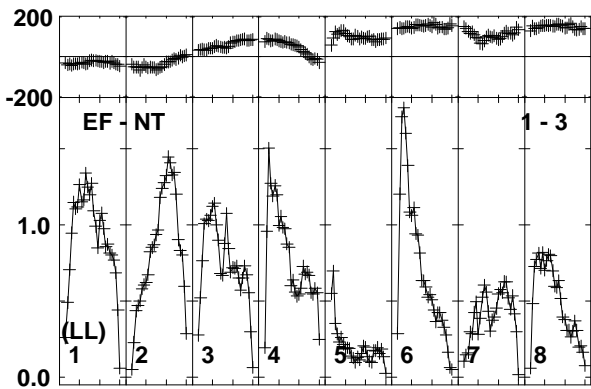
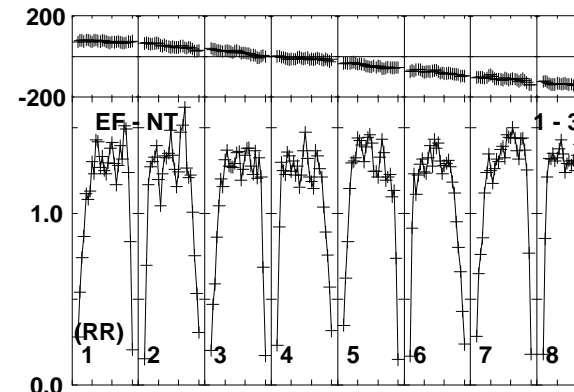
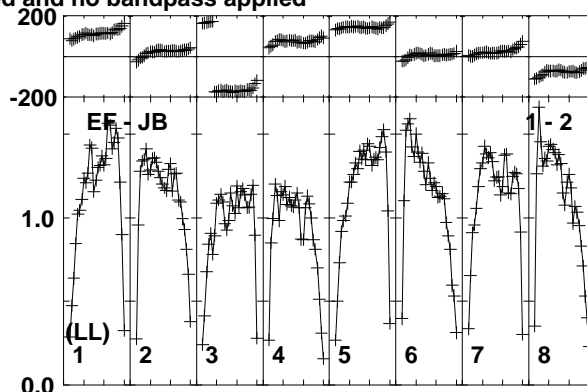
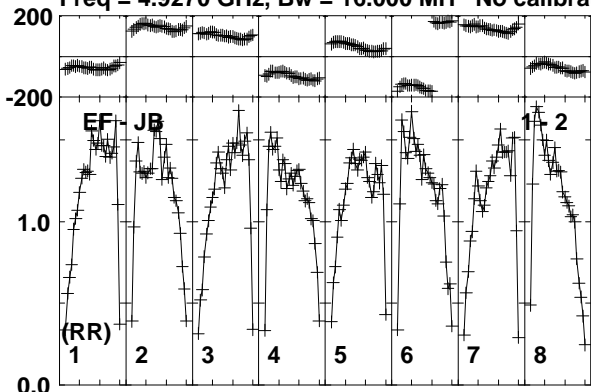

Lower frame: Milli Ampl Jy Top frame: Phas deg
Vector averaged cross-power spectrum Baseline: EF (01) - JB (02)
Timerange: 01/05:57:43 to 01/05:59:39

Plot file version 354 created 26-MAR-2015 15:27:56

J1455+2131 EG082E.UVDATA.1

Freq = 4.9270 GHz, Bw = 16.000 MH No calibration applied and no bandpass applied

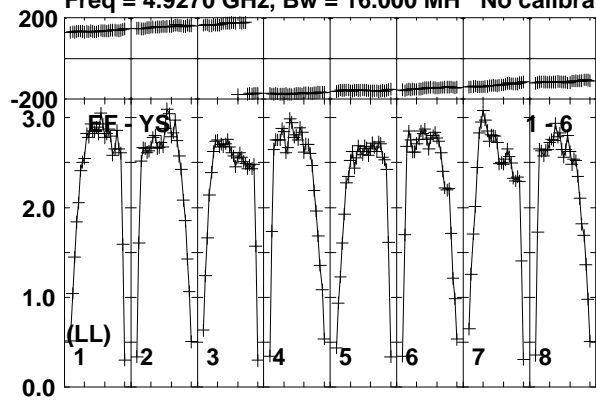

Lower frame: Milli Ampl Jy Top frame: Phas deg
Vector averaged cross-power spectrum Baseline: EF (01) - YS (06)
Timerange: 01/05:57:43 to 01/05:59:39

Plot file version 355 created 26-MAR-2015 15:27:56

J1504+2218 EG082E.UVDATA.1

Freq = 4.9270 GHz, Bw = 16.000 MH No calibration applied and no bandpass applied

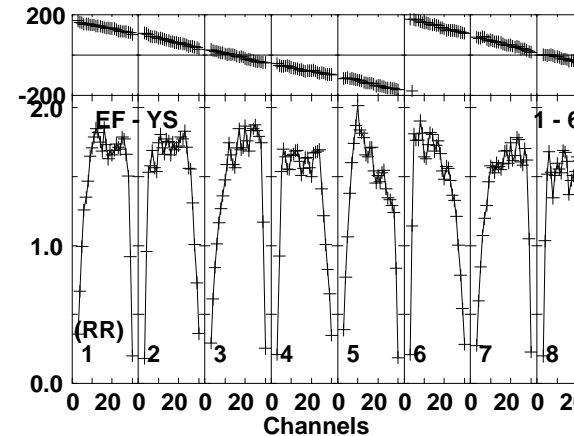
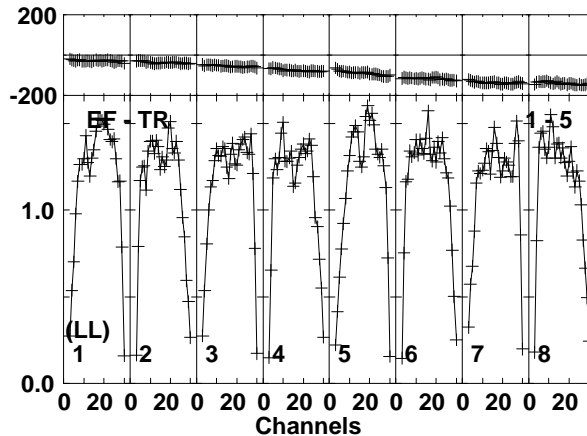
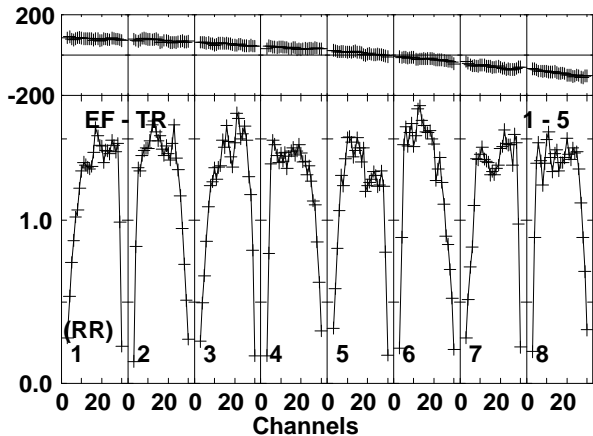
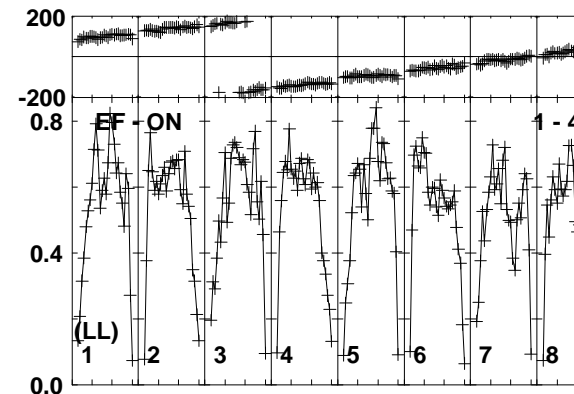
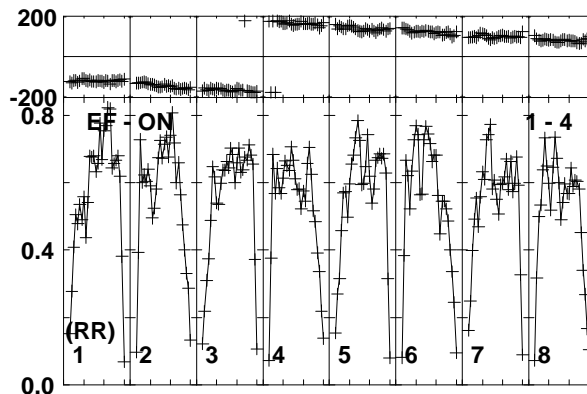
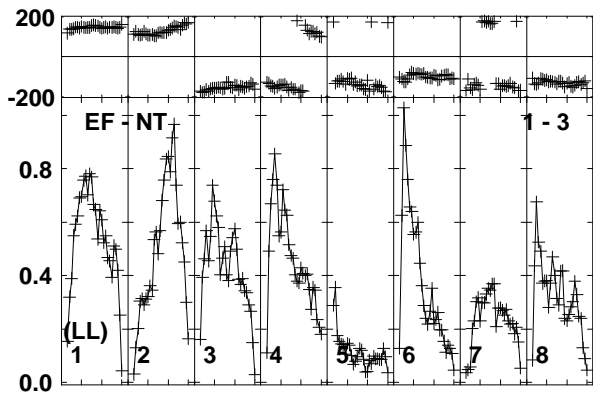
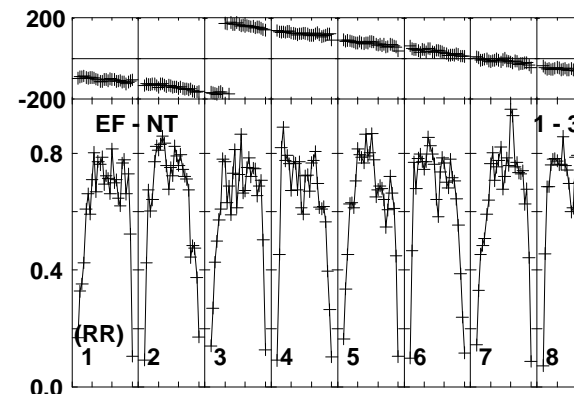
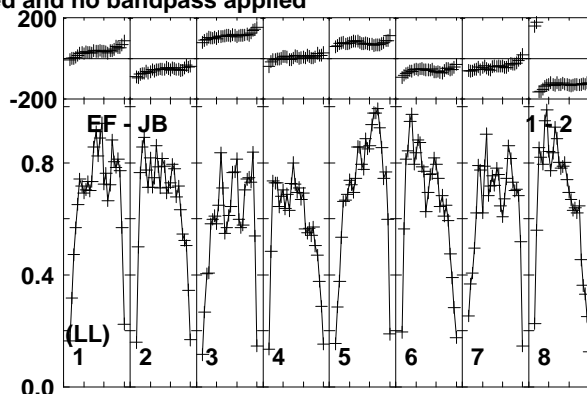
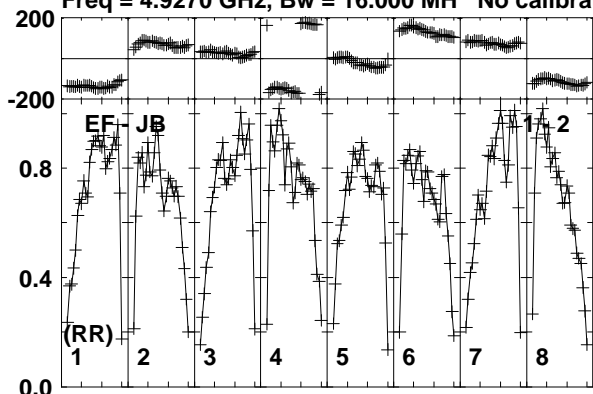

Lower frame: Milli Ampl Jy Top frame: Phas deg
Vector averaged cross-power spectrum Baseline: EF (01) - JB (02)
Timerange: 01/05:59:43 to 01/06:03:09

Plot file version 356 created 26-MAR-2015 15:27:56
J1504+2218 EG082E.UVDATA.1
Freq = 4.9270 GHz, Bw = 16.000 MH No calibration applied and no bandpass applied

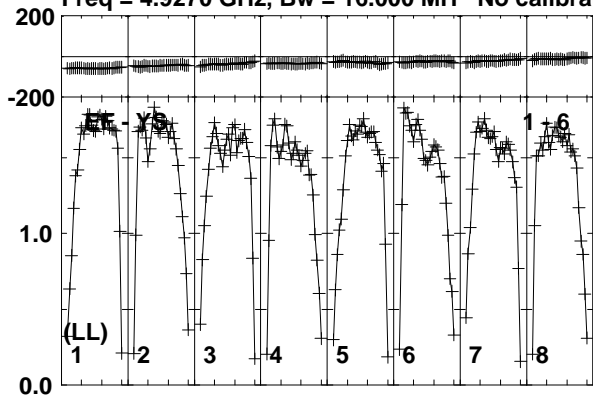

Lower frame: Milli Ampl Jy Top frame: Phas deg
Vector averaged cross-power spectrum Baseline: EF (01) - YS (06)
Timerange: 01/05:59:43 to 01/06:03:09

Plot file version 357 created 26-MAR-2015 15:27:56

J1455+2131 EG082E.UVDATA.1

Freq = 4.9270 GHz, Bw = 16.000 MH No calibration applied and no bandpass applied

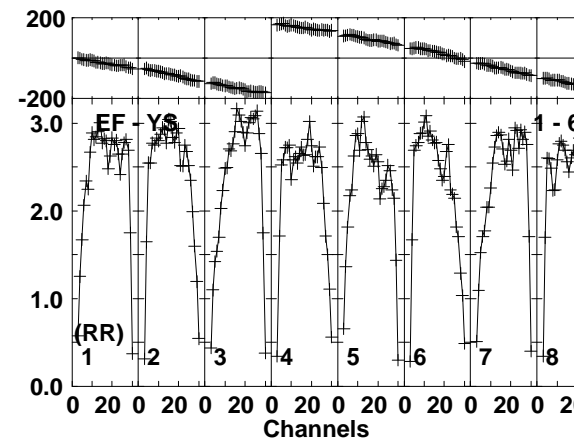
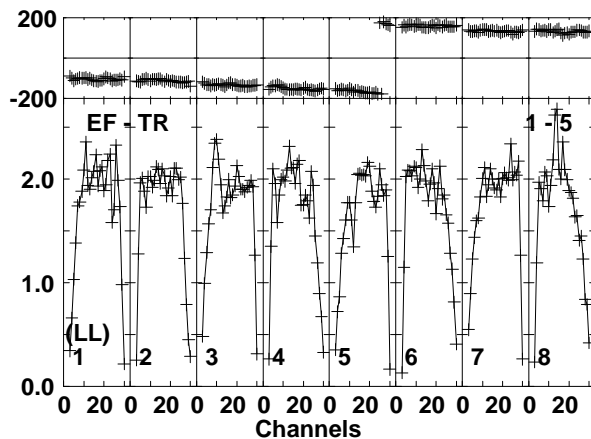
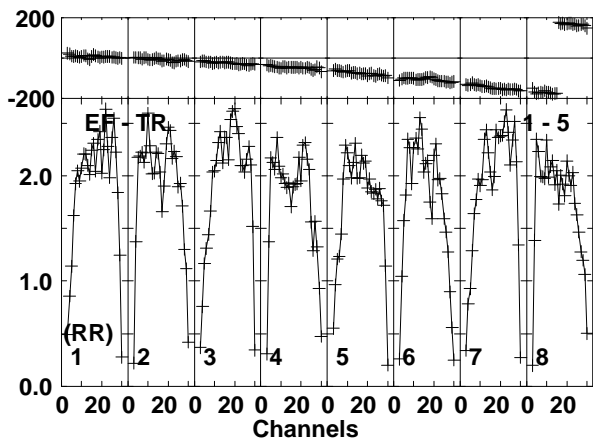
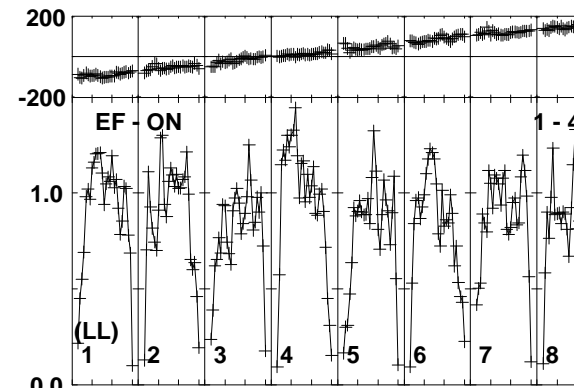
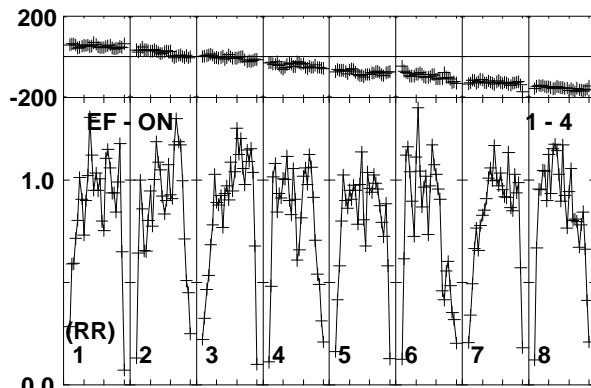
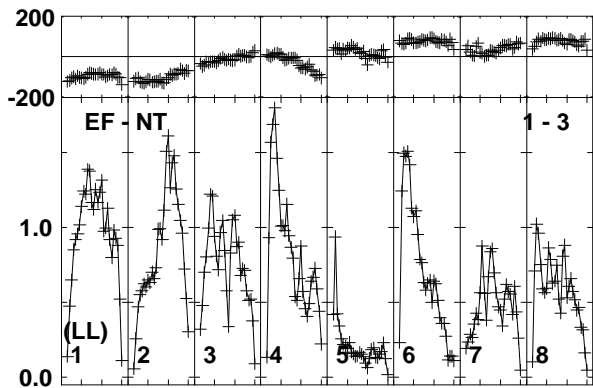
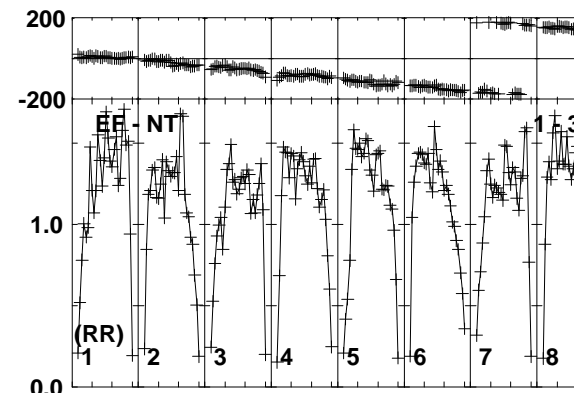
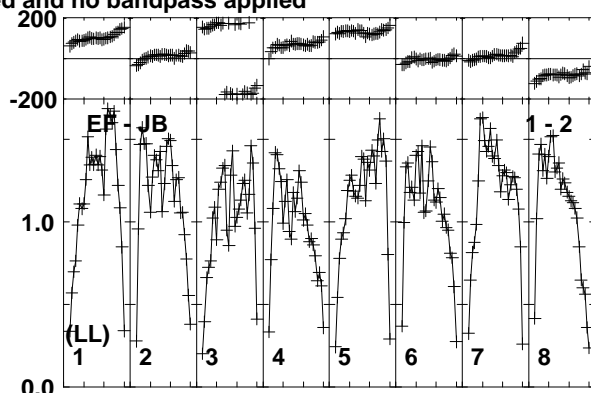
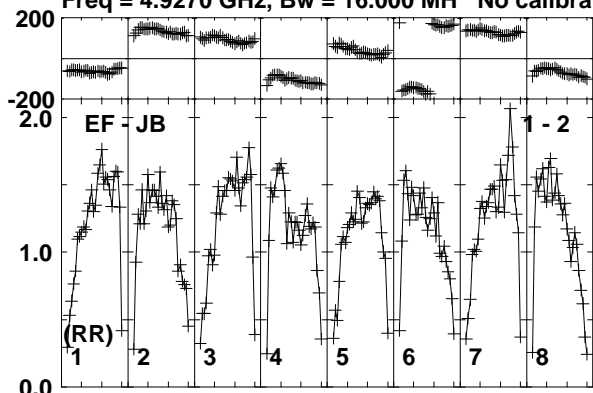

Lower frame: Milli Ampl Jy Top frame: Phas deg
Vector averaged cross-power spectrum Baseline: EF (01) - JB (02)
Timerange: 01/06:03:43 to 01/06:04:39

Plot file version 358 created 26-MAR-2015 15:27:56

J1455+2131 EG082E.UVDATA.1

Freq = 4.9270 GHz, Bw = 16.000 MH No calibration applied and no bandpass applied

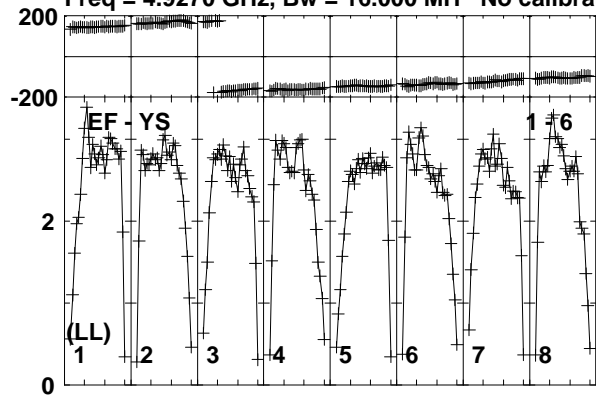

Lower frame: Milli Ampl Jy Top frame: Phas deg
Vector averaged cross-power spectrum Baseline: EF (01) - YS (06)
Timerange: 01/06:03:43 to 01/06:04:39

Plot file version 359 created 26-MAR-2015 15:27:56

TVLM513 EG082E.UVDATA.1

Freq = 4.9270 GHz, Bw = 16.000 MH No calibration applied and no bandpass applied

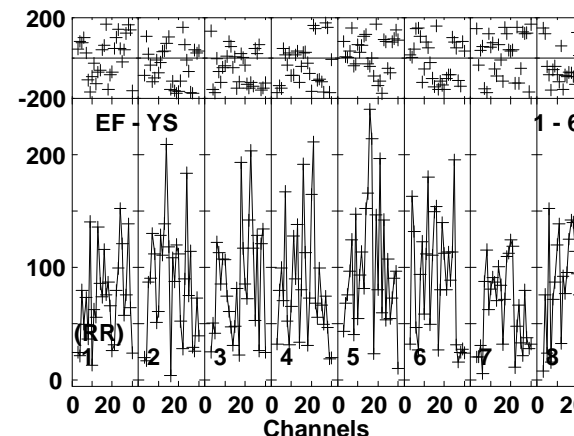
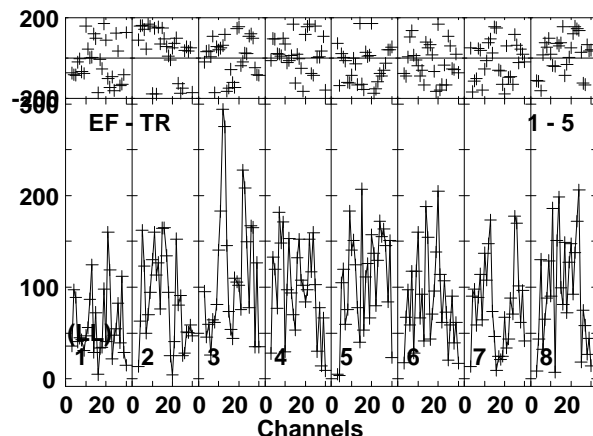
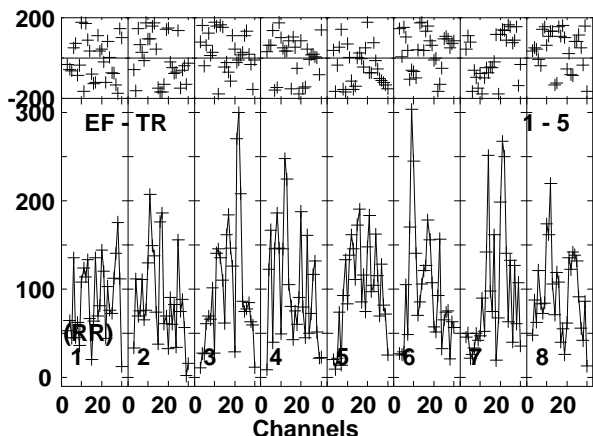
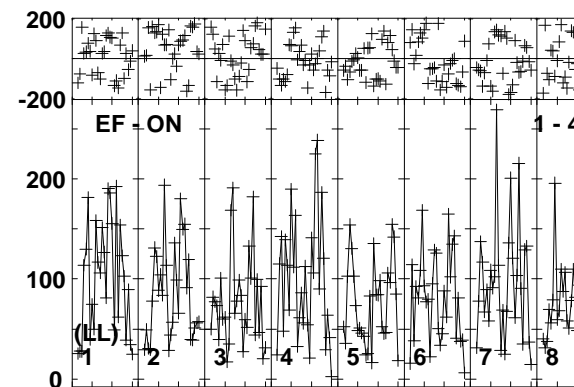
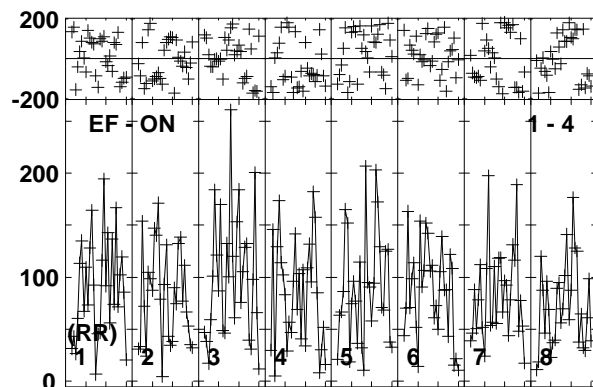
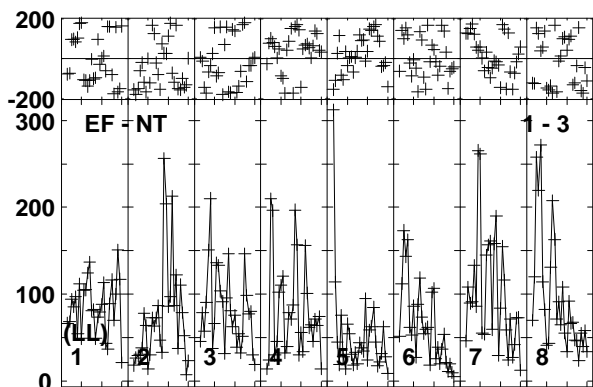
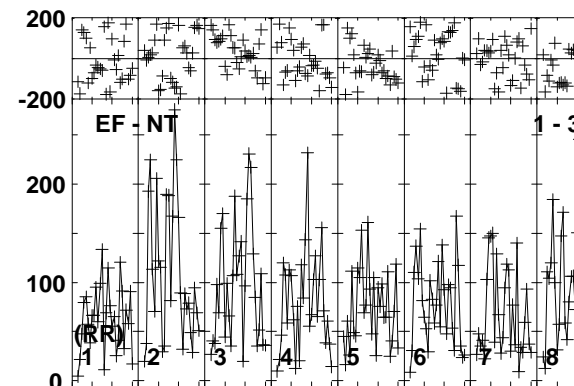
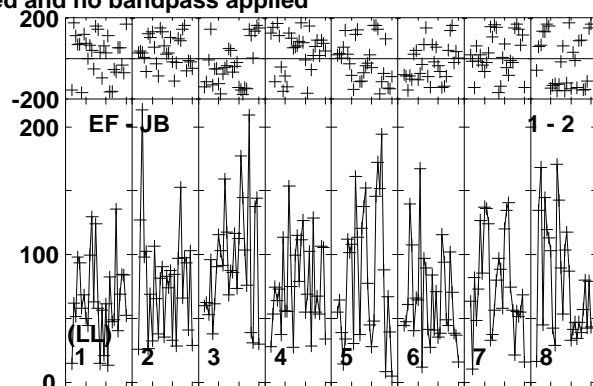
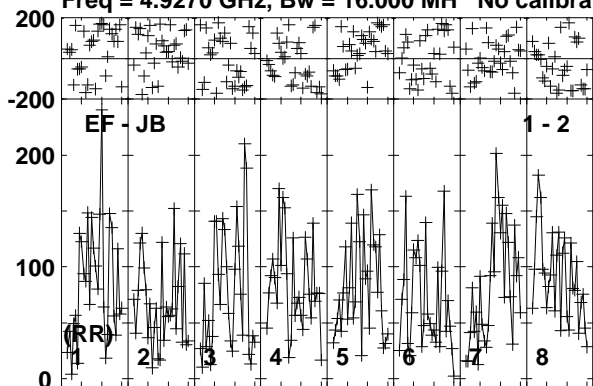

Lower frame: Micro Ampl Jy Top frame: Phas deg
Vector averaged cross-power spectrum Baseline: EF (01) - JB (02)
Timerange: 01/06:04:43 to 01/06:08:09

Plot file version 360 created 26-MAR-2015 15:27:56

TVLM513 EG082E.UVDATA.1

Freq = 4.9270 GHz, Bw = 16.000 MH No calibration applied and no bandpass applied

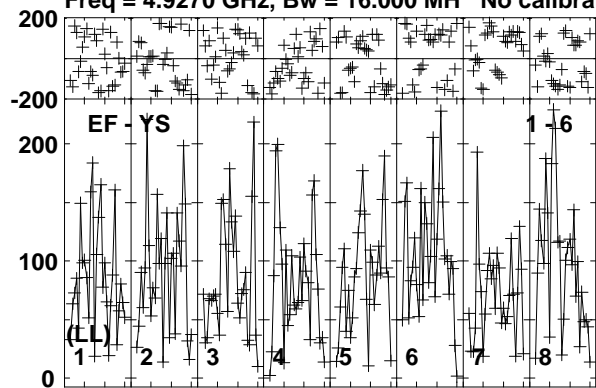

Lower frame: Micro Ampl Jy Top frame: Phas deg
Vector averaged cross-power spectrum Baseline: EF (01) - YS (06)
Timerange: 01/06:04:43 to 01/06:08:09

Plot file version 361 created 26-MAR-2015 15:27:56

J1455+2131 EG082E.UVDATA.1

Freq = 4.9270 GHz, Bw = 16.000 MH No calibration applied and no bandpass applied

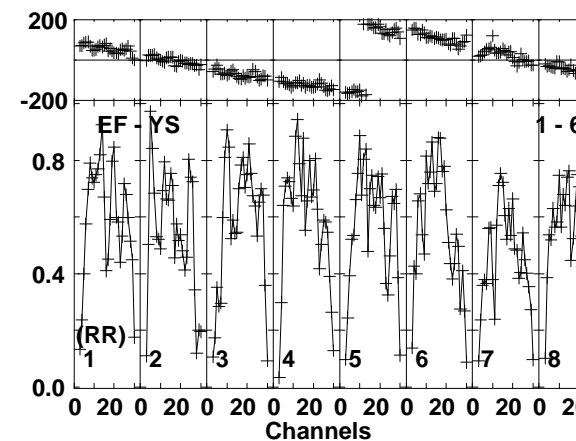
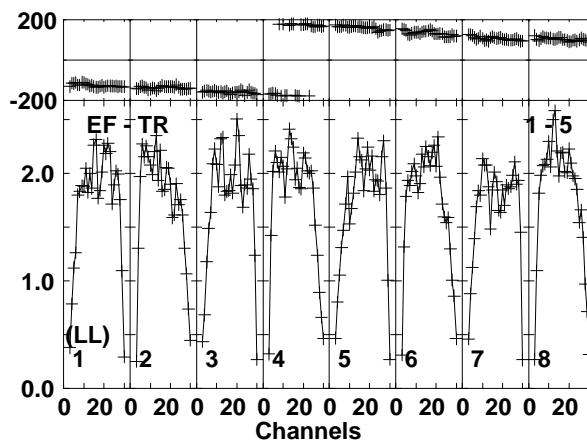
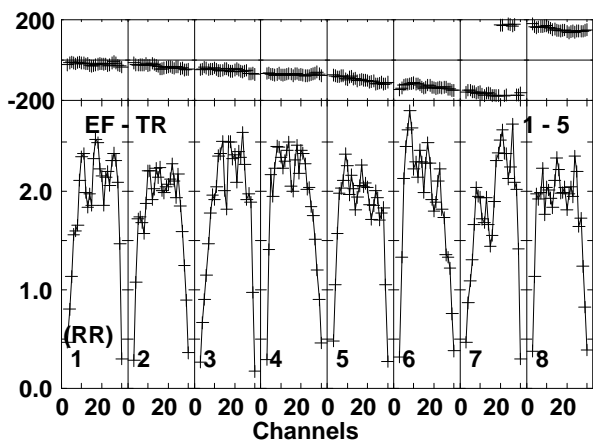
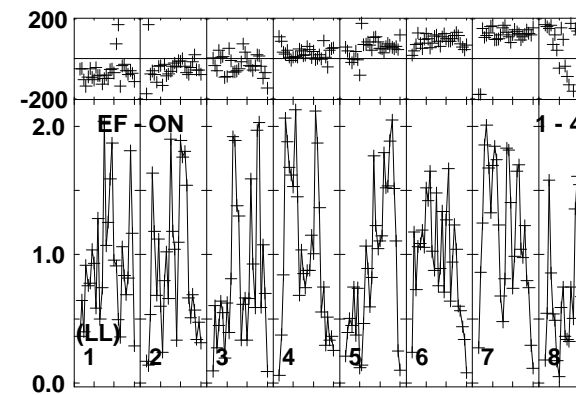
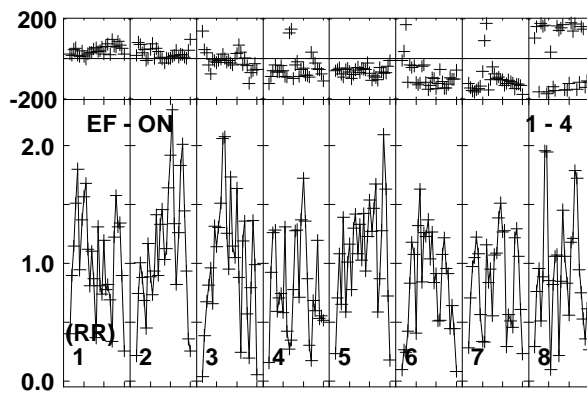
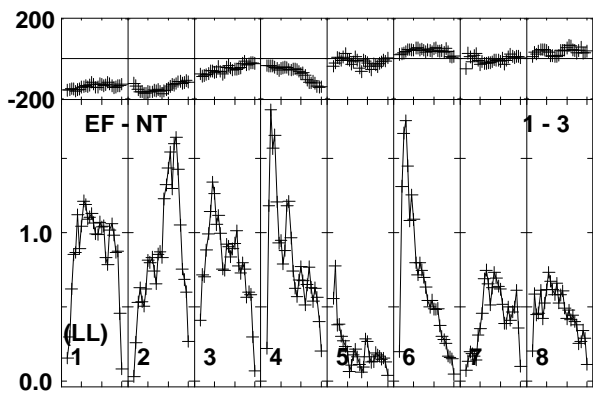
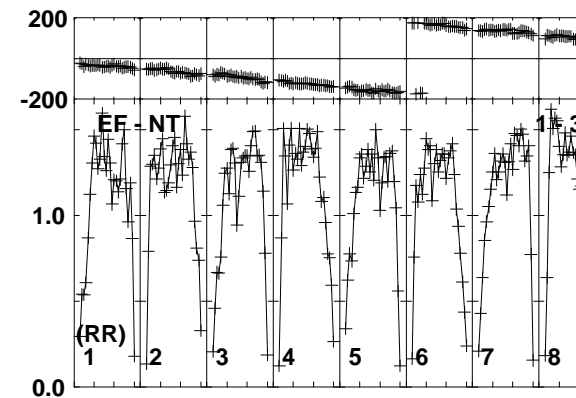
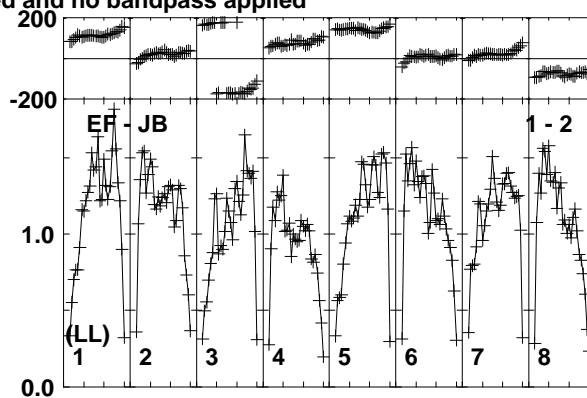
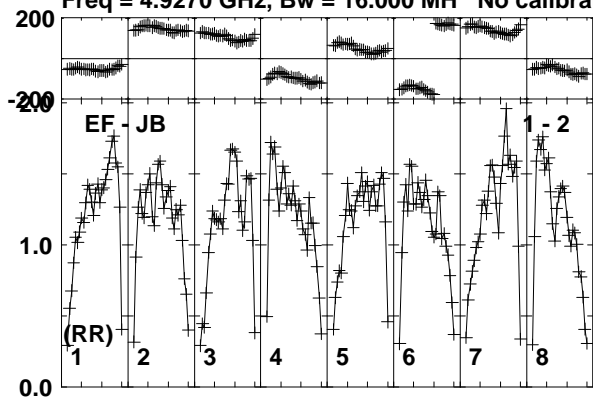

Lower frame: Milli Ampl Jy Top frame: Phas deg
Vector averaged cross-power spectrum Baseline: EF (01) - JB (02)
Timerange: 01/06:08:13 to 01/06:09:39

Plot file version 362 created 26-MAR-2015 15:27:56

J1455+2131 EG082E.UVDATA.1

Freq = 4.9270 GHz, Bw = 16.000 MH No calibration applied and no bandpass applied

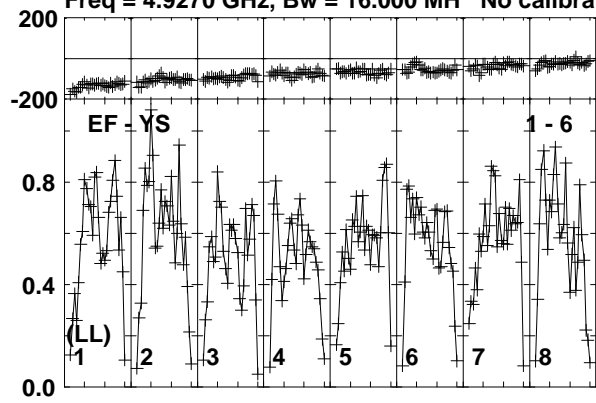

Lower frame: Milli Ampl Jy Top frame: Phas deg
Vector averaged cross-power spectrum Baseline: EF (01) - YS (06)
Timerange: 01/06:08:13 to 01/06:09:39

Plot file version 363 created 26-MAR-2015 15:27:57

TVLM513 EG082E.UVDATA.1

Freq = 4.9270 GHz, Bw = 16.000 MH No calibration applied and no bandpass applied

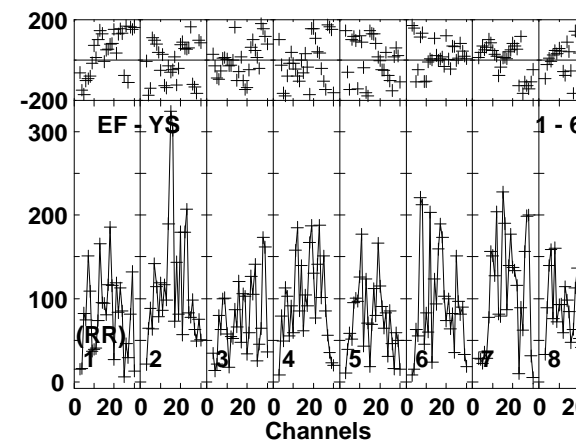
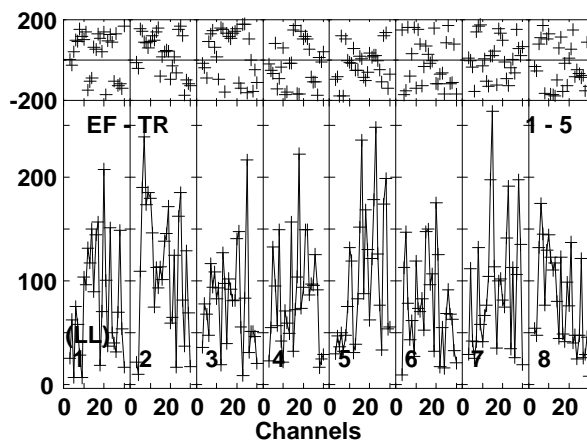
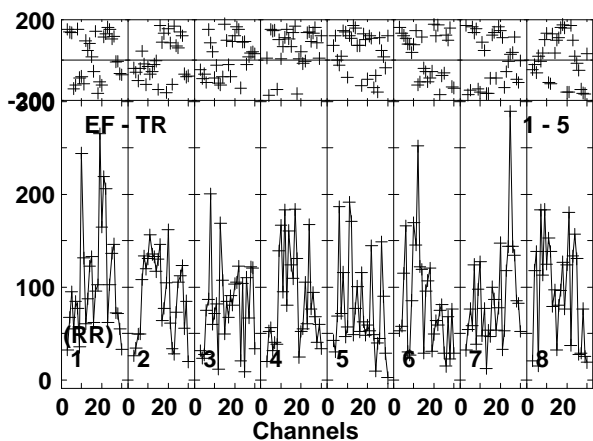
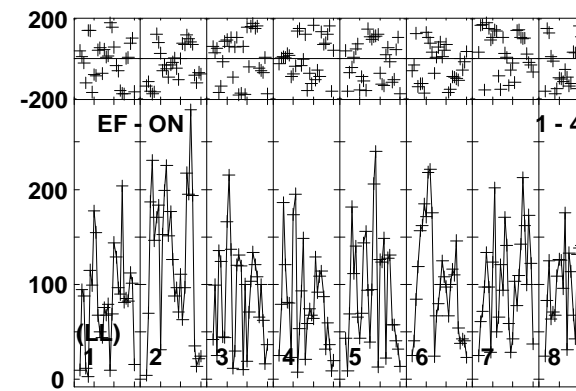
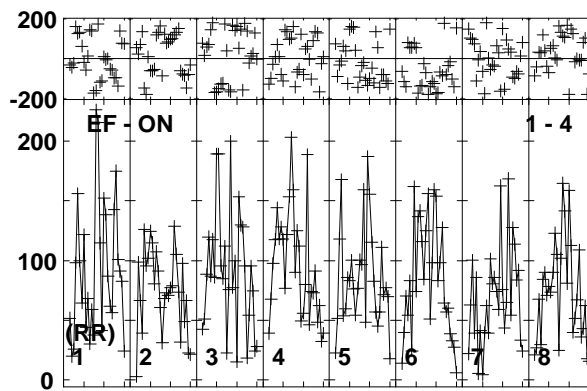
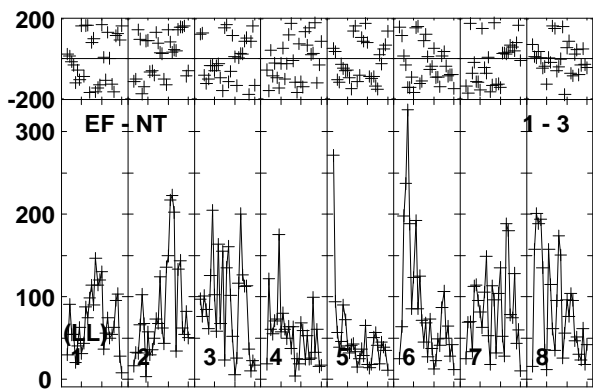
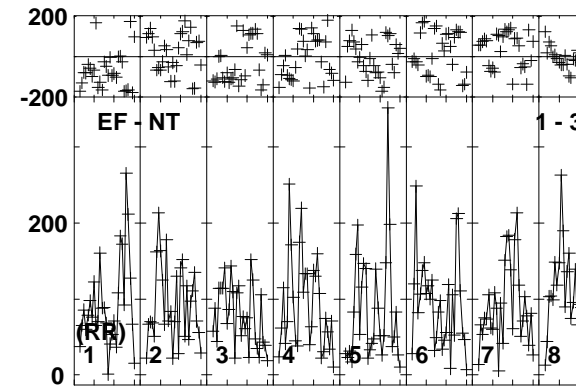
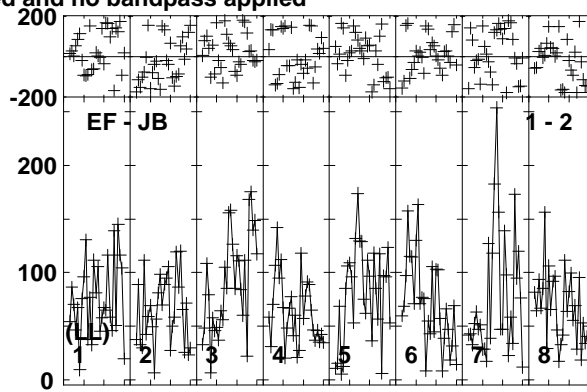
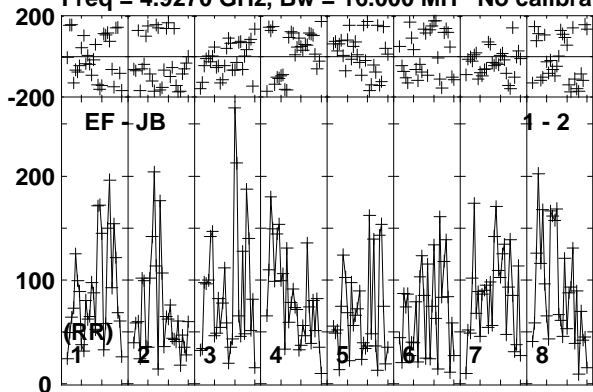

Lower frame: Micro Ampl Jy Top frame: Phas deg
Vector averaged cross-power spectrum Baseline: EF (01) - JB (02)
Timerange: 01/06:09:43 to 01/06:13:09

Plot file version 364 created 26-MAR-2015 15:27:57

TVLM513 EG082E.UVDATA.1

Freq = 4.9270 GHz, Bw = 16.000 MH No calibration applied and no bandpass applied

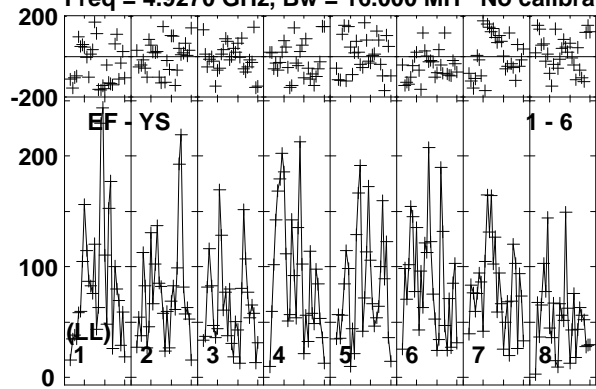

Lower frame: Micro Ampl Jy Top frame: Phas deg
Vector averaged cross-power spectrum Baseline: EF (01) - YS (06)
Timerange: 01/06:09:43 to 01/06:13:09

Plot file version 365 created 26-MAR-2015 15:27:57

J1455+2131 EG082E.UVDATA.1

Freq = 4.9270 GHz, Bw = 16.000 MH No calibration applied and no bandpass applied

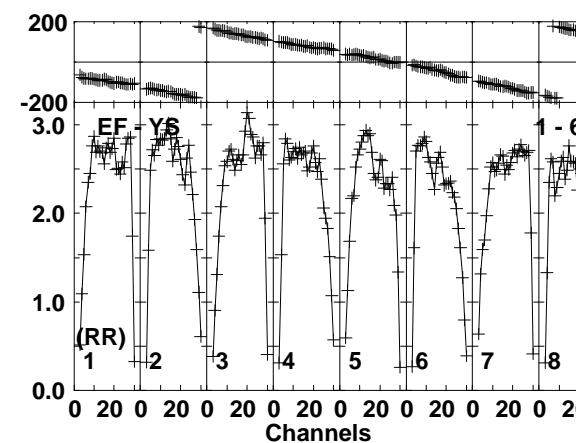
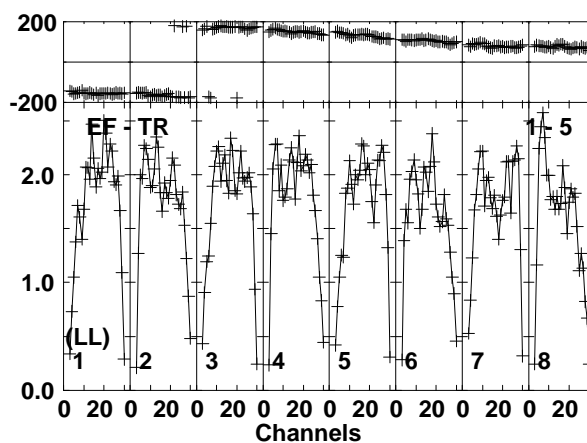
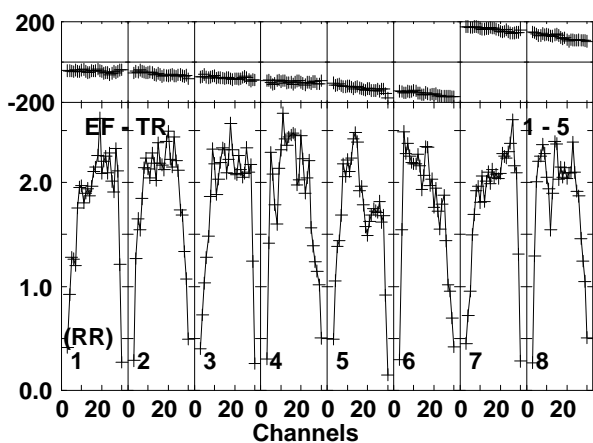
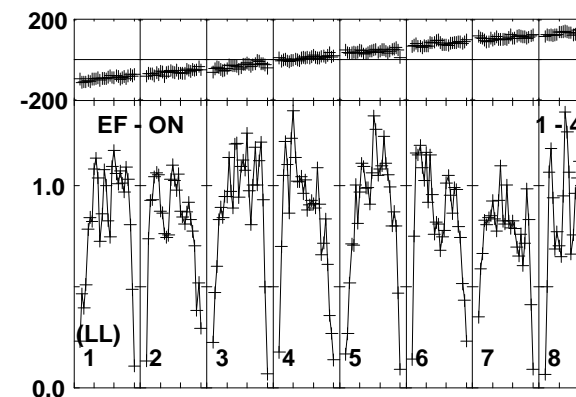
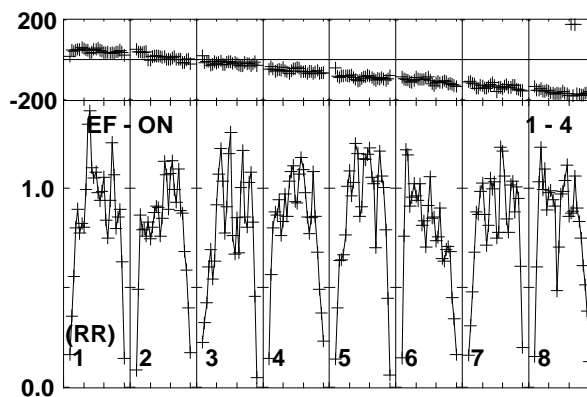
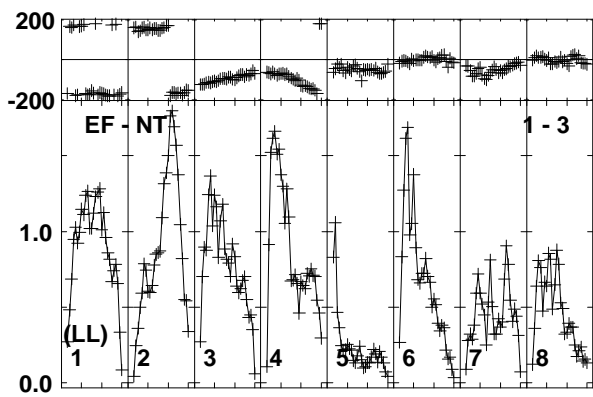
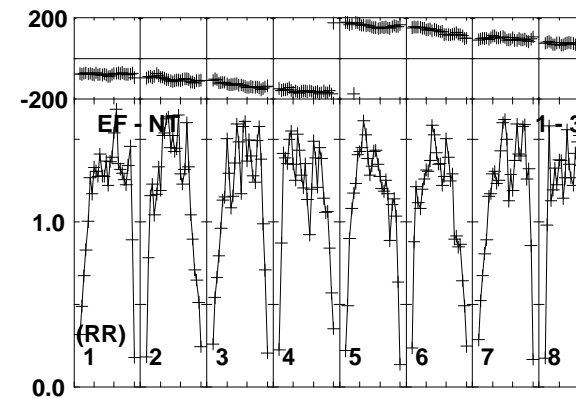
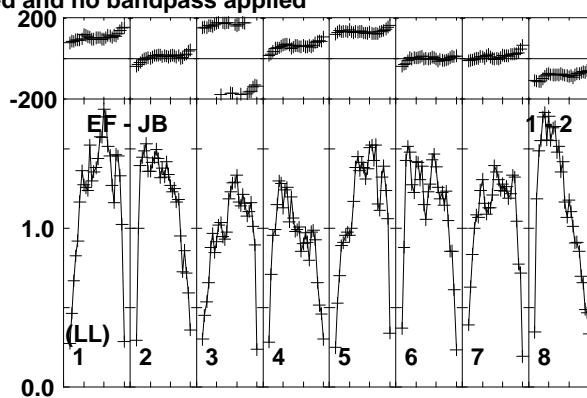
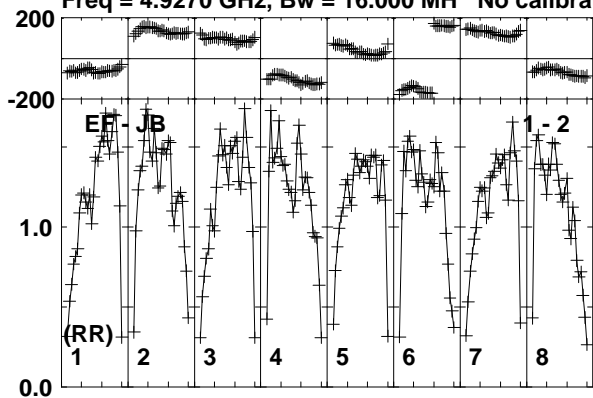

Lower frame: Milli Ampl Jy Top frame: Phas deg
Vector averaged cross-power spectrum Baseline: EF (01) - JB (02)
Timerange: 01/06:13:43 to 01/06:14:39

Plot file version 366 created 26-MAR-2015 15:27:57

J1455+2131 EG082E.UVDATA.1

Freq = 4.9270 GHz, Bw = 16.000 MH No calibration applied and no bandpass applied

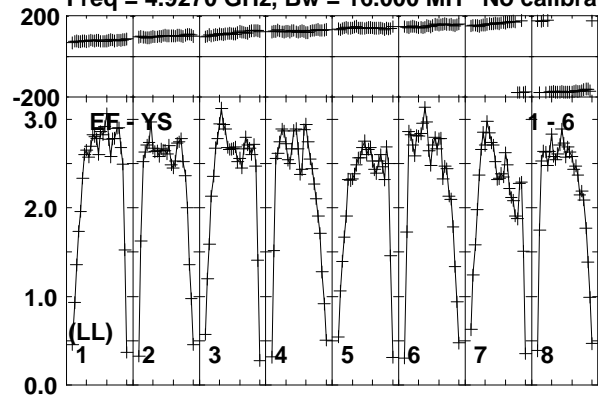

Lower frame: Milli Ampl Jy Top frame: Phas deg
Vector averaged cross-power spectrum Baseline: EF (01) - YS (06)
Timerange: 01/06:13:43 to 01/06:14:39

Plot file version 367 created 26-MAR-2015 15:27:57

TVLM513 EG082E.UVDATA.1

Freq = 4.9270 GHz, Bw = 16.000 MH No calibration applied and no bandpass applied

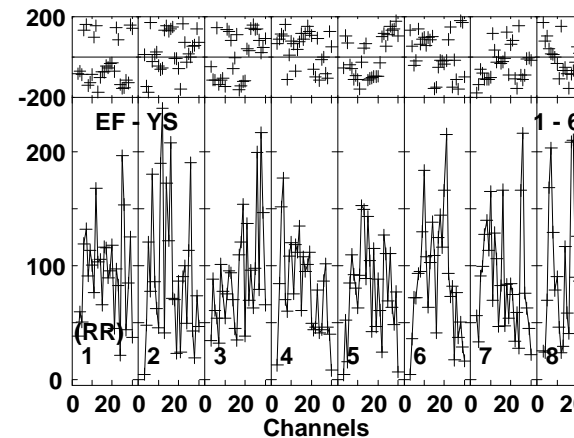
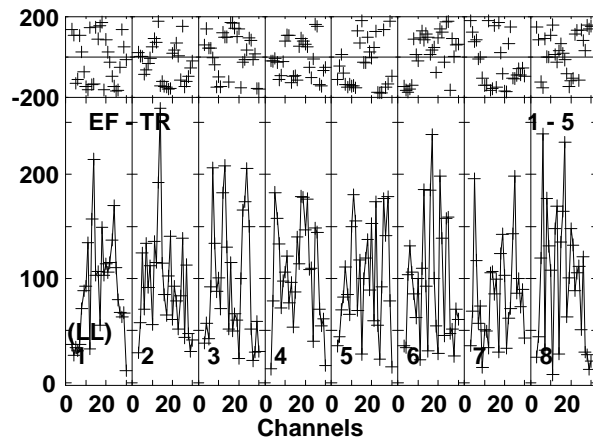
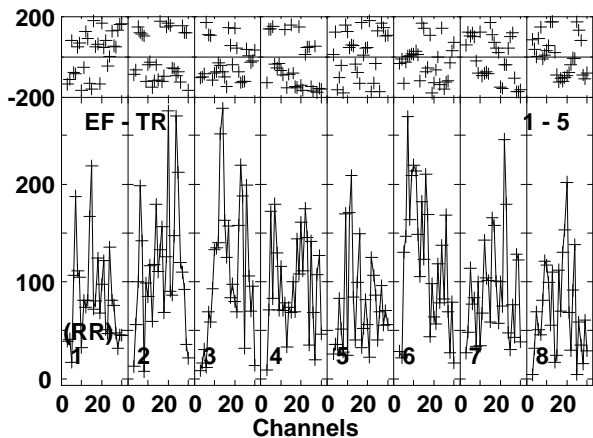
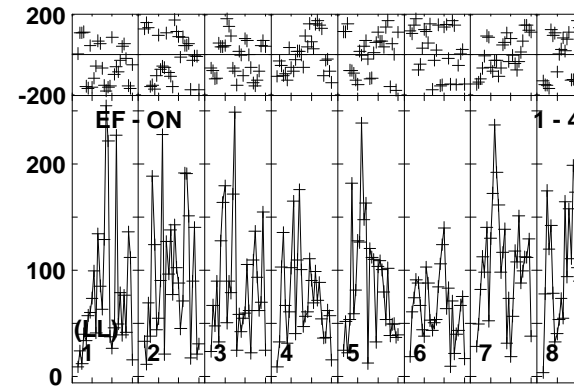
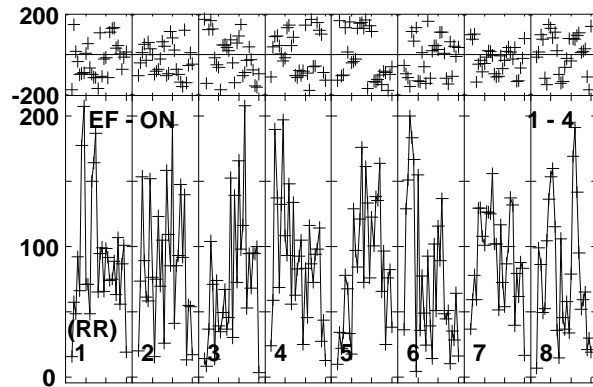
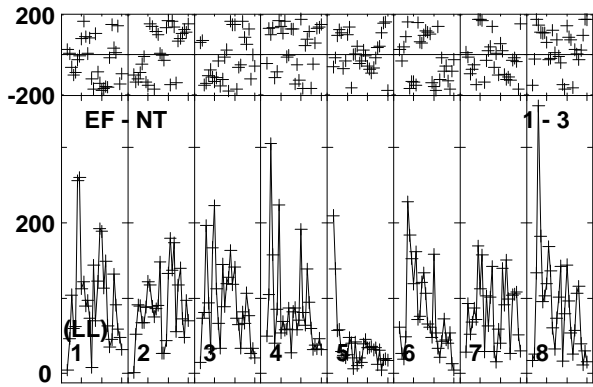
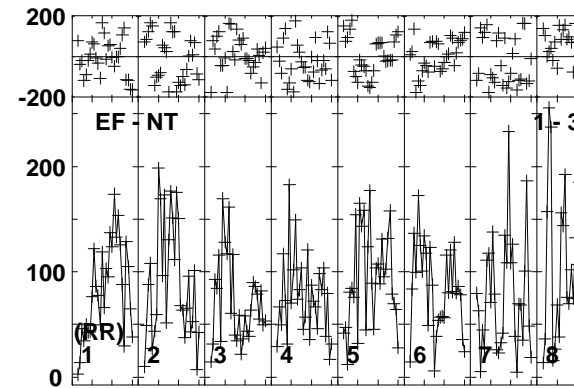
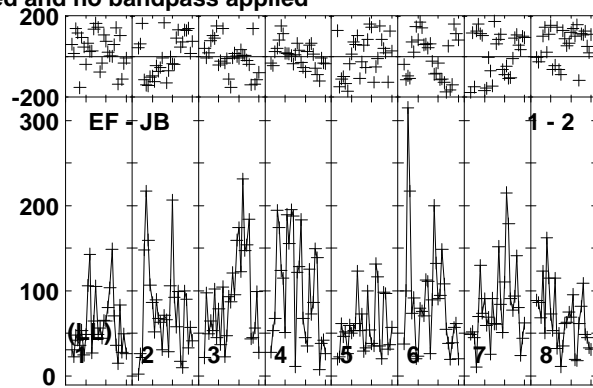
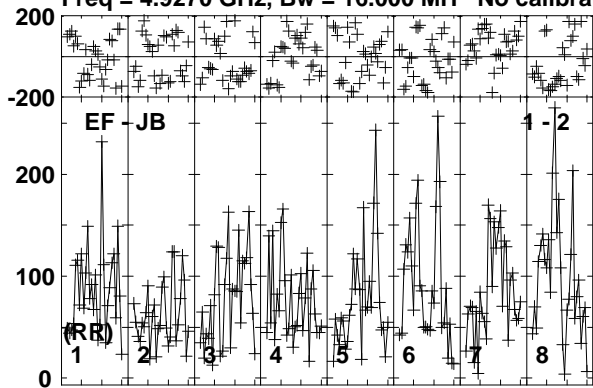

Lower frame: Micro Ampl Jy Top frame: Phas deg
Vector averaged cross-power spectrum Baseline: EF (01) - JB (02)
Timerange: 01/06:14:43 to 01/06:18:09

Plot file version 368 created 26-MAR-2015 15:27:57

TVLM513 EG082E.UVDATA.1

Freq = 4.9270 GHz, Bw = 16.000 MH No calibration applied and no bandpass applied

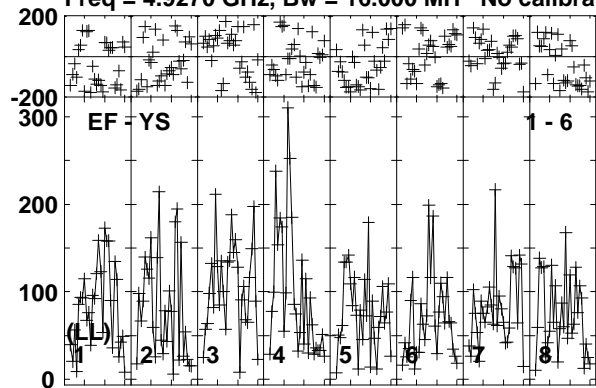

Lower frame: Micro Ampl Jy Top frame: Phas deg
Vector averaged cross-power spectrum Baseline: EF (01) - YS (06)
Timerange: 01/06:14:43 to 01/06:18:09

Plot file version 369 created 26-MAR-2015 15:27:57

J1455+2131 EG082E.UVDATA.1

Freq = 4.9270 GHz, Bw = 16.000 MH No calibration applied and no bandpass applied

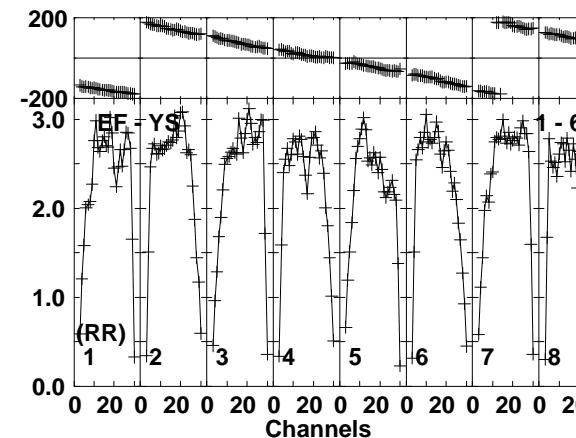
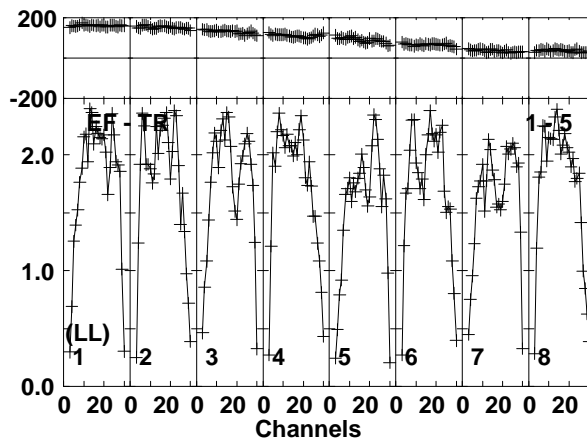
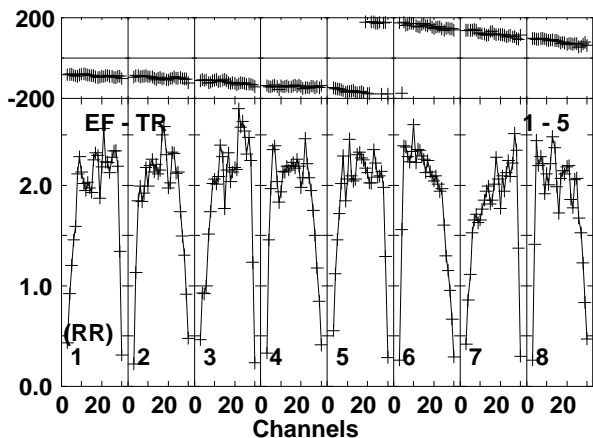
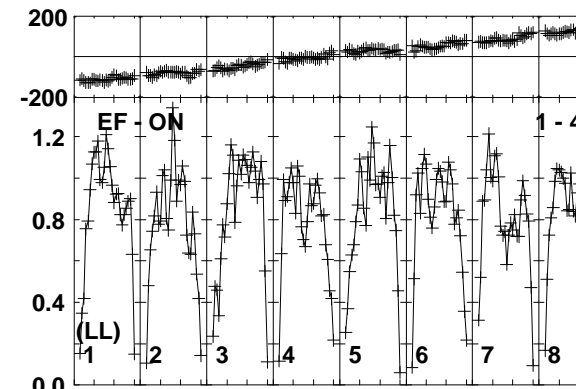
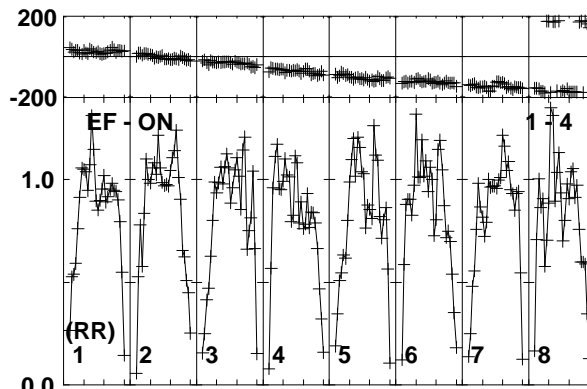
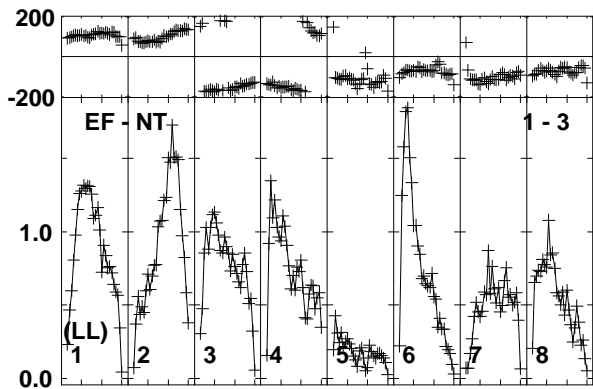
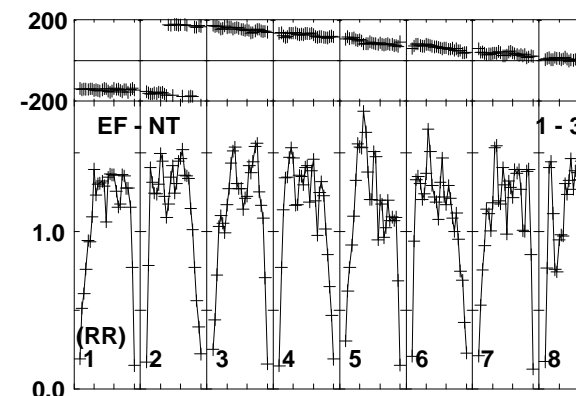
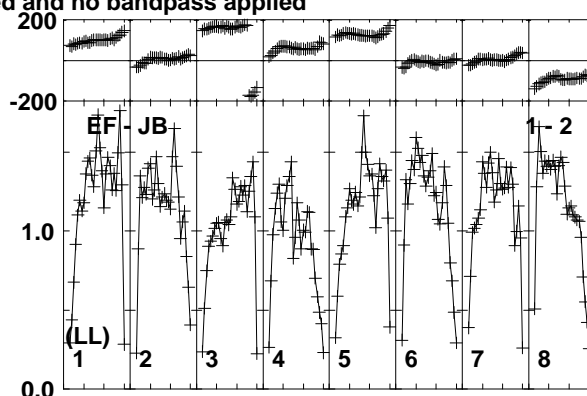
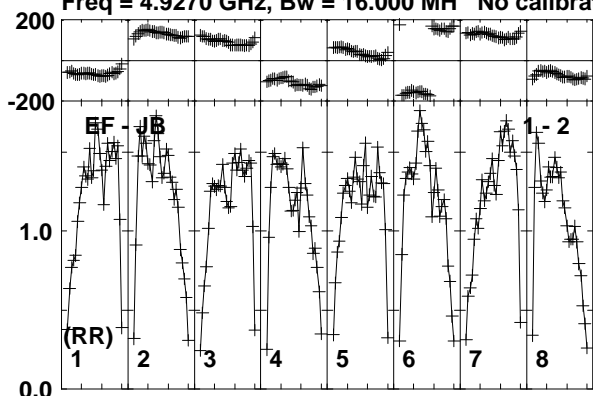

Lower frame: Milli Ampl Jy Top frame: Phas deg
Vector averaged cross-power spectrum Baseline: EF (01) - JB (02)
Timerange: 01/06:18:13 to 01/06:19:39

Plot file version 370 created 26-MAR-2015 15:27:57

J1455+2131 EG082E.UVDATA.1

Freq = 4.9270 GHz, Bw = 16.000 MH No calibration applied and no bandpass applied

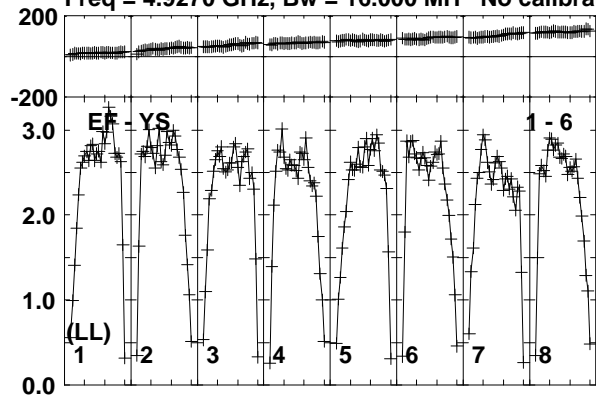

Lower frame: Milli Ampl Jy Top frame: Phas deg
Vector averaged cross-power spectrum Baseline: EF (01) - YS (06)
Timerange: 01/06:18:13 to 01/06:19:39

Plot file version 371 created 26-MAR-2015 15:27:57

TVLM513 EG082E.UVDATA.1

Freq = 4.9270 GHz, Bw = 16.000 MH No calibration applied and no bandpass applied

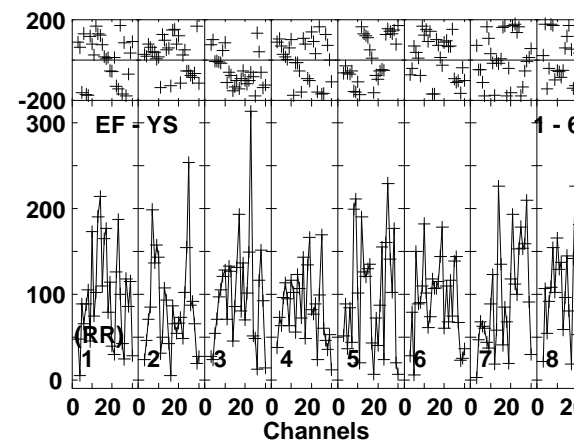
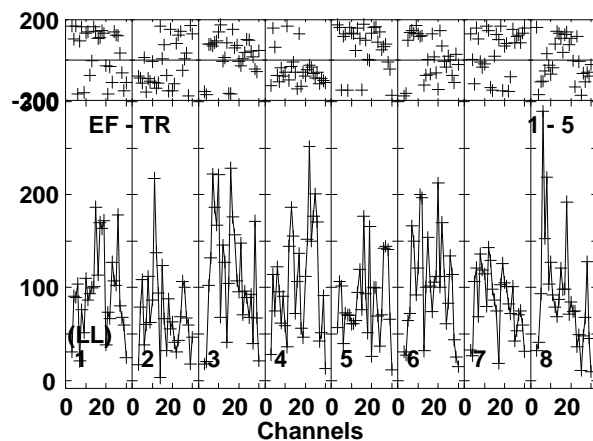
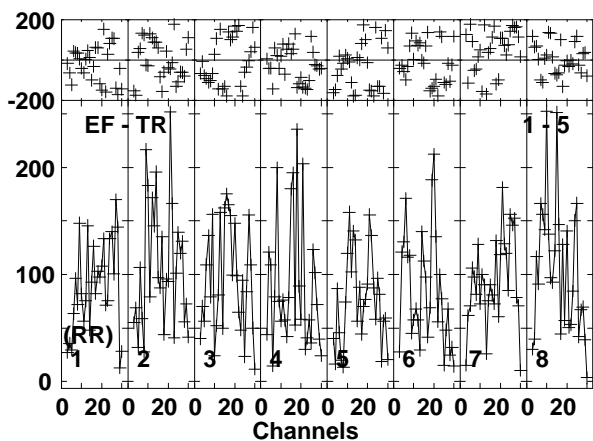
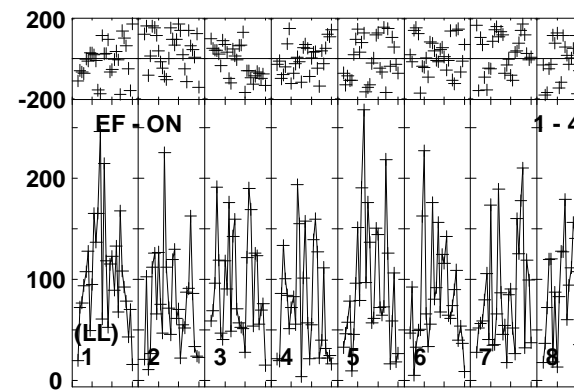
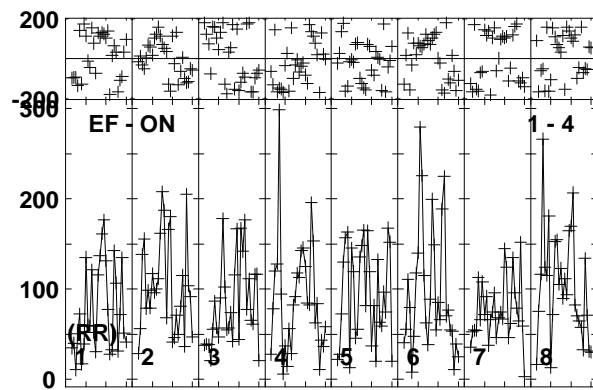
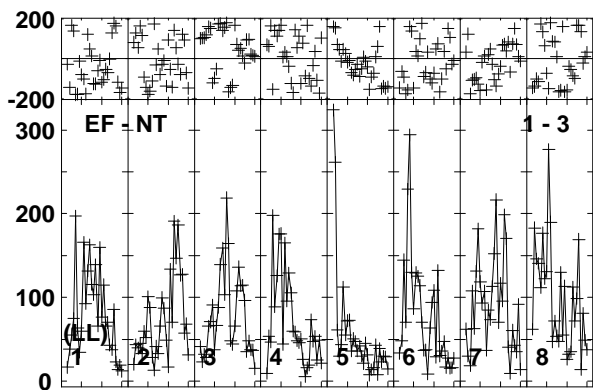
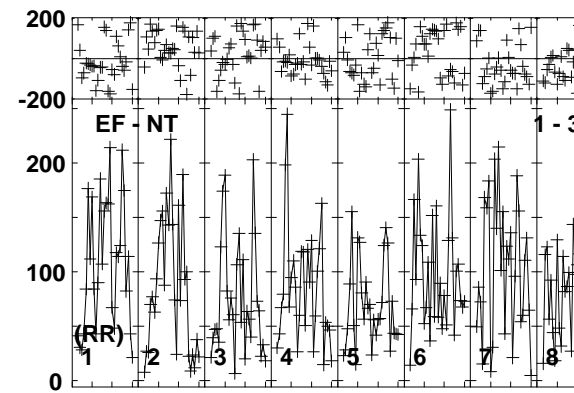
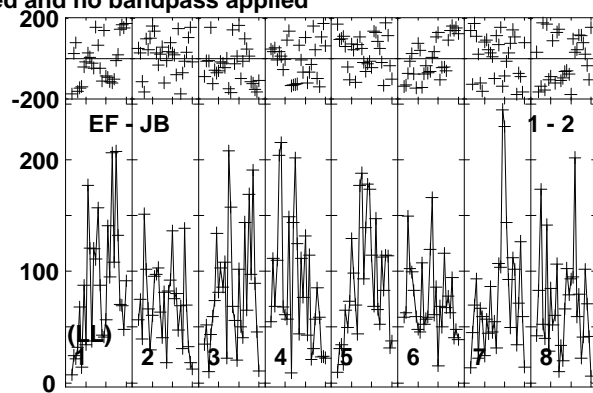
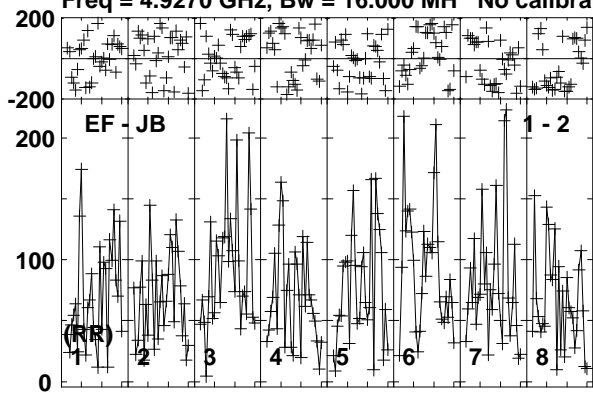

Lower frame: Micro Ampl Jy Top frame: Phas deg
Vector averaged cross-power spectrum Baseline: EF (01) - JB (02)
Timerange: 01/06:19:43 to 01/06:23:09

Plot file version 372 created 26-MAR-2015 15:27:57

TVLM513 EG082E.UVDATA.1

Freq = 4.9270 GHz, Bw = 16.000 MH No calibration applied and no bandpass applied

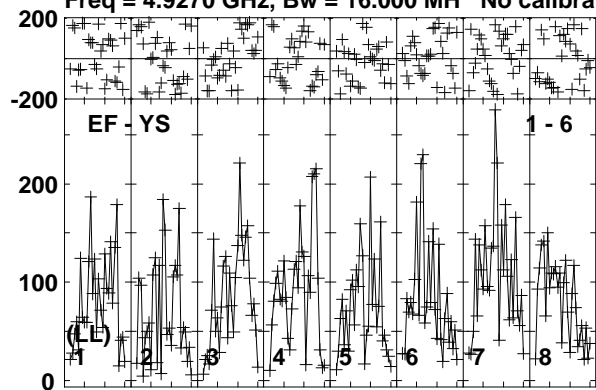

Lower frame: Micro Ampl Jy Top frame: Phas deg
Vector averaged cross-power spectrum Baseline: EF (01) - YS (06)
Timerange: 01/06:19:43 to 01/06:23:09

Plot file version 373 created 26-MAR-2015 15:27:57

J1455+2131 EG082E.UVDATA.1

Freq = 4.9270 GHz, Bw = 16.000 MH No calibration applied and no bandpass applied

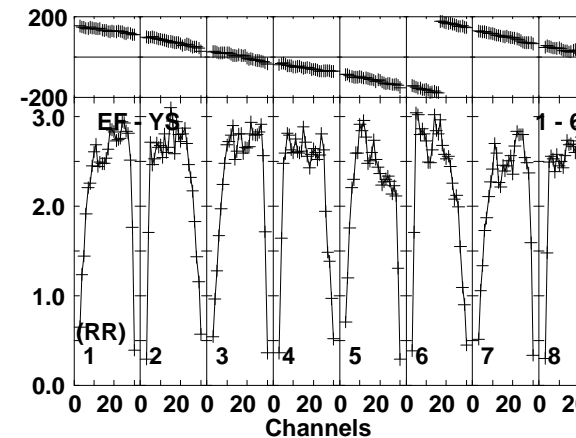
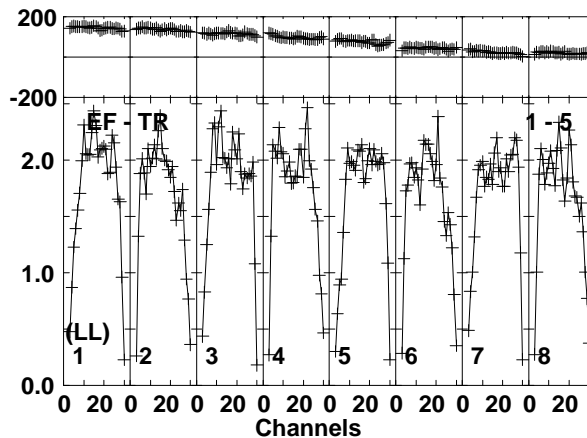
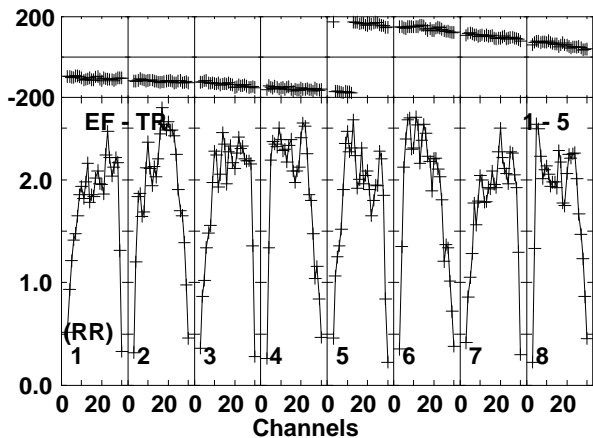
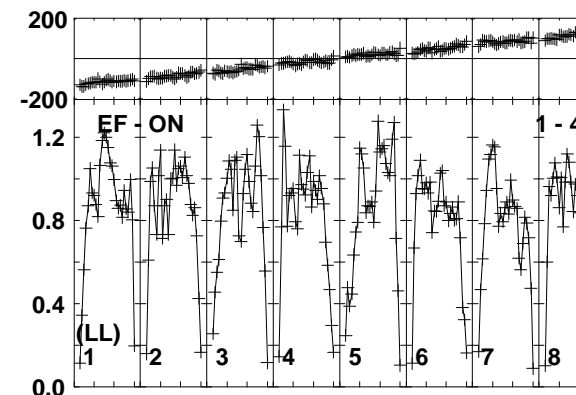
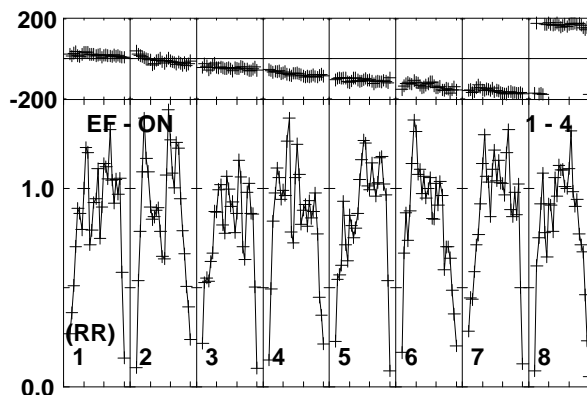
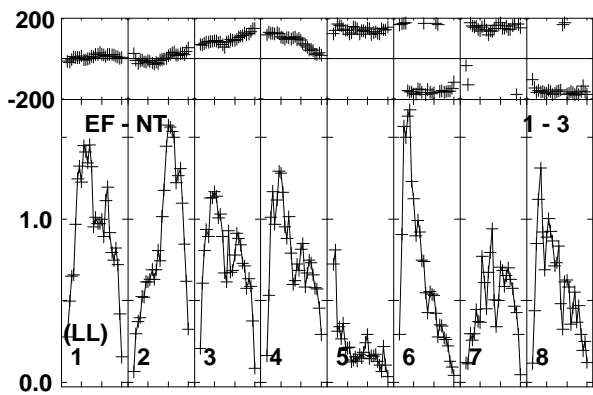
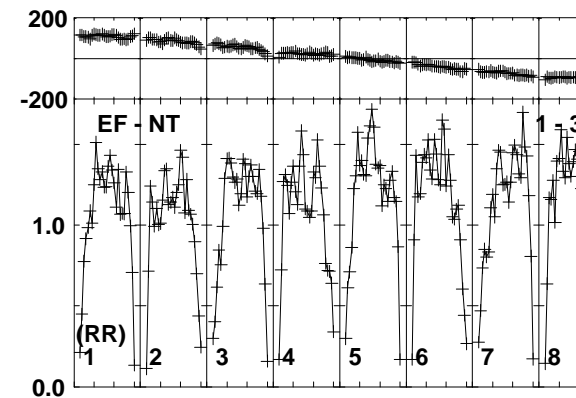
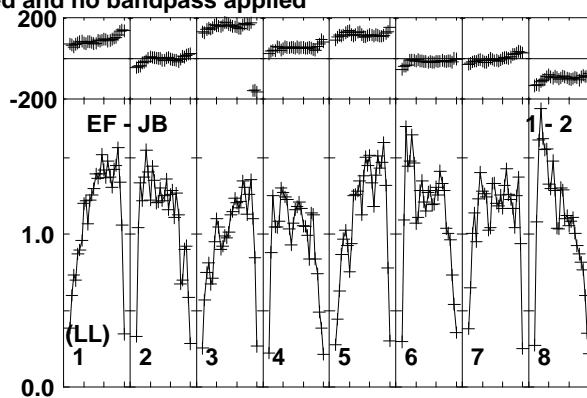
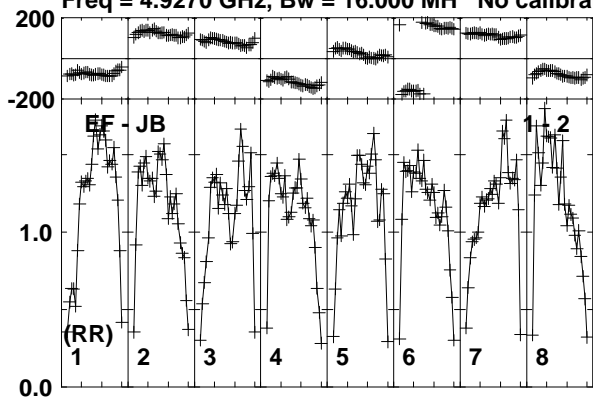

Lower frame: Milli Ampl Jy Top frame: Phas deg
Vector averaged cross-power spectrum Baseline: EF (01) - JB (02)
Timerange: 01/06:23:43 to 01/06:24:39

Plot file version 374 created 26-MAR-2015 15:27:57

J1455+2131 EG082E.UVDATA.1

Freq = 4.9270 GHz, Bw = 16.000 MH No calibration applied and no bandpass applied

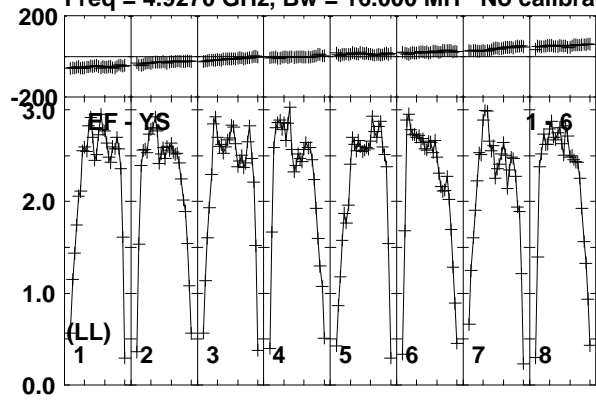

Lower frame: Milli Ampl Jy Top frame: Phas deg
Vector averaged cross-power spectrum Baseline: EF (01) - YS (06)
Timerange: 01/06:23:43 to 01/06:24:39

Plot file version 375 created 26-MAR-2015 15:27:57

TVLM513 EG082E.UVDATA.1

Freq = 4.9270 GHz, Bw = 16.000 MH No calibration applied and no bandpass applied

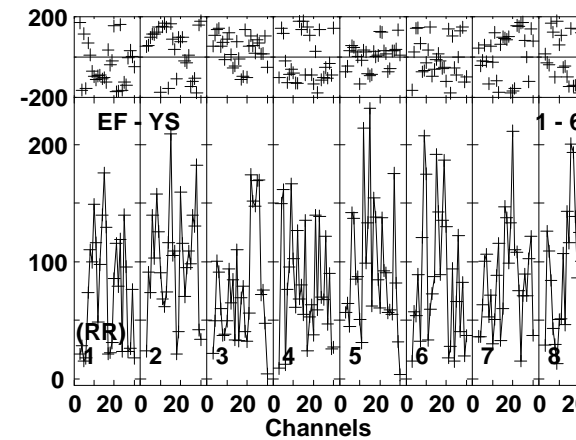
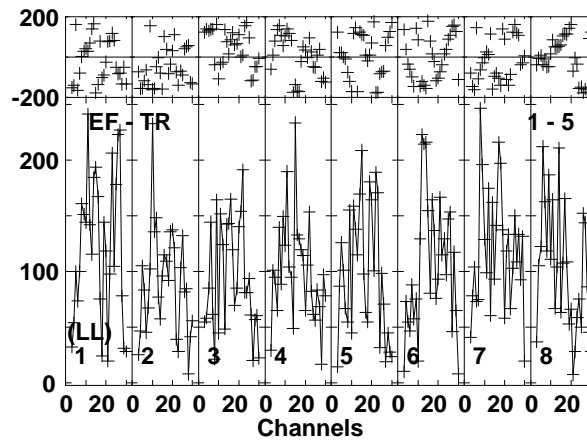
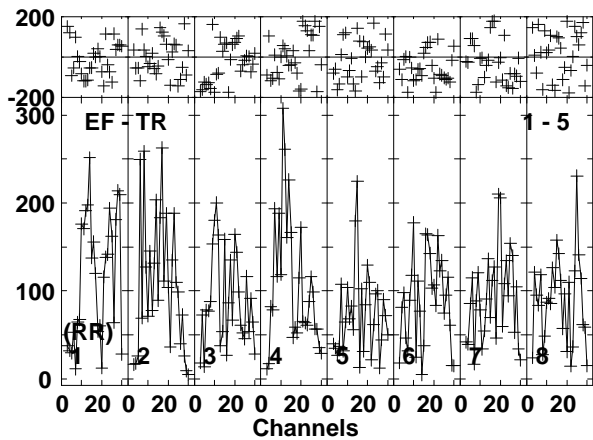
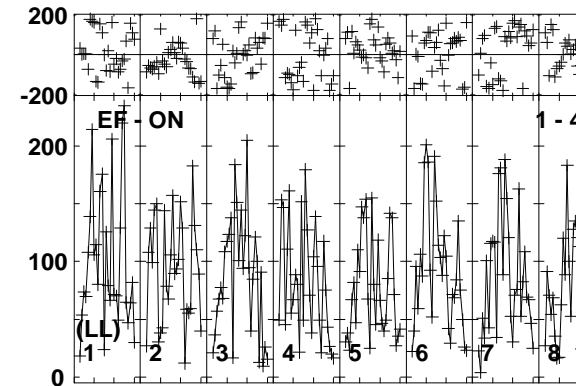
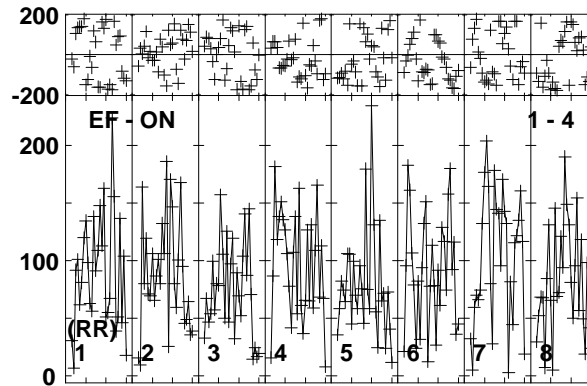
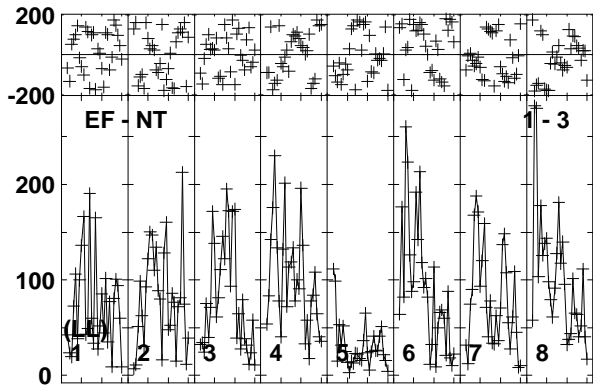
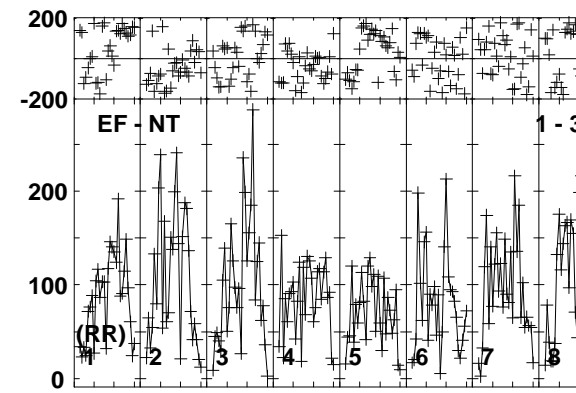
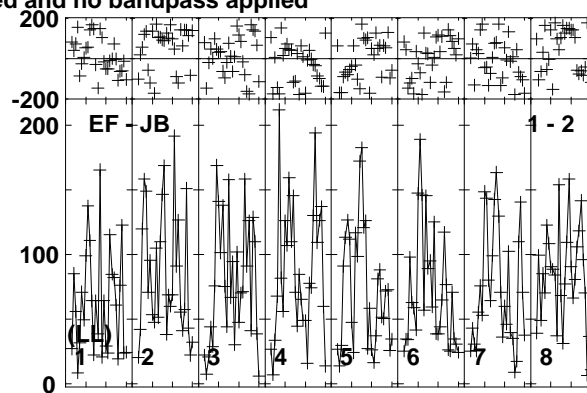
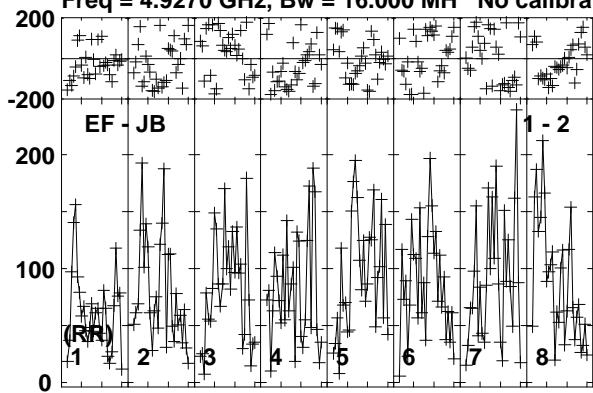

Lower frame: Micro Ampl Jy Top frame: Phas deg
Vector averaged cross-power spectrum Baseline: EF (01) - JB (02)
Timerange: 01/06:24:43 to 01/06:28:09

Plot file version 376 created 26-MAR-2015 15:27:57

TVLM513 EG082E.UVDATA.1

Freq = 4.9270 GHz, Bw = 16.000 MH No calibration applied and no bandpass applied

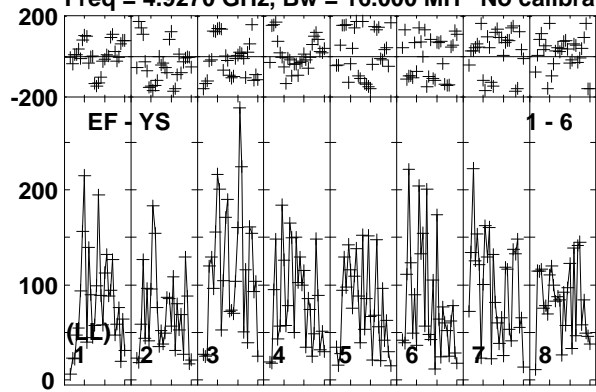

Lower frame: Micro Ampl Jy Top frame: Phas deg
Vector averaged cross-power spectrum Baseline: EF (01) - YS (06)
Timerange: 01/06:24:43 to 01/06:28:09

Plot file version 377 created 26-MAR-2015 15:27:57

J1455+2131 EG082E.UVDATA.1

Freq = 4.9270 GHz, Bw = 16.000 MH No calibration applied and no bandpass applied

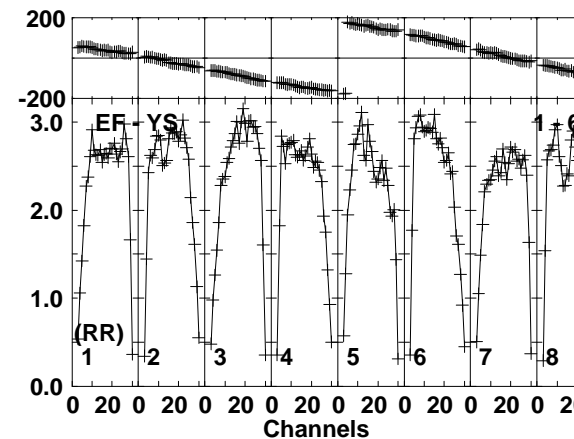
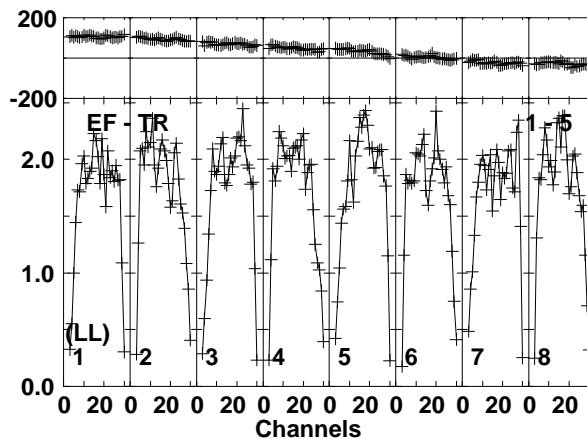
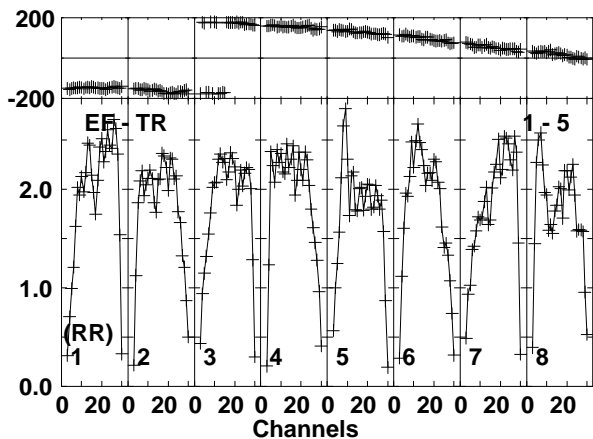
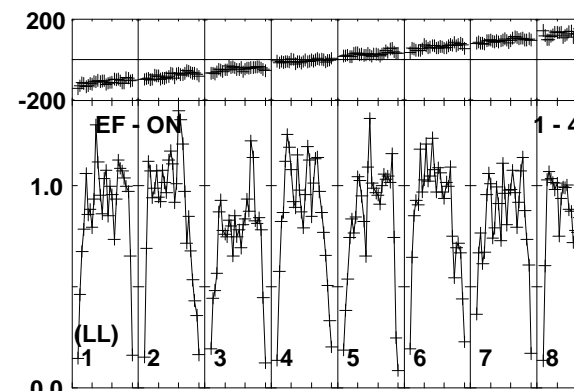
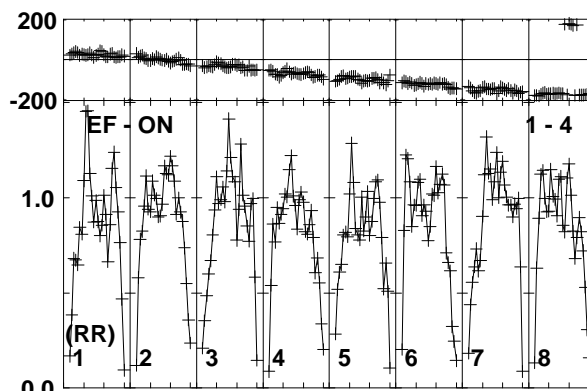
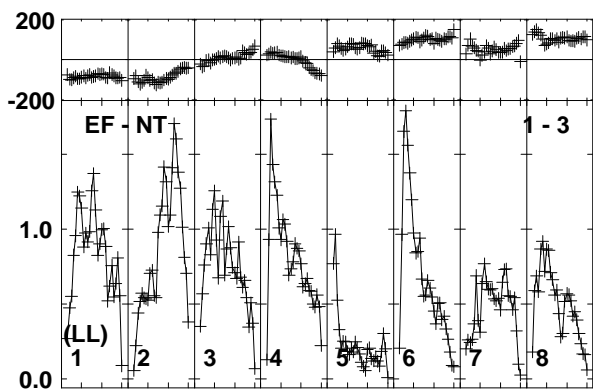
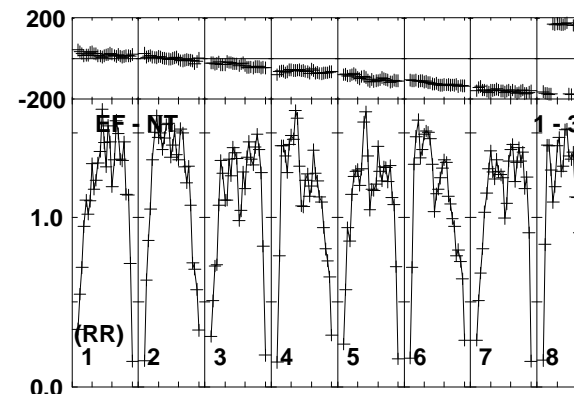
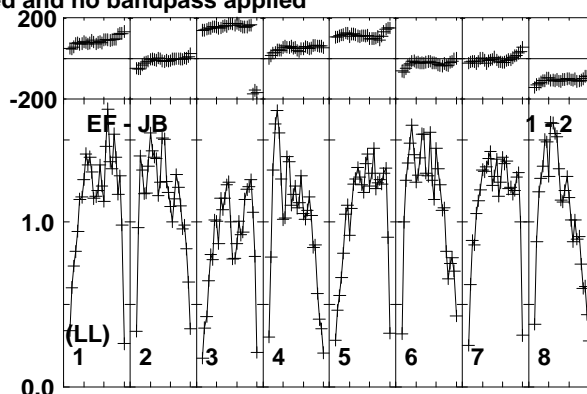
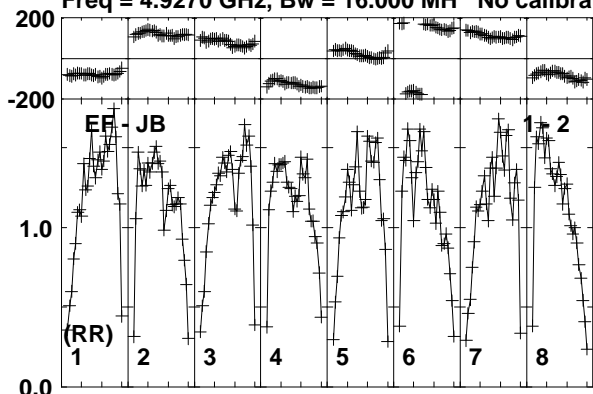

Lower frame: Milli Ampl Jy Top frame: Phas deg
Vector averaged cross-power spectrum Baseline: EF (01) - JB (02)
Timerange: 01/06:28:13 to 01/06:29:39

Plot file version 378 created 26-MAR-2015 15:27:57

J1455+2131 EG082E.UVDATA.1

Freq = 4.9270 GHz, Bw = 16.000 MH No calibration applied and no bandpass applied

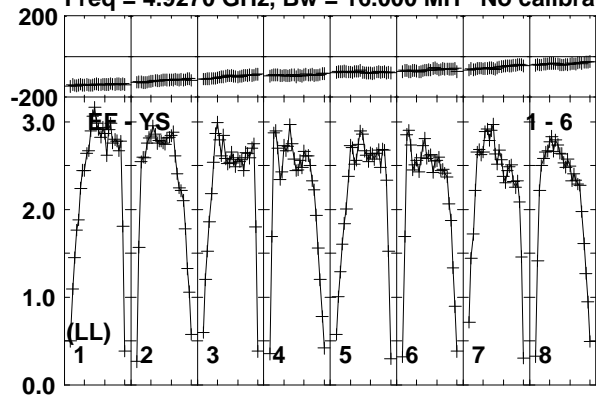

Lower frame: Milli Ampl Jy Top frame: Phas deg
Vector averaged cross-power spectrum Baseline: EF (01) - YS (06)
Timerange: 01/06:28:13 to 01/06:29:39

Plot file version 379 created 26-MAR-2015 15:27:57

J1504+2218 EG082E.UVDATA.1

Freq = 4.9270 GHz, Bw = 16.000 MH No calibration applied and no bandpass applied

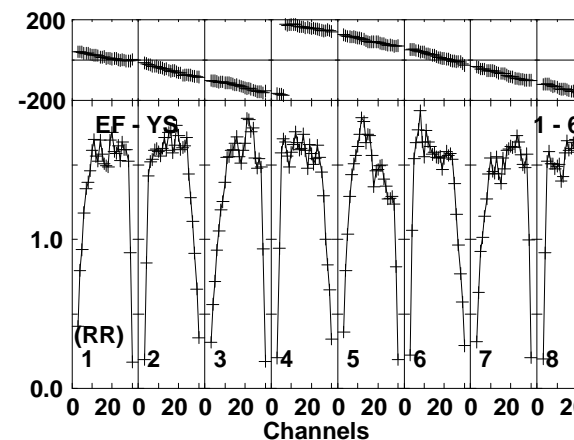
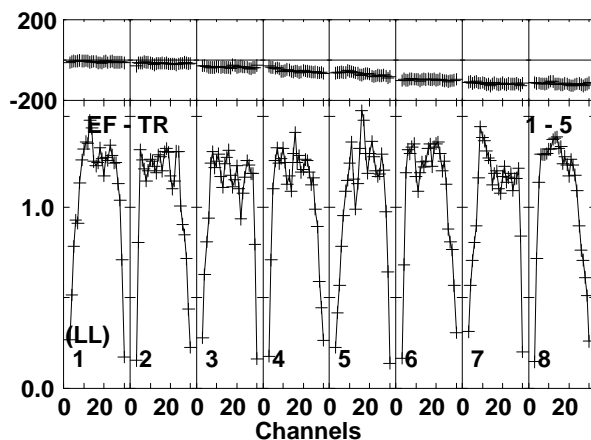
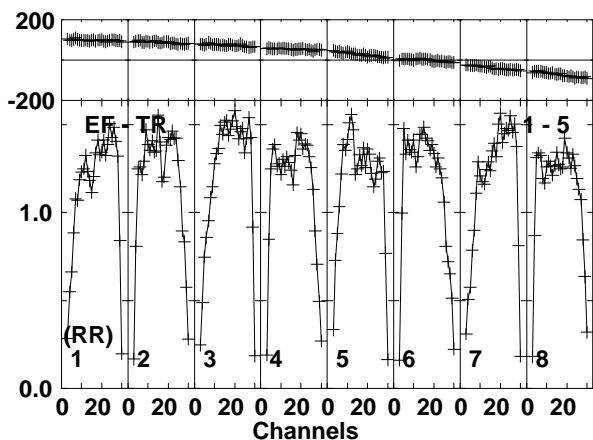
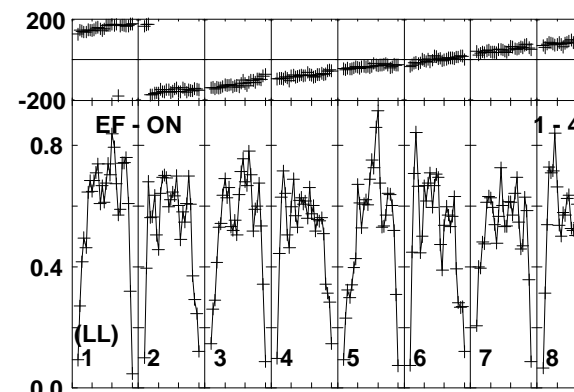
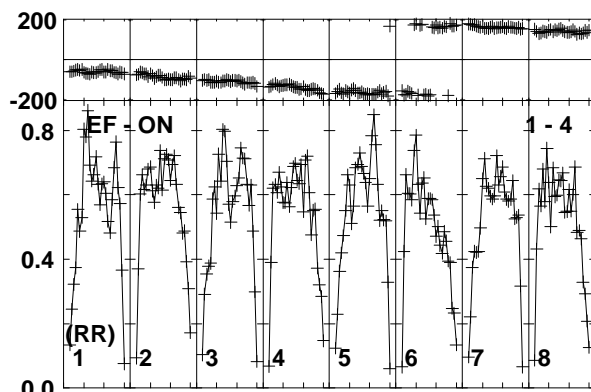
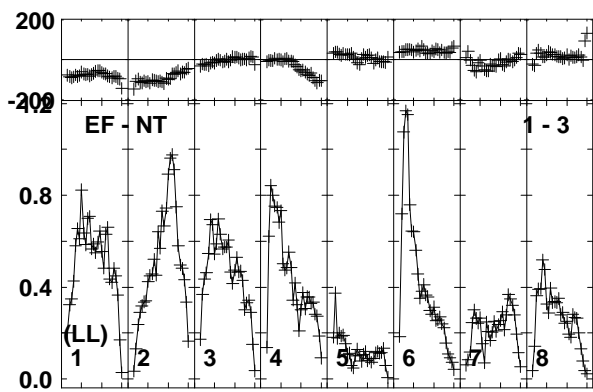
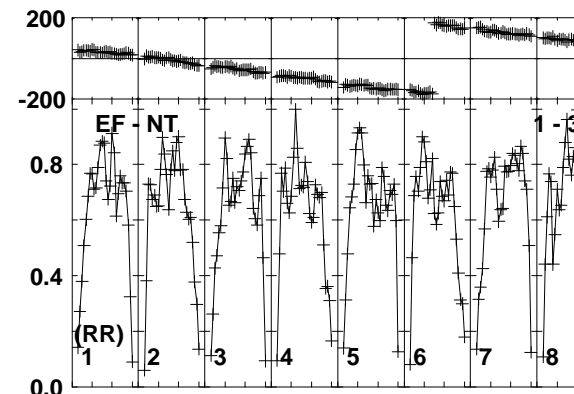
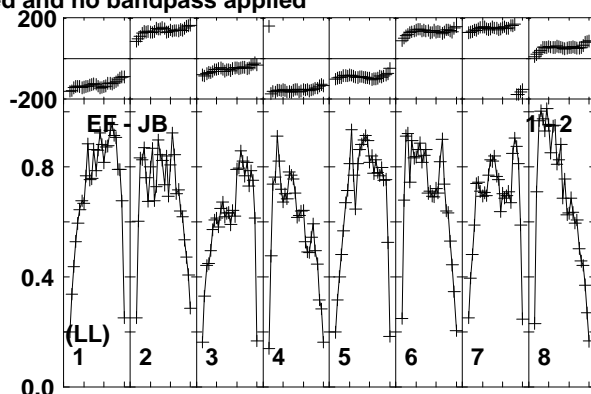
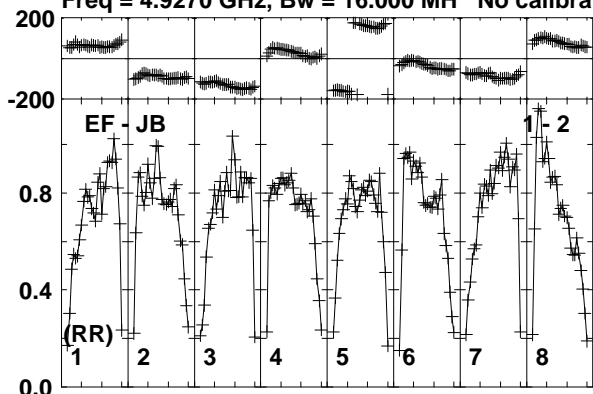

Lower frame: Milli Ampl Jy Top frame: Phas deg
Vector averaged cross-power spectrum Baseline: EF (01) - JB (02)
Timerange: 01/06:29:43 to 01/06:33:09

Plot file version 380 created 26-MAR-2015 15:27:57

J1504+2218 EG082E.UVDATA.1

Freq = 4.9270 GHz, Bw = 16.000 MH No calibration applied and no bandpass applied

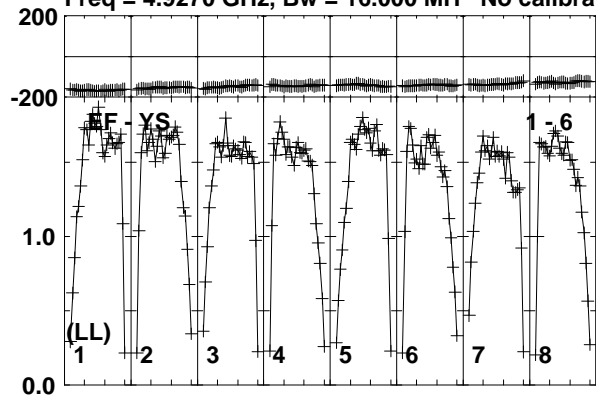

Lower frame: Milli Ampl Jy Top frame: Phas deg
Vector averaged cross-power spectrum Baseline: EF (01) - YS (06)
Timerange: 01/06:29:43 to 01/06:33:09

Plot file version 381 created 26-MAR-2015 15:27:57

J1455+2131 EG082E.UVDATA.1

Freq = 4.9270 GHz, Bw = 16.000 MH No calibration applied and no bandpass applied

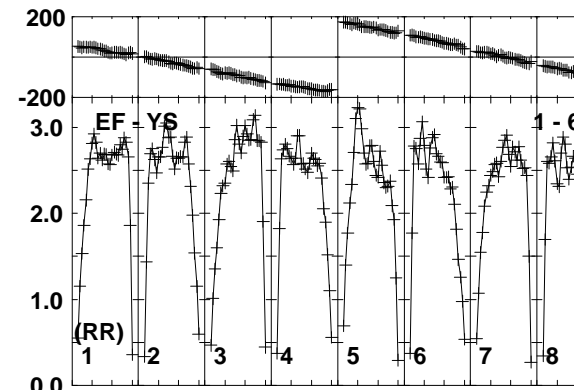
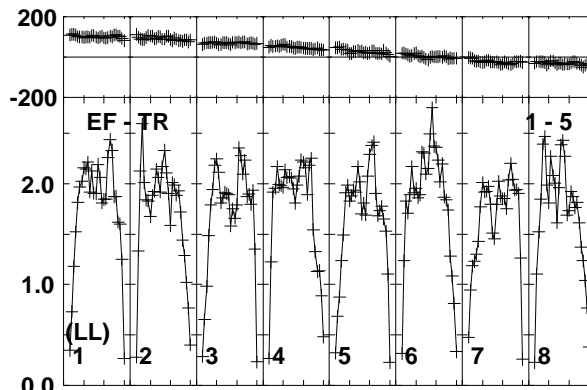
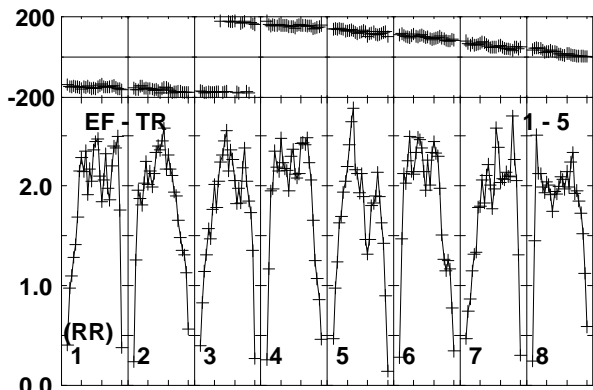
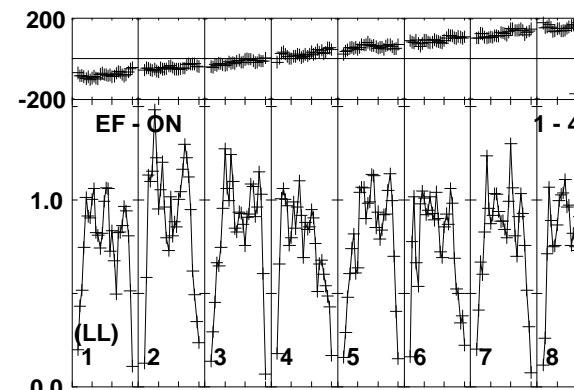
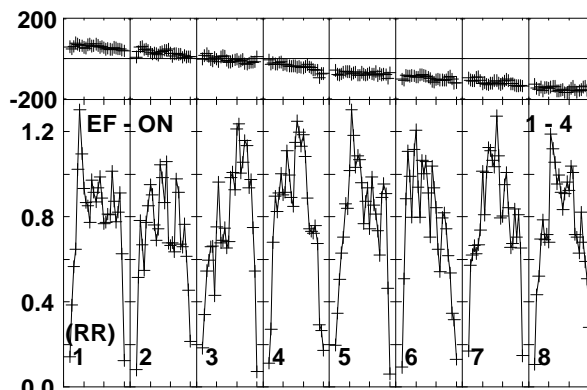
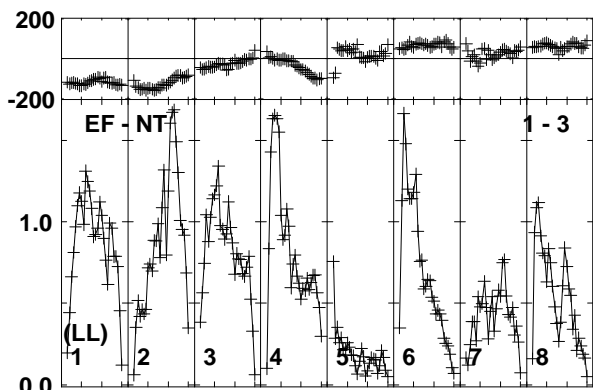
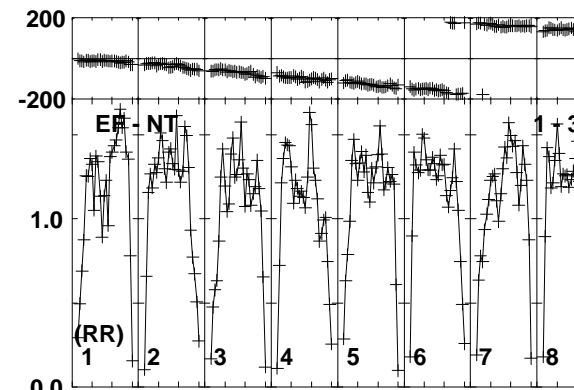
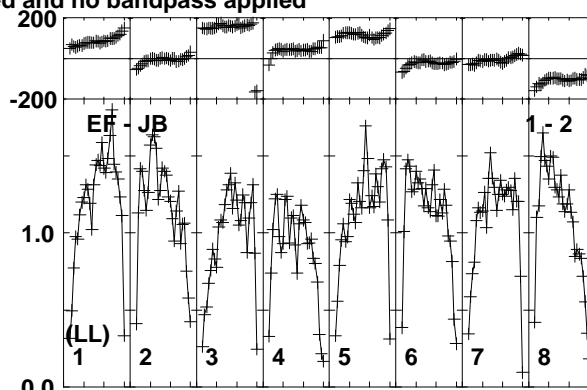
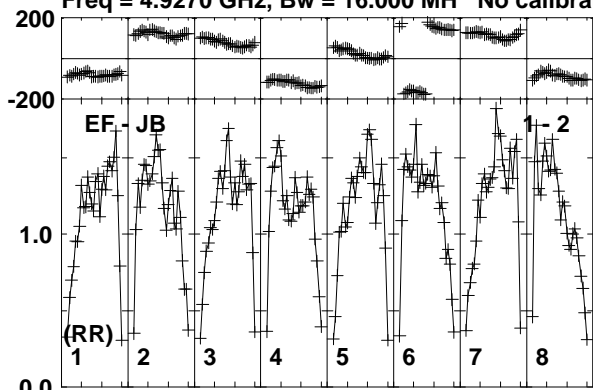

Lower frame: Milli Ampl Jy Top frame: Phas deg
Vector averaged cross-power spectrum Baseline: EF (01) - JB (02)
Timerange: 01/06:33:43 to 01/06:34:39

Plot file version 382 created 26-MAR-2015 15:27:57

J1455+2131 EG082E.UVDATA.1

Freq = 4.9270 GHz, Bw = 16.000 MH No calibration applied and no bandpass applied

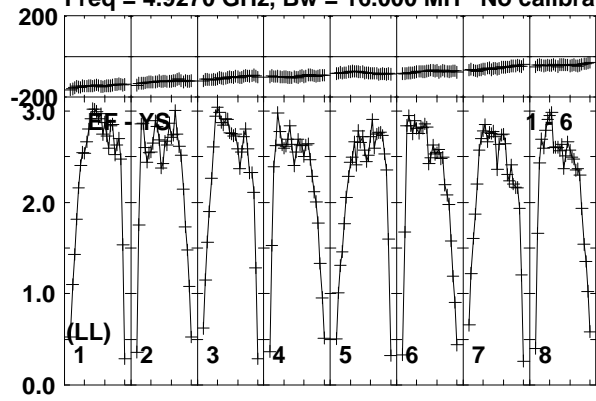

Lower frame: Milli Ampl Jy Top frame: Phas deg
Vector averaged cross-power spectrum Baseline: EF (01) - YS (06)
Timerange: 01/06:33:43 to 01/06:34:39

Plot file version 383 created 26-MAR-2015 15:27:57

TVLM513 EG082E.UVDATA.1

Freq = 4.9270 GHz, Bw = 16.000 MH No calibration applied and no bandpass applied

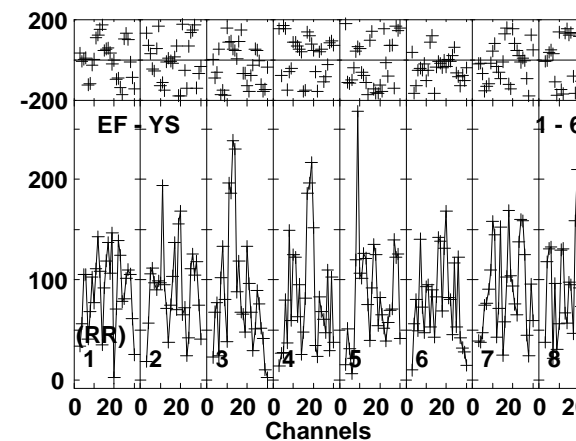
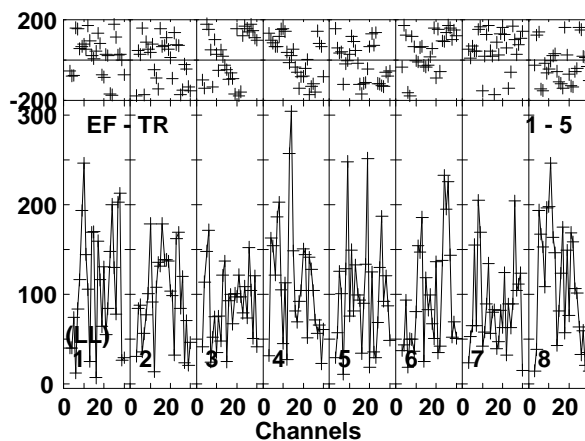
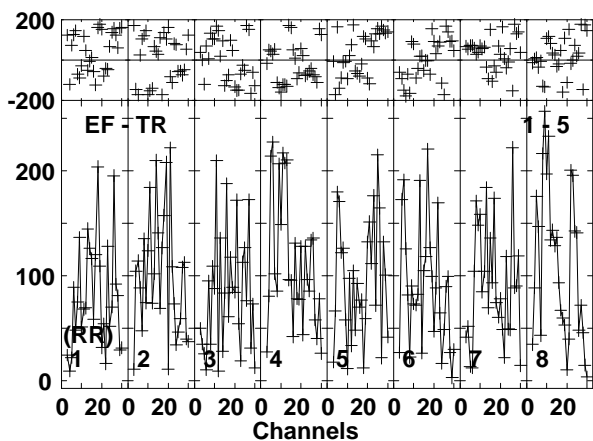
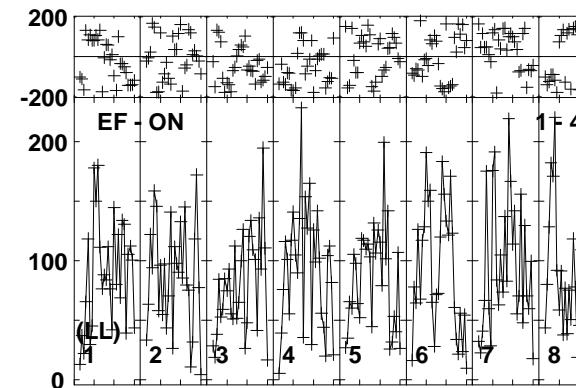
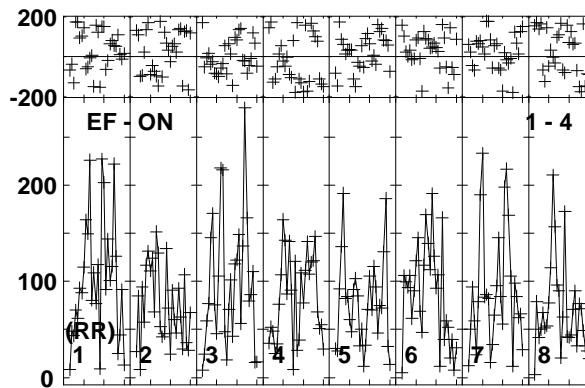
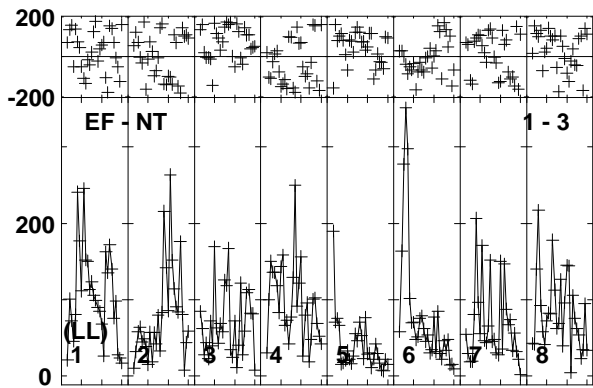
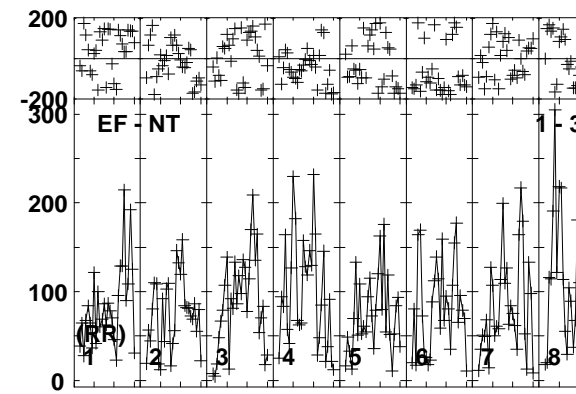
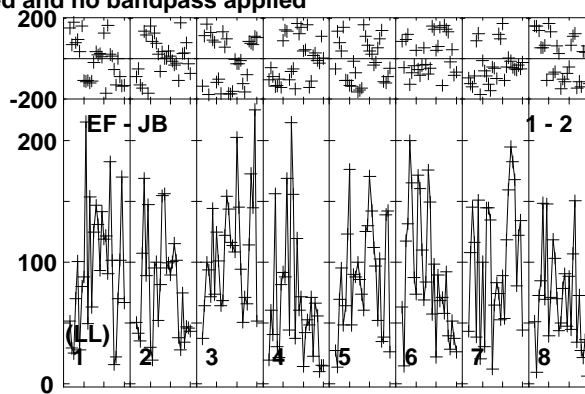
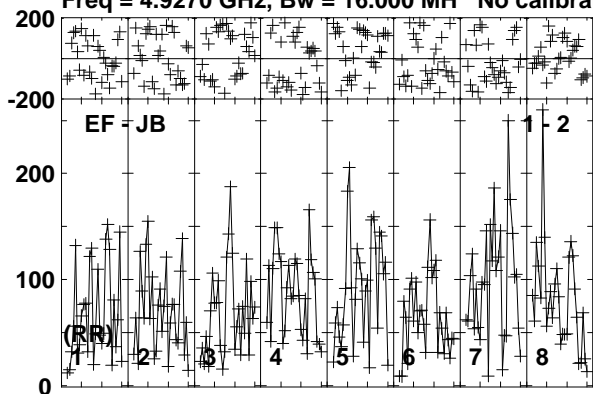

Lower frame: Micro Ampl Jy Top frame: Phas deg
Vector averaged cross-power spectrum Baseline: EF (01) - JB (02)
Timerange: 01/06:34:43 to 01/06:38:09

Plot file version 384 created 26-MAR-2015 15:27:57

TVLM513 EG082E.UVDATA.1

Freq = 4.9270 GHz, Bw = 16.000 MH No calibration applied and no bandpass applied

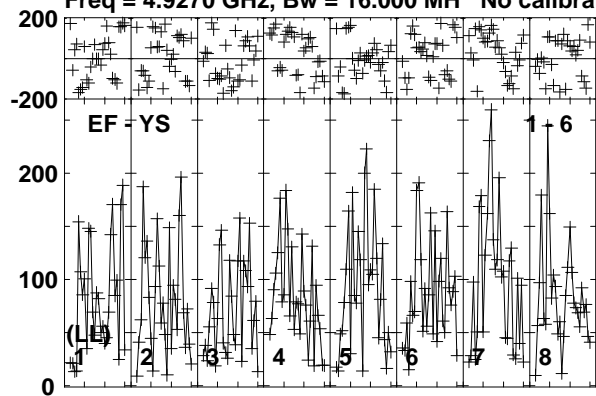

Lower frame: Micro Ampl Jy Top frame: Phas deg
Vector averaged cross-power spectrum Baseline: EF (01) - YS (06)
Timerange: 01/06:34:43 to 01/06:38:09

Plot file version 385 created 26-MAR-2015 15:27:58

J1455+2131 EG082E.UVDATA.1

Freq = 4.9270 GHz, Bw = 16.000 MH No calibration applied and no bandpass applied

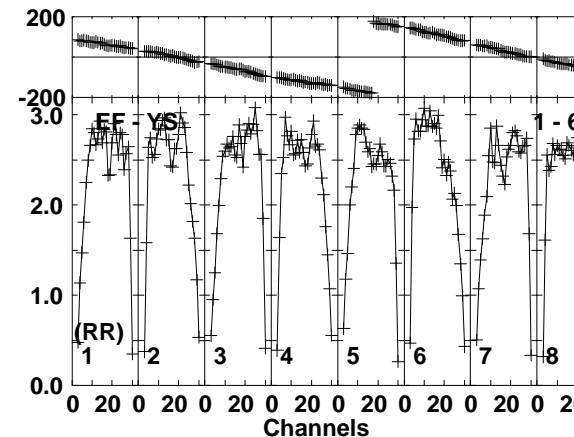
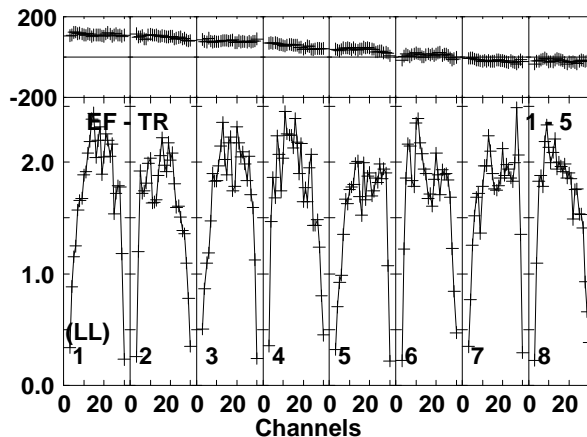
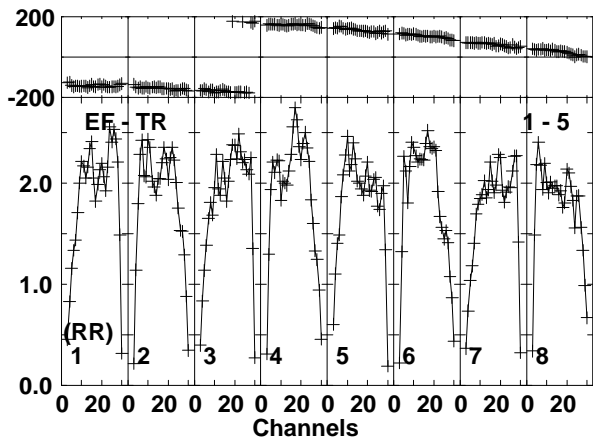
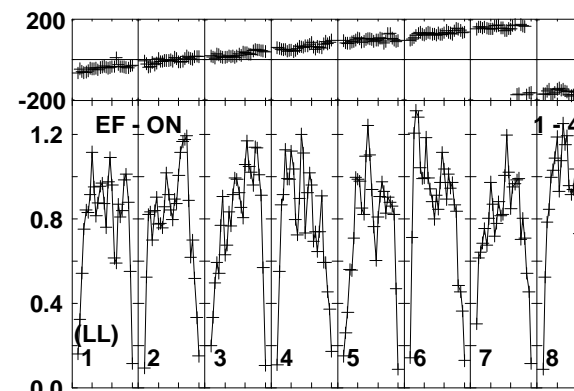
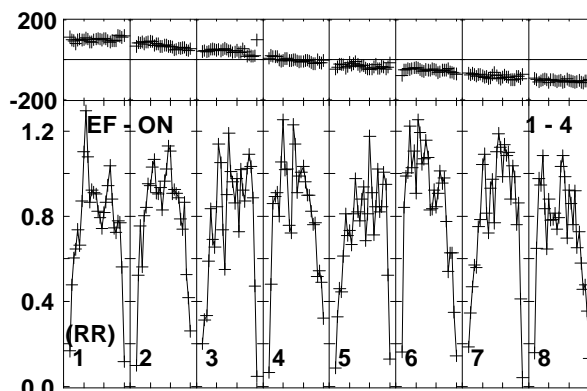
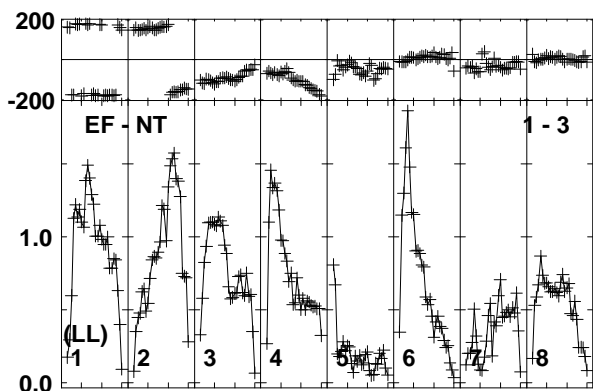
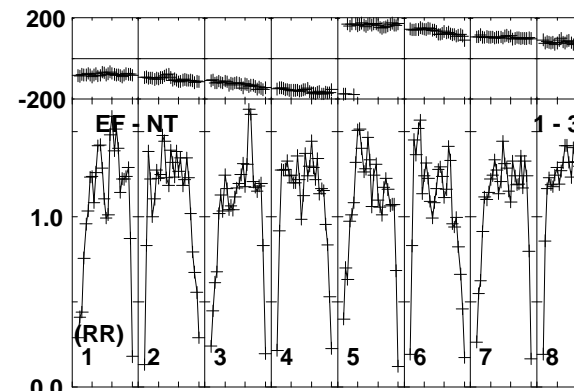
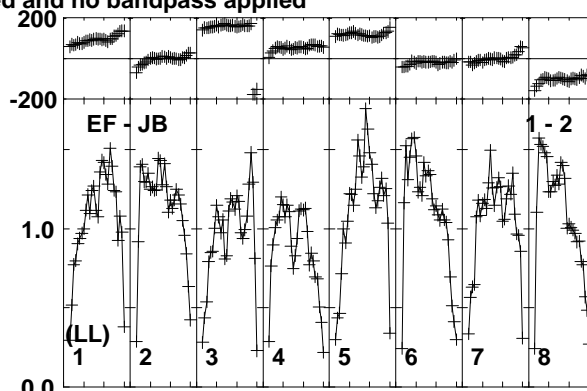
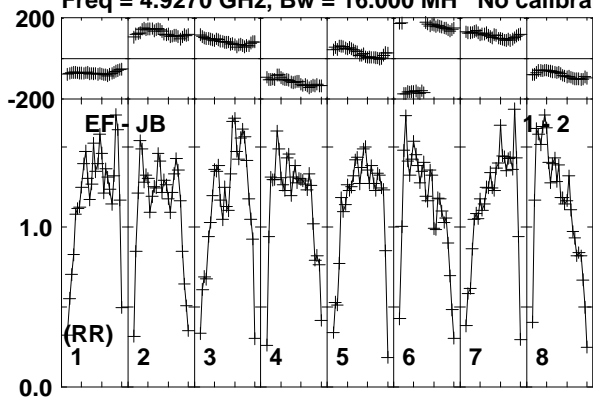

Lower frame: Milli Ampl Jy Top frame: Phas deg
Vector averaged cross-power spectrum Baseline: EF (01) - JB (02)
Timerange: 01/06:38:13 to 01/06:39:39

Plot file version 386 created 26-MAR-2015 15:27:58

J1455+2131 EG082E.UVDATA.1

Freq = 4.9270 GHz, Bw = 16.000 MH No calibration applied and no bandpass applied

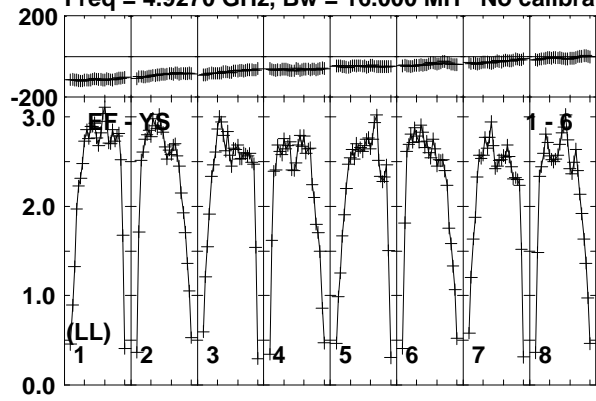

Lower frame: Milli Ampl Jy Top frame: Phas deg
Vector averaged cross-power spectrum Baseline: EF (01) - YS (06)
Timerange: 01/06:38:13 to 01/06:39:39

Plot file version 387 created 26-MAR-2015 15:27:58

TVLM513 EG082E.UVDATA.1

Freq = 4.9270 GHz, Bw = 16.000 MH No calibration applied and no bandpass applied

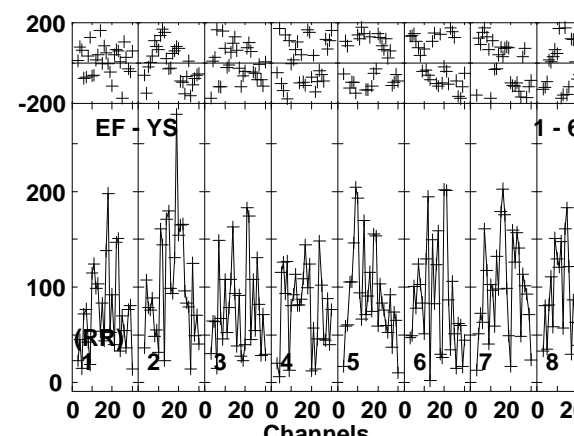
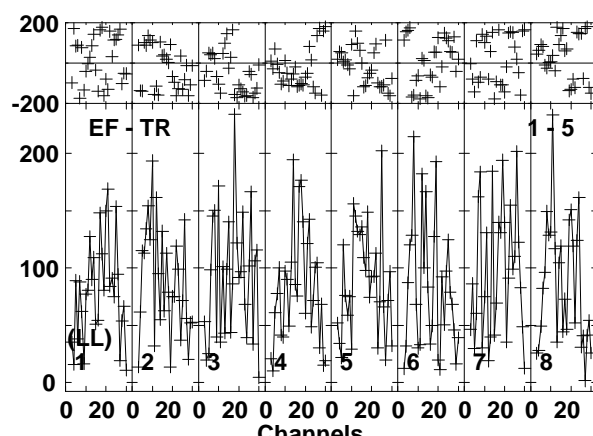
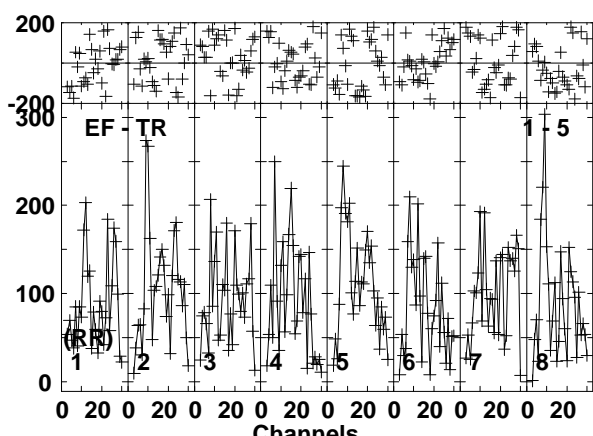
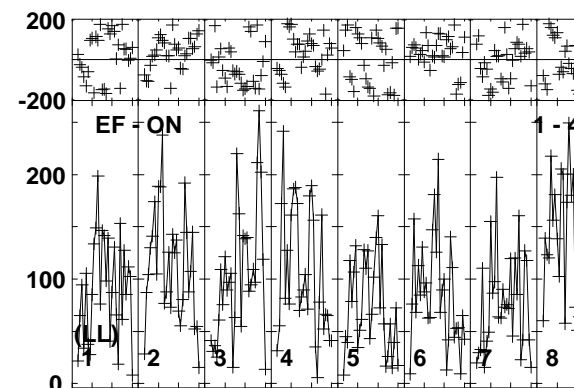
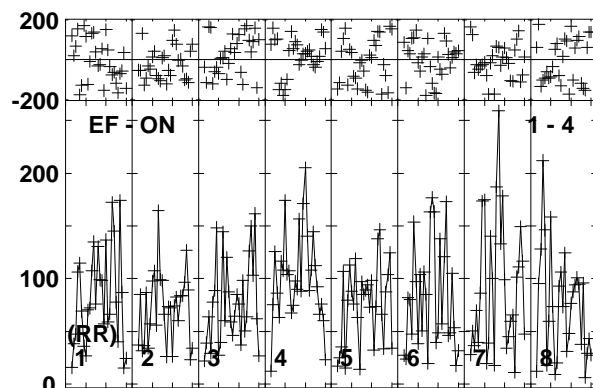
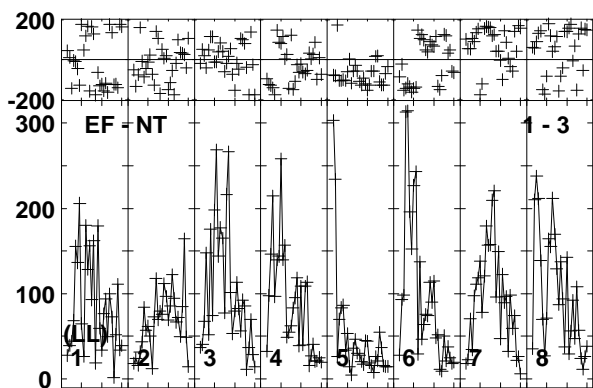
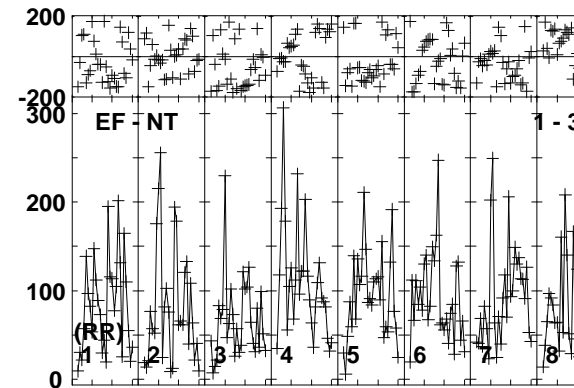
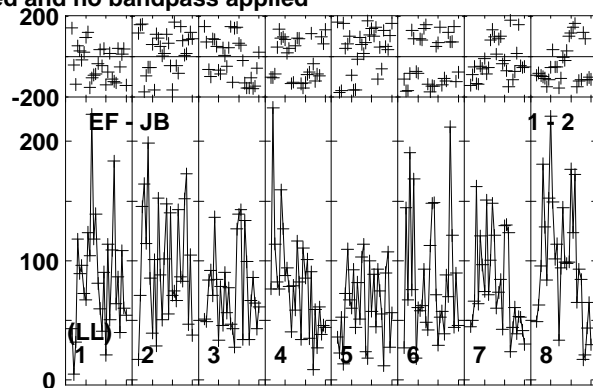
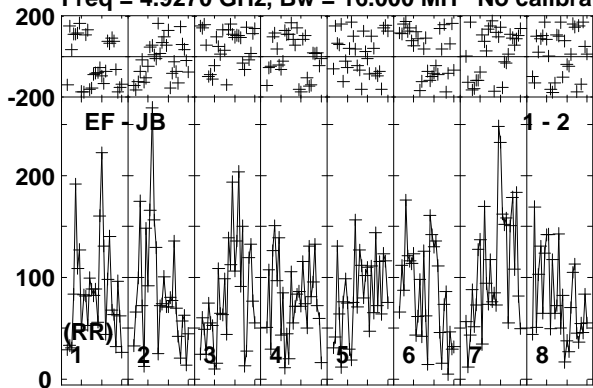

Lower frame: Micro Ampl Jy Top frame: Phas deg
Vector averaged cross-power spectrum Baseline: EF (01) - JB (02)
Timerange: 01/06:39:43 to 01/06:43:09

Plot file version 388 created 26-MAR-2015 15:27:58

TVLM513 EG082E.UVDATA.1

Freq = 4.9270 GHz, Bw = 16.000 MH No calibration applied and no bandpass applied

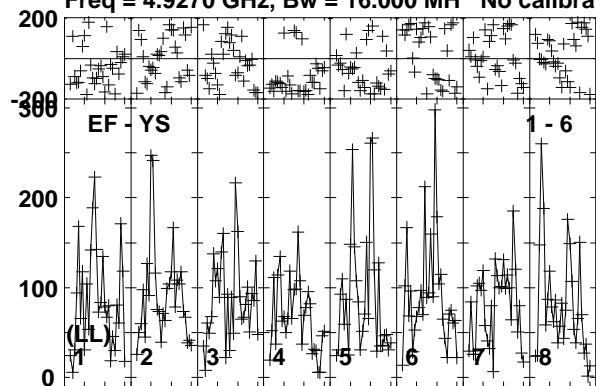

Lower frame: Micro Ampl Jy Top frame: Phas deg
Vector averaged cross-power spectrum Baseline: EF (01) - YS (06)
Timerange: 01/06:39:43 to 01/06:43:09

Plot file version 389 created 26-MAR-2015 15:27:58

J1455+2131 EG082E.UVDATA.1

Freq = 4.9270 GHz, Bw = 16.000 MH No calibration applied and no bandpass applied

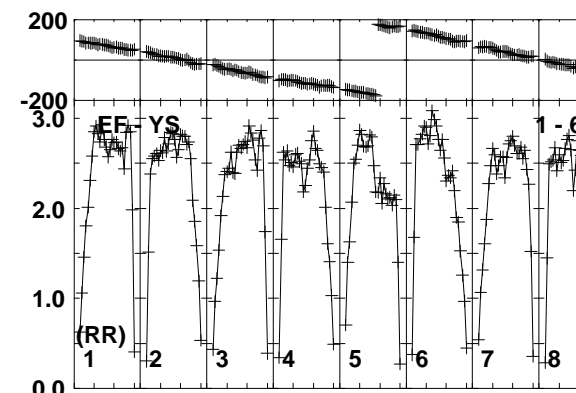
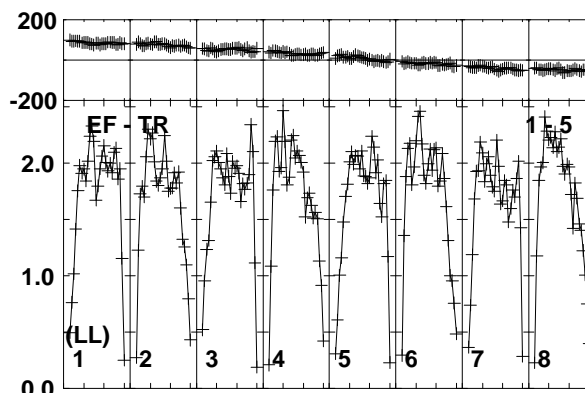
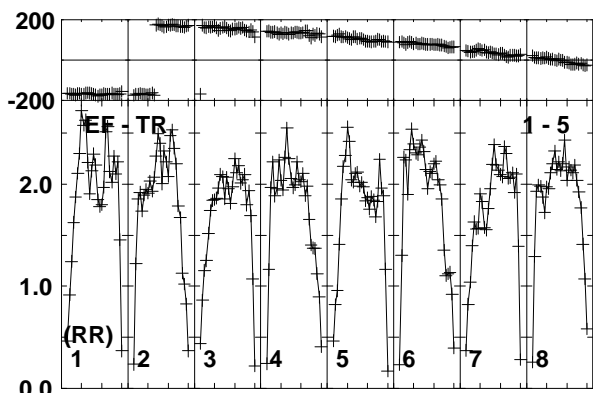
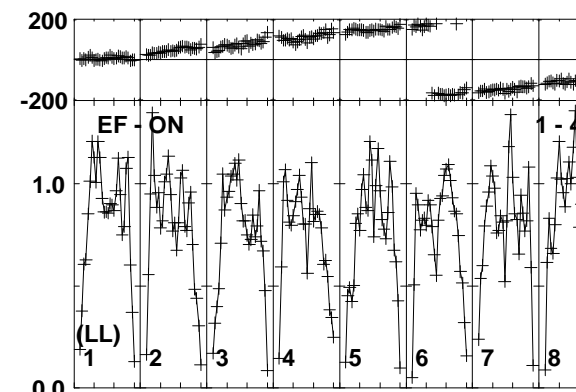
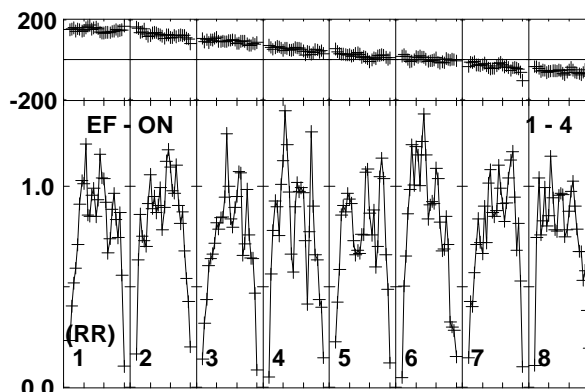
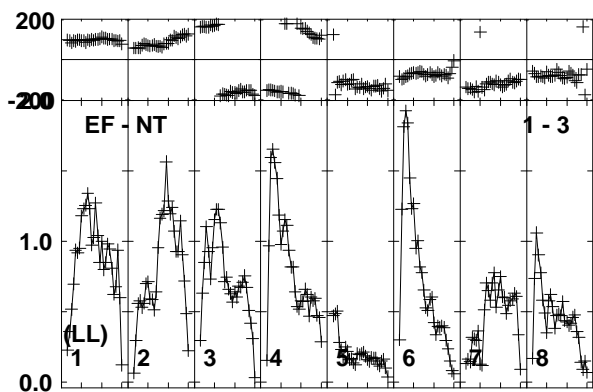
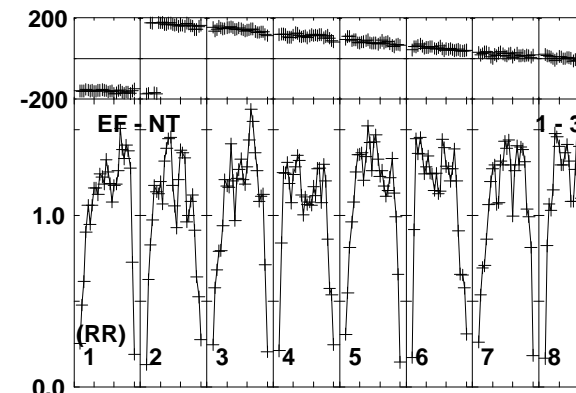
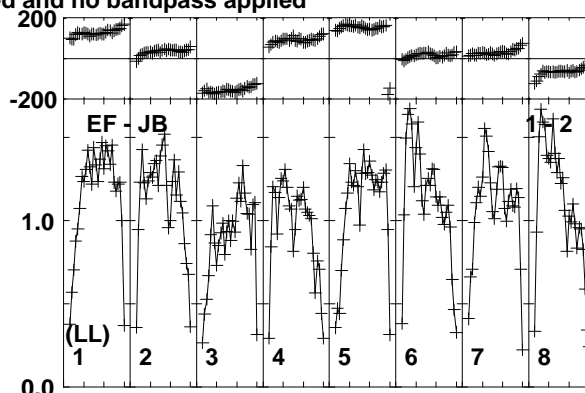
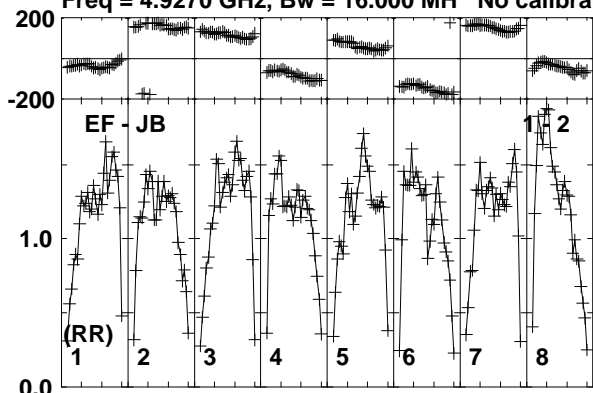

Lower frame: Milli Ampl Jy Top frame: Phas deg
Vector averaged cross-power spectrum Baseline: EF (01) - JB (02)
Timerange: 01/06:43:43 to 01/06:44:39

Plot file version 390 created 26-MAR-2015 15:27:58

J1455+2131 EG082E.UVDATA.1

Freq = 4.9270 GHz, Bw = 16.000 MH No calibration applied and no bandpass applied

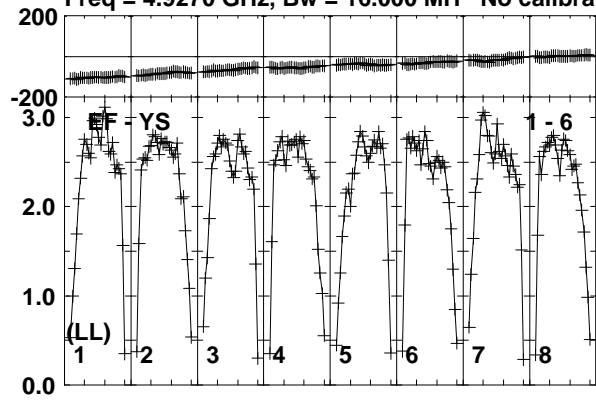

Lower frame: Milli Ampl Jy Top frame: Phas deg
Vector averaged cross-power spectrum Baseline: EF (01) - YS (06)
Timerange: 01/06:43:43 to 01/06:44:39

Plot file version 392 created 26-MAR-2015 15:27:58

TVLM513 EG082E.UVDATA.1

Freq = 4.9270 GHz, Bw = 16.000 MH No calibration applied and no bandpass applied

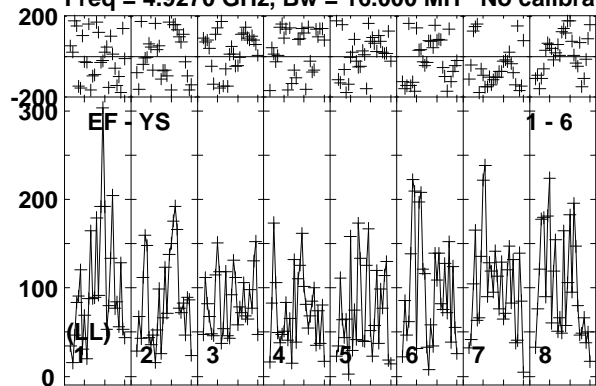

Lower frame: Micro Ampl Jy Top frame: Phas deg
Vector averaged cross-power spectrum Baseline: EF (01) - YS (06)
Timerange: 01/06:44:43 to 01/06:48:09

Plot file version 393 created 26-MAR-2015 15:27:58

J1455+2131 EG082E.UVDATA.1

Freq = 4.9270 GHz, Bw = 16.000 MH No calibration applied and no bandpass applied

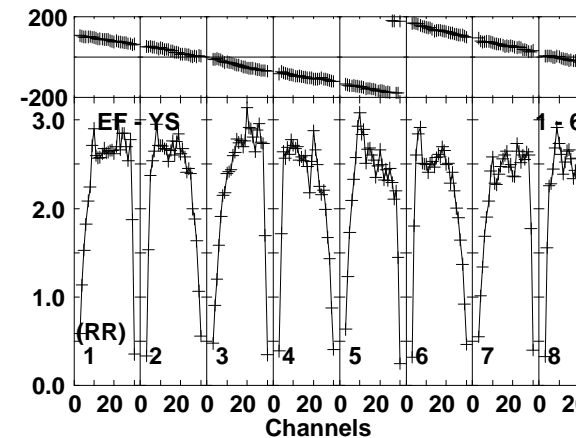
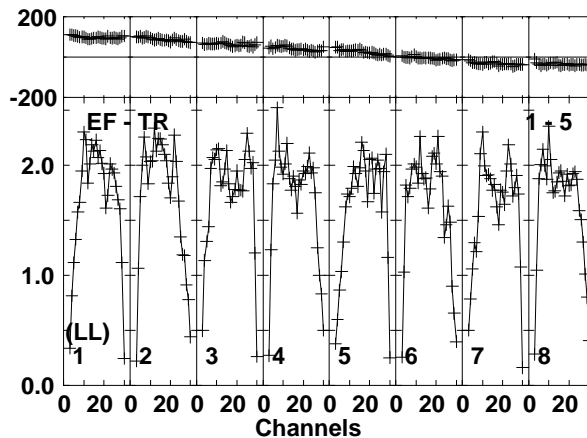
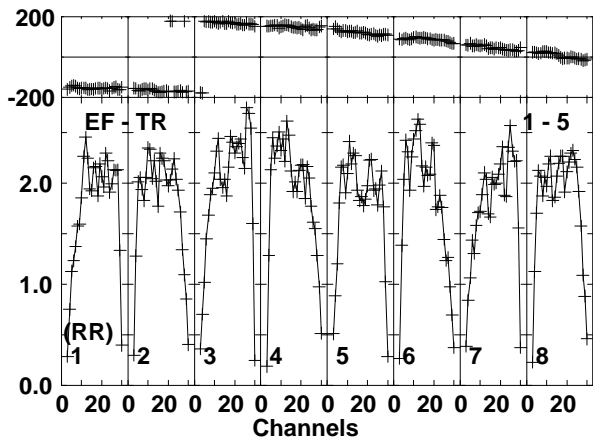
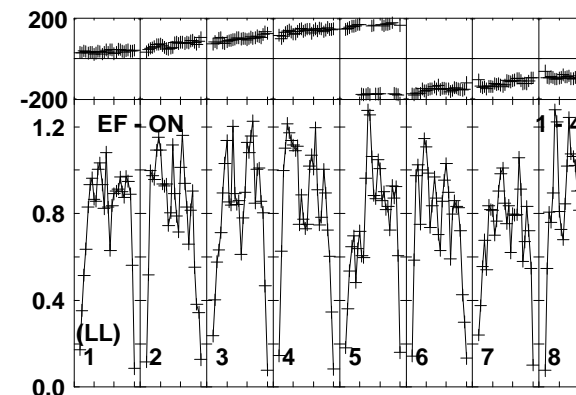
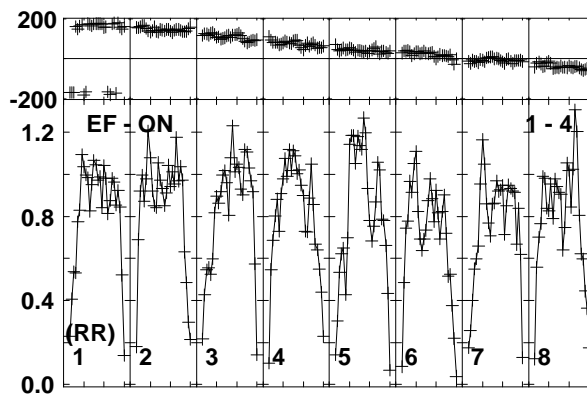
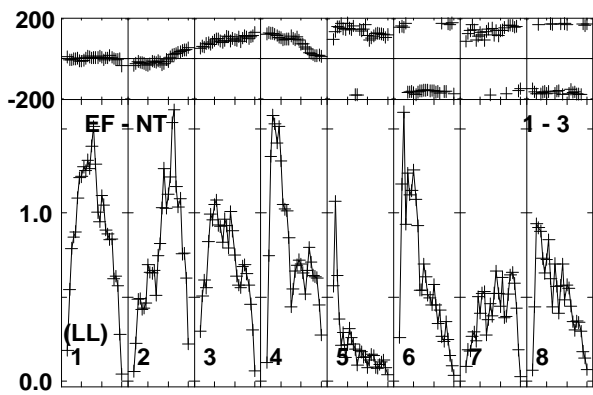
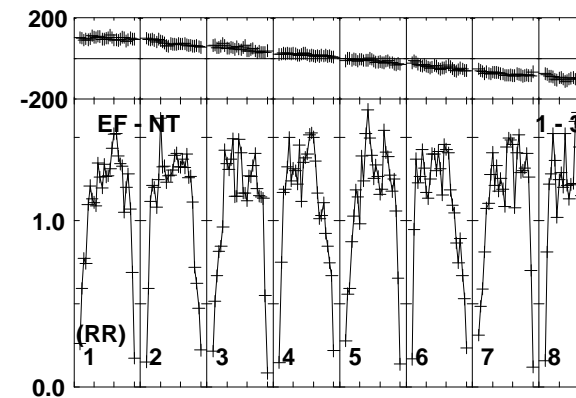
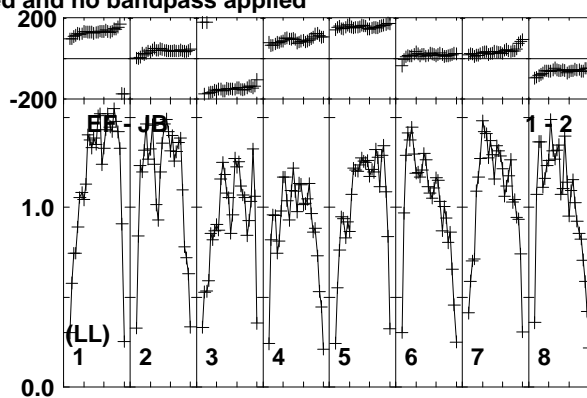
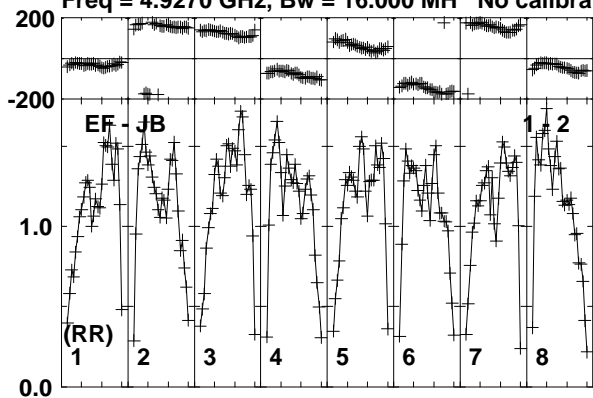

Lower frame: Milli Ampl Jy Top frame: Phas deg
Vector averaged cross-power spectrum Baseline: EF (01) - JB (02)
Timerange: 01/06:48:13 to 01/06:49:39

Plot file version 394 created 26-MAR-2015 15:27:58

J1455+2131 EG082E.UVDATA.1

Freq = 4.9270 GHz, Bw = 16.000 MH No calibration applied and no bandpass applied

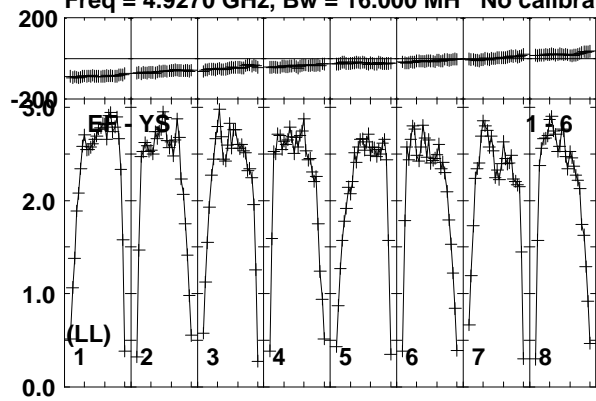

Lower frame: Milli Ampl Jy Top frame: Phas deg
Vector averaged cross-power spectrum Baseline: EF (01) - YS (06)
Timerange: 01/06:48:13 to 01/06:49:39

Plot file version 395 created 26-MAR-2015 15:27:58

TVLM513 EG082E.UVDATA.1

Freq = 4.9270 GHz, Bw = 16.000 MH No calibration applied and no bandpass applied

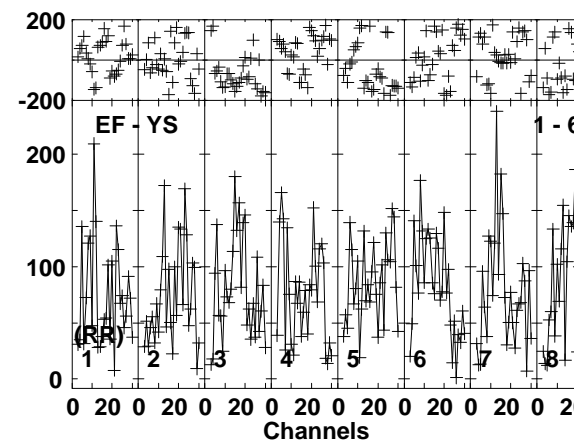
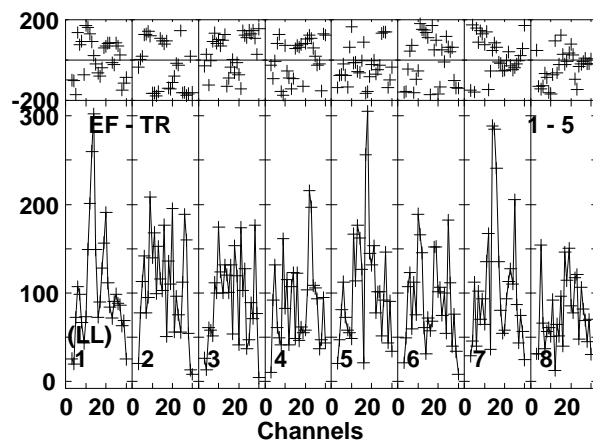
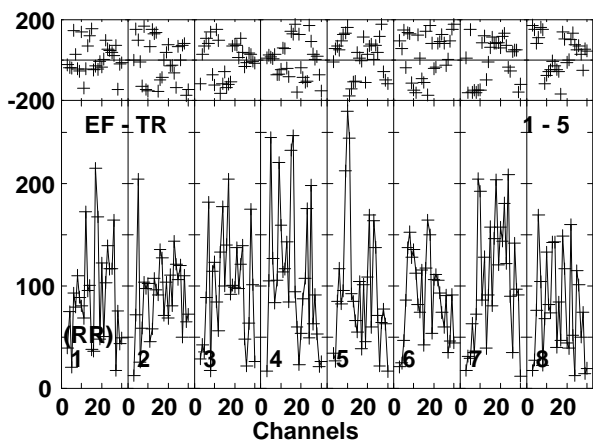
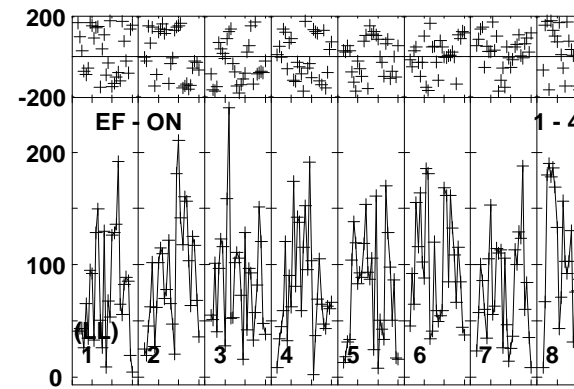
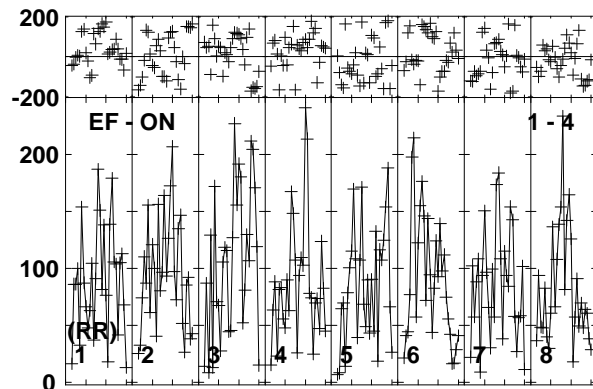
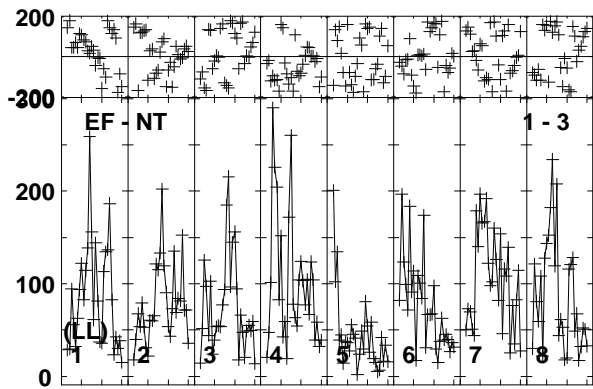
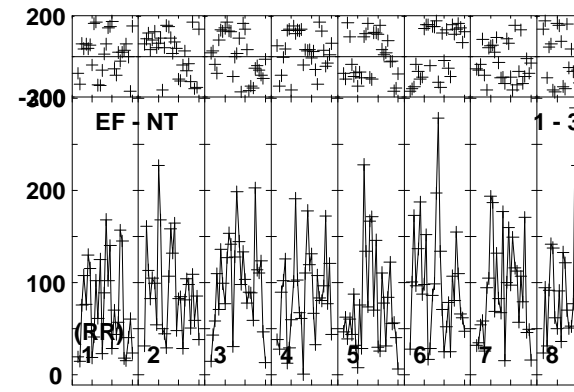
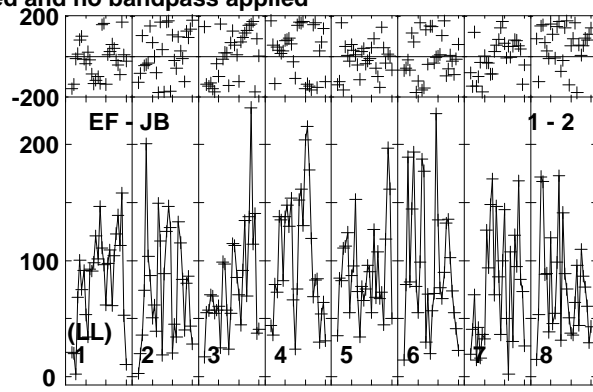
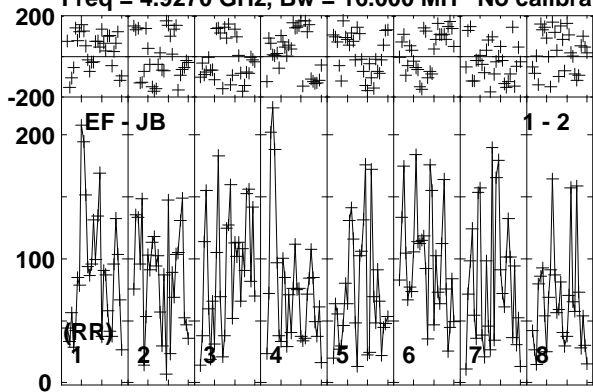

Lower frame: Micro Ampl Jy Top frame: Phas deg
Vector averaged cross-power spectrum Baseline: EF (01) - JB (02)
Timerange: 01/06:49:43 to 01/06:53:09

Plot file version 396 created 26-MAR-2015 15:27:58

TVLM513 EG082E.UVDATA.1

Freq = 4.9270 GHz, Bw = 16.000 MH No calibration applied and no bandpass applied

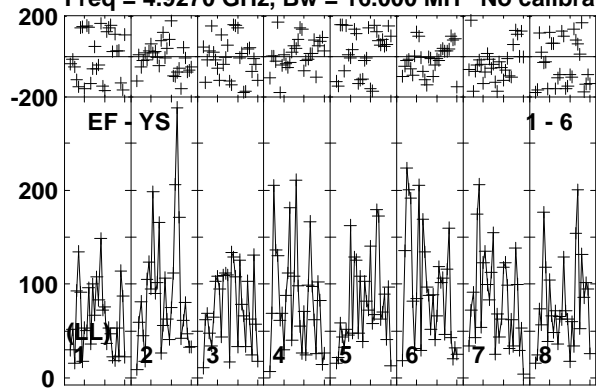

Lower frame: Micro Ampl Jy Top frame: Phas deg
Vector averaged cross-power spectrum Baseline: EF (01) - YS (06)
Timerange: 01/06:49:43 to 01/06:53:09

Plot file version 397 created 26-MAR-2015 15:27:58

J1455+2131 EG082E.UVDATA.1

Freq = 4.9270 GHz, Bw = 16.000 MH No calibration applied and no bandpass applied

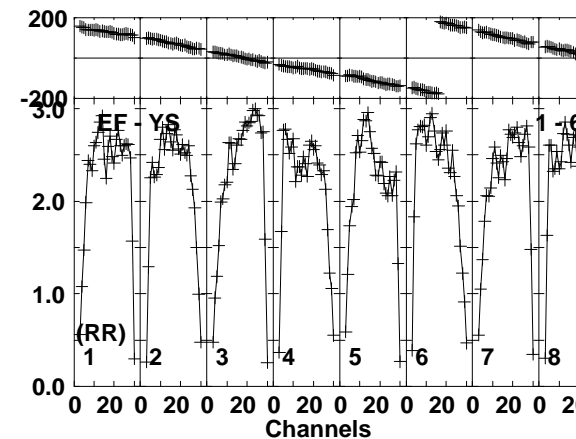
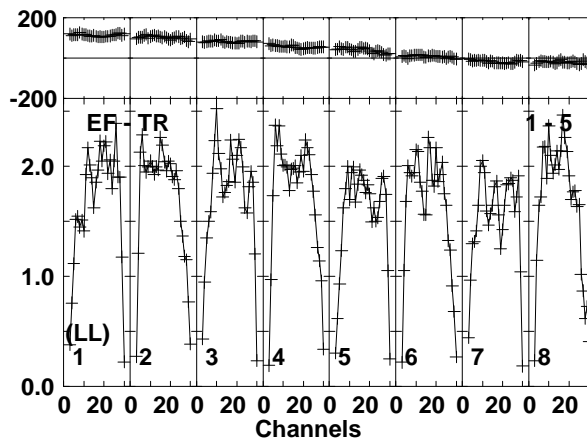
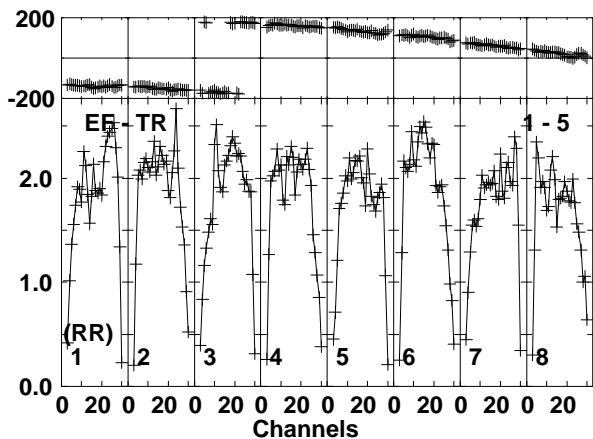
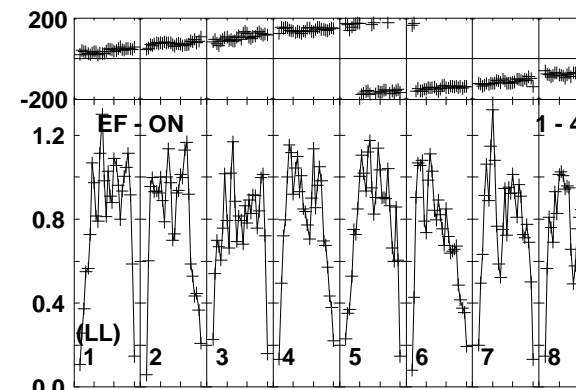
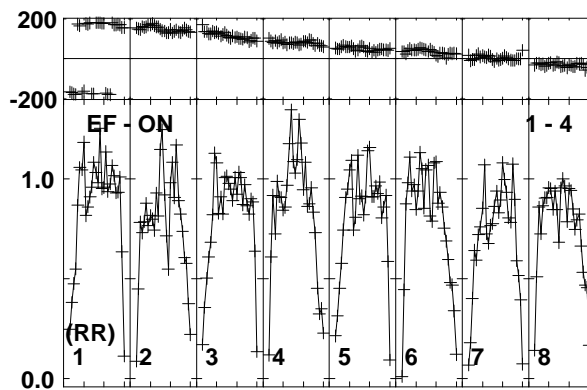
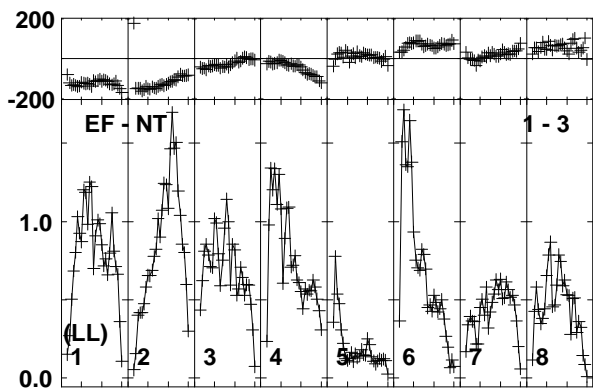
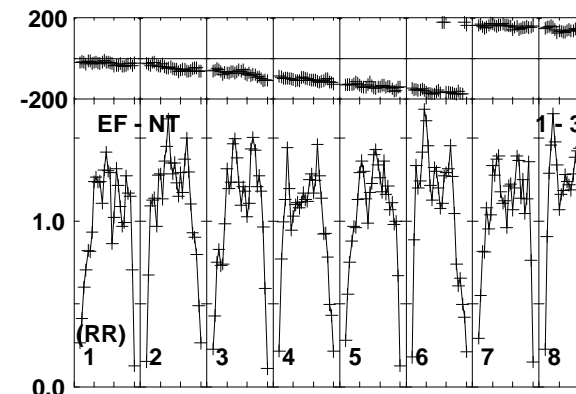
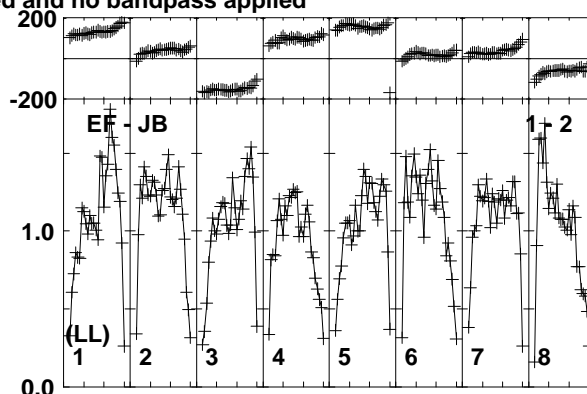
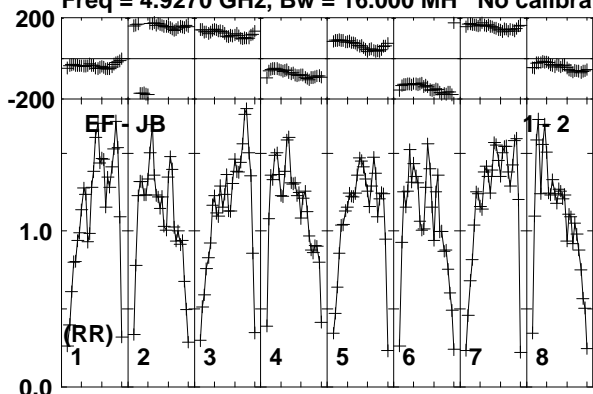

Lower frame: Milli Ampl Jy Top frame: Phas deg
Vector averaged cross-power spectrum Baseline: EF (01) - JB (02)
Timerange: 01/06:53:43 to 01/06:54:39

Plot file version 398 created 26-MAR-2015 15:27:58

J1455+2131 EG082E.UVDATA.1

Freq = 4.9270 GHz, Bw = 16.000 MH No calibration applied and no bandpass applied

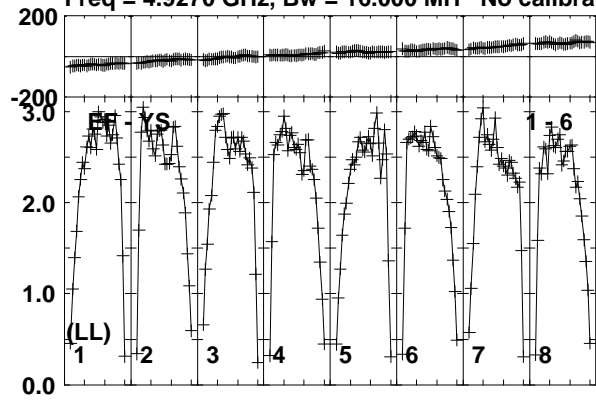

Lower frame: Milli Ampl Jy Top frame: Phas deg
Vector averaged cross-power spectrum Baseline: EF (01) - YS (06)
Timerange: 01/06:53:43 to 01/06:54:39

Plot file version 399 created 26-MAR-2015 15:27:58

TVLM513 EG082E.UVDATA.1

Freq = 4.9270 GHz, Bw = 16.000 MH No calibration applied and no bandpass applied

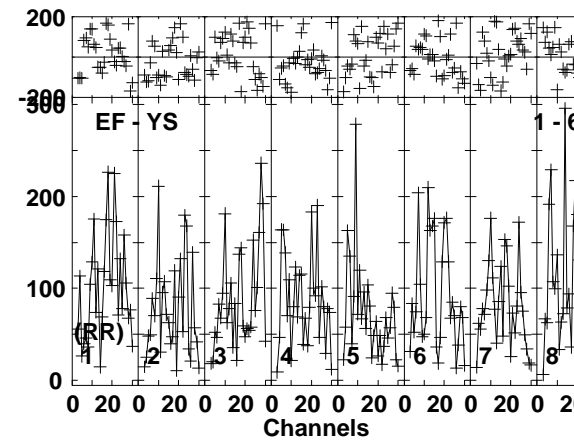
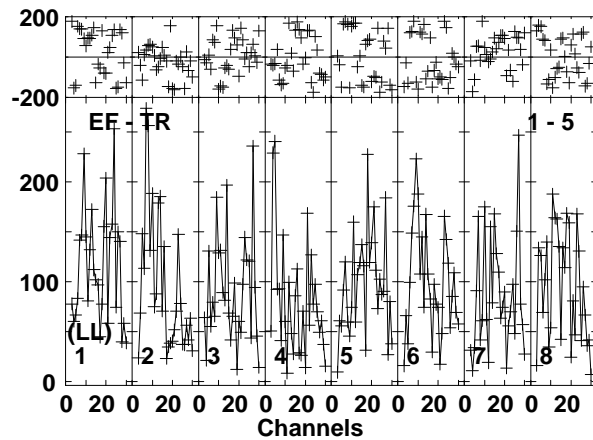
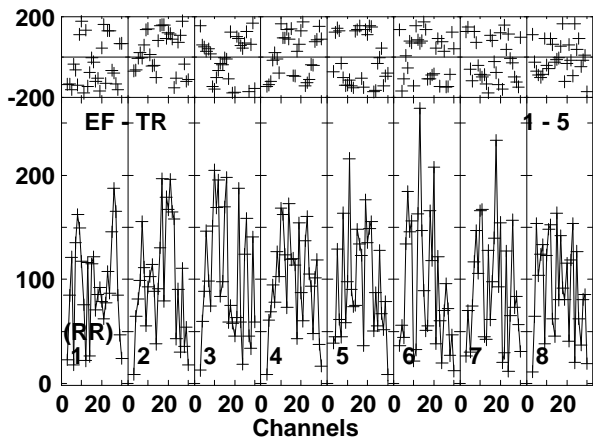
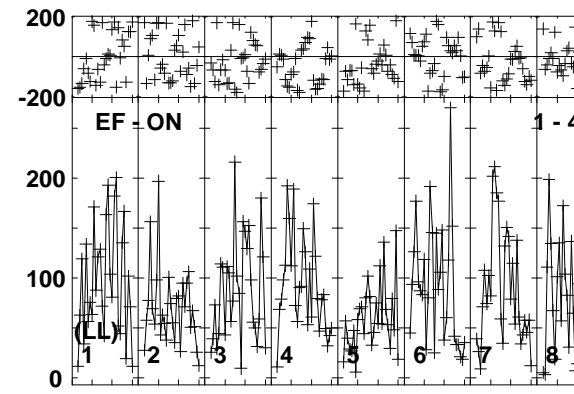
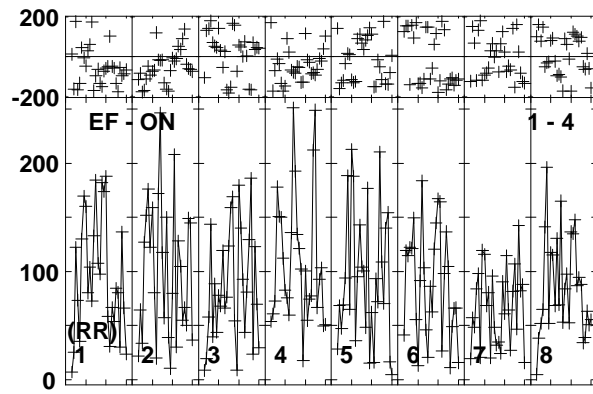
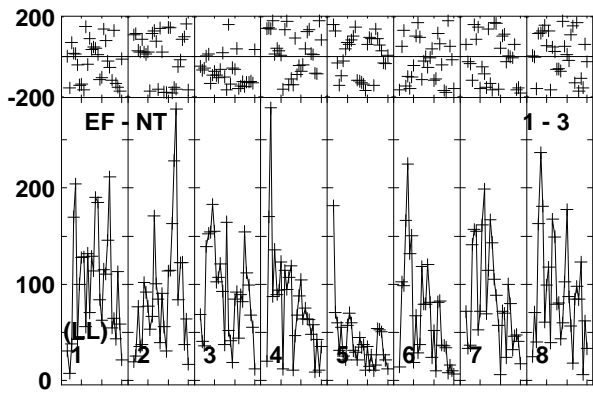
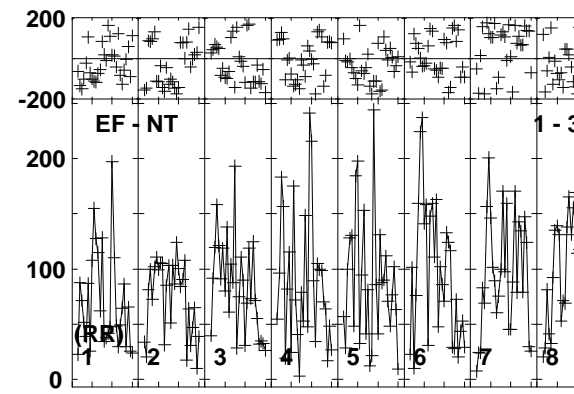
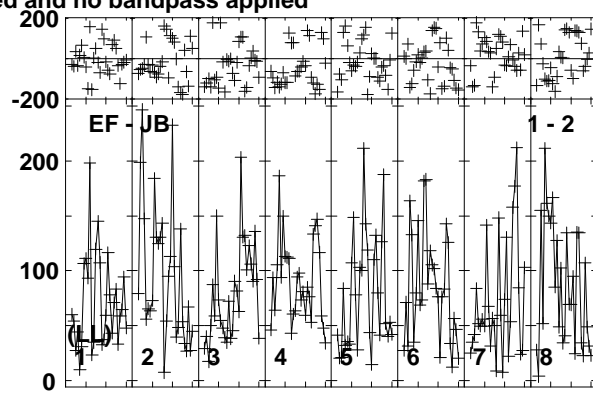
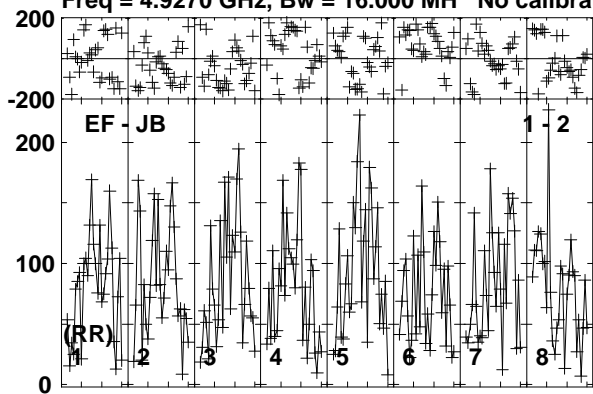

Lower frame: Micro Ampl Jy Top frame: Phas deg
Vector averaged cross-power spectrum Baseline: EF (01) - JB (02)
Timerange: 01/06:54:43 to 01/06:58:09

Plot file version 400 created 26-MAR-2015 15:27:58

TVLM513 EG082E.UVDATA.1

Freq = 4.9270 GHz, Bw = 16.000 MH No calibration applied and no bandpass applied

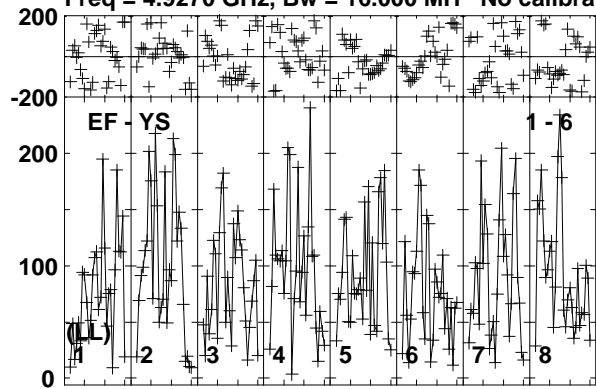

Lower frame: Micro Ampl Jy Top frame: Phas deg
Vector averaged cross-power spectrum Baseline: EF (01) - YS (06)
Timerange: 01/06:54:43 to 01/06:58:09

Plot file version 401 created 26-MAR-2015 15:27:58

J1455+2131 EG082E.UVDATA.1

Freq = 4.9270 GHz, Bw = 16.000 MH No calibration applied and no bandpass applied

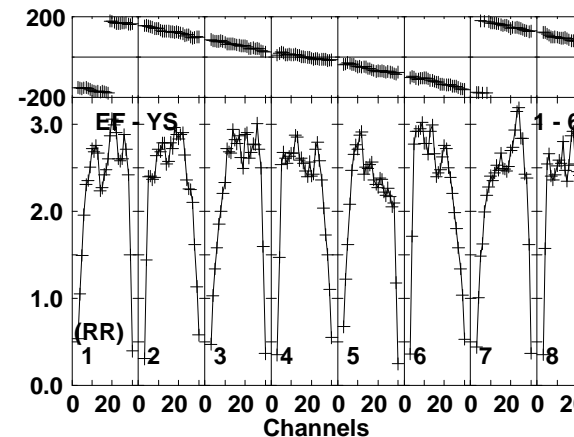
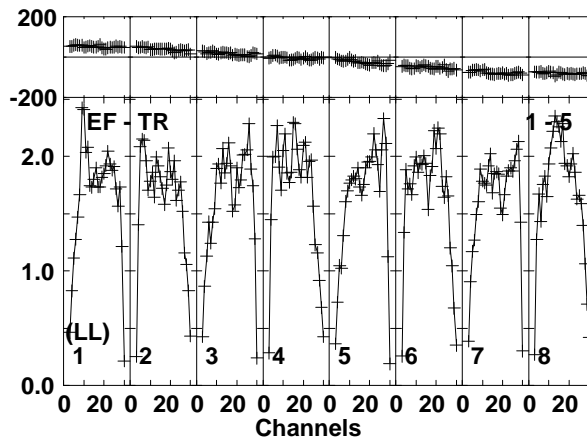
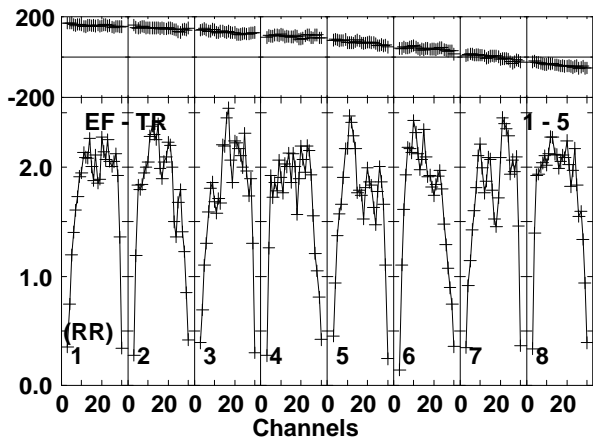
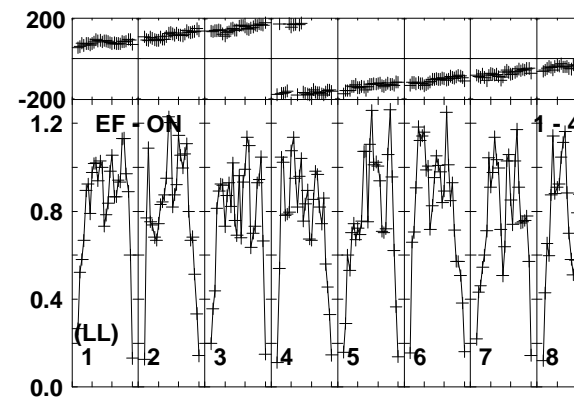
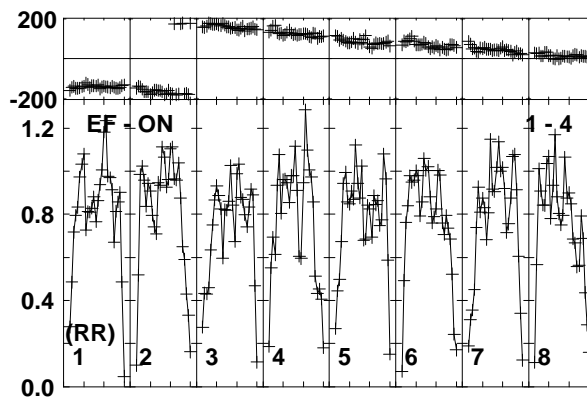
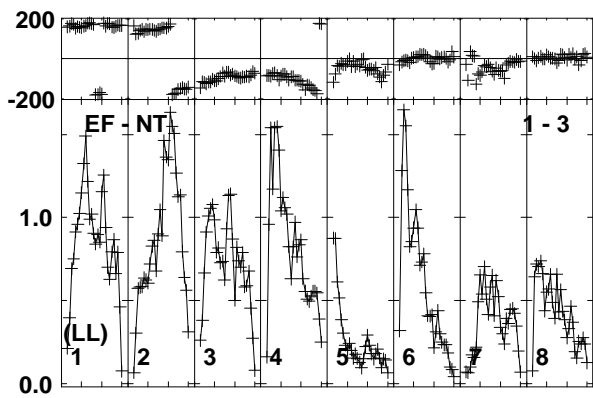
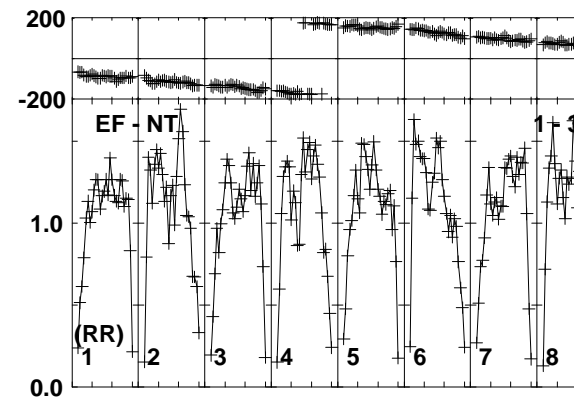
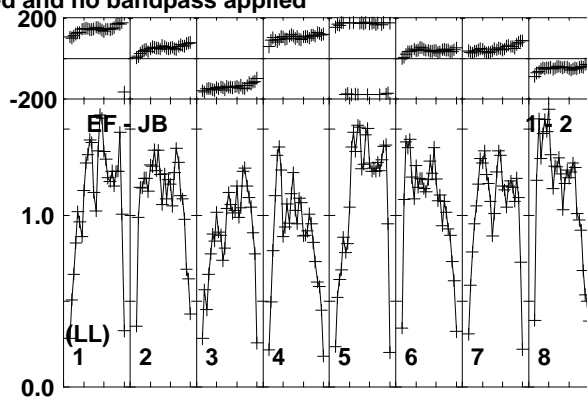
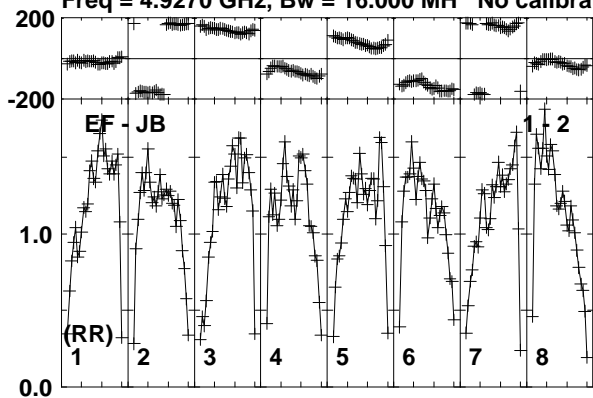

Lower frame: Milli Ampl Jy Top frame: Phas deg
Vector averaged cross-power spectrum Baseline: EF (01) - JB (02)
Timerange: 01/06:58:13 to 01/06:59:39

Plot file version 402 created 26-MAR-2015 15:27:58

J1455+2131 EG082E.UVDATA.1

Freq = 4.9270 GHz, Bw = 16.000 MH No calibration applied and no bandpass applied

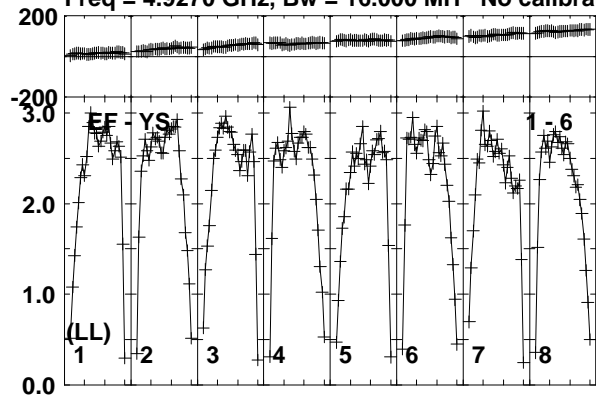

Lower frame: Milli Ampl Jy Top frame: Phas deg
Vector averaged cross-power spectrum Baseline: EF (01) - YS (06)
Timerange: 01/06:58:13 to 01/06:59:39

Plot file version 403 created 26-MAR-2015 15:27:58

J1504+2218 EG082E.UVDATA.1

Freq = 4.9270 GHz, Bw = 16.000 MH No calibration applied and no bandpass applied

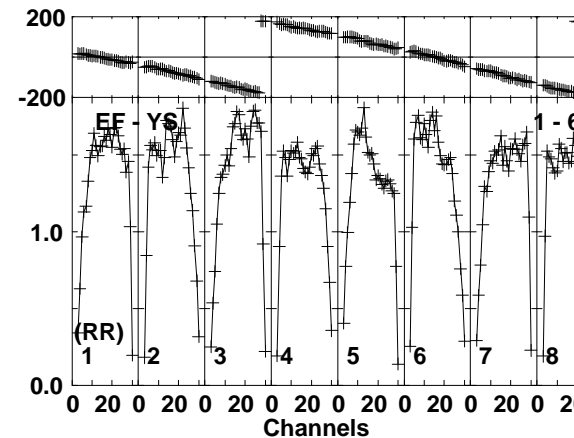
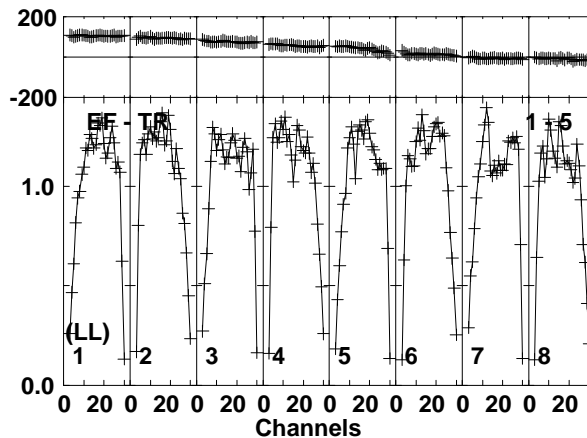
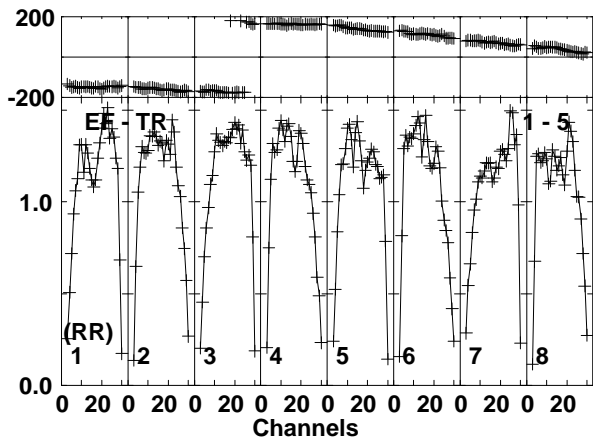
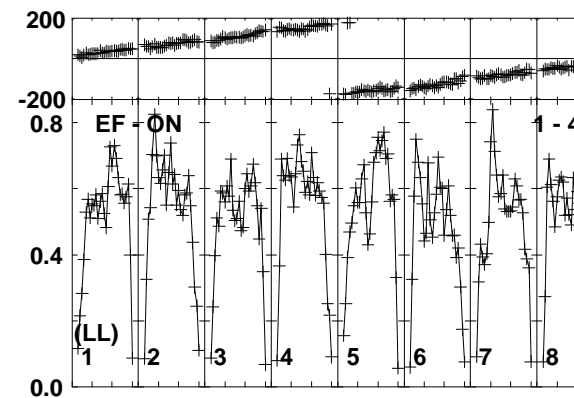
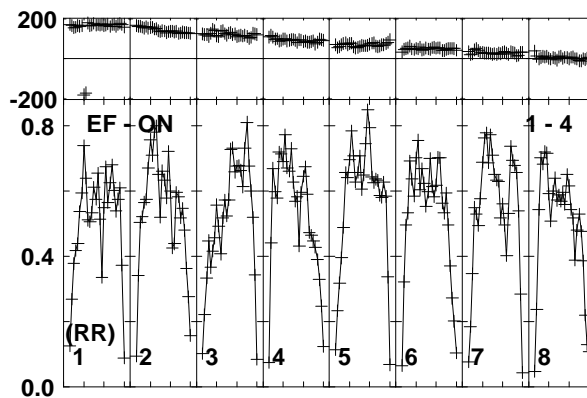
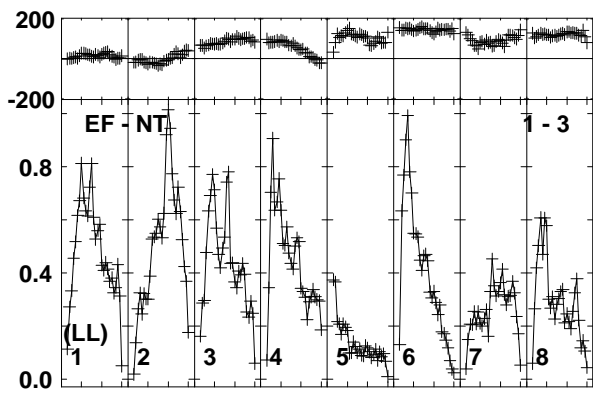
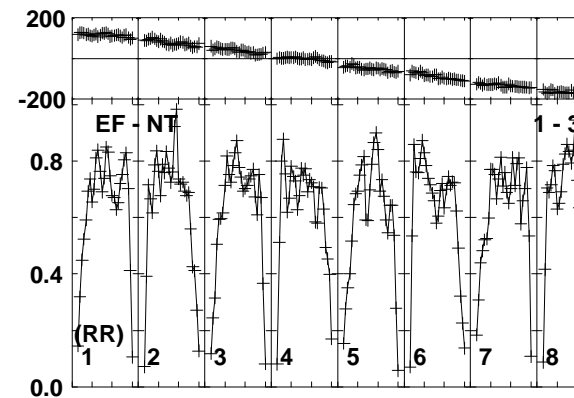
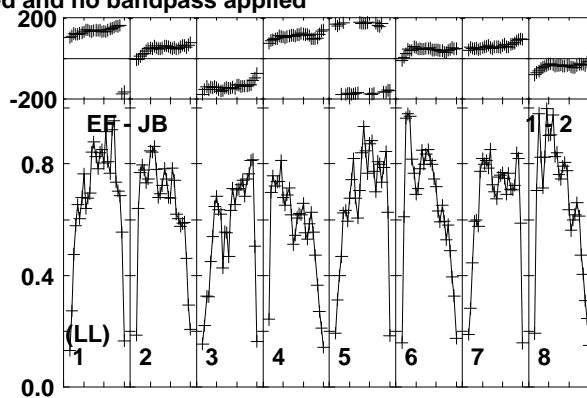
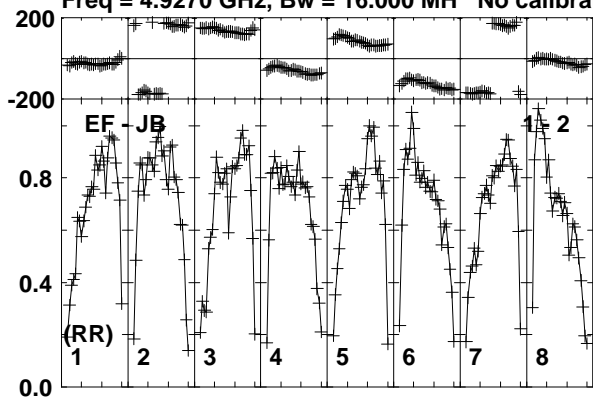

Lower frame: Milli Ampl Jy Top frame: Phas deg
Vector averaged cross-power spectrum Baseline: EF (01) - JB (02)
Timerange: 01/06:59:43 to 01/07:03:09

Plot file version 404 created 26-MAR-2015 15:27:58

J1504+2218 EG082E.UVDATA.1

Freq = 4.9270 GHz, Bw = 16.000 MH No calibration applied and no bandpass applied

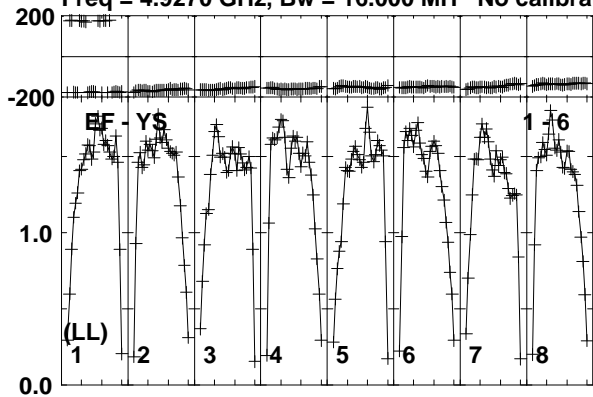

Lower frame: Milli Ampl Jy Top frame: Phas deg
Vector averaged cross-power spectrum Baseline: EF (01) - YS (06)
Timerange: 01/06:59:43 to 01/07:03:09

Plot file version 405 created 26-MAR-2015 15:27:58

J1455+2131 EG082E.UVDATA.1

Freq = 4.9270 GHz, Bw = 16.000 MH No calibration applied and no bandpass applied

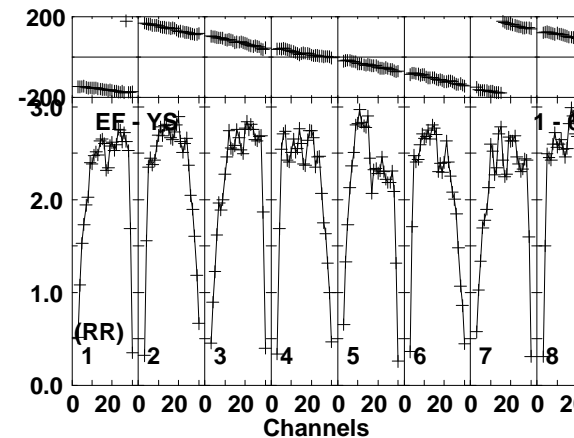
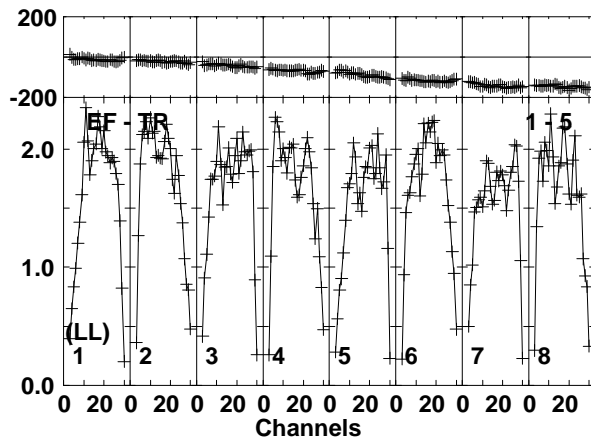
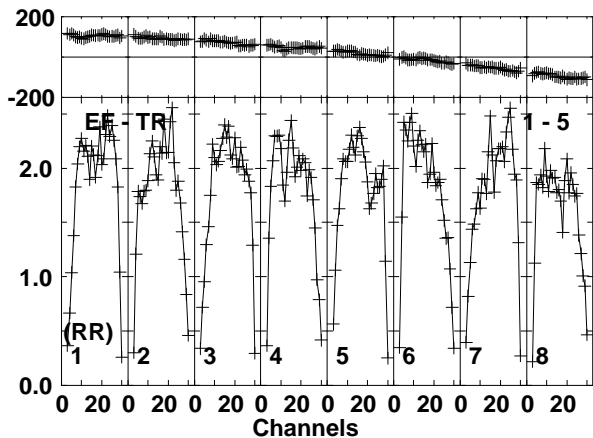
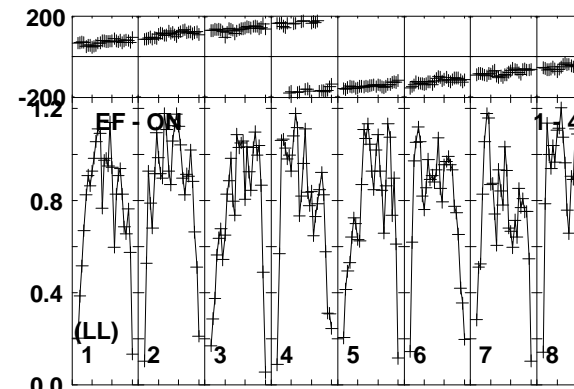
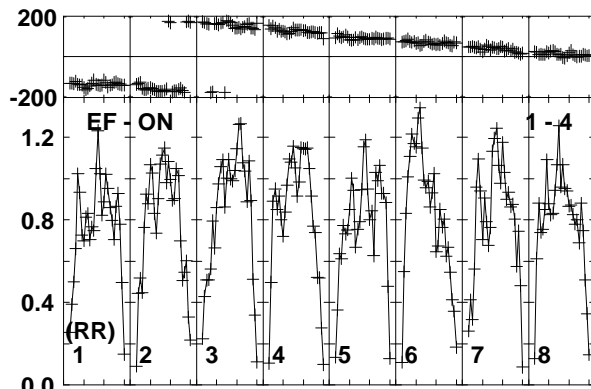
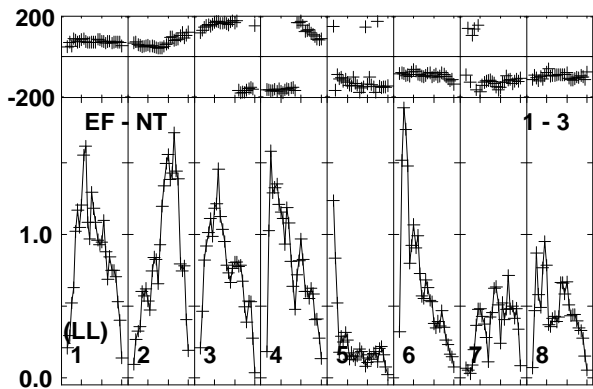
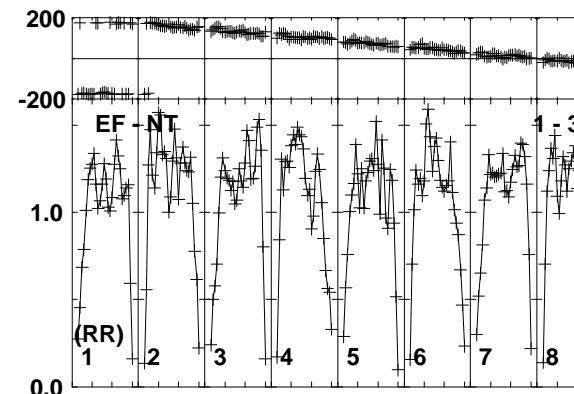
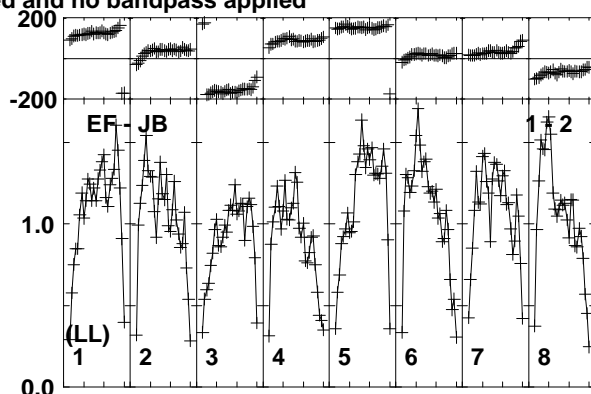
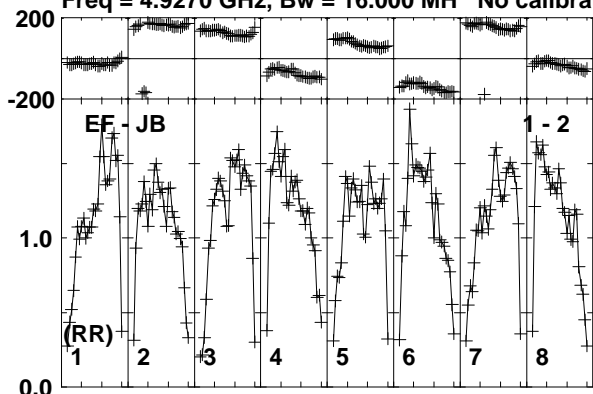

Lower frame: Milli Ampl Jy Top frame: Phas deg
Vector averaged cross-power spectrum Baseline: EF (01) - JB (02)
Timerange: 01/07:03:43 to 01/07:04:39

Plot file version 406 created 26-MAR-2015 15:27:59

J1455+2131 EG082E.UVDATA.1

Freq = 4.9270 GHz, Bw = 16.000 MH No calibration applied and no bandpass applied

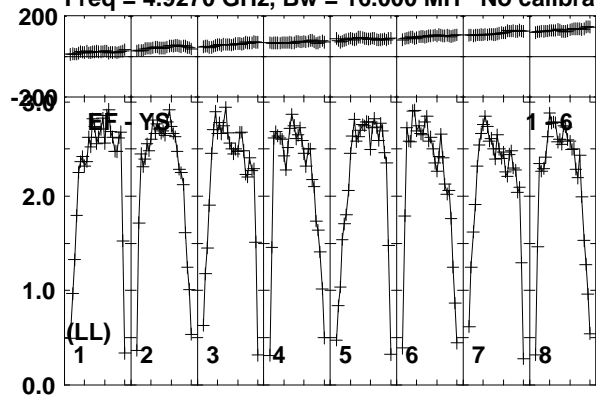

Lower frame: Milli Ampl Jy Top frame: Phas deg
Vector averaged cross-power spectrum Baseline: EF (01) - YS (06)
Timerange: 01/07:03:43 to 01/07:04:39

Plot file version 407 created 26-MAR-2015 15:27:59

TVLM513 EG082E.UVDATA.1

Freq = 4.9270 GHz, Bw = 16.000 MH No calibration applied and no bandpass applied

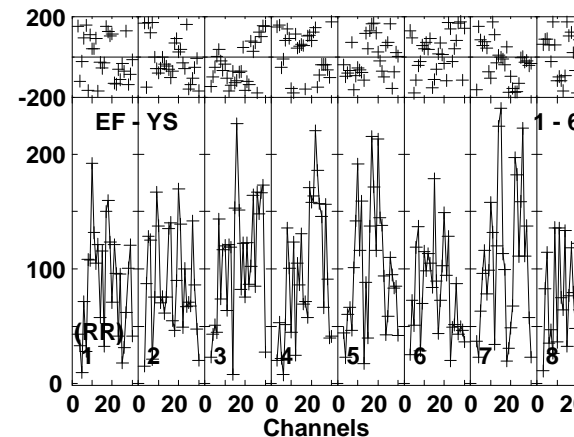
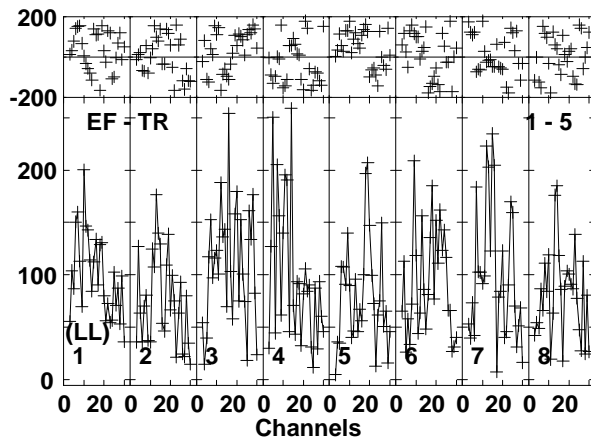
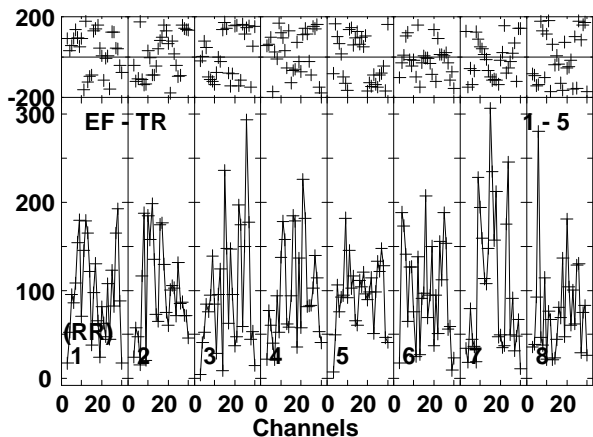
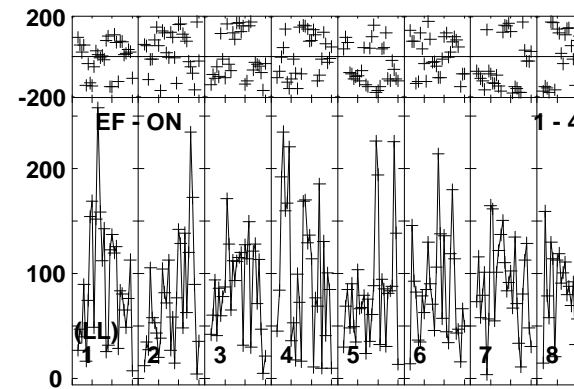
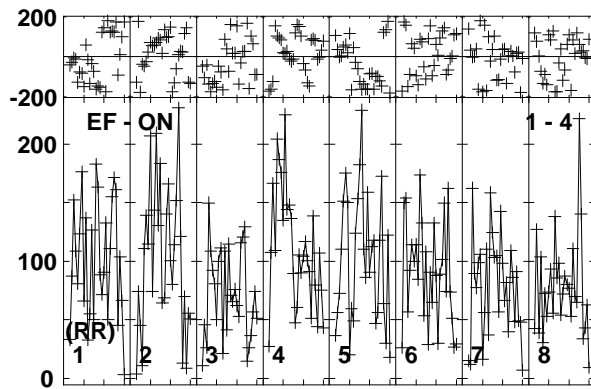
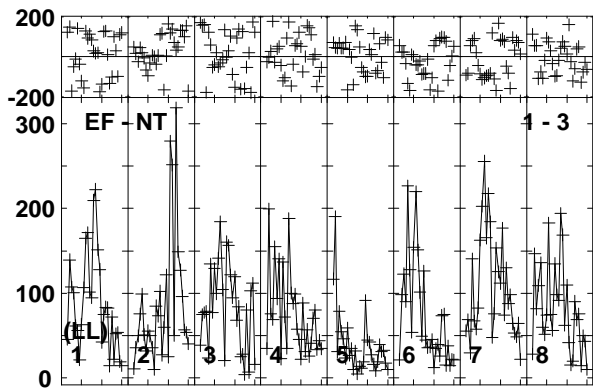
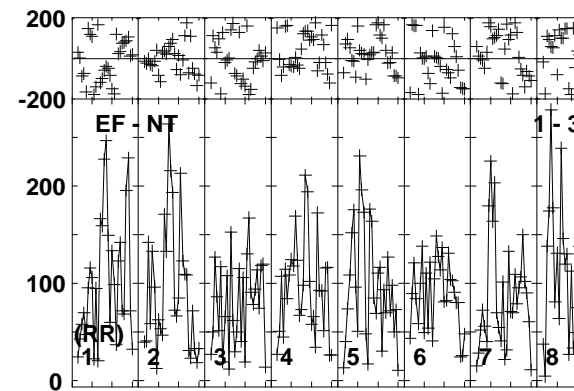
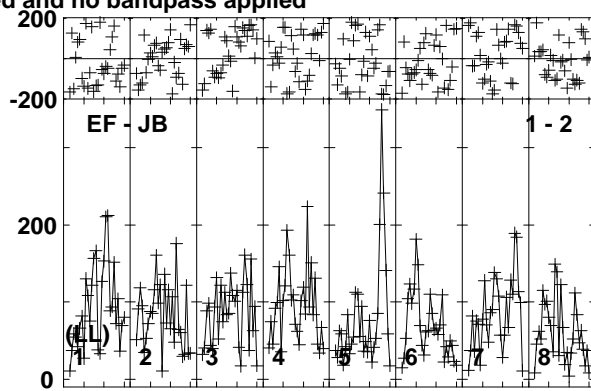
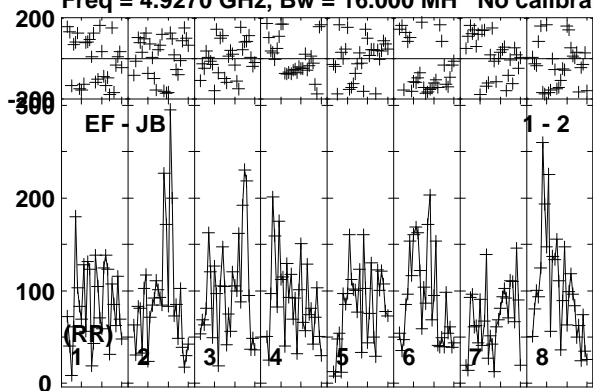

Lower frame: Micro Ampl Jy Top frame: Phas deg
Vector averaged cross-power spectrum Baseline: EF (01) - JB (02)
Timerange: 01/07:04:43 to 01/07:08:09

Plot file version 408 created 26-MAR-2015 15:27:59

TVLM513 EG082E.UVDATA.1

Freq = 4.9270 GHz, Bw = 16.000 MH No calibration applied and no bandpass applied

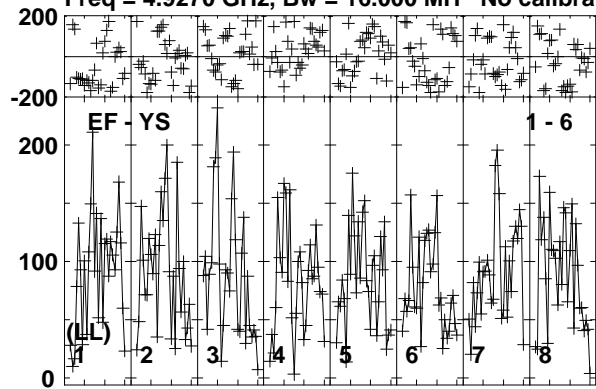

Lower frame: Micro Ampl Jy Top frame: Phas deg
Vector averaged cross-power spectrum Baseline: EF (01) - YS (06)
Timerange: 01/07:04:43 to 01/07:08:09

Plot file version 409 created 26-MAR-2015 15:27:59

J1455+2131 EG082E.UVDATA.1

Freq = 4.9270 GHz, Bw = 16.000 MH No calibration applied and no bandpass applied

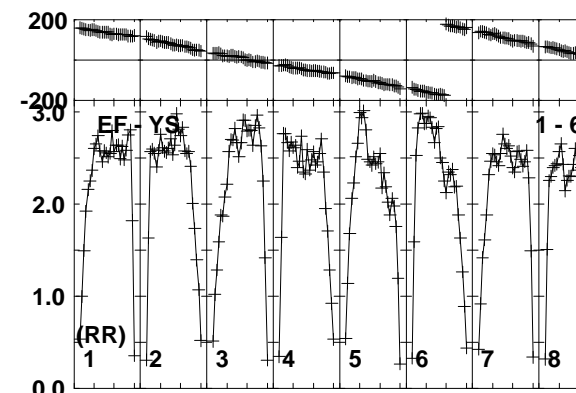
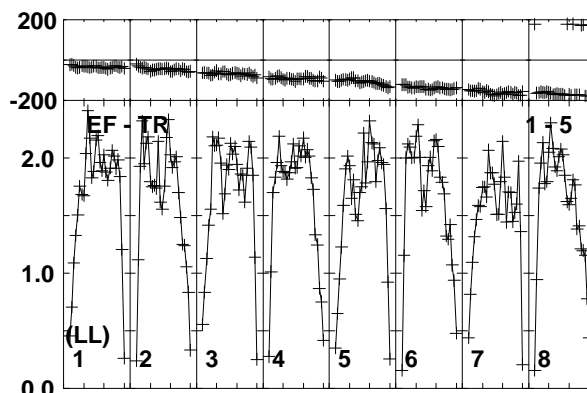
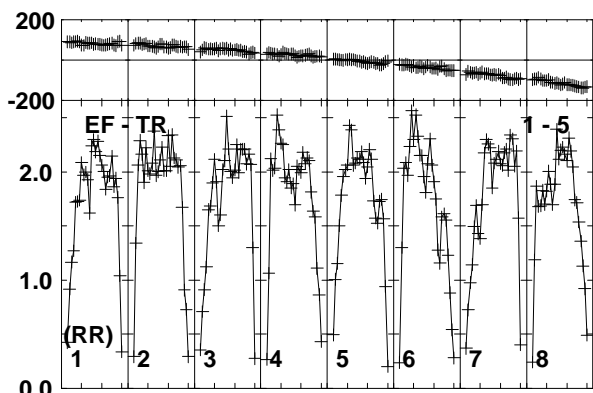
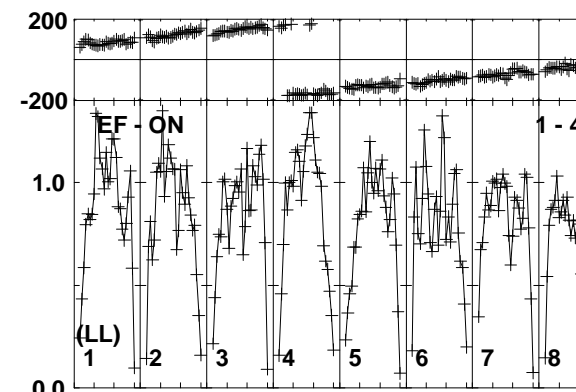
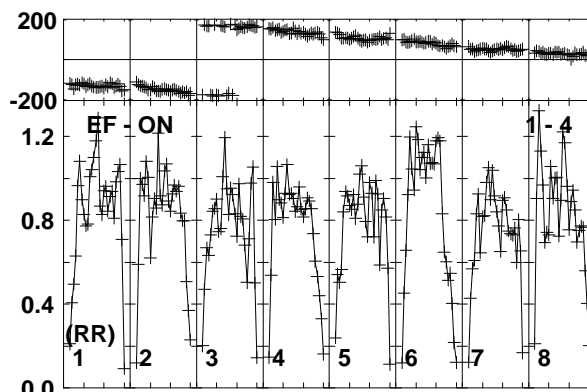
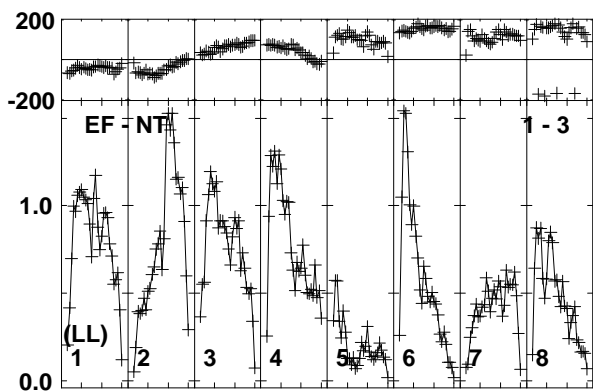
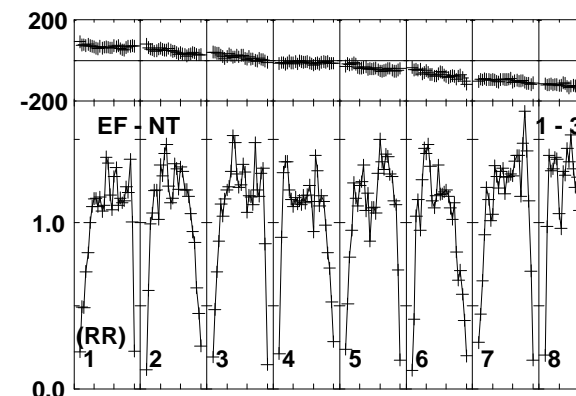
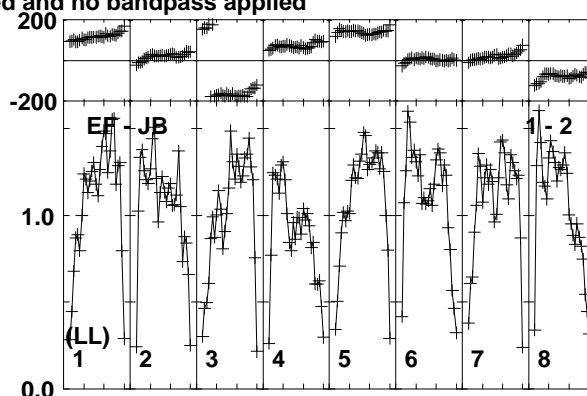
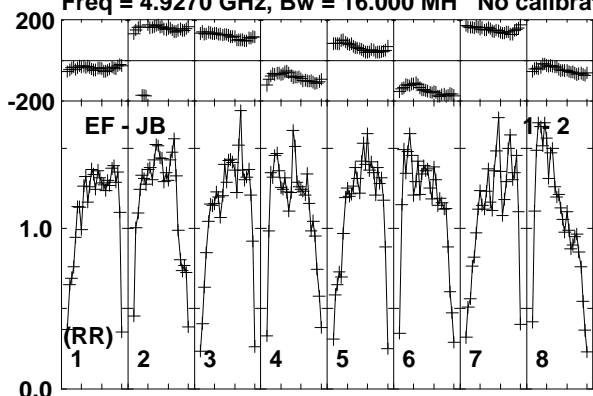

Lower frame: Milli Ampl Jy Top frame: Phas deg
Vector averaged cross-power spectrum Baseline: EF (01) - JB (02)
Timerange: 01/07:08:13 to 01/07:09:39

Plot file version 410 created 26-MAR-2015 15:27:59

J1455+2131 EG082E.UVDATA.1

Freq = 4.9270 GHz, Bw = 16.000 MH No calibration applied and no bandpass applied

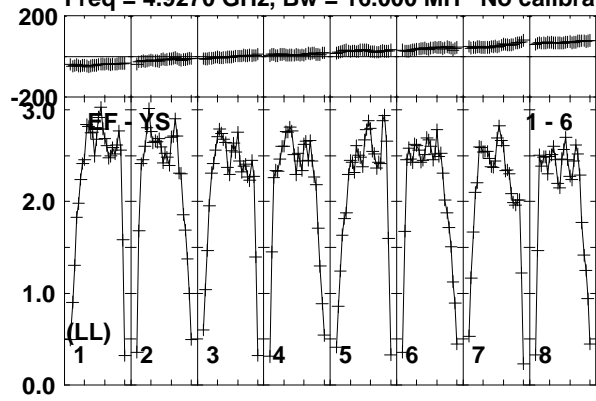

Lower frame: Milli Ampl Jy Top frame: Phas deg
Vector averaged cross-power spectrum Baseline: EF (01) - YS (06)
Timerange: 01/07:08:13 to 01/07:09:39

Plot file version 411 created 26-MAR-2015 15:27:59

TVLM513 EG082E.UVDATA.1

Freq = 4.9270 GHz, Bw = 16.000 MH No calibration applied and no bandpass applied

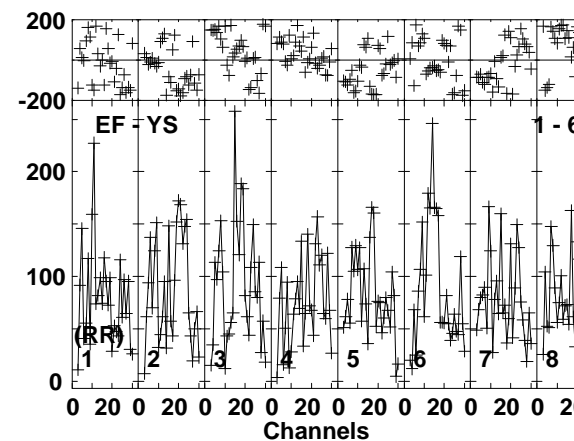
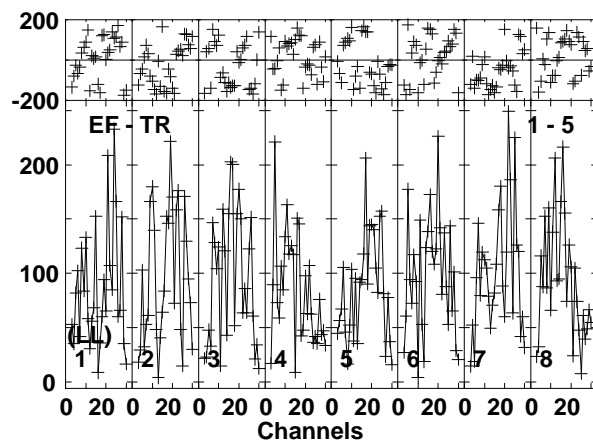
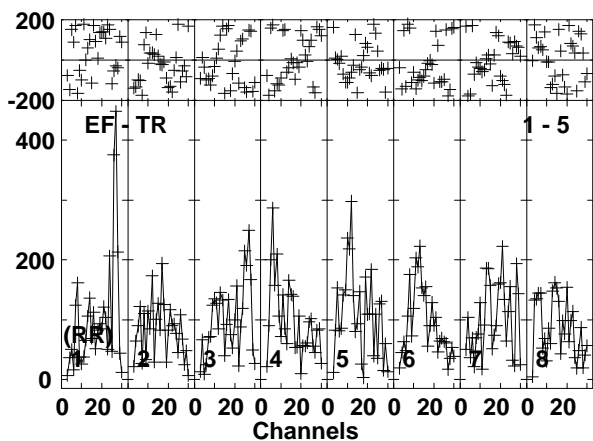
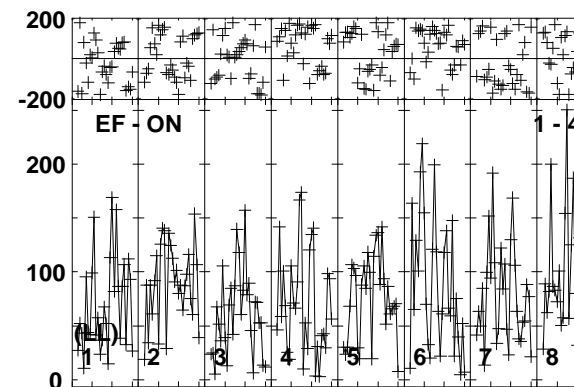
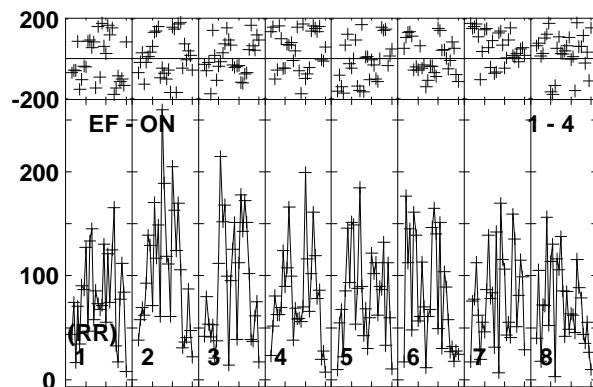
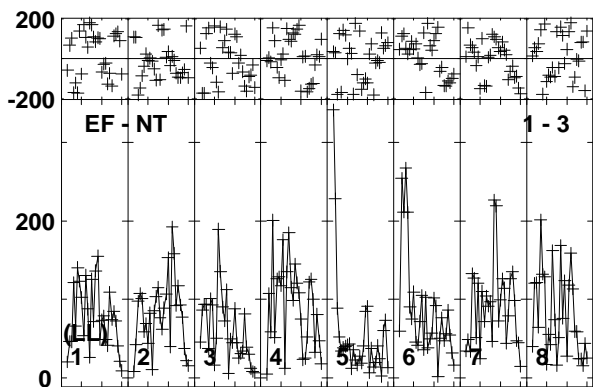
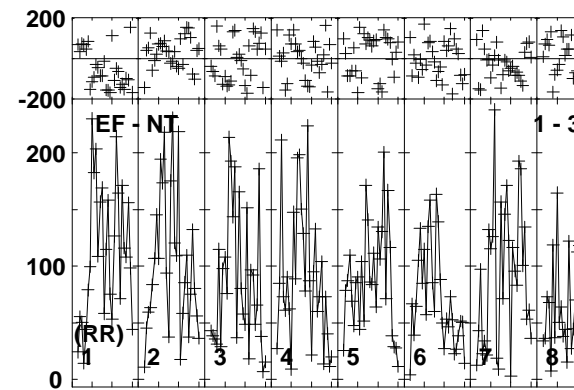
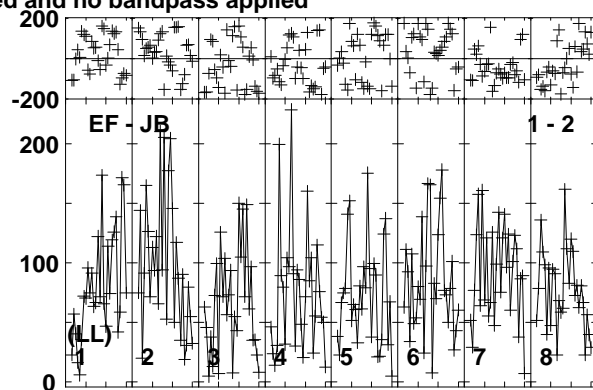
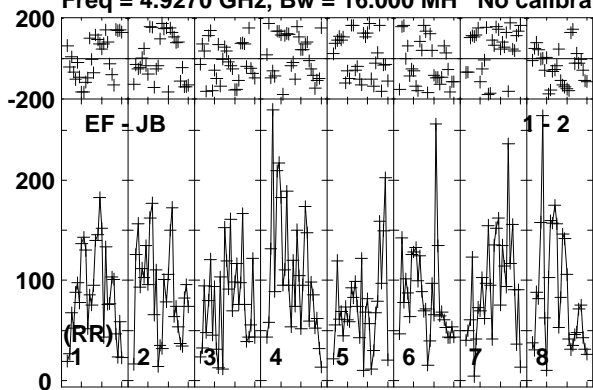

Lower frame: Micro Ampl Jy Top frame: Phas deg
Vector averaged cross-power spectrum Baseline: EF (01) - JB (02)
Timerange: 01/07:09:43 to 01/07:13:09

Plot file version 412 created 26-MAR-2015 15:27:59

TVLM513 EG082E.UVDATA.1

Freq = 4.9270 GHz, Bw = 16.000 MH No calibration applied and no bandpass applied

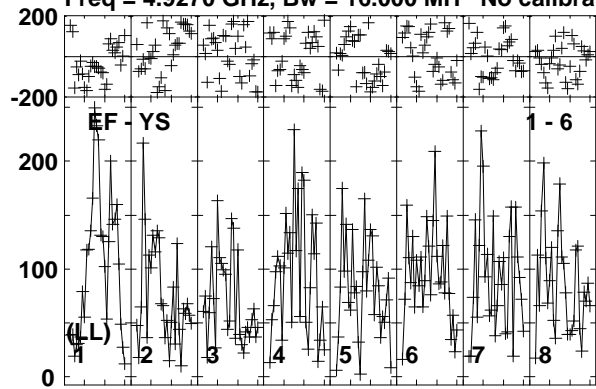

Lower frame: Micro Ampl Jy Top frame: Phas deg
Vector averaged cross-power spectrum Baseline: EF (01) - YS (06)
Timerange: 01/07:09:43 to 01/07:13:09

Plot file version 413 created 26-MAR-2015 15:27:59

J1455+2131 EG082E.UVDATA.1

Freq = 4.9270 GHz, Bw = 16.000 MH No calibration applied and no bandpass applied

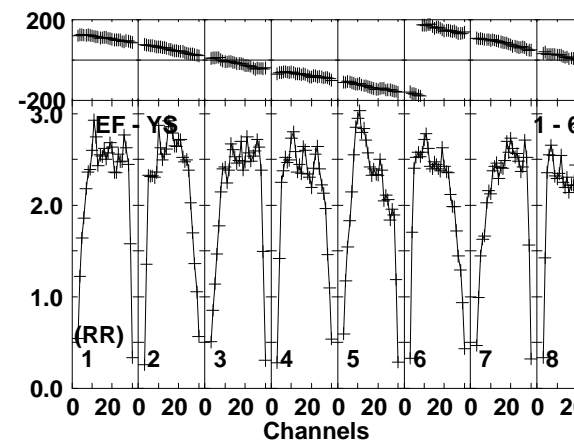
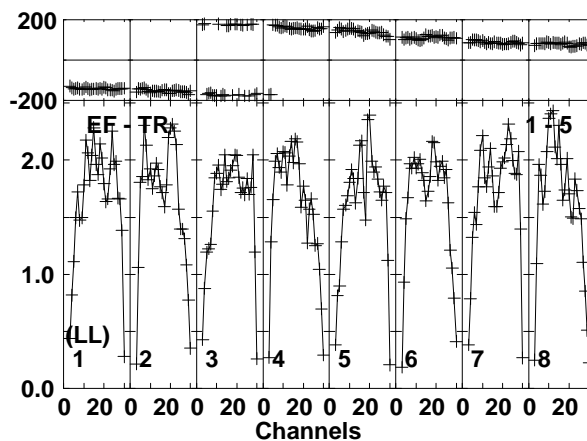
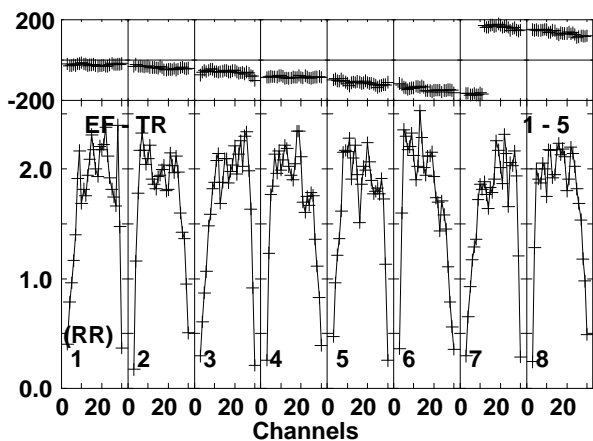
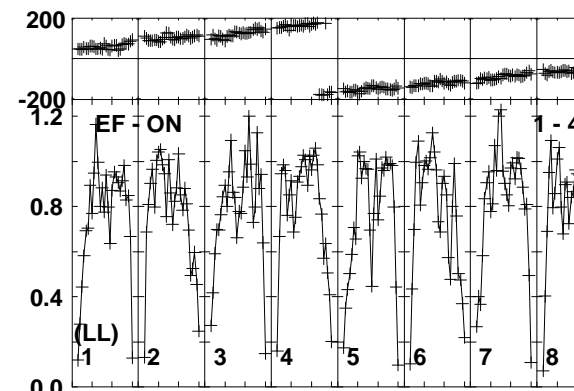
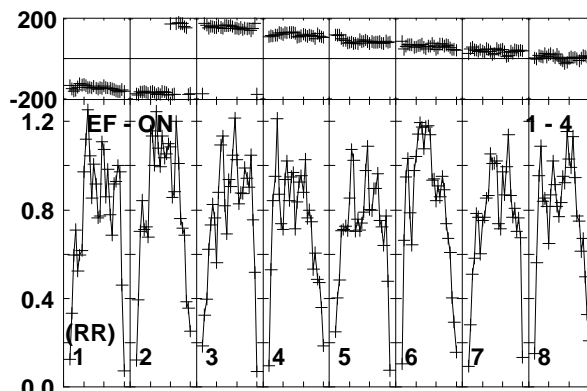
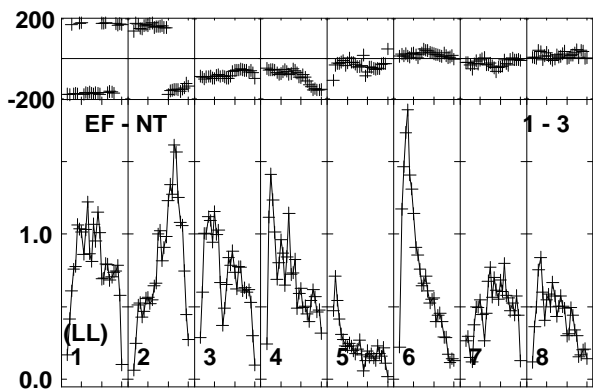
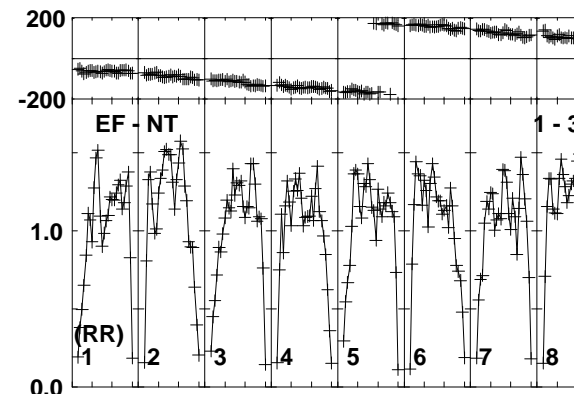
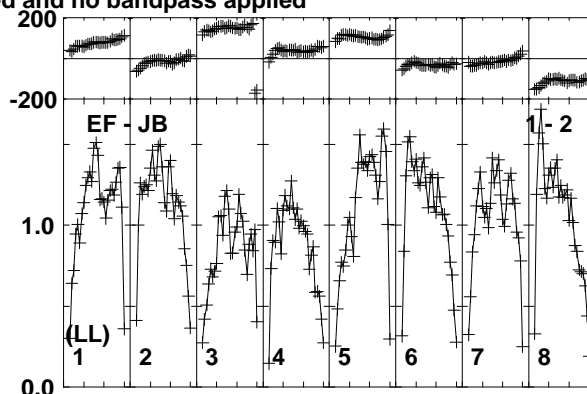
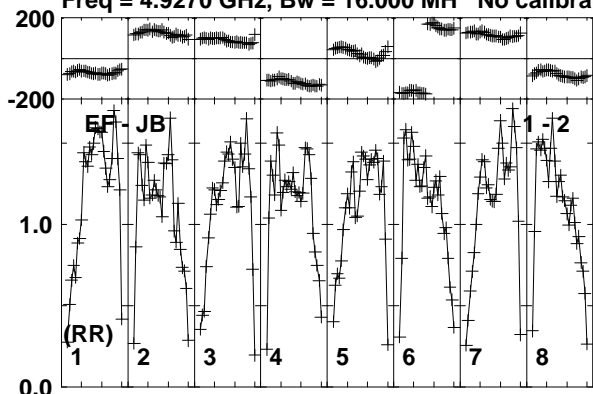

Lower frame: Milli Ampl Jy Top frame: Phas deg
Vector averaged cross-power spectrum Baseline: EF (01) - JB (02)
Timerange: 01/07:13:43 to 01/07:14:39

Plot file version 414 created 26-MAR-2015 15:27:59

J1455+2131 EG082E.UVDATA.1

Freq = 4.9270 GHz, Bw = 16.000 MH No calibration applied and no bandpass applied

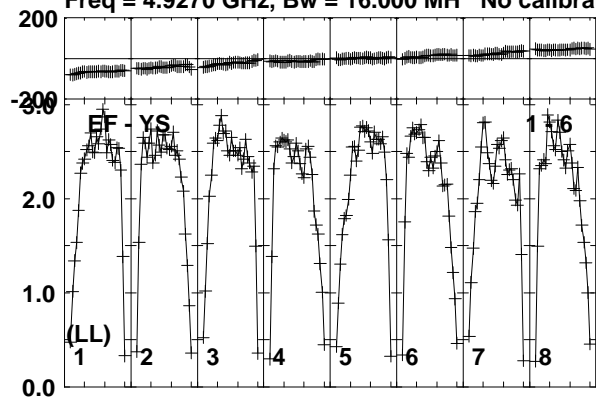

Lower frame: Milli Ampl Jy Top frame: Phas deg
Vector averaged cross-power spectrum Baseline: EF (01) - YS (06)
Timerange: 01/07:13:43 to 01/07:14:39

Plot file version 415 created 26-MAR-2015 15:27:59

TVLM513 EG082E.UVDATA.1

Freq = 4.9270 GHz, Bw = 16.000 MH No calibration applied and no bandpass applied

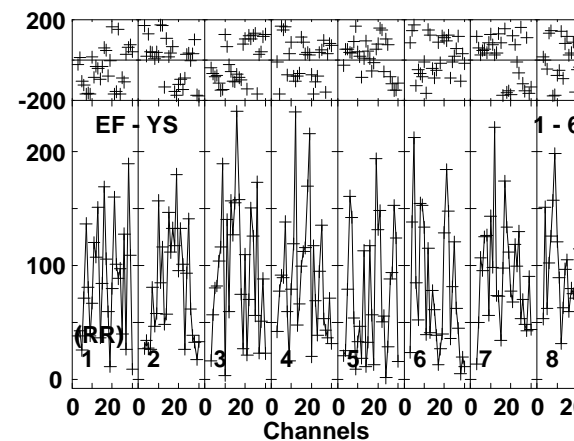
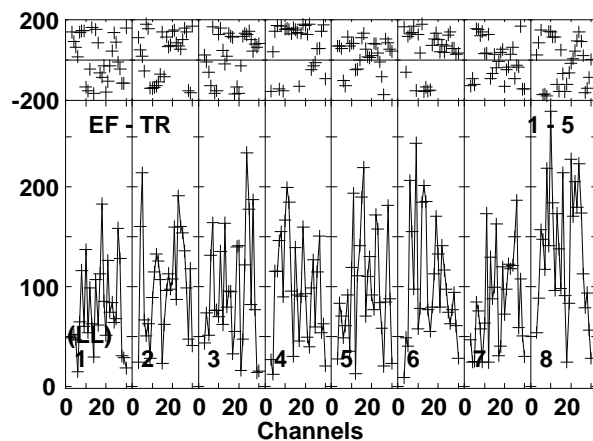
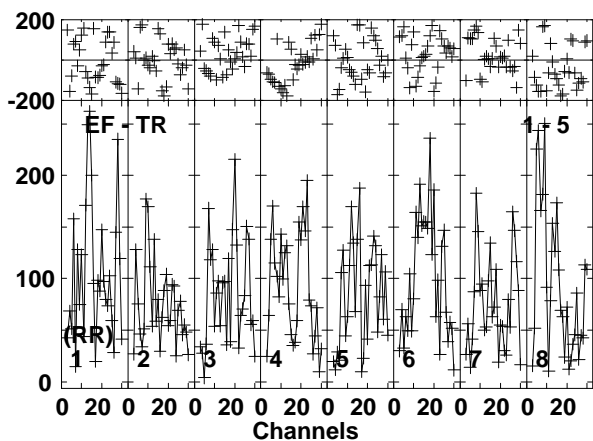
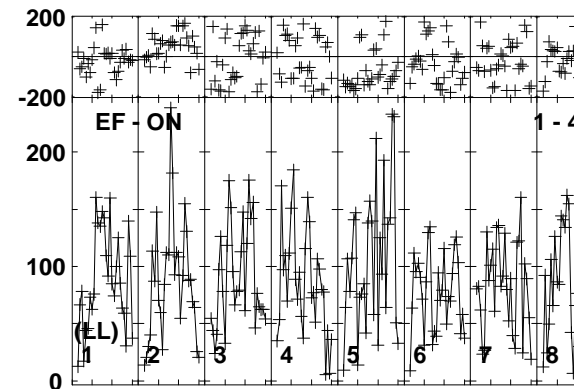
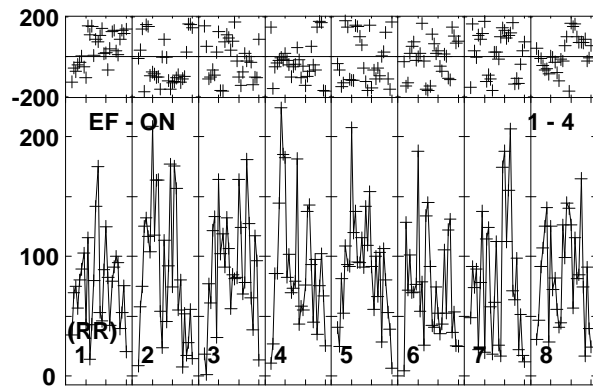
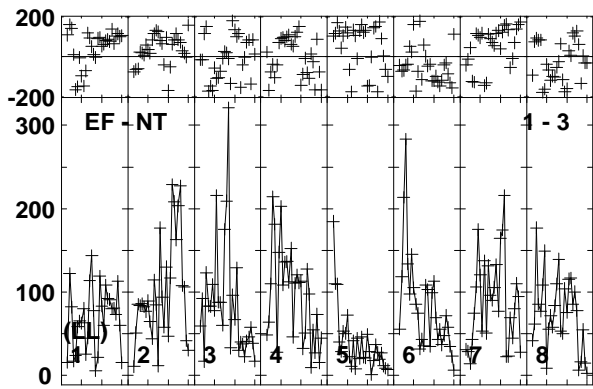
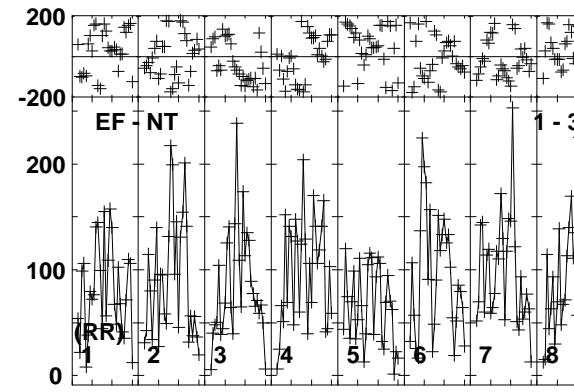
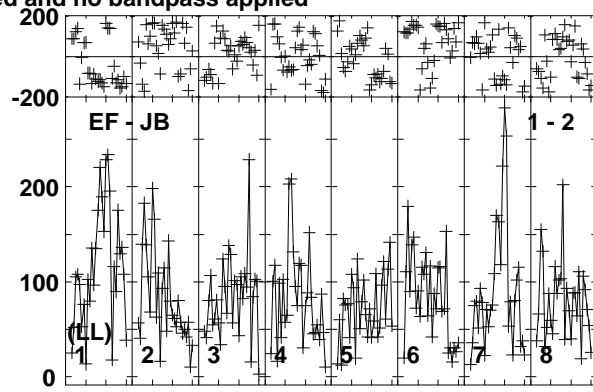
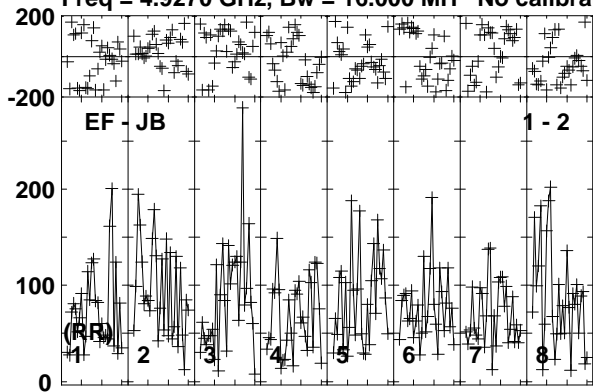

Lower frame: Micro Ampl Jy Top frame: Phas deg
Vector averaged cross-power spectrum Baseline: EF (01) - JB (02)
Timerange: 01/07:14:43 to 01/07:18:09

Plot file version 416 created 26-MAR-2015 15:27:59

TVLM513 EG082E.UVDATA.1

Freq = 4.9270 GHz, Bw = 16.000 MH No calibration applied and no bandpass applied

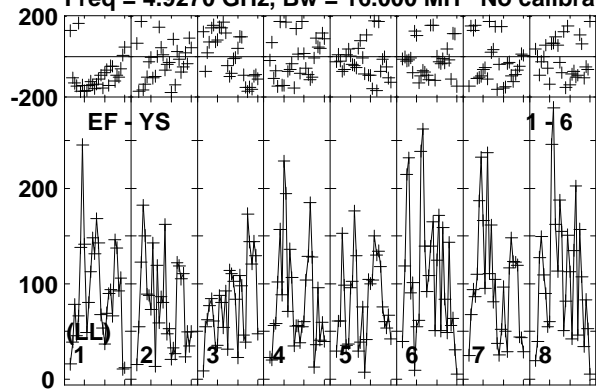

Lower frame: Micro Ampl Jy Top frame: Phas deg
Vector averaged cross-power spectrum Baseline: EF (01) - YS (06)
Timerange: 01/07:14:43 to 01/07:18:09

Plot file version 417 created 26-MAR-2015 15:27:59

J1455+2131 EG082E.UVDATA.1

Freq = 4.9270 GHz, Bw = 16.000 MH No calibration applied and no bandpass applied

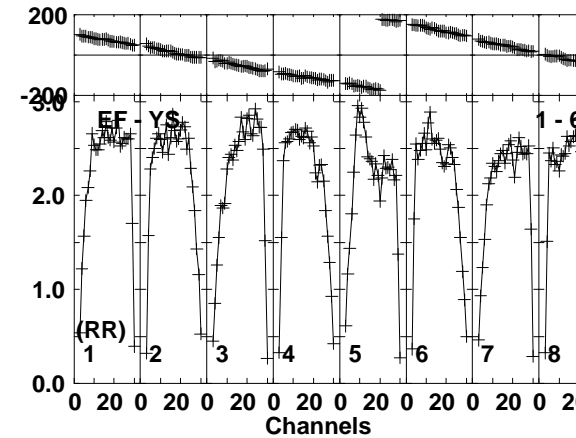
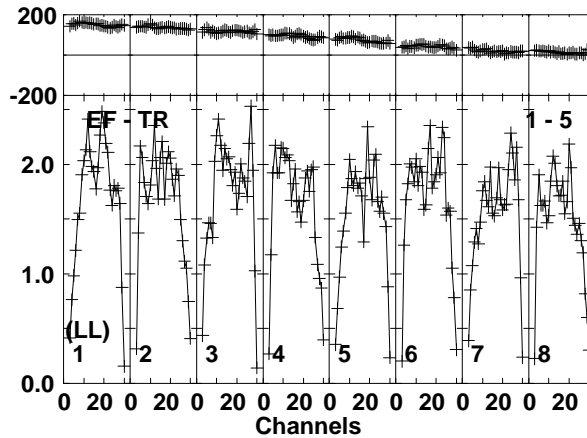
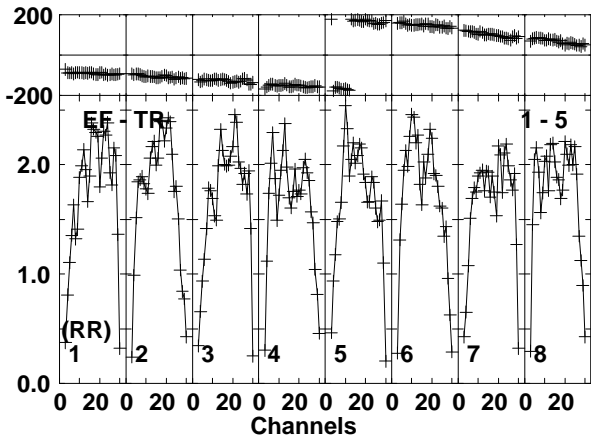
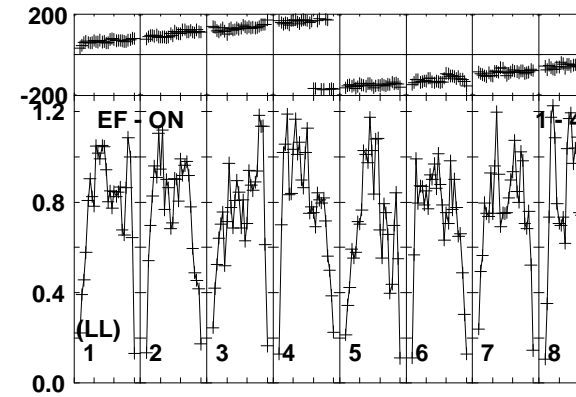
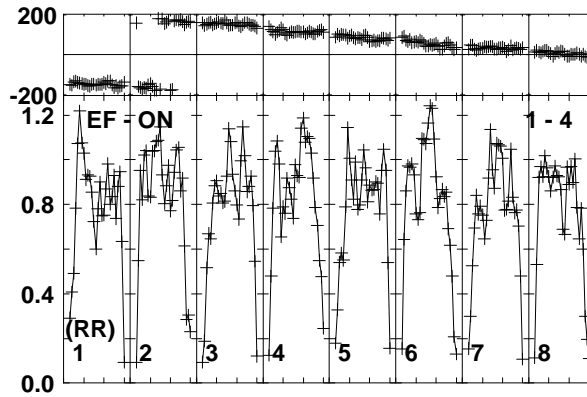
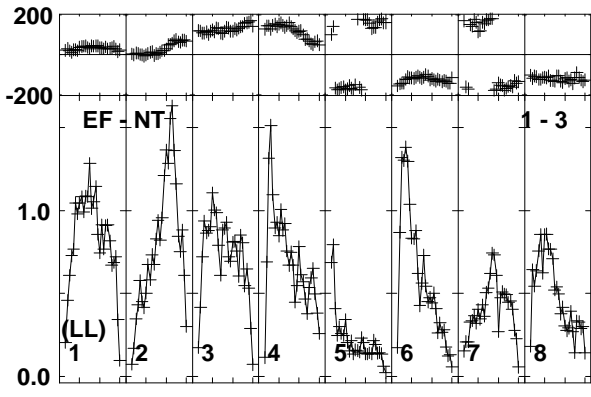
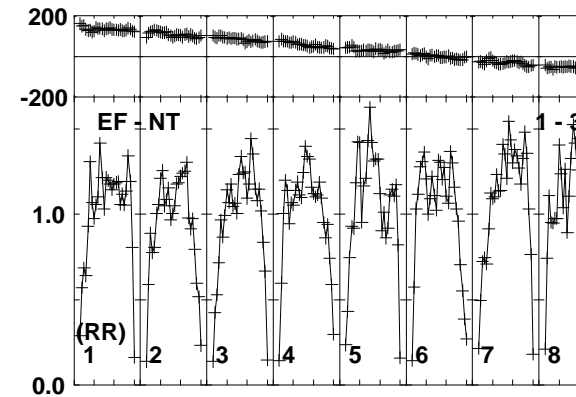
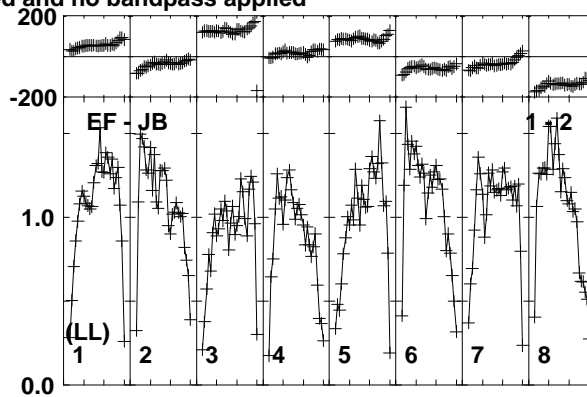
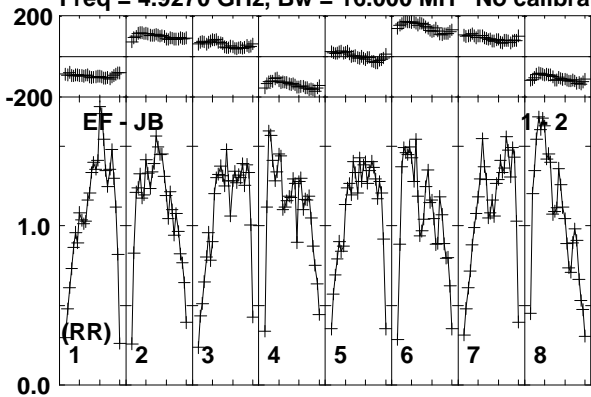

Lower frame: Milli Ampl Jy Top frame: Phas deg
Vector averaged cross-power spectrum Baseline: EF (01) - JB (02)
Timerange: 01/07:18:13 to 01/07:19:39

Plot file version 418 created 26-MAR-2015 15:27:59

J1455+2131 EG082E.UVDATA.1

Freq = 4.9270 GHz, Bw = 16.000 MH No calibration applied and no bandpass applied

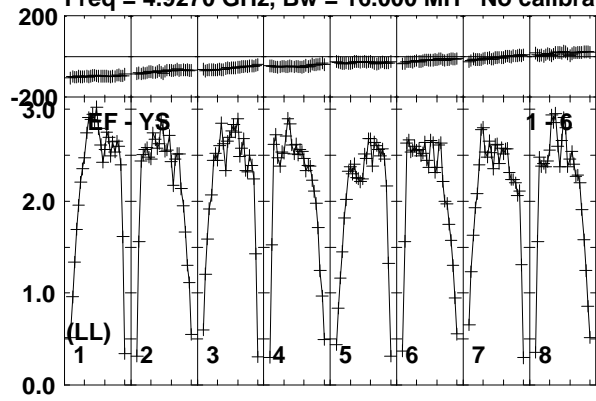

Lower frame: Milli Ampl Jy Top frame: Phas deg
Vector averaged cross-power spectrum Baseline: EF (01) - YS (06)
Timerange: 01/07:18:13 to 01/07:19:39

Plot file version 419 created 26-MAR-2015 15:27:59

TVLM513 EG082E.UVDATA.1

Freq = 4.9270 GHz, Bw = 16.000 MH No calibration applied and no bandpass applied

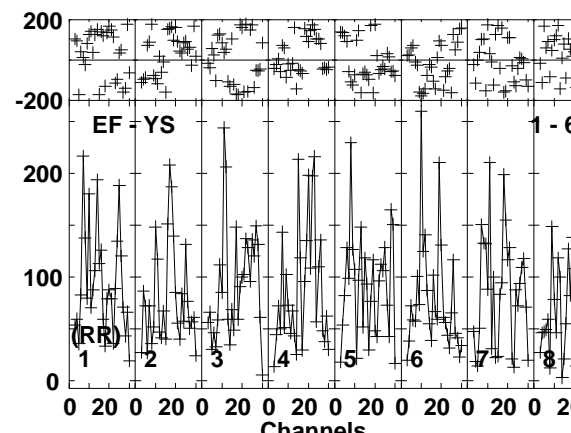
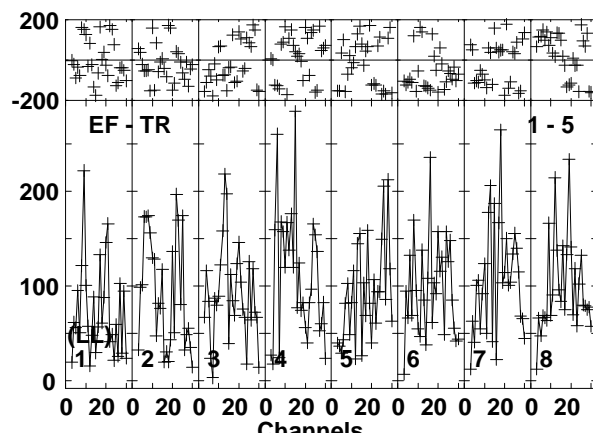
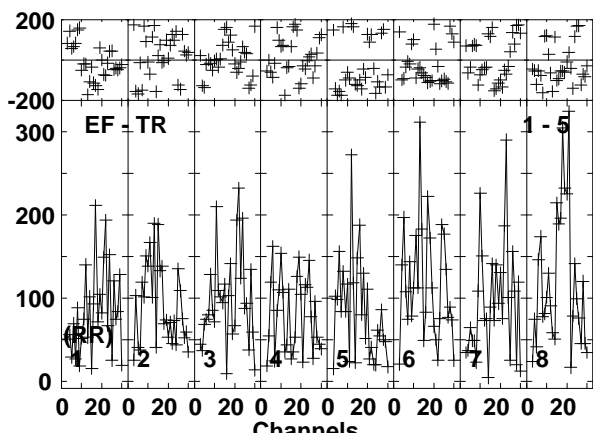
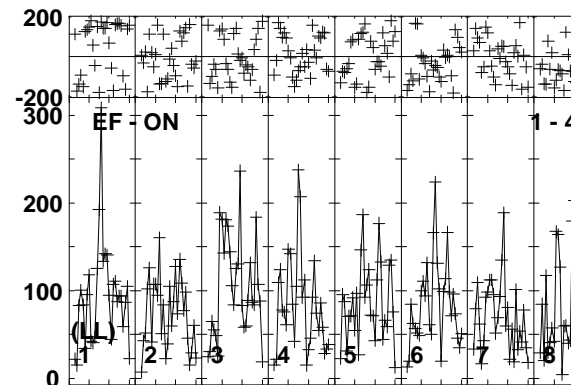
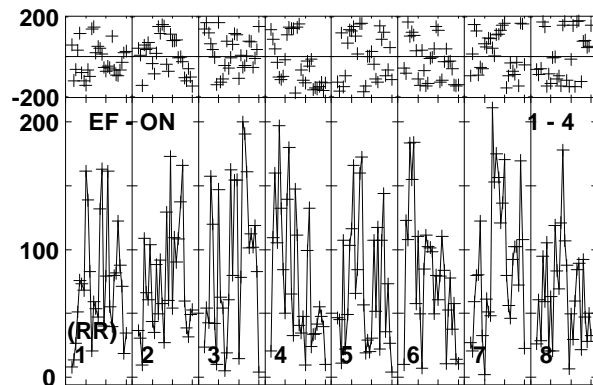
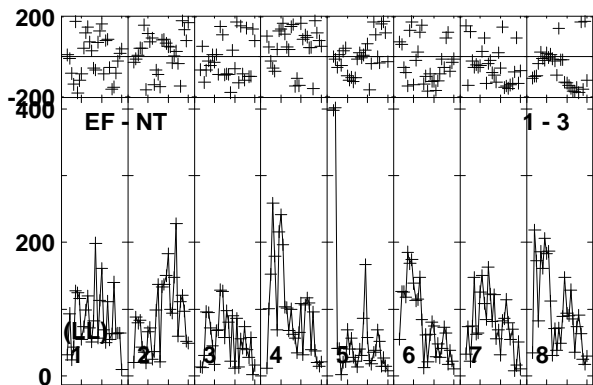
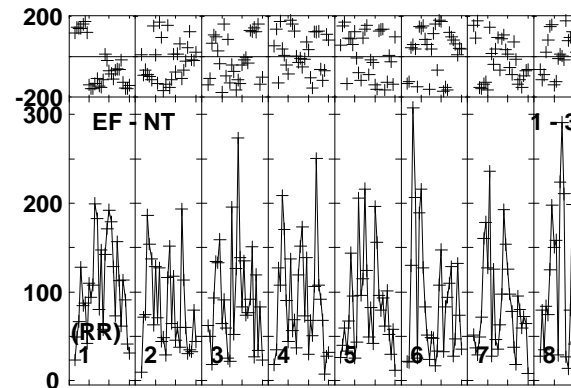
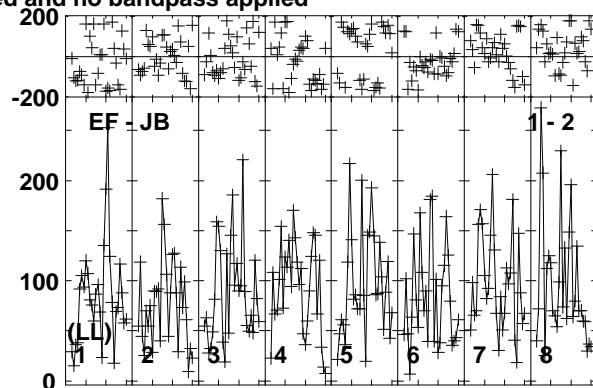
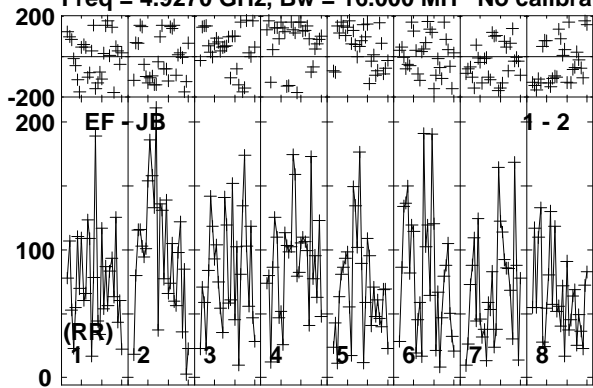

Lower frame: Micro Ampl Jy Top frame: Phas deg
Vector averaged cross-power spectrum Baseline: EF (01) - JB (02)
Timerange: 01/07:19:43 to 01/07:23:09

Plot file version 420 created 26-MAR-2015 15:27:59

TVLM513 EG082E.UVDATA.1

Freq = 4.9270 GHz, Bw = 16.000 MH No calibration applied and no bandpass applied

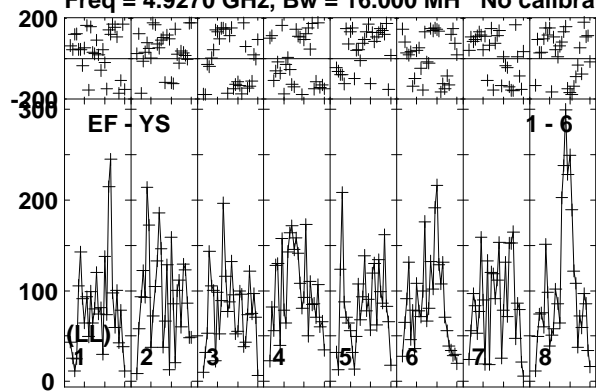

Lower frame: Micro Ampl Jy Top frame: Phas deg
Vector averaged cross-power spectrum Baseline: EF (01) - YS (06)
Timerange: 01/07:19:43 to 01/07:23:09

Plot file version 421 created 26-MAR-2015 15:27:59

J1455+2131 EG082E.UVDATA.1

Freq = 4.9270 GHz, Bw = 16.000 MH No calibration applied and no bandpass applied

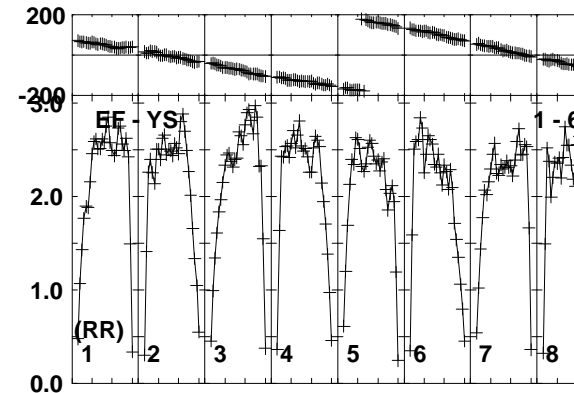
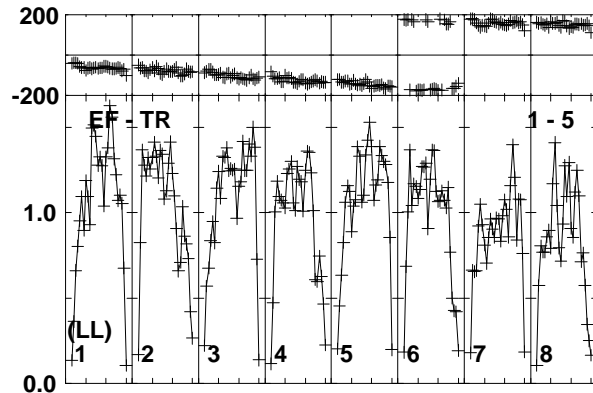
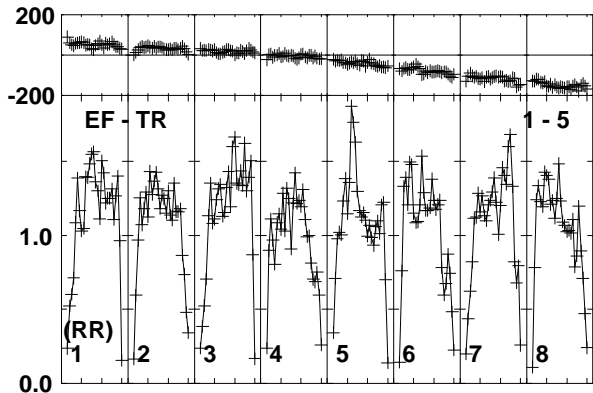
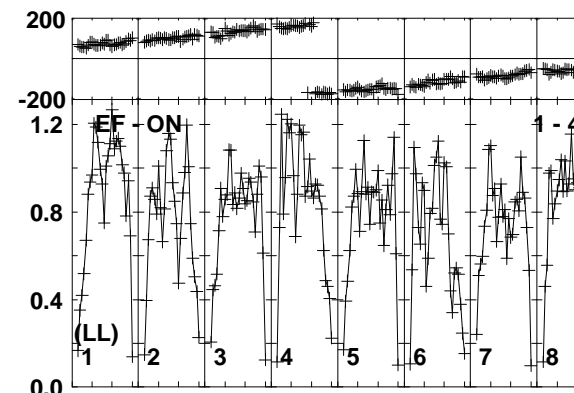
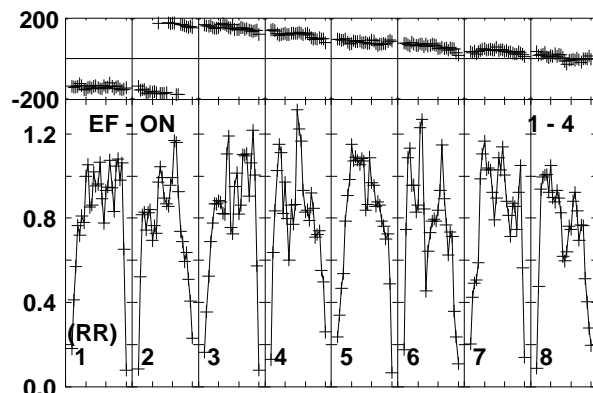
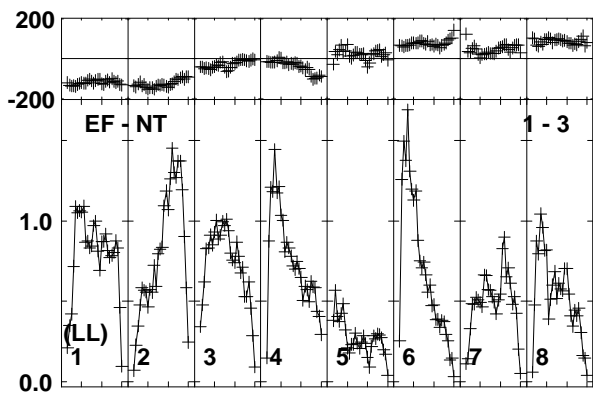
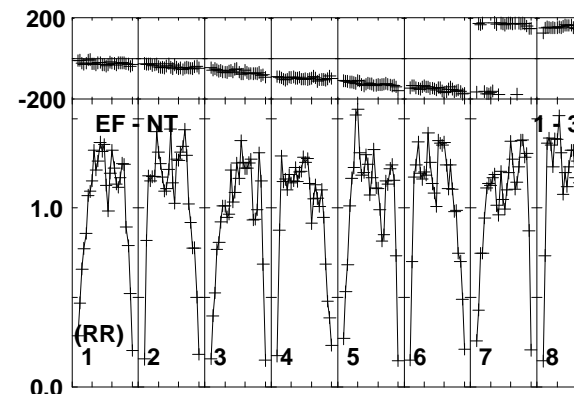
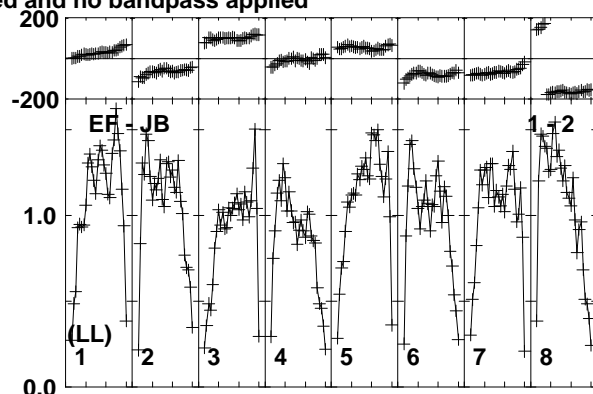
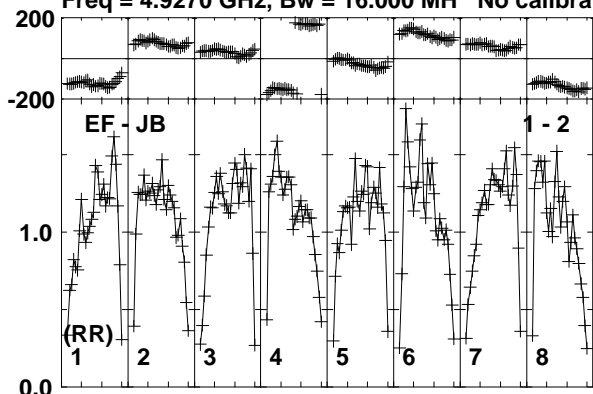

Lower frame: Milli Ampl Jy Top frame: Phas deg
Vector averaged cross-power spectrum Baseline: EF (01) - JB (02)
Timerange: 01/07:23:43 to 01/07:24:39

Plot file version 422 created 26-MAR-2015 15:27:59

J1455+2131 EG082E.UVDATA.1

Freq = 4.9270 GHz, Bw = 16.000 MH No calibration applied and no bandpass applied

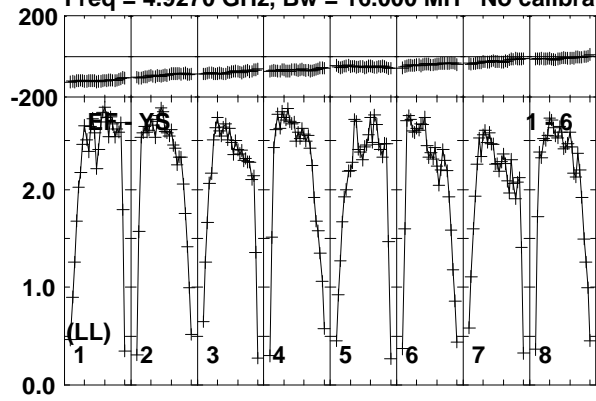

Lower frame: Milli Ampl Jy Top frame: Phas deg
Vector averaged cross-power spectrum Baseline: EF (01) - YS (06)
Timerange: 01/07:23:43 to 01/07:24:39

Plot file version 423 created 26-MAR-2015 15:27:59

TVLM513 EG082E.UVDATA.1

Freq = 4.9270 GHz, Bw = 16.000 MH No calibration applied and no bandpass applied

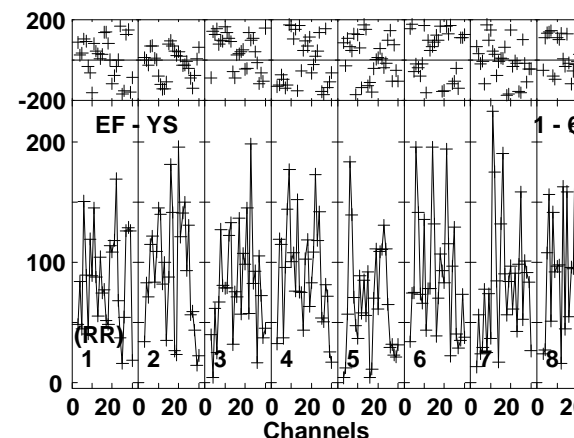
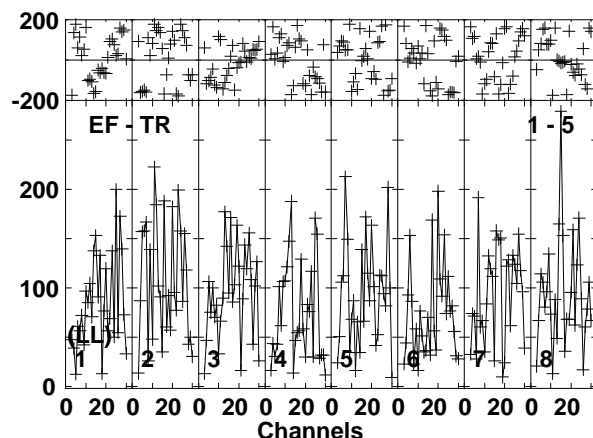
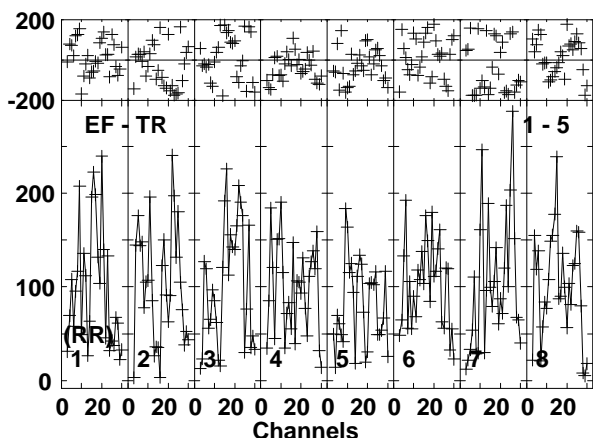
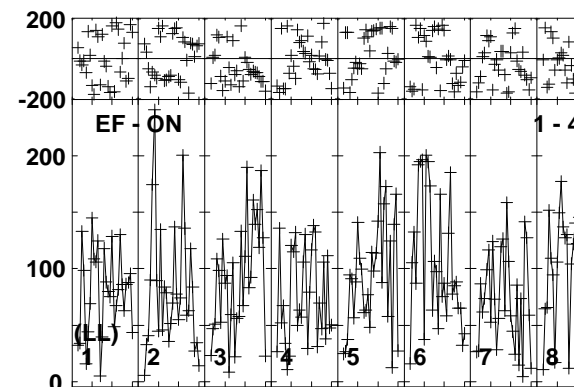
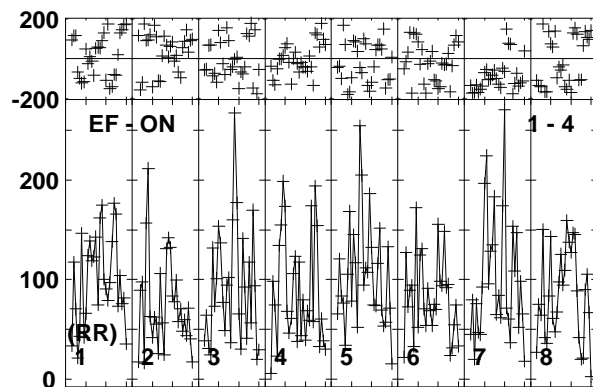
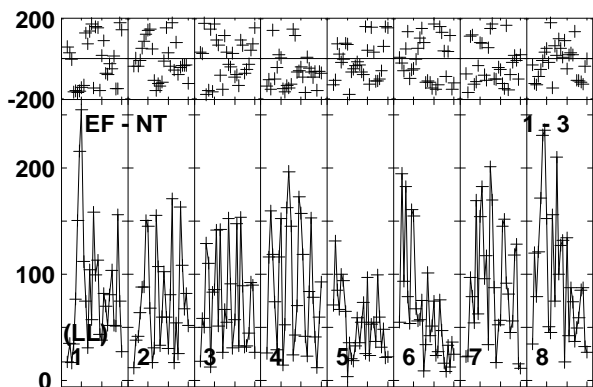
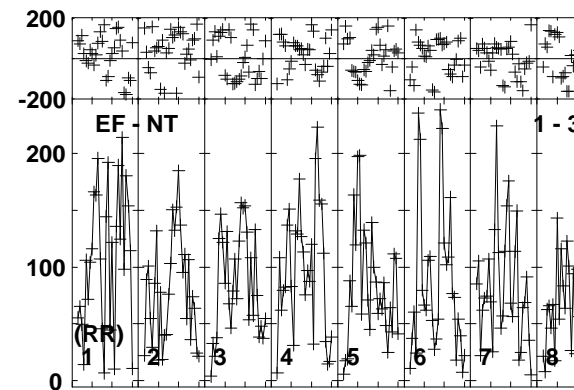
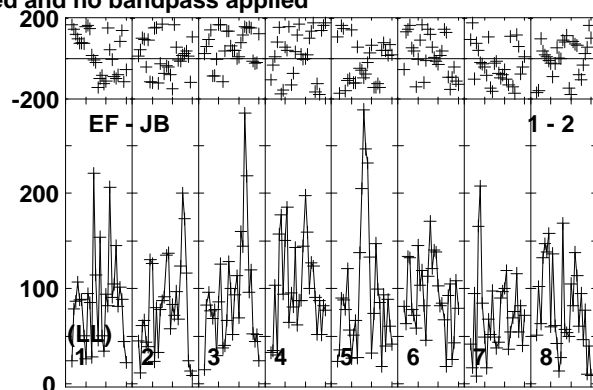
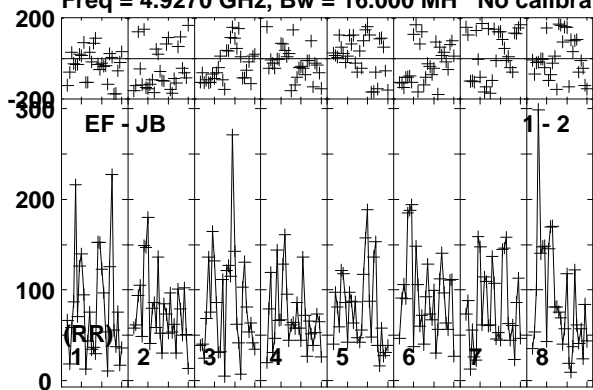

Lower frame: Micro Ampl Jy Top frame: Phas deg
Vector averaged cross-power spectrum Baseline: EF (01) - JB (02)
Timerange: 01/07:24:43 to 01/07:28:09

Plot file version 424 created 26-MAR-2015 15:27:59

TVLM513 EG082E.UVDATA.1

Freq = 4.9270 GHz, Bw = 16.000 MH No calibration applied and no bandpass applied

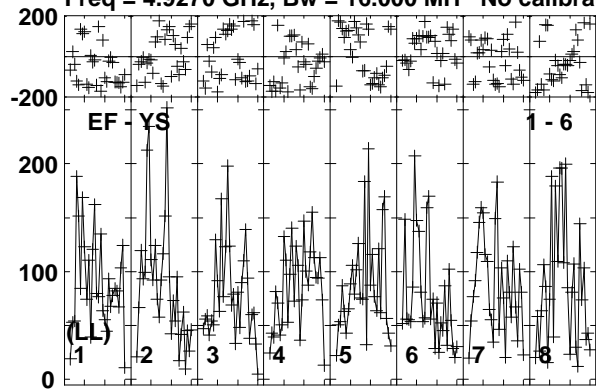

Lower frame: Micro Ampl Jy Top frame: Phas deg
Vector averaged cross-power spectrum Baseline: EF (01) - YS (06)
Timerange: 01/07:24:43 to 01/07:28:09

Plot file version 425 created 26-MAR-2015 15:27:59

J1455+2131 EG082E.UVDATA.1

Freq = 4.9270 GHz, Bw = 16.000 MH No calibration applied and no bandpass applied

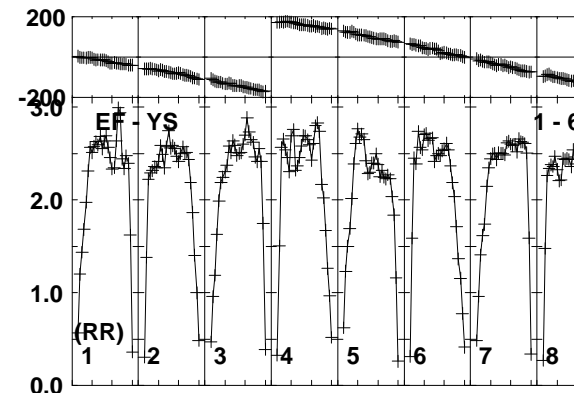
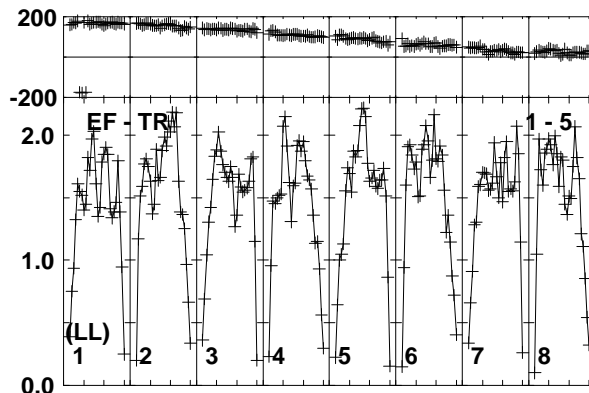
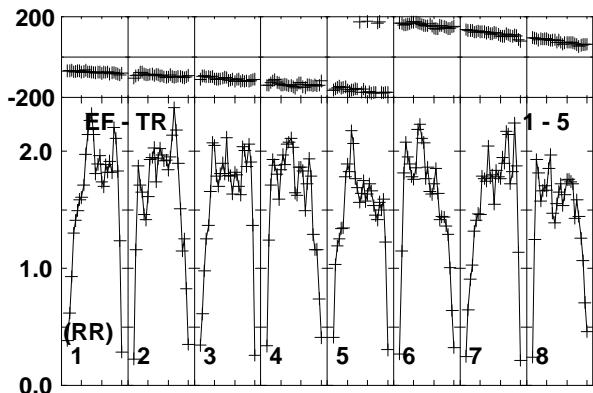
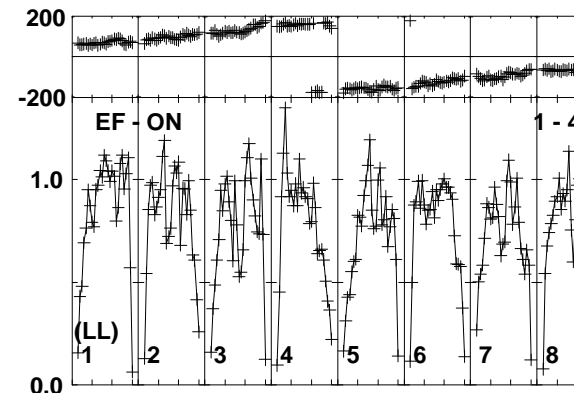
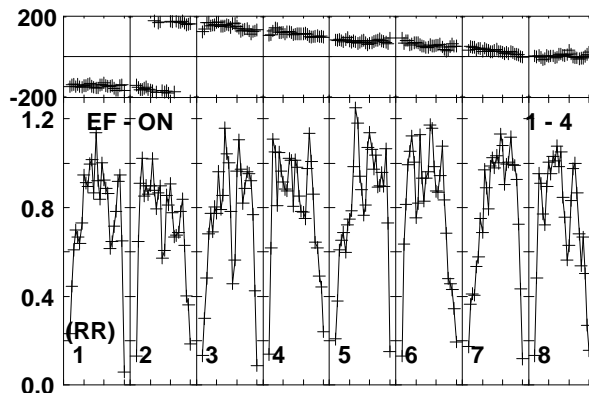
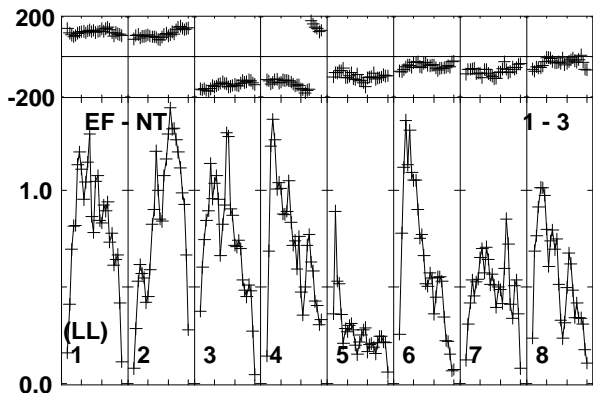
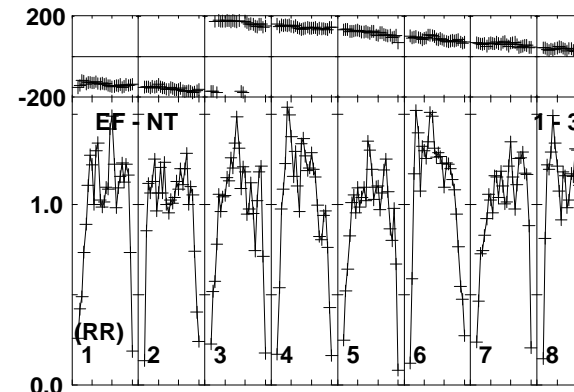
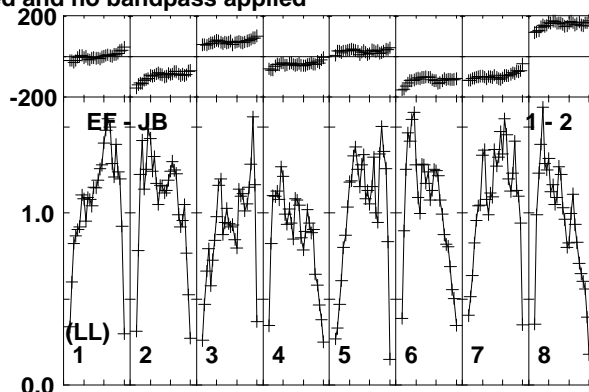
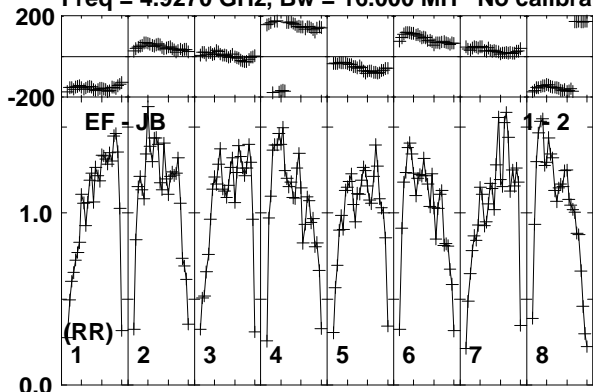

Lower frame: Milli Ampl Jy Top frame: Phas deg
Vector averaged cross-power spectrum Baseline: EF (01) - JB (02)
Timerange: 01/07:28:13 to 01/07:29:39

Plot file version 426 created 26-MAR-2015 15:27:59

J1455+2131 EG082E.UVDATA.1

Freq = 4.9270 GHz, Bw = 16.000 MH No calibration applied and no bandpass applied

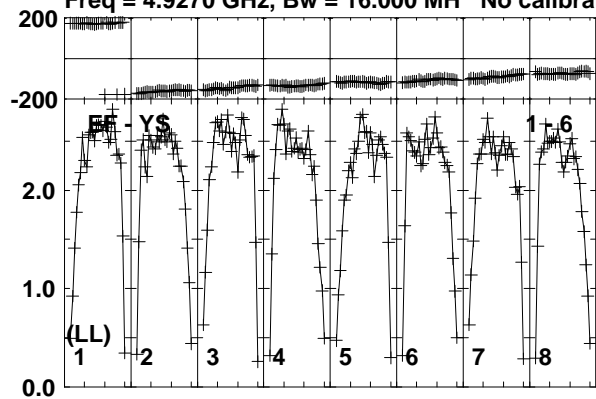

Lower frame: Milli Ampl Jy Top frame: Phas deg
Vector averaged cross-power spectrum Baseline: EF (01) - YS (06)
Timerange: 01/07:28:13 to 01/07:29:39

Plot file version 427 created 26-MAR-2015 15:27:59

J1504+2218 EG082E.UVDATA.1

Freq = 4.9270 GHz, Bw = 16.000 MH No calibration applied and no bandpass applied

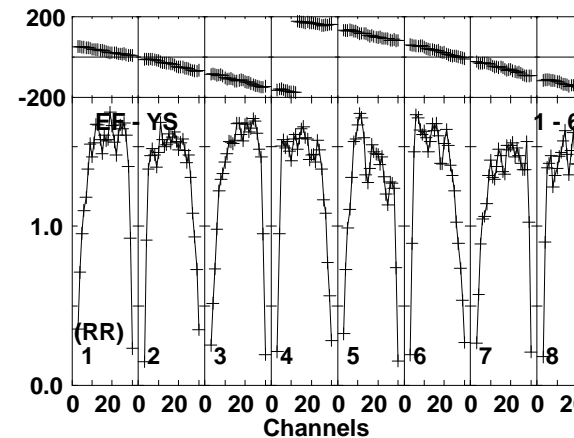
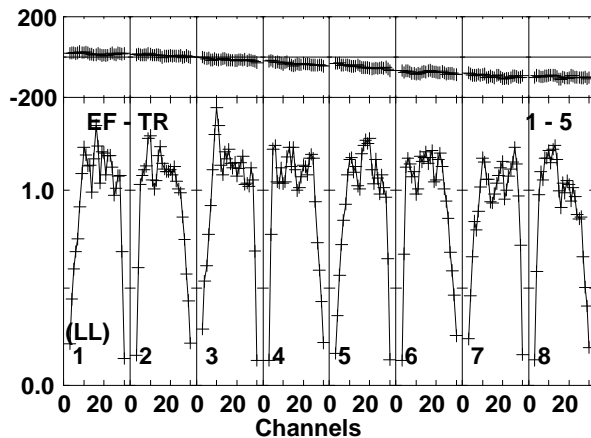
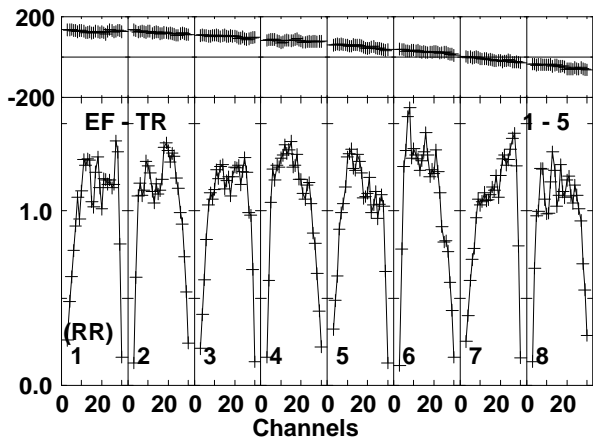
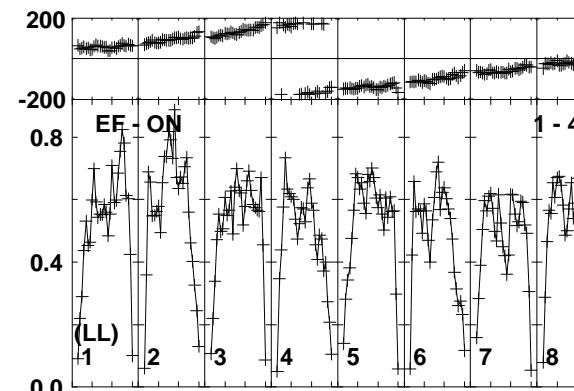
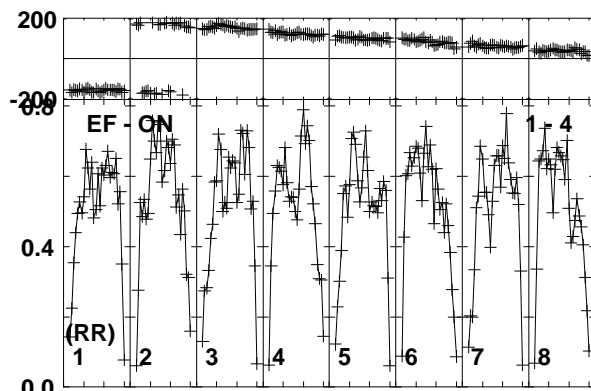
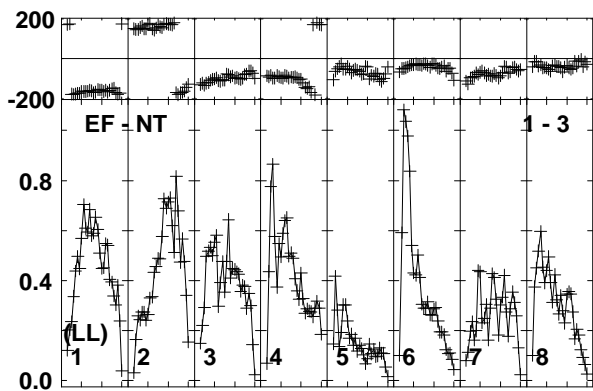
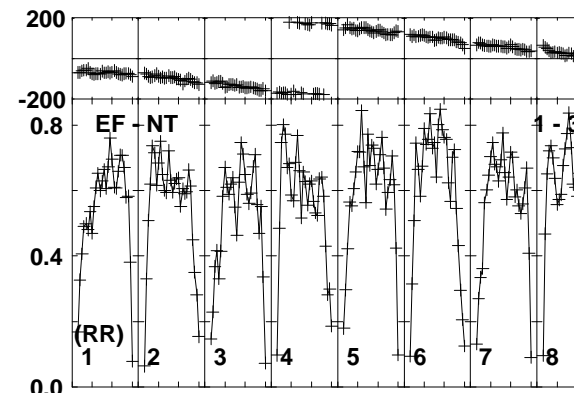
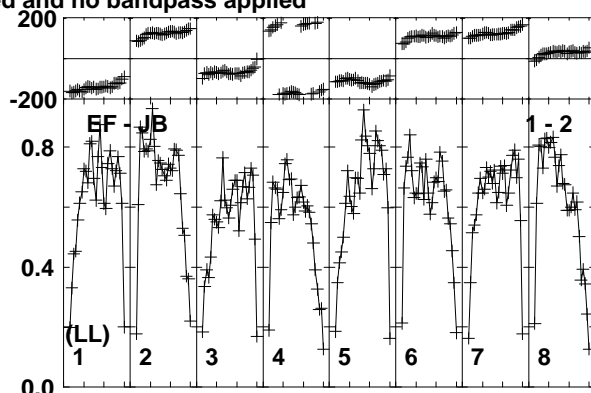
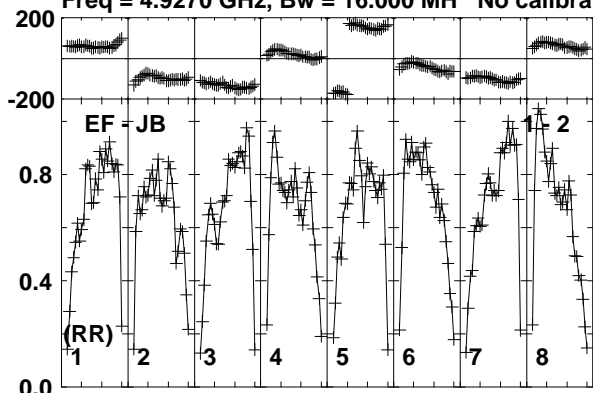

Lower frame: Milli Ampl Jy Top frame: Phas deg
Vector averaged cross-power spectrum Baseline: EF (01) - JB (02)
Timerange: 01/07:29:43 to 01/07:33:09

Plot file version 428 created 26-MAR-2015 15:28:00
J1504+2218 EG082E.UVDATA.1
Freq = 4.9270 GHz, Bw = 16.000 MH No calibration applied and no bandpass applied

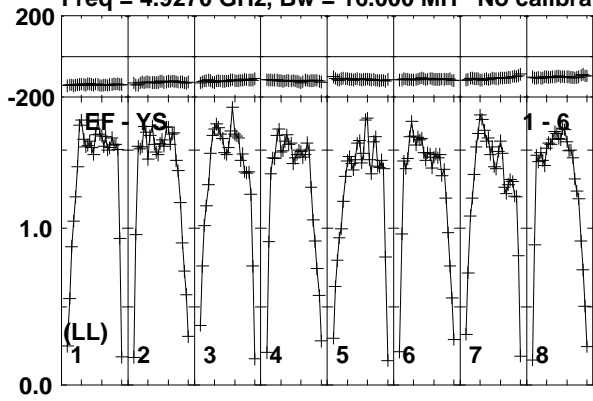

Lower frame: Milli Ampl Jy Top frame: Phas deg
Vector averaged cross-power spectrum Baseline: EF (01) - YS (06)
Timerange: 01/07:29:43 to 01/07:33:09

Plot file version 429 created 26-MAR-2015 15:28:00

J1455+2131 EG082E.UVDATA.1

Freq = 4.9270 GHz, Bw = 16.000 MH No calibration applied and no bandpass applied

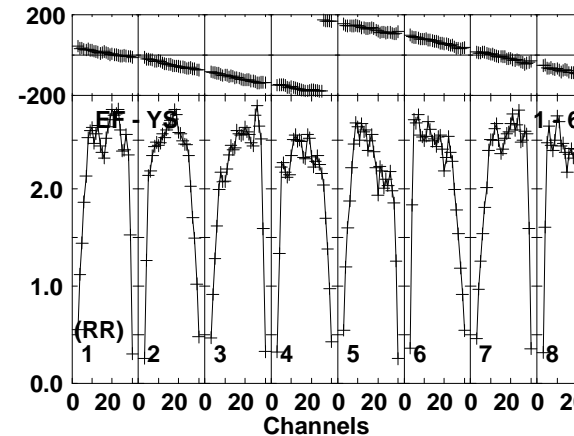
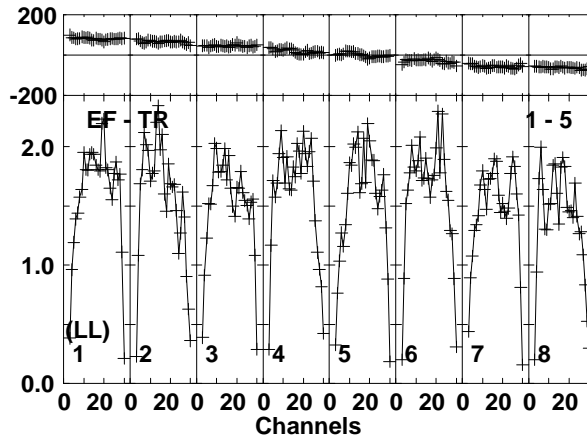
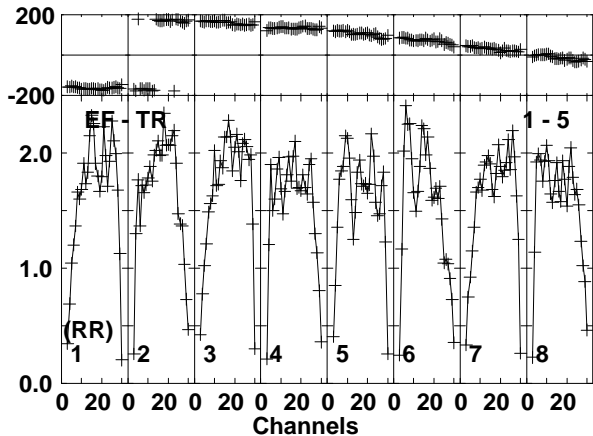
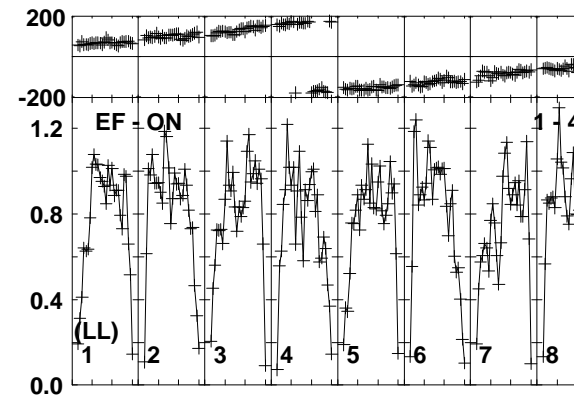
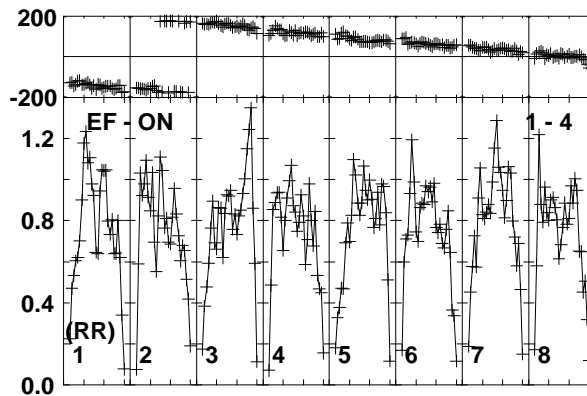
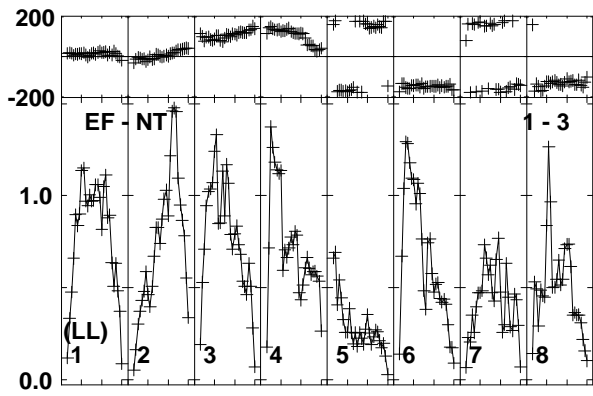
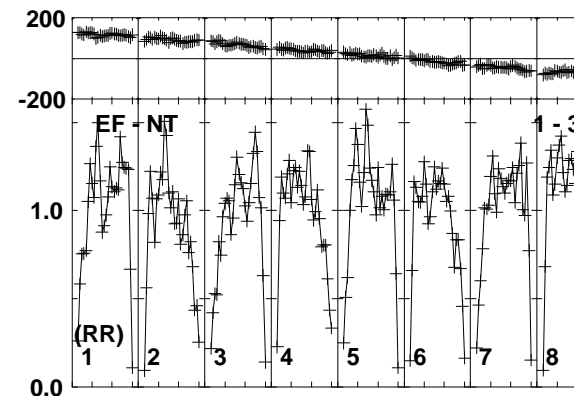
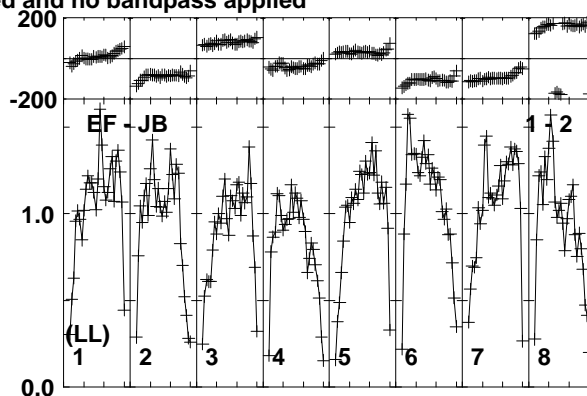
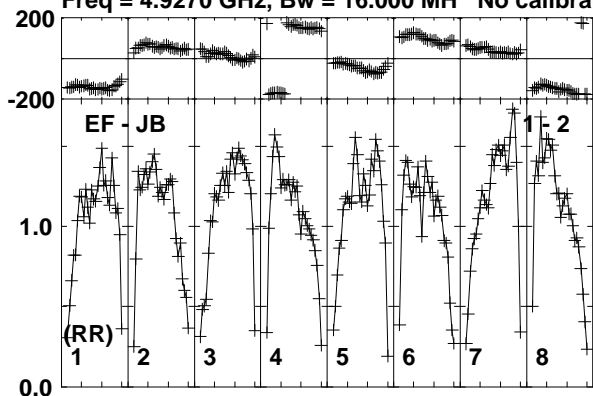

Lower frame: Milli Ampl Jy Top frame: Phas deg
Vector averaged cross-power spectrum Baseline: EF (01) - JB (02)
Timerange: 01/07:33:43 to 01/07:34:39

Plot file version 430 created 26-MAR-2015 15:28:00

J1455+2131 EG082E.UVDATA.1

Freq = 4.9270 GHz, Bw = 16.000 MH No calibration applied and no bandpass applied

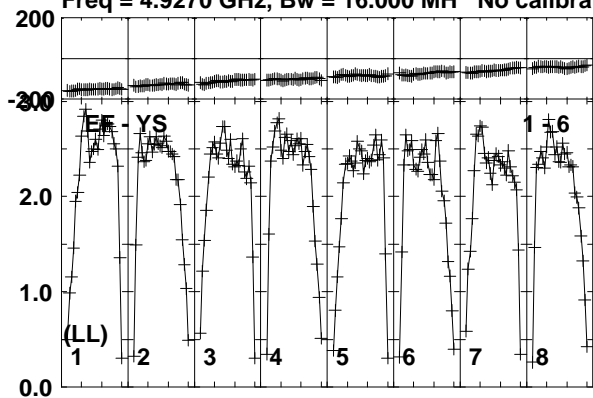

Lower frame: Milli Ampl Jy Top frame: Phas deg
Vector averaged cross-power spectrum Baseline: EF (01) - YS (06)
Timerange: 01/07:33:43 to 01/07:34:39

Plot file version 431 created 26-MAR-2015 15:28:00

TVLM513 EG082E.UVDATA.1

Freq = 4.9270 GHz, Bw = 16.000 MH No calibration applied and no bandpass applied

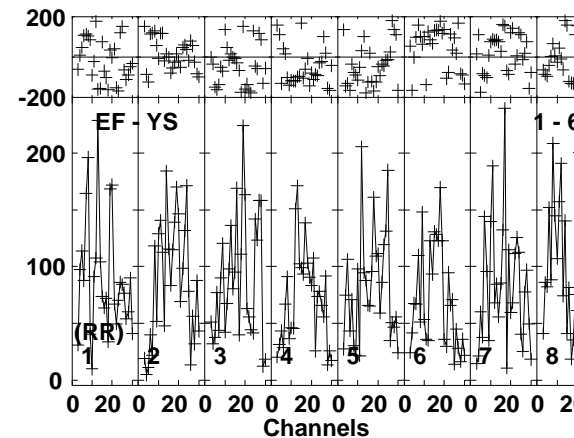
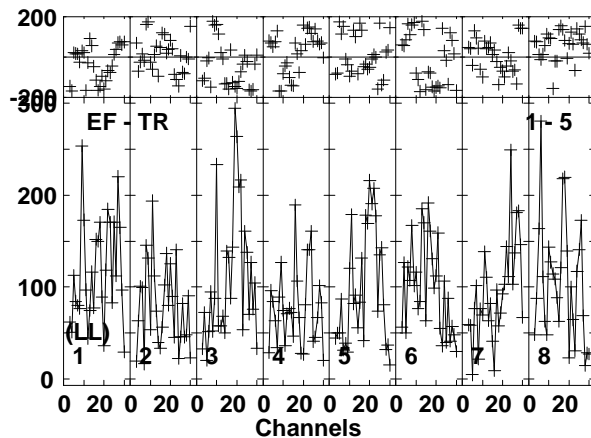
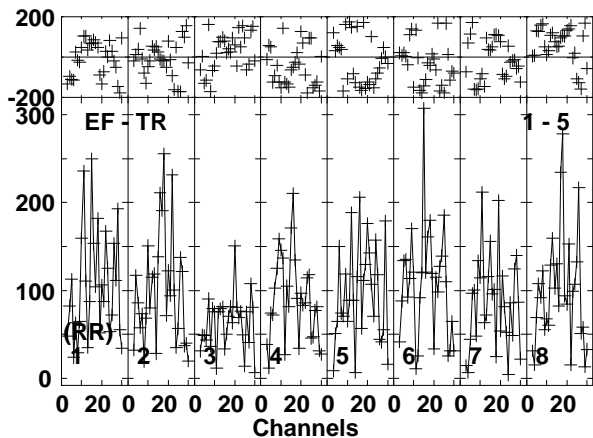
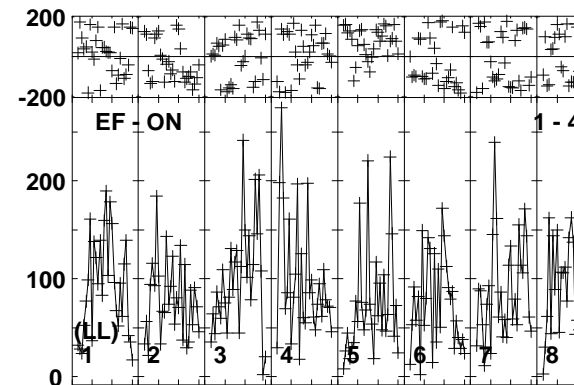
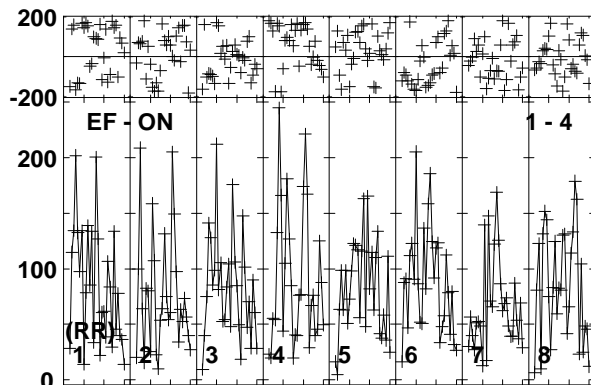
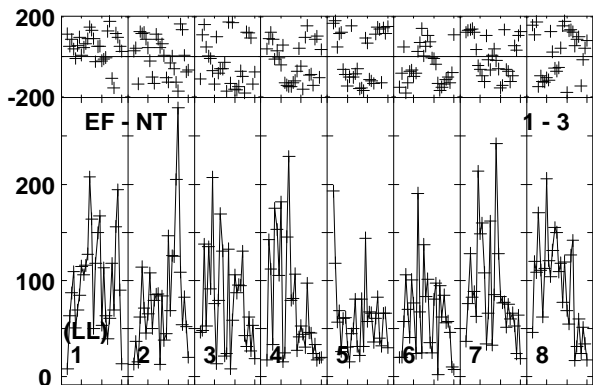
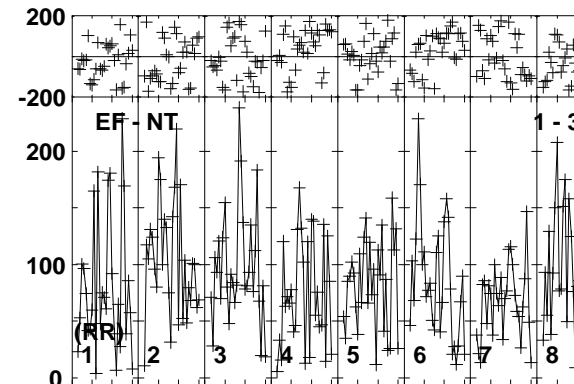
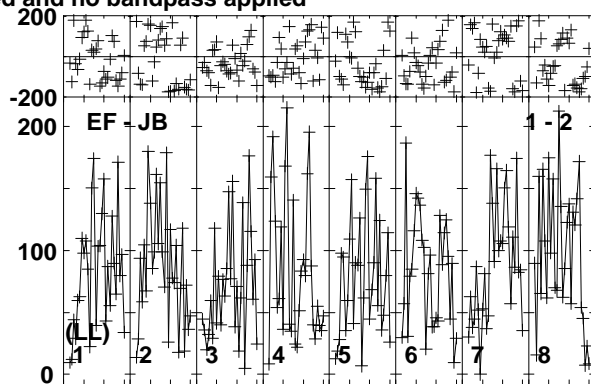
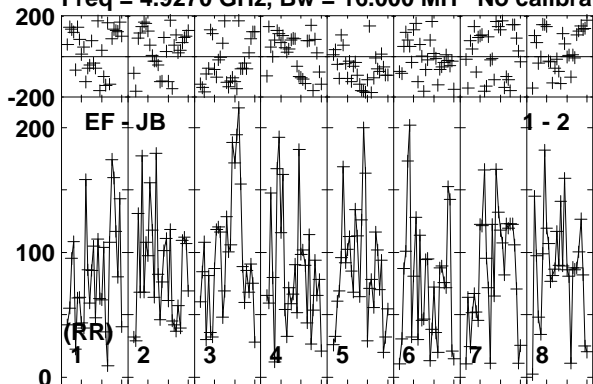

Lower frame: Micro Ampl Jy Top frame: Phas deg
Vector averaged cross-power spectrum Baseline: EF (01) - JB (02)
Timerange: 01/07:34:43 to 01/07:38:09

Plot file version 432 created 26-MAR-2015 15:28:00

TVLM513 EG082E.UVDATA.1

Freq = 4.9270 GHz, Bw = 16.000 MH No calibration applied and no bandpass applied

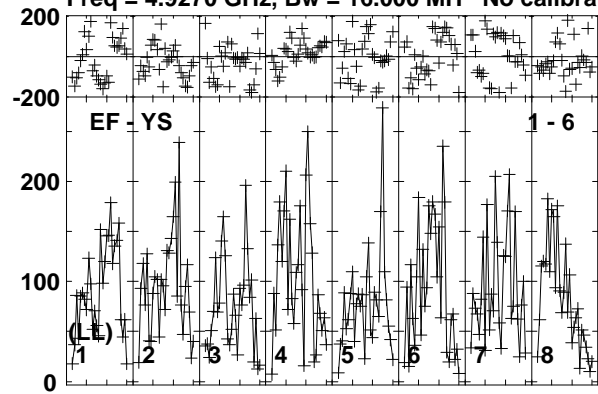

Lower frame: Micro Ampl Jy Top frame: Phas deg
Vector averaged cross-power spectrum Baseline: EF (01) - YS (06)
Timerange: 01/07:34:43 to 01/07:38:09

Plot file version 433 created 26-MAR-2015 15:28:00

J1455+2131 EG082E.UVDATA.1

Freq = 4.9270 GHz, Bw = 16.000 MH No calibration applied and no bandpass applied

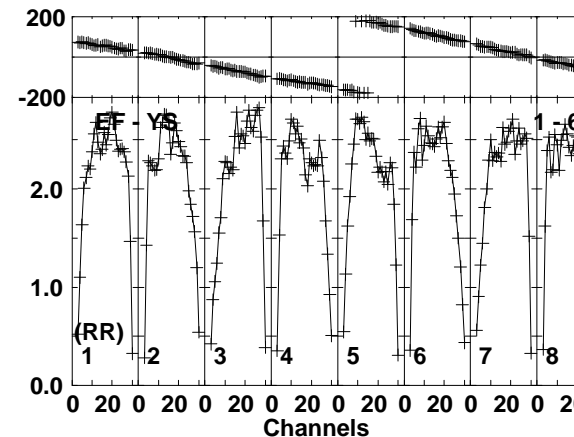
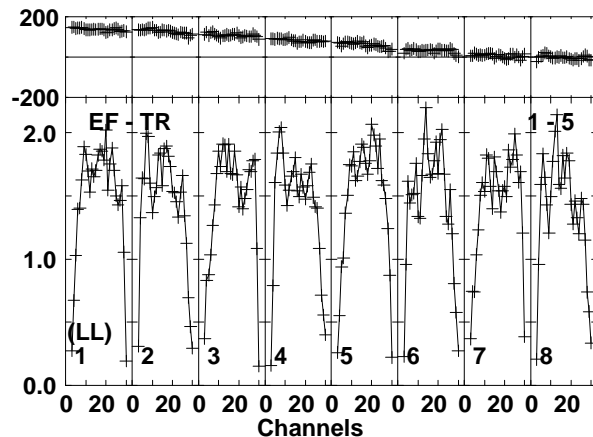
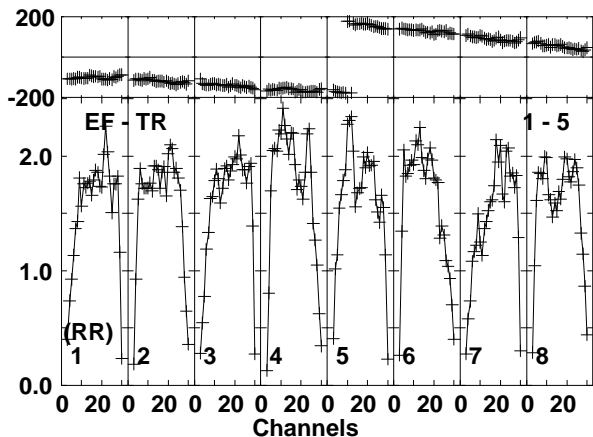
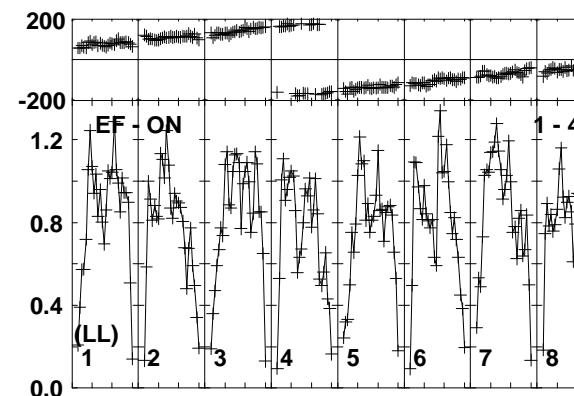
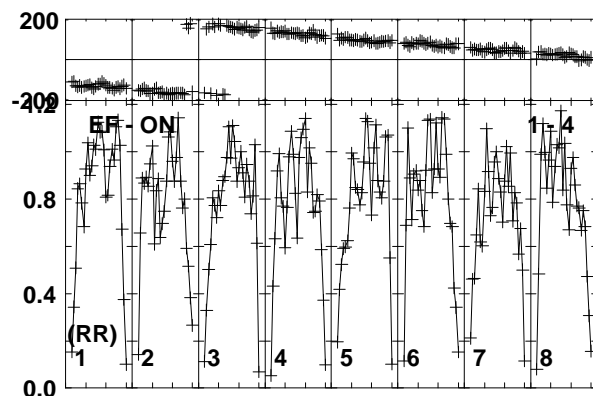
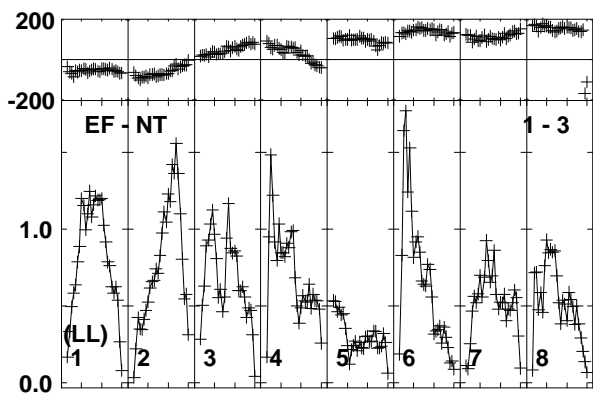
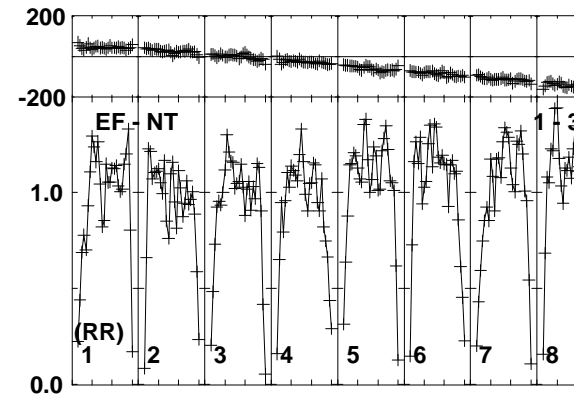
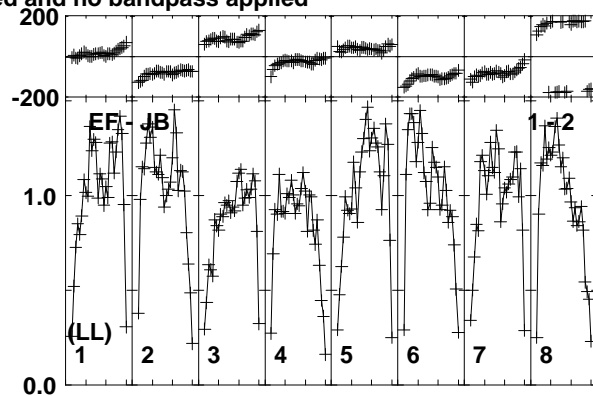
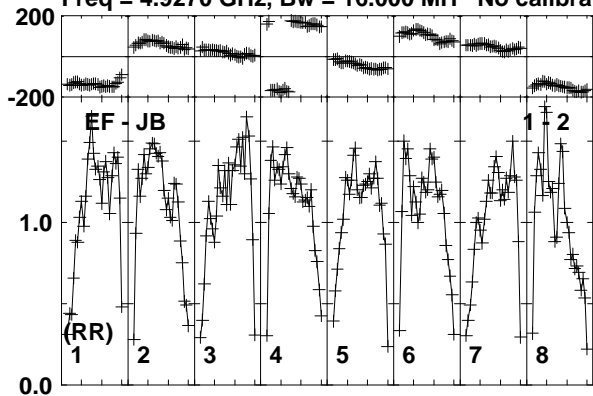

Lower frame: Milli Ampl Jy Top frame: Phas deg
Vector averaged cross-power spectrum Baseline: EF (01) - JB (02)
Timerange: 01/07:38:13 to 01/07:39:39

Plot file version 434 created 26-MAR-2015 15:28:00

J1455+2131 EG082E.UVDATA.1

Freq = 4.9270 GHz, Bw = 16.000 MH No calibration applied and no bandpass applied

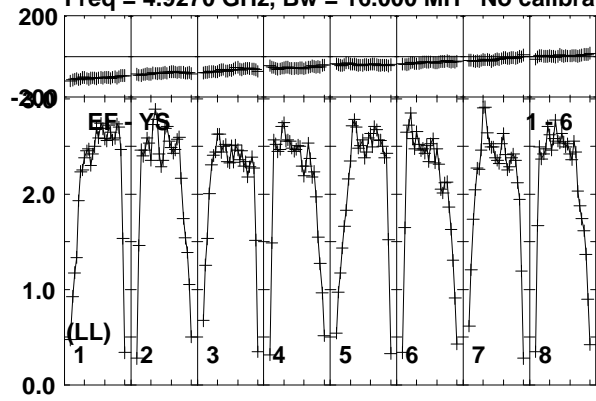

Lower frame: Milli Ampl Jy Top frame: Phas deg
Vector averaged cross-power spectrum Baseline: EF (01) - YS (06)
Timerange: 01/07:38:13 to 01/07:39:39

Plot file version 435 created 26-MAR-2015 15:28:00

TVLM513 EG082E.UVDATA.1

Freq = 4.9270 GHz, Bw = 16.000 MH No calibration applied and no bandpass applied

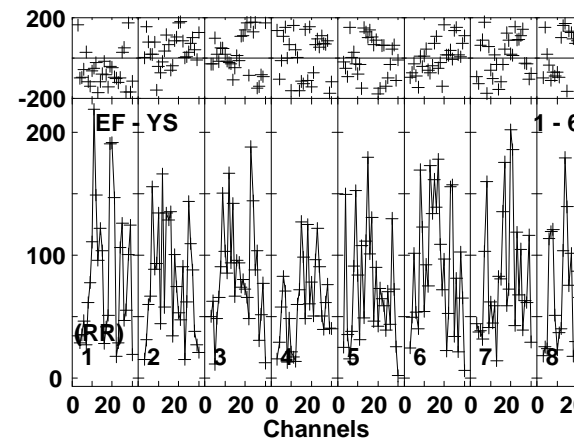
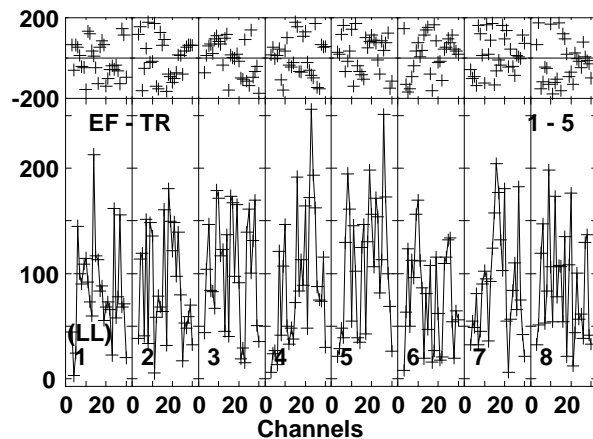
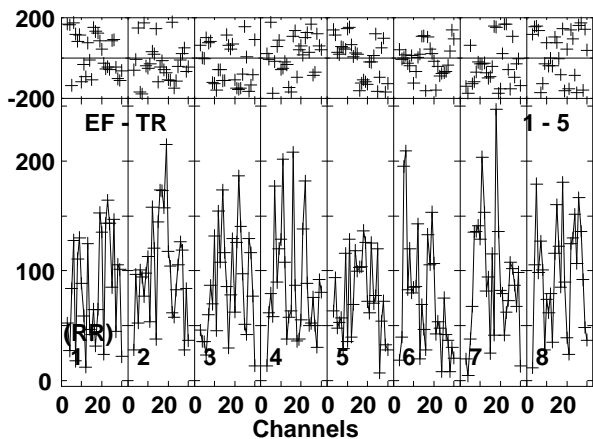
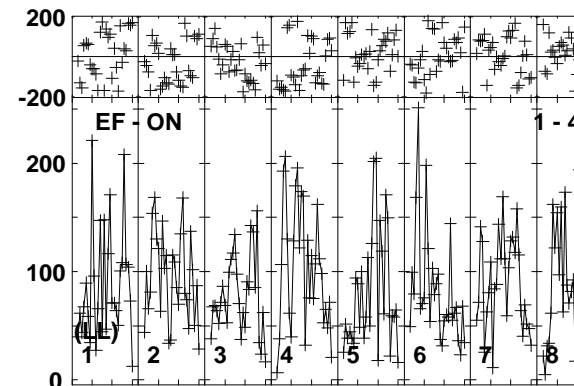
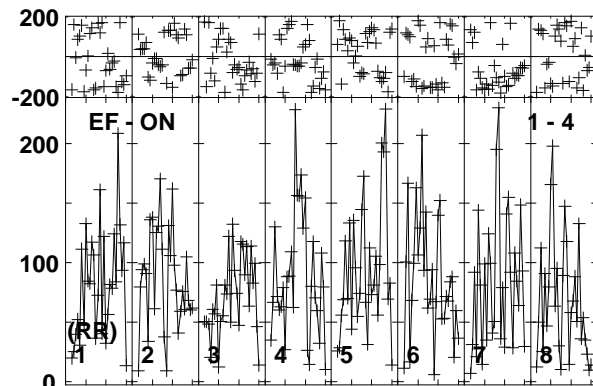
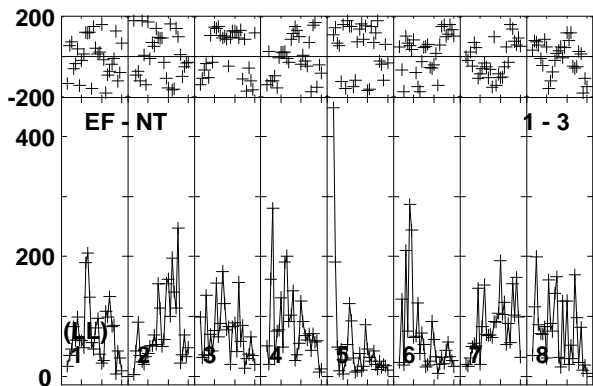
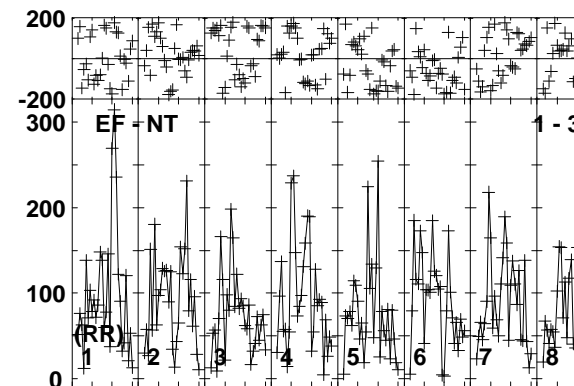
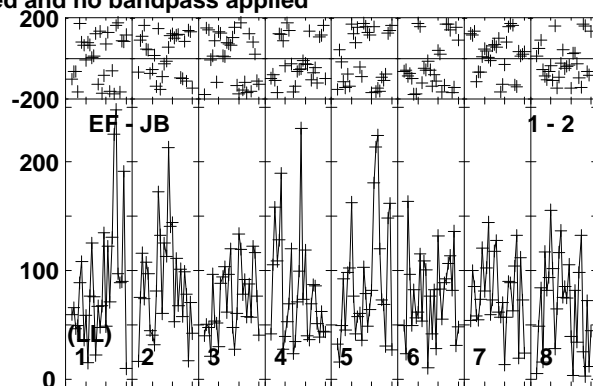
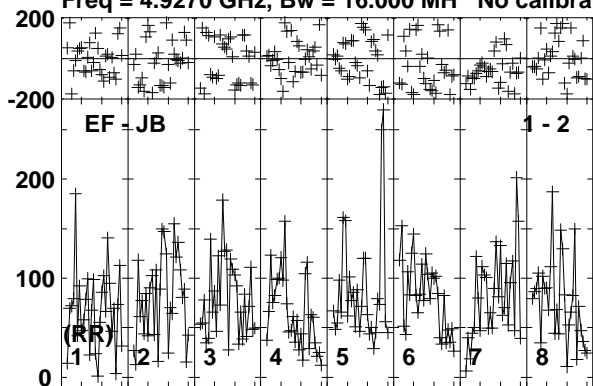

Lower frame: Micro Ampl Jy Top frame: Phas deg
Vector averaged cross-power spectrum Baseline: EF (01) - JB (02)
Timerange: 01/07:39:43 to 01/07:43:09

Plot file version 436 created 26-MAR-2015 15:28:00

TVLM513 EG082E.UVDATA.1

Freq = 4.9270 GHz, Bw = 16.000 MH No calibration applied and no bandpass applied

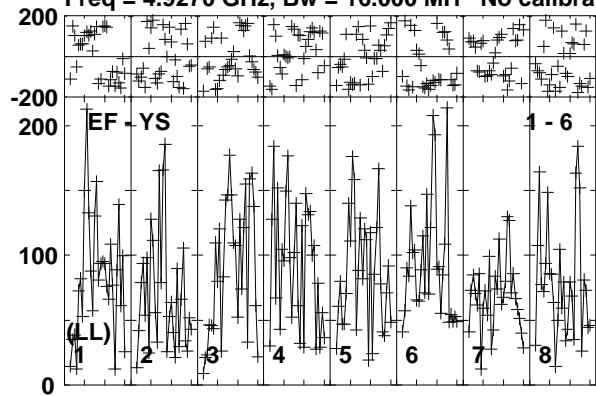

Lower frame: Micro Ampl Jy Top frame: Phas deg
Vector averaged cross-power spectrum Baseline: EF (01) - YS (06)
Timerange: 01/07:39:43 to 01/07:43:09

Plot file version 437 created 26-MAR-2015 15:28:00

J1455+2131 EG082E.UVDATA.1

Freq = 4.9270 GHz, Bw = 16.000 MH No calibration applied and no bandpass applied

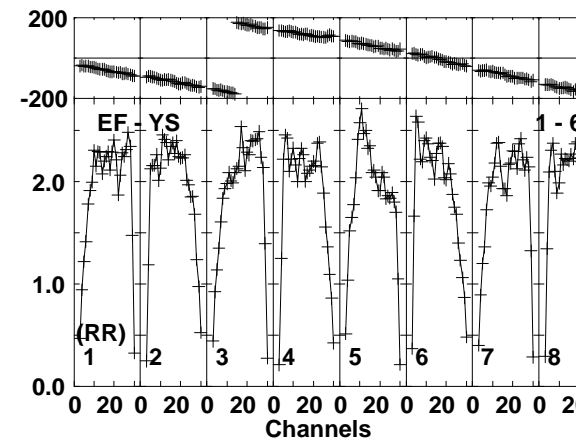
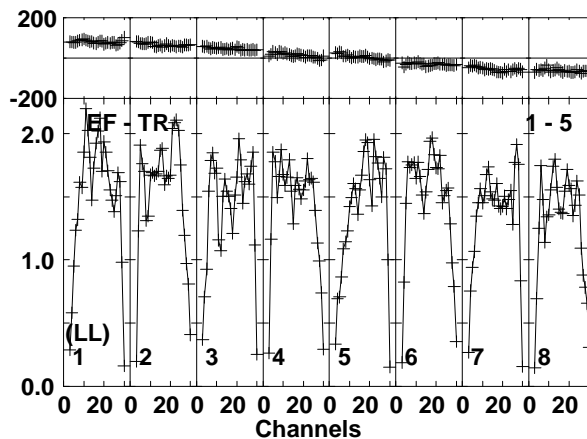
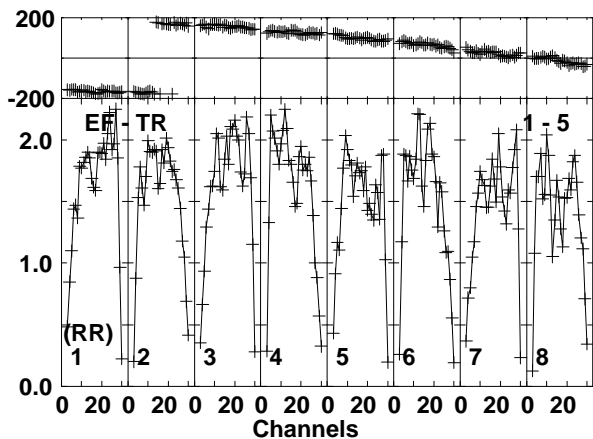
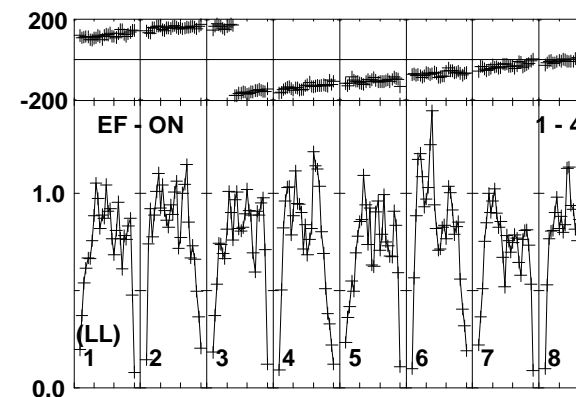
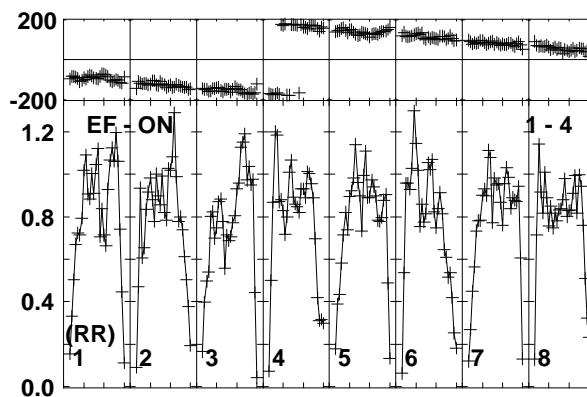
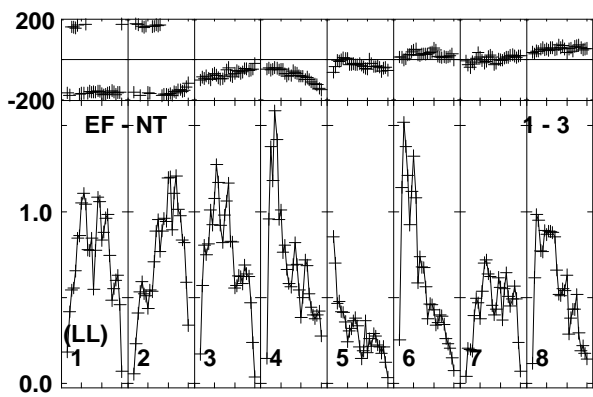
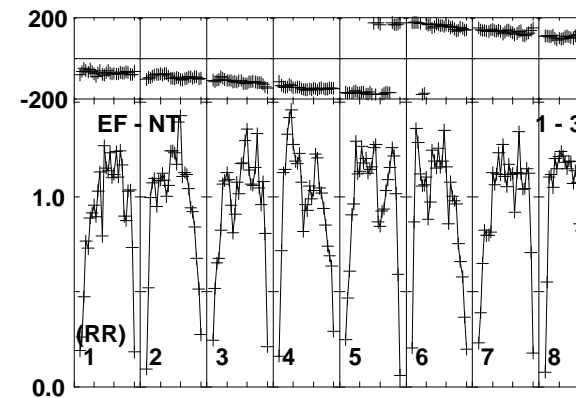
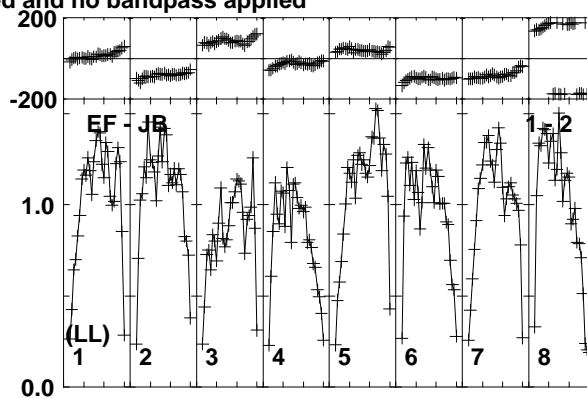
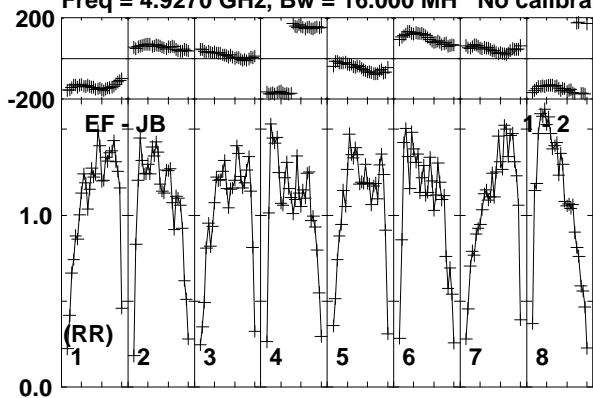

Lower frame: Milli Ampl Jy Top frame: Phas deg
Vector averaged cross-power spectrum Baseline: EF (01) - JB (02)
Timerange: 01/07:43:43 to 01/07:44:39

Plot file version 438 created 26-MAR-2015 15:28:00

J1455+2131 EG082E.UVDATA.1

Freq = 4.9270 GHz, Bw = 16.000 MH No calibration applied and no bandpass applied

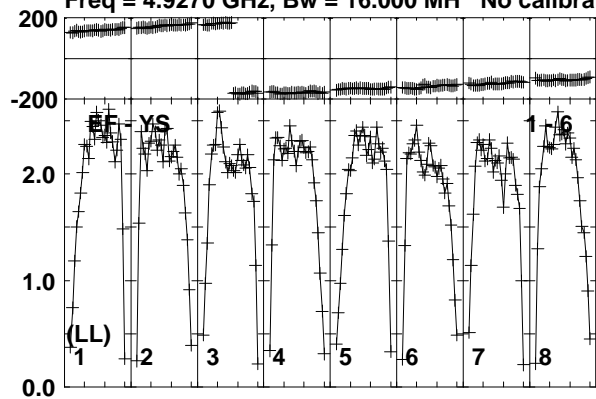

Lower frame: Milli Ampl Jy Top frame: Phas deg
Vector averaged cross-power spectrum Baseline: EF (01) - YS (06)
Timerange: 01/07:43:43 to 01/07:44:39

Plot file version 439 created 26-MAR-2015 15:28:00

TVLM513 EG082E.UVDATA.1

Freq = 4.9270 GHz, Bw = 16.000 MH No calibration applied and no bandpass applied

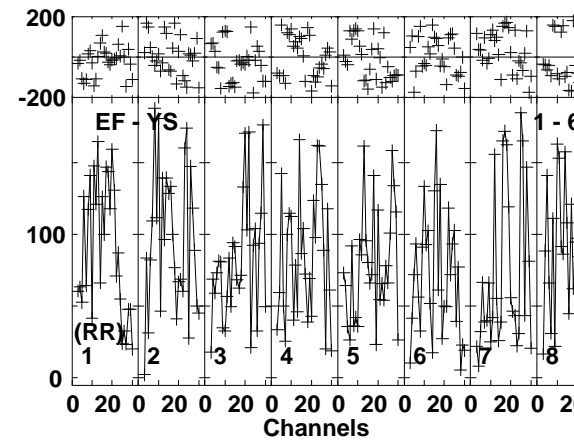
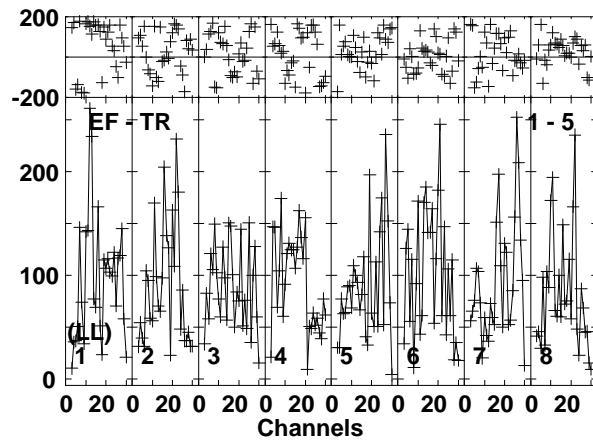
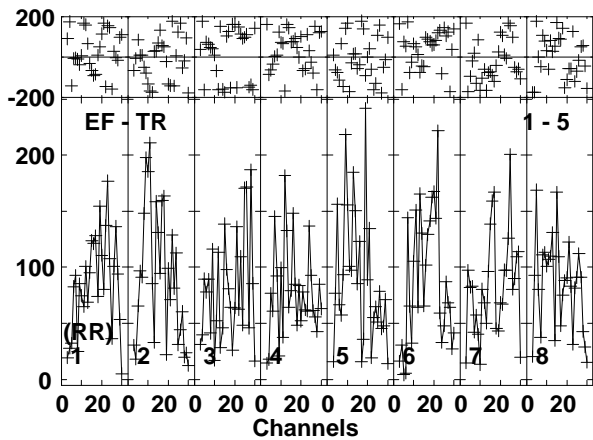
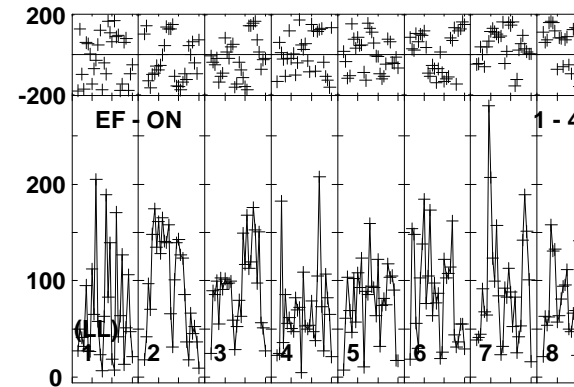
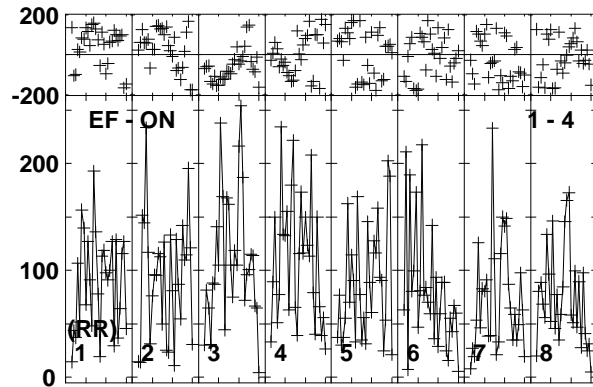
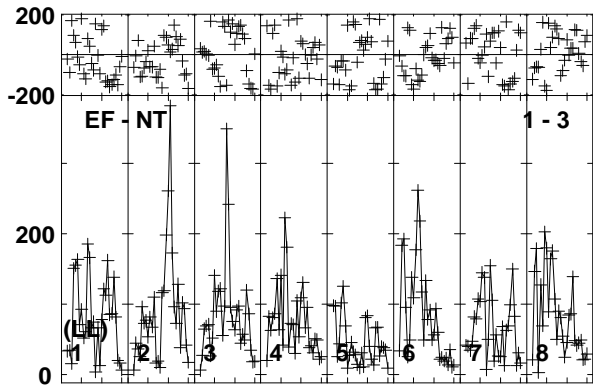
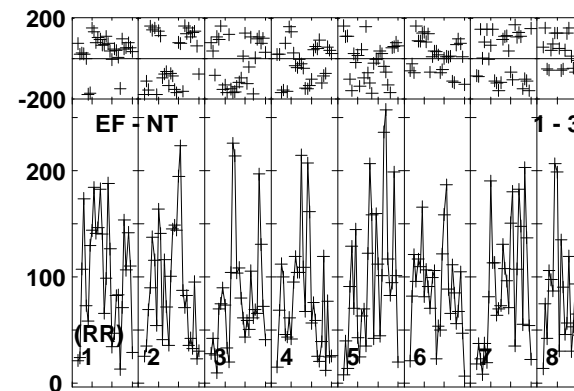
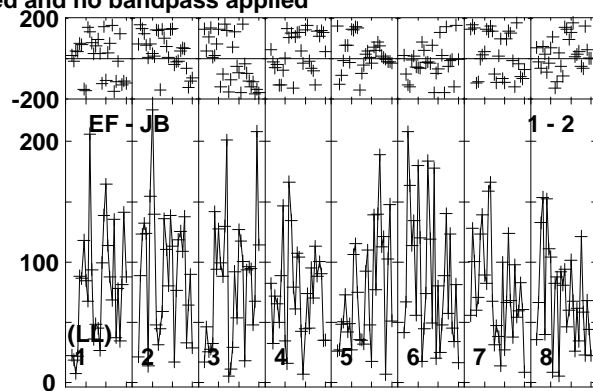
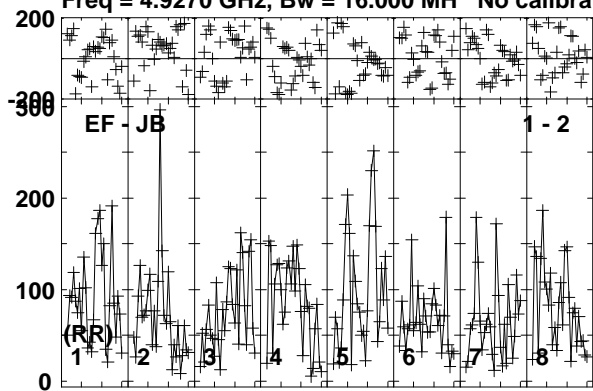

Lower frame: Micro Ampl Jy Top frame: Phas deg
Vector averaged cross-power spectrum Baseline: EF (01) - JB (02)
Timerange: 01/07:44:43 to 01/07:48:09

Plot file version 440 created 26-MAR-2015 15:28:00

TVLM513 EG082E.UVDATA.1

Freq = 4.9270 GHz, Bw = 16.000 MH No calibration applied and no bandpass applied

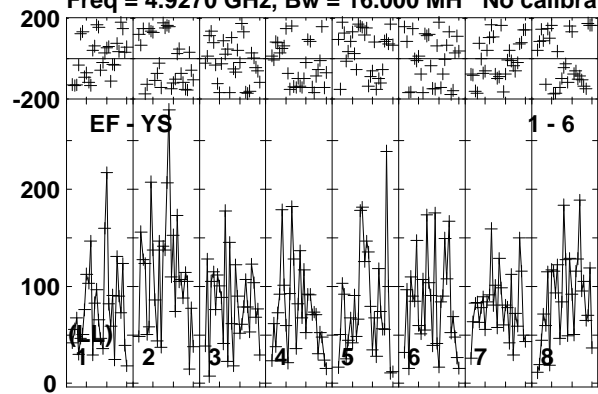

Lower frame: Micro Ampl Jy Top frame: Phas deg
Vector averaged cross-power spectrum Baseline: EF (01) - YS (06)
Timerange: 01/07:44:43 to 01/07:48:09

Plot file version 441 created 26-MAR-2015 15:28:00

J1455+2131 EG082E.UVDATA.1

Freq = 4.9270 GHz, Bw = 16.000 MH No calibration applied and no bandpass applied

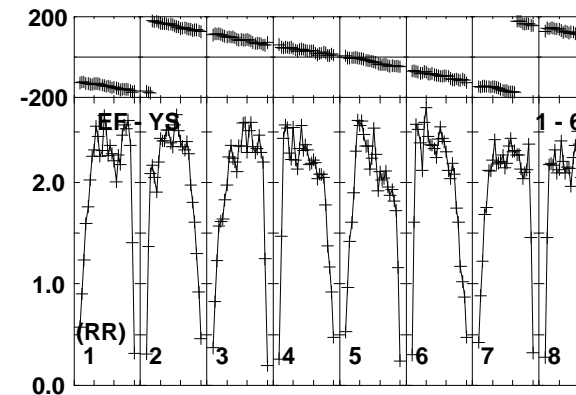
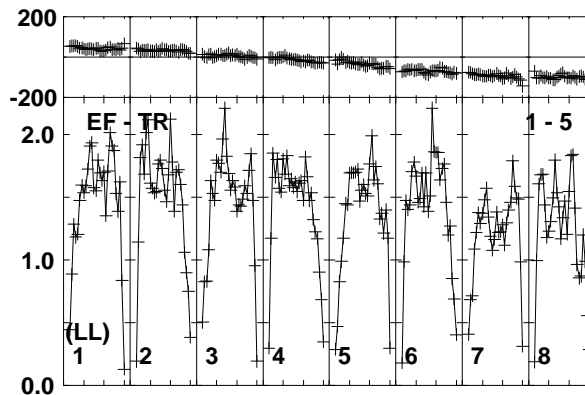
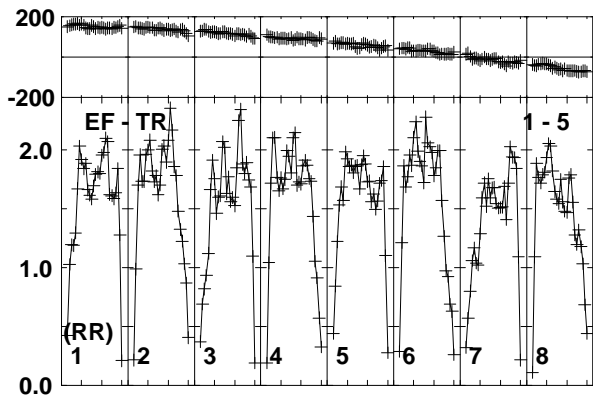
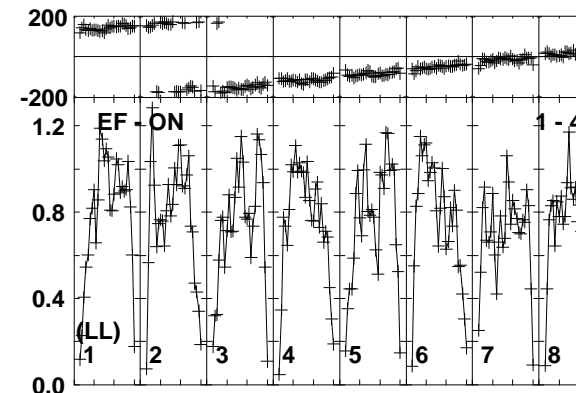
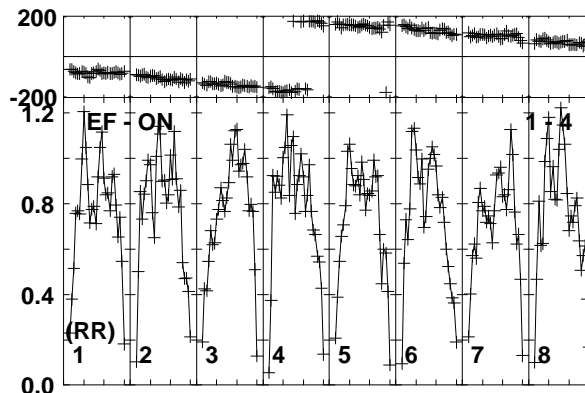
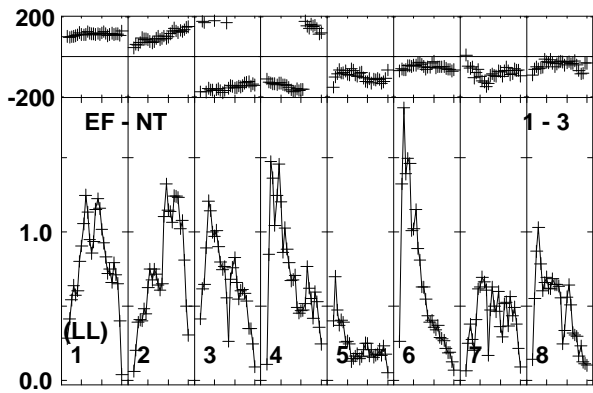
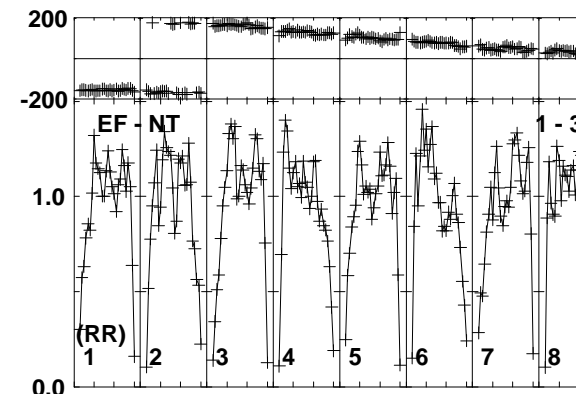
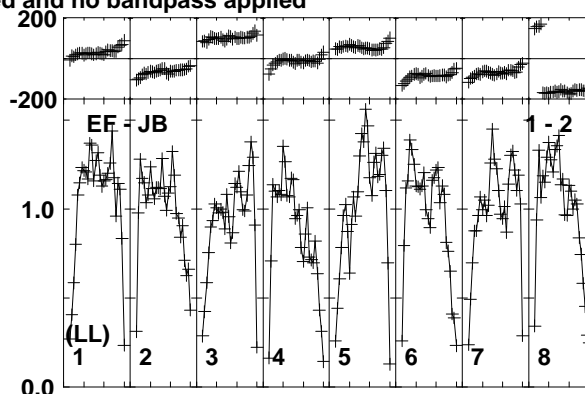
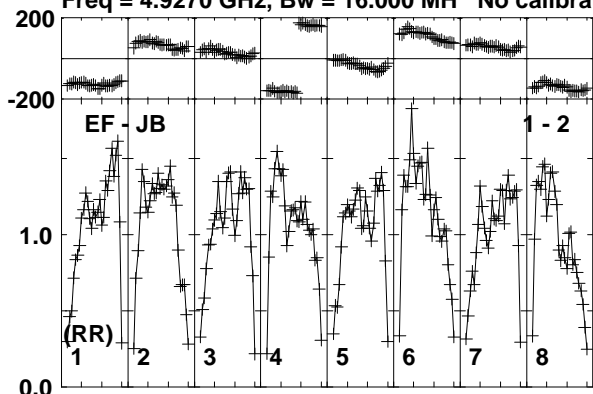

Lower frame: Milli Ampl Jy Top frame: Phas deg
Vector averaged cross-power spectrum Baseline: EF (01) - JB (02)
Timerange: 01/07:48:13 to 01/07:49:39

Plot file version 442 created 26-MAR-2015 15:28:00

J1455+2131 EG082E.UVDATA.1

Freq = 4.9270 GHz, Bw = 16.000 MH No calibration applied and no bandpass applied

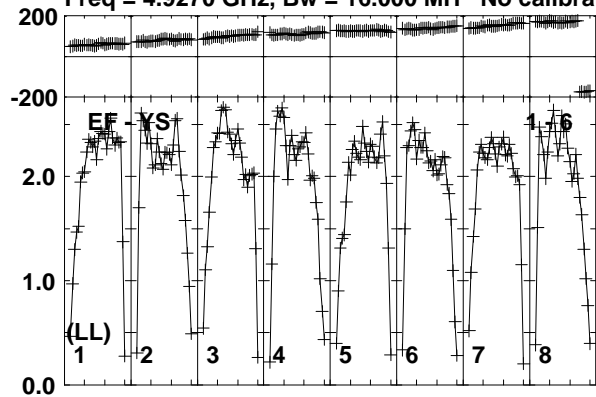

Lower frame: Milli Ampl Jy Top frame: Phas deg
Vector averaged cross-power spectrum Baseline: EF (01) - YS (06)
Timerange: 01/07:48:13 to 01/07:49:39

Plot file version 443 created 26-MAR-2015 15:28:00

TVLM513 EG082E.UVDATA.1

Freq = 4.9270 GHz, Bw = 16.000 MH No calibration applied and no bandpass applied

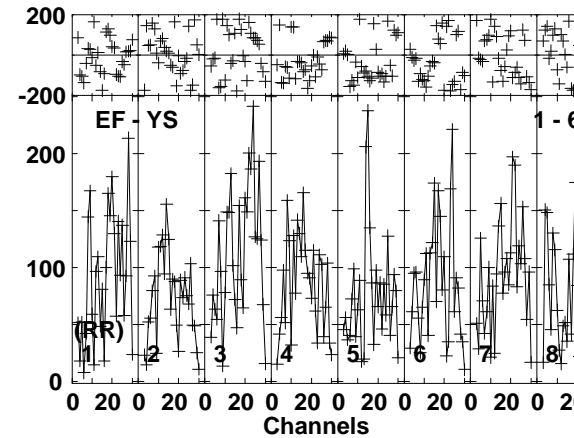
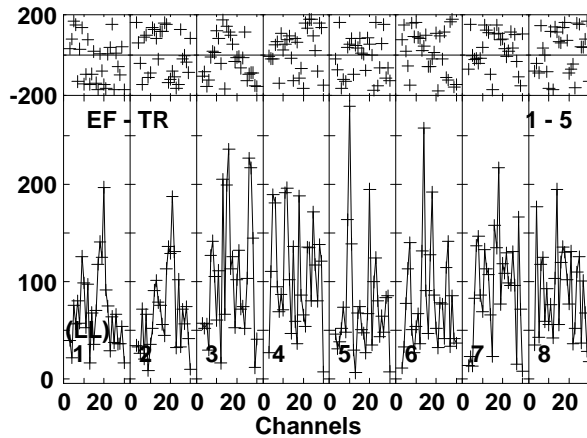
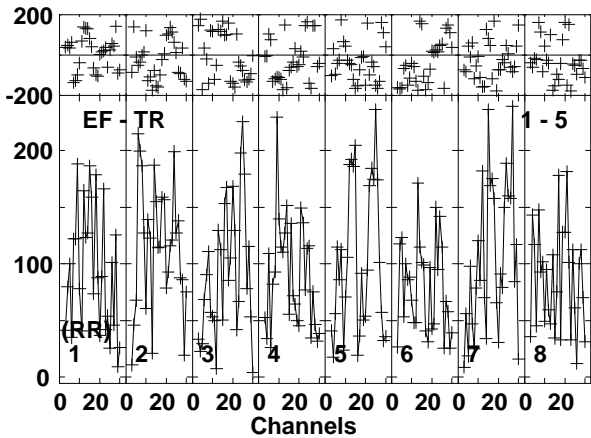
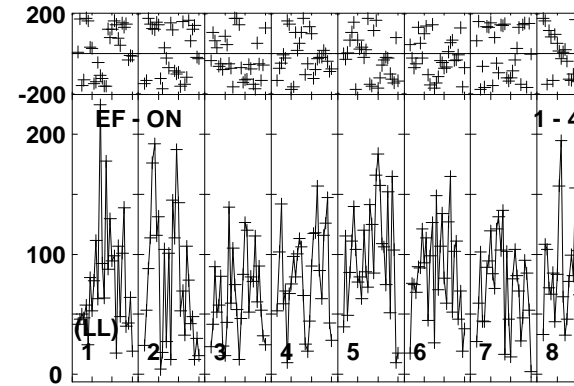
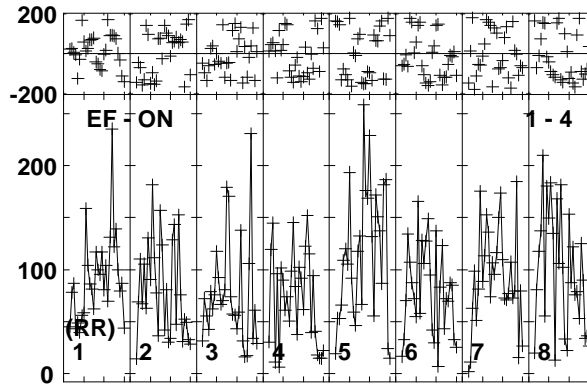
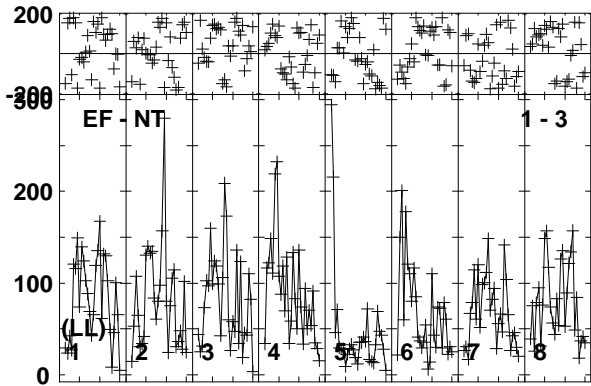
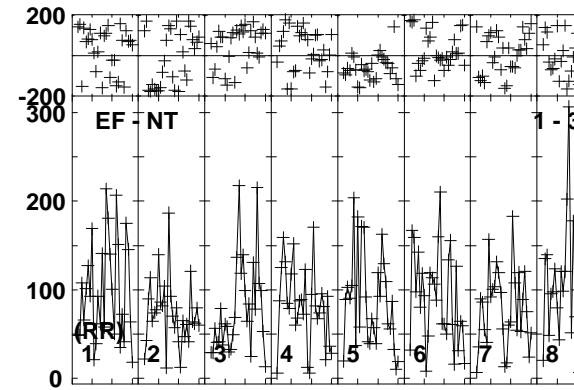
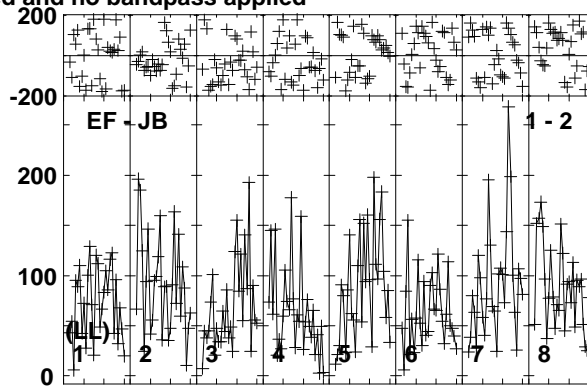
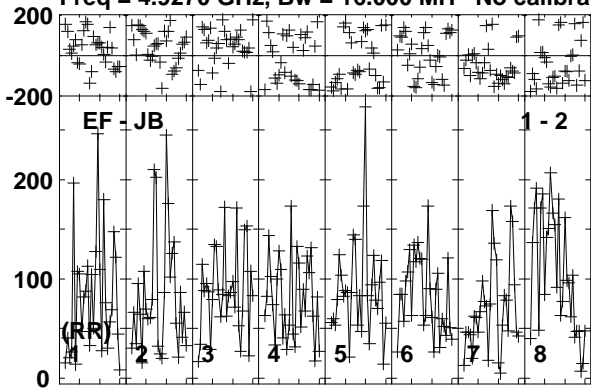

Lower frame: Micro Ampl Jy Top frame: Phas deg
Vector averaged cross-power spectrum Baseline: EF (01) - JB (02)
Timerange: 01/07:49:43 to 01/07:53:09

Plot file version 444 created 26-MAR-2015 15:28:00

TVLM513 EG082E.UVDATA.1

Freq = 4.9270 GHz, Bw = 16.000 MH No calibration applied and no bandpass applied

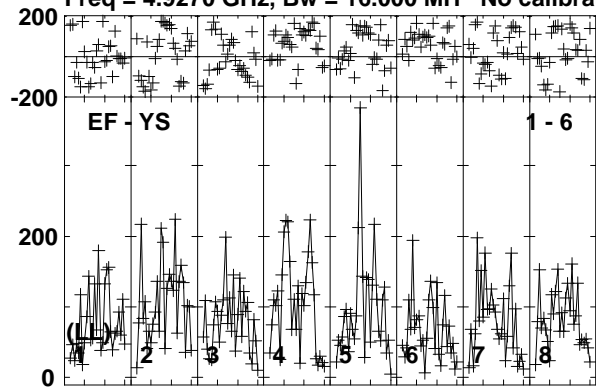

Lower frame: Micro Ampl Jy Top frame: Phas deg
Vector averaged cross-power spectrum Baseline: EF (01) - YS (06)
Timerange: 01/07:49:43 to 01/07:53:09

Plot file version 445 created 26-MAR-2015 15:28:00

J1455+2131 EG082E.UVDATA.1

Freq = 4.9270 GHz, Bw = 16.000 MH No calibration applied and no bandpass applied

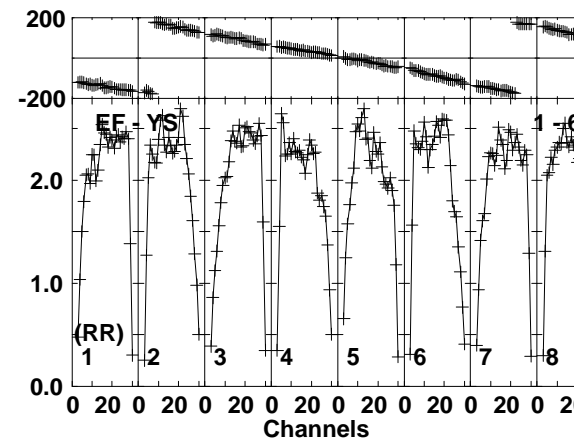
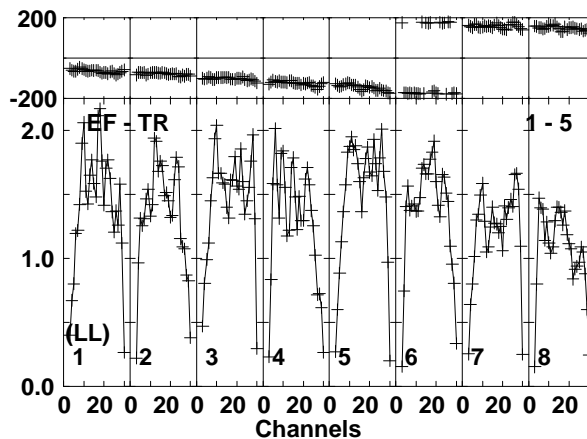
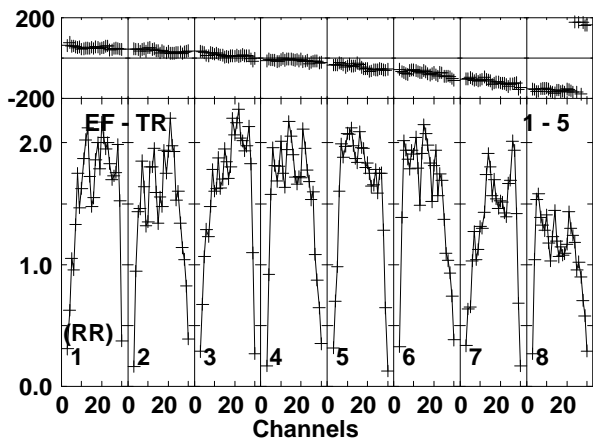
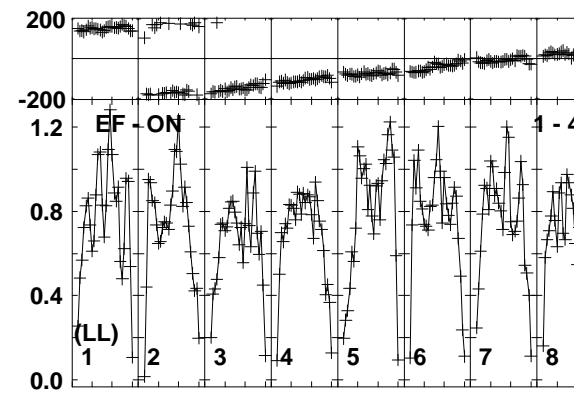
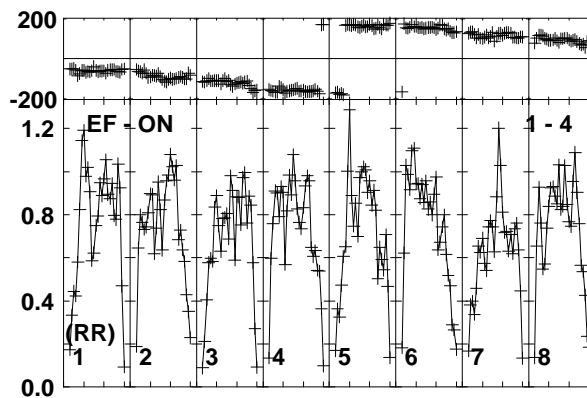
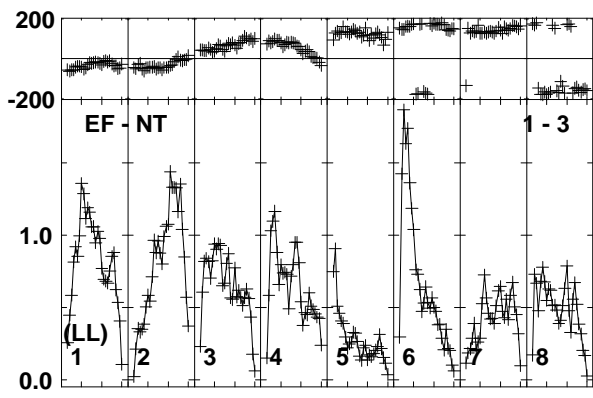
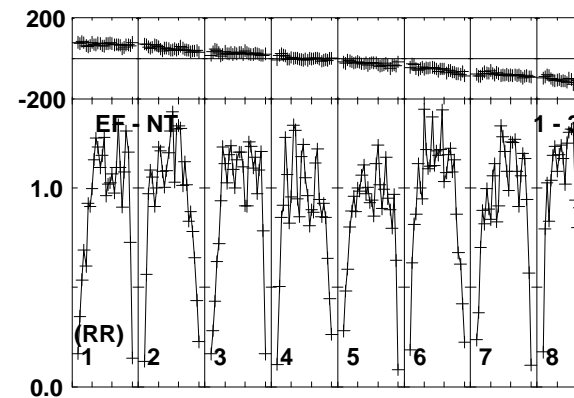
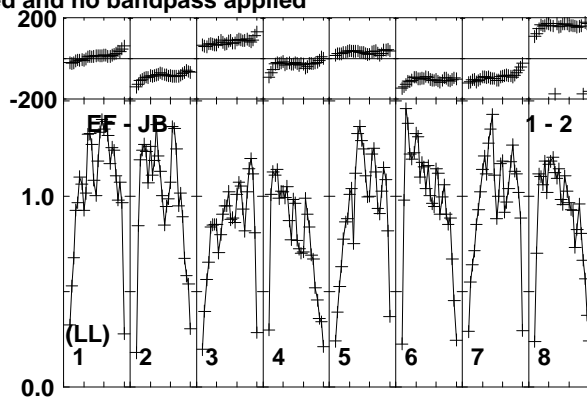
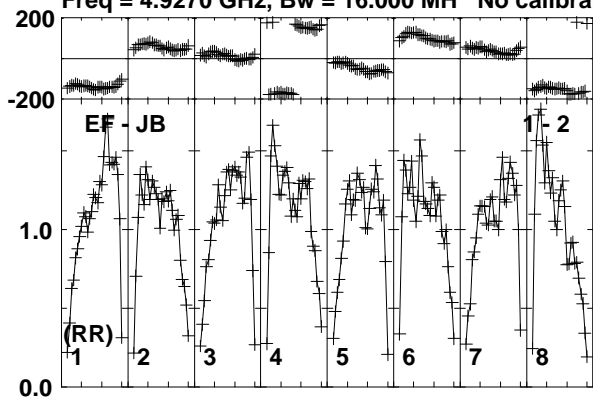

Lower frame: Milli Ampl Jy Top frame: Phas deg
Vector averaged cross-power spectrum Baseline: EF (01) - JB (02)
Timerange: 01/07:53:43 to 01/07:54:39

Plot file version 446 created 26-MAR-2015 15:28:00
J1455+2131 EG082E.UVDATA.1
Freq = 4.9270 GHz, Bw = 16.000 MH No calibration applied and no bandpass applied

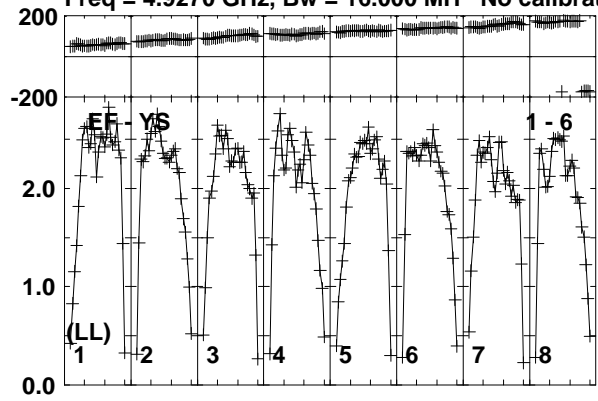

Lower frame: Milli Ampl Jy Top frame: Phas deg
Vector averaged cross-power spectrum Baseline: EF (01) - YS (06)
Timerange: 01/07:53:43 to 01/07:54:39

Plot file version 447 created 26-MAR-2015 15:28:01

TVLM513 EG082E.UVDATA.1

Freq = 4.9270 GHz, Bw = 16.000 MH No calibration applied and no bandpass applied

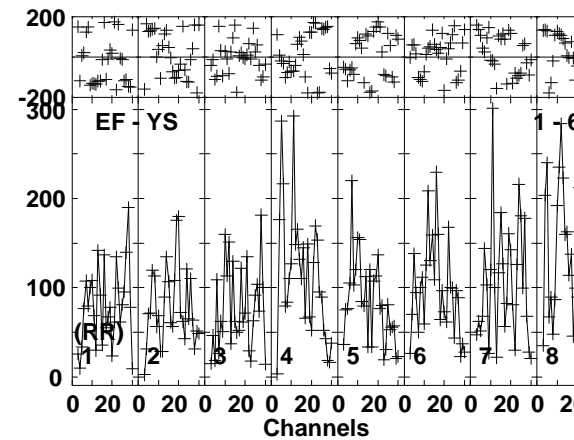
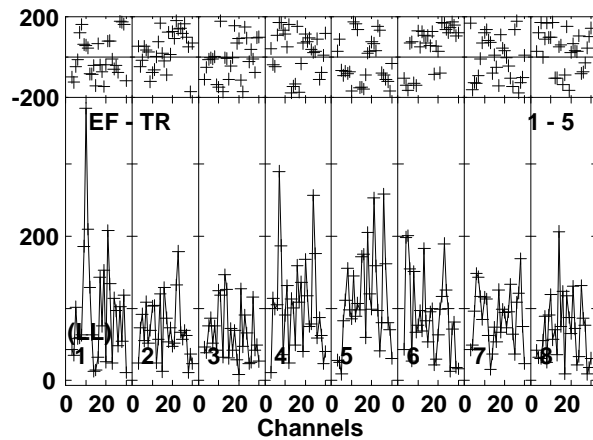
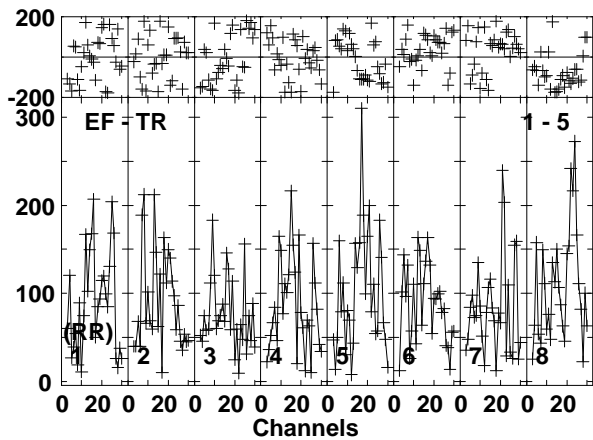
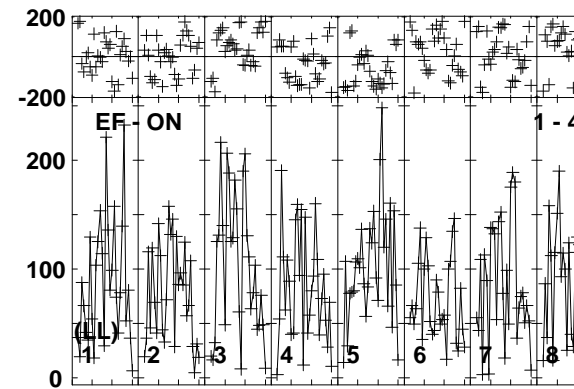
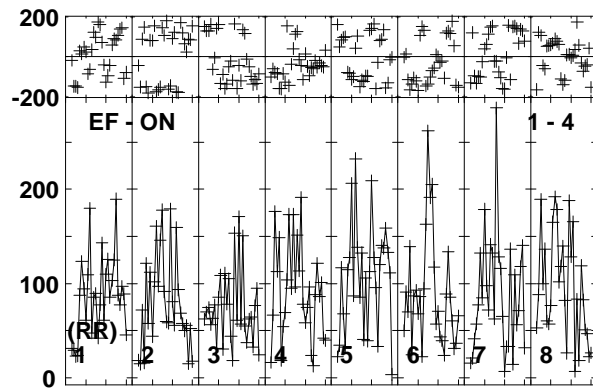
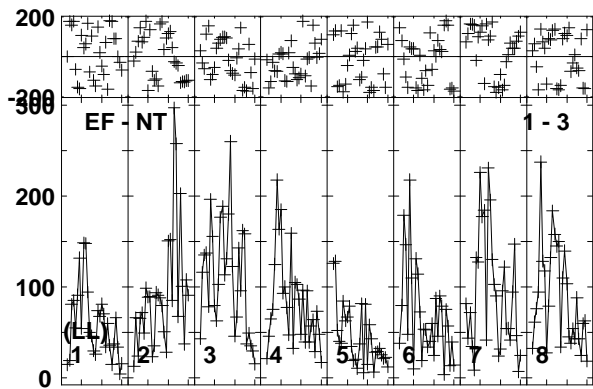
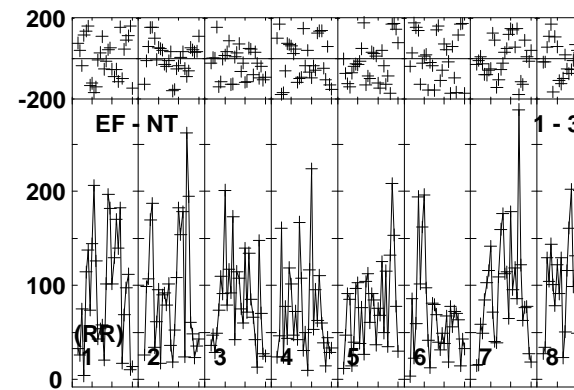
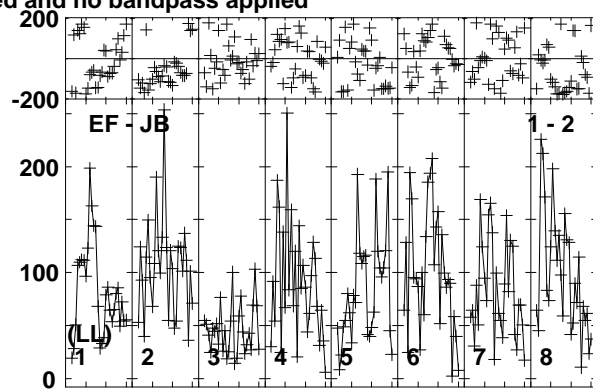
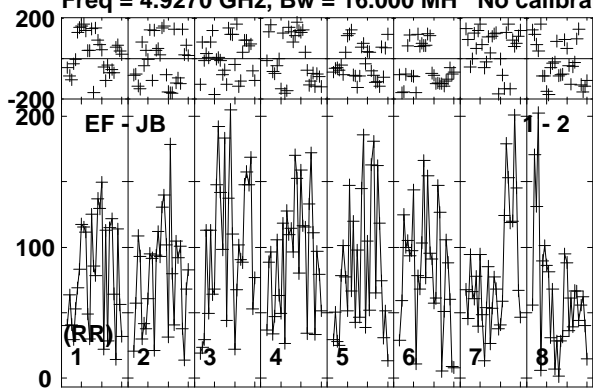

Lower frame: Micro Ampl Jy Top frame: Phas deg
Vector averaged cross-power spectrum Baseline: EF (01) - JB (02)
Timerange: 01/07:54:43 to 01/07:58:09

Plot file version 448 created 26-MAR-2015 15:28:01

TVLM513 EG082E.UVDATA.1

Freq = 4.9270 GHz, Bw = 16.000 MH No calibration applied and no bandpass applied

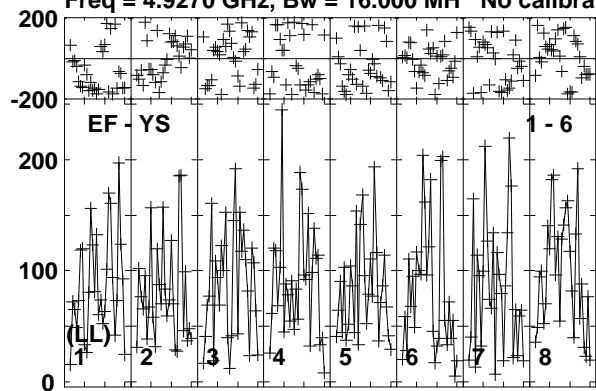

Lower frame: Micro Ampl Jy Top frame: Phas deg
Vector averaged cross-power spectrum Baseline: EF (01) - YS (06)
Timerange: 01/07:54:43 to 01/07:58:09

Plot file version 449 created 26-MAR-2015 15:28:01

J1455+2131 EG082E.UVDATA.1

Freq = 4.9270 GHz, Bw = 16.000 MH No calibration applied and no bandpass applied

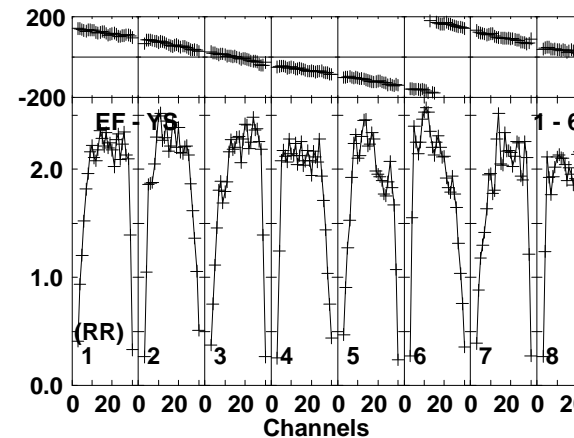
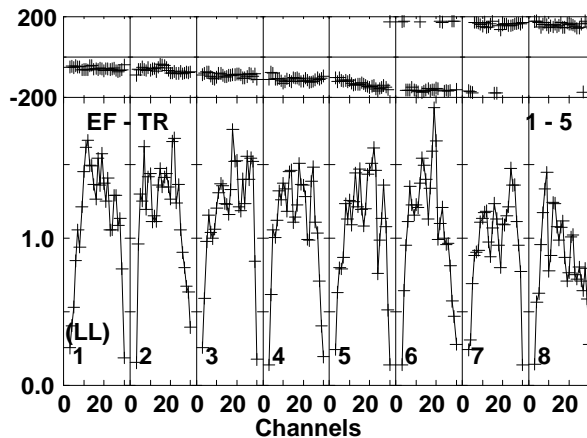
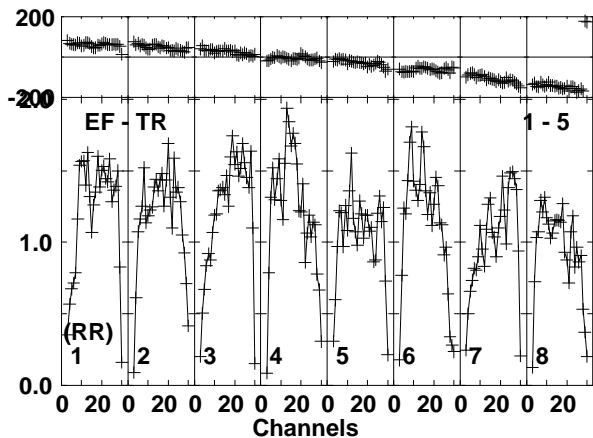
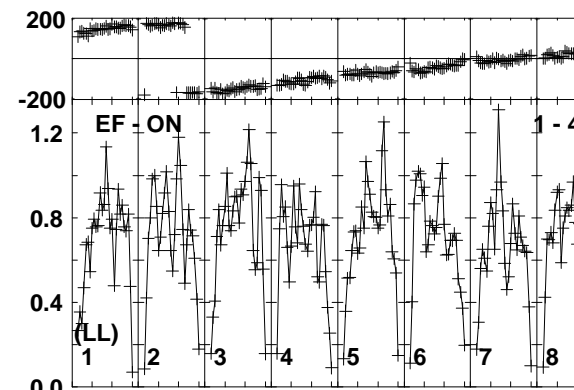
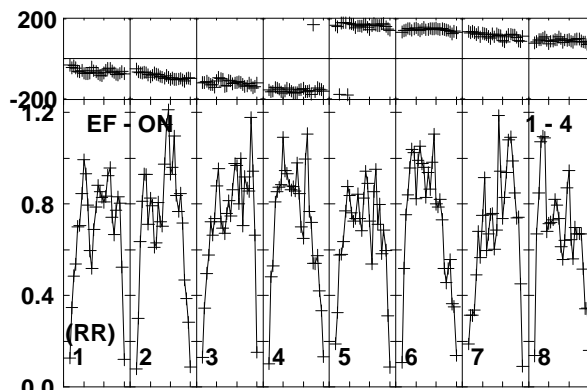
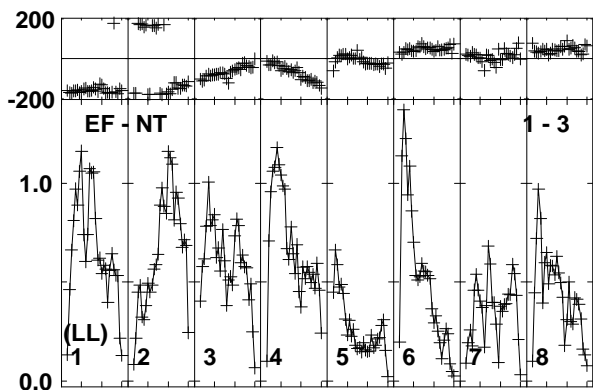
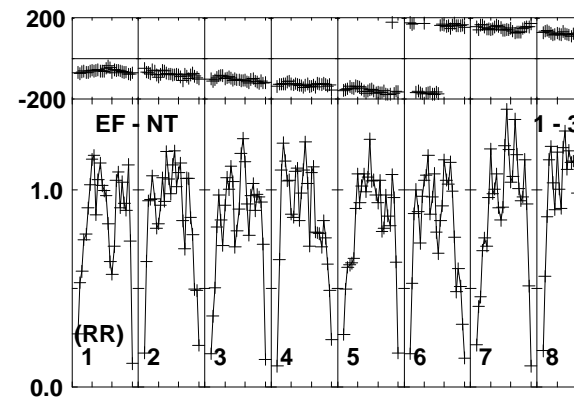
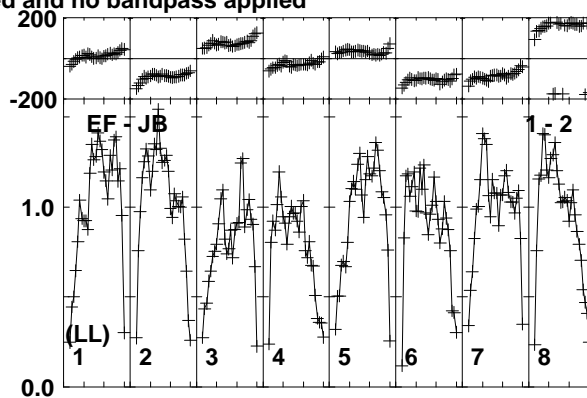
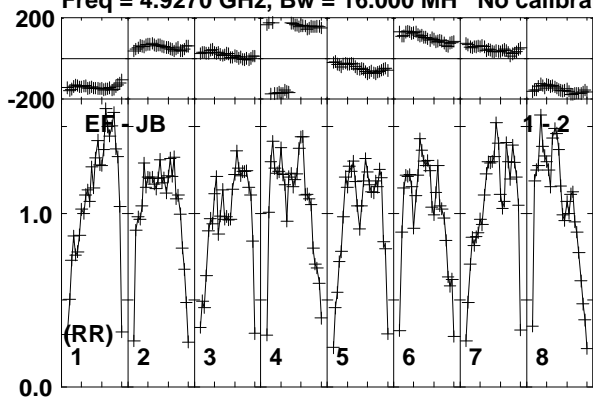

Lower frame: Milli Ampl Jy Top frame: Phas deg
Vector averaged cross-power spectrum Baseline: EF (01) - JB (02)
Timerange: 01/07:58:13 to 01/07:59:39

Plot file version 450 created 26-MAR-2015 15:28:01

J1455+2131 EG082E.UVDATA.1

Freq = 4.9270 GHz, Bw = 16.000 MH No calibration applied and no bandpass applied

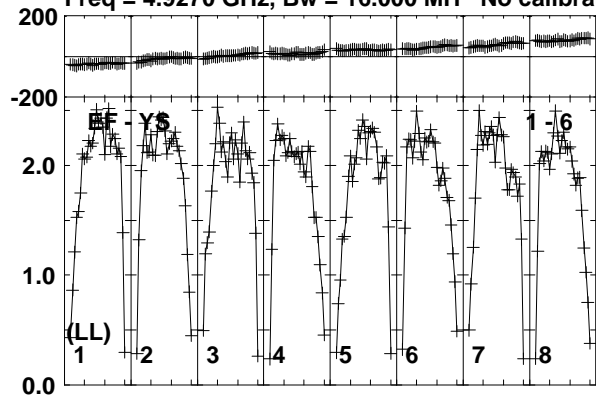

Lower frame: Milli Ampl Jy Top frame: Phas deg
Vector averaged cross-power spectrum Baseline: EF (01) - YS (06)
Timerange: 01/07:58:13 to 01/07:59:39

Plot file version 451 created 26-MAR-2015 15:28:01

J1504+2218 EG082E.UVDATA.1

Freq = 4.9270 GHz, Bw = 16.000 MH No calibration applied and no bandpass applied

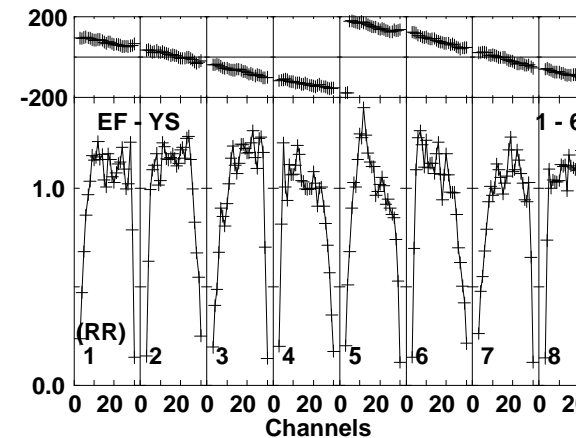
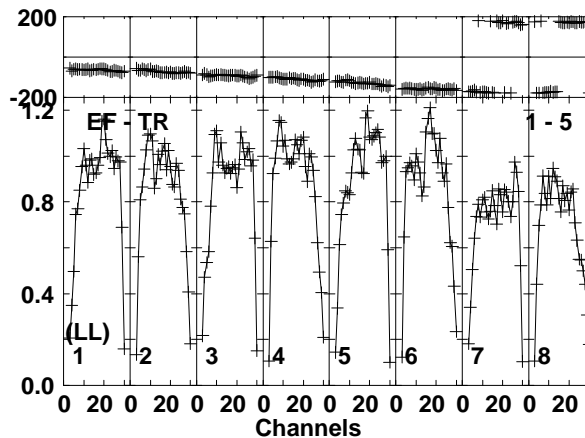
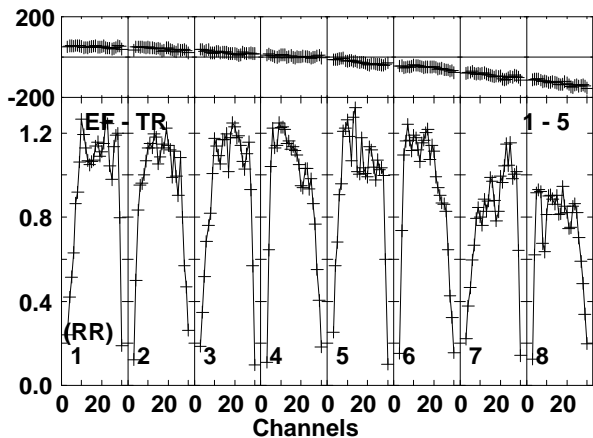
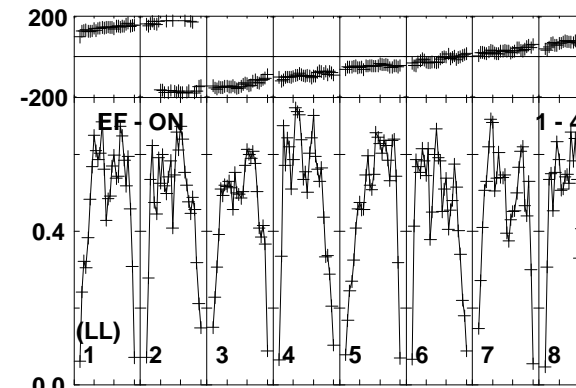
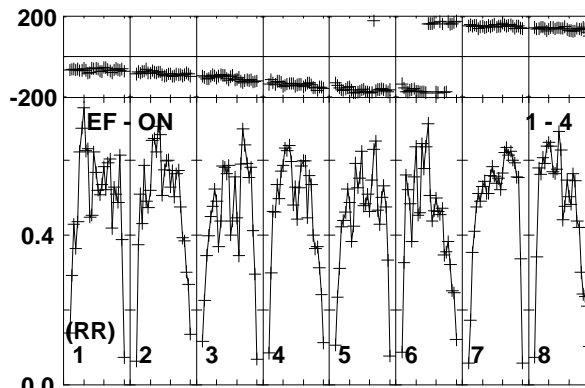
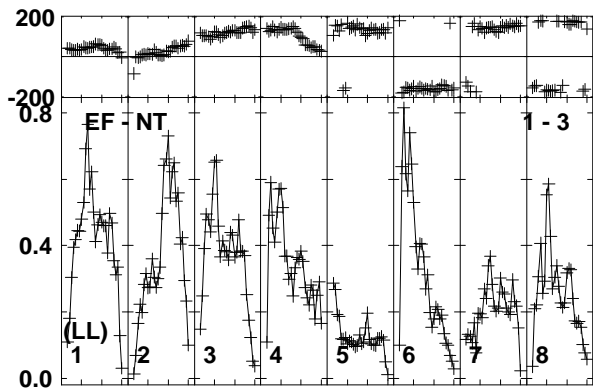
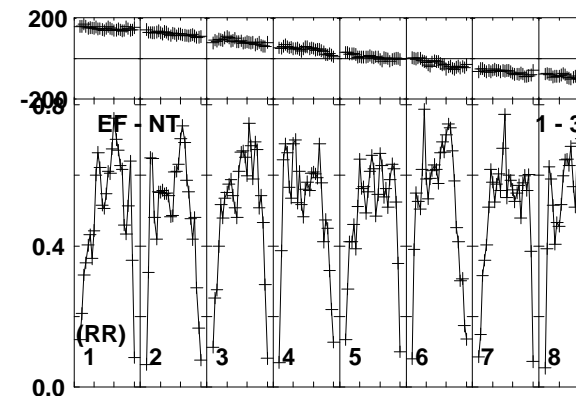
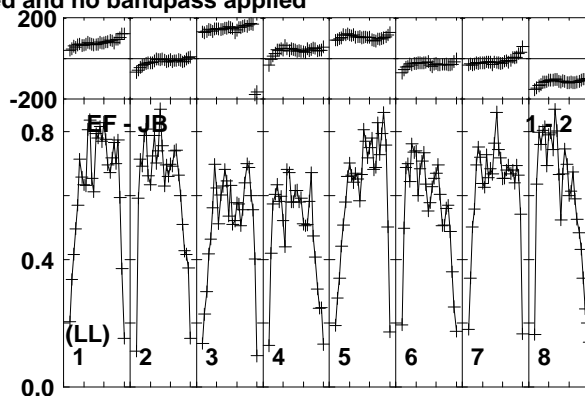
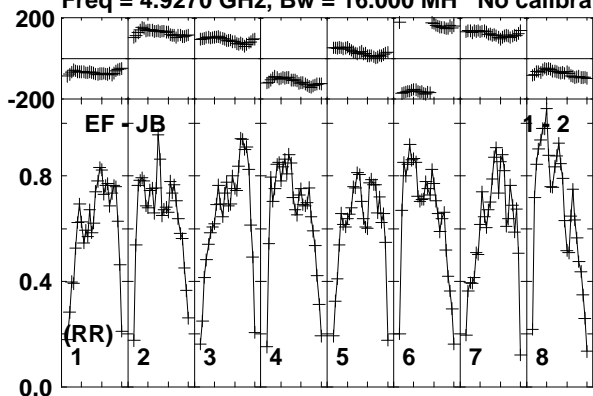

Lower frame: Milli Ampl Jy Top frame: Phas deg
Vector averaged cross-power spectrum Baseline: EF (01) - JB (02)
Timerange: 01/07:59:43 to 01/08:03:09

Plot file version 452 created 26-MAR-2015 15:28:01

J1504+2218 EG082E.UVDATA.1

Freq = 4.9270 GHz, Bw = 16.000 MH No calibration applied and no bandpass applied

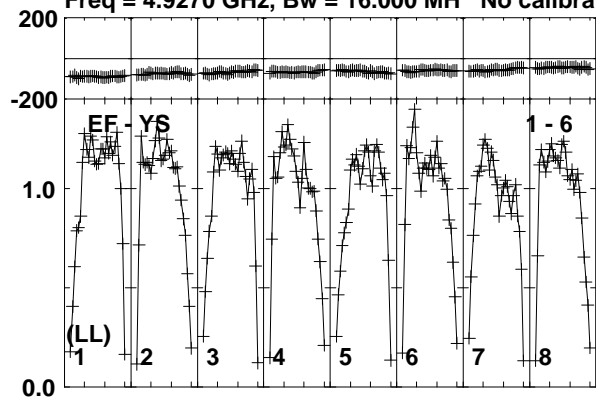

Lower frame: Milli Ampl Jy Top frame: Phas deg
Vector averaged cross-power spectrum Baseline: EF (01) - YS (06)
Timerange: 01/07:59:43 to 01/08:03:09

Plot file version 453 created 26-MAR-2015 15:28:01

J1455+2131 EG082E.UVDATA.1

Freq = 4.9270 GHz, Bw = 16.000 MH No calibration applied and no bandpass applied

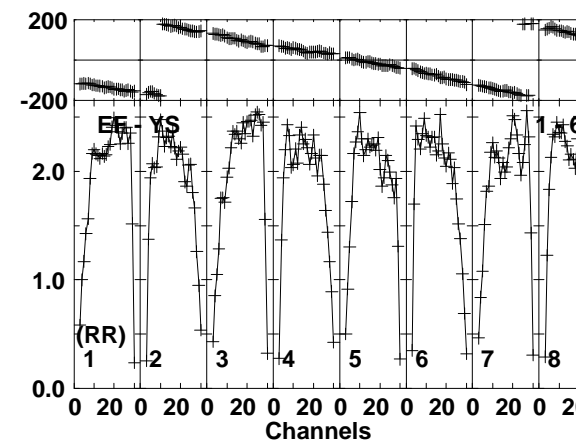
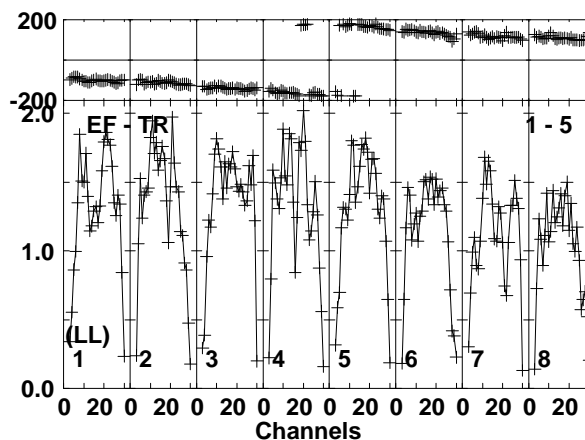
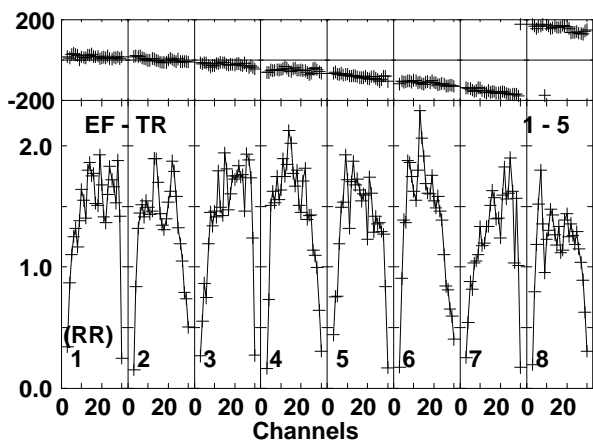
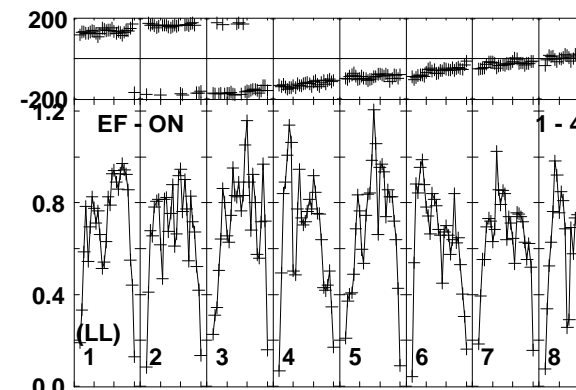
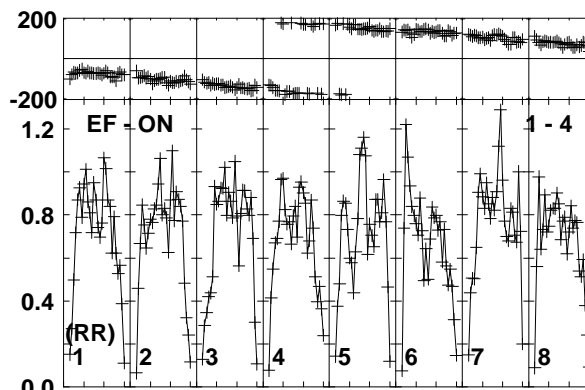
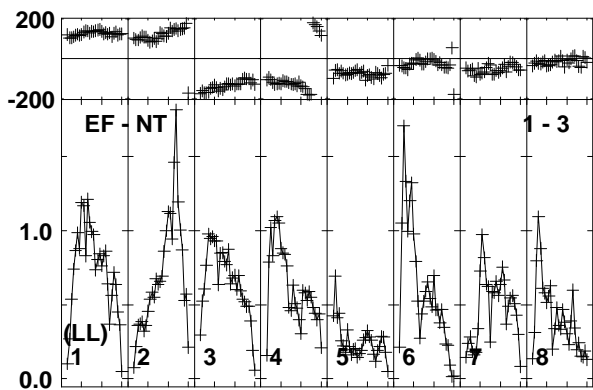
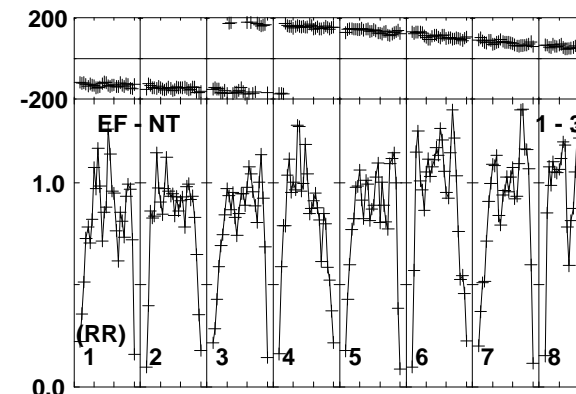
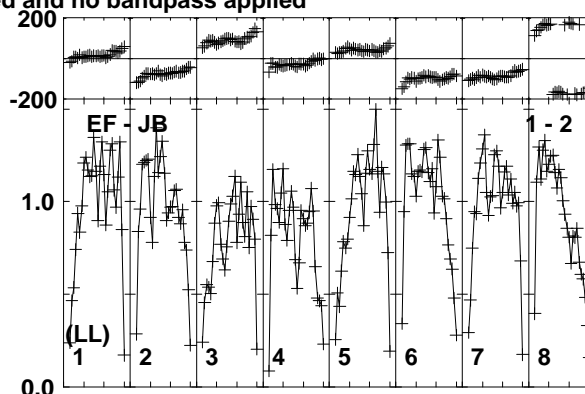
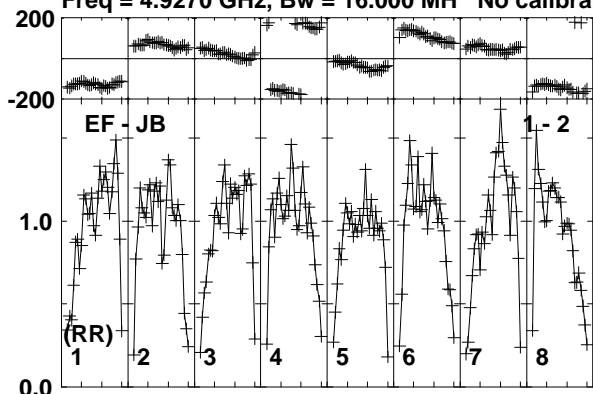

Lower frame: Milli Ampl Jy Top frame: Phas deg
Vector averaged cross-power spectrum Baseline: EF (01) - JB (02)
Timerange: 01/08:03:43 to 01/08:04:39

Plot file version 454 created 26-MAR-2015 15:28:01

J1455+2131 EG082E.UVDATA.1

Freq = 4.9270 GHz, Bw = 16.000 MH No calibration applied and no bandpass applied

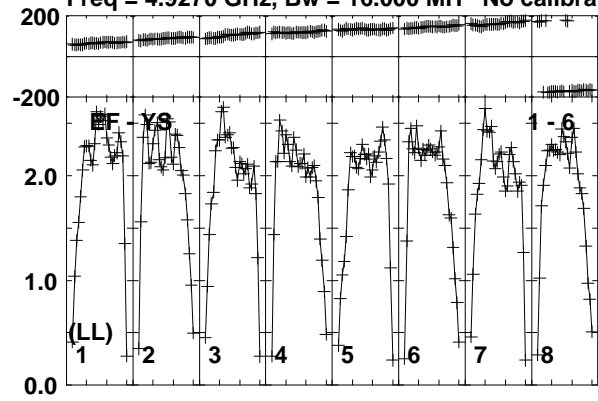

Lower frame: Milli Ampl Jy Top frame: Phas deg
Vector averaged cross-power spectrum Baseline: EF (01) - YS (06)
Timerange: 01/08:03:43 to 01/08:04:39

Plot file version 455 created 26-MAR-2015 15:28:01

TVLM513 EG082E.UVDATA.1

Freq = 4.9270 GHz, Bw = 16.000 MH No calibration applied and no bandpass applied

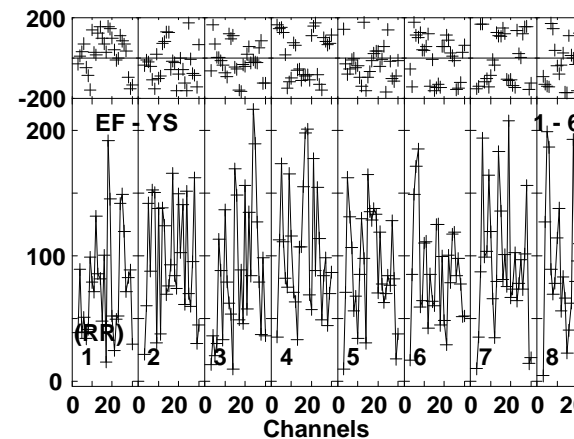
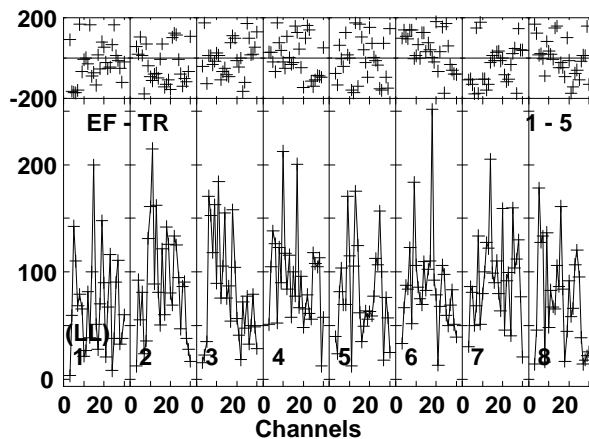
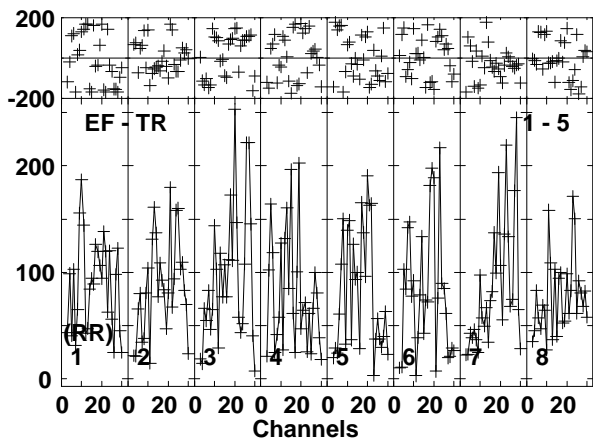
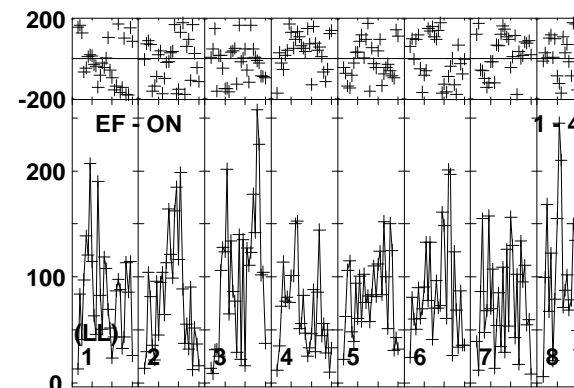
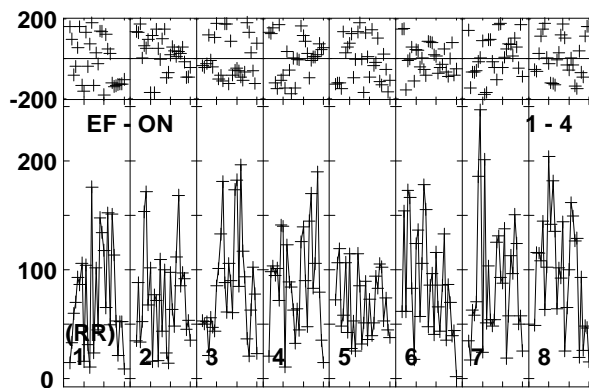
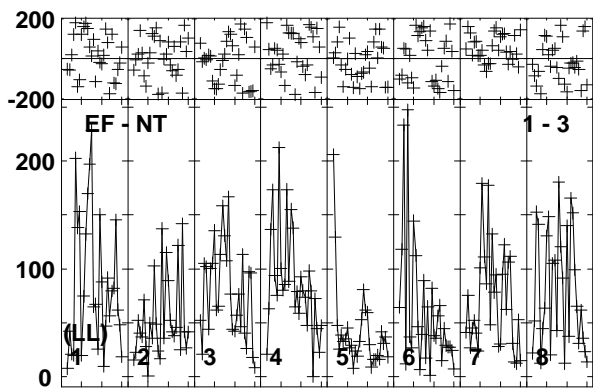
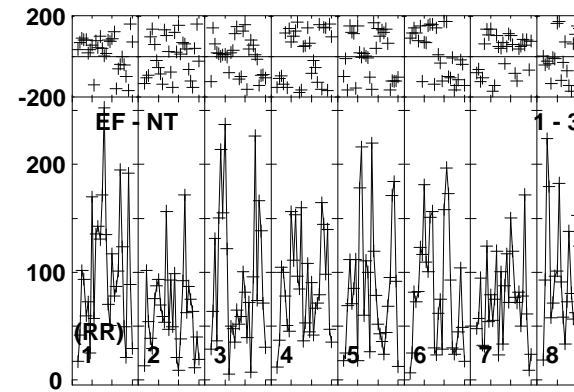
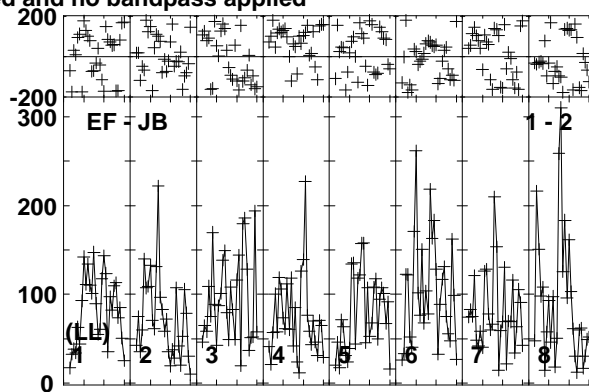
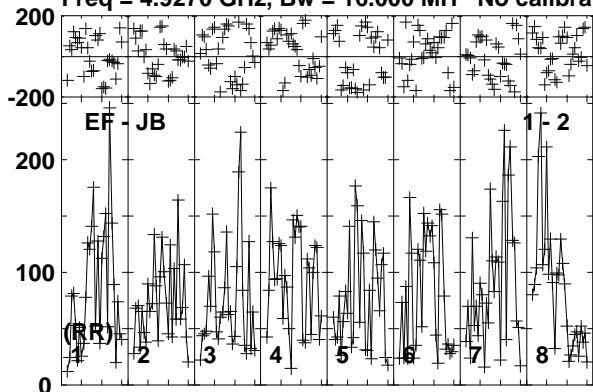

Lower frame: Micro Ampl Jy Top frame: Phas deg
Vector averaged cross-power spectrum Baseline: EF (01) - JB (02)
Timerange: 01/08:04:43 to 01/08:08:09

Plot file version 456 created 26-MAR-2015 15:28:01

TVLM513 EG082E.UVDATA.1

Freq = 4.9270 GHz, Bw = 16.000 MH No calibration applied and no bandpass applied

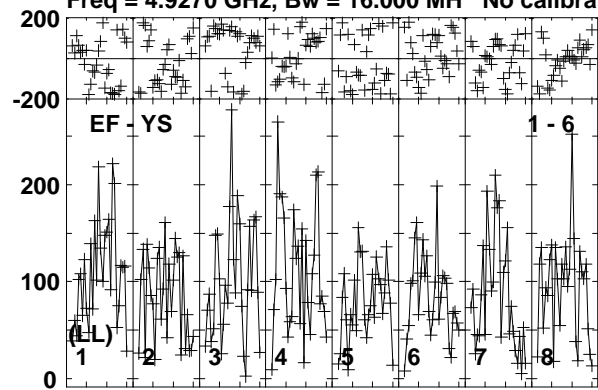

Lower frame: Micro Ampl Jy Top frame: Phas deg
Vector averaged cross-power spectrum Baseline: EF (01) - YS (06)
Timerange: 01/08:04:43 to 01/08:08:09

Plot file version 457 created 26-MAR-2015 15:28:01

J1455+2131 EG082E.UVDATA.1

Freq = 4.9270 GHz, Bw = 16.000 MH No calibration applied and no bandpass applied

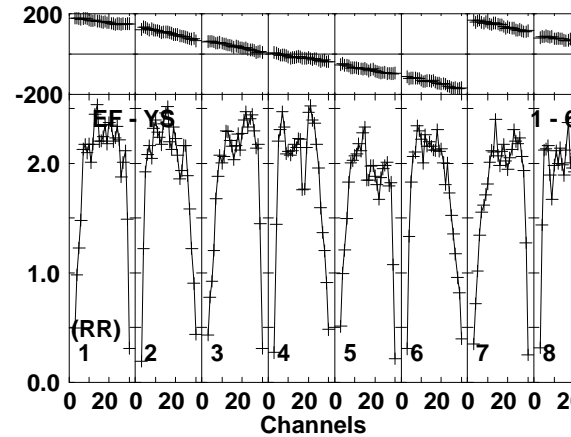
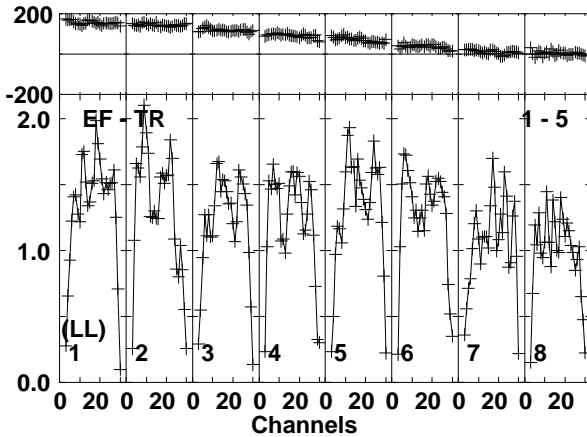
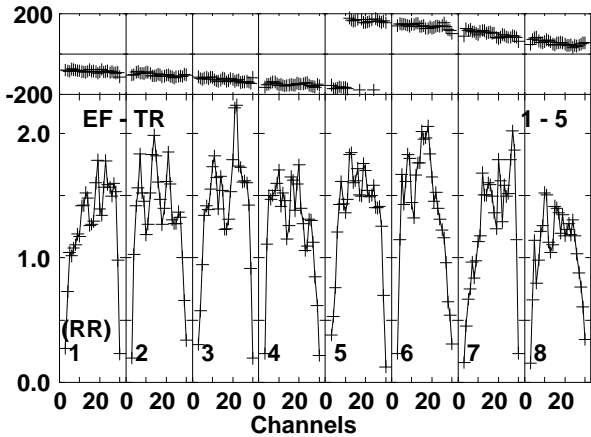
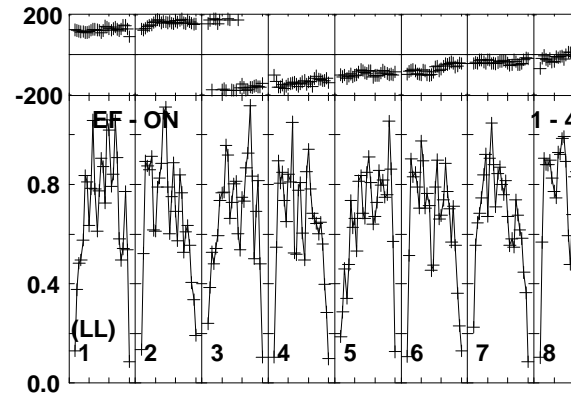
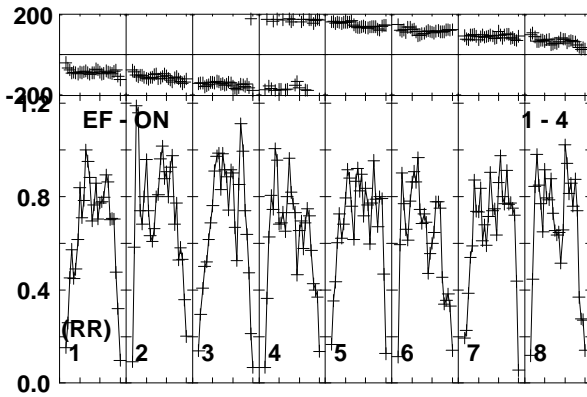
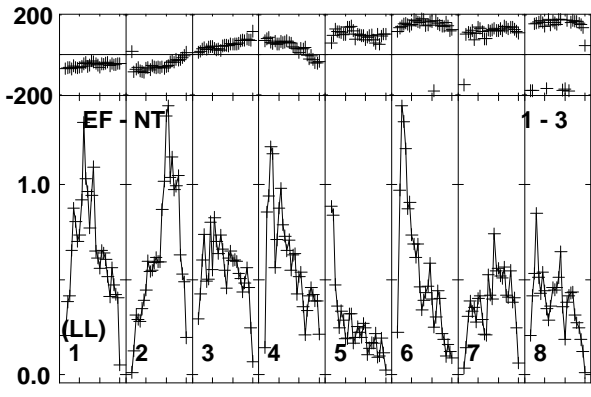
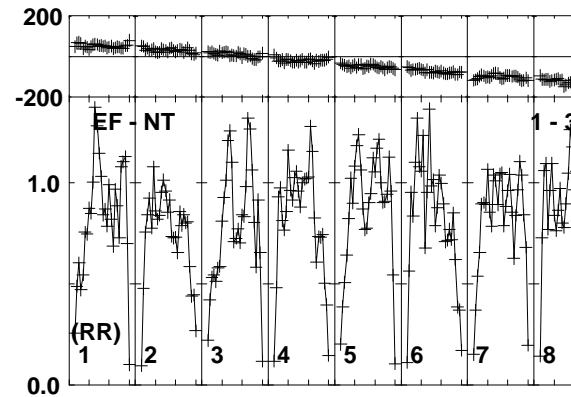
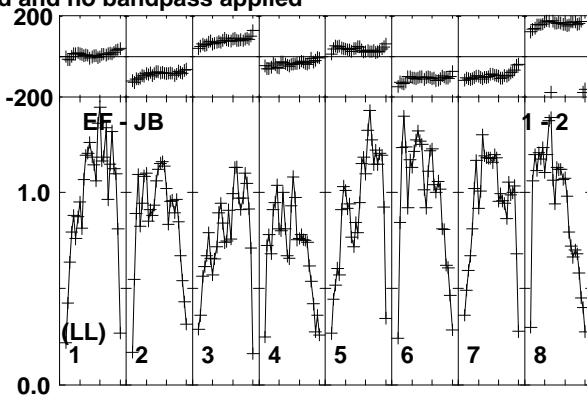
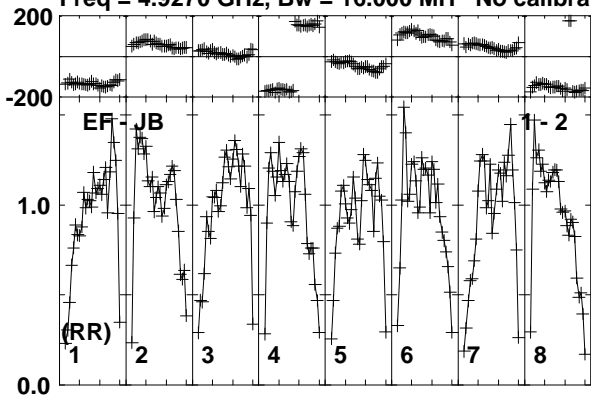

Lower frame: Milli Ampl Jy Top frame: Phas deg
Vector averaged cross-power spectrum Baseline: EF (01) - JB (02)
Timerange: 01/08:08:13 to 01/08:09:39

Plot file version 458 created 26-MAR-2015 15:28:01

J1455+2131 EG082E.UVDATA.1

Freq = 4.9270 GHz, Bw = 16.000 MH No calibration applied and no bandpass applied

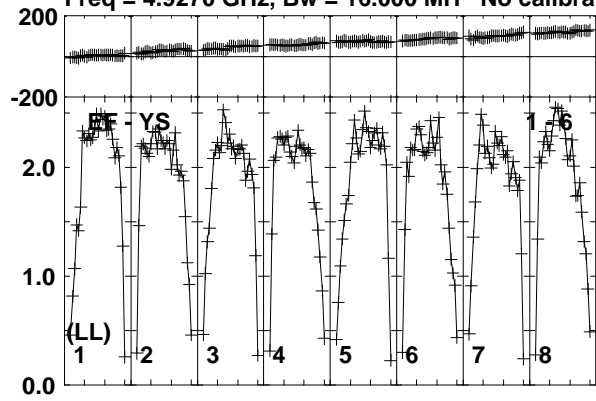

Lower frame: Milli Ampl Jy Top frame: Phas deg
Vector averaged cross-power spectrum Baseline: EF (01) - YS (06)
Timerange: 01/08:08:13 to 01/08:09:39

Plot file version 459 created 26-MAR-2015 15:28:01

TVLM513 EG082E.UVDATA.1

Freq = 4.9270 GHz, Bw = 16.000 MH No calibration applied and no bandpass applied

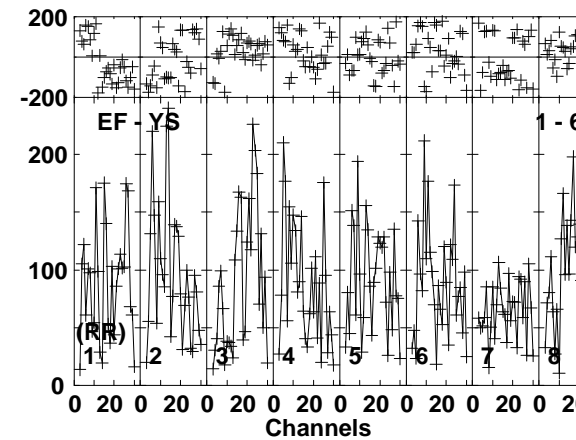
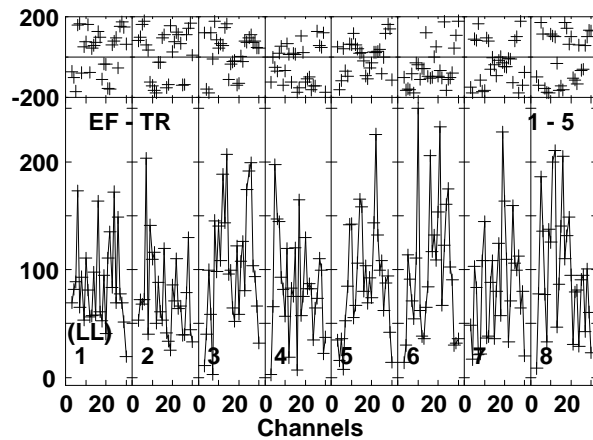
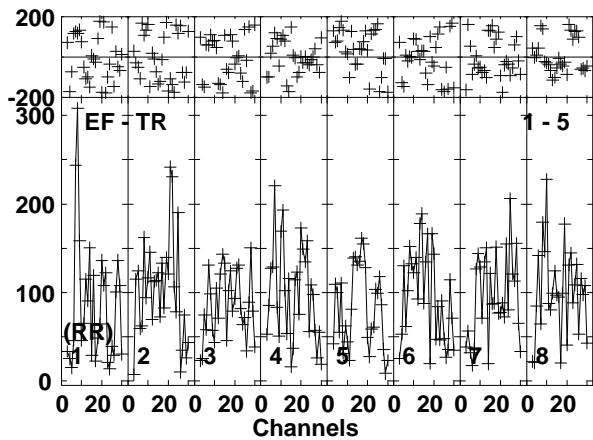
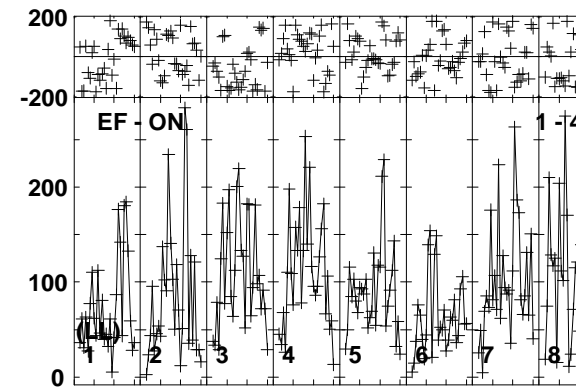
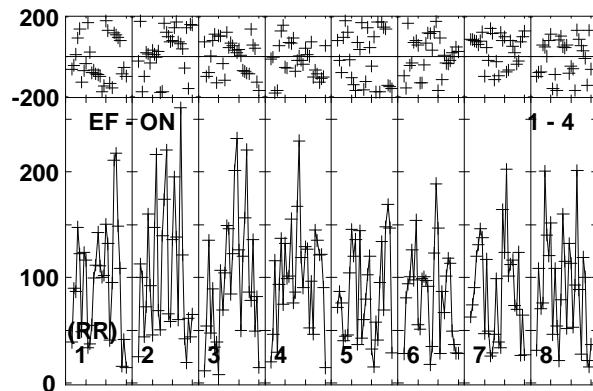
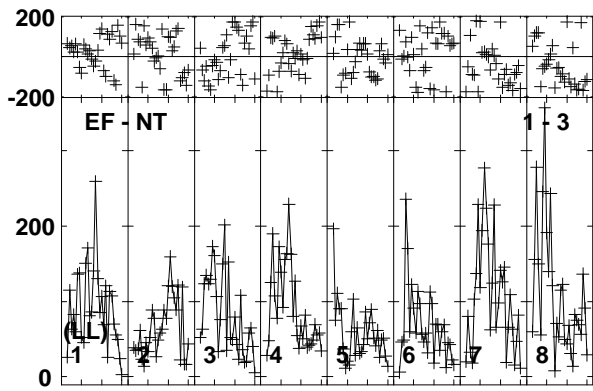
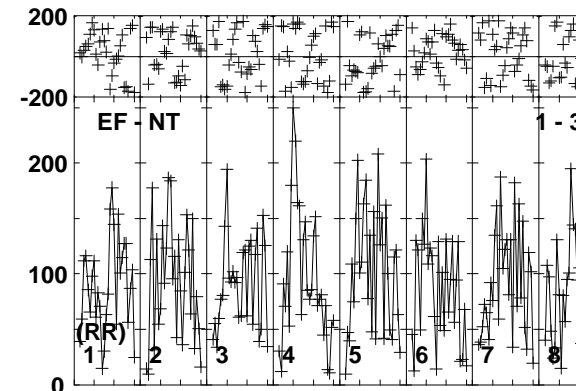
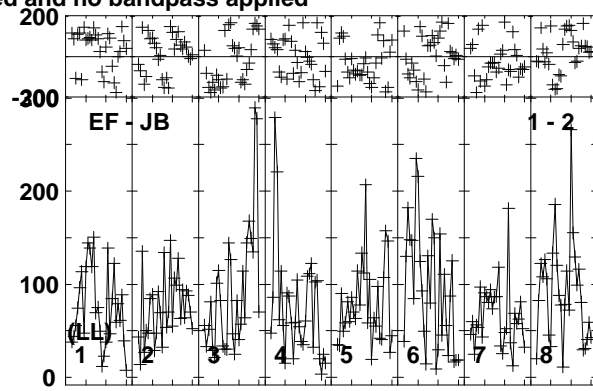
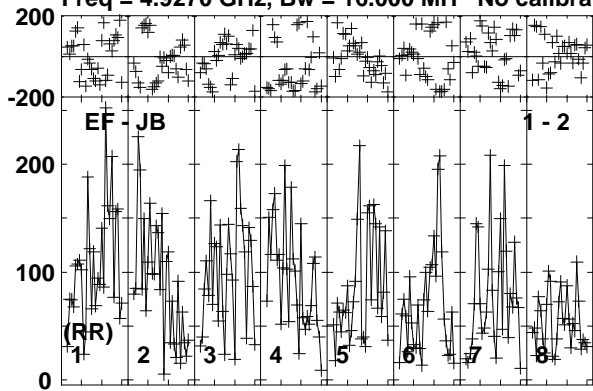

Lower frame: Micro Ampl Jy Top frame: Phas deg
Vector averaged cross-power spectrum Baseline: EF (01) - JB (02)
Timerange: 01/08:09:43 to 01/08:13:09

Plot file version 460 created 26-MAR-2015 15:28:01

TVLM513 EG082E.UVDATA.1

Freq = 4.9270 GHz, Bw = 16.000 MH No calibration applied and no bandpass applied

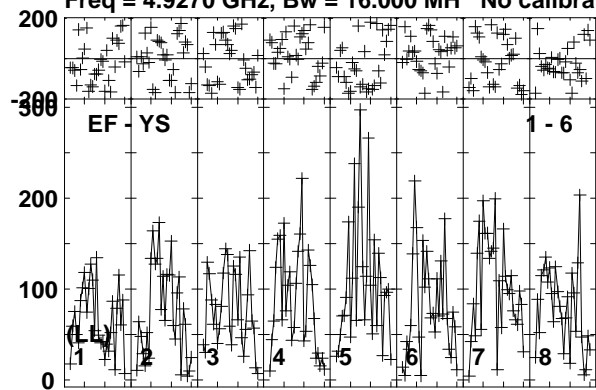

Lower frame: Micro Ampl Jy Top frame: Phas deg
Vector averaged cross-power spectrum Baseline: EF (01) - YS (06)
Timerange: 01/08:09:43 to 01/08:13:09

Plot file version 461 created 26-MAR-2015 15:28:01

J1455+2131 EG082E.UVDATA.1

Freq = 4.9270 GHz, Bw = 16.000 MH No calibration applied and no bandpass applied

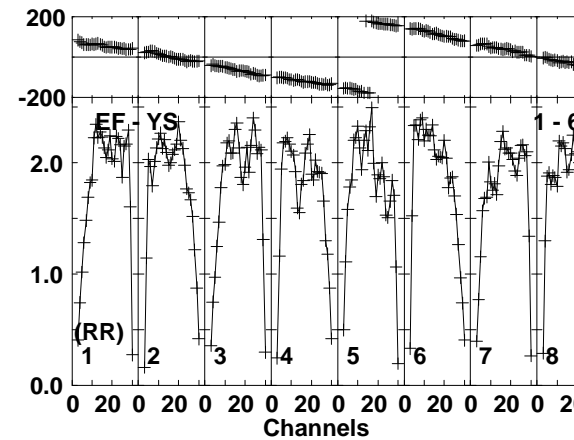
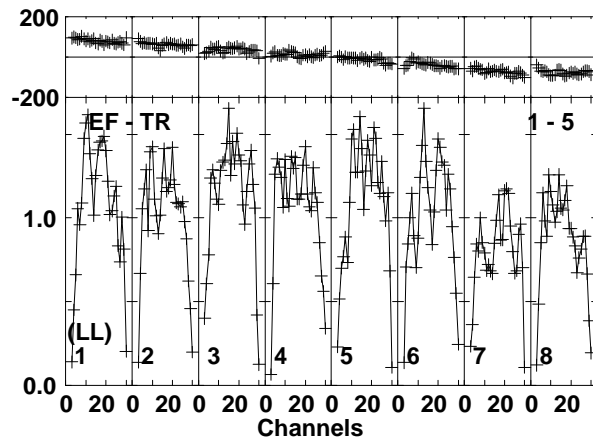
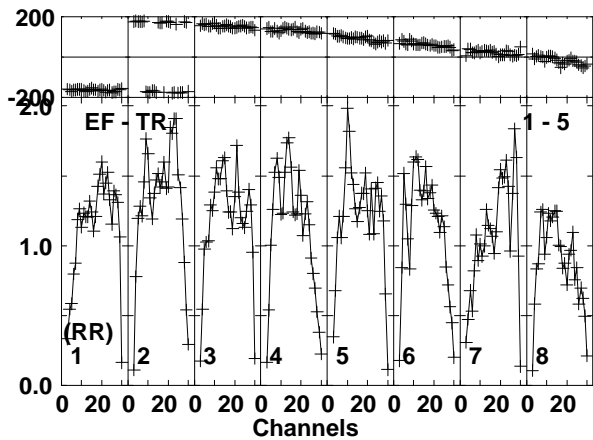
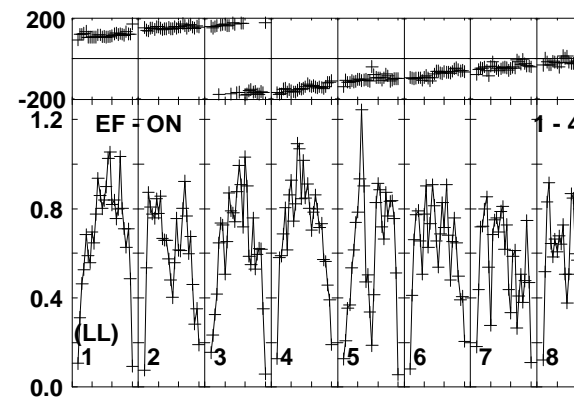
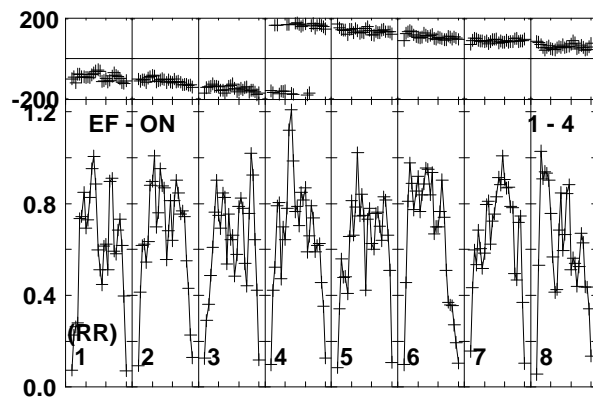
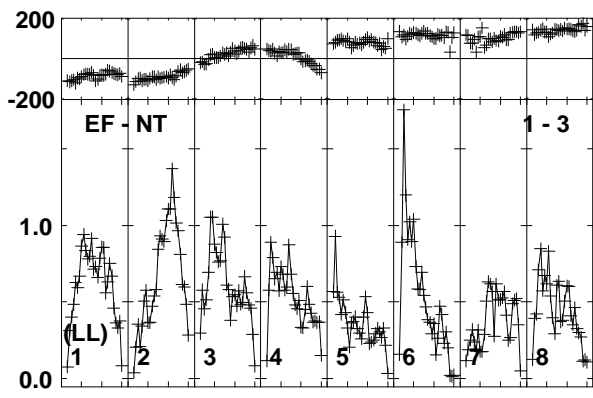
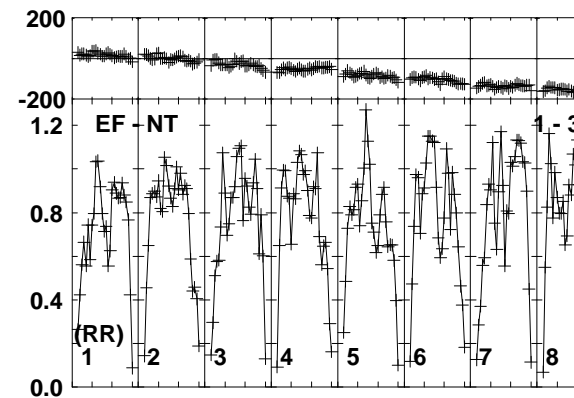
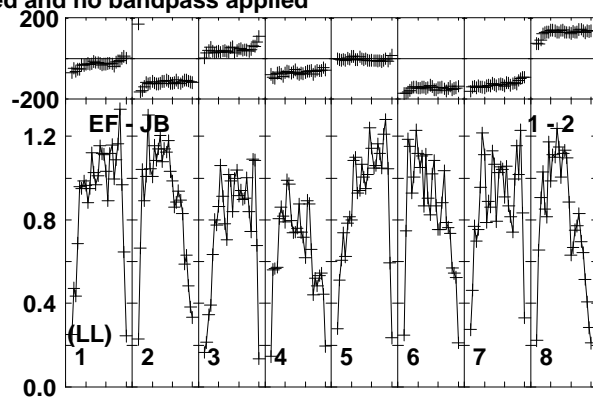
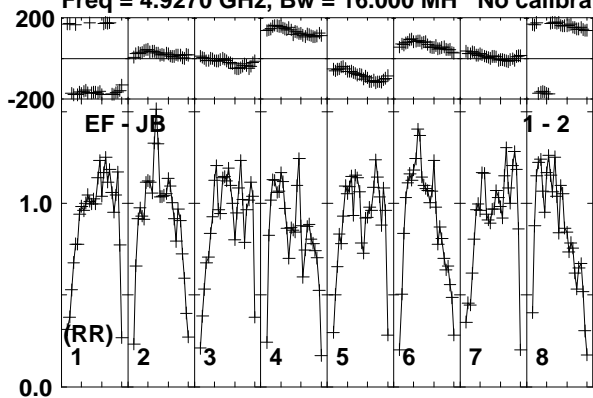

Lower frame: Milli Ampl Jy Top frame: Phas deg
Vector averaged cross-power spectrum Baseline: EF (01) - JB (02)
Timerange: 01/08:13:43 to 01/08:14:39

Plot file version 462 created 26-MAR-2015 15:28:01

J1455+2131 EG082E.UVDATA.1

Freq = 4.9270 GHz, Bw = 16.000 MH No calibration applied and no bandpass applied

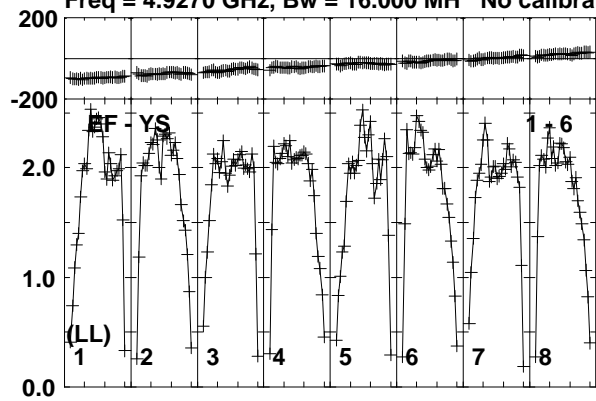

Lower frame: Milli Ampl Jy Top frame: Phas deg
Vector averaged cross-power spectrum Baseline: EF (01) - YS (06)
Timerange: 01/08:13:43 to 01/08:14:39

Plot file version 463 created 26-MAR-2015 15:28:01

TVLM513 EG082E.UVDATA.1

Freq = 4.9270 GHz, Bw = 16.000 MH No calibration applied and no bandpass applied

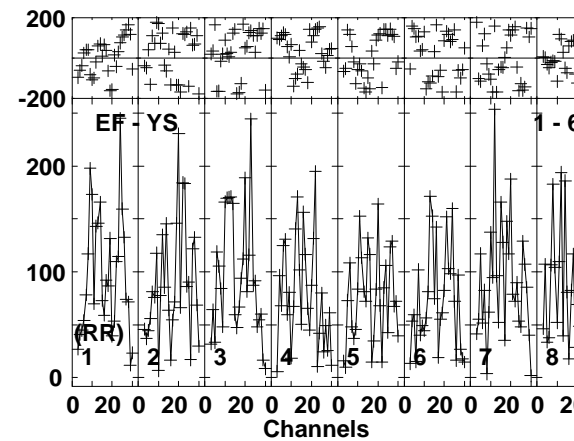
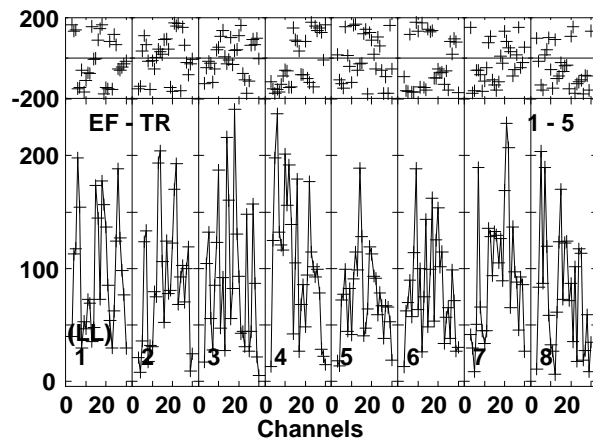
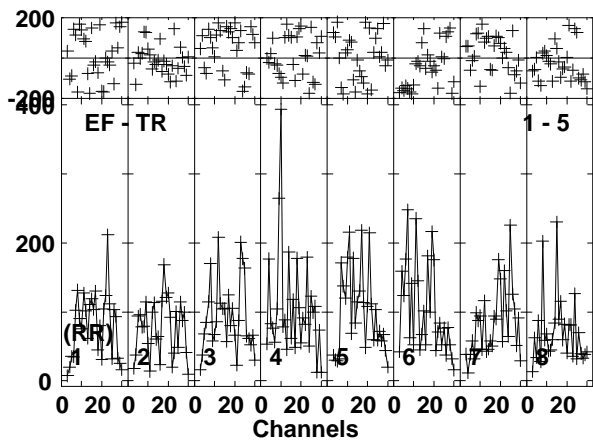
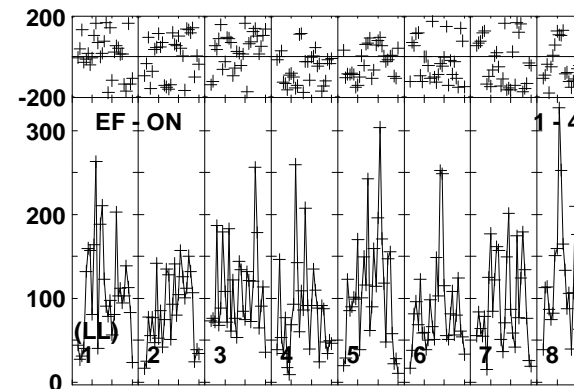
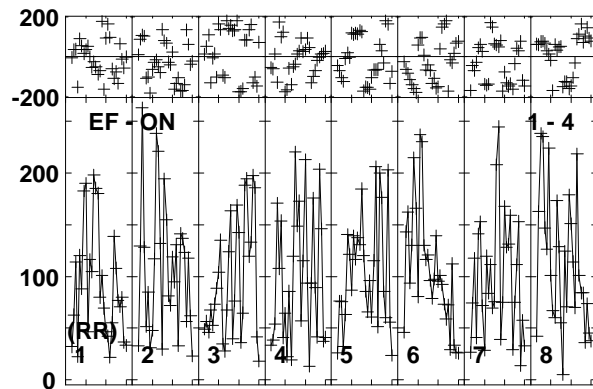
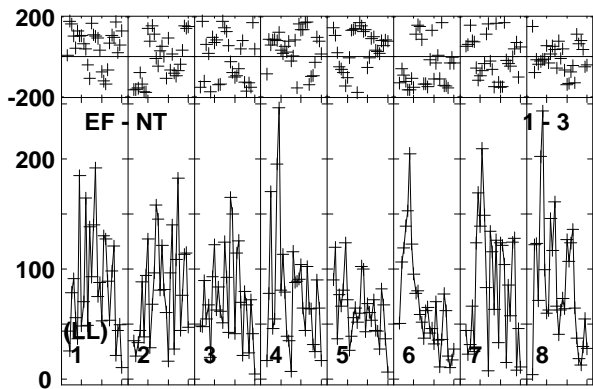
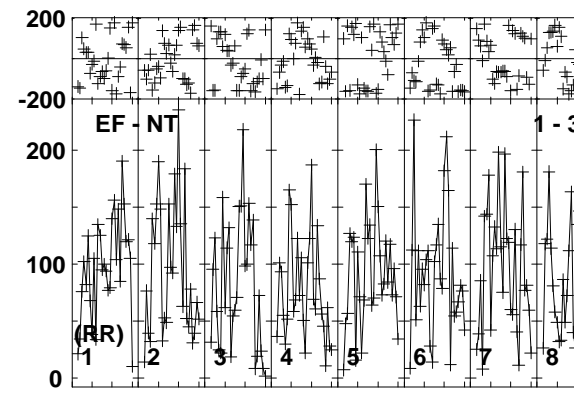
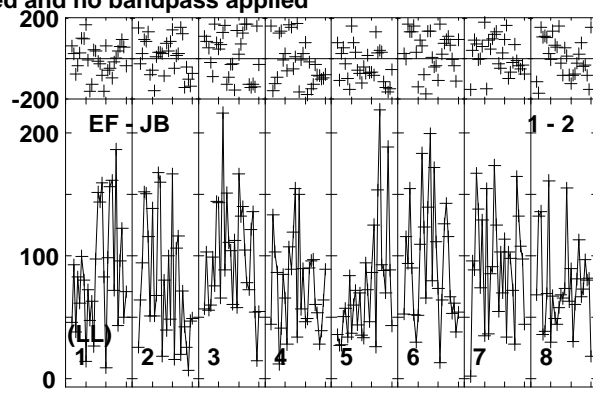
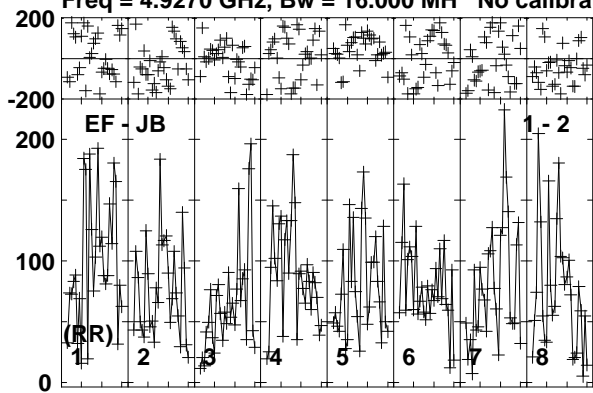

Lower frame: Micro Ampl Jy Top frame: Phas deg
Vector averaged cross-power spectrum Baseline: EF (01) - JB (02)
Timerange: 01/08:14:43 to 01/08:18:09

Plot file version 464 created 26-MAR-2015 15:28:01

TVLM513 EG082E.UVDATA.1

Freq = 4.9270 GHz, Bw = 16.000 MH No calibration applied and no bandpass applied

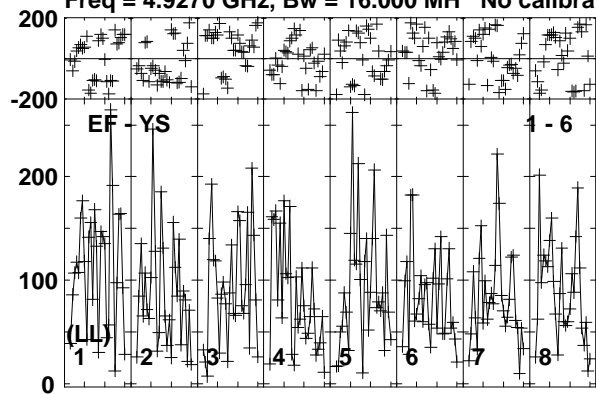

Lower frame: Micro Ampl Jy Top frame: Phas deg
Vector averaged cross-power spectrum Baseline: EF (01) - YS (06)
Timerange: 01/08:14:43 to 01/08:18:09

Plot file version 465 created 26-MAR-2015 15:28:01

J1455+2131 EG082E.UVDATA.1

Freq = 4.9270 GHz, Bw = 16.000 MH No calibration applied and no bandpass applied

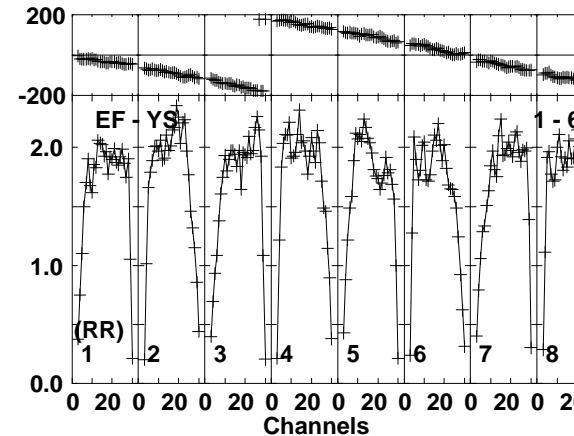
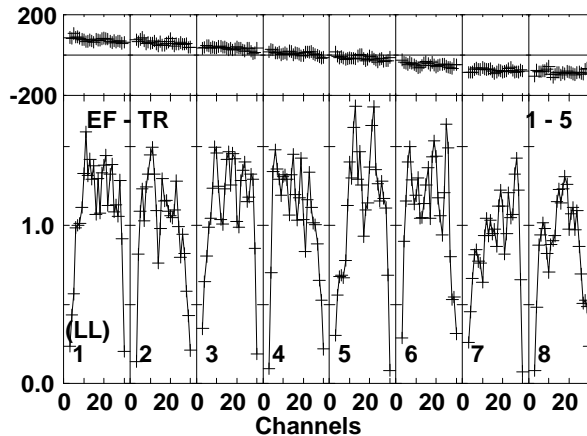
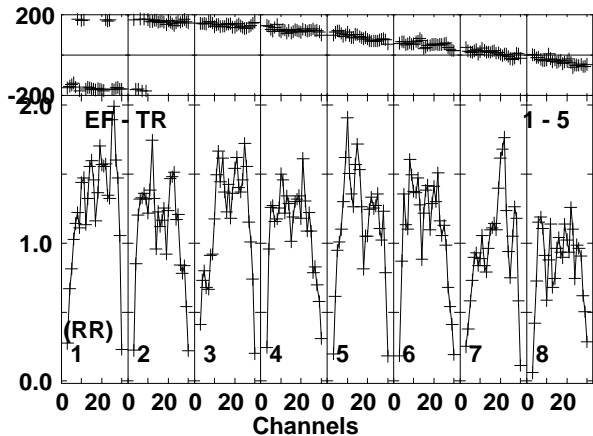
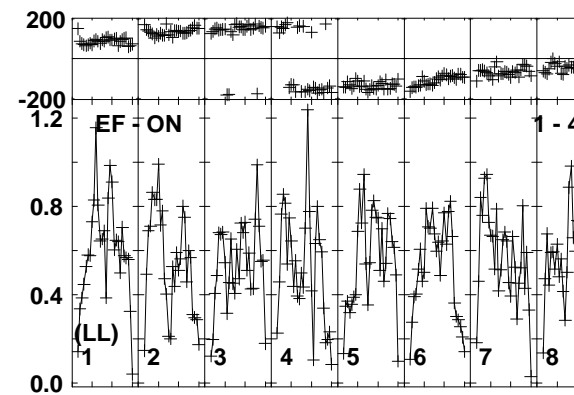
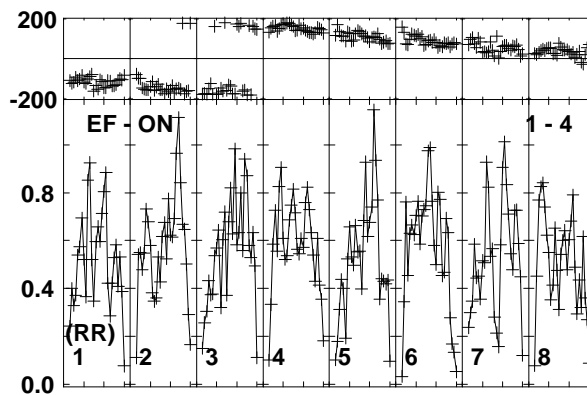
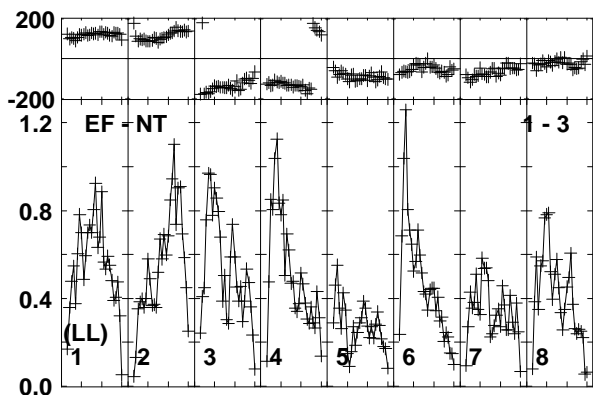
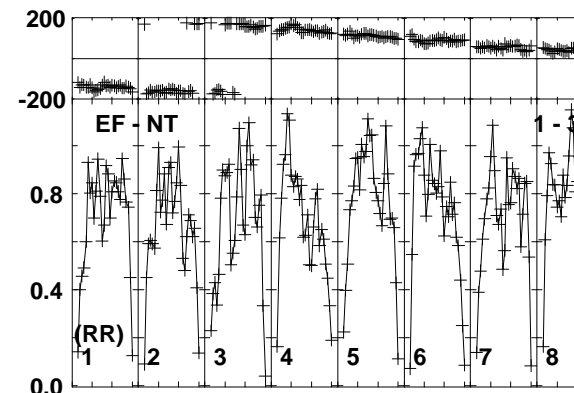
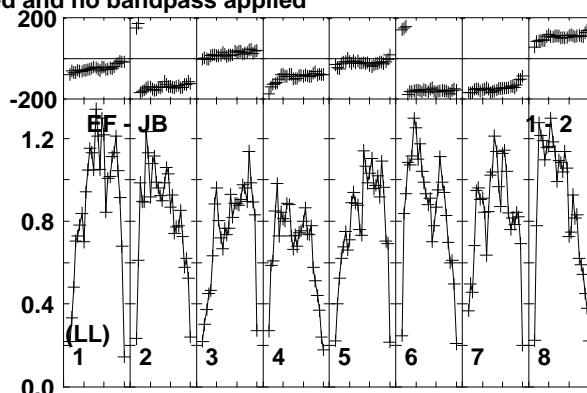
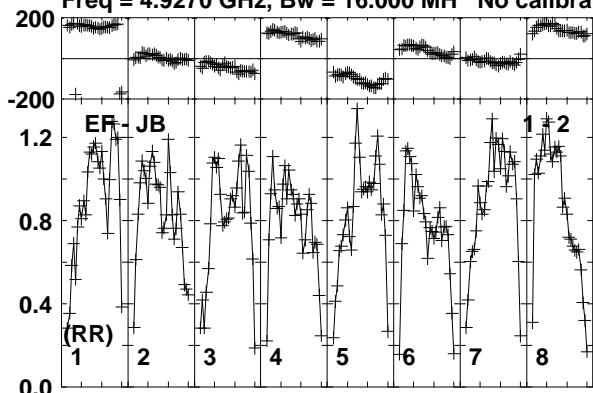

Lower frame: Milli Ampl Jy Top frame: Phas deg
Vector averaged cross-power spectrum Baseline: EF (01) - JB (02)
Timerange: 01/08:18:13 to 01/08:19:39

Plot file version 466 created 26-MAR-2015 15:28:01

J1455+2131 EG082E.UVDATA.1

Freq = 4.9270 GHz, Bw = 16.000 MH No calibration applied and no bandpass applied

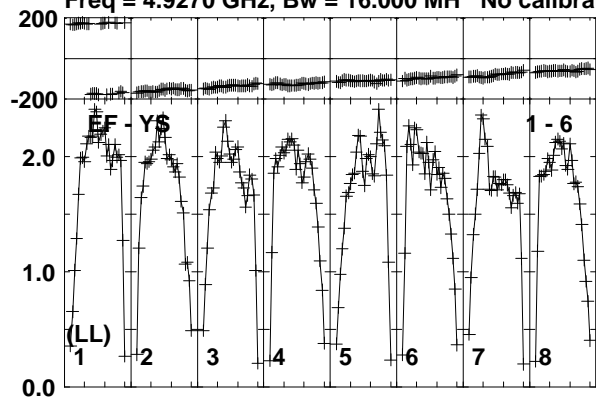

Lower frame: Milli Ampl Jy Top frame: Phas deg
Vector averaged cross-power spectrum Baseline: EF (01) - YS (06)
Timerange: 01/08:18:13 to 01/08:19:39

Plot file version 468 created 26-MAR-2015 15:28:02

TVLM513 EG082E.UVDATA.1

Freq = 4.9270 GHz, Bw = 16.000 MH No calibration applied and no bandpass applied

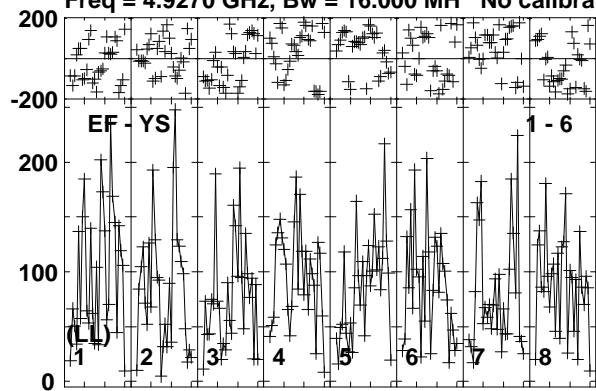

Lower frame: Micro Ampl Jy Top frame: Phas deg
Vector averaged cross-power spectrum Baseline: EF (01) - YS (06)
Timerange: 01/08:19:43 to 01/08:23:09

Plot file version 469 created 26-MAR-2015 15:28:02

J1455+2131 EG082E.UVDATA.1

Freq = 4.9270 GHz, Bw = 16.000 MH No calibration applied and no bandpass applied

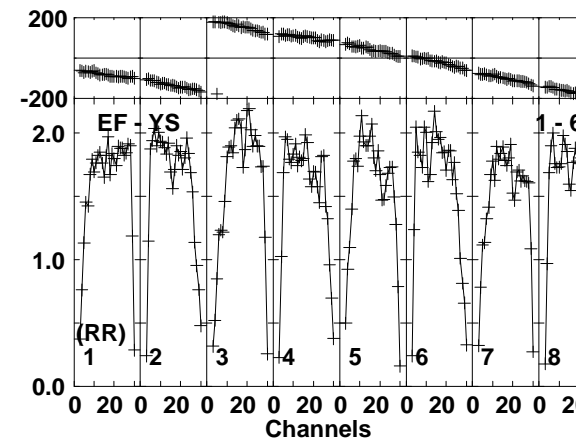
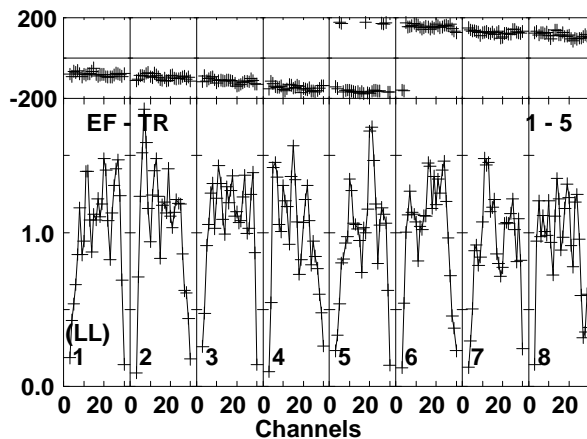
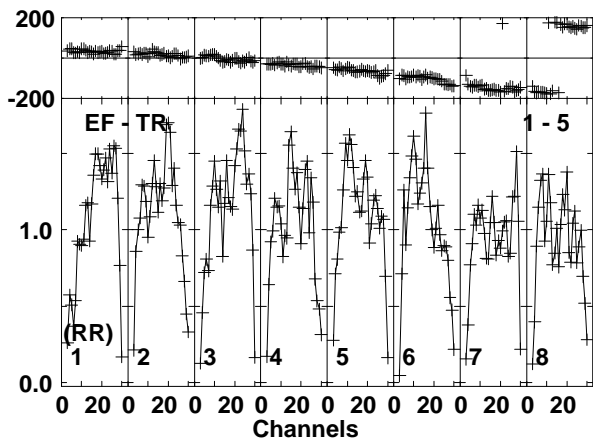
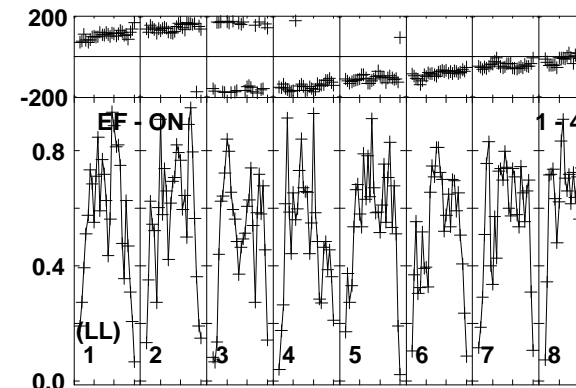
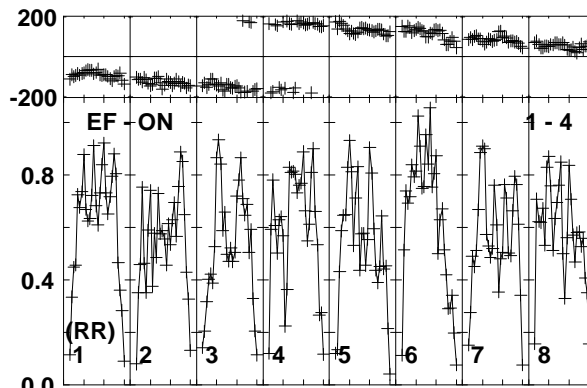
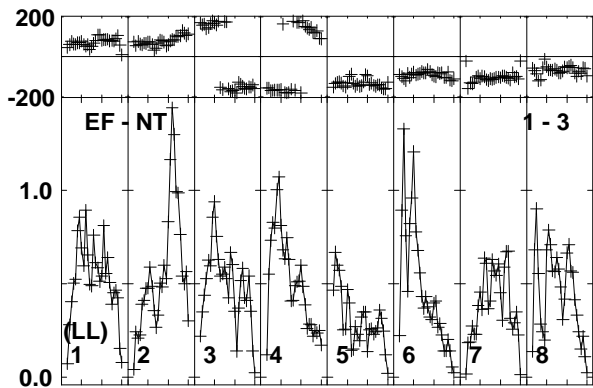
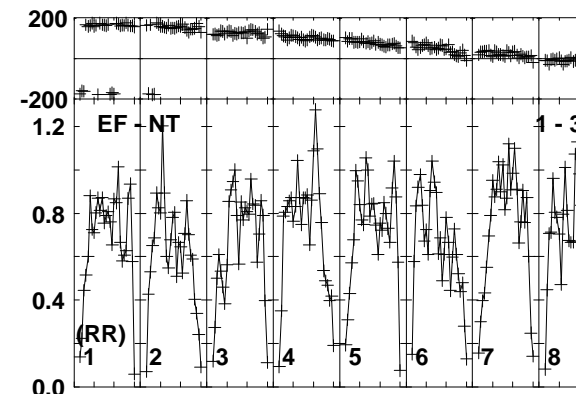
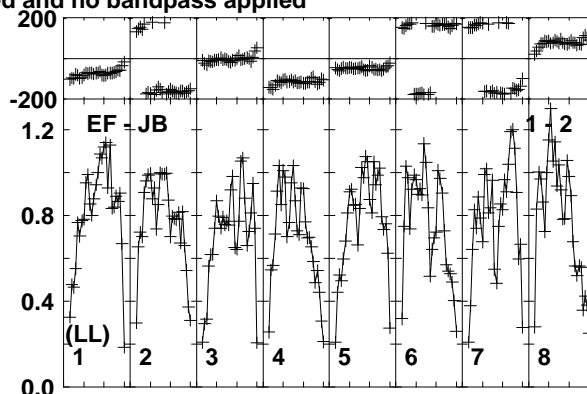
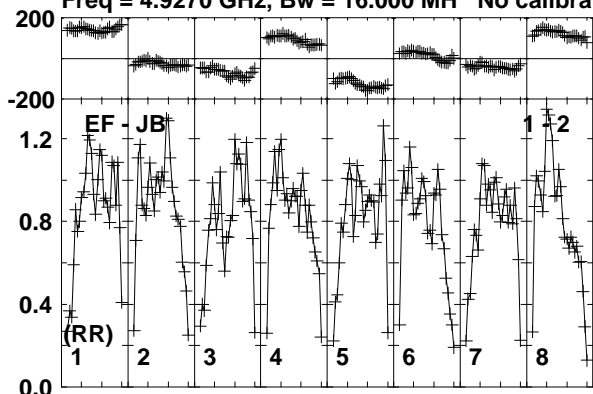

Lower frame: Milli Ampl Jy Top frame: Phas deg
Vector averaged cross-power spectrum Baseline: EF (01) - JB (02)
Timerange: 01/08:23:43 to 01/08:24:39

Plot file version 470 created 26-MAR-2015 15:28:02

J1455+2131 EG082E.UVDATA.1

Freq = 4.9270 GHz, Bw = 16.000 MH No calibration applied and no bandpass applied

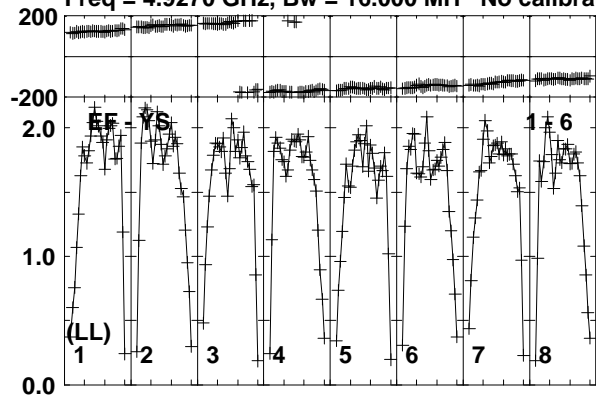

Lower frame: Milli Ampl Jy Top frame: Phas deg
Vector averaged cross-power spectrum Baseline: EF (01) - YS (06)
Timerange: 01/08:23:43 to 01/08:24:39

Plot file version 471 created 26-MAR-2015 15:28:02

TVLM513 EG082E.UVDATA.1

Freq = 4.9270 GHz, Bw = 16.000 MH No calibration applied and no bandpass applied

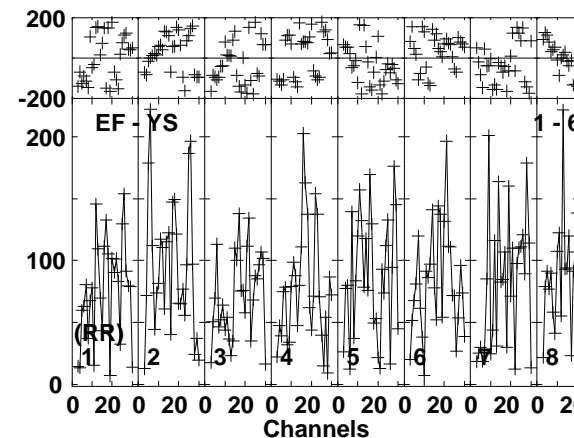
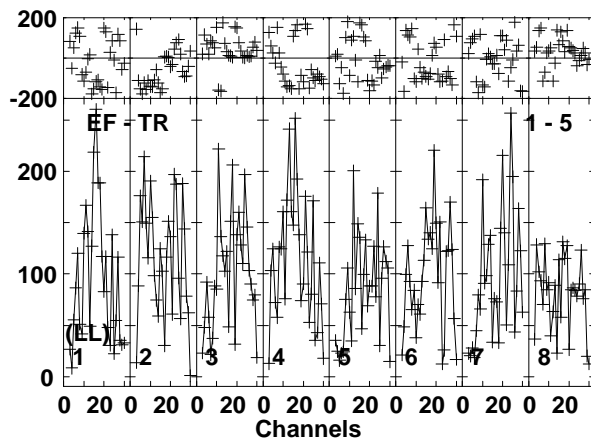
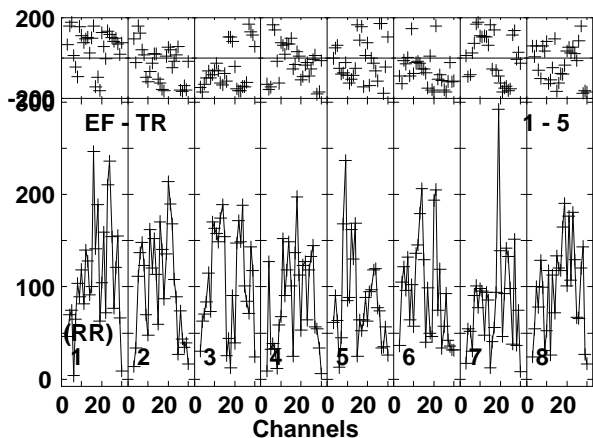
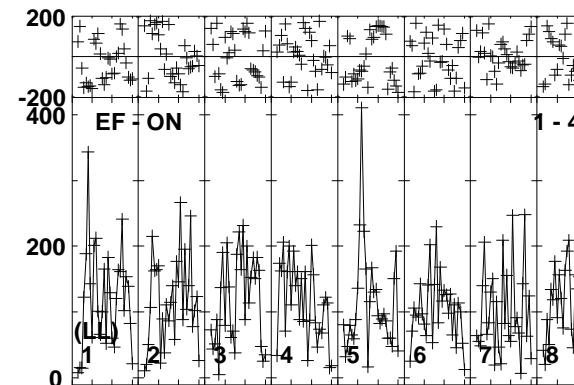
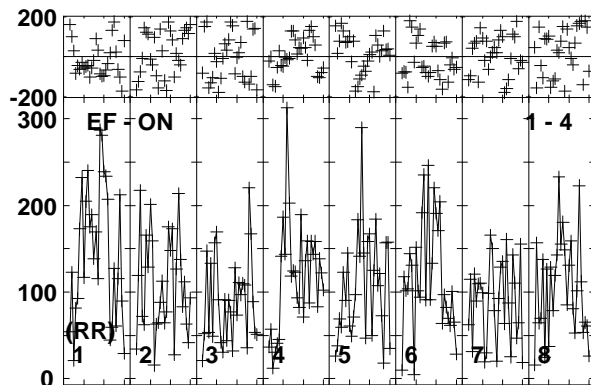
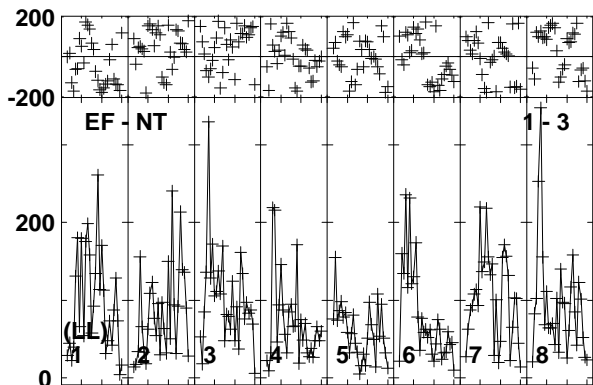
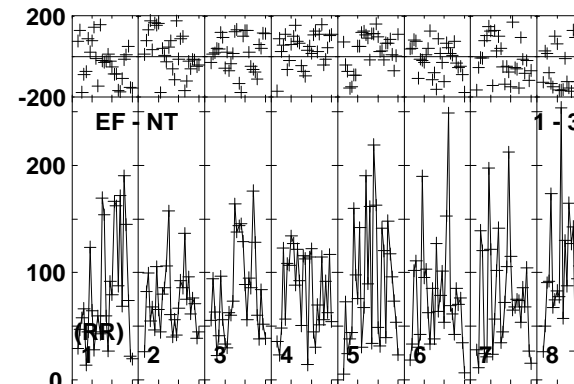
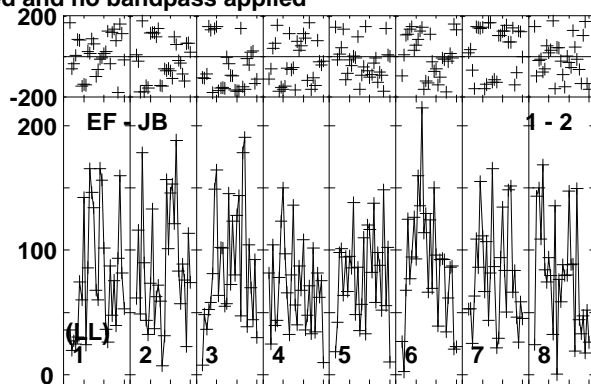
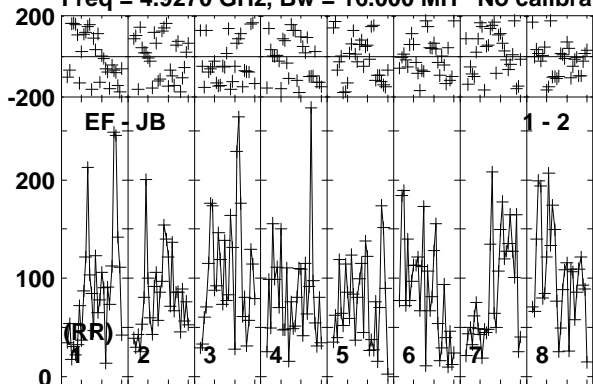

Lower frame: Micro Ampl Jy Top frame: Phas deg
Vector averaged cross-power spectrum Baseline: EF (01) - JB (02)
Timerange: 01/08:24:43 to 01/08:28:09

Plot file version 472 created 26-MAR-2015 15:28:02

TVLM513 EG082E.UVDATA.1

Freq = 4.9270 GHz, Bw = 16.000 MH No calibration applied and no bandpass applied

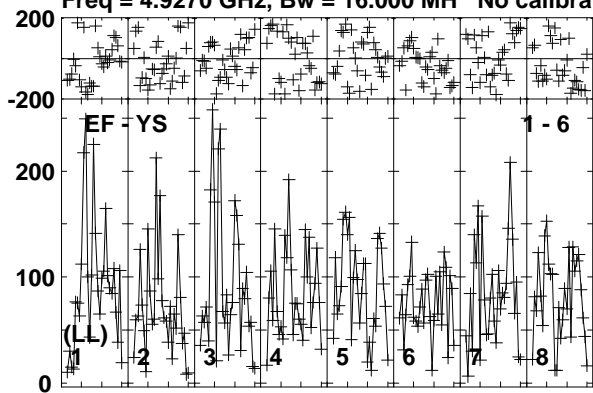

Lower frame: Micro Ampl Jy Top frame: Phas deg
Vector averaged cross-power spectrum Baseline: EF (01) - YS (06)
Timerange: 01/08:24:43 to 01/08:28:09

Plot file version 473 created 26-MAR-2015 15:28:02

J1455+2131 EG082E.UVDATA.1

Freq = 4.9270 GHz, Bw = 16.000 MH No calibration applied and no bandpass applied

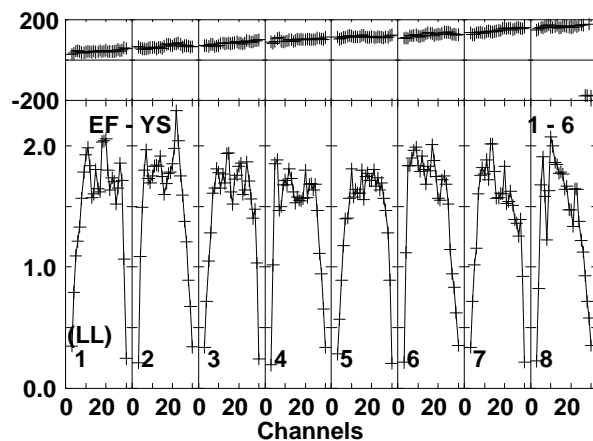
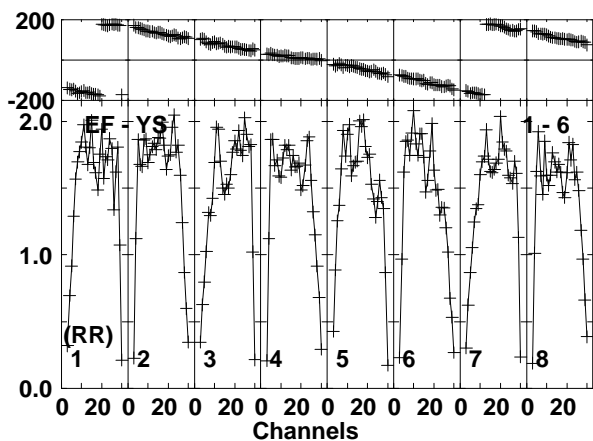
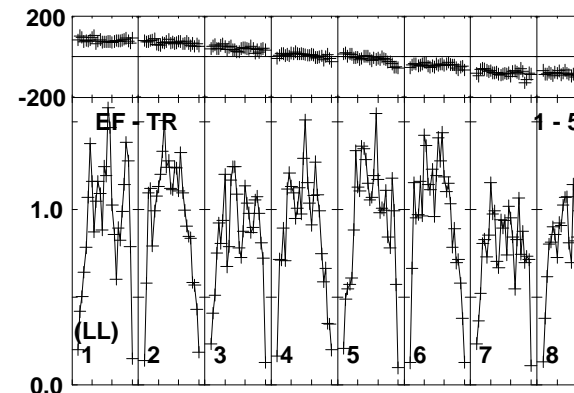
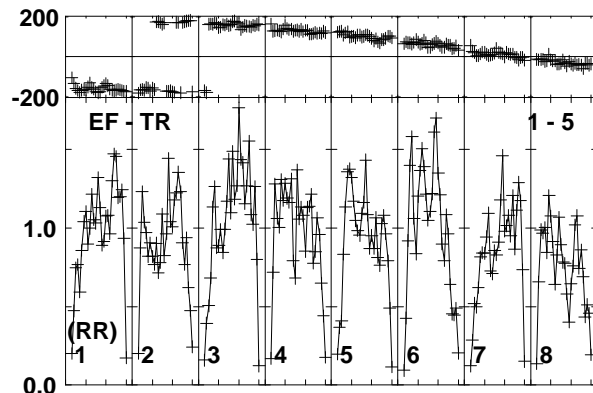
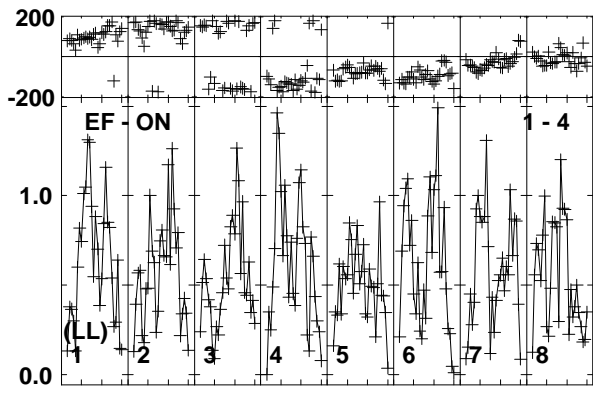
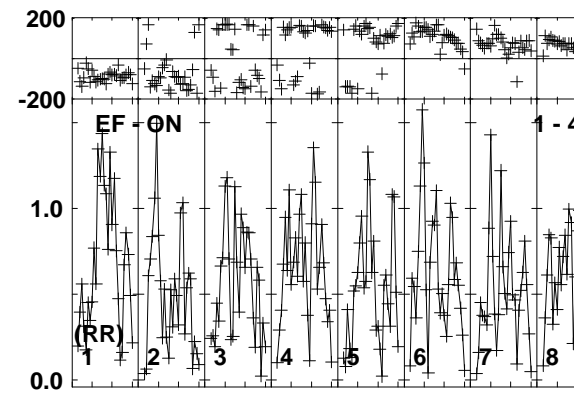
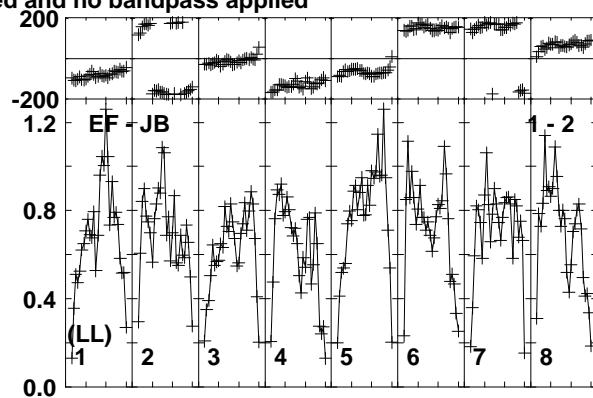
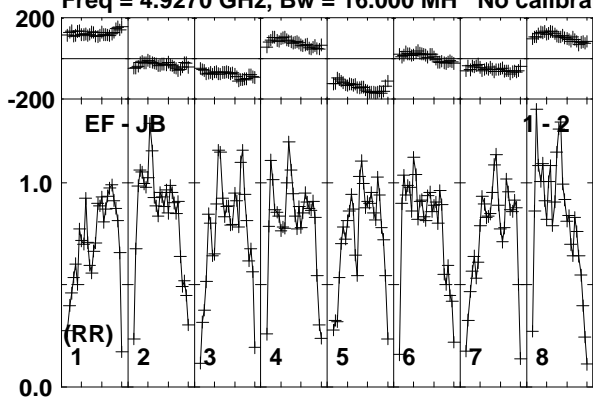

Lower frame: Milli Ampl Jy Top frame: Phas deg
Vector averaged cross-power spectrum Baseline: EF (01) - JB (02)
Timerange: 01/08:28:13 to 01/08:29:39

Plot file version 474 created 26-MAR-2015 15:28:02

J1504+2218 EG082E.UVDATA.1

Freq = 4.9270 GHz, Bw = 16.000 MH No calibration applied and no bandpass applied

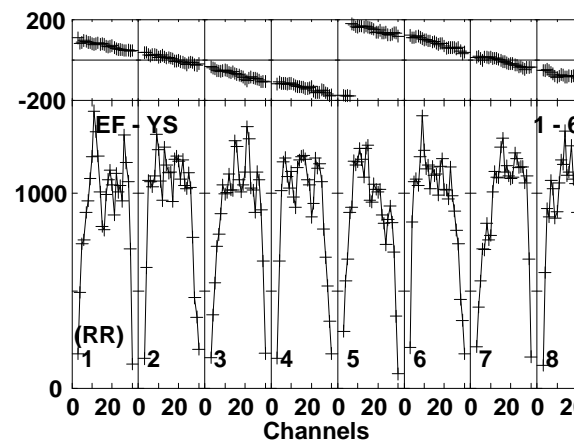
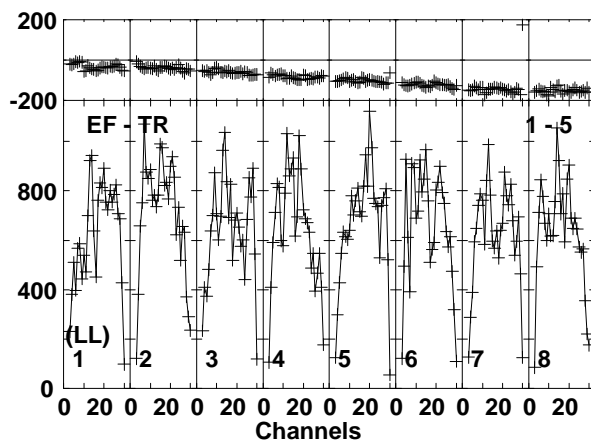
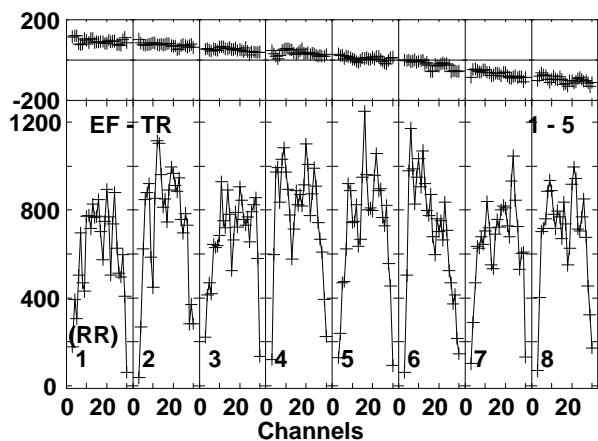
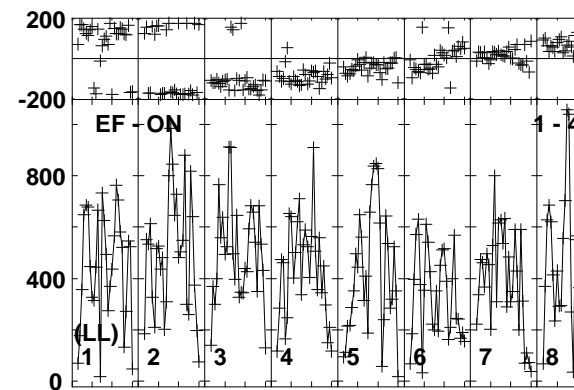
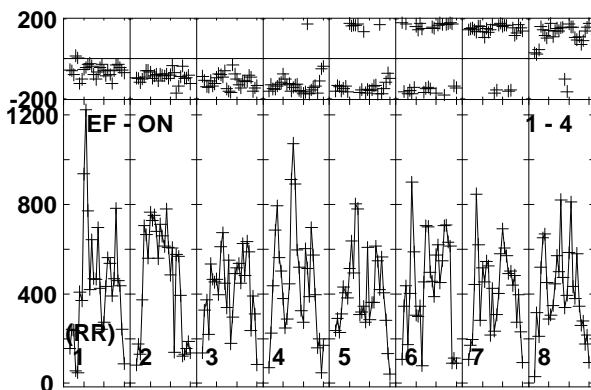
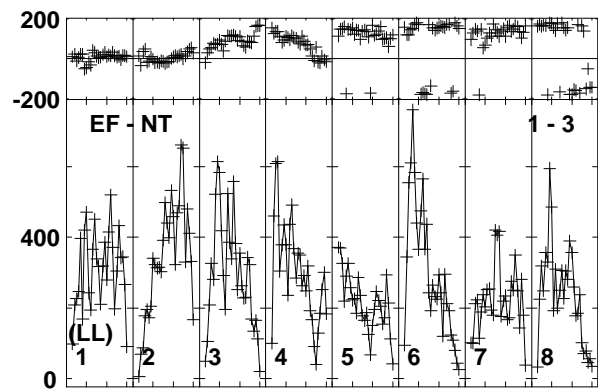
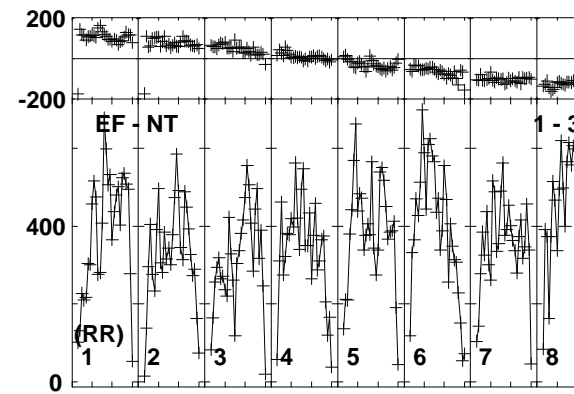
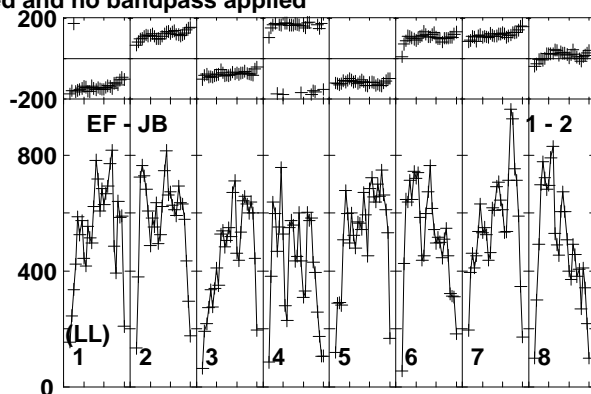
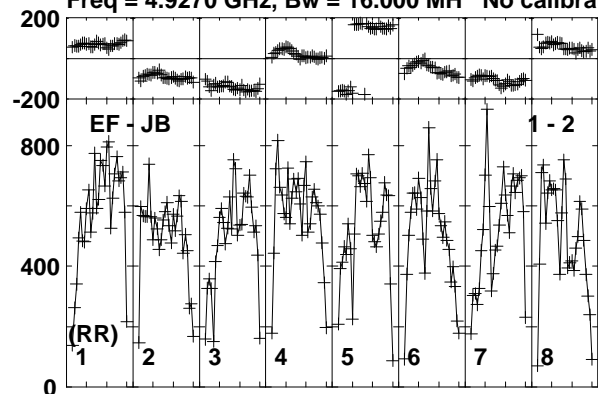

Lower frame: Micro Ampl Jy Top frame: Phas deg
Vector averaged cross-power spectrum Baseline: EF (01) - JB (02)
Timerange: 01/08:29:43 to 01/08:33:09

Plot file version 475 created 26-MAR-2015 15:28:02

J1504+2218 EG082E.UVDATA.1

Freq = 4.9270 GHz, Bw = 16.000 MH No calibration applied and no bandpass applied

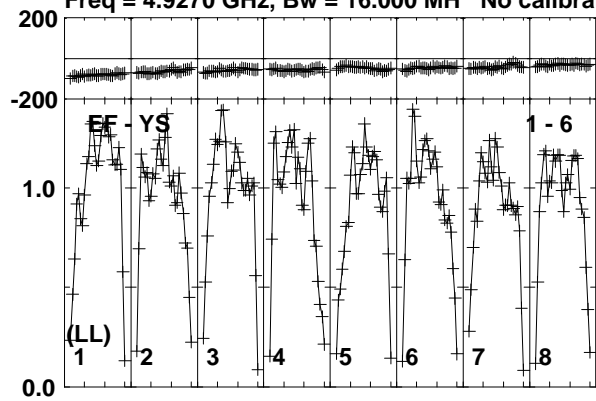

Lower frame: Milli Ampl Jy Top frame: Phas deg
Vector averaged cross-power spectrum Baseline: EF (01) - YS (06)
Timerange: 01/08:29:43 to 01/08:33:09

Plot file version 476 created 26-MAR-2015 15:28:02

J1455+2131 EG082E.UVDATA.1

Freq = 4.9270 GHz, Bw = 16.000 MH No calibration applied and no bandpass applied

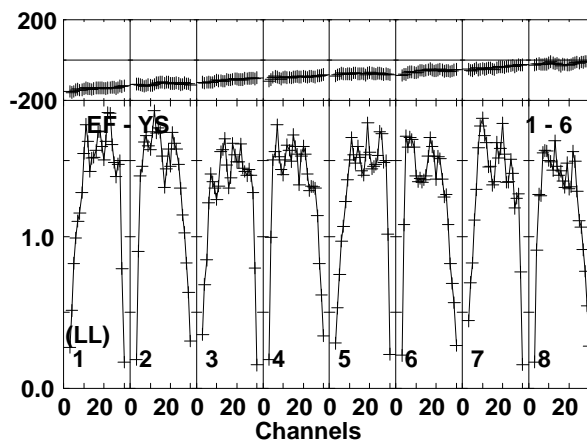
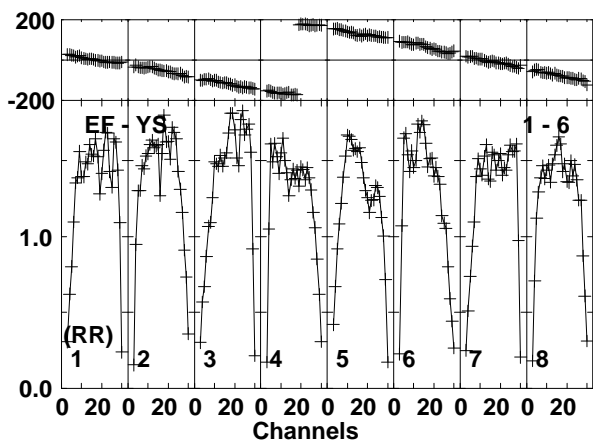
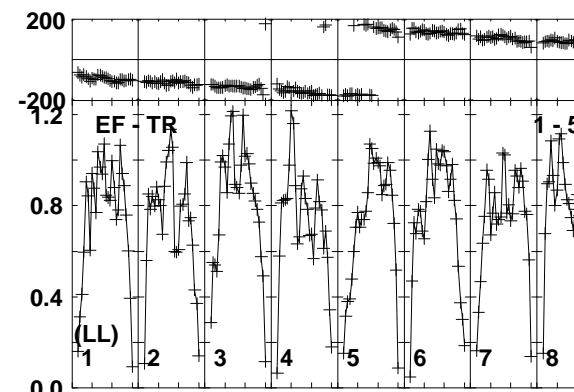
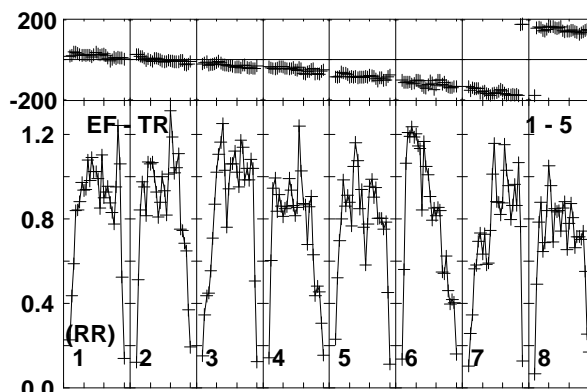
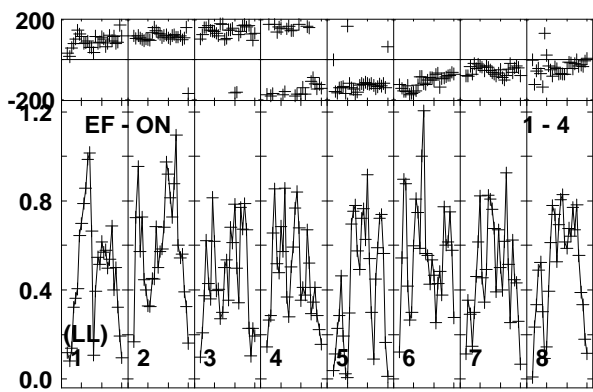
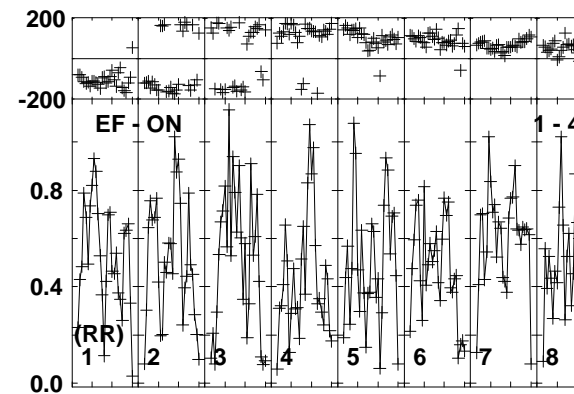
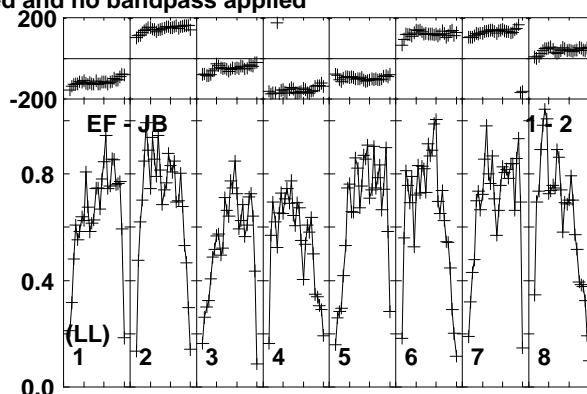
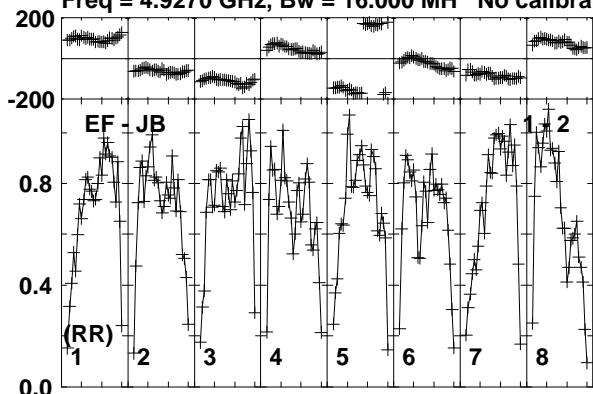

Lower frame: Milli Ampl Jy Top frame: Phas deg
Vector averaged cross-power spectrum Baseline: EF (01) - JB (02)
Timerange: 01/08:33:43 to 01/08:35:09

Plot file version 477 created 26-MAR-2015 15:28:02

J0147+5840 EG082E.UVDATA.1

Freq = 4.9270 GHz, Bw = 16.000 MH No calibration applied and no bandpass applied

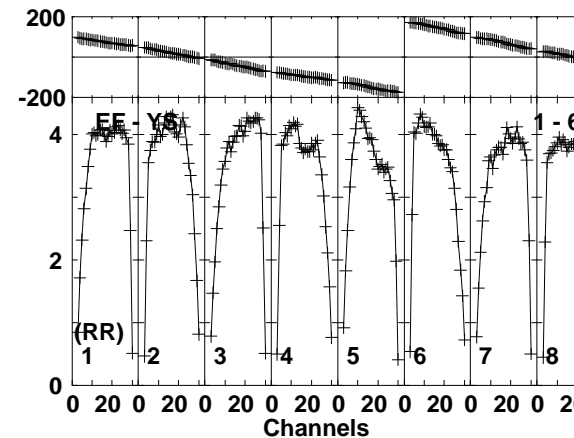
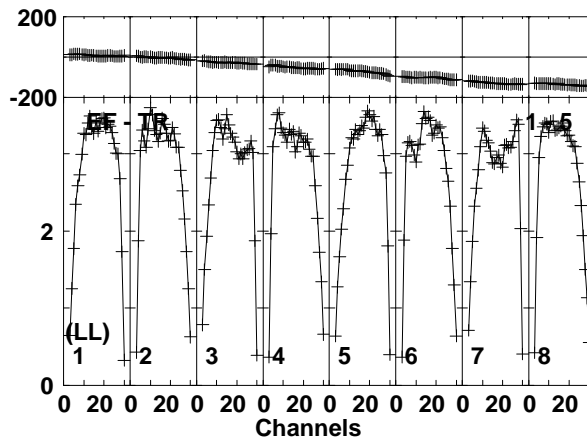
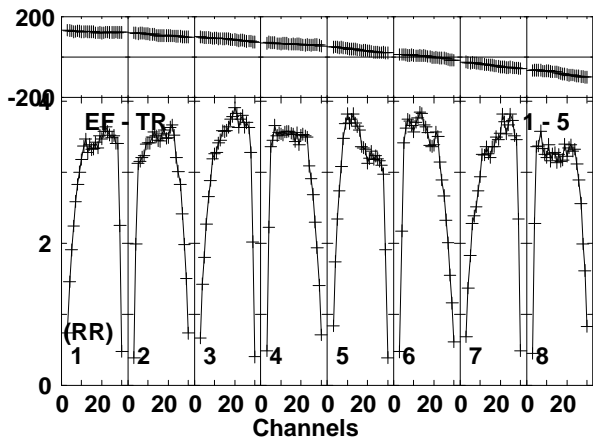
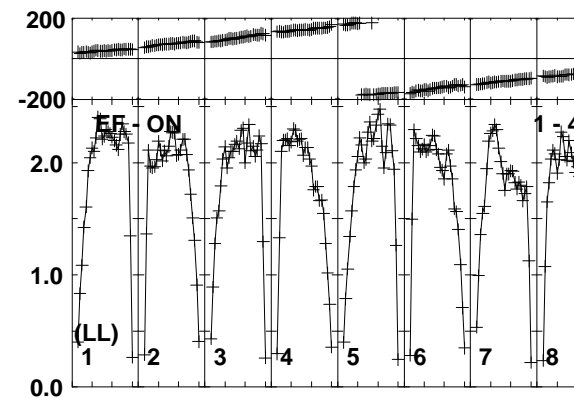
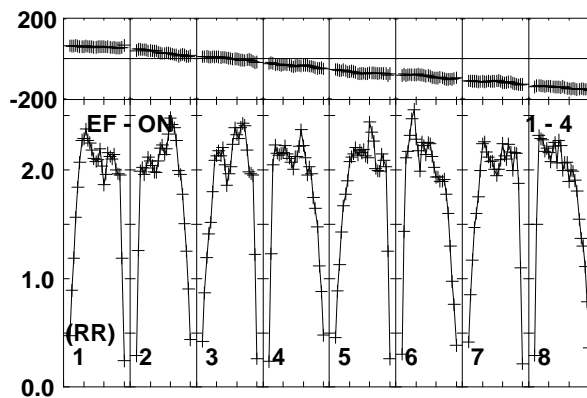
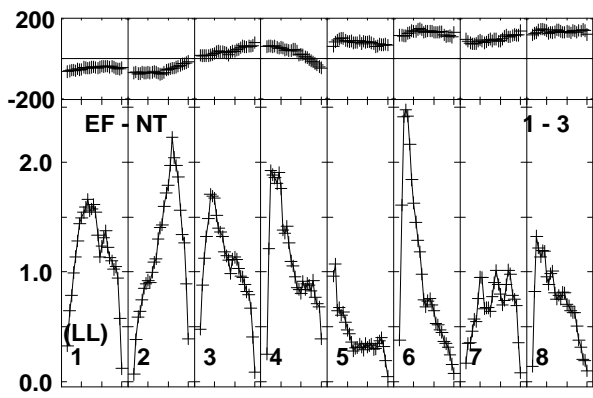
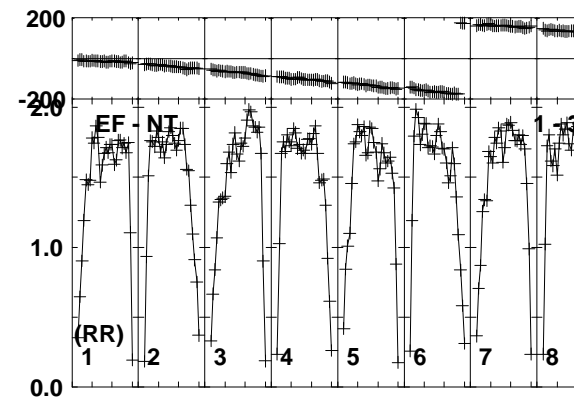
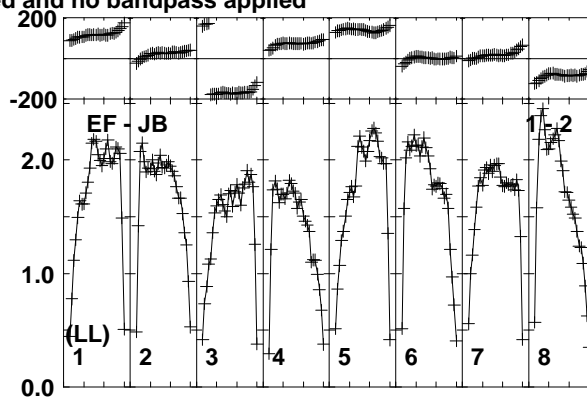
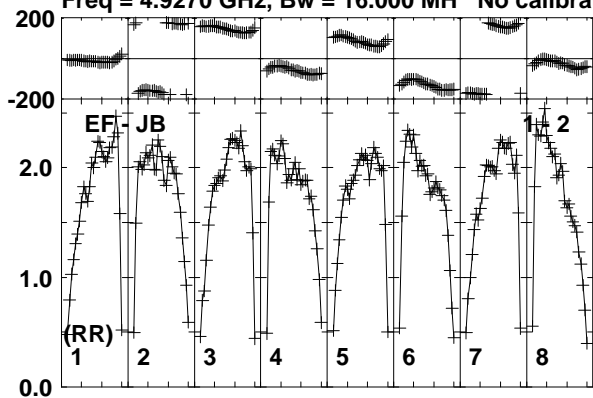

Lower frame: Milli Ampl Jy Top frame: Phas deg
Vector averaged cross-power spectrum Baseline: EF (01) - JB (02)
Timerange: 01/08:46:13 to 01/08:50:49

Plot file version 478 created 26-MAR-2015 15:28:02

J0147+5840 EG082E.UVDATA.1

Freq = 4.9270 GHz, Bw = 16.000 MH No calibration applied and no bandpass applied

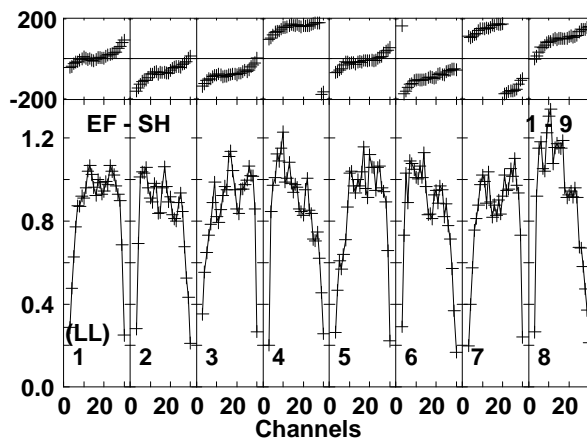
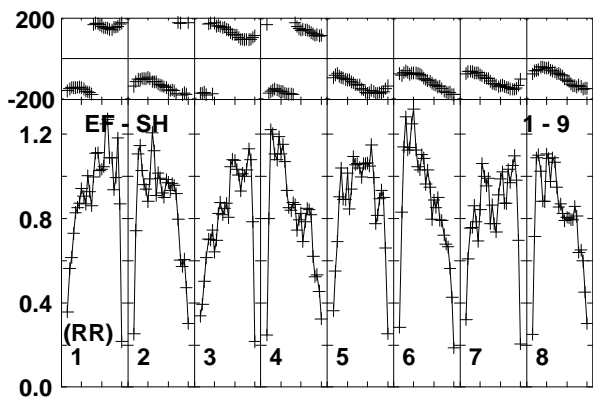
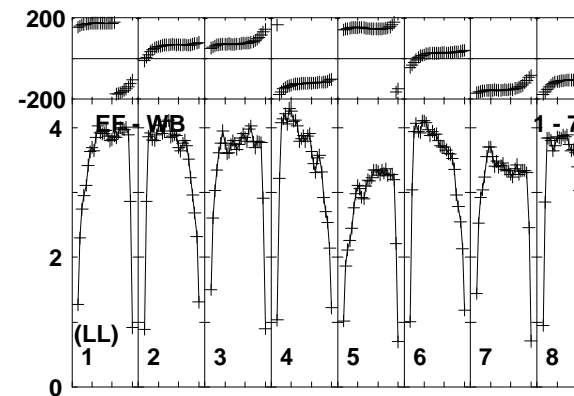
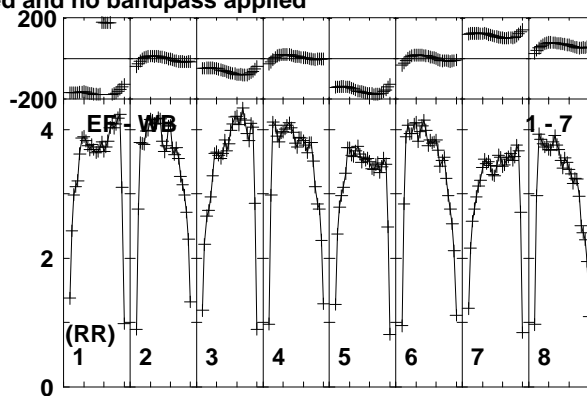
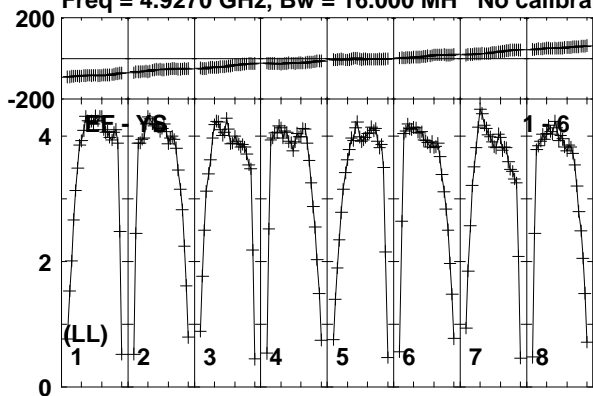

Lower frame: Milli Ampl Jy Top frame: Phas deg
Vector averaged cross-power spectrum Baseline: EF (01) - YS (06)
Timerange: 01/08:46:13 to 01/08:50:49

Plot file version 479 created 26-MAR-2015 15:28:02

J0151+5454 EG082E.UVDATA.1

Freq = 4.9270 GHz, Bw = 16.000 MH No calibration applied and no bandpass applied

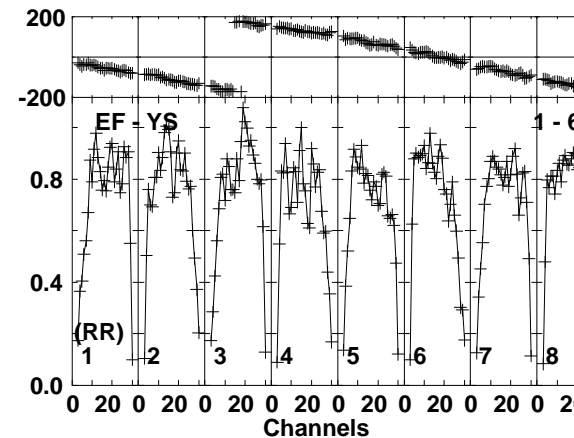
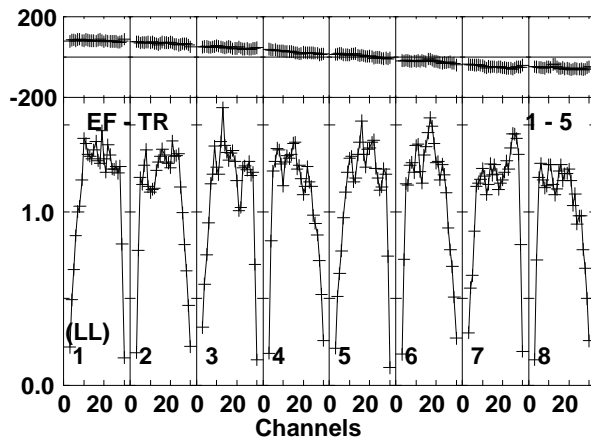
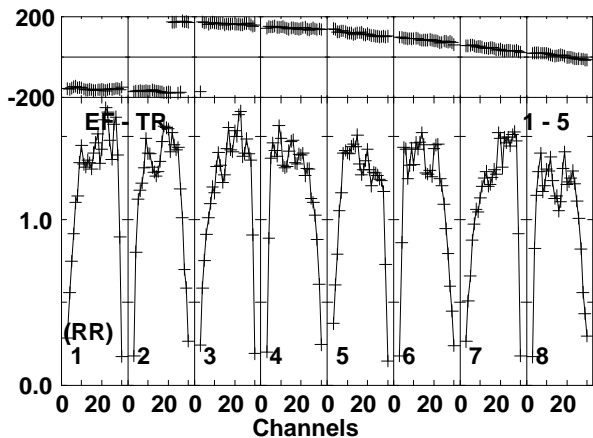
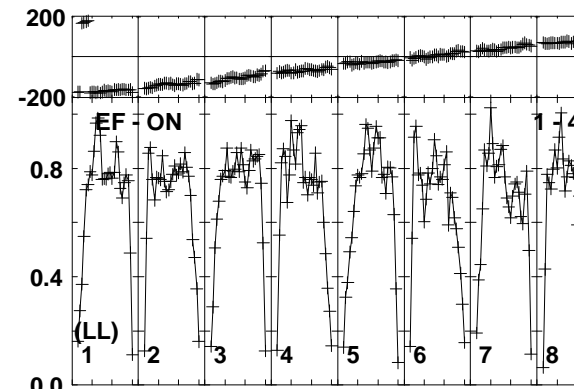
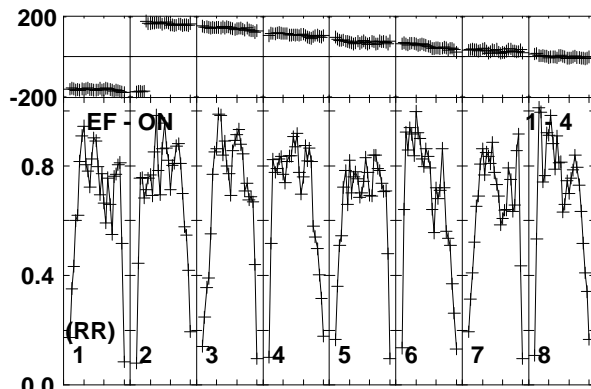
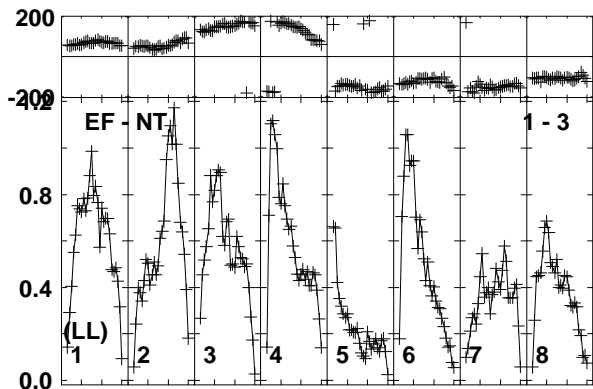
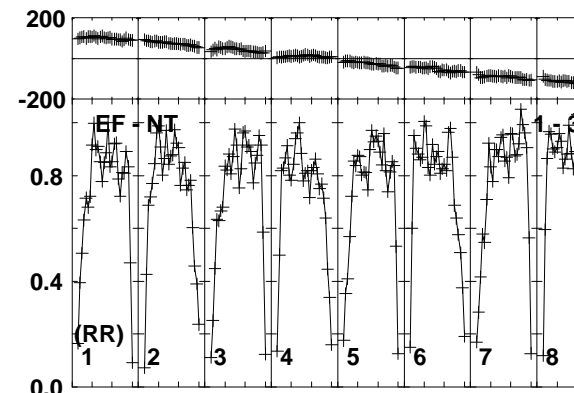
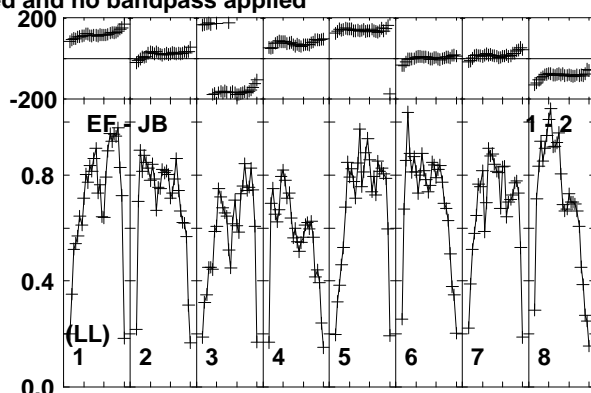
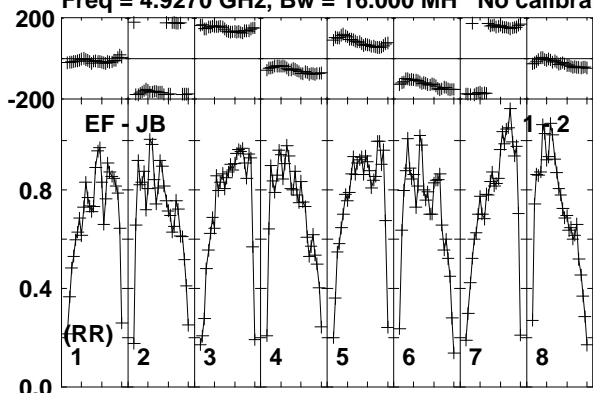

Lower frame: Milli Ampl Jy Top frame: Phas deg
Vector averaged cross-power spectrum Baseline: EF (01) - JB (02)
Timerange: 01/08:50:53 to 01/08:54:19

Plot file version 480 created 26-MAR-2015 15:28:02

J0151+5454 EG082E.UVDATA.1

Freq = 4.9270 GHz, Bw = 16.000 MH No calibration applied and no bandpass applied

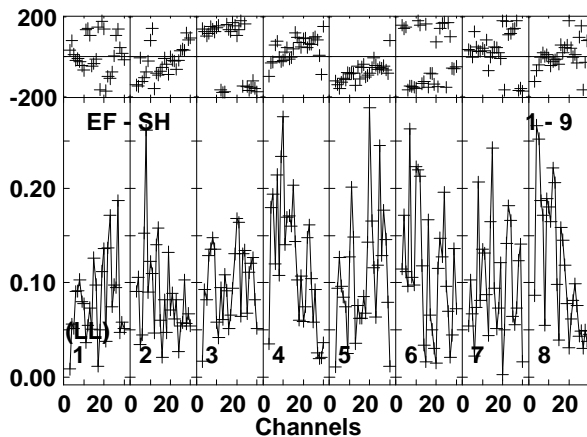
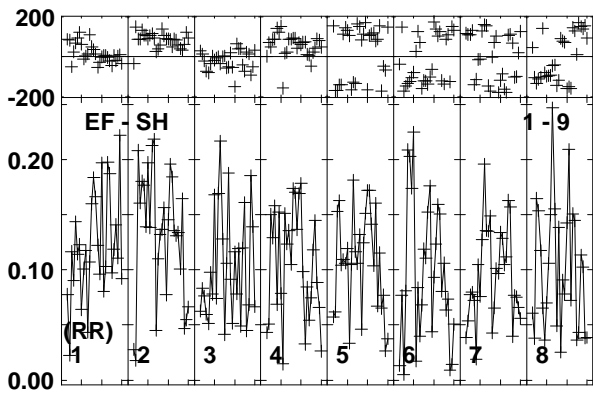
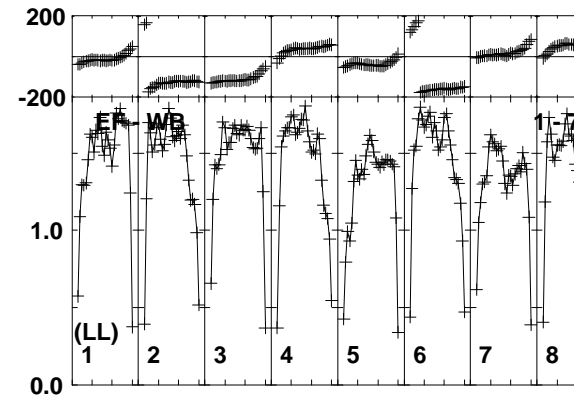
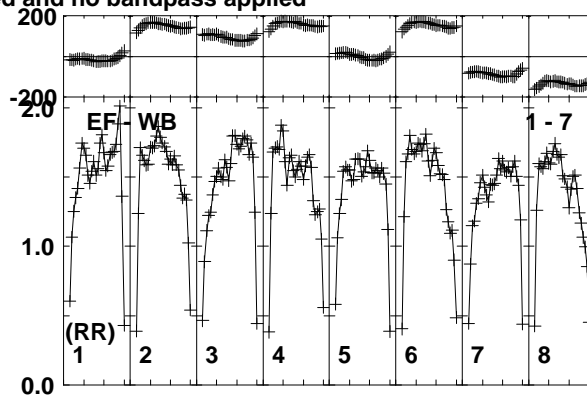
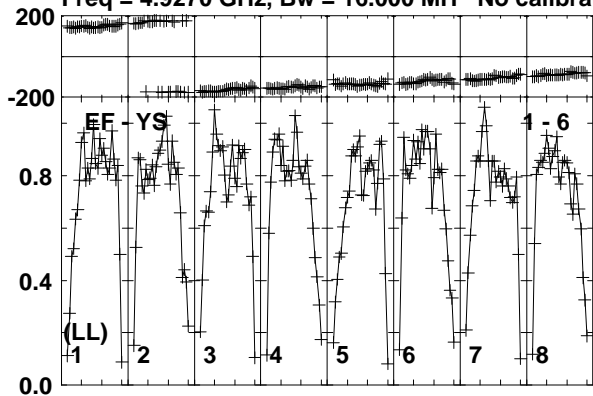

Lower frame: Milli Ampl Jy Top frame: Phas deg
Vector averaged cross-power spectrum Baseline: EF (01) - YS (06)
Timerange: 01/08:50:53 to 01/08:54:19

Plot file version 481 created 26-MAR-2015 15:28:02

J0147+5840 EG082E.UVDATA.1

Freq = 4.9270 GHz, Bw = 16.000 MH No calibration applied and no bandpass applied

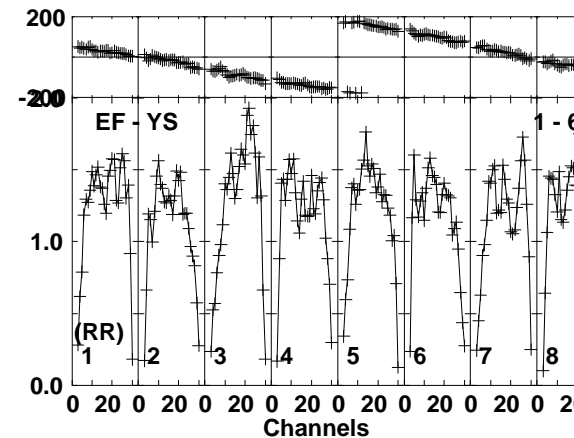
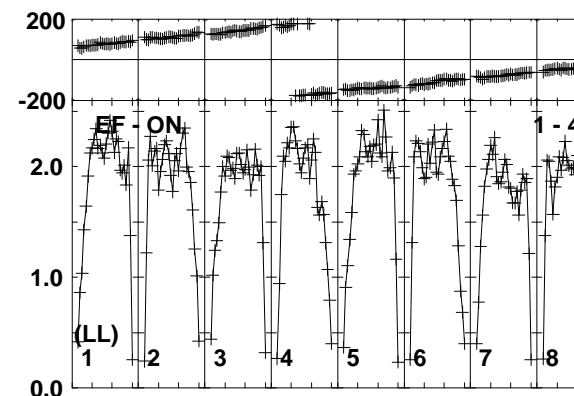
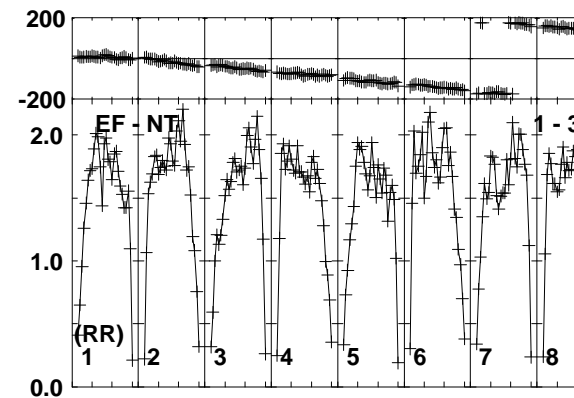
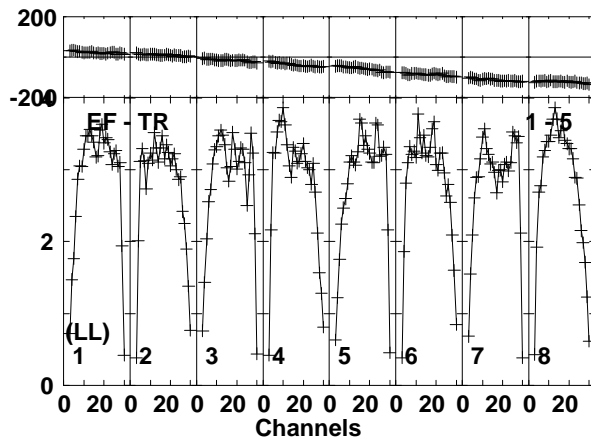
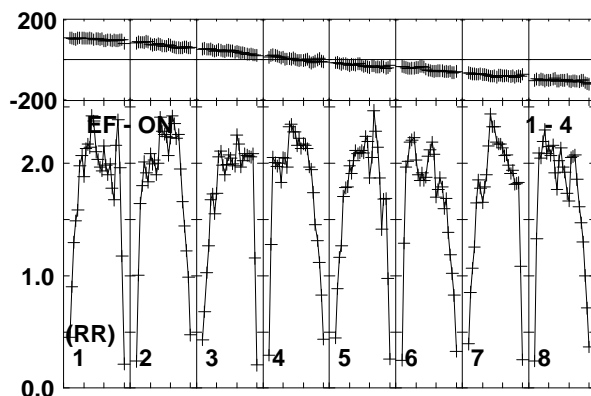
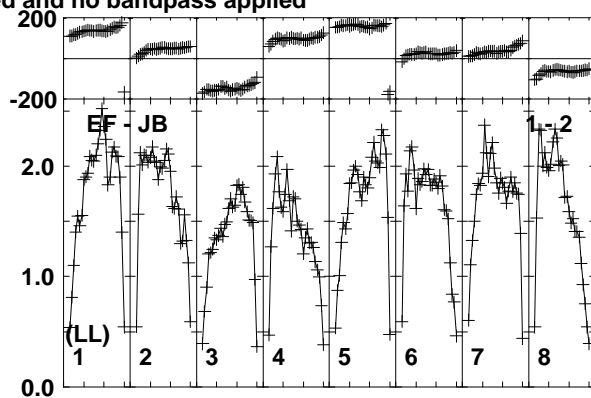
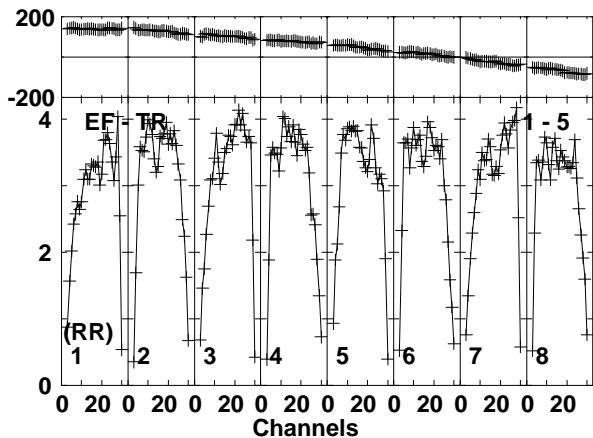
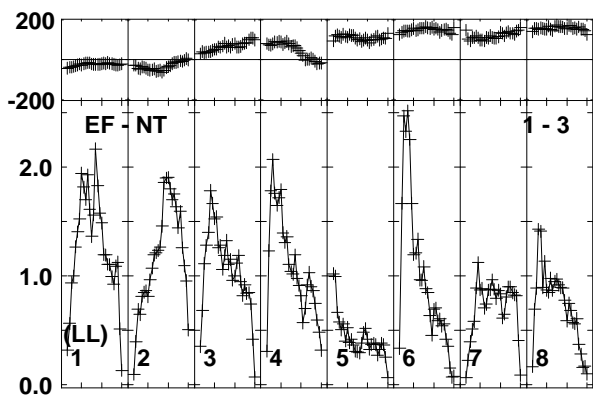
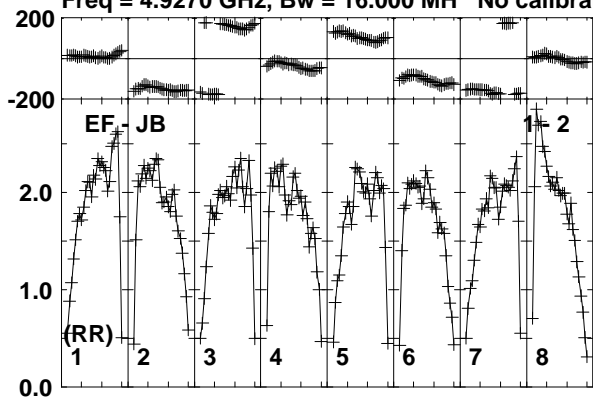

Lower frame: Milli Ampl Jy Top frame: Phas deg
Vector averaged cross-power spectrum Baseline: EF (01) - JB (02)
Timerange: 01/08:54:53 to 01/08:55:49

Plot file version 482 created 26-MAR-2015 15:28:02

J0147+5840 EG082E.UVDATA.1

Freq = 4.9270 GHz, Bw = 16.000 MH No calibration applied and no bandpass applied

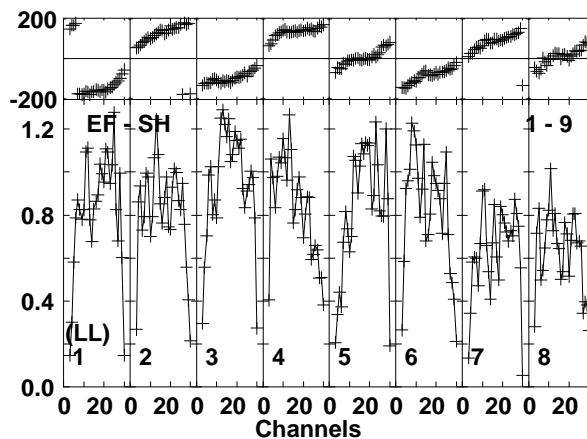
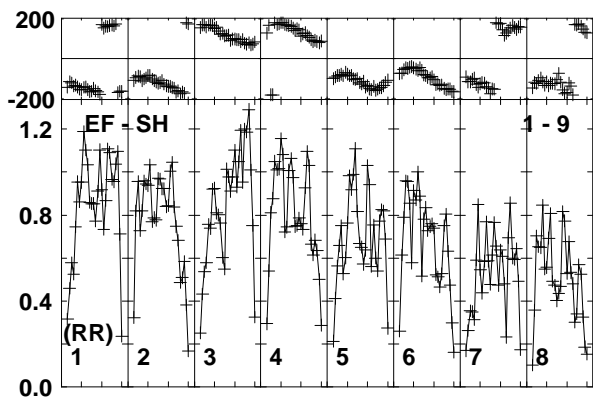
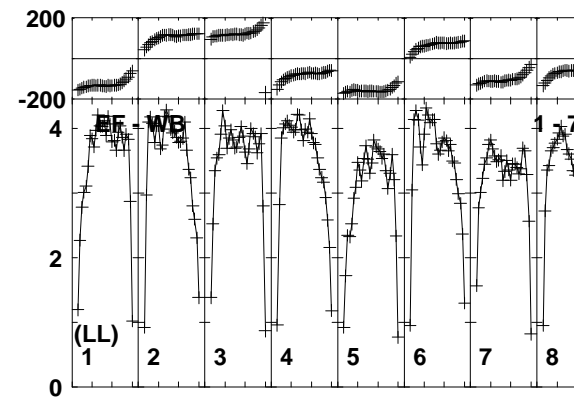
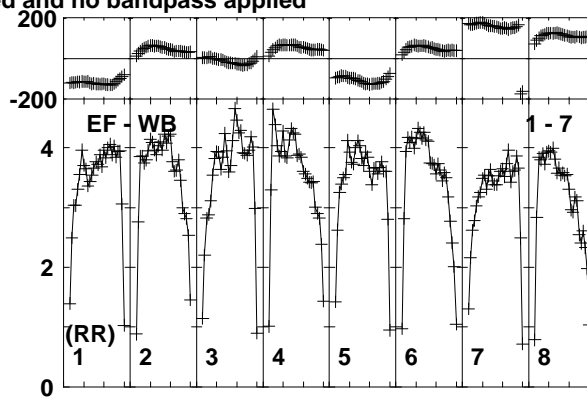
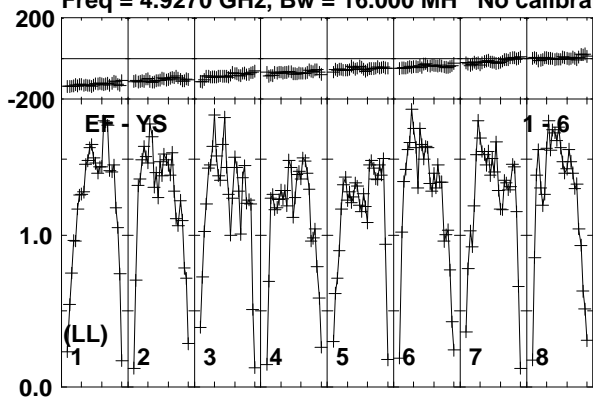

Lower frame: Milli Ampl Jy Top frame: Phas deg
Vector averaged cross-power spectrum Baseline: EF (01) - YS (06)
Timerange: 01/08:54:53 to 01/08:55:49

Plot file version 483 created 26-MAR-2015 15:28:02

V596CAS EG082E.UVDATA.1

Freq = 4.9270 GHz, Bw = 16.000 MH No calibration applied and no bandpass applied

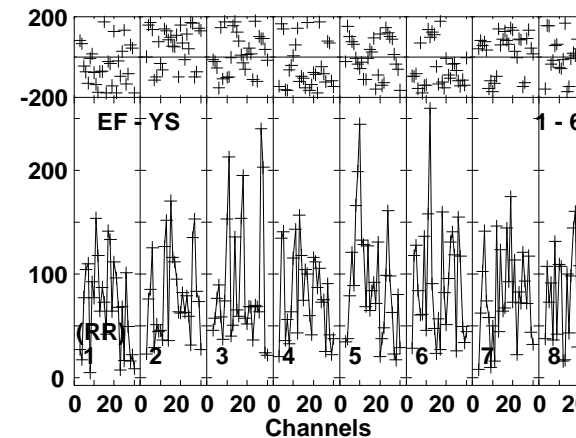
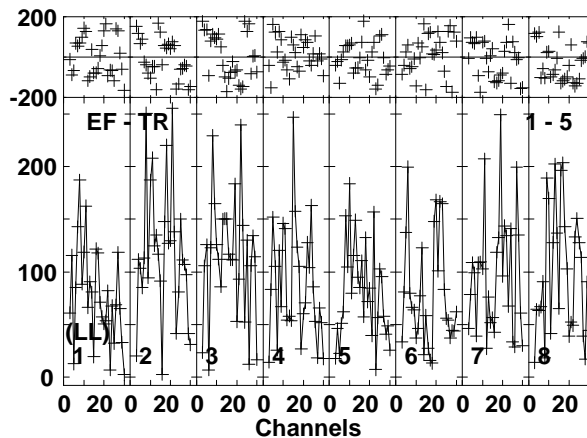
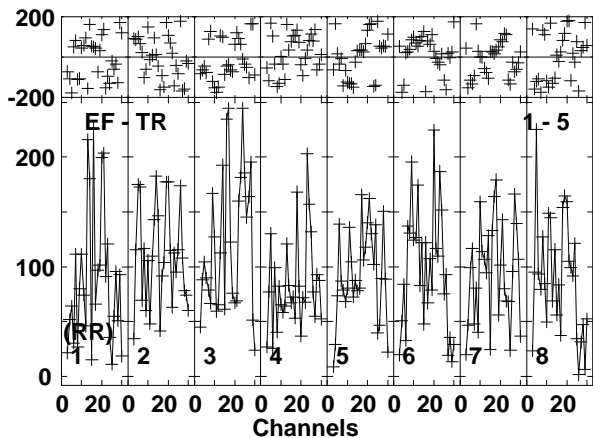
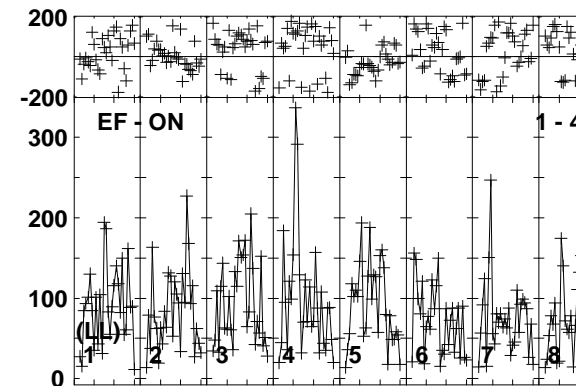
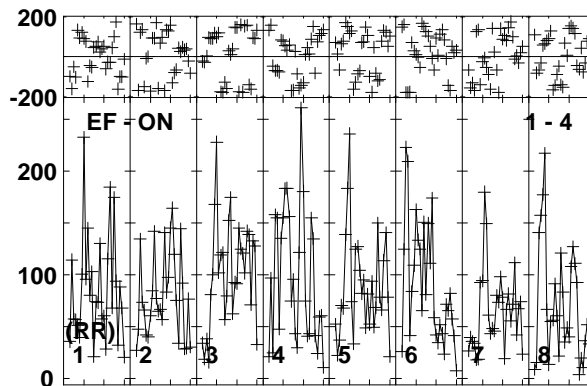
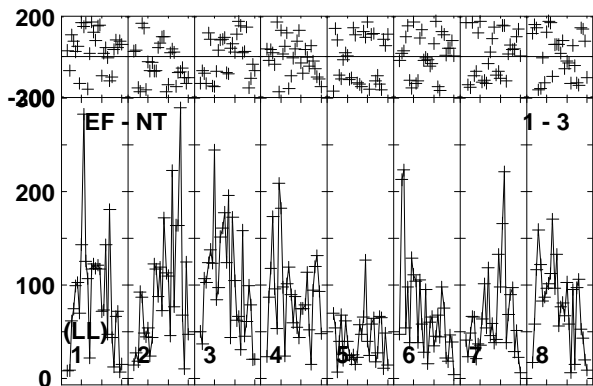
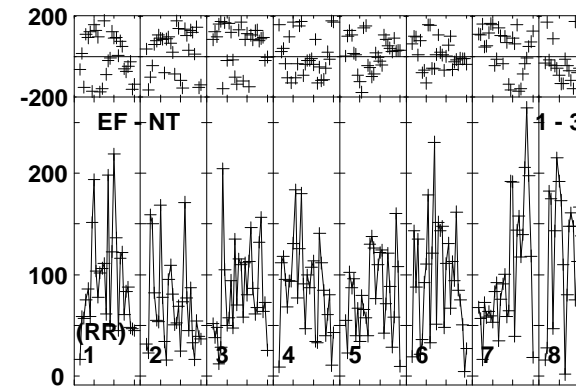
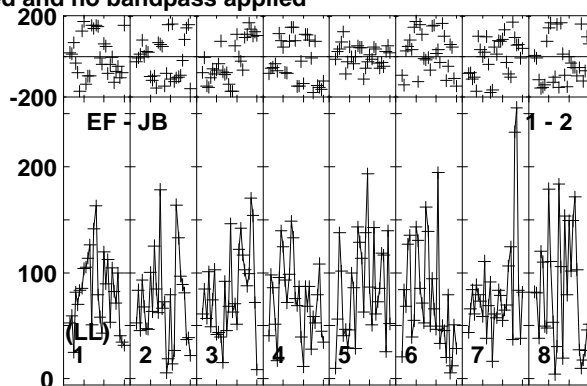
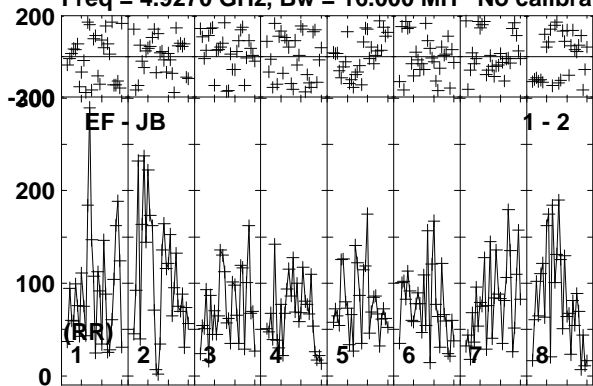

Lower frame: Micro Ampl Jy Top frame: Phas deg
Vector averaged cross-power spectrum Baseline: EF (01) - JB (02)
Timerange: 01/08:55:53 to 01/08:59:19

Plot file version 484 created 26-MAR-2015 15:28:03
V596CAS EG082E.UVDATA.1

Freq = 4.9270 GHz, Bw = 16.000 MH No calibration applied and no bandpass applied

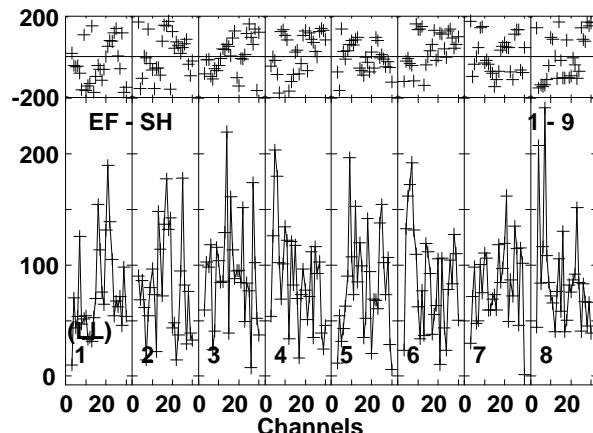
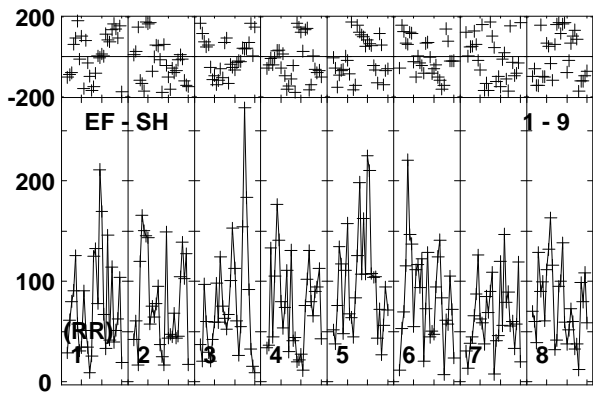
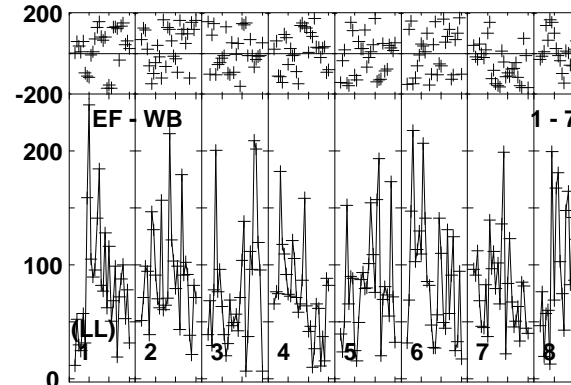
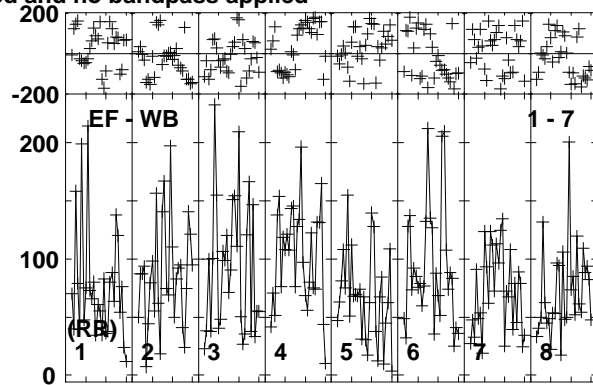
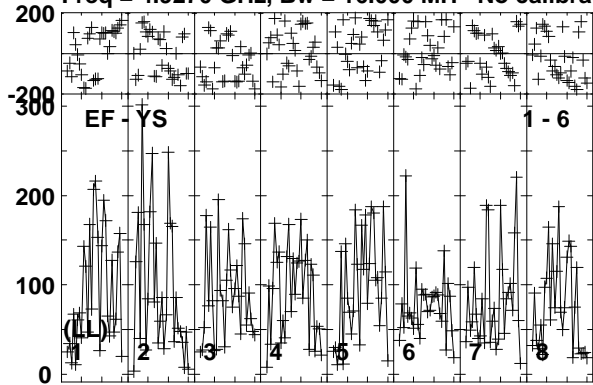

Lower frame: Micro Ampl Jy Top frame: Phas deg
Vector averaged cross-power spectrum Baseline: EF (01) - YS (06)
Timerange: 01/08:55:53 to 01/08:59:19

Plot file version 485 created 26-MAR-2015 15:28:03

J0147+5840 EG082E.UVDATA.1

Freq = 4.9270 GHz, Bw = 16.000 MH No calibration applied and no bandpass applied

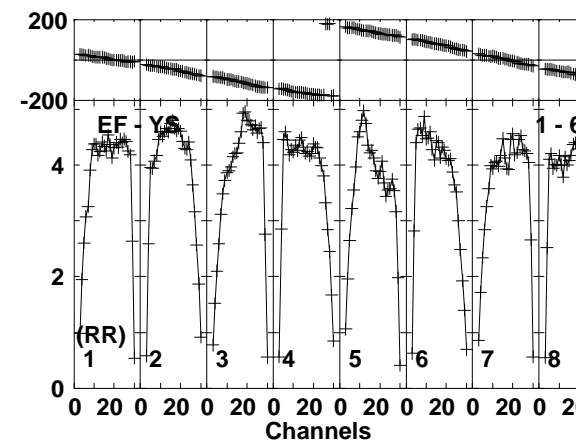
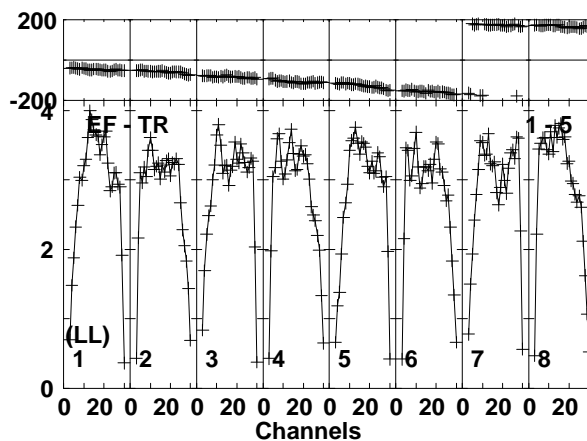
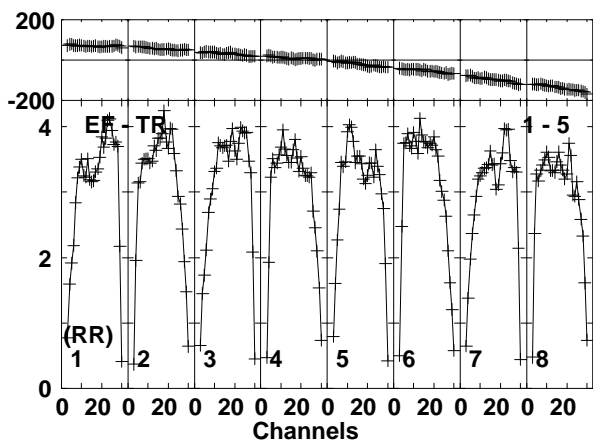
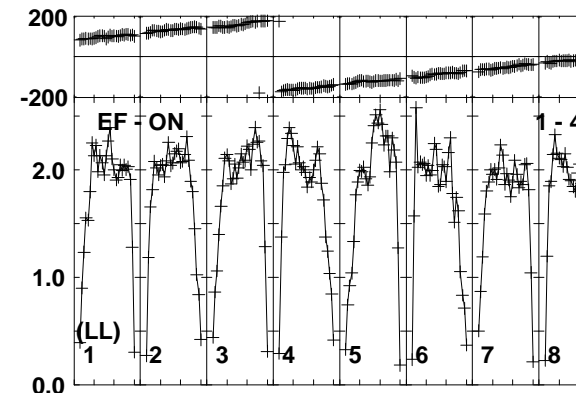
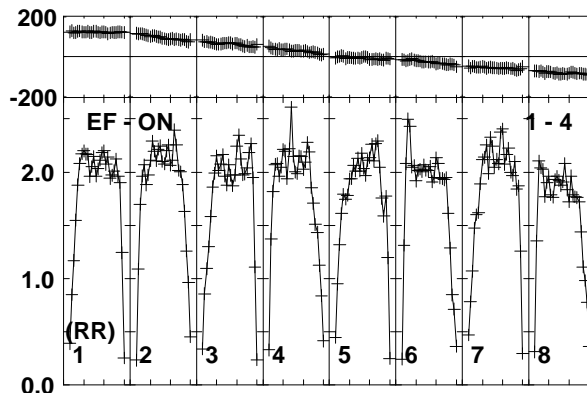
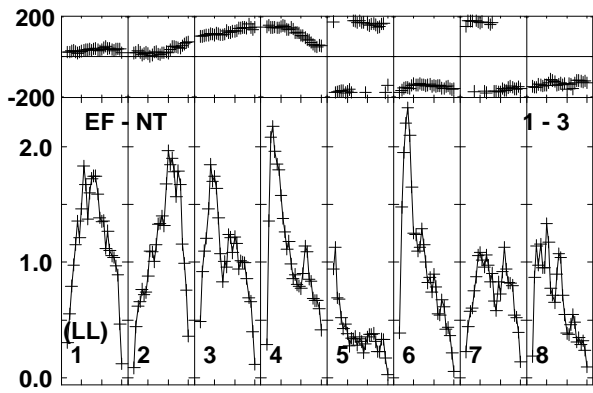
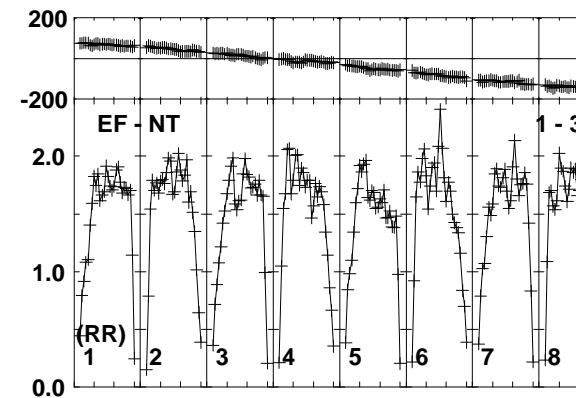
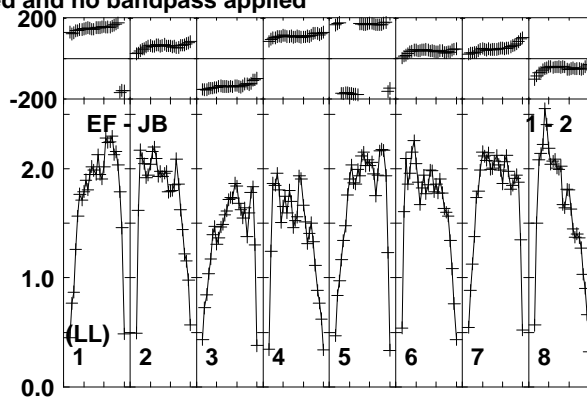
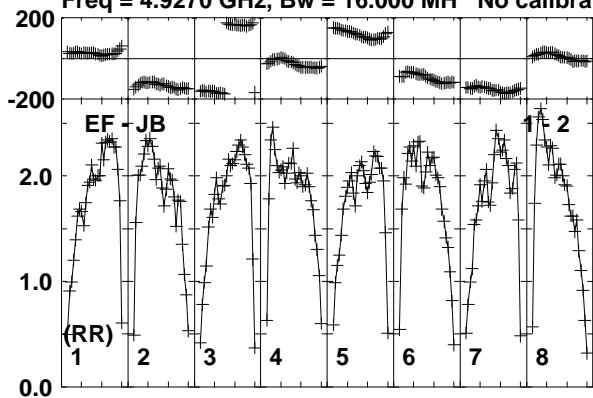

Lower frame: Milli Ampl Jy Top frame: Phas deg
Vector averaged cross-power spectrum Baseline: EF (01) - JB (02)
Timerange: 01/08:59:23 to 01/09:00:49

Plot file version 486 created 26-MAR-2015 15:28:03

J0147+5840 EG082E.UVDATA.1

Freq = 4.9270 GHz, Bw = 16.000 MH No calibration applied and no bandpass applied

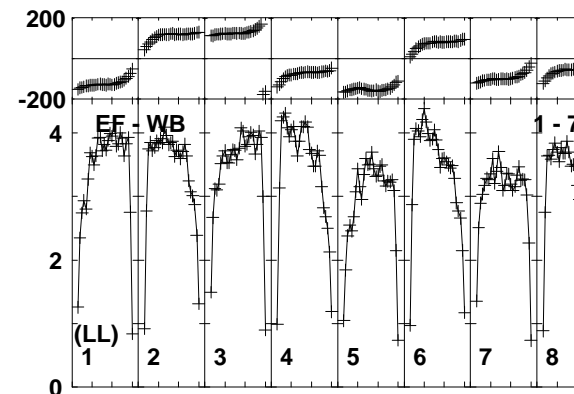
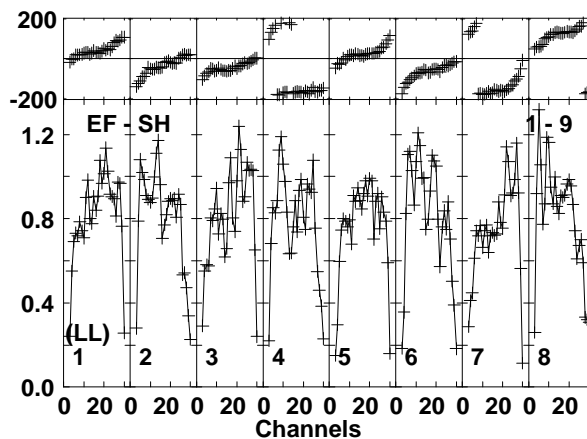
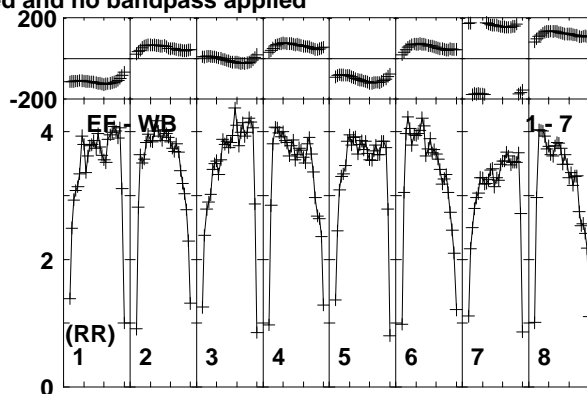
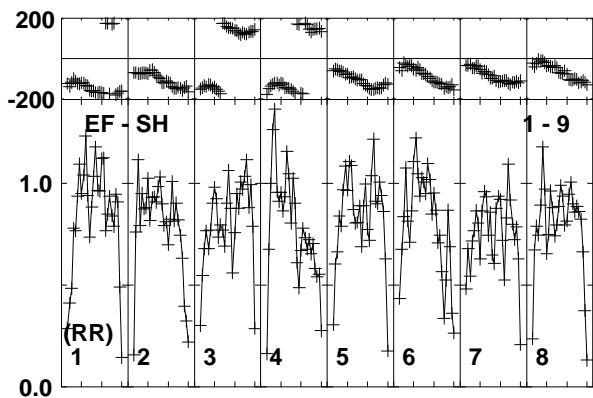
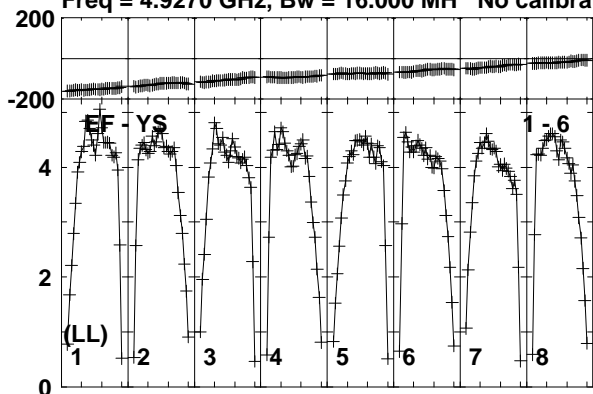

Lower frame: Milli Ampl Jy Top frame: Phas deg
Vector averaged cross-power spectrum Baseline: EF (01) - YS (06)
Timerange: 01/08:59:23 to 01/09:00:49

Plot file version 487 created 26-MAR-2015 15:28:03

V596CAS EG082E.UVDATA.1

Freq = 4.9270 GHz, Bw = 16.000 MH No calibration applied and no bandpass applied

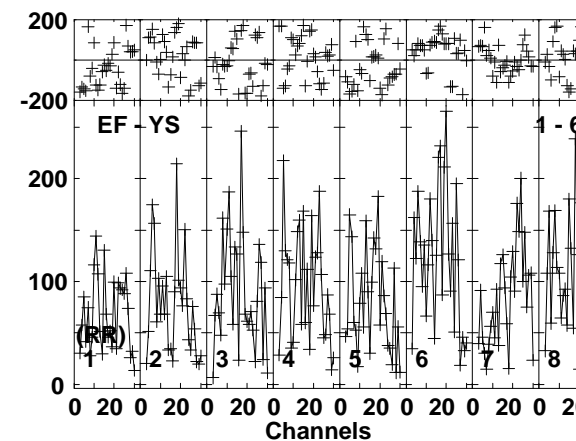
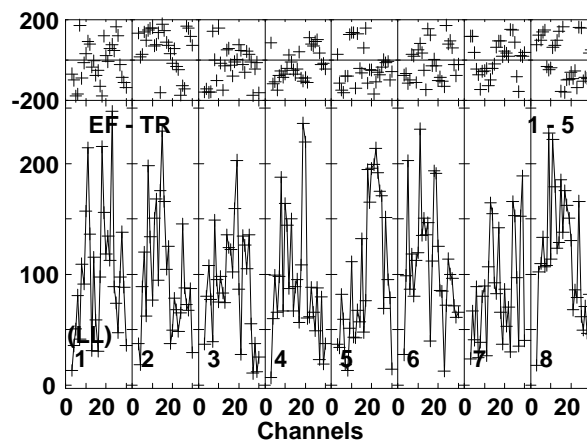
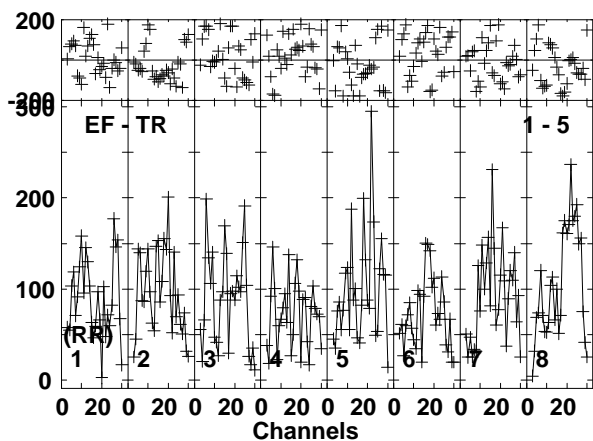
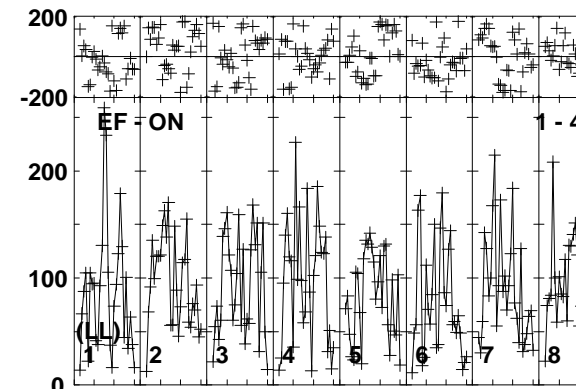
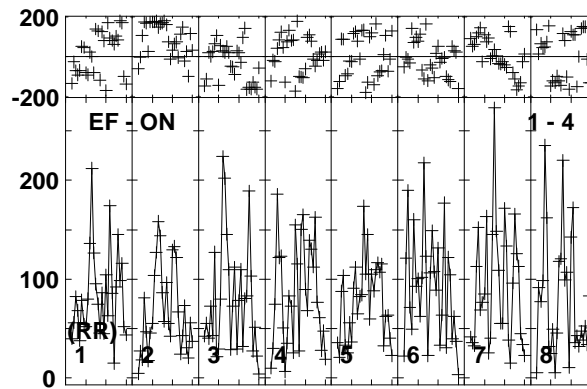
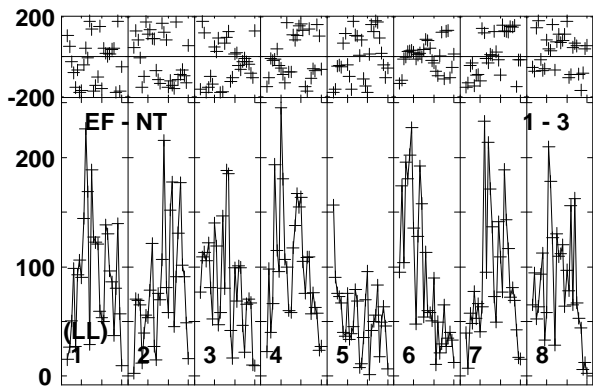
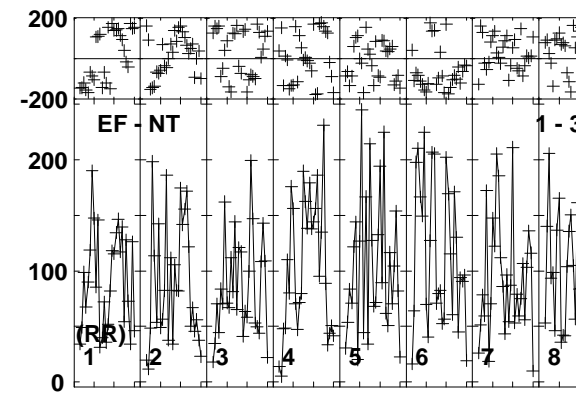
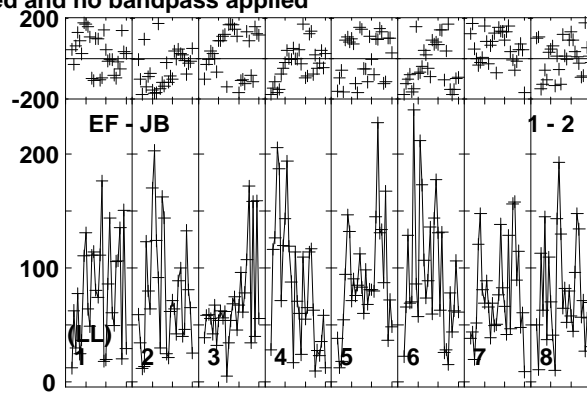
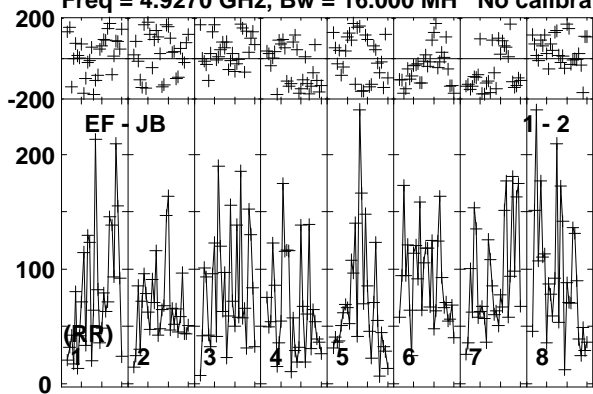

Lower frame: Micro Ampl Jy Top frame: Phas deg
Vector averaged cross-power spectrum Baseline: EF (01) - JB (02)
Timerange: 01/09:00:53 to 01/09:04:19

Plot file version 488 created 26-MAR-2015 15:28:03

V596CAS EG082E.UVDATA.1

Freq = 4.9270 GHz, Bw = 16.000 MH No calibration applied and no bandpass applied

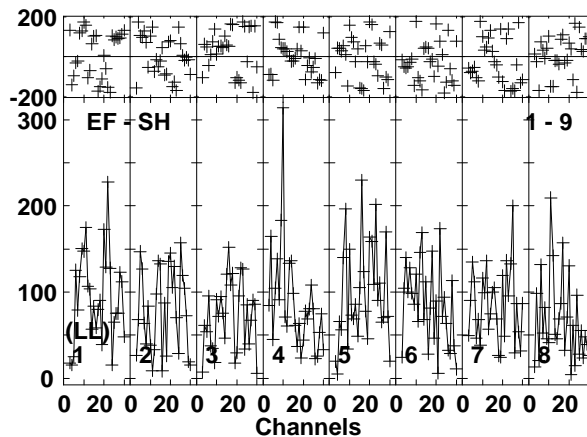
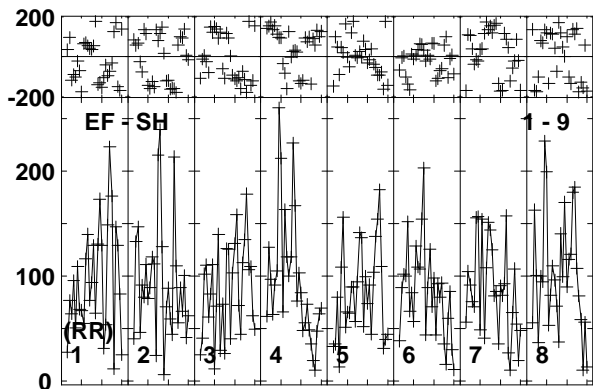
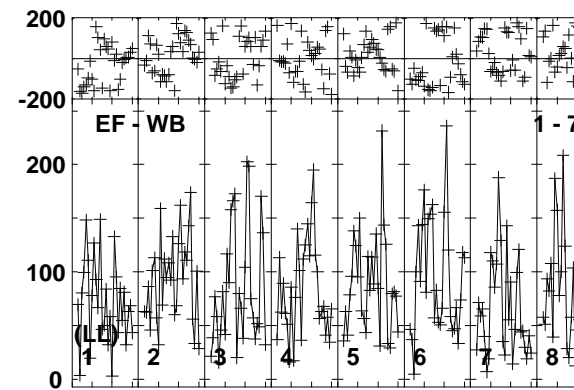
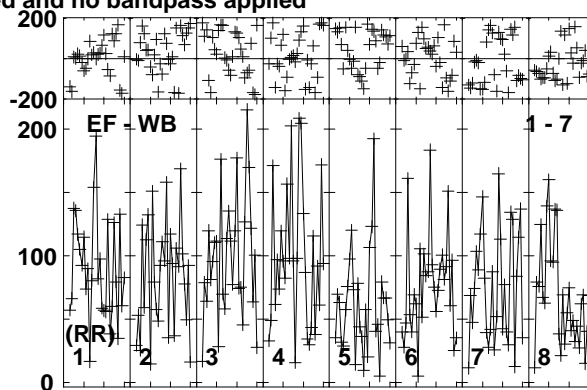
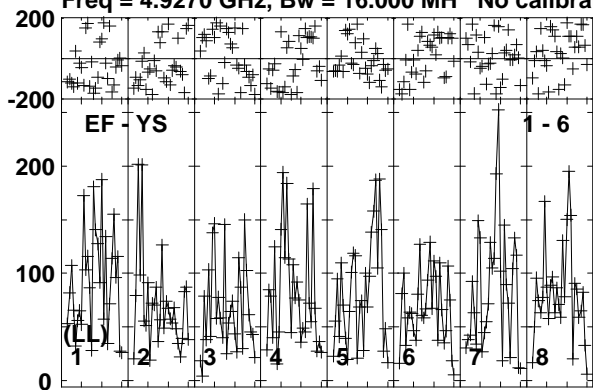

Lower frame: Micro Ampl Jy Top frame: Phas deg
Vector averaged cross-power spectrum Baseline: EF (01) - YS (06)
Timerange: 01/09:00:53 to 01/09:04:19

Plot file version 489 created 26-MAR-2015 15:28:03

J0147+5840 EG082E.UVDATA.1

Freq = 4.9270 GHz, Bw = 16.000 MH No calibration applied and no bandpass applied

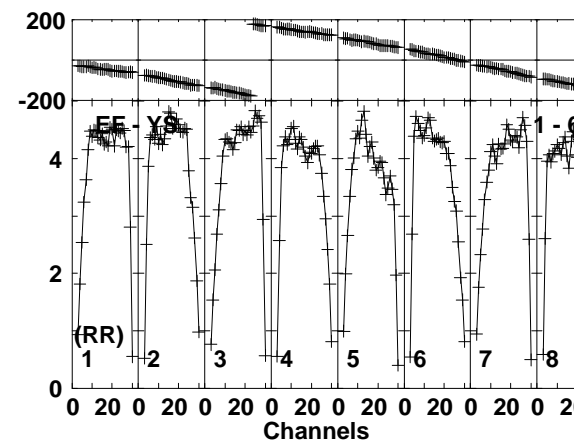
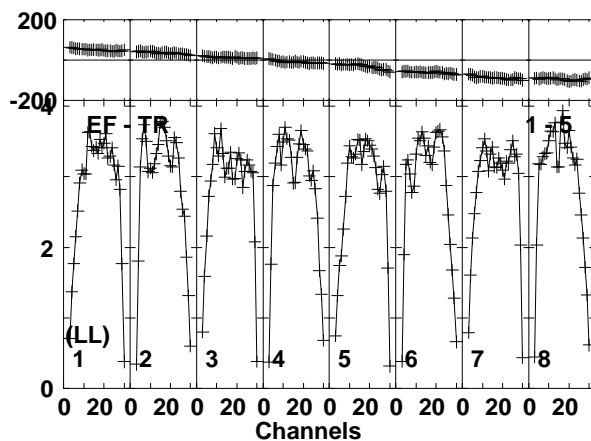
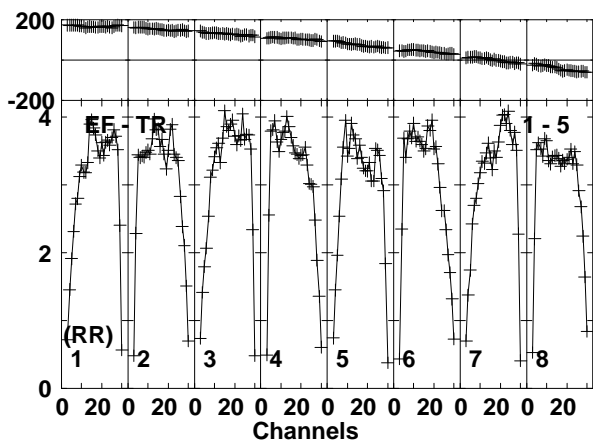
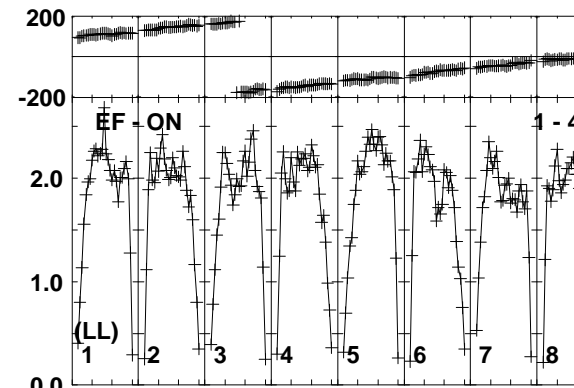
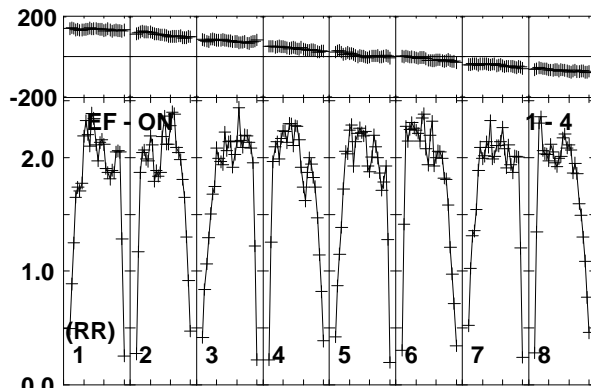
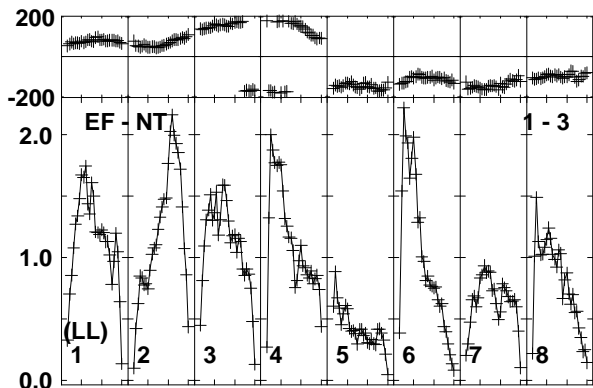
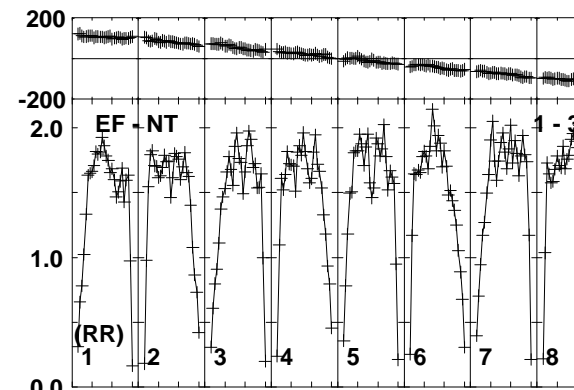
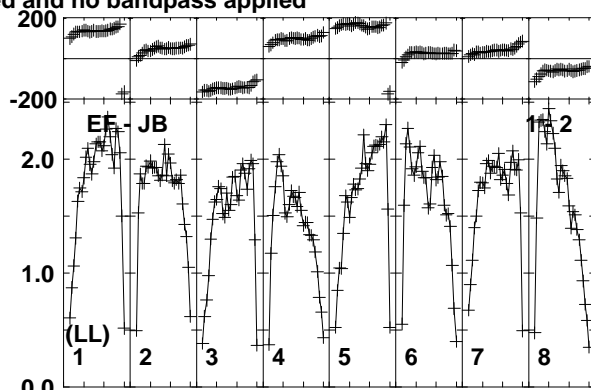
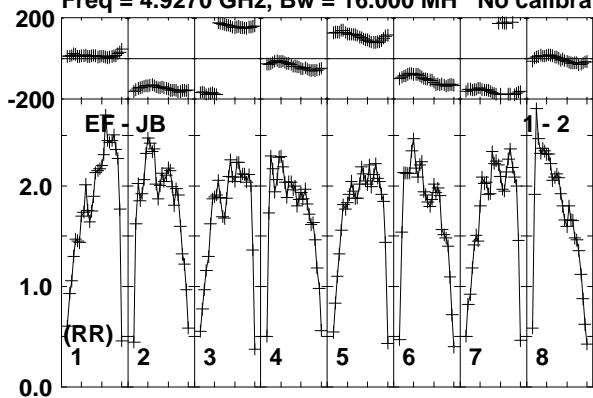

Lower frame: Milli Ampl Jy Top frame: Phas deg
Vector averaged cross-power spectrum Baseline: EF (01) - JB (02)
Timerange: 01/09:04:53 to 01/09:05:49

Plot file version 490 created 26-MAR-2015 15:28:03

J0147+5840 EG082E.UVDATA.1

Freq = 4.9270 GHz, Bw = 16.000 MH No calibration applied and no bandpass applied

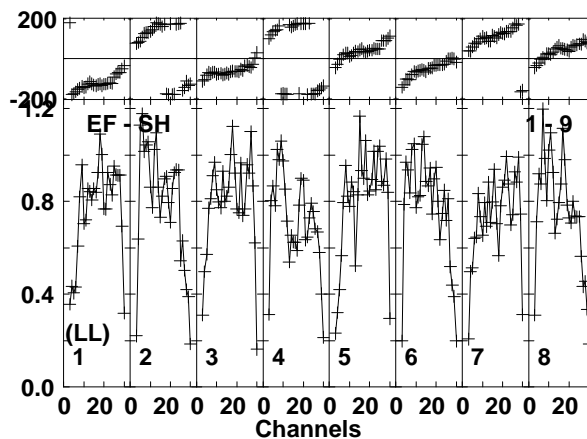
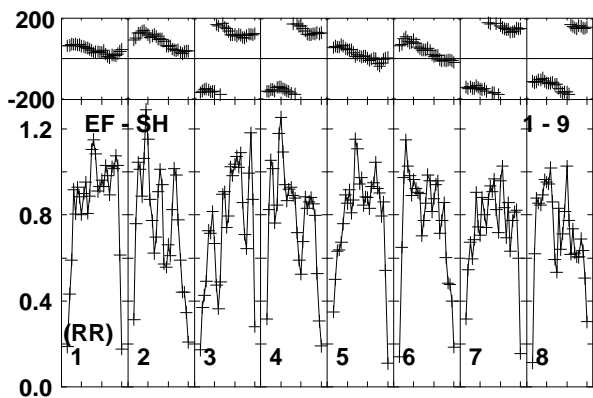
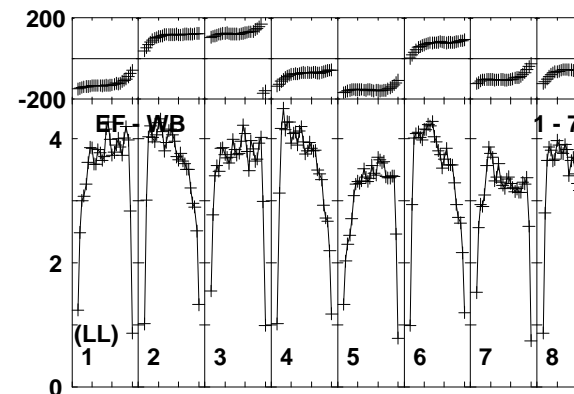
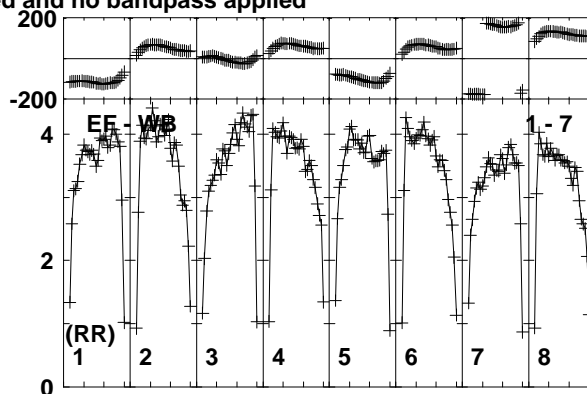
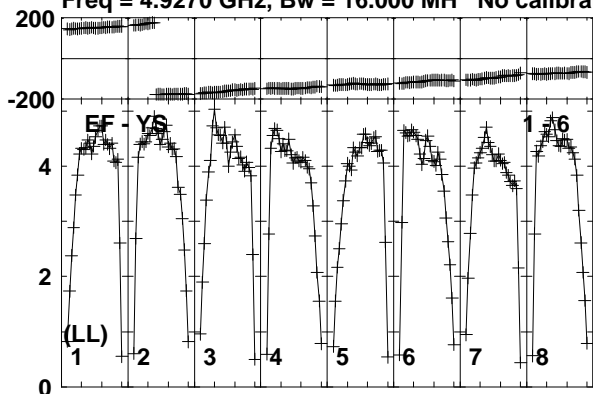

Lower frame: Milli Ampl Jy Top frame: Phas deg
Vector averaged cross-power spectrum Baseline: EF (01) - YS (06)
Timerange: 01/09:04:53 to 01/09:05:49

Plot file version 491 created 26-MAR-2015 15:28:03

V596CAS EG082E.UVDATA.1

Freq = 4.9270 GHz, Bw = 16.000 MH No calibration applied and no bandpass applied

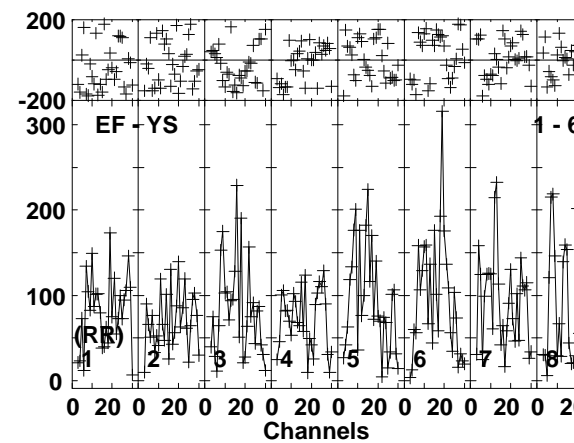
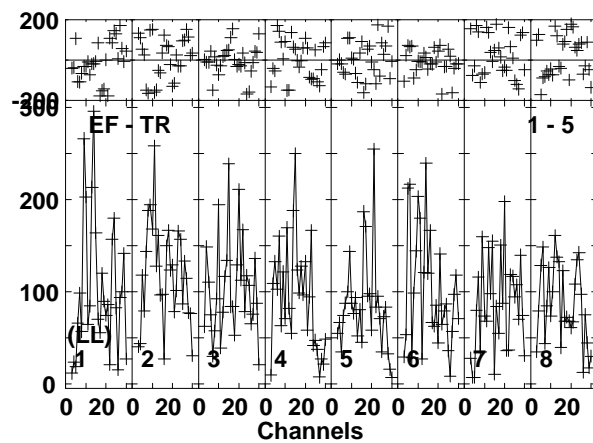
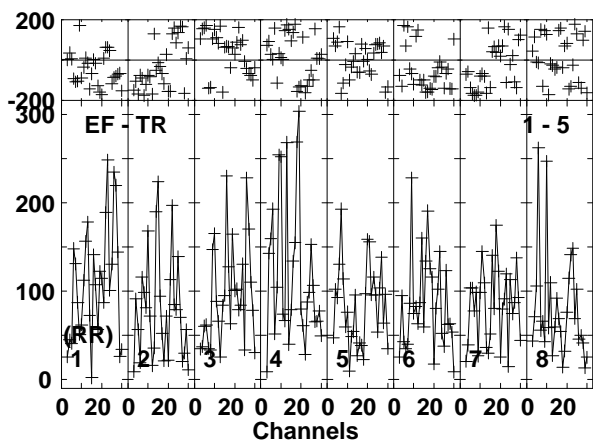
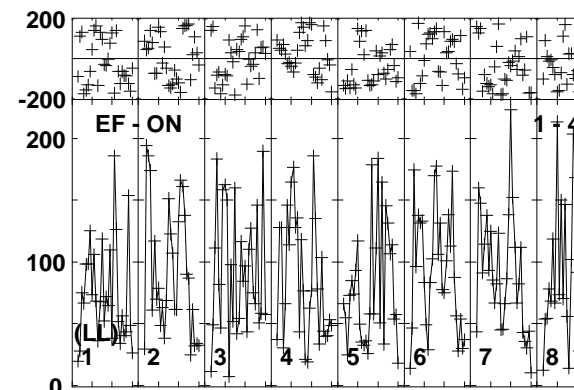
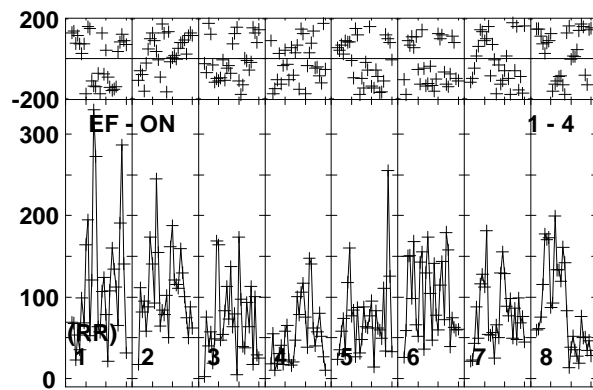
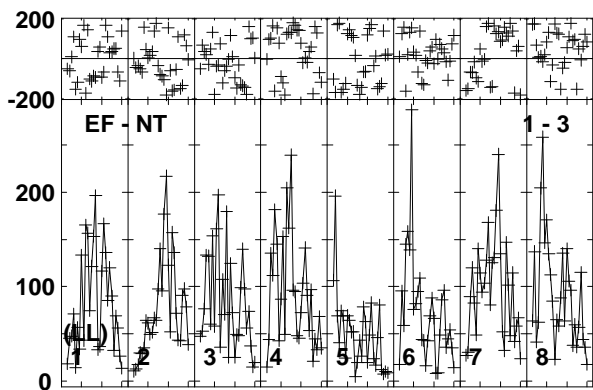
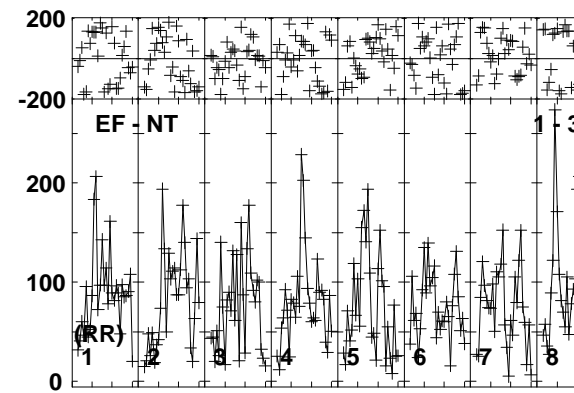
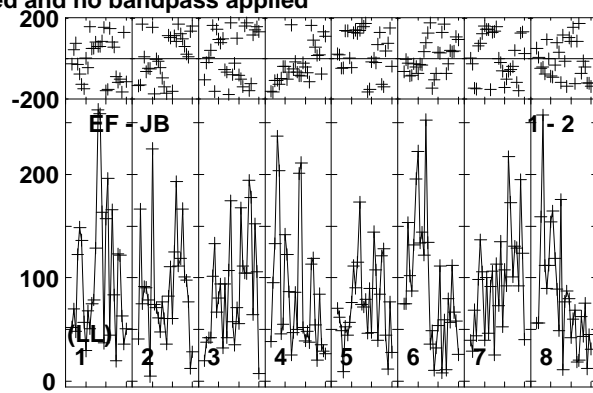
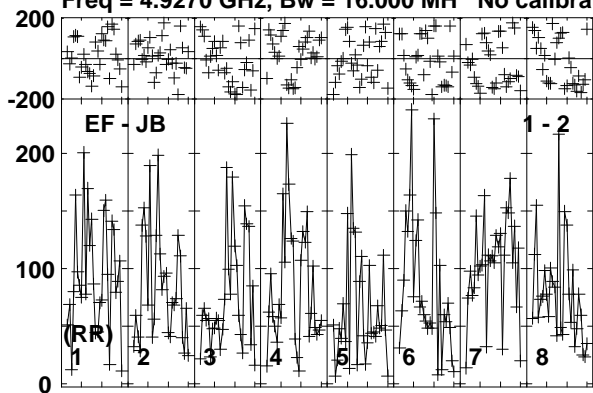

Lower frame: Micro Ampl Jy Top frame: Phas deg
Vector averaged cross-power spectrum Baseline: EF (01) - JB (02)
Timerange: 01/09:05:53 to 01/09:09:19

Plot file version 492 created 26-MAR-2015 15:28:03

V596CAS EG082E.UVDATA.1

Freq = 4.9270 GHz, Bw = 16.000 MH No calibration applied and no bandpass applied

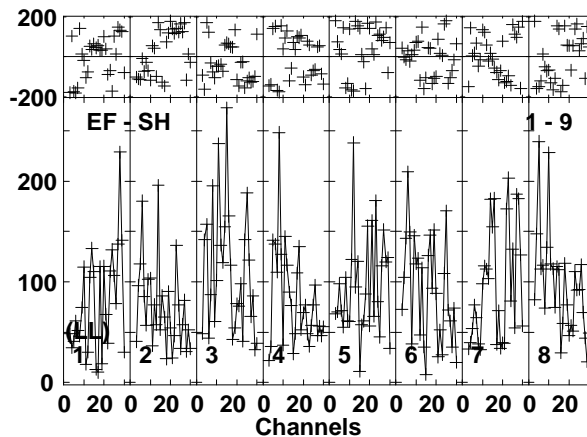
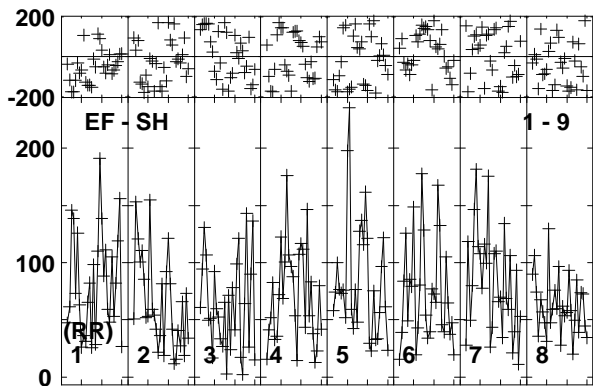
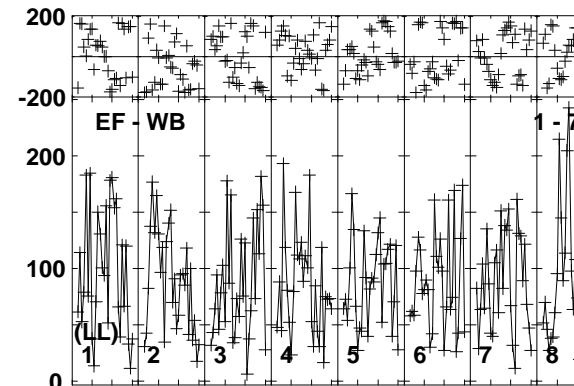
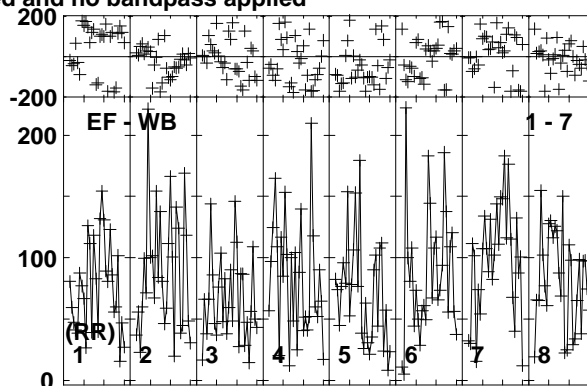
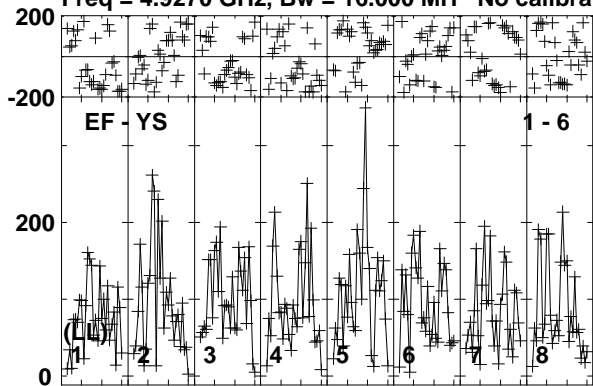

Lower frame: Micro Ampl Jy Top frame: Phas deg
Vector averaged cross-power spectrum Baseline: EF (01) - YS (06)
Timerange: 01/09:05:53 to 01/09:09:19

Plot file version 493 created 26-MAR-2015 15:28:03

J0147+5840 EG082E.UVDATA.1

Freq = 4.9270 GHz, Bw = 16.000 MH No calibration applied and no bandpass applied

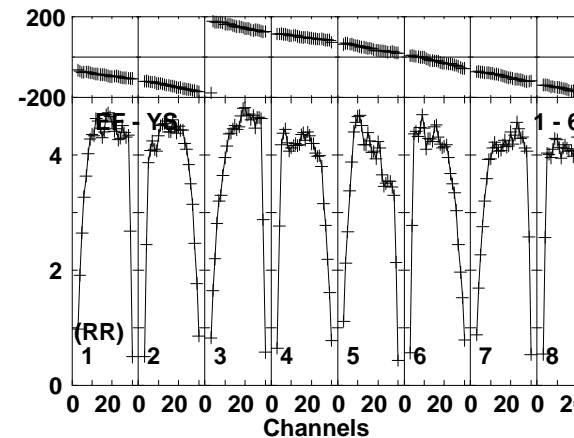
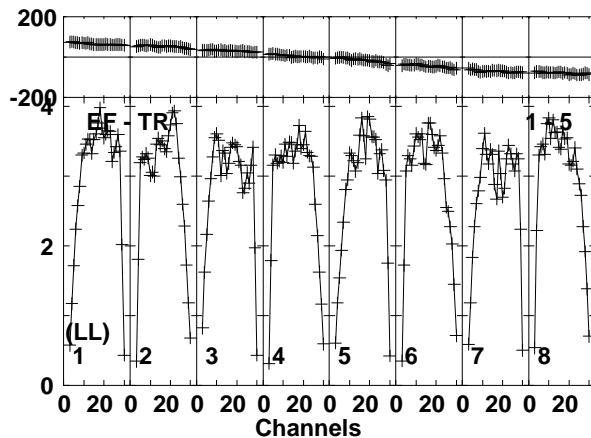
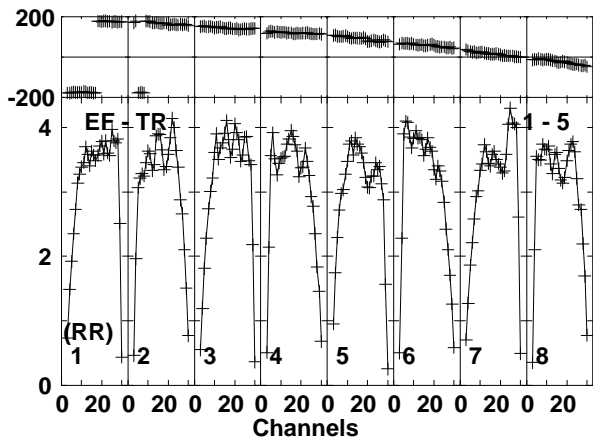
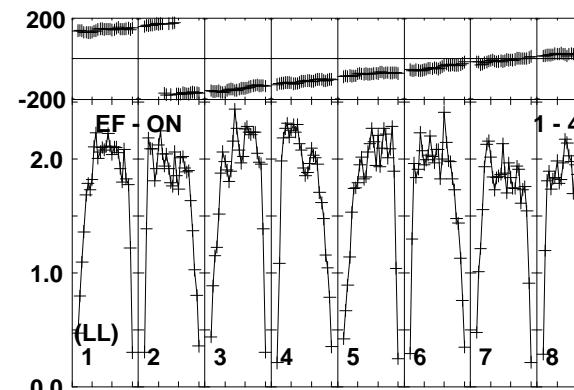
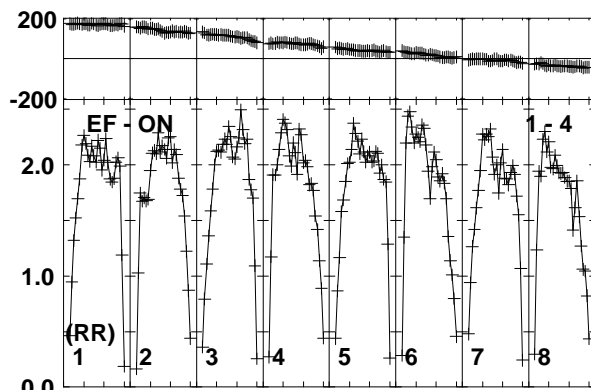
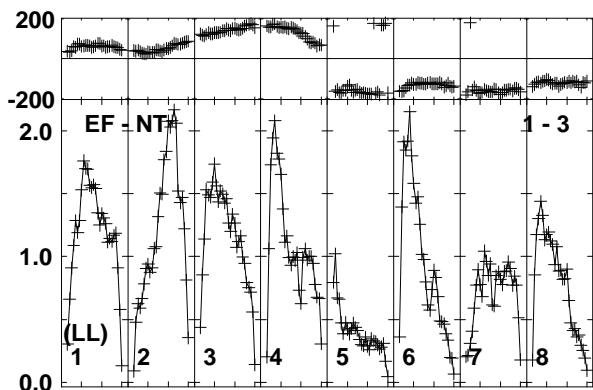
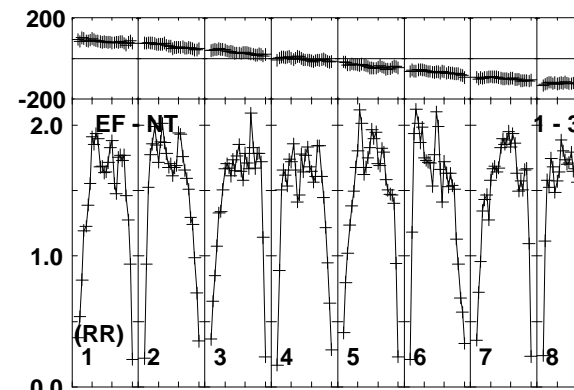
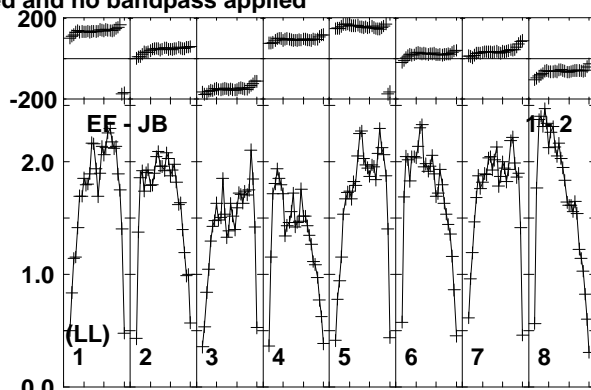
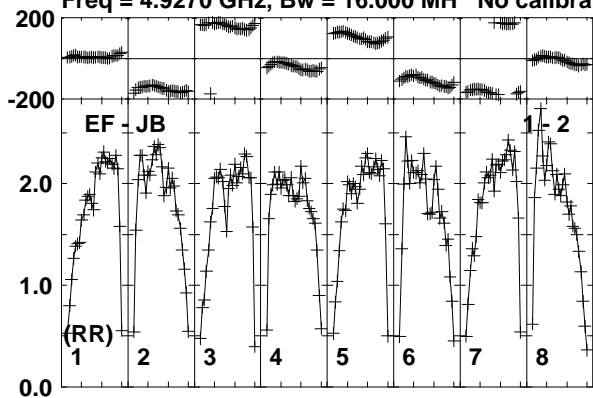

Lower frame: Milli Ampl Jy Top frame: Phas deg
Vector averaged cross-power spectrum Baseline: EF (01) - JB (02)
Timerange: 01/09:09:23 to 01/09:10:49

Plot file version 494 created 26-MAR-2015 15:28:03

J0147+5840 EG082E.UVDATA.1

Freq = 4.9270 GHz, Bw = 16.000 MH No calibration applied and no bandpass applied

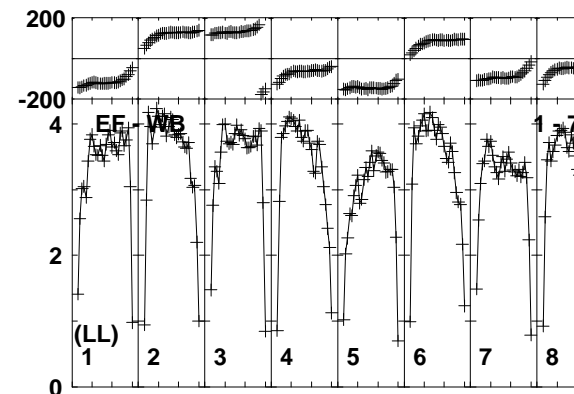
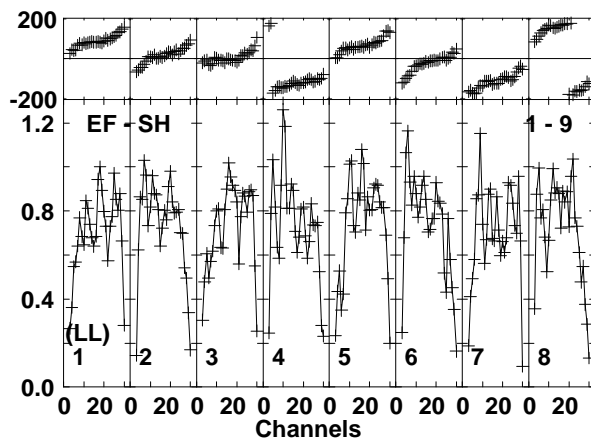
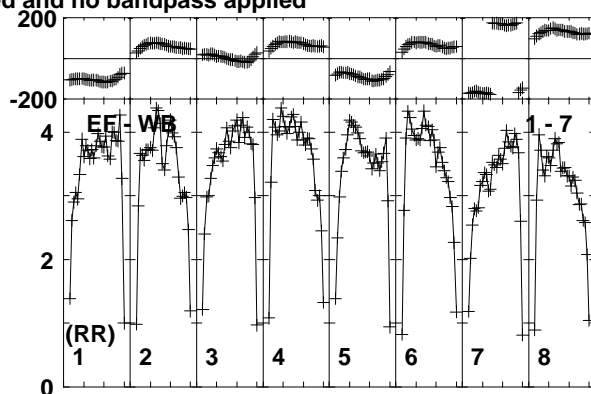
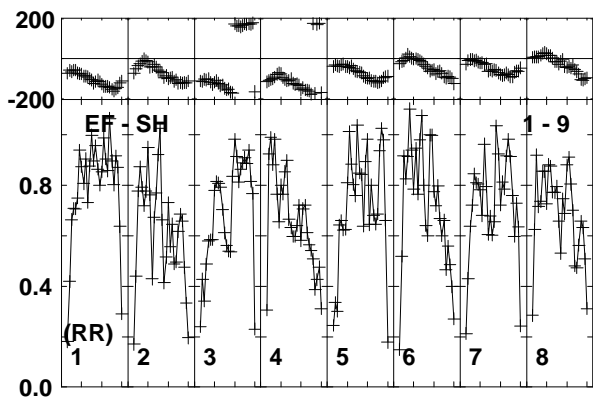
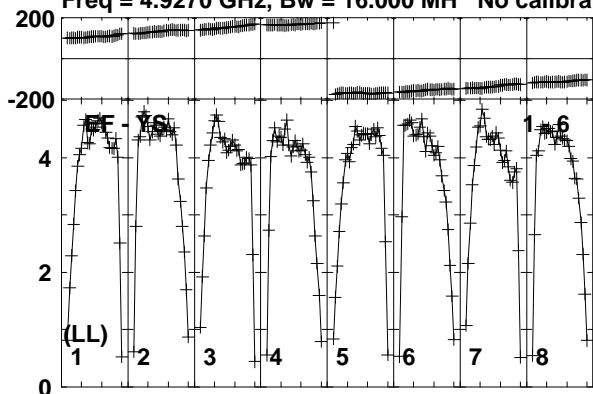

Lower frame: Milli Ampl Jy Top frame: Phas deg
Vector averaged cross-power spectrum Baseline: EF (01) - YS (06)
Timerange: 01/09:09:23 to 01/09:10:49

Plot file version 495 created 26-MAR-2015 15:28:03

V596CAS EG082E.UVDATA.1

Freq = 4.9270 GHz, Bw = 16.000 MH No calibration applied and no bandpass applied

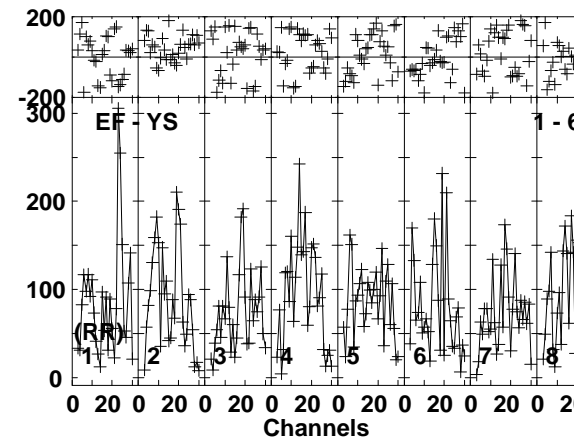
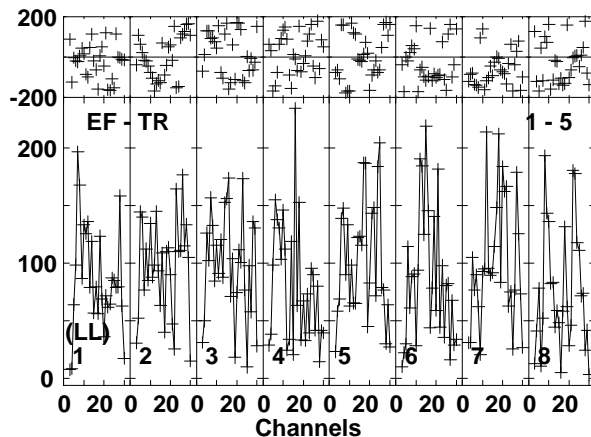
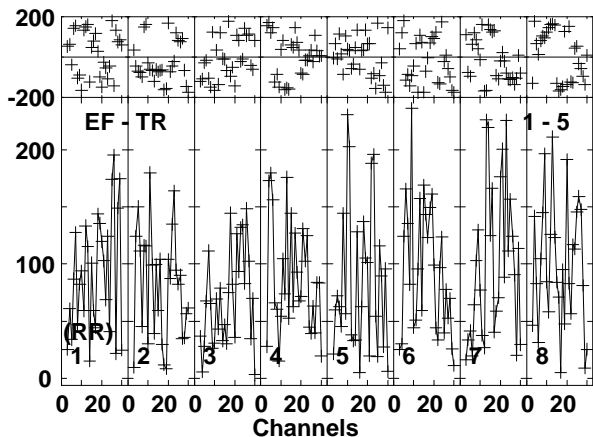
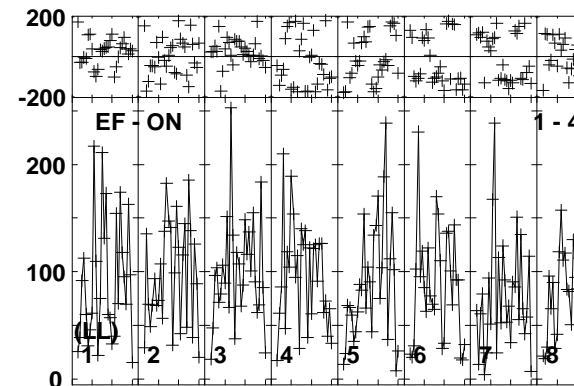
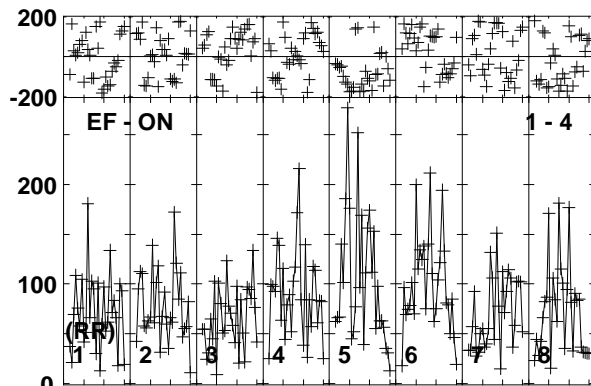
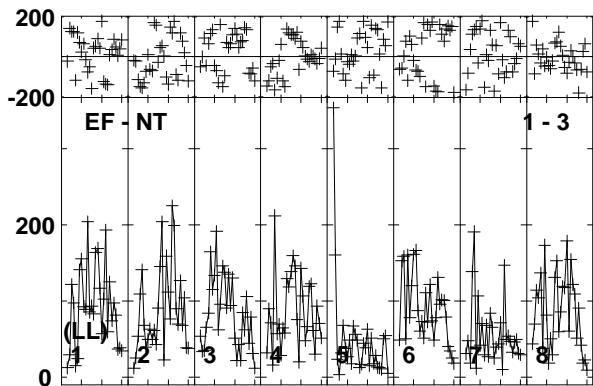
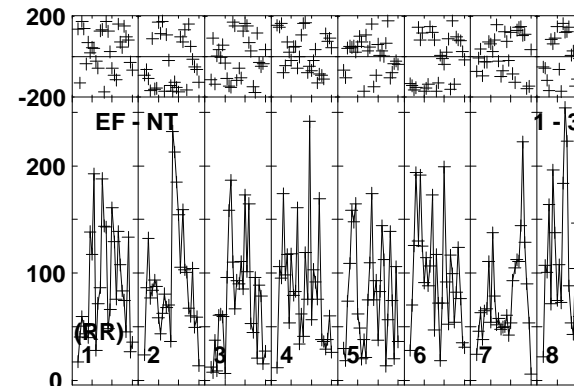
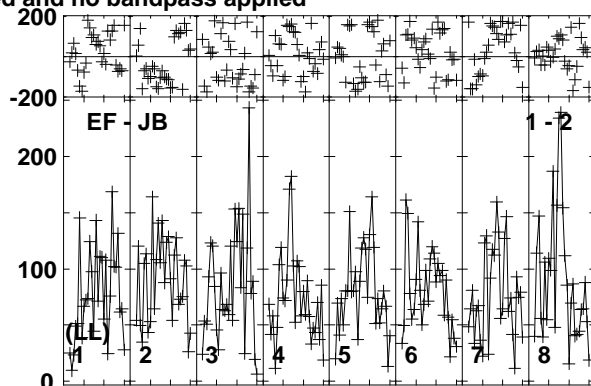
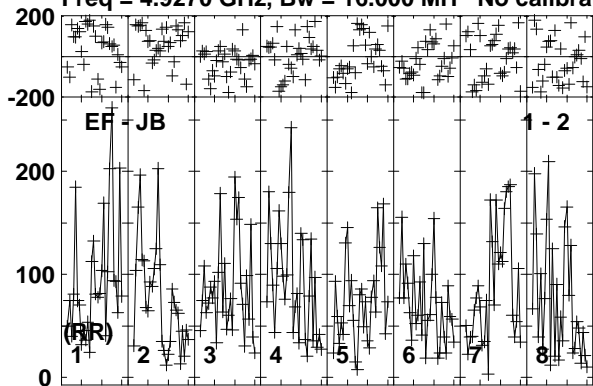

Lower frame: Micro Ampl Jy Top frame: Phas deg
Vector averaged cross-power spectrum Baseline: EF (01) - JB (02)
Timerange: 01/09:10:53 to 01/09:14:19

Plot file version 496 created 26-MAR-2015 15:28:03
V596CAS EG082E.UVDATA.1

Freq = 4.9270 GHz, Bw = 16.000 MH No calibration applied and no bandpass applied

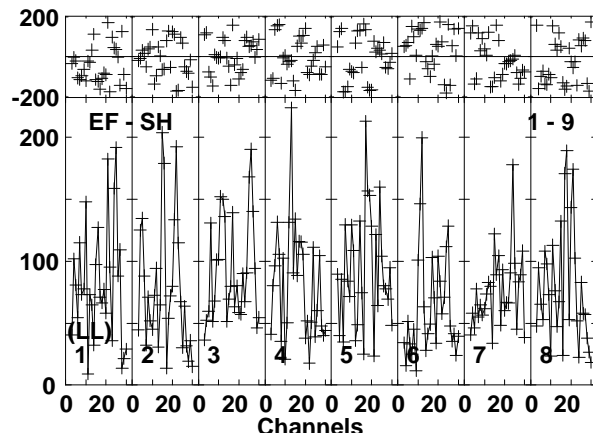
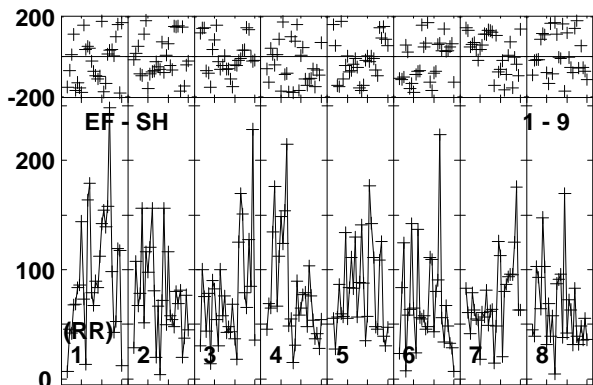
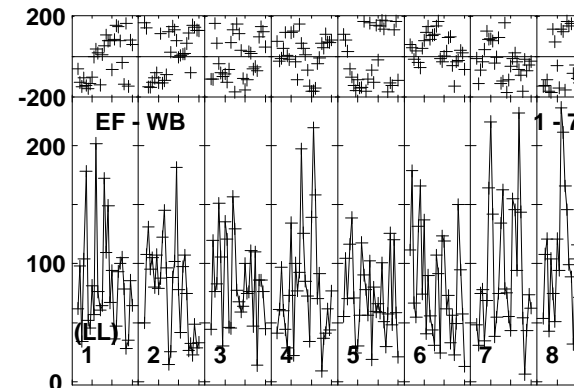
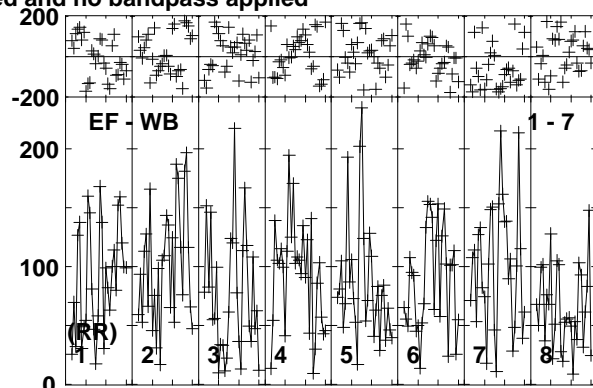
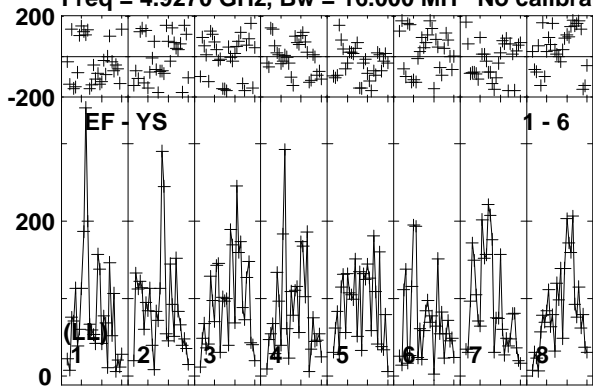

Lower frame: Micro Ampl Jy Top frame: Phas deg
Vector averaged cross-power spectrum Baseline: EF (01) - YS (06)
Timerange: 01/09:10:53 to 01/09:14:19

Plot file version 497 created 26-MAR-2015 15:28:03

J0147+5840 EG082E.UVDATA.1

Freq = 4.9270 GHz, Bw = 16.000 MH No calibration applied and no bandpass applied

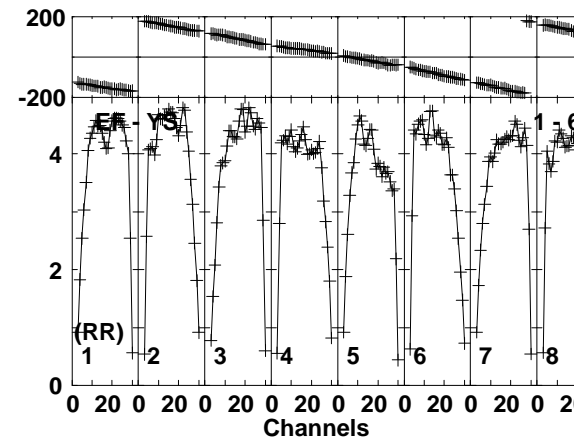
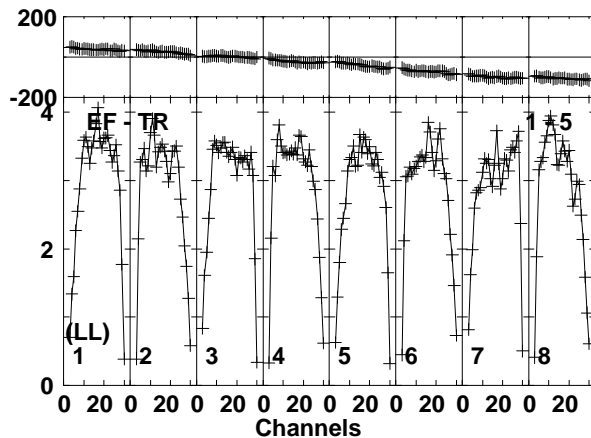
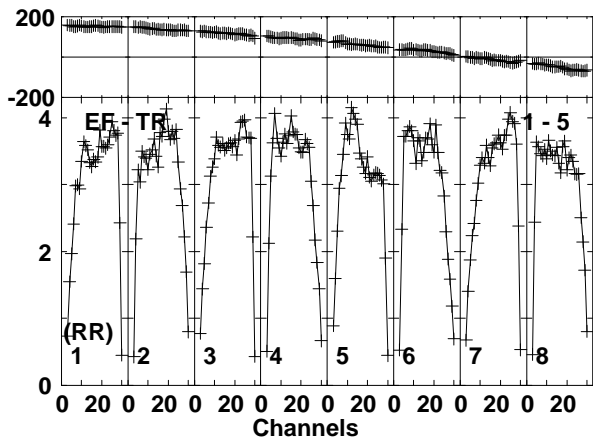
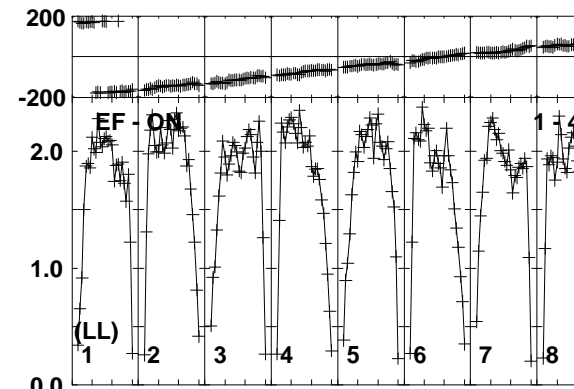
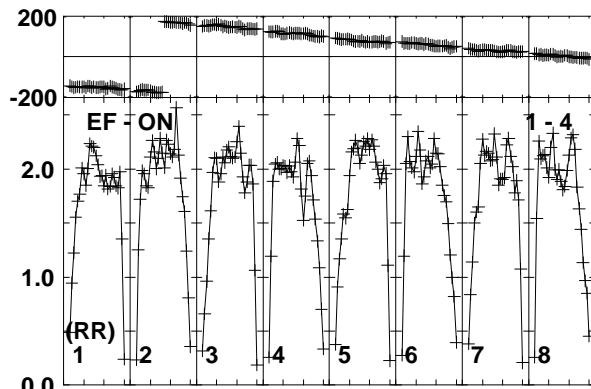
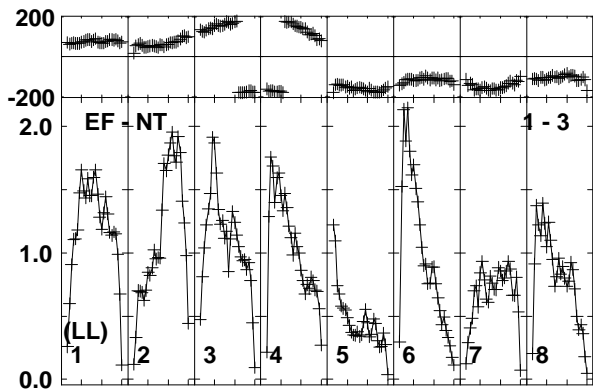
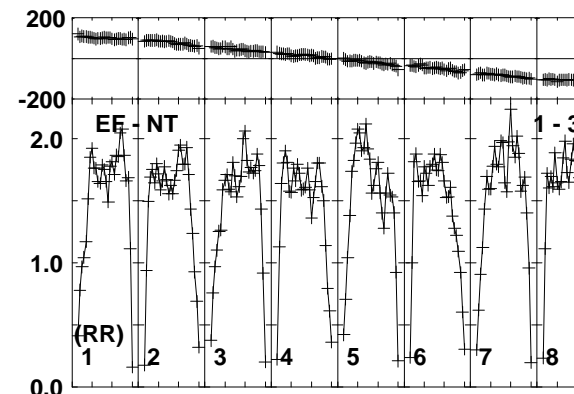
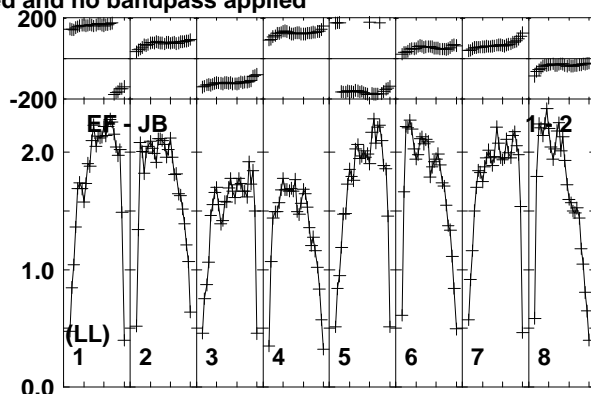
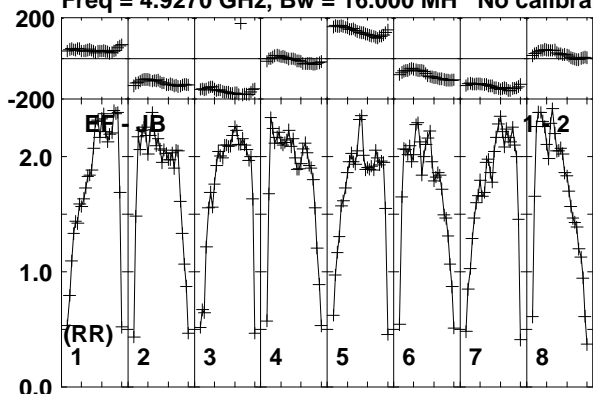

Lower frame: Milli Ampl Jy Top frame: Phas deg
Vector averaged cross-power spectrum Baseline: EF (01) - JB (02)
Timerange: 01/09:14:53 to 01/09:15:49

Plot file version 498 created 26-MAR-2015 15:28:03

J0147+5840 EG082E.UVDATA.1

Freq = 4.9270 GHz, Bw = 16.000 MH No calibration applied and no bandpass applied

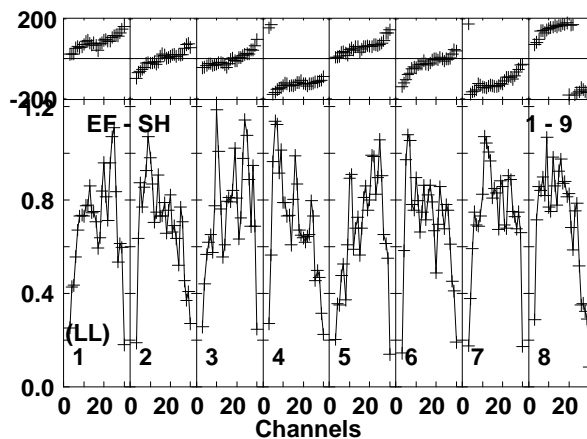
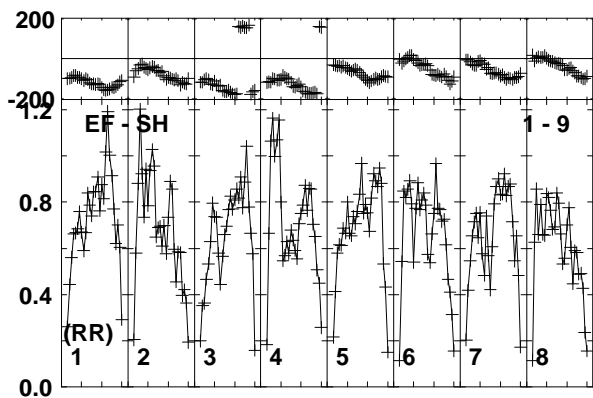
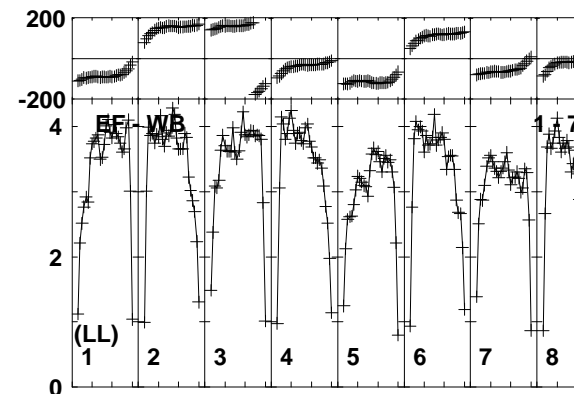
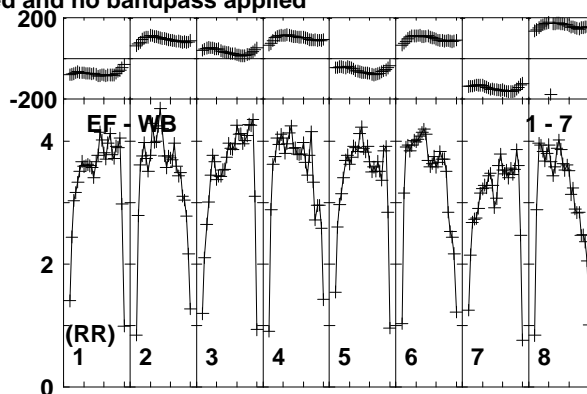
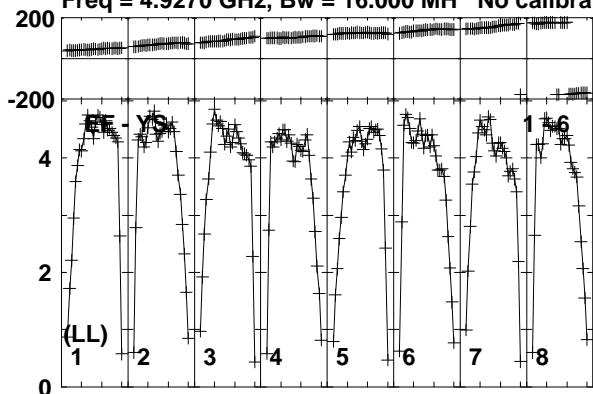

Lower frame: Milli Ampl Jy Top frame: Phas deg
Vector averaged cross-power spectrum Baseline: EF (01) - YS (06)
Timerange: 01/09:14:53 to 01/09:15:49

Plot file version 499 created 26-MAR-2015 15:28:03

V596CAS EG082E.UVDATA.1

Freq = 4.9270 GHz, Bw = 16.000 MH No calibration applied and no bandpass applied

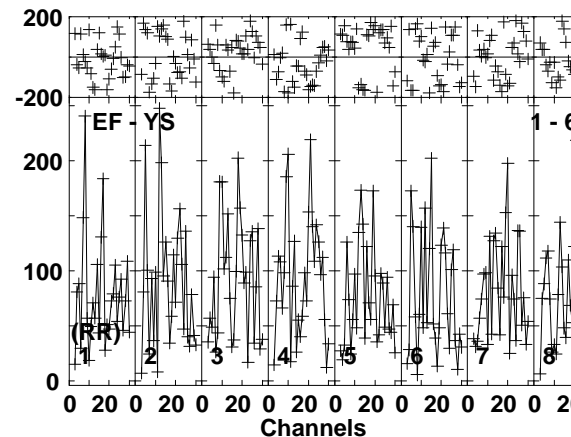
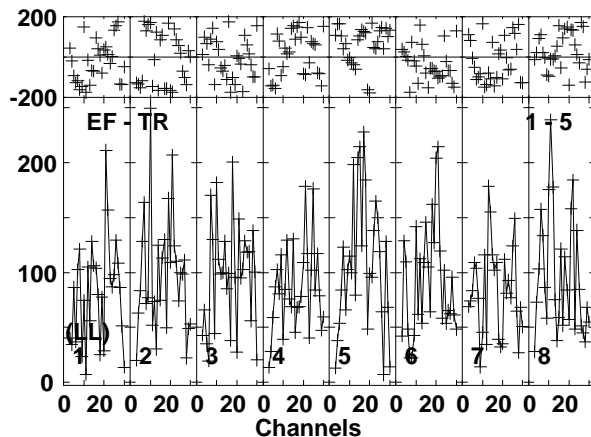
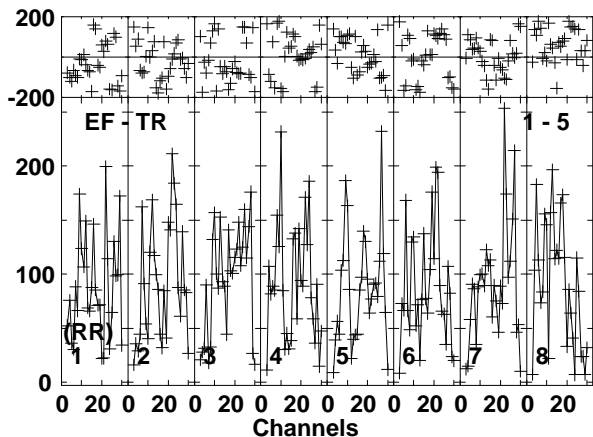
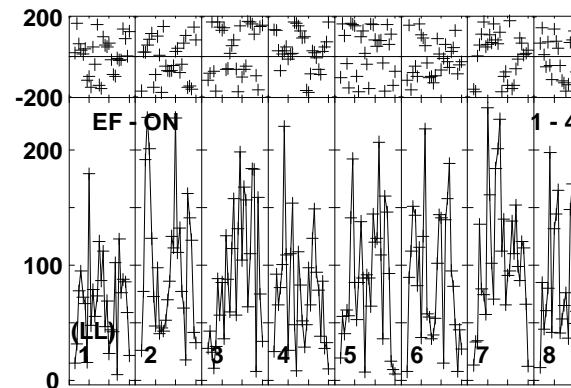
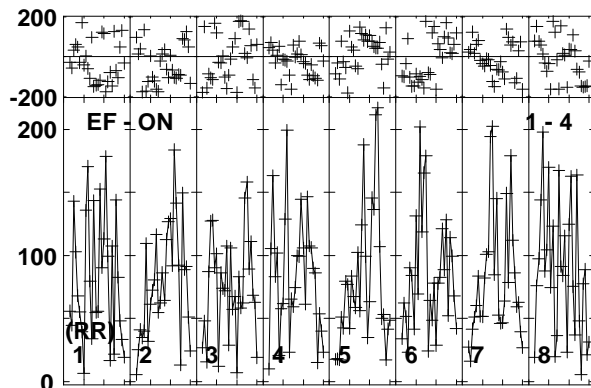
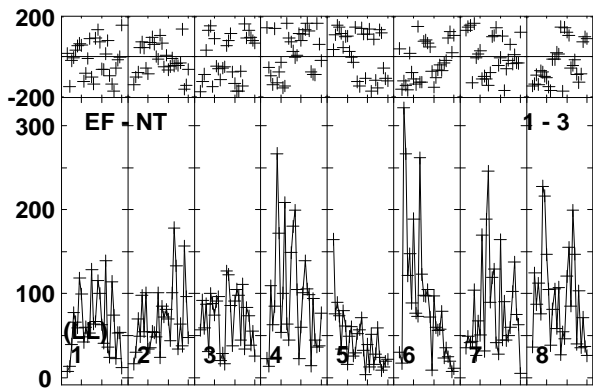
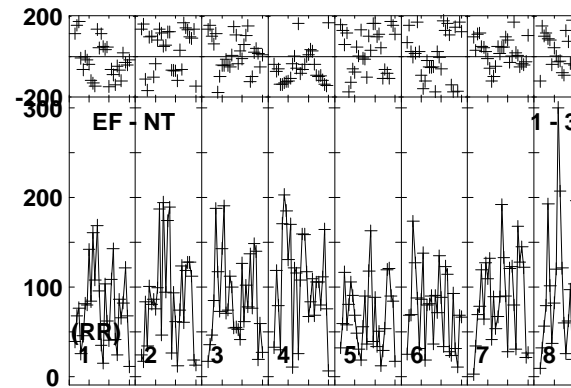
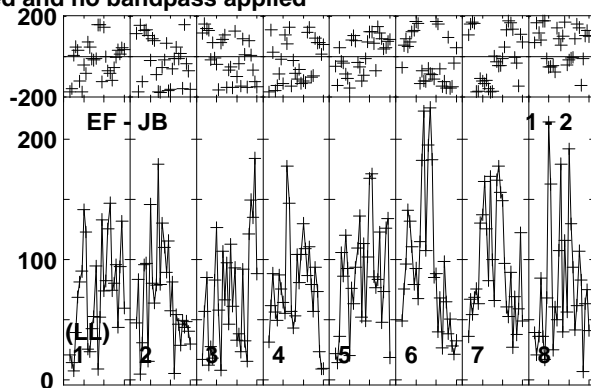
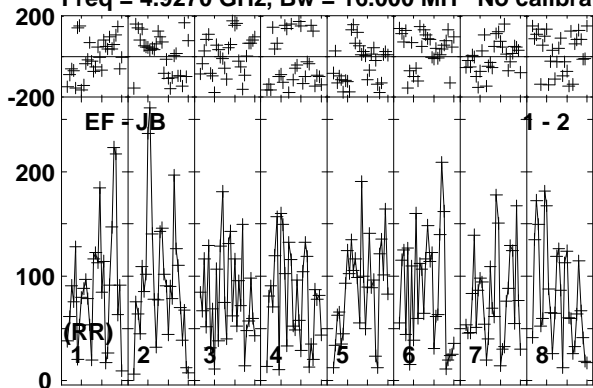

Lower frame: Micro Ampl Jy Top frame: Phas deg
Vector averaged cross-power spectrum Baseline: EF (01) - JB (02)
Timerange: 01/09:15:53 to 01/09:19:19

Plot file version 500 created 26-MAR-2015 15:28:04

V596CAS EG082E.UVDATA.1

Freq = 4.9270 GHz, Bw = 16.000 MH No calibration applied and no bandpass applied

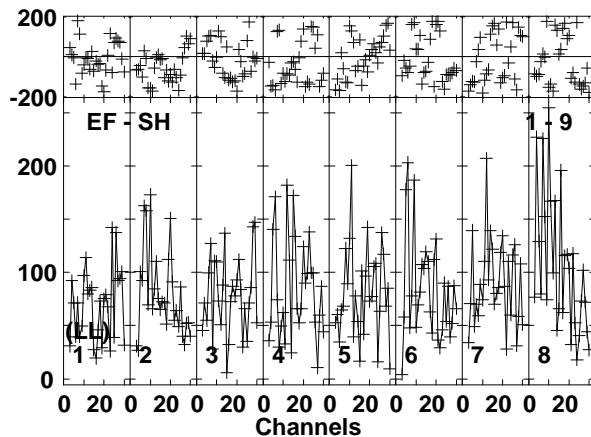
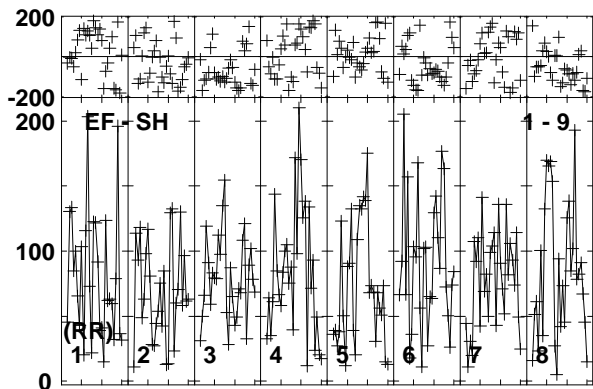
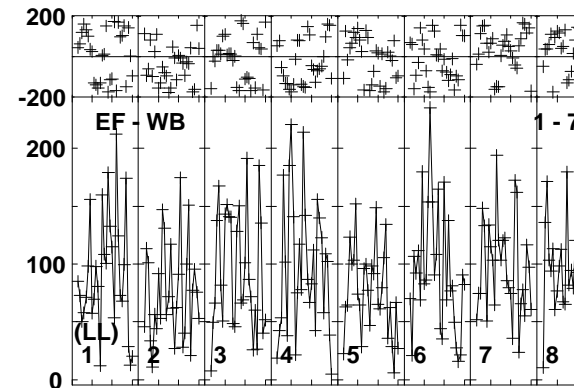
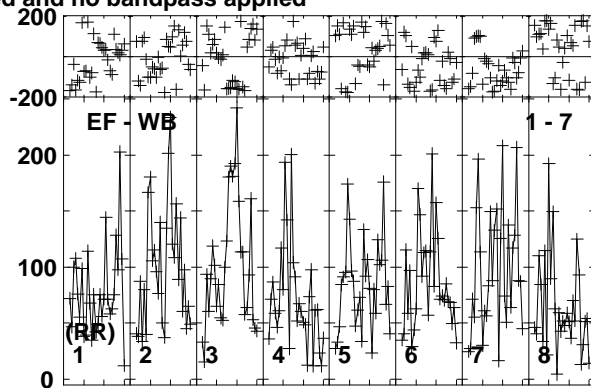
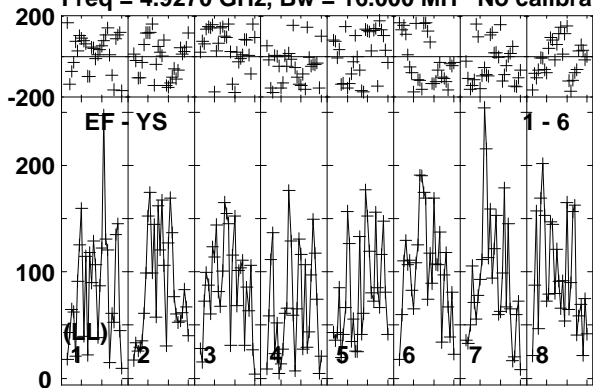

Lower frame: Micro Ampl Jy Top frame: Phas deg
Vector averaged cross-power spectrum Baseline: EF (01) - YS (06)
Timerange: 01/09:15:53 to 01/09:19:19

Plot file version 501 created 26-MAR-2015 15:28:04

J0147+5840 EG082E.UVDATA.1

Freq = 4.9270 GHz, Bw = 16.000 MH No calibration applied and no bandpass applied

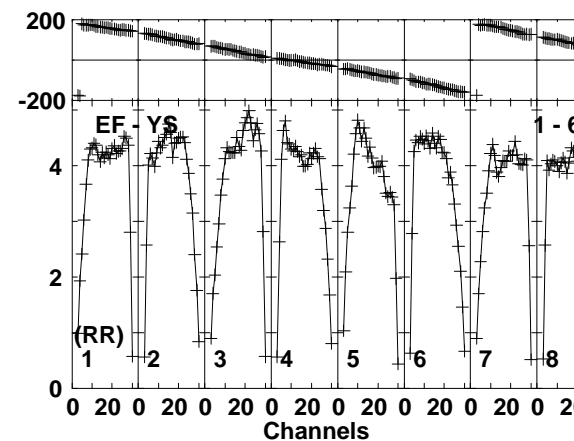
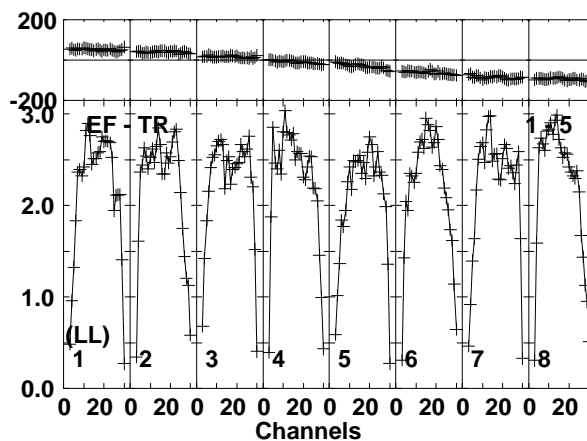
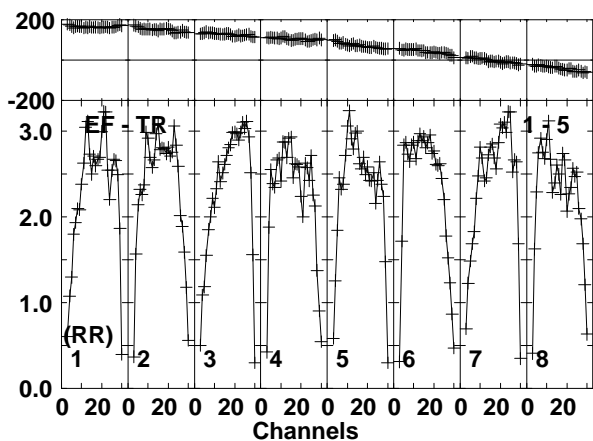
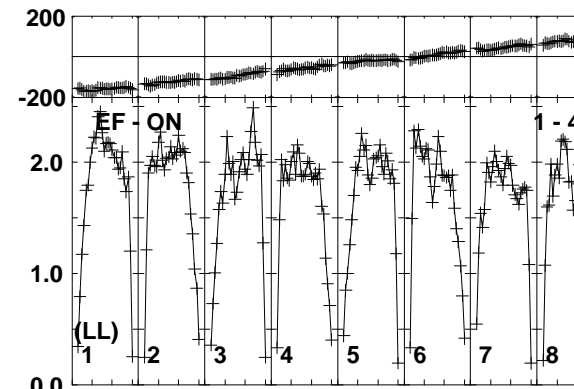
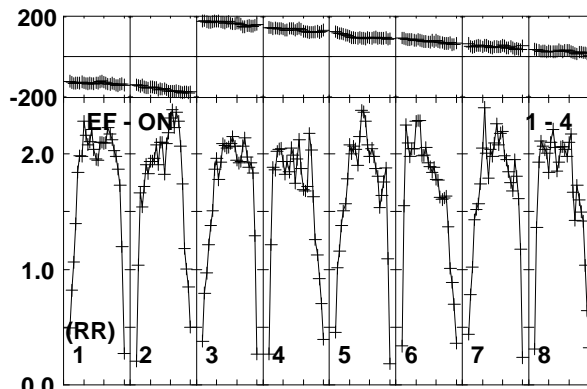
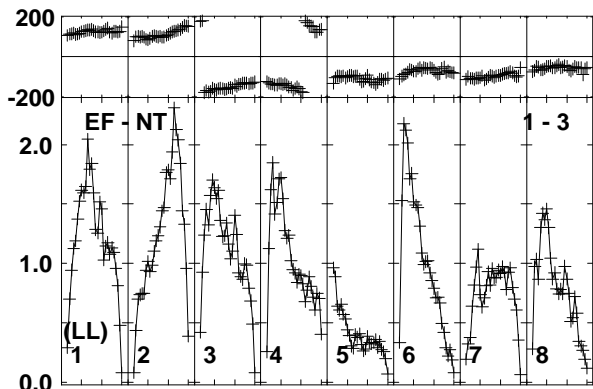
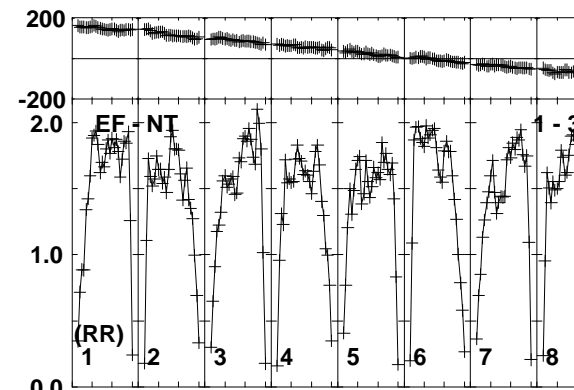
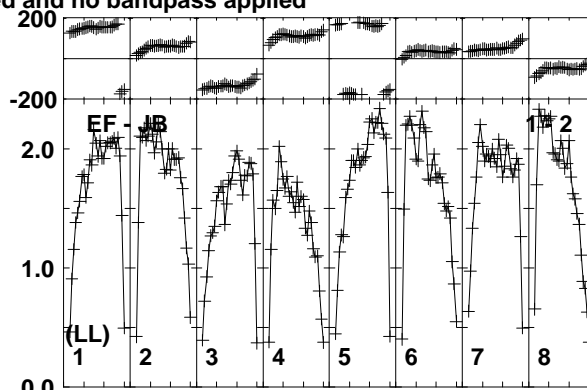
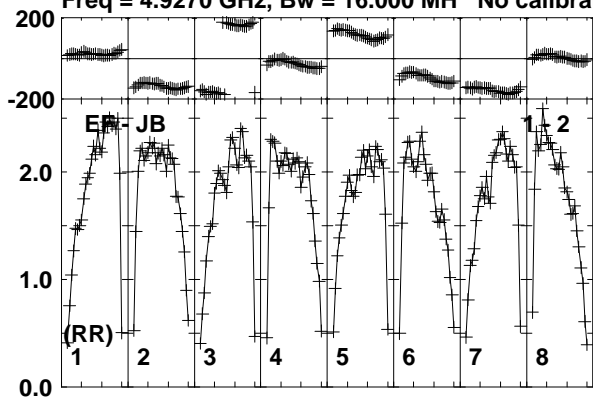

Lower frame: Milli Ampl Jy Top frame: Phas deg
Vector averaged cross-power spectrum Baseline: EF (01) - JB (02)
Timerange: 01/09:19:23 to 01/09:20:49

Plot file version 502 created 26-MAR-2015 15:28:04

J0147+5840 EG082E.UVDATA.1

Freq = 4.9270 GHz, Bw = 16.000 MH No calibration applied and no bandpass applied

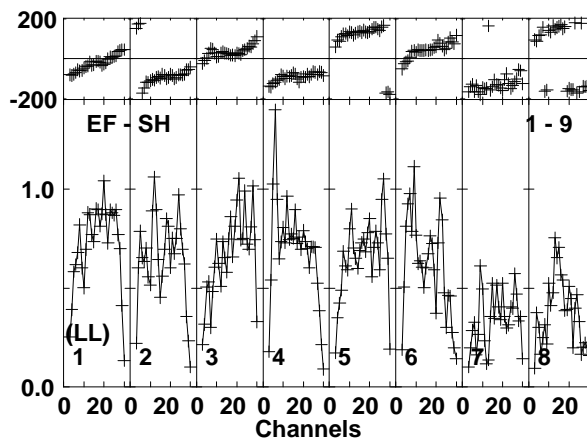
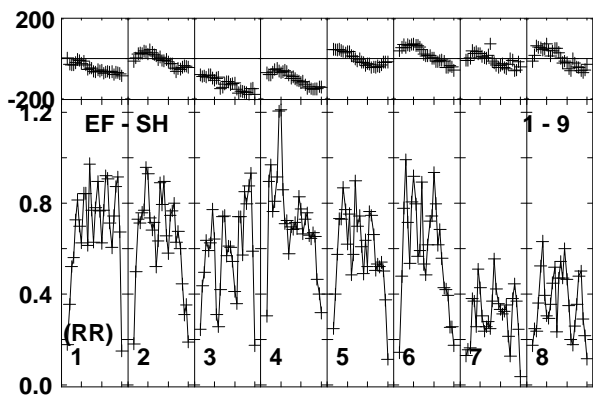
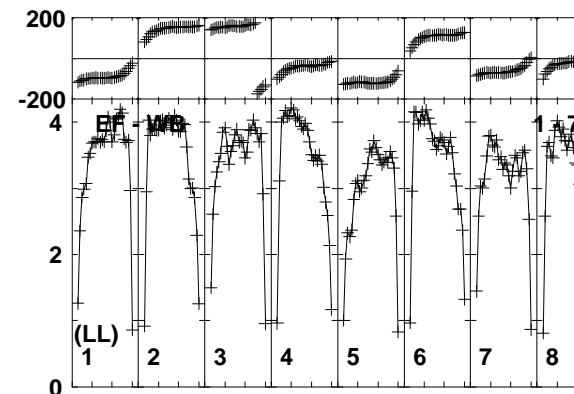
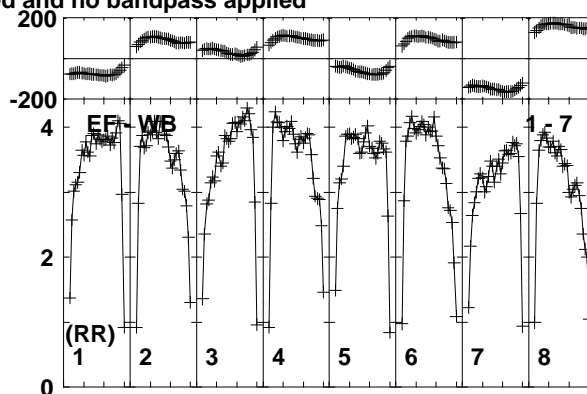
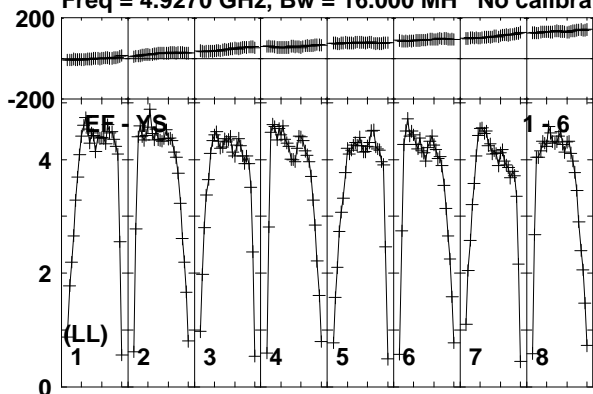

Lower frame: Milli Ampl Jy Top frame: Phas deg
Vector averaged cross-power spectrum Baseline: EF (01) - YS (06)
Timerange: 01/09:19:23 to 01/09:20:49

Plot file version 503 created 26-MAR-2015 15:28:04

J0151+5454 EG082E.UVDATA.1

Freq = 4.9270 GHz, Bw = 16.000 MH No calibration applied and no bandpass applied

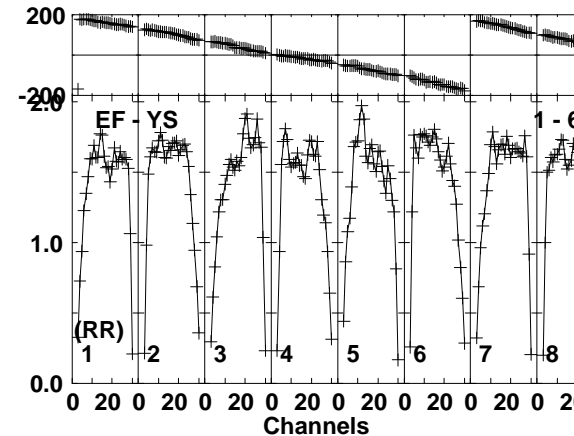
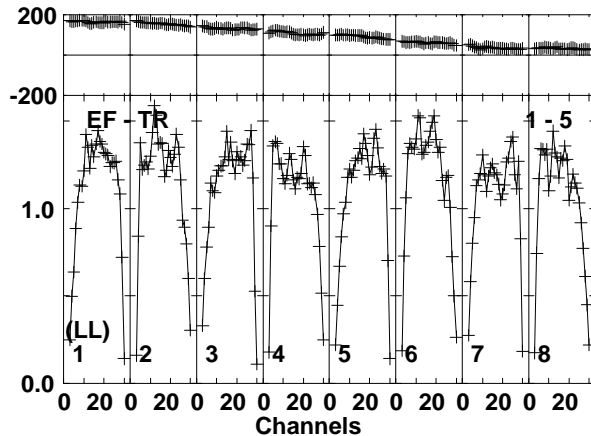
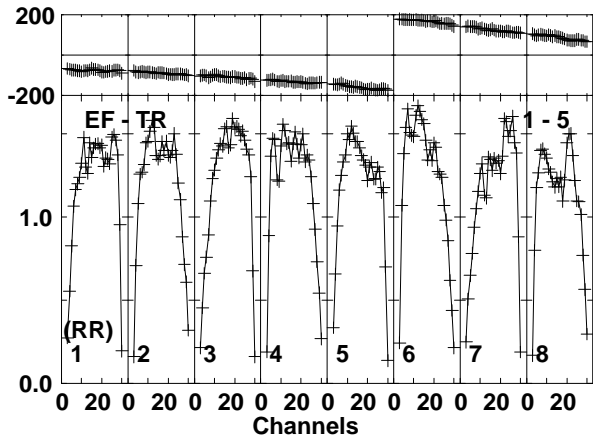
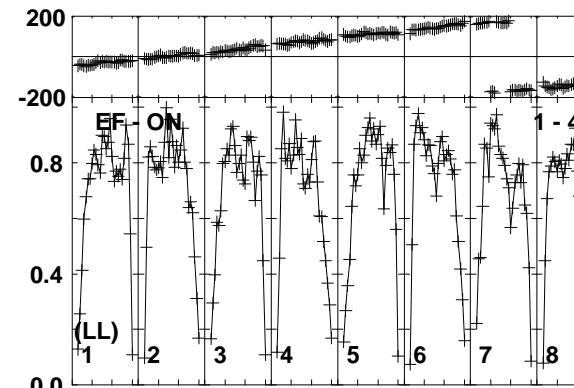
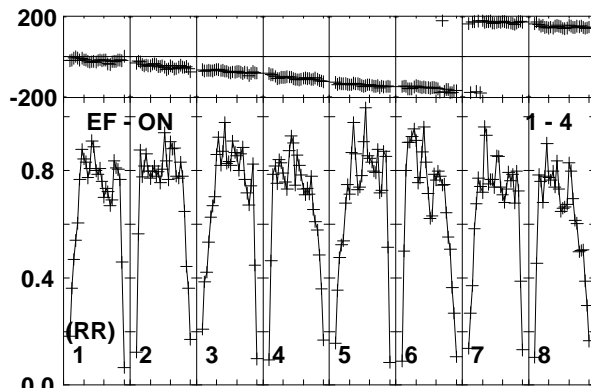
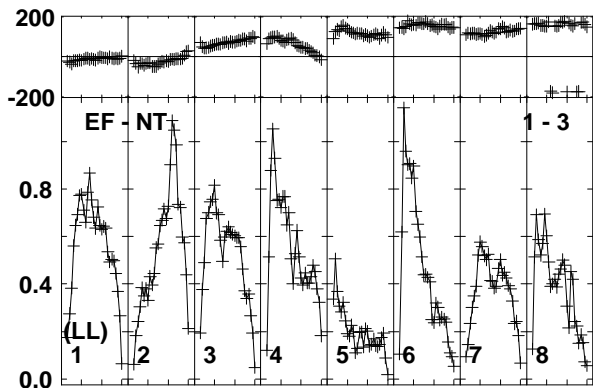
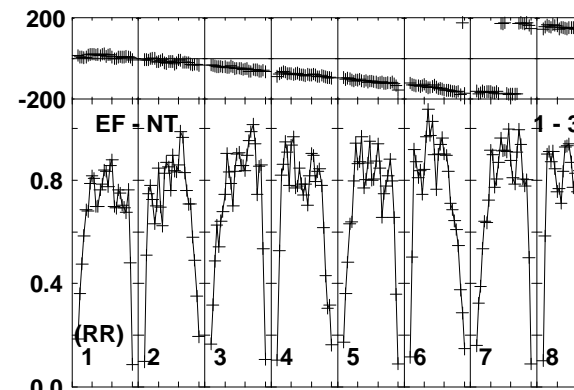
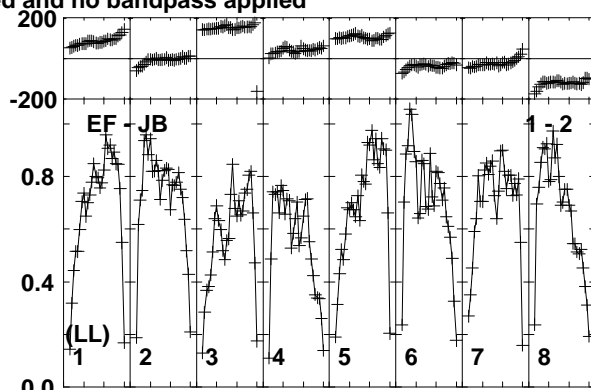
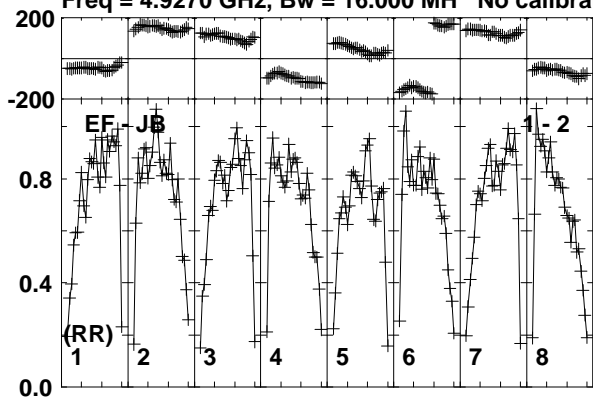

Lower frame: Milli Ampl Jy Top frame: Phas deg
Vector averaged cross-power spectrum Baseline: EF (01) - JB (02)
Timerange: 01/09:20:53 to 01/09:24:19

Plot file version 504 created 26-MAR-2015 15:28:04

J0151+5454 EG082E.UVDATA.1

Freq = 4.9270 GHz, Bw = 16.000 MH No calibration applied and no bandpass applied

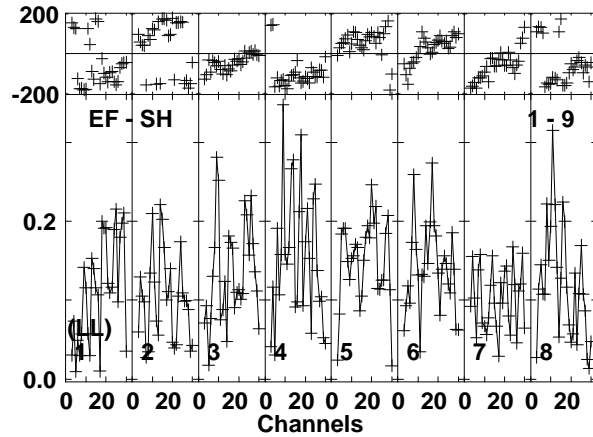
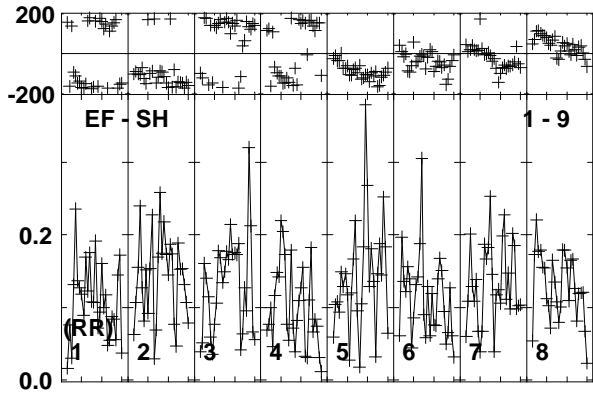
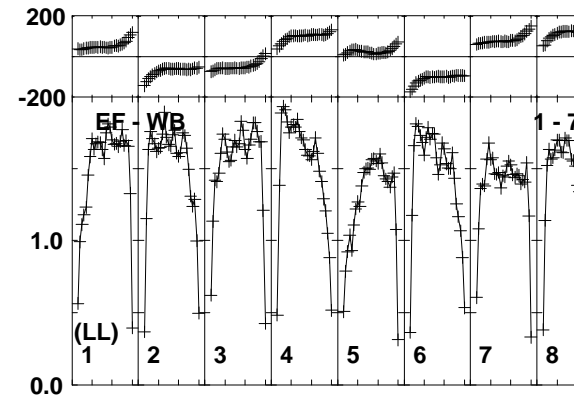
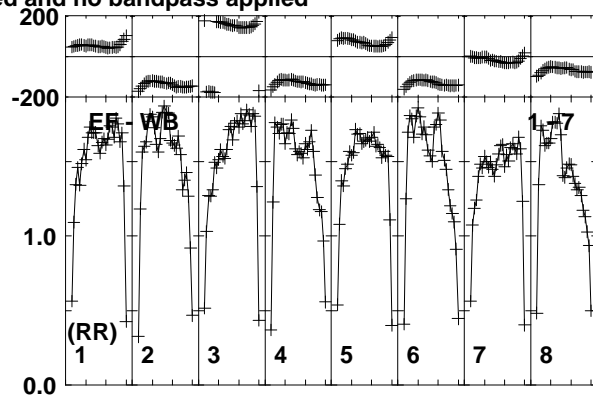
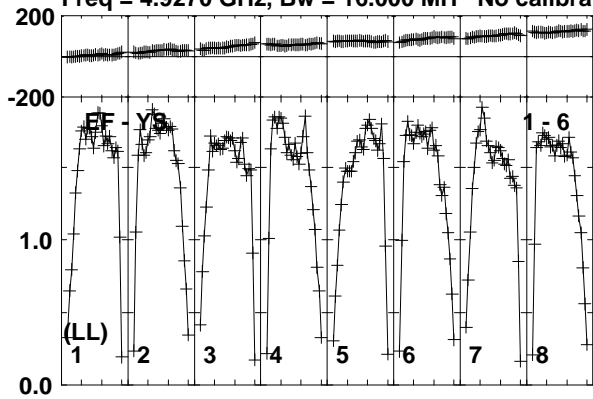

Lower frame: Milli Ampl Jy Top frame: Phas deg
Vector averaged cross-power spectrum Baseline: EF (01) - YS (06)
Timerange: 01/09:20:53 to 01/09:24:19

Plot file version 505 created 26-MAR-2015 15:28:04

J0147+5840 EG082E.UVDATA.1

Freq = 4.9270 GHz, Bw = 16.000 MH No calibration applied and no bandpass applied

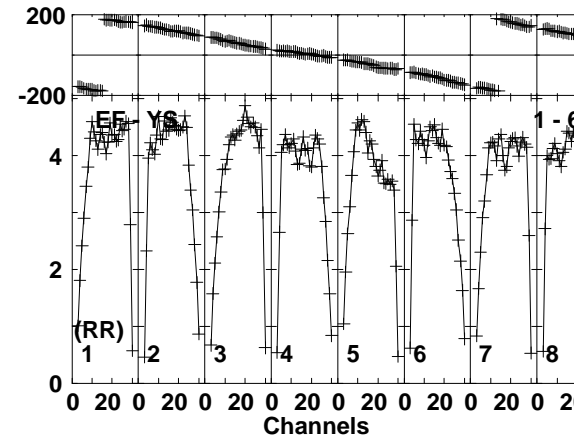
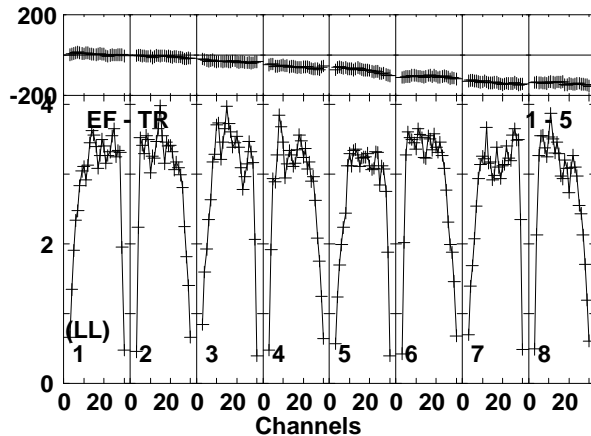
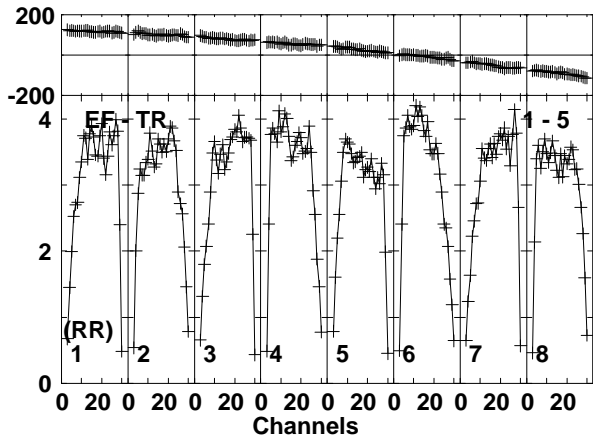
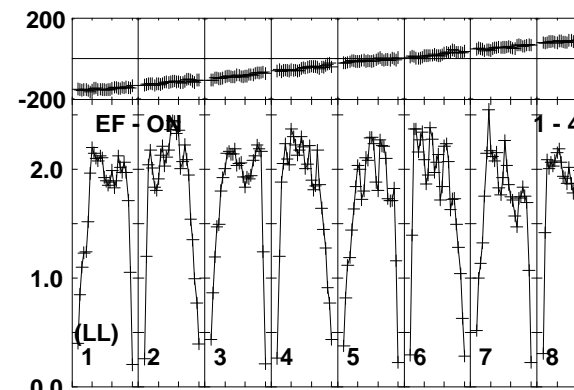
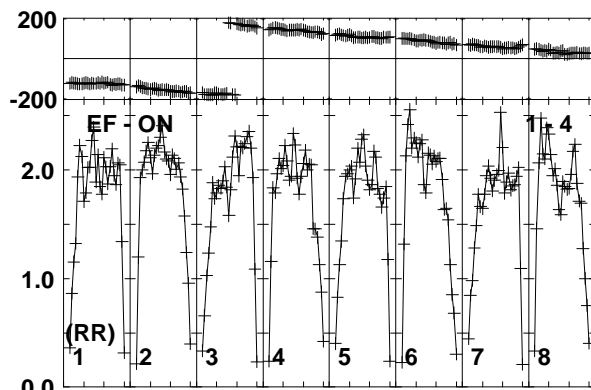
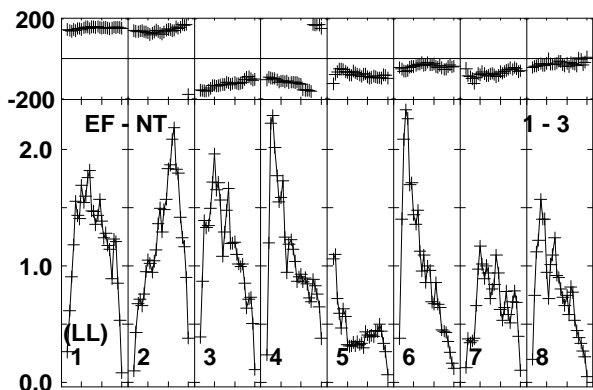
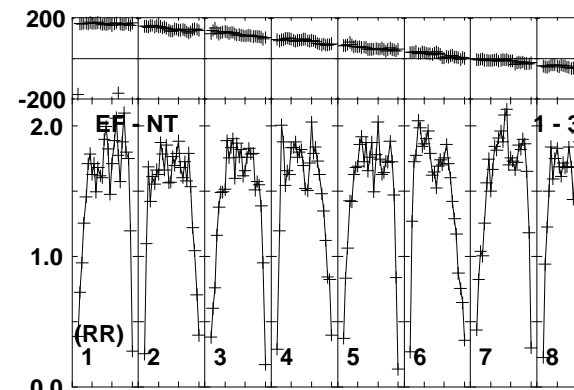
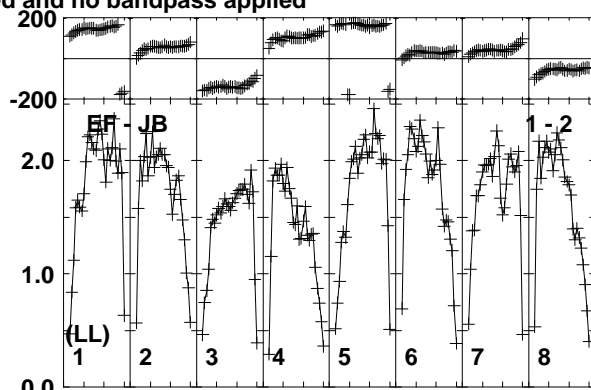
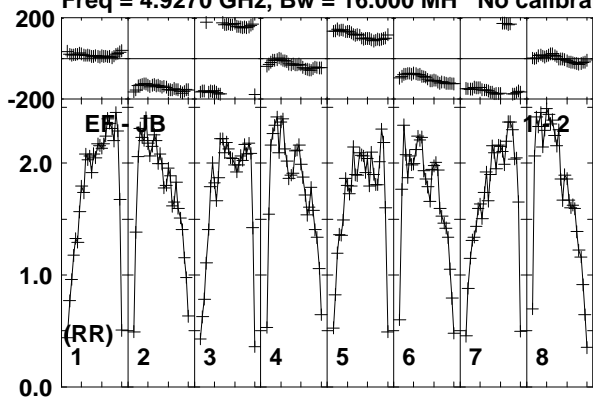

Lower frame: Milli Ampl Jy Top frame: Phas deg
Vector averaged cross-power spectrum Baseline: EF (01) - JB (02)
Timerange: 01/09:24:53 to 01/09:25:49

Plot file version 506 created 26-MAR-2015 15:28:04

J0147+5840 EG082E.UVDATA.1

Freq = 4.9270 GHz, Bw = 16.000 MH No calibration applied and no bandpass applied

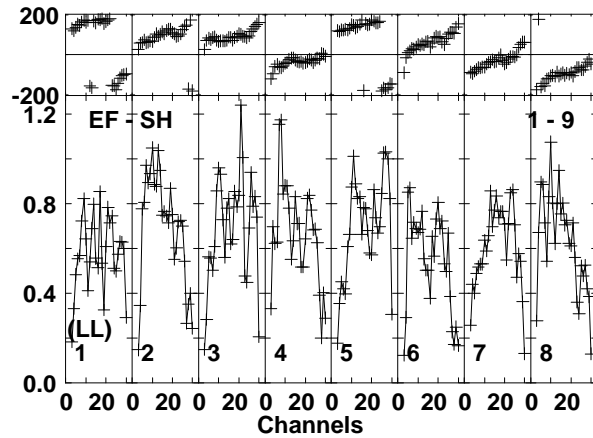
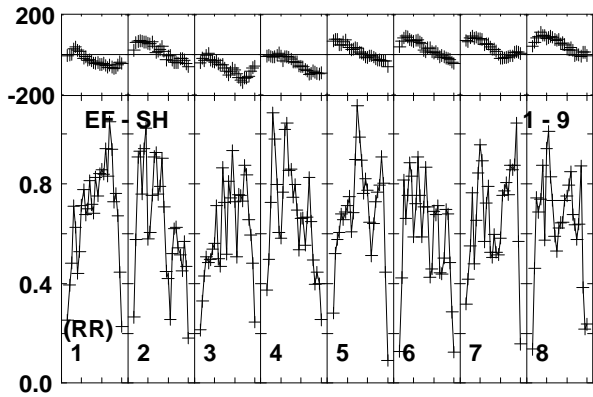
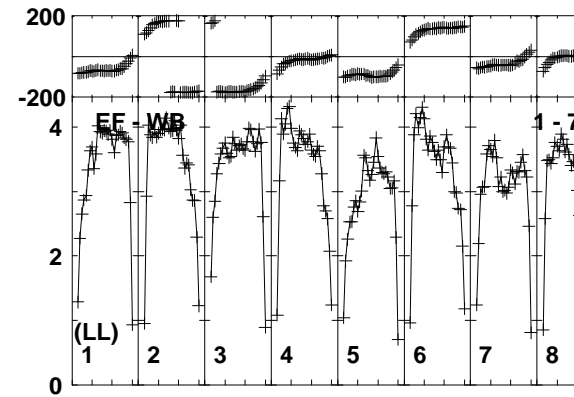
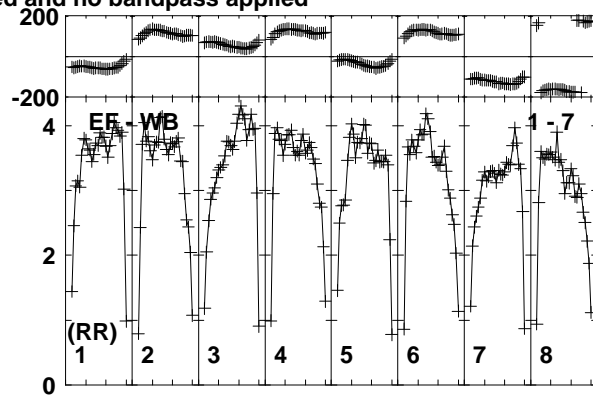
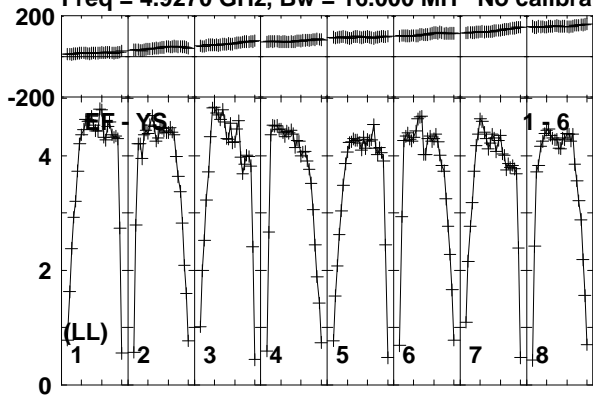

Lower frame: Milli Ampl Jy Top frame: Phas deg
Vector averaged cross-power spectrum Baseline: EF (01) - YS (06)
Timerange: 01/09:24:53 to 01/09:25:49

Plot file version 507 created 26-MAR-2015 15:28:04

V596CAS EG082E.UVDATA.1

Freq = 4.9270 GHz, Bw = 16.000 MH No calibration applied and no bandpass applied

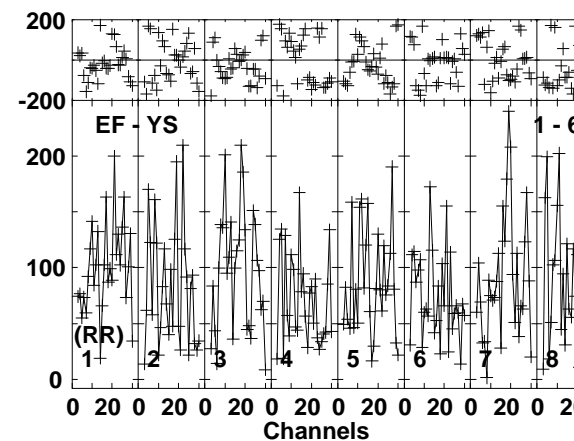
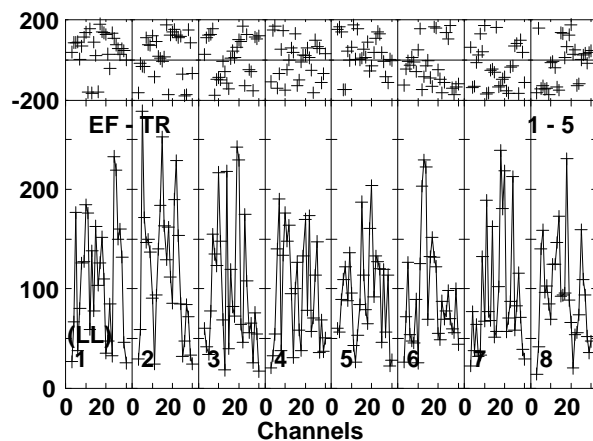
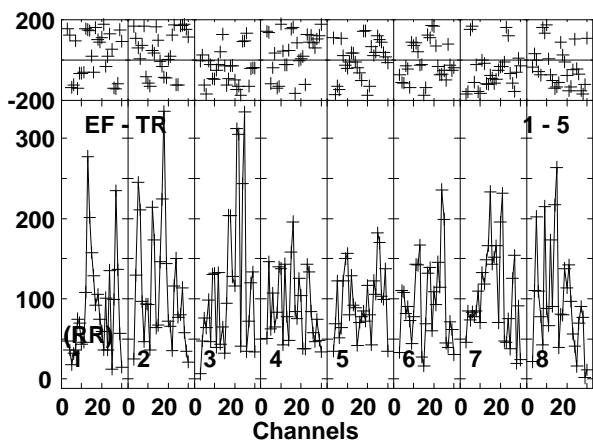
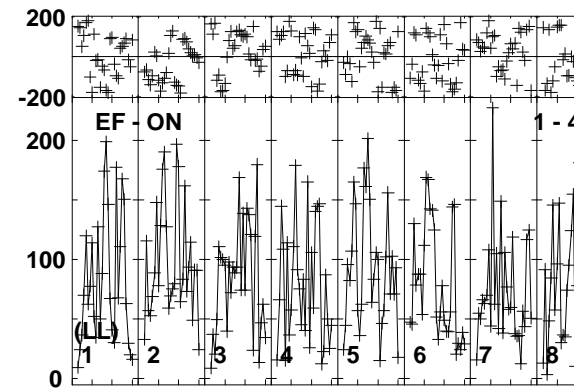
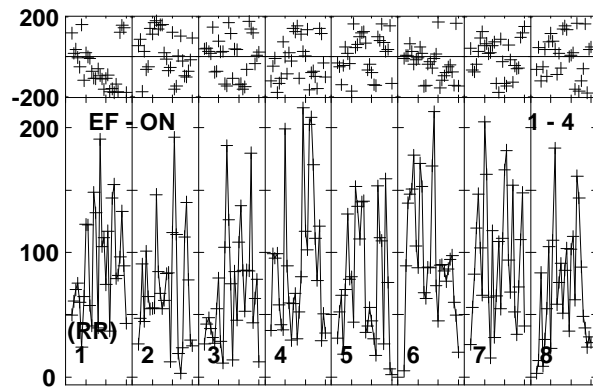
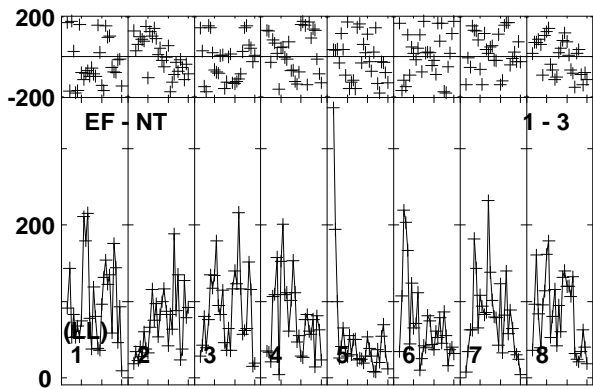
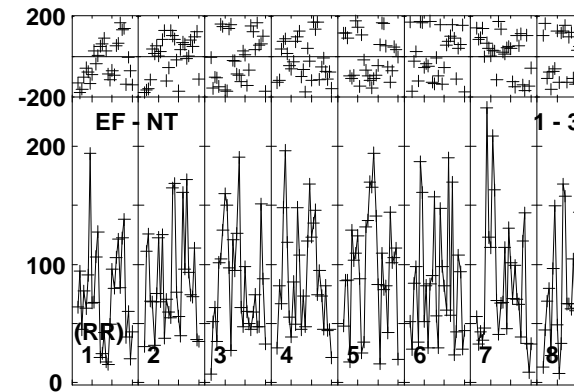
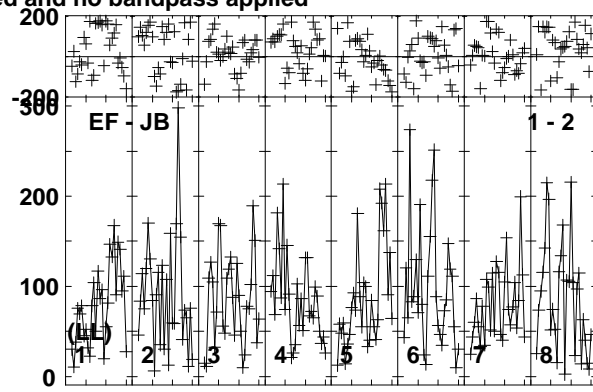
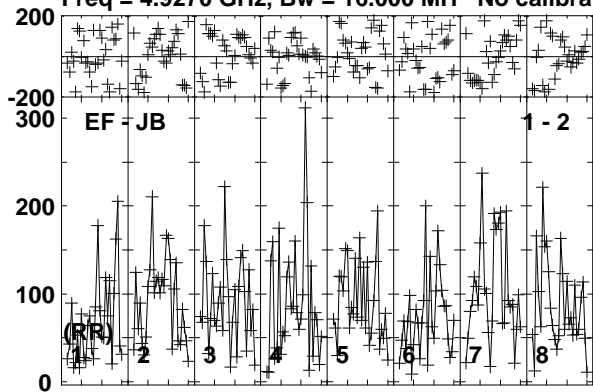

Lower frame: Micro Ampl Jy Top frame: Phas deg
Vector averaged cross-power spectrum Baseline: EF (01) - JB (02)
Timerange: 01/09:25:53 to 01/09:29:19

Plot file version 508 created 26-MAR-2015 15:28:04

V596CAS EG082E.UVDATA.1

Freq = 4.9270 GHz, Bw = 16.000 MH No calibration applied and no bandpass applied

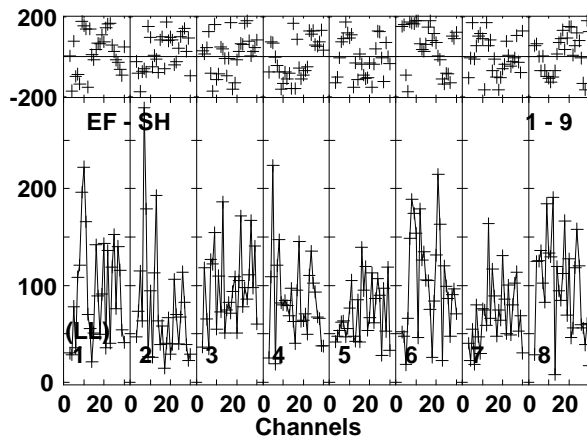
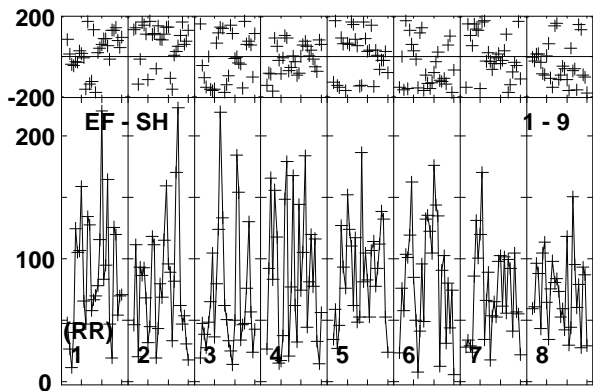
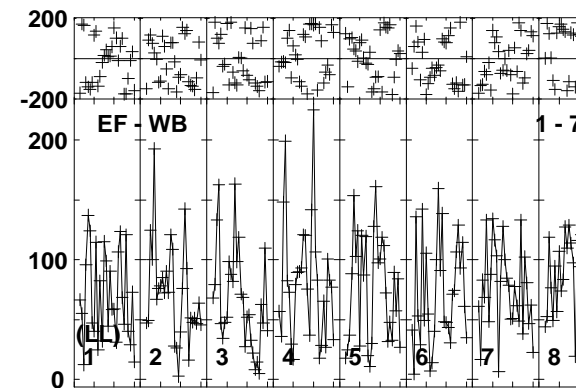
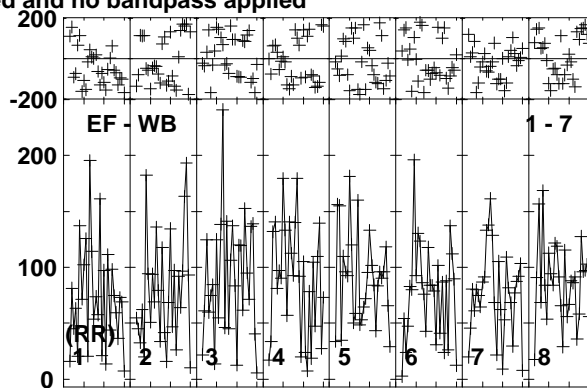
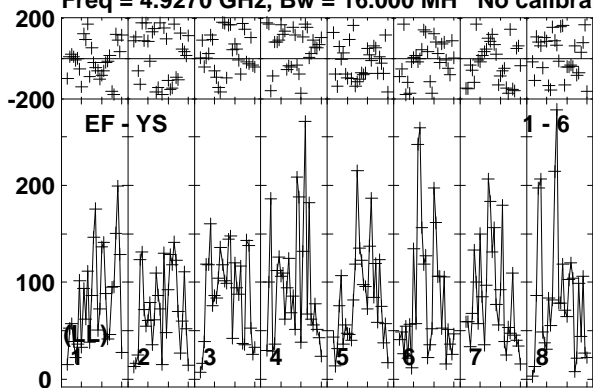

Lower frame: Micro Ampl Jy Top frame: Phas deg
Vector averaged cross-power spectrum Baseline: EF (01) - YS (06)
Timerange: 01/09:25:53 to 01/09:29:19

Plot file version 509 created 26-MAR-2015 15:28:04

J0147+5840 EG082E.UVDATA.1

Freq = 4.9270 GHz, Bw = 16.000 MH No calibration applied and no bandpass applied

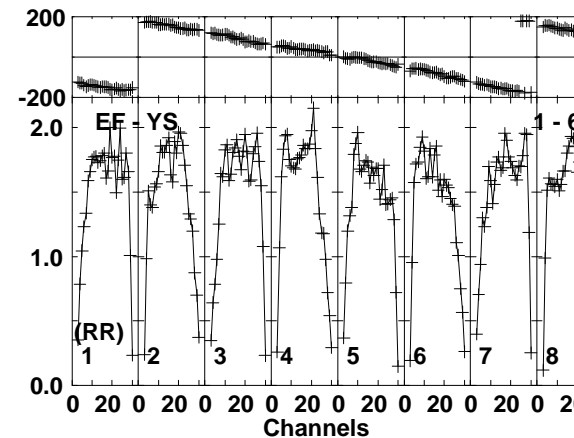
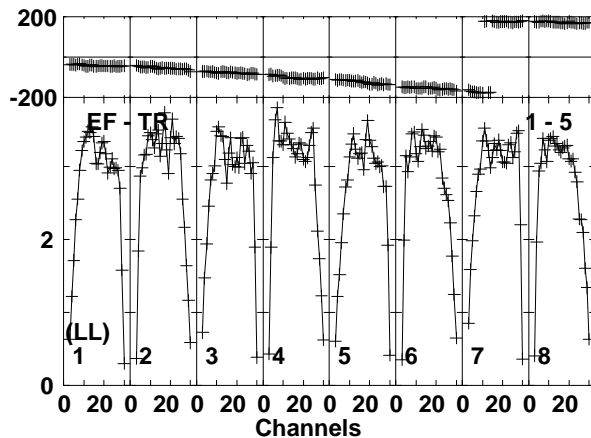
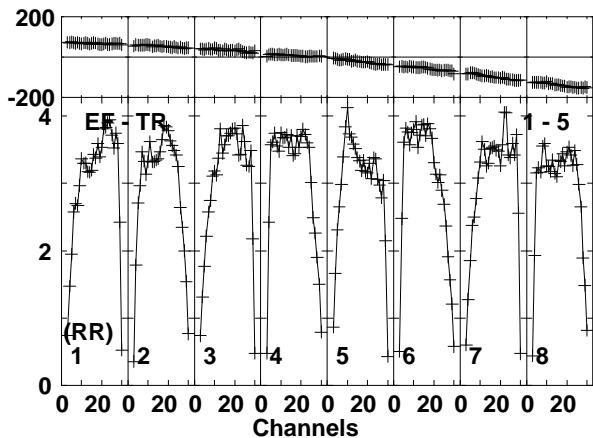
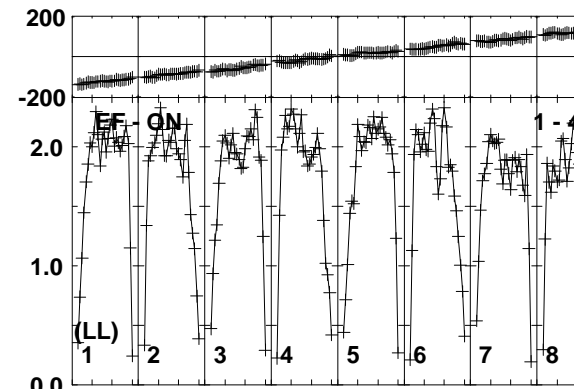
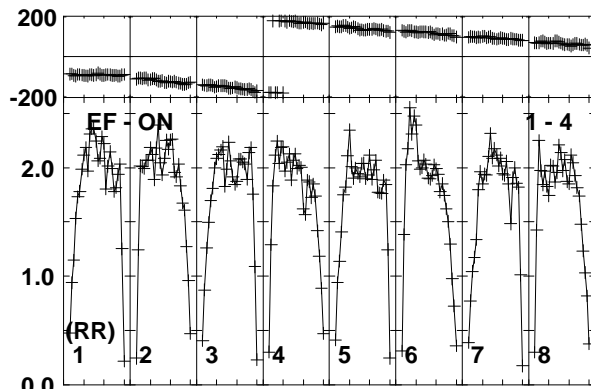
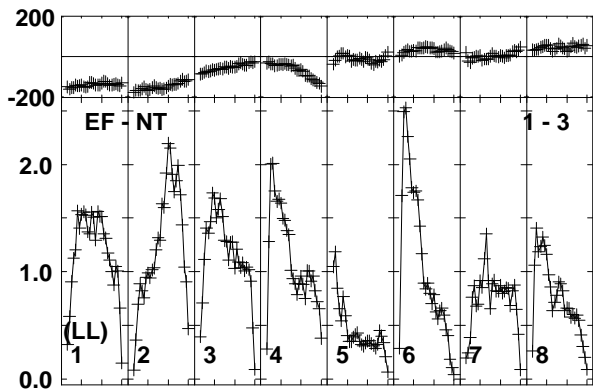
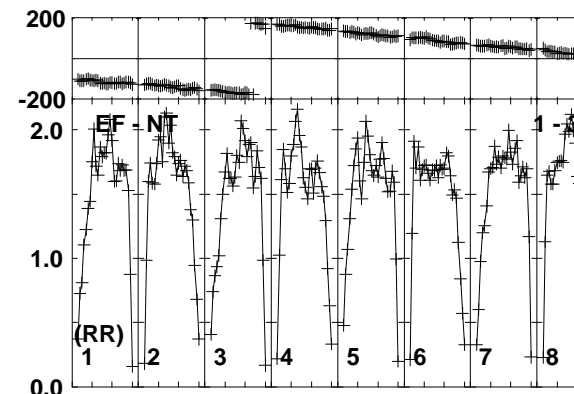
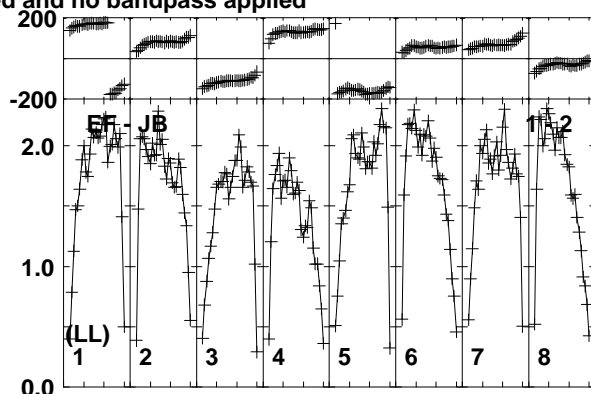
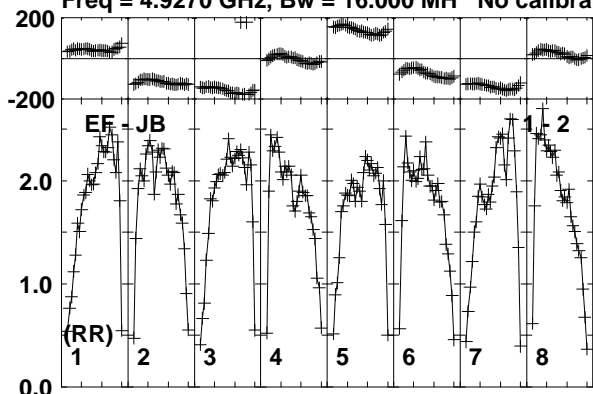

Lower frame: Milli Ampl Jy Top frame: Phas deg
Vector averaged cross-power spectrum Baseline: EF (01) - JB (02)
Timerange: 01/09:29:23 to 01/09:30:49

Plot file version 510 created 26-MAR-2015 15:28:04

J0147+5840 EG082E.UVDATA.1

Freq = 4.9270 GHz, Bw = 16.000 MH No calibration applied and no bandpass applied

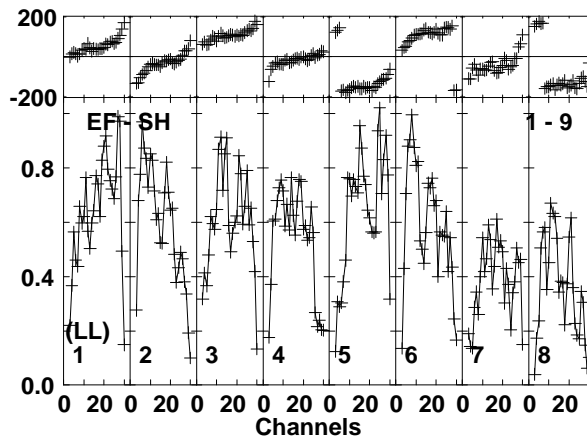
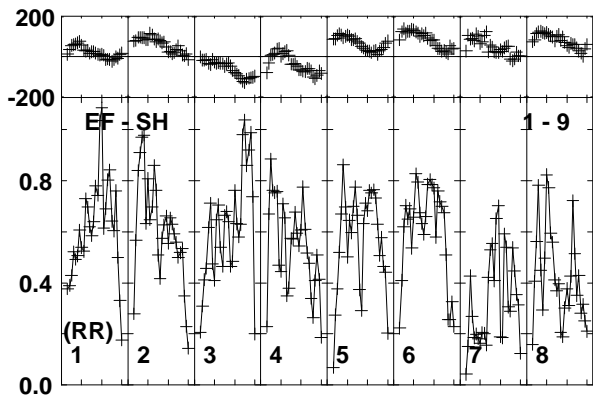
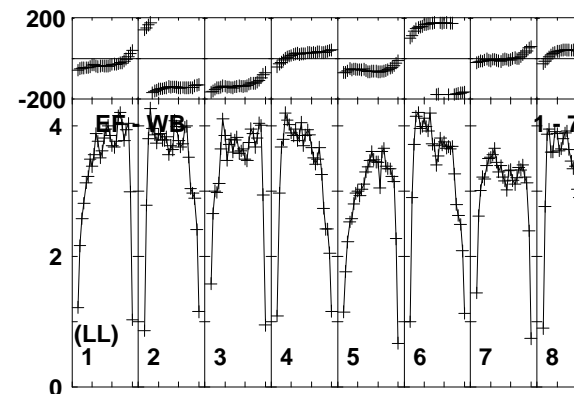
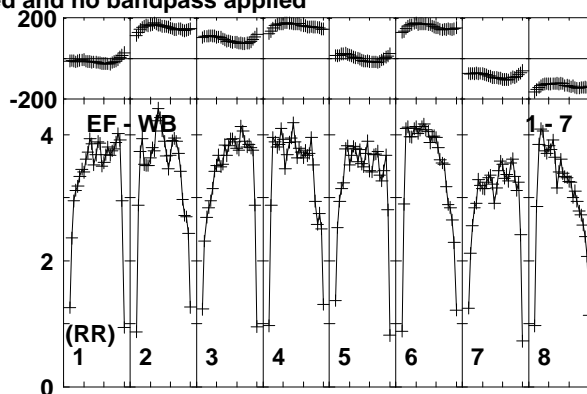
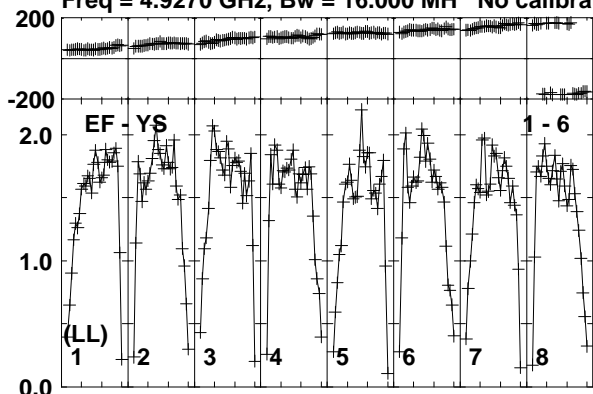

Lower frame: Milli Ampl Jy Top frame: Phas deg
Vector averaged cross-power spectrum Baseline: EF (01) - YS (06)
Timerange: 01/09:29:23 to 01/09:30:49

Plot file version 511 created 26-MAR-2015 15:28:04

V596CAS EG082E.UVDATA.1

Freq = 4.9270 GHz, Bw = 16.000 MH No calibration applied and no bandpass applied

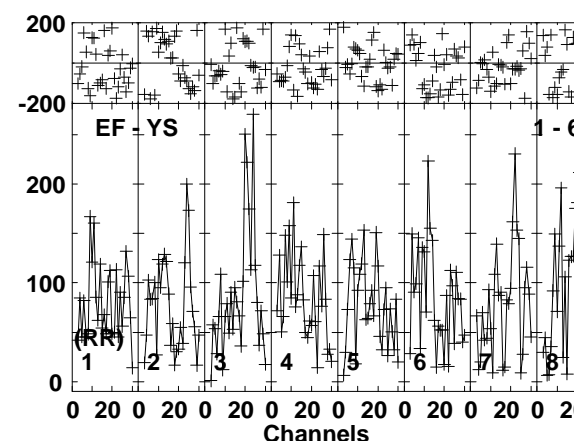
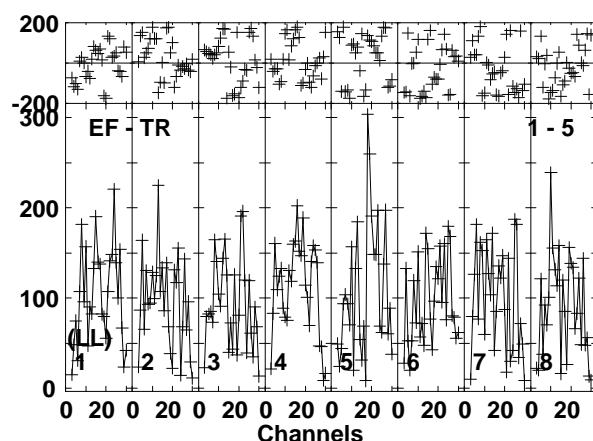
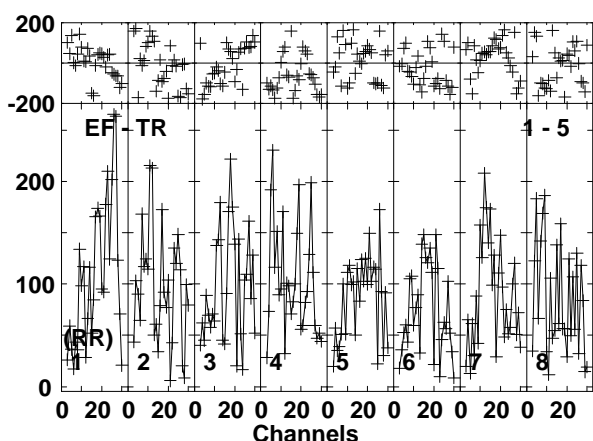
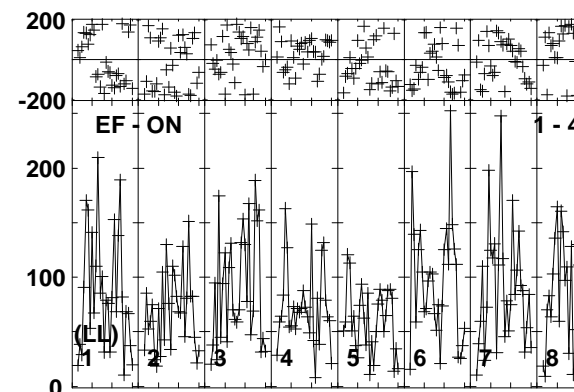
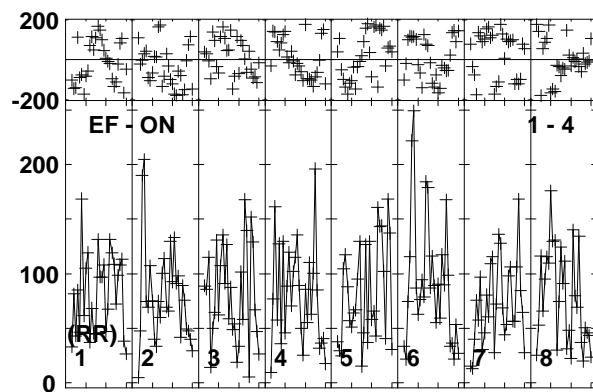
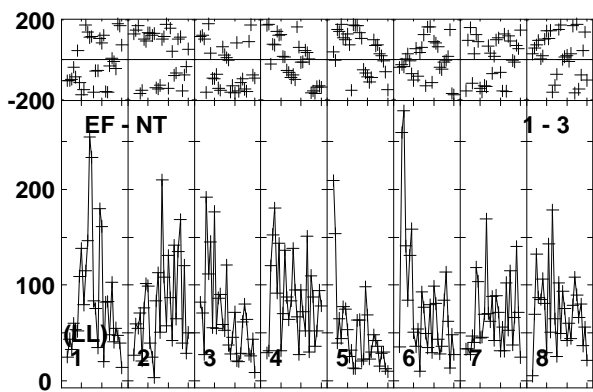
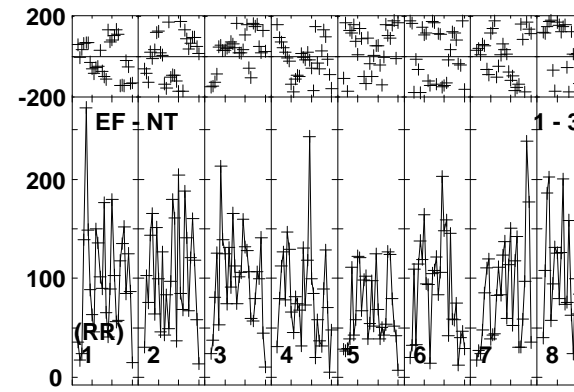
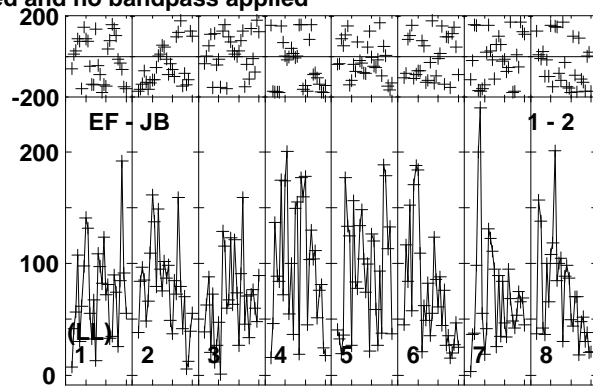
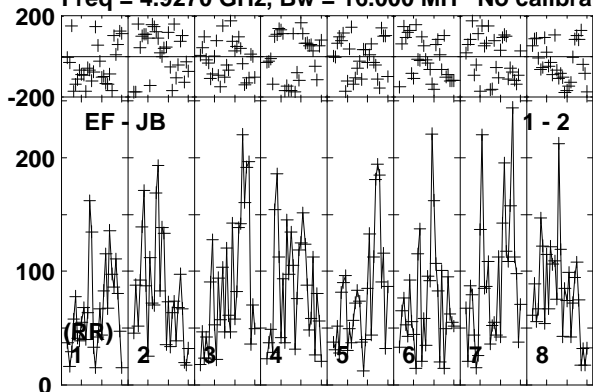

Lower frame: Micro Ampl Jy Top frame: Phas deg
Vector averaged cross-power spectrum Baseline: EF (01) - JB (02)
Timerange: 01/09:30:53 to 01/09:34:19

Plot file version 512 created 26-MAR-2015 15:28:04

V596CAS EG082E.UVDATA.1

Freq = 4.9270 GHz, Bw = 16.000 MH No calibration applied and no bandpass applied

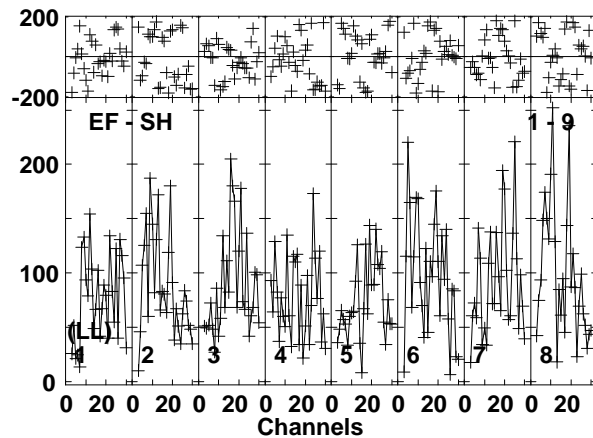
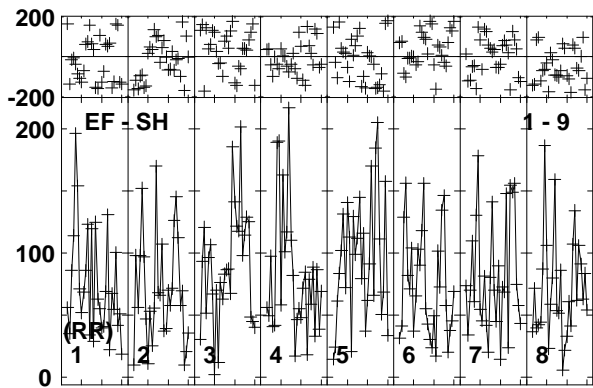
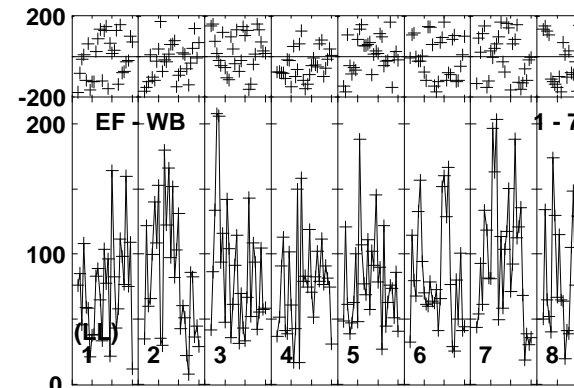
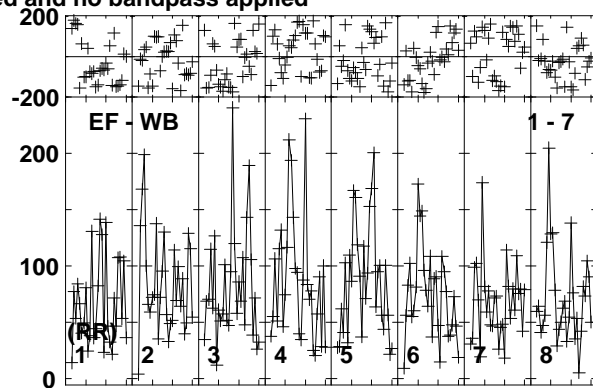
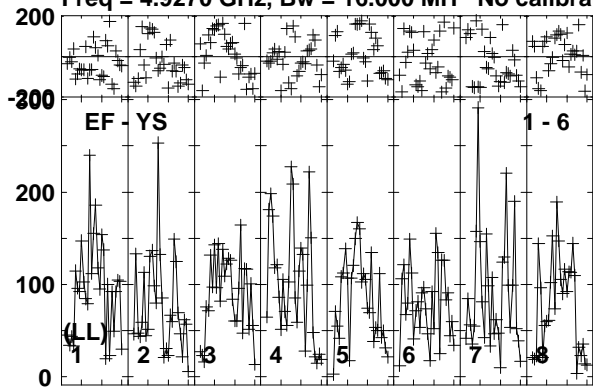

Lower frame: Micro Ampl Jy Top frame: Phas deg
Vector averaged cross-power spectrum Baseline: EF (01) - YS (06)
Timerange: 01/09:30:53 to 01/09:34:19

Plot file version 513 created 26-MAR-2015 15:28:04

J0147+5840 EG082E.UVDATA.1

Freq = 4.9270 GHz, Bw = 16.000 MH No calibration applied and no bandpass applied

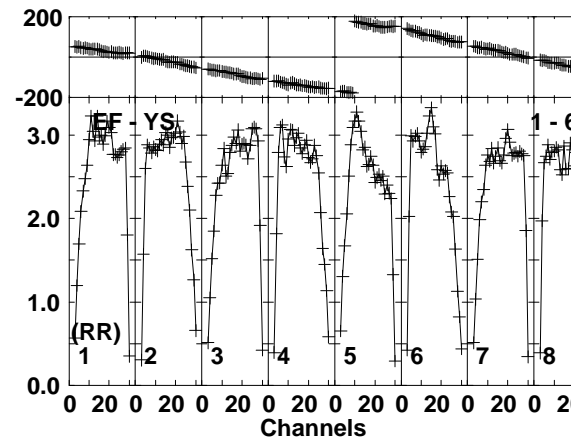
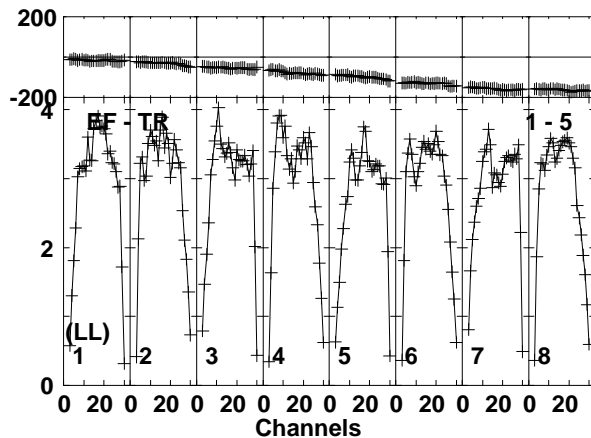
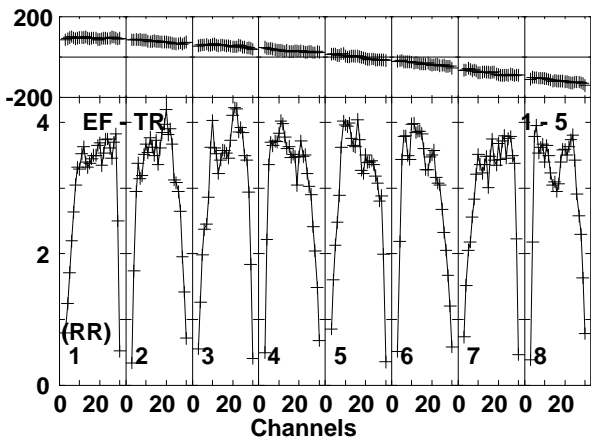
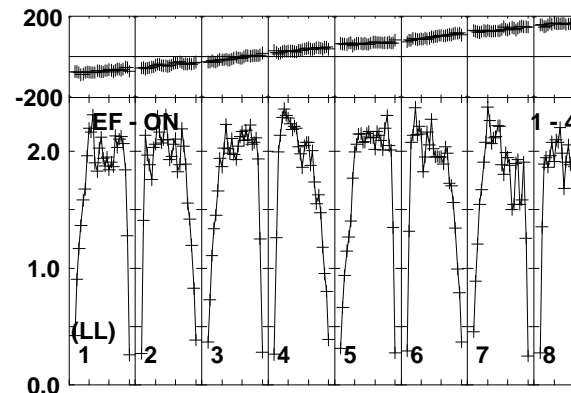
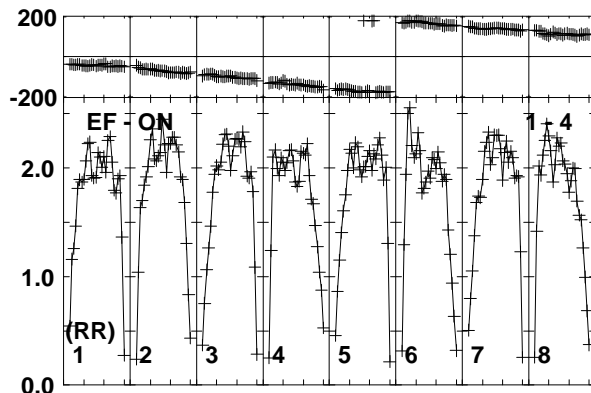
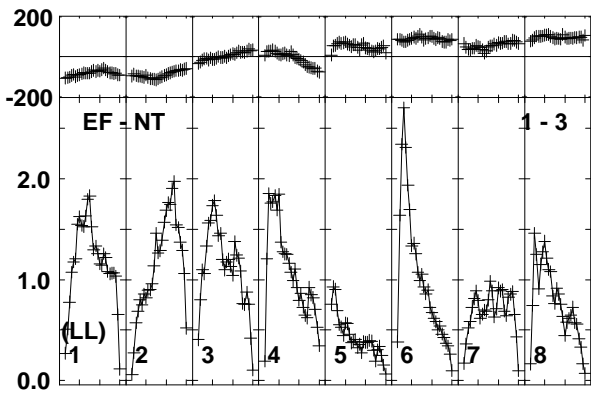
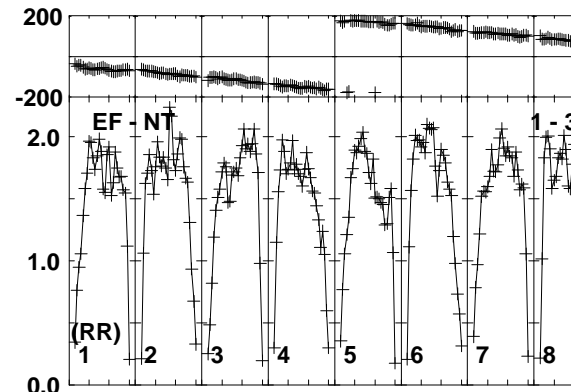
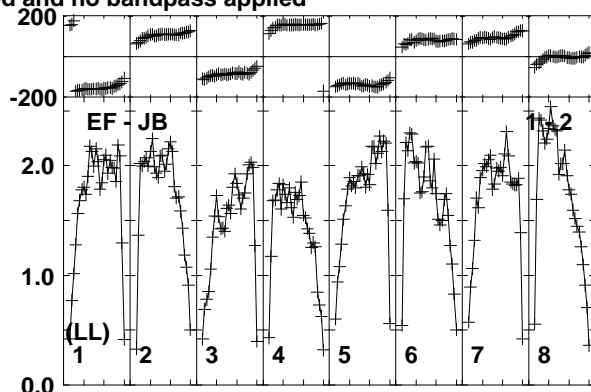
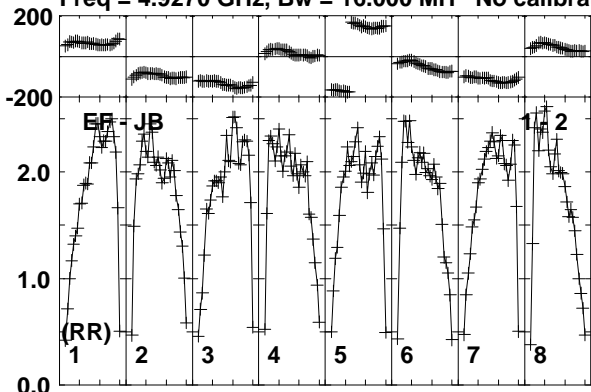

Lower frame: Milli Ampl Jy Top frame: Phas deg
Vector averaged cross-power spectrum Baseline: EF (01) - JB (02)
Timerange: 01/09:34:53 to 01/09:35:49

Plot file version 514 created 26-MAR-2015 15:28:04

J0147+5840 EG082E.UVDATA.1

Freq = 4.9270 GHz, Bw = 16.000 MH No calibration applied and no bandpass applied

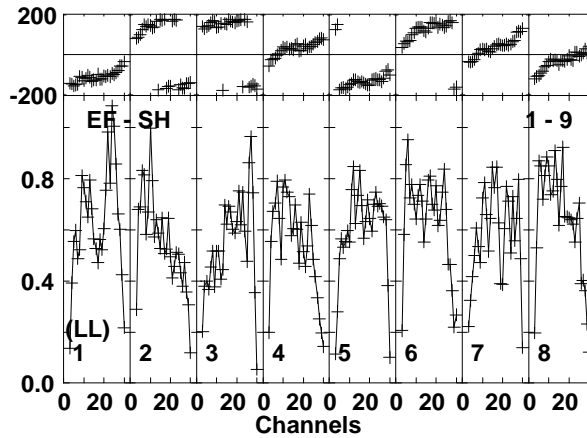
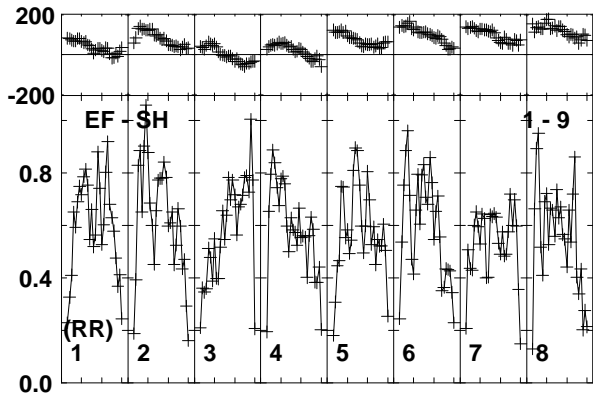
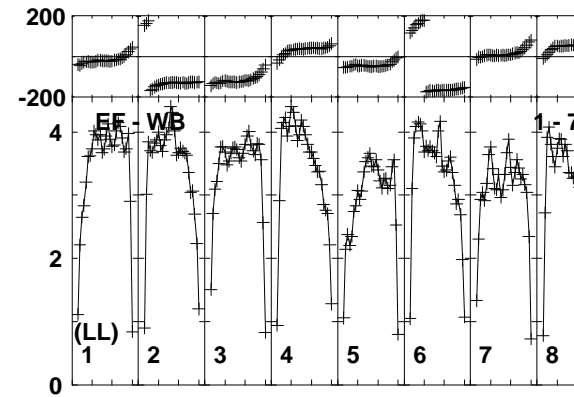
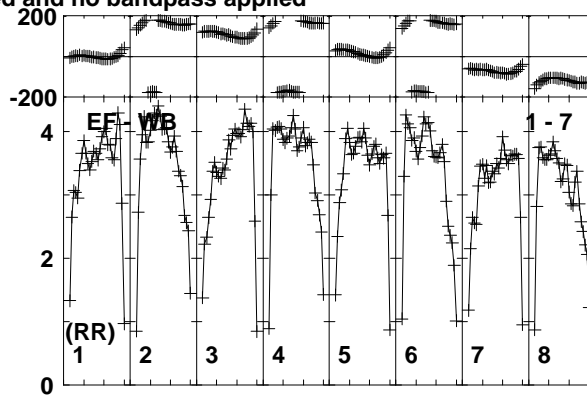
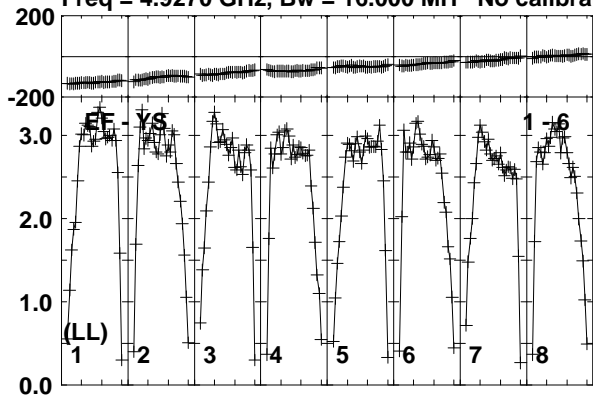

Lower frame: Milli Ampl Jy Top frame: Phas deg
Vector averaged cross-power spectrum Baseline: EF (01) - YS (06)
Timerange: 01/09:34:53 to 01/09:35:49

Plot file version 515 created 26-MAR-2015 15:28:04

V596CAS EG082E.UVDATA.1

Freq = 4.9270 GHz, Bw = 16.000 MH No calibration applied and no bandpass applied

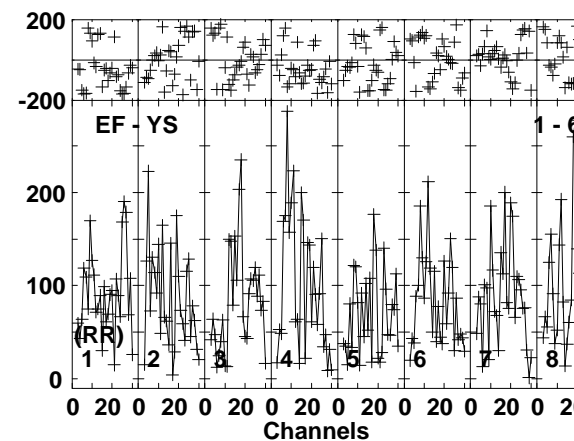
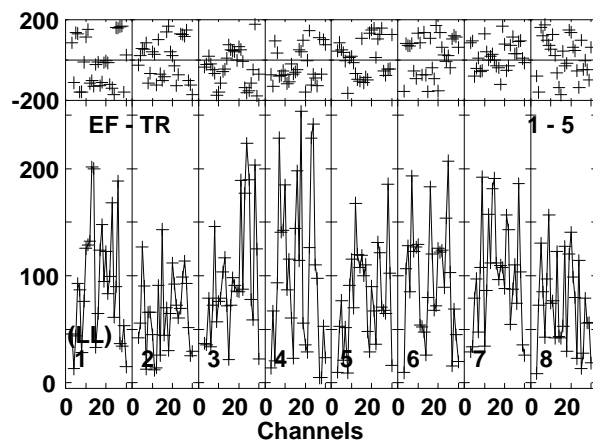
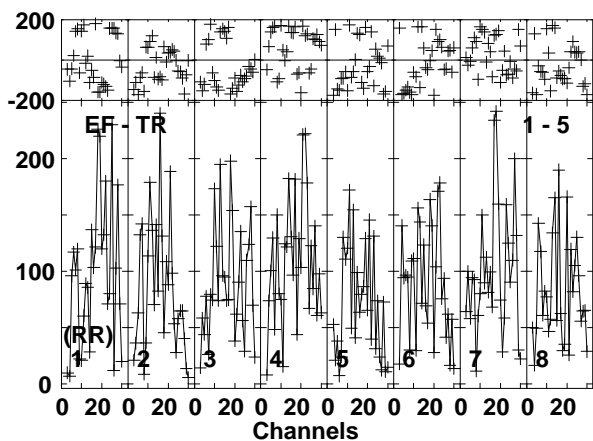
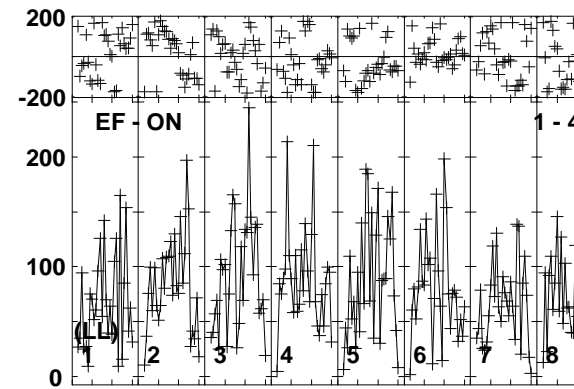
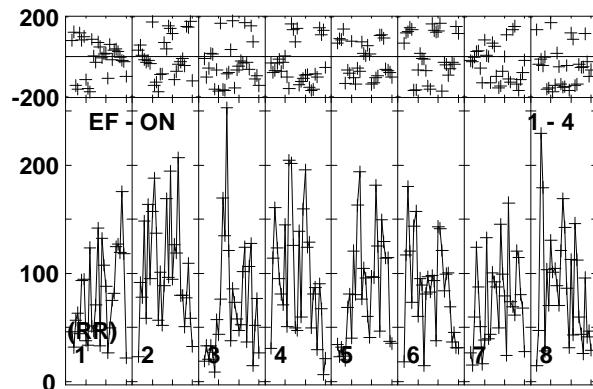
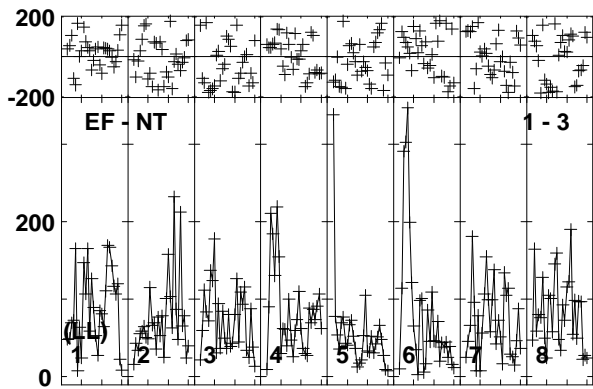
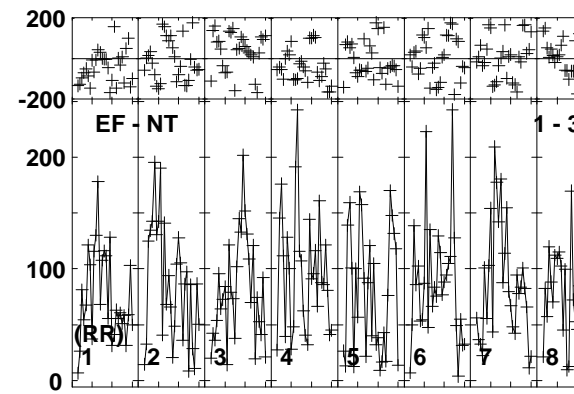
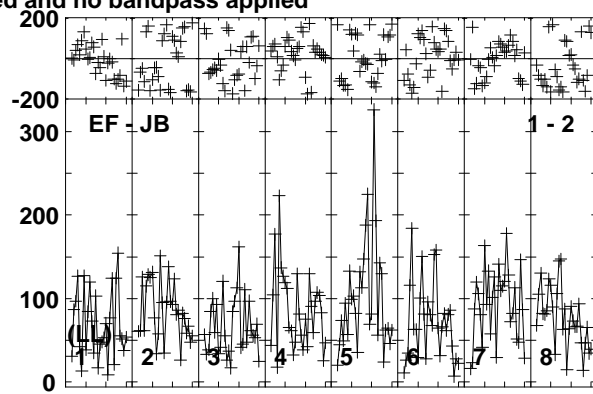
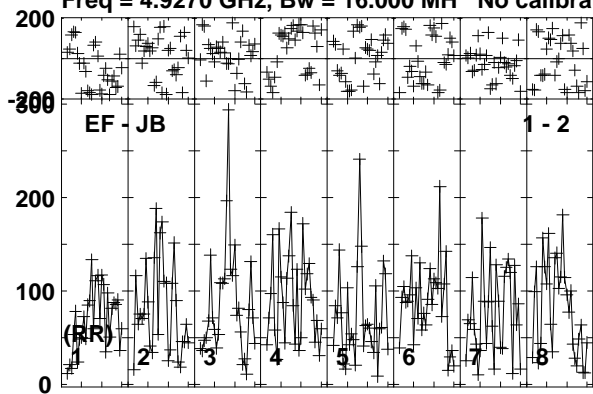

Lower frame: Micro Ampl Jy Top frame: Phas deg
Vector averaged cross-power spectrum Baseline: EF (01) - JB (02)
Timerange: 01/09:35:53 to 01/09:39:19

Plot file version 516 created 26-MAR-2015 15:28:04

V596CAS EG082E.UVDATA.1

Freq = 4.9270 GHz, Bw = 16.000 MH No calibration applied and no bandpass applied

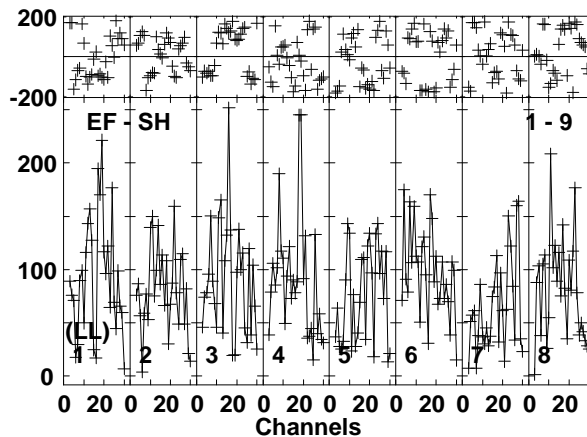
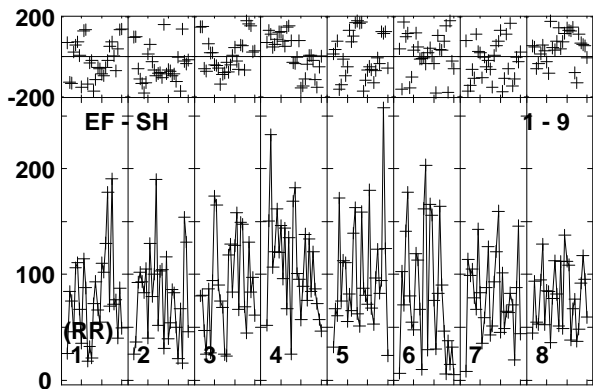
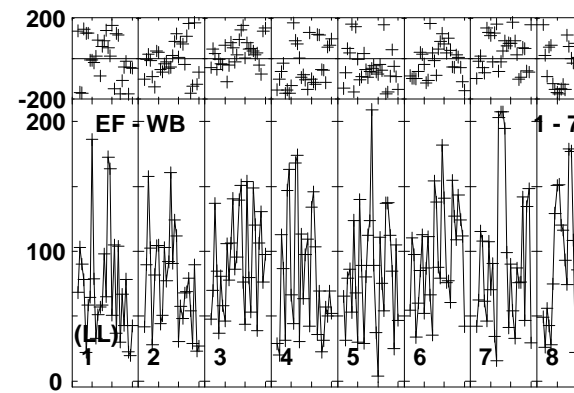
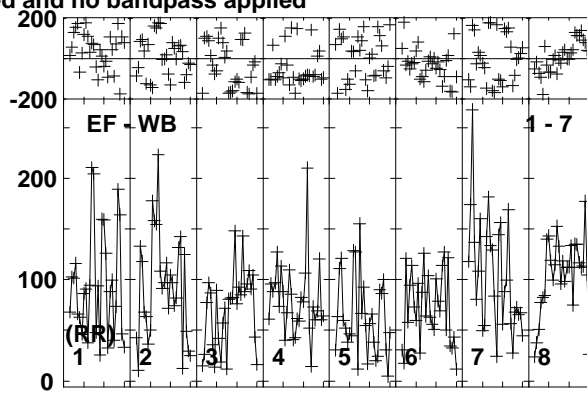
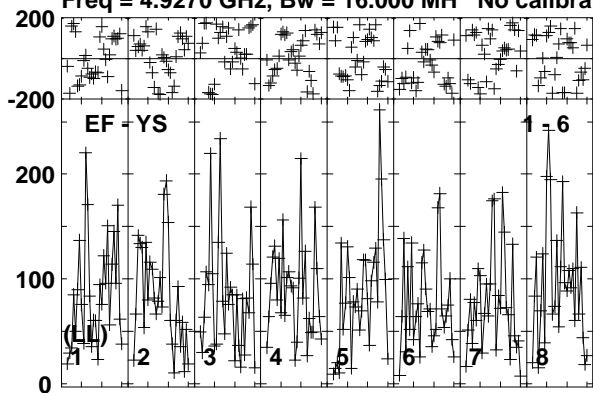

Lower frame: Micro Ampl Jy Top frame: Phas deg
Vector averaged cross-power spectrum Baseline: EF (01) - YS (06)
Timerange: 01/09:35:53 to 01/09:39:19

Plot file version 517 created 26-MAR-2015 15:28:05

J0147+5840 EG082E.UVDATA.1

Freq = 4.9270 GHz, Bw = 16.000 MH No calibration applied and no bandpass applied

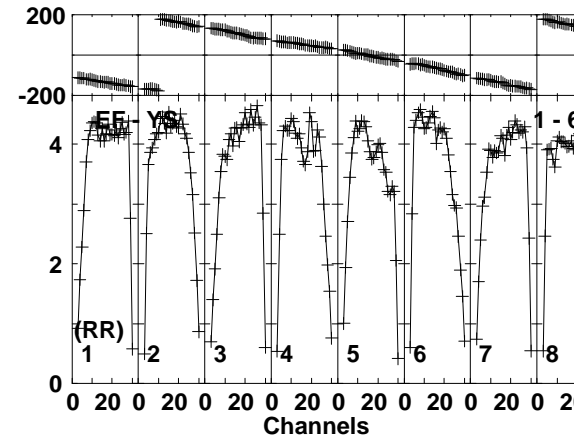
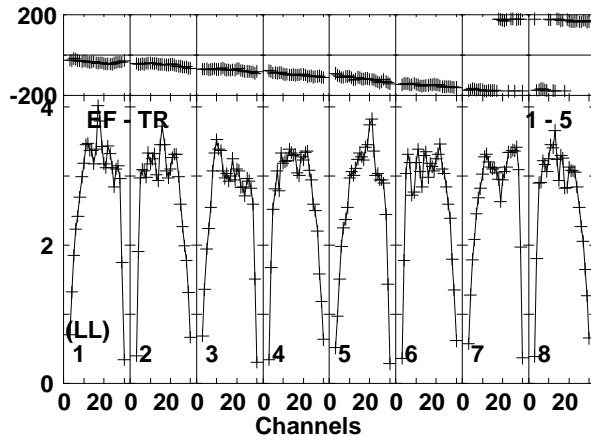
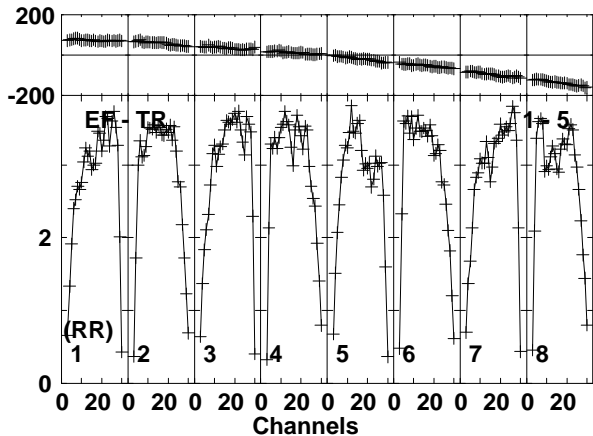
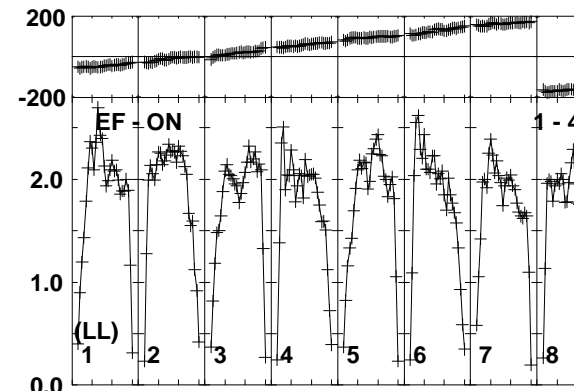
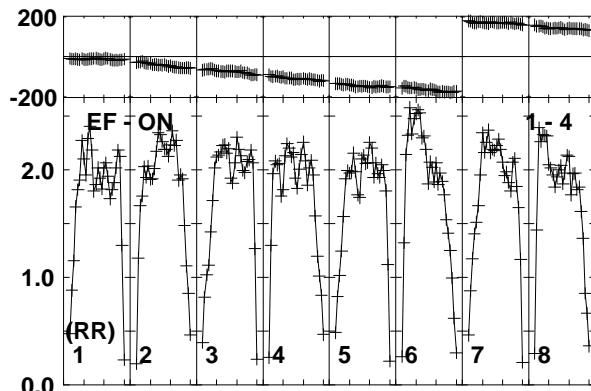
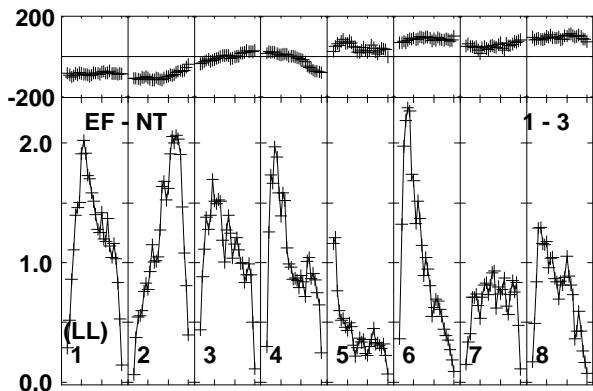
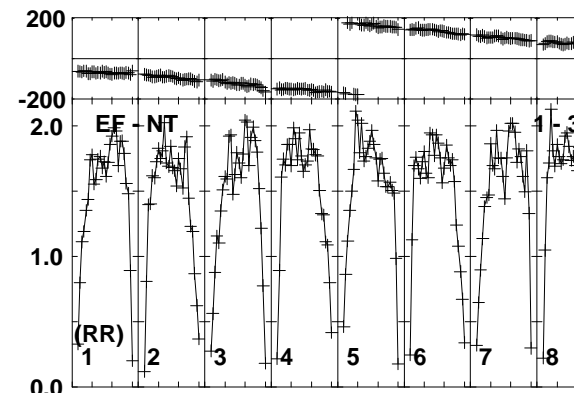
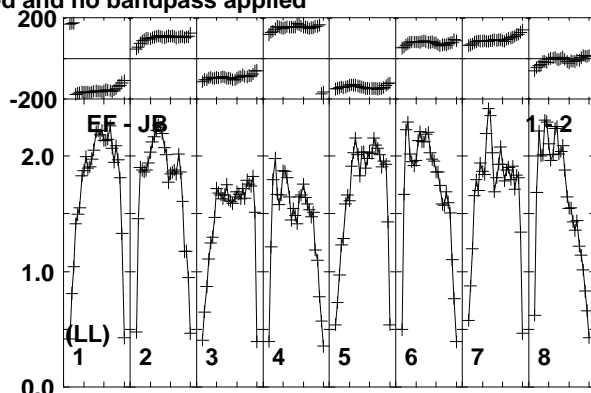
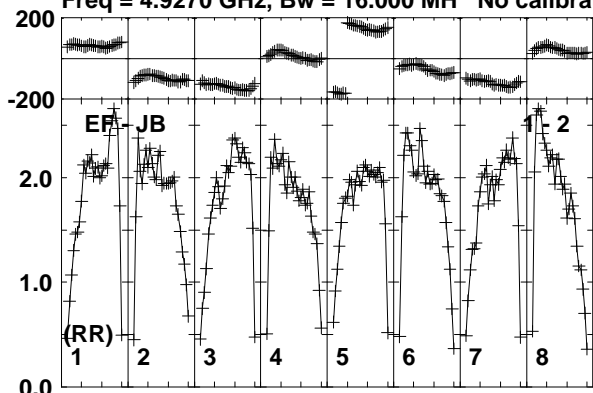

Lower frame: Milli Ampl Jy Top frame: Phas deg
Vector averaged cross-power spectrum Baseline: EF (01) - JB (02)
Timerange: 01/09:39:23 to 01/09:40:49

Plot file version 518 created 26-MAR-2015 15:28:05

J0147+5840 EG082E.UVDATA.1

Freq = 4.9270 GHz, Bw = 16.000 MH No calibration applied and no bandpass applied

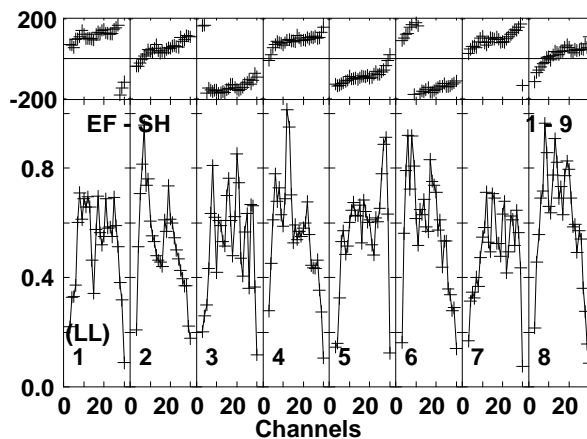
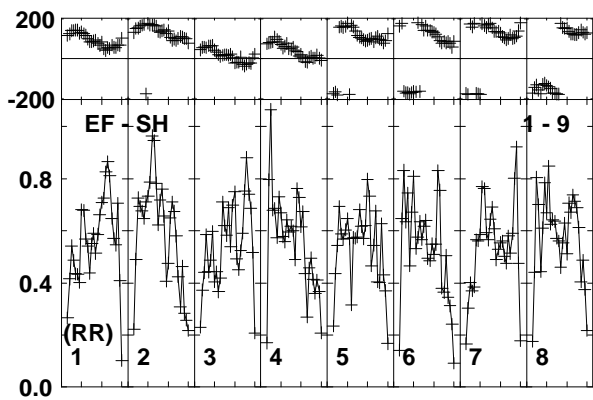
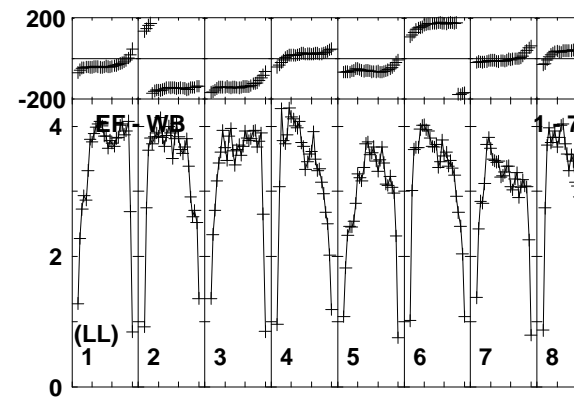
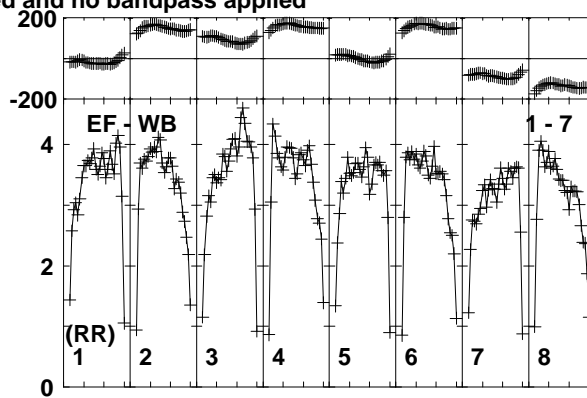
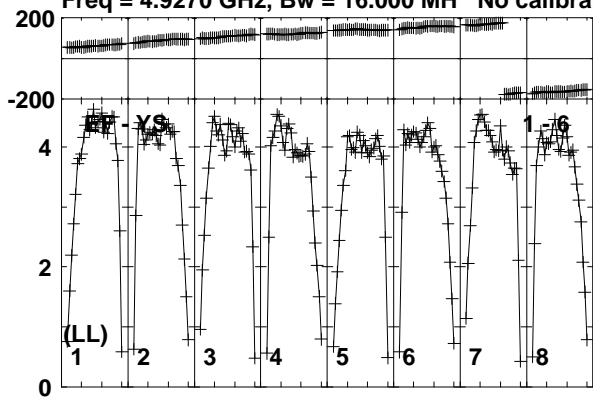

Lower frame: Milli Ampl Jy Top frame: Phas deg
Vector averaged cross-power spectrum Baseline: EF (01) - YS (06)
Timerange: 01/09:39:23 to 01/09:40:49

Plot file version 519 created 26-MAR-2015 15:28:05

V596CAS EG082E.UVDATA.1

Freq = 4.9270 GHz, Bw = 16.000 MH No calibration applied and no bandpass applied

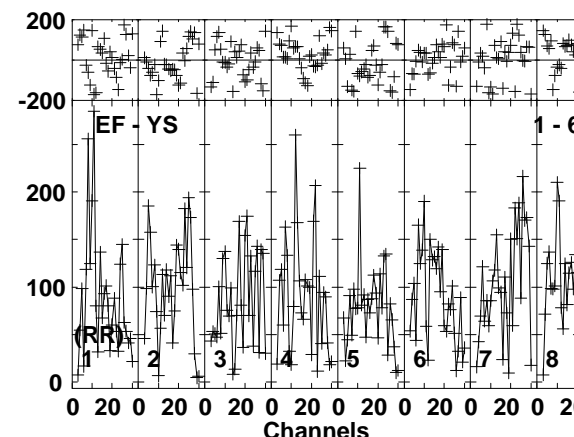
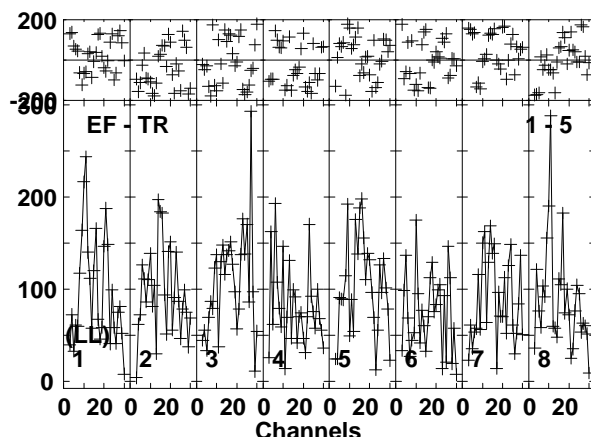
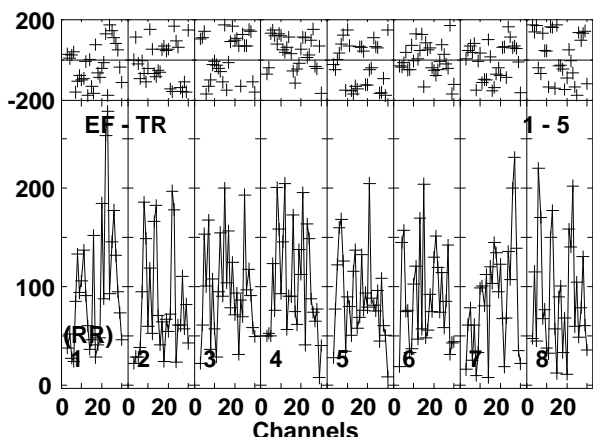
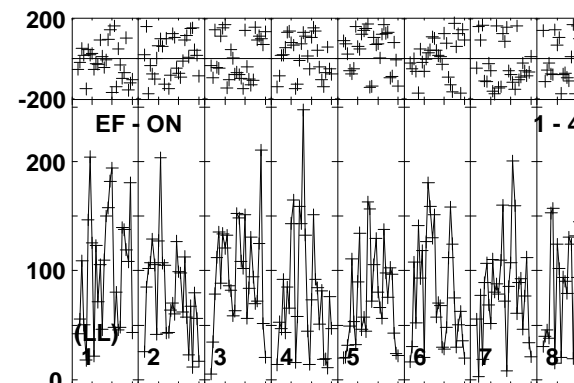
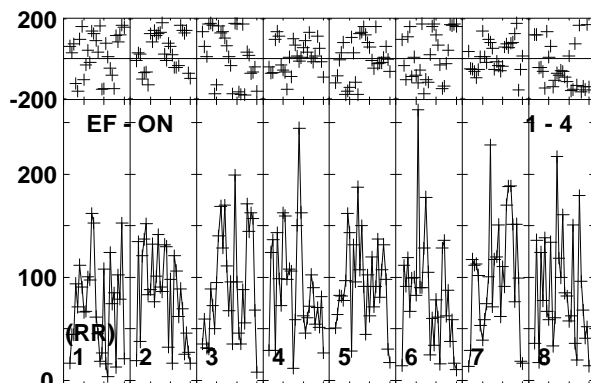
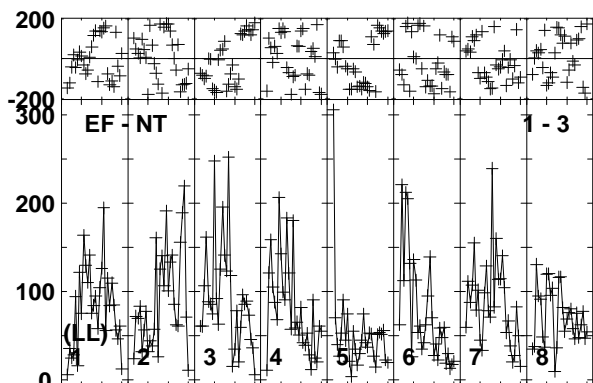
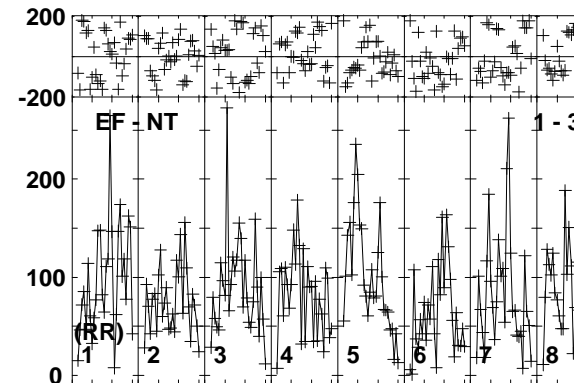
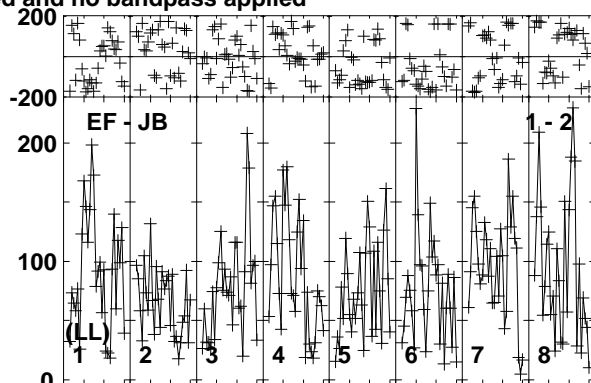
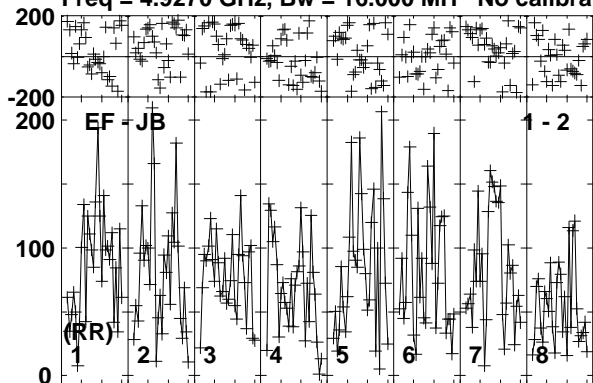

Lower frame: Micro Ampl Jy Top frame: Phas deg
Vector averaged cross-power spectrum Baseline: EF (01) - JB (02)
Timerange: 01/09:40:53 to 01/09:44:19

Plot file version 520 created 26-MAR-2015 15:28:05

V596CAS EG082E.UVDATA.1

Freq = 4.9270 GHz, Bw = 16.000 MH No calibration applied and no bandpass applied

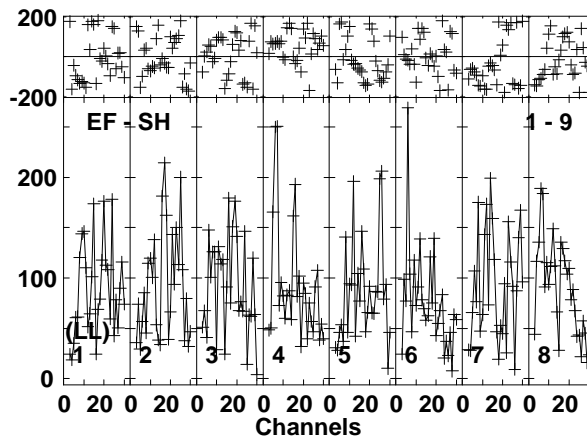
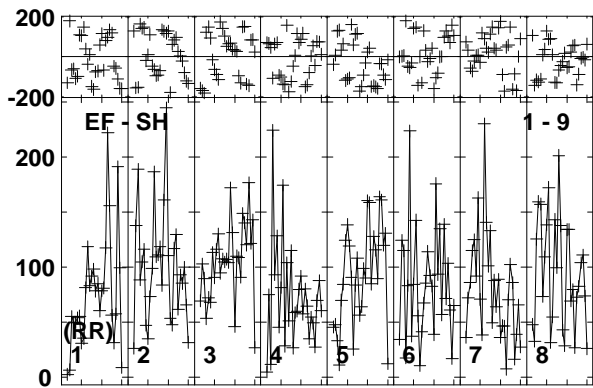
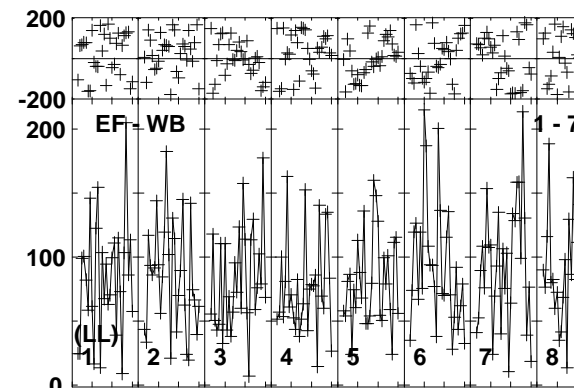
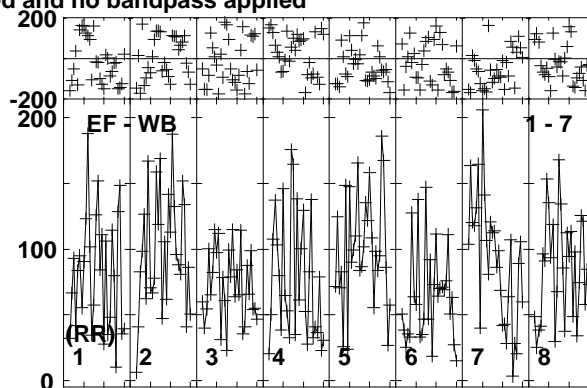
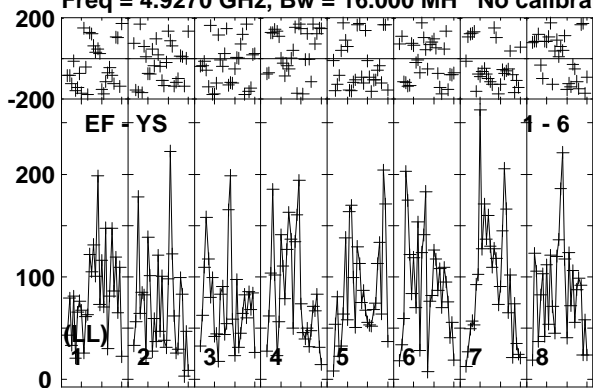

Lower frame: Micro Ampl Jy Top frame: Phas deg
Vector averaged cross-power spectrum Baseline: EF (01) - YS (06)
Timerange: 01/09:40:53 to 01/09:44:19

Plot file version 521 created 26-MAR-2015 15:28:05

J0147+5840 EG082E.UVDATA.1

Freq = 4.9270 GHz, Bw = 16.000 MH No calibration applied and no bandpass applied

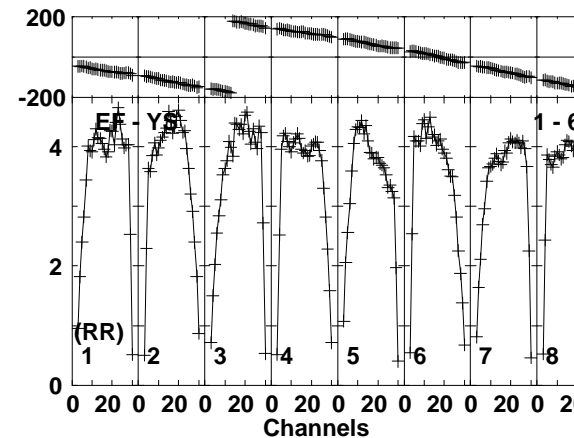
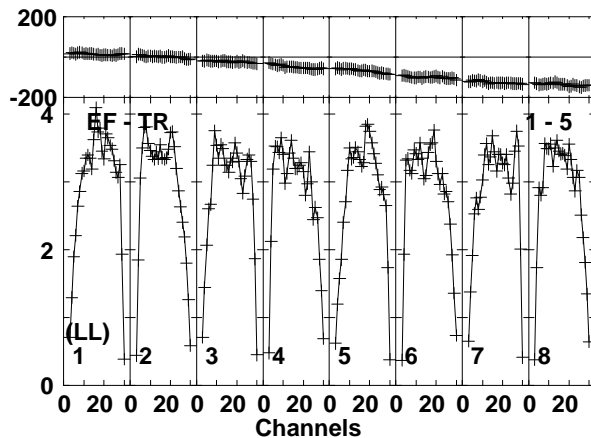
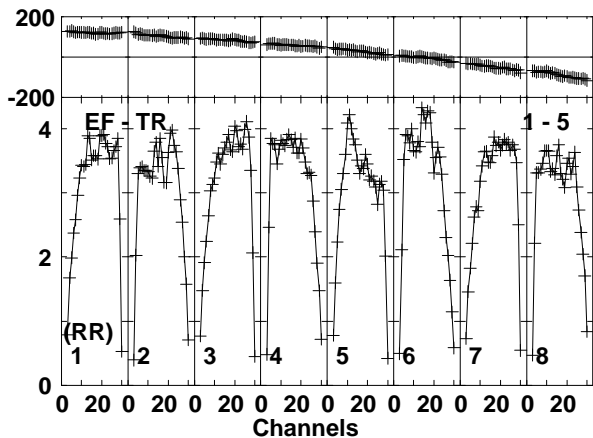
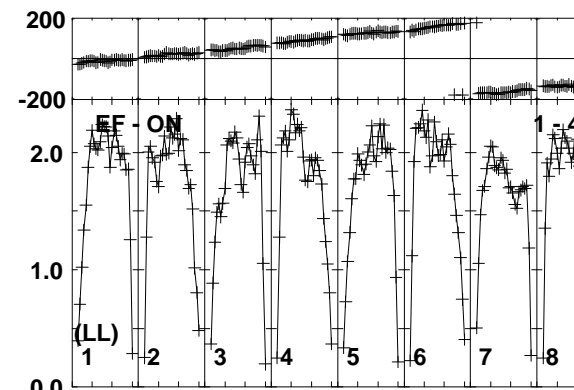
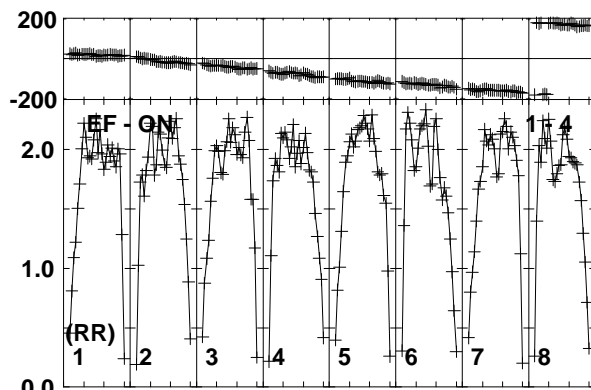
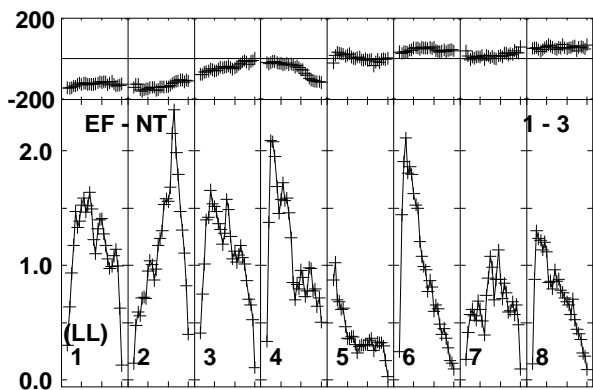
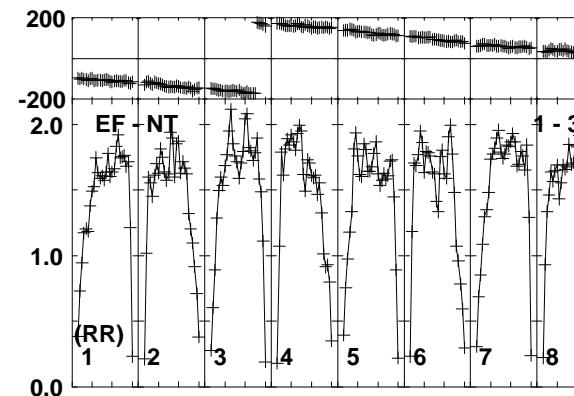
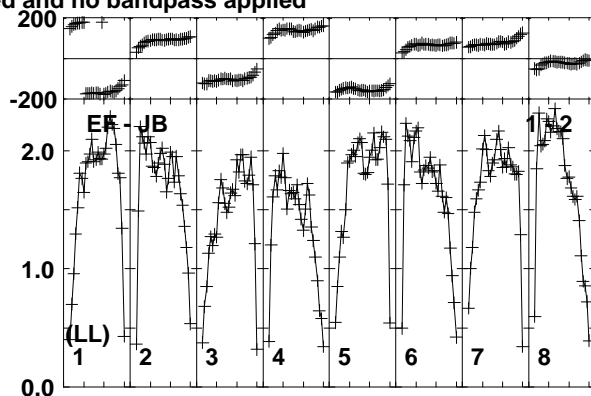
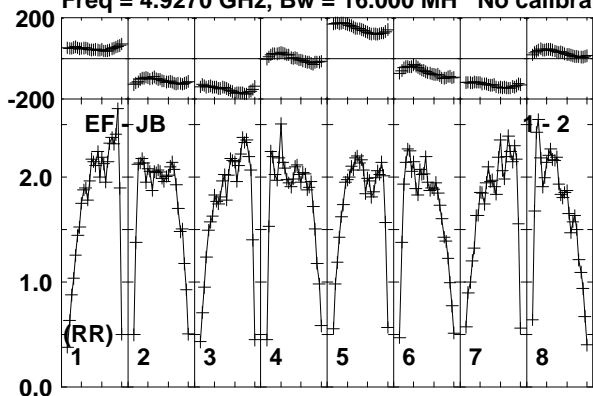

Lower frame: Milli Ampl Jy Top frame: Phas deg
Vector averaged cross-power spectrum Baseline: EF (01) - JB (02)
Timerange: 01/09:44:53 to 01/09:45:49

Plot file version 522 created 26-MAR-2015 15:28:05

J0147+5840 EG082E.UVDATA.1

Freq = 4.9270 GHz, Bw = 16.000 MH No calibration applied and no bandpass applied

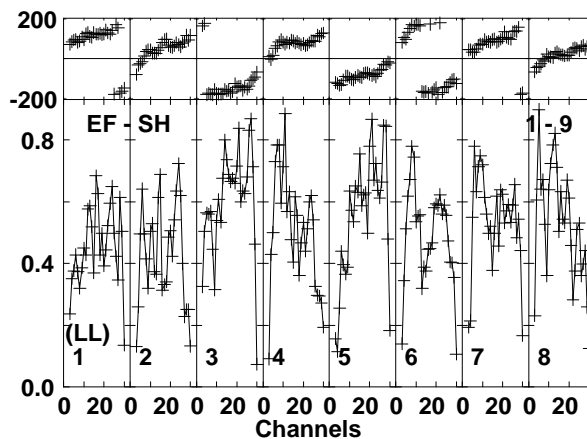
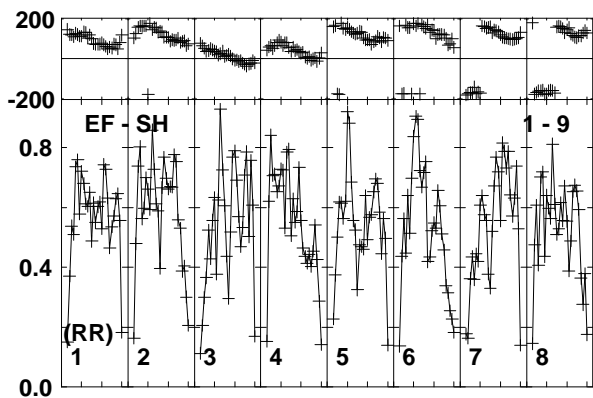
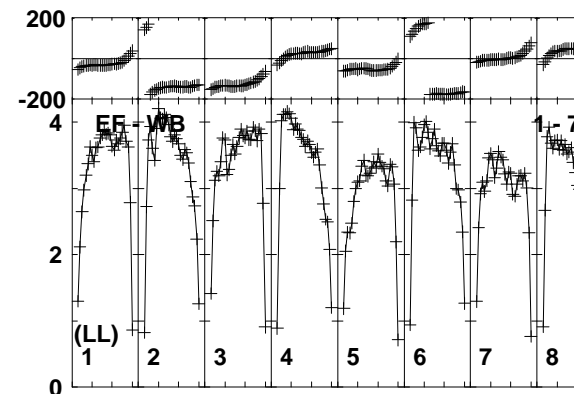
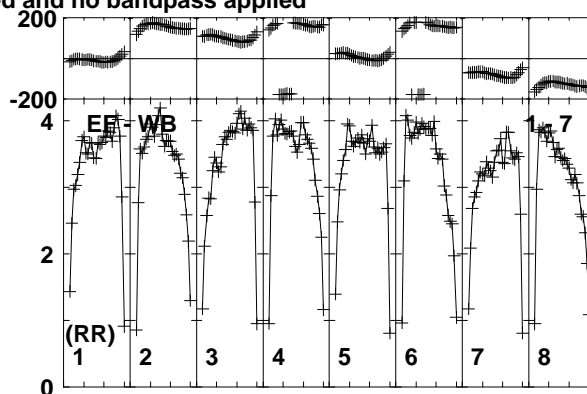
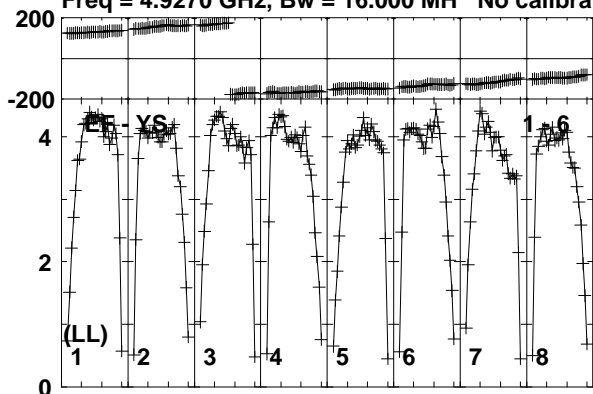

Lower frame: Milli Ampl Jy Top frame: Phas deg
Vector averaged cross-power spectrum Baseline: EF (01) - YS (06)
Timerange: 01/09:44:53 to 01/09:45:49

Plot file version 524 created 26-MAR-2015 15:28:05

V596CAS EG082E.UVDATA.1

Freq = 4.9270 GHz, Bw = 16.000 MH No calibration applied and no bandpass applied

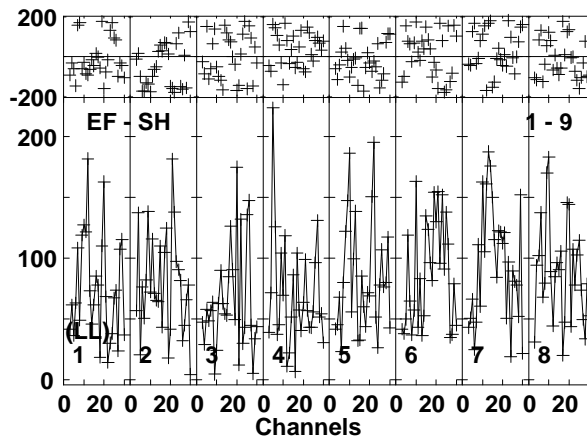
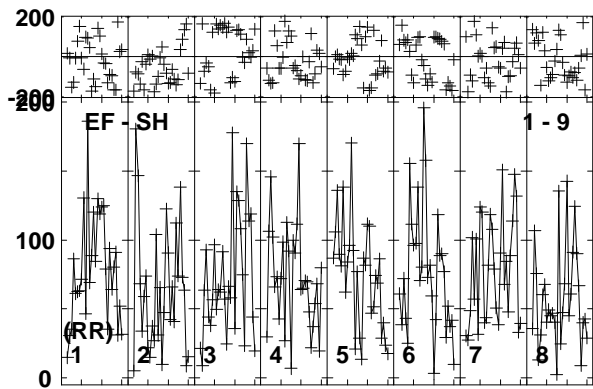
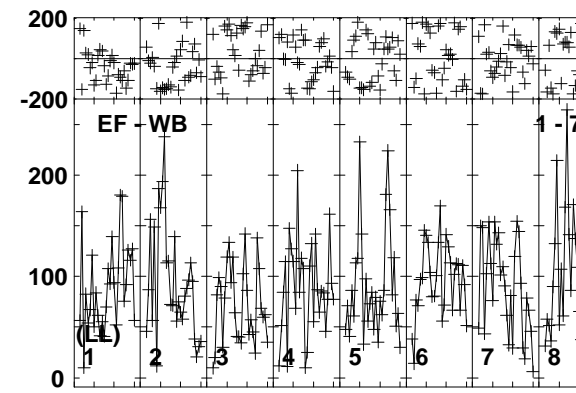
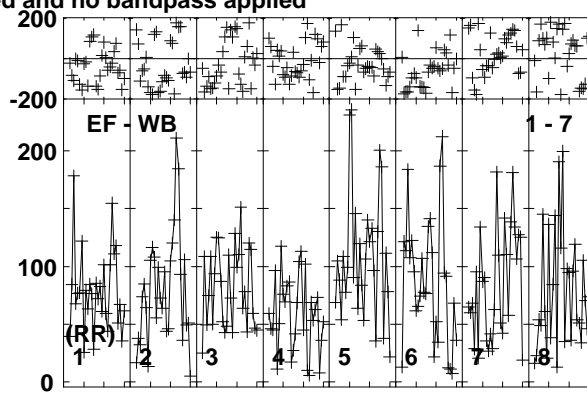
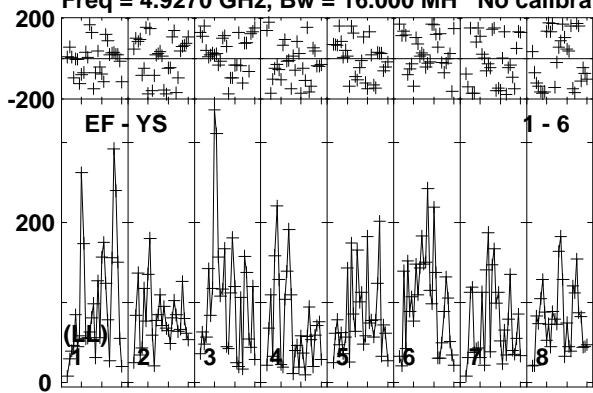

Lower frame: Micro Ampl Jy Top frame: Phas deg
Vector averaged cross-power spectrum Baseline: EF (01) - YS (06)
Timerange: 01/09:45:53 to 01/09:49:19

Plot file version 525 created 26-MAR-2015 15:28:05

J0147+5840 EG082E.UVDATA.1

Freq = 4.9270 GHz, Bw = 16.000 MH No calibration applied and no bandpass applied

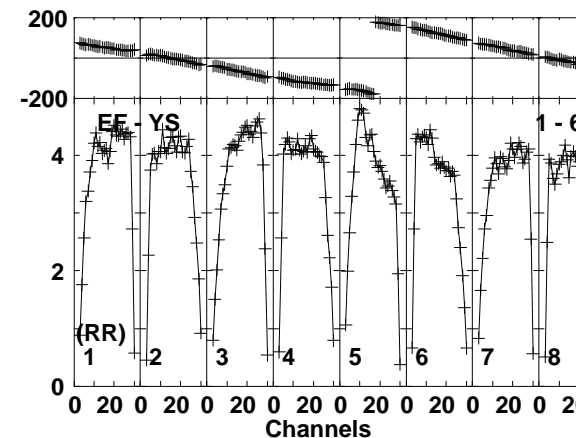
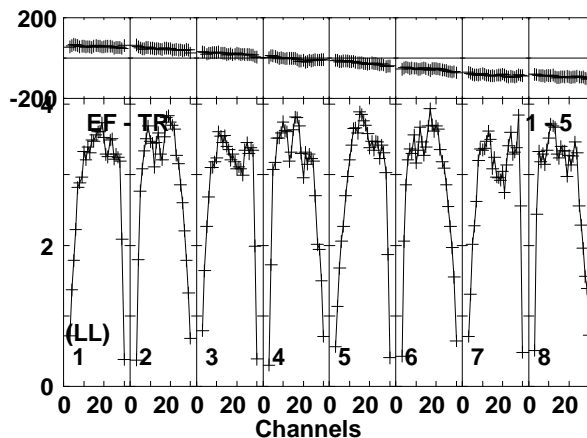
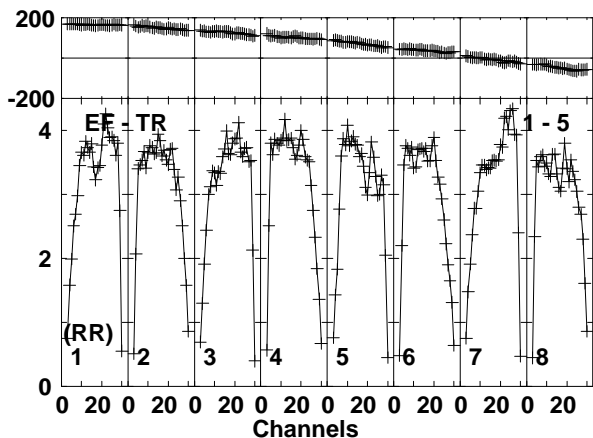
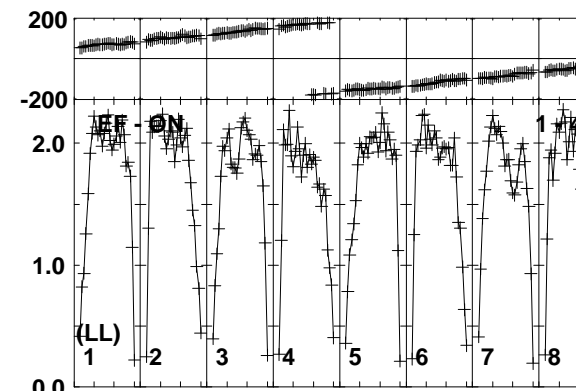
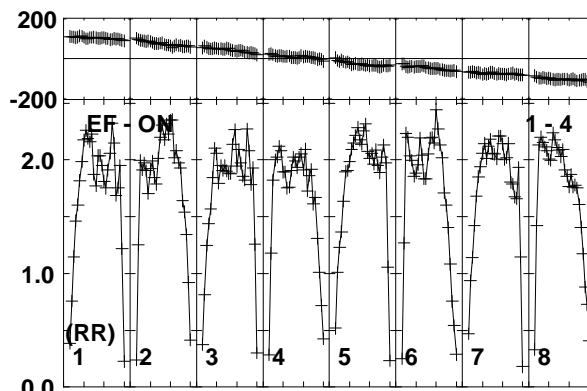
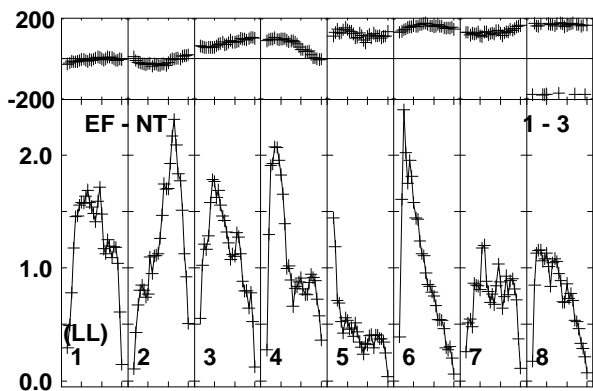
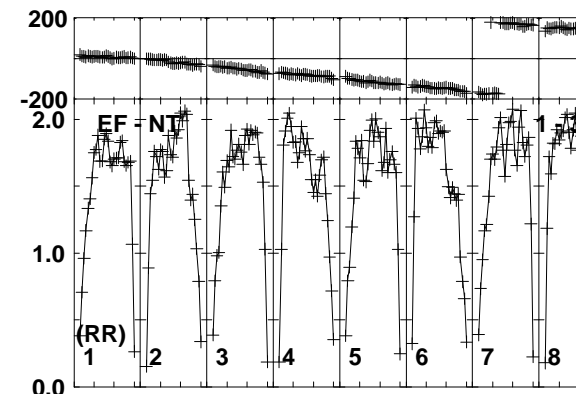
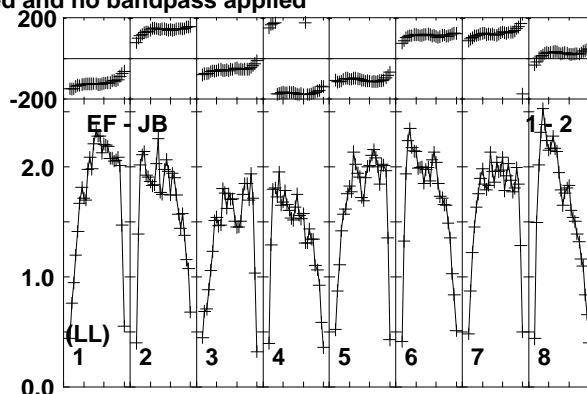
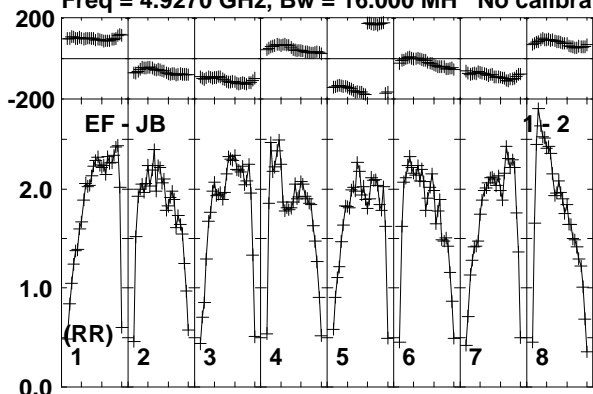

Lower frame: Milli Ampl Jy Top frame: Phas deg
Vector averaged cross-power spectrum Baseline: EF (01) - JB (02)
Timerange: 01/09:49:23 to 01/09:50:49

Plot file version 526 created 26-MAR-2015 15:28:05

J0147+5840 EG082E.UVDATA.1

Freq = 4.9270 GHz, Bw = 16.000 MH No calibration applied and no bandpass applied

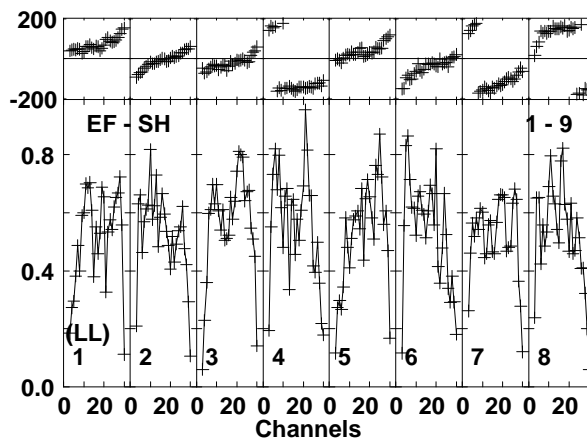
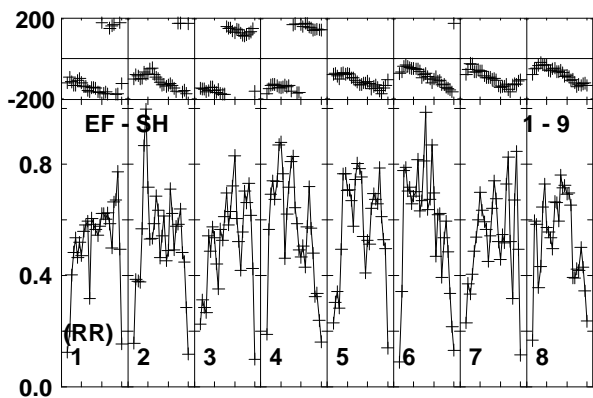
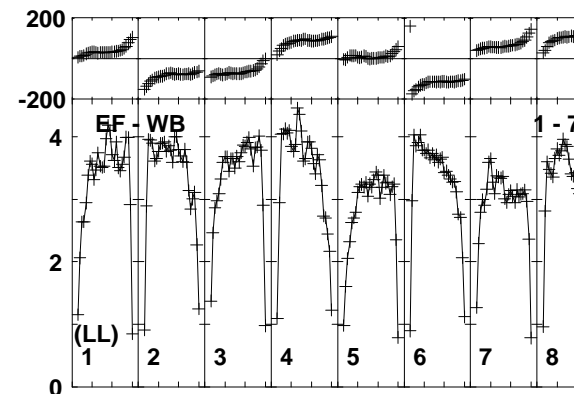
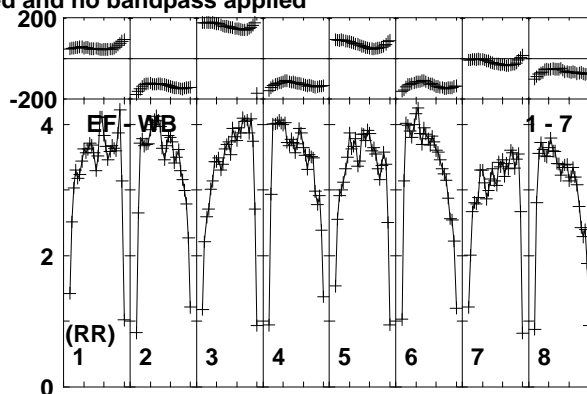
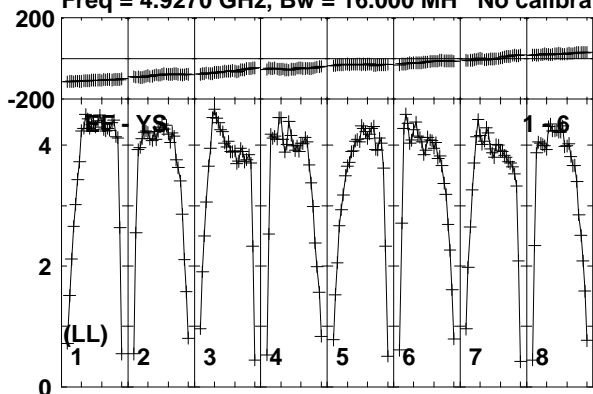

Lower frame: Milli Ampl Jy Top frame: Phas deg
Vector averaged cross-power spectrum Baseline: EF (01) - YS (06)
Timerange: 01/09:49:23 to 01/09:50:49

Plot file version 527 created 26-MAR-2015 15:28:05

J0151+5454 EG082E.UVDATA.1

Freq = 4.9270 GHz, Bw = 16.000 MH No calibration applied and no bandpass applied

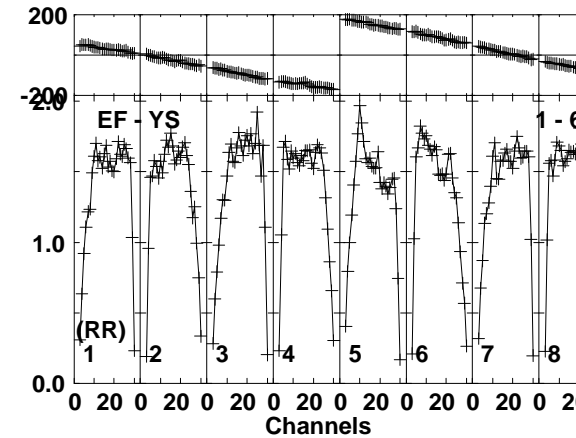
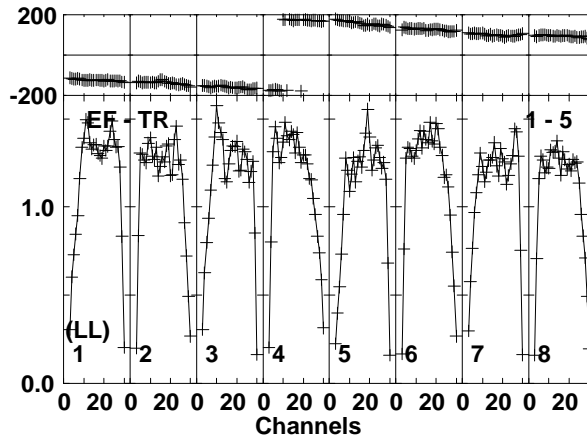
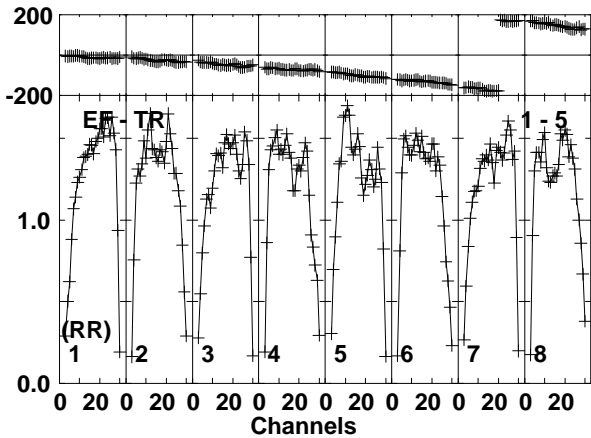
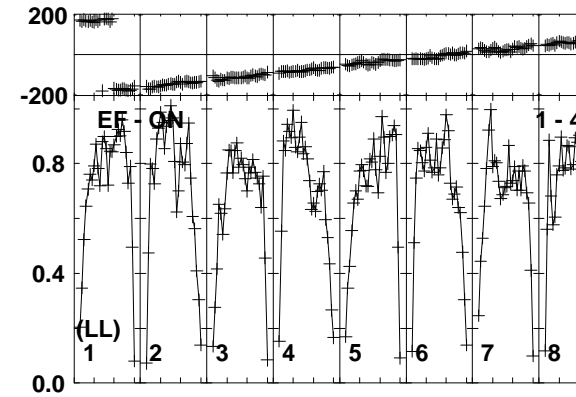
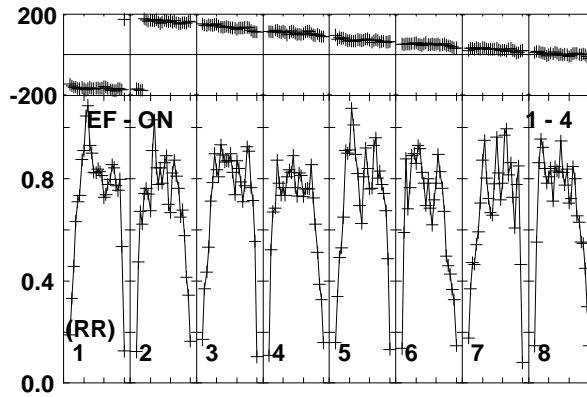
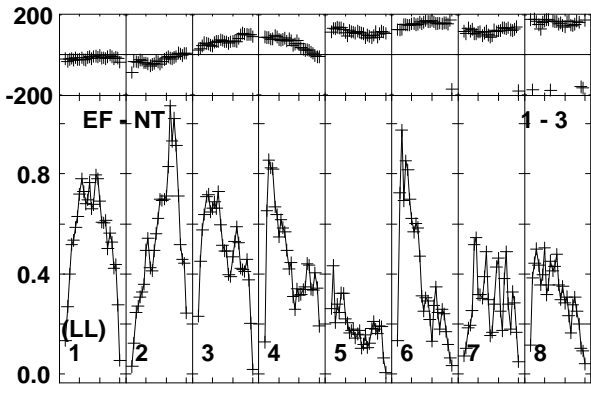
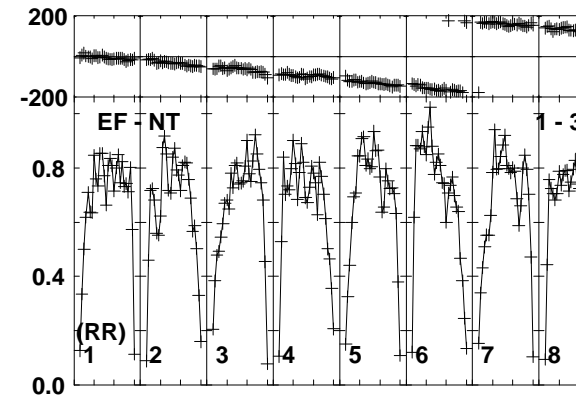
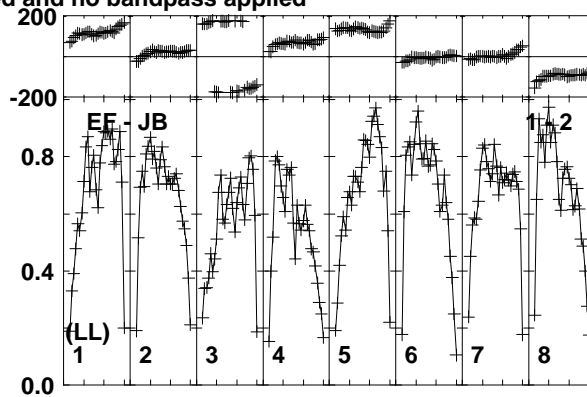
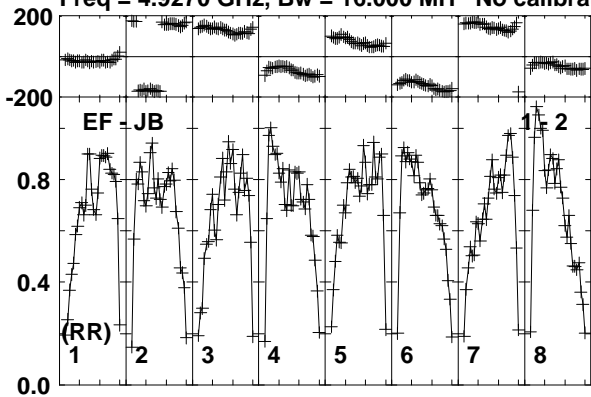

Lower frame: Milli Ampl Jy Top frame: Phas deg
Vector averaged cross-power spectrum Baseline: EF (01) - JB (02)
Timerange: 01/09:50:53 to 01/09:54:19

Plot file version 528 created 26-MAR-2015 15:28:05

J0151+5454 EG082E.UVDATA.1

Freq = 4.9270 GHz, Bw = 16.000 MH No calibration applied and no bandpass applied

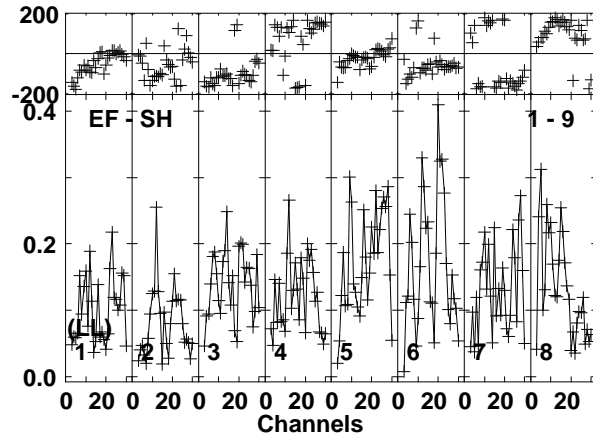
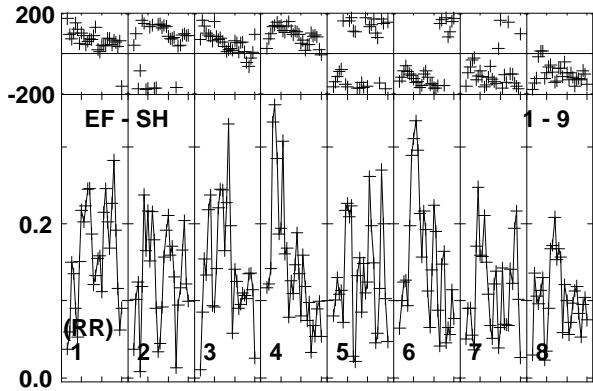
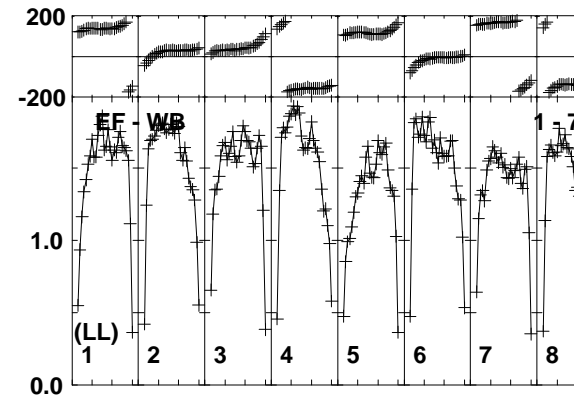
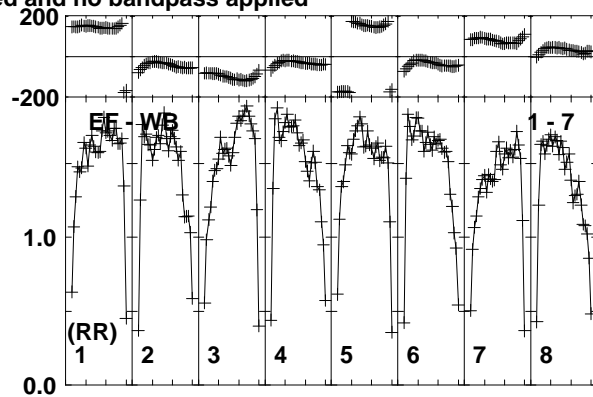
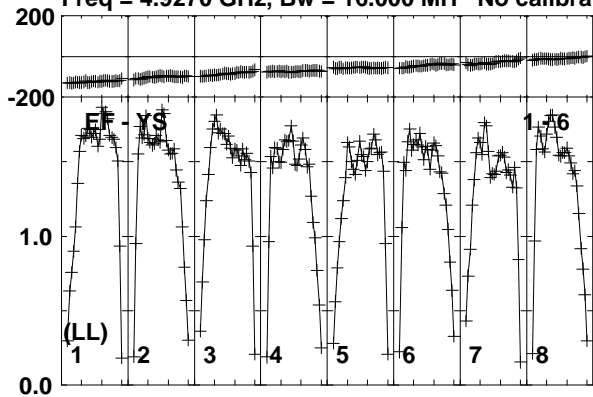

Lower frame: Milli Ampl Jy Top frame: Phas deg
Vector averaged cross-power spectrum Baseline: EF (01) - YS (06)
Timerange: 01/09:50:53 to 01/09:54:19

Plot file version 529 created 26-MAR-2015 15:28:05

J0147+5840 EG082E.UVDATA.1

Freq = 4.9270 GHz, Bw = 16.000 MH No calibration applied and no bandpass applied

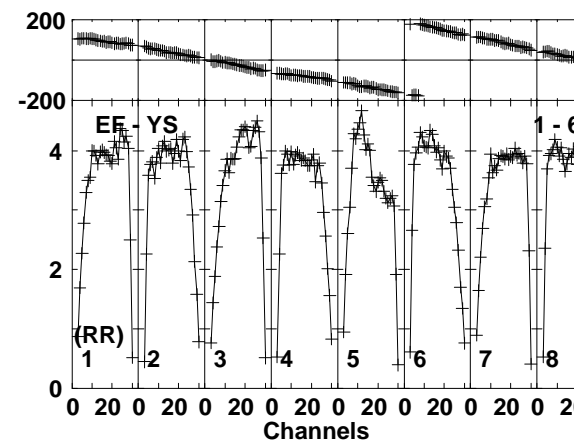
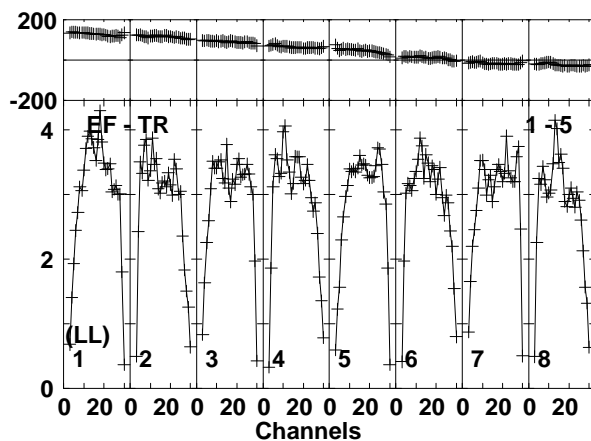
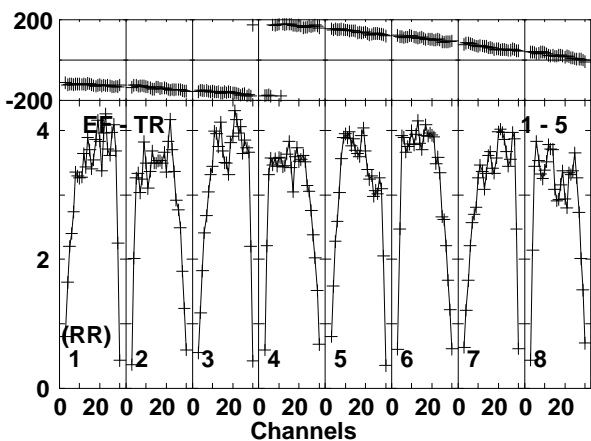
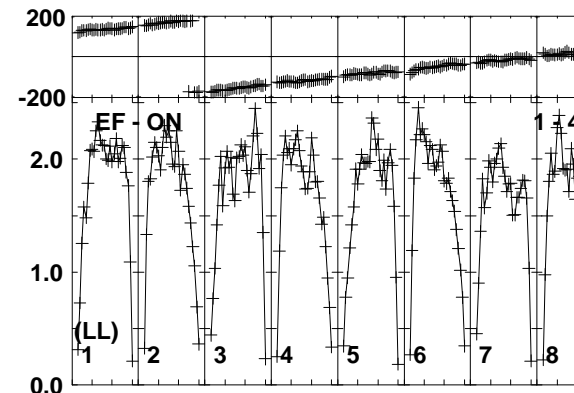
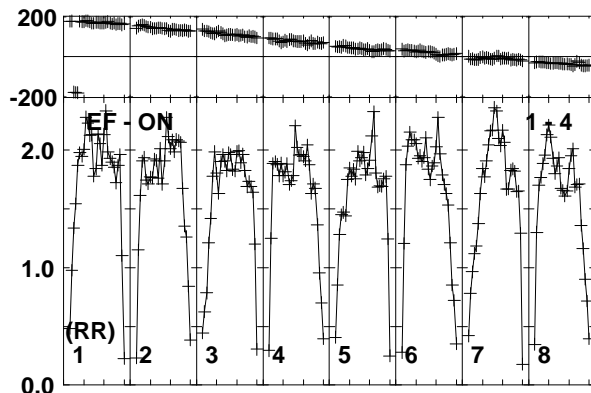
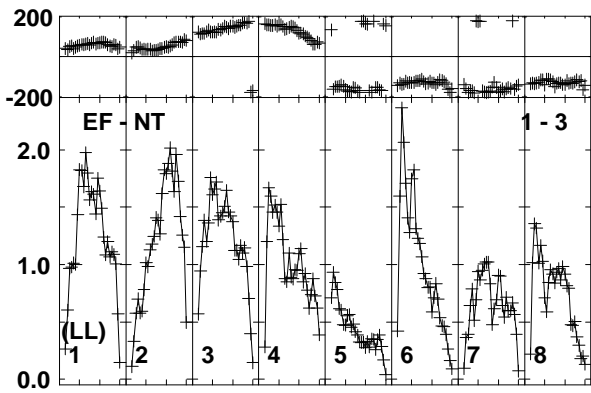
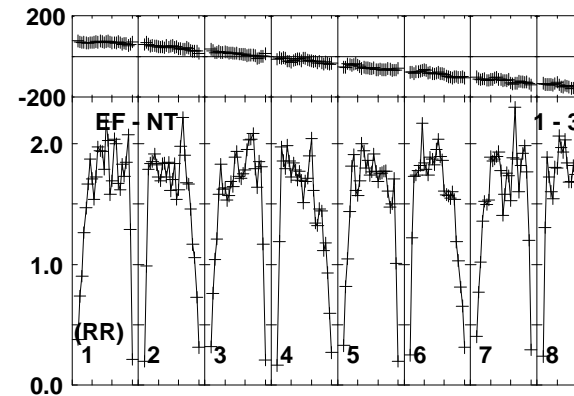
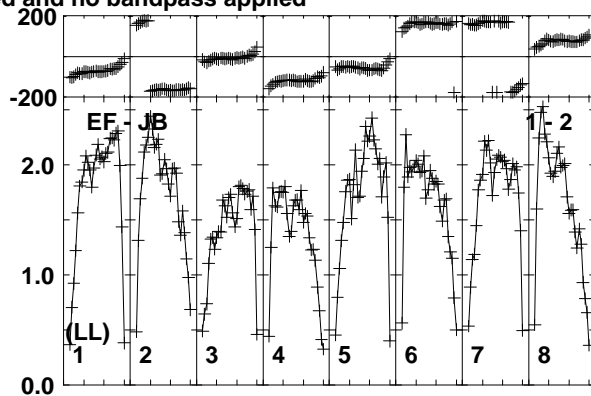
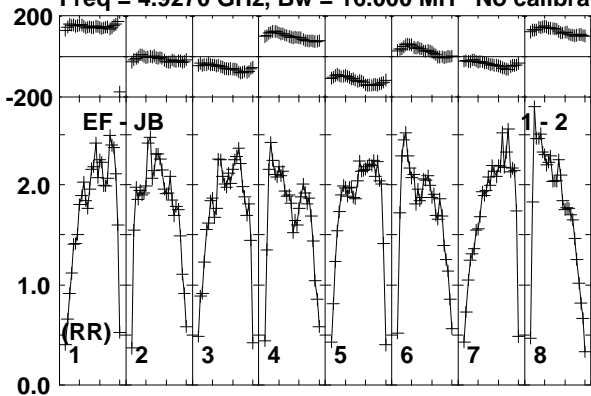

Lower frame: Milli Ampl Jy Top frame: Phas deg
Vector averaged cross-power spectrum Baseline: EF (01) - JB (02)
Timerange: 01/09:54:53 to 01/09:55:49

Plot file version 530 created 26-MAR-2015 15:28:05

J0147+5840 EG082E.UVDATA.1

Freq = 4.9270 GHz, Bw = 16.000 MH No calibration applied and no bandpass applied

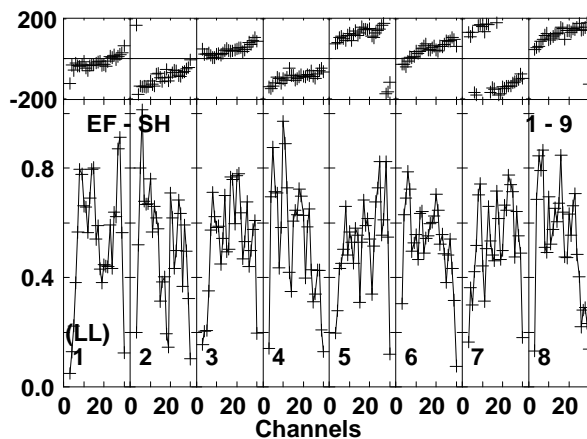
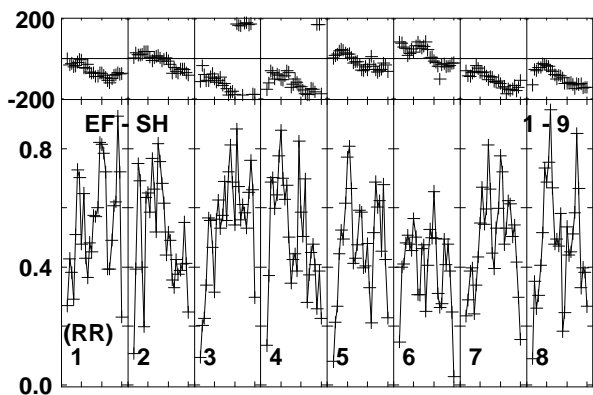
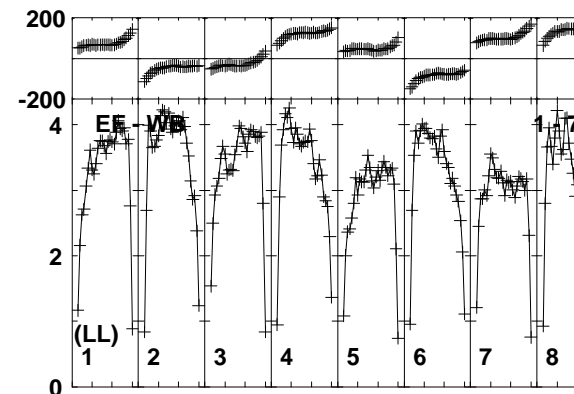
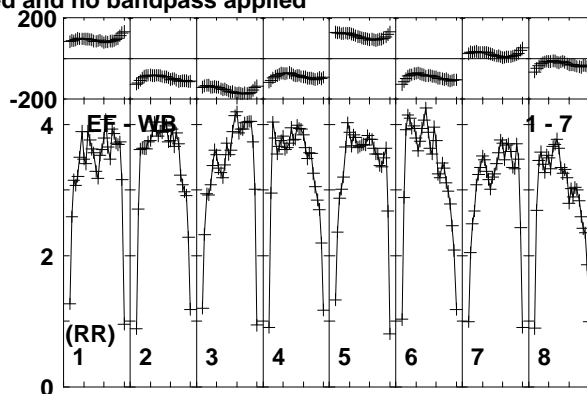
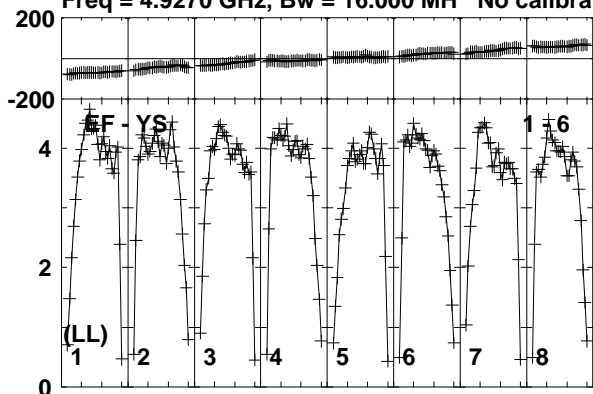

Lower frame: Milli Ampl Jy Top frame: Phas deg
Vector averaged cross-power spectrum Baseline: EF (01) - YS (06)
Timerange: 01/09:54:53 to 01/09:55:49

Plot file version 531 created 26-MAR-2015 15:28:05

V596CAS EG082E.UVDATA.1

Freq = 4.9270 GHz, Bw = 16.000 MH No calibration applied and no bandpass applied

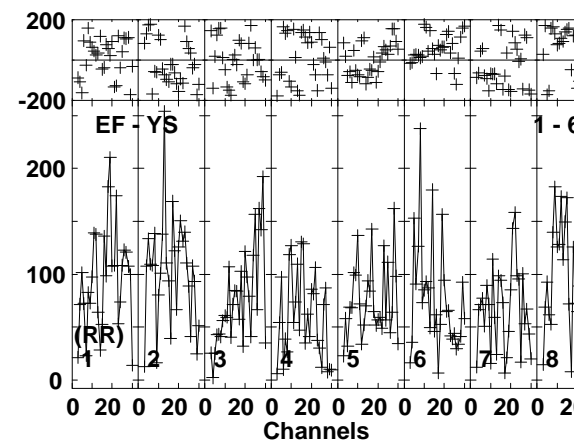
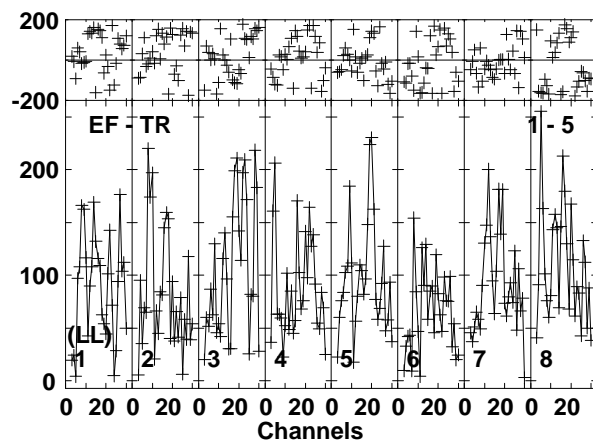
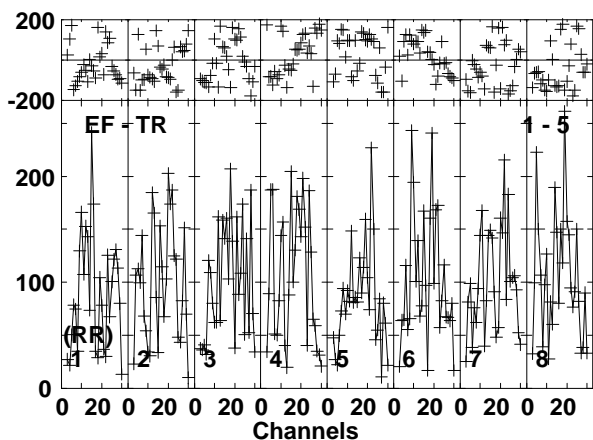
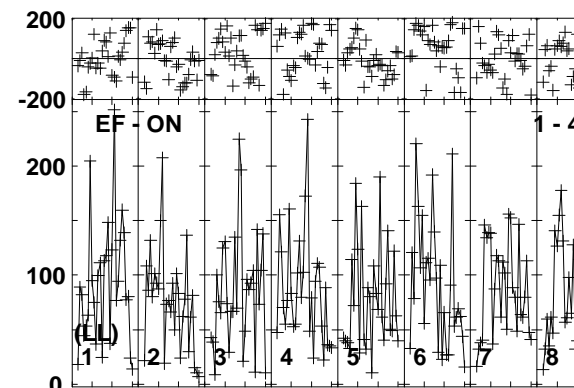
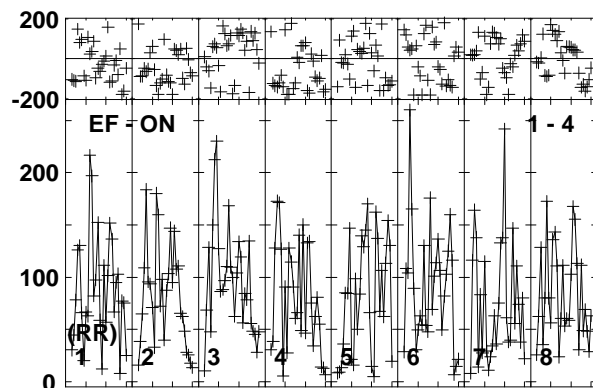
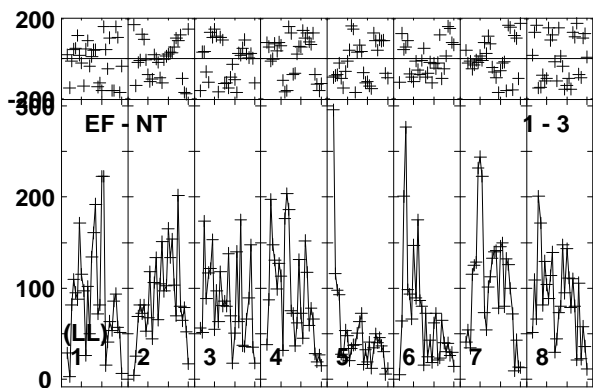
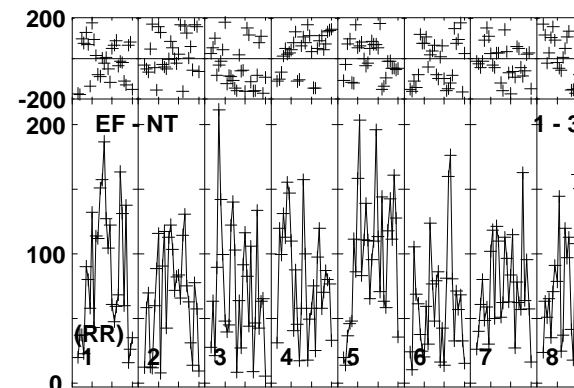
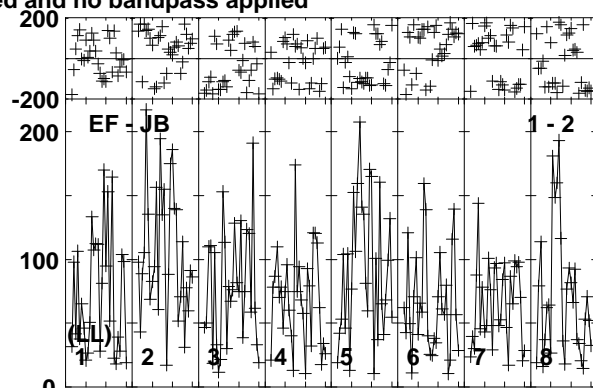
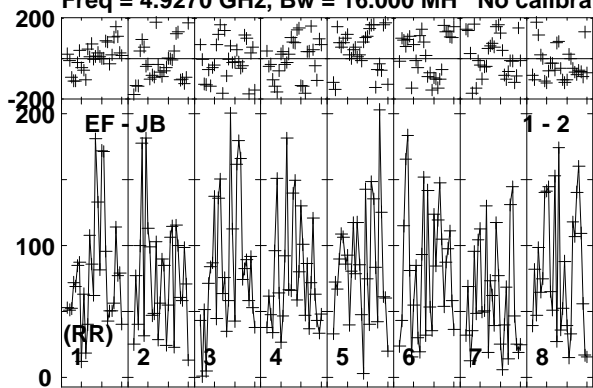

Lower frame: Micro Ampl Jy Top frame: Phas deg
Vector averaged cross-power spectrum Baseline: EF (01) - JB (02)
Timerange: 01/09:55:53 to 01/09:59:19

Plot file version 532 created 26-MAR-2015 15:28:05

V596CAS EG082E.UVDATA.1

Freq = 4.9270 GHz, Bw = 16.000 MH No calibration applied and no bandpass applied

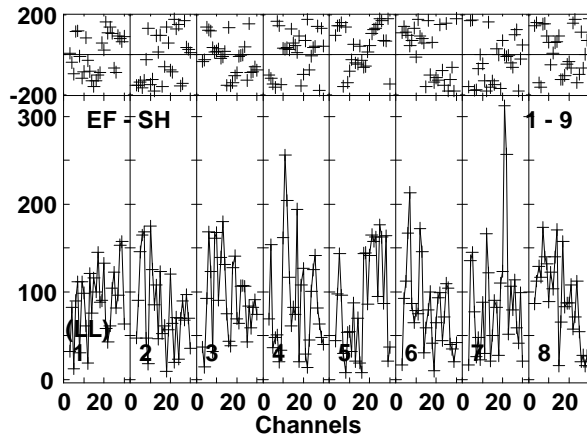
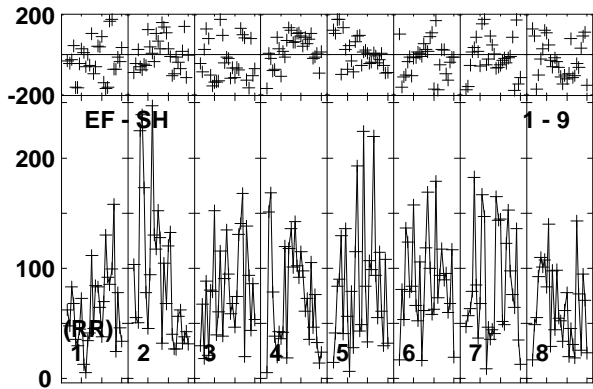
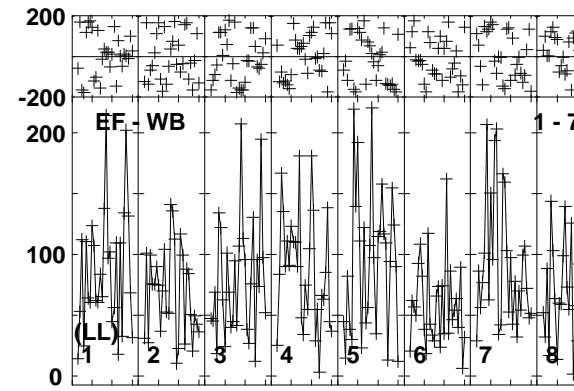
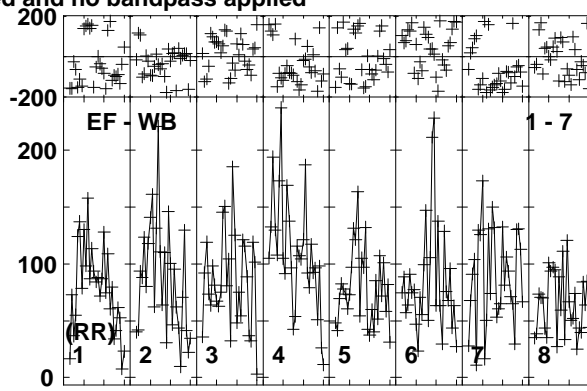
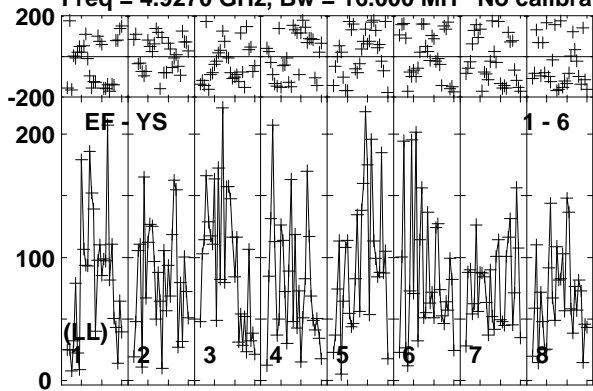

Lower frame: Micro Ampl Jy Top frame: Phas deg
Vector averaged cross-power spectrum Baseline: EF (01) - YS (06)
Timerange: 01/09:55:53 to 01/09:59:19

Plot file version 533 created 26-MAR-2015 15:28:06

J0147+5840 EG082E.UVDATA.1

Freq = 4.9270 GHz, Bw = 16.000 MH No calibration applied and no bandpass applied

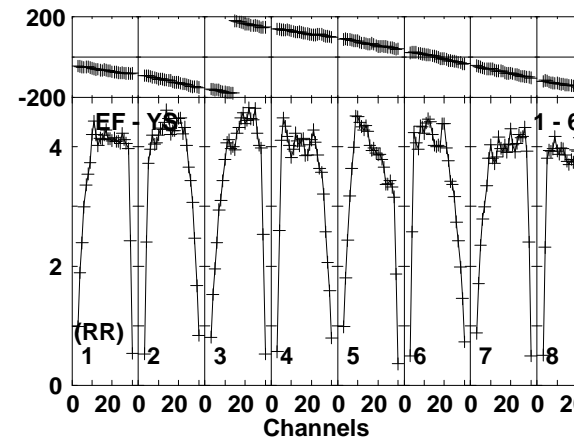
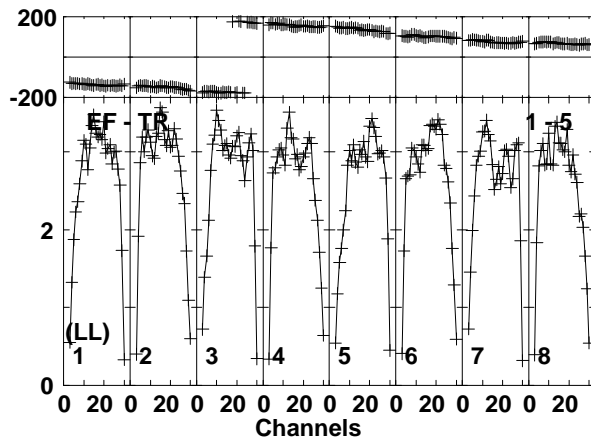
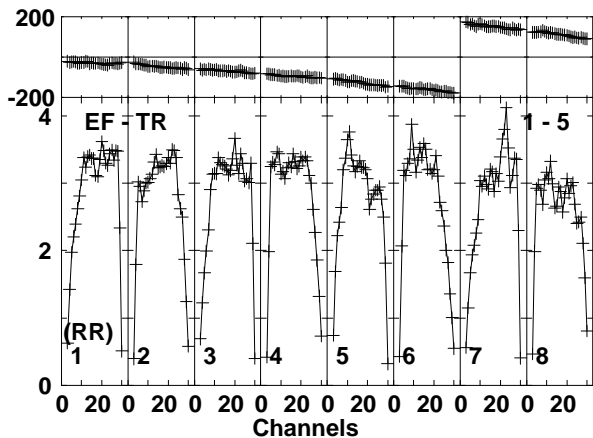
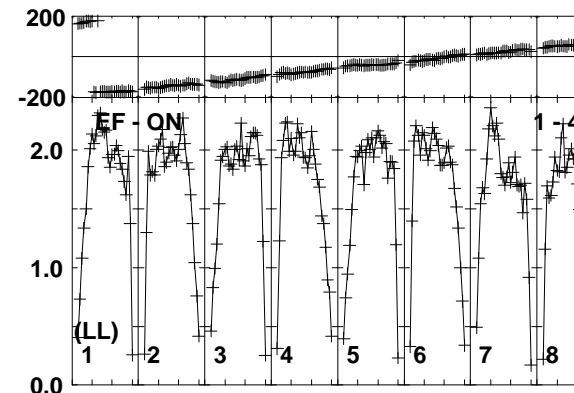
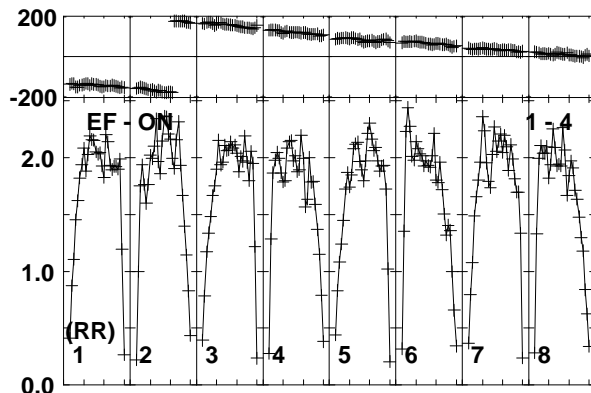
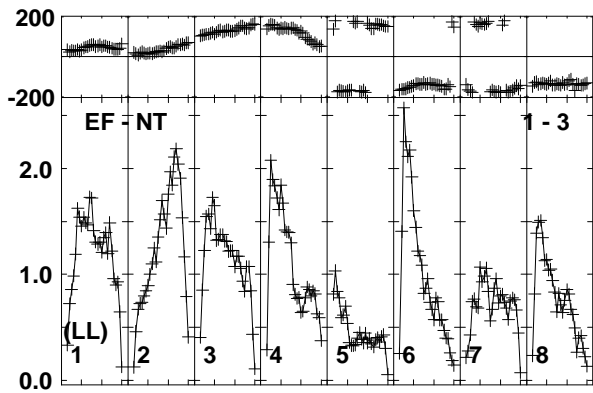
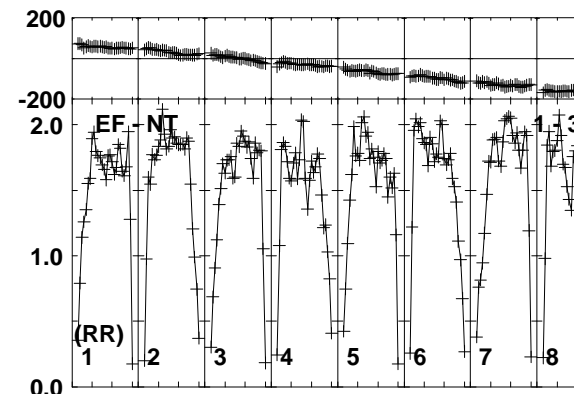
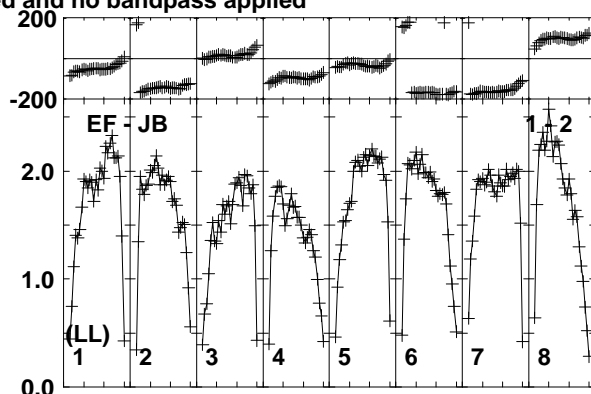
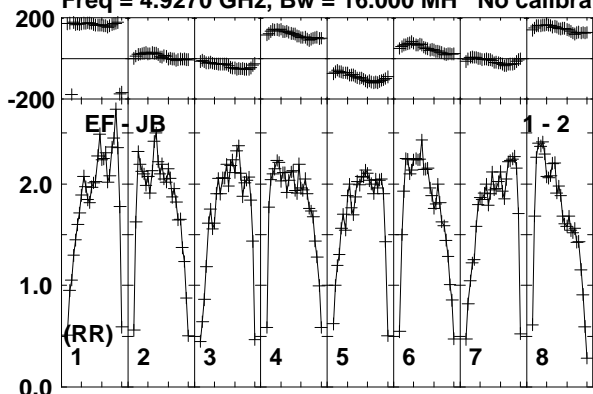

Lower frame: Milli Ampl Jy Top frame: Phas deg
Vector averaged cross-power spectrum Baseline: EF (01) - JB (02)
Timerange: 01/09:59:23 to 01/10:00:49

Plot file version 534 created 26-MAR-2015 15:28:06

J0147+5840 EG082E.UVDATA.1

Freq = 4.9270 GHz, Bw = 16.000 MH No calibration applied and no bandpass applied

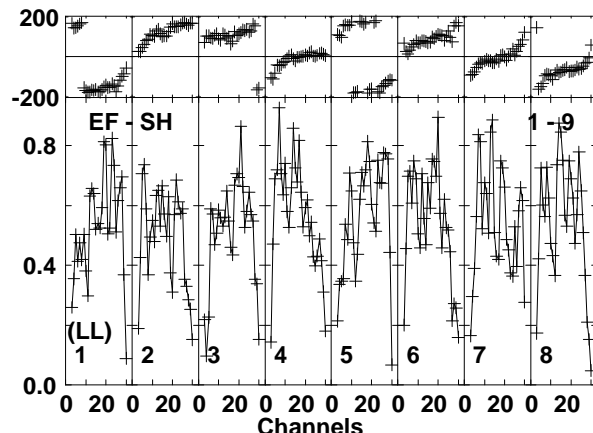
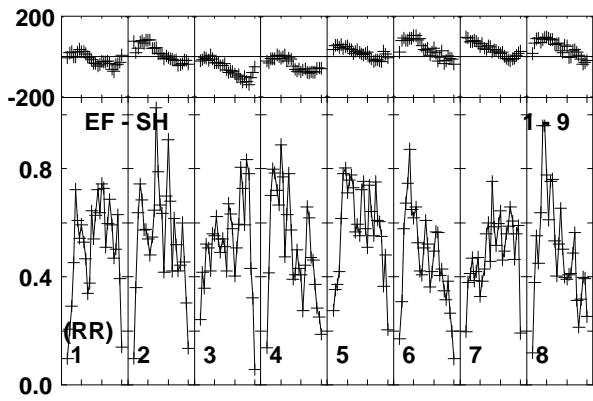
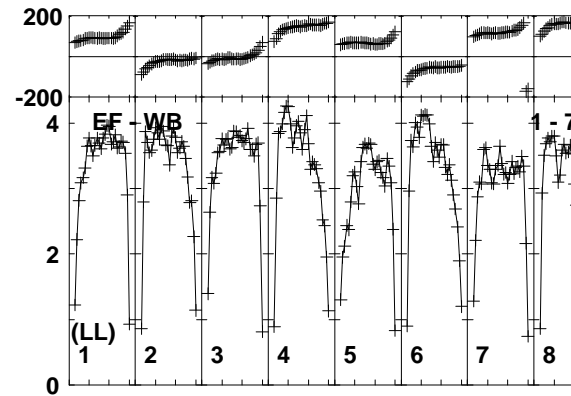
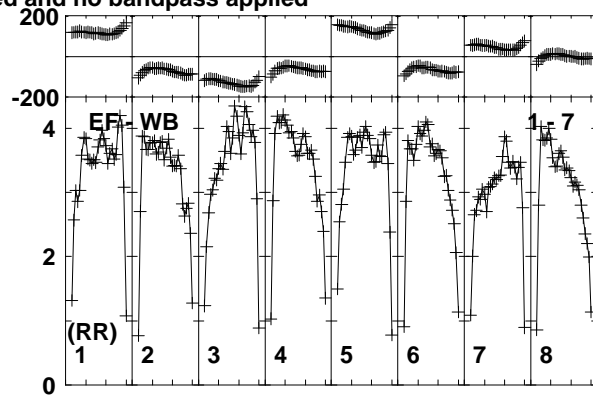
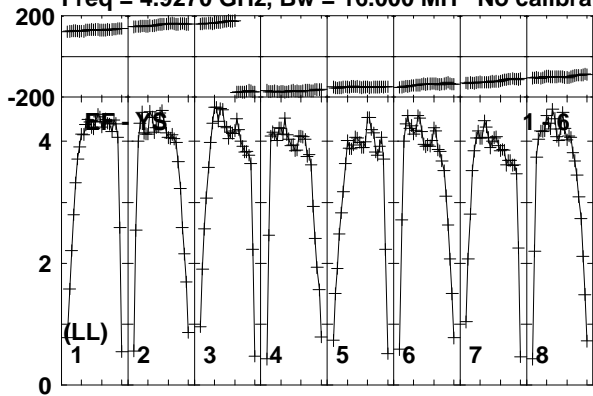

Lower frame: Milli Ampl Jy Top frame: Phas deg
Vector averaged cross-power spectrum Baseline: EF (01) - YS (06)
Timerange: 01/09:59:23 to 01/10:00:49

Plot file version 535 created 26-MAR-2015 15:28:06

V596CAS EG082E.UVDATA.1

Freq = 4.9270 GHz, Bw = 16.000 MH No calibration applied and no bandpass applied

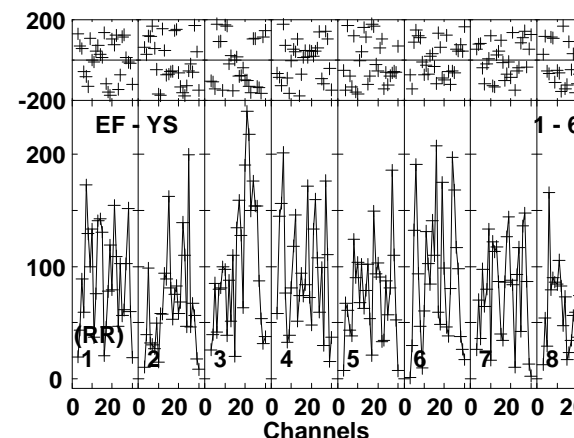
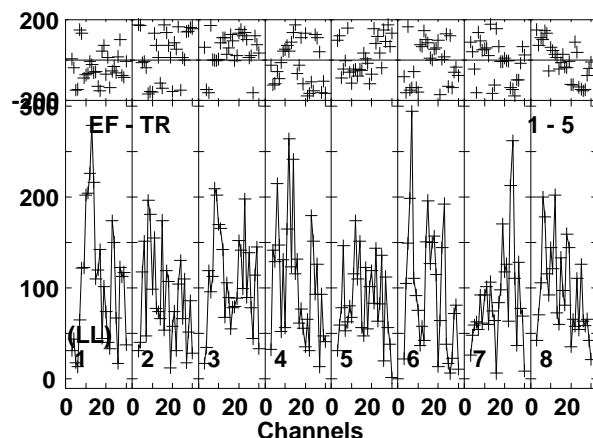
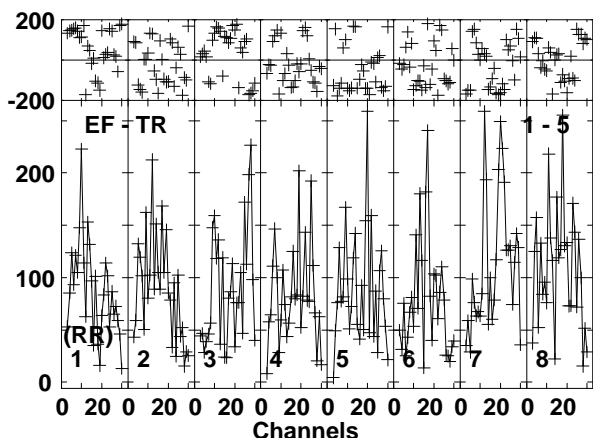
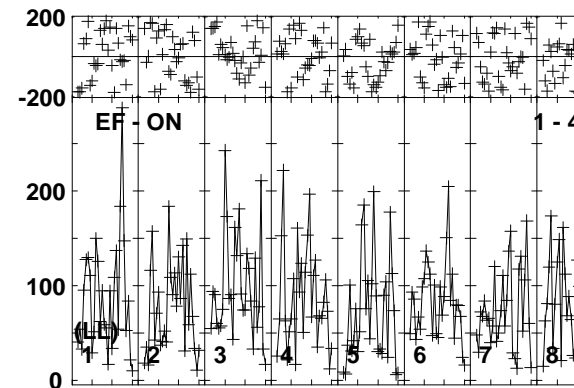
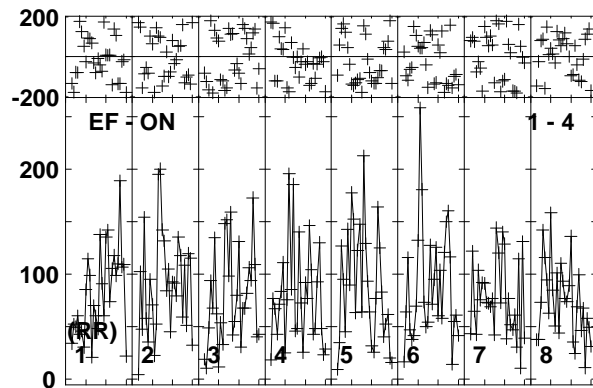
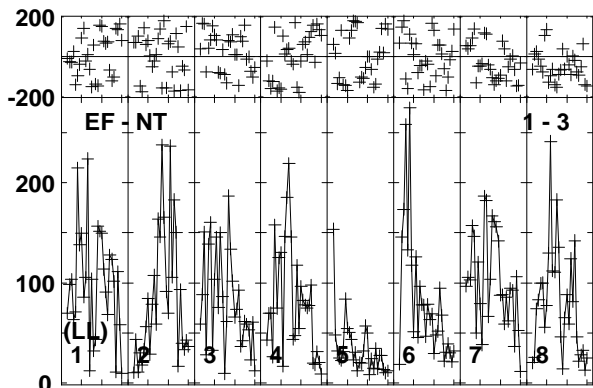
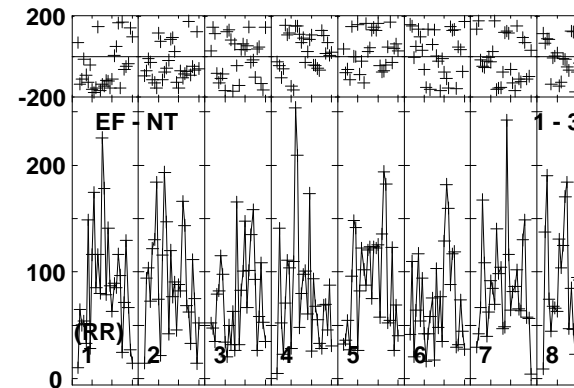
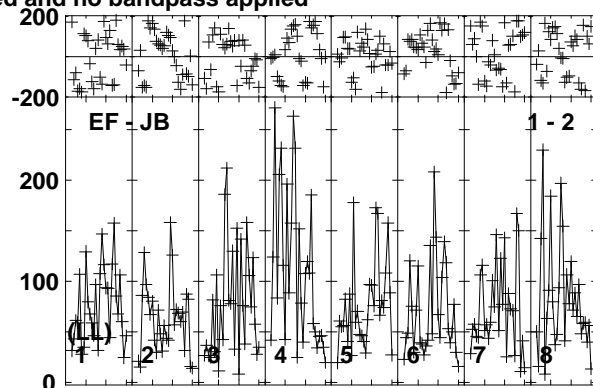
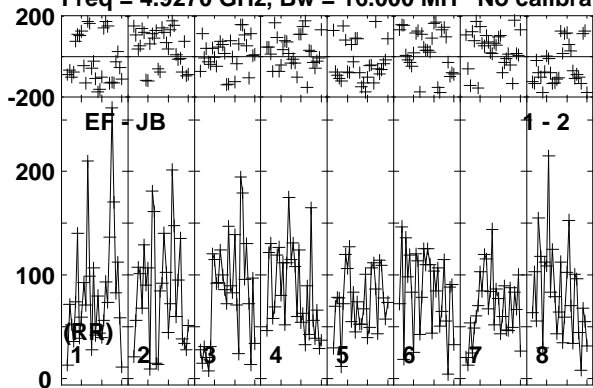

Lower frame: Micro Ampl Jy Top frame: Phas deg
Vector averaged cross-power spectrum Baseline: EF (01) - JB (02)
Timerange: 01/10:00:53 to 01/10:04:19

Plot file version 536 created 26-MAR-2015 15:28:06

V596CAS EG082E.UVDATA.1

Freq = 4.9270 GHz, Bw = 16.000 MH No calibration applied and no bandpass applied

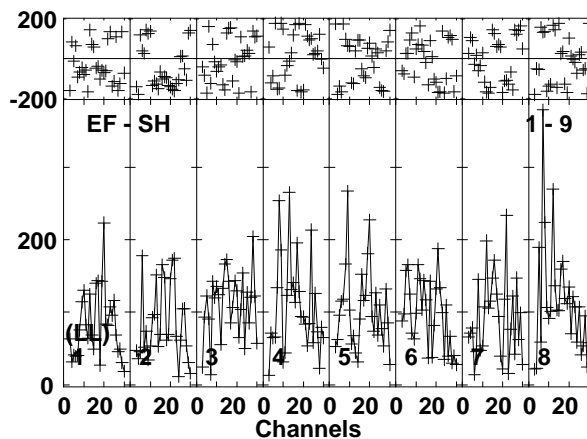
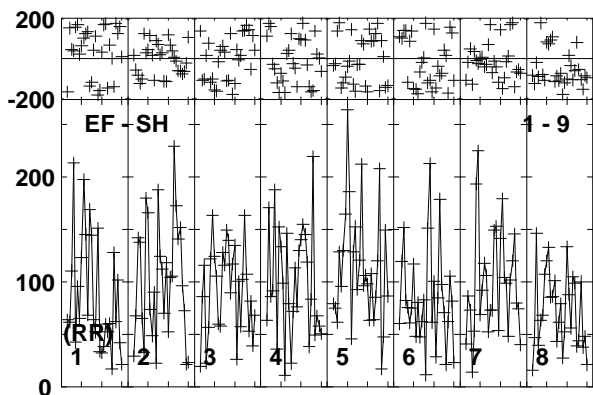
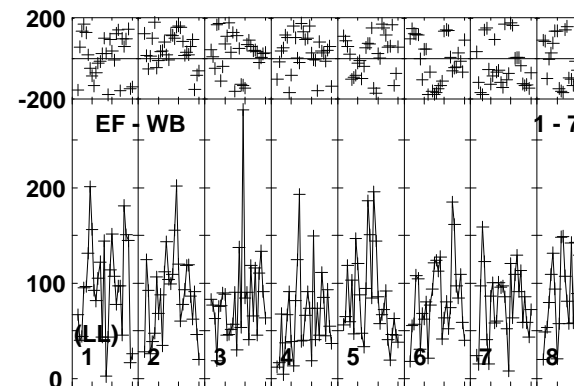
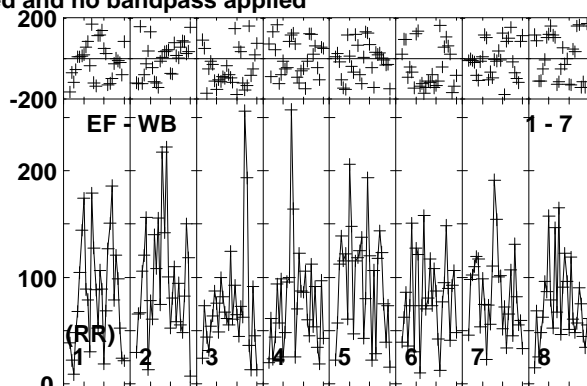
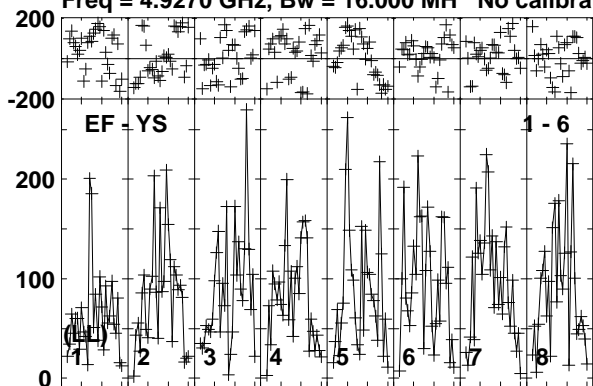

Lower frame: Micro Ampl Jy Top frame: Phas deg
Vector averaged cross-power spectrum Baseline: EF (01) - YS (06)
Timerange: 01/10:00:53 to 01/10:04:19

Plot file version 537 created 26-MAR-2015 15:28:06

J0147+5840 EG082E.UVDATA.1

Freq = 4.9270 GHz, Bw = 16.000 MH No calibration applied and no bandpass applied

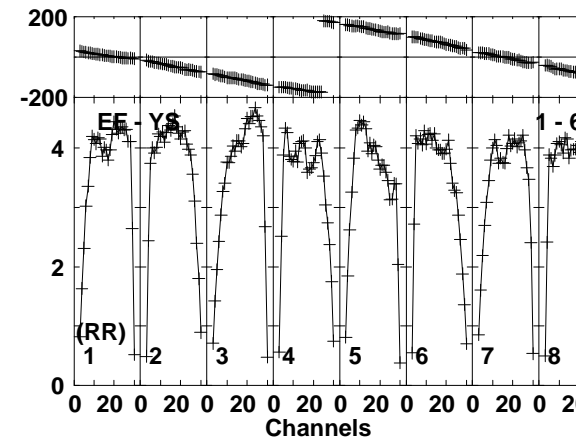
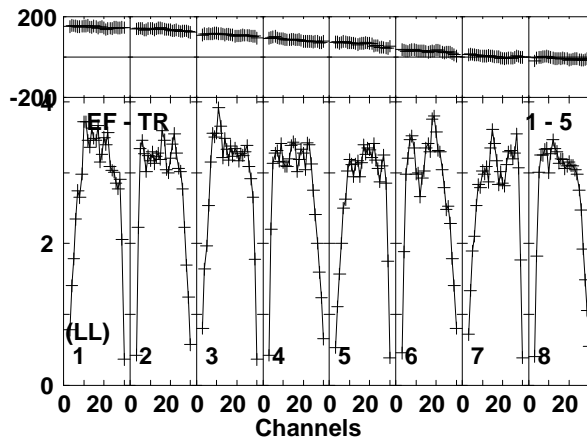
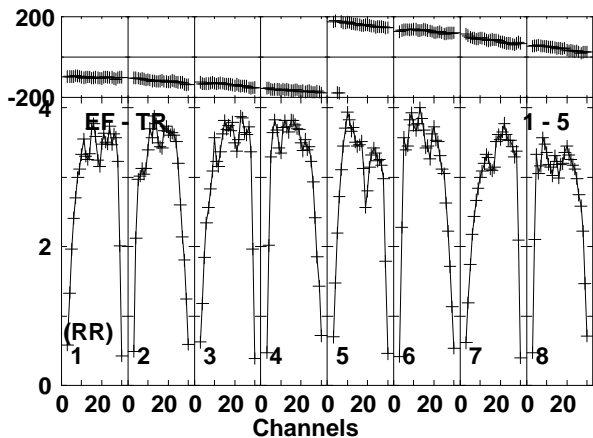
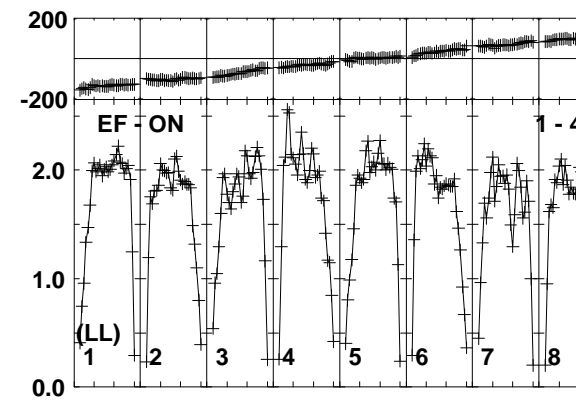
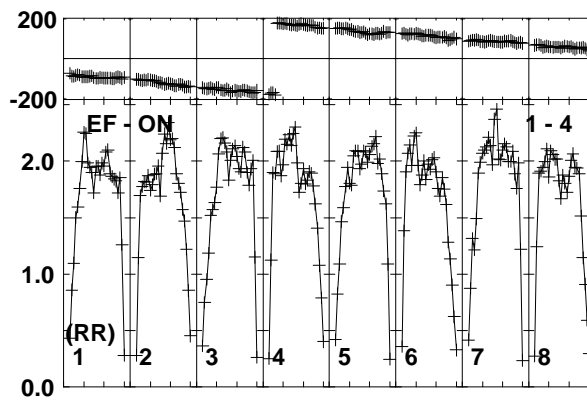
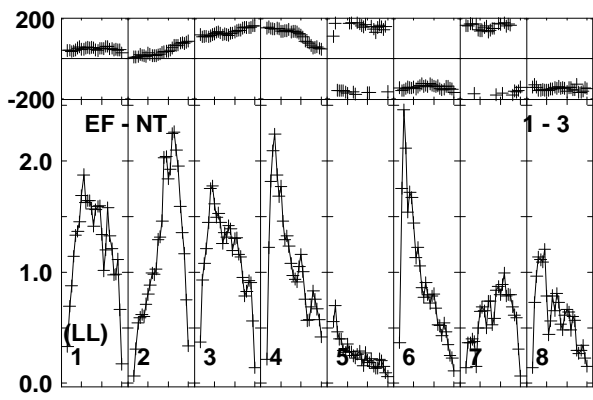
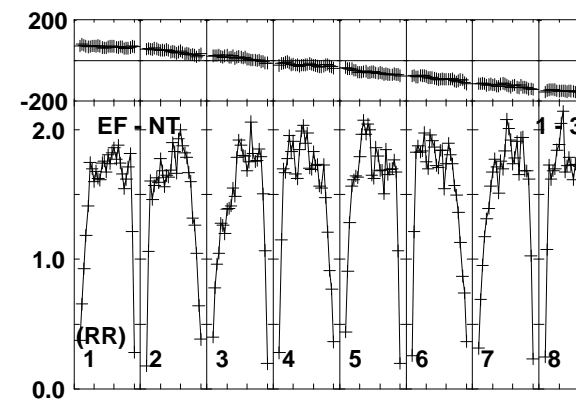
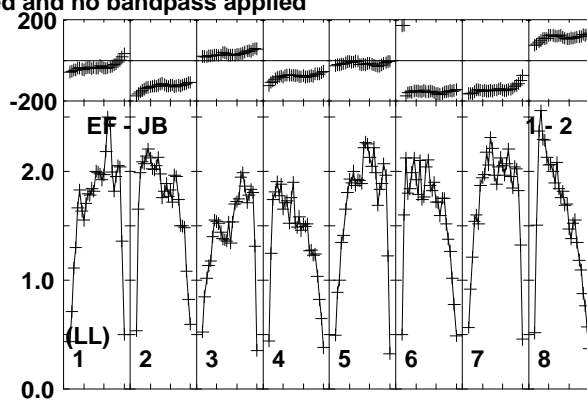
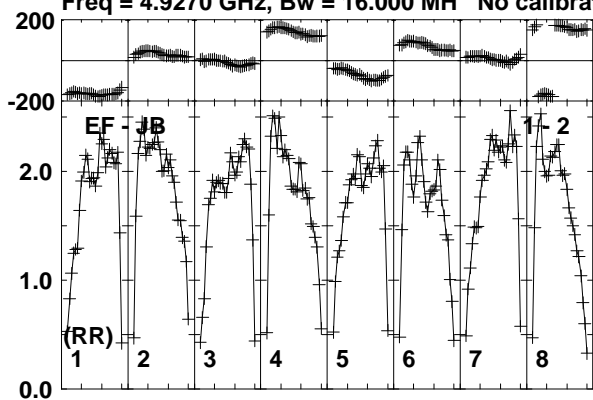

Lower frame: Milli Ampl Jy Top frame: Phas deg
Vector averaged cross-power spectrum Baseline: EF (01) - JB (02)
Timerange: 01/10:04:53 to 01/10:05:49

Plot file version 538 created 26-MAR-2015 15:28:06

J0147+5840 EG082E.UVDATA.1

Freq = 4.9270 GHz, Bw = 16.000 MH No calibration applied and no bandpass applied

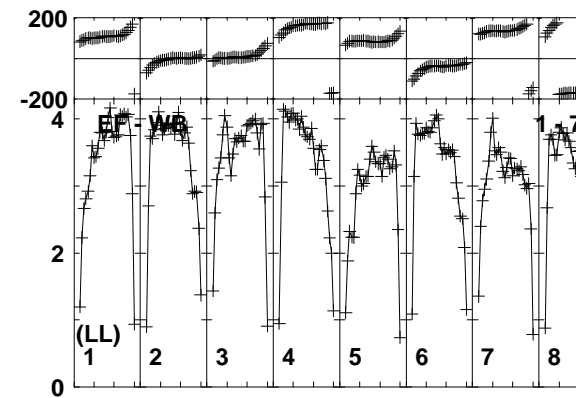
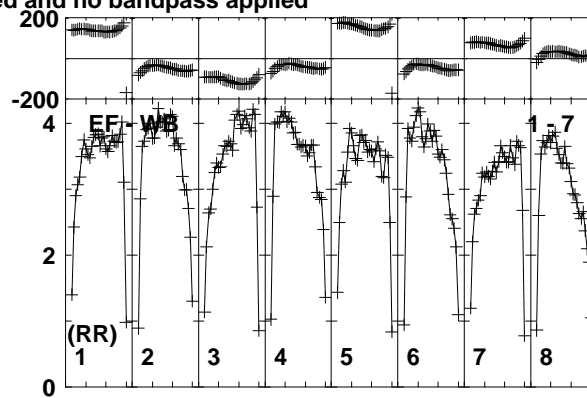
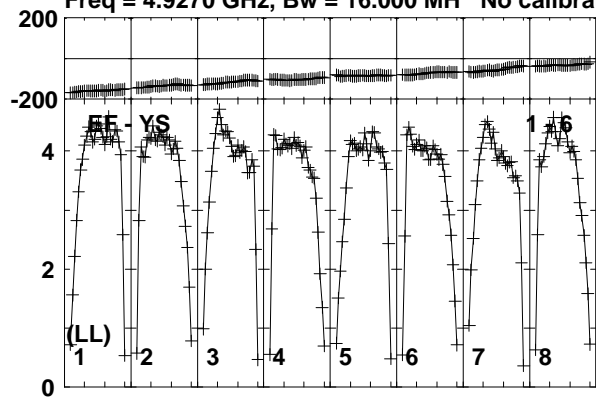

Lower frame: Milli Ampl Jy Top frame: Phas deg
Vector averaged cross-power spectrum Baseline: EF (01) - YS (06)
Timerange: 01/10:04:53 to 01/10:05:49

Plot file version 539 created 26-MAR-2015 15:28:06

V596CAS EG082E.UVDATA.1

Freq = 4.9270 GHz, Bw = 16.000 MH No calibration applied and no bandpass applied

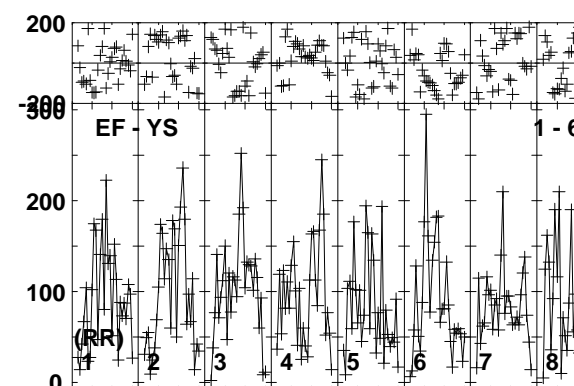
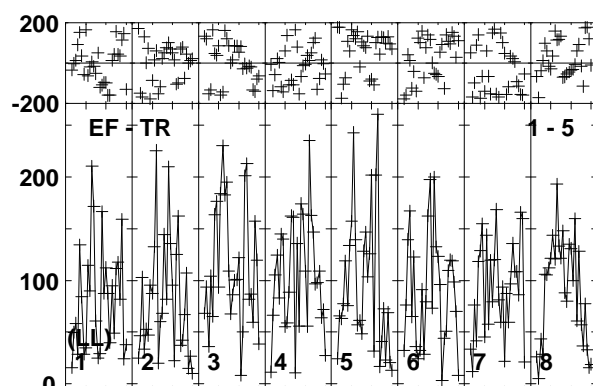
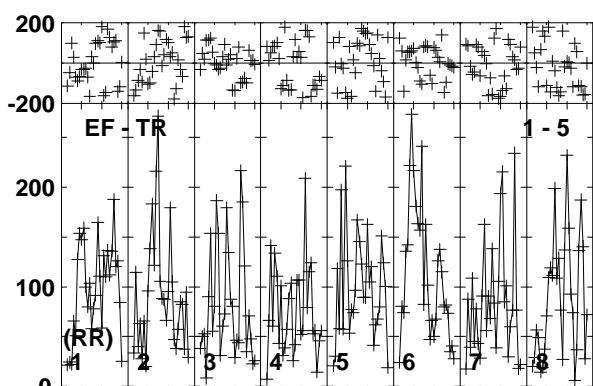
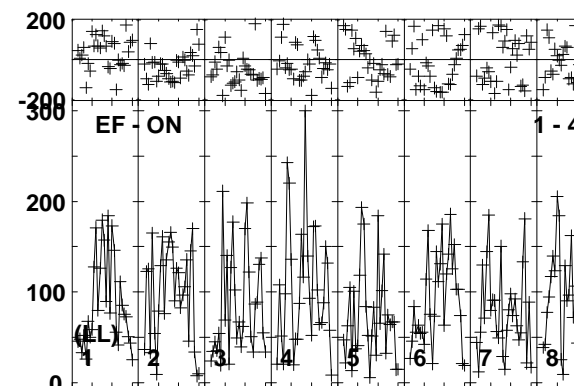
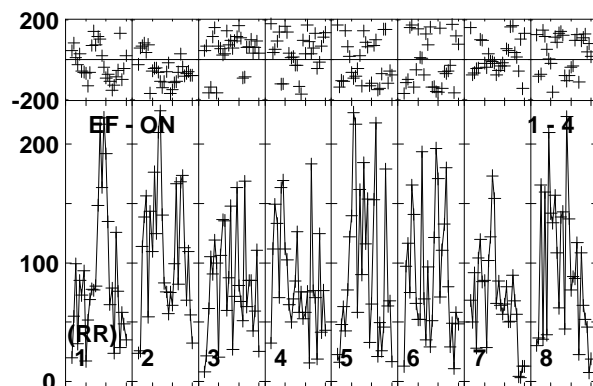
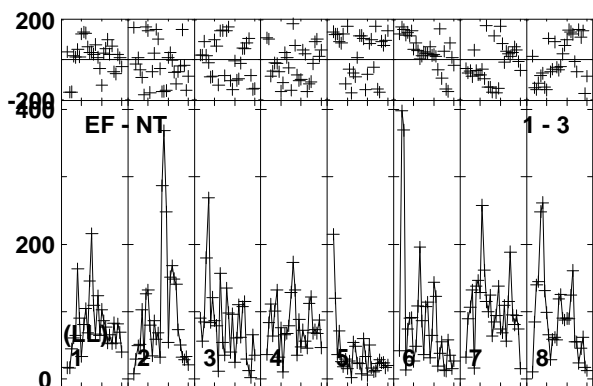
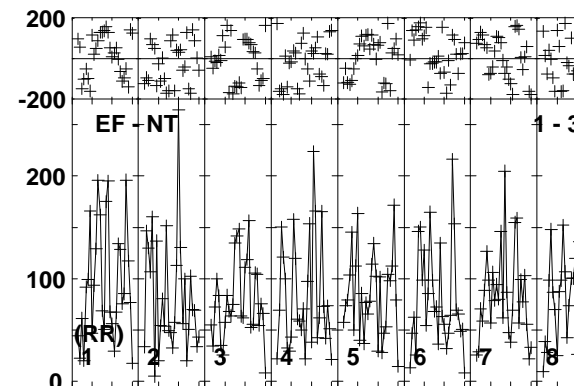
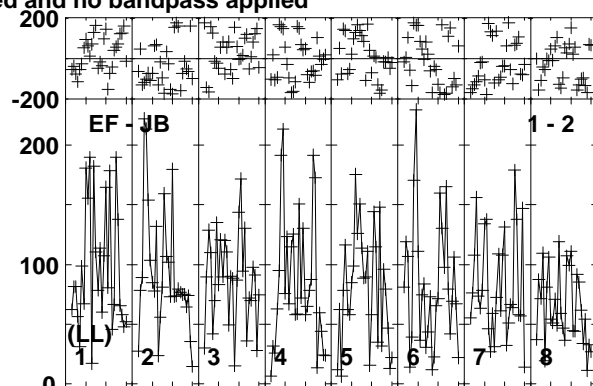
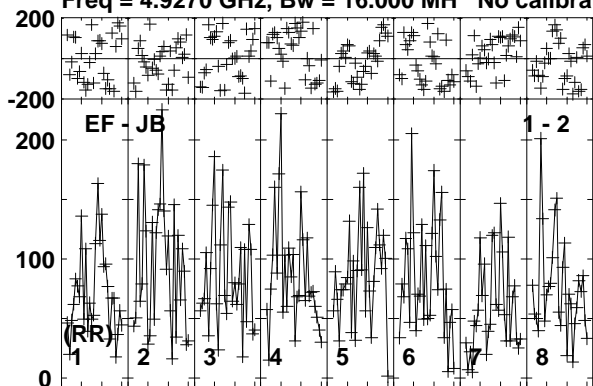

Lower frame: Micro Ampl Jy Top frame: Phas deg
Vector averaged cross-power spectrum Baseline: EF (01) - JB (02)
Timerange: 01/10:05:53 to 01/10:09:19

Plot file version 540 created 26-MAR-2015 15:28:06

V596CAS EG082E.UVDATA.1

Freq = 4.9270 GHz, Bw = 16.000 MH No calibration applied and no bandpass applied

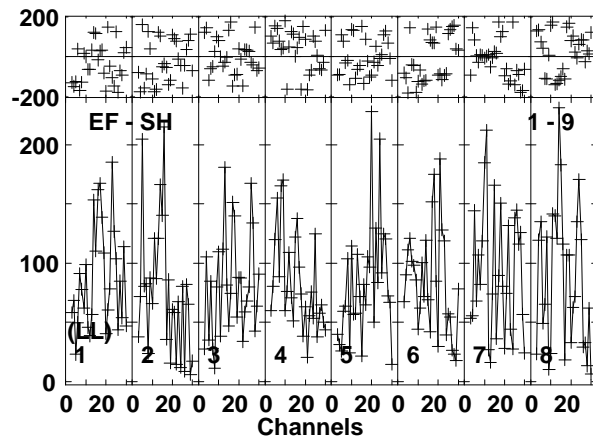
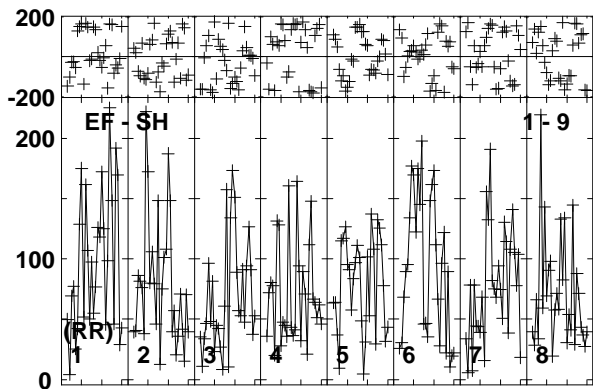
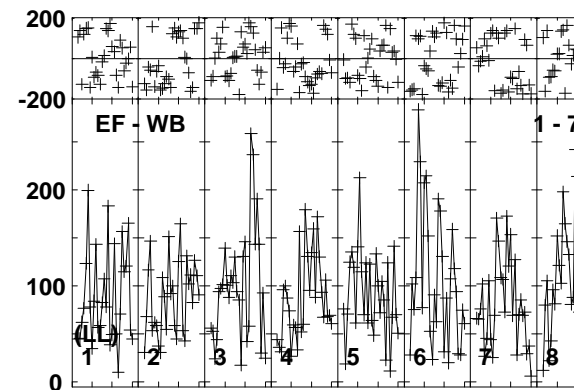
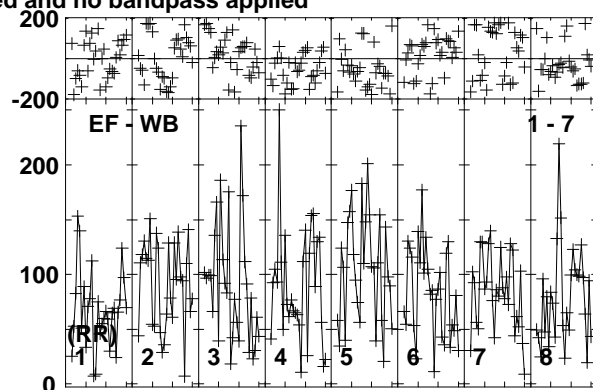
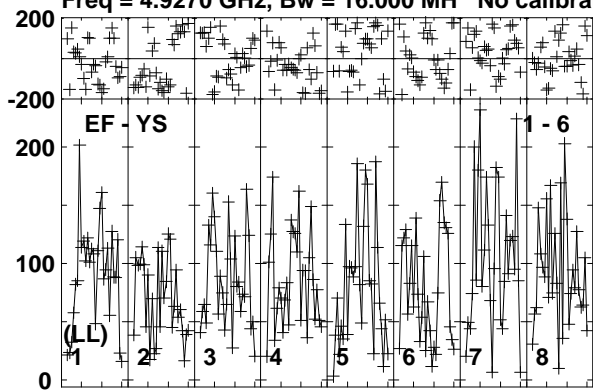

Lower frame: Micro Ampl Jy Top frame: Phas deg
Vector averaged cross-power spectrum Baseline: EF (01) - YS (06)
Timerange: 01/10:05:53 to 01/10:09:19

Plot file version 541 created 26-MAR-2015 15:28:06

J0147+5840 EG082E.UVDATA.1

Freq = 4.9270 GHz, Bw = 16.000 MH No calibration applied and no bandpass applied

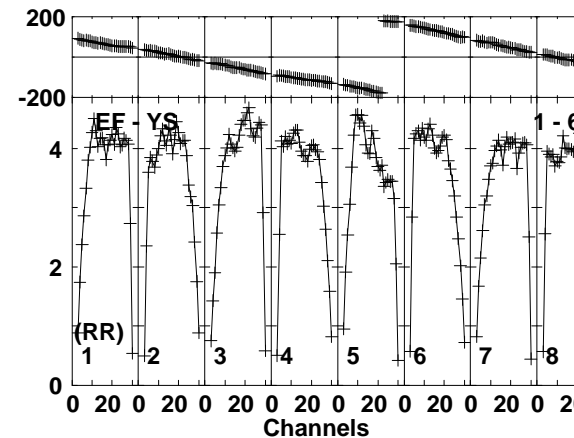
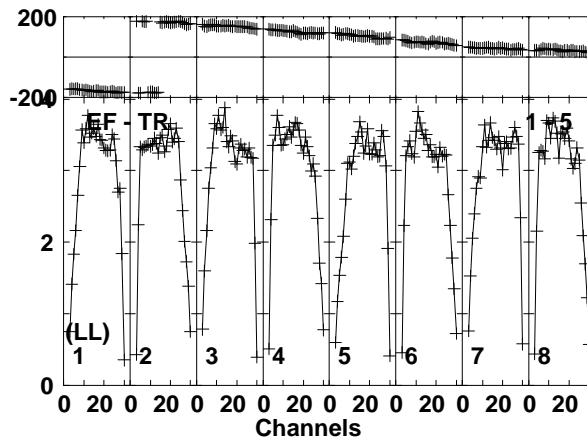
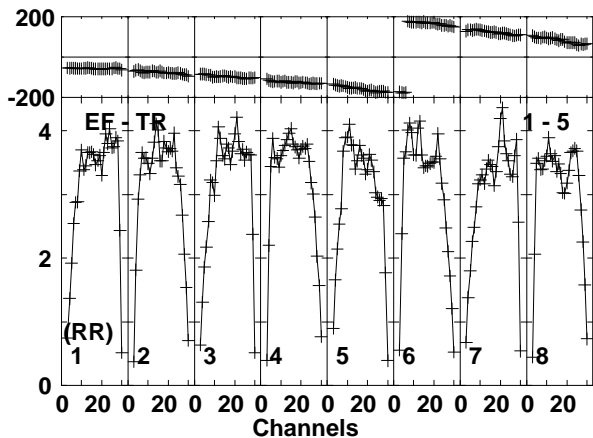
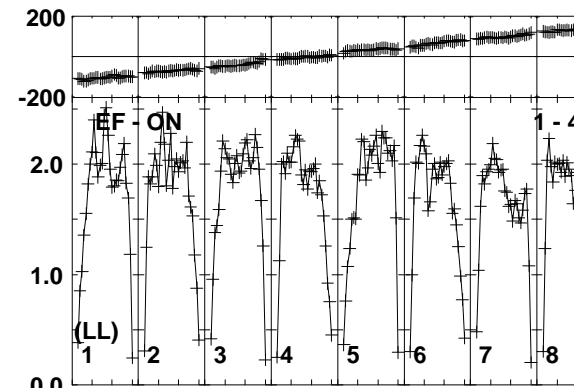
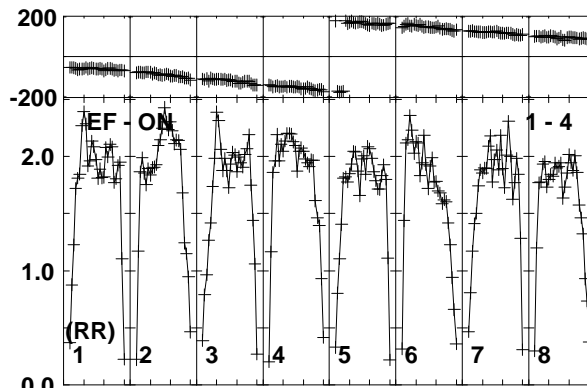
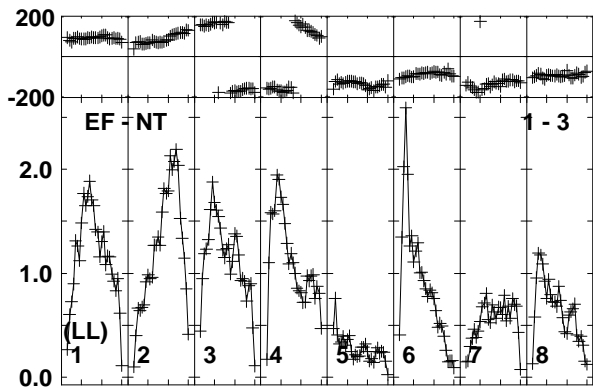
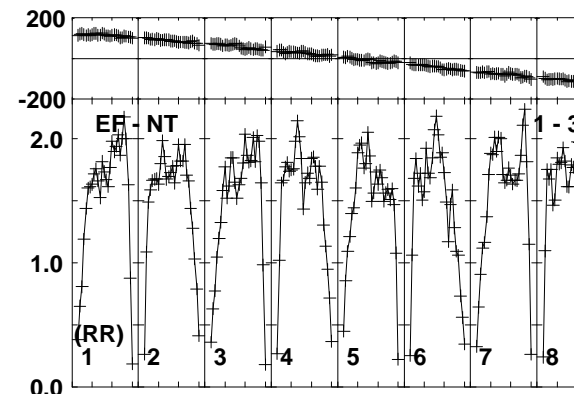
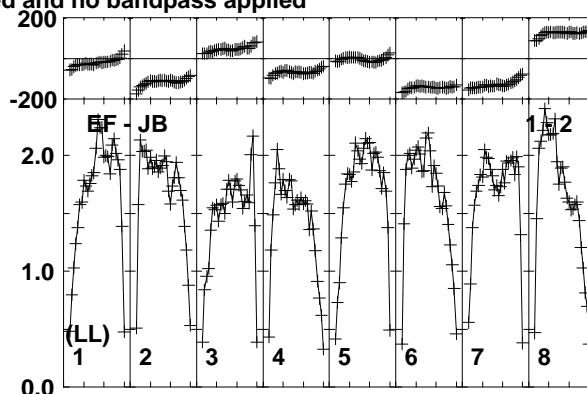
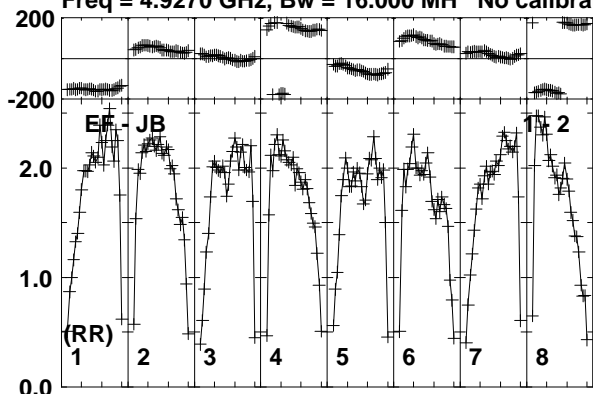

Lower frame: Milli Ampl Jy Top frame: Phas deg
Vector averaged cross-power spectrum Baseline: EF (01) - JB (02)
Timerange: 01/10:09:23 to 01/10:10:49

Plot file version 542 created 26-MAR-2015 15:28:06

J0147+5840 EG082E.UVDATA.1

Freq = 4.9270 GHz, Bw = 16.000 MH No calibration applied and no bandpass applied

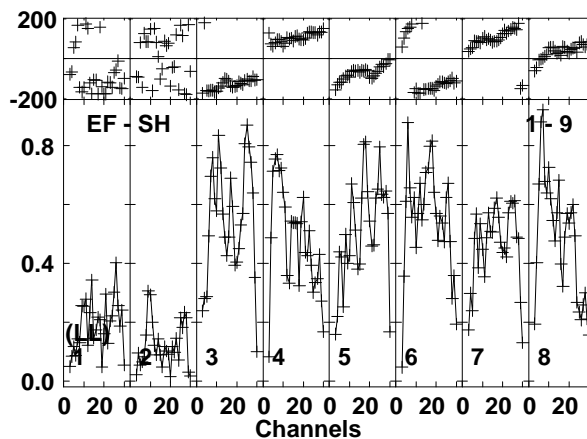
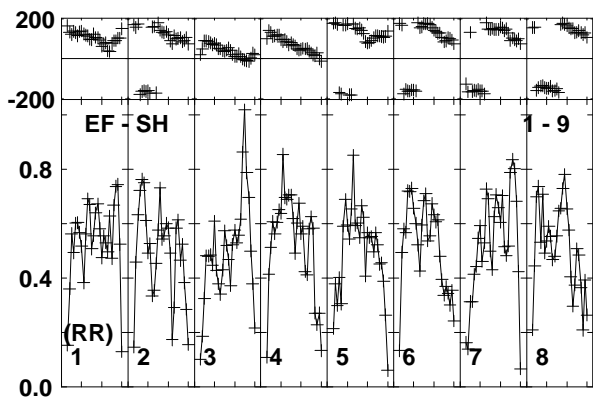
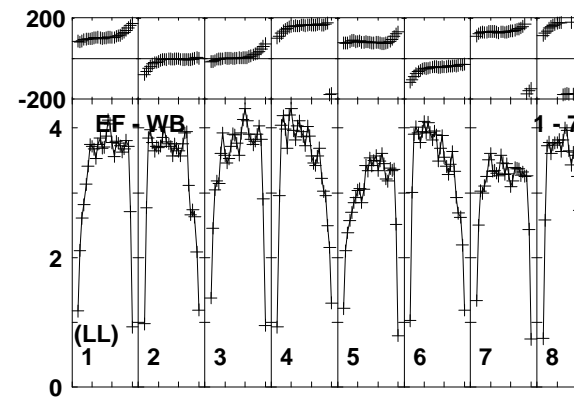
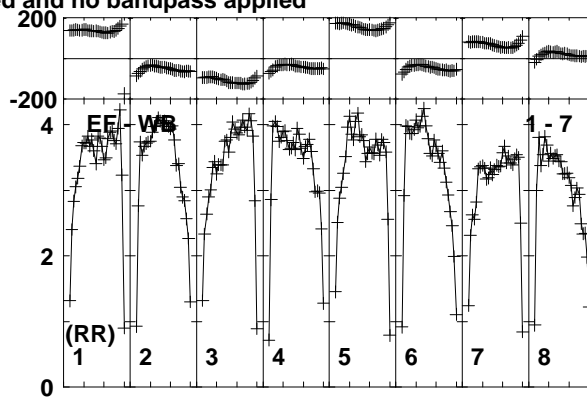
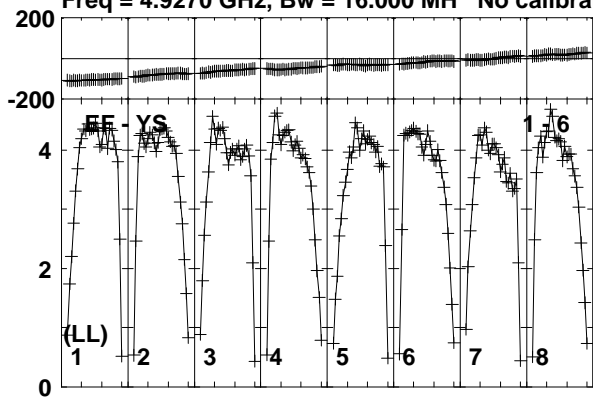

Lower frame: Milli Ampl Jy Top frame: Phas deg
Vector averaged cross-power spectrum Baseline: EF (01) - YS (06)
Timerange: 01/10:09:23 to 01/10:10:49

Plot file version 543 created 26-MAR-2015 15:28:06

V596CAS EG082E.UVDATA.1

Freq = 4.9270 GHz, Bw = 16.000 MH No calibration applied and no bandpass applied

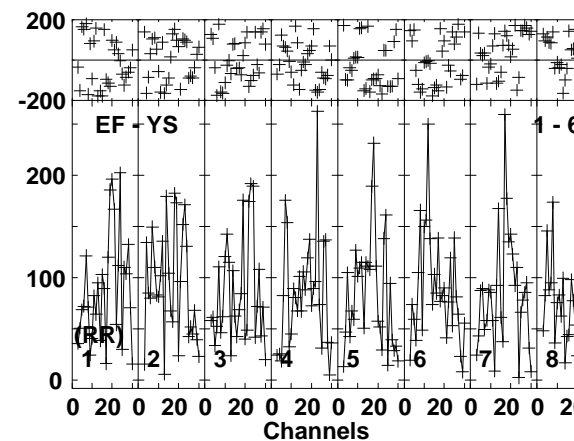
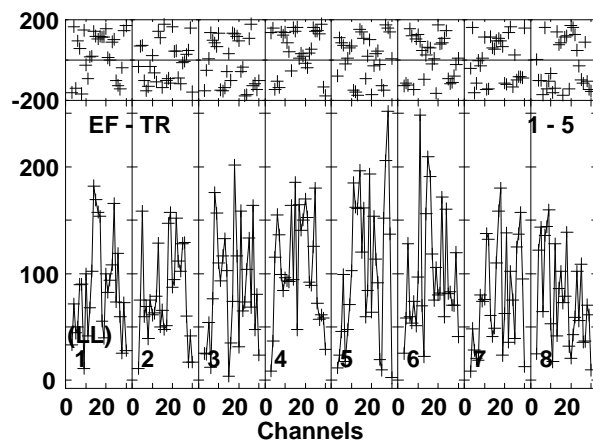
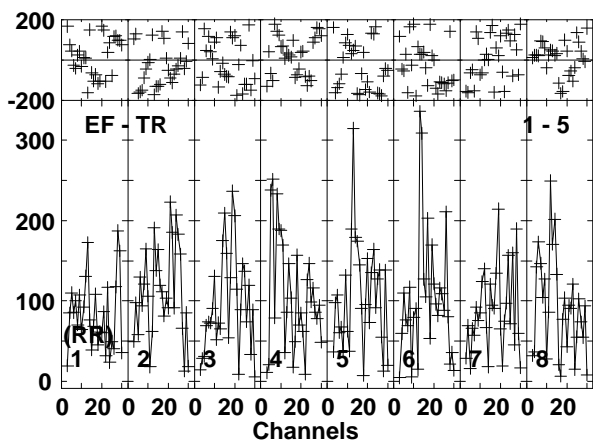
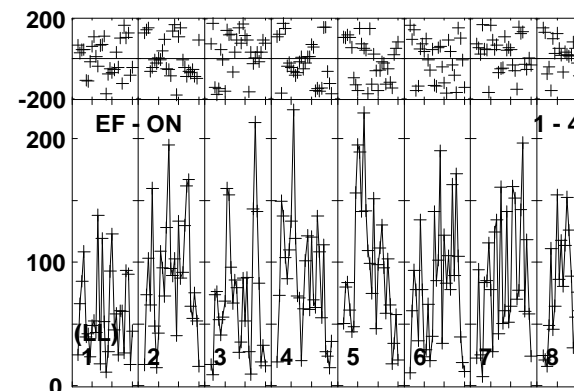
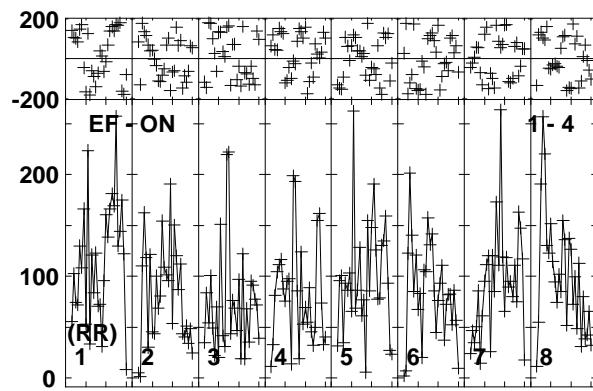
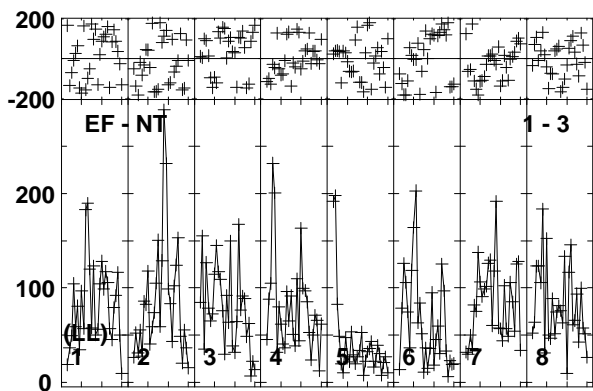
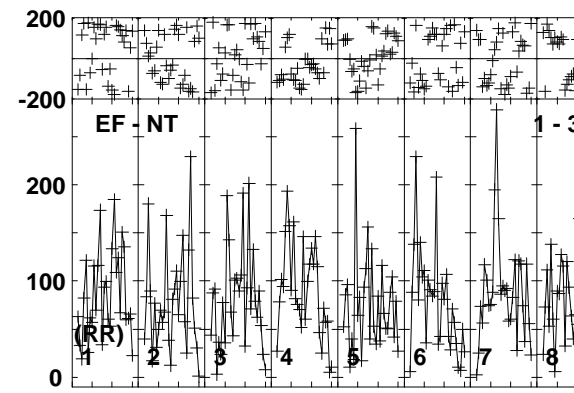
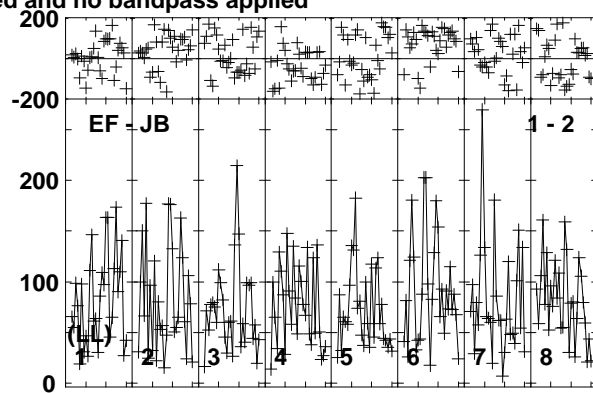
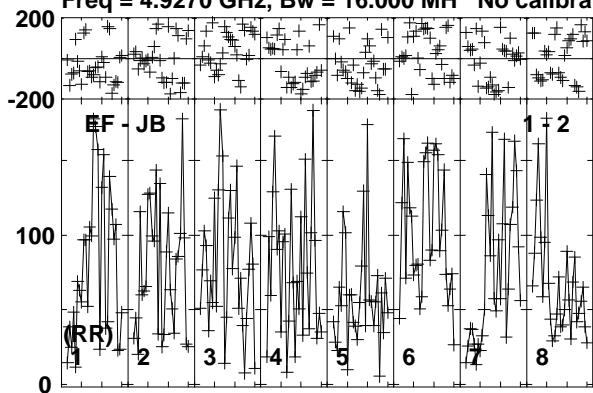

Lower frame: Micro Ampl Jy Top frame: Phas deg
Vector averaged cross-power spectrum Baseline: EF (01) - JB (02)
Timerange: 01/10:10:53 to 01/10:14:19

Plot file version 544 created 26-MAR-2015 15:28:06

V596CAS EG082E.UVDATA.1

Freq = 4.9270 GHz, Bw = 16.000 MH No calibration applied and no bandpass applied

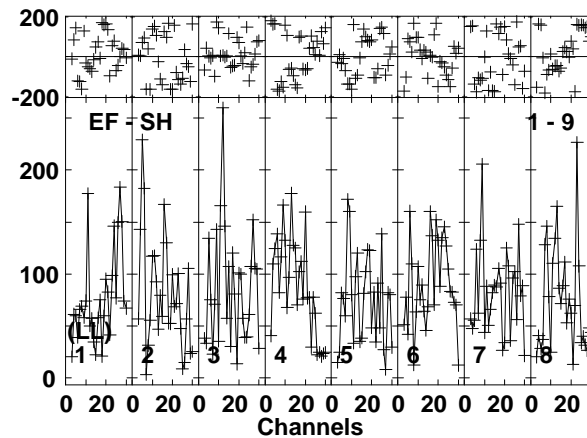
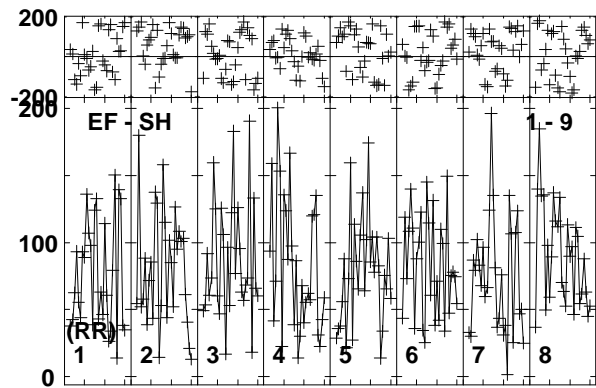
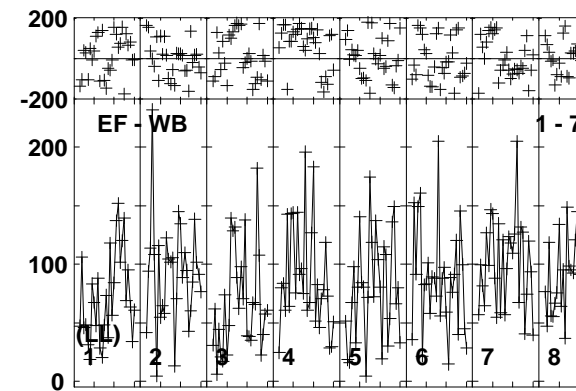
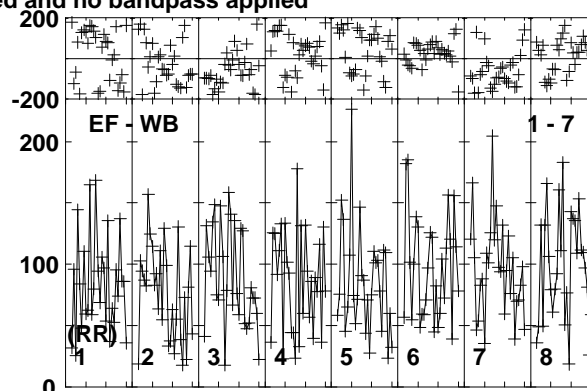
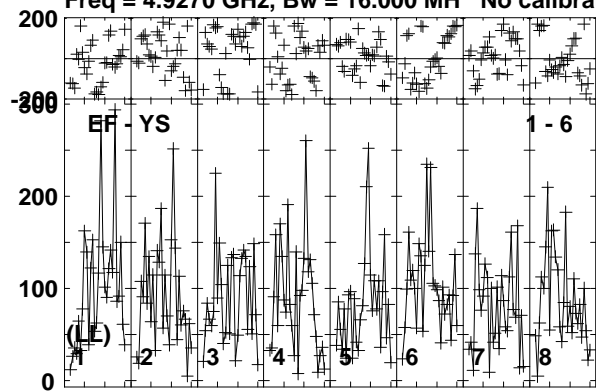

Lower frame: Micro Ampl Jy Top frame: Phas deg
Vector averaged cross-power spectrum Baseline: EF (01) - YS (06)
Timerange: 01/10:10:53 to 01/10:14:19

Plot file version 545 created 26-MAR-2015 15:28:06

J0147+5840 EG082E.UVDATA.1

Freq = 4.9270 GHz, Bw = 16.000 MH No calibration applied and no bandpass applied

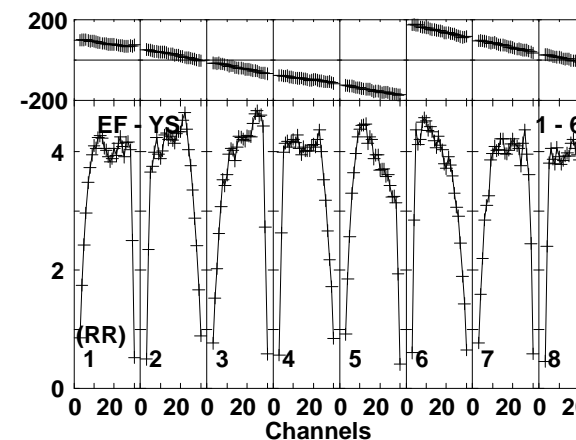
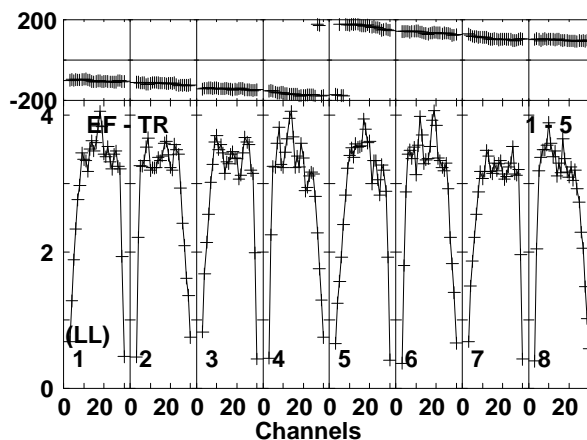
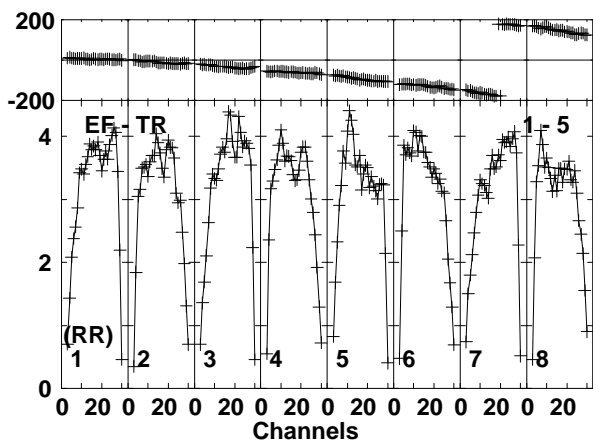
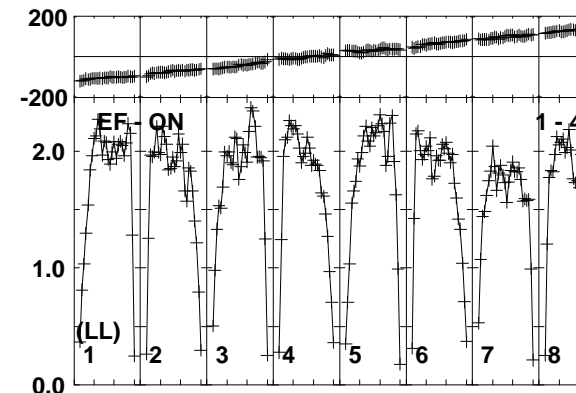
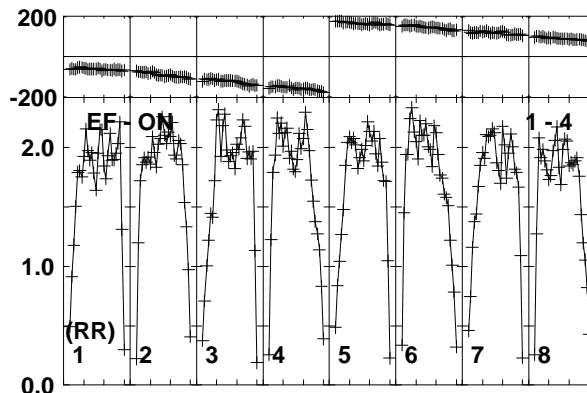
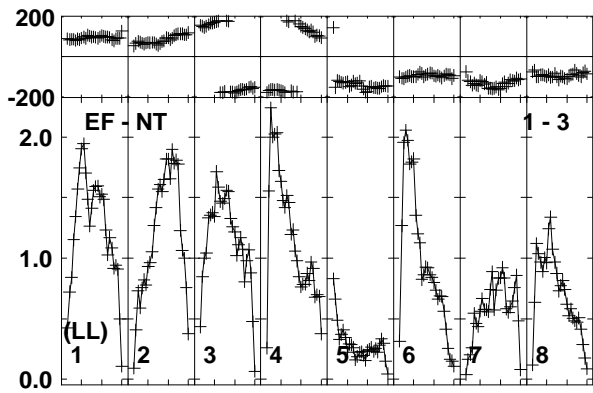
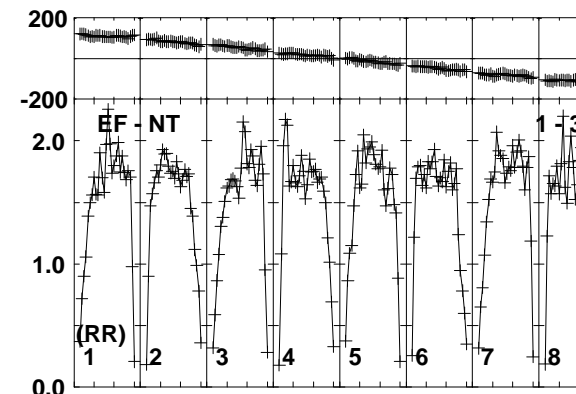
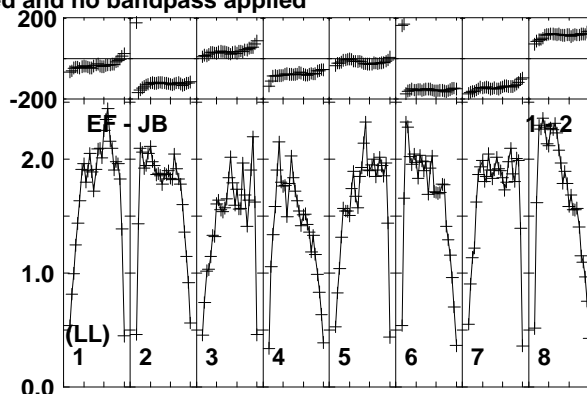
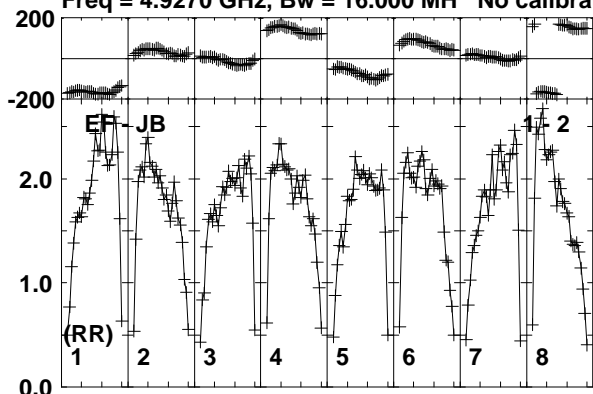

Lower frame: Milli Ampl Jy Top frame: Phas deg
Vector averaged cross-power spectrum Baseline: EF (01) - JB (02)
Timerange: 01/10:14:53 to 01/10:15:49

Plot file version 546 created 26-MAR-2015 15:28:06
J0147+5840 EG082E.UVDATA.1

Freq = 4.9270 GHz, Bw = 16.000 MH No calibration applied and no bandpass applied

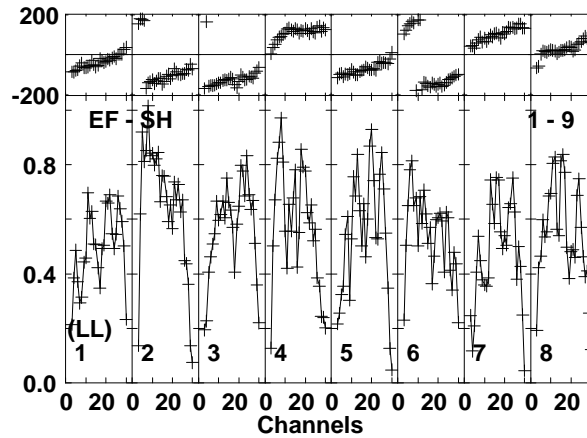
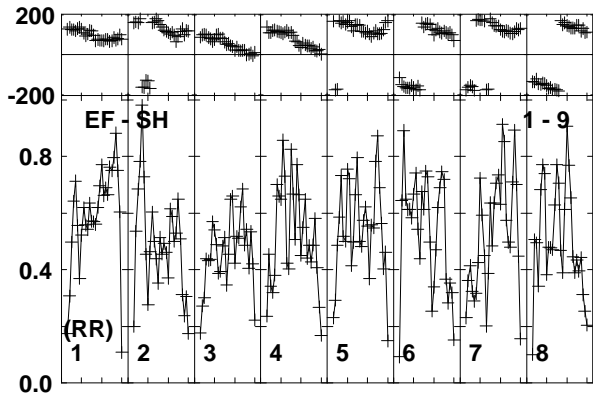
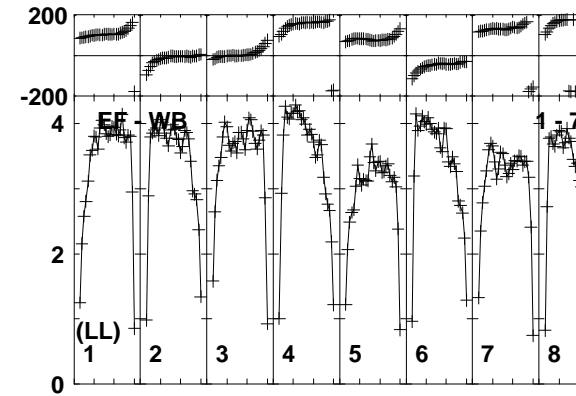
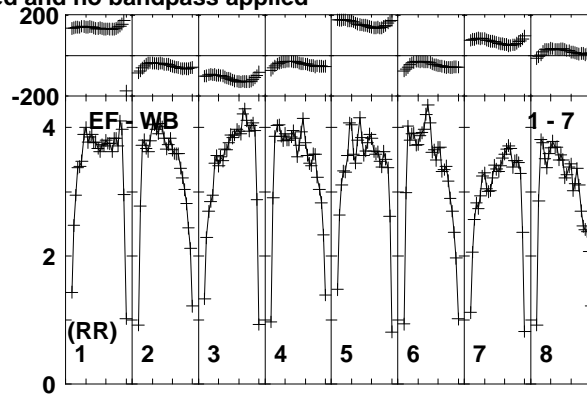
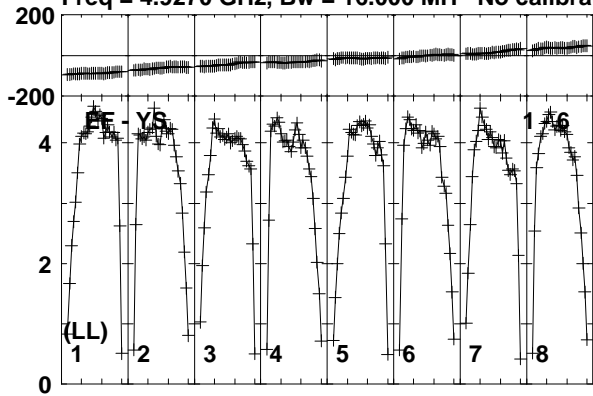

Lower frame: Milli Ampl Jy Top frame: Phas deg
Vector averaged cross-power spectrum Baseline: EF (01) - YS (06)
Timerange: 01/10:14:53 to 01/10:15:49

Plot file version 547 created 26-MAR-2015 15:28:07

V596CAS EG082E.UVDATA.1

Freq = 4.9270 GHz, Bw = 16.000 MH No calibration applied and no bandpass applied

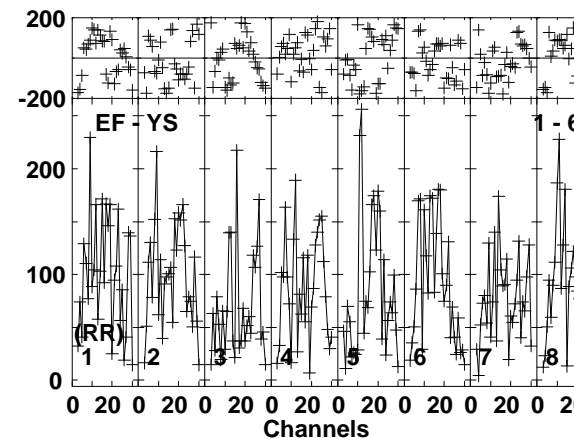
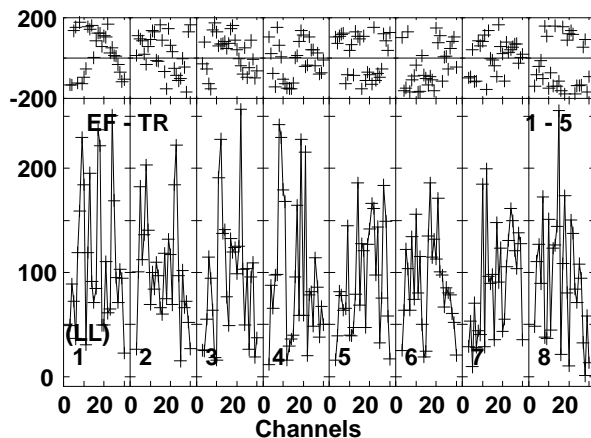
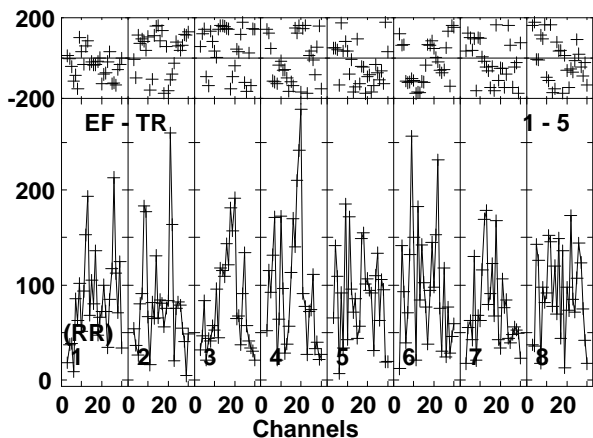
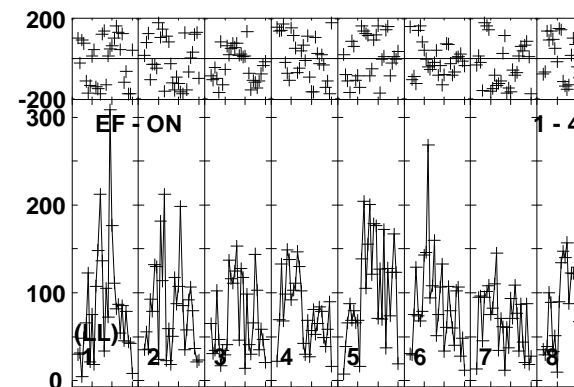
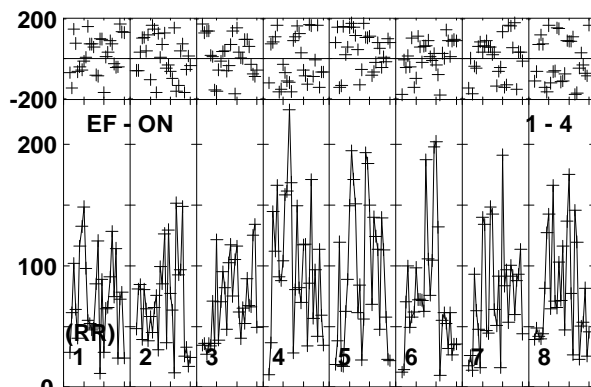
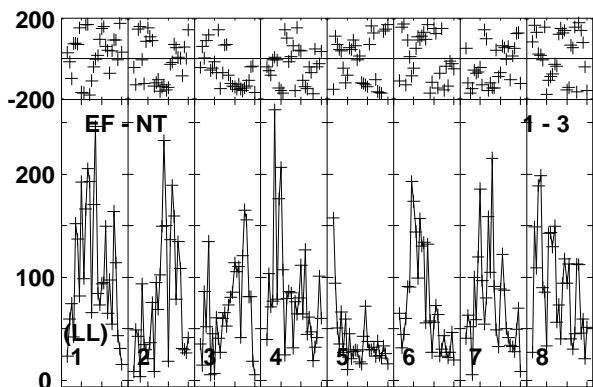
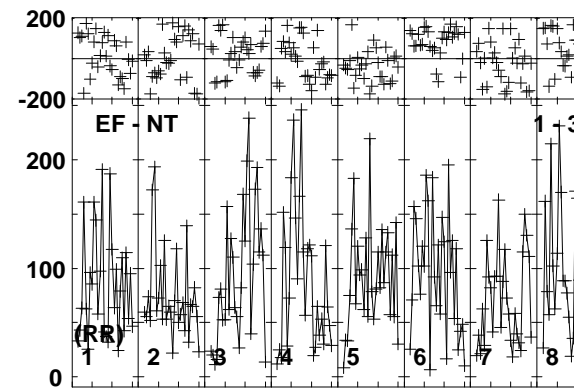
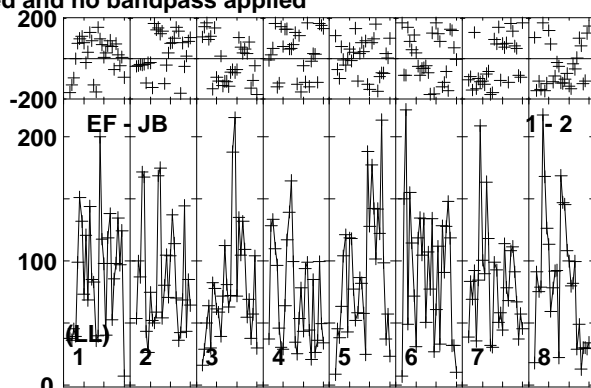
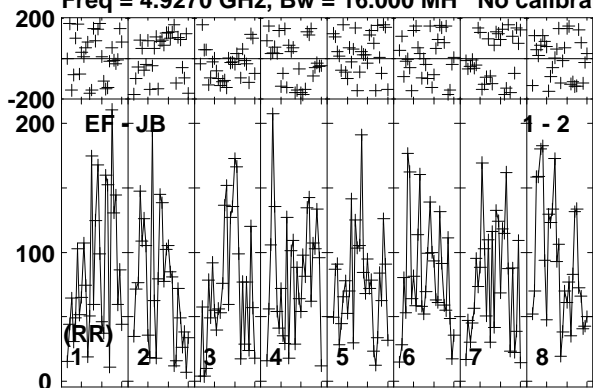

Lower frame: Micro Ampl Jy Top frame: Phas deg
Vector averaged cross-power spectrum Baseline: EF (01) - JB (02)
Timerange: 01/10:15:53 to 01/10:19:19

Plot file version 548 created 26-MAR-2015 15:28:07

V596CAS EG082E.UVDATA.1

Freq = 4.9270 GHz, Bw = 16.000 MH No calibration applied and no bandpass applied

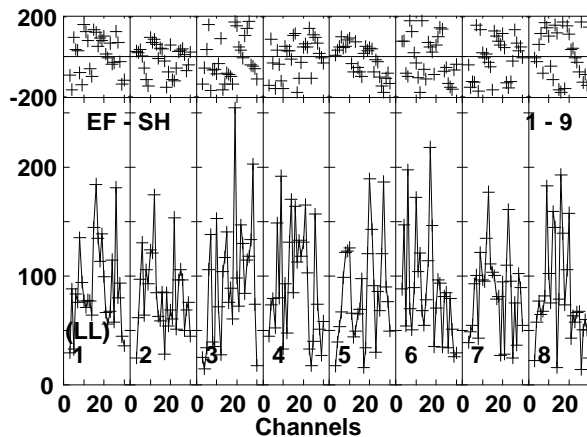
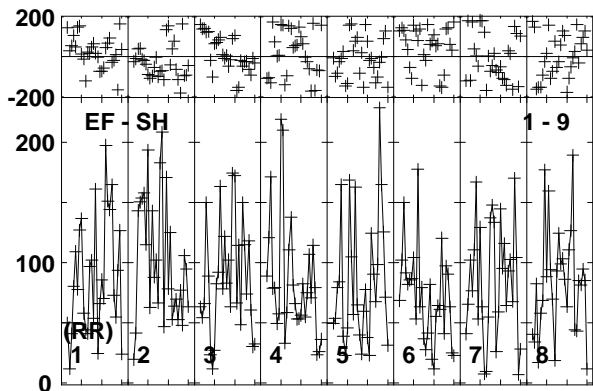
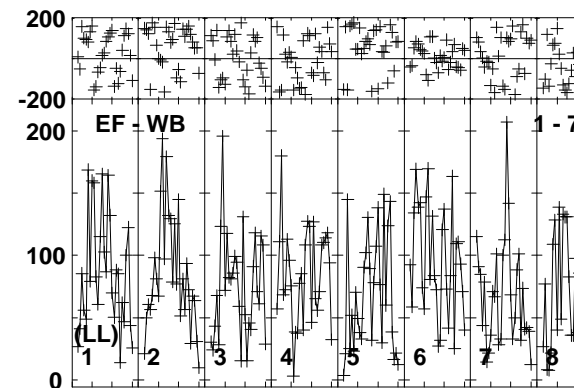
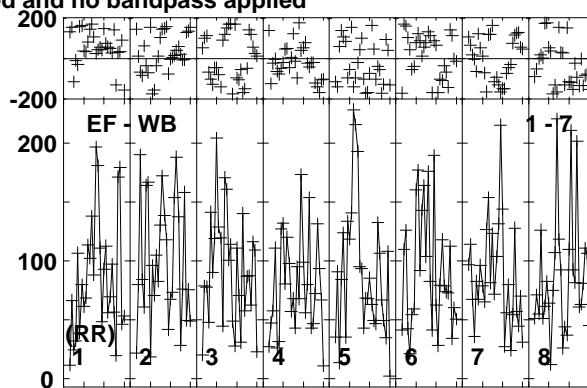
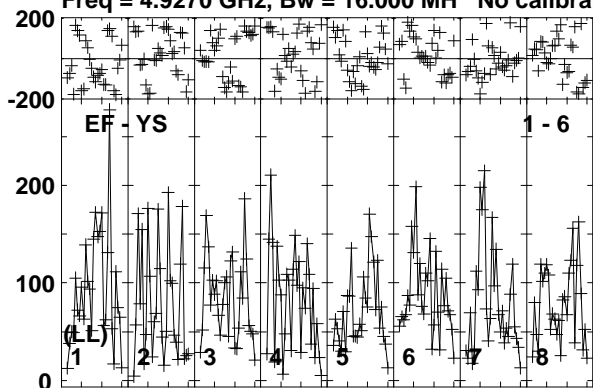

Lower frame: Micro Ampl Jy Top frame: Phas deg
Vector averaged cross-power spectrum Baseline: EF (01) - YS (06)
Timerange: 01/10:15:53 to 01/10:19:19

Plot file version 549 created 26-MAR-2015 15:28:07

J0147+5840 EG082E.UVDATA.1

Freq = 4.9270 GHz, Bw = 16.000 MH No calibration applied and no bandpass applied

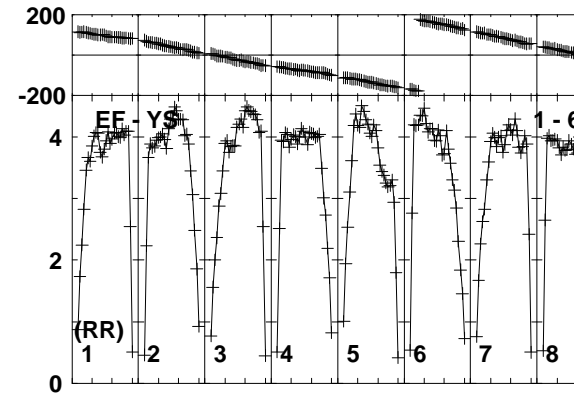
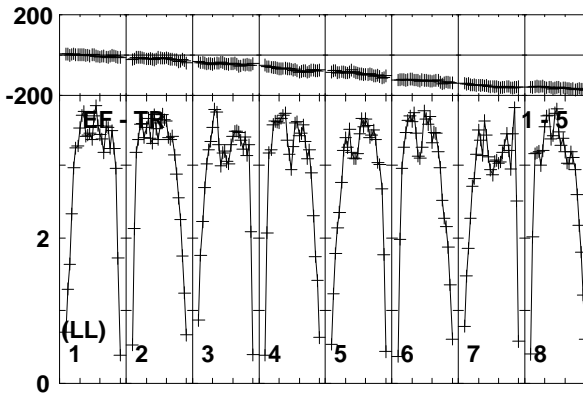
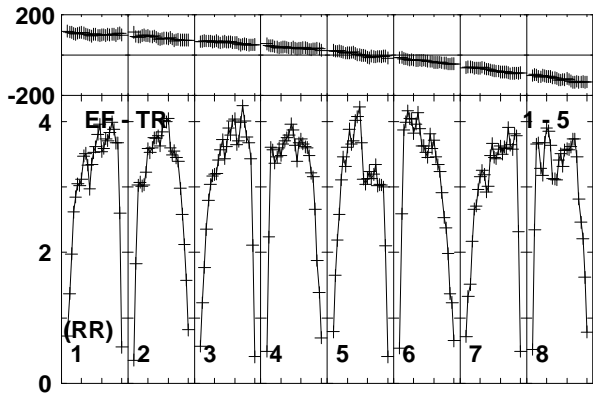
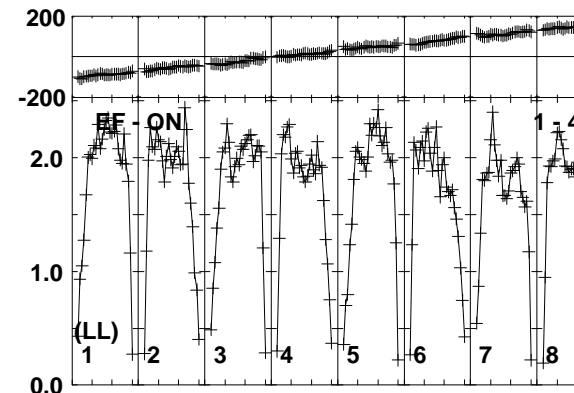
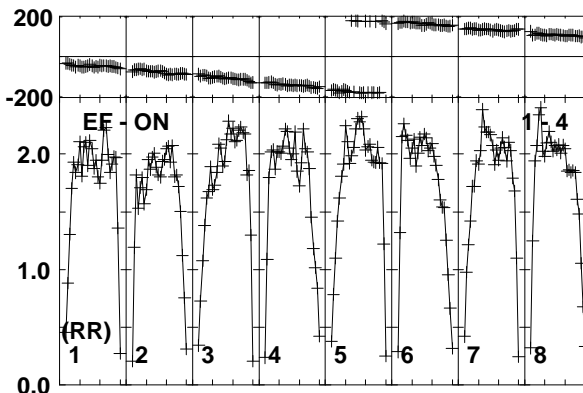
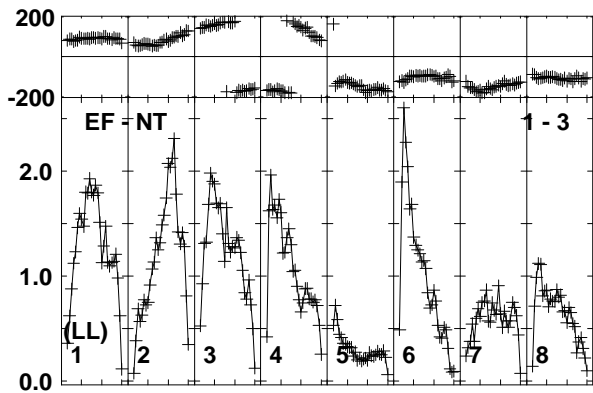
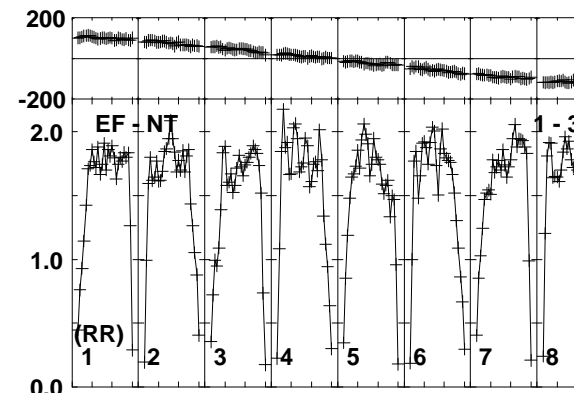
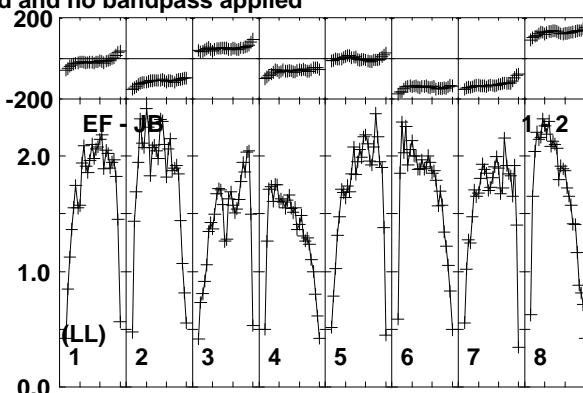
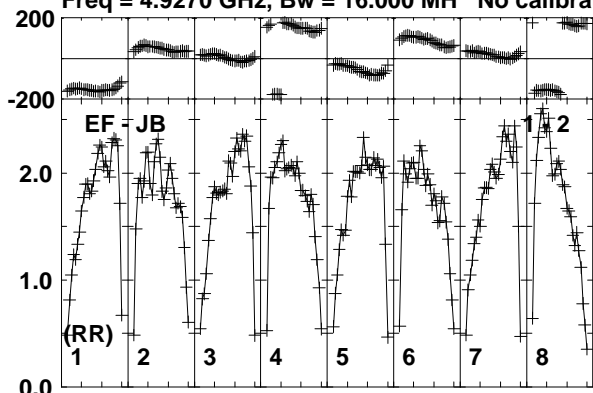

Lower frame: Milli Ampl Jy Top frame: Phas deg
Vector averaged cross-power spectrum Baseline: EF (01) - JB (02)
Timerange: 01/10:19:23 to 01/10:20:49

Plot file version 550 created 26-MAR-2015 15:28:07

J0147+5840 EG082E.UVDATA.1

Freq = 4.9270 GHz, Bw = 16.000 MH No calibration applied and no bandpass applied

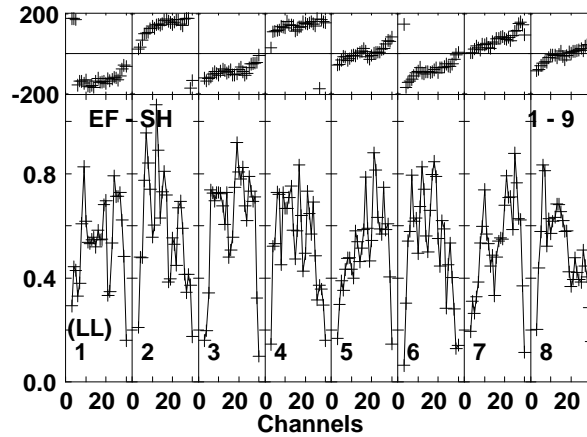
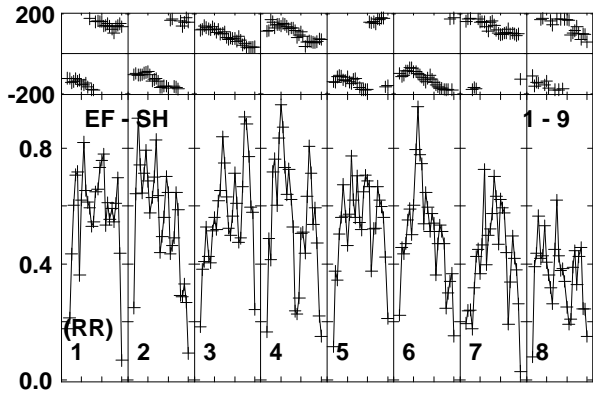
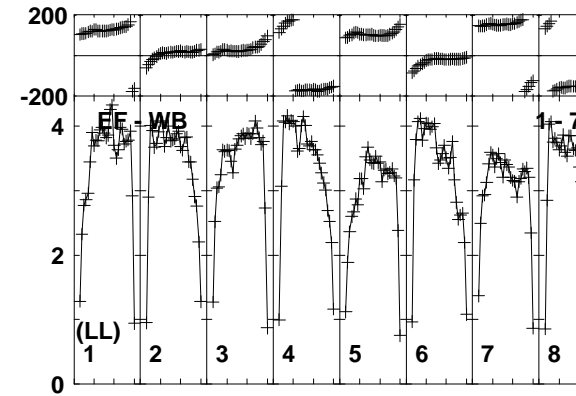
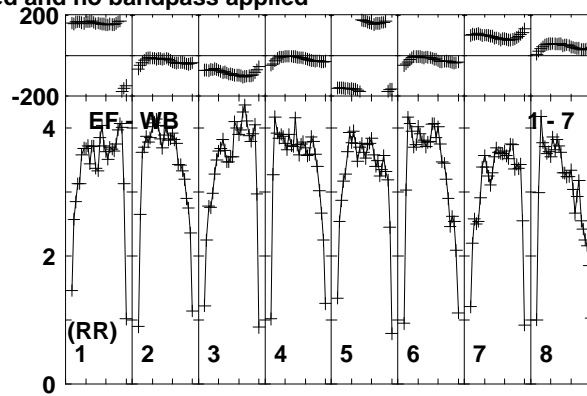
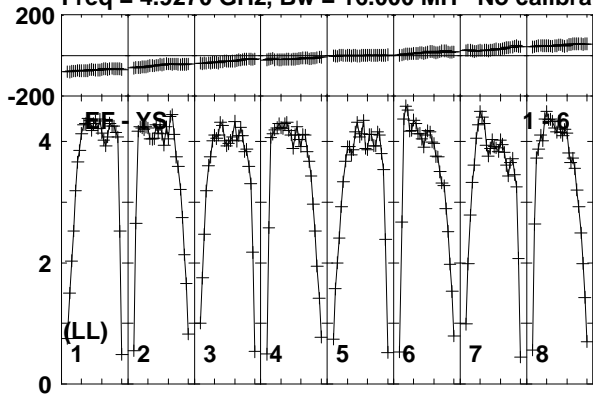

Lower frame: Milli Ampl Jy Top frame: Phas deg
Vector averaged cross-power spectrum Baseline: EF (01) - YS (06)
Timerange: 01/10:19:23 to 01/10:20:49

Plot file version 551 created 26-MAR-2015 15:28:07

J0151+5454 EG082E.UVDATA.1

Freq = 4.9270 GHz, Bw = 16.000 MH No calibration applied and no bandpass applied

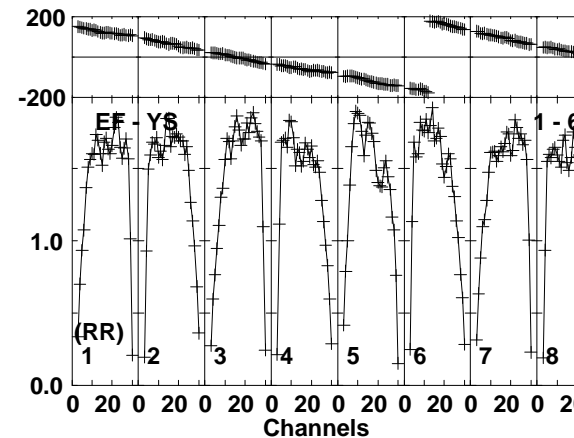
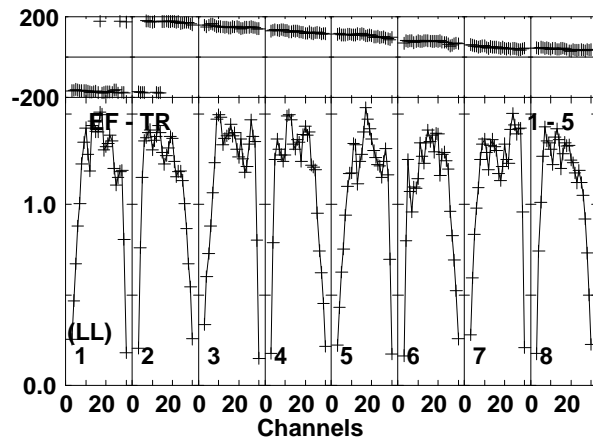
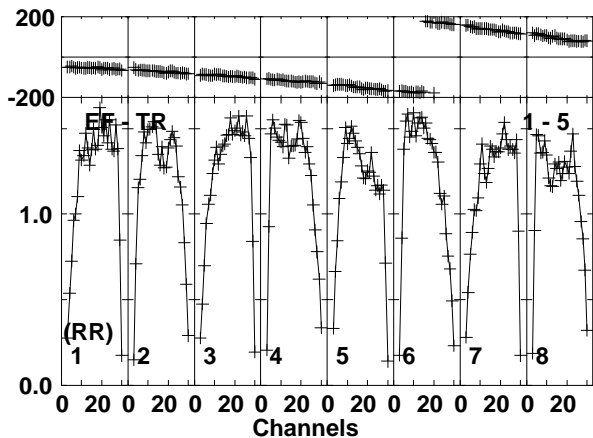
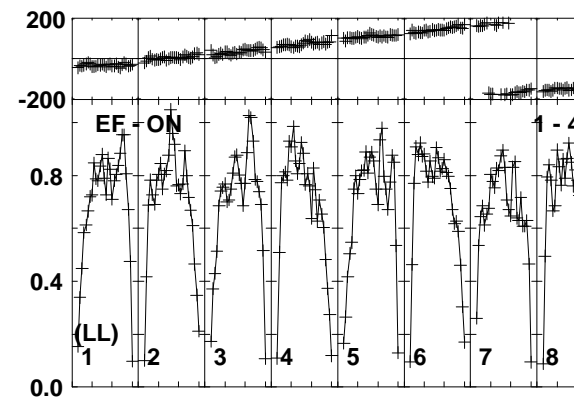
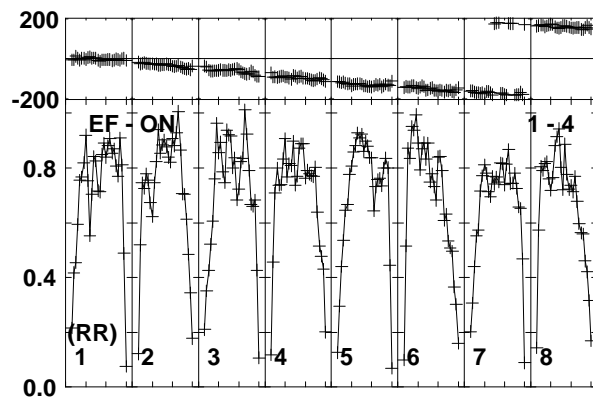
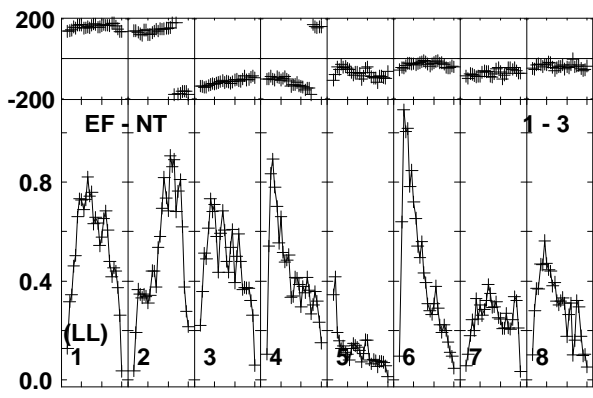
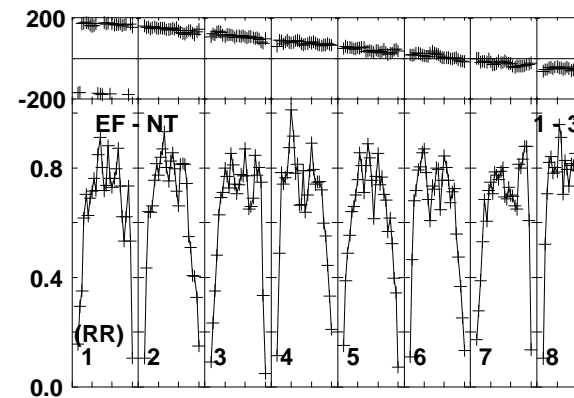
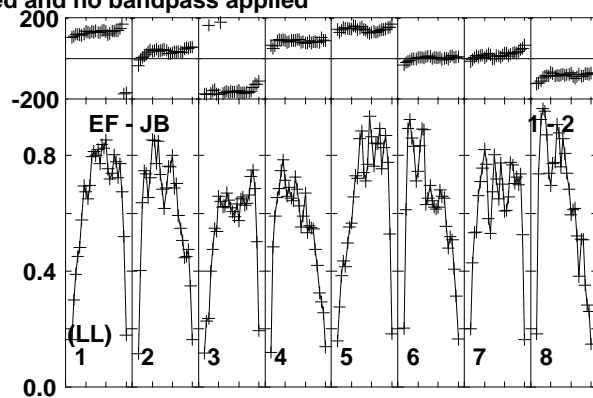
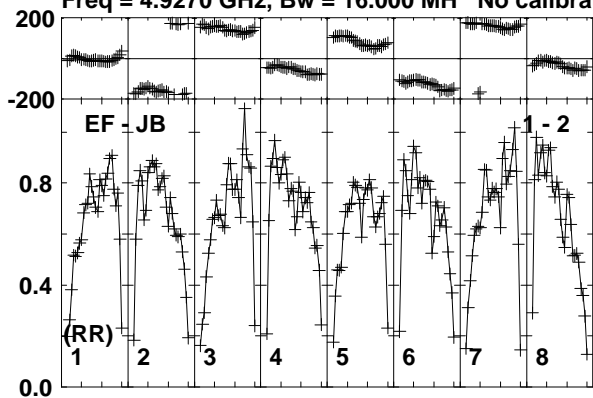

Lower frame: Milli Ampl Jy Top frame: Phas deg
Vector averaged cross-power spectrum Baseline: EF (01) - JB (02)
Timerange: 01/10:20:53 to 01/10:24:19

Plot file version 552 created 26-MAR-2015 15:28:07

J0151+5454 EG082E.UVDATA.1

Freq = 4.9270 GHz, Bw = 16.000 MH No calibration applied and no bandpass applied

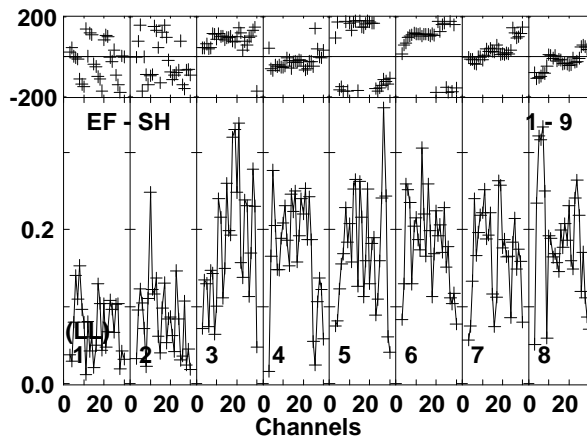
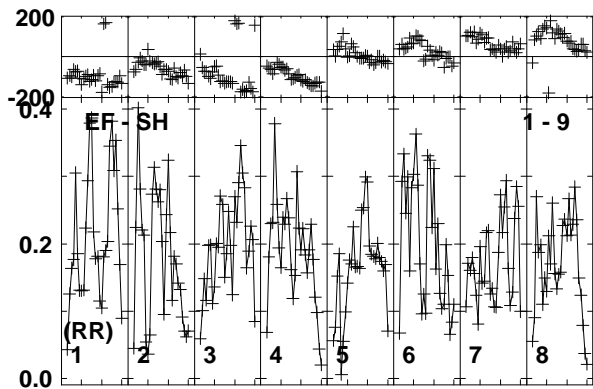
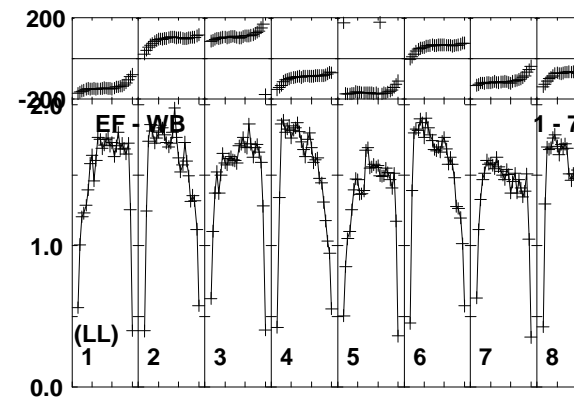
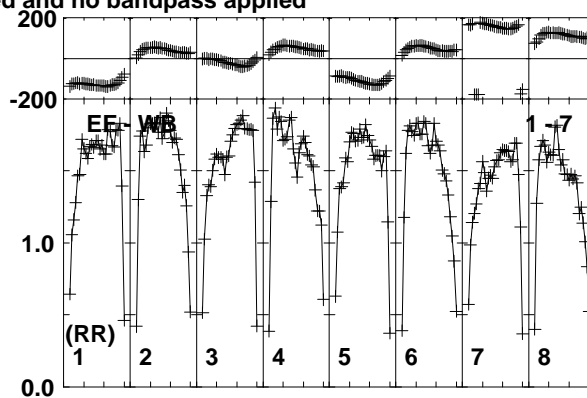
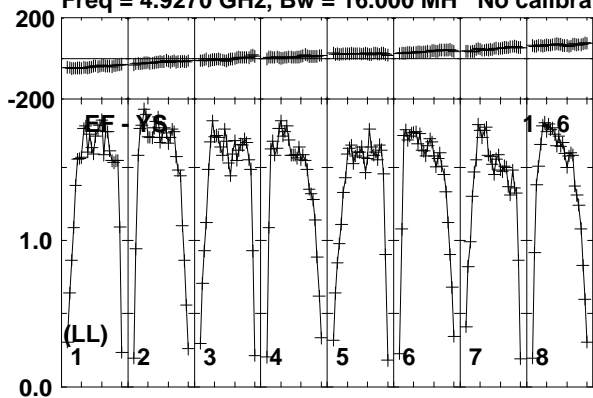

Lower frame: Milli Ampl Jy Top frame: Phas deg
Vector averaged cross-power spectrum Baseline: EF (01) - YS (06)
Timerange: 01/10:20:53 to 01/10:24:19

Plot file version 553 created 26-MAR-2015 15:28:07

J0147+5840 EG082E.UVDATA.1

Freq = 4.9270 GHz, Bw = 16.000 MH No calibration applied and no bandpass applied

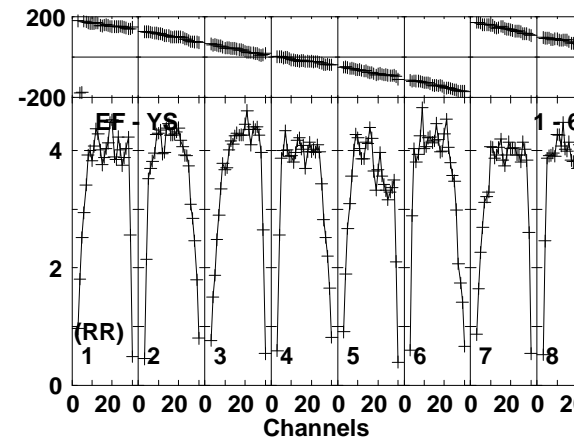
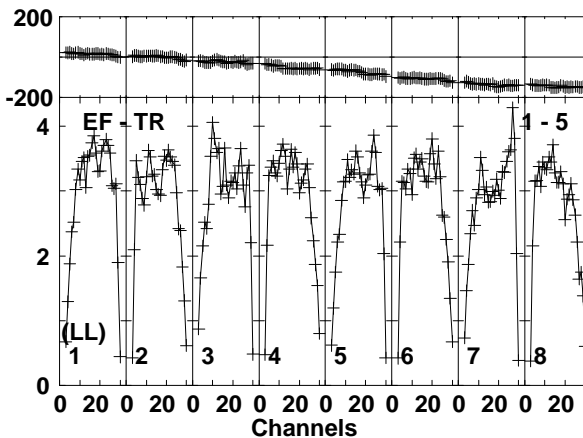
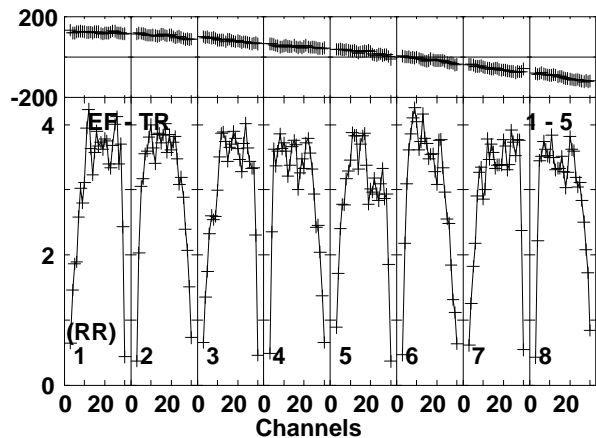
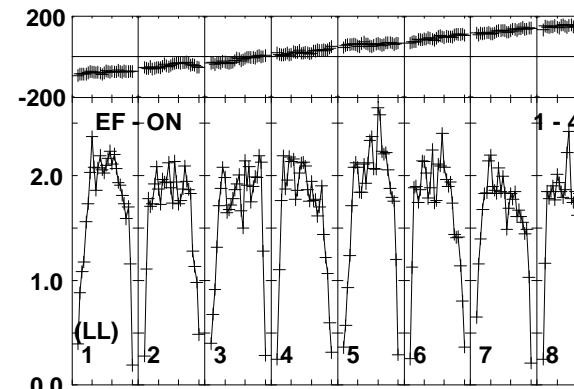
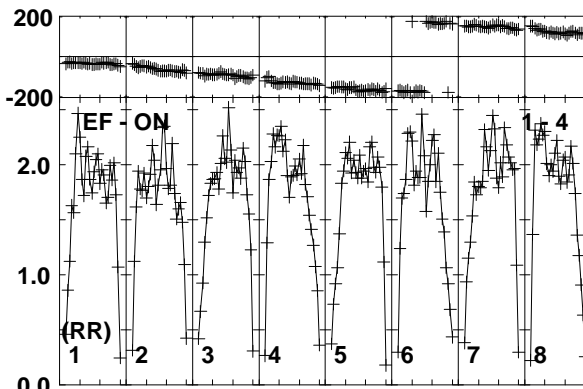
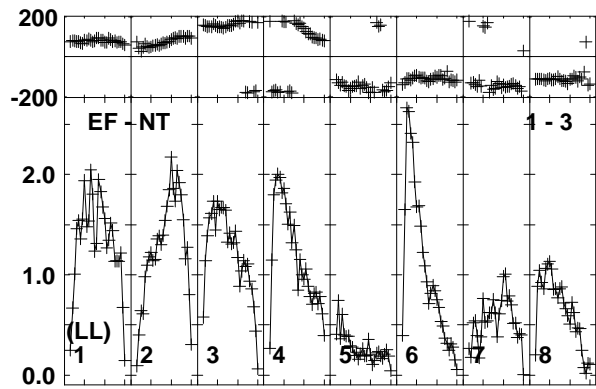
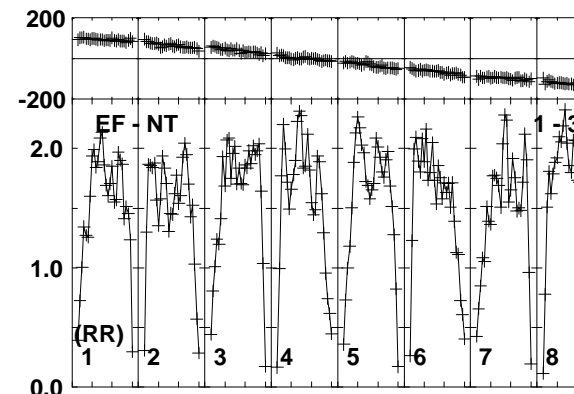
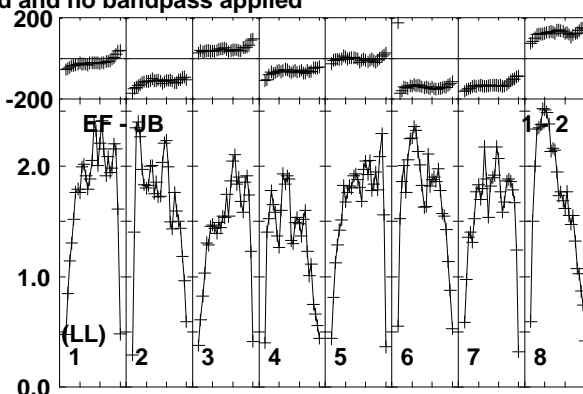
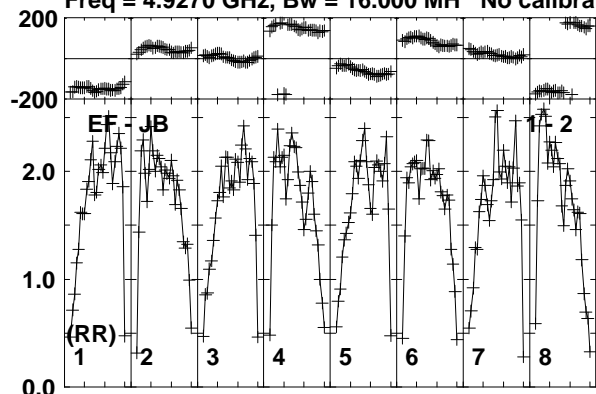

Lower frame: Milli Ampl Jy Top frame: Phas deg
Vector averaged cross-power spectrum Baseline: EF (01) - JB (02)
Timerange: 01/10:24:53 to 01/10:25:49

Plot file version 554 created 26-MAR-2015 15:28:07

J0147+5840 EG082E.UVDATA.1

Freq = 4.9270 GHz, Bw = 16.000 MH No calibration applied and no bandpass applied

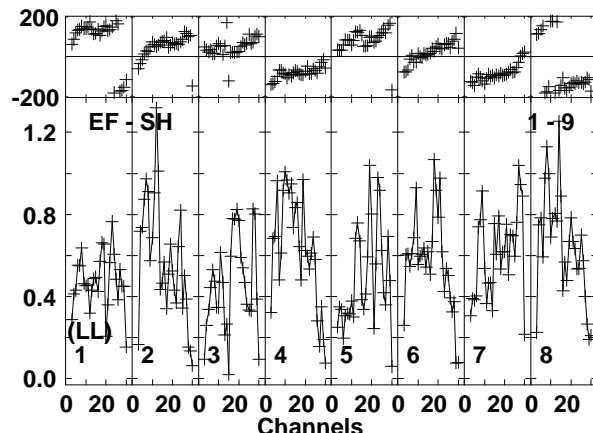
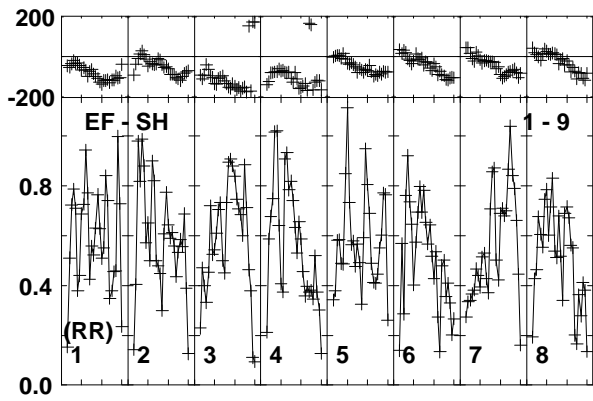
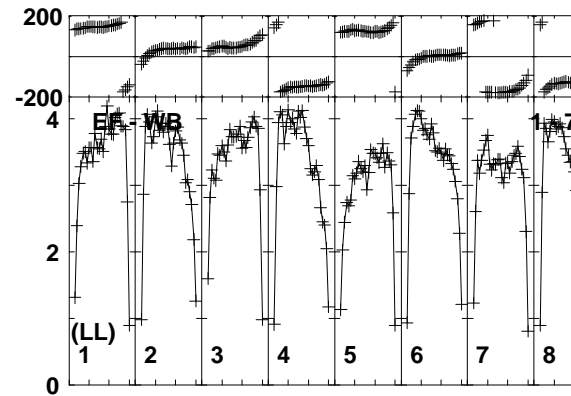
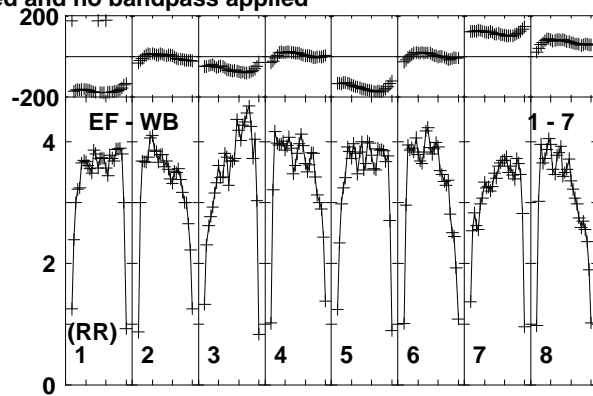
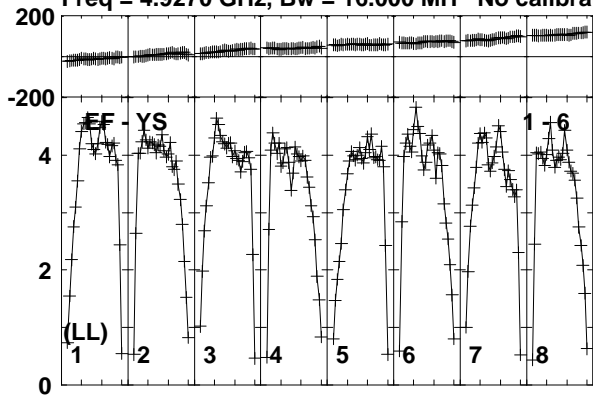

Lower frame: Milli Ampl Jy Top frame: Phas deg
Vector averaged cross-power spectrum Baseline: EF (01) - YS (06)
Timerange: 01/10:24:53 to 01/10:25:49

Plot file version 555 created 26-MAR-2015 15:28:07

V596CAS EG082E.UVDATA.1

Freq = 4.9270 GHz, Bw = 16.000 MH No calibration applied and no bandpass applied

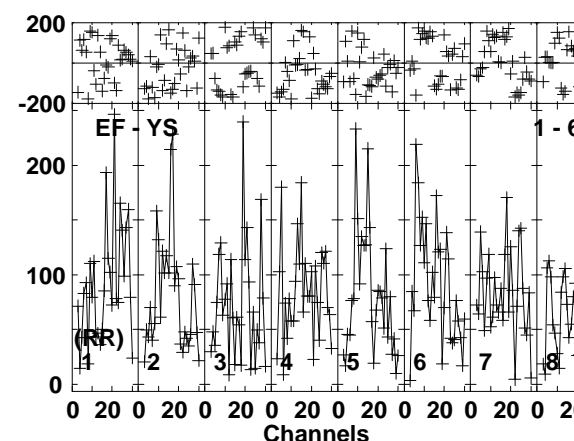
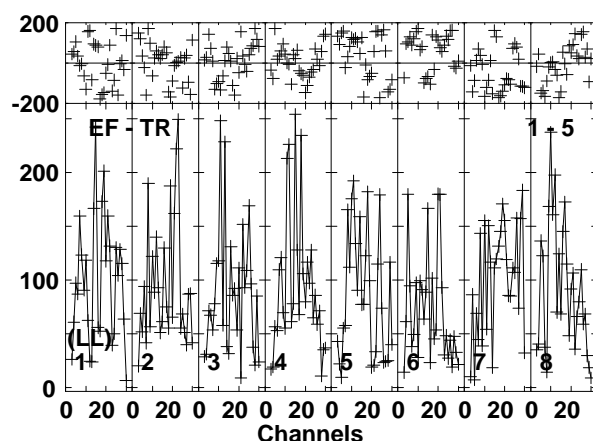
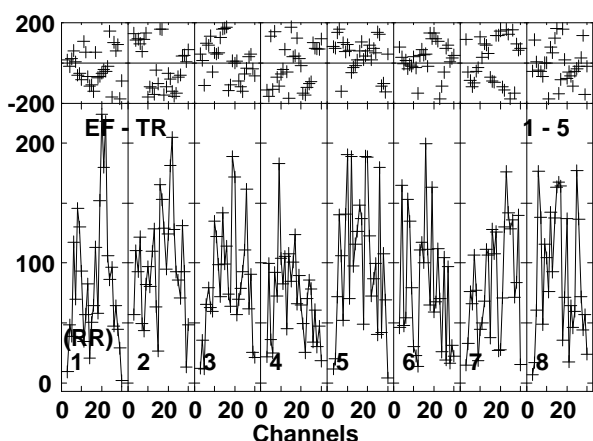
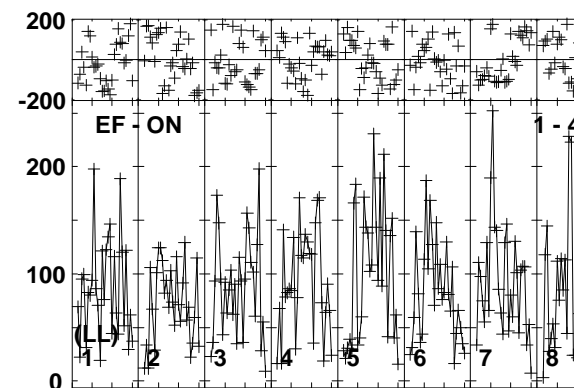
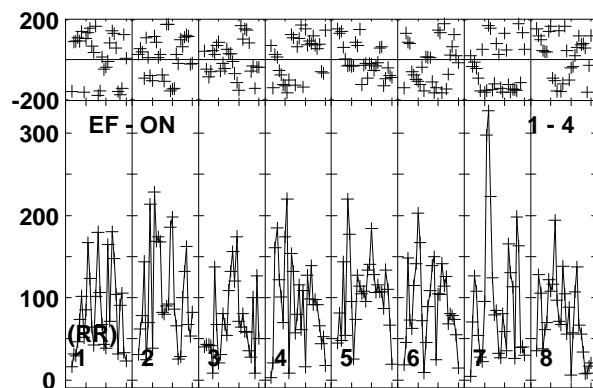
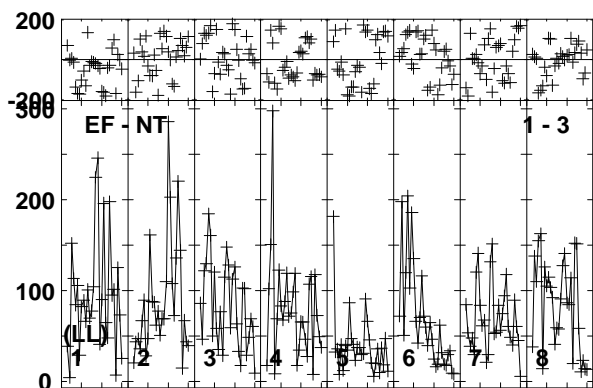
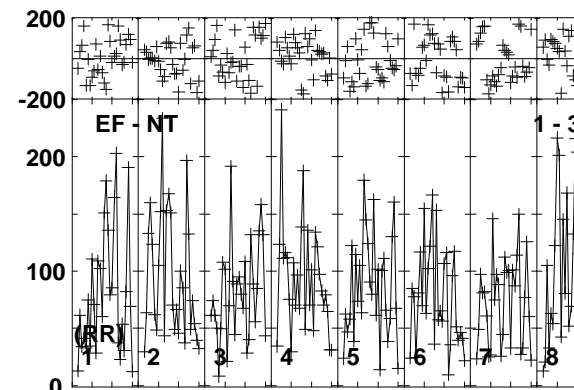
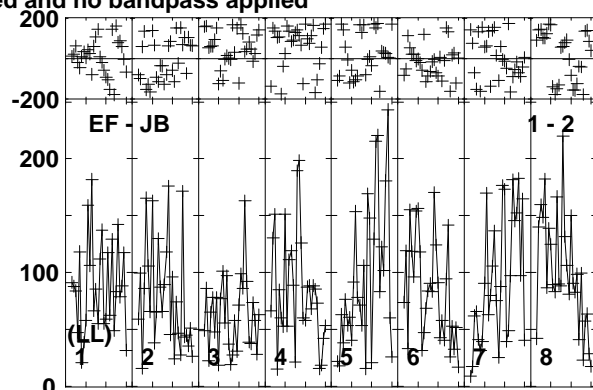
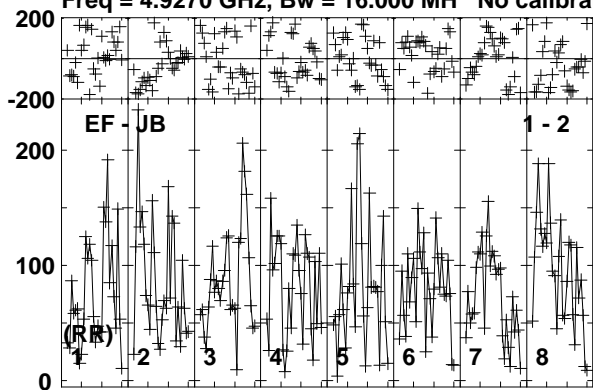

Lower frame: Micro Ampl Jy Top frame: Phas deg
Vector averaged cross-power spectrum Baseline: EF (01) - JB (02)
Timerange: 01/10:25:53 to 01/10:29:19

Plot file version 556 created 26-MAR-2015 15:28:07

V596CAS EG082E.UVDATA.1

Freq = 4.9270 GHz, Bw = 16.000 MH No calibration applied and no bandpass applied

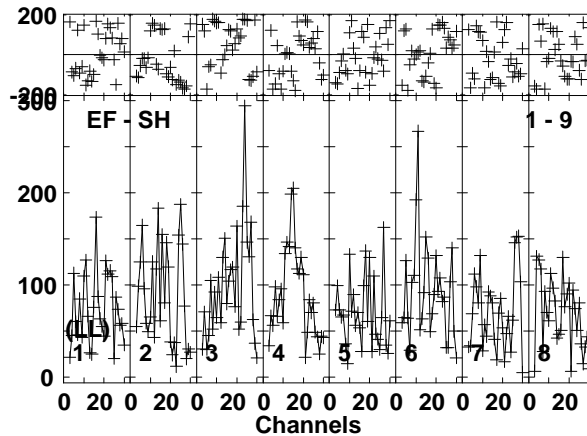
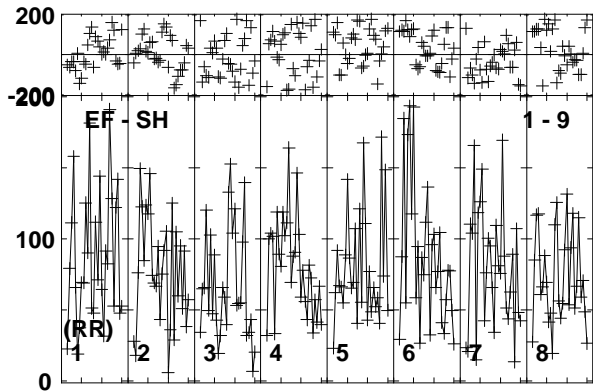
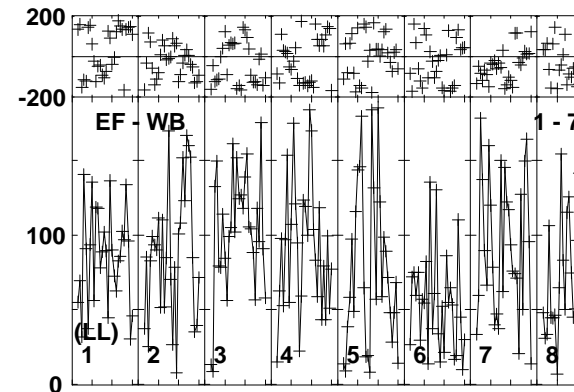
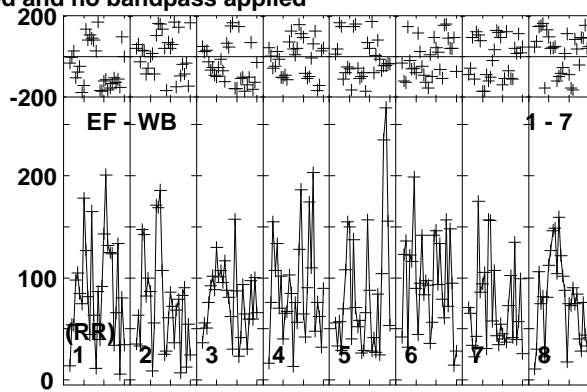
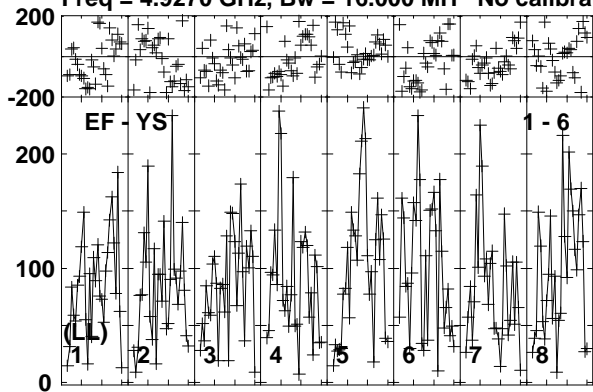

Lower frame: Micro Ampl Jy Top frame: Phas deg
Vector averaged cross-power spectrum Baseline: EF (01) - YS (06)
Timerange: 01/10:25:53 to 01/10:29:19

Plot file version 557 created 26-MAR-2015 15:28:07

J0147+5840 EG082E.UVDATA.1

Freq = 4.9270 GHz, Bw = 16.000 MH No calibration applied and no bandpass applied

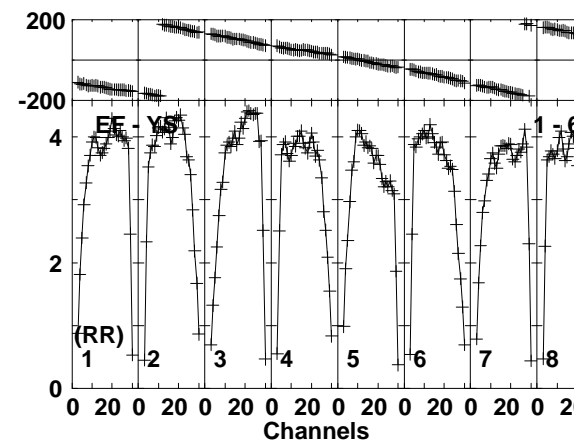
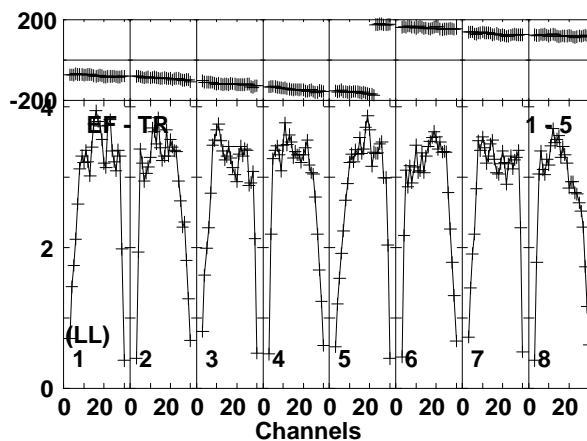
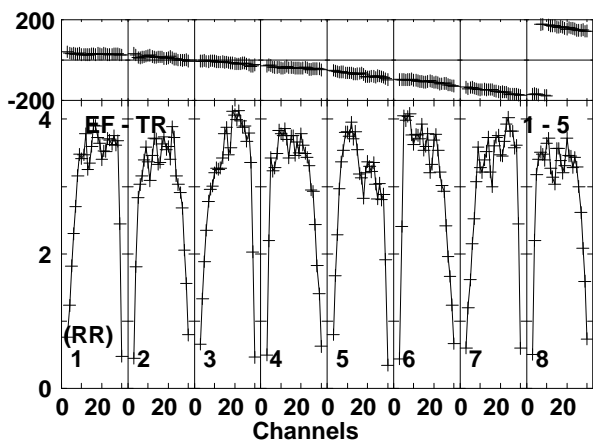
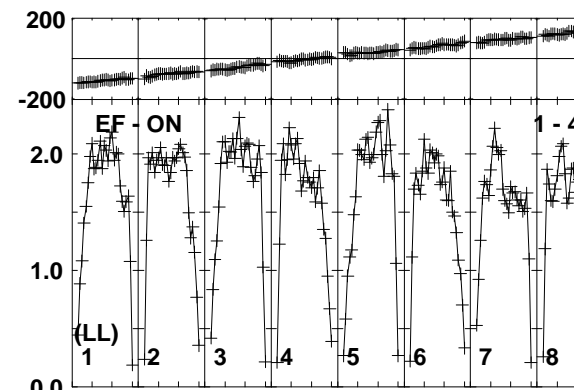
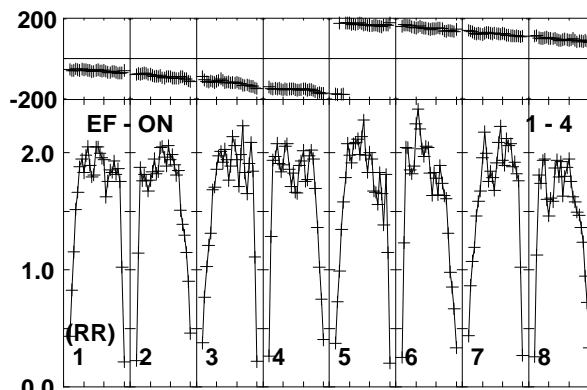
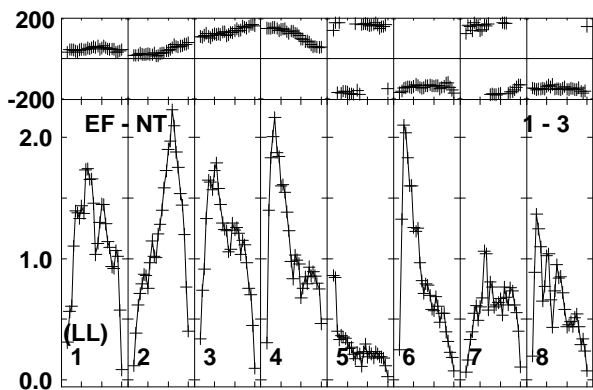
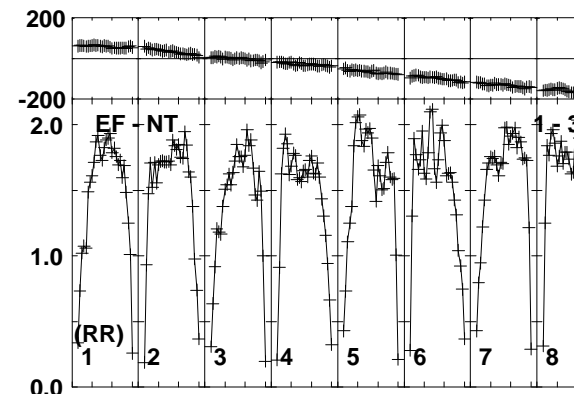
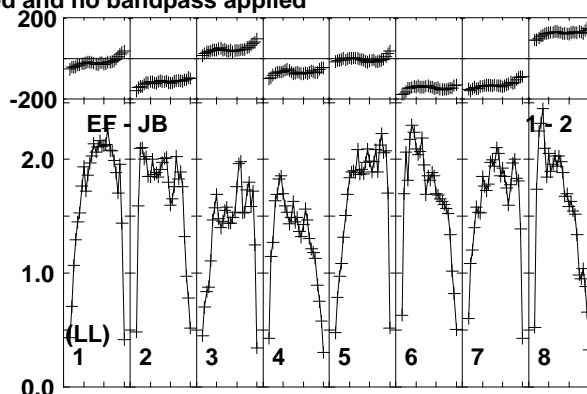
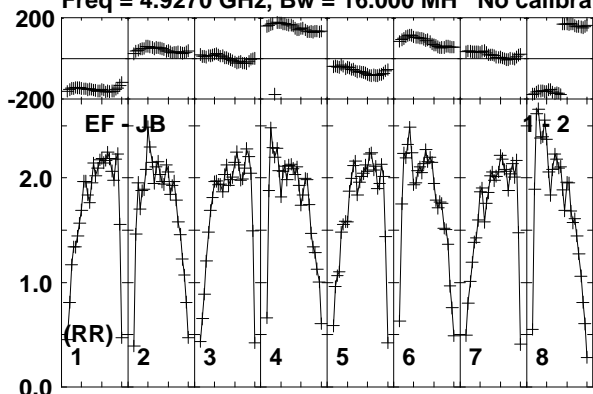

Lower frame: Milli Ampl Jy Top frame: Phas deg
Vector averaged cross-power spectrum Baseline: EF (01) - JB (02)
Timerange: 01/10:29:23 to 01/10:30:49

Plot file version 558 created 26-MAR-2015 15:28:07

J0147+5840 EG082E.UVDATA.1

Freq = 4.9270 GHz, Bw = 16.000 MH No calibration applied and no bandpass applied

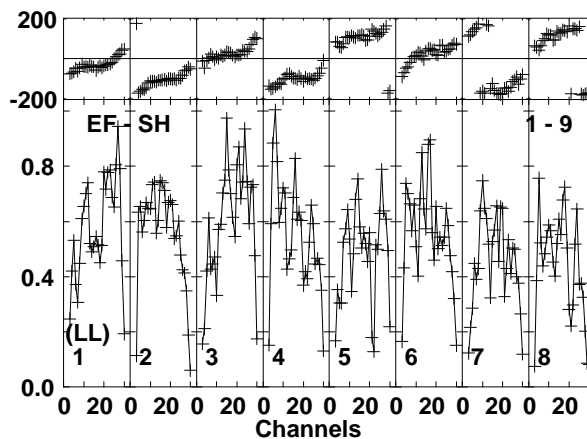
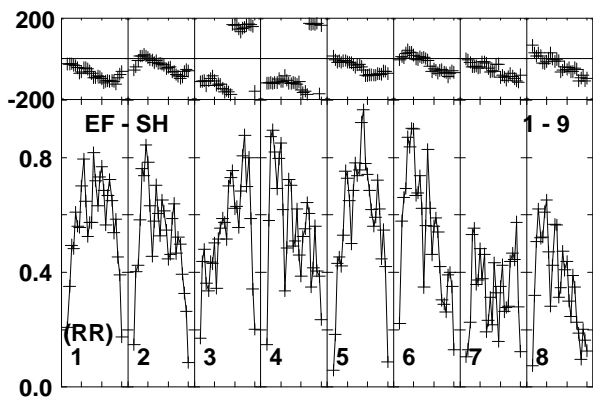
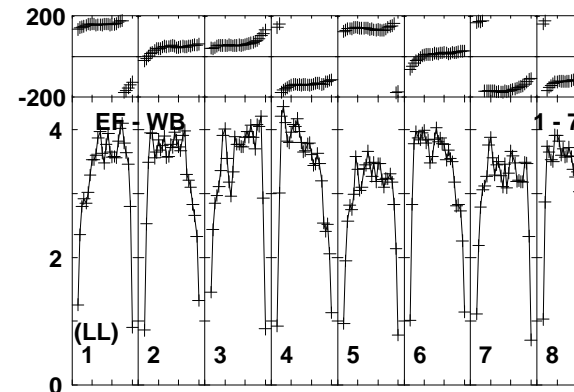
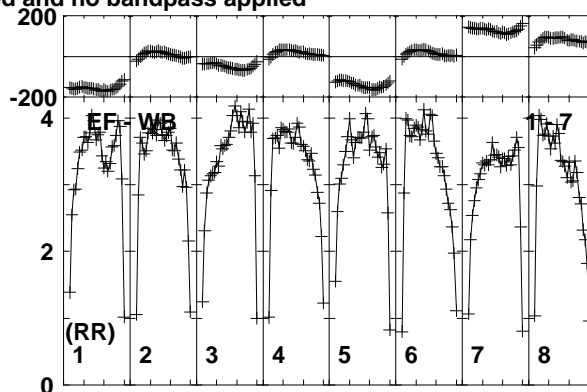
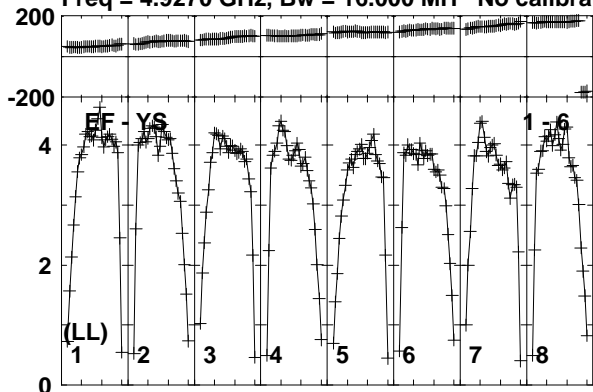

Lower frame: Milli Ampl Jy Top frame: Phas deg
Vector averaged cross-power spectrum Baseline: EF (01) - YS (06)
Timerange: 01/10:29:23 to 01/10:30:49

Plot file version 559 created 26-MAR-2015 15:28:07

V596CAS EG082E.UVDATA.1

Freq = 4.9270 GHz, Bw = 16.000 MH No calibration applied and no bandpass applied

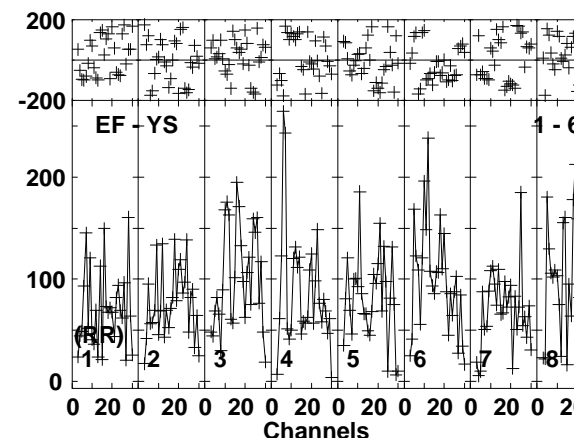
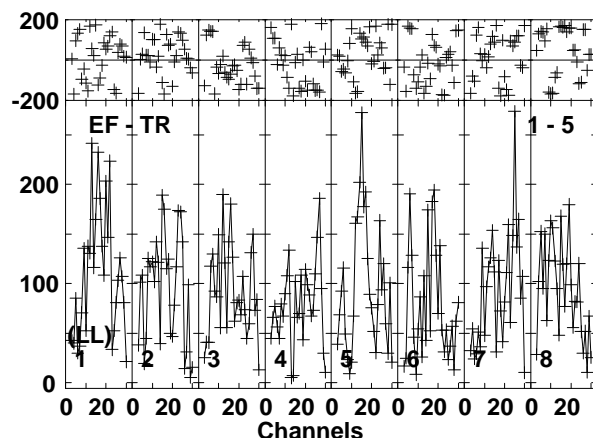
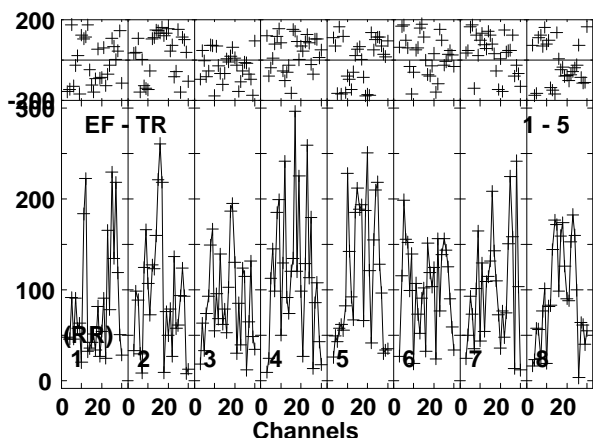
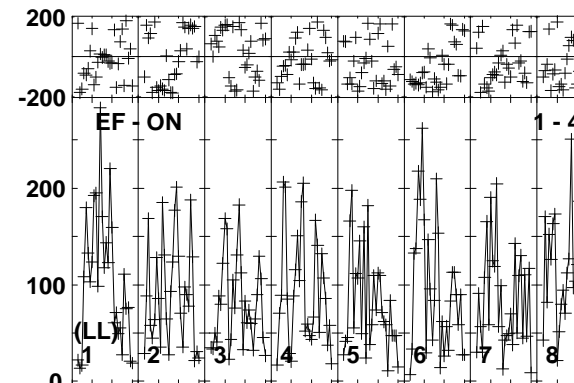
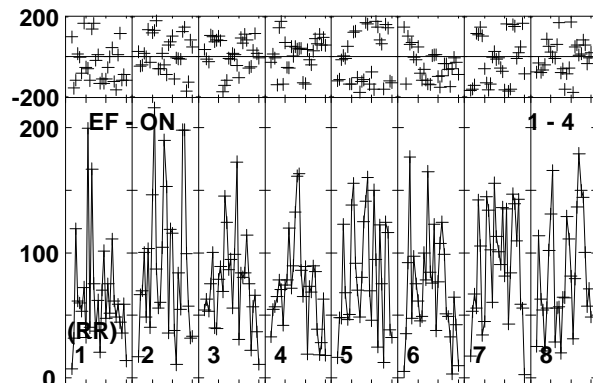
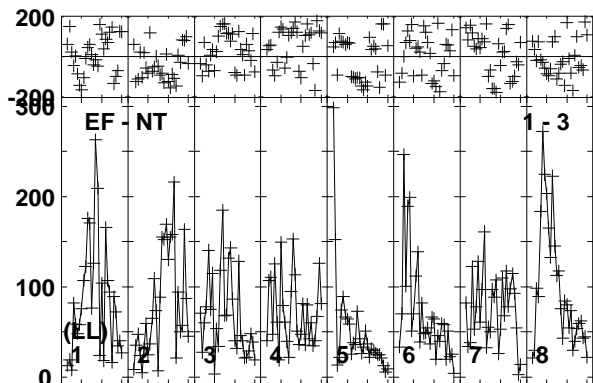
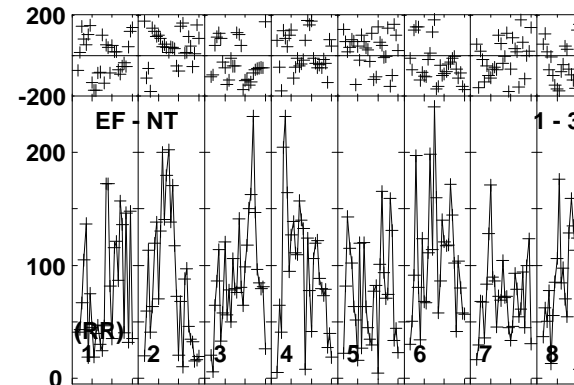
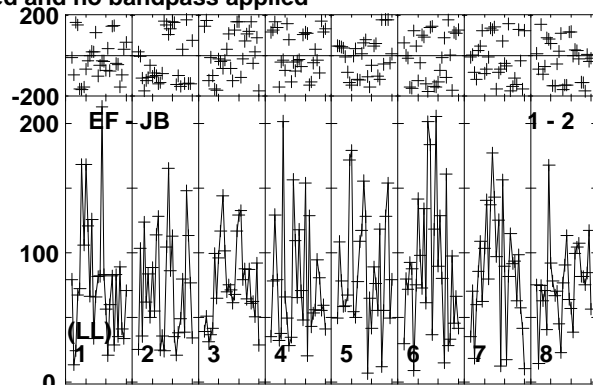
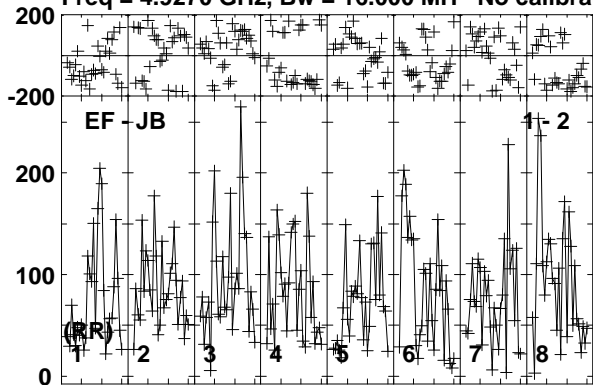

Lower frame: Micro Ampl Jy Top frame: Phas deg
Vector averaged cross-power spectrum Baseline: EF (01) - JB (02)
Timerange: 01/10:30:53 to 01/10:34:19

Plot file version 560 created 26-MAR-2015 15:28:07

V596CAS EG082E.UVDATA.1

Freq = 4.9270 GHz, Bw = 16.000 MH No calibration applied and no bandpass applied

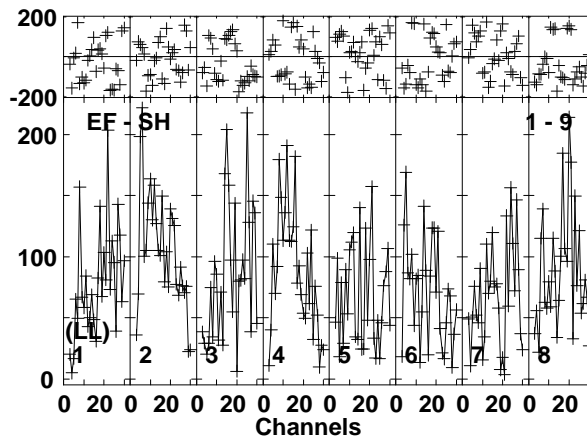
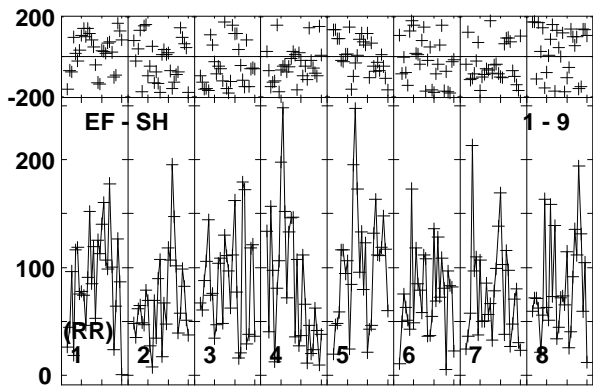
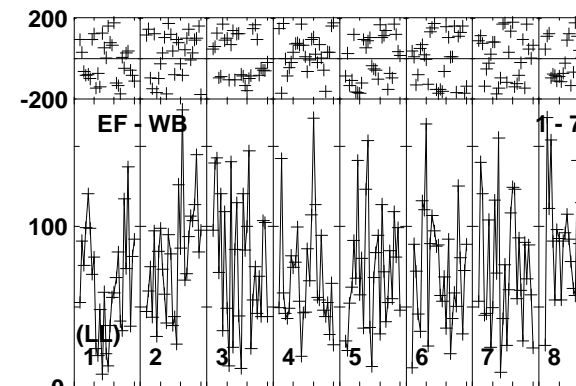
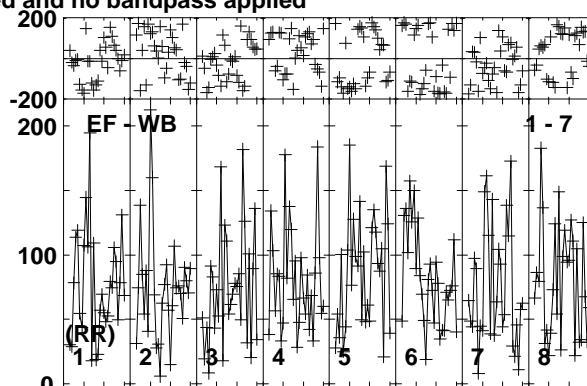
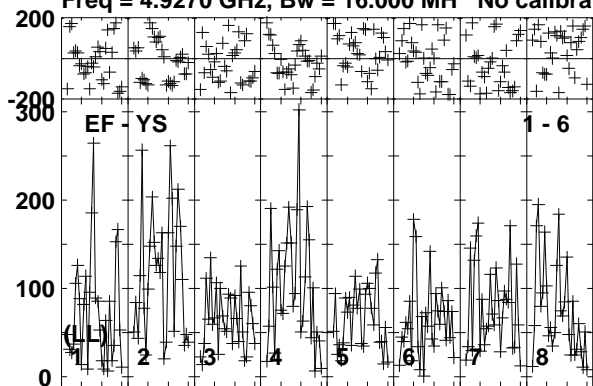

Lower frame: Micro Ampl Jy Top frame: Phas deg
Vector averaged cross-power spectrum Baseline: EF (01) - YS (06)
Timerange: 01/10:30:53 to 01/10:34:19

Plot file version 561 created 26-MAR-2015 15:28:07

J0147+5840 EG082E.UVDATA.1

Freq = 4.9270 GHz, Bw = 16.000 MH No calibration applied and no bandpass applied

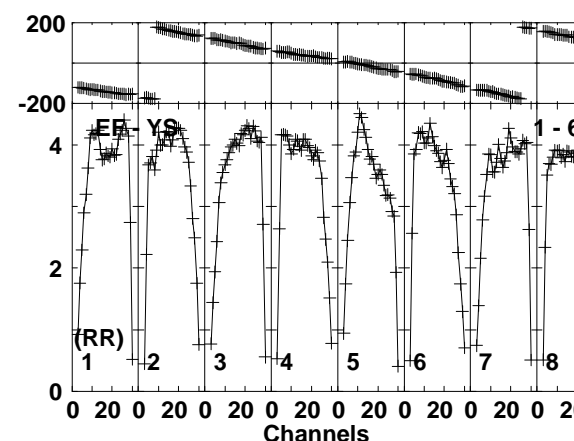
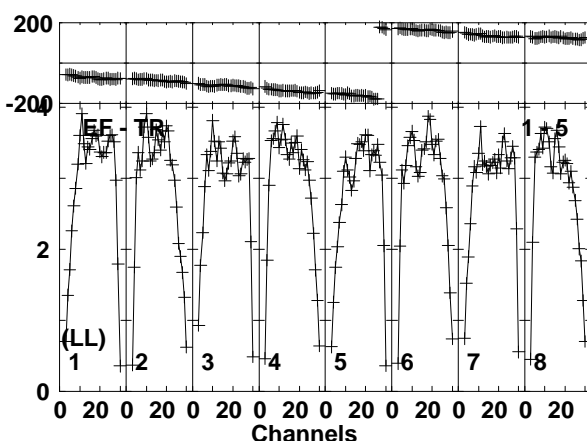
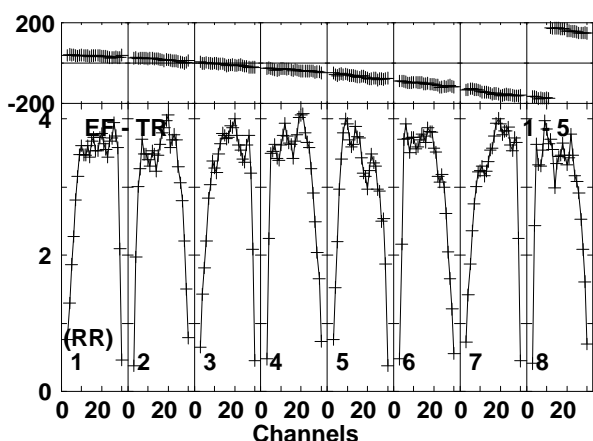
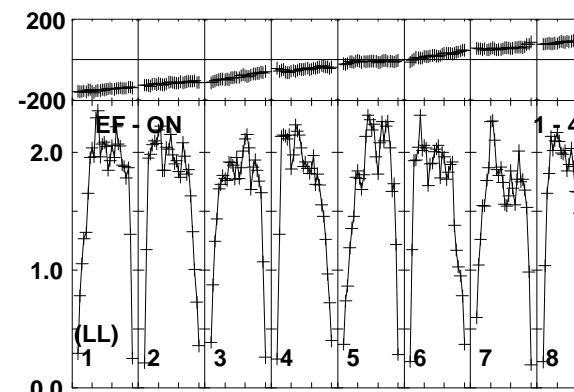
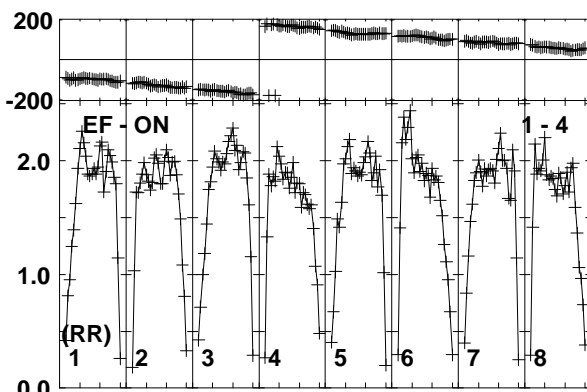
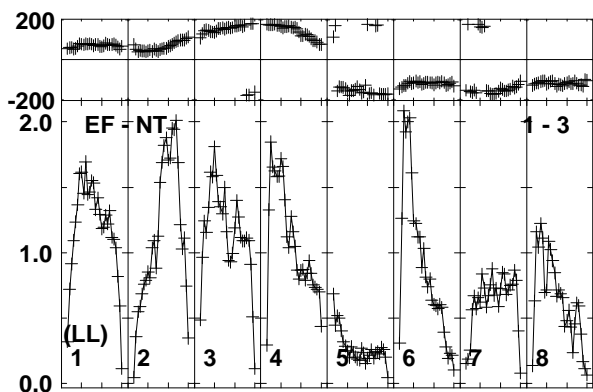
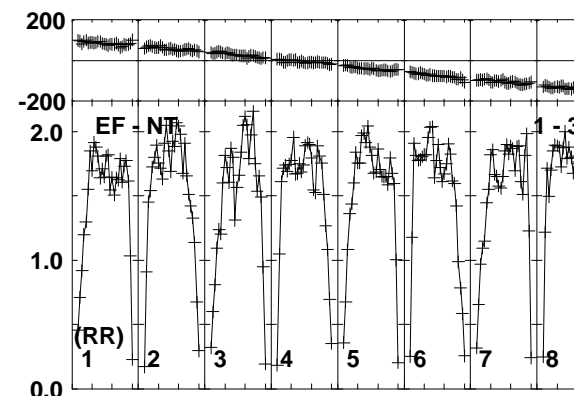
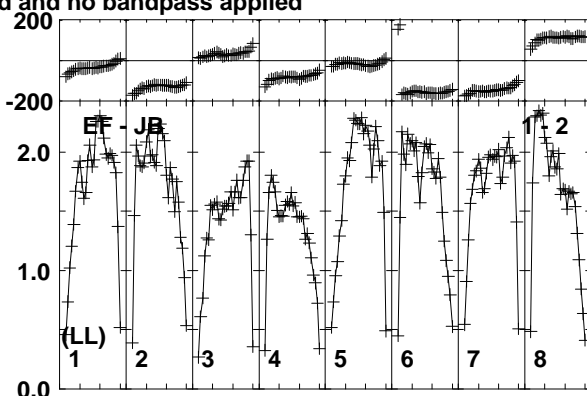
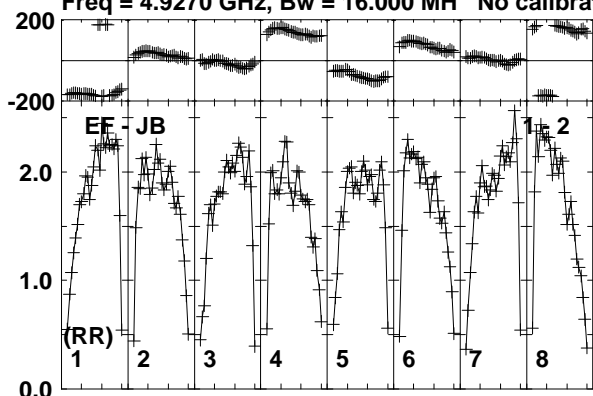

Lower frame: Milli Ampl Jy Top frame: Phas deg
Vector averaged cross-power spectrum Baseline: EF (01) - JB (02)
Timerange: 01/10:34:53 to 01/10:35:49

Plot file version 562 created 26-MAR-2015 15:28:08

J0147+5840 EG082E.UVDATA.1

Freq = 4.9270 GHz, Bw = 16.000 MH No calibration applied and no bandpass applied

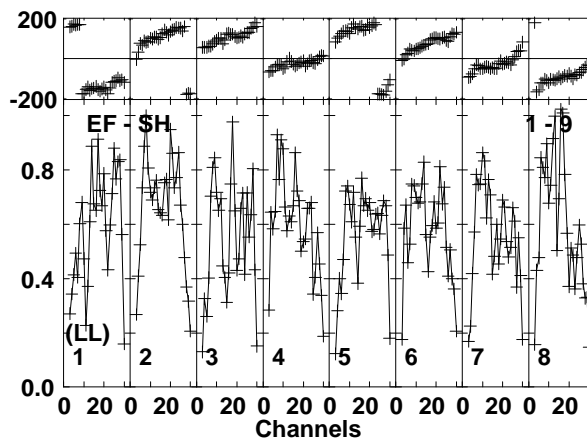
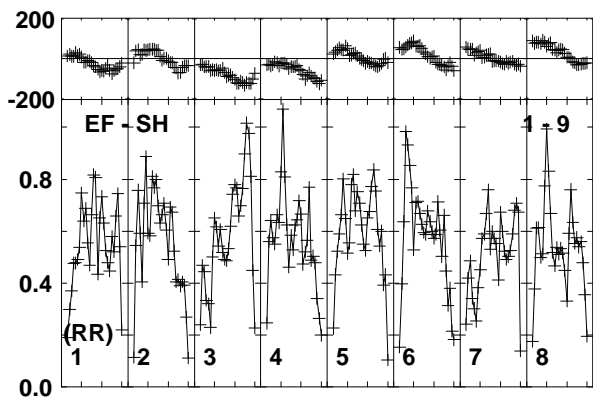
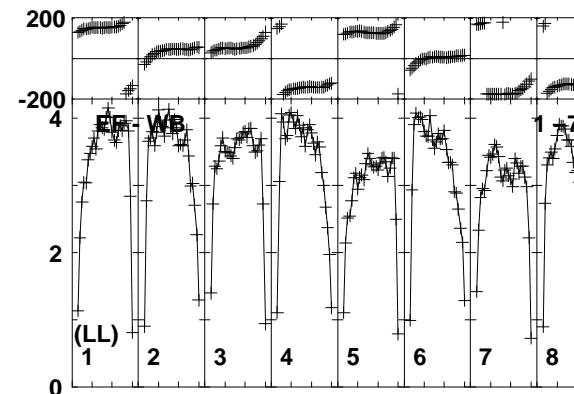
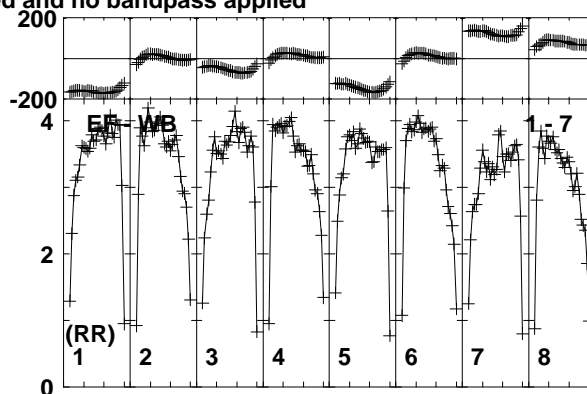
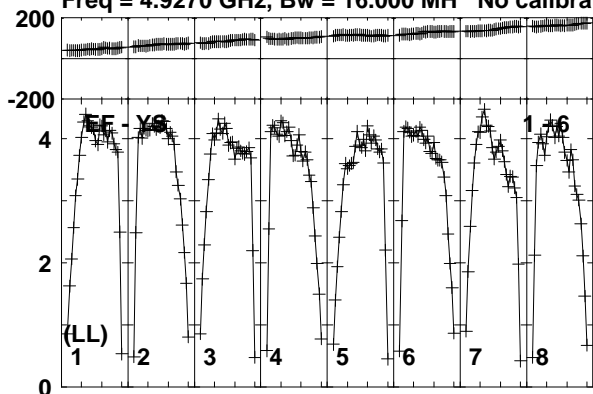

Lower frame: Milli Ampl Jy Top frame: Phas deg
Vector averaged cross-power spectrum Baseline: EF (01) - YS (06)
Timerange: 01/10:34:53 to 01/10:35:49

Plot file version 563 created 26-MAR-2015 15:28:08

V596CAS EG082E.UVDATA.1

Freq = 4.9270 GHz, Bw = 16.000 MH No calibration applied and no bandpass applied

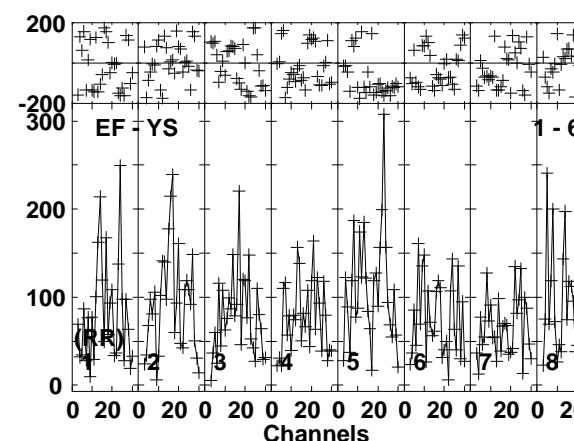
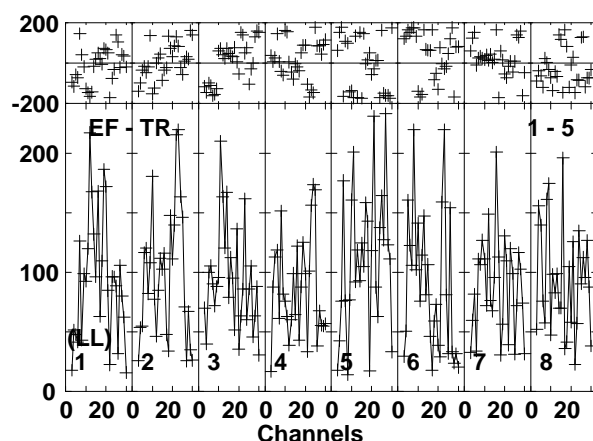
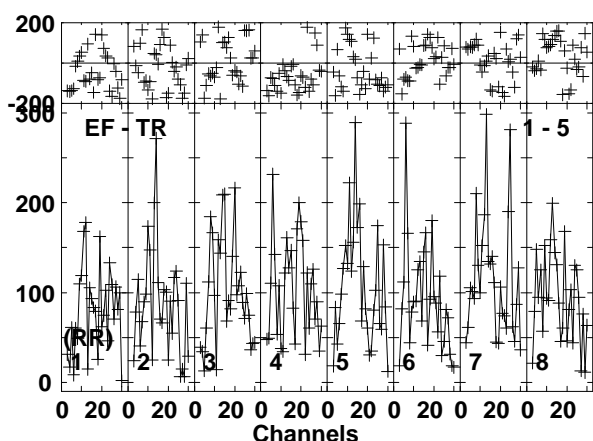
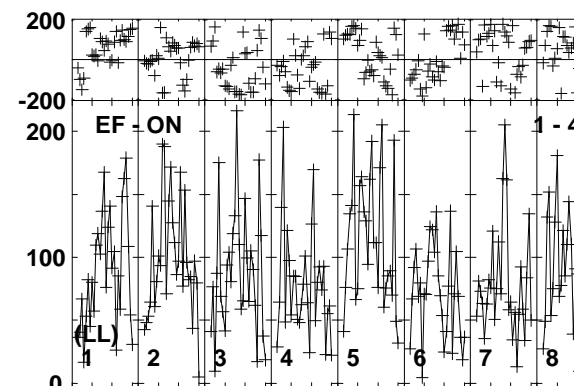
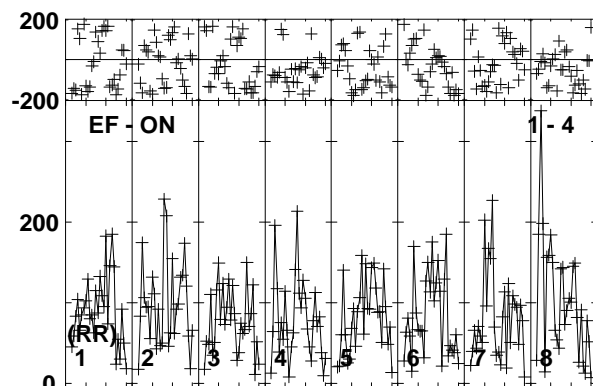
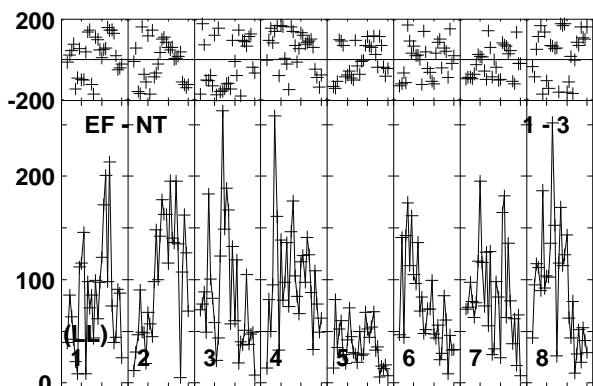
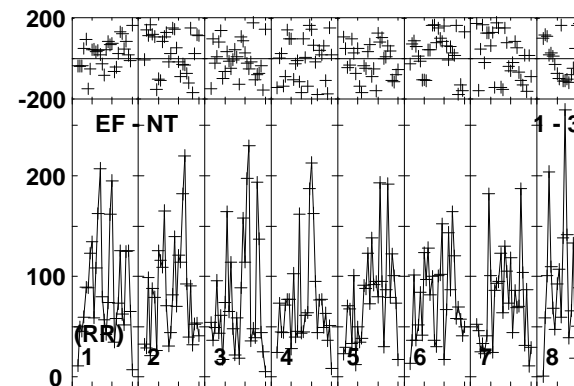
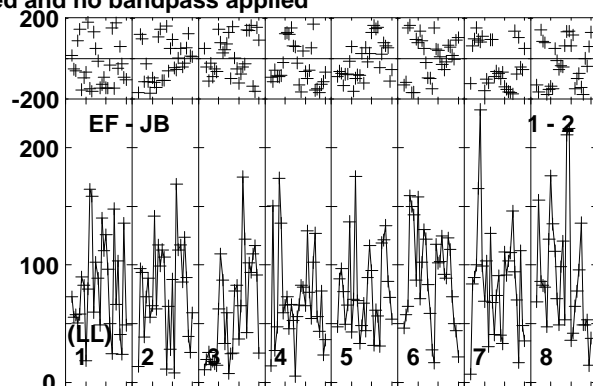
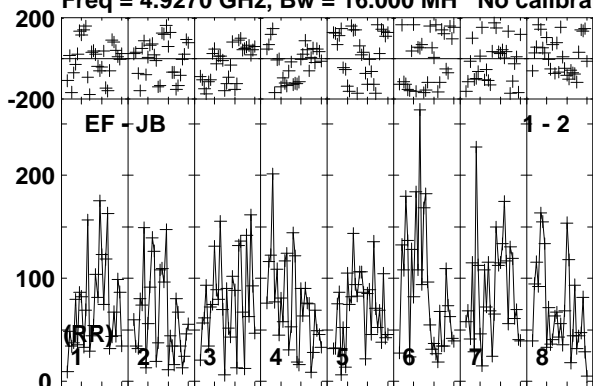

Lower frame: Micro Ampl Jy Top frame: Phas deg
Vector averaged cross-power spectrum Baseline: EF (01) - JB (02)
Timerange: 01/10:35:53 to 01/10:39:19

Plot file version 564 created 26-MAR-2015 15:28:08

V596CAS EG082E.UVDATA.1

Freq = 4.9270 GHz, Bw = 16.000 MH No calibration applied and no bandpass applied

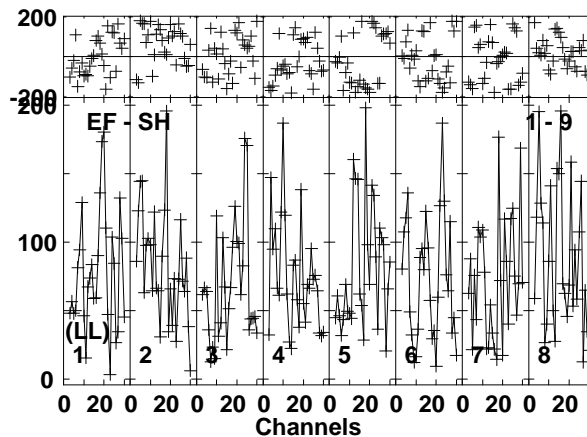
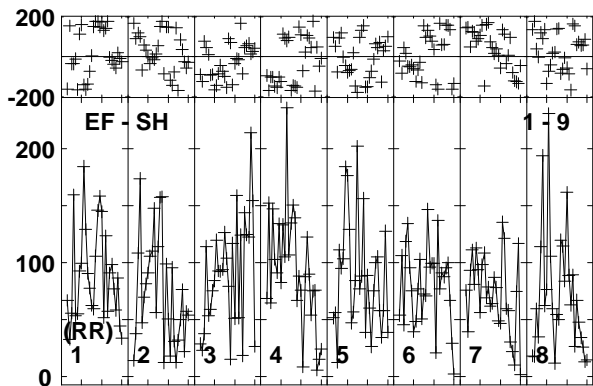
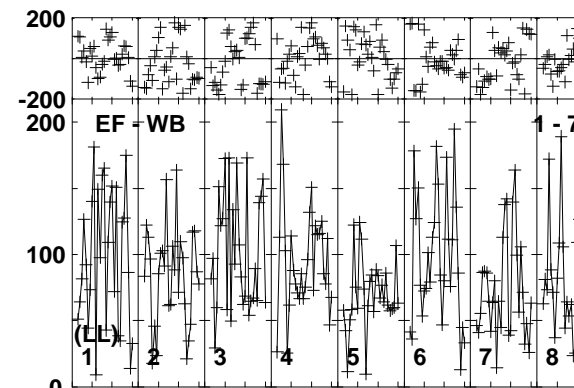
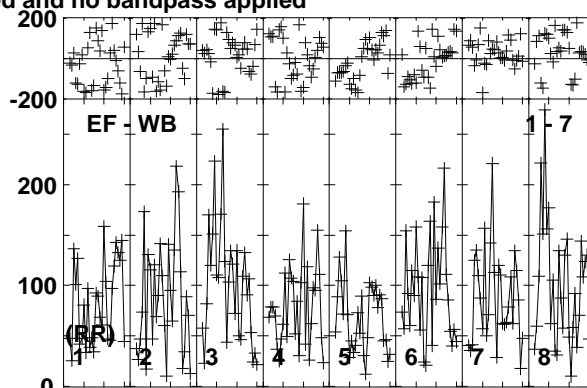
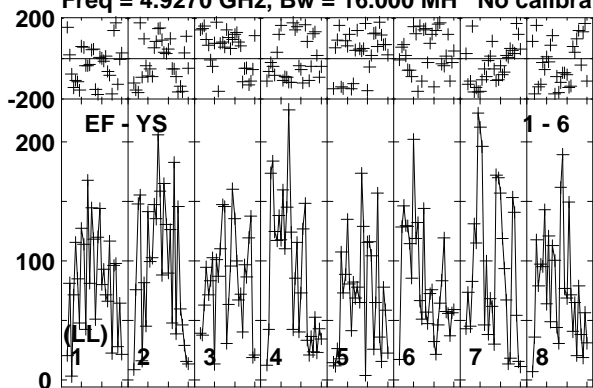

Lower frame: Micro Ampl Jy Top frame: Phas deg
Vector averaged cross-power spectrum Baseline: EF (01) - YS (06)
Timerange: 01/10:35:53 to 01/10:39:19

Plot file version 565 created 26-MAR-2015 15:28:08

J0147+5840 EG082E.UVDATA.1

Freq = 4.9270 GHz, Bw = 16.000 MH No calibration applied and no bandpass applied

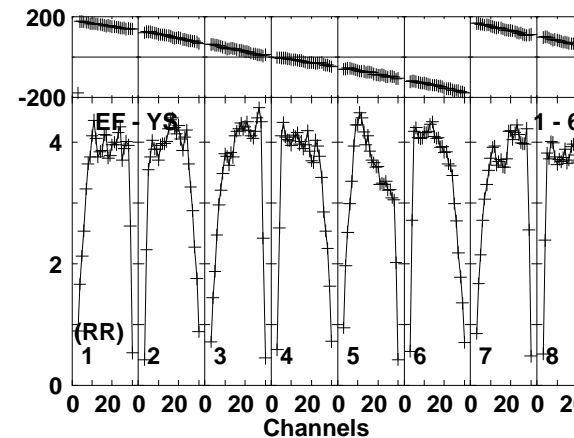
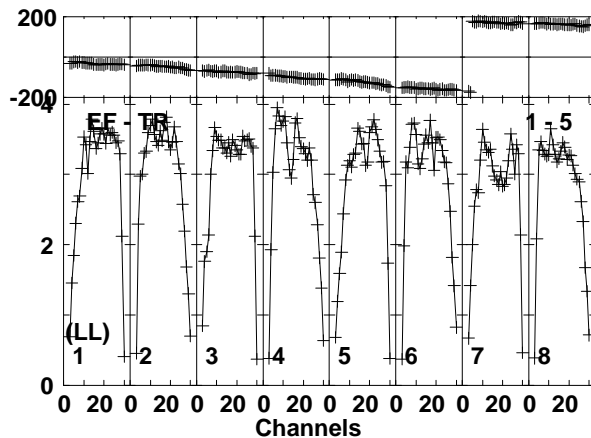
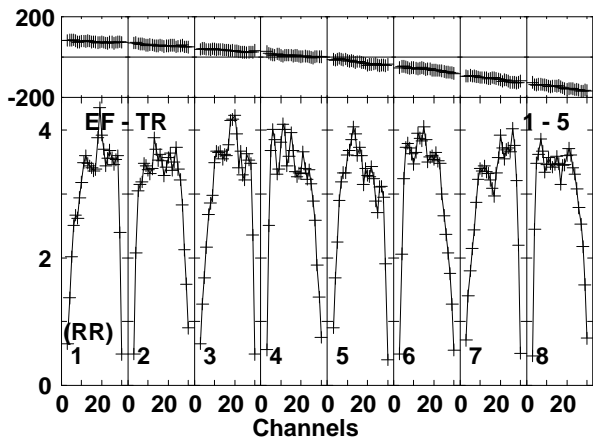
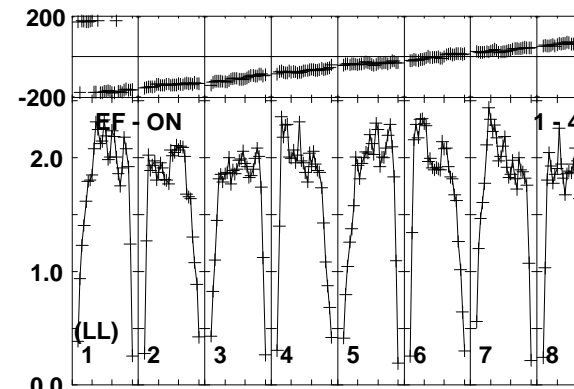
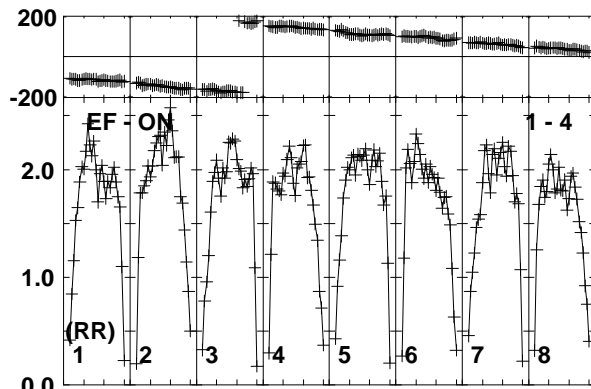
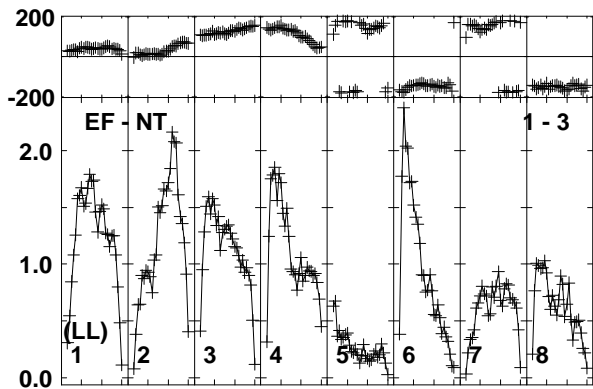
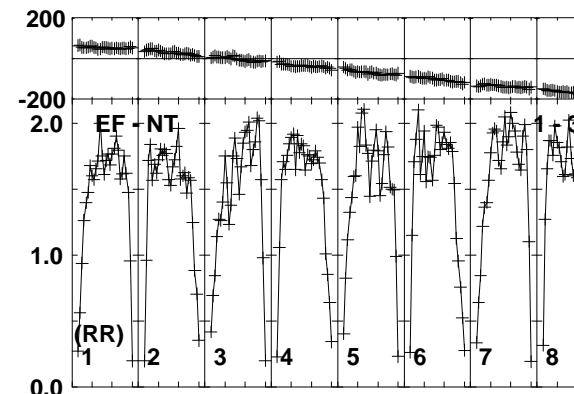
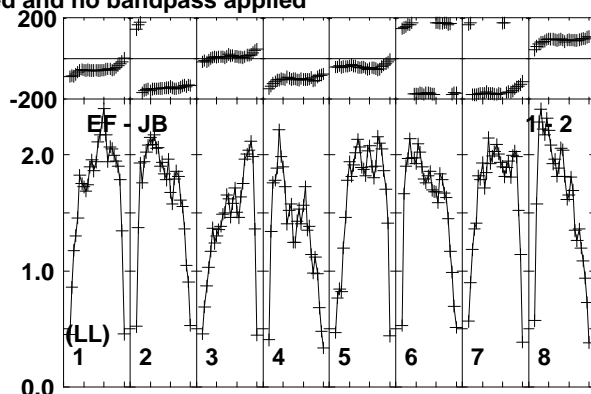
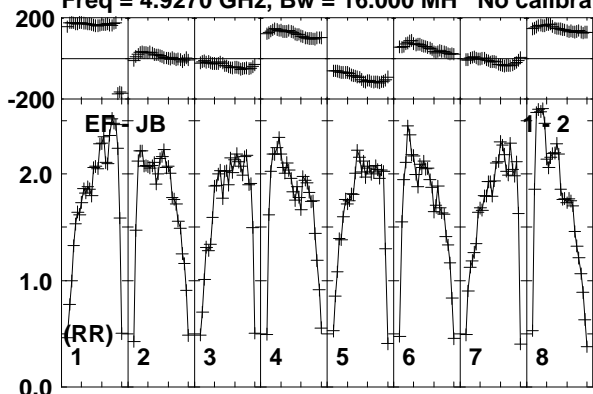

Lower frame: Milli Ampl Jy Top frame: Phas deg
Vector averaged cross-power spectrum Baseline: EF (01) - JB (02)
Timerange: 01/10:39:23 to 01/10:40:49

Plot file version 566 created 26-MAR-2015 15:28:08

J0147+5840 EG082E.UVDATA.1

Freq = 4.9270 GHz, Bw = 16.000 MH No calibration applied and no bandpass applied

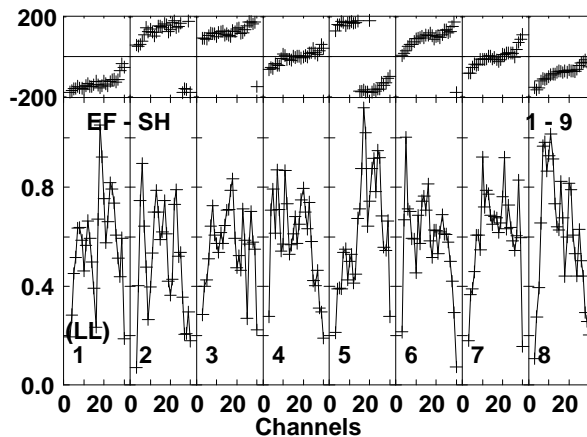
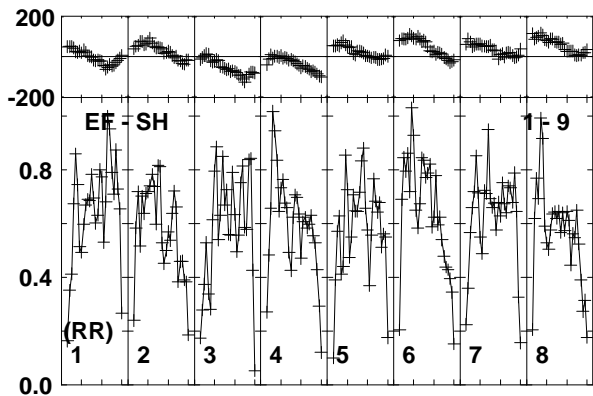
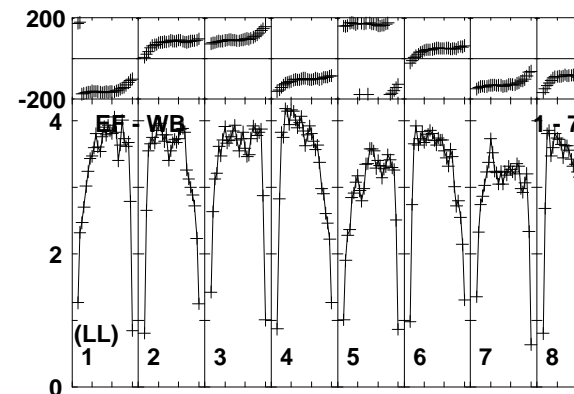
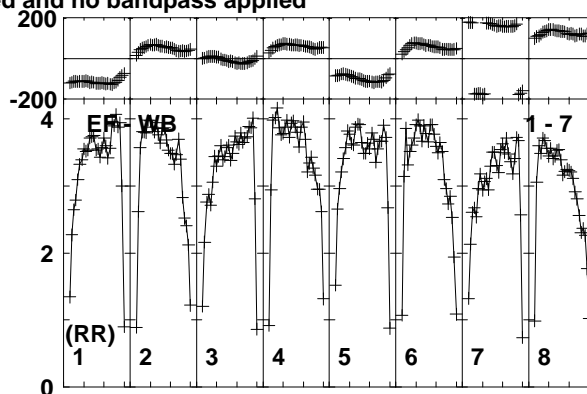
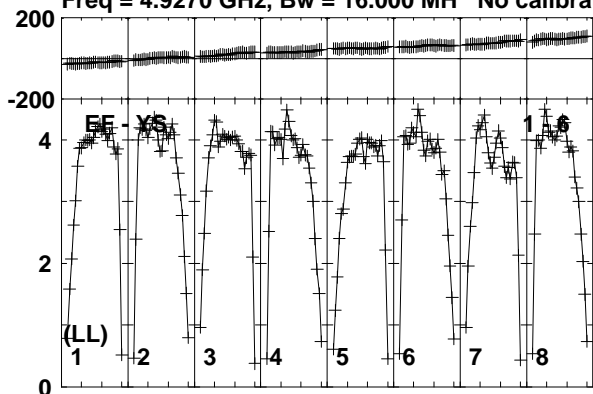

Lower frame: Milli Ampl Jy Top frame: Phas deg
Vector averaged cross-power spectrum Baseline: EF (01) - YS (06)
Timerange: 01/10:39:23 to 01/10:40:49

Plot file version 567 created 26-MAR-2015 15:28:08

V596CAS EG082E.UVDATA.1

Freq = 4.9270 GHz, Bw = 16.000 MH No calibration applied and no bandpass applied

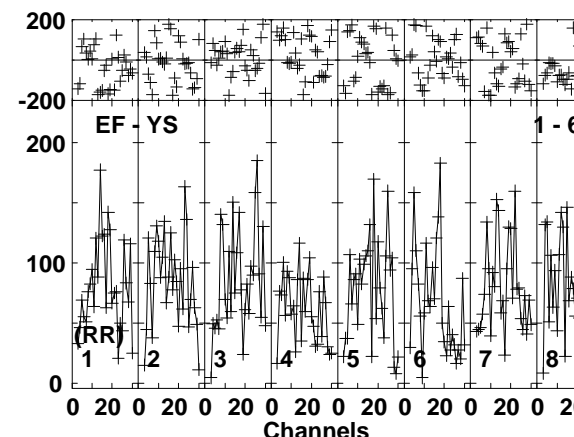
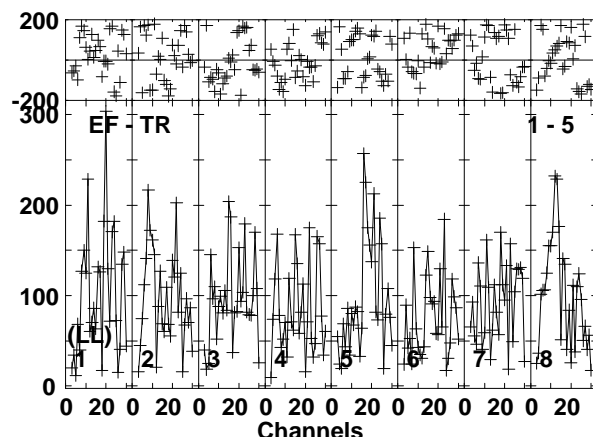
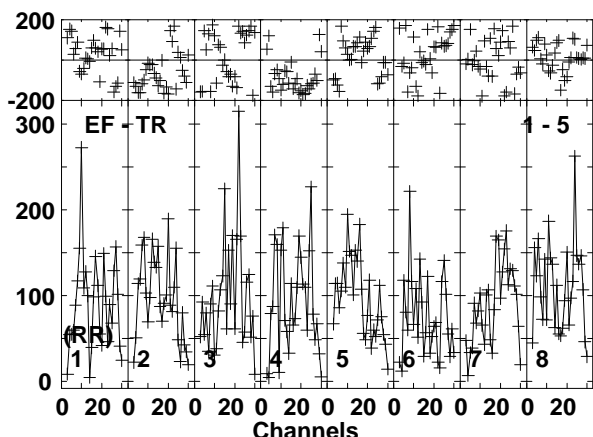
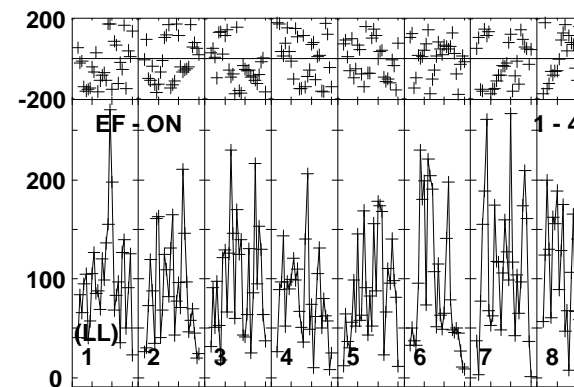
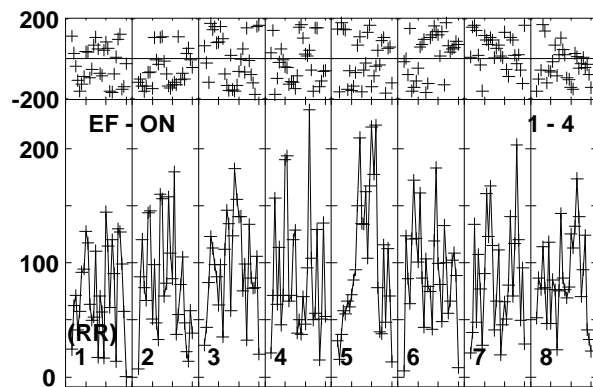
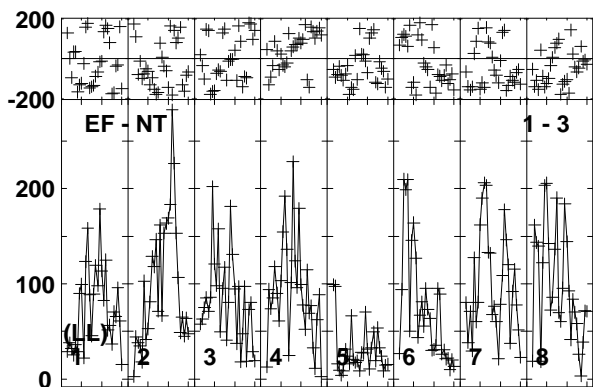
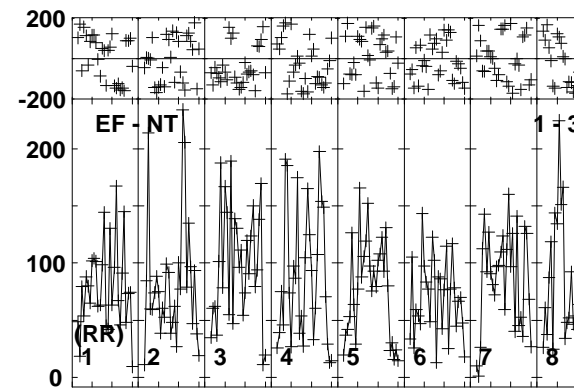
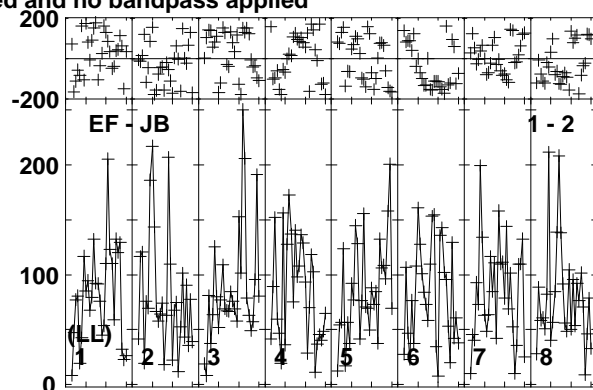
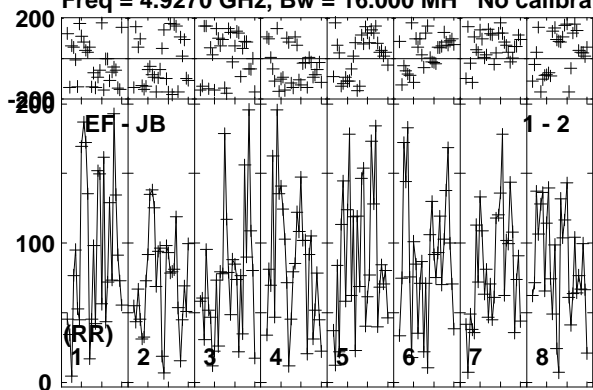

Lower frame: Micro Ampl Jy Top frame: Phas deg
Vector averaged cross-power spectrum Baseline: EF (01) - JB (02)
Timerange: 01/10:40:53 to 01/10:44:19

Plot file version 568 created 26-MAR-2015 15:28:08

V596CAS EG082E.UVDATA.1

Freq = 4.9270 GHz, Bw = 16.000 MH No calibration applied and no bandpass applied

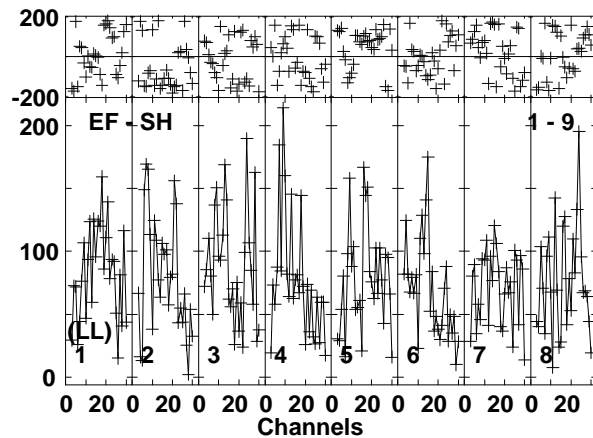
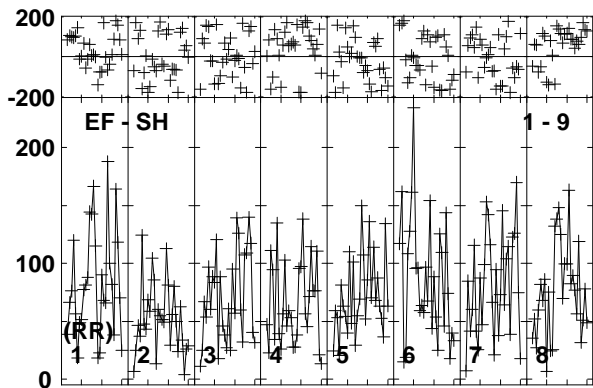
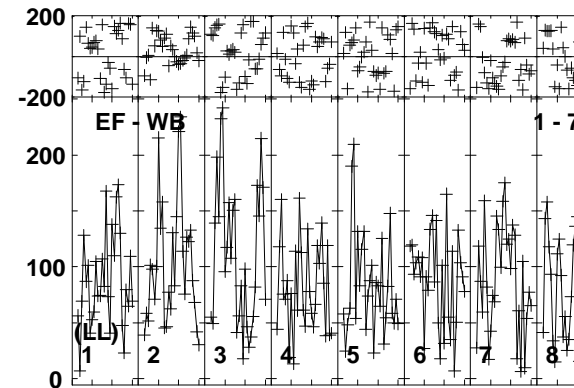
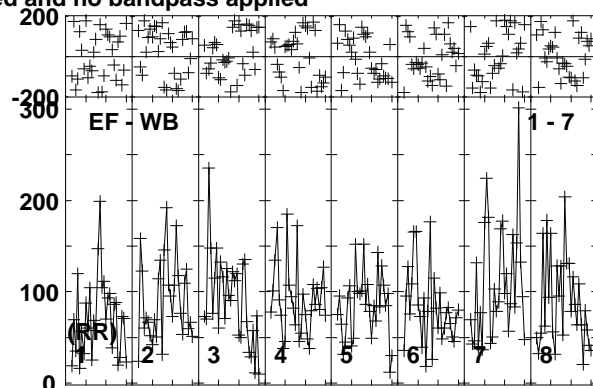
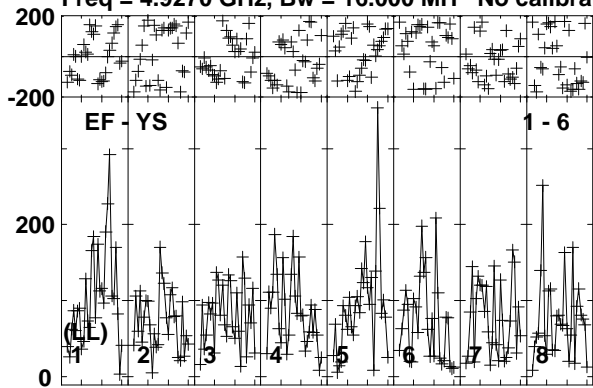

Lower frame: Micro Ampl Jy Top frame: Phas deg
Vector averaged cross-power spectrum Baseline: EF (01) - YS (06)
Timerange: 01/10:40:53 to 01/10:44:19

Plot file version 569 created 26-MAR-2015 15:28:08

J0147+5840 EG082E.UVDATA.1

Freq = 4.9270 GHz, Bw = 16.000 MH No calibration applied and no bandpass applied

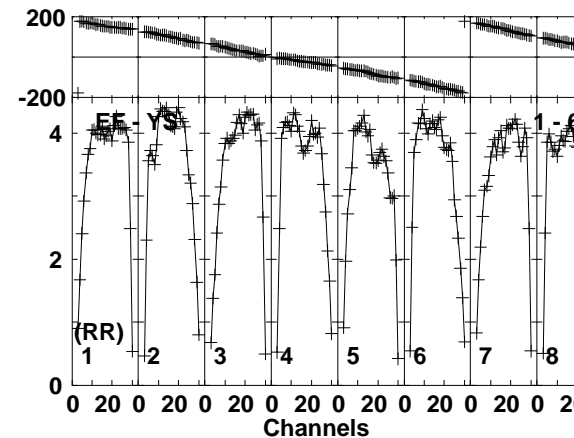
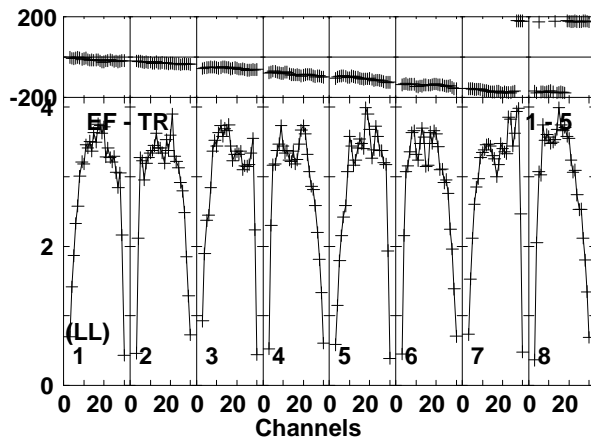
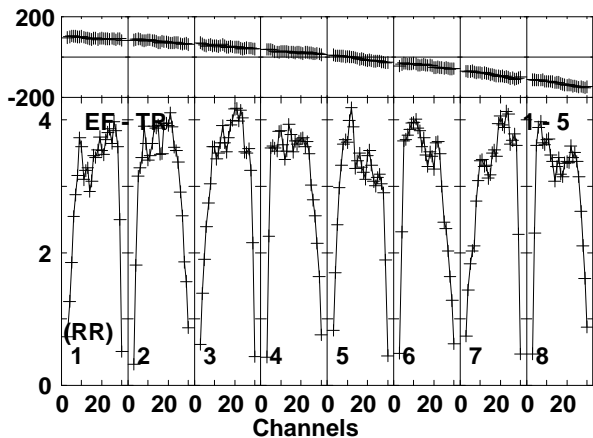
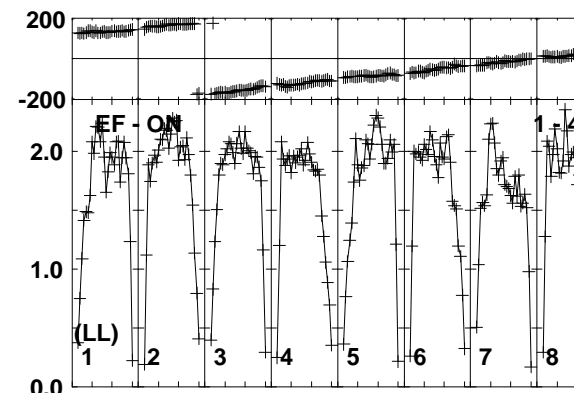
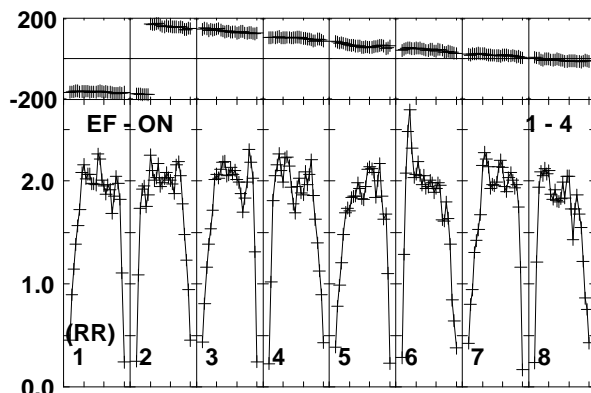
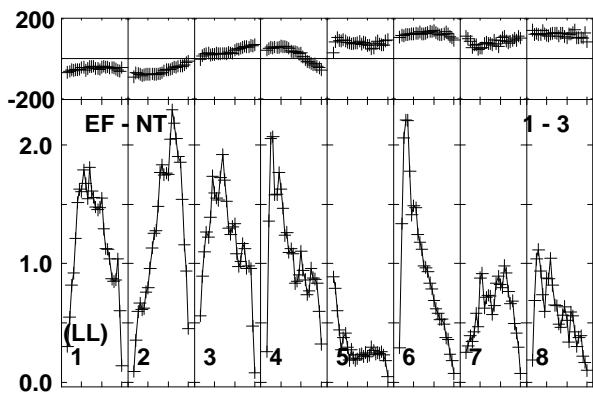
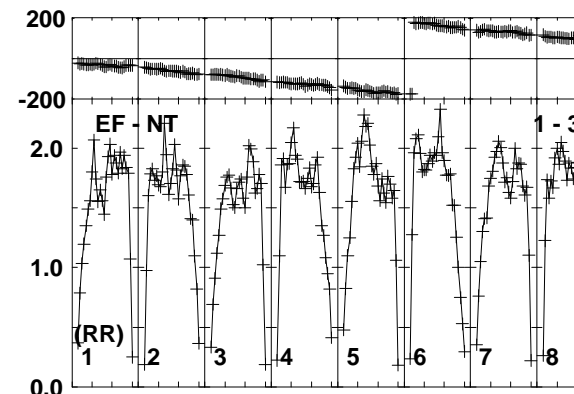
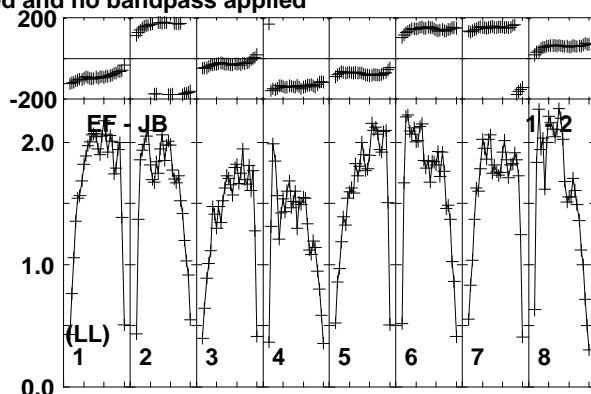
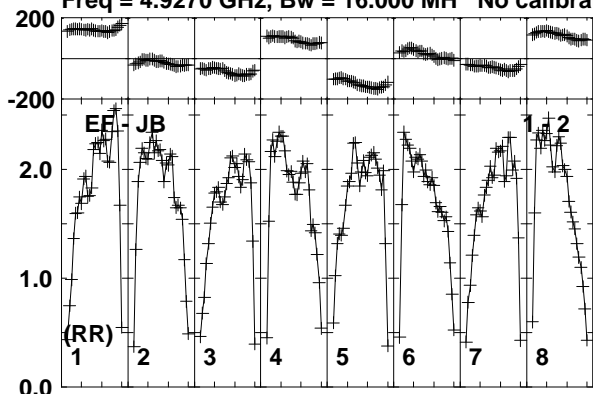

Lower frame: Milli Ampl Jy Top frame: Phas deg
Vector averaged cross-power spectrum Baseline: EF (01) - JB (02)
Timerange: 01/10:44:53 to 01/10:45:49

Plot file version 570 created 26-MAR-2015 15:28:08

J0147+5840 EG082E.UVDATA.1

Freq = 4.9270 GHz, Bw = 16.000 MH No calibration applied and no bandpass applied

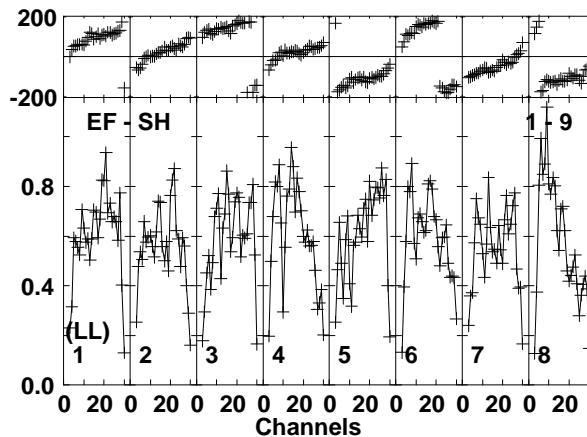
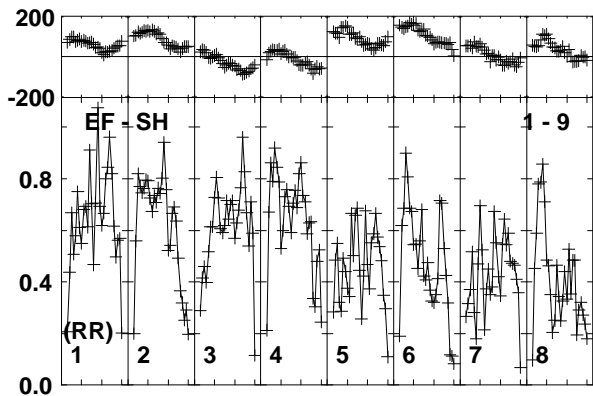
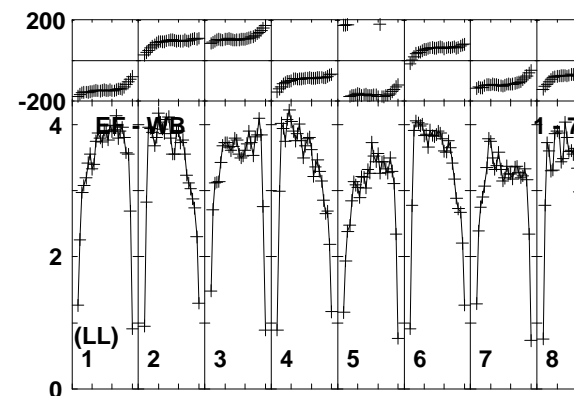
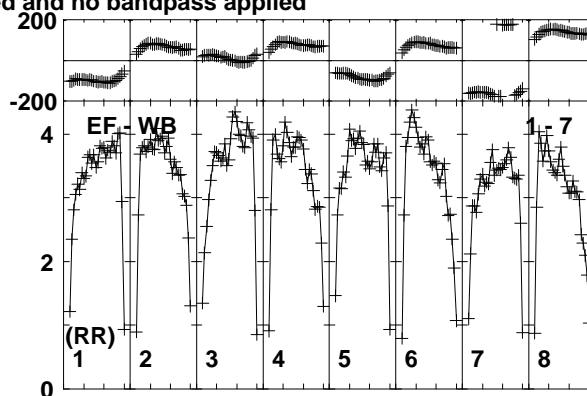
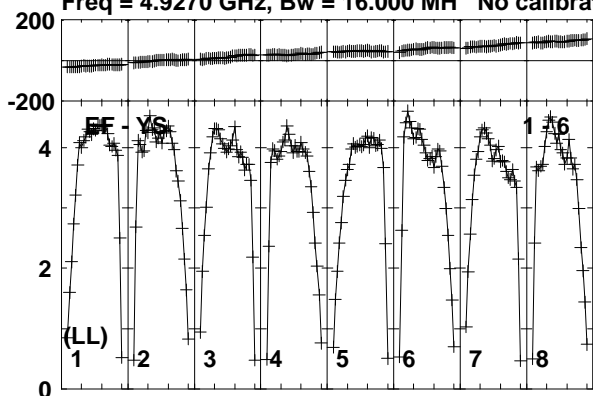

Lower frame: Milli Ampl Jy Top frame: Phas deg
Vector averaged cross-power spectrum Baseline: EF (01) - YS (06)
Timerange: 01/10:44:53 to 01/10:45:49

Plot file version 571 created 26-MAR-2015 15:28:08

V596CAS EG082E.UVDATA.1

Freq = 4.9270 GHz, Bw = 16.000 MH No calibration applied and no bandpass applied

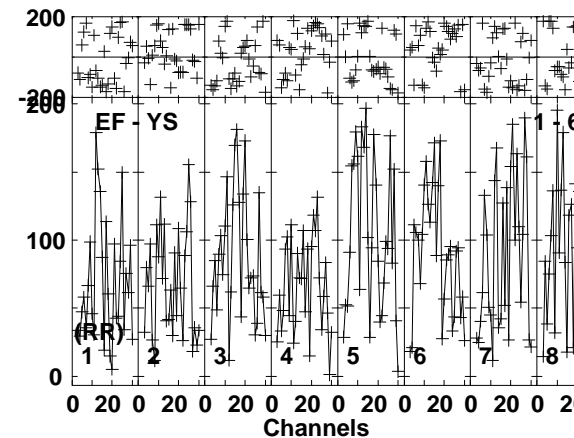
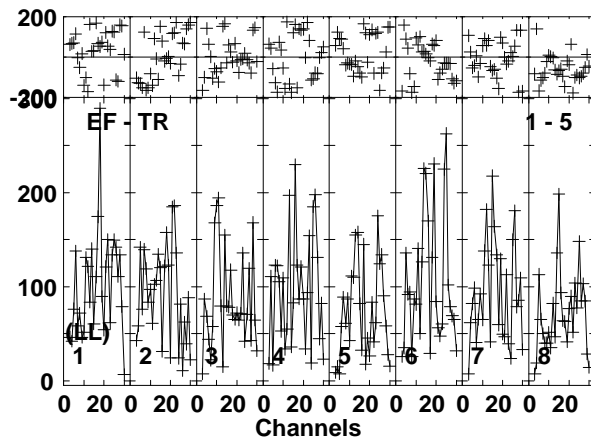
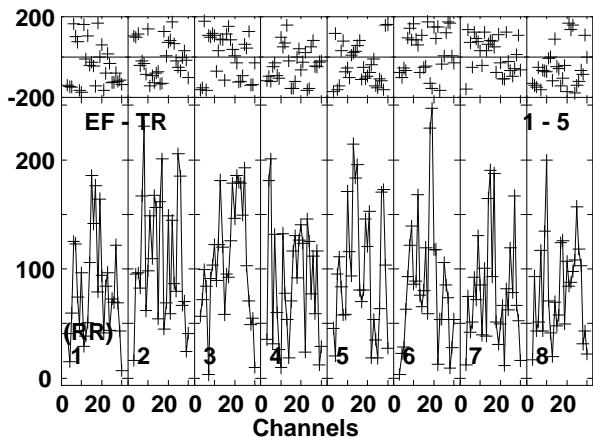
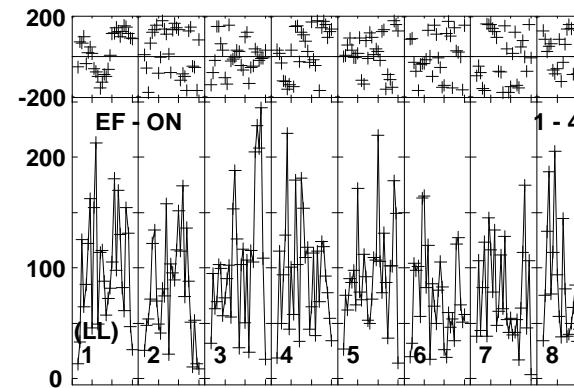
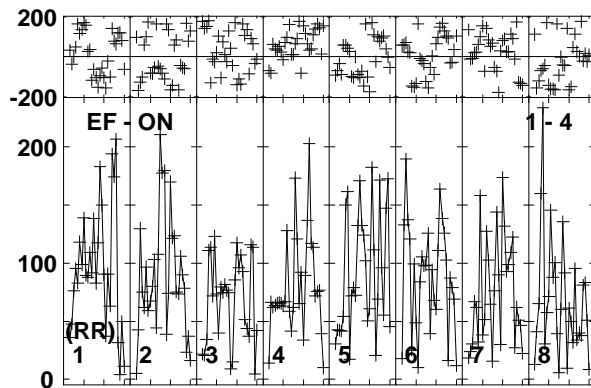
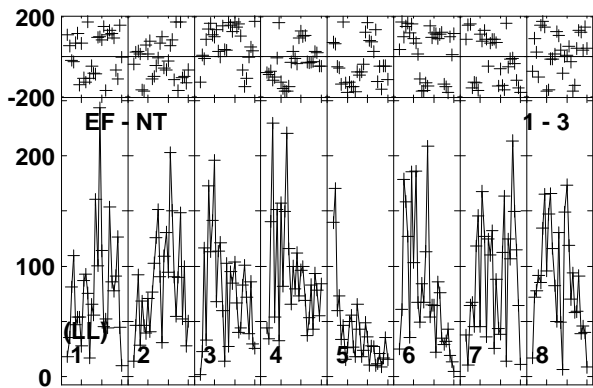
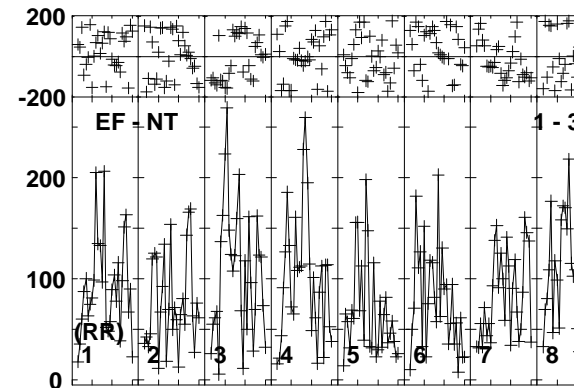
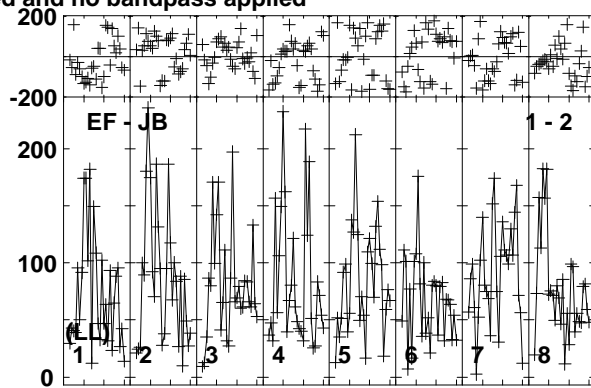
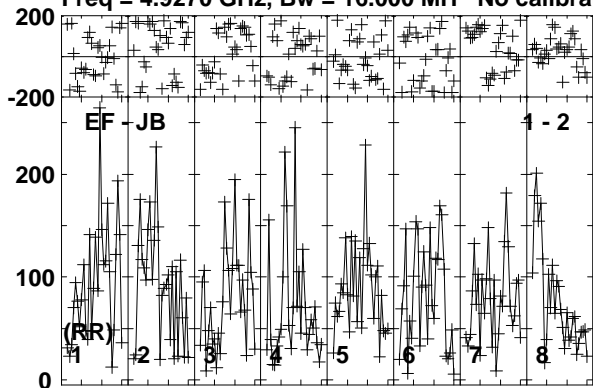

Lower frame: Micro Ampl Jy Top frame: Phas deg
Vector averaged cross-power spectrum Baseline: EF (01) - JB (02)
Timerange: 01/10:45:53 to 01/10:49:19

Plot file version 572 created 26-MAR-2015 15:28:08

V596CAS EG082E.UVDATA.1

Freq = 4.9270 GHz, Bw = 16.000 MH No calibration applied and no bandpass applied

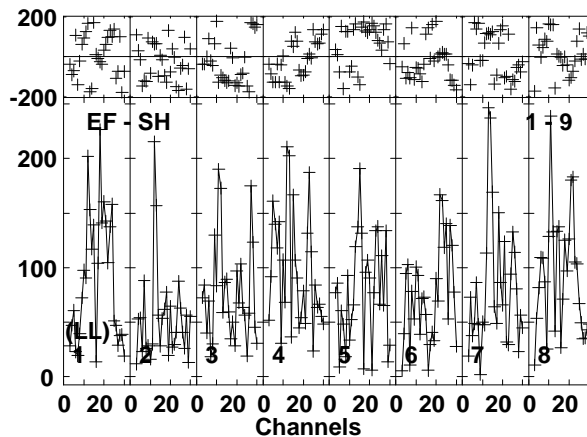
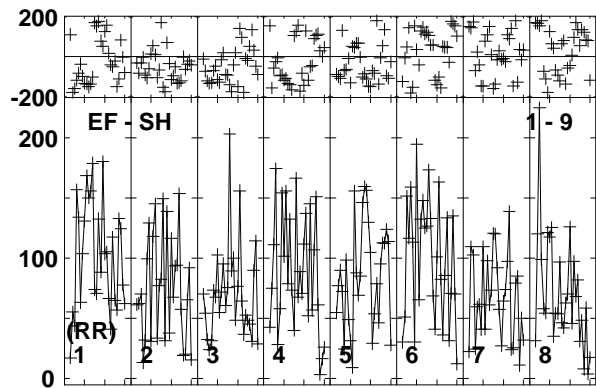
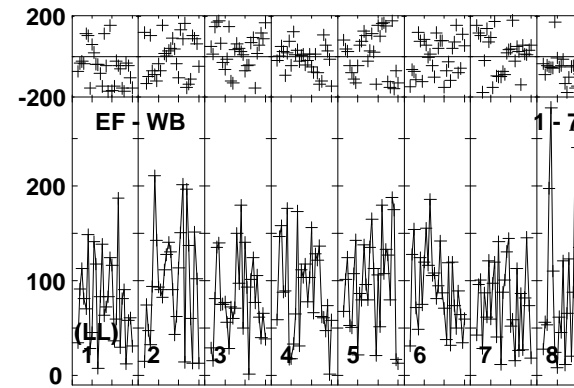
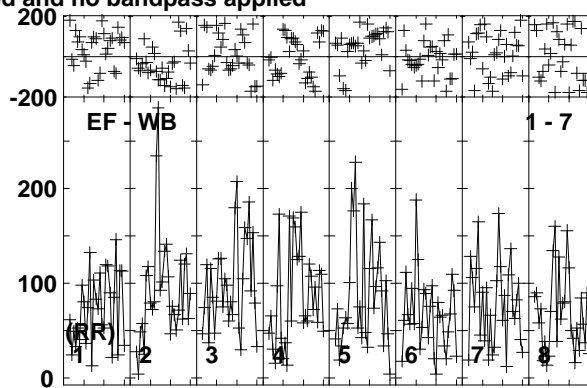
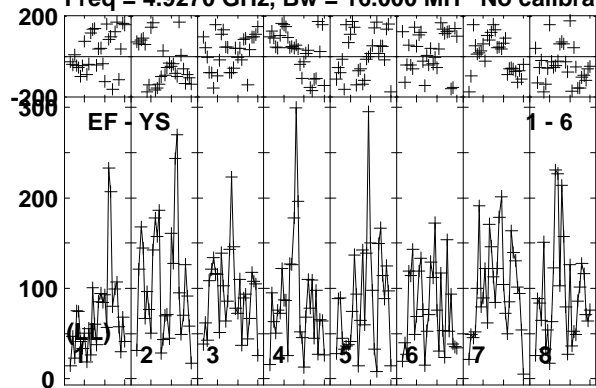

Lower frame: Micro Ampl Jy Top frame: Phas deg
Vector averaged cross-power spectrum Baseline: EF (01) - YS (06)
Timerange: 01/10:45:53 to 01/10:49:19

Plot file version 573 created 26-MAR-2015 15:28:08

J0147+5840 EG082E.UVDATA.1

Freq = 4.9270 GHz, Bw = 16.000 MH No calibration applied and no bandpass applied

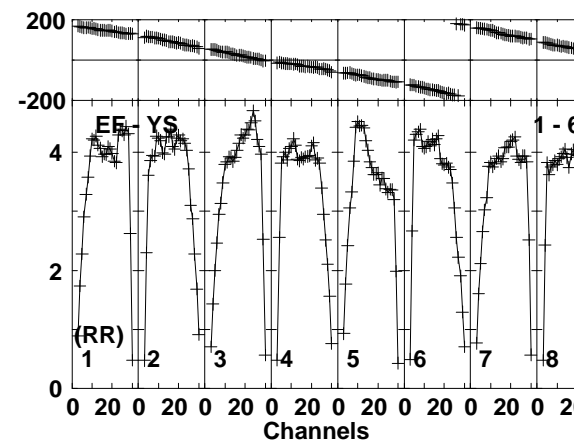
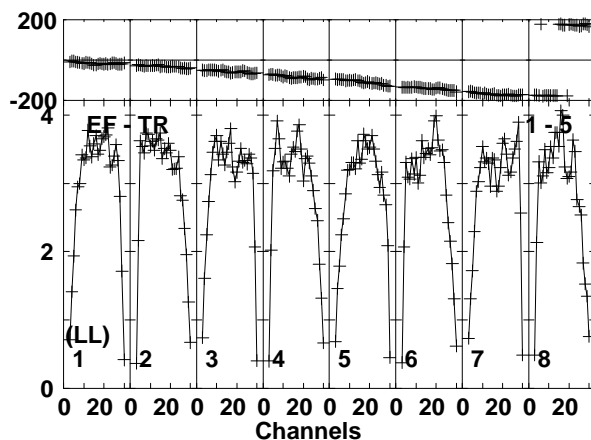
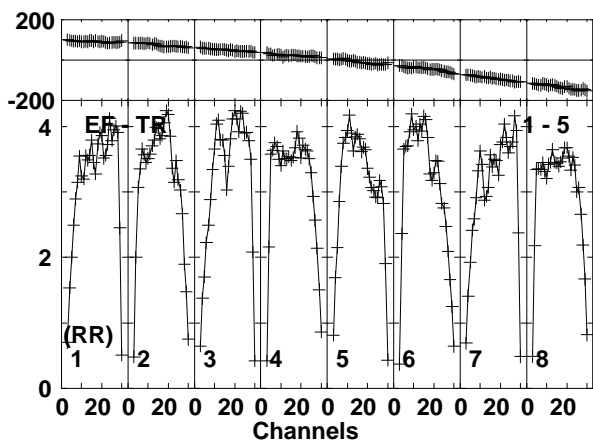
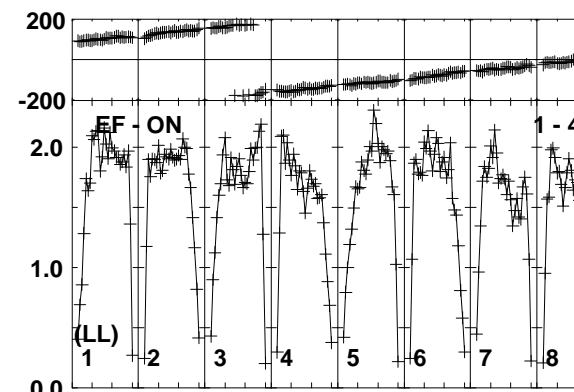
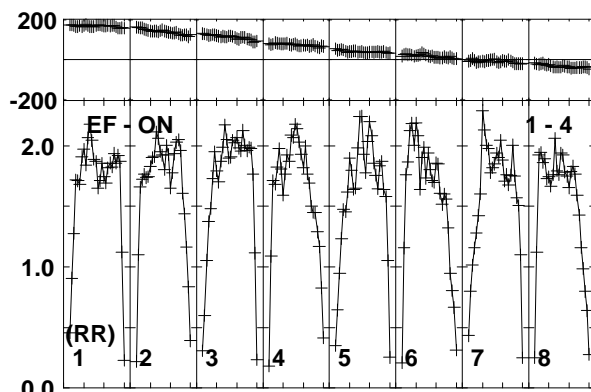
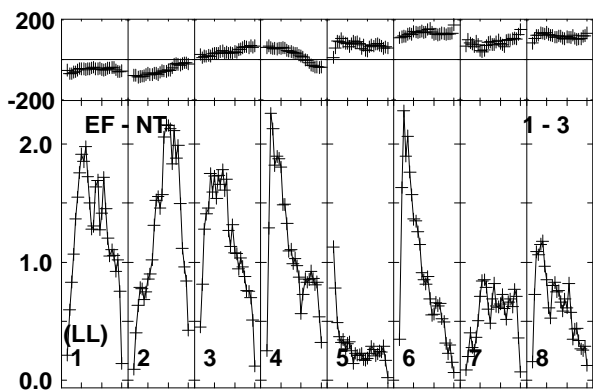
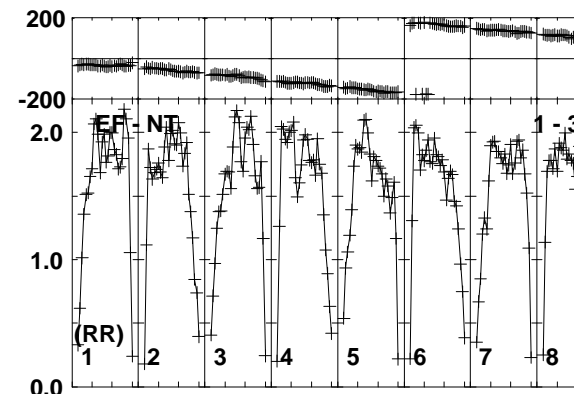
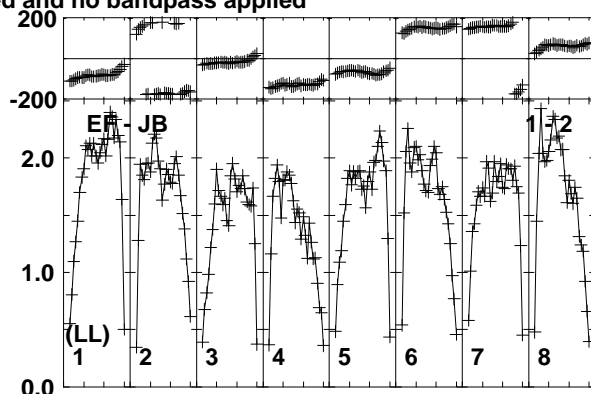
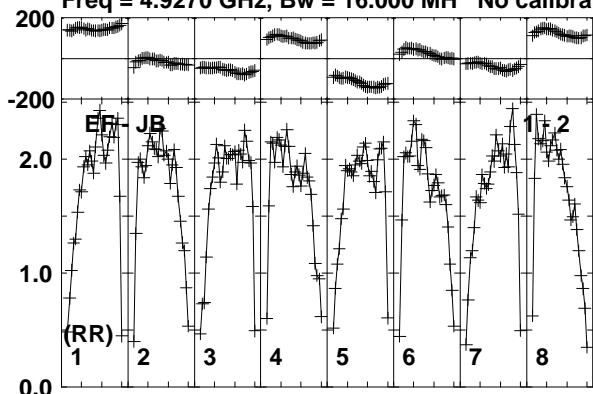

Lower frame: Milli Ampl Jy Top frame: Phas deg
Vector averaged cross-power spectrum Baseline: EF (01) - JB (02)
Timerange: 01/10:49:23 to 01/10:50:49

Plot file version 574 created 26-MAR-2015 15:28:08

J0147+5840 EG082E.UVDATA.1

Freq = 4.9270 GHz, Bw = 16.000 MH No calibration applied and no bandpass applied

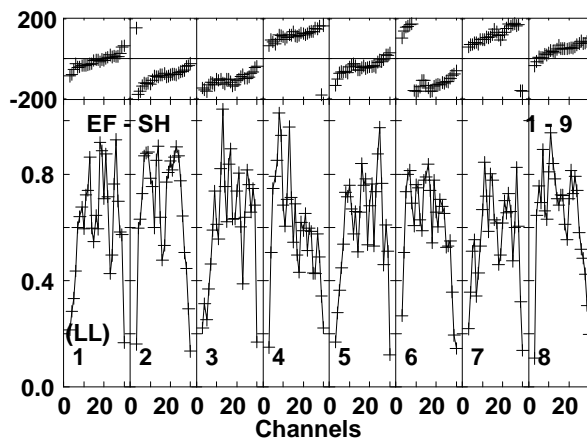
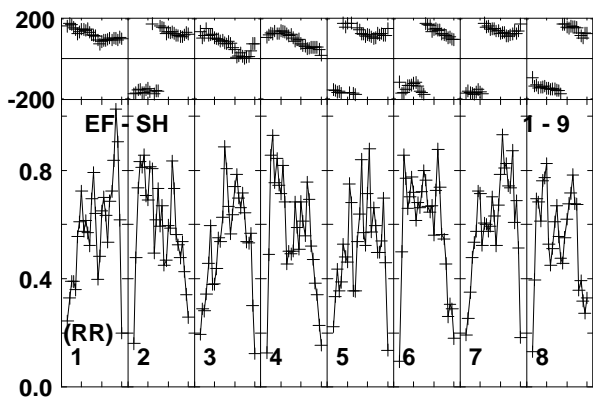
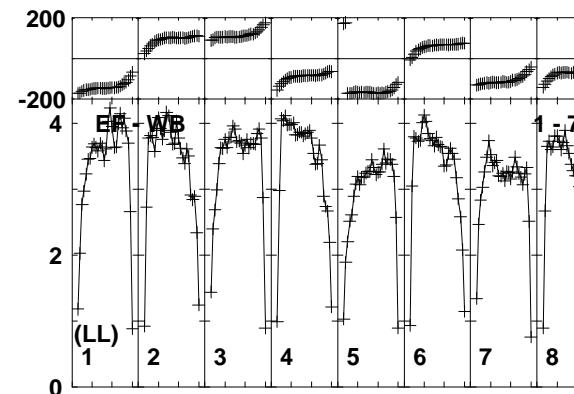
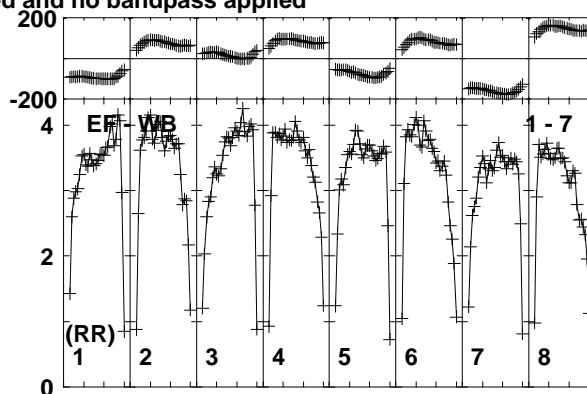
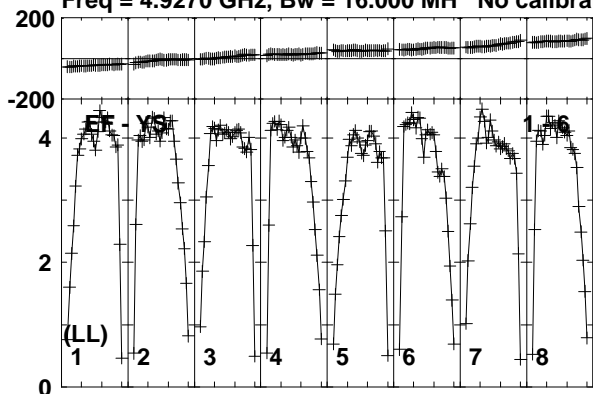

Lower frame: Milli Ampl Jy Top frame: Phas deg
Vector averaged cross-power spectrum Baseline: EF (01) - YS (06)
Timerange: 01/10:49:23 to 01/10:50:49

Plot file version 575 created 26-MAR-2015 15:28:08

J0151+5454 EG082E.UVDATA.1

Freq = 4.9270 GHz, Bw = 16.000 MH No calibration applied and no bandpass applied

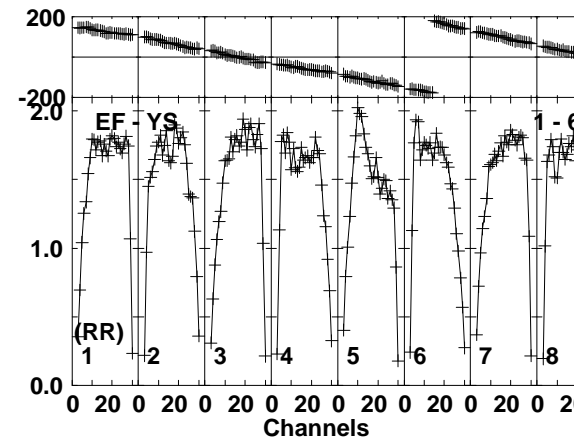
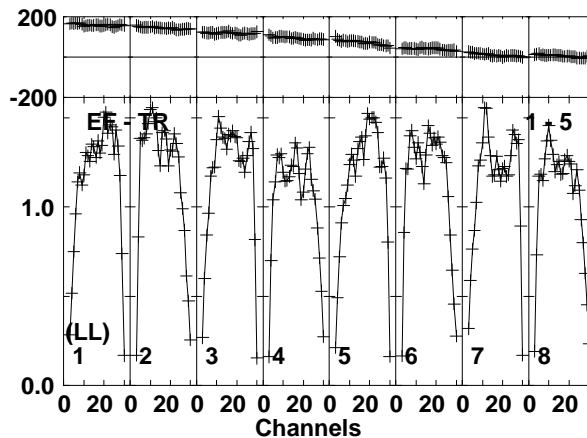
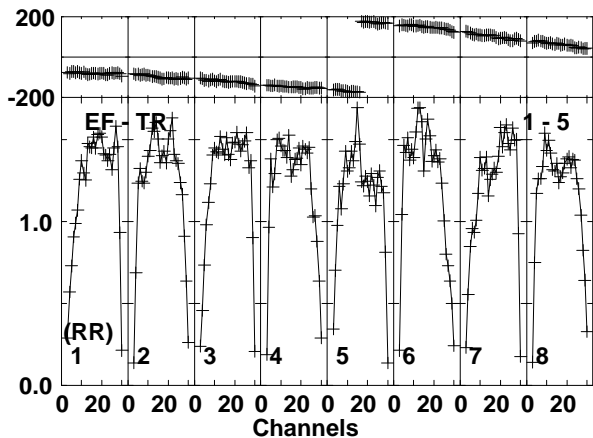
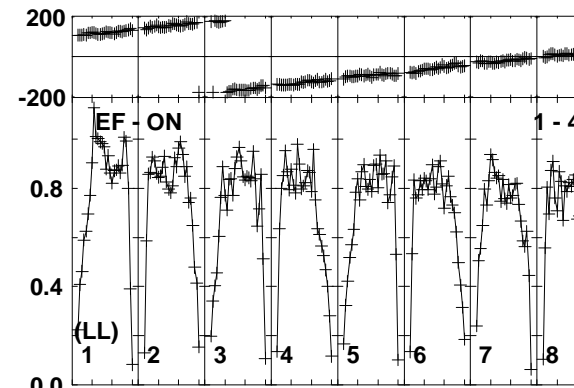
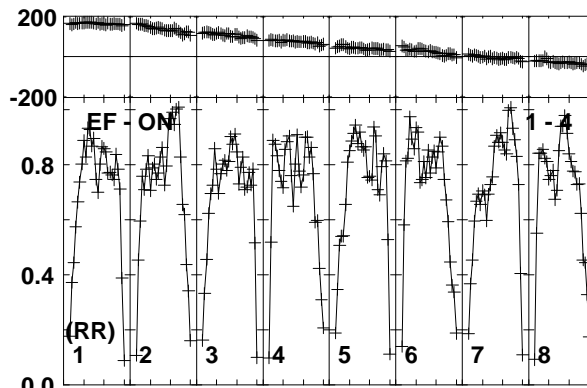
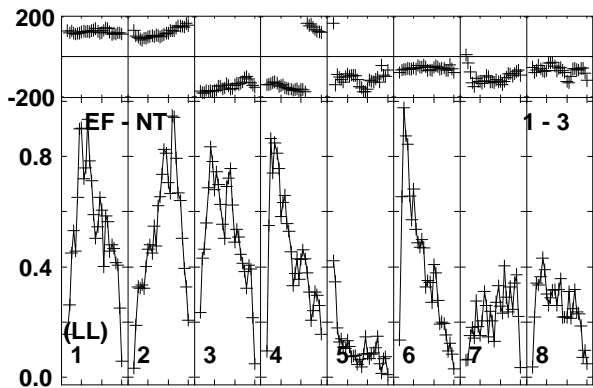
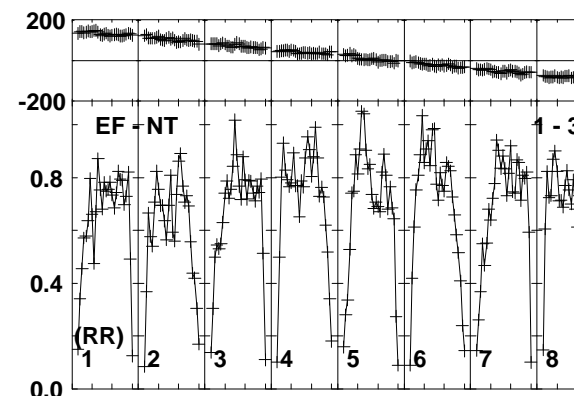
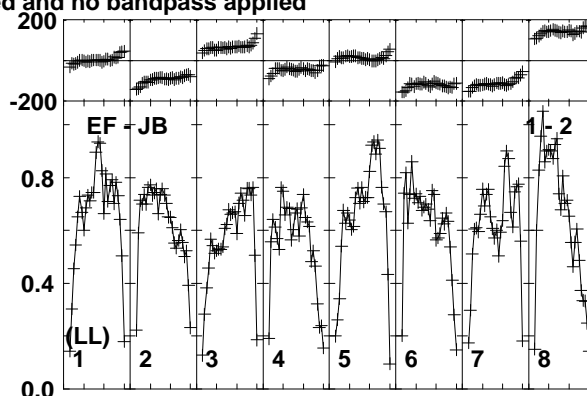
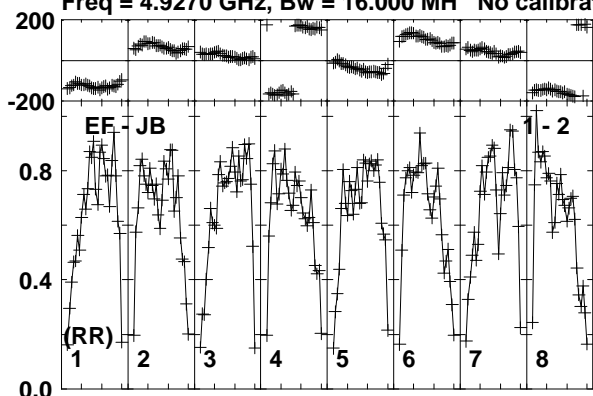

Lower frame: Milli Ampl Jy Top frame: Phas deg
Vector averaged cross-power spectrum Baseline: EF (01) - JB (02)
Timerange: 01/10:50:53 to 01/10:54:19

Plot file version 576 created 26-MAR-2015 15:28:08

J0151+5454 EG082E.UVDATA.1

Freq = 4.9270 GHz, Bw = 16.000 MH No calibration applied and no bandpass applied

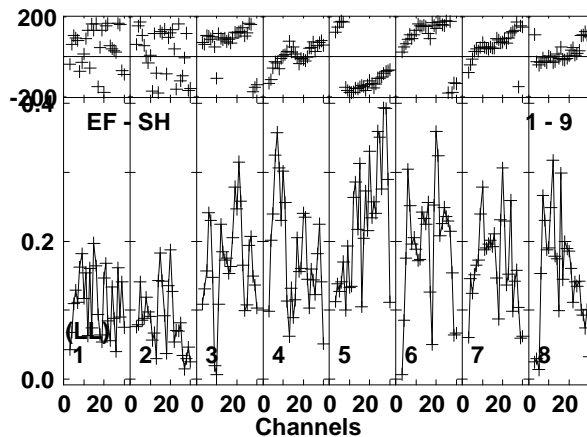
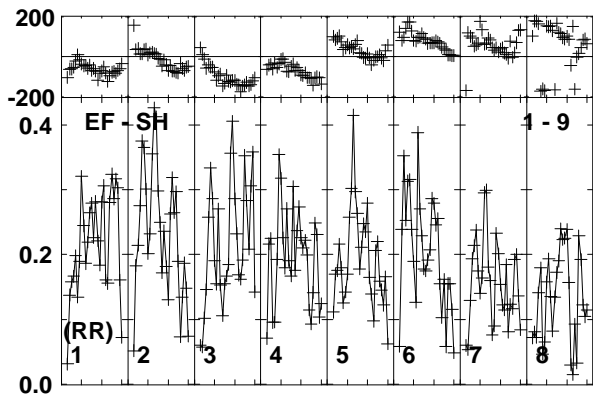
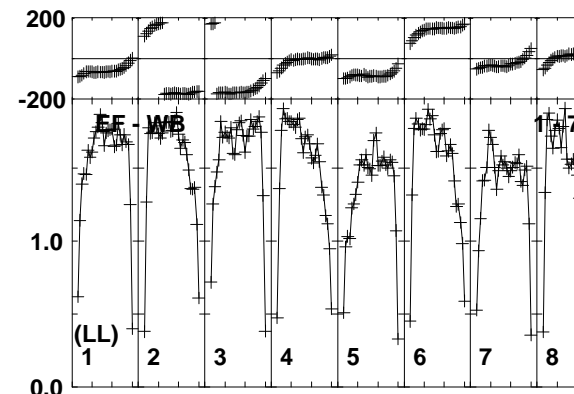
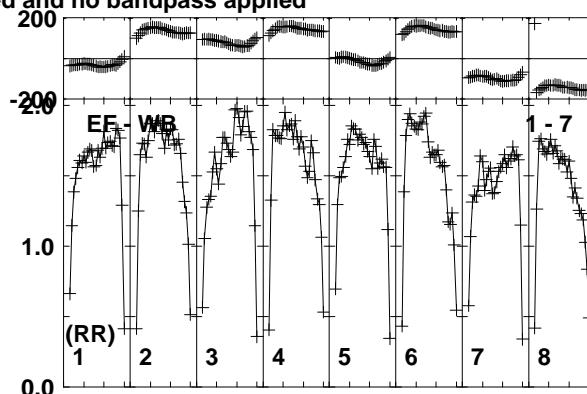
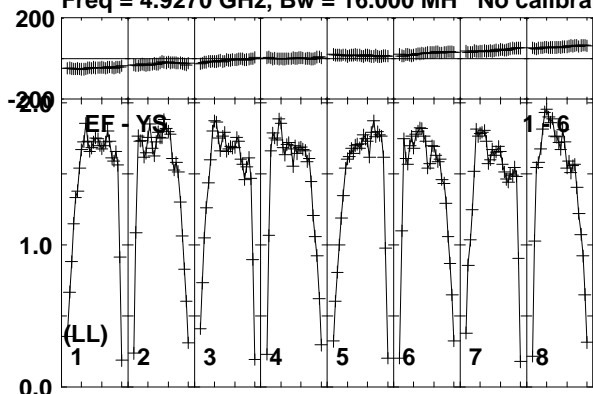

Lower frame: Milli Ampl Jy Top frame: Phas deg
Vector averaged cross-power spectrum Baseline: EF (01) - YS (06)
Timerange: 01/10:50:53 to 01/10:54:19

Plot file version 577 created 26-MAR-2015 15:28:08

J0147+5840 EG082E.UVDATA.1

Freq = 4.9270 GHz, Bw = 16.000 MH No calibration applied and no bandpass applied

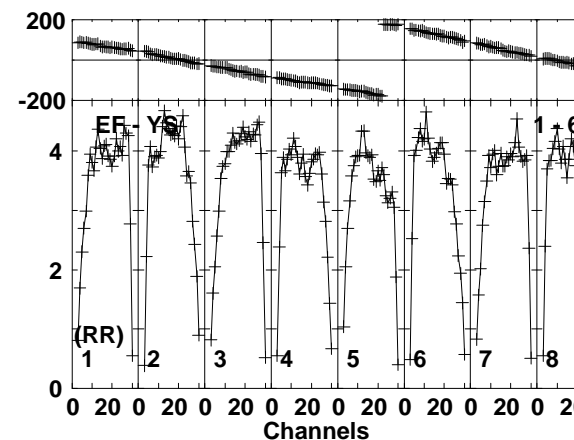
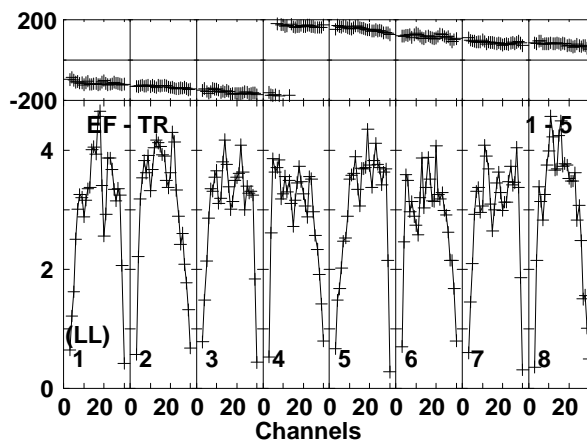
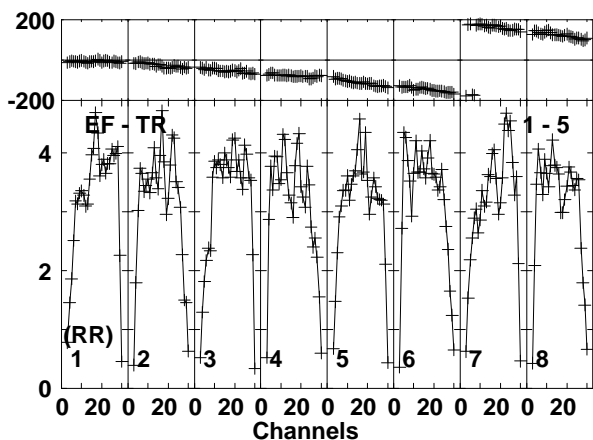
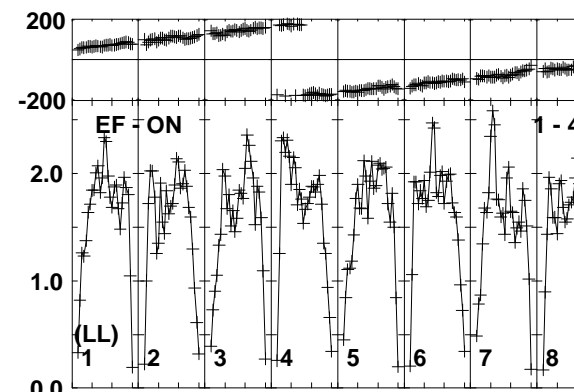
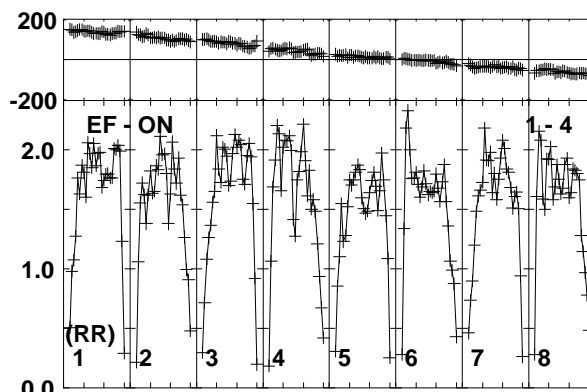
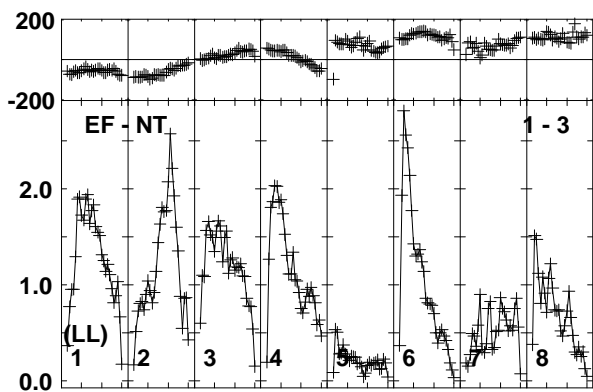
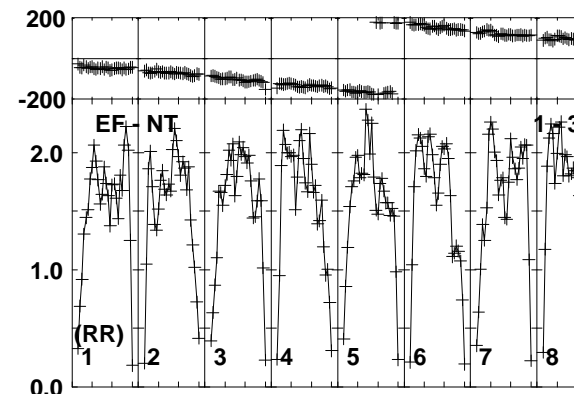
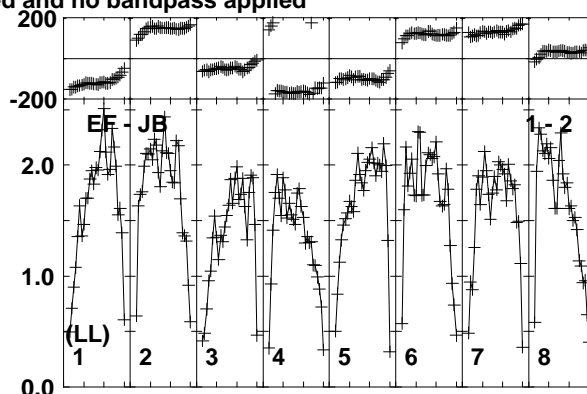
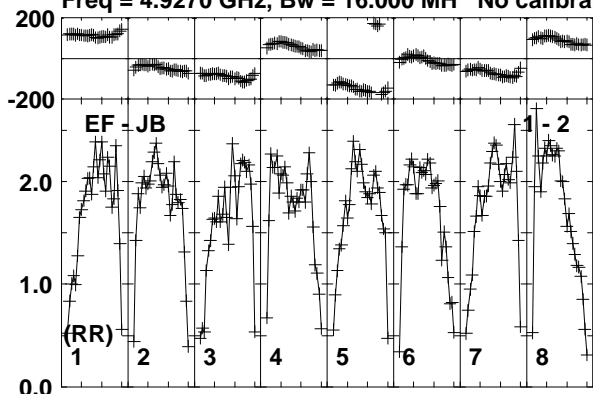

Lower frame: Milli Ampl Jy Top frame: Phas deg
Vector averaged cross-power spectrum Baseline: EF (01) - JB (02)
Timerange: 01/10:54:53 to 01/10:55:49

Plot file version 578 created 26-MAR-2015 15:28:08

J0147+5840 EG082E.UVDATA.1

Freq = 4.9270 GHz, Bw = 16.000 MH No calibration applied and no bandpass applied

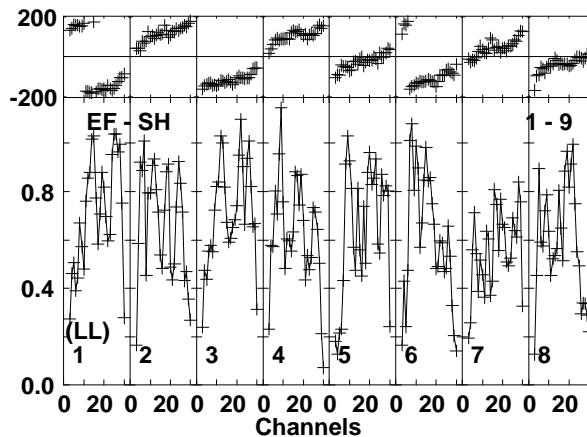
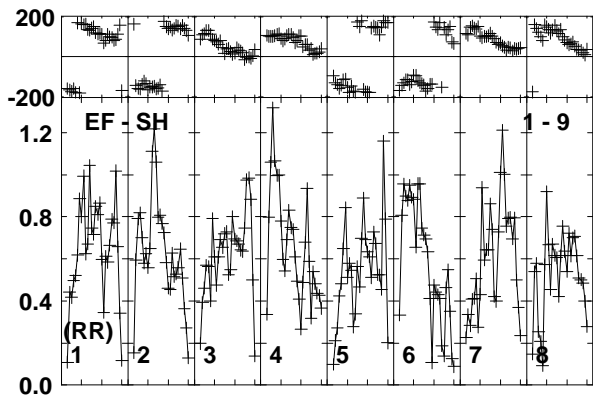
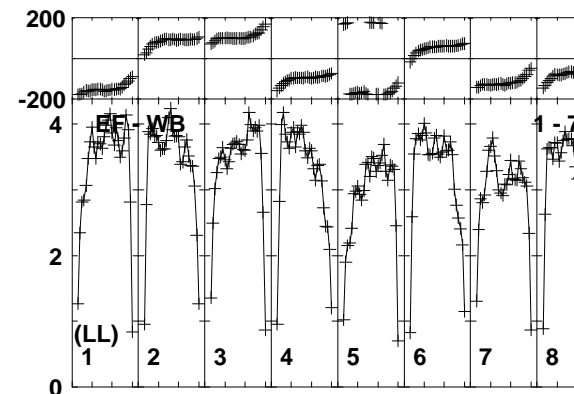
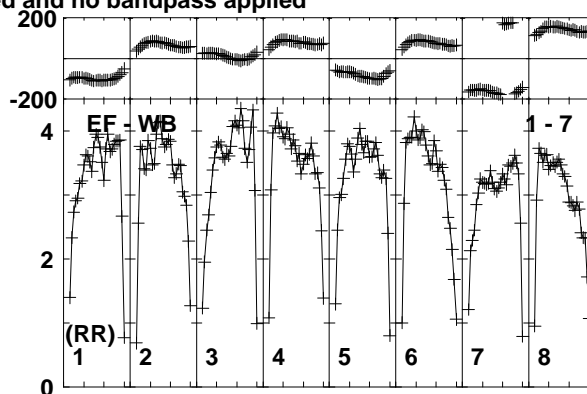
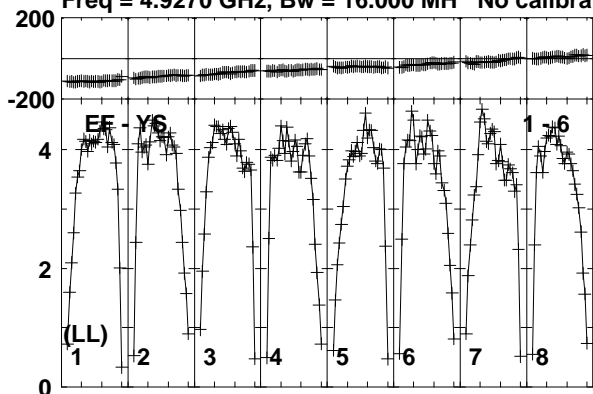

Lower frame: Milli Ampl Jy Top frame: Phas deg
Vector averaged cross-power spectrum Baseline: EF (01) - YS (06)
Timerange: 01/10:54:53 to 01/10:55:49

Plot file version 579 created 26-MAR-2015 15:28:09

V596CAS EG082E.UVDATA.1

Freq = 4.9270 GHz, Bw = 16.000 MH No calibration applied and no bandpass applied

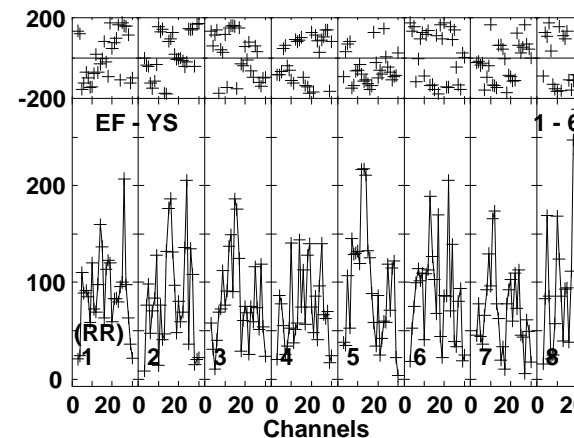
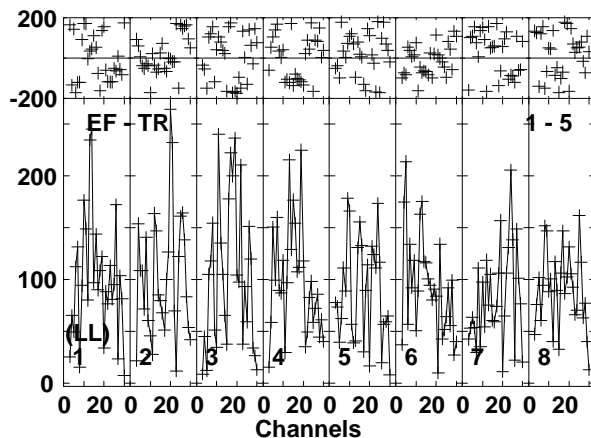
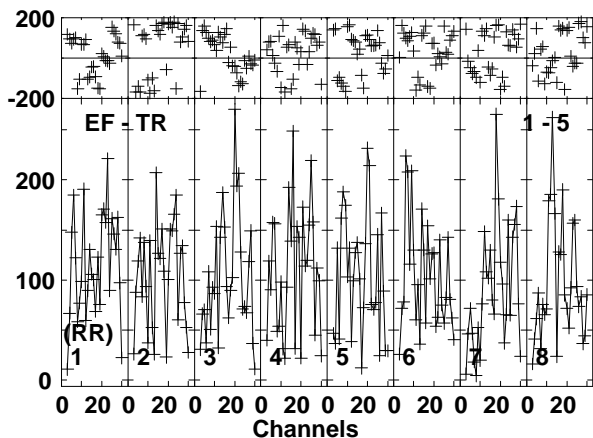
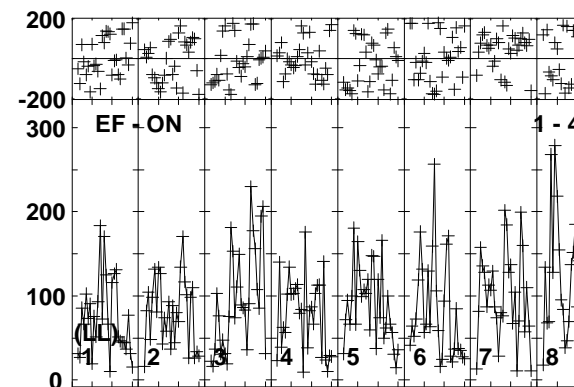
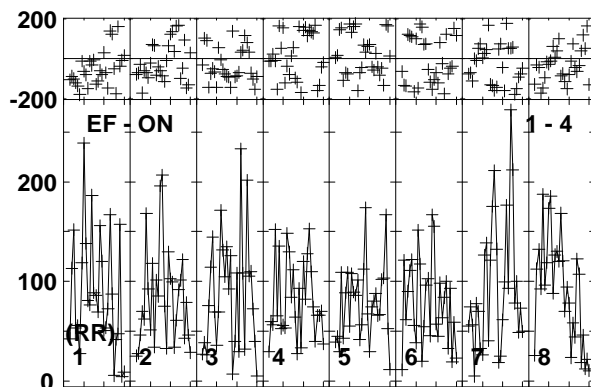
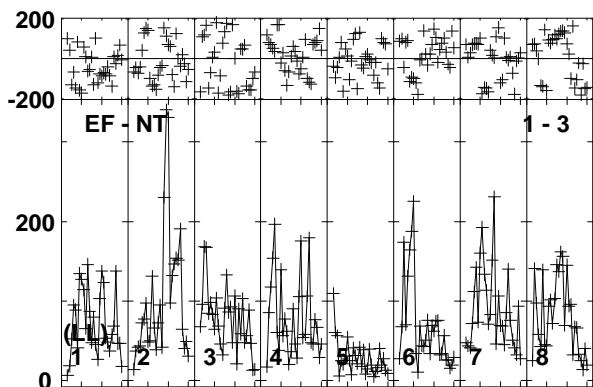
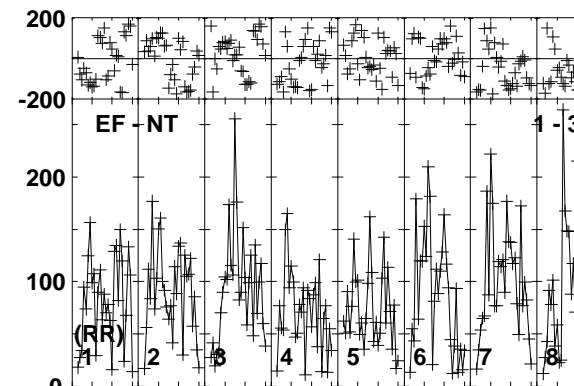
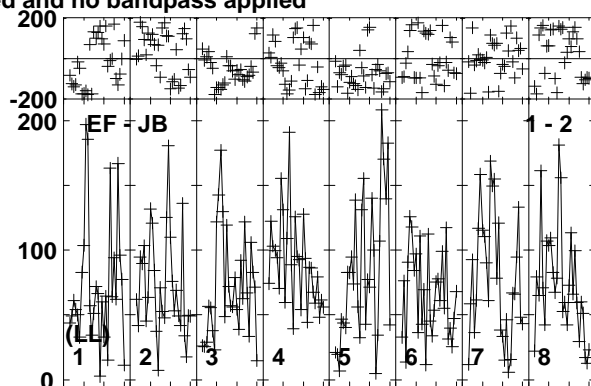
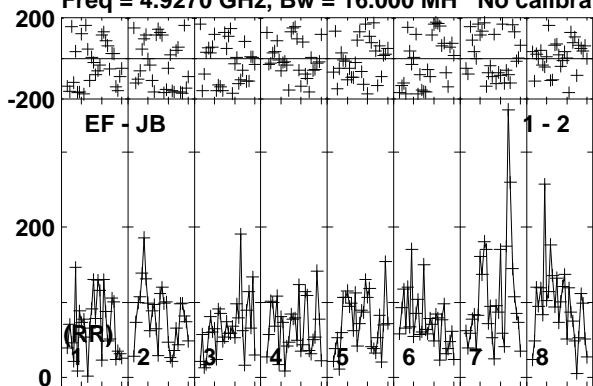

Lower frame: Micro Ampl Jy Top frame: Phas deg
Vector averaged cross-power spectrum Baseline: EF (01) - JB (02)
Timerange: 01/10:55:53 to 01/10:59:19

Plot file version 580 created 26-MAR-2015 15:28:09

V596CAS EG082E.UVDATA.1

Freq = 4.9270 GHz, Bw = 16.000 MH No calibration applied and no bandpass applied

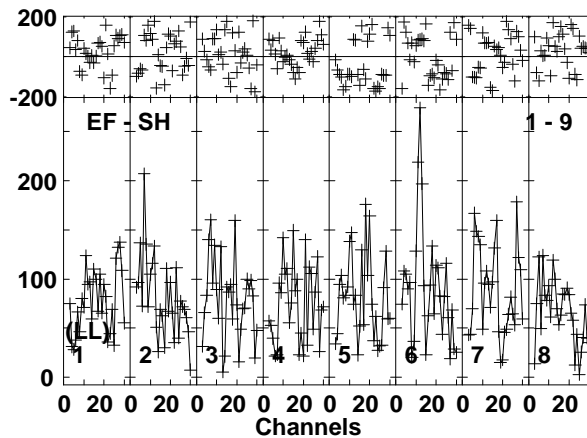
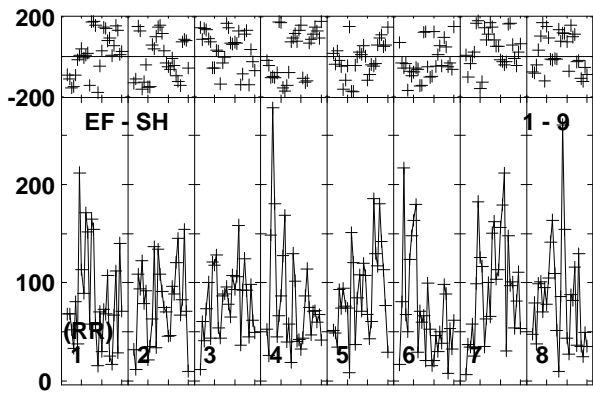
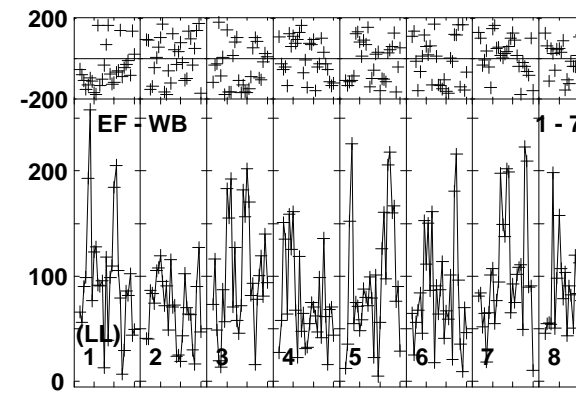
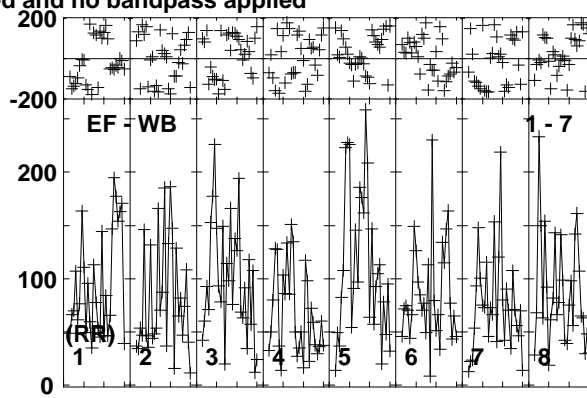
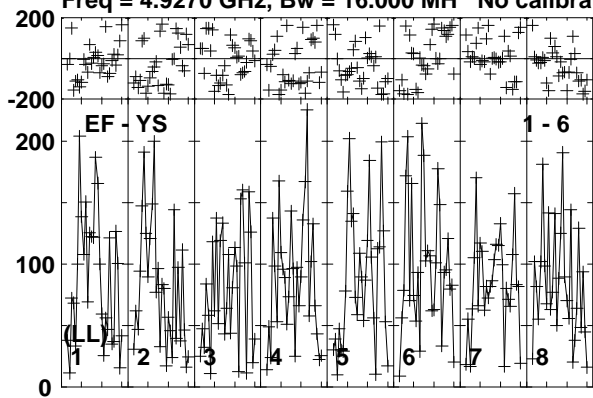

Lower frame: Micro Ampl Jy Top frame: Phas deg
Vector averaged cross-power spectrum Baseline: EF (01) - YS (06)
Timerange: 01/10:55:53 to 01/10:59:19

Plot file version 581 created 26-MAR-2015 15:28:09

J0147+5840 EG082E.UVDATA.1

Freq = 4.9270 GHz, Bw = 16.000 MH No calibration applied and no bandpass applied

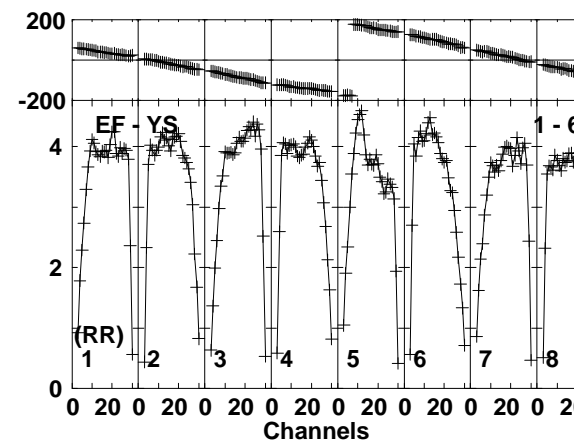
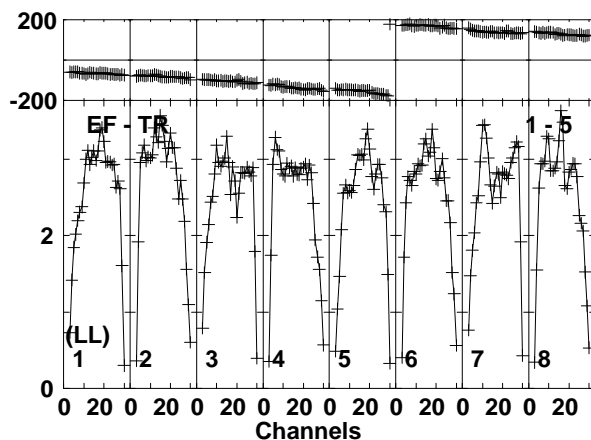
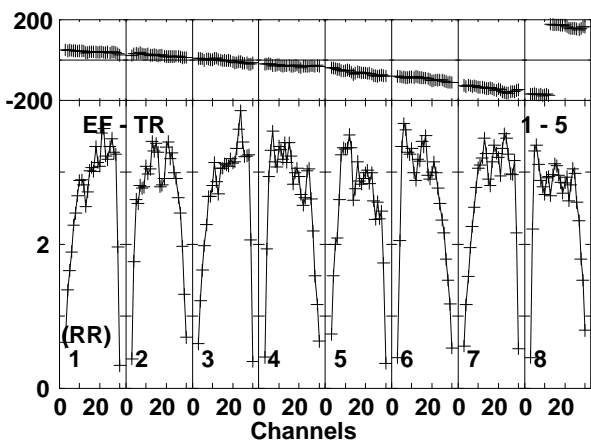
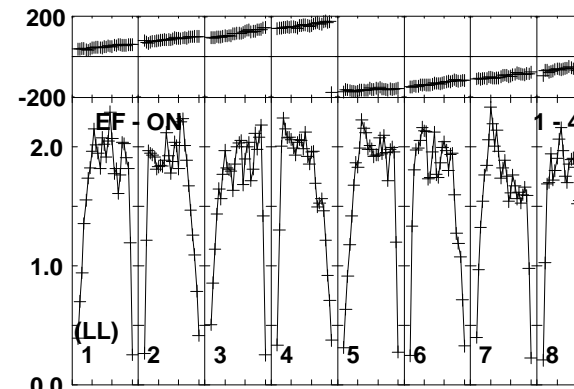
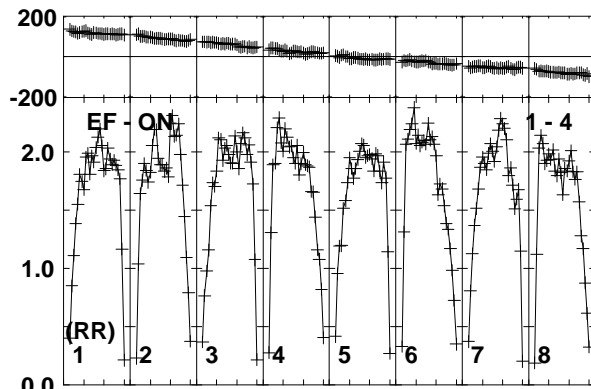
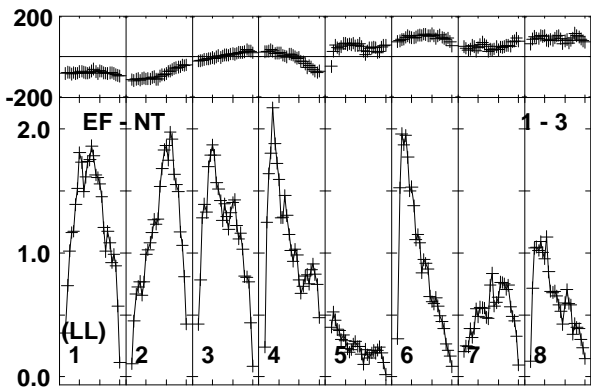
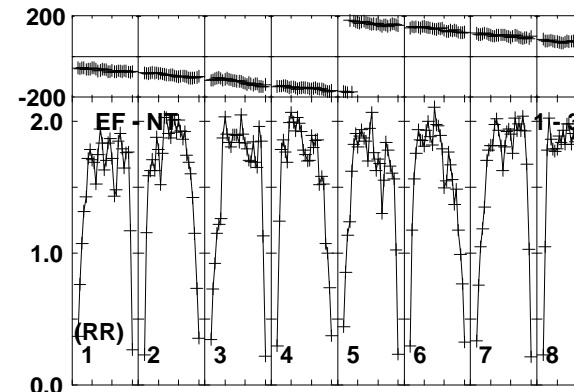
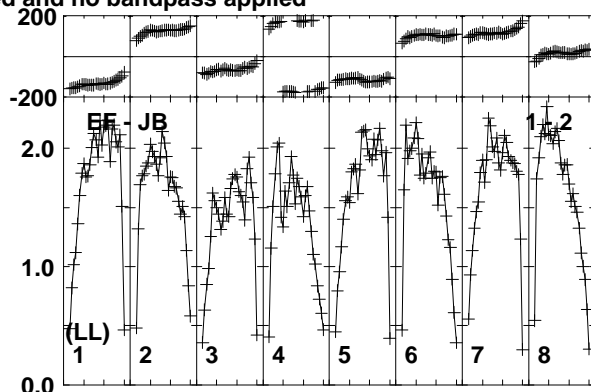
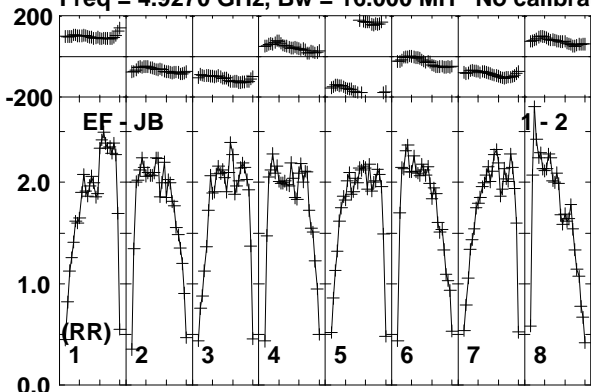

Lower frame: Milli Ampl Jy Top frame: Phas deg
Vector averaged cross-power spectrum Baseline: EF (01) - JB (02)
Timerange: 01/10:59:23 to 01/11:00:49

Plot file version 582 created 26-MAR-2015 15:28:09

J0147+5840 EG082E.UVDATA.1

Freq = 4.9270 GHz, Bw = 16.000 MH No calibration applied and no bandpass applied

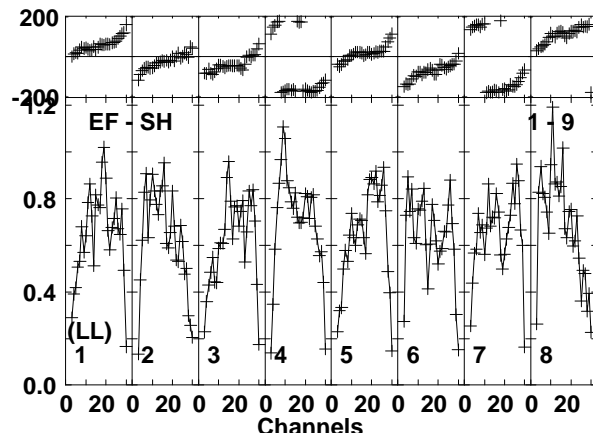
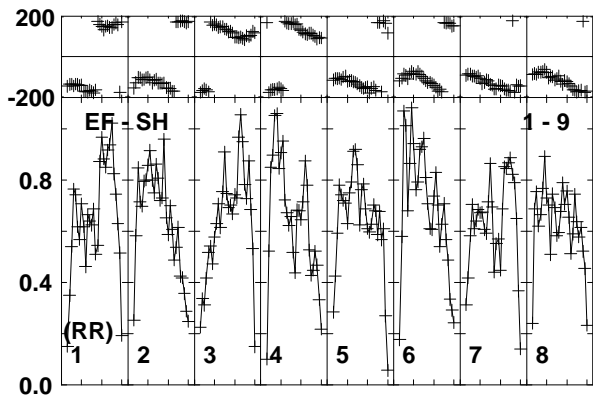
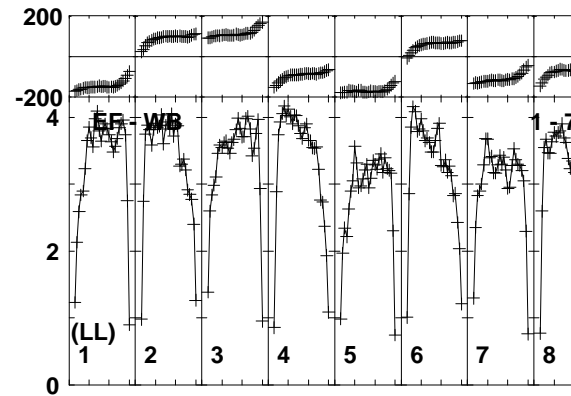
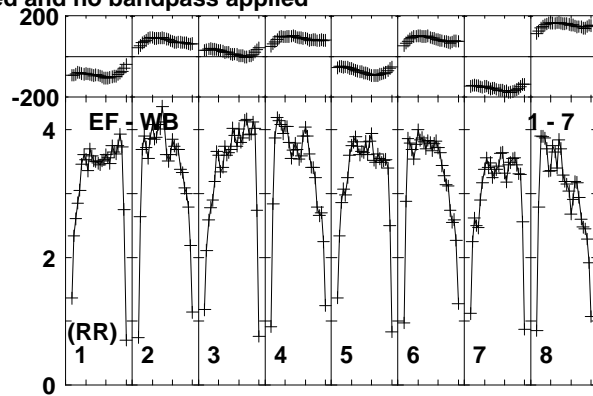
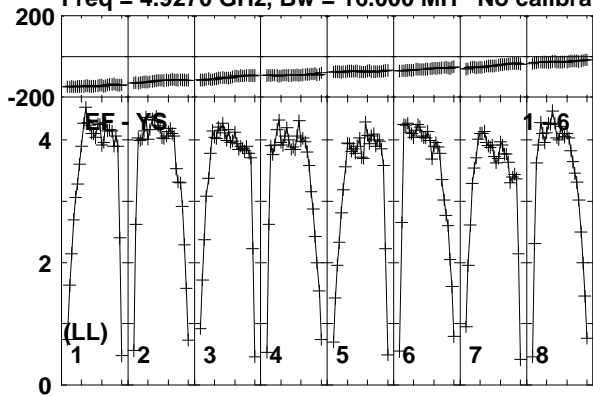

Lower frame: Milli Ampl Jy Top frame: Phas deg
Vector averaged cross-power spectrum Baseline: EF (01) - YS (06)
Timerange: 01/10:59:23 to 01/11:00:49

Plot file version 583 created 26-MAR-2015 15:28:09

V596CAS EG082E.UVDATA.1

Freq = 4.9270 GHz, Bw = 16.000 MH No calibration applied and no bandpass applied

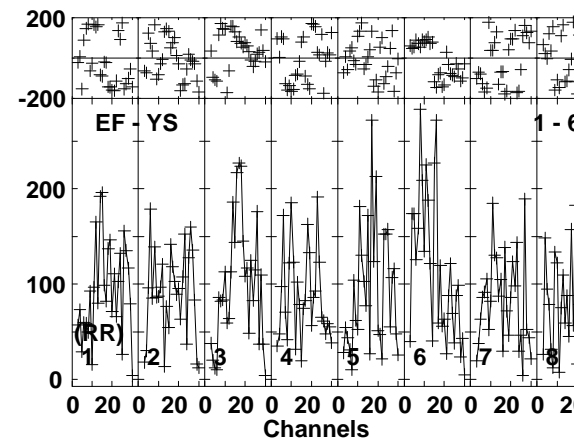
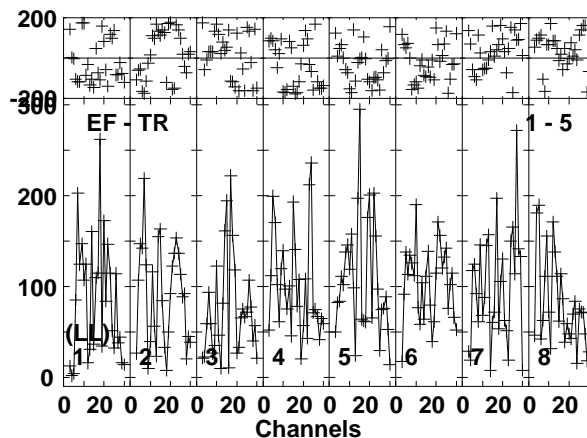
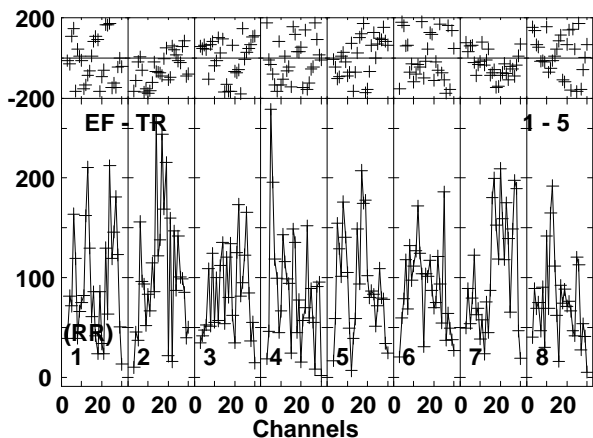
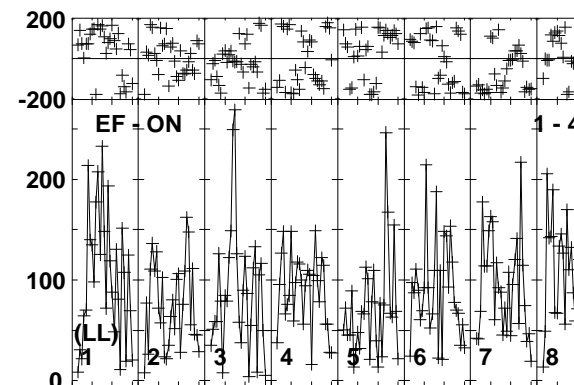
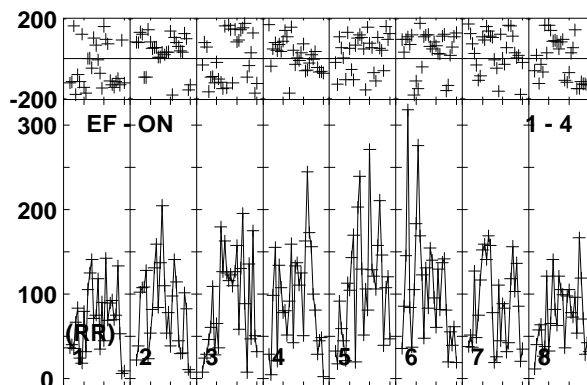
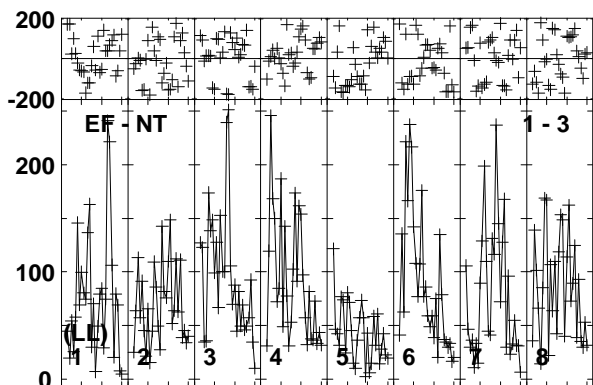
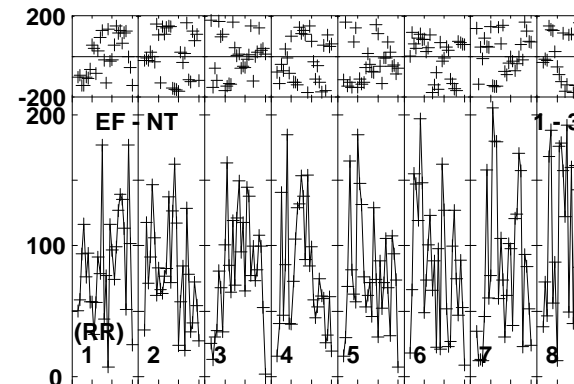
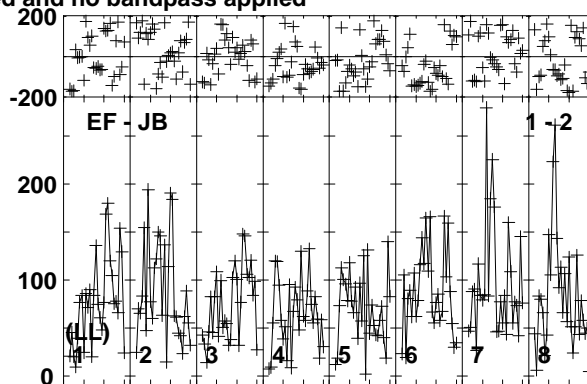
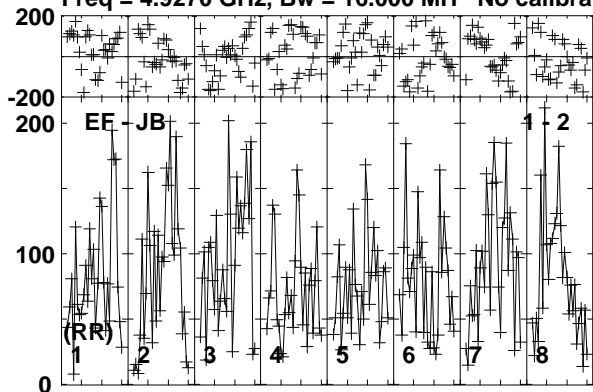

Lower frame: Micro Ampl Jy Top frame: Phas deg
Vector averaged cross-power spectrum Baseline: EF (01) - JB (02)
Timerange: 01/11:00:53 to 01/11:04:19

Plot file version 584 created 26-MAR-2015 15:28:09

V596CAS EG082E.UVDATA.1

Freq = 4.9270 GHz, Bw = 16.000 MH No calibration applied and no bandpass applied

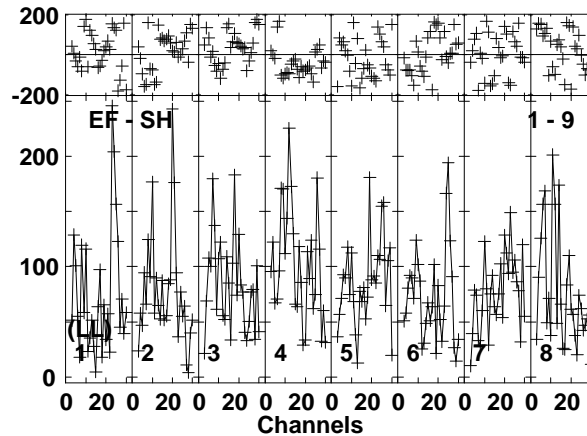
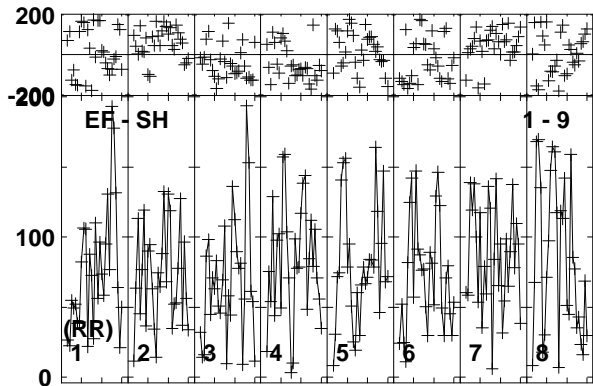
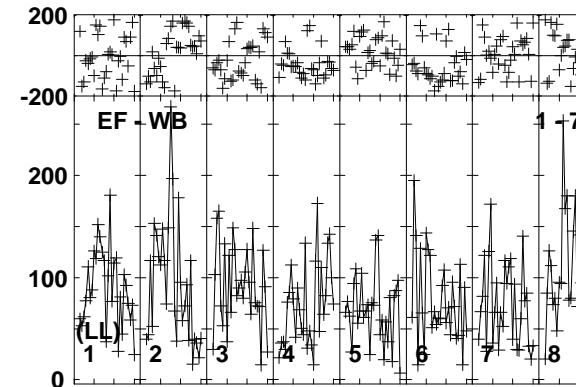
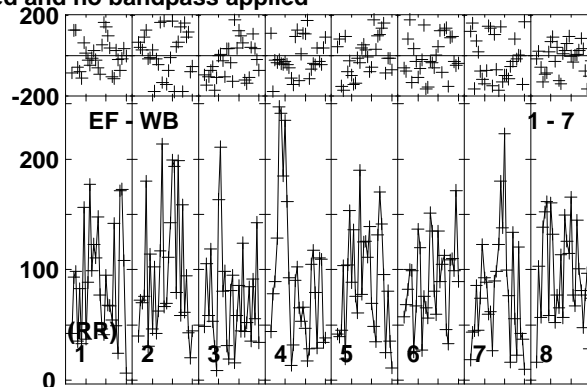
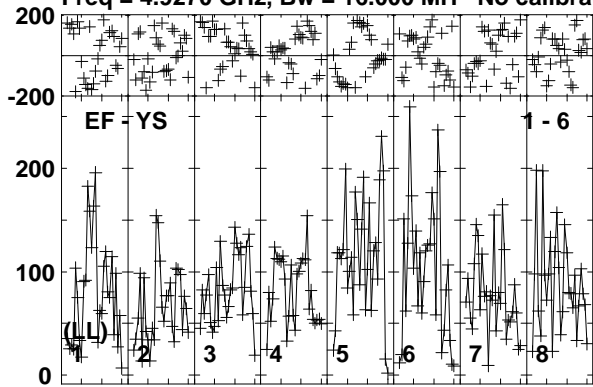

Lower frame: Micro Ampl Jy Top frame: Phas deg
Vector averaged cross-power spectrum Baseline: EF (01) - YS (06)
Timerange: 01/11:00:53 to 01/11:04:19

Plot file version 585 created 26-MAR-2015 15:28:09

J0147+5840 EG082E.UVDATA.1

Freq = 4.9270 GHz, Bw = 16.000 MH No calibration applied and no bandpass applied

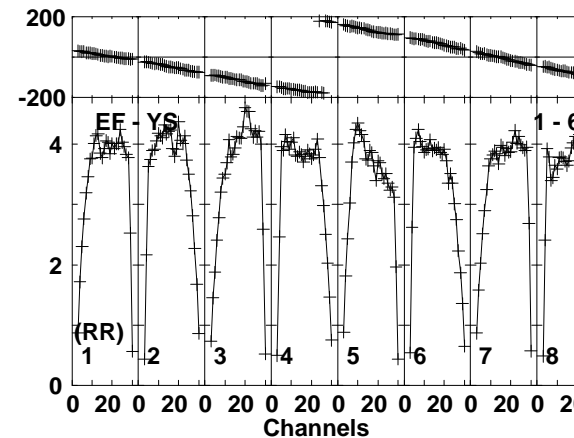
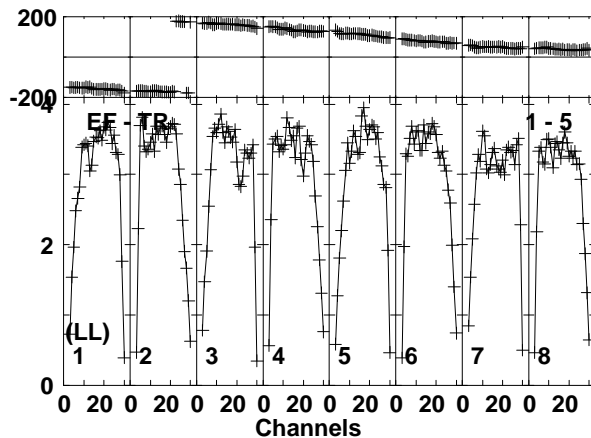
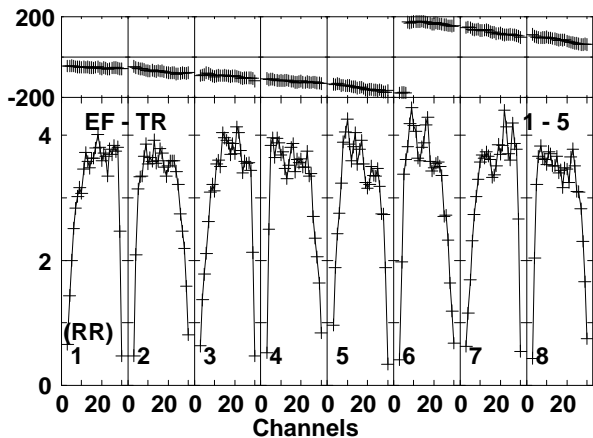
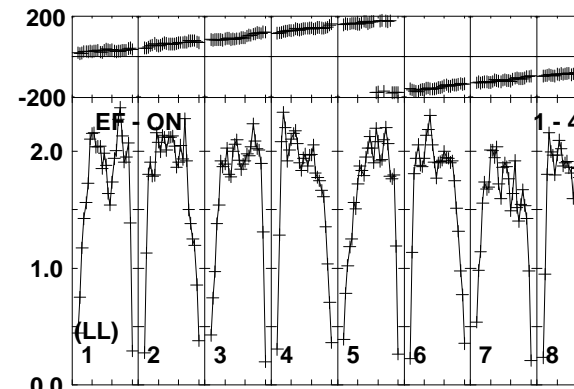
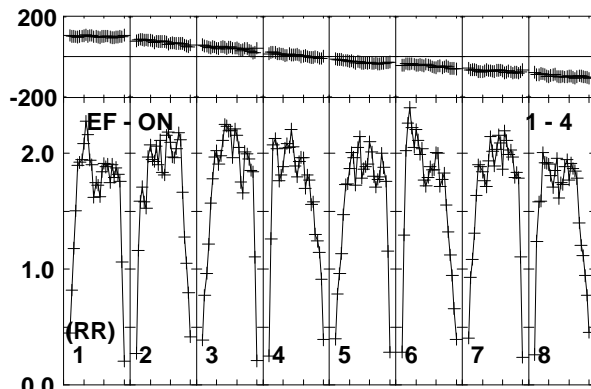
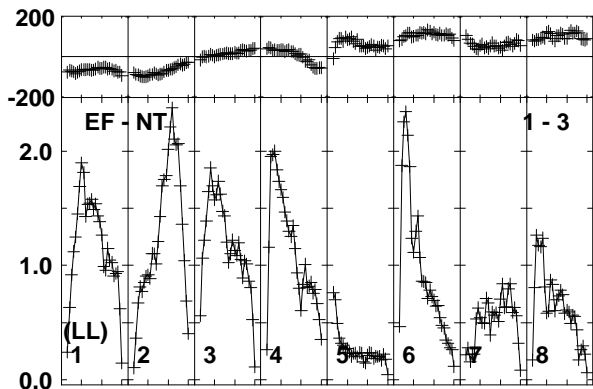
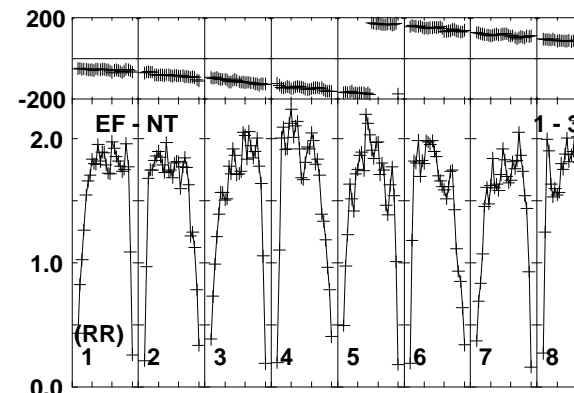
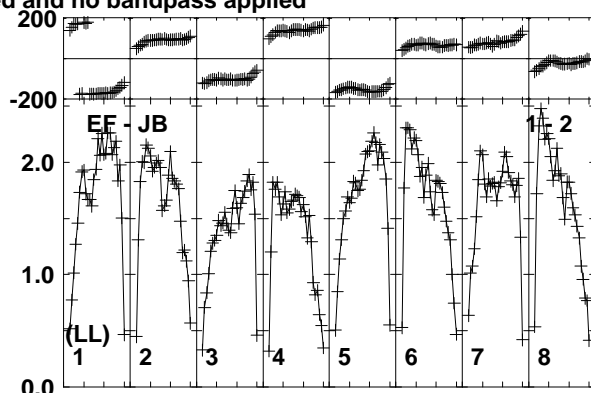
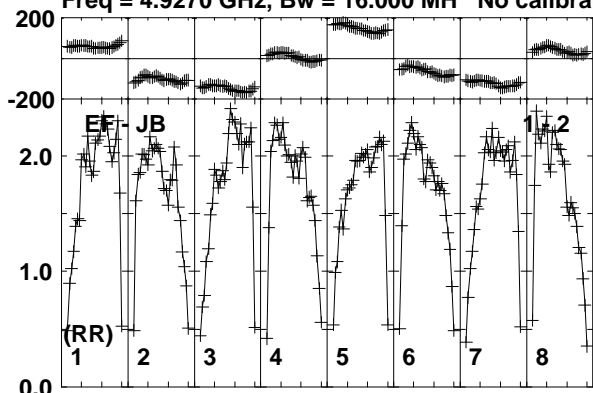

Lower frame: Milli Ampl Jy Top frame: Phas deg
Vector averaged cross-power spectrum Baseline: EF (01) - JB (02)
Timerange: 01/11:04:53 to 01/11:05:49

Plot file version 586 created 26-MAR-2015 15:28:09

J0147+5840 EG082E.UVDATA.1

Freq = 4.9270 GHz, Bw = 16.000 MH No calibration applied and no bandpass applied

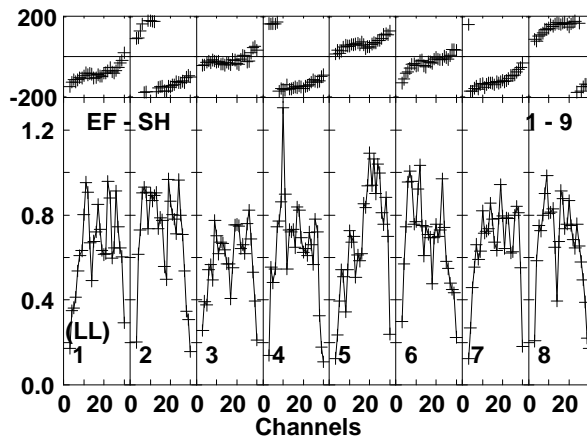
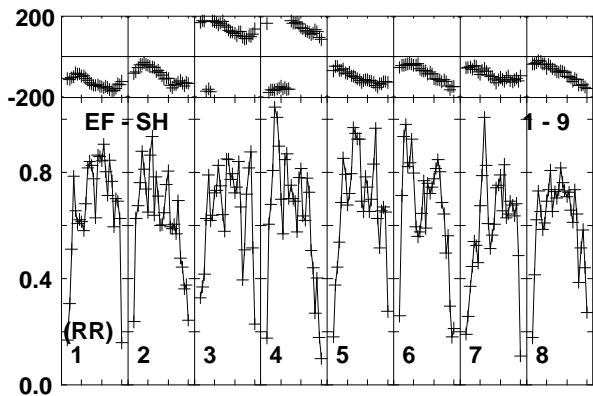
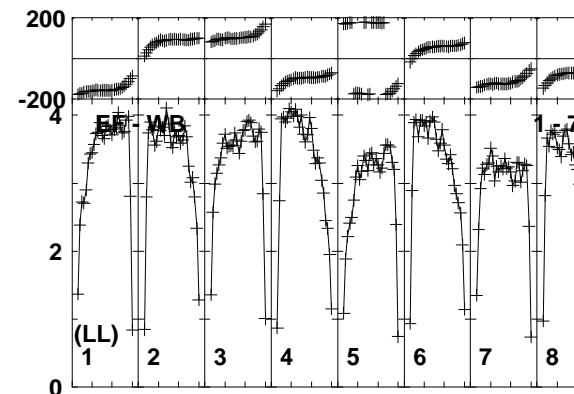
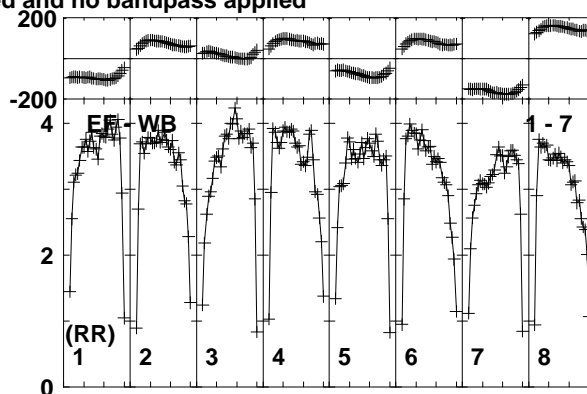
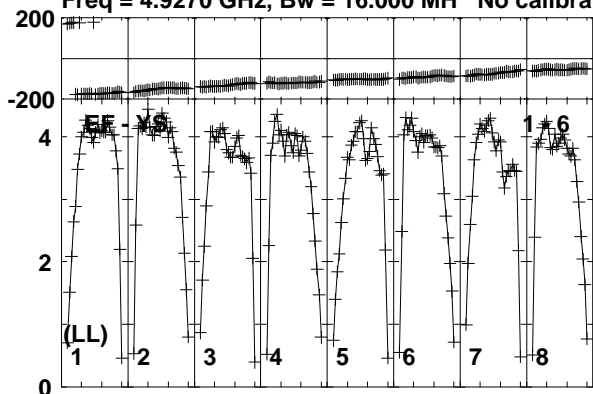

Lower frame: Milli Ampl Jy Top frame: Phas deg
Vector averaged cross-power spectrum Baseline: EF (01) - YS (06)
Timerange: 01/11:04:53 to 01/11:05:49

Plot file version 587 created 26-MAR-2015 15:28:09

V596CAS EG082E.UVDATA.1

Freq = 4.9270 GHz, Bw = 16.000 MH No calibration applied and no bandpass applied

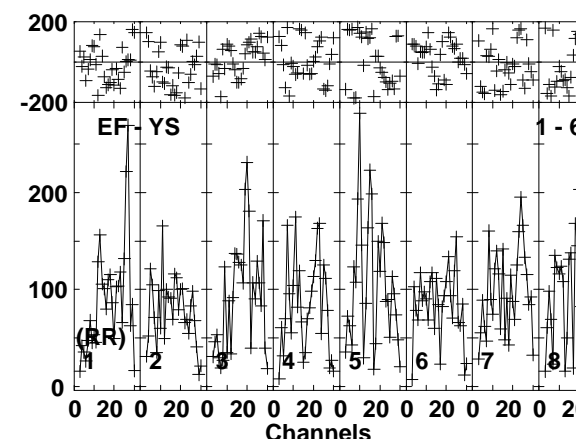
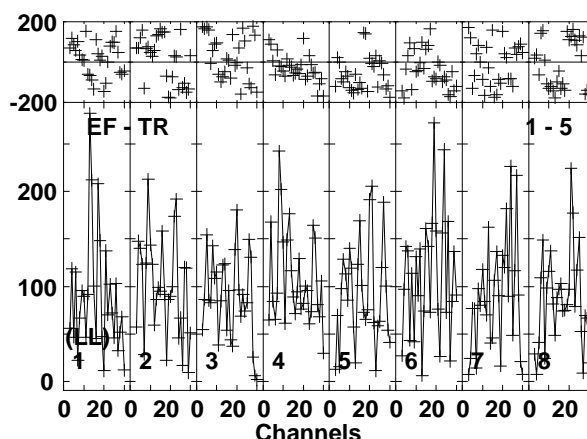
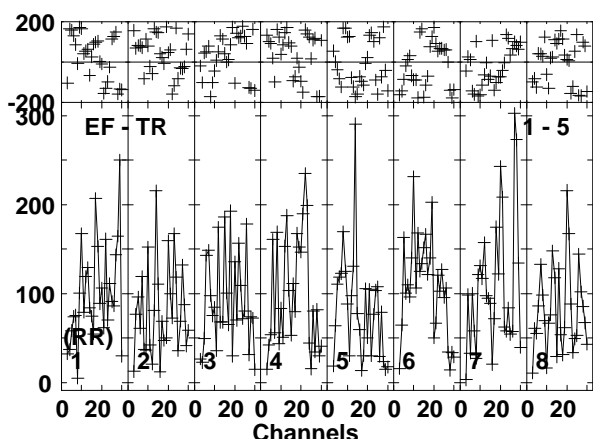
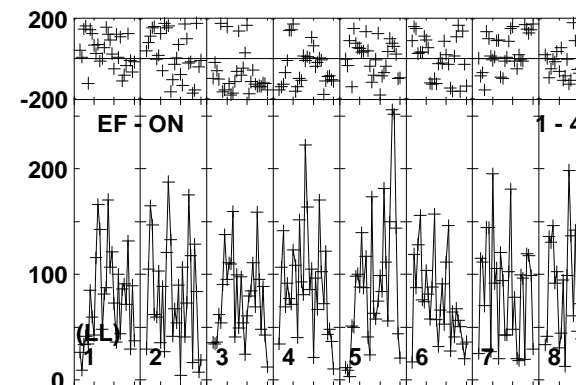
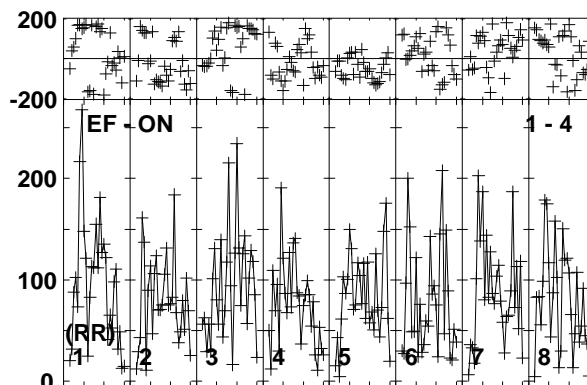
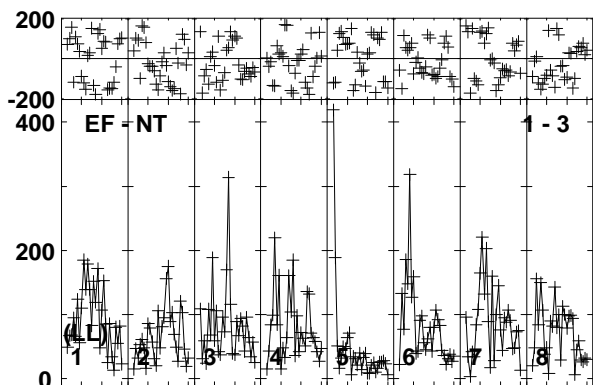
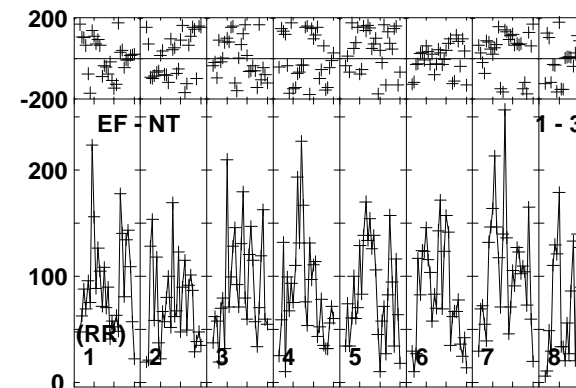
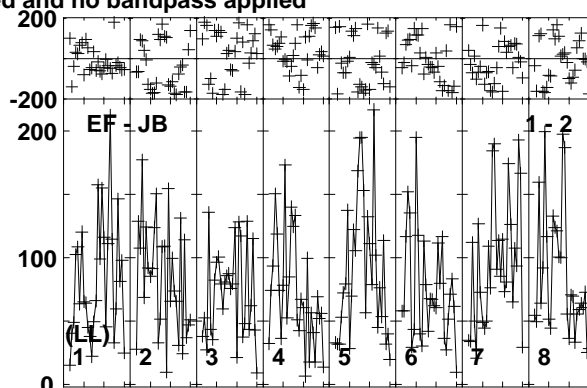
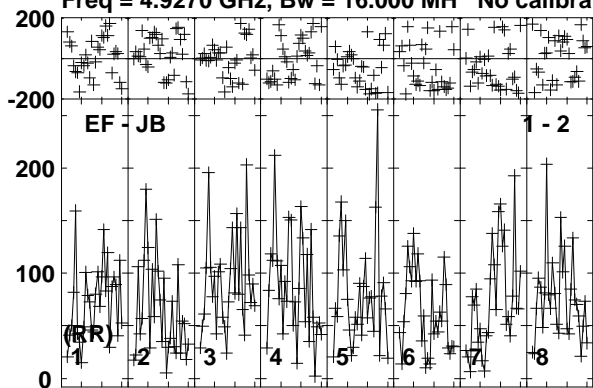

Lower frame: Micro Ampl Jy Top frame: Phas deg
Vector averaged cross-power spectrum Baseline: EF (01) - JB (02)
Timerange: 01/11:05:53 to 01/11:09:19

Plot file version 588 created 26-MAR-2015 15:28:09

V596CAS EG082E.UVDATA.1

Freq = 4.9270 GHz, Bw = 16.000 MH No calibration applied and no bandpass applied

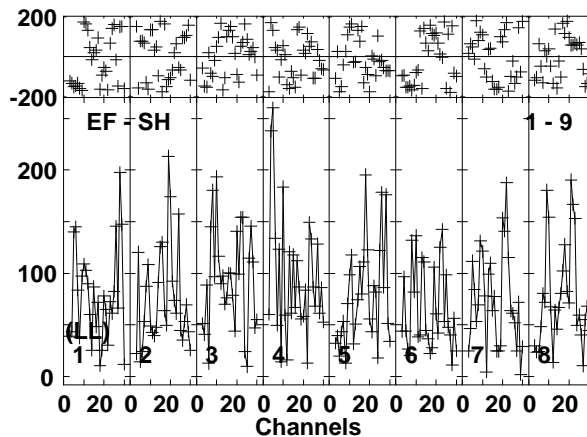
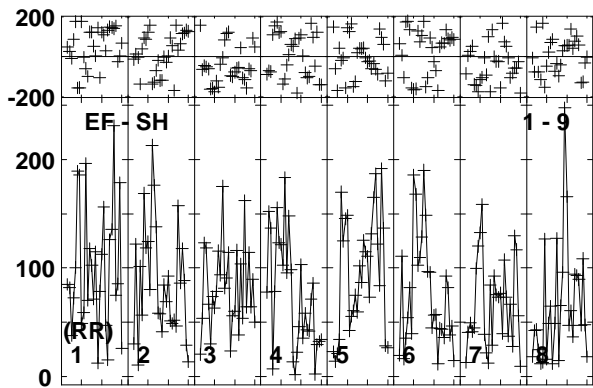
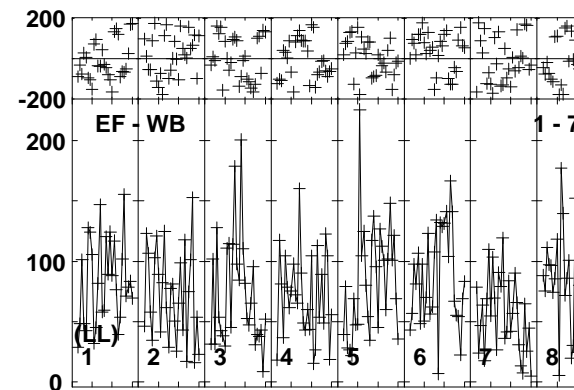
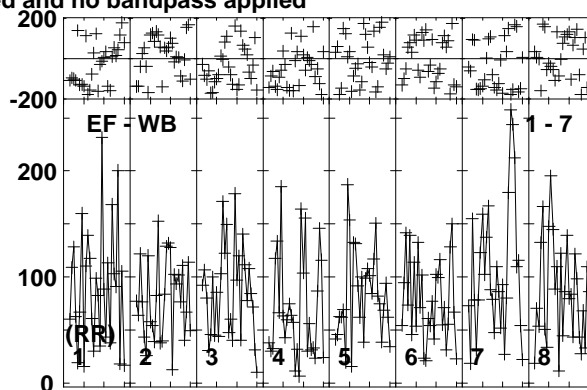
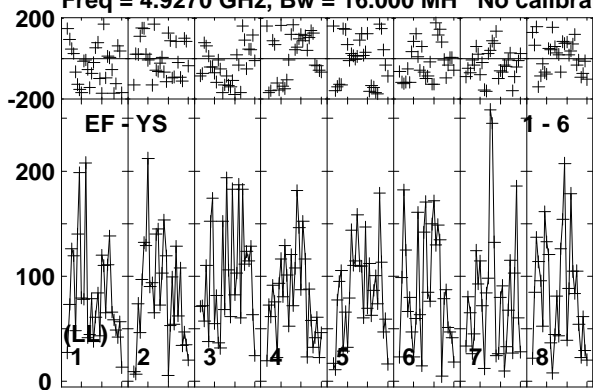

Lower frame: Micro Ampl Jy Top frame: Phas deg
Vector averaged cross-power spectrum Baseline: EF (01) - YS (06)
Timerange: 01/11:05:53 to 01/11:09:19

Plot file version 589 created 26-MAR-2015 15:28:09

J0147+5840 EG082E.UVDATA.1

Freq = 4.9270 GHz, Bw = 16.000 MH No calibration applied and no bandpass applied

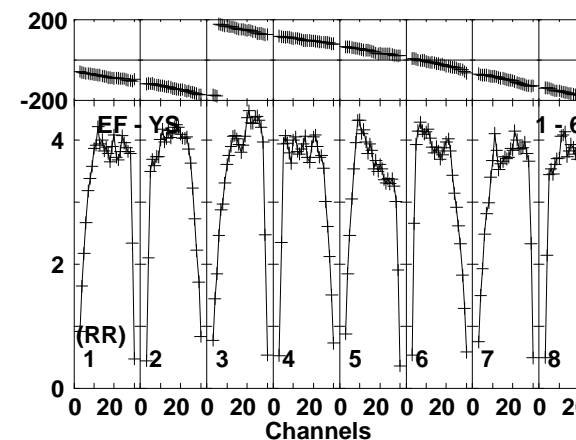
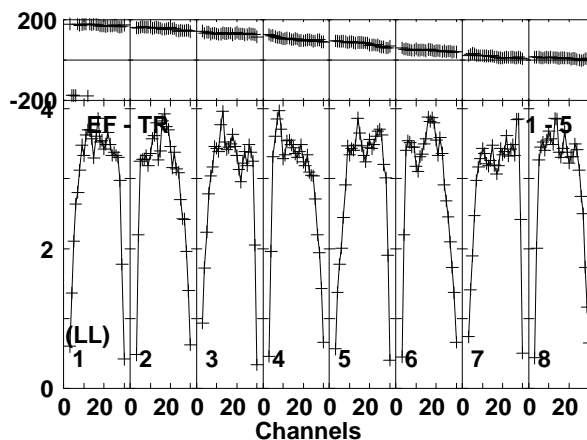
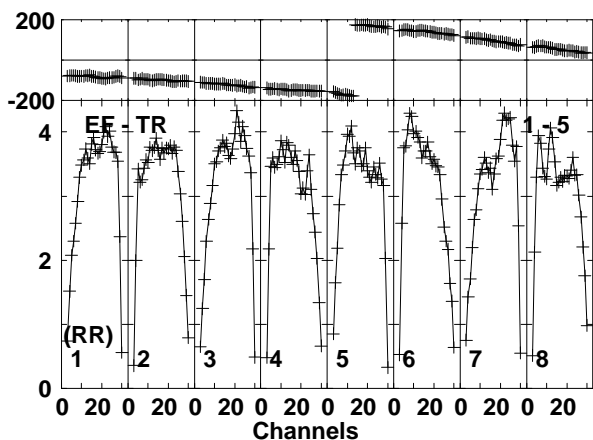
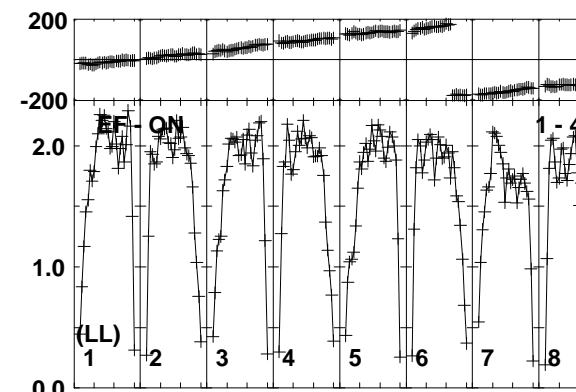
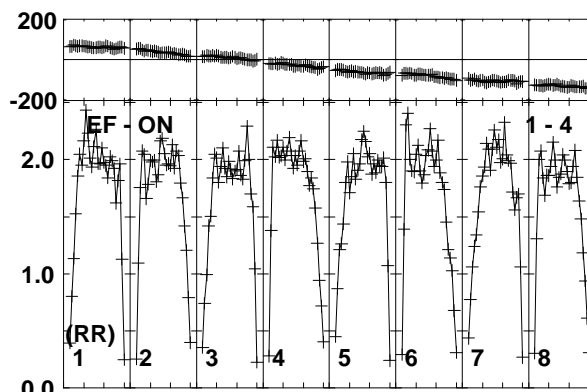
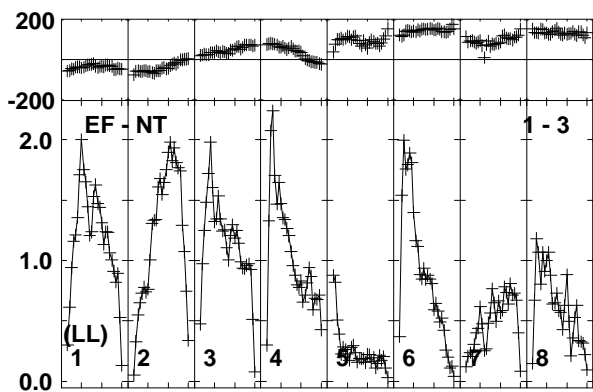
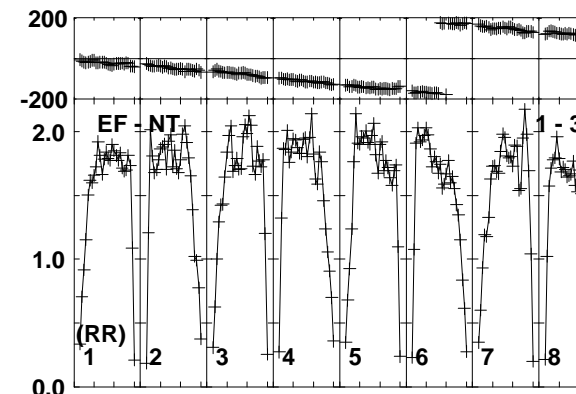
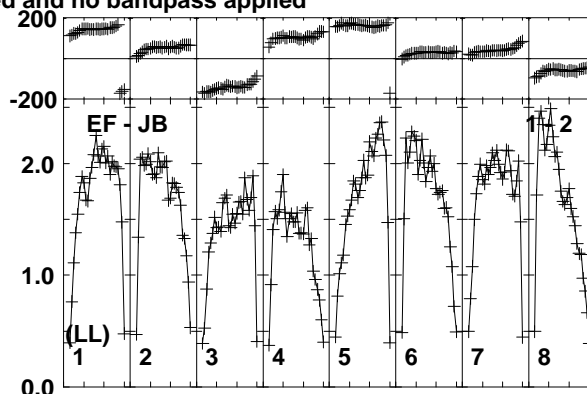
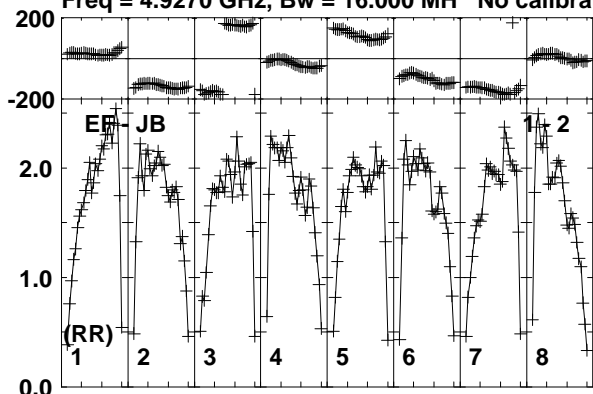

Lower frame: Milli Ampl Jy Top frame: Phas deg
Vector averaged cross-power spectrum Baseline: EF (01) - JB (02)
Timerange: 01/11:09:23 to 01/11:10:49

Plot file version 590 created 26-MAR-2015 15:28:09

J0147+5840 EG082E.UVDATA.1

Freq = 4.9270 GHz, Bw = 16.000 MH No calibration applied and no bandpass applied

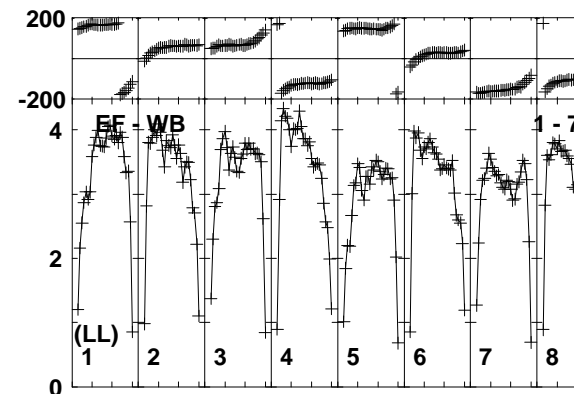
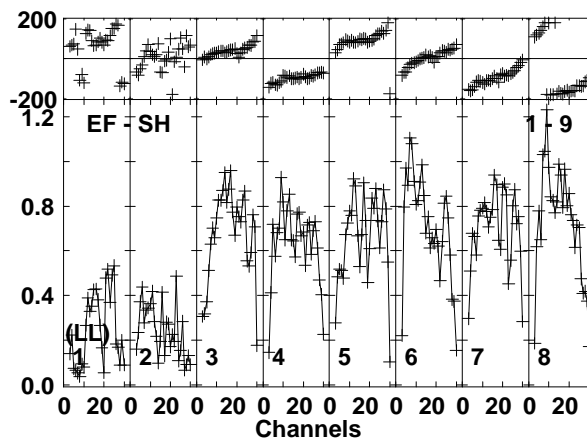
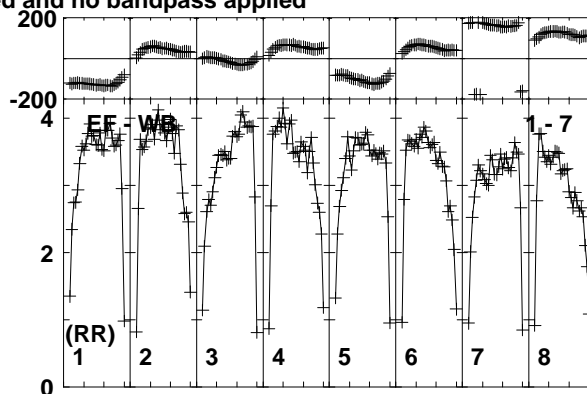
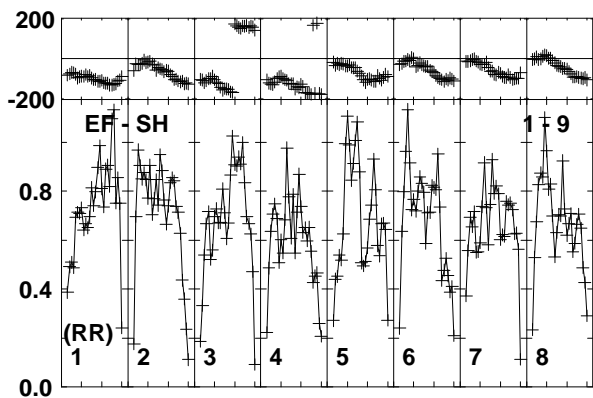
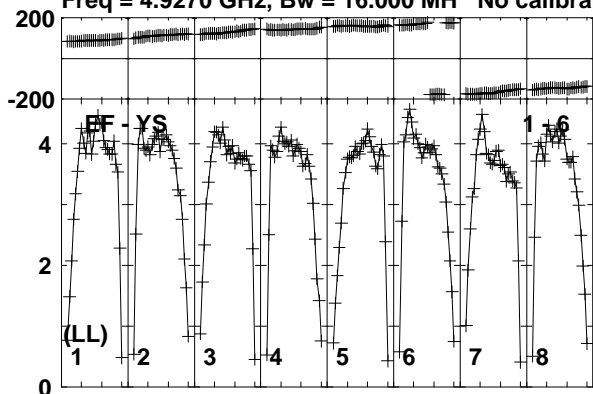

Lower frame: Milli Ampl Jy Top frame: Phas deg
Vector averaged cross-power spectrum Baseline: EF (01) - YS (06)
Timerange: 01/11:09:23 to 01/11:10:49

Plot file version 591 created 26-MAR-2015 15:28:09

V596CAS EG082E.UVDATA.1

Freq = 4.9270 GHz, Bw = 16.000 MH No calibration applied and no bandpass applied

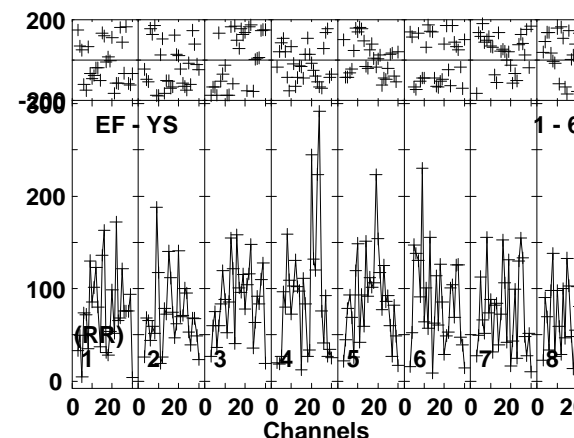
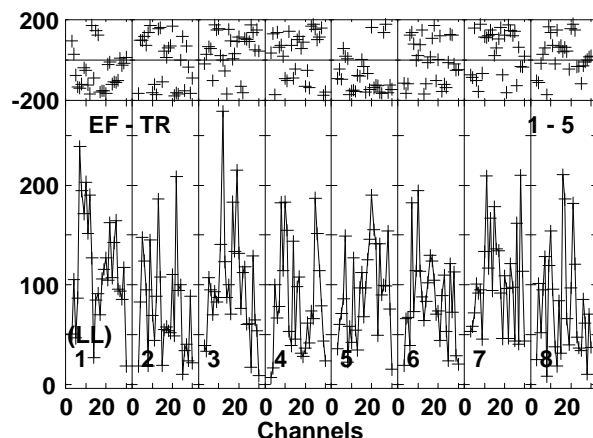
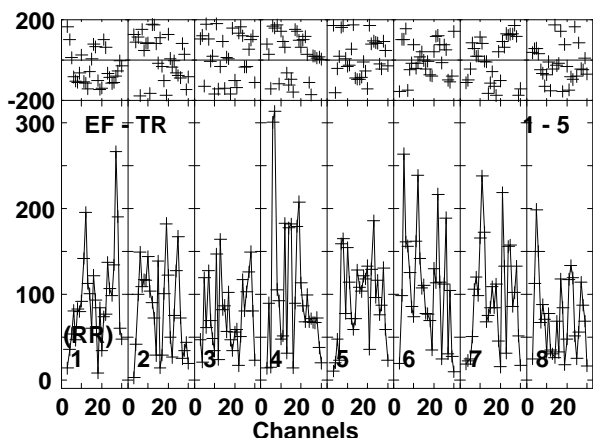
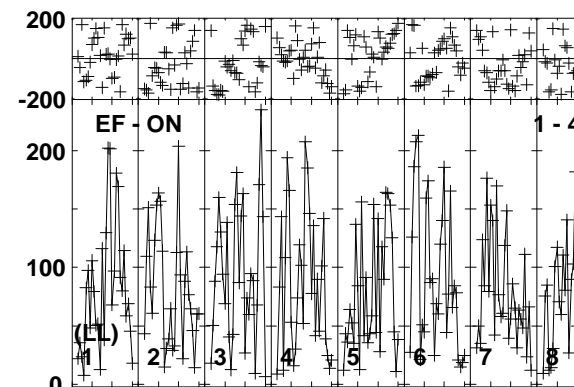
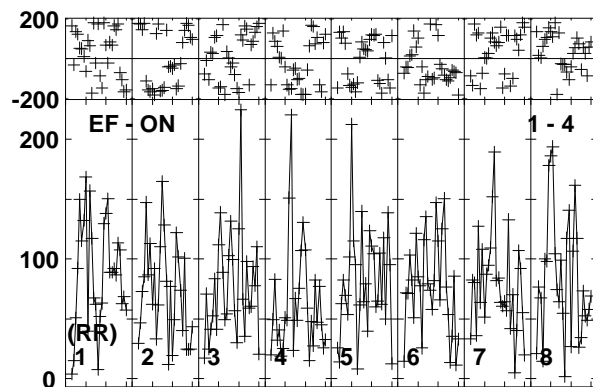
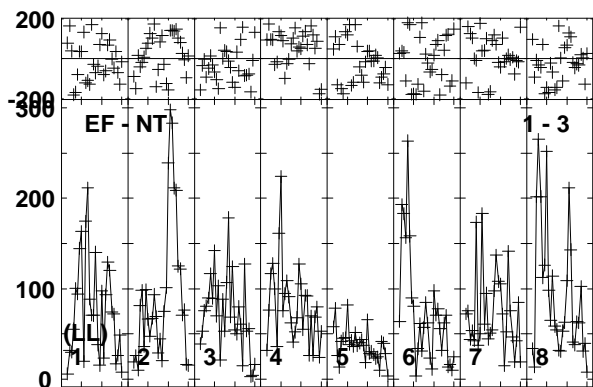
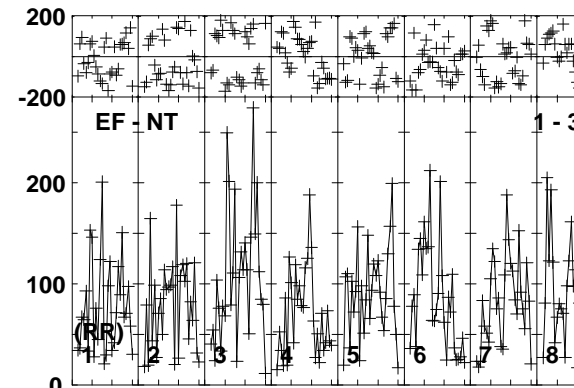
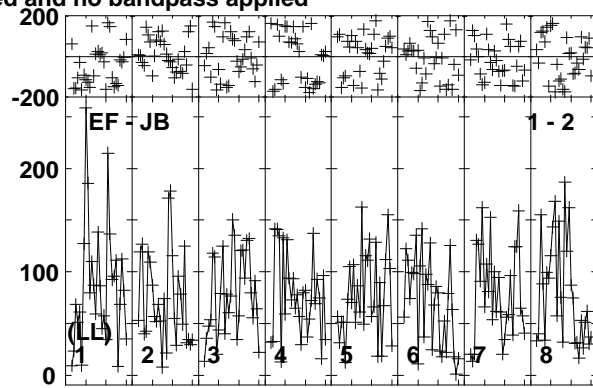
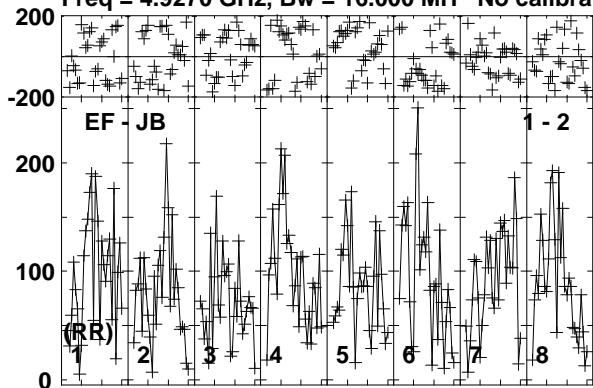

Lower frame: Micro Ampl Jy Top frame: Phas deg
Vector averaged cross-power spectrum Baseline: EF (01) - JB (02)
Timerange: 01/11:10:53 to 01/11:14:19

Plot file version 592 created 26-MAR-2015 15:28:09
V596CAS EG082E.UVDATA.1

Freq = 4.9270 GHz, Bw = 16.000 MH No calibration applied and no bandpass applied

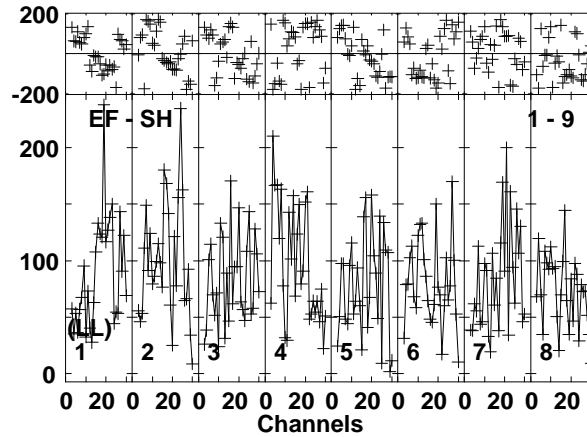
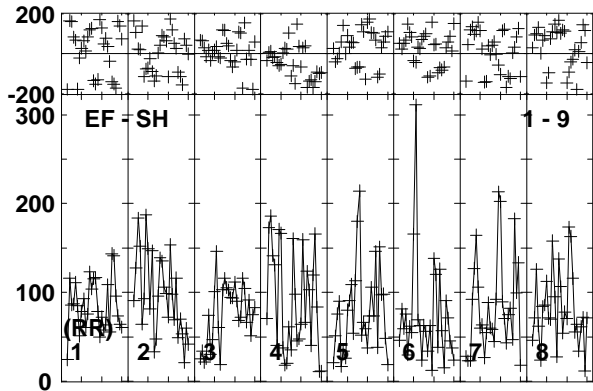
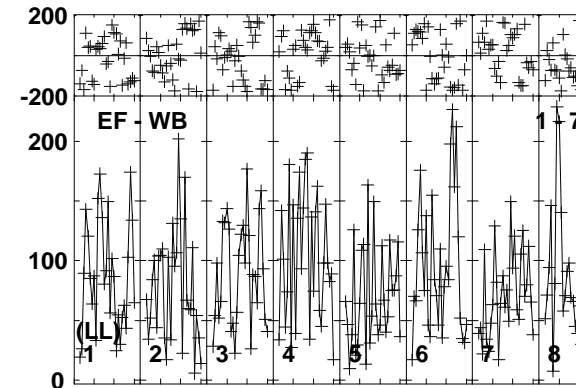
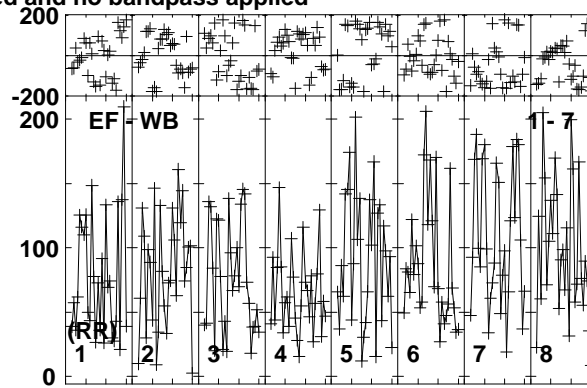
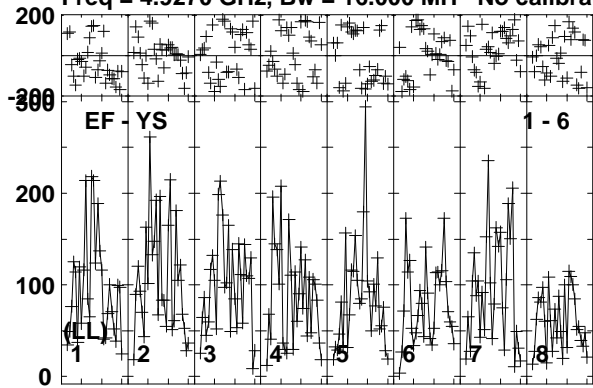

Lower frame: Micro Ampl Jy Top frame: Phas deg
Vector averaged cross-power spectrum Baseline: EF (01) - YS (06)
Timerange: 01/11:10:53 to 01/11:14:19

Plot file version 593 created 26-MAR-2015 15:28:09

J0147+5840 EG082E.UVDATA.1

Freq = 4.9270 GHz, Bw = 16.000 MH No calibration applied and no bandpass applied

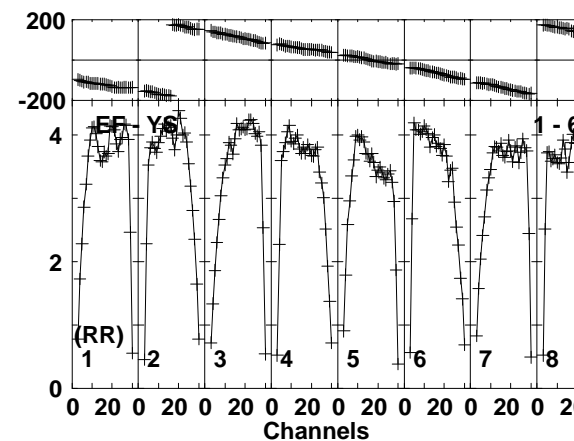
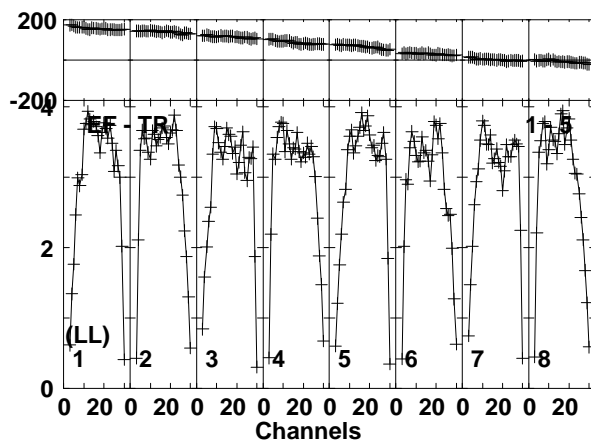
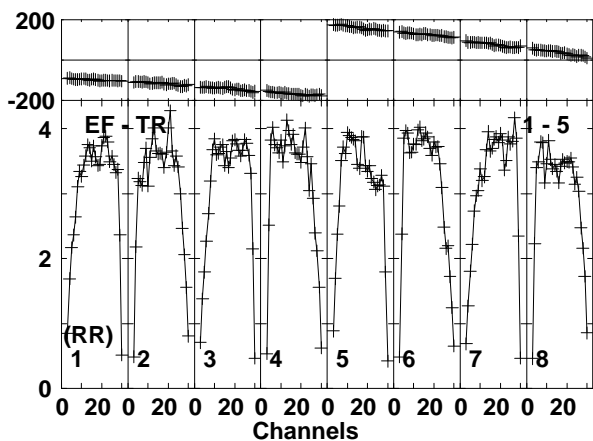
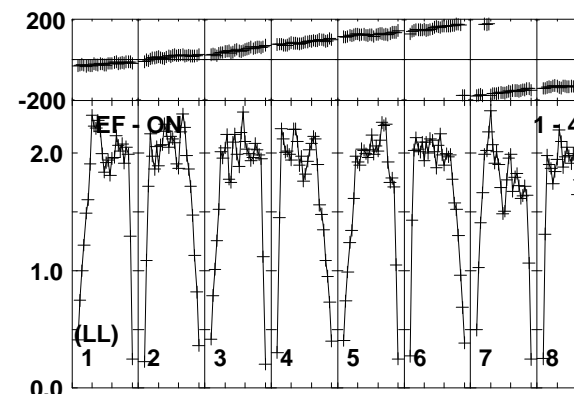
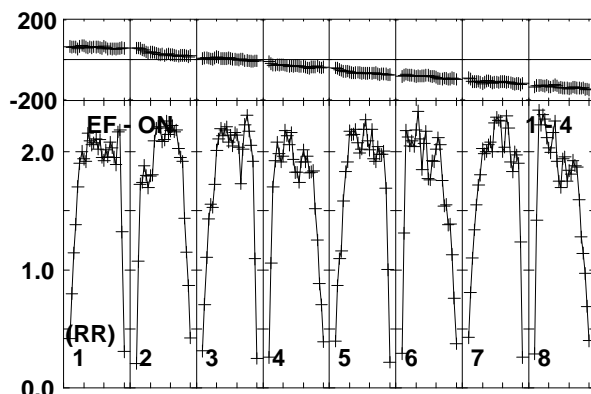
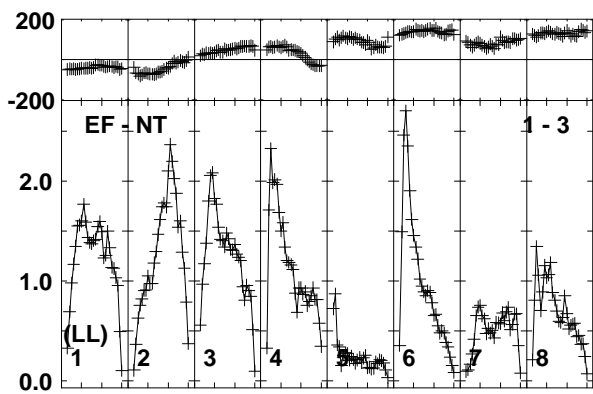
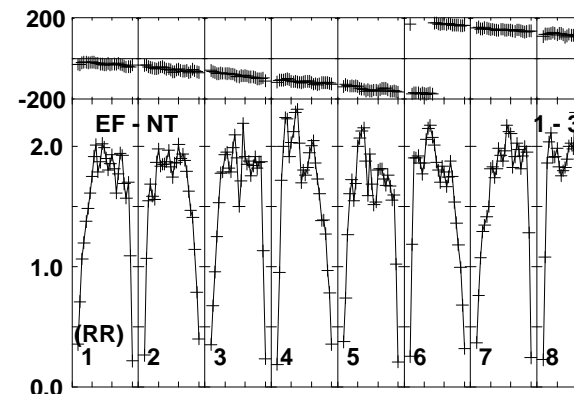
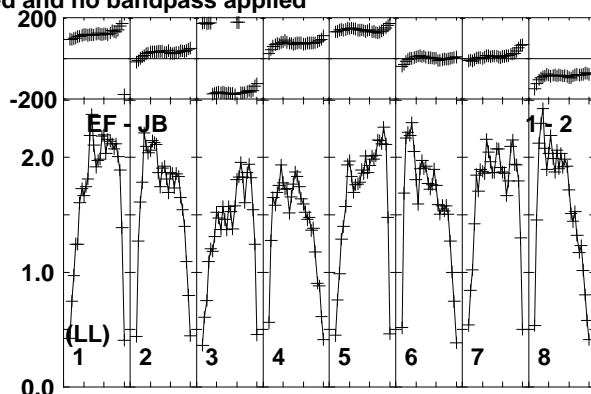
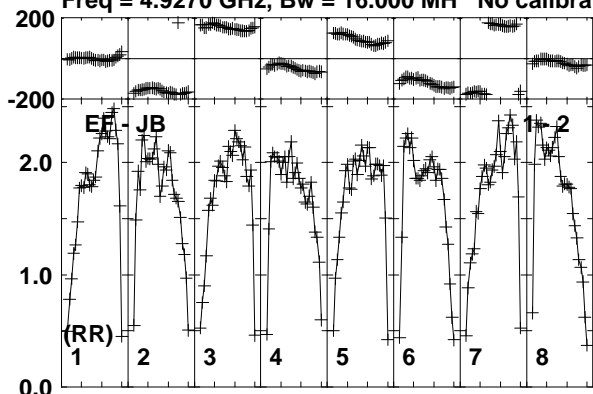

Lower frame: Milli Ampl Jy Top frame: Phas deg
Vector averaged cross-power spectrum Baseline: EF (01) - JB (02)
Timerange: 01/11:14:53 to 01/11:15:49

Plot file version 594 created 26-MAR-2015 15:28:09

J0147+5840 EG082E.UVDATA.1

Freq = 4.9270 GHz, Bw = 16.000 MH No calibration applied and no bandpass applied

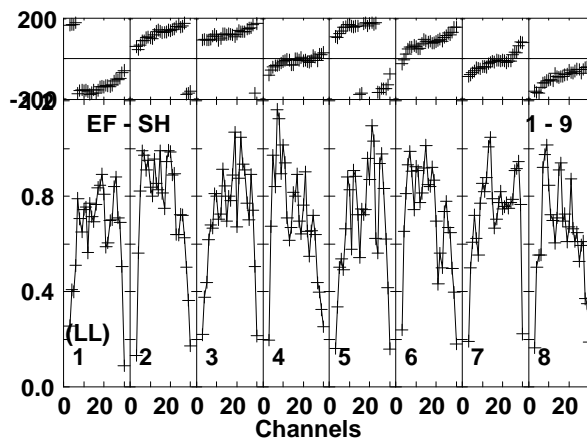
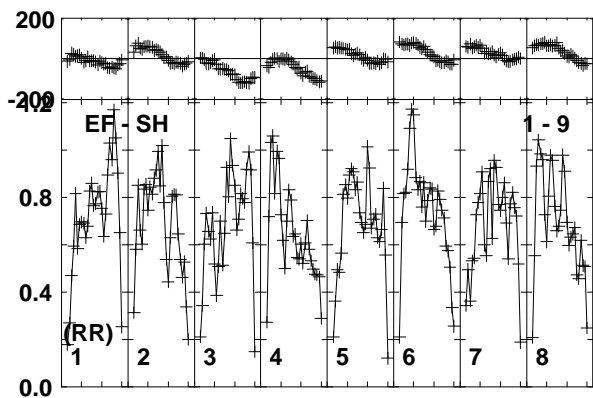
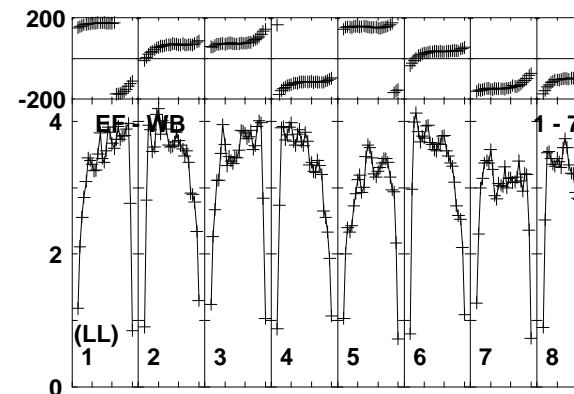
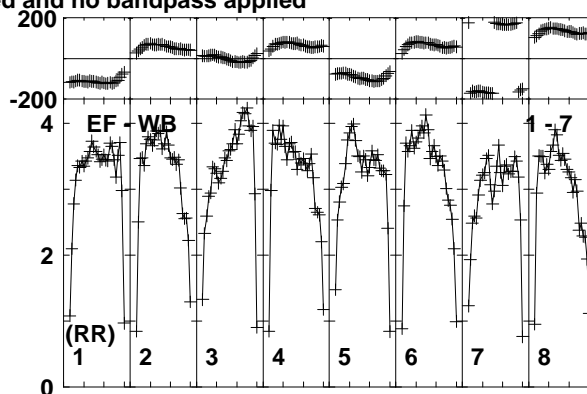
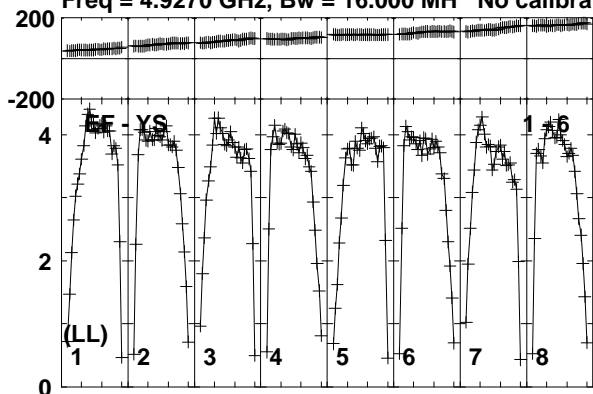

Lower frame: Milli Ampl Jy Top frame: Phas deg
Vector averaged cross-power spectrum Baseline: EF (01) - YS (06)
Timerange: 01/11:14:53 to 01/11:15:49

Plot file version 595 created 26-MAR-2015 15:28:10

V596CAS EG082E.UVDATA.1

Freq = 4.9270 GHz, Bw = 16.000 MH No calibration applied and no bandpass applied

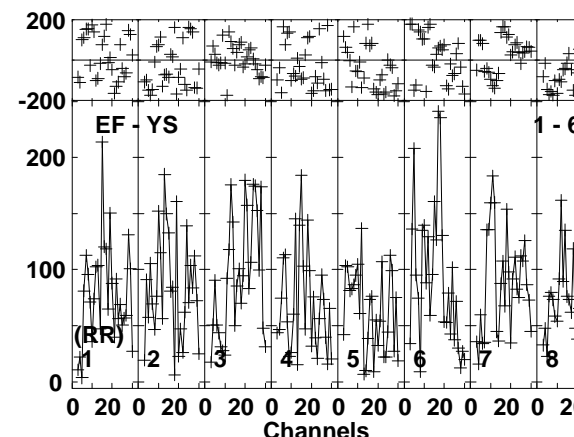
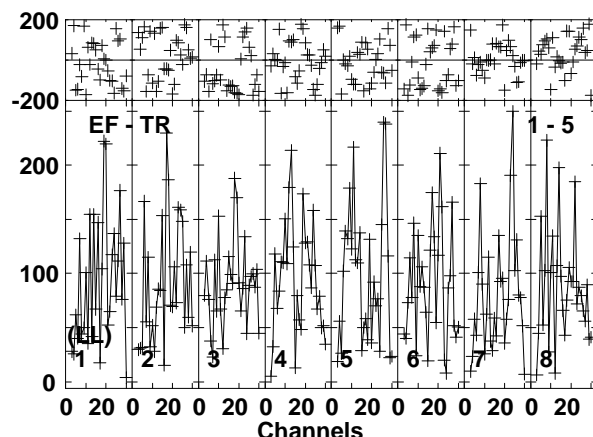
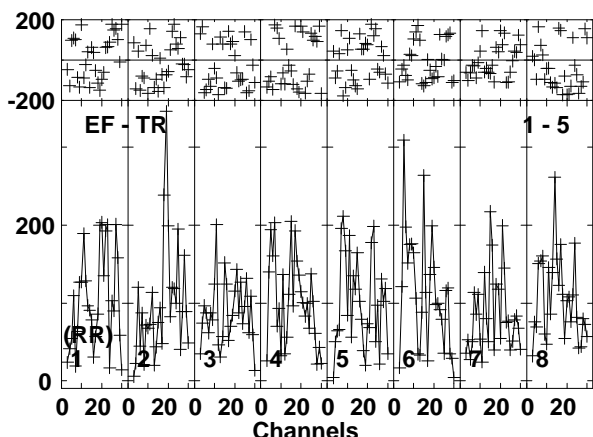
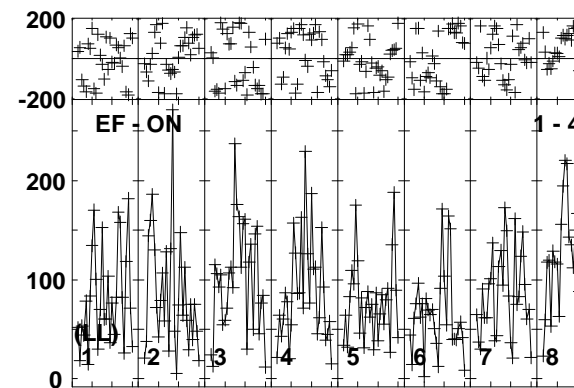
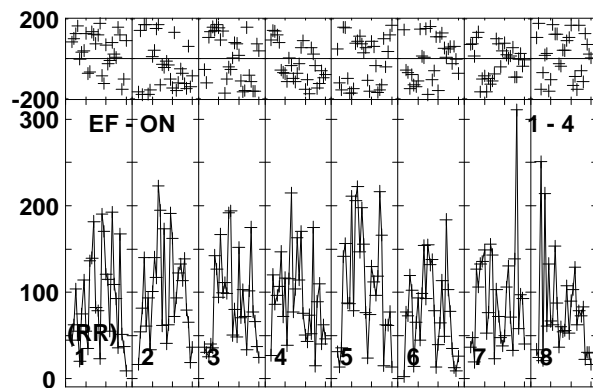
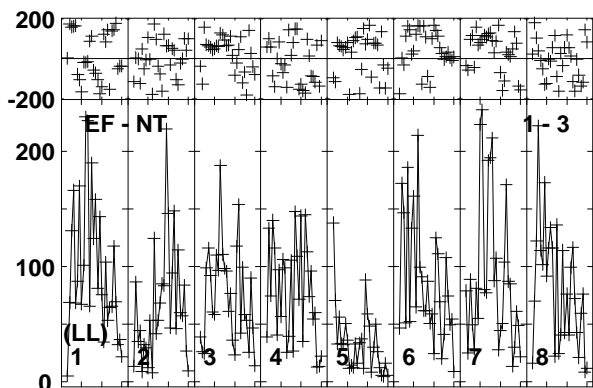
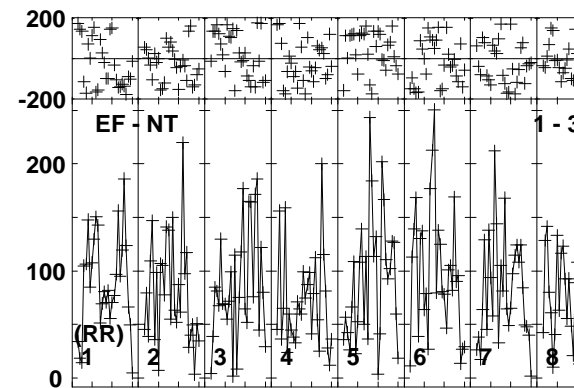
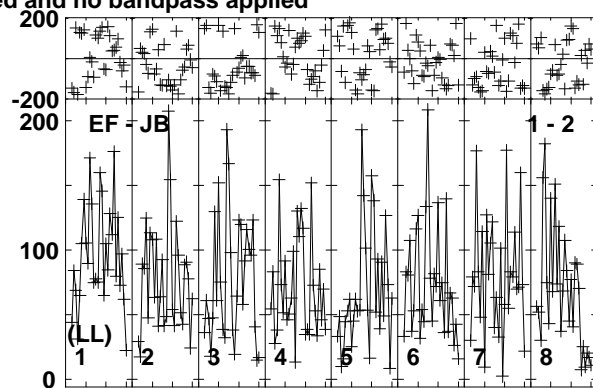
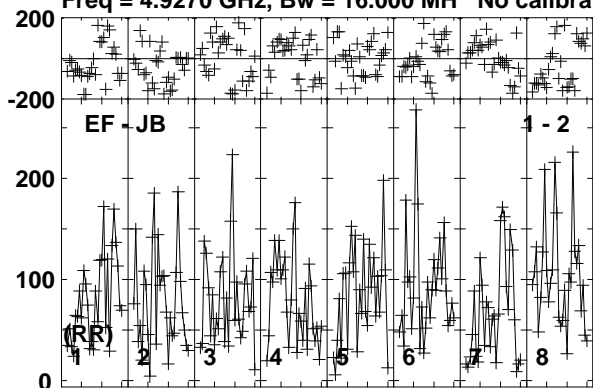

Lower frame: Micro Ampl Jy Top frame: Phas deg
Vector averaged cross-power spectrum Baseline: EF (01) - JB (02)
Timerange: 01/11:15:53 to 01/11:19:19

Plot file version 596 created 26-MAR-2015 15:28:10

V596CAS EG082E.UVDATA.1

Freq = 4.9270 GHz, Bw = 16.000 MH No calibration applied and no bandpass applied

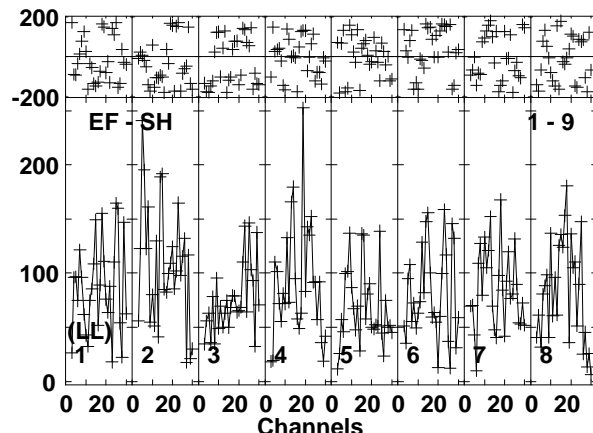
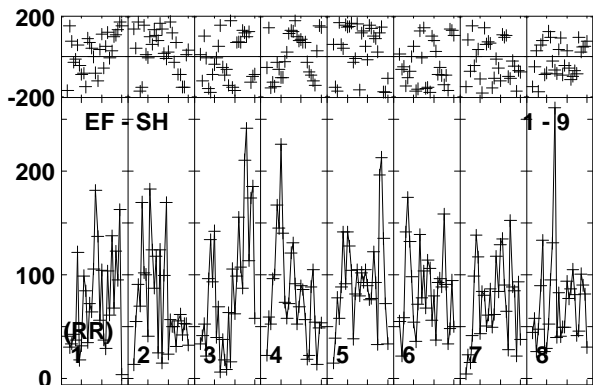
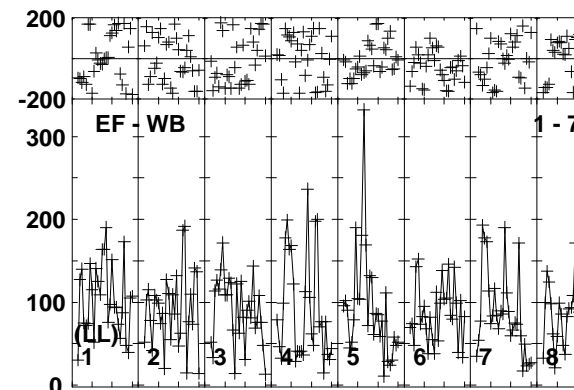
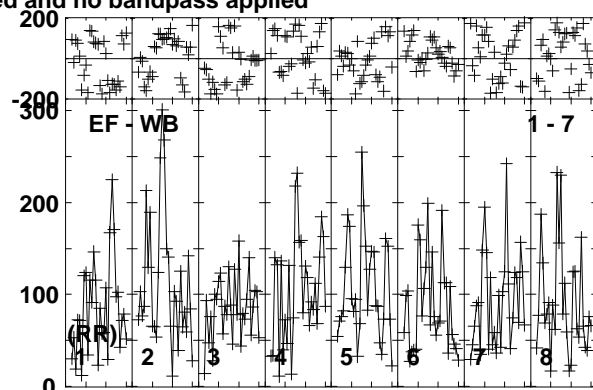
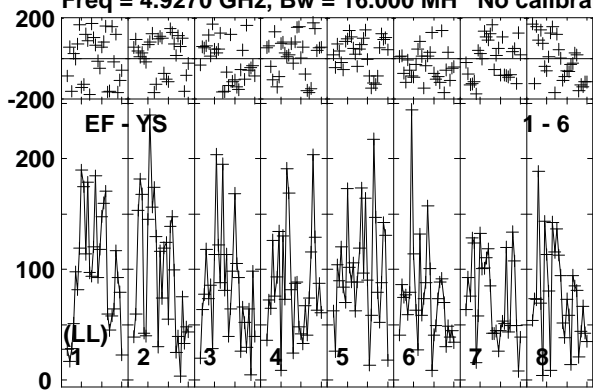

Lower frame: Micro Ampl Jy Top frame: Phas deg
Vector averaged cross-power spectrum Baseline: EF (01) - YS (06)
Timerange: 01/11:15:53 to 01/11:19:19

Plot file version 597 created 26-MAR-2015 15:28:10

J0147+5840 EG082E.UVDATA.1

Freq = 4.9270 GHz, Bw = 16.000 MH No calibration applied and no bandpass applied

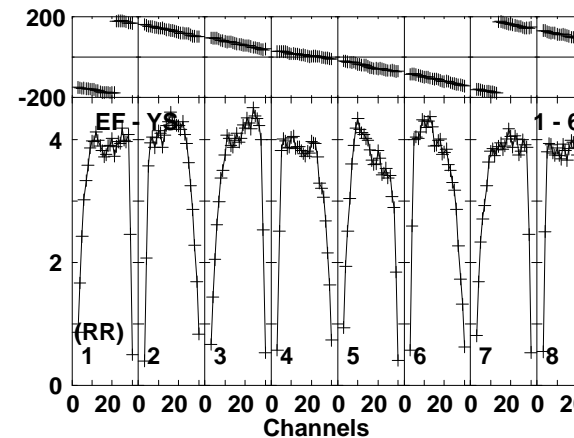
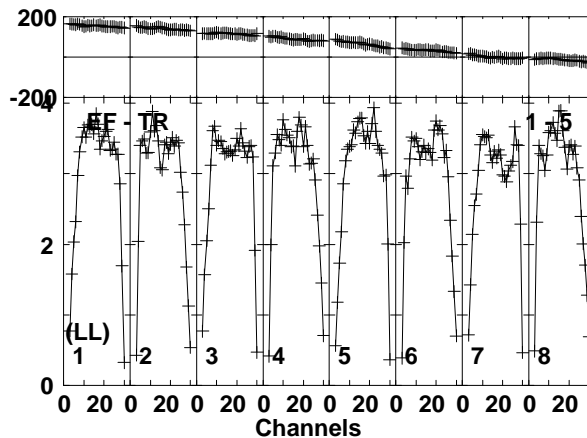
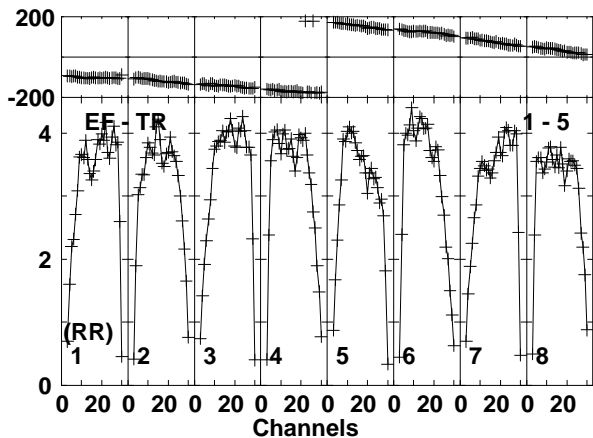
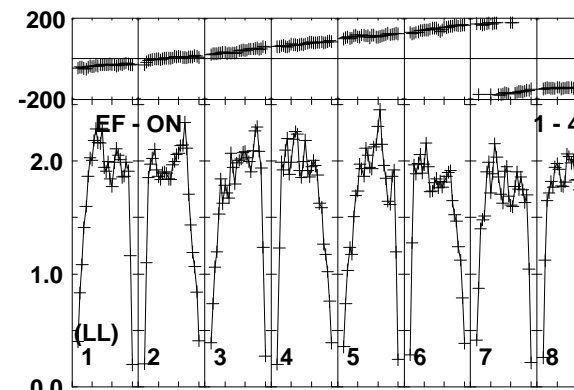
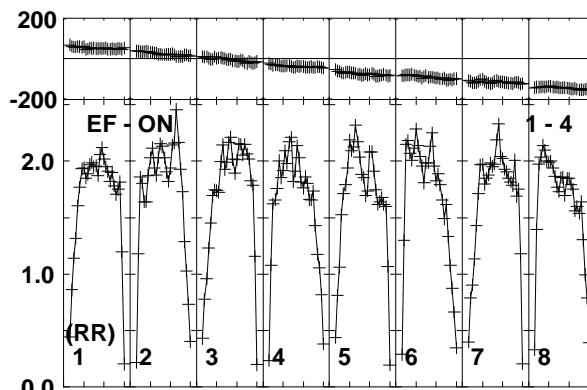
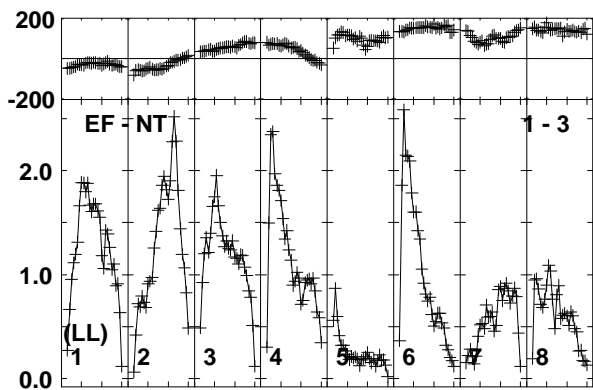
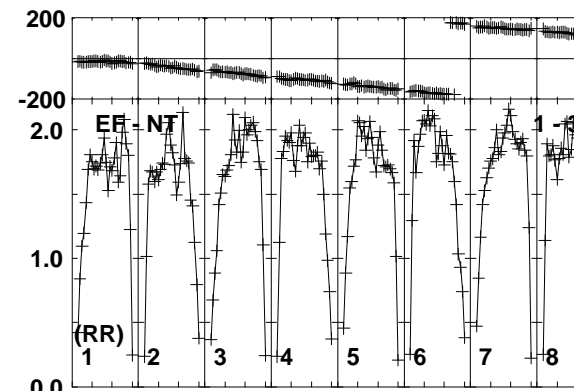
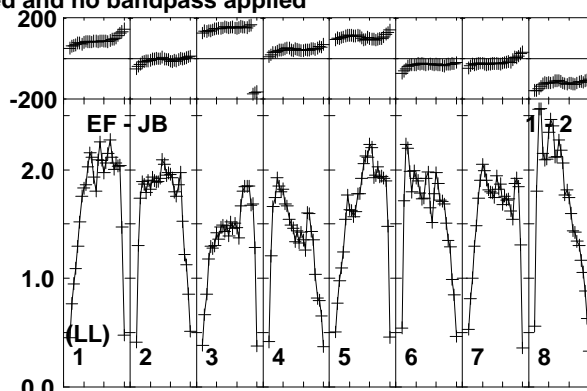
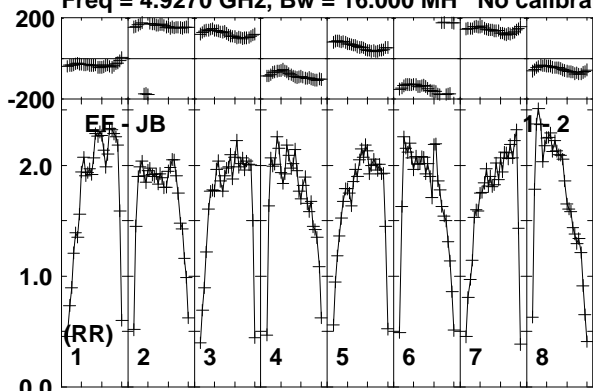

Lower frame: Milli Ampl Jy Top frame: Phas deg
Vector averaged cross-power spectrum Baseline: EF (01) - JB (02)
Timerange: 01/11:19:23 to 01/11:20:49

Plot file version 598 created 26-MAR-2015 15:28:10

J0147+5840 EG082E.UVDATA.1

Freq = 4.9270 GHz, Bw = 16.000 MH No calibration applied and no bandpass applied

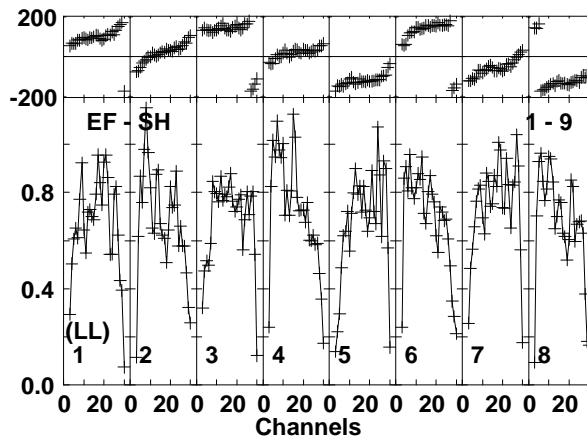
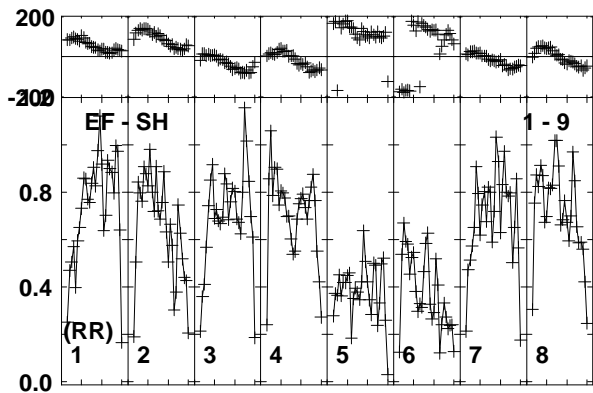
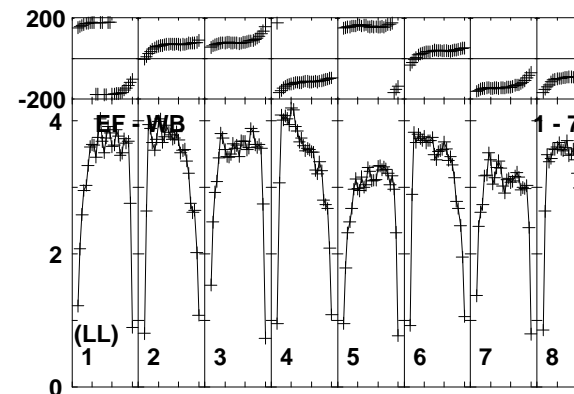
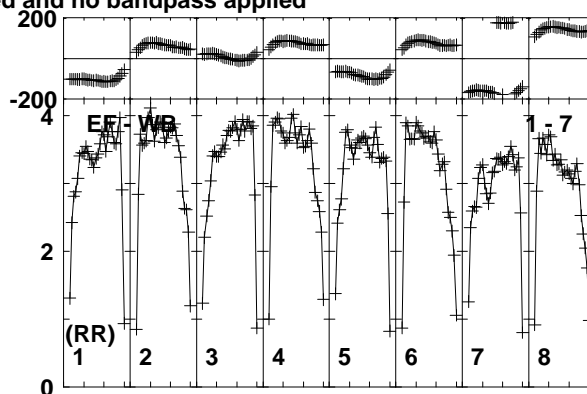
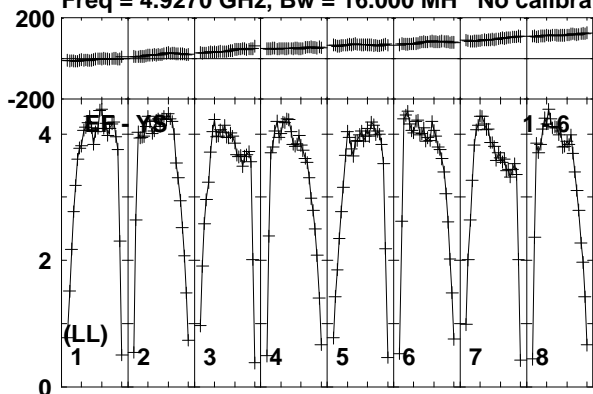

Lower frame: Milli Ampl Jy Top frame: Phas deg
Vector averaged cross-power spectrum Baseline: EF (01) - YS (06)
Timerange: 01/11:19:23 to 01/11:20:49

Plot file version 599 created 26-MAR-2015 15:28:10

J0151+5454 EG082E.UVDATA.1

Freq = 4.9270 GHz, Bw = 16.000 MH No calibration applied and no bandpass applied

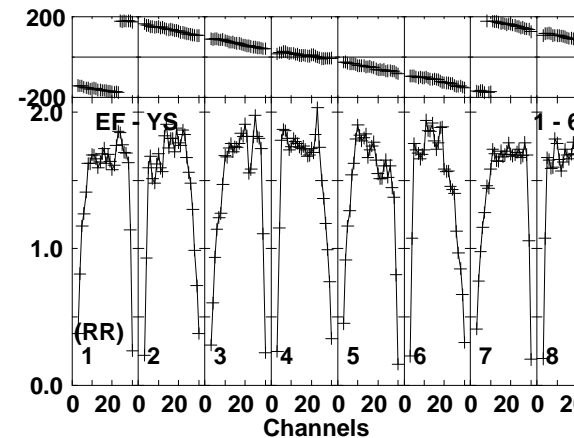
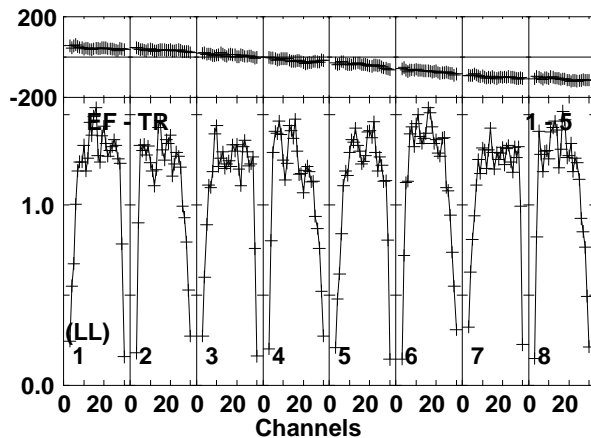
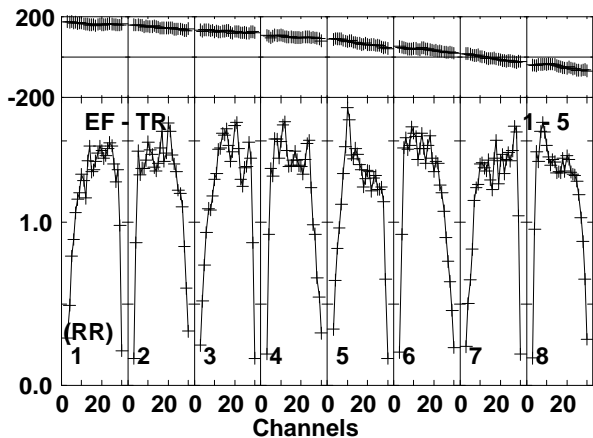
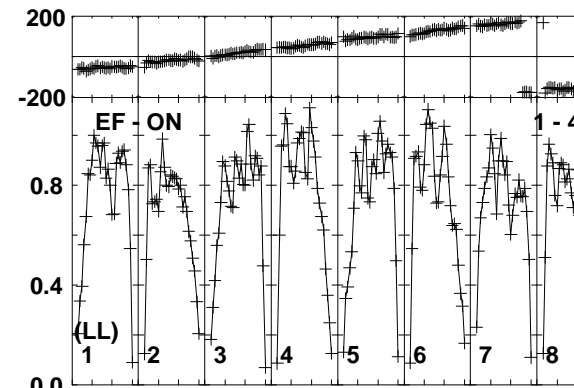
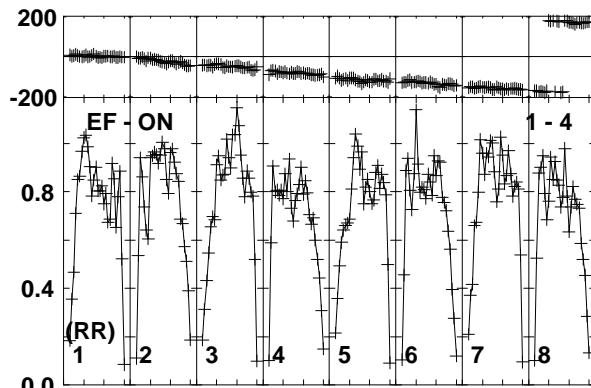
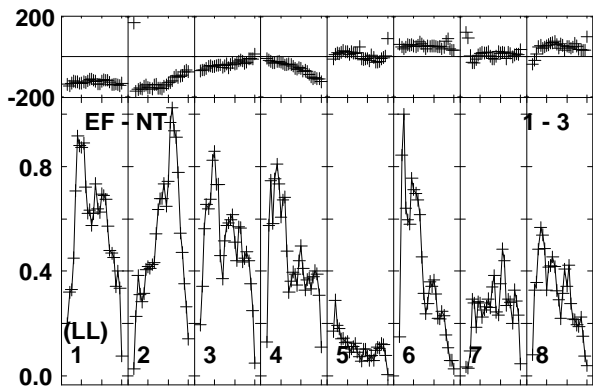
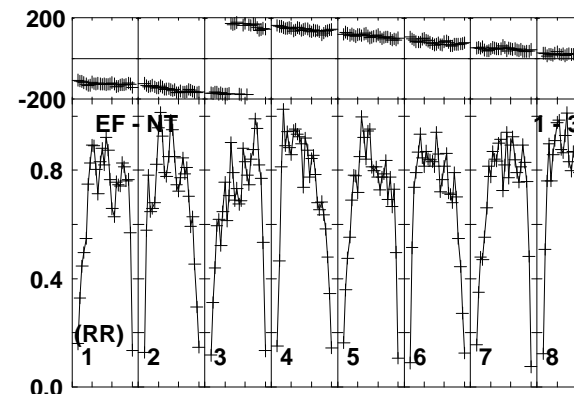
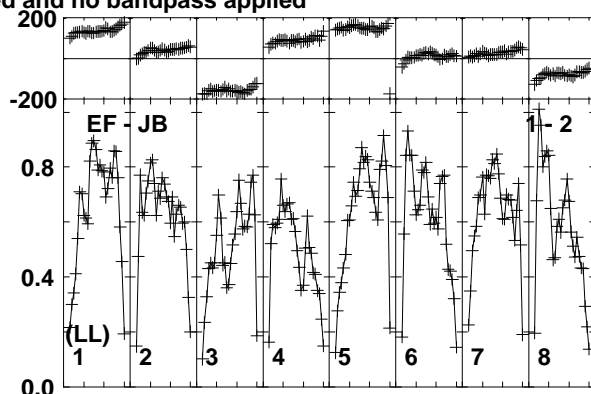
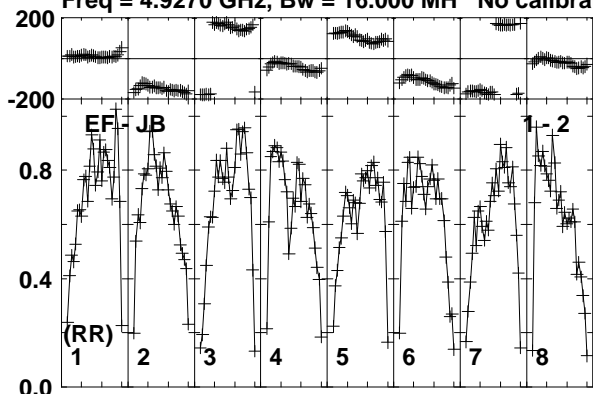

Lower frame: Milli Ampl Jy Top frame: Phas deg
Vector averaged cross-power spectrum Baseline: EF (01) - JB (02)
Timerange: 01/11:20:53 to 01/11:24:19

Plot file version 600 created 26-MAR-2015 15:28:10

J0151+5454 EG082E.UVDATA.1

Freq = 4.9270 GHz, Bw = 16.000 MH No calibration applied and no bandpass applied

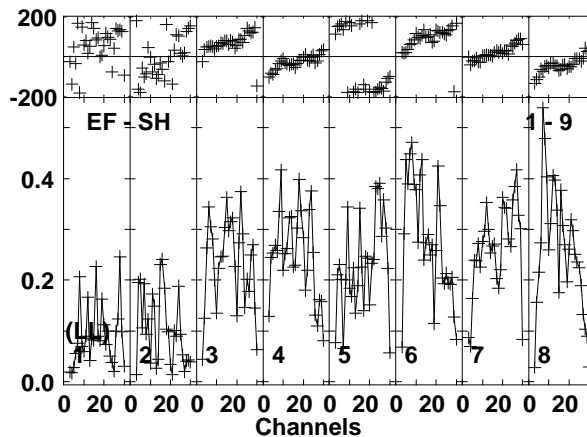
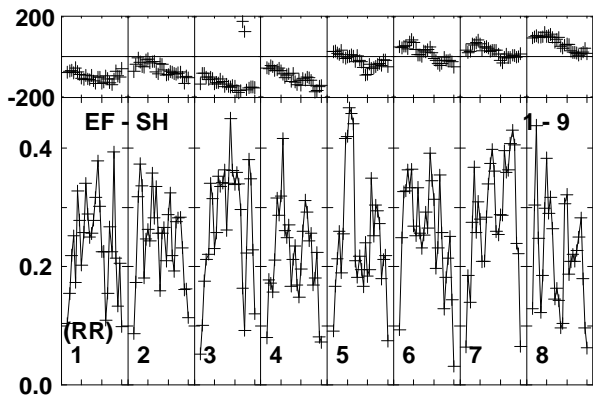
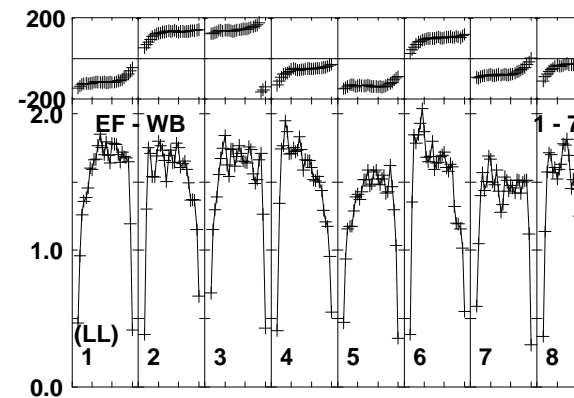
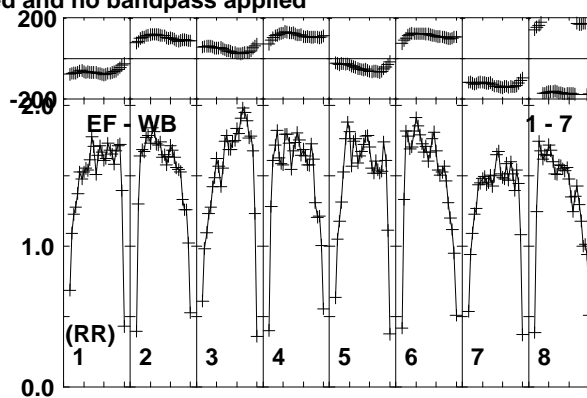
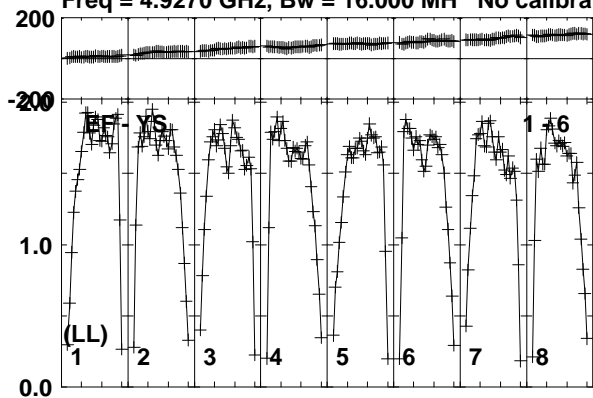

Lower frame: Milli Ampl Jy Top frame: Phas deg
Vector averaged cross-power spectrum Baseline: EF (01) - YS (06)
Timerange: 01/11:20:53 to 01/11:24:19

Plot file version 601 created 26-MAR-2015 15:28:10

J0147+5840 EG082E.UVDATA.1

Freq = 4.9270 GHz, Bw = 16.000 MH No calibration applied and no bandpass applied

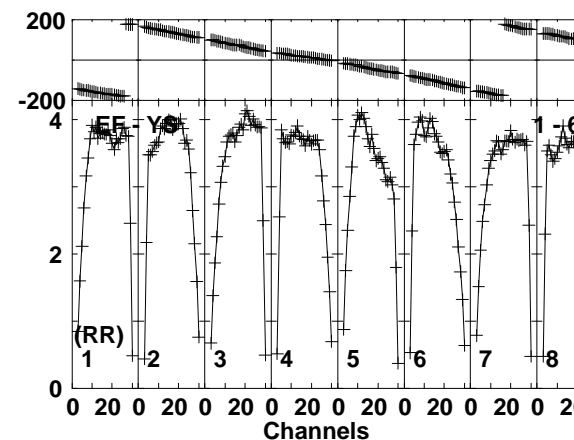
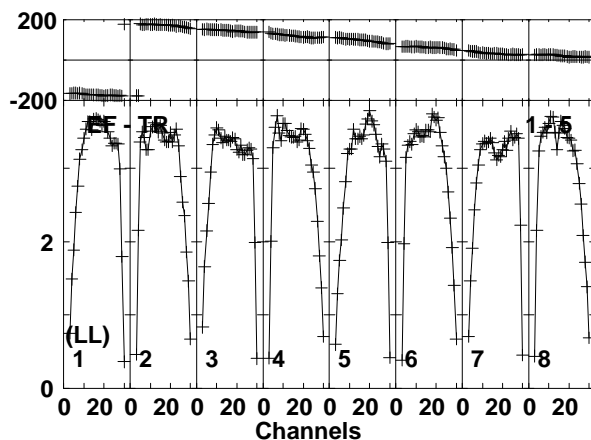
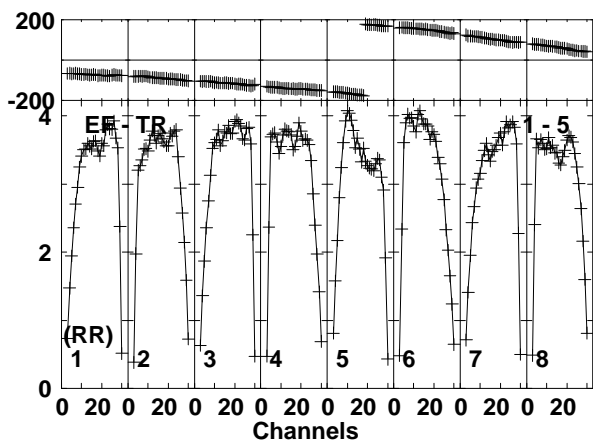
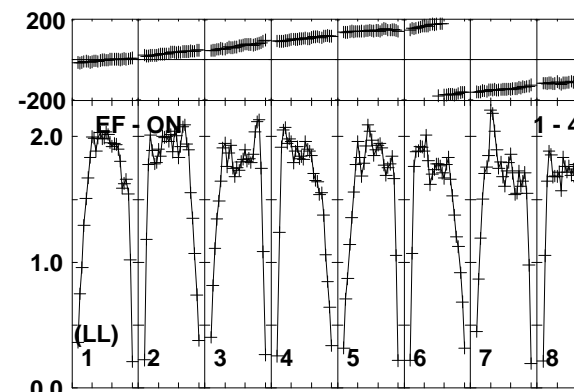
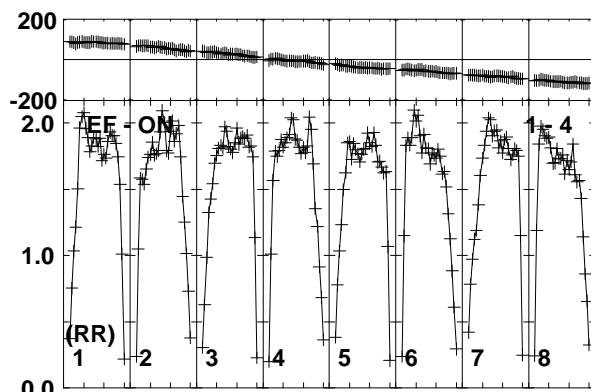
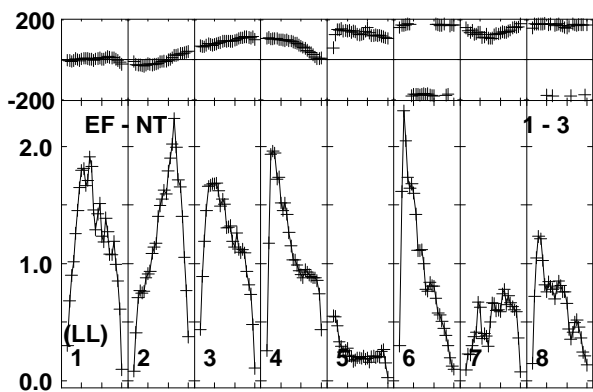
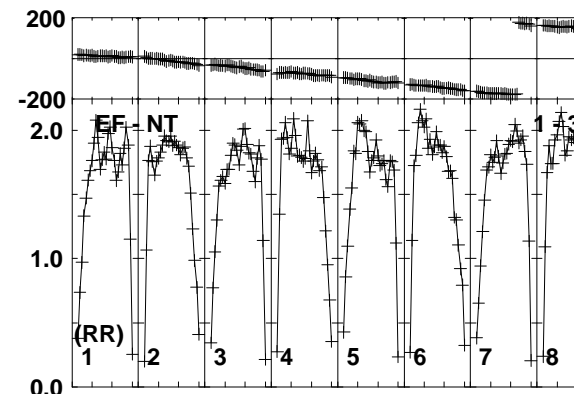
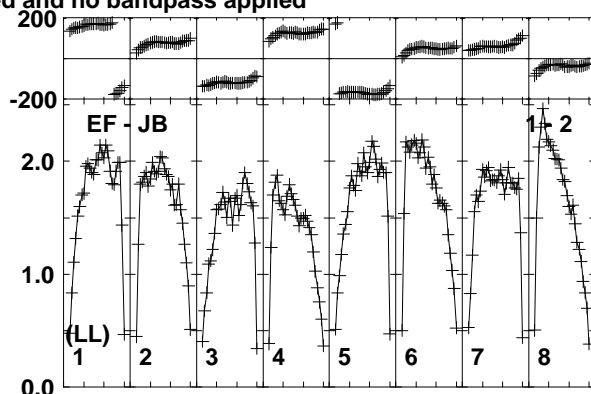
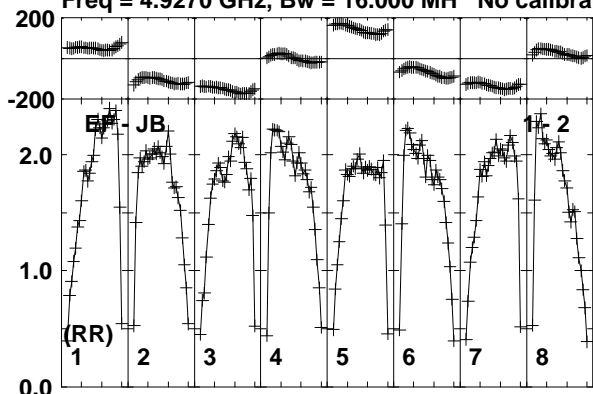

Lower frame: Milli Ampl Jy Top frame: Phas deg
Vector averaged cross-power spectrum Baseline: EF (01) - JB (02)
Timerange: 01/11:24:53 to 01/11:27:19

Plot file version 602 created 26-MAR-2015 15:28:10

J0147+5840 EG082E.UVDATA.1

Freq = 4.9270 GHz, Bw = 16.000 MH No calibration applied and no bandpass applied

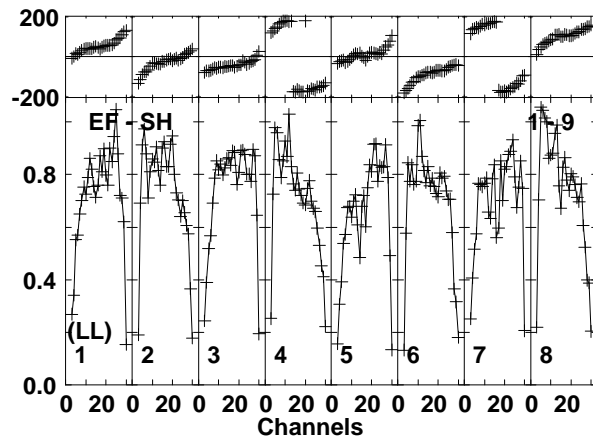
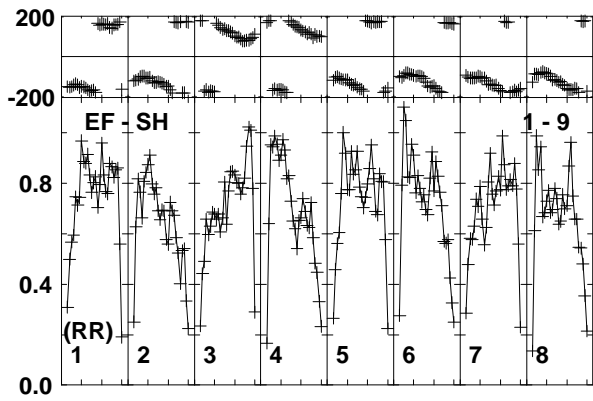
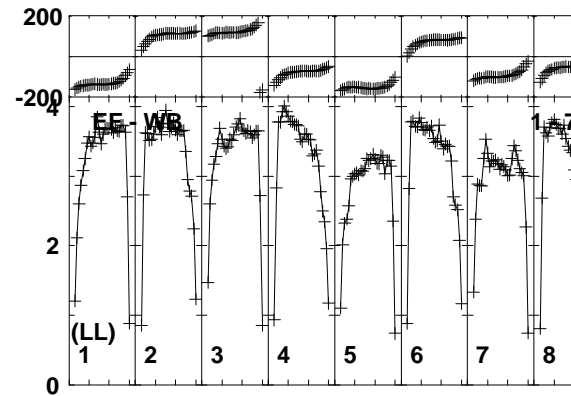
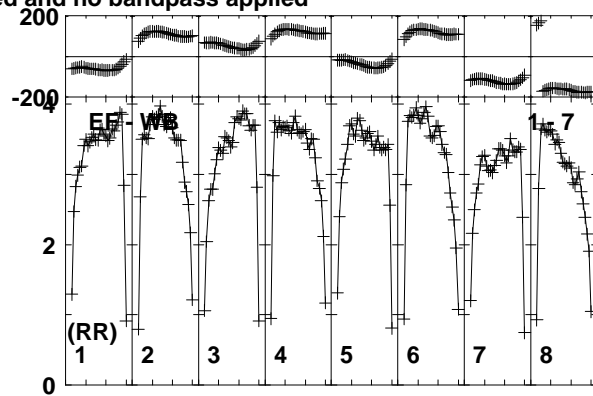
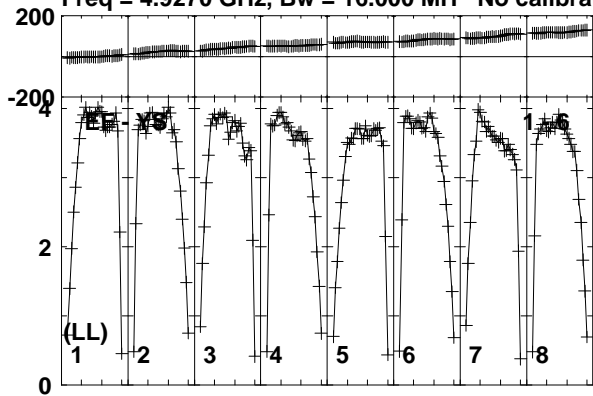

Lower frame: Milli Ampl Jy Top frame: Phas deg
Vector averaged cross-power spectrum Baseline: EF (01) - YS (06)
Timerange: 01/11:24:53 to 01/11:27:19