

Plot file version 1 created 21-FEB-2017 15:10:40

J0927+3902 EG096A.UVDATA.1

Freq = 4.7990 GHz, Bw = 32.000 MH No calibration applied and no bandpass applied

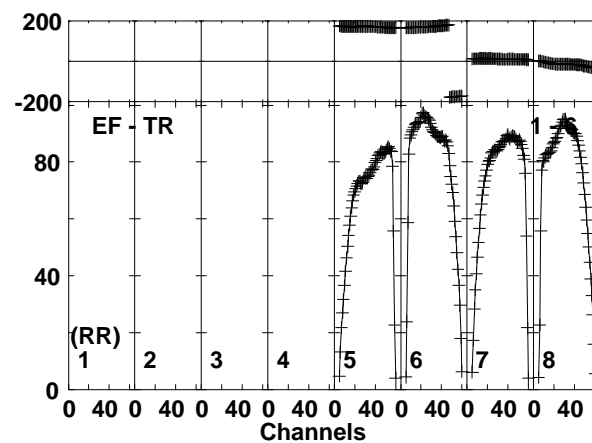
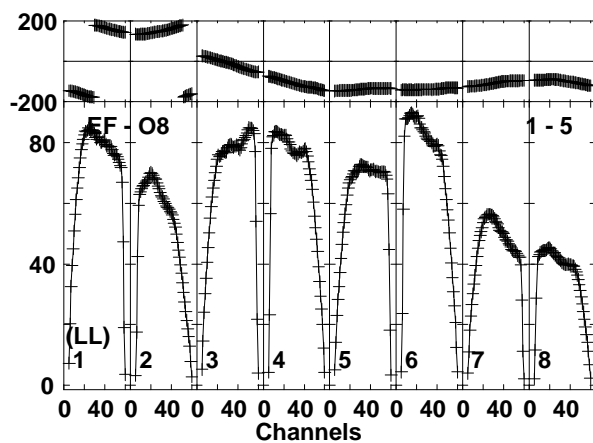
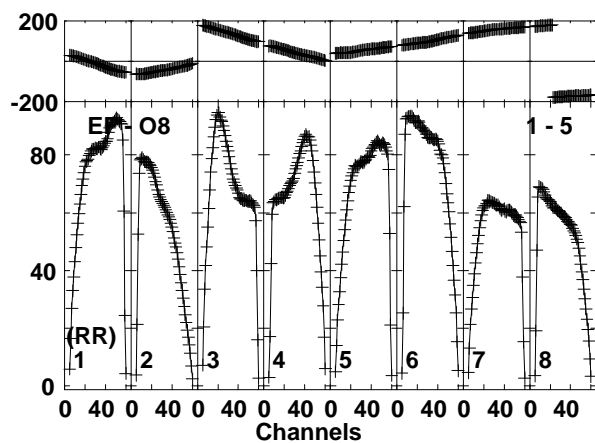
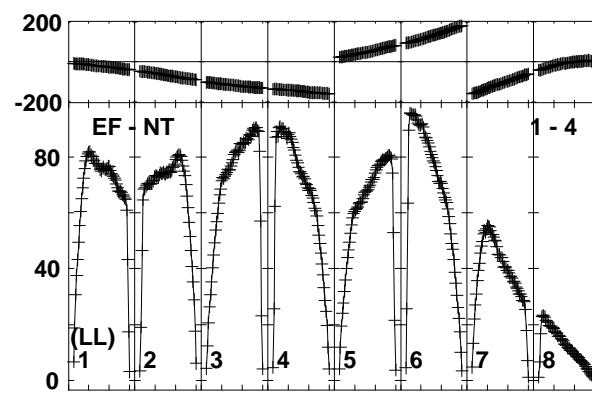
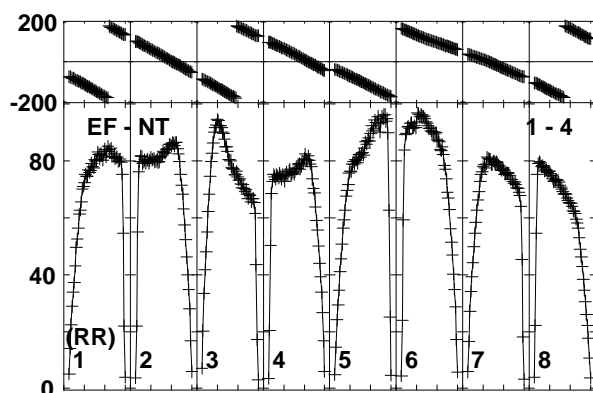
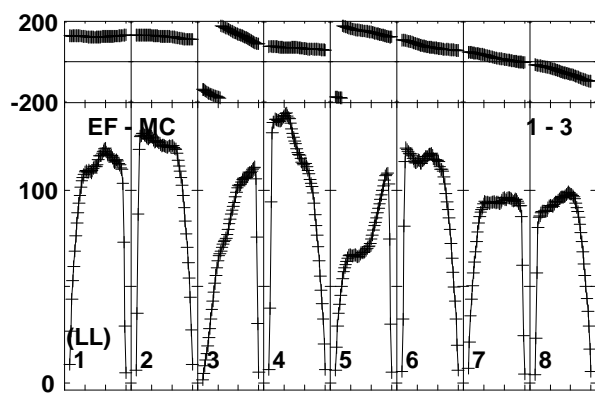
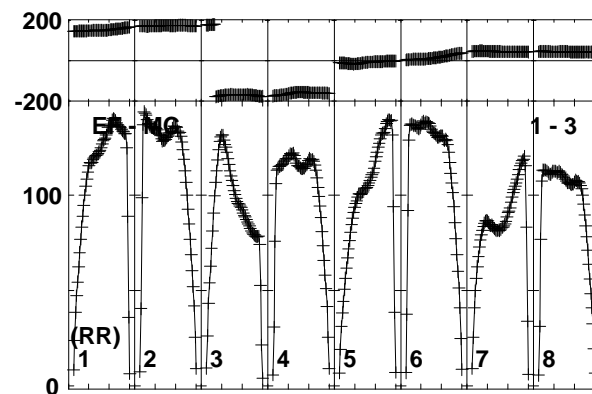
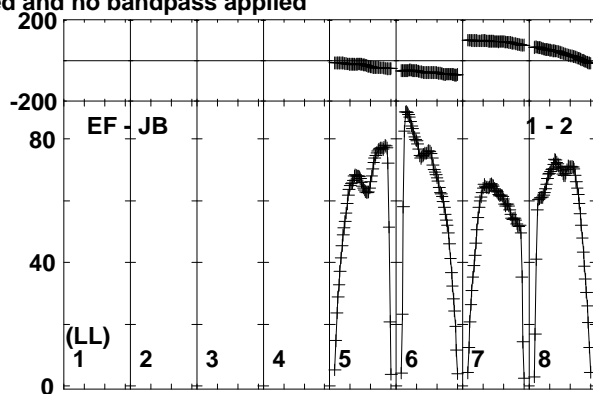
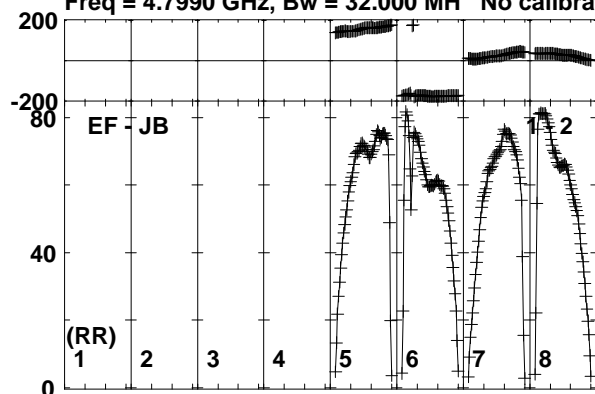

Lower frame: Milli Ampl Jy Top frame: Phas deg

Vector averaged cross-power spectrum Baseline: EF (01) - JB (02)

Timerange: 00/20:49:05 to 00/20:52:59

Plot file version 2 created 21-FEB-2017 15:10:40

J0927+3902 EG096A.UVDATA.1

Freq = 4.7990 GHz, Bw = 32.000 MH No calibration applied and no bandpass applied

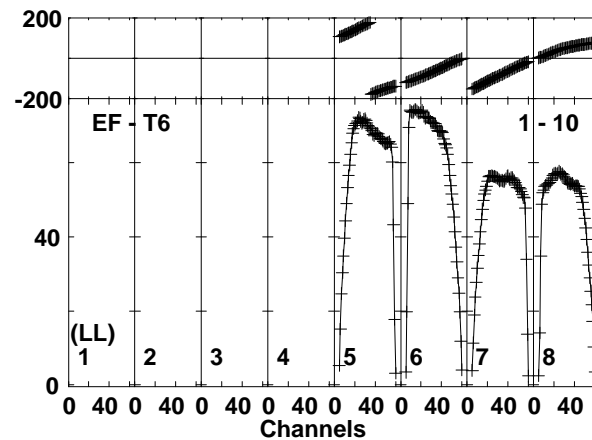
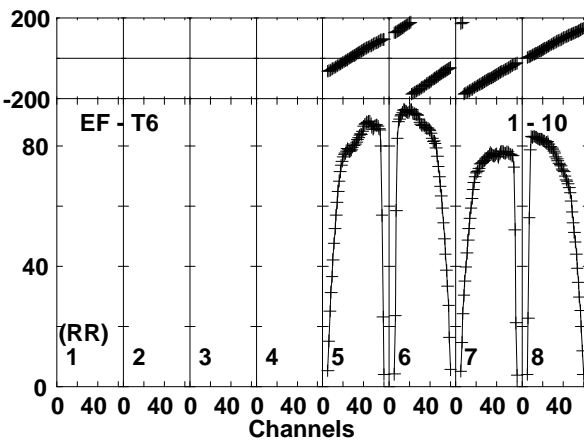
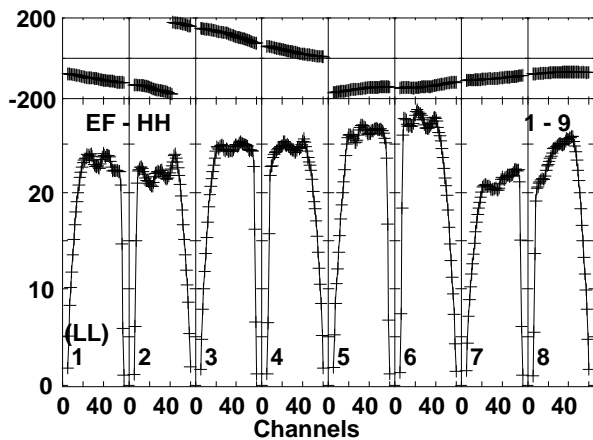
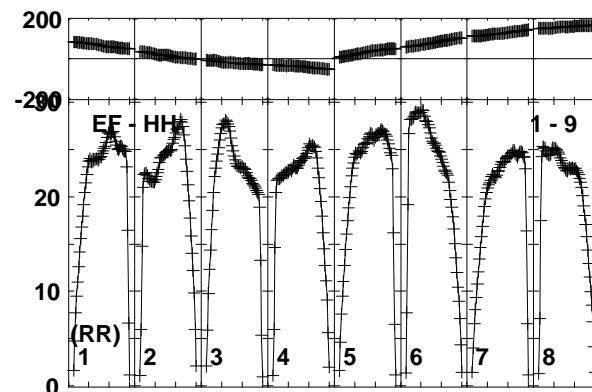
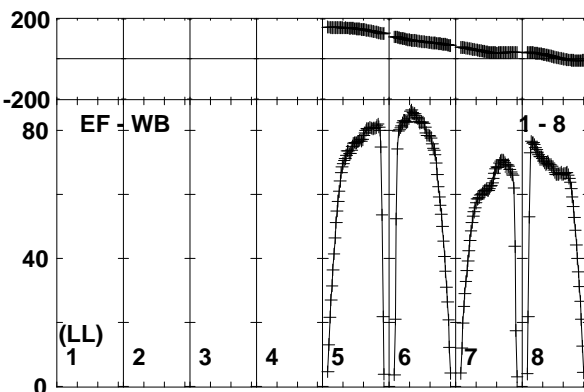
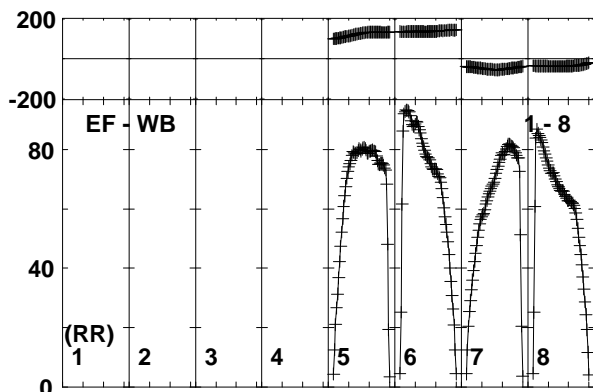
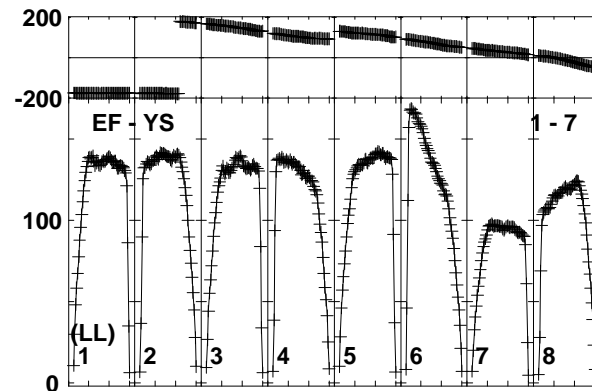
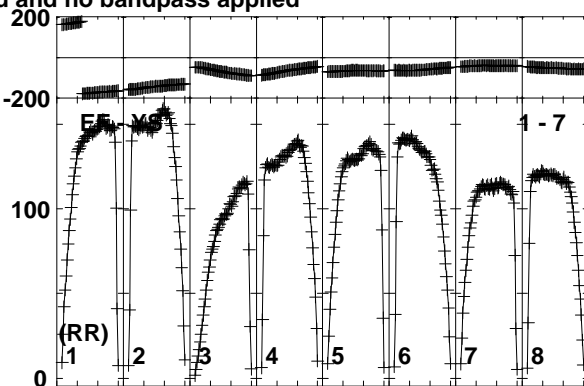
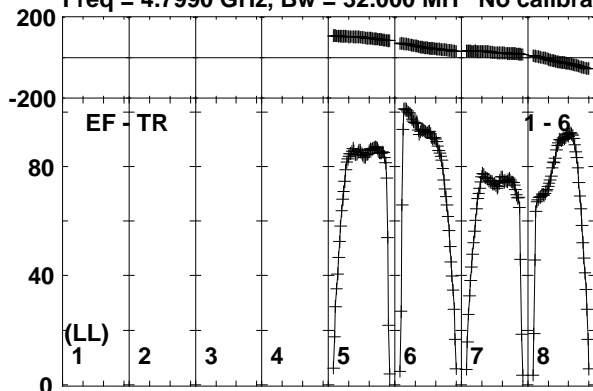

Lower frame: Milli Ampl Jy Top frame: Phas deg
Vector averaged cross-power spectrum Baseline: EF (01) - TR (06)
Timerange: 00/20:49:05 to 00/20:52:59

Plot file version 3 created 21-FEB-2017 15:10:41

J1108+4330 EG096A.UVDATA.1

Freq = 4.7990 GHz, Bw = 32.000 MH No calibration applied and no bandpass applied

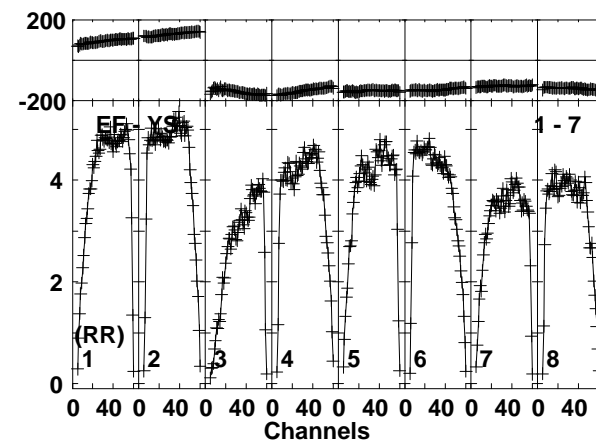
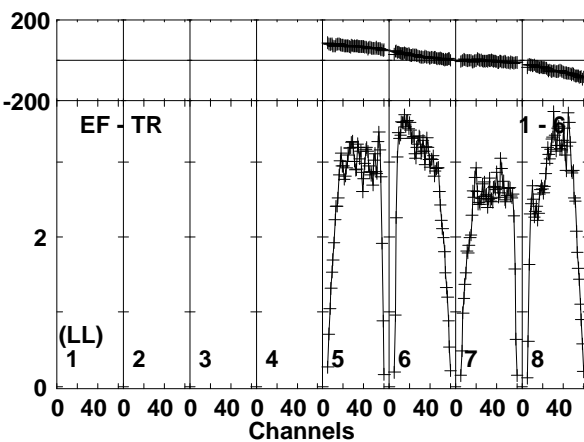
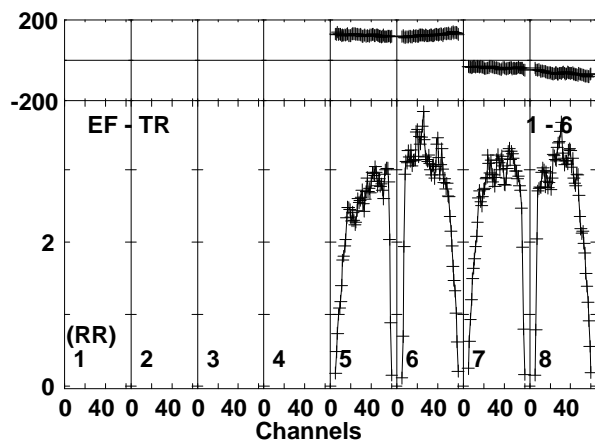
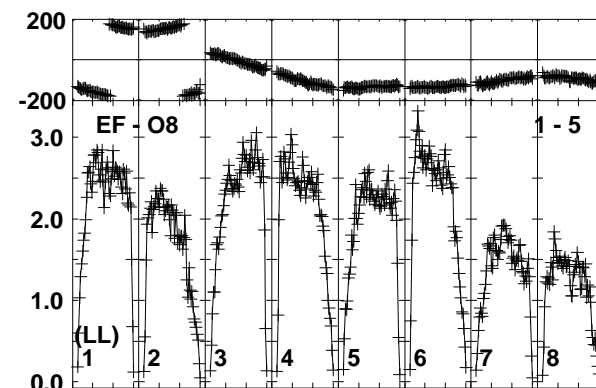
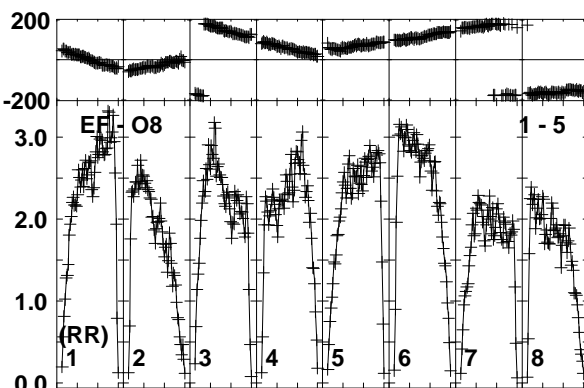
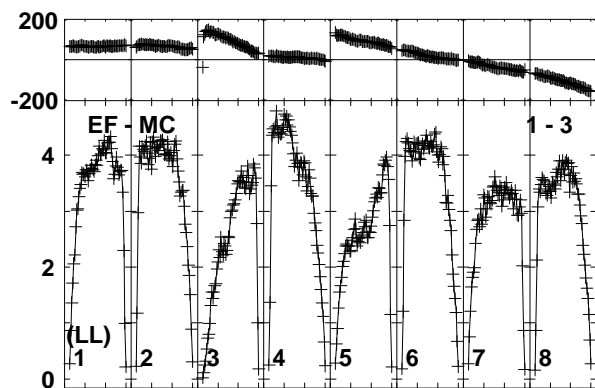
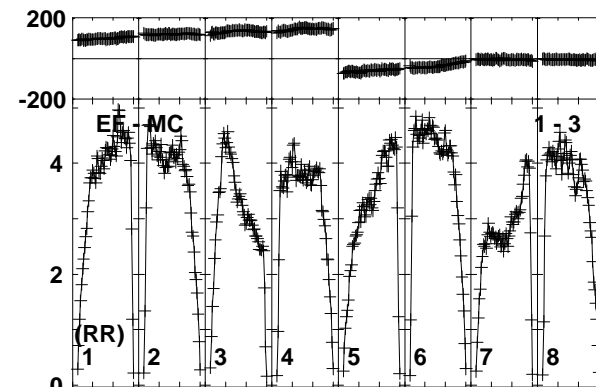
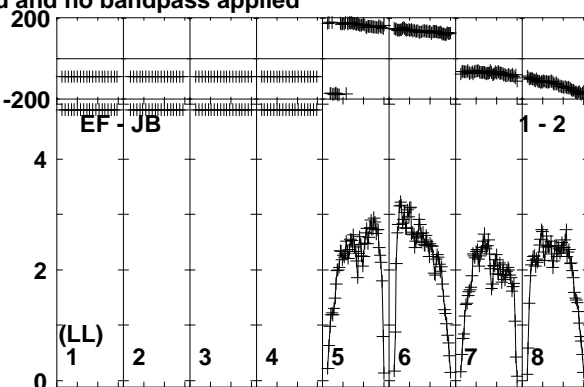
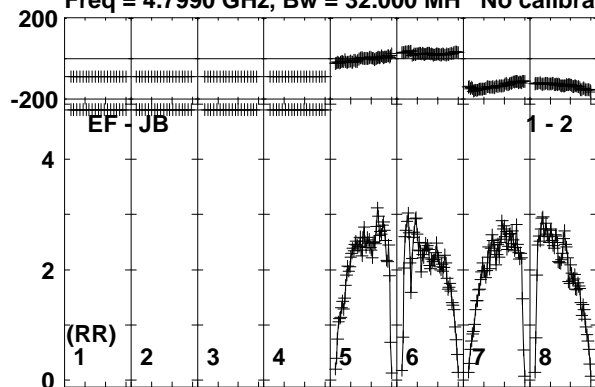

Lower frame: Milli Ampl Jy Top frame: Phas deg
Vector averaged cross-power spectrum Baseline: EF (01) - JB (02)
Timerange: 00/20:55:16 to 00/20:56:00

Plot file version 4 created 21-FEB-2017 15:10:41

J1108+4330 EG096A.UVDATA.1

Freq = 4.7990 GHz, Bw = 32.000 MH No calibration applied and no bandpass applied

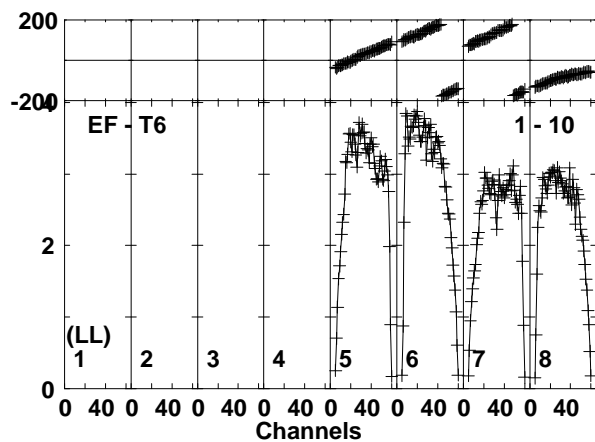
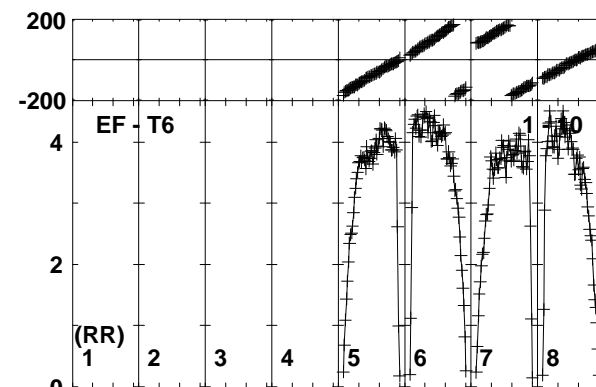
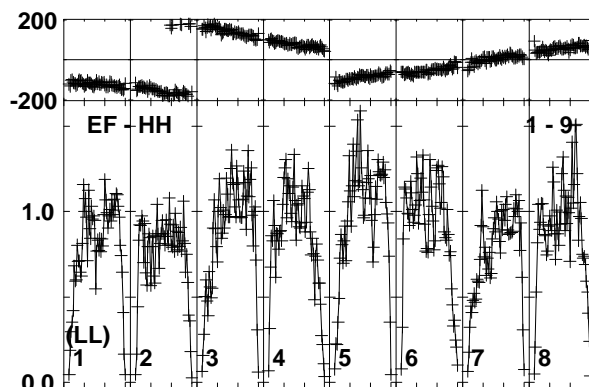
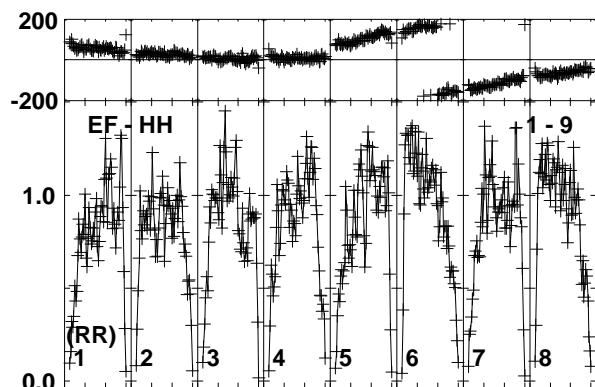
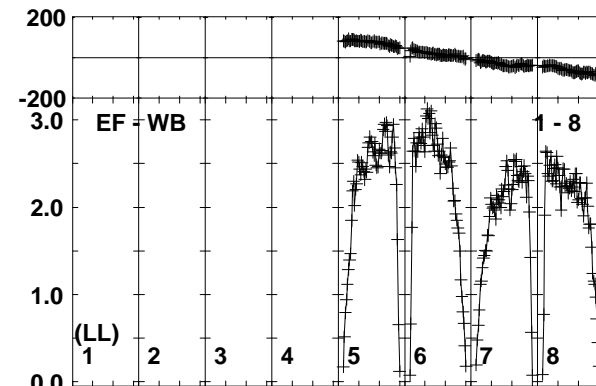
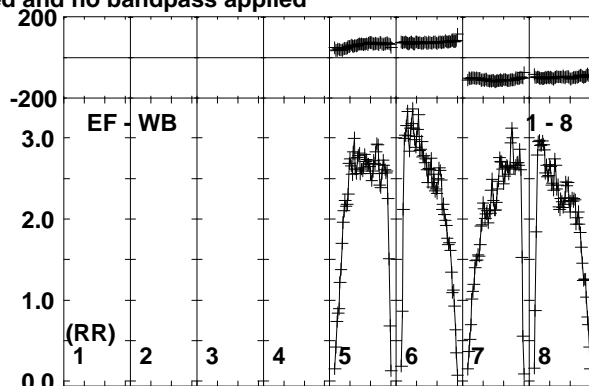
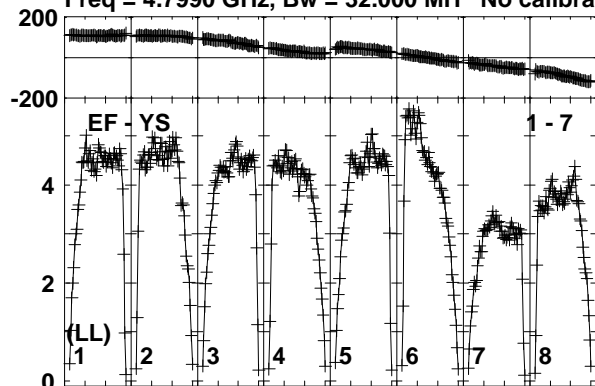

Lower frame: Milli Ampl Jy Top frame: Phas deg
Vector averaged cross-power spectrum Baseline: EF (01) - YS (07)
Timerange: 00/20:55:16 to 00/20:56:00

Plot file version 5 created 21-FEB-2017 15:10:41

J1108+4330 EG096A.UVDATA.1

Freq = 4.7990 GHz, Bw = 32.000 MH No calibration applied and no bandpass applied

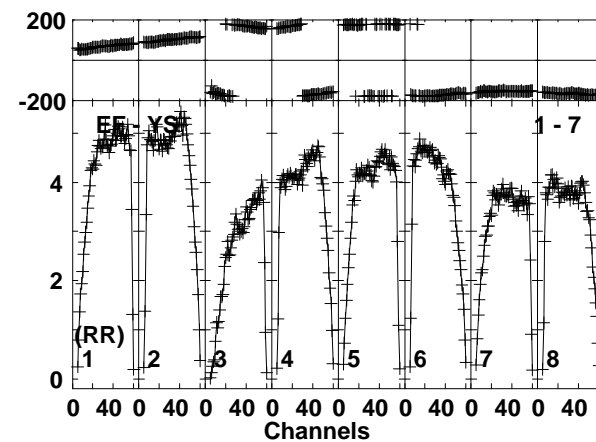
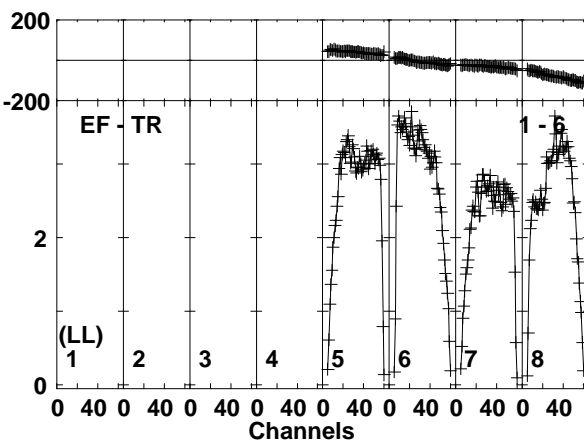
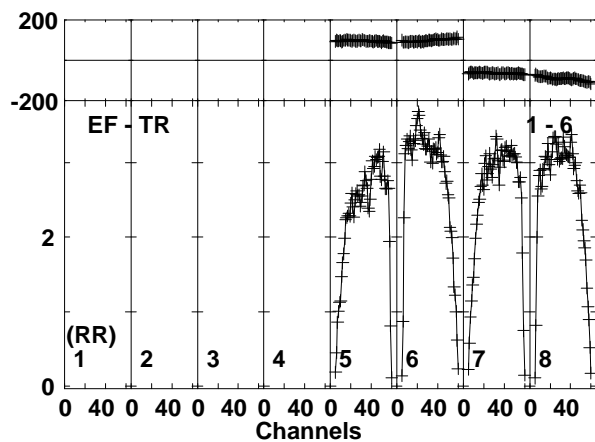
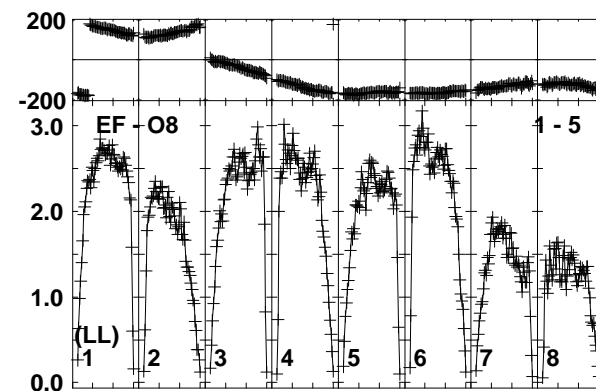
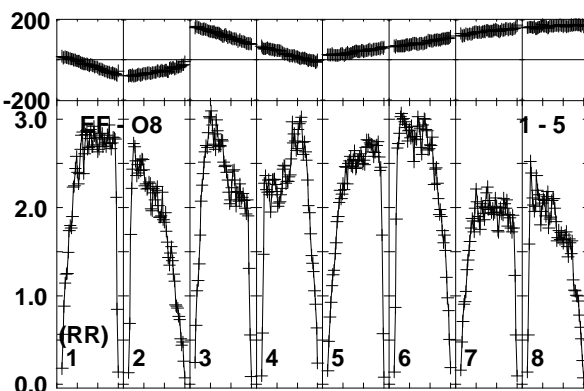
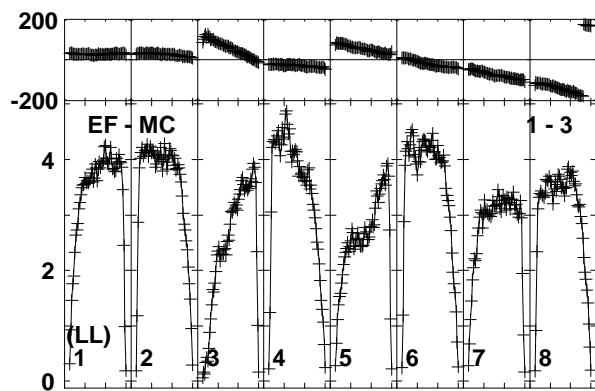
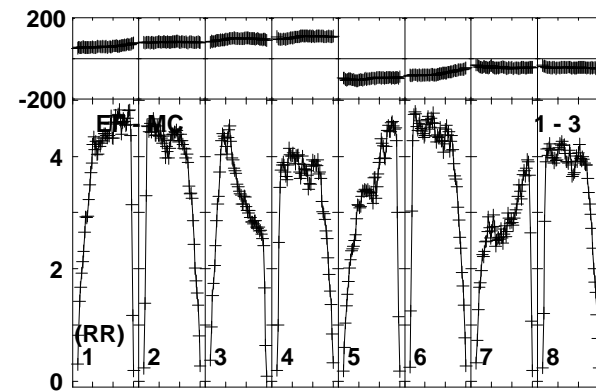
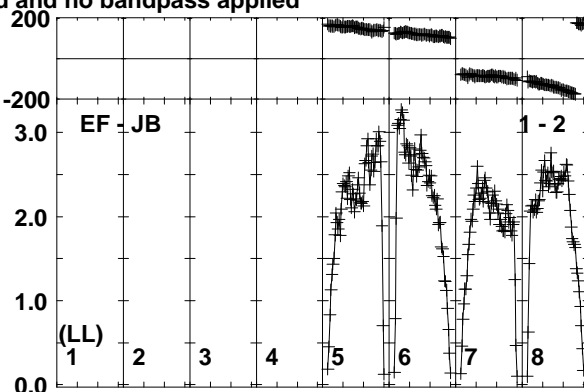
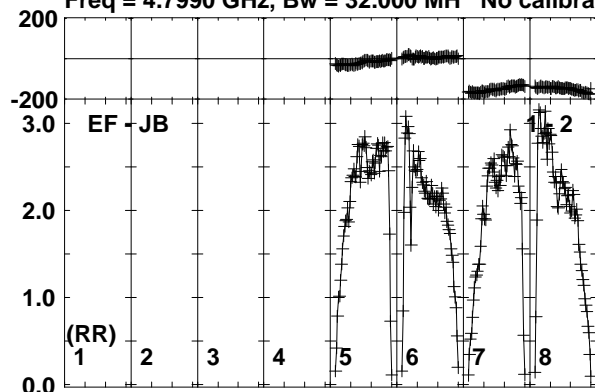

Lower frame: Milli Ampl Jy Top frame: Phas deg
Vector averaged cross-power spectrum Baseline: EF (01) - JB (02)
Timerange: 00/20:56:41 to 00/20:57:39

Plot file version 6 created 21-FEB-2017 15:10:41

J1108+4330 EG096A.UVDATA.1

Freq = 4.7990 GHz, Bw = 32.000 MH No calibration applied and no bandpass applied

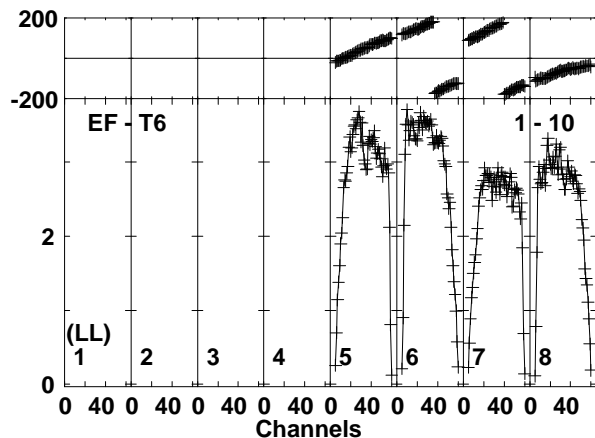
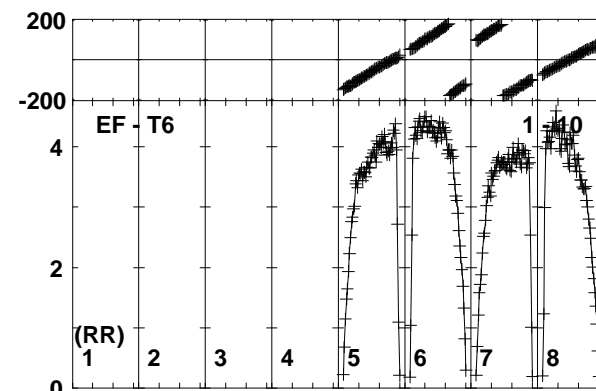
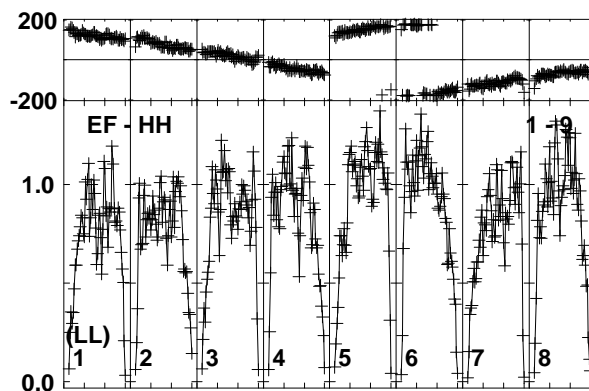
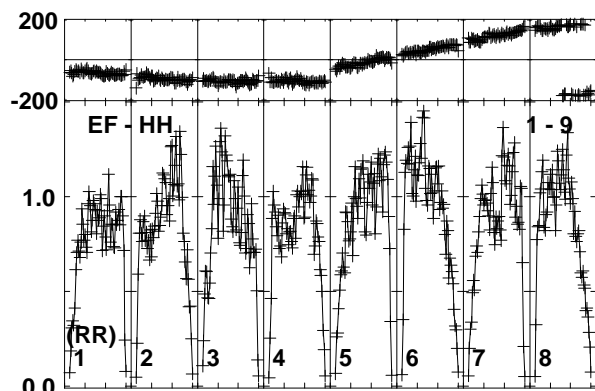
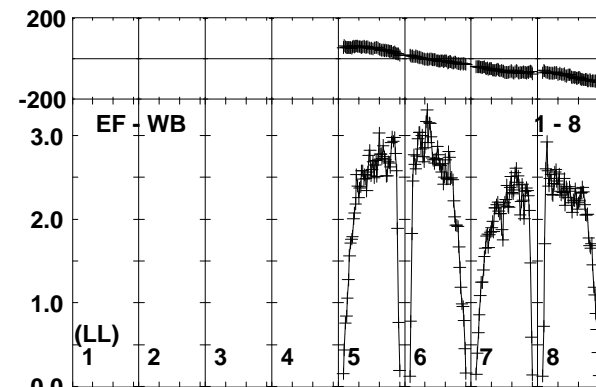
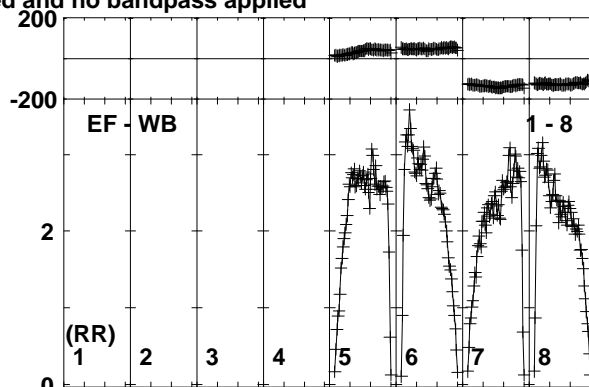
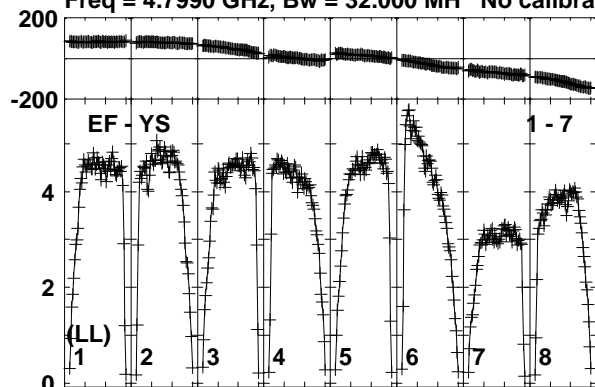

Lower frame: Milli Ampl Jy Top frame: Phas deg
Vector averaged cross-power spectrum Baseline: EF (01) - YS (07)
Timerange: 00/20:56:41 to 00/20:57:39

Plot file version 7 created 21-FEB-2017 15:10:41

J1112+4301 EG096A.UVDATA.1

Freq = 4.7990 GHz, Bw = 32.000 MH No calibration applied and no bandpass applied

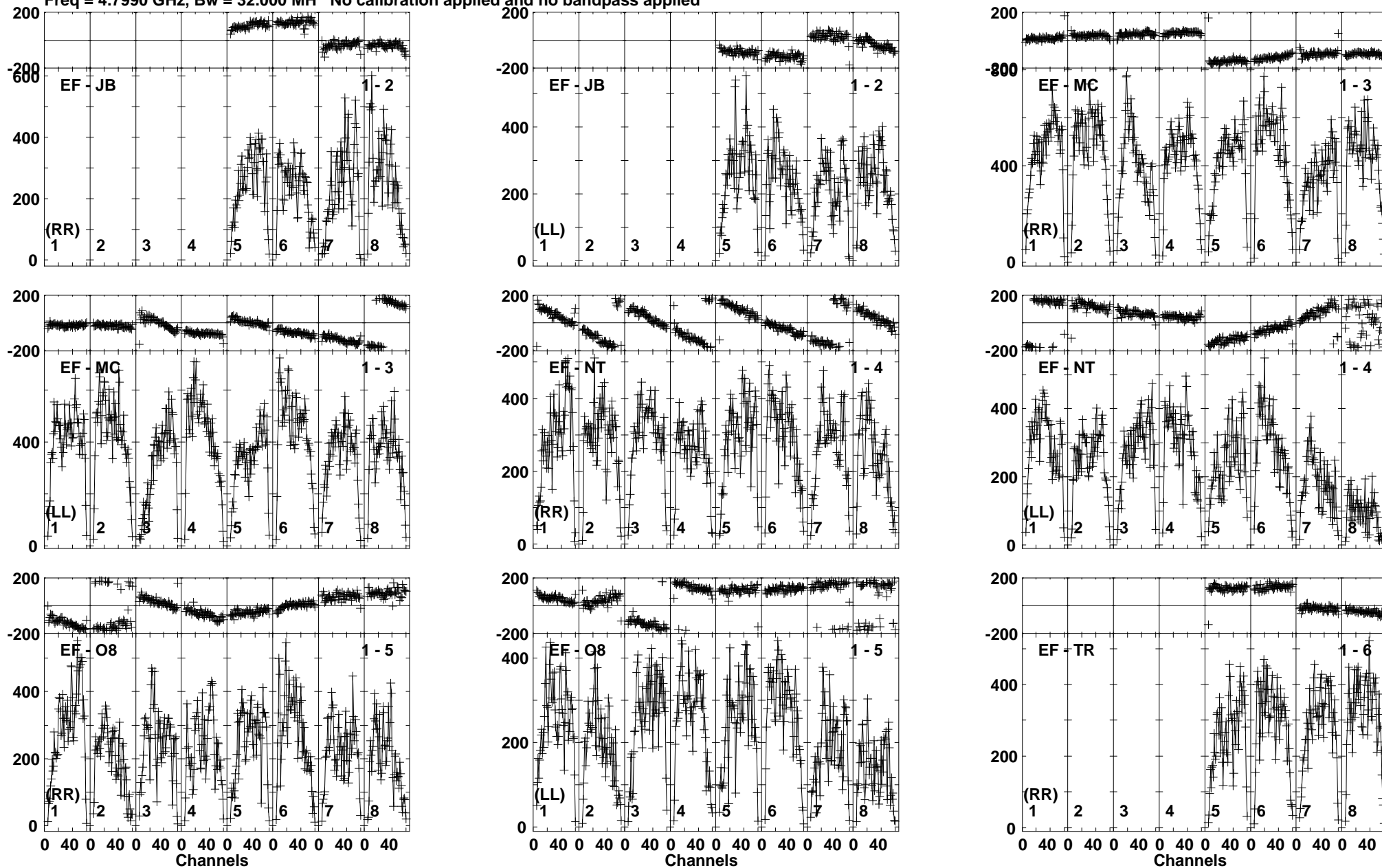

Lower frame: Micro Ampl Jy Top frame: Phas deg
Vector averaged cross-power spectrum Baseline: EF (01) - JB (02)
Timerange: 00/20:57:41 to 00/21:01:10

Plot file version 8 created 21-FEB-2017 15:10:42

J1112+4301 EG096A.UVDATA.1

Freq = 4.7990 GHz, Bw = 32.000 MH No calibration applied and no bandpass applied

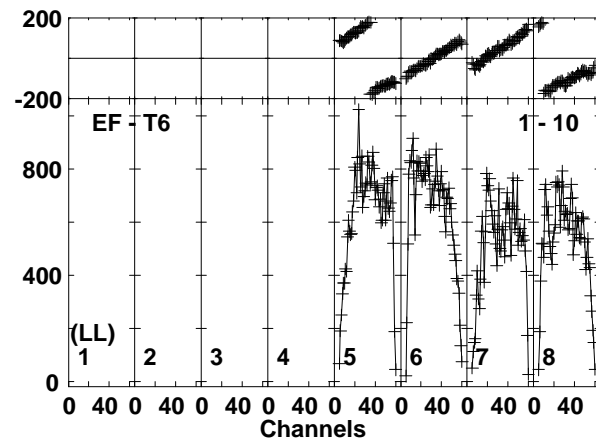
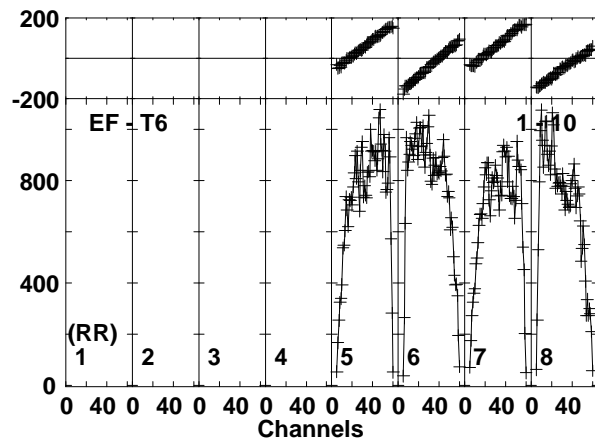
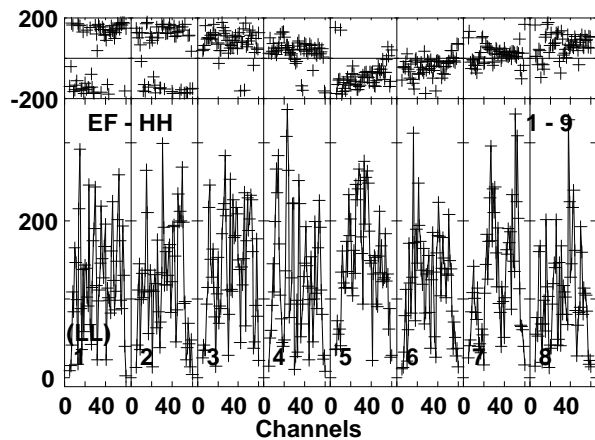
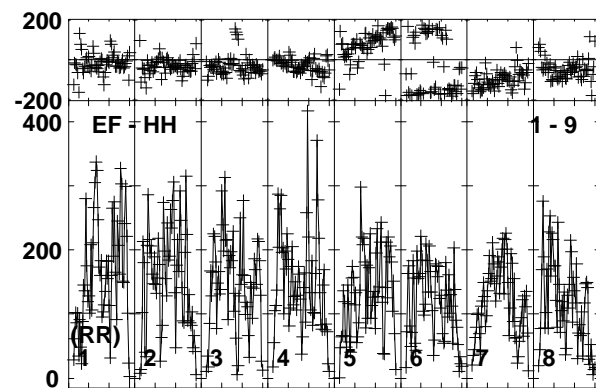
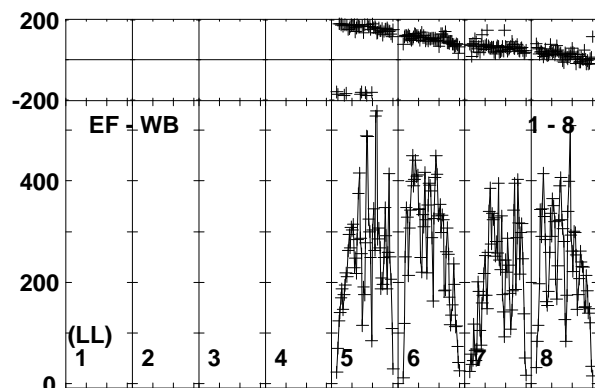
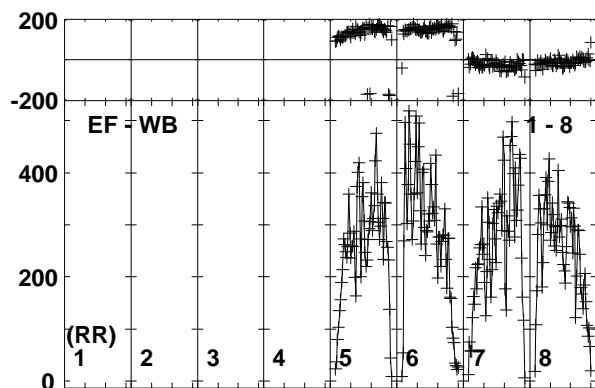
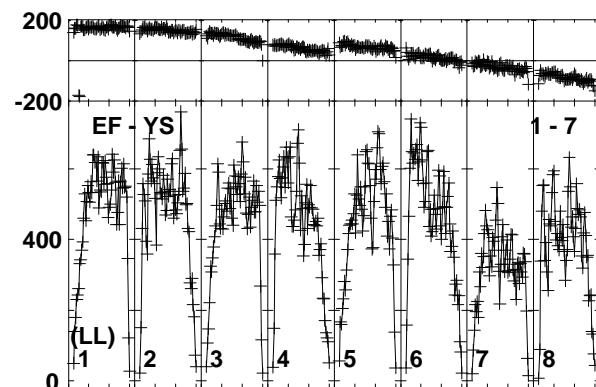
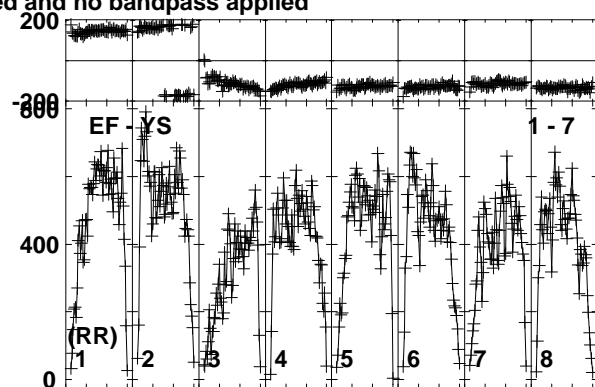
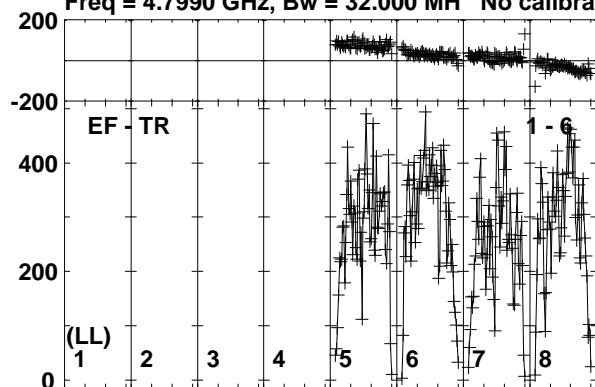

Lower frame: Micro Ampl Jy Top frame: Phas deg
Vector averaged cross-power spectrum Baseline: EF (01) - TR (06)
Timerange: 00/20:57:41 to 00/21:01:10

Plot file version 9 created 21-FEB-2017 15:10:42

J1108+4330 EG096A.UVDATA.1

Freq = 4.7990 GHz, Bw = 32.000 MH No calibration applied and no bandpass applied

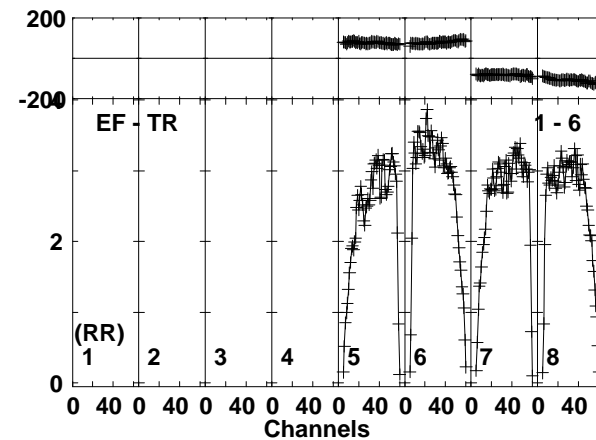
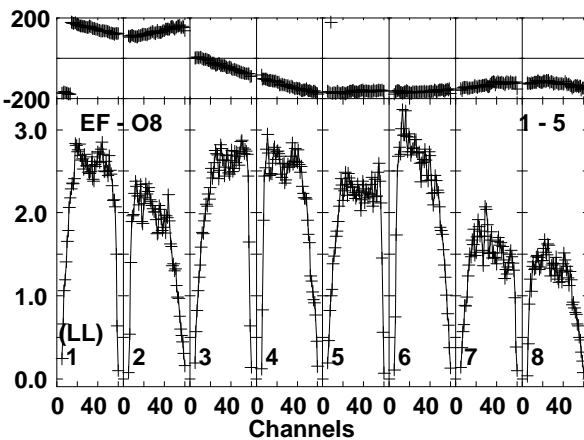
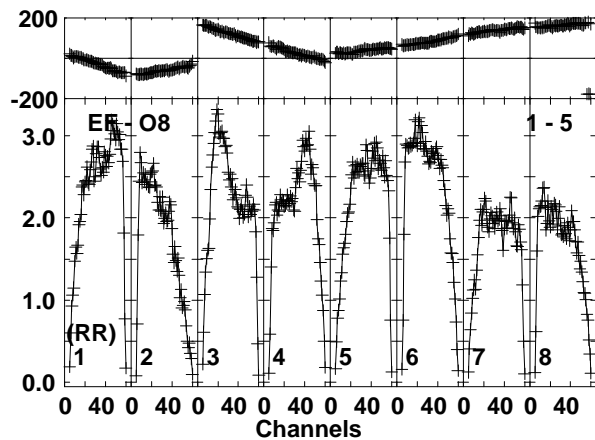
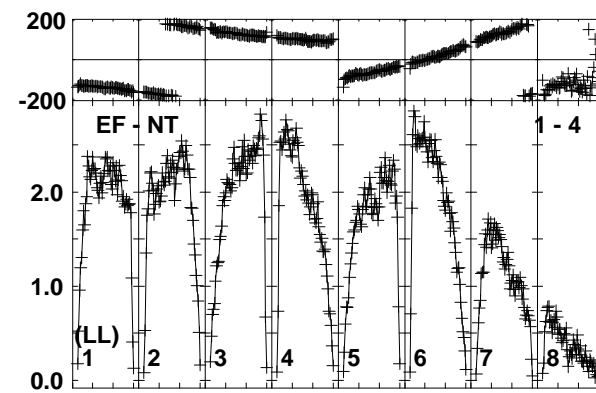
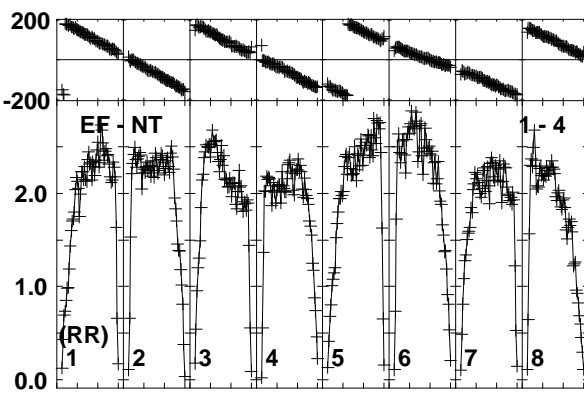
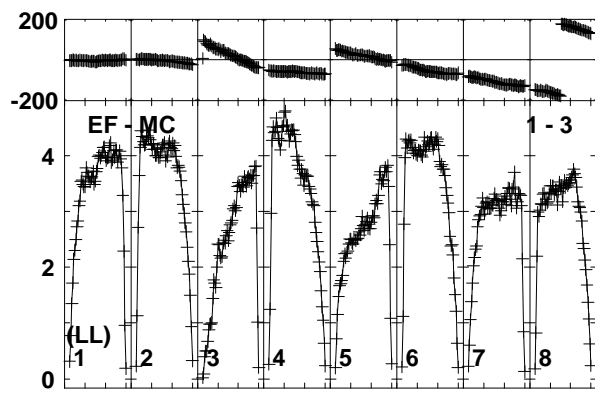
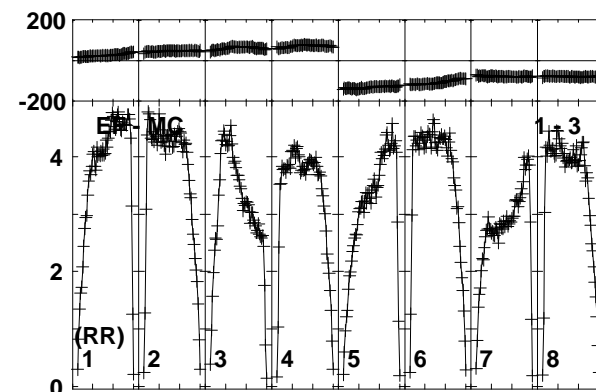
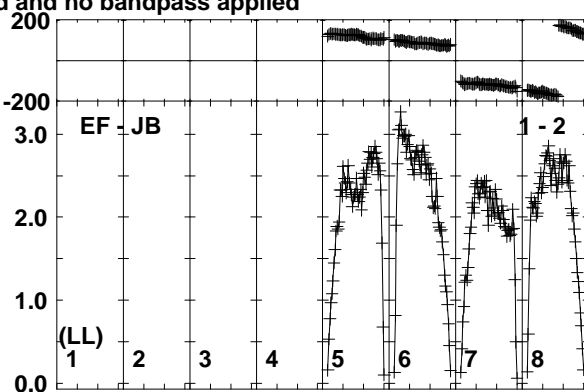
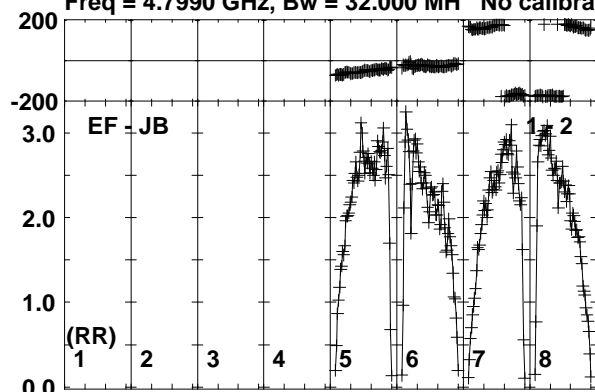

Lower frame: Milli Ampl Jy Top frame: Phas deg
Vector averaged cross-power spectrum Baseline: EF (01) - JB (02)
Timerange: 00/21:01:11 to 00/21:02:40

Plot file version 10 created 21-FEB-2017 15:10:42

J1108+4330 EG096A.UVDATA.1

Freq = 4.7990 GHz, Bw = 32.000 MH No calibration applied and no bandpass applied

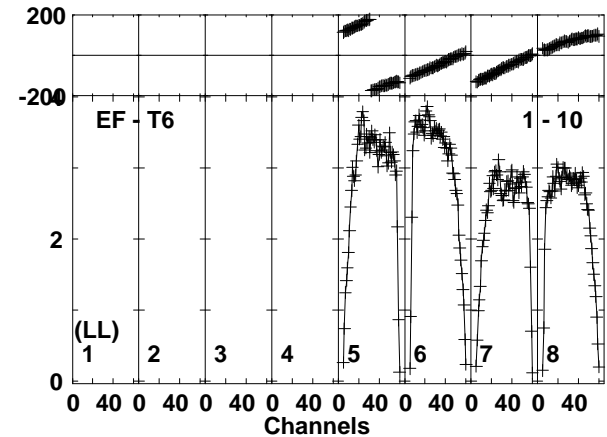
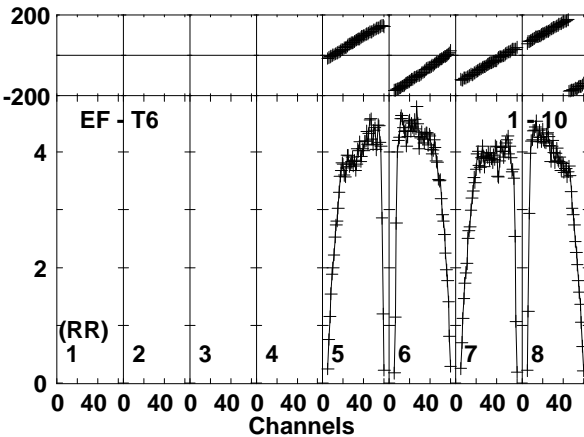
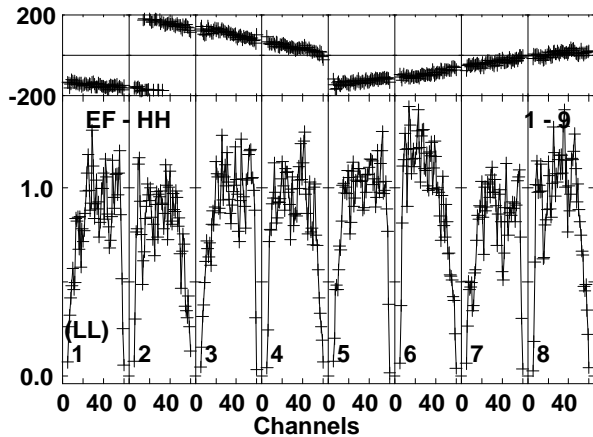
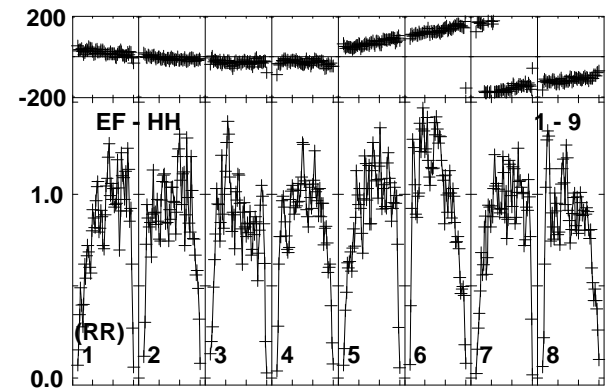
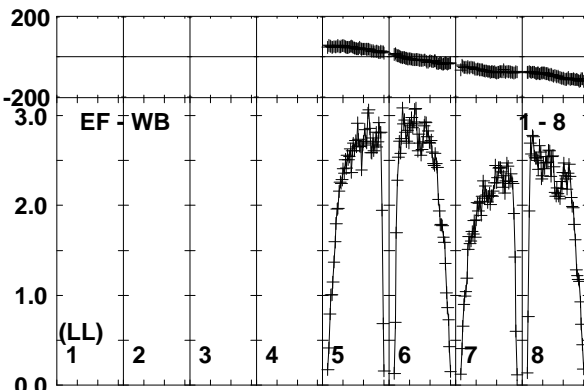
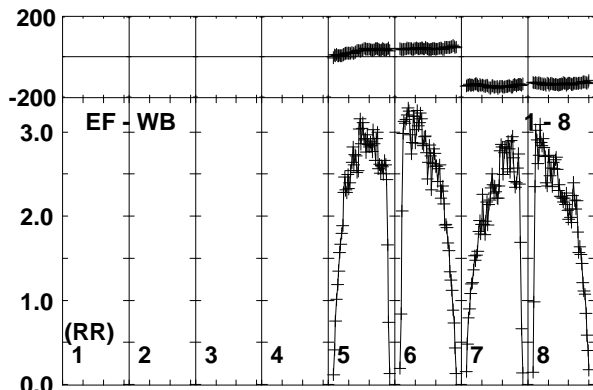
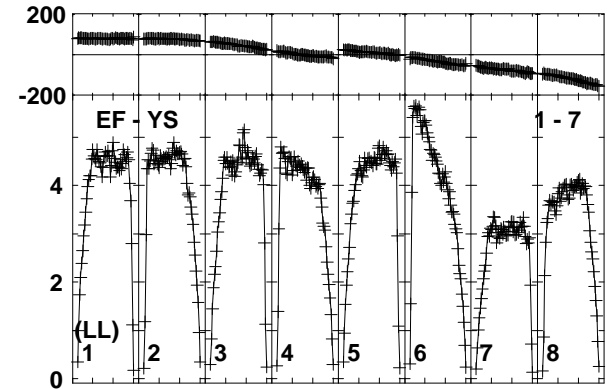
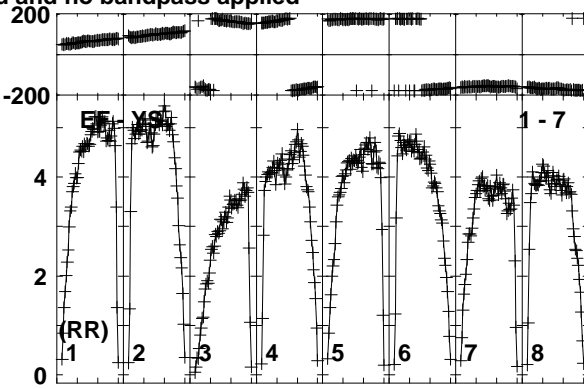
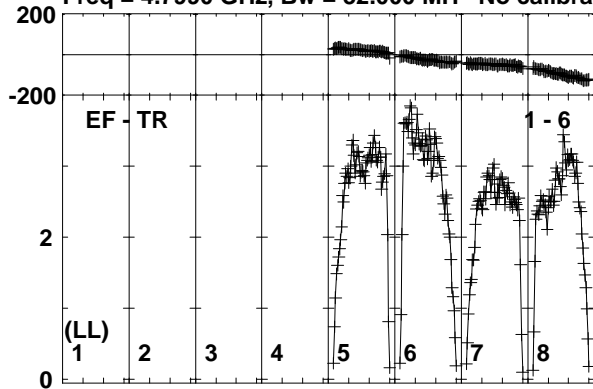

Lower frame: Milli Ampl Jy Top frame: Phas deg
Vector averaged cross-power spectrum Baseline: EF (01) - TR (06)
Timerange: 00/21:01:11 to 00/21:02:40

Plot file version 11 created 21-FEB-2017 15:10:42

ARUMA EG096A.UVDATA.1

Freq = 4.7990 GHz, Bw = 32.000 MH No calibration applied and no bandpass applied

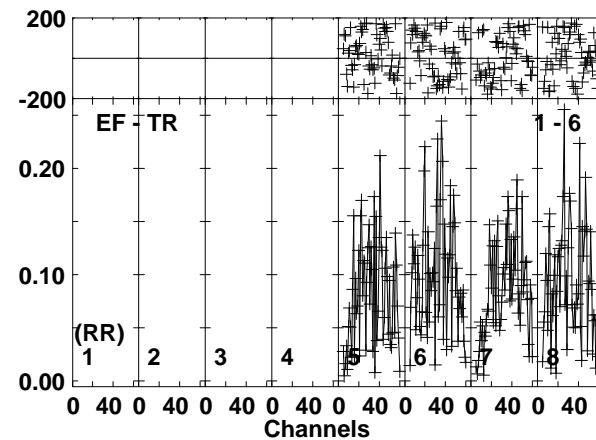
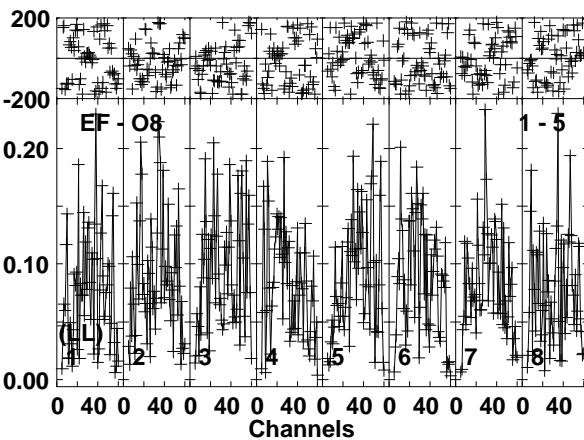
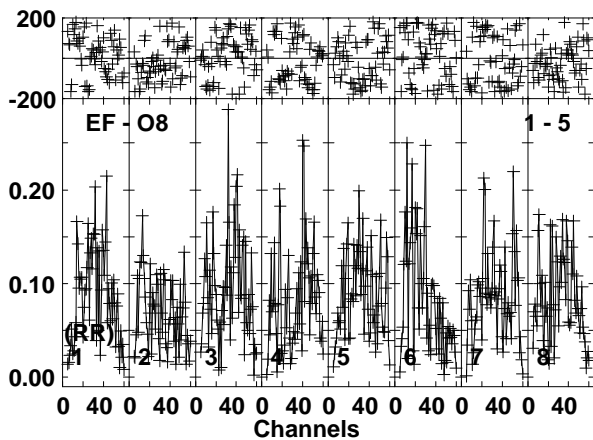
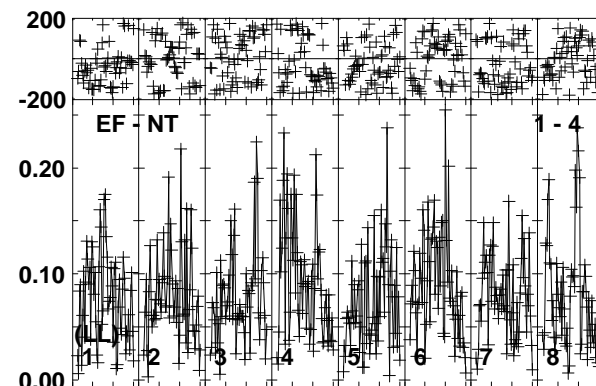
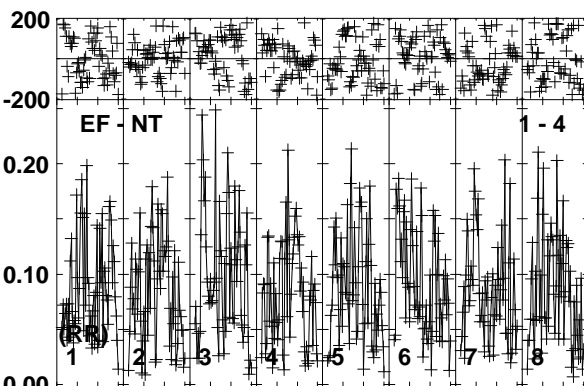
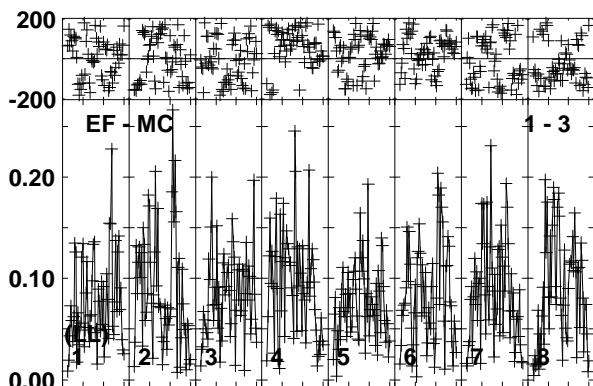
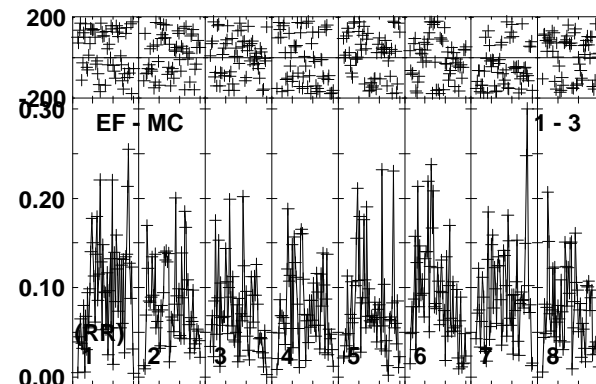
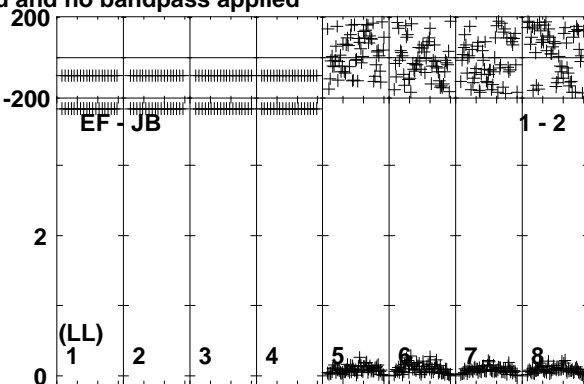
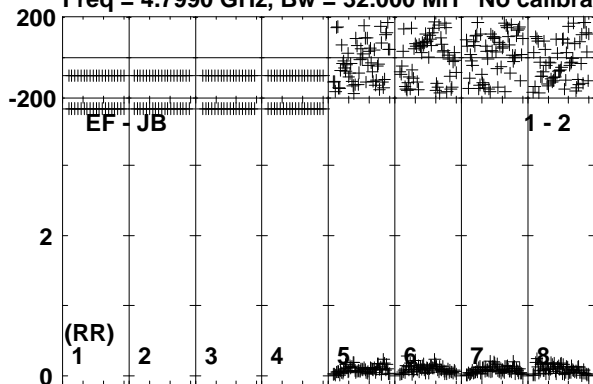

Lower frame: Milli Ampl Jy Top frame: Phas deg
Vector averaged cross-power spectrum Baseline: EF (01) - JB (02)
Timerange: 00/21:02:40 to 00/21:06:09

Plot file version 12 created 21-FEB-2017 15:10:43

ARUMA EG096A.UVDATA.1

Freq = 4.7990 GHz, Bw = 32.000 MH No calibration applied and no bandpass applied

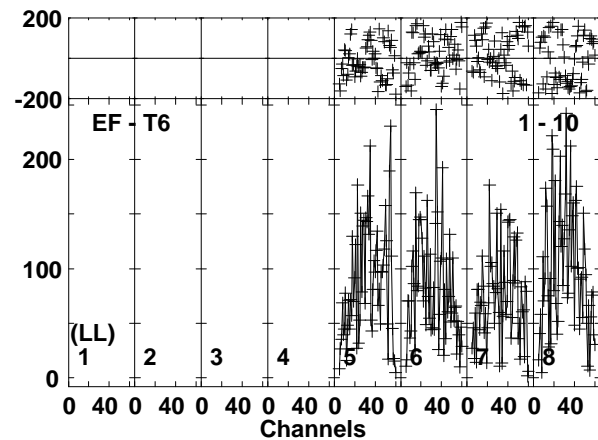
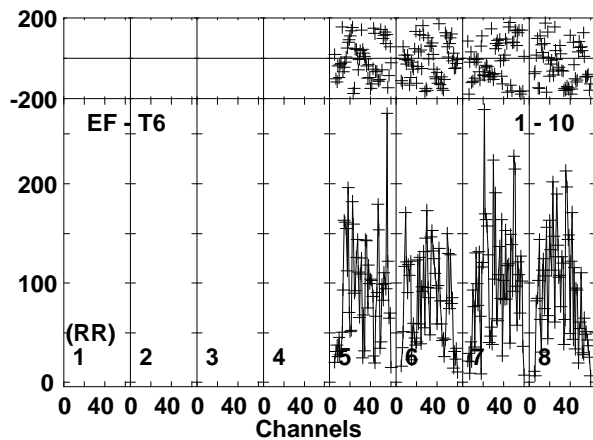
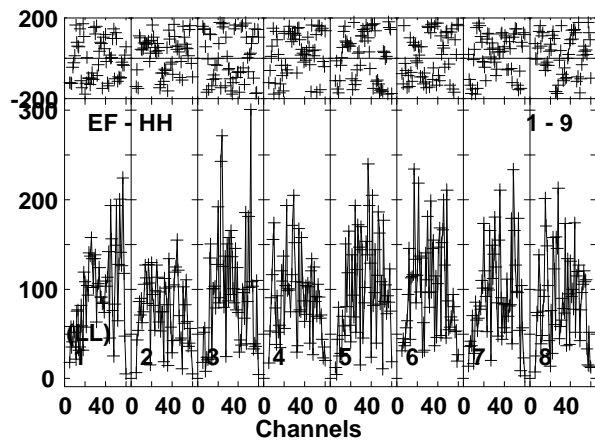
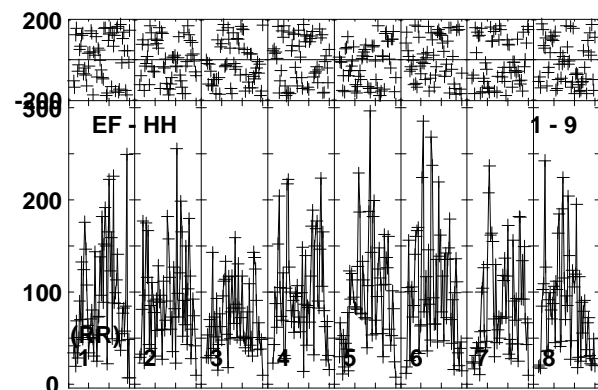
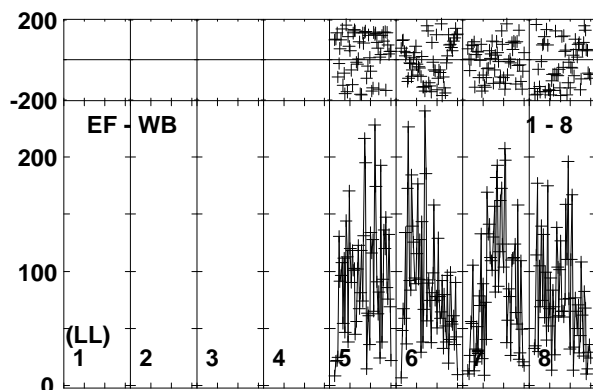
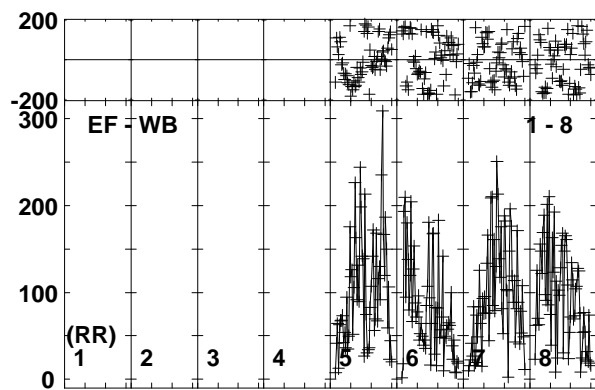
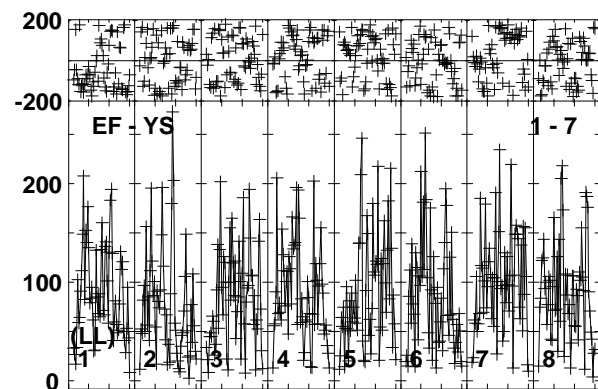
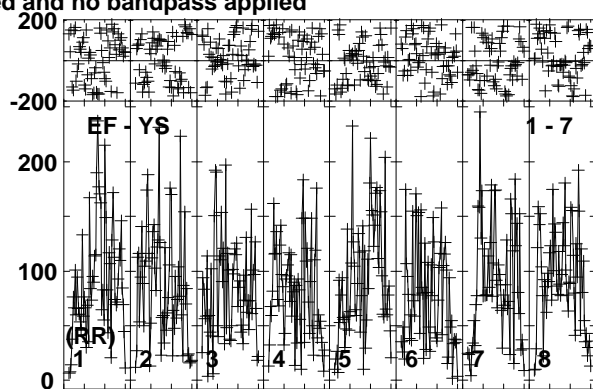
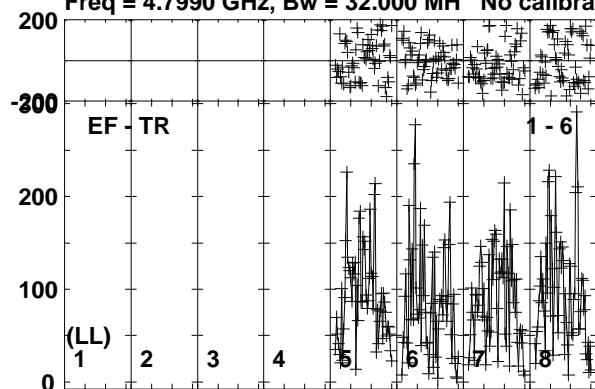

Lower frame: Micro Ampl Jy Top frame: Phas deg
Vector averaged cross-power spectrum Baseline: EF (01) - TR (06)
Timerange: 00/21:02:40 to 00/21:06:09

Plot file version 13 created 21-FEB-2017 15:10:43

J1108+4330 EG096A.UVDATA.1

Freq = 4.7990 GHz, Bw = 32.000 MH No calibration applied and no bandpass applied

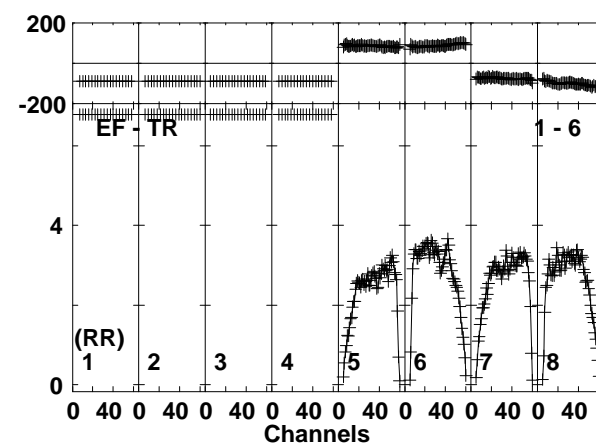
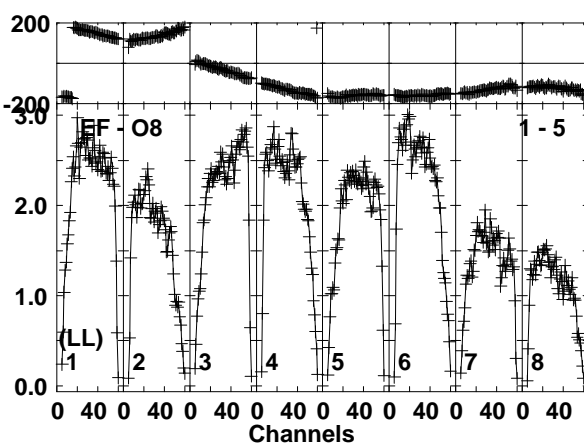
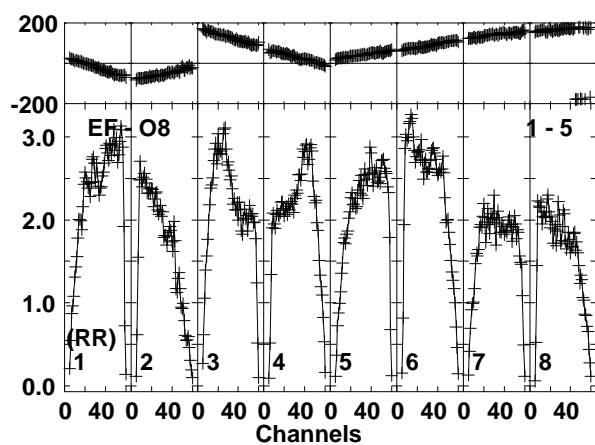
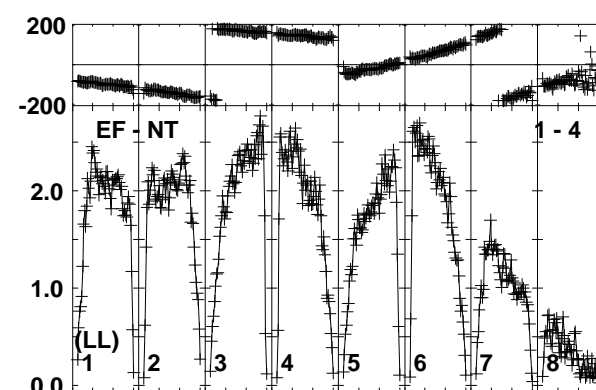
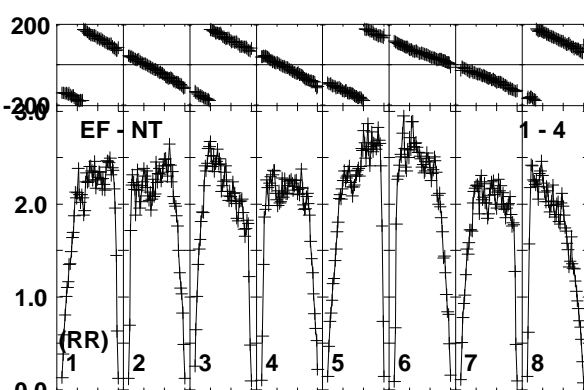
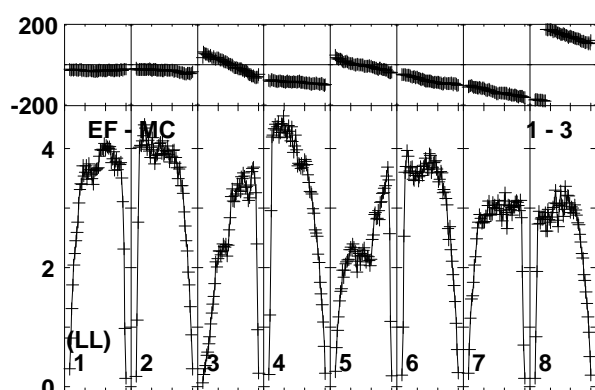
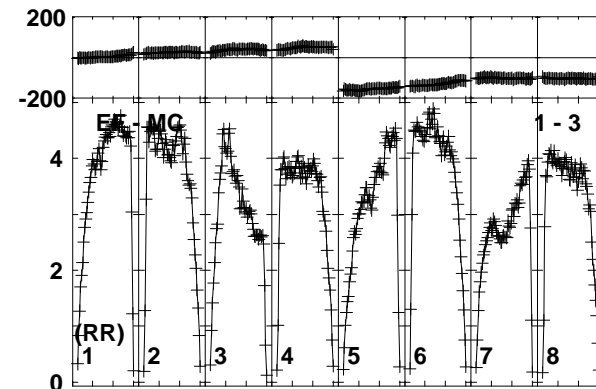
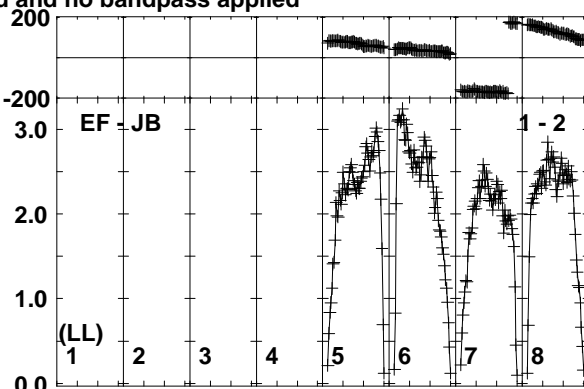
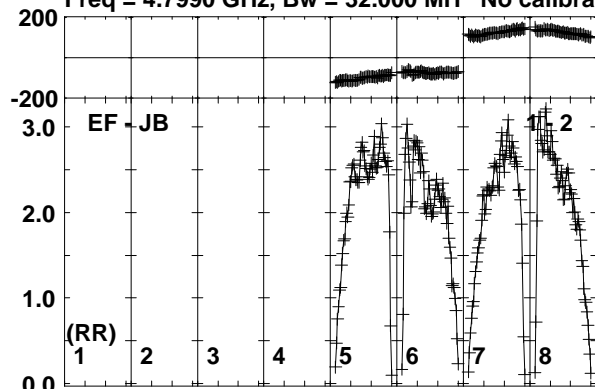

Lower frame: Milli Ampl Jy Top frame: Phas deg
Vector averaged cross-power spectrum Baseline: EF (01) - JB (02)
Timerange: 00/21:06:51 to 00/21:07:50

Plot file version 14 created 21-FEB-2017 15:10:43

J1108+4330 EG096A.UVDATA.1

Freq = 4.7990 GHz, Bw = 32.000 MH No calibration applied and no bandpass applied

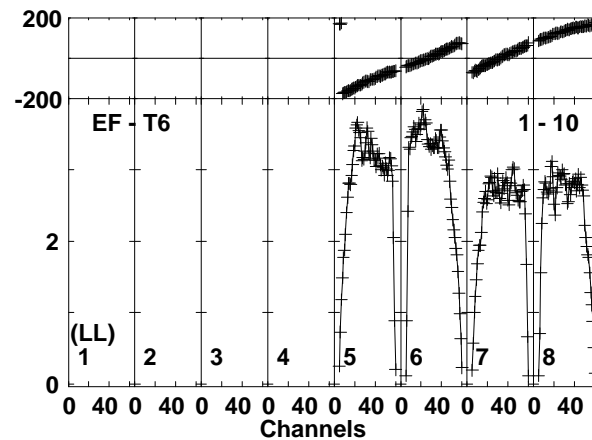
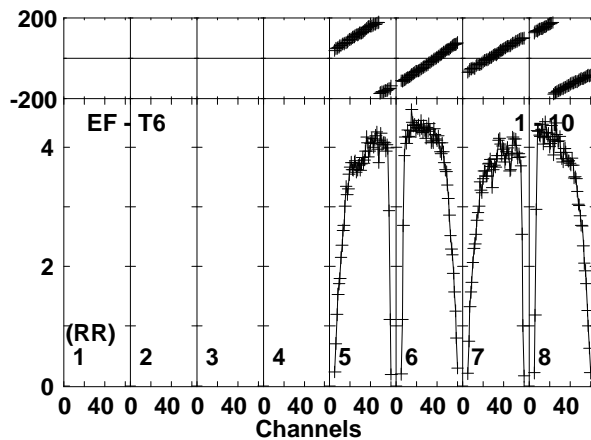
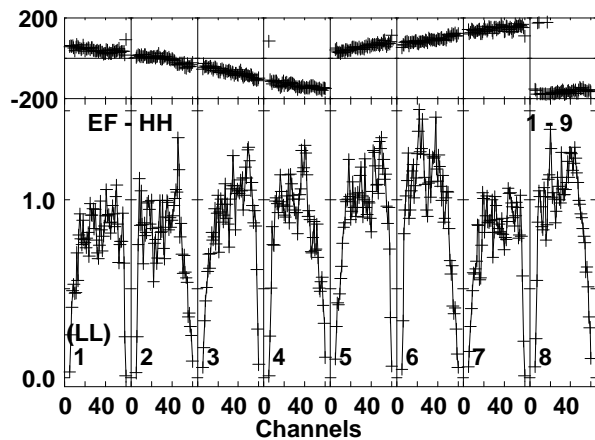
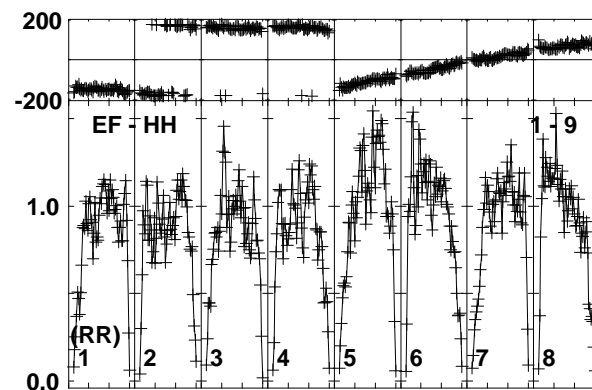
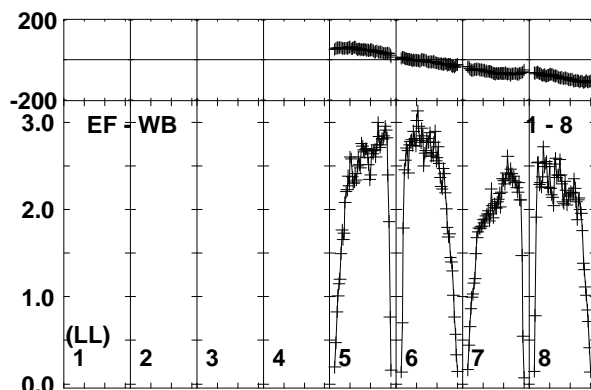
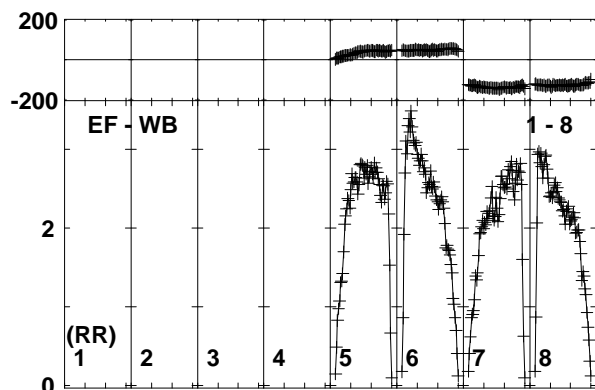
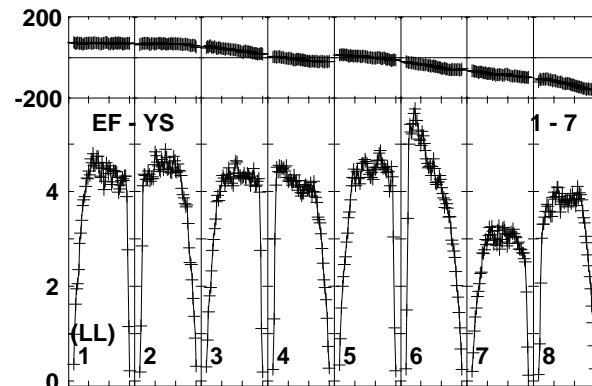
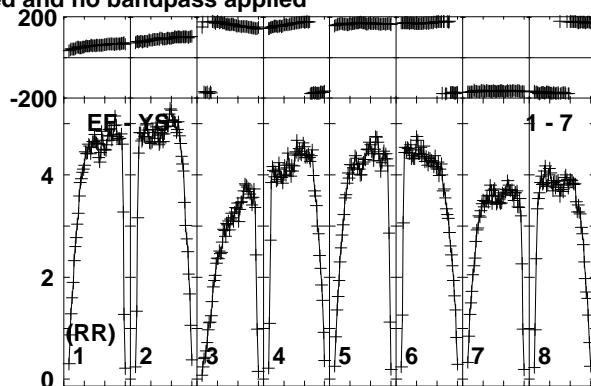
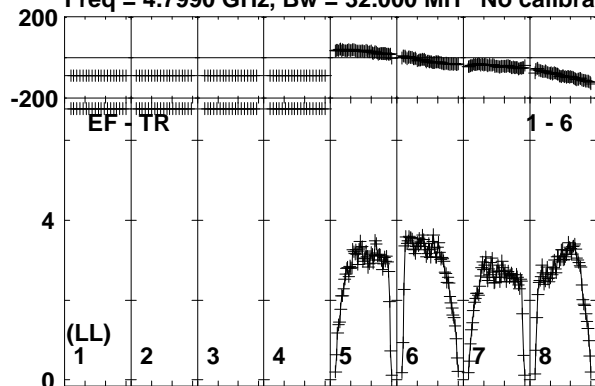

Lower frame: Milli Ampl Jy Top frame: Phas deg
Vector averaged cross-power spectrum Baseline: EF (01) - TR (06)
Timerange: 00/21:06:51 to 00/21:07:50

Plot file version 15 created 21-FEB-2017 15:10:43

ARUMA EG096A.UVDATA.1

Freq = 4.7990 GHz, Bw = 32.000 MH No calibration applied and no bandpass applied

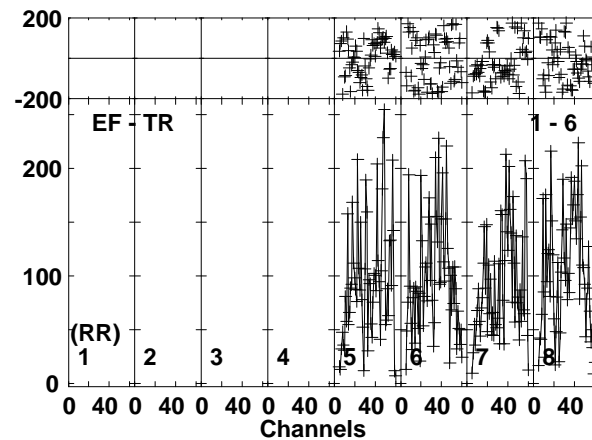
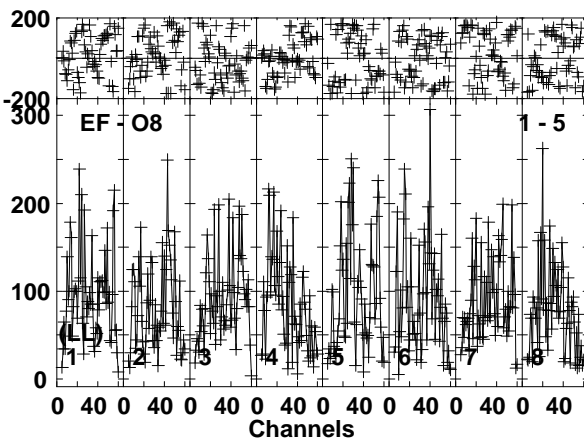
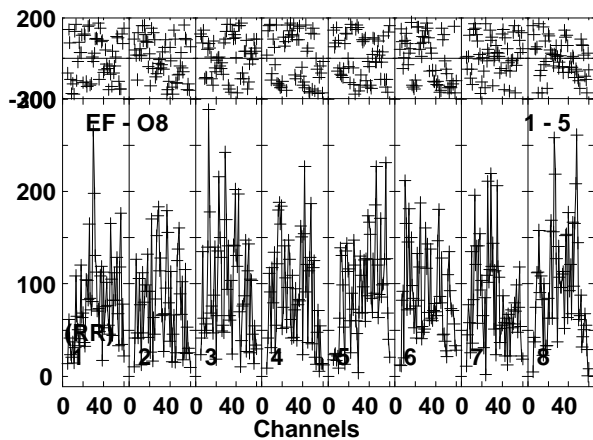
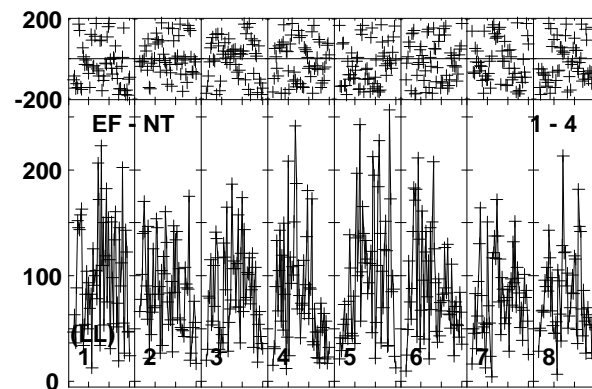
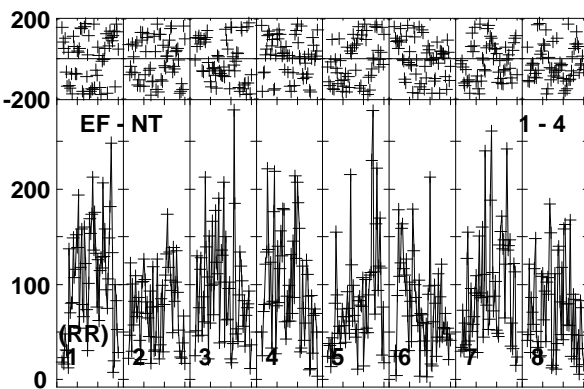
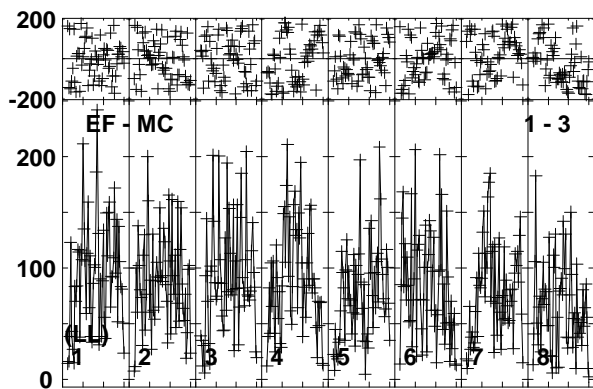
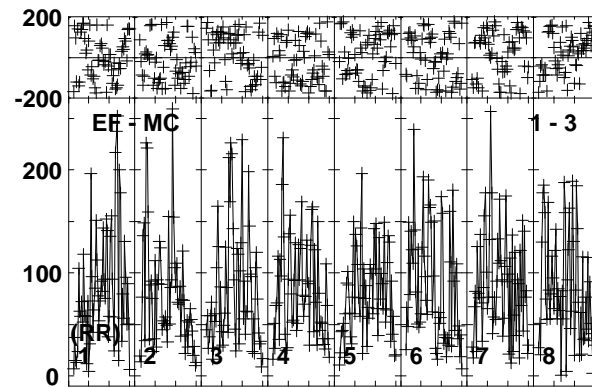
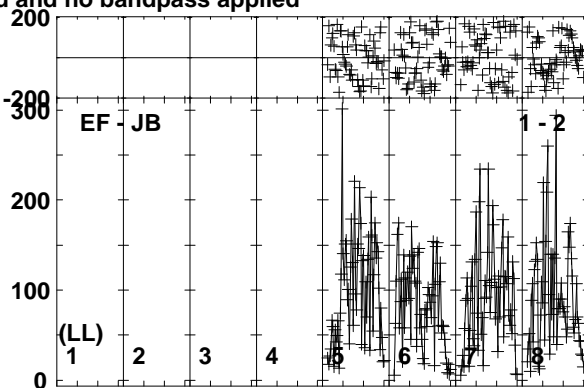
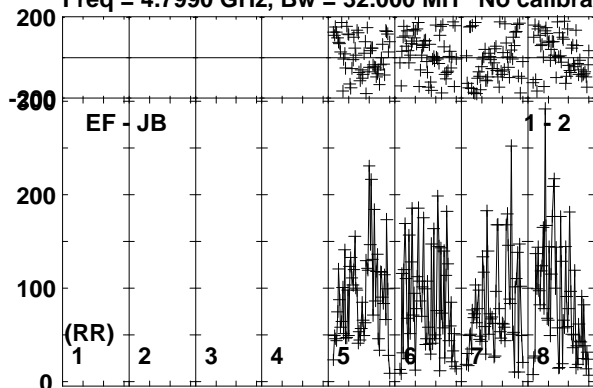

Lower frame: Micro Ampl Jy Top frame: Phas deg
Vector averaged cross-power spectrum Baseline: EF (01) - JB (02)
Timerange: 00/21:07:51 to 00/21:11:20

Plot file version 16 created 21-FEB-2017 15:10:44

ARUMA EG096A.UVDATA.1

Freq = 4.7990 GHz, Bw = 32.000 MH No calibration applied and no bandpass applied

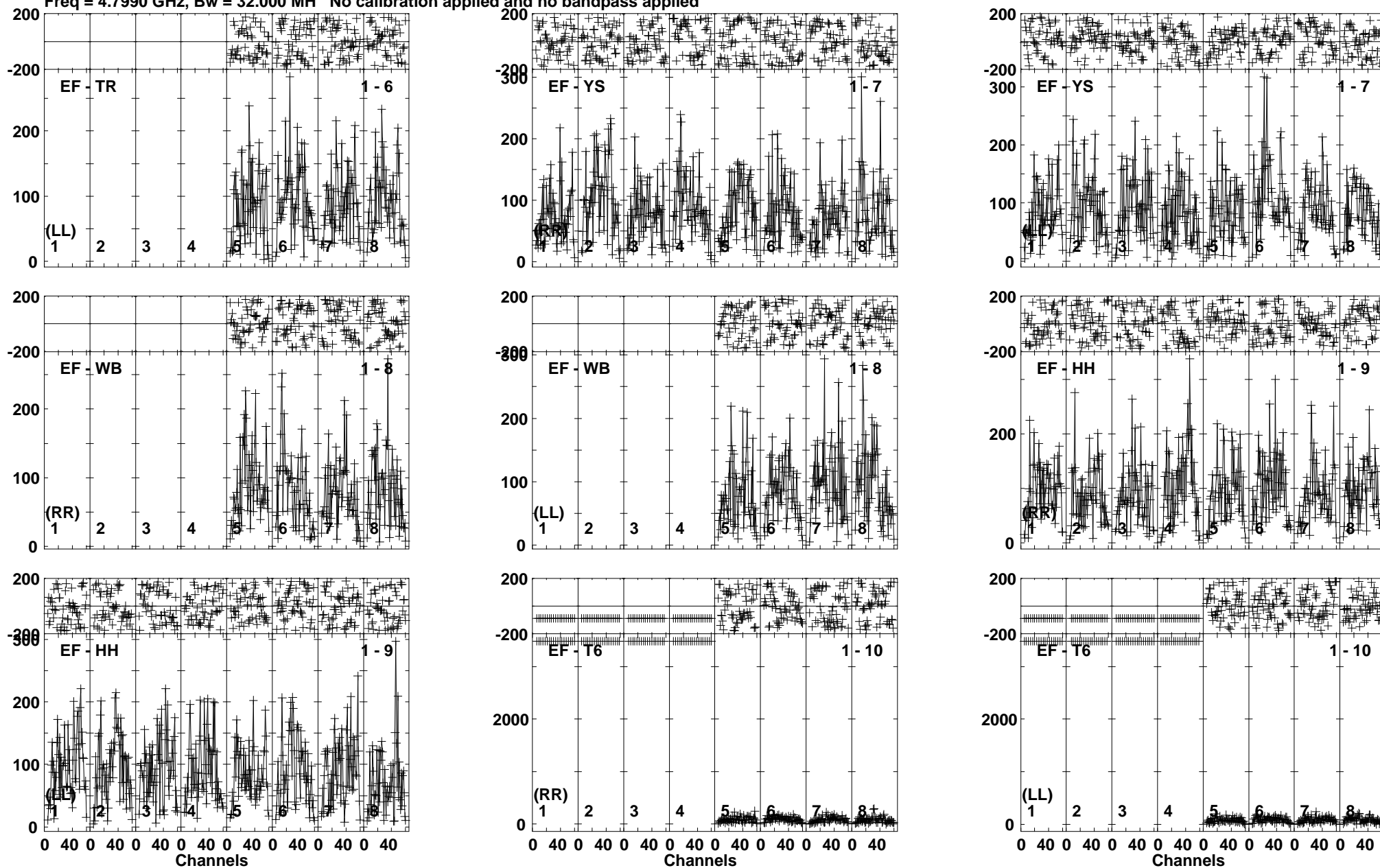

Lower frame: Micro Ampl Jy Top frame: Phas deg
Vector averaged cross-power spectrum Baseline: EF (01) - TR (06)
Timerange: 00/21:07:51 to 00/21:11:20

Plot file version 17 created 21-FEB-2017 15:10:44

J1108+4330 EG096A.UVDATA.1

Freq = 4.7990 GHz, Bw = 32.000 MH No calibration applied and no bandpass applied

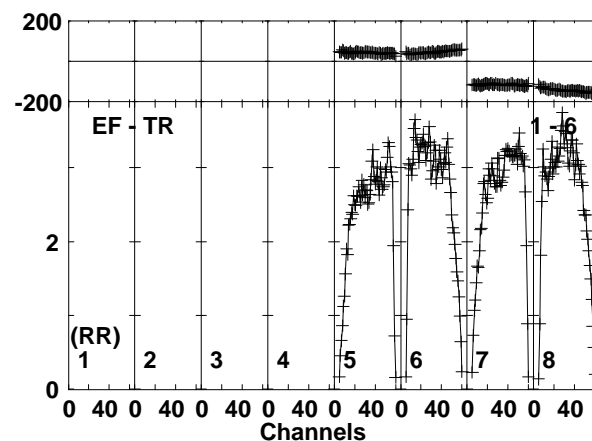
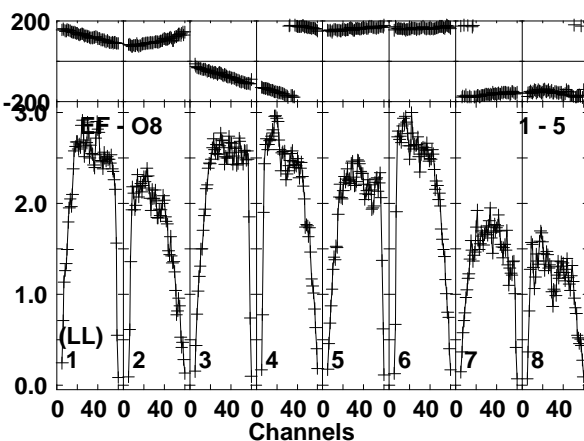
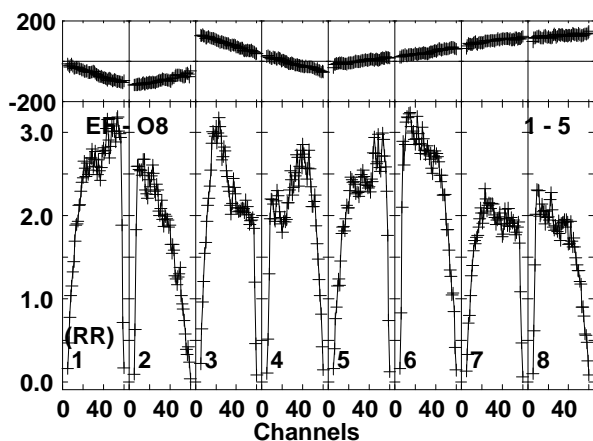
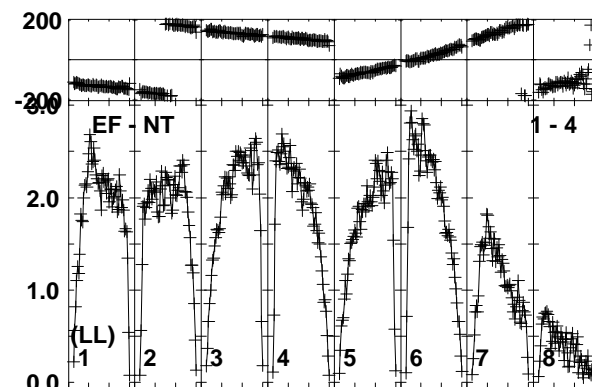
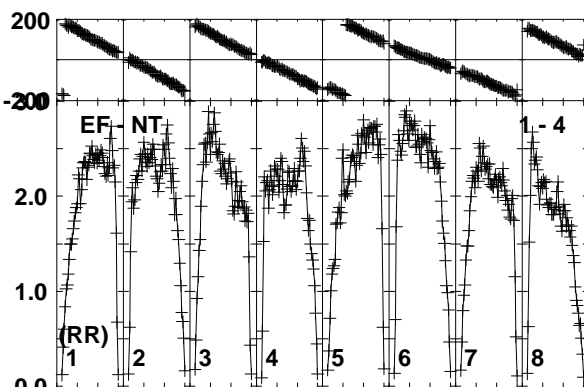
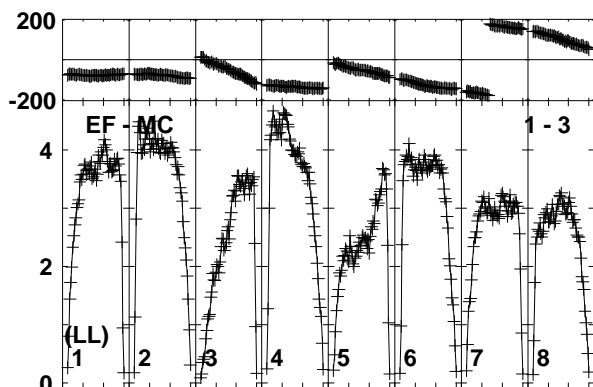
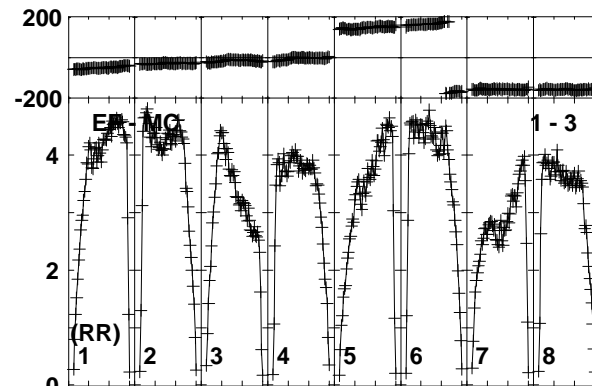
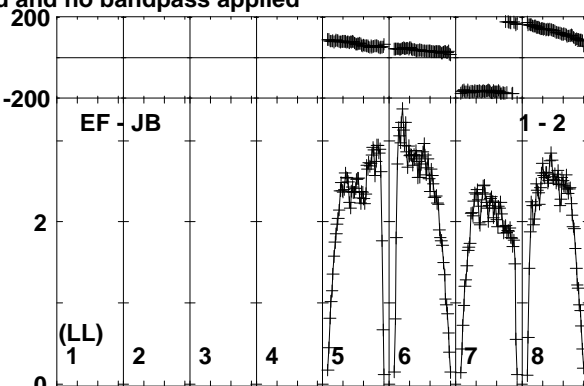
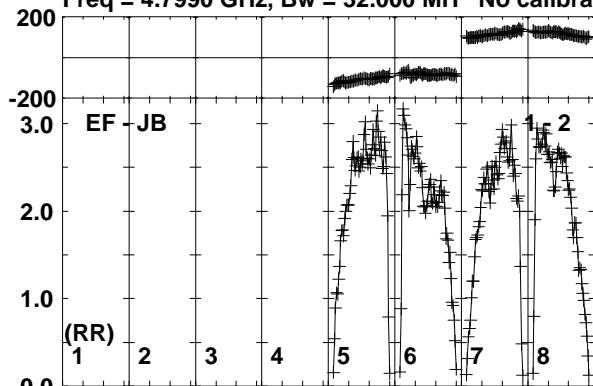

Lower frame: Milli Ampl Jy Top frame: Phas deg
Vector averaged cross-power spectrum Baseline: EF (01) - JB (02)
Timerange: 00/21:11:21 to 00/21:12:49

Plot file version 18 created 21-FEB-2017 15:10:44

J1108+4330 EG096A.UVDATA.1

Freq = 4.7990 GHz, Bw = 32.000 MH No calibration applied and no bandpass applied

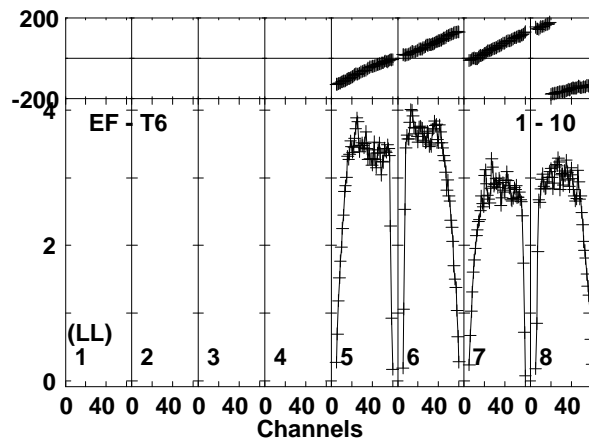
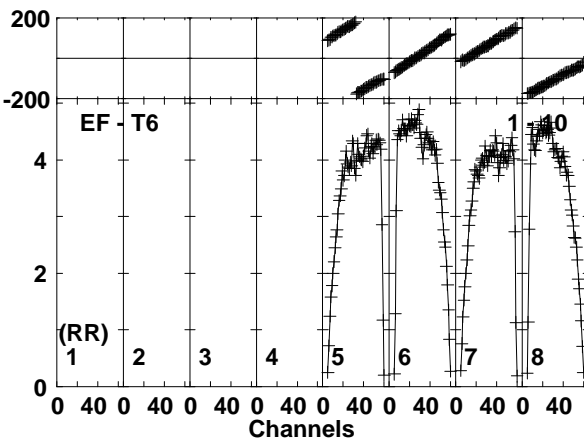
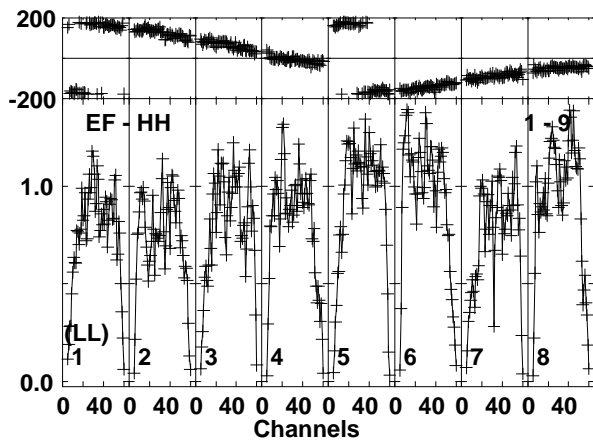
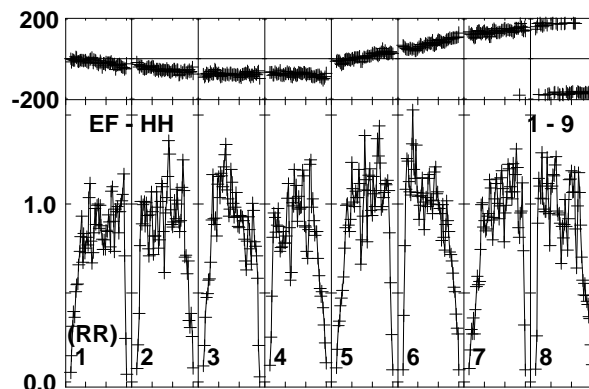
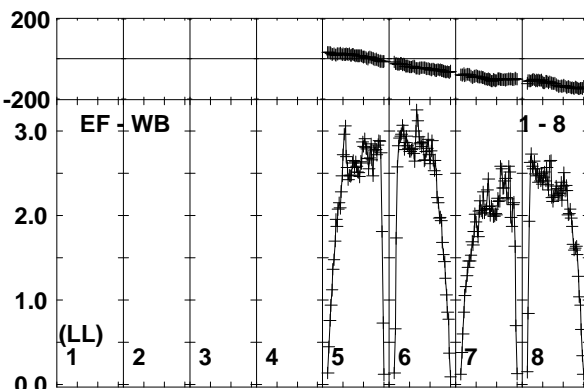
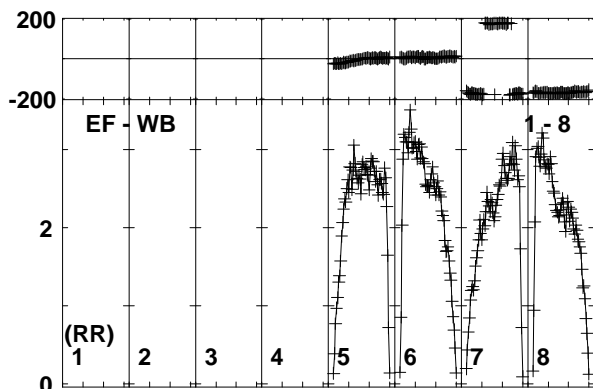
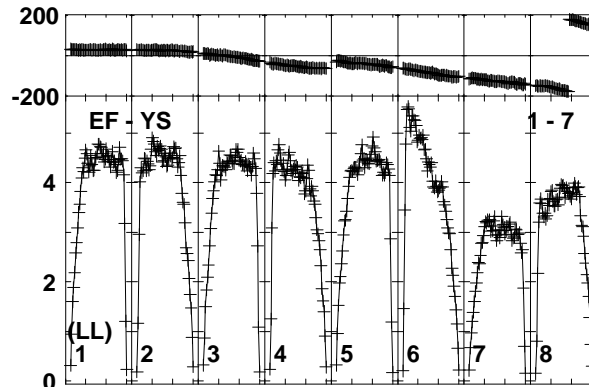
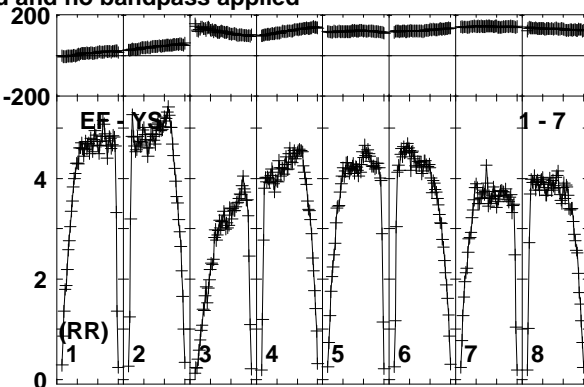
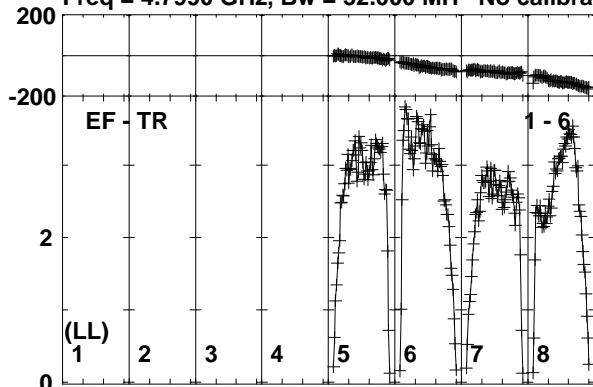

Lower frame: Milli Ampl Jy Top frame: Phas deg
Vector averaged cross-power spectrum Baseline: EF (01) - TR (06)
Timerange: 00/21:11:21 to 00/21:12:49

Plot file version 19 created 21-FEB-2017 15:10:45

ARUMA EG096A.UVDATA.1

Freq = 4.7990 GHz, Bw = 32.000 MH No calibration applied and no bandpass applied

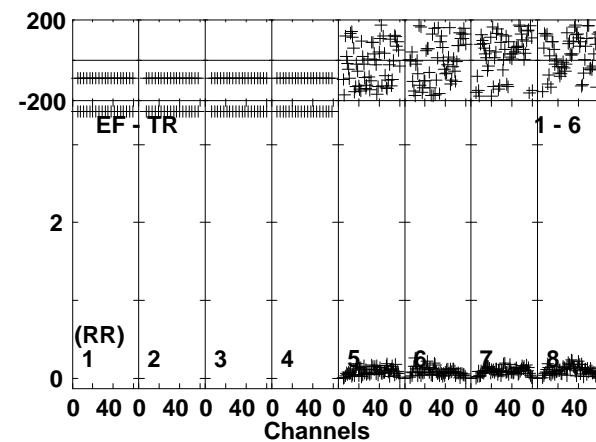
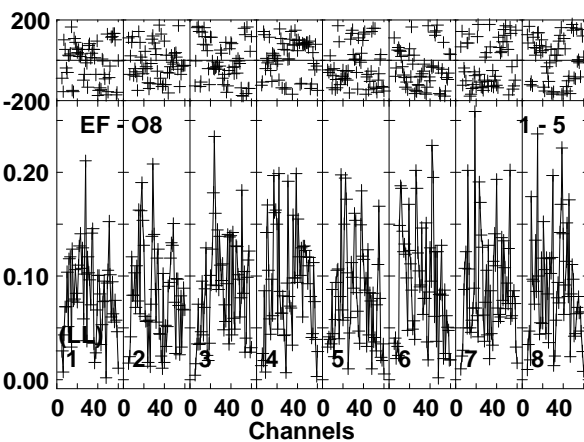
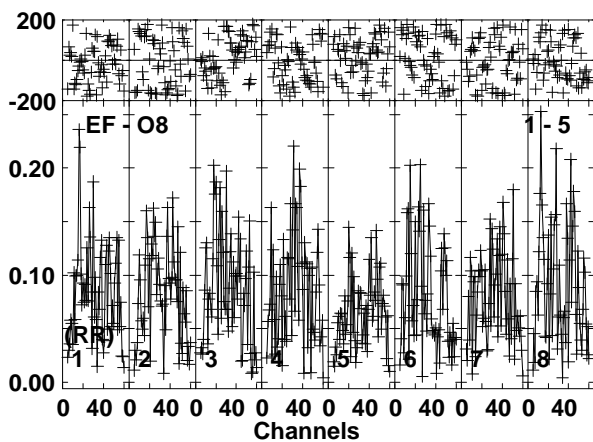
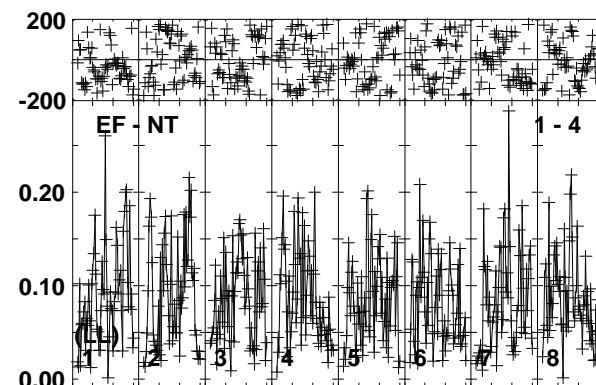
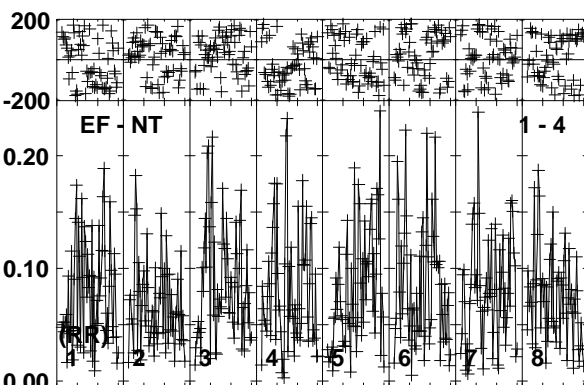
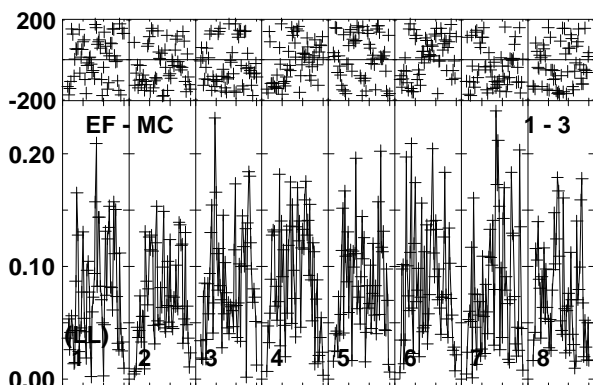
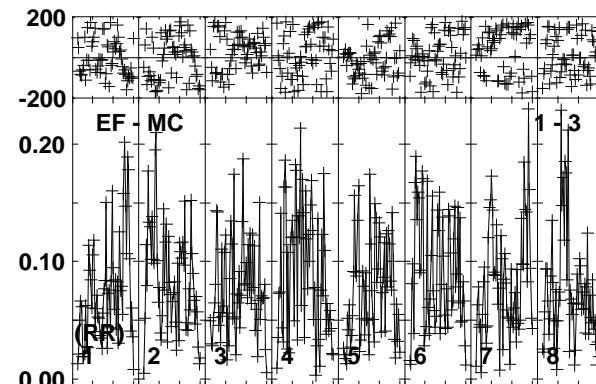
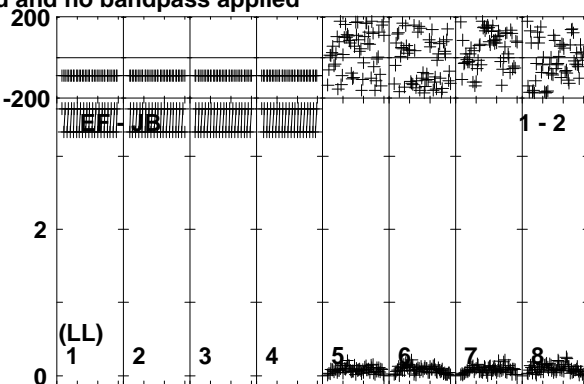
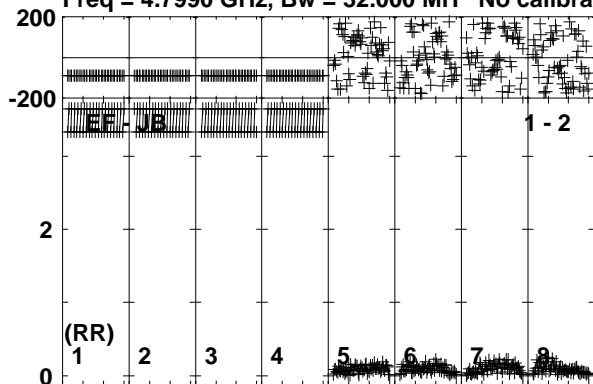

Lower frame: Milli Ampl Jy Top frame: Phas deg
Vector averaged cross-power spectrum Baseline: EF (01) - JB (02)
Timerange: 00/21:12:50 to 00/21:16:19

Plot file version 20 created 21-FEB-2017 15:10:45

ARUMA EG096A.UVDATA.1

Freq = 4.7990 GHz, Bw = 32.000 MH No calibration applied and no bandpass applied

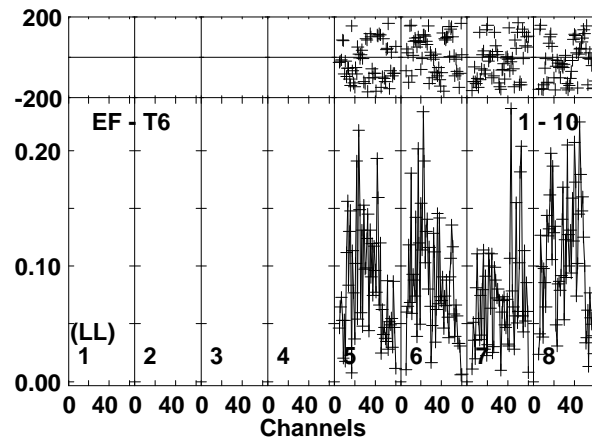
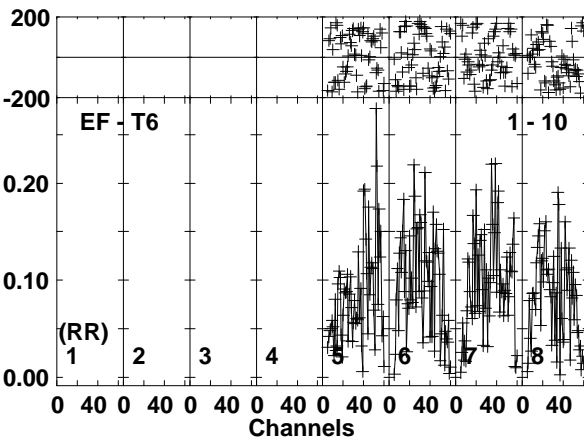
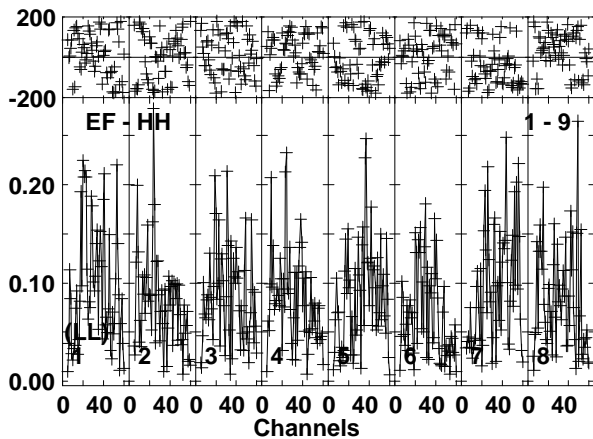
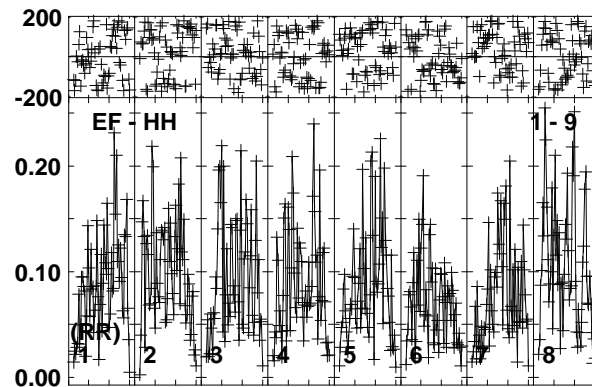
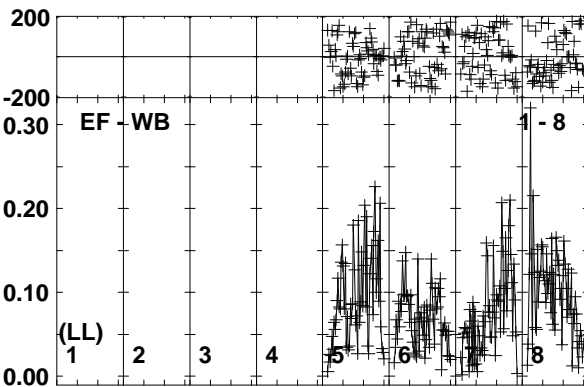
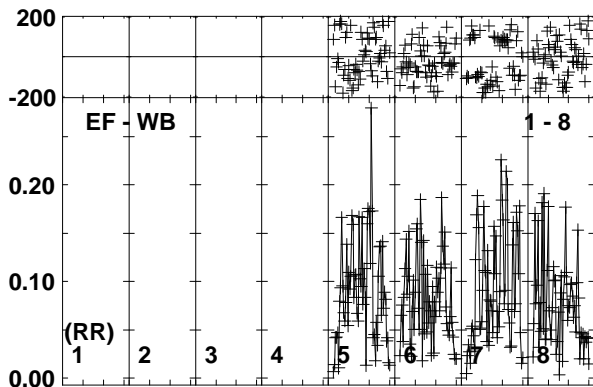
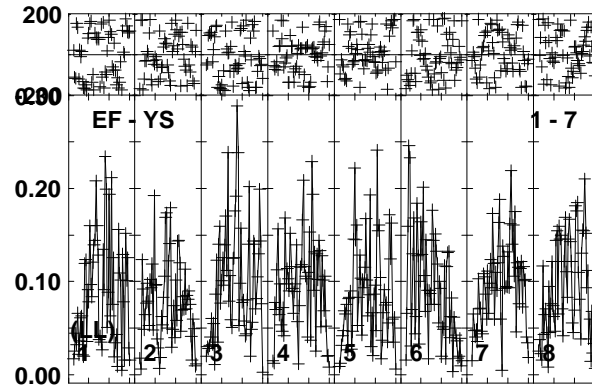
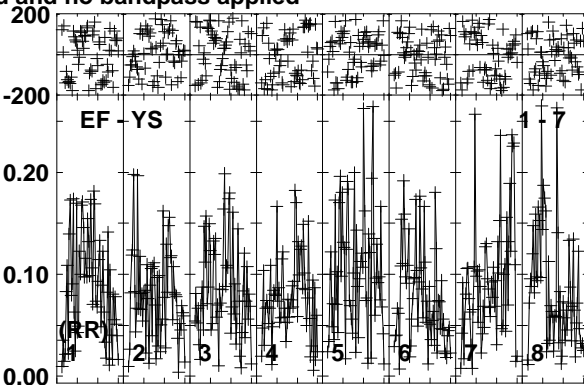
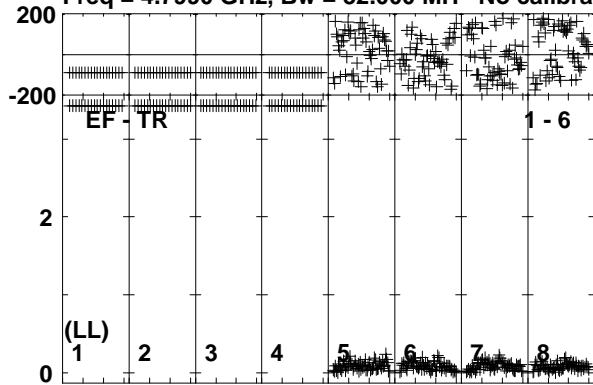

Lower frame: Milli Ampl Jy Top frame: Phas deg
Vector averaged cross-power spectrum Baseline: EF (01) - TR (06)
Timerange: 00/21:12:50 to 00/21:16:19

Plot file version 21 created 21-FEB-2017 15:10:45

J1108+4330 EG096A.UVDATA.1

Freq = 4.7990 GHz, Bw = 32.000 MH No calibration applied and no bandpass applied

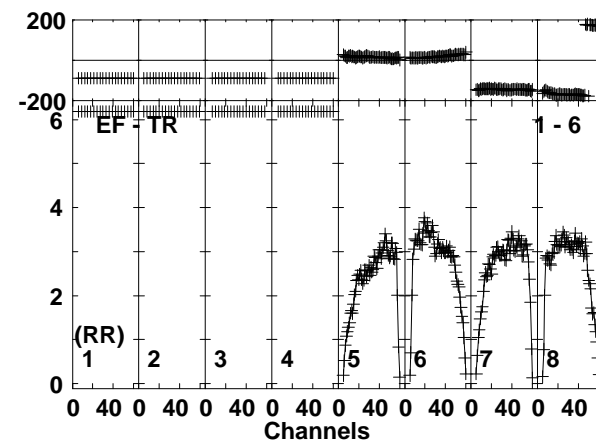
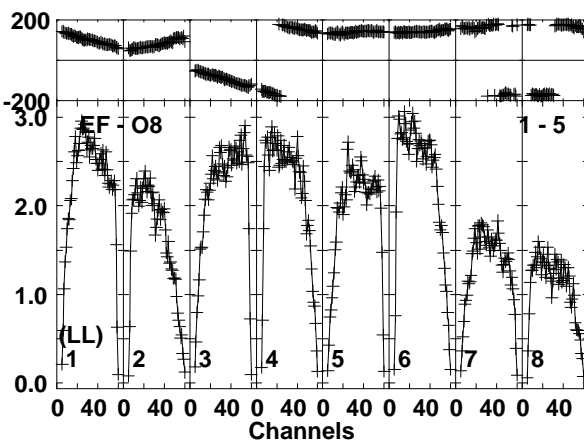
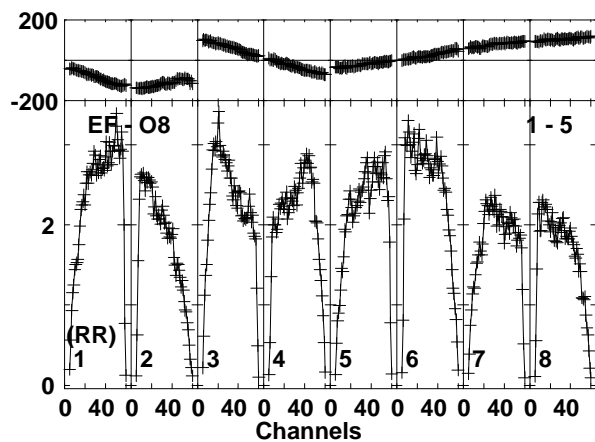
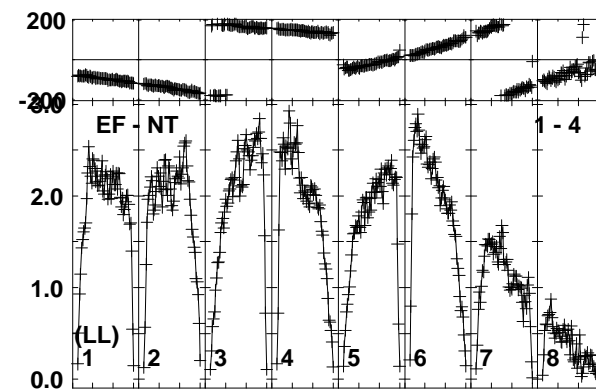
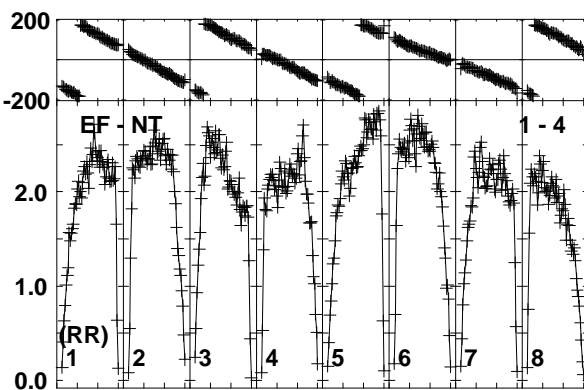
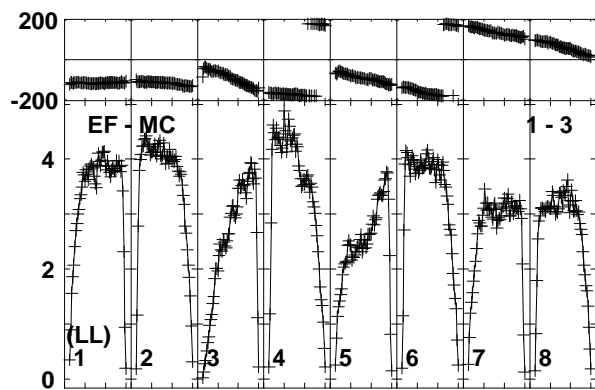
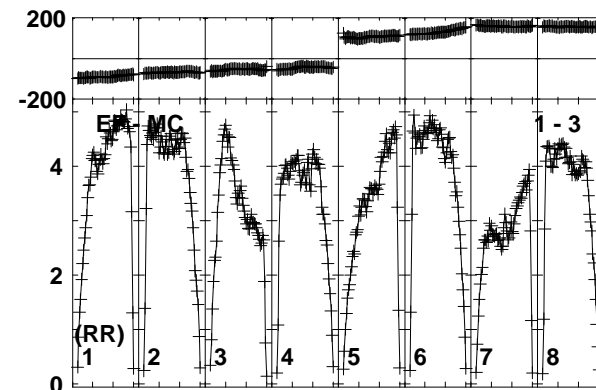
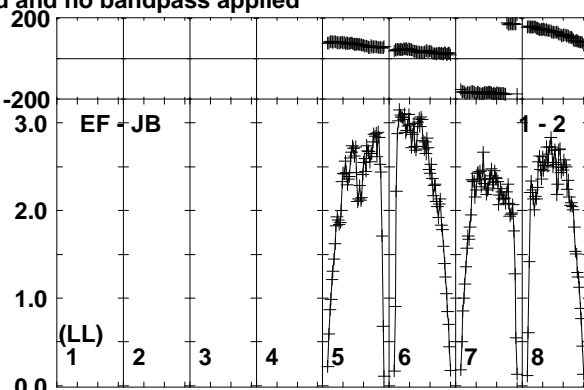
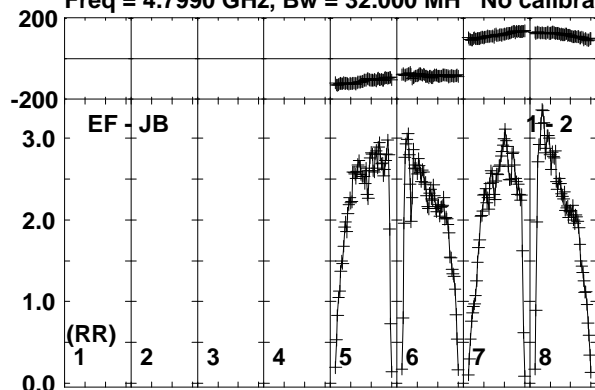

Lower frame: Milli Ampl Jy Top frame: Phas deg
Vector averaged cross-power spectrum Baseline: EF (01) - JB (02)
Timerange: 00/21:17:01 to 00/21:18:00

Plot file version 22 created 21-FEB-2017 15:10:45

J1108+4330 EG096A.UVDATA.1

Freq = 4.7990 GHz, Bw = 32.000 MH No calibration applied and no bandpass applied

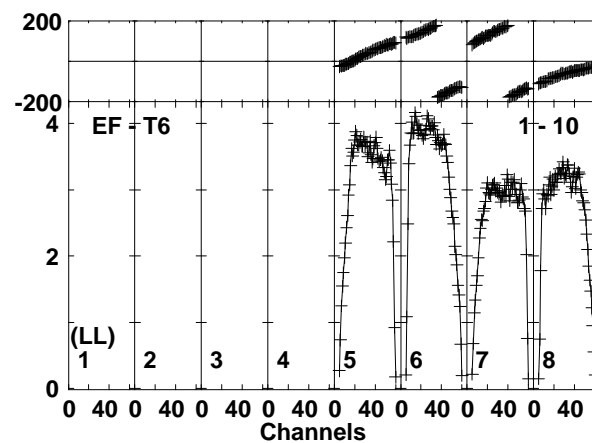
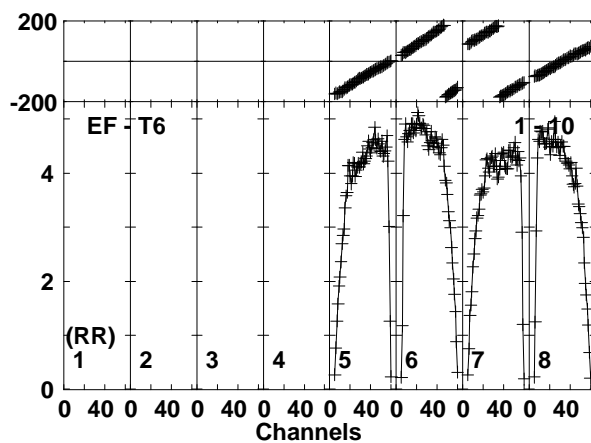
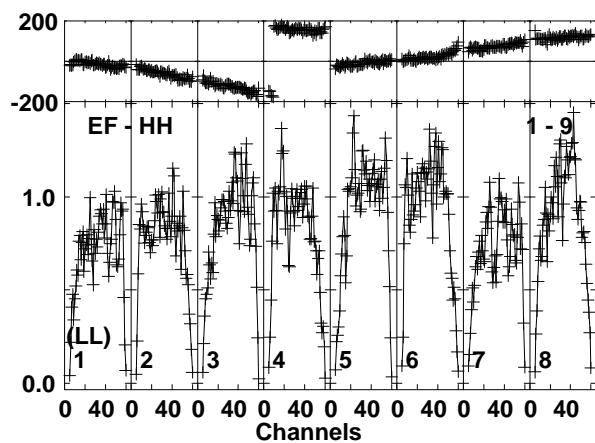
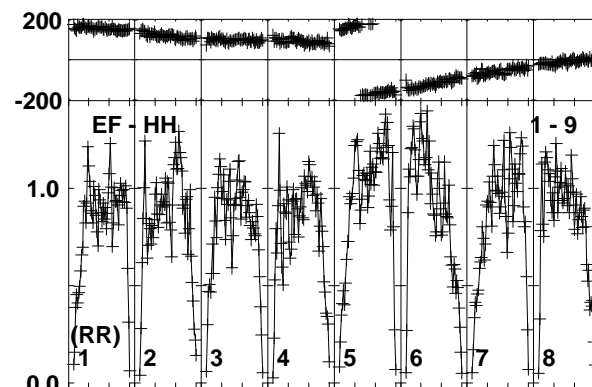
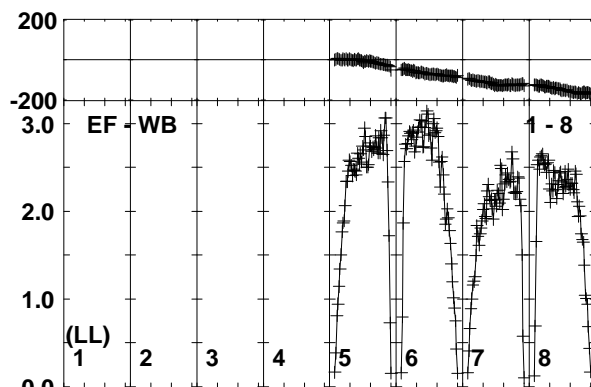
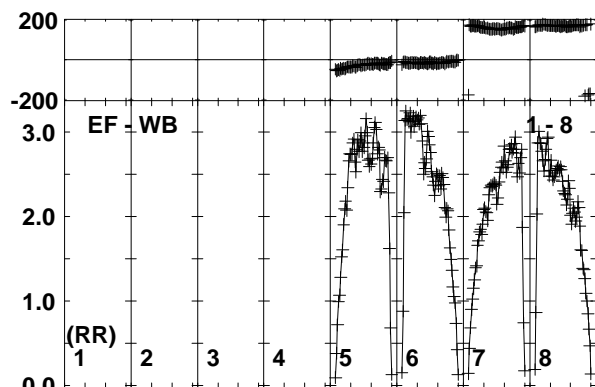
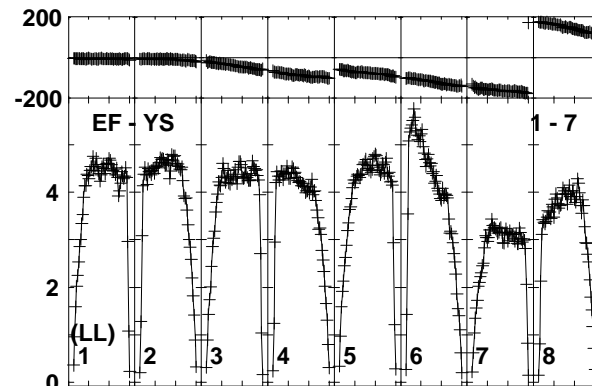
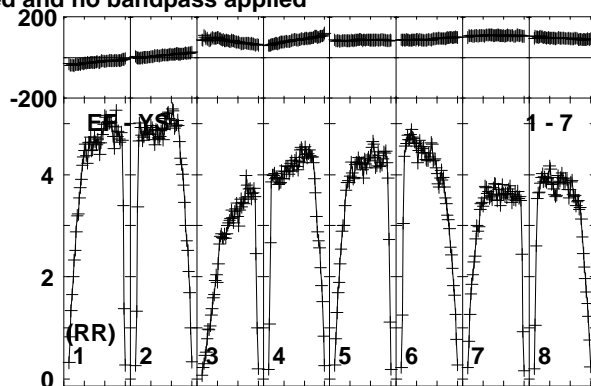
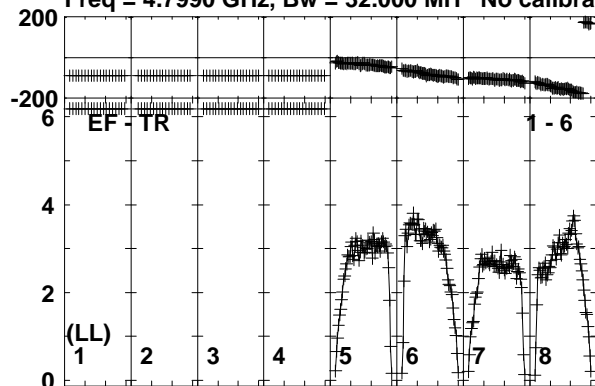

Lower frame: Milli Ampl Jy Top frame: Phas deg
Vector averaged cross-power spectrum Baseline: EF (01) - TR (06)
Timerange: 00/21:17:01 to 00/21:18:00

Plot file version 23 created 21-FEB-2017 15:10:46

ARUMA EG096A.UVDATA.1

Freq = 4.7990 GHz, Bw = 32.000 MH No calibration applied and no bandpass applied

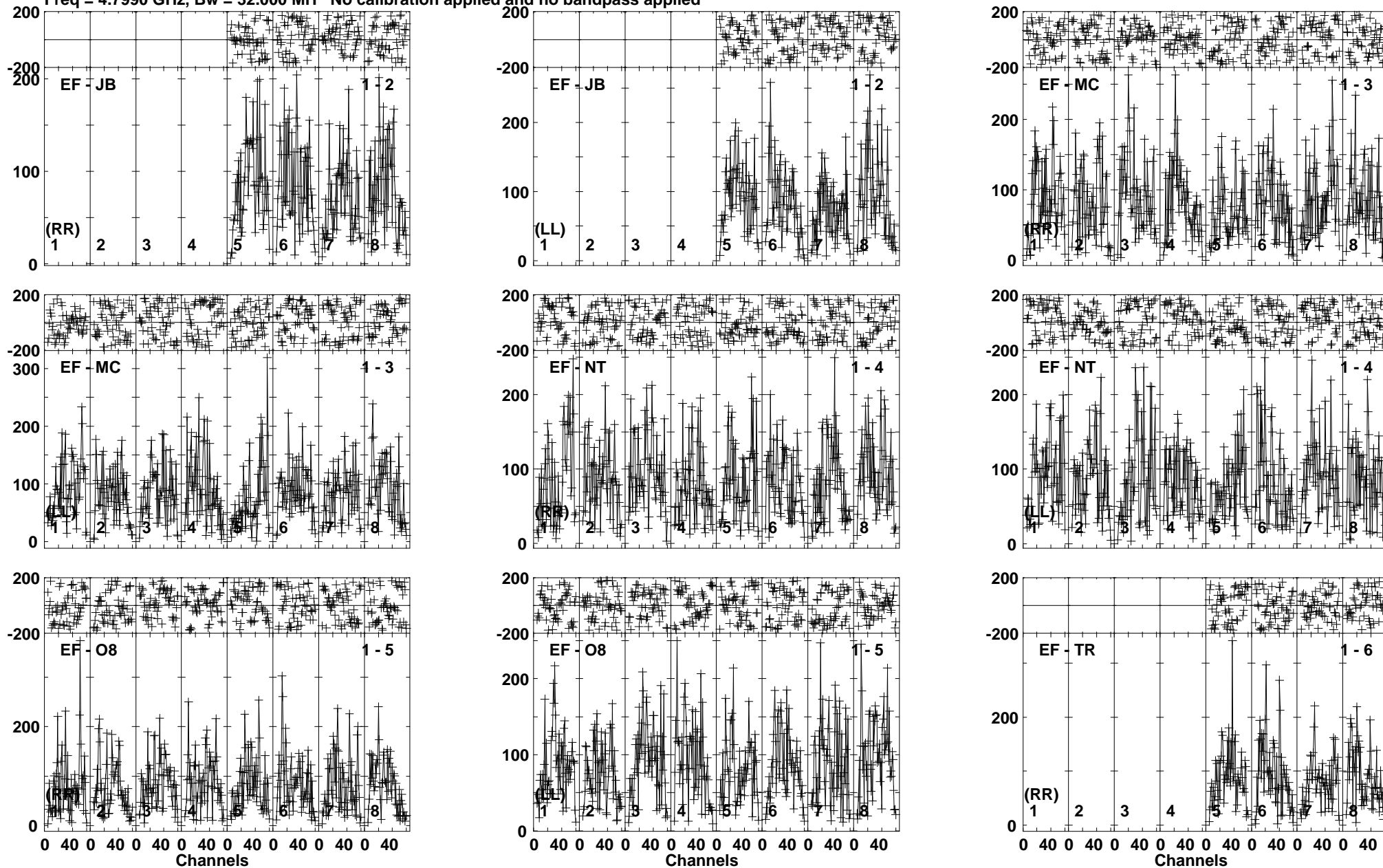

Lower frame: Micro Ampl Jy Top frame: Phas deg
Vector averaged cross-power spectrum Baseline: EF (01) - JB (02)
Timerange: 00/21:18:00 to 00/21:21:29

Plot file version 24 created 21-FEB-2017 15:10:46

ARUMA EG096A.UVDATA.1

Freq = 4.7990 GHz, Bw = 32.000 MH No calibration applied and no bandpass applied

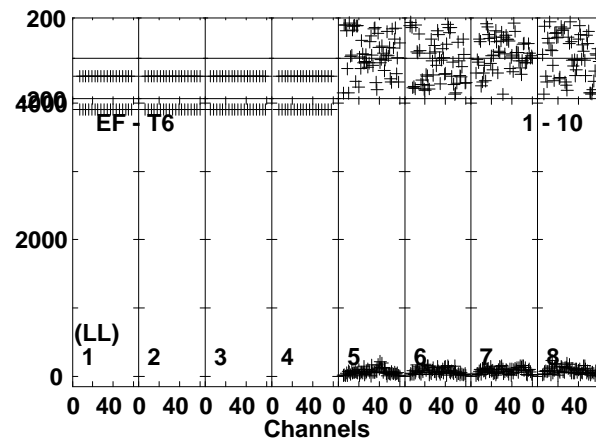
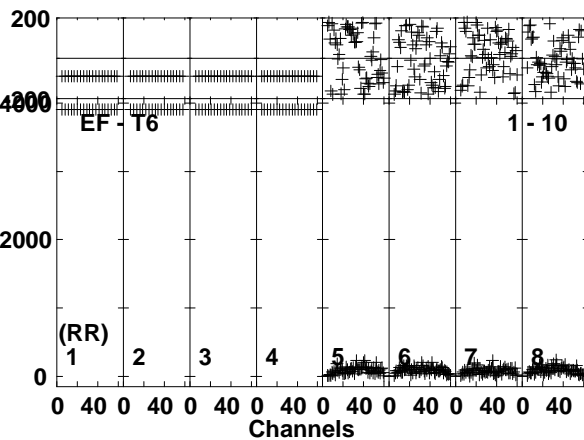
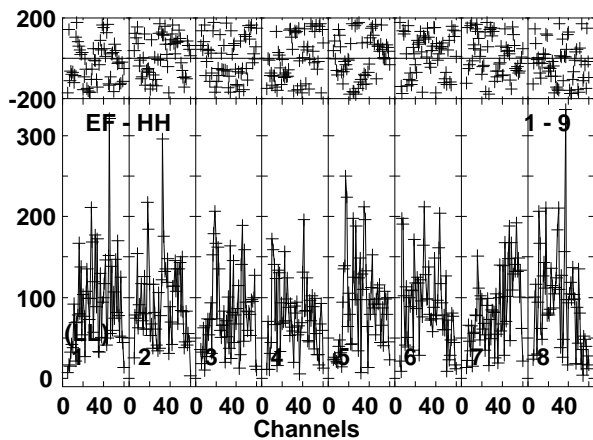
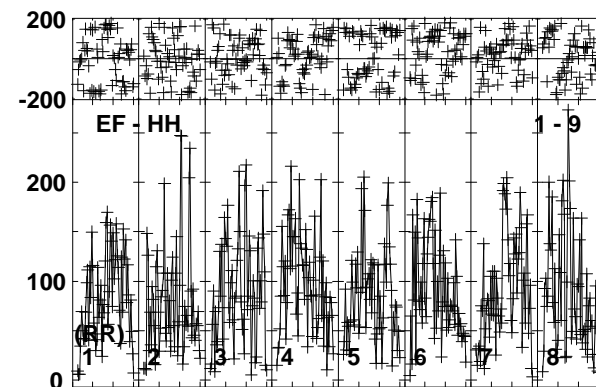
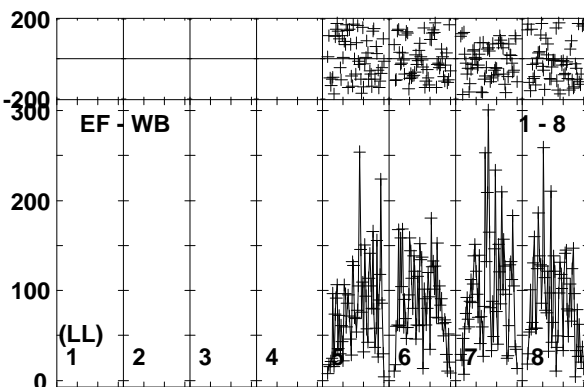
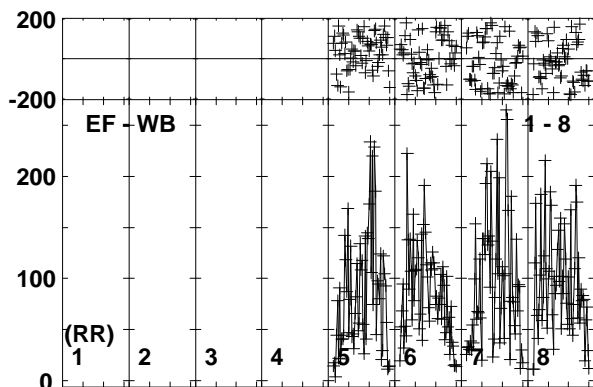
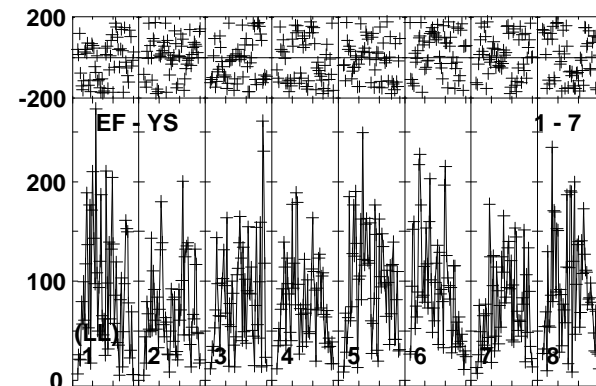
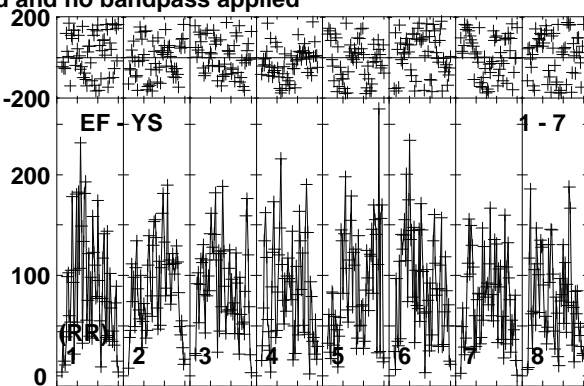
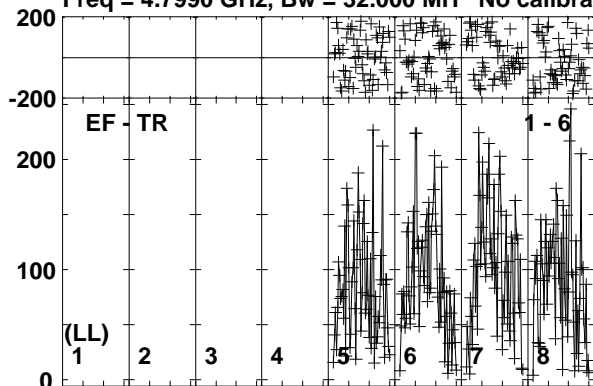

Lower frame: Micro Ampl Jy Top frame: Phas deg
Vector averaged cross-power spectrum Baseline: EF (01) - TR (06)
Timerange: 00/21:18:00 to 00/21:21:29

Plot file version 25 created 21-FEB-2017 15:10:46

J1108+4330 EG096A.UVDATA.1

Freq = 4.7990 GHz, Bw = 32.000 MH No calibration applied and no bandpass applied

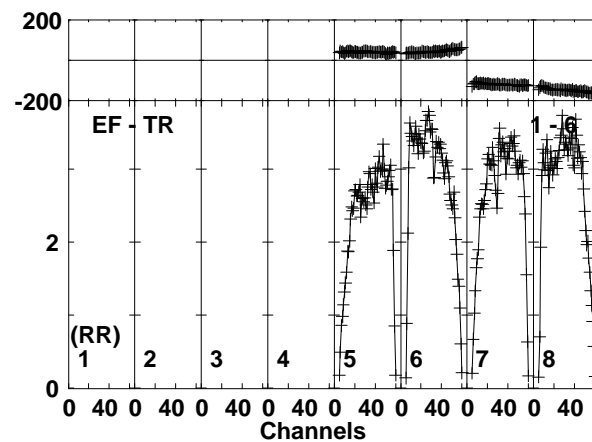
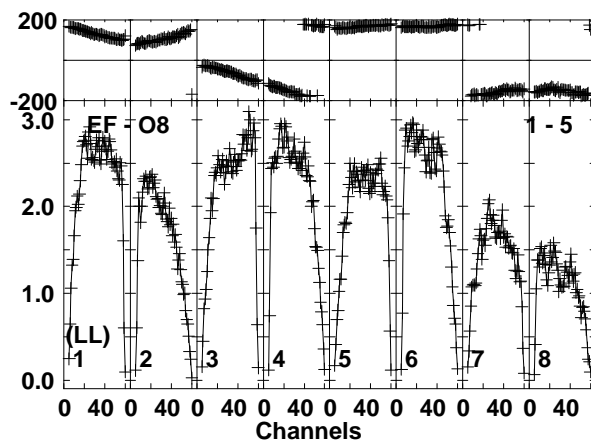
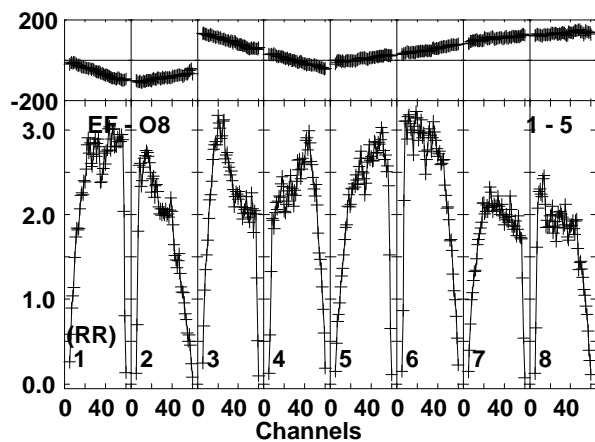
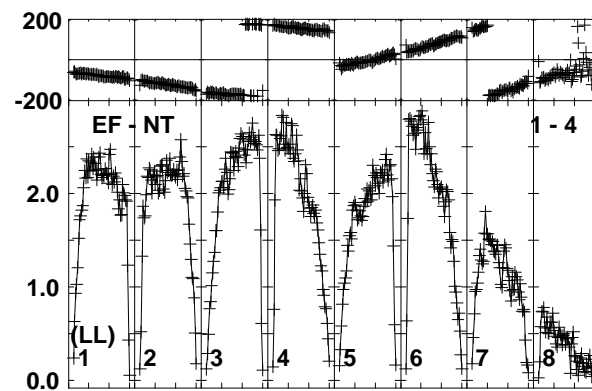
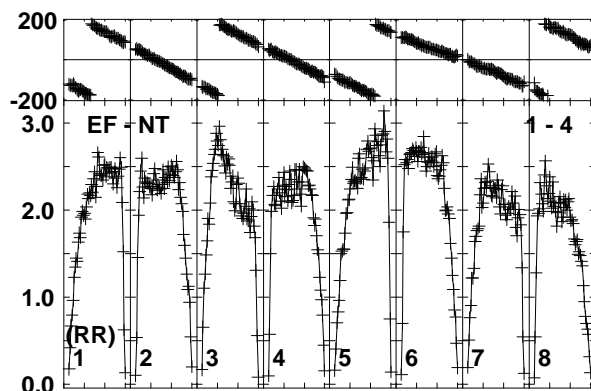
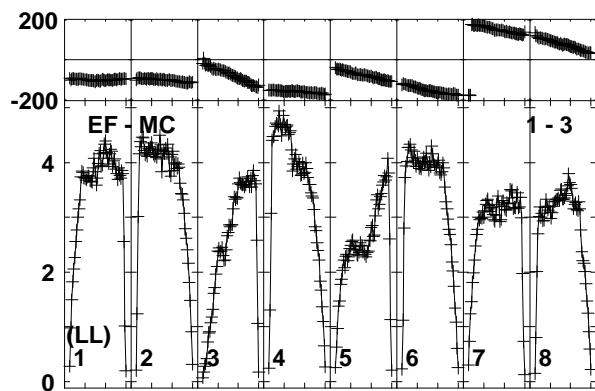
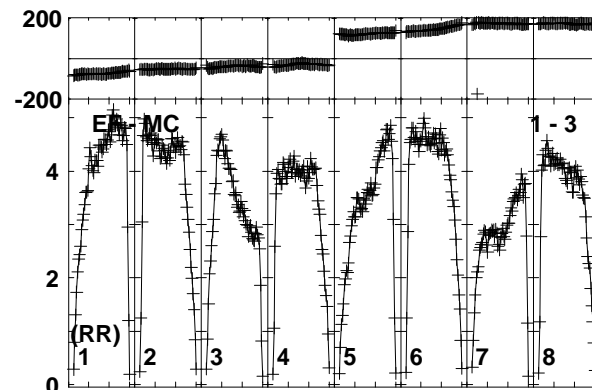
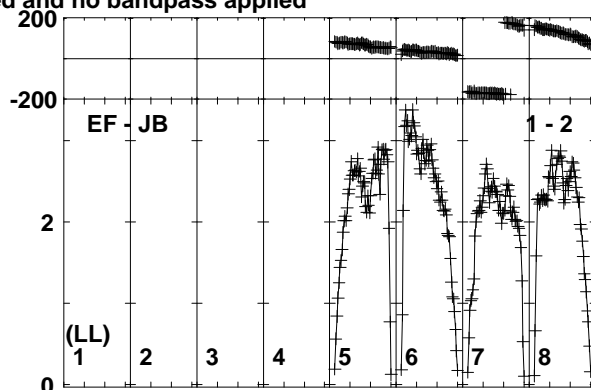
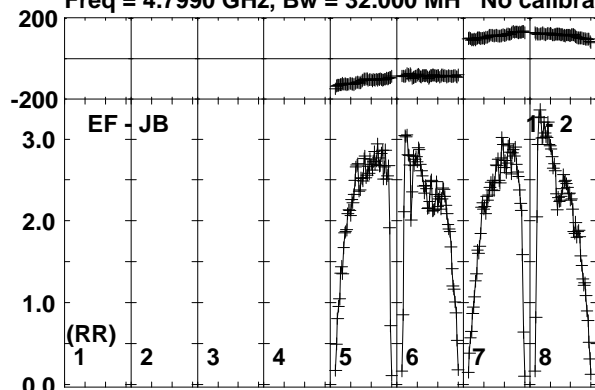

Lower frame: Milli Ampl Jy Top frame: Phas deg
Vector averaged cross-power spectrum Baseline: EF (01) - JB (02)
Timerange: 00/21:21:30 to 00/21:22:59

Plot file version 26 created 21-FEB-2017 15:10:47

J1108+4330 EG096A.UVDATA.1

Freq = 4.7990 GHz, Bw = 32.000 MH No calibration applied and no bandpass applied

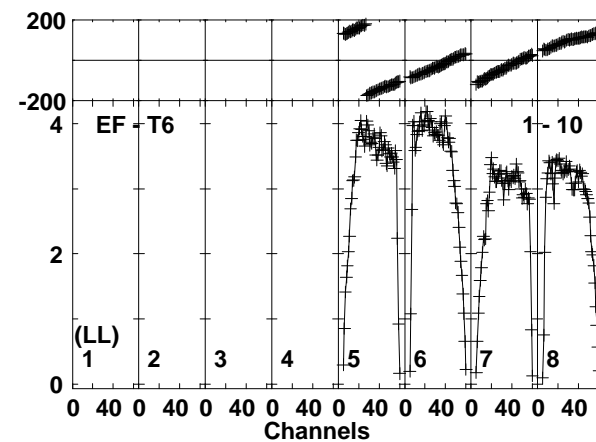
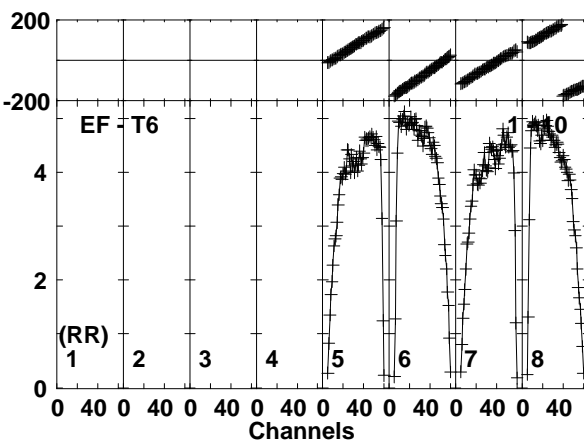
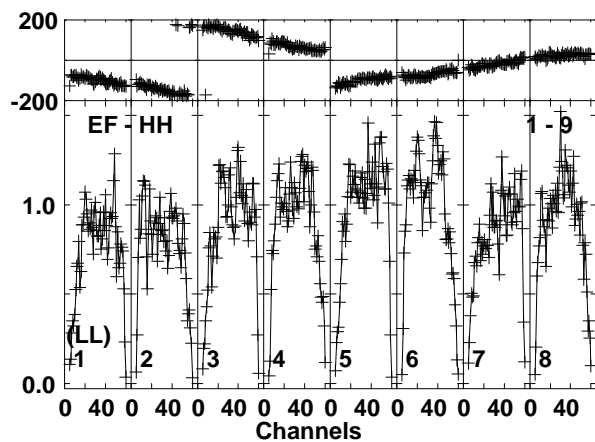
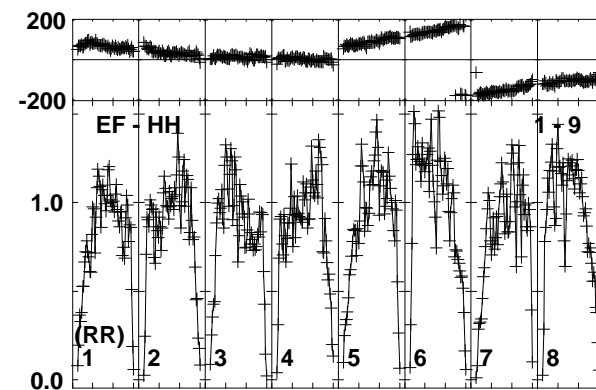
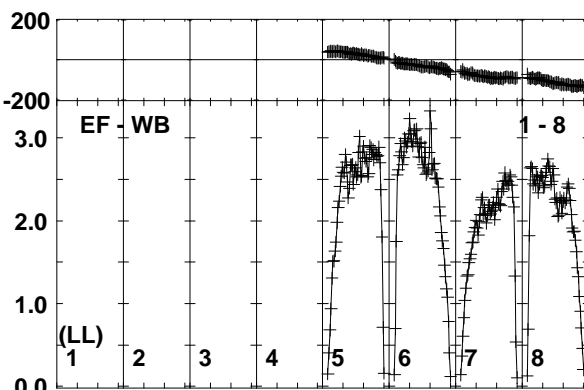
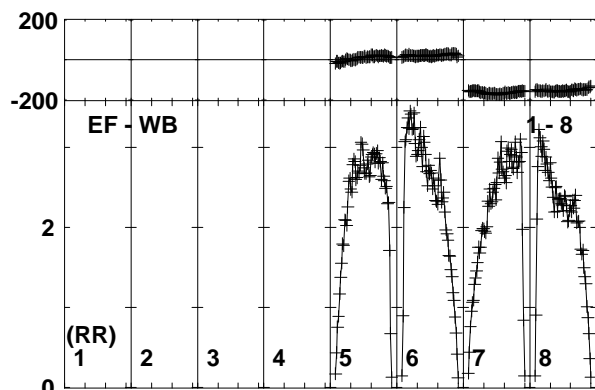
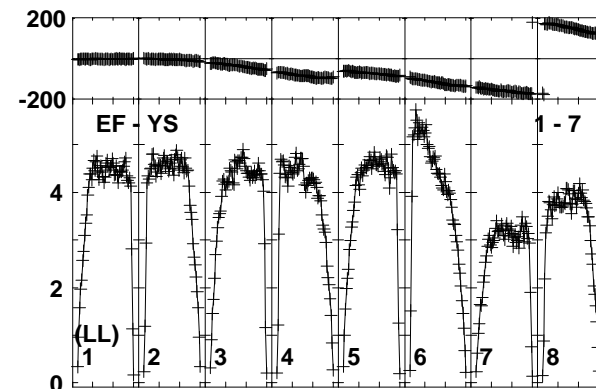
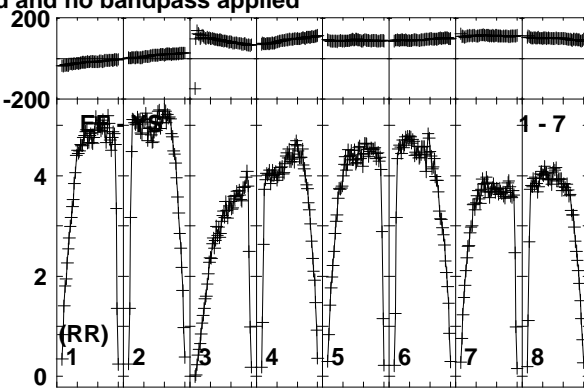
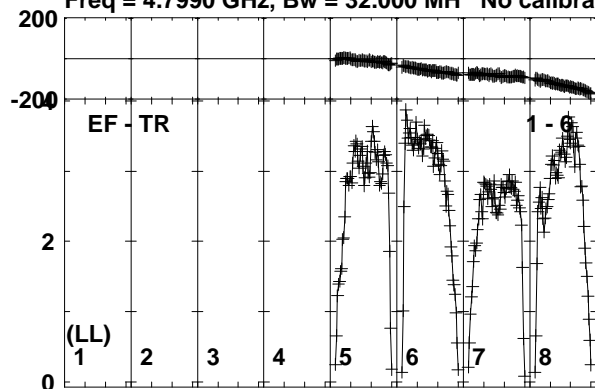

Lower frame: Milli Ampl Jy Top frame: Phas deg
Vector averaged cross-power spectrum Baseline: EF (01) - TR (06)
Timerange: 00/21:21:30 to 00/21:22:59

Plot file version 27 created 21-FEB-2017 15:10:47

ARUMA EG096A.UVDATA.1

Freq = 4.7990 GHz, Bw = 32.000 MH No calibration applied and no bandpass applied

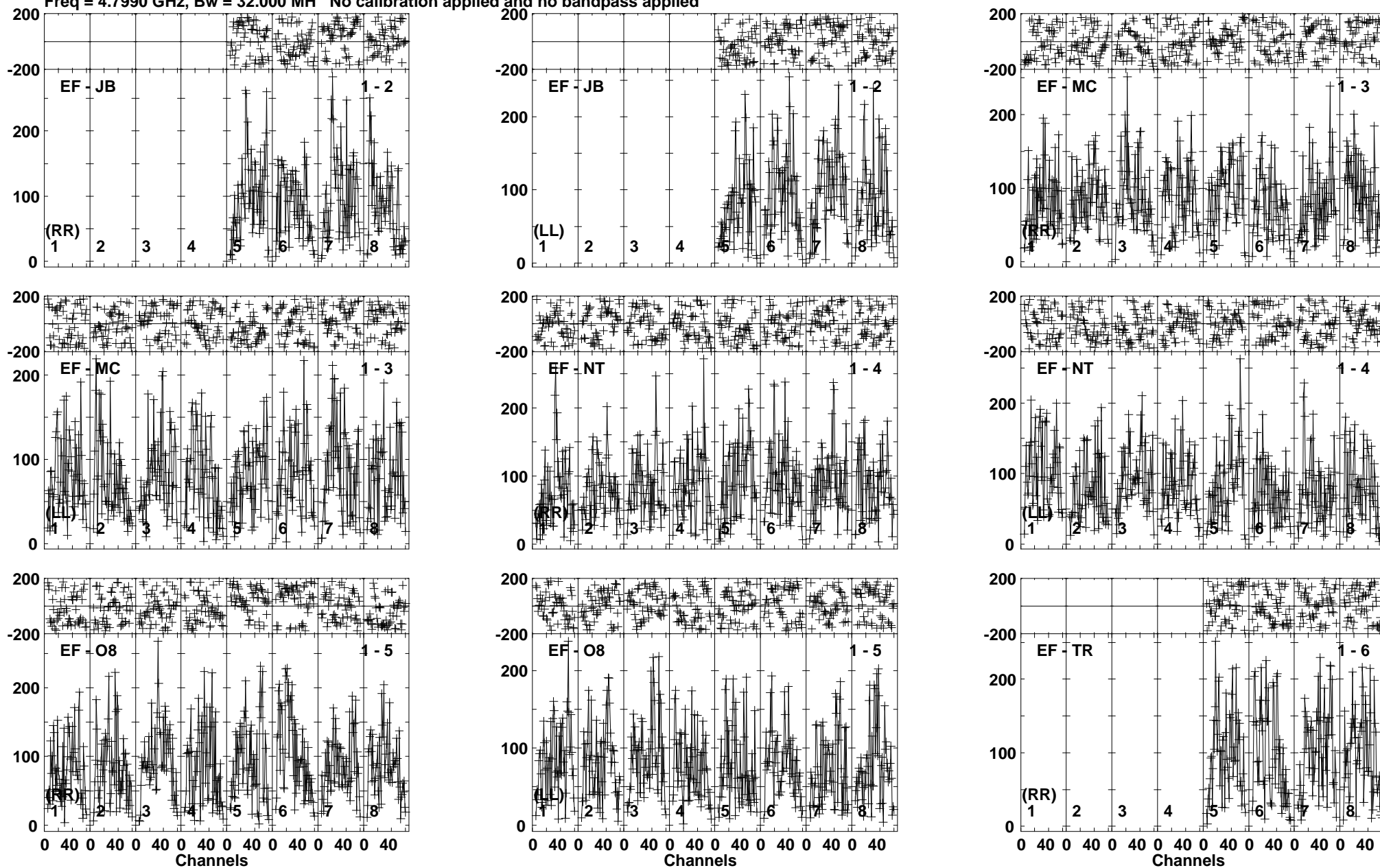

Lower frame: Micro Ampl Jy Top frame: Phas deg
Vector averaged cross-power spectrum Baseline: EF (01) - JB (02)
Timerange: 00/21:23:01 to 00/21:26:30

Plot file version 28 created 21-FEB-2017 15:10:47

ARUMA EG096A.UVDATA.1

Freq = 4.7990 GHz, Bw = 32.000 MH No calibration applied and no bandpass applied

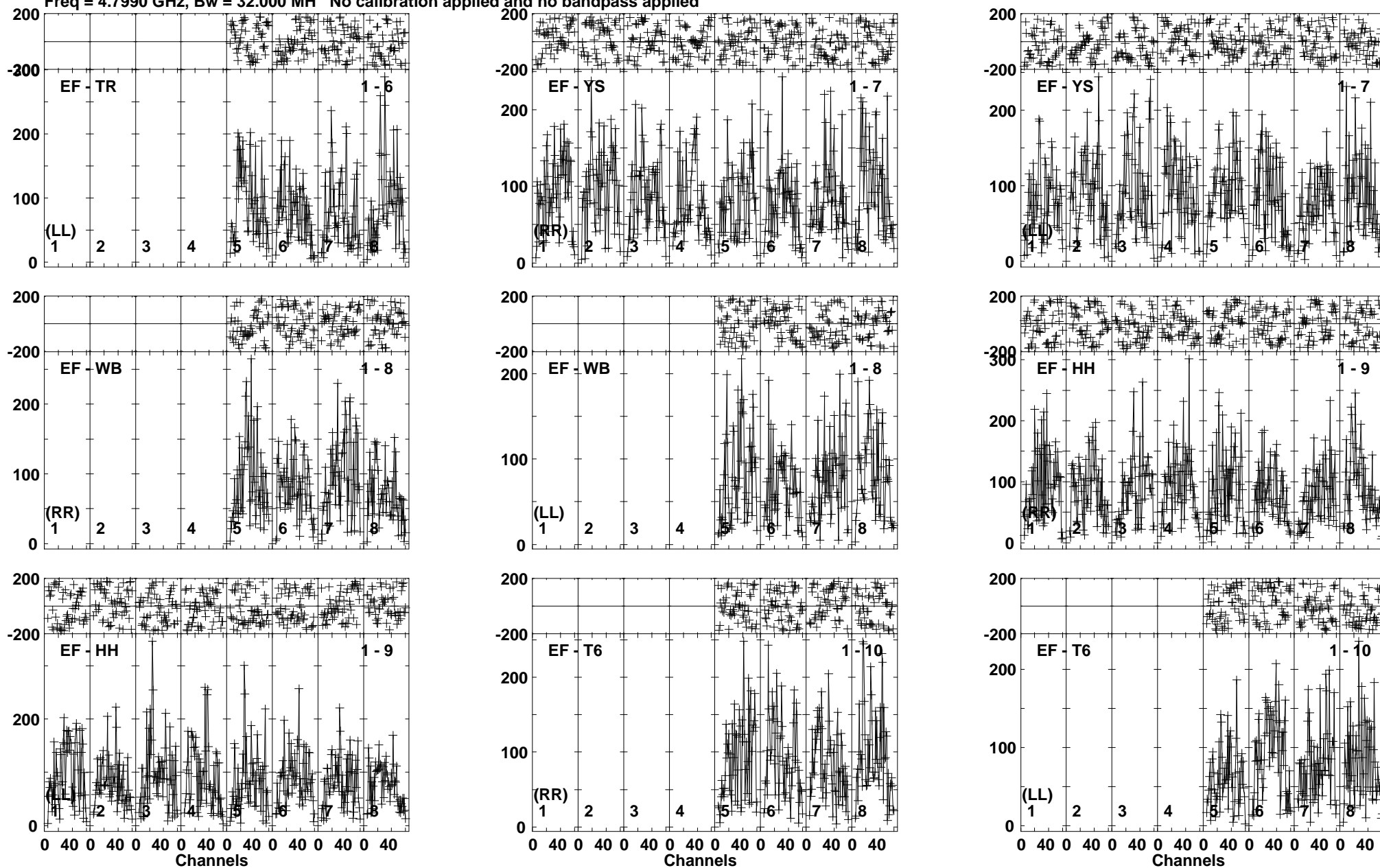

Lower frame: Micro Ampl Jy Top frame: Phas deg
Vector averaged cross-power spectrum Baseline: EF (01) - TR (06)
Timerange: 00/21:23:01 to 00/21:26:30

Plot file version 29 created 21-FEB-2017 15:10:48

J1108+4330 EG096A.UVDATA.1

Freq = 4.7990 GHz, Bw = 32.000 MH No calibration applied and no bandpass applied

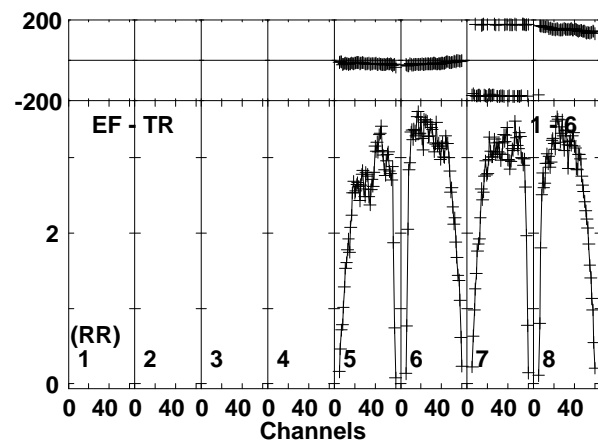
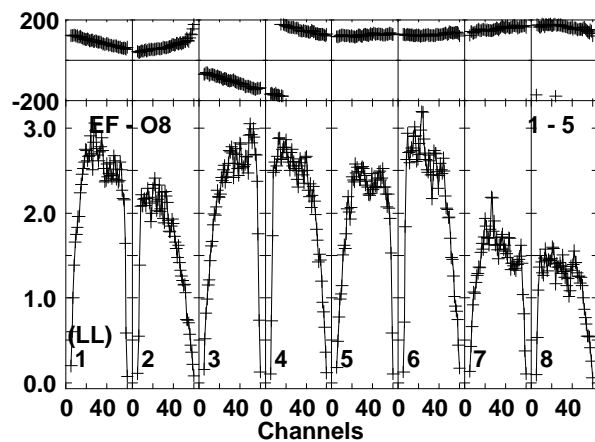
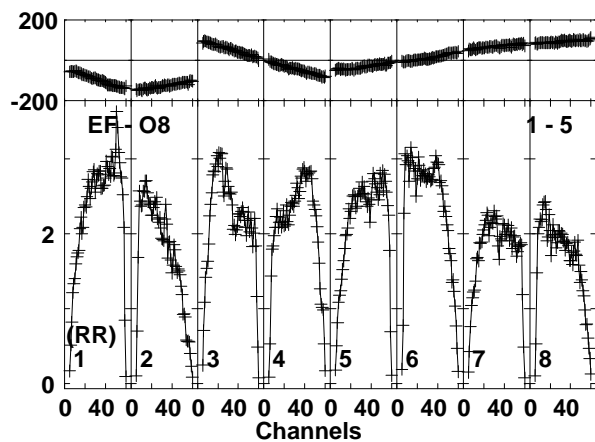
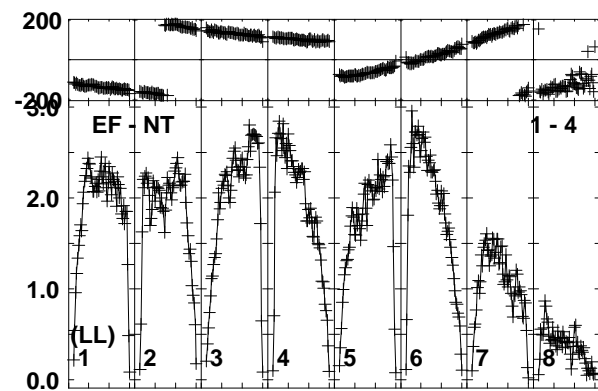
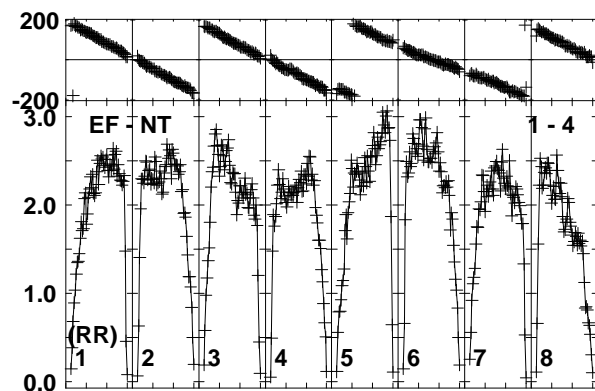
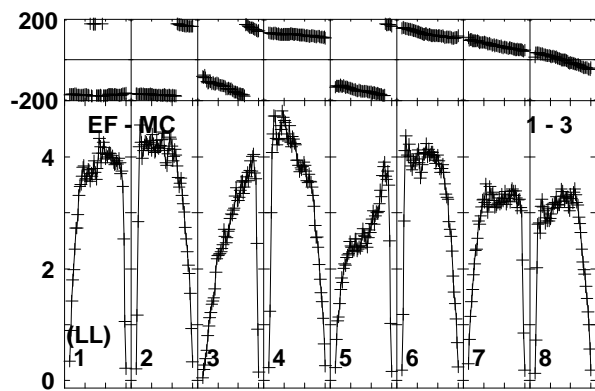
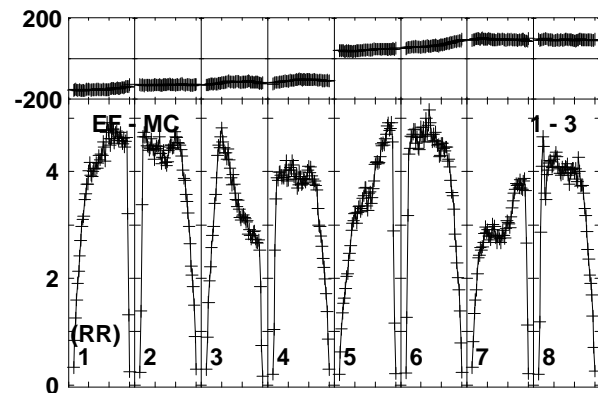
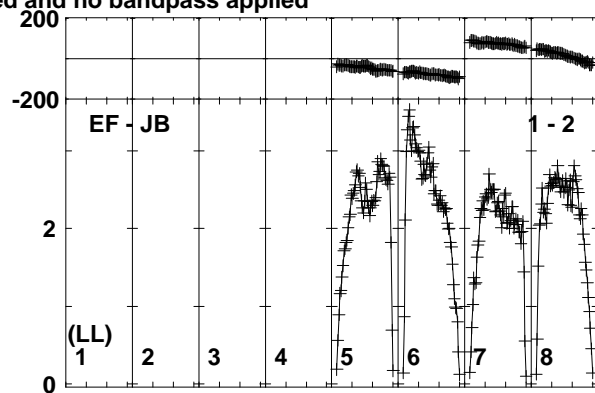
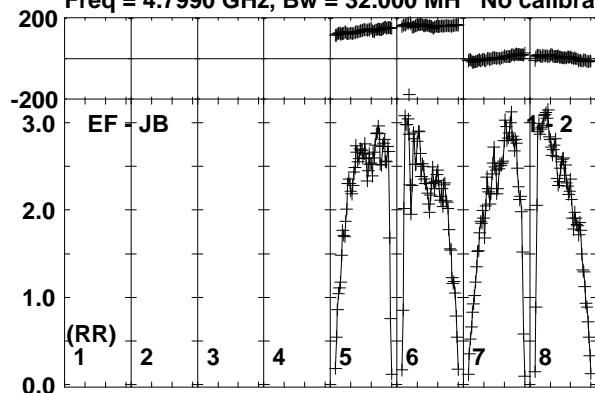

Lower frame: Milli Ampl Jy Top frame: Phas deg
Vector averaged cross-power spectrum Baseline: EF (01) - JB (02)
Timerange: 00/21:27:11 to 00/21:28:09

Plot file version 30 created 21-FEB-2017 15:10:48

J1108+4330 EG096A.UVDATA.1

Freq = 4.7990 GHz, Bw = 32.000 MH No calibration applied and no bandpass applied

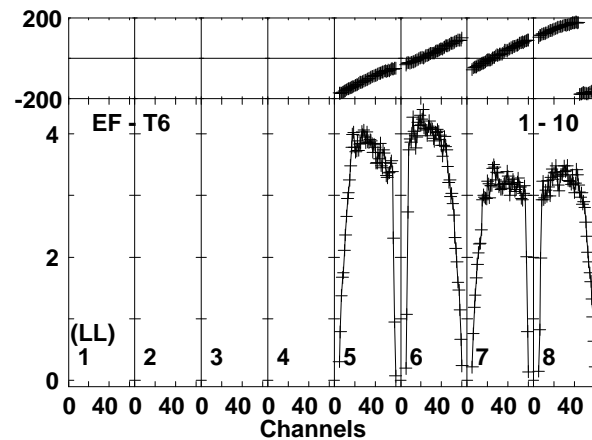
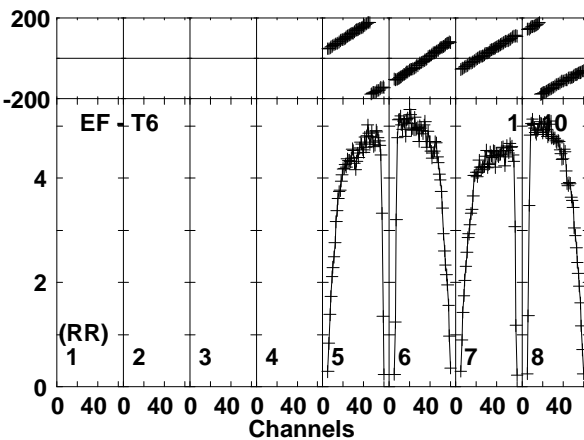
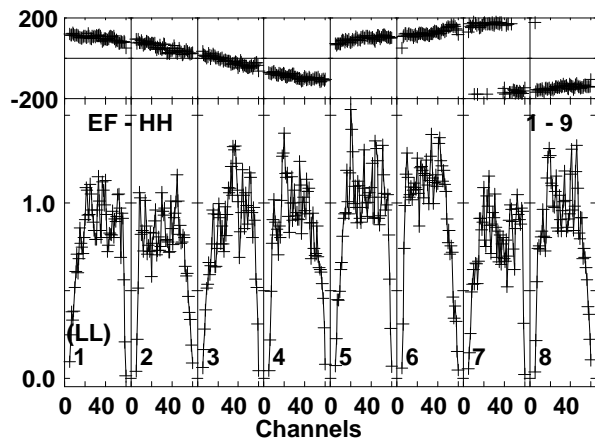
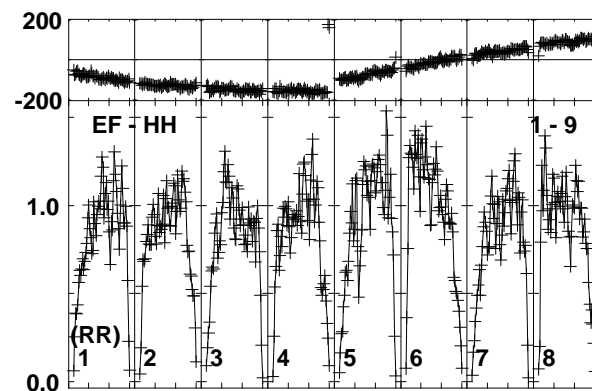
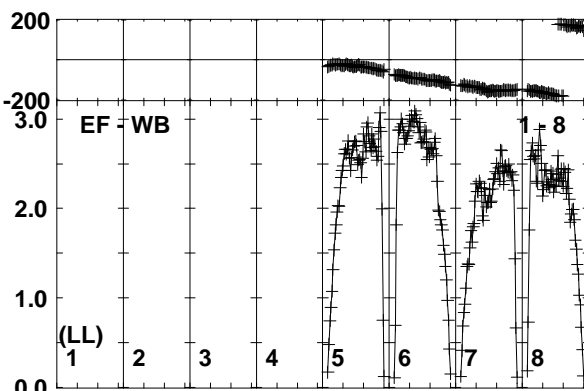
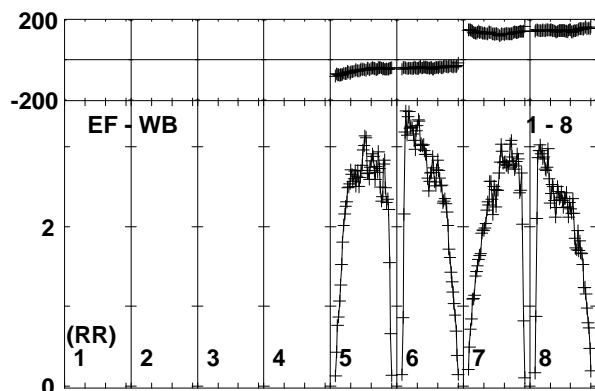
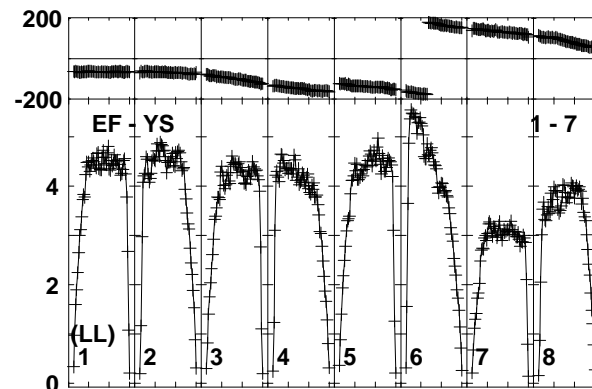
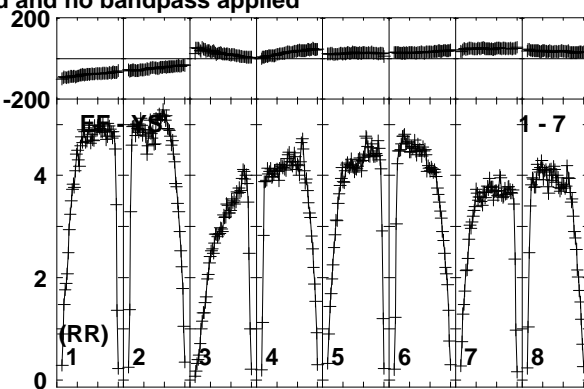
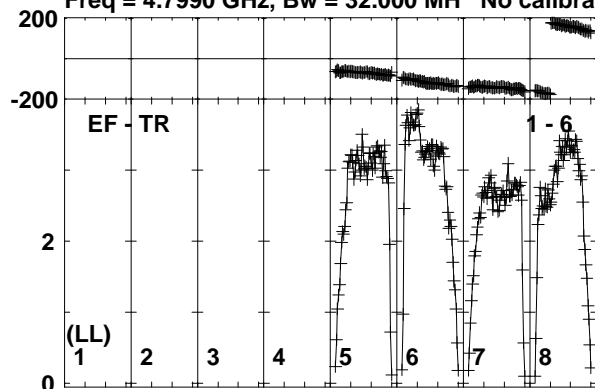

Lower frame: Milli Ampl Jy Top frame: Phas deg
Vector averaged cross-power spectrum Baseline: EF (01) - TR (06)
Timerange: 00/21:27:11 to 00/21:28:09

Plot file version 31 created 21-FEB-2017 15:10:48

J1112+4301 EG096A.UVDATA.1

Freq = 4.7990 GHz, Bw = 32.000 MH No calibration applied and no bandpass applied

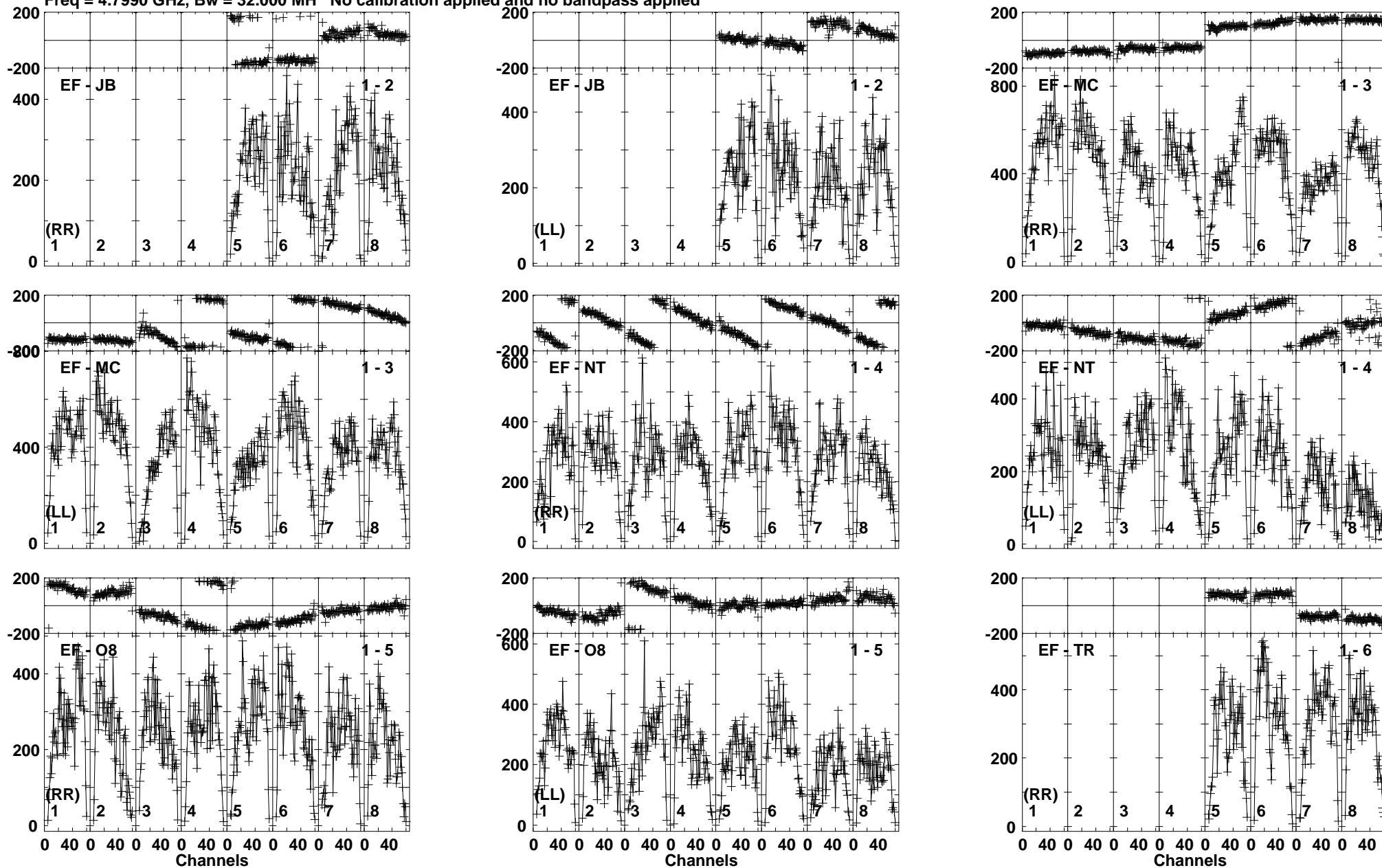

Lower frame: Micro Ampl Jy Top frame: Phas deg
Vector averaged cross-power spectrum Baseline: EF (01) - JB (02)
Timerange: 00/21:28:10 to 00/21:31:39

Plot file version 32 created 21-FEB-2017 15:10:48

J1112+4301 EG096A.UVDATA.1

Freq = 4.7990 GHz, Bw = 32.000 MH No calibration applied and no bandpass applied

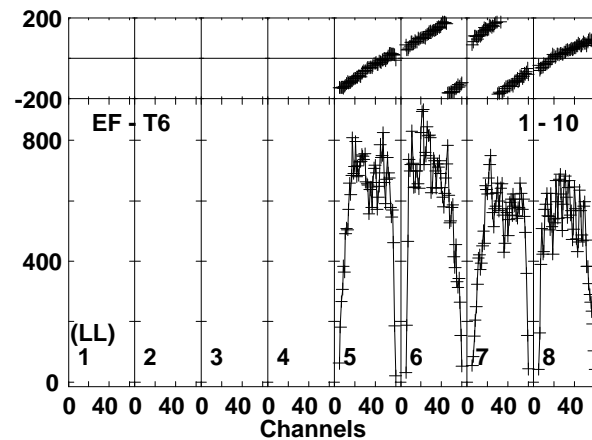
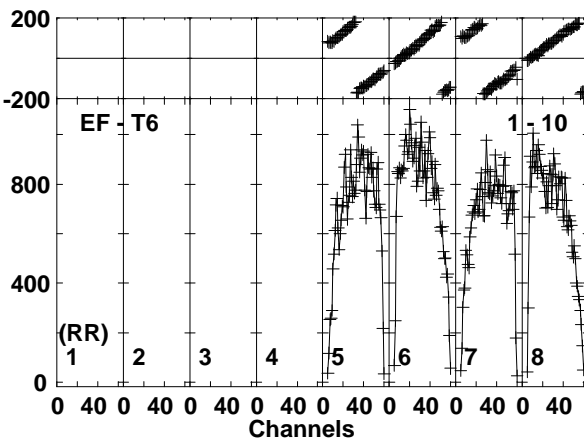
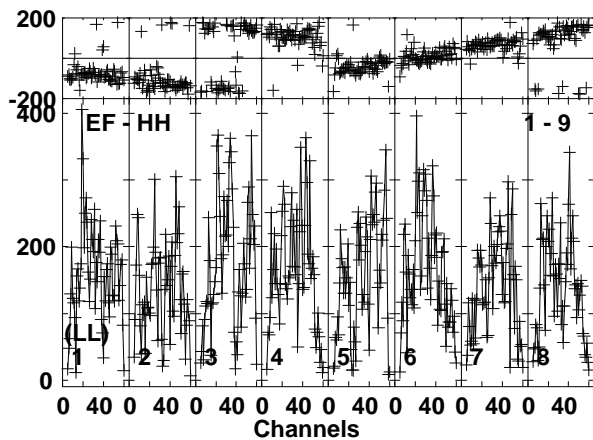
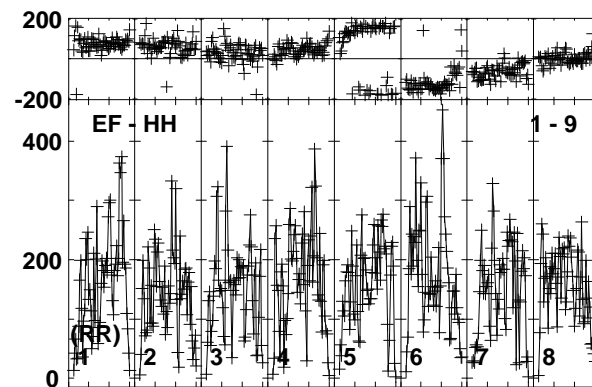
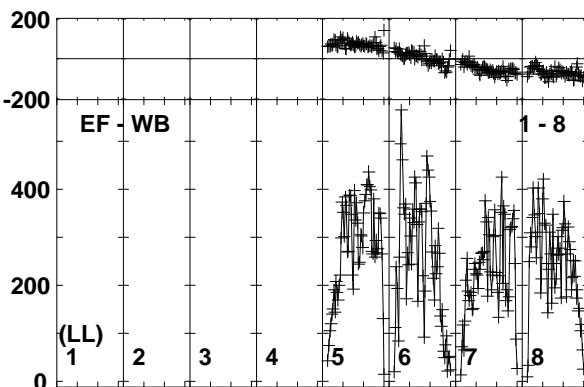
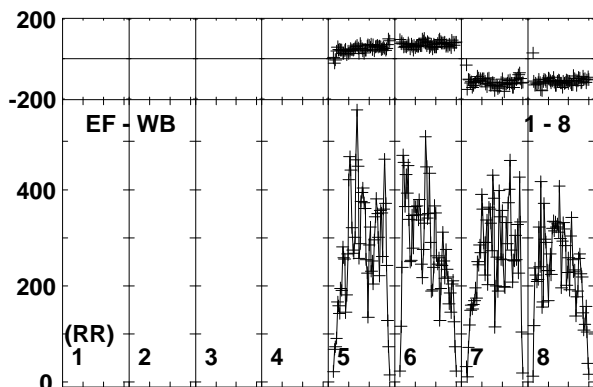
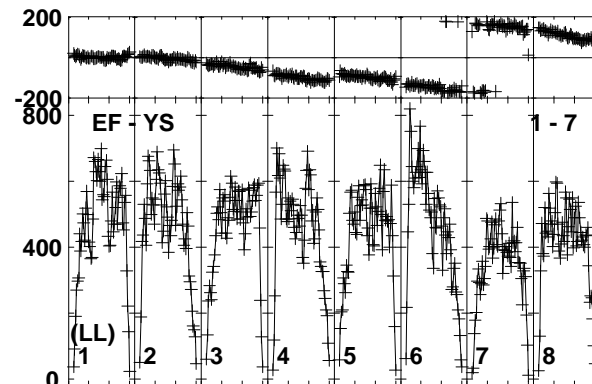
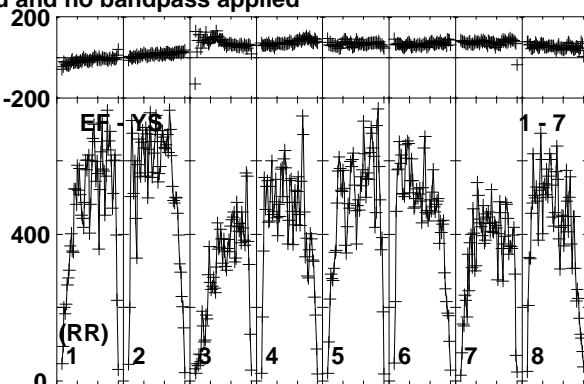
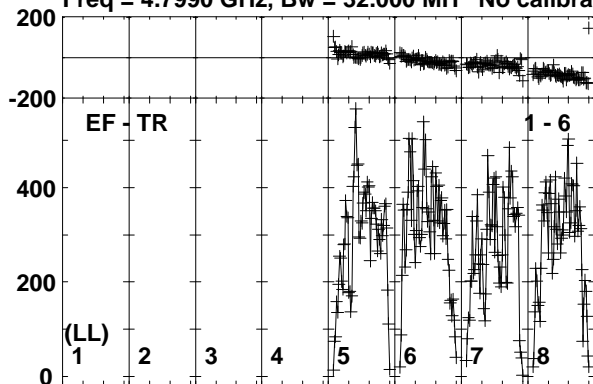

Lower frame: Micro Ampl Jy Top frame: Phas deg
Vector averaged cross-power spectrum Baseline: EF (01) - TR (06)
Timerange: 00/21:28:10 to 00/21:31:39

Plot file version 33 created 21-FEB-2017 15:10:49

J1108+4330 EG096A.UVDATA.1

Freq = 4.7990 GHz, Bw = 32.000 MH No calibration applied and no bandpass applied

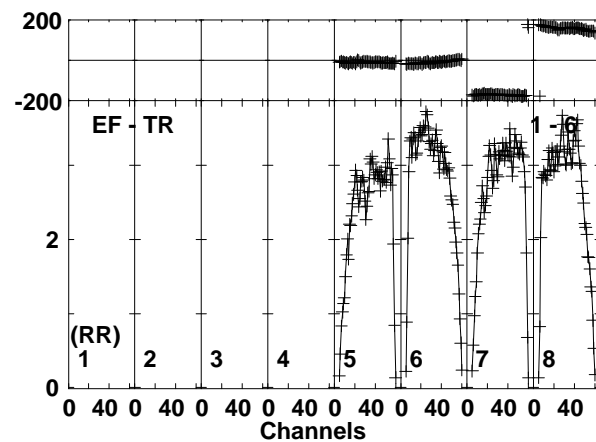
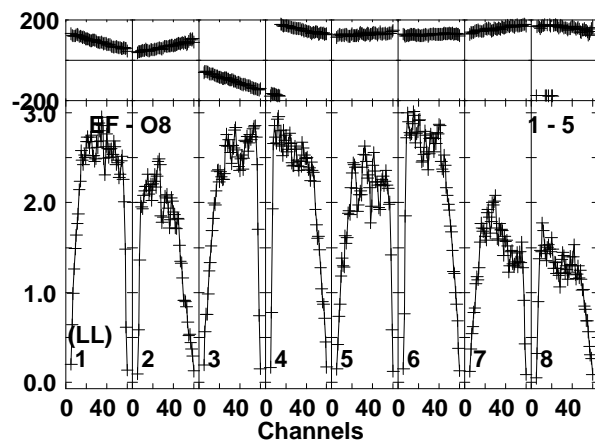
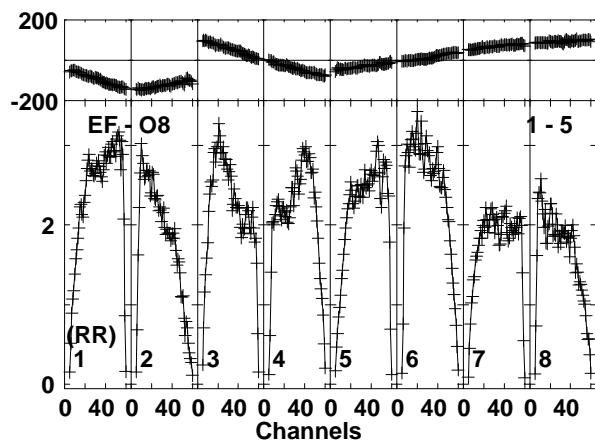
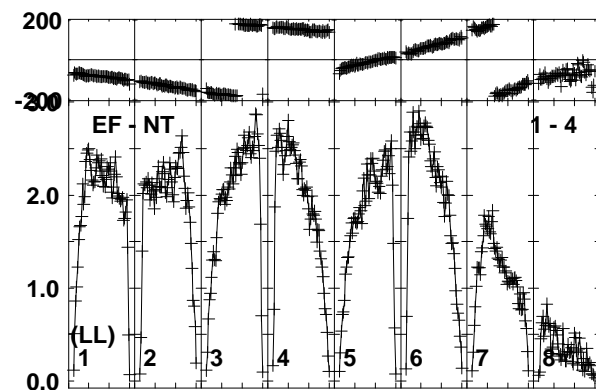
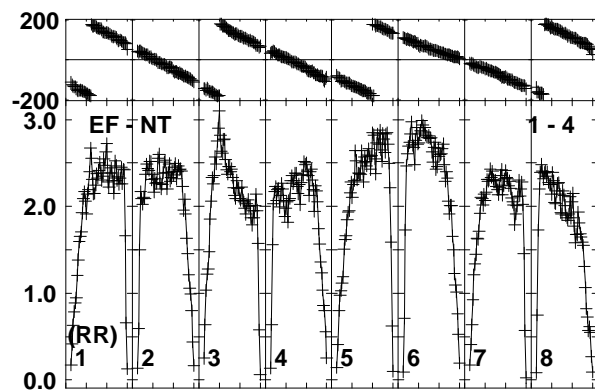
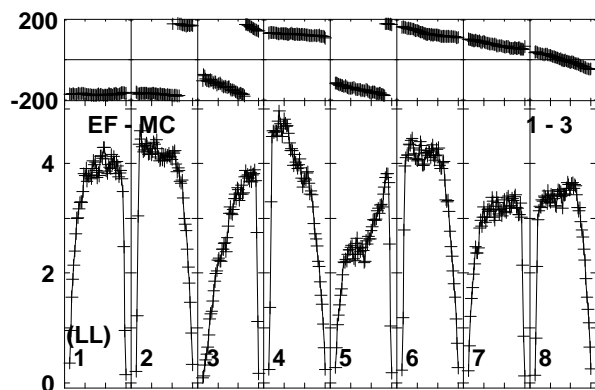
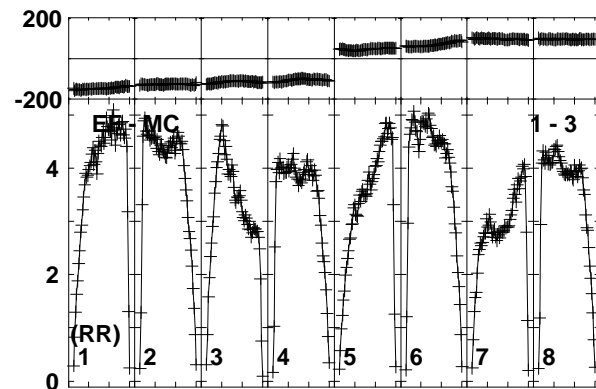
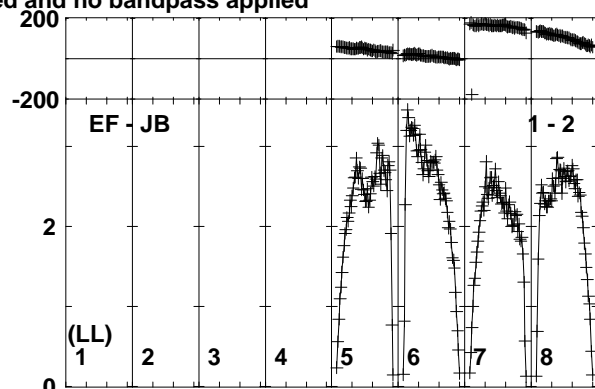
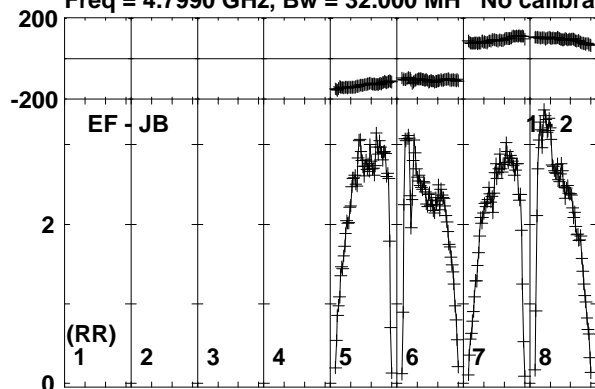

Lower frame: Milli Ampl Jy Top frame: Phas deg
Vector averaged cross-power spectrum Baseline: EF (01) - JB (02)
Timerange: 00/21:31:40 to 00/21:33:10

Plot file version 34 created 21-FEB-2017 15:10:49

J1108+4330 EG096A.UVDATA.1

Freq = 4.7990 GHz, Bw = 32.000 MH No calibration applied and no bandpass applied

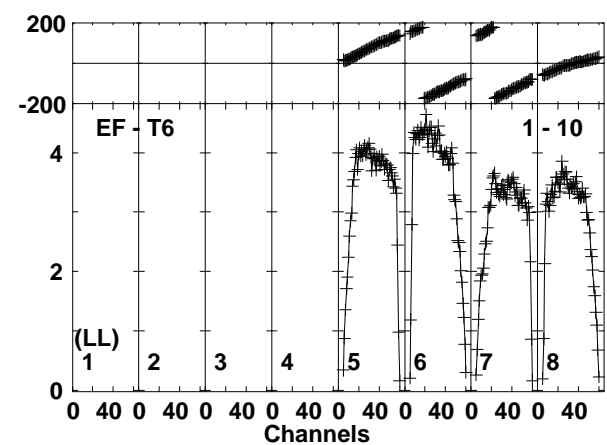
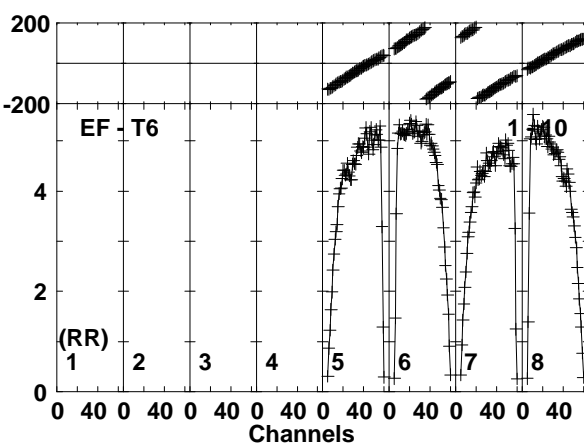
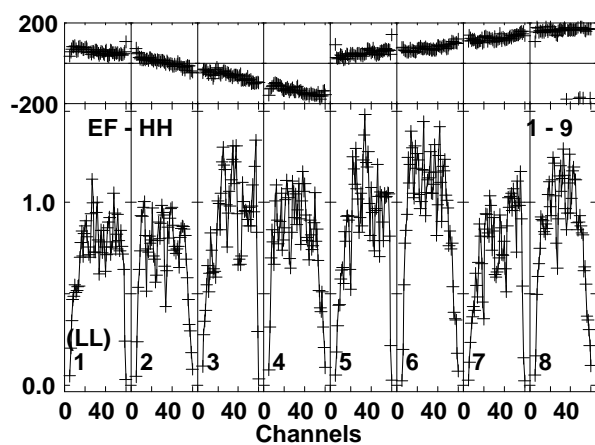
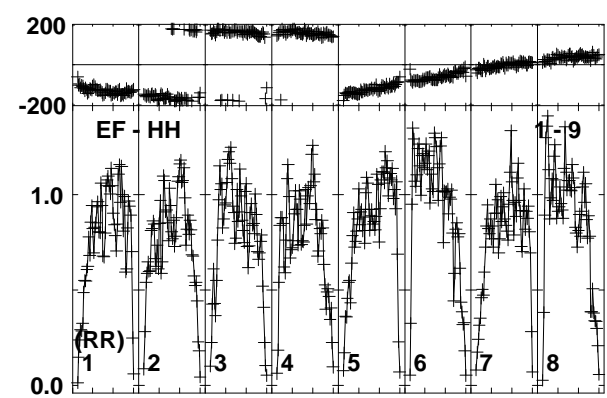
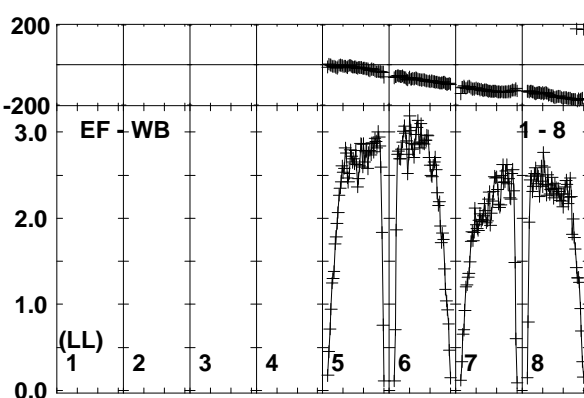
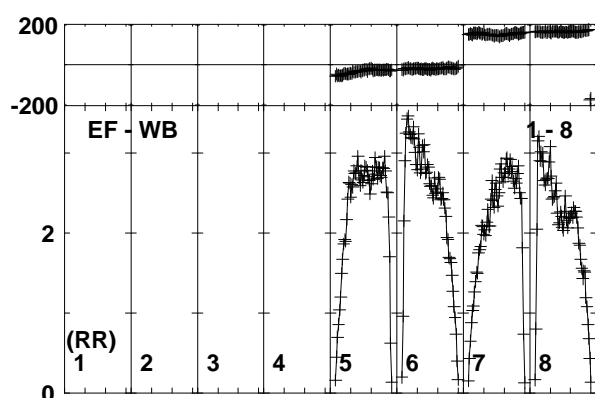
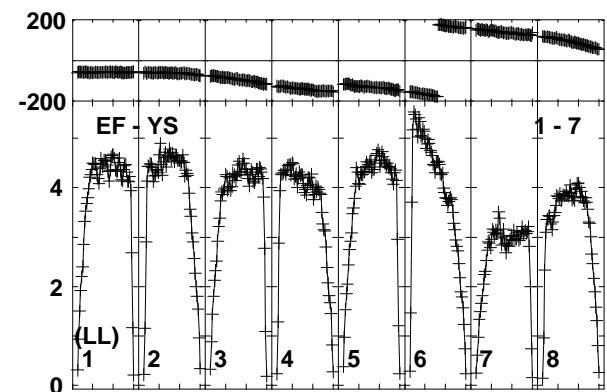
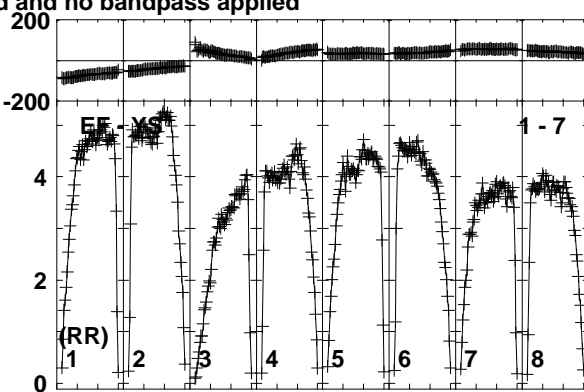
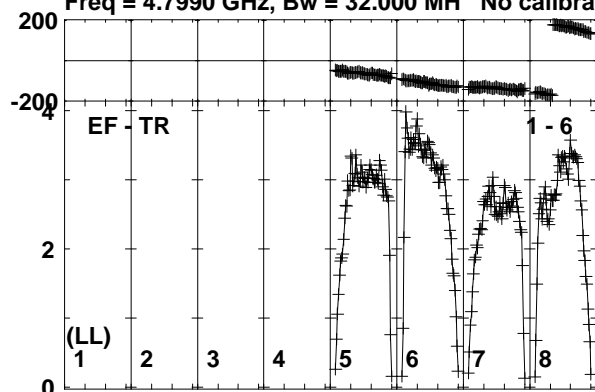

Lower frame: Milli Ampl Jy Top frame: Phas deg
Vector averaged cross-power spectrum Baseline: EF (01) - TR (06)
Timerange: 00/21:31:40 to 00/21:33:10

Plot file version 35 created 21-FEB-2017 15:10:49

ARUMA EG096A.UVDATA.1

Freq = 4.7990 GHz, Bw = 32.000 MH No calibration applied and no bandpass applied

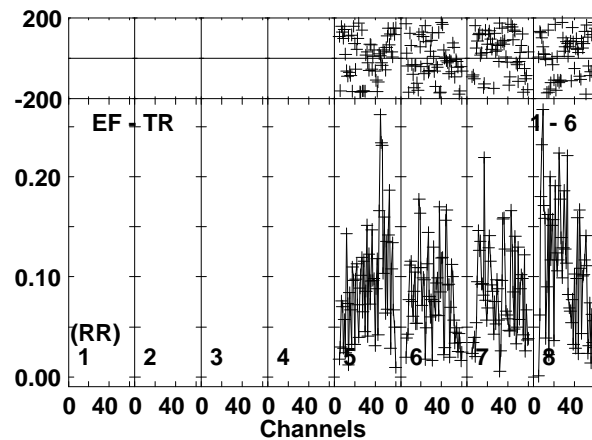
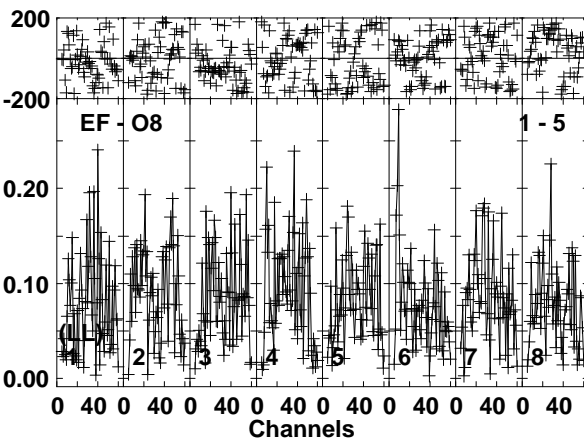
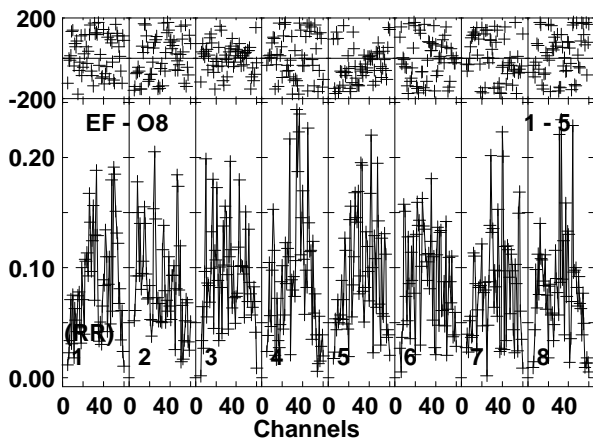
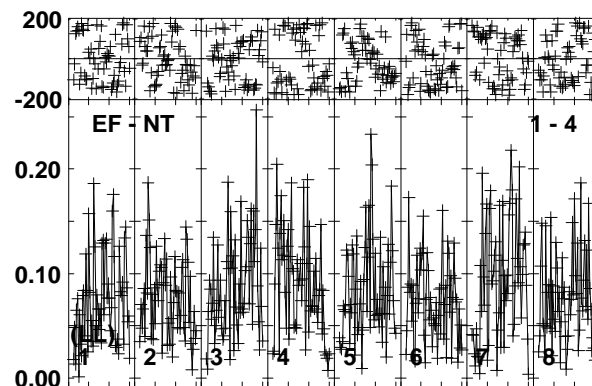
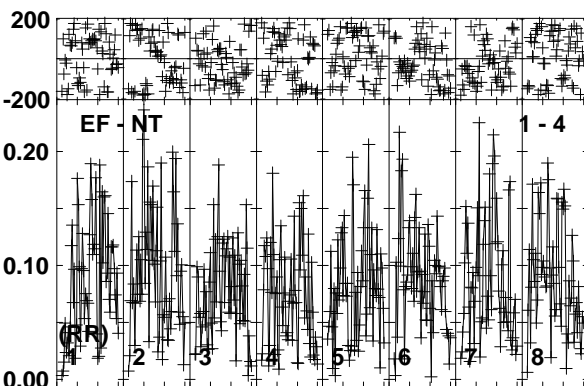
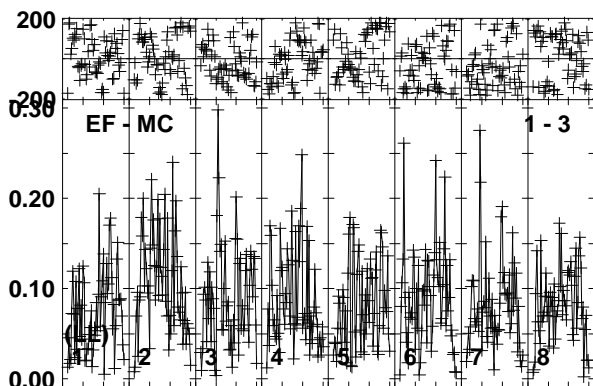
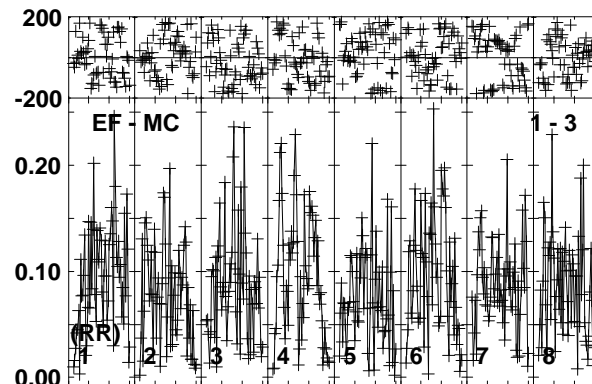
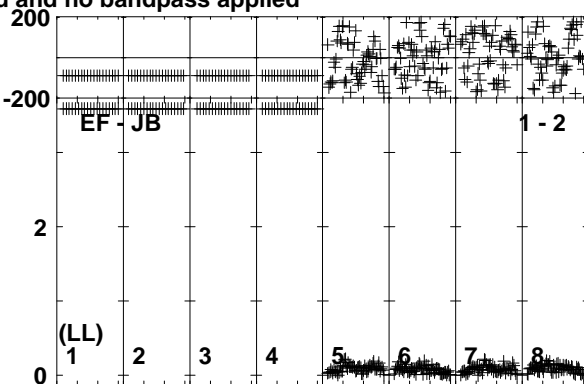
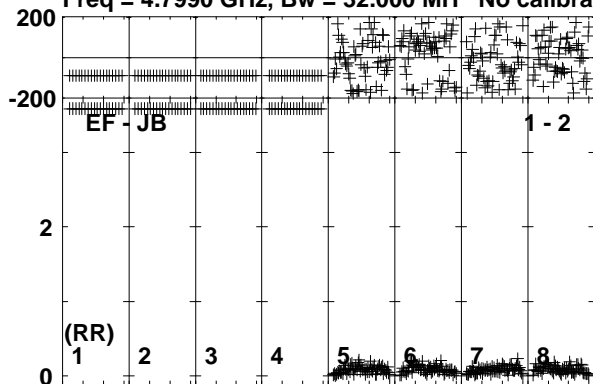

Lower frame: Milli Ampl Jy Top frame: Phas deg
Vector averaged cross-power spectrum Baseline: EF (01) - JB (02)
Timerange: 00/21:33:11 to 00/21:36:40

Plot file version 36 created 21-FEB-2017 15:10:50

ARUMA EG096A.UVDATA.1

Freq = 4.7990 GHz, Bw = 32.000 MH No calibration applied and no bandpass applied

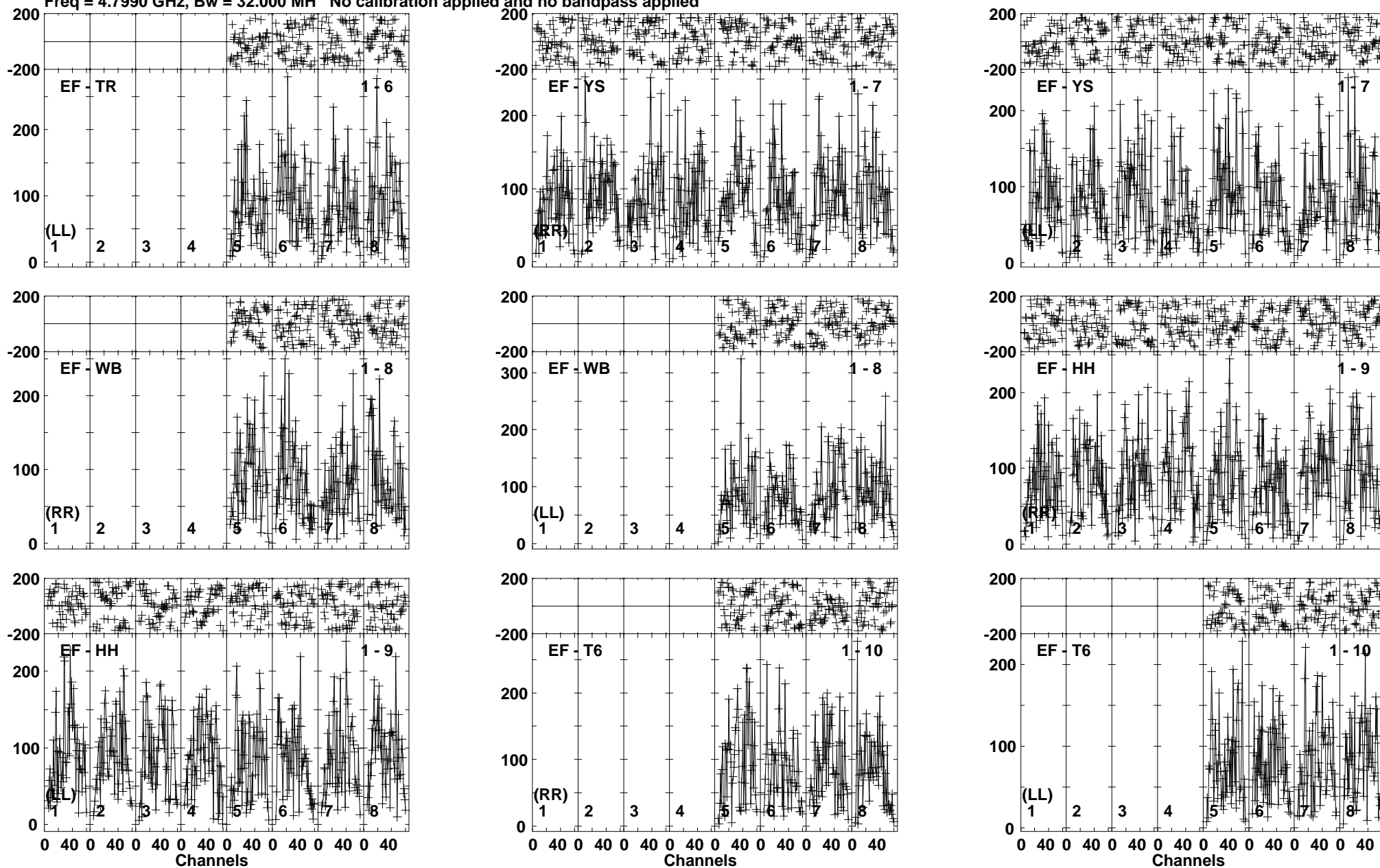

Lower frame: Micro Ampl Jy Top frame: Phas deg
Vector averaged cross-power spectrum Baseline: EF (01) - TR (06)
Timerange: 00/21:33:11 to 00/21:36:40

Plot file version 37 created 21-FEB-2017 15:10:50

J1108+4330 EG096A.UVDATA.1

Freq = 4.7990 GHz, Bw = 32.000 MH No calibration applied and no bandpass applied

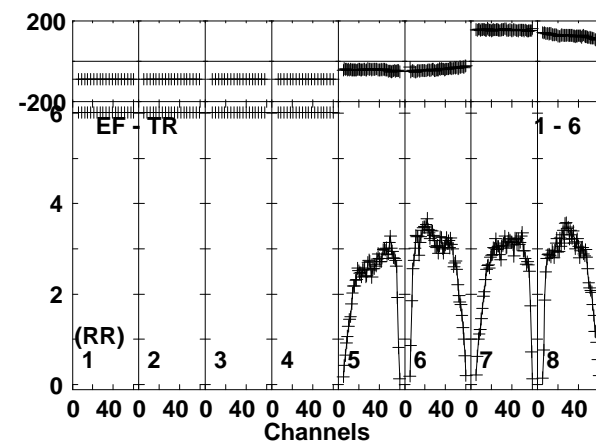
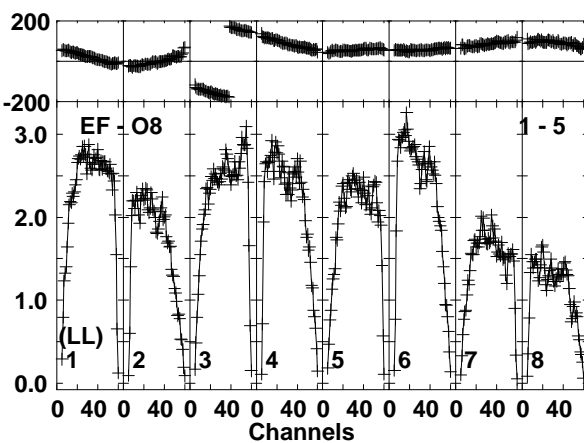
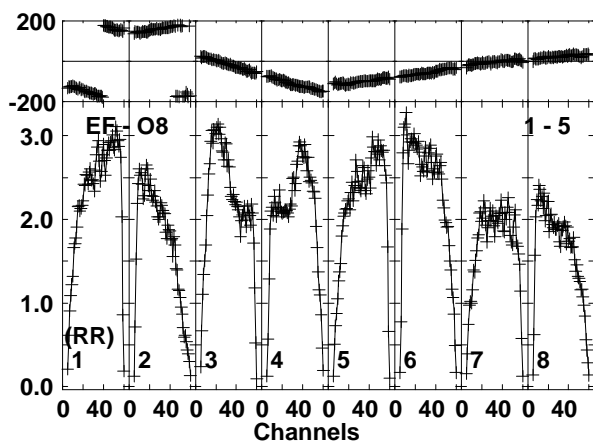
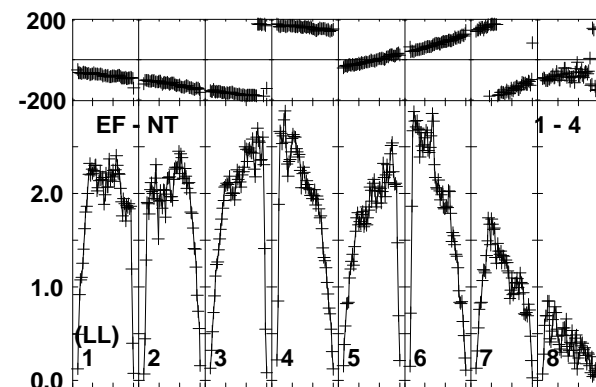
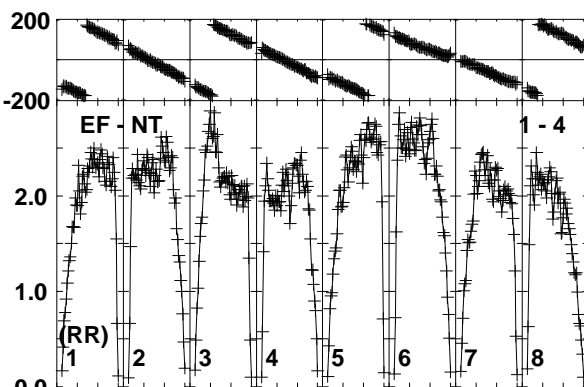
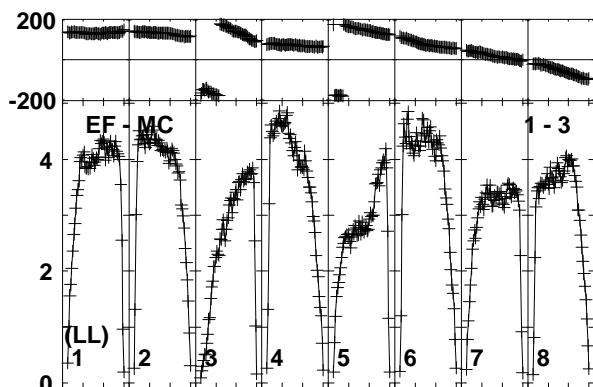
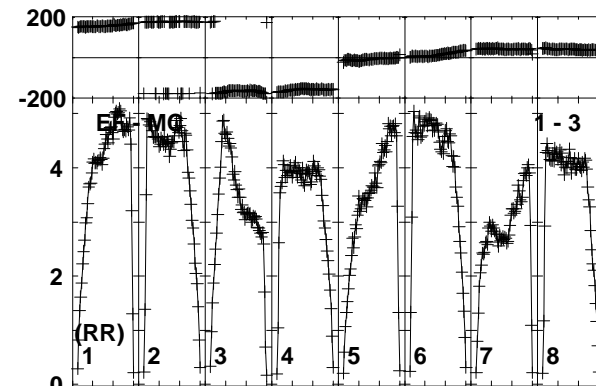
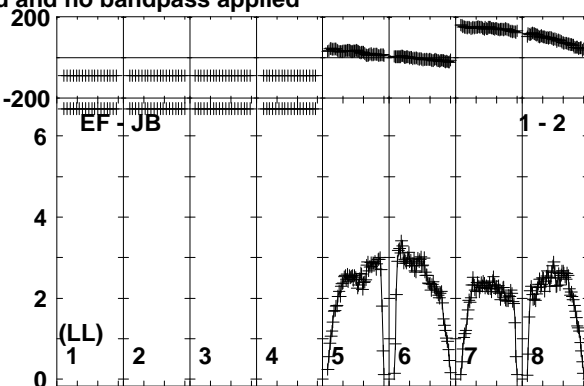
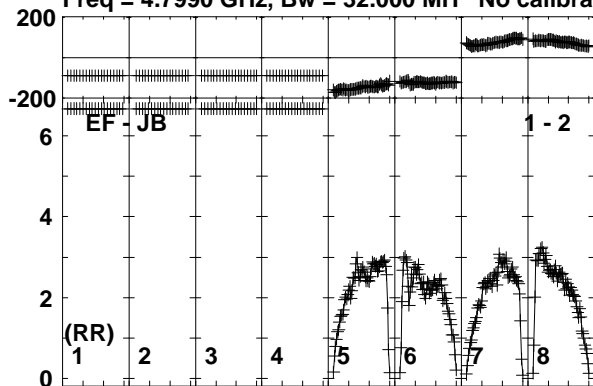

Lower frame: Milli Ampl Jy Top frame: Phas deg
Vector averaged cross-power spectrum Baseline: EF (01) - JB (02)
Timerange: 00/21:37:20 to 00/21:38:19

Plot file version 38 created 21-FEB-2017 15:10:50

J1108+4330 EG096A.UVDATA.1

Freq = 4.7990 GHz, Bw = 32.000 MH No calibration applied and no bandpass applied

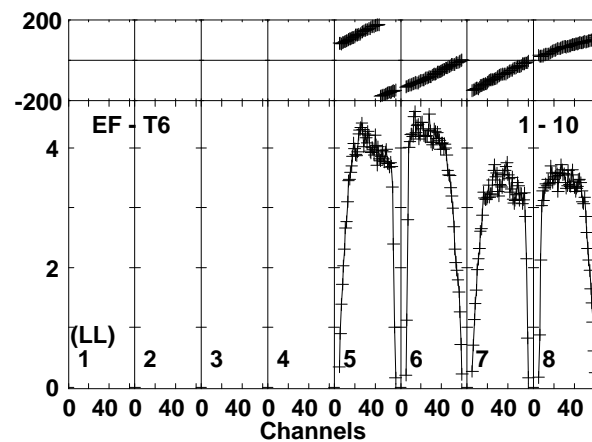
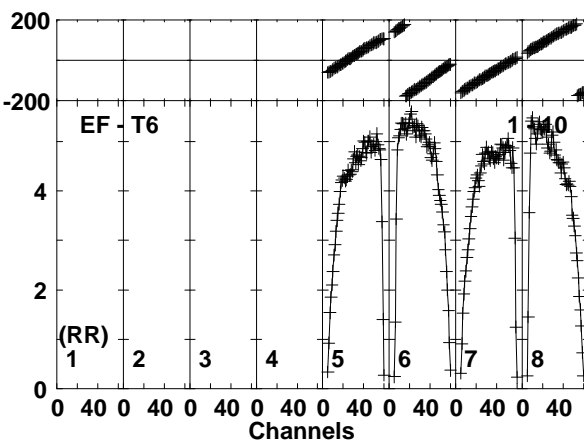
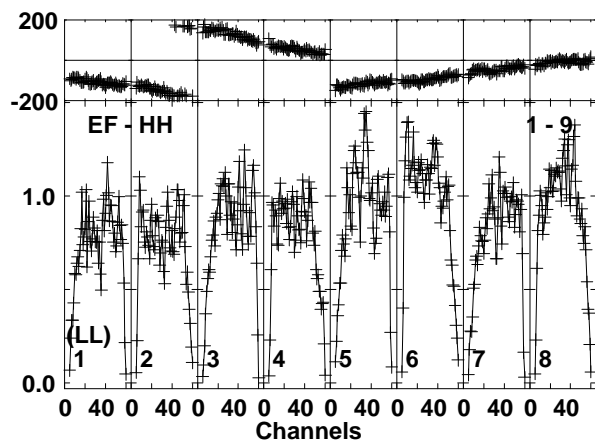
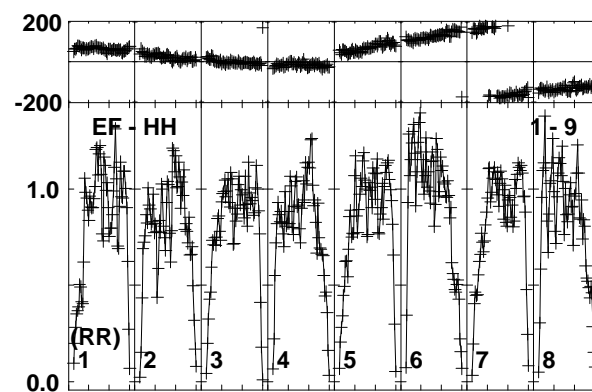
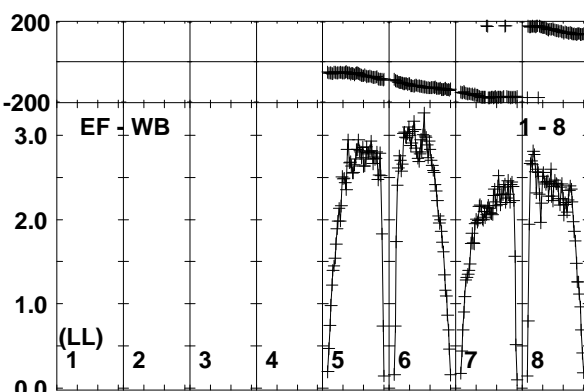
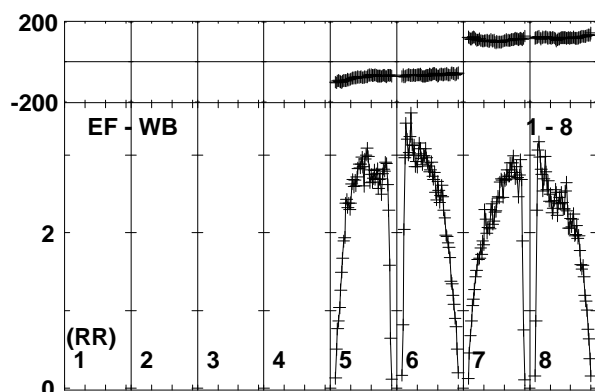
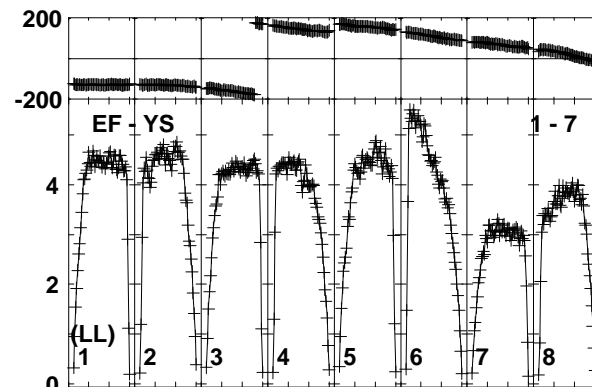
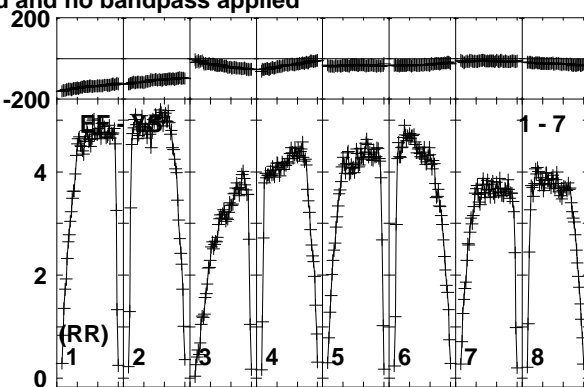
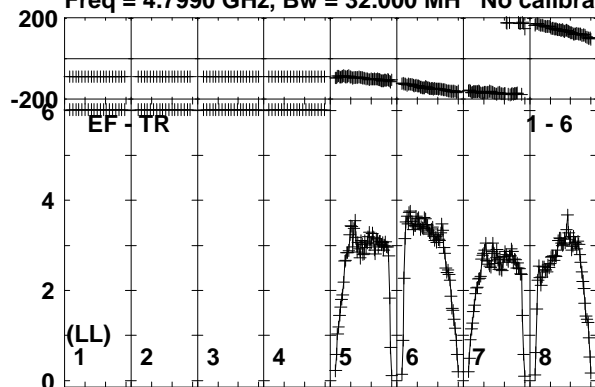

Lower frame: Milli Ampl Jy Top frame: Phas deg
Vector averaged cross-power spectrum Baseline: EF (01) - TR (06)
Timerange: 00/21:37:20 to 00/21:38:19

Plot file version 39 created 21-FEB-2017 15:10:50

ARUMA EG096A.UVDATA.1

Freq = 4.7990 GHz, Bw = 32.000 MH No calibration applied and no bandpass applied

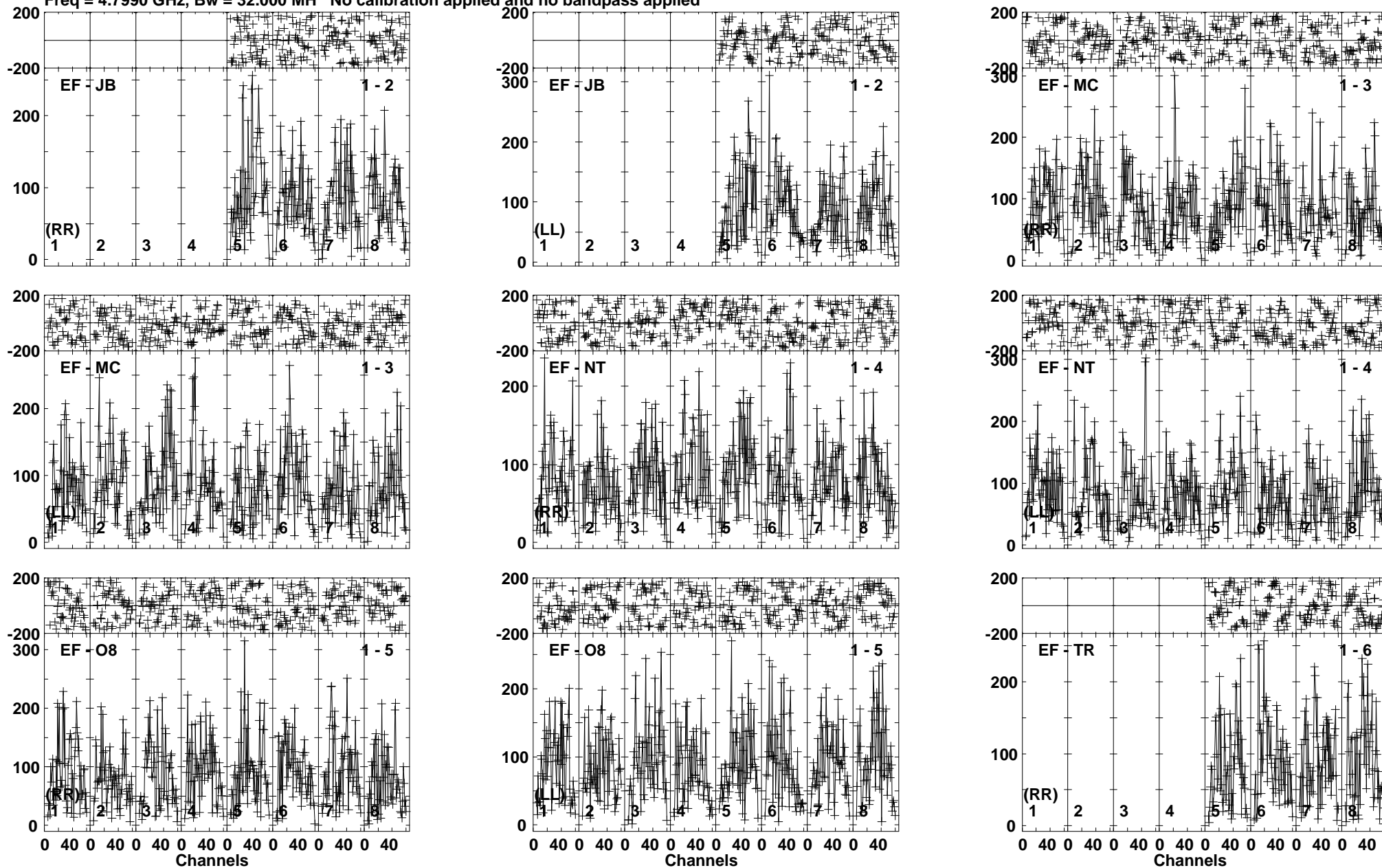

Lower frame: Micro Ampl Jy Top frame: Phas deg
Vector averaged cross-power spectrum Baseline: EF (01) - JB (02)
Timerange: 00/21:38:21 to 00/21:41:50

Plot file version 40 created 21-FEB-2017 15:10:51

ARUMA EG096A.UVDATA.1

Freq = 4.7990 GHz, Bw = 32.000 MH No calibration applied and no bandpass applied

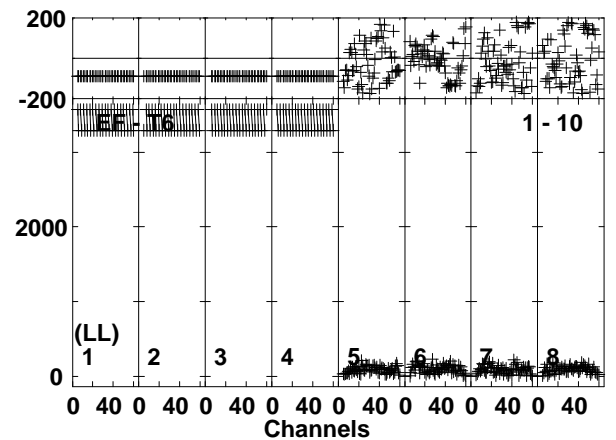
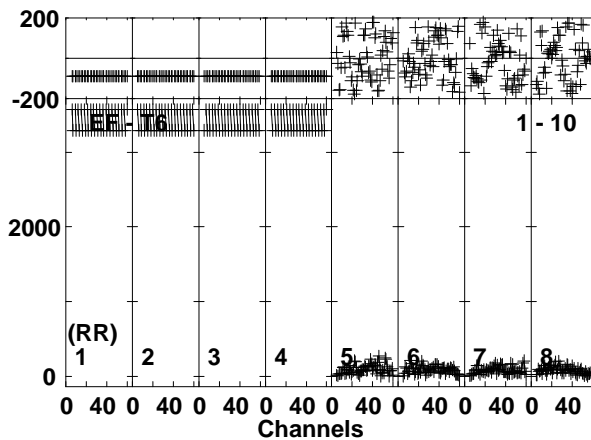
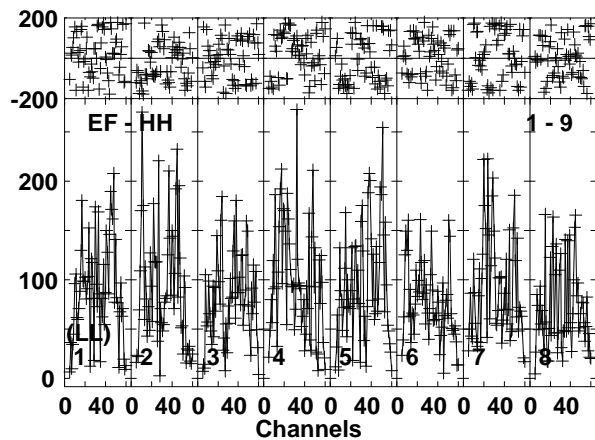
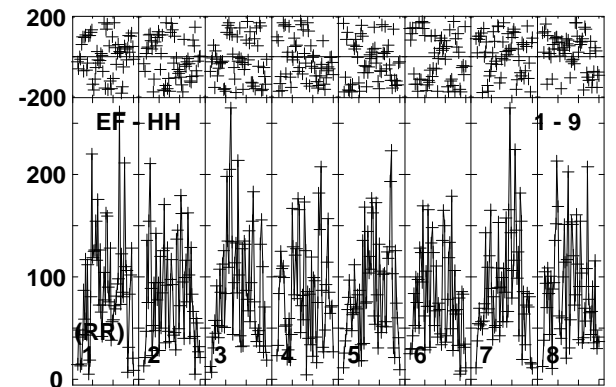
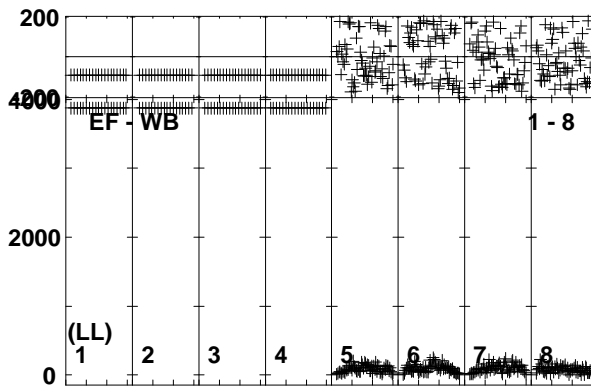
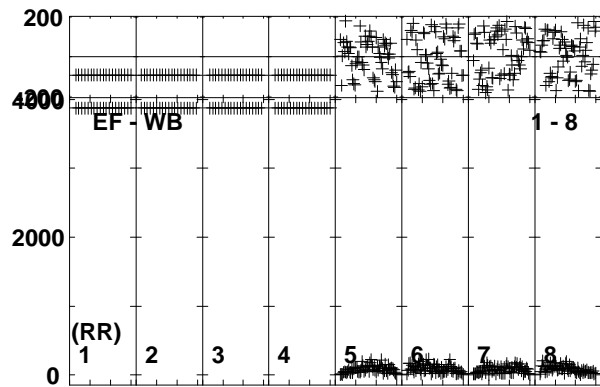
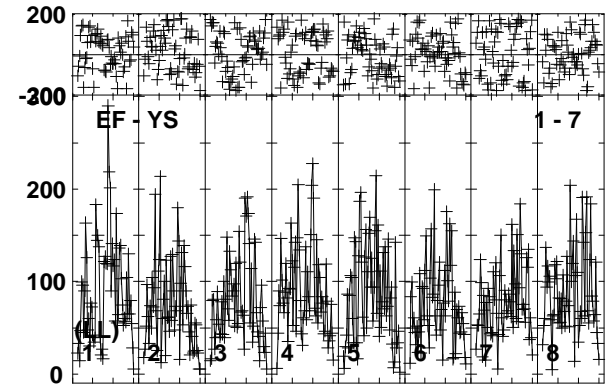
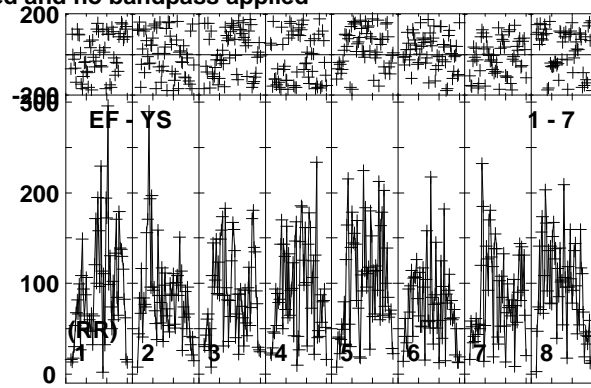
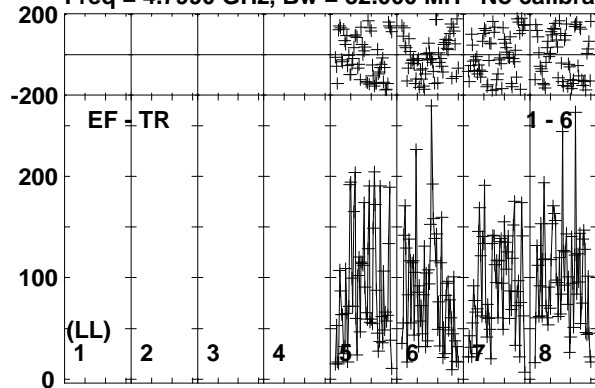

Lower frame: Micro Ampl Jy Top frame: Phas deg
Vector averaged cross-power spectrum Baseline: EF (01) - TR (06)
Timerange: 00/21:38:21 to 00/21:41:50

Plot file version 41 created 21-FEB-2017 15:10:51

J1108+4330 EG096A.UVDATA.1

Freq = 4.7990 GHz, Bw = 32.000 MH No calibration applied and no bandpass applied

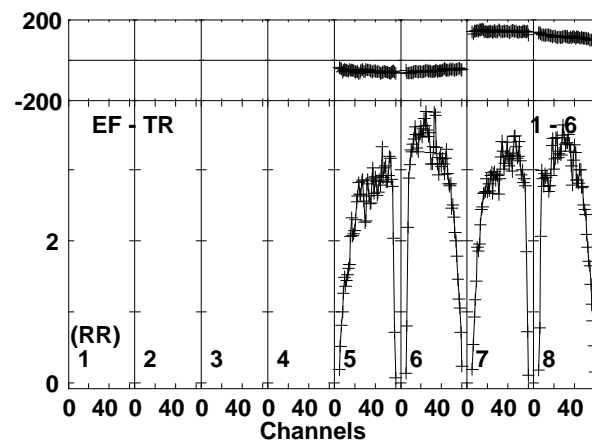
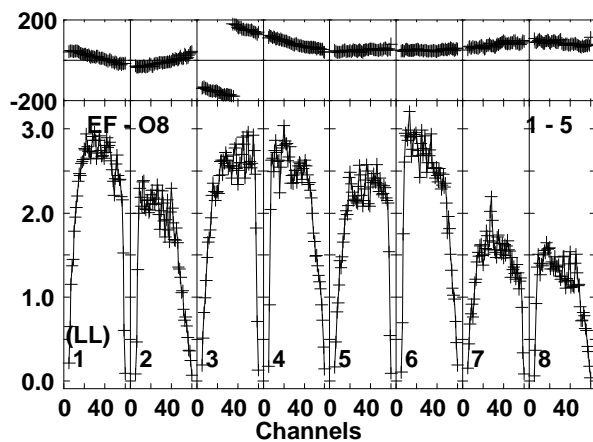
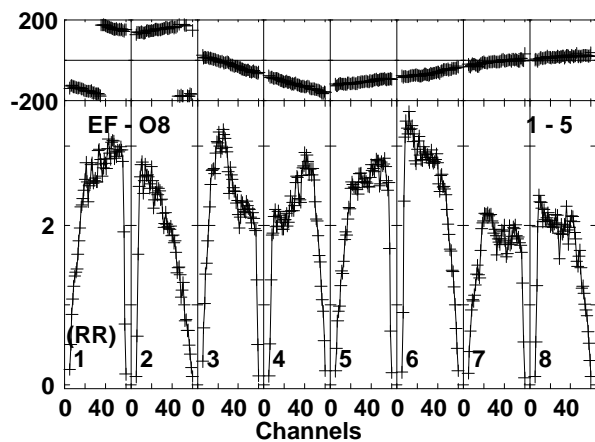
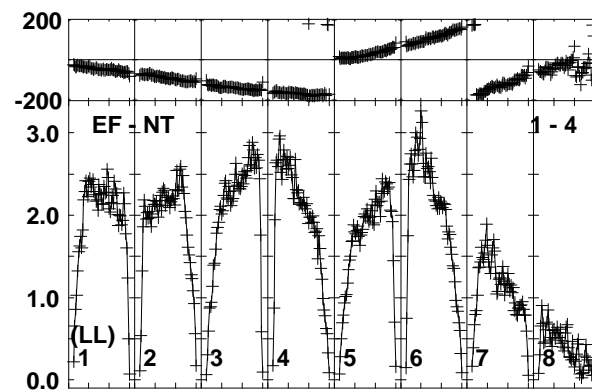
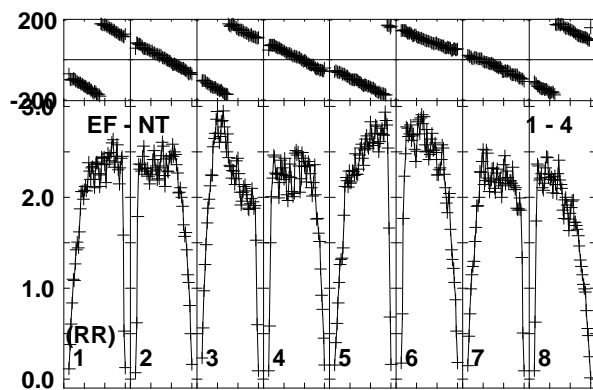
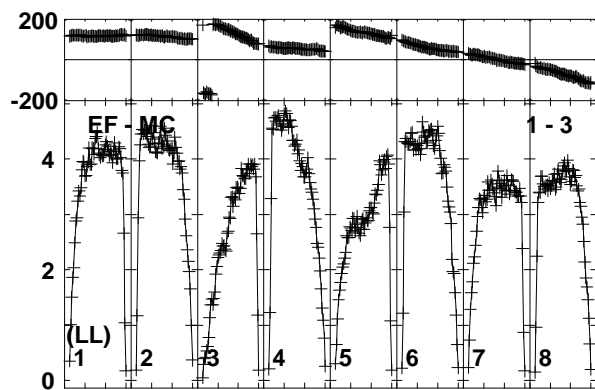
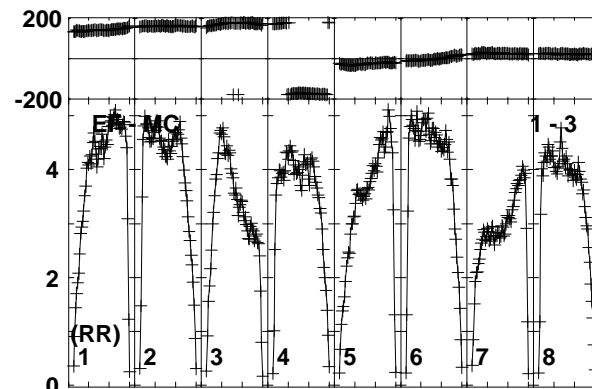
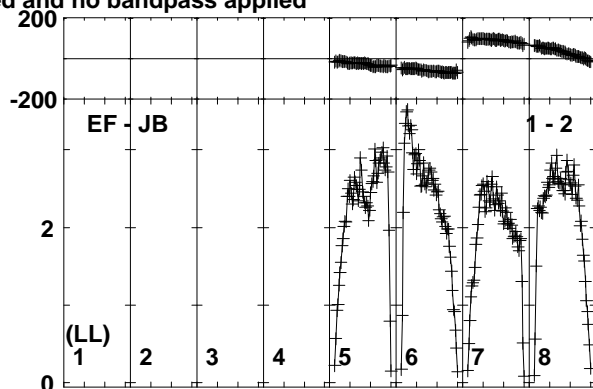
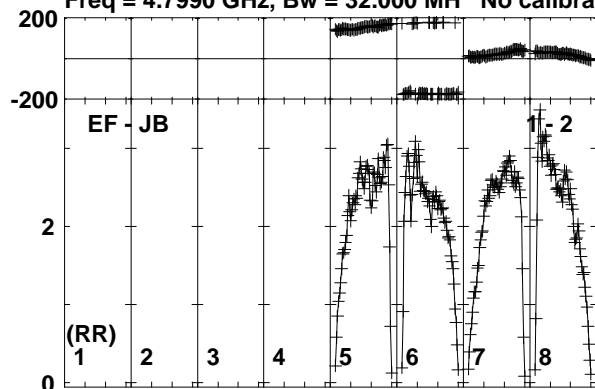

Lower frame: Milli Ampl Jy Top frame: Phas deg
Vector averaged cross-power spectrum Baseline: EF (01) - JB (02)
Timerange: 00/21:41:50 to 00/21:43:20

Plot file version 42 created 21-FEB-2017 15:10:51

J1108+4330 EG096A.UVDATA.1

Freq = 4.7990 GHz, Bw = 32.000 MH No calibration applied and no bandpass applied

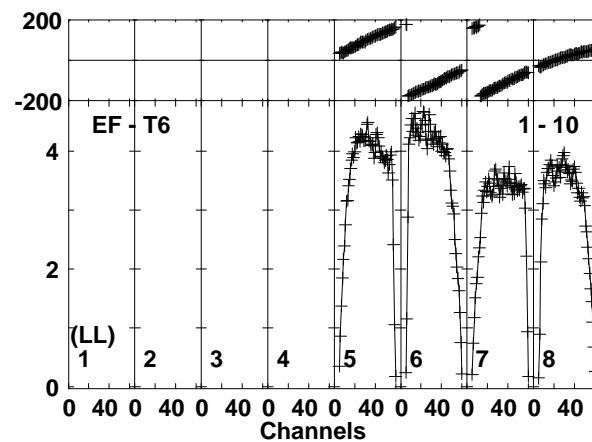
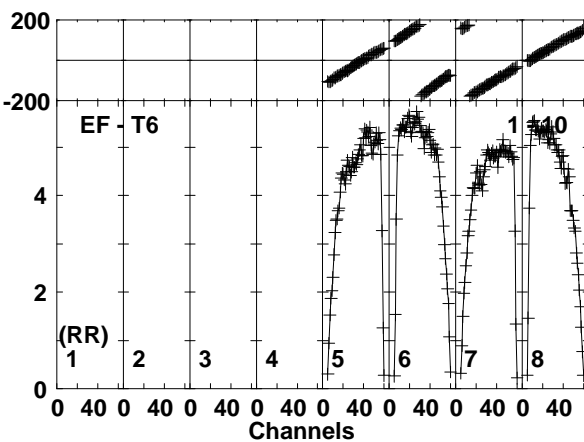
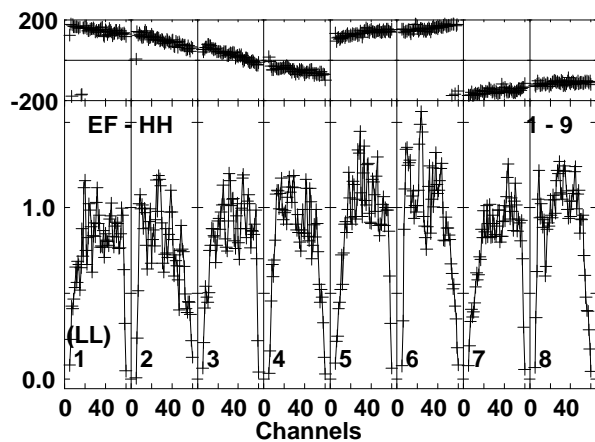
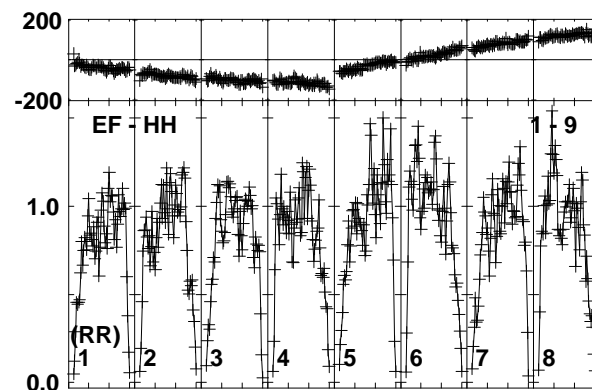
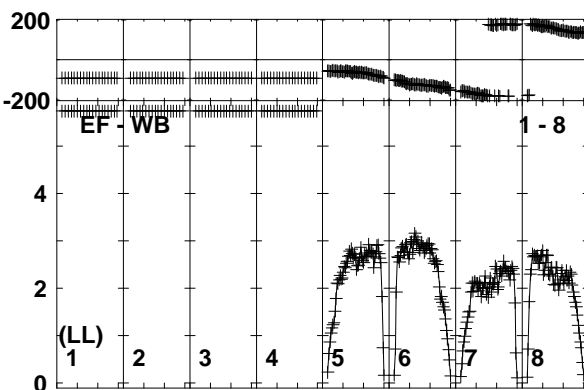
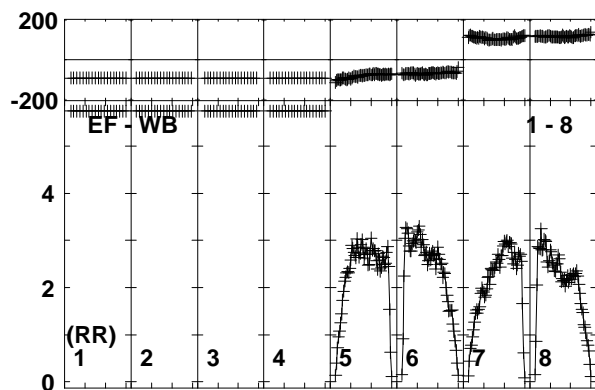
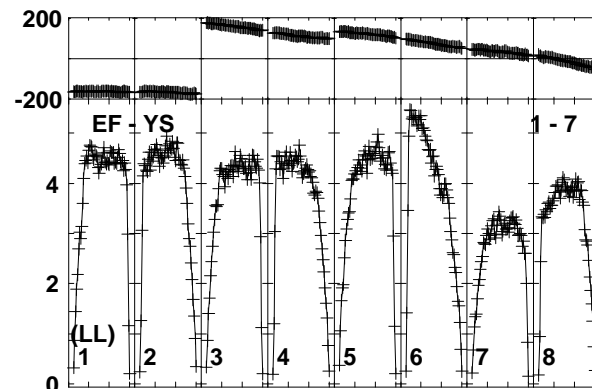
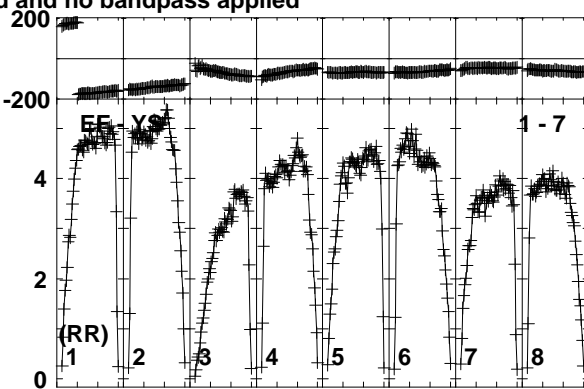
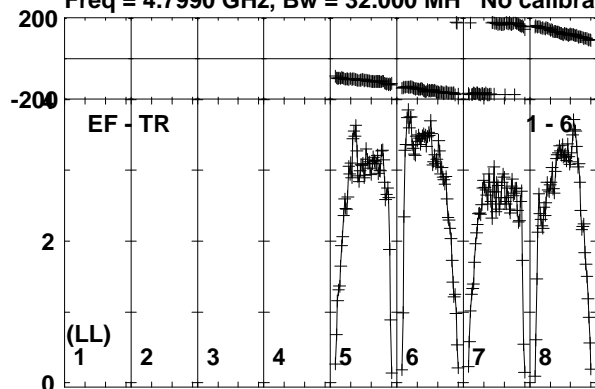

Lower frame: Milli Ampl Jy Top frame: Phas deg
Vector averaged cross-power spectrum Baseline: EF (01) - TR (06)
Timerange: 00/21:41:50 to 00/21:43:20

Plot file version 43 created 21-FEB-2017 15:10:52

ARUMA EG096A.UVDATA.1

Freq = 4.7990 GHz, Bw = 32.000 MH No calibration applied and no bandpass applied

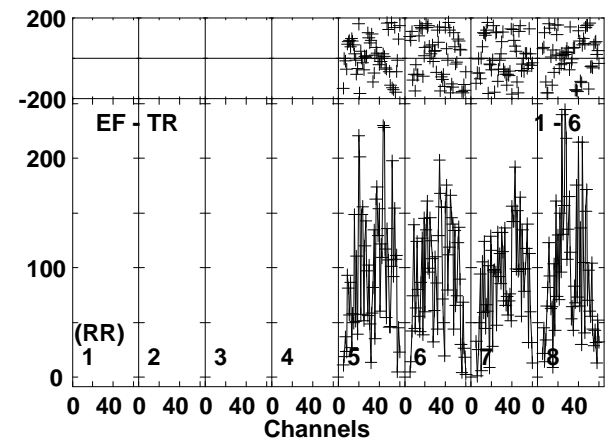
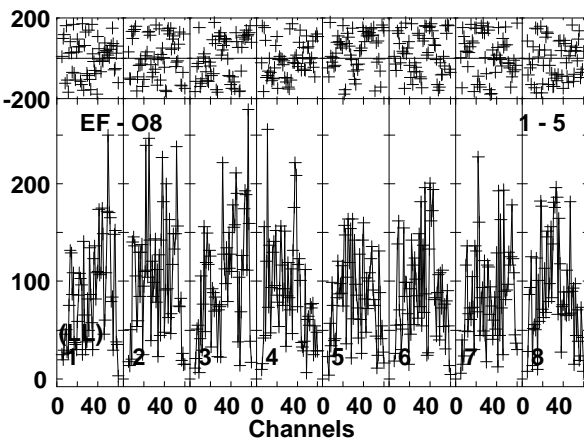
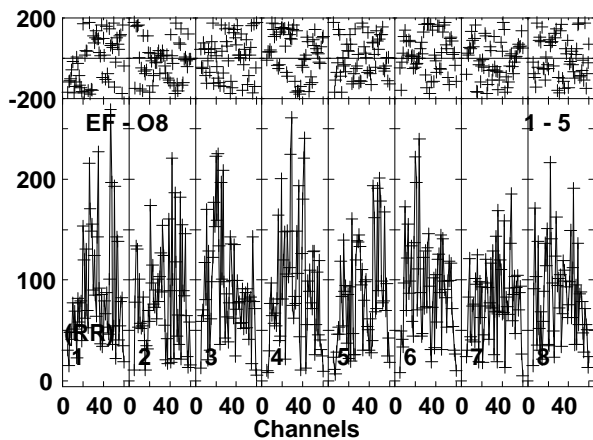
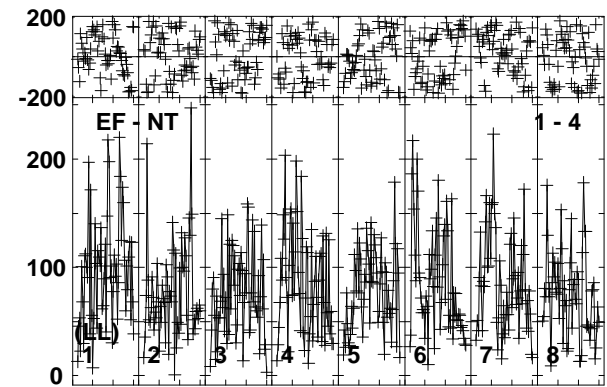
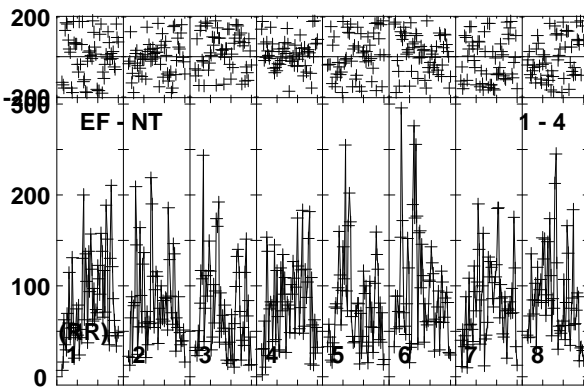
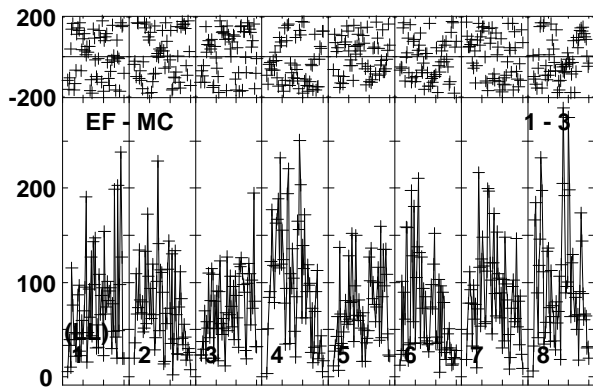
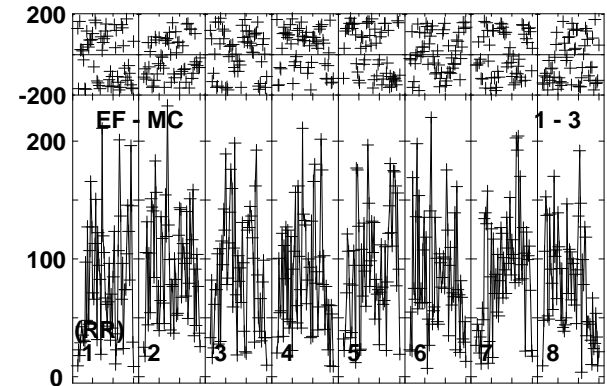
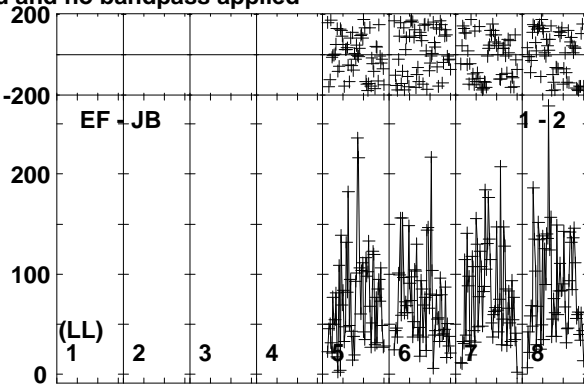
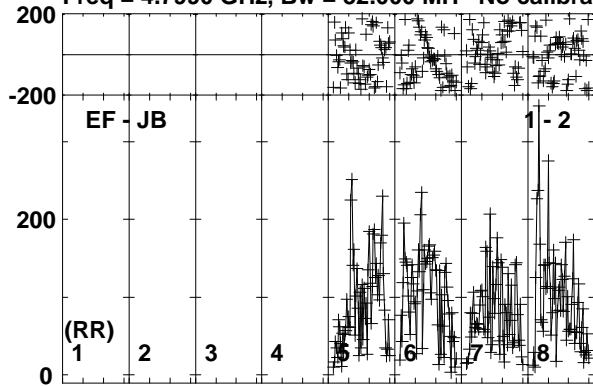

Lower frame: Micro Ampl Jy Top frame: Phas deg
Vector averaged cross-power spectrum Baseline: EF (01) - JB (02)
Timerange: 00/21:43:20 to 00/21:46:49

Plot file version 44 created 21-FEB-2017 15:10:52

ARUMA EG096A.UVDATA.1

Freq = 4.7990 GHz, Bw = 32.000 MH No calibration applied and no bandpass applied

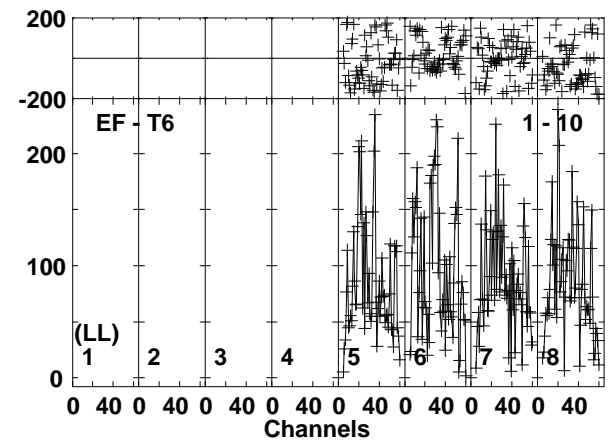
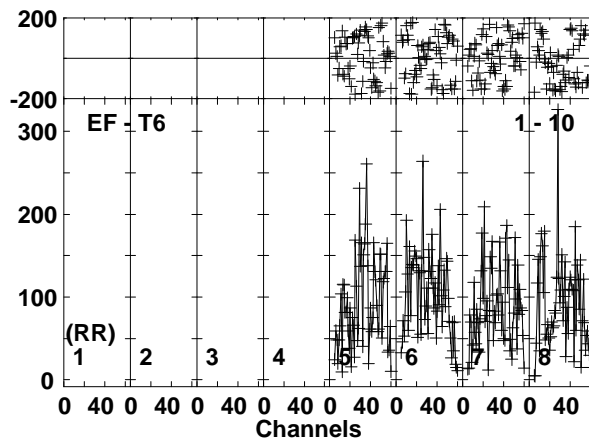
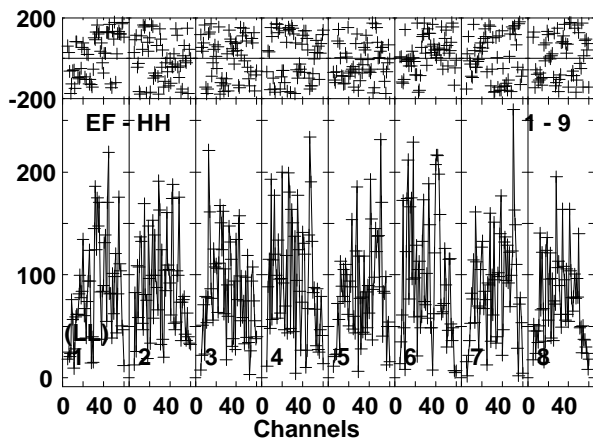
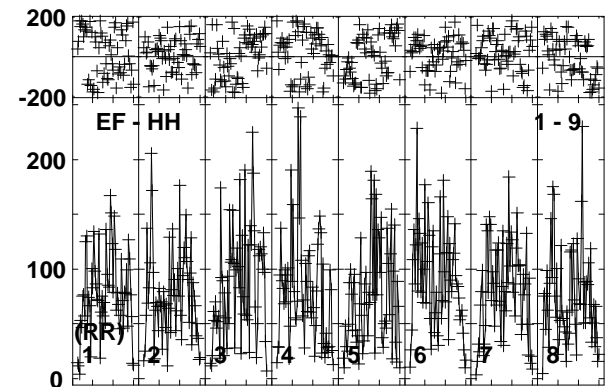
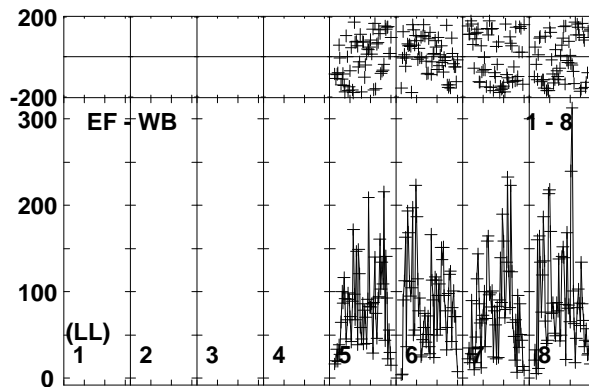
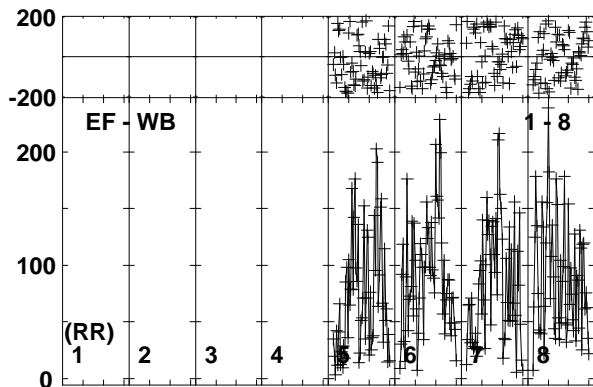
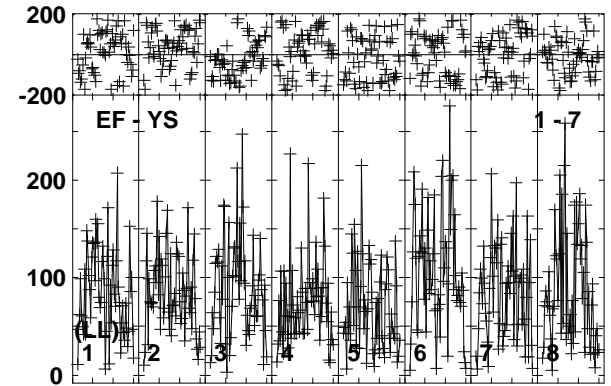
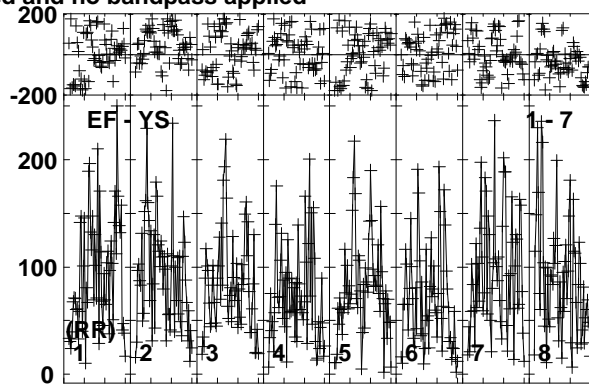
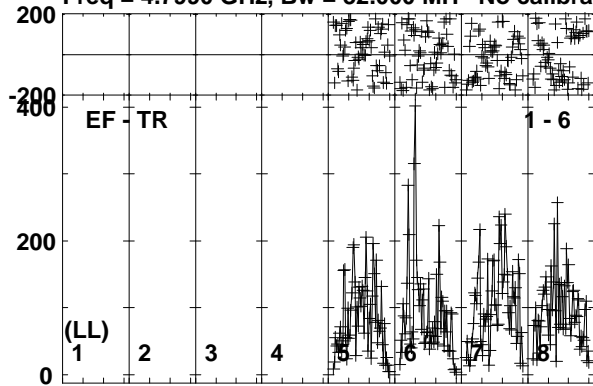

Lower frame: Micro Ampl Jy Top frame: Phas deg
Vector averaged cross-power spectrum Baseline: EF (01) - TR (06)
Timerange: 00/21:43:20 to 00/21:46:49

Plot file version 45 created 21-FEB-2017 15:10:52

J1108+4330 EG096A.UVDATA.1

Freq = 4.7990 GHz, Bw = 32.000 MH No calibration applied and no bandpass applied

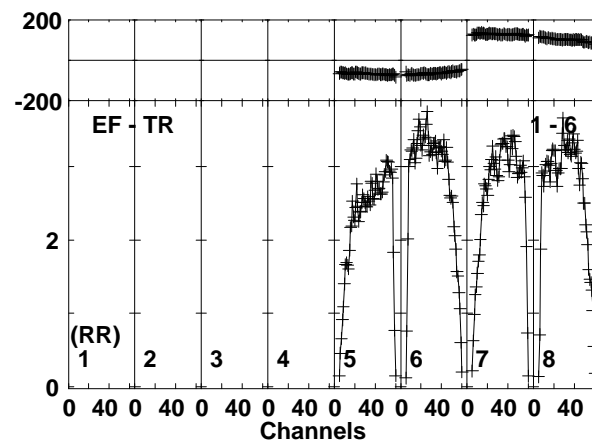
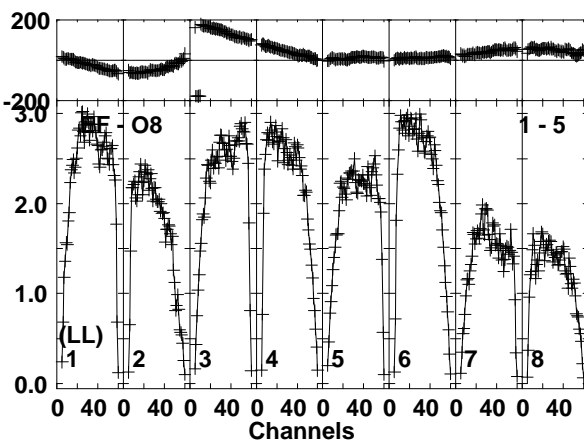
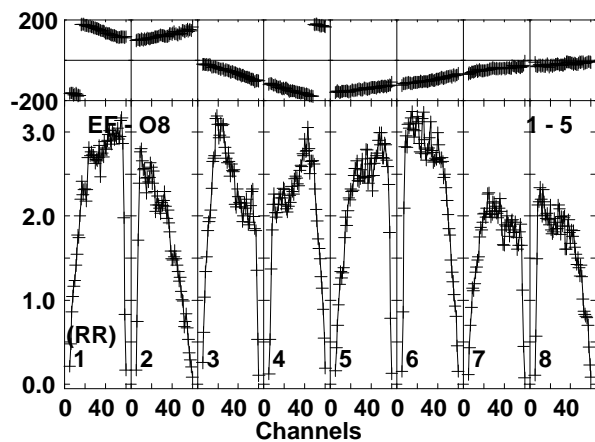
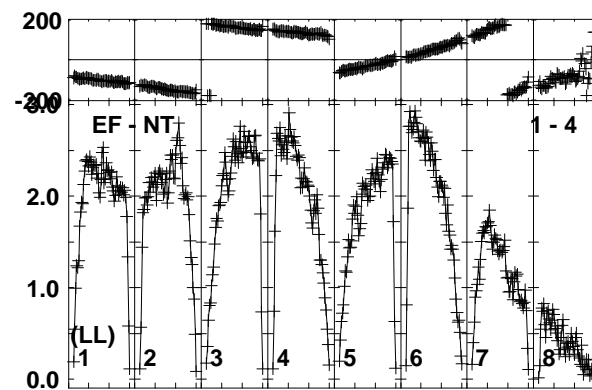
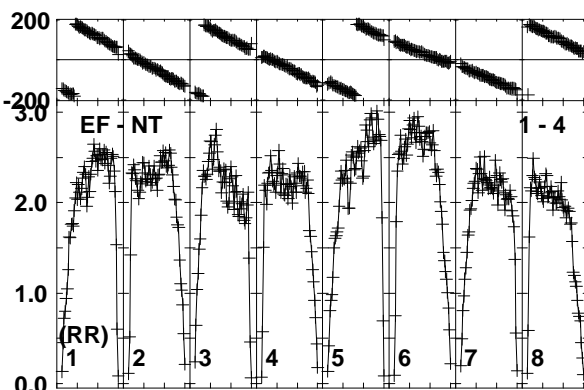
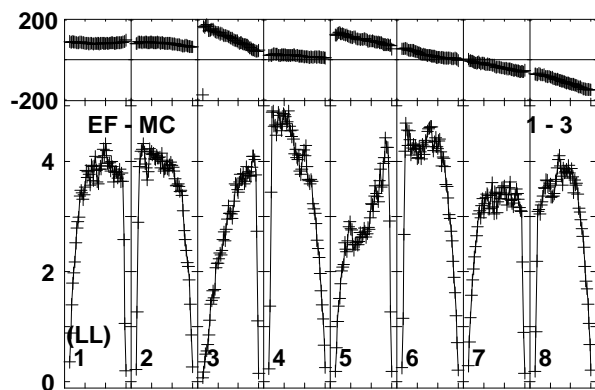
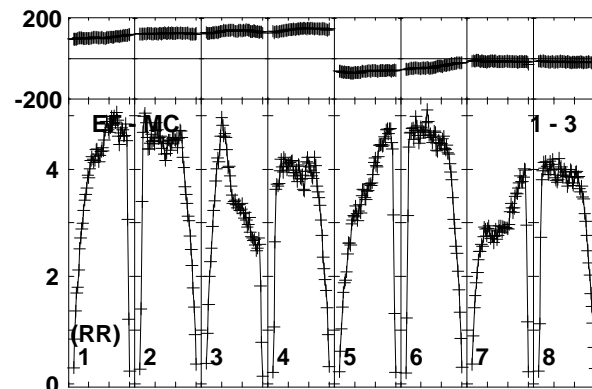
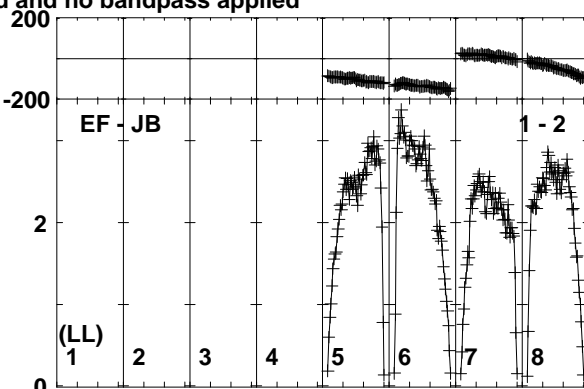
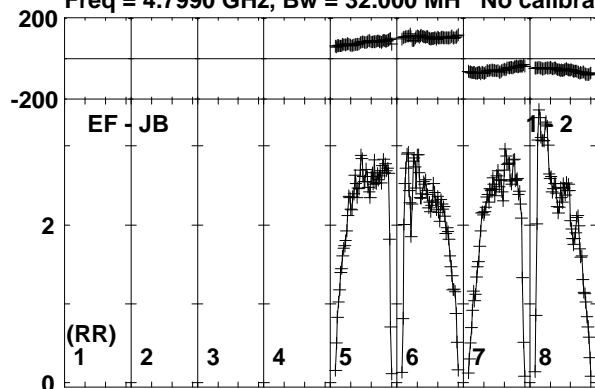

Lower frame: Milli Ampl Jy Top frame: Phas deg
Vector averaged cross-power spectrum Baseline: EF (01) - JB (02)
Timerange: 00/21:47:30 to 00/21:48:29

Plot file version 46 created 21-FEB-2017 15:10:52

J1108+4330 EG096A.UVDATA.1

Freq = 4.7990 GHz, Bw = 32.000 MH No calibration applied and no bandpass applied

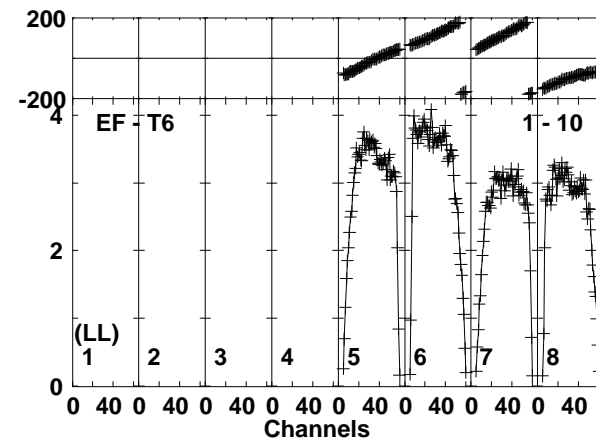
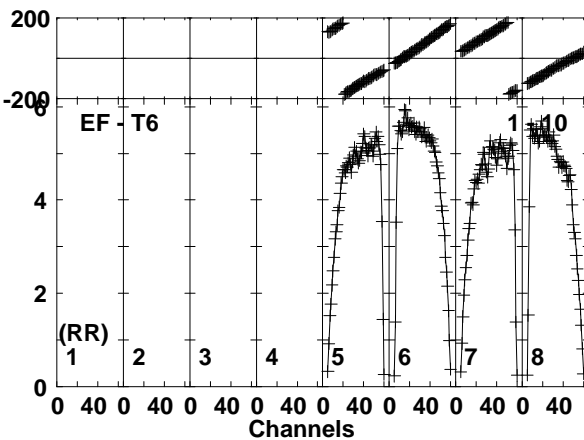
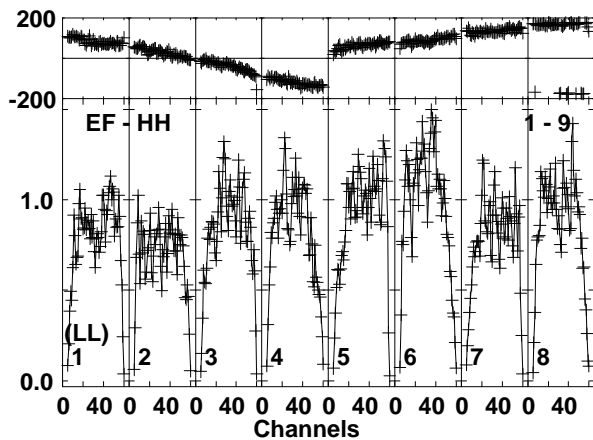
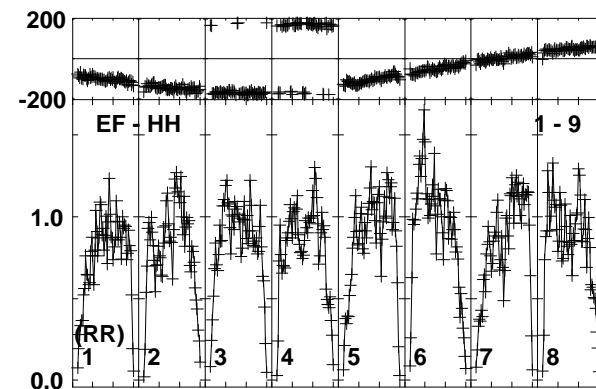
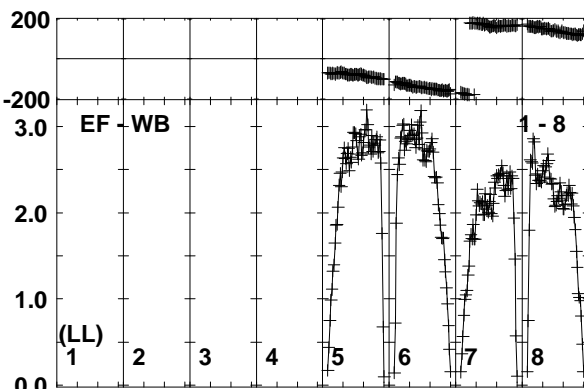
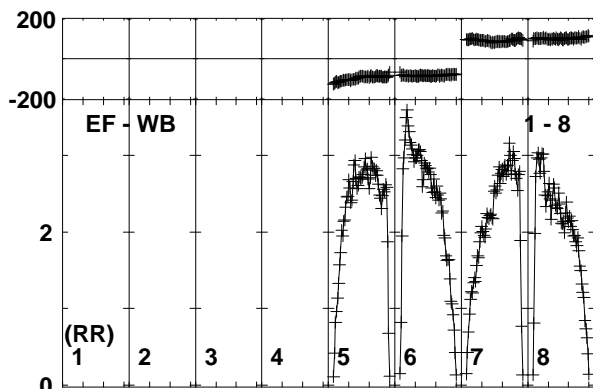
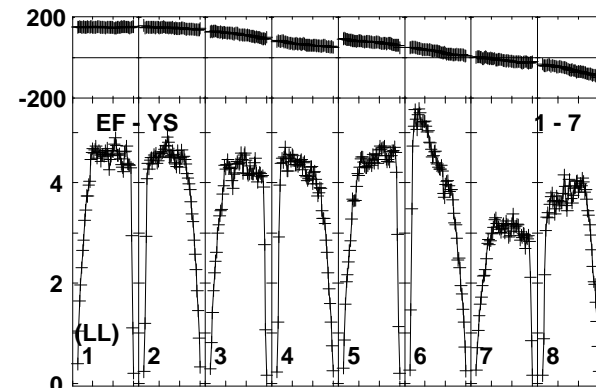
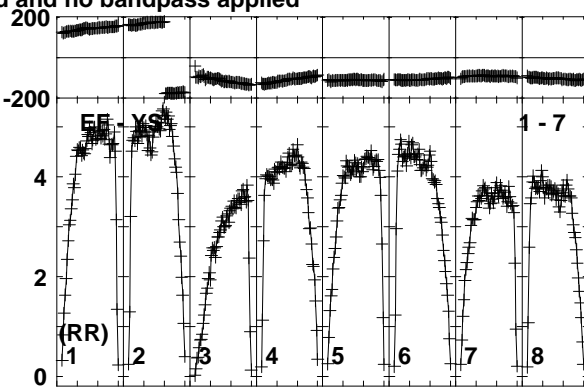
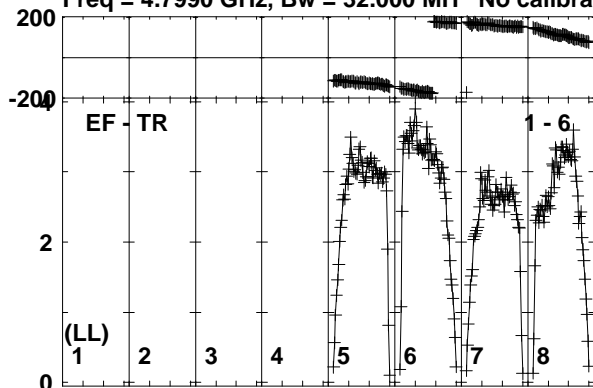

Lower frame: Milli Ampl Jy Top frame: Phas deg
Vector averaged cross-power spectrum Baseline: EF (01) - TR (06)
Timerange: 00/21:47:30 to 00/21:48:29

Plot file version 47 created 21-FEB-2017 15:10:53

ARUMA EG096A.UVDATA.1

Freq = 4.7990 GHz, Bw = 32.000 MH No calibration applied and no bandpass applied

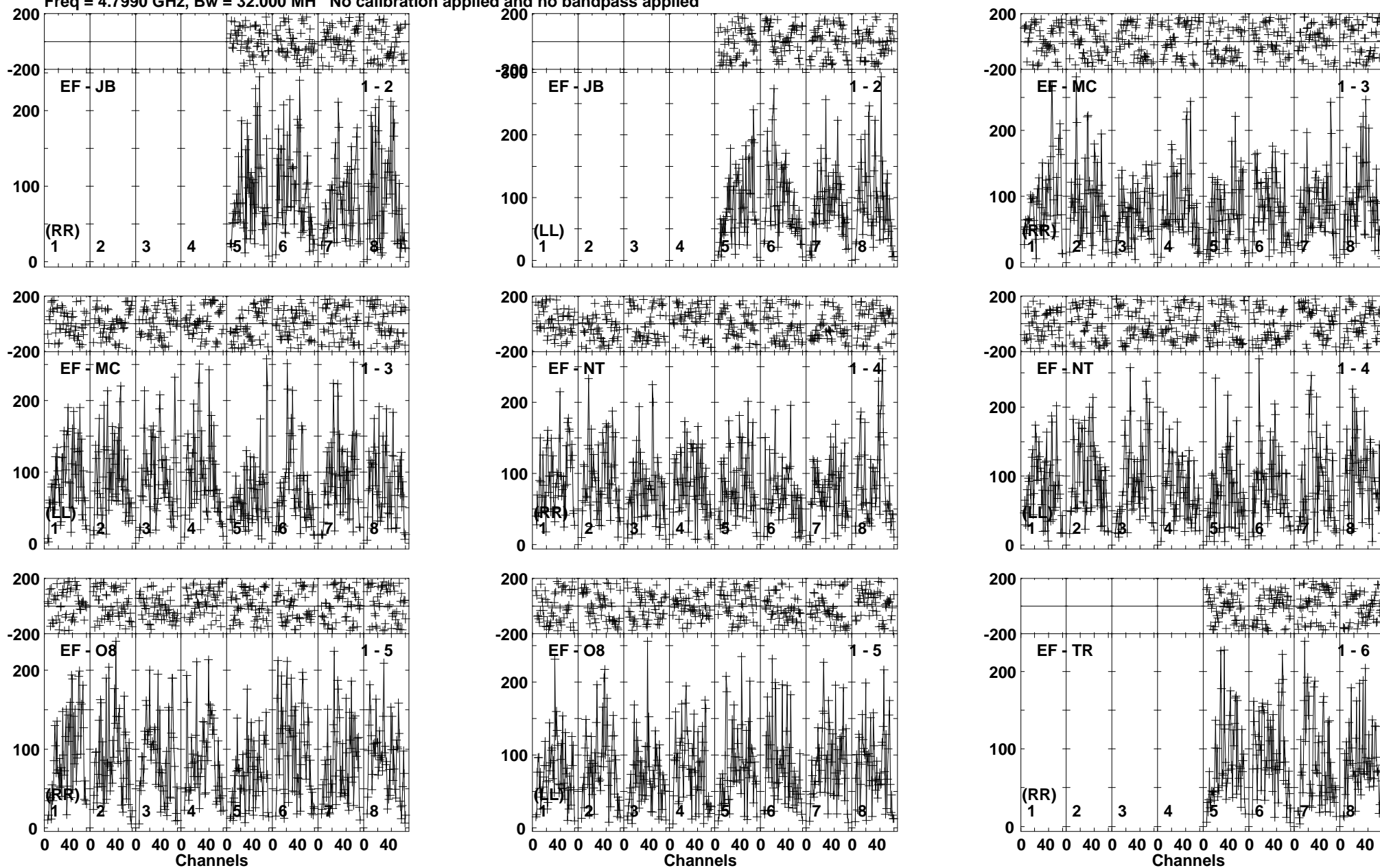

Lower frame: Micro Ampl Jy Top frame: Phas deg
Vector averaged cross-power spectrum Baseline: EF (01) - JB (02)
Timerange: 00/21:48:30 to 00/21:51:59

Plot file version 48 created 21-FEB-2017 15:10:53

ARUMA EG096A.UVDATA.1

Freq = 4.7990 GHz, Bw = 32.000 MH No calibration applied and no bandpass applied

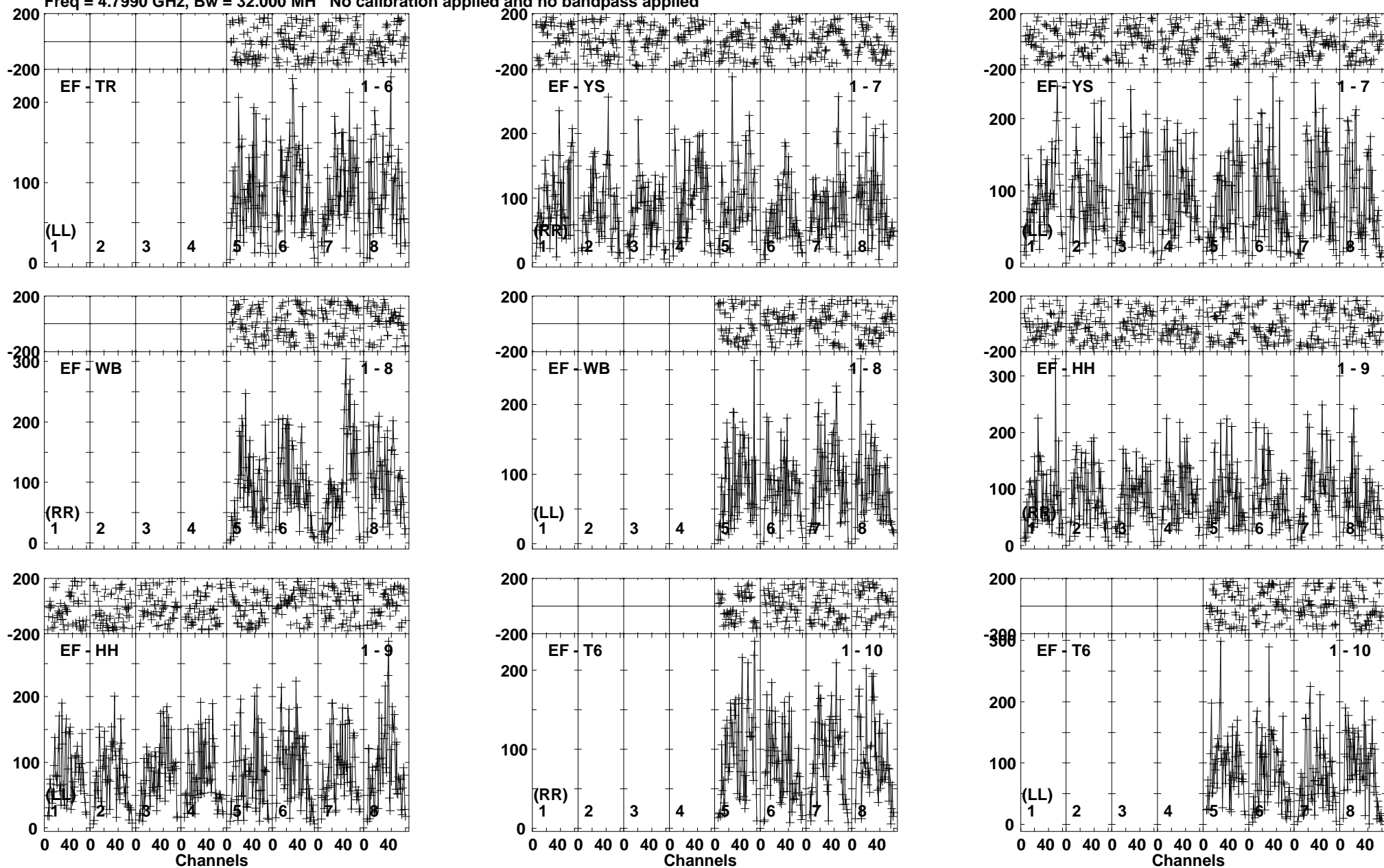

Lower frame: Micro Ampl Jy Top frame: Phas deg
Vector averaged cross-power spectrum Baseline: EF (01) - TR (06)
Timerange: 00/21:48:30 to 00/21:51:59

Plot file version 49 created 21-FEB-2017 15:10:53

J1108+4330 EG096A.UVDATA.1

Freq = 4.7990 GHz, Bw = 32.000 MH No calibration applied and no bandpass applied

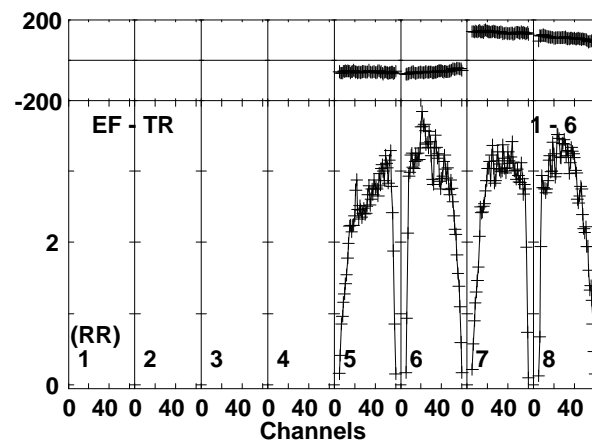
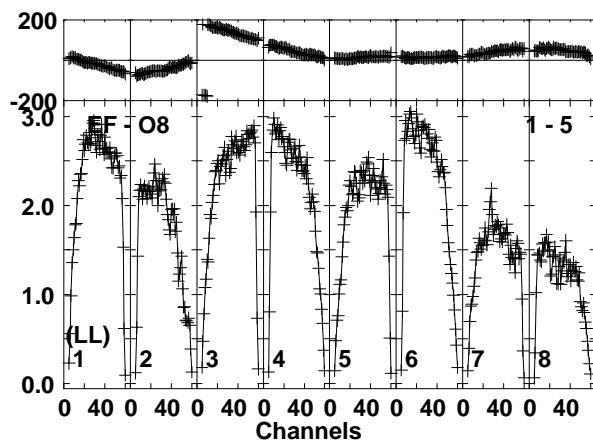
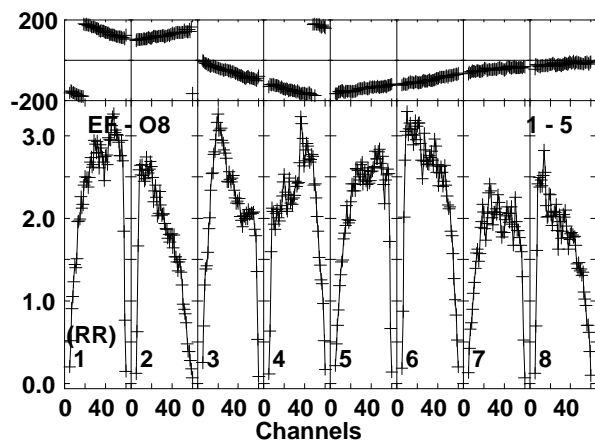
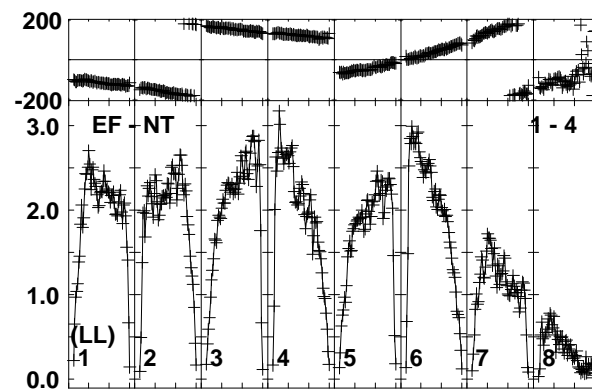
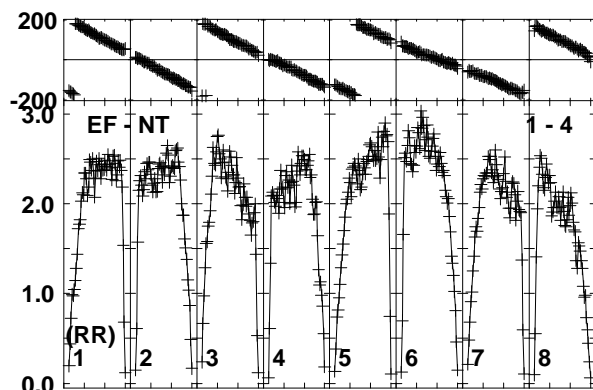
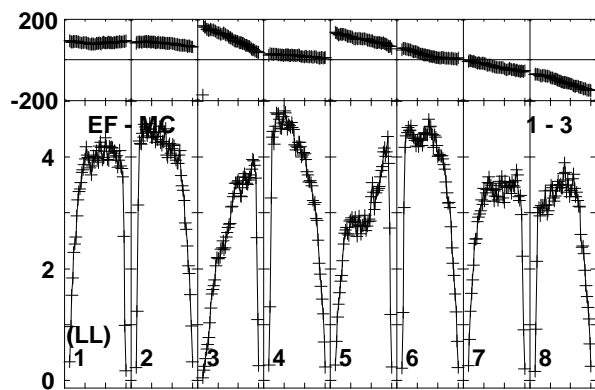
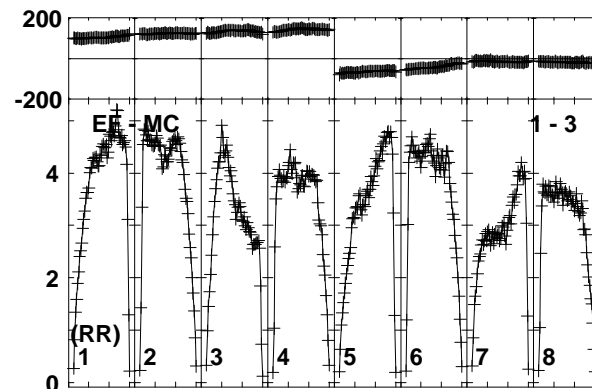
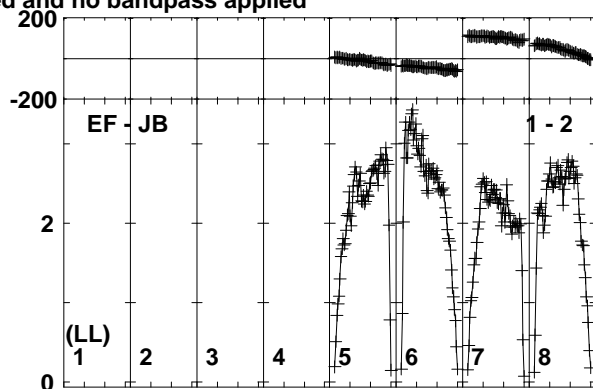
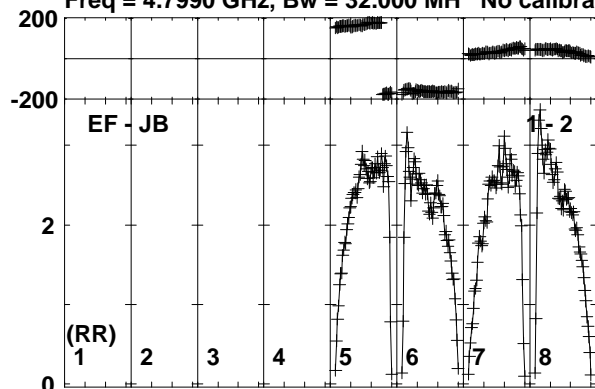

Lower frame: Milli Ampl Jy Top frame: Phas deg
Vector averaged cross-power spectrum Baseline: EF (01) - JB (02)
Timerange: 00/21:52:01 to 00/21:53:29

Plot file version 50 created 21-FEB-2017 15:10:53

J1108+4330 EG096A.UVDATA.1

Freq = 4.7990 GHz, Bw = 32.000 MH No calibration applied and no bandpass applied

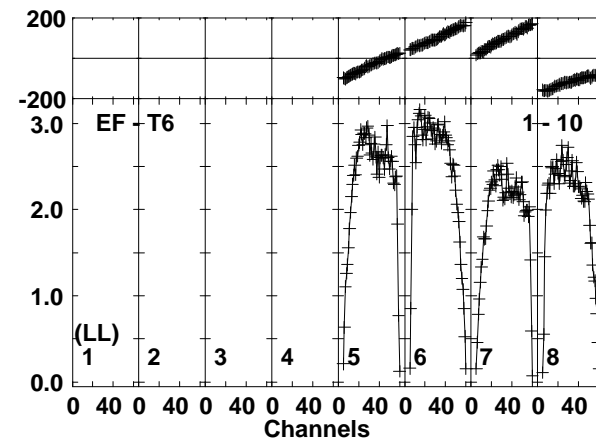
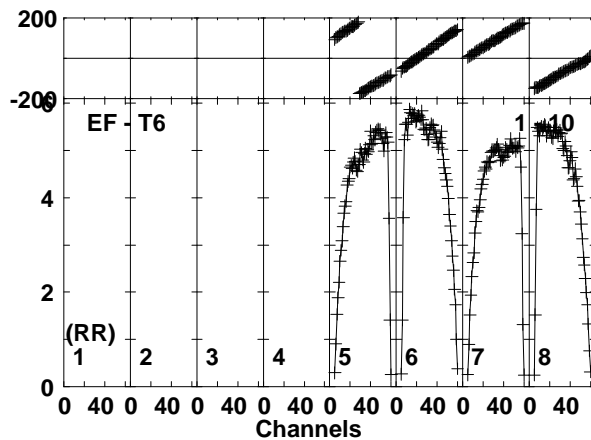
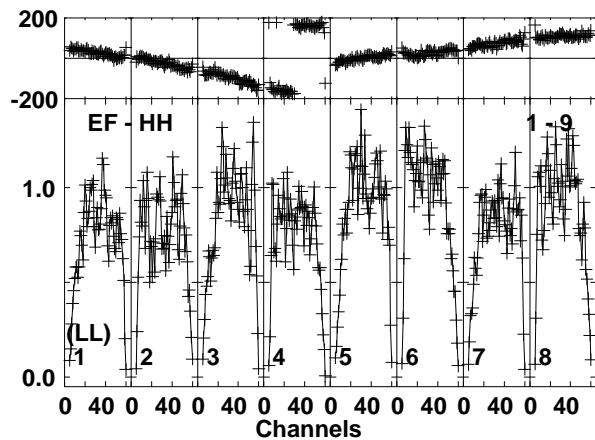
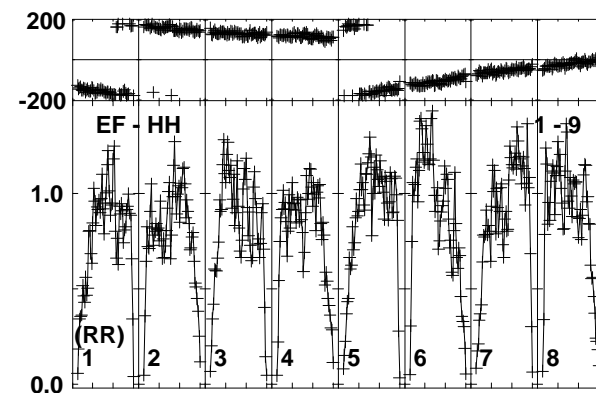
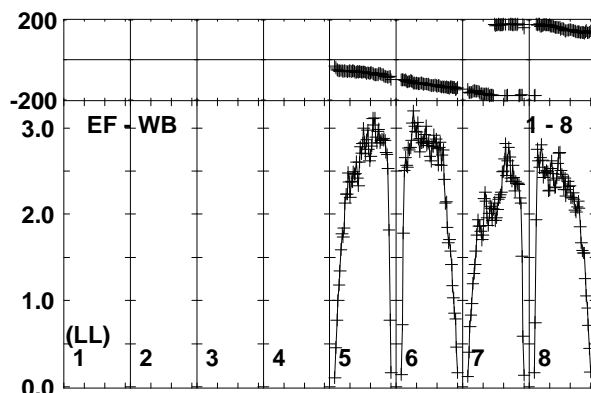
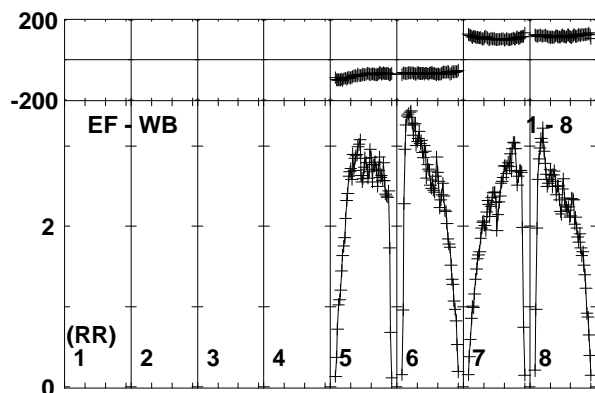
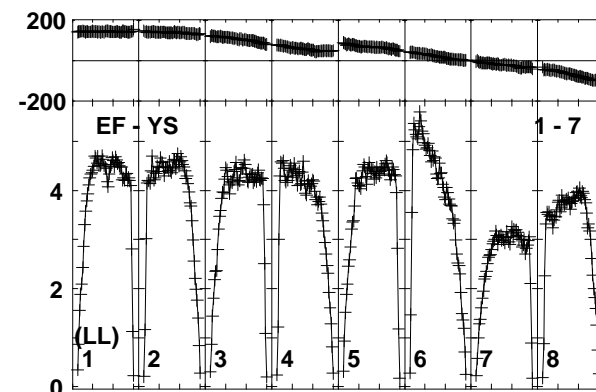
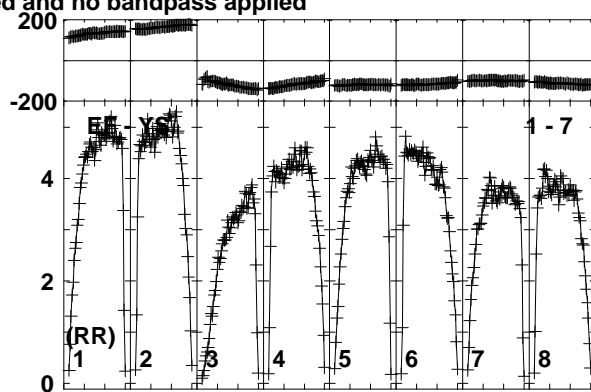
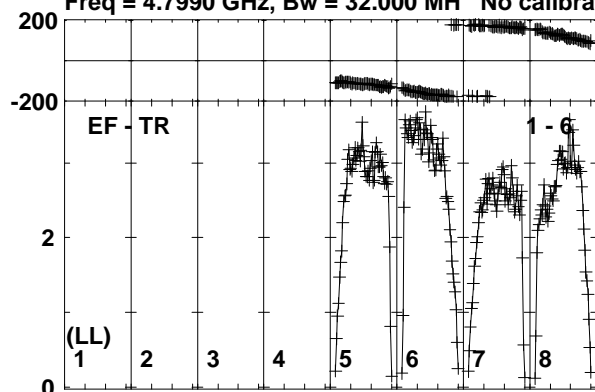

Lower frame: Milli Ampl Jy Top frame: Phas deg
Vector averaged cross-power spectrum Baseline: EF (01) - TR (06)
Timerange: 00/21:52:01 to 00/21:53:29

Plot file version 51 created 21-FEB-2017 15:10:54

ARUMA EG096A.UVDATA.1

Freq = 4.7990 GHz, Bw = 32.000 MH No calibration applied and no bandpass applied

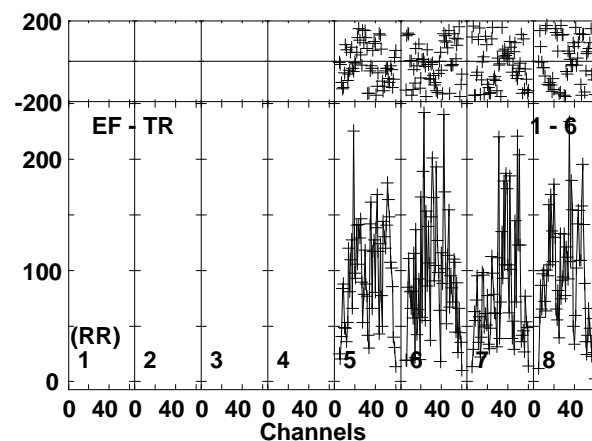
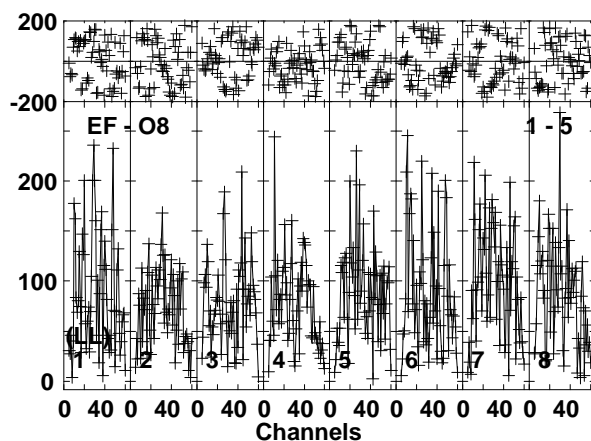
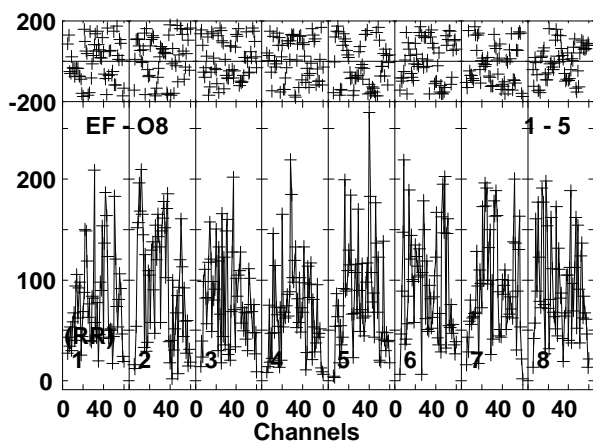
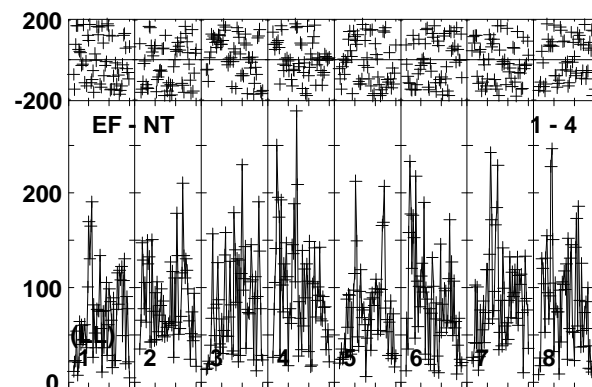
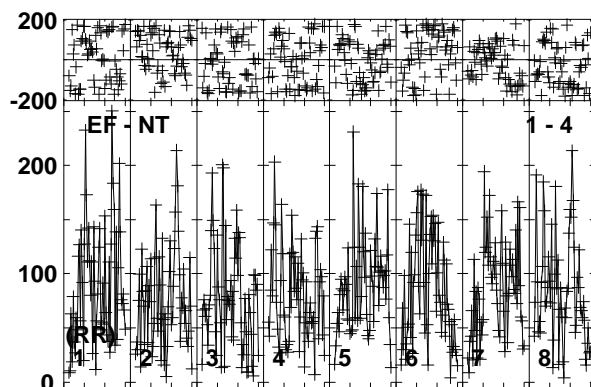
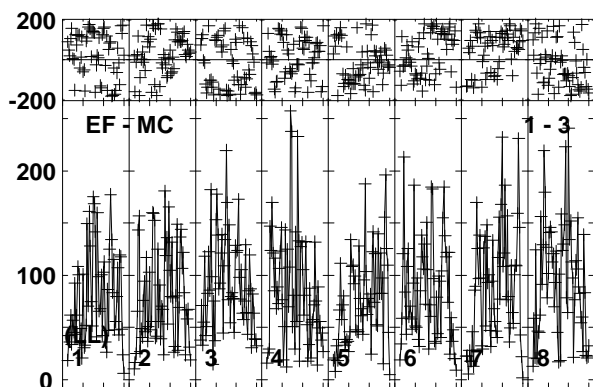
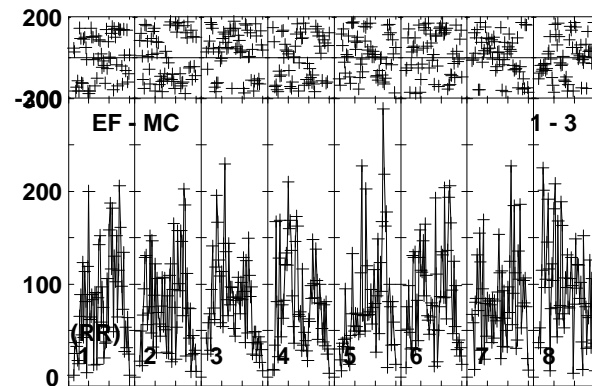
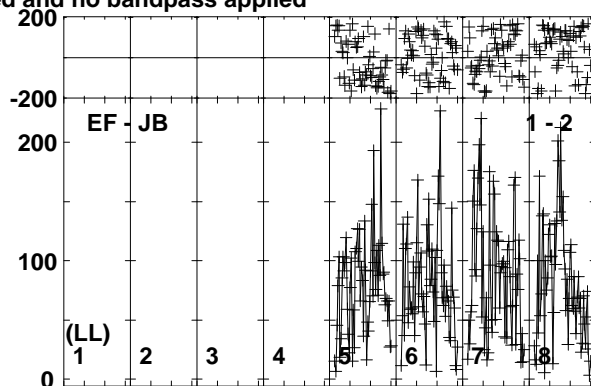
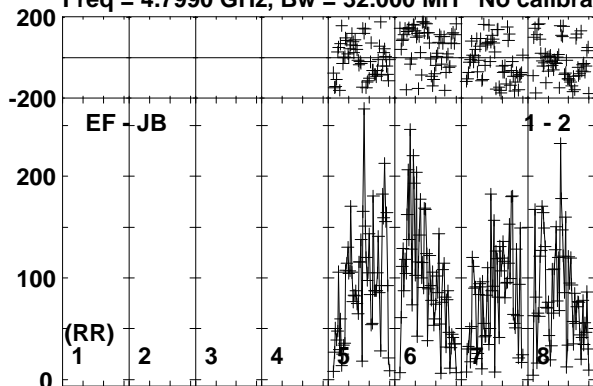

Lower frame: Micro Ampl Jy Top frame: Phas deg
Vector averaged cross-power spectrum Baseline: EF (01) - JB (02)
Timerange: 00/21:53:31 to 00/21:57:00

Plot file version 52 created 21-FEB-2017 15:10:54

ARUMA EG096A.UVDATA.1

Freq = 4.7990 GHz, Bw = 32.000 MH No calibration applied and no bandpass applied

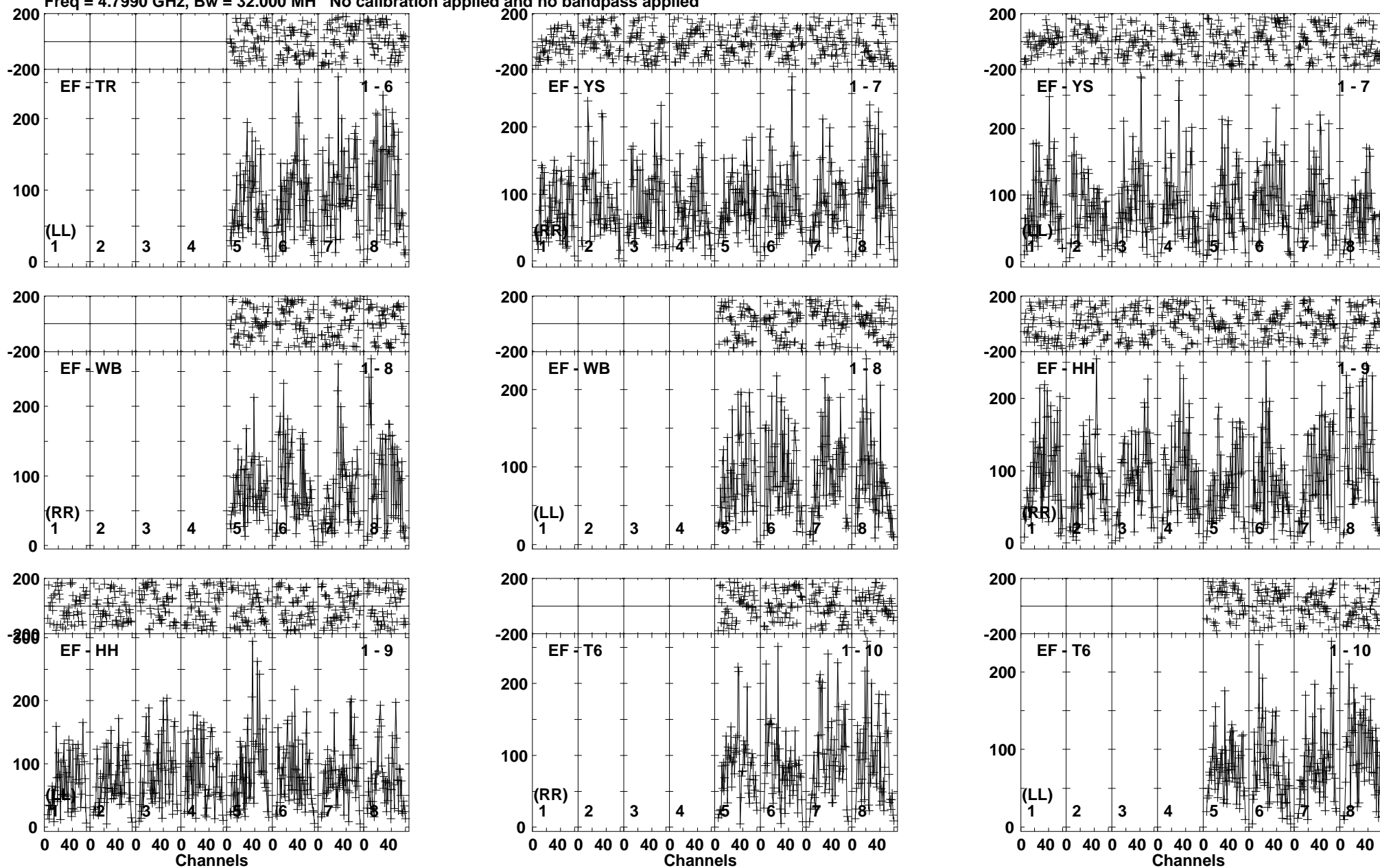

Lower frame: Micro Ampl Jy Top frame: Phas deg
Vector averaged cross-power spectrum Baseline: EF (01) - TR (06)
Timerange: 00/21:53:31 to 00/21:57:00

Plot file version 53 created 21-FEB-2017 15:10:54

J1108+4330 EG096A.UVDATA.1

Freq = 4.7990 GHz, Bw = 32.000 MH No calibration applied and no bandpass applied

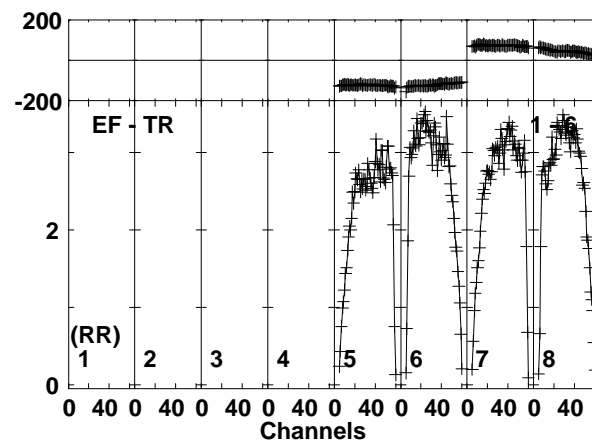
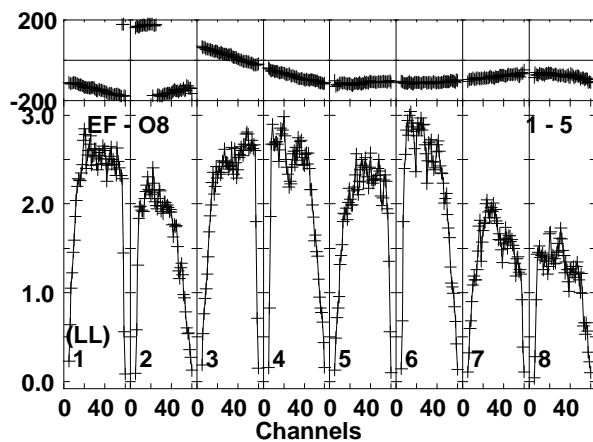
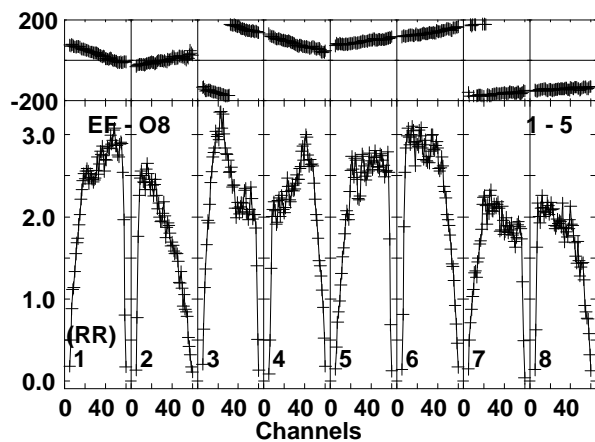
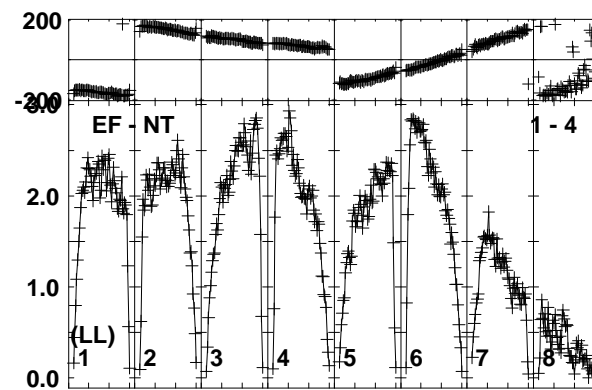
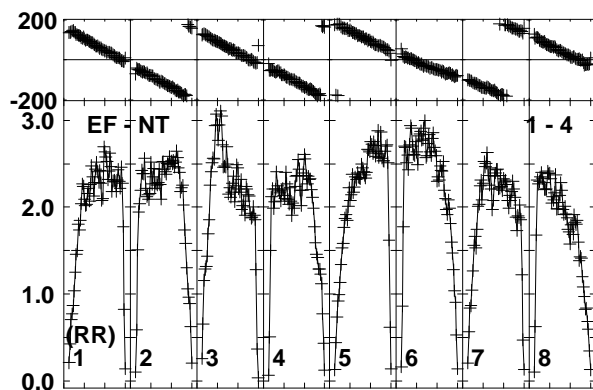
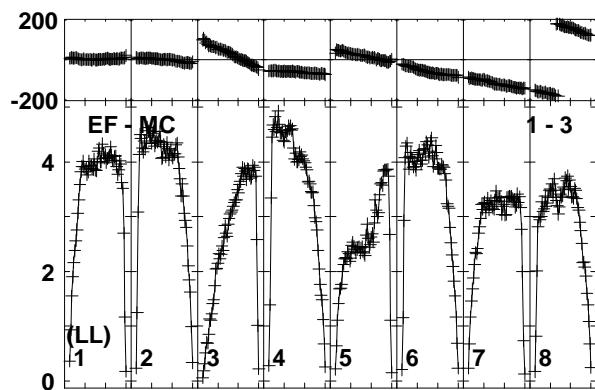
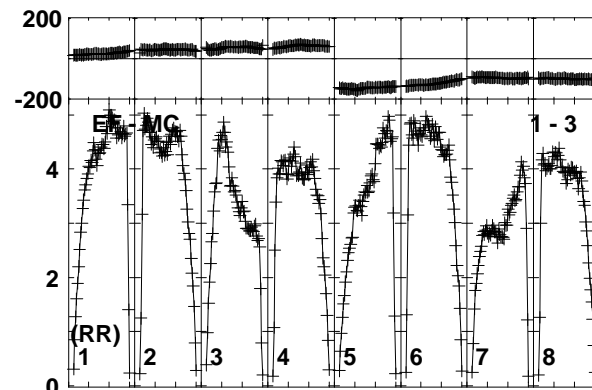
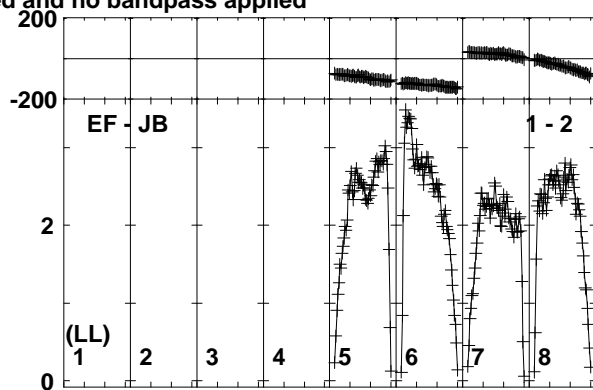
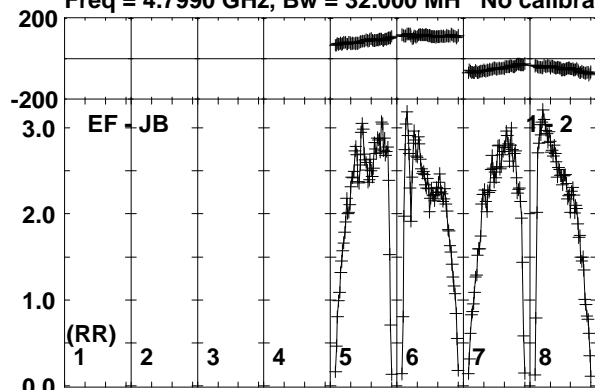

Lower frame: Milli Ampl Jy Top frame: Phas deg
Vector averaged cross-power spectrum Baseline: EF (01) - JB (02)
Timerange: 00/21:57:41 to 00/21:58:39

Plot file version 54 created 21-FEB-2017 15:10:55

J1108+4330 EG096A.UVDATA.1

Freq = 4.7990 GHz, Bw = 32.000 MH No calibration applied and no bandpass applied

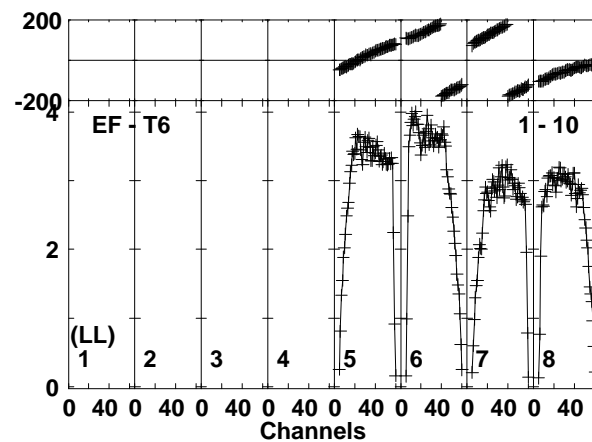
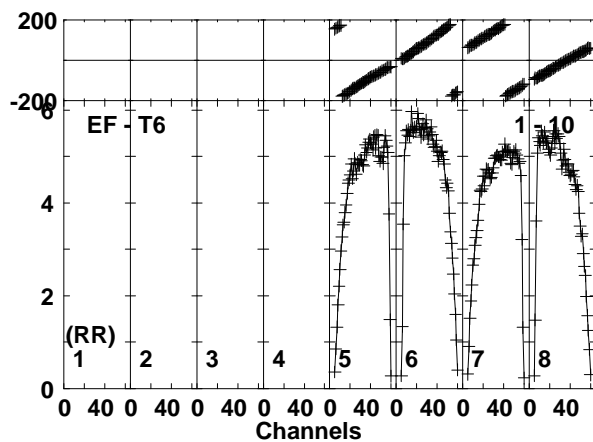
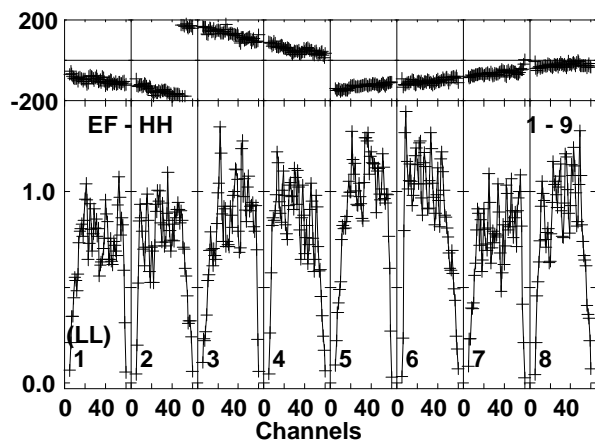
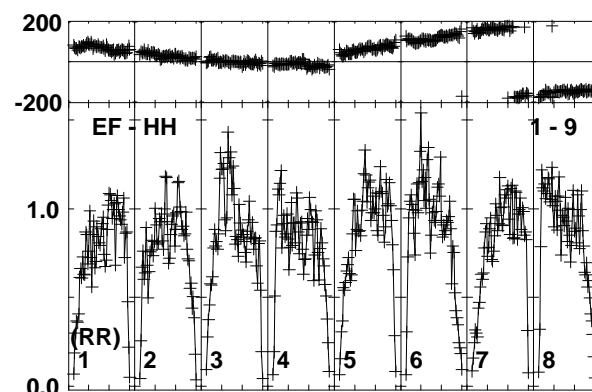
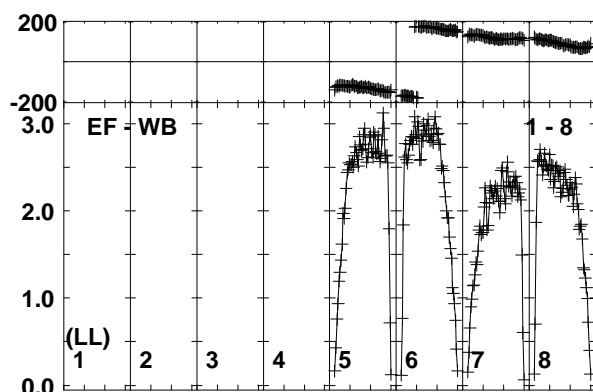
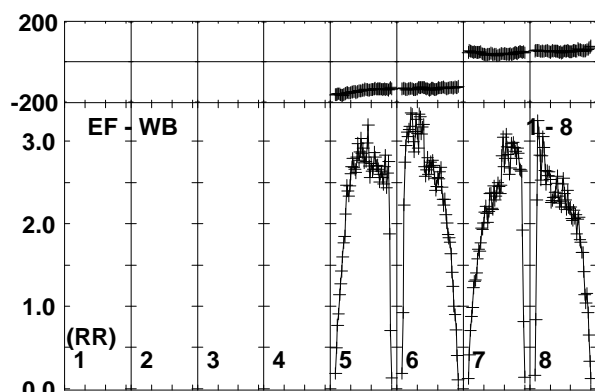
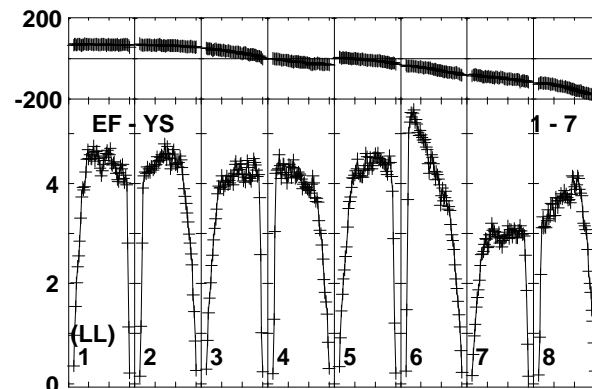
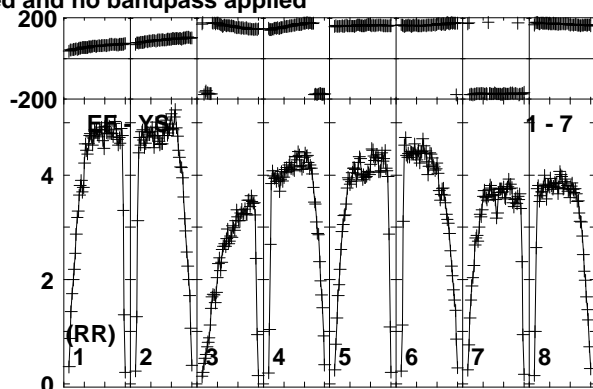
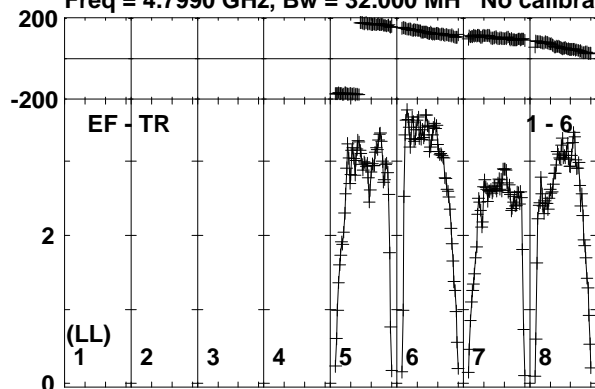

Lower frame: Milli Ampl Jy Top frame: Phas deg
Vector averaged cross-power spectrum Baseline: EF (01) - TR (06)
Timerange: 00/21:57:41 to 00/21:58:39

Plot file version 55 created 21-FEB-2017 15:10:55

J1112+4301 EG096A.UVDATA.1

Freq = 4.7990 GHz, Bw = 32.000 MH No calibration applied and no bandpass applied

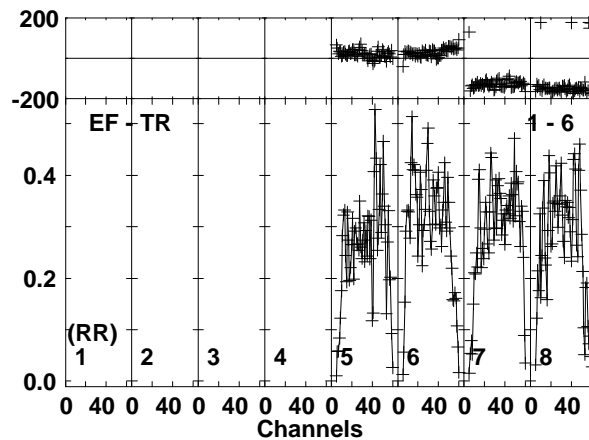
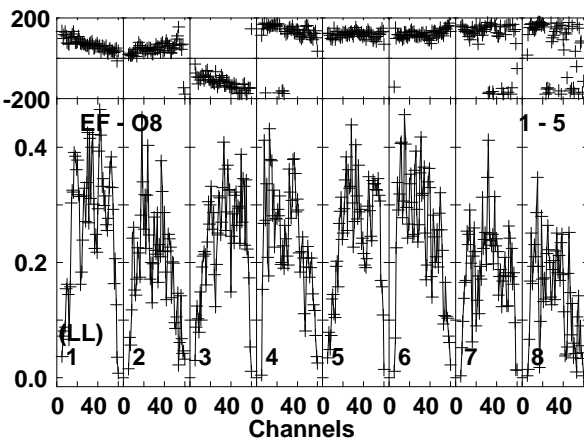
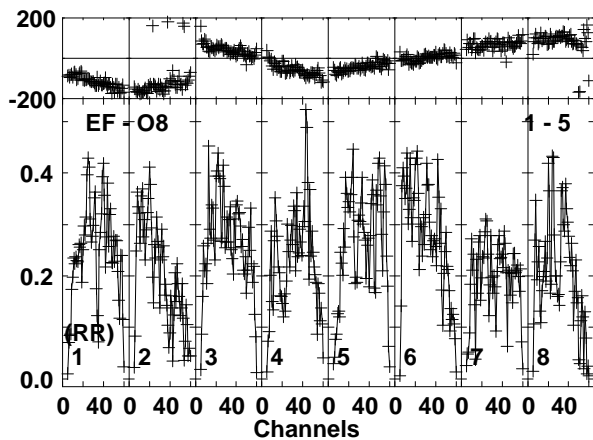
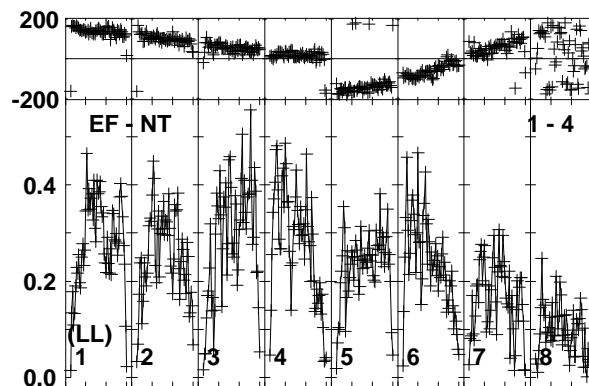
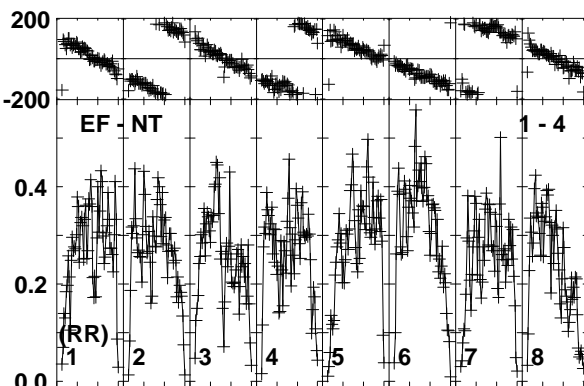
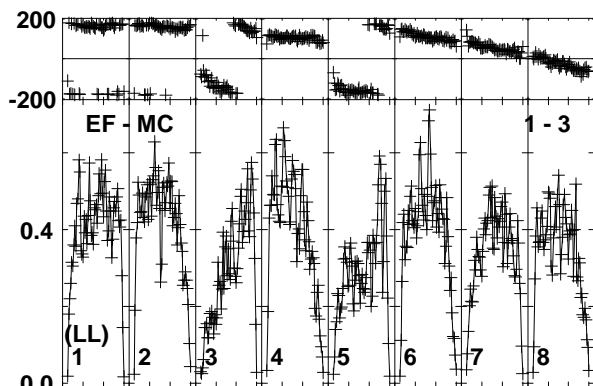
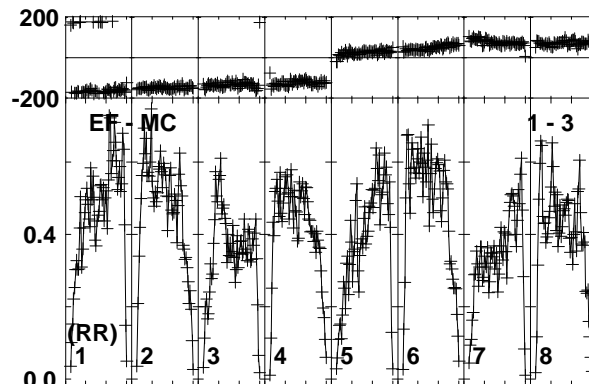
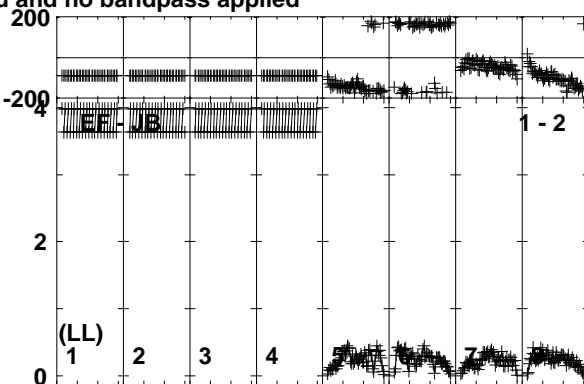
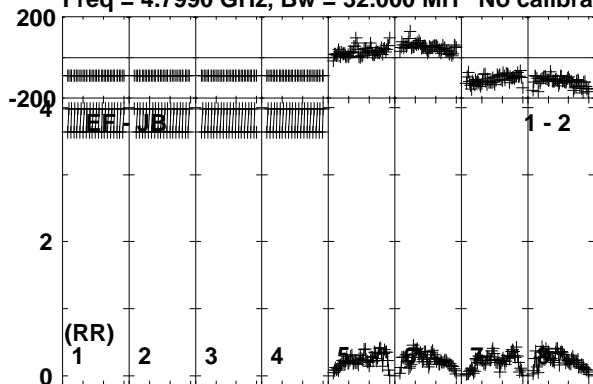

Lower frame: Milli Ampl Jy Top frame: Phas deg
Vector averaged cross-power spectrum Baseline: EF (01) - JB (02)
Timerange: 00/21:58:41 to 00/22:02:10

Plot file version 56 created 21-FEB-2017 15:10:55

J1112+4301 EG096A.UVDATA.1

Freq = 4.7990 GHz, Bw = 32.000 MH No calibration applied and no bandpass applied

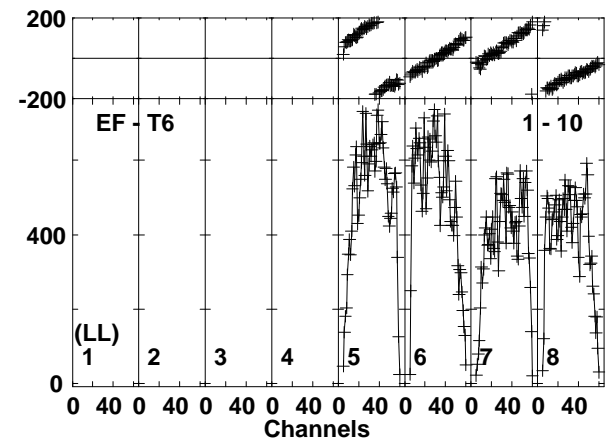
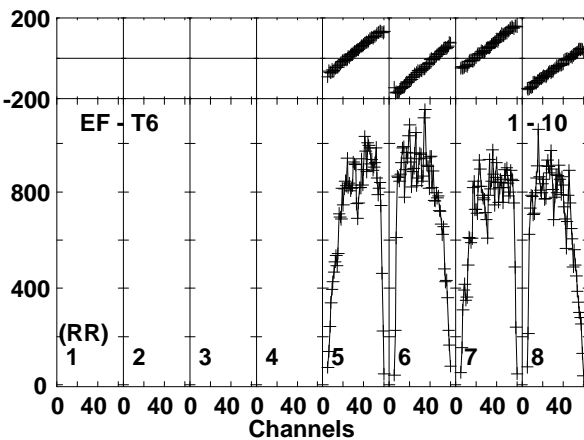
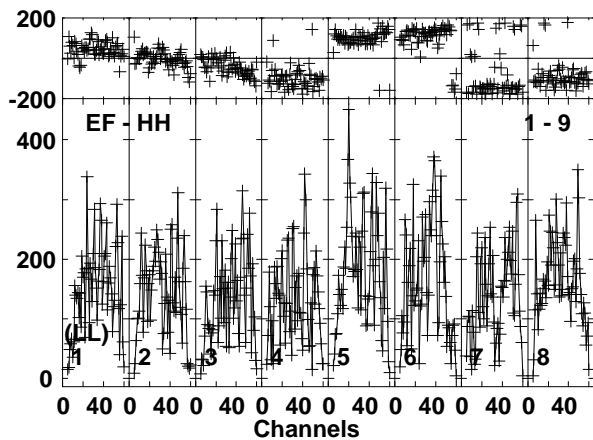
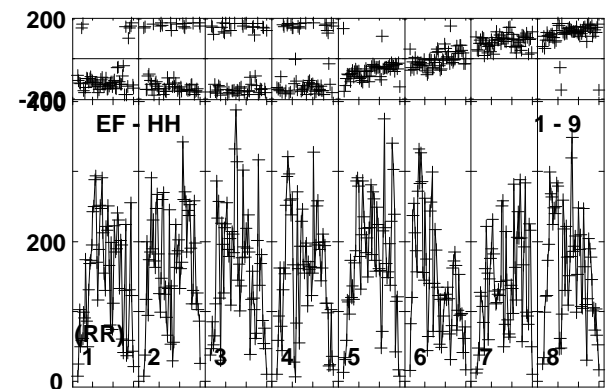
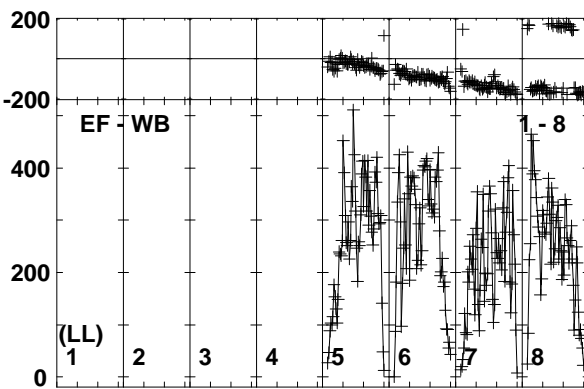
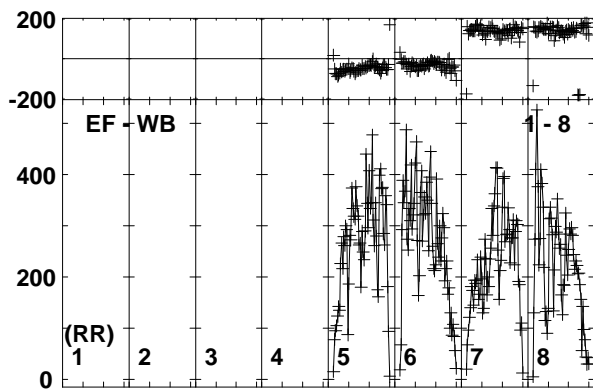
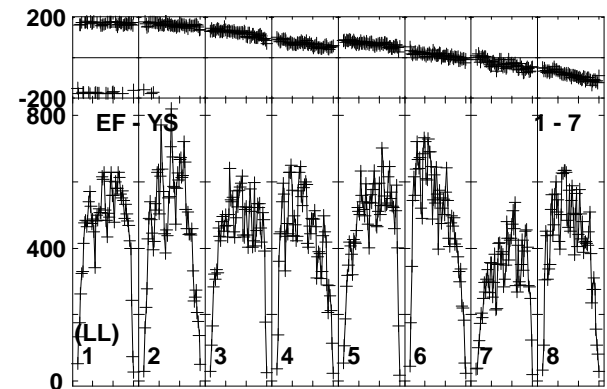
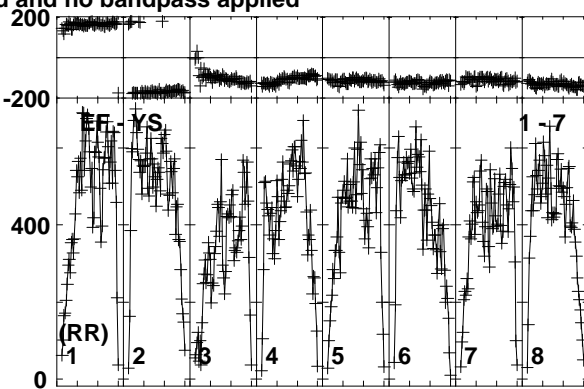
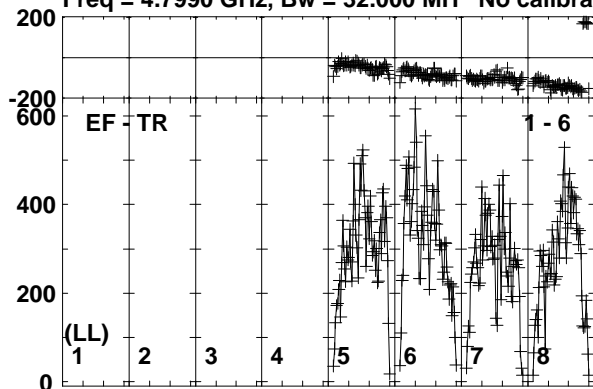

Lower frame: Micro Ampl Jy Top frame: Phas deg
Vector averaged cross-power spectrum Baseline: EF (01) - TR (06)
Timerange: 00/21:58:41 to 00/22:02:10

Plot file version 57 created 21-FEB-2017 15:10:56

J1108+4330 EG096A.UVDATA.1

Freq = 4.7990 GHz, Bw = 32.000 MH No calibration applied and no bandpass applied

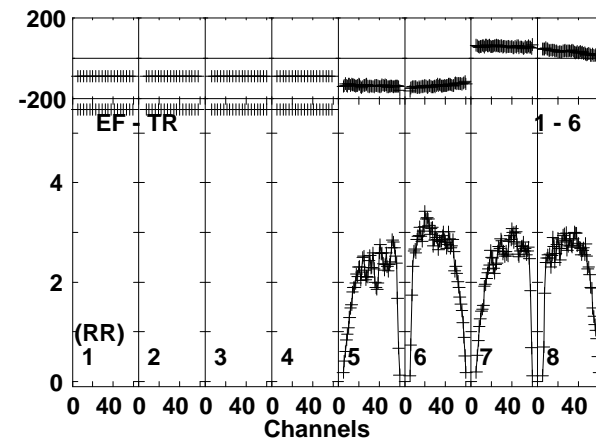
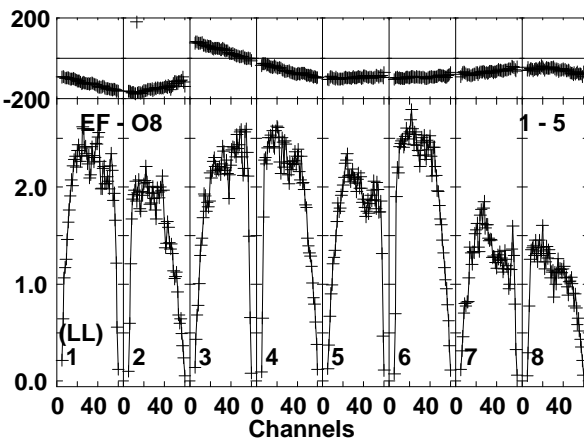
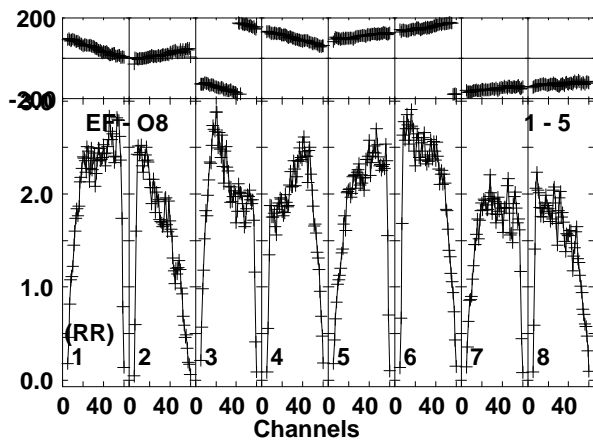
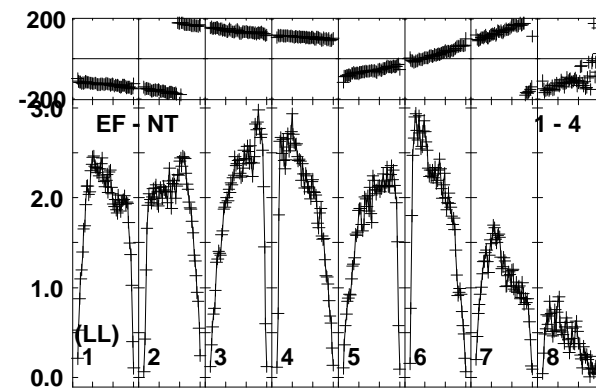
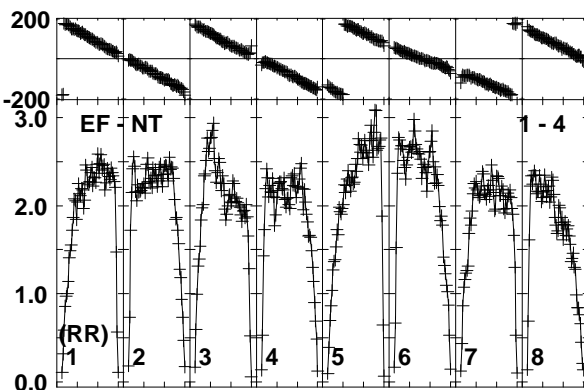
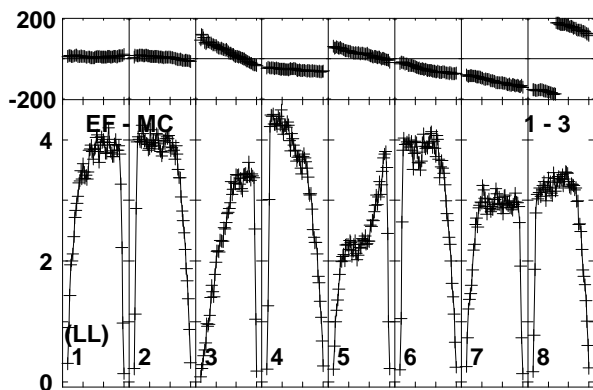
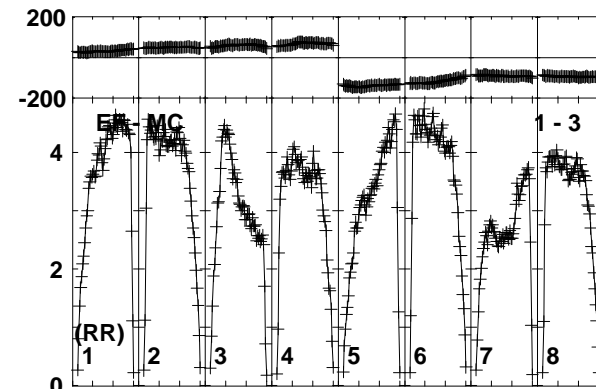
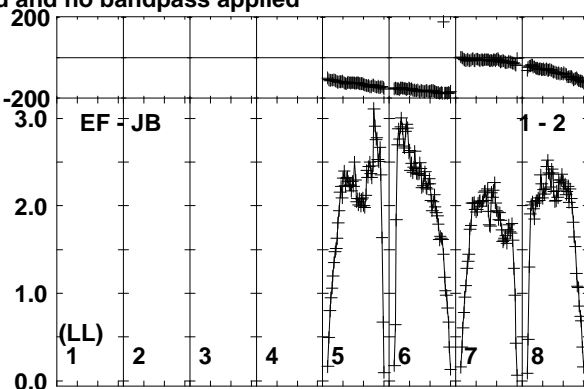
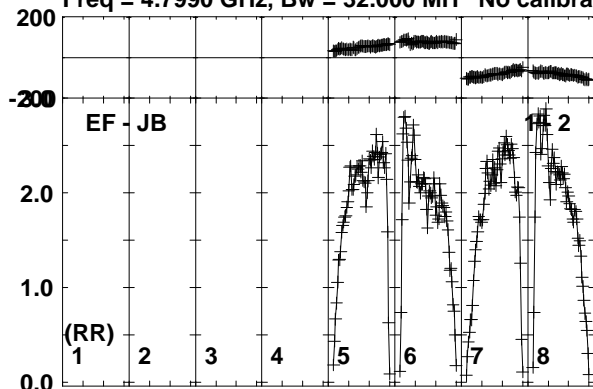

Lower frame: Milli Ampl Jy Top frame: Phas deg
Vector averaged cross-power spectrum Baseline: EF (01) - JB (02)
Timerange: 00/22:02:10 to 00/22:03:39

Plot file version 58 created 21-FEB-2017 15:10:56

J1108+4330 EG096A.UVDATA.1

Freq = 4.7990 GHz, Bw = 32.000 MH No calibration applied and no bandpass applied

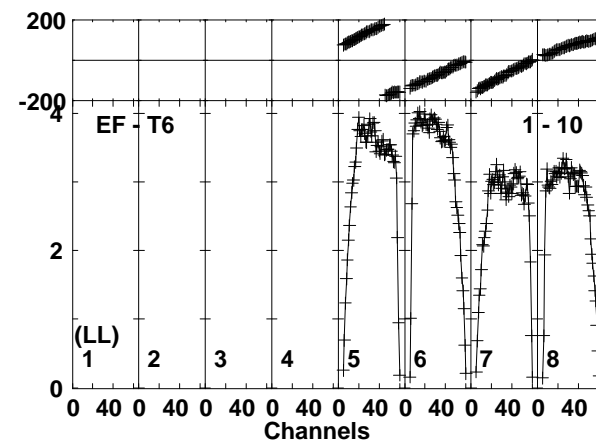
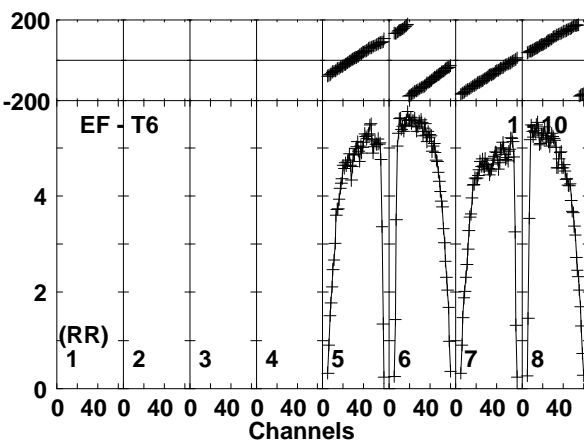
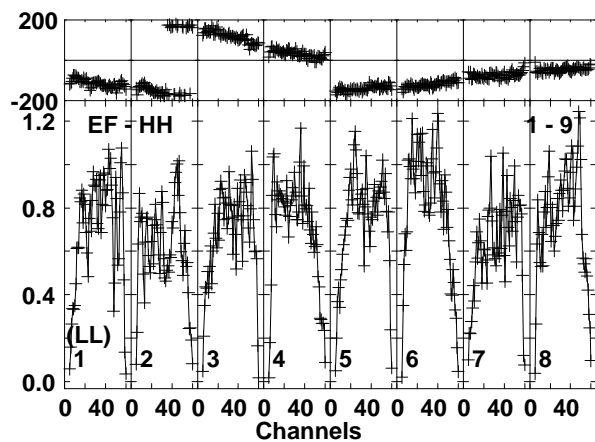
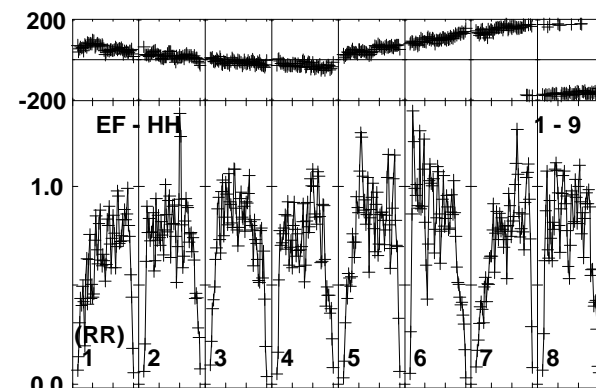
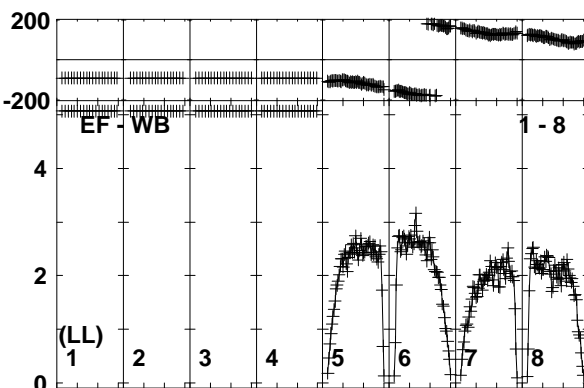
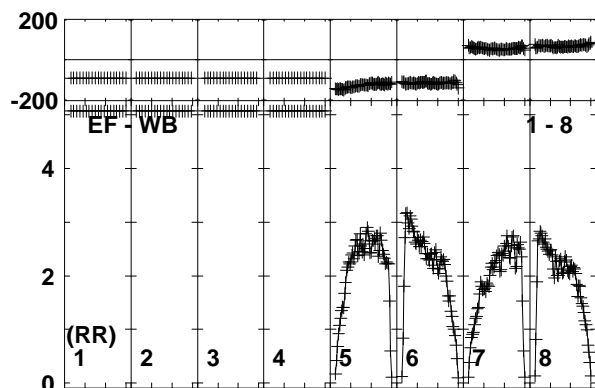
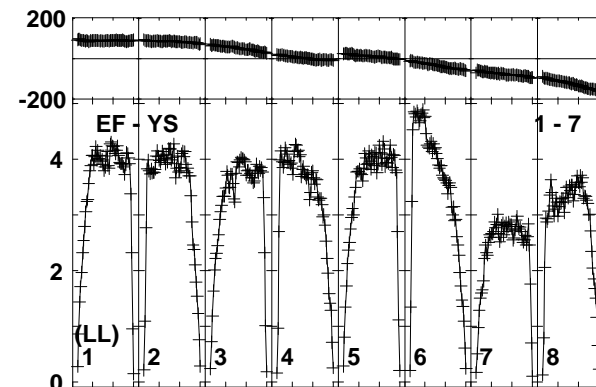
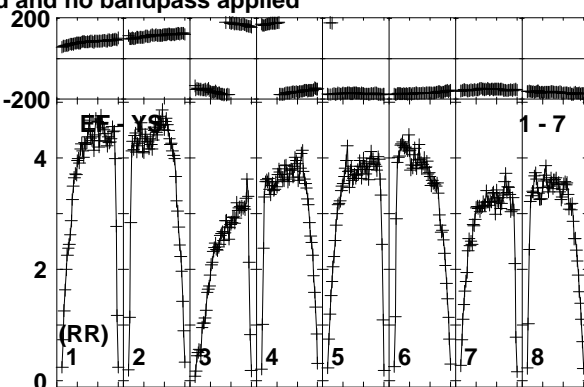
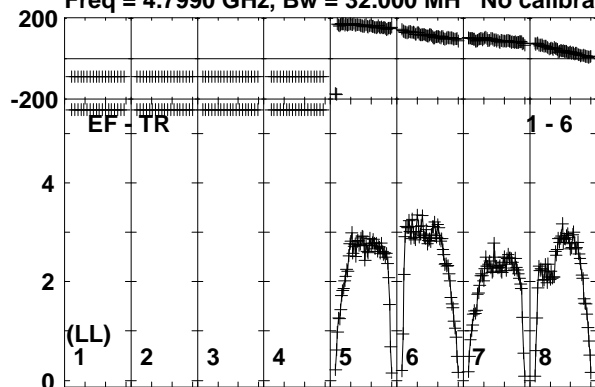

Lower frame: Milli Ampl Jy Top frame: Phas deg
Vector averaged cross-power spectrum Baseline: EF (01) - TR (06)
Timerange: 00/22:02:10 to 00/22:03:39

Plot file version 59 created 21-FEB-2017 15:10:56

ARUMA EG096A.UVDATA.1

Freq = 4.7990 GHz, Bw = 32.000 MH No calibration applied and no bandpass applied

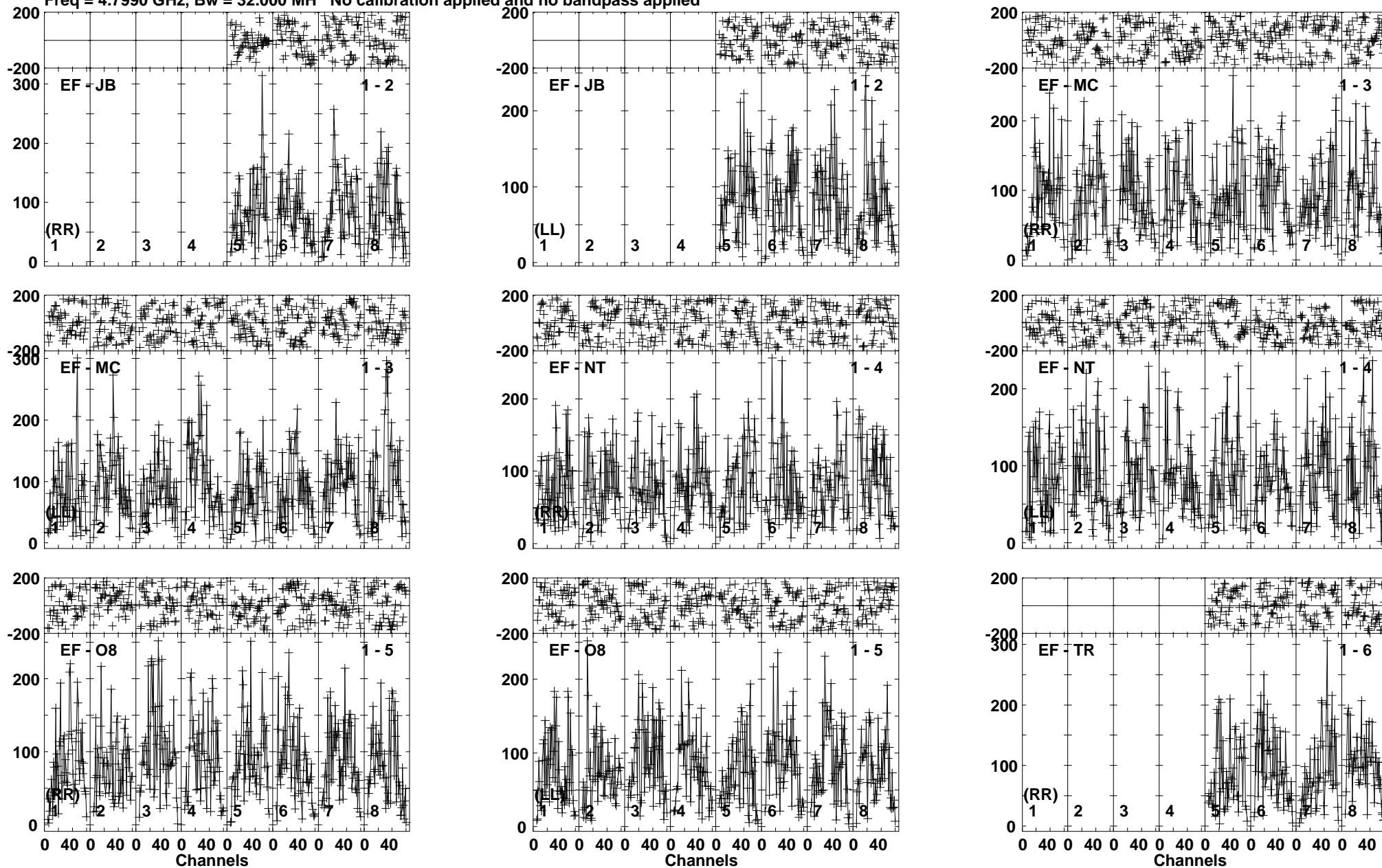

Lower frame: Micro Ampl Jy Top frame: Phas deg
Vector averaged cross-power spectrum Baseline: EF (01) - JB (02)
Timerange: 00:22:03:41 to 00:22:07:10

Plot file version 60 created 21-FEB-2017 15:10:56

ARUMA EG096A.UVDATA.1

Freq = 4.7990 GHz, Bw = 32.000 MH No calibration applied and no bandpass applied

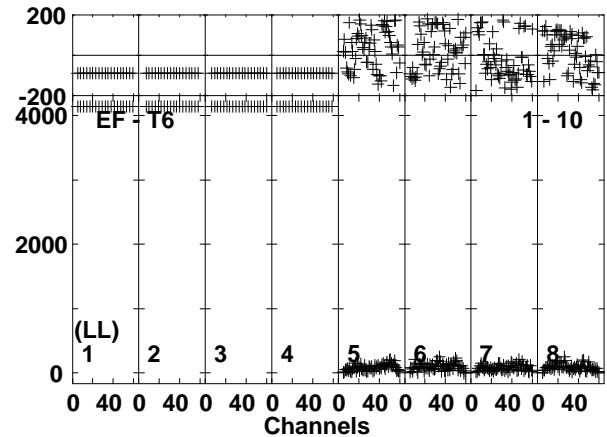
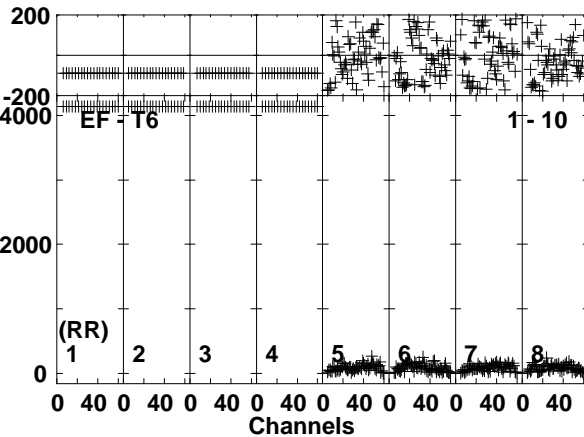
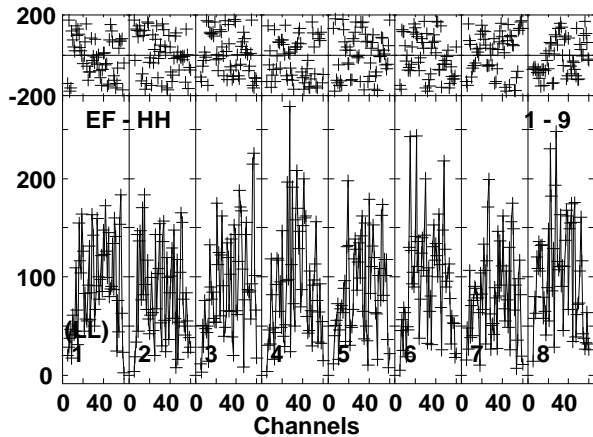
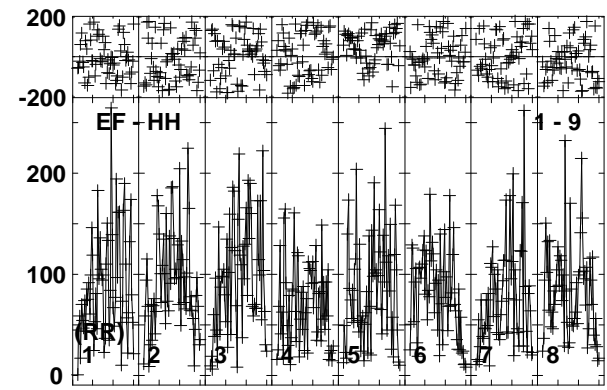
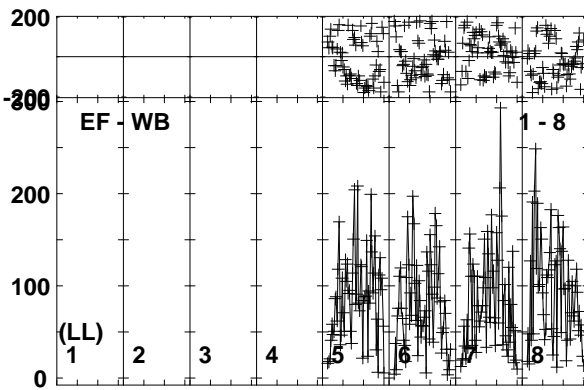
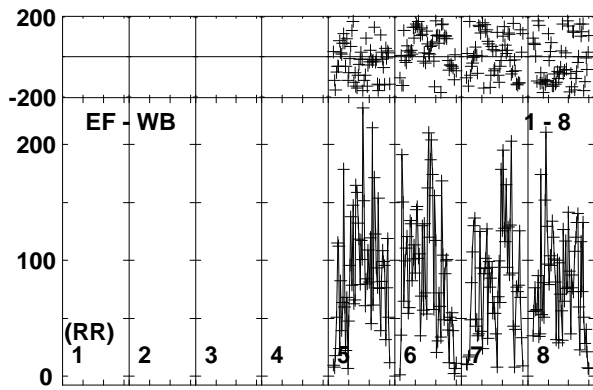
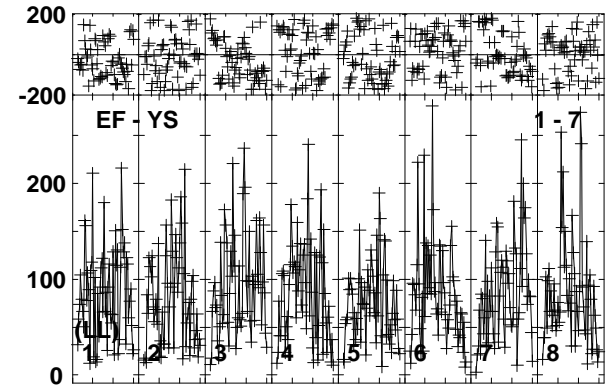
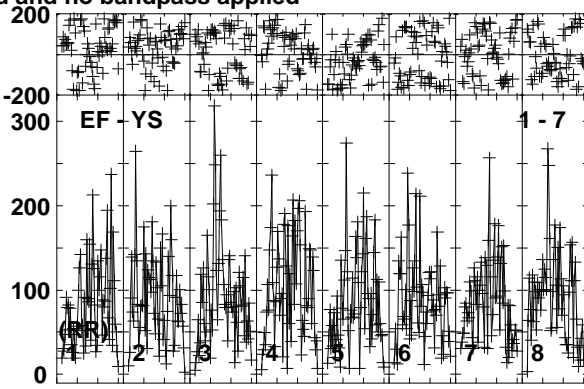
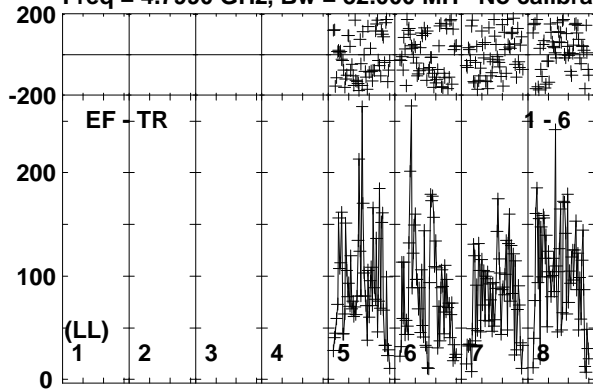

Lower frame: Micro Ampl Jy Top frame: Phas deg
Vector averaged cross-power spectrum Baseline: EF (01) - TR (06)
Timerange: 00/22:03:41 to 00/22:07:10

Plot file version 61 created 21-FEB-2017 15:10:57

J1108+4330 EG096A.UVDATA.1

Freq = 4.7990 GHz, Bw = 32.000 MH No calibration applied and no bandpass applied

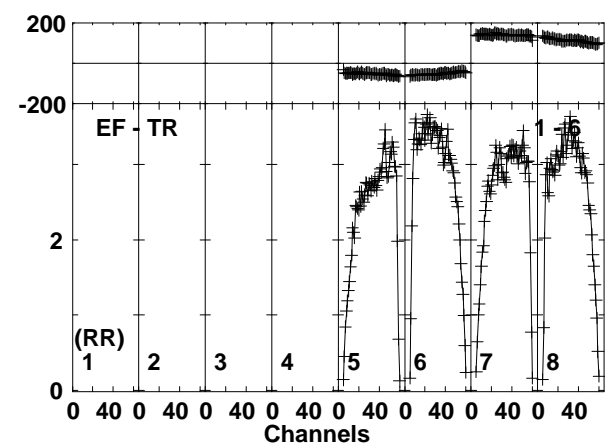
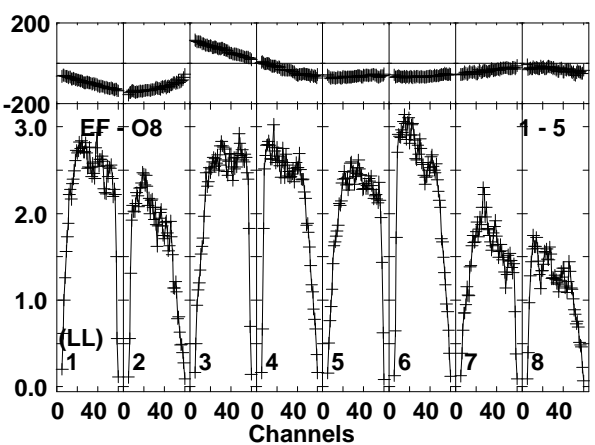
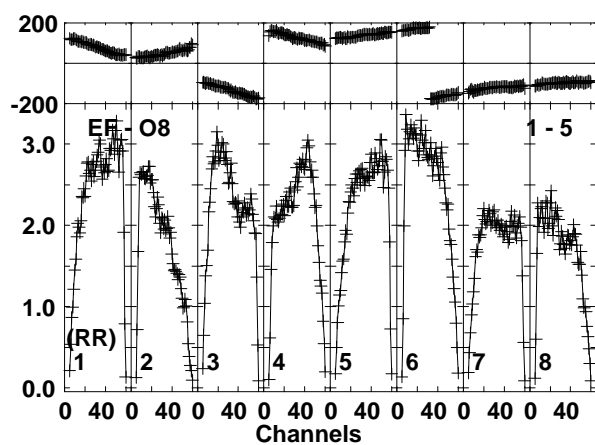
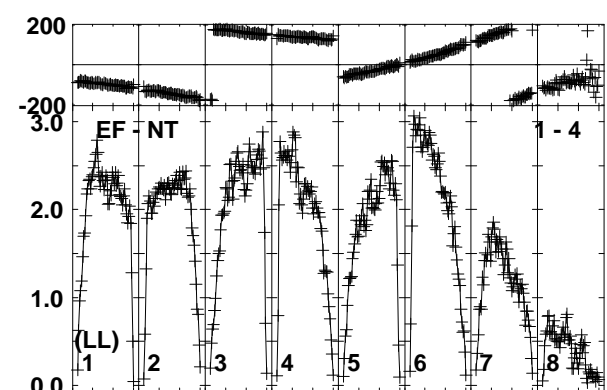
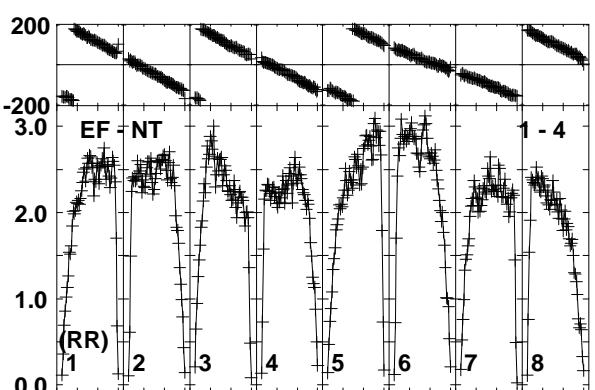
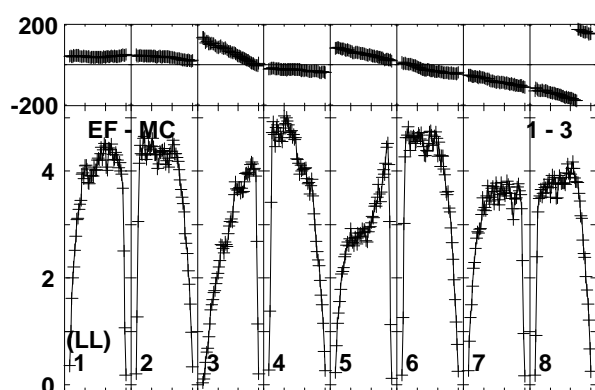
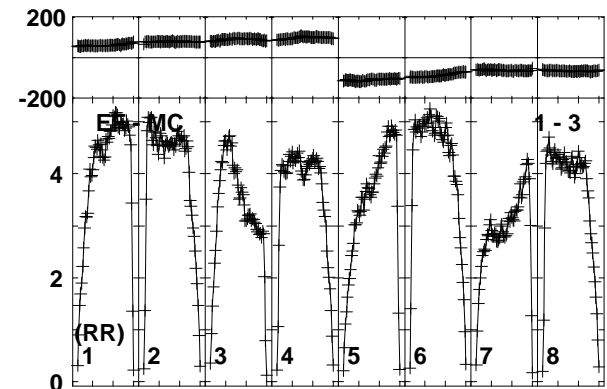
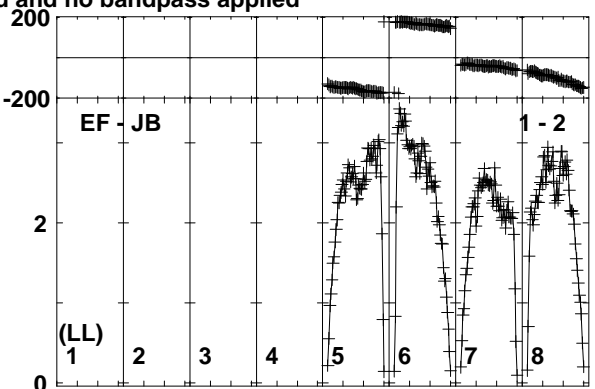
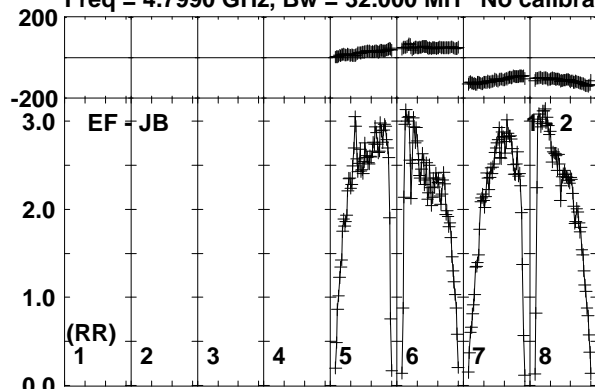

Lower frame: Milli Ampl Jy Top frame: Phas deg
Vector averaged cross-power spectrum Baseline: EF (01) - JB (02)
Timerange: 00/22:07:51 to 00/22:08:49

Plot file version 62 created 21-FEB-2017 15:10:57

J1108+4330 EG096A.UVDATA.1

Freq = 4.7990 GHz, Bw = 32.000 MH No calibration applied and no bandpass applied

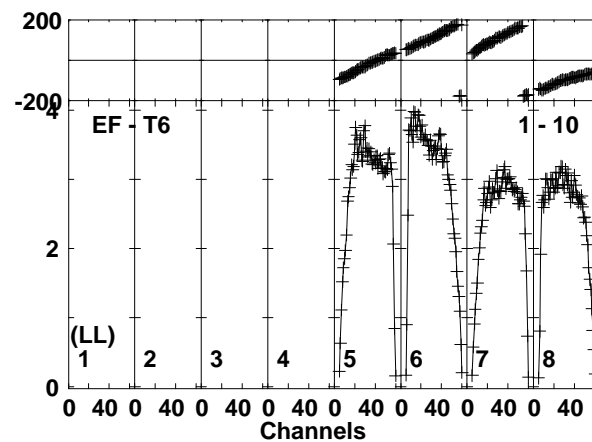
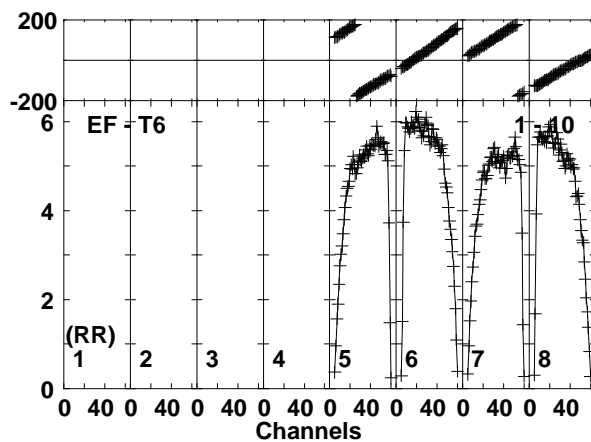
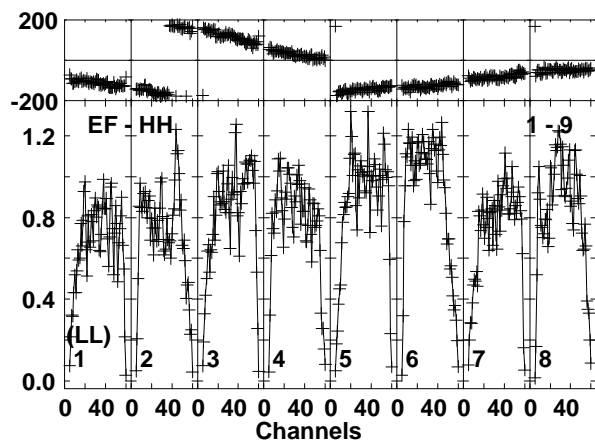
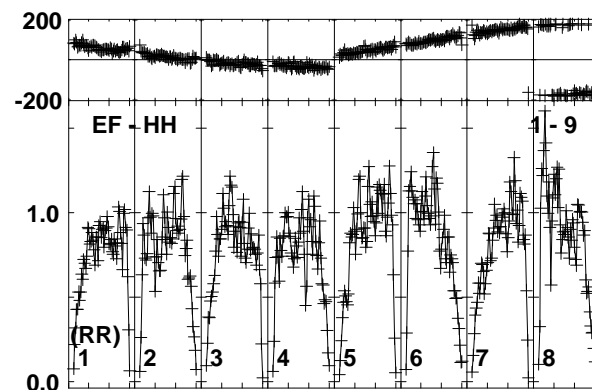
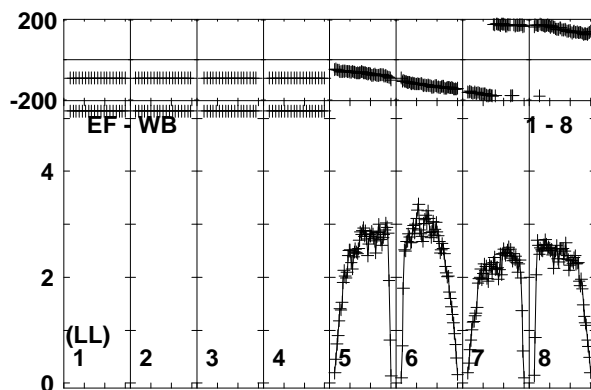
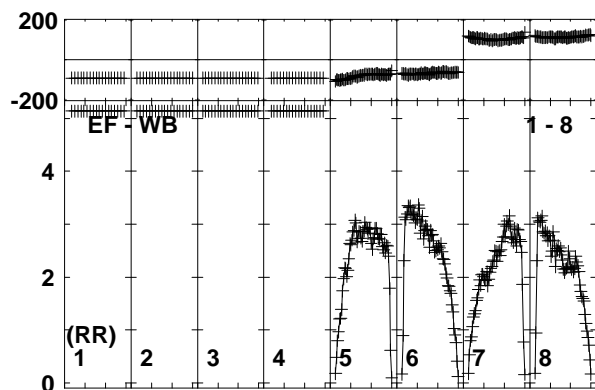
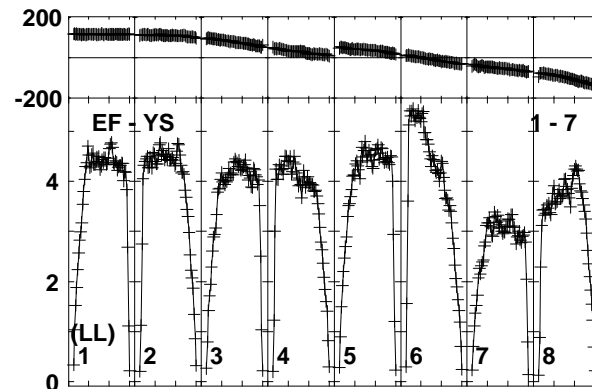
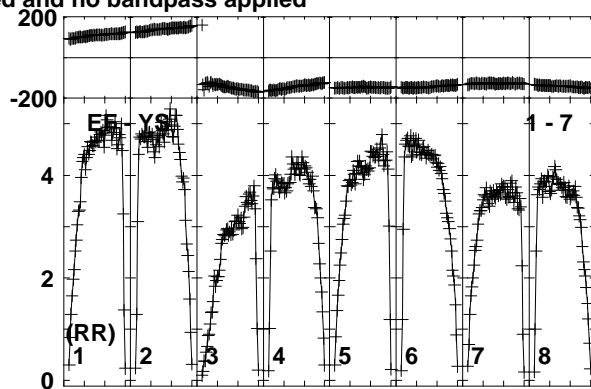
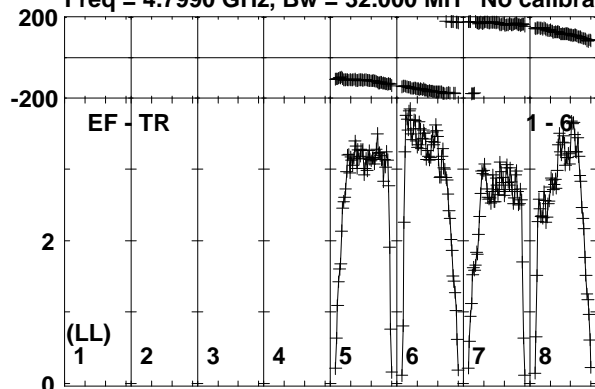

Lower frame: Milli Ampl Jy Top frame: Phas deg
Vector averaged cross-power spectrum Baseline: EF (01) - TR (06)
Timerange: 00/22:07:51 to 00/22:08:49

Plot file version 63 created 21-FEB-2017 15:10:57

ARUMA EG096A.UVDATA.1

Freq = 4.7990 GHz, Bw = 32.000 MH No calibration applied and no bandpass applied

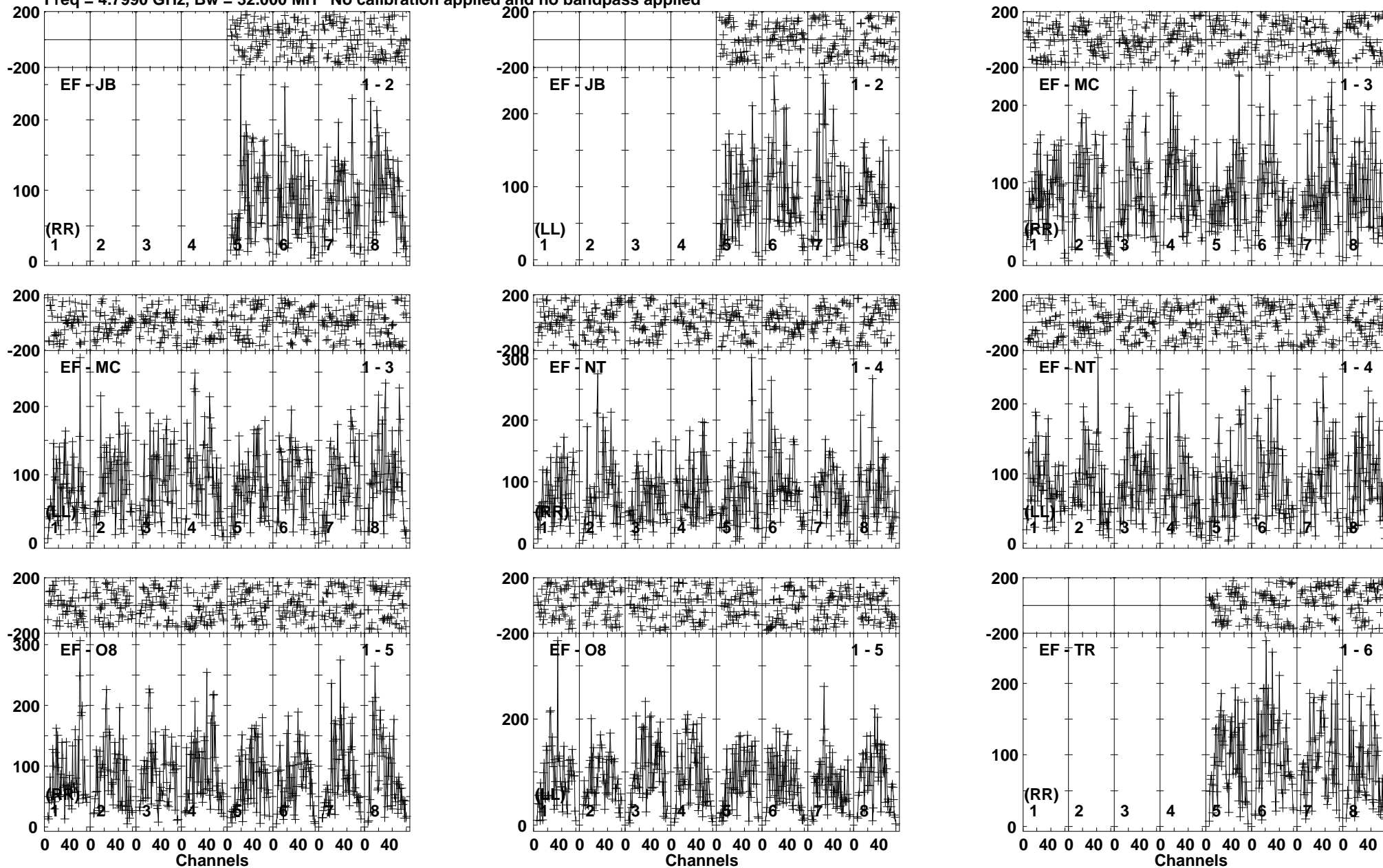

Lower frame: Micro Ampl Jy Top frame: Phas deg
Vector averaged cross-power spectrum Baseline: EF (01) - JB (02)
Timerange: 00/22:08:51 to 00/22:12:20

Plot file version 64 created 21-FEB-2017 15:10:57

ARUMA EG096A.UVDATA.1

Freq = 4.7990 GHz, Bw = 32.000 MH No calibration applied and no bandpass applied

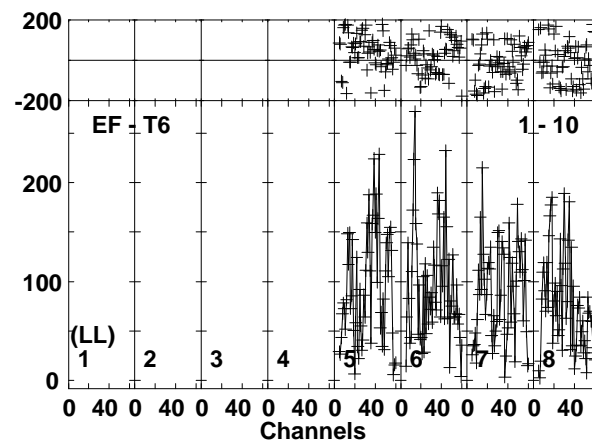
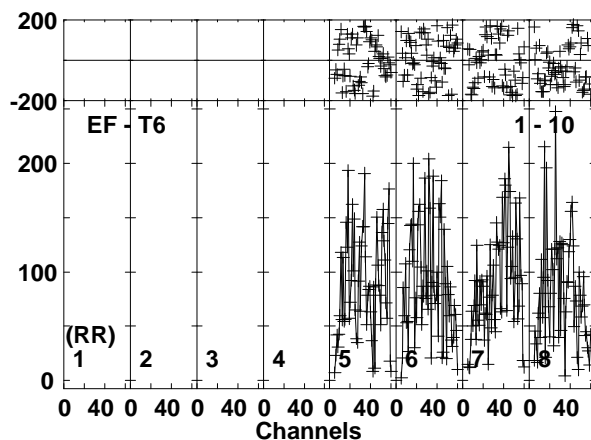
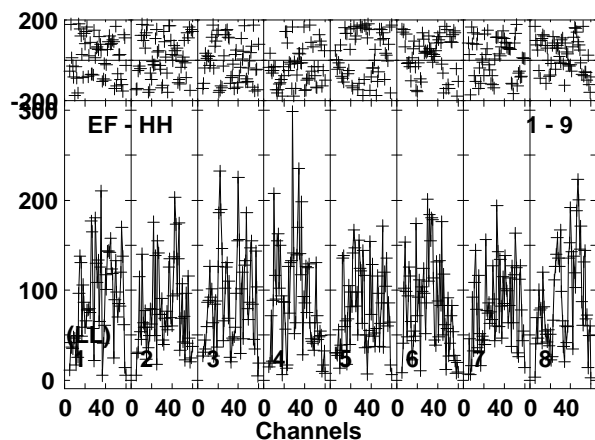
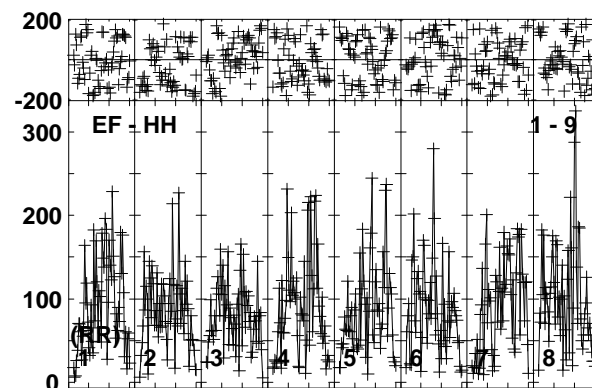
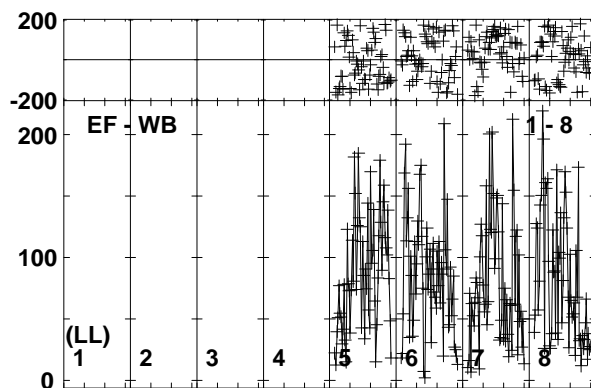
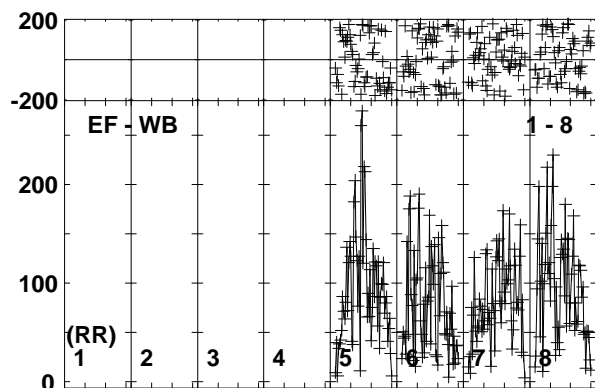
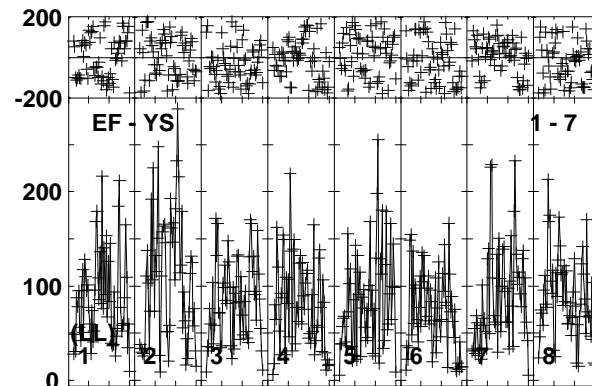
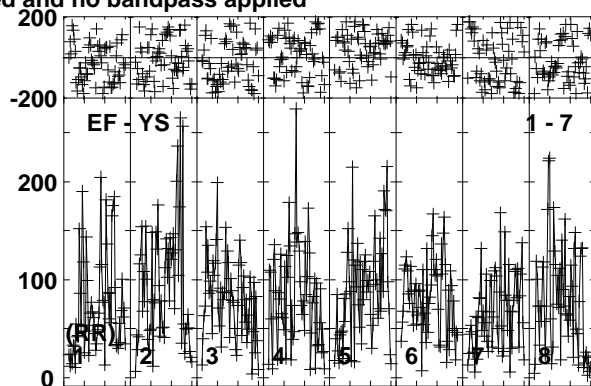
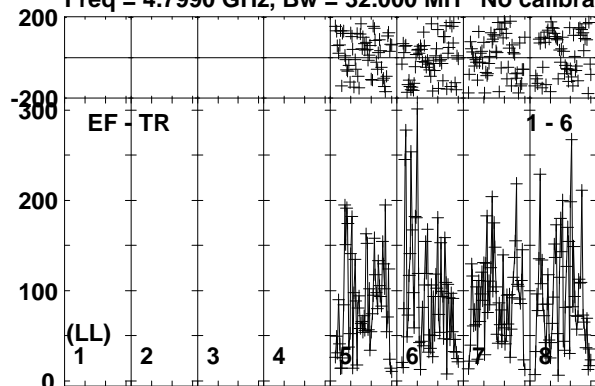

Lower frame: Micro Ampl Jy Top frame: Phas deg
Vector averaged cross-power spectrum Baseline: EF (01) - TR (06)
Timerange: 00/22:08:51 to 00/22:12:20

Plot file version 65 created 21-FEB-2017 15:10:58

J1108+4330 EG096A.UVDATA.1

Freq = 4.7990 GHz, Bw = 32.000 MH No calibration applied and no bandpass applied

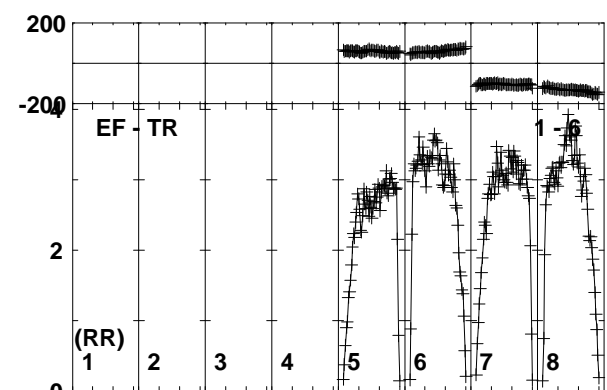
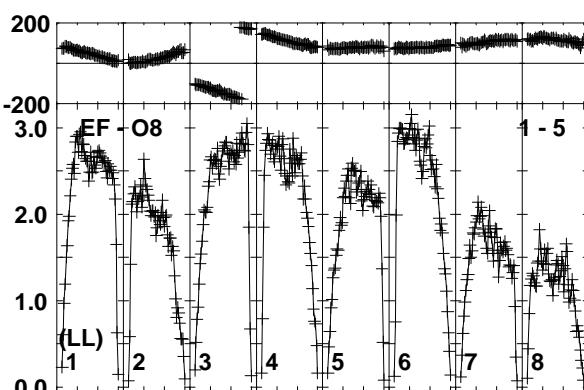
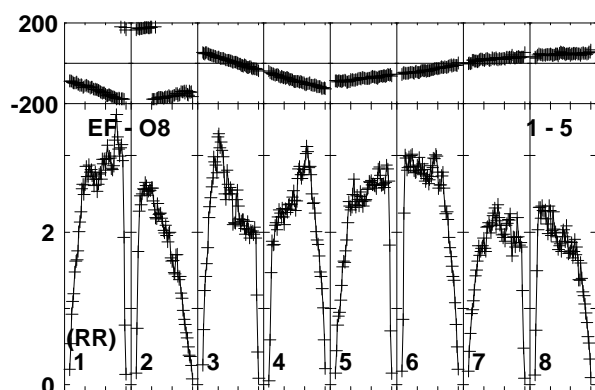
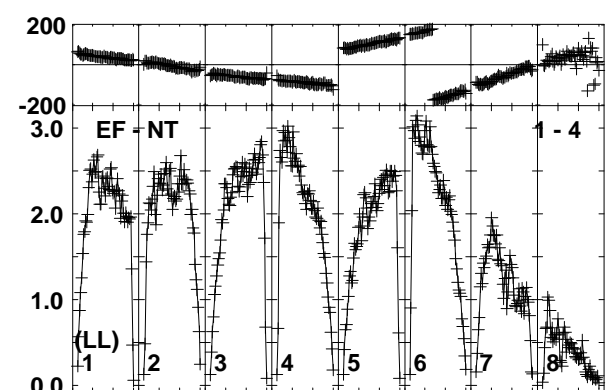
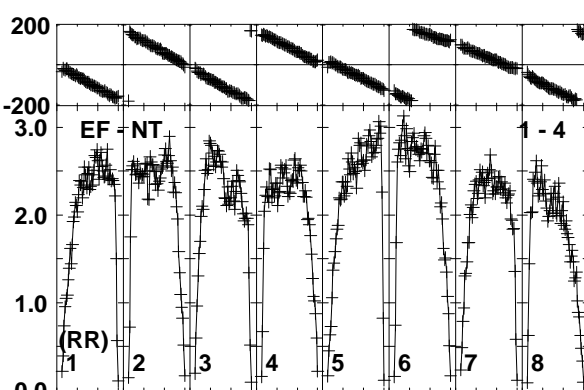
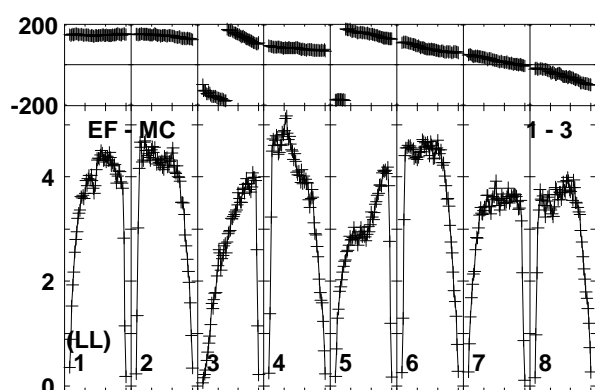
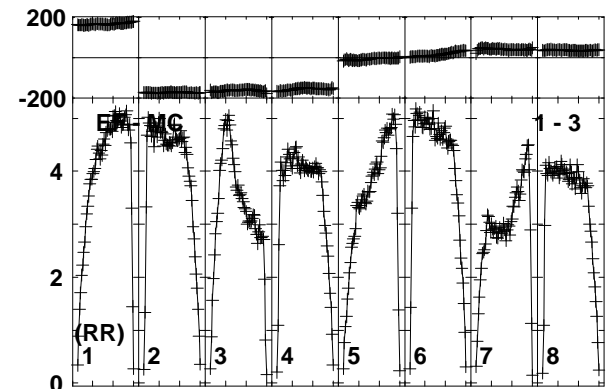
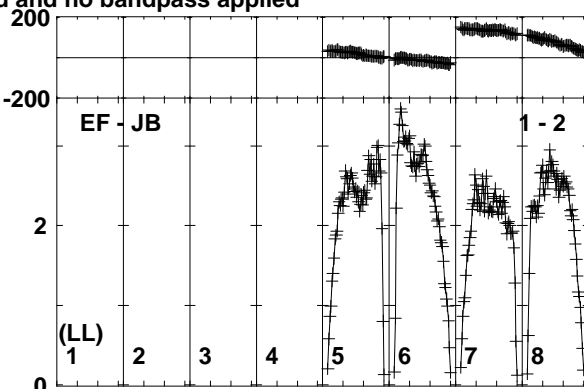
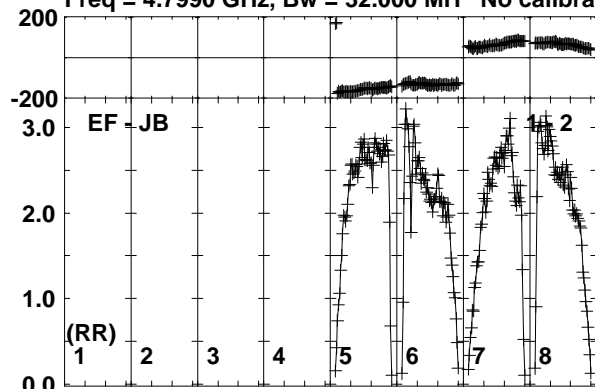

Lower frame: Milli Ampl Jy Top frame: Phas deg
Vector averaged cross-power spectrum Baseline: EF (01) - JB (02)
Timerange: 00/22:12:21 to 00/22:13:50

Plot file version 66 created 21-FEB-2017 15:10:58

J1108+4330 EG096A.UVDATA.1

Freq = 4.7990 GHz, Bw = 32.000 MH No calibration applied and no bandpass applied

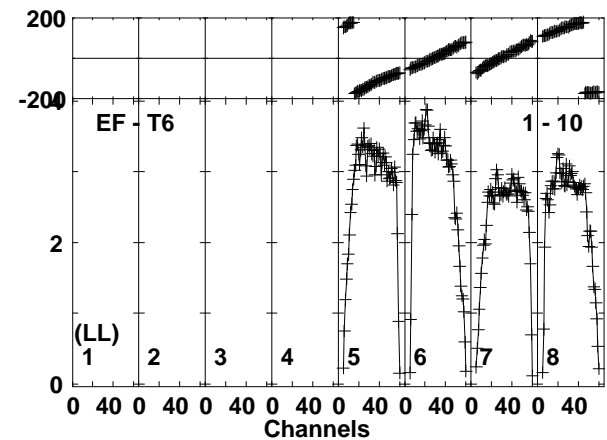
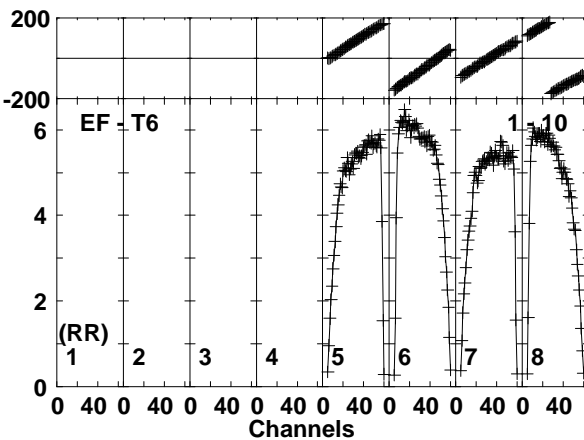
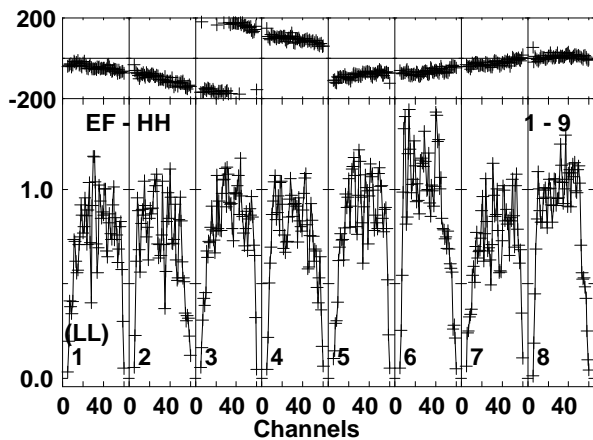
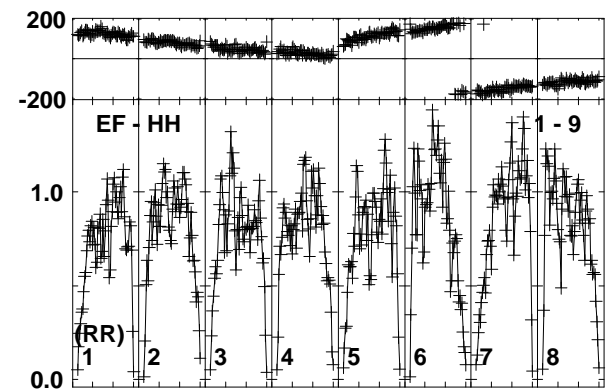
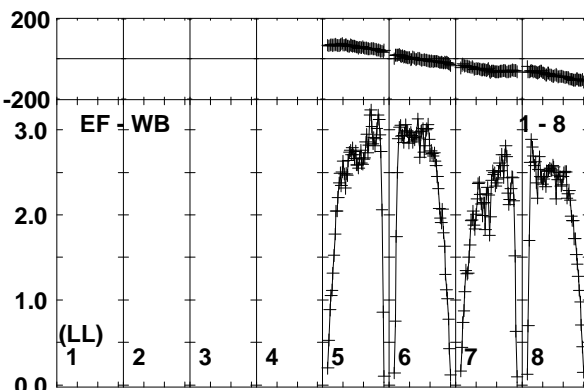
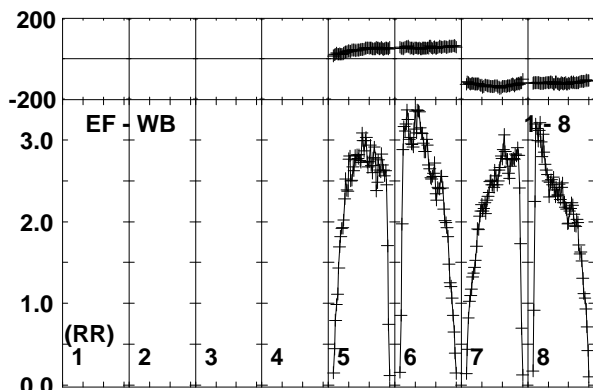
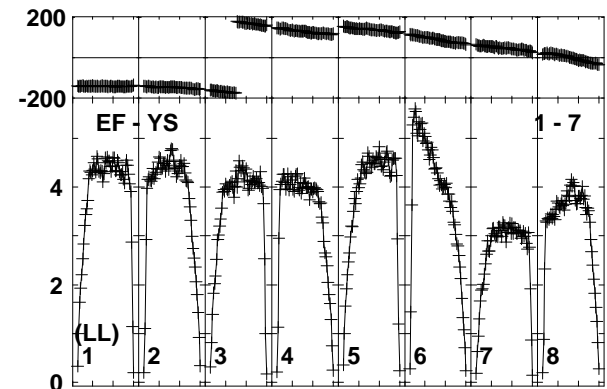
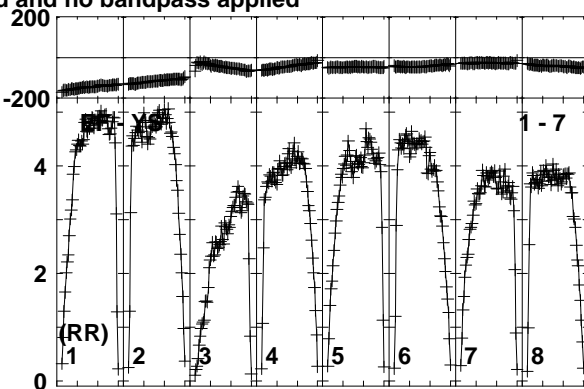
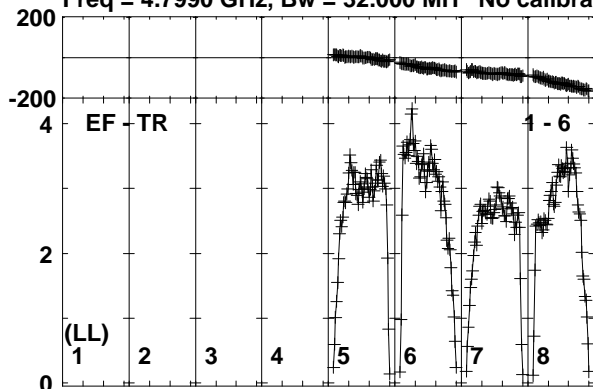

Lower frame: Milli Ampl Jy Top frame: Phas deg
Vector averaged cross-power spectrum Baseline: EF (01) - TR (06)
Timerange: 00/22:12:21 to 00/22:13:50

Plot file version 67 created 21-FEB-2017 15:10:58

ARUMA EG096A.UVDATA.1

Freq = 4.7990 GHz, Bw = 32.000 MH No calibration applied and no bandpass applied

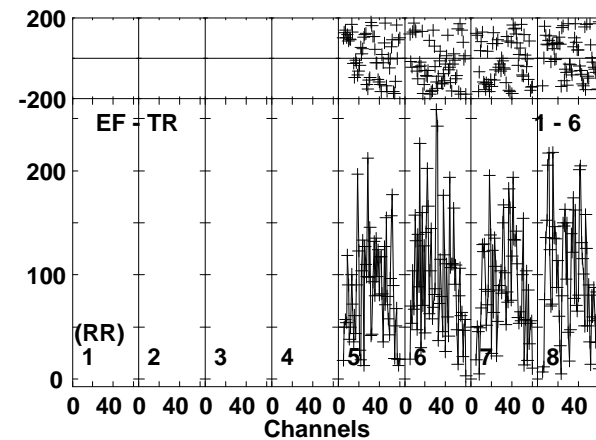
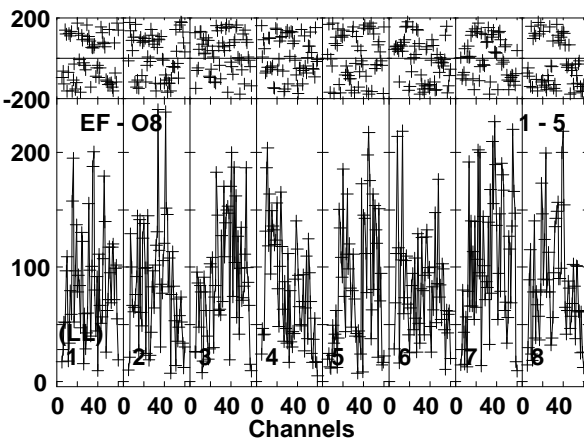
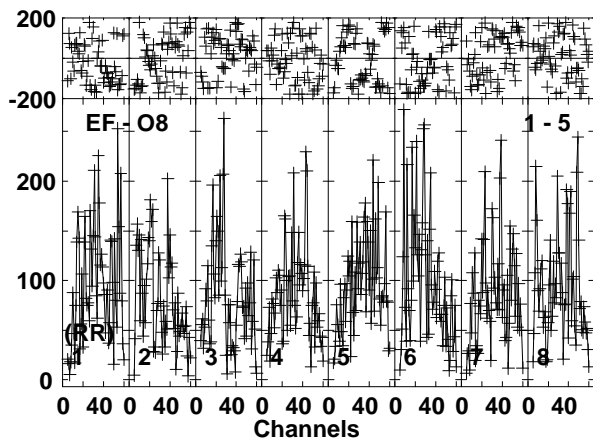
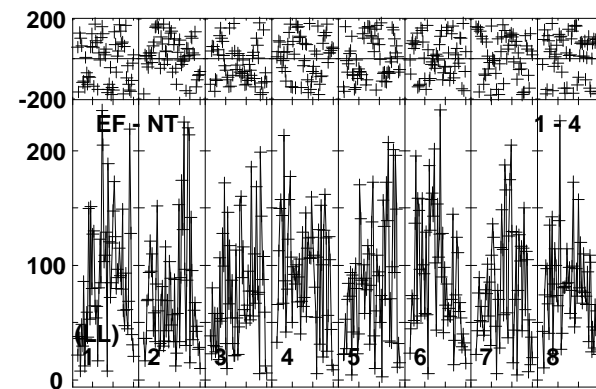
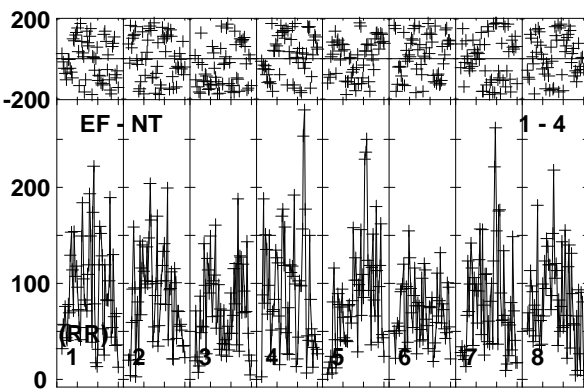
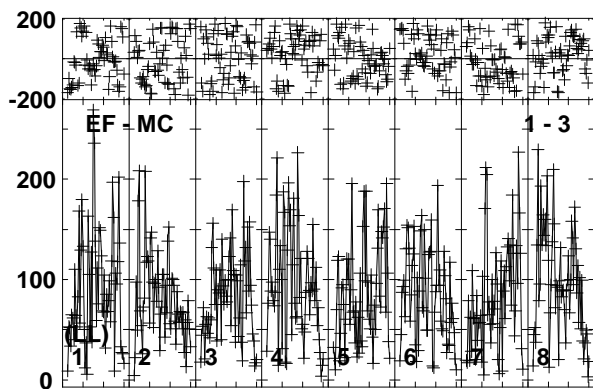
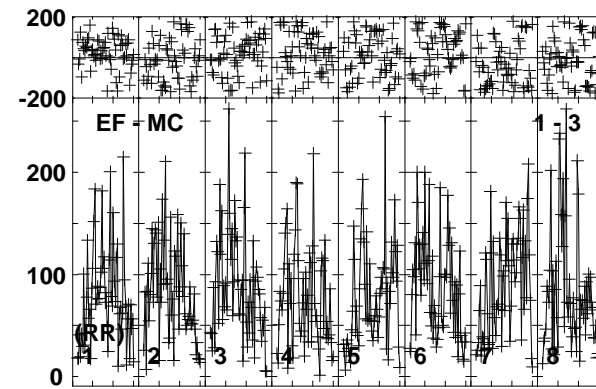
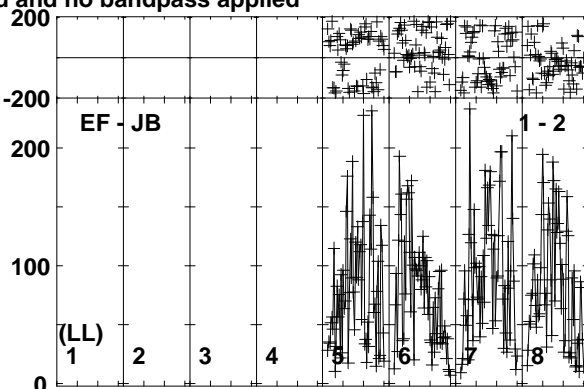
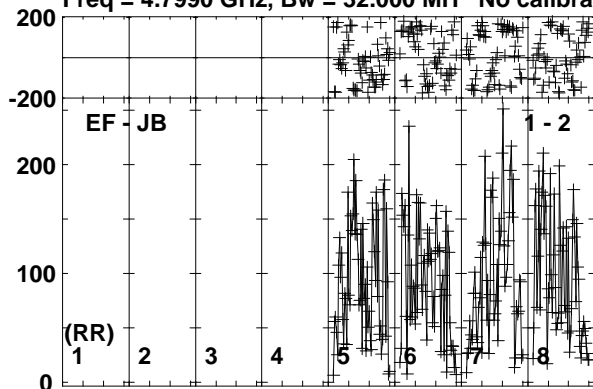

Lower frame: Micro Ampl Jy Top frame: Phas deg
Vector averaged cross-power spectrum Baseline: EF (01) - JB (02)
Timerange: 00:22:13:50 to 00:22:17:19

Plot file version 68 created 21-FEB-2017 15:10:58

ARUMA EG096A.UVDATA.1

Freq = 4.7990 GHz, Bw = 32.000 MH No calibration applied and no bandpass applied

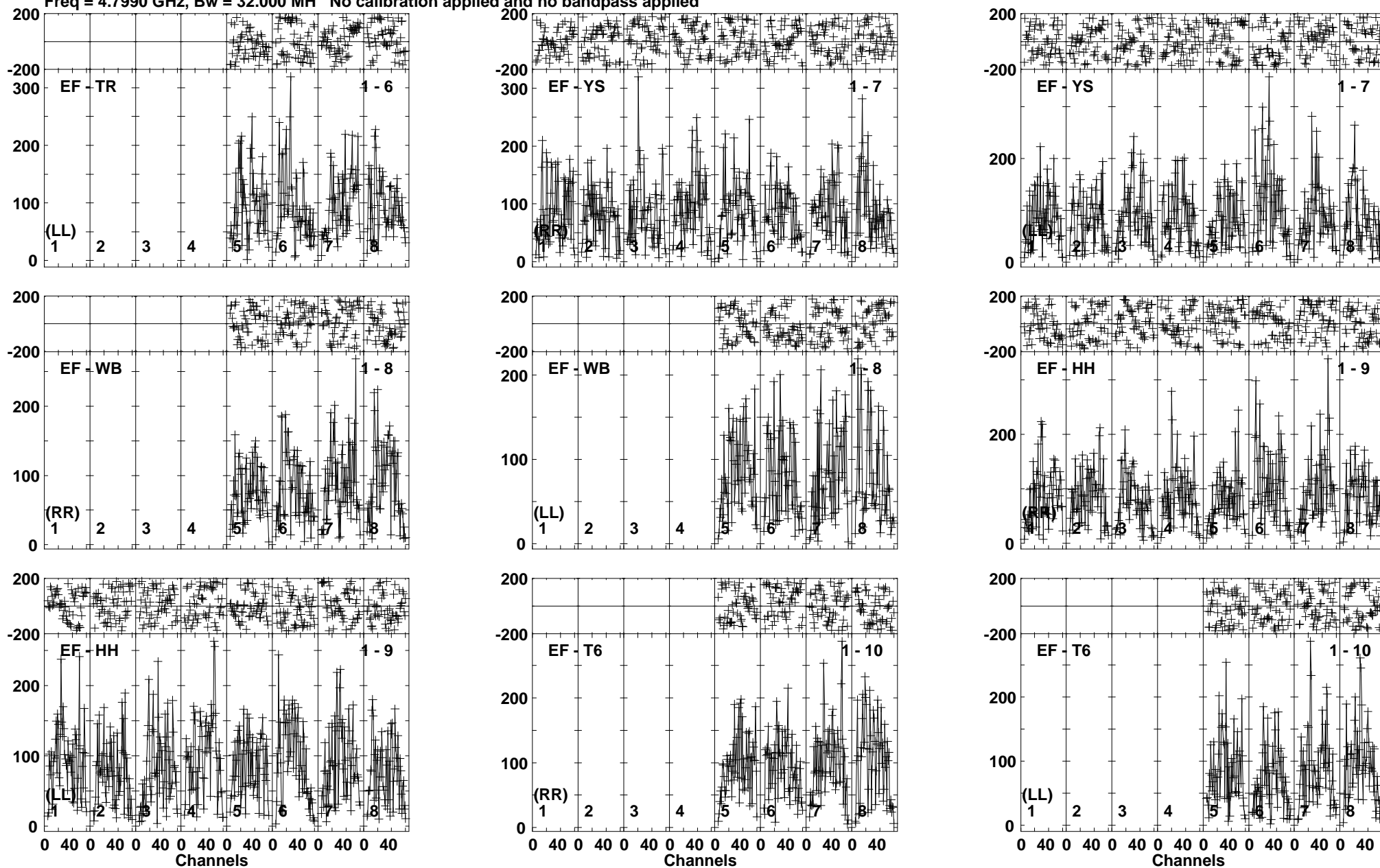

Lower frame: Micro Ampl Jy Top frame: Phas deg
Vector averaged cross-power spectrum Baseline: EF (01) - TR (06)
Timerange: 00/22:13:50 to 00/22:17:19

Plot file version 69 created 21-FEB-2017 15:10:59

J1108+4330 EG096A.UVDATA.1

Freq = 4.7990 GHz, Bw = 32.000 MH No calibration applied and no bandpass applied

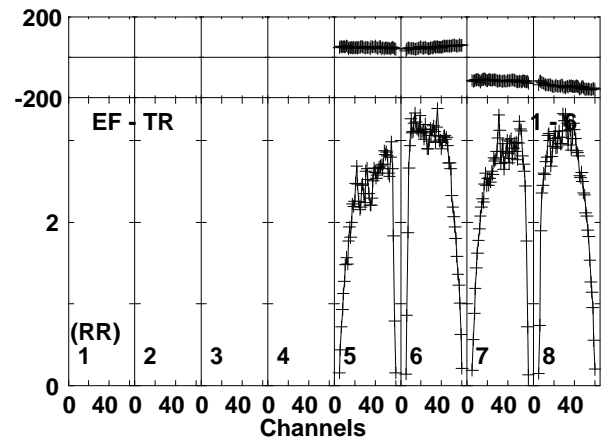
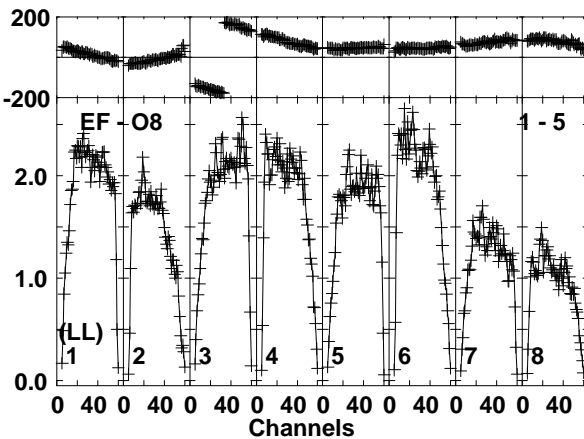
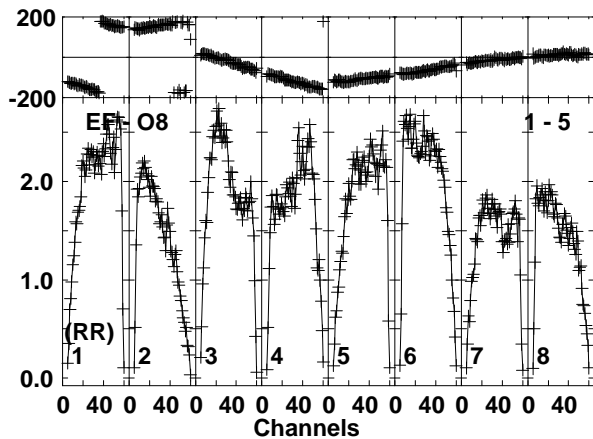
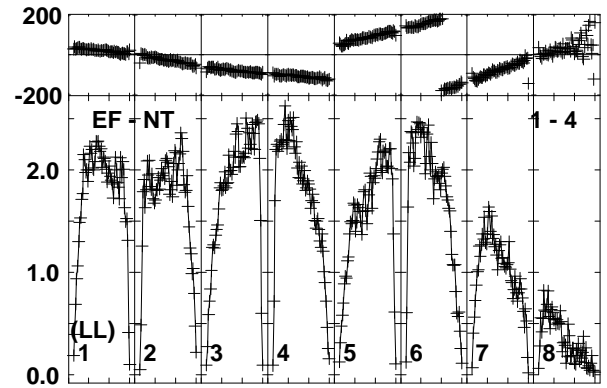
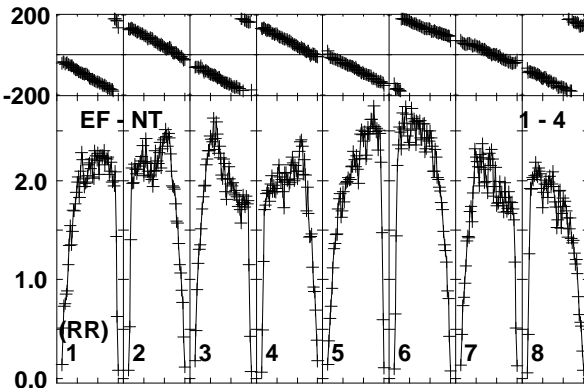
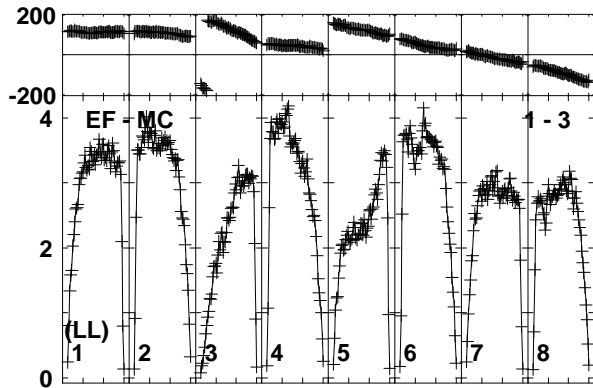
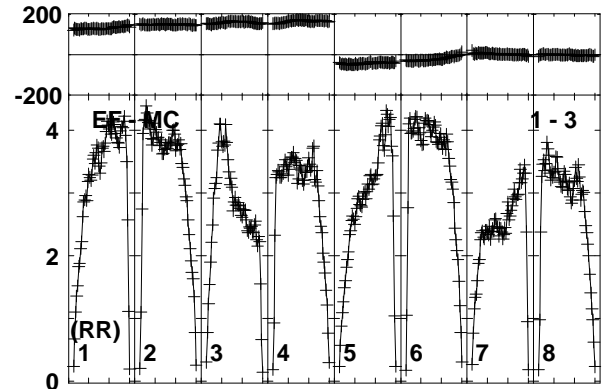
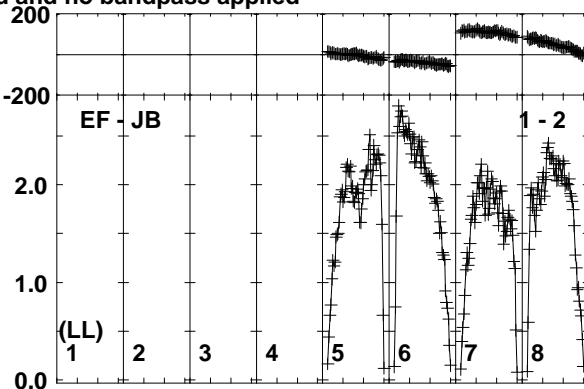
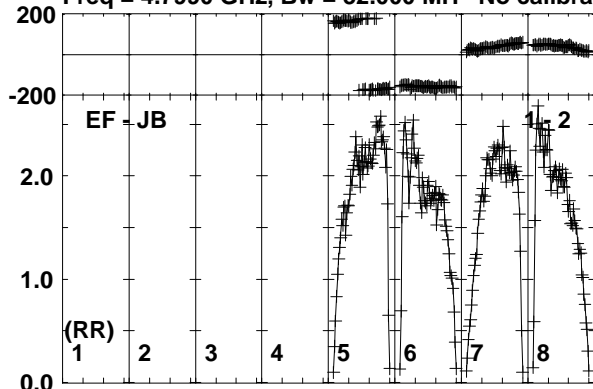

Lower frame: Milli Ampl Jy Top frame: Phas deg
Vector averaged cross-power spectrum Baseline: EF (01) - JB (02)
Timerange: 00:22:18:01 to 00:22:19:00

Plot file version 70 created 21-FEB-2017 15:10:59

J1108+4330 EG096A.UVDATA.1

Freq = 4.7990 GHz, Bw = 32.000 MH No calibration applied and no bandpass applied

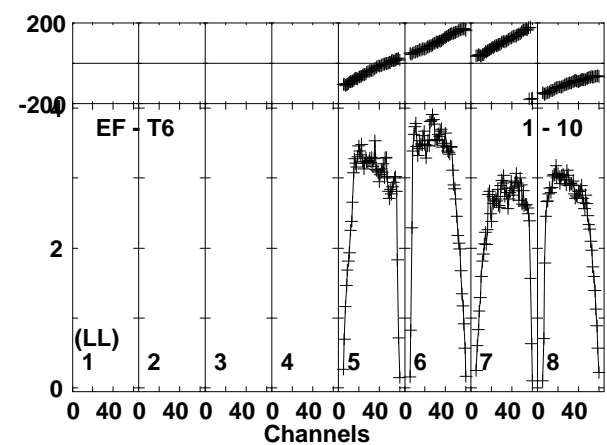
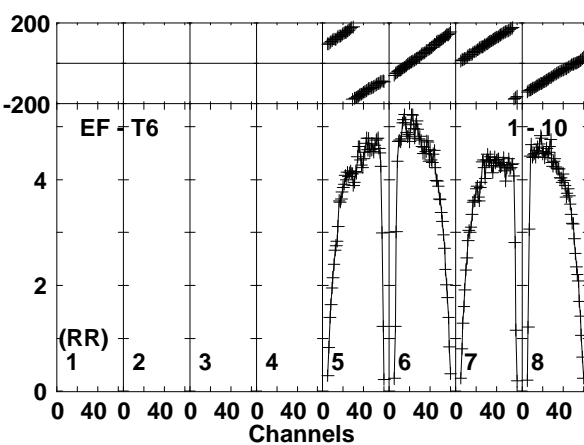
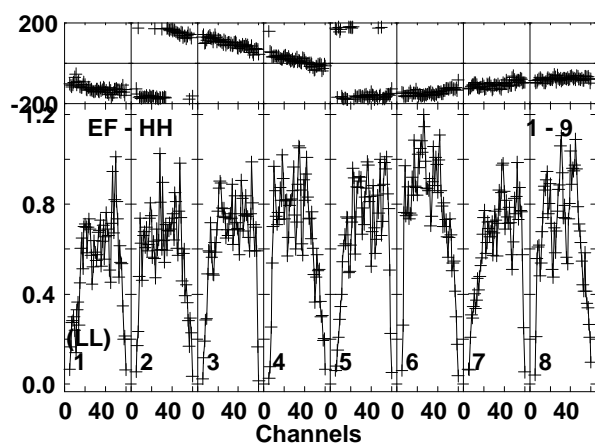
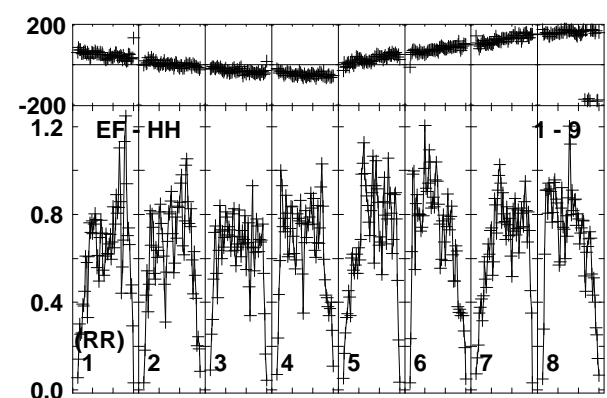
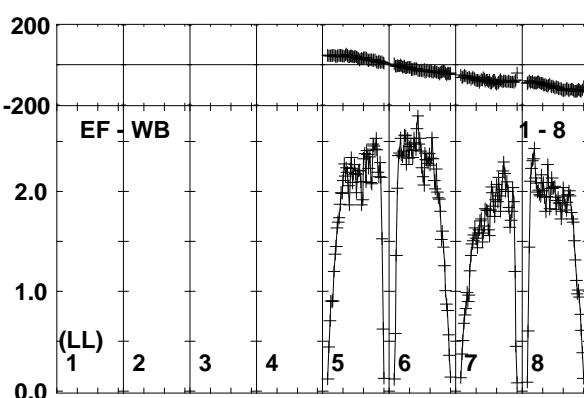
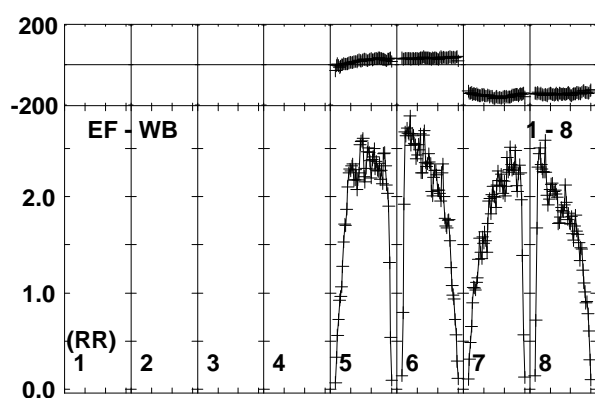
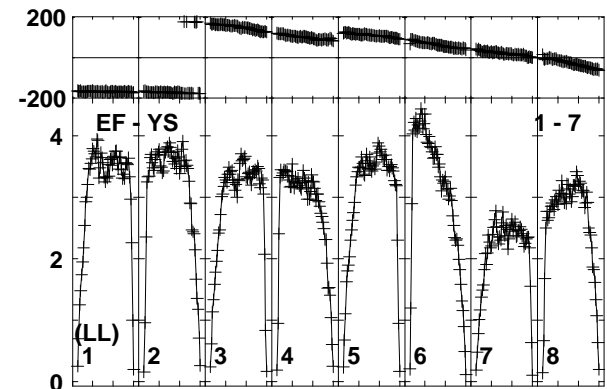
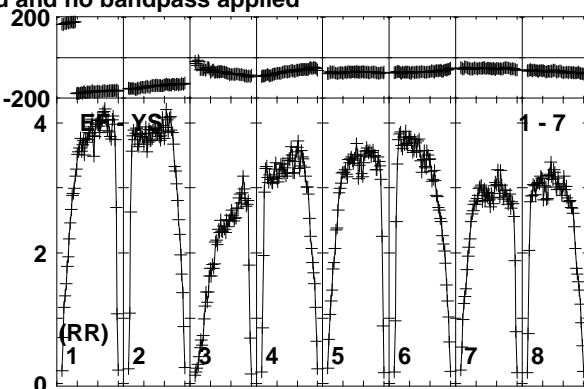
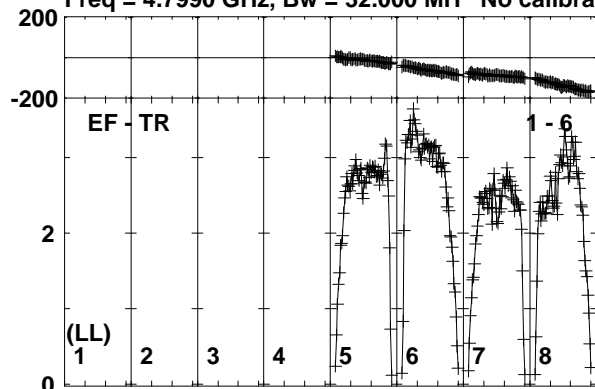

Lower frame: Milli Ampl Jy Top frame: Phas deg
Vector averaged cross-power spectrum Baseline: EF (01) - TR (06)
Timerange: 00/22:18:01 to 00/22:19:00

Plot file version 71 created 21-FEB-2017 15:10:59

ARUMA EG096A.UVDATA.1

Freq = 4.7990 GHz, Bw = 32.000 MH No calibration applied and no bandpass applied

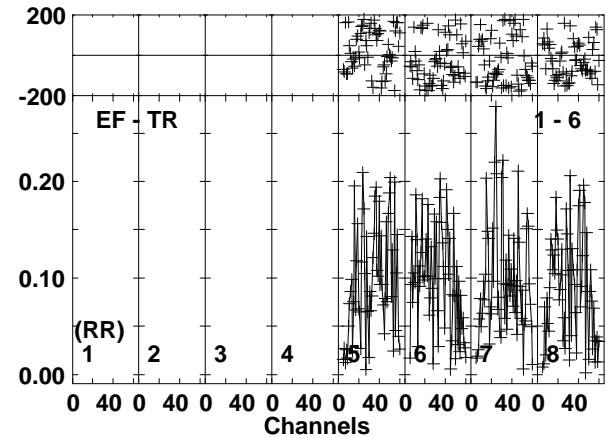
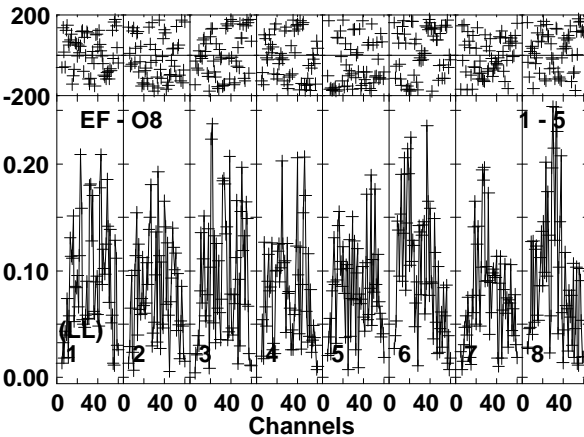
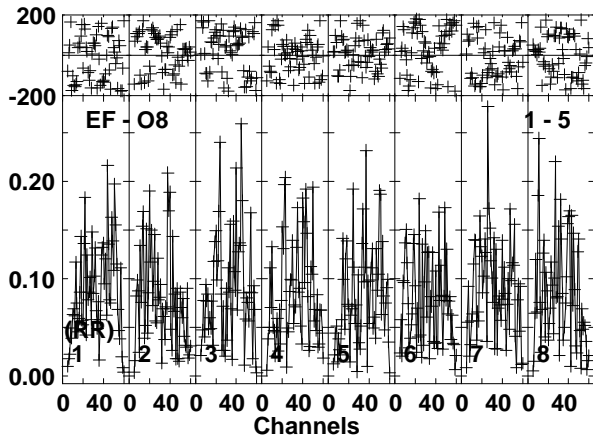
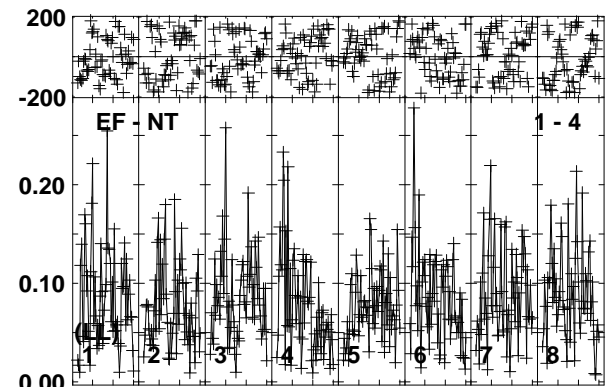
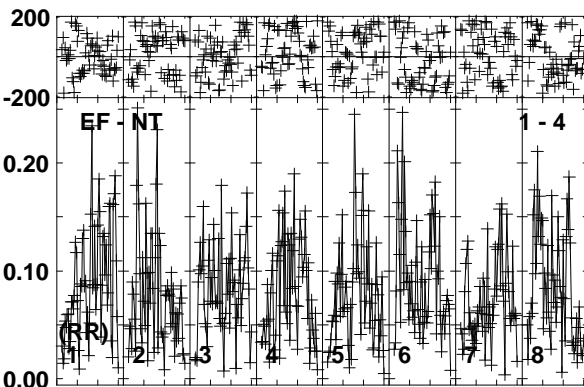
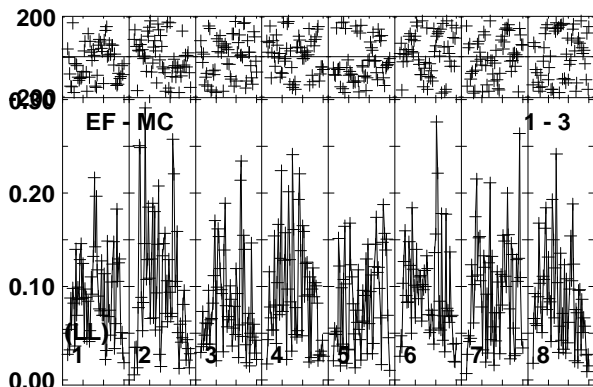
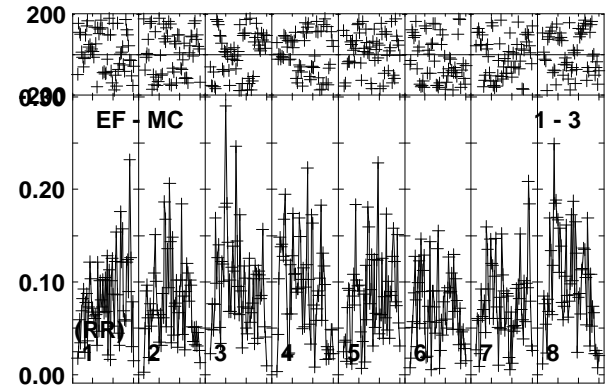
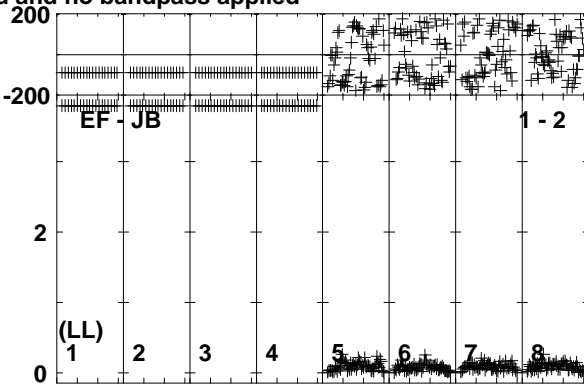
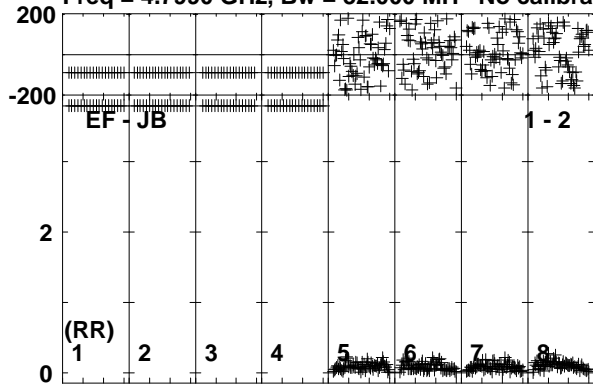

Lower frame: Milli Ampl Jy Top frame: Phas deg
Vector averaged cross-power spectrum Baseline: EF (01) - JB (02)
Timerange: 00/22:19:01 to 00/22:22:30

Plot file version 72 created 21-FEB-2017 15:11:00

ARUMA EG096A.UVDATA.1

Freq = 4.7990 GHz, Bw = 32.000 MH No calibration applied and no bandpass applied

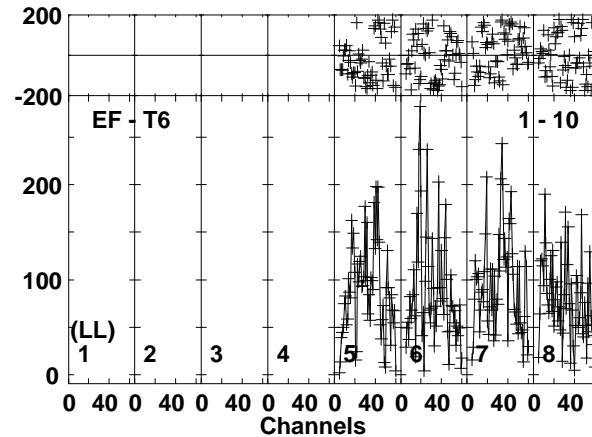
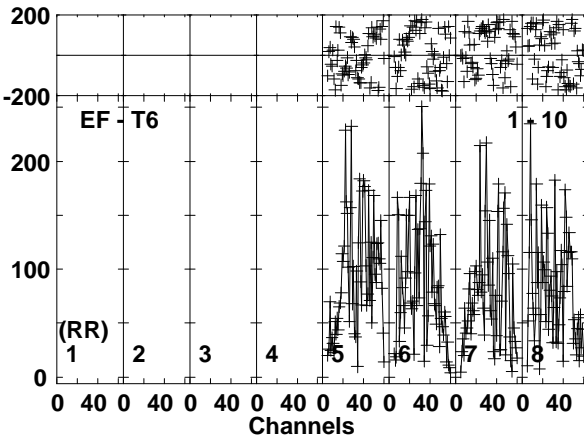
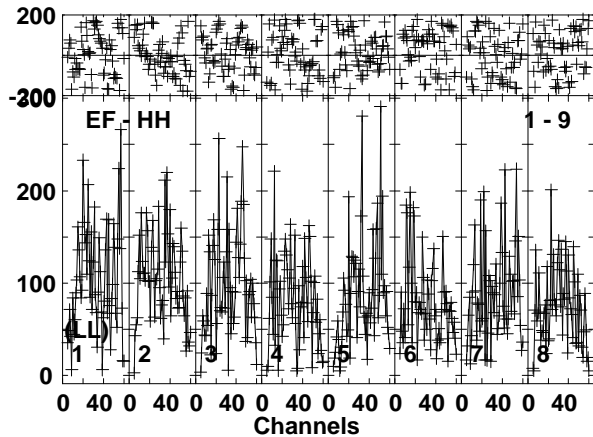
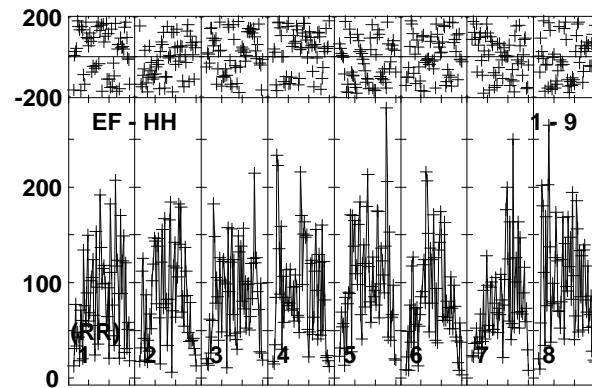
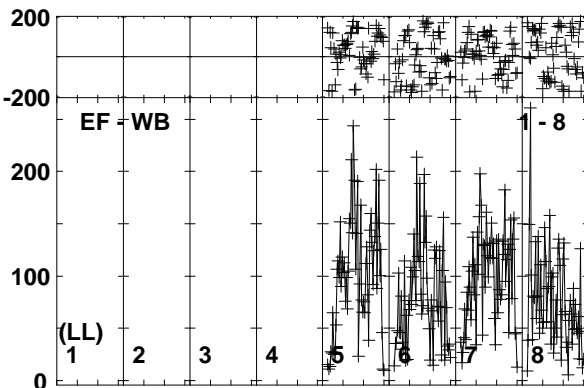
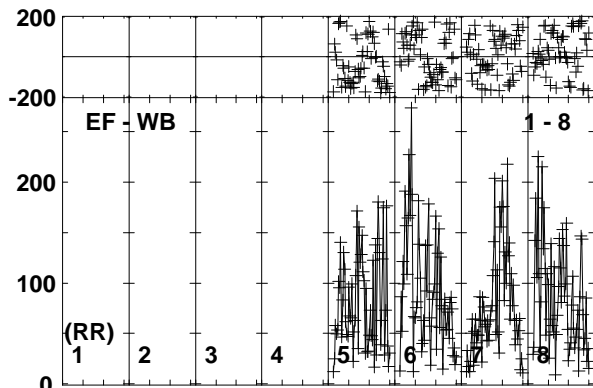
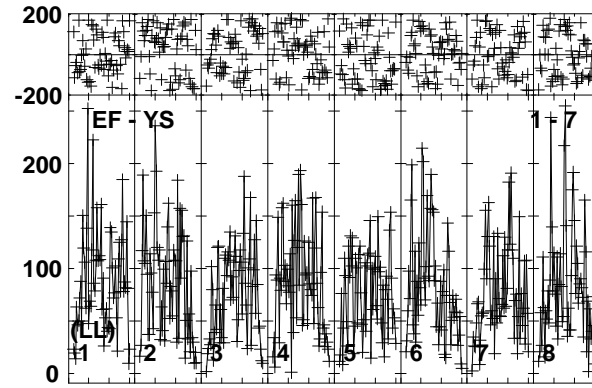
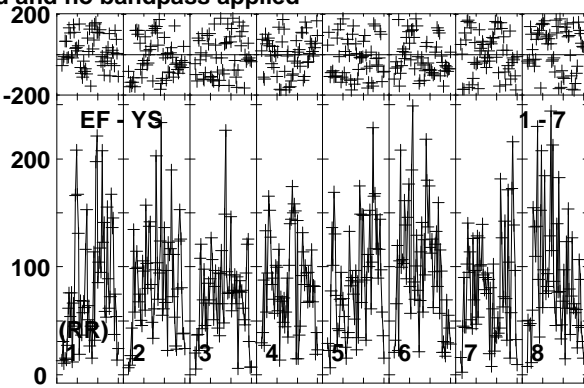
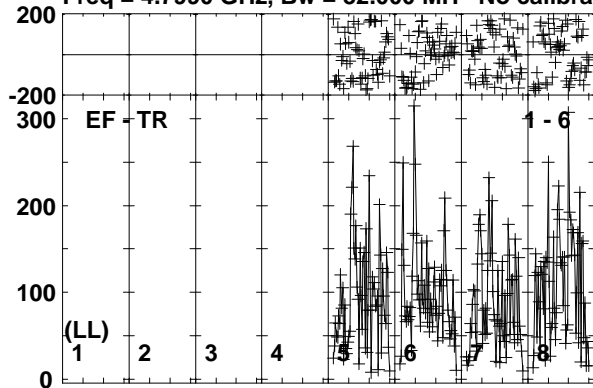

Lower frame: Micro Ampl Jy Top frame: Phas deg
Vector averaged cross-power spectrum Baseline: EF (01) - TR (06)
Timerange: 00/22:19:01 to 00/22:22:30

Plot file version 73 created 21-FEB-2017 15:11:00

J1108+4330 EG096A.UVDATA.1

Freq = 4.7990 GHz, Bw = 32.000 MH No calibration applied and no bandpass applied

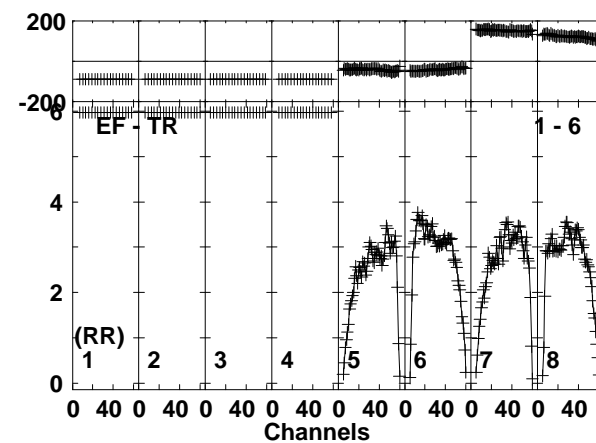
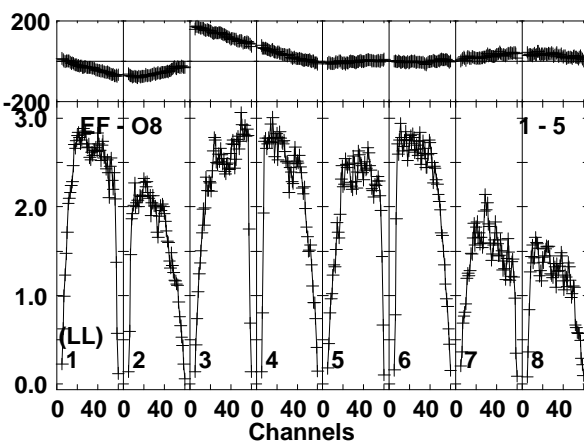
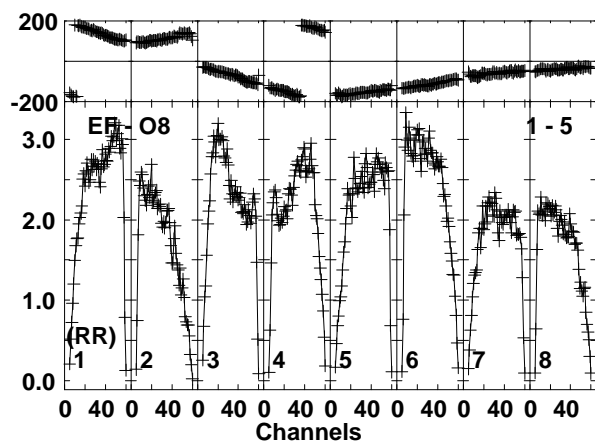
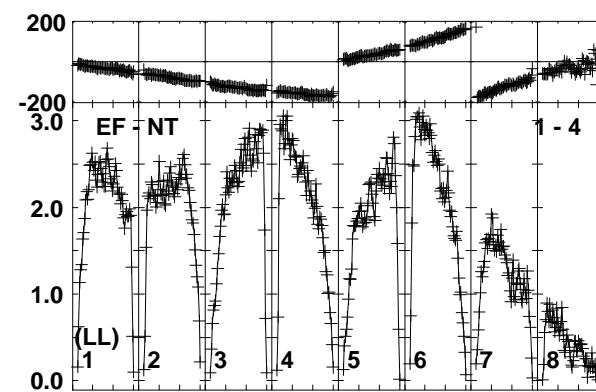
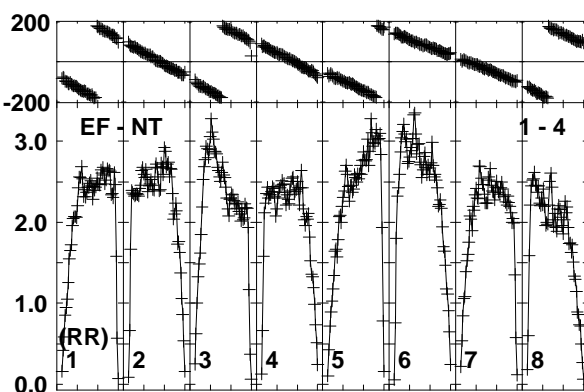
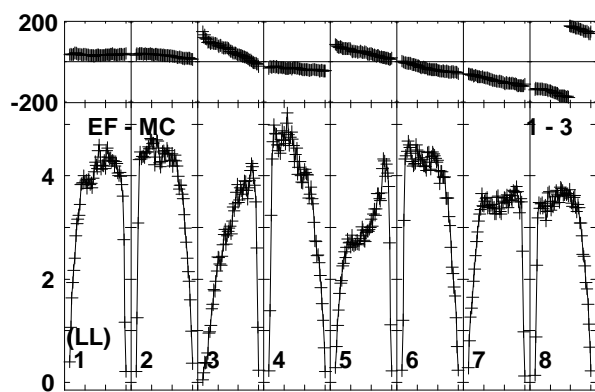
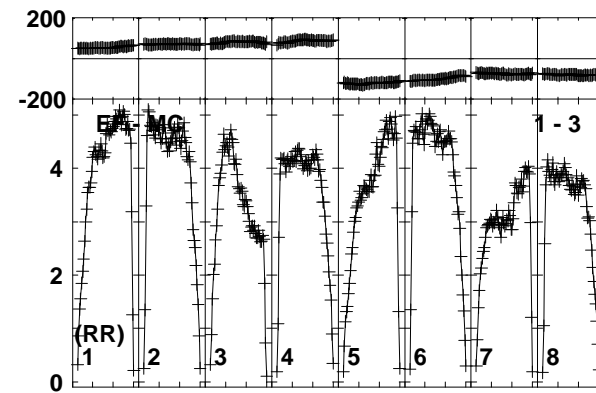
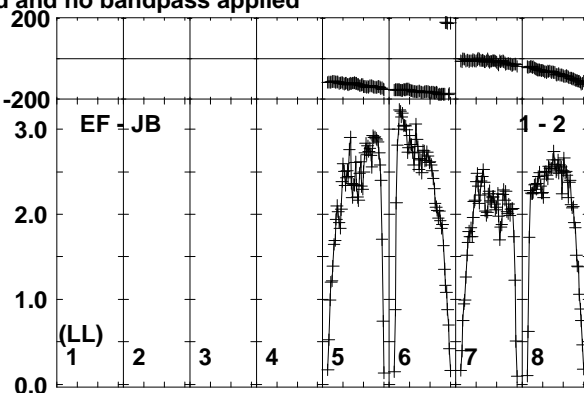
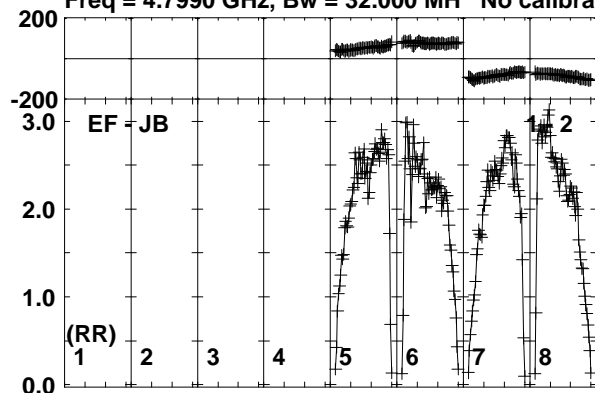

Lower frame: Milli Ampl Jy Top frame: Phas deg
Vector averaged cross-power spectrum Baseline: EF (01) - JB (02)
Timerange: 00/22:22:31 to 00/22:23:59

Plot file version 74 created 21-FEB-2017 15:11:00

J1108+4330 EG096A.UVDATA.1

Freq = 4.7990 GHz, Bw = 32.000 MH No calibration applied and no bandpass applied

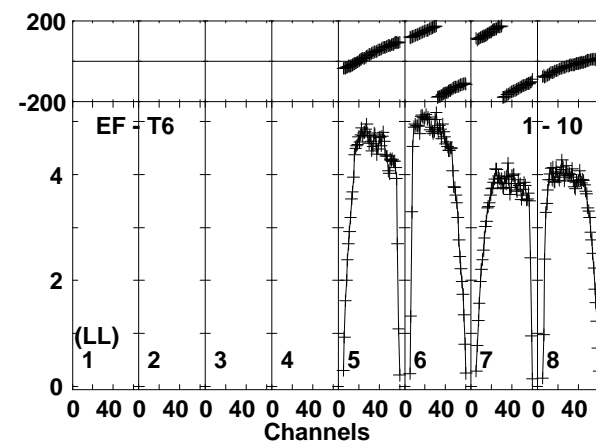
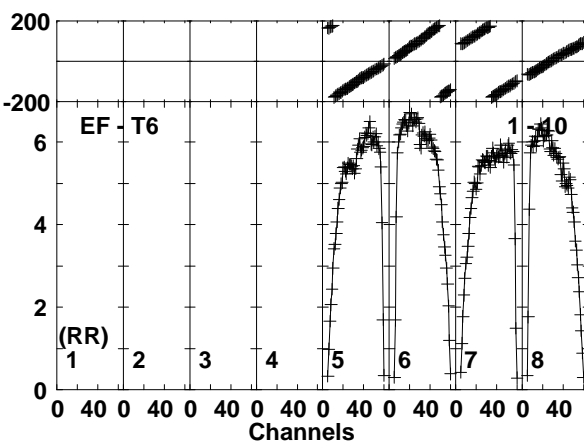
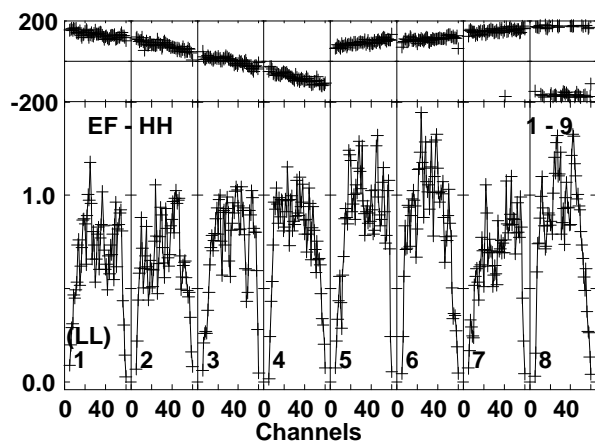
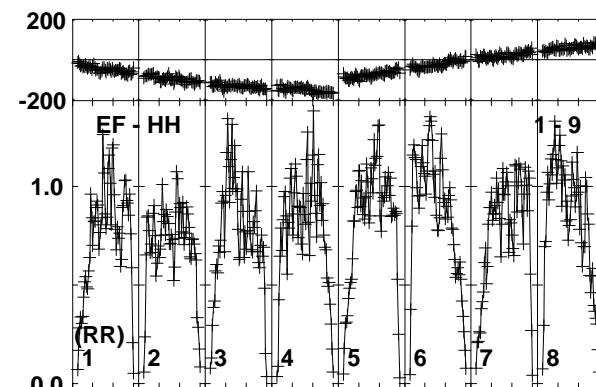
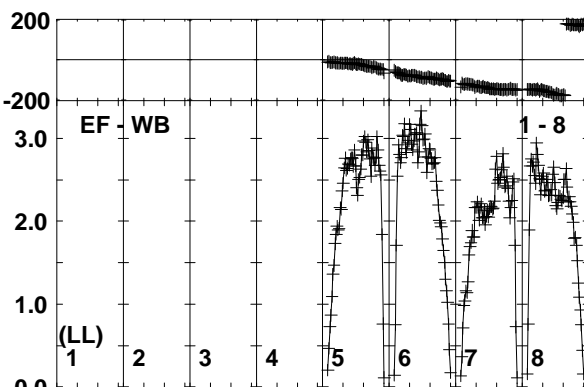
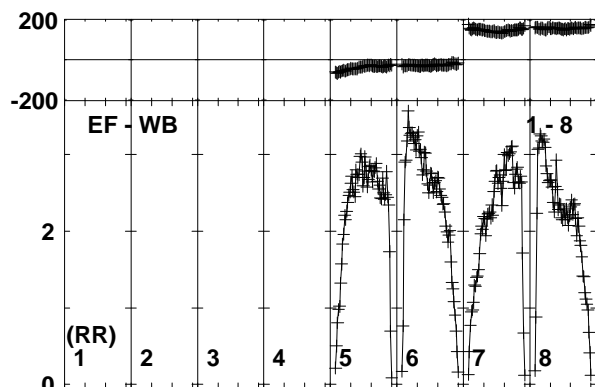
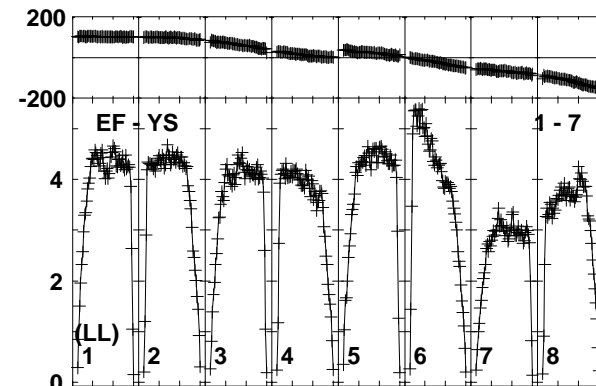
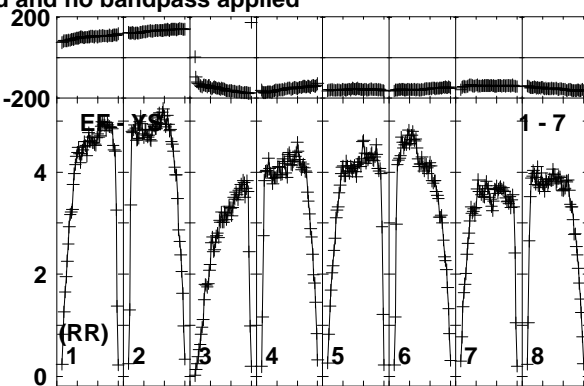
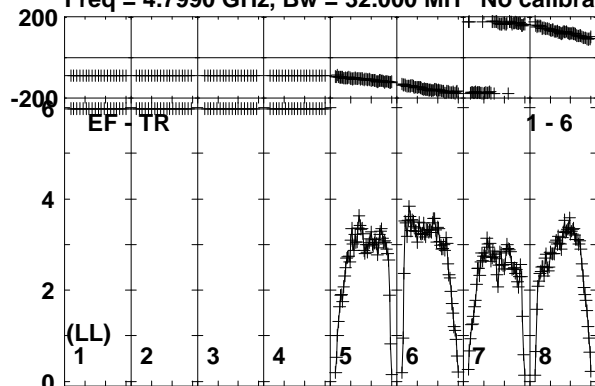

Lower frame: Milli Ampl Jy Top frame: Phas deg
Vector averaged cross-power spectrum Baseline: EF (01) - TR (06)
Timerange: 00/22:22:31 to 00/22:23:59

Plot file version 75 created 21-FEB-2017 15:11:01
 ARUMA EG096A.UVDATA.1
 Freq = 4.7990 GHz, Bw = 32.000 MH No calibration applied and no bandpass applied

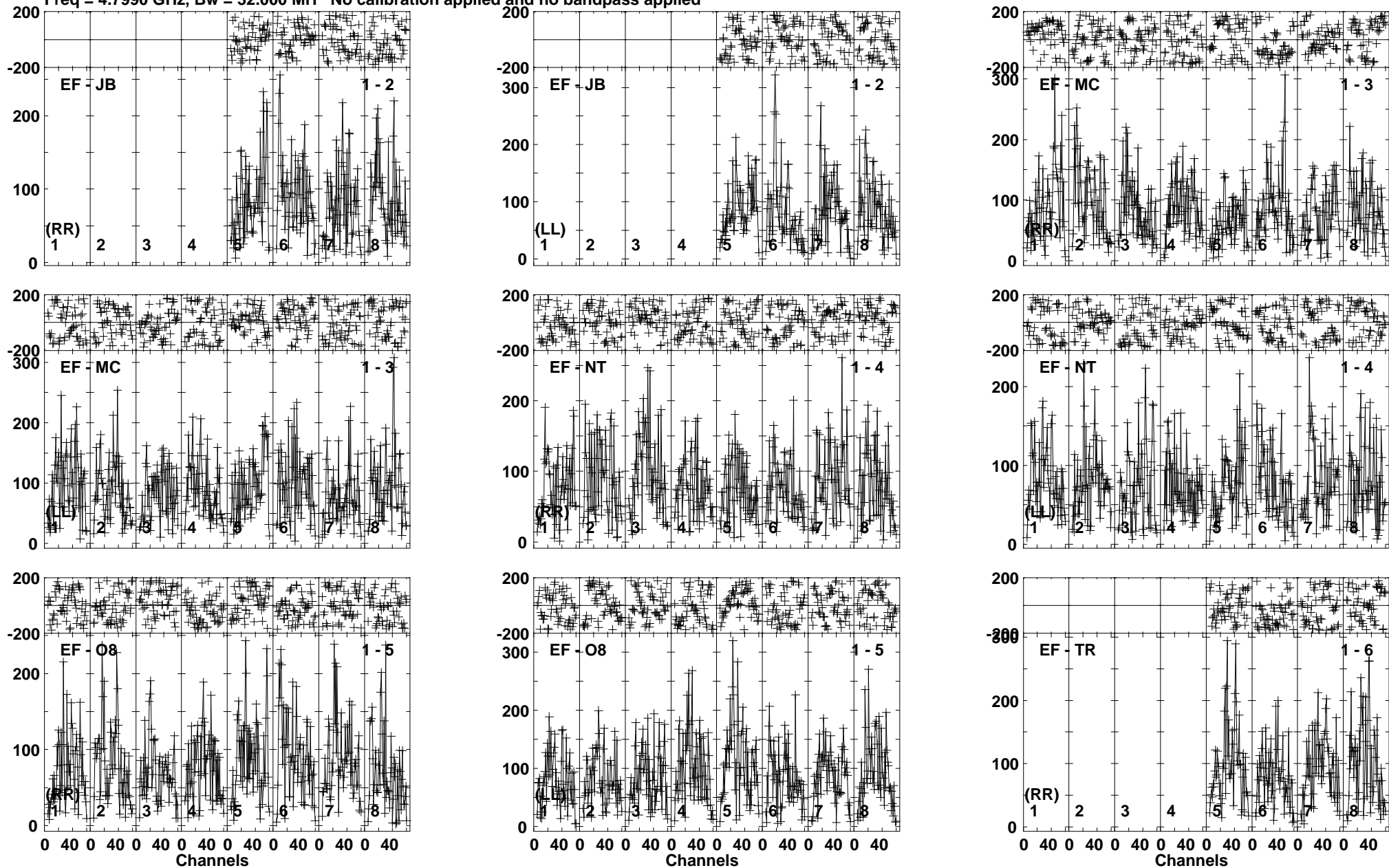

Lower frame: Micro Ampl Jy Top frame: Phas deg
 Vector averaged cross-power spectrum Baseline: EF (01) - JB (02)
 Timerange: 00/22:24:00 to 00/22:27:30

Plot file version 76 created 21-FEB-2017 15:11:01

ARUMA EG096A.UVDATA.1

Freq = 4.7990 GHz, Bw = 32.000 MH No calibration applied and no bandpass applied

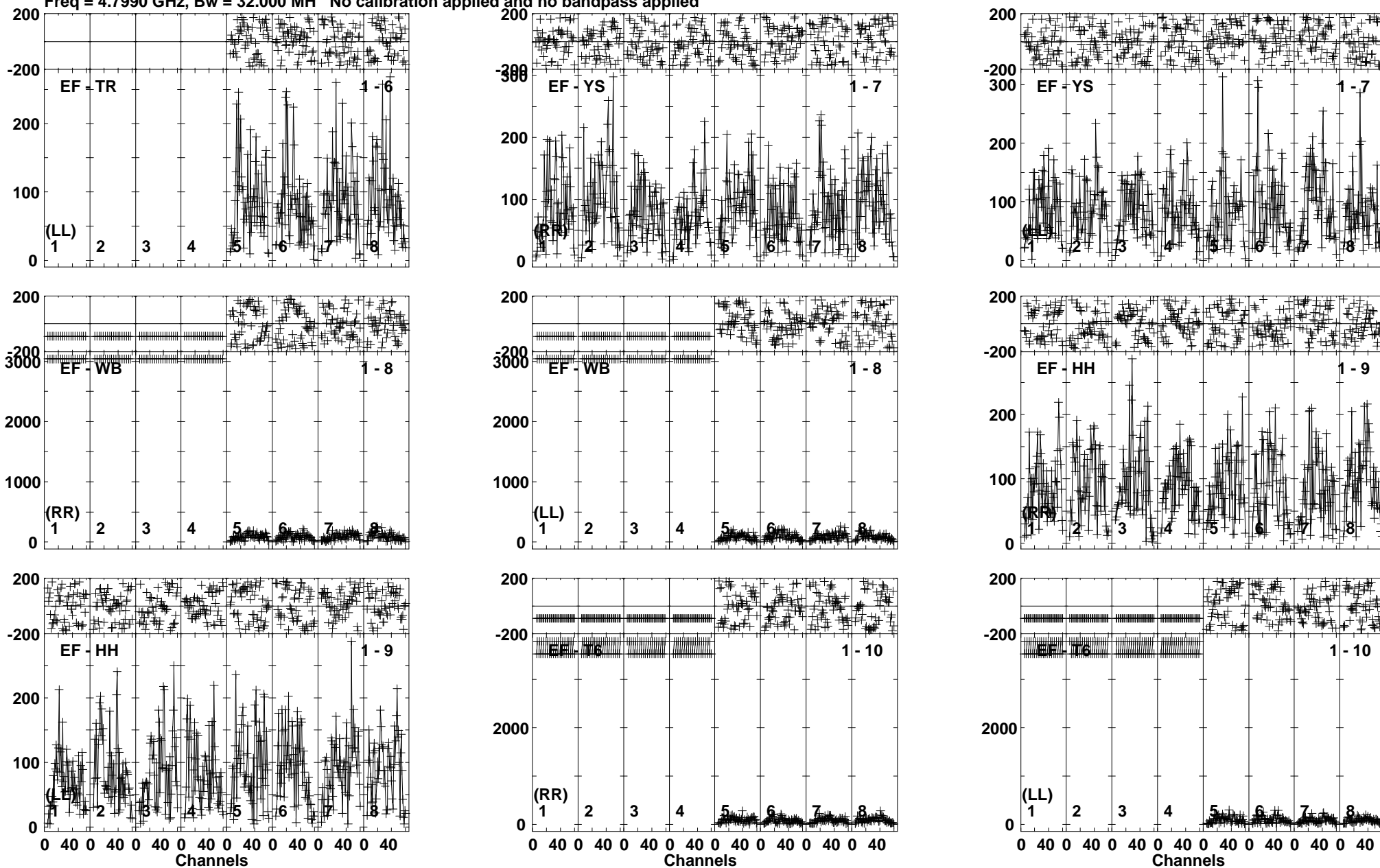

Lower frame: Micro Ampl Jy Top frame: Phas deg
Vector averaged cross-power spectrum Baseline: EF (01) - TR (06)
Timerange: 00:22:24:00 to 00:22:27:30

Plot file version 77 created 21-FEB-2017 15:11:01

J1108+4330 EG096A.UVDATA.1

Freq = 4.7990 GHz, Bw = 32.000 MH No calibration applied and no bandpass applied

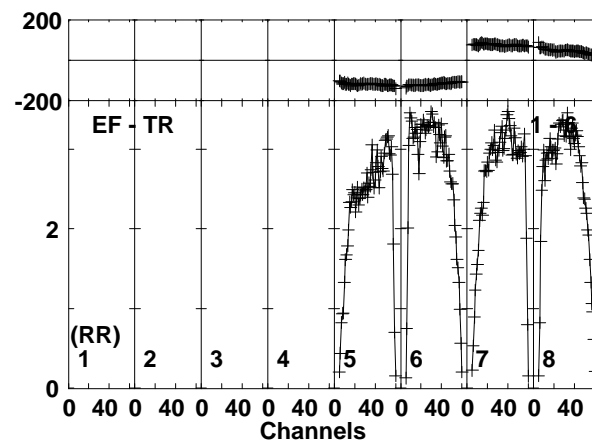
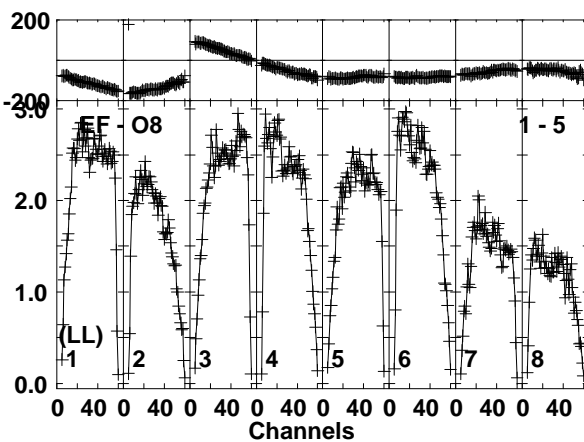
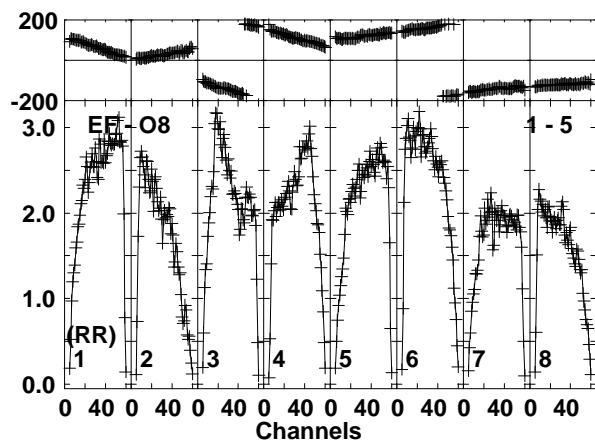
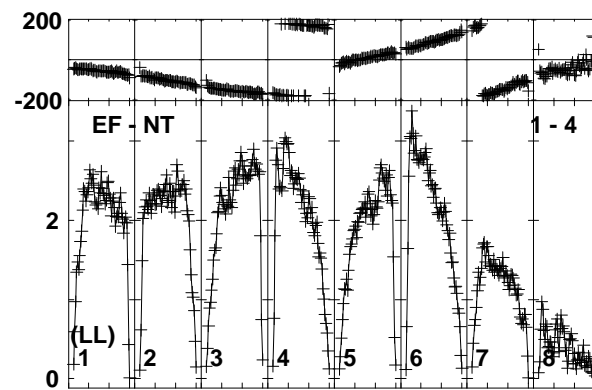
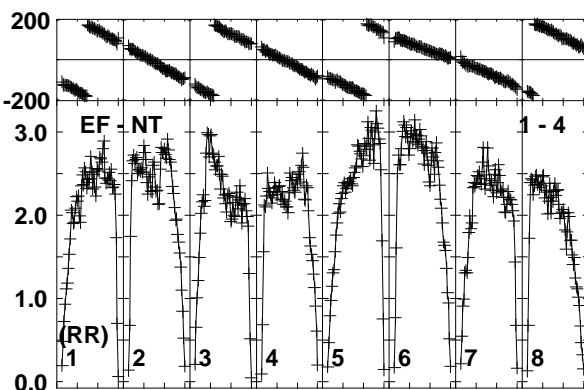
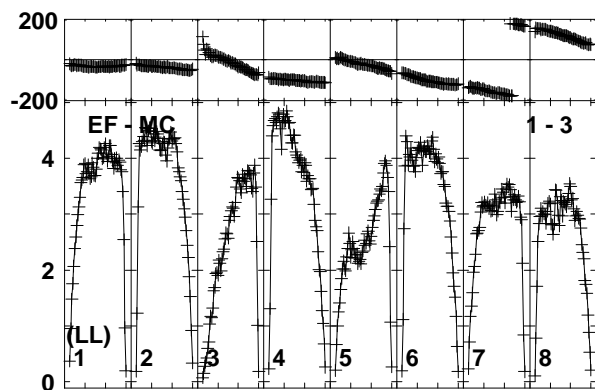
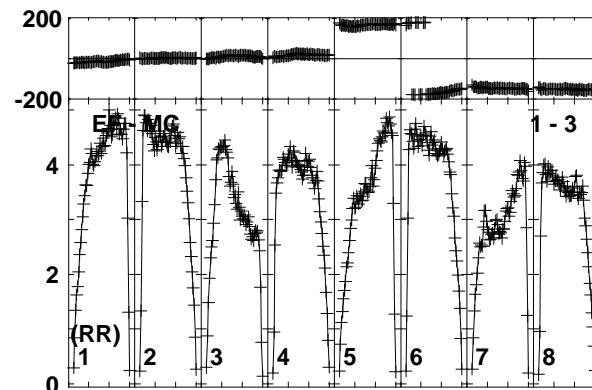
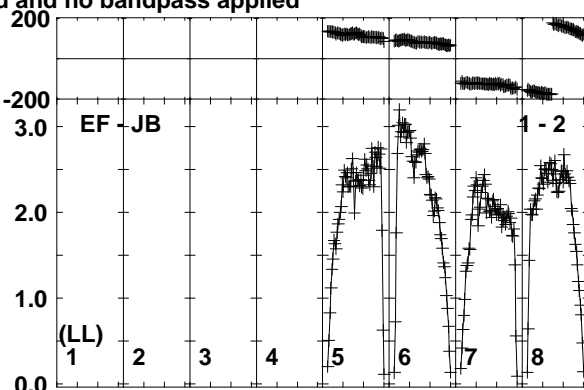
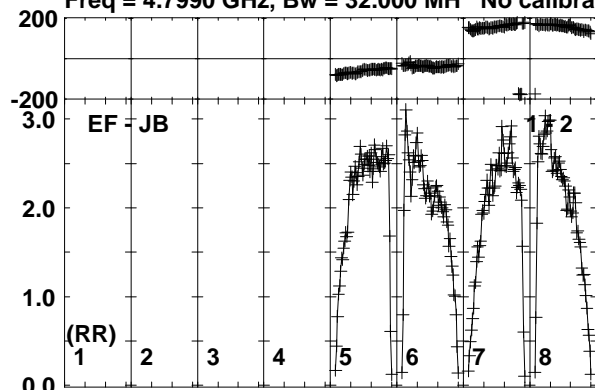

Lower frame: Milli Ampl Jy Top frame: Phas deg
Vector averaged cross-power spectrum Baseline: EF (01) - JB (02)
Timerange: 00/22:28:11 to 00/22:29:10

Plot file version 78 created 21-FEB-2017 15:11:01

J1108+4330 EG096A.UVDATA.1

Freq = 4.7990 GHz, Bw = 32.000 MH No calibration applied and no bandpass applied

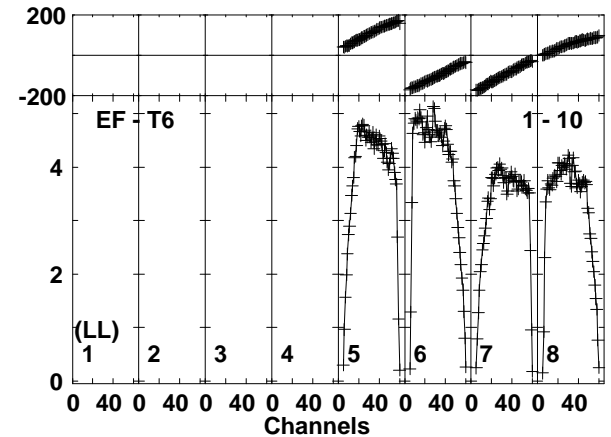
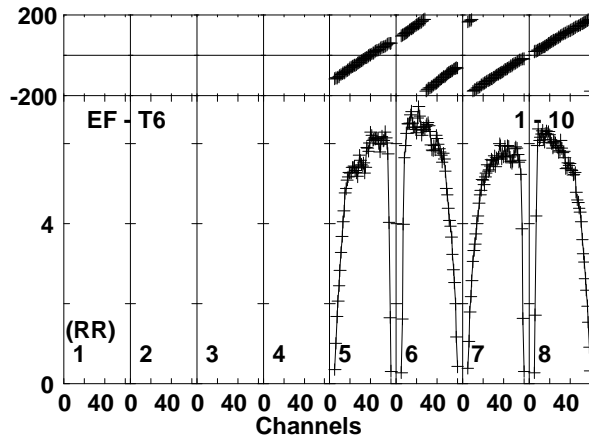
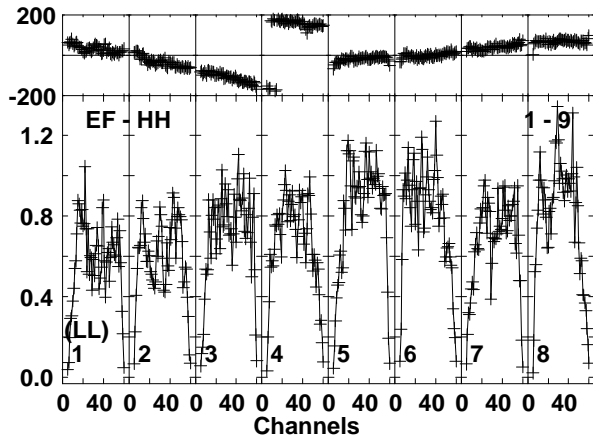
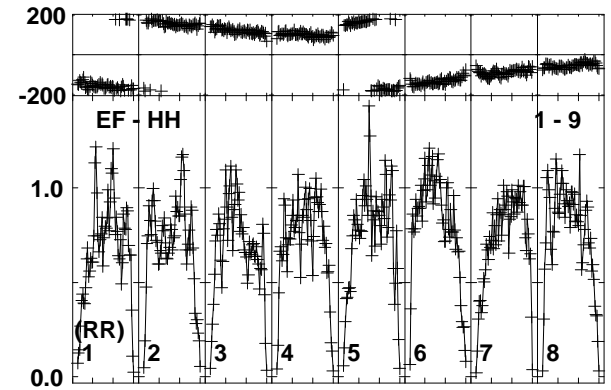
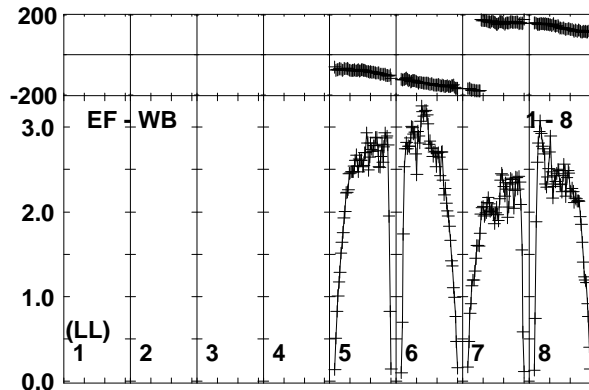
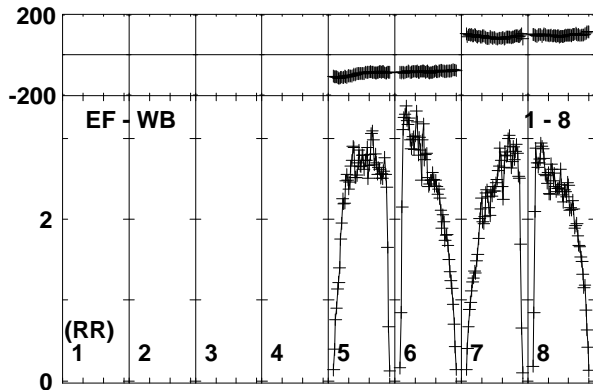
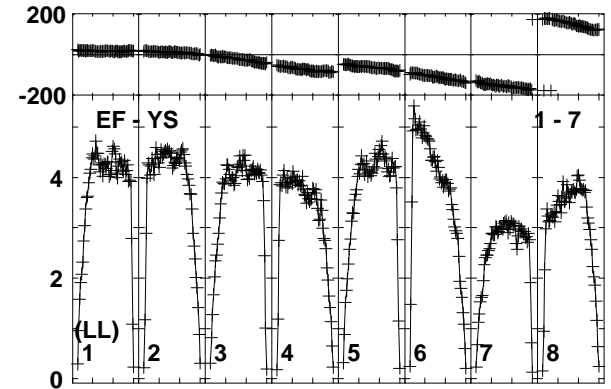
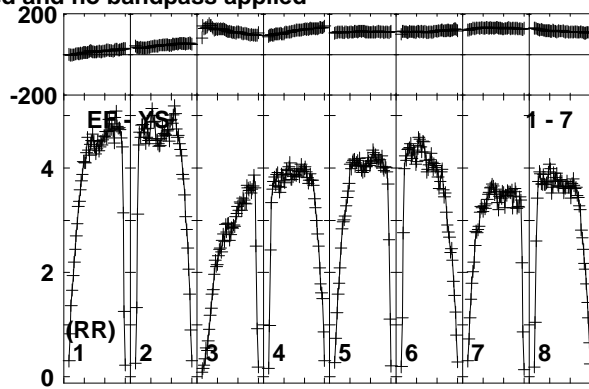
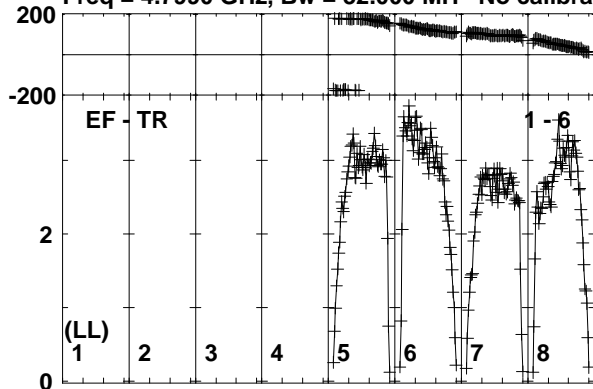

Lower frame: Milli Ampl Jy Top frame: Phas deg
Vector averaged cross-power spectrum Baseline: EF (01) - TR (06)
Timerange: 00/22:28:11 to 00/22:29:10

Plot file version 79 created 21-FEB-2017 15:11:02

J1112+4301 EG096A.UVDATA.1

Freq = 4.7990 GHz, Bw = 32.000 MH No calibration applied and no bandpass applied

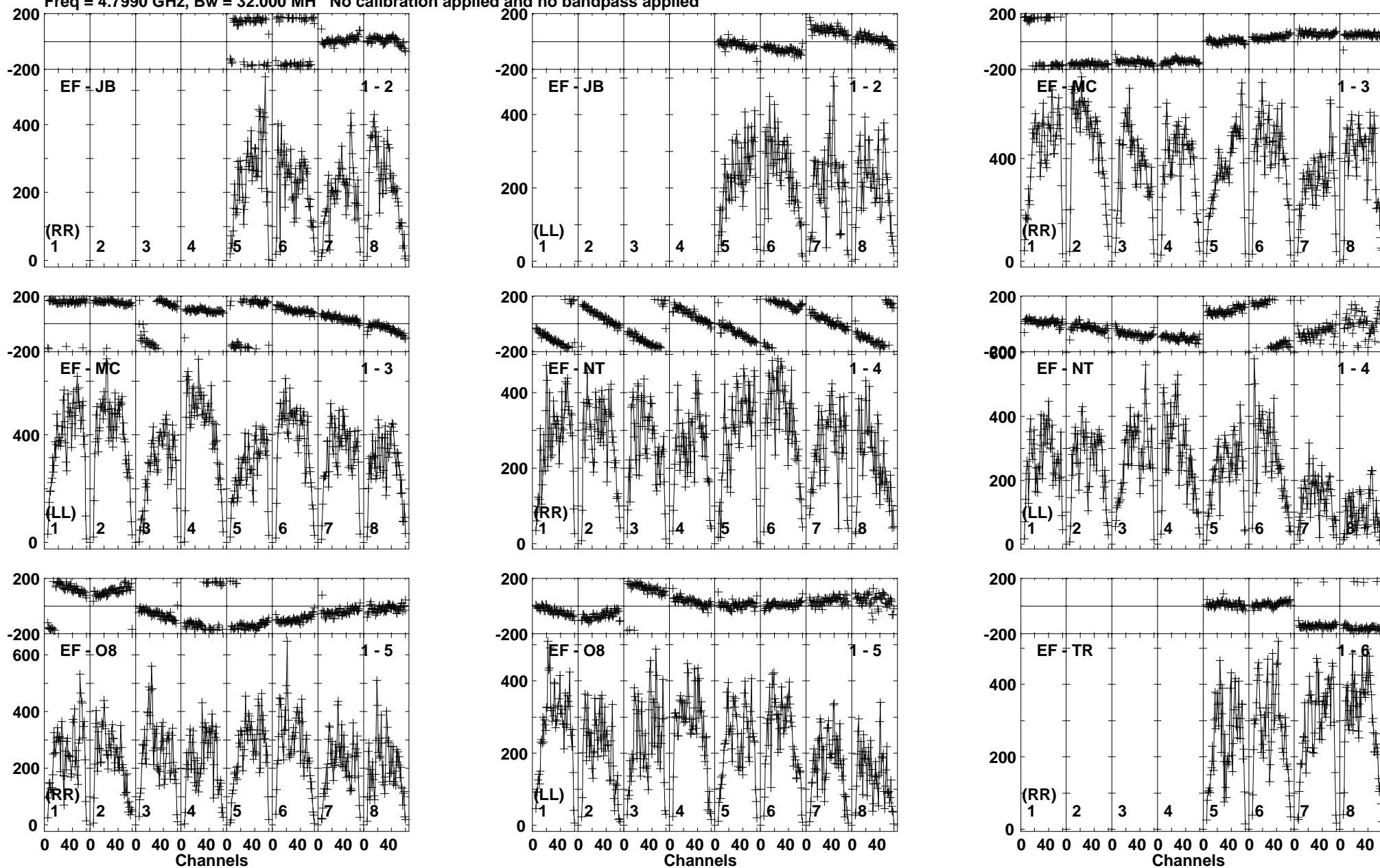

Lower frame: Micro Ampl Jy Top frame: Phas deg
Vector averaged cross-power spectrum Baseline: EF (01) - JB (02)
Timerange: 00:22:29:10 to 00:22:32:40

Plot file version 80 created 21-FEB-2017 15:11:02

J1112+4301 EG096A.UVDATA.1

Freq = 4.7990 GHz, Bw = 32.000 MH No calibration applied and no bandpass applied

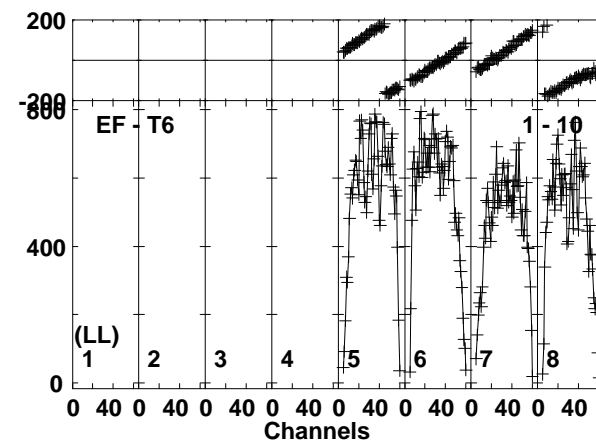
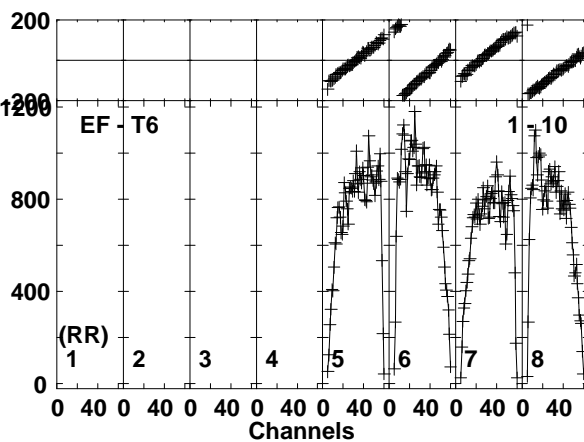
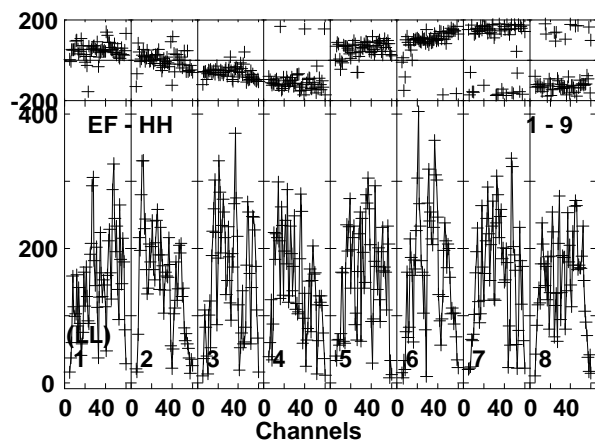
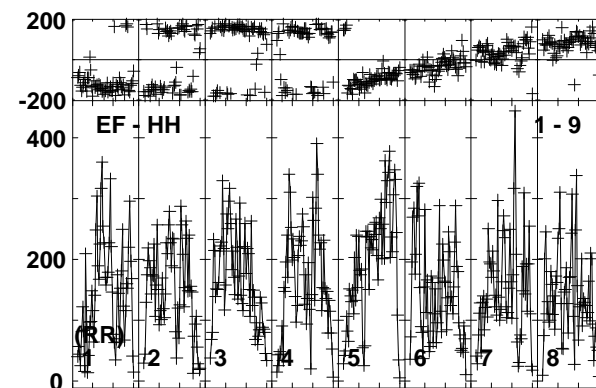
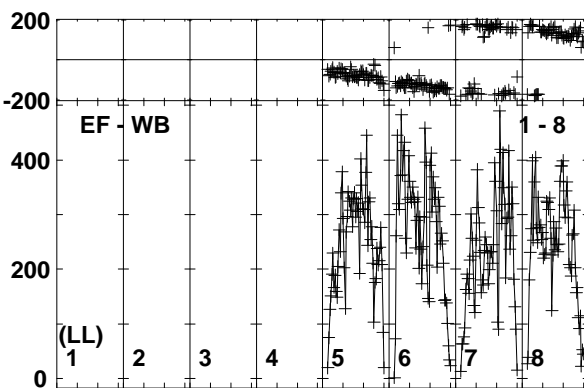
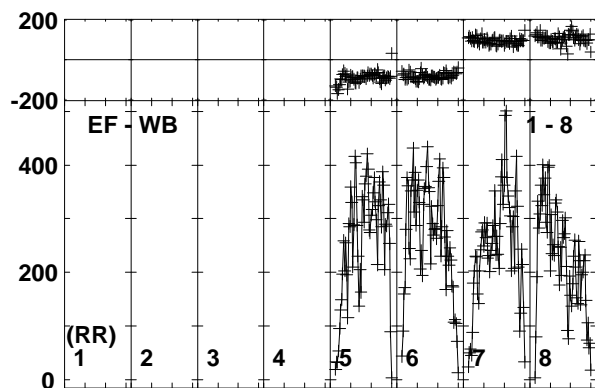
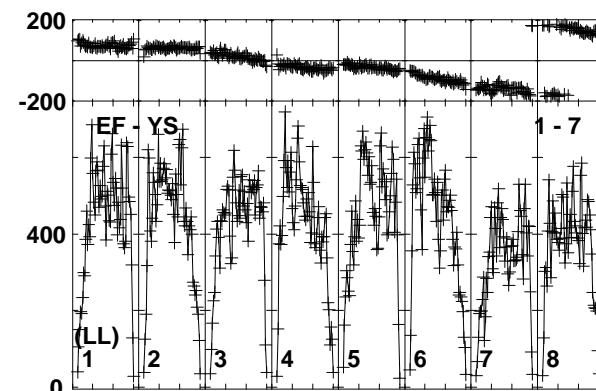
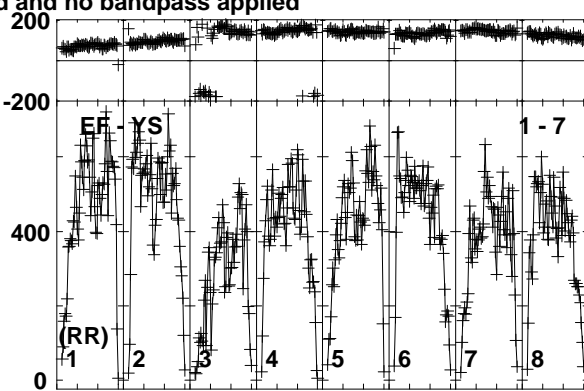
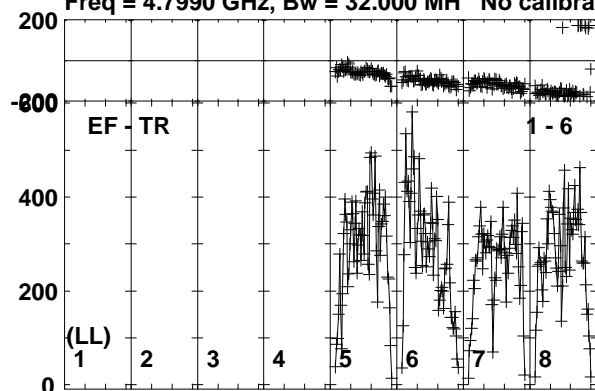

Lower frame: Micro Ampl Jy Top frame: Phas deg
Vector averaged cross-power spectrum Baseline: EF (01) - TR (06)
Timerange: 00/22:29:10 to 00/22:32:40

Plot file version 81 created 21-FEB-2017 15:11:02

J1108+4330 EG096A.UVDATA.1

Freq = 4.7990 GHz, Bw = 32.000 MH No calibration applied and no bandpass applied

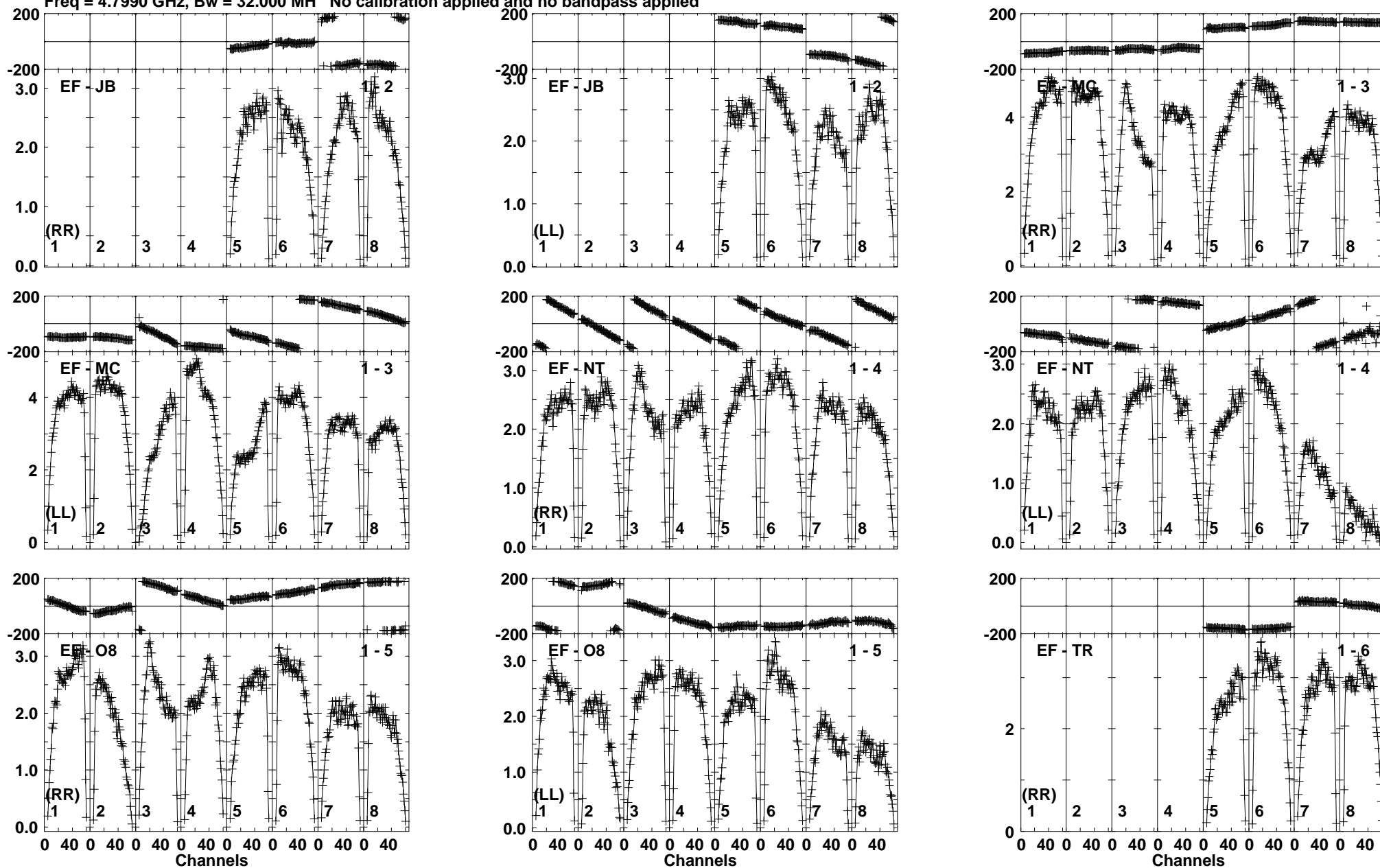

Lower frame: Milli Ampl Jy Top frame: Phas deg
Vector averaged cross-power spectrum Baseline: EF (01) - JB (02)
Timerange: 00:22:32:40 to 00:22:34:09

Plot file version 82 created 21-FEB-2017 15:11:02

J1108+4330 EG096A.UVDATA.1

Freq = 4.7990 GHz, Bw = 32.000 MH No calibration applied and no bandpass applied

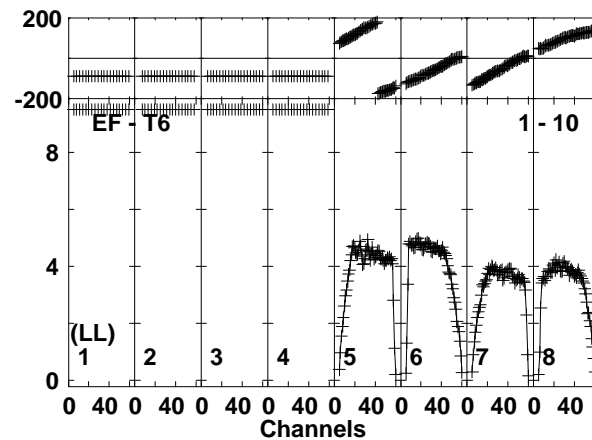
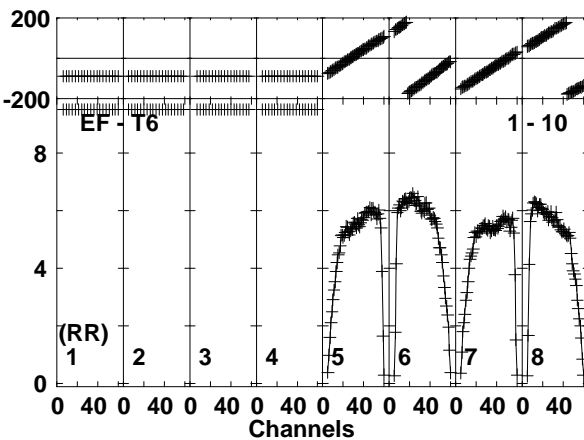
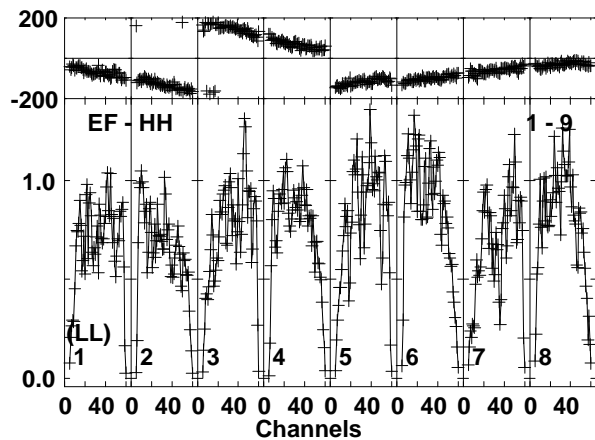
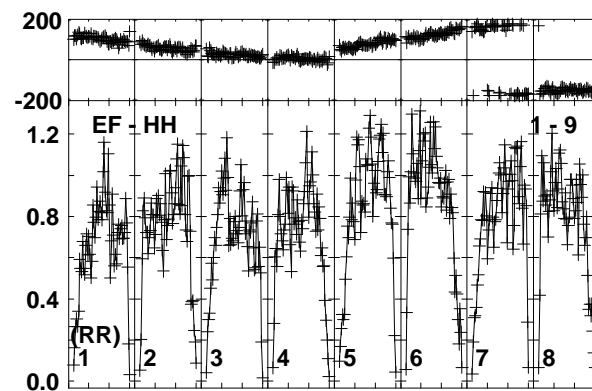
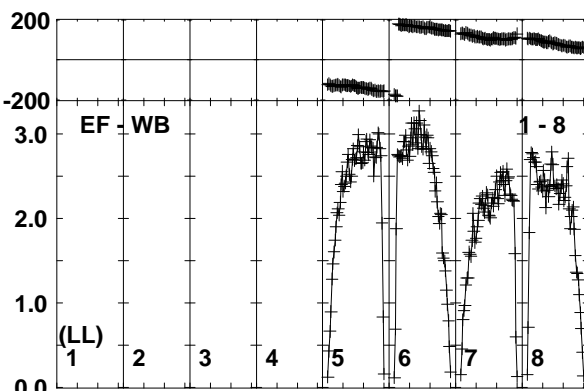
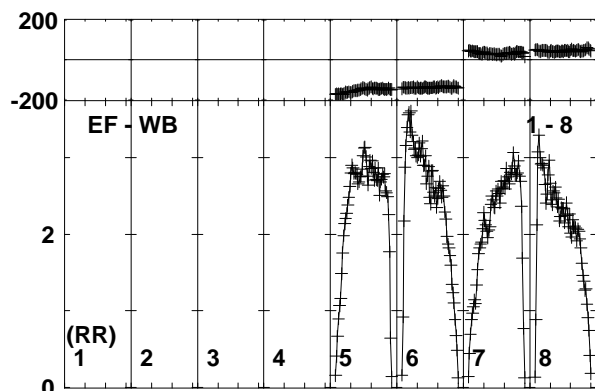
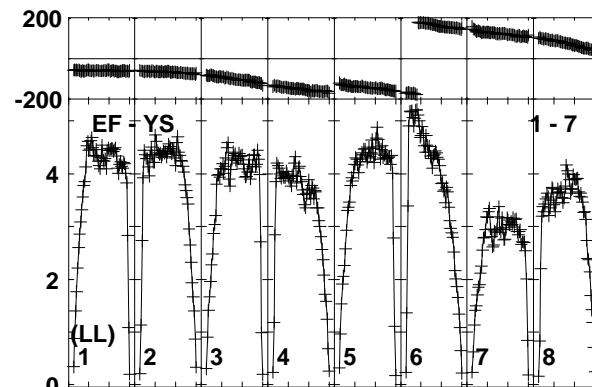
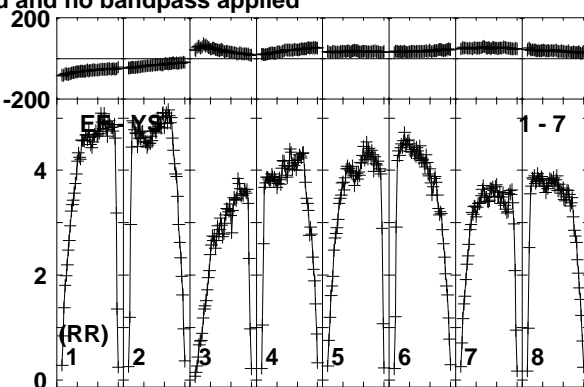
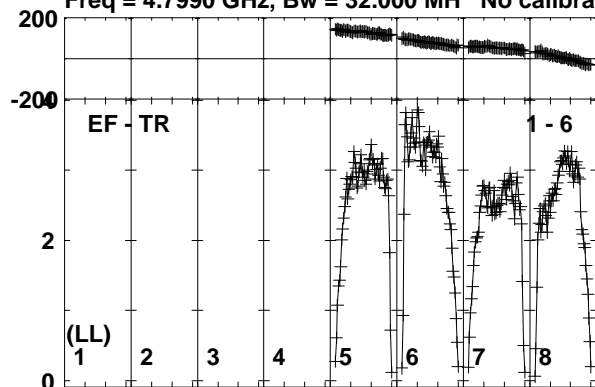

Lower frame: Milli Ampl Jy Top frame: Phas deg
Vector averaged cross-power spectrum Baseline: EF (01) - TR (06)
Timerange: 00/22:32:40 to 00/22:34:09

Plot file version 83 created 21-FEB-2017 15:11:03

ARUMA EG096A.UVDATA.1

Freq = 4.7990 GHz, Bw = 32.000 MH No calibration applied and no bandpass applied

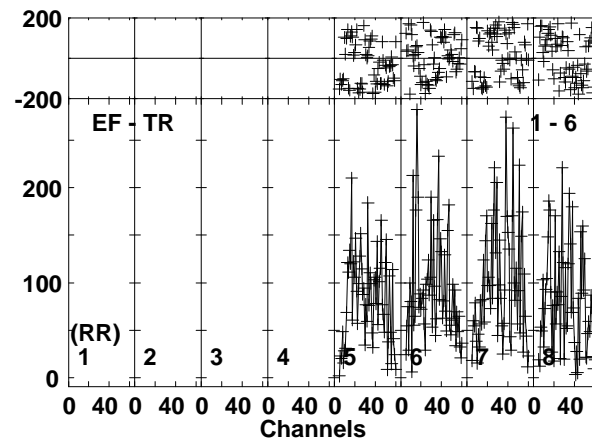
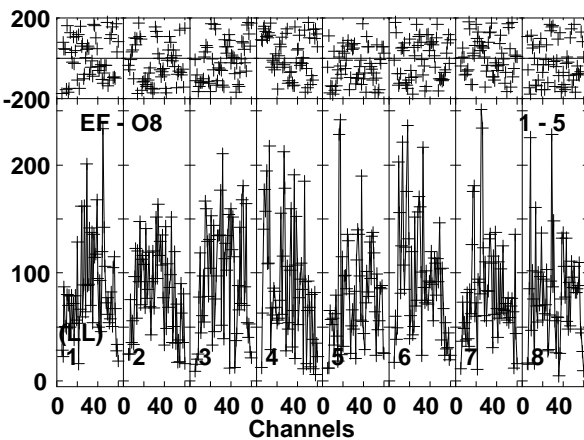
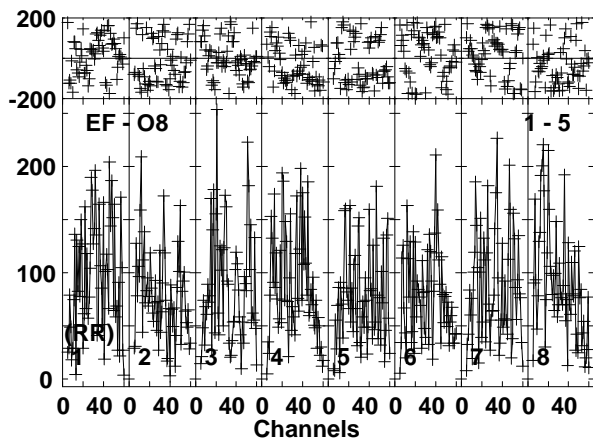
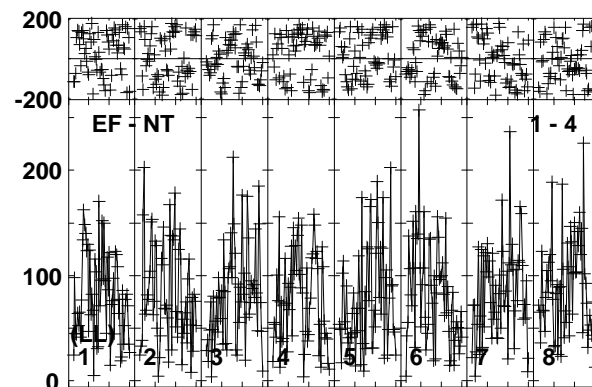
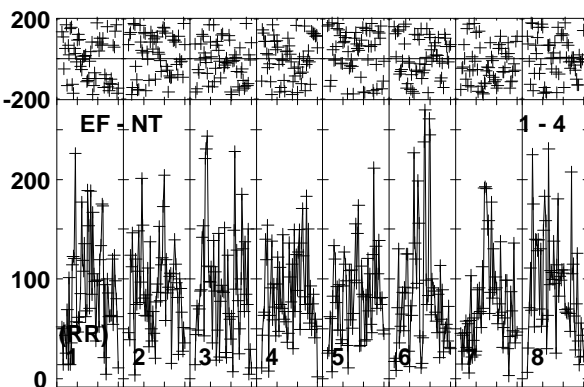
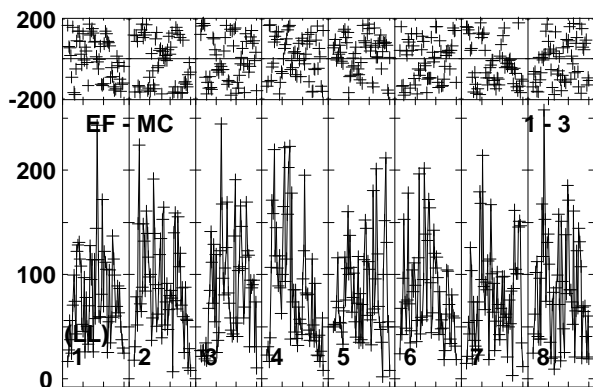
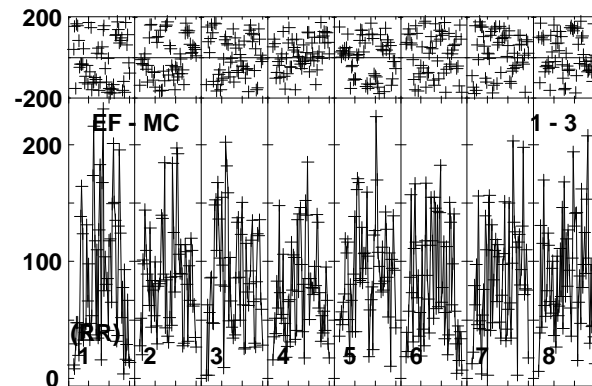
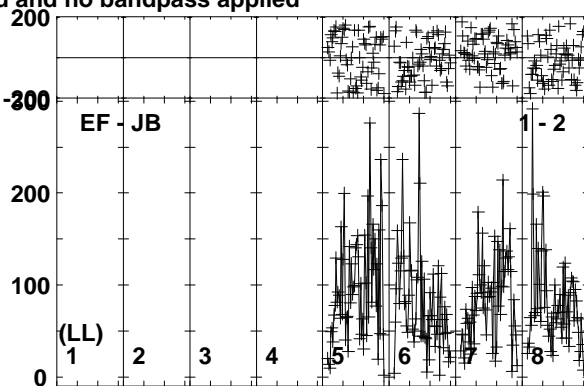
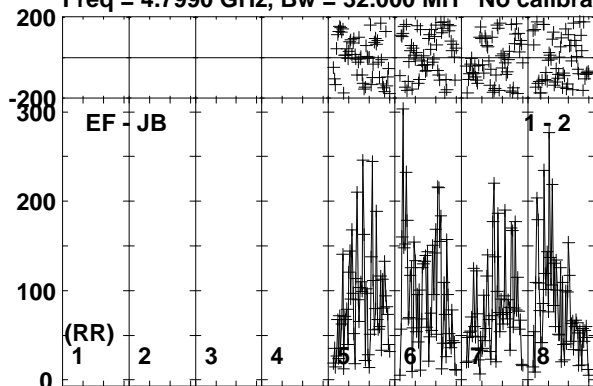

Lower frame: Micro Ampl Jy Top frame: Phas deg
Vector averaged cross-power spectrum Baseline: EF (01) - JB (02)
Timerange: 00:22:34:11 to 00:22:37:40

Plot file version 84 created 21-FEB-2017 15:11:03

ARUMA EG096A.UVDATA.1

Freq = 4.7990 GHz, Bw = 32.000 MH No calibration applied and no bandpass applied

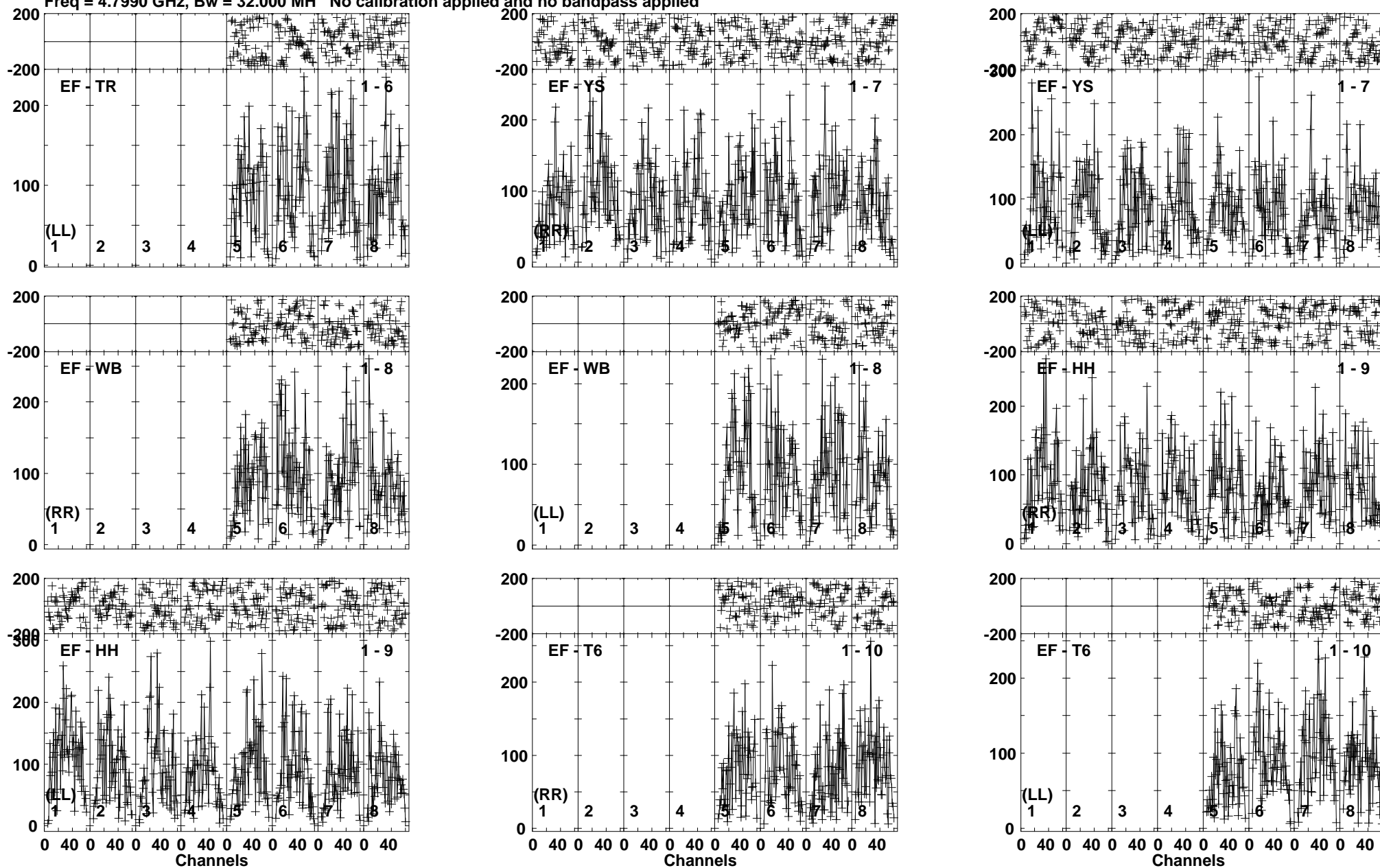

Lower frame: Micro Ampl Jy Top frame: Phas deg
Vector averaged cross-power spectrum Baseline: EF (01) - TR (06)
Timerange: 00/22:34:11 to 00/22:37:40

Plot file version 85 created 21-FEB-2017 15:11:03

J1108+4330 EG096A.UVDATA.1

Freq = 4.7990 GHz, Bw = 32.000 MH No calibration applied and no bandpass applied

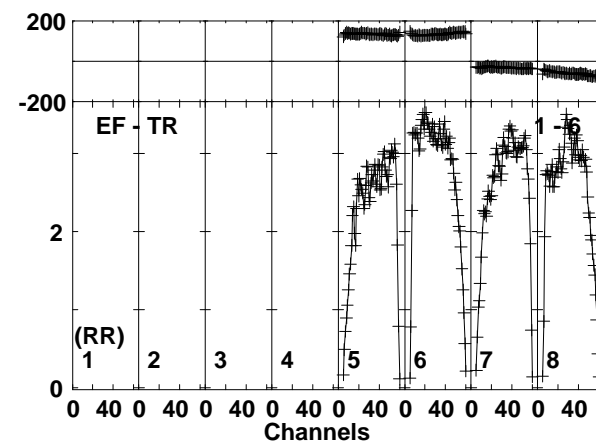
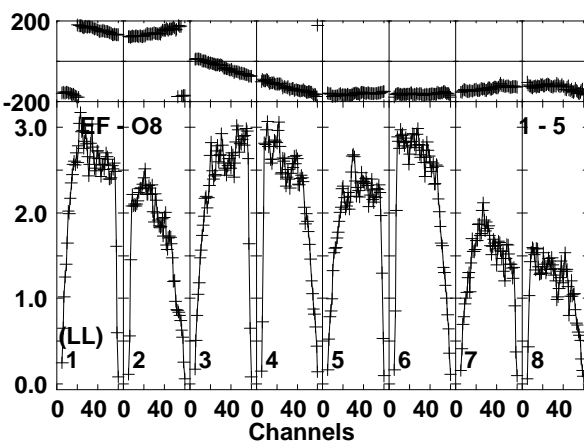
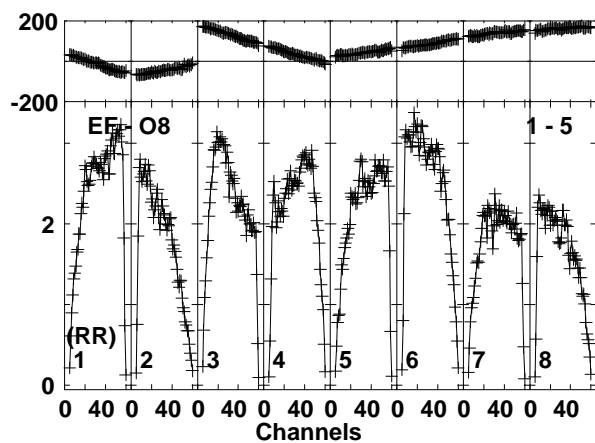
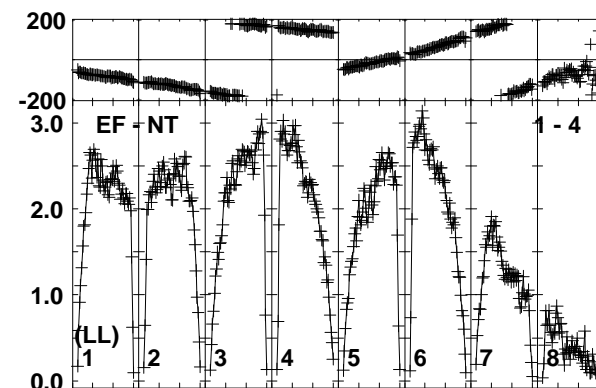
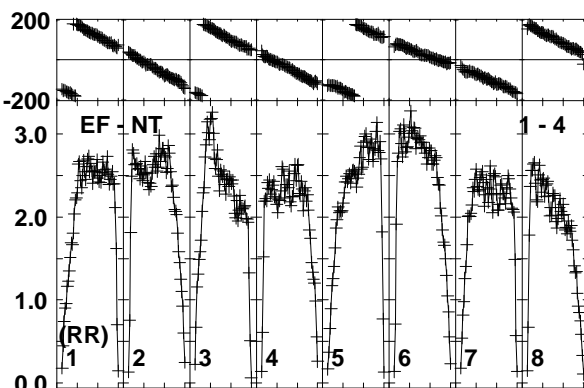
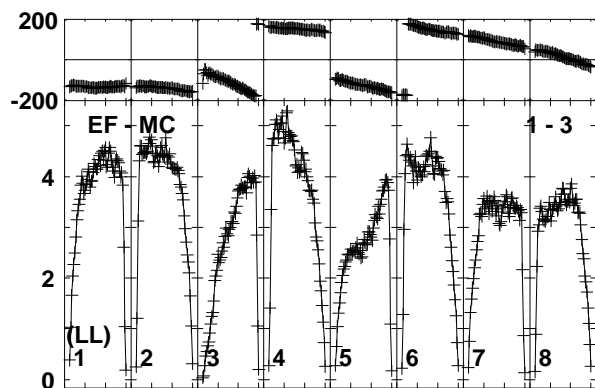
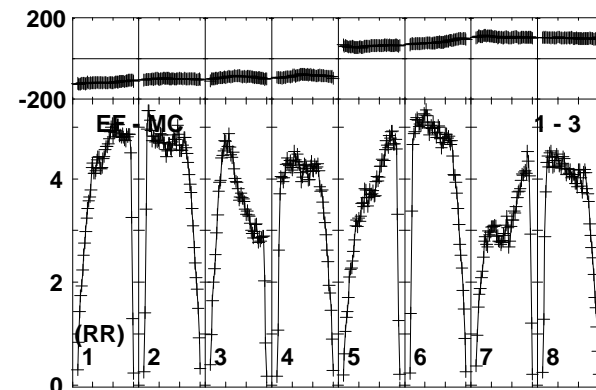
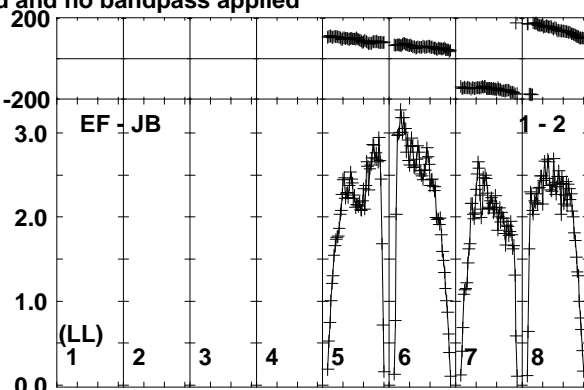
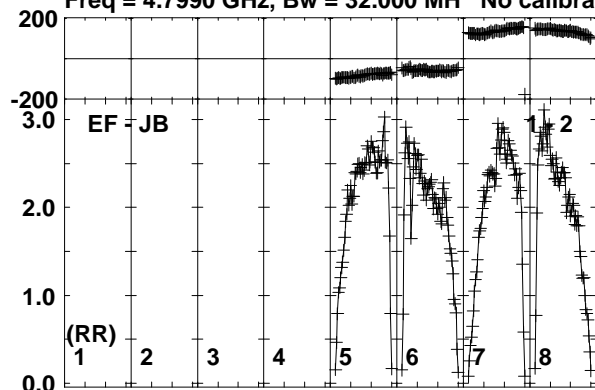

Lower frame: Milli Ampl Jy Top frame: Phas deg
Vector averaged cross-power spectrum Baseline: EF (01) - JB (02)
Timerange: 00/22:38:21 to 00/22:39:19

Plot file version 86 created 21-FEB-2017 15:11:03

J1108+4330 EG096A.UVDATA.1

Freq = 4.7990 GHz, Bw = 32.000 MH No calibration applied and no bandpass applied

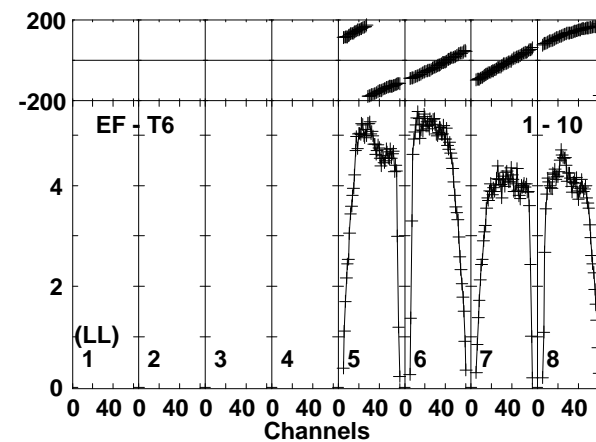
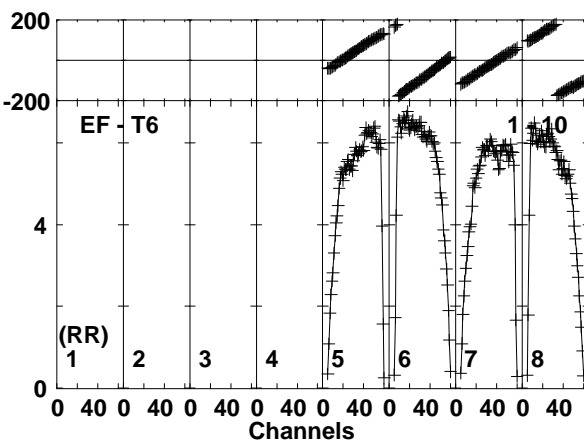
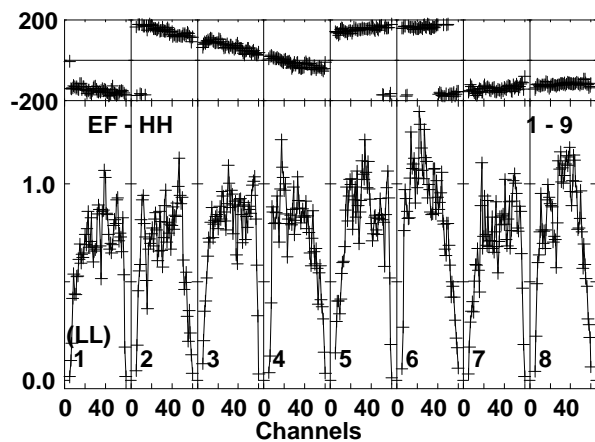
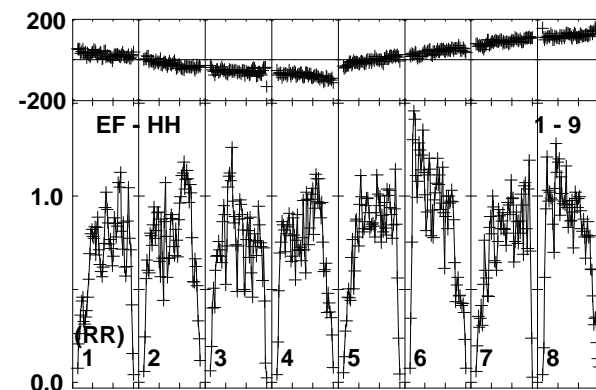
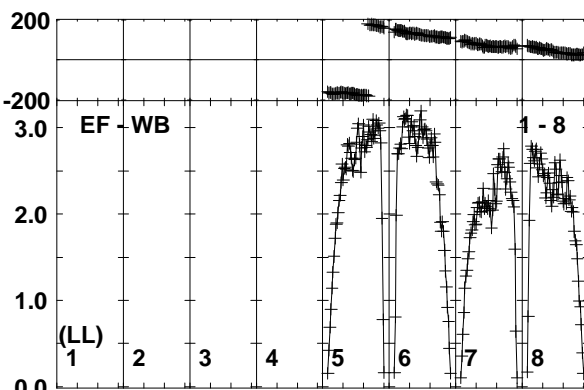
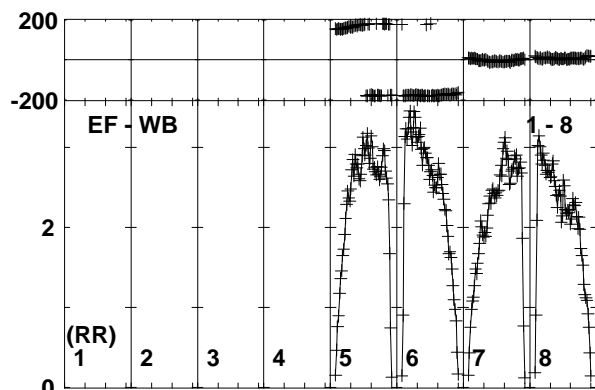
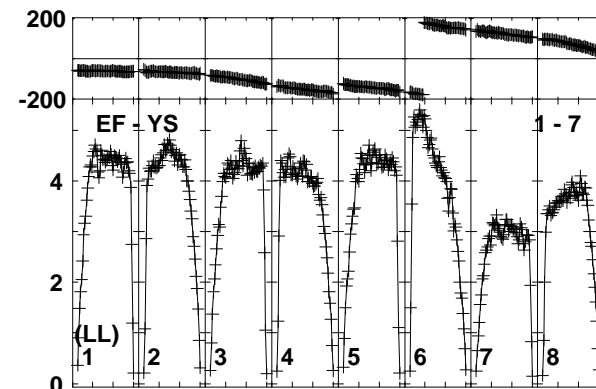
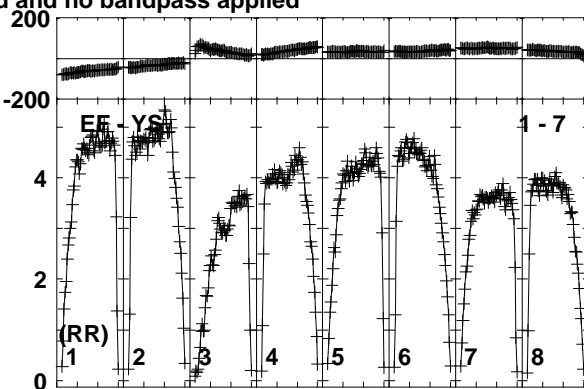
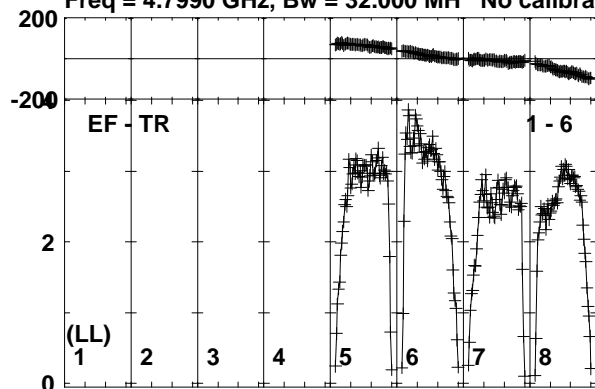

Lower frame: Milli Ampl Jy Top frame: Phas deg
Vector averaged cross-power spectrum Baseline: EF (01) - TR (06)
Timerange: 00/22:38:21 to 00/22:39:19

Plot file version 87 created 21-FEB-2017 15:11:04

ARUMA EG096A.UVDATA.1

Freq = 4.7990 GHz, Bw = 32.000 MH No calibration applied and no bandpass applied

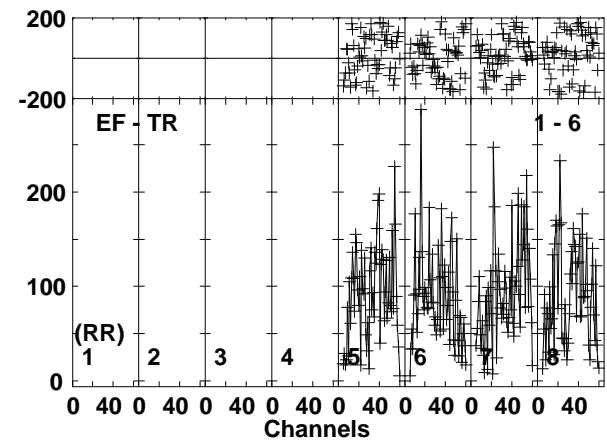
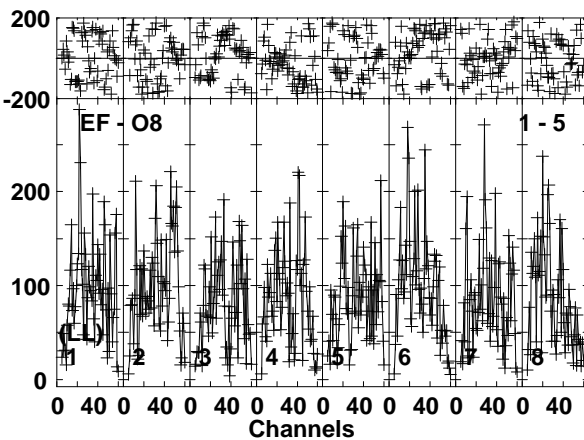
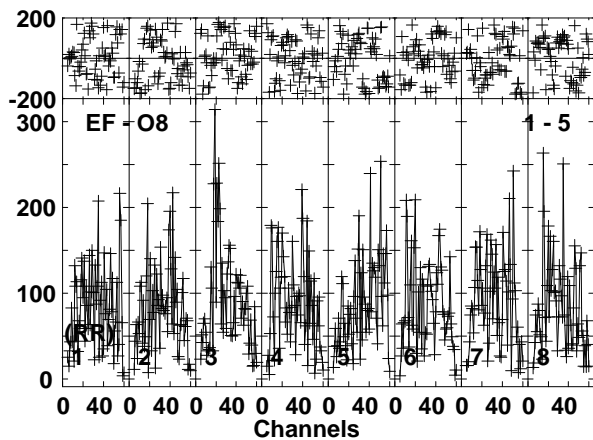
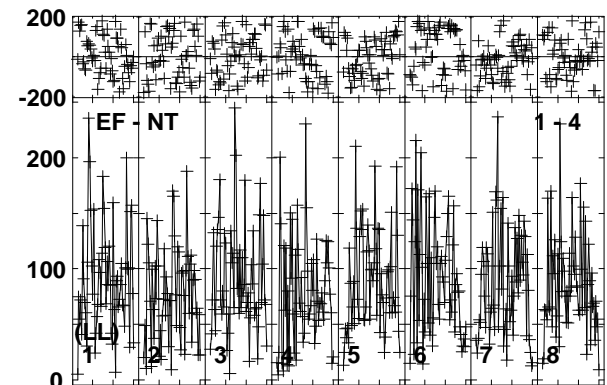
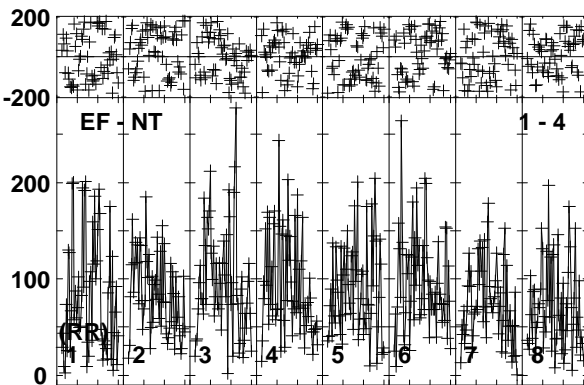
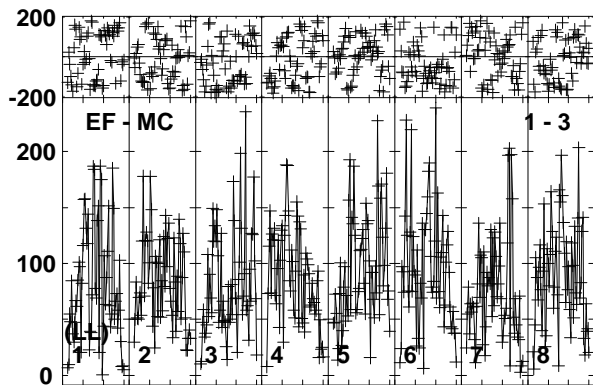
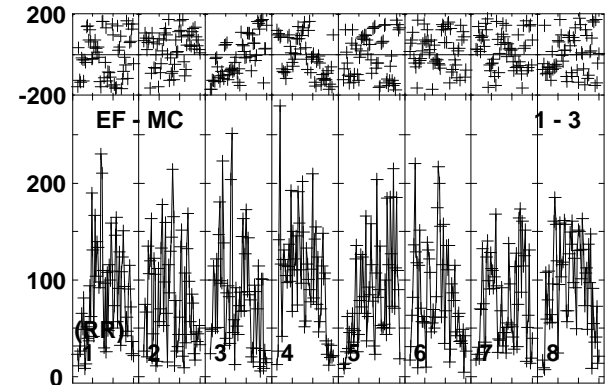
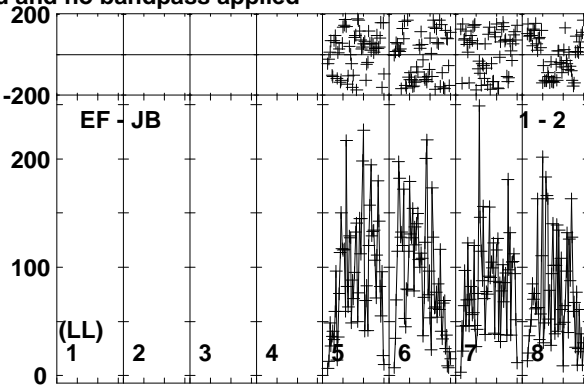
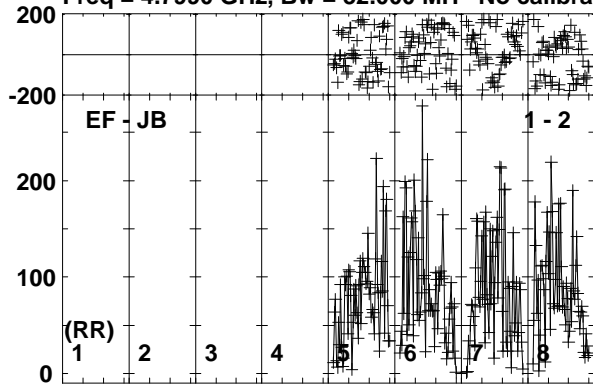

Lower frame: Micro Ampl Jy Top frame: Phas deg
Vector averaged cross-power spectrum Baseline: EF (01) - JB (02)
Timerange: 00/22:39:20 to 00/22:42:49

Plot file version 88 created 21-FEB-2017 15:11:04

ARUMA EG096A.UVDATA.1

Freq = 4.7990 GHz, Bw = 32.000 MH No calibration applied and no bandpass applied

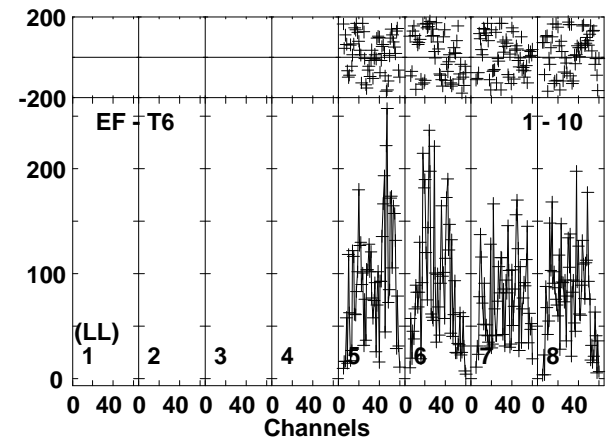
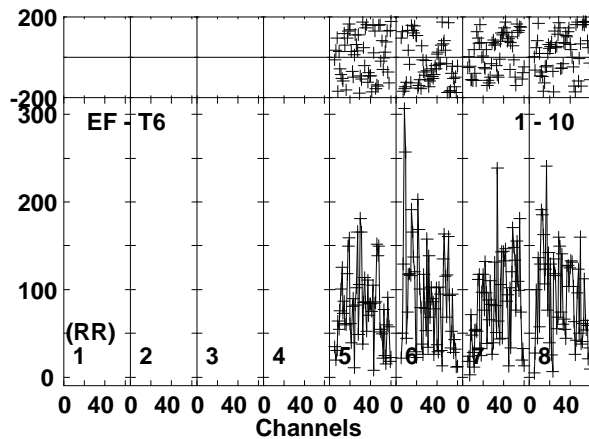
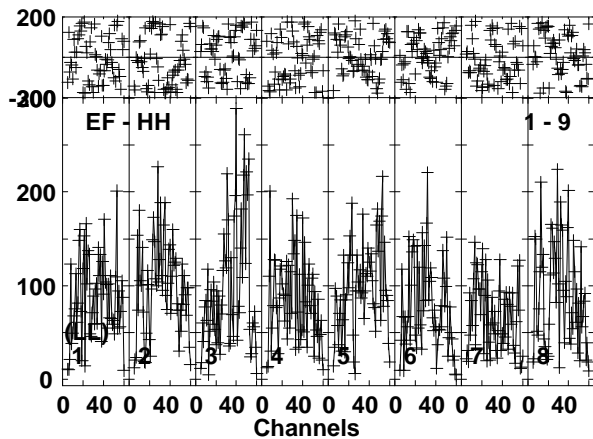
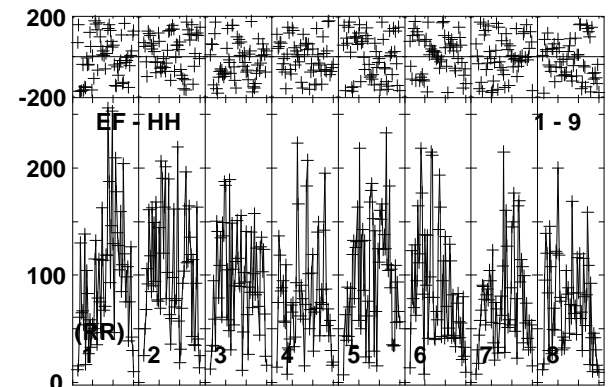
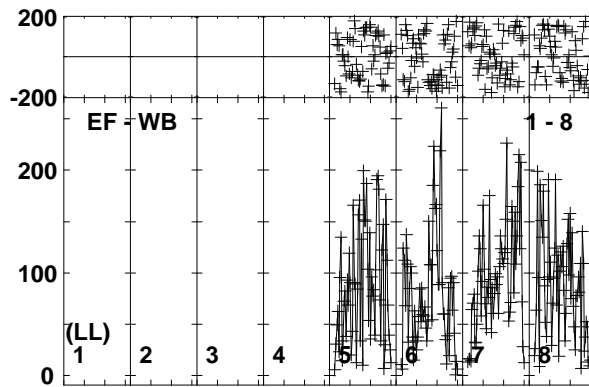
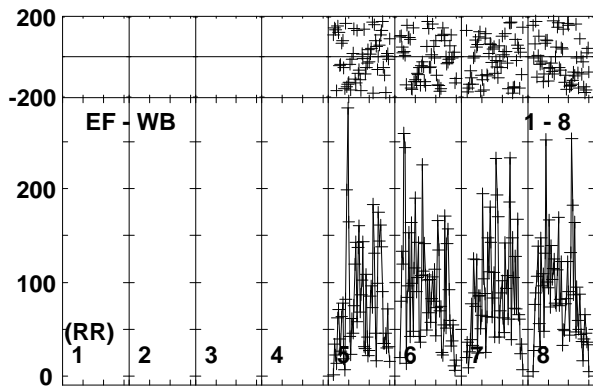
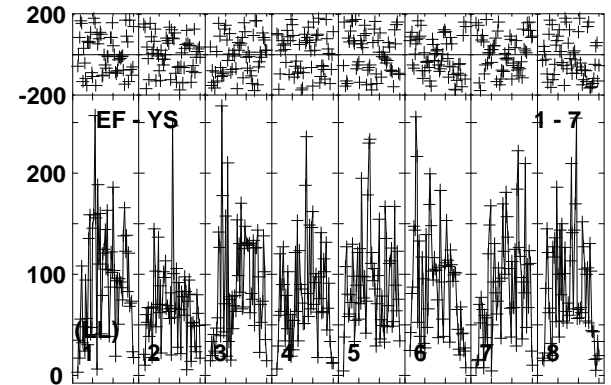
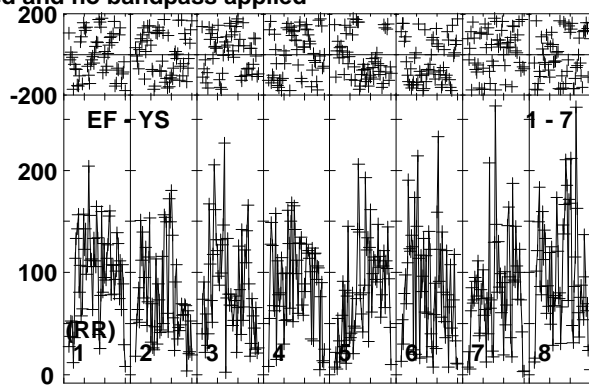
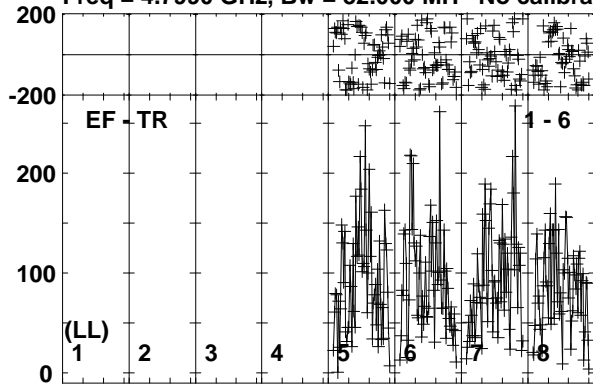

Lower frame: Micro Ampl Jy Top frame: Phas deg
Vector averaged cross-power spectrum Baseline: EF (01) - TR (06)
Timerange: 00:22:39:20 to 00:22:42:49

Plot file version 89 created 21-FEB-2017 15:11:04

J1108+4330 EG096A.UVDATA.1

Freq = 4.7990 GHz, Bw = 32.000 MH No calibration applied and no bandpass applied

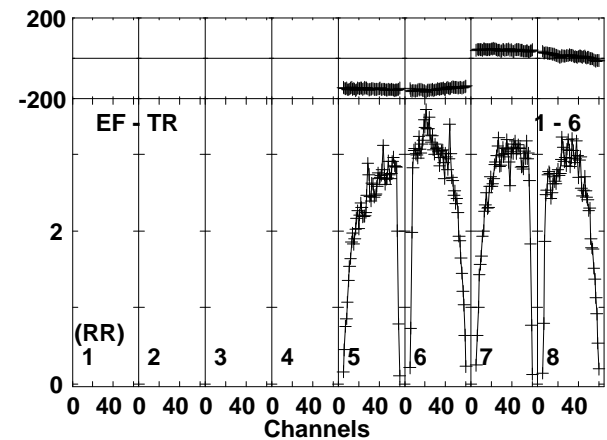
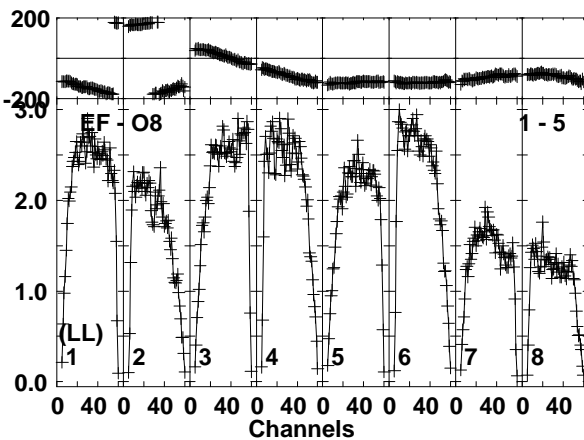
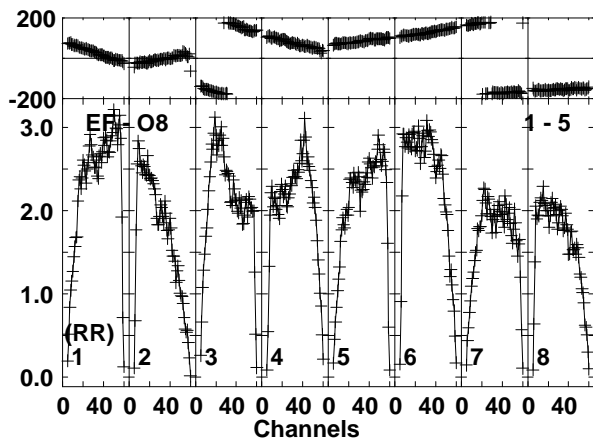
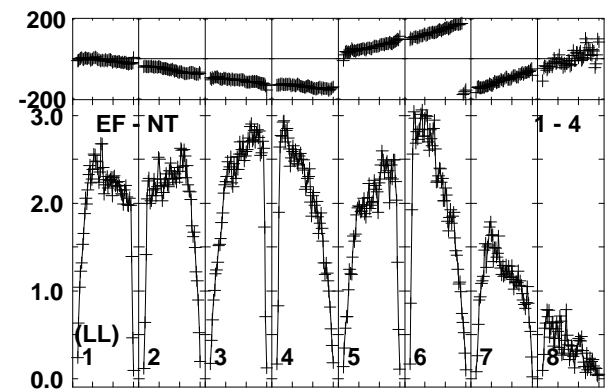
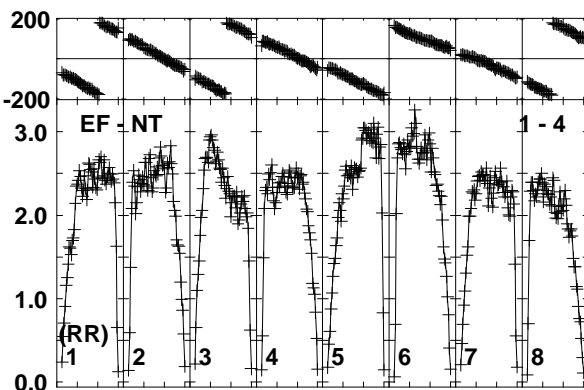
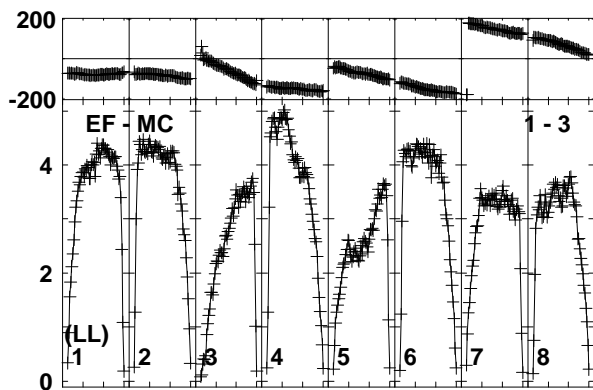
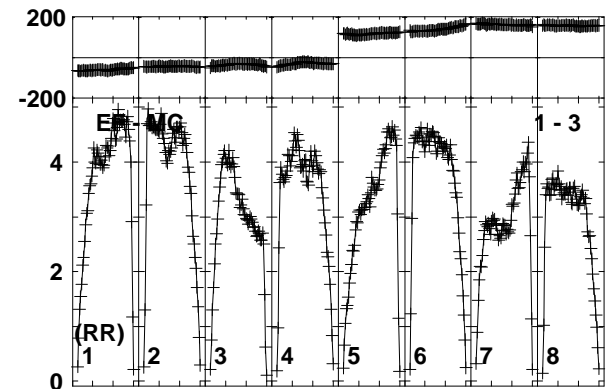
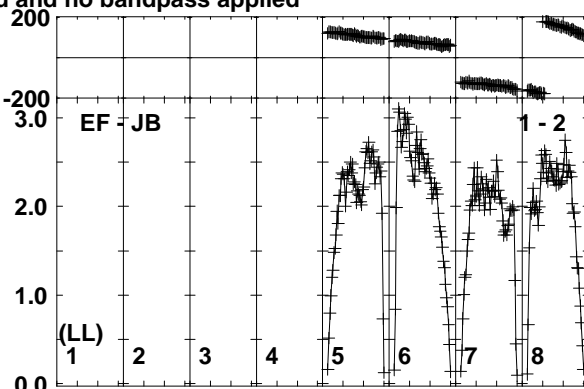
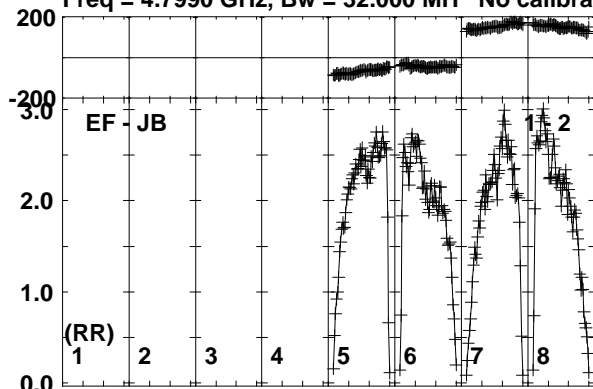

Lower frame: Milli Ampl Jy Top frame: Phas deg
Vector averaged cross-power spectrum Baseline: EF (01) - JB (02)
Timerange: 00:22:42:50 to 00:22:44:20

Plot file version 90 created 21-FEB-2017 15:11:05

J1108+4330 EG096A.UVDATA.1

Freq = 4.7990 GHz, Bw = 32.000 MH No calibration applied and no bandpass applied

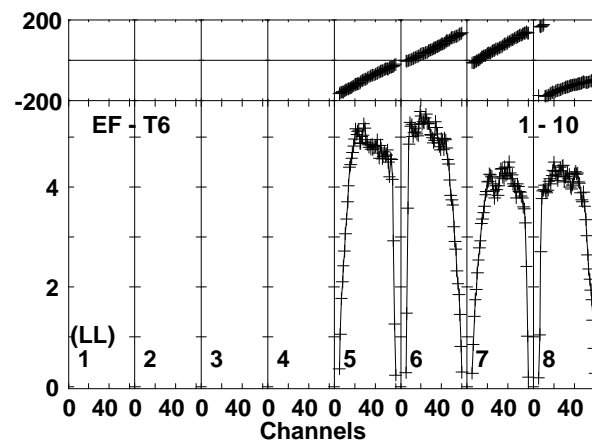
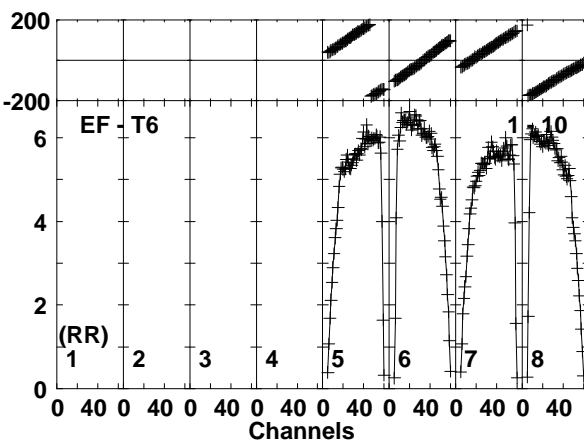
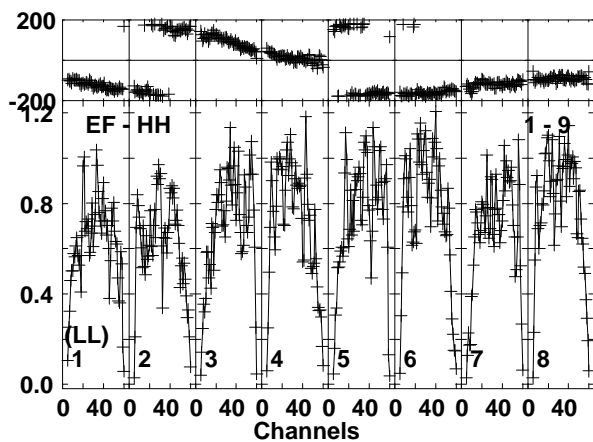
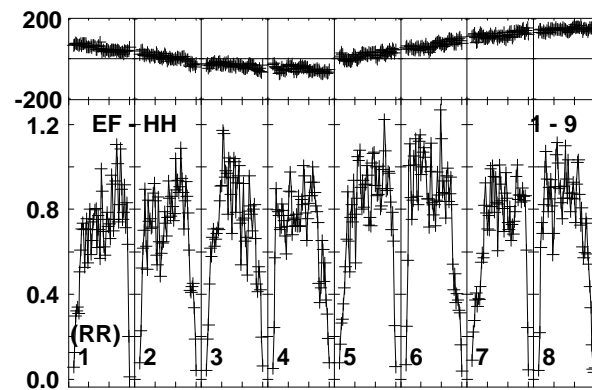
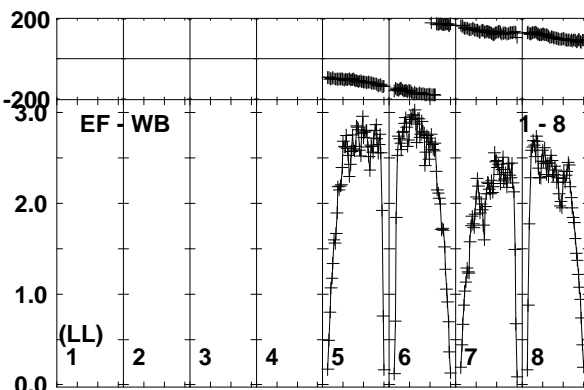
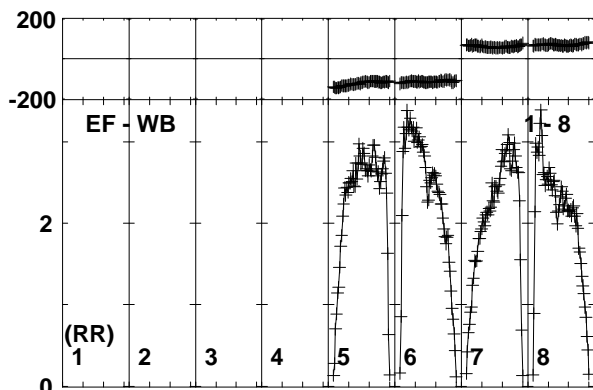
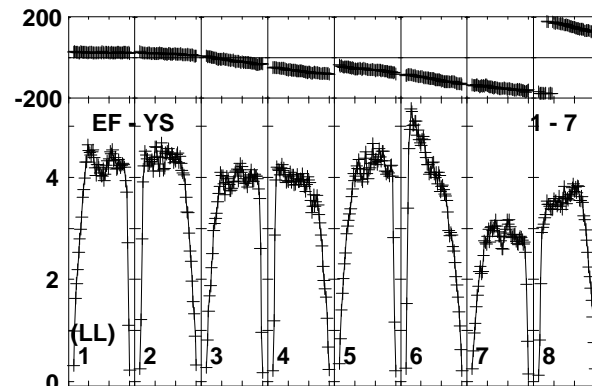
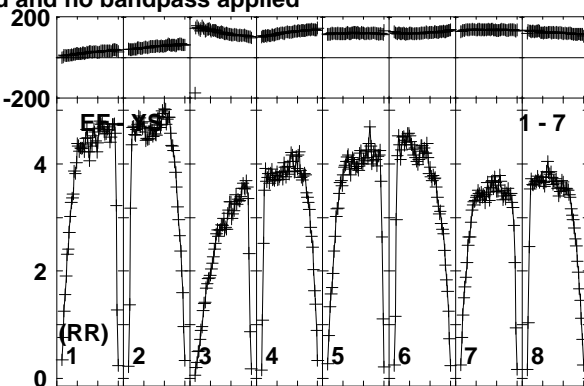
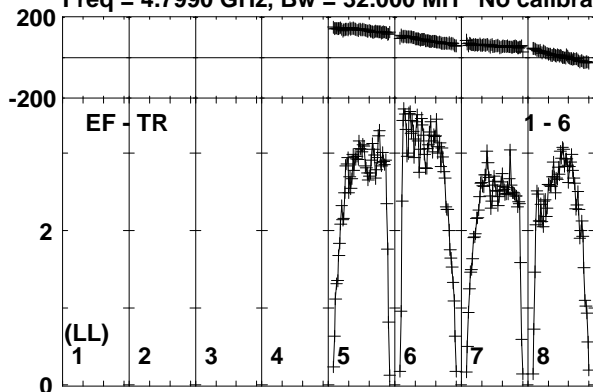

Lower frame: Milli Ampl Jy Top frame: Phas deg
Vector averaged cross-power spectrum Baseline: EF (01) - TR (06)
Timerange: 00/22:42:50 to 00/22:44:20

Plot file version 91 created 21-FEB-2017 15:11:05

ARUMA EG096A.UVDATA.1

Freq = 4.7990 GHz, Bw = 32.000 MH No calibration applied and no bandpass applied

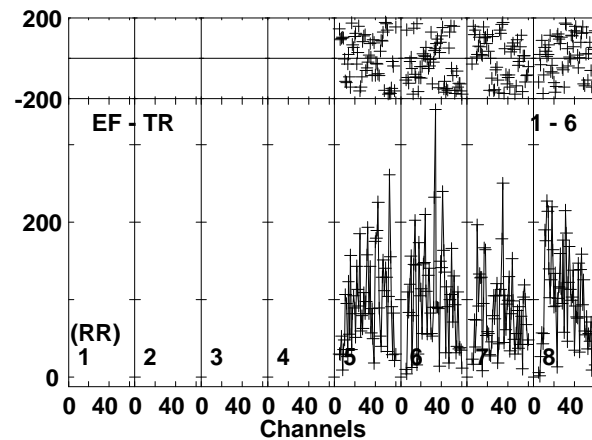
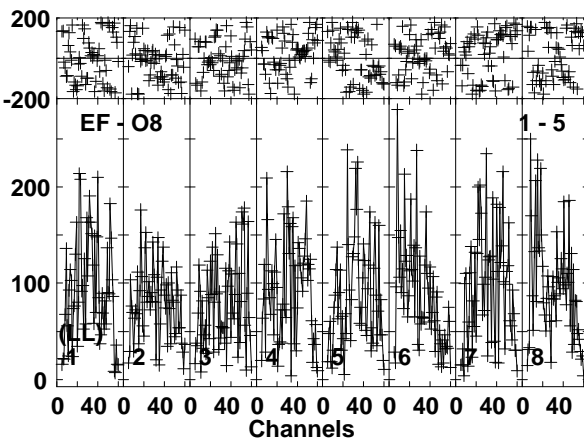
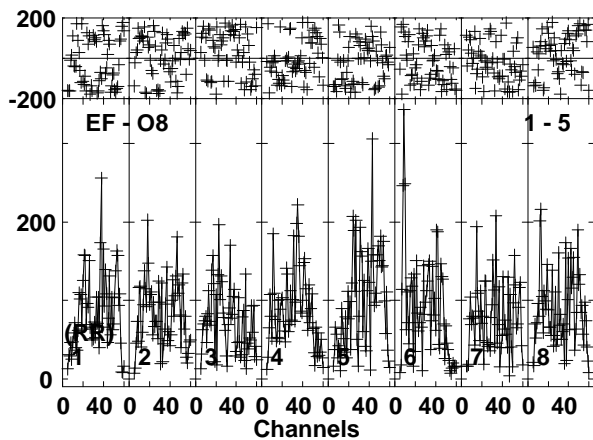
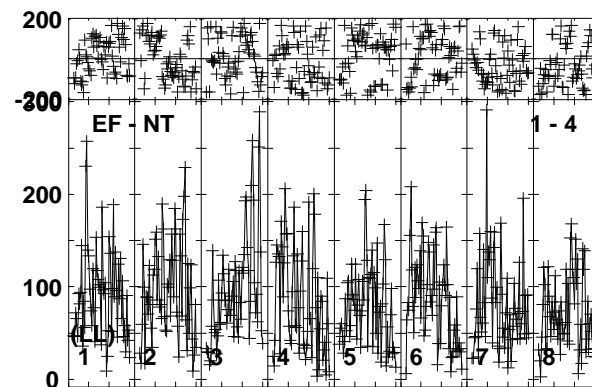
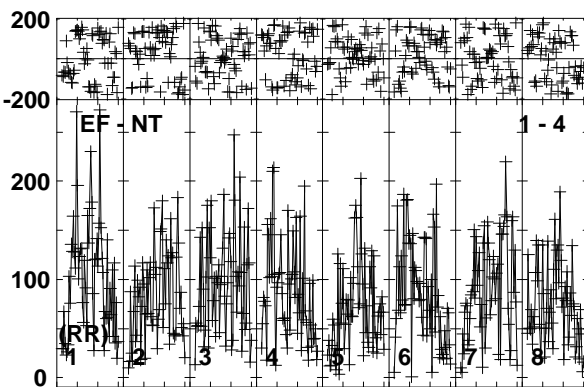
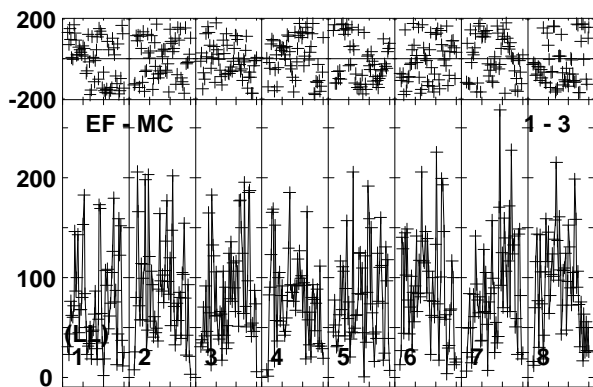
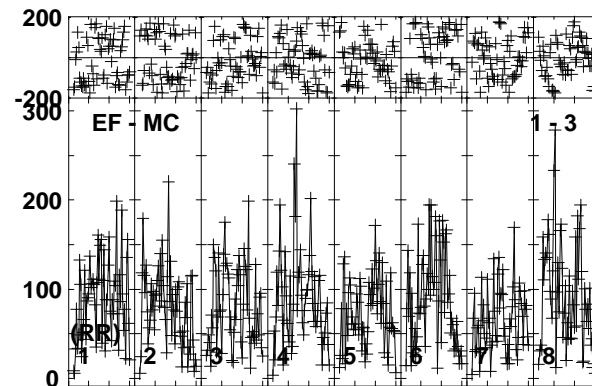
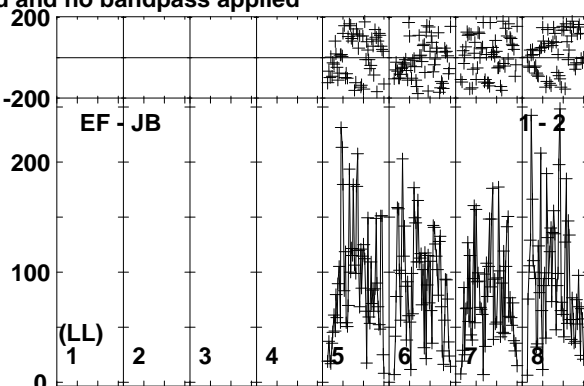
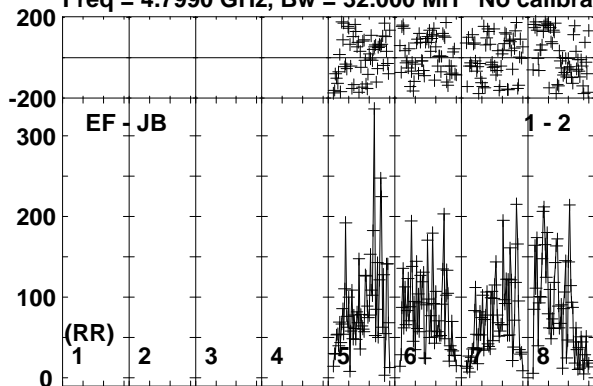

Lower frame: Micro Ampl Jy Top frame: Phas deg
Vector averaged cross-power spectrum Baseline: EF (01) - JB (02)
Timerange: 00/22:44:20 to 00/22:47:49

Plot file version 93 created 21-FEB-2017 15:11:06

J1108+4330 EG096A.UVDATA.1

Freq = 4.7990 GHz, Bw = 32.000 MH No calibration applied and no bandpass applied

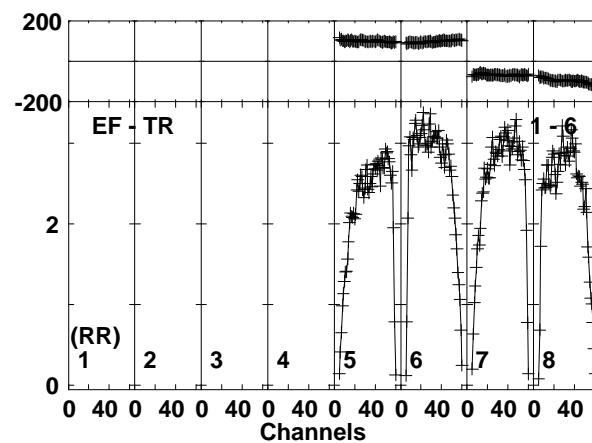
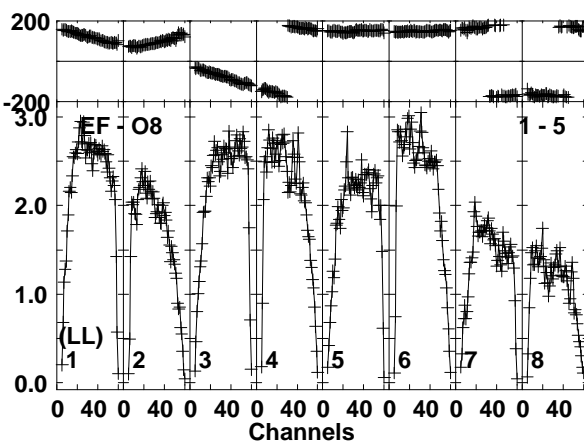
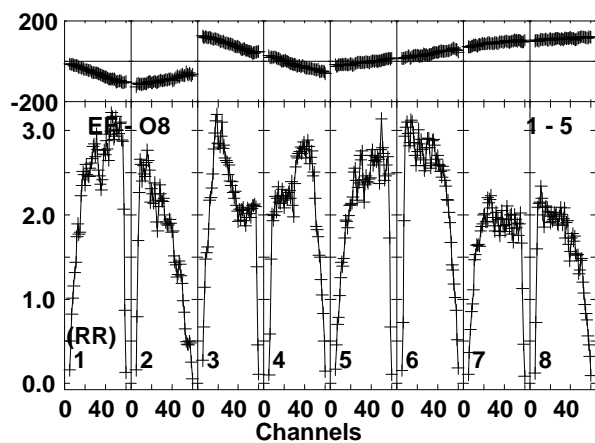
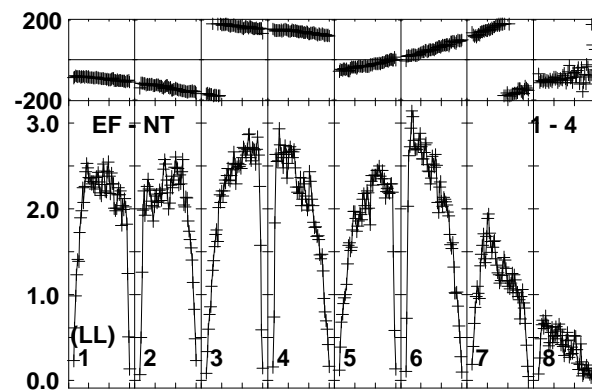
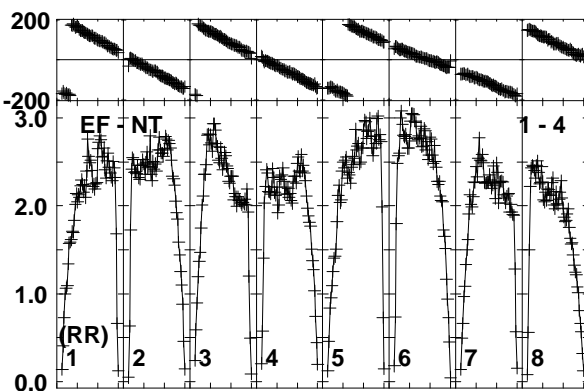
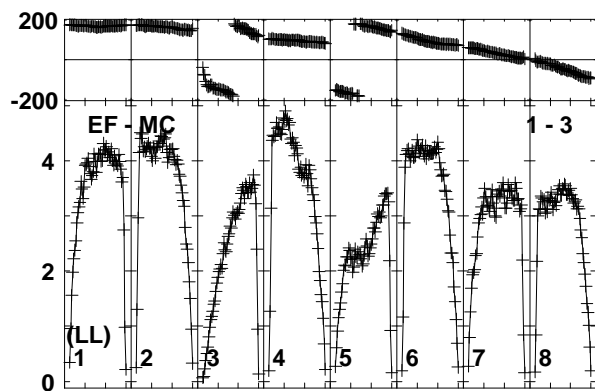
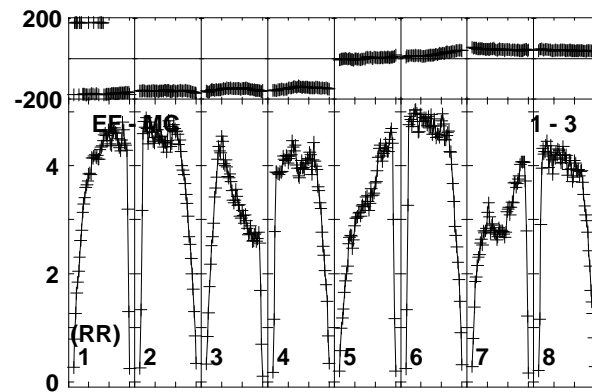
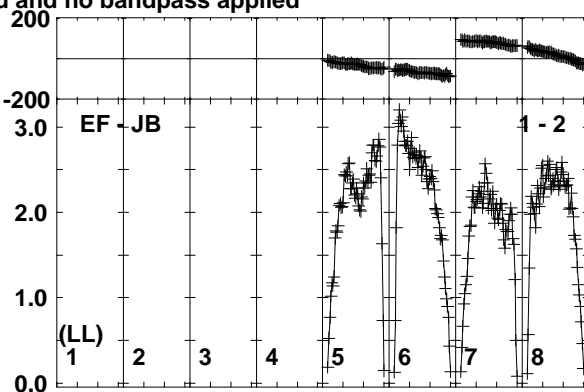
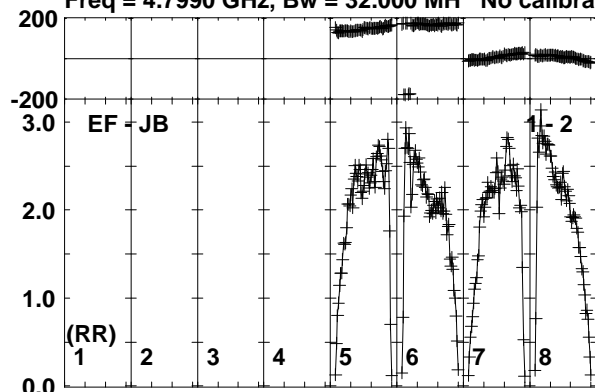

Lower frame: Milli Ampl Jy Top frame: Phas deg
Vector averaged cross-power spectrum Baseline: EF (01) - JB (02)
Timerange: 00/22:48:30 to 00/22:49:29

Plot file version 94 created 21-FEB-2017 15:11:06

J1108+4330 EG096A.UVDATA.1

Freq = 4.7990 GHz, Bw = 32.000 MH No calibration applied and no bandpass applied

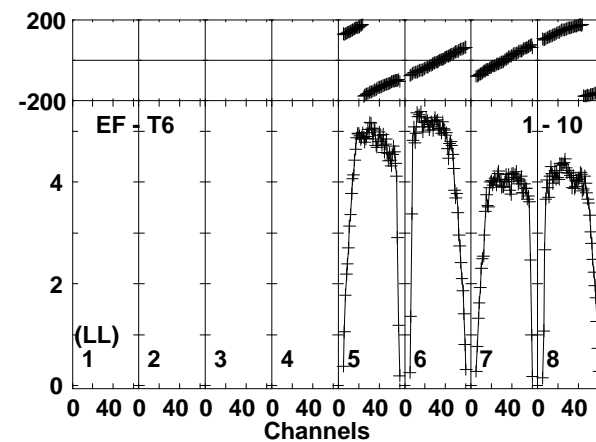
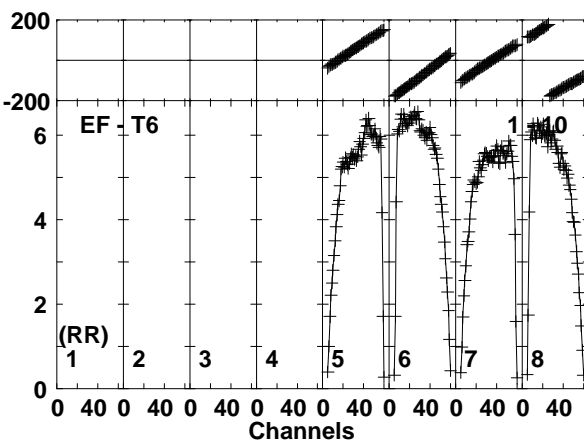
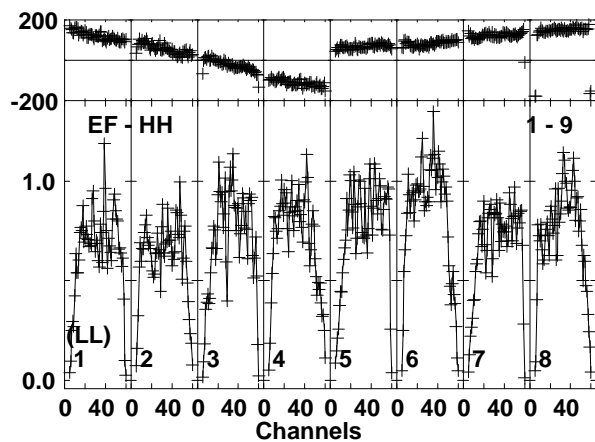
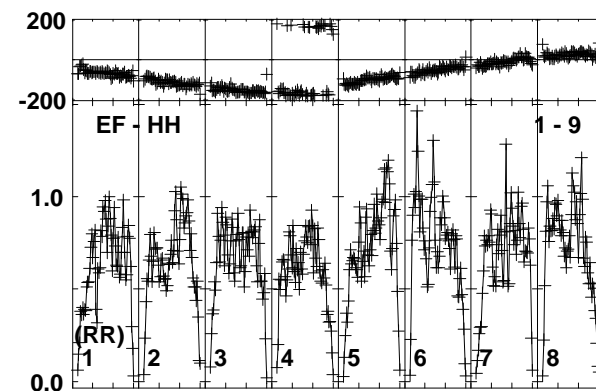
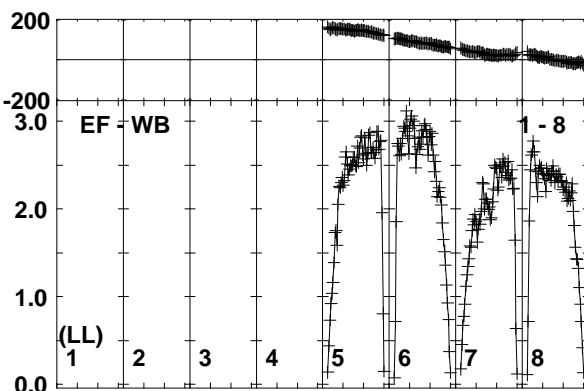
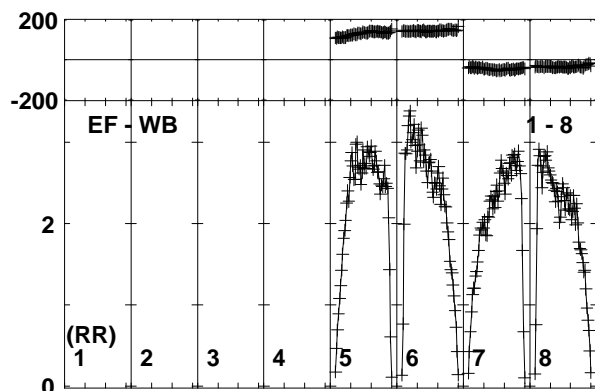
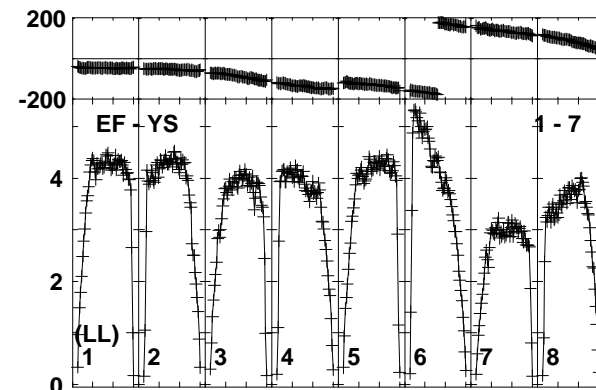
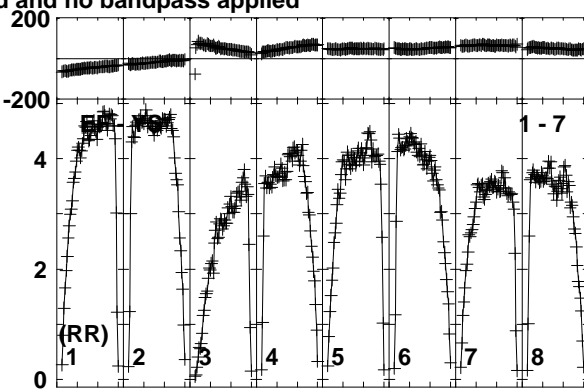
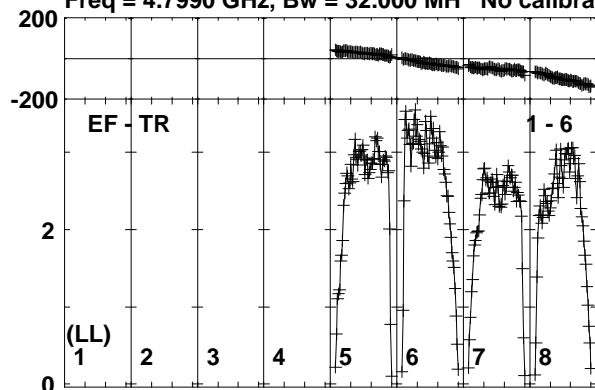

Lower frame: Milli Ampl Jy Top frame: Phas deg
Vector averaged cross-power spectrum Baseline: EF (01) - TR (06)
Timerange: 00/22:48:30 to 00/22:49:29

Plot file version 95 created 21-FEB-2017 15:11:06

ARUMA EG096A.UVDATA.1

Freq = 4.7990 GHz, Bw = 32.000 MH No calibration applied and no bandpass applied

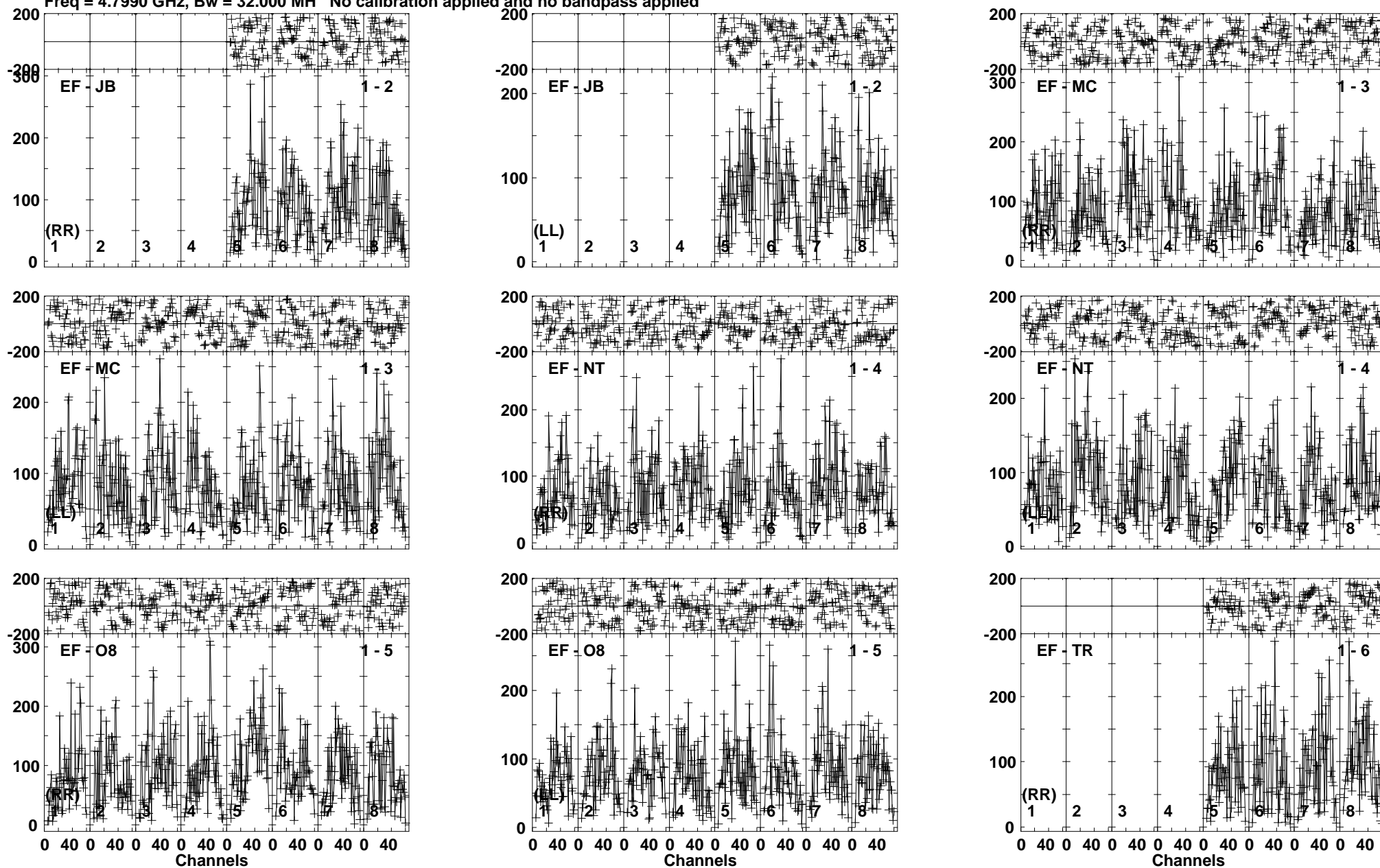

Lower frame: Micro Ampl Jy Top frame: Phas deg
Vector averaged cross-power spectrum Baseline: EF (01) - JB (02)
Timerange: 00/22:49:30 to 00/22:52:59

Plot file version 96 created 21-FEB-2017 15:11:06

ARUMA EG096A.UVDATA.1

Freq = 4.7990 GHz, Bw = 32.000 MH No calibration applied and no bandpass applied

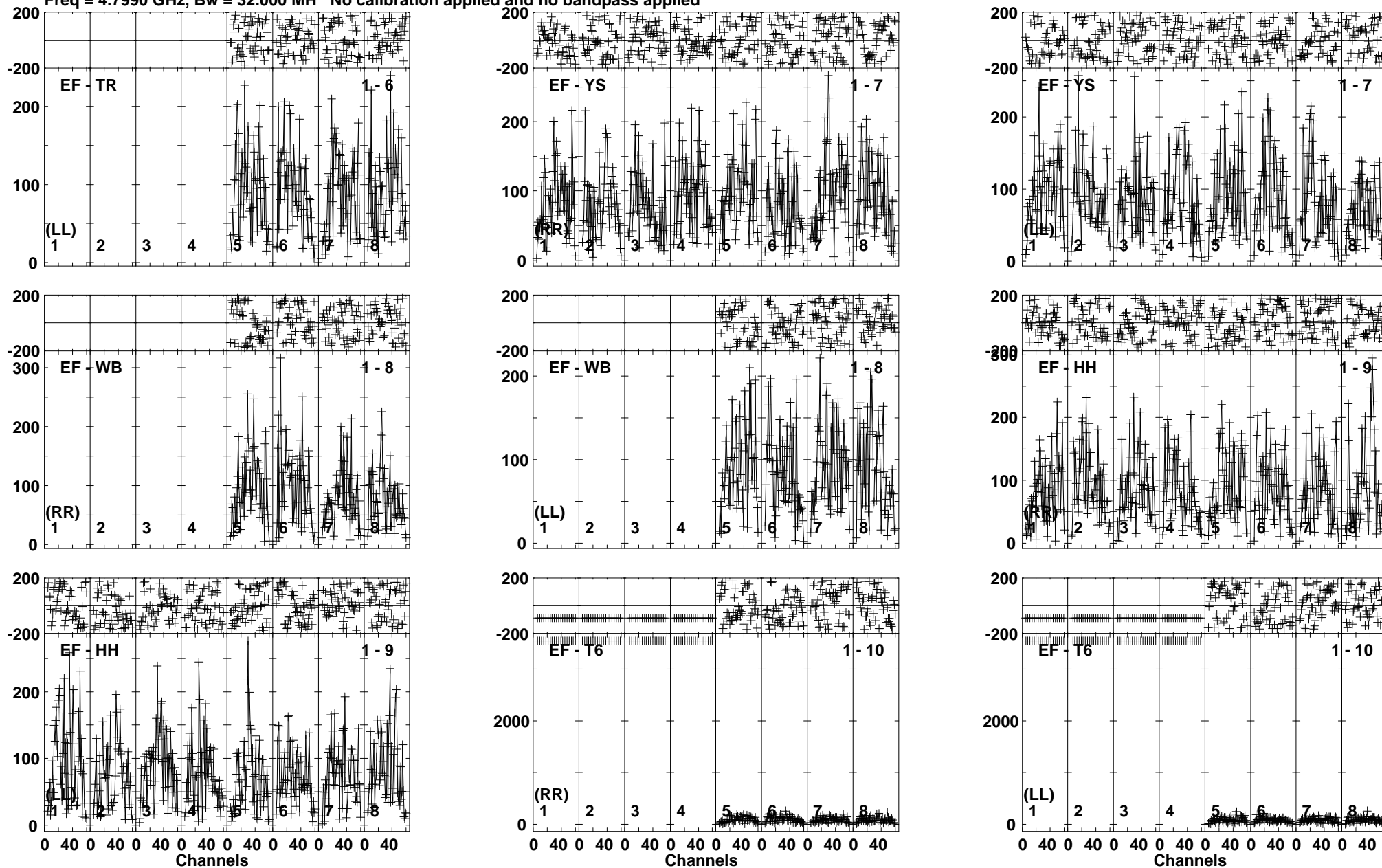

Lower frame: Micro Ampl Jy Top frame: Phas deg
Vector averaged cross-power spectrum Baseline: EF (01) - TR (06)
Timerange: 00:22:49:30 to 00:22:52:59

Plot file version 97 created 21-FEB-2017 15:11:07

J1108+4330 EG096A.UVDATA.1

Freq = 4.7990 GHz, Bw = 32.000 MH No calibration applied and no bandpass applied

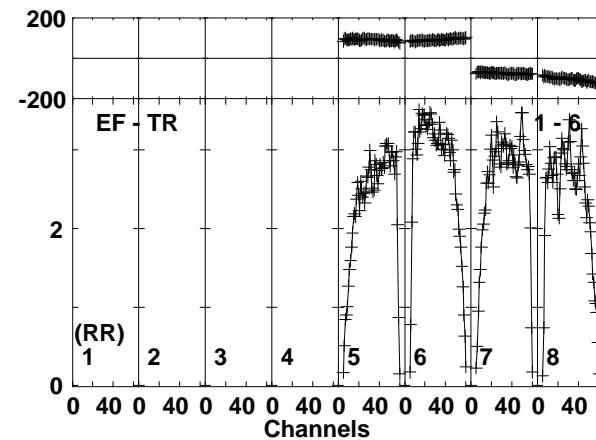
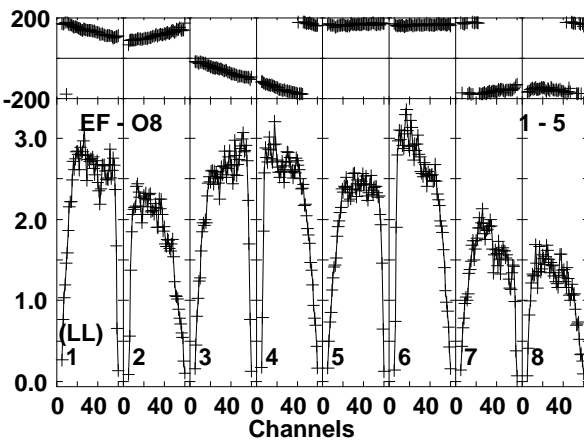
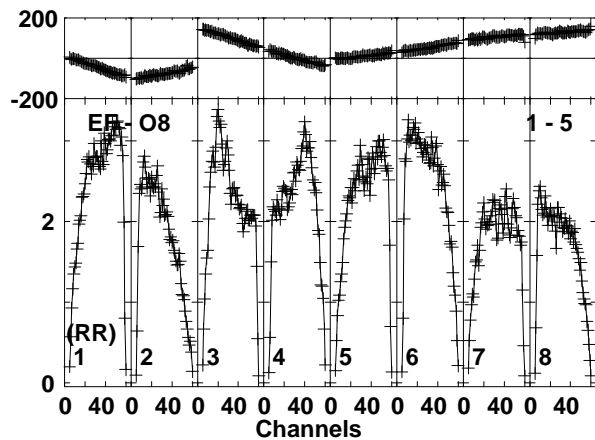
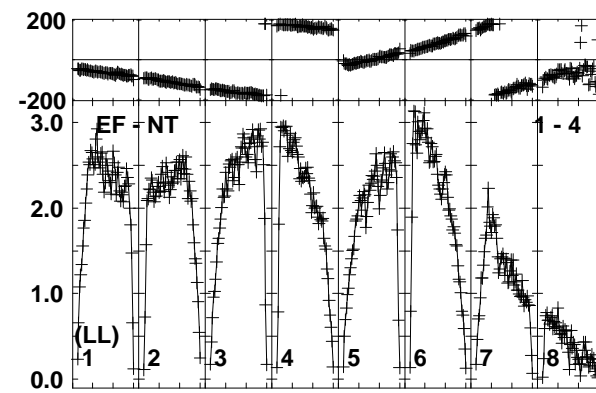
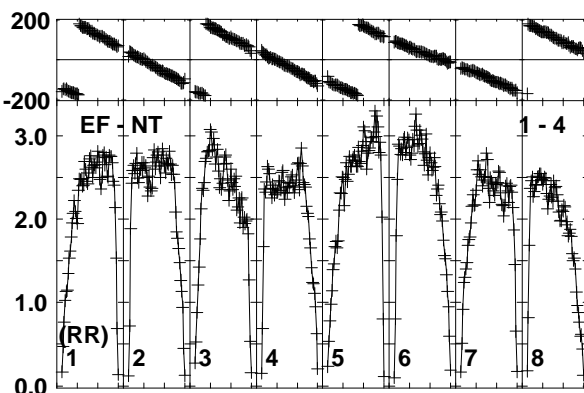
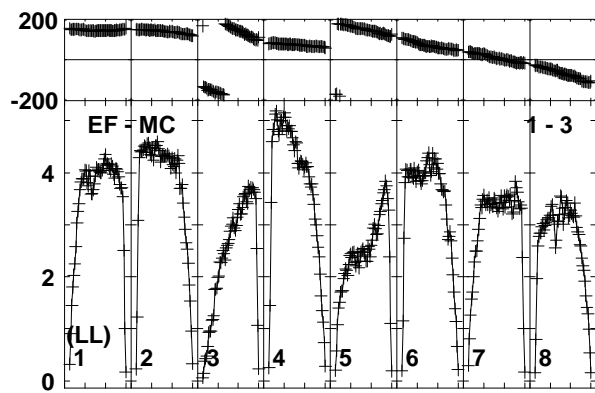
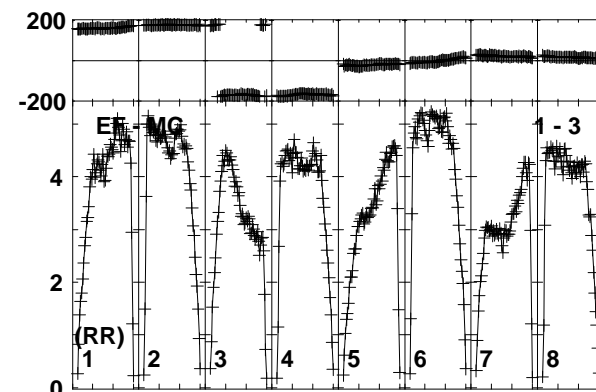
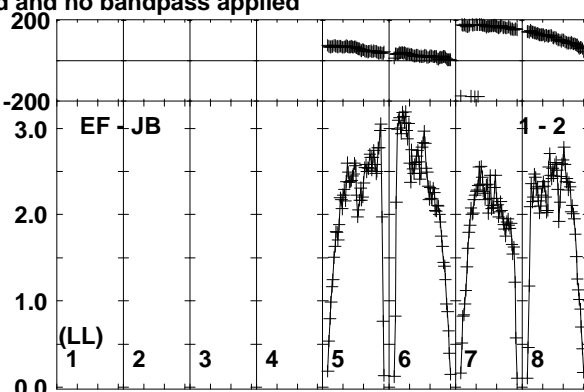
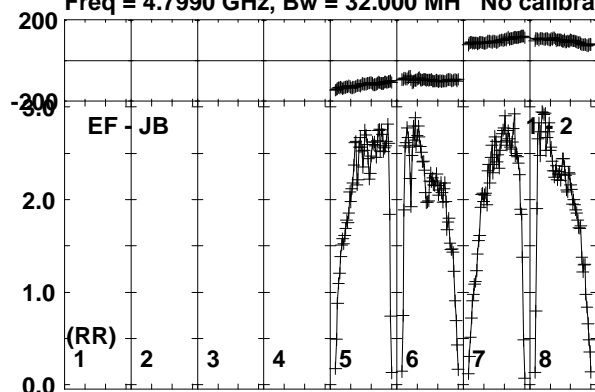

Lower frame: Milli Ampl Jy Top frame: Phas deg
Vector averaged cross-power spectrum Baseline: EF (01) - JB (02)
Timerange: 00/22:53:01 to 00/22:54:30

Plot file version 98 created 21-FEB-2017 15:11:07

J1108+4330 EG096A.UVDATA.1

Freq = 4.7990 GHz, Bw = 32.000 MH No calibration applied and no bandpass applied

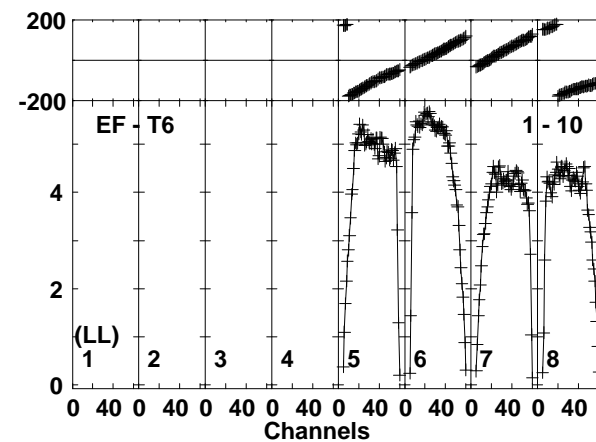
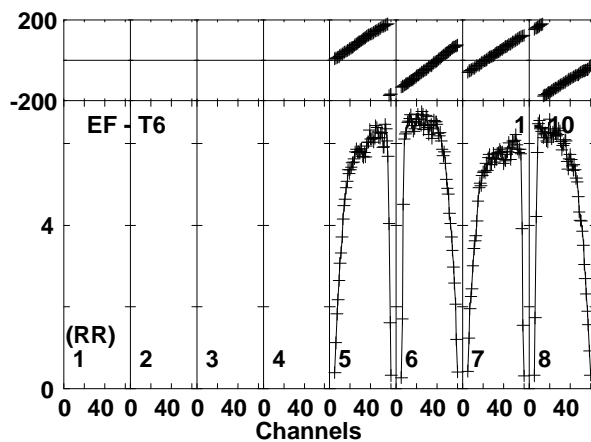
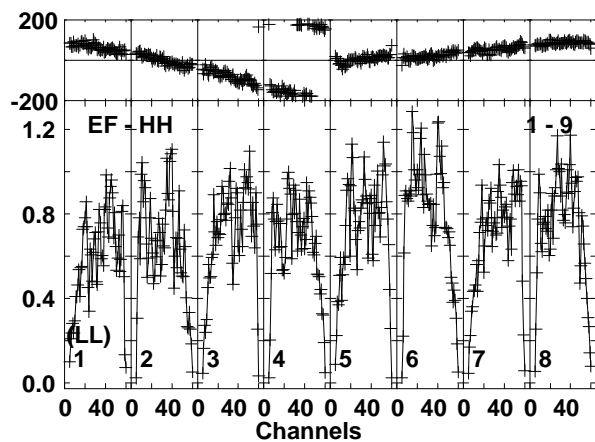
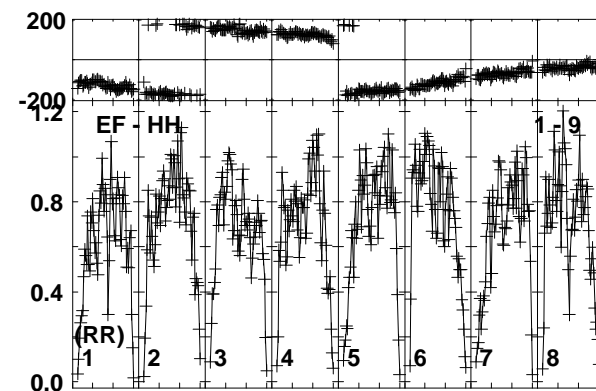
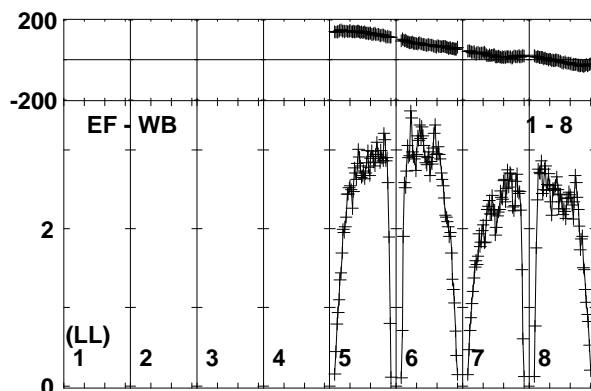
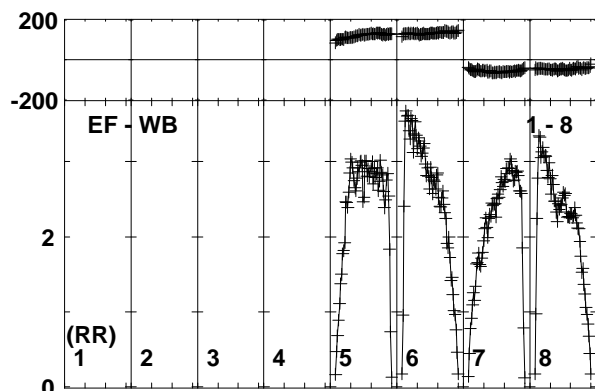
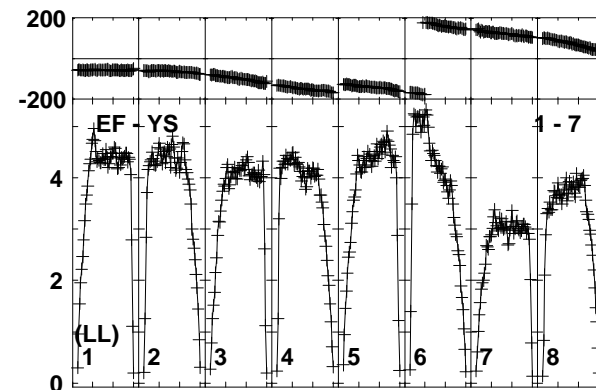
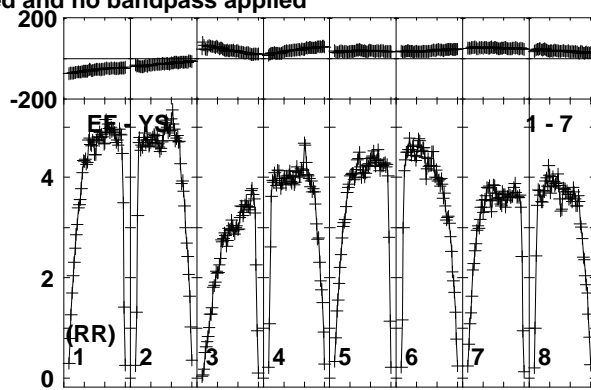
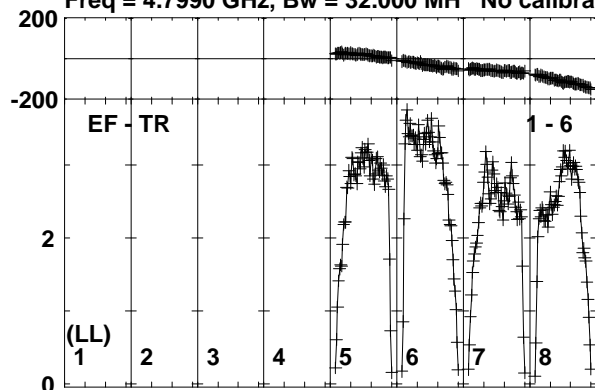

Lower frame: Milli Ampl Jy Top frame: Phas deg
Vector averaged cross-power spectrum Baseline: EF (01) - TR (06)
Timerange: 00/22:53:01 to 00/22:54:30

Plot file version 99 created 21-FEB-2017 15:11:07

ARUMA EG096A.UVDATA.1

Freq = 4.7990 GHz, Bw = 32.000 MH No calibration applied and no bandpass applied

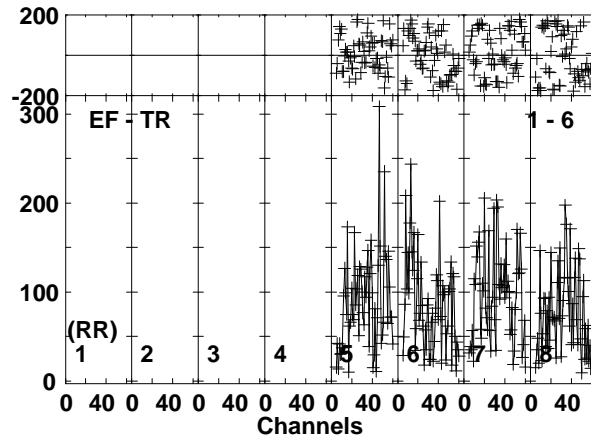
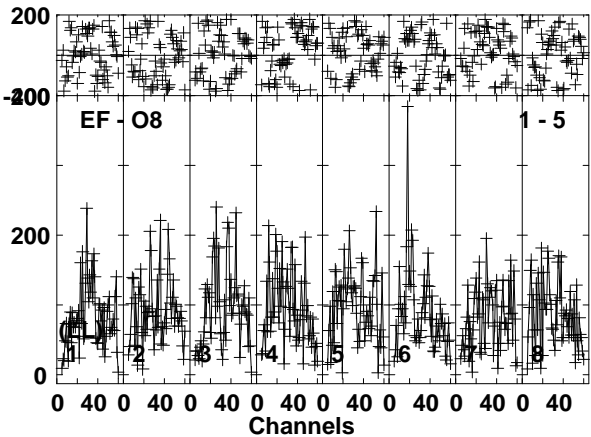
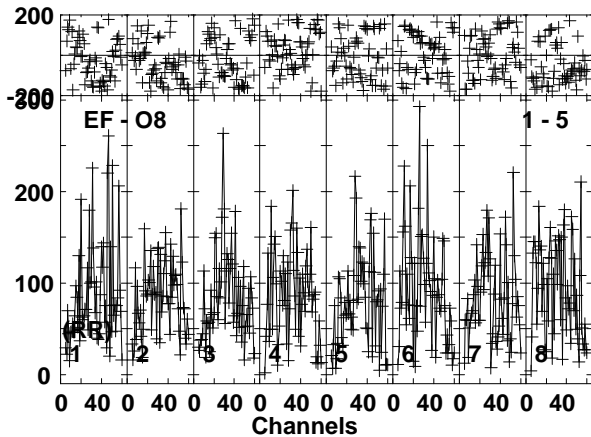
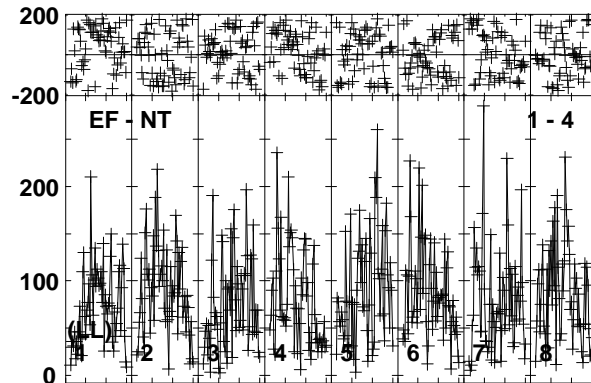
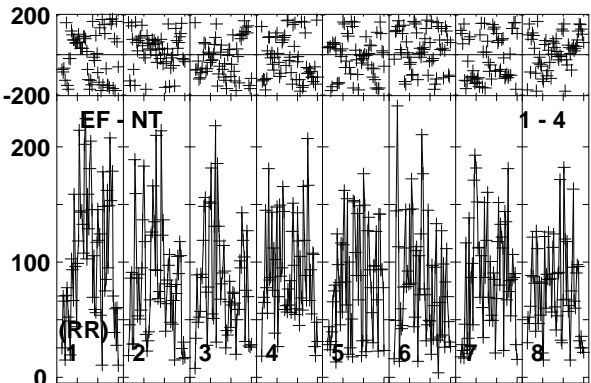
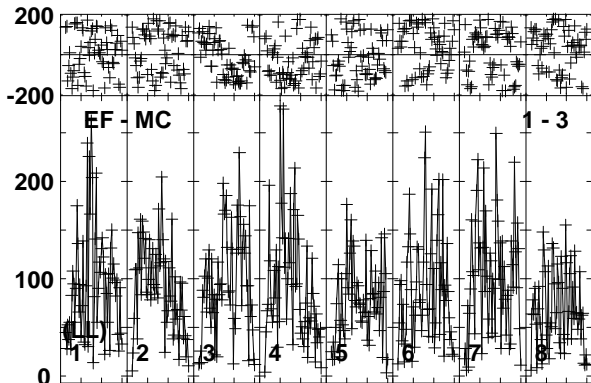
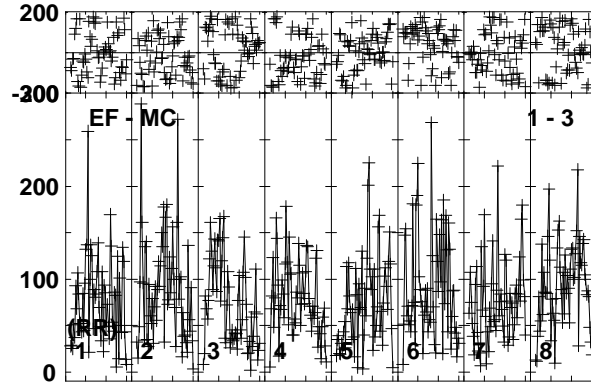
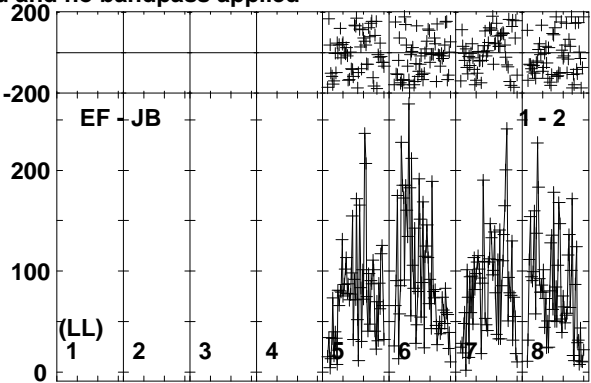
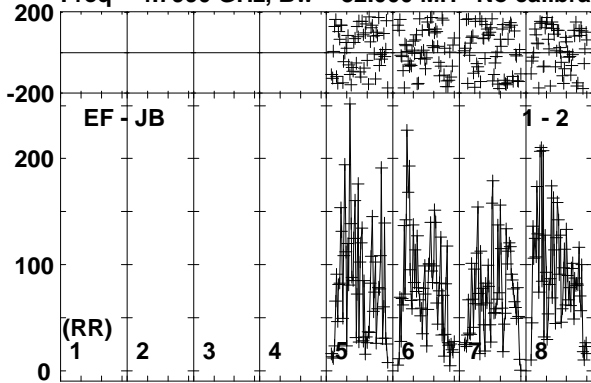

Lower frame: Micro Ampl Jy Top frame: Phas deg
Vector averaged cross-power spectrum Baseline: EF (01) - JB (02)
Timerange: 00:22:54:30 to 00:22:58:00

Plot file version 100 created 21-FEB-2017 15:11:08

ARUMA EG096A.UVDATA.1

Freq = 4.7990 GHz, Bw = 32.000 MH No calibration applied and no bandpass applied

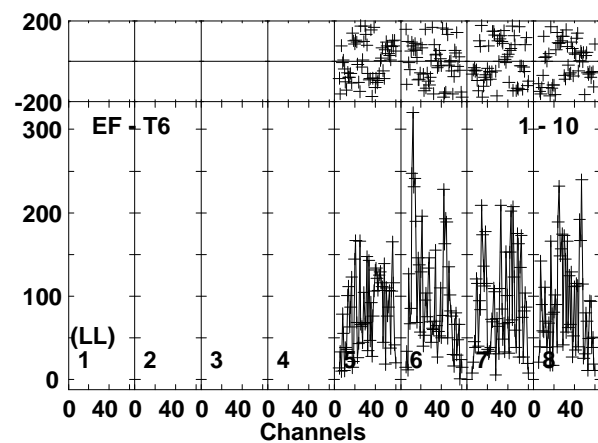
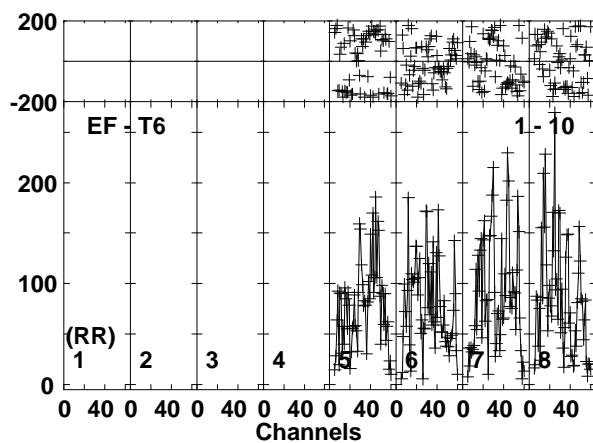
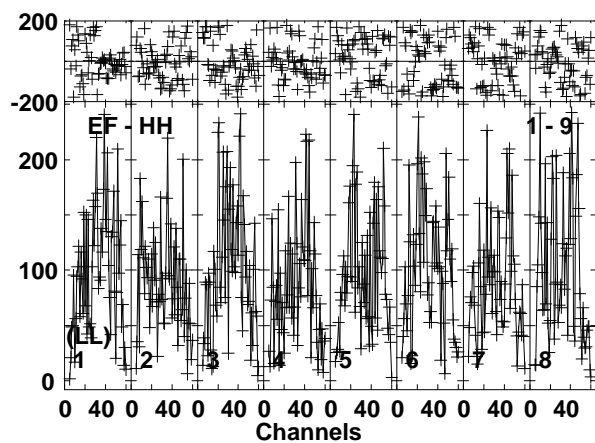
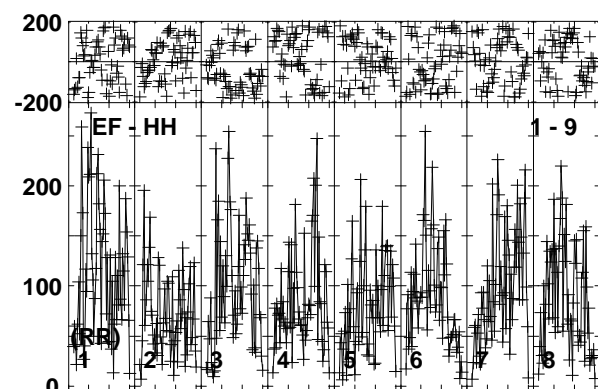
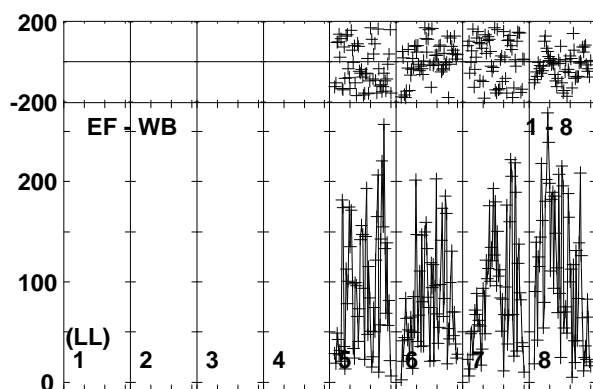
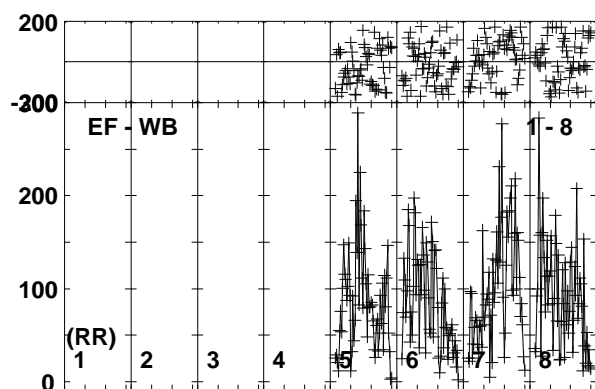
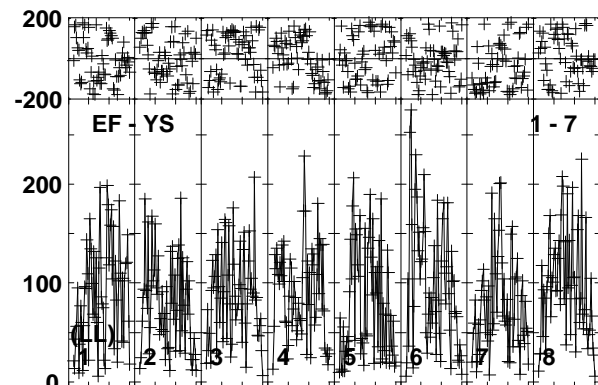
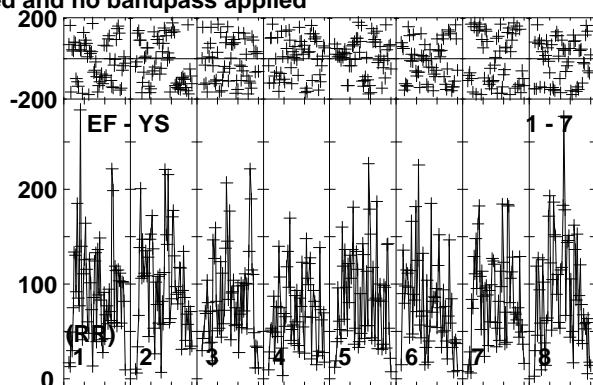
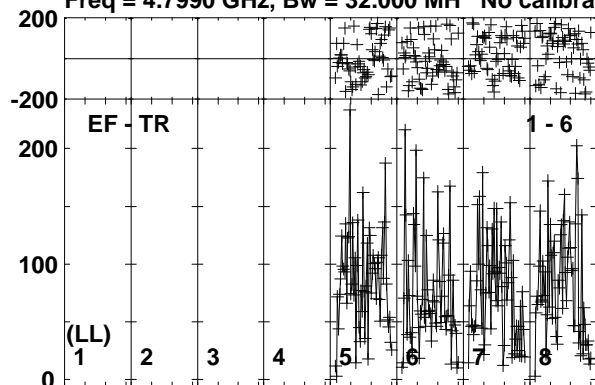

Lower frame: Micro Ampl Jy Top frame: Phas deg
Vector averaged cross-power spectrum Baseline: EF (01) - TR (06)
Timerange: 00:22:54:30 to 00:22:58:00

Plot file version 101 created 21-FEB-2017 15:11:08

J1108+4330 EG096A.UVDATA.1

Freq = 4.7990 GHz, Bw = 32.000 MH No calibration applied and no bandpass applied

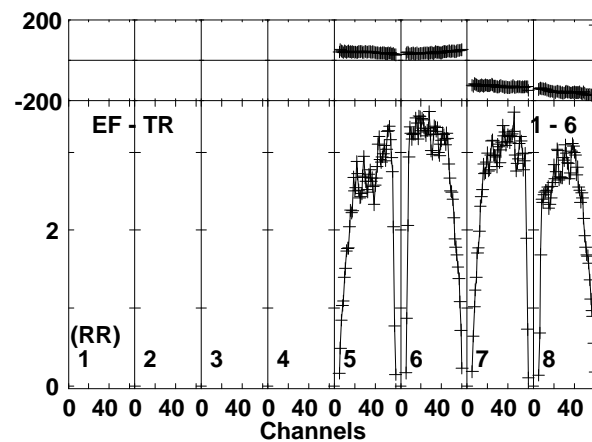
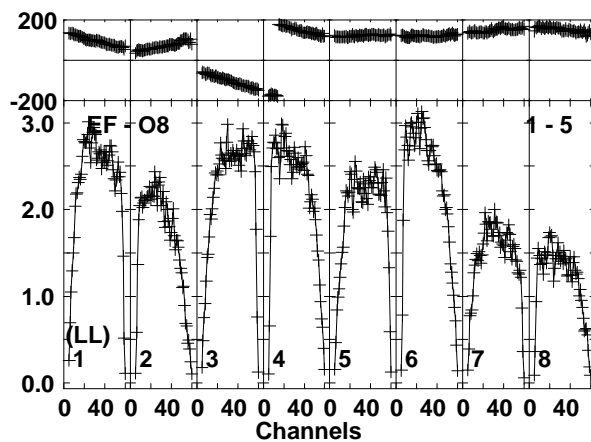
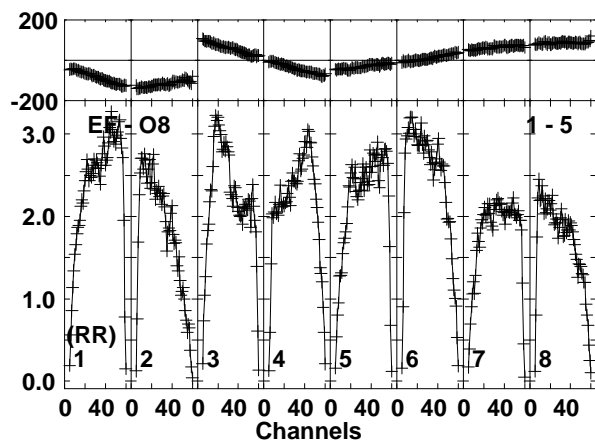
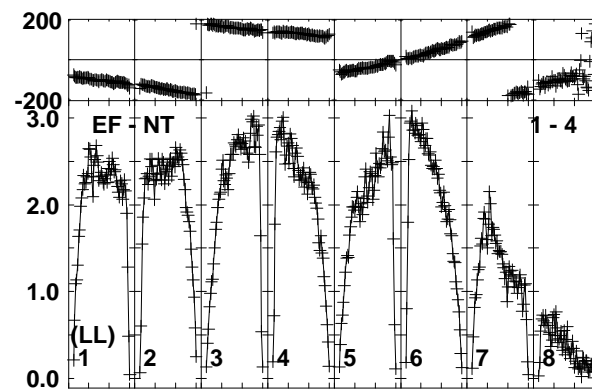
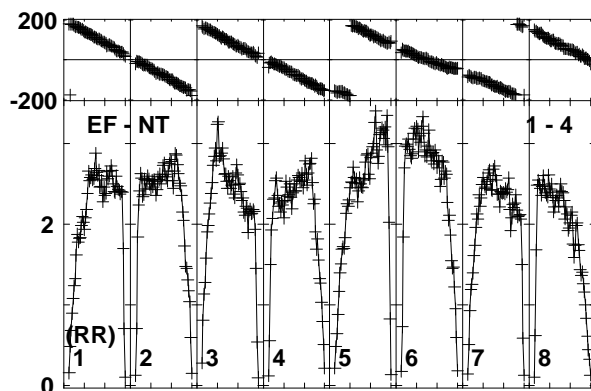
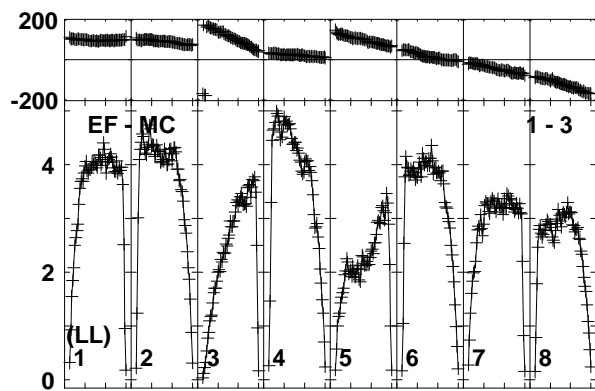
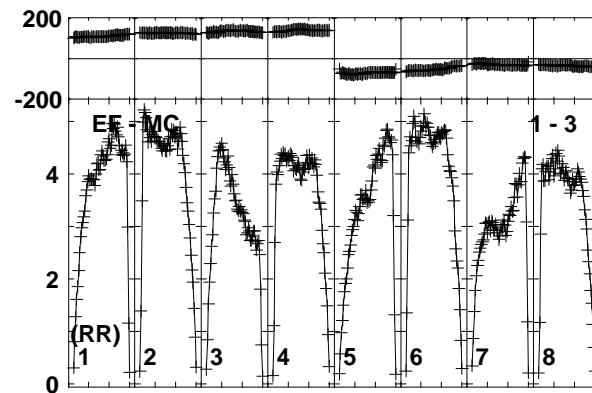
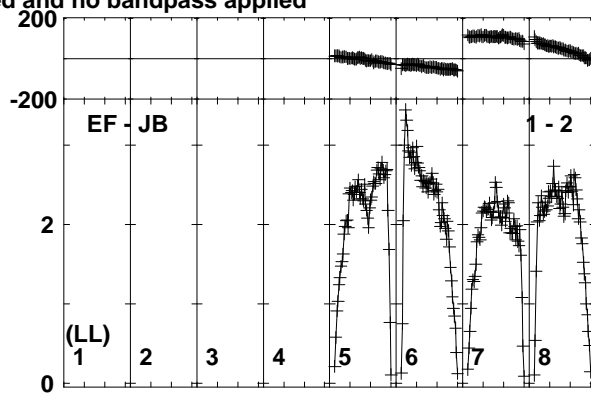
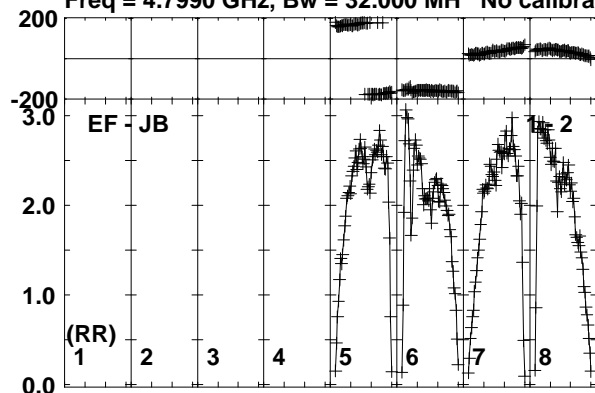

Lower frame: Milli Ampl Jy Top frame: Phas deg
Vector averaged cross-power spectrum Baseline: EF (01) - JB (02)
Timerange: 00/22:58:41 to 00/22:59:39

Plot file version 102 created 21-FEB-2017 15:11:08

J1108+4330 EG096A.UVDATA.1

Freq = 4.7990 GHz, Bw = 32.000 MH No calibration applied and no bandpass applied

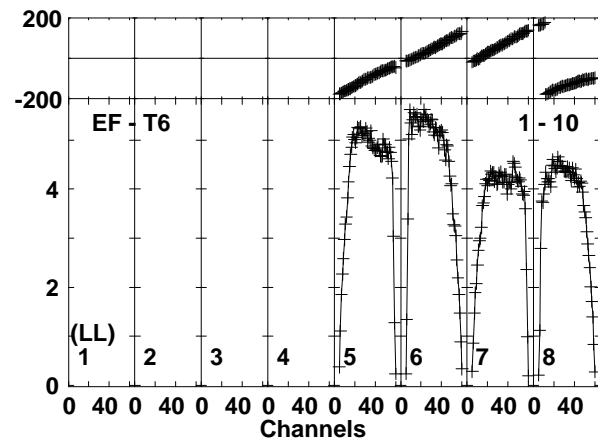
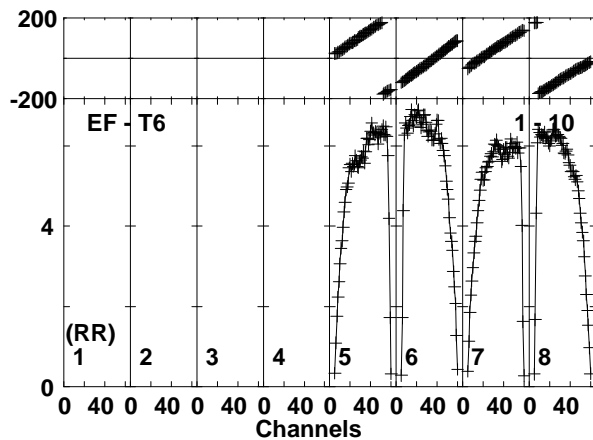
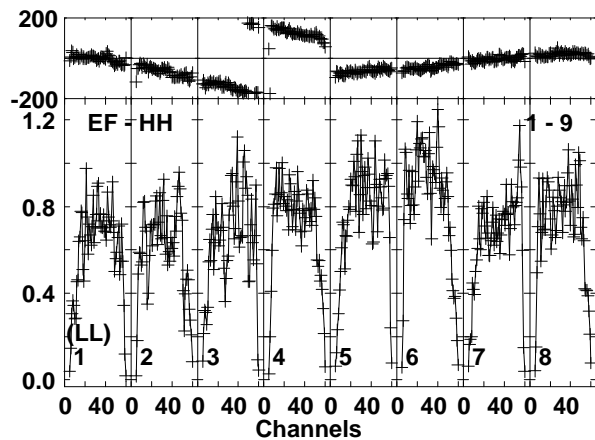
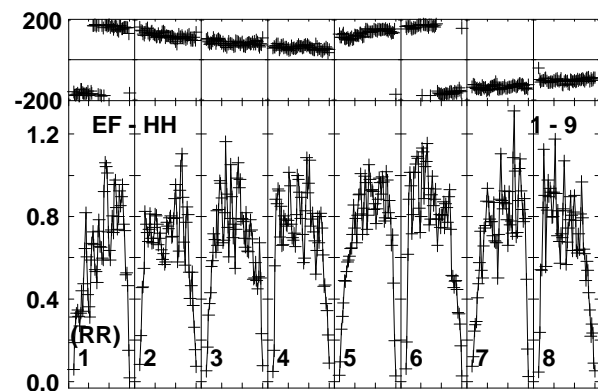
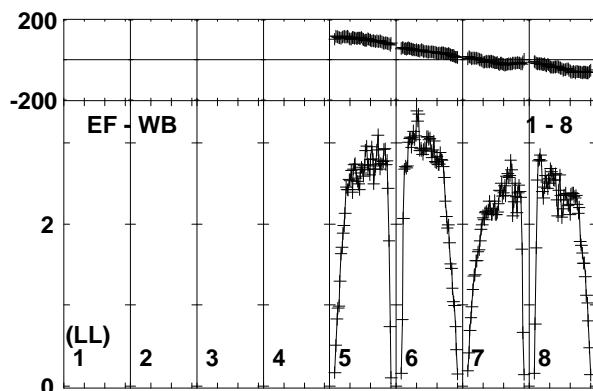
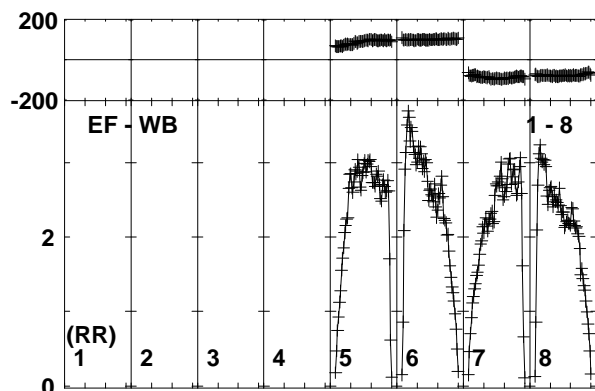
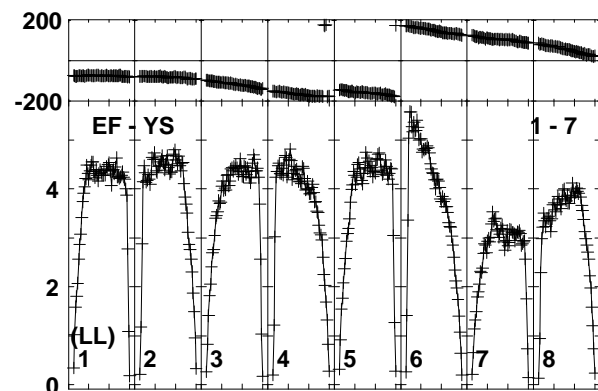
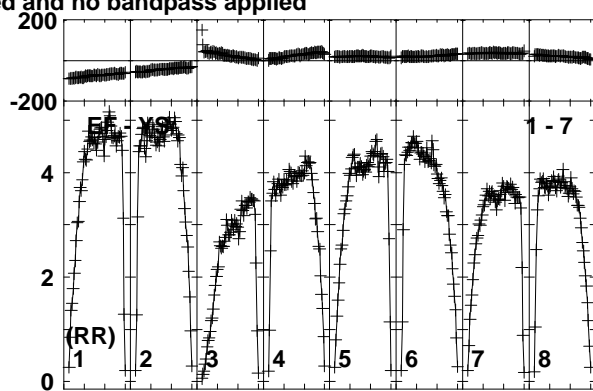
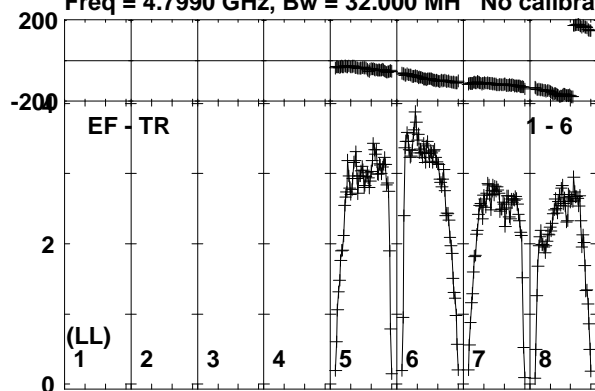

Lower frame: Milli Ampl Jy Top frame: Phas deg
Vector averaged cross-power spectrum Baseline: EF (01) - TR (06)
Timerange: 00/22:58:41 to 00/22:59:39

Plot file version 103 created 21-FEB-2017 15:11:08

J1112+4301 EG096A.UVDATA.1

Freq = 4.7990 GHz, Bw = 32.000 MH No calibration applied and no bandpass applied

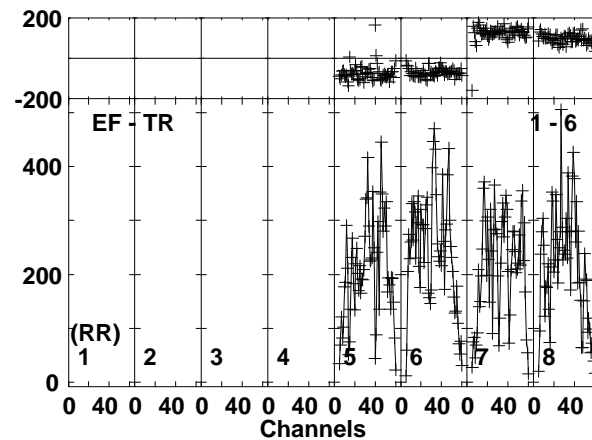
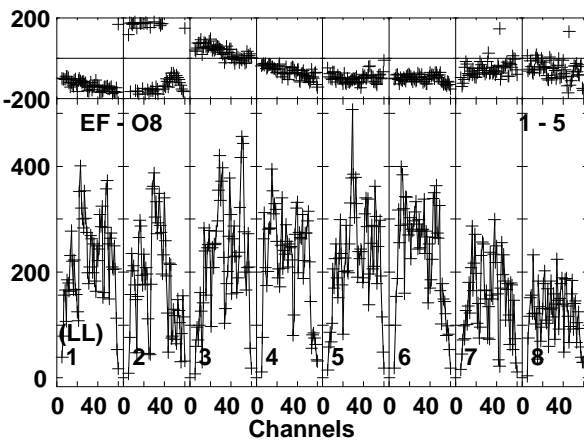
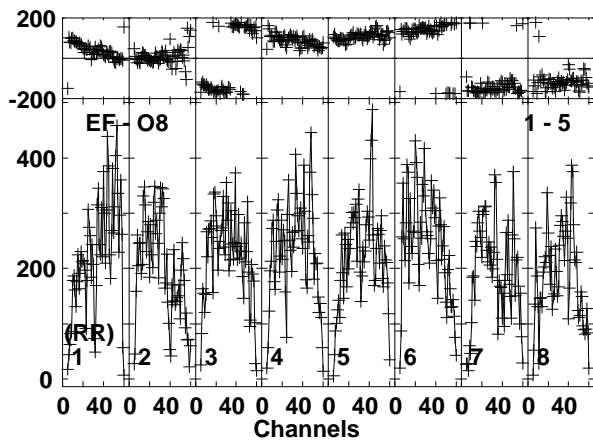
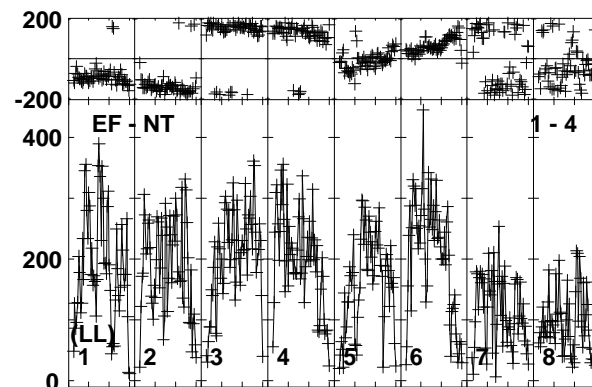
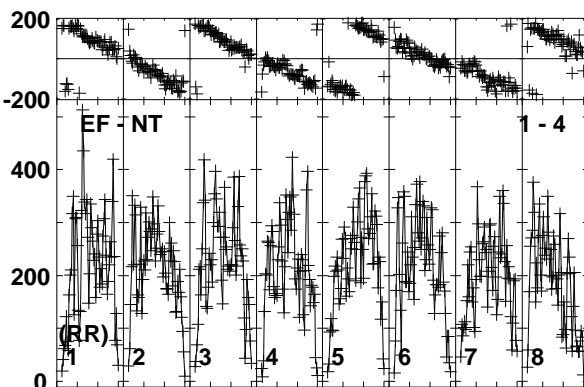
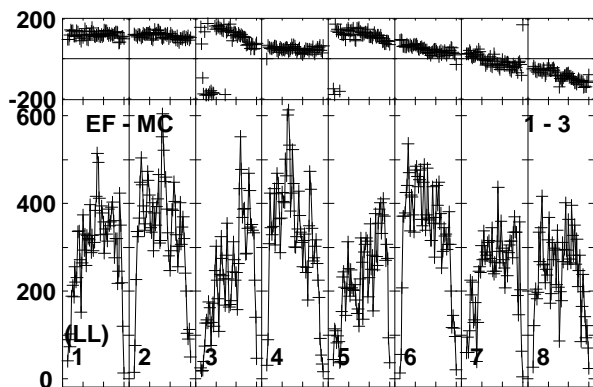
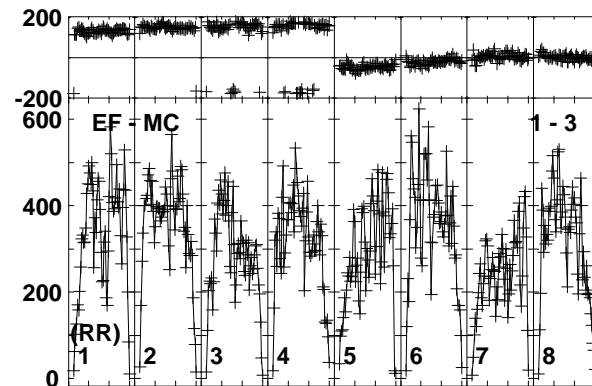
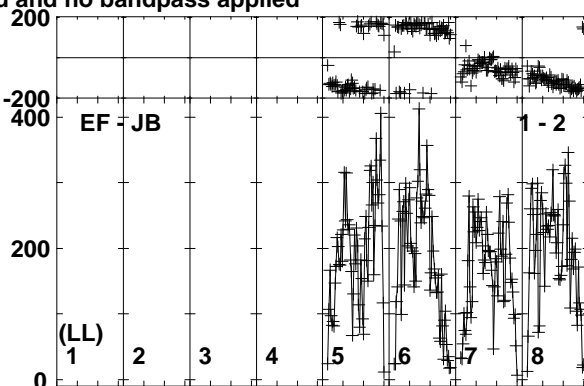
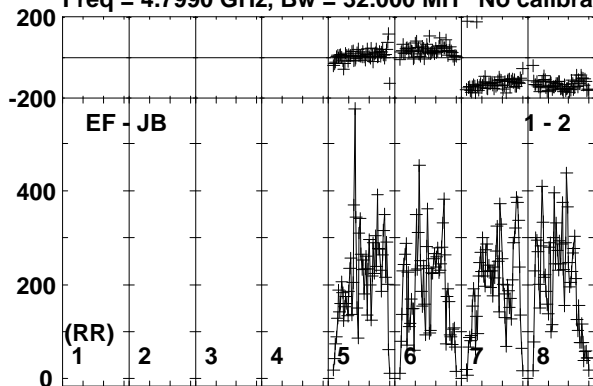

Lower frame: Micro Ampl Jy Top frame: Phas deg
Vector averaged cross-power spectrum Baseline: EF (01) - JB (02)
Timerange: 00/22:59:40 to 00/23:03:10

Plot file version 104 created 21-FEB-2017 15:11:09

J1112+4301 EG096A.UVDATA.1

Freq = 4.7990 GHz, Bw = 32.000 MH No calibration applied and no bandpass applied

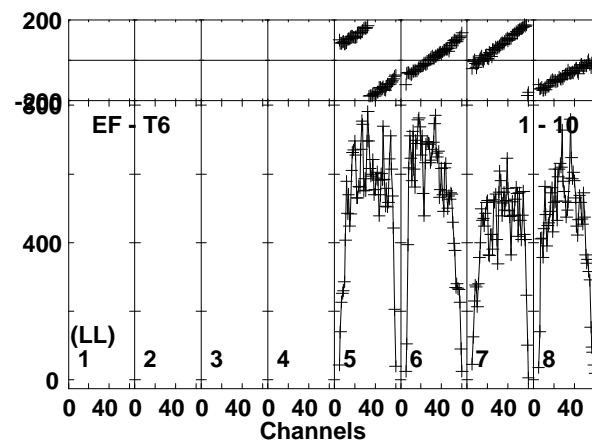
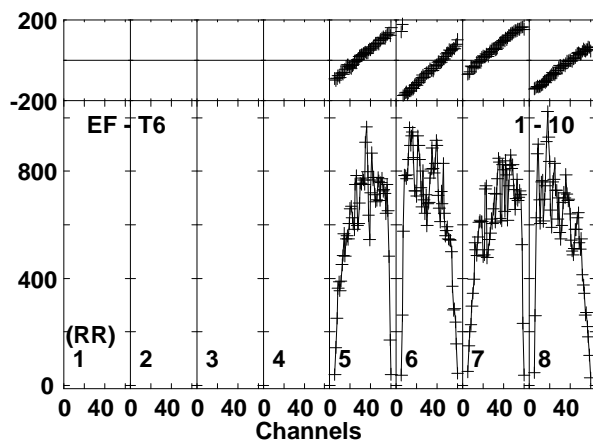
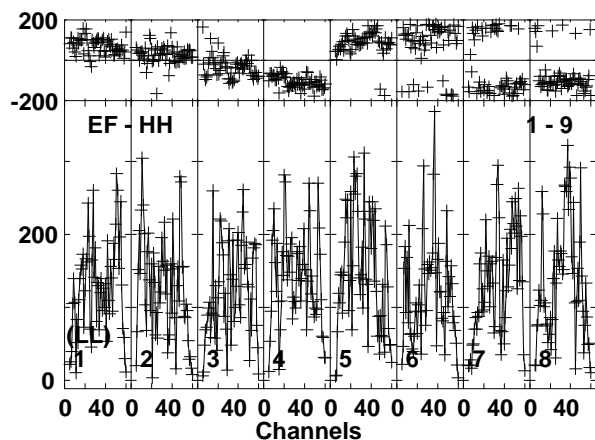
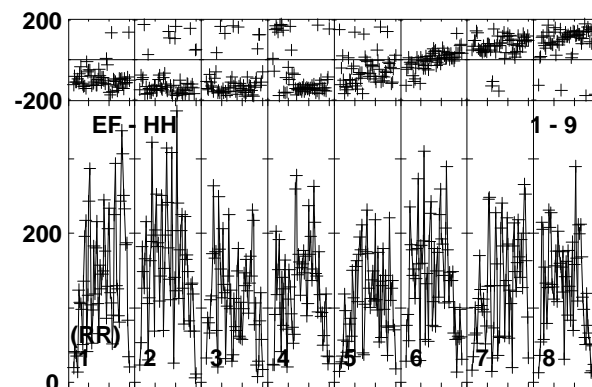
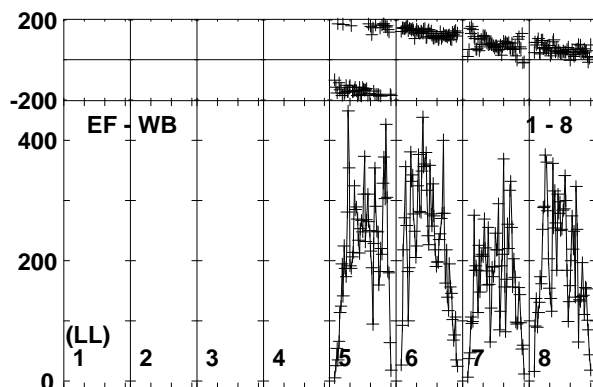
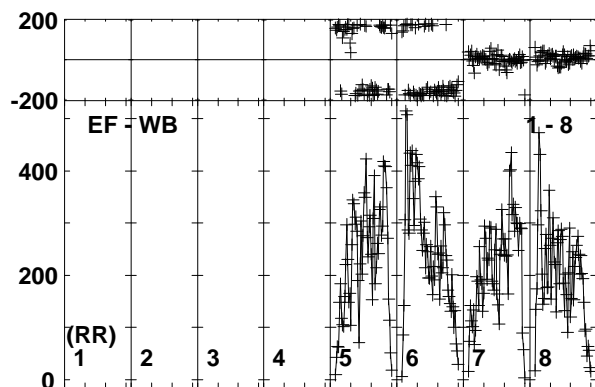
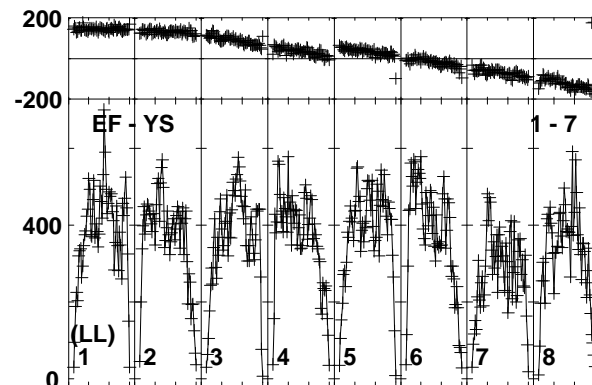
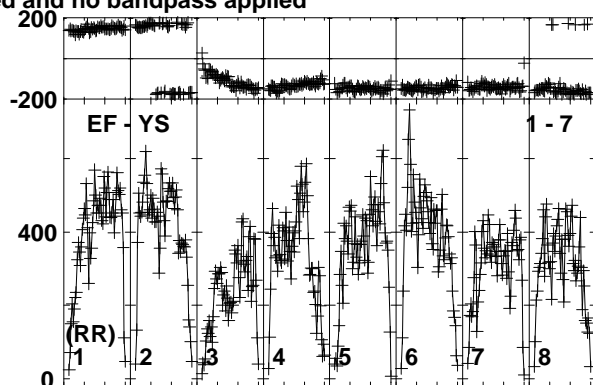
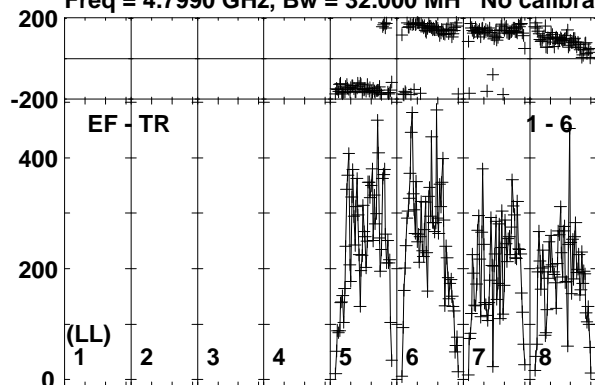

Lower frame: Micro Ampl Jy Top frame: Phas deg
Vector averaged cross-power spectrum Baseline: EF (01) - TR (06)
Timerange: 00/22:59:40 to 00/23:03:10

Plot file version 105 created 21-FEB-2017 15:11:09

J1108+4330 EG096A.UVDATA.1

Freq = 4.7990 GHz, Bw = 32.000 MH No calibration applied and no bandpass applied

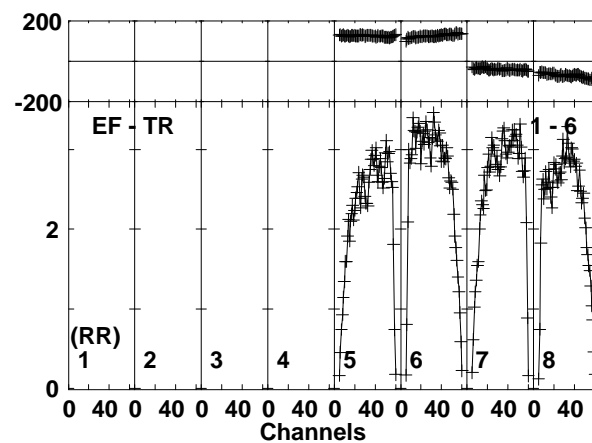
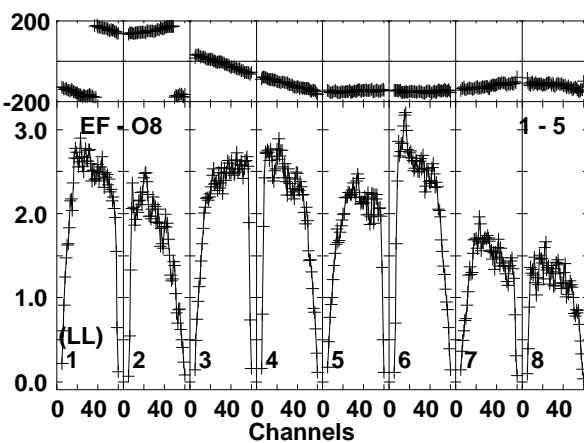
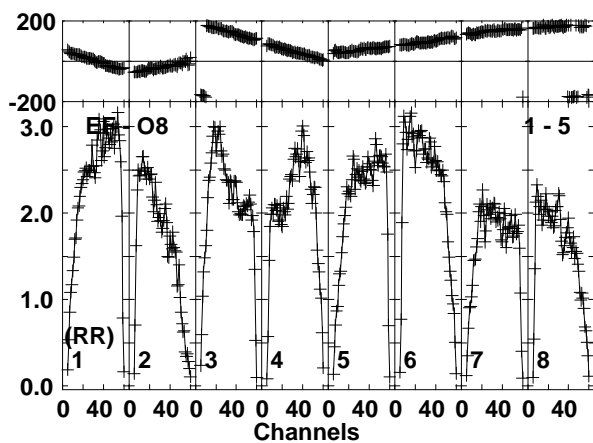
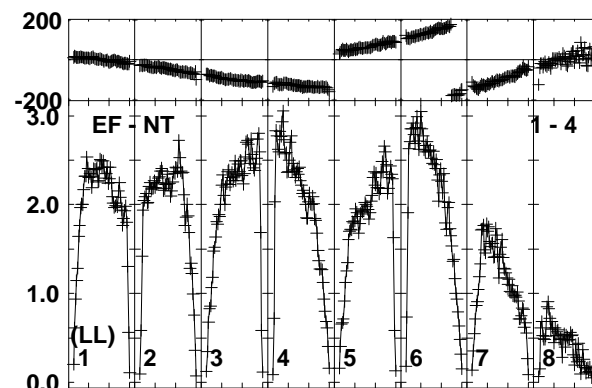
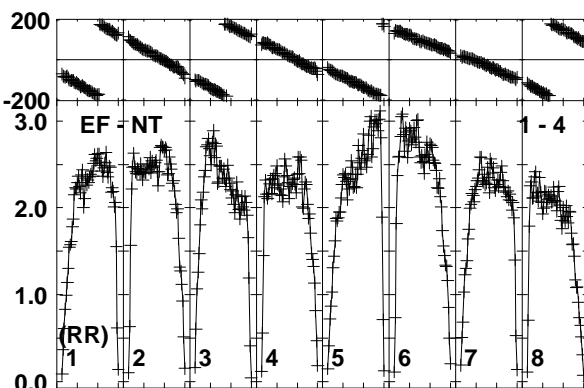
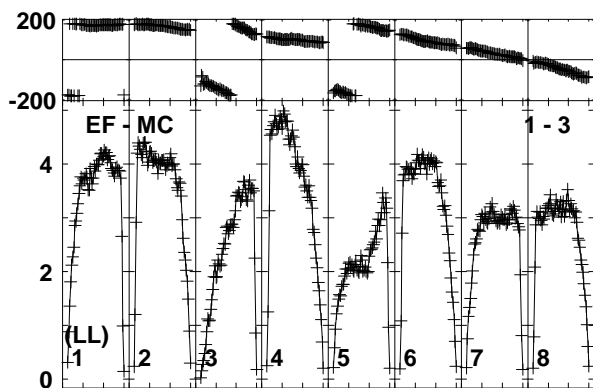
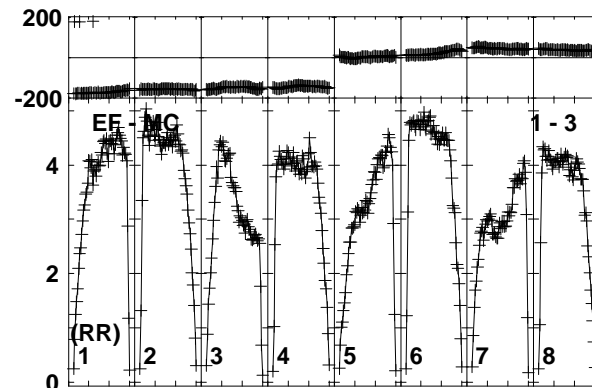
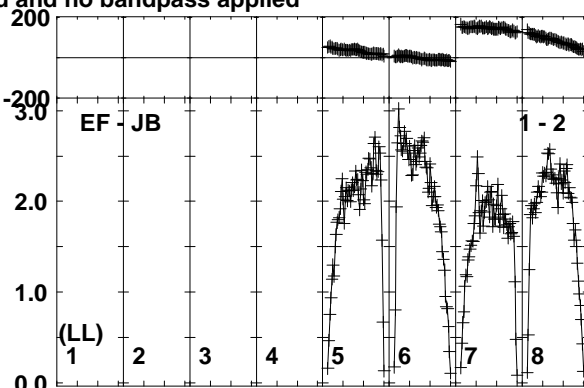
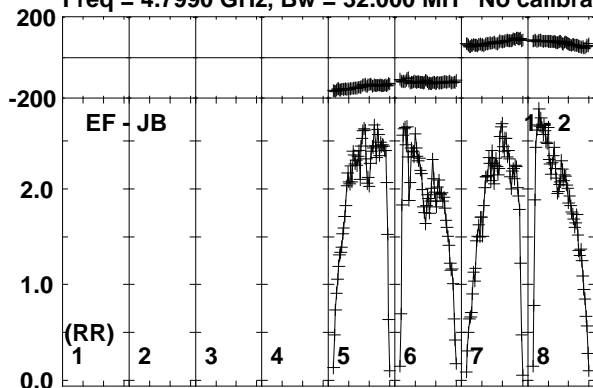

Lower frame: Milli Ampl Jy Top frame: Phas deg
Vector averaged cross-power spectrum Baseline: EF (01) - JB (02)
Timerange: 00/23:03:11 to 00/23:04:39

Plot file version 106 created 21-FEB-2017 15:11:09

J1108+4330 EG096A.UVDATA.1

Freq = 4.7990 GHz, Bw = 32.000 MH No calibration applied and no bandpass applied

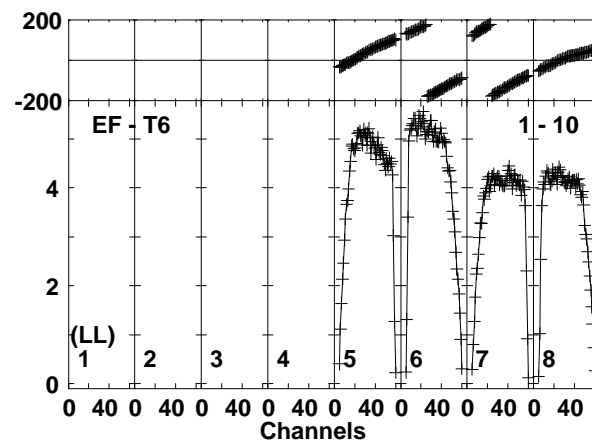
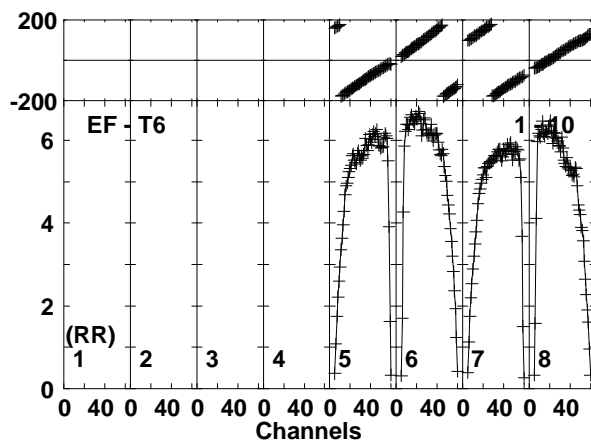
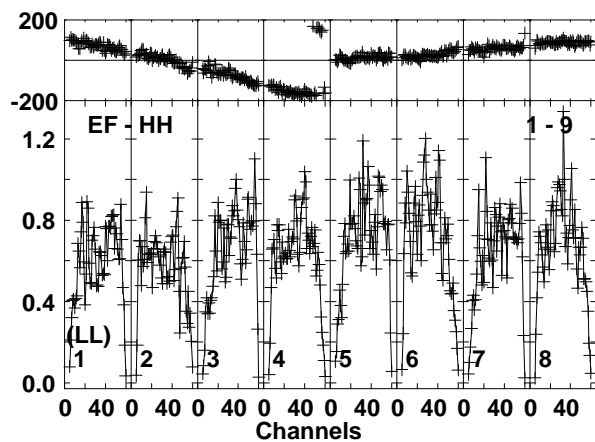
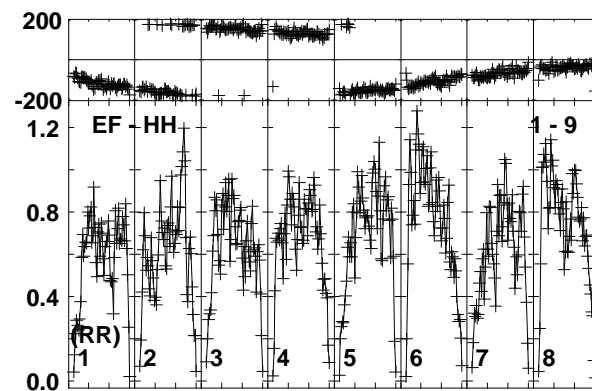
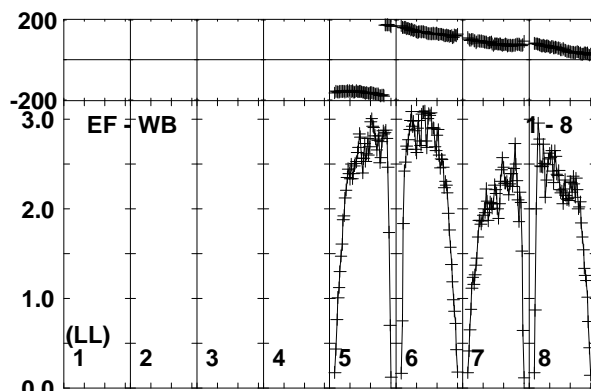
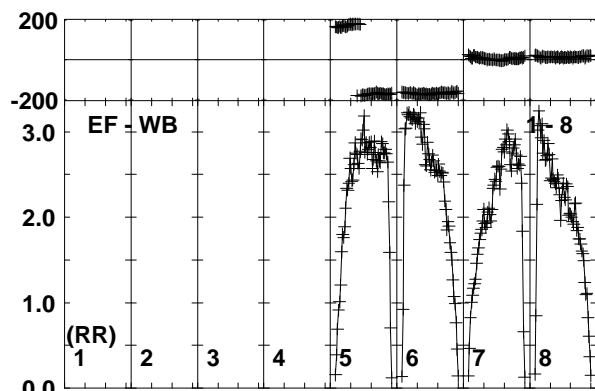
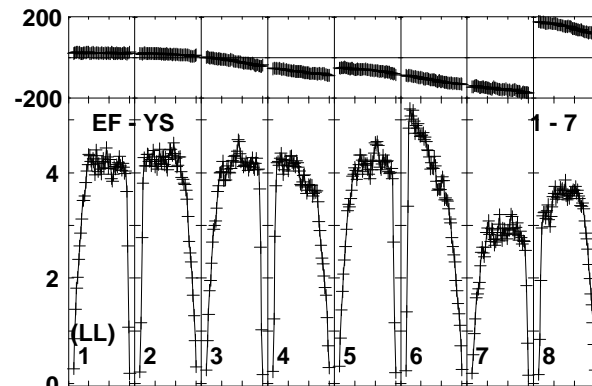
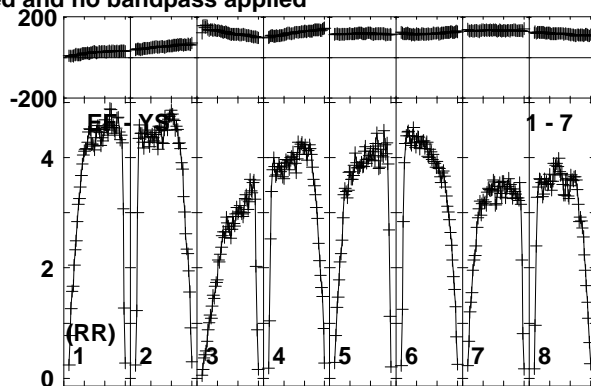
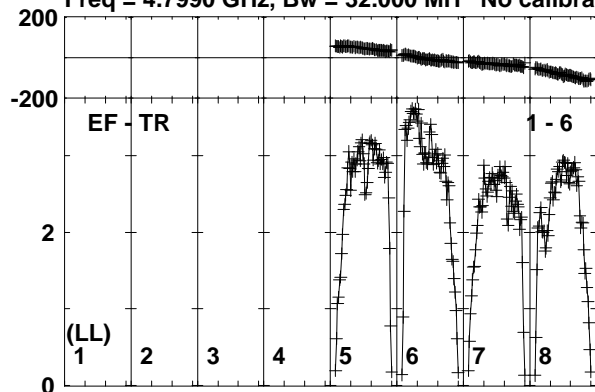

Lower frame: Milli Ampl Jy Top frame: Phas deg
Vector averaged cross-power spectrum Baseline: EF (01) - TR (06)
Timerange: 00/23:03:11 to 00/23:04:39

Plot file version 107 created 21-FEB-2017 15:11:09

ARUMA EG096A.UVDATA.1

Freq = 4.7990 GHz, Bw = 32.000 MH No calibration applied and no bandpass applied

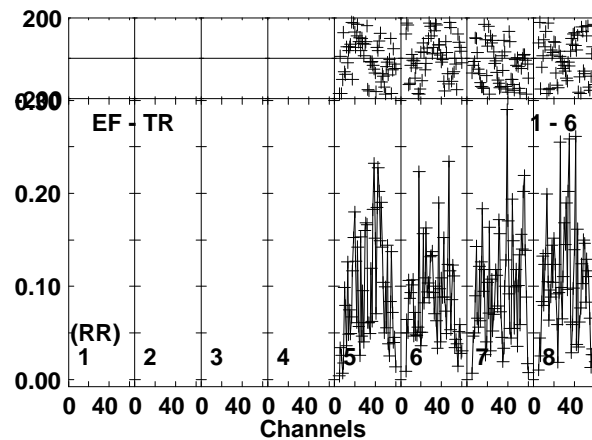
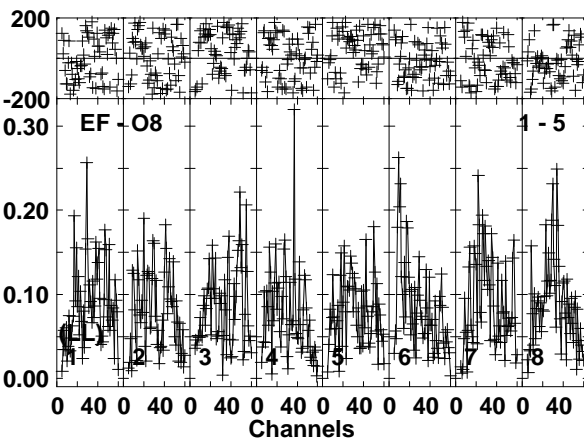
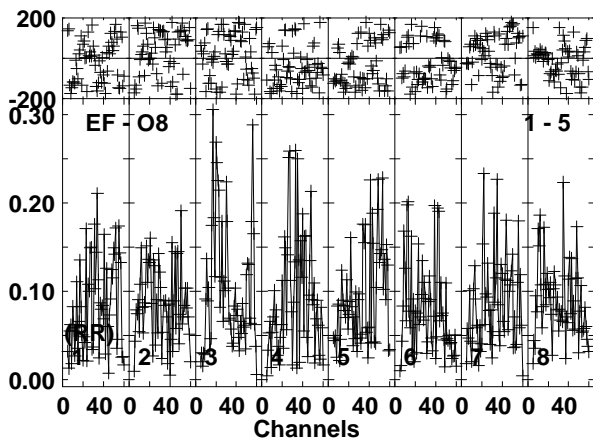
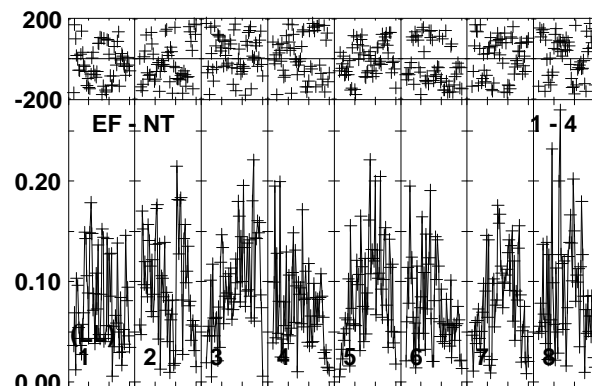
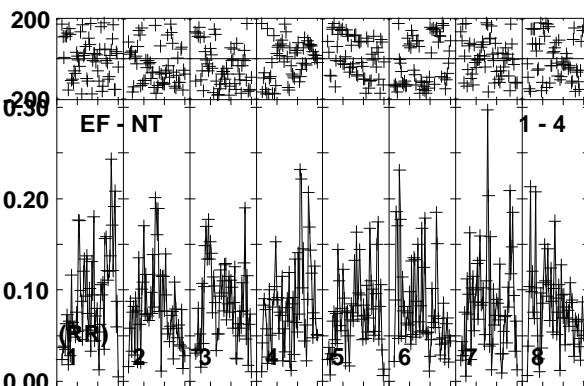
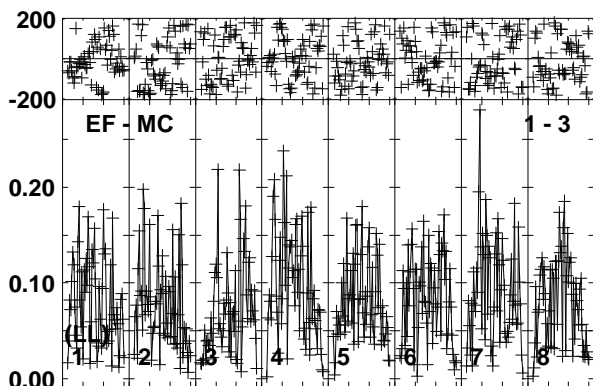
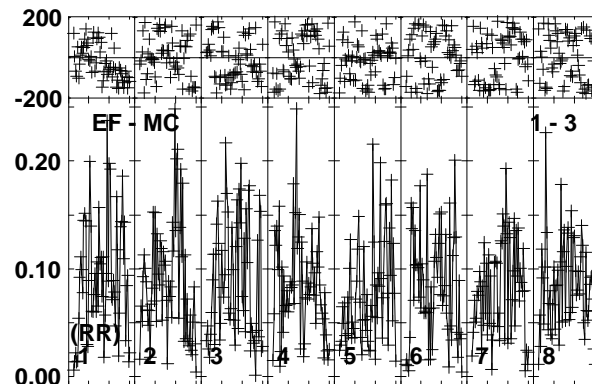
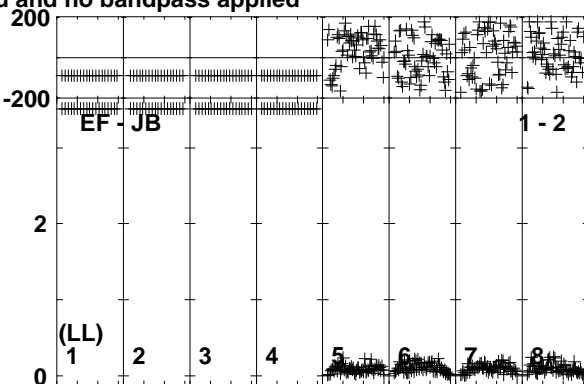
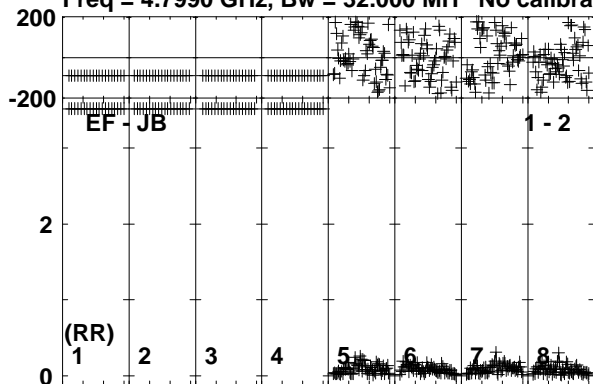

Lower frame: Milli Ampl Jy Top frame: Phas deg
Vector averaged cross-power spectrum Baseline: EF (01) - JB (02)
Timerange: 00/23:04:41 to 00/23:08:10

Plot file version 108 created 21-FEB-2017 15:11:10

ARUMA EG096A.UVDATA.1

Freq = 4.7990 GHz, Bw = 32.000 MH No calibration applied and no bandpass applied

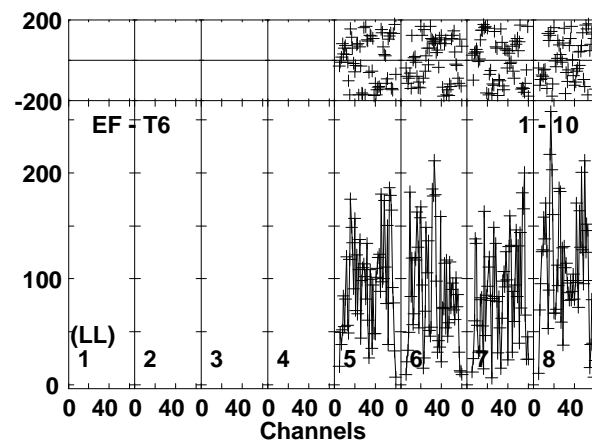
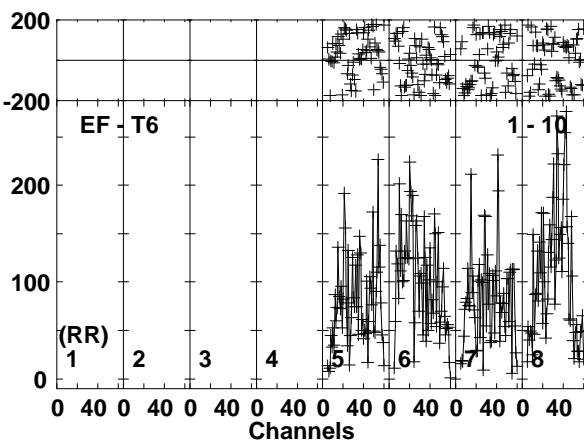
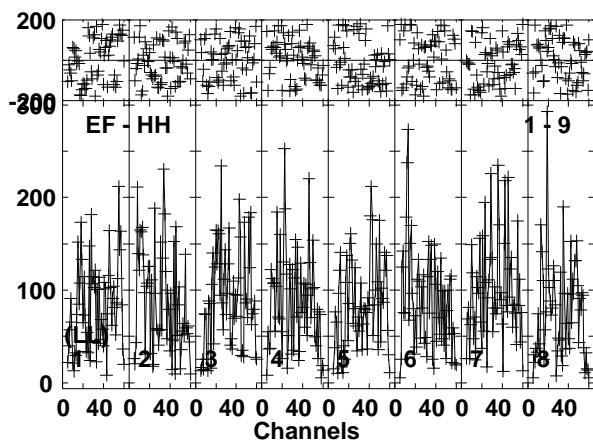
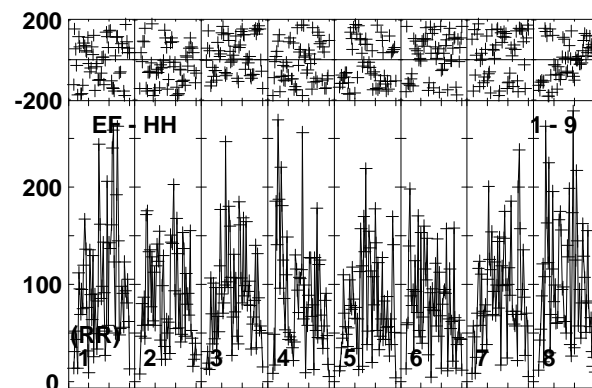
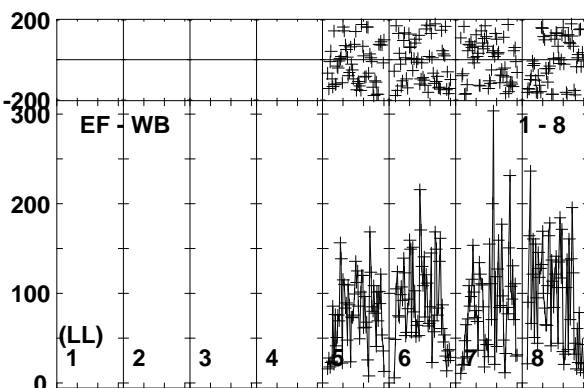
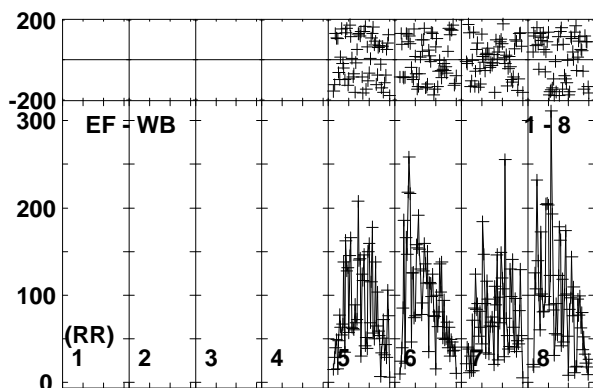
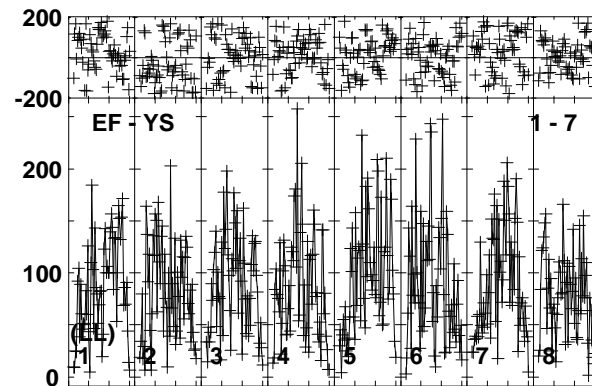
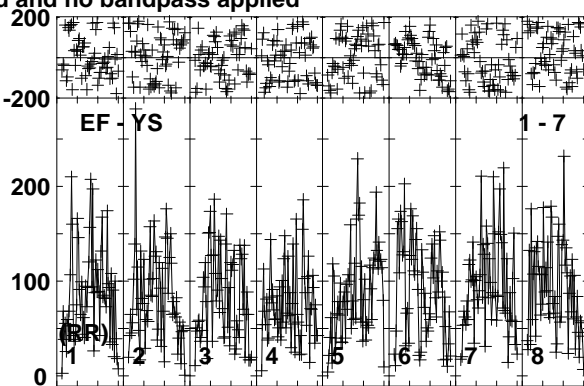
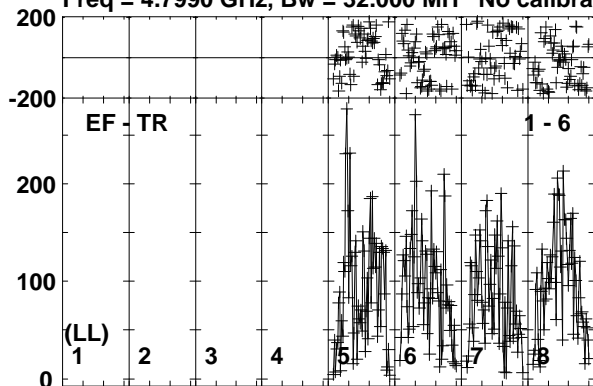

Lower frame: Micro Ampl Jy Top frame: Phas deg
Vector averaged cross-power spectrum Baseline: EF (01) - TR (06)
Timerange: 00/23:04:41 to 00/23:08:10

Plot file version 109 created 21-FEB-2017 15:11:10

J1108+4330 EG096A.UVDATA.1

Freq = 4.7990 GHz, Bw = 32.000 MH No calibration applied and no bandpass applied

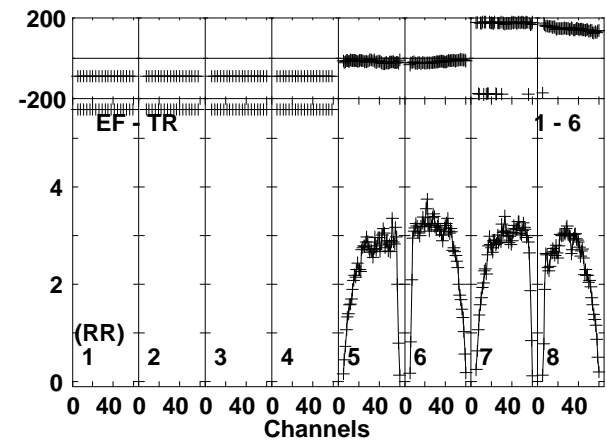
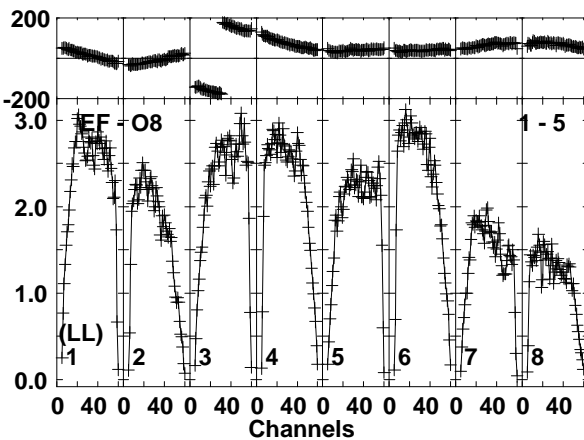
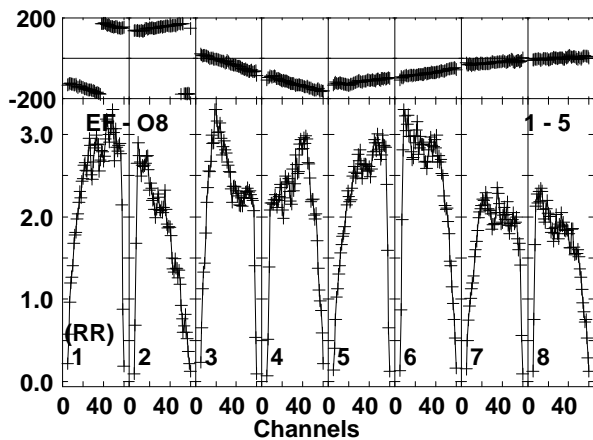
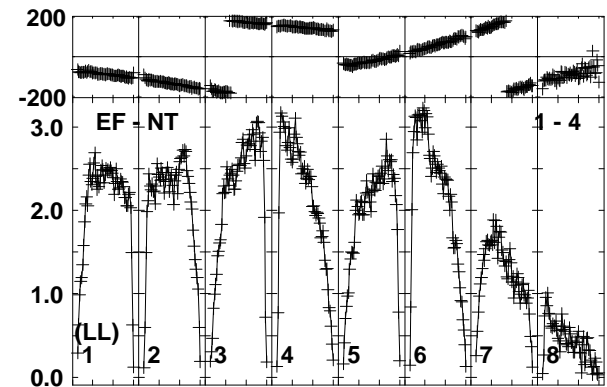
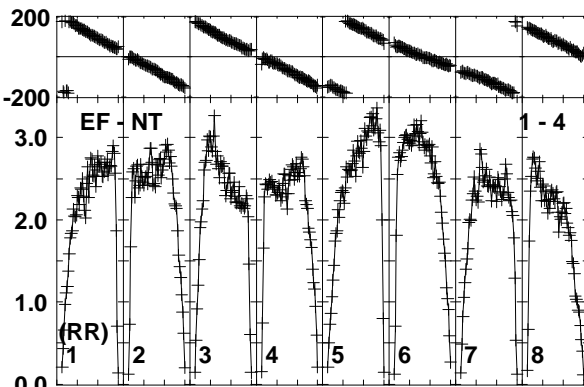
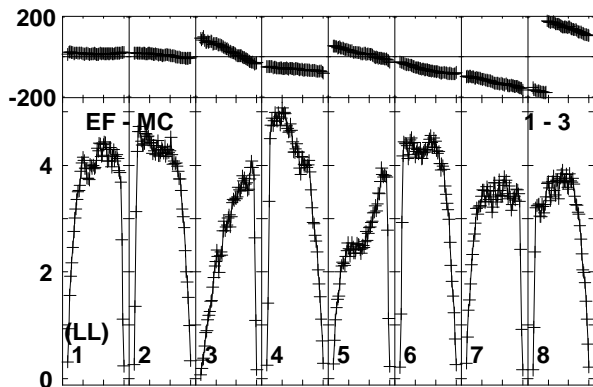
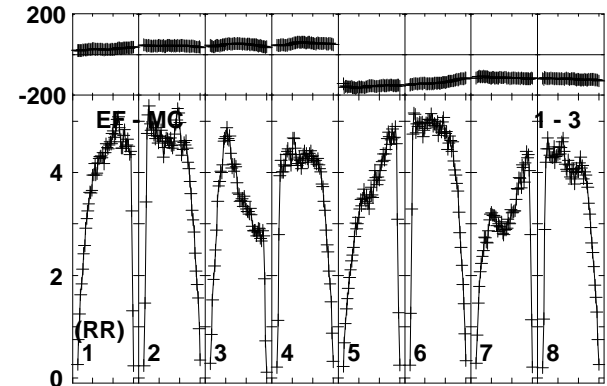
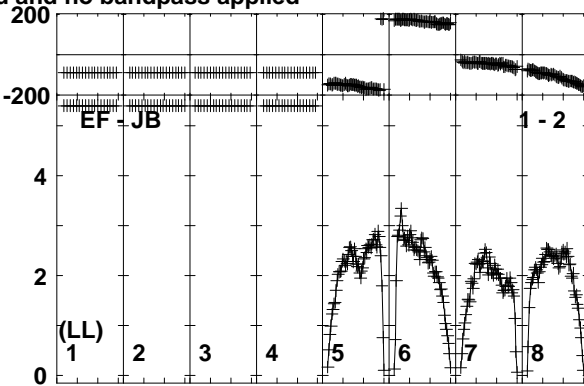
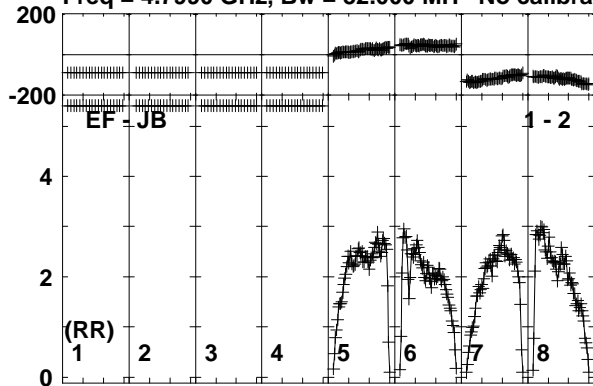

Lower frame: Milli Ampl Jy Top frame: Phas deg
Vector averaged cross-power spectrum Baseline: EF (01) - JB (02)
Timerange: 00/23:08:51 to 00/23:09:49

Plot file version 110 created 21-FEB-2017 15:11:10

J1108+4330 EG096A.UVDATA.1

Freq = 4.7990 GHz, Bw = 32.000 MH No calibration applied and no bandpass applied

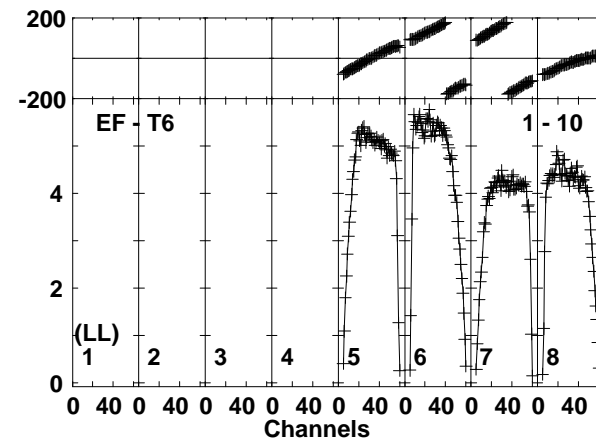
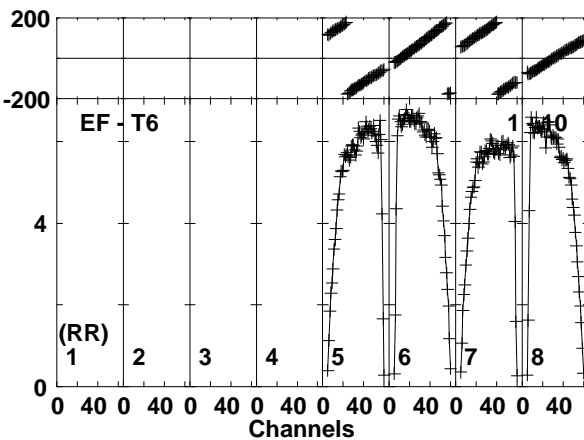
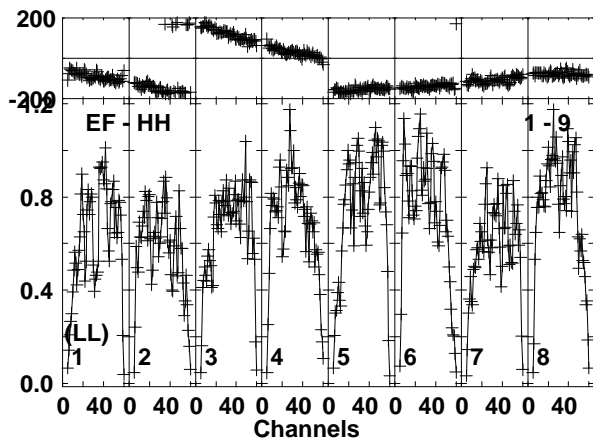
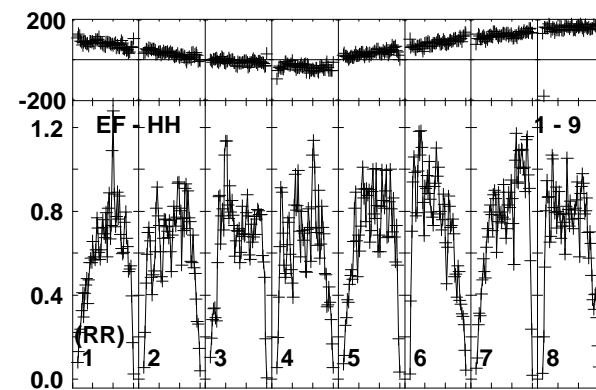
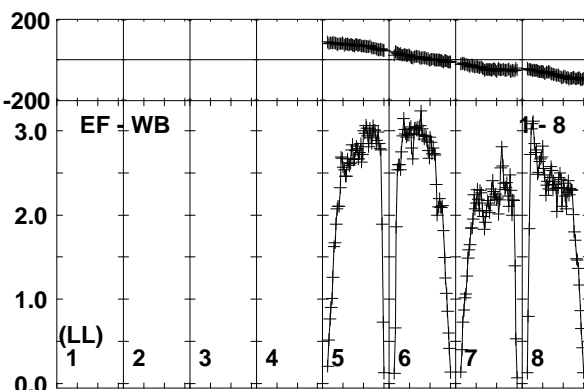
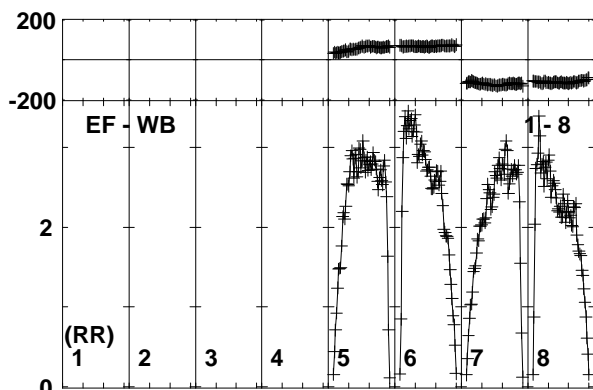
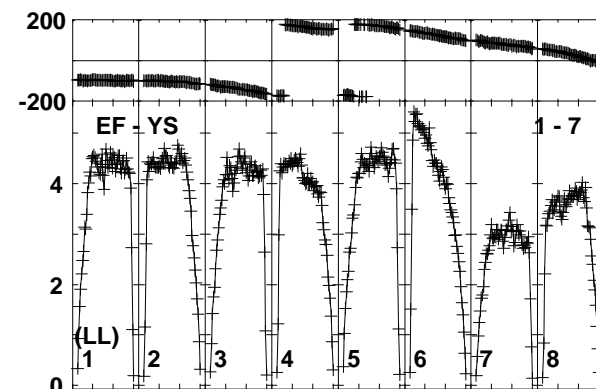
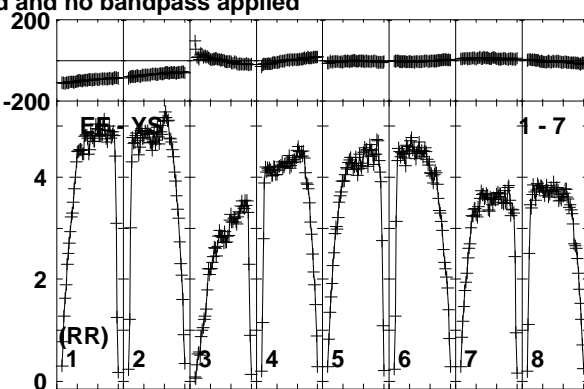
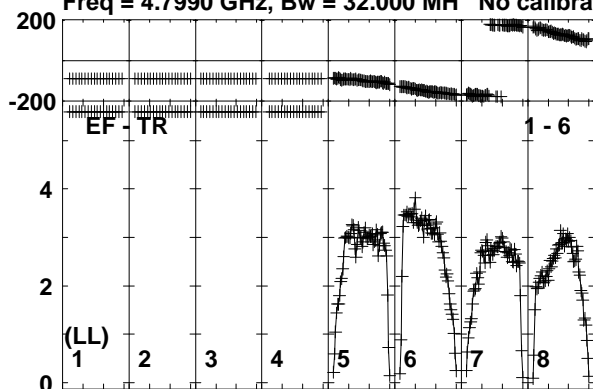

Lower frame: Milli Ampl Jy Top frame: Phas deg
Vector averaged cross-power spectrum Baseline: EF (01) - TR (06)
Timerange: 00/23:08:51 to 00/23:09:49

Plot file version 111 created 21-FEB-2017 15:11:11

ARUMA EG096A.UVDATA.1

Freq = 4.7990 GHz, Bw = 32.000 MH No calibration applied and no bandpass applied

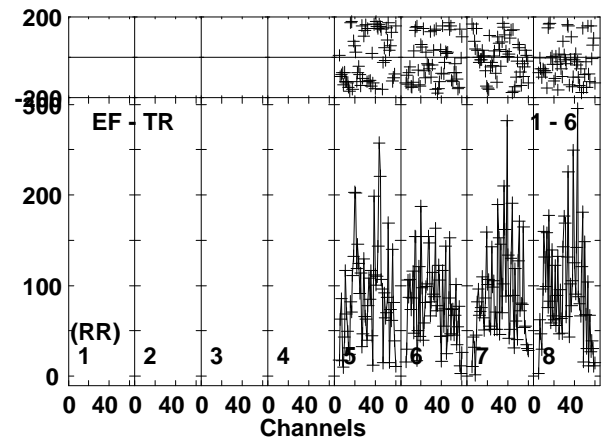
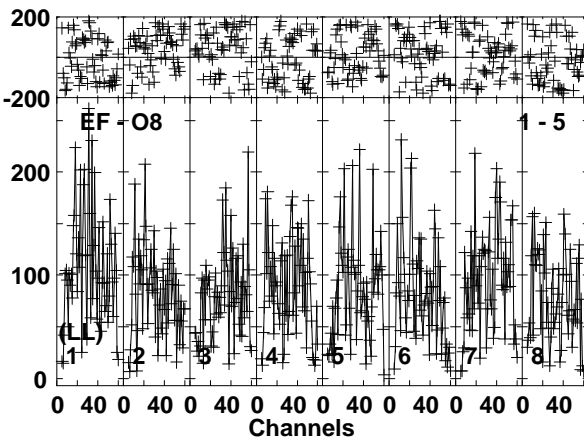
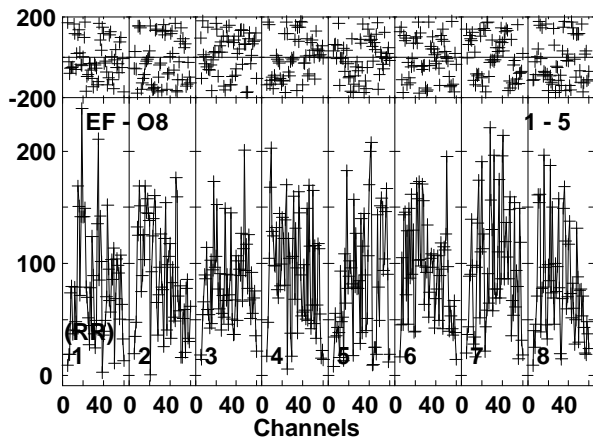
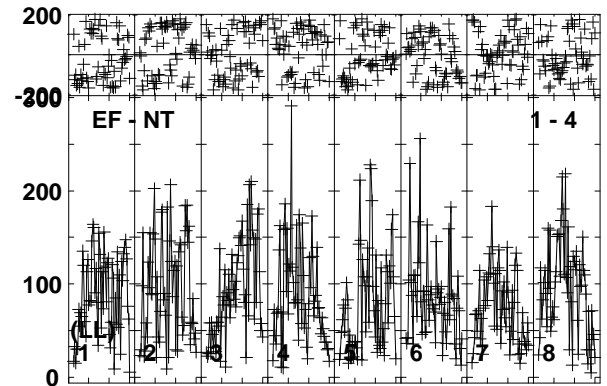
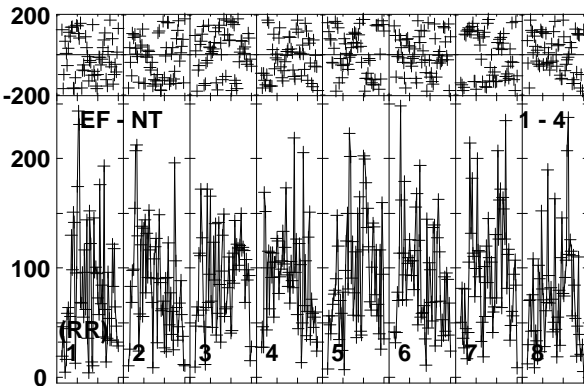
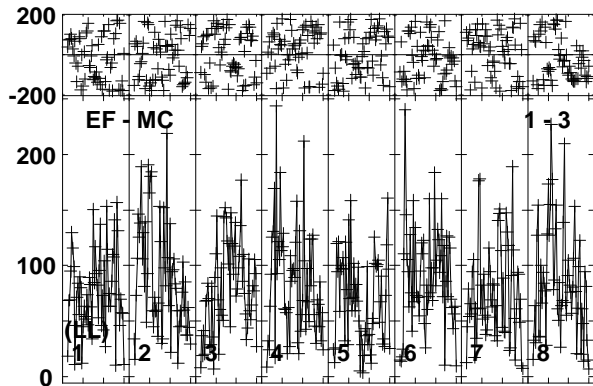
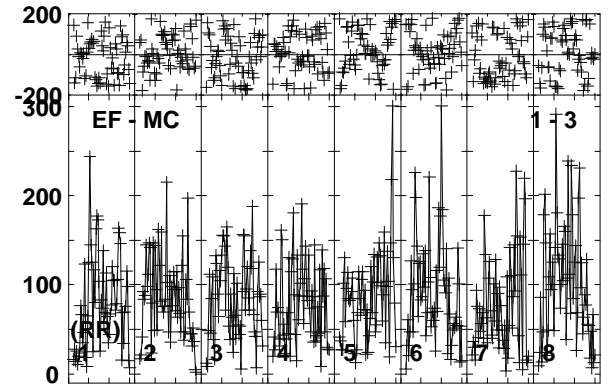
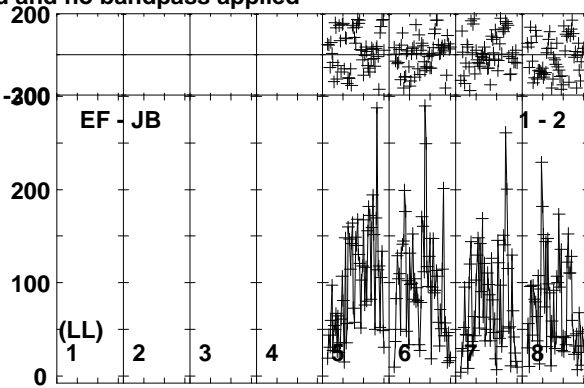
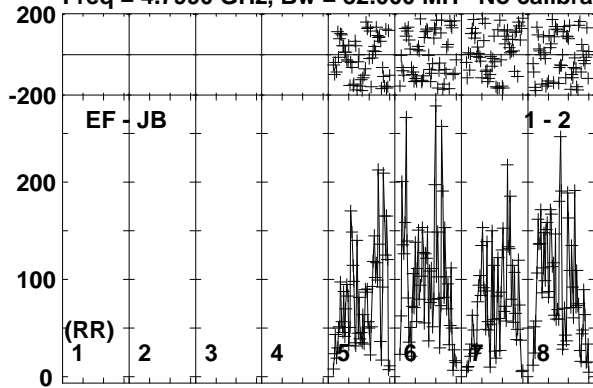

Lower frame: Micro Ampl Jy Top frame: Phas deg
Vector averaged cross-power spectrum Baseline: EF (01) - JB (02)
Timerange: 00/23:09:51 to 00/23:13:20

Plot file version 112 created 21-FEB-2017 15:11:11

ARUMA EG096A.UVDATA.1

Freq = 4.7990 GHz, Bw = 32.000 MH No calibration applied and no bandpass applied

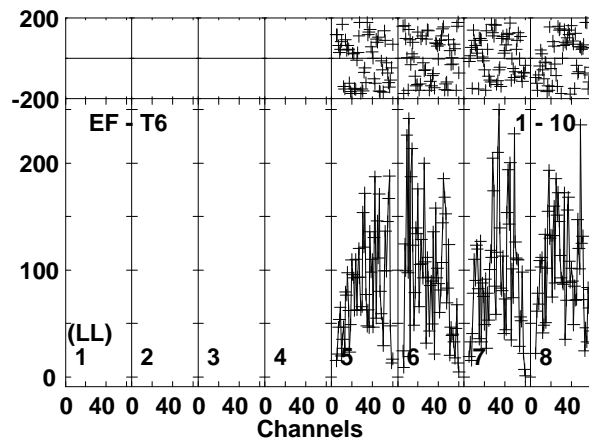
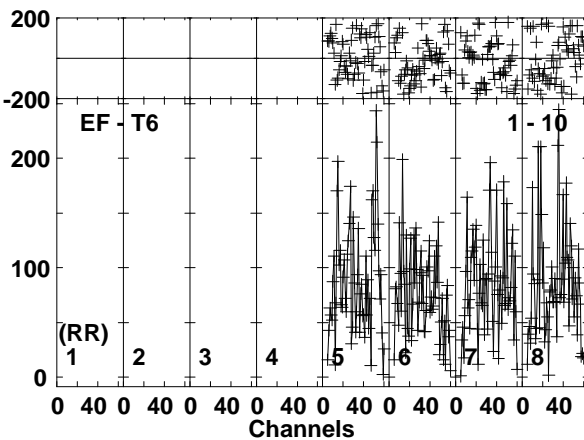
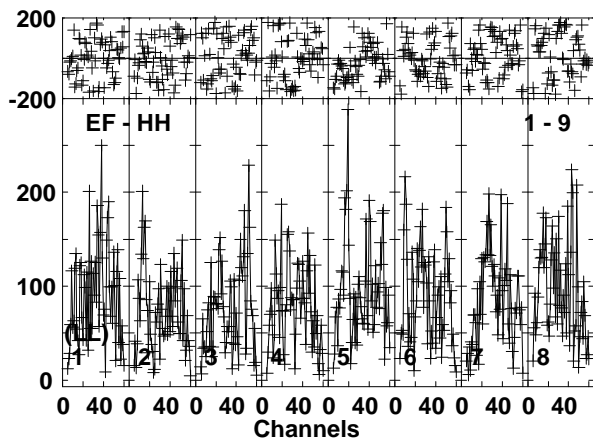
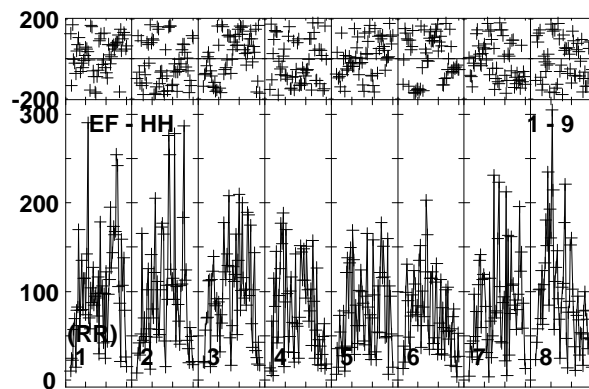
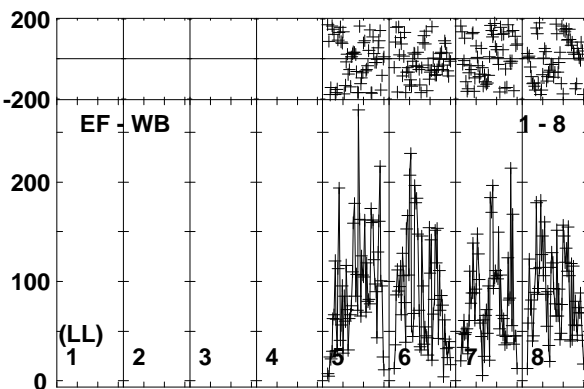
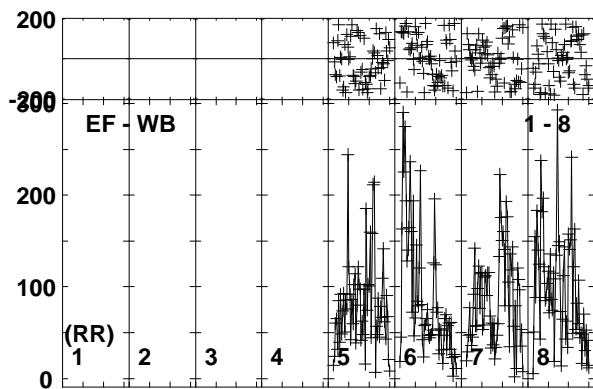
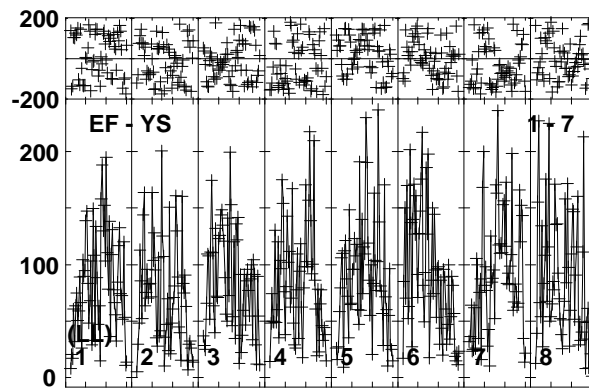
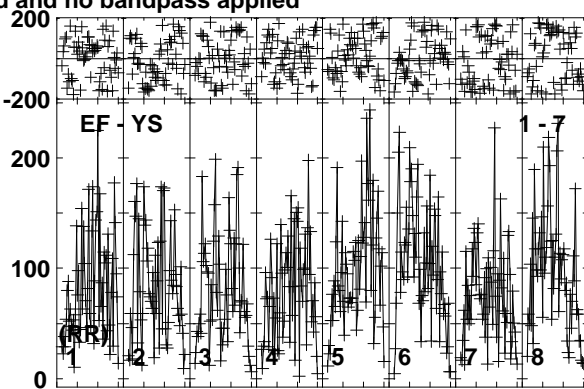
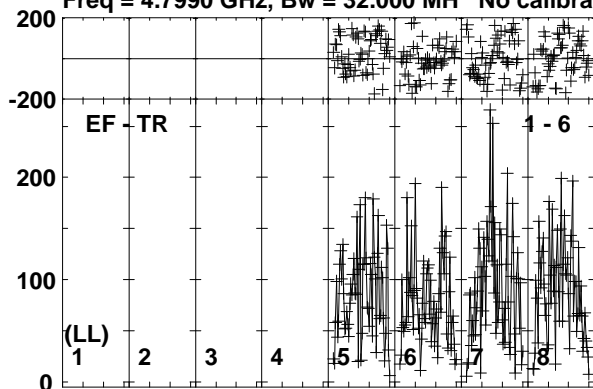

Lower frame: Micro Ampl Jy Top frame: Phas deg
Vector averaged cross-power spectrum Baseline: EF (01) - TR (06)
Timerange: 00/23:09:51 to 00/23:13:20

Plot file version 113 created 21-FEB-2017 15:11:11

J1108+4330 EG096A.UVDATA.1

Freq = 4.7990 GHz, Bw = 32.000 MH No calibration applied and no bandpass applied

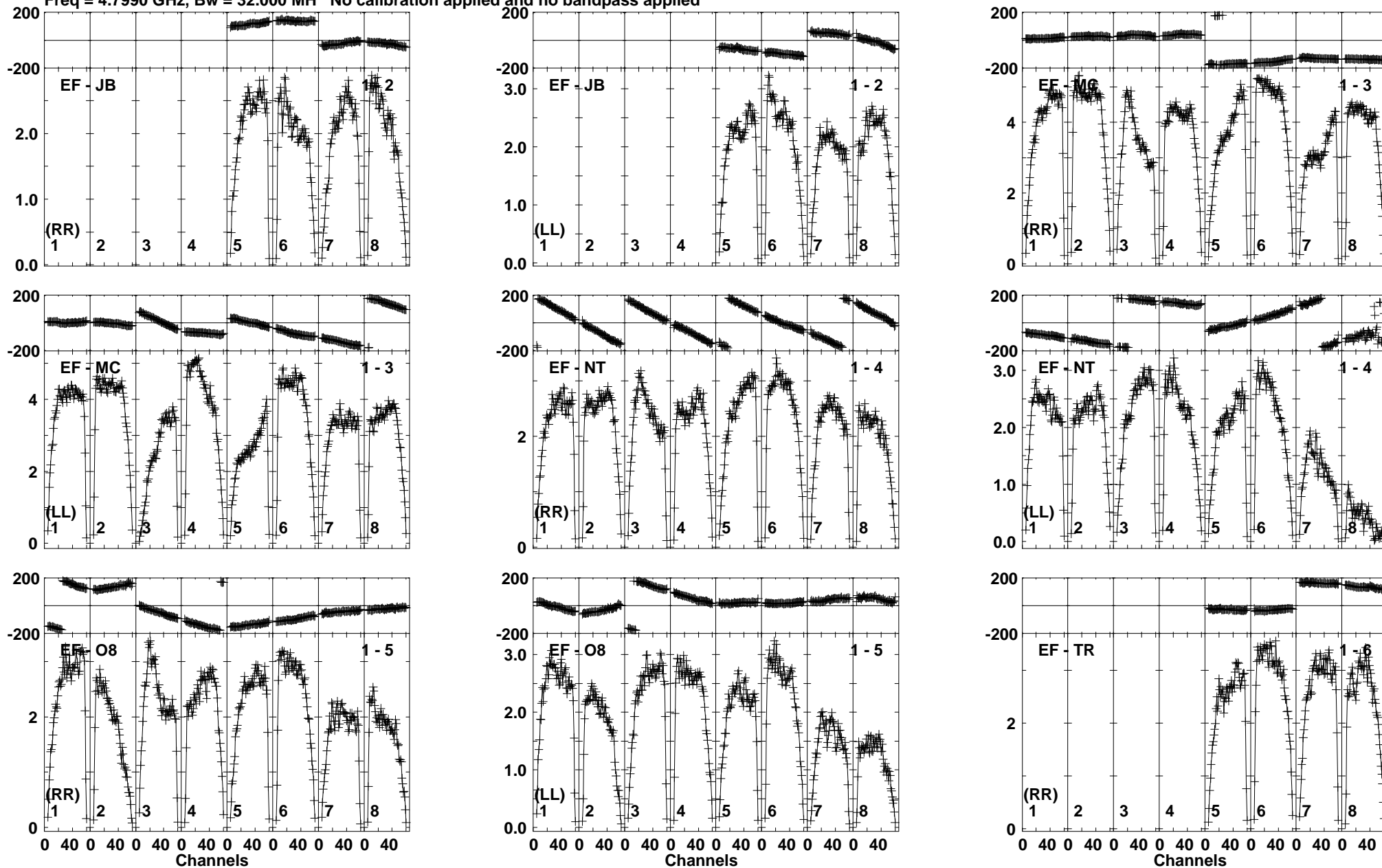

Lower frame: Milli Ampl Jy Top frame: Phas deg
Vector averaged cross-power spectrum Baseline: EF (01) - JB (02)
Timerange: 00/23:13:20 to 00/23:14:50

Plot file version 114 created 21-FEB-2017 15:11:12

J1108+4330 EG096A.UVDATA.1

Freq = 4.7990 GHz, Bw = 32.000 MH No calibration applied and no bandpass applied

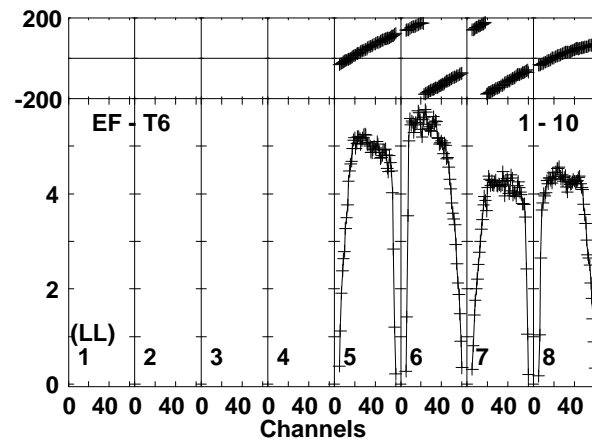
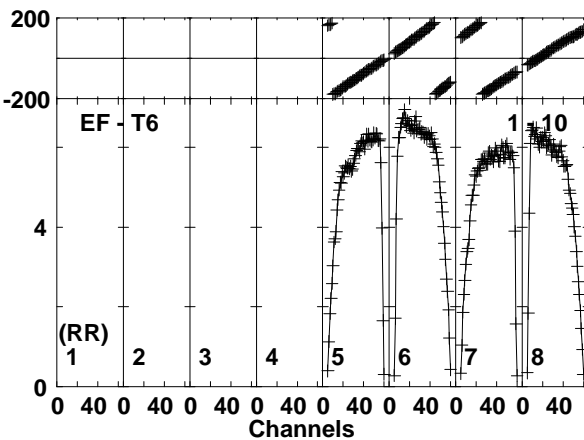
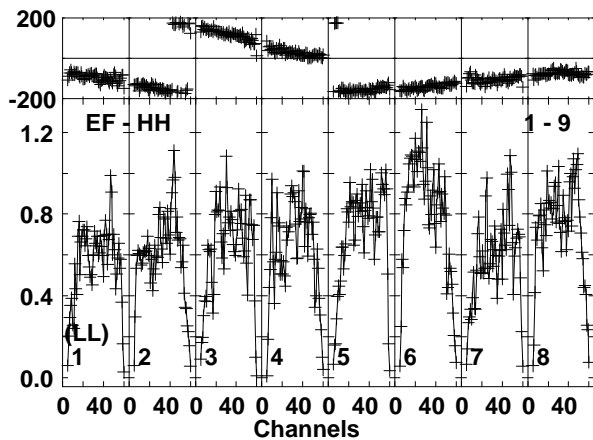
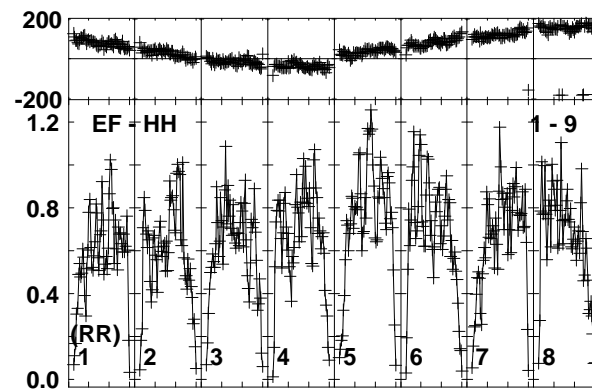
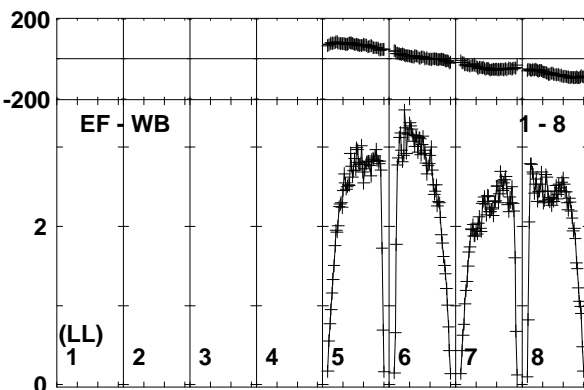
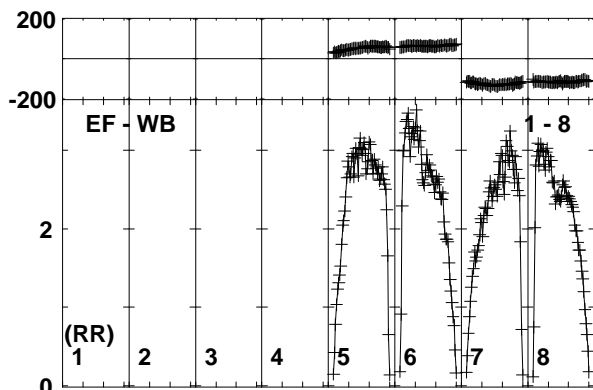
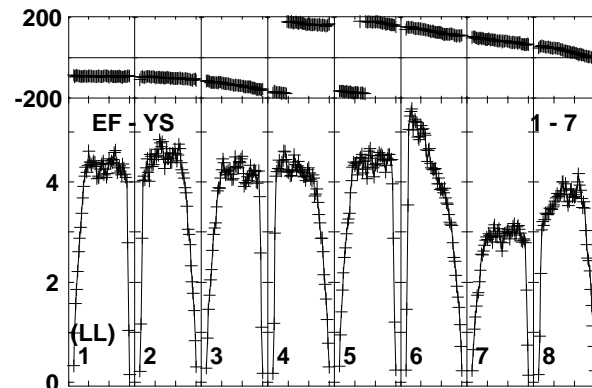
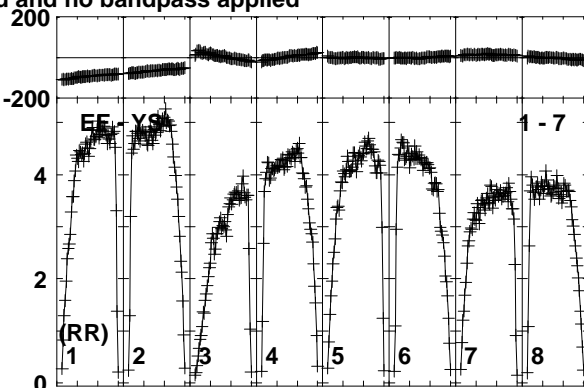
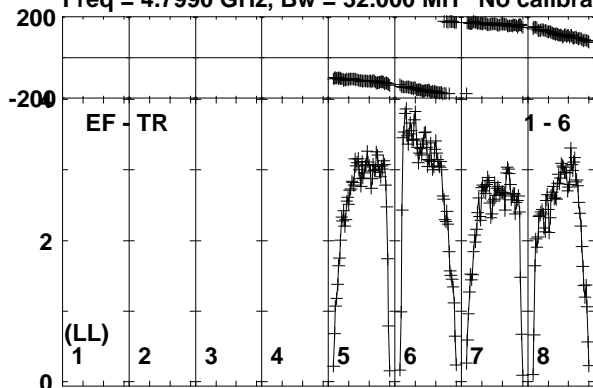

Lower frame: Milli Ampl Jy Top frame: Phas deg
Vector averaged cross-power spectrum Baseline: EF (01) - TR (06)
Timerange: 00/23:13:20 to 00/23:14:50

Plot file version 115 created 21-FEB-2017 15:11:12
 ARUMA EG096A.UVDATA.1
 Freq = 4.7990 GHz, Bw = 32.000 MH No calibration applied and no bandpass applied

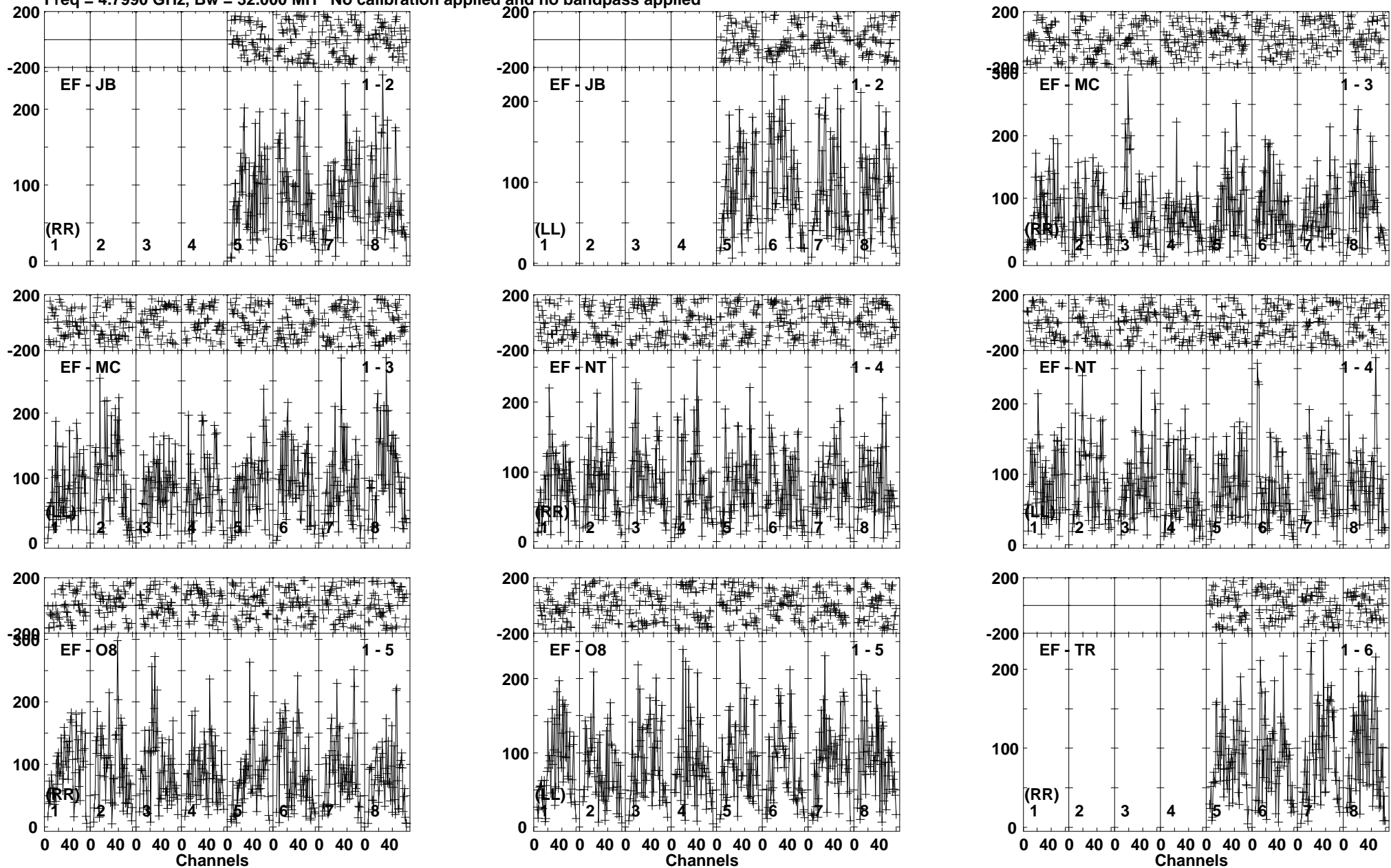

Lower frame: Micro Ampl Jy Top frame: Phas deg
 Vector averaged cross-power spectrum Baseline: EF (01) - JB (02)
 Timerange: 00/23:14:50 to 00/23:18:19

Plot file version 116 created 21-FEB-2017 15:11:12

ARUMA EG096A.UVDATA.1

Freq = 4.7990 GHz, Bw = 32.000 MH No calibration applied and no bandpass applied

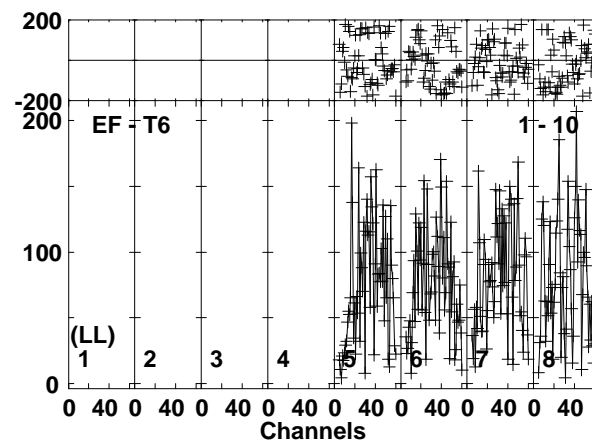
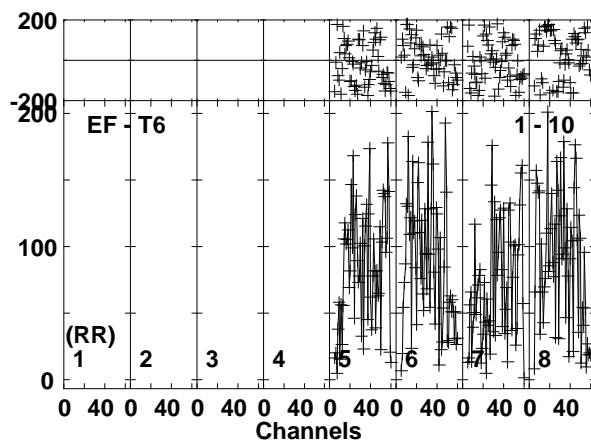
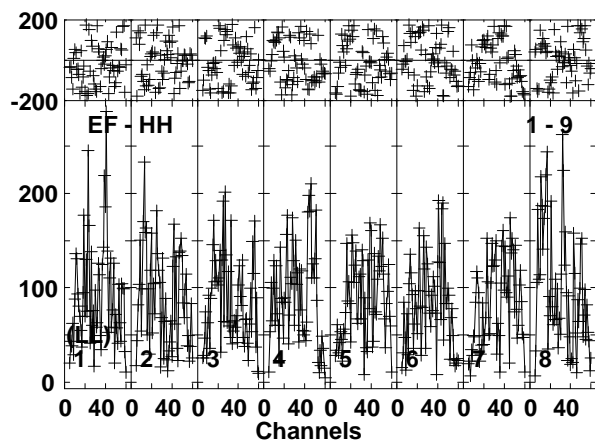
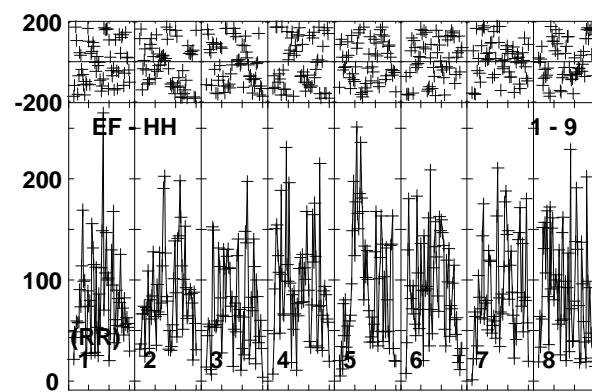
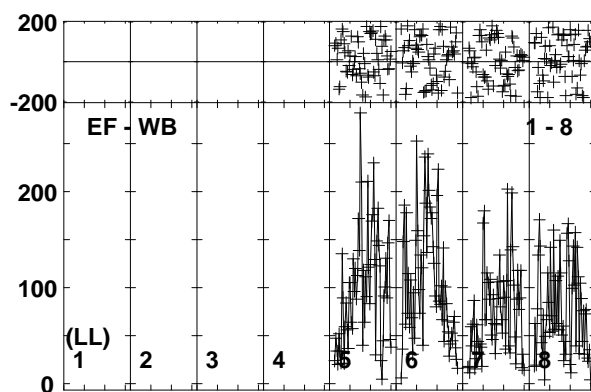
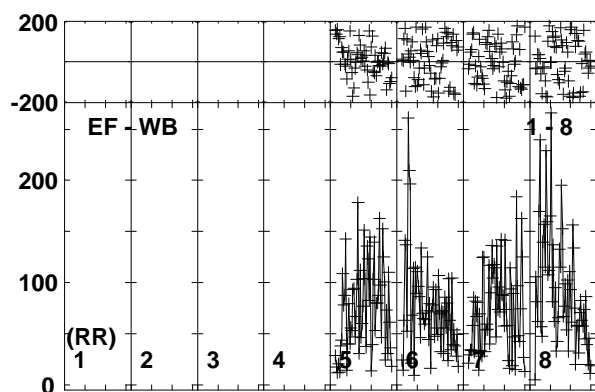
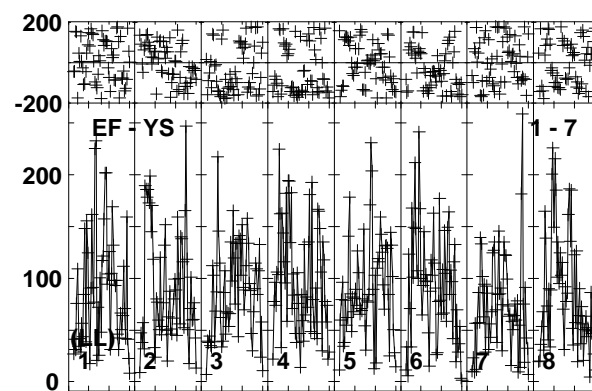
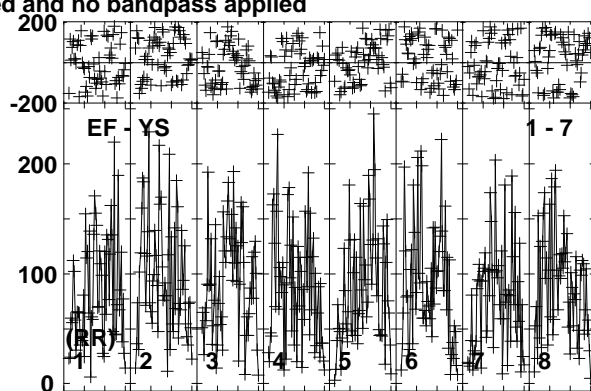
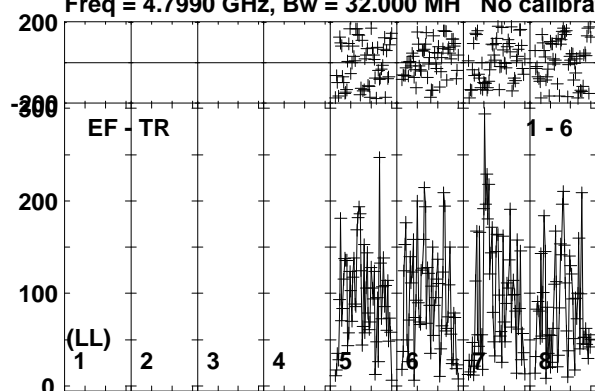

Lower frame: Micro Ampl Jy Top frame: Phas deg
Vector averaged cross-power spectrum Baseline: EF (01) - TR (06)
Timerange: 00/23:14:50 to 00/23:18:19

Plot file version 117 created 21-FEB-2017 15:11:12

J1108+4330 EG096A.UVDATA.1

Freq = 4.7990 GHz, Bw = 32.000 MH No calibration applied and no bandpass applied

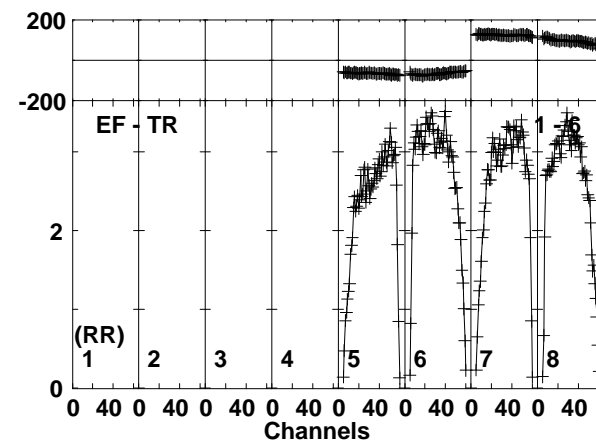
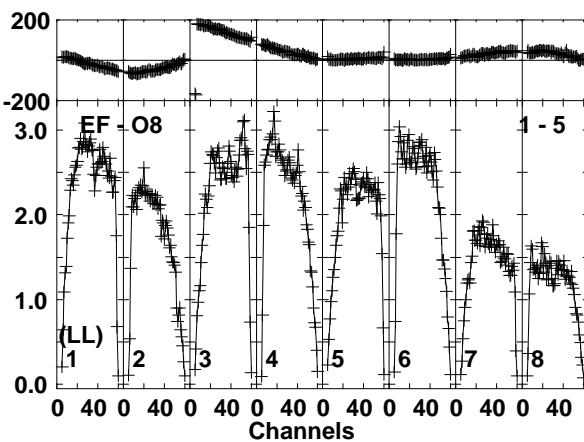
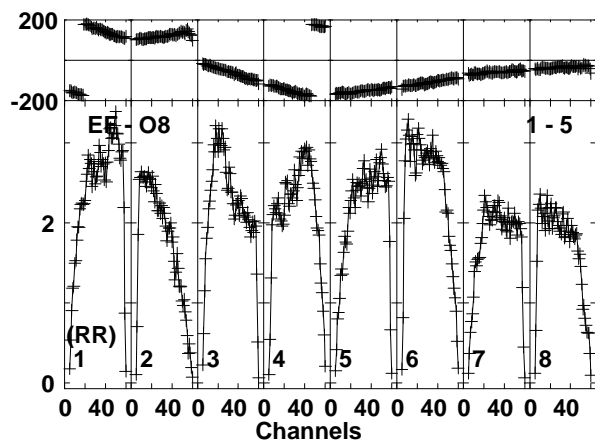
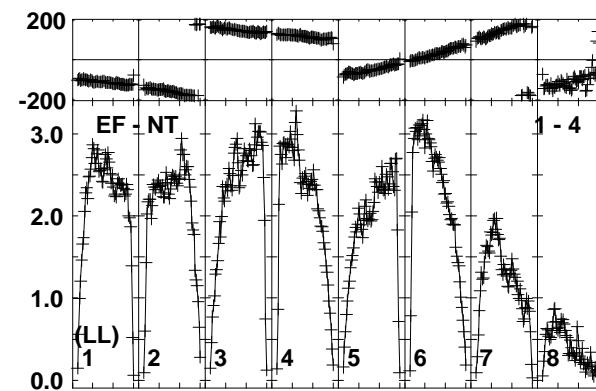
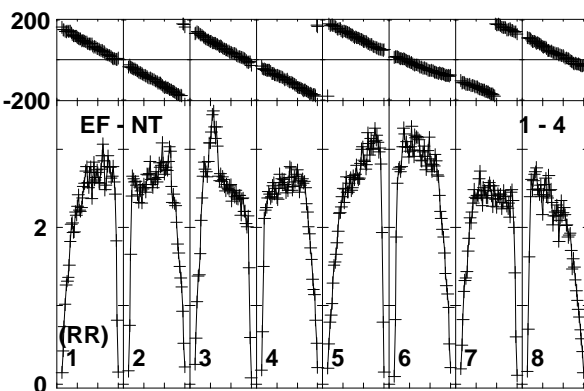
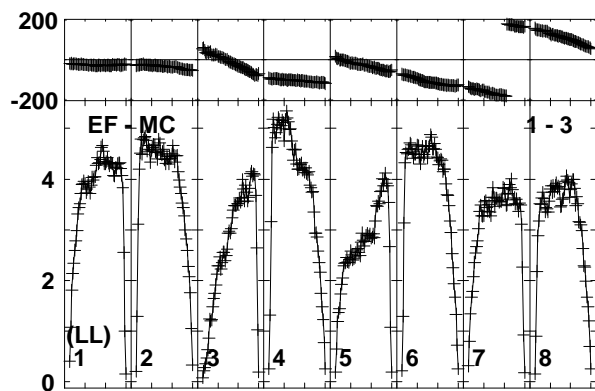
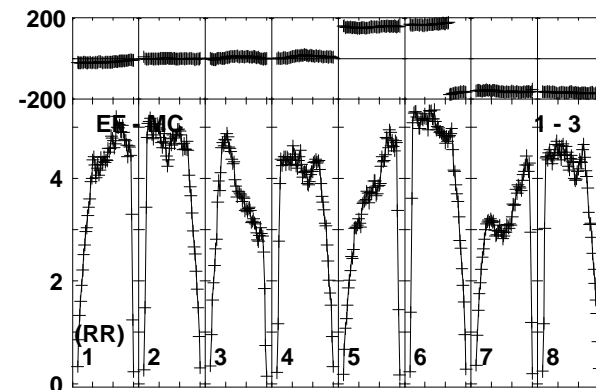
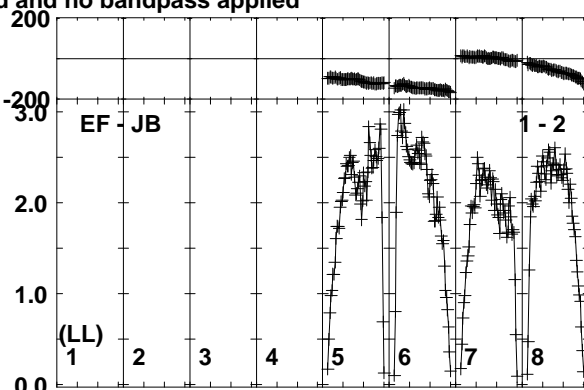
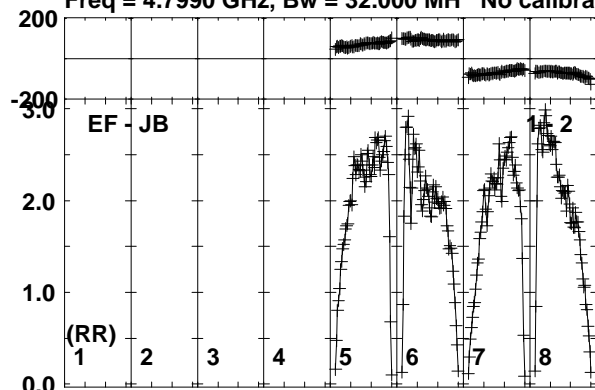

Lower frame: Milli Ampl Jy Top frame: Phas deg
Vector averaged cross-power spectrum Baseline: EF (01) - JB (02)
Timerange: 00/23:19:00 to 00/23:19:59

Plot file version 118 created 21-FEB-2017 15:11:13

J1108+4330 EG096A.UVDATA.1

Freq = 4.7990 GHz, Bw = 32.000 MH No calibration applied and no bandpass applied

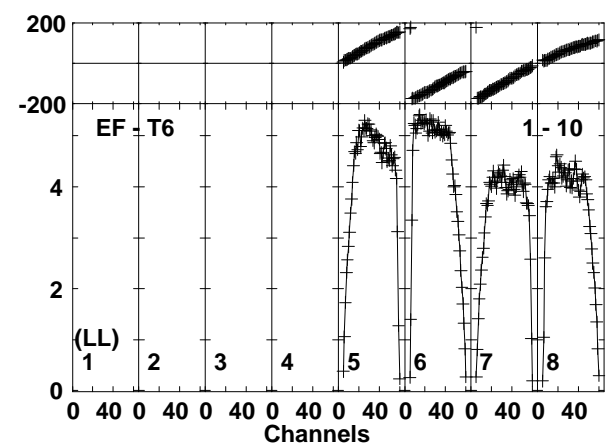
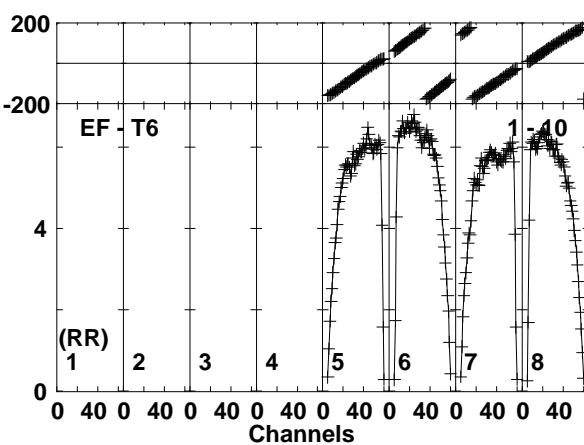
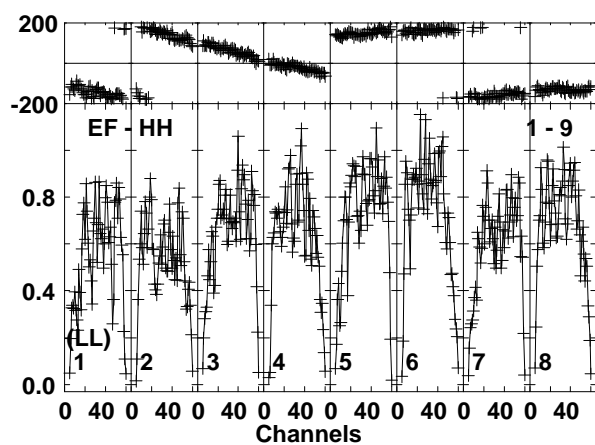
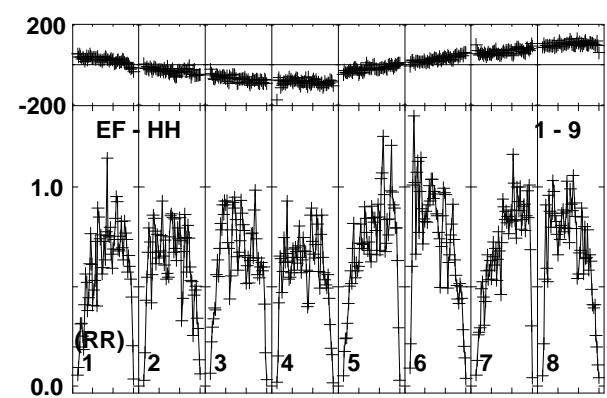
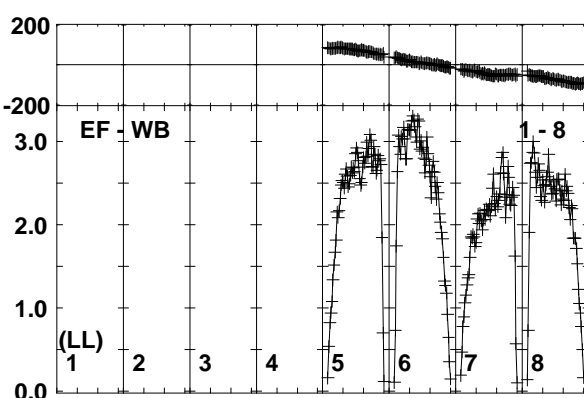
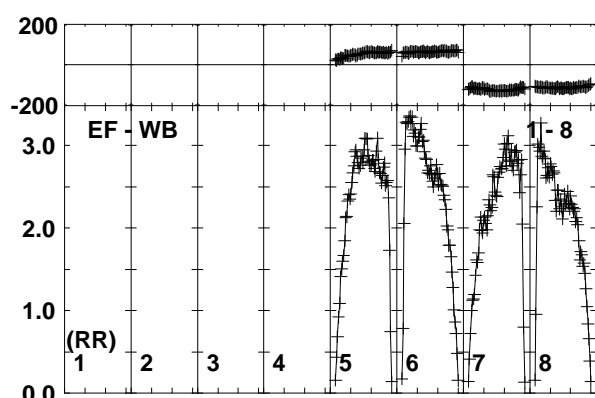
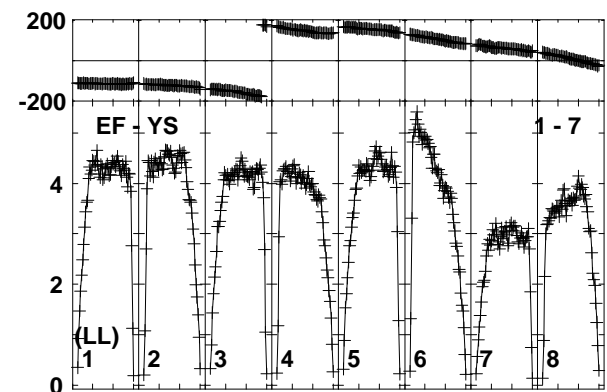
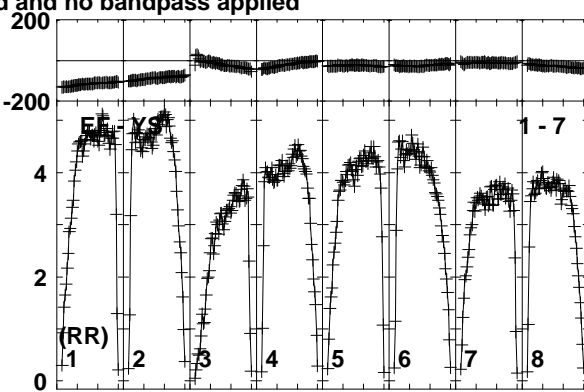
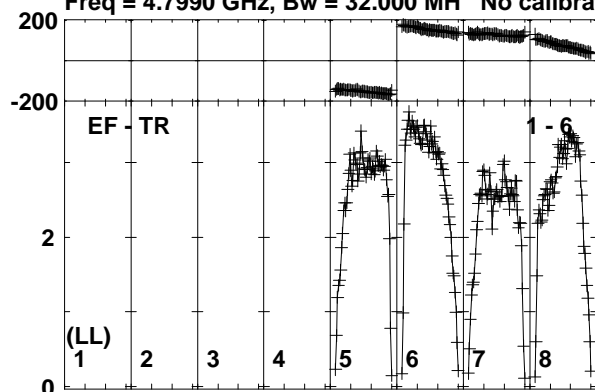

Lower frame: Milli Ampl Jy Top frame: Phas deg
Vector averaged cross-power spectrum Baseline: EF (01) - TR (06)
Timerange: 00/23:19:00 to 00/23:19:59

Plot file version 119 created 21-FEB-2017 15:11:13

ARUMA EG096A.UVDATA.1

Freq = 4.7990 GHz, Bw = 32.000 MH No calibration applied and no bandpass applied

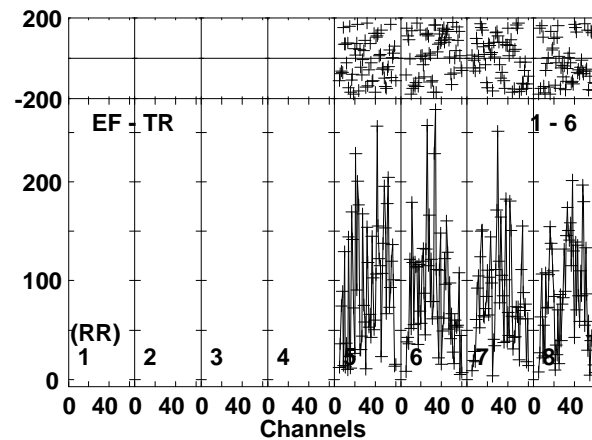
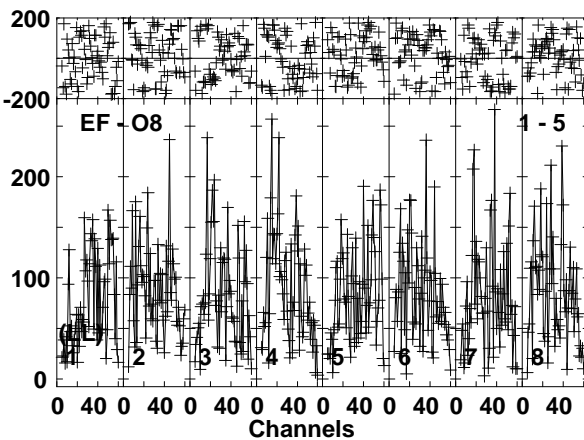
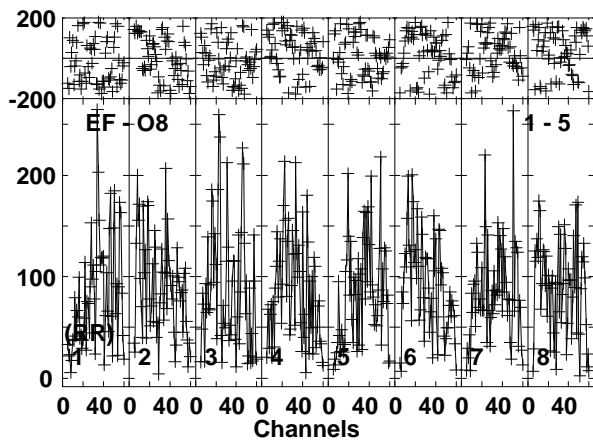
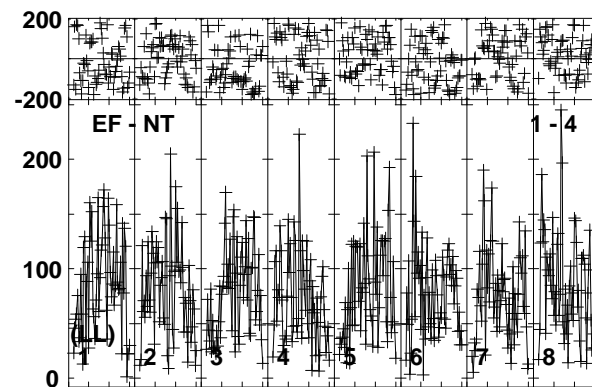
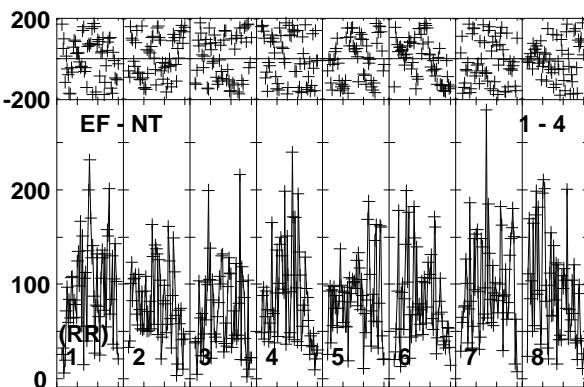
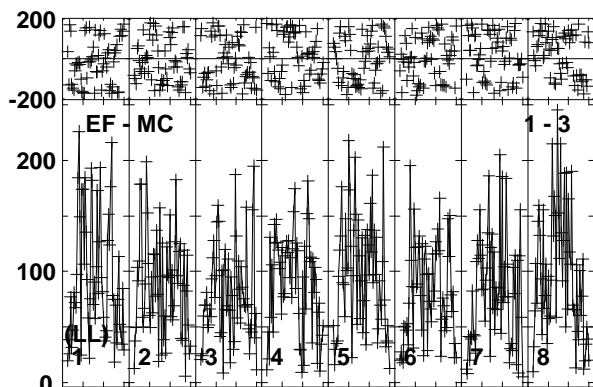
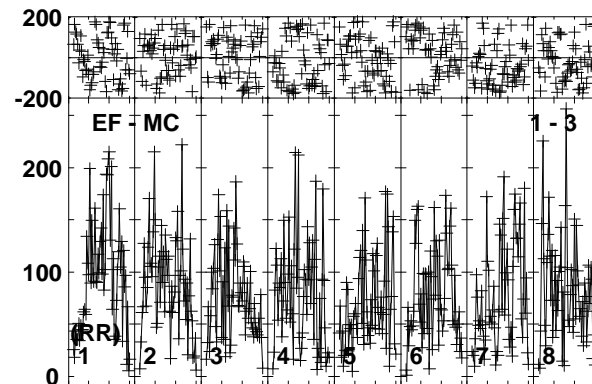
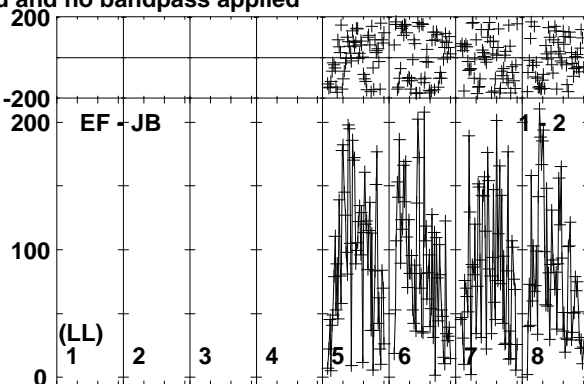
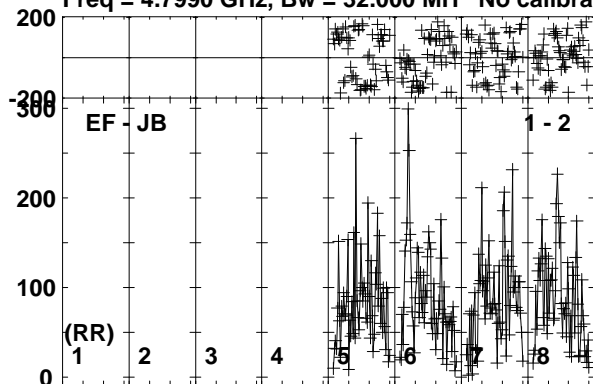

Lower frame: Micro Ampl Jy Top frame: Phas deg
Vector averaged cross-power spectrum Baseline: EF (01) - JB (02)
Timerange: 00/23:20:00 to 00/23:23:29

Plot file version 120 created 21-FEB-2017 15:11:13

ARUMA EG096A.UVDATA.1

Freq = 4.7990 GHz, Bw = 32.000 MH No calibration applied and no bandpass applied

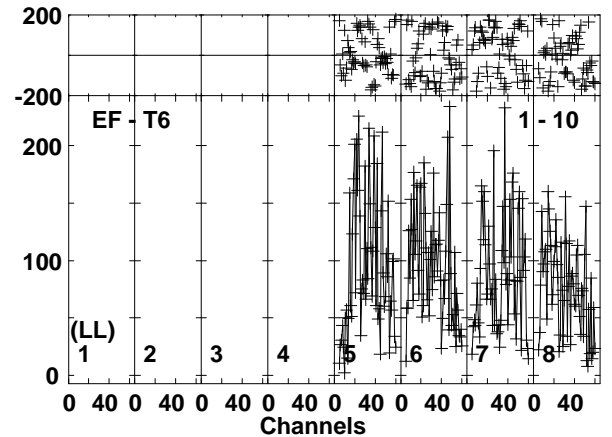
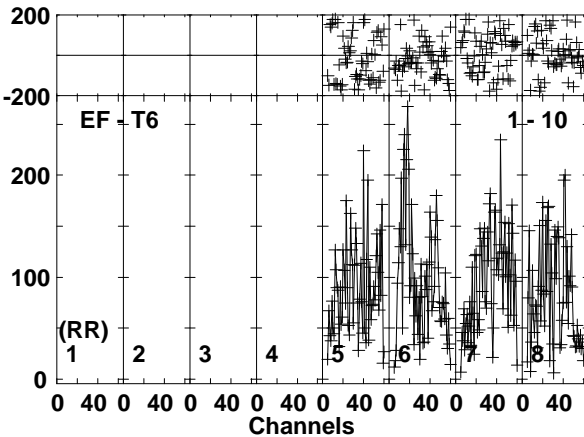
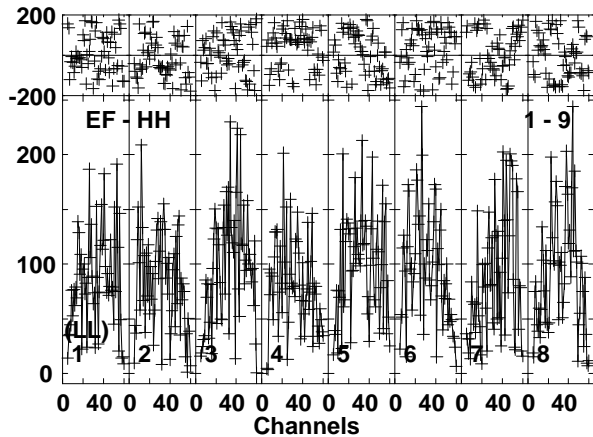
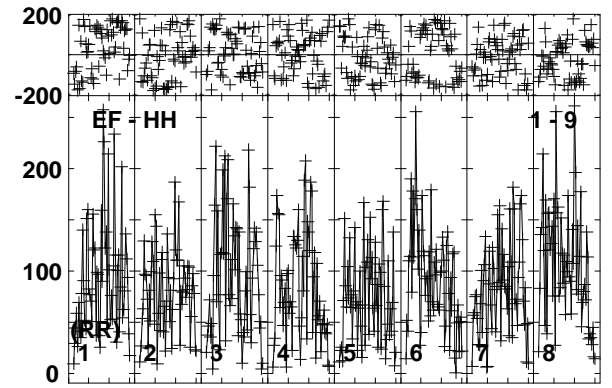
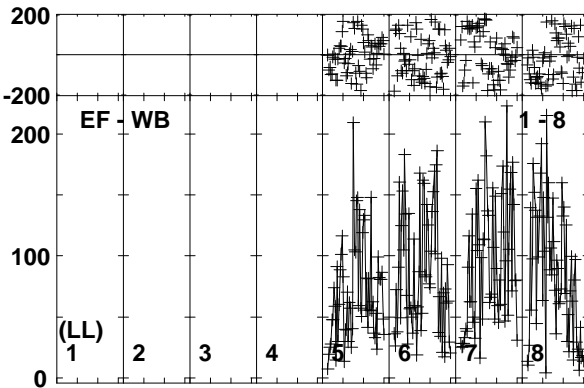
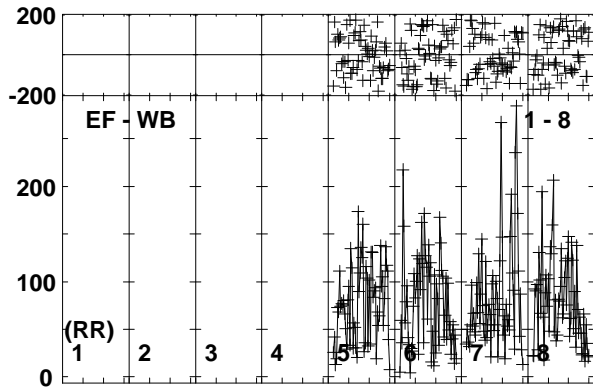
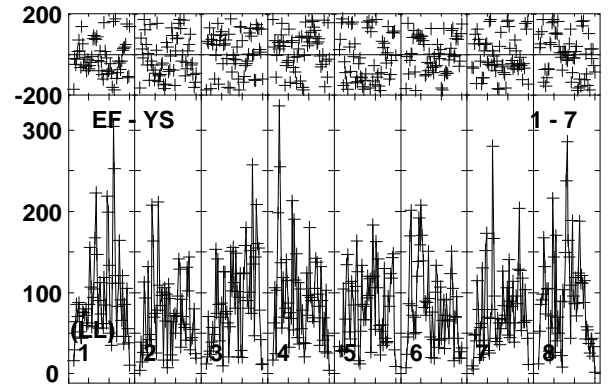
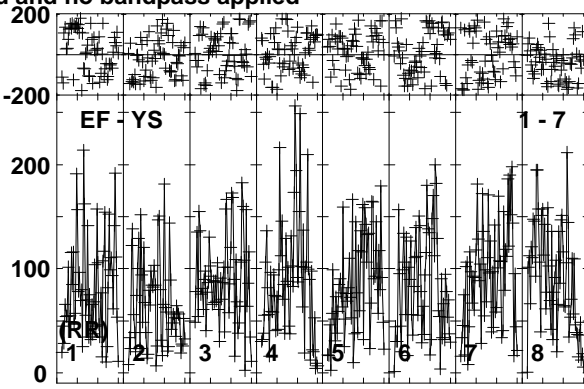
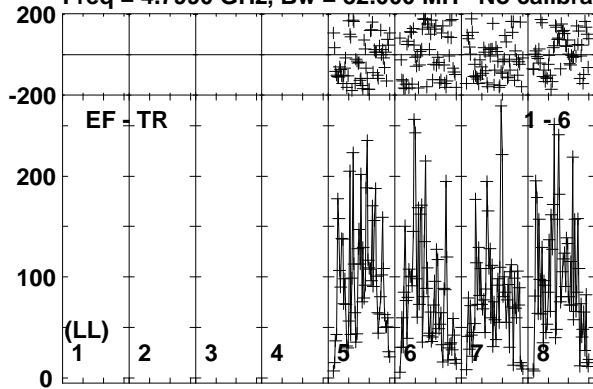

Lower frame: Micro Ampl Jy Top frame: Phas deg
Vector averaged cross-power spectrum Baseline: EF (01) - TR (06)
Timerange: 00/23:20:00 to 00/23:23:29

Plot file version 121 created 21-FEB-2017 15:11:13

J1108+4330 EG096A.UVDATA.1

Freq = 4.7990 GHz, Bw = 32.000 MH No calibration applied and no bandpass applied

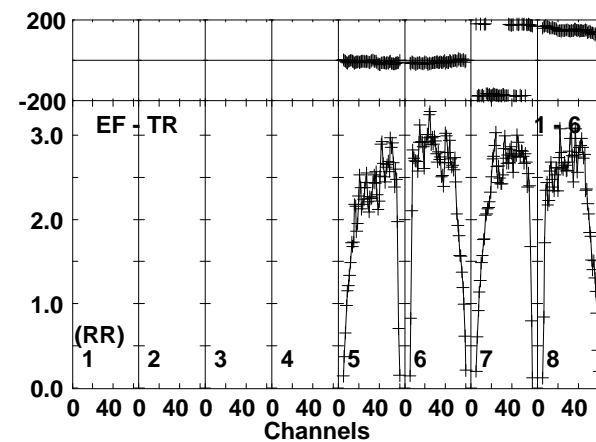
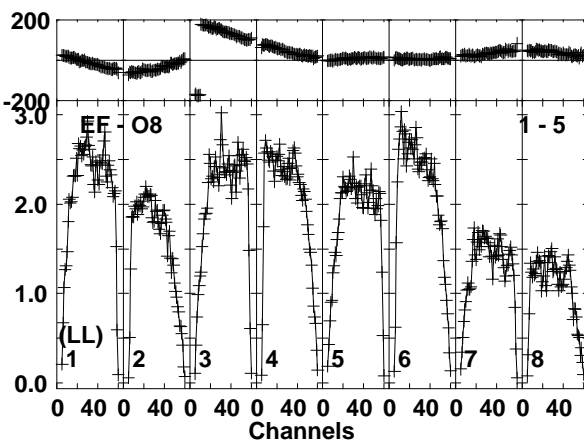
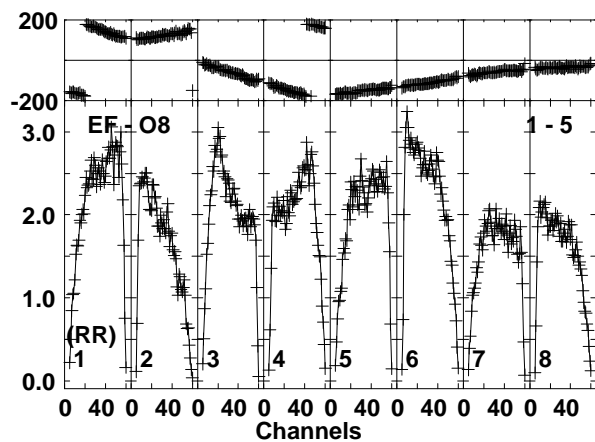
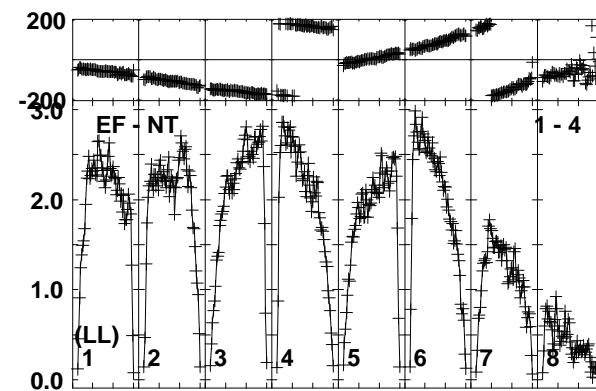
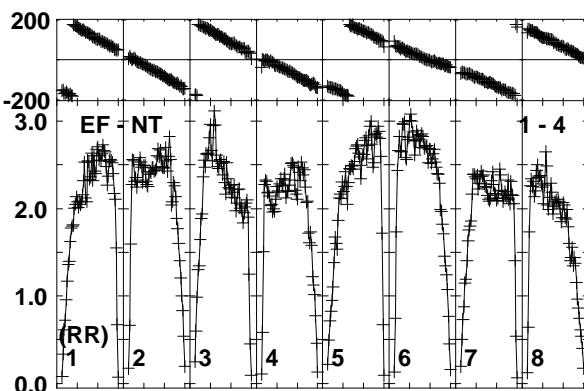
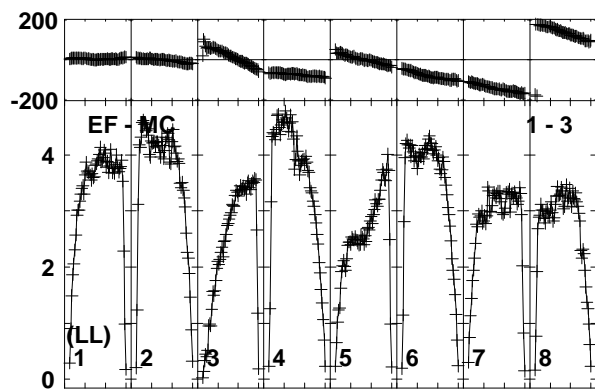
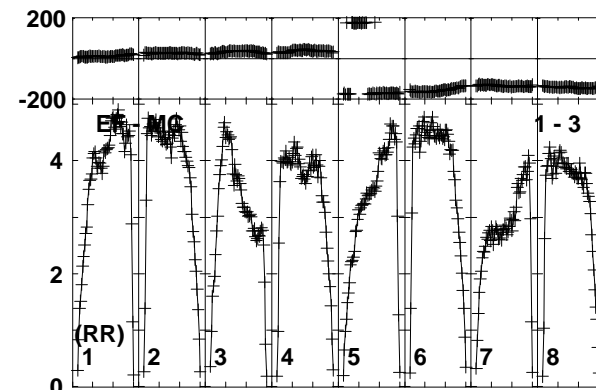
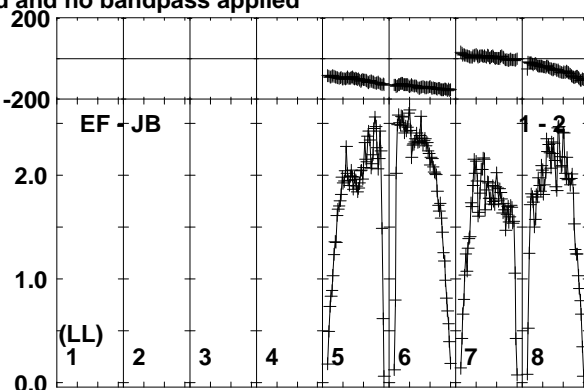
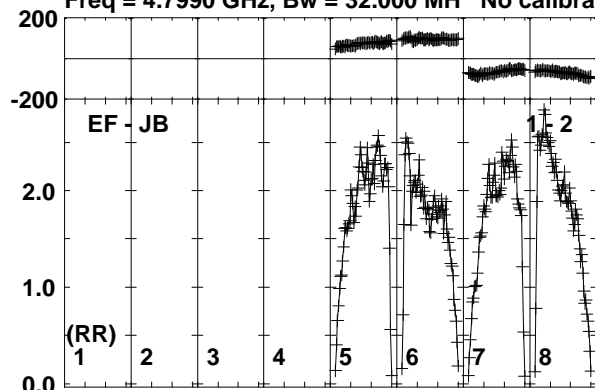

Lower frame: Milli Ampl Jy Top frame: Phas deg
Vector averaged cross-power spectrum Baseline: EF (01) - JB (02)
Timerange: 00/23:23:31 to 00/23:24:59

Plot file version 122 created 21-FEB-2017 15:11:14

J1108+4330 EG096A.UVDATA.1

Freq = 4.7990 GHz, Bw = 32.000 MH No calibration applied and no bandpass applied

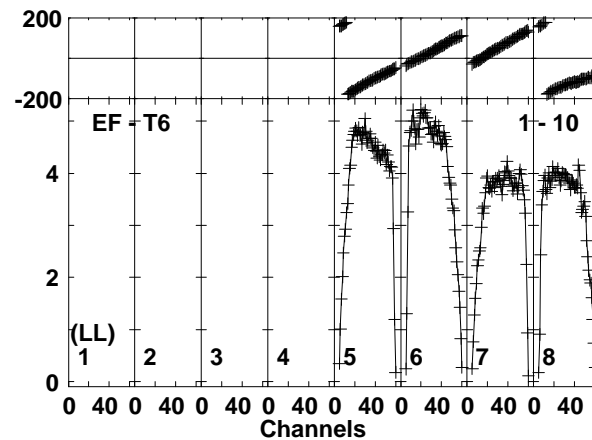
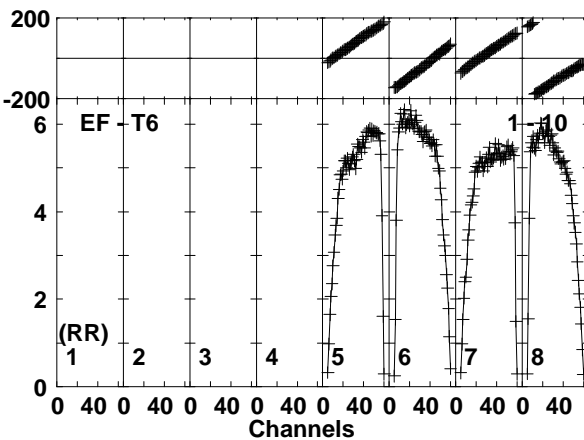
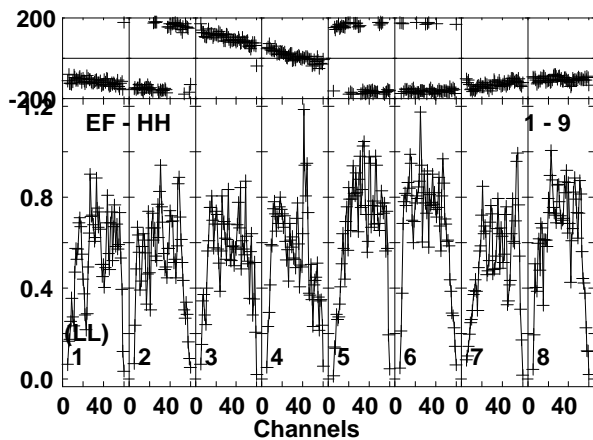
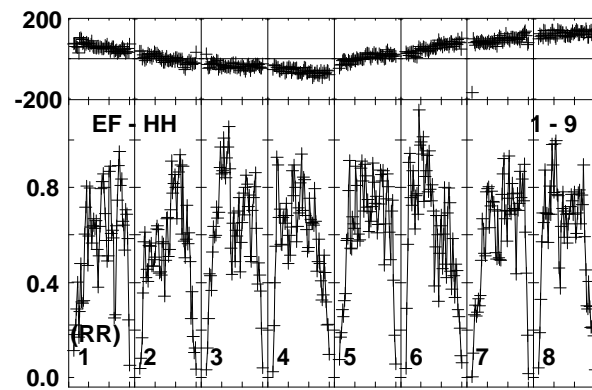
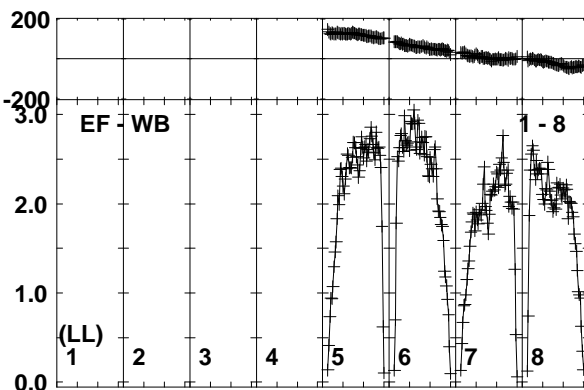
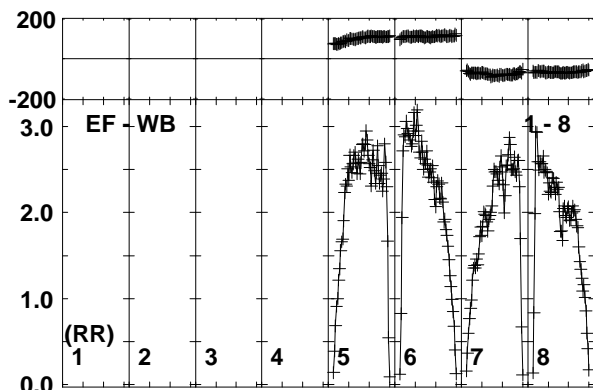
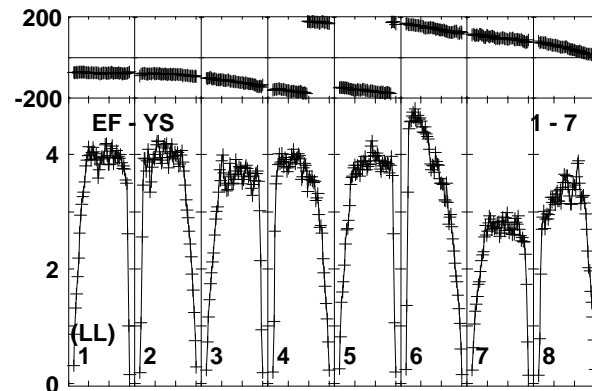
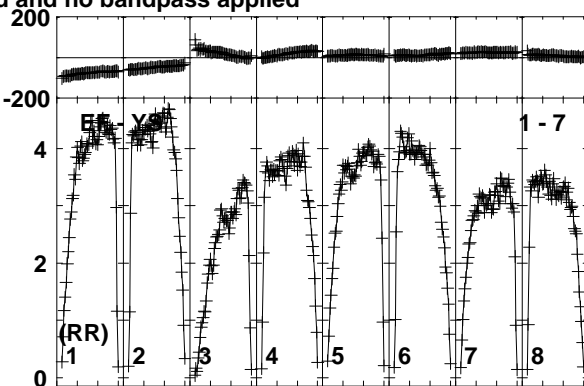
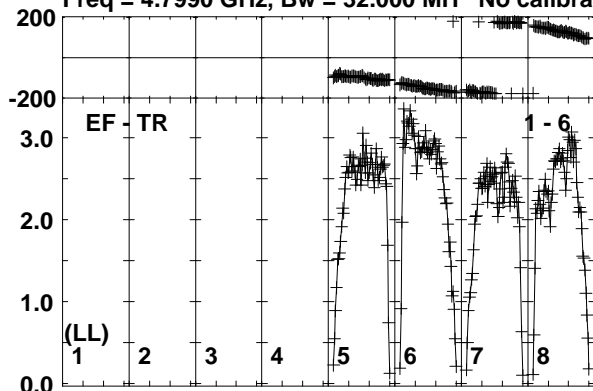

Lower frame: Milli Ampl Jy Top frame: Phas deg
Vector averaged cross-power spectrum Baseline: EF (01) - TR (06)
Timerange: 00/23:23:31 to 00/23:24:59

Plot file version 123 created 21-FEB-2017 15:11:14

ARUMA EG096A.UVDATA.1

Freq = 4.7990 GHz, Bw = 32.000 MH No calibration applied and no bandpass applied

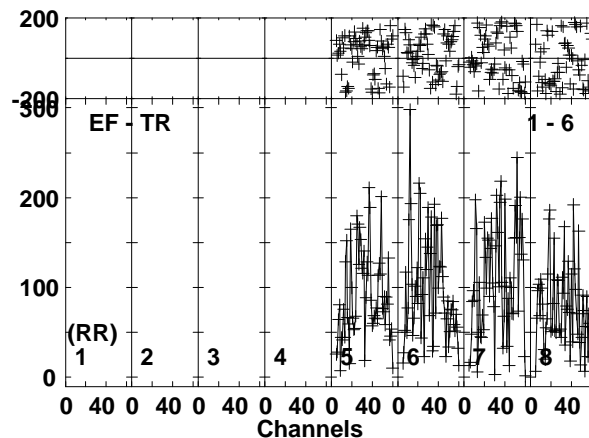
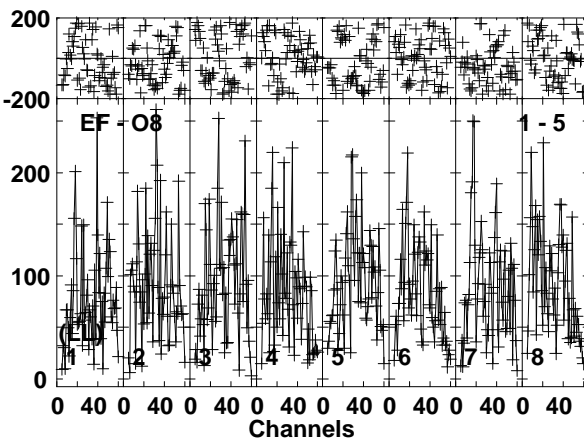
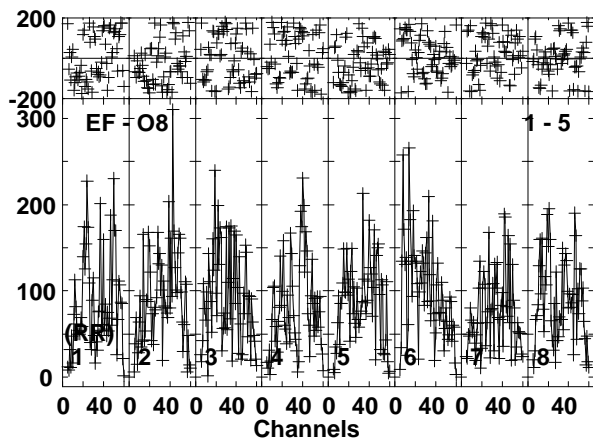
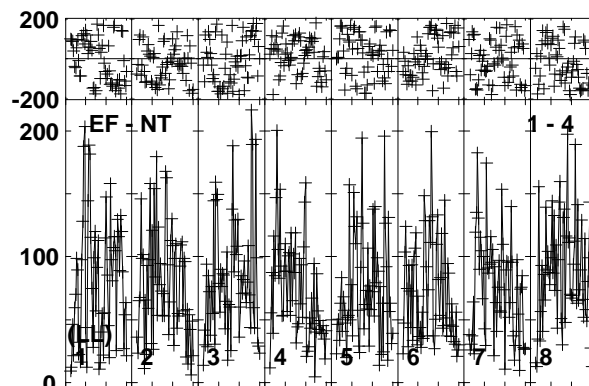
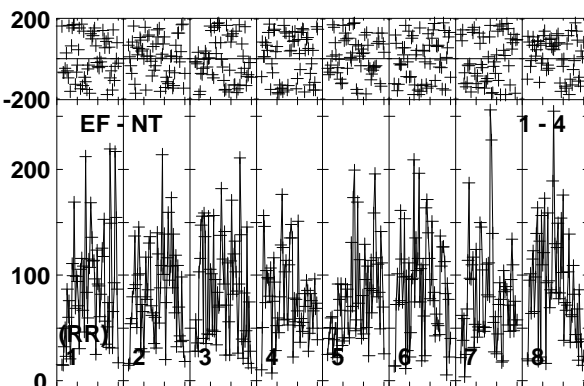
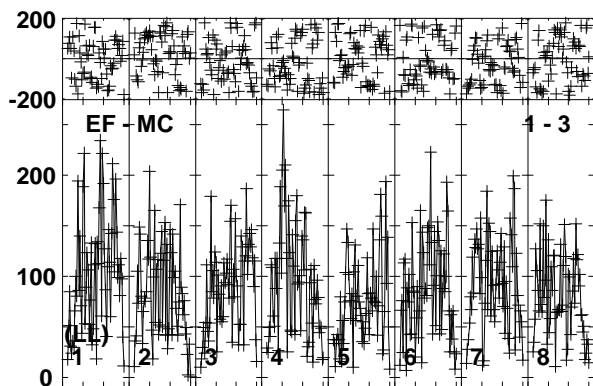
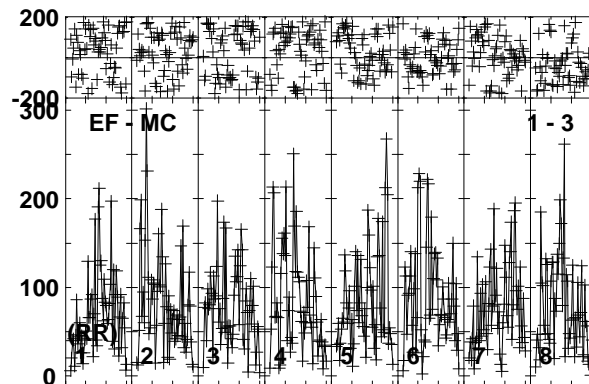
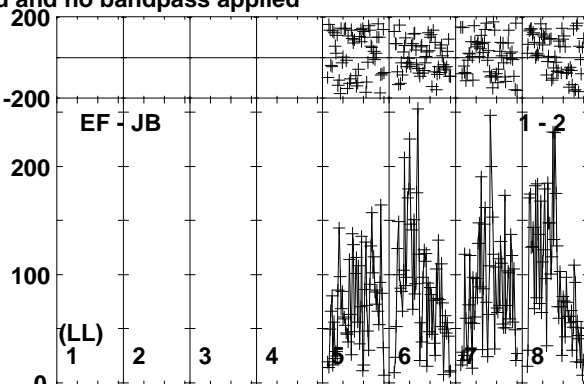
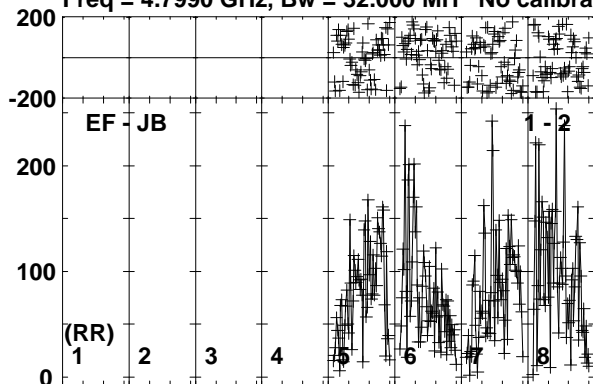

Lower frame: Micro Ampl Jy Top frame: Phas deg
Vector averaged cross-power spectrum Baseline: EF (01) - JB (02)
Timerange: 00/23:25:00 to 00/23:28:30

Plot file version 124 created 21-FEB-2017 15:11:14

ARUMA EG096A.UVDATA.1

Freq = 4.7990 GHz, Bw = 32.000 MH No calibration applied and no bandpass applied

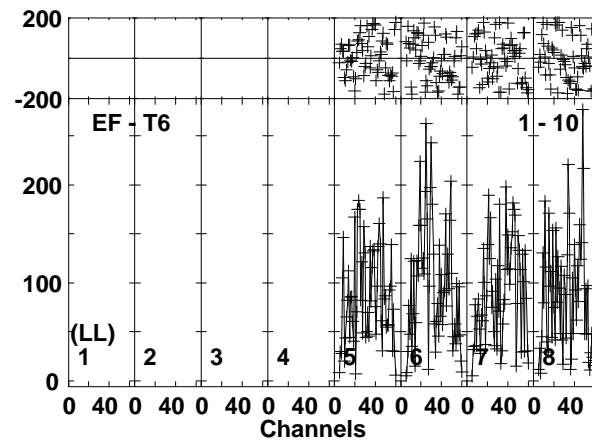
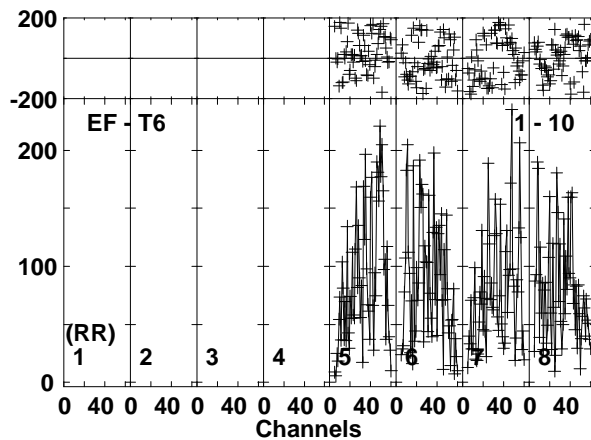
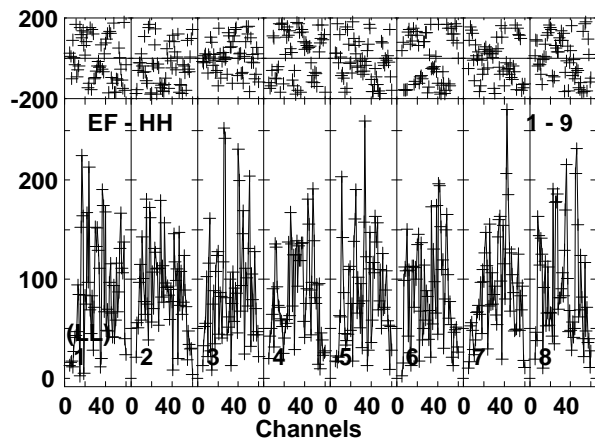
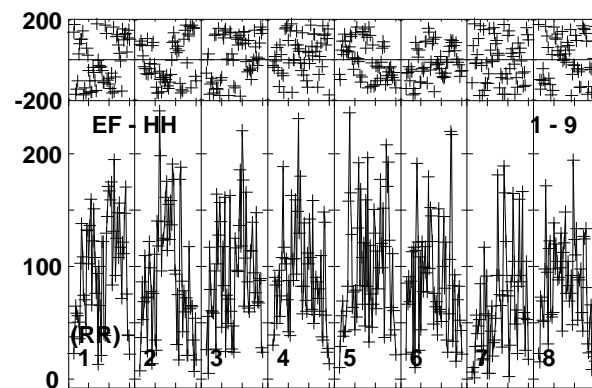
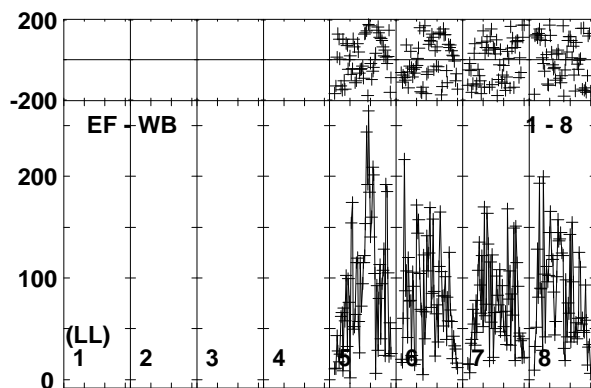
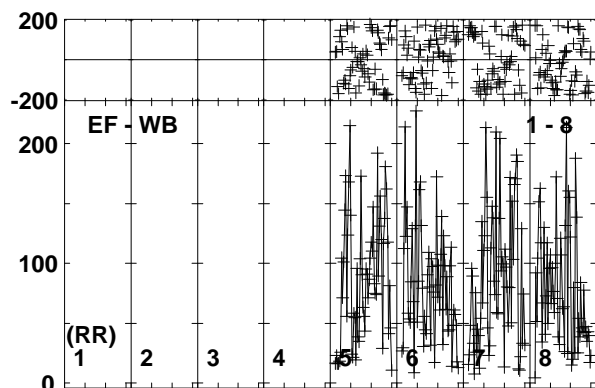
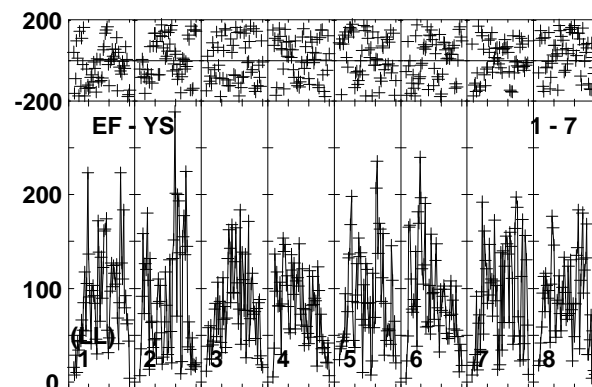
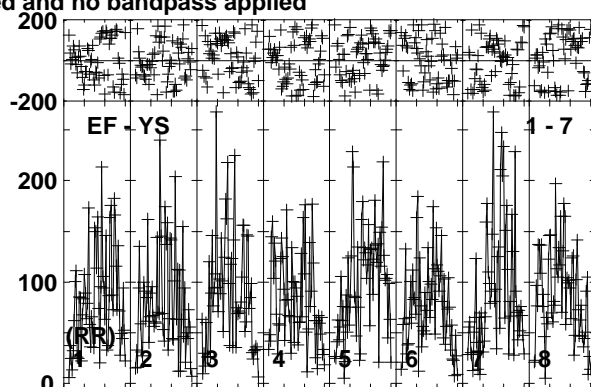
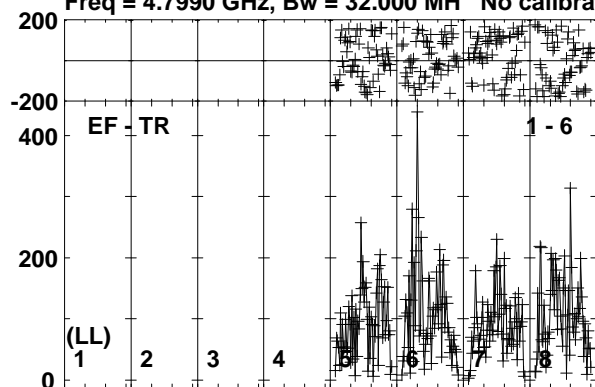

Lower frame: Micro Ampl Jy Top frame: Phas deg
Vector averaged cross-power spectrum Baseline: EF (01) - TR (06)
Timerange: 00/23:25:00 to 00/23:28:30

Plot file version 125 created 21-FEB-2017 15:11:15

J1108+4330 EG096A.UVDATA.1

Freq = 4.7990 GHz, Bw = 32.000 MH No calibration applied and no bandpass applied

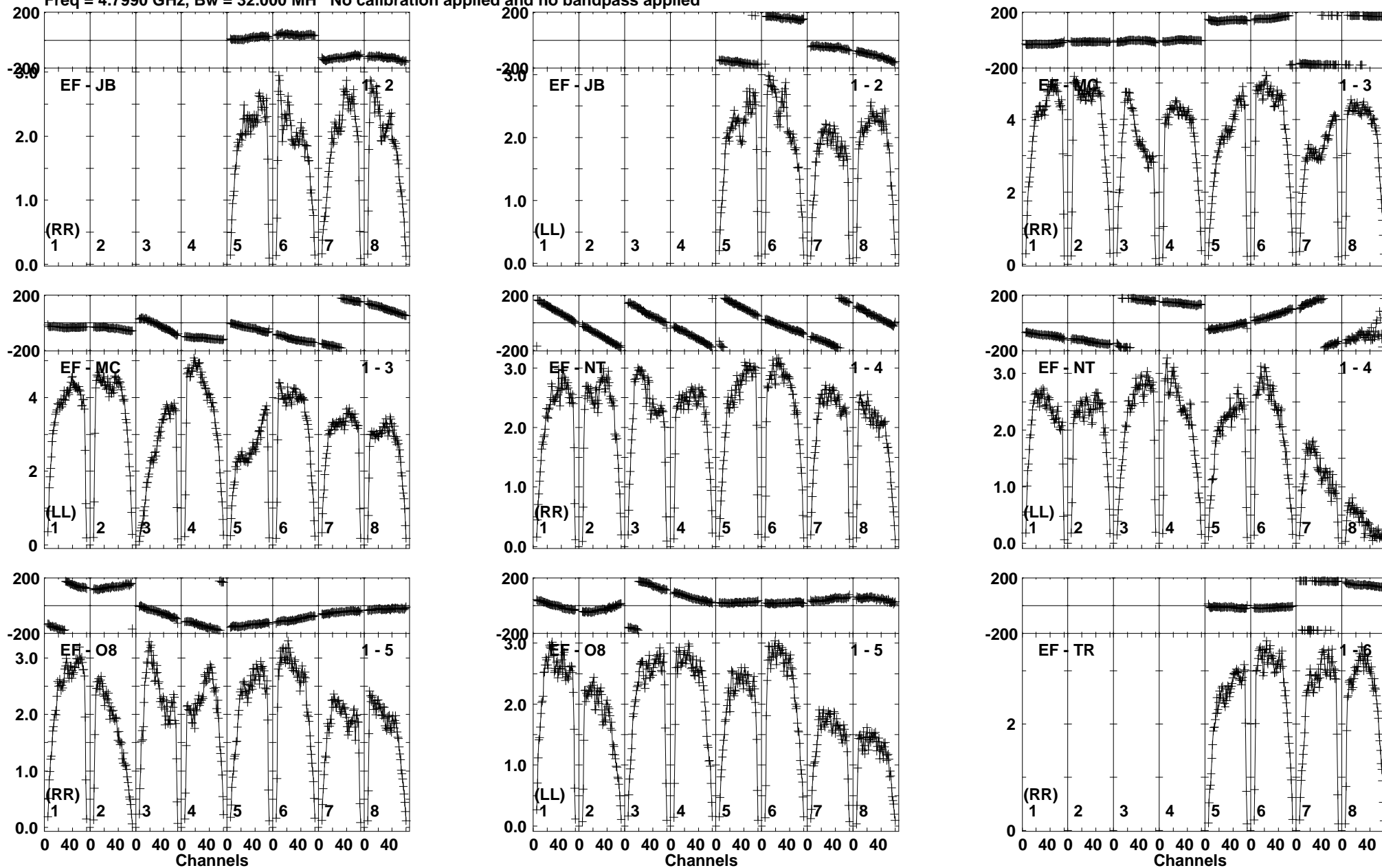

Lower frame: Milli Ampl Jy Top frame: Phas deg
Vector averaged cross-power spectrum Baseline: EF (01) - JB (02)
Timerange: 00/23:29:10 to 00/23:30:09

Plot file version 126 created 21-FEB-2017 15:11:15

J1108+4330 EG096A.UVDATA.1

Freq = 4.7990 GHz, Bw = 32.000 MH No calibration applied and no bandpass applied

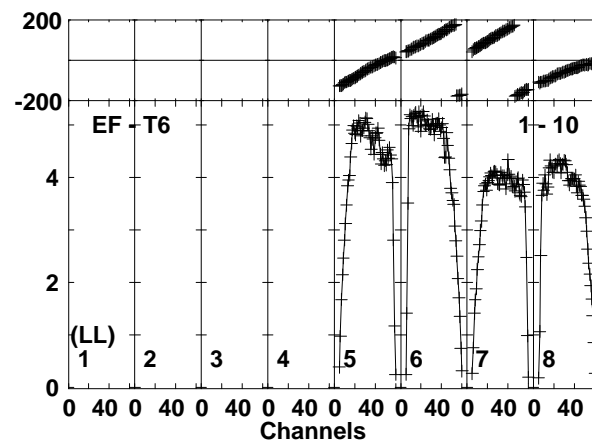
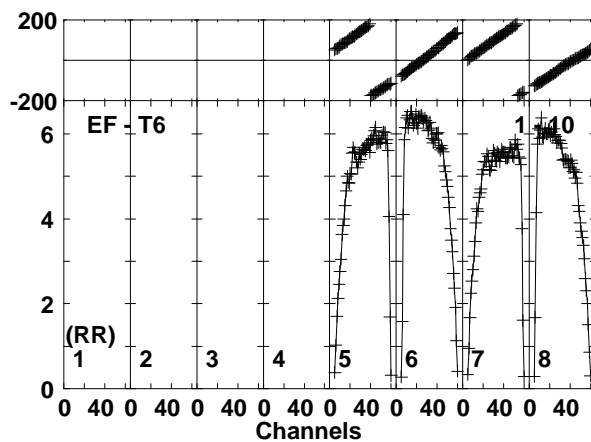
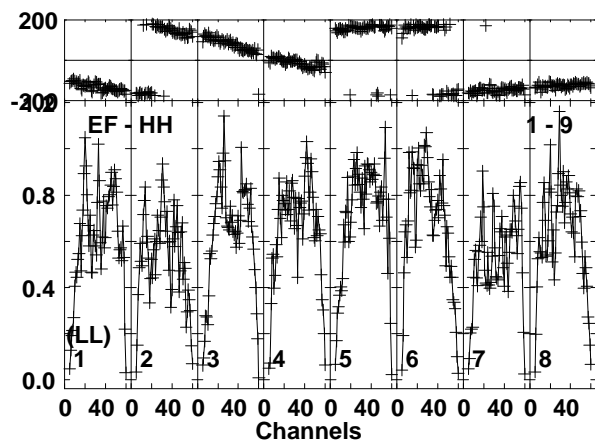
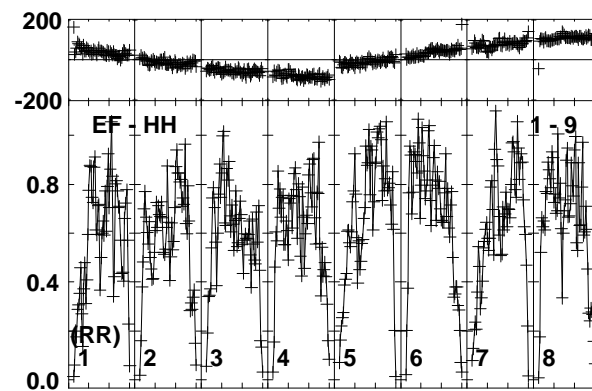
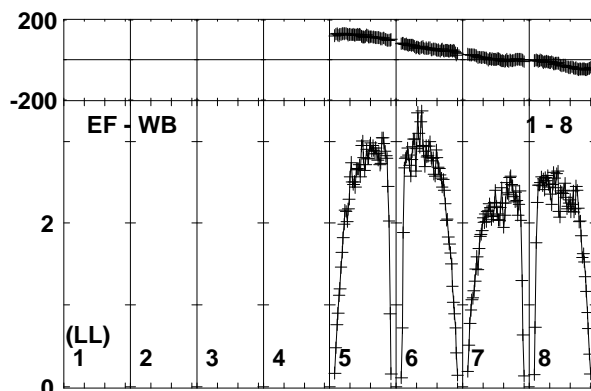
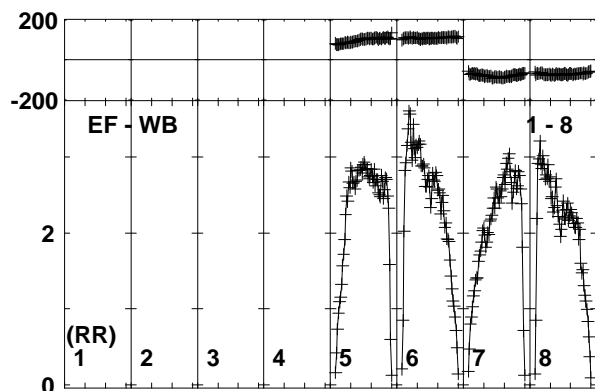
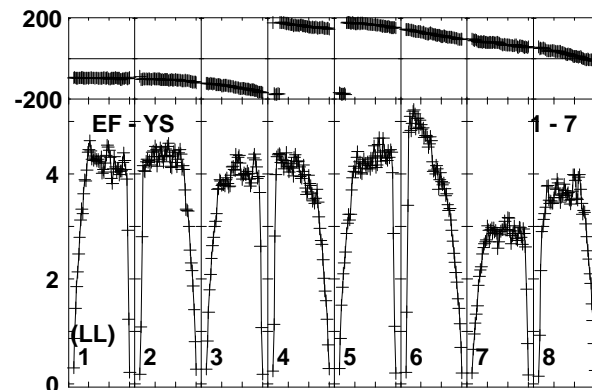
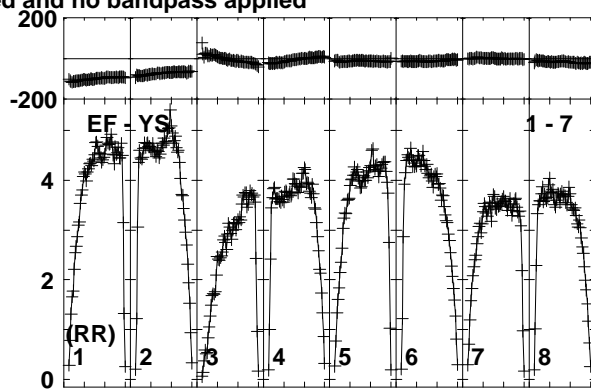
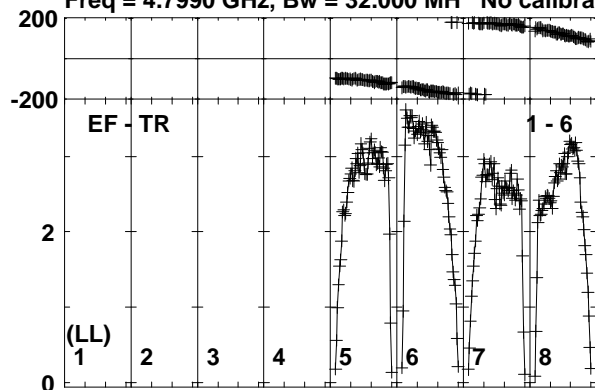

Lower frame: Milli Ampl Jy Top frame: Phas deg
Vector averaged cross-power spectrum Baseline: EF (01) - TR (06)
Timerange: 00/23:29:10 to 00/23:30:09

Plot file version 127 created 21-FEB-2017 15:11:15

J1112+4301 EG096A.UVDATA.1

Freq = 4.7990 GHz, Bw = 32.000 MH No calibration applied and no bandpass applied

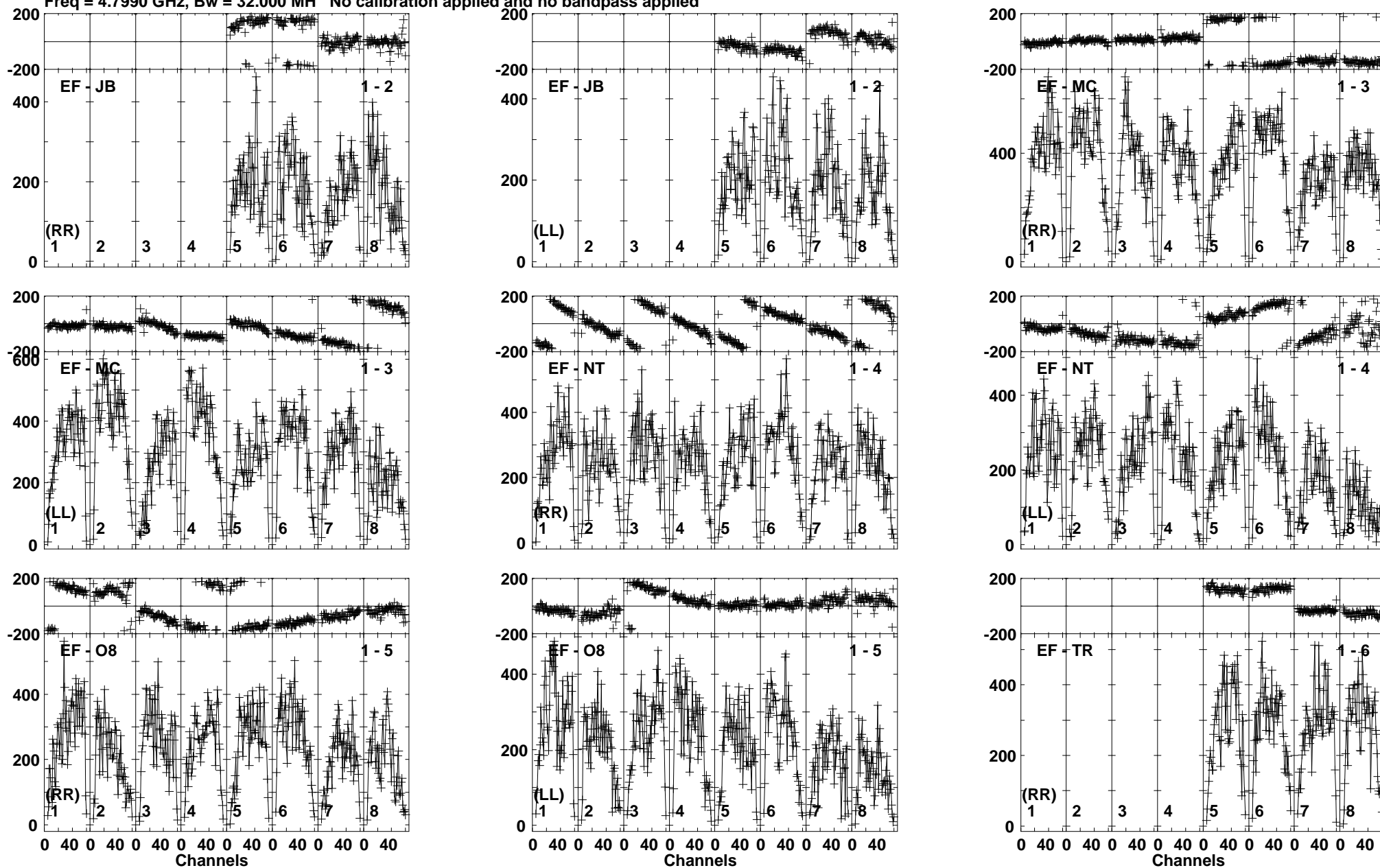

Lower frame: Micro Ampl Jy Top frame: Phas deg
Vector averaged cross-power spectrum Baseline: EF (01) - JB (02)
Timerange: 00/23:30:11 to 00/23:33:40

Plot file version 128 created 21-FEB-2017 15:11:15

J1112+4301 EG096A.UVDATA.1

Freq = 4.7990 GHz, Bw = 32.000 MH No calibration applied and no bandpass applied

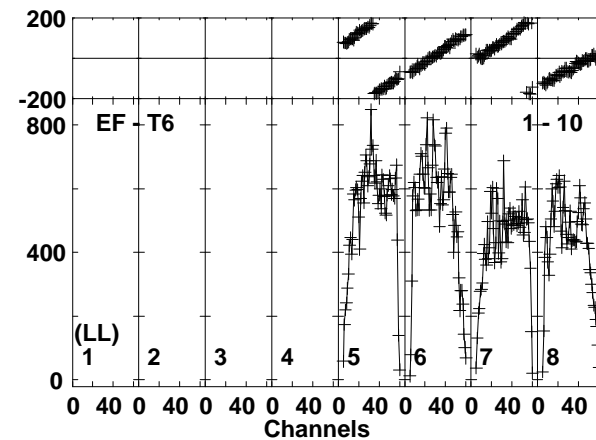
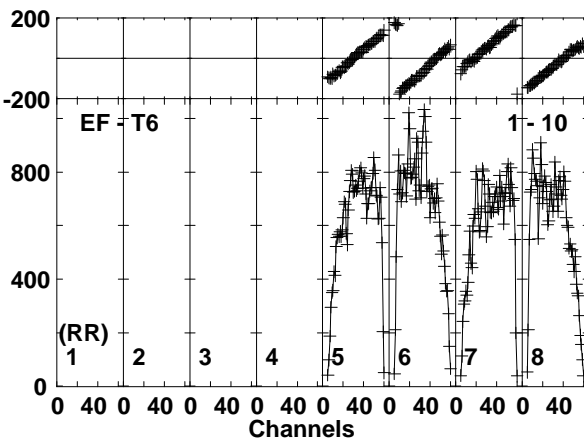
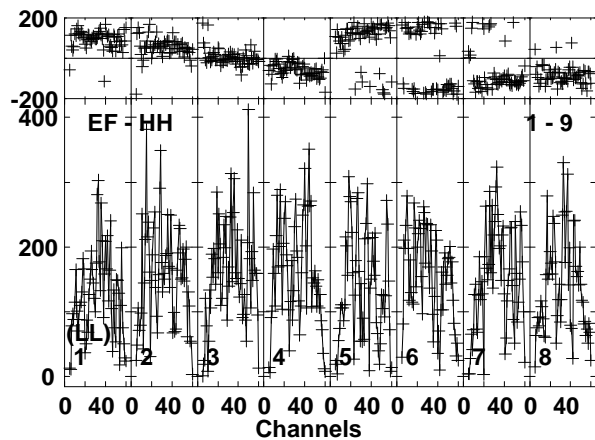
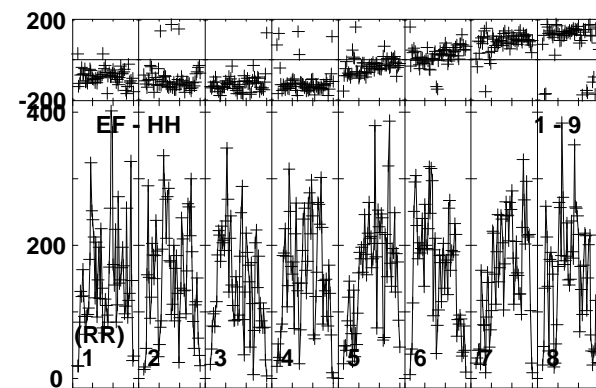
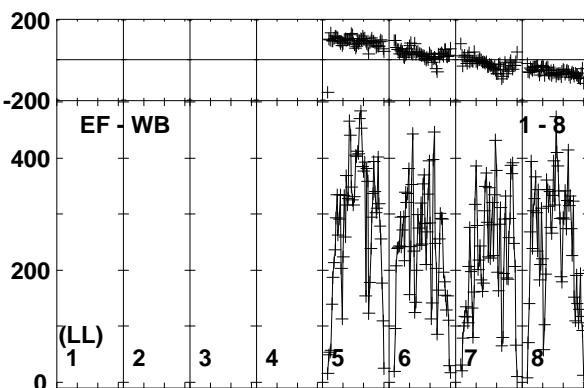
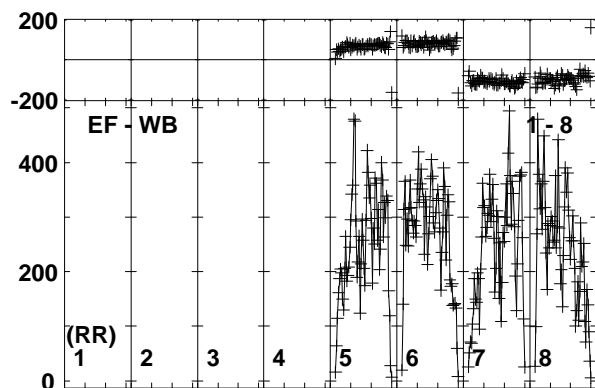
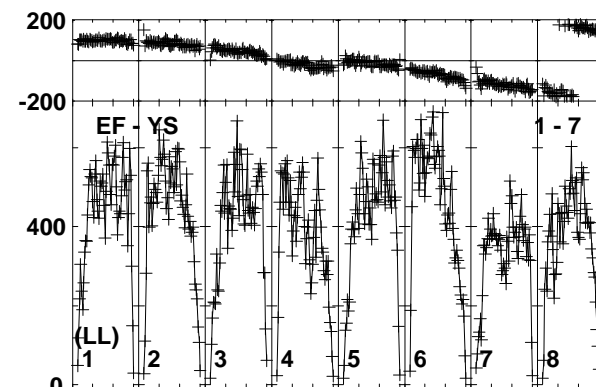
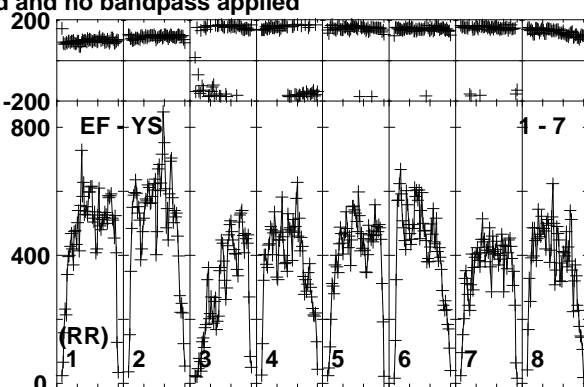
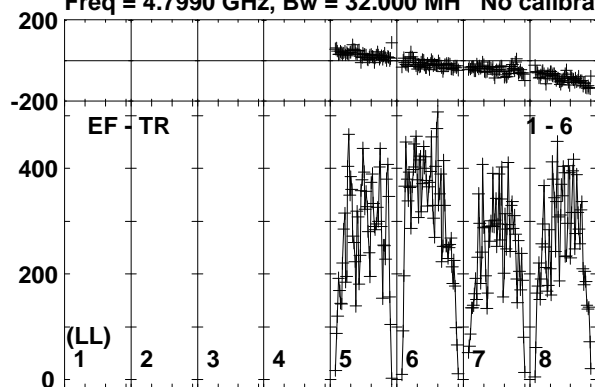

Lower frame: Micro Ampl Jy Top frame: Phas deg
Vector averaged cross-power spectrum Baseline: EF (01) - TR (06)
Timerange: 00/23:30:11 to 00/23:33:40

Plot file version 129 created 21-FEB-2017 15:11:16

J1108+4330 EG096A.UVDATA.1

Freq = 4.7990 GHz, Bw = 32.000 MH No calibration applied and no bandpass applied

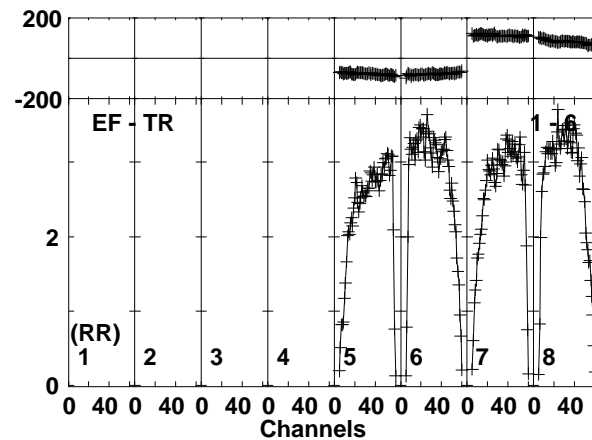
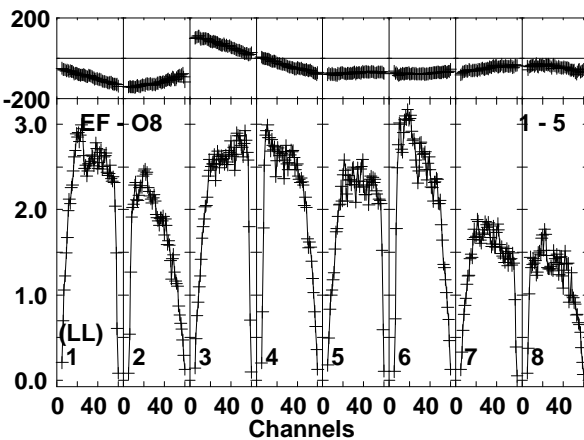
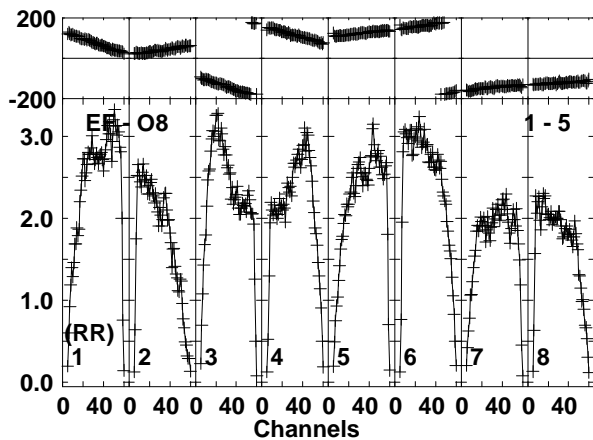
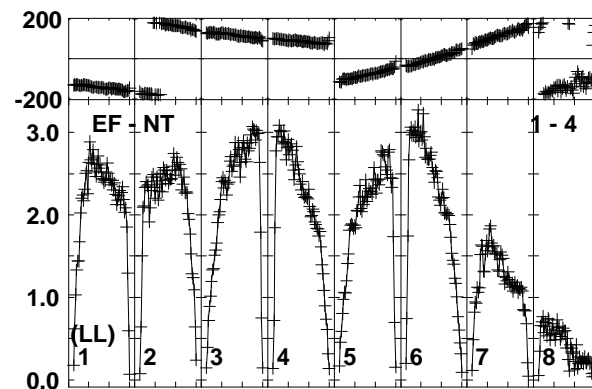
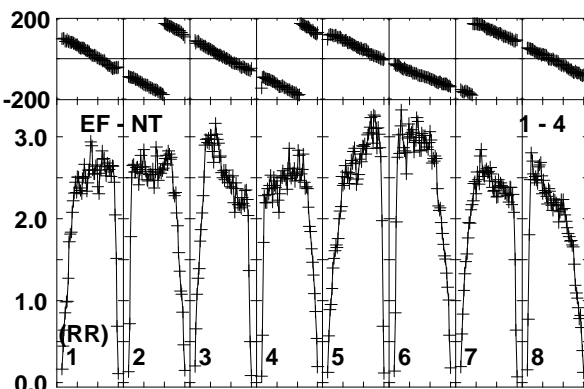
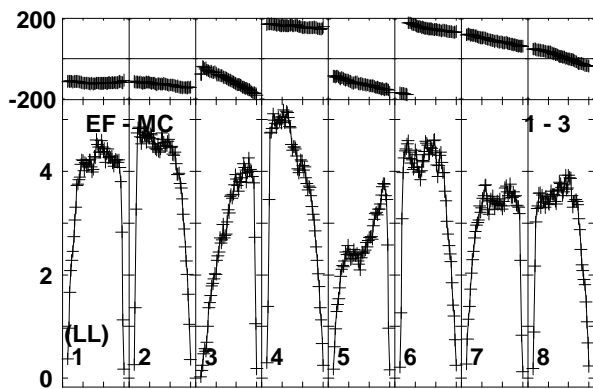
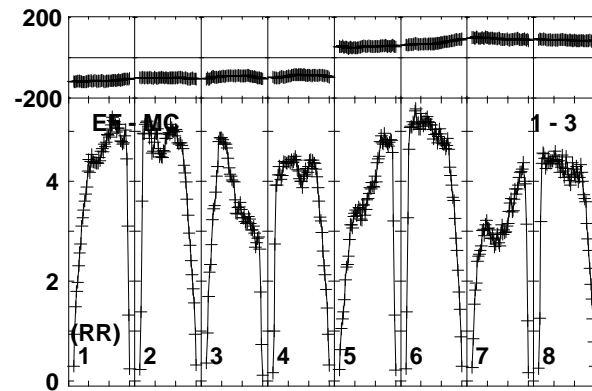
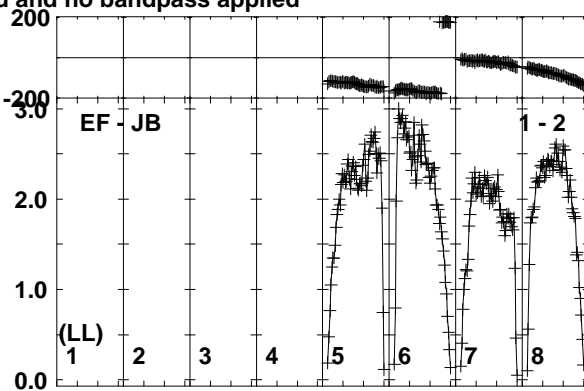
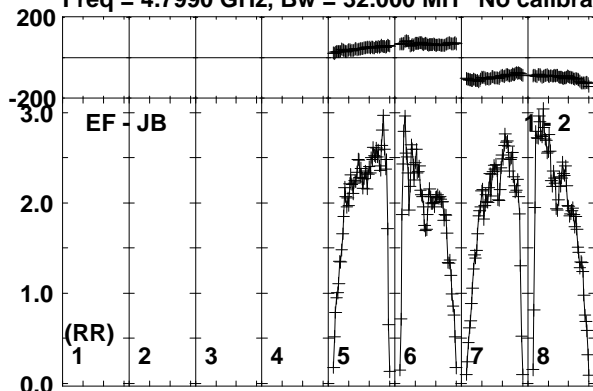

Lower frame: Milli Ampl Jy Top frame: Phas deg
Vector averaged cross-power spectrum Baseline: EF (01) - JB (02)
Timerange: 00/23:33:41 to 00/23:35:09

Plot file version 130 created 21-FEB-2017 15:11:16

J1108+4330 EG096A.UVDATA.1

Freq = 4.7990 GHz, Bw = 32.000 MH No calibration applied and no bandpass applied

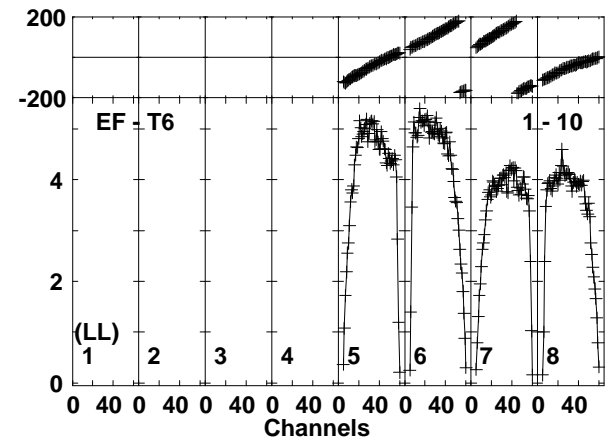
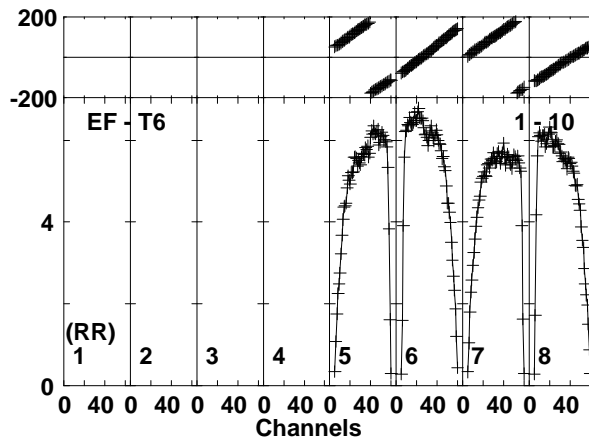
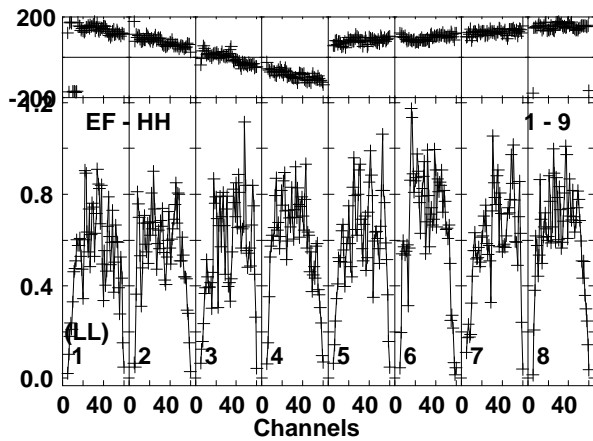
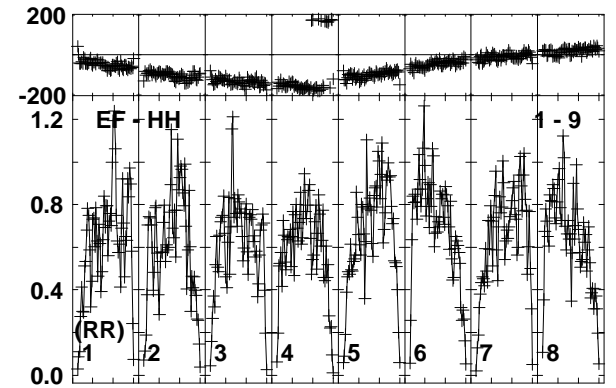
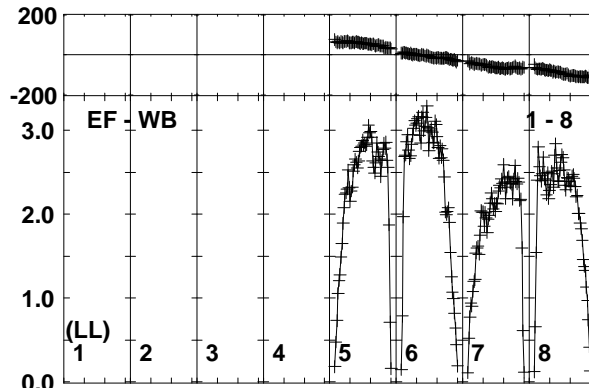
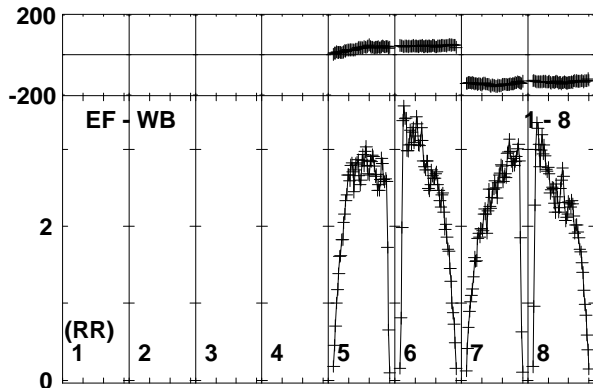
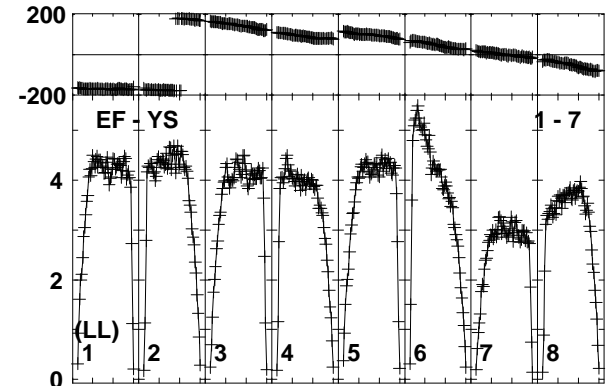
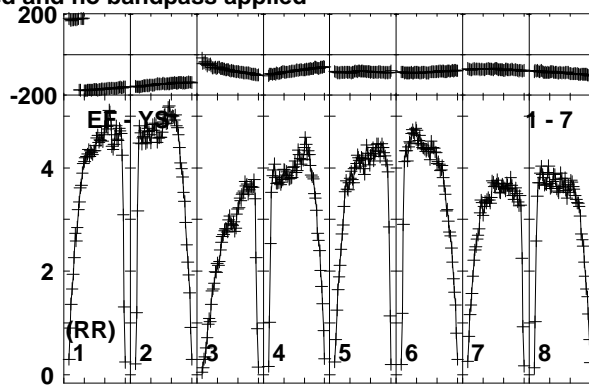
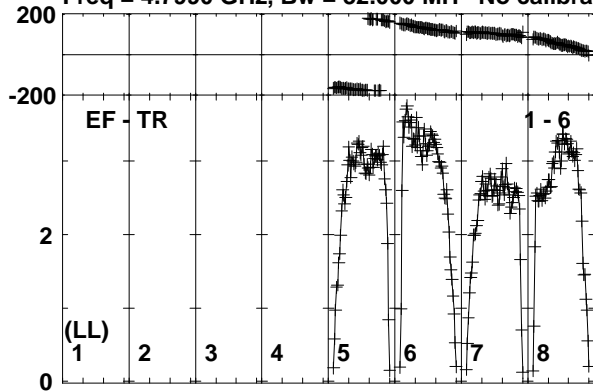

Lower frame: Milli Ampl Jy Top frame: Phas deg
Vector averaged cross-power spectrum Baseline: EF (01) - TR (06)
Timerange: 00/23:33:41 to 00/23:35:09

Plot file version 131 created 21-FEB-2017 15:11:16

ARUMA EG096A.UVDATA.1

Freq = 4.7990 GHz, Bw = 32.000 MH No calibration applied and no bandpass applied

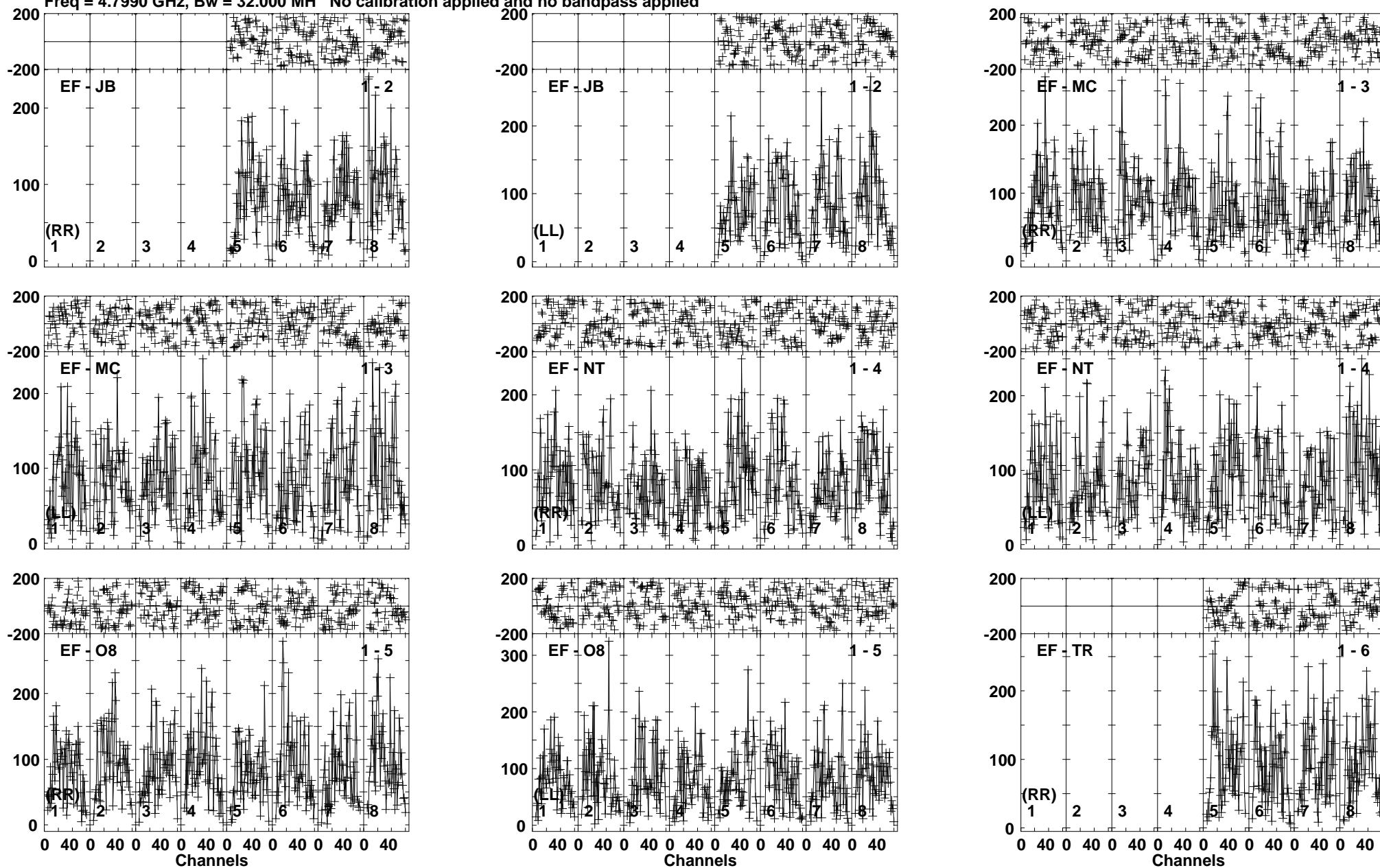

Lower frame: Micro Ampl Jy Top frame: Phas deg
Vector averaged cross-power spectrum Baseline: EF (01) - JB (02)
Timerange: 00/23:35:11 to 00/23:38:40

Plot file version 132 created 21-FEB-2017 15:11:17

ARUMA EG096A.UVDATA.1

Freq = 4.7990 GHz, Bw = 32.000 MH No calibration applied and no bandpass applied

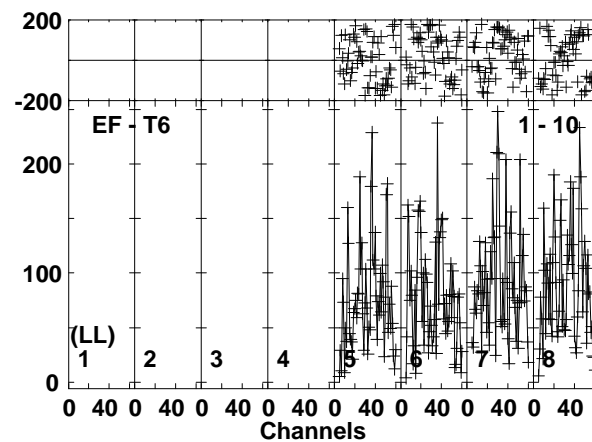
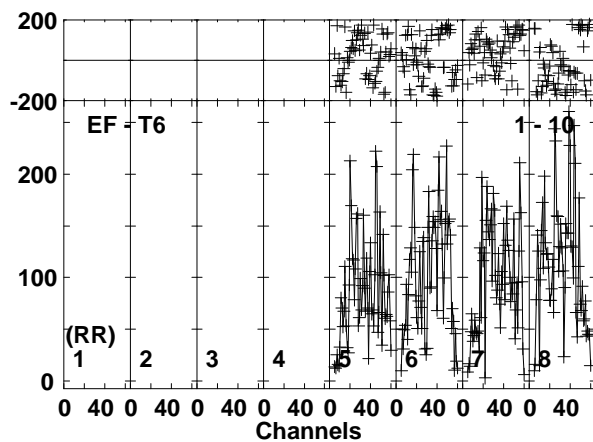
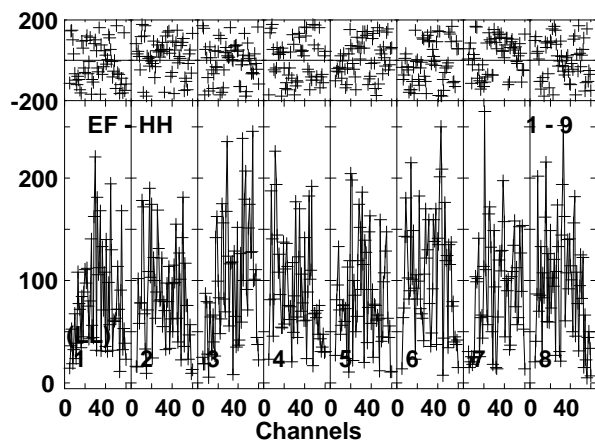
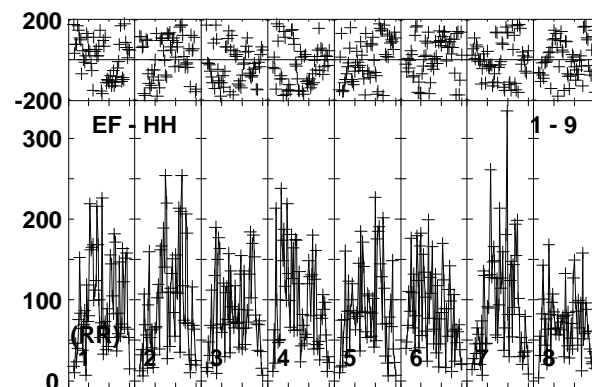
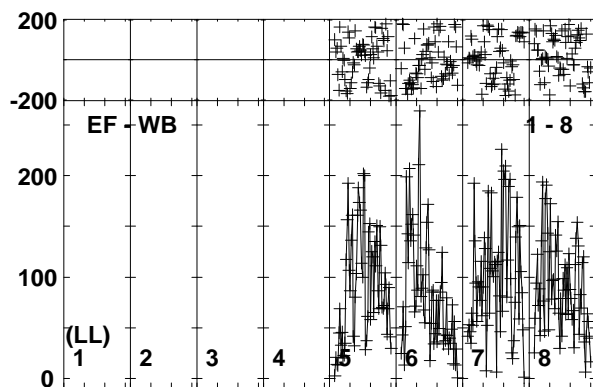
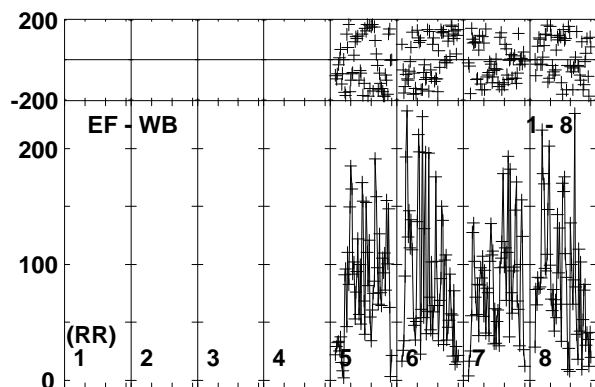
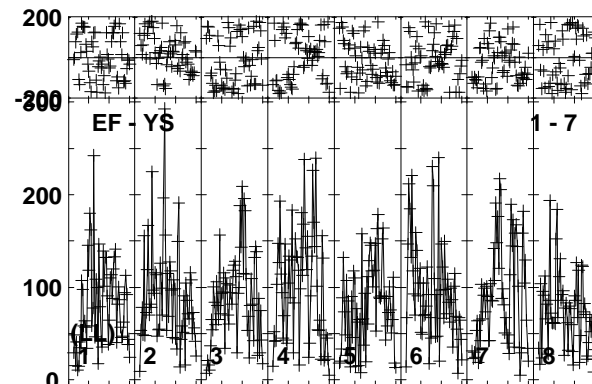
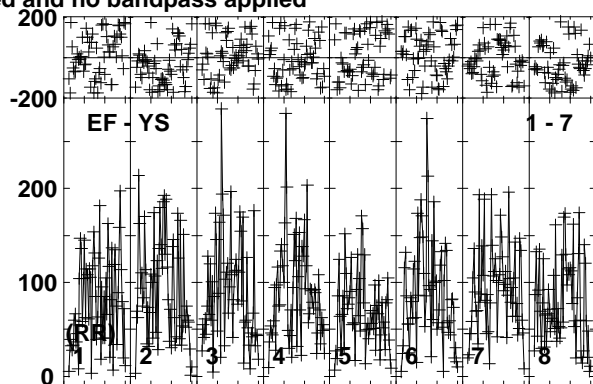
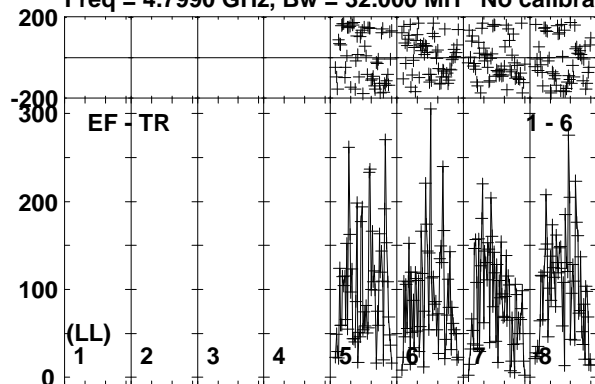

Lower frame: Micro Ampl Jy Top frame: Phas deg
Vector averaged cross-power spectrum Baseline: EF (01) - TR (06)
Timerange: 00/23:35:11 to 00/23:38:40

Plot file version 133 created 21-FEB-2017 15:11:17

J1108+4330 EG096A.UVDATA.1

Freq = 4.7990 GHz, Bw = 32.000 MH No calibration applied and no bandpass applied

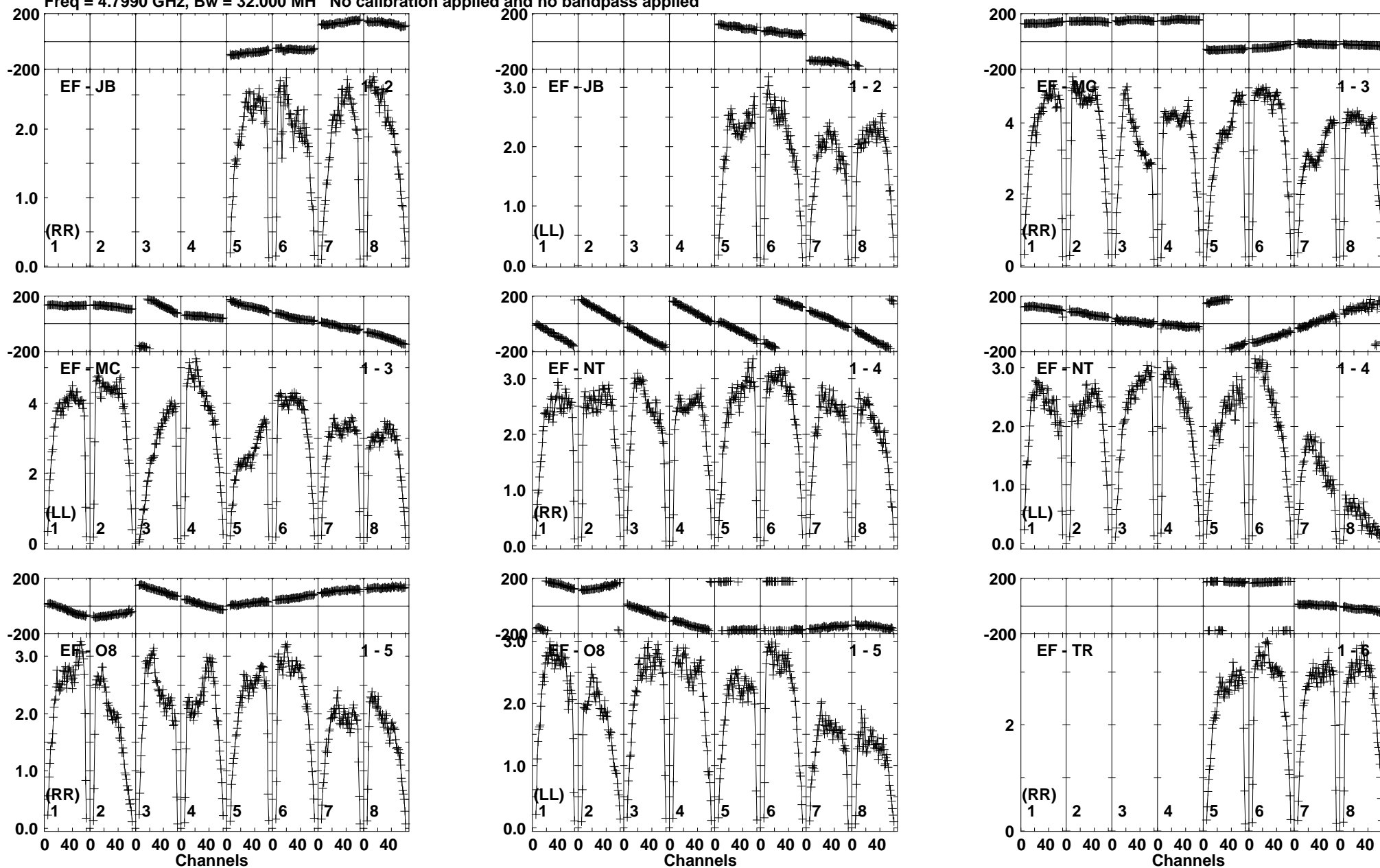

Lower frame: Milli Ampl Jy Top frame: Phas deg
Vector averaged cross-power spectrum Baseline: EF (01) - JB (02)
Timerange: 00/23:39:21 to 00/23:40:20

Plot file version 134 created 21-FEB-2017 15:11:17

J1108+4330 EG096A.UVDATA.1

Freq = 4.7990 GHz, Bw = 32.000 MH No calibration applied and no bandpass applied

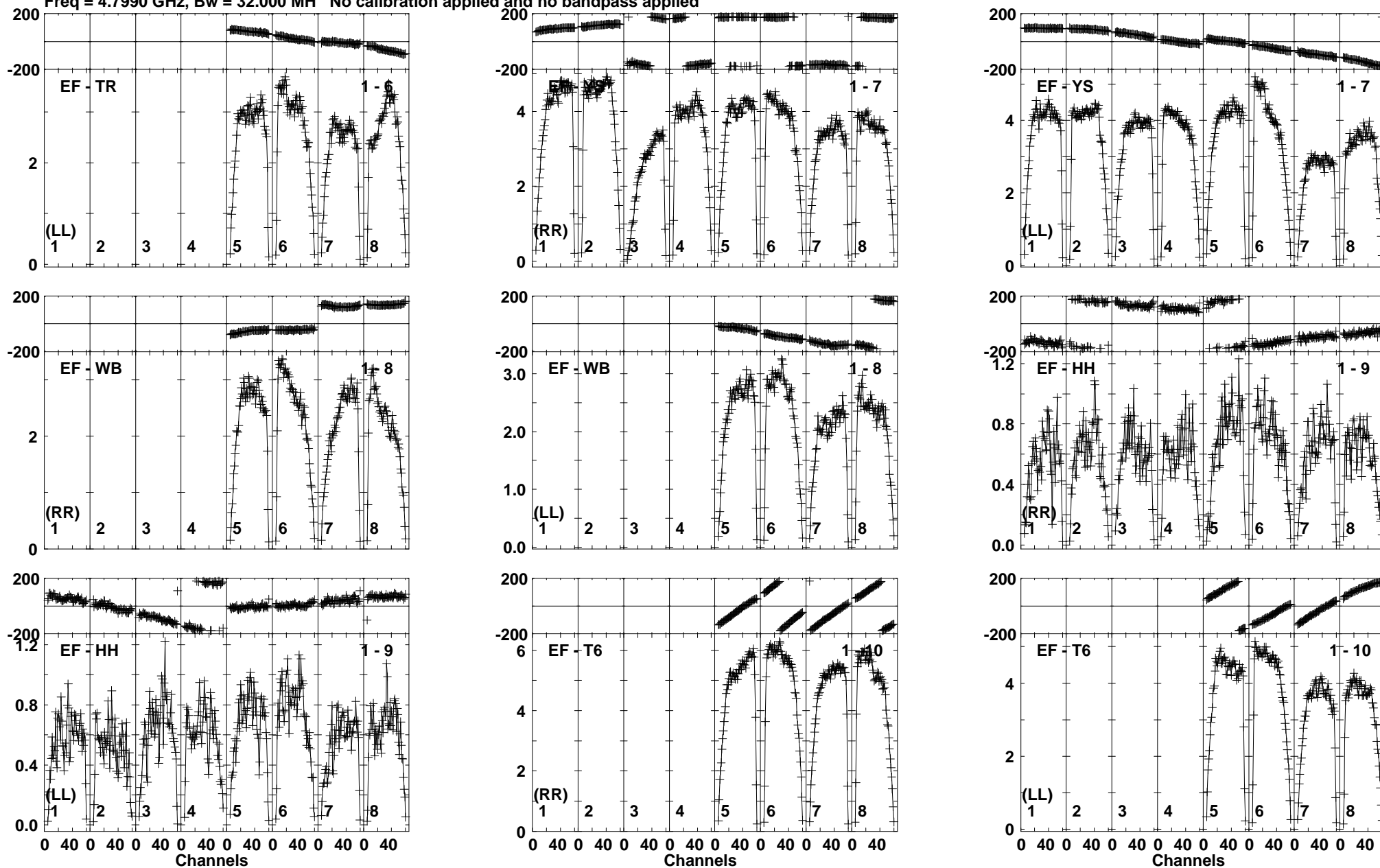

Lower frame: Milli Ampl Jy Top frame: Phas deg
Vector averaged cross-power spectrum Baseline: EF (01) - TR (06)
Timerange: 00/23:39:21 to 00/23:40:20

Plot file version 135 created 21-FEB-2017 15:11:17

ARUMA EG096A.UVDATA.1

Freq = 4.7990 GHz, Bw = 32.000 MH No calibration applied and no bandpass applied

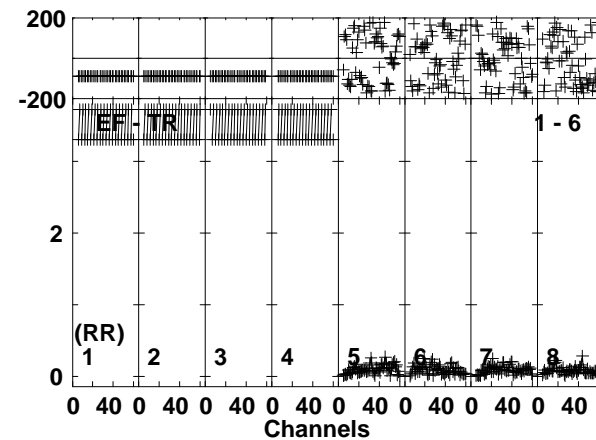
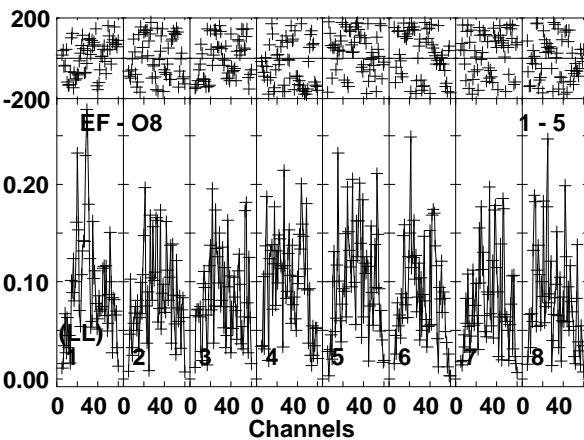
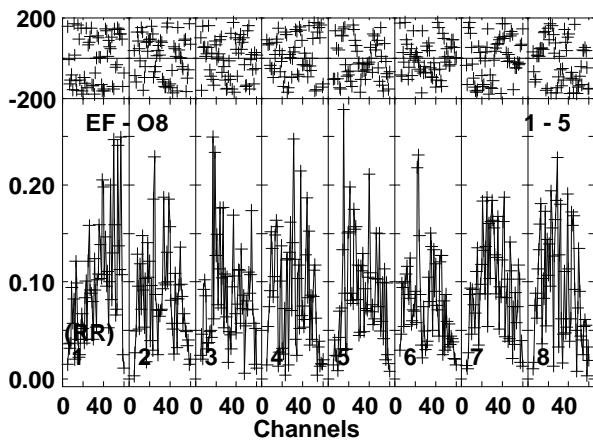
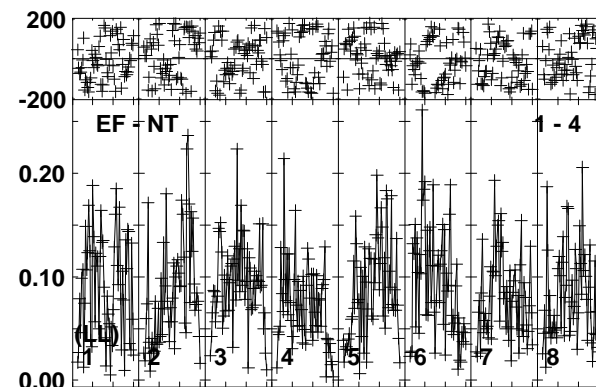
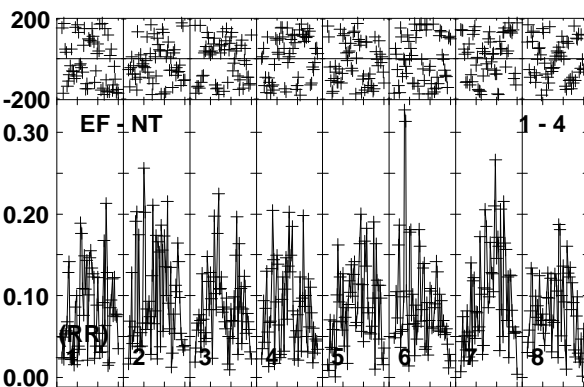
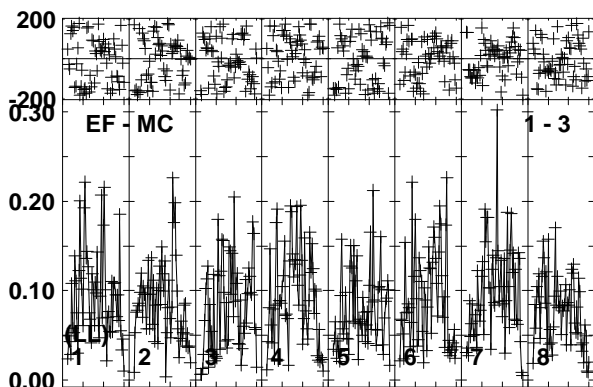
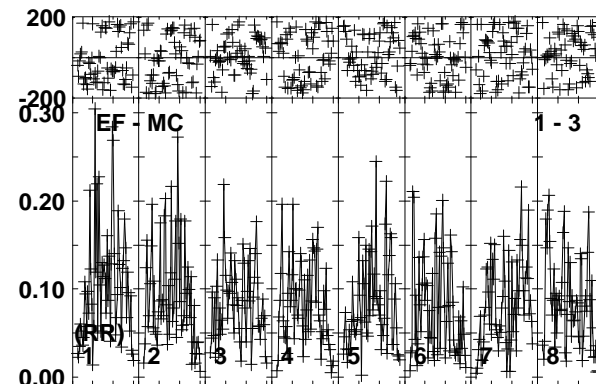
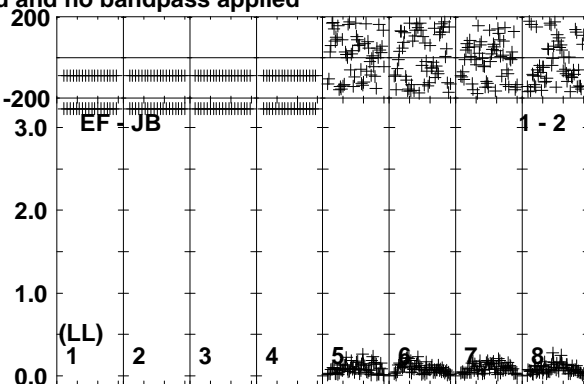
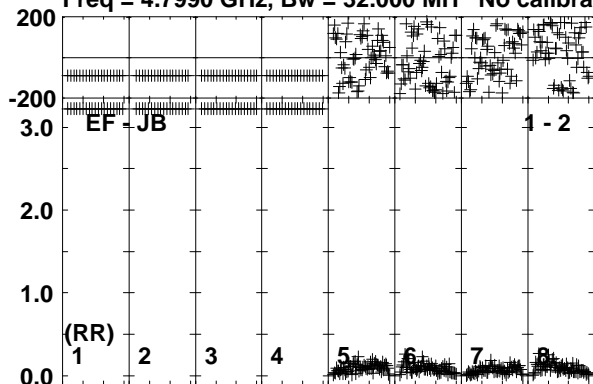

Lower frame: Milli Ampl Jy Top frame: Phas deg
Vector averaged cross-power spectrum Baseline: EF (01) - JB (02)
Timerange: 00/23:40:21 to 00/23:43:50

Plot file version 136 created 21-FEB-2017 15:11:18

ARUMA EG096A.UVDATA.1

Freq = 4.7990 GHz, Bw = 32.000 MH No calibration applied and no bandpass applied

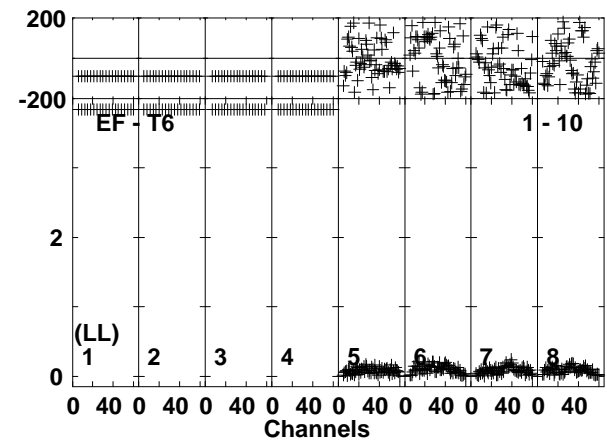
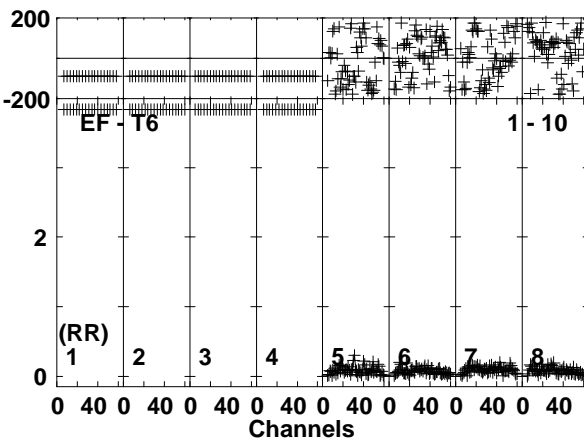
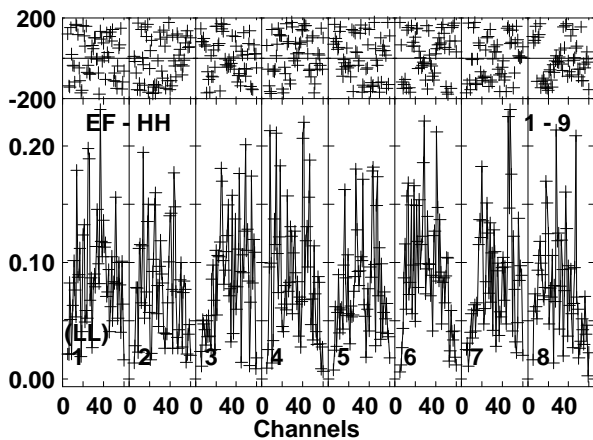
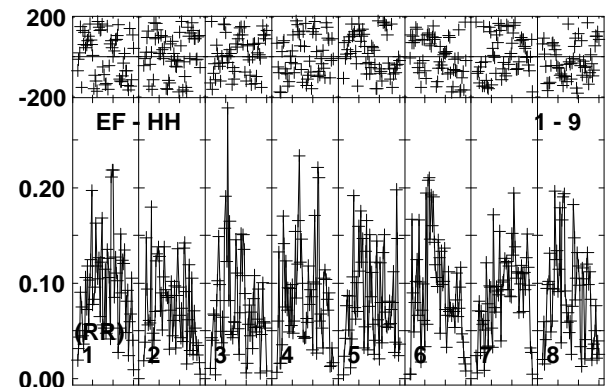
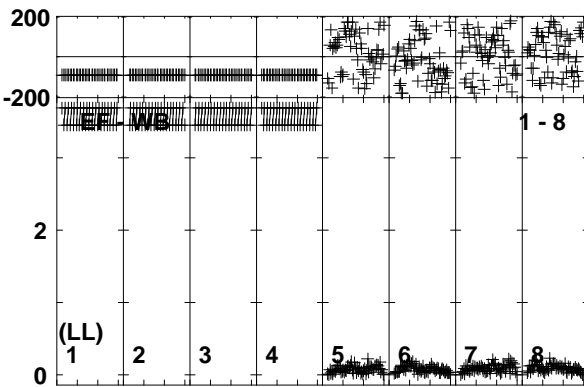
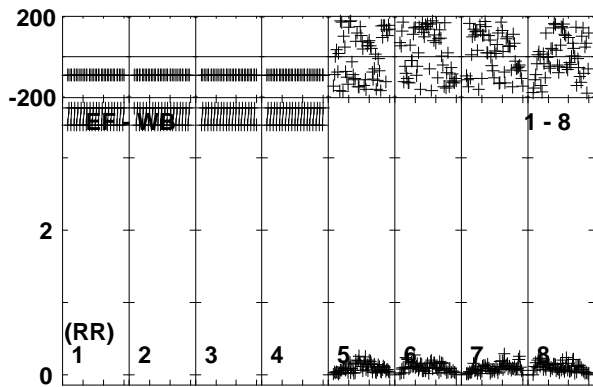
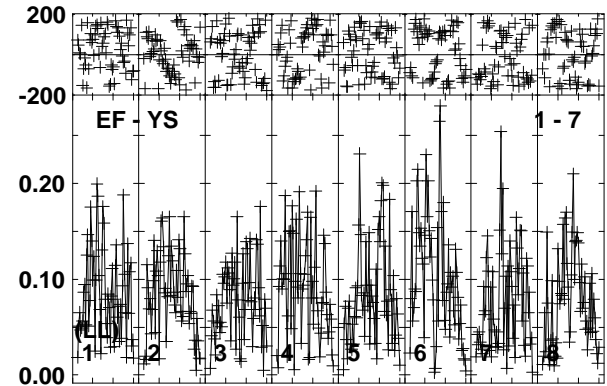
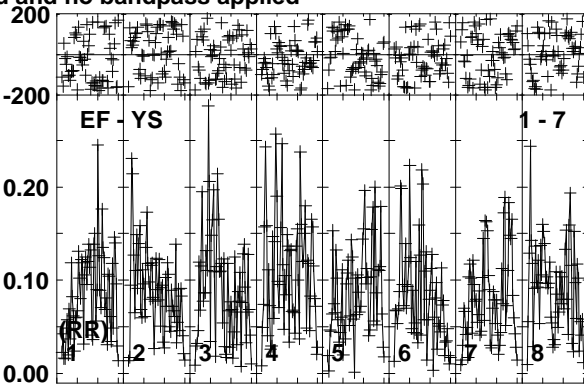
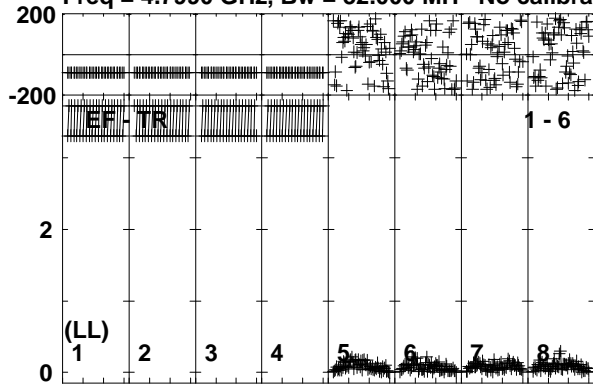

Lower frame: Milli Ampl Jy Top frame: Phas deg
Vector averaged cross-power spectrum Baseline: EF (01) - TR (06)
Timerange: 00/23:40:21 to 00/23:43:50

Plot file version 137 created 21-FEB-2017 15:11:18

J1108+4330 EG096A.UVDATA.1

Freq = 4.7990 GHz, Bw = 32.000 MH No calibration applied and no bandpass applied

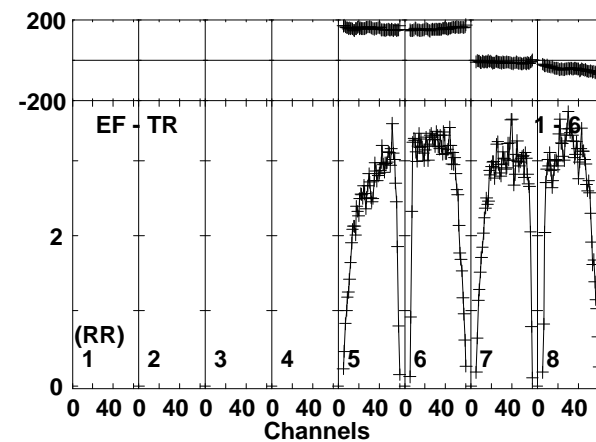
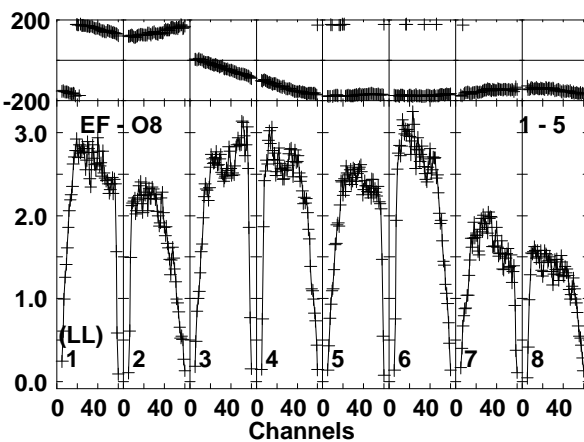
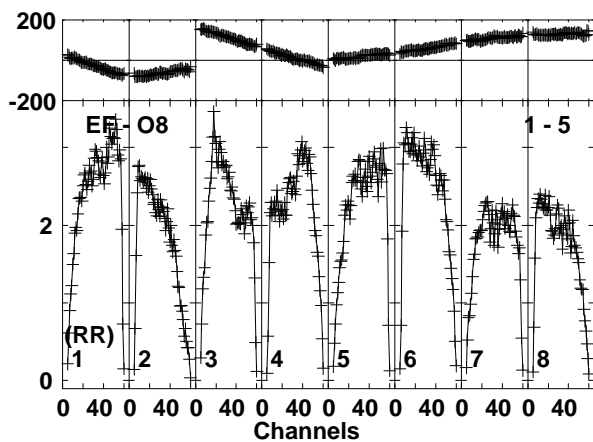
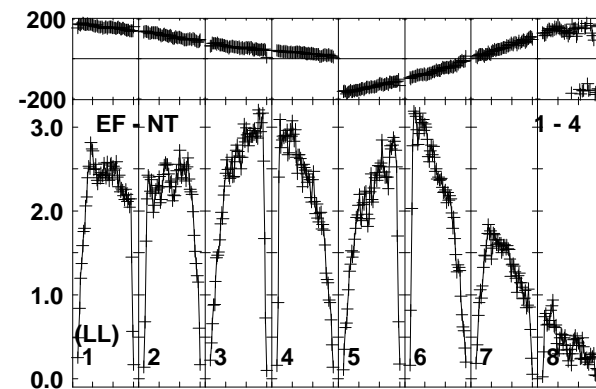
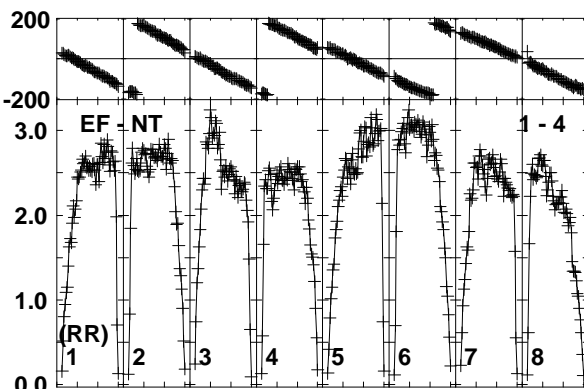
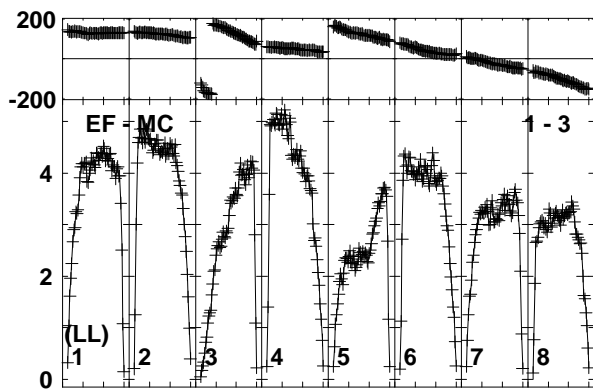
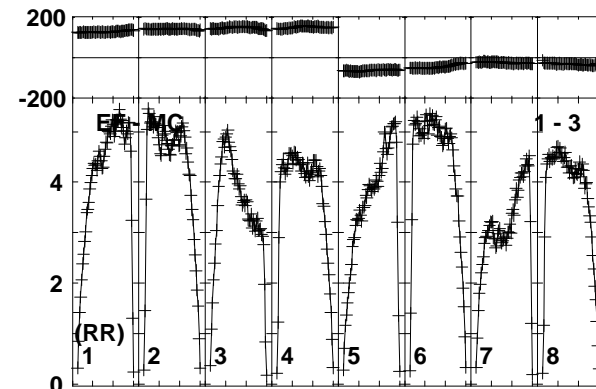
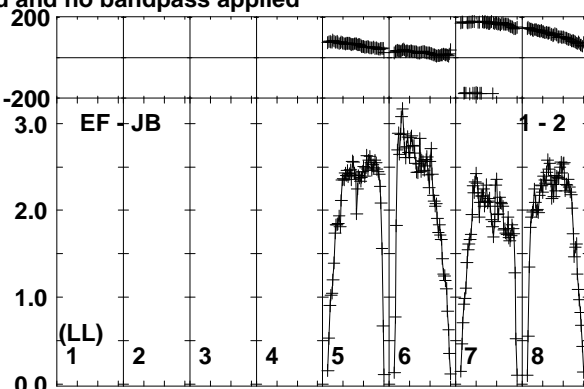
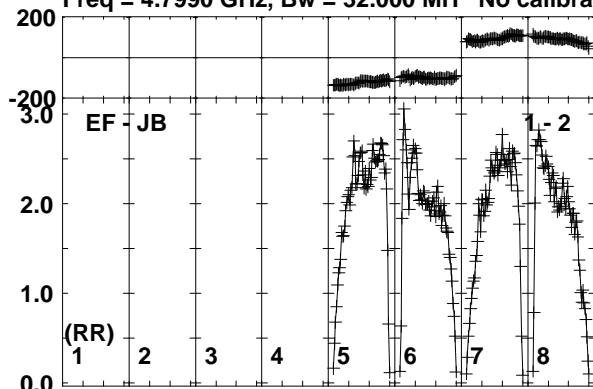

Lower frame: Milli Ampl Jy Top frame: Phas deg
Vector averaged cross-power spectrum Baseline: EF (01) - JB (02)
Timerange: 00/23:43:50 to 00/23:45:20

Plot file version 138 created 21-FEB-2017 15:11:18

J1108+4330 EG096A.UVDATA.1

Freq = 4.7990 GHz, Bw = 32.000 MH No calibration applied and no bandpass applied

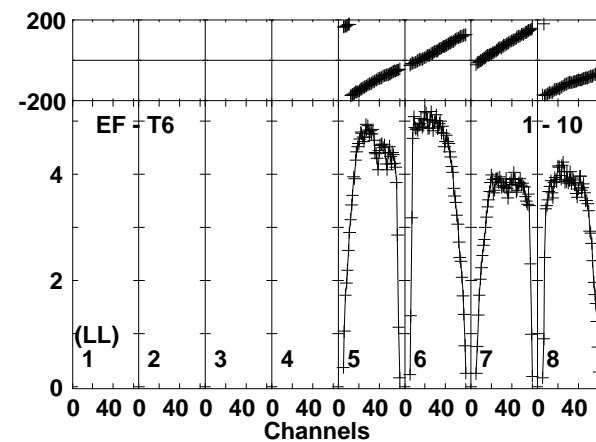
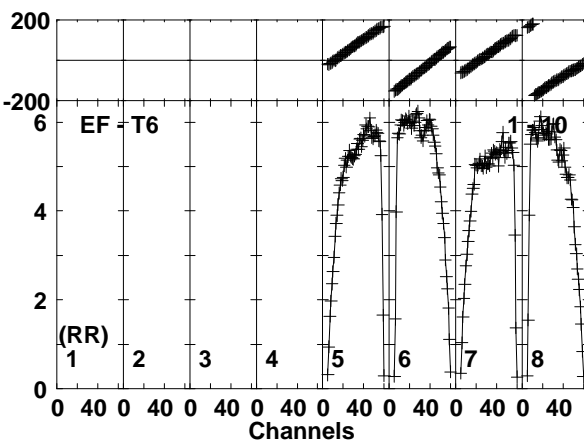
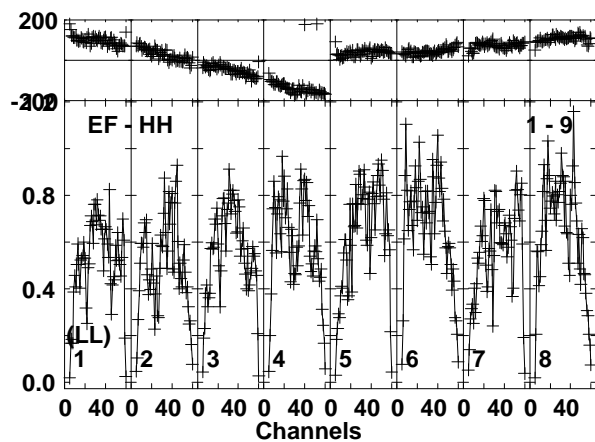
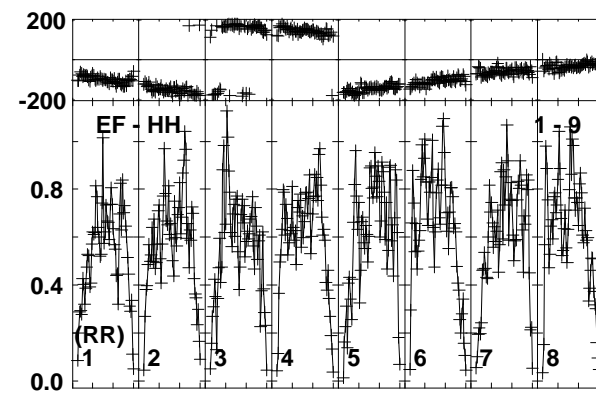
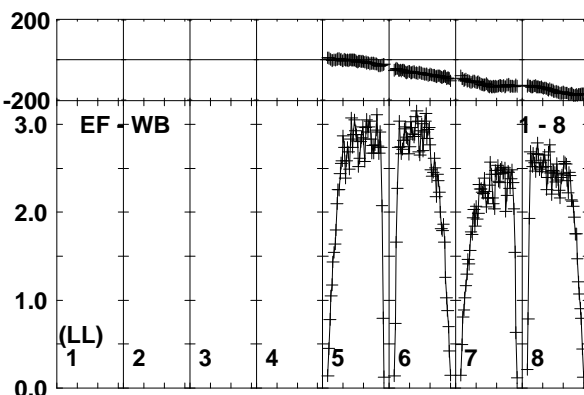
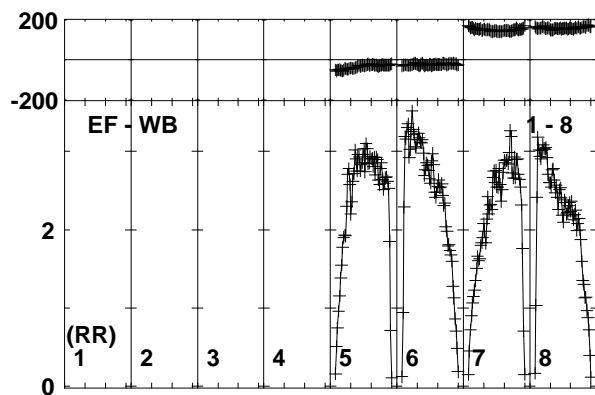
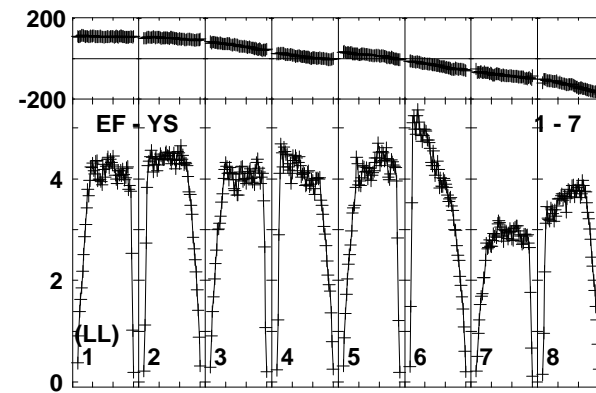
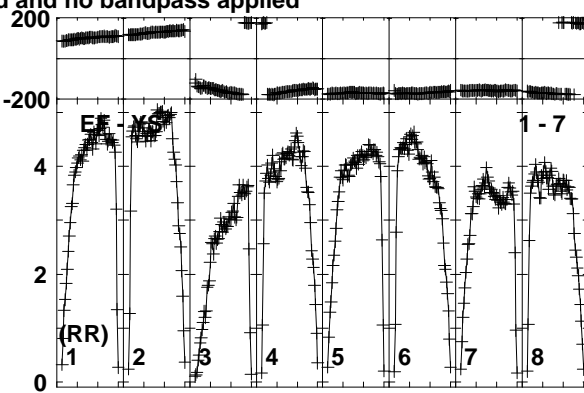
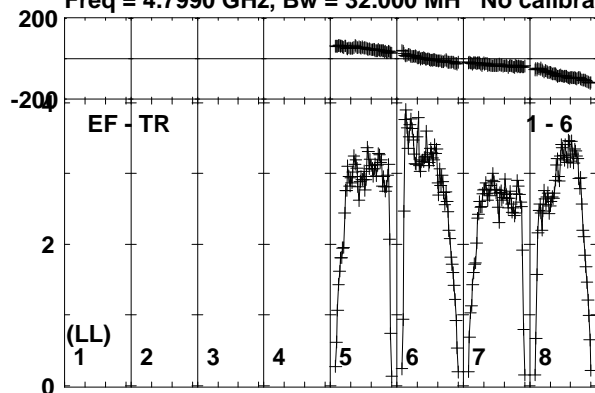

Lower frame: Milli Ampl Jy Top frame: Phas deg
Vector averaged cross-power spectrum Baseline: EF (01) - TR (06)
Timerange: 00/23:43:50 to 00/23:45:20

Plot file version 139 created 21-FEB-2017 15:11:19

ARUMA EG096A.UVDATA.1

Freq = 4.7990 GHz, Bw = 32.000 MH No calibration applied and no bandpass applied

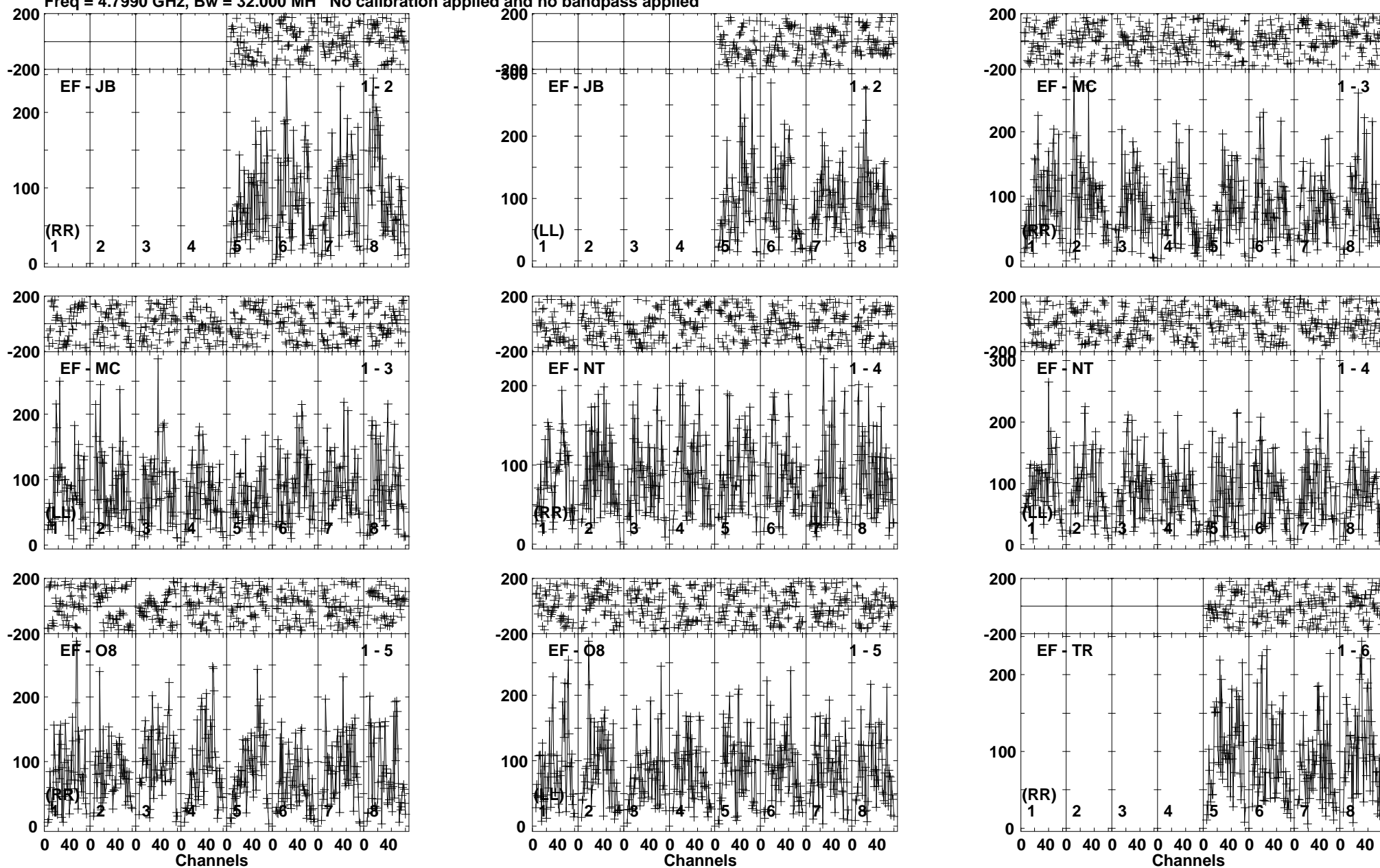

Lower frame: Micro Ampl Jy Top frame: Phas deg
Vector averaged cross-power spectrum Baseline: EF (01) - JB (02)
Timerange: 00/23:45:21 to 00/23:48:50

Plot file version 140 created 21-FEB-2017 15:11:19

ARUMA EG096A.UVDATA.1

Freq = 4.7990 GHz, Bw = 32.000 MH No calibration applied and no bandpass applied

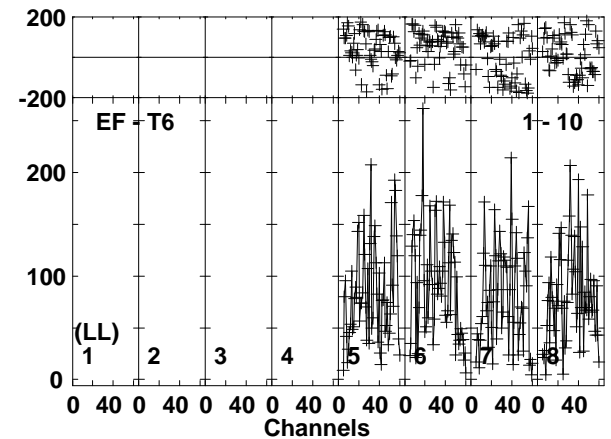
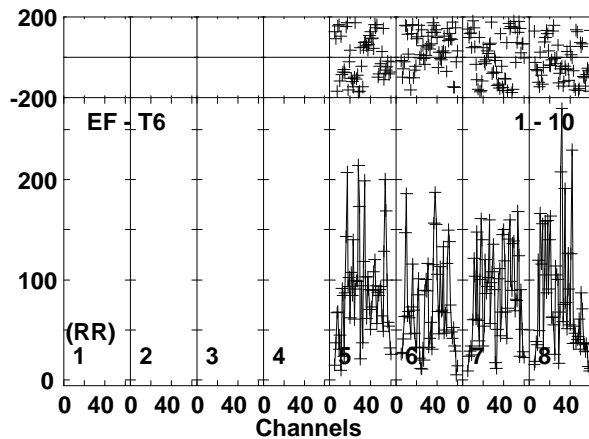
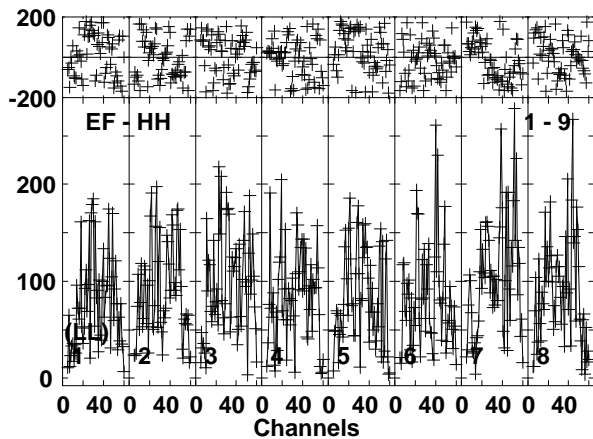
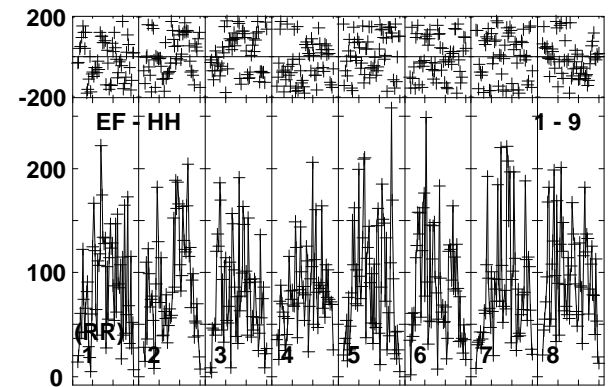
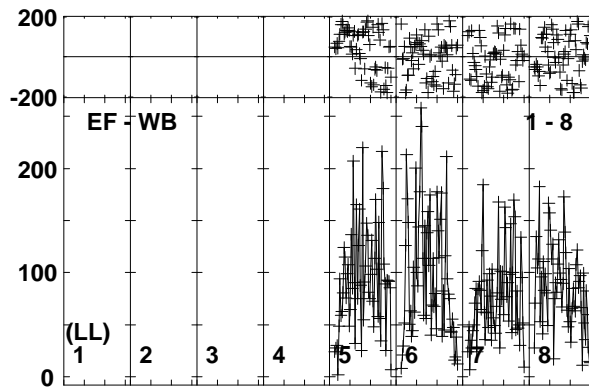
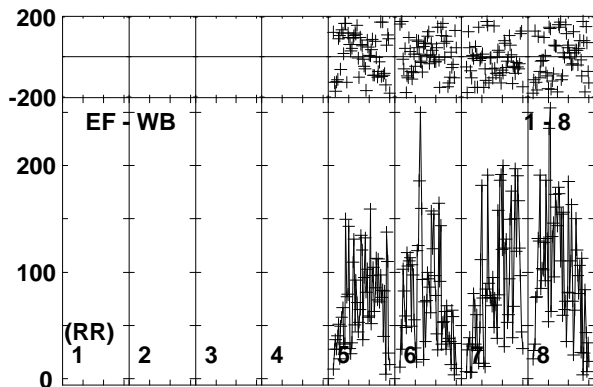
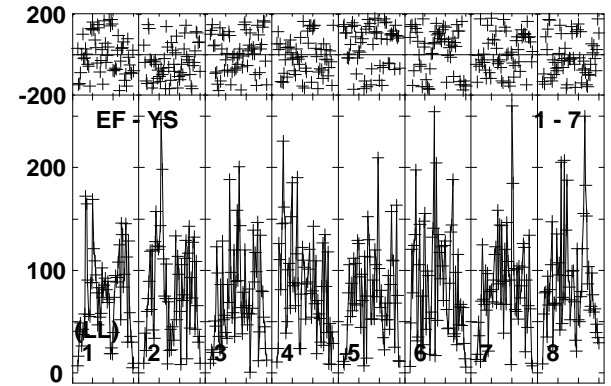
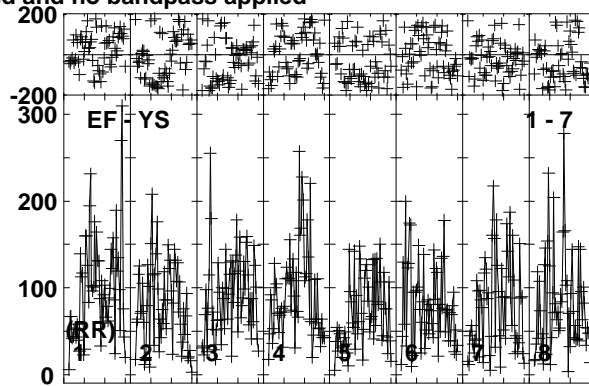
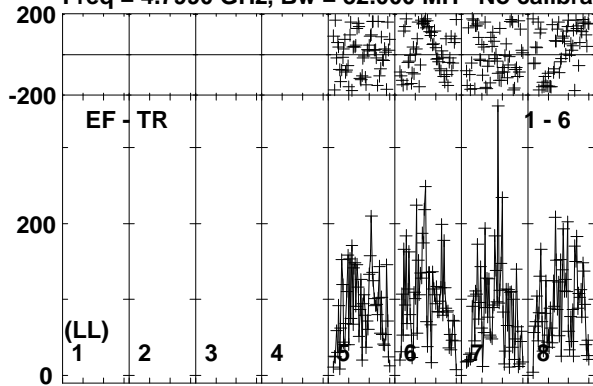

Lower frame: Micro Ampl Jy Top frame: Phas deg
Vector averaged cross-power spectrum Baseline: EF (01) - TR (06)
Timerange: 00/23:45:21 to 00/23:48:50

Plot file version 141 created 21-FEB-2017 15:11:19

J1108+4330 EG096A.UVDATA.1

Freq = 4.7990 GHz, Bw = 32.000 MH No calibration applied and no bandpass applied

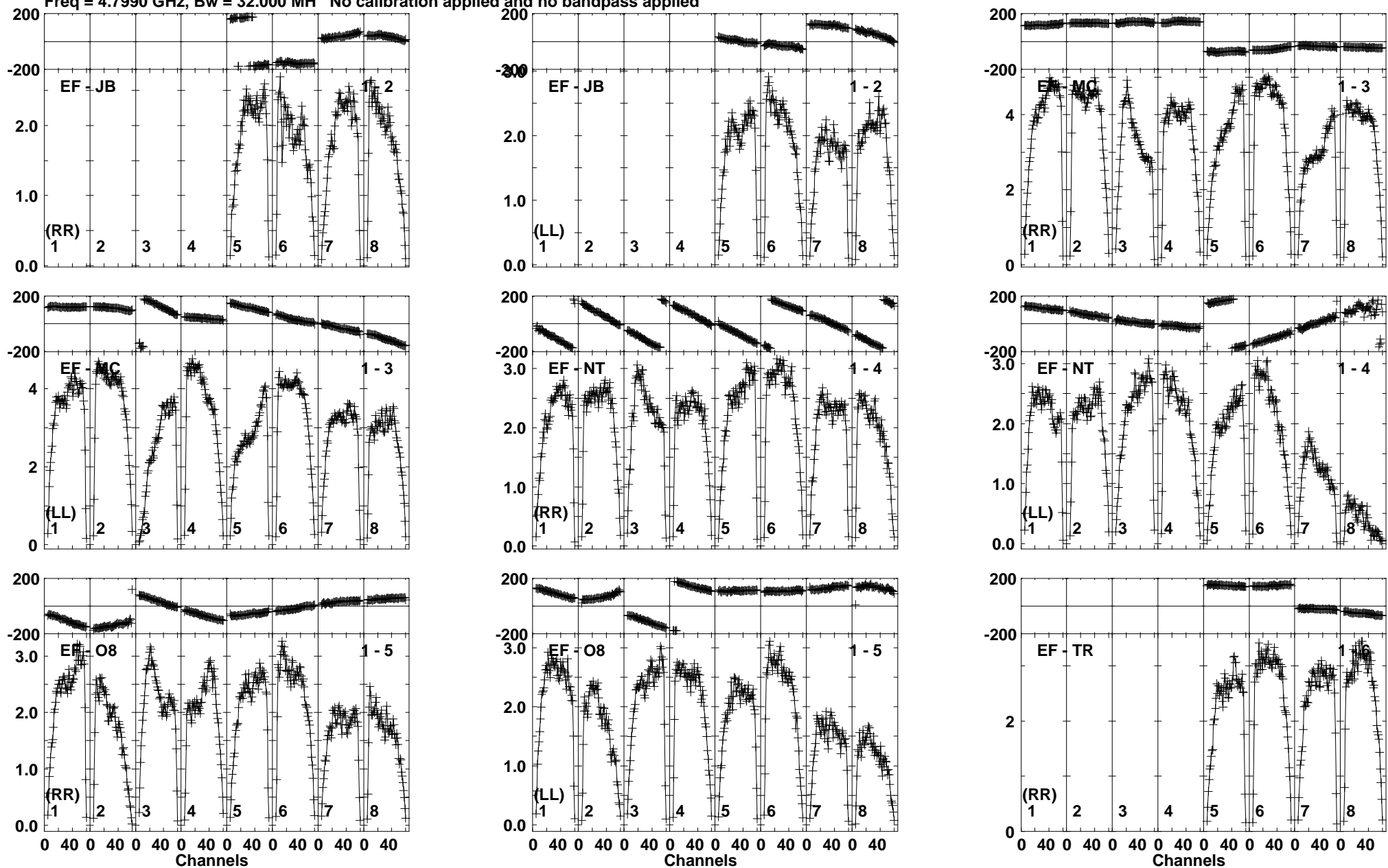

Lower frame: Milli Ampl Jy Top frame: Phas deg
Vector averaged cross-power spectrum Baseline: EF (01) - JB (02)
Timerange: 00/23:49:31 to 00/23:50:30

Plot file version 142 created 21-FEB-2017 15:11:19

J1108+4330 EG096A.UVDATA.1

Freq = 4.7990 GHz, Bw = 32.000 MH No calibration applied and no bandpass applied

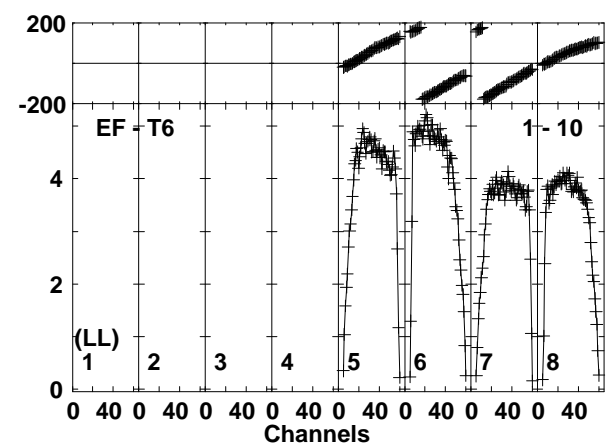
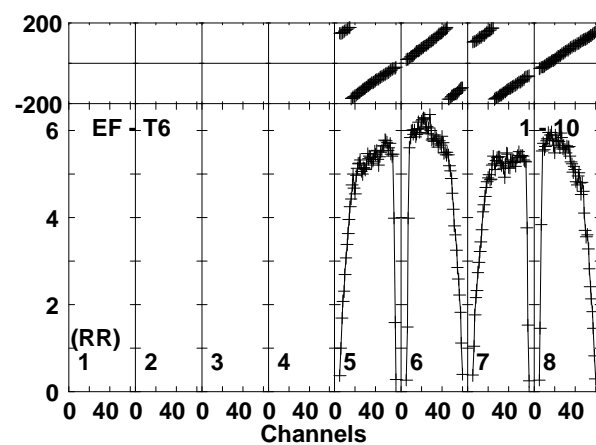
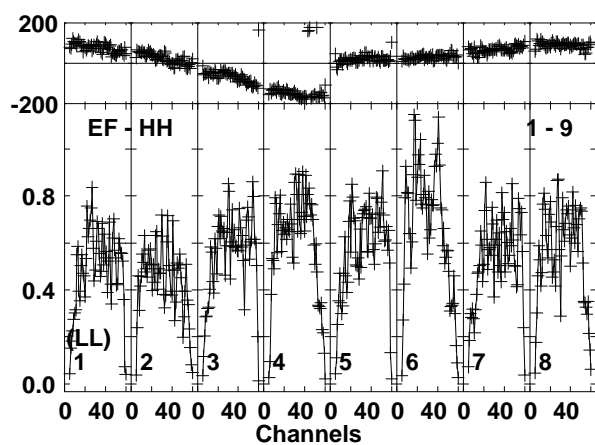
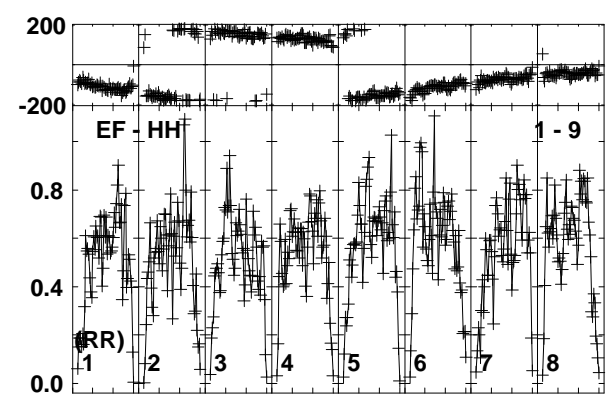
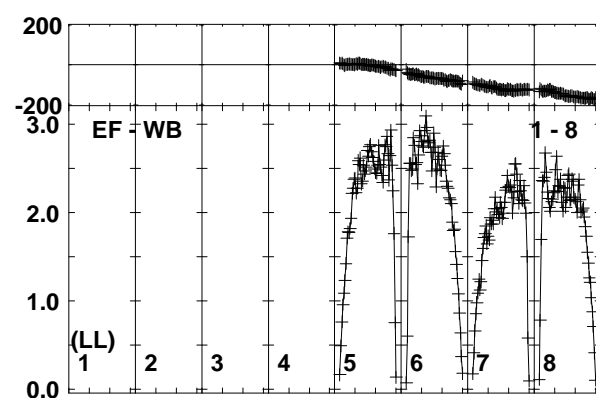
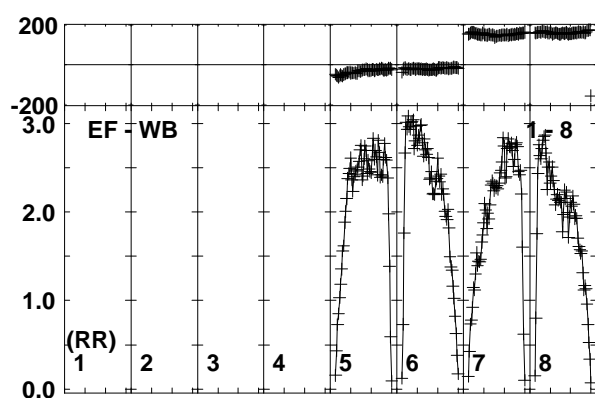
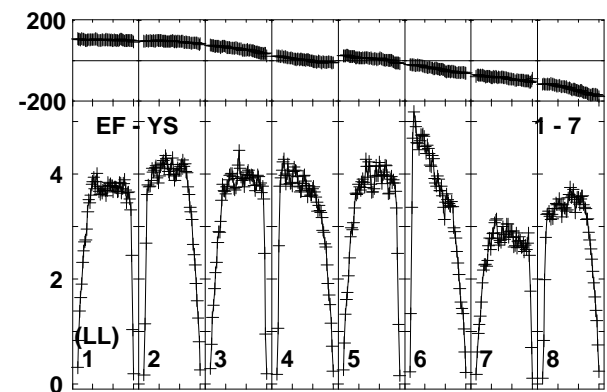
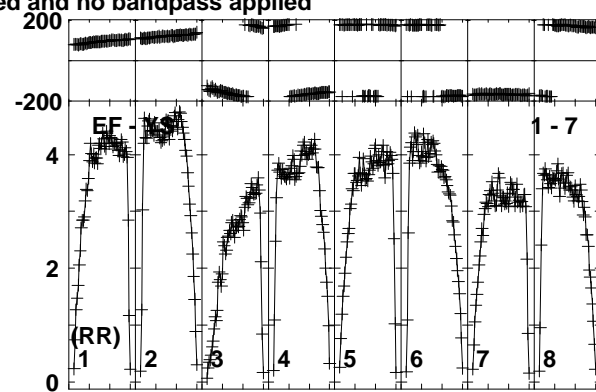
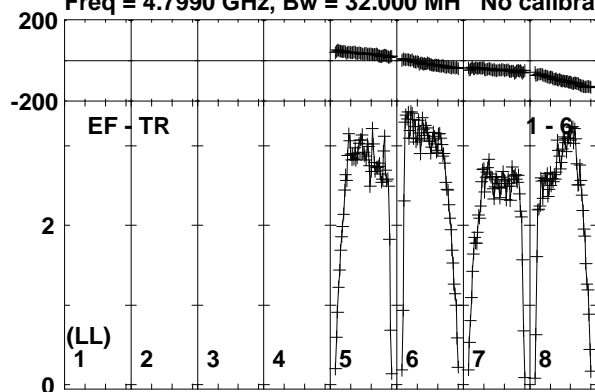

Lower frame: Milli Ampl Jy Top frame: Phas deg
Vector averaged cross-power spectrum Baseline: EF (01) - TR (06)
Timerange: 00/23:49:31 to 00/23:50:30

Plot file version 143 created 21-FEB-2017 15:11:20

ARUMA EG096A.UVDATA.1

Freq = 4.7990 GHz, Bw = 32.000 MH No calibration applied and no bandpass applied

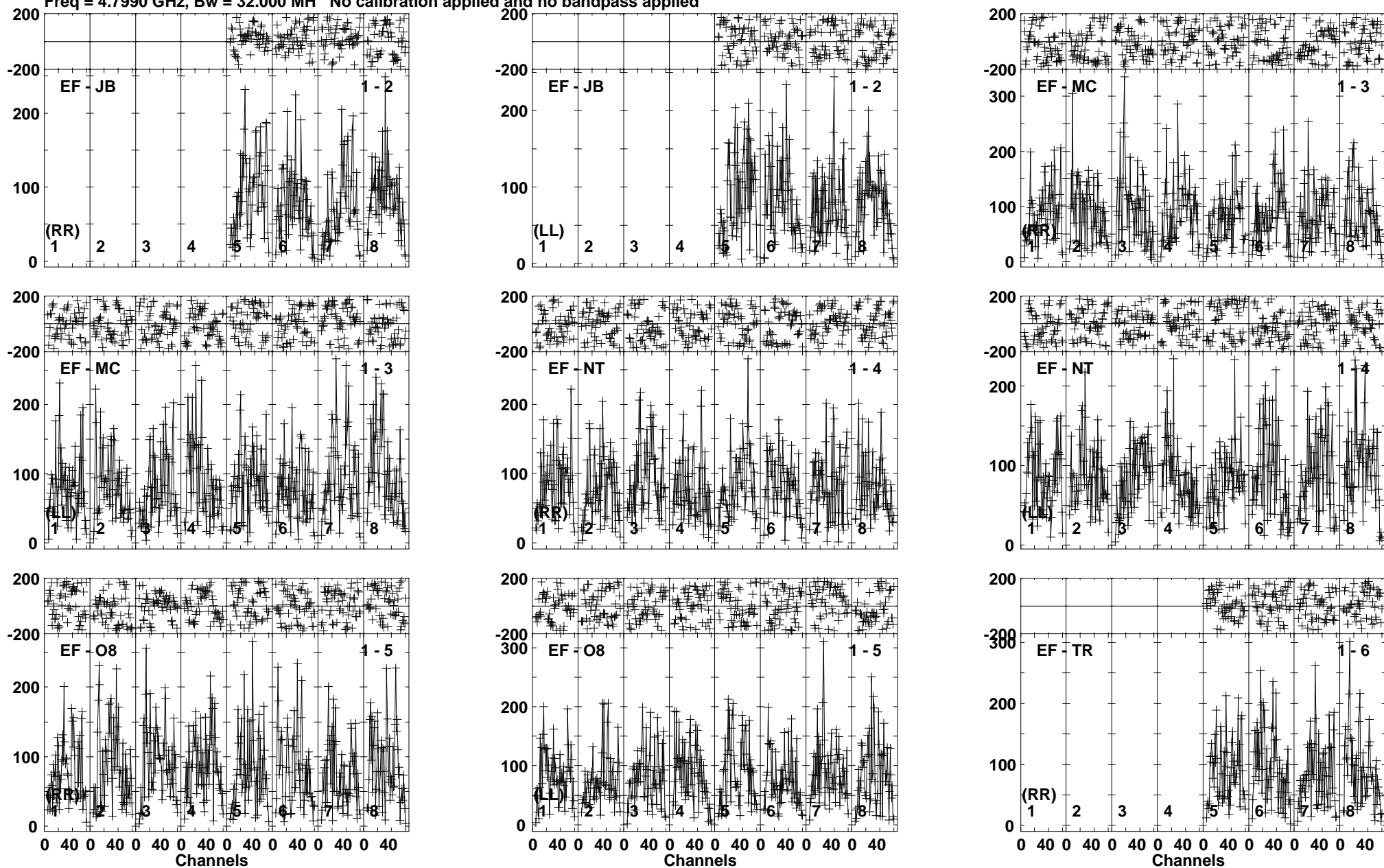

Lower frame: Micro Ampl Jy Top frame: Phas deg
Vector averaged cross-power spectrum Baseline: EF (01) - JB (02)
Timerange: 00/23:50:30 to 00/23:53:59

Plot file version 144 created 21-FEB-2017 15:11:20

ARUMA EG096A.UVDATA.1

Freq = 4.7990 GHz, Bw = 32.000 MH No calibration applied and no bandpass applied

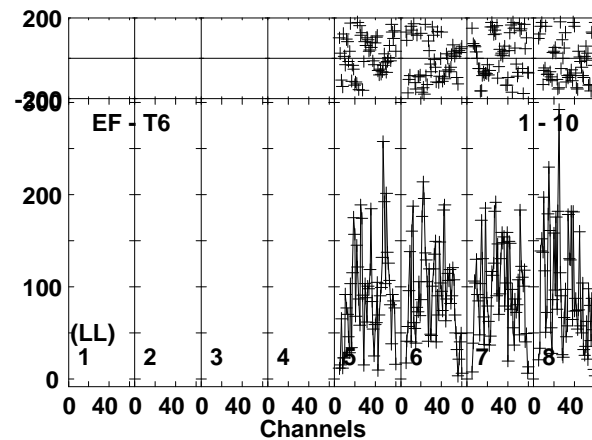
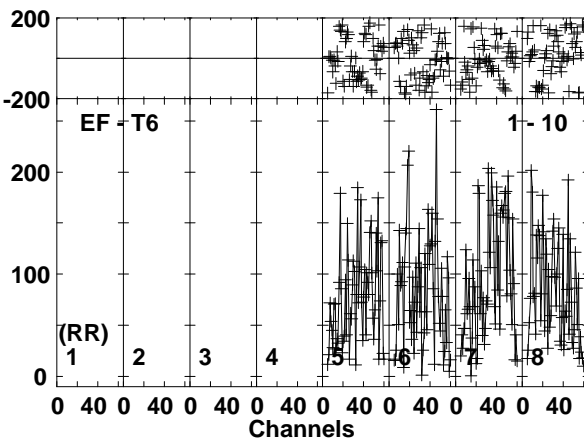
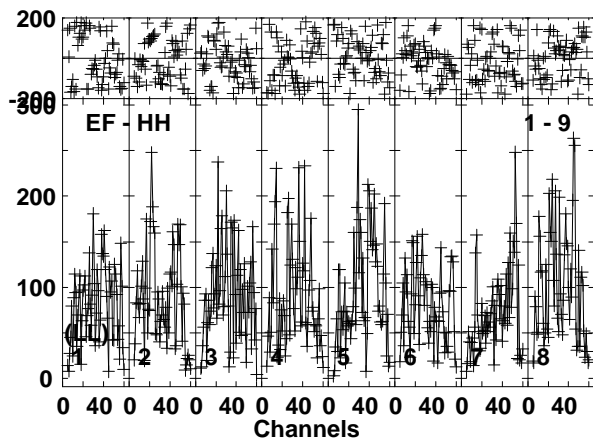
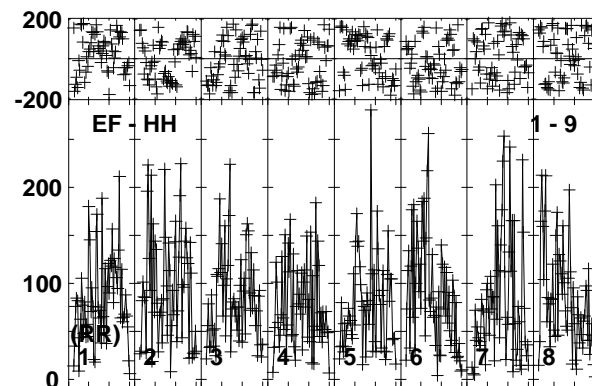
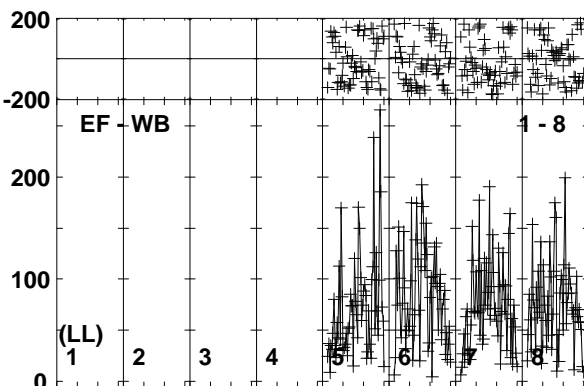
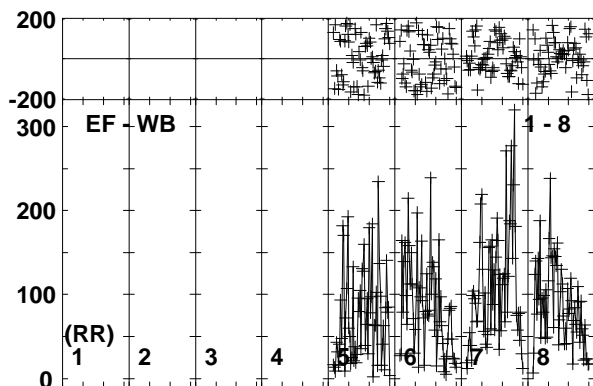
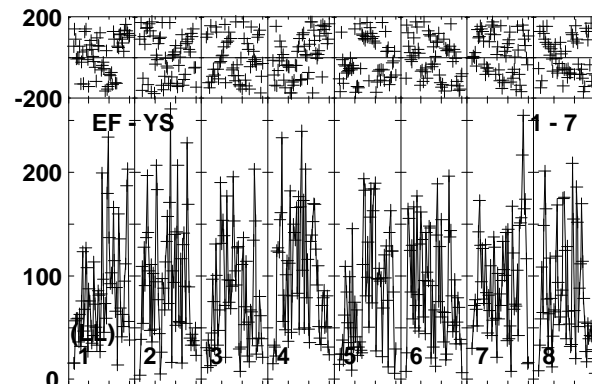
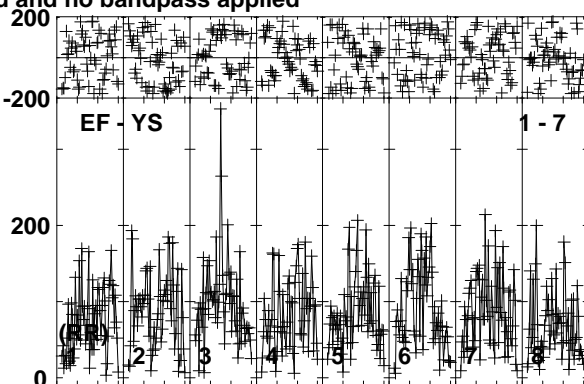
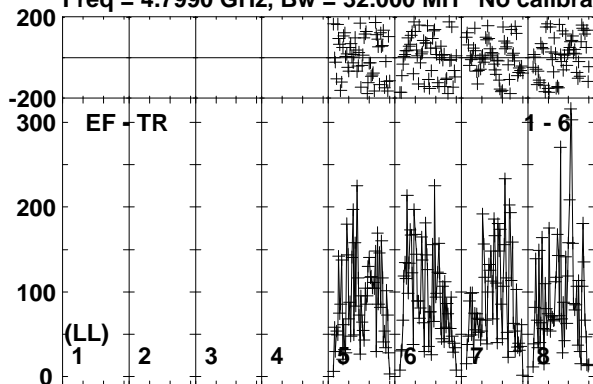

Lower frame: Micro Ampl Jy Top frame: Phas deg
Vector averaged cross-power spectrum Baseline: EF (01) - TR (06)
Timerange: 00/23:50:30 to 00/23:53:59

Plot file version 145 created 21-FEB-2017 15:11:20

J1108+4330 EG096A.UVDATA.1

Freq = 4.7990 GHz, Bw = 32.000 MH No calibration applied and no bandpass applied

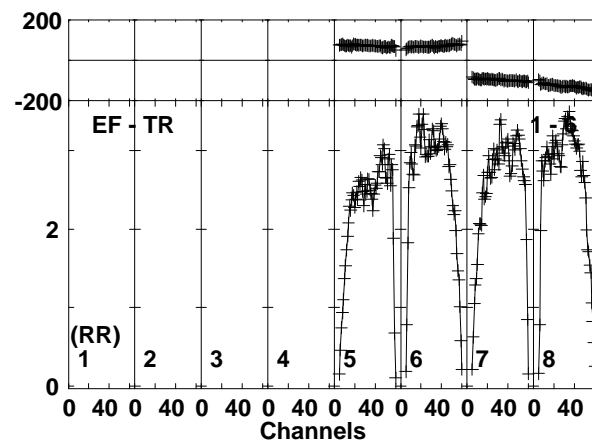
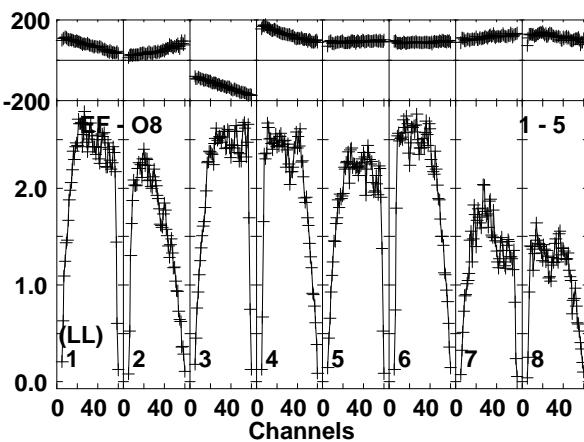
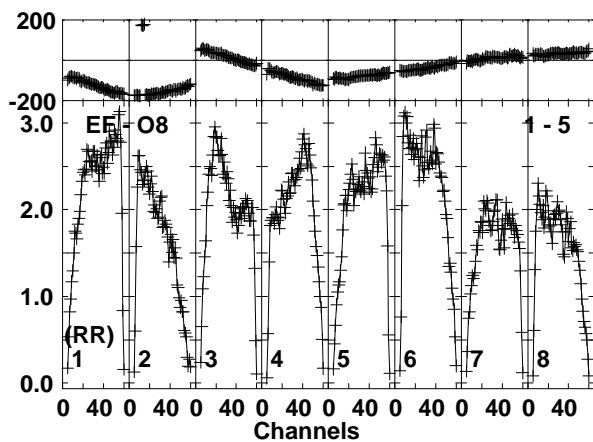
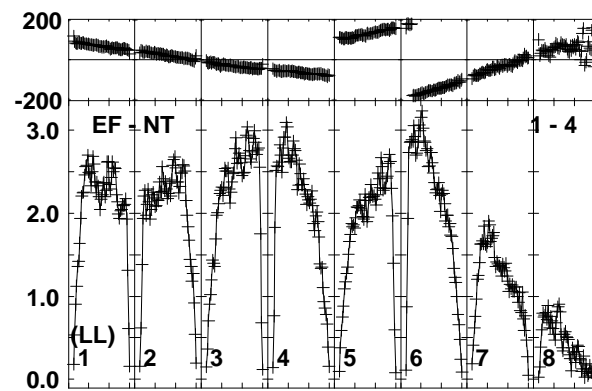
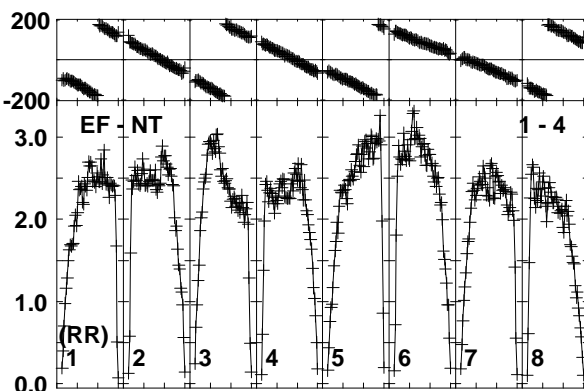
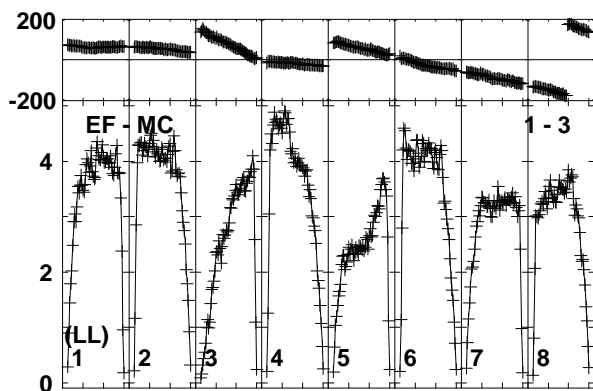
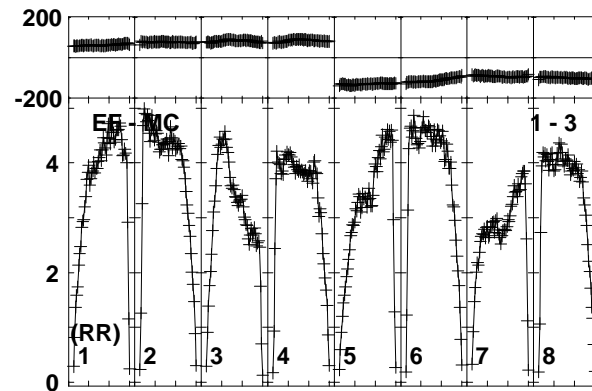
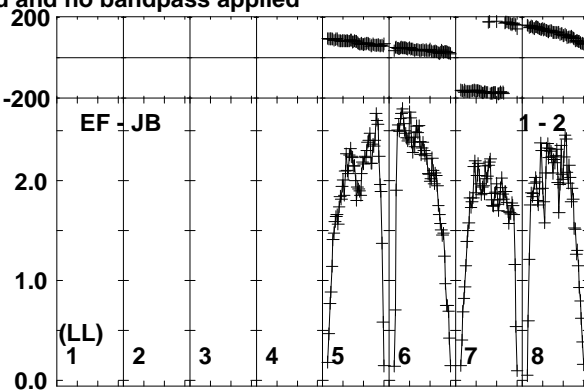
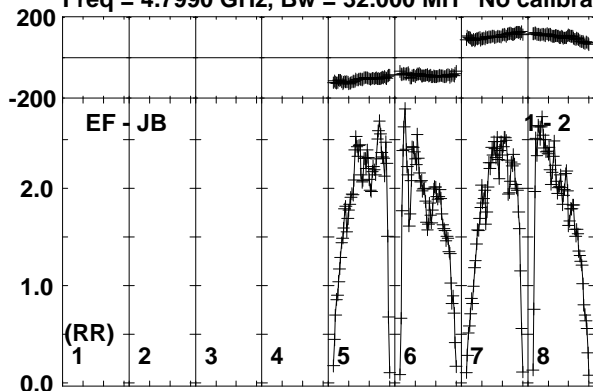

Lower frame: Milli Ampl Jy Top frame: Phas deg
Vector averaged cross-power spectrum Baseline: EF (01) - JB (02)
Timerange: 00/23:54:00 to 00/23:55:30

Plot file version 146 created 21-FEB-2017 15:11:21

J1108+4330 EG096A.UVDATA.1

Freq = 4.7990 GHz, Bw = 32.000 MH No calibration applied and no bandpass applied

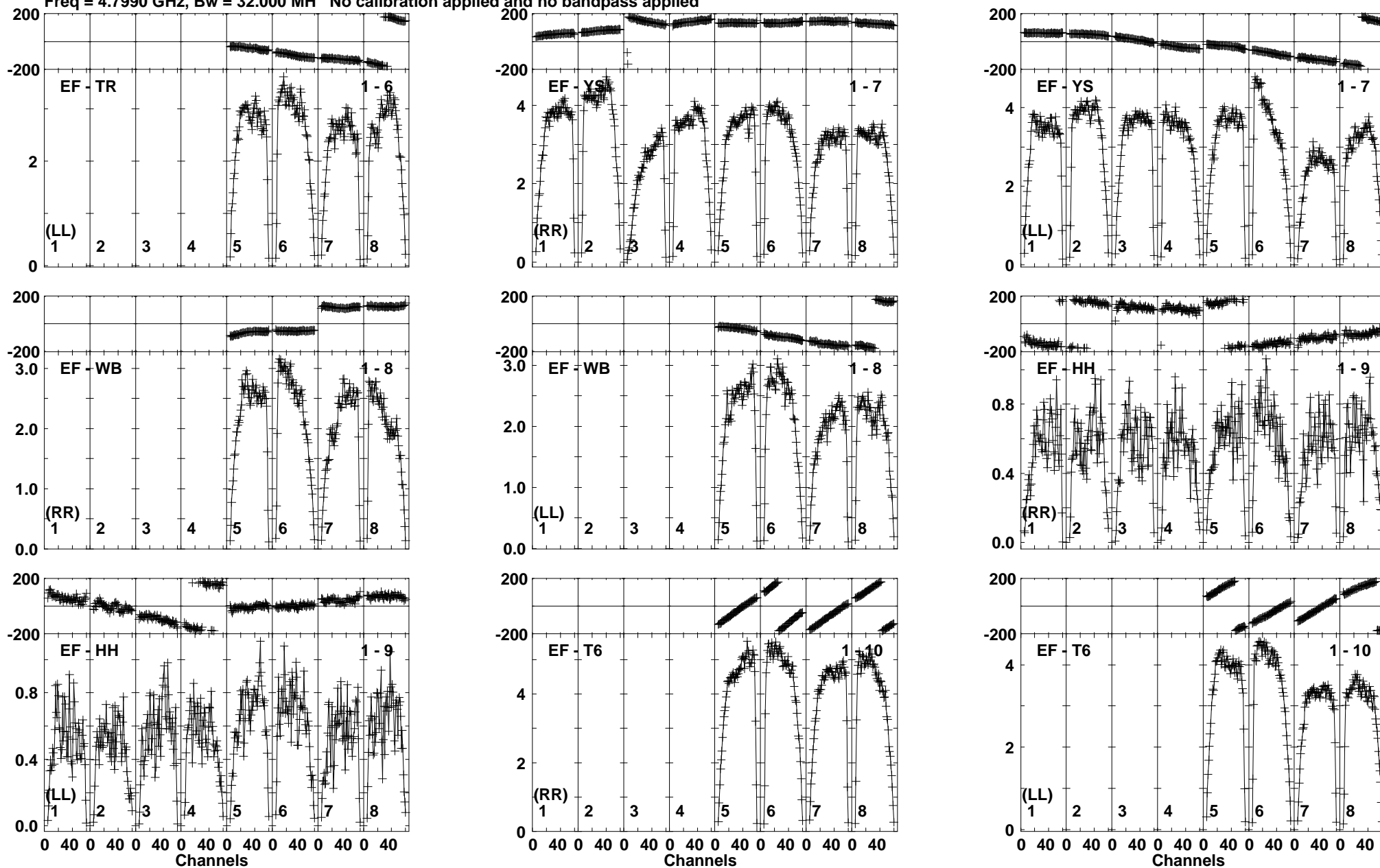

Lower frame: Milli Ampl Jy Top frame: Phas deg
Vector averaged cross-power spectrum Baseline: EF (01) - TR (06)
Timerange: 00/23:54:00 to 00/23:55:30

Plot file version 147 created 21-FEB-2017 15:11:21

ARUMA EG096A.UVDATA.1

Freq = 4.7990 GHz, Bw = 32.000 MH No calibration applied and no bandpass applied

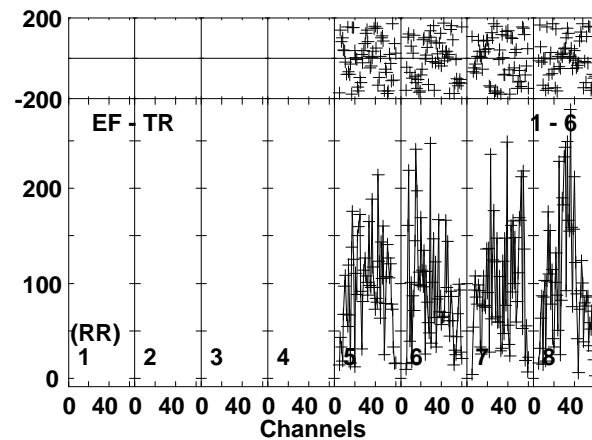
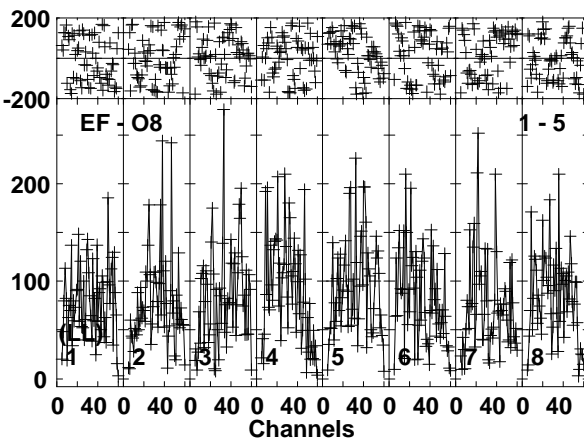
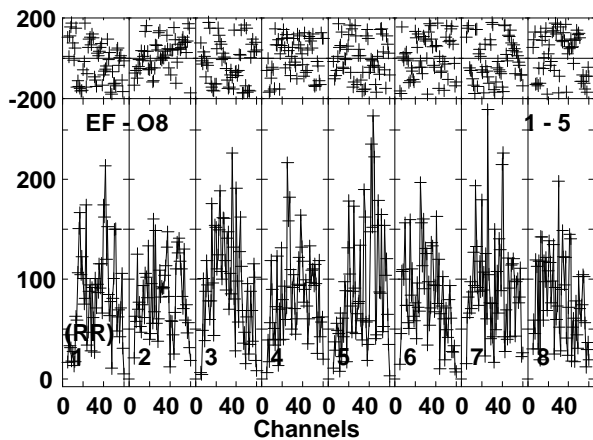
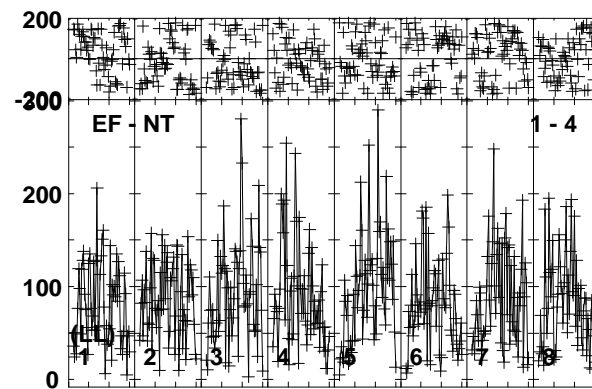
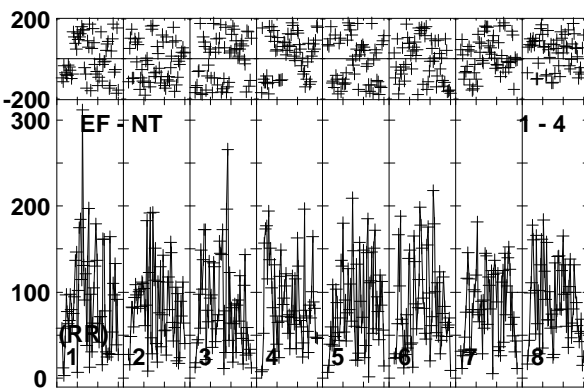
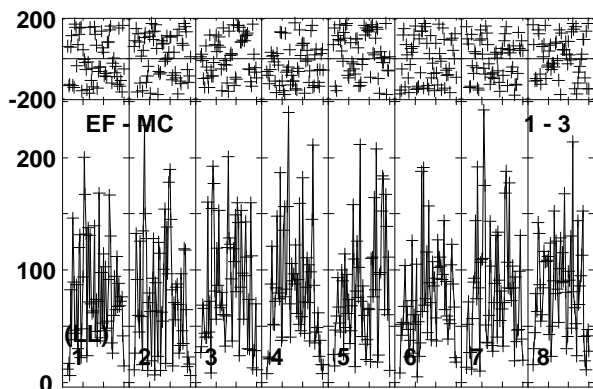
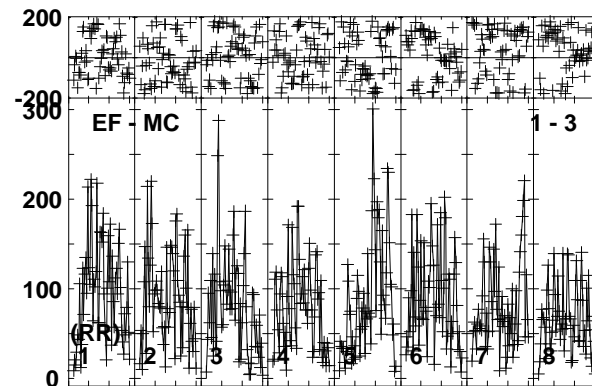
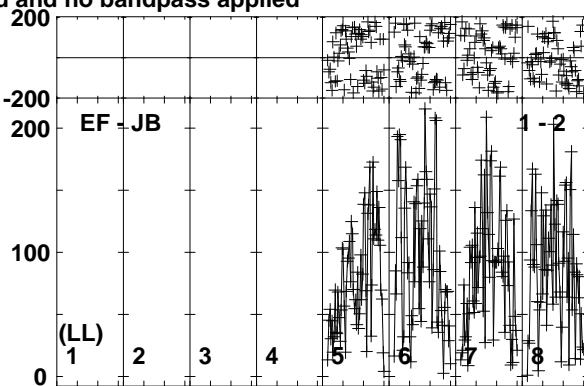
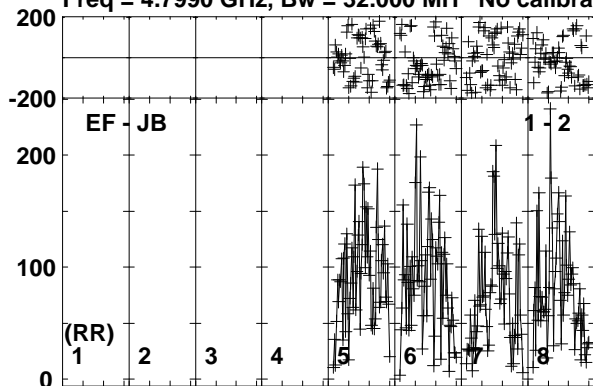

Lower frame: Micro Ampl Jy Top frame: Phas deg
Vector averaged cross-power spectrum Baseline: EF (01) - JB (02)
Timerange: 00/23:55:30 to 00/23:58:59

Plot file version 148 created 21-FEB-2017 15:11:21

ARUMA EG096A.UVDATA.1

Freq = 4.7990 GHz, Bw = 32.000 MH No calibration applied and no bandpass applied

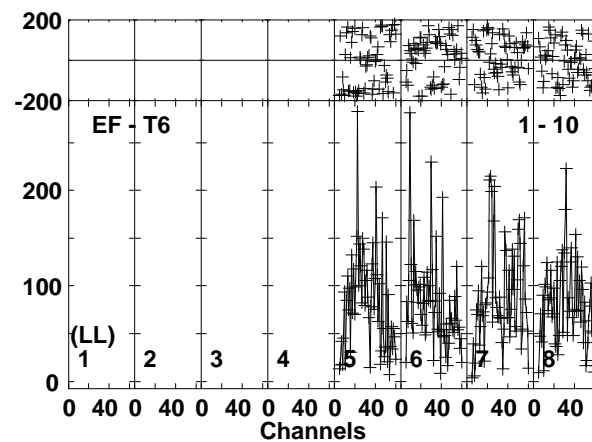
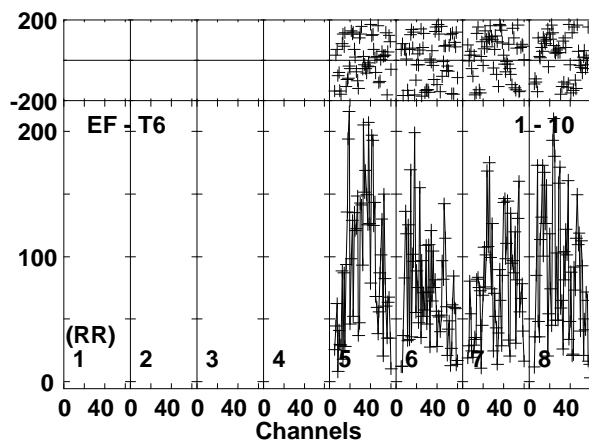
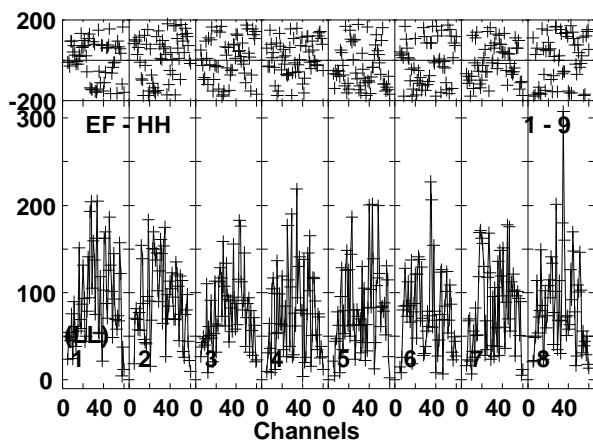
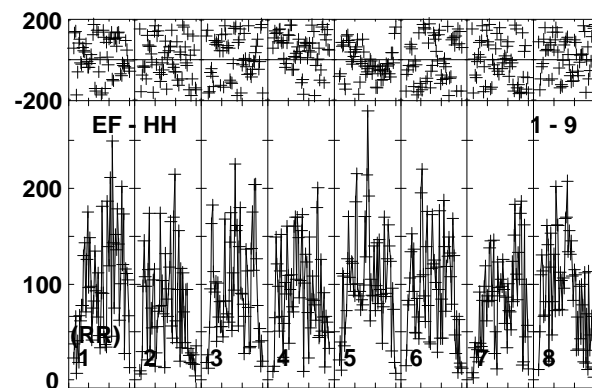
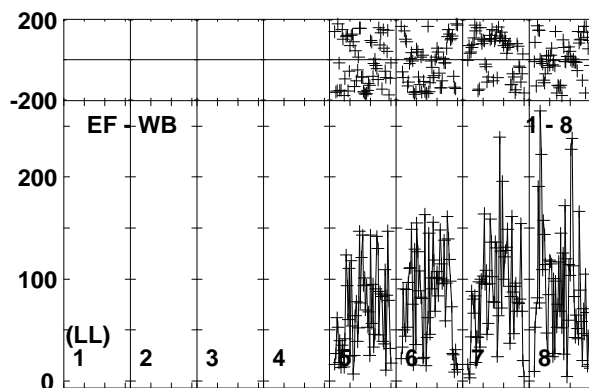
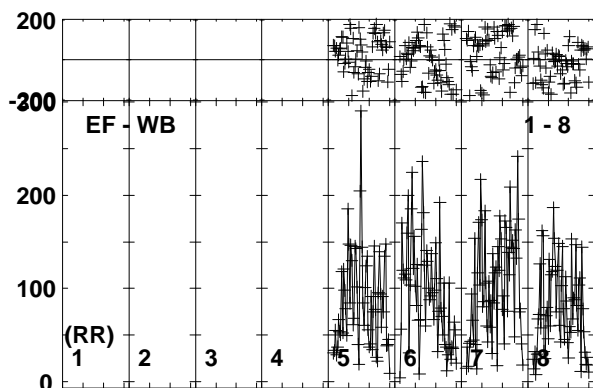
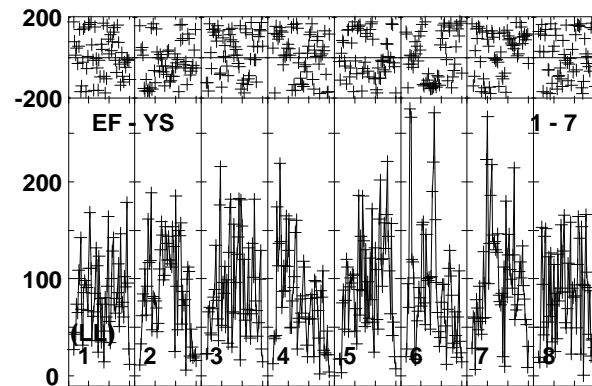
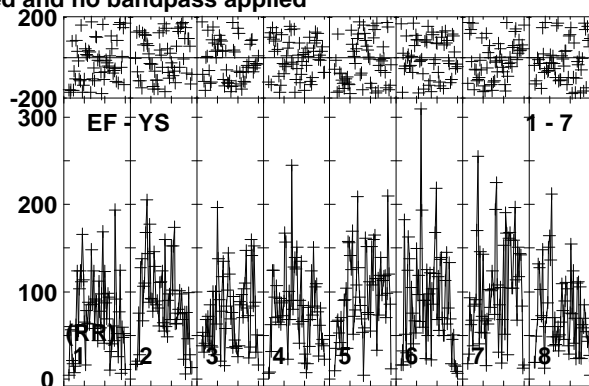
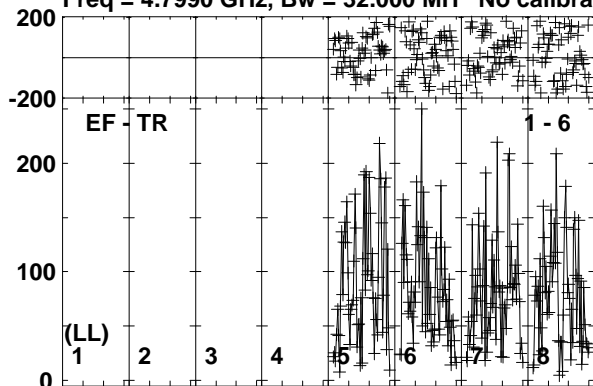

Lower frame: Micro Ampl Jy Top frame: Phas deg
Vector averaged cross-power spectrum Baseline: EF (01) - TR (06)
Timerange: 00/23:55:30 to 00/23:58:59

Plot file version 149 created 21-FEB-2017 15:11:22

J1108+4330 EG096A.UVDATA.1

Freq = 4.7990 GHz, Bw = 32.000 MH No calibration applied and no bandpass applied

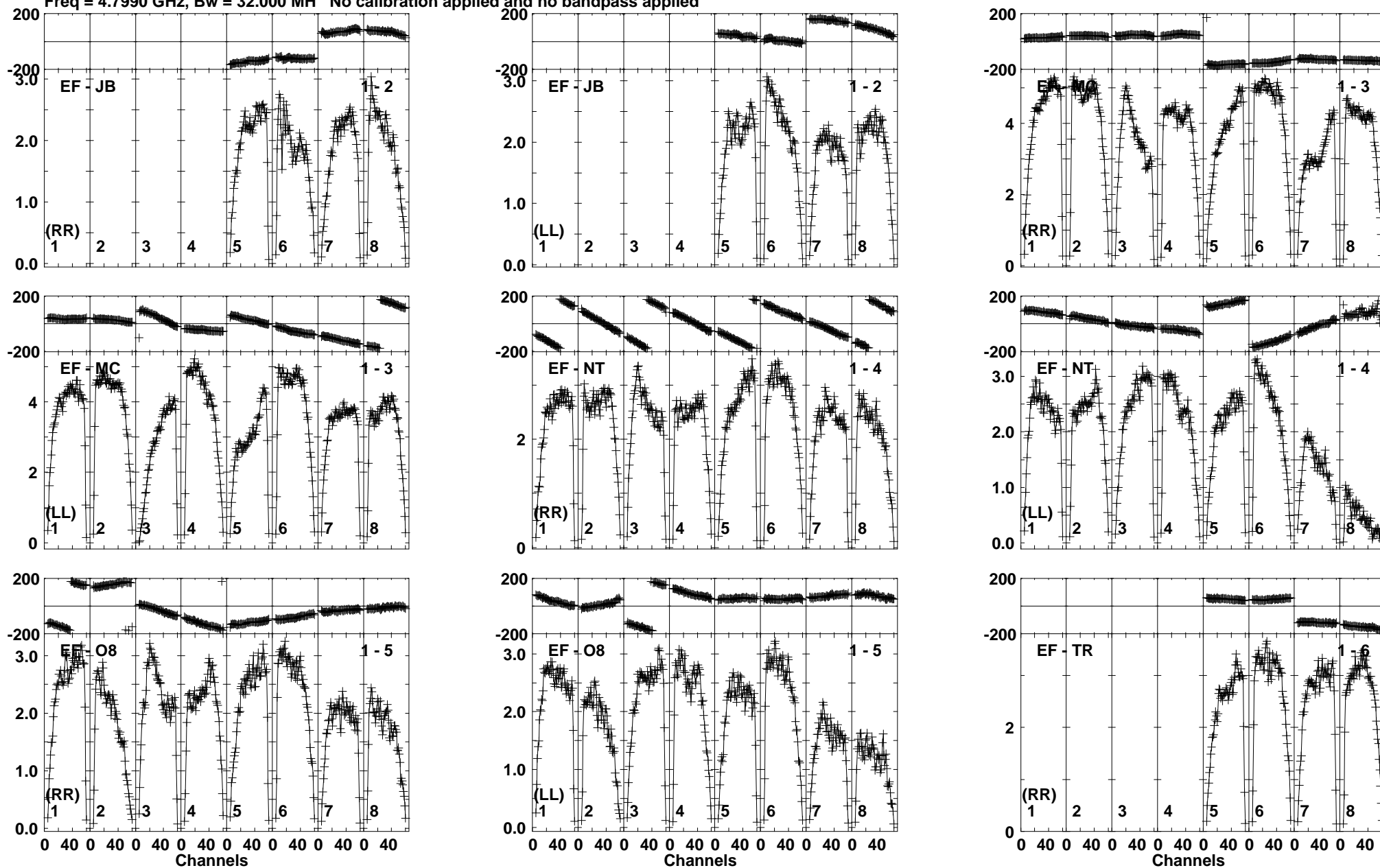

Lower frame: Milli Ampl Jy Top frame: Phas deg
Vector averaged cross-power spectrum Baseline: EF (01) - JB (02)
Timerange: 00/23:59:40 to 01/00:00:39

Plot file version 150 created 21-FEB-2017 15:11:22

J1108+4330 EG096A.UVDATA.1

Freq = 4.7990 GHz, Bw = 32.000 MH No calibration applied and no bandpass applied

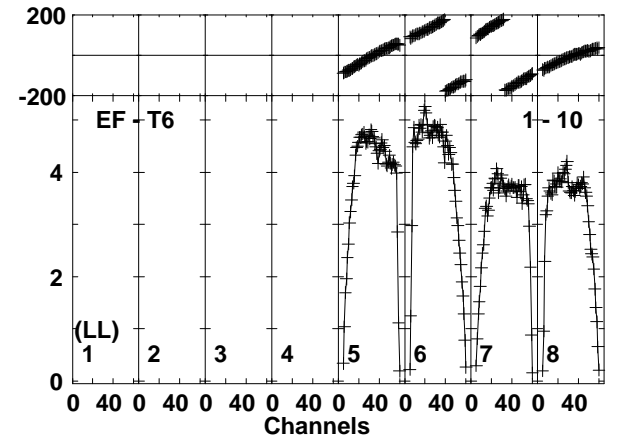
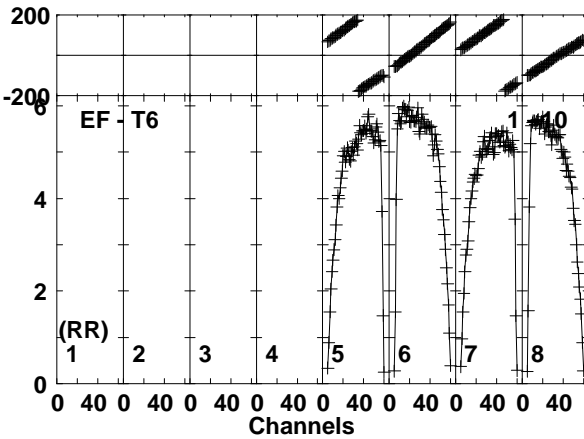
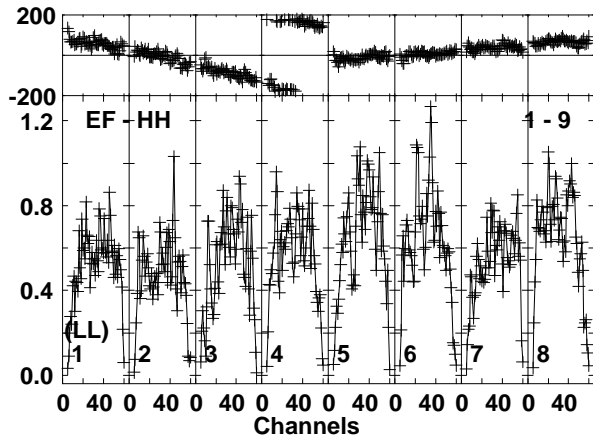
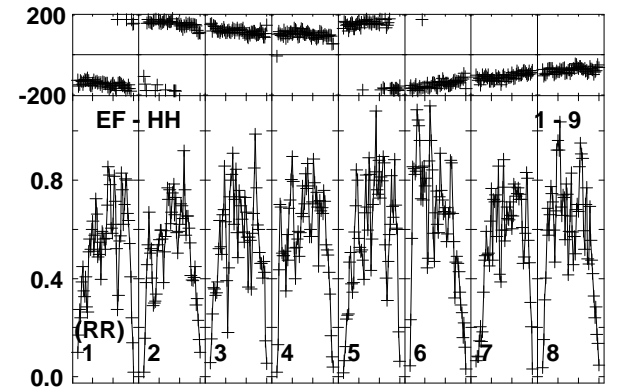
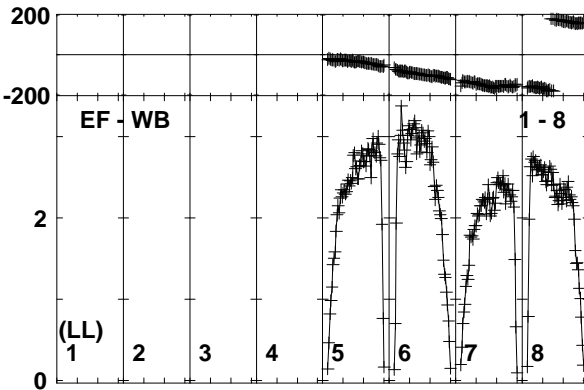
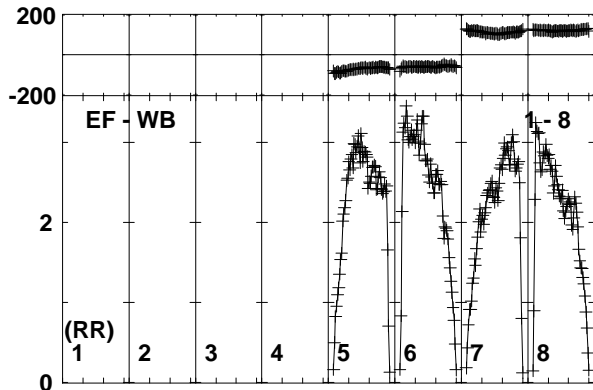
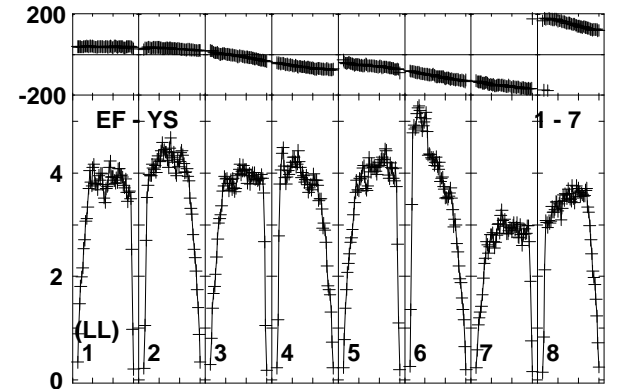
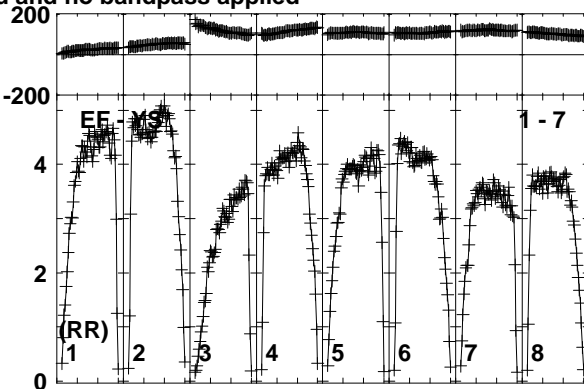
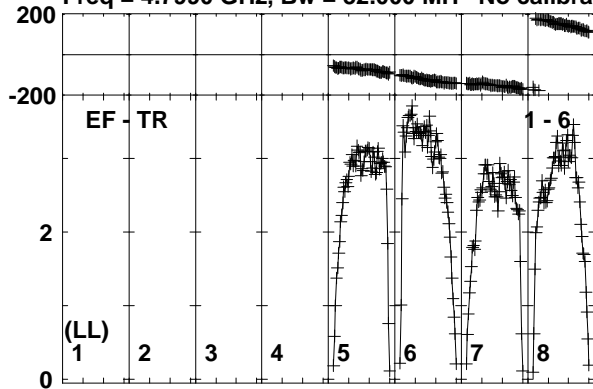

Lower frame: Milli Ampl Jy Top frame: Phas deg
Vector averaged cross-power spectrum Baseline: EF (01) - TR (06)
Timerange: 00/23:59:40 to 01/00:00:39

Plot file version 151 created 21-FEB-2017 15:11:22

J1112+4301 EG096A.UVDATA.1

Freq = 4.7990 GHz, Bw = 32.000 MH No calibration applied and no bandpass applied

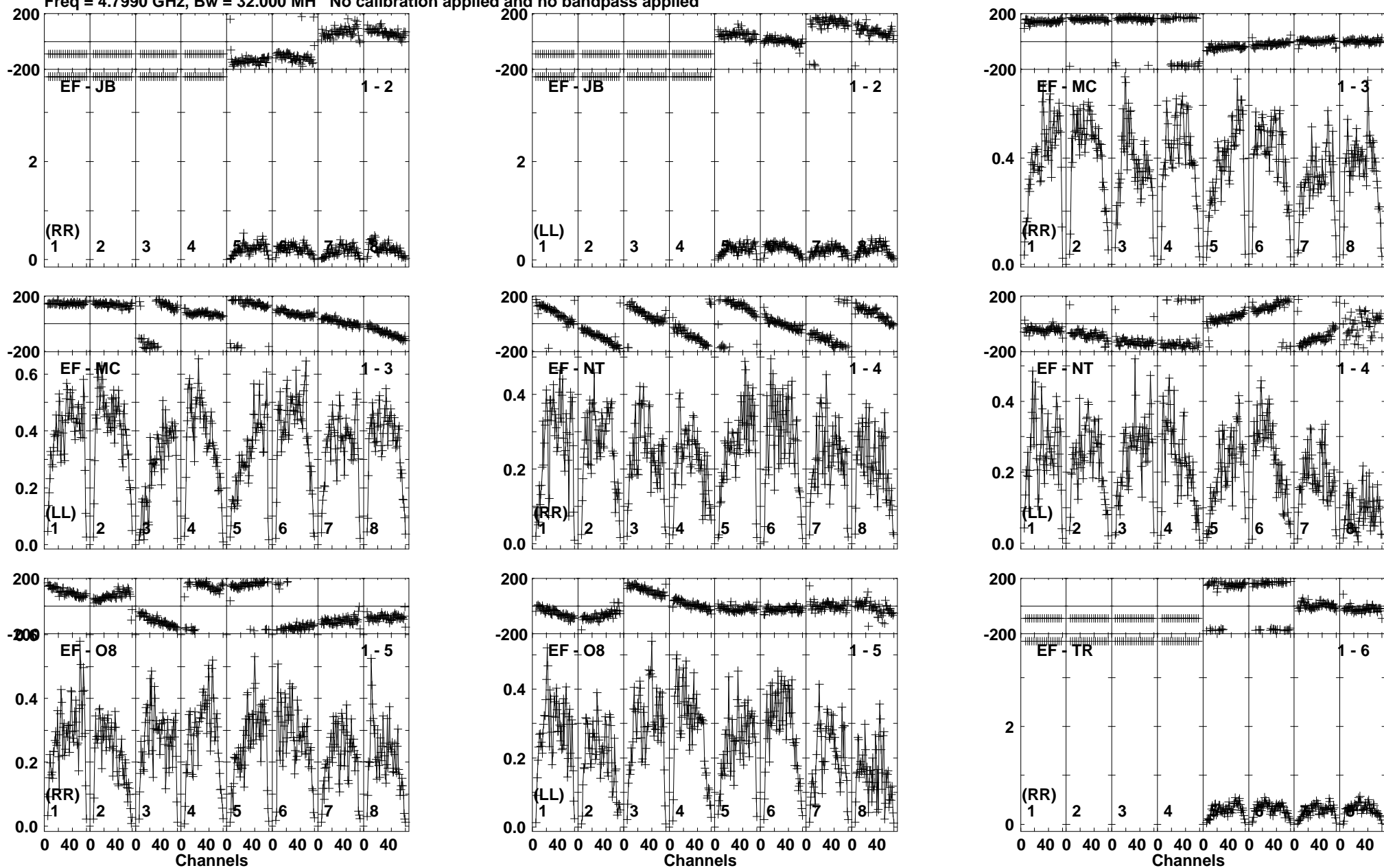

Lower frame: Milli Ampl Jy Top frame: Phas deg
Vector averaged cross-power spectrum Baseline: EF (01) - JB (02)
Timerange: 01/00:00:40 to 01/00:04:09

Plot file version 152 created 21-FEB-2017 15:11:22

J1112+4301 EG096A.UVDATA.1

Freq = 4.7990 GHz, Bw = 32.000 MH No calibration applied and no bandpass applied

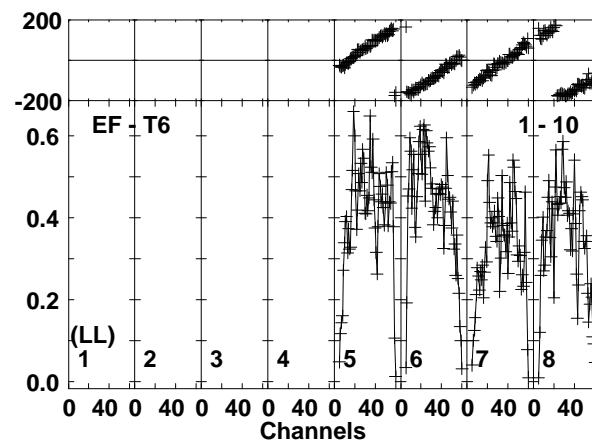
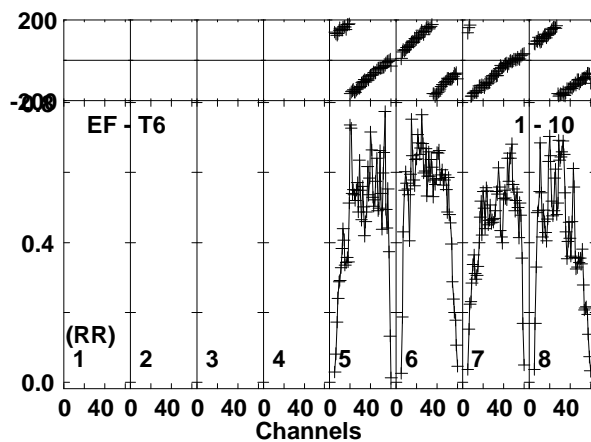
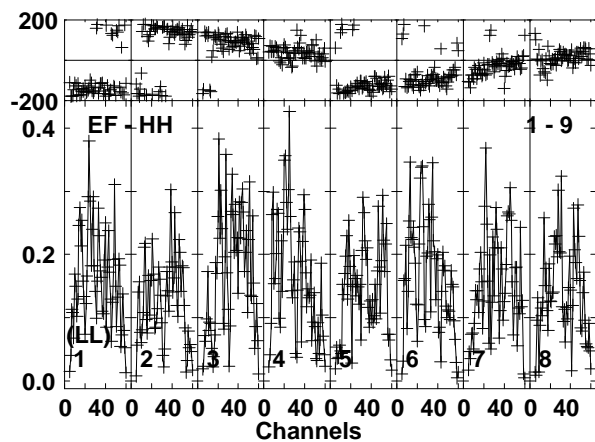
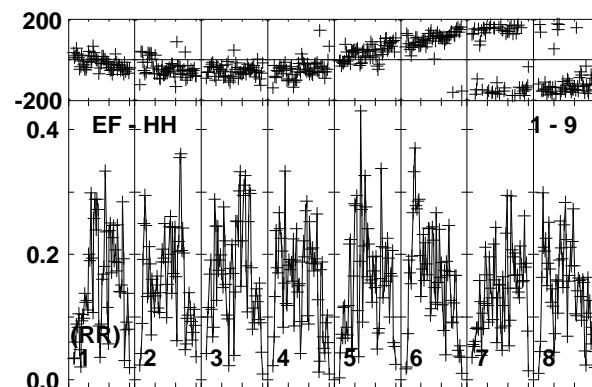
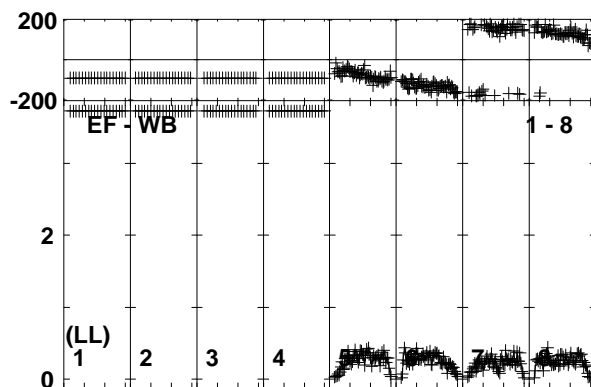
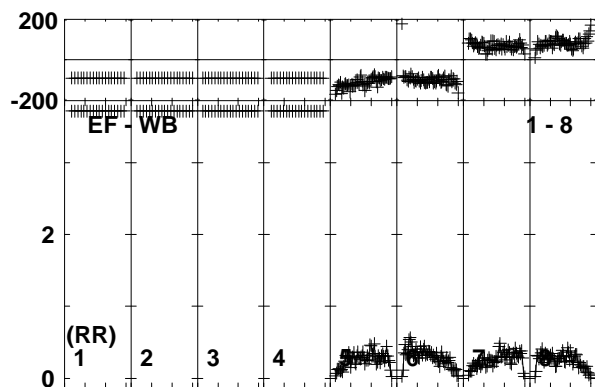
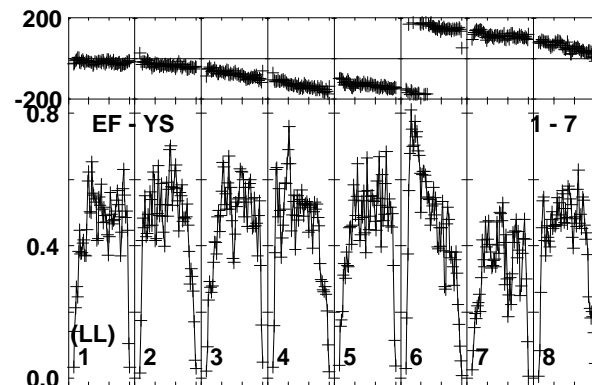
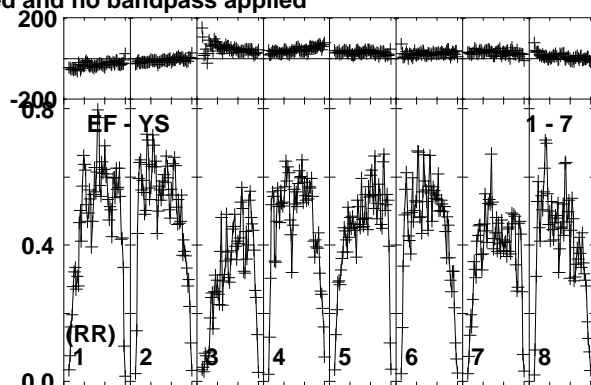
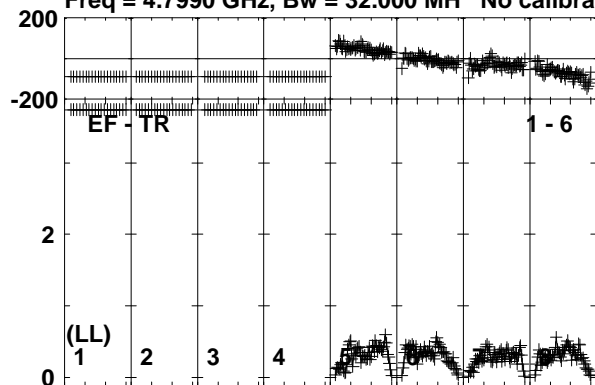

Lower frame: Milli Ampl Jy Top frame: Phas deg
Vector averaged cross-power spectrum Baseline: EF (01) - TR (06)
Timerange: 01/00:00:40 to 01/00:04:09

Plot file version 153 created 21-FEB-2017 15:11:23

J1108+4330 EG096A.UVDATA.1

Freq = 4.7990 GHz, Bw = 32.000 MH No calibration applied and no bandpass applied

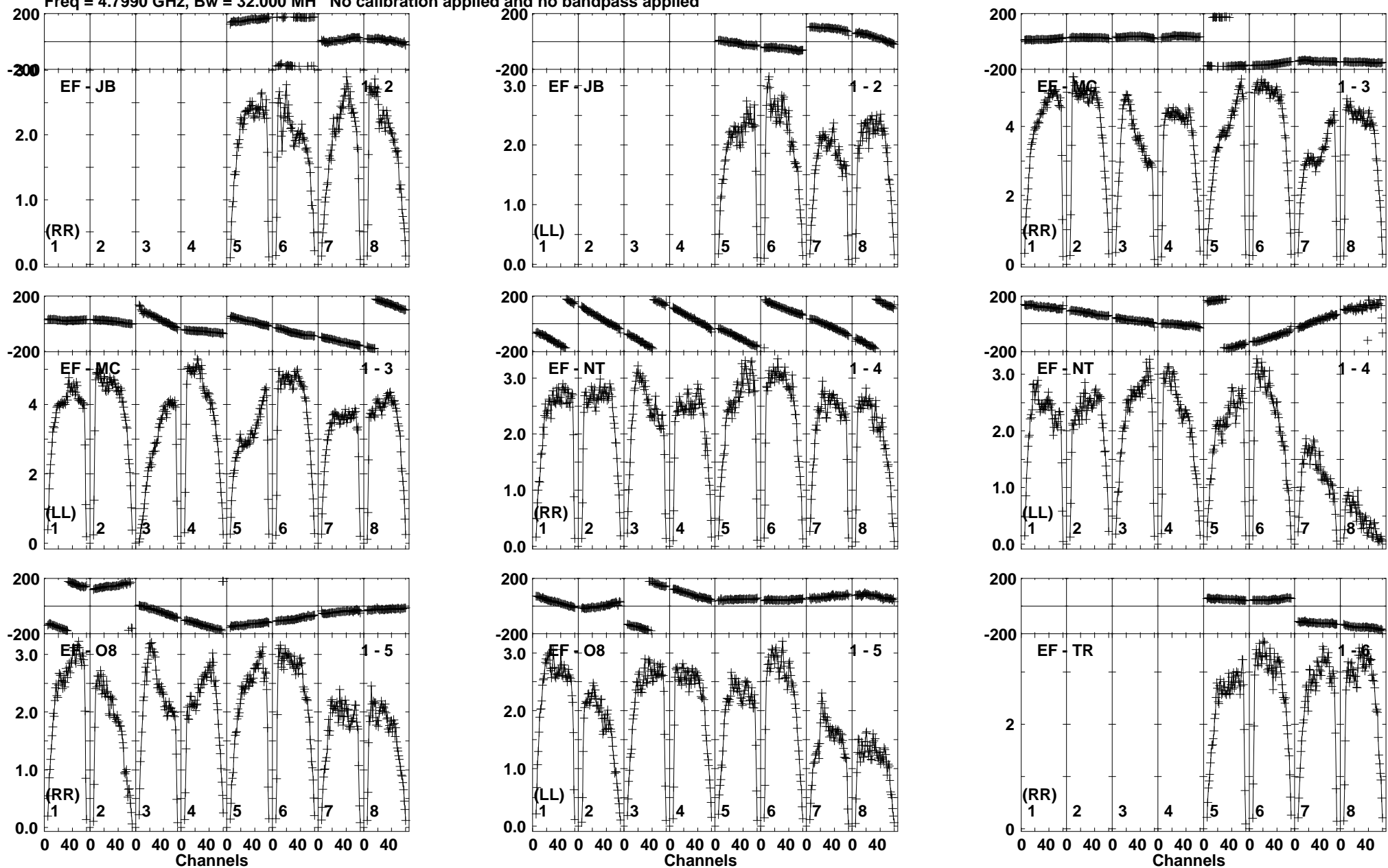

Lower frame: Milli Ampl Jy Top frame: Phas deg
Vector averaged cross-power spectrum Baseline: EF (01) - JB (02)
Timerange: 01/00:04:11 to 01/00:05:39

Plot file version 154 created 21-FEB-2017 15:11:23

J1108+4330 EG096A.UVDATA.1

Freq = 4.7990 GHz, Bw = 32.000 MH No calibration applied and no bandpass applied

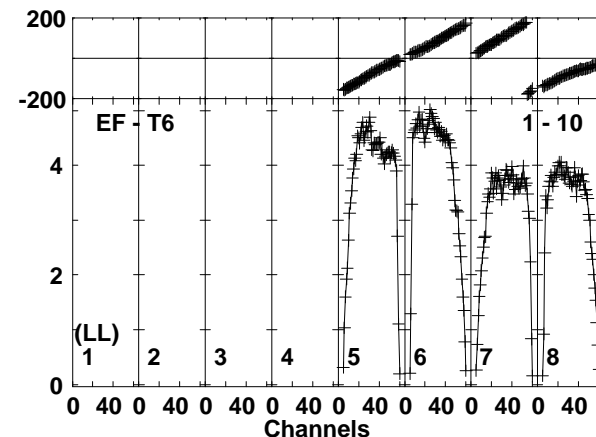
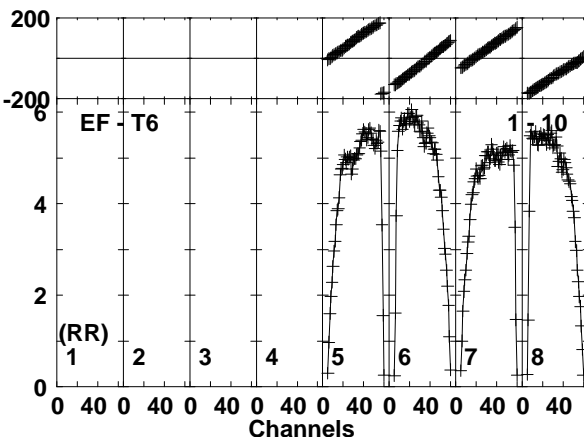
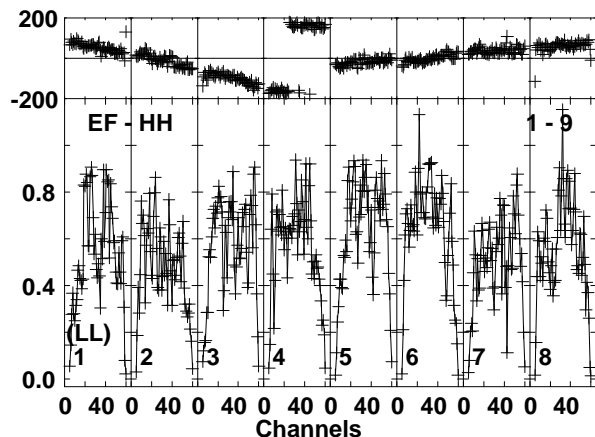
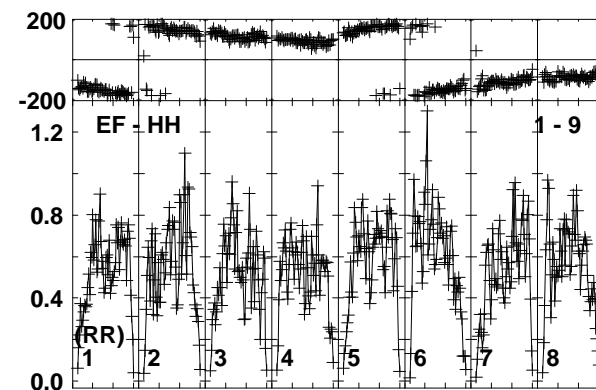
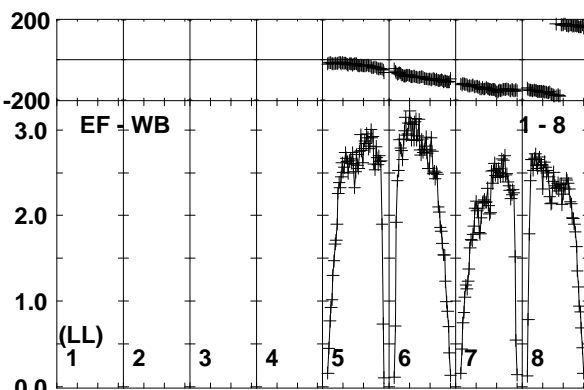
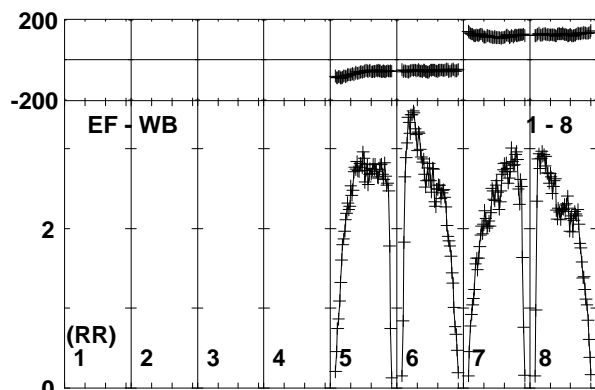
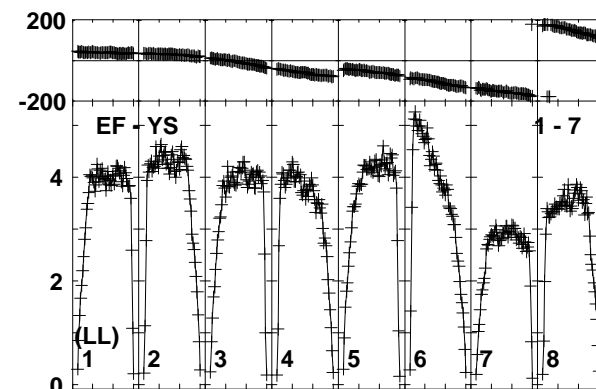
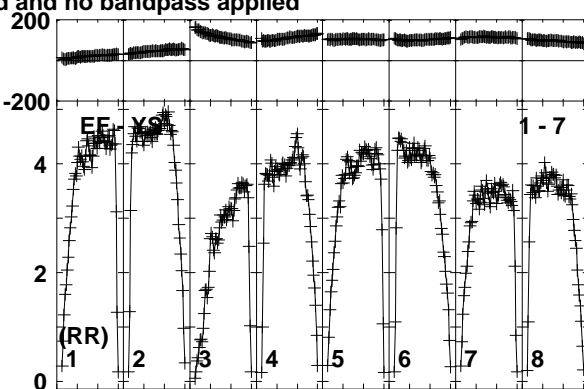
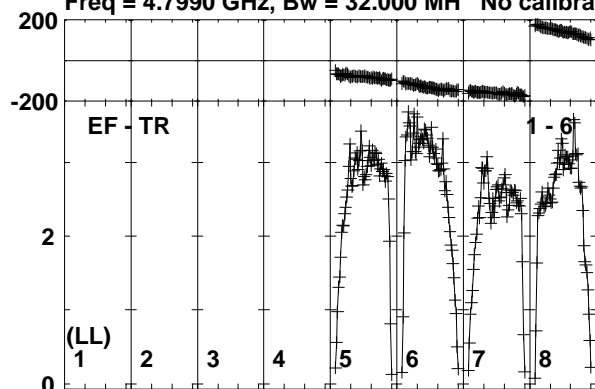

Lower frame: Milli Ampl Jy Top frame: Phas deg
Vector averaged cross-power spectrum Baseline: EF (01) - TR (06)
Timerange: 01/00:04:11 to 01/00:05:39

Plot file version 155 created 21-FEB-2017 15:11:23

ARUMA EG096A.UVDATA.1

Freq = 4.7990 GHz, Bw = 32.000 MH No calibration applied and no bandpass applied

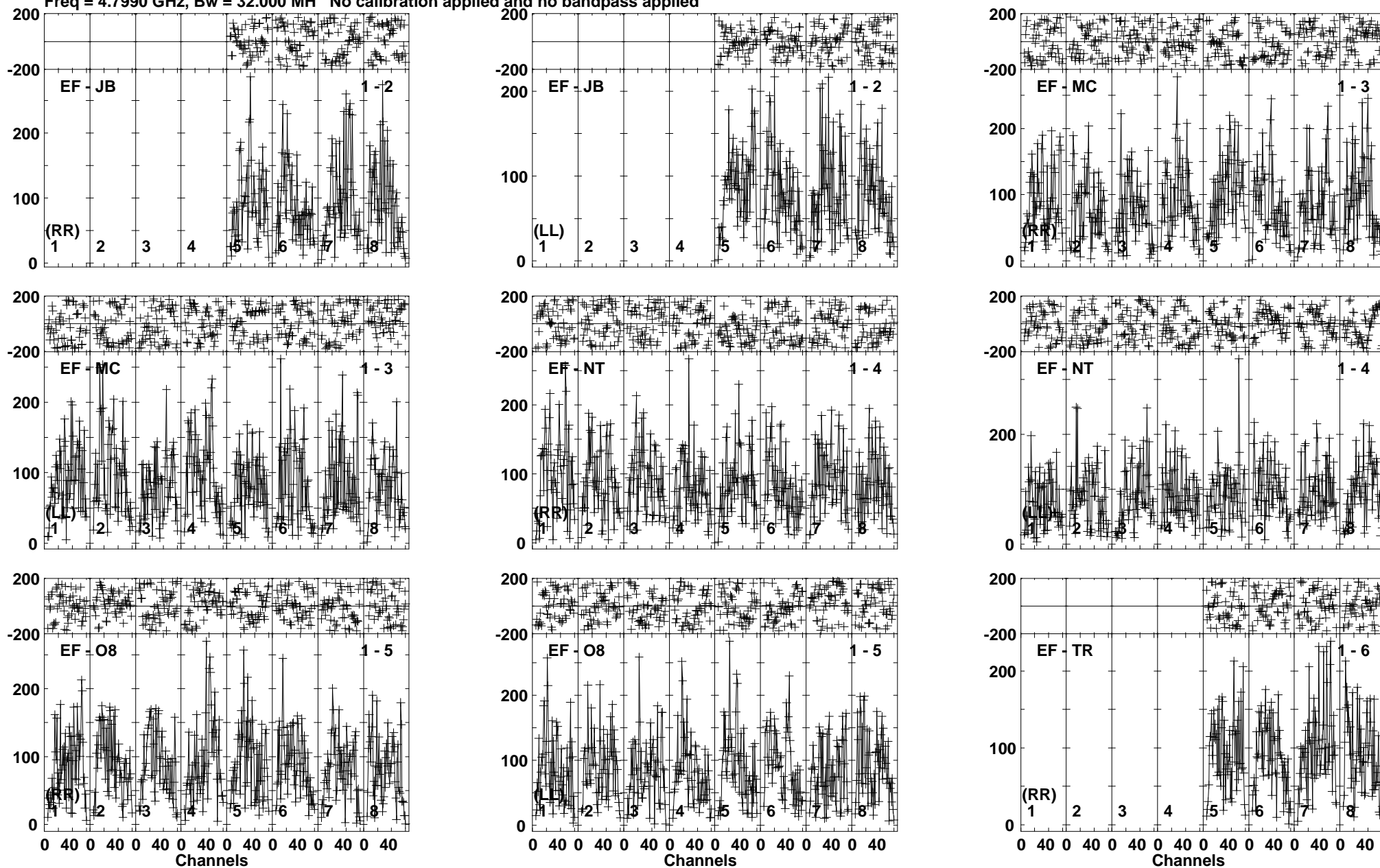

Lower frame: Micro Ampl Jy Top frame: Phas deg
Vector averaged cross-power spectrum Baseline: EF (01) - JB (02)
Timerange: 01/00:05:40 to 01/00:09:09

Plot file version 156 created 21-FEB-2017 15:11:23

ARUMA EG096A.UVDATA.1

Freq = 4.7990 GHz, Bw = 32.000 MH No calibration applied and no bandpass applied

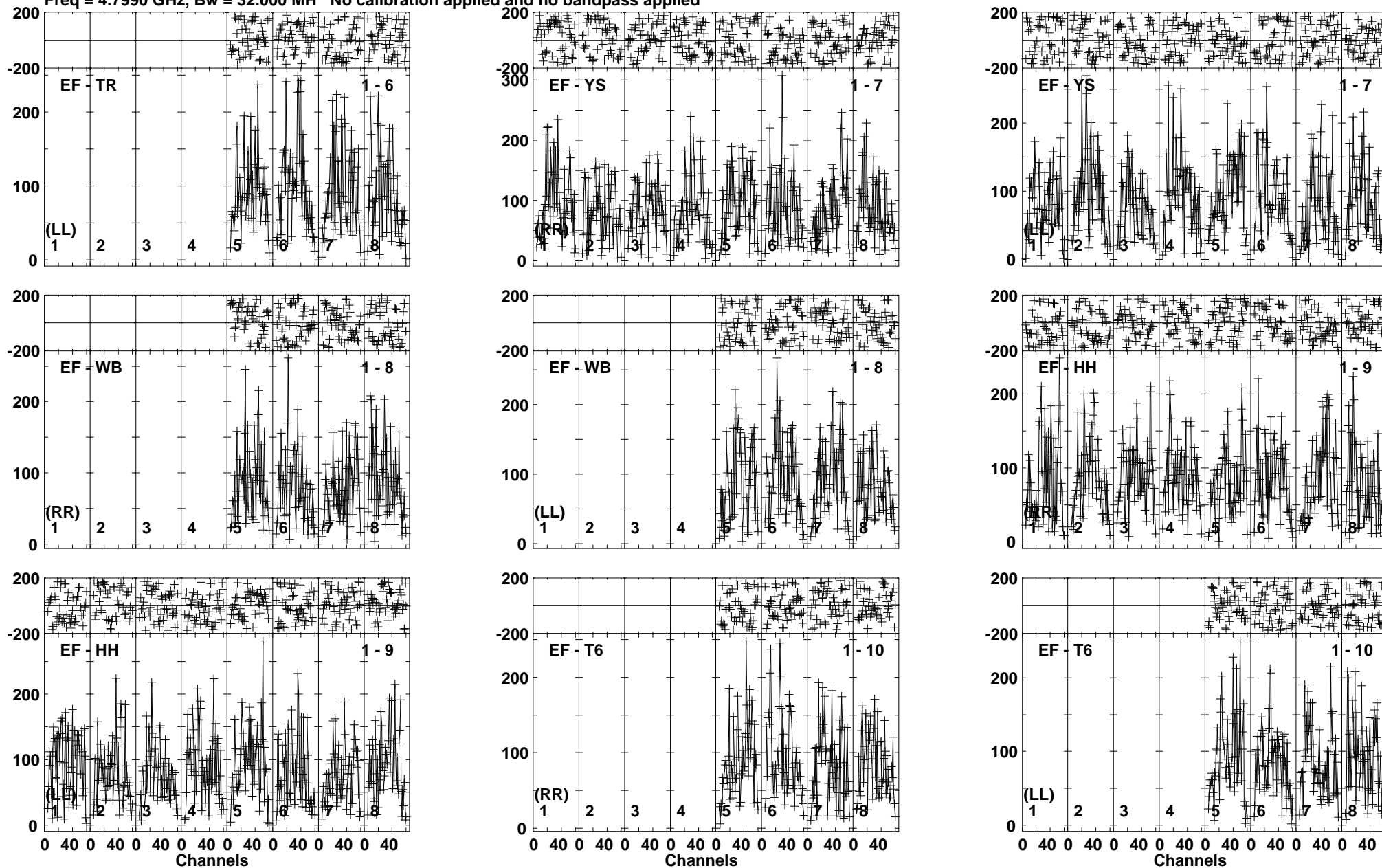

Lower frame: Micro Ampl Jy Top frame: Phas deg
Vector averaged cross-power spectrum Baseline: EF (01) - TR (06)
Timerange: 01/00:05:40 to 01/00:09:09

Plot file version 157 created 21-FEB-2017 15:11:24

J1108+4330 EG096A.UVDATA.1

Freq = 4.7990 GHz, Bw = 32.000 MH No calibration applied and no bandpass applied

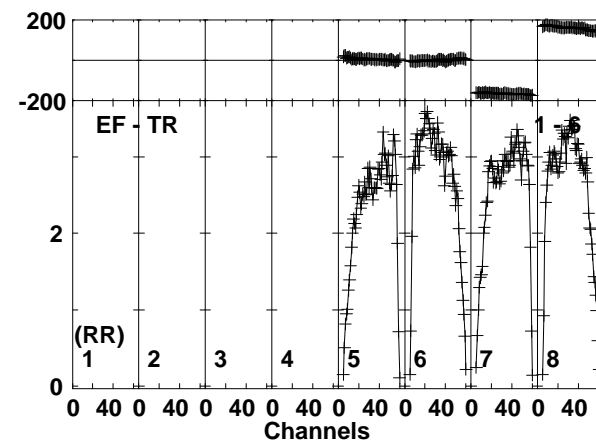
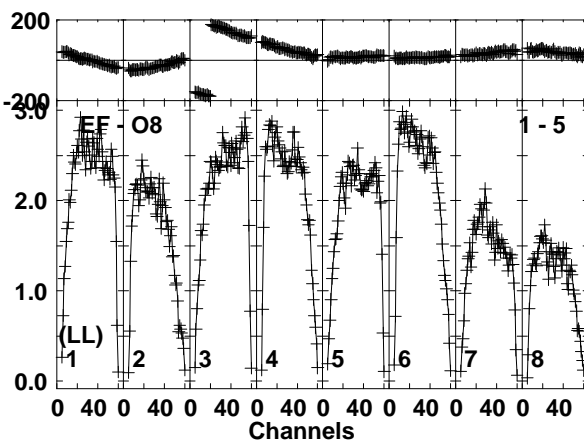
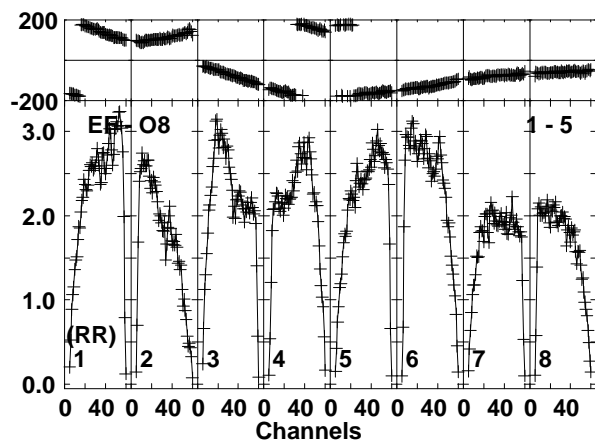
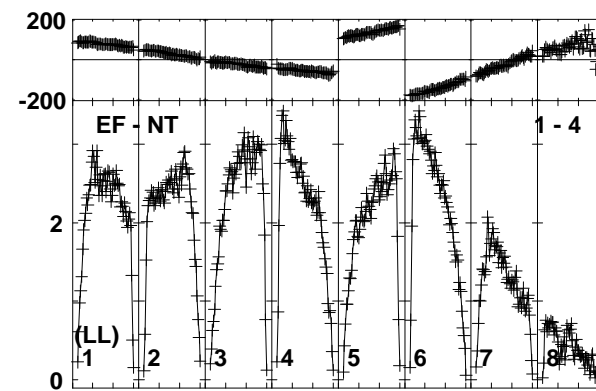
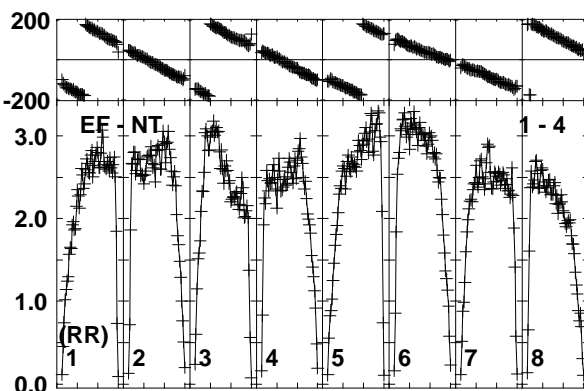
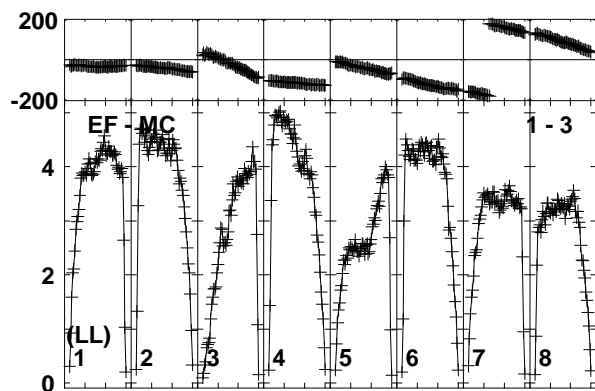
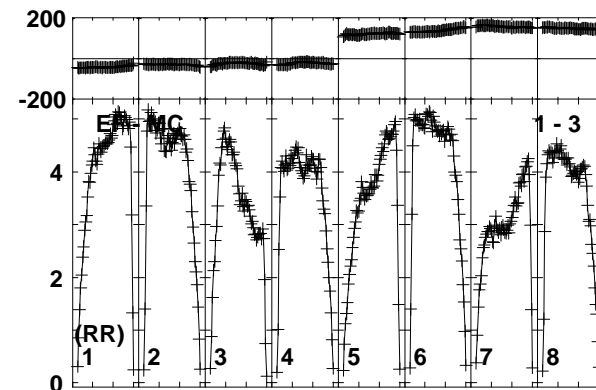
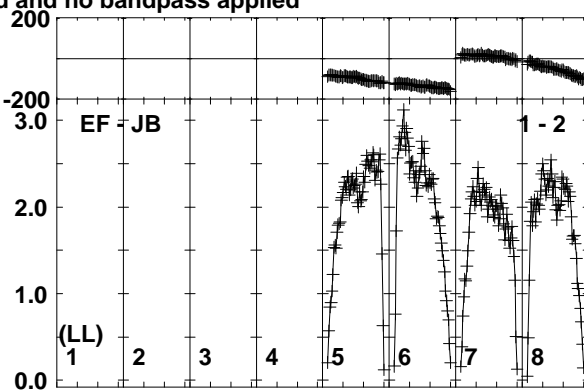
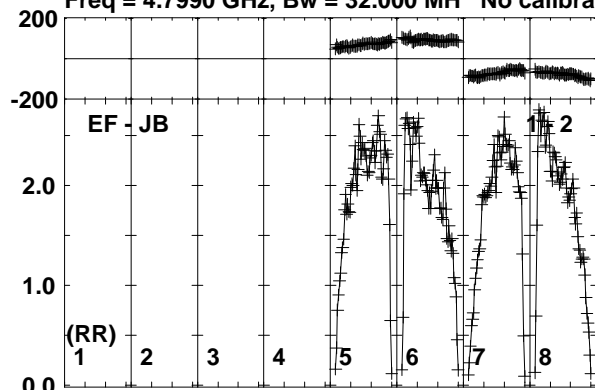

Lower frame: Milli Ampl Jy Top frame: Phas deg
Vector averaged cross-power spectrum Baseline: EF (01) - JB (02)
Timerange: 01/00:09:51 to 01/00:10:49

Plot file version 158 created 21-FEB-2017 15:11:24

J1108+4330 EG096A.UVDATA.1

Freq = 4.7990 GHz, Bw = 32.000 MH No calibration applied and no bandpass applied

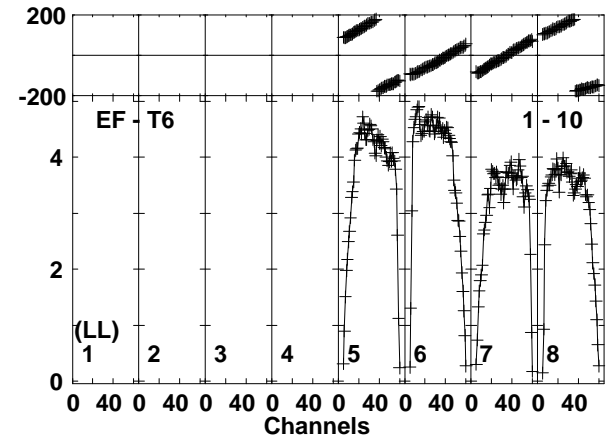
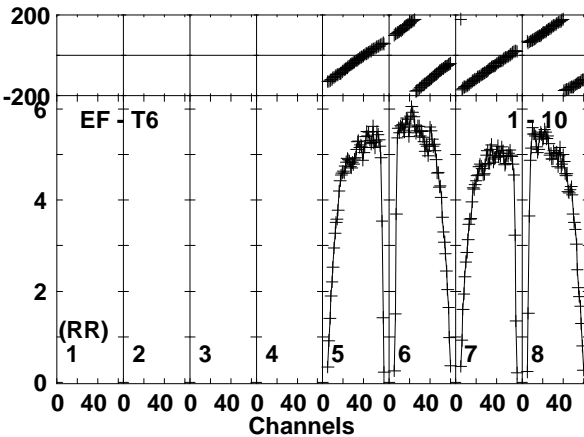
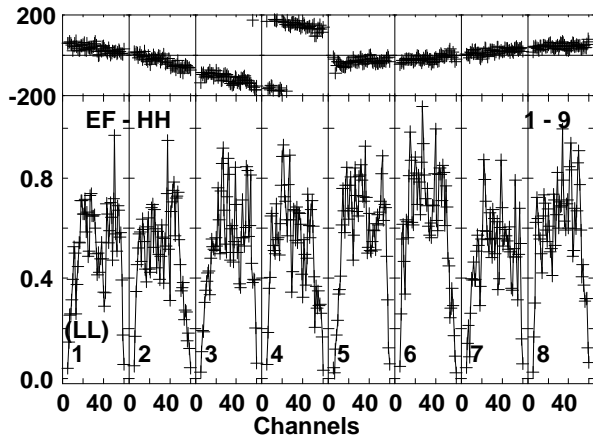
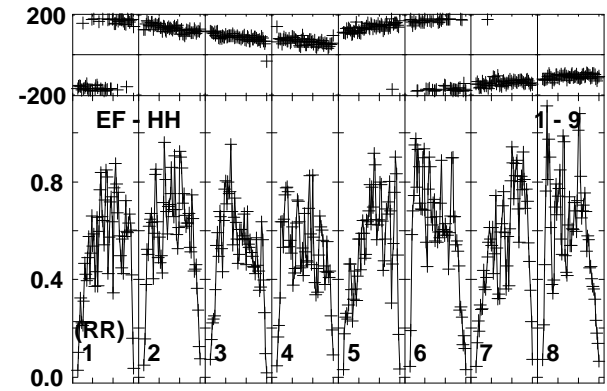
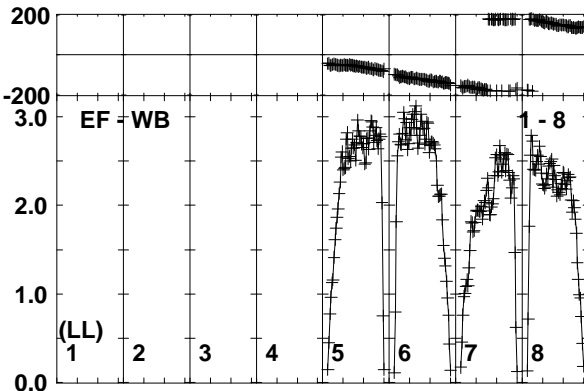
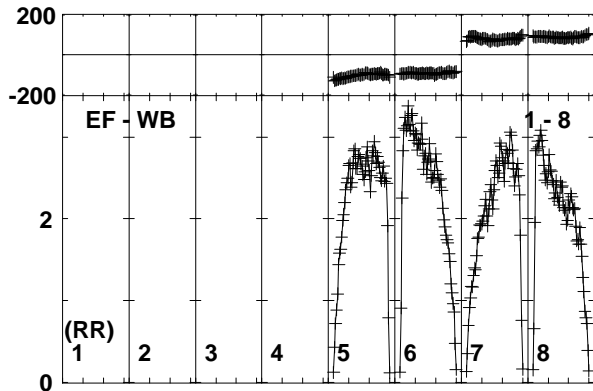
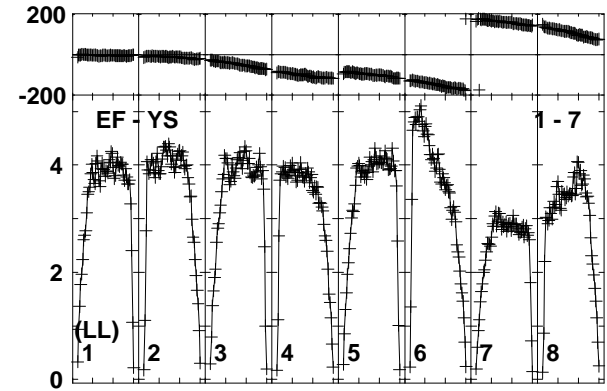
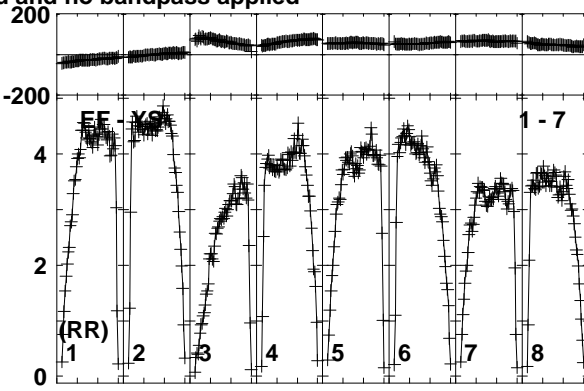
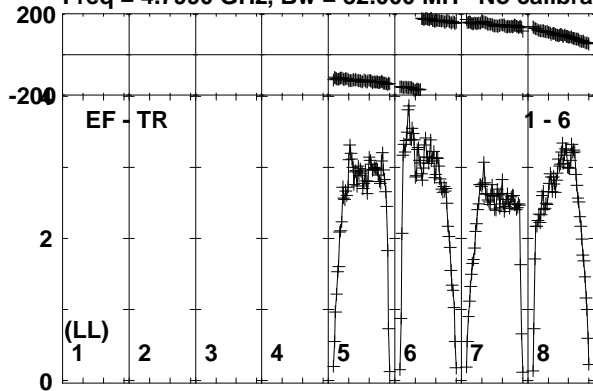

Lower frame: Milli Ampl Jy Top frame: Phas deg
Vector averaged cross-power spectrum Baseline: EF (01) - TR (06)
Timerange: 01/00:09:51 to 01/00:10:49

Plot file version 159 created 21-FEB-2017 15:11:24
 ARUMA EG096A.UVDATA.1
 Freq = 4.7990 GHz, Bw = 32.000 MH No calibration applied and no bandpass applied

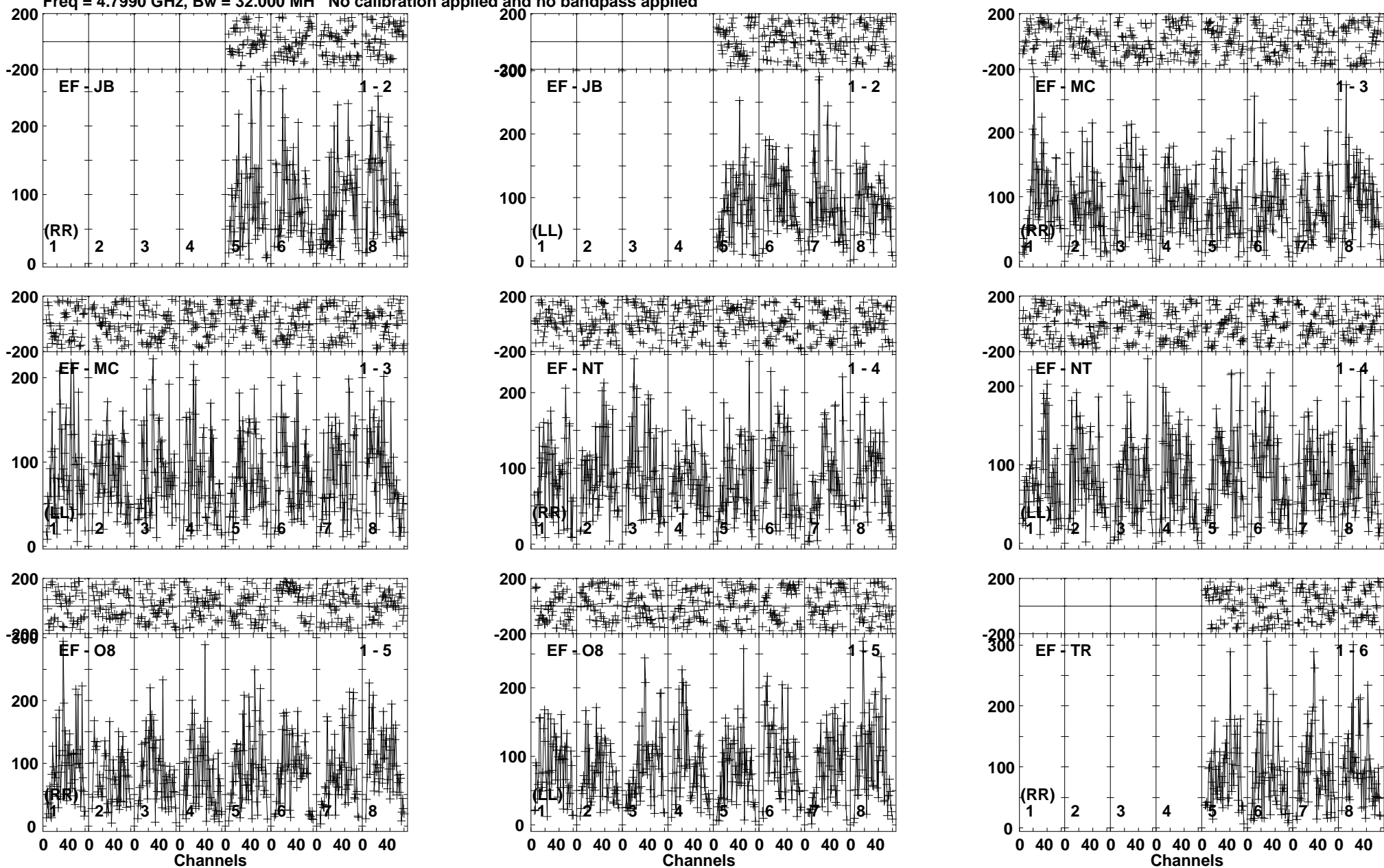

Lower frame: Micro Ampl Jy Top frame: Phas deg
 Vector averaged cross-power spectrum Baseline: EF (01) - JB (02)
 Timerange: 01/00:10:50 to 01/00:14:19

Plot file version 160 created 21-FEB-2017 15:11:24

ARUMA EG096A.UVDATA.1

Freq = 4.7990 GHz, Bw = 32.000 MH No calibration applied and no bandpass applied

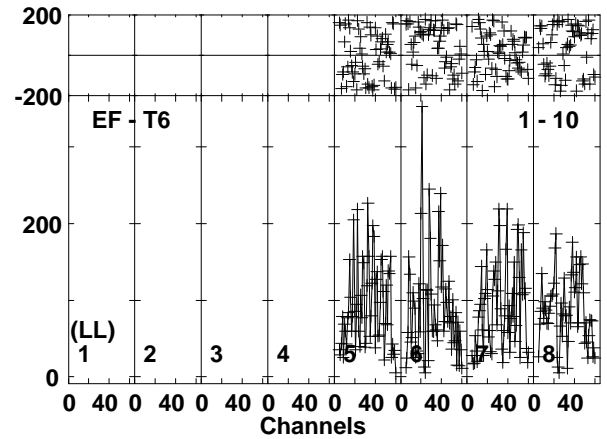
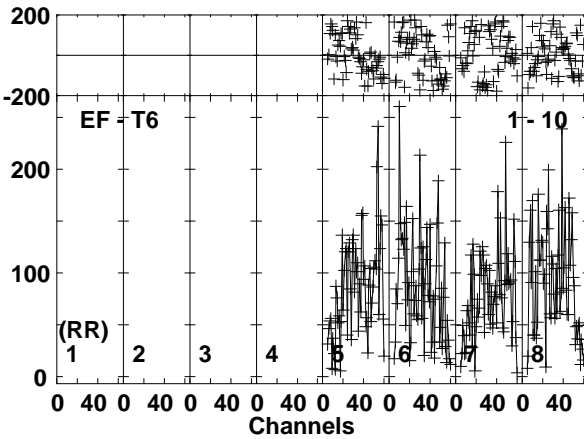
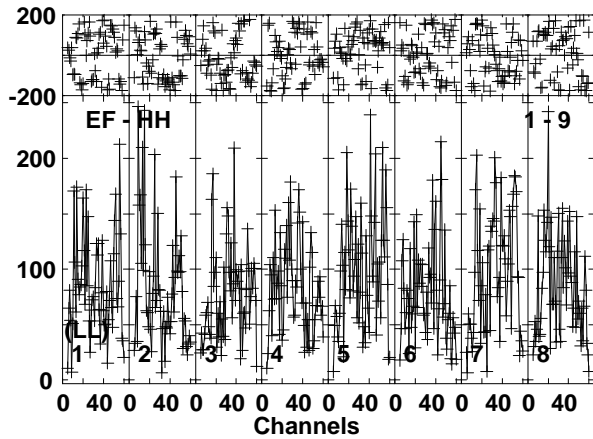
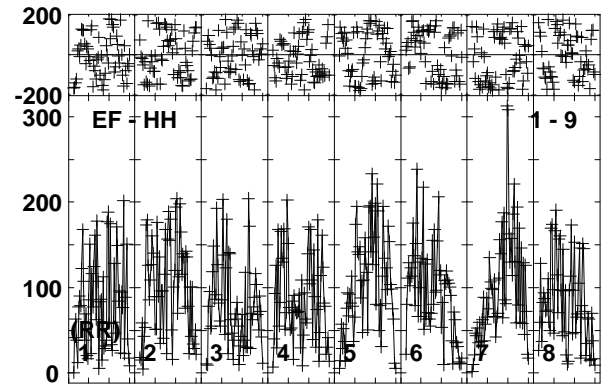
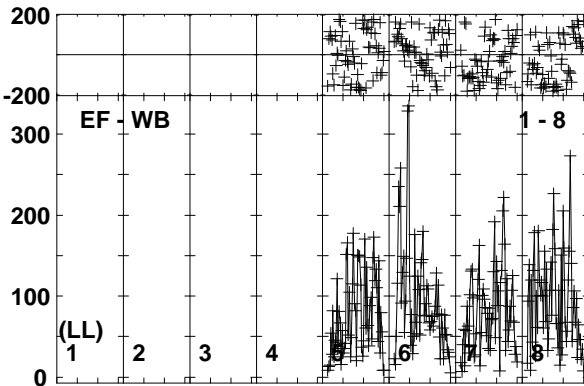
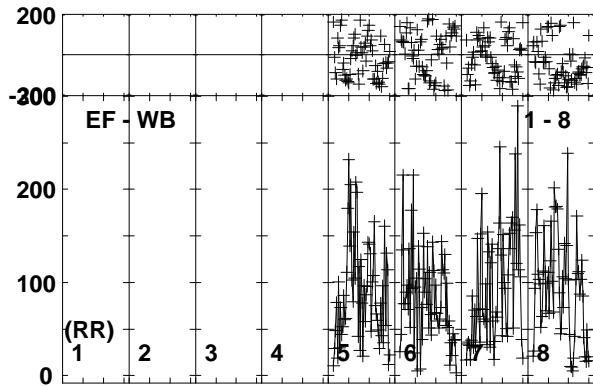
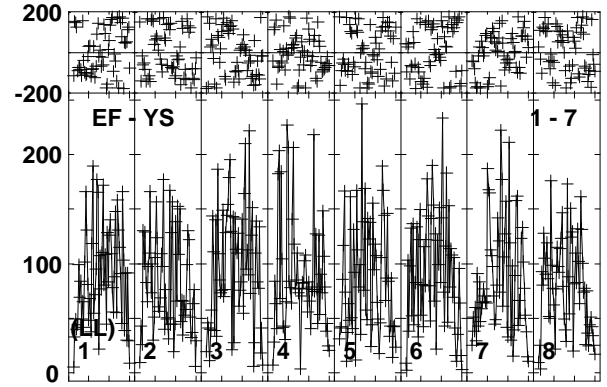
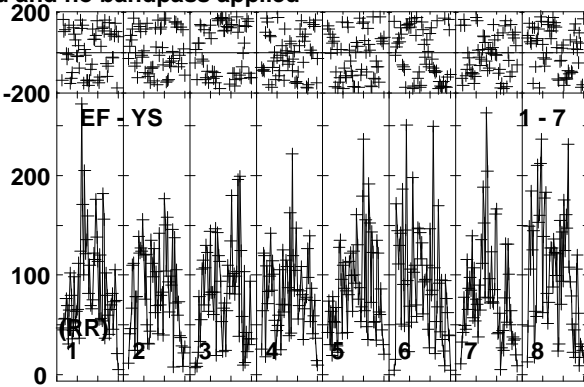
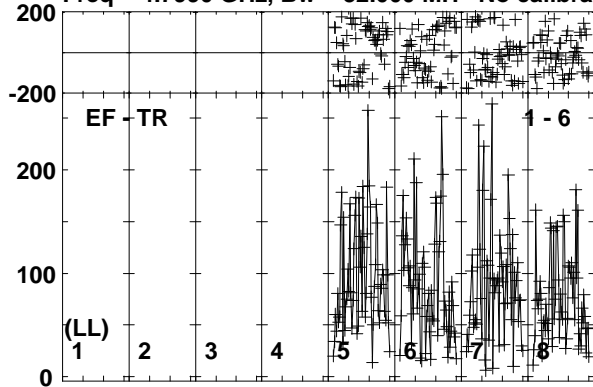

Lower frame: Micro Ampl Jy Top frame: Phas deg
Vector averaged cross-power spectrum Baseline: EF (01) - TR (06)
Timerange: 01/00:10:50 to 01/00:14:19

Plot file version 161 created 21-FEB-2017 15:11:25

J1108+4330 EG096A.UVDATA.1

Freq = 4.7990 GHz, Bw = 32.000 MH No calibration applied and no bandpass applied

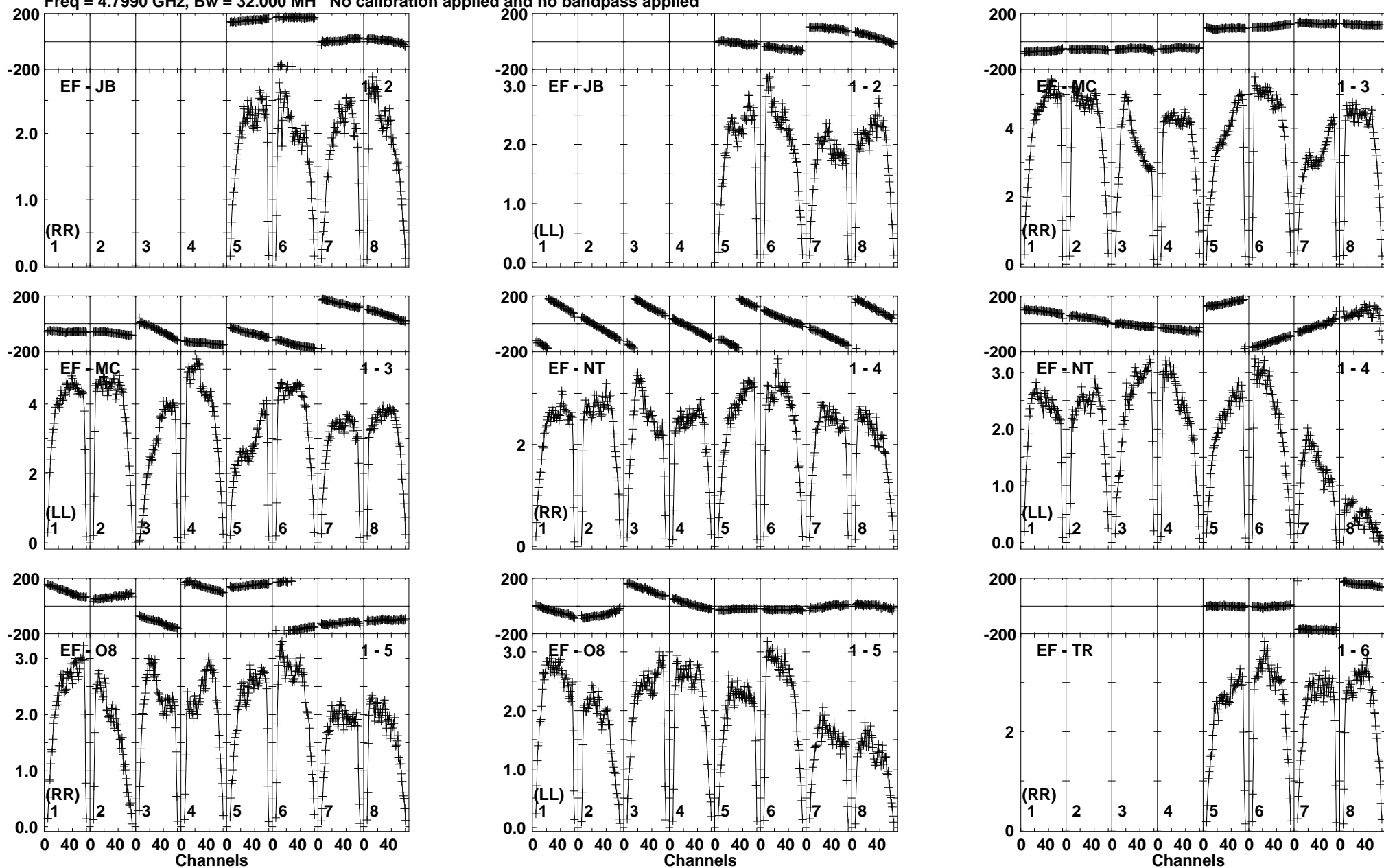

Lower frame: Milli Ampl Jy Top frame: Phas deg
Vector averaged cross-power spectrum Baseline: EF (01) - JB (02)
Timerange: 01/00:14:20 to 01/00:15:49

Plot file version 162 created 21-FEB-2017 15:11:25

J1108+4330 EG096A.UVDATA.1

Freq = 4.7990 GHz, Bw = 32.000 MH No calibration applied and no bandpass applied

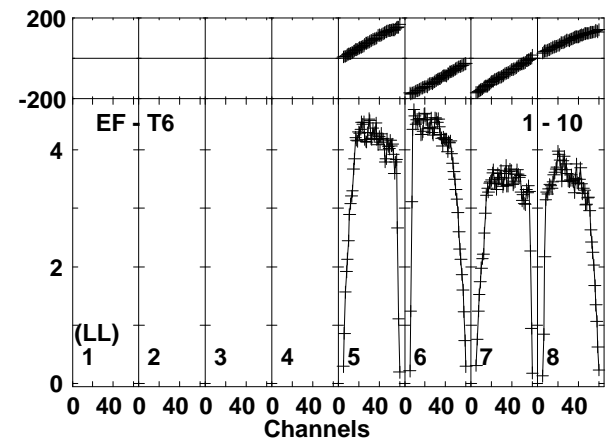
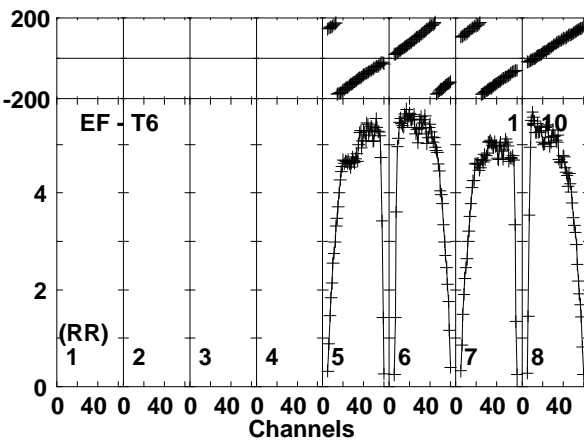
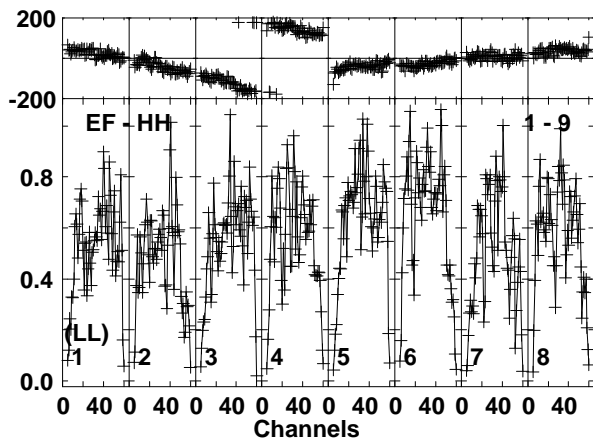
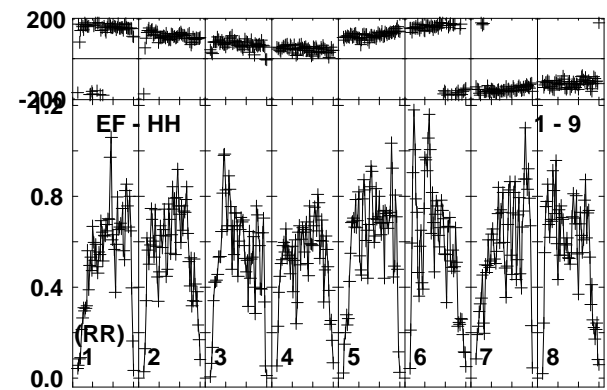
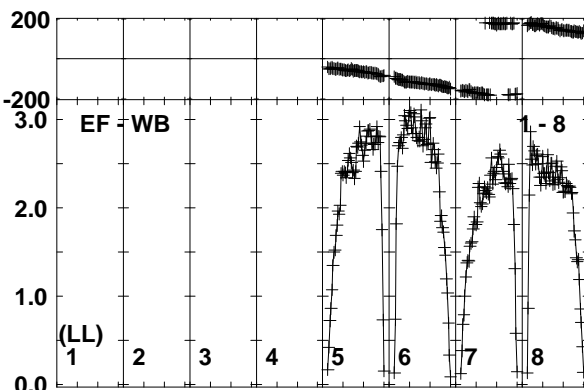
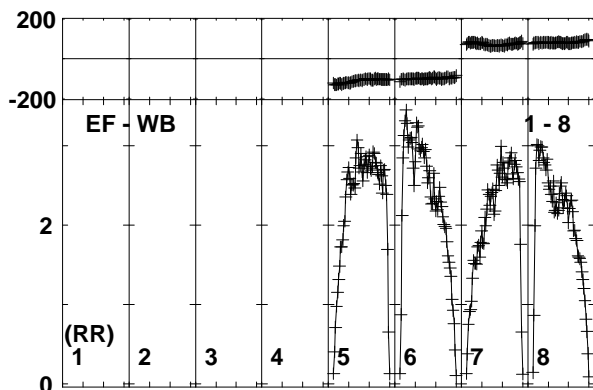
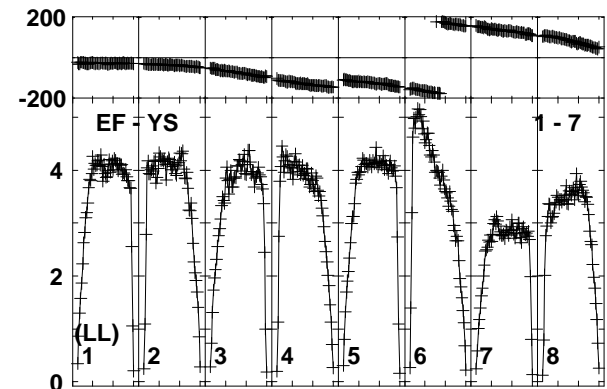
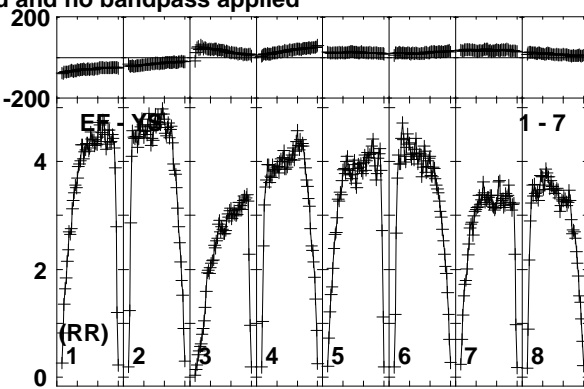
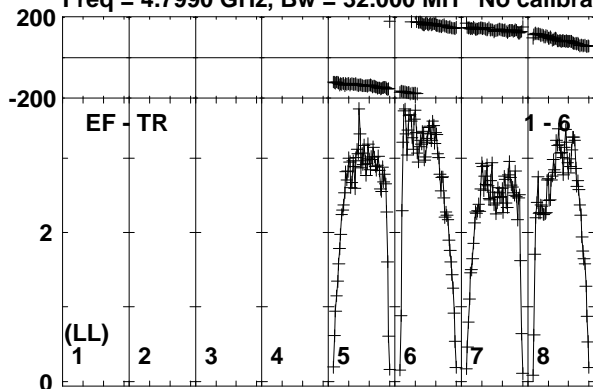

Lower frame: Milli Ampl Jy Top frame: Phas deg
Vector averaged cross-power spectrum Baseline: EF (01) - TR (06)
Timerange: 01/00:14:20 to 01/00:15:49

Plot file version 163 created 21-FEB-2017 15:11:25

ARUMA EG096A.UVDATA.1

Freq = 4.7990 GHz, Bw = 32.000 MH No calibration applied and no bandpass applied

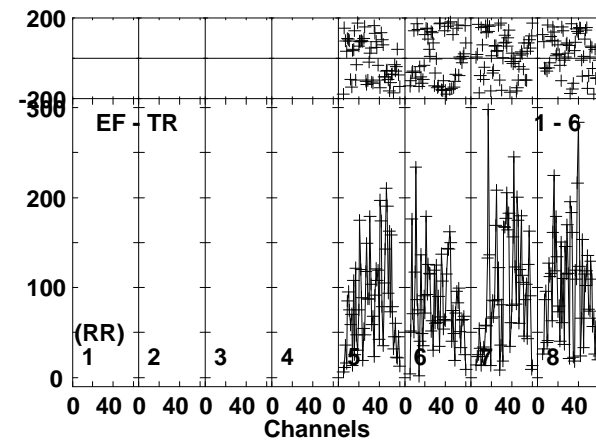
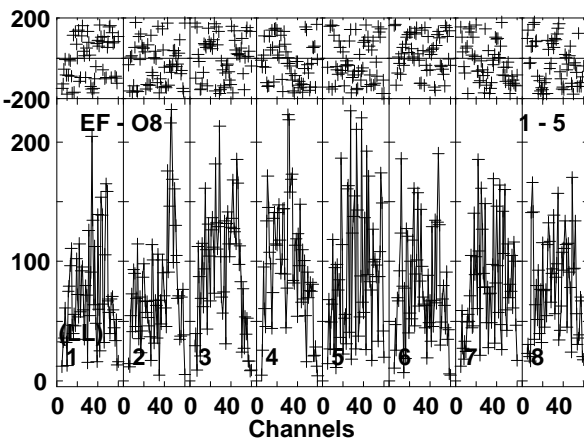
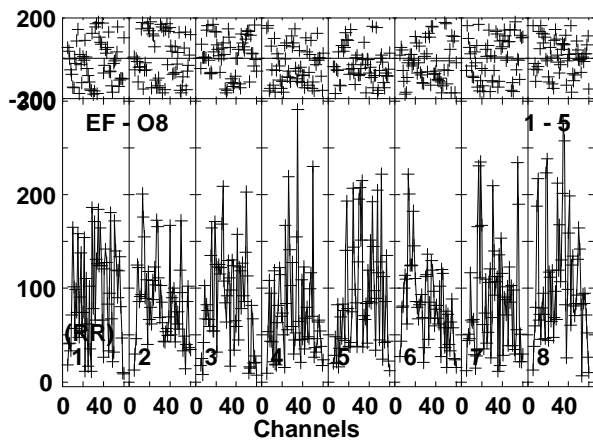
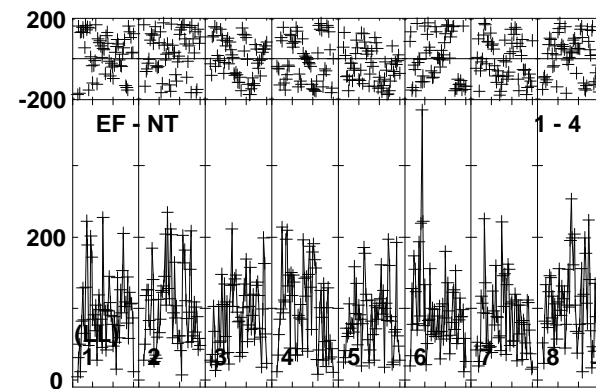
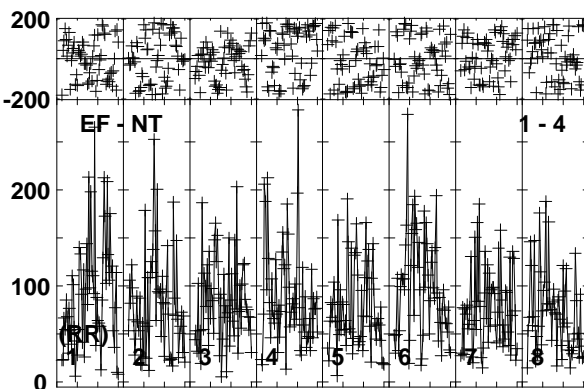
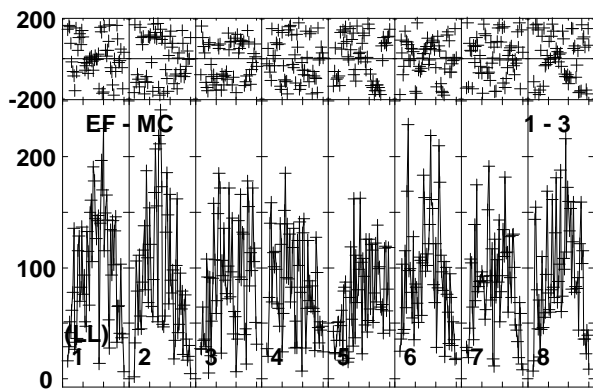
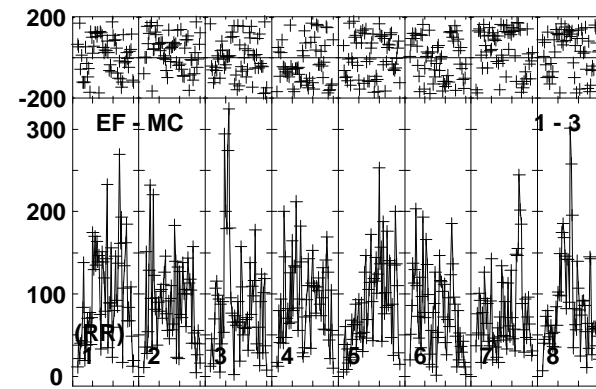
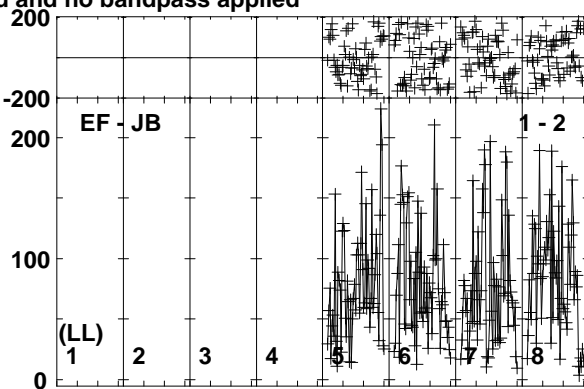
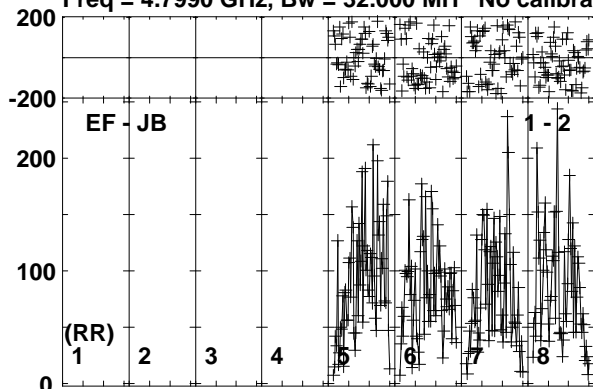

Lower frame: Micro Ampl Jy Top frame: Phas deg
Vector averaged cross-power spectrum Baseline: EF (01) - JB (02)
Timerange: 01/00:15:50 to 01/00:19:19

Plot file version 164 created 21-FEB-2017 15:11:26

ARUMA EG096A.UVDATA.1

Freq = 4.7990 GHz, Bw = 32.000 MH No calibration applied and no bandpass applied

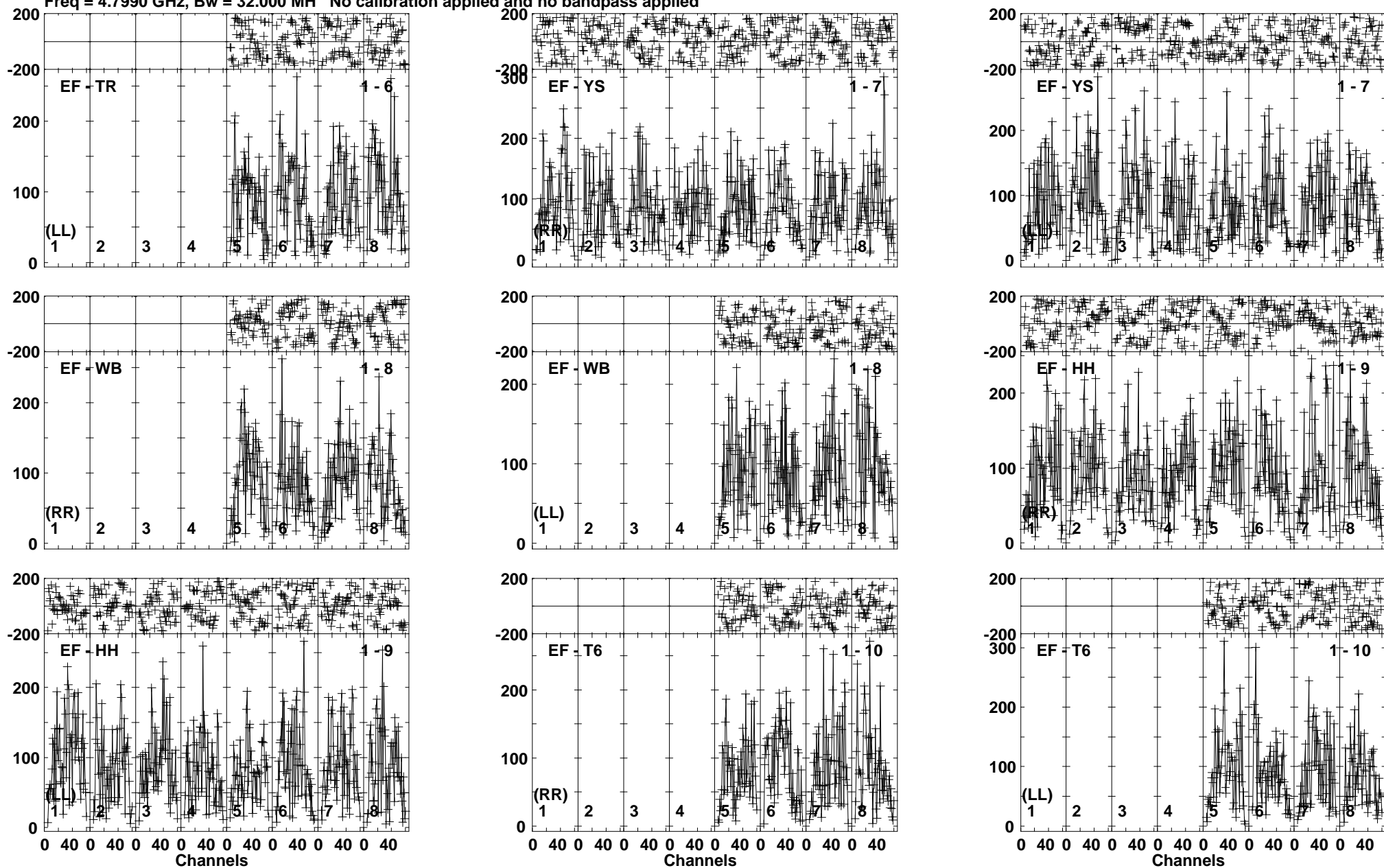

Lower frame: Micro Ampl Jy Top frame: Phas deg
Vector averaged cross-power spectrum Baseline: EF (01) - TR (06)
Timerange: 01/00:15:50 to 01/00:19:19

Plot file version 165 created 21-FEB-2017 15:11:26

J1108+4330 EG096A.UVDATA.1

Freq = 4.7990 GHz, Bw = 32.000 MH No calibration applied and no bandpass applied

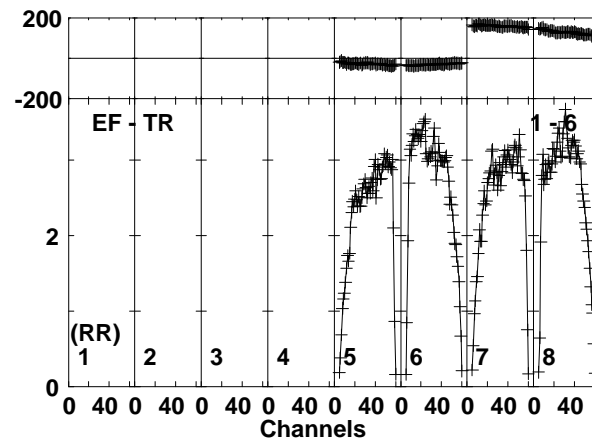
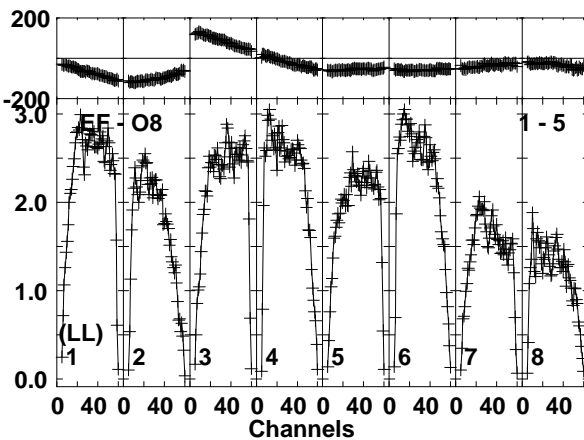
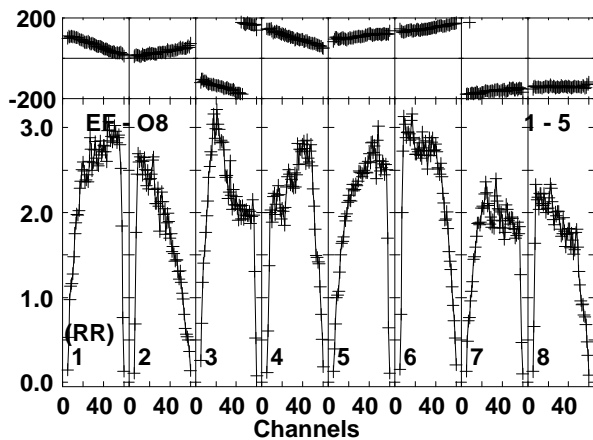
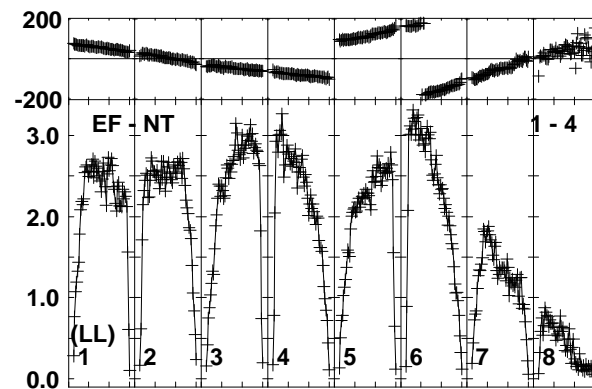
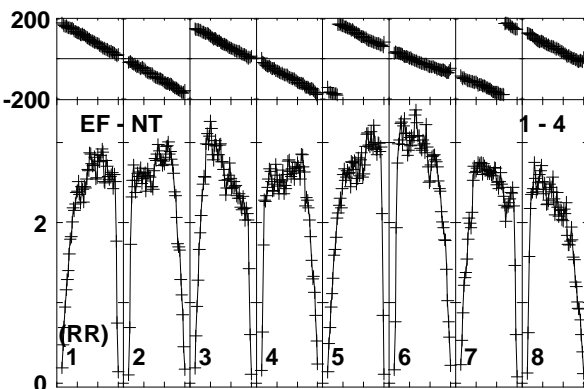
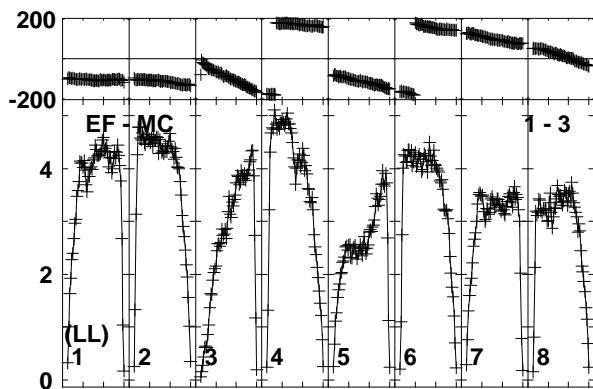
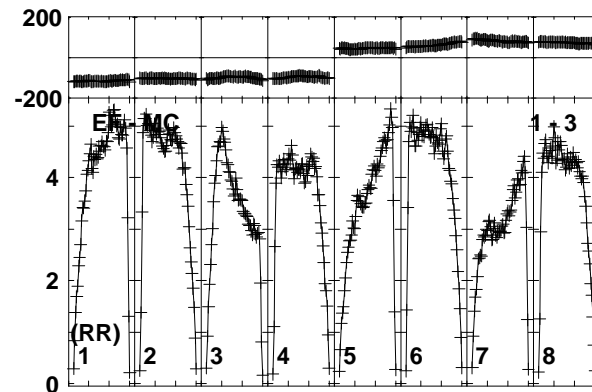
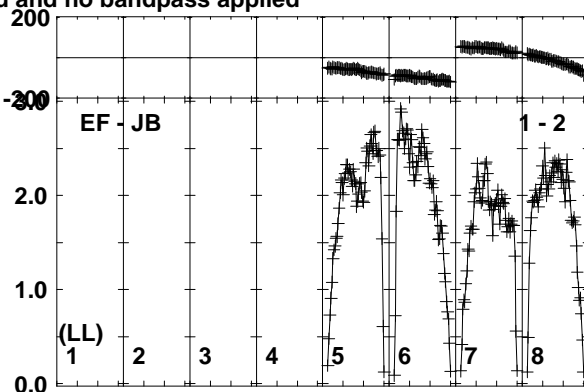
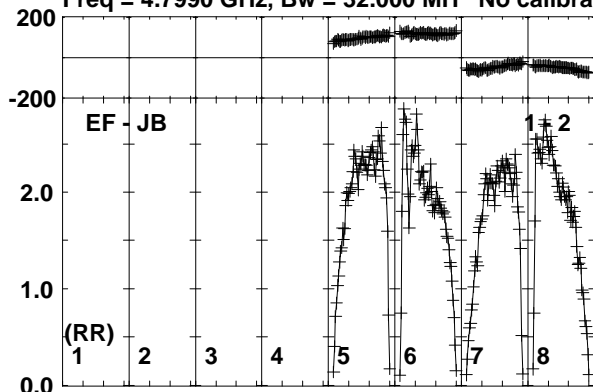

Lower frame: Milli Ampl Jy Top frame: Phas deg
Vector averaged cross-power spectrum Baseline: EF (01) - JB (02)
Timerange: 01/00:20:01 to 01/00:20:59

Plot file version 166 created 21-FEB-2017 15:11:26

J1108+4330 EG096A.UVDATA.1

Freq = 4.7990 GHz, Bw = 32.000 MH No calibration applied and no bandpass applied

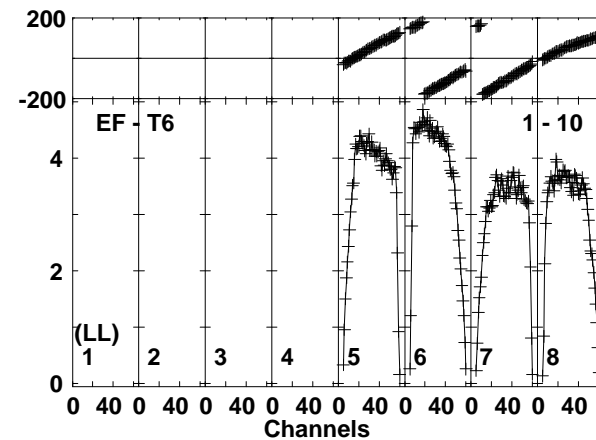
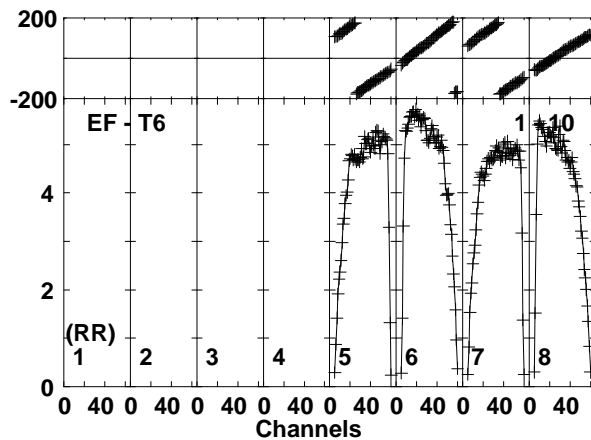
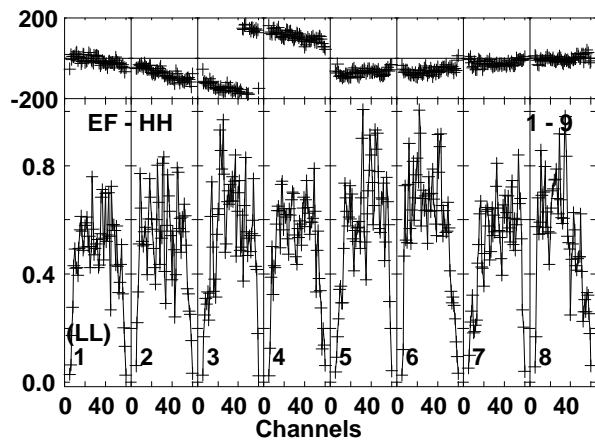
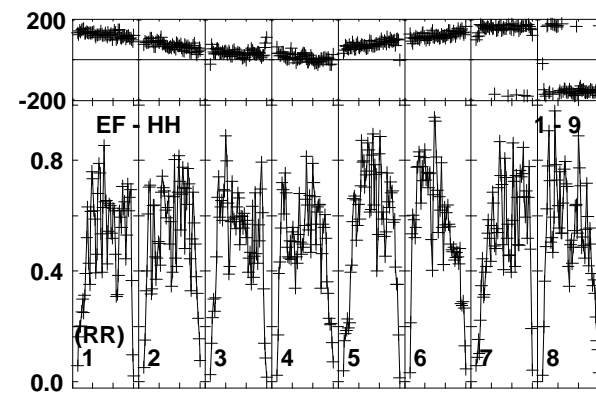
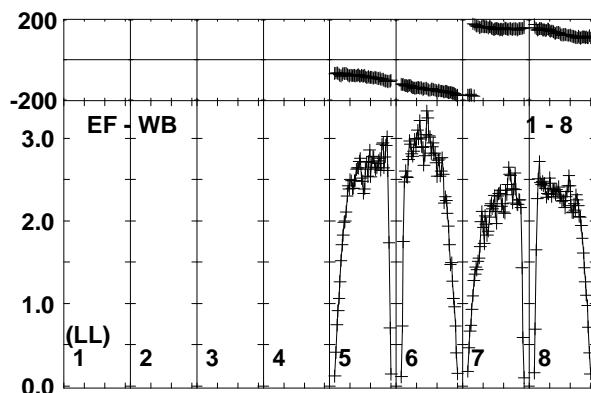
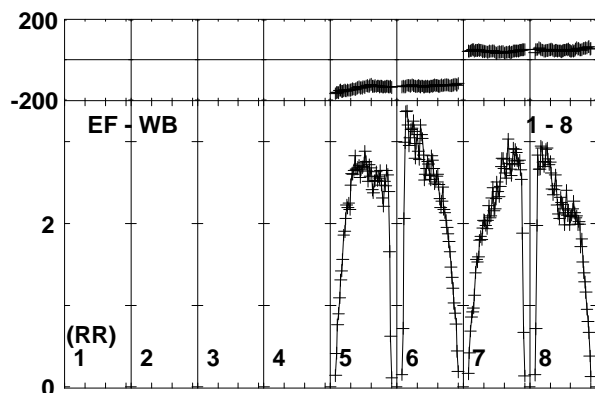
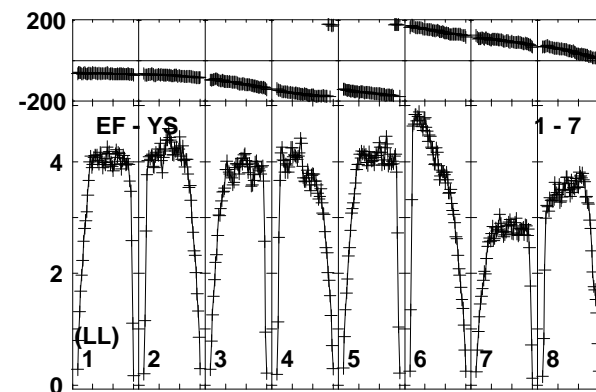
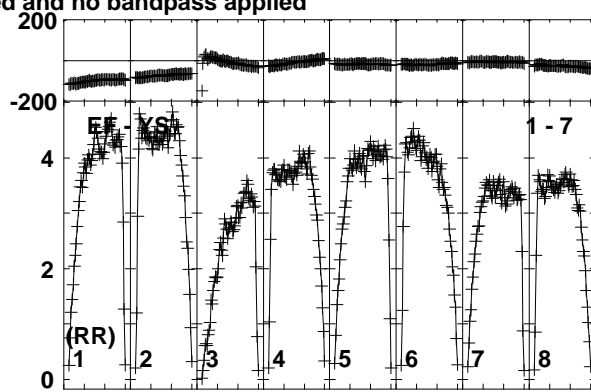
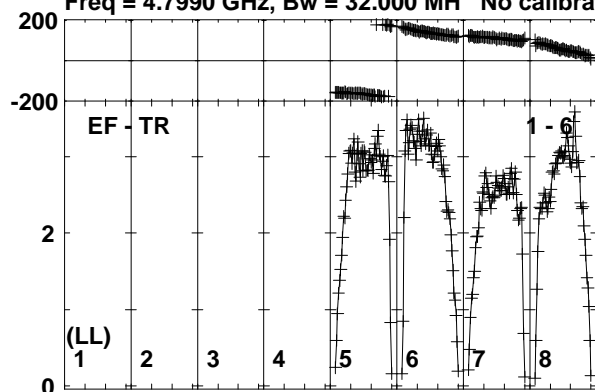

Lower frame: Milli Ampl Jy Top frame: Phas deg
Vector averaged cross-power spectrum Baseline: EF (01) - TR (06)
Timerange: 01/00:20:01 to 01/00:20:59

Plot file version 167 created 21-FEB-2017 15:11:26

ARUMA EG096A.UVDATA.1

Freq = 4.7990 GHz, Bw = 32.000 MH No calibration applied and no bandpass applied

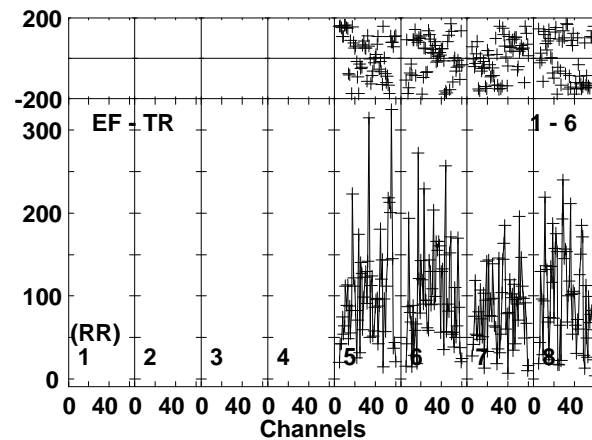
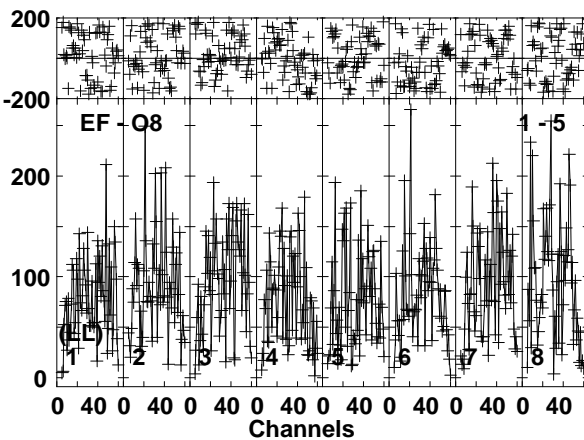
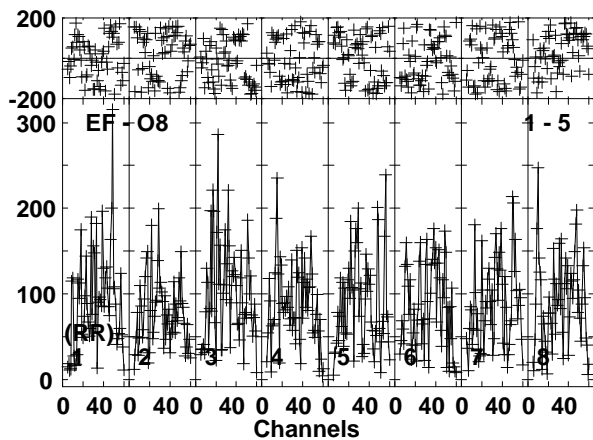
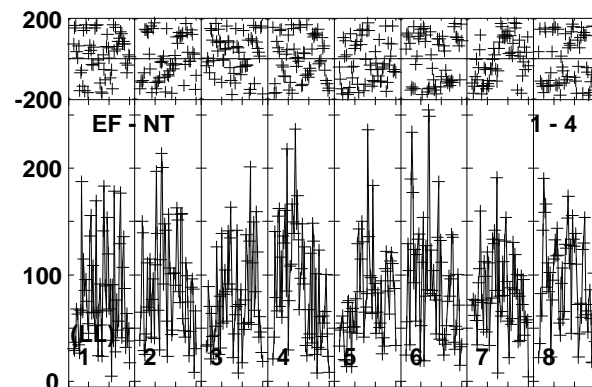
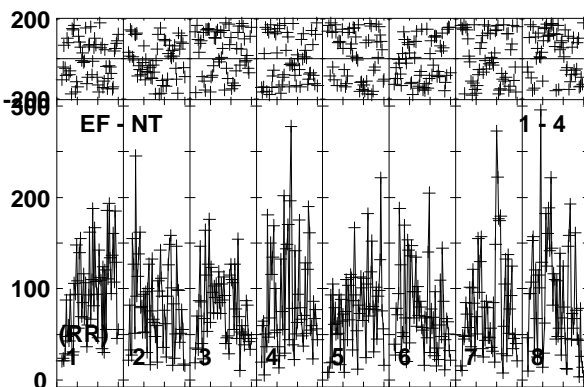
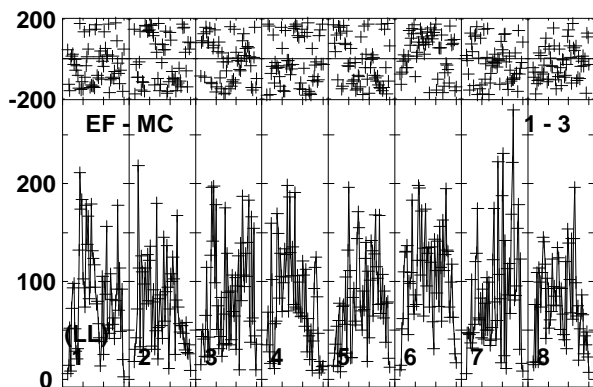
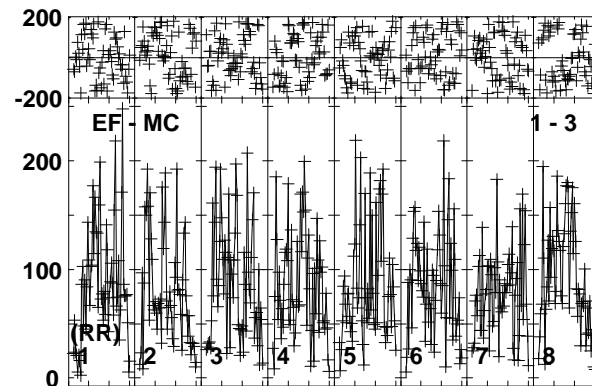
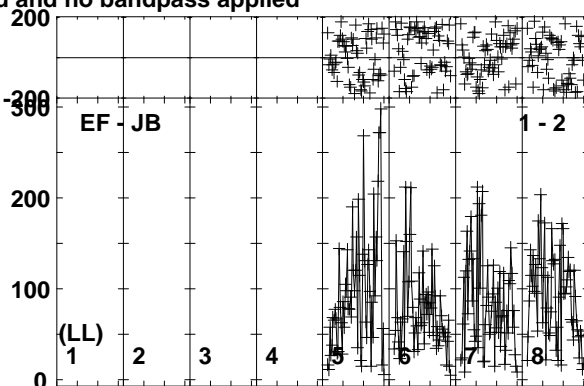
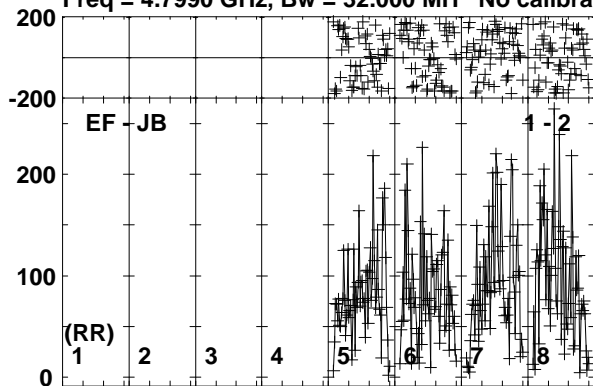

Lower frame: Micro Ampl Jy Top frame: Phas deg
Vector averaged cross-power spectrum Baseline: EF (01) - JB (02)
Timerange: 01/00:21:00 to 01/00:24:29

Plot file version 168 created 21-FEB-2017 15:11:27

ARUMA EG096A.UVDATA.1

Freq = 4.7990 GHz, Bw = 32.000 MH No calibration applied and no bandpass applied

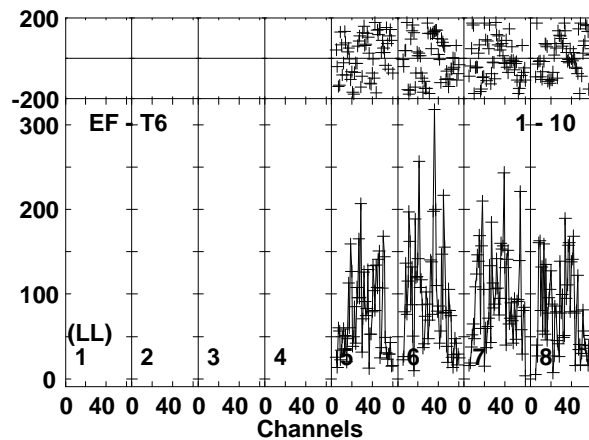
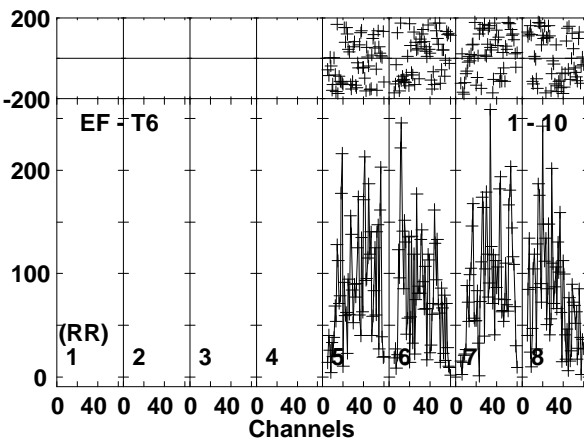
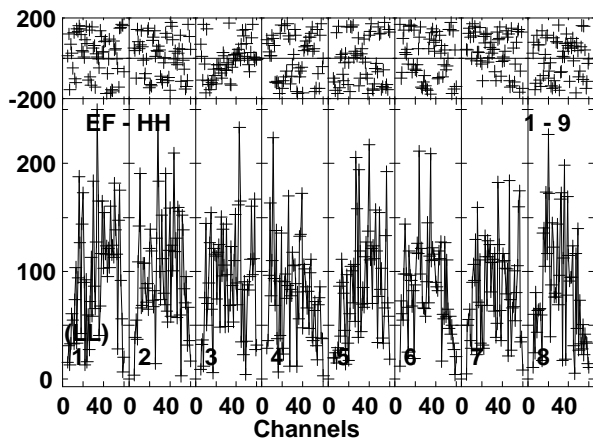
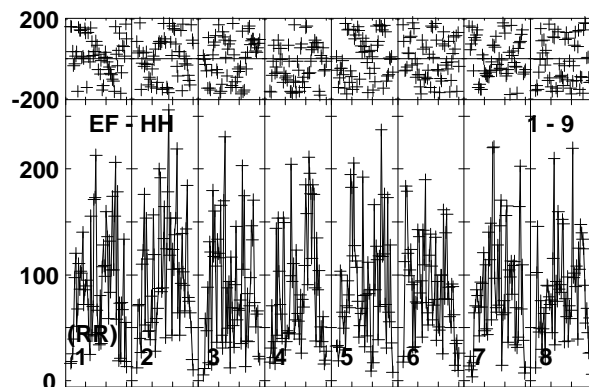
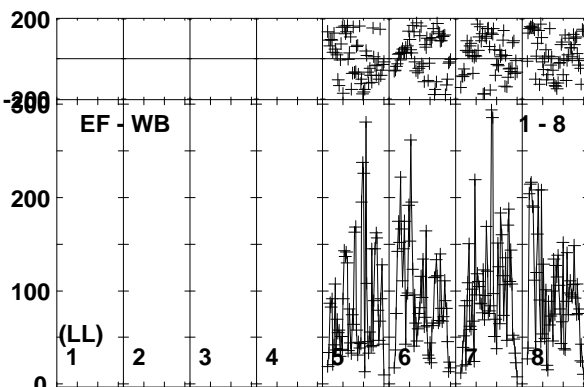
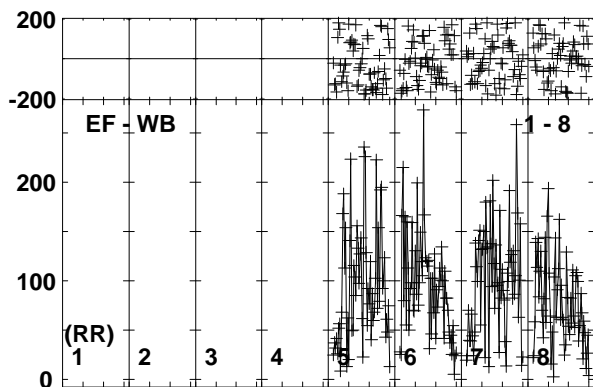
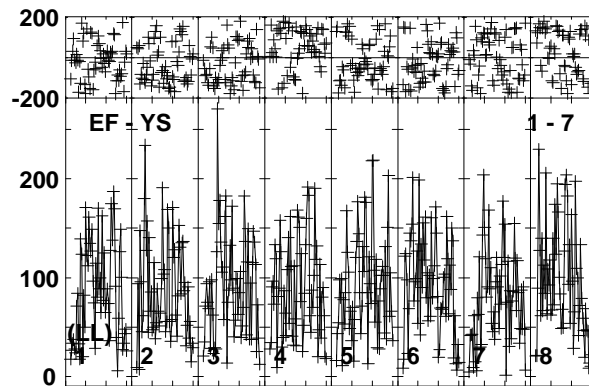
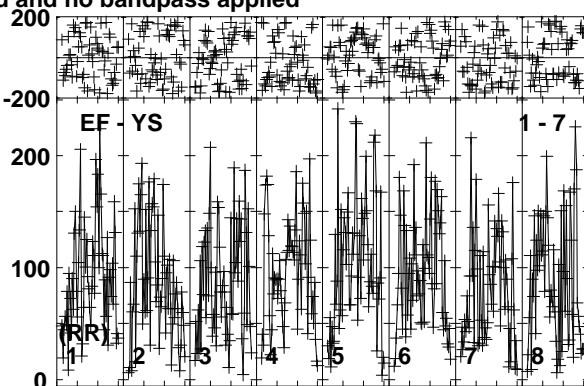
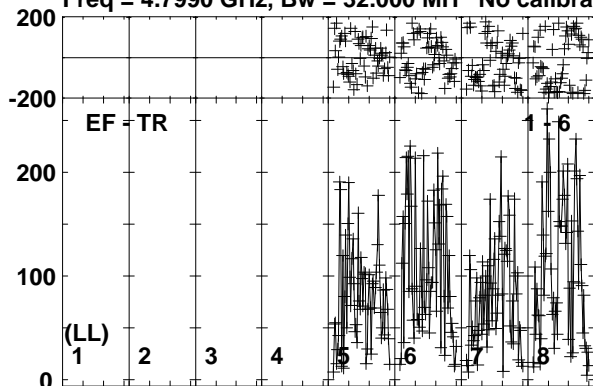

Lower frame: Micro Ampl Jy Top frame: Phas deg
Vector averaged cross-power spectrum Baseline: EF (01) - TR (06)
Timerange: 01/00:21:00 to 01/00:24:29

Plot file version 169 created 21-FEB-2017 15:11:27

J1108+4330 EG096A.UVDATA.1

Freq = 4.7990 GHz, Bw = 32.000 MH No calibration applied and no bandpass applied

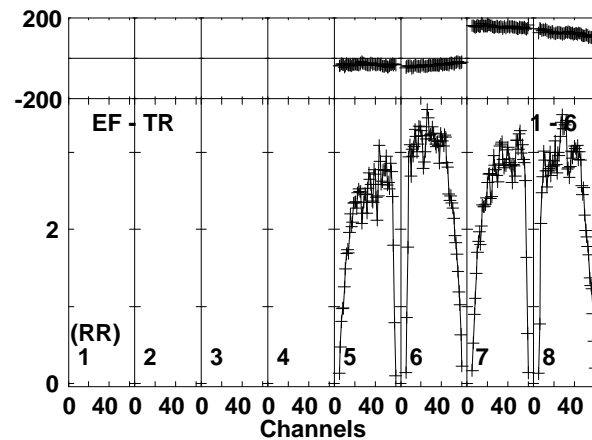
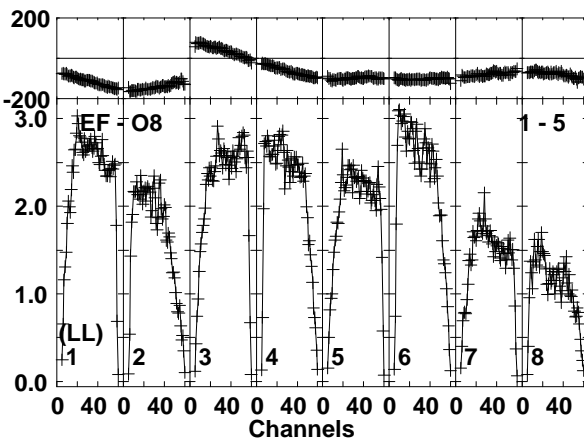
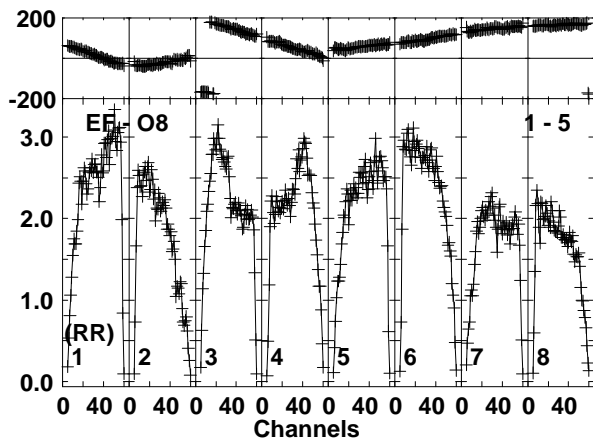
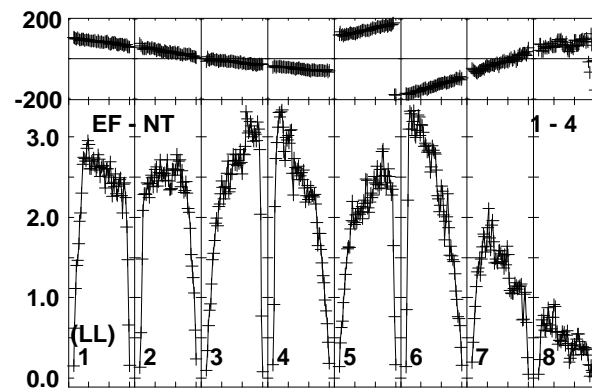
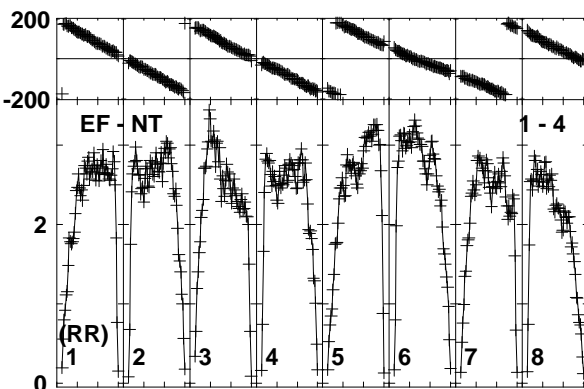
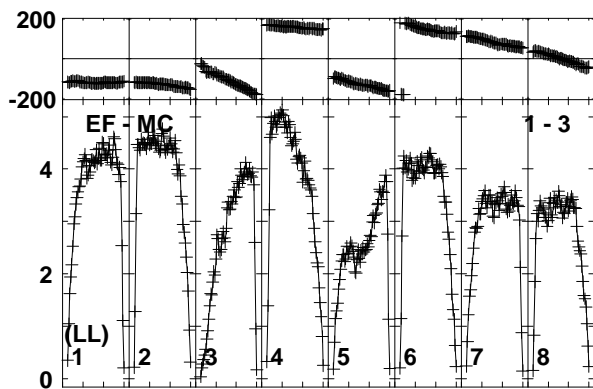
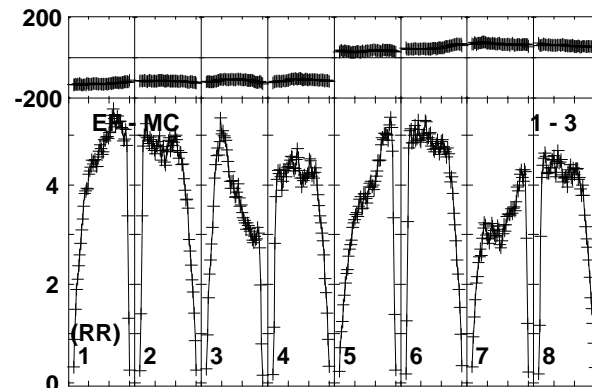
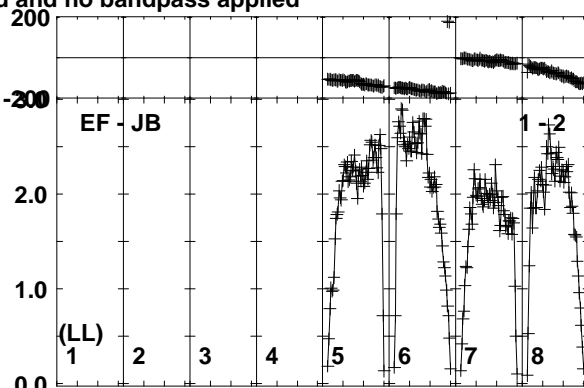
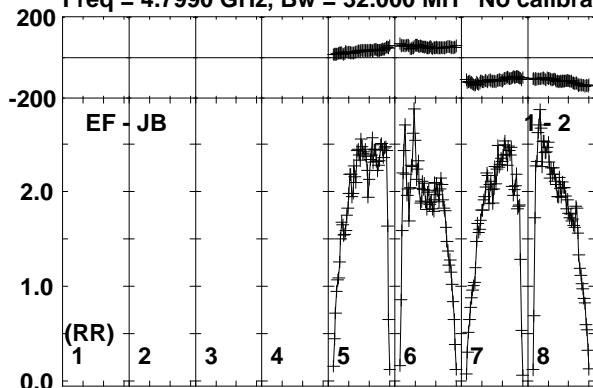

Lower frame: Milli Ampl Jy Top frame: Phas deg
Vector averaged cross-power spectrum Baseline: EF (01) - JB (02)
Timerange: 01/00:24:31 to 01/00:25:59

Plot file version 170 created 21-FEB-2017 15:11:27

J1108+4330 EG096A.UVDATA.1

Freq = 4.7990 GHz, Bw = 32.000 MH No calibration applied and no bandpass applied

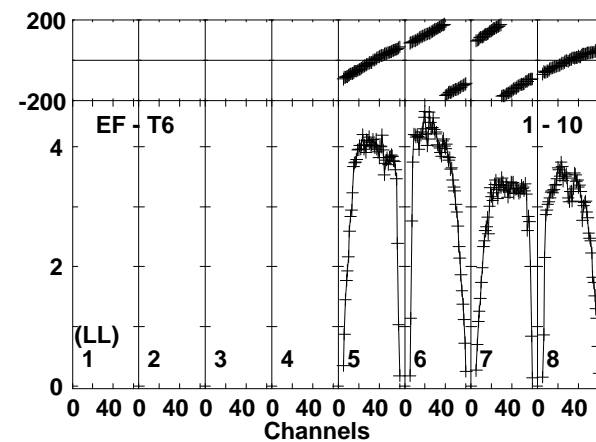
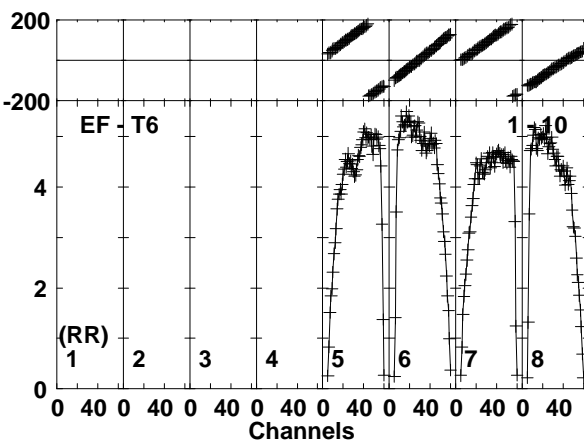
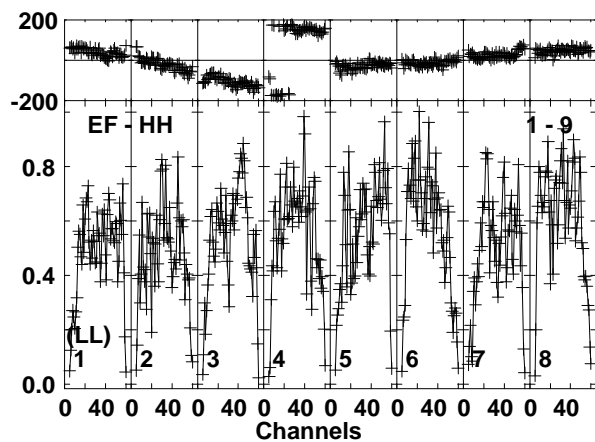
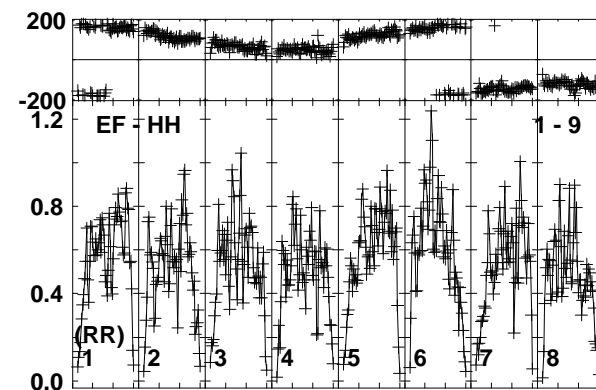
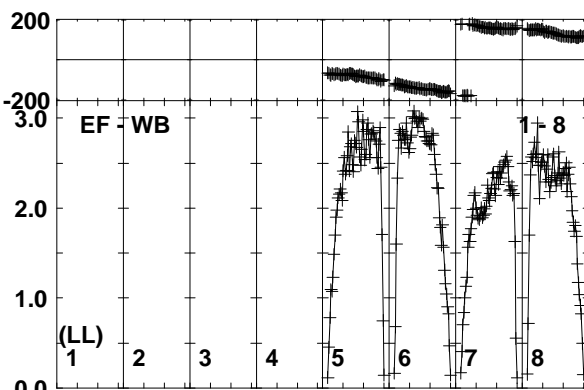
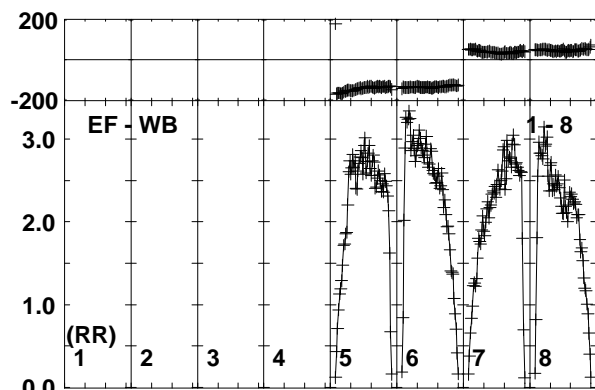
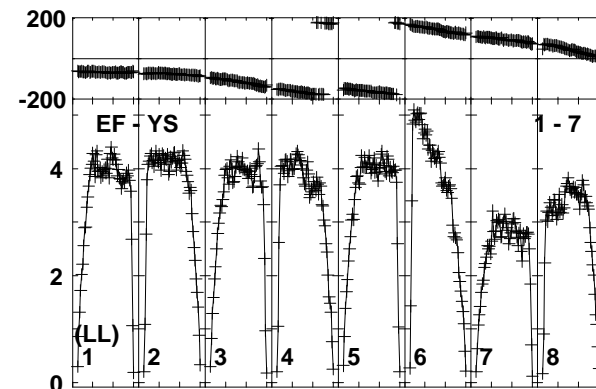
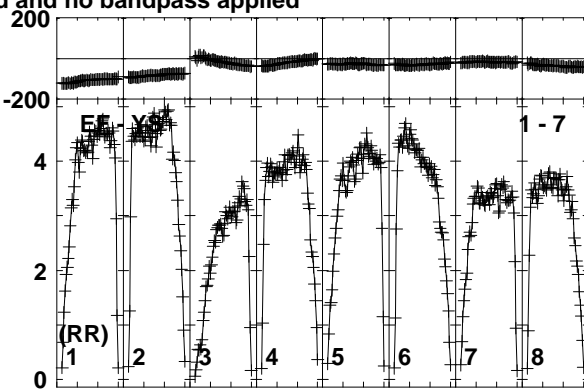
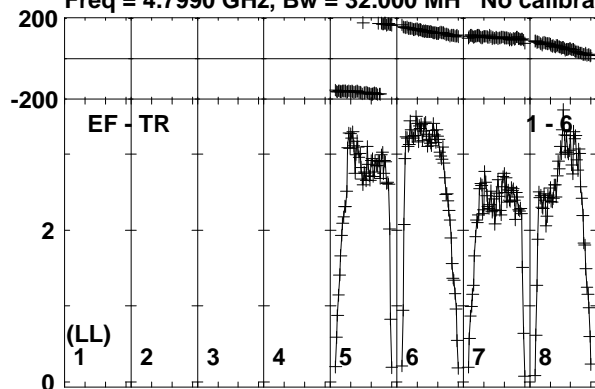

Lower frame: Milli Ampl Jy Top frame: Phas deg
Vector averaged cross-power spectrum Baseline: EF (01) - TR (06)
Timerange: 01/00:24:31 to 01/00:25:59

Plot file version 171 created 21-FEB-2017 15:11:28

ARUMA EG096A.UVDATA.1

Freq = 4.7990 GHz, Bw = 32.000 MH No calibration applied and no bandpass applied

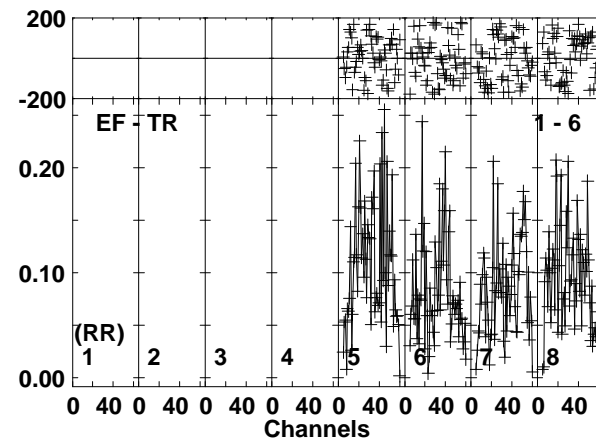
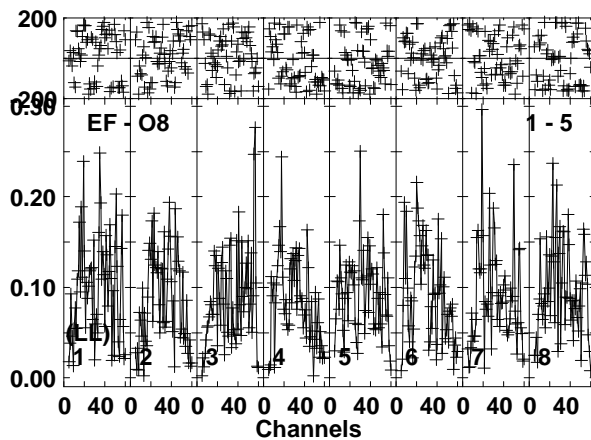
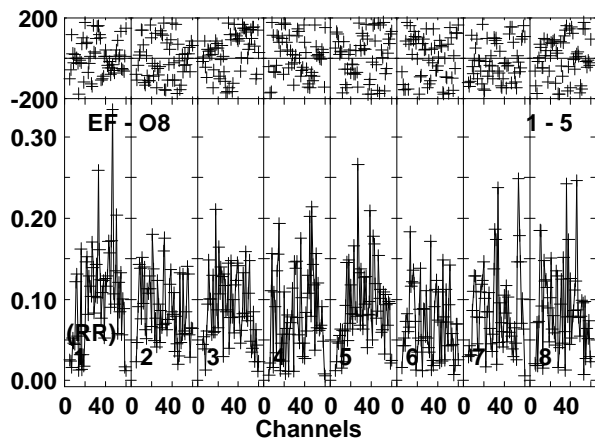
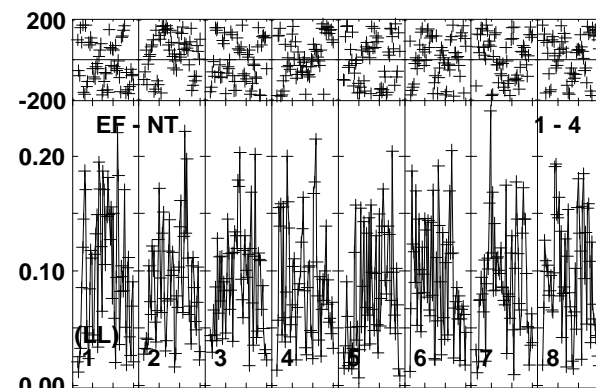
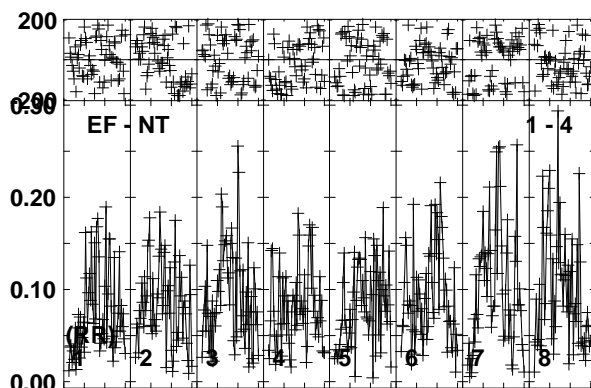
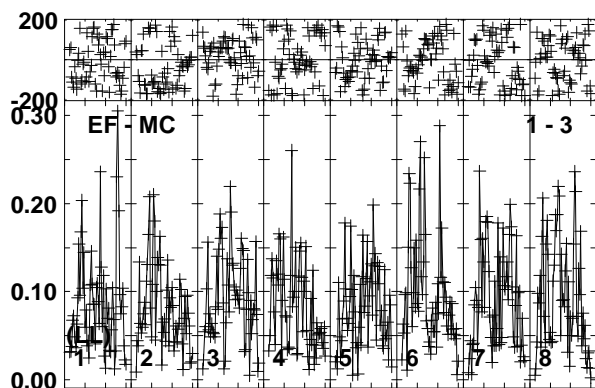
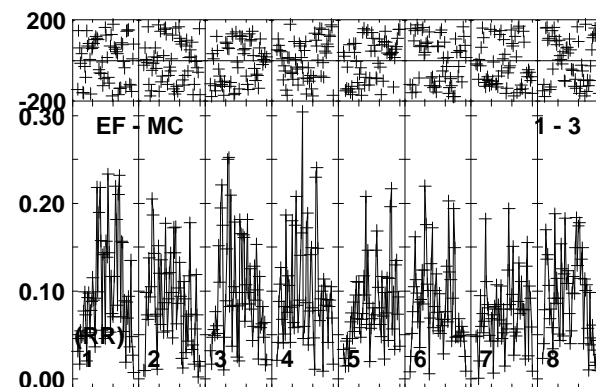
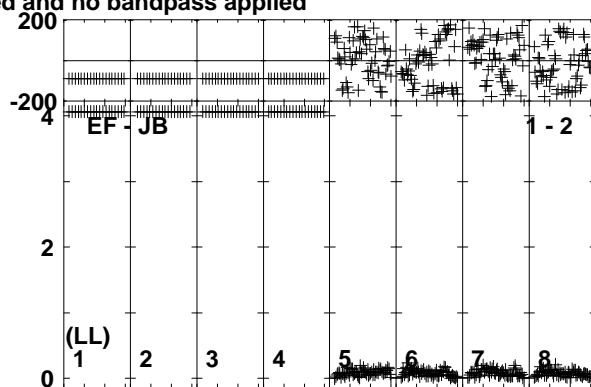
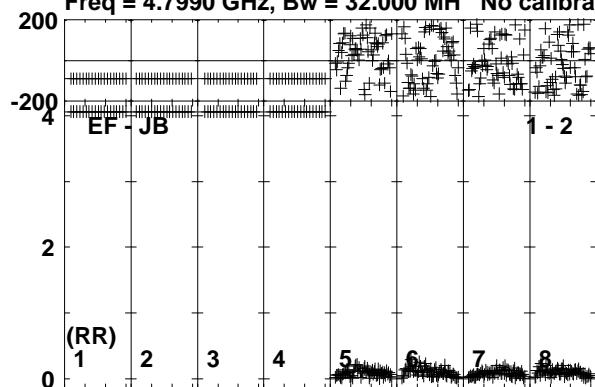

Lower frame: Milli Ampl Jy Top frame: Phas deg
Vector averaged cross-power spectrum Baseline: EF (01) - JB (02)
Timerange: 01/00:26:01 to 01/00:29:30

Plot file version 172 created 21-FEB-2017 15:11:28

ARUMA EG096A.UVDATA.1

Freq = 4.7990 GHz, Bw = 32.000 MH No calibration applied and no bandpass applied

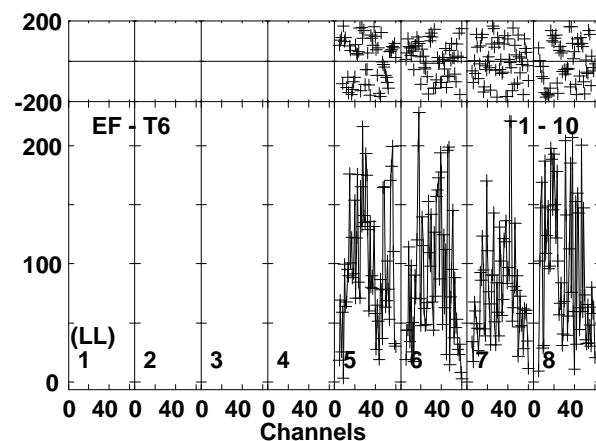
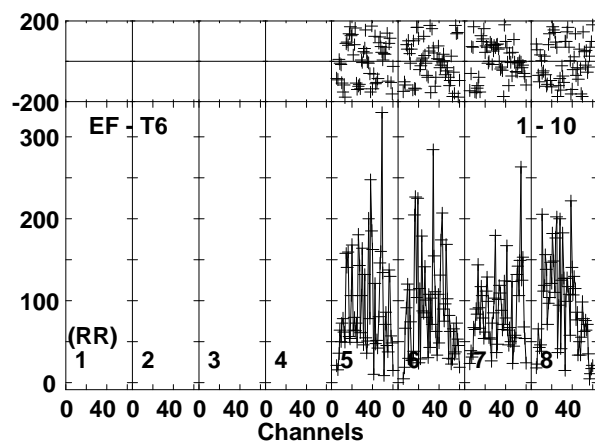
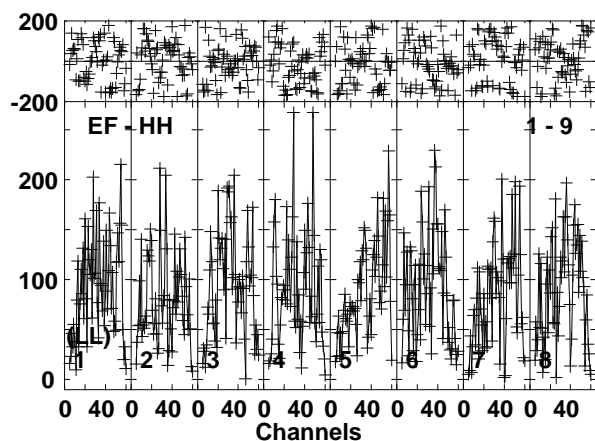
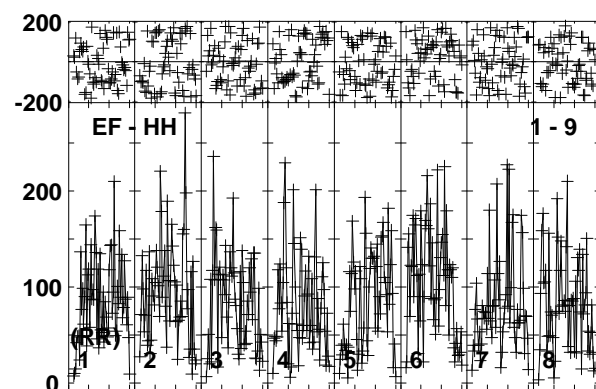
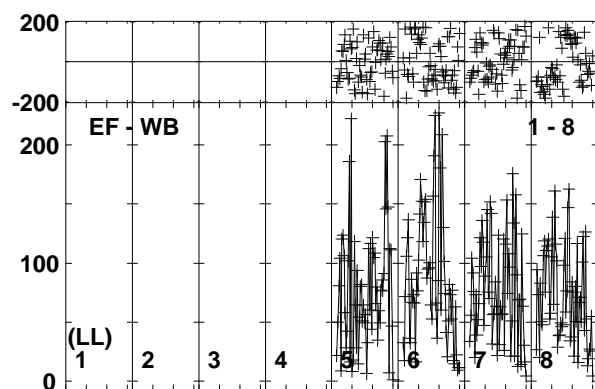
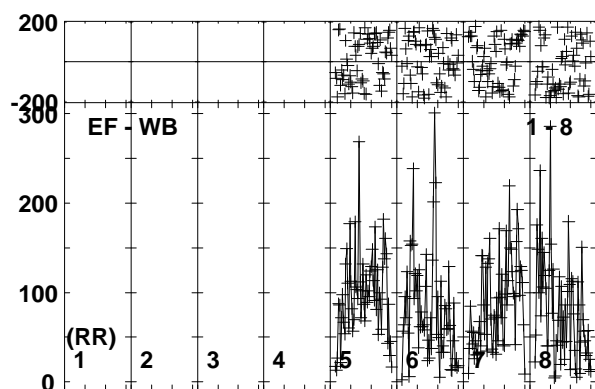
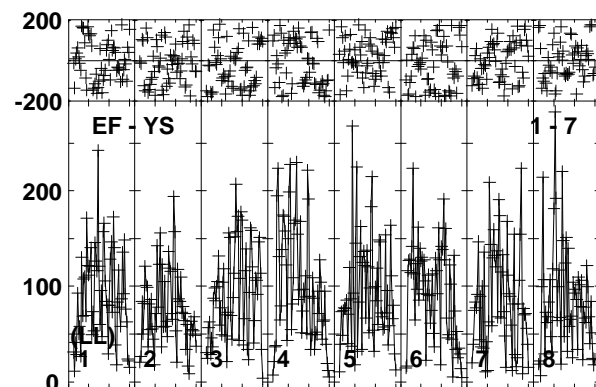
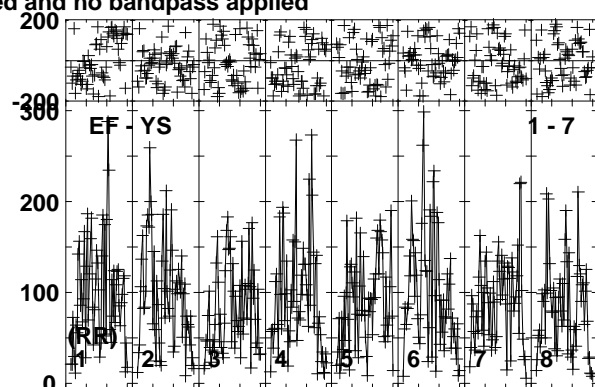
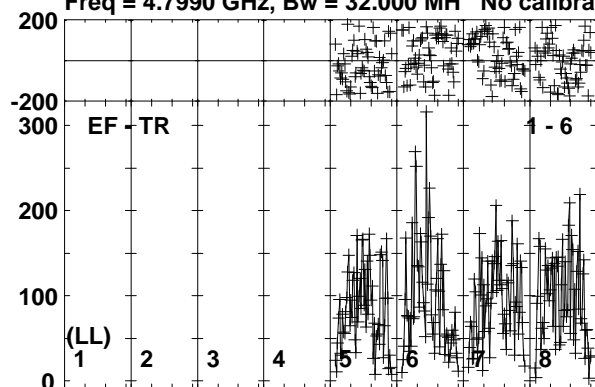

Lower frame: Micro Ampl Jy Top frame: Phas deg
Vector averaged cross-power spectrum Baseline: EF (01) - TR (06)
Timerange: 01/00:26:01 to 01/00:29:30

Plot file version 173 created 21-FEB-2017 15:11:28

J1108+4330 EG096A.UVDATA.1

Freq = 4.7990 GHz, Bw = 32.000 MH No calibration applied and no bandpass applied

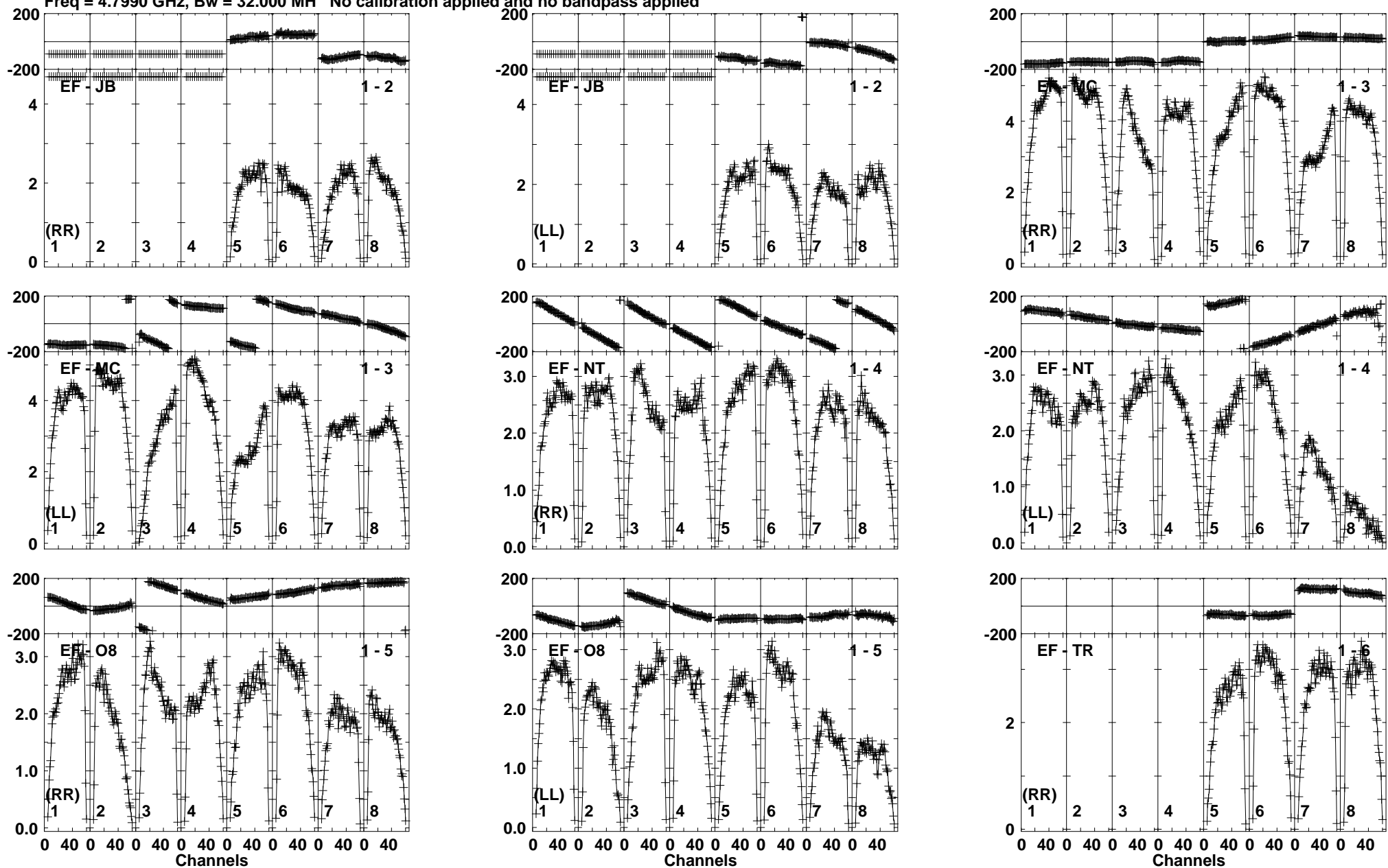

Lower frame: Milli Ampl Jy Top frame: Phas deg
Vector averaged cross-power spectrum Baseline: EF (01) - JB (02)
Timerange: 01/00:30:10 to 01/00:31:09

Plot file version 174 created 21-FEB-2017 15:11:28

J1108+4330 EG096A.UVDATA.1

Freq = 4.7990 GHz, Bw = 32.000 MH No calibration applied and no bandpass applied

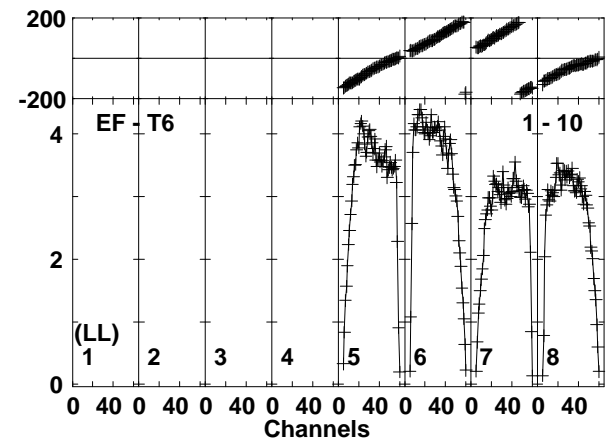
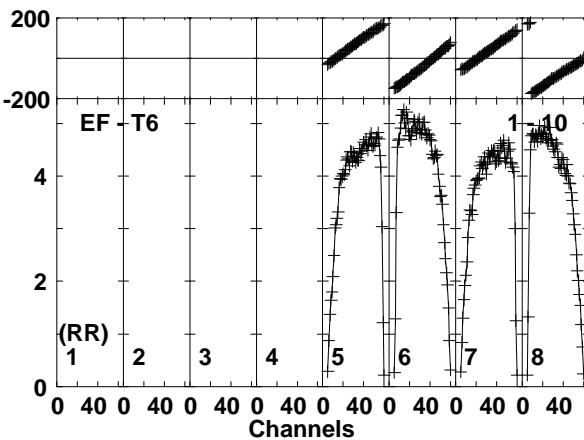
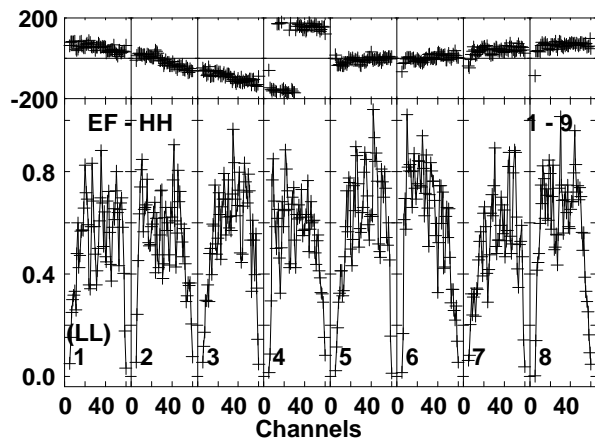
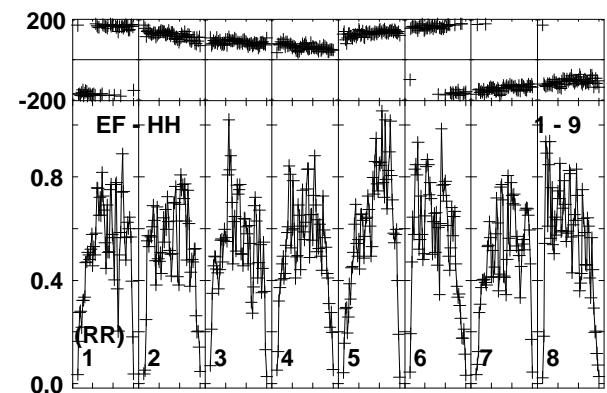
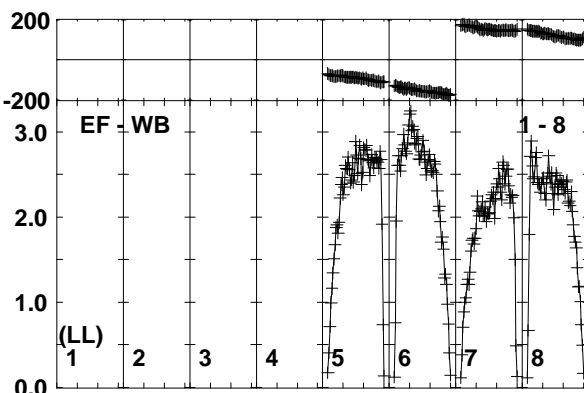
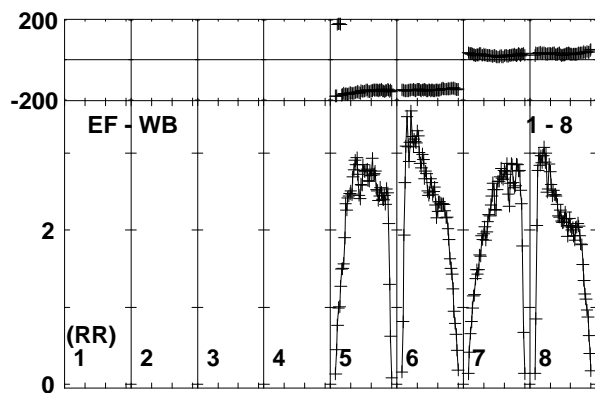
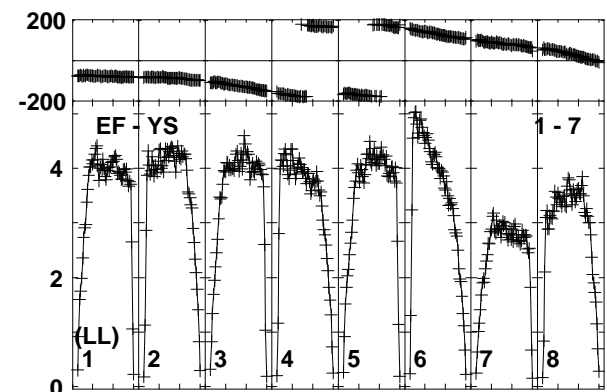
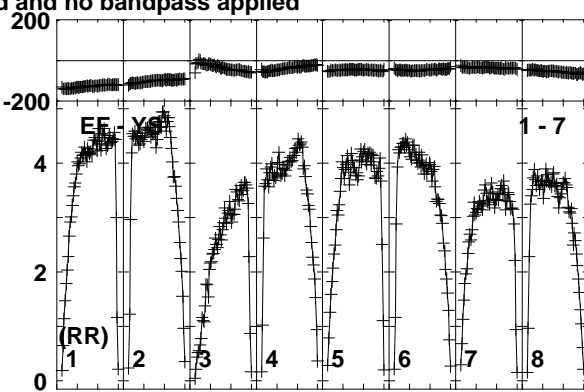
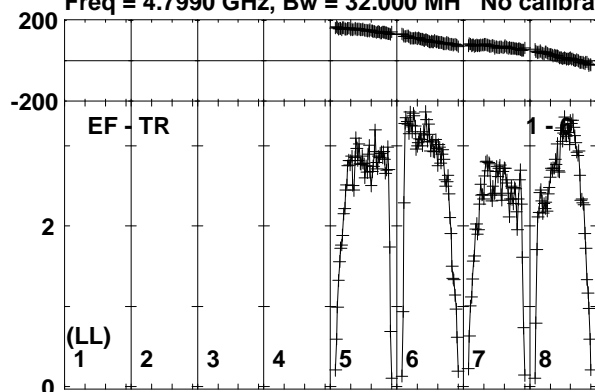

Lower frame: Milli Ampl Jy Top frame: Phas deg
Vector averaged cross-power spectrum Baseline: EF (01) - TR (06)
Timerange: 01/00:30:10 to 01/00:31:09

Plot file version 175 created 21-FEB-2017 15:11:29

ARUMA EG096A.UVDATA.1

Freq = 4.7990 GHz, Bw = 32.000 MH No calibration applied and no bandpass applied

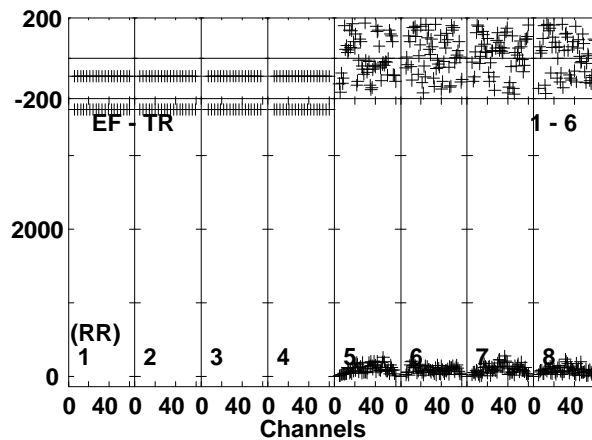
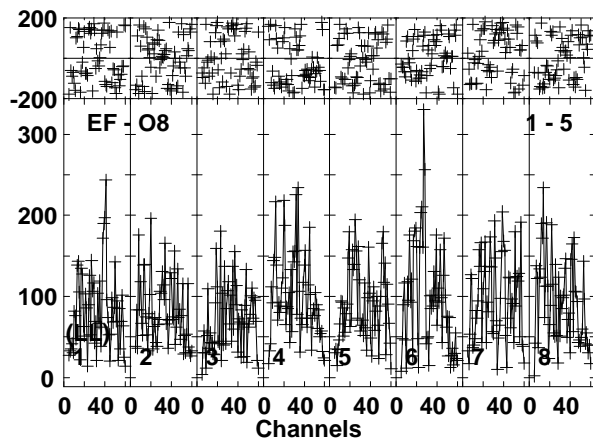
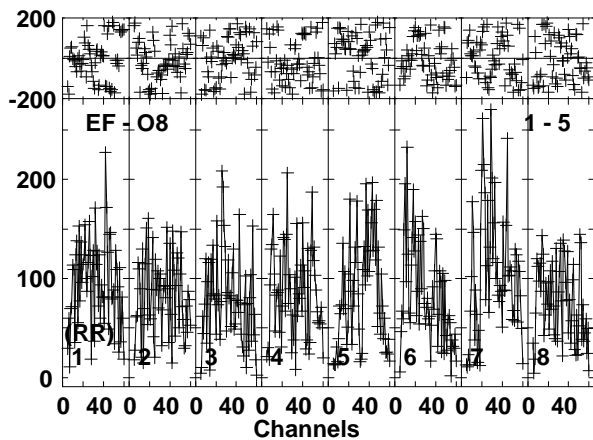
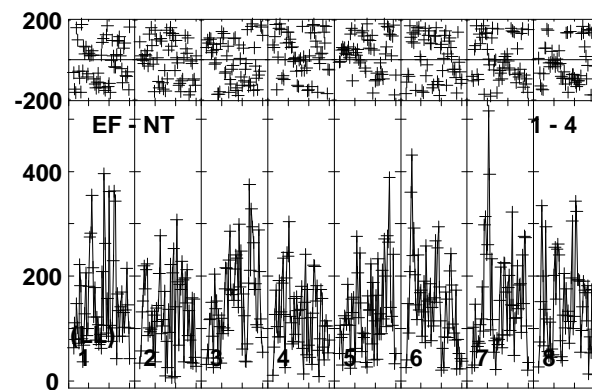
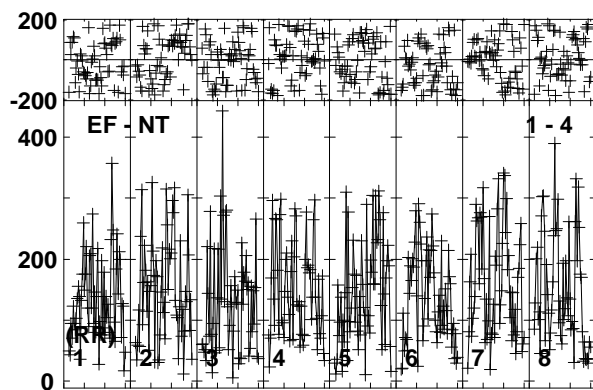
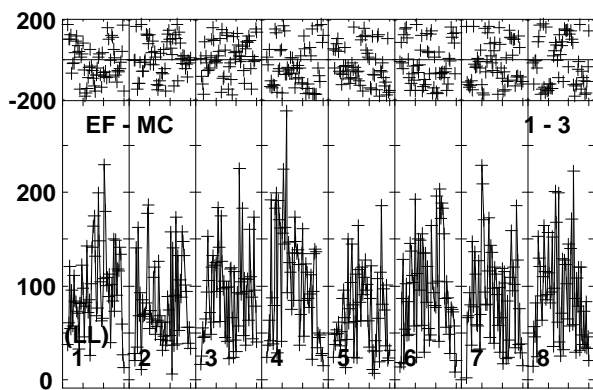
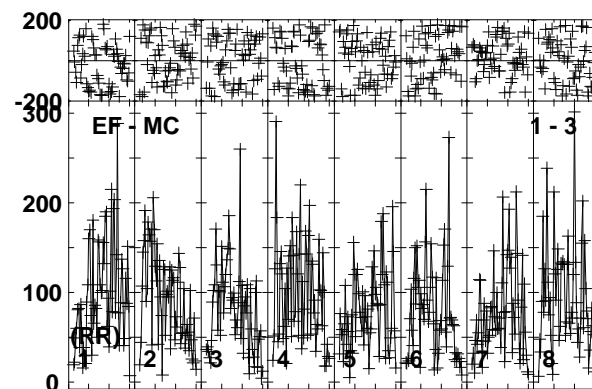
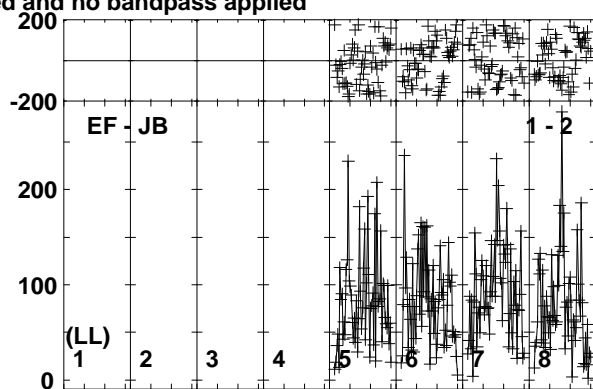
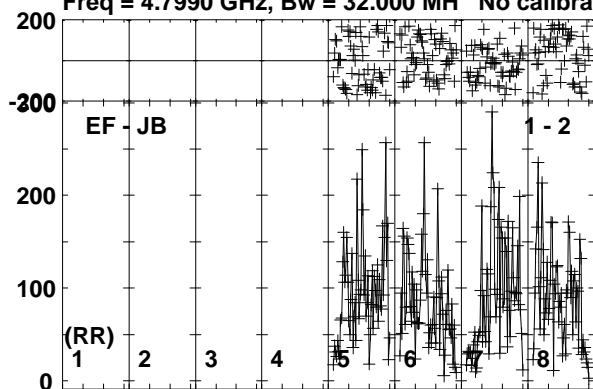

Lower frame: Micro Ampl Jy Top frame: Phas deg
Vector averaged cross-power spectrum Baseline: EF (01) - JB (02)
Timerange: 01/00:31:11 to 01/00:34:40

Plot file version 176 created 21-FEB-2017 15:11:29

ARUMA EG096A.UVDATA.1

Freq = 4.7990 GHz, Bw = 32.000 MH No calibration applied and no bandpass applied

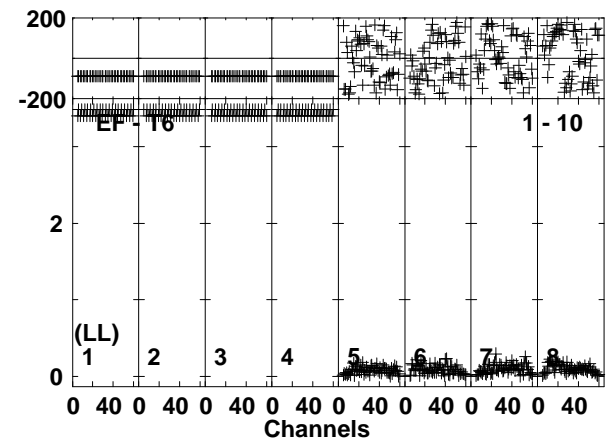
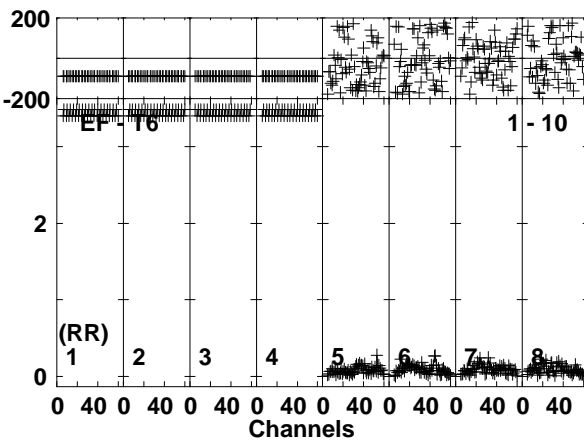
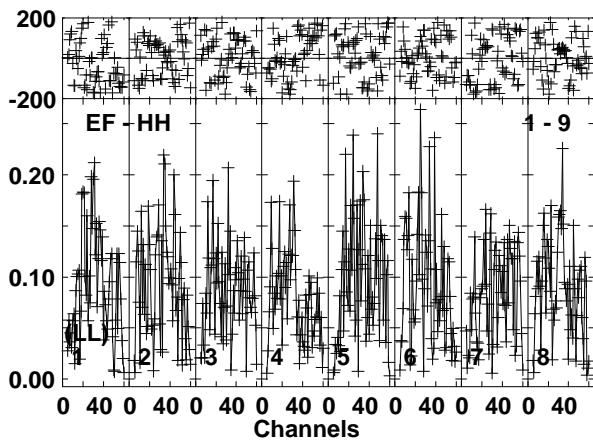
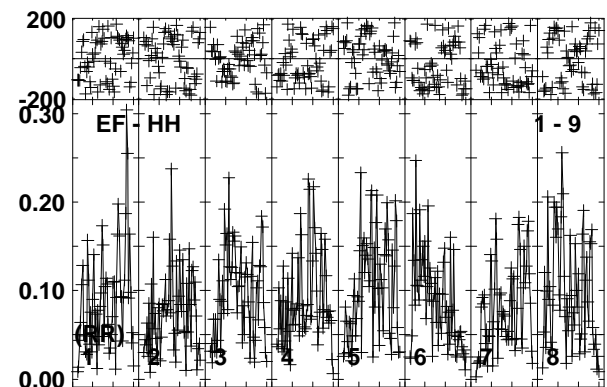
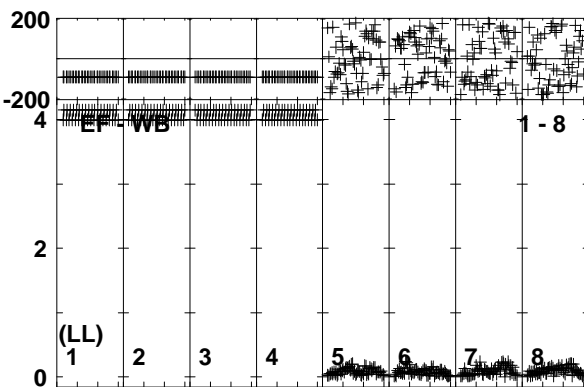
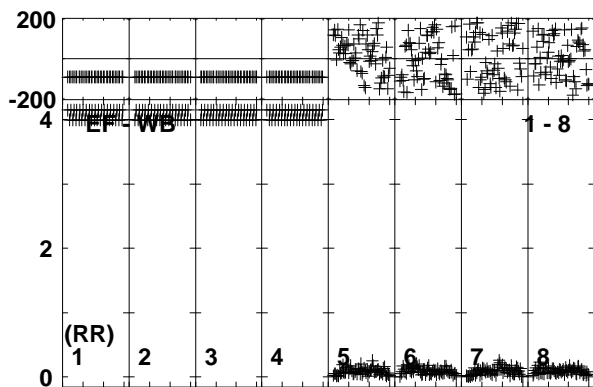
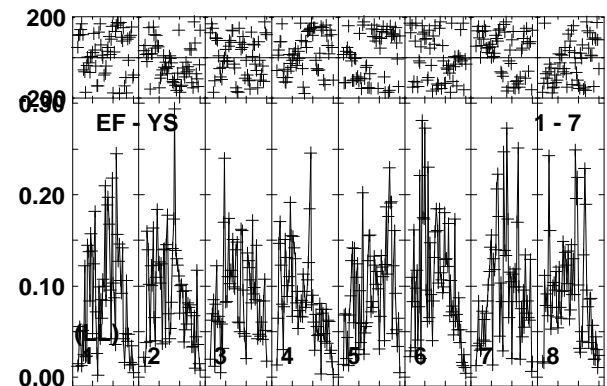
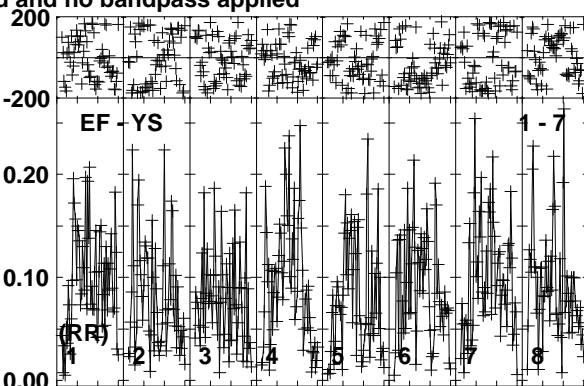
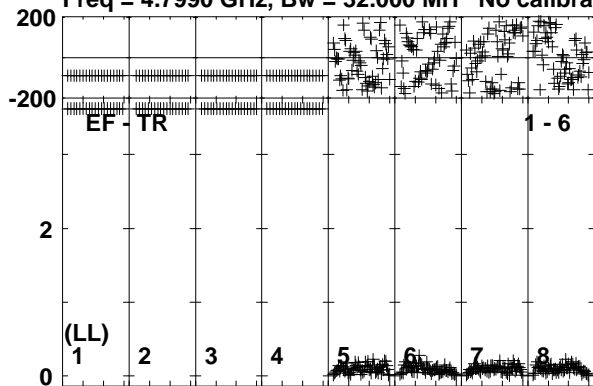

Lower frame: Milli Ampl Jy Top frame: Phas deg
Vector averaged cross-power spectrum Baseline: EF (01) - TR (06)
Timerange: 01/00:31:11 to 01/00:34:40

Plot file version 177 created 21-FEB-2017 15:11:29

J1108+4330 EG096A.UVDATA.1

Freq = 4.7990 GHz, Bw = 32.000 MH No calibration applied and no bandpass applied

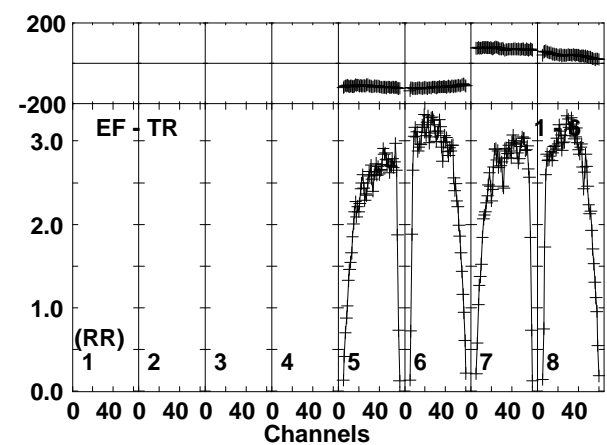
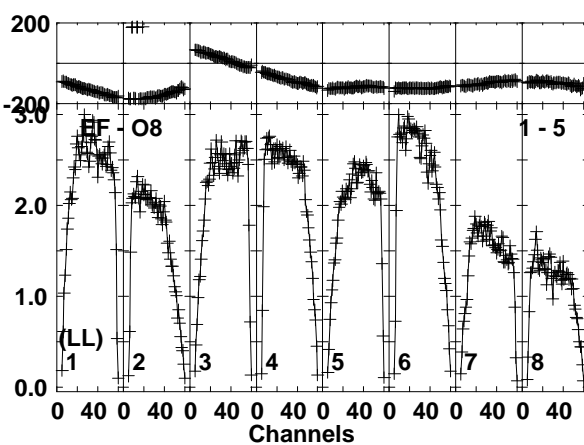
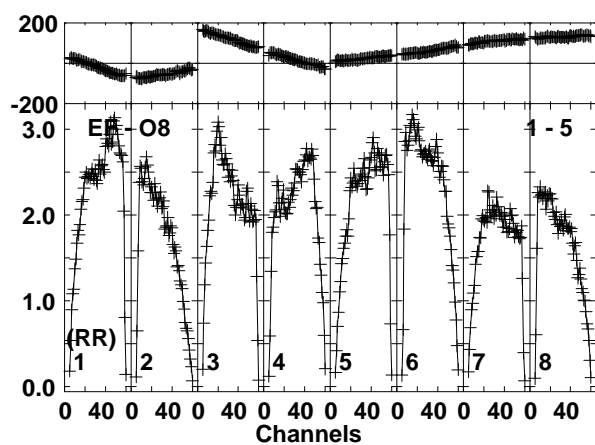
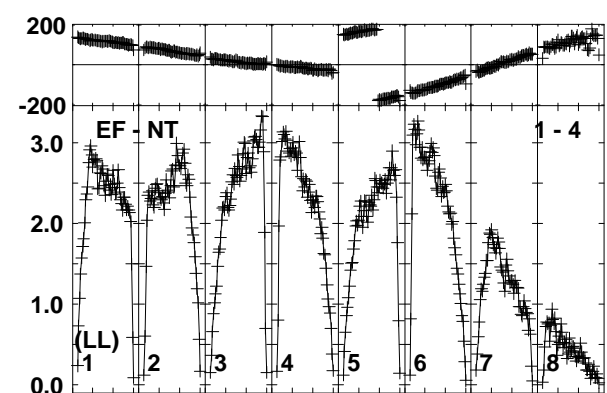
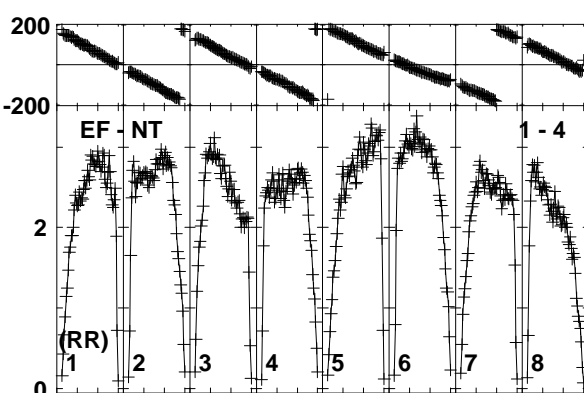
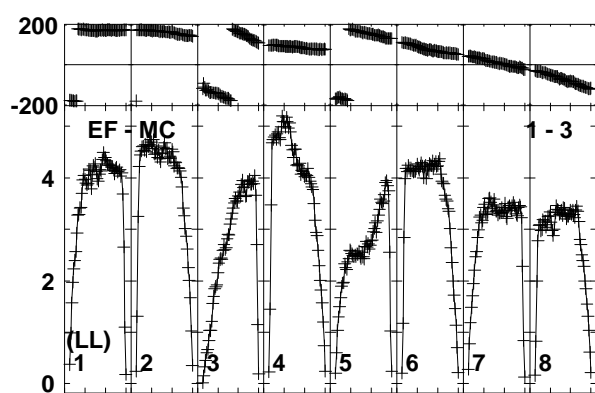
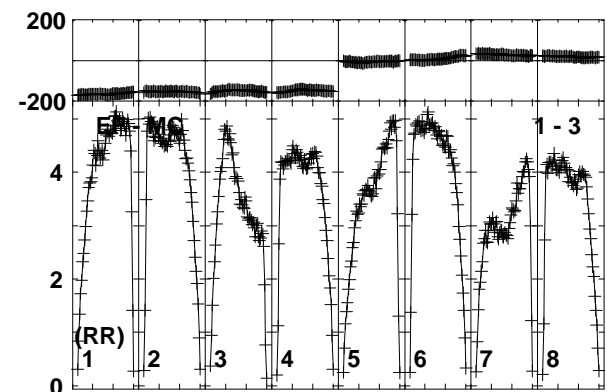
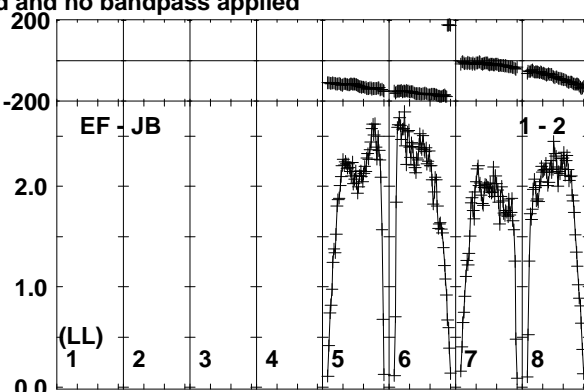
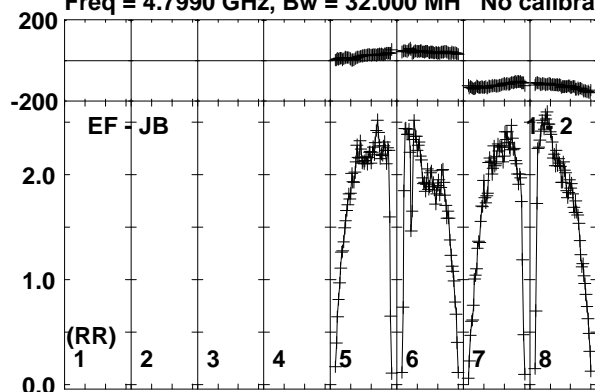

Lower frame: Milli Ampl Jy Top frame: Phas deg
Vector averaged cross-power spectrum Baseline: EF (01) - JB (02)
Timerange: 01/00:35:20 to 01/00:36:49

Plot file version 178 created 21-FEB-2017 15:11:30

J1108+4330 EG096A.UVDATA.1

Freq = 4.7990 GHz, Bw = 32.000 MH No calibration applied and no bandpass applied

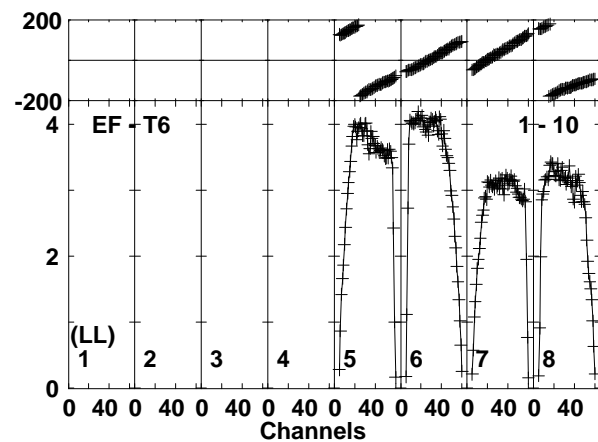
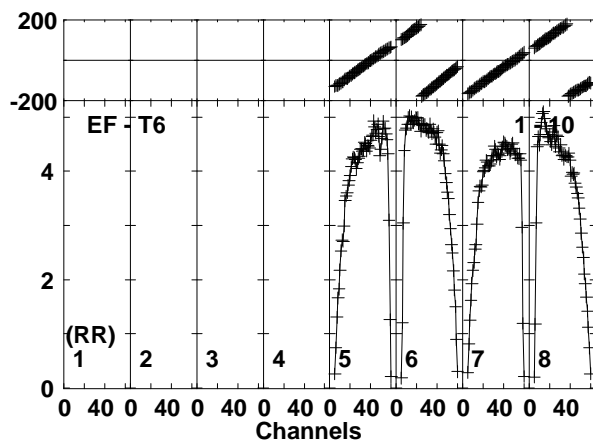
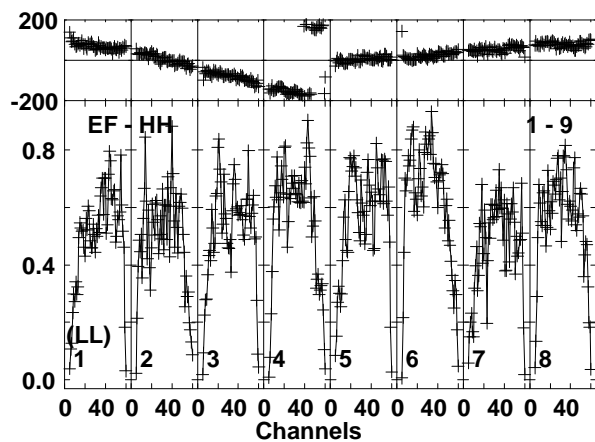
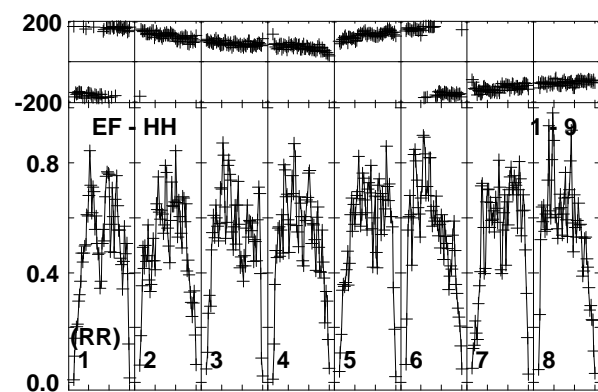
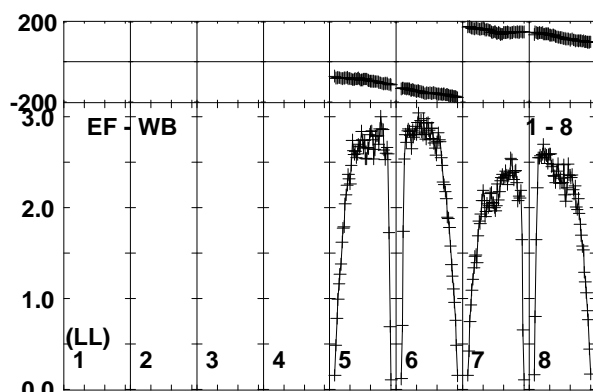
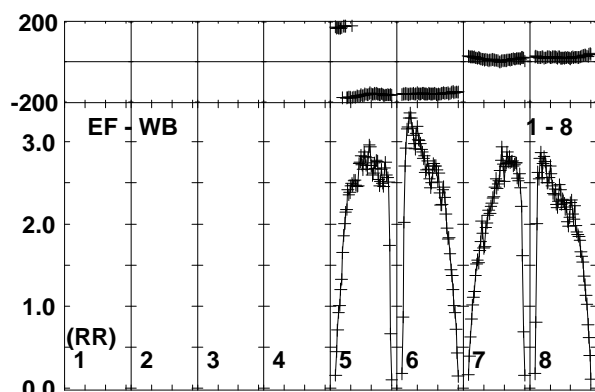
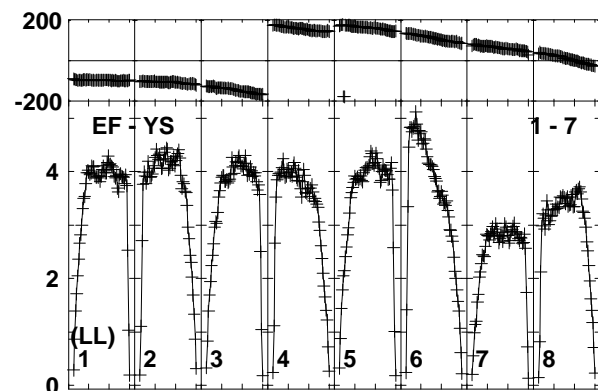
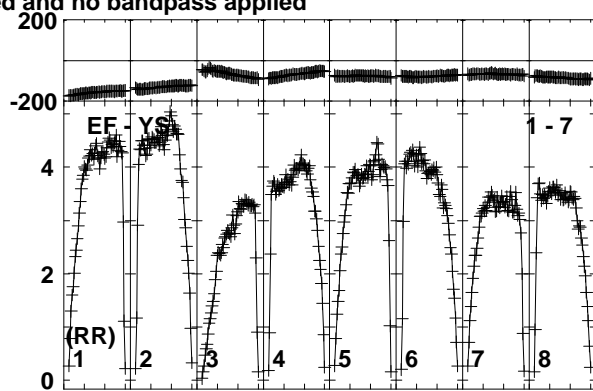
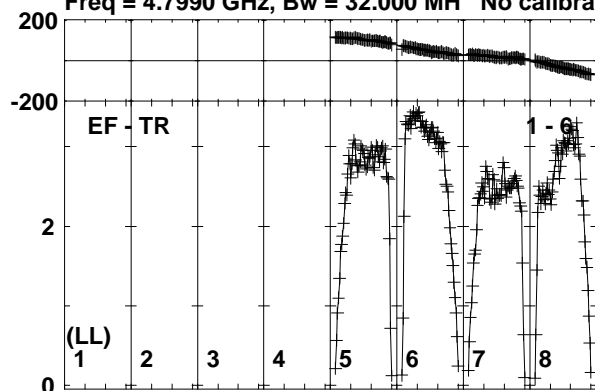

Lower frame: Milli Ampl Jy Top frame: Phas deg
Vector averaged cross-power spectrum Baseline: EF (01) - TR (06)
Timerange: 01/00:35:20 to 01/00:36:49

Plot file version 179 created 21-FEB-2017 15:11:30

J1310+3233 EG096A.UVDATA.1

Freq = 4.7990 GHz, Bw = 32.000 MH No calibration applied and no bandpass applied

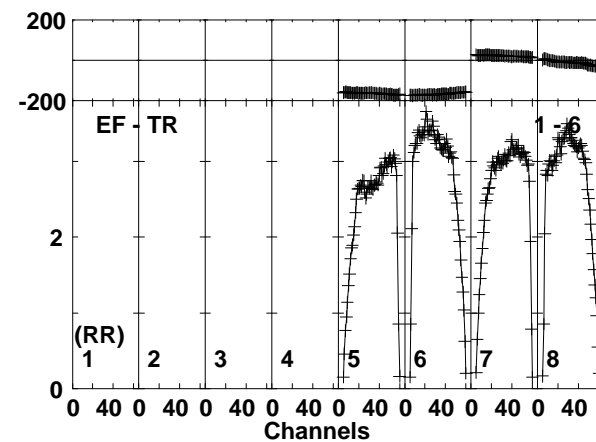
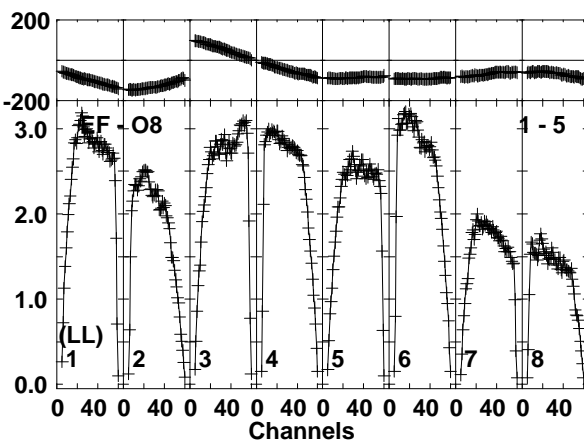
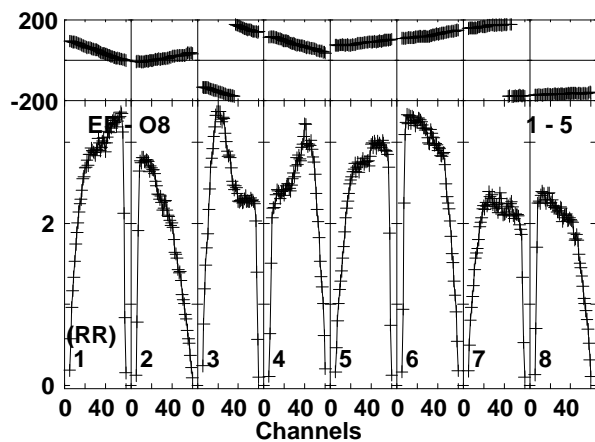
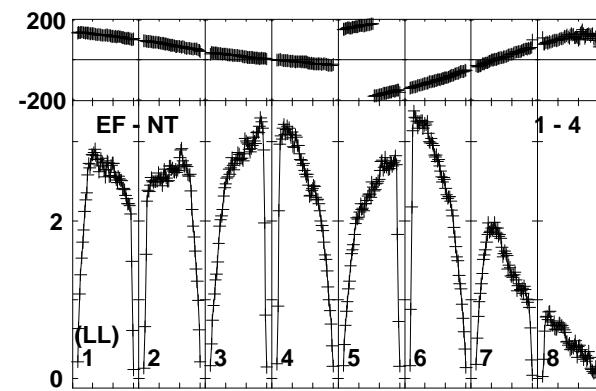
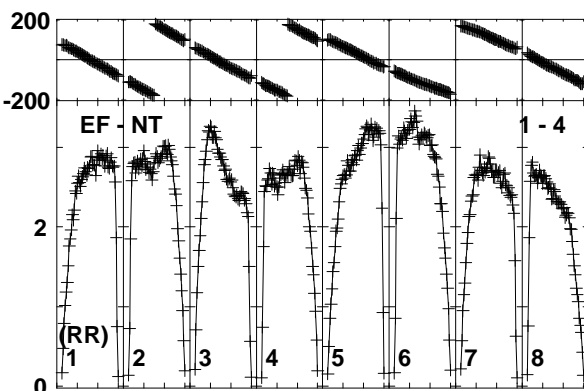
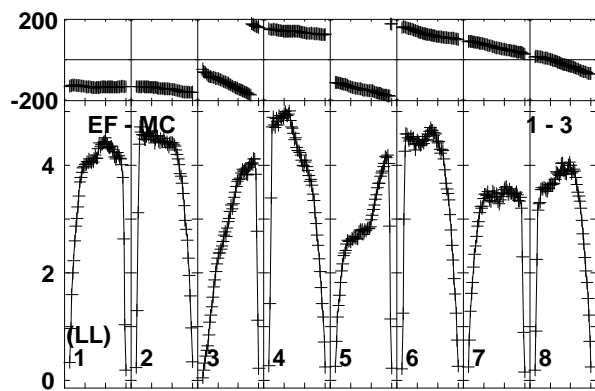
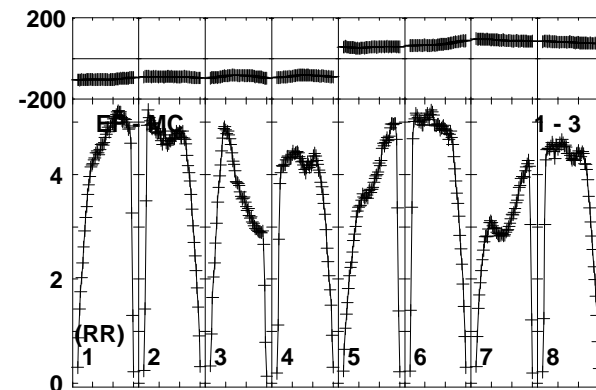
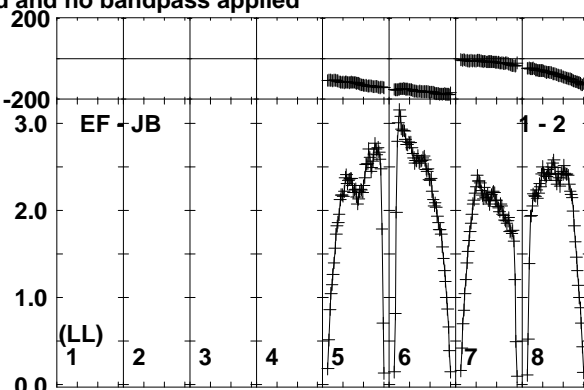
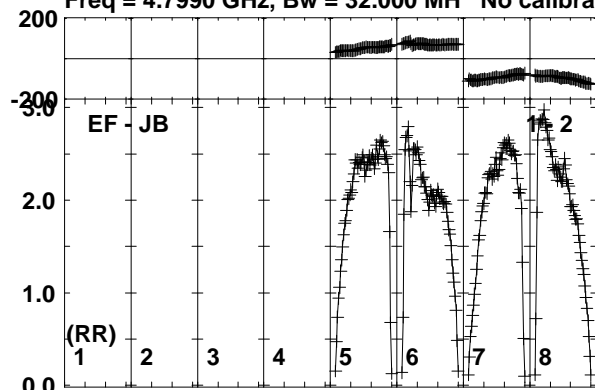

Lower frame: Milli Ampl Jy Top frame: Phas deg
Vector averaged cross-power spectrum Baseline: EF (01) - JB (02)
Timerange: 01/00:39:51 to 01/00:44:59

Plot file version 180 created 21-FEB-2017 15:11:30

J1310+3233 EG096A.UVDATA.1

Freq = 4.7990 GHz, Bw = 32.000 MH No calibration applied and no bandpass applied

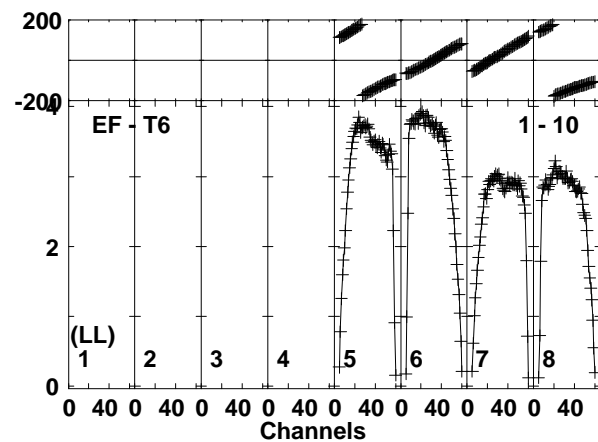
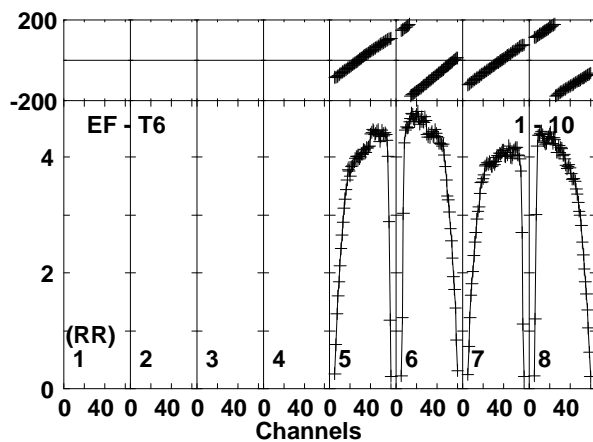
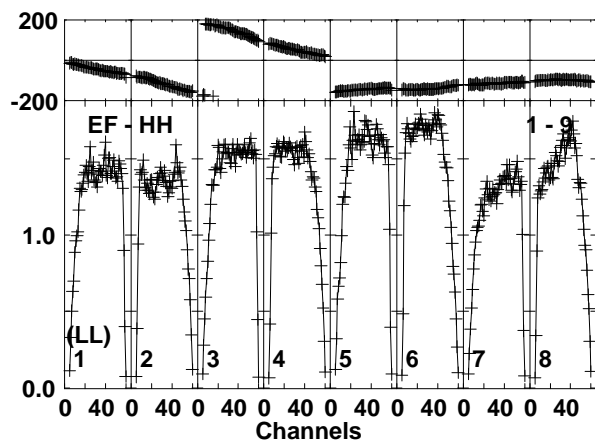
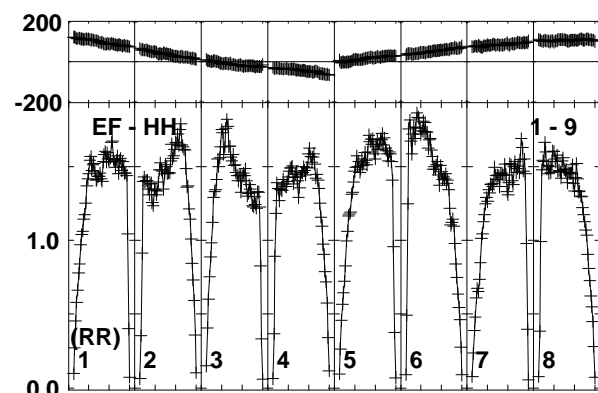
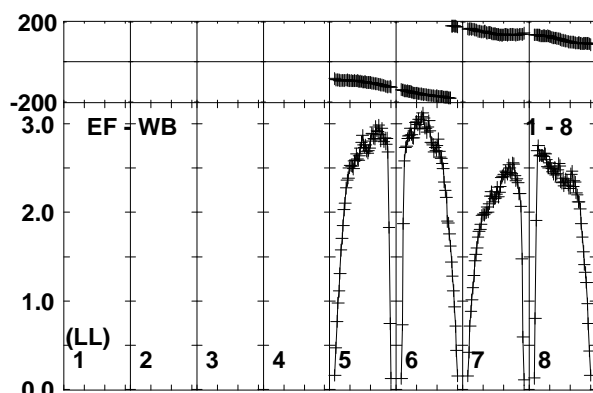
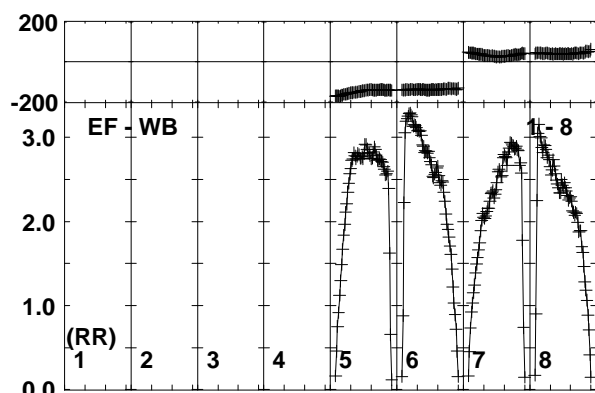
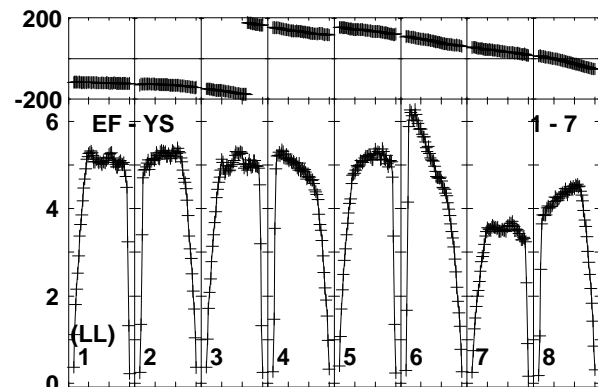
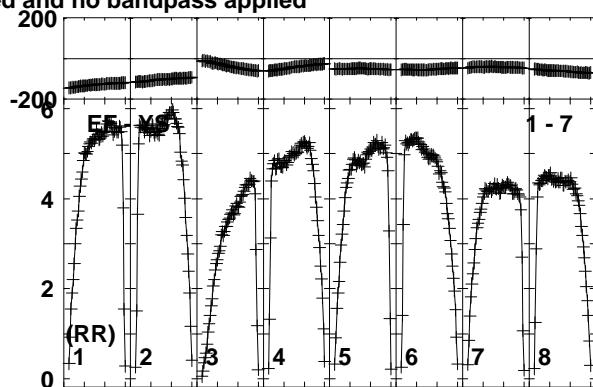
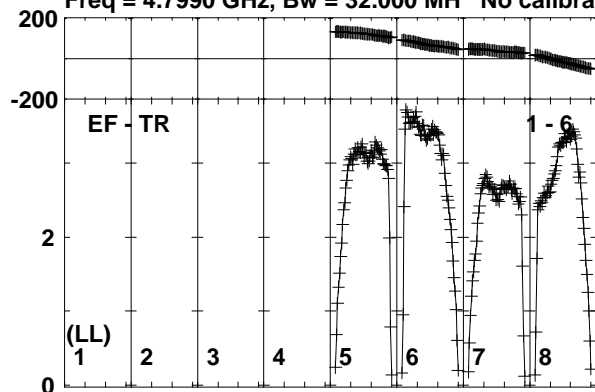

Lower frame: Milli Ampl Jy Top frame: Phas deg
Vector averaged cross-power spectrum Baseline: EF (01) - TR (06)
Timerange: 01/00:39:51 to 01/00:44:59