

Plot file version 1 created 24-NOV-2017 10:09:32

J0927+3902 EG096D.UVDATA.1

Freq = 4.7990 GHz, Bw = 32.000 MH No calibration applied and no bandpass applied

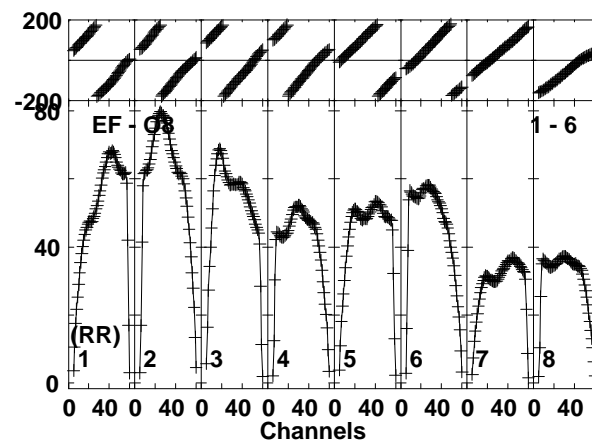
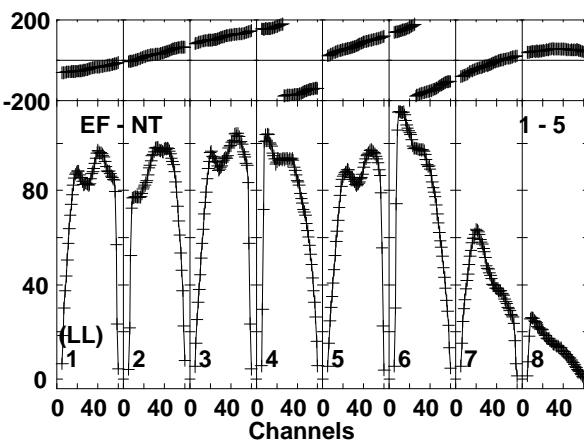
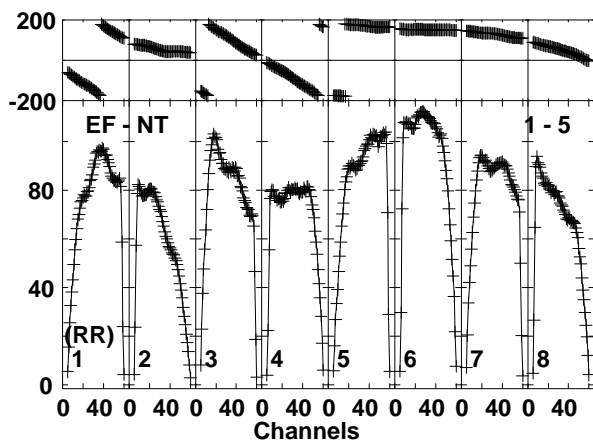
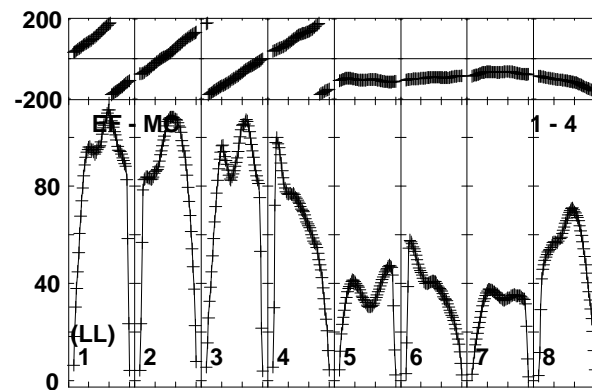
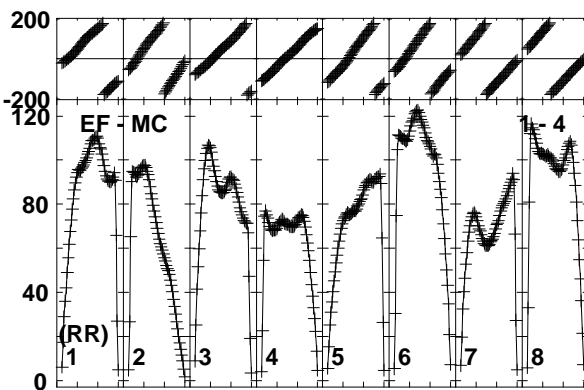
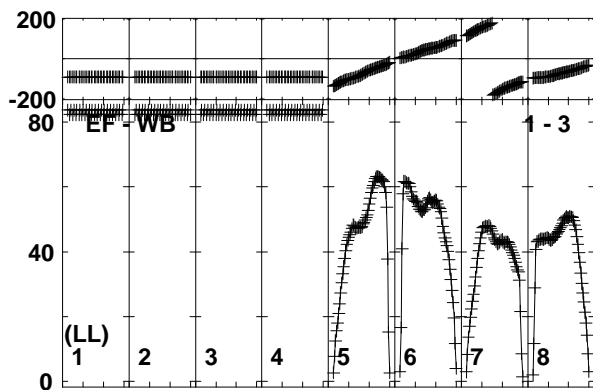
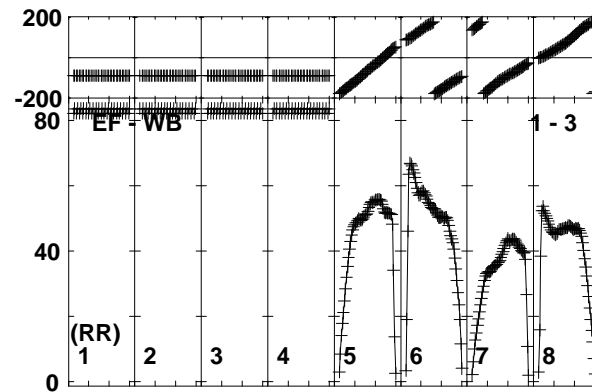
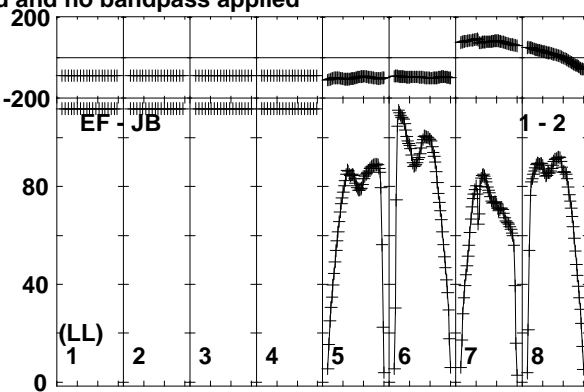
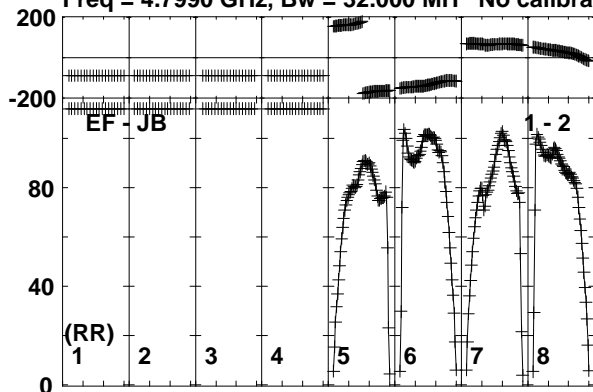

Lower frame: Milli Ampl Jy Top frame: Phas deg  
Vector averaged cross-power spectrum Baseline: EF (01) - JB (02)  
Timerange: 00/00:57:23 to 00/01:00:50

Plot file version 2 created 24-NOV-2017 10:09:32

J0927+3902 EG096D.UVDATA.1

Freq = 4.7990 GHz, Bw = 32.000 MH No calibration applied and no bandpass applied

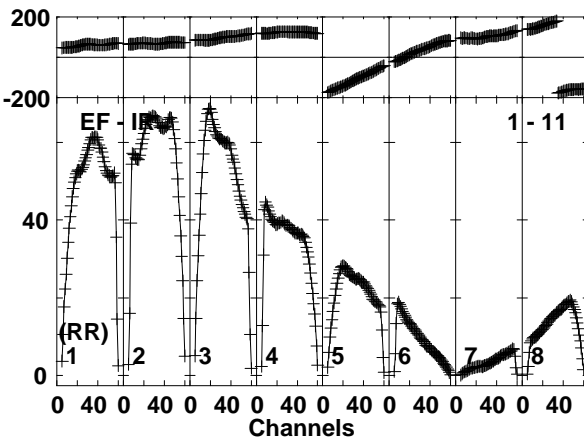
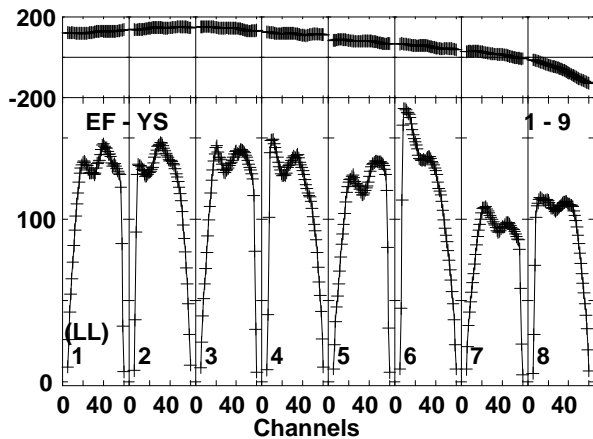
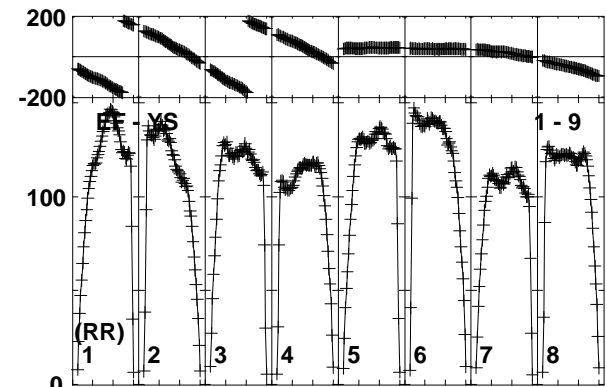
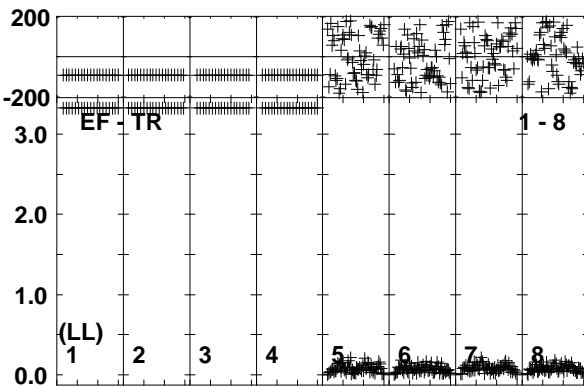
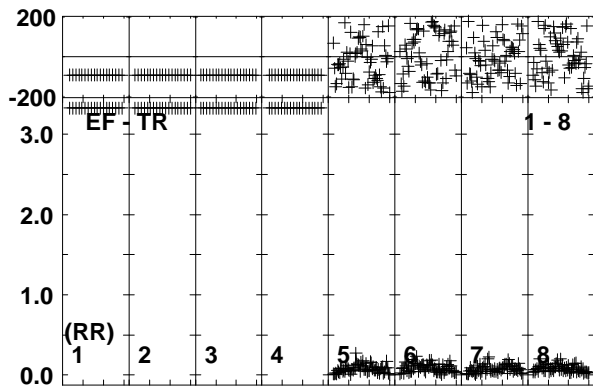
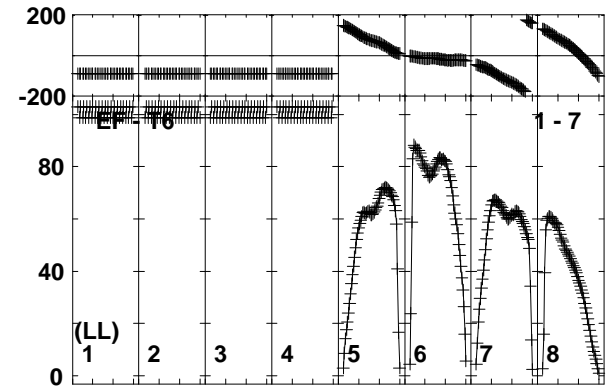
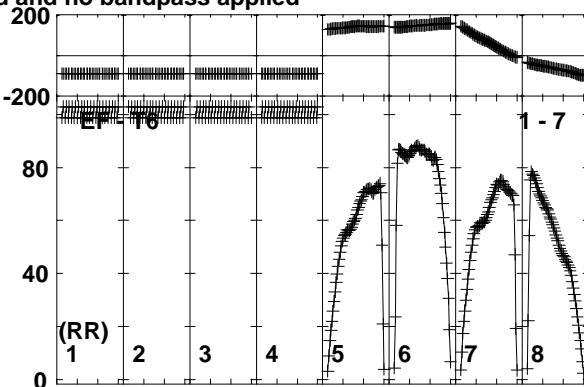
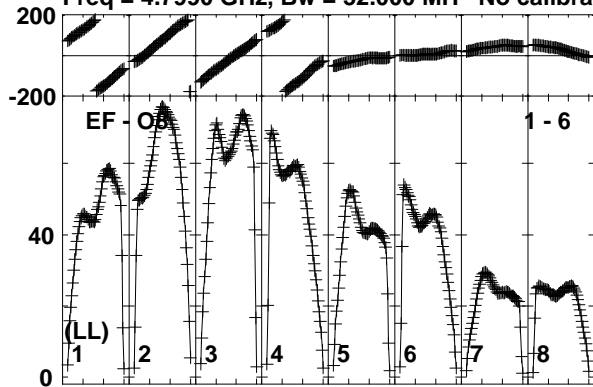

Lower frame: Milli Ampl Jy Top frame: Phas deg  
Vector averaged cross-power spectrum Baseline: EF (01) - O8 (06)  
Timerange: 00/00:57:23 to 00/01:00:50



Plot file version 3 created 24-NOV-2017 10:09:33

J1108+4330 EG096D.UVDATA.1

Freq = 4.7990 GHz, Bw = 32.000 MH No calibration applied and no bandpass applied

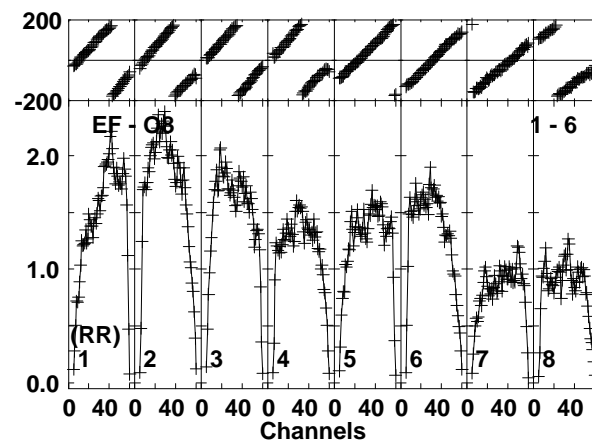
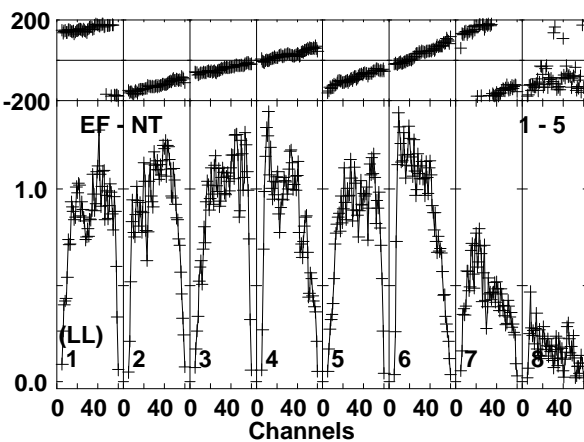
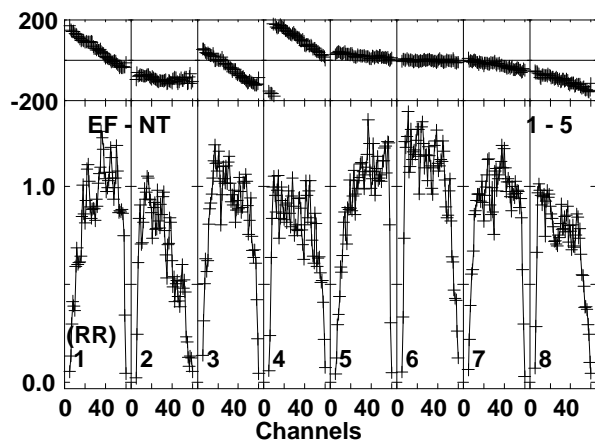
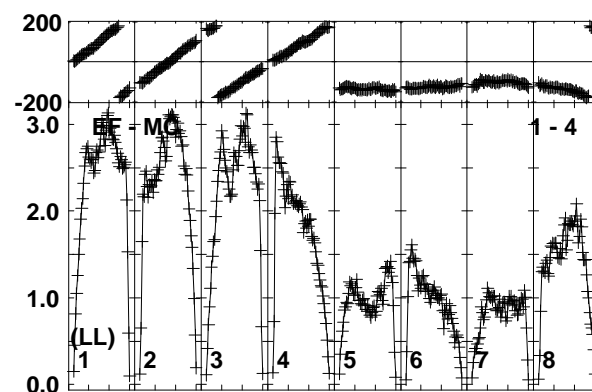
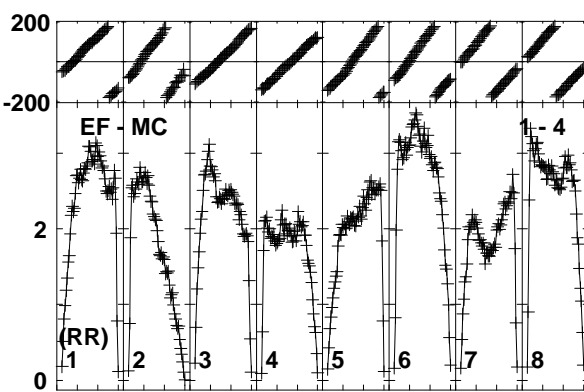
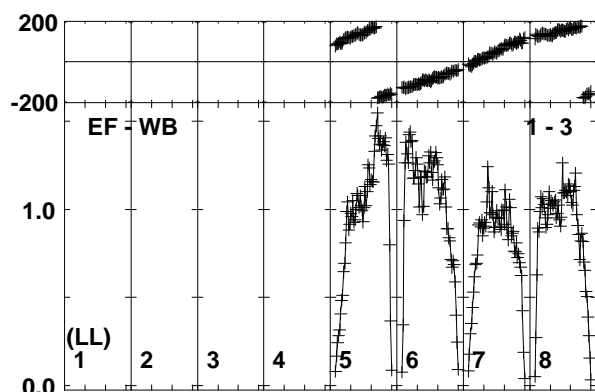
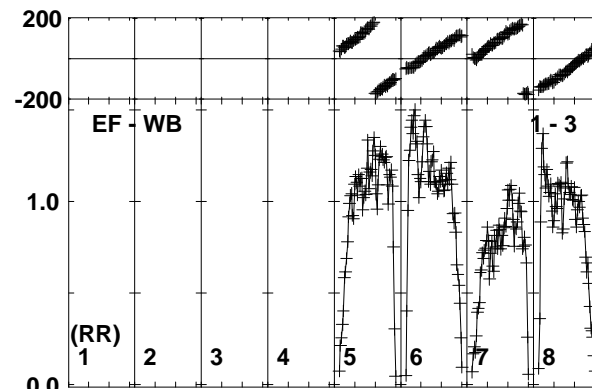
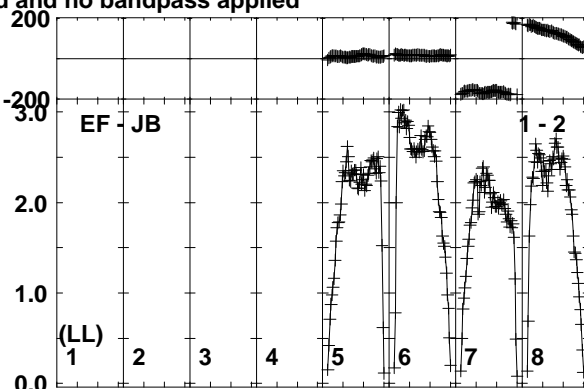
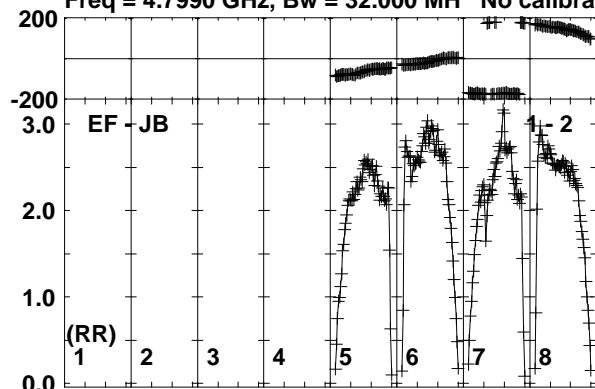

Lower frame: Milli Ampl Jy Top frame: Phas deg  
Vector averaged cross-power spectrum Baseline: EF (01) - JB (02)  
Timerange: 00/01:03:51 to 00/01:05:49

Plot file version 4 created 24-NOV-2017 10:09:33

J1108+4330 EG096D.UVDATA.1

Freq = 4.7990 GHz, Bw = 32.000 MH No calibration applied and no bandpass applied

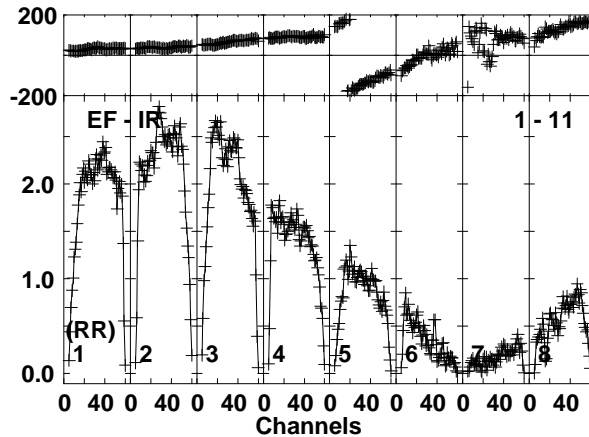
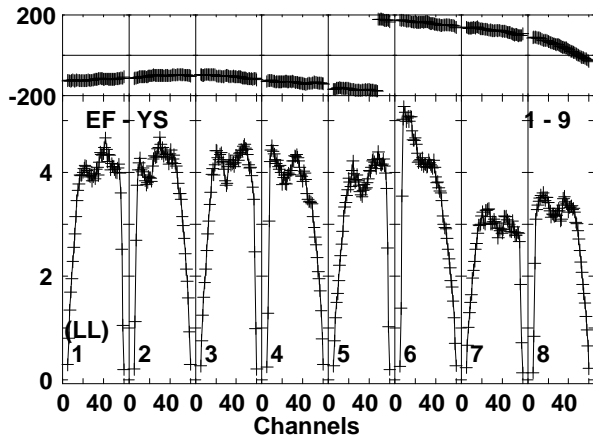
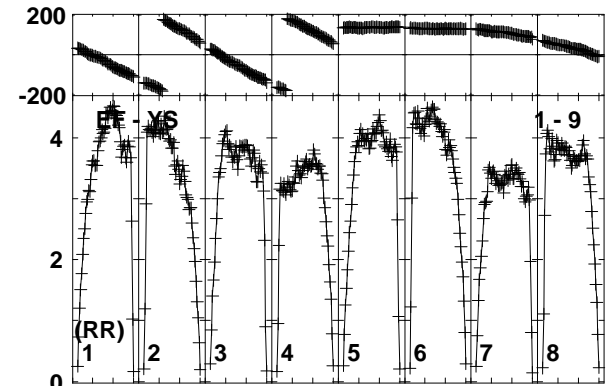
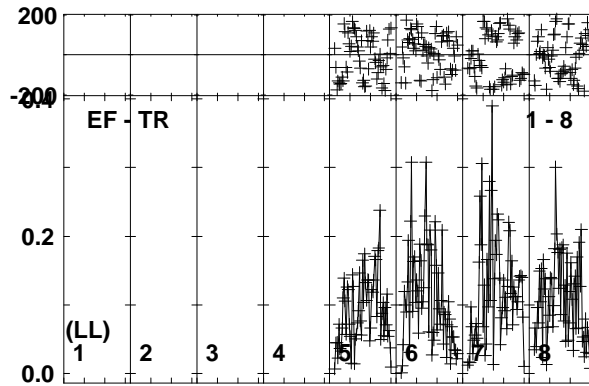
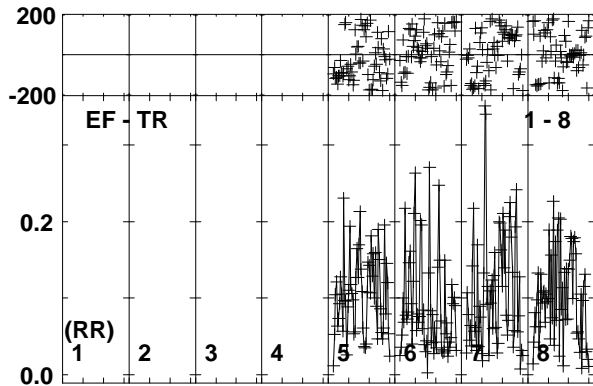
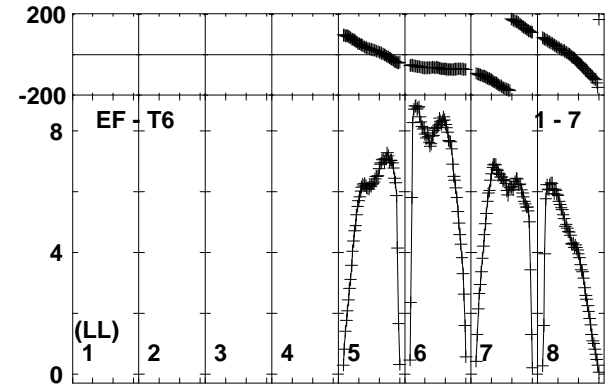
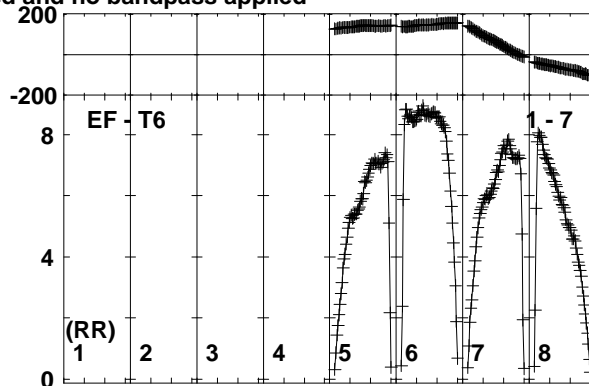
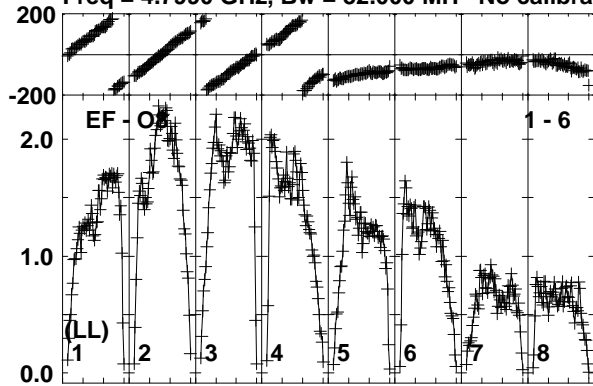

Lower frame: Milli Ampl Jy Top frame: Phas deg  
Vector averaged cross-power spectrum Baseline: EF (01) - O8 (06)  
Timerange: 00/01:03:51 to 00/01:05:49

Plot file version 5 created 24-NOV-2017 10:09:33

J1108+4330 EG096D.UVDATA.1

Freq = 4.7990 GHz, Bw = 32.000 MH No calibration applied and no bandpass applied

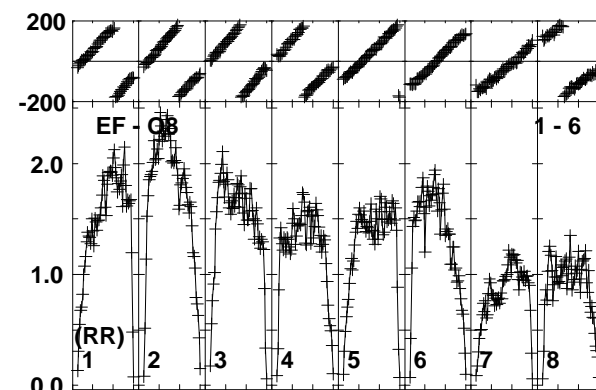
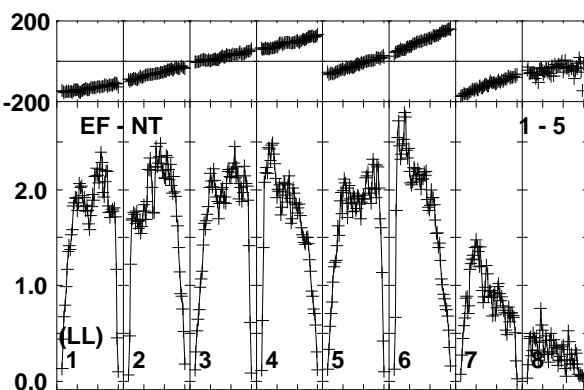
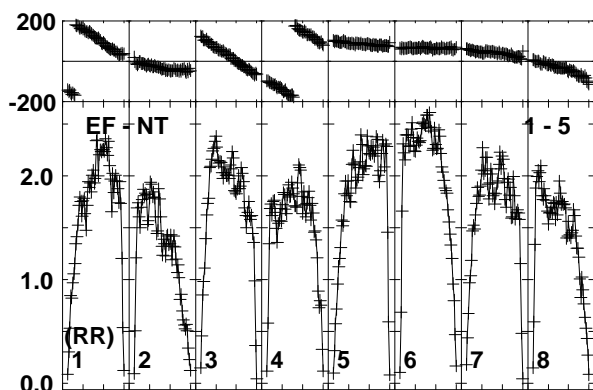
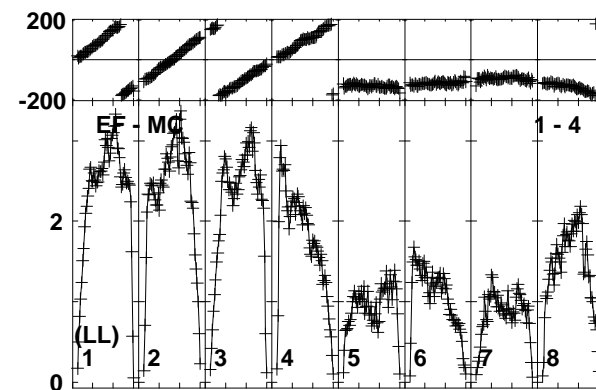
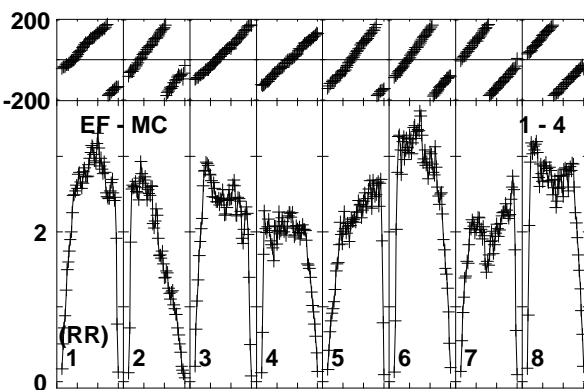
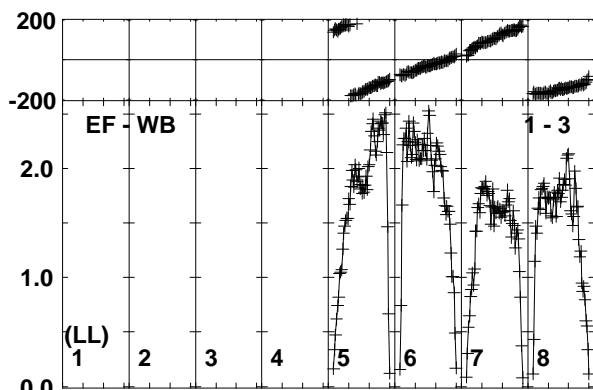
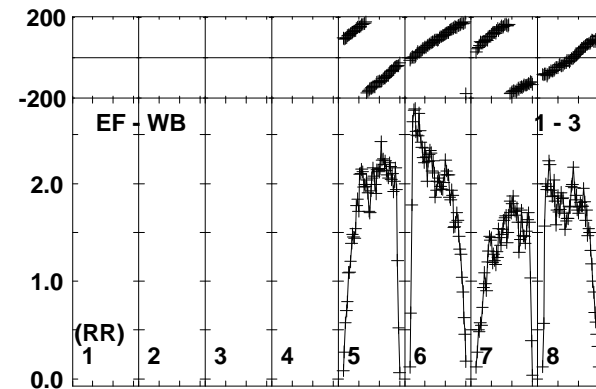
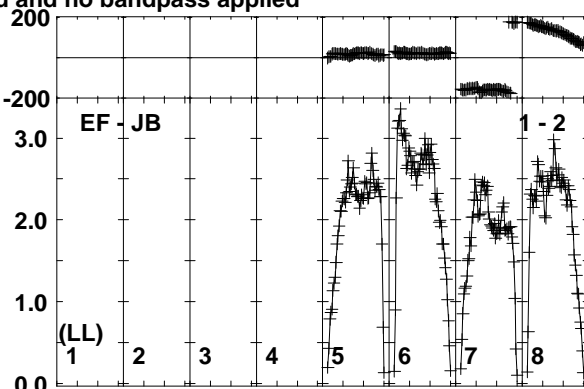
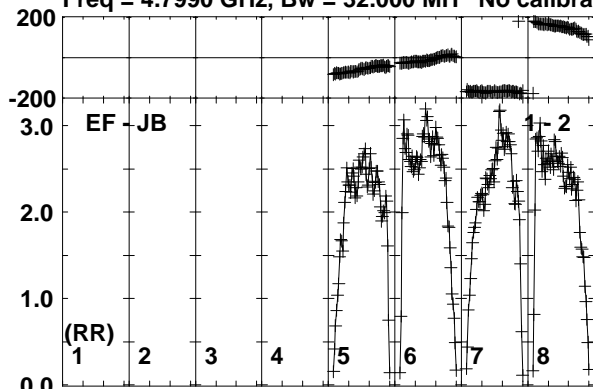

Lower frame: Milli Ampl Jy Top frame: Phas deg  
Vector averaged cross-power spectrum Baseline: EF (01) - JB (02)  
Timerange: 00/01:06:31 to 00/01:07:30

Plot file version 6 created 24-NOV-2017 10:09:33

J1108+4330 EG096D.UVDATA.1

Freq = 4.7990 GHz, Bw = 32.000 MH No calibration applied and no bandpass applied

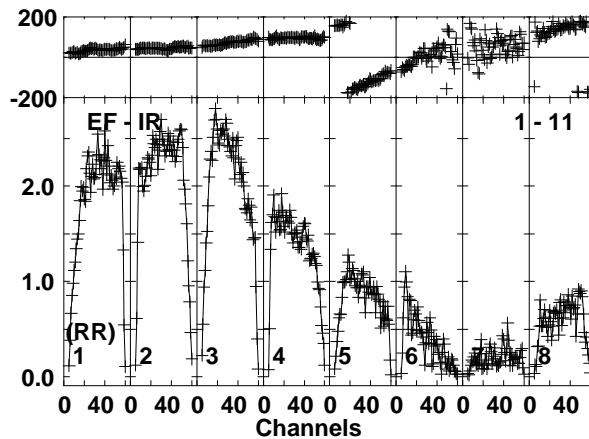
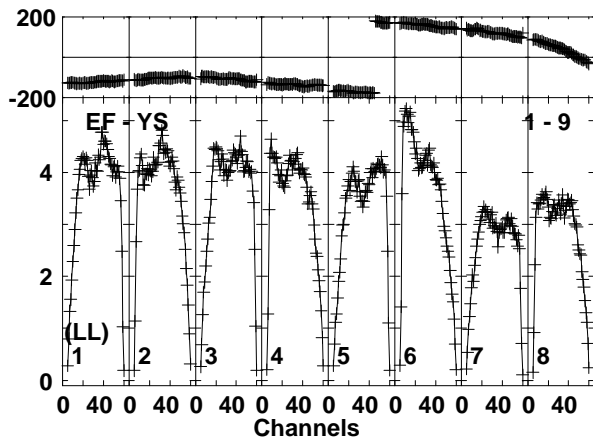
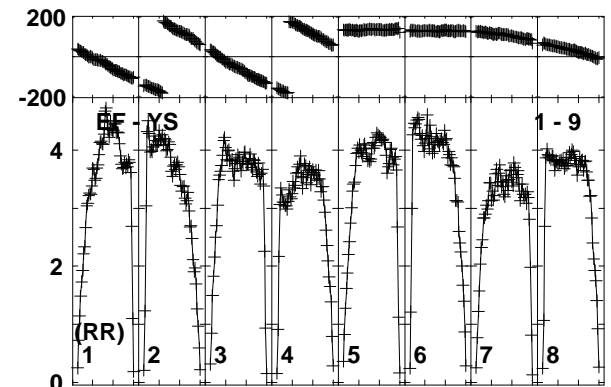
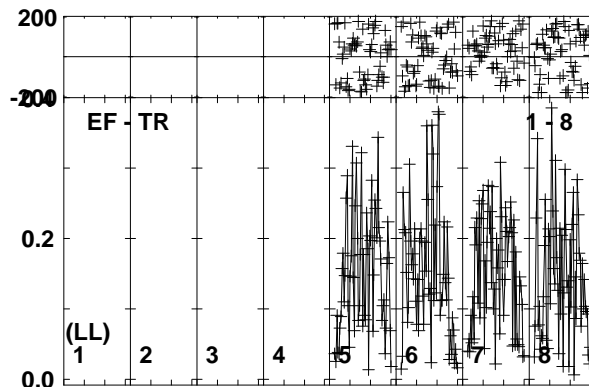
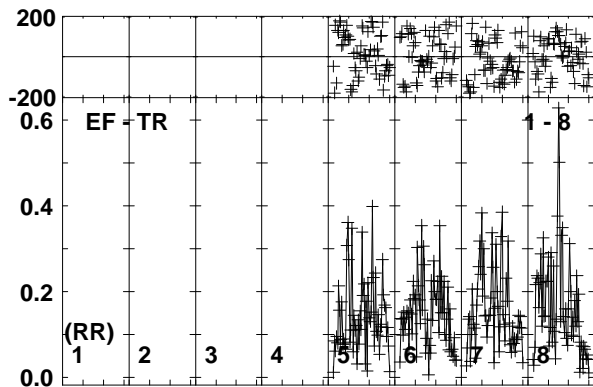
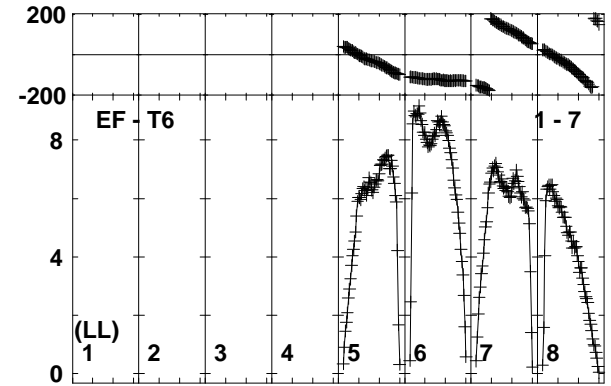
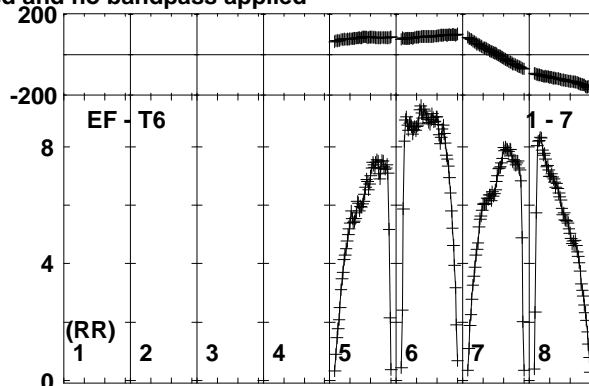
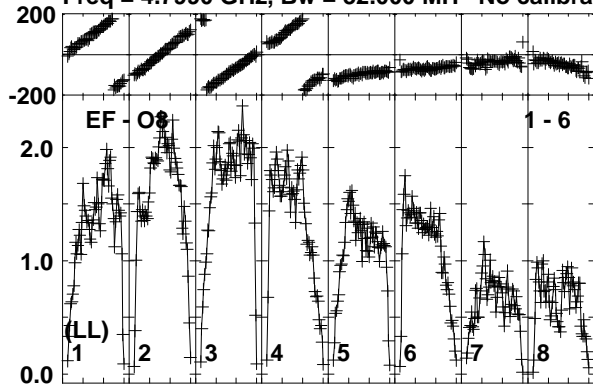

Lower frame: Milli Ampl Jy Top frame: Phas deg  
Vector averaged cross-power spectrum Baseline: EF (01) - O8 (06)  
Timerange: 00/01:06:31 to 00/01:07:30

Plot file version 7 created 24-NOV-2017 10:09:34

J1112+4301 EG096D.UVDATA.1

Freq = 4.7990 GHz, Bw = 32.000 MH No calibration applied and no bandpass applied

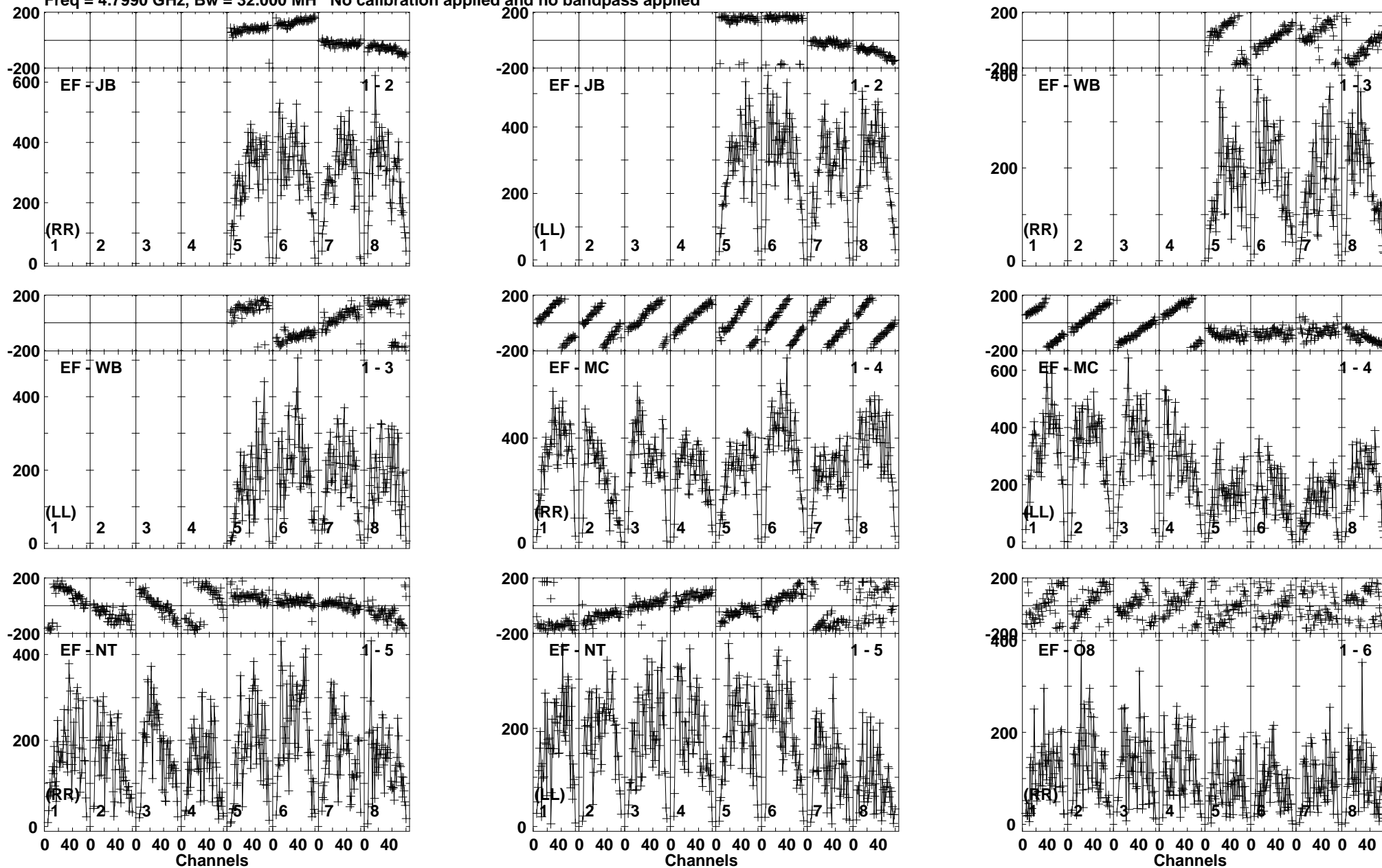

Lower frame: Micro Ampl Jy Top frame: Phas deg  
Vector averaged cross-power spectrum Baseline: EF (01) - JB (02)  
Timerange: 00/01:07:31 to 00/01:10:59

Plot file version 8 created 24-NOV-2017 10:09:34

J1112+4301 EG096D.UVDATA.1

Freq = 4.7990 GHz, Bw = 32.000 MH No calibration applied and no bandpass applied

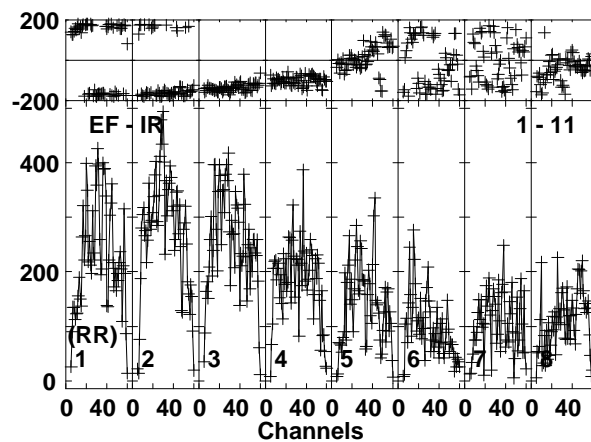
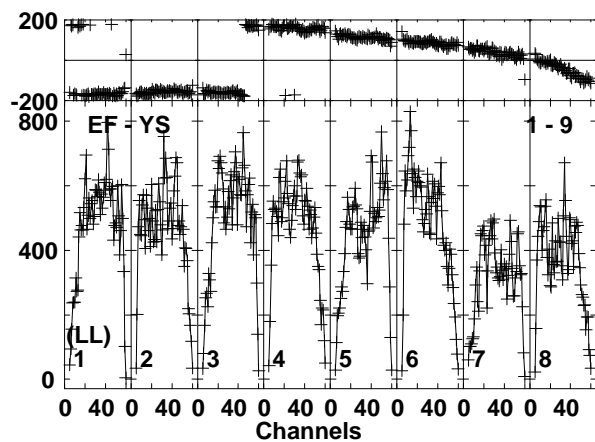
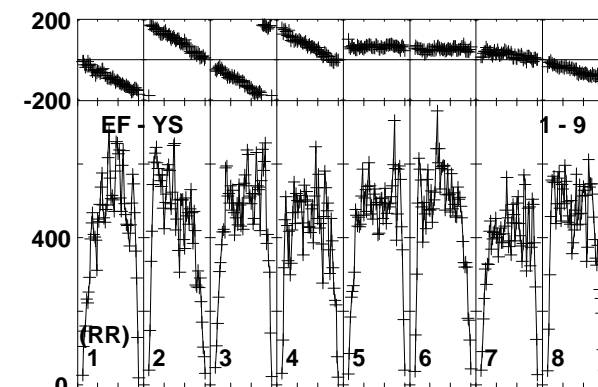
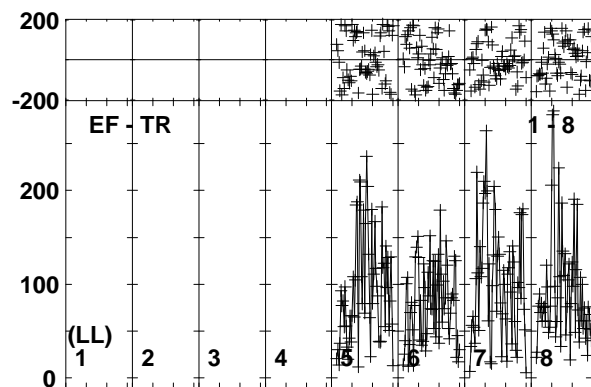
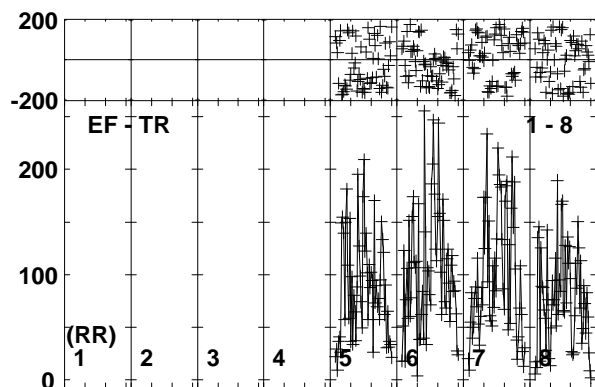
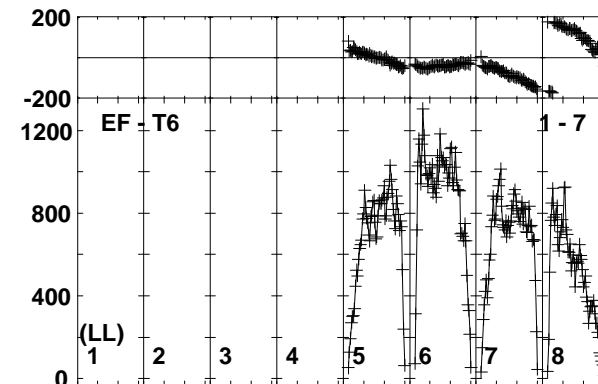
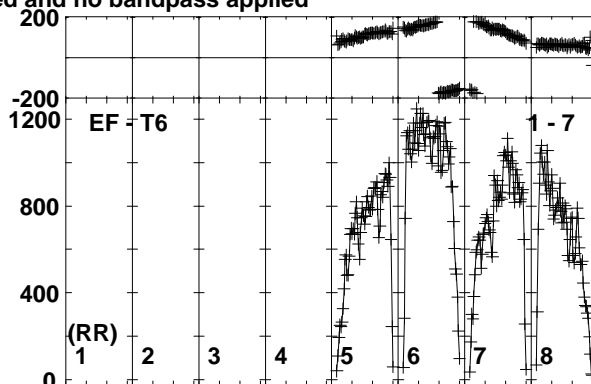
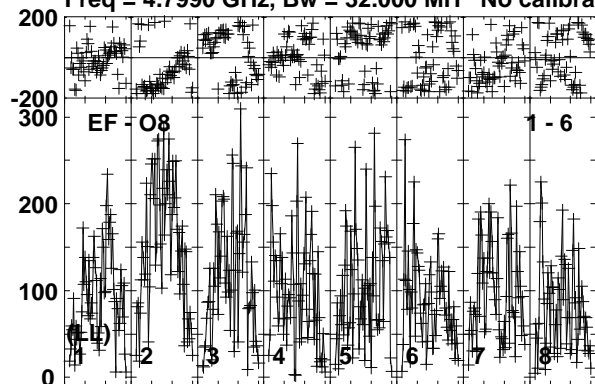

Lower frame: Micro Ampl Jy Top frame: Phas deg  
Vector averaged cross-power spectrum Baseline: EF (01) - O8 (06)  
Timerange: 00/01:07:31 to 00/01:10:59

Plot file version 9 created 24-NOV-2017 10:09:34

J1108+4330 EG096D.UVDATA.1

Freq = 4.7990 GHz, Bw = 32.000 MH No calibration applied and no bandpass applied

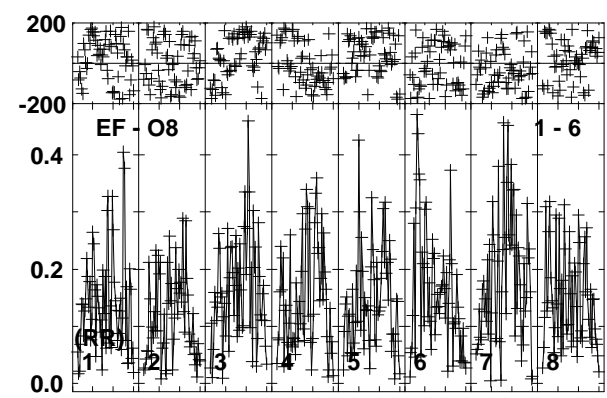
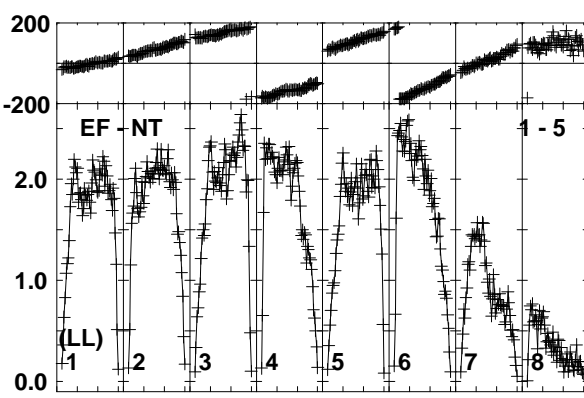
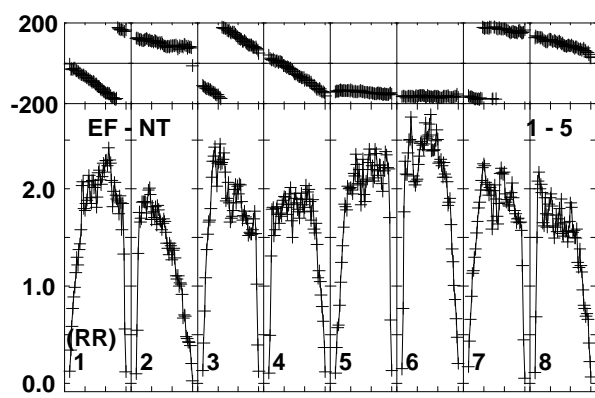
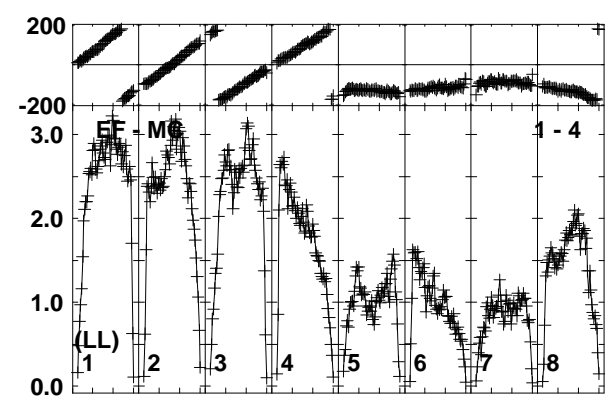
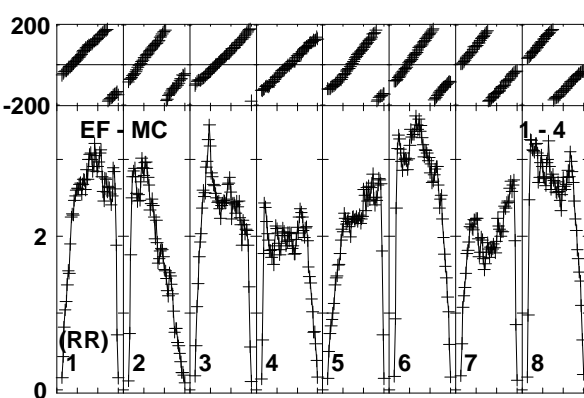
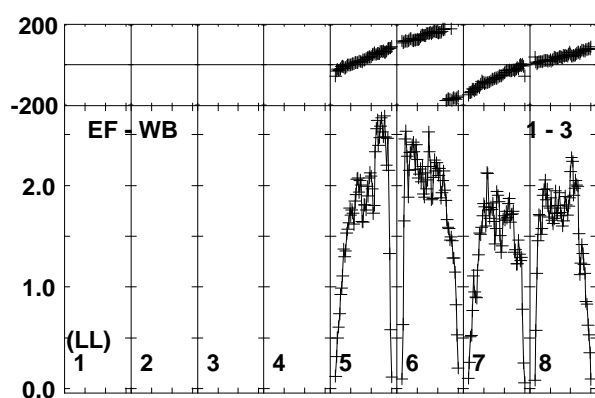
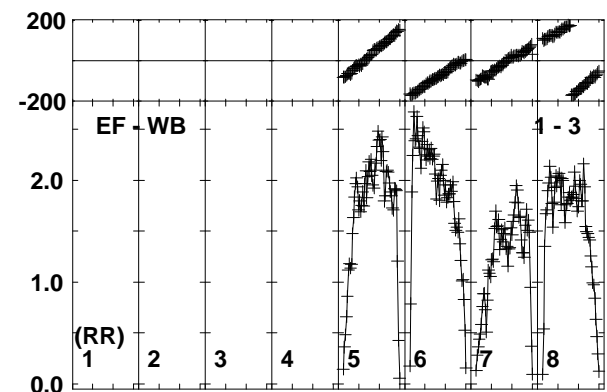
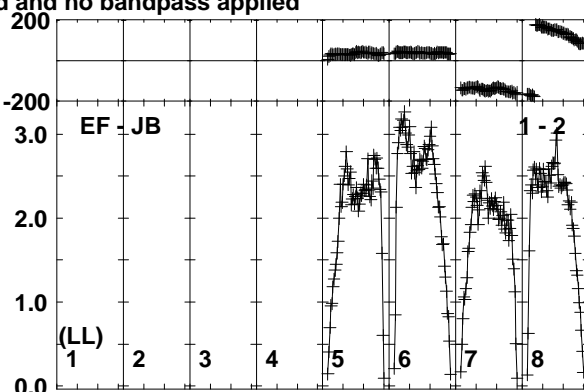
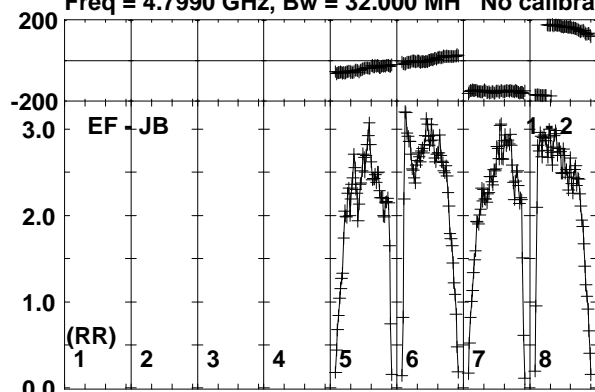

Lower frame: Milli Ampl Jy Top frame: Phas deg  
Vector averaged cross-power spectrum Baseline: EF (01) - JB (02)  
Timerange: 00/01:11:01 to 00/01:12:30

Plot file version 10 created 24-NOV-2017 10:09:34

J1108+4330 EG096D.UVDATA.1

Freq = 4.7990 GHz, Bw = 32.000 MH No calibration applied and no bandpass applied

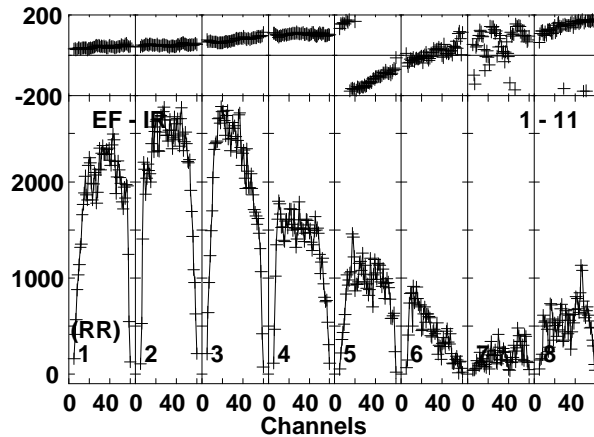
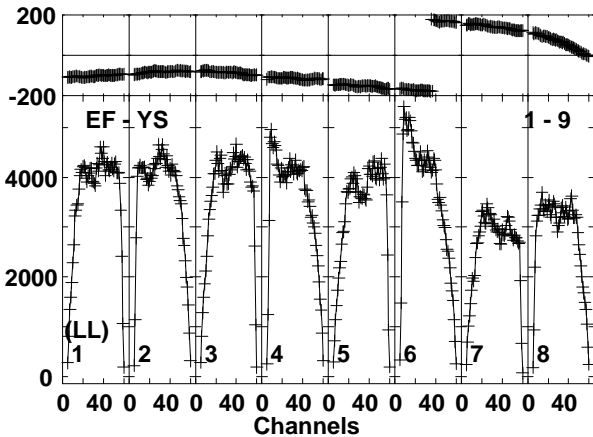
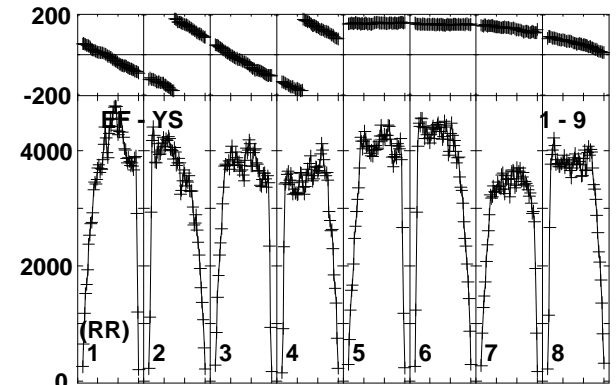
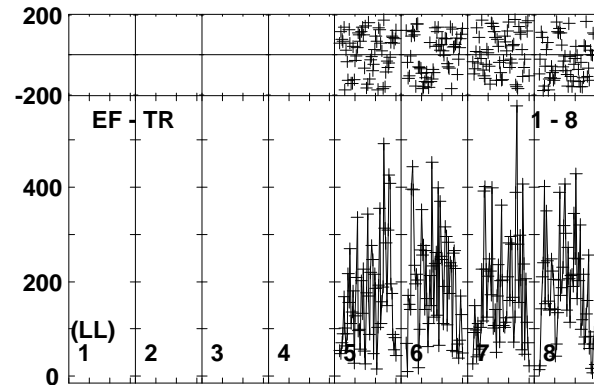
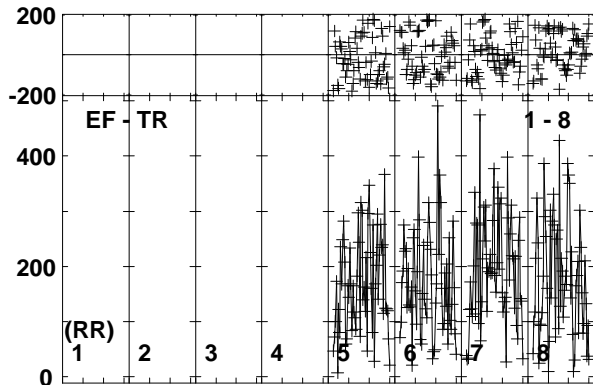
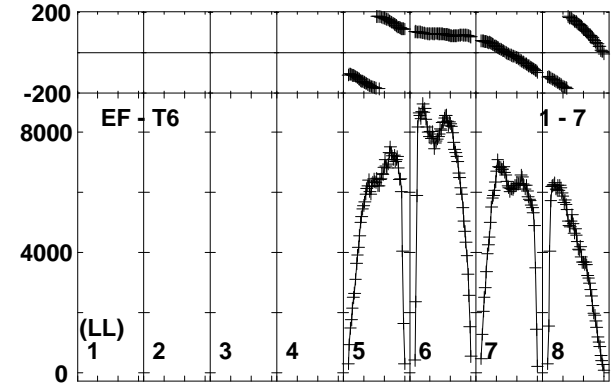
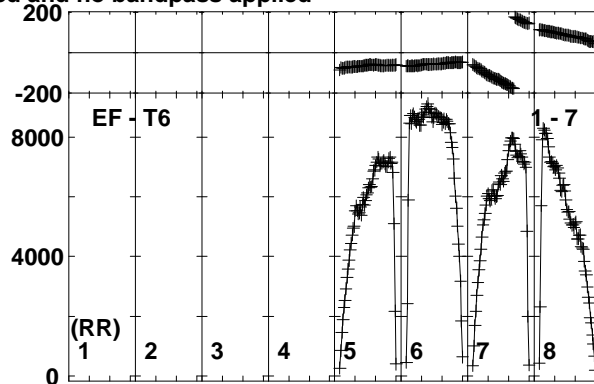
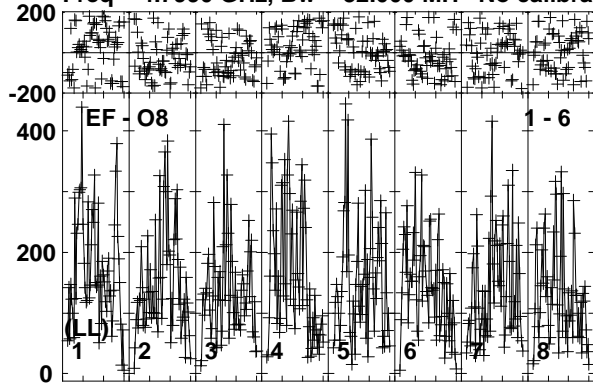

Lower frame: Micro Ampl Jy Top frame: Phas deg  
Vector averaged cross-power spectrum Baseline: EF (01) - O8 (06)  
Timerange: 00/01:11:01 to 00/01:12:30



Plot file version 11 created 24-NOV-2017 10:09:35

ARUMA EG096D.UVDATA.1

Freq = 4.7990 GHz, Bw = 32.000 MH No calibration applied and no bandpass applied

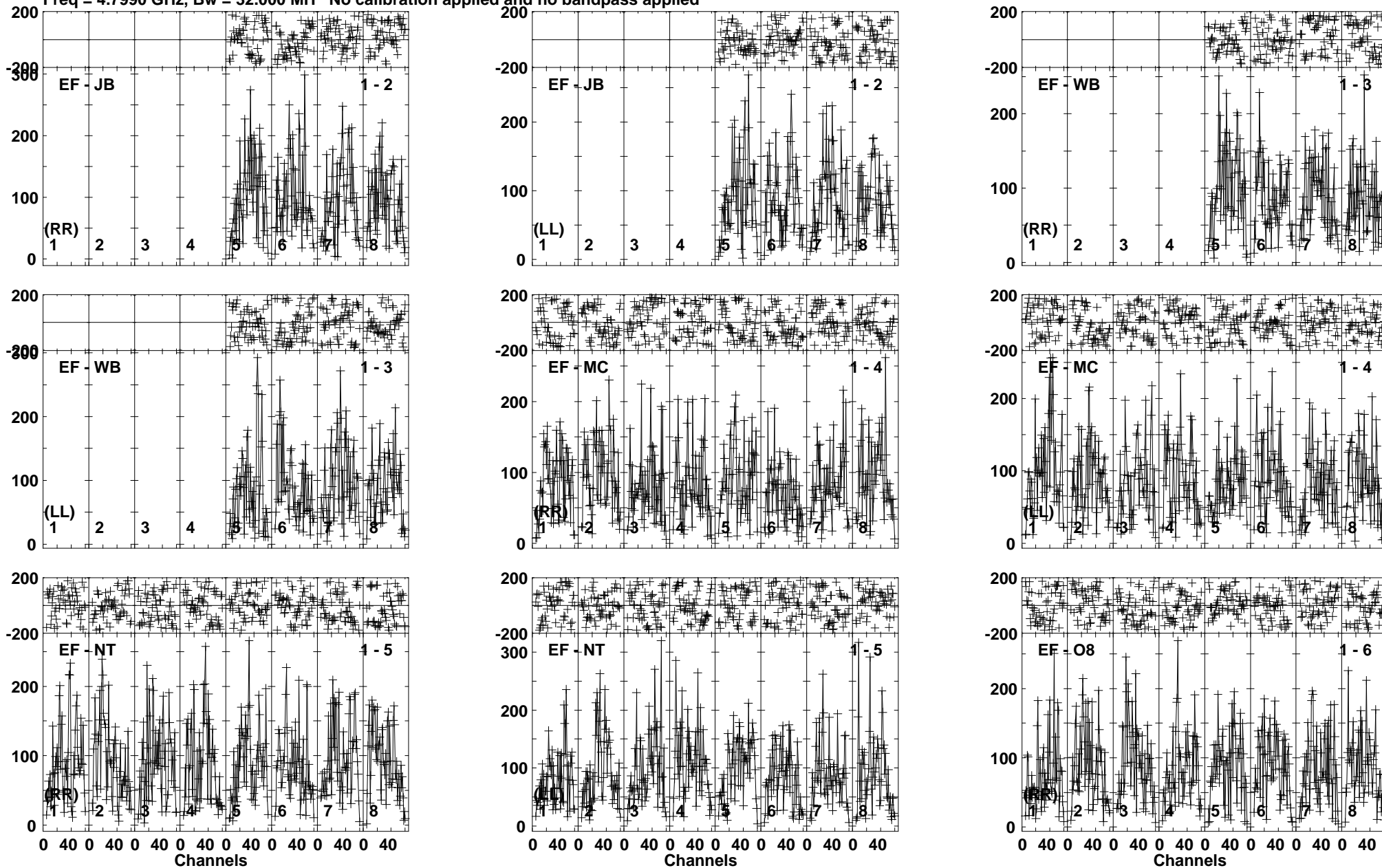

Lower frame: Micro Ampl Jy Top frame: Phas deg  
Vector averaged cross-power spectrum Baseline: EF (01) - JB (02)  
Timerange: 00/01:12:31 to 00/01:16:00

Plot file version 12 created 24-NOV-2017 10:09:35

ARUMA EG096D.UVDATA.1

Freq = 4.7990 GHz, Bw = 32.000 MH No calibration applied and no bandpass applied

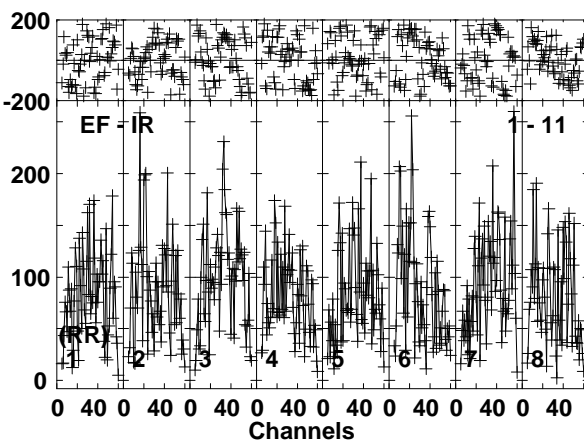
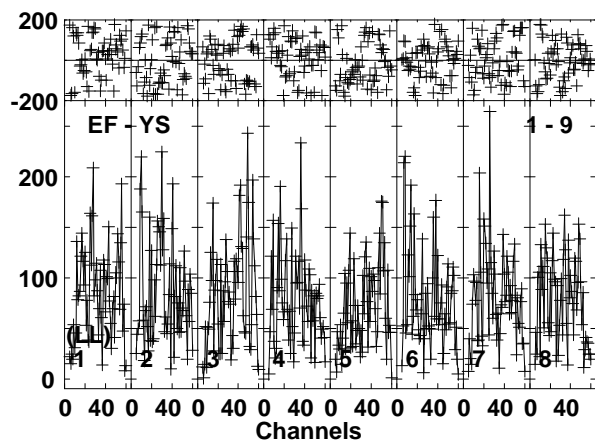
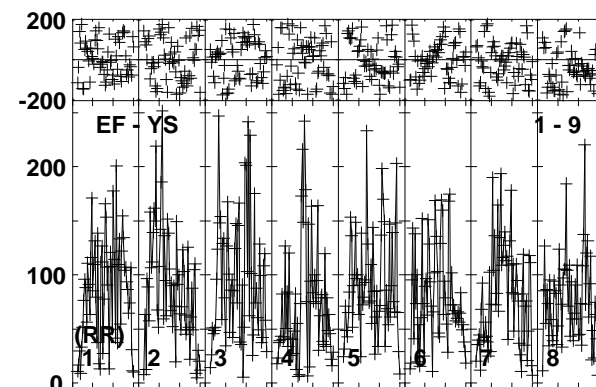
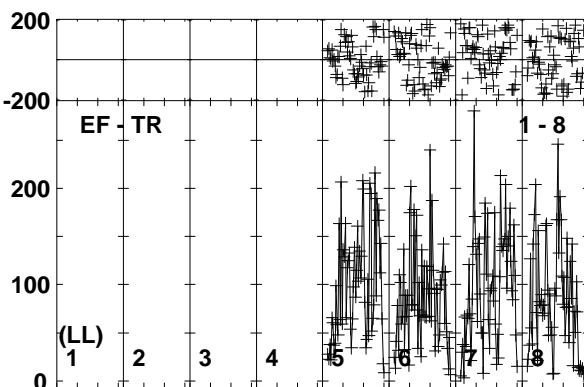
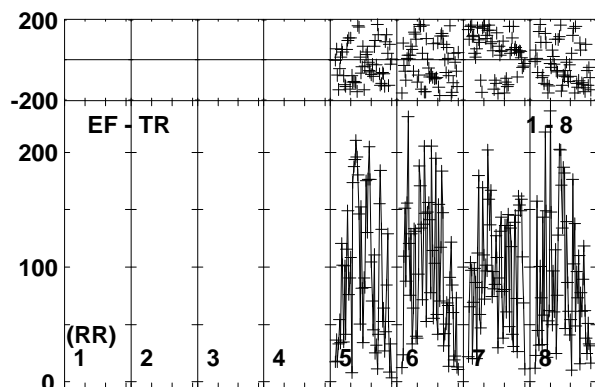
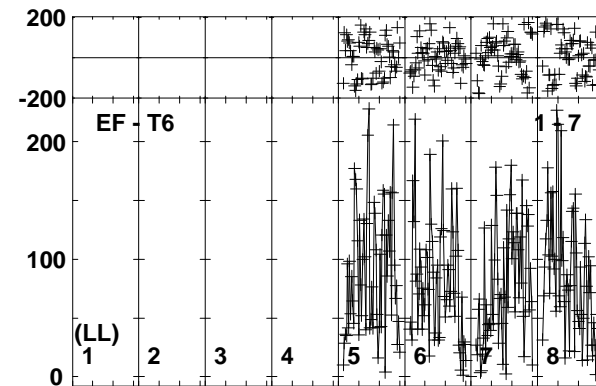
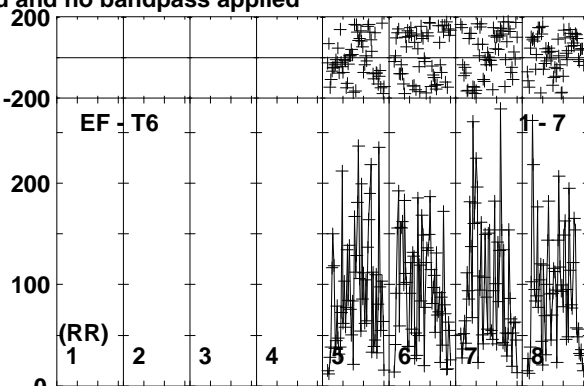
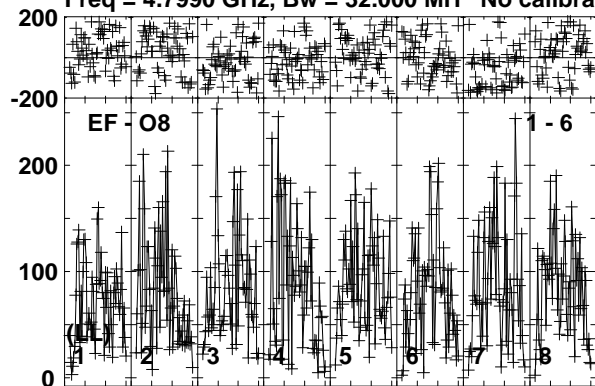

Lower frame: Micro Ampl Jy Top frame: Phas deg  
Vector averaged cross-power spectrum Baseline: EF (01) - O8 (06)  
Timerange: 00/01:12:31 to 00/01:16:00

Plot file version 13 created 24-NOV-2017 10:09:35

J1108+4330 EG096D.UVDATA.1

Freq = 4.7990 GHz, Bw = 32.000 MH No calibration applied and no bandpass applied

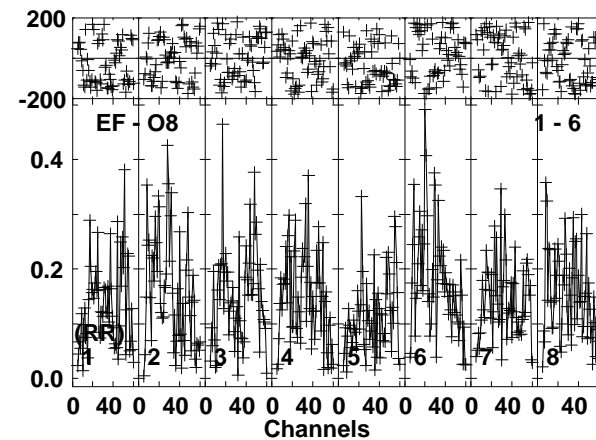
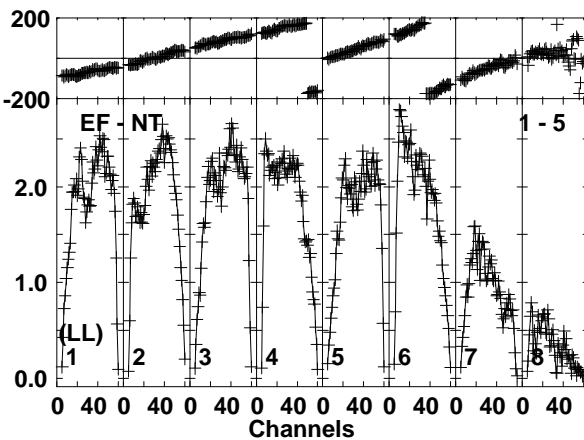
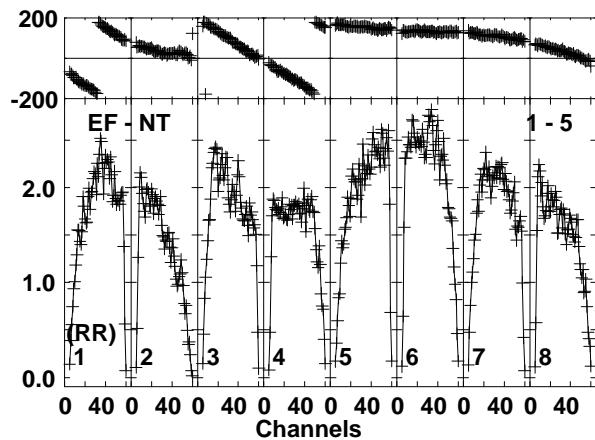
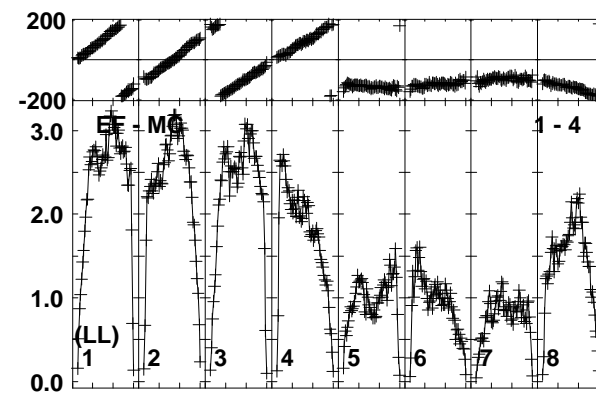
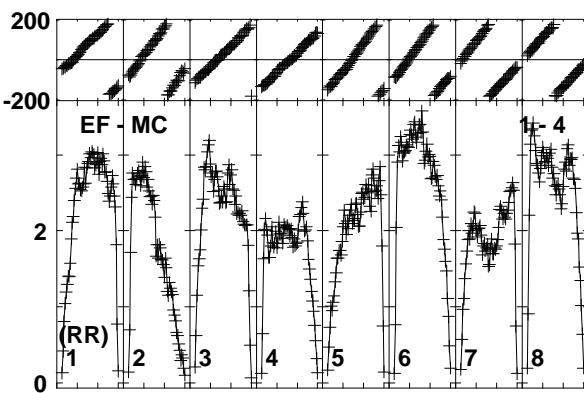
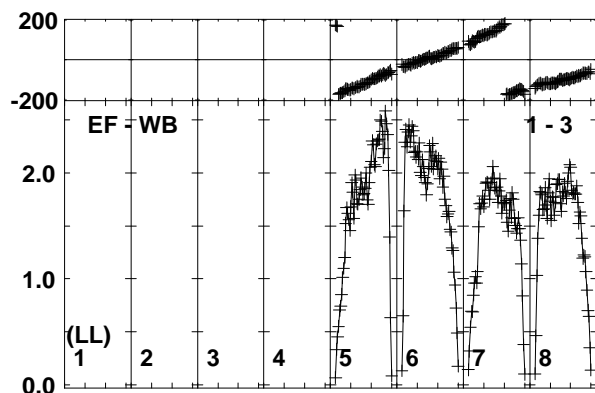
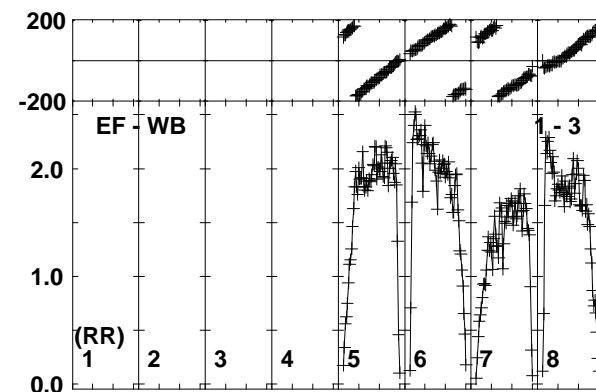
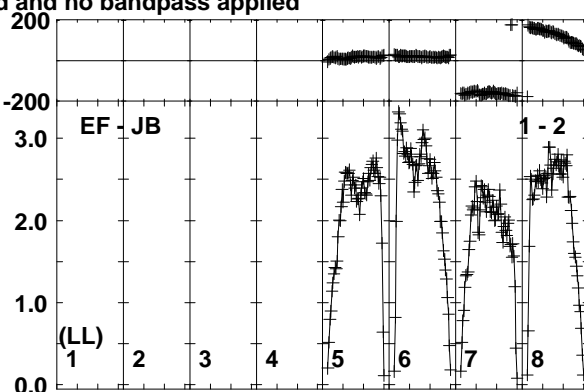
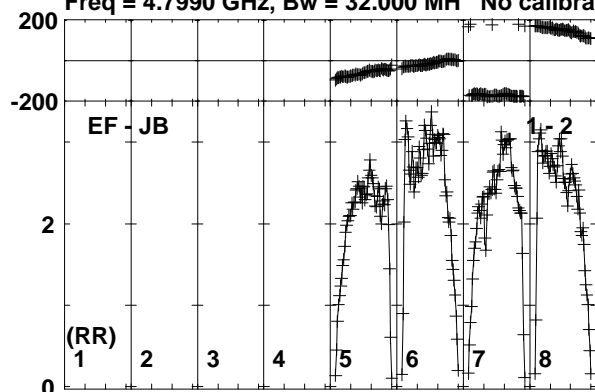

Lower frame: Milli Ampl Jy Top frame: Phas deg  
Vector averaged cross-power spectrum Baseline: EF (01) - JB (02)  
Timerange: 00/01:16:40 to 00/01:17:40

Plot file version 14 created 24-NOV-2017 10:09:36

J1108+4330 EG096D.UVDATA.1

Freq = 4.7990 GHz, Bw = 32.000 MH No calibration applied and no bandpass applied

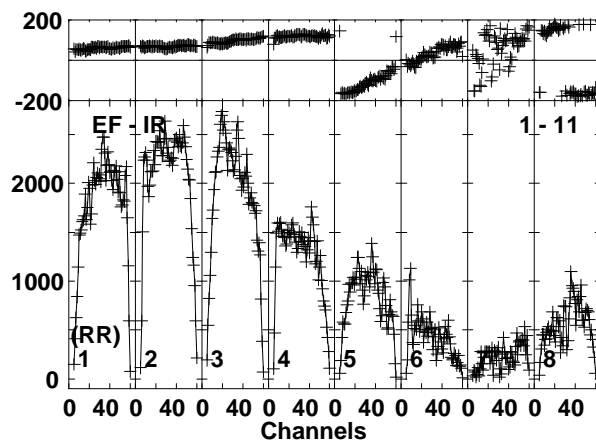
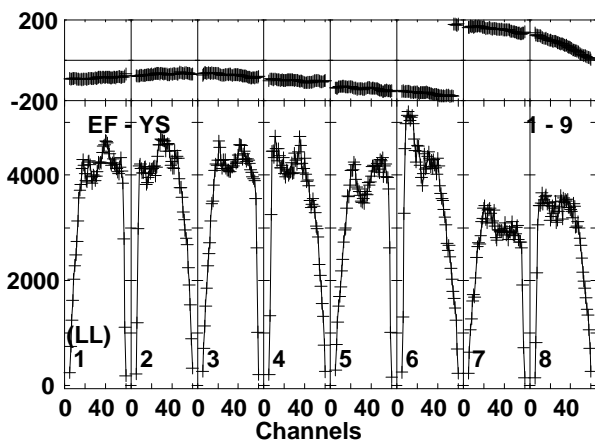
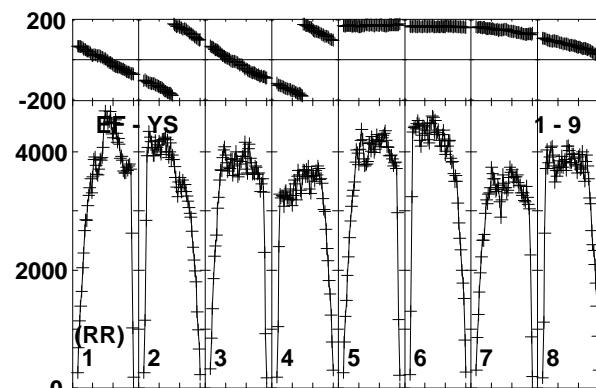
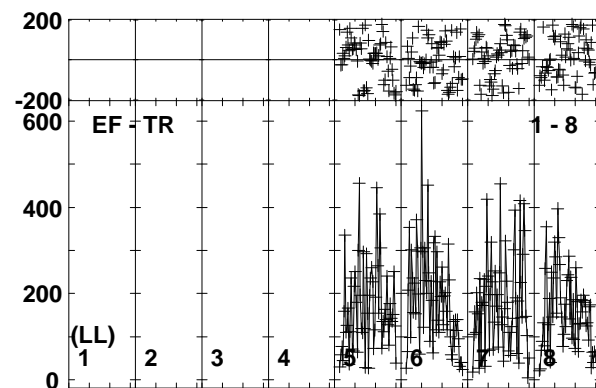
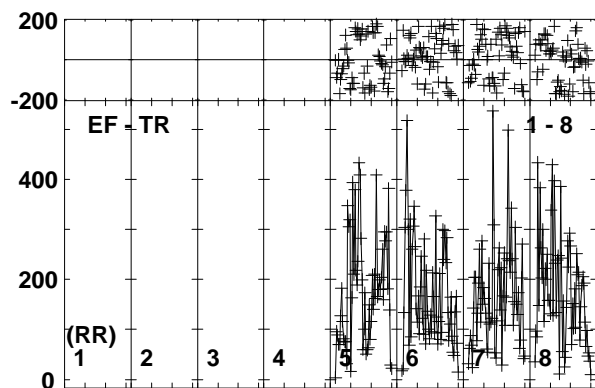
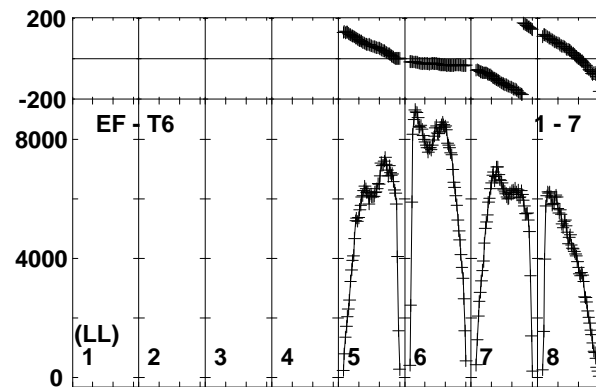
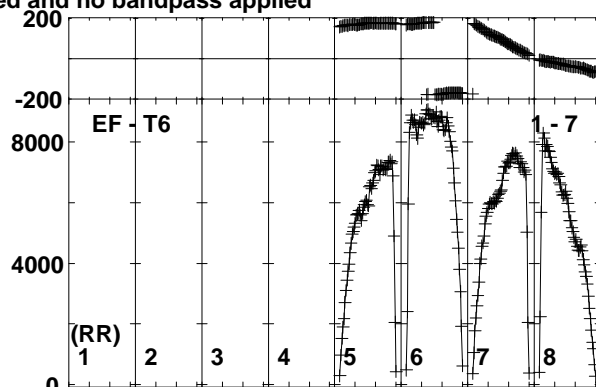
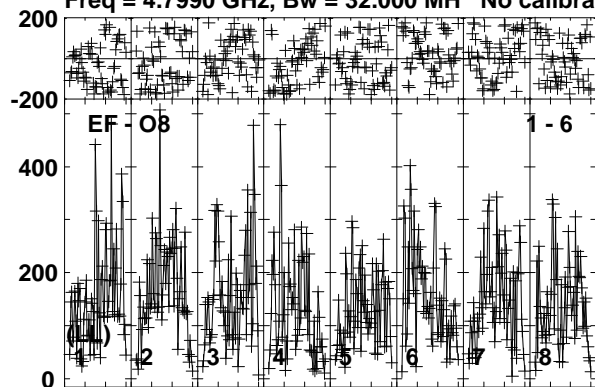

Lower frame: Micro Ampl Jy Top frame: Phas deg  
Vector averaged cross-power spectrum Baseline: EF (01) - O8 (06)  
Timerange: 00/01:16:40 to 00/01:17:40

Plot file version 15 created 24-NOV-2017 10:09:36

ARUMA EG096D.UVDATA.1

Freq = 4.7990 GHz, Bw = 32.000 MH No calibration applied and no bandpass applied

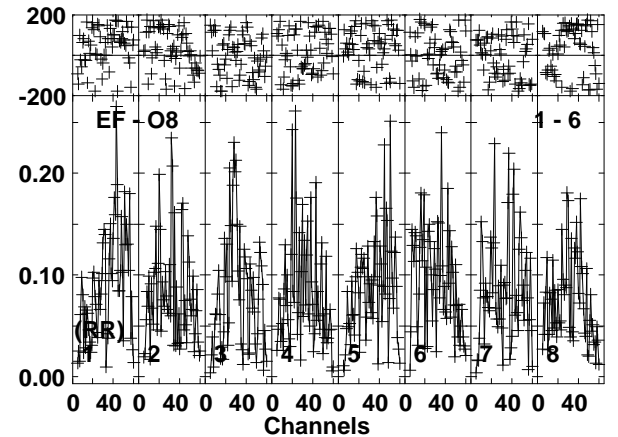
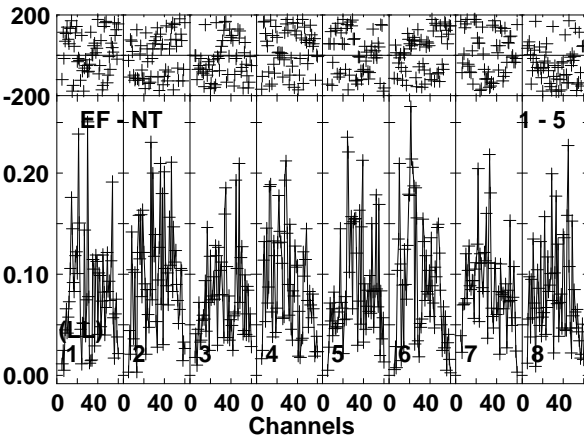
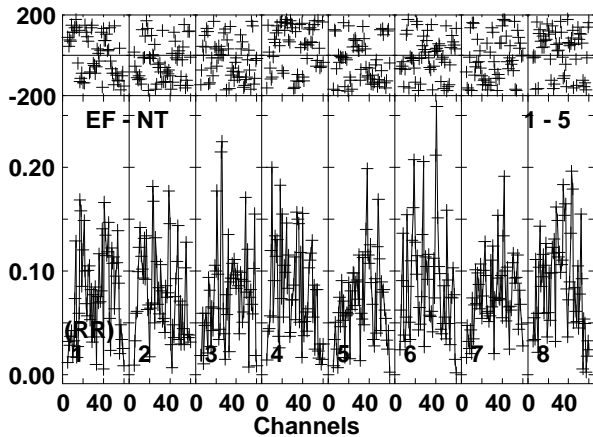
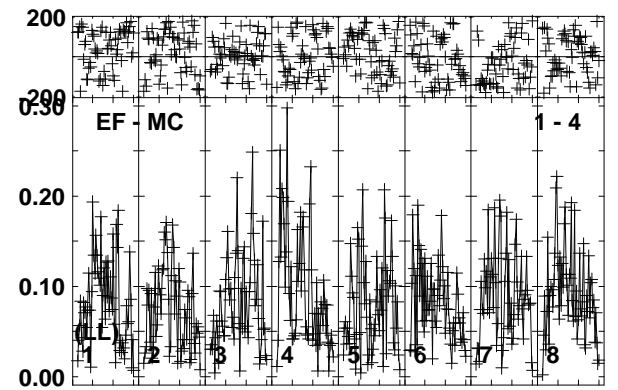
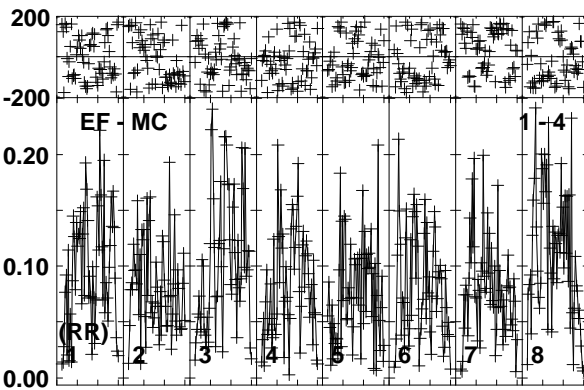
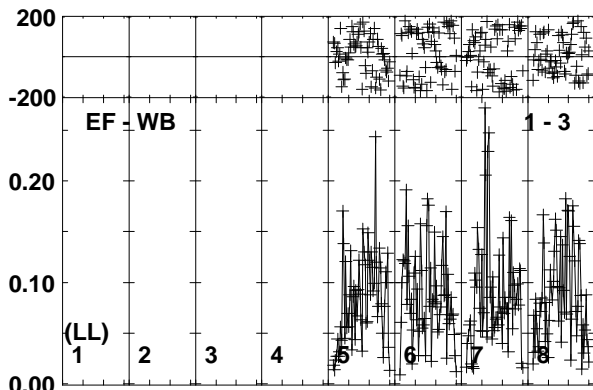
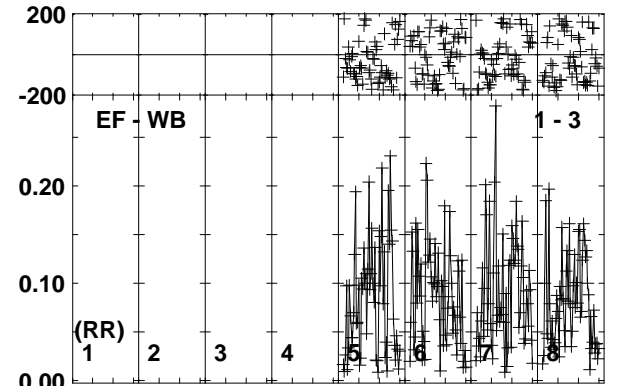
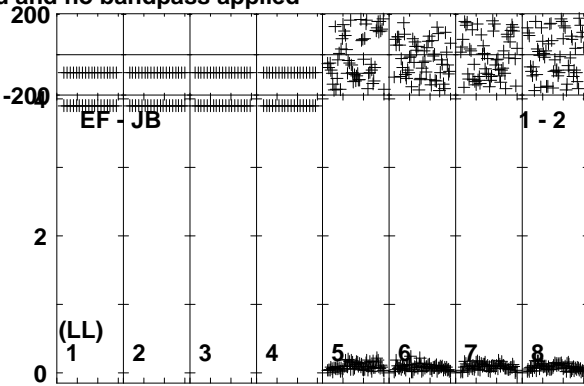
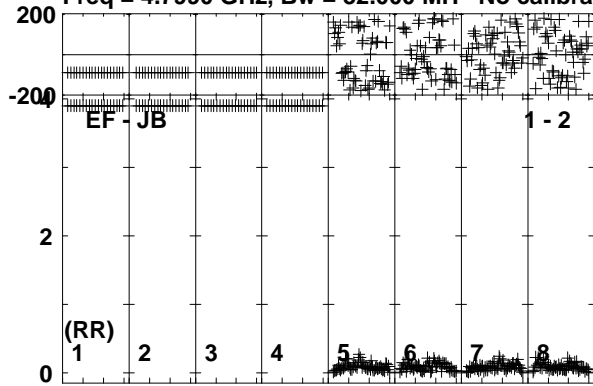

Lower frame: Milli Ampl Jy Top frame: Phas deg  
Vector averaged cross-power spectrum Baseline: EF (01) - JB (02)  
Timerange: 00/01:17:40 to 00/01:21:10

Plot file version 16 created 24-NOV-2017 10:09:36

ARUMA EG096D.UVDATA.1

Freq = 4.7990 GHz, Bw = 32.000 MH No calibration applied and no bandpass applied

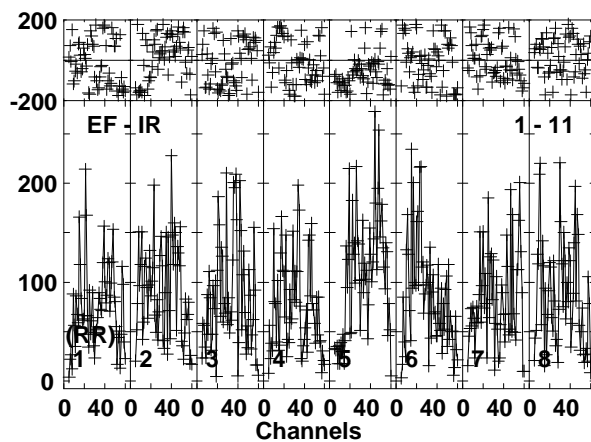
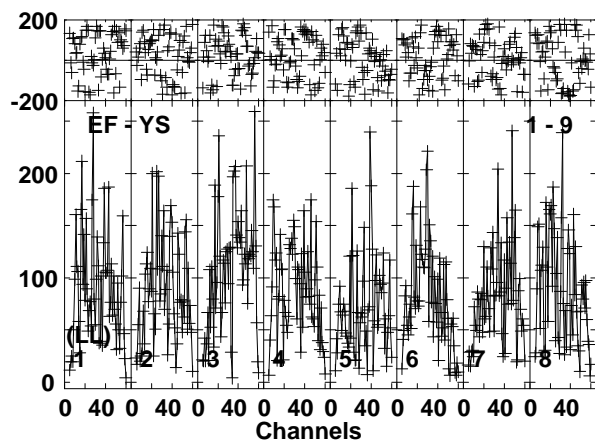
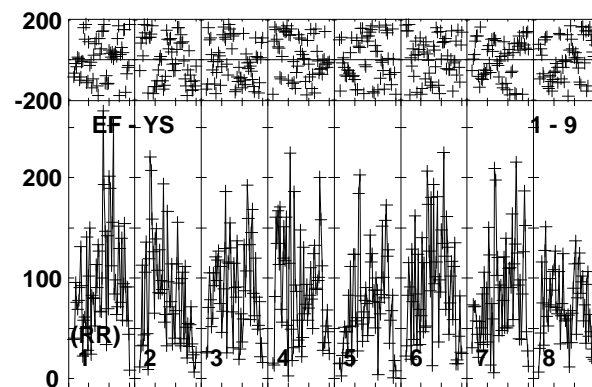
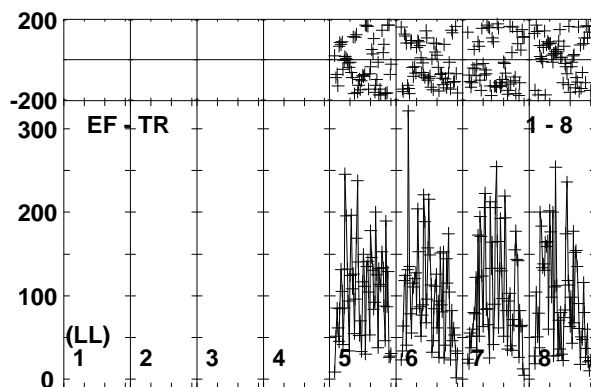
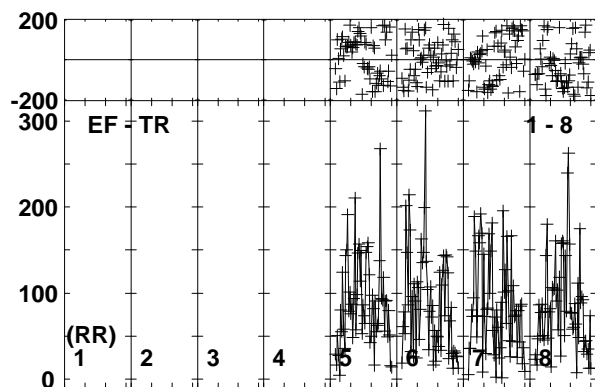
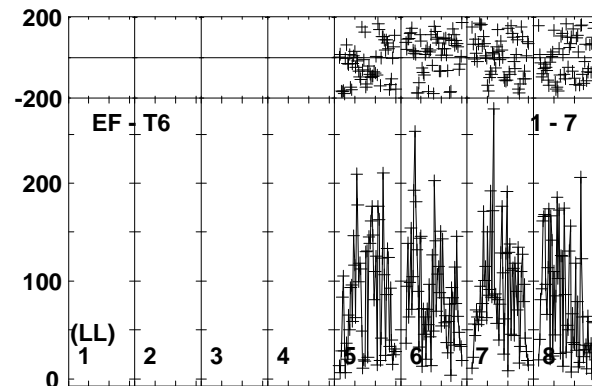
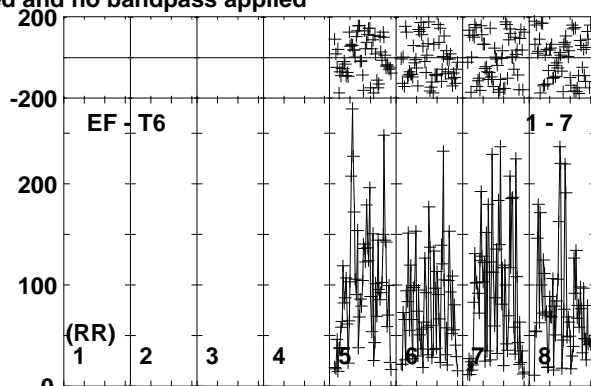
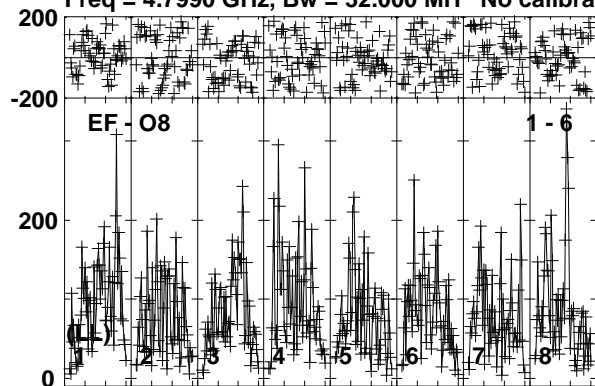

Lower frame: Micro Ampl Jy Top frame: Phas deg  
Vector averaged cross-power spectrum Baseline: EF (01) - O8 (06)  
Timerange: 00/01:17:40 to 00/01:21:10

Plot file version 17 created 24-NOV-2017 10:09:37

J1108+4330 EG096D.UVDATA.1

Freq = 4.7990 GHz, Bw = 32.000 MH No calibration applied and no bandpass applied

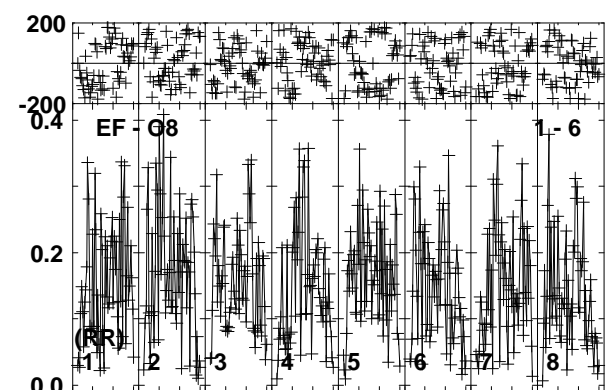
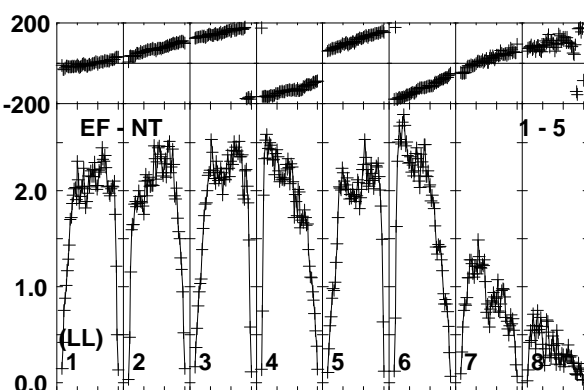
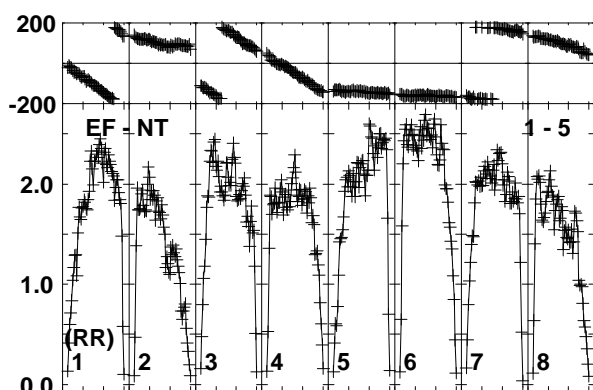
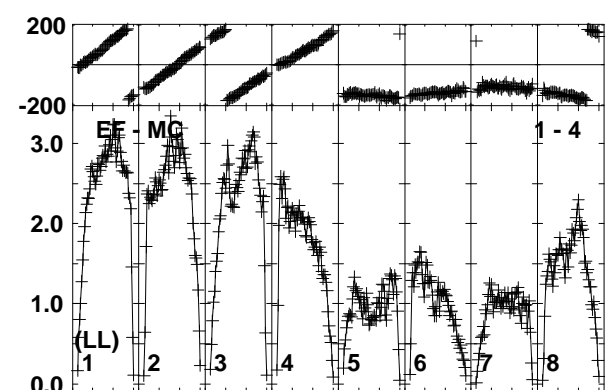
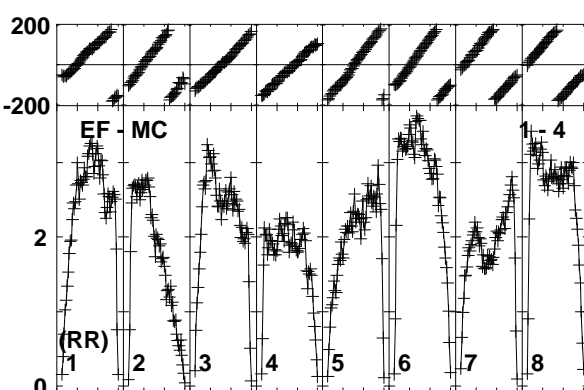
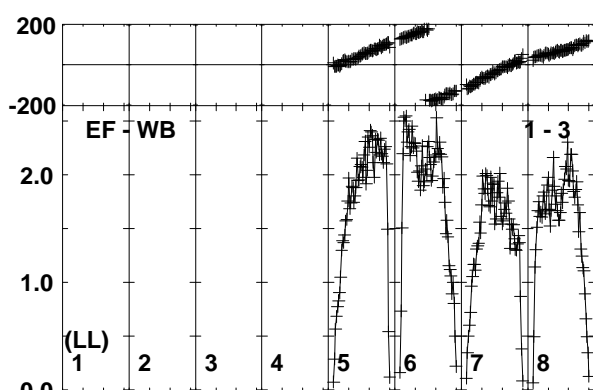
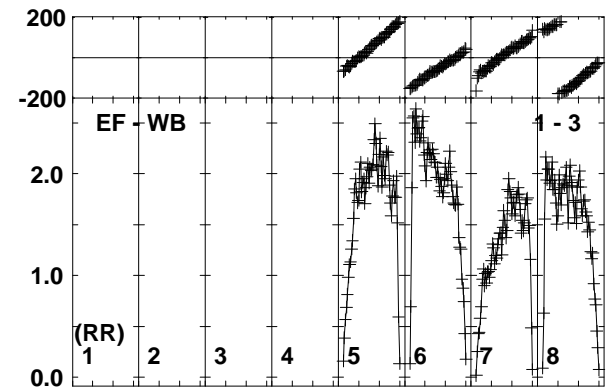
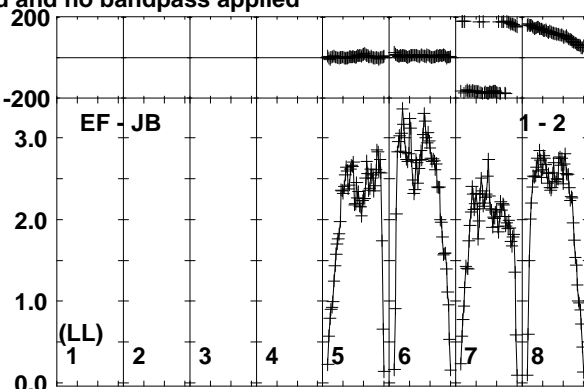
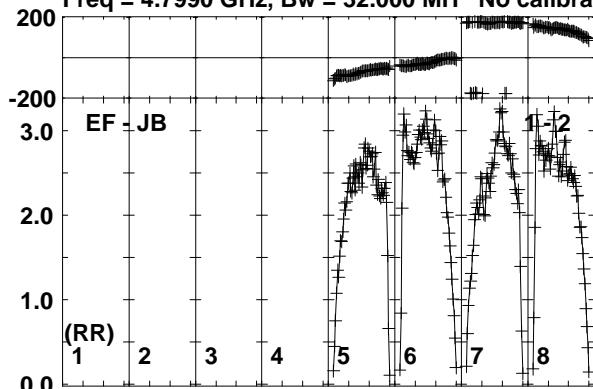

Lower frame: Milli Ampl Jy Top frame: Phas deg  
Vector averaged cross-power spectrum Baseline: EF (01) - JB (02)  
Timerange: 00/01:21:11 to 00/01:22:39

Plot file version 18 created 24-NOV-2017 10:09:37

J1108+4330 EG096D.UVDATA.1

Freq = 4.7990 GHz, Bw = 32.000 MH No calibration applied and no bandpass applied

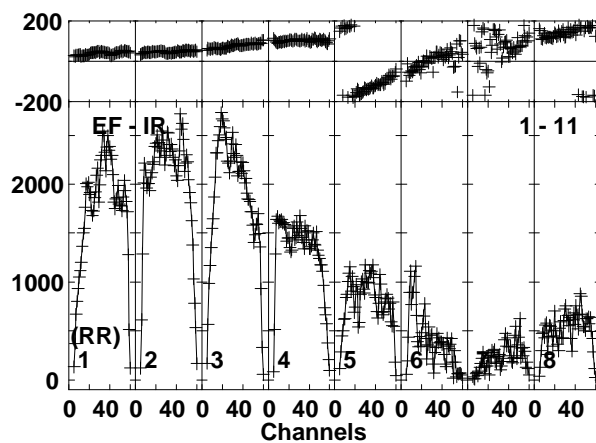
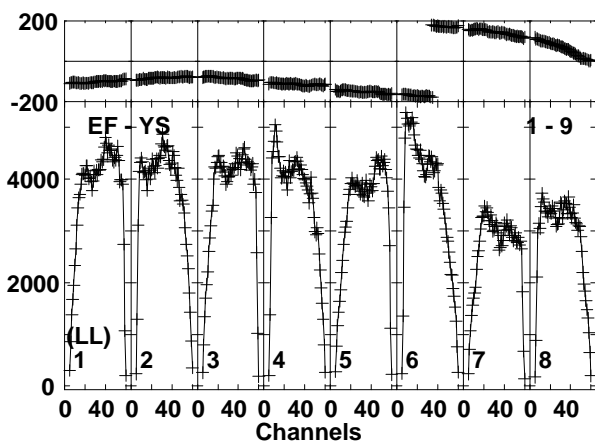
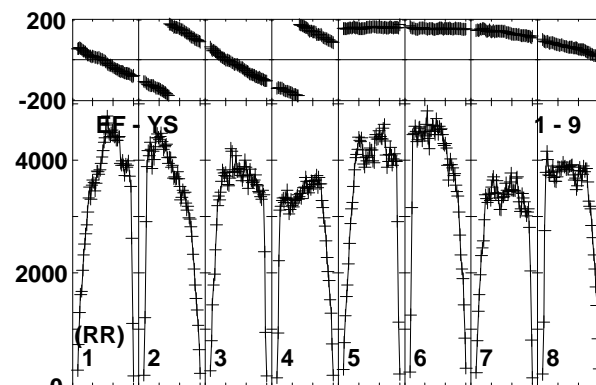
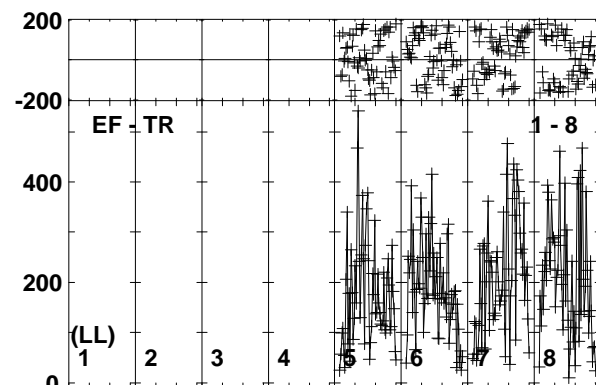
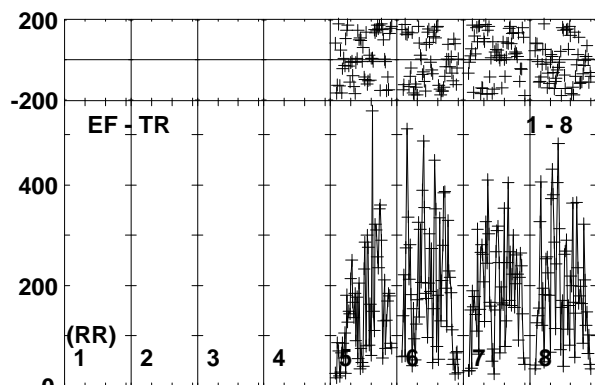
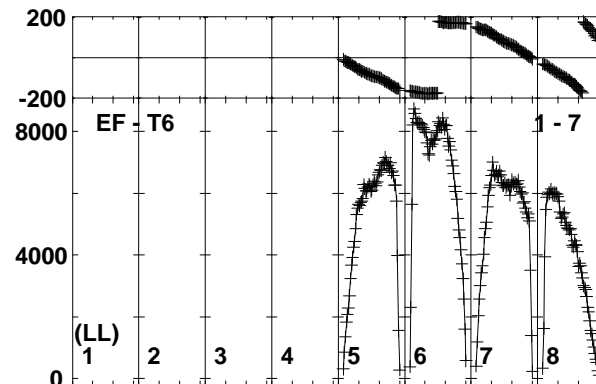
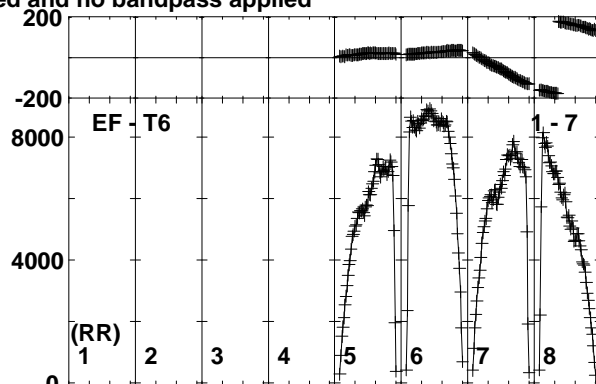
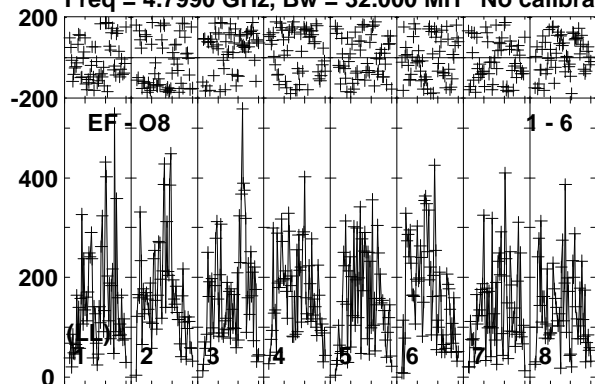

Lower frame: Micro Ampl Jy Top frame: Phas deg  
Vector averaged cross-power spectrum Baseline: EF (01) - O8 (06)  
Timerange: 00/01:21:11 to 00/01:22:39



Plot file version 19 created 24-NOV-2017 10:09:37

ARUMA EG096D.UVDATA.1

Freq = 4.7990 GHz, Bw = 32.000 MH No calibration applied and no bandpass applied

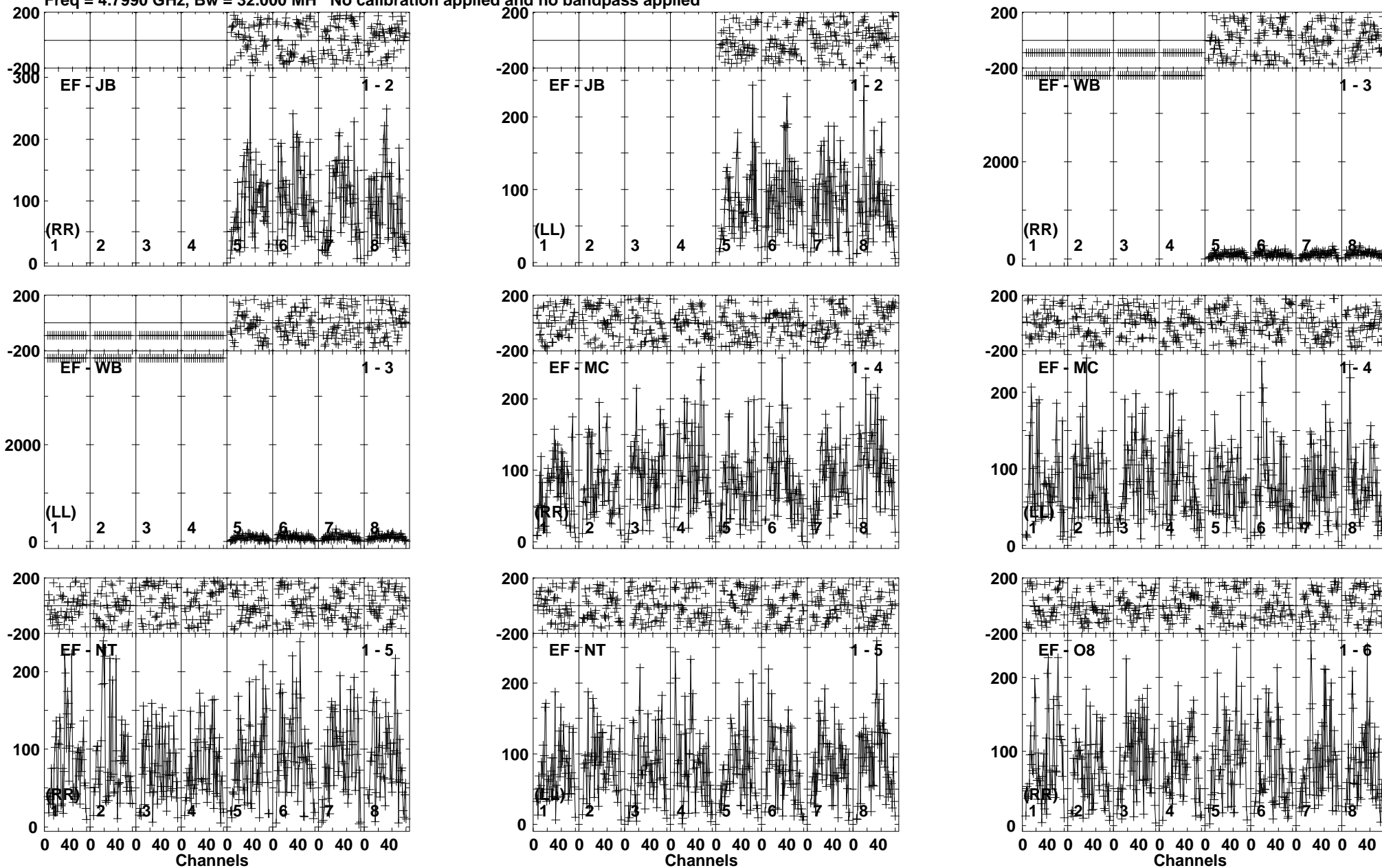

Lower frame: Micro Ampl Jy Top frame: Phas deg  
Vector averaged cross-power spectrum Baseline: EF (01) - JB (02)  
Timerange: 00/01:22:41 to 00/01:26:09

Plot file version 20 created 24-NOV-2017 10:09:38

ARUMA EG096D.UVDATA.1

Freq = 4.7990 GHz, Bw = 32.000 MH No calibration applied and no bandpass applied

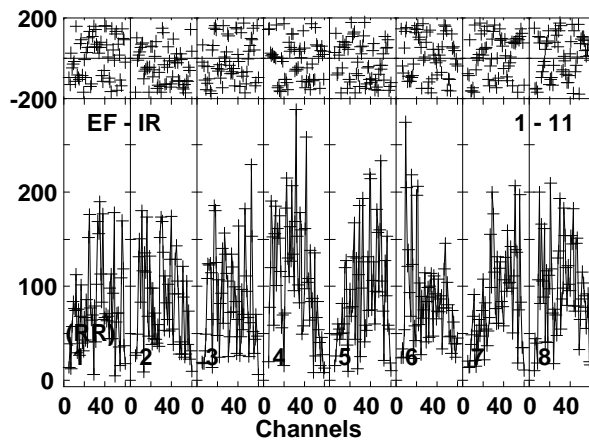
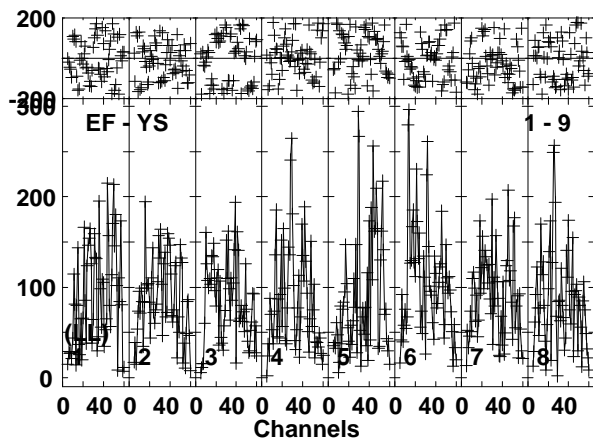
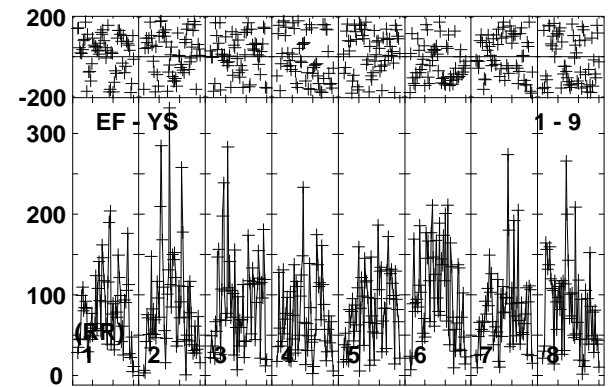
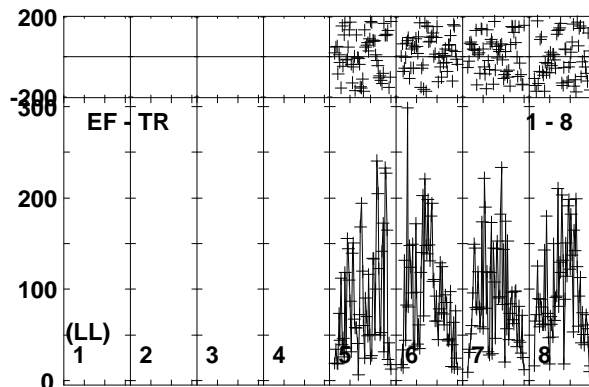
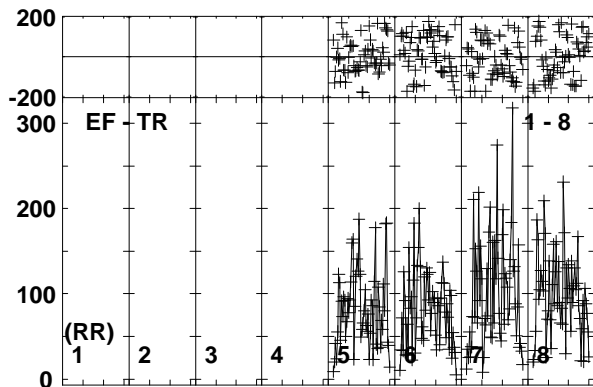
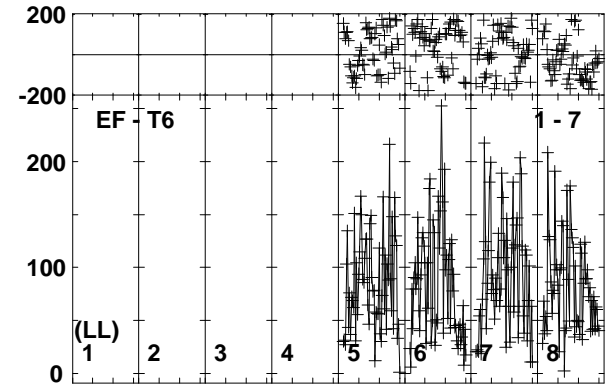
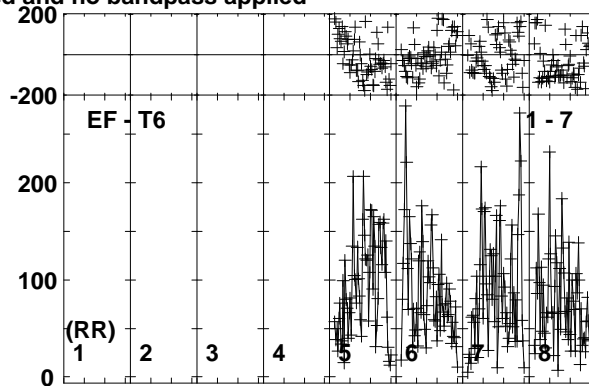
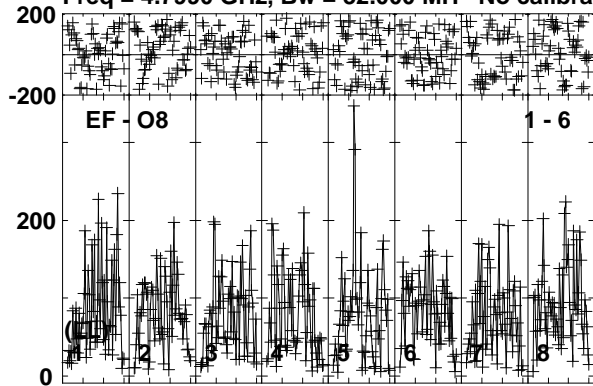

Lower frame: Micro Ampl Jy Top frame: Phas deg  
Vector averaged cross-power spectrum Baseline: EF (01) - O8 (06)  
Timerange: 00/01:22:41 to 00/01:26:09

Plot file version 21 created 24-NOV-2017 10:09:38

J1108+4330 EG096D.UVDATA.1

Freq = 4.7990 GHz, Bw = 32.000 MH No calibration applied and no bandpass applied

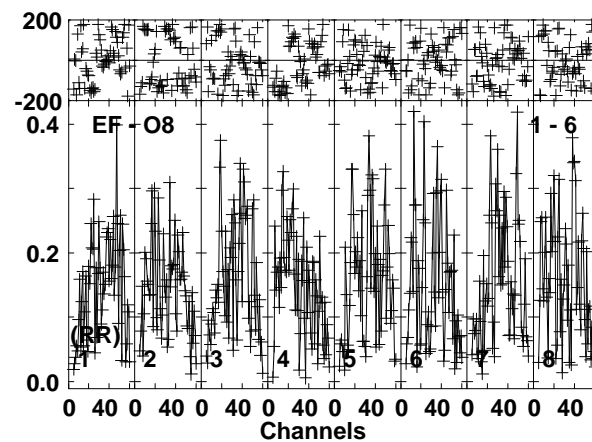
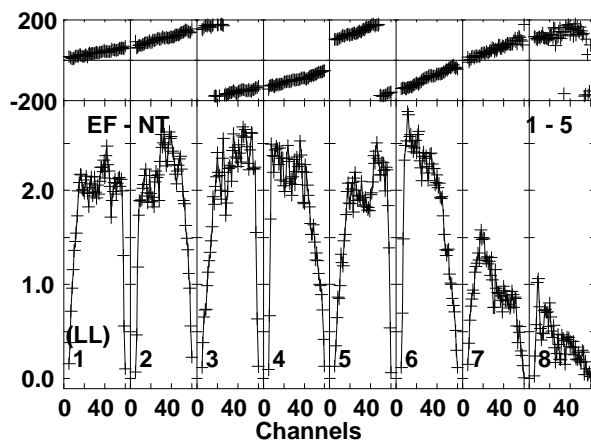
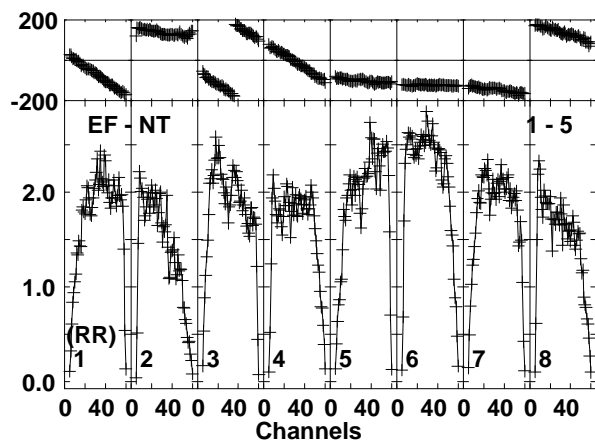
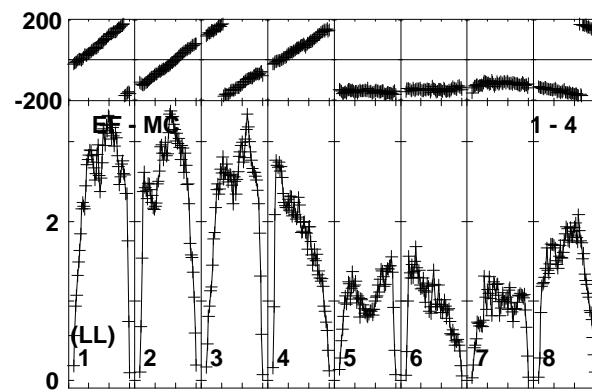
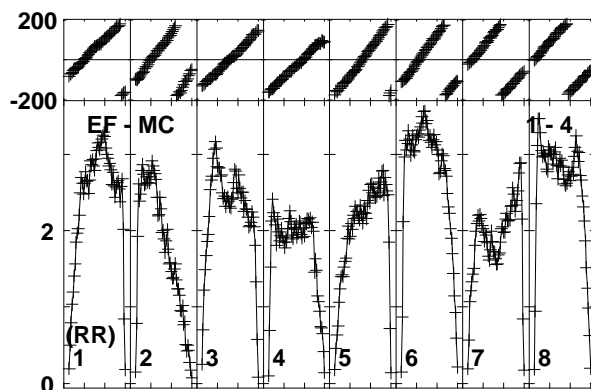
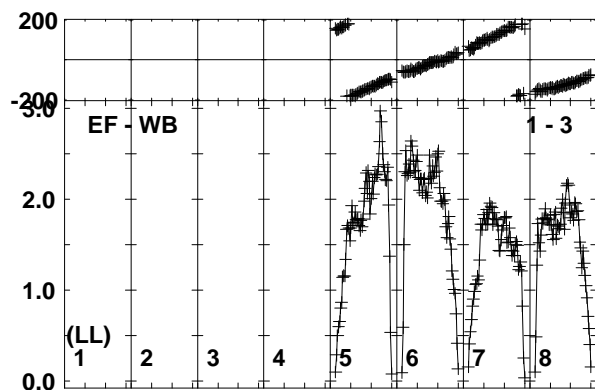
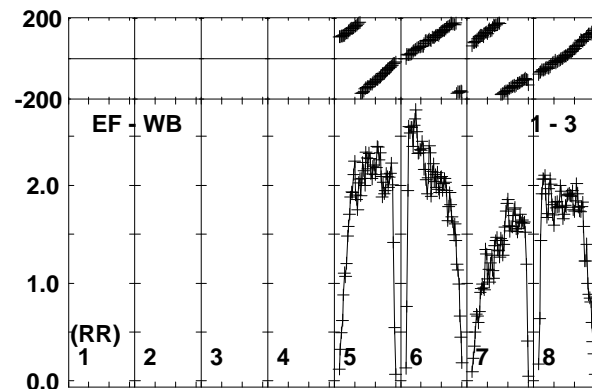
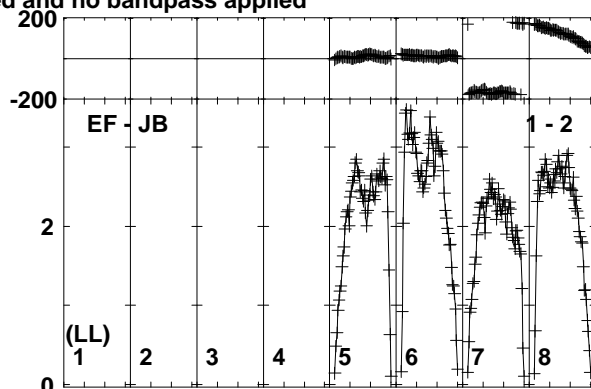
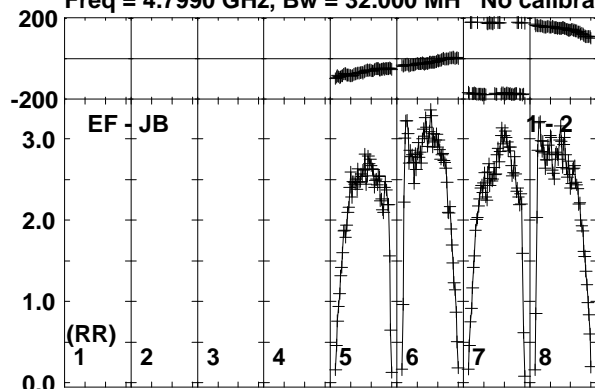

Lower frame: Milli Ampl Jy Top frame: Phas deg  
Vector averaged cross-power spectrum Baseline: EF (01) - JB (02)  
Timerange: 00/01:26:51 to 00/01:27:50

Plot file version 22 created 24-NOV-2017 10:09:38

J1108+4330 EG096D.UVDATA.1

Freq = 4.7990 GHz, Bw = 32.000 MH No calibration applied and no bandpass applied

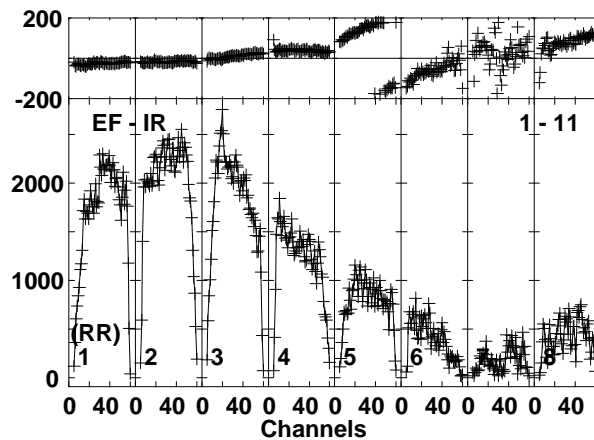
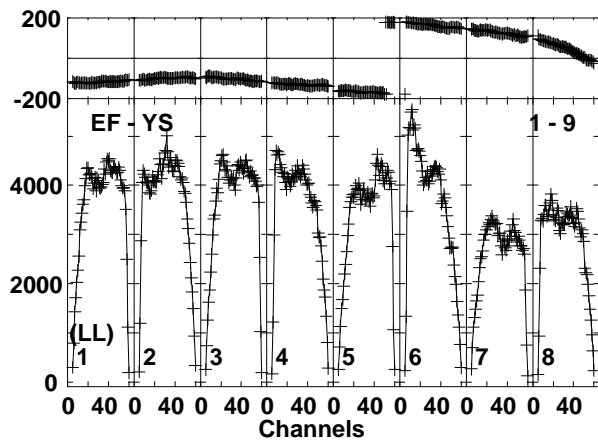
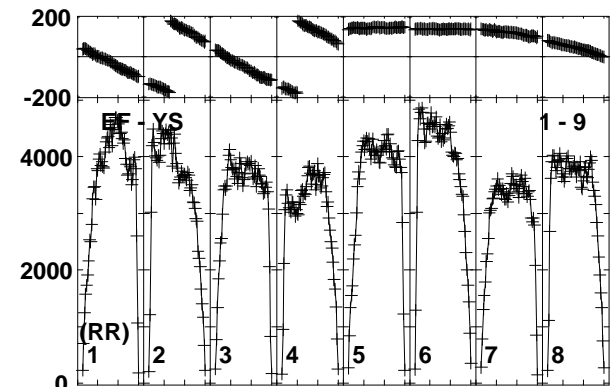
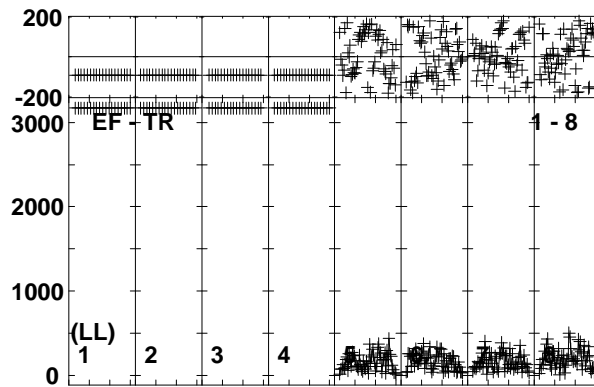
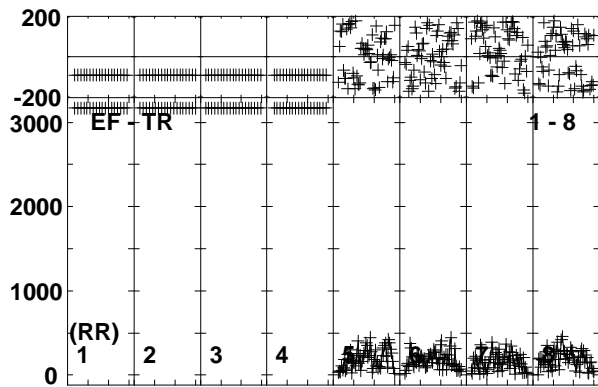
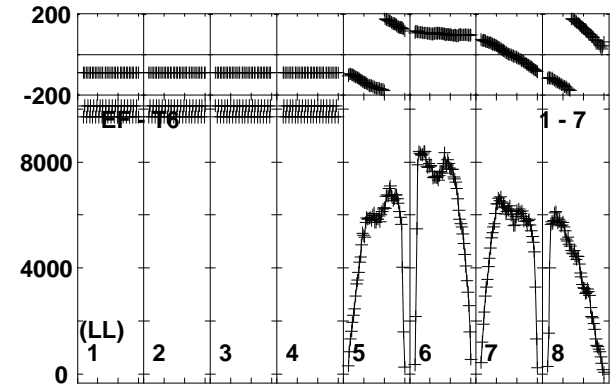
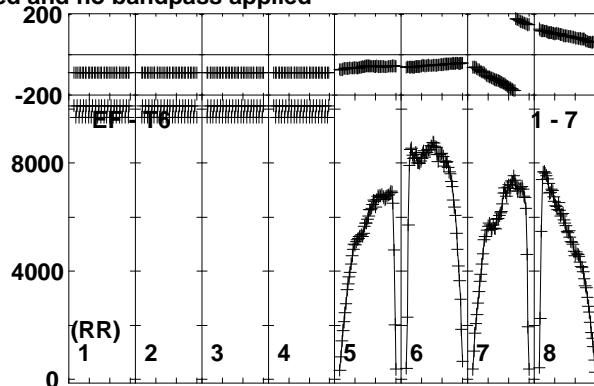
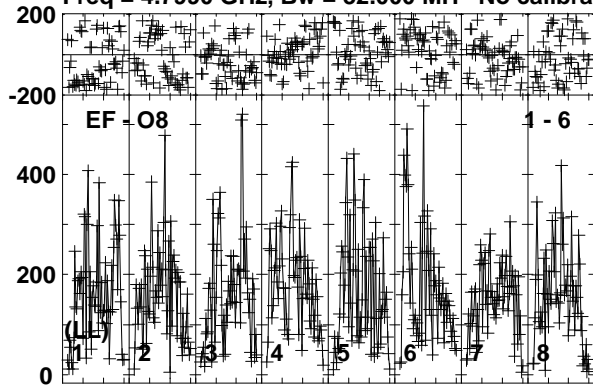

Lower frame: Micro Ampl Jy Top frame: Phas deg  
Vector averaged cross-power spectrum Baseline: EF (01) - O8 (06)  
Timerange: 00/01:26:51 to 00/01:27:50

Plot file version 23 created 24-NOV-2017 10:09:38

ARUMA EG096D.UVDATA.1

Freq = 4.7990 GHz, Bw = 32.000 MH No calibration applied and no bandpass applied

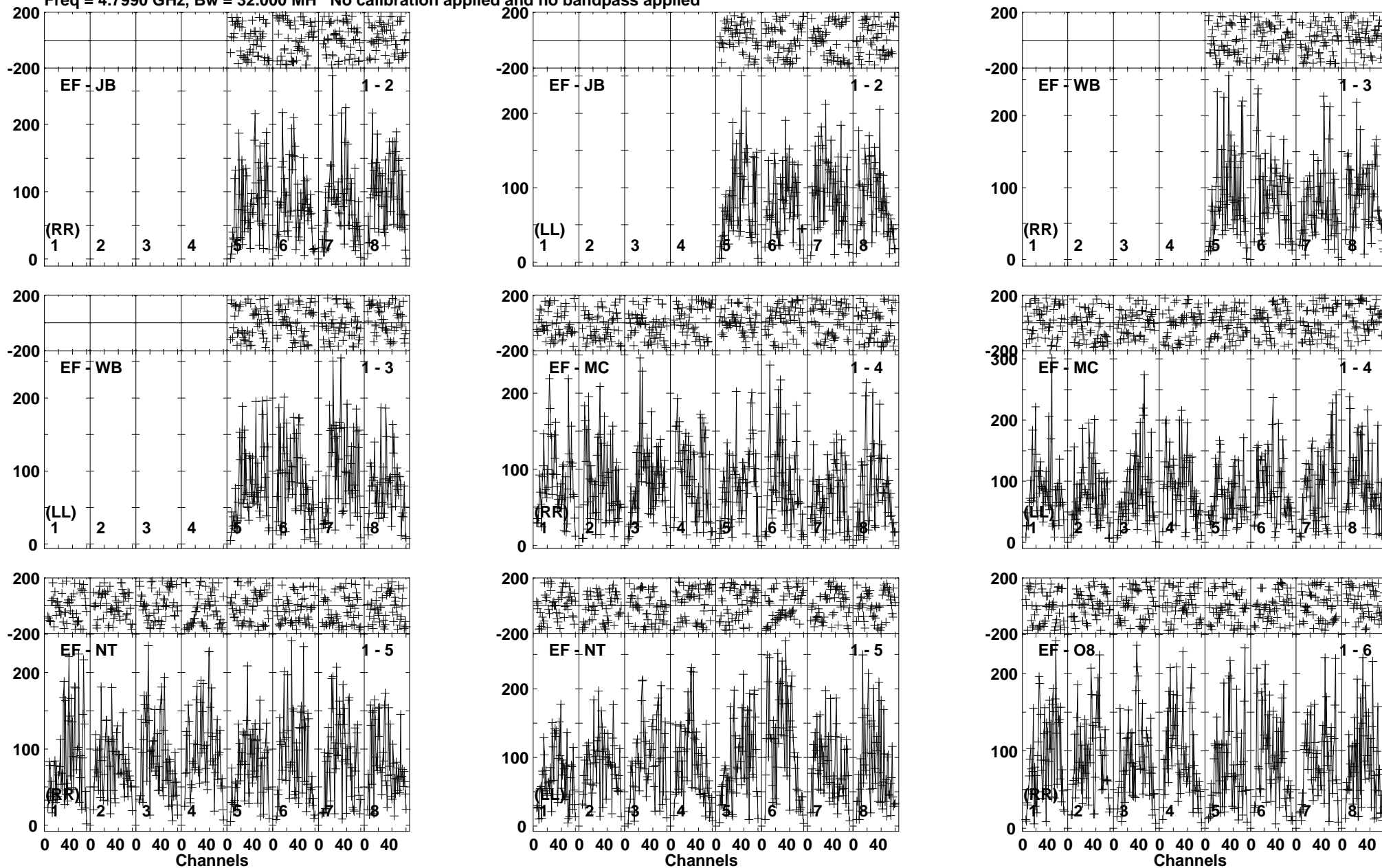

Lower frame: Micro Ampl Jy Top frame: Phas deg  
Vector averaged cross-power spectrum Baseline: EF (01) - JB (02)  
Timerange: 00/01:27:51 to 00/01:31:19

Plot file version 24 created 24-NOV-2017 10:09:39

ARUMA EG096D.UVDATA.1

Freq = 4.7990 GHz, Bw = 32.000 MH No calibration applied and no bandpass applied

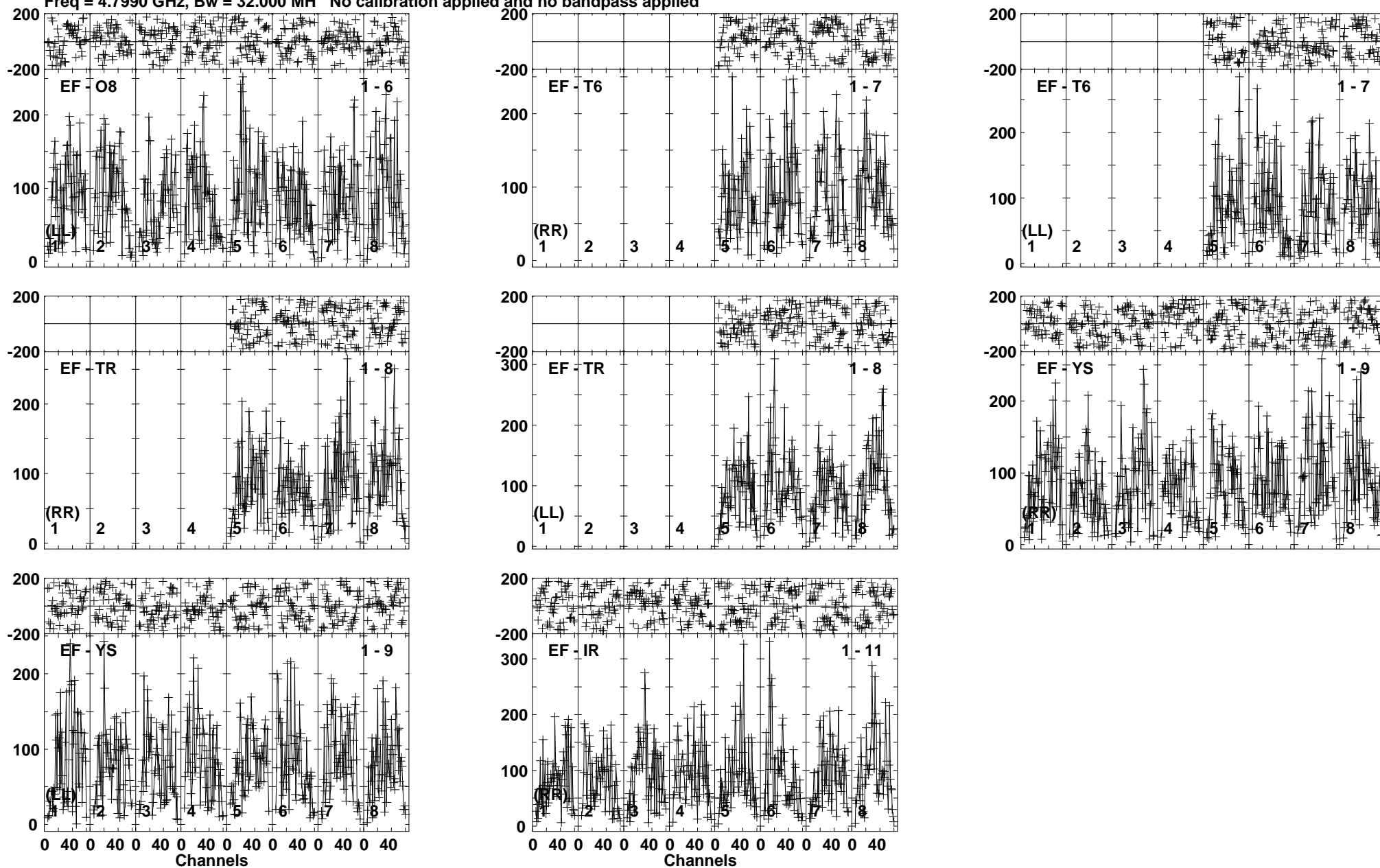

Lower frame: Micro Ampl Jy Top frame: Phas deg  
Vector averaged cross-power spectrum Baseline: EF (01) - O8 (06)  
Timerange: 00/01:27:51 to 00/01:31:19

Plot file version 25 created 24-NOV-2017 10:09:39

J1108+4330 EG096D.UVDATA.1

Freq = 4.7990 GHz, Bw = 32.000 MH No calibration applied and no bandpass applied

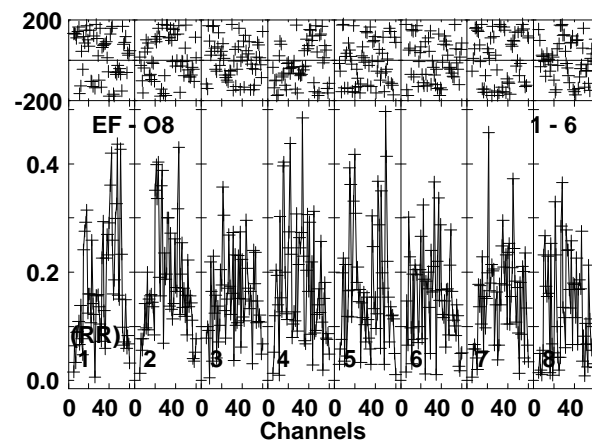
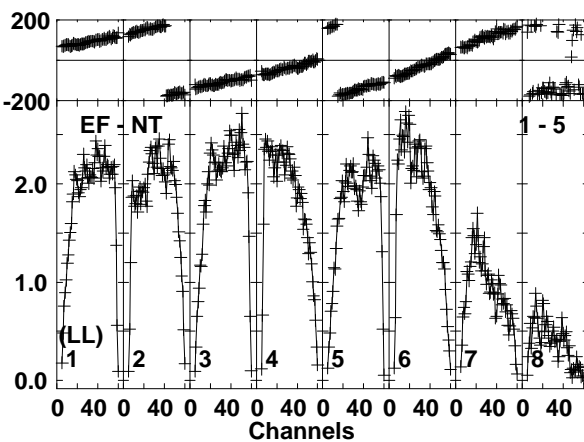
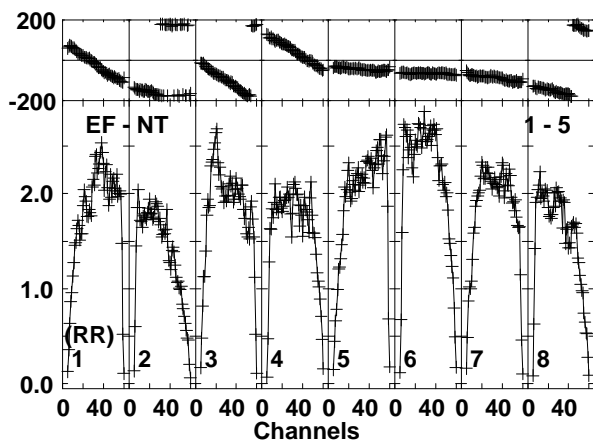
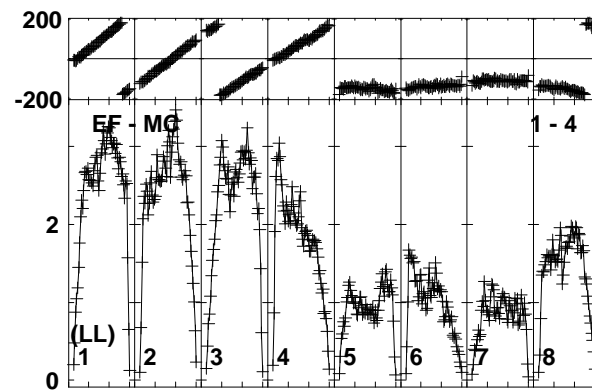
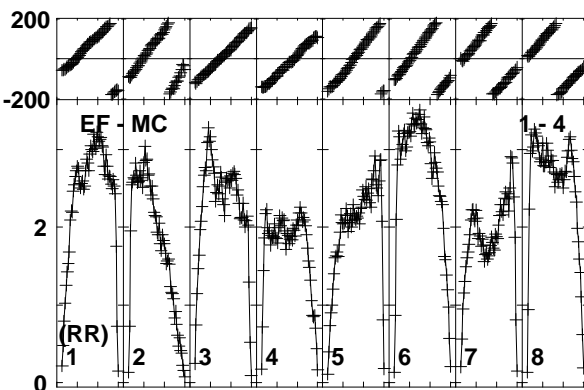
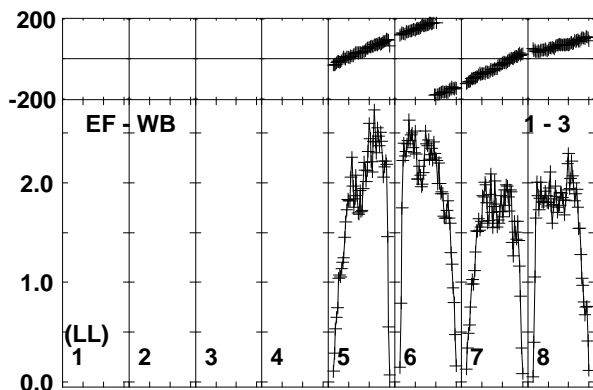
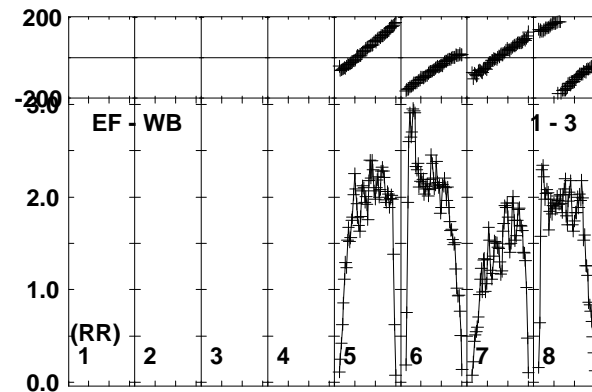
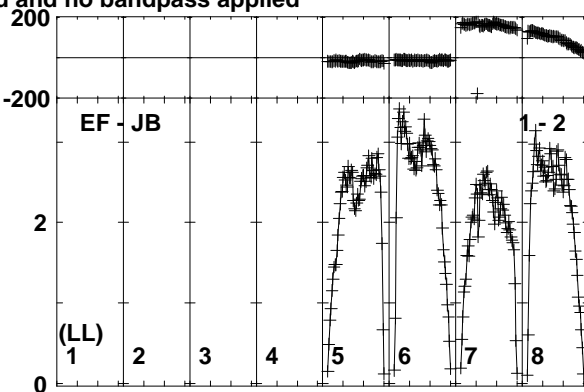
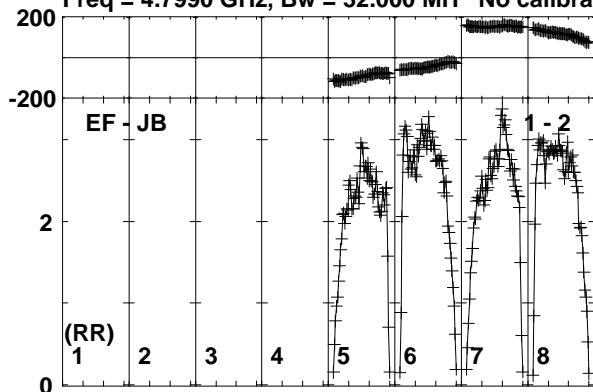

Lower frame: Milli Ampl Jy Top frame: Phas deg  
Vector averaged cross-power spectrum Baseline: EF (01) - JB (02)  
Timerange: 00/01:31:20 to 00/01:32:49

Plot file version 26 created 24-NOV-2017 10:09:39

J1108+4330 EG096D.UVDATA.1

Freq = 4.7990 GHz, Bw = 32.000 MH No calibration applied and no bandpass applied

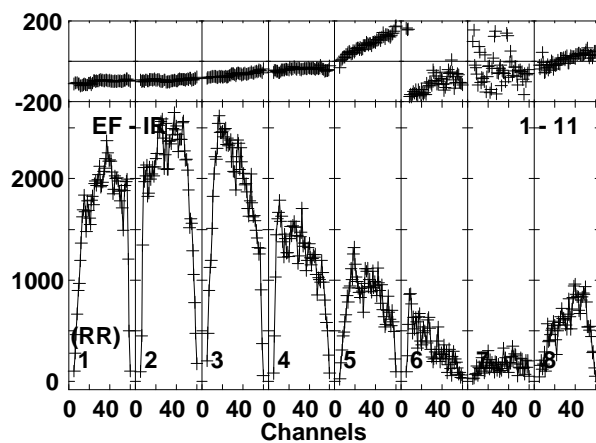
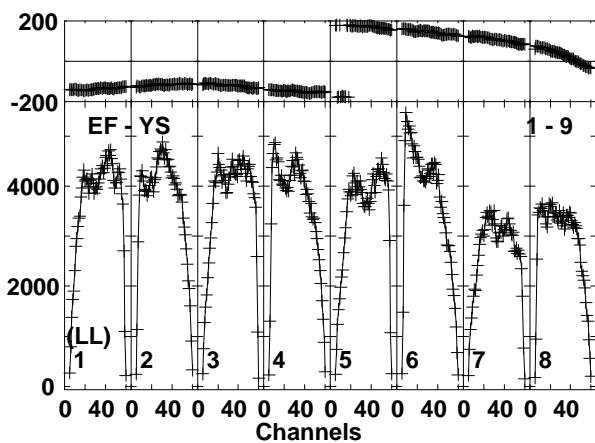
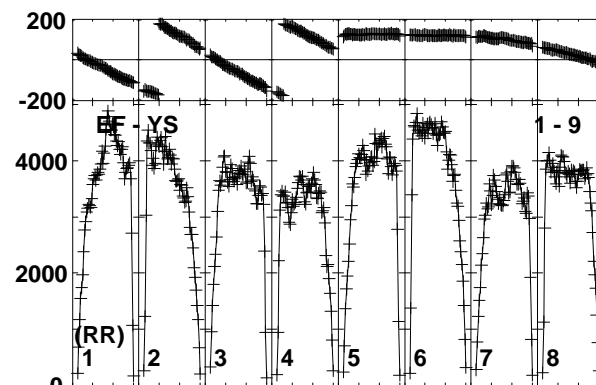
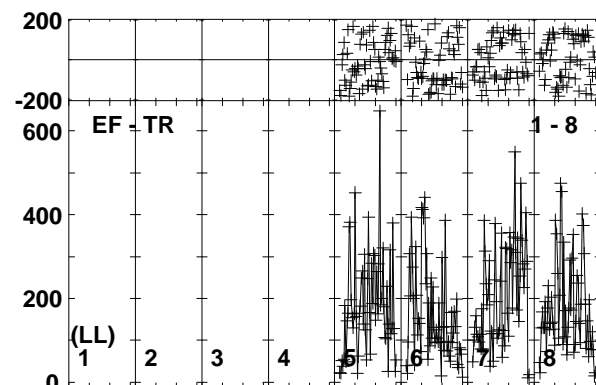
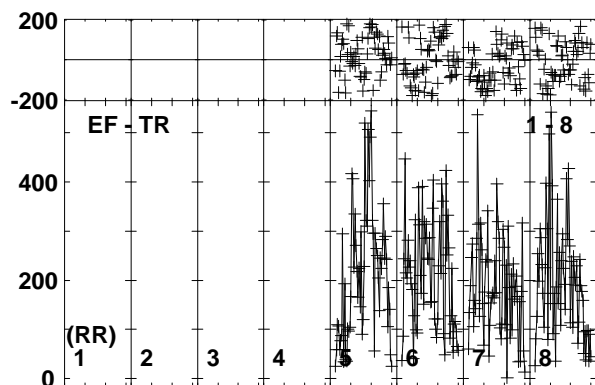
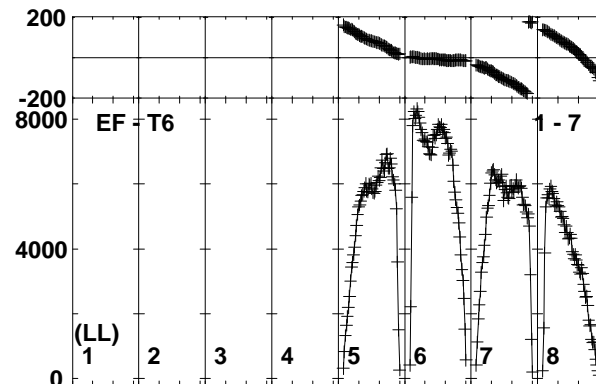
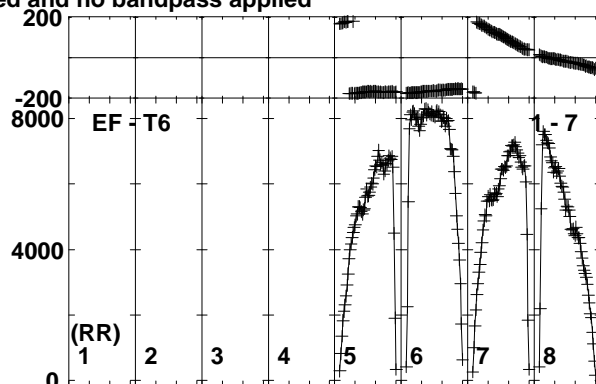
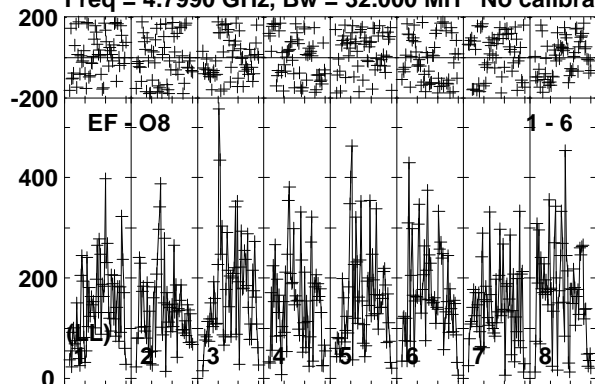

Lower frame: Micro Ampl Jy Top frame: Phas deg  
Vector averaged cross-power spectrum Baseline: EF (01) - O8 (06)  
Timerange: 00/01:31:20 to 00/01:32:49



Plot file version 27 created 24-NOV-2017 10:09:40

ARUMA EG096D.UVDATA.1

Freq = 4.7990 GHz, Bw = 32.000 MH No calibration applied and no bandpass applied

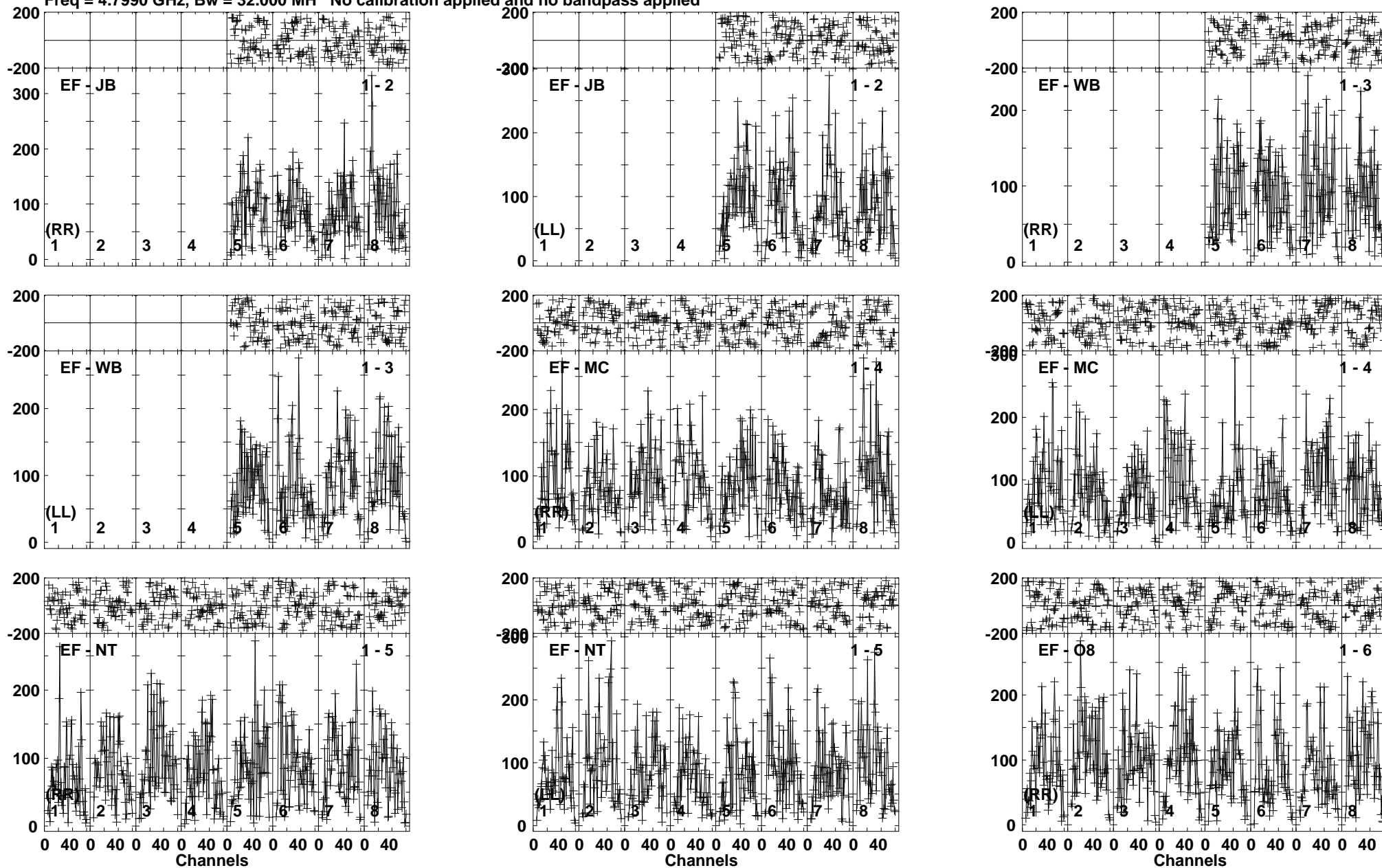

Lower frame: Micro Ampl Jy Top frame: Phas deg  
Vector averaged cross-power spectrum Baseline: EF (01) - JB (02)  
Timerange: 00/01:32:51 to 00/01:36:20

Plot file version 28 created 24-NOV-2017 10:09:40

ARUMA EG096D.UVDATA.1

Freq = 4.7990 GHz, Bw = 32.000 MH No calibration applied and no bandpass applied

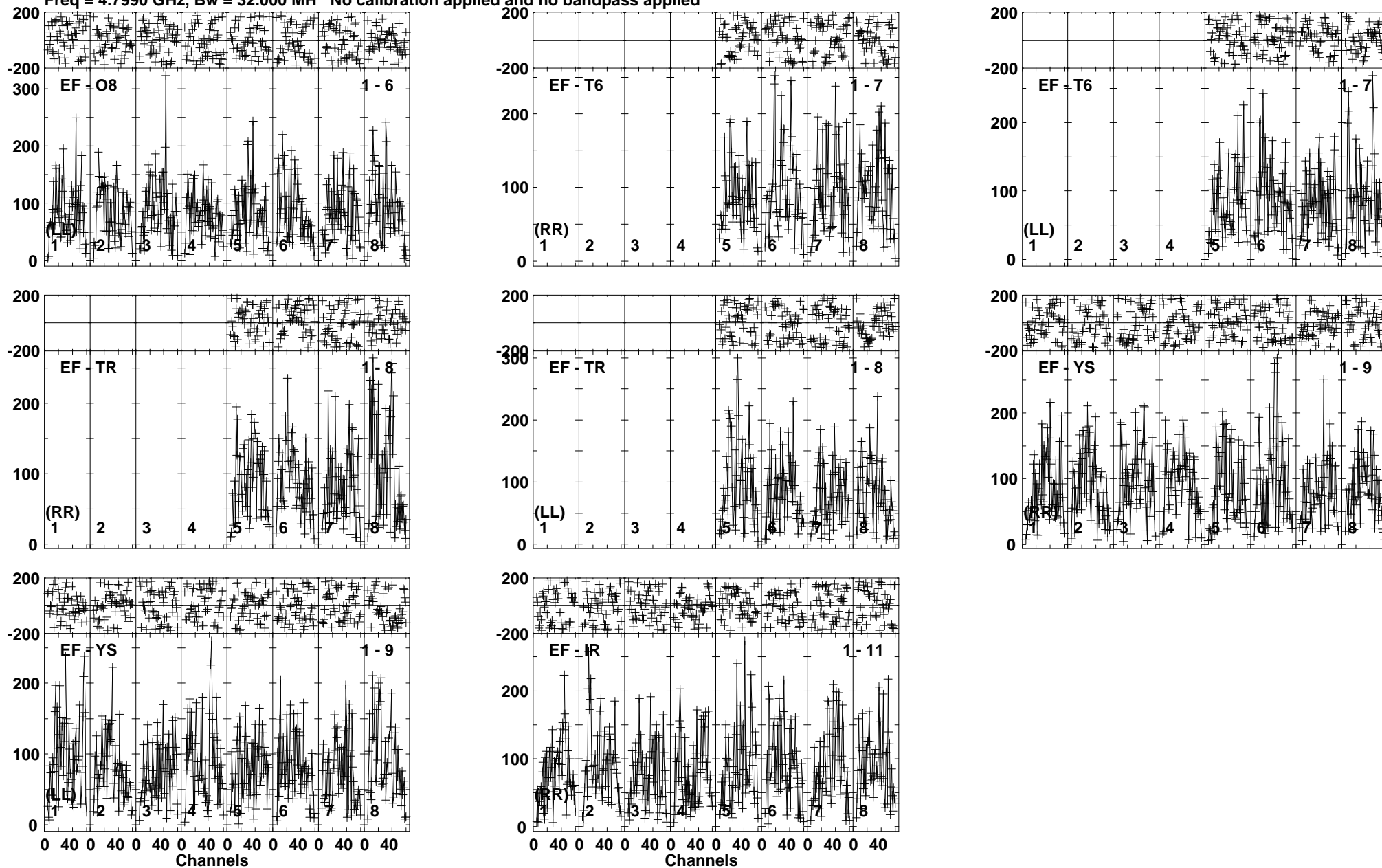

Lower frame: Micro Ampl Jy Top frame: Phas deg  
Vector average cross-power spectrum Baseline: EF (01) - O8 (06)  
Timerange: 00/01:32:51 to 00/01:36:20

Plot file version 29 created 24-NOV-2017 10:09:41

J1108+4330 EG096D.UVDATA.1

Freq = 4.7990 GHz, Bw = 32.000 MH No calibration applied and no bandpass applied

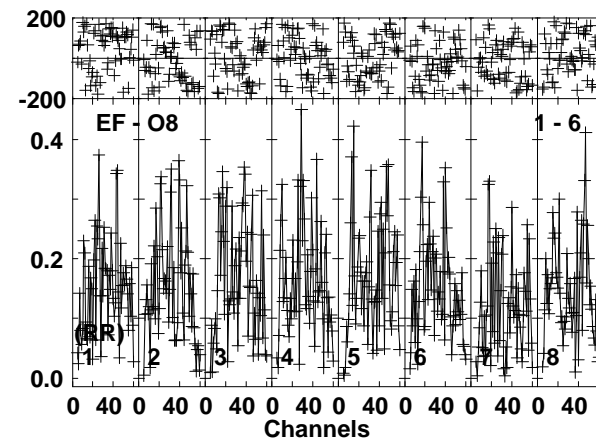
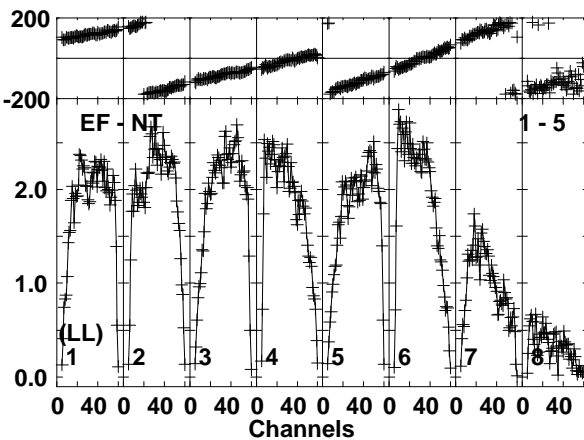
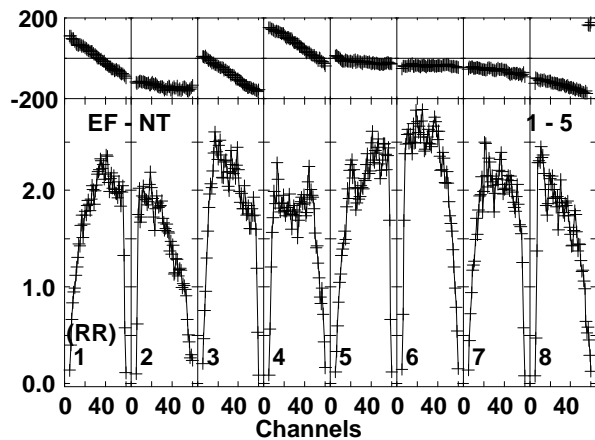
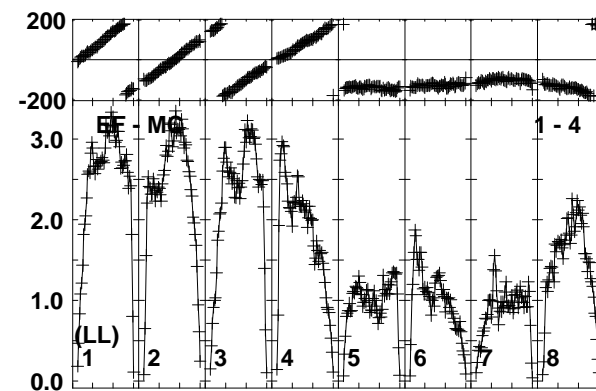
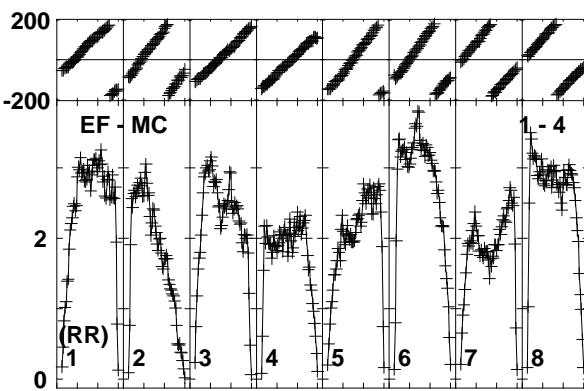
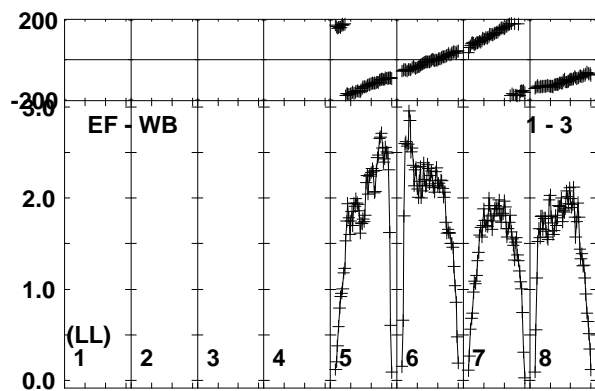
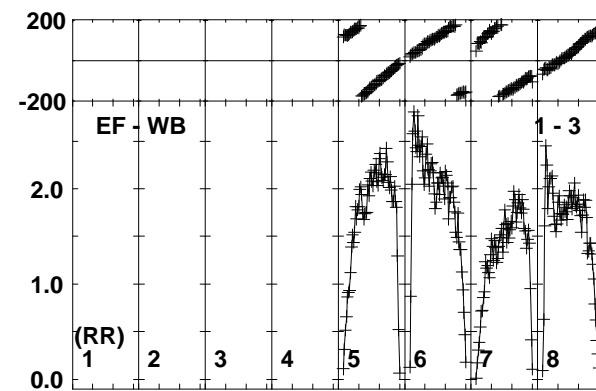
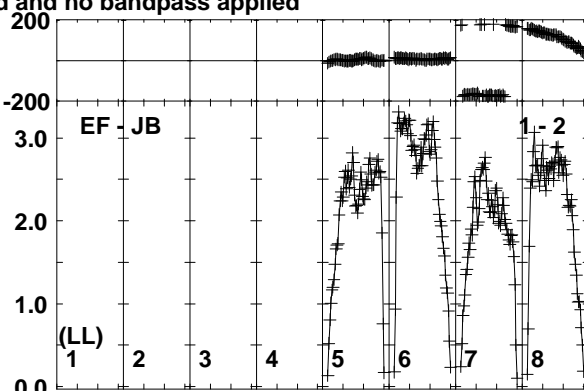
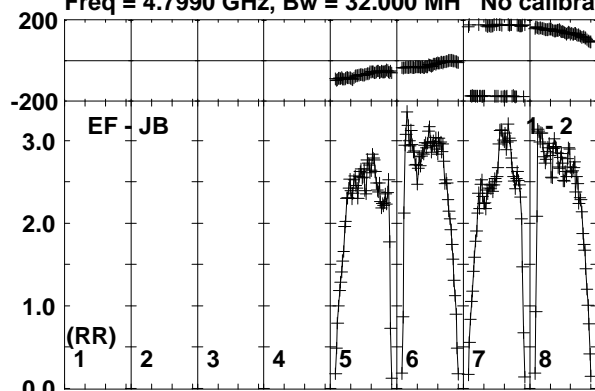

Lower frame: Milli Ampl Jy Top frame: Phas deg  
Vector averaged cross-power spectrum Baseline: EF (01) - JB (02)  
Timerange: 00/01:37:00 to 00/01:37:59

Plot file version 30 created 24-NOV-2017 10:09:41

J1108+4330 EG096D.UVDATA.1

Freq = 4.7990 GHz, Bw = 32.000 MH No calibration applied and no bandpass applied

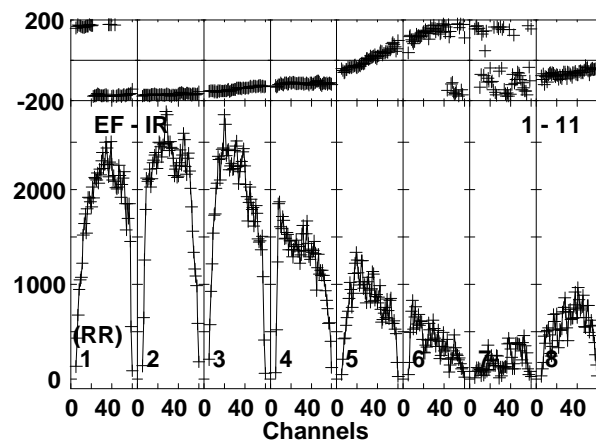
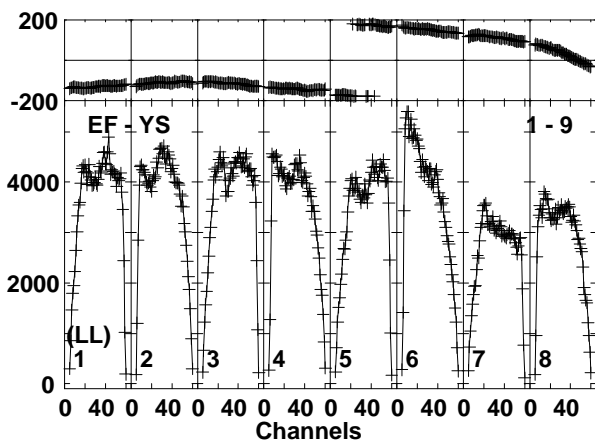
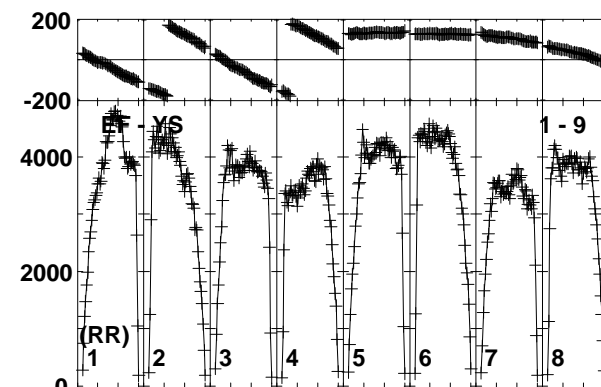
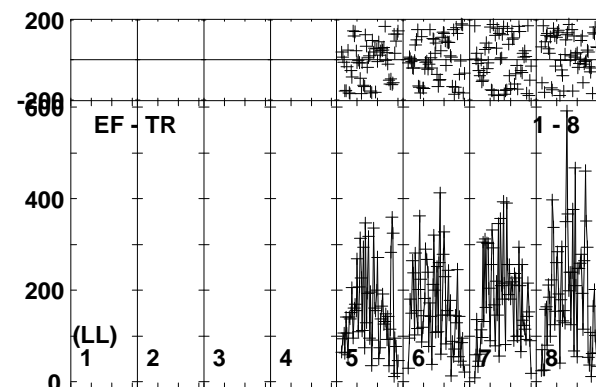
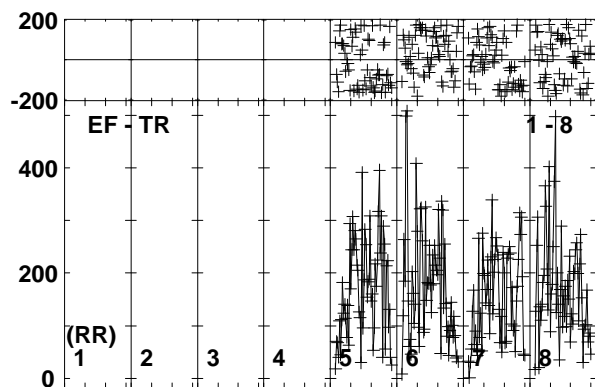
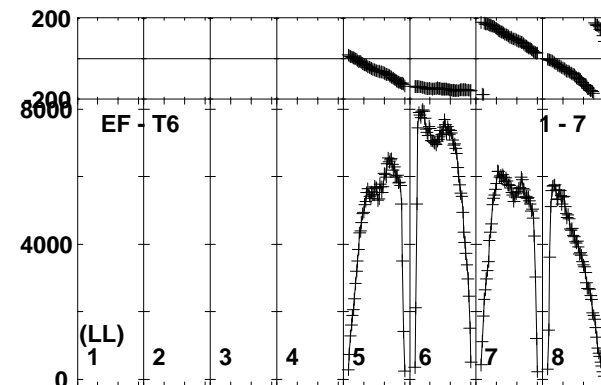
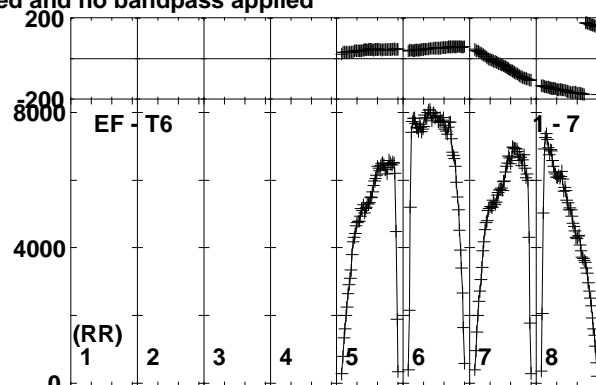
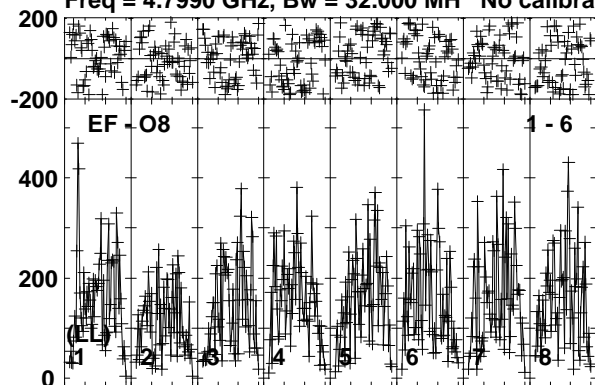

Lower frame: Micro Ampl Jy Top frame: Phas deg  
Vector averaged cross-power spectrum Baseline: EF (01) - O8 (06)  
Timerange: 00/01:37:00 to 00/01:37:59

Plot file version 31 created 24-NOV-2017 10:09:41

J1112+4301 EG096D.UVDATA.1

Freq = 4.7990 GHz, Bw = 32.000 MH No calibration applied and no bandpass applied

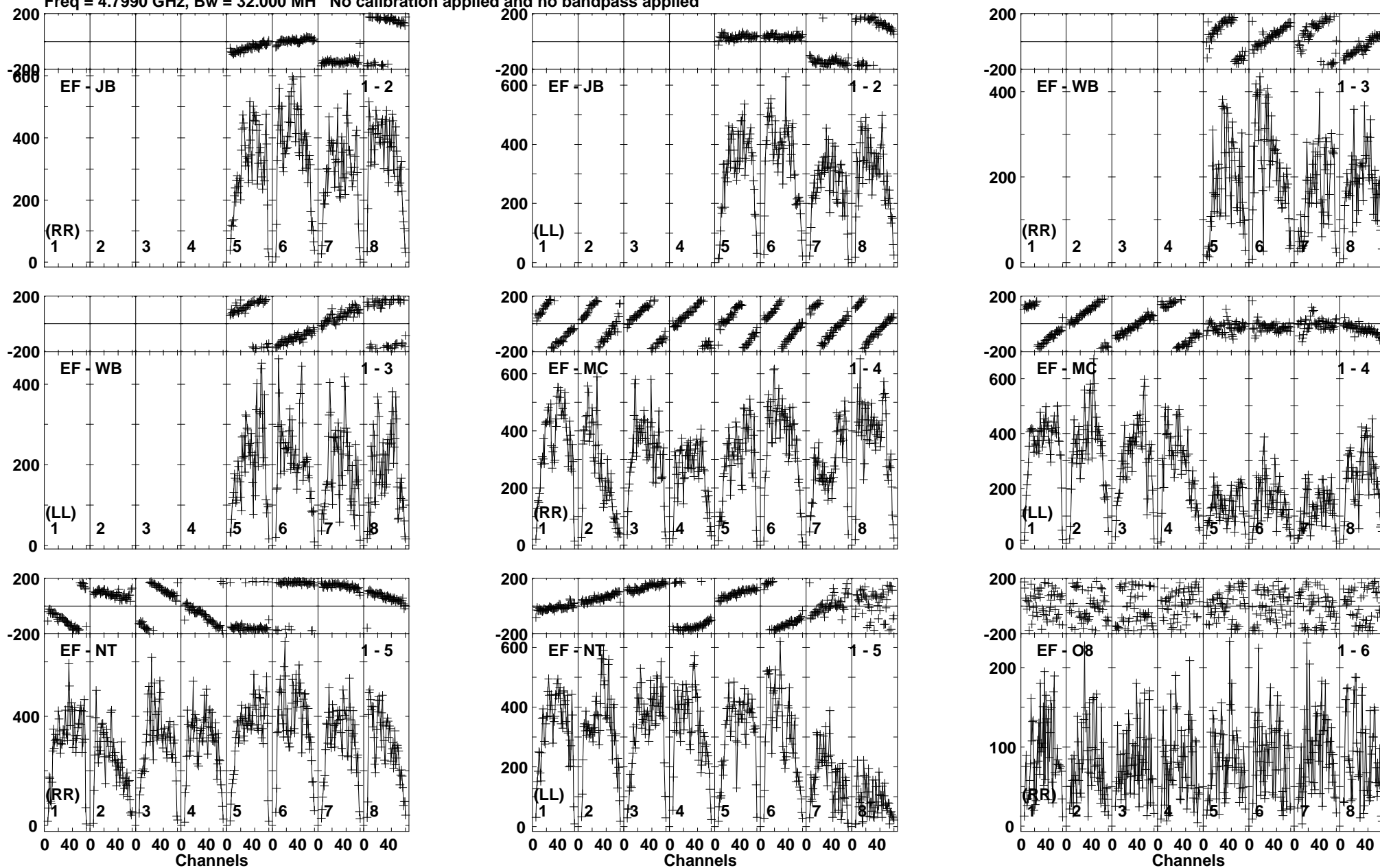

Lower frame: Micro Ampl Jy Top frame: Phas deg  
Vector averaged cross-power spectrum Baseline: EF (01) - JB (02)  
Timerange: 00/01:38:00 to 00/01:41:30

Plot file version 32 created 24-NOV-2017 10:09:41

J1112+4301 EG096D.UVDATA.1

Freq = 4.7990 GHz, Bw = 32.000 MH No calibration applied and no bandpass applied

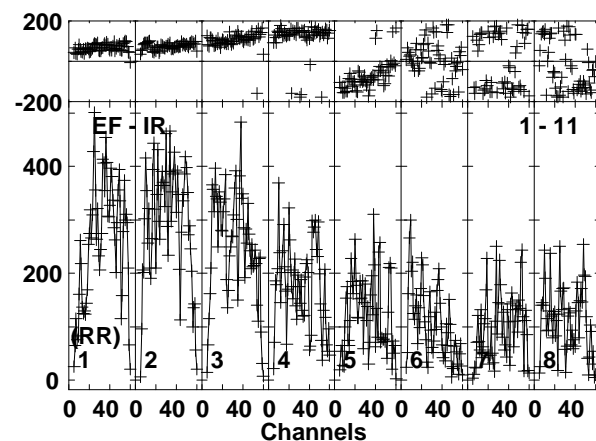
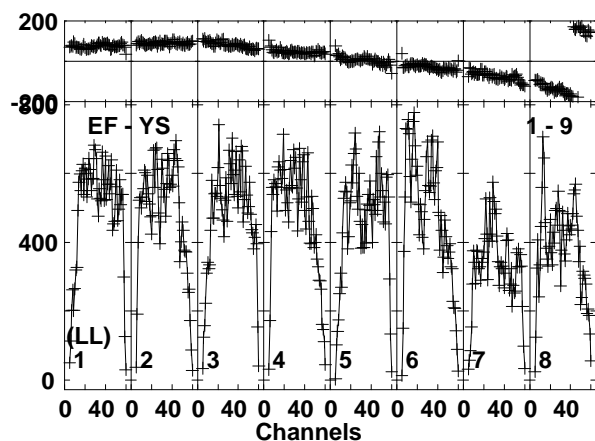
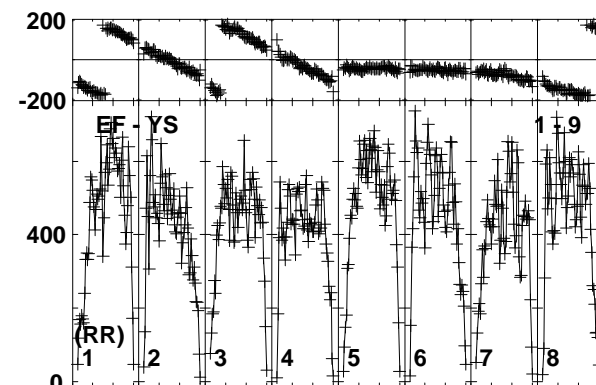
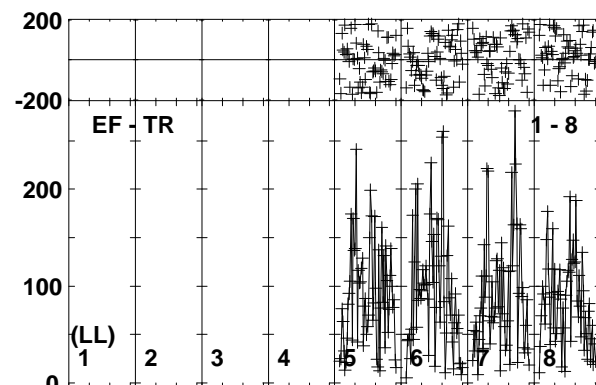
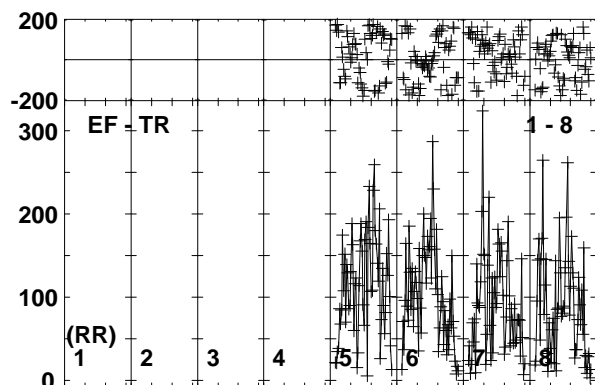
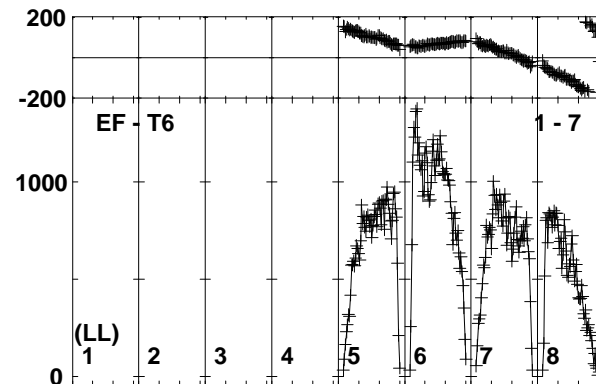
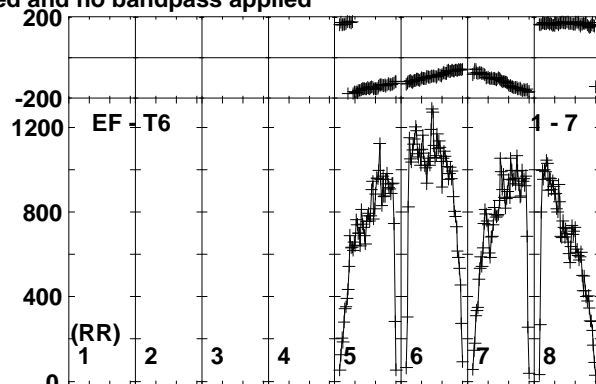
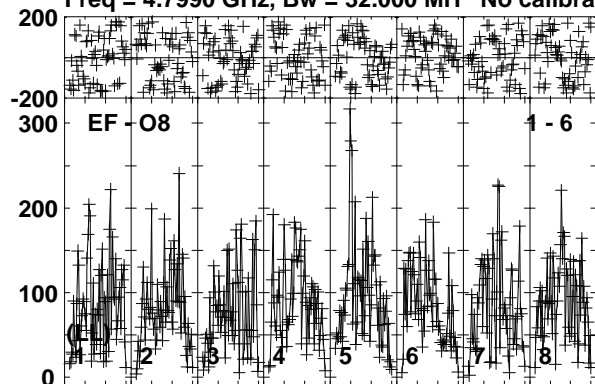

Lower frame: Micro Ampl Jy Top frame: Phas deg  
Vector averaged cross-power spectrum Baseline: EF (01) - O8 (06)  
Timerange: 00/01:38:00 to 00/01:41:30

Plot file version 33 created 24-NOV-2017 10:09:42

J1108+4330 EG096D.UVDATA.1

Freq = 4.7990 GHz, Bw = 32.000 MH No calibration applied and no bandpass applied

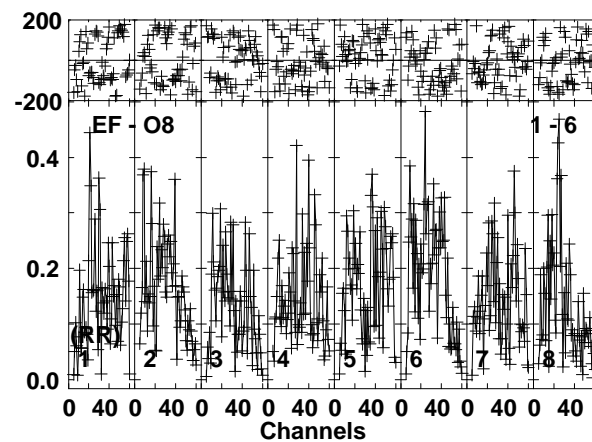
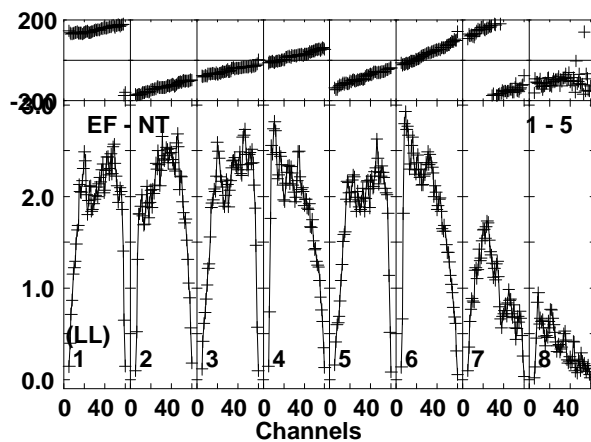
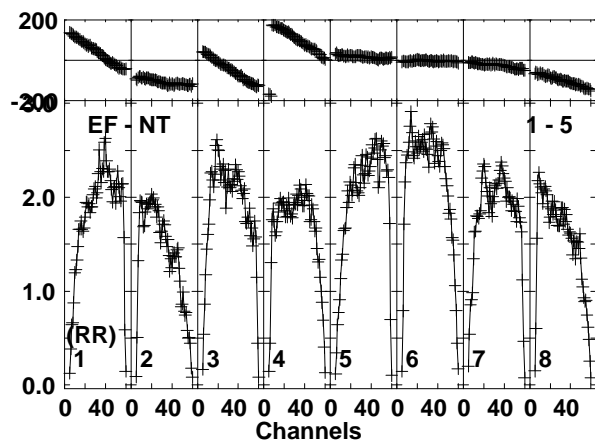
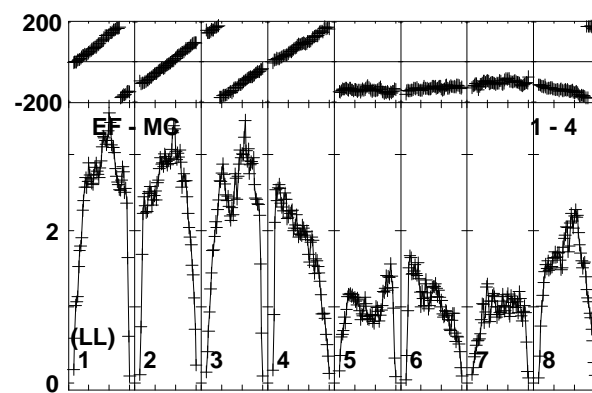
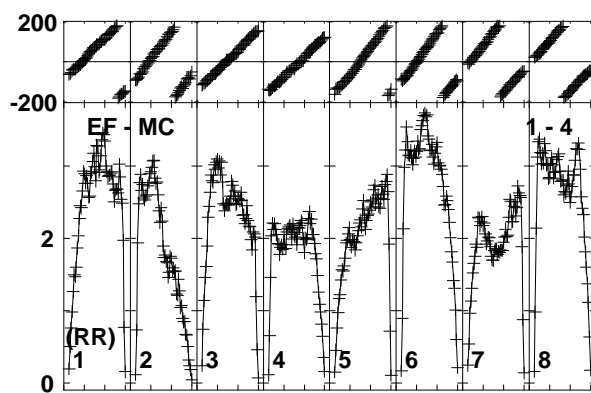
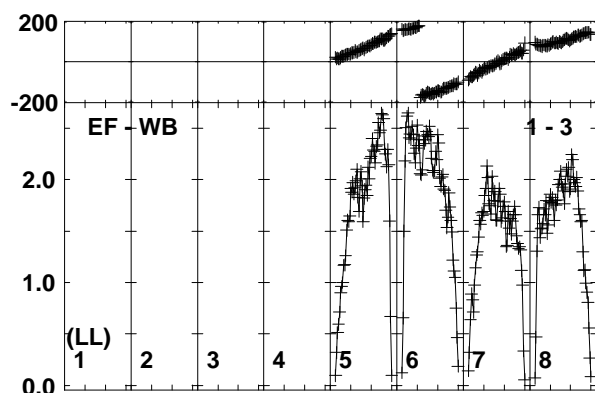
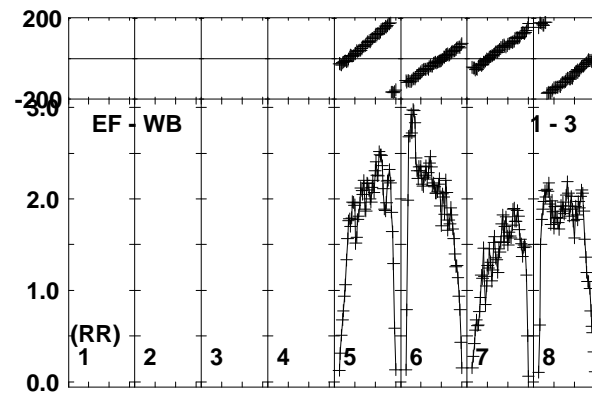
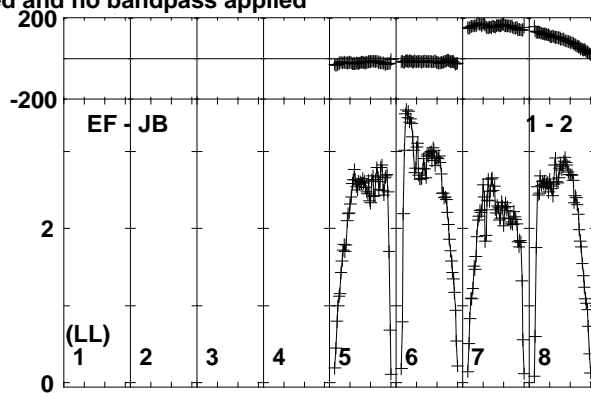
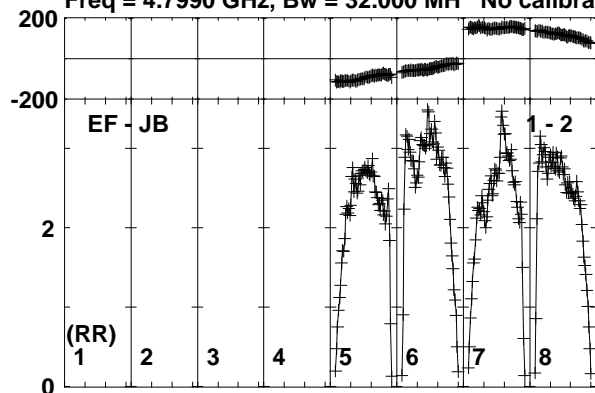

Lower frame: Milli Ampl Jy Top frame: Phas deg  
Vector averaged cross-power spectrum Baseline: EF (01) - JB (02)  
Timerange: 00/01:41:30 to 00/01:42:59

Plot file version 34 created 24-NOV-2017 10:09:42

J1108+4330 EG096D.UVDATA.1

Freq = 4.7990 GHz, Bw = 32.000 MH No calibration applied and no bandpass applied

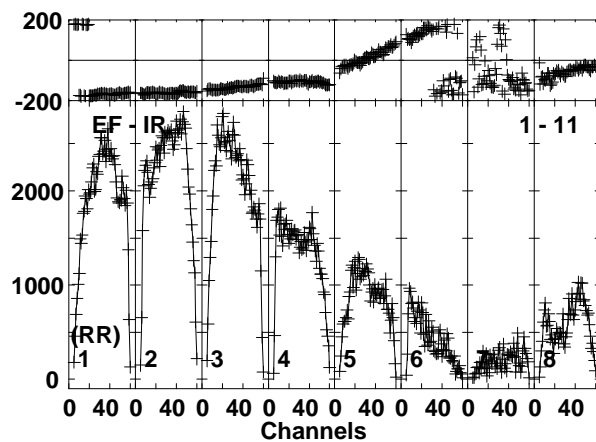
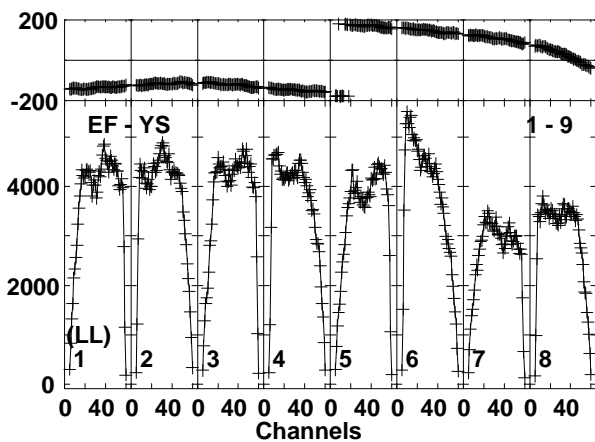
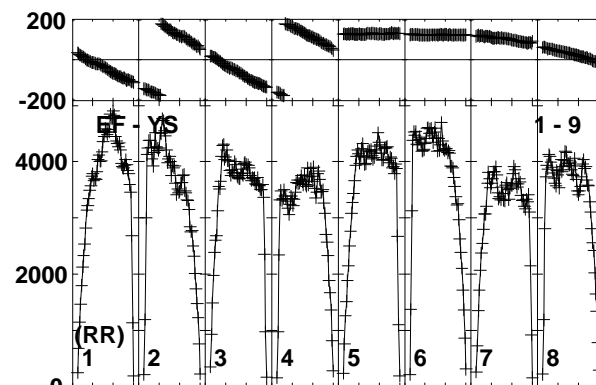
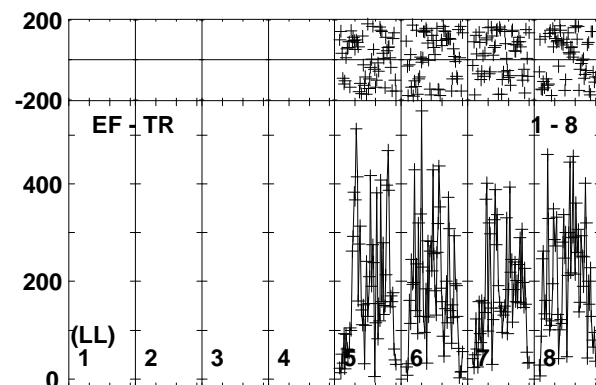
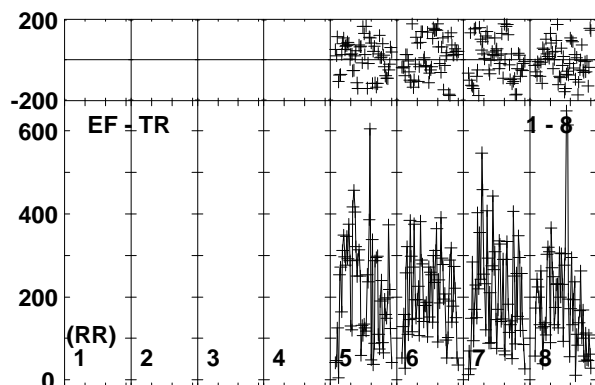
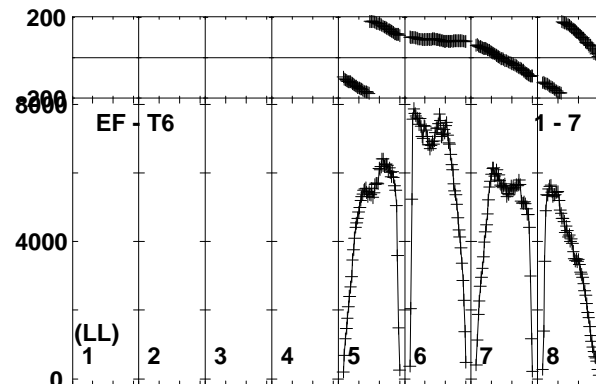
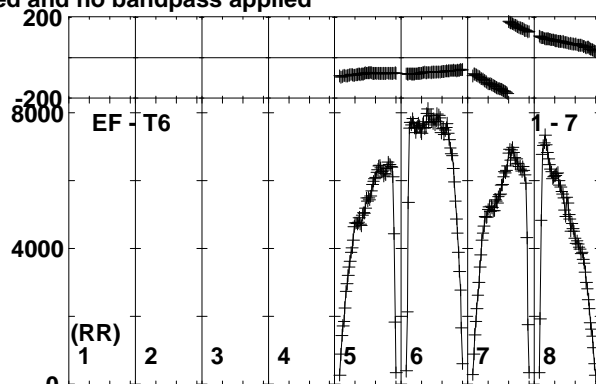
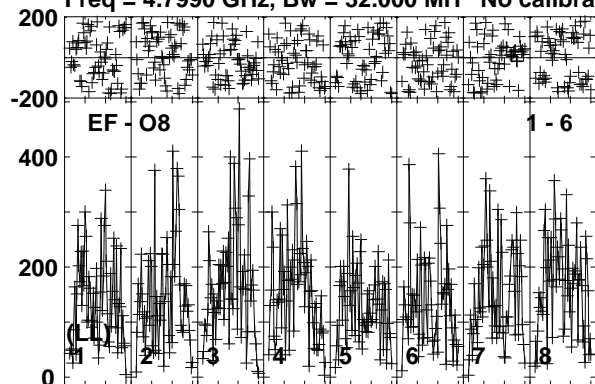

Lower frame: Micro Ampl Jy Top frame: Phas deg  
Vector averaged cross-power spectrum Baseline: EF (01) - O8 (06)  
Timerange: 00/01:41:30 to 00/01:42:59



Plot file version 35 created 24-NOV-2017 10:09:42  
 ARUMA EG096D.UVDATA.1  
 Freq = 4.7990 GHz, Bw = 32.000 MH No calibration applied and no bandpass applied

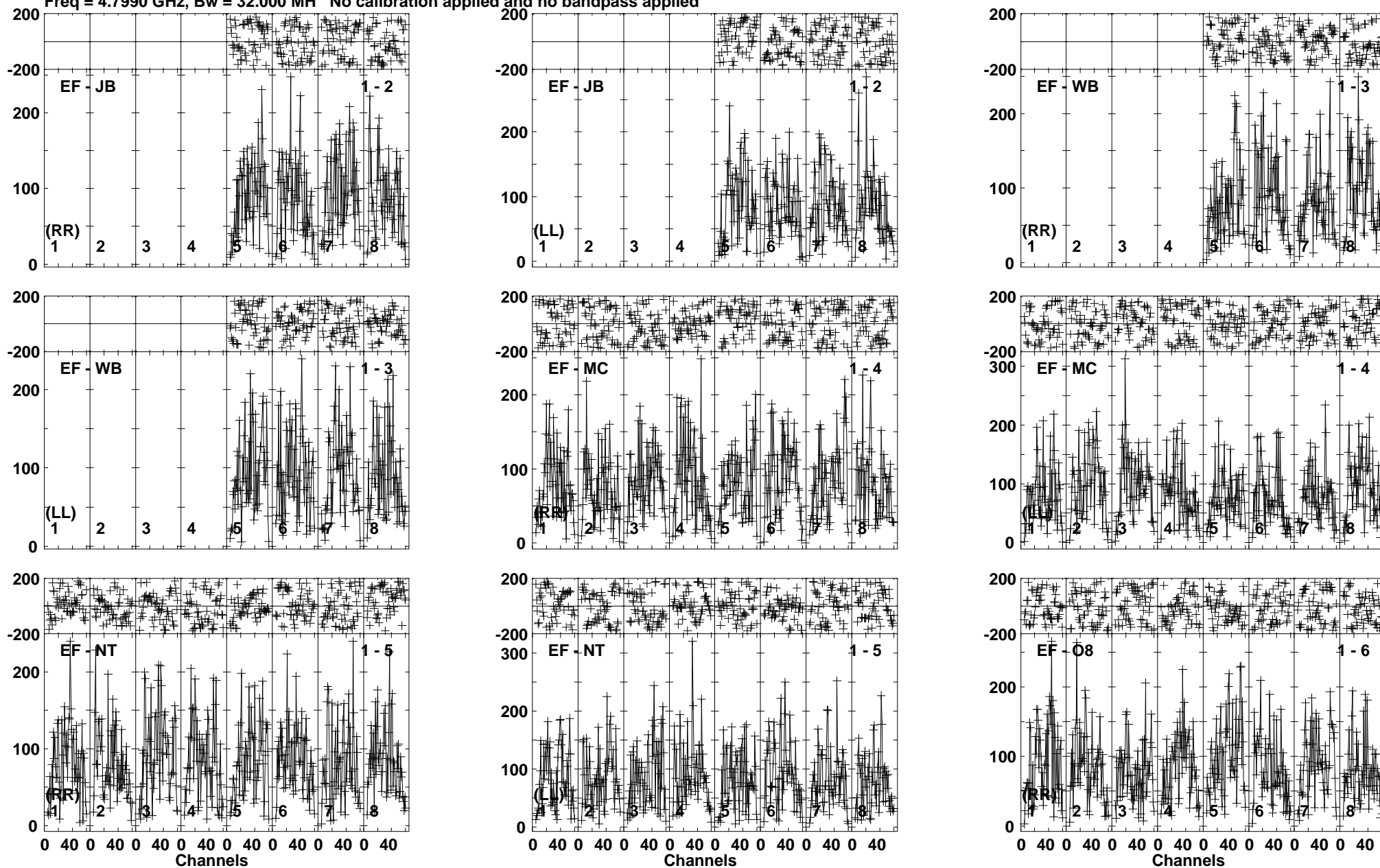

Lower frame: Micro Ampl Jy Top frame: Phas deg  
 Vector averaged cross-power spectrum Baseline: EF (01) - JB (02)  
 Timerange: 00/01:43:01 to 00/01:46:29

Plot file version 36 created 24-NOV-2017 10:09:43

ARUMA EG096D.UVDATA.1

Freq = 4.7990 GHz, Bw = 32.000 MH No calibration applied and no bandpass applied

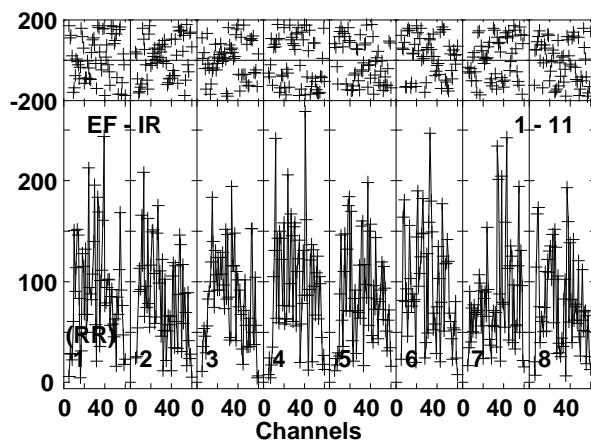
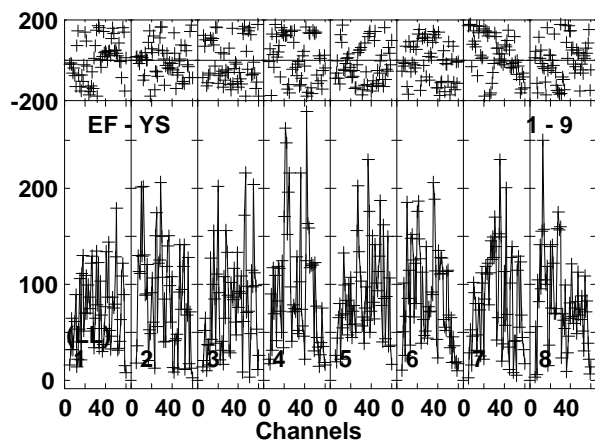
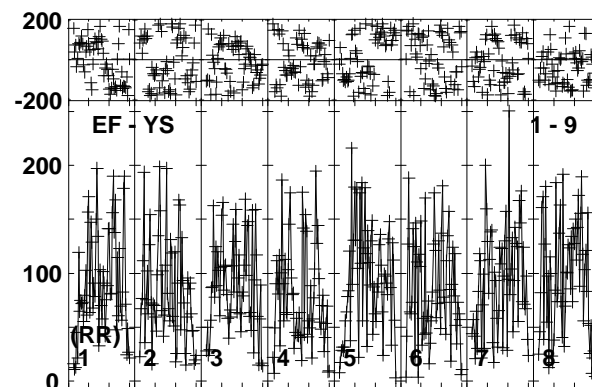
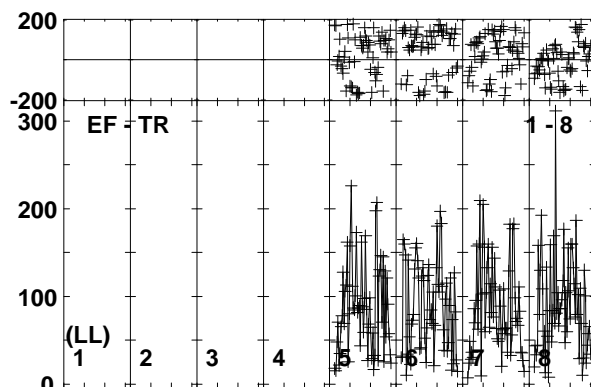
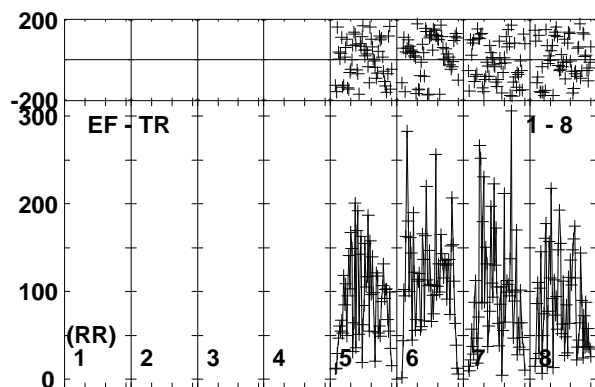
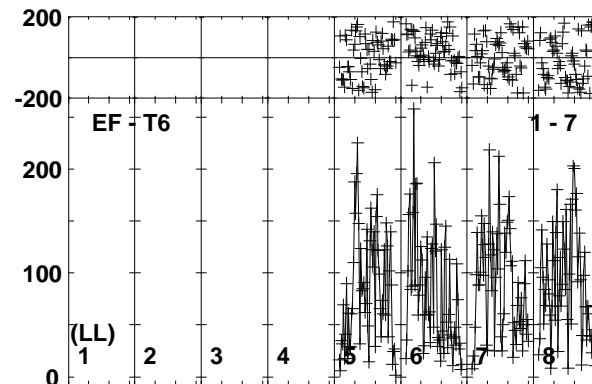
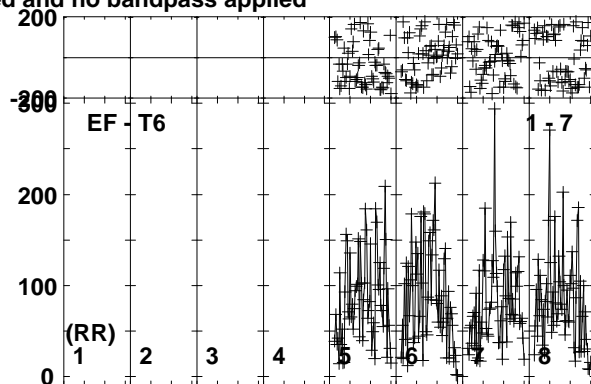
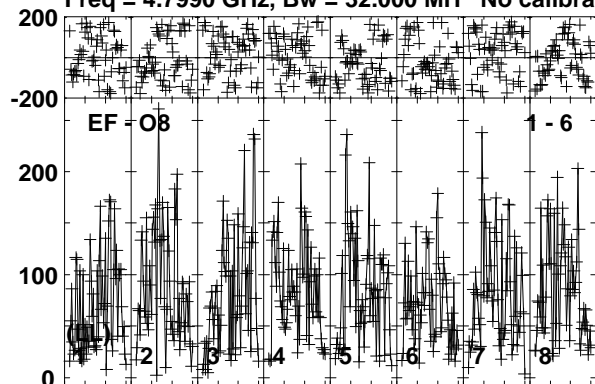

Lower frame: Micro Ampl Jy Top frame: Phas deg  
Vector averaged cross-power spectrum Baseline: EF (01) - O8 (06)  
Timerange: 00/01:43:01 to 00/01:46:29

Plot file version 37 created 24-NOV-2017 10:09:43

J1108+4330 EG096D.UVDATA.1

Freq = 4.7990 GHz, Bw = 32.000 MH No calibration applied and no bandpass applied

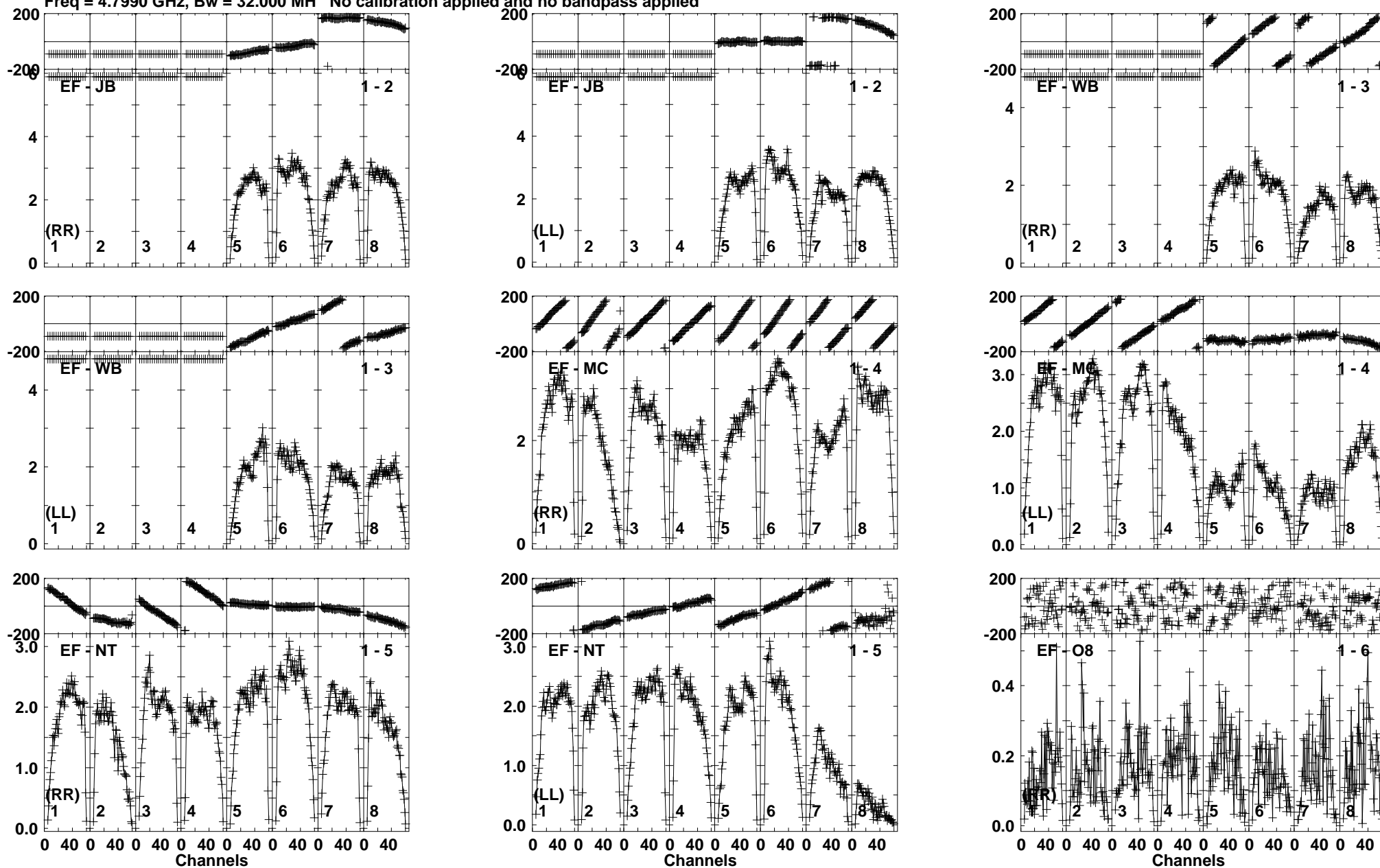

Lower frame: Milli Ampl Jy Top frame: Phas deg  
Vector averaged cross-power spectrum Baseline: EF (01) - JB (02)  
Timerange: 00/01:47:10 to 00/01:48:09

Plot file version 38 created 24-NOV-2017 10:09:43

J1108+4330 EG096D.UVDATA.1

Freq = 4.7990 GHz, Bw = 32.000 MH No calibration applied and no bandpass applied

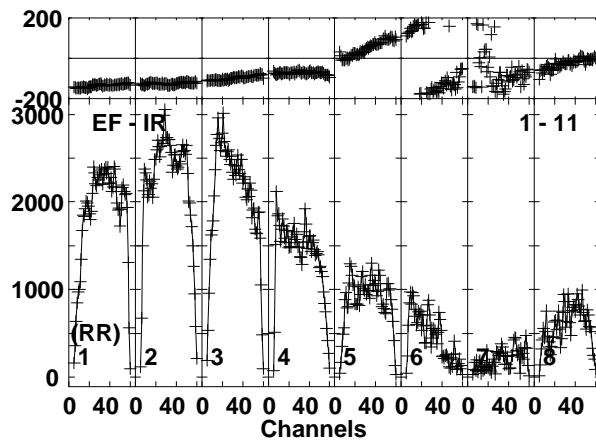
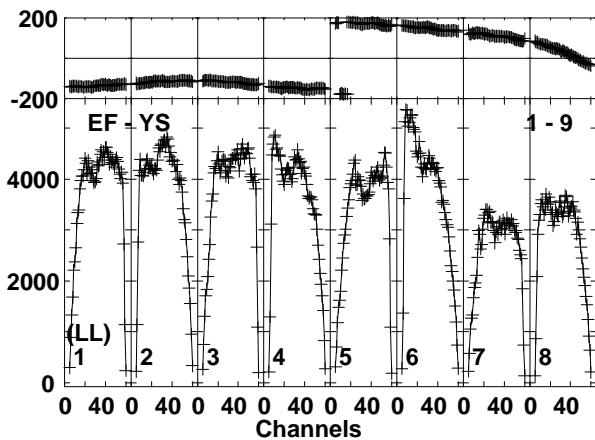
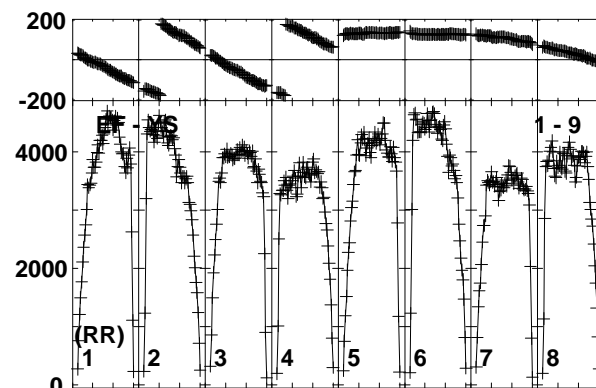
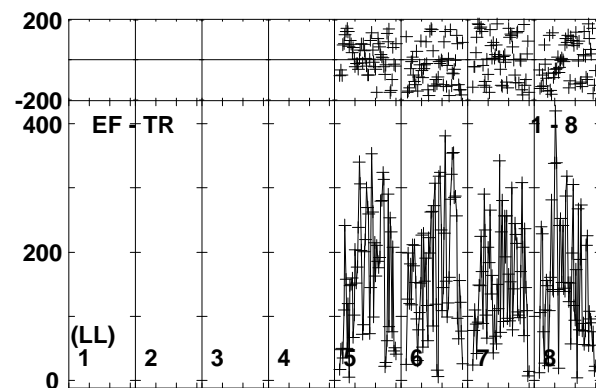
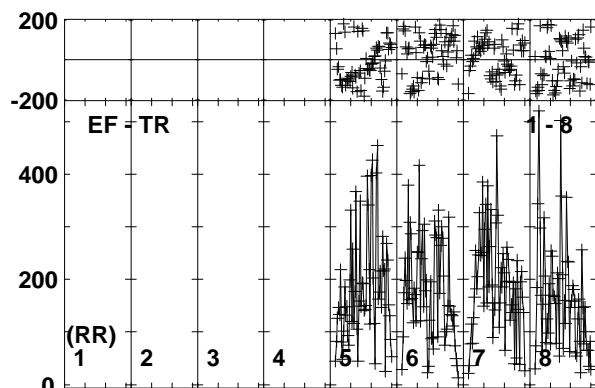
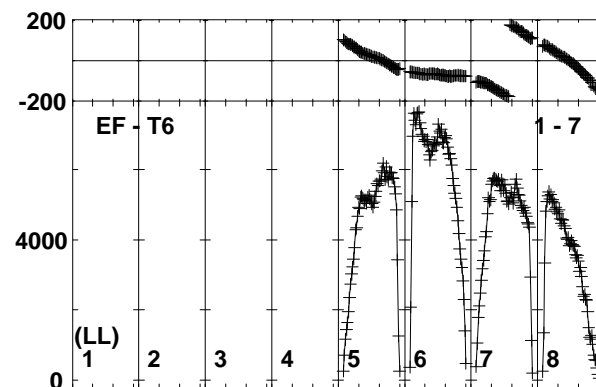
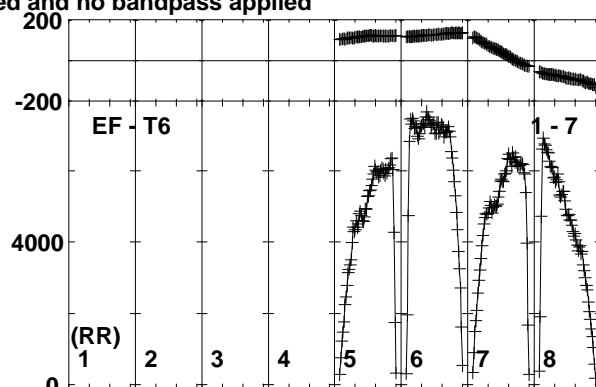
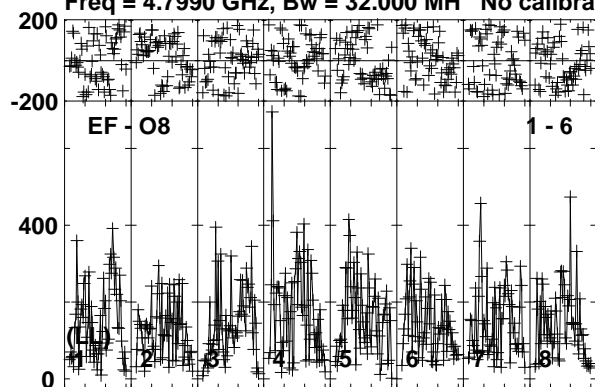

Lower frame: Micro Ampl Jy Top frame: Phas deg  
Vector averaged cross-power spectrum Baseline: EF (01) - O8 (06)  
Timerange: 00/01:47:10 to 00/01:48:09

Plot file version 39 created 24-NOV-2017 10:09:43

ARUMA EG096D.UVDATA.1

Freq = 4.7990 GHz, Bw = 32.000 MH No calibration applied and no bandpass applied

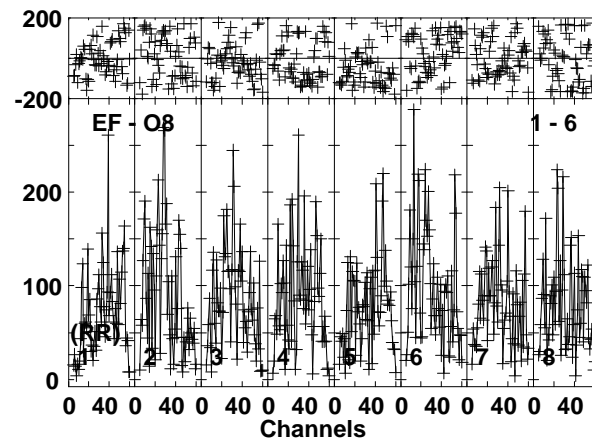
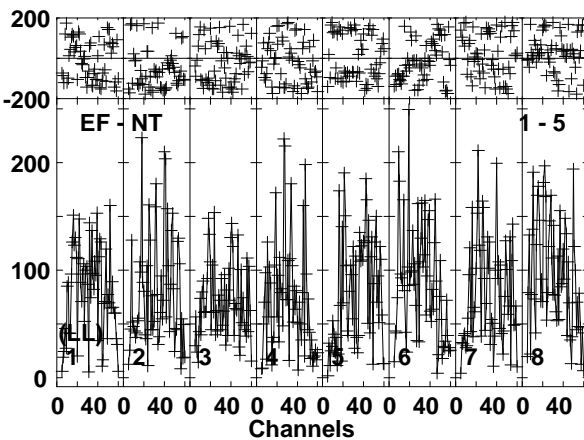
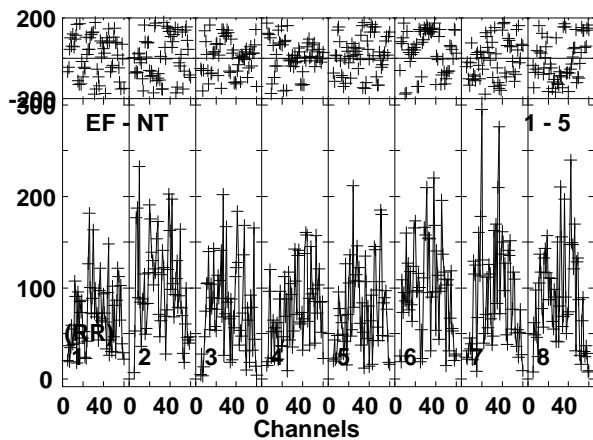
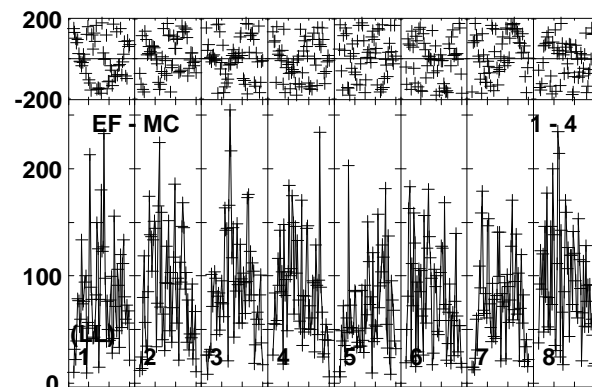
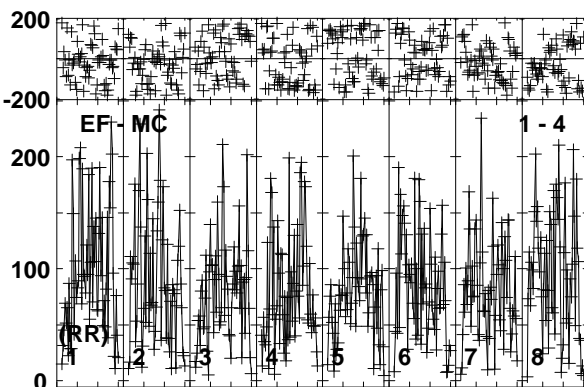
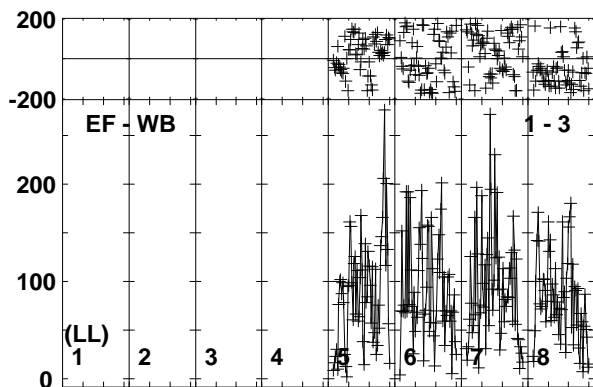
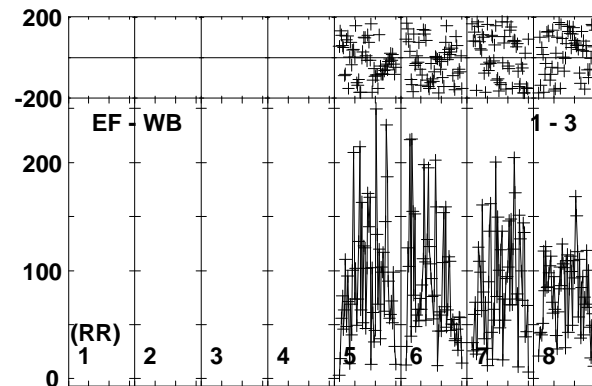
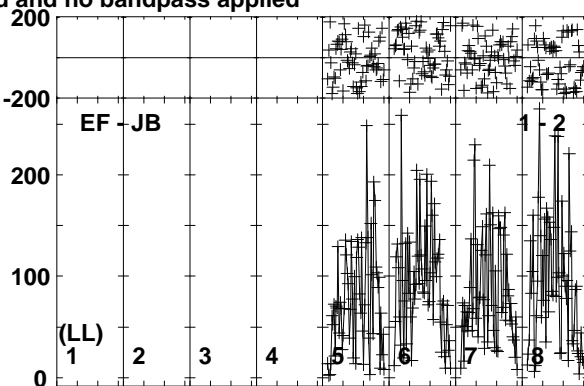
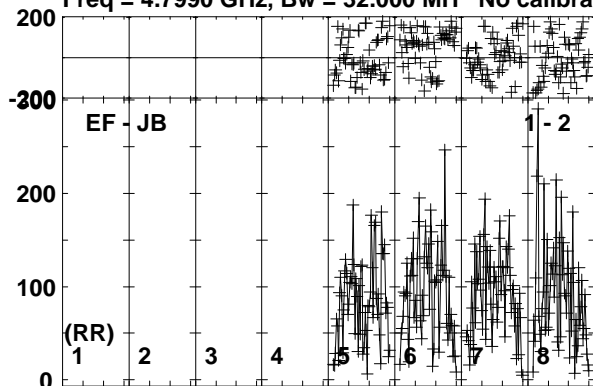

Lower frame: Micro Ampl Jy Top frame: Phas deg  
Vector averaged cross-power spectrum Baseline: EF (01) - JB (02)  
Timerange: 00/01:48:11 to 00/01:51:39

Plot file version 40 created 24-NOV-2017 10:09:44

ARUMA EG096D.UVDATA.1

Freq = 4.7990 GHz, Bw = 32.000 MH No calibration applied and no bandpass applied

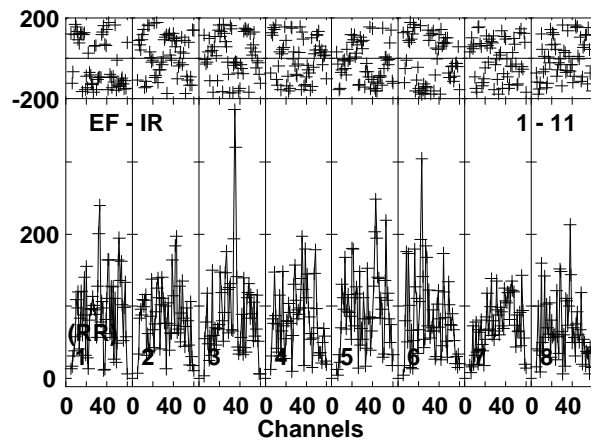
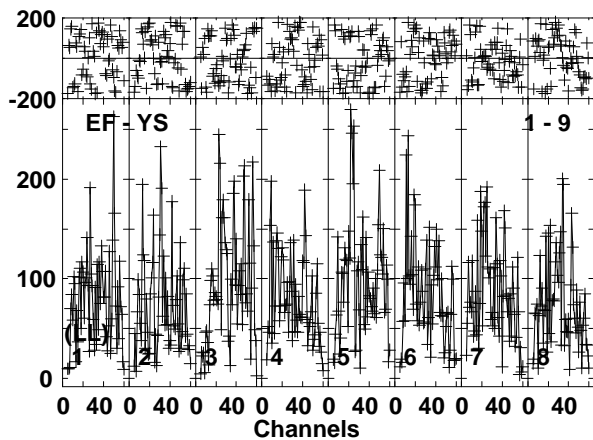
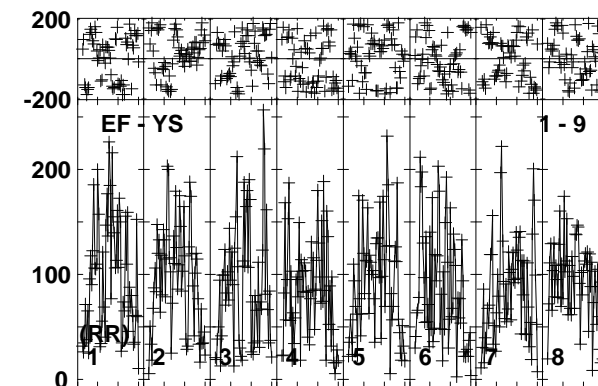
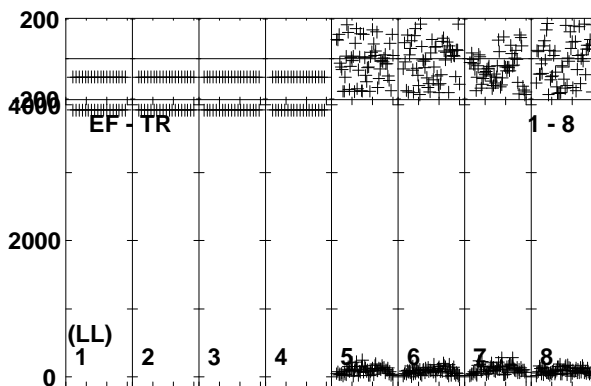
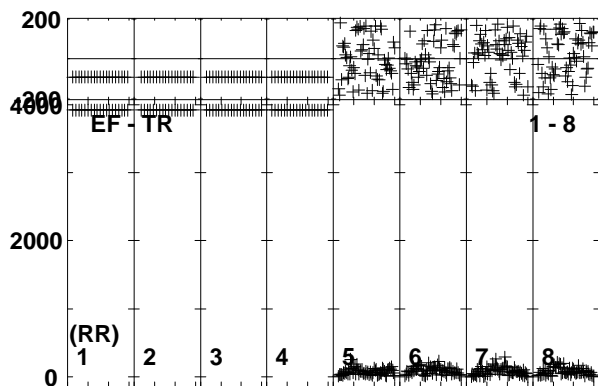
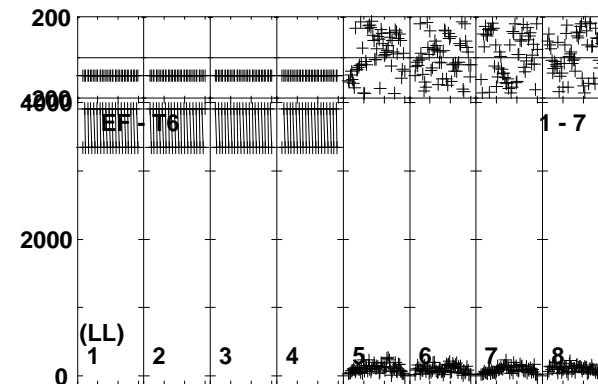
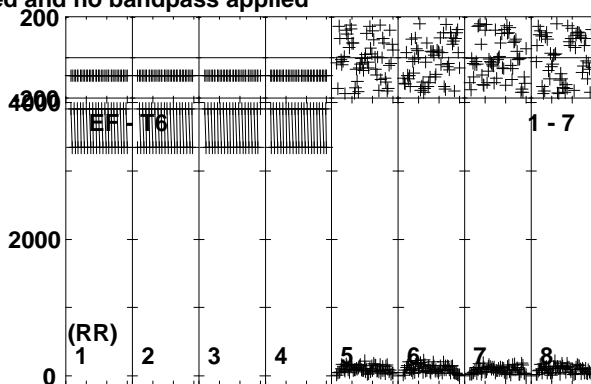
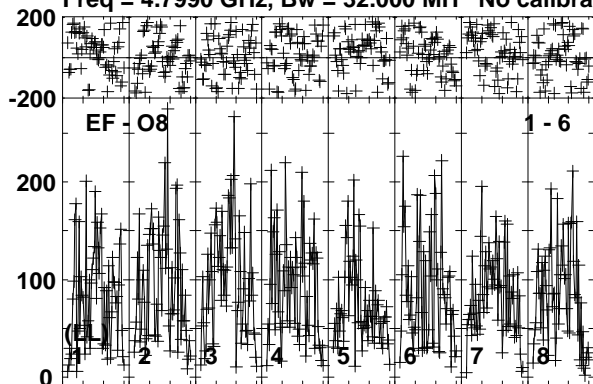

Lower frame: Micro Ampl Jy Top frame: Phas deg  
Vector averaged cross-power spectrum Baseline: EF (01) - O8 (06)  
Timerange: 00/01:48:11 to 00/01:51:39

Plot file version 41 created 24-NOV-2017 10:09:44

J1108+4330 EG096D.UVDATA.1

Freq = 4.7990 GHz, Bw = 32.000 MH No calibration applied and no bandpass applied

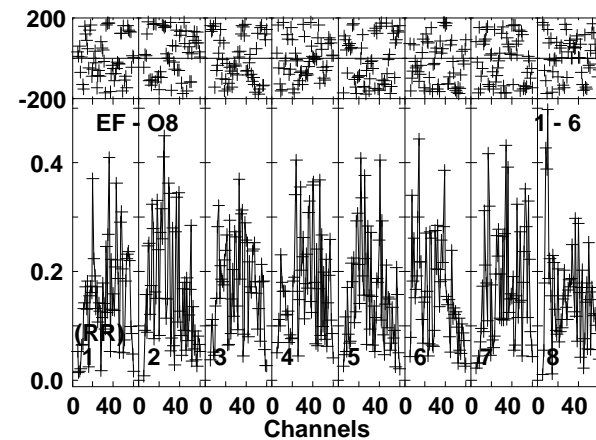
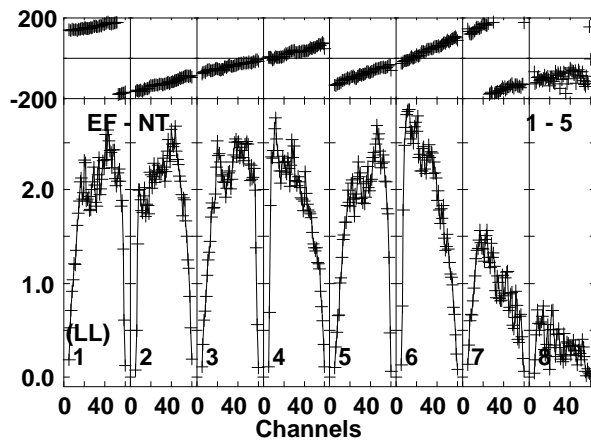
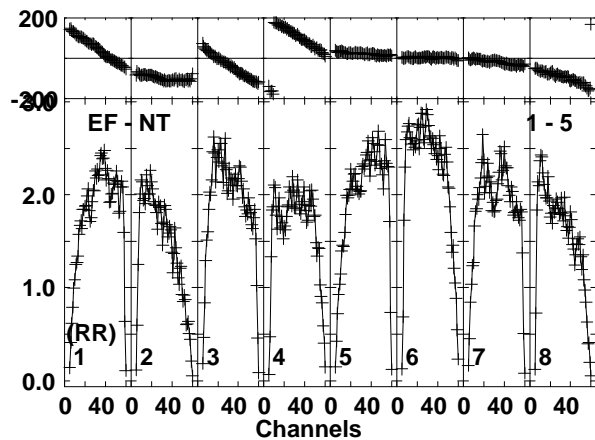
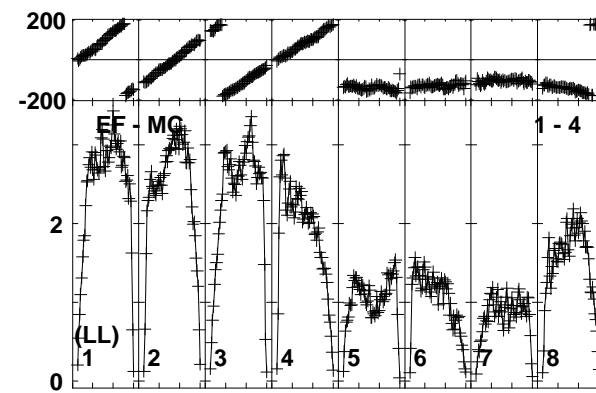
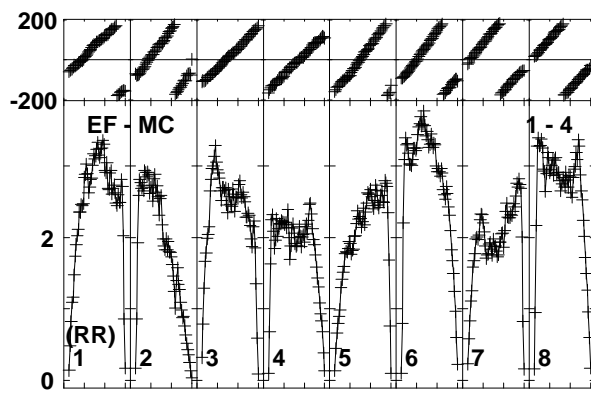
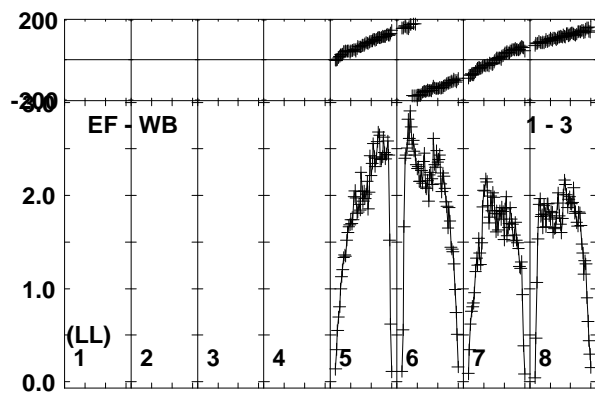
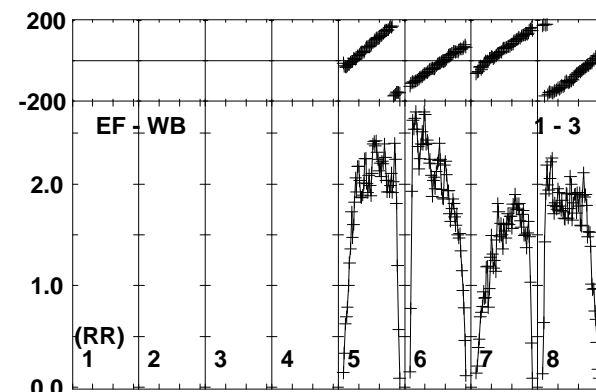
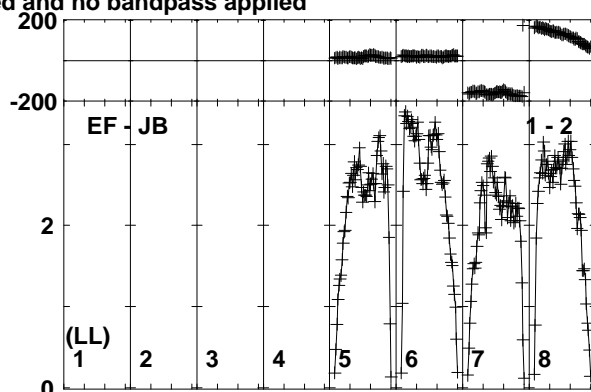
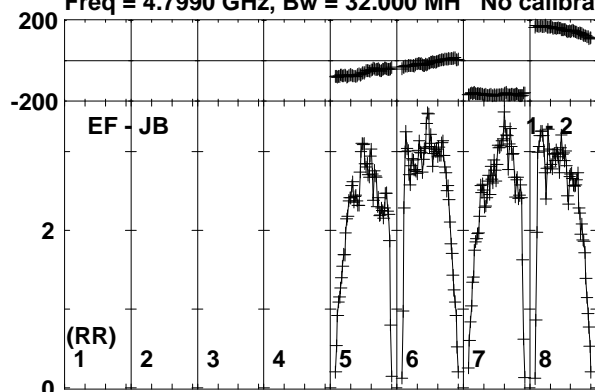

Lower frame: Milli Ampl Jy Top frame: Phas deg  
Vector averaged cross-power spectrum Baseline: EF (01) - JB (02)  
Timerange: 00/01:51:40 to 00/01:53:09

Plot file version 42 created 24-NOV-2017 10:09:44

J1108+4330 EG096D.UVDATA.1

Freq = 4.7990 GHz, Bw = 32.000 MH No calibration applied and no bandpass applied

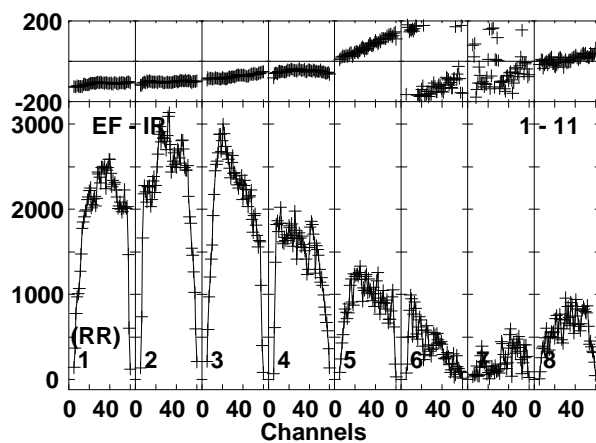
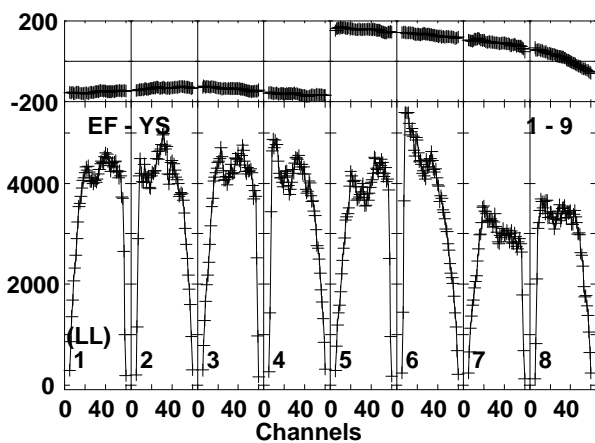
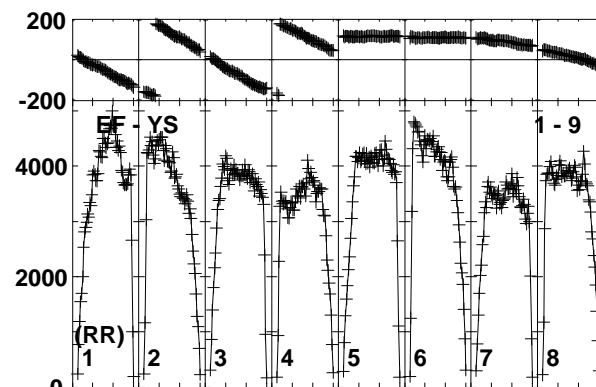
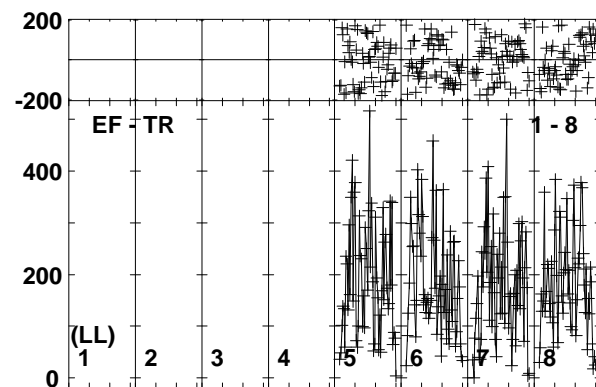
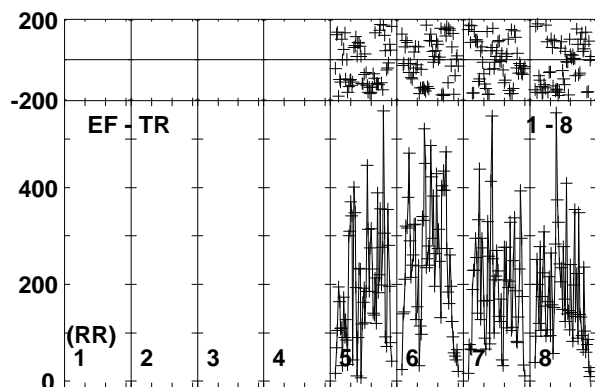
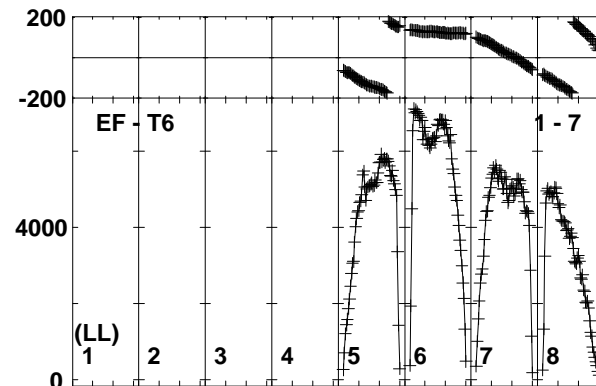
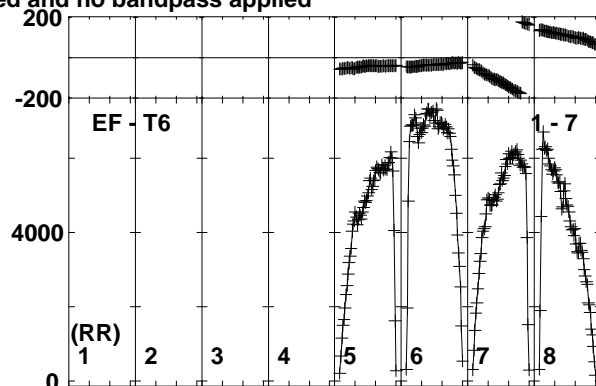
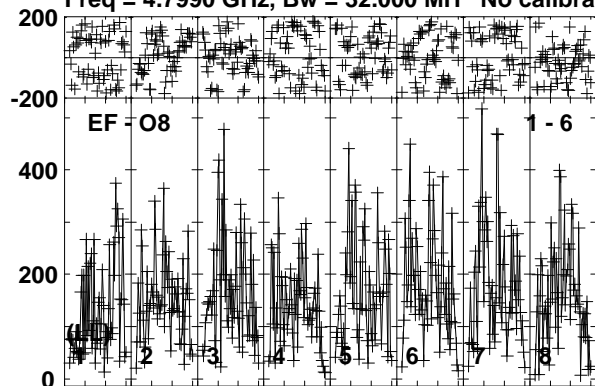

Lower frame: Micro Ampl Jy Top frame: Phas deg  
Vector averaged cross-power spectrum Baseline: EF (01) - O8 (06)  
Timerange: 00/01:51:40 to 00/01:53:09



Plot file version 43 created 24-NOV-2017 10:09:45

ARUMA EG096D.UVDATA.1

Freq = 4.7990 GHz, Bw = 32.000 MH No calibration applied and no bandpass applied

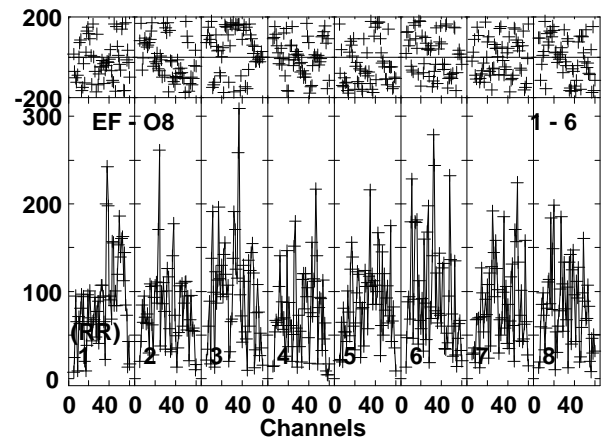
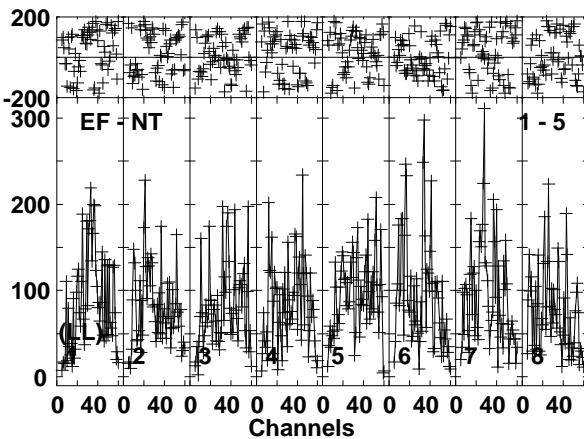
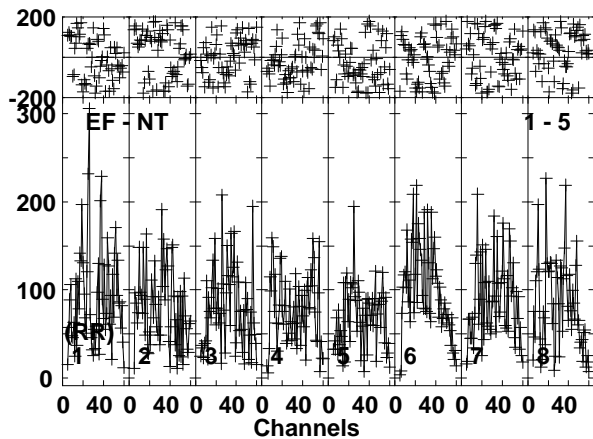
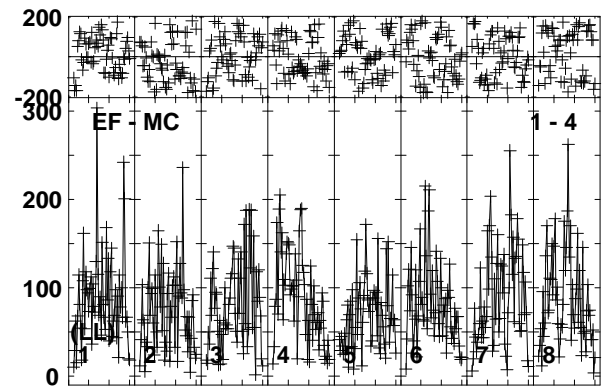
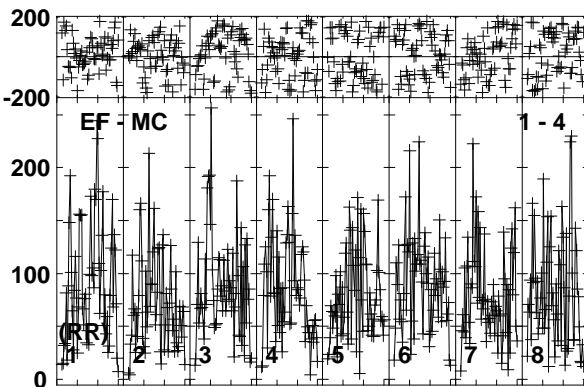
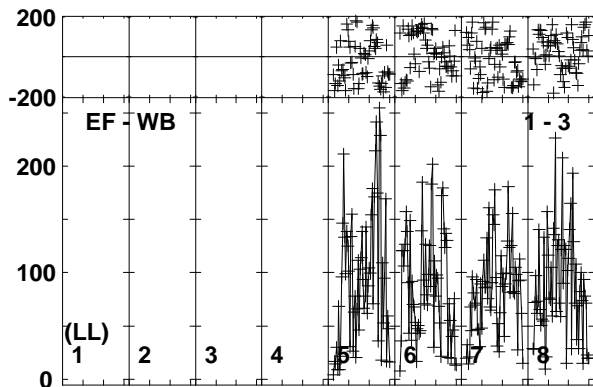
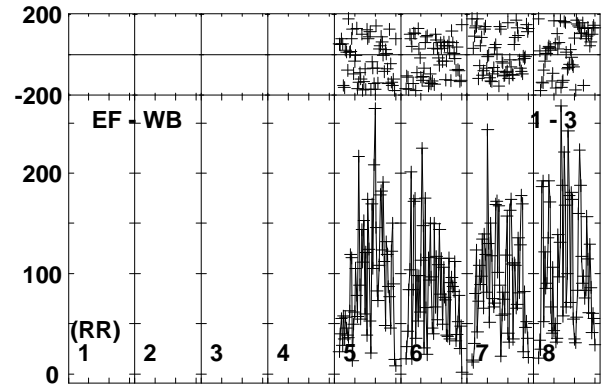
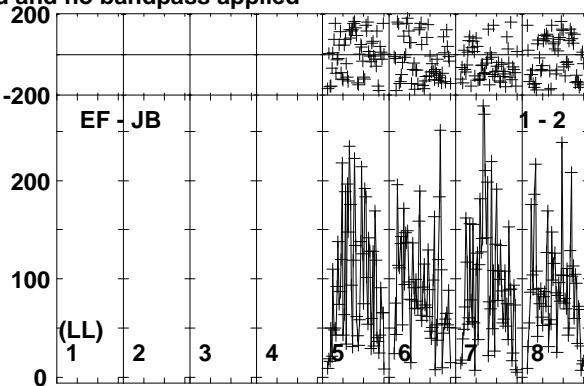
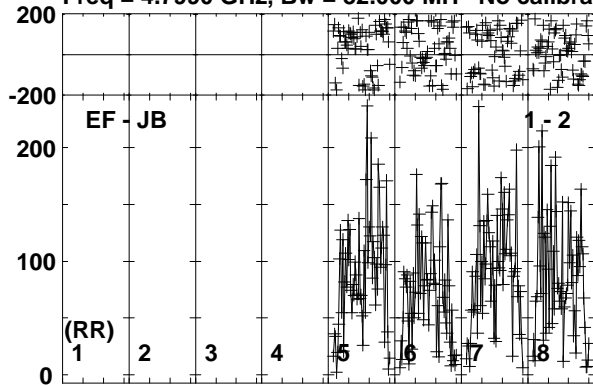

Lower frame: Micro Ampl Jy Top frame: Phas deg  
Vector averaged cross-power spectrum Baseline: EF (01) - JB (02)  
Timerange: 00/01:53:11 to 00/01:56:40

Plot file version 44 created 24-NOV-2017 10:09:45

ARUMA EG096D.UVDATA.1

Freq = 4.7990 GHz, Bw = 32.000 MH No calibration applied and no bandpass applied

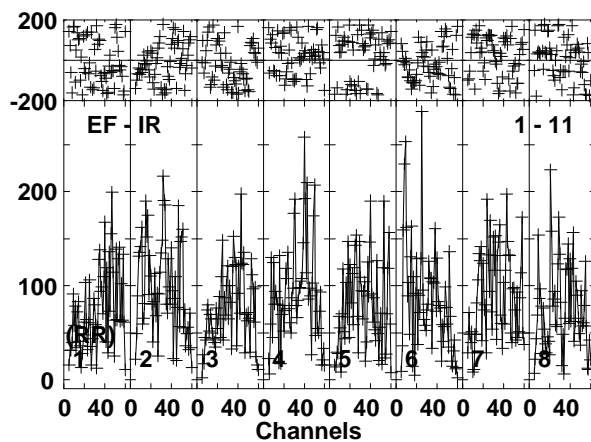
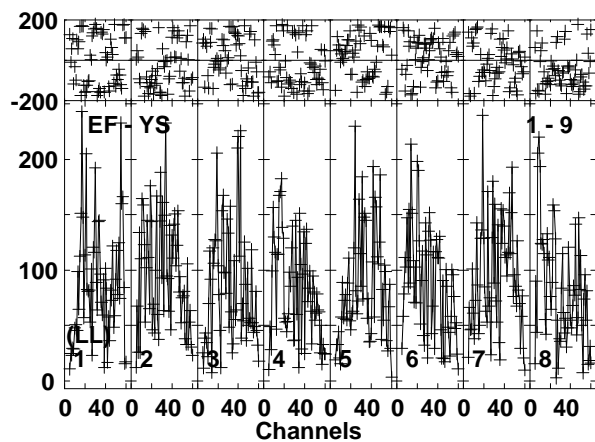
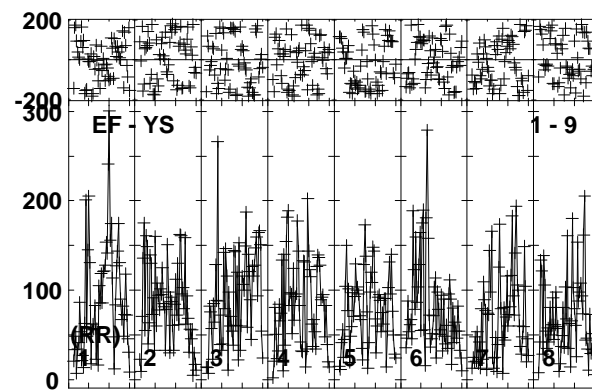
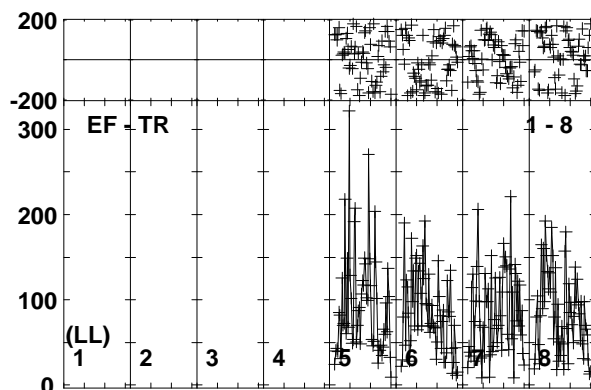
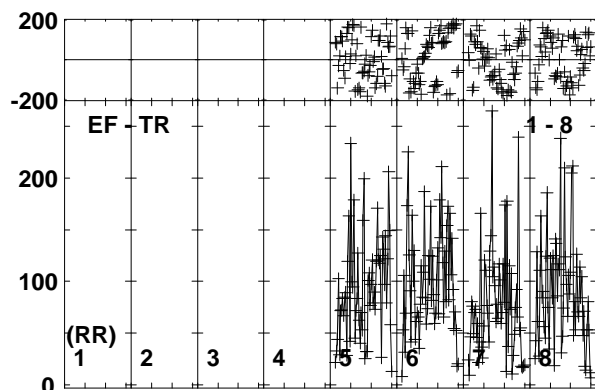
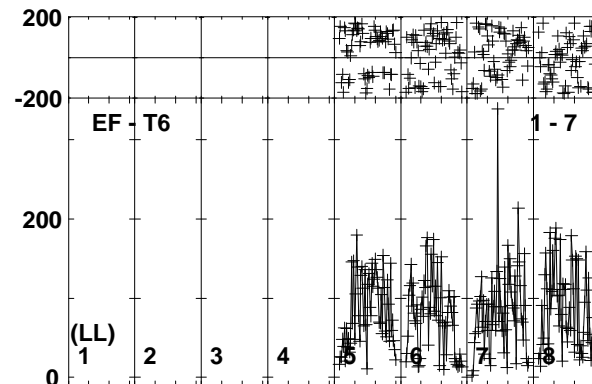
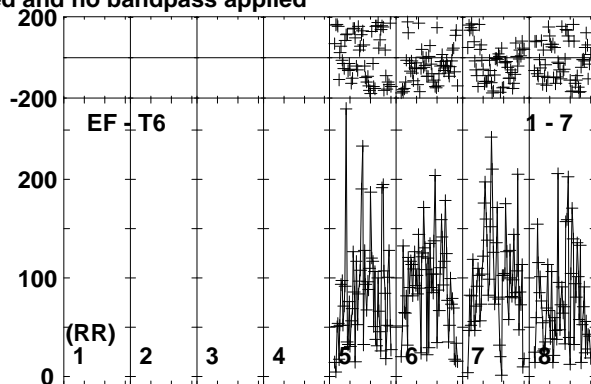
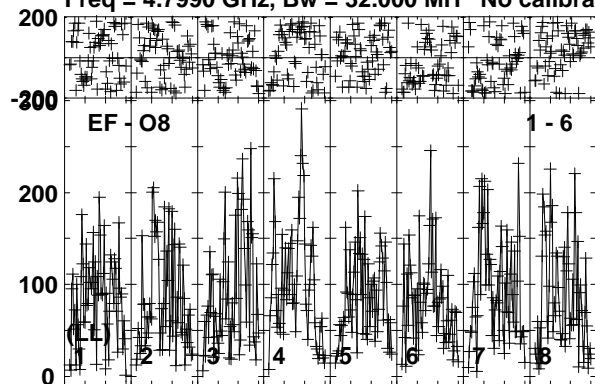

Lower frame: Micro Ampl Jy Top frame: Phas deg  
Vector averaged cross-power spectrum Baseline: EF (01) - O8 (06)  
Timerange: 00/01:53:11 to 00/01:56:40

Plot file version 45 created 24-NOV-2017 10:09:45

J1108+4330 EG096D.UVDATA.1

Freq = 4.7990 GHz, Bw = 32.000 MH No calibration applied and no bandpass applied

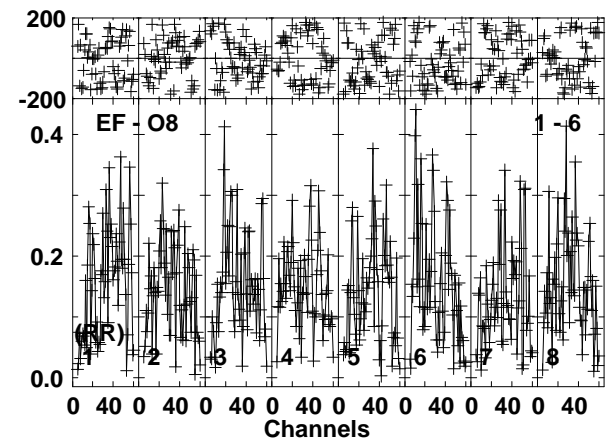
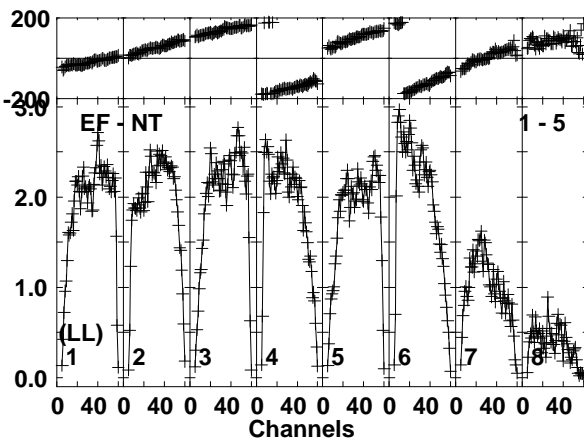
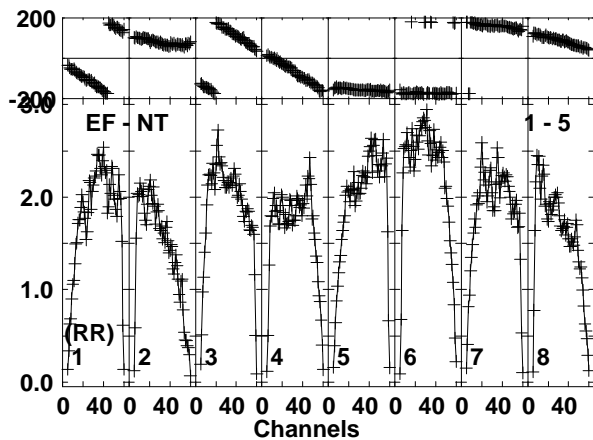
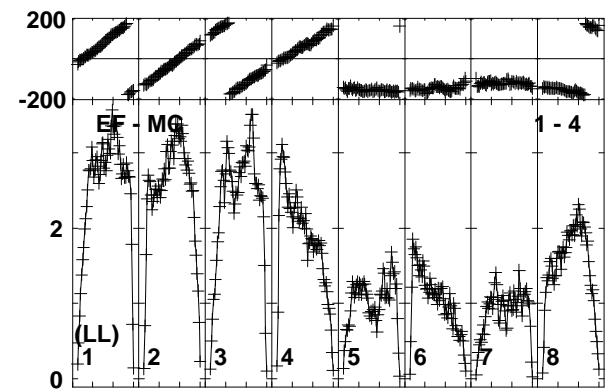
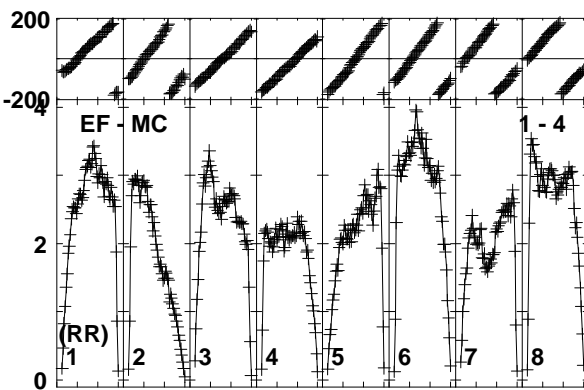
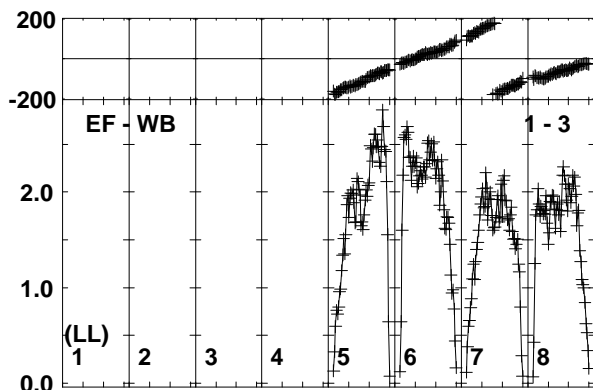
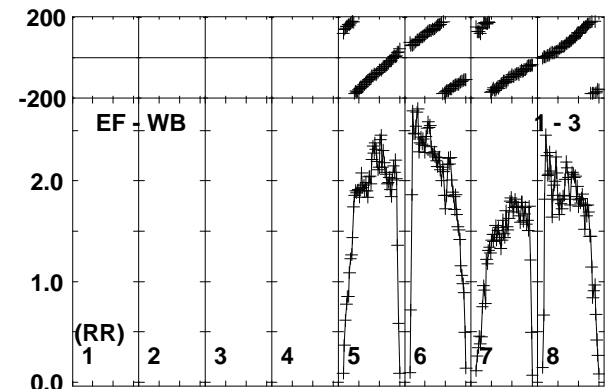
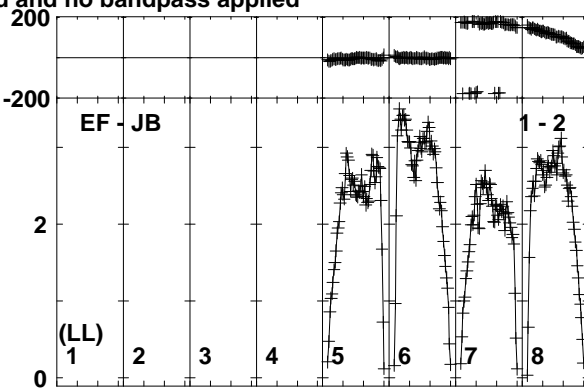
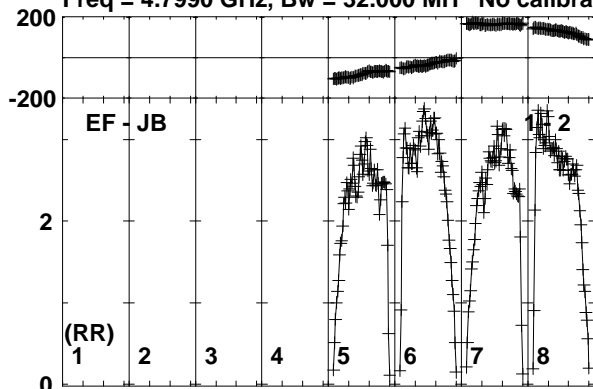

Lower frame: Milli Ampl Jy Top frame: Phas deg  
Vector averaged cross-power spectrum Baseline: EF (01) - JB (02)  
Timerange: 00/01:57:21 to 00/01:58:19

Plot file version 46 created 24-NOV-2017 10:09:45

J1108+4330 EG096D.UVDATA.1

Freq = 4.7990 GHz, Bw = 32.000 MH No calibration applied and no bandpass applied

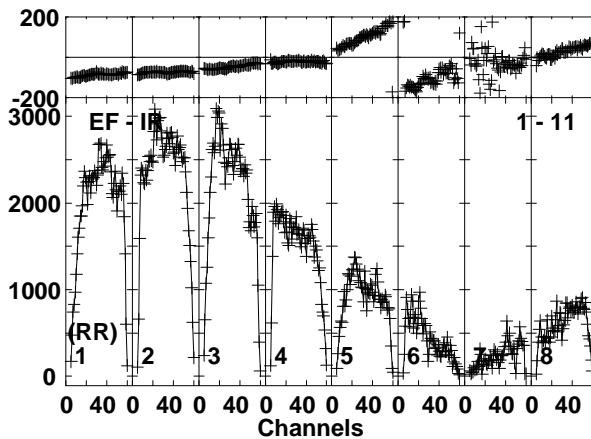
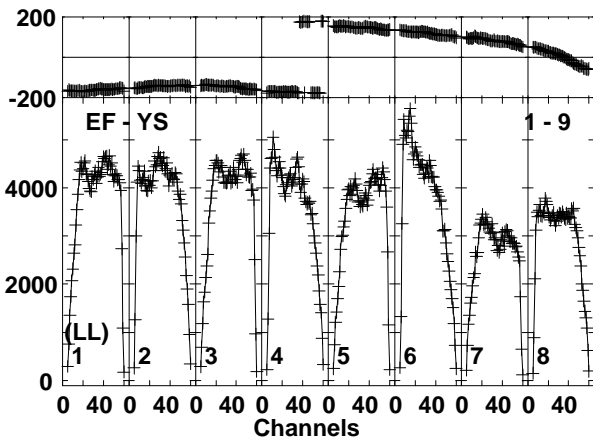
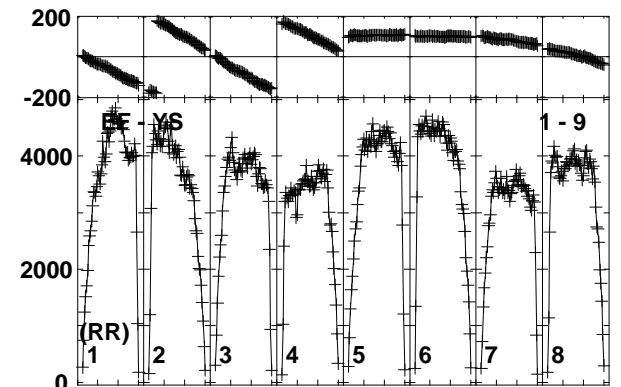
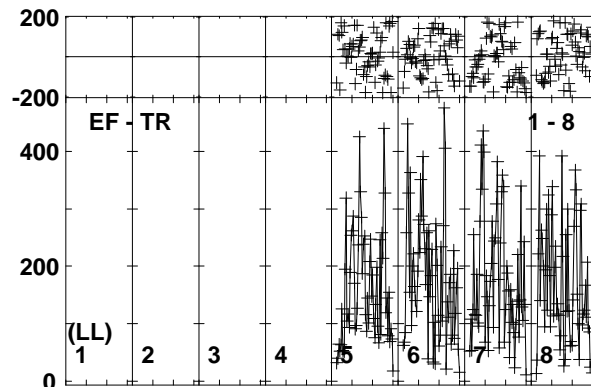
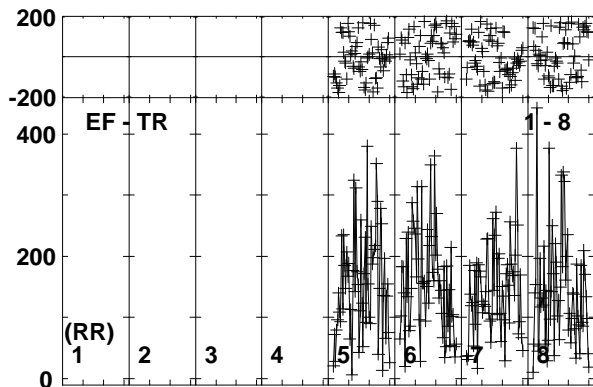
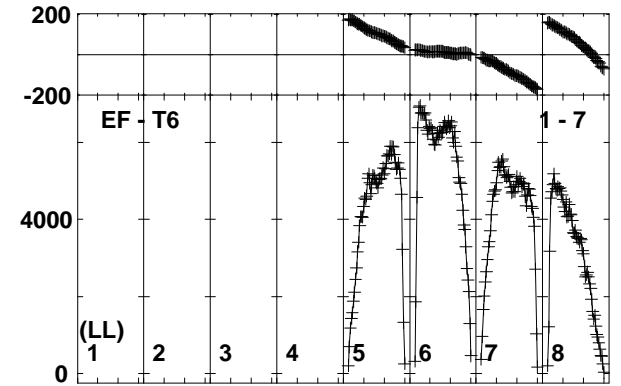
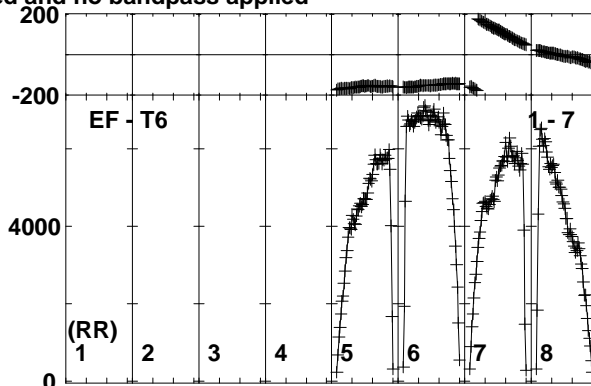
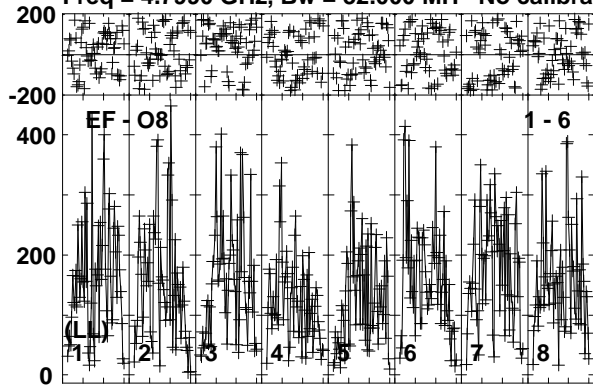

Lower frame: Micro Ampl Jy Top frame: Phas deg

Vector averaged cross-power spectrum Baseline: EF (01) - O8 (06)

Timerange: 00/01:57:21 to 00/01:58:19

Plot file version 47 created 24-NOV-2017 10:09:46

ARUMA EG096D.UVDATA.1

Freq = 4.7990 GHz, Bw = 32.000 MH No calibration applied and no bandpass applied

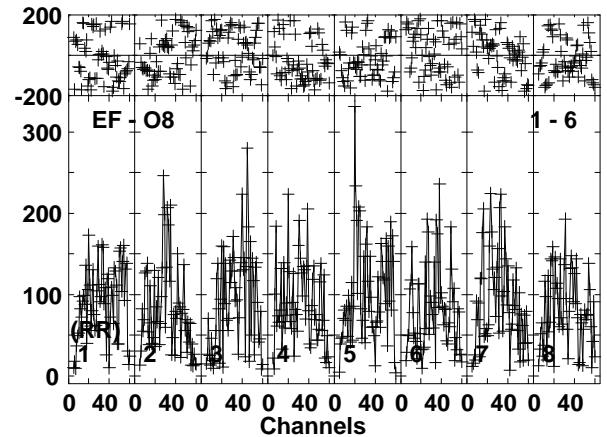
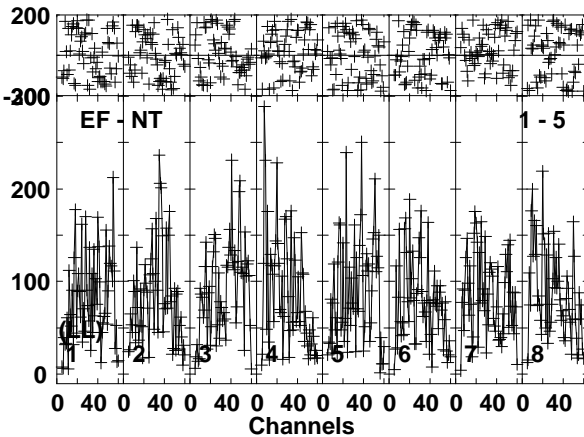
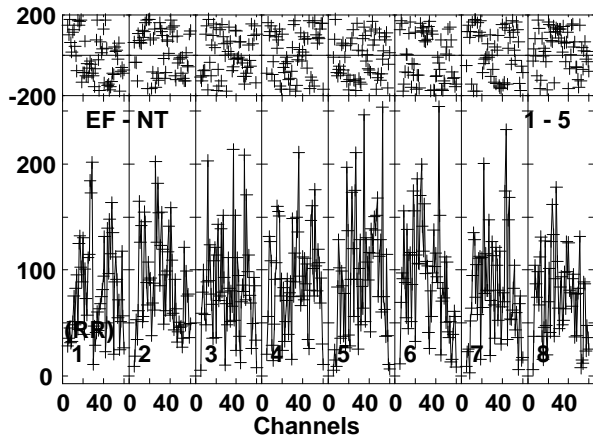
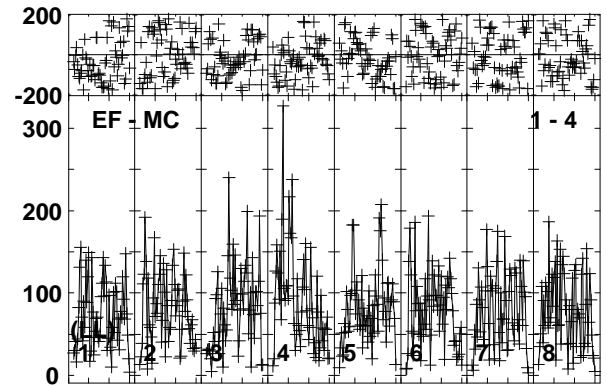
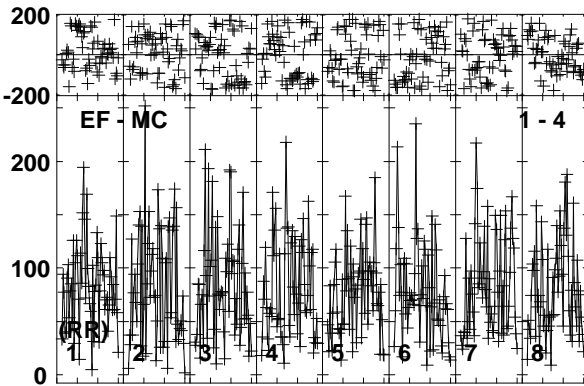
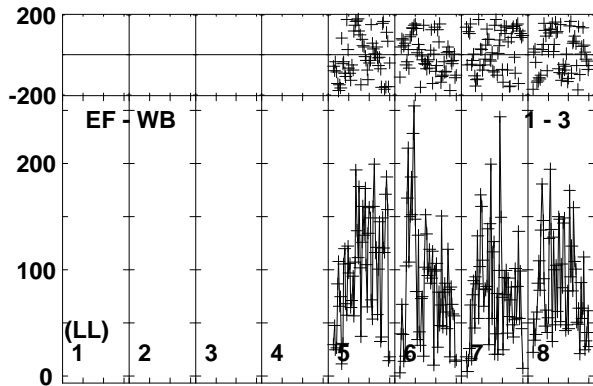
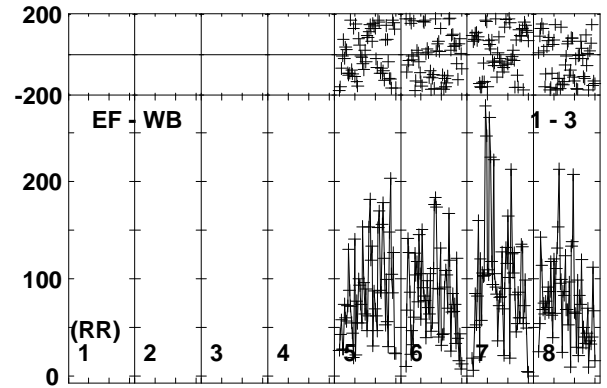
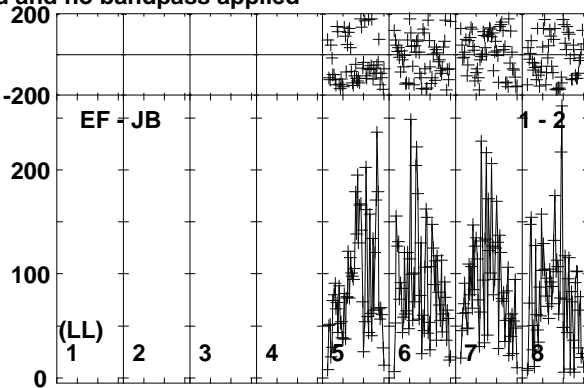
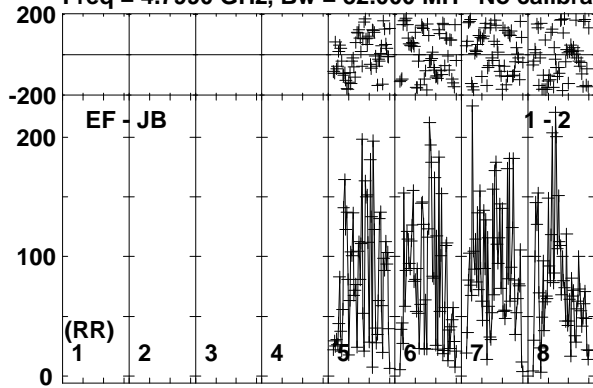

Lower frame: Micro Ampl Jy Top frame: Phas deg  
Vector averaged cross-power spectrum Baseline: EF (01) - JB (02)  
Timerange: 00/01:58:21 to 00/02:01:50

Plot file version 48 created 24-NOV-2017 10:09:46

ARUMA EG096D.UVDATA.1

Freq = 4.7990 GHz, Bw = 32.000 MH No calibration applied and no bandpass applied

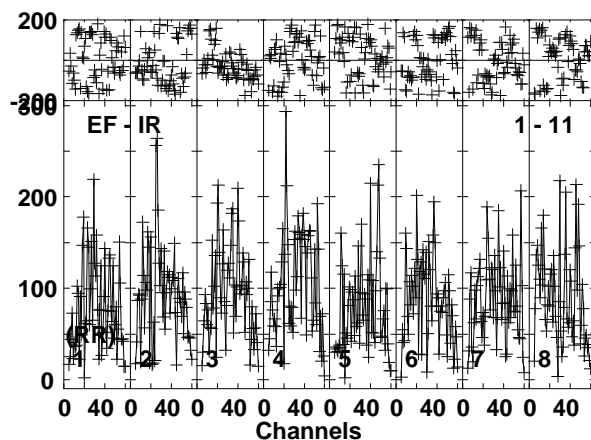
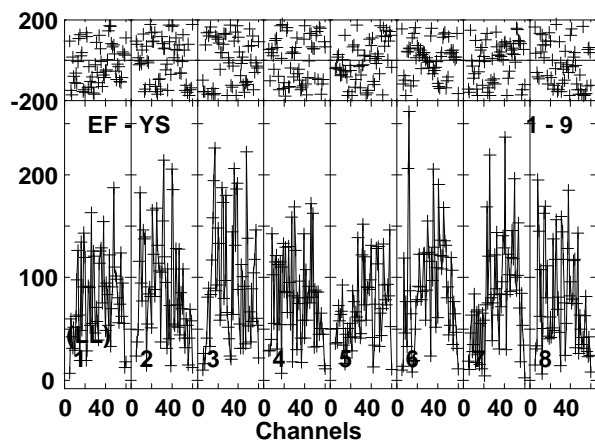
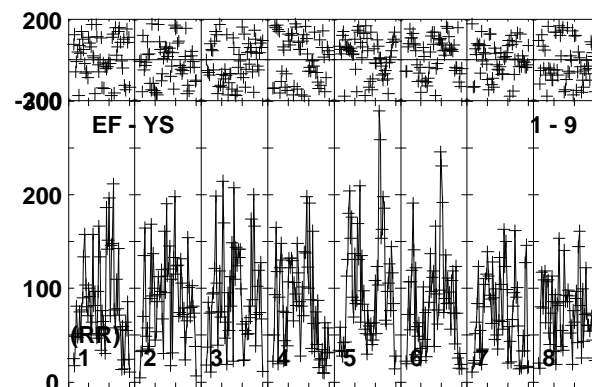
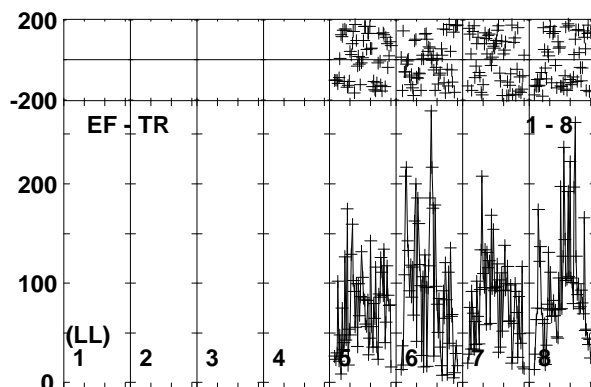
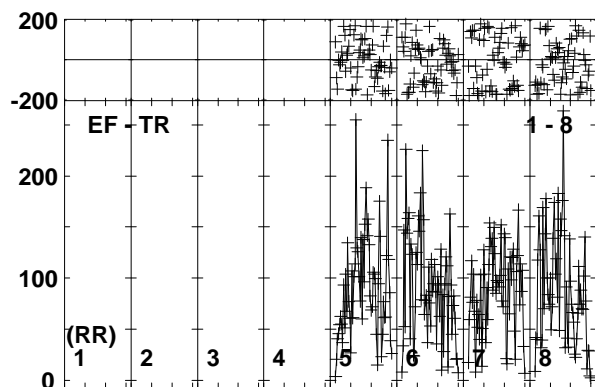
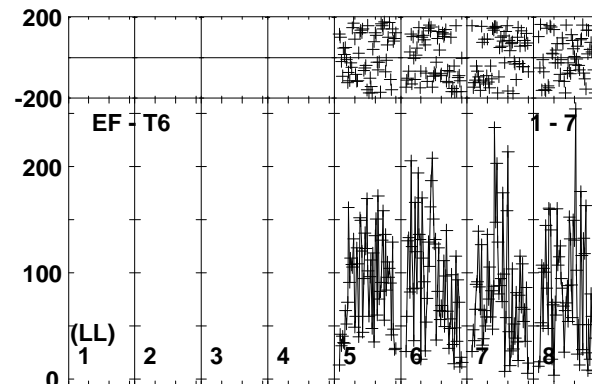
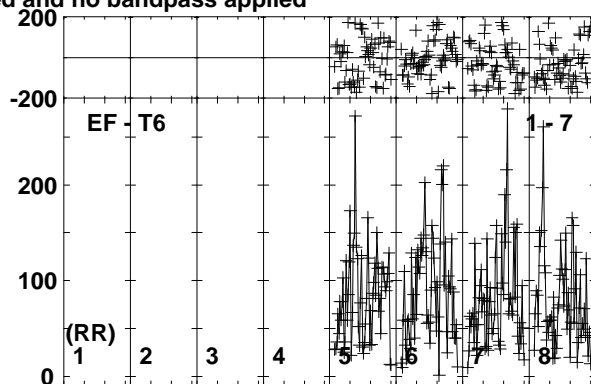
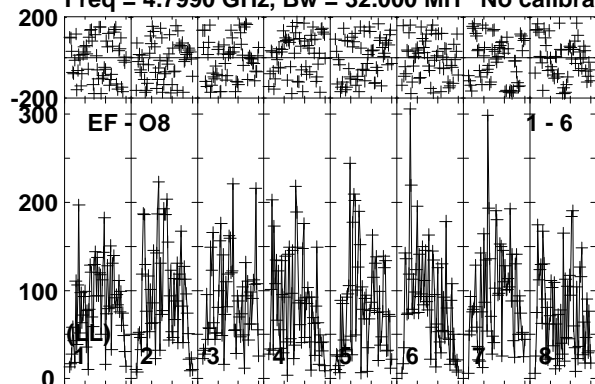

Lower frame: Micro Ampl Jy Top frame: Phas deg  
Vector averaged cross-power spectrum Baseline: EF (01) - O8 (06)  
Timerange: 00/01:58:21 to 00/02:01:50

Plot file version 49 created 24-NOV-2017 10:09:46

J1108+4330 EG096D.UVDATA.1

Freq = 4.7990 GHz, Bw = 32.000 MH No calibration applied and no bandpass applied

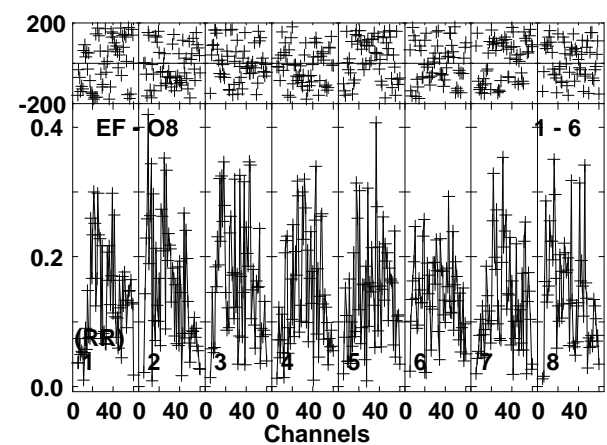
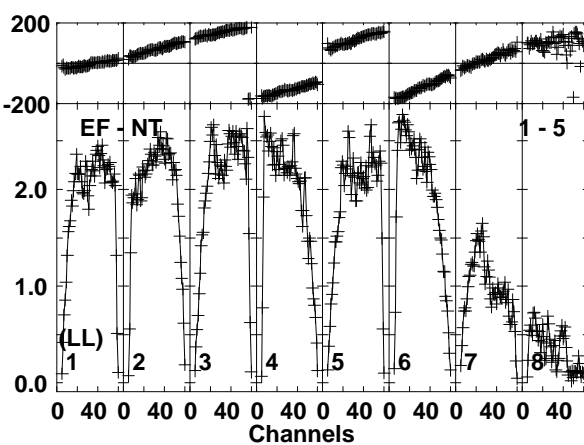
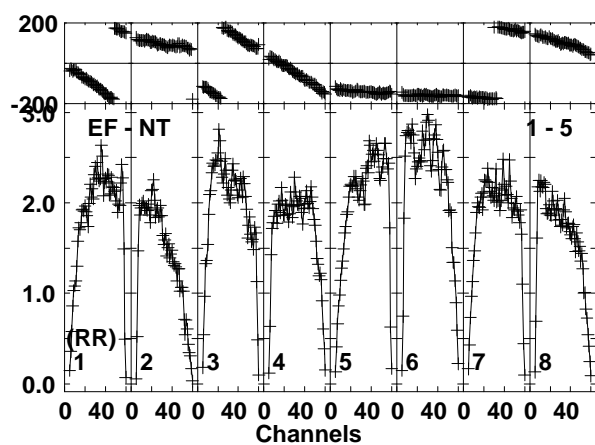
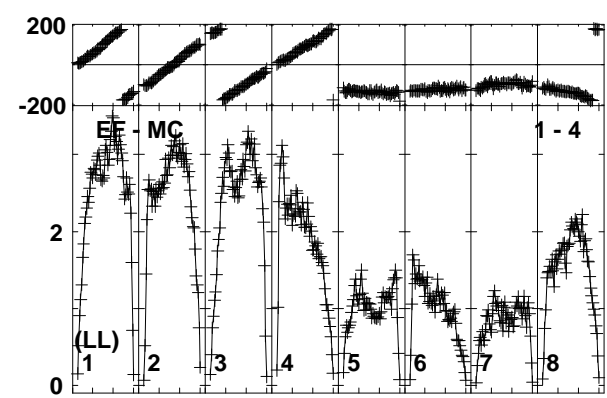
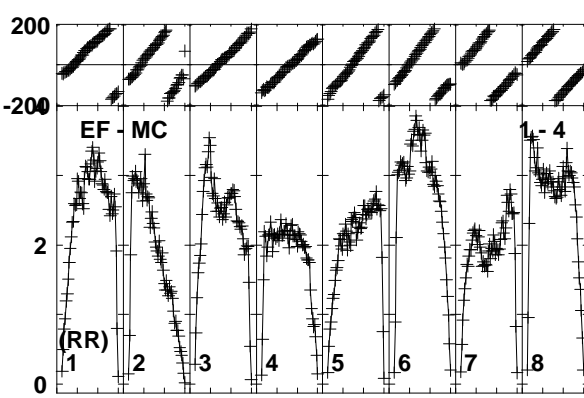
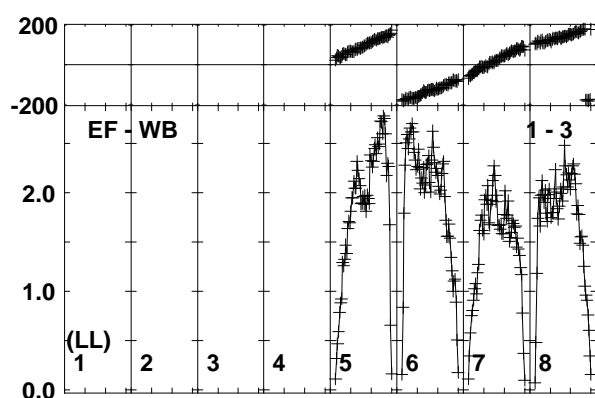
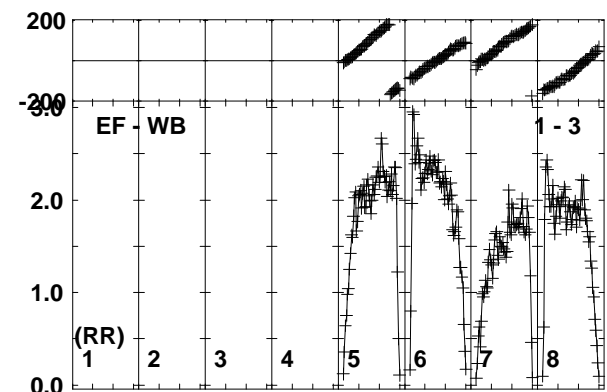
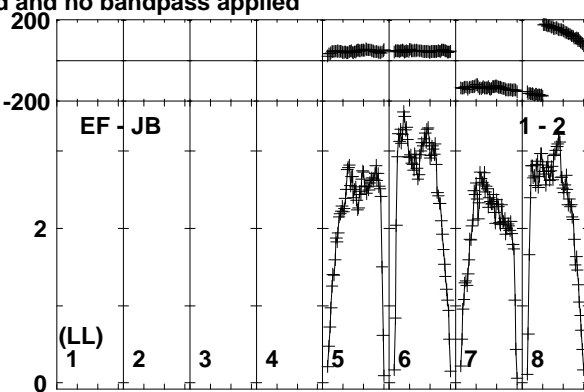
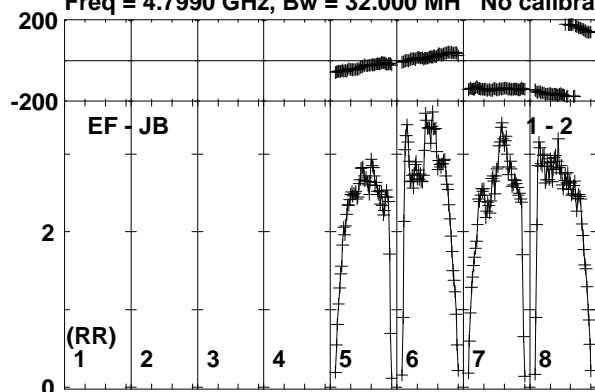

Lower frame: Milli Ampl Jy Top frame: Phas deg  
Vector averaged cross-power spectrum Baseline: EF (01) - JB (02)  
Timerange: 00/02:01:51 to 00/02:03:19

Plot file version 50 created 24-NOV-2017 10:09:47

J1108+4330 EG096D.UVDATA.1

Freq = 4.7990 GHz, Bw = 32.000 MH No calibration applied and no bandpass applied

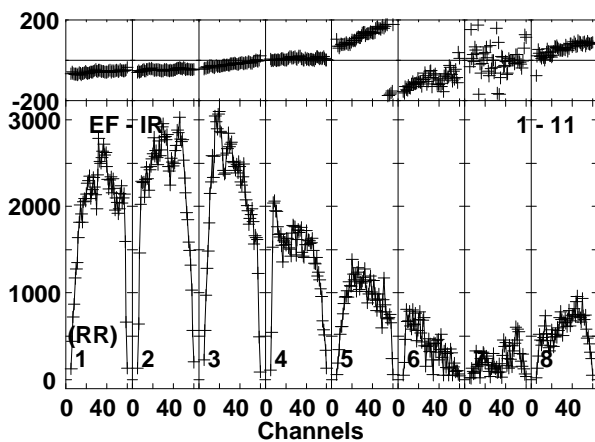
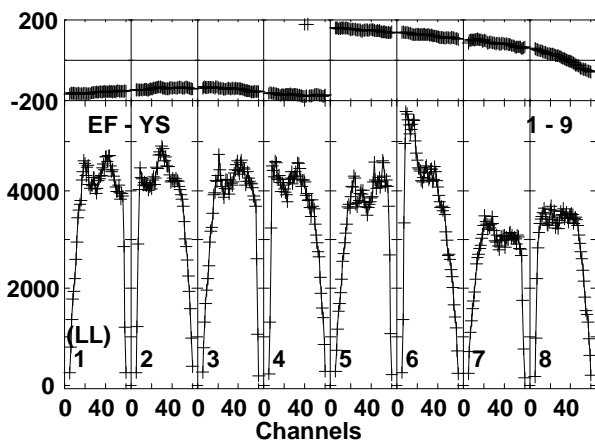
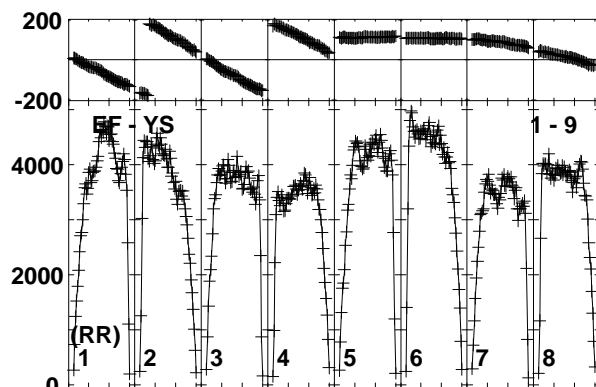
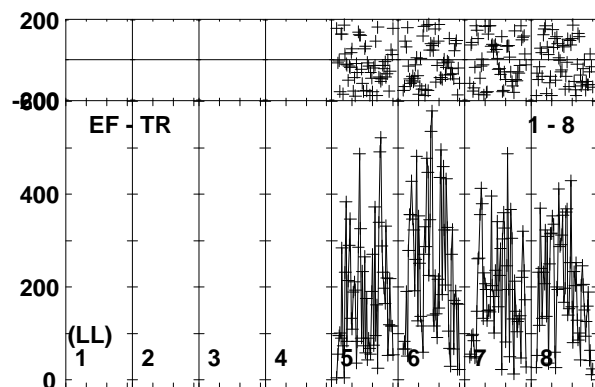
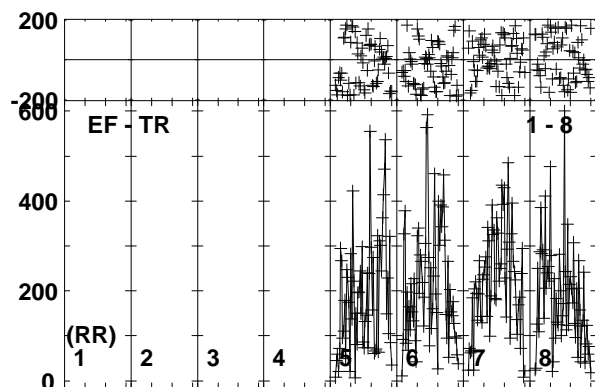
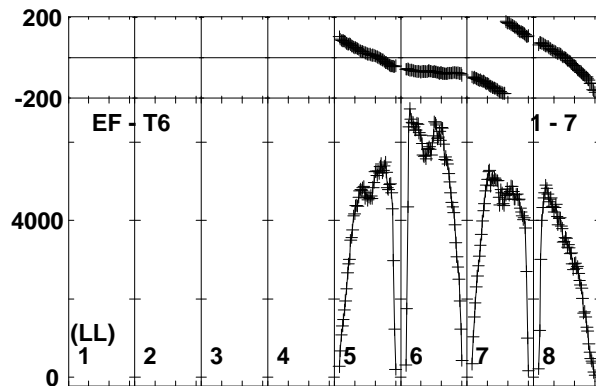
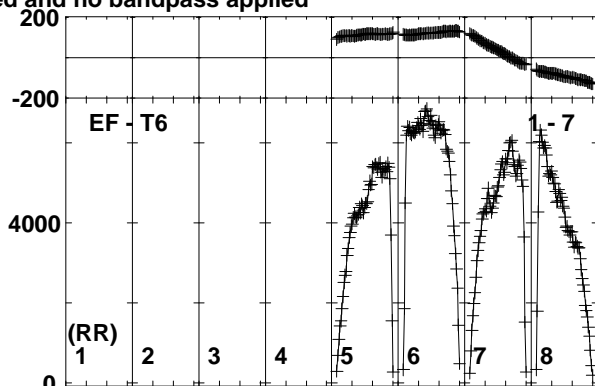
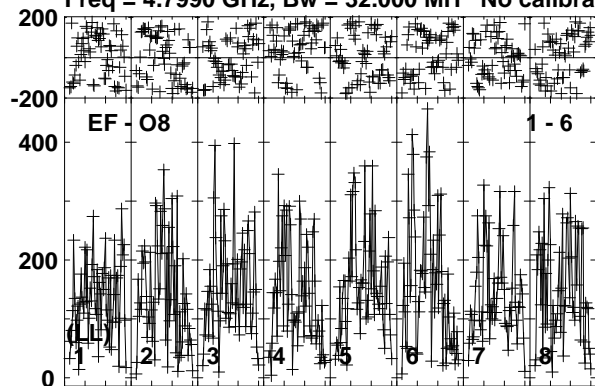

Lower frame: Micro Ampl Jy Top frame: Phas deg  
Vector averaged cross-power spectrum Baseline: EF (01) - O8 (06)  
Timerange: 00/02:01:51 to 00/02:03:19



Plot file version 51 created 24-NOV-2017 10:09:47

ARUMA EG096D.UVDATA.1

Freq = 4.7990 GHz, Bw = 32.000 MH No calibration applied and no bandpass applied

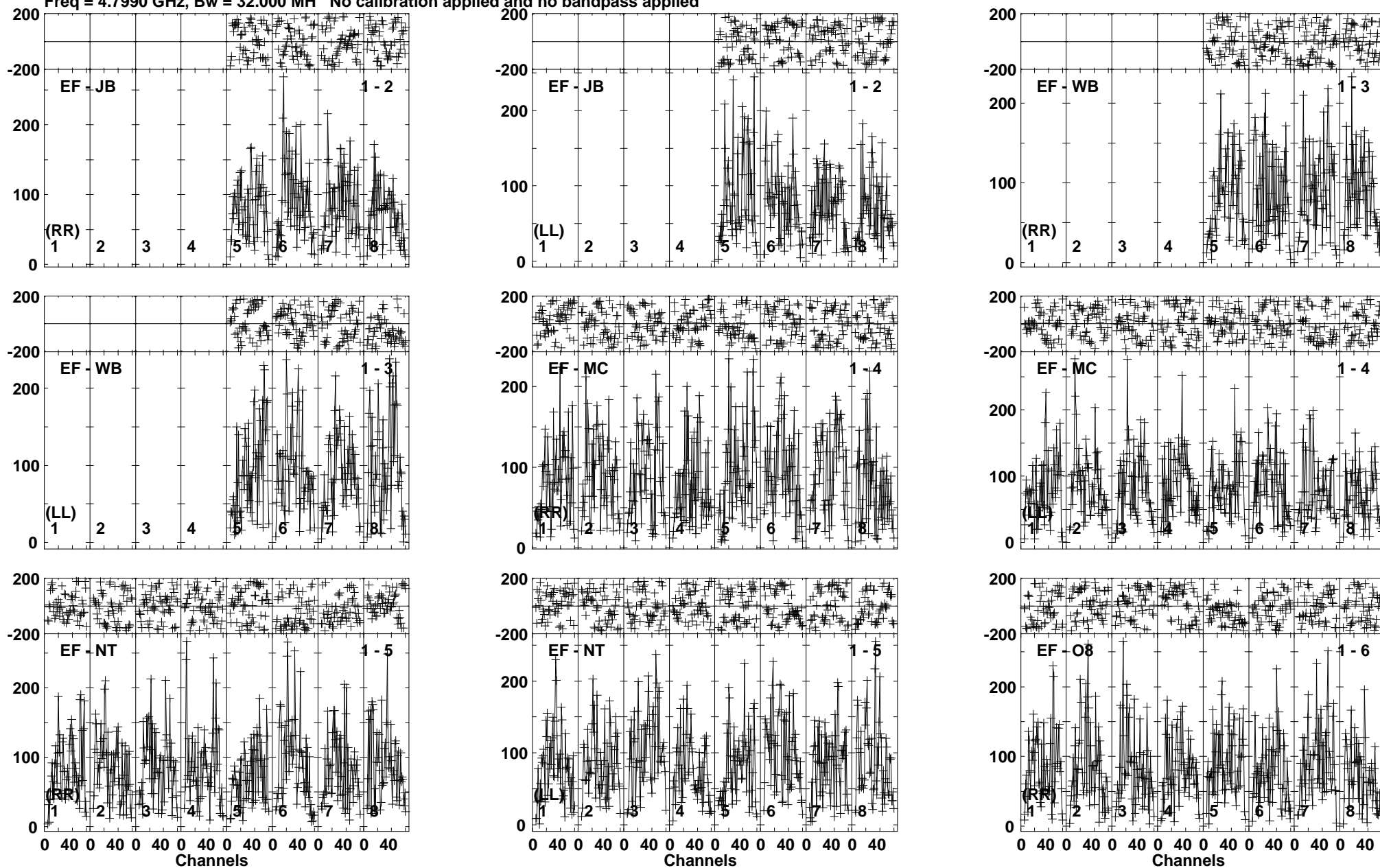

Lower frame: Micro Ampl Jy Top frame: Phas deg  
Vector averaged cross-power spectrum Baseline: EF (01) - JB (02)  
Timerange: 00/02:03:21 to 00/02:06:49

Plot file version 52 created 24-NOV-2017 10:09:47

ARUMA EG096D.UVDATA.1

Freq = 4.7990 GHz, Bw = 32.000 MH No calibration applied and no bandpass applied

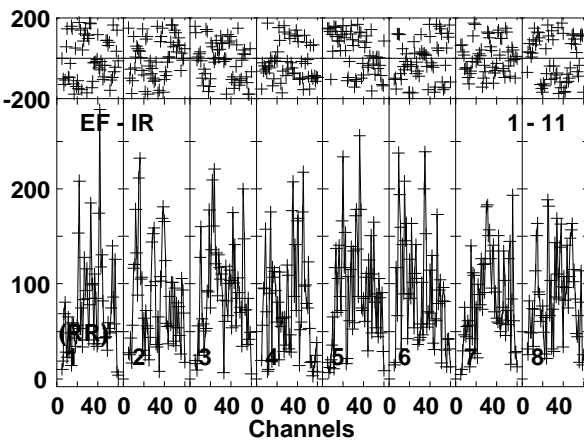
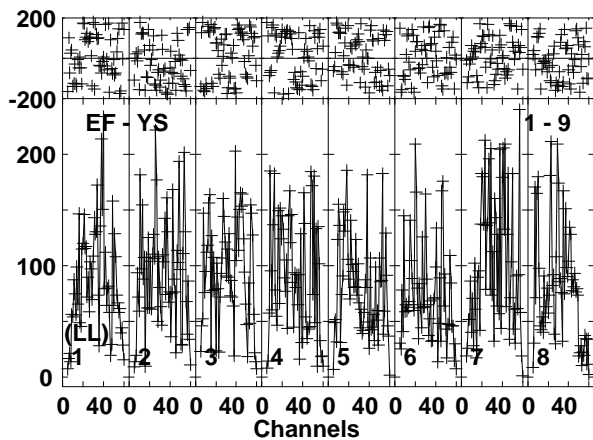
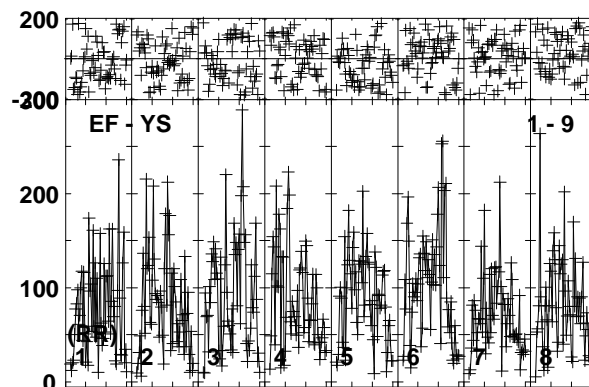
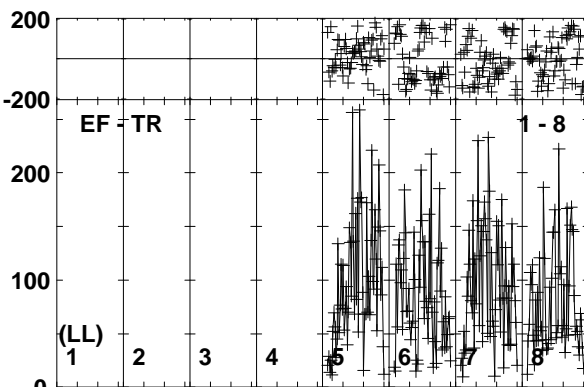
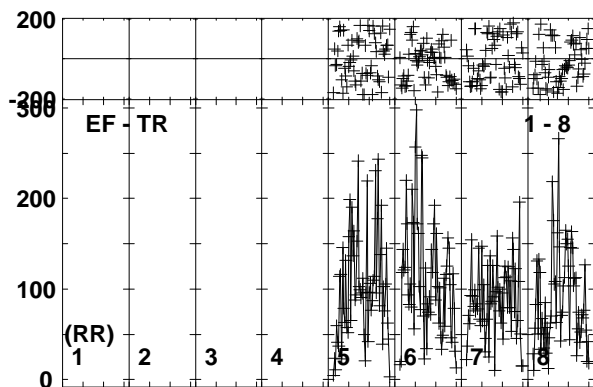
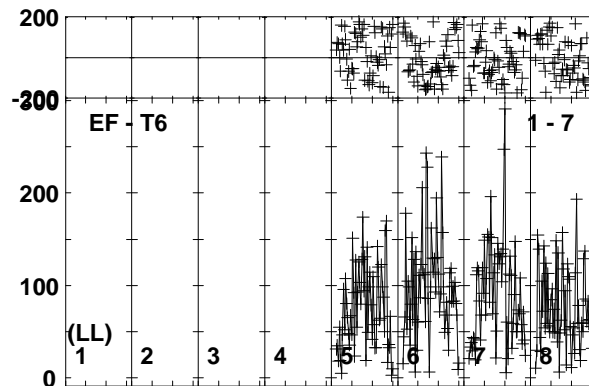
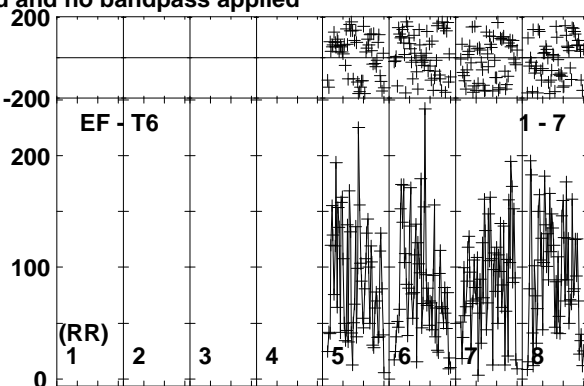
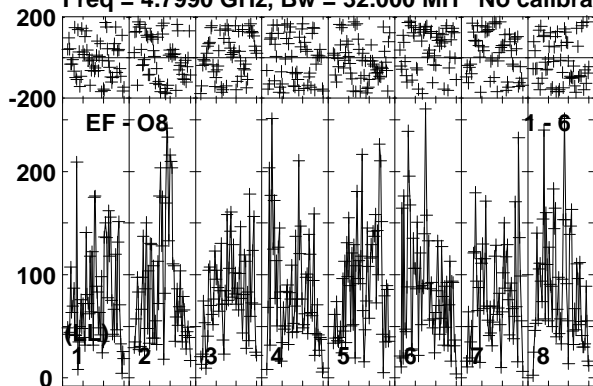

Lower frame: Micro Ampl Jy Top frame: Phas deg  
Vector averaged cross-power spectrum Baseline: EF (01) - O8 (06)  
Timerange: 00/02:03:21 to 00/02:06:49

Plot file version 53 created 24-NOV-2017 10:09:48

J1108+4330 EG096D.UVDATA.1

Freq = 4.7990 GHz, Bw = 32.000 MH No calibration applied and no bandpass applied

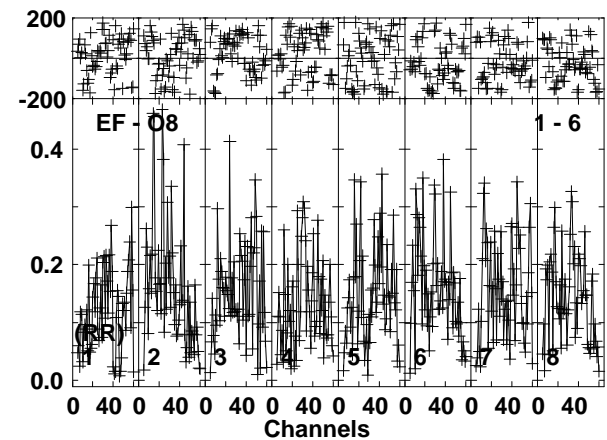
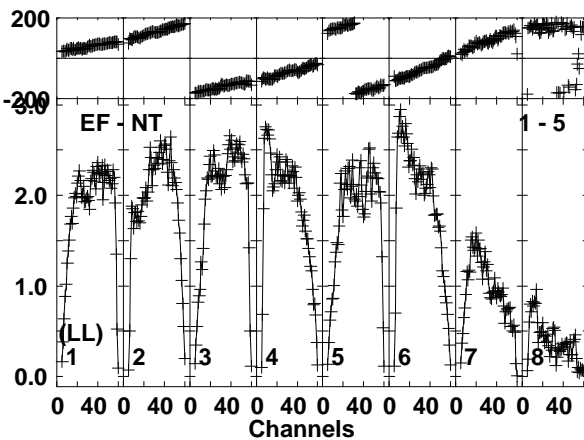
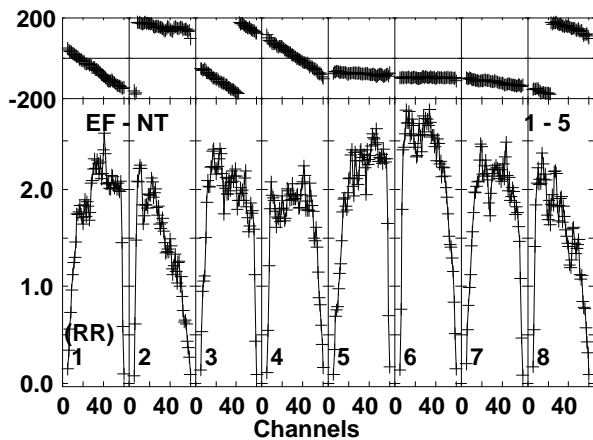
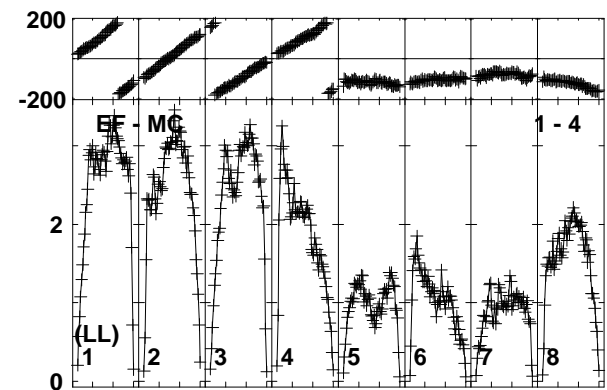
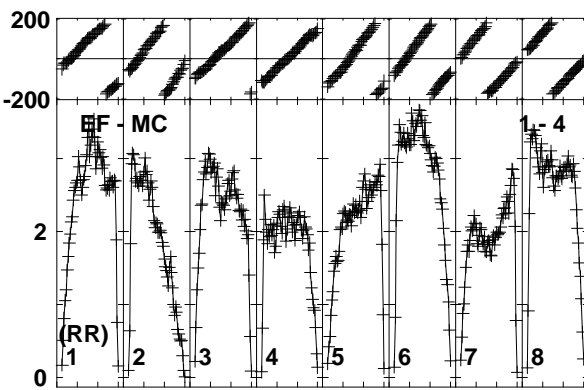
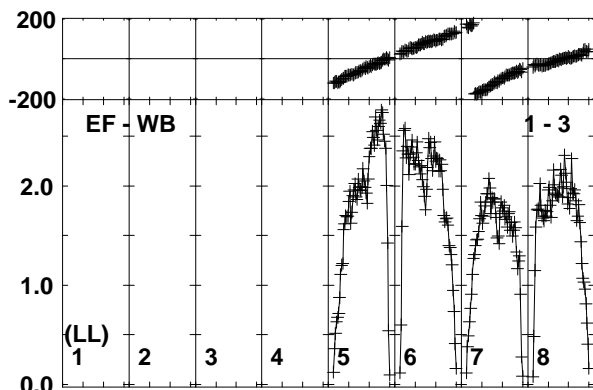
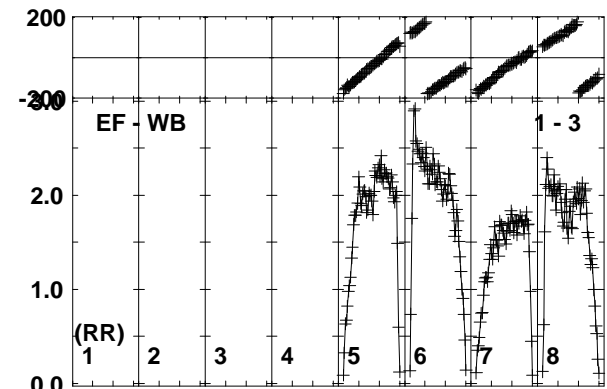
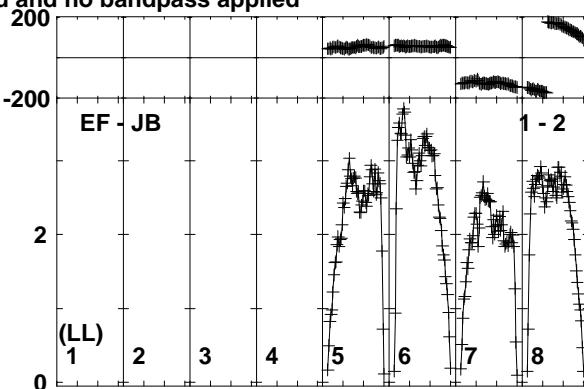
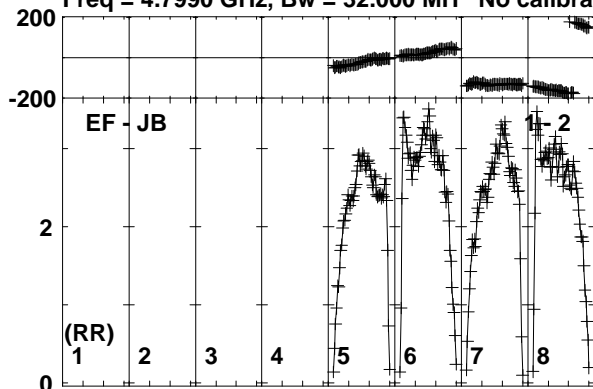

Lower frame: Milli Ampl Jy Top frame: Phas deg  
Vector averaged cross-power spectrum Baseline: EF (01) - JB (02)  
Timerange: 00/02:07:30 to 00/02:08:29

Plot file version 54 created 24-NOV-2017 10:09:48

J1108+4330 EG096D.UVDATA.1

Freq = 4.7990 GHz, Bw = 32.000 MH No calibration applied and no bandpass applied

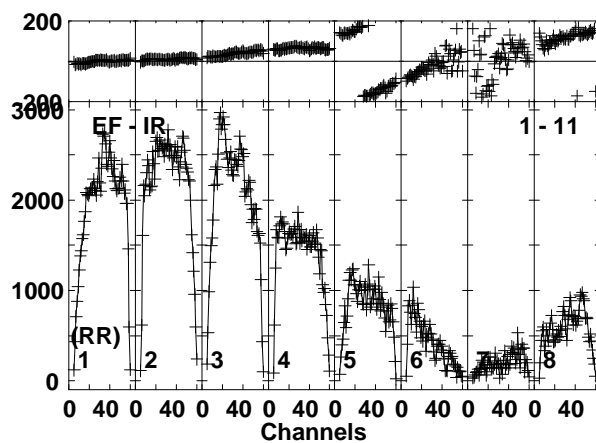
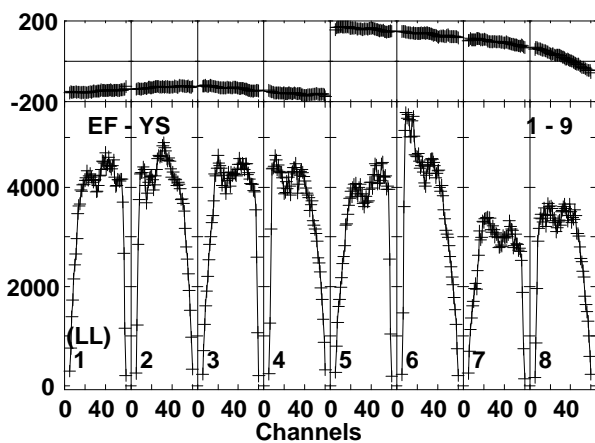
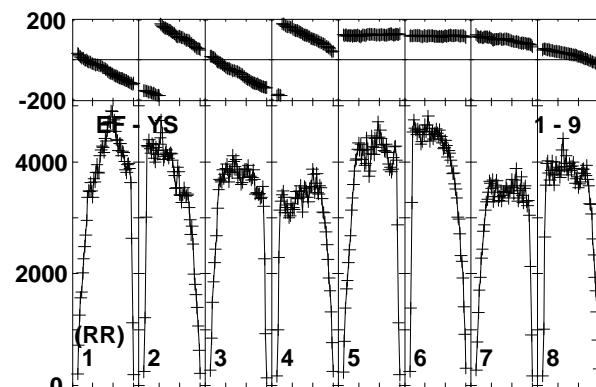
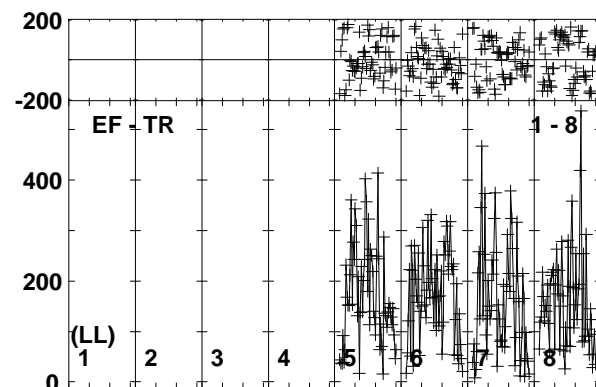
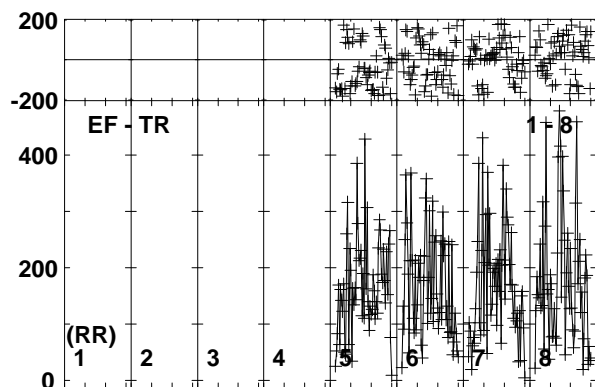
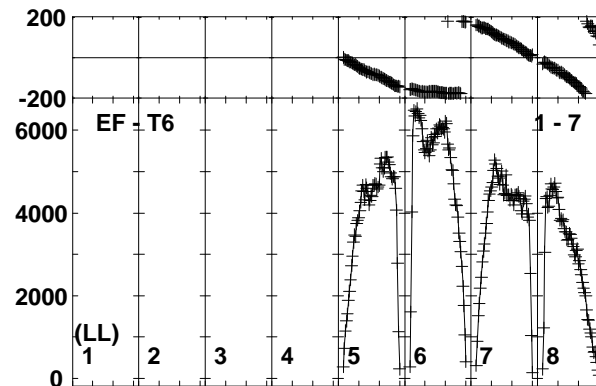
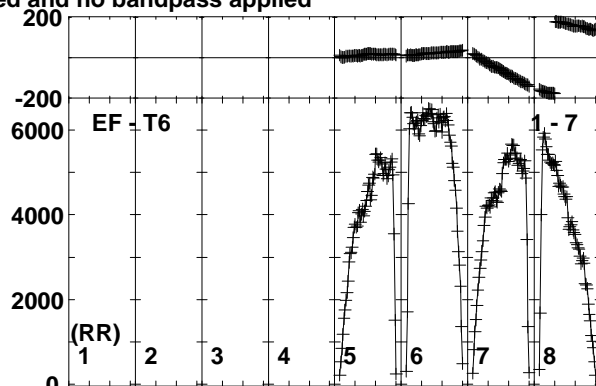
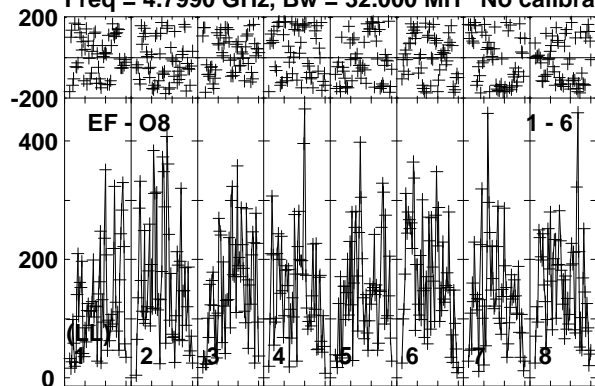

Lower frame: Micro Ampl Jy Top frame: Phas deg  
Vector averaged cross-power spectrum Baseline: EF (01) - O8 (06)  
Timerange: 00/02:07:30 to 00/02:08:29

Plot file version 55 created 24-NOV-2017 10:09:48

J1112+4301 EG096D.UVDATA.1

Freq = 4.7990 GHz, Bw = 32.000 MH No calibration applied and no bandpass applied

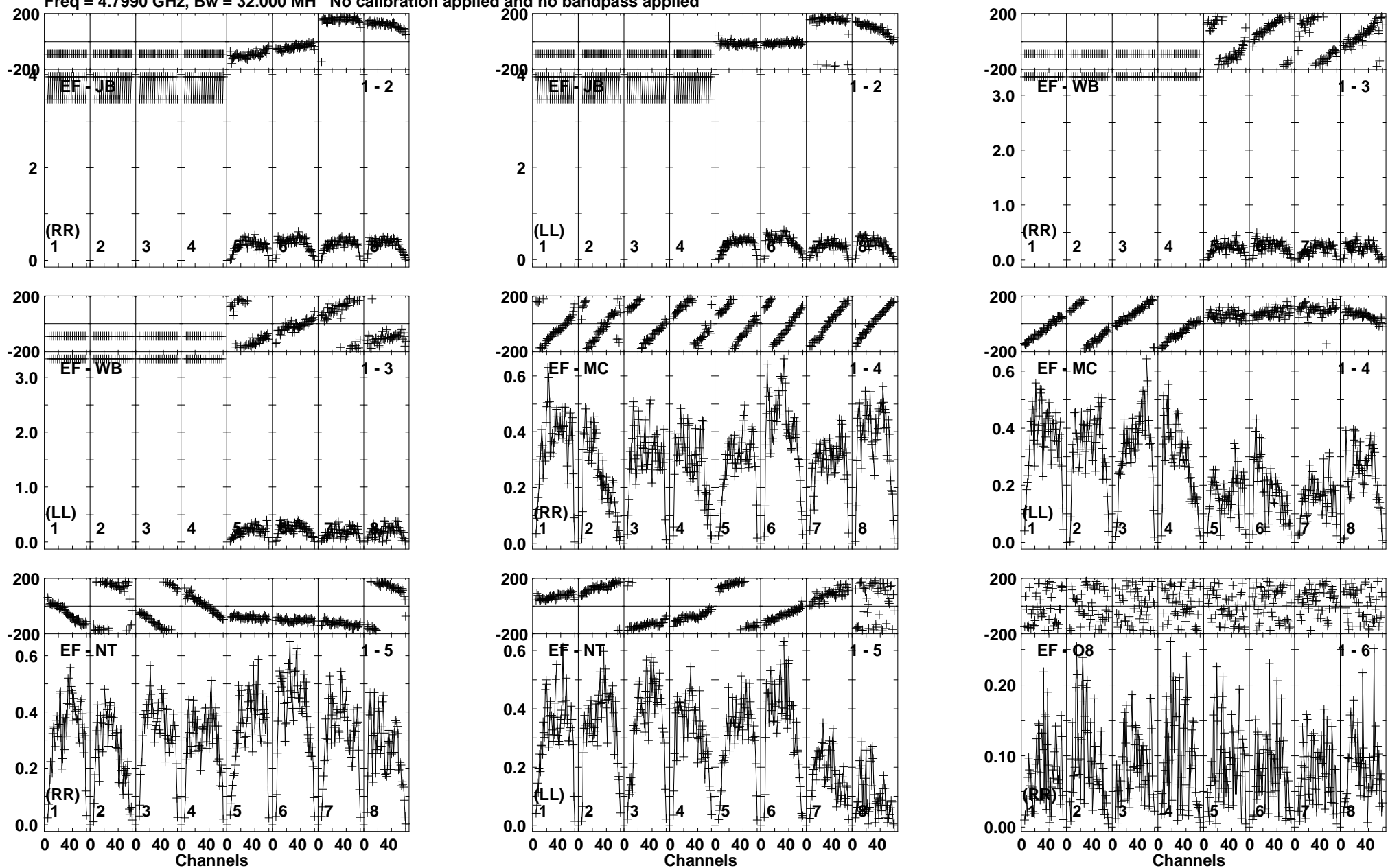

Lower frame: Milli Ampl Jy Top frame: Phas deg  
Vector averaged cross-power spectrum Baseline: EF (01) - JB (02)  
Timerange: 00/02:08:31 to 00/02:11:59

Plot file version 56 created 24-NOV-2017 10:09:48

J1112+4301 EG096D.UVDATA.1

Freq = 4.7990 GHz, Bw = 32.000 MH No calibration applied and no bandpass applied

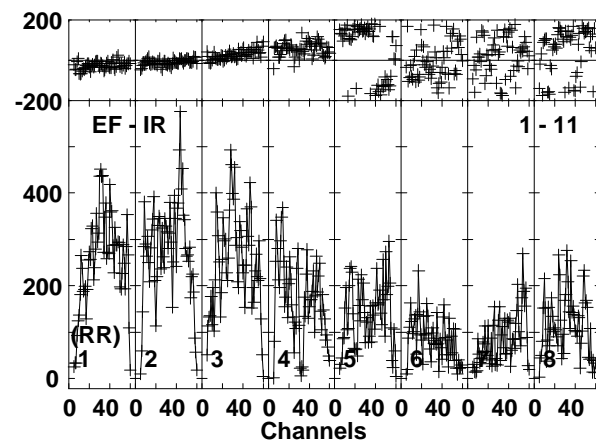
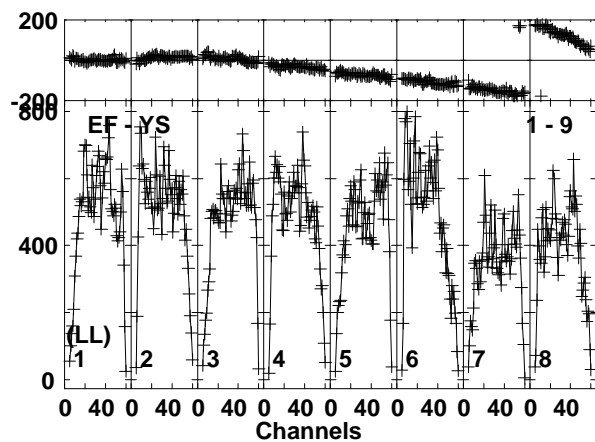
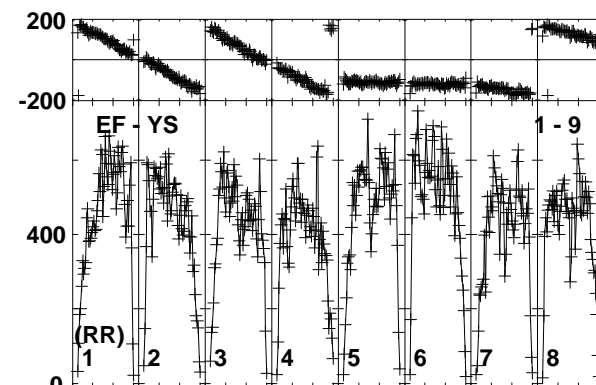
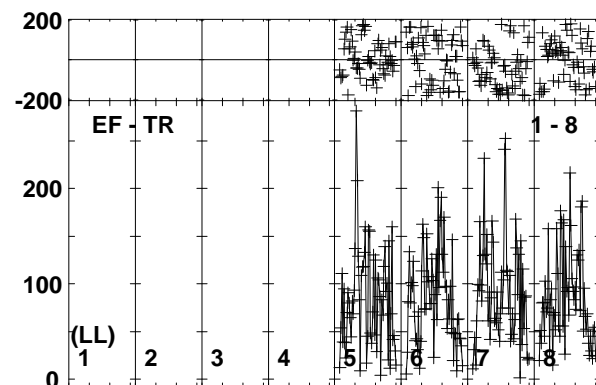
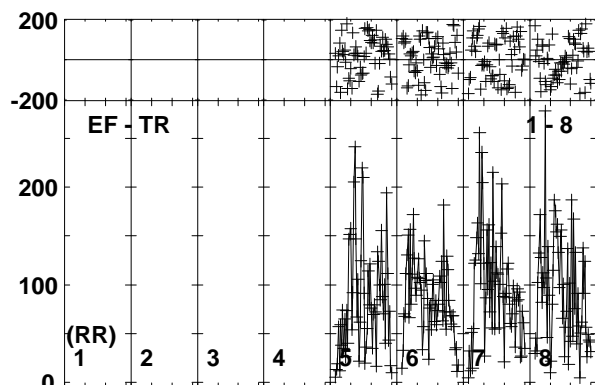
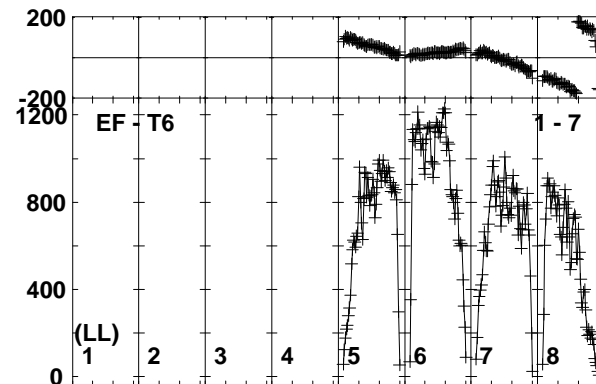
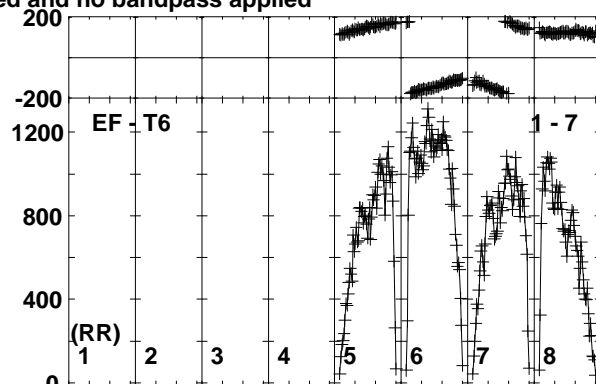
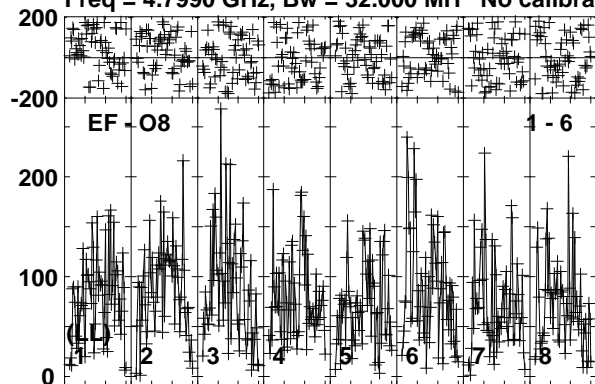

Lower frame: Micro Ampl Jy Top frame: Phas deg  
Vector averaged cross-power spectrum Baseline: EF (01) - O8 (06)  
Timerange: 00/02:08:31 to 00/02:11:59

Plot file version 57 created 24-NOV-2017 10:09:49

J1108+4330 EG096D.UVDATA.1

Freq = 4.7990 GHz, Bw = 32.000 MH No calibration applied and no bandpass applied

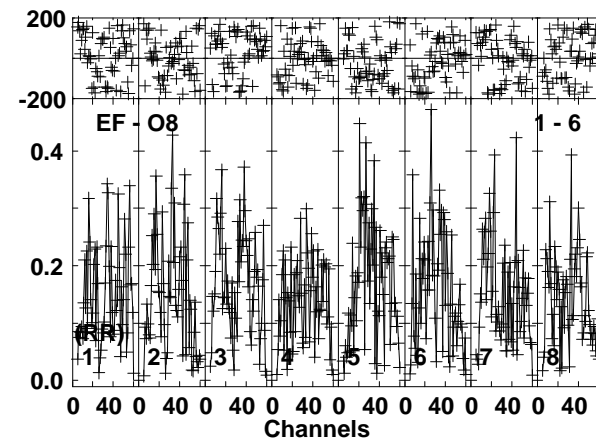
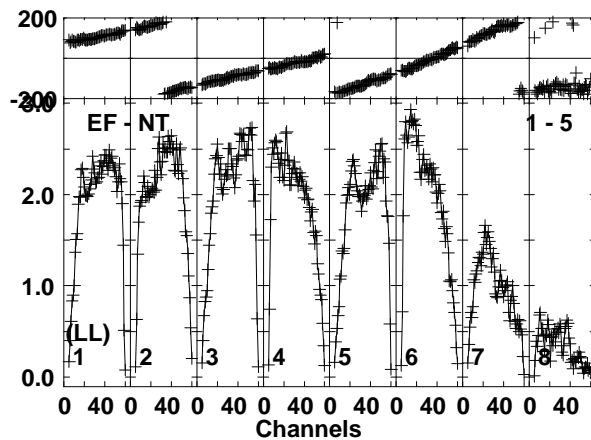
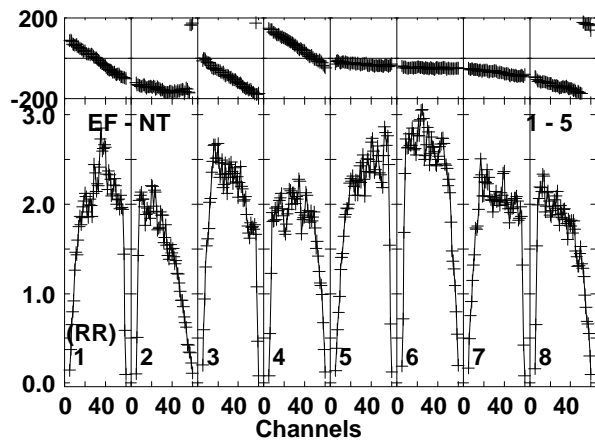
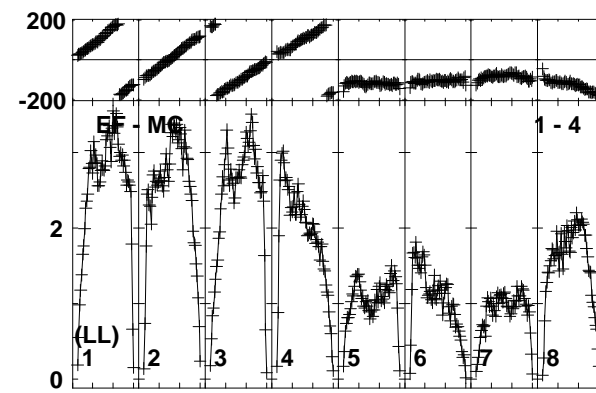
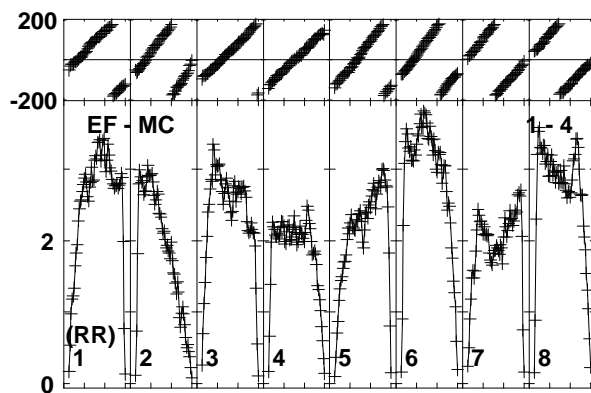
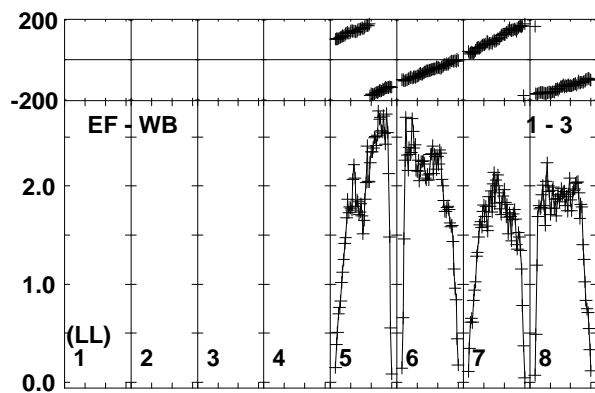
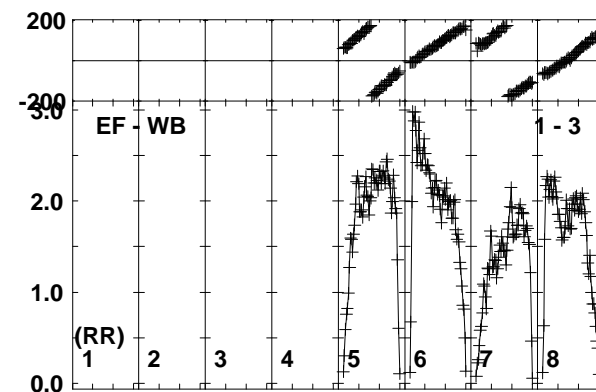
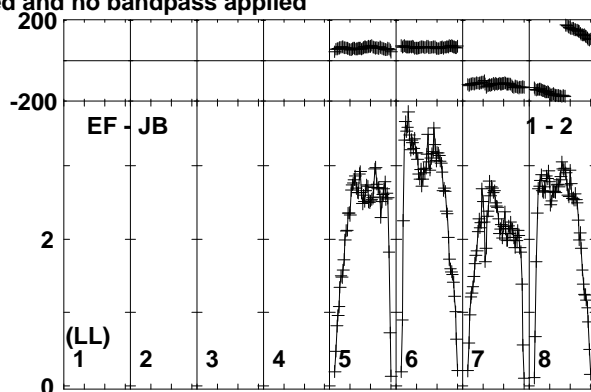
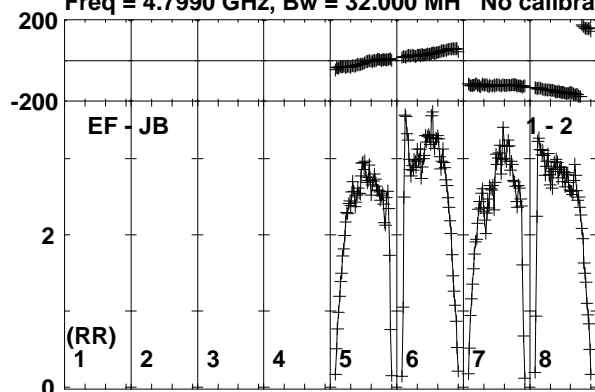

Lower frame: Milli Ampl Jy Top frame: Phas deg  
Vector averaged cross-power spectrum Baseline: EF (01) - JB (02)  
Timerange: 00/02:12:00 to 00/02:13:29

Plot file version 58 created 24-NOV-2017 10:09:49

J1108+4330 EG096D.UVDATA.1

Freq = 4.7990 GHz, Bw = 32.000 MH No calibration applied and no bandpass applied

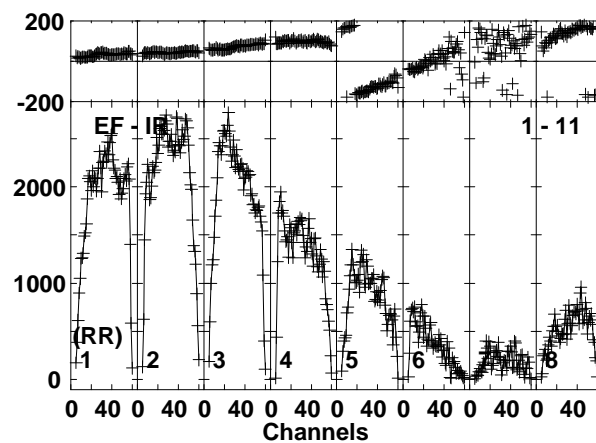
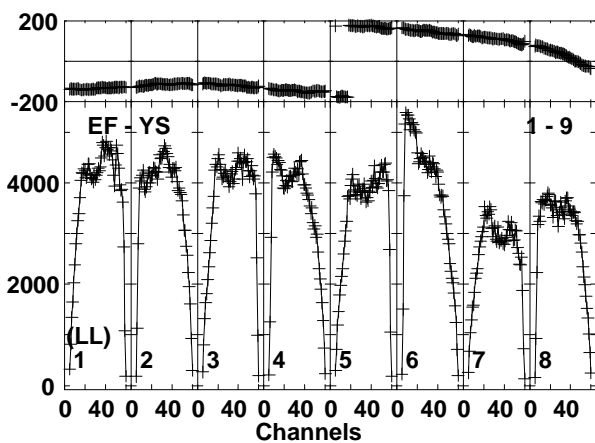
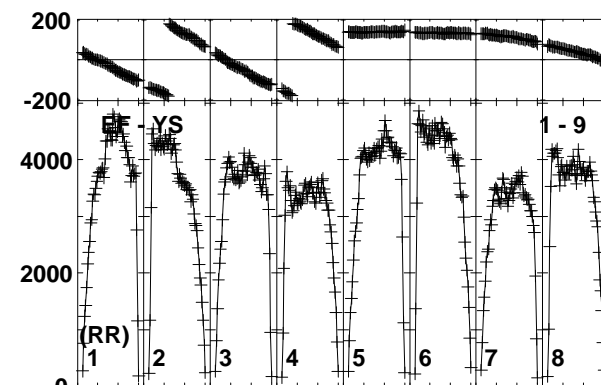
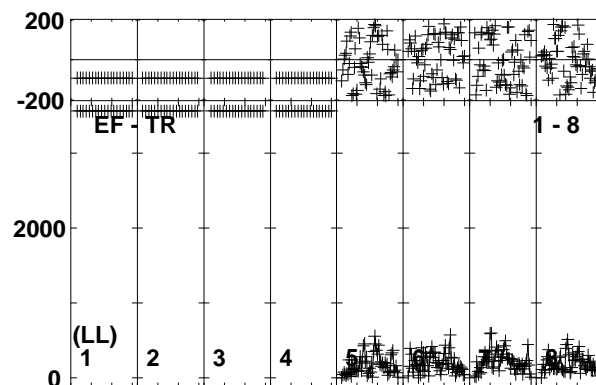
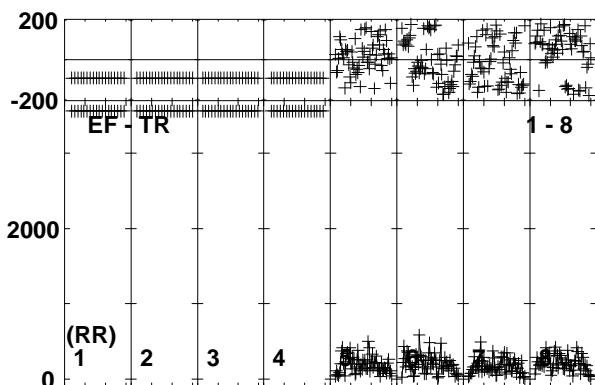
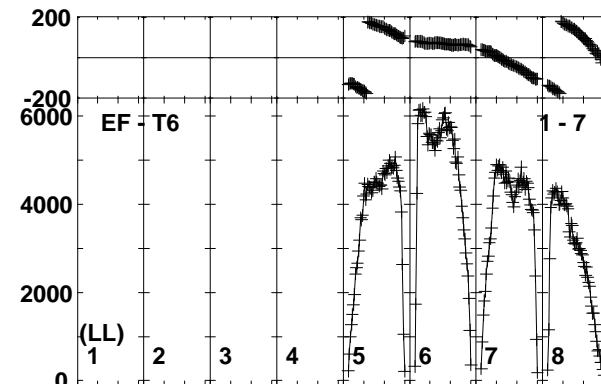
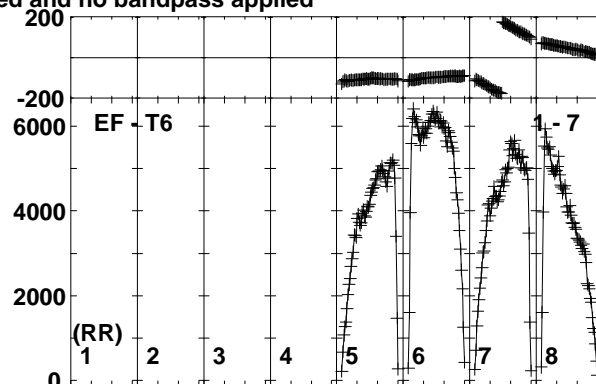
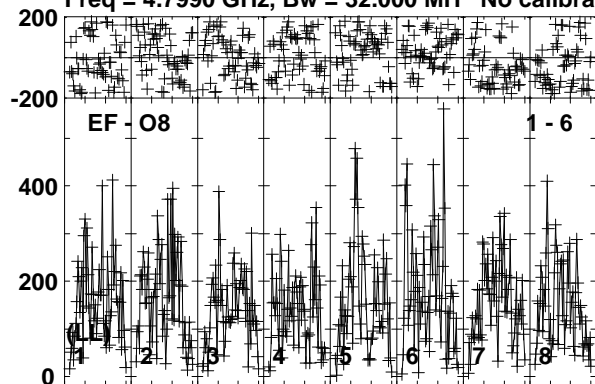

Lower frame: Micro Ampl Jy Top frame: Phas deg  
Vector averaged cross-power spectrum Baseline: EF (01) - O8 (06)  
Timerange: 00/02:12:00 to 00/02:13:29



Plot file version 59 created 24-NOV-2017 10:09:49

ARUMA EG096D.UVDATA.1

Freq = 4.7990 GHz, Bw = 32.000 MH No calibration applied and no bandpass applied

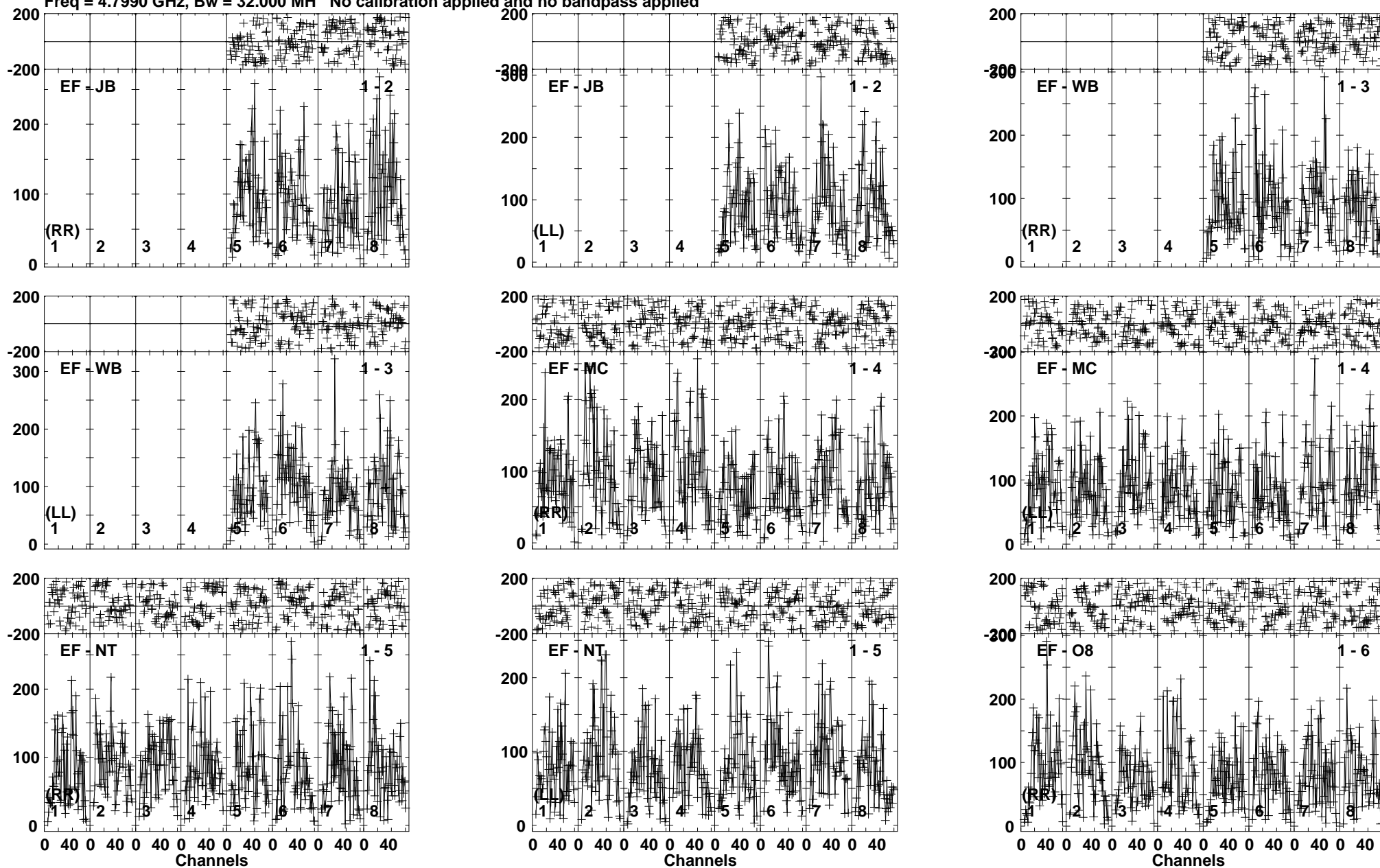

Lower frame: Micro Ampl Jy Top frame: Phas deg  
Vector averaged cross-power spectrum Baseline: EF (01) - JB (02)  
Timerange: 00/02:13:31 to 00/02:17:00

Plot file version 60 created 24-NOV-2017 10:09:49

ARUMA EG096D.UVDATA.1

Freq = 4.7990 GHz, Bw = 32.000 MH No calibration applied and no bandpass applied

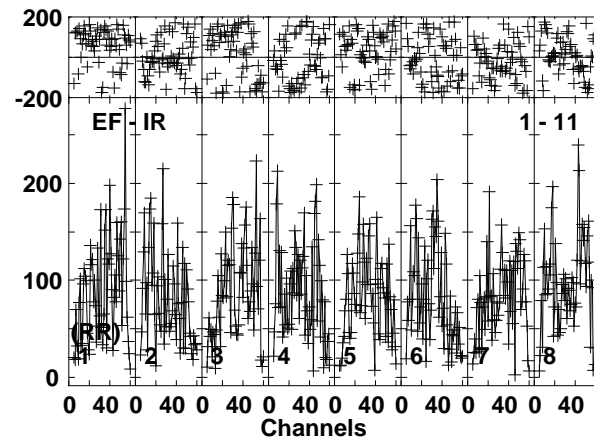
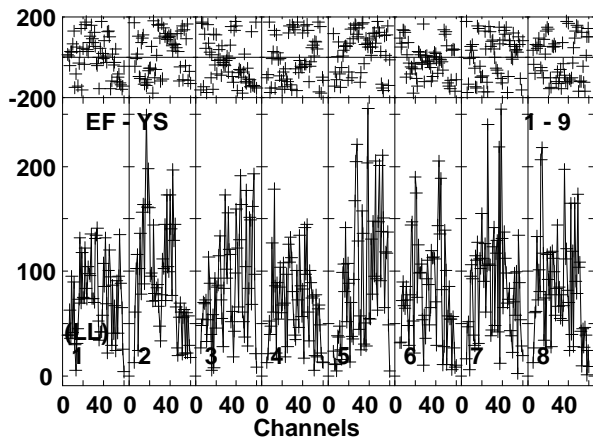
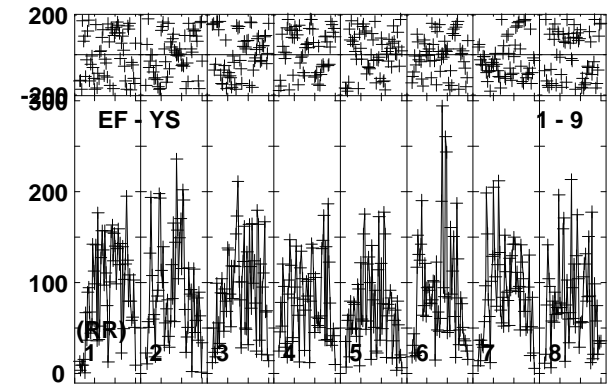
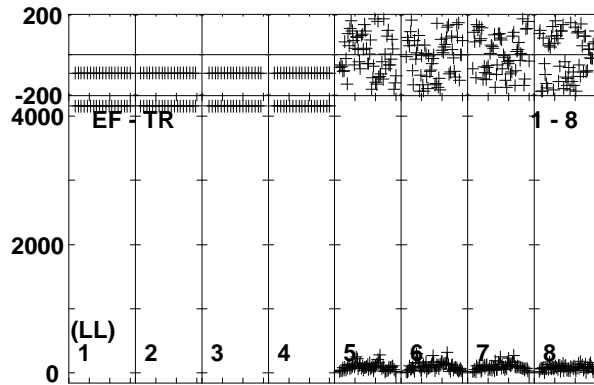
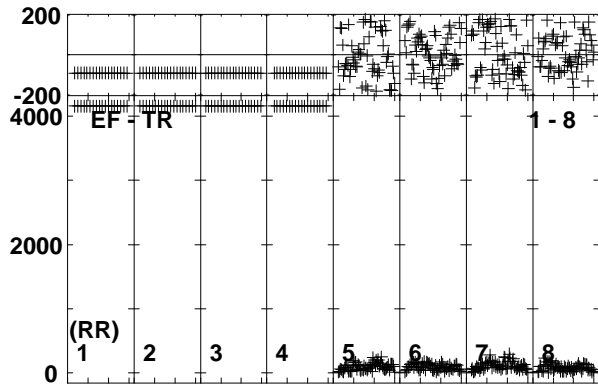
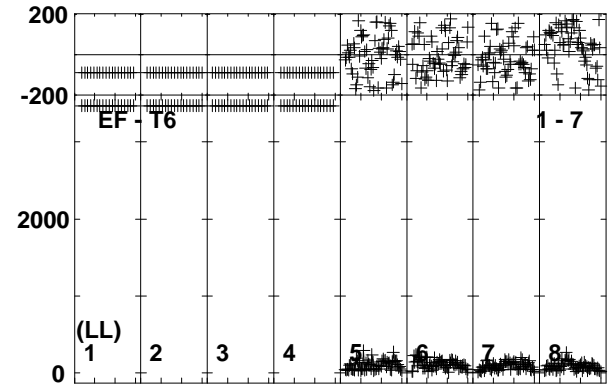
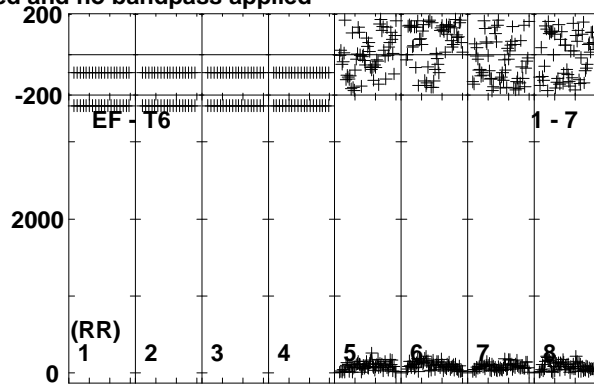
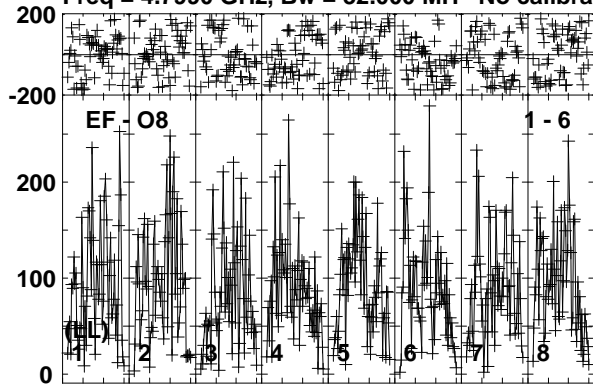

Lower frame: Micro Ampl Jy Top frame: Phas deg  
Vector averaged cross-power spectrum Baseline: EF (01) - O8 (06)  
Timerange: 00/02:13:31 to 00/02:17:00

Plot file version 61 created 24-NOV-2017 10:09:50

J1108+4330 EG096D.UVDATA.1

Freq = 4.7990 GHz, Bw = 32.000 MH No calibration applied and no bandpass applied

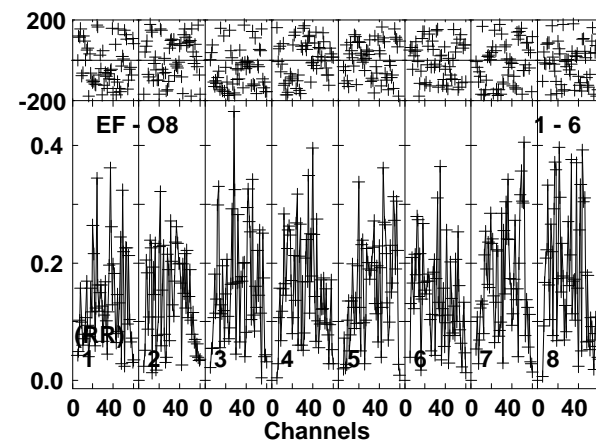
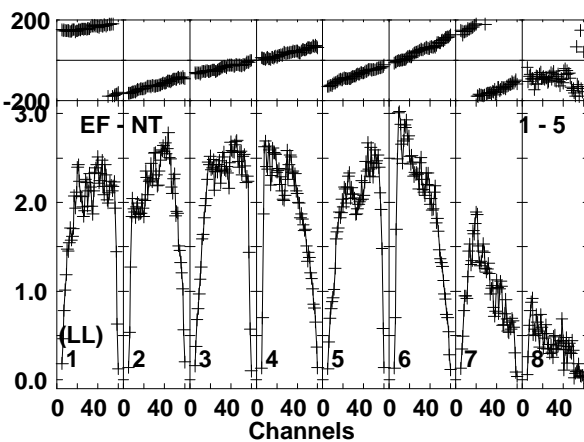
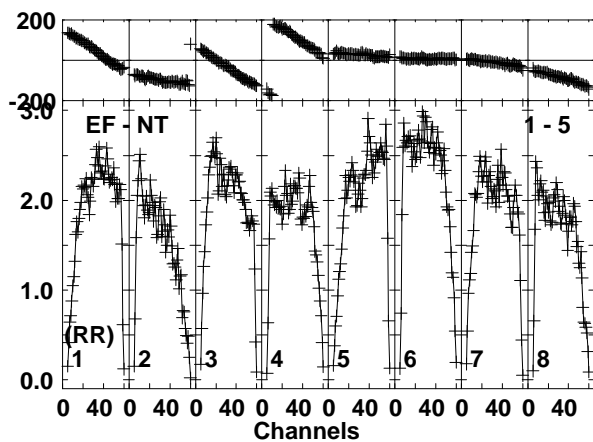
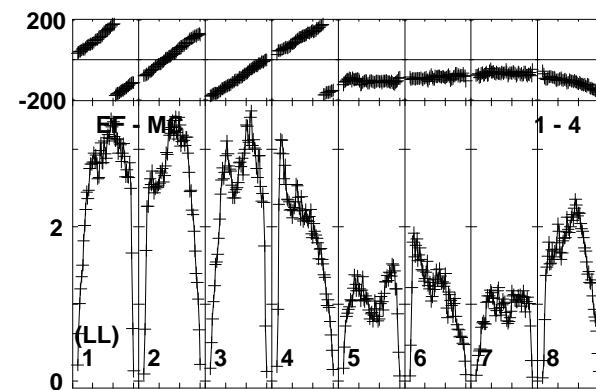
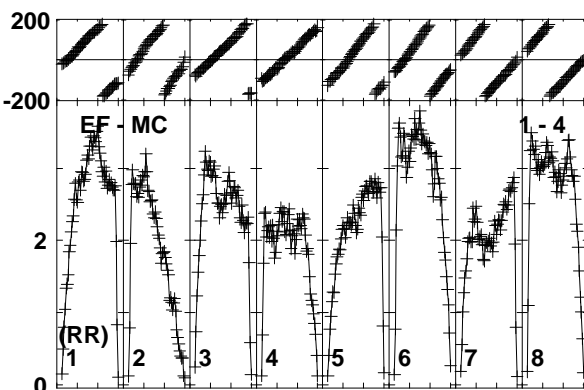
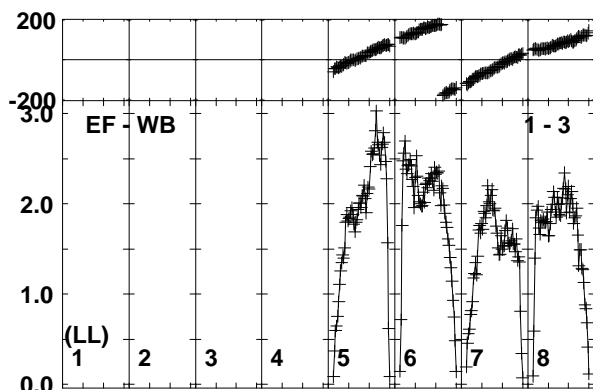
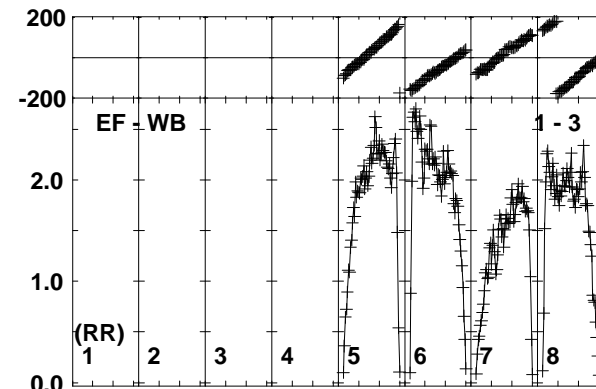
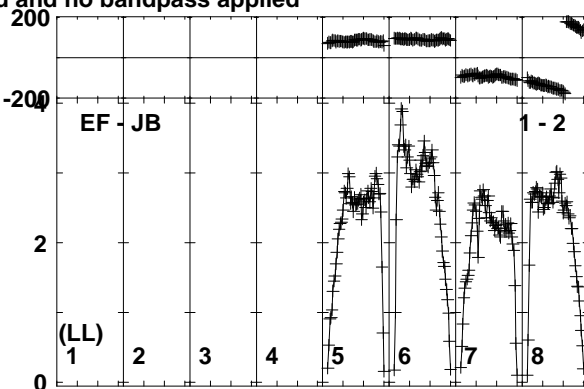
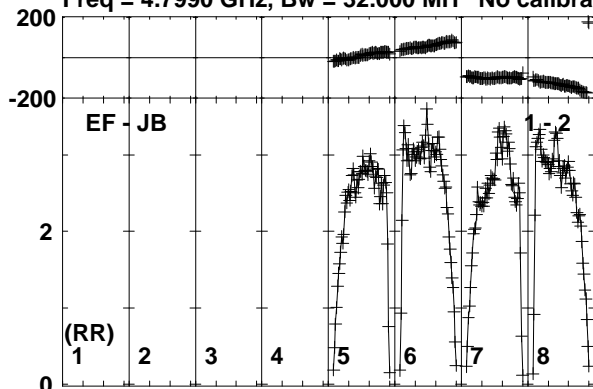

Lower frame: Milli Ampl Jy Top frame: Phas deg  
Vector averaged cross-power spectrum Baseline: EF (01) - JB (02)  
Timerange: 00/02:17:40 to 00/02:18:39

Plot file version 62 created 24-NOV-2017 10:09:50

J1108+4330 EG096D.UVDATA.1

Freq = 4.7990 GHz, Bw = 32.000 MH No calibration applied and no bandpass applied

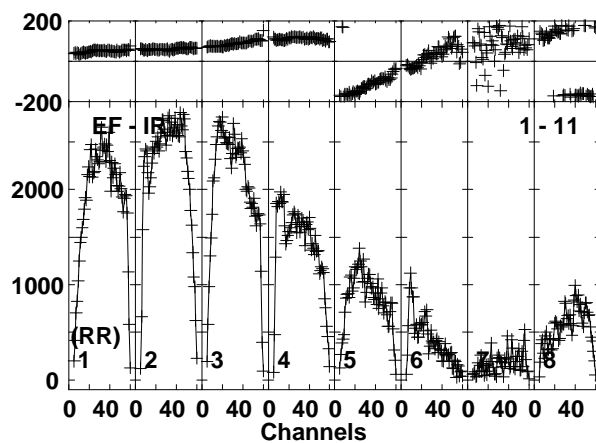
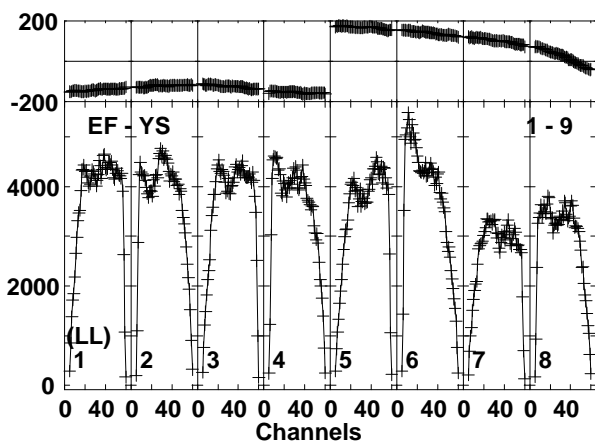
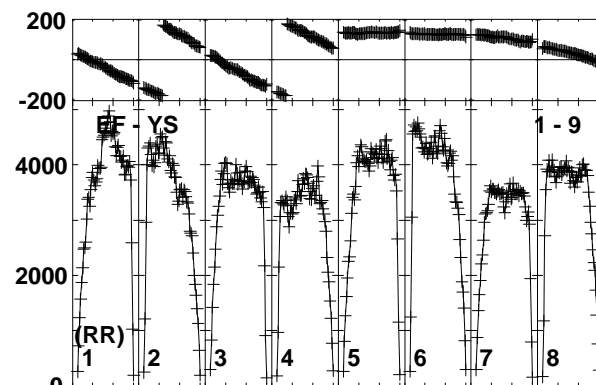
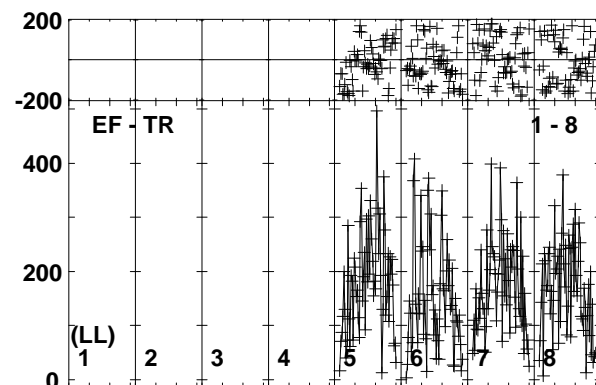
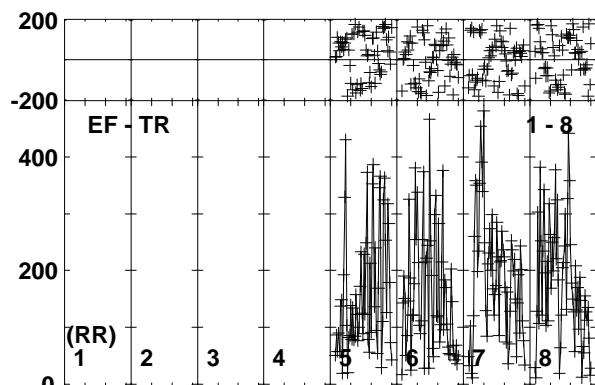
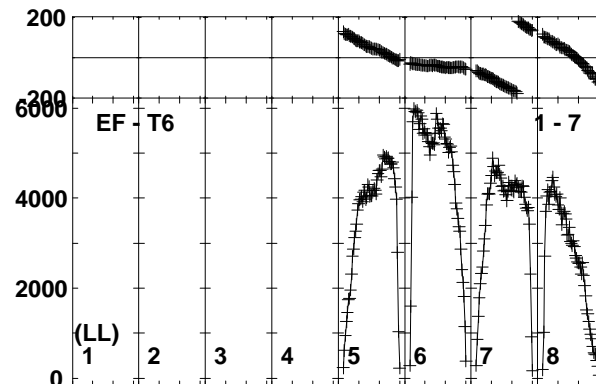
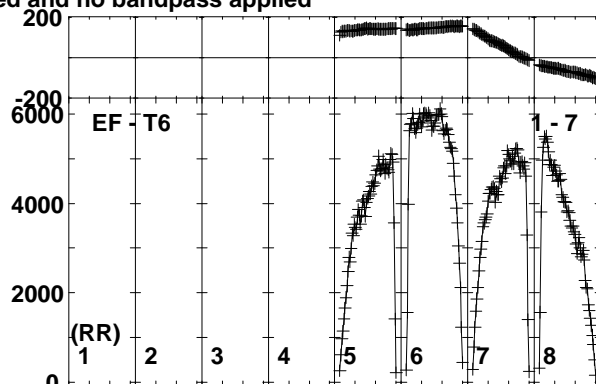
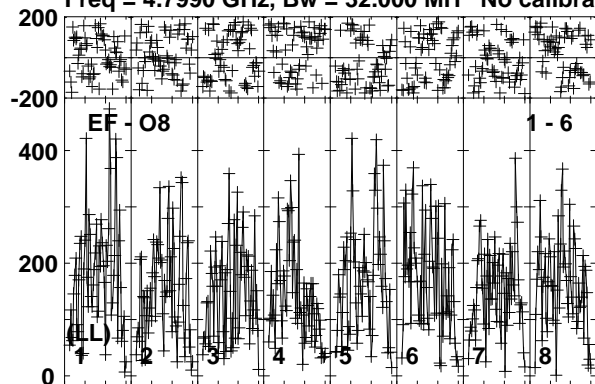

Lower frame: Micro Ampl Jy Top frame: Phas deg  
Vector averaged cross-power spectrum Baseline: EF (01) - O8 (06)  
Timerange: 00:02:17:40 to 00:02:18:39

Plot file version 63 created 24-NOV-2017 10:09:50

ARUMA EG096D.UVDATA.1

Freq = 4.7990 GHz, Bw = 32.000 MH No calibration applied and no bandpass applied

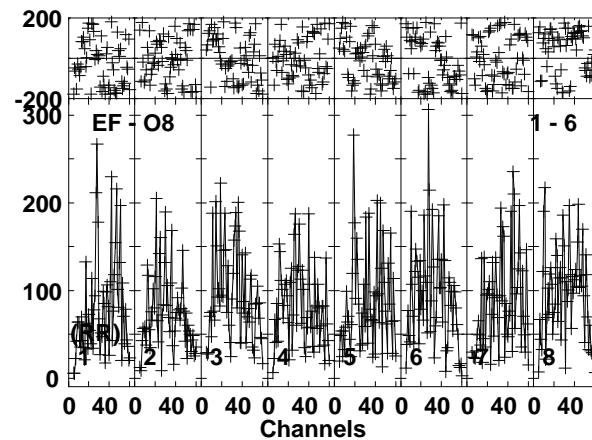
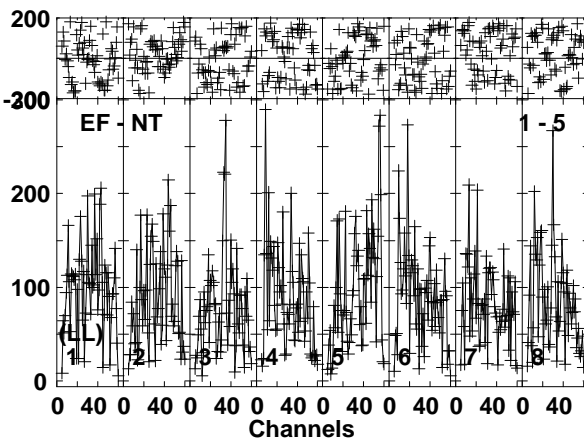
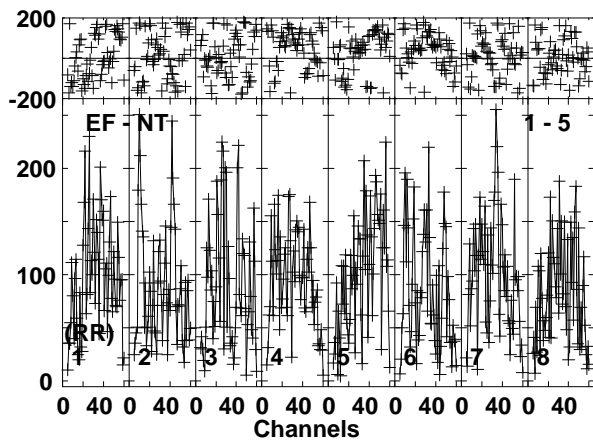
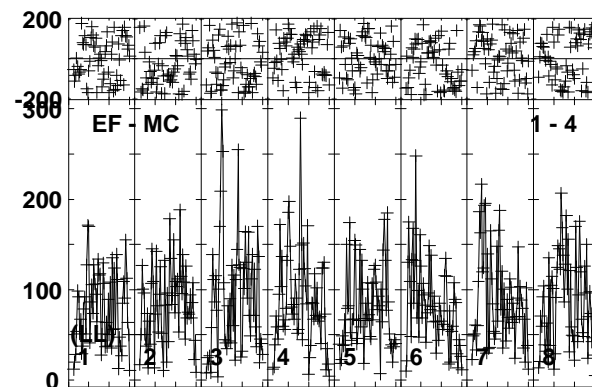
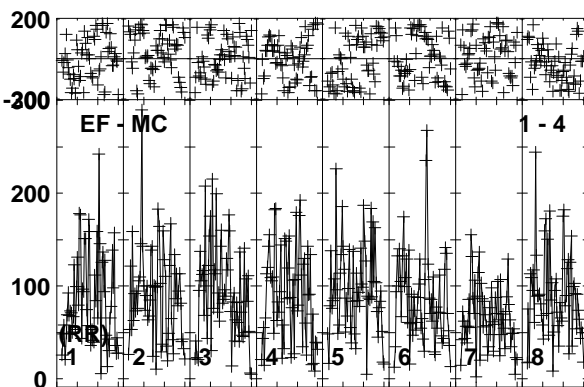
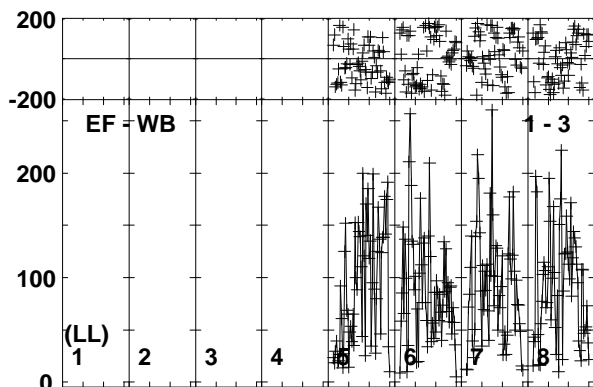
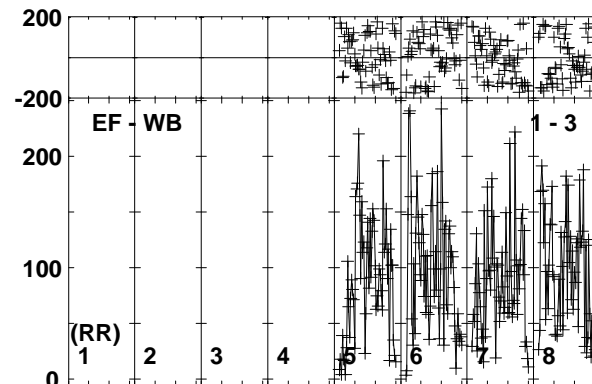
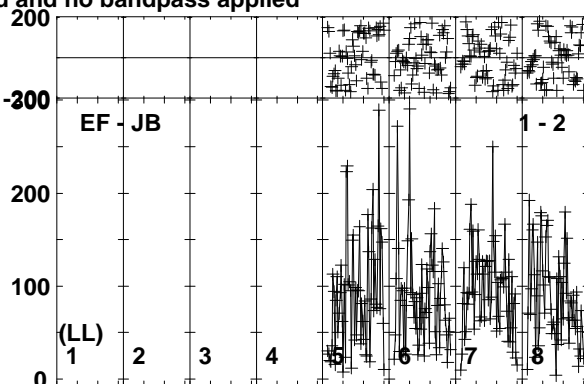
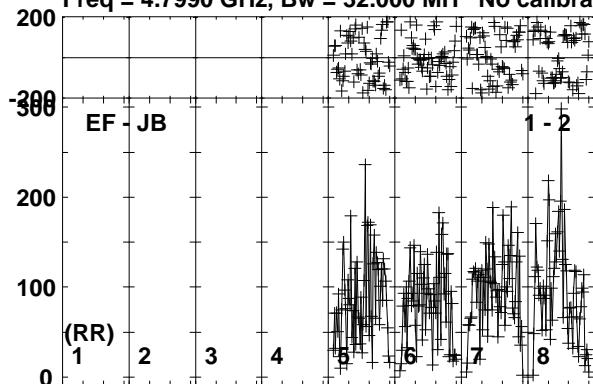

Lower frame: Micro Ampl Jy Top frame: Phas deg  
Vector averaged cross-power spectrum Baseline: EF (01) - JB (02)  
Timerange: 00/02:18:40 to 00/02:22:10

Plot file version 64 created 24-NOV-2017 10:09:50  
 ARUMA EG096D.UVDATA.1  
 Freq = 4.7990 GHz, Bw = 32.000 MH No calibration applied and no bandpass applied

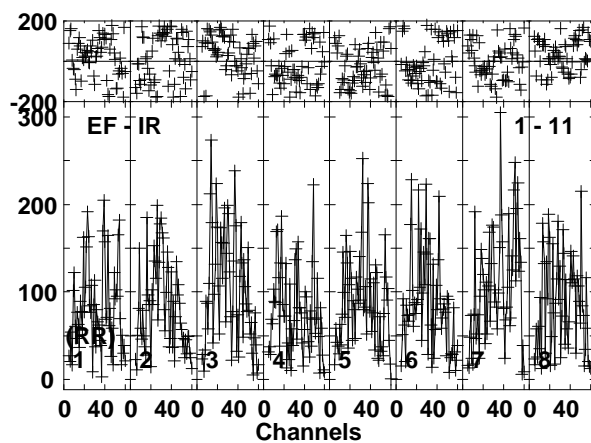
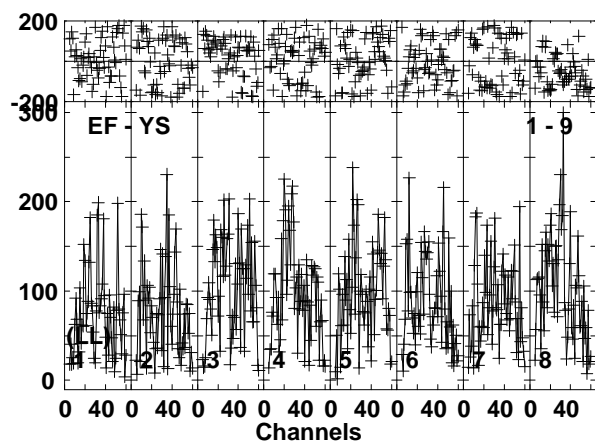
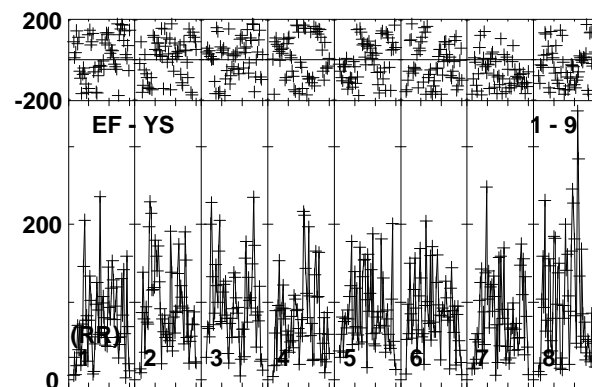
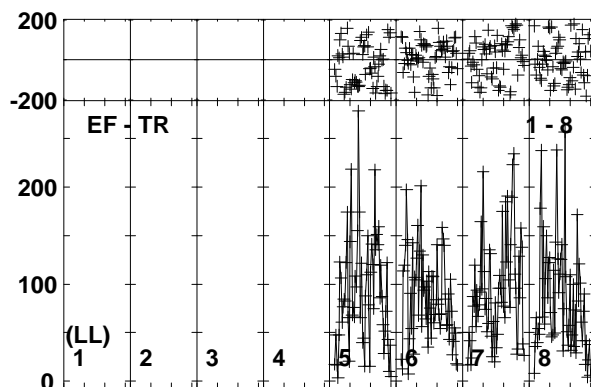
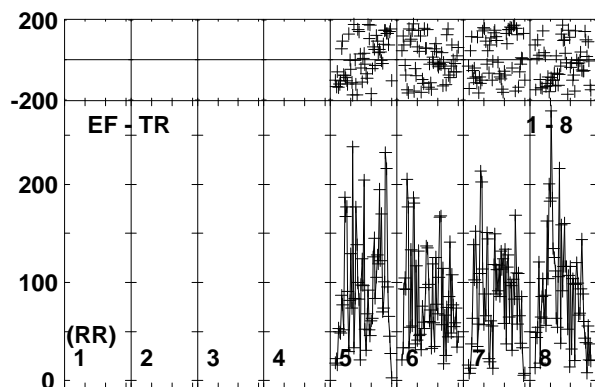
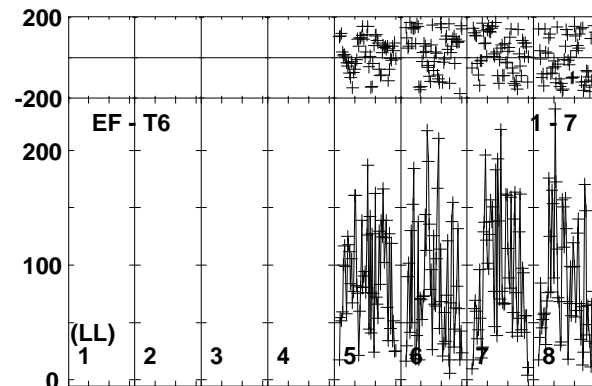
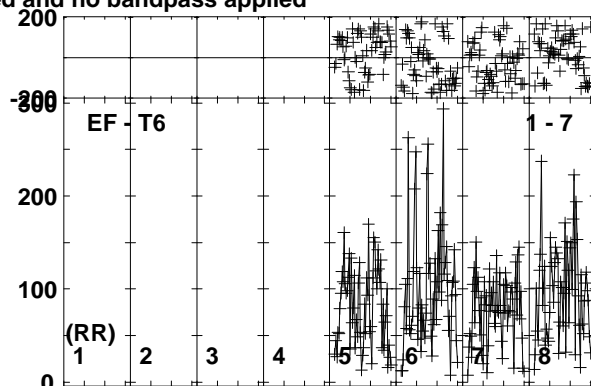
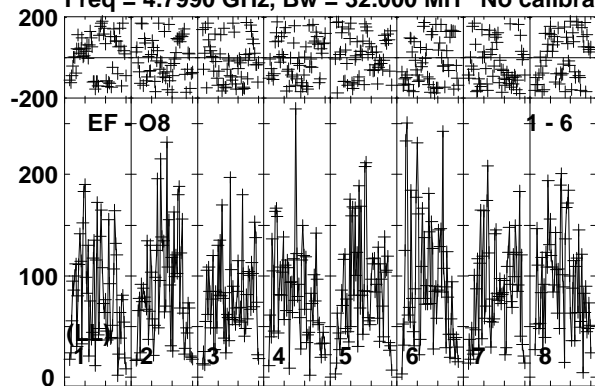

Lower frame: Micro Ampl Jy Top frame: Phas deg  
 Vector averaged cross-power spectrum Baseline: EF (01) - O8 (06)  
 Timerange: 00/02:18:40 to 00/02:22:10

Plot file version 65 created 24-NOV-2017 10:09:51

J1108+4330 EG096D.UVDATA.1

Freq = 4.7990 GHz, Bw = 32.000 MH No calibration applied and no bandpass applied

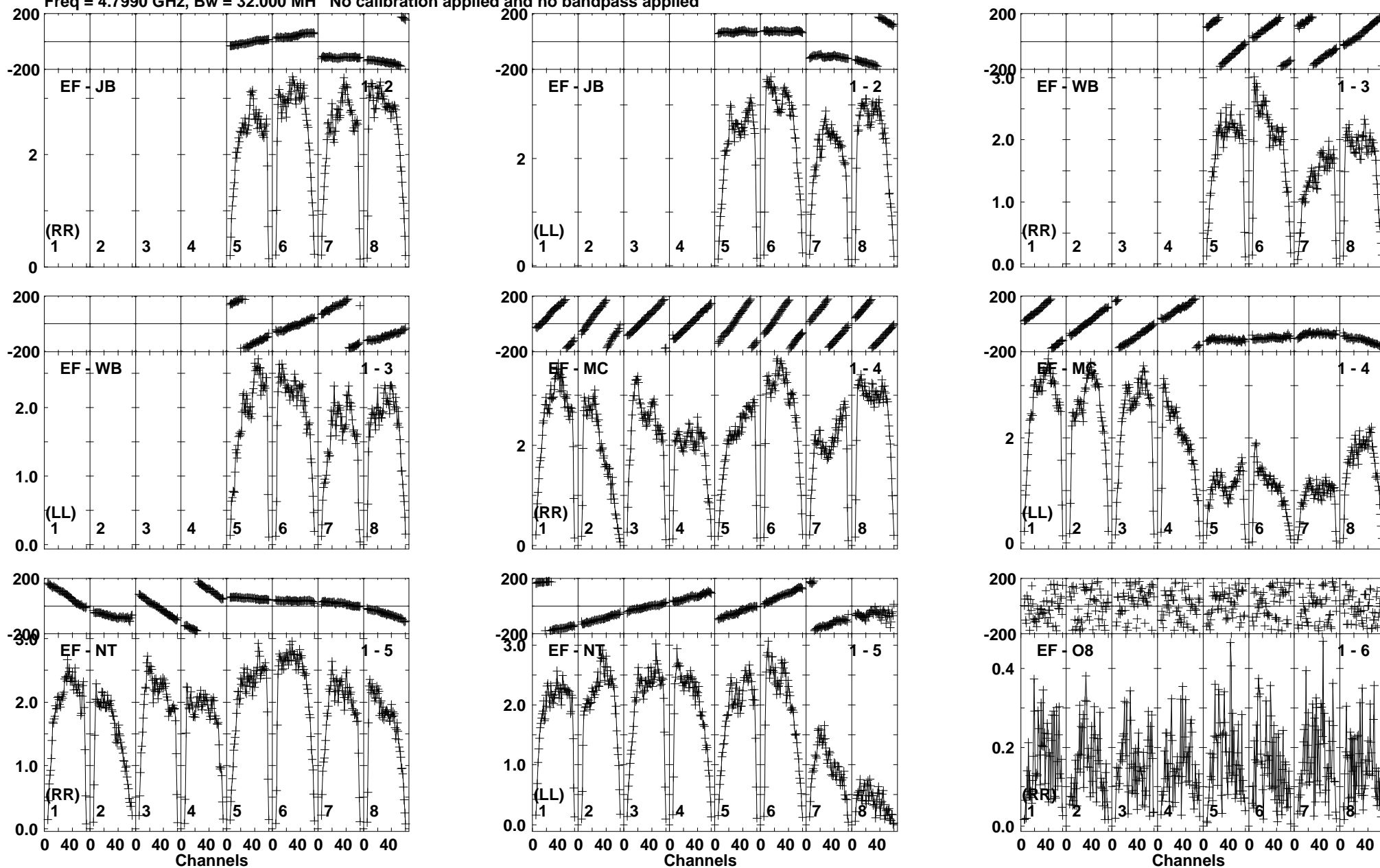

Lower frame: Milli Ampl Jy Top frame: Phas deg  
Vector averaged cross-power spectrum Baseline: EF (01) - JB (02)  
Timerange: 00/02:22:10 to 00/02:23:39

Plot file version 66 created 24-NOV-2017 10:09:51

J1108+4330 EG096D.UVDATA.1

Freq = 4.7990 GHz, Bw = 32.000 MH No calibration applied and no bandpass applied

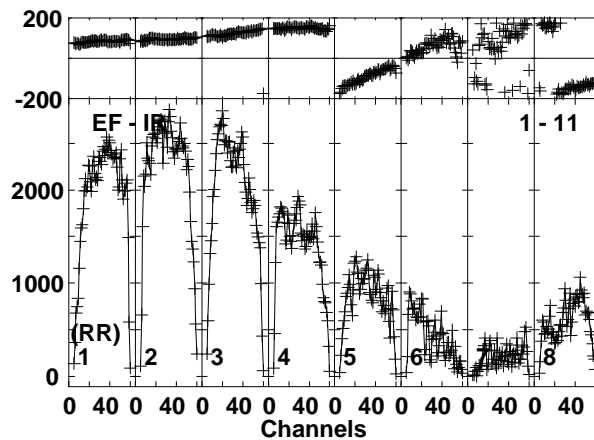
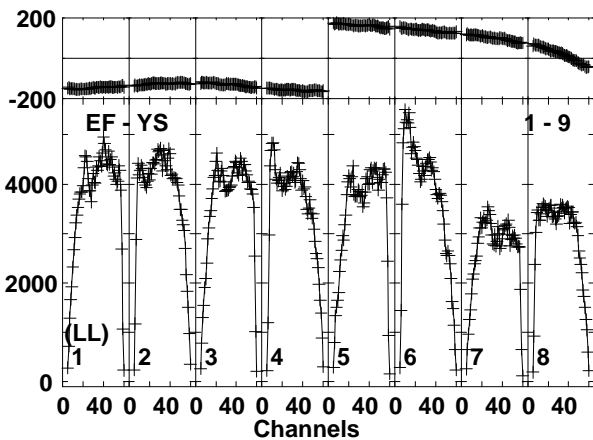
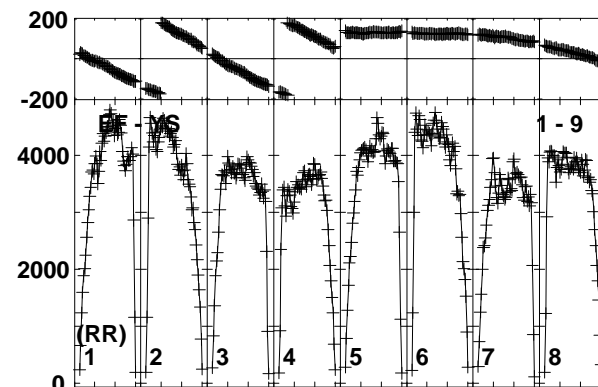
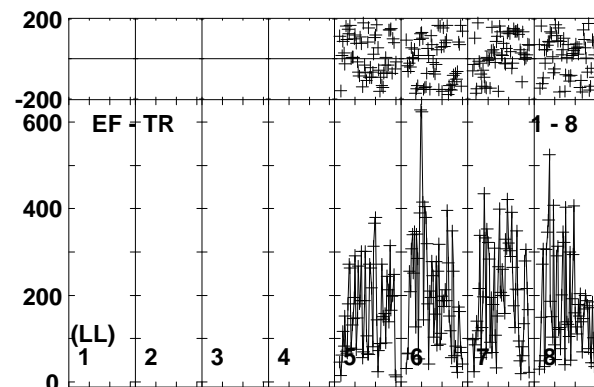
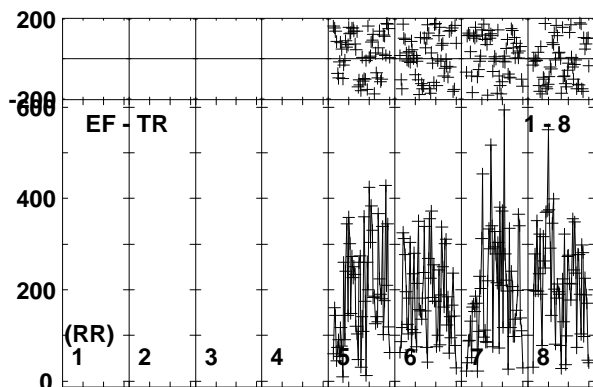
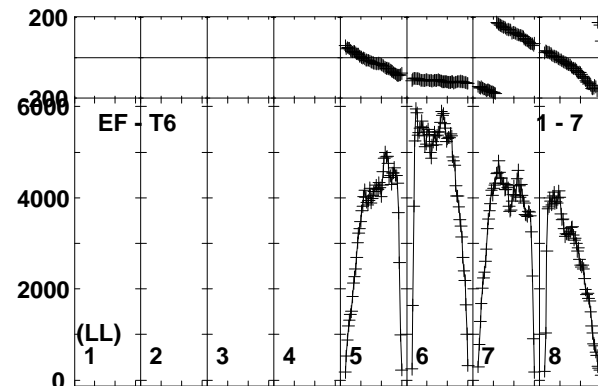
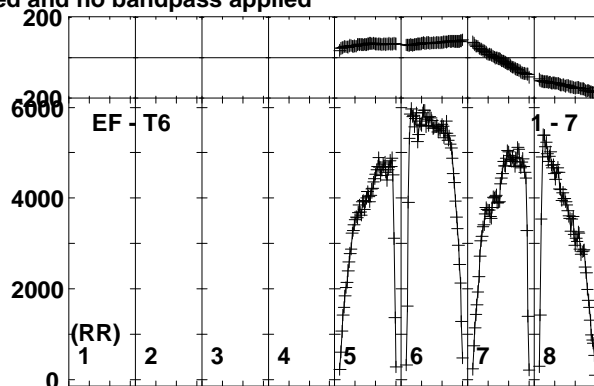
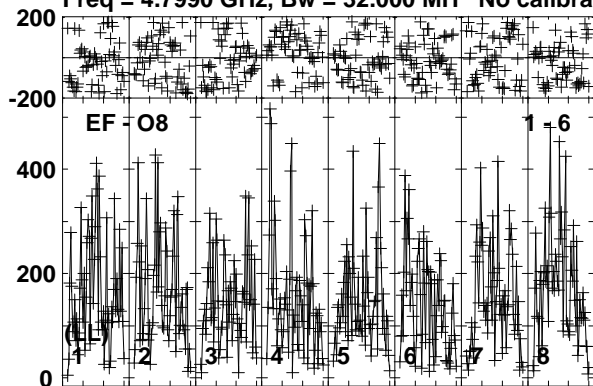

Lower frame: Micro Ampl Jy Top frame: Phas deg  
Vector averaged cross-power spectrum Baseline: EF (01) - O8 (06)  
Timerange: 00/02:22:10 to 00/02:23:39



Plot file version 67 created 24-NOV-2017 10:09:51  
 ARUMA EG096D.UVDATA.1  
 Freq = 4.7990 GHz, Bw = 32.000 MH No calibration applied and no bandpass applied

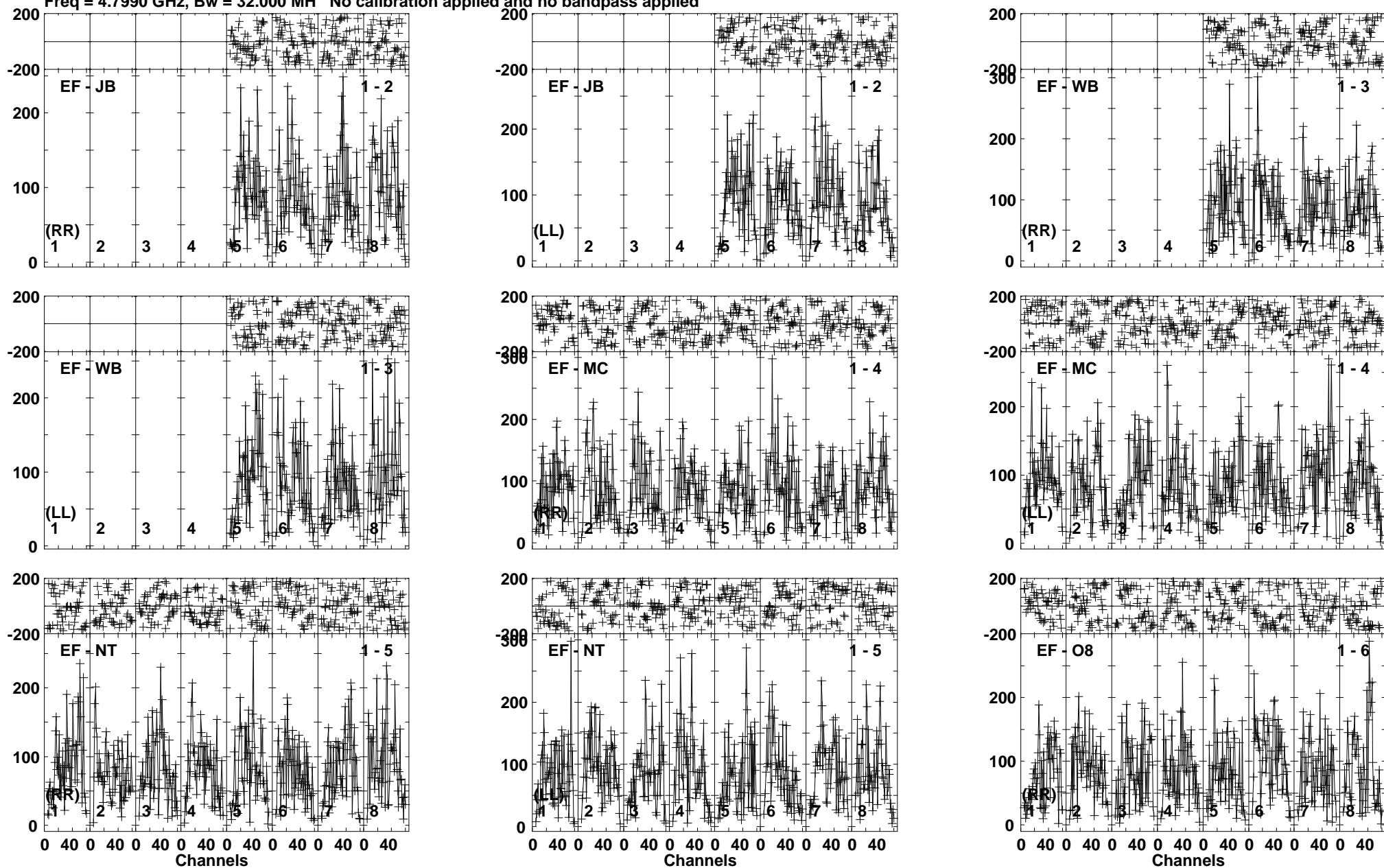

Lower frame: Micro Ampl Jy Top frame: Phas deg  
 Vector averaged cross-power spectrum Baseline: EF (01) - JB (02)  
 Timerange: 00/02:23:41 to 00/02:27:09

Plot file version 68 created 24-NOV-2017 10:09:52

ARUMA EG096D.UVDATA.1

Freq = 4.7990 GHz, Bw = 32.000 MH No calibration applied and no bandpass applied

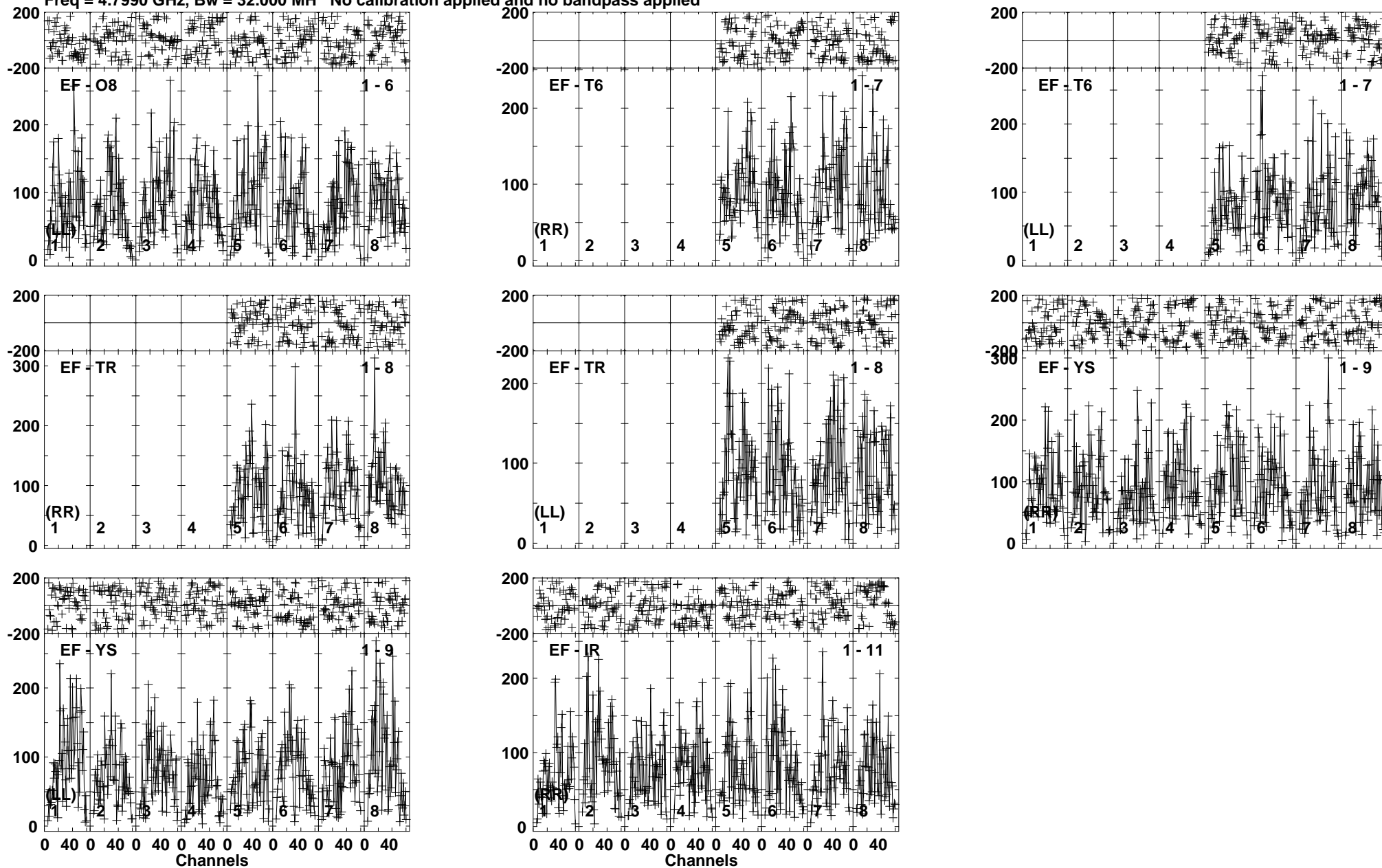

Lower frame: Micro Ampl Jy Top frame: Phas deg  
Vector averaged cross-power spectrum Baseline: EF (01) - O8 (06)  
Timerange: 00/02:23:41 to 00/02:27:09

Plot file version 69 created 24-NOV-2017 10:09:52  
 J1108+4330 EG096D.UVDATA.1  
 Freq = 4.7990 GHz, Bw = 32.000 MH No calibration applied and no bandpass applied

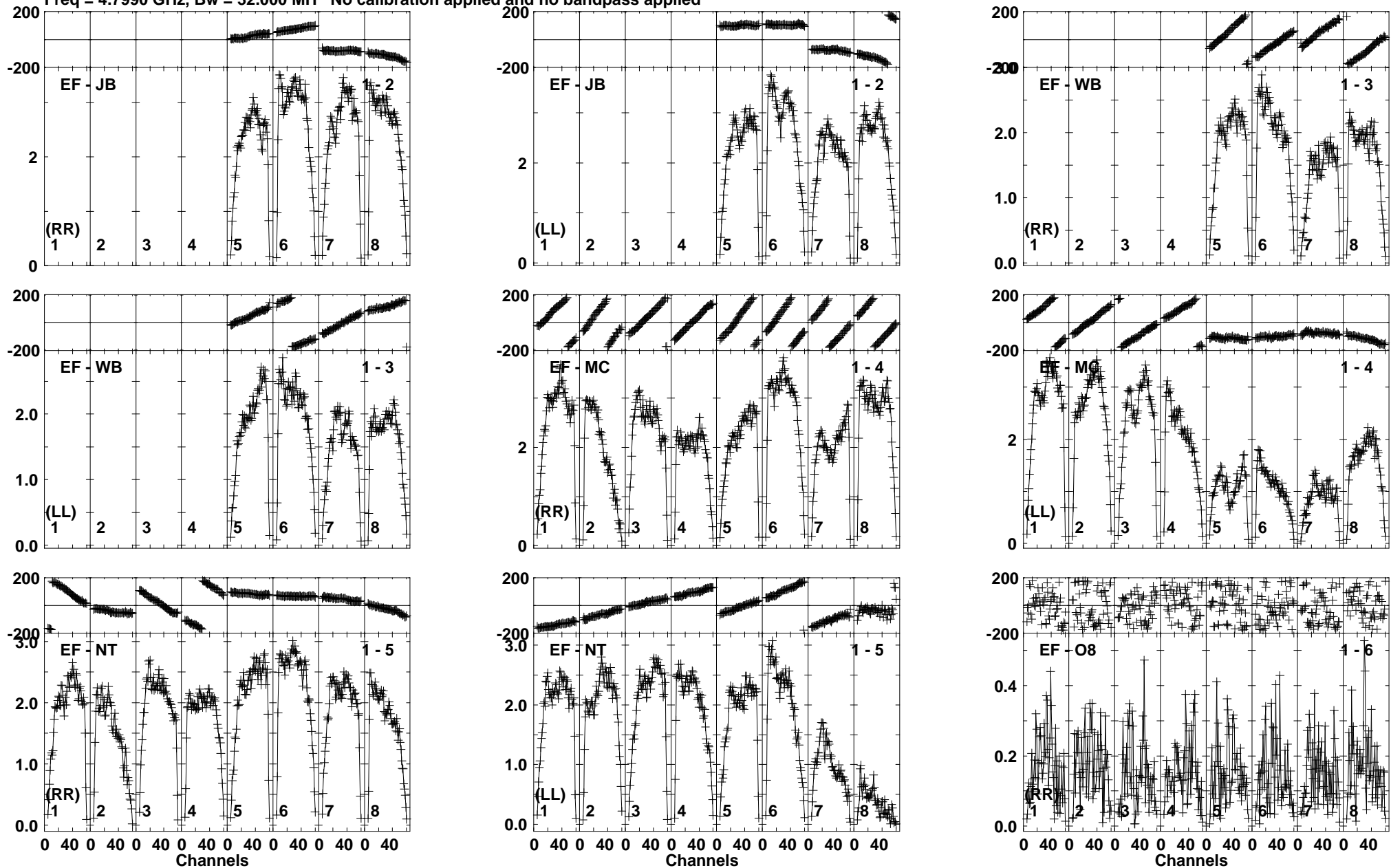

Lower frame: Milli Ampl Jy Top frame: Phas deg  
 Vector averaged cross-power spectrum Baseline: EF (01) - JB (02)  
 Timerange: 00/02:27:51 to 00/02:28:49

Plot file version 70 created 24-NOV-2017 10:09:52

J1108+4330 EG096D.UVDATA.1

Freq = 4.7990 GHz, Bw = 32.000 MH No calibration applied and no bandpass applied

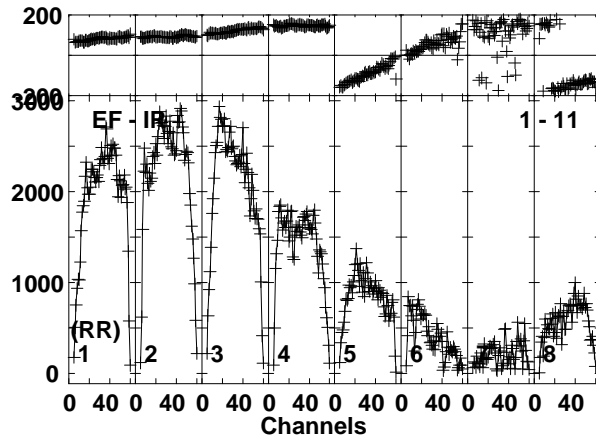
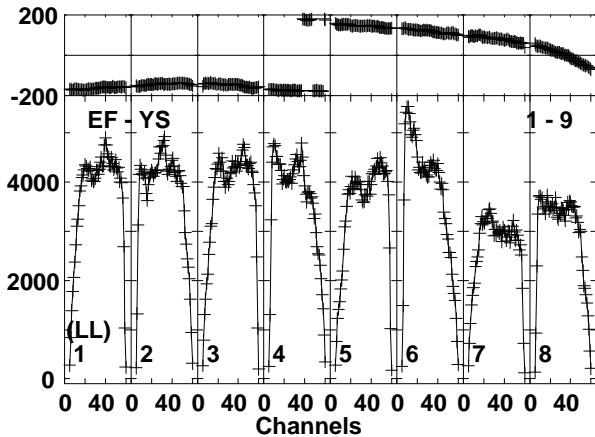
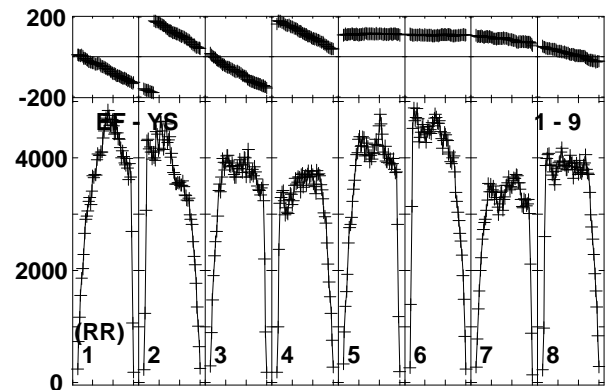
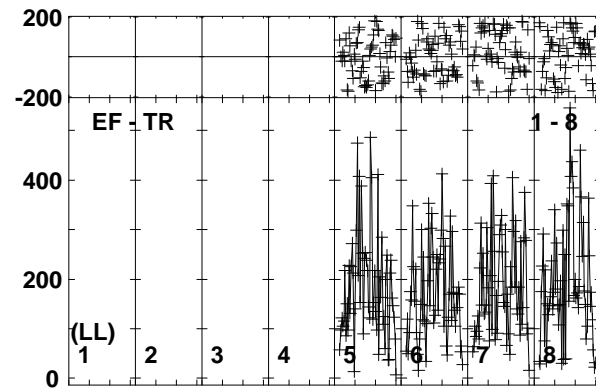
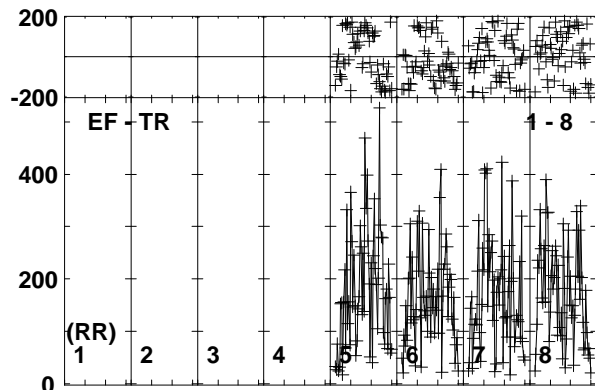
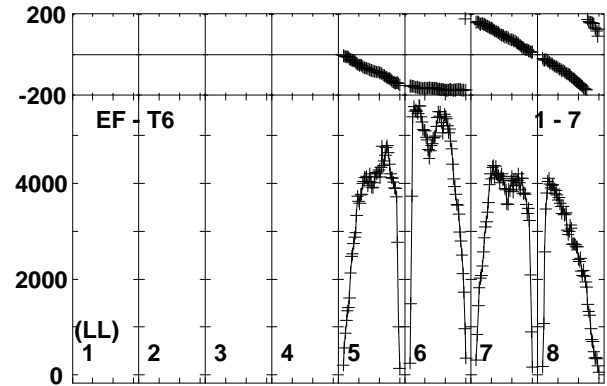
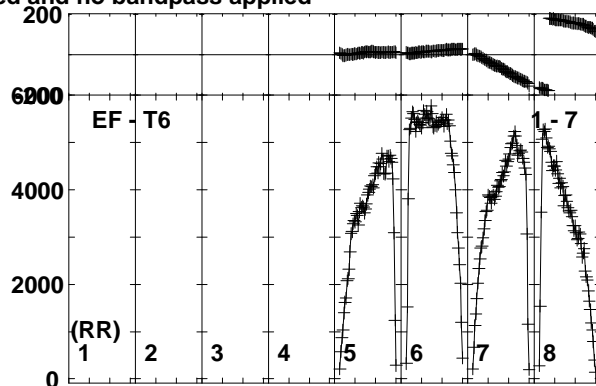
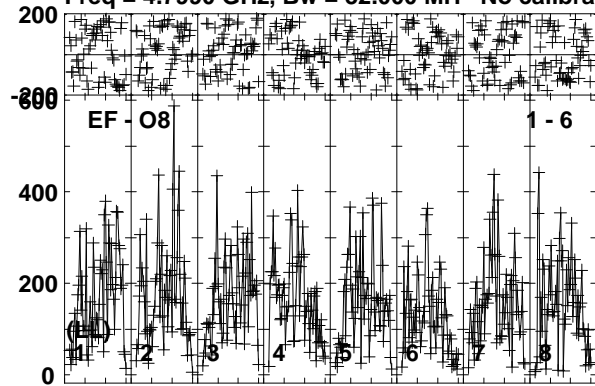

Lower frame: Micro Ampl Jy Top frame: Phas deg  
Vector averaged cross-power spectrum Baseline: EF (01) - O8 (06)  
Timerange: 00/02:27:51 to 00/02:28:49

Plot file version 71 created 24-NOV-2017 10:09:52

ARUMA EG096D.UVDATA.1

Freq = 4.7990 GHz, Bw = 32.000 MH No calibration applied and no bandpass applied

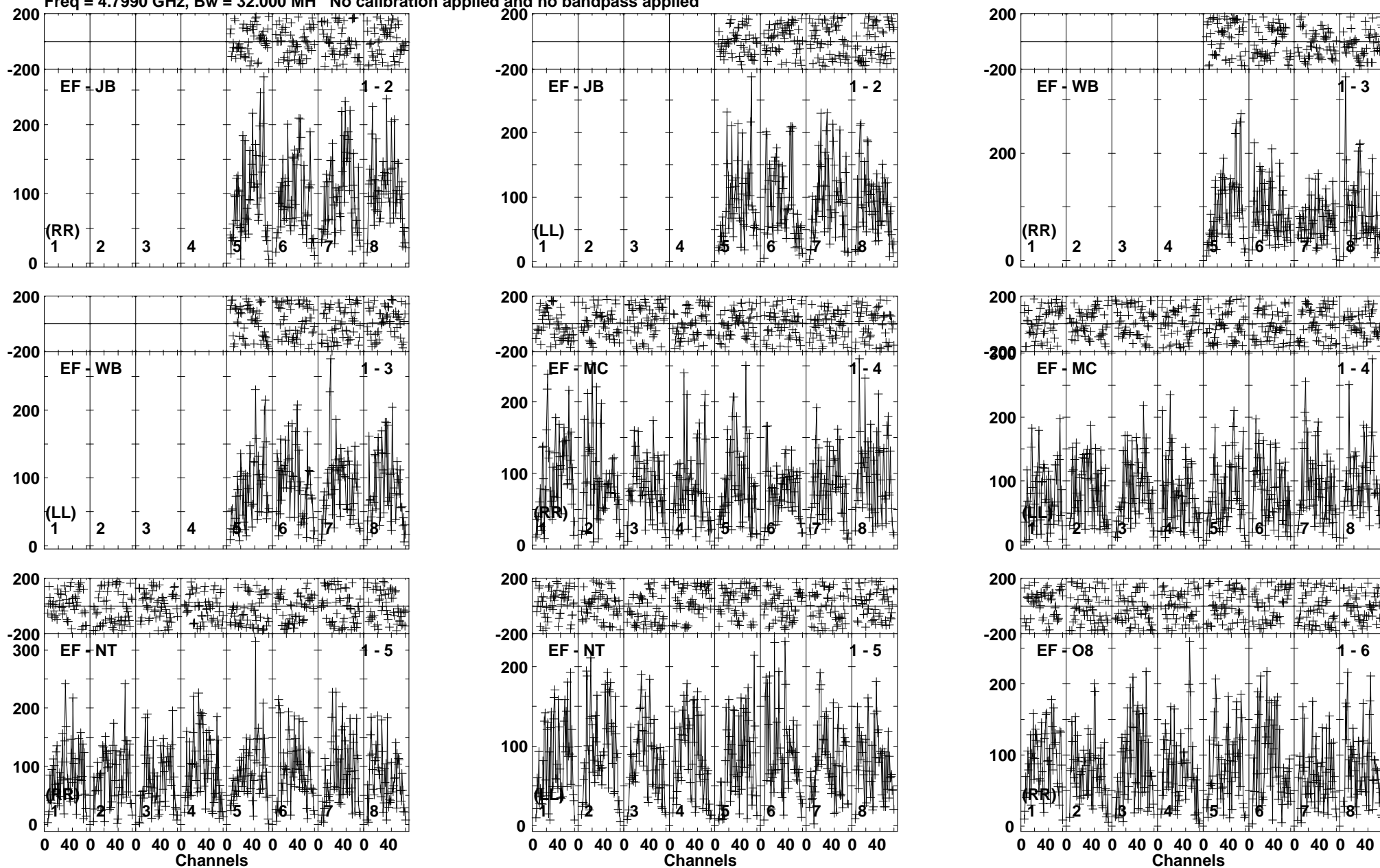

Lower frame: Micro Ampl Jy Top frame: Phas deg  
Vector averaged cross-power spectrum Baseline: EF (01) - JB (02)  
Timerange: 00/02:28:51 to 00/02:32:19

Plot file version 72 created 24-NOV-2017 10:09:53

ARUMA EG096D.UVDATA.1

Freq = 4.7990 GHz, Bw = 32.000 MH No calibration applied and no bandpass applied

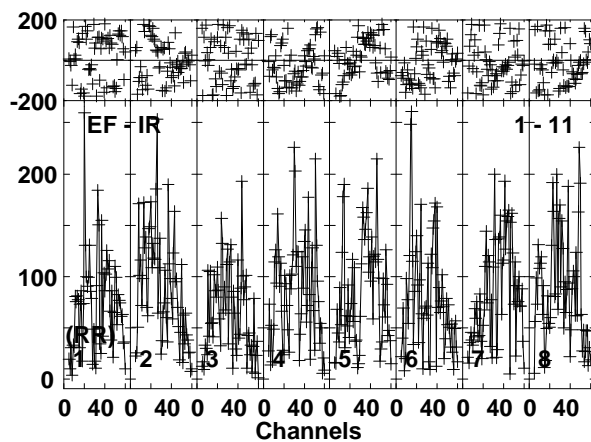
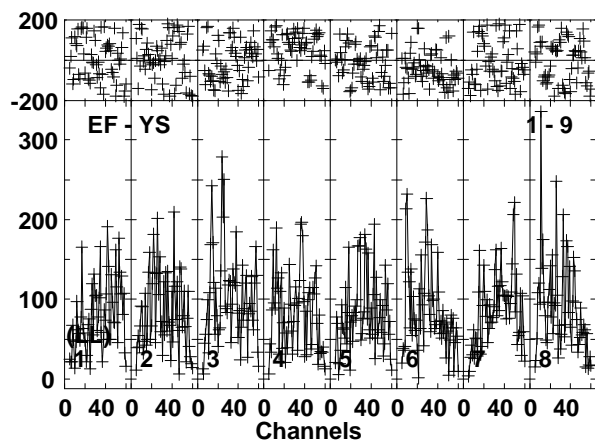
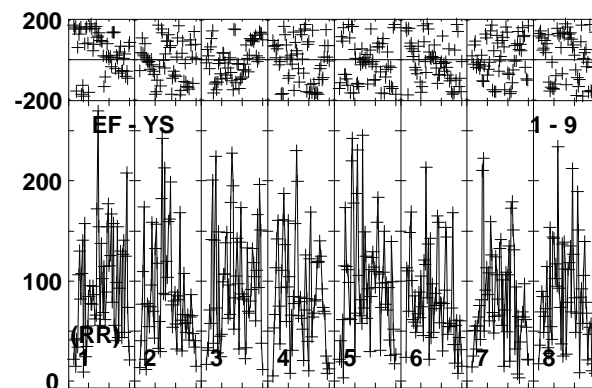
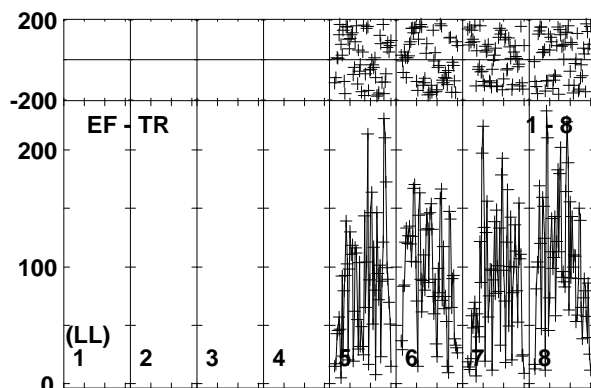
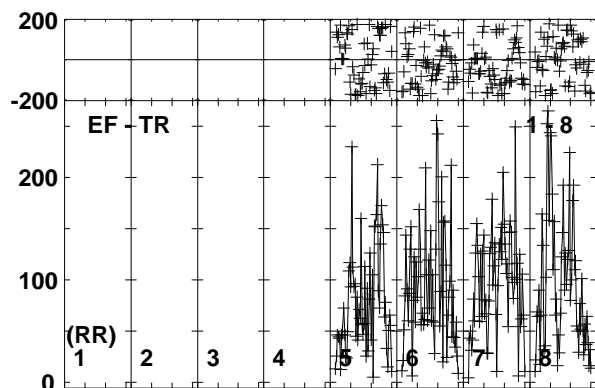
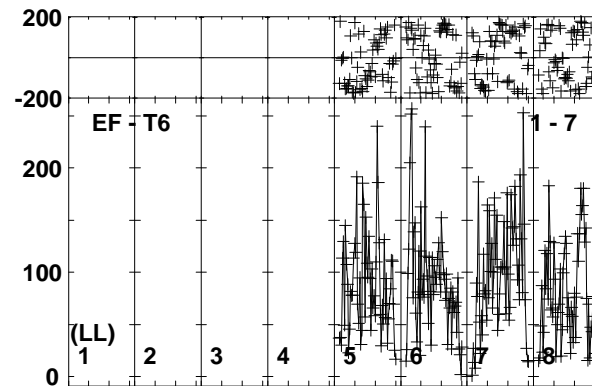
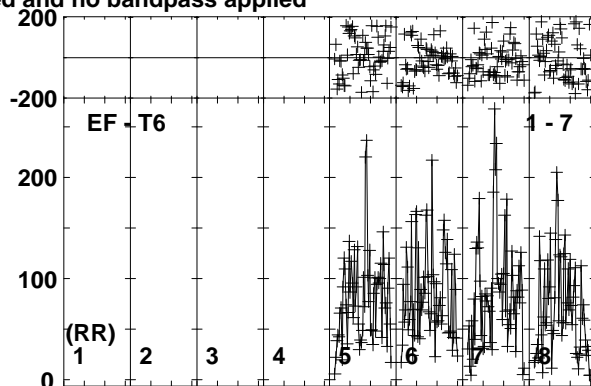
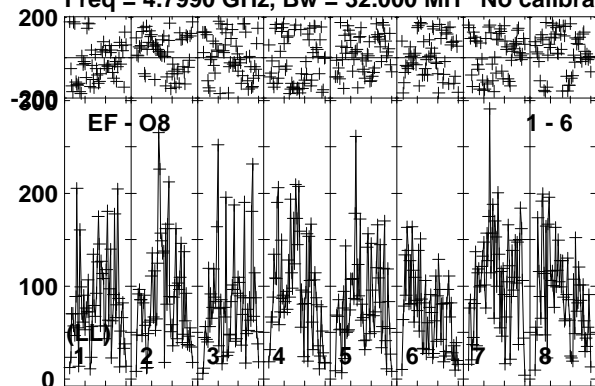

Lower frame: Micro Ampl Jy Top frame: Phas deg  
Vector averaged cross-power spectrum Baseline: EF (01) - O8 (06)  
Timerange: 00/02:28:51 to 00/02:32:19

Plot file version 73 created 24-NOV-2017 10:09:53

J1108+4330 EG096D.UVDATA.1

Freq = 4.7990 GHz, Bw = 32.000 MH No calibration applied and no bandpass applied

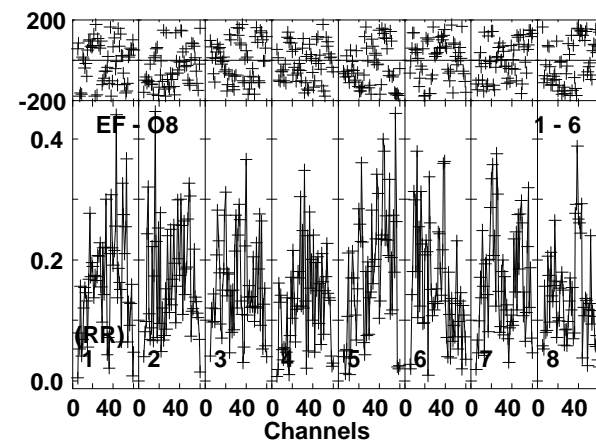
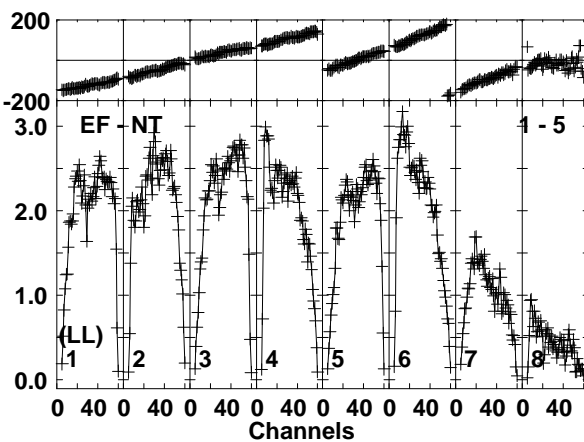
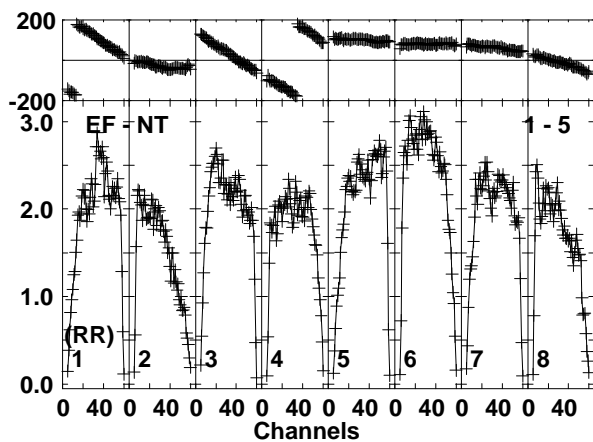
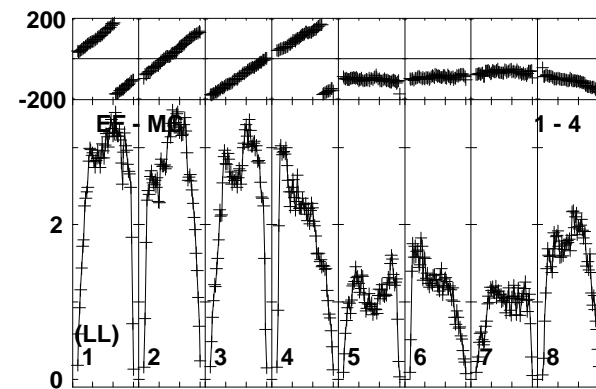
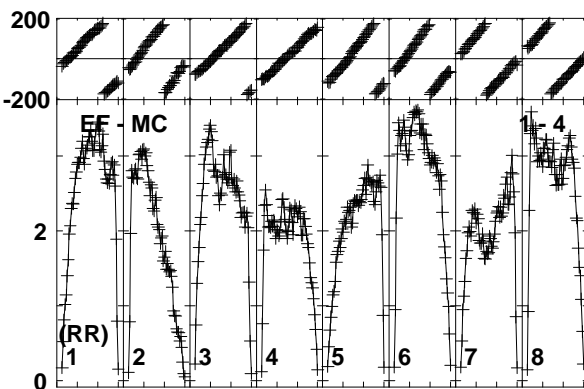
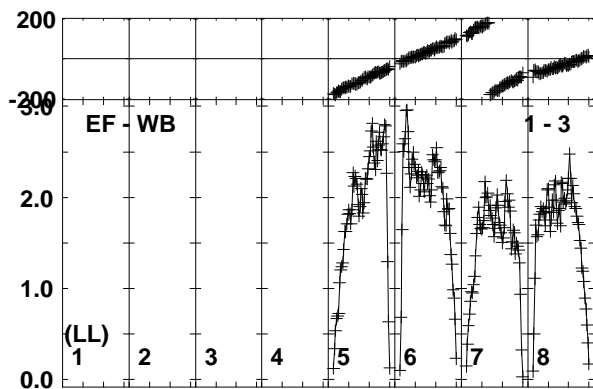
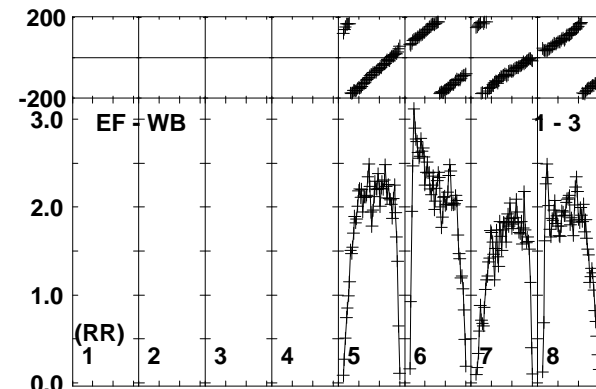
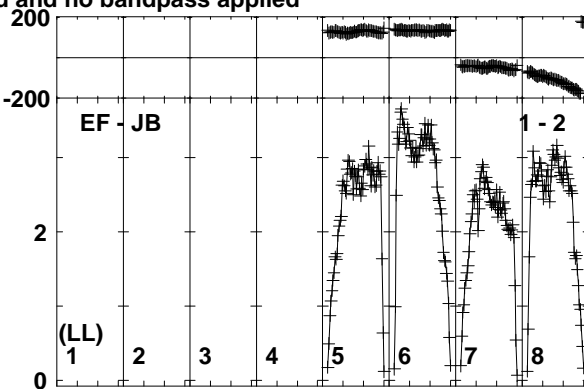
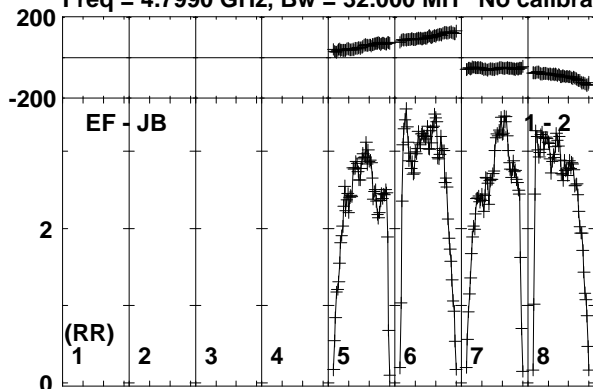

Lower frame: Milli Ampl Jy Top frame: Phas deg  
Vector averaged cross-power spectrum Baseline: EF (01) - JB (02)  
Timerange: 00/02:32:20 to 00/02:33:49

Plot file version 74 created 24-NOV-2017 10:09:53

J1108+4330 EG096D.UVDATA.1

Freq = 4.7990 GHz, Bw = 32.000 MH No calibration applied and no bandpass applied

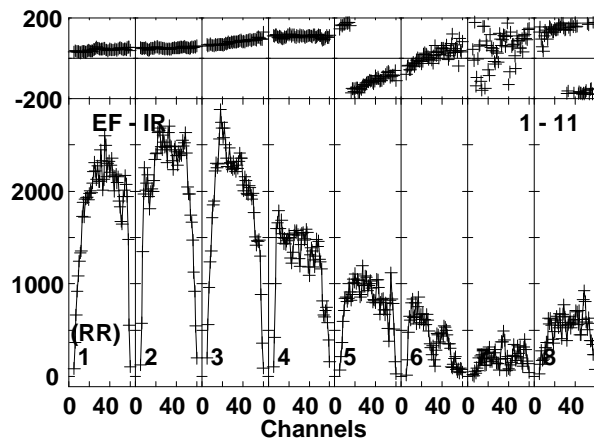
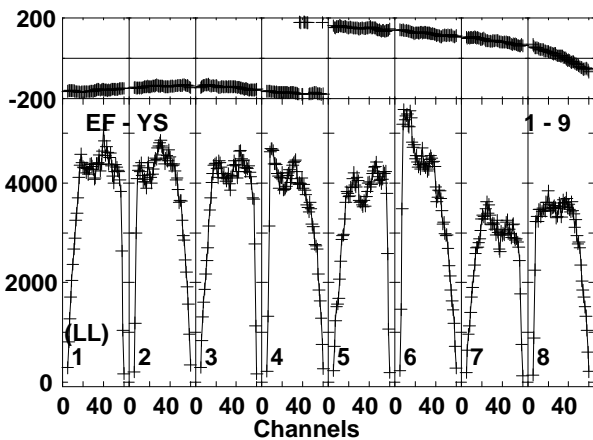
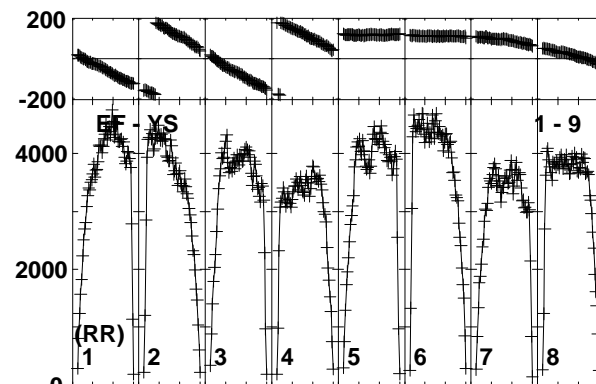
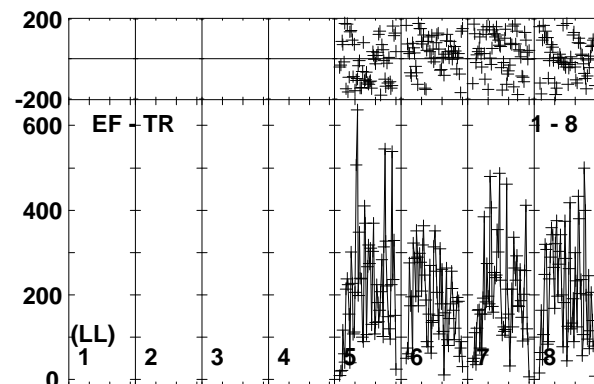
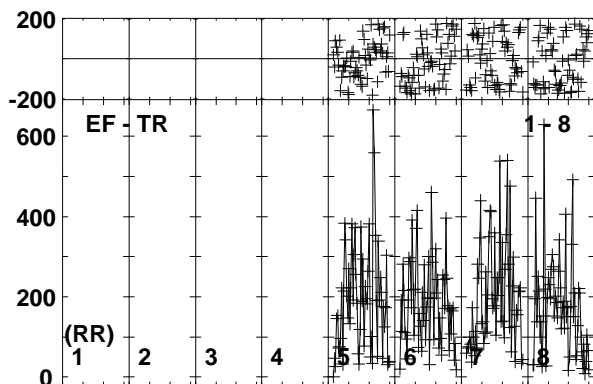
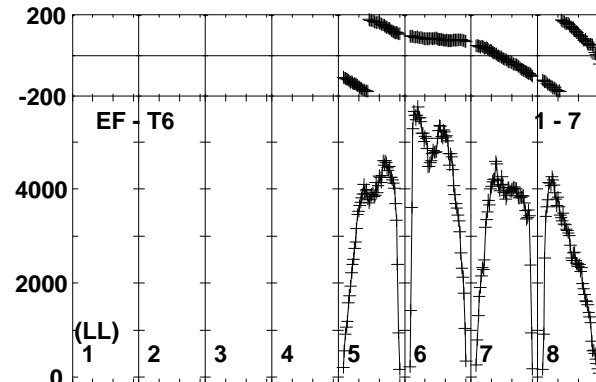
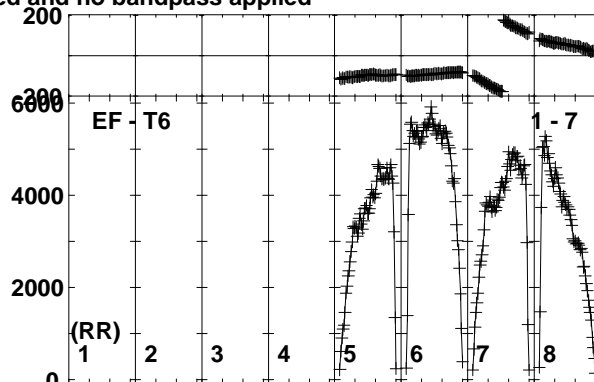
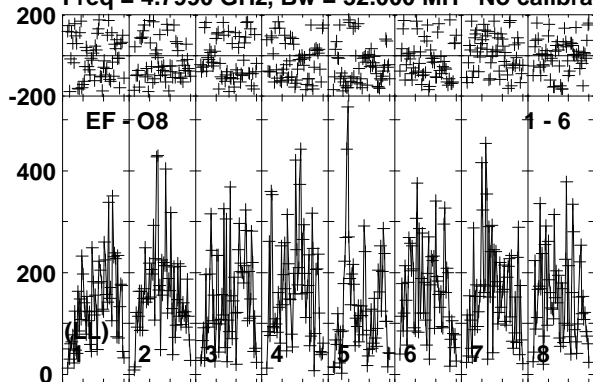

Lower frame: Micro Ampl Jy Top frame: Phas deg  
Vector averaged cross-power spectrum Baseline: EF (01) - O8 (06)  
Timerange: 00/02:32:20 to 00/02:33:49



Plot file version 75 created 24-NOV-2017 10:09:54

ARUMA EG096D.UVDATA.1

Freq = 4.7990 GHz, Bw = 32.000 MH No calibration applied and no bandpass applied

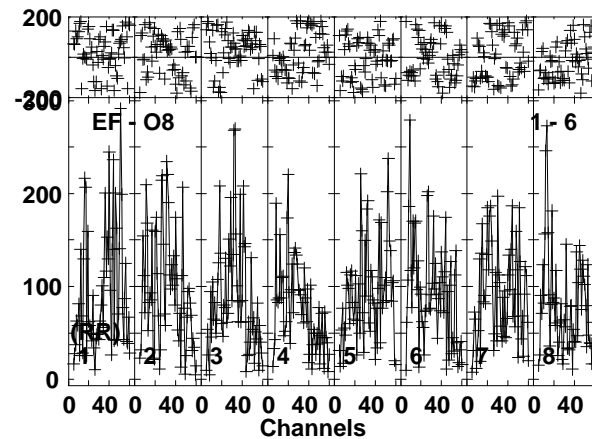
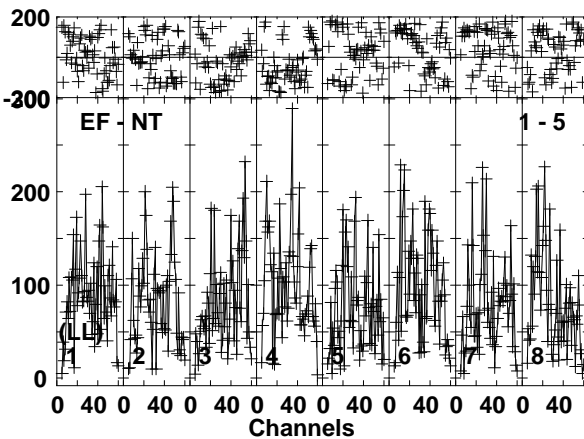
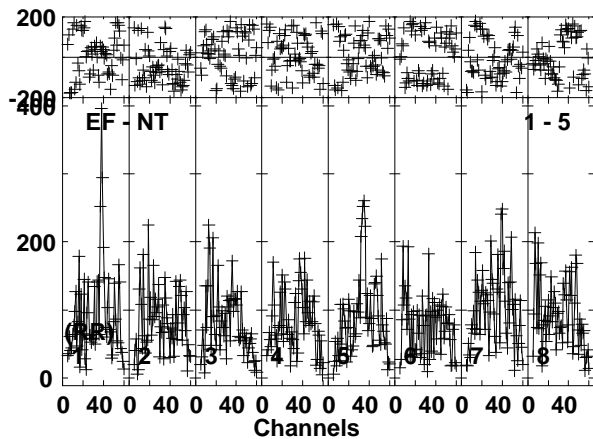
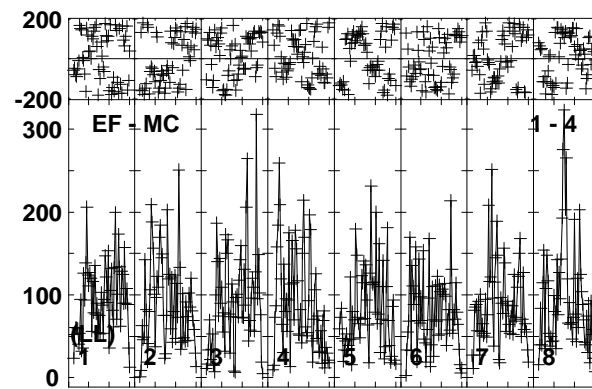
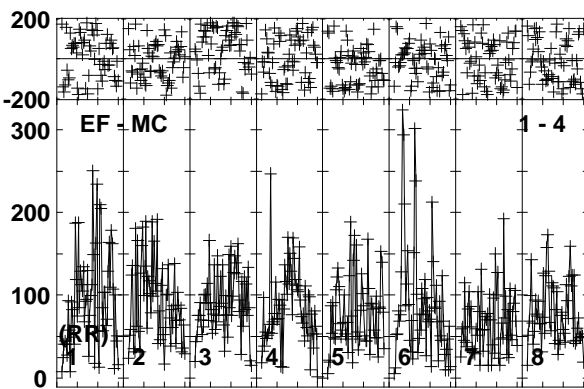
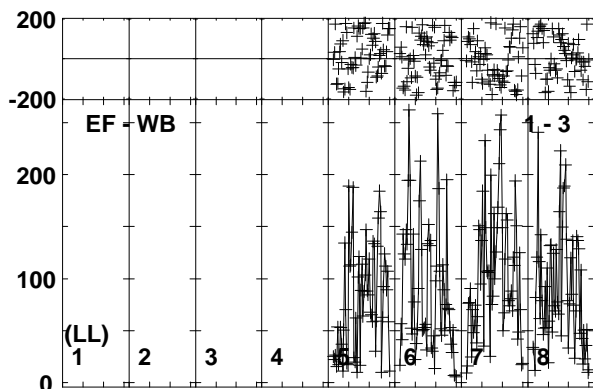
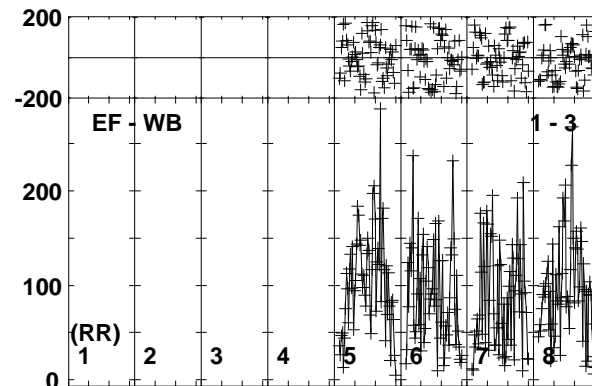
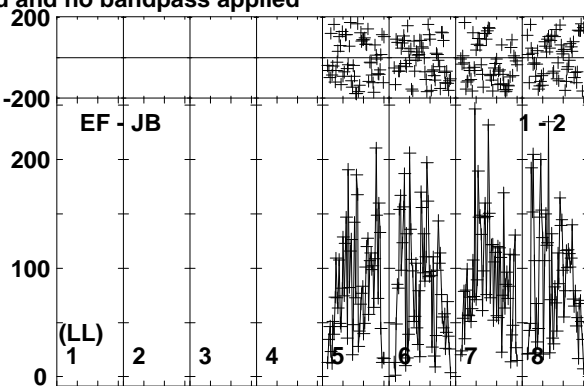
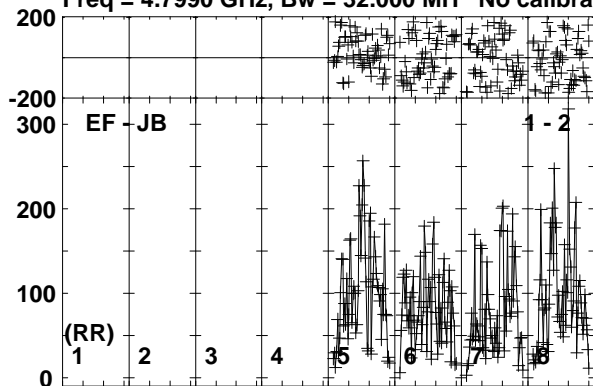

Lower frame: Micro Ampl Jy Top frame: Phas deg  
Vector averaged cross-power spectrum Baseline: EF (01) - JB (02)  
Timerange: 00/02:33:51 to 00/02:37:20



Plot file version 77 created 24-NOV-2017 10:09:54

J1108+4330 EG096D.UVDATA.1

Freq = 4.7990 GHz, Bw = 32.000 MH No calibration applied and no bandpass applied

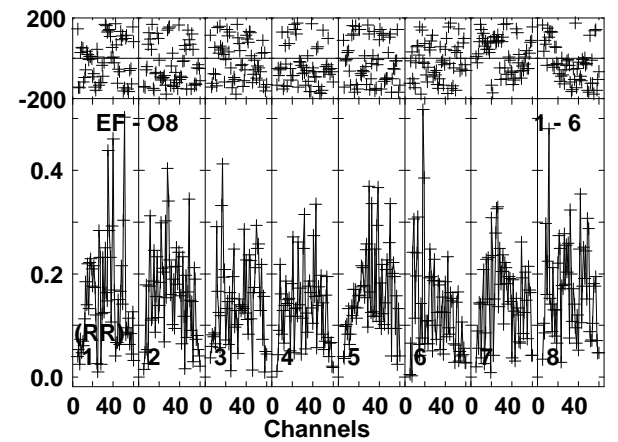
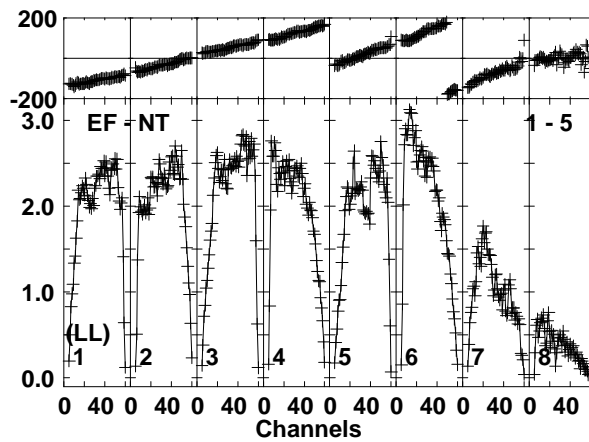
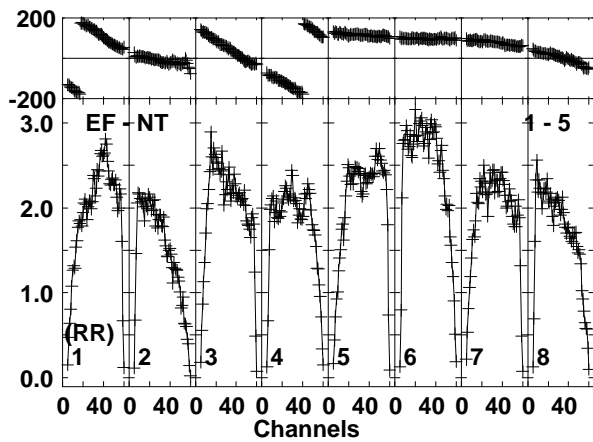
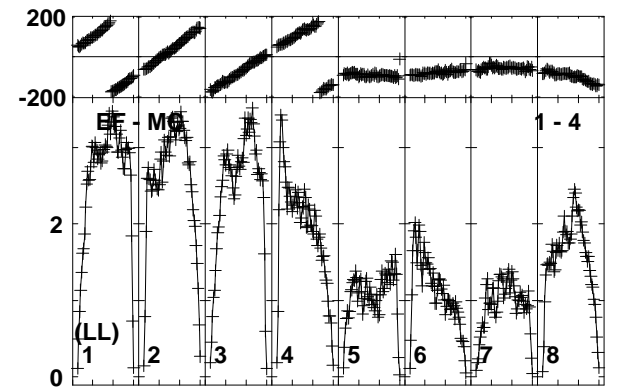
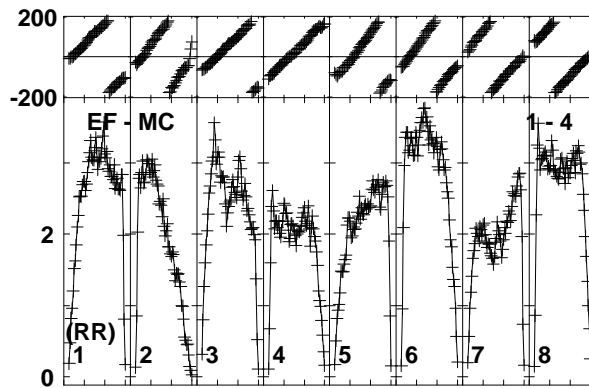
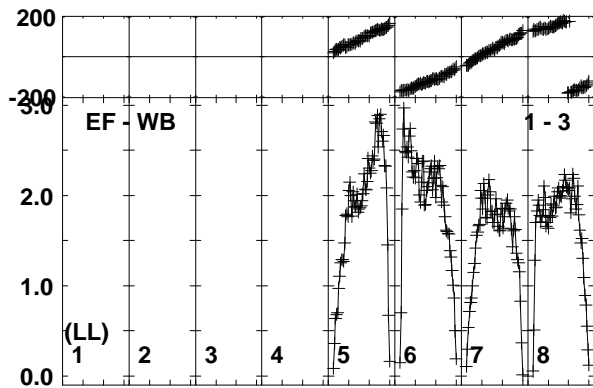
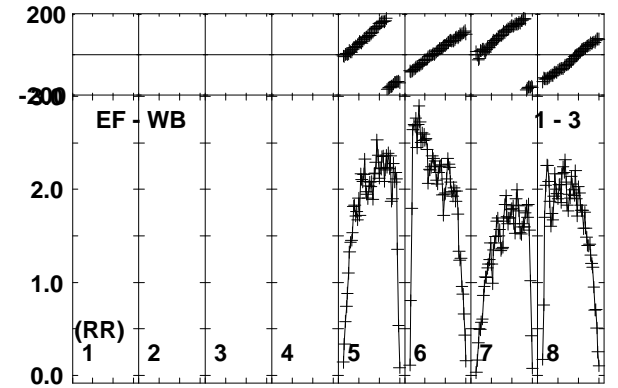
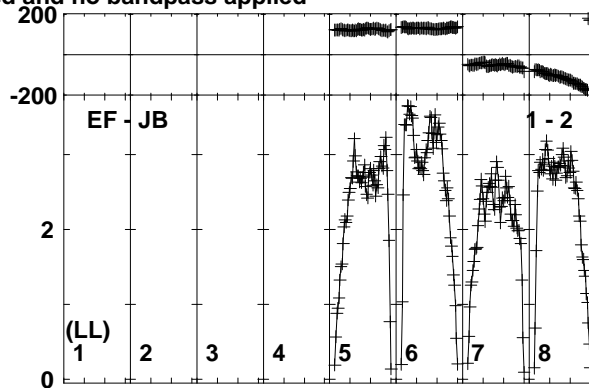
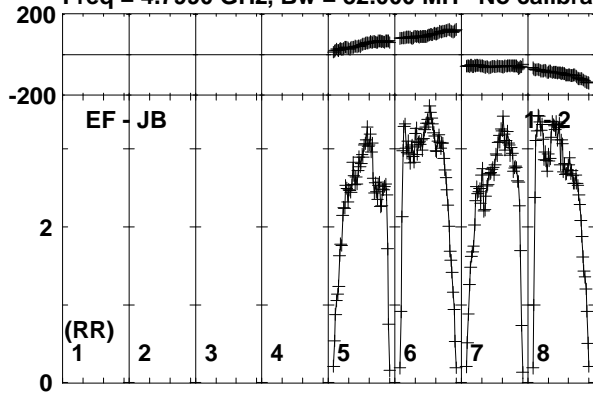

Lower frame: Milli Ampl Jy Top frame: Phas deg  
Vector averaged cross-power spectrum Baseline: EF (01) - JB (02)  
Timerange: 00/02:37:21 to 00/02:38:49

Plot file version 78 created 24-NOV-2017 10:09:55

J1108+4330 EG096D.UVDATA.1

Freq = 4.7990 GHz, Bw = 32.000 MH No calibration applied and no bandpass applied

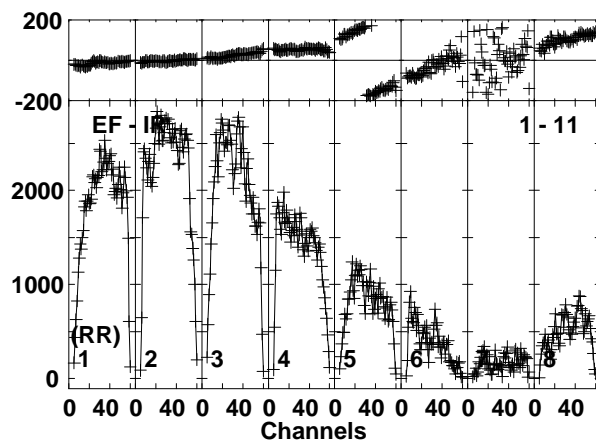
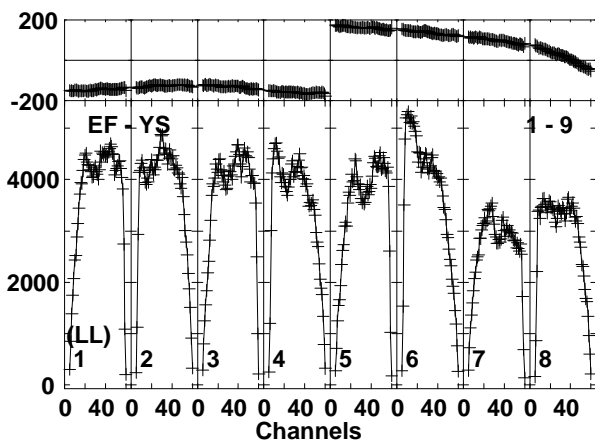
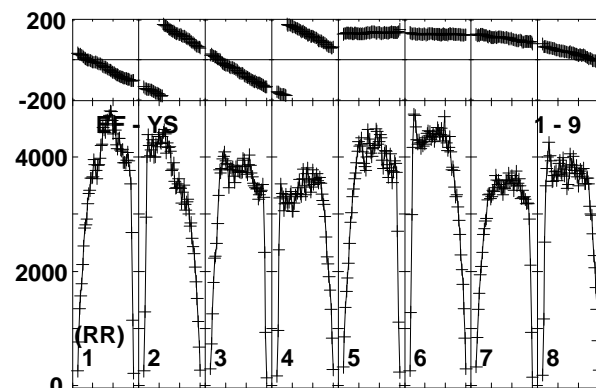
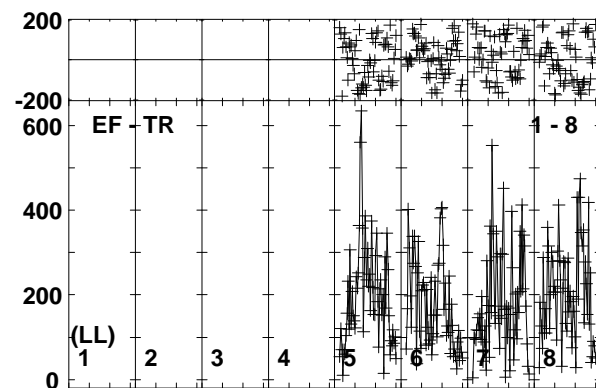
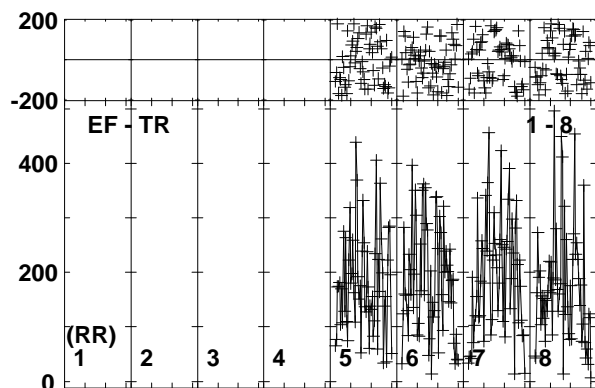
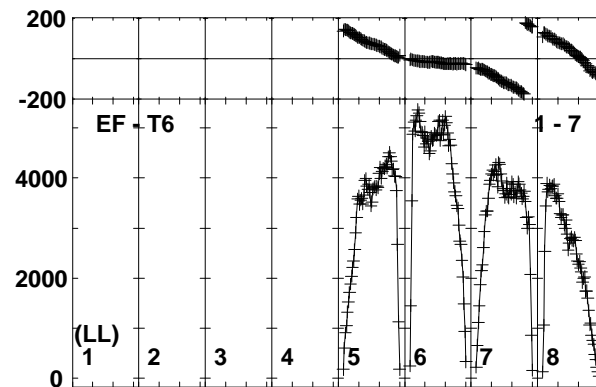
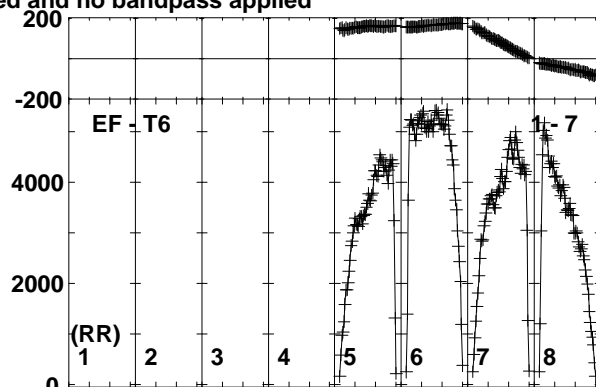
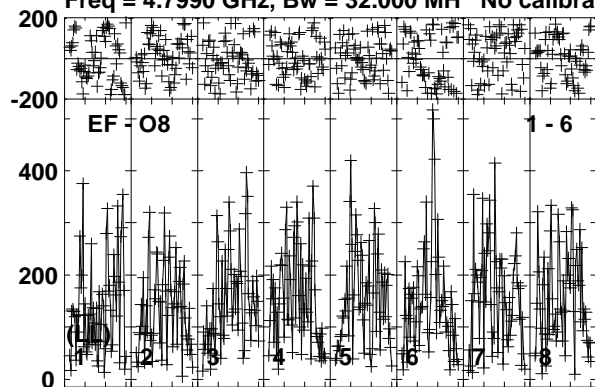

Lower frame: Micro Ampl Jy Top frame: Phas deg  
Vector averaged cross-power spectrum Baseline: EF (01) - O8 (06)  
Timerange: 00/02:37:21 to 00/02:38:49

Plot file version 79 created 24-NOV-2017 10:09:55

J0927+3902 EG096D.UVDATA.1

Freq = 4.7990 GHz, Bw = 32.000 MH No calibration applied and no bandpass applied

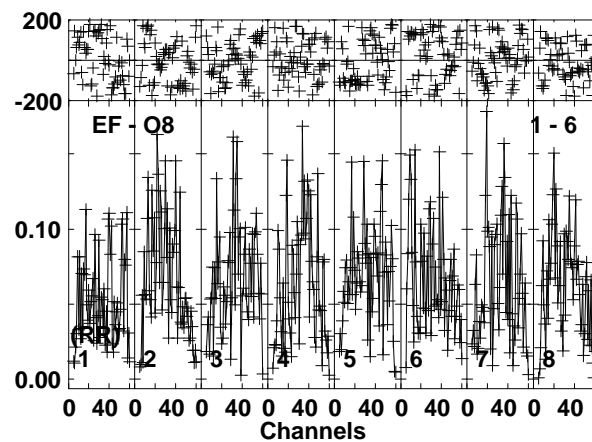
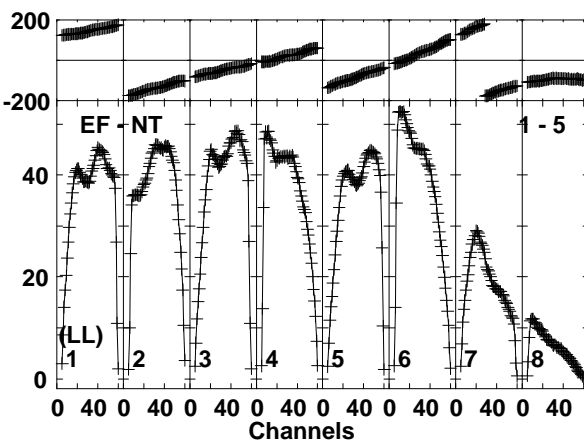
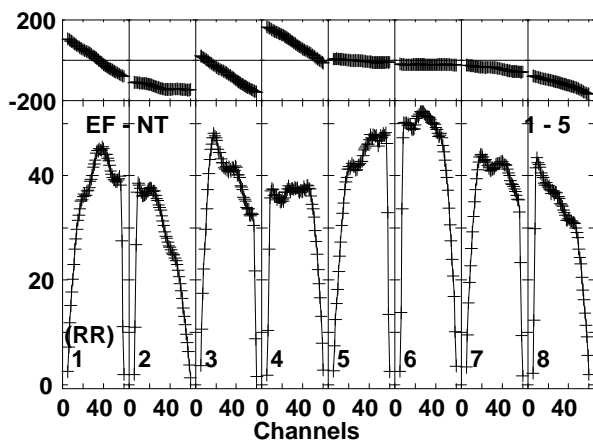
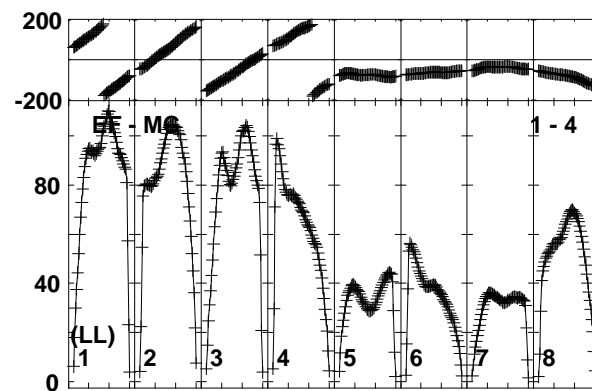
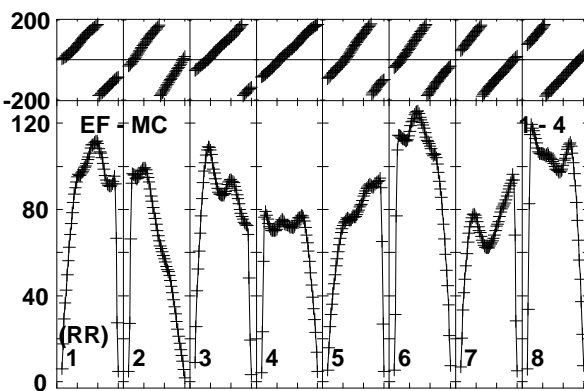
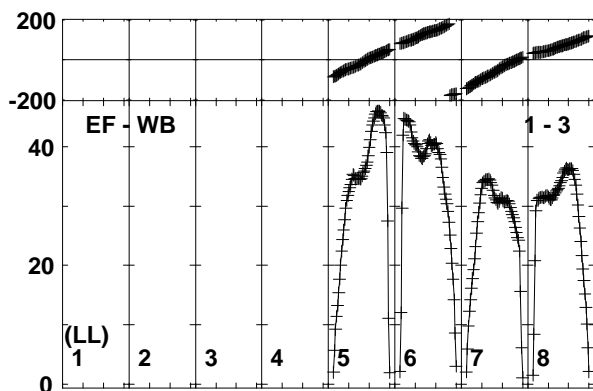
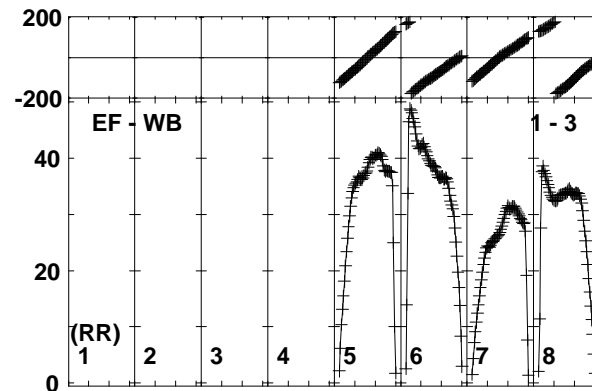
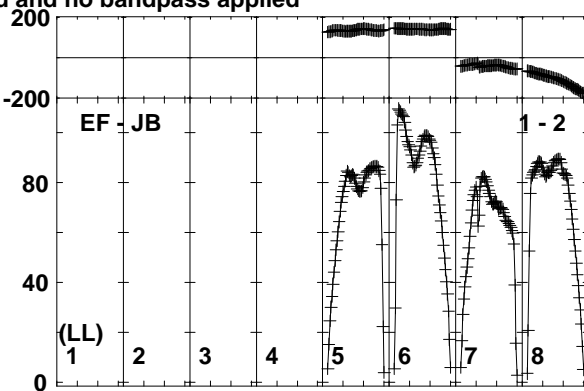
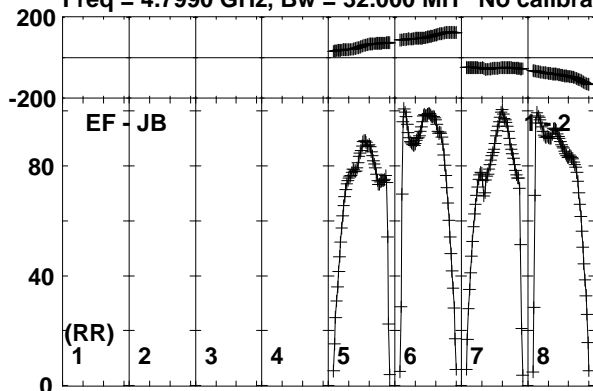

Lower frame: Milli Ampl Jy Top frame: Phas deg  
Vector averaged cross-power spectrum Baseline: EF (01) - JB (02)  
Timerange: 00/02:40:51 to 00/02:45:50

Plot file version 80 created 24-NOV-2017 10:09:55

J0927+3902 EG096D.UVDATA.1

Freq = 4.7990 GHz, Bw = 32.000 MH No calibration applied and no bandpass applied

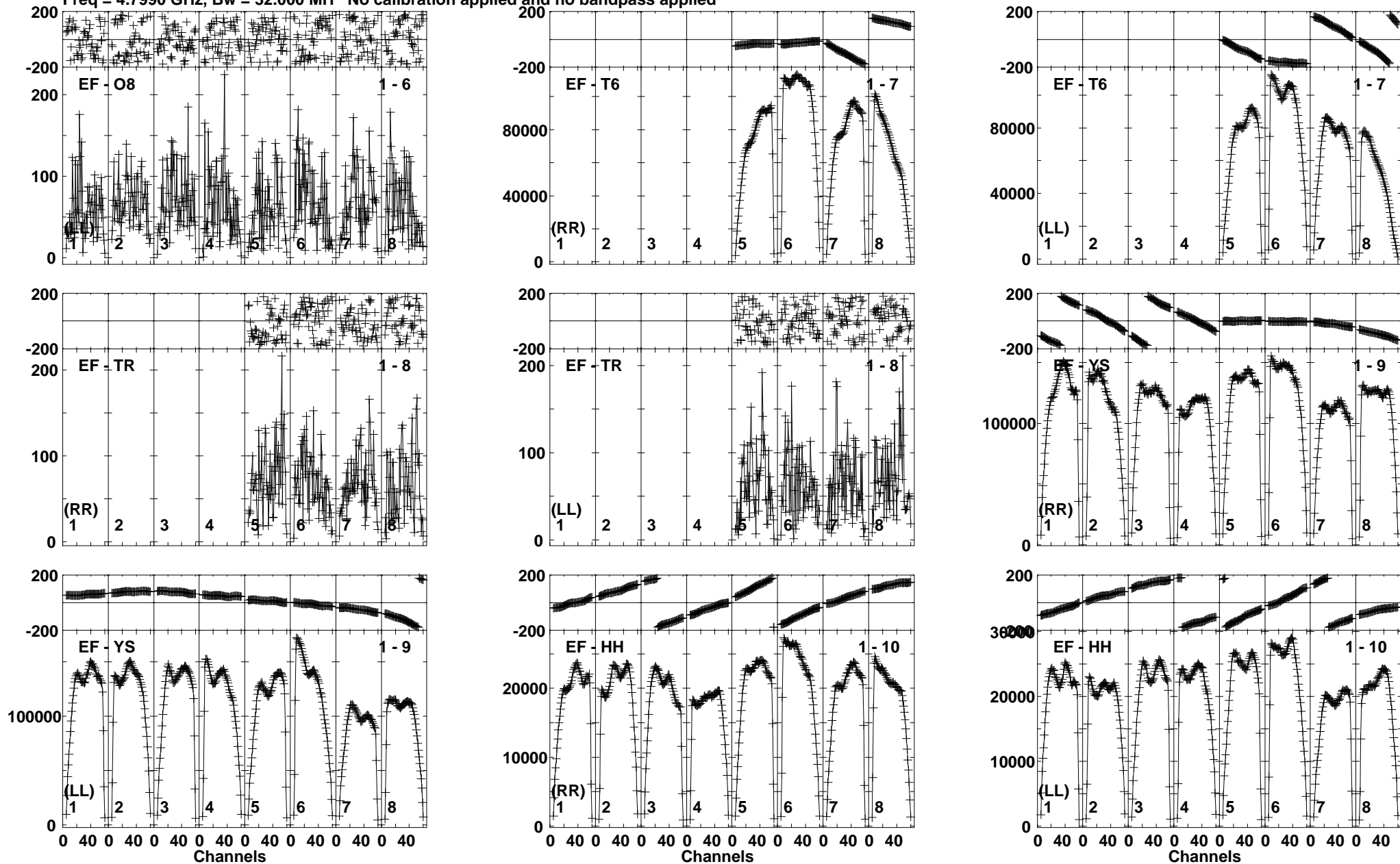

Lower frame: Micro Ampl Jy Top frame: Phas deg  
Vector averaged cross-power spectrum Baseline: EF (01) - O8 (06)  
Timerange: 00/02:40:51 to 00/02:45:50

Plot file version 81 created 24-NOV-2017 10:09:56  
J0927+3902 EG096D.UVDATA.1  
Freq = 4.7990 GHz, Bw = 32.000 MH No calibration applied and no bandpass applied

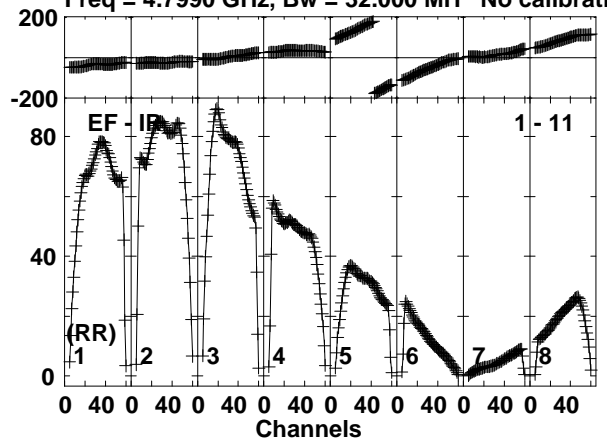

Lower frame: Milli Ampl Jy Top frame: Phas deg  
Vector averaged cross-power spectrum Baseline: EF (01) - IR (11)  
Timerange: 00/02:40:51 to 00/02:45:50

Plot file version 82 created 24-NOV-2017 10:09:56

J1108+4330 EG096D.UVDATA.1

Freq = 4.7990 GHz, Bw = 32.000 MH No calibration applied and no bandpass applied

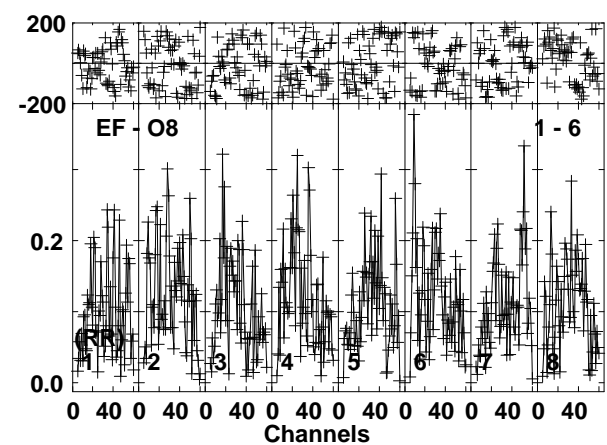
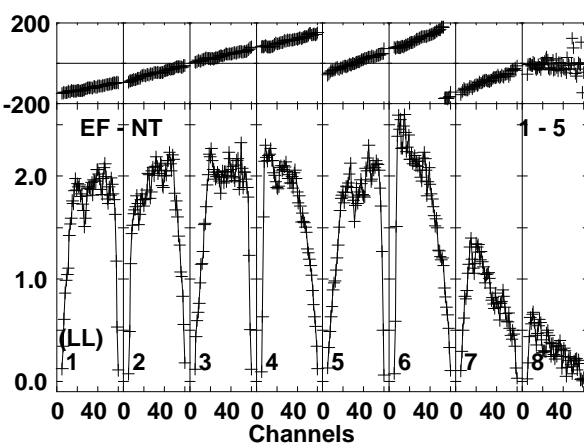
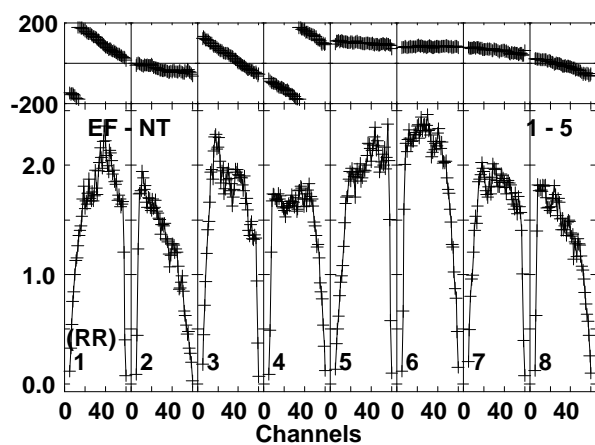
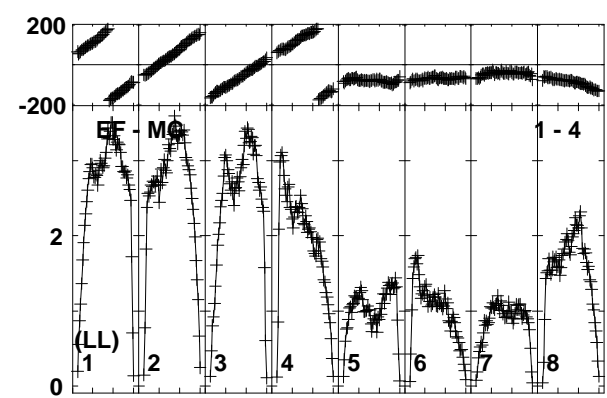
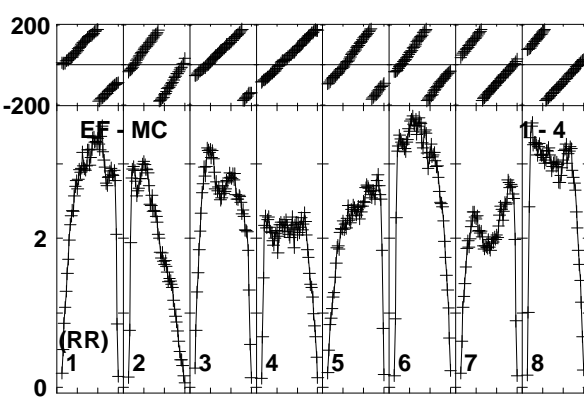
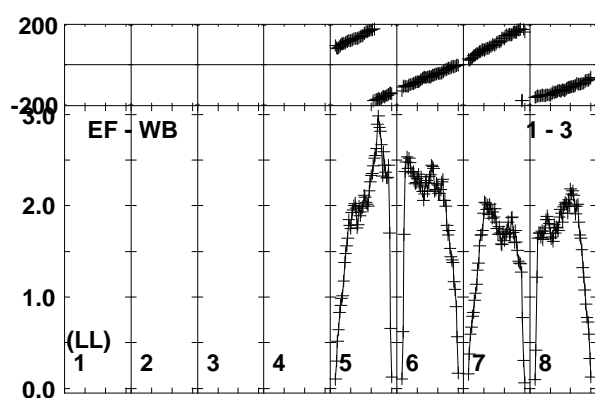
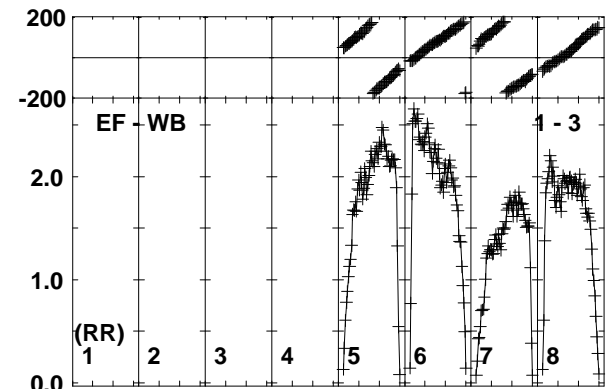
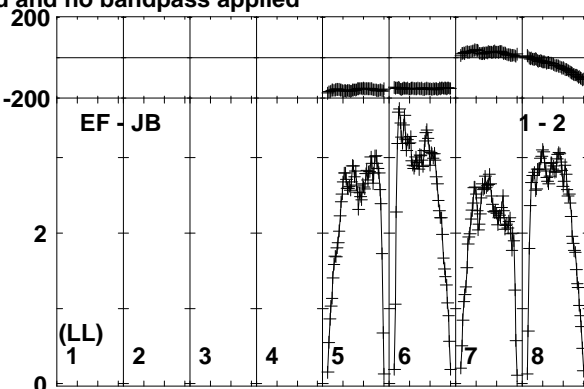
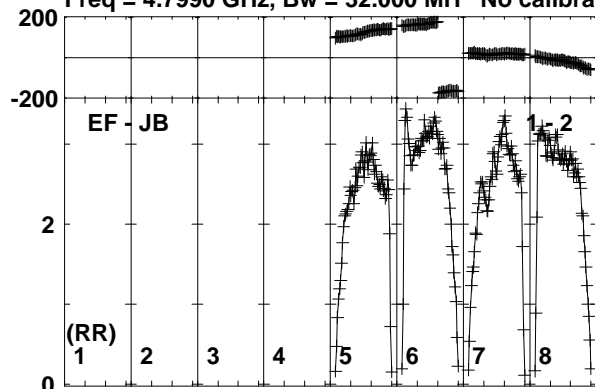

Lower frame: Milli Ampl Jy Top frame: Phas deg  
Vector averaged cross-power spectrum Baseline: EF (01) - JB (02)  
Timerange: 00/02:48:03 to 00/02:49:50



Plot file version 83 created 24-NOV-2017 10:09:56

J1108+4330 EG096D.UVDATA.1

Freq = 4.7990 GHz, Bw = 32.000 MH No calibration applied and no bandpass applied

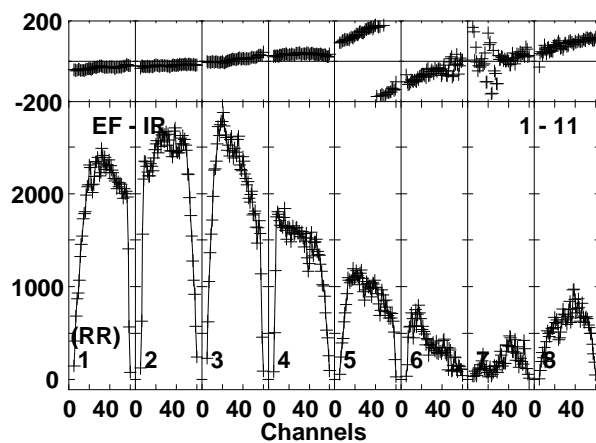
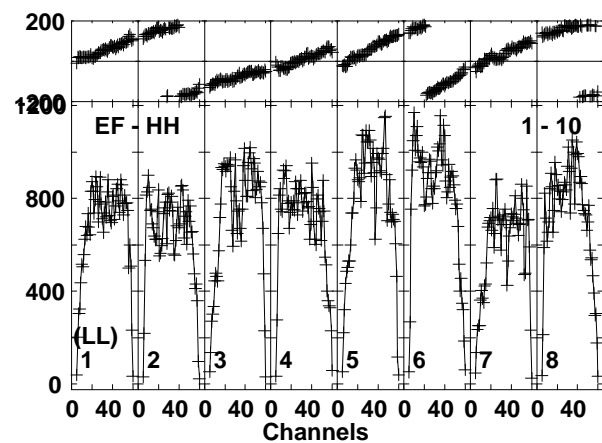
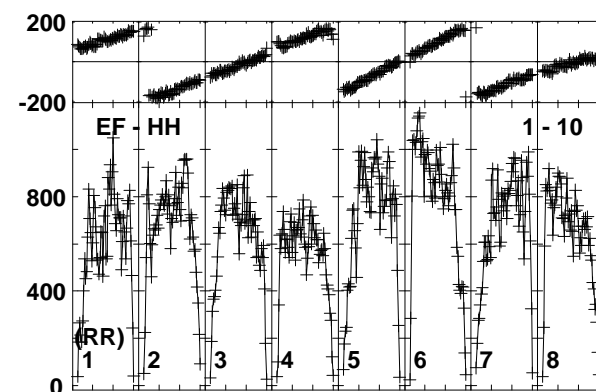
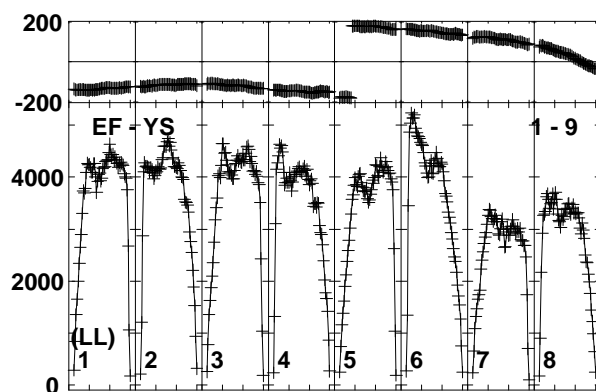
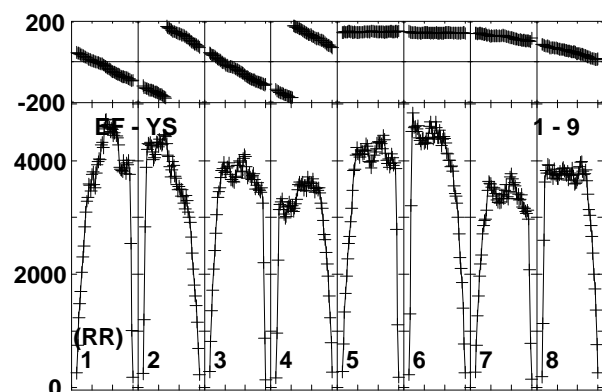
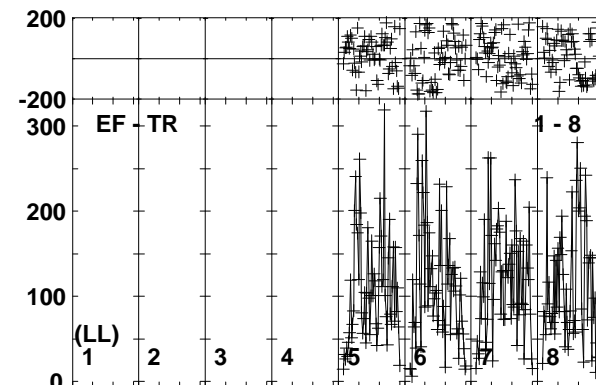
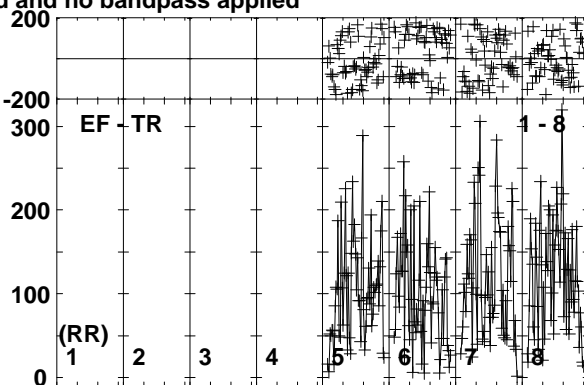
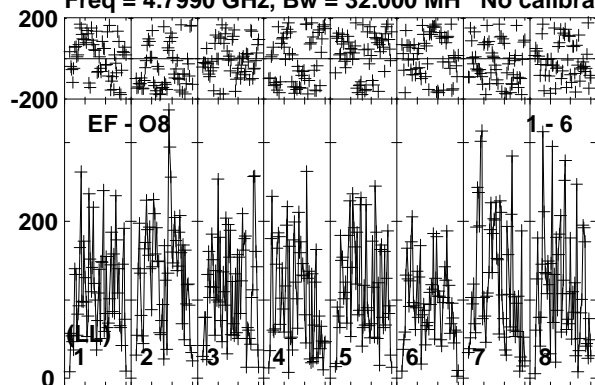

Lower frame: Micro Ampl Jy Top frame: Phas deg  
Vector averaged cross-power spectrum Baseline: EF (01) - O8 (06)  
Timerange: 00:02:48:03 to 00:02:49:50

Plot file version 84 created 24-NOV-2017 10:09:56

J1108+4330 EG096D.UVDATA.1

Freq = 4.7990 GHz, Bw = 32.000 MH No calibration applied and no bandpass applied

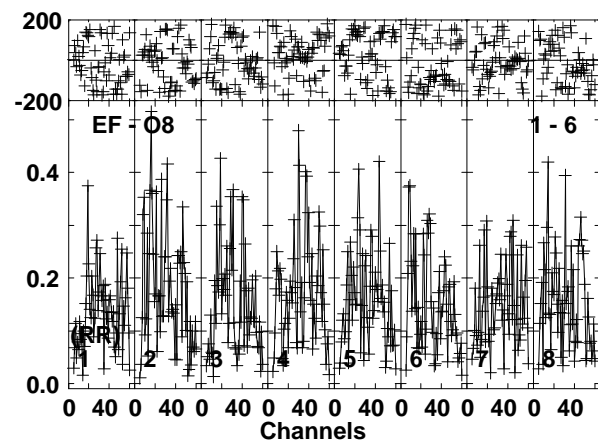
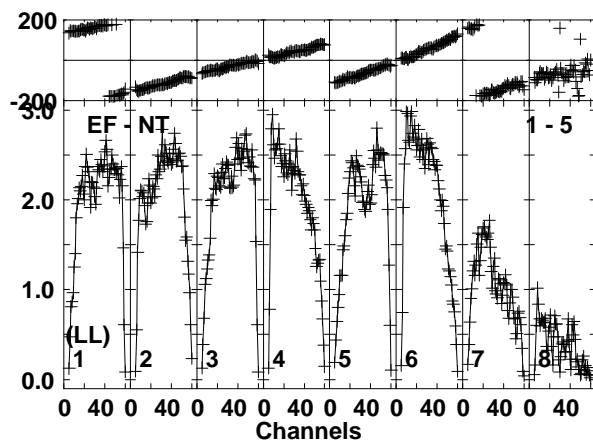
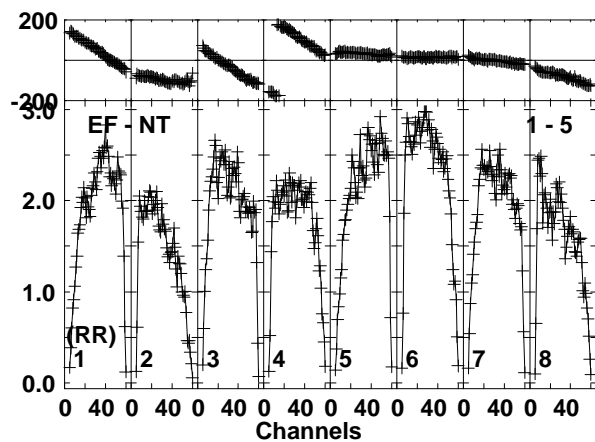
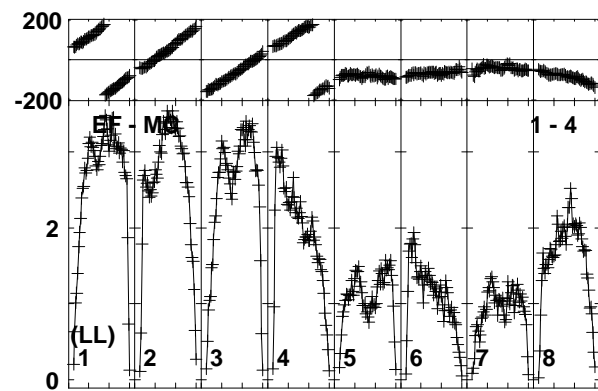
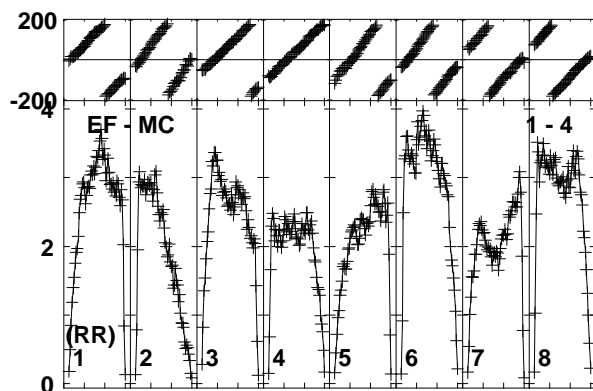
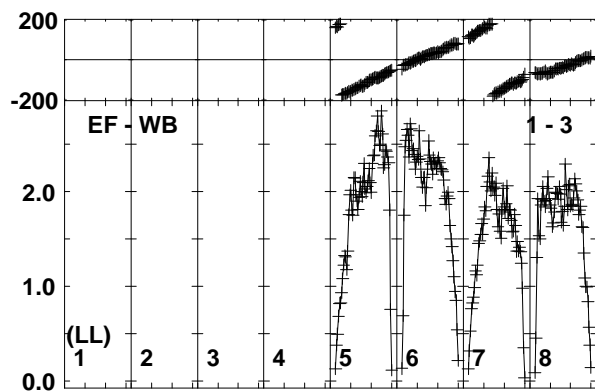
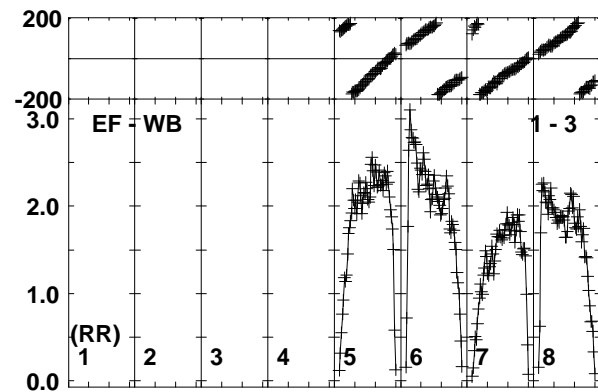
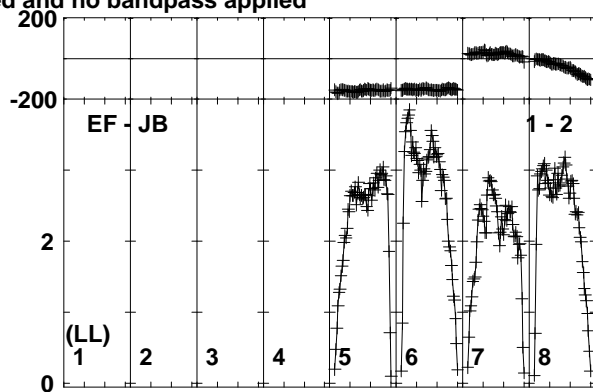
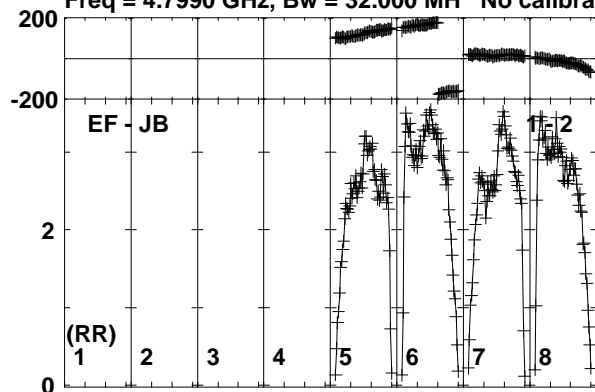

Lower frame: Milli Ampl Jy Top frame: Phas deg  
Vector averaged cross-power spectrum Baseline: EF (01) - JB (02)  
Timerange: 00/02:50:31 to 00/02:51:29

Plot file version 85 created 24-NOV-2017 10:09:57

J1108+4330 EG096D.UVDATA.1

Freq = 4.7990 GHz, Bw = 32.000 MH No calibration applied and no bandpass applied

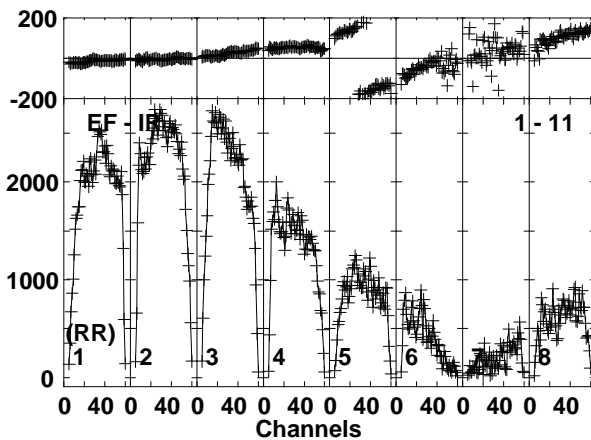
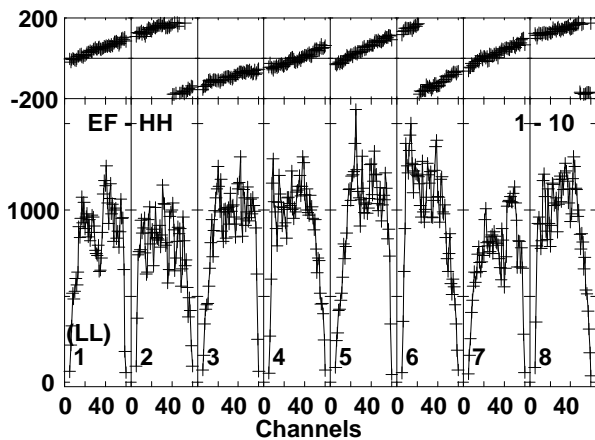
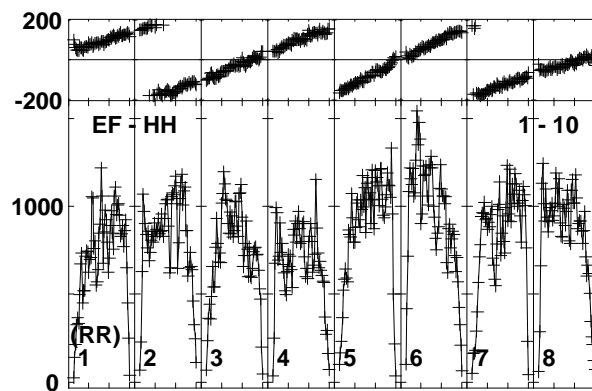
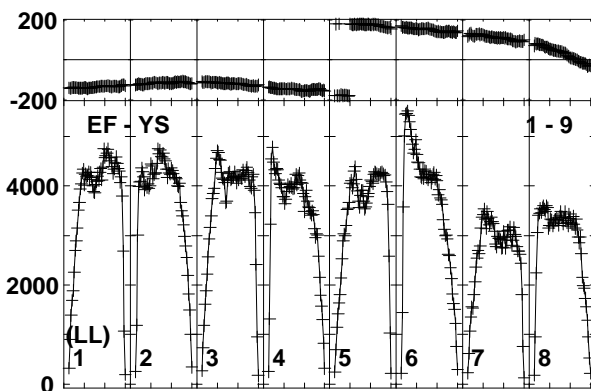
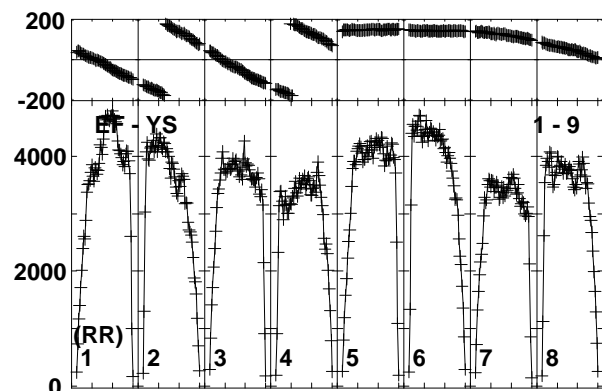
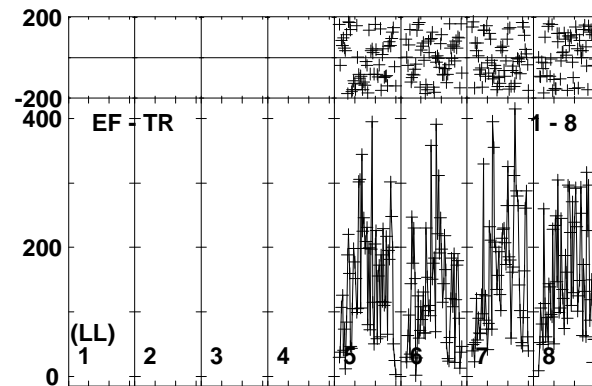
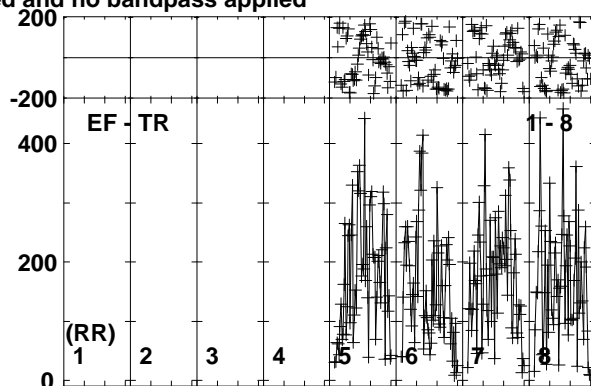
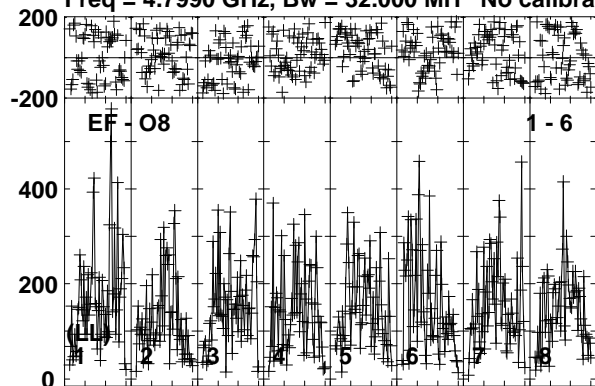

Lower frame: Micro Ampl Jy Top frame: Phas deg  
Vector averaged cross-power spectrum Baseline: EF (01) - O8 (06)  
Timerange: 00/02:50:31 to 00/02:51:29

Plot file version 86 created 24-NOV-2017 10:09:57

J1112+4301 EG096D.UVDATA.1

Freq = 4.7990 GHz, Bw = 32.000 MH No calibration applied and no bandpass applied

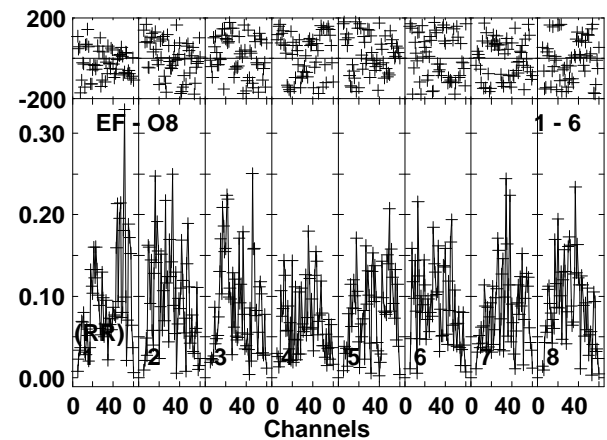
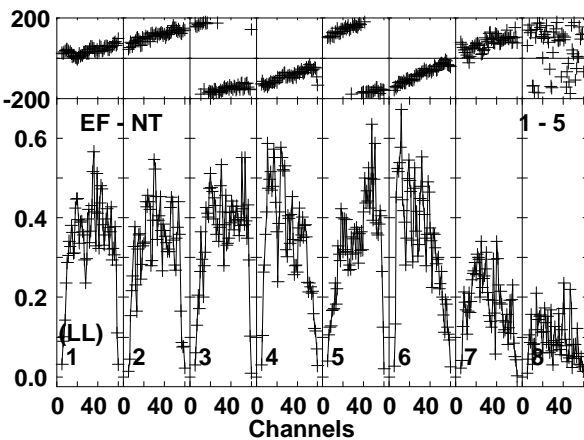
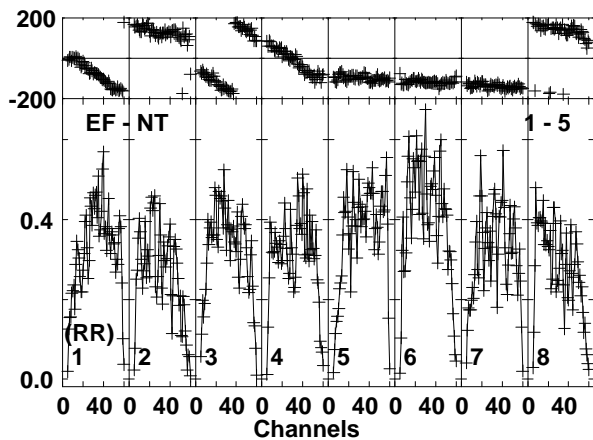
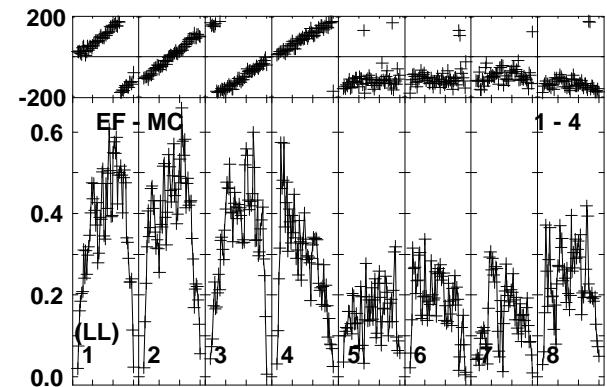
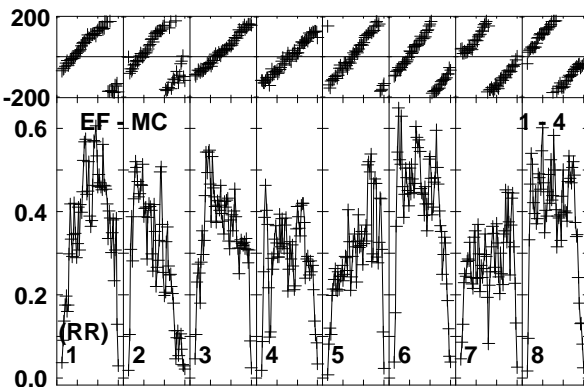
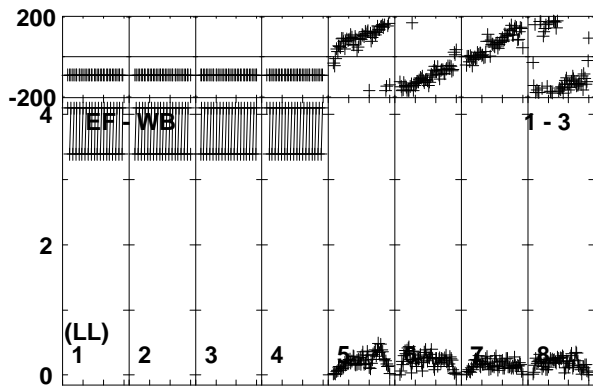
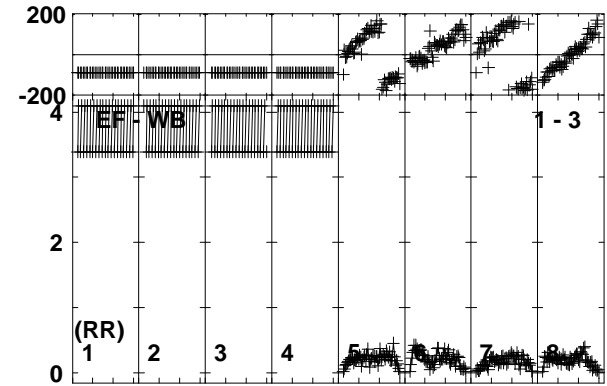
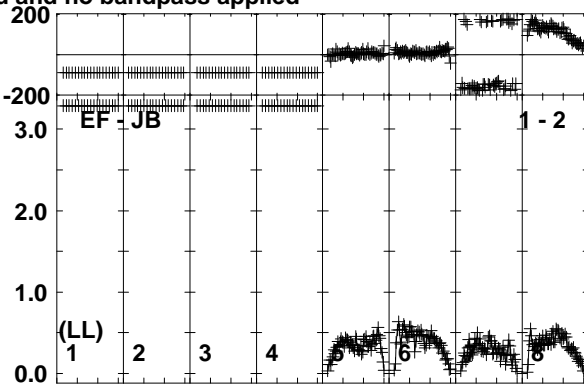
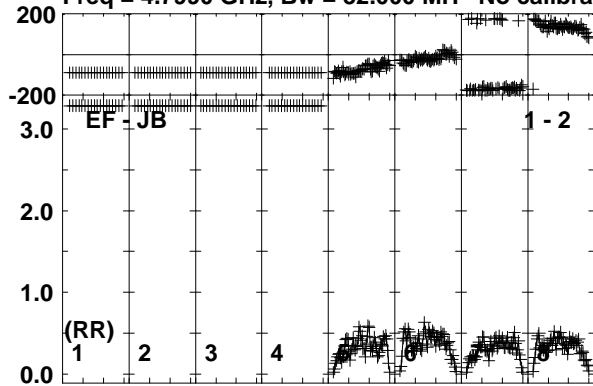

Lower frame: Milli Ampl Jy Top frame: Phas deg  
Vector averaged cross-power spectrum Baseline: EF (01) - JB (02)  
Timerange: 00/02:51:30 to 00/02:54:59

Plot file version 87 created 24-NOV-2017 10:09:57

J1112+4301 EG096D.UVDATA.1

Freq = 4.7990 GHz, Bw = 32.000 MH No calibration applied and no bandpass applied

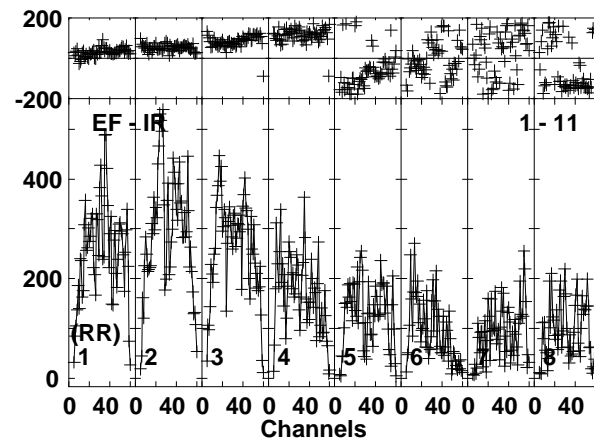
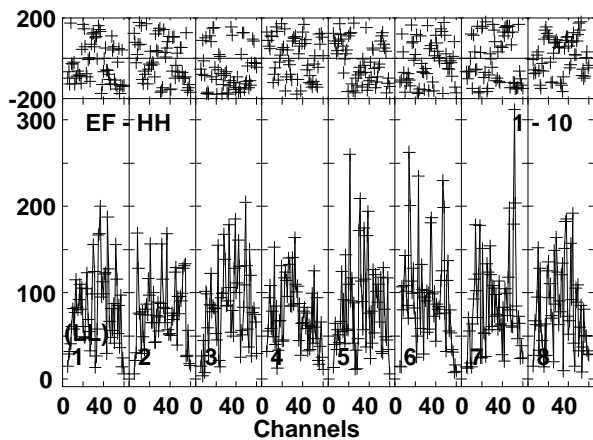
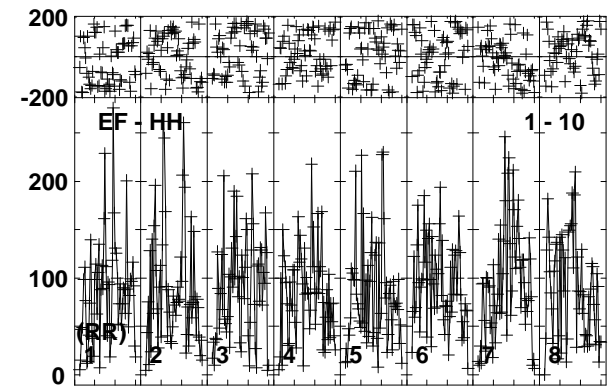
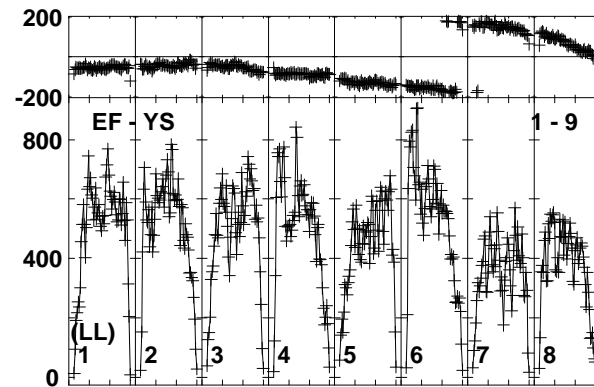
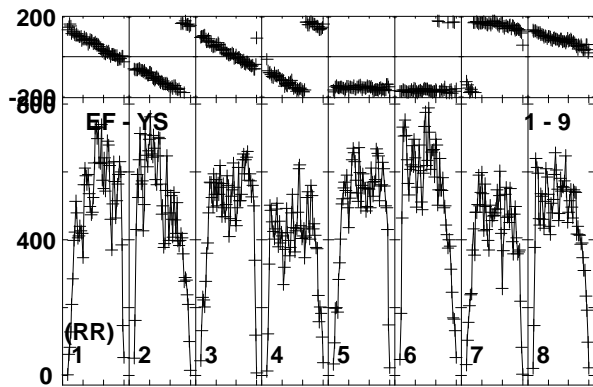
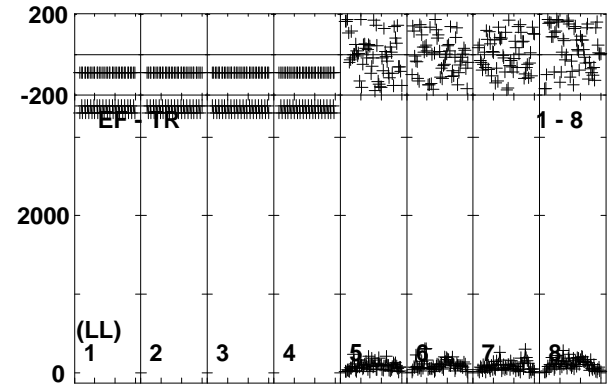
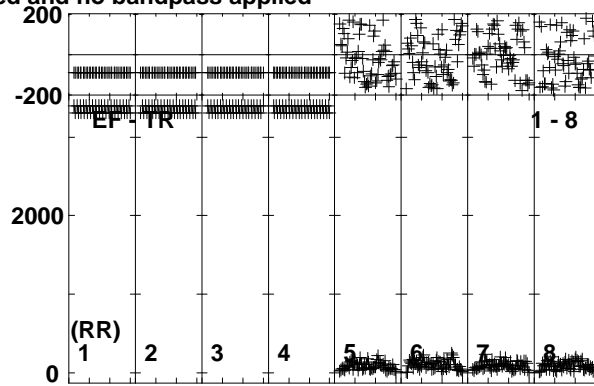
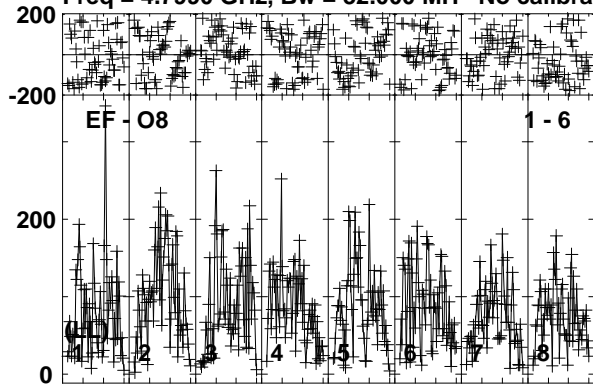

Lower frame: Micro Ampl Jy Top frame: Phas deg  
Vector averaged cross-power spectrum Baseline: EF (01) - O8 (06)  
Timerange: 00/02:51:30 to 00/02:54:59

Plot file version 88 created 24-NOV-2017 10:09:58

J1108+4330 EG096D.UVDATA.1

Freq = 4.7990 GHz, Bw = 32.000 MH No calibration applied and no bandpass applied

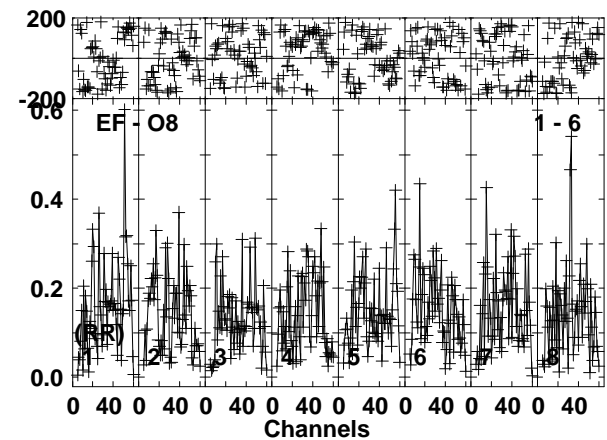
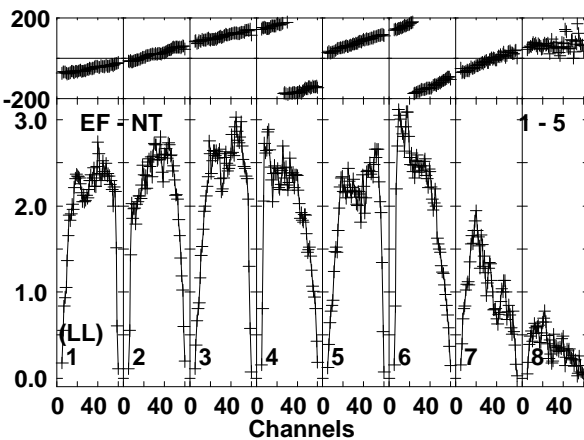
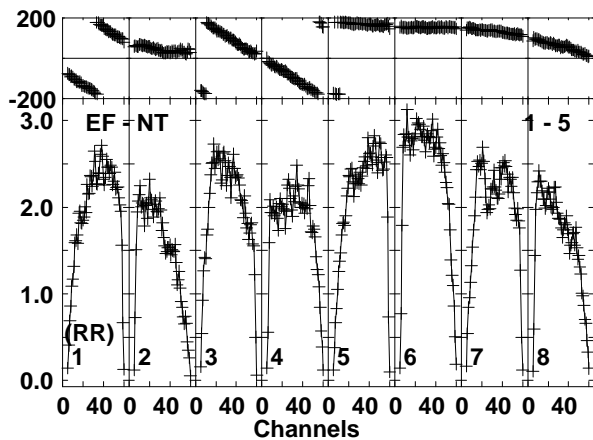
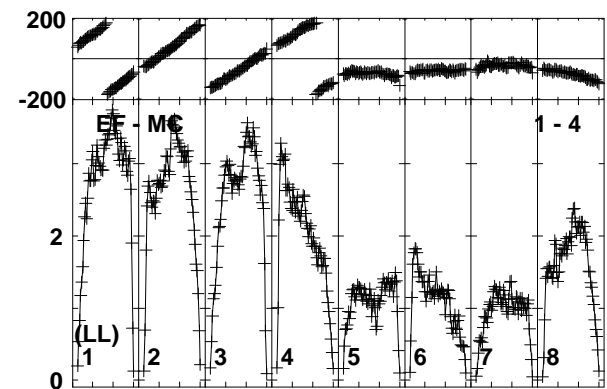
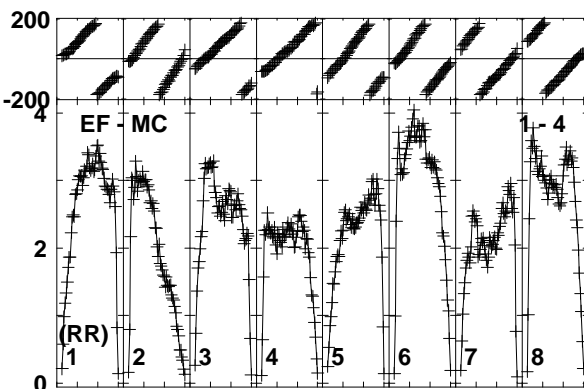
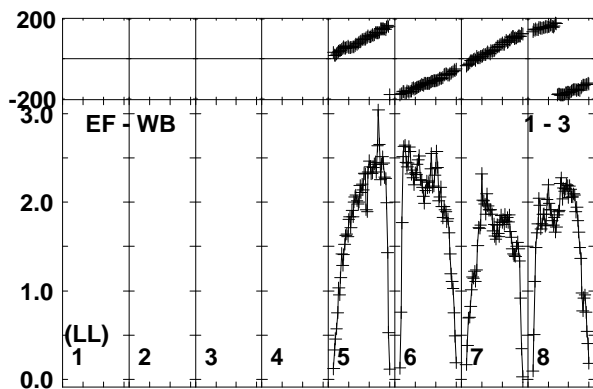
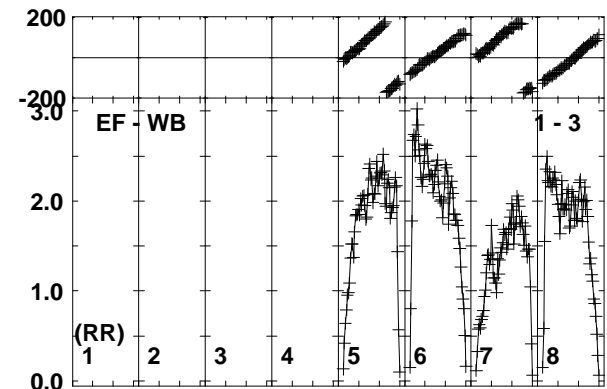
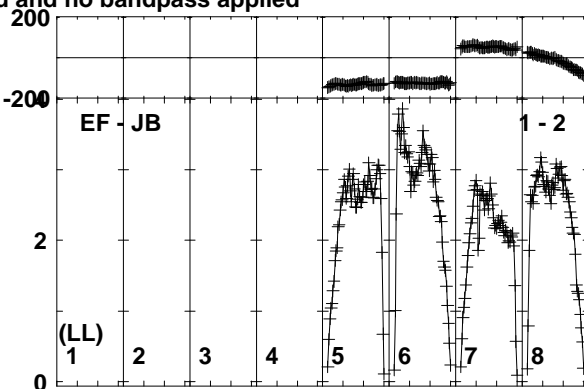
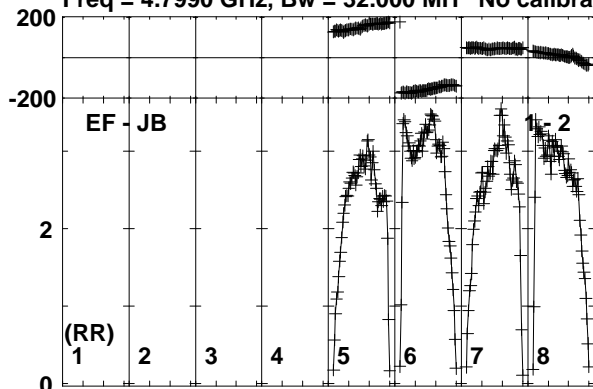

Lower frame: Milli Ampl Jy Top frame: Phas deg  
Vector averaged cross-power spectrum Baseline: EF (01) - JB (02)  
Timerange: 00/02:55:01 to 00/02:56:30

Plot file version 89 created 24-NOV-2017 10:09:58  
 J1108+4330 EG096D.UVDATA.1  
 Freq = 4.7990 GHz, Bw = 32.000 MH No calibration applied and no bandpass applied

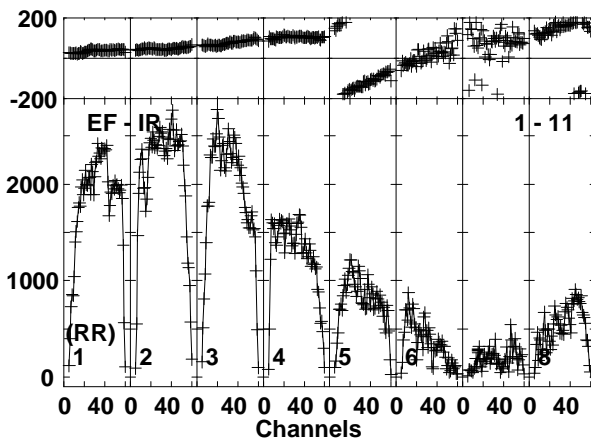
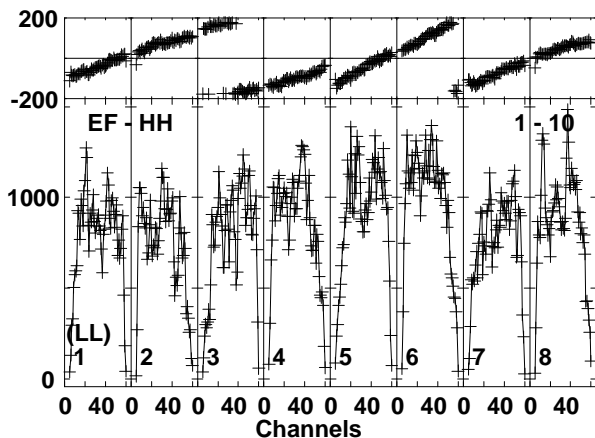
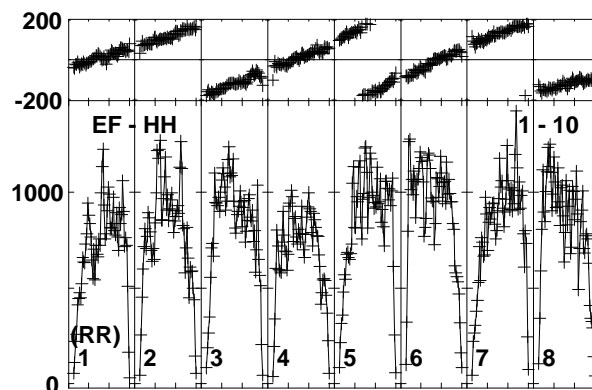
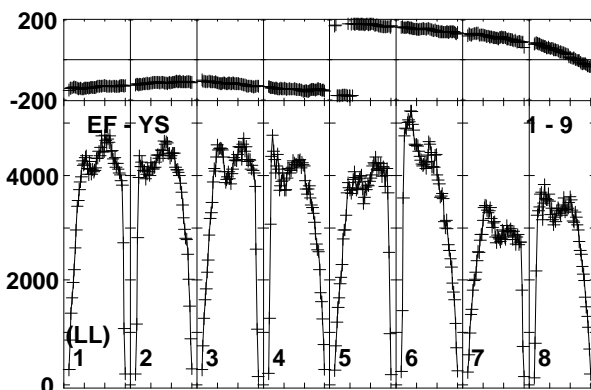
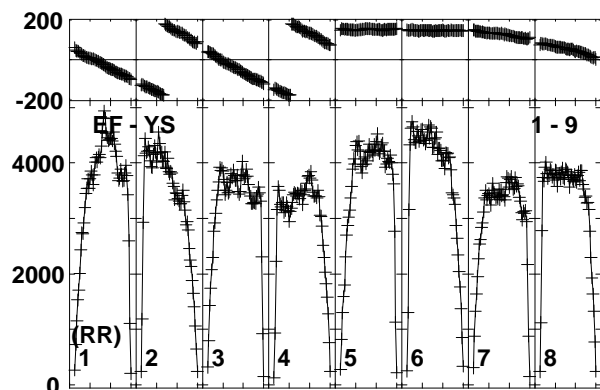
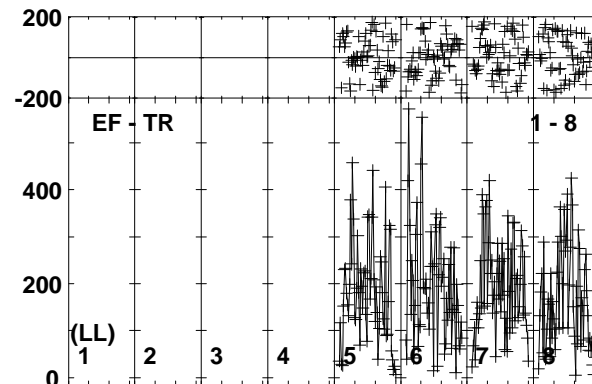
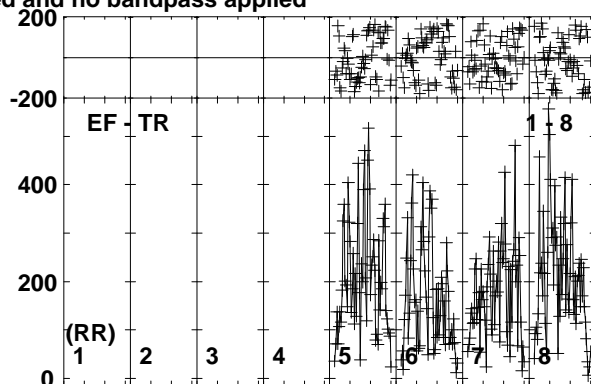
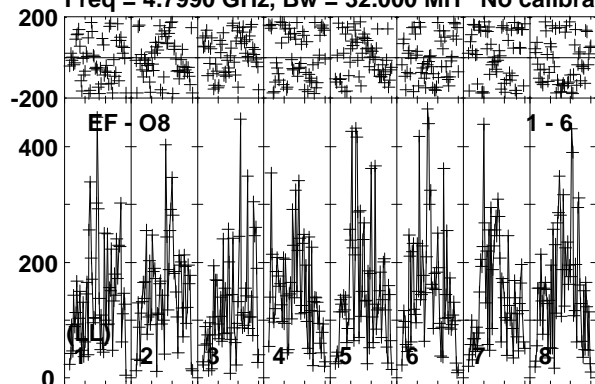

Lower frame: Micro Ampl Jy Top frame: Phas deg  
 Vector averaged cross-power spectrum Baseline: EF (01) - O8 (06)  
 Timerange: 00/02:55:01 to 00/02:56:30

Plot file version 90 created 24-NOV-2017 10:09:58

ARUMA EG096D.UVDATA.1

Freq = 4.7990 GHz, Bw = 32.000 MH No calibration applied and no bandpass applied

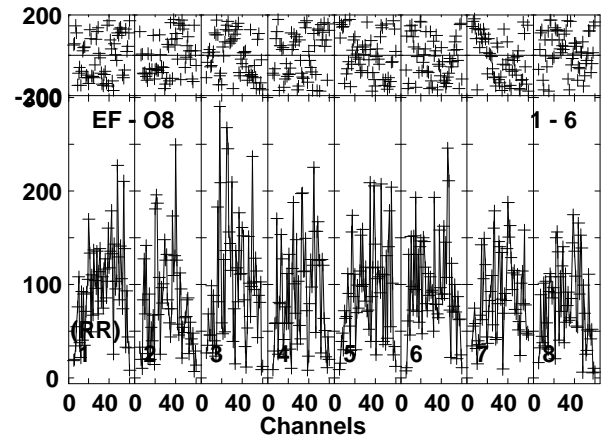
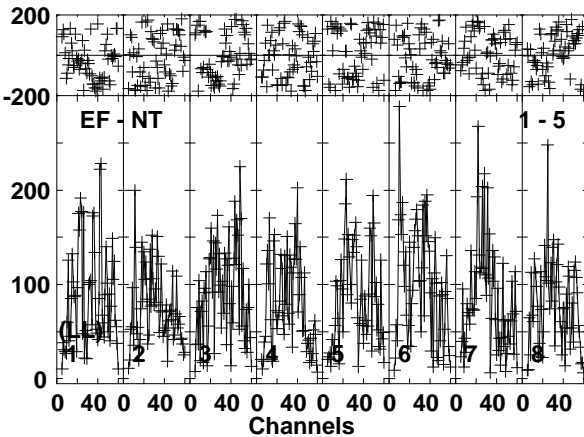
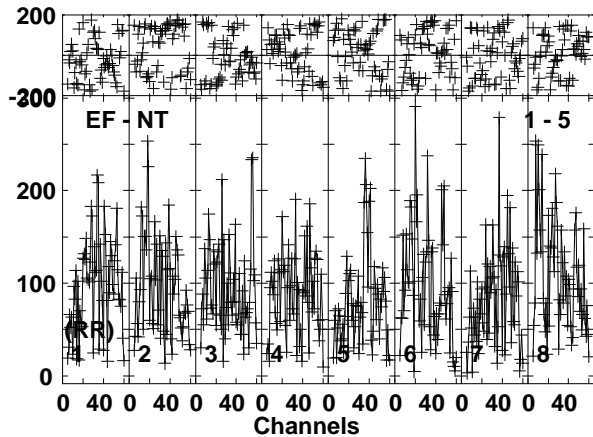
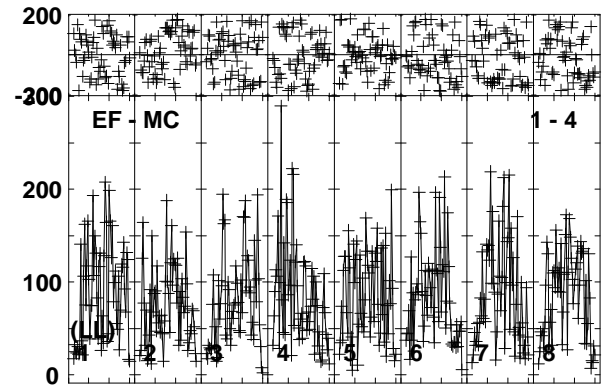
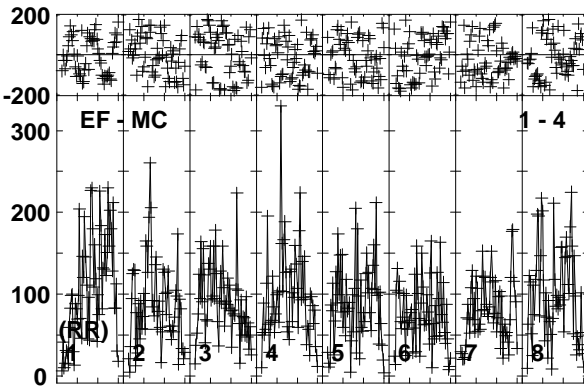
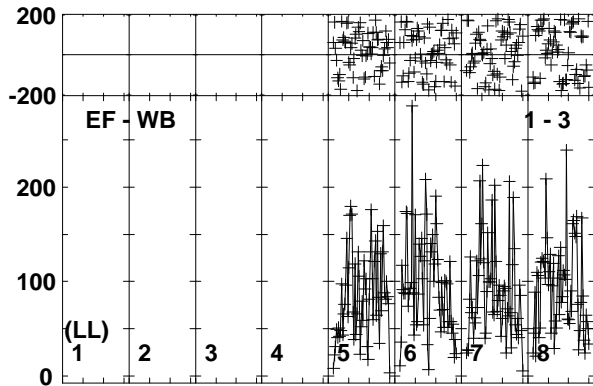
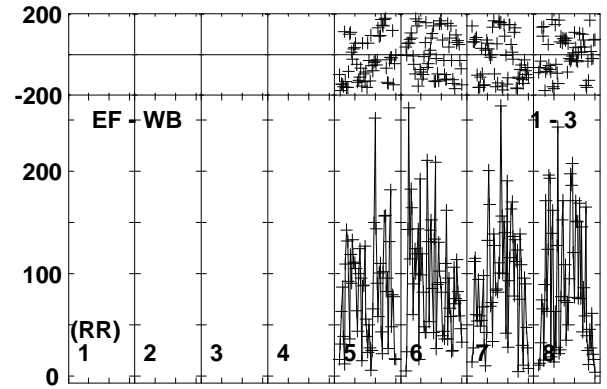
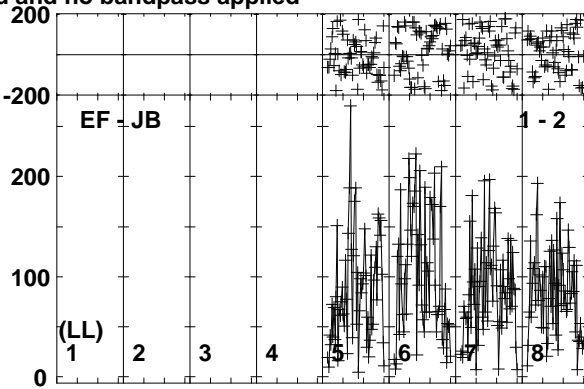
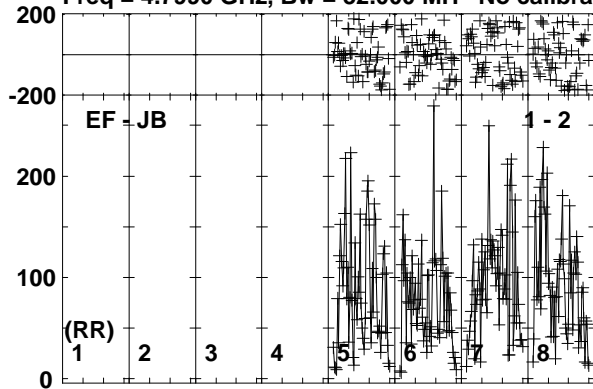

Lower frame: Micro Ampl Jy Top frame: Phas deg  
Vector averaged cross-power spectrum Baseline: EF (01) - JB (02)  
Timerange: 00/02:56:31 to 00/02:59:59



Plot file version 91 created 24-NOV-2017 10:09:59

ARUMA EG096D.UVDATA.1

Freq = 4.7990 GHz, Bw = 32.000 MH No calibration applied and no bandpass applied

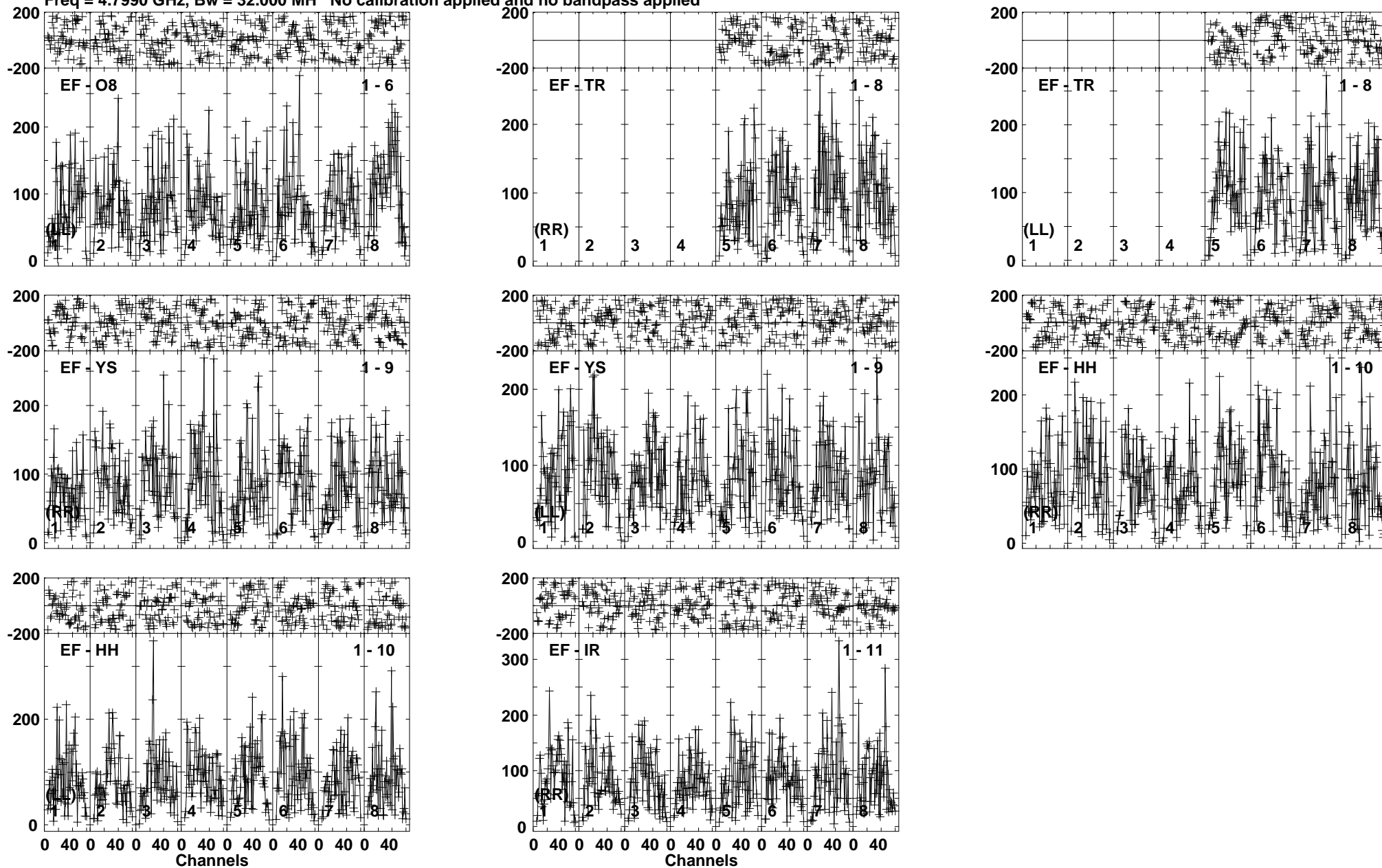

Lower frame: Micro Ampl Jy Top frame: Phas deg  
Vector averaged cross-power spectrum Baseline: EF (01) - O8 (06)  
Timerange: 00/02:56:31 to 00/02:59:59

Plot file version 92 created 24-NOV-2017 10:09:59

J1108+4330 EG096D.UVDATA.1

Freq = 4.7990 GHz, Bw = 32.000 MH No calibration applied and no bandpass applied

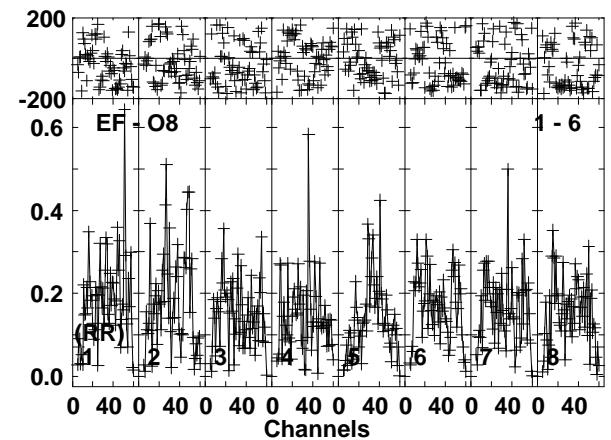
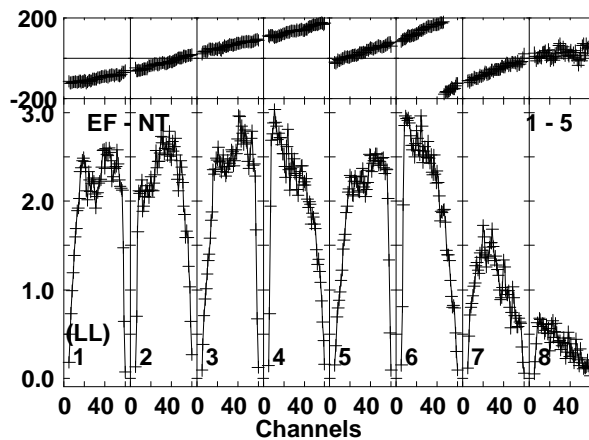
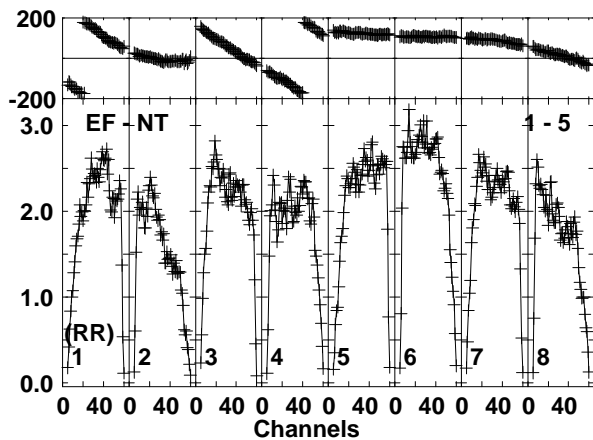
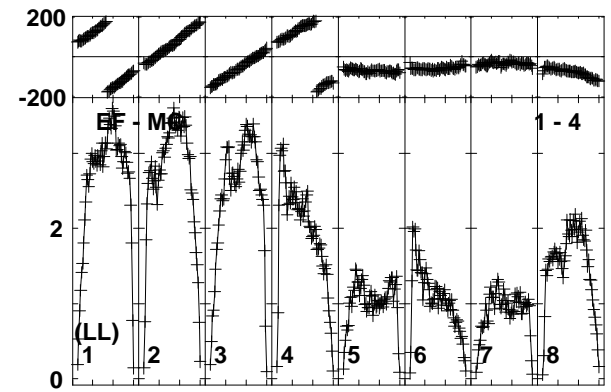
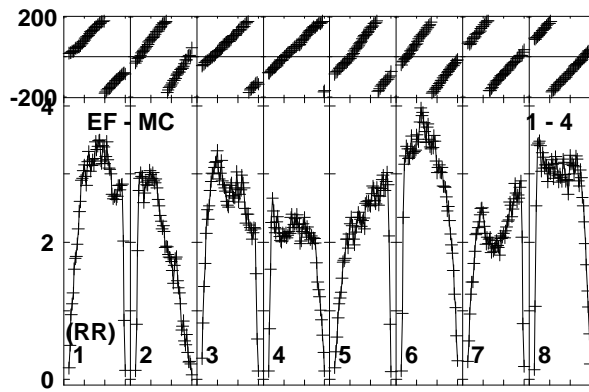
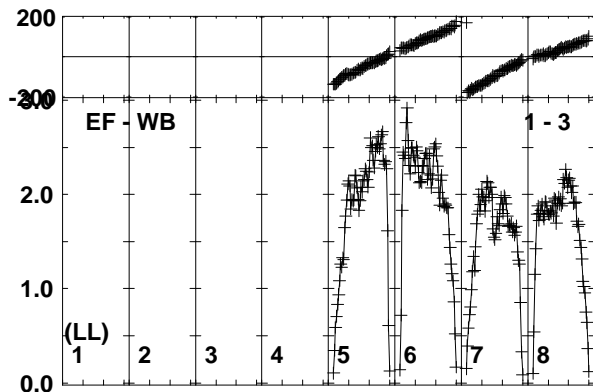
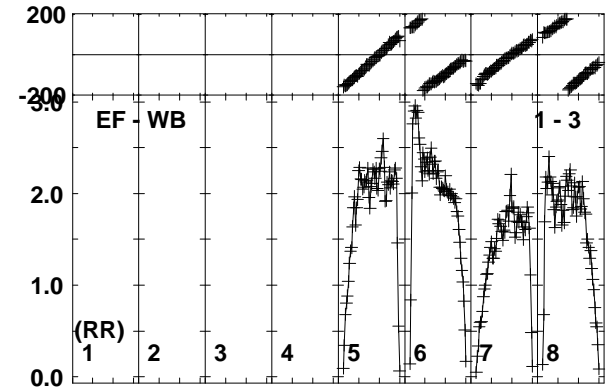
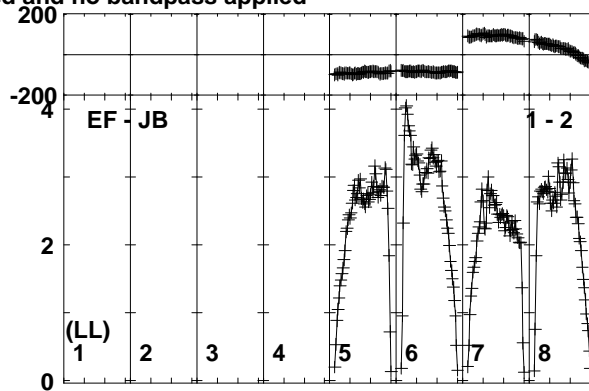
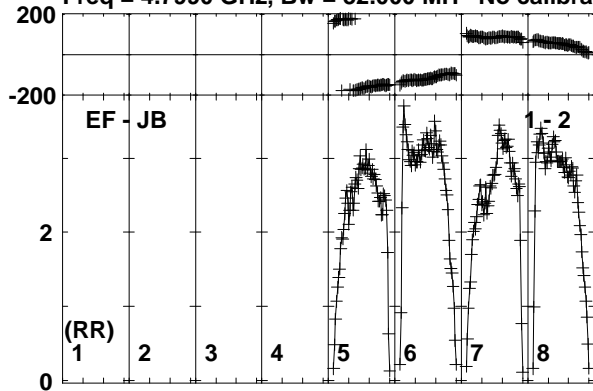

Lower frame: Milli Ampl Jy Top frame: Phas deg  
Vector averaged cross-power spectrum Baseline: EF (01) - JB (02)  
Timerange: 00/03:00:40 to 00/03:01:40

Plot file version 93 created 24-NOV-2017 10:09:59

J1108+4330 EG096D.UVDATA.1

Freq = 4.7990 GHz, Bw = 32.000 MH No calibration applied and no bandpass applied

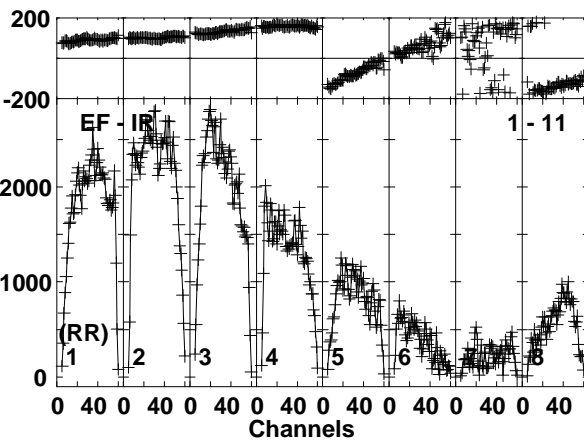
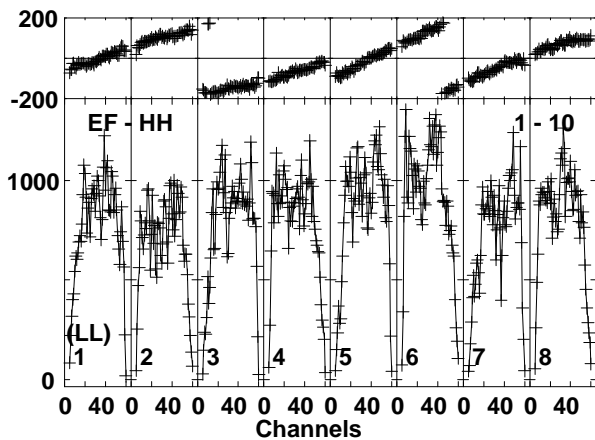
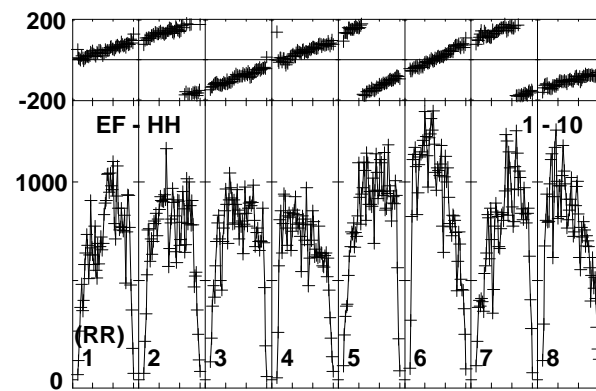
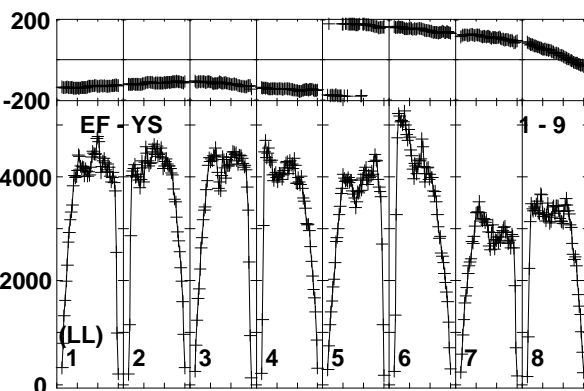
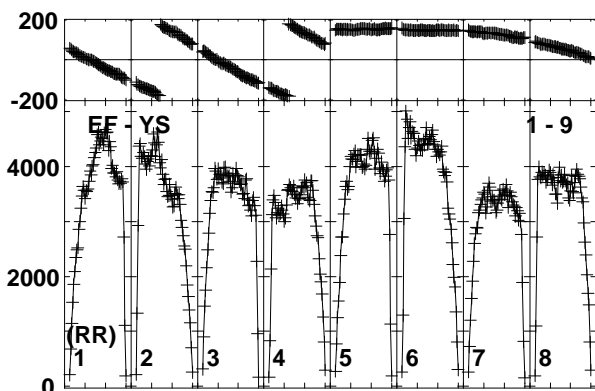
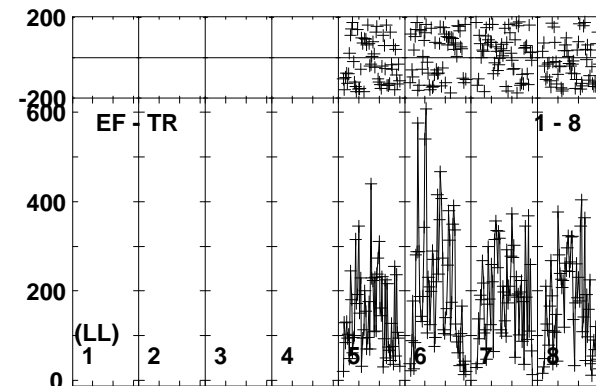
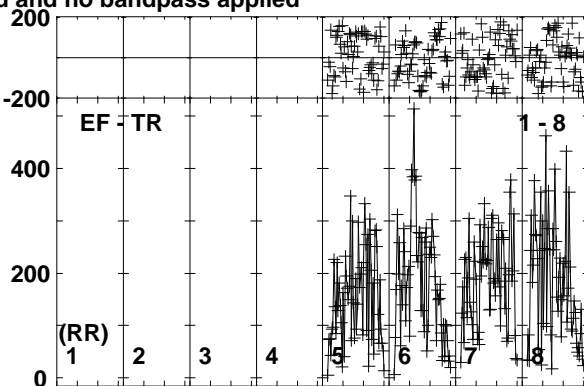
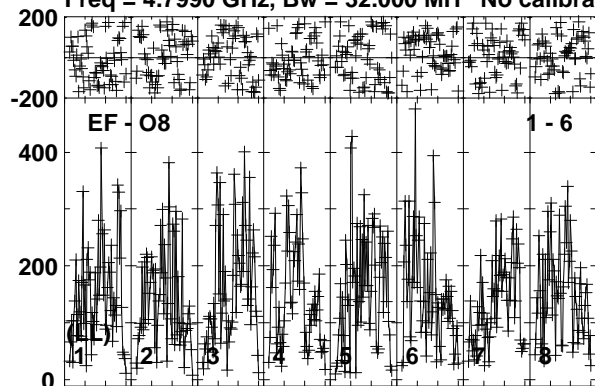

Lower frame: Micro Ampl Jy Top frame: Phas deg  
Vector averaged cross-power spectrum Baseline: EF (01) - O8 (06)  
Timerange: 00/03:00:40 to 00/03:01:40

Plot file version 94 created 24-NOV-2017 10:09:59

ARUMA EG096D.UVDATA.1

Freq = 4.7990 GHz, Bw = 32.000 MH No calibration applied and no bandpass applied

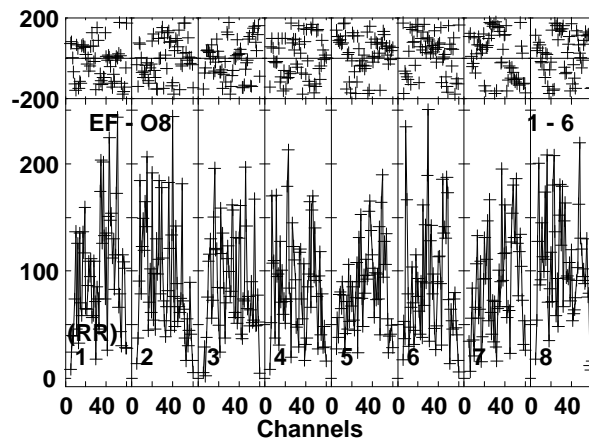
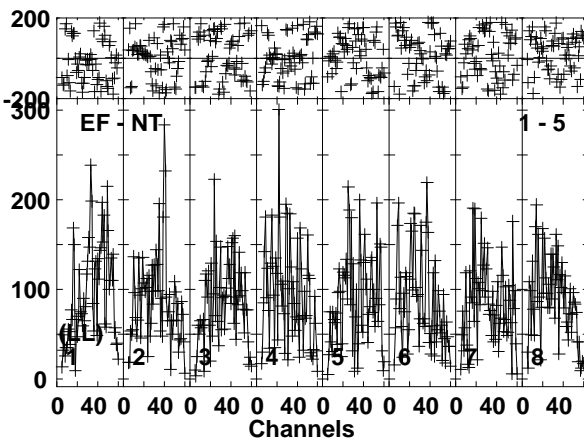
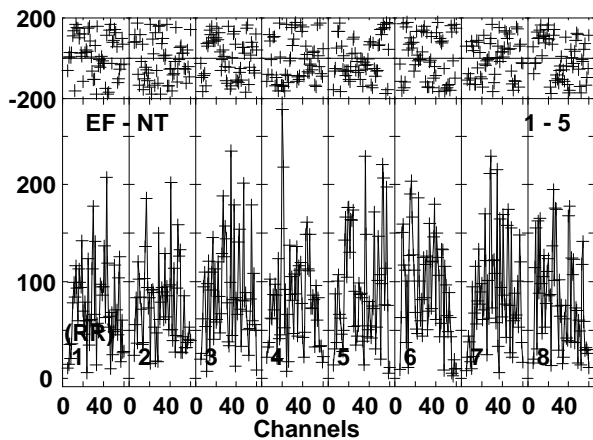
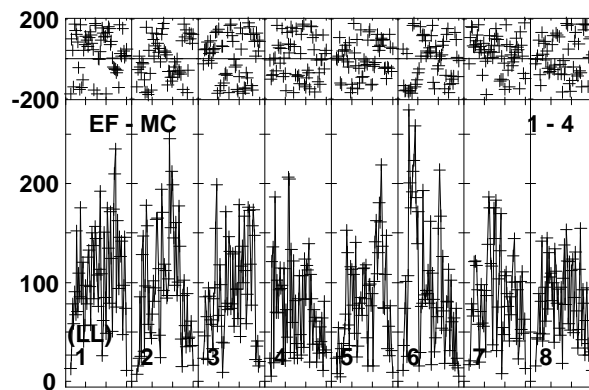
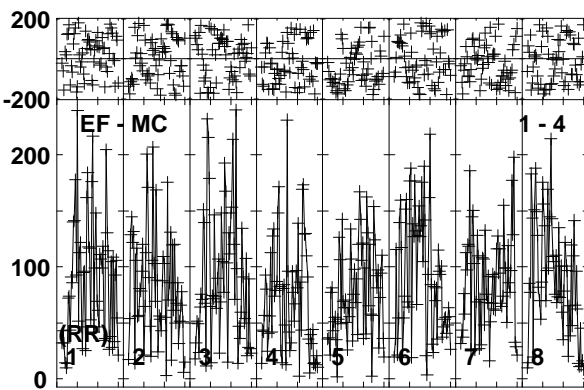
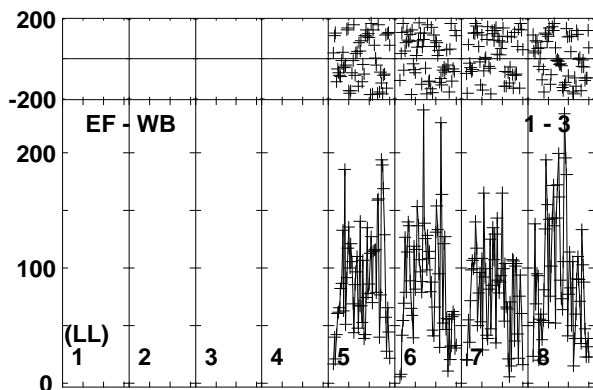
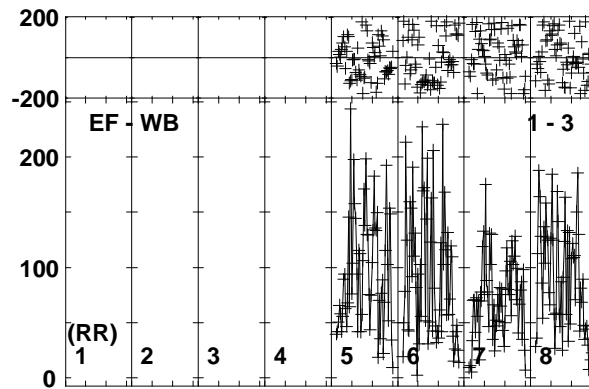
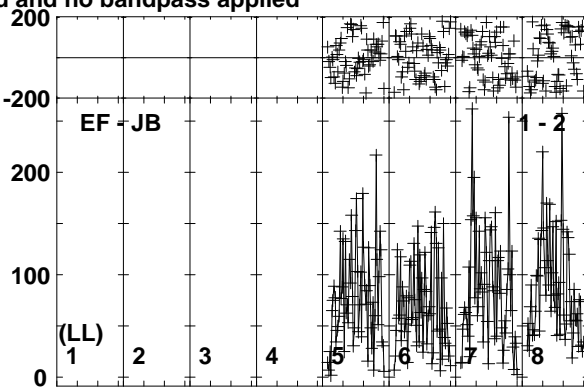
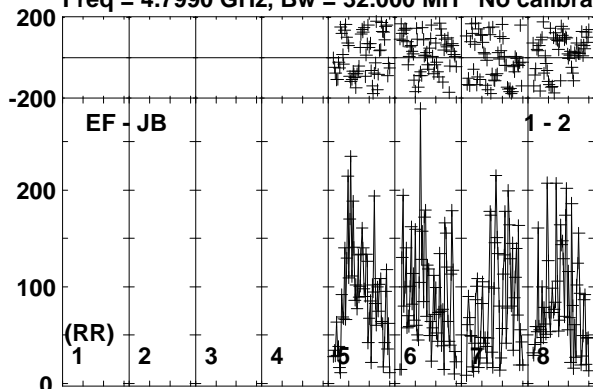

Lower frame: Micro Ampl Jy Top frame: Phas deg  
Vector averaged cross-power spectrum Baseline: EF (01) - JB (02)  
Timerange: 00/03:01:40 to 00/03:05:10

Plot file version 95 created 24-NOV-2017 10:10:00

ARUMA EG096D.UVDATA.1

Freq = 4.7990 GHz, Bw = 32.000 MH No calibration applied and no bandpass applied

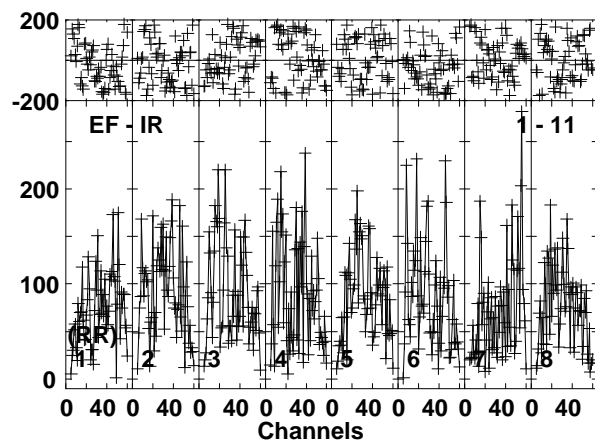
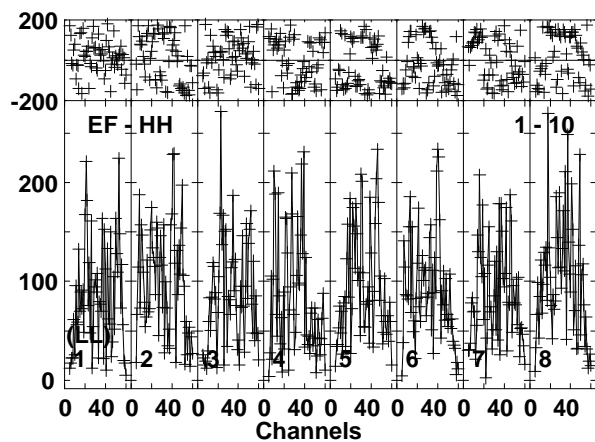
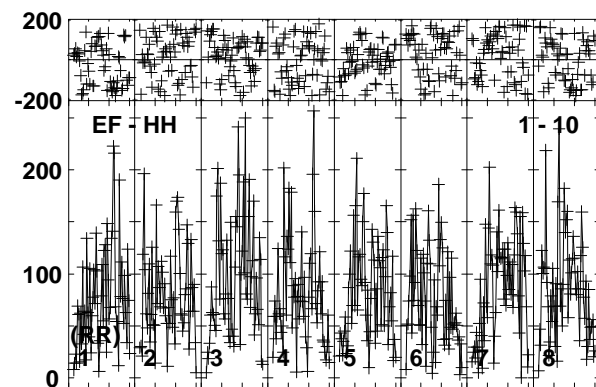
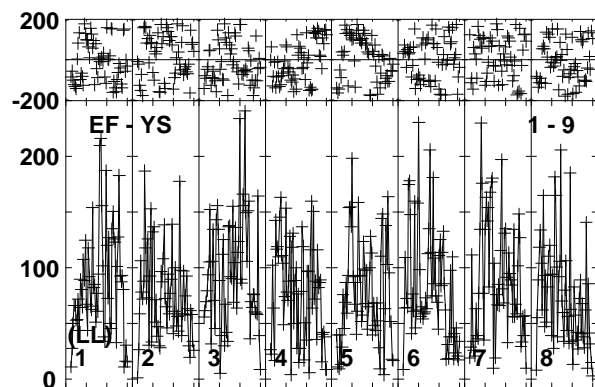
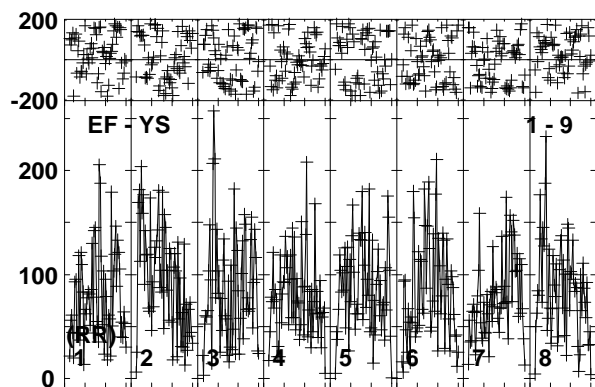
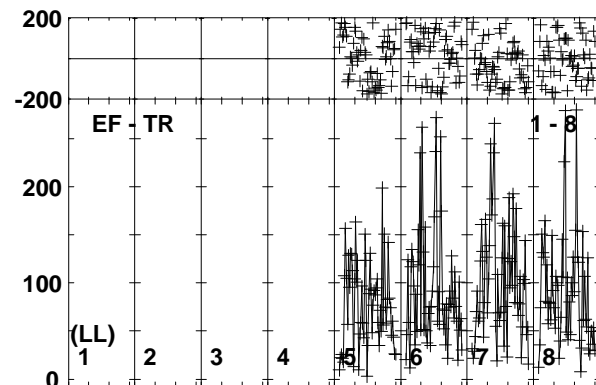
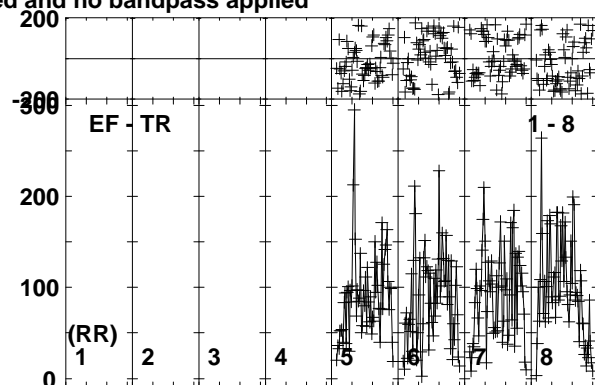
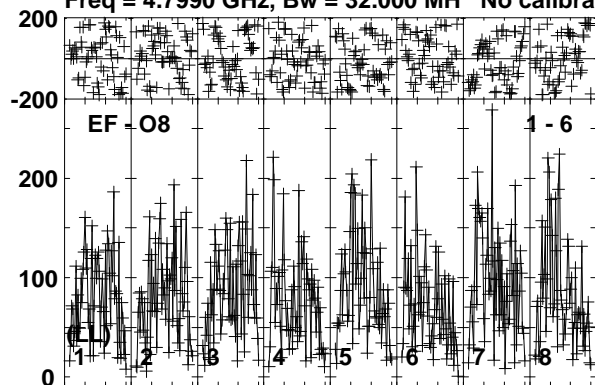

Lower frame: Micro Ampl Jy Top frame: Phas deg  
Vector averaged cross-power spectrum Baseline: EF (01) - O8 (06)  
Timerange: 00/03:01:40 to 00/03:05:10

Plot file version 96 created 24-NOV-2017 10:10:00

J1108+4330 EG096D.UVDATA.1

Freq = 4.7990 GHz, Bw = 32.000 MH No calibration applied and no bandpass applied

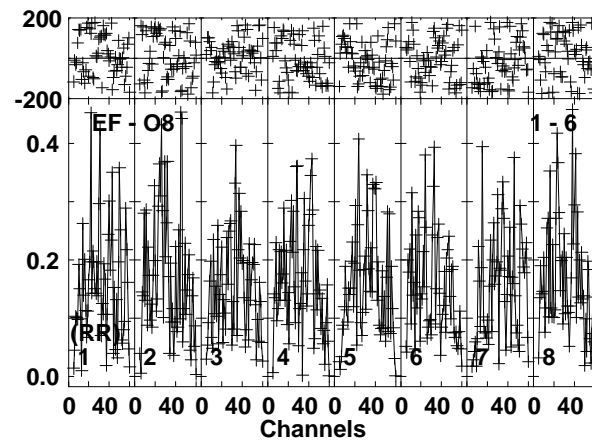
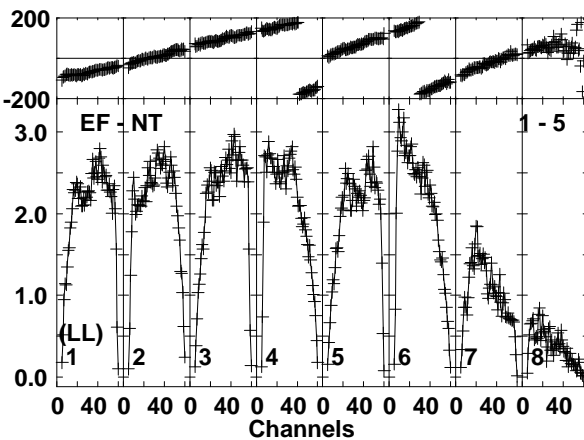
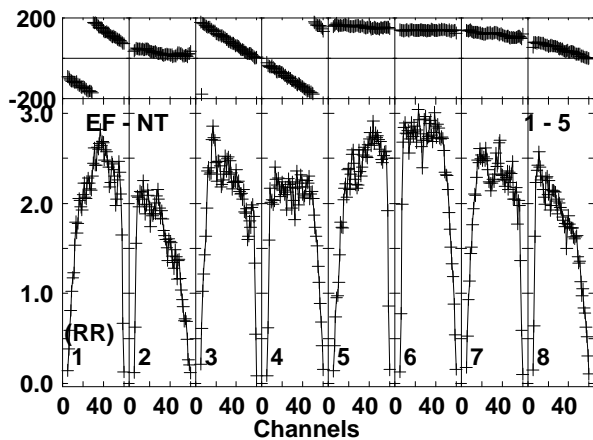
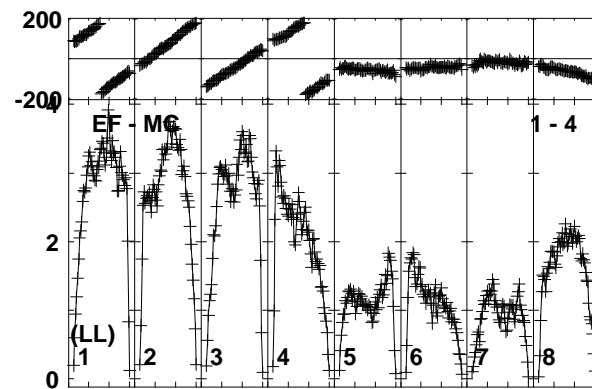
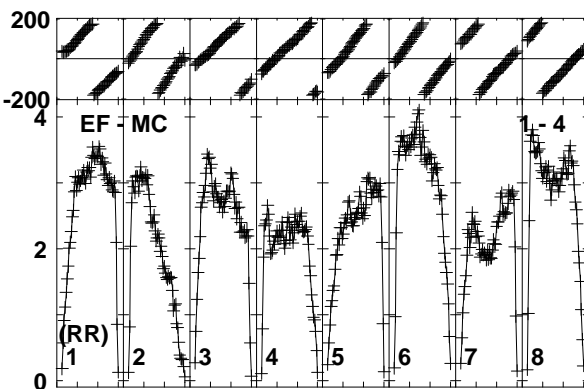
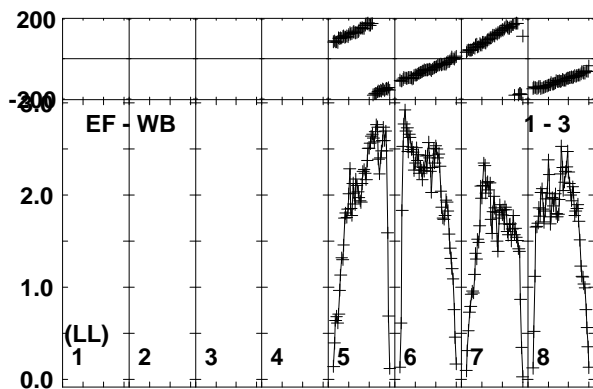
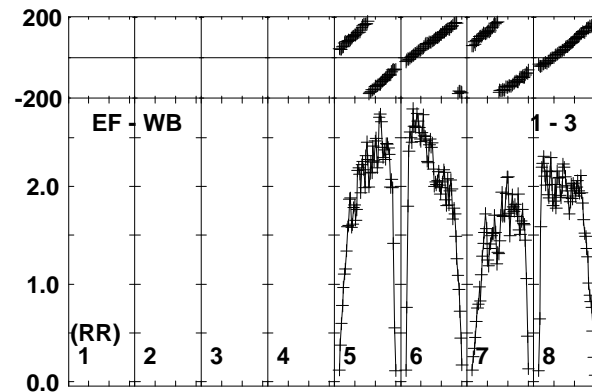
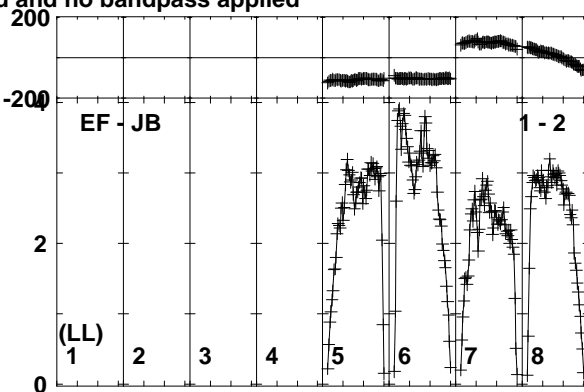
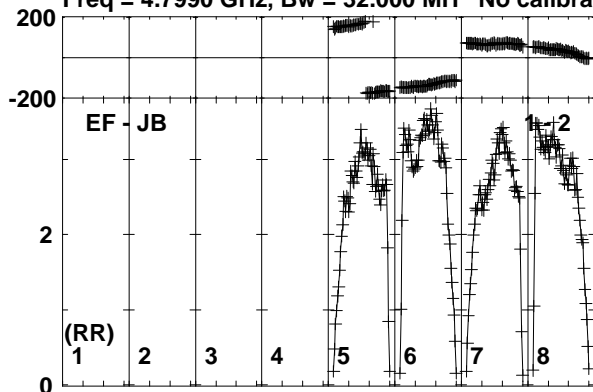

Lower frame: Milli Ampl Jy Top frame: Phas deg  
Vector averaged cross-power spectrum Baseline: EF (01) - JB (02)  
Timerange: 00/03:05:10 to 00/03:06:39

Plot file version 97 created 24-NOV-2017 10:10:00

J1108+4330 EG096D.UVDATA.1

Freq = 4.7990 GHz, Bw = 32.000 MH No calibration applied and no bandpass applied

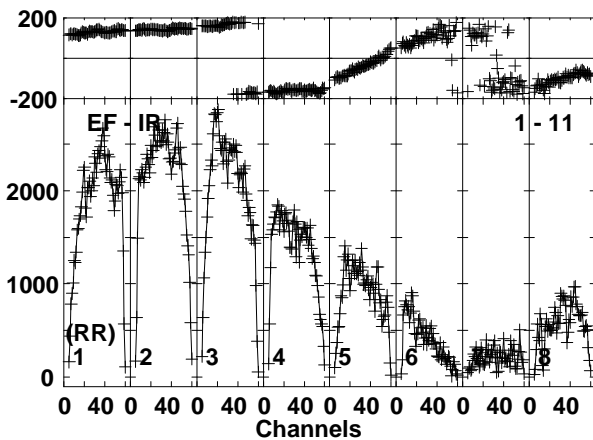
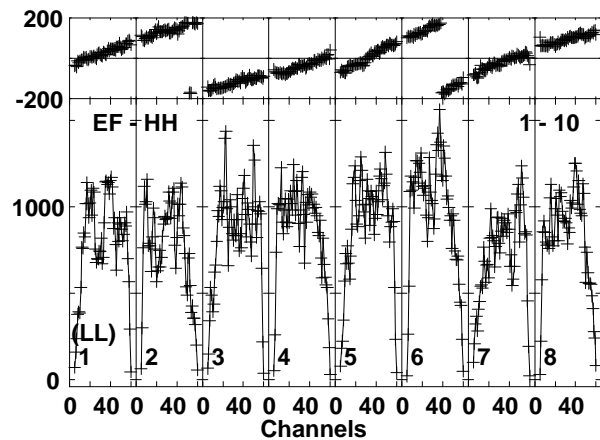
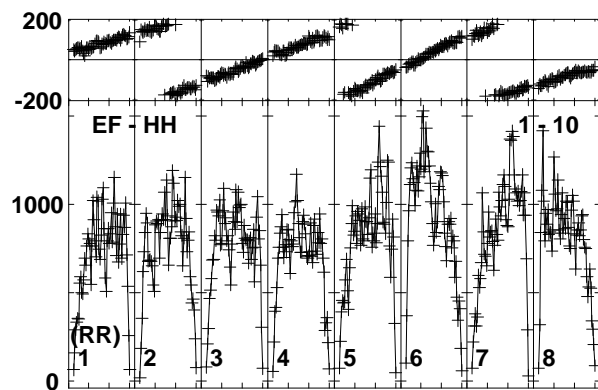
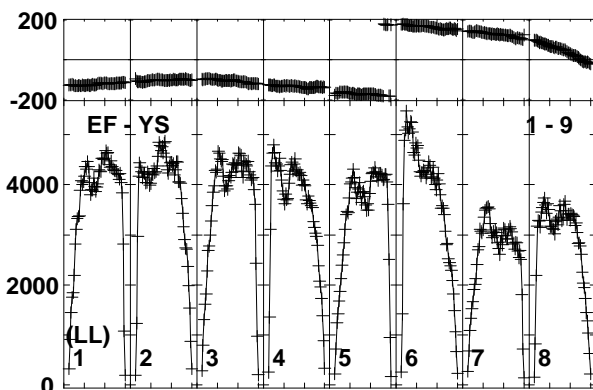
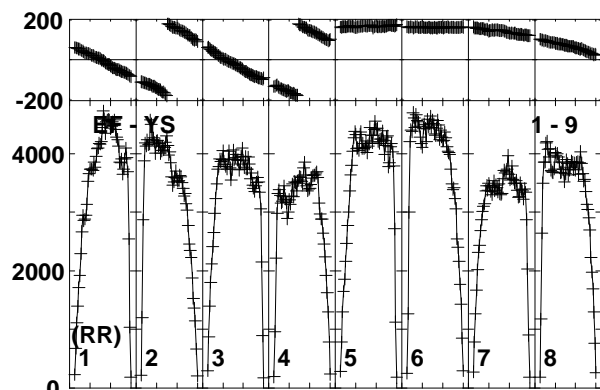
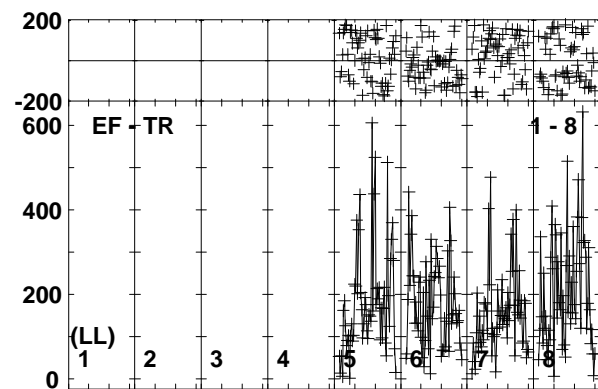
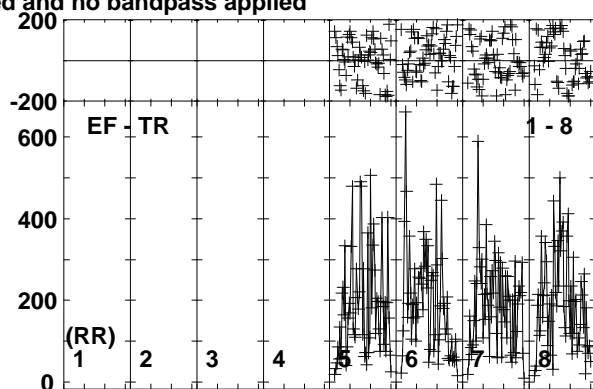
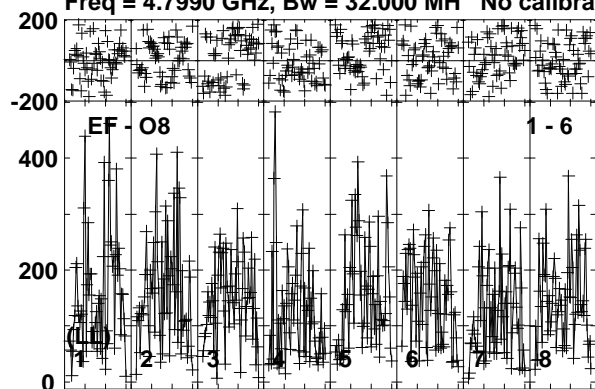

Lower frame: Micro Ampl Jy Top frame: Phas deg  
Vector averaged cross-power spectrum Baseline: EF (01) - O8 (06)  
Timerange: 00/03:05:10 to 00/03:06:39





Plot file version 99 created 24-NOV-2017 10:10:01

ARUMA EG096D.UVDATA.1

Freq = 4.7990 GHz, Bw = 32.000 MH No calibration applied and no bandpass applied

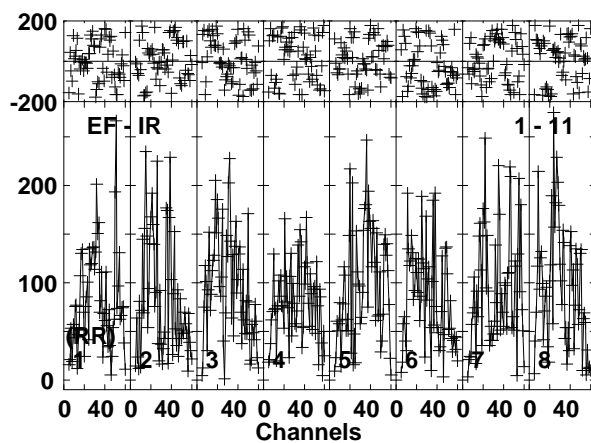
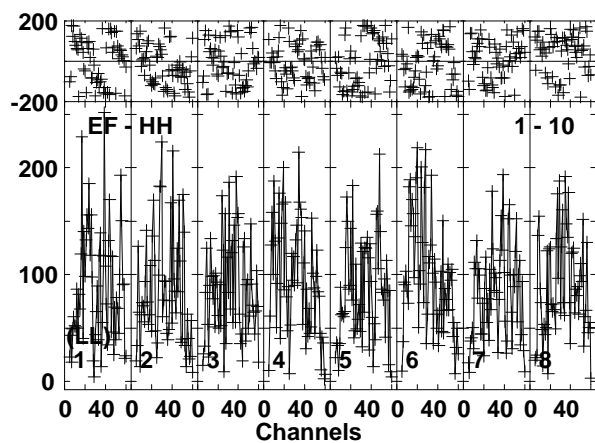
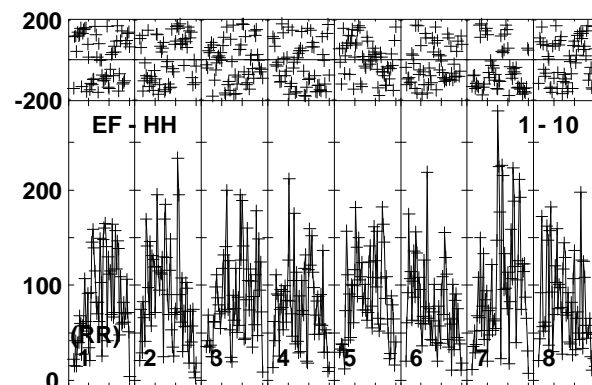
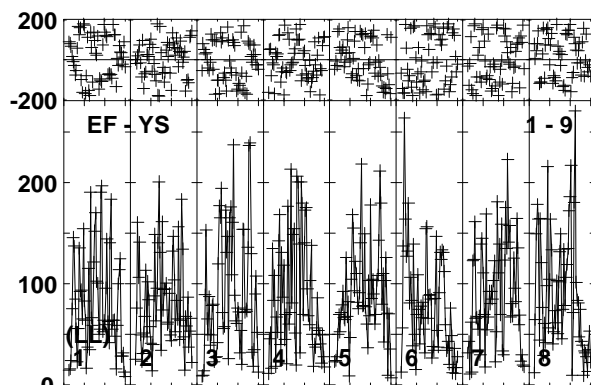
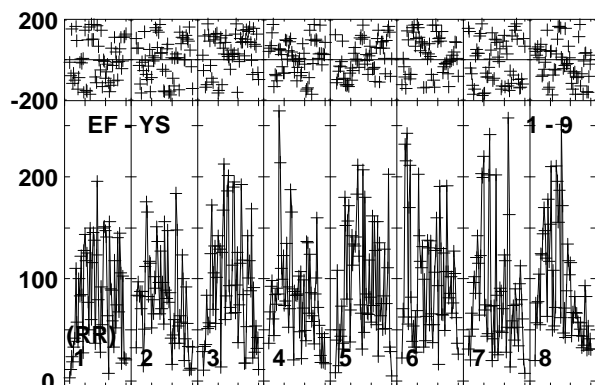
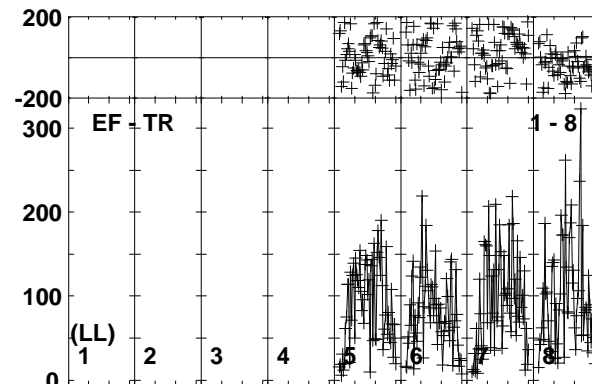
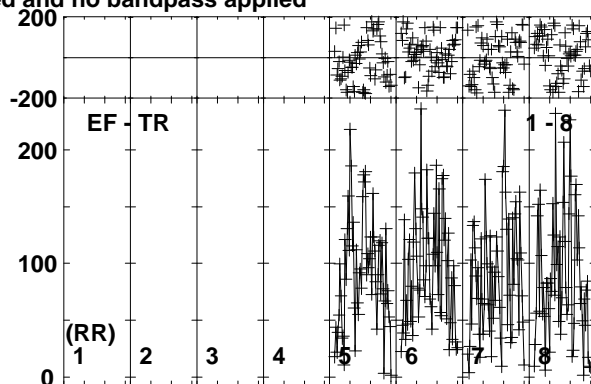
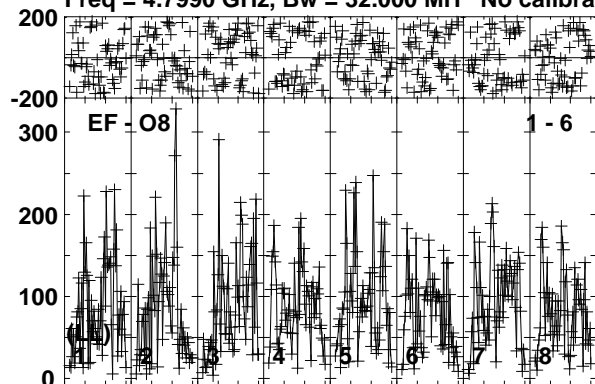

Lower frame: Micro Ampl Jy Top frame: Phas deg  
Vector averaged cross-power spectrum Baseline: EF (01) - O8 (06)  
Timerange: 00/03:06:41 to 00/03:10:10

Plot file version 100 created 24-NOV-2017 10:10:01

J1108+4330 EG096D.UVDATA.1

Freq = 4.7990 GHz, Bw = 32.000 MH No calibration applied and no bandpass applied

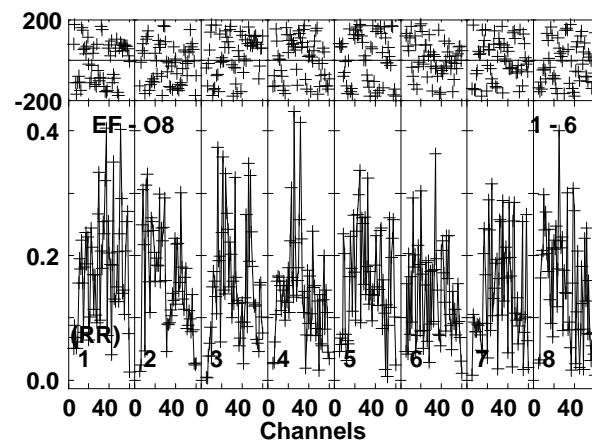
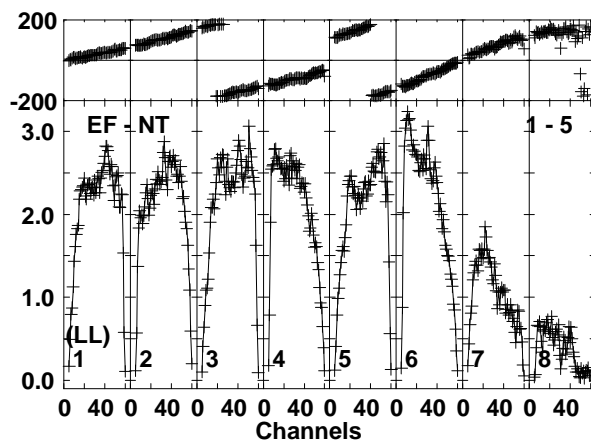
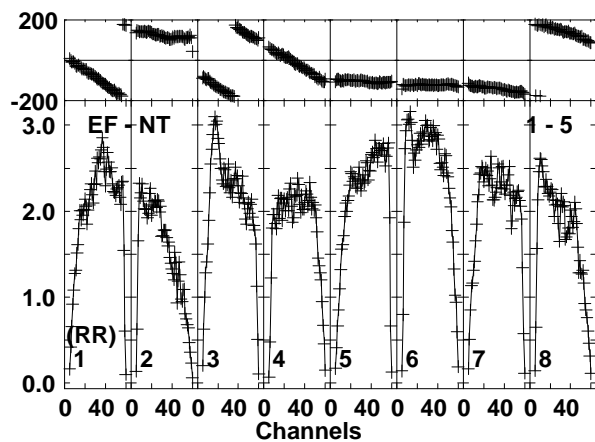
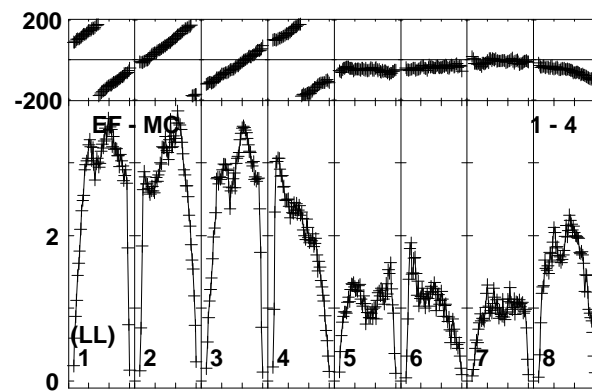
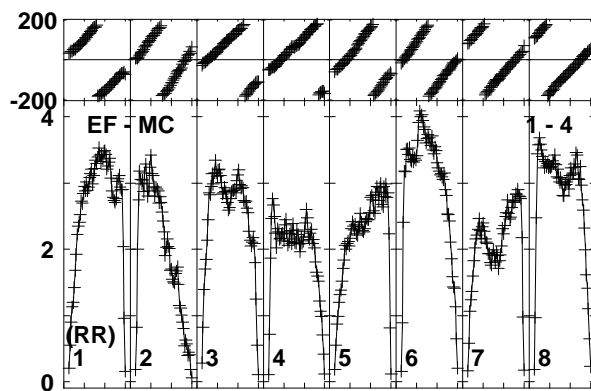
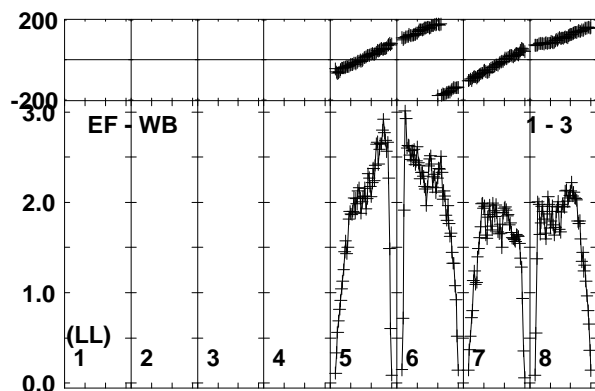
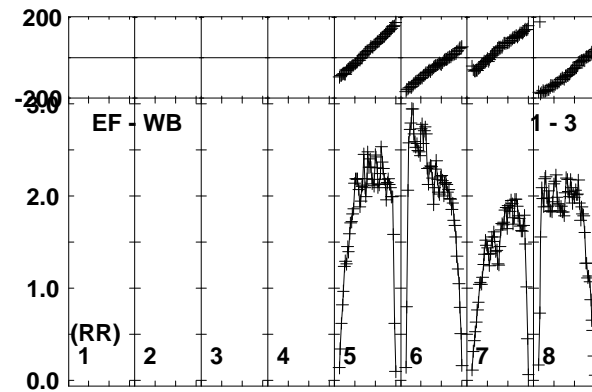
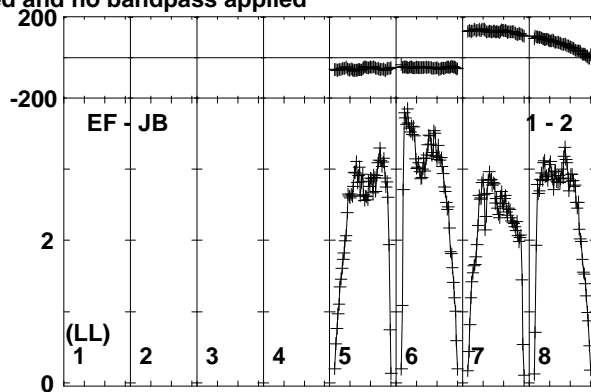
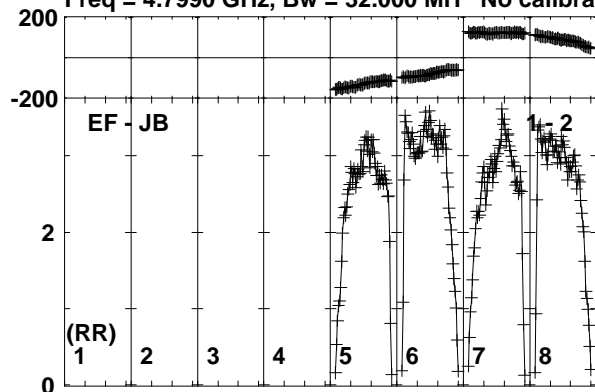

Lower frame: Milli Ampl Jy Top frame: Phas deg  
Vector averaged cross-power spectrum Baseline: EF (01) - JB (02)  
Timerange: 00/03:10:50 to 00/03:11:50

Plot file version 101 created 24-NOV-2017 10:10:02

J1108+4330 EG096D.UVDATA.1

Freq = 4.7990 GHz, Bw = 32.000 MH No calibration applied and no bandpass applied

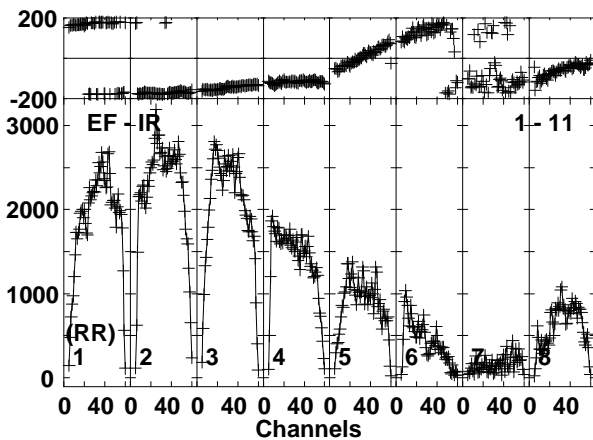
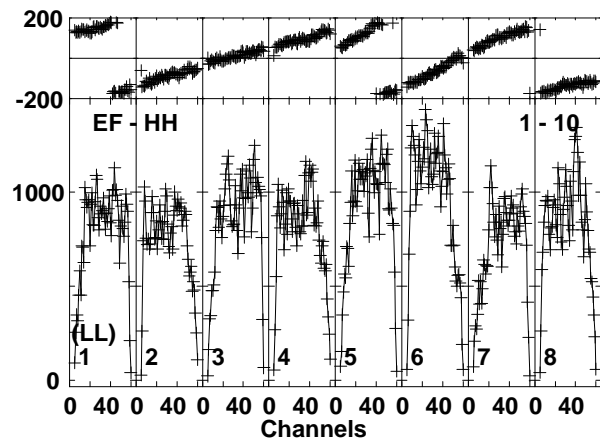
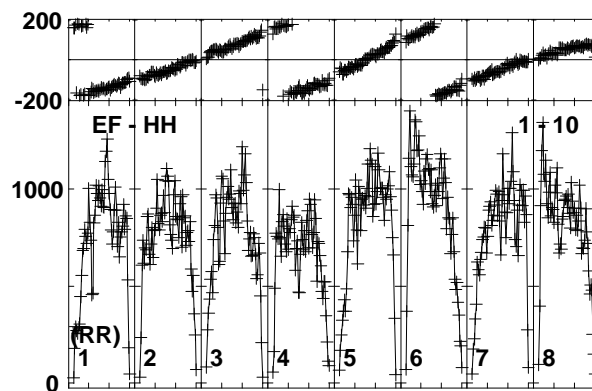
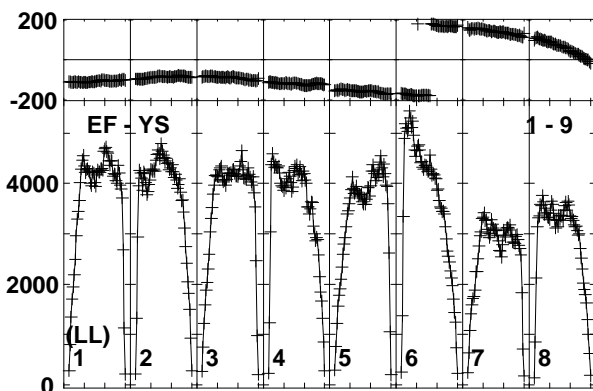
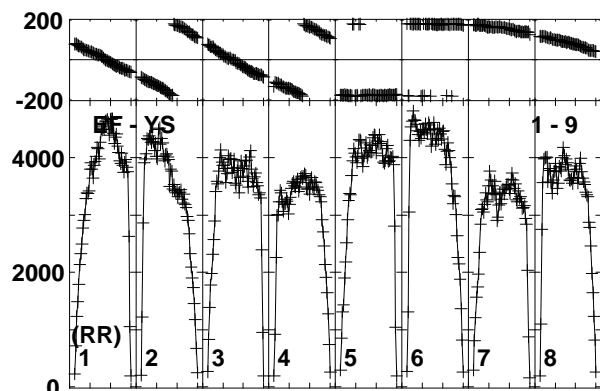
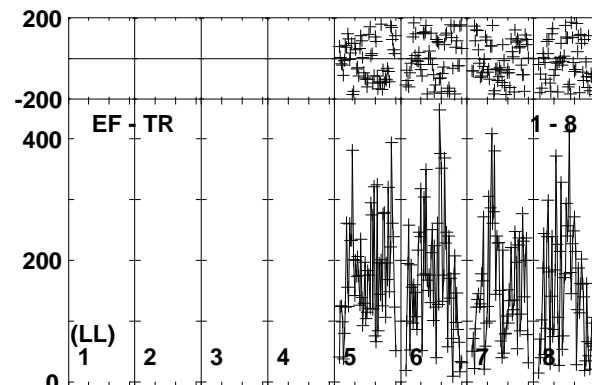
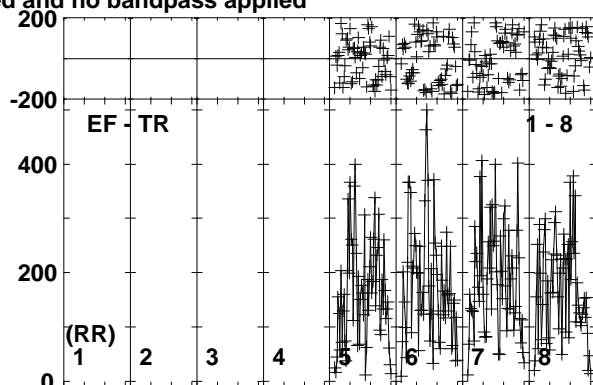
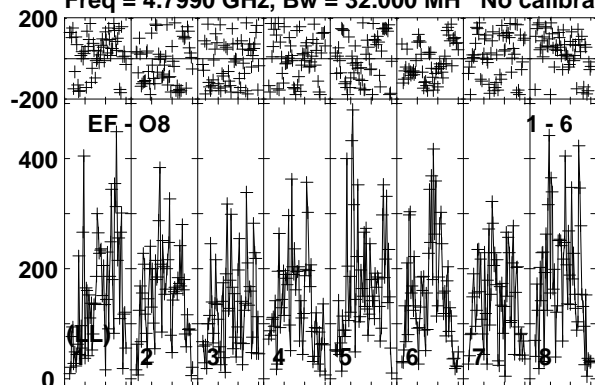

Lower frame: Micro Ampl Jy Top frame: Phas deg  
Vector averaged cross-power spectrum Baseline: EF (01) - O8 (06)  
Timerange: 00/03:10:50 to 00/03:11:50

Plot file version 102 created 24-NOV-2017 10:10:02

ARUMA EG096D.UVDATA.1

Freq = 4.7990 GHz, Bw = 32.000 MH No calibration applied and no bandpass applied

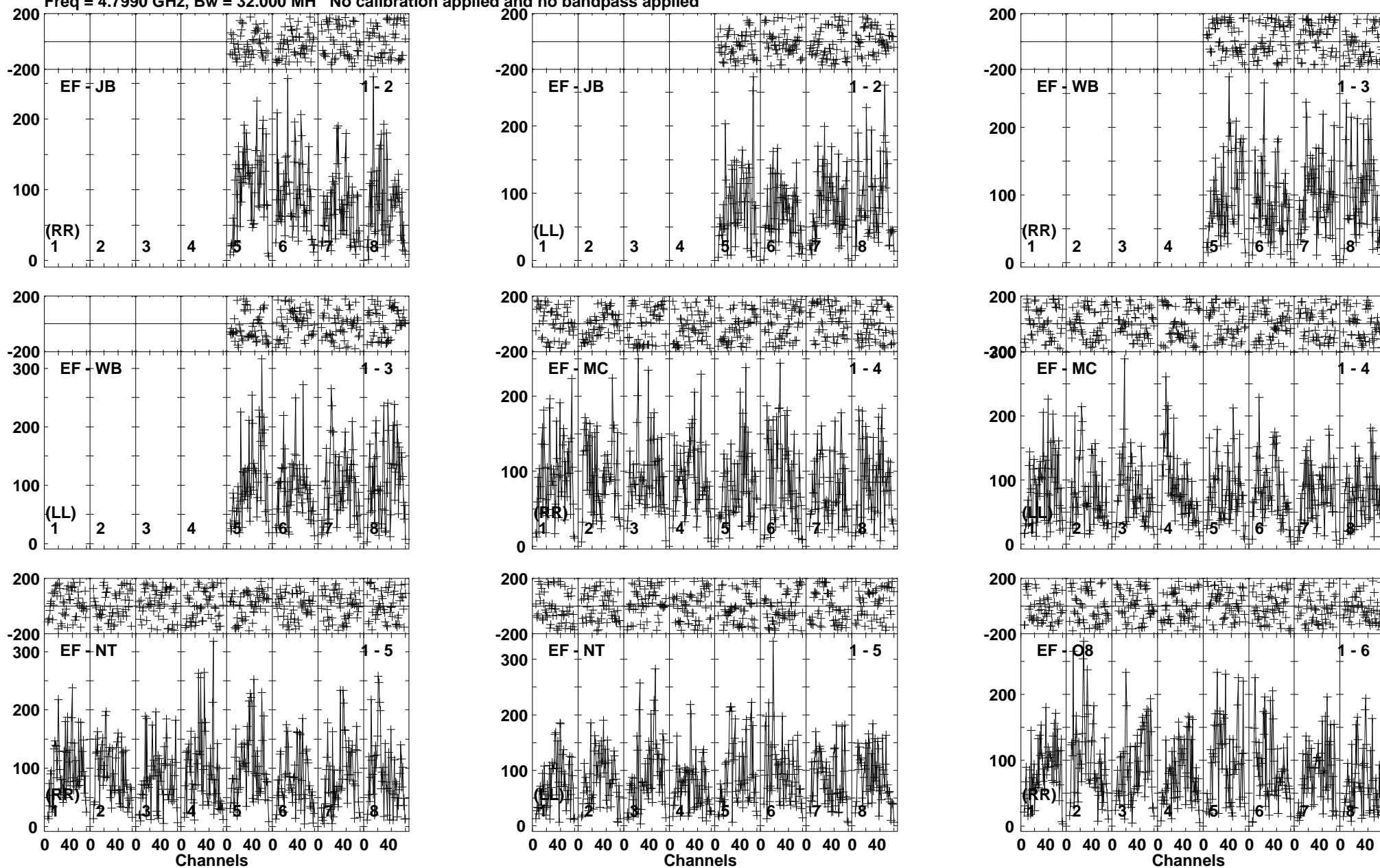

Lower frame: Micro Ampl Jy Top frame: Phas deg  
Vector averaged cross-power spectrum Baseline: EF (01) - JB (02)  
Timerange: 00/03:11:51 to 00/03:15:20

Plot file version 103 created 24-NOV-2017 10:10:02

ARUMA EG096D.UVDATA.1

Freq = 4.7990 GHz, Bw = 32.000 MH No calibration applied and no bandpass applied

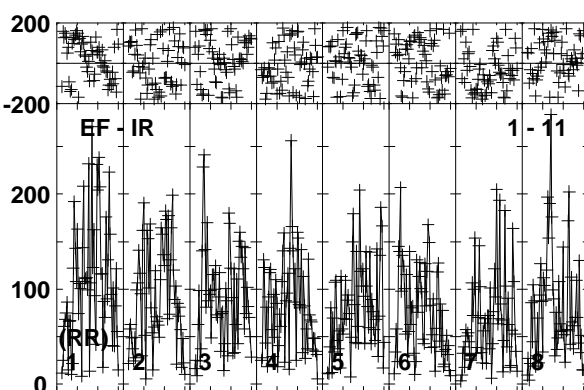
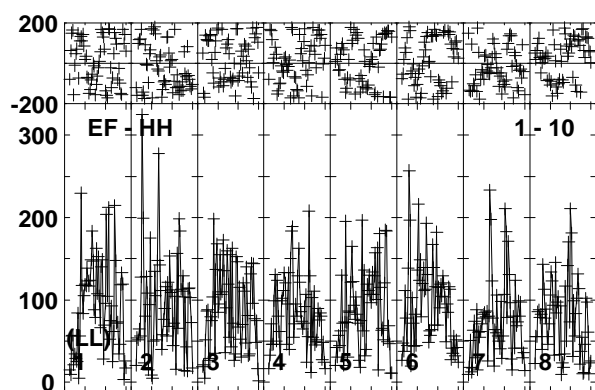
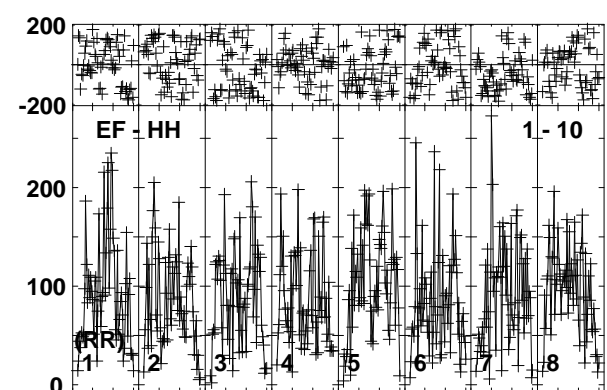
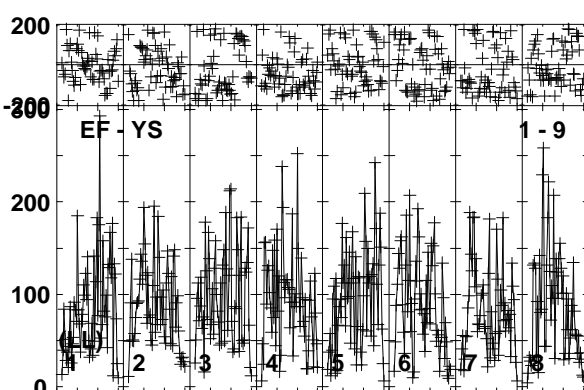
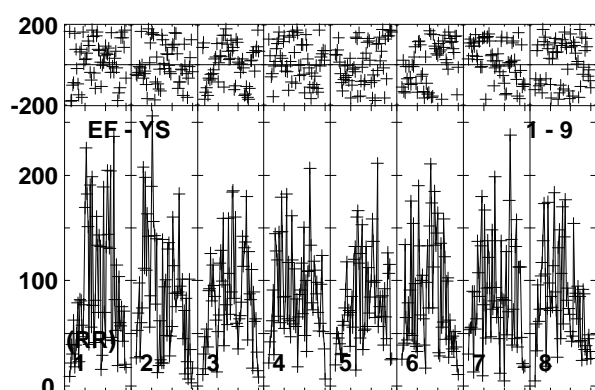
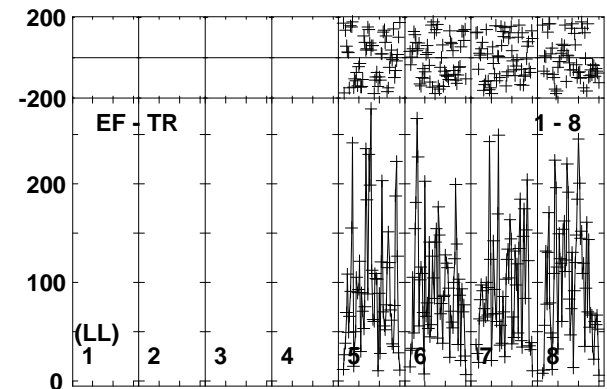
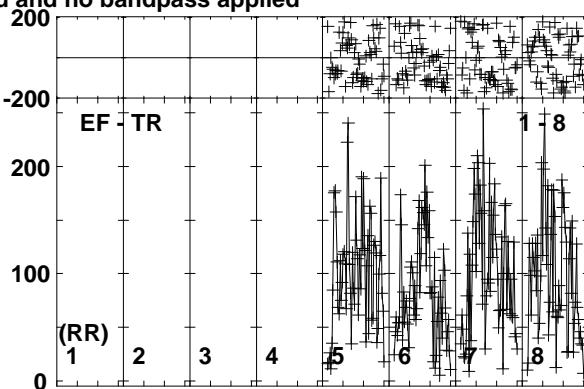
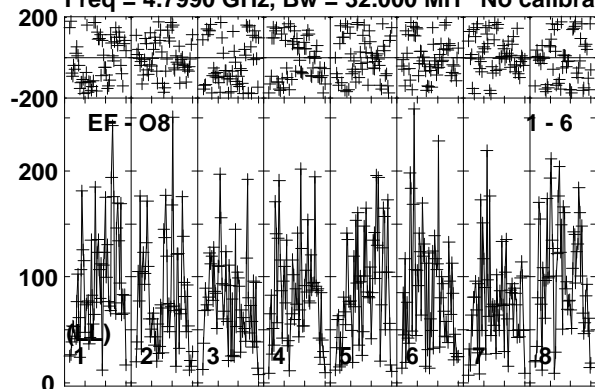

Lower frame: Micro Ampl Jy Top frame: Phas deg  
Vector averaged cross-power spectrum Baseline: EF (01) - O8 (06)  
Timerange: 00/03:11:51 to 00/03:15:20

Plot file version 104 created 24-NOV-2017 10:10:03

J1108+4330 EG096D.UVDATA.1

Freq = 4.7990 GHz, Bw = 32.000 MH No calibration applied and no bandpass applied

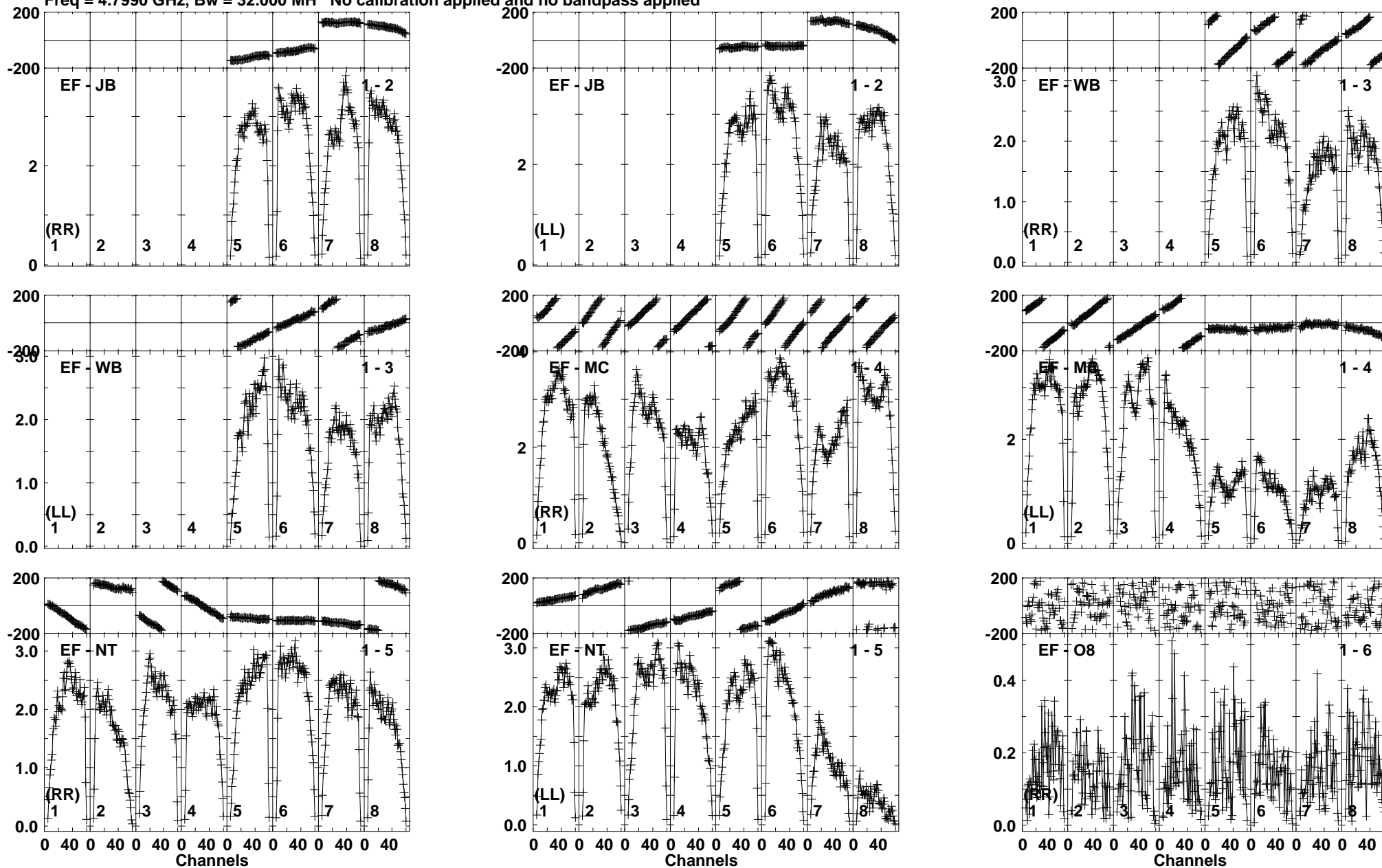

Lower frame: Milli Ampl Jy Top frame: Phas deg  
Vector averaged cross-power spectrum Baseline: EF (01) - JB (02)  
Timerange: 00/03:15:21 to 00/03:16:50

Plot file version 105 created 24-NOV-2017 10:10:03

J1108+4330 EG096D.UVDATA.1

Freq = 4.7990 GHz, Bw = 32.000 MH No calibration applied and no bandpass applied

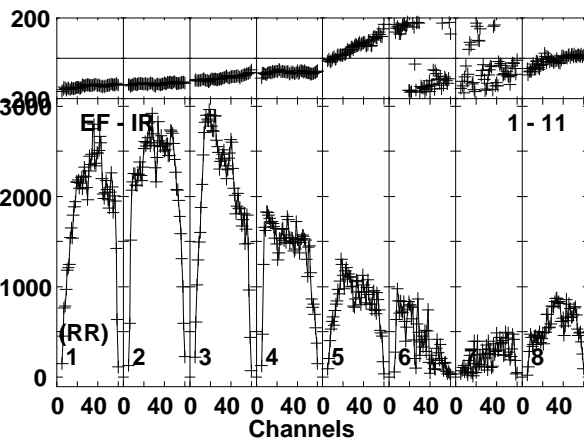
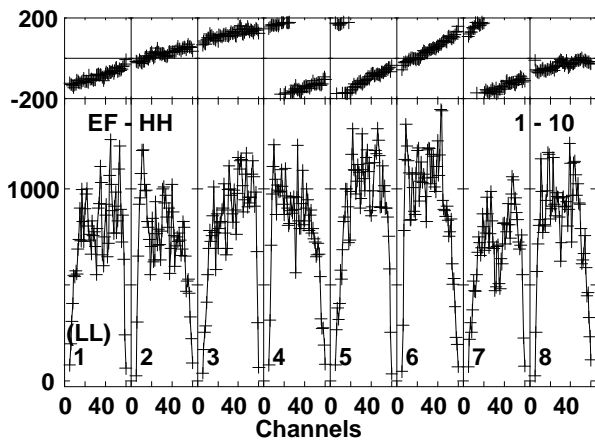
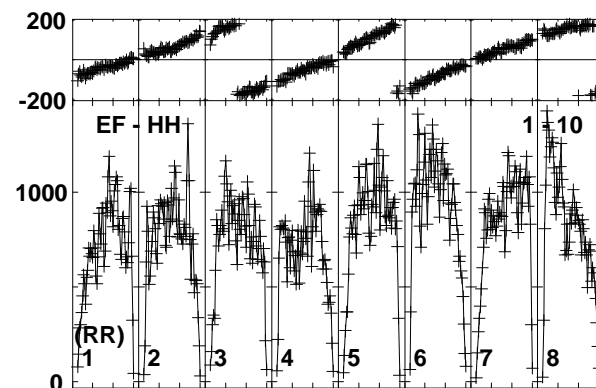
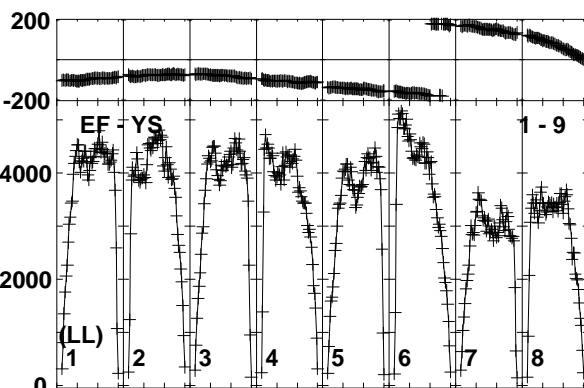
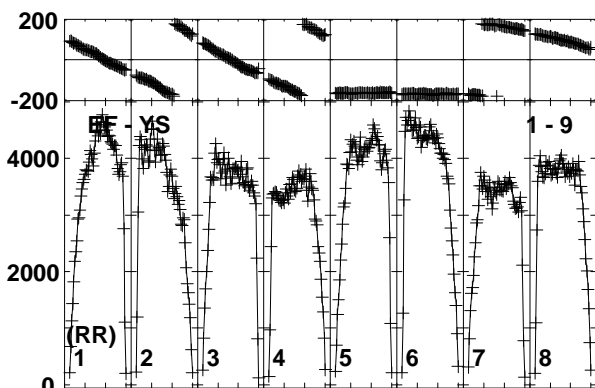
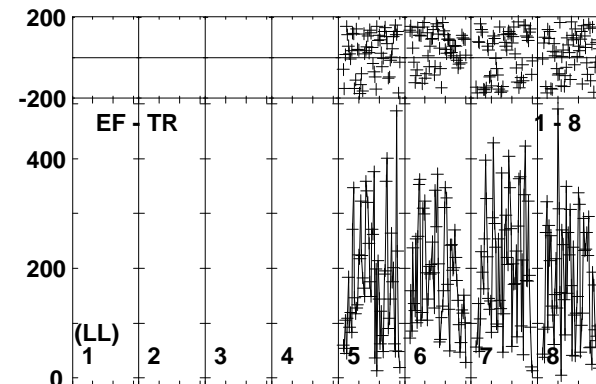
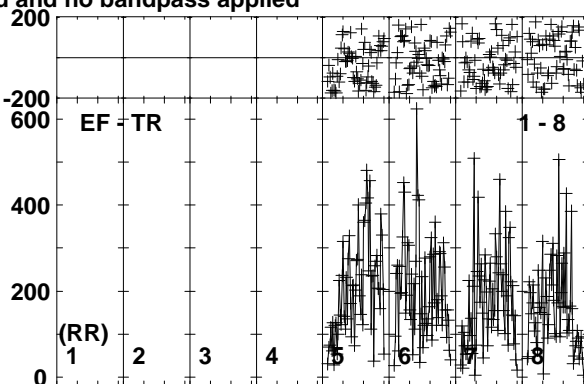
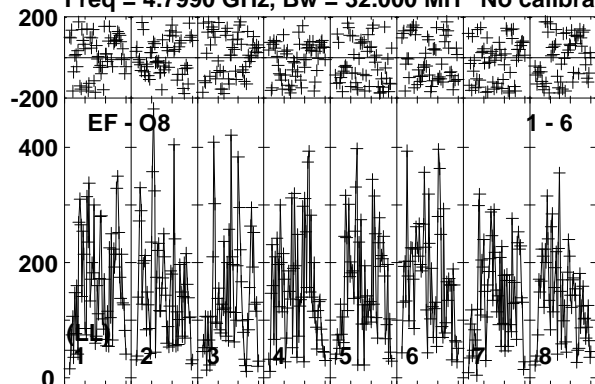

Lower frame: Micro Ampl Jy Top frame: Phas deg  
Vector averaged cross-power spectrum Baseline: EF (01) - O8 (06)  
Timerange: 00/03:15:21 to 00/03:16:50

Plot file version 106 created 24-NOV-2017 10:10:03

ARUMA EG096D.UVDATA.1

Freq = 4.7990 GHz, Bw = 32.000 MH No calibration applied and no bandpass applied

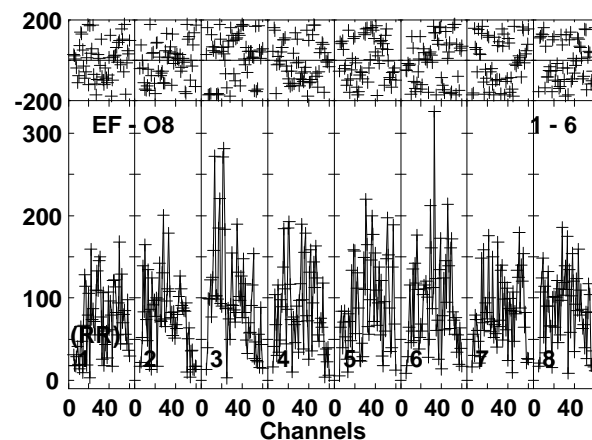
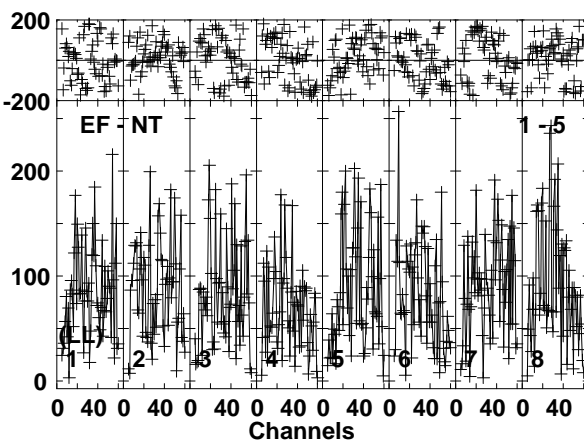
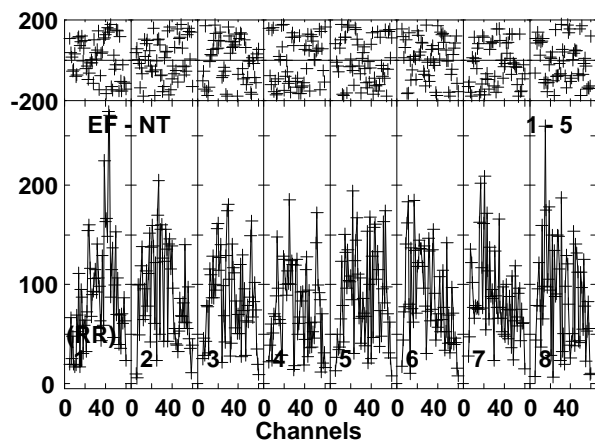
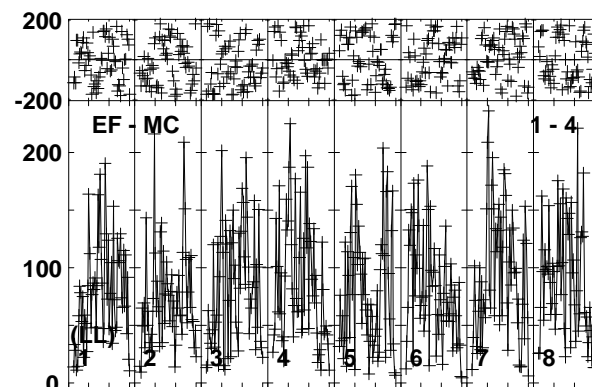
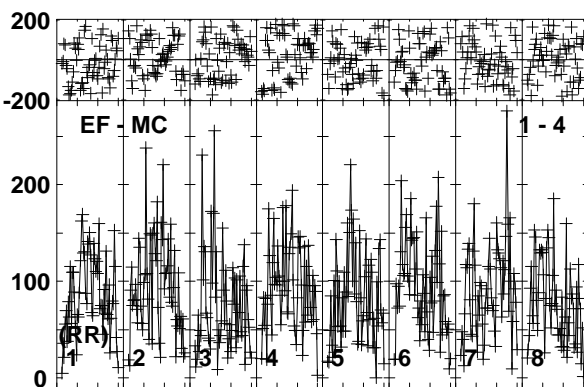
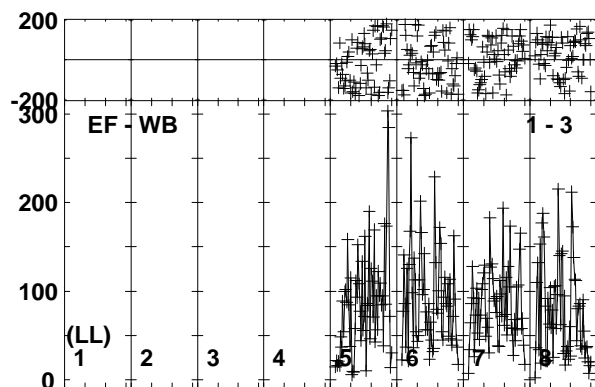
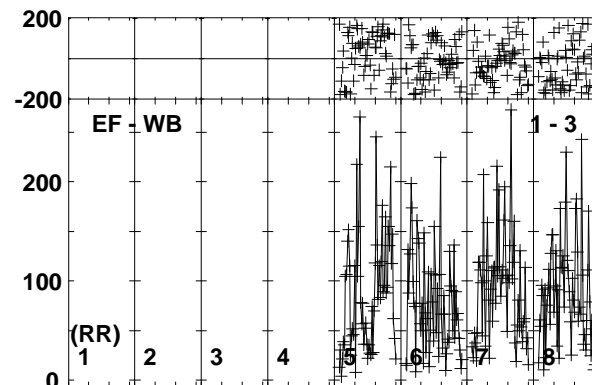
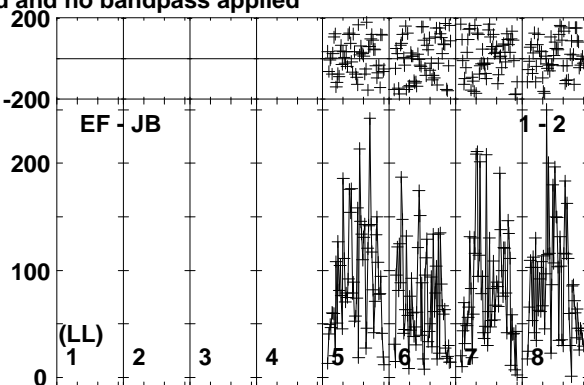
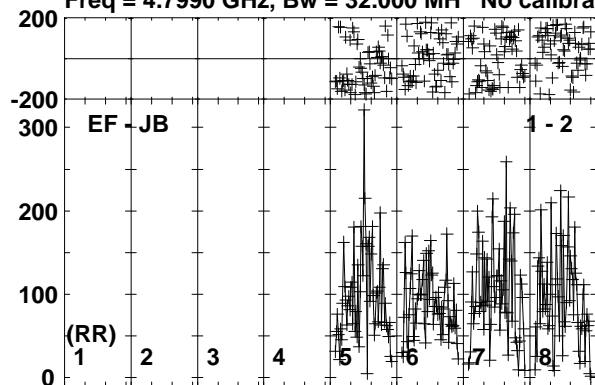

Lower frame: Micro Ampl Jy Top frame: Phas deg  
Vector averaged cross-power spectrum Baseline: EF (01) - JB (02)  
Timerange: 00/03:16:50 to 00/03:20:20





Plot file version 108 created 24-NOV-2017 10:10:04  
ARUMA EG096D.UVDATA.1  
Freq = 4.7990 GHz, Bw = 32.000 MH No calibration applied and no bandpass applied

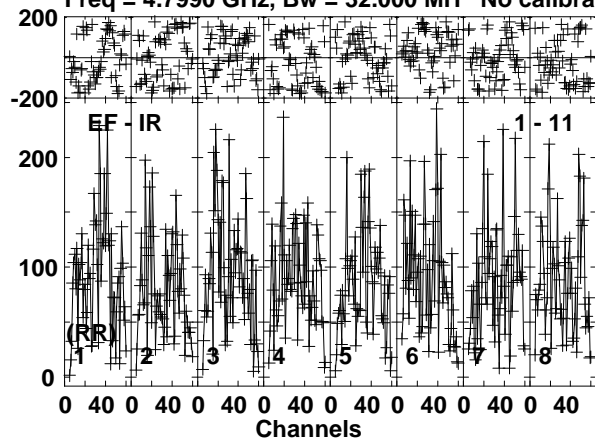

Lower frame: Micro Ampl Jy Top frame: Phas deg  
Vector averaged cross-power spectrum Baseline: EF (01) - IR (11)  
Timerange: 00/03:16:50 to 00/03:20:20

Plot file version 109 created 24-NOV-2017 10:10:04

J1108+4330 EG096D.UVDATA.1

Freq = 4.7990 GHz, Bw = 32.000 MH No calibration applied and no bandpass applied

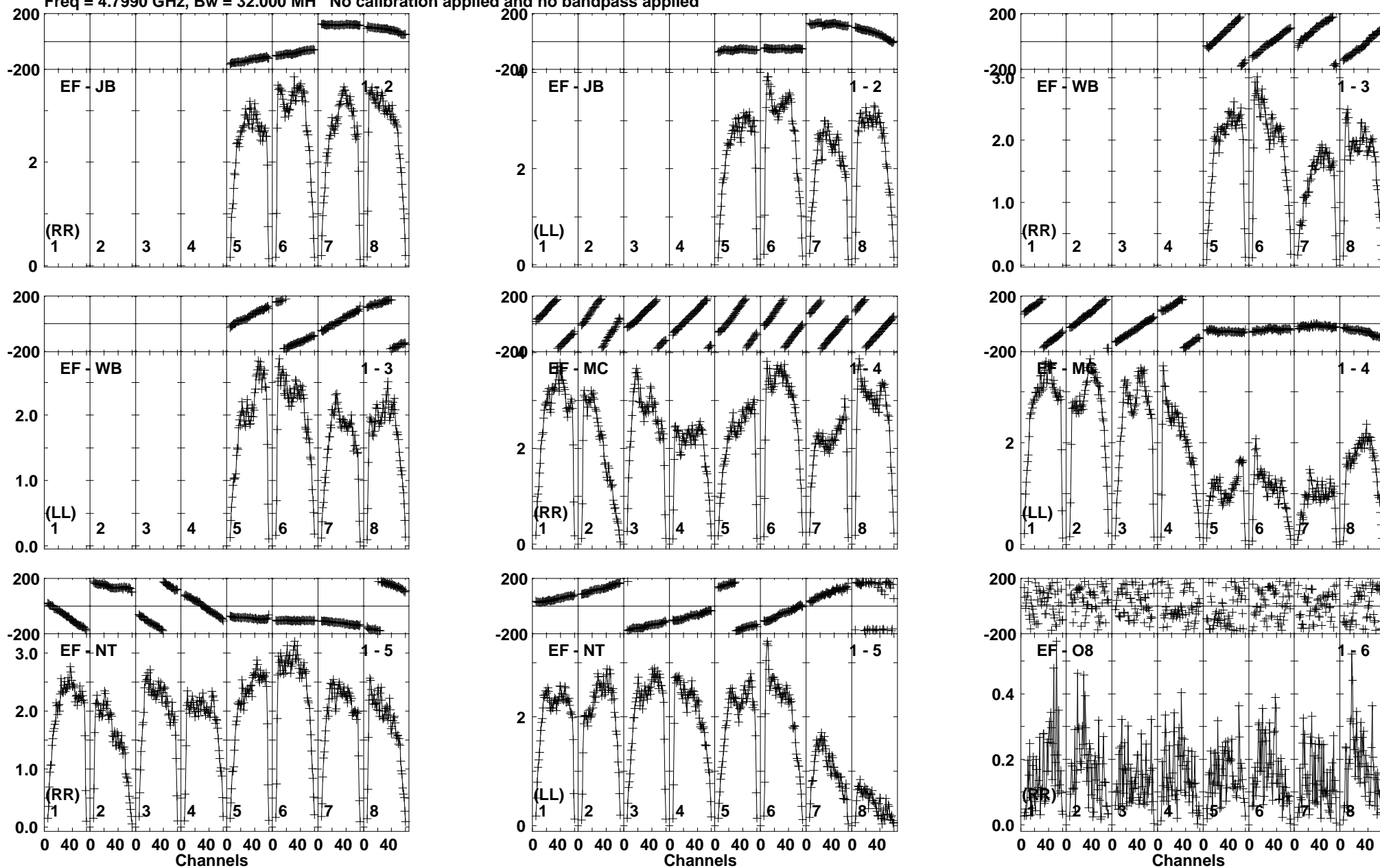

Lower frame: Milli Ampl Jy Top frame: Phas deg  
Vector averaged cross-power spectrum Baseline: EF (01) - JB (02)  
Timerange: 00/03:21:00 to 00/03:22:00

Plot file version 110 created 24-NOV-2017 10:10:04

J1108+4330 EG096D.UVDATA.1

Freq = 4.7990 GHz, Bw = 32.000 MH No calibration applied and no bandpass applied

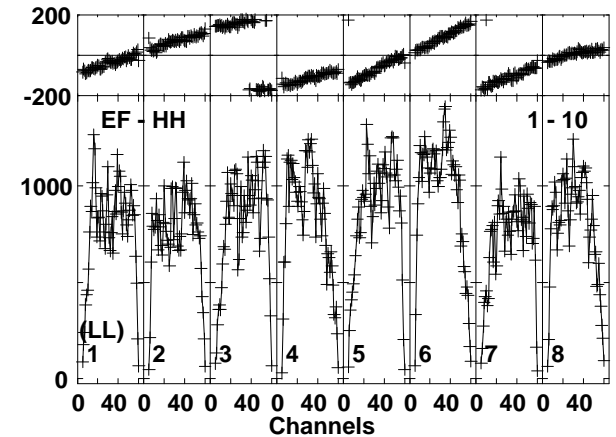
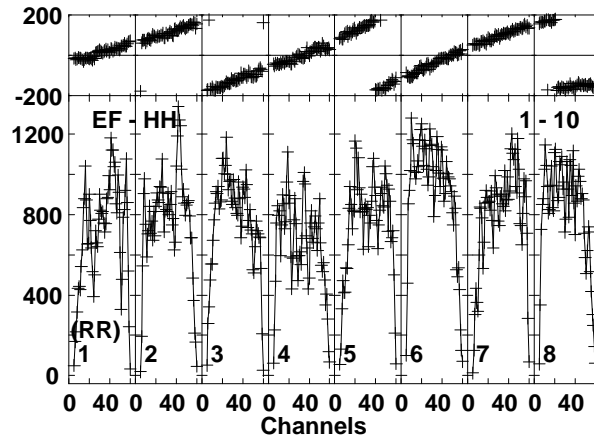
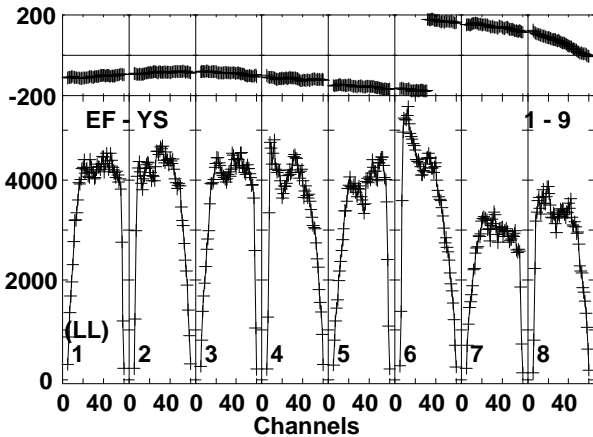
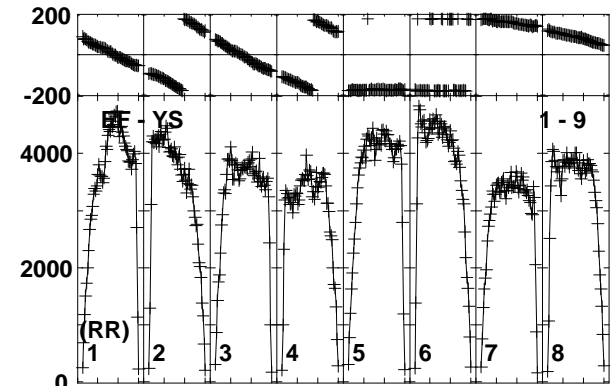
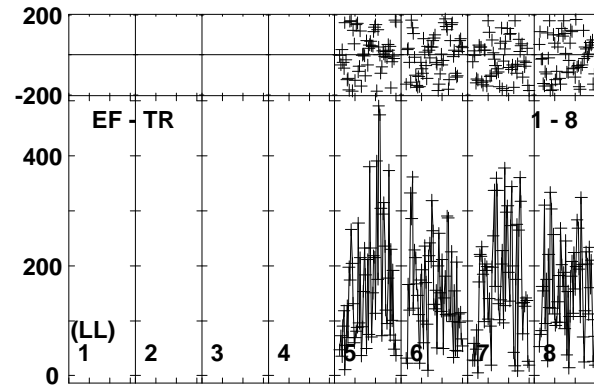
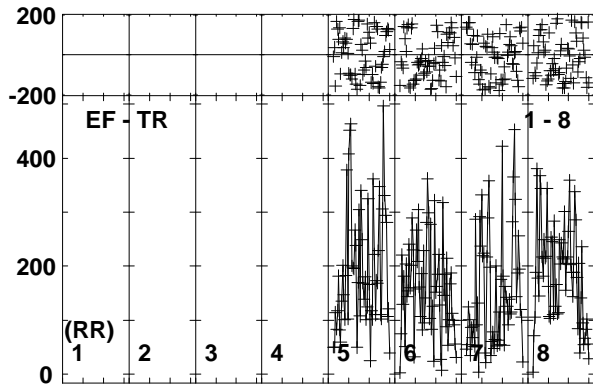
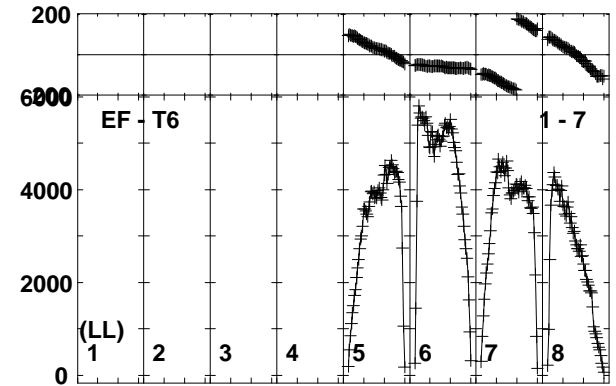
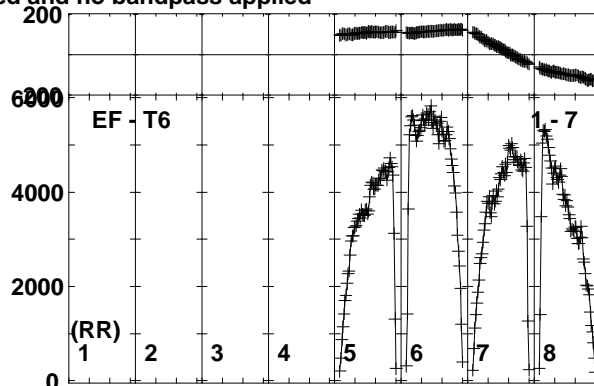
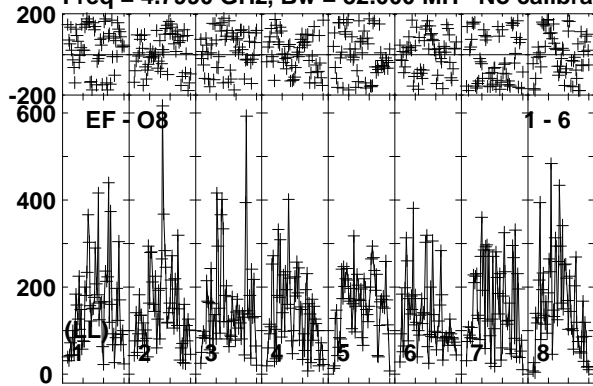

Lower frame: Micro Ampl Jy Top frame: Phas deg  
Vector averaged cross-power spectrum Baseline: EF (01) - O8 (06)  
Timerange: 00/03:21:00 to 00/03:22:00

Plot file version 111 created 24-NOV-2017 10:10:04  
J1108+4330 EG096D.UVDATA.1  
Freq = 4.7990 GHz, Bw = 32.000 MH No calibration applied and no bandpass applied

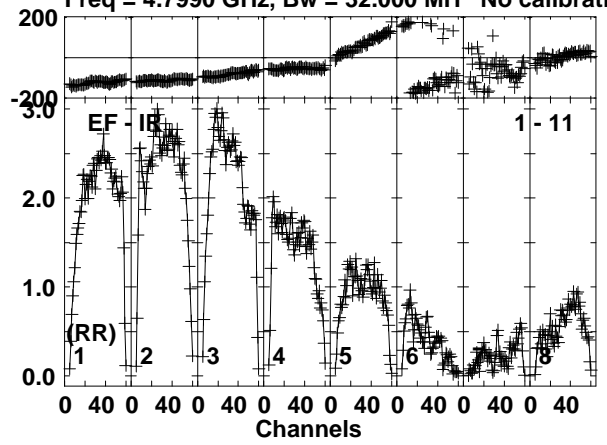

Lower frame: Milli Ampl Jy Top frame: Phas deg  
Vector averaged cross-power spectrum Baseline: EF (01) - IR (11)  
Timerange: 00/03:21:00 to 00/03:22:00

Plot file version 112 created 24-NOV-2017 10:10:05

J1112+4301 EG096D.UVDATA.1

Freq = 4.7990 GHz, Bw = 32.000 MH No calibration applied and no bandpass applied

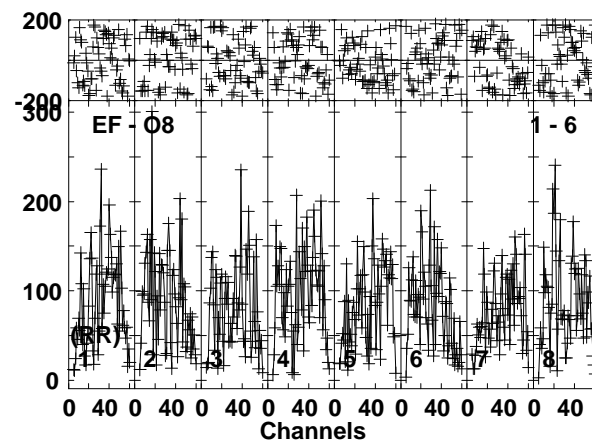
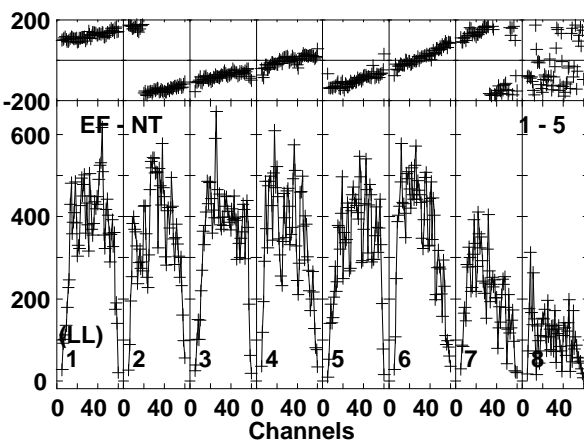
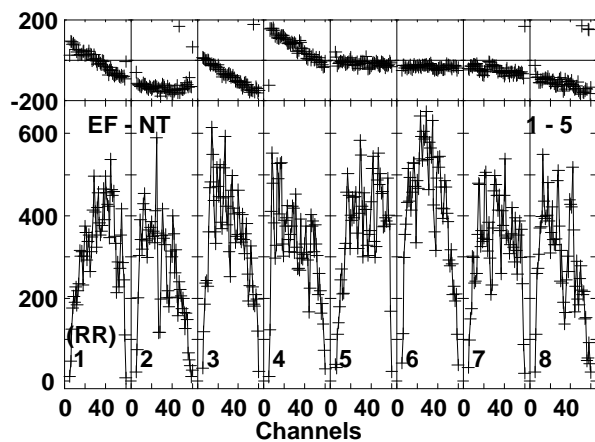
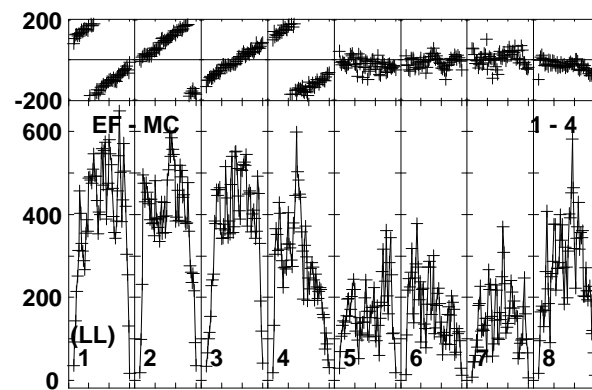
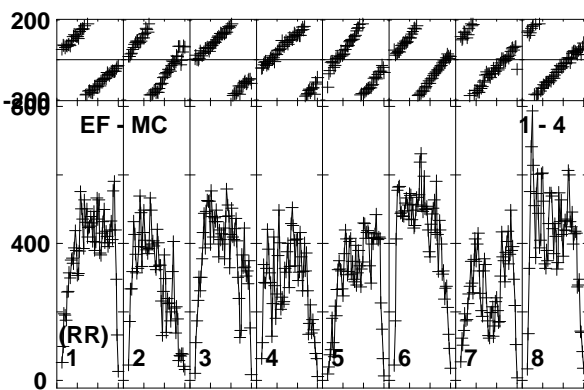
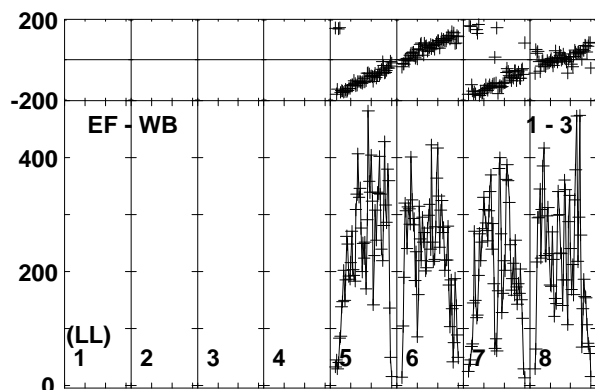
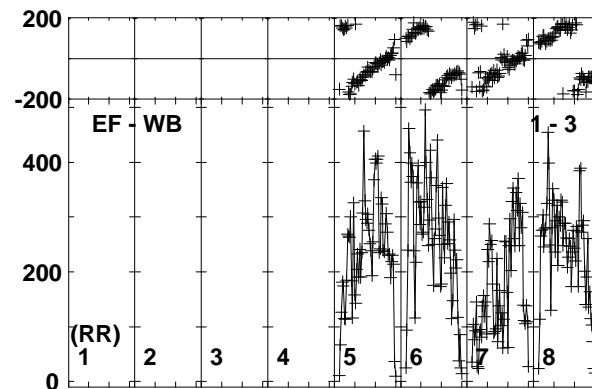
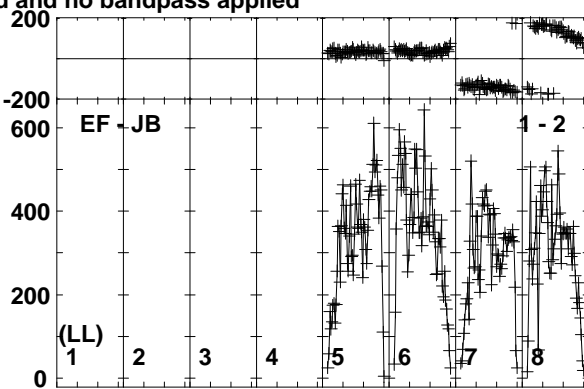
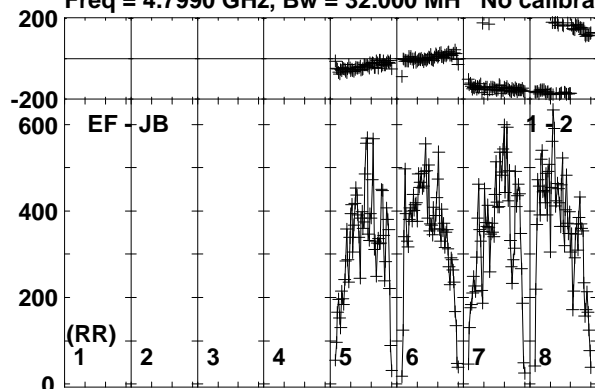

Lower frame: Micro Ampl Jy Top frame: Phas deg  
Vector averaged cross-power spectrum Baseline: EF (01) - JB (02)  
Timerange: 00/03:22:00 to 00/03:25:30

Plot file version 113 created 24-NOV-2017 10:10:05

J1112+4301 EG096D.UVDATA.1

Freq = 4.7990 GHz, Bw = 32.000 MH No calibration applied and no bandpass applied

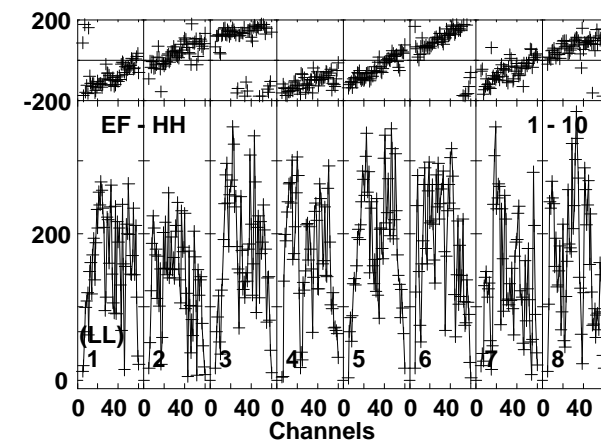
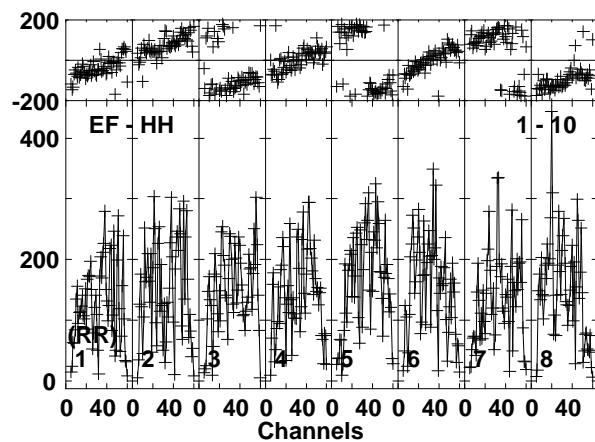
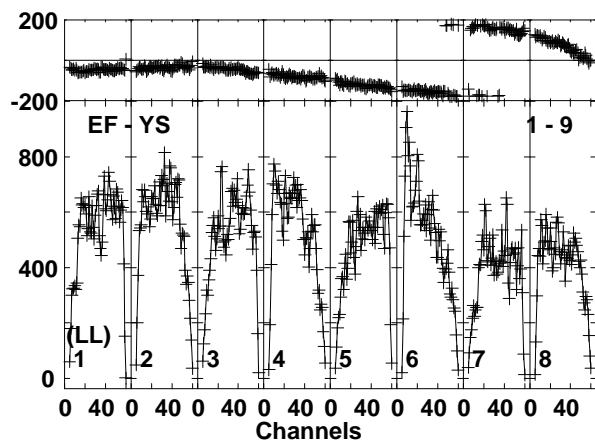
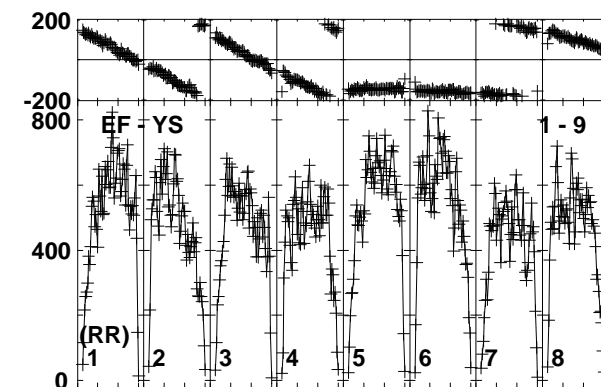
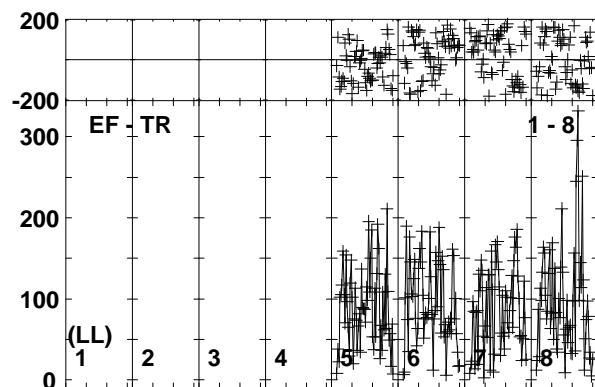
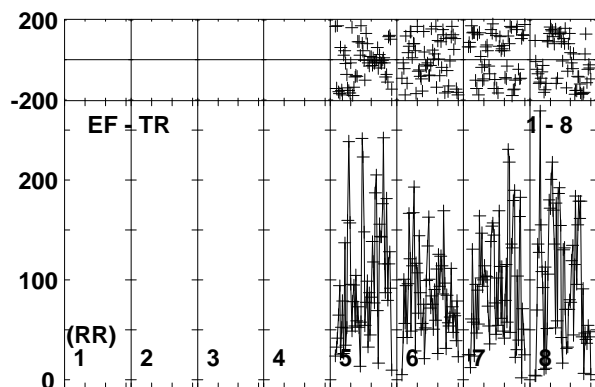
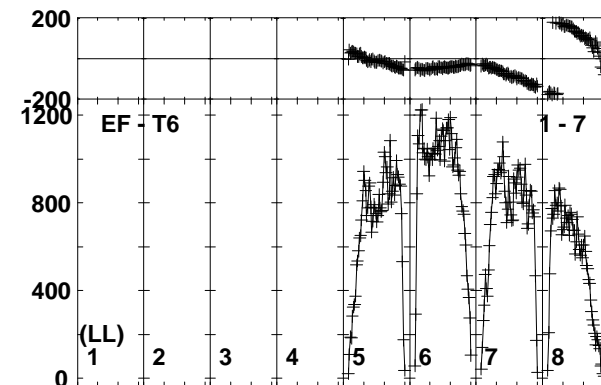
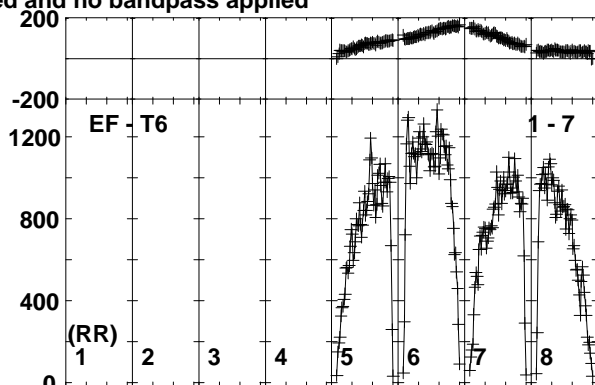
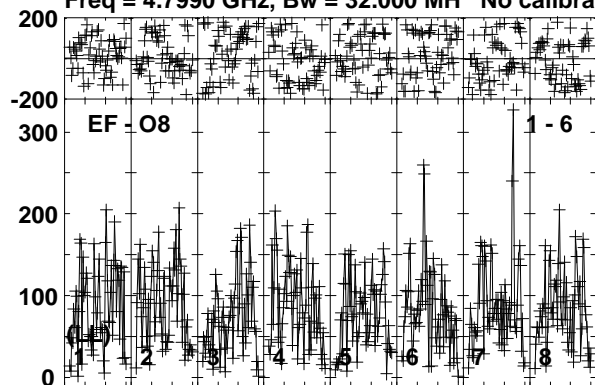

Lower frame: Micro Ampl Jy Top frame: Phas deg  
Vector averaged cross-power spectrum Baseline: EF (01) - O8 (06)  
Timerange: 00/03:22:00 to 00/03:25:30

Plot file version 114 created 24-NOV-2017 10:10:05  
J1112+4301 EG096D.UVDATA.1  
Freq = 4.7990 GHz, Bw = 32.000 MH No calibration applied and no bandpass applied

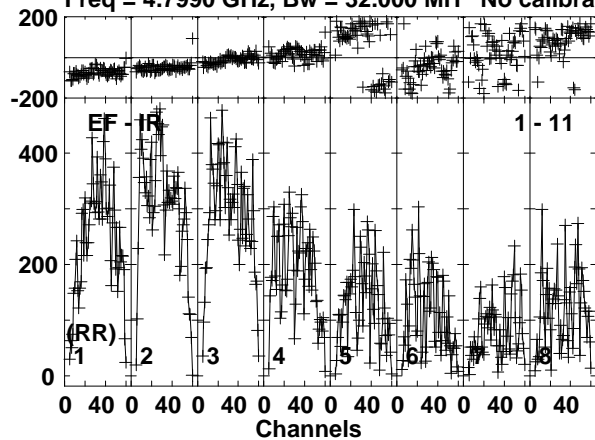

Lower frame: Micro Ampl Jy Top frame: Phas deg  
Vector averaged cross-power spectrum Baseline: EF (01) - IR (11)  
Timerange: 00/03:22:00 to 00/03:25:30



Plot file version 115 created 24-NOV-2017 10:10:05

J1108+4330 EG096D.UVDATA.1

Freq = 4.7990 GHz, Bw = 32.000 MH No calibration applied and no bandpass applied

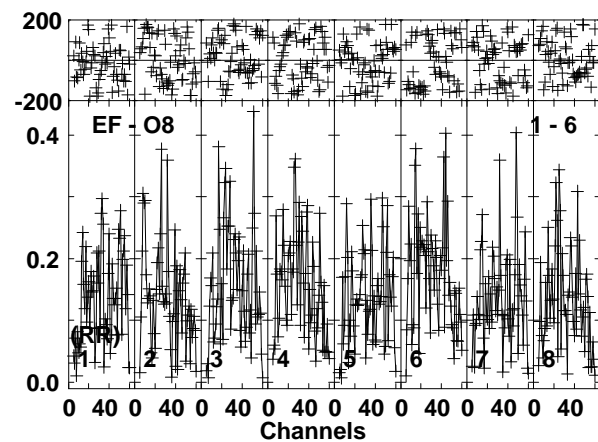
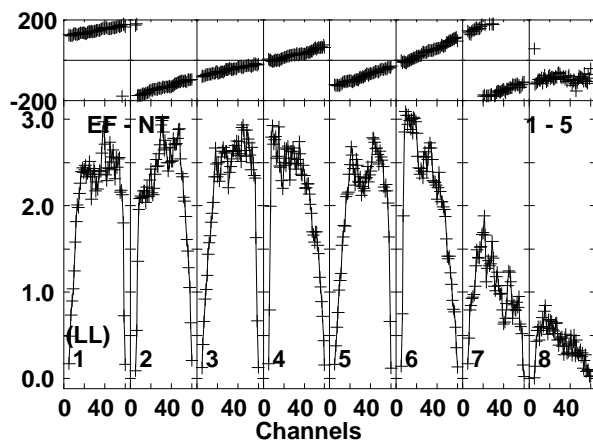
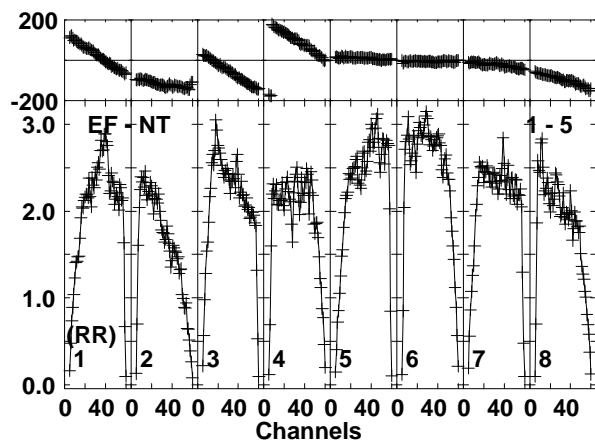
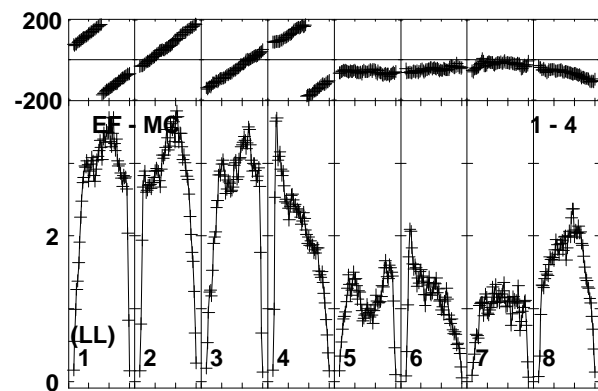
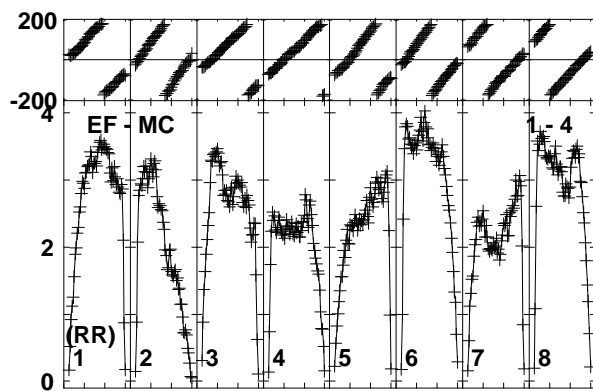
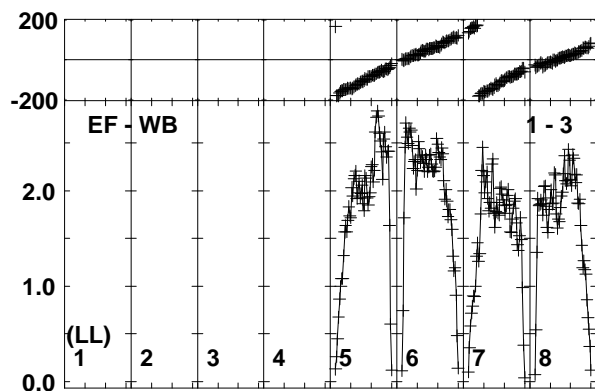
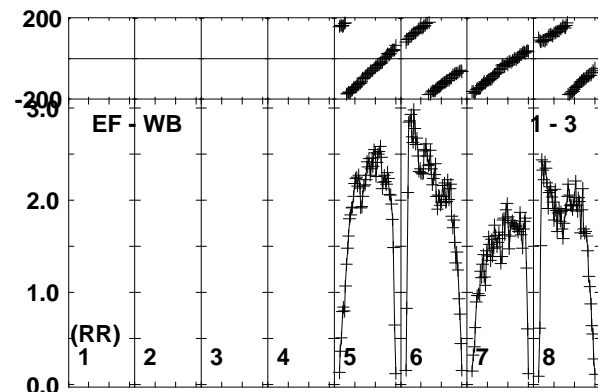
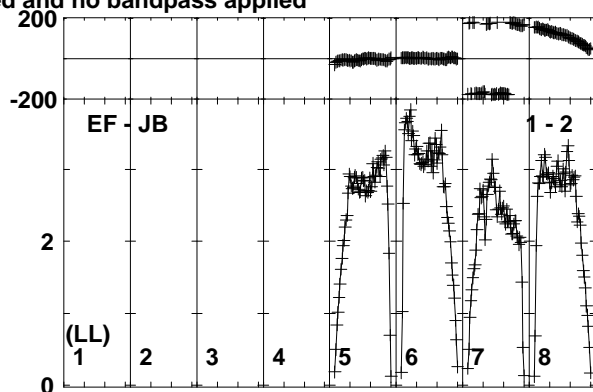
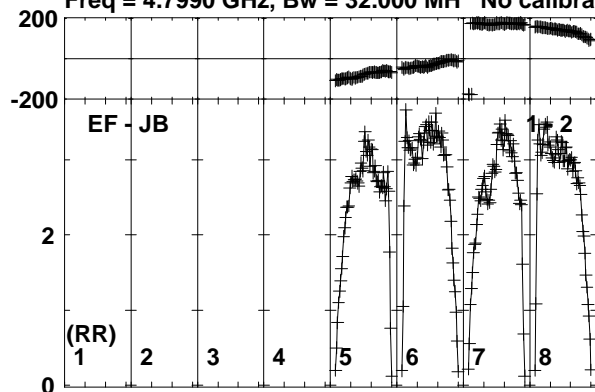

Lower frame: Milli Ampl Jy Top frame: Phas deg  
Vector averaged cross-power spectrum Baseline: EF (01) - JB (02)  
Timerange: 00/03:25:30 to 00/03:26:59

Plot file version 116 created 24-NOV-2017 10:10:06

J1108+4330 EG096D.UVDATA.1

Freq = 4.7990 GHz, Bw = 32.000 MH No calibration applied and no bandpass applied

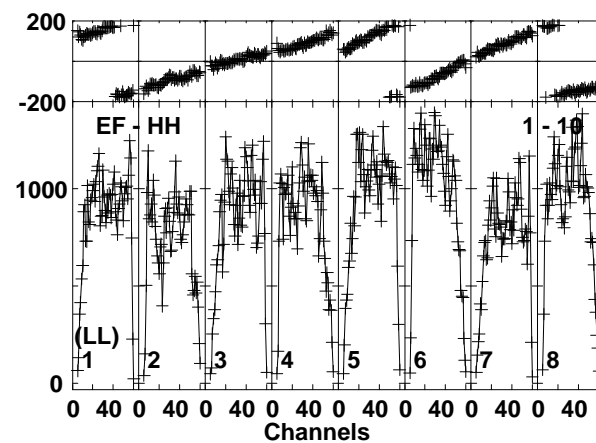
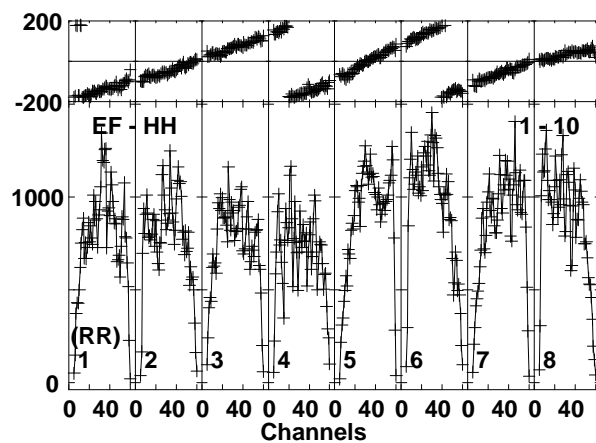
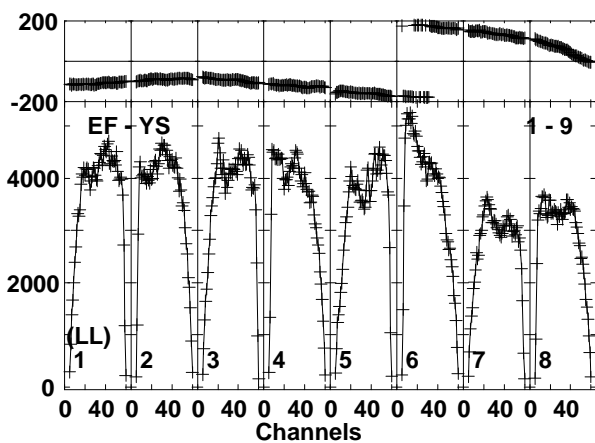
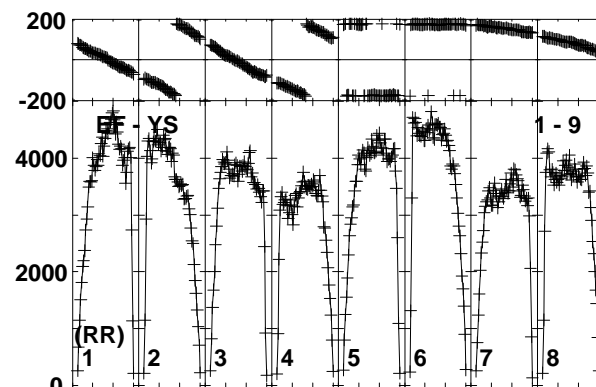
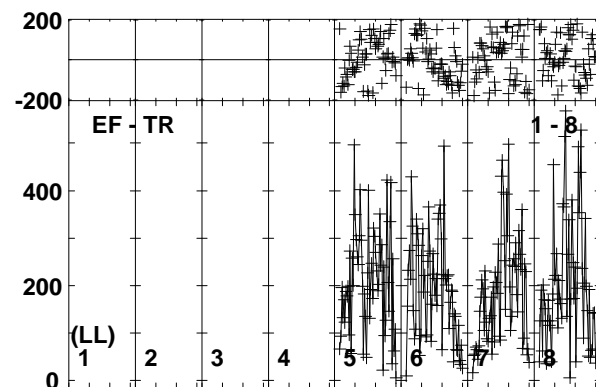
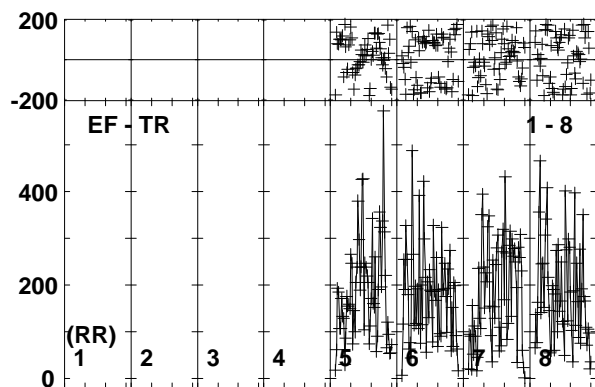
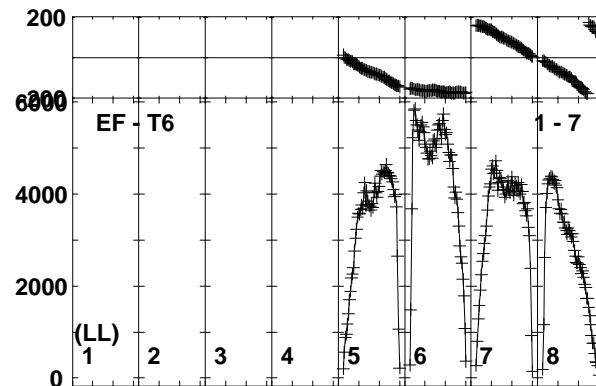
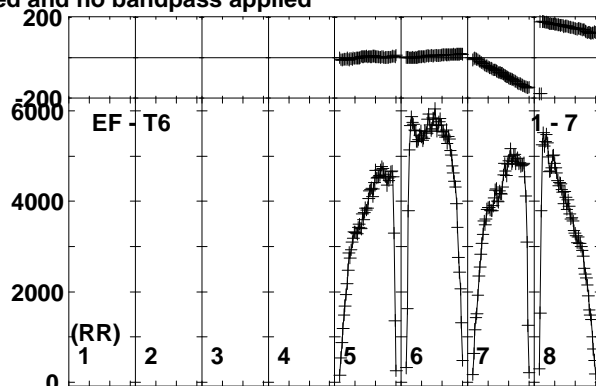
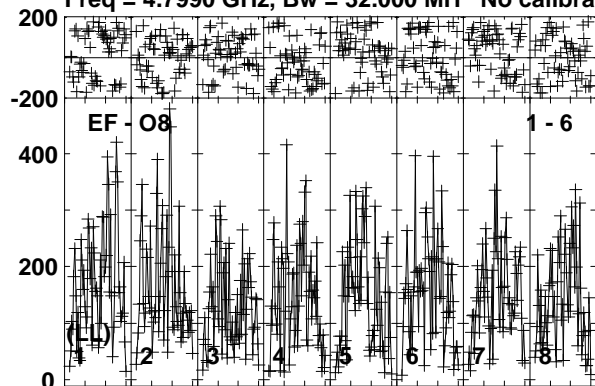

Lower frame: Micro Ampl Jy Top frame: Phas deg  
Vector averaged cross-power spectrum Baseline: EF (01) - O8 (06)  
Timerange: 00/03:25:30 to 00/03:26:59

Plot file version 117 created 24-NOV-2017 10:10:06  
J1108+4330 EG096D.UVDATA.1  
Freq = 4.7990 GHz, Bw = 32.000 MH No calibration applied and no bandpass applied

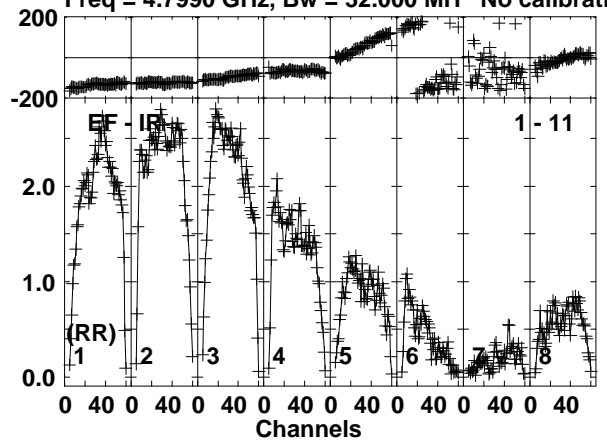

Lower frame: Milli Ampl Jy Top frame: Phas deg  
Vector averaged cross-power spectrum Baseline: EF (01) - IR (11)  
Timerange: 00/03:25:30 to 00/03:26:59

Plot file version 118 created 24-NOV-2017 10:10:06

ARUMA EG096D.UVDATA.1

Freq = 4.7990 GHz, Bw = 32.000 MH No calibration applied and no bandpass applied

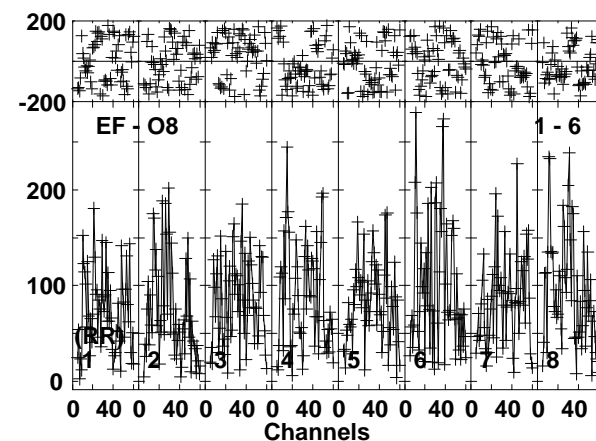
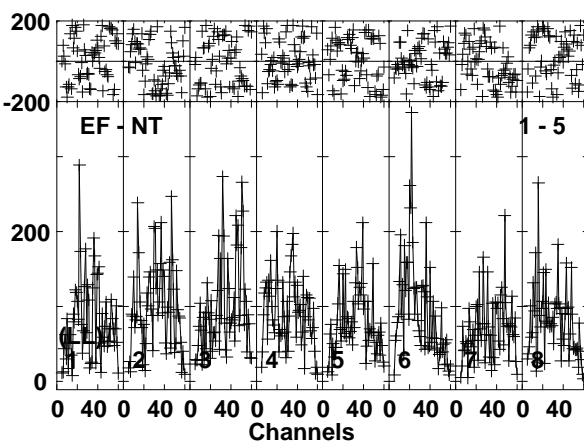
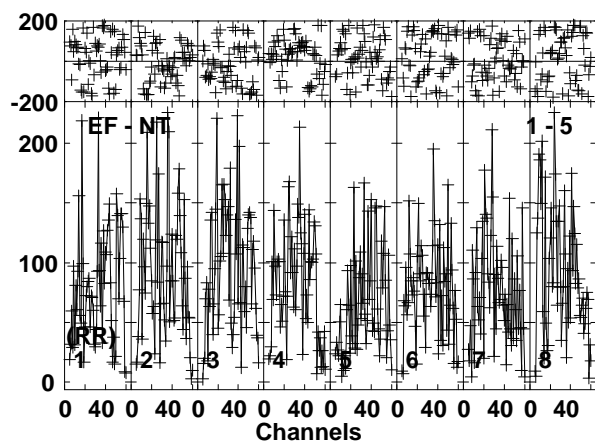
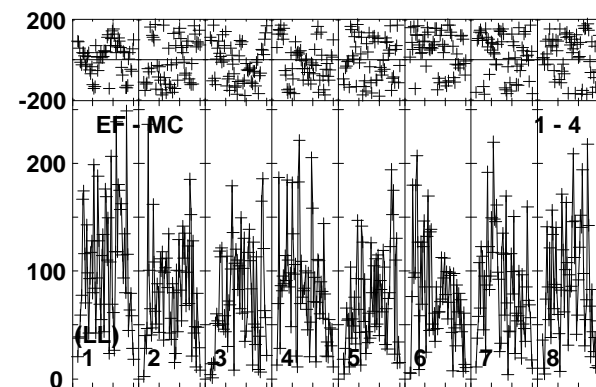
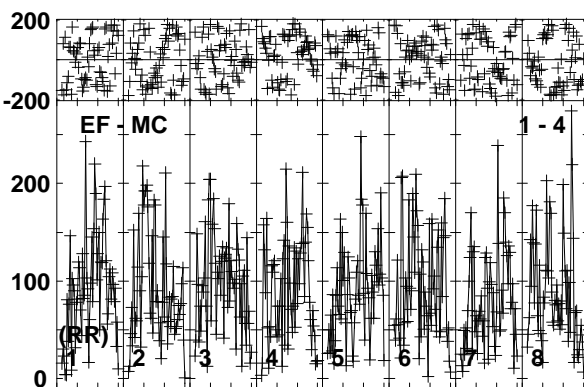
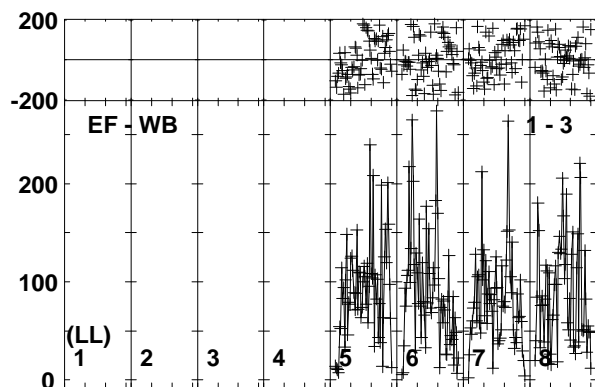
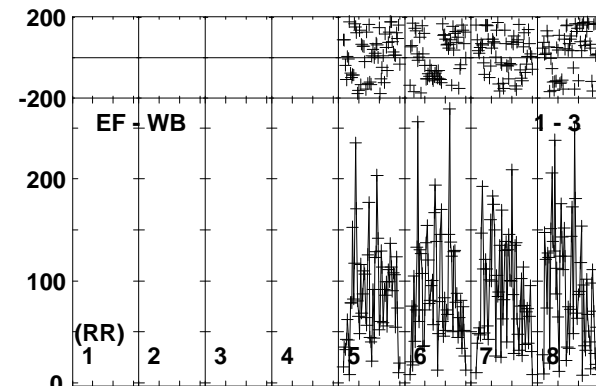
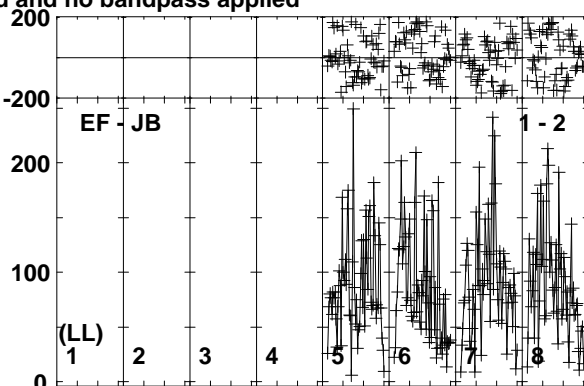
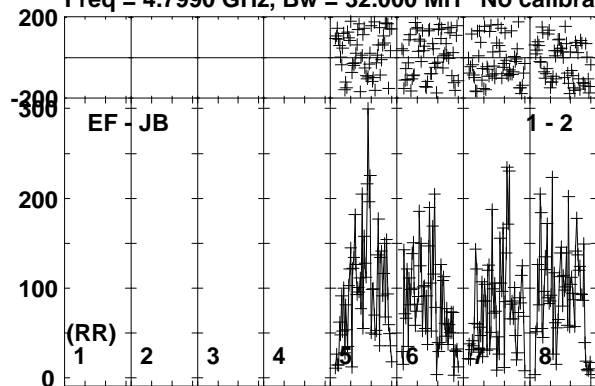

Lower frame: Micro Ampl Jy Top frame: Phas deg  
Vector averaged cross-power spectrum Baseline: EF (01) - JB (02)  
Timerange: 00/03:27:01 to 00/03:30:30

Plot file version 119 created 24-NOV-2017 10:10:06

ARUMA EG096D.UVDATA.1

Freq = 4.7990 GHz, Bw = 32.000 MH No calibration applied and no bandpass applied

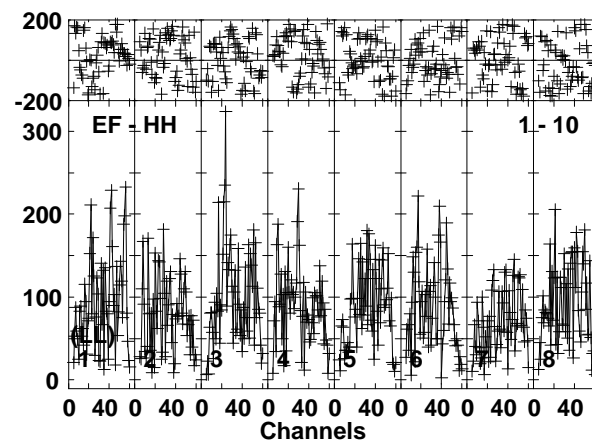
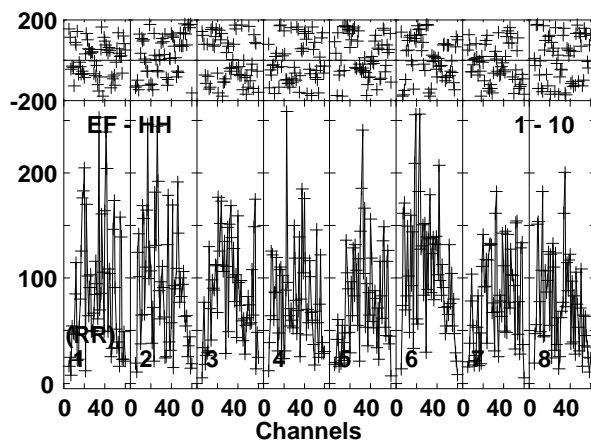
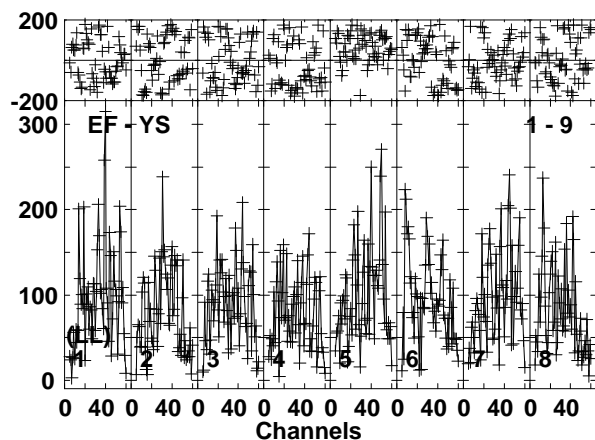
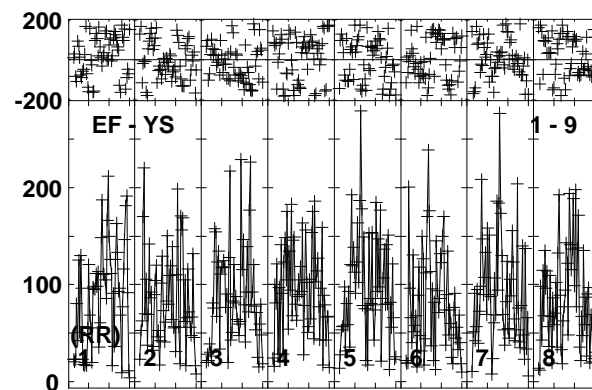
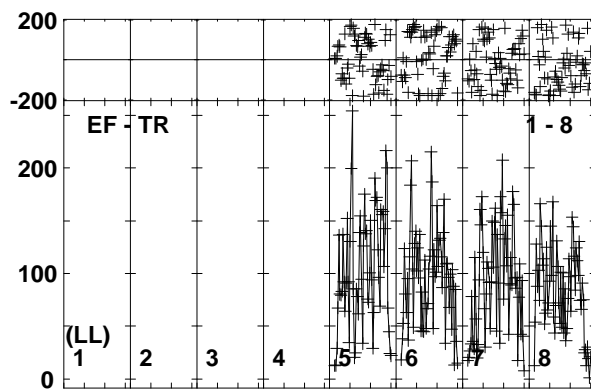
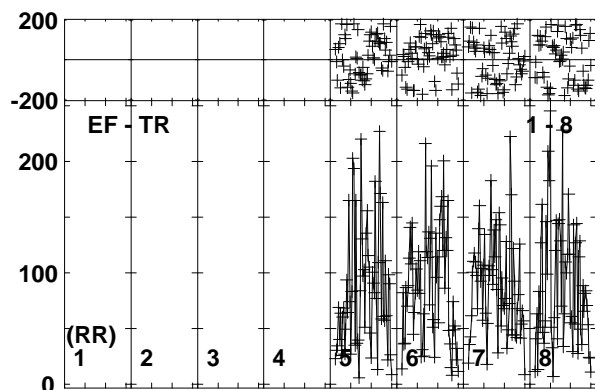
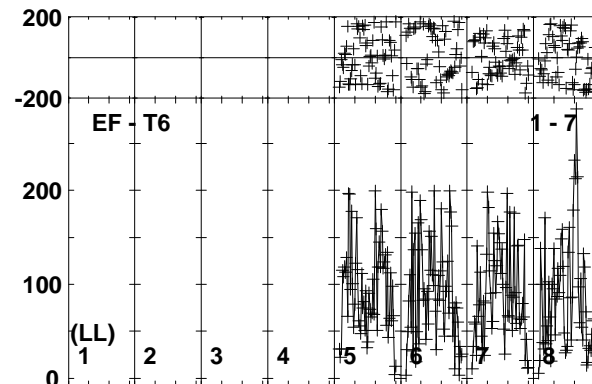
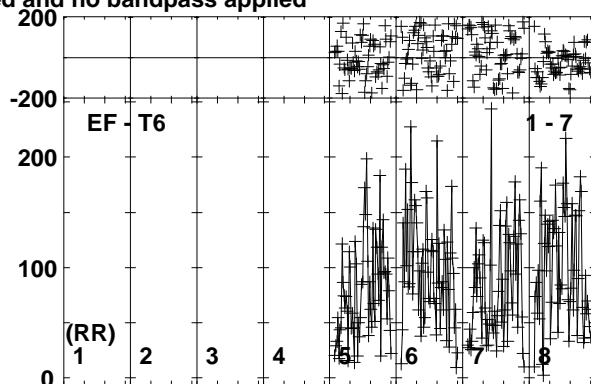
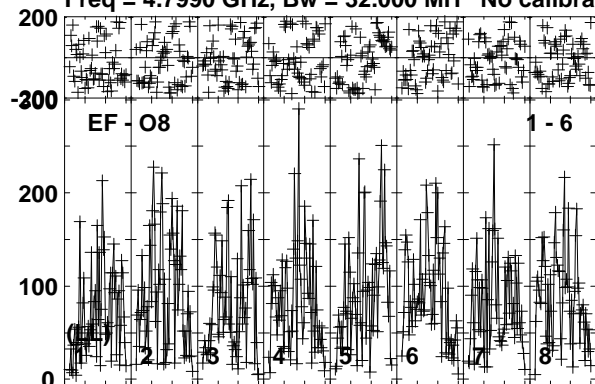

Lower frame: Micro Ampl Jy Top frame: Phas deg  
Vector averaged cross-power spectrum Baseline: EF (01) - O8 (06)  
Timerange: 00/03:27:01 to 00/03:30:30

Plot file version 120 created 24-NOV-2017 10:10:07

ARUMA EG096D.UVDATA.1

Freq = 4.7990 GHz, Bw = 32.000 MH No calibration applied and no bandpass applied

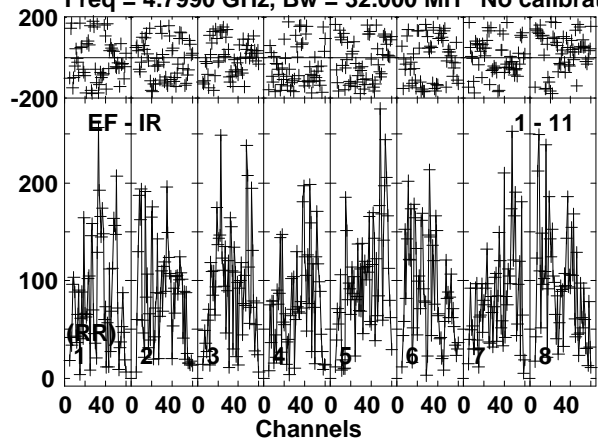

Lower frame: Micro Ampl Jy Top frame: Phas deg  
Vector averaged cross-power spectrum Baseline: EF (01) - IR (11)  
Timerange: 00/03:27:01 to 00/03:30:30

Plot file version 121 created 24-NOV-2017 10:10:07

J1108+4330 EG096D.UVDATA.1

Freq = 4.7990 GHz, Bw = 32.000 MH No calibration applied and no bandpass applied

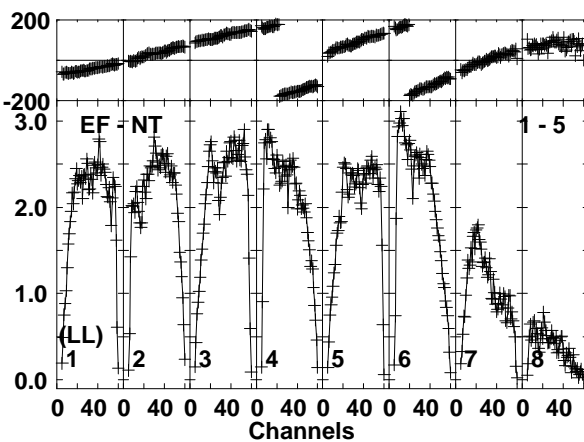
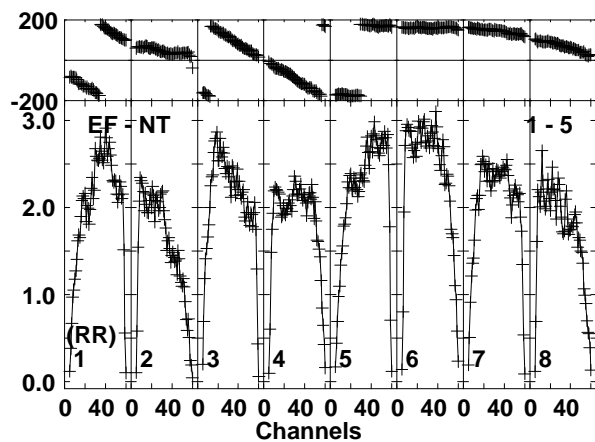
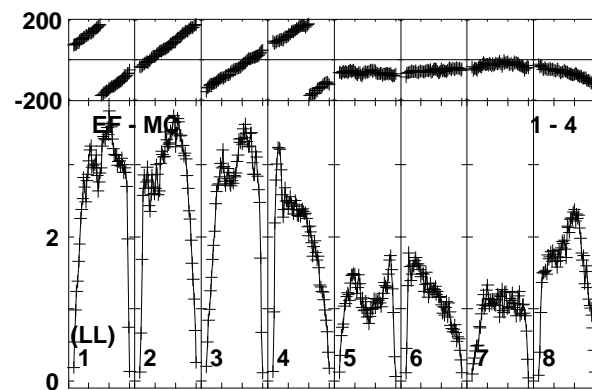
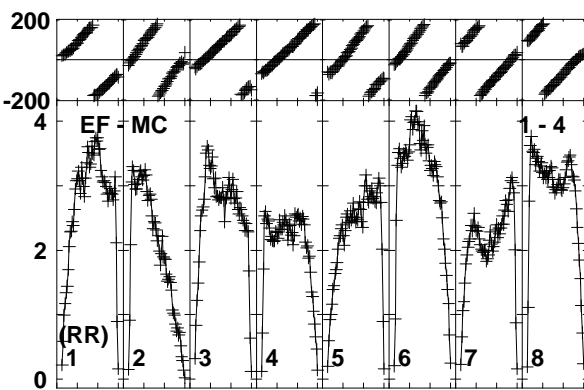
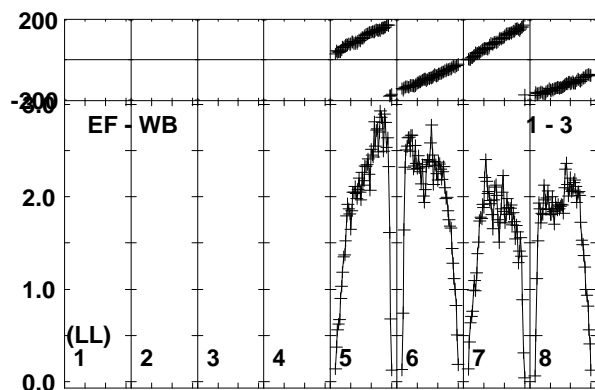
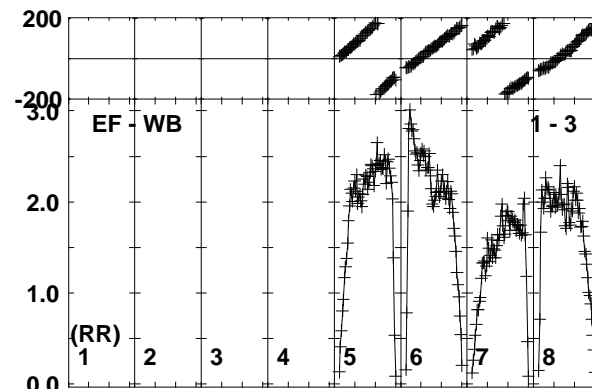
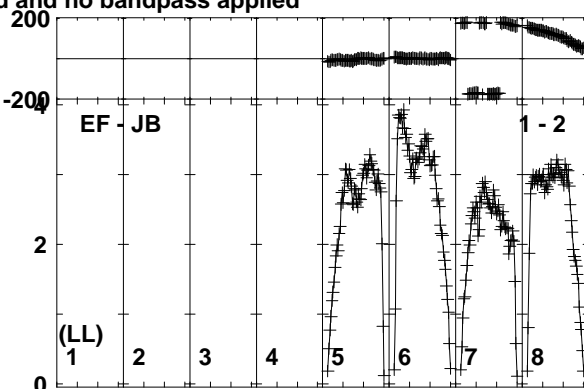
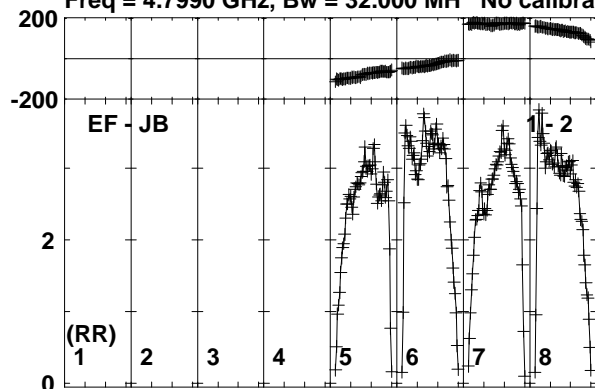

Lower frame: Milli Ampl Jy Top frame: Phas deg  
Vector averaged cross-power spectrum Baseline: EF (01) - JB (02)  
Timerange: 00/03:31:10 to 00/03:32:10

Plot file version 122 created 24-NOV-2017 10:10:07

J1108+4330 EG096D.UVDATA.1

Freq = 4.7990 GHz, Bw = 32.000 MH No calibration applied and no bandpass applied

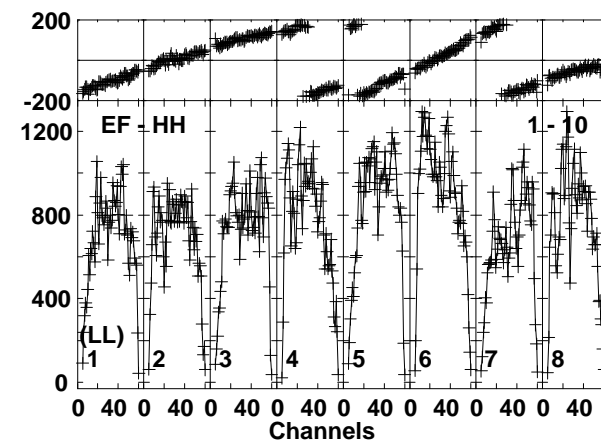
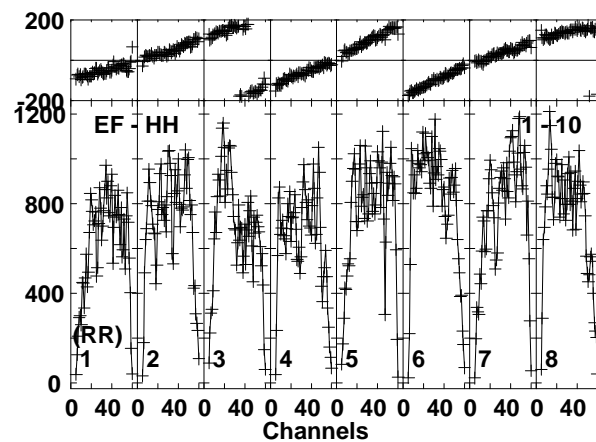
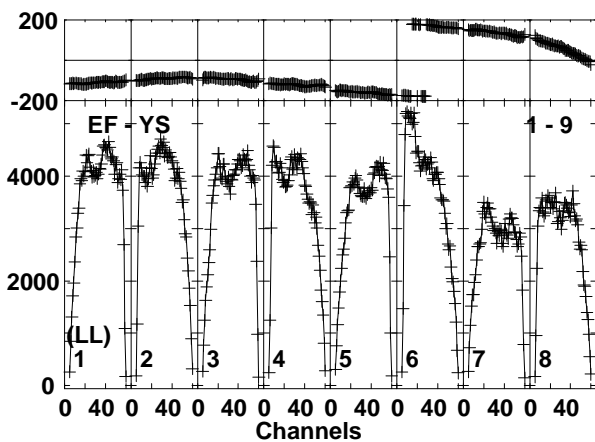
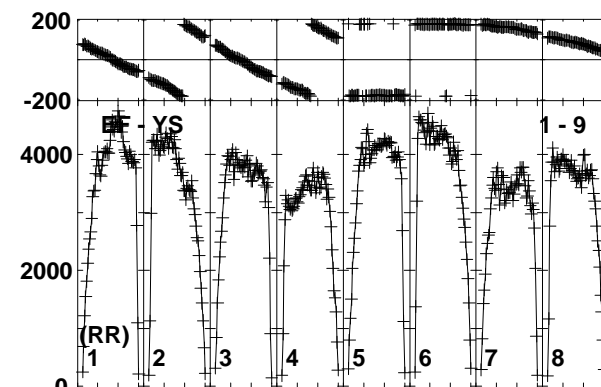
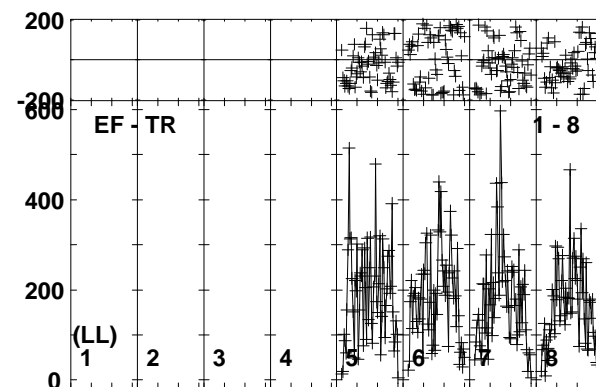
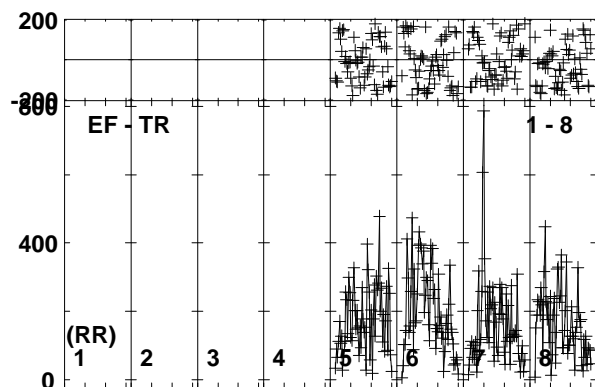
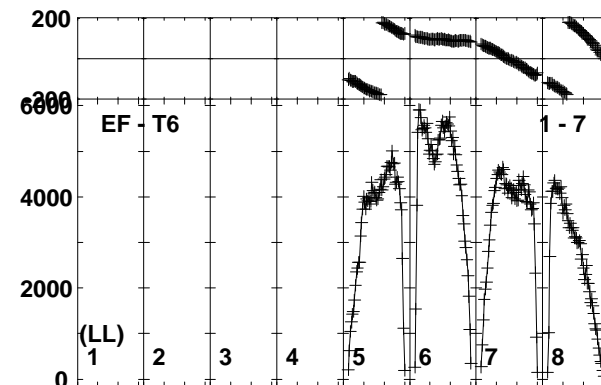
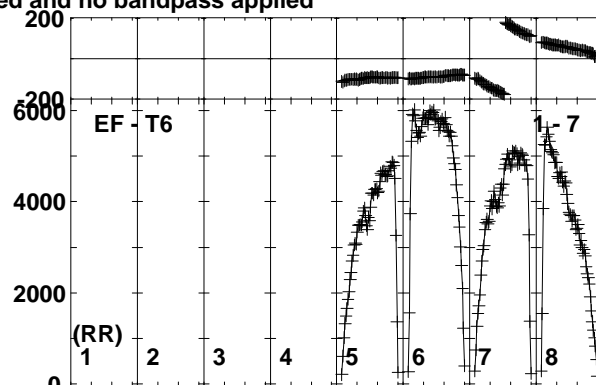
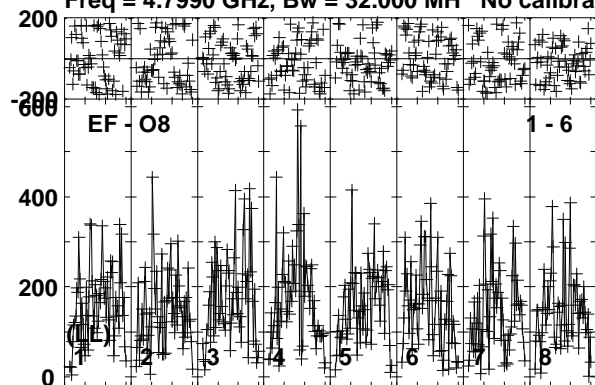

Lower frame: Micro Ampl Jy Top frame: Phas deg  
Vector averaged cross-power spectrum Baseline: EF (01) - O8 (06)  
Timerange: 00/03:31:10 to 00/03:32:10



Plot file version 123 created 24-NOV-2017 10:10:07

J1108+4330 EG096D.UVDATA.1

Freq = 4.7990 GHz, Bw = 32.000 MH No calibration applied and no bandpass applied

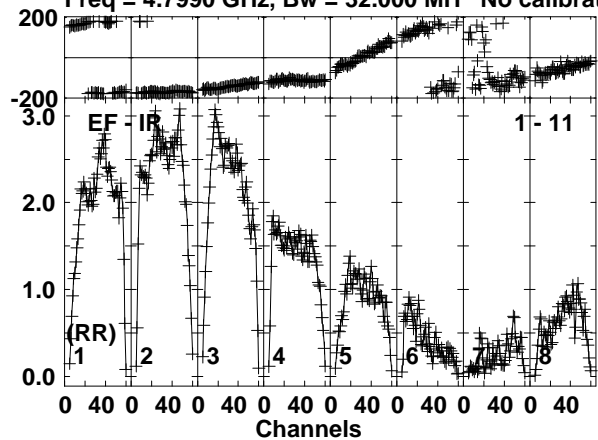

Lower frame: Milli Ampl Jy Top frame: Phas deg

Vector averaged cross-power spectrum Baseline: EF (01) - IR (11)

Timerange: 00/03:31:10 to 00/03:32:10

Plot file version 124 created 24-NOV-2017 10:10:07

ARUMA EG096D.UVDATA.1

Freq = 4.7990 GHz, Bw = 32.000 MH No calibration applied and no bandpass applied

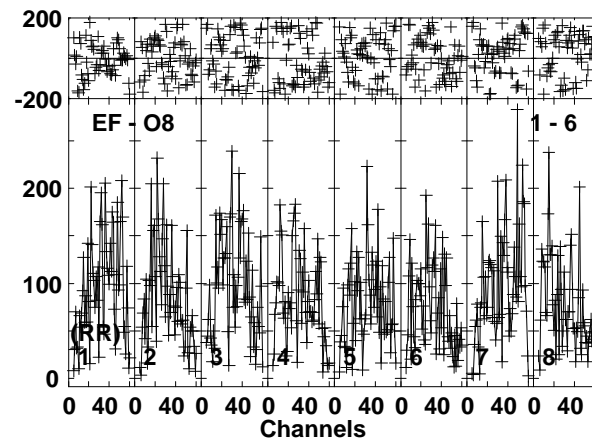
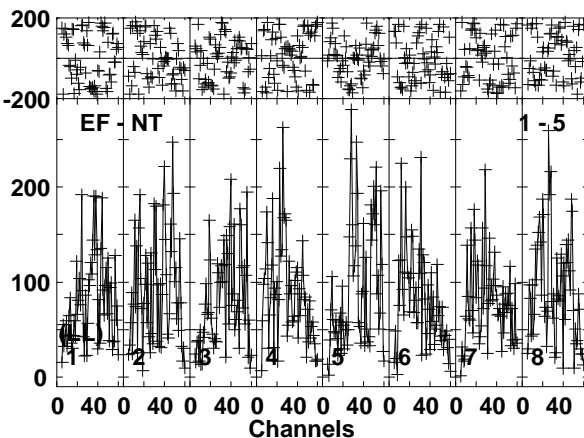
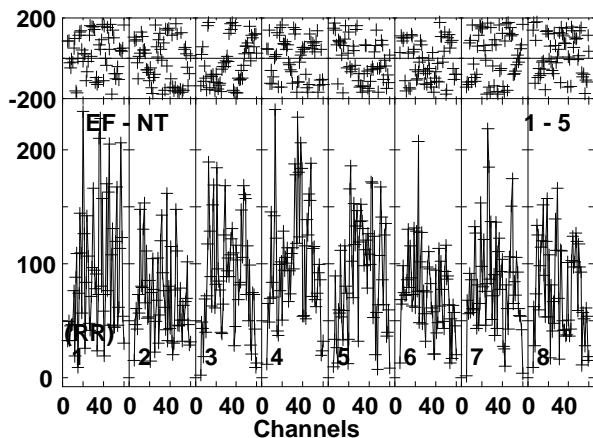
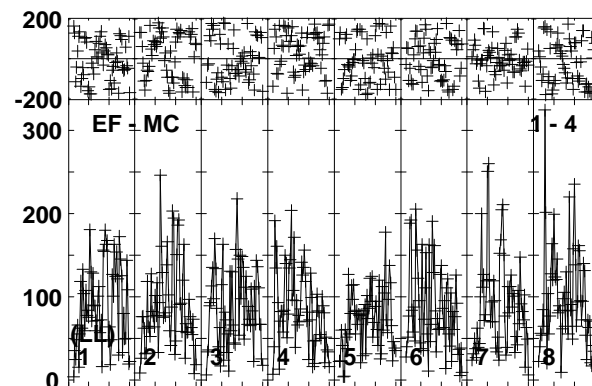
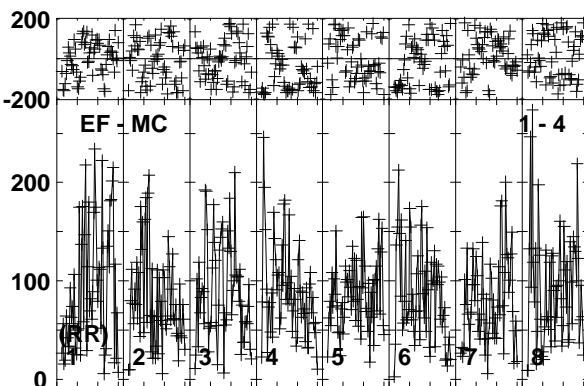
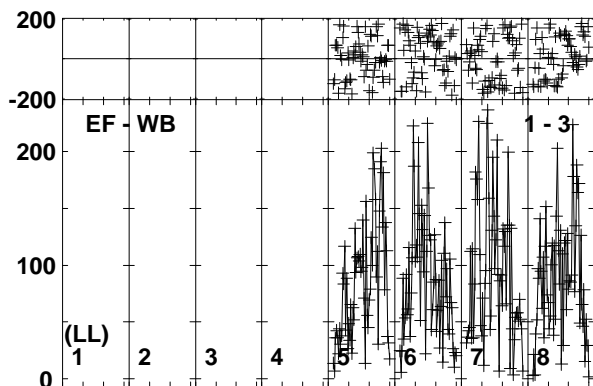
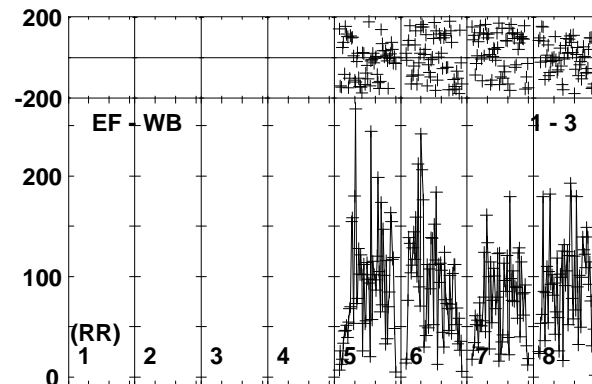
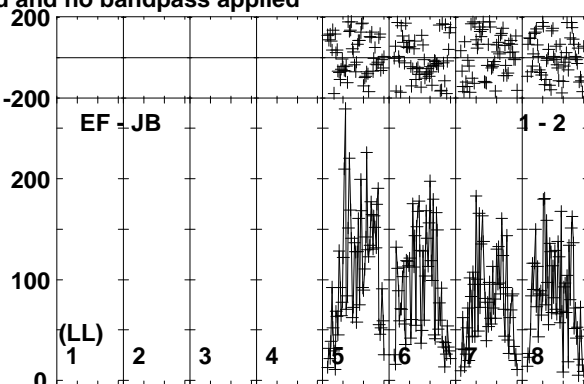
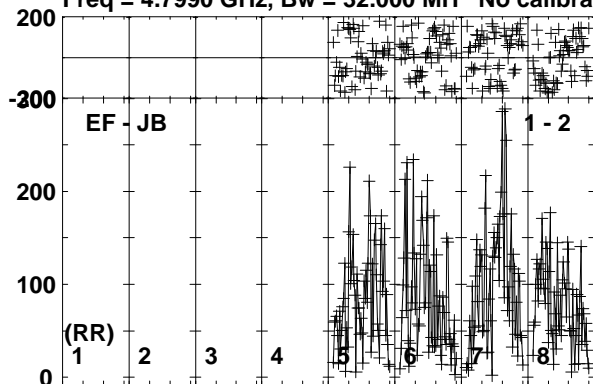

Lower frame: Micro Ampl Jy Top frame: Phas deg  
Vector averaged cross-power spectrum Baseline: EF (01) - JB (02)  
Timerange: 00/03:32:11 to 00/03:35:40

Plot file version 125 created 24-NOV-2017 10:10:08

ARUMA EG096D.UVDATA.1

Freq = 4.7990 GHz, Bw = 32.000 MH No calibration applied and no bandpass applied

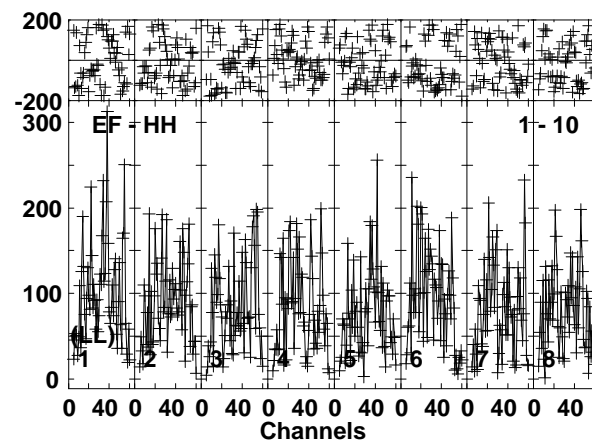
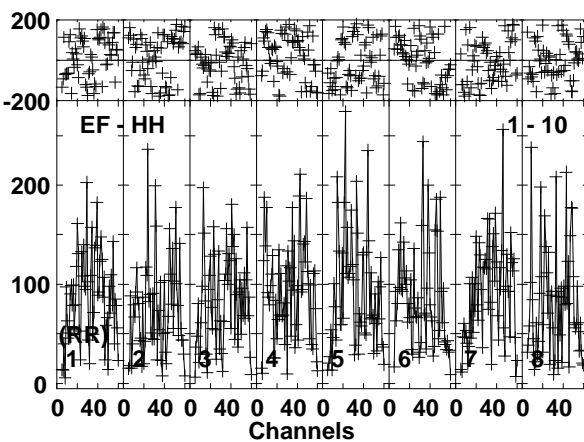
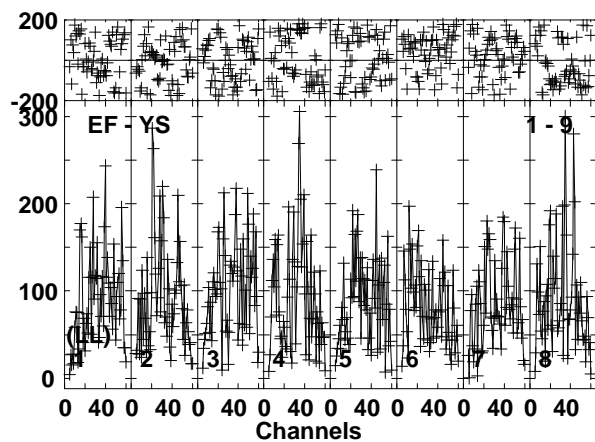
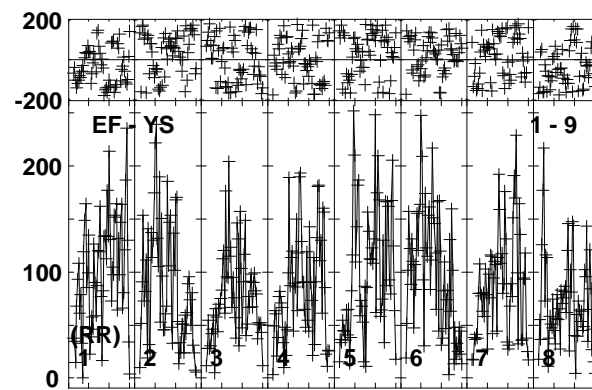
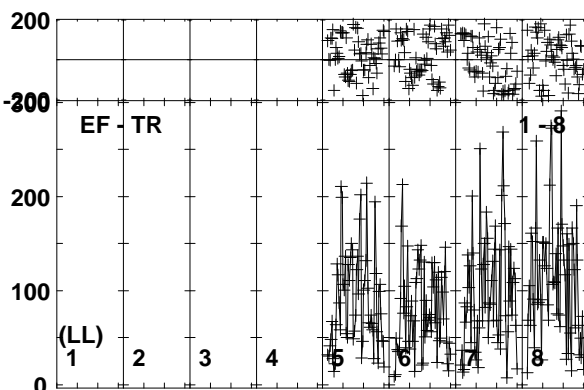
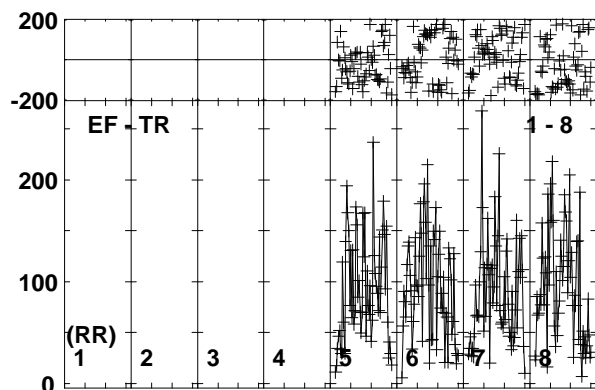
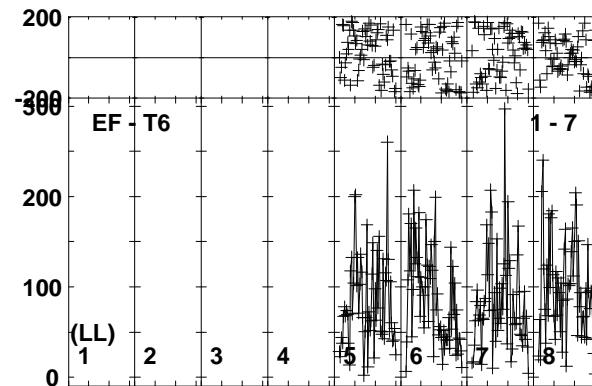
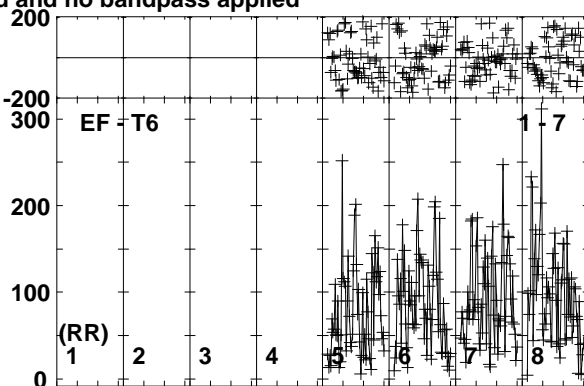
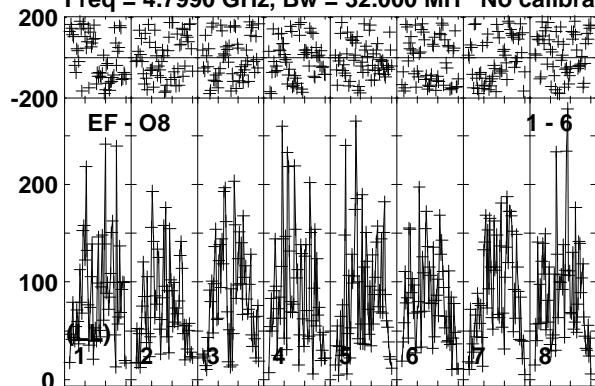

Lower frame: Micro Ampl Jy Top frame: Phas deg  
Vector averaged cross-power spectrum Baseline: EF (01) - O8 (06)  
Timerange: 00/03:32:11 to 00/03:35:40

Plot file version 126 created 24-NOV-2017 10:10:08  
ARUMA EG096D.UVDATA.1  
Freq = 4.7990 GHz, Bw = 32.000 MH No calibration applied and no bandpass applied

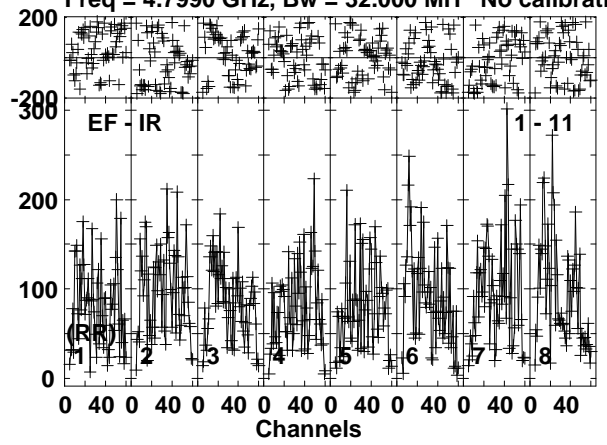

Lower frame: Micro Ampl Jy Top frame: Phas deg  
Vector averaged cross-power spectrum Baseline: EF (01) - IR (11)  
Timerange: 00/03:32:11 to 00/03:35:40

Plot file version 127 created 24-NOV-2017 10:10:08

J1108+4330 EG096D.UVDATA.1

Freq = 4.7990 GHz, Bw = 32.000 MH No calibration applied and no bandpass applied

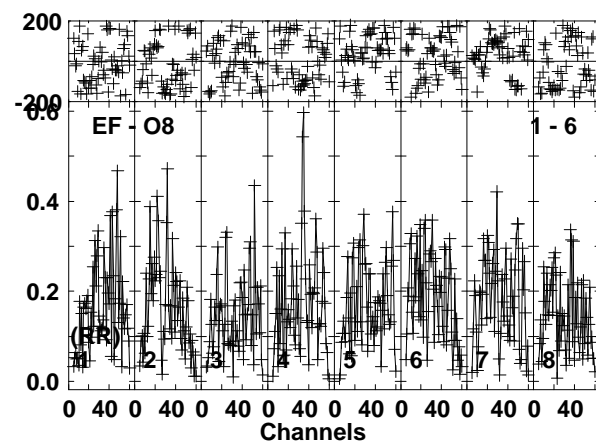
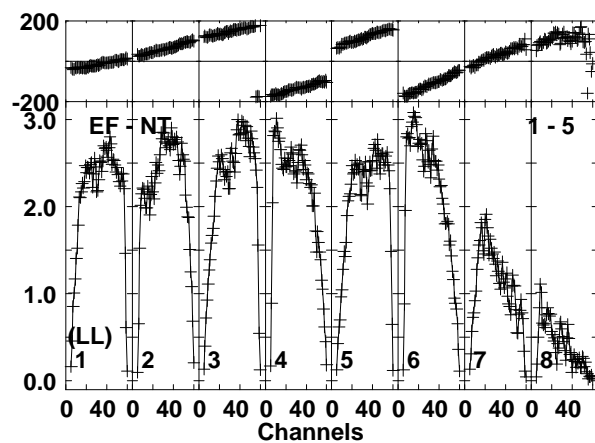
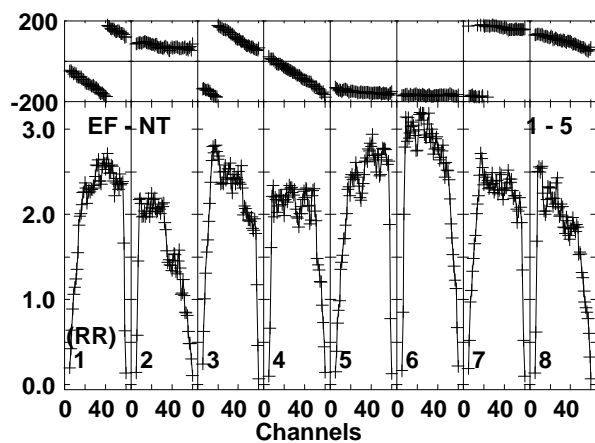
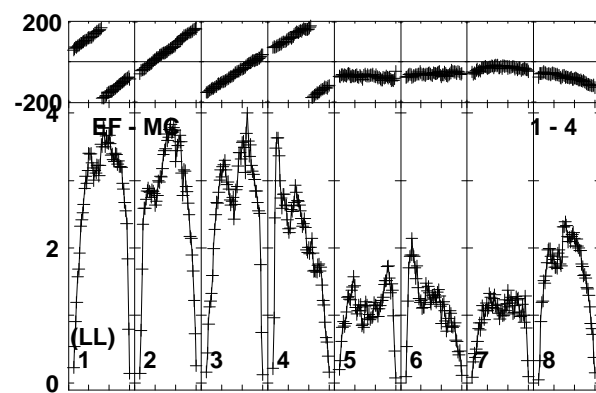
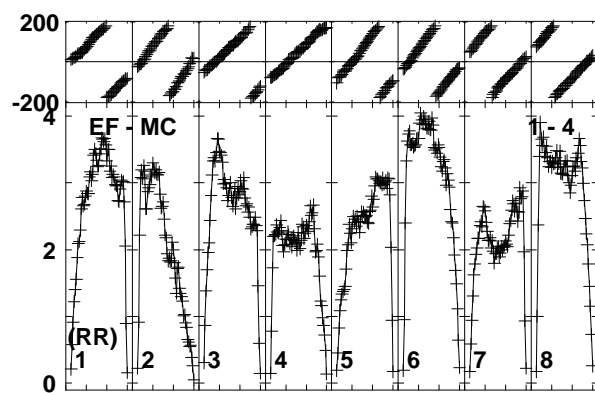
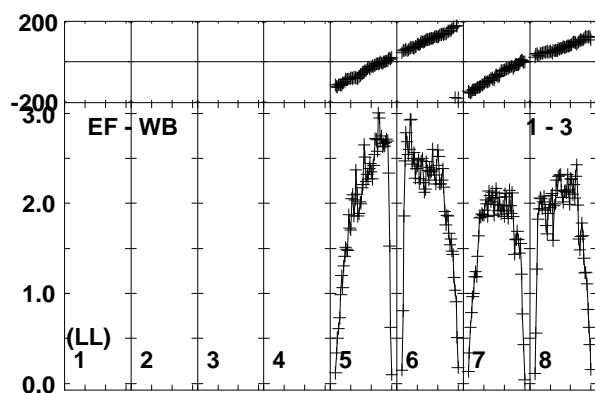
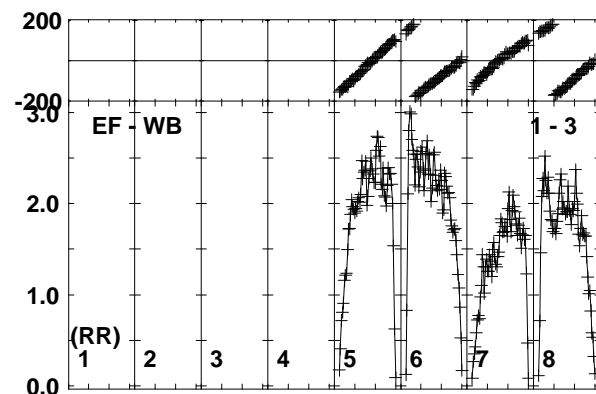
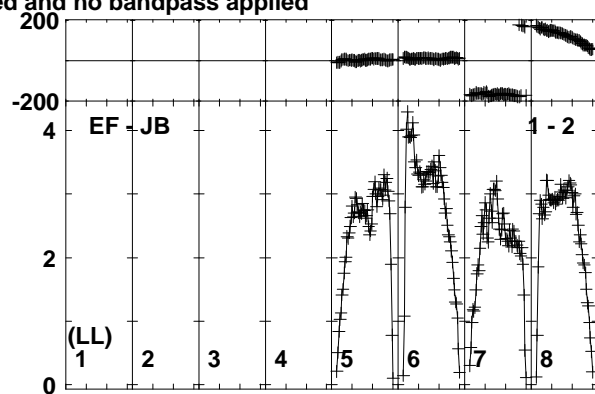
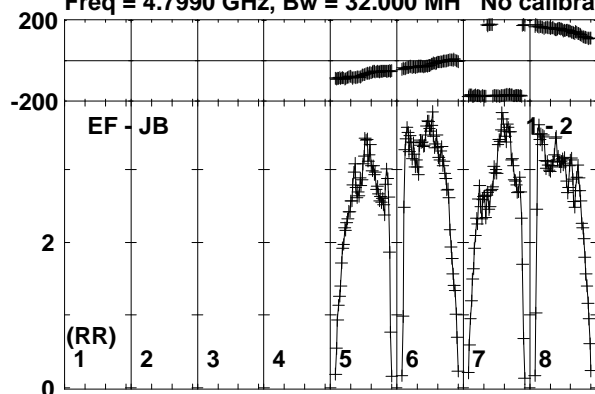

Lower frame: Milli Ampl Jy Top frame: Phas deg  
Vector averaged cross-power spectrum Baseline: EF (01) - JB (02)  
Timerange: 00/03:35:41 to 00/03:37:10

Plot file version 128 created 24-NOV-2017 10:10:08

J1108+4330 EG096D.UVDATA.1

Freq = 4.7990 GHz, Bw = 32.000 MH No calibration applied and no bandpass applied

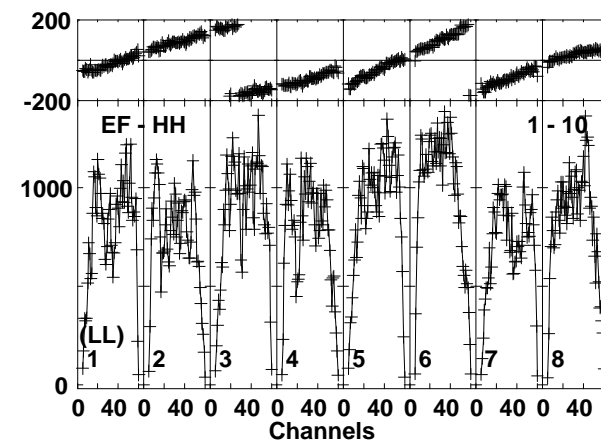
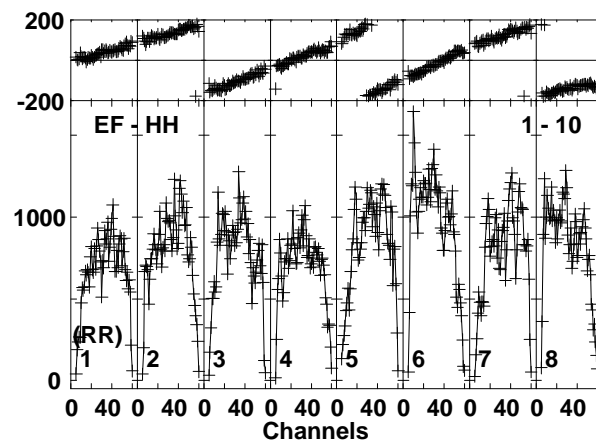
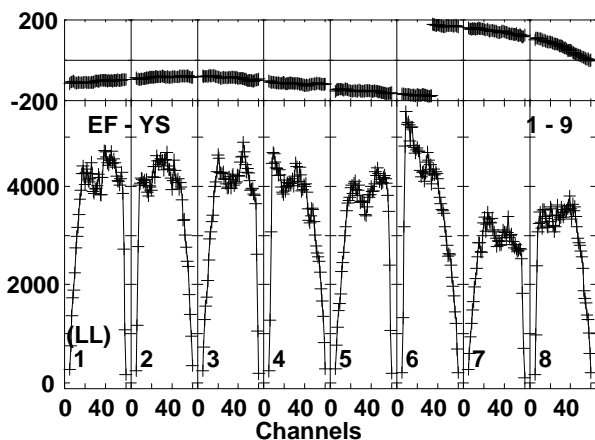
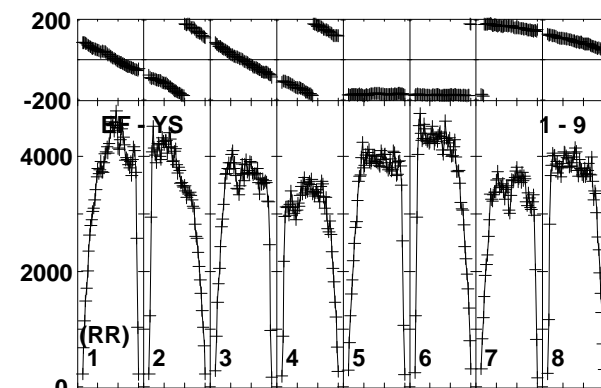
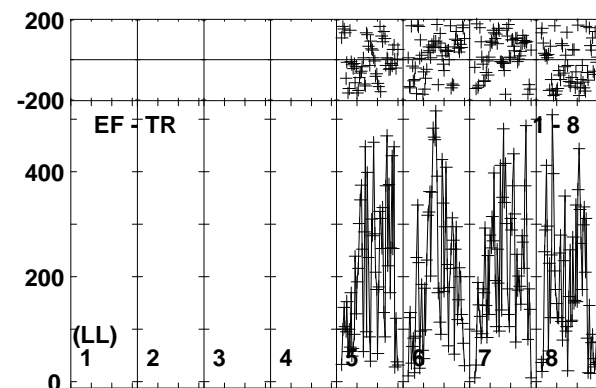
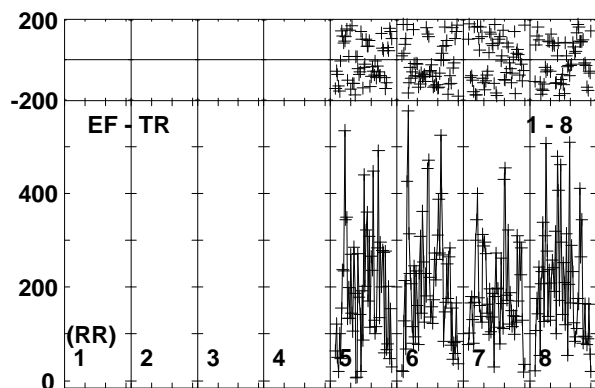
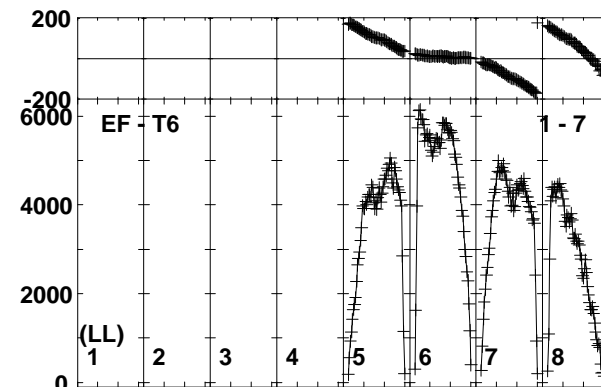
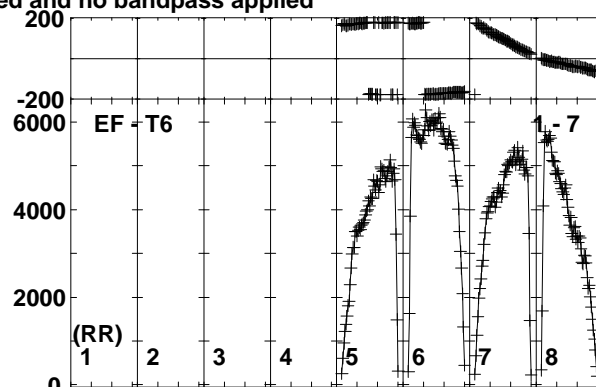
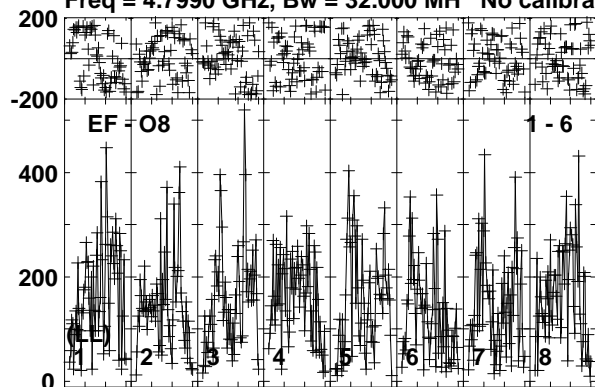

Lower frame: Micro Ampl Jy Top frame: Phas deg  
Vector averaged cross-power spectrum Baseline: EF (01) - O8 (06)  
Timerange: 00/03:35:41 to 00/03:37:10

Plot file version 129 created 24-NOV-2017 10:10:09  
J1108+4330 EG096D.UVDATA.1  
Freq = 4.7990 GHz, Bw = 32.000 MH No calibration applied and no bandpass applied

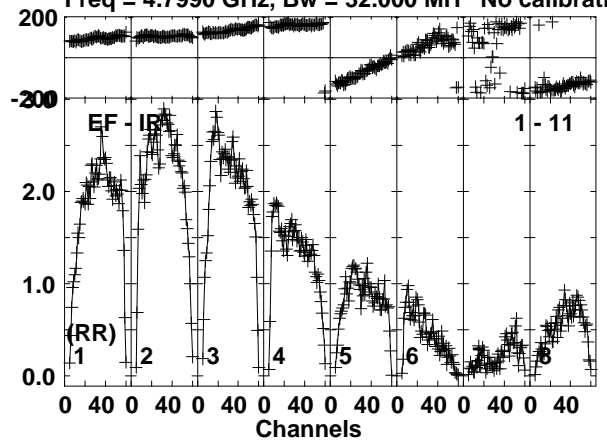

Lower frame: Milli Ampl Jy Top frame: Phas deg  
Vector averaged cross-power spectrum Baseline: EF (01) - IR (11)  
Timerange: 00/03:35:41 to 00/03:37:10

Plot file version 130 created 24-NOV-2017 10:10:09

ARUMA EG096D.UVDATA.1

Freq = 4.7990 GHz, Bw = 32.000 MH No calibration applied and no bandpass applied

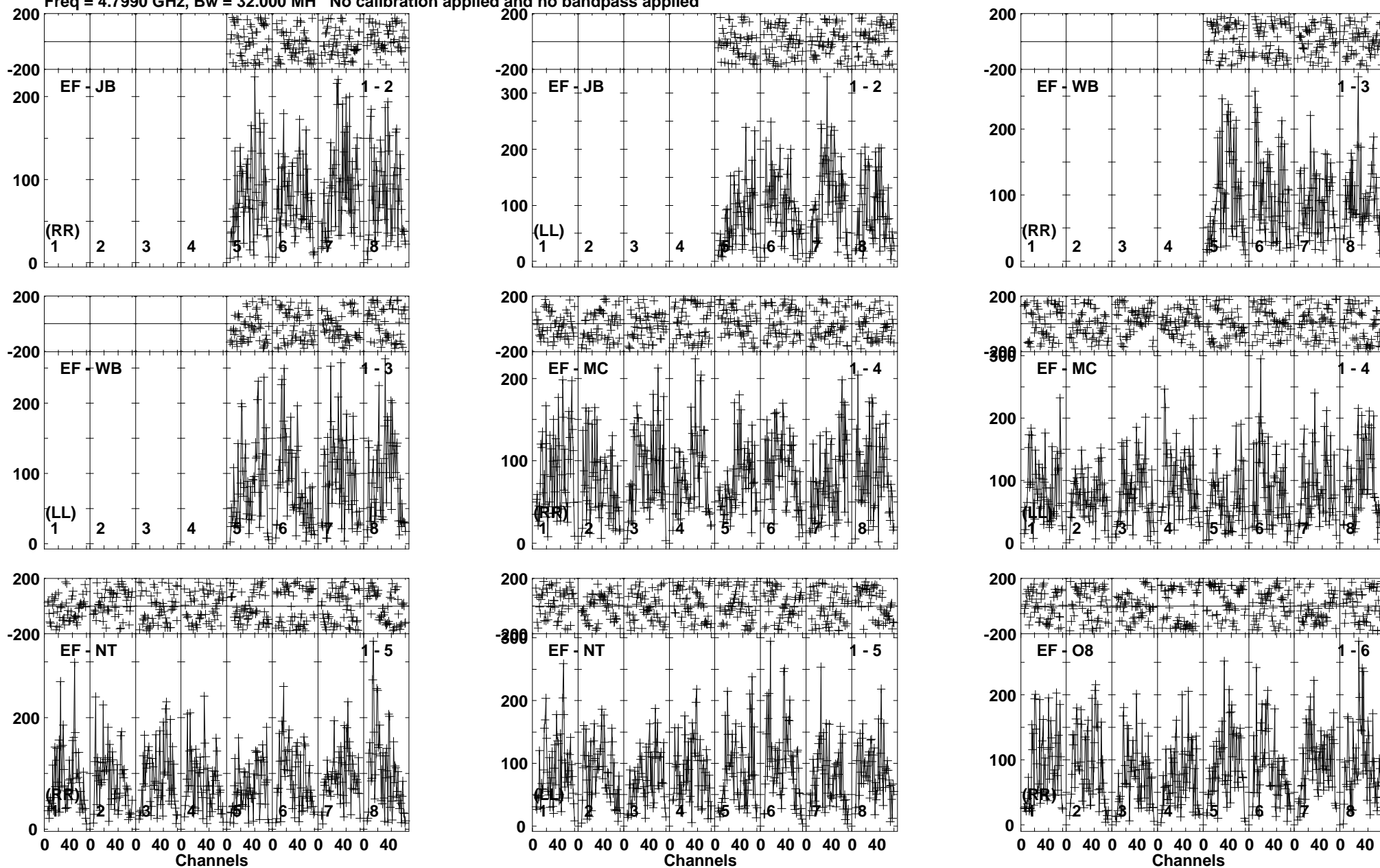

Lower frame: Micro Ampl Jy Top frame: Phas deg  
Vector averaged cross-power spectrum Baseline: EF (01) - JB (02)  
Timerange: 00/03:37:10 to 00/03:40:40



Plot file version 131 created 24-NOV-2017 10:10:09

ARUMA EG096D.UVDATA.1

Freq = 4.7990 GHz, Bw = 32.000 MH No calibration applied and no bandpass applied

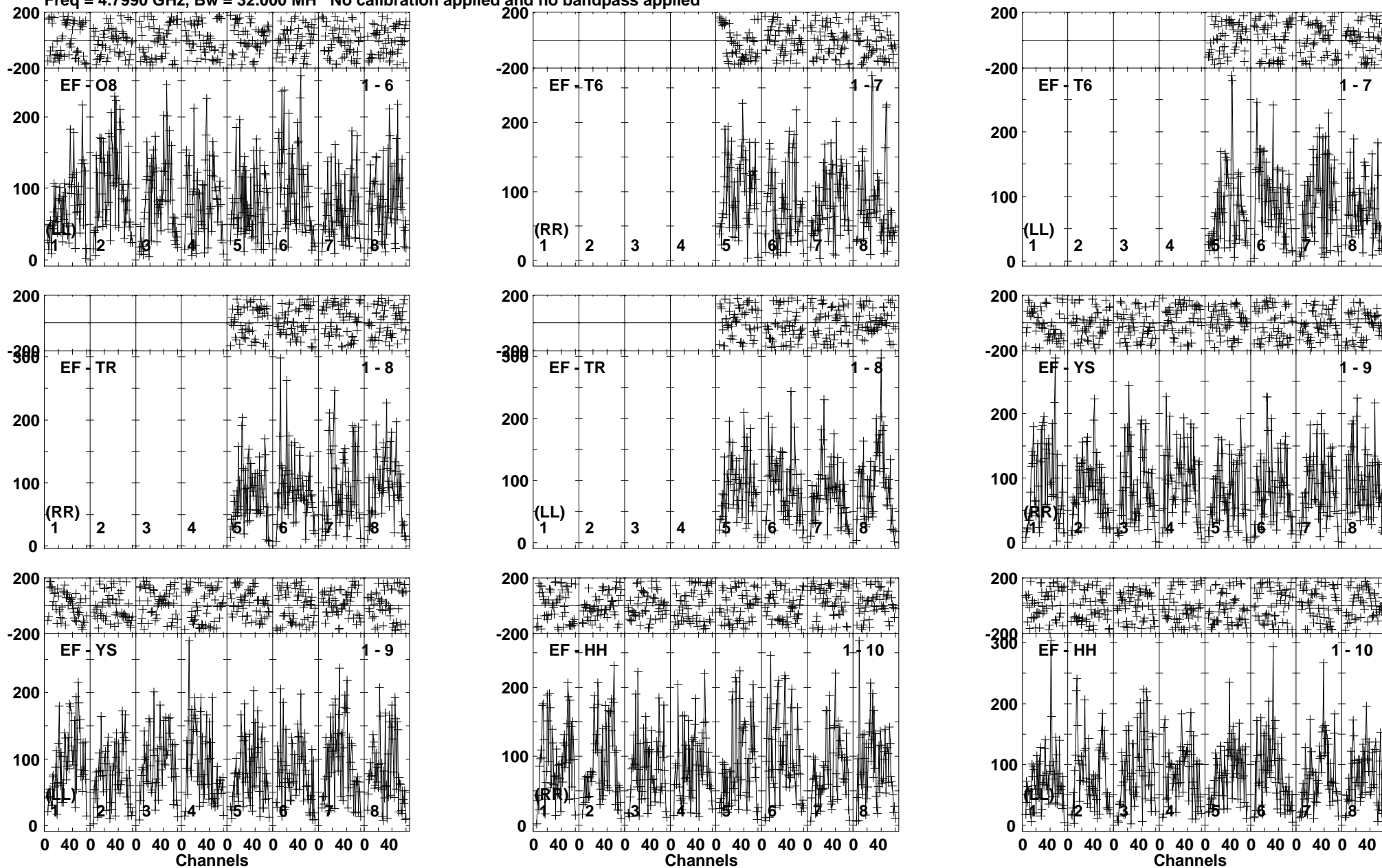

Lower frame: Micro Ampl Jy Top frame: Phas deg  
Vector averaged cross-power spectrum Baseline: EF (01) - O8 (06)  
Timerange: 00/03:37:10 to 00/03:40:40

Plot file version 132 created 24-NOV-2017 10:10:10  
ARUMA EG096D.UVDATA.1  
Freq = 4.7990 GHz, Bw = 32.000 MH No calibration applied and no bandpass applied

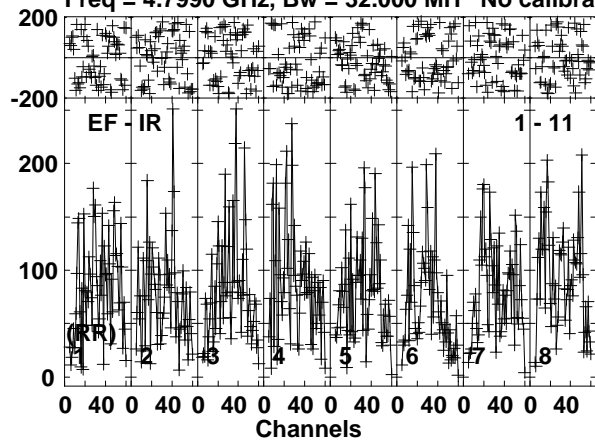

Lower frame: Micro Ampl Jy Top frame: Phas deg  
Vector averaged cross-power spectrum Baseline: EF (01) - IR (11)  
Timerange: 00/03:37:10 to 00/03:40:40

Plot file version 133 created 24-NOV-2017 10:10:10

J1108+4330 EG096D.UVDATA.1

Freq = 4.7990 GHz, Bw = 32.000 MH No calibration applied and no bandpass applied

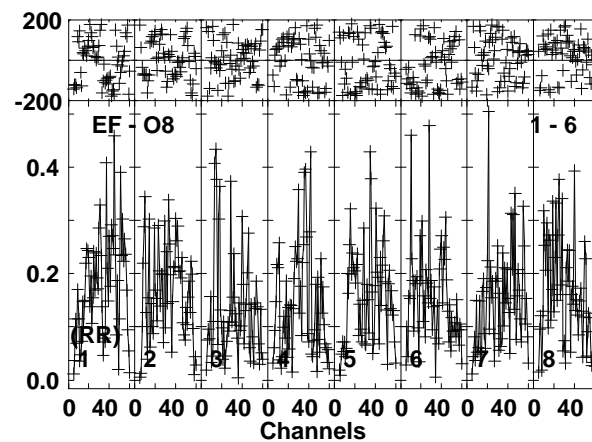
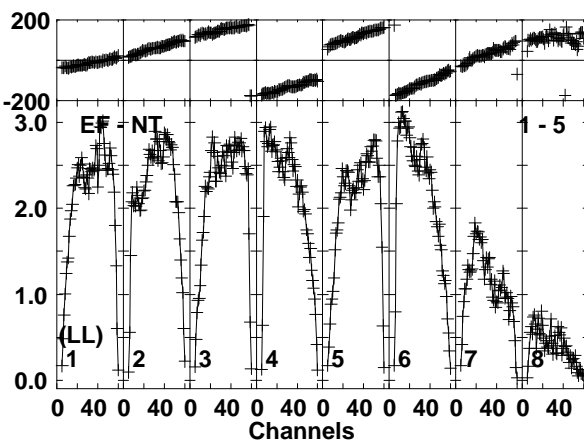
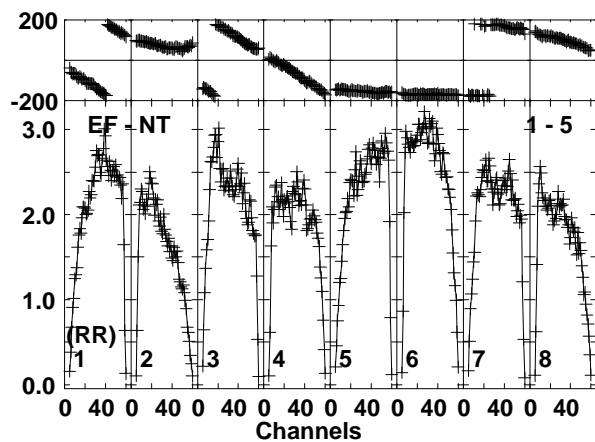
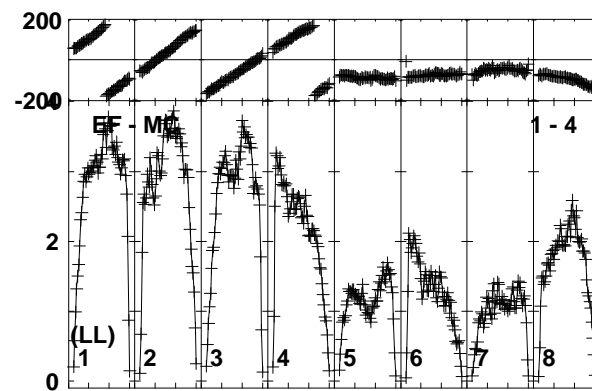
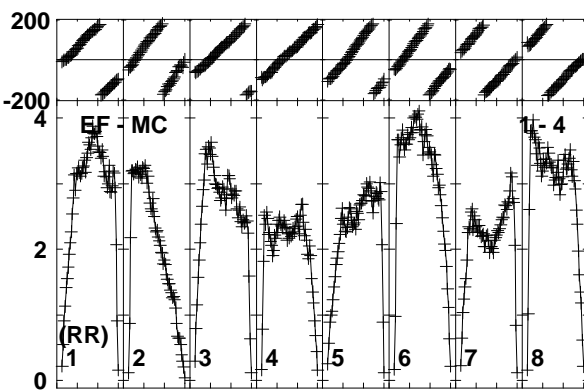
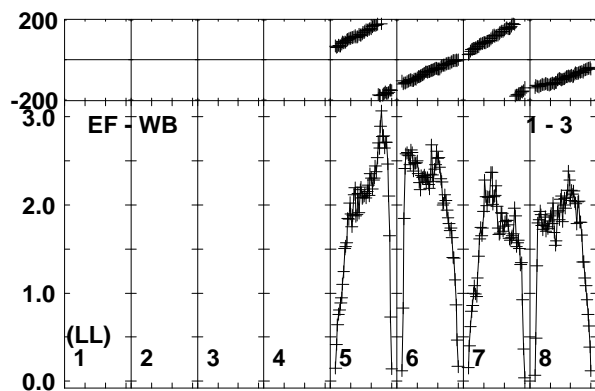
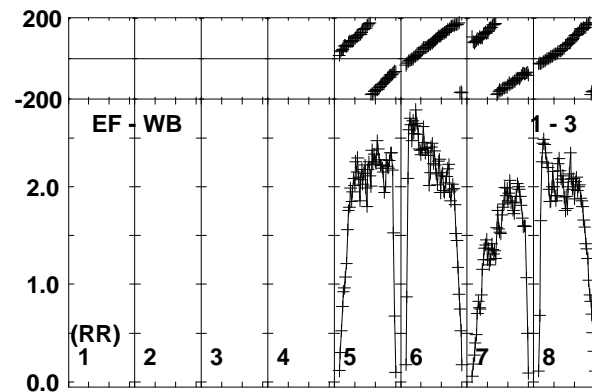
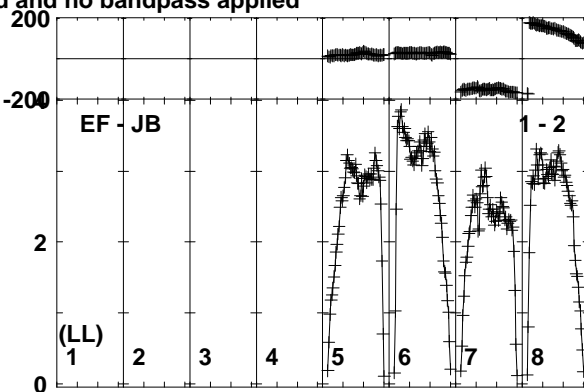
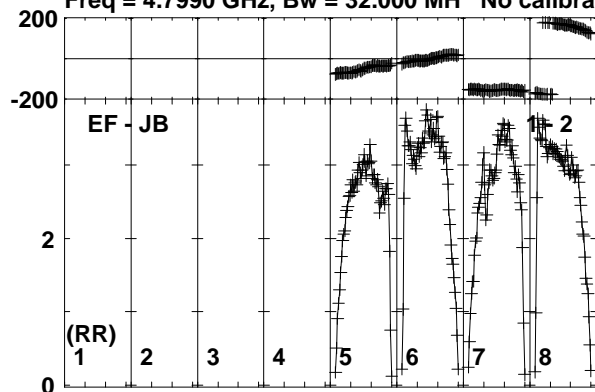

Lower frame: Milli Ampl Jy Top frame: Phas deg  
Vector averaged cross-power spectrum Baseline: EF (01) - JB (02)  
Timerange: 00/03:41:20 to 00/03:42:20

Plot file version 134 created 24-NOV-2017 10:10:10

J1108+4330 EG096D.UVDATA.1

Freq = 4.7990 GHz, Bw = 32.000 MH No calibration applied and no bandpass applied

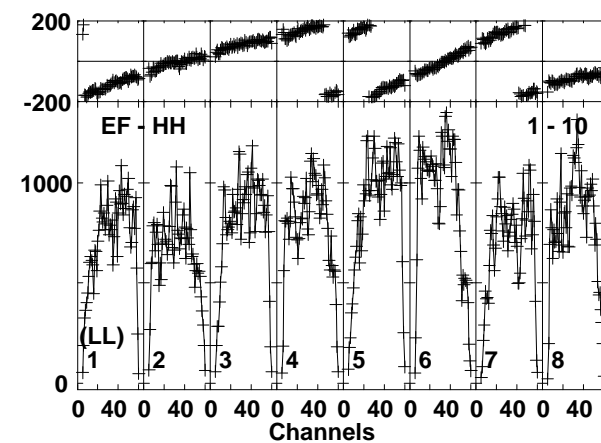
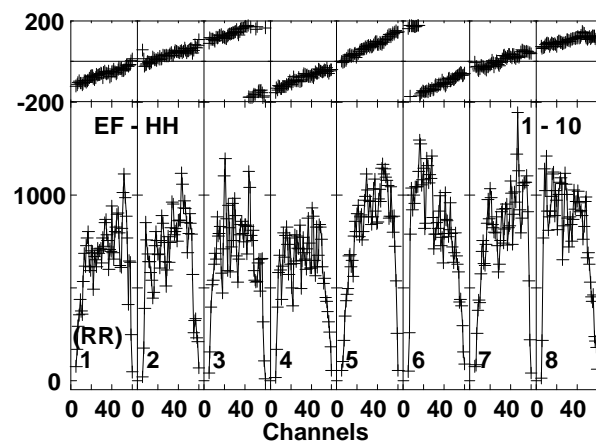
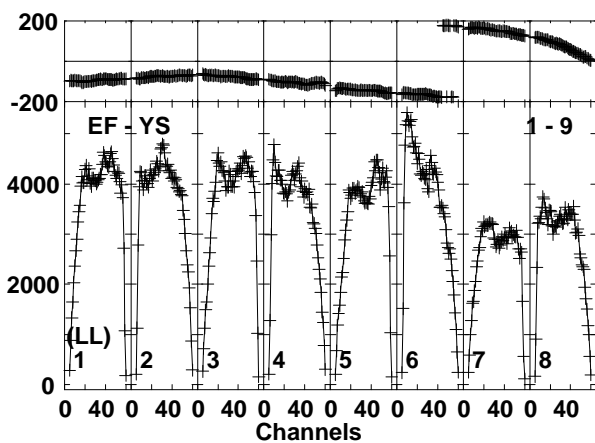
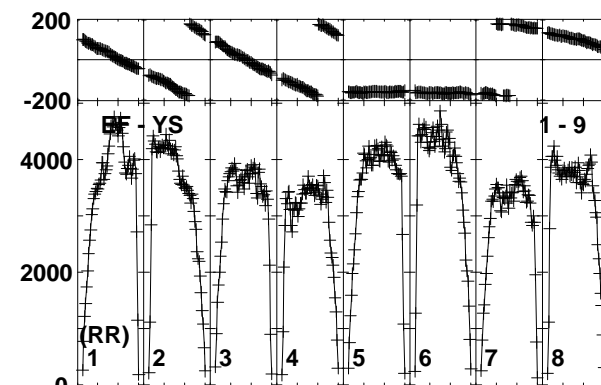
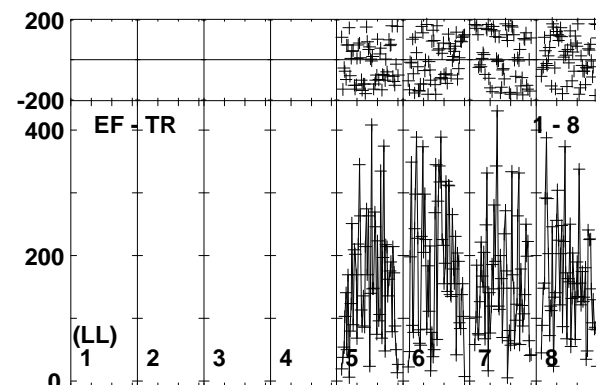
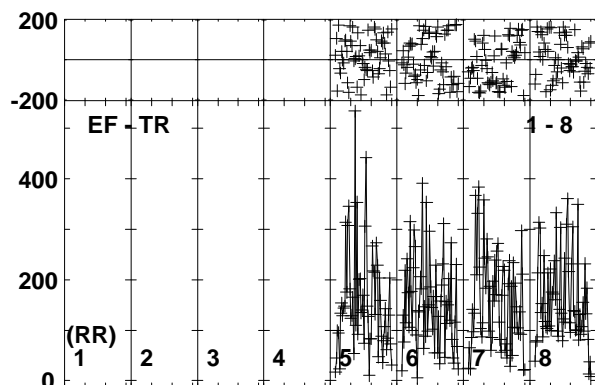
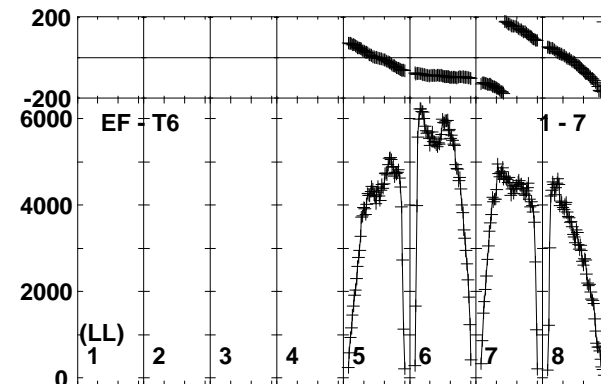
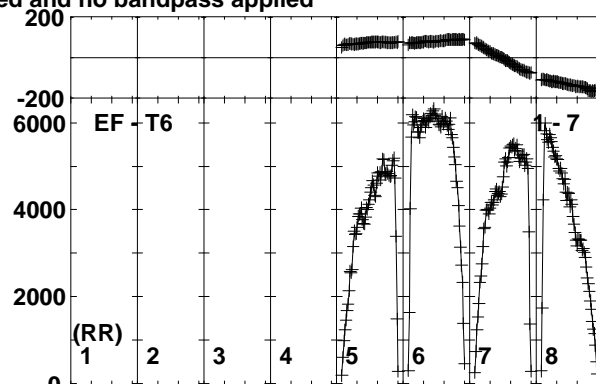
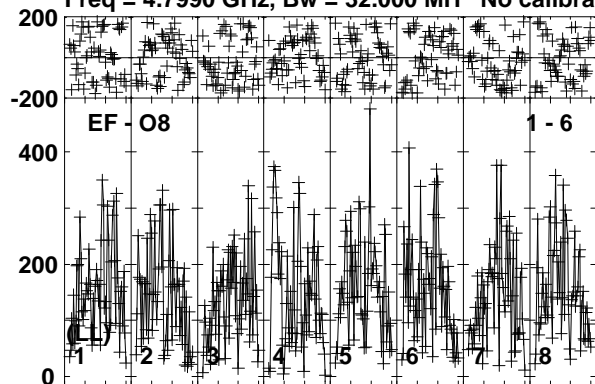

Lower frame: Micro Ampl Jy Top frame: Phas deg  
Vector averaged cross-power spectrum Baseline: EF (01) - O8 (06)  
Timerange: 00/03:41:20 to 00/03:42:20

Plot file version 135 created 24-NOV-2017 10:10:10  
J1108+4330 EG096D.UVDATA.1  
Freq = 4.7990 GHz, Bw = 32.000 MH No calibration applied and no bandpass applied

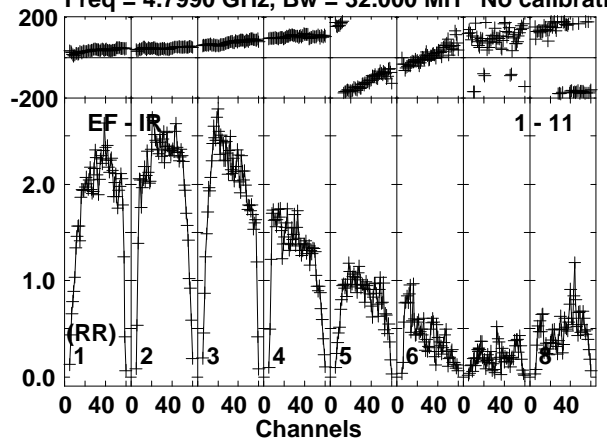

Lower frame: Milli Ampl Jy Top frame: Phas deg  
Vector averaged cross-power spectrum Baseline: EF (01) - IR (11)  
Timerange: 00/03:41:20 to 00/03:42:20

Plot file version 136 created 24-NOV-2017 10:10:10

ARUMA EG096D.UVDATA.1

Freq = 4.7990 GHz, Bw = 32.000 MH No calibration applied and no bandpass applied

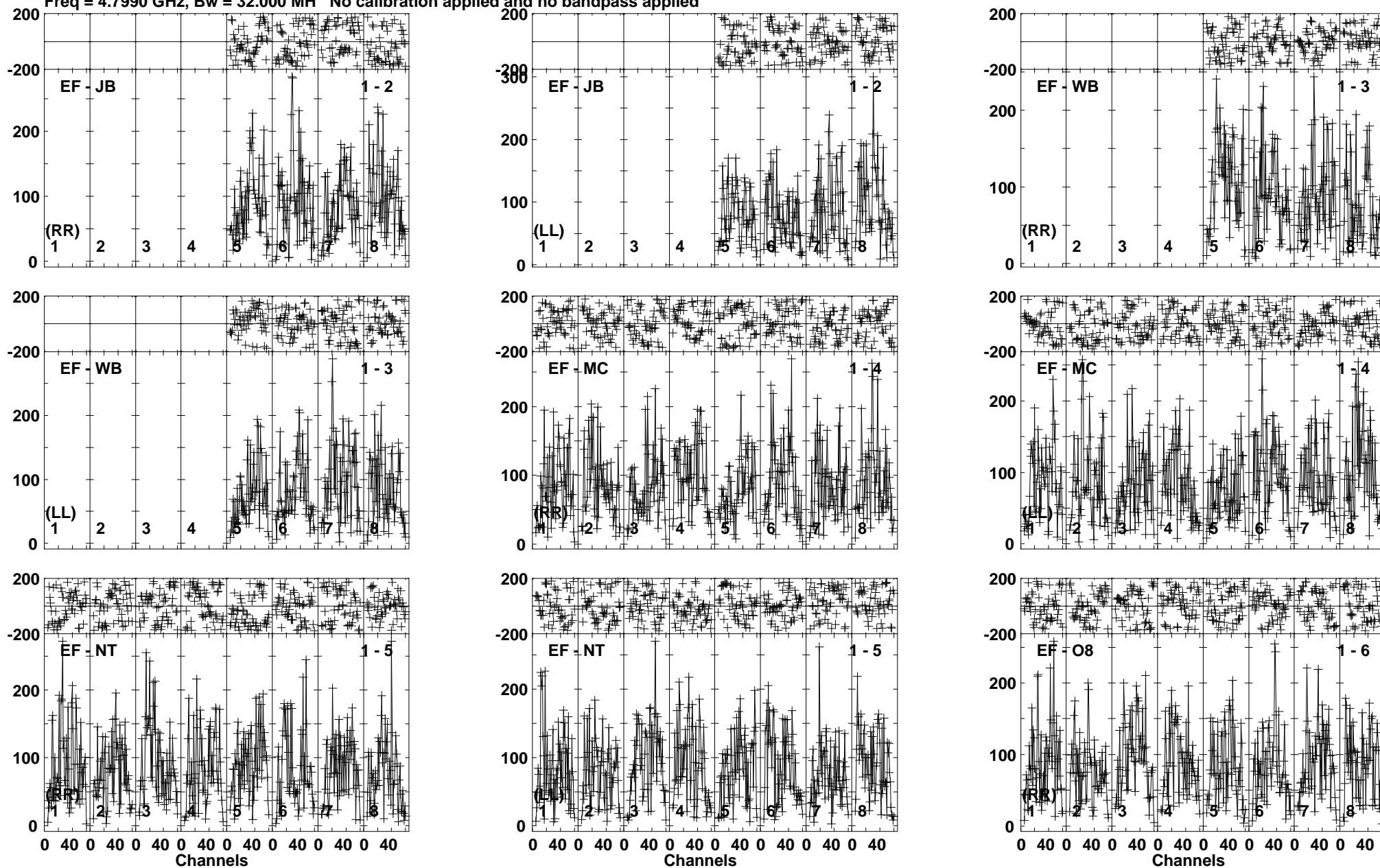

Lower frame: Micro Ampl Jy Top frame: Phas deg  
Vector averaged cross-power spectrum Baseline: EF (01) - JB (02)  
Timerange: 00/03:42:20 to 00/03:45:50

Plot file version 137 created 24-NOV-2017 10:10:10  
 ARUMA EG096D.UVDATA.1  
 Freq = 4.7990 GHz, Bw = 32.000 MH No calibration applied and no bandpass applied

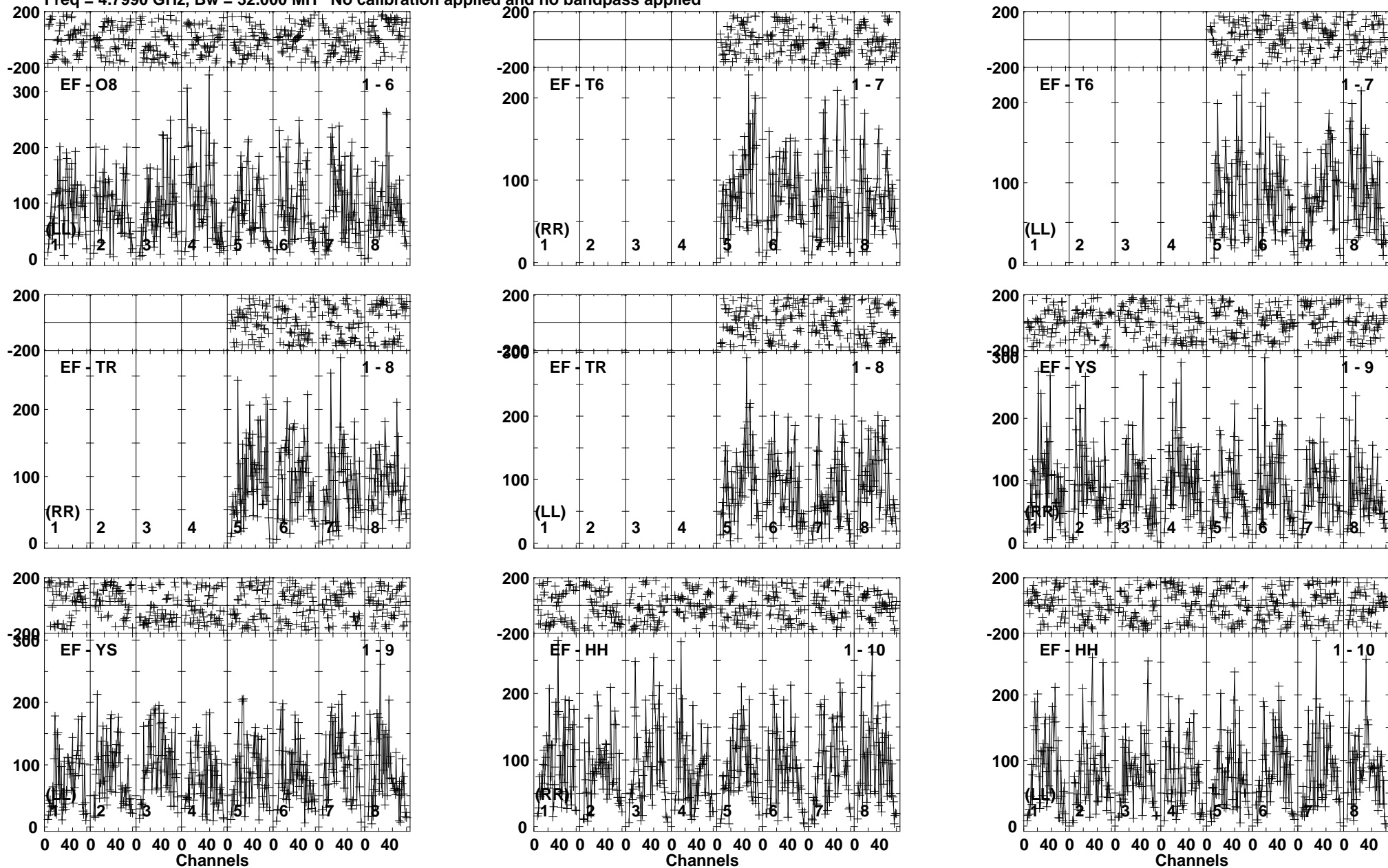

Lower frame: Micro Ampl Jy Top frame: Phas deg  
 Vector averaged cross-power spectrum Baseline: EF (01) - O8 (06)  
 Timerange: 00/03:42:20 to 00/03:45:50

Plot file version 138 created 24-NOV-2017 10:10:11  
ARUMA EG096D.UVDATA.1  
Freq = 4.7990 GHz, Bw = 32.000 MH No calibration applied and no bandpass applied

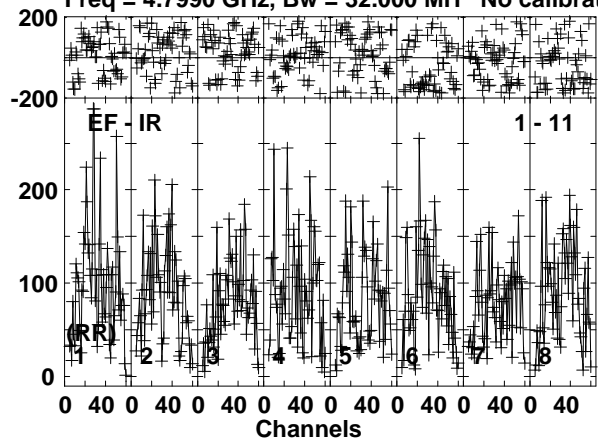

Lower frame: Micro Ampl Jy Top frame: Phas deg  
Vector averaged cross-power spectrum Baseline: EF (01) - IR (11)  
Timerange: 00/03:42:20 to 00/03:45:50



Plot file version 139 created 24-NOV-2017 10:10:11

J1108+4330 EG096D.UVDATA.1

Freq = 4.7990 GHz, Bw = 32.000 MH No calibration applied and no bandpass applied

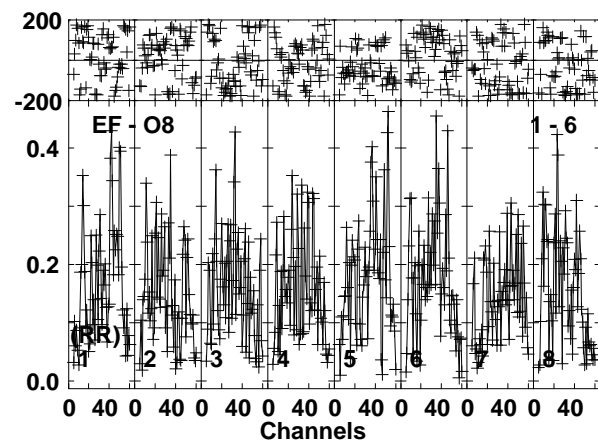
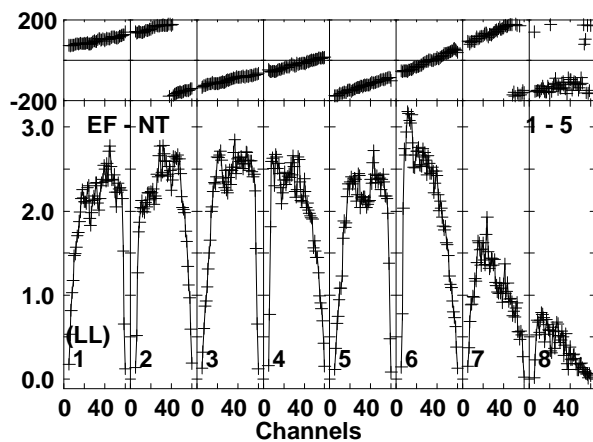
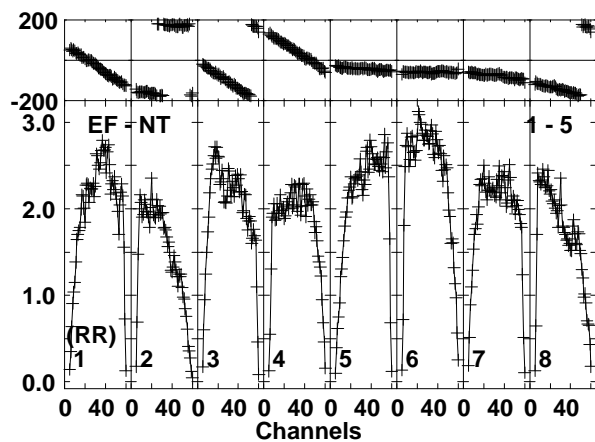
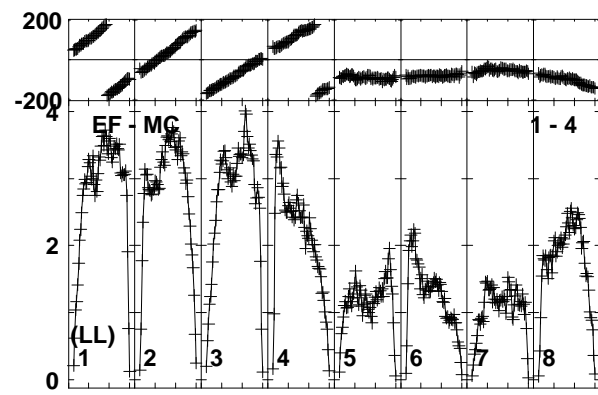
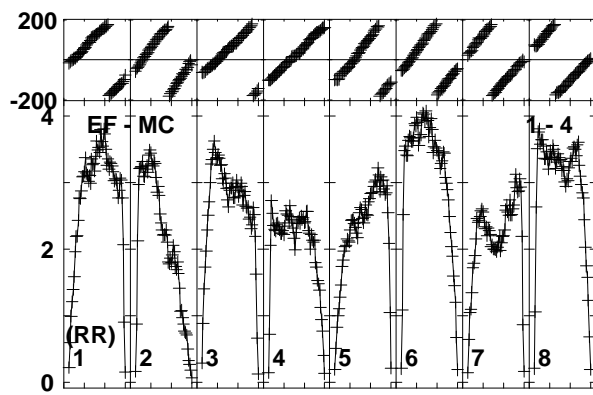
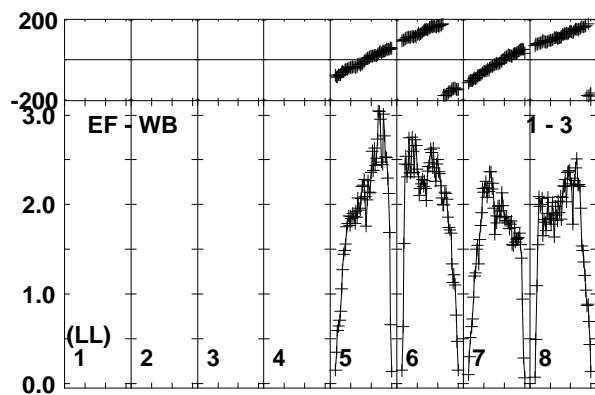
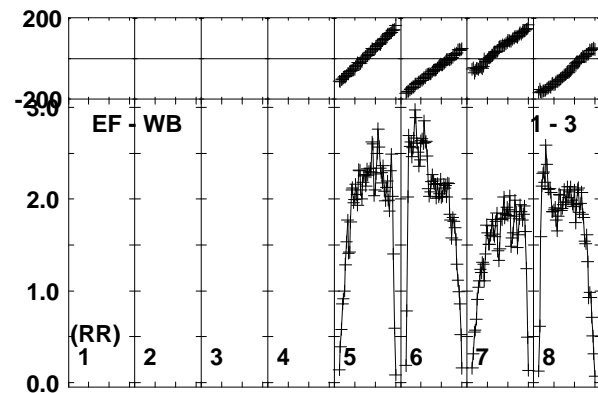
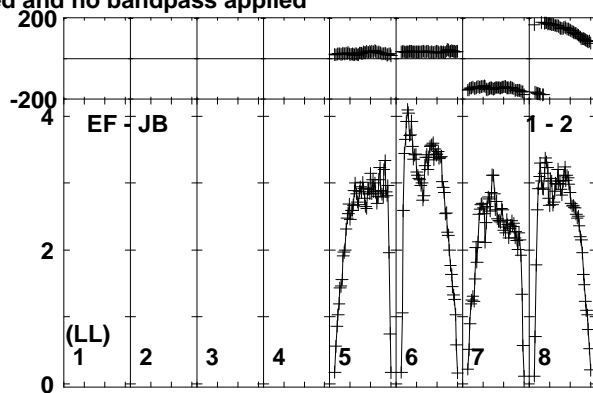
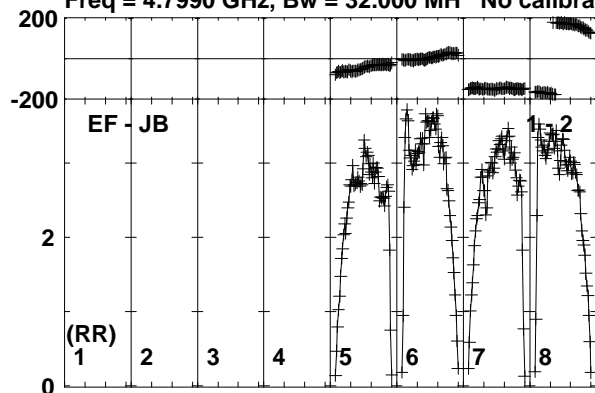

Lower frame: Milli Ampl Jy Top frame: Phas deg  
Vector averaged cross-power spectrum Baseline: EF (01) - JB (02)  
Timerange: 00/03:45:51 to 00/03:47:20

Plot file version 140 created 24-NOV-2017 10:10:11

J1108+4330 EG096D.UVDATA.1

Freq = 4.7990 GHz, Bw = 32.000 MH No calibration applied and no bandpass applied

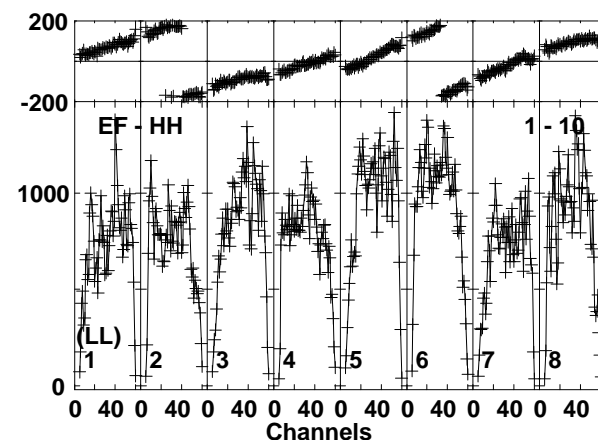
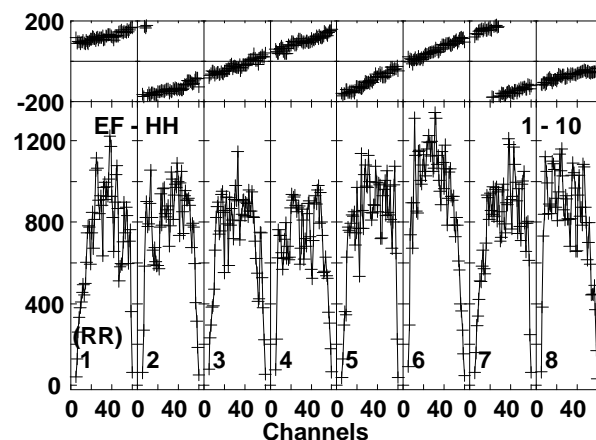
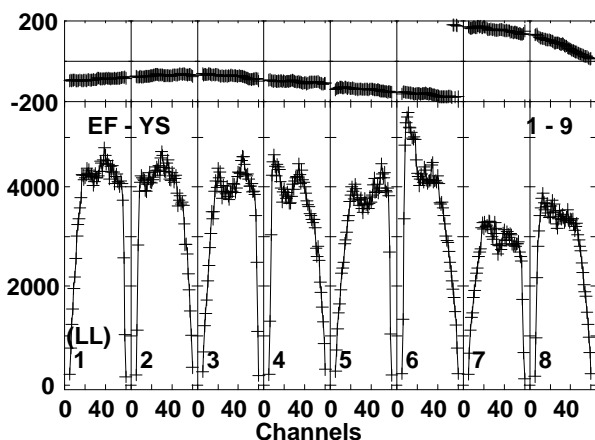
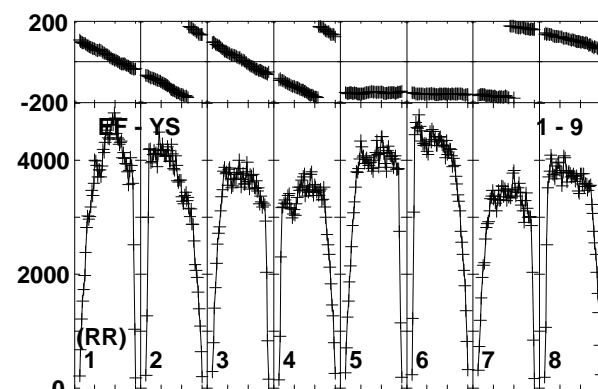
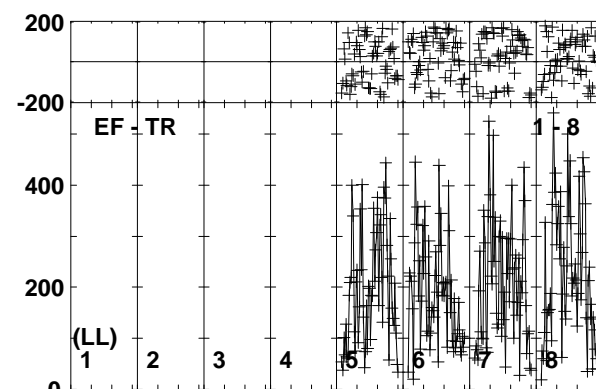
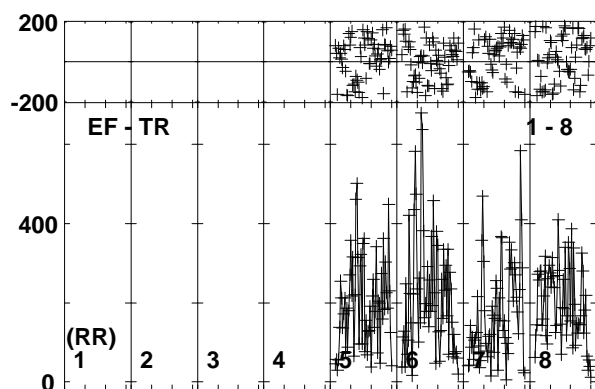
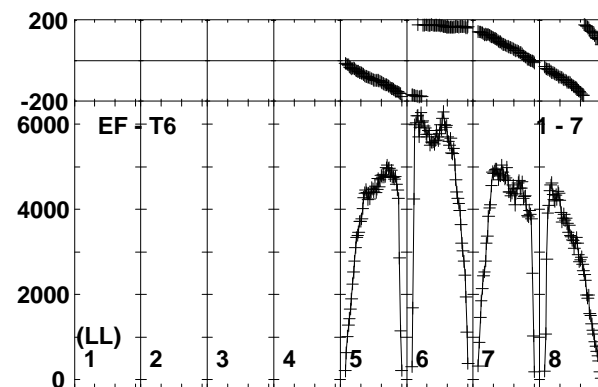
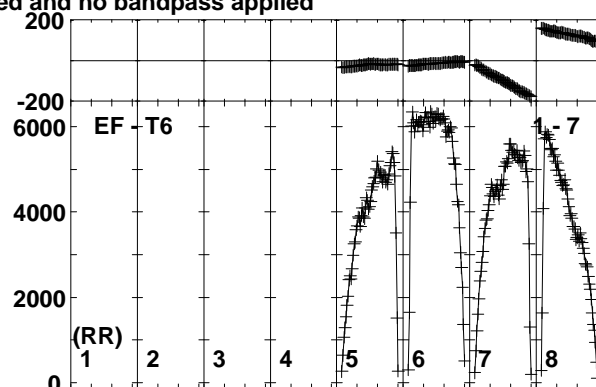
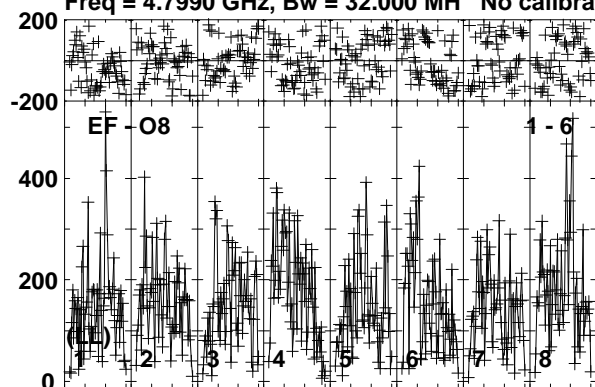

Lower frame: Micro Ampl Jy Top frame: Phas deg  
Vector averaged cross-power spectrum Baseline: EF (01) - O8 (06)  
Timerange: 00/03:45:51 to 00/03:47:20

Plot file version 141 created 24-NOV-2017 10:10:11

J1108+4330 EG096D.UVDATA.1

Freq = 4.7990 GHz, Bw = 32.000 MH No calibration applied and no bandpass applied

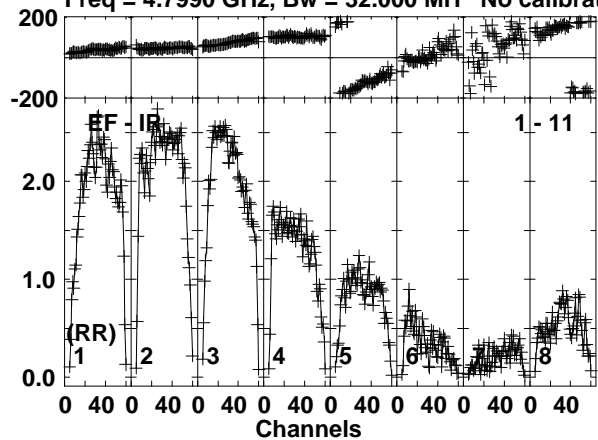

Lower frame: Milli Ampl Jy Top frame: Phas deg

Vector averaged cross-power spectrum Baseline: EF (01) - IR (11)

Timerange: 00/03:45:51 to 00/03:47:20

Plot file version 142 created 24-NOV-2017 10:10:12

ARUMA EG096D.UVDATA.1

Freq = 4.7990 GHz, Bw = 32.000 MH No calibration applied and no bandpass applied

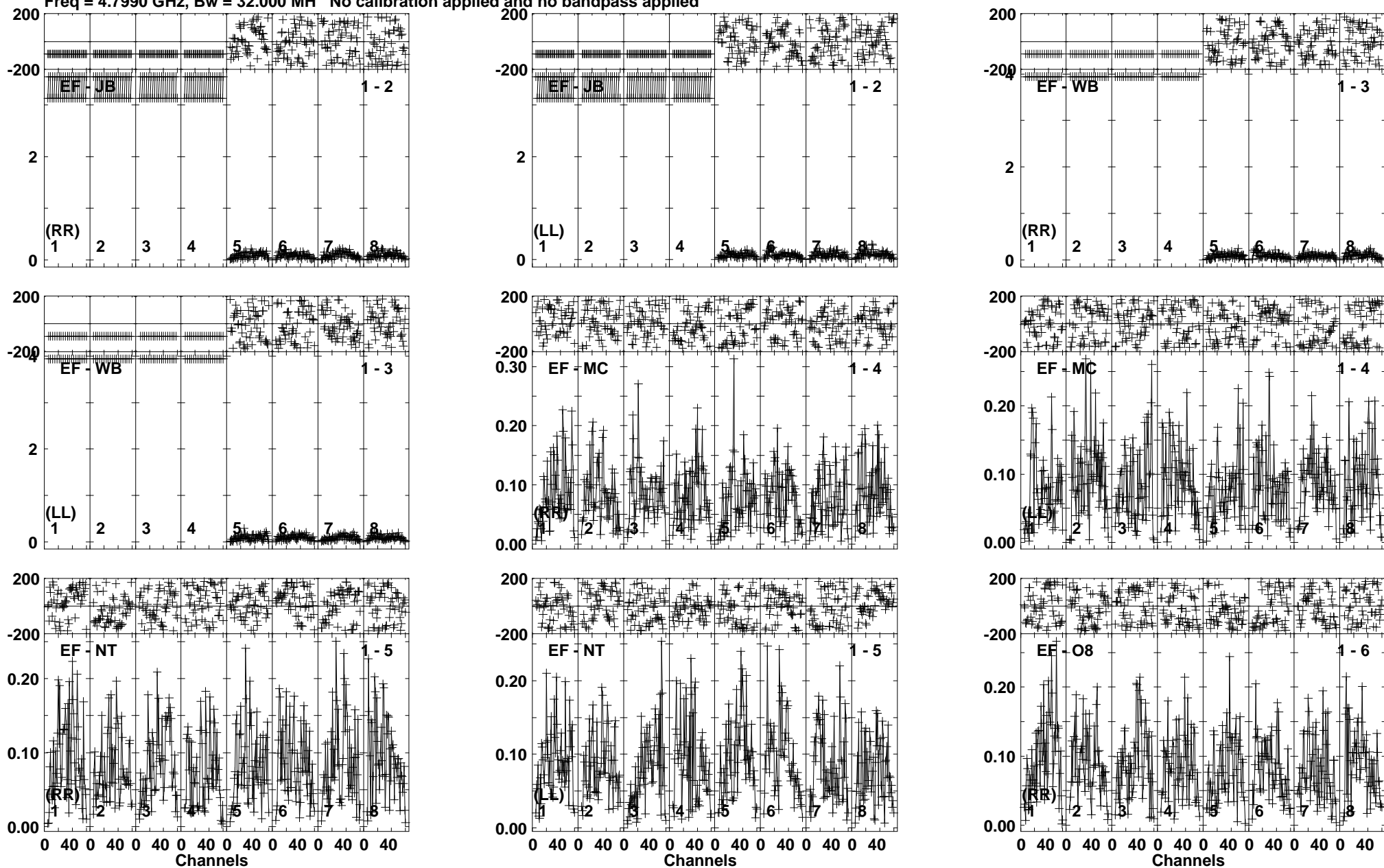

Lower frame: Milli Ampl Jy Top frame: Phas deg  
Vector averaged cross-power spectrum Baseline: EF (01) - JB (02)  
Timerange: 00/03:47:21 to 00/03:50:50

Plot file version 143 created 24-NOV-2017 10:10:12

ARUMA EG096D.UVDATA.1

Freq = 4.7990 GHz, Bw = 32.000 MH No calibration applied and no bandpass applied

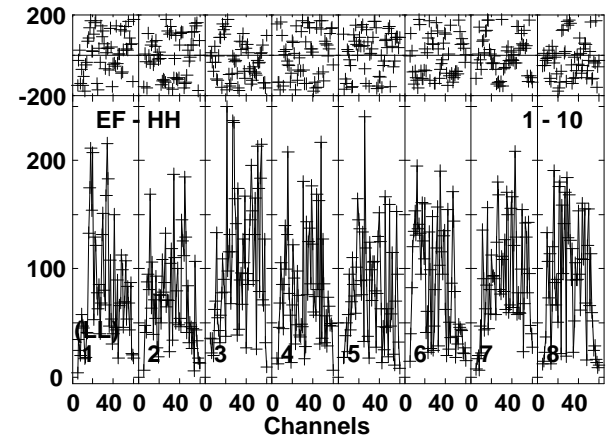
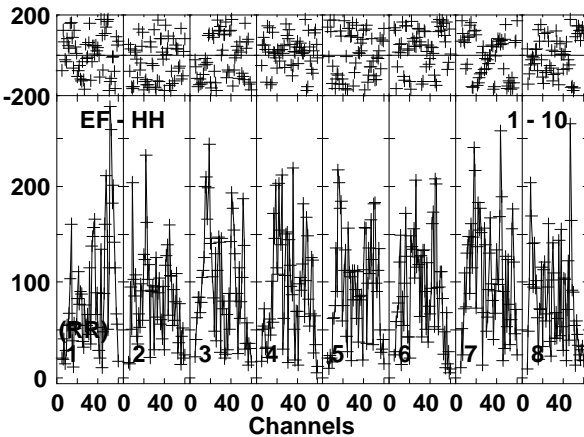
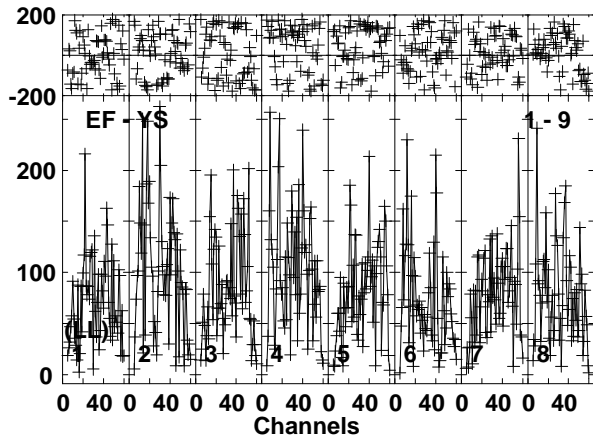
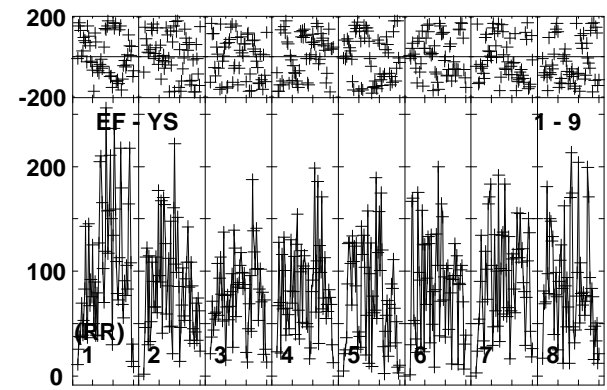
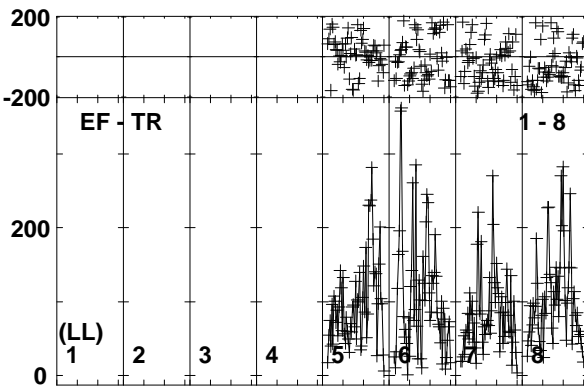
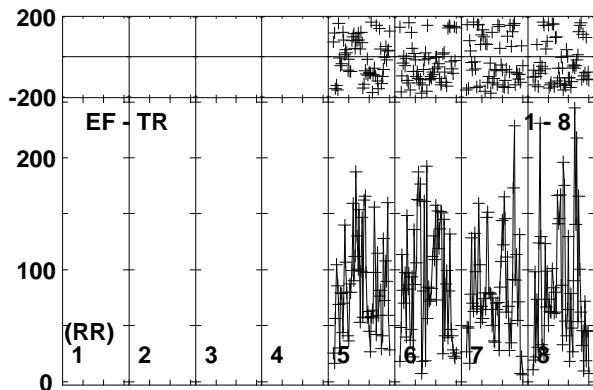
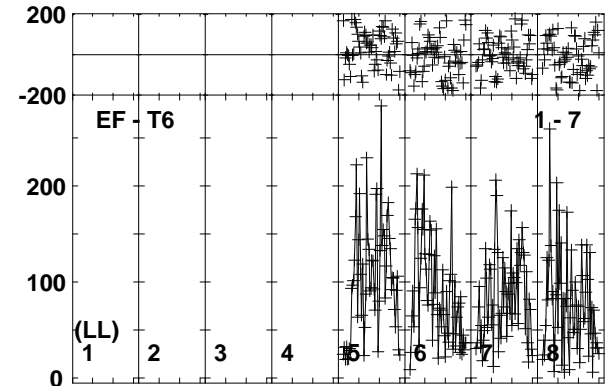
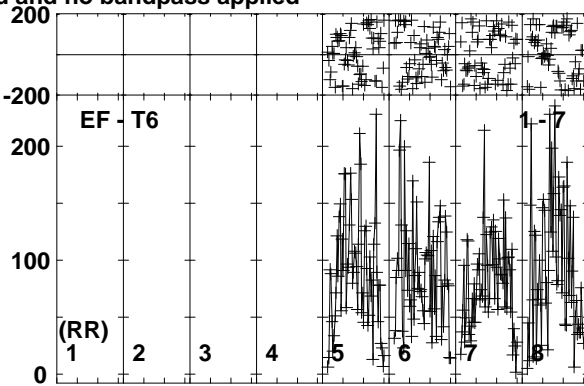
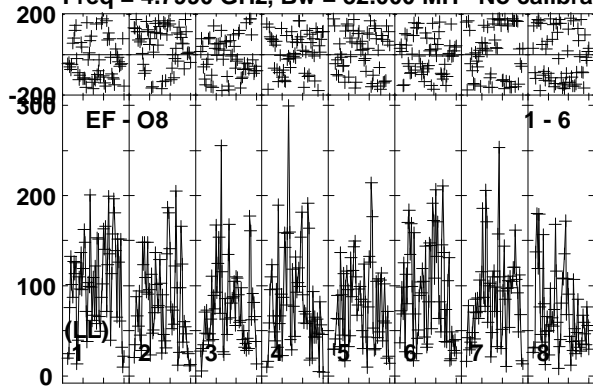

Lower frame: Micro Ampl Jy Top frame: Phas deg  
Vector averaged cross-power spectrum Baseline: EF (01) - O8 (06)  
Timerange: 00/03:47:21 to 00/03:50:50

Plot file version 144 created 24-NOV-2017 10:10:12  
ARUMA EG096D.UVDATA.1  
Freq = 4.7990 GHz, Bw = 32.000 MH No calibration applied and no bandpass applied

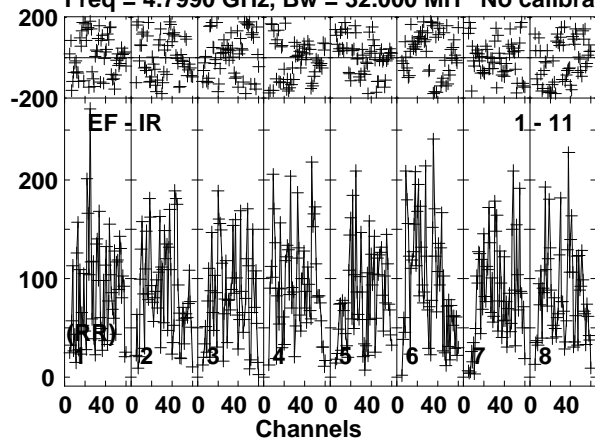

Lower frame: Micro Ampl Jy Top frame: Phas deg  
Vector averaged cross-power spectrum Baseline: EF (01) - IR (11)  
Timerange: 00/03:47:21 to 00/03:50:50

Plot file version 145 created 24-NOV-2017 10:10:12

J1108+4330 EG096D.UVDATA.1

Freq = 4.7990 GHz, Bw = 32.000 MH No calibration applied and no bandpass applied

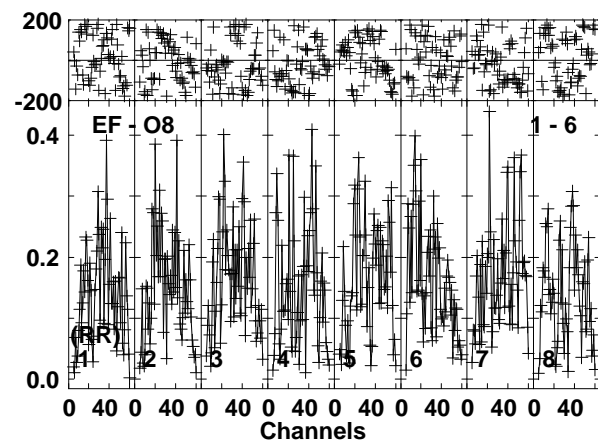
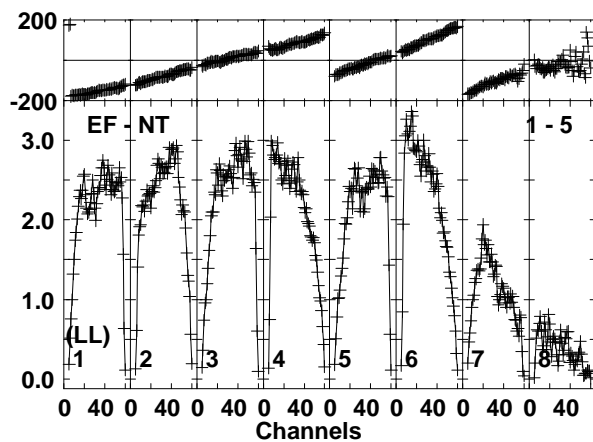
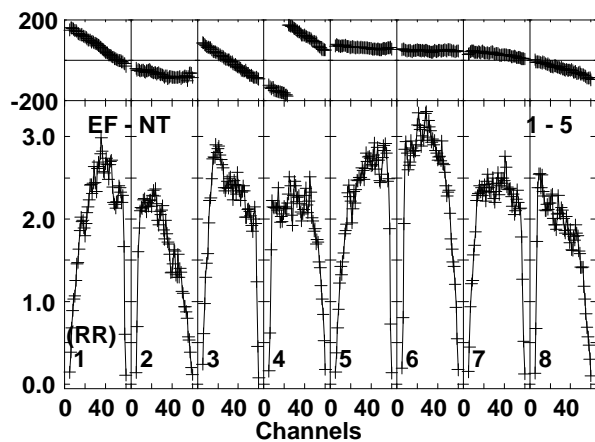
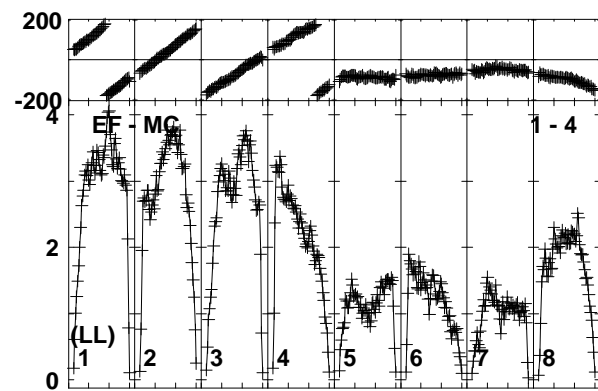
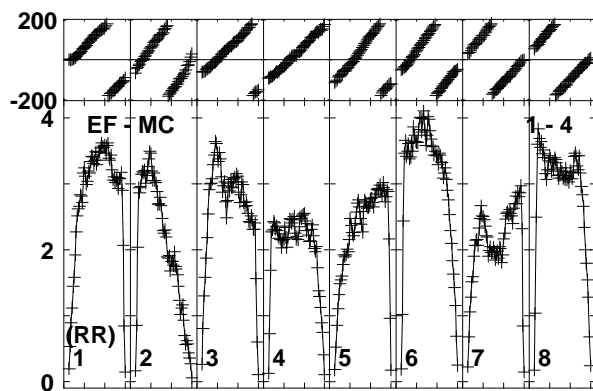
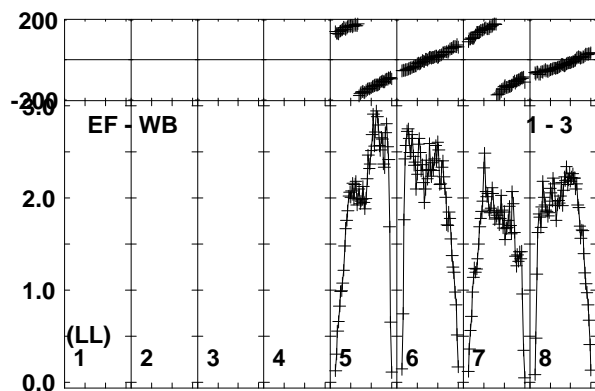
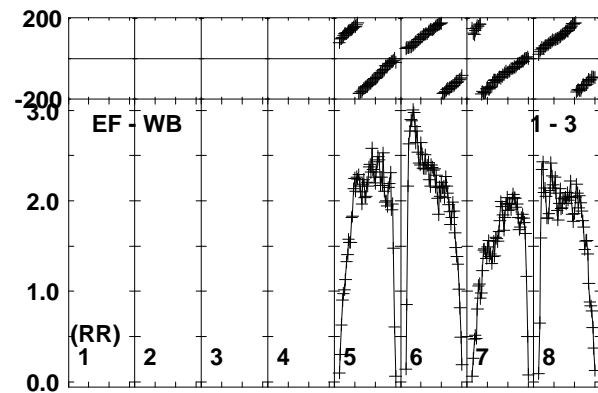
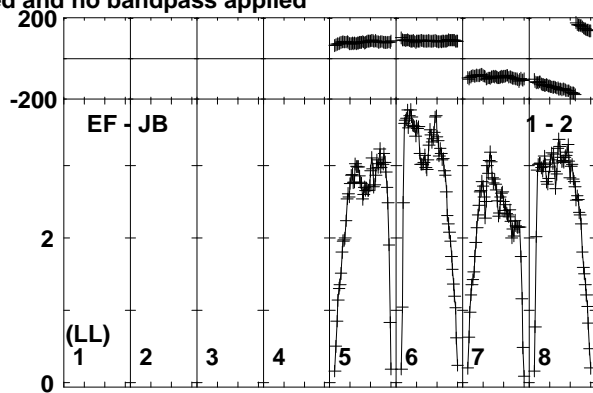
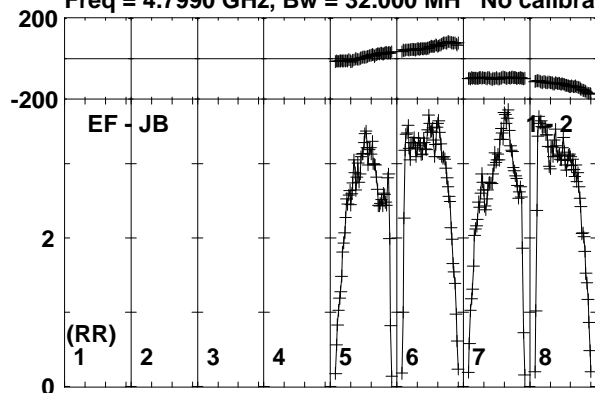

Lower frame: Milli Ampl Jy Top frame: Phas deg  
Vector averaged cross-power spectrum Baseline: EF (01) - JB (02)  
Timerange: 00/03:51:30 to 00/03:52:30

Plot file version 146 created 24-NOV-2017 10:10:12

J1108+4330 EG096D.UVDATA.1

Freq = 4.7990 GHz, Bw = 32.000 MH No calibration applied and no bandpass applied

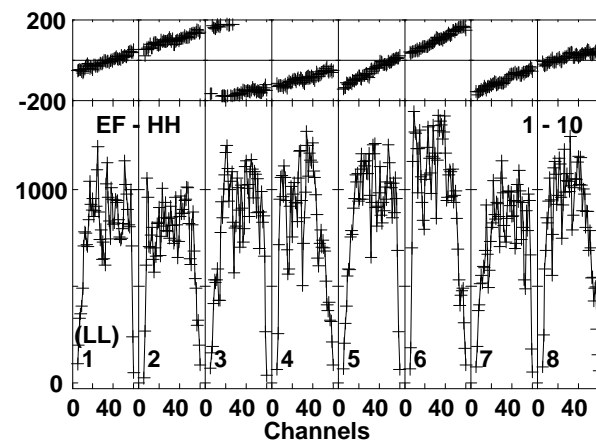
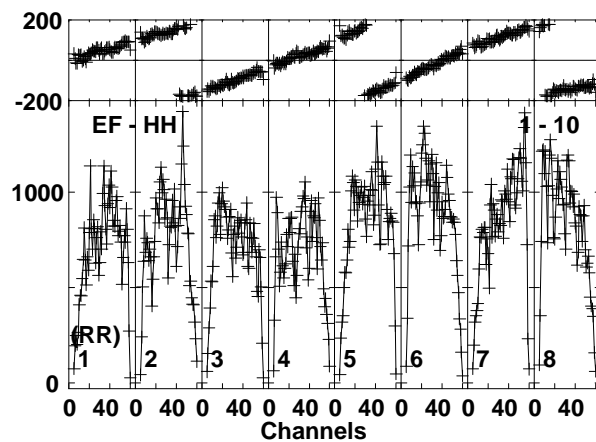
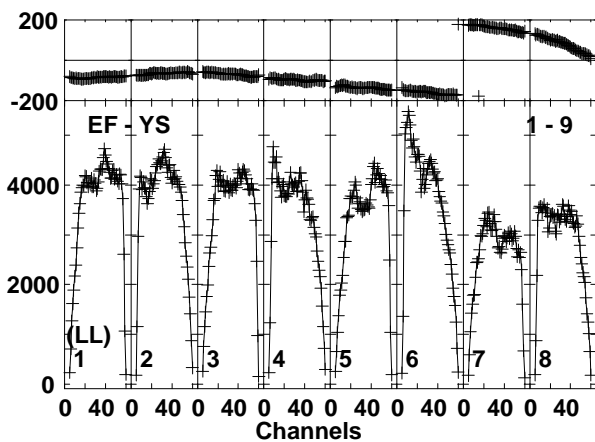
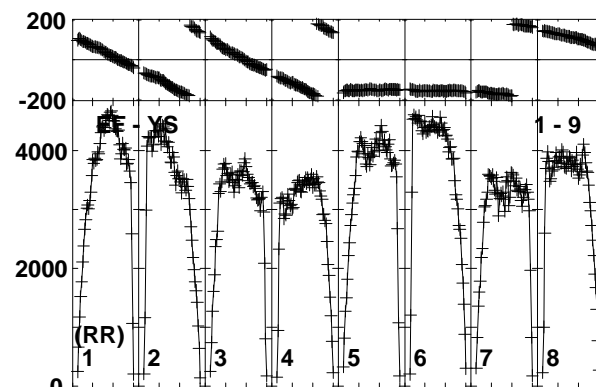
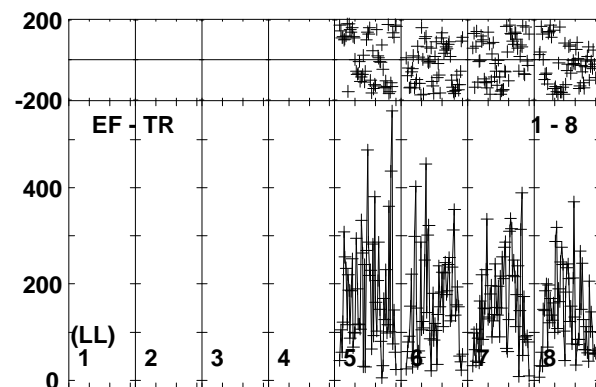
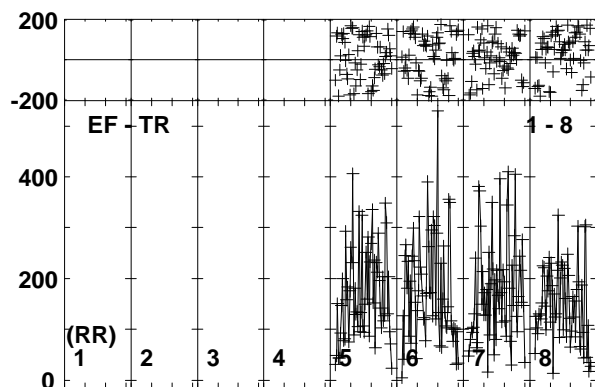
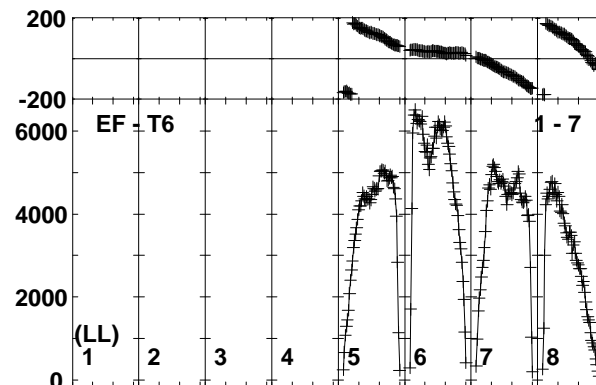
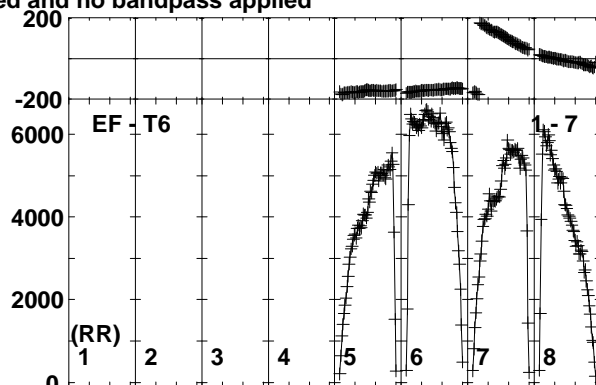
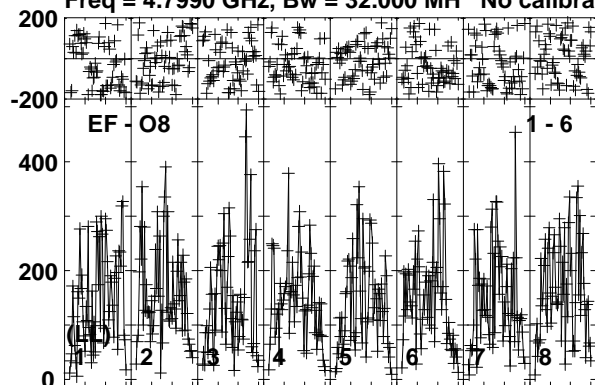

Lower frame: Micro Ampl Jy Top frame: Phas deg  
Vector averaged cross-power spectrum Baseline: EF (01) - O8 (06)  
Timerange: 00/03:51:30 to 00/03:52:30



Plot file version 147 created 24-NOV-2017 10:10:13  
J1108+4330 EG096D.UVDATA.1  
Freq = 4.7990 GHz, Bw = 32.000 MH No calibration applied and no bandpass applied

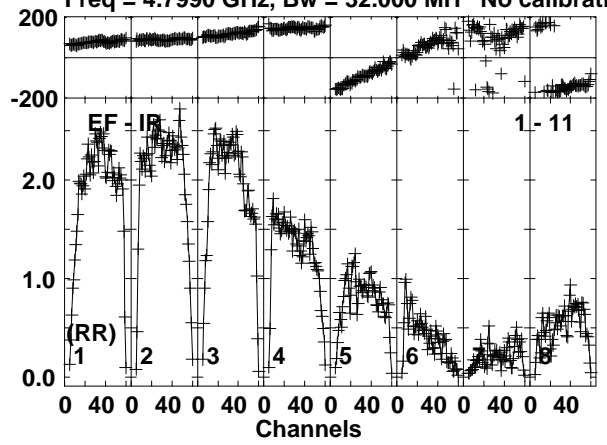

Lower frame: Milli Ampl Jy Top frame: Phas deg  
Vector averaged cross-power spectrum Baseline: EF (01) - IR (11)  
Timerange: 00/03:51:30 to 00/03:52:30

Plot file version 148 created 24-NOV-2017 10:10:13

J1112+4301 EG096D.UVDATA.1

Freq = 4.7990 GHz, Bw = 32.000 MH No calibration applied and no bandpass applied

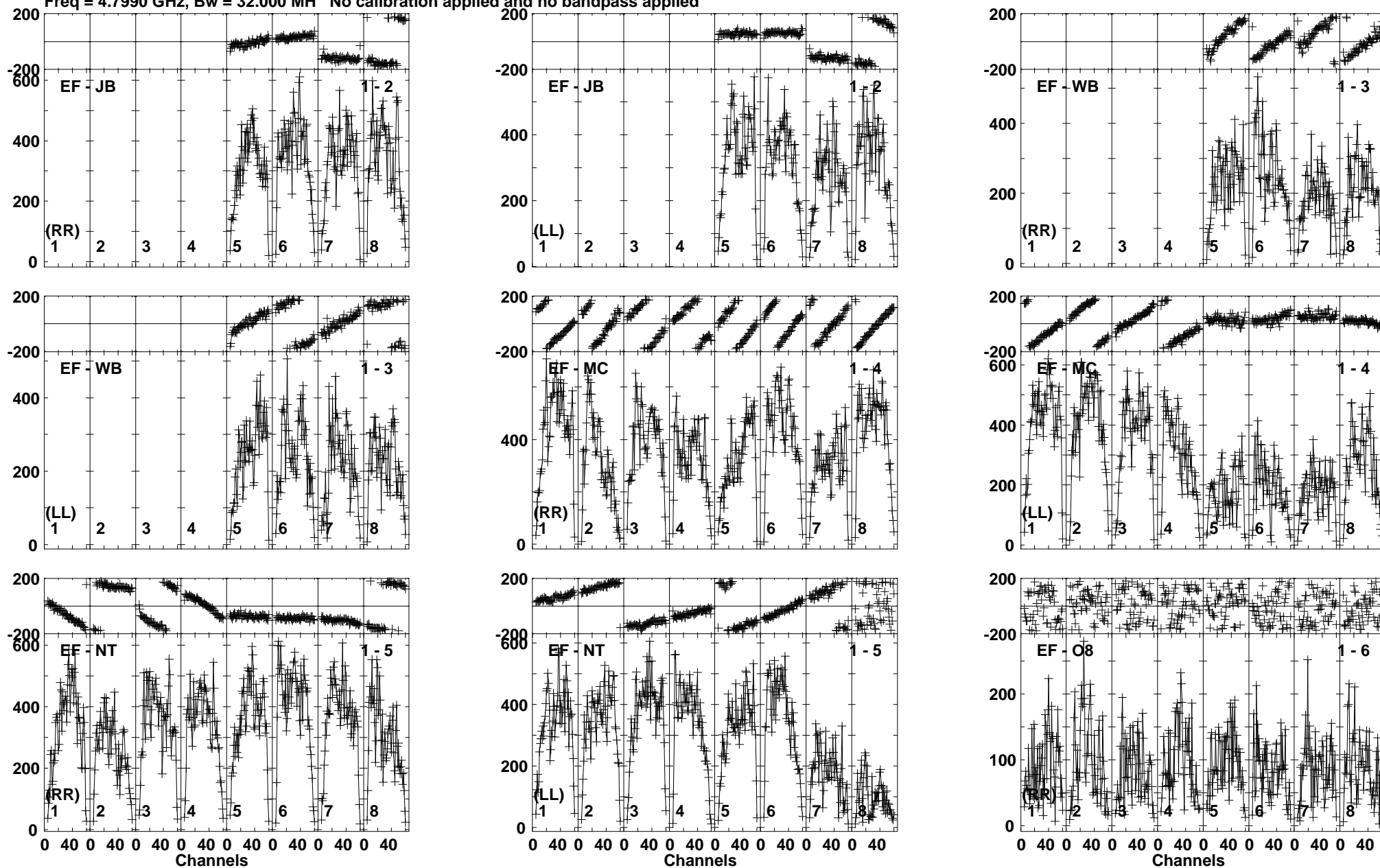

Lower frame: Micro Ampl Jy Top frame: Phas deg  
Vector averaged cross-power spectrum Baseline: EF (01) - JB (02)  
Timerange: 00/03:52:31 to 00/03:56:00

Plot file version 149 created 24-NOV-2017 10:10:13

J1112+4301 EG096D.UVDATA.1

Freq = 4.7990 GHz, Bw = 32.000 MH No calibration applied and no bandpass applied

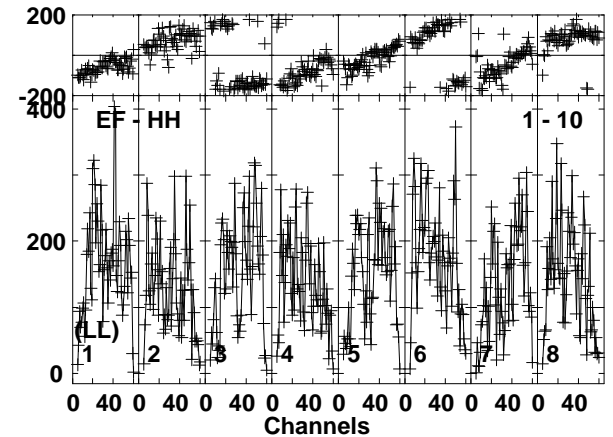
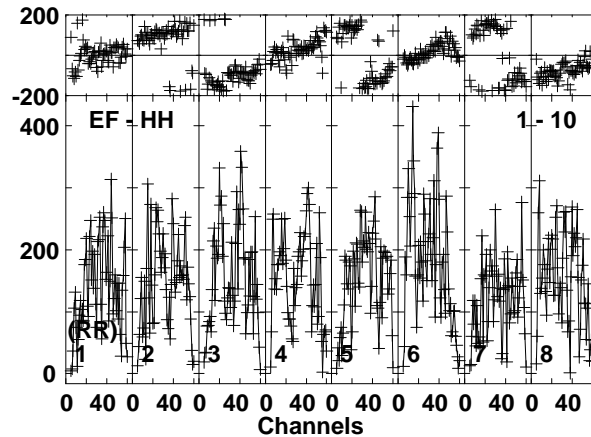
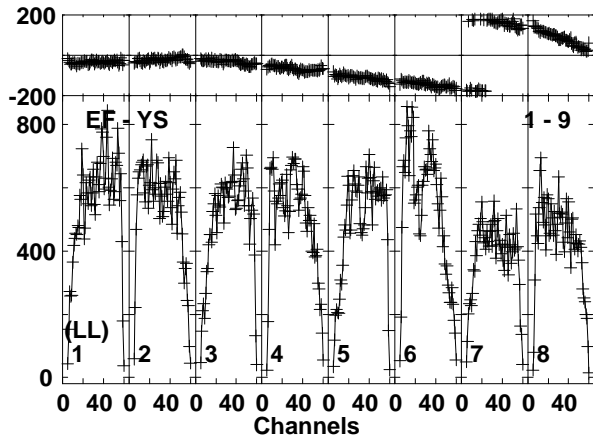
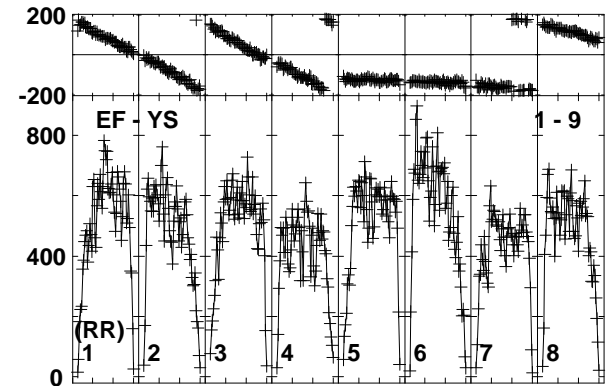
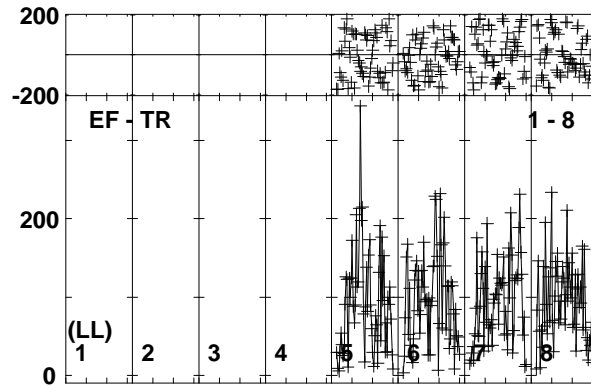
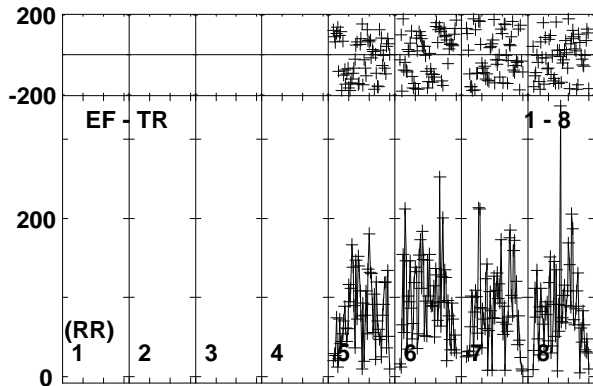
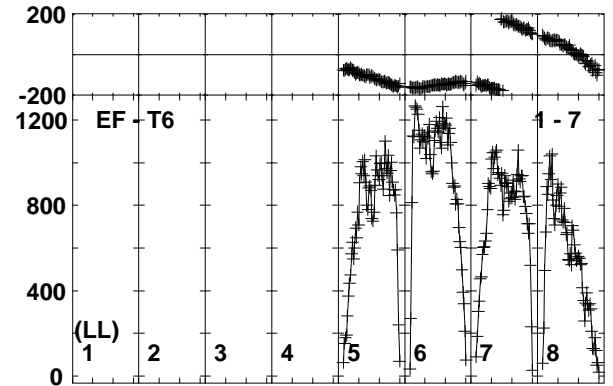
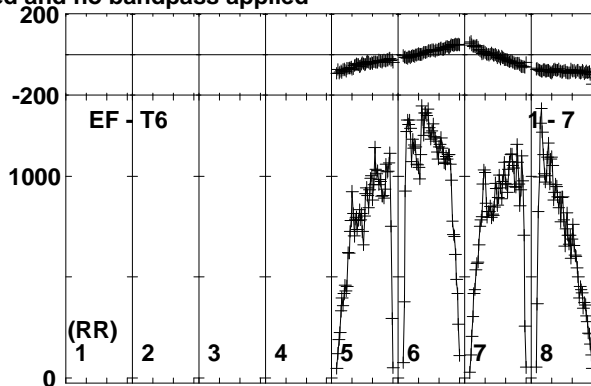
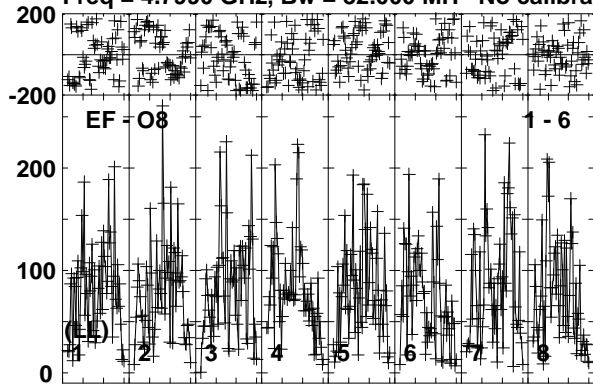

Lower frame: Micro Ampl Jy Top frame: Phas deg  
Vector averaged cross-power spectrum Baseline: EF (01) - O8 (06)  
Timerange: 00/03:52:31 to 00/03:56:00

Plot file version 150 created 24-NOV-2017 10:10:13

J1112+4301 EG096D.UVDATA.1

Freq = 4.7990 GHz, Bw = 32.000 MH No calibration applied and no bandpass applied

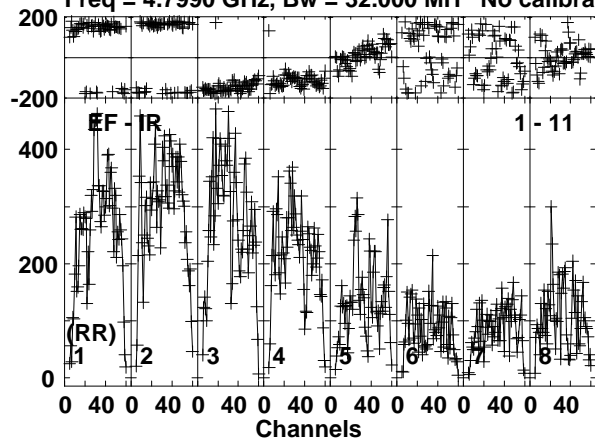

Lower frame: Micro Ampl Jy Top frame: Phas deg  
Vector averaged cross-power spectrum Baseline: EF (01) - IR (11)  
Timerange: 00/03:52:31 to 00/03:56:00

Plot file version 151 created 24-NOV-2017 10:10:14

J1108+4330 EG096D.UVDATA.1

Freq = 4.7990 GHz, Bw = 32.000 MH No calibration applied and no bandpass applied

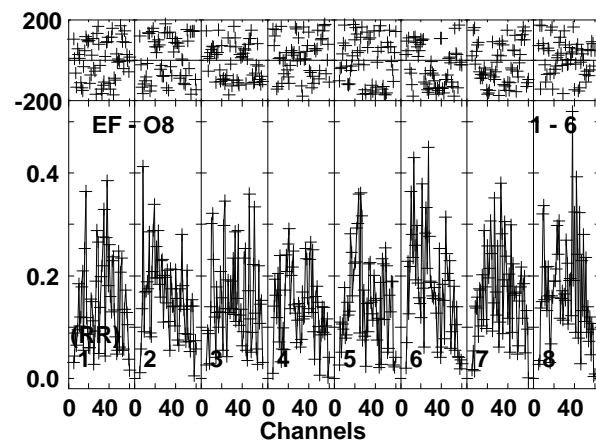
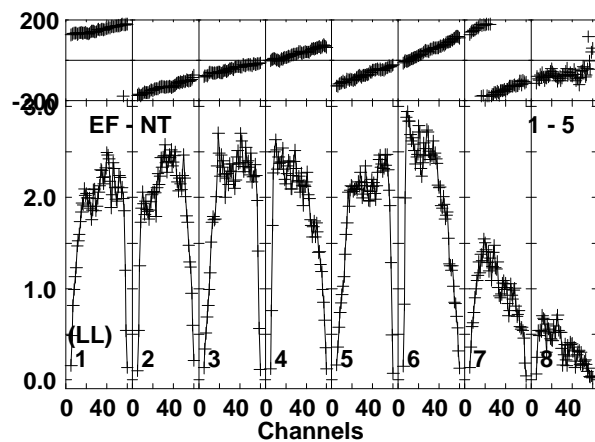
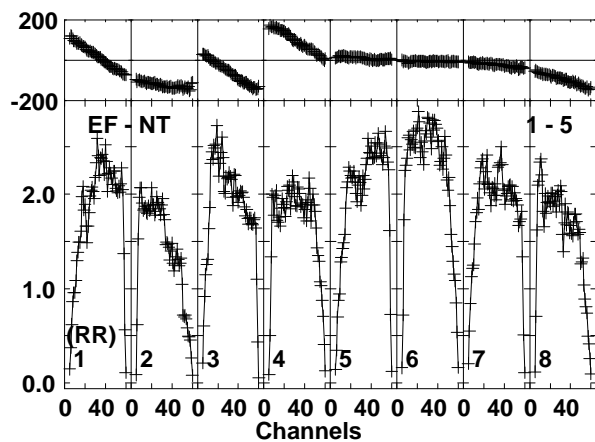
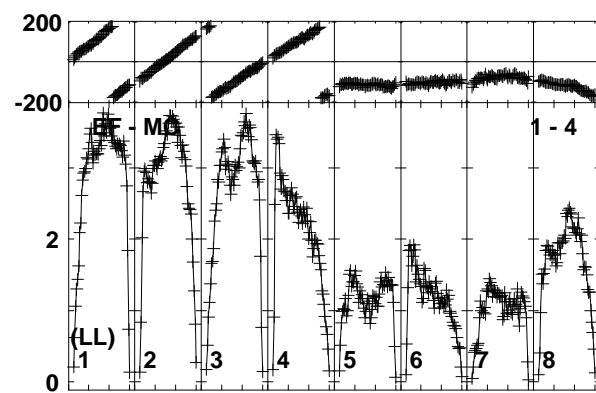
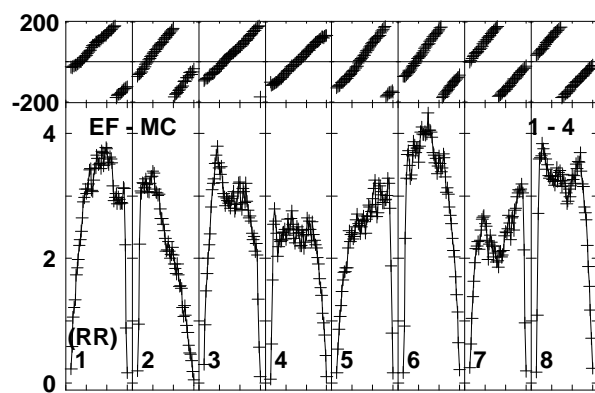
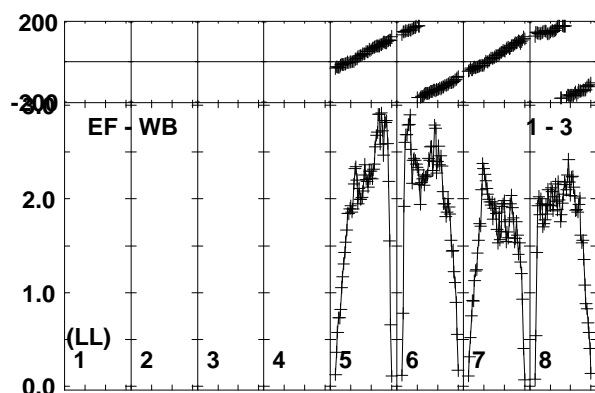
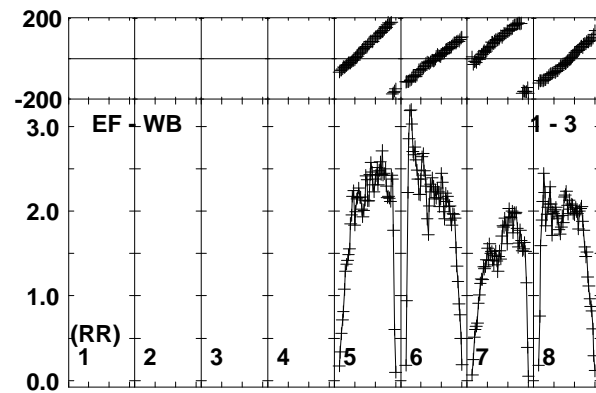
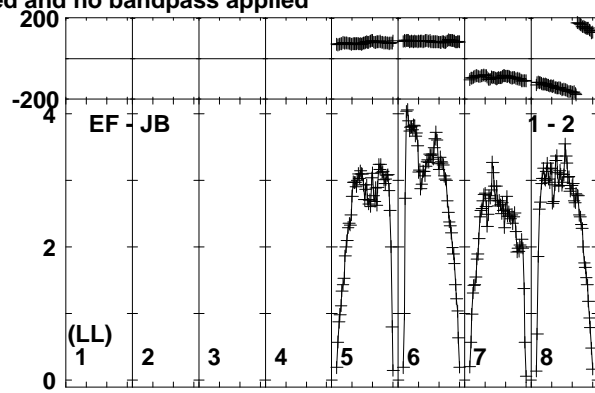
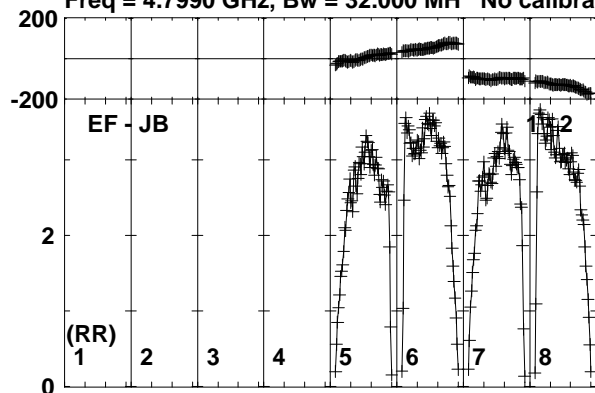

Lower frame: Milli Ampl Jy Top frame: Phas deg  
Vector averaged cross-power spectrum Baseline: EF (01) - JB (02)  
Timerange: 00/03:56:01 to 00/03:57:30

Plot file version 152 created 24-NOV-2017 10:10:14

J1108+4330 EG096D.UVDATA.1

Freq = 4.7990 GHz, Bw = 32.000 MH No calibration applied and no bandpass applied

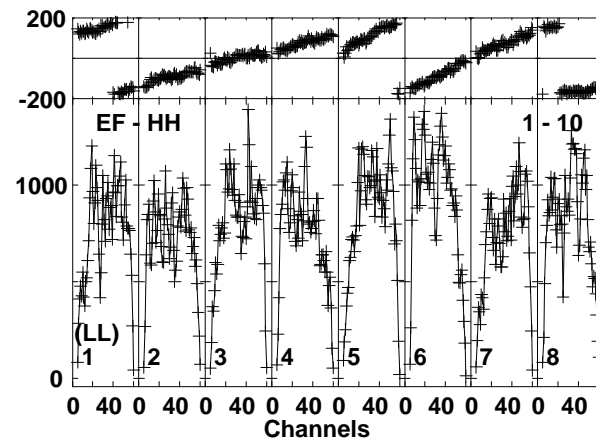
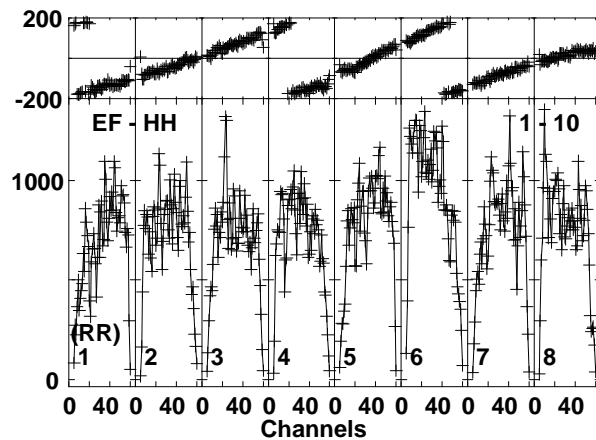
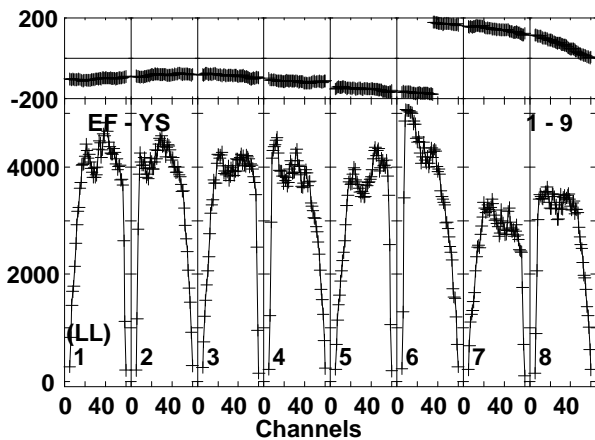
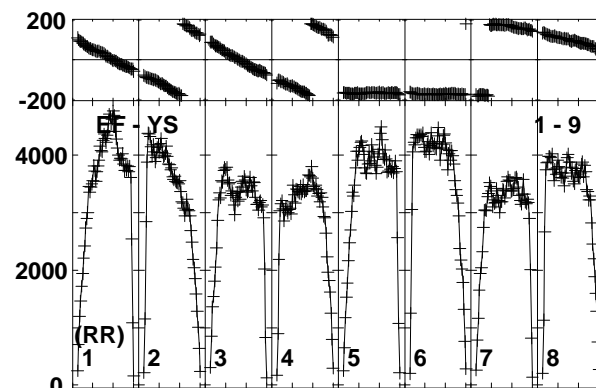
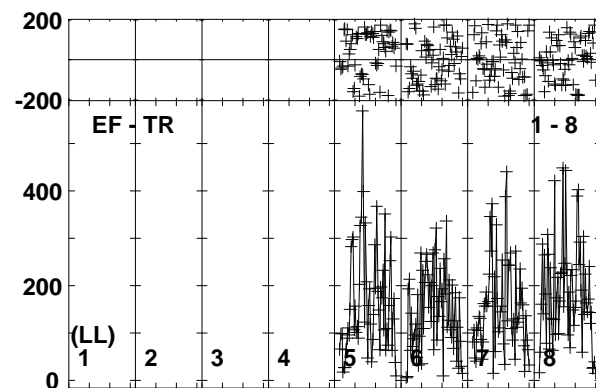
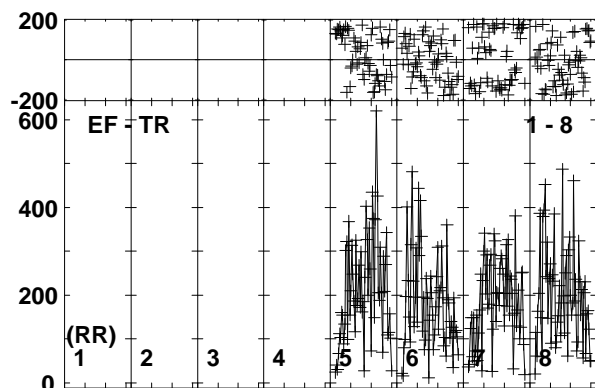
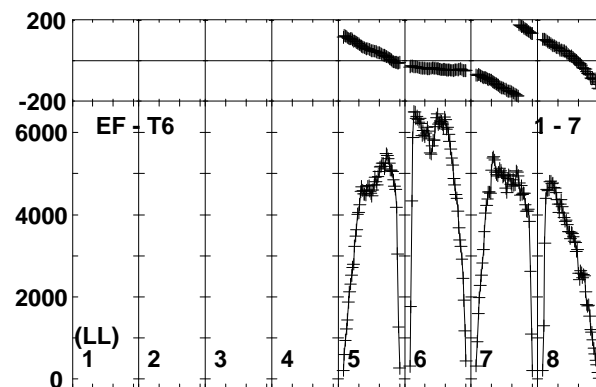
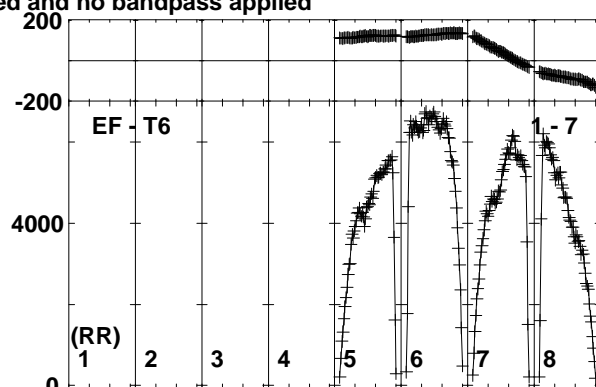
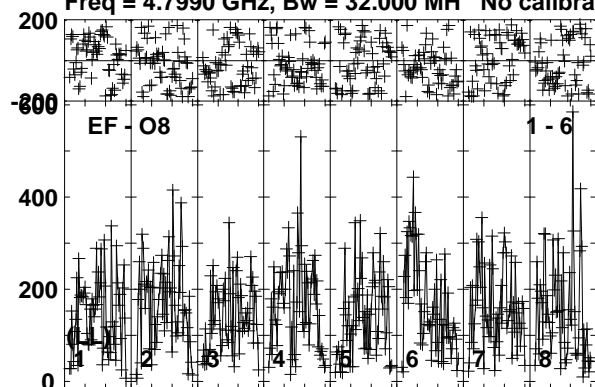

Lower frame: Micro Ampl Jy Top frame: Phas deg  
Vector averaged cross-power spectrum Baseline: EF (01) - O8 (06)  
Timerange: 00/03:56:01 to 00/03:57:30

Plot file version 153 created 24-NOV-2017 10:10:14  
J1108+4330 EG096D.UVDATA.1  
Freq = 4.7990 GHz, Bw = 32.000 MH No calibration applied and no bandpass applied

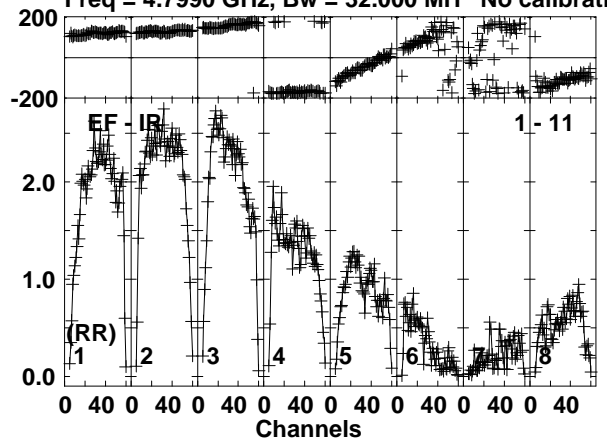

Lower frame: Milli Ampl Jy Top frame: Phas deg  
Vector averaged cross-power spectrum Baseline: EF (01) - IR (11)  
Timerange: 00/03:56:01 to 00/03:57:30

Plot file version 154 created 24-NOV-2017 10:10:14

ARUMA EG096D.UVDATA.1

Freq = 4.7990 GHz, Bw = 32.000 MH No calibration applied and no bandpass applied

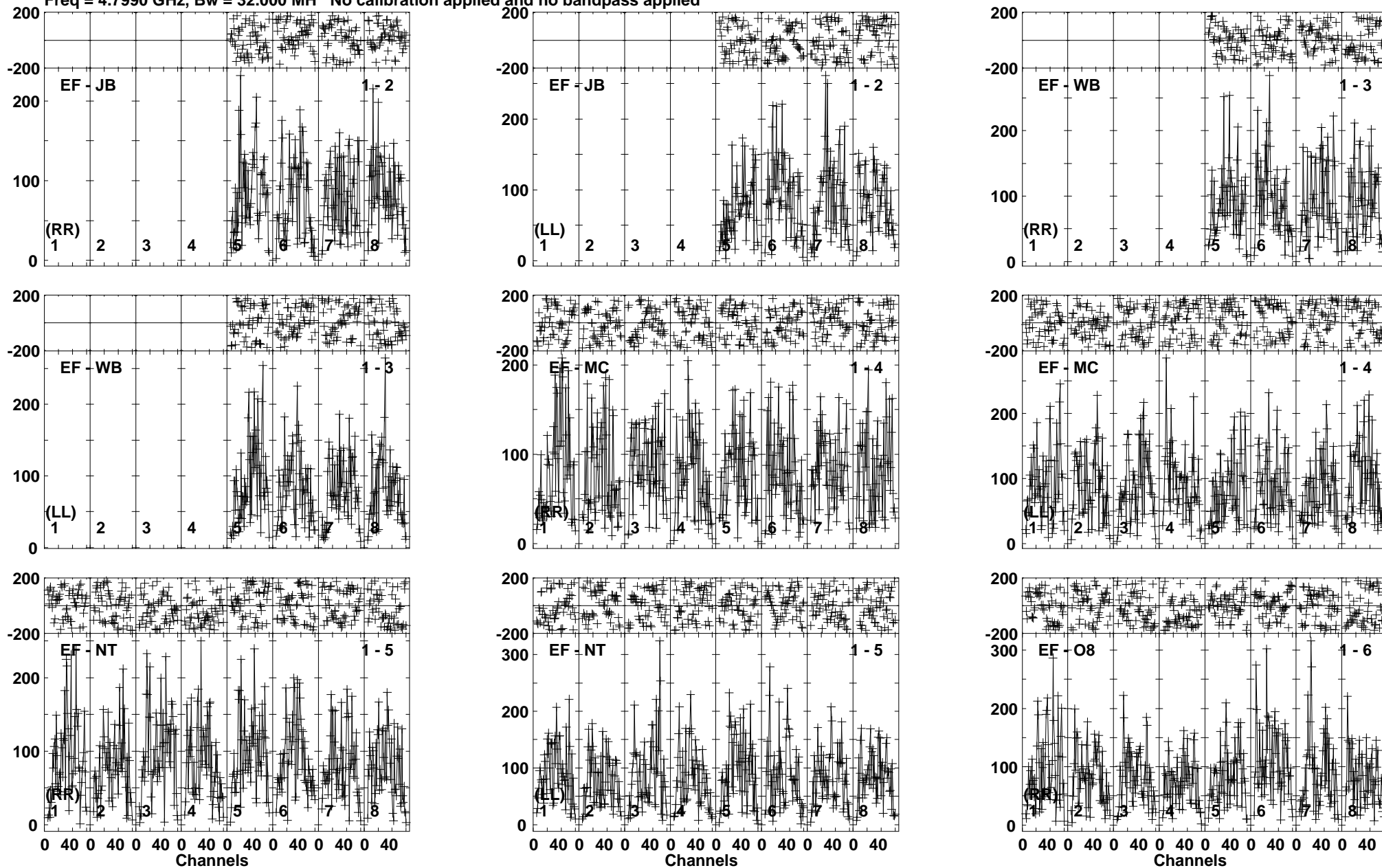

Lower frame: Micro Ampl Jy Top frame: Phas deg  
Vector averaged cross-power spectrum Baseline: EF (01) - JB (02)  
Timerange: 00/03:57:30 to 00/04:01:00



Plot file version 155 created 24-NOV-2017 10:10:14

ARUMA EG096D.UVDATA.1

Freq = 4.7990 GHz, Bw = 32.000 MH No calibration applied and no bandpass applied

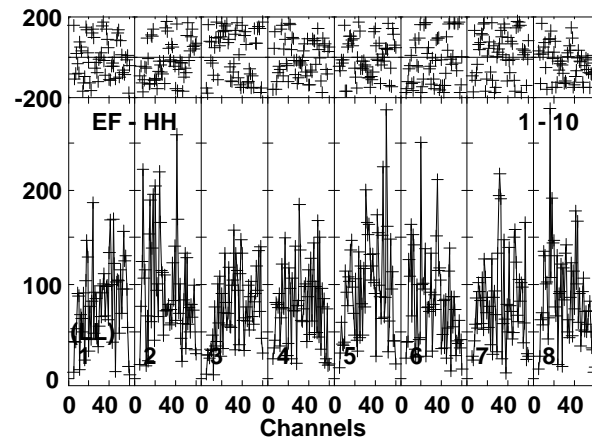
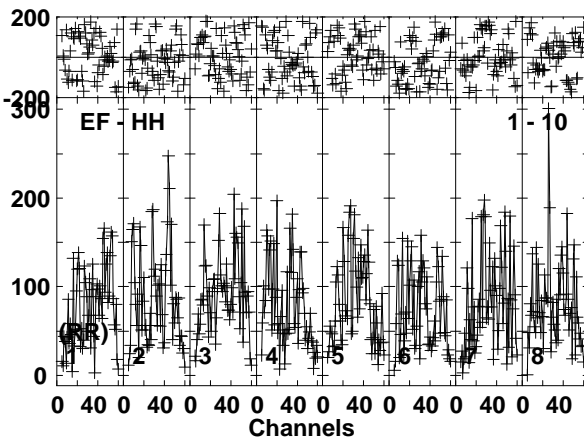
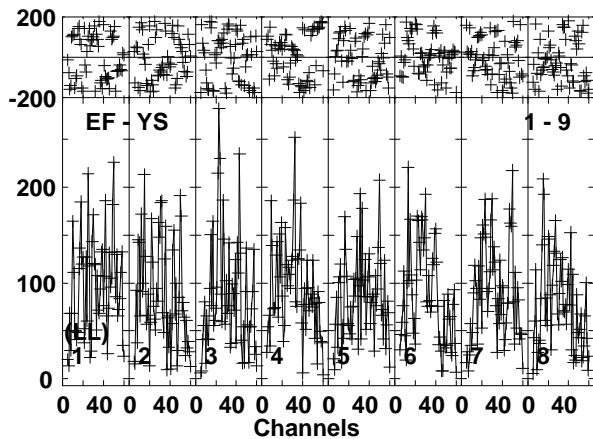
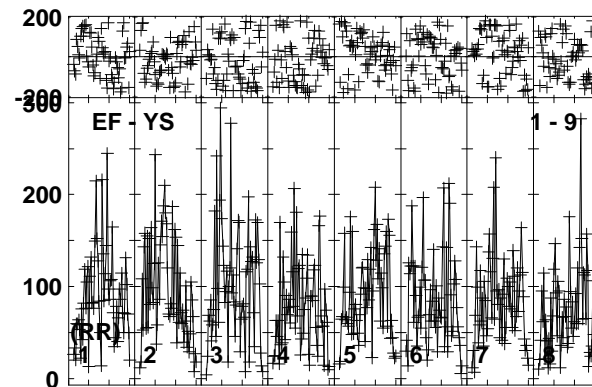
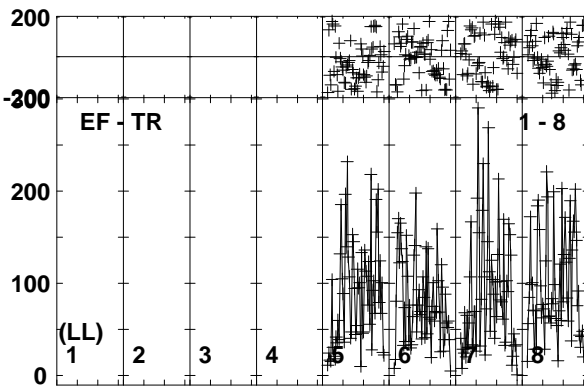
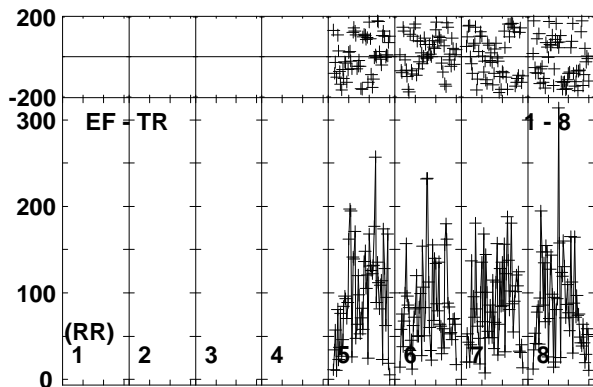
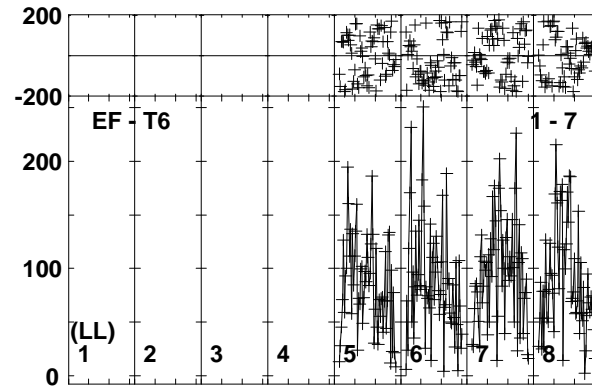
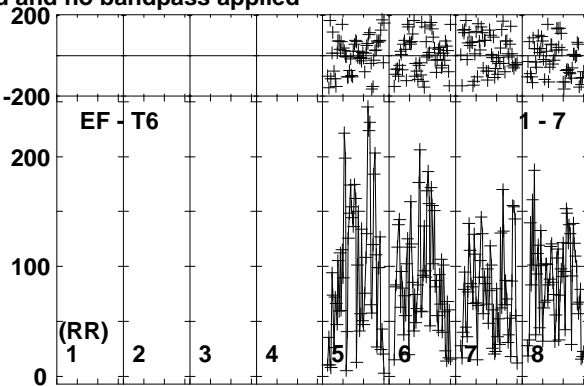
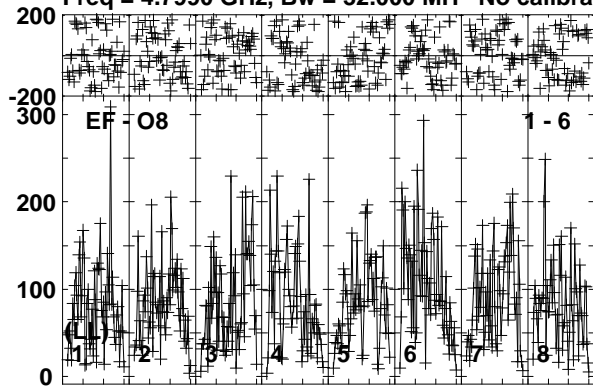

Lower frame: Micro Ampl Jy Top frame: Phas deg  
Vector averaged cross-power spectrum Baseline: EF (01) - O8 (06)  
Timerange: 00/03:57:30 to 00/04:01:00

Plot file version 156 created 24-NOV-2017 10:10:15  
ARUMA EG096D.UVDATA.1  
Freq = 4.7990 GHz, Bw = 32.000 MH No calibration applied and no bandpass applied

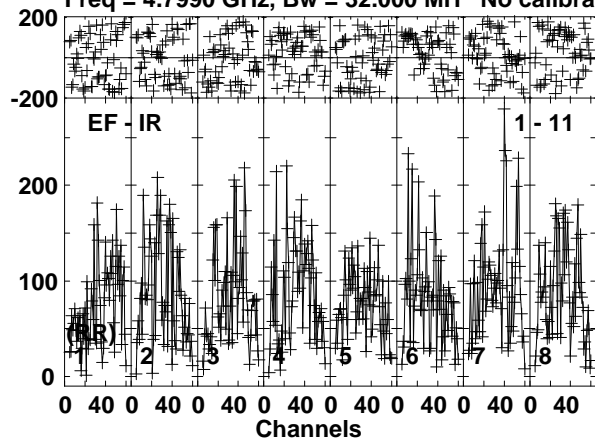

Lower frame: Micro Ampl Jy Top frame: Phas deg  
Vector averaged cross-power spectrum Baseline: EF (01) - IR (11)  
Timerange: 00/03:57:30 to 00/04:01:00

Plot file version 157 created 24-NOV-2017 10:10:15

J1108+4330 EG096D.UVDATA.1

Freq = 4.7990 GHz, Bw = 32.000 MH No calibration applied and no bandpass applied

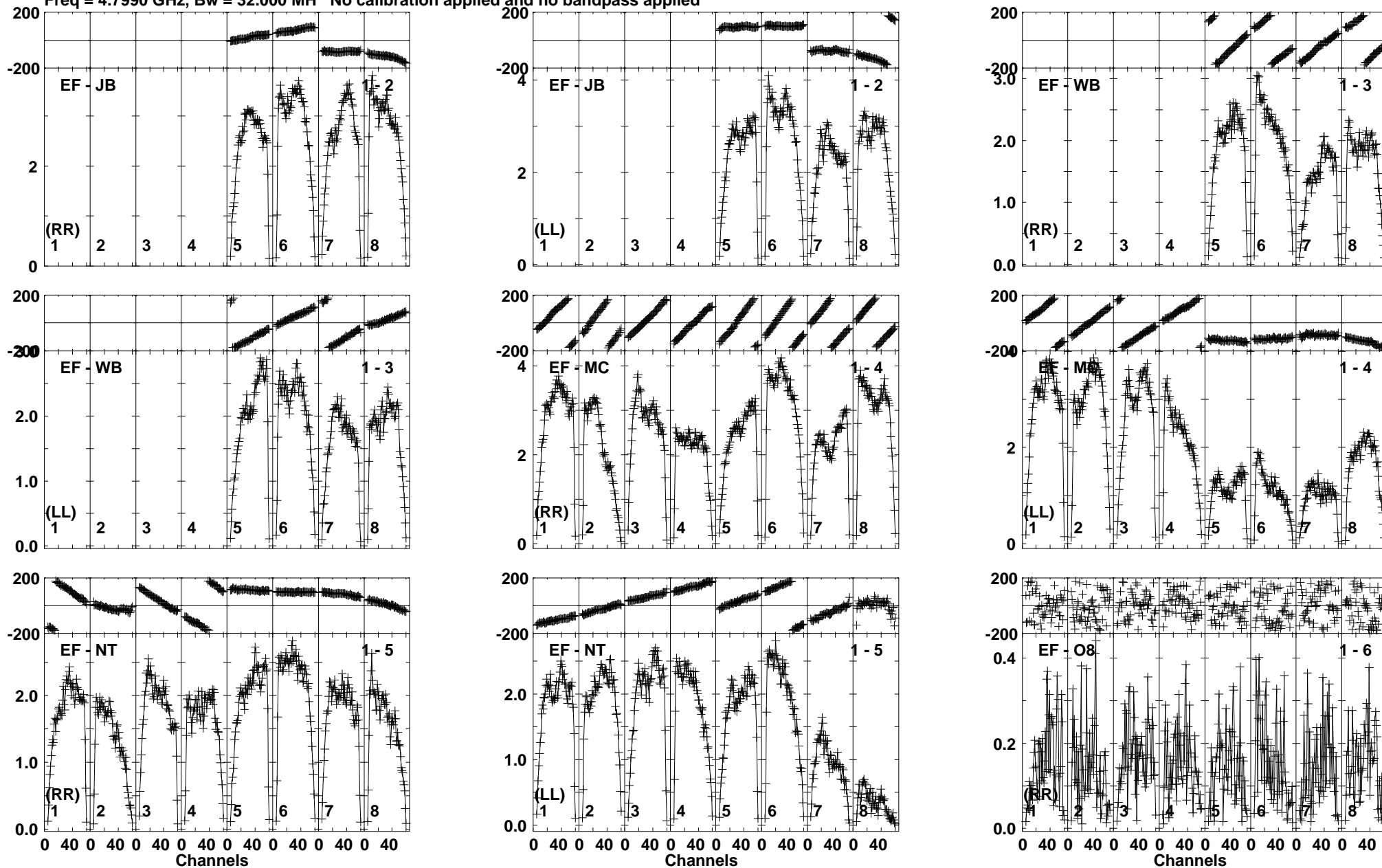

Lower frame: Milli Ampl Jy Top frame: Phas deg  
Vector averaged cross-power spectrum Baseline: EF (01) - JB (02)  
Timerange: 00/04:01:40 to 00/04:02:40

Plot file version 158 created 24-NOV-2017 10:10:15

J1108+4330 EG096D.UVDATA.1

Freq = 4.7990 GHz, Bw = 32.000 MH No calibration applied and no bandpass applied

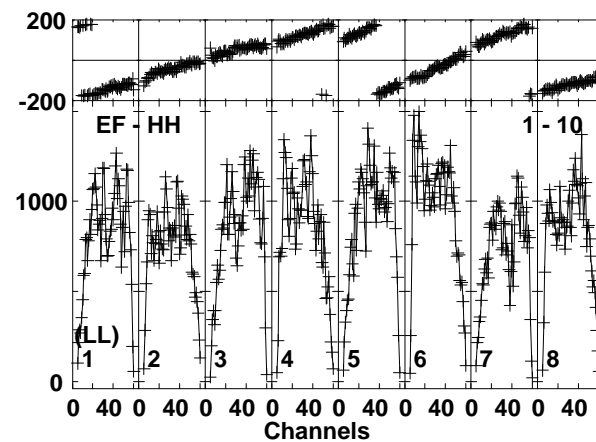
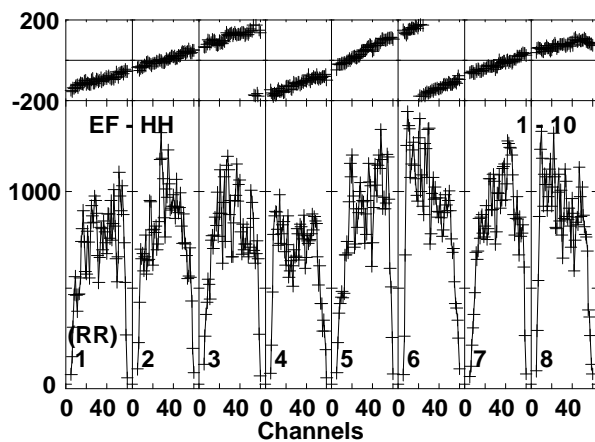
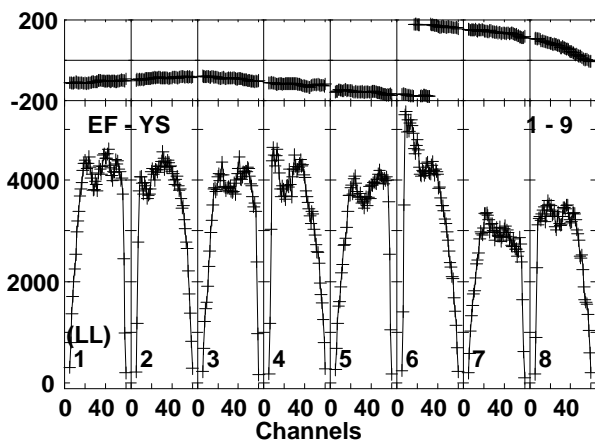
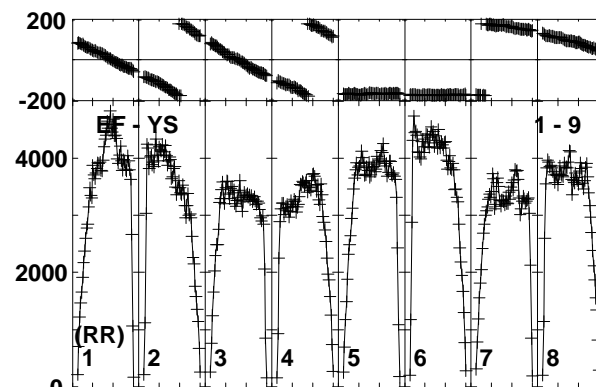
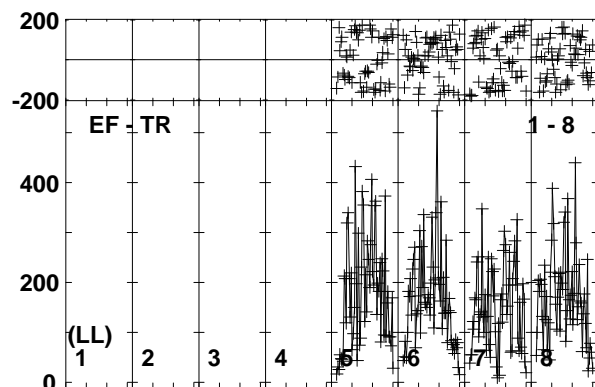
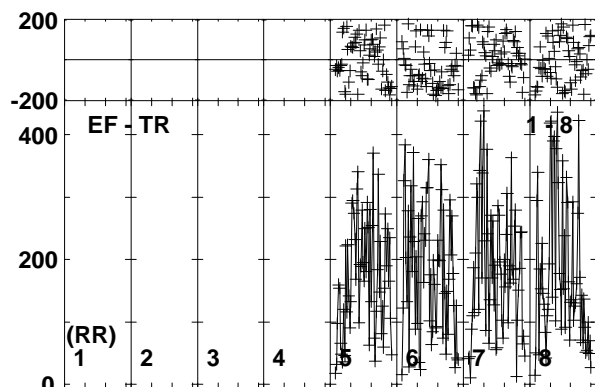
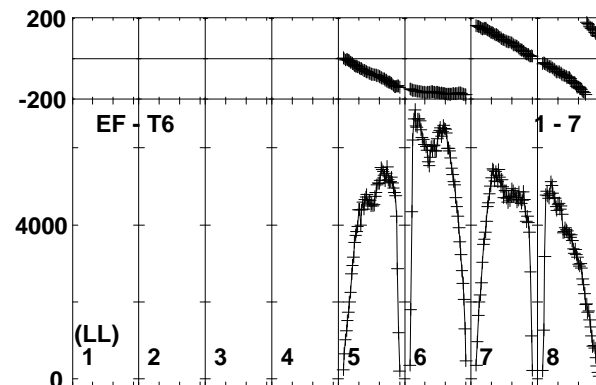
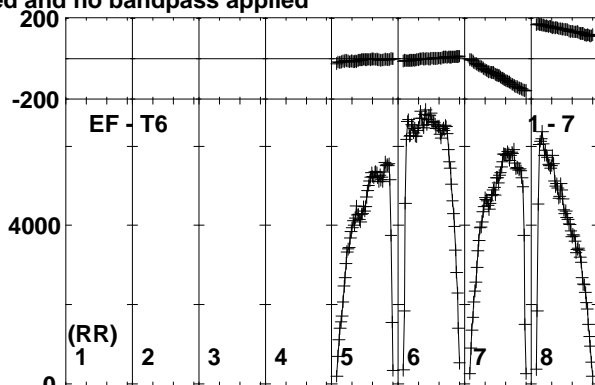
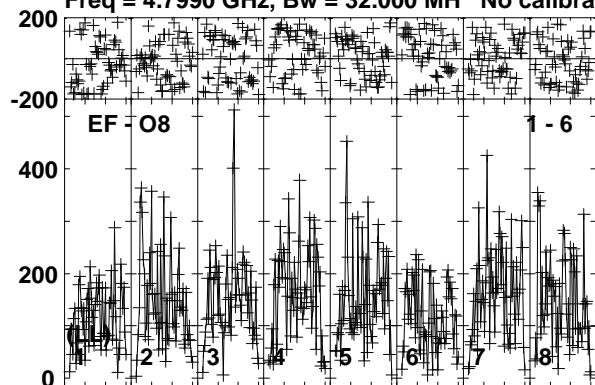

Lower frame: Micro Ampl Jy Top frame: Phas deg  
Vector averaged cross-power spectrum Baseline: EF (01) - O8 (06)  
Timerange: 00/04:01:40 to 00/04:02:40

Plot file version 159 created 24-NOV-2017 10:10:15  
J1108+4330 EG096D.UVDATA.1  
Freq = 4.7990 GHz, Bw = 32.000 MH No calibration applied and no bandpass applied

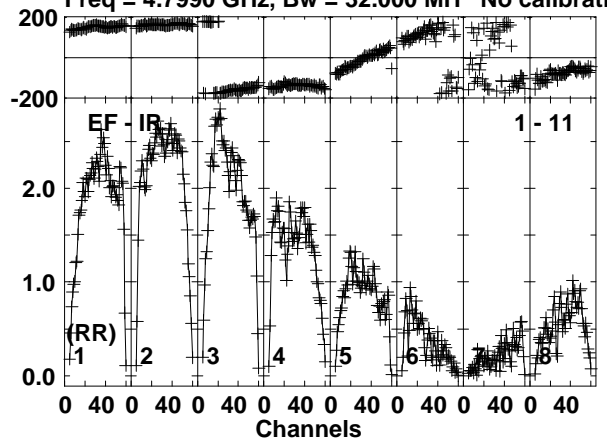

Lower frame: Milli Ampl Jy Top frame: Phas deg  
Vector averaged cross-power spectrum Baseline: EF (01) - IR (11)  
Timerange: 00/04:01:40 to 00/04:02:40

Plot file version 160 created 24-NOV-2017 10:10:15

ARUMA EG096D.UVDATA.1

Freq = 4.7990 GHz, Bw = 32.000 MH No calibration applied and no bandpass applied

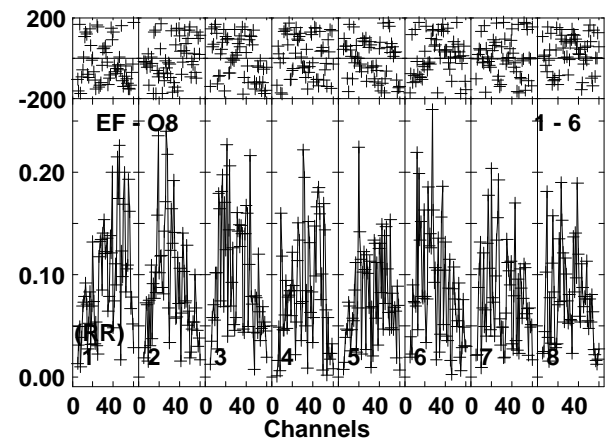
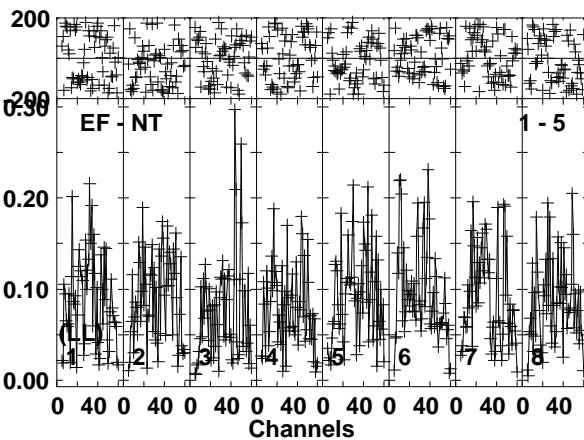
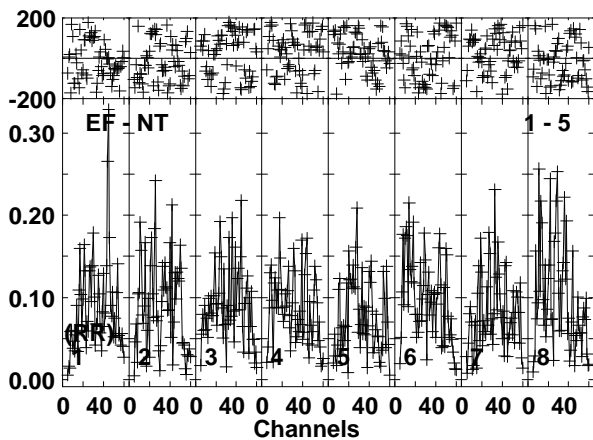
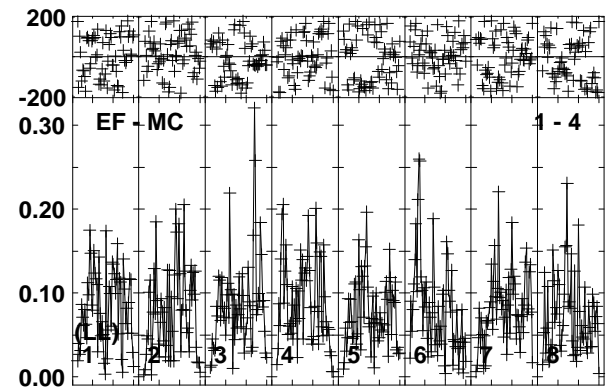
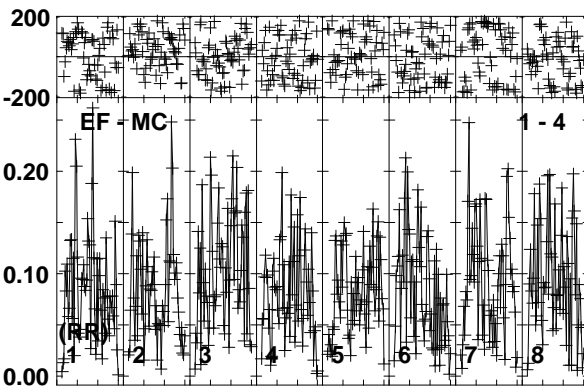
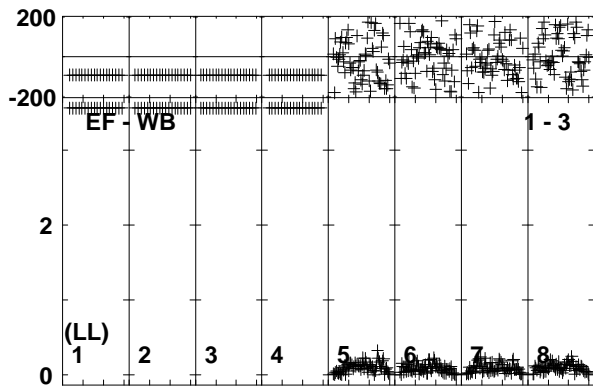
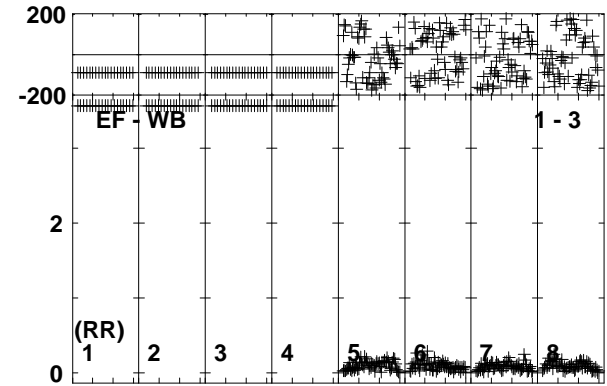
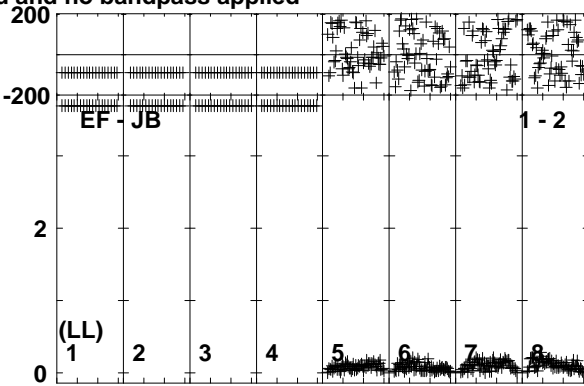
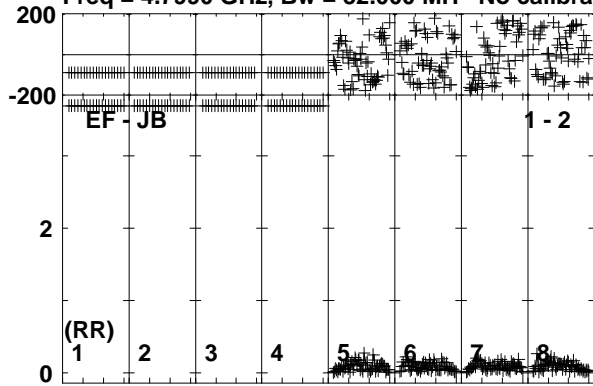

Lower frame: Milli Ampl Jy Top frame: Phas deg  
Vector averaged cross-power spectrum Baseline: EF (01) - JB (02)  
Timerange: 00/04:02:40 to 00/04:06:10

Plot file version 161 created 24-NOV-2017 10:10:16

ARUMA EG096D.UVDATA.1

Freq = 4.7990 GHz, Bw = 32.000 MH No calibration applied and no bandpass applied

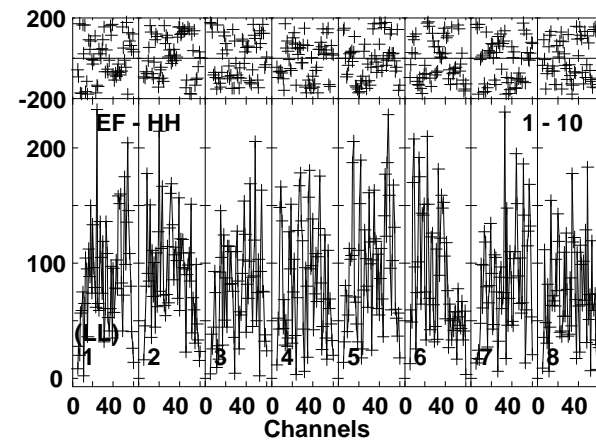
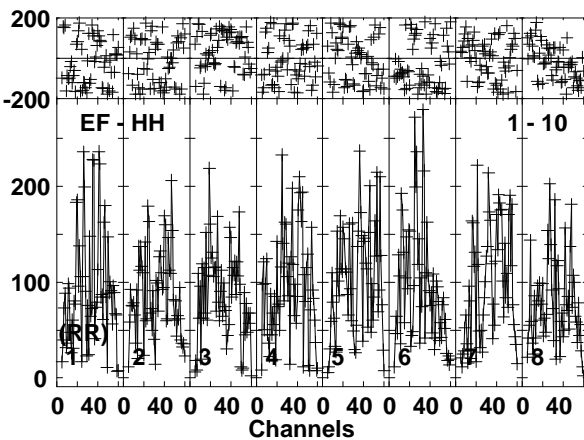
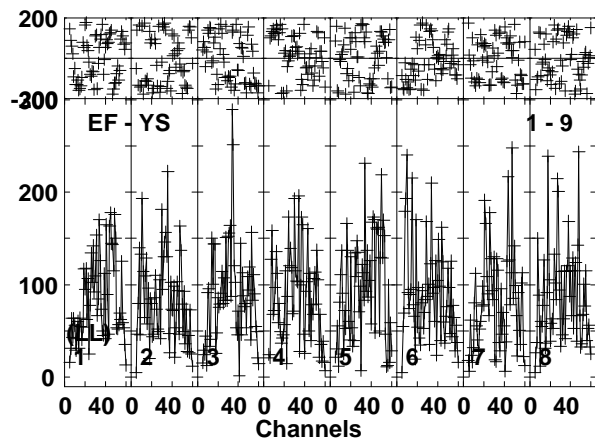
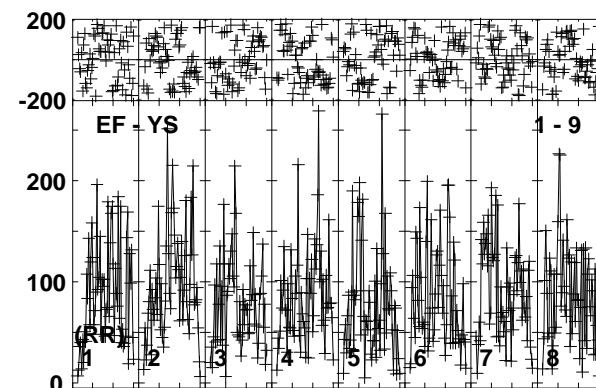
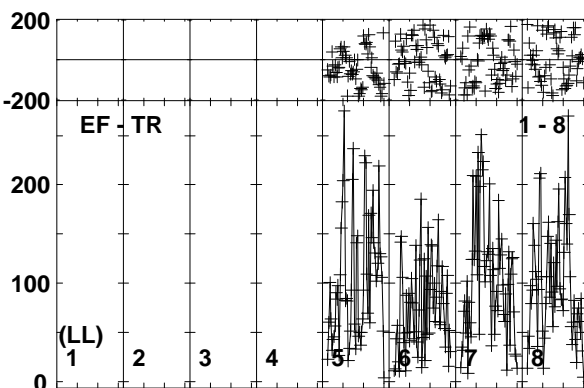
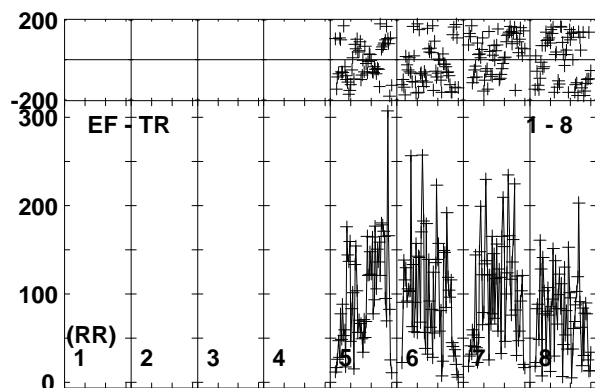
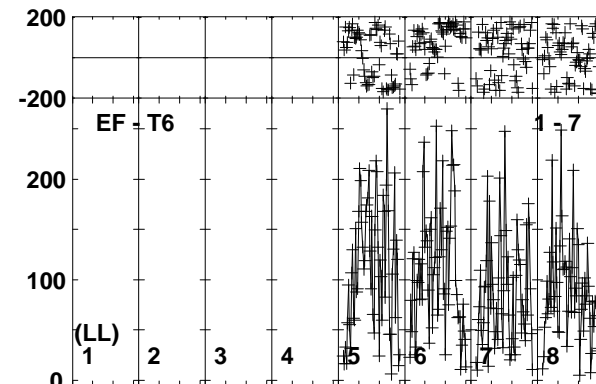
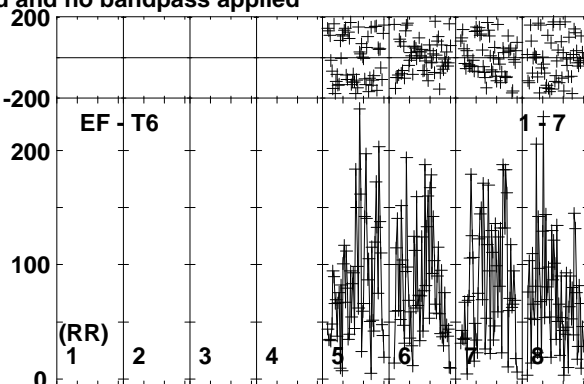
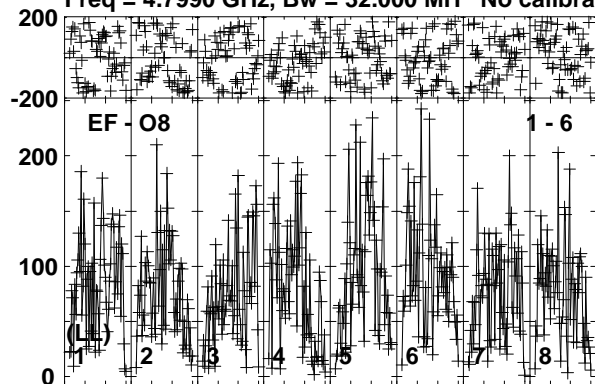

Lower frame: Micro Ampl Jy Top frame: Phas deg  
Vector averaged cross-power spectrum Baseline: EF (01) - O8 (06)  
Timerange: 00/04:02:40 to 00/04:06:10

Plot file version 162 created 24-NOV-2017 10:10:16  
ARUMA EG096D.UVDATA.1  
Freq = 4.7990 GHz, Bw = 32.000 MH No calibration applied and no bandpass applied

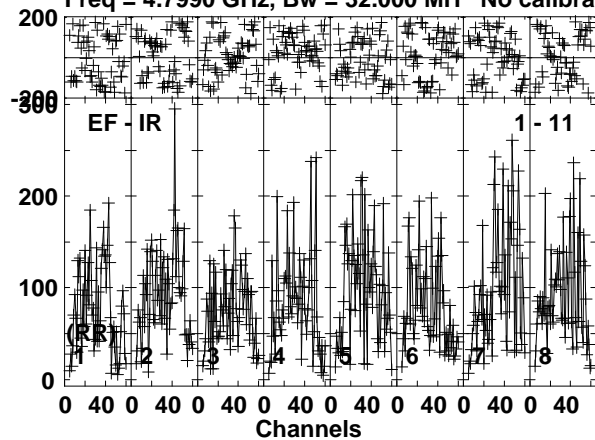

Lower frame: Micro Ampl Jy Top frame: Phas deg  
Vector averaged cross-power spectrum Baseline: EF (01) - IR (11)  
Timerange: 00/04:02:40 to 00/04:06:10



Plot file version 163 created 24-NOV-2017 10:10:16

J1108+4330 EG096D.UVDATA.1

Freq = 4.7990 GHz, Bw = 32.000 MH No calibration applied and no bandpass applied

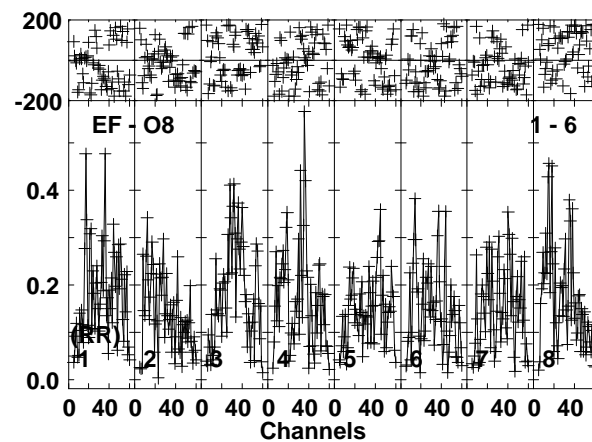
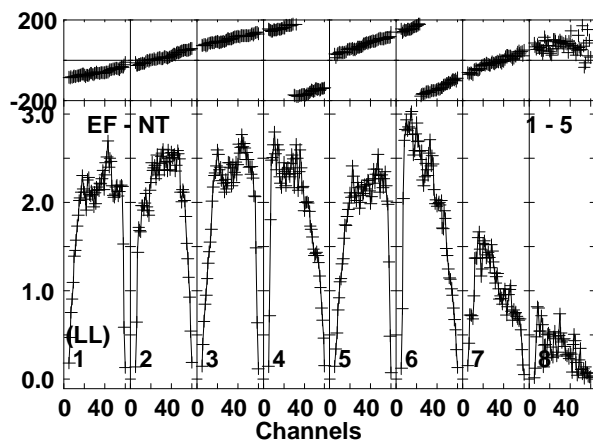
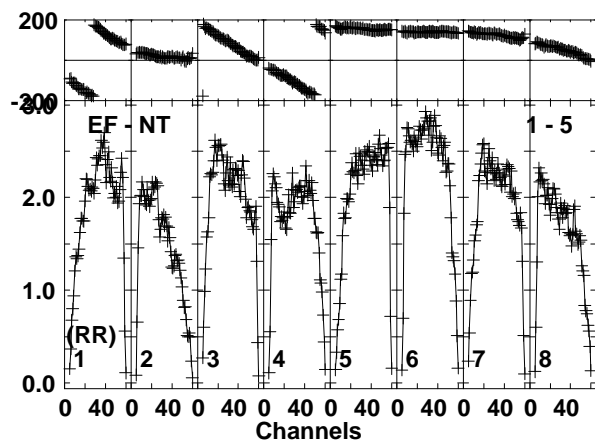
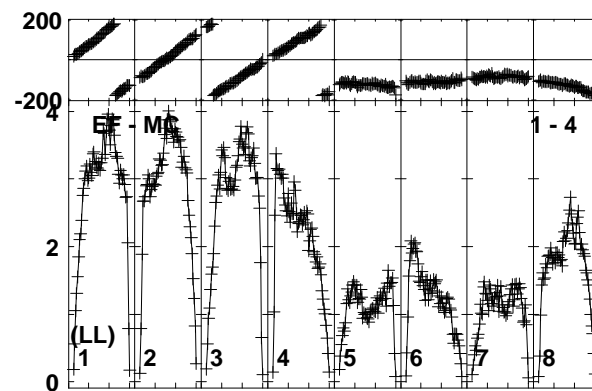
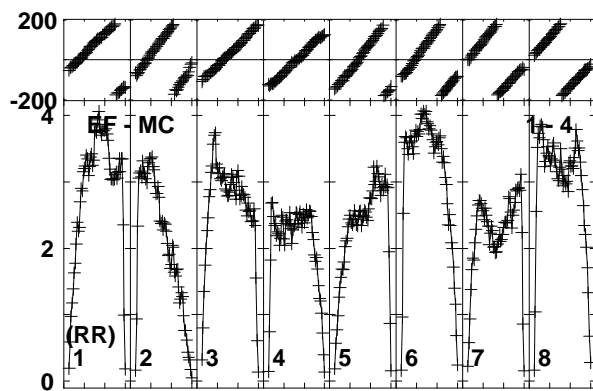
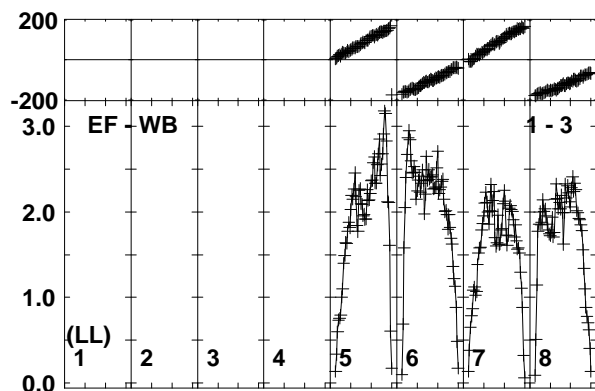
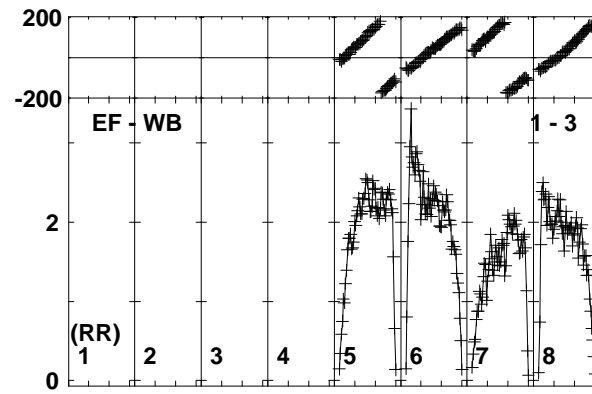
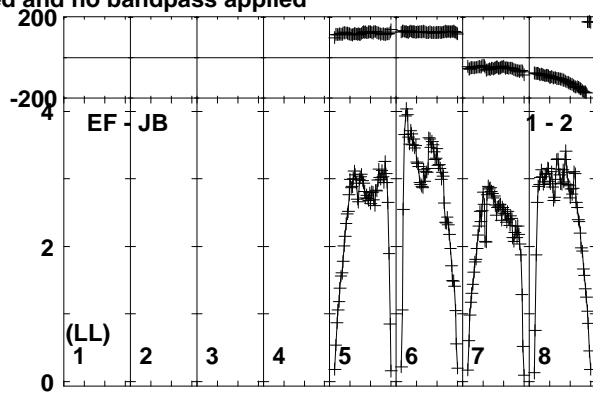
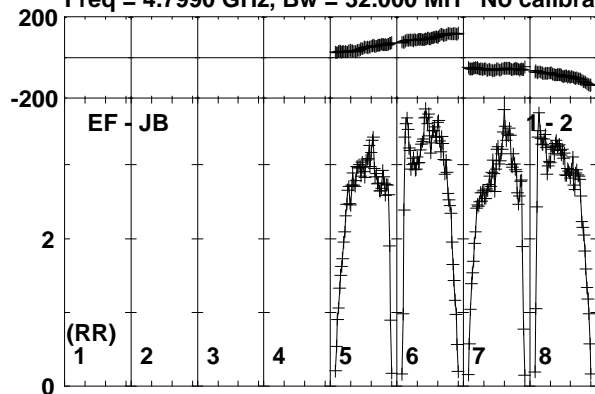

Lower frame: Milli Ampl Jy Top frame: Phas deg  
Vector averaged cross-power spectrum Baseline: EF (01) - JB (02)  
Timerange: 00/04:06:11 to 00/04:07:39

Plot file version 164 created 24-NOV-2017 10:10:16

J1108+4330 EG096D.UVDATA.1

Freq = 4.7990 GHz, Bw = 32.000 MH No calibration applied and no bandpass applied

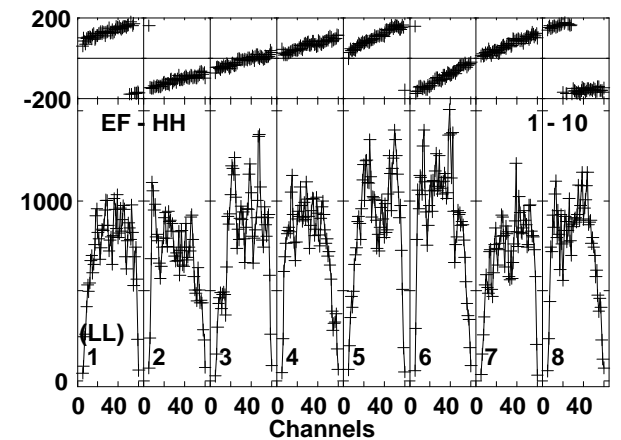
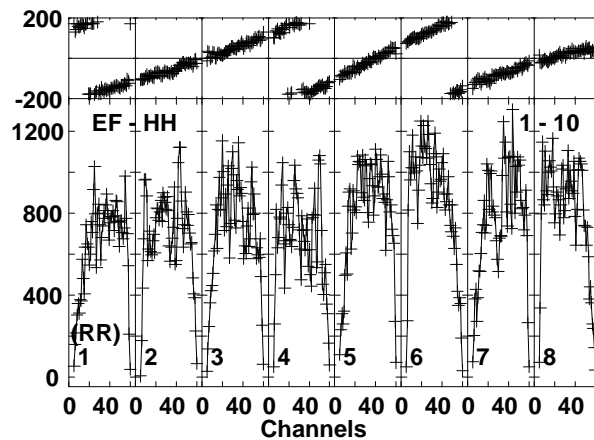
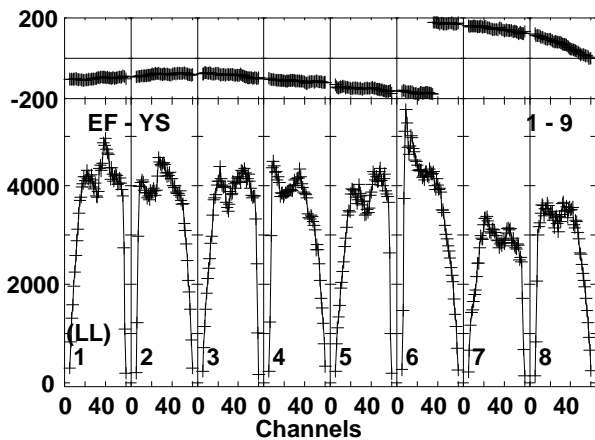
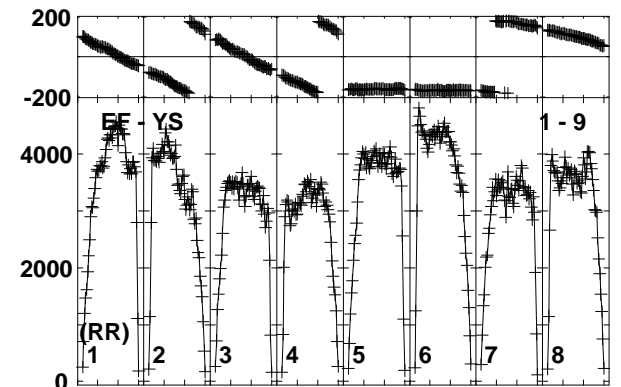
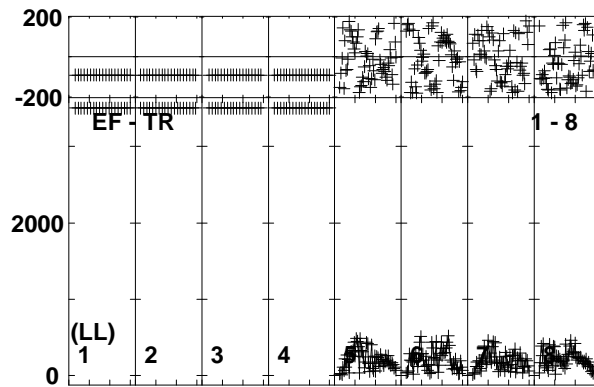
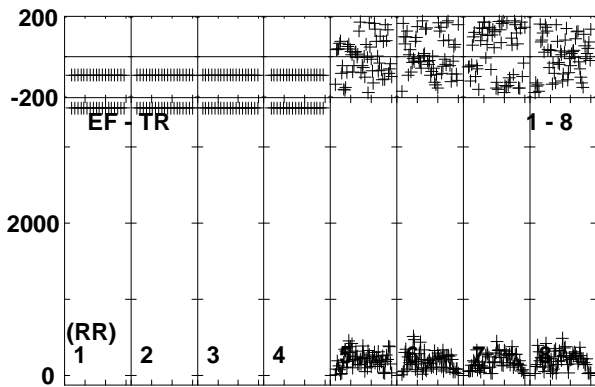
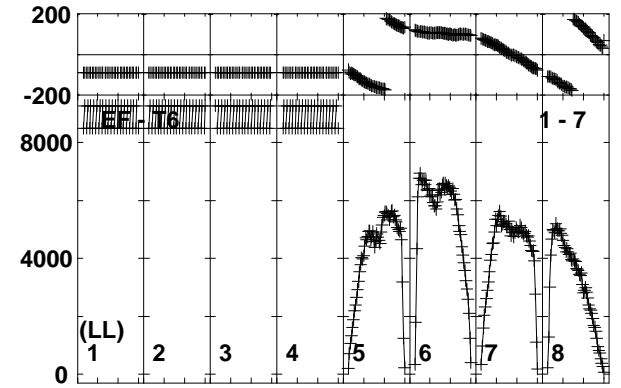
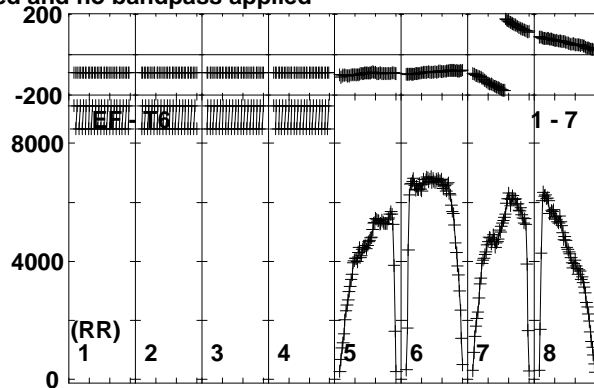
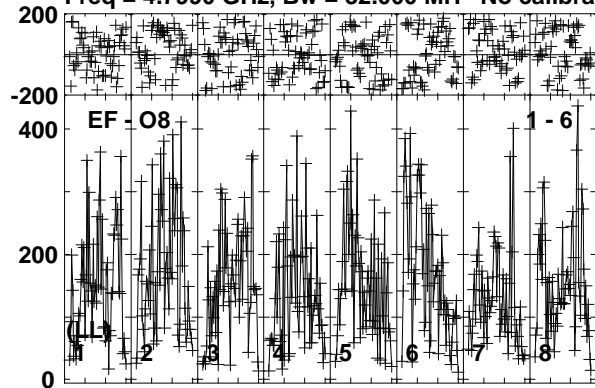

Lower frame: Micro Ampl Jy Top frame: Phas deg  
Vector averaged cross-power spectrum Baseline: EF (01) - O8 (06)  
Timerange: 00/04:06:11 to 00/04:07:39

Plot file version 165 created 24-NOV-2017 10:10:17  
J1108+4330 EG096D.UVDATA.1  
Freq = 4.7990 GHz, Bw = 32.000 MH No calibration applied and no bandpass applied

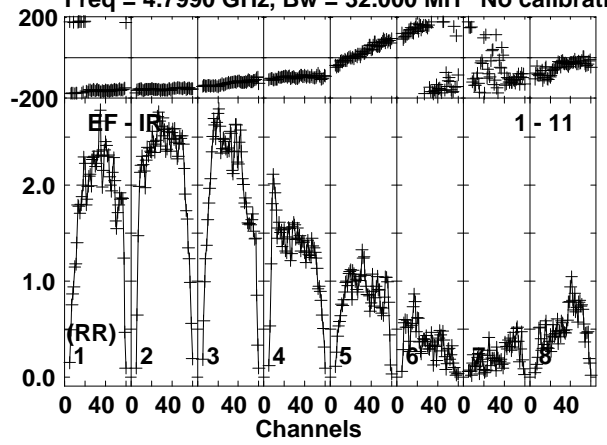

Lower frame: Milli Ampl Jy Top frame: Phas deg  
Vector averaged cross-power spectrum Baseline: EF (01) - IR (11)  
Timerange: 00/04:06:11 to 00/04:07:39

Plot file version 166 created 24-NOV-2017 10:10:17

ARUMA EG096D.UVDATA.1

Freq = 4.7990 GHz, Bw = 32.000 MH No calibration applied and no bandpass applied

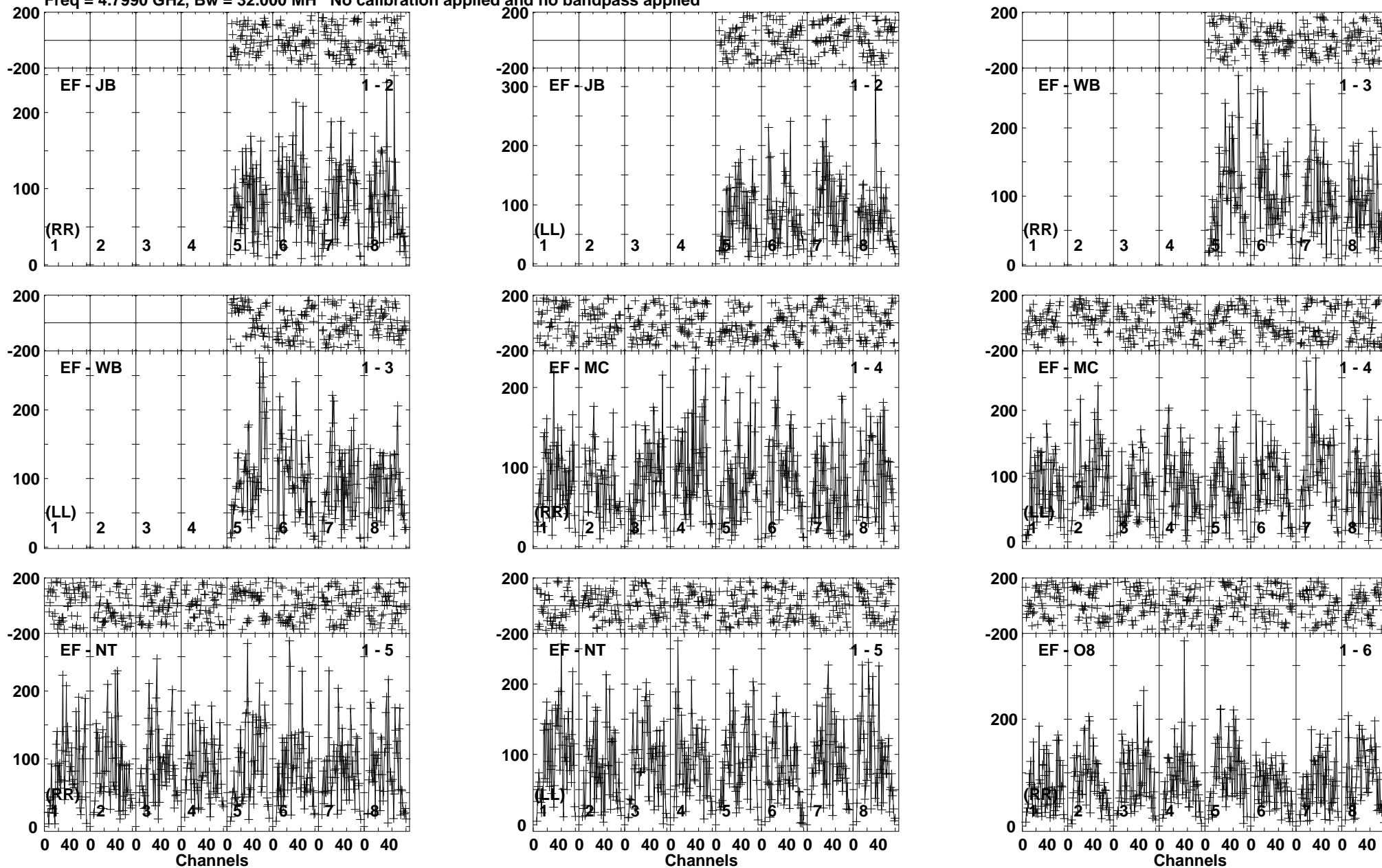

Lower frame: Micro Ampl Jy Top frame: Phas deg  
Vector averaged cross-power spectrum Baseline: EF (01) - JB (02)  
Timerange: 00/04:07:41 to 00/04:11:10

Plot file version 167 created 24-NOV-2017 10:10:17

ARUMA EG096D.UVDATA.1

Freq = 4.7990 GHz, Bw = 32.000 MH No calibration applied and no bandpass applied

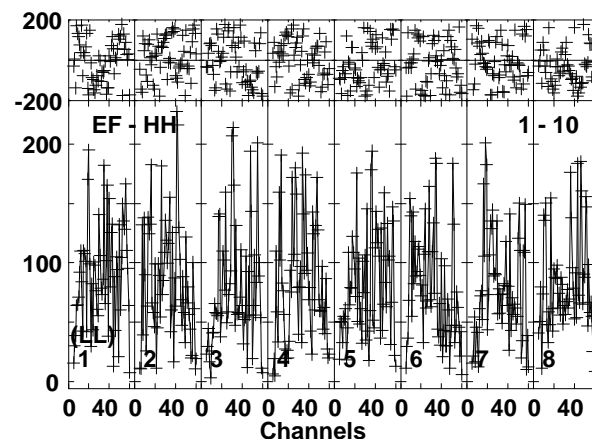
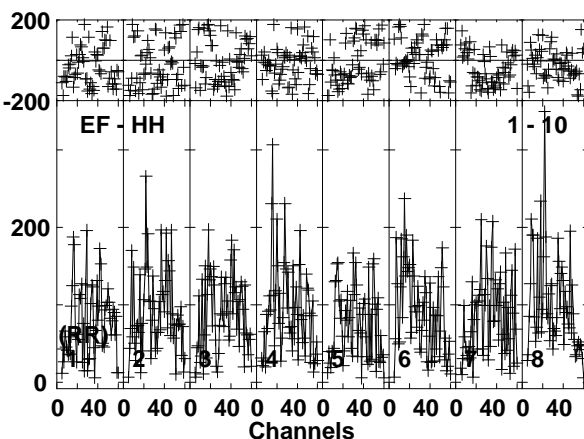
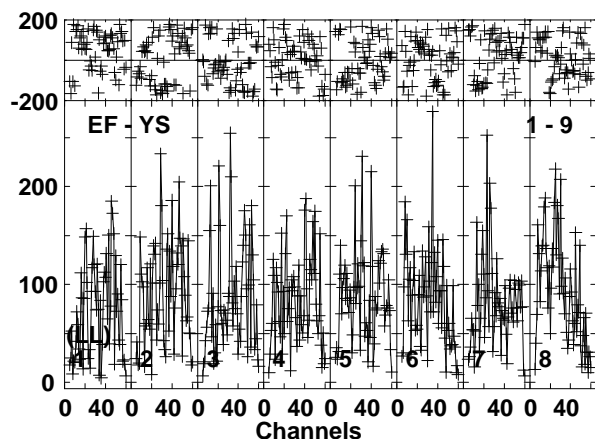
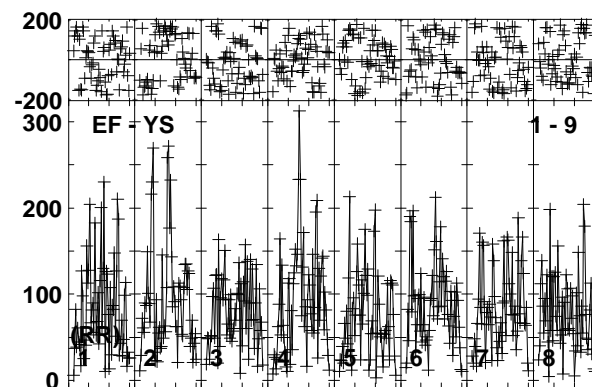
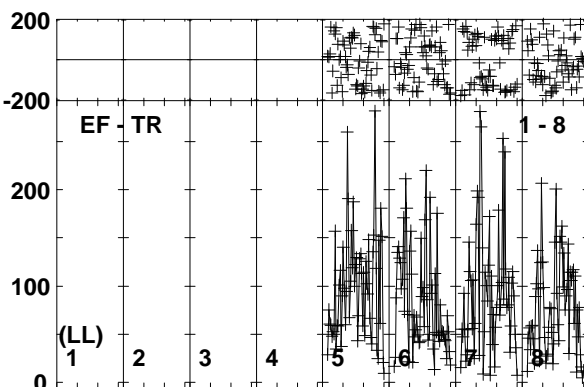
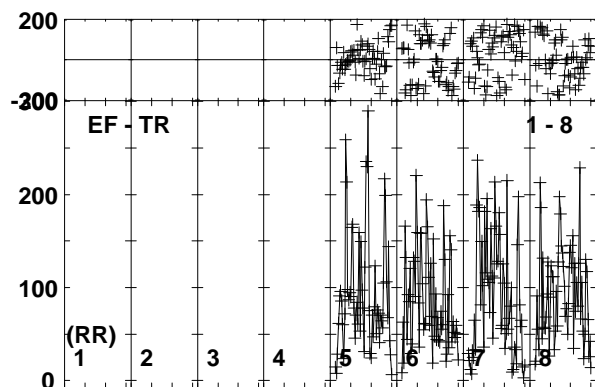
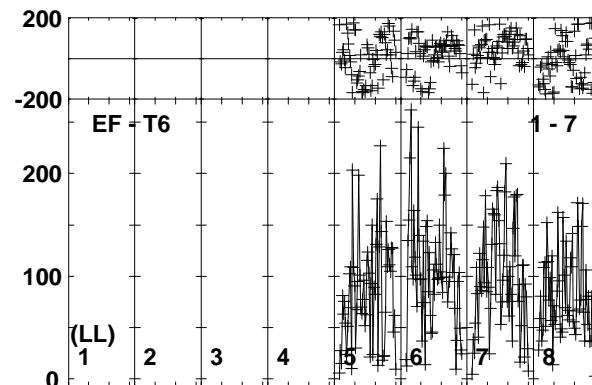
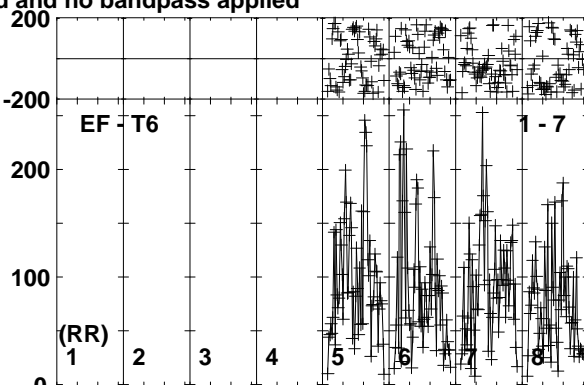
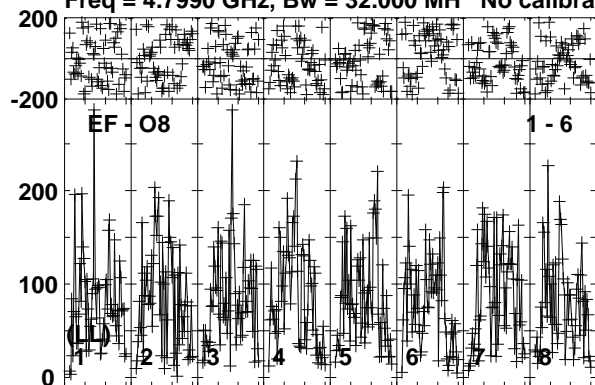

Lower frame: Micro Ampl Jy Top frame: Phas deg  
Vector averaged cross-power spectrum Baseline: EF (01) - O8 (06)  
Timerange: 00/04:07:41 to 00/04:11:10

Plot file version 168 created 24-NOV-2017 10:10:17  
ARUMA EG096D.UVDATA.1  
Freq = 4.7990 GHz, Bw = 32.000 MH No calibration applied and no bandpass applied

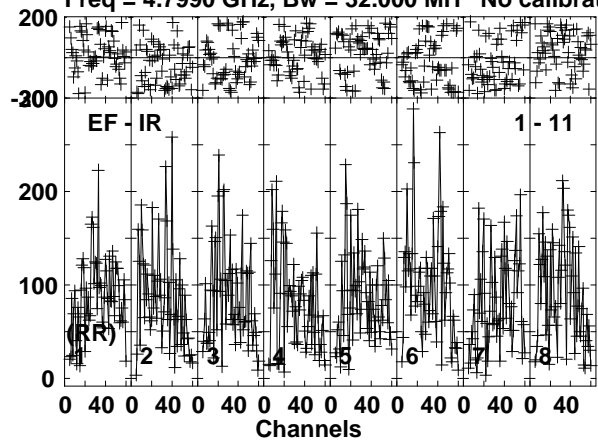

Lower frame: Micro Ampl Jy Top frame: Phas deg  
Vector averaged cross-power spectrum Baseline: EF (01) - IR (11)  
Timerange: 00/04:07:41 to 00/04:11:10

Plot file version 169 created 24-NOV-2017 10:10:18

J1108+4330 EG096D.UVDATA.1

Freq = 4.7990 GHz, Bw = 32.000 MH No calibration applied and no bandpass applied

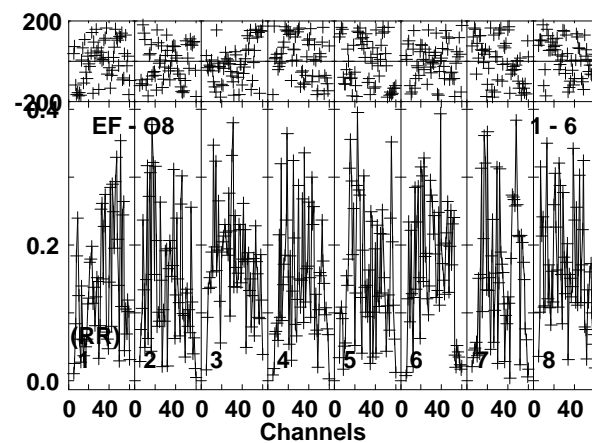
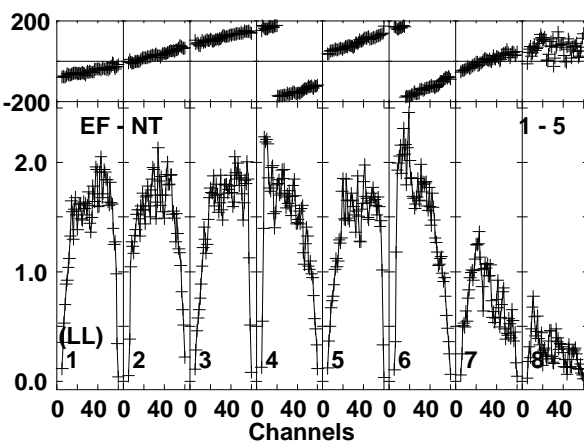
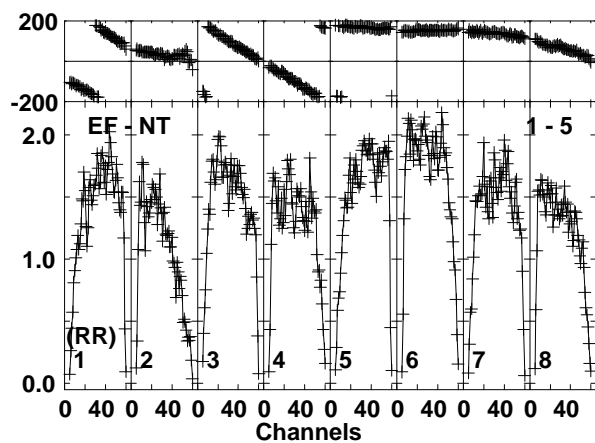
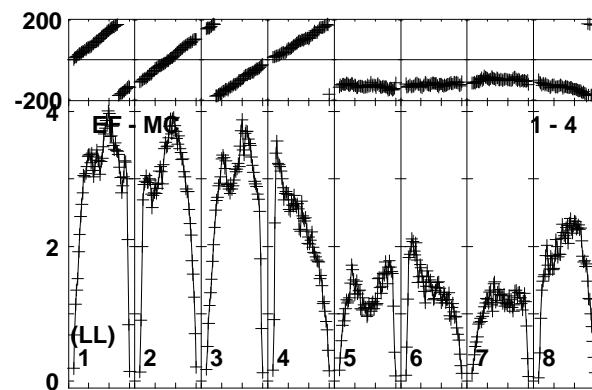
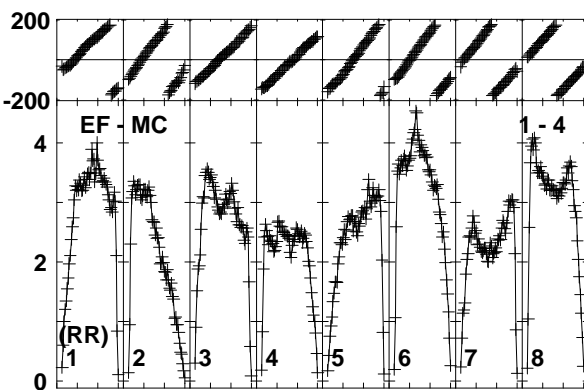
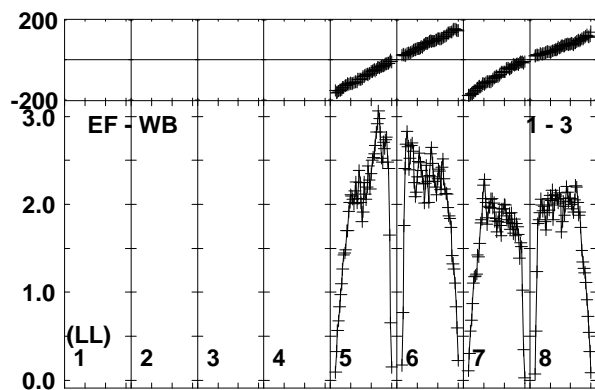
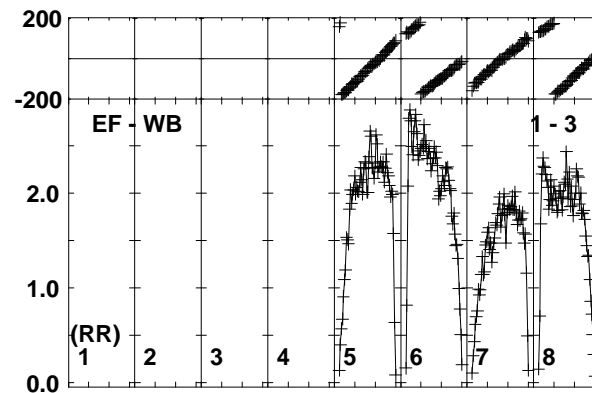
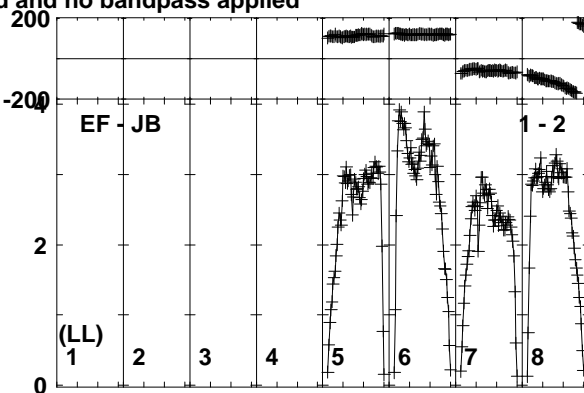
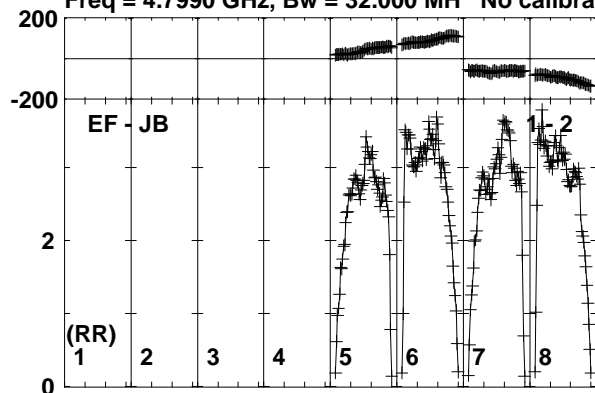

Lower frame: Milli Ampl Jy Top frame: Phas deg  
Vector averaged cross-power spectrum Baseline: EF (01) - JB (02)  
Timerange: 00/04:11:50 to 00/04:12:50

Plot file version 170 created 24-NOV-2017 10:10:18

J1108+4330 EG096D.UVDATA.1

Freq = 4.7990 GHz, Bw = 32.000 MH No calibration applied and no bandpass applied

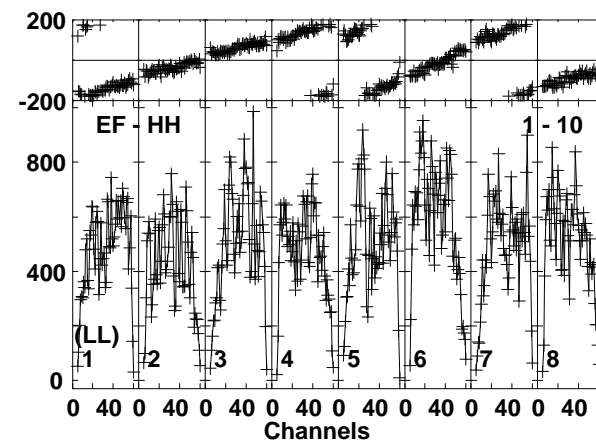
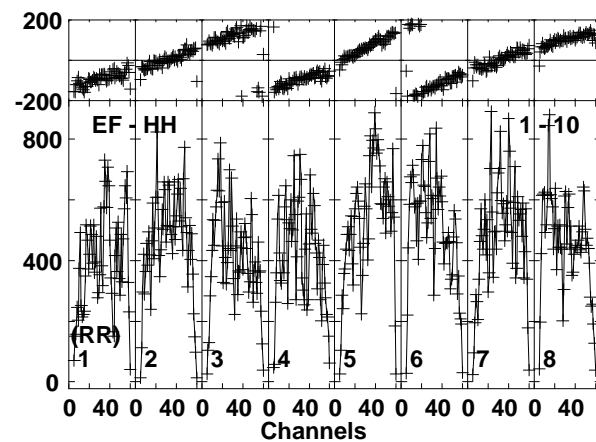
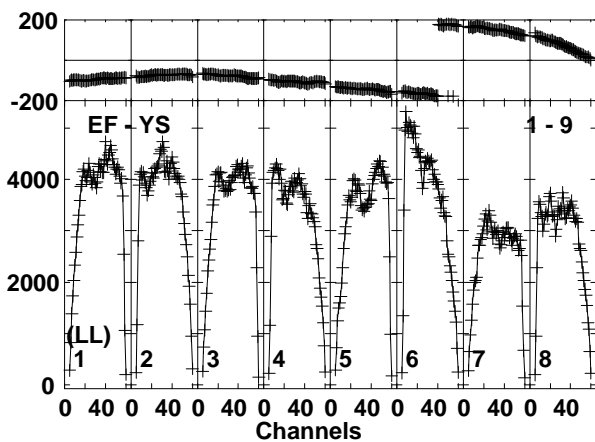
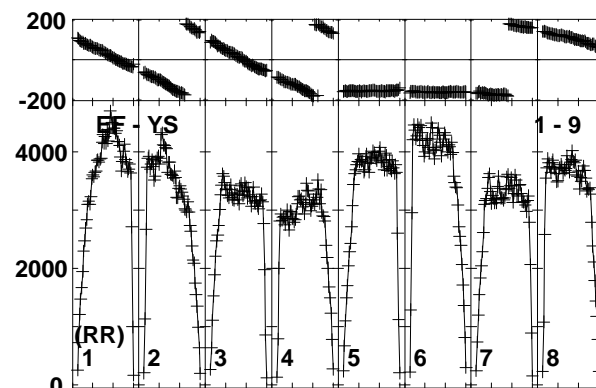
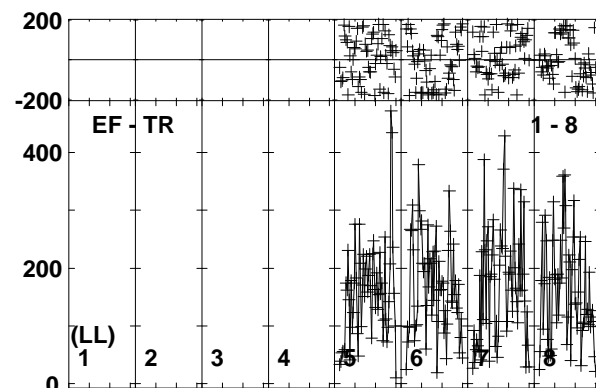
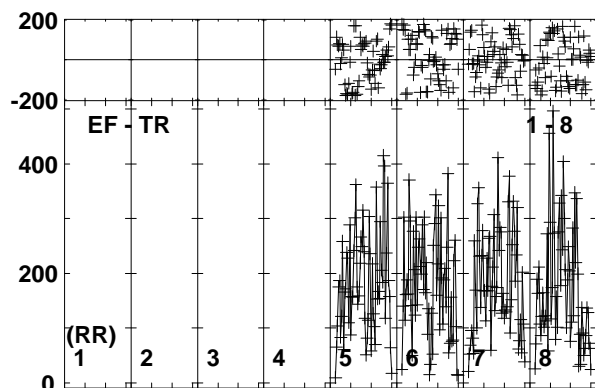
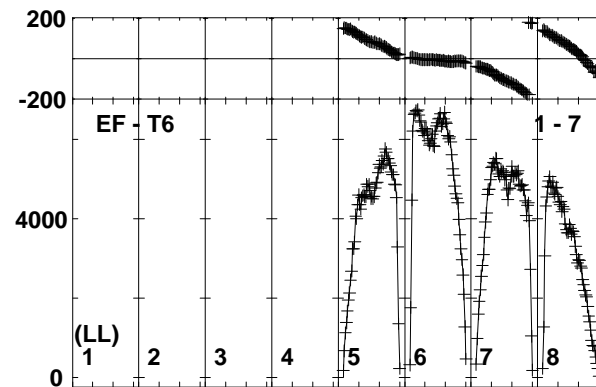
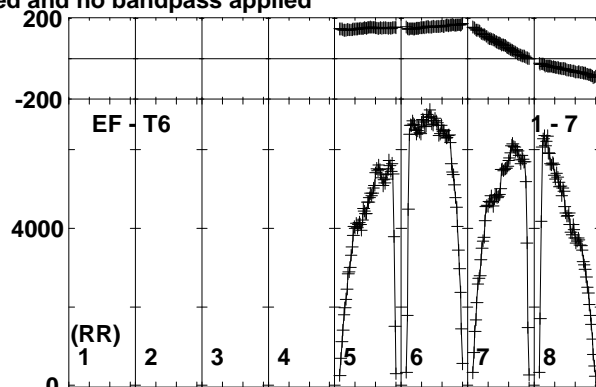
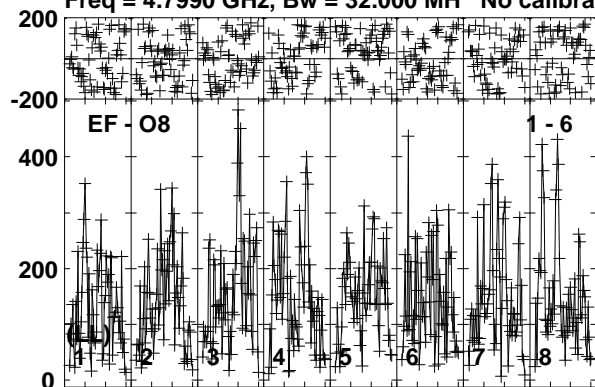

Lower frame: Micro Ampl Jy Top frame: Phas deg  
Vector averaged cross-power spectrum Baseline: EF (01) - O8 (06)  
Timerange: 00/04:11:50 to 00/04:12:50



Plot file version 171 created 24-NOV-2017 10:10:18

J1108+4330 EG096D.UVDATA.1

Freq = 4.7990 GHz, Bw = 32.000 MH No calibration applied and no bandpass applied

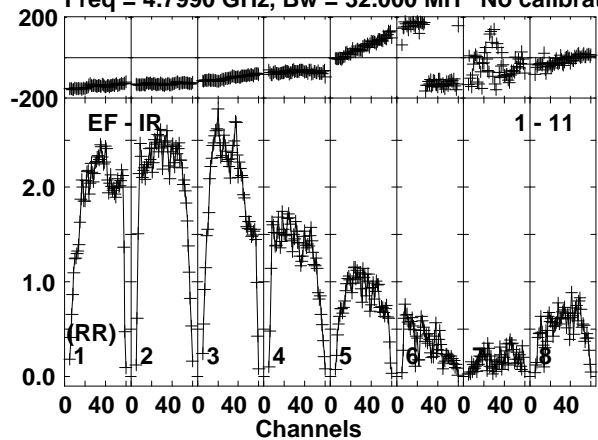

Lower frame: Milli Ampl Jy Top frame: Phas deg  
Vector averaged cross-power spectrum Baseline: EF (01) - IR (11)  
Timerange: 00/04:11:50 to 00/04:12:50

Plot file version 172 created 24-NOV-2017 10:10:18

ARUMA EG096D.UVDATA.1

Freq = 4.7990 GHz, Bw = 32.000 MH No calibration applied and no bandpass applied

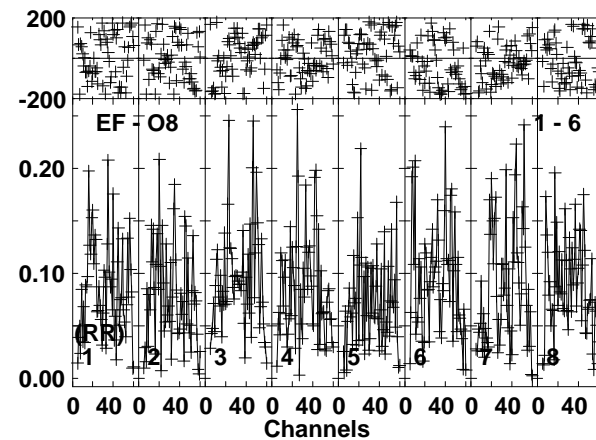
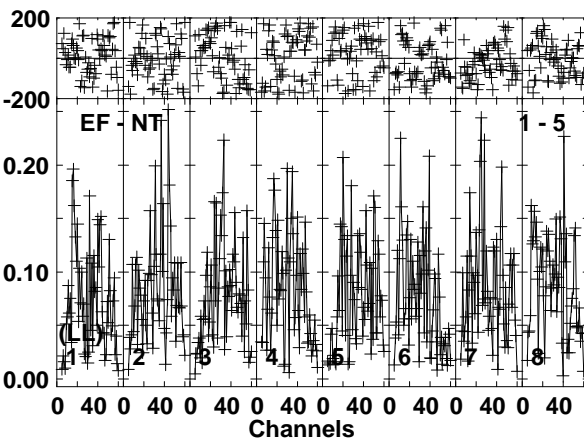
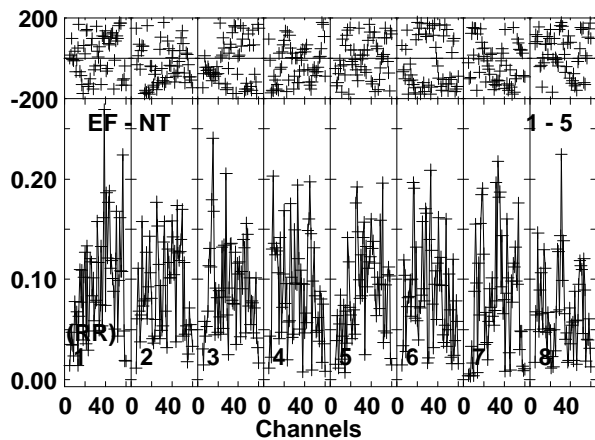
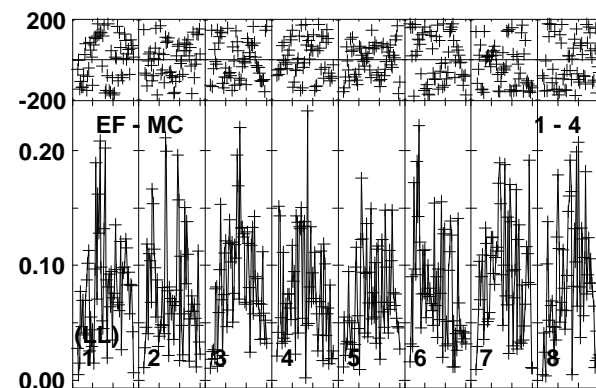
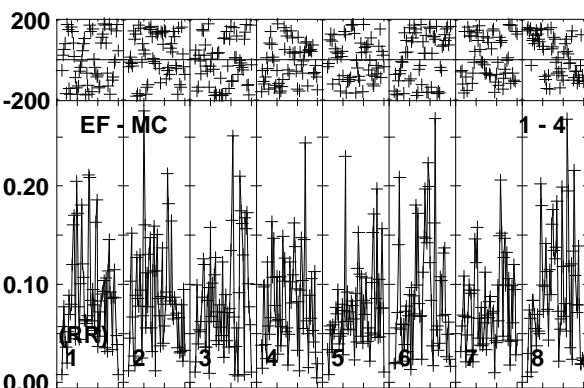
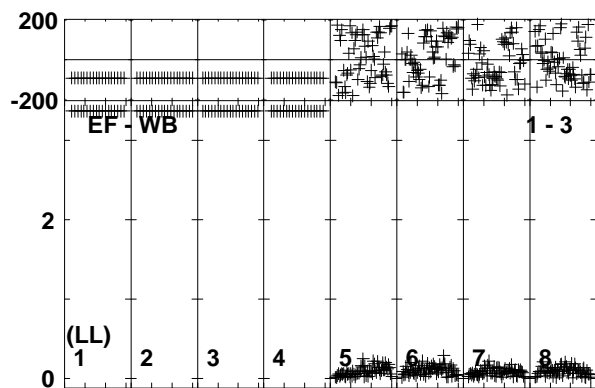
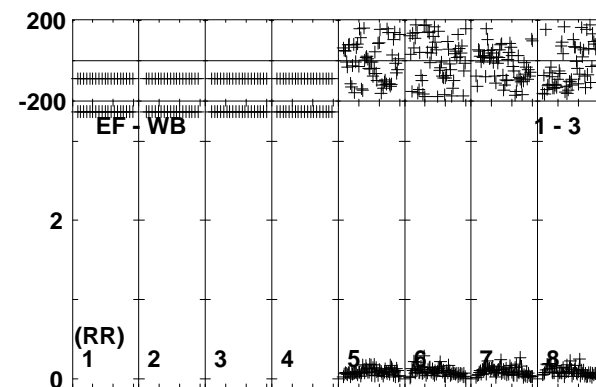
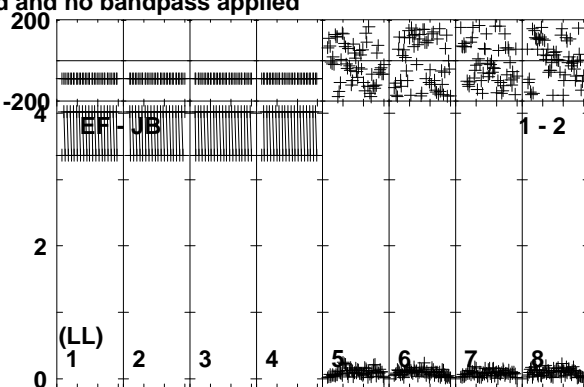
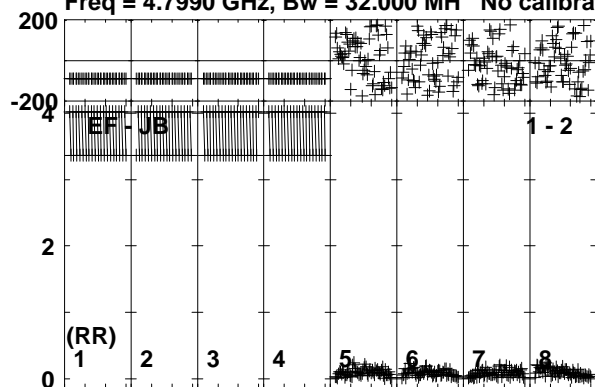

Lower frame: Milli Ampl Jy Top frame: Phas deg  
Vector averaged cross-power spectrum Baseline: EF (01) - JB (02)  
Timerange: 00/04:12:51 to 00/04:16:20

Plot file version 173 created 24-NOV-2017 10:10:18

ARUMA EG096D.UVDATA.1

Freq = 4.7990 GHz, Bw = 32.000 MH No calibration applied and no bandpass applied

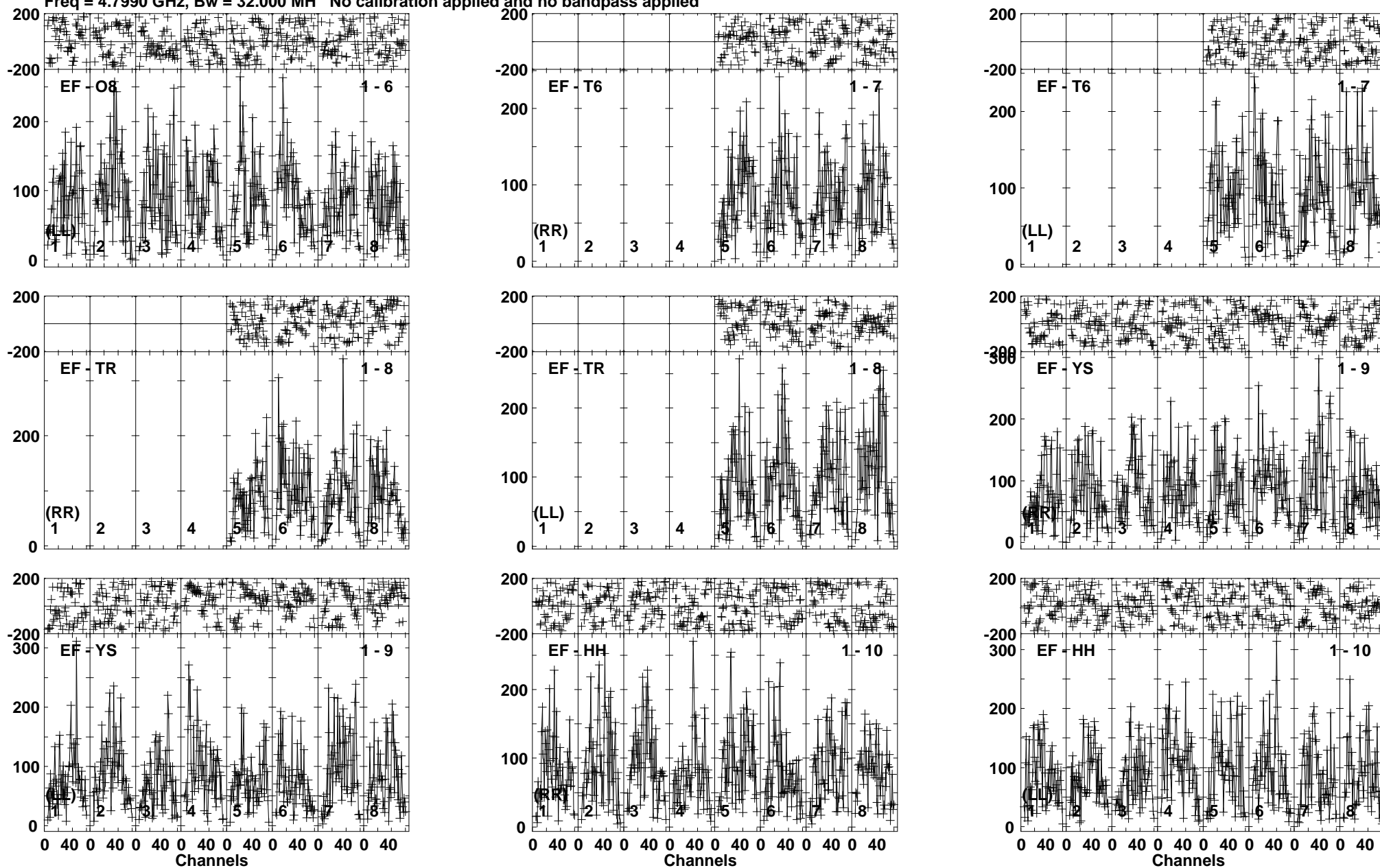

Lower frame: Micro Ampl Jy Top frame: Phas deg  
Vector averaged cross-power spectrum Baseline: EF (01) - O8 (06)  
Timerange: 00/04:12:51 to 00/04:16:20

Plot file version 174 created 24-NOV-2017 10:10:19  
ARUMA EG096D.UVDATA.1  
Freq = 4.7990 GHz, Bw = 32.000 MH No calibration applied and no bandpass applied

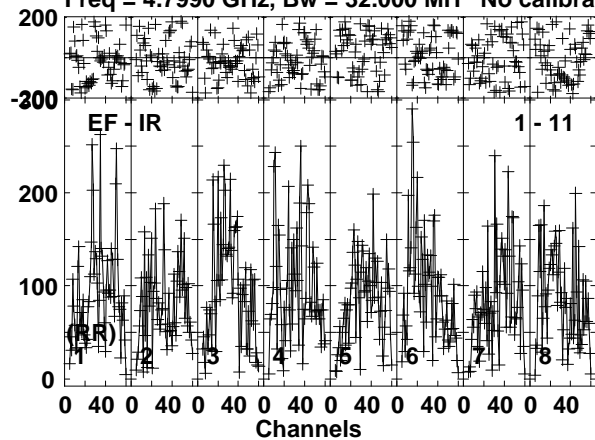

Lower frame: Micro Ampl Jy Top frame: Phas deg  
Vector averaged cross-power spectrum Baseline: EF (01) - IR (11)  
Timerange: 00/04:12:51 to 00/04:16:20

Plot file version 175 created 24-NOV-2017 10:10:19

J1108+4330 EG096D.UVDATA.1

Freq = 4.7990 GHz, Bw = 32.000 MH No calibration applied and no bandpass applied

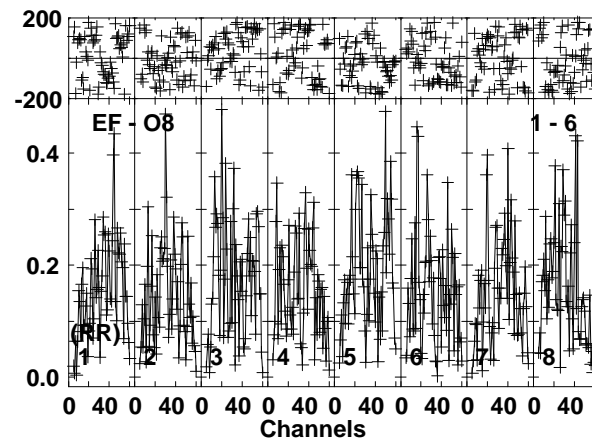
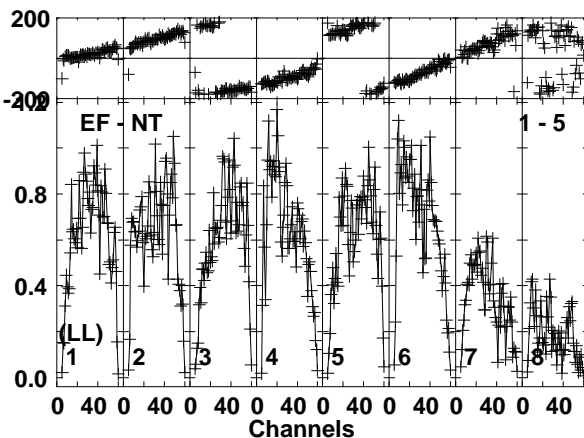
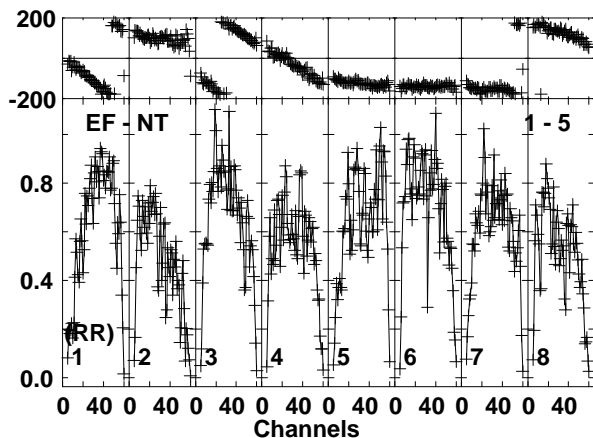
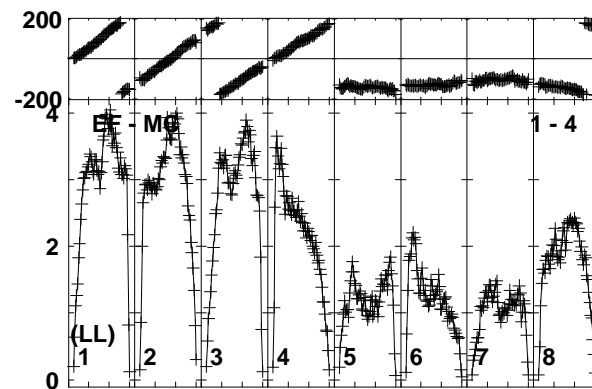
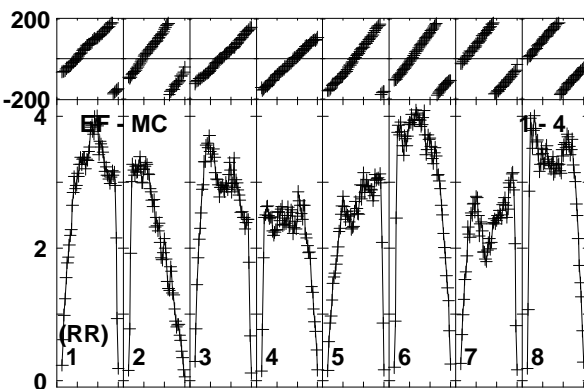
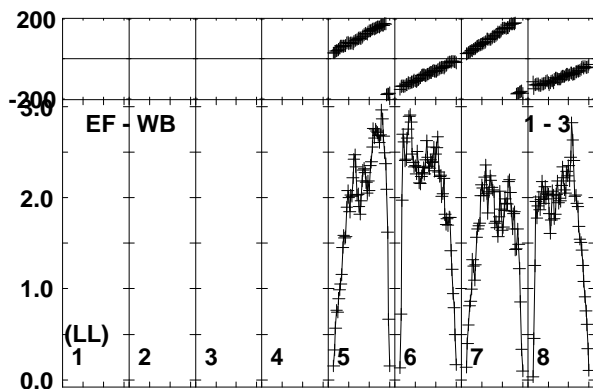
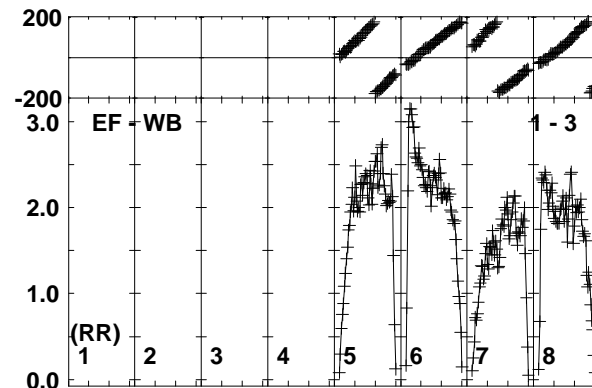
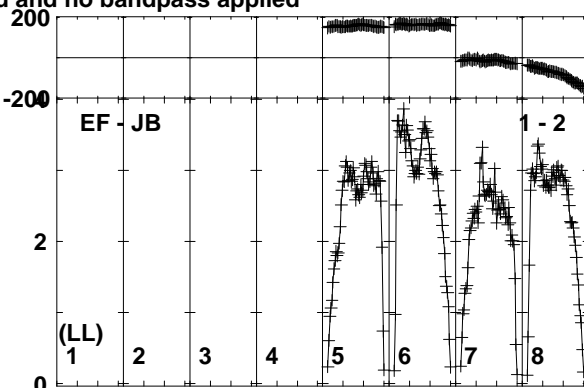
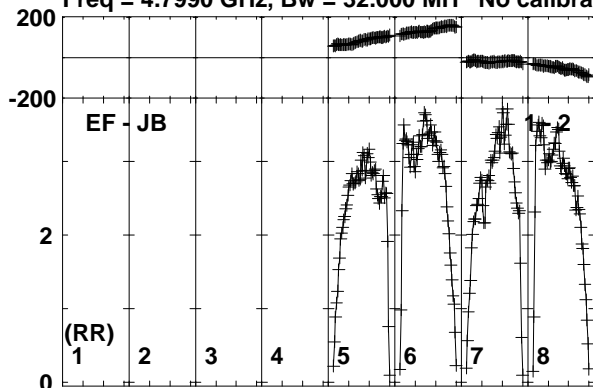

Lower frame: Milli Ampl Jy Top frame: Phas deg  
Vector averaged cross-power spectrum Baseline: EF (01) - JB (02)  
Timerange: 00/04:16:21 to 00/04:17:50

Plot file version 176 created 24-NOV-2017 10:10:19

J1108+4330 EG096D.UVDATA.1

Freq = 4.7990 GHz, Bw = 32.000 MH No calibration applied and no bandpass applied

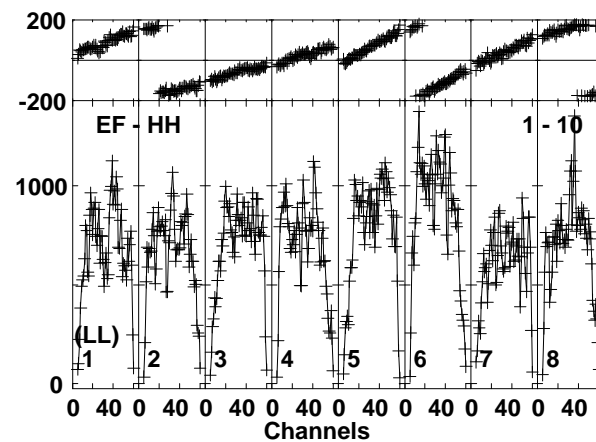
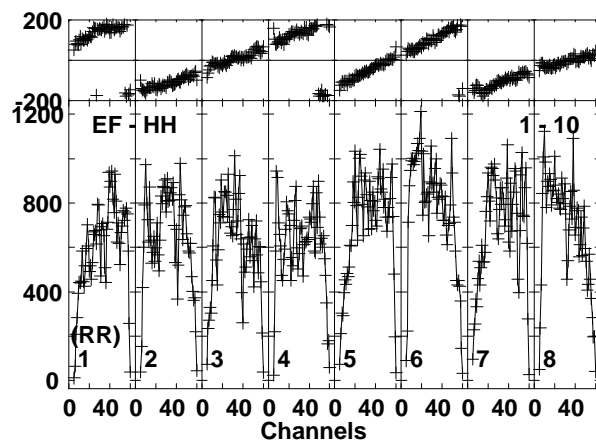
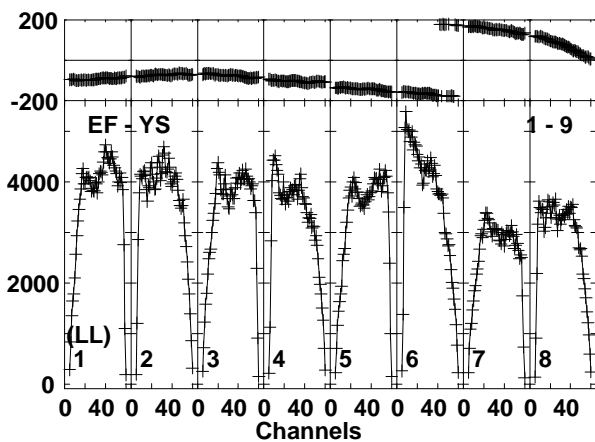
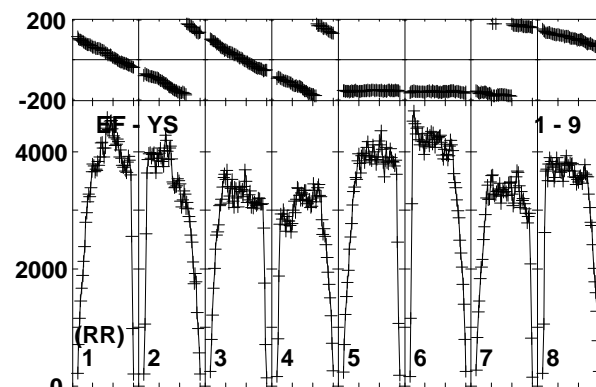
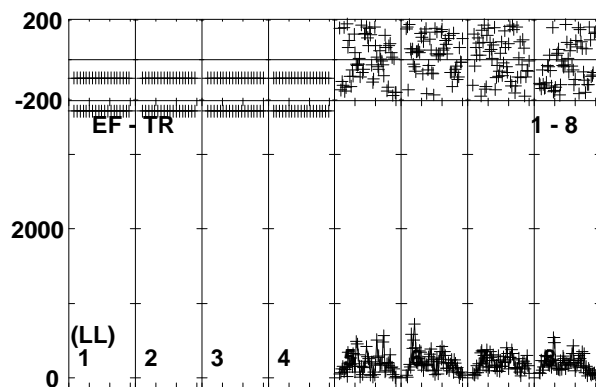
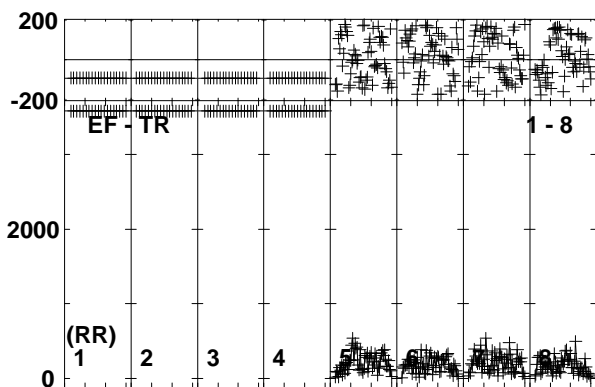
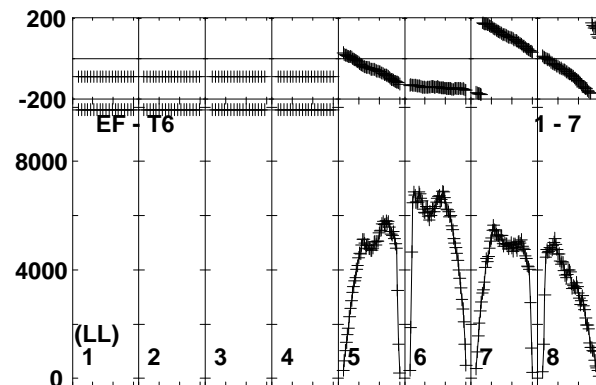
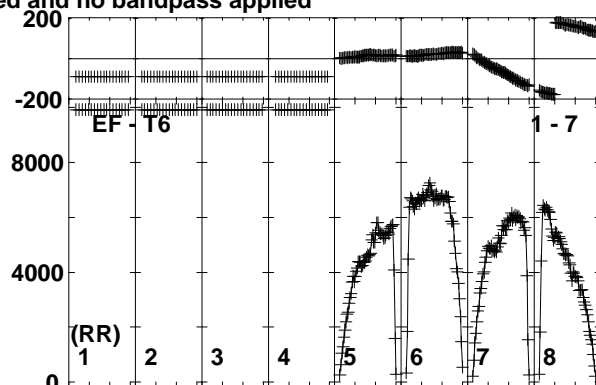
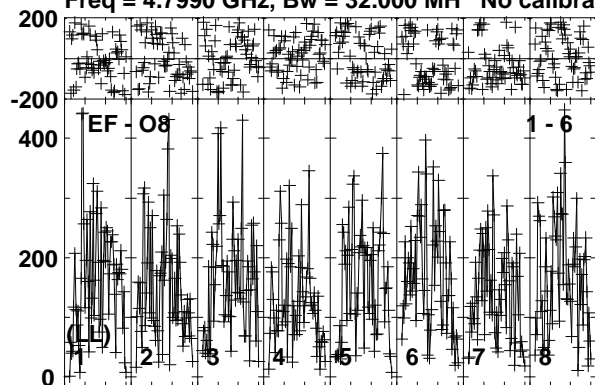

Lower frame: Micro Ampl Jy Top frame: Phas deg  
Vector averaged cross-power spectrum Baseline: EF (01) - O8 (06)  
Timerange: 00/04:16:21 to 00/04:17:50

Plot file version 177 created 24-NOV-2017 10:10:19  
J1108+4330 EG096D.UVDATA.1  
Freq = 4.7990 GHz, Bw = 32.000 MH No calibration applied and no bandpass applied

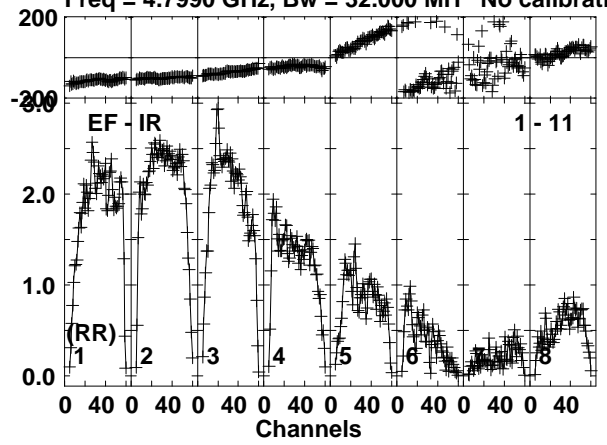

Lower frame: Milli Ampl Jy Top frame: Phas deg  
Vector averaged cross-power spectrum Baseline: EF (01) - IR (11)  
Timerange: 00/04:16:21 to 00/04:17:50

Plot file version 178 created 24-NOV-2017 10:10:19

ARUMA EG096D.UVDATA.1

Freq = 4.7990 GHz, Bw = 32.000 MH No calibration applied and no bandpass applied

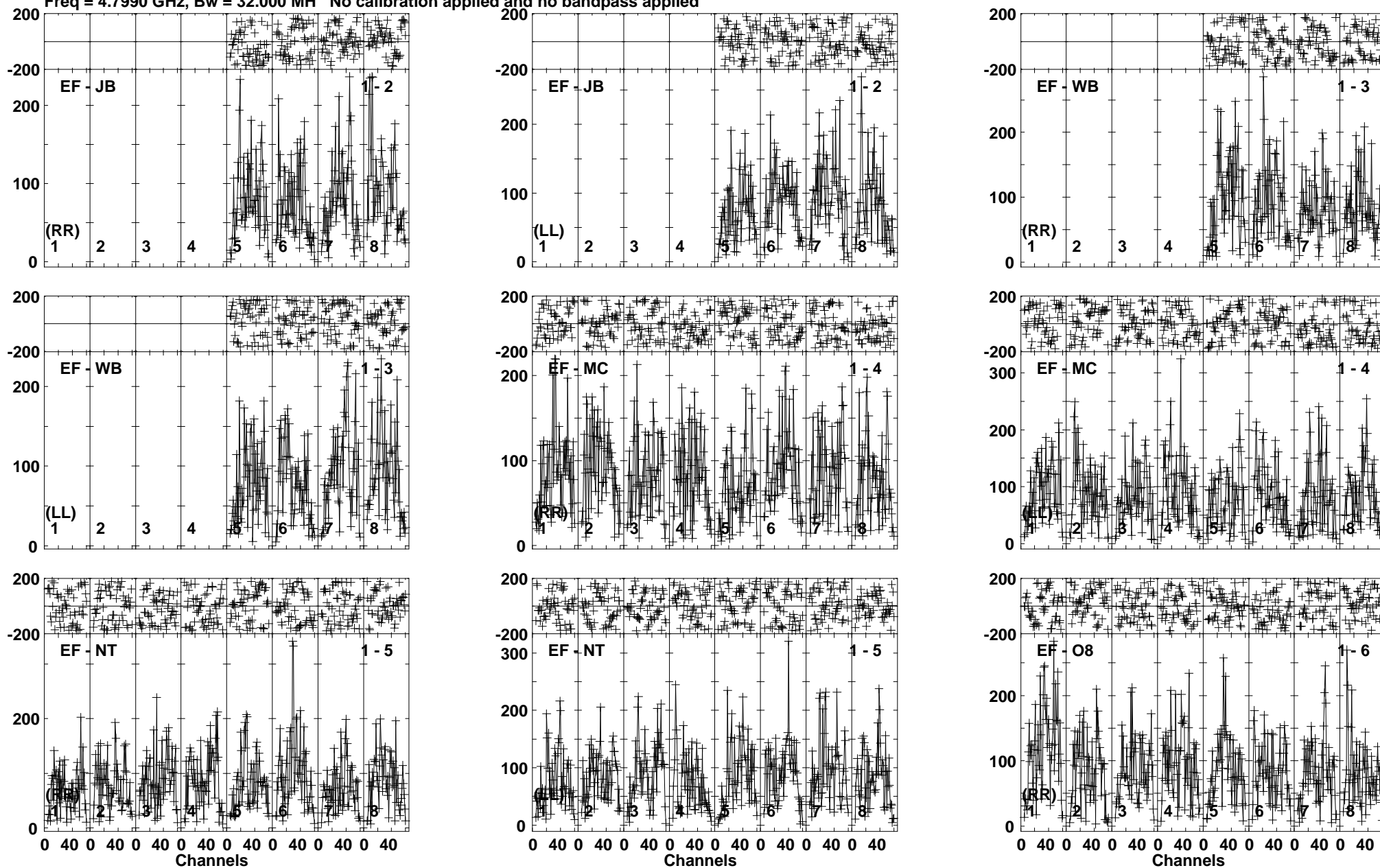

Lower frame: Micro Ampl Jy Top frame: Phas deg  
Vector averaged cross-power spectrum Baseline: EF (01) - JB (02)  
Timerange: 00/04:17:50 to 00/04:21:20



Plot file version 179 created 24-NOV-2017 10:10:20

ARUMA EG096D.UVDATA.1

Freq = 4.7990 GHz, Bw = 32.000 MH No calibration applied and no bandpass applied

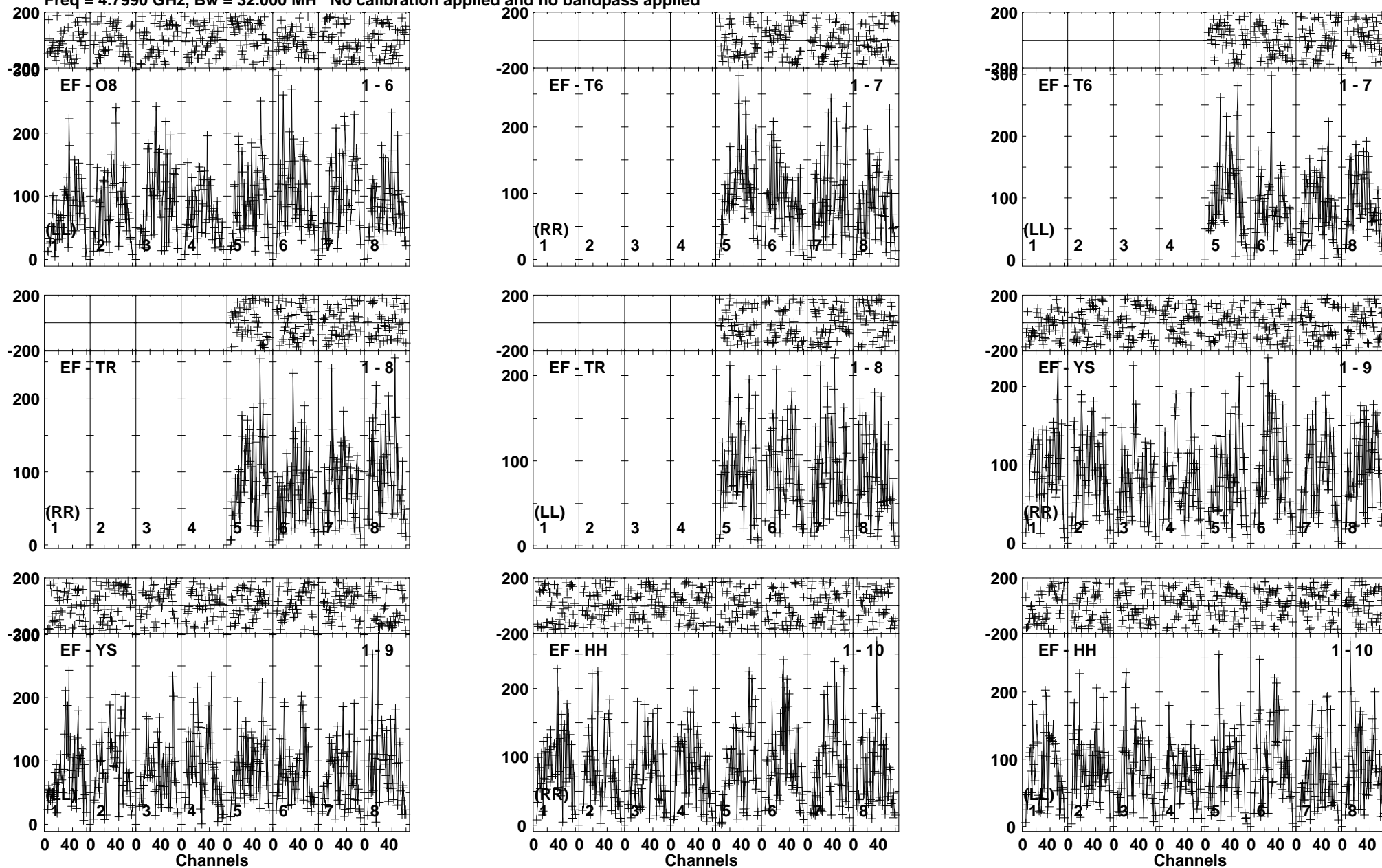

Lower frame: Micro Ampl Jy Top frame: Phas deg  
Vector averaged cross-power spectrum Baseline: EF (01) - O8 (06)  
Timerange: 00/04:17:50 to 00/04:21:20

Plot file version 180 created 24-NOV-2017 10:10:20  
ARUMA EG096D.UVDATA.1  
Freq = 4.7990 GHz, Bw = 32.000 MH No calibration applied and no bandpass applied

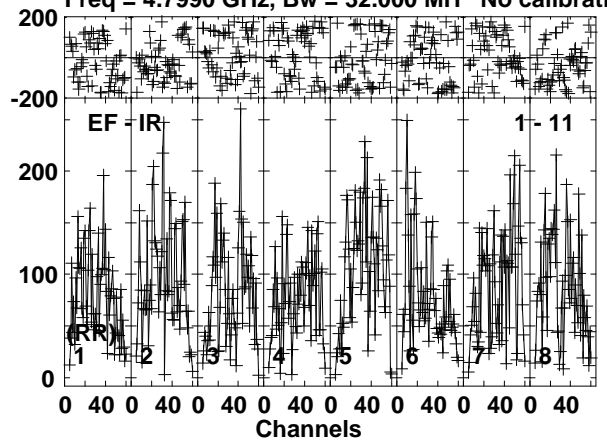

Lower frame: Micro Ampl Jy Top frame: Phas deg  
Vector averaged cross-power spectrum Baseline: EF (01) - IR (11)  
Timerange: 00/04:17:50 to 00/04:21:20

Plot file version 181 created 24-NOV-2017 10:10:20  
 J1108+4330 EG096D.UVDATA.1  
 Freq = 4.7990 GHz, Bw = 32.000 MH No calibration applied and no bandpass applied

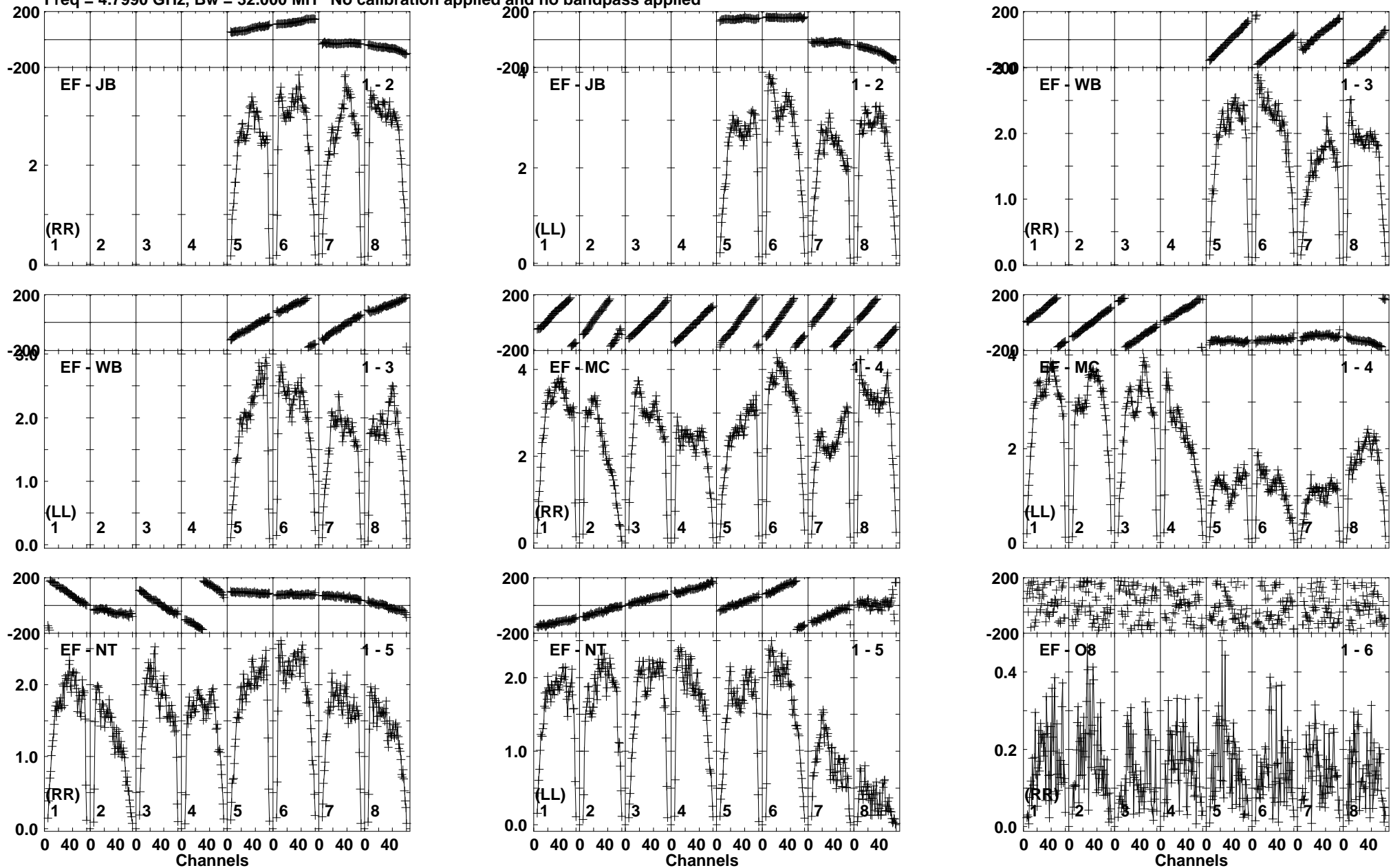

Lower frame: Milli Ampl Jy Top frame: Phas deg  
 Vector averaged cross-power spectrum Baseline: EF (01) - JB (02)  
 Timerange: 00/04:22:00 to 00/04:23:00

Plot file version 182 created 24-NOV-2017 10:10:20

J1108+4330 EG096D.UVDATA.1

Freq = 4.7990 GHz, Bw = 32.000 MH No calibration applied and no bandpass applied

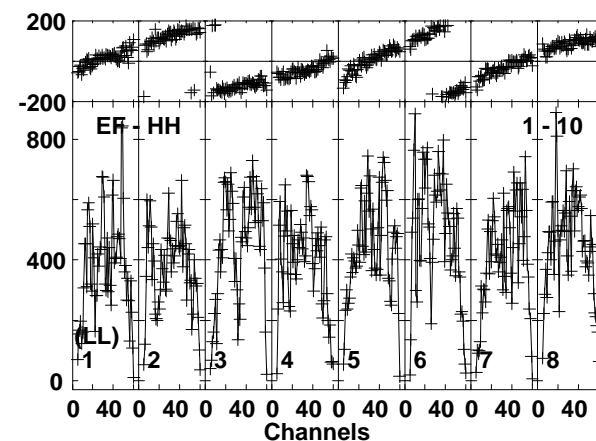
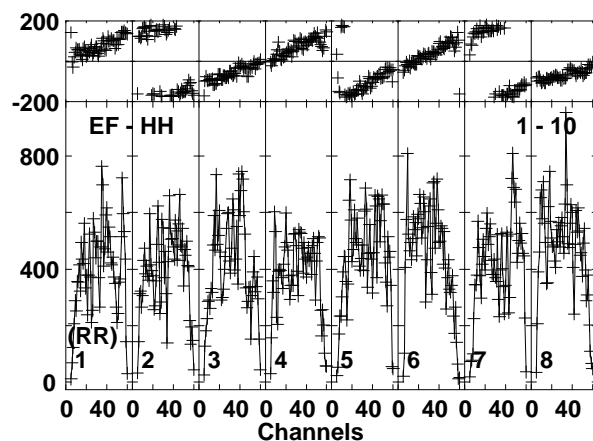
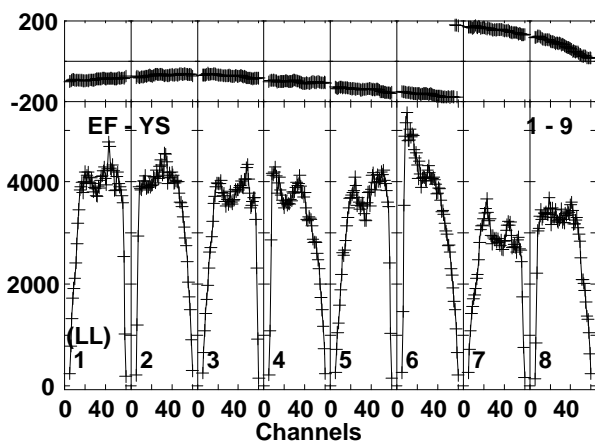
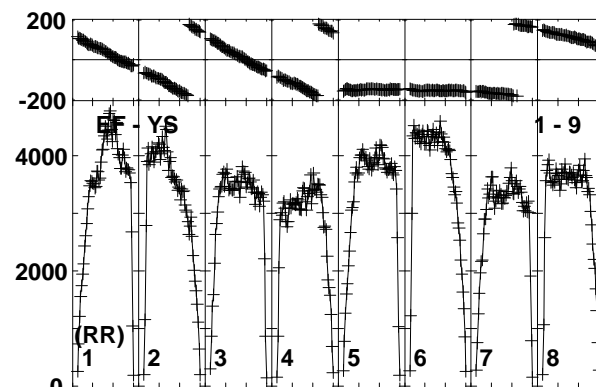
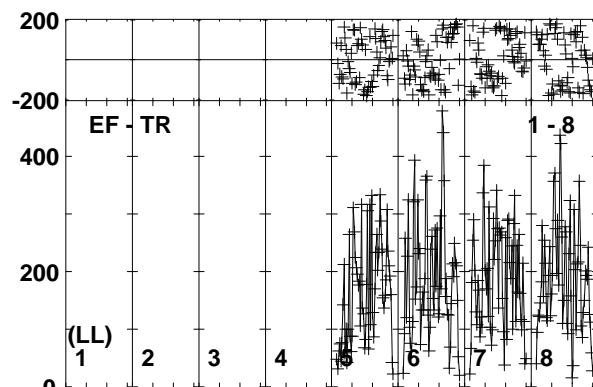
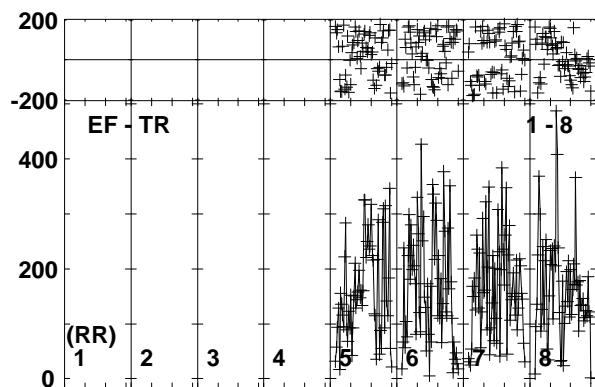
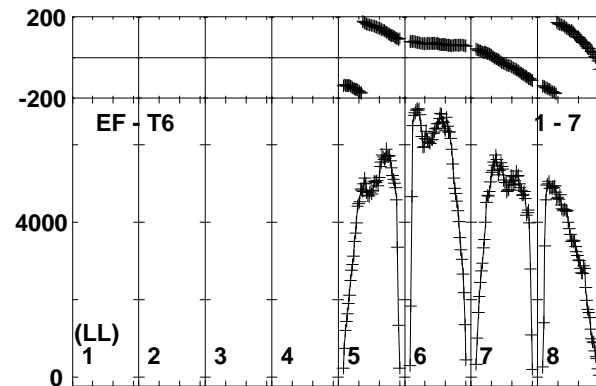
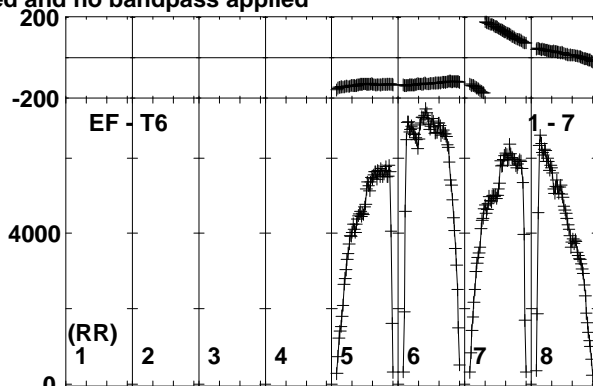
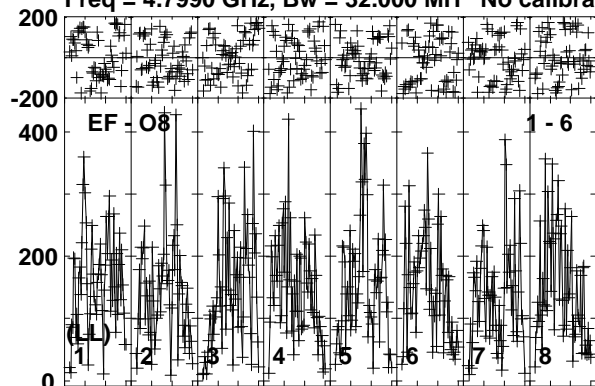

Lower frame: Micro Ampl Jy Top frame: Phas deg  
Vector averaged cross-power spectrum Baseline: EF (01) - O8 (06)  
Timerange: 00/04:22:00 to 00/04:23:00

Plot file version 183 created 24-NOV-2017 10:10:21  
J1108+4330 EG096D.UVDATA.1  
Freq = 4.7990 GHz, Bw = 32.000 MH No calibration applied and no bandpass applied

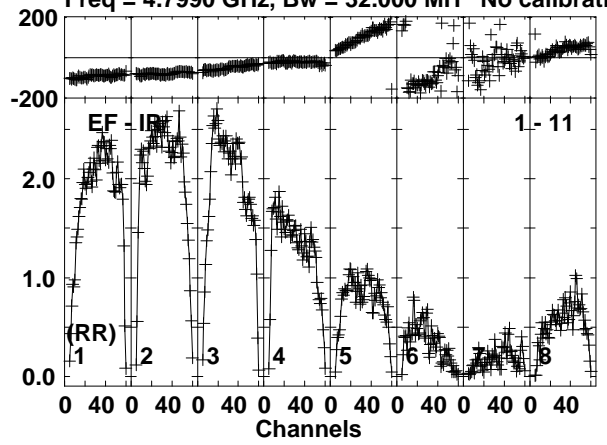

Lower frame: Milli Ampl Jy Top frame: Phas deg  
Vector averaged cross-power spectrum Baseline: EF (01) - IR (11)  
Timerange: 00/04:22:00 to 00/04:23:00

Plot file version 184 created 24-NOV-2017 10:10:21

J1112+4301 EG096D.UVDATA.1

Freq = 4.7990 GHz, Bw = 32.000 MH No calibration applied and no bandpass applied

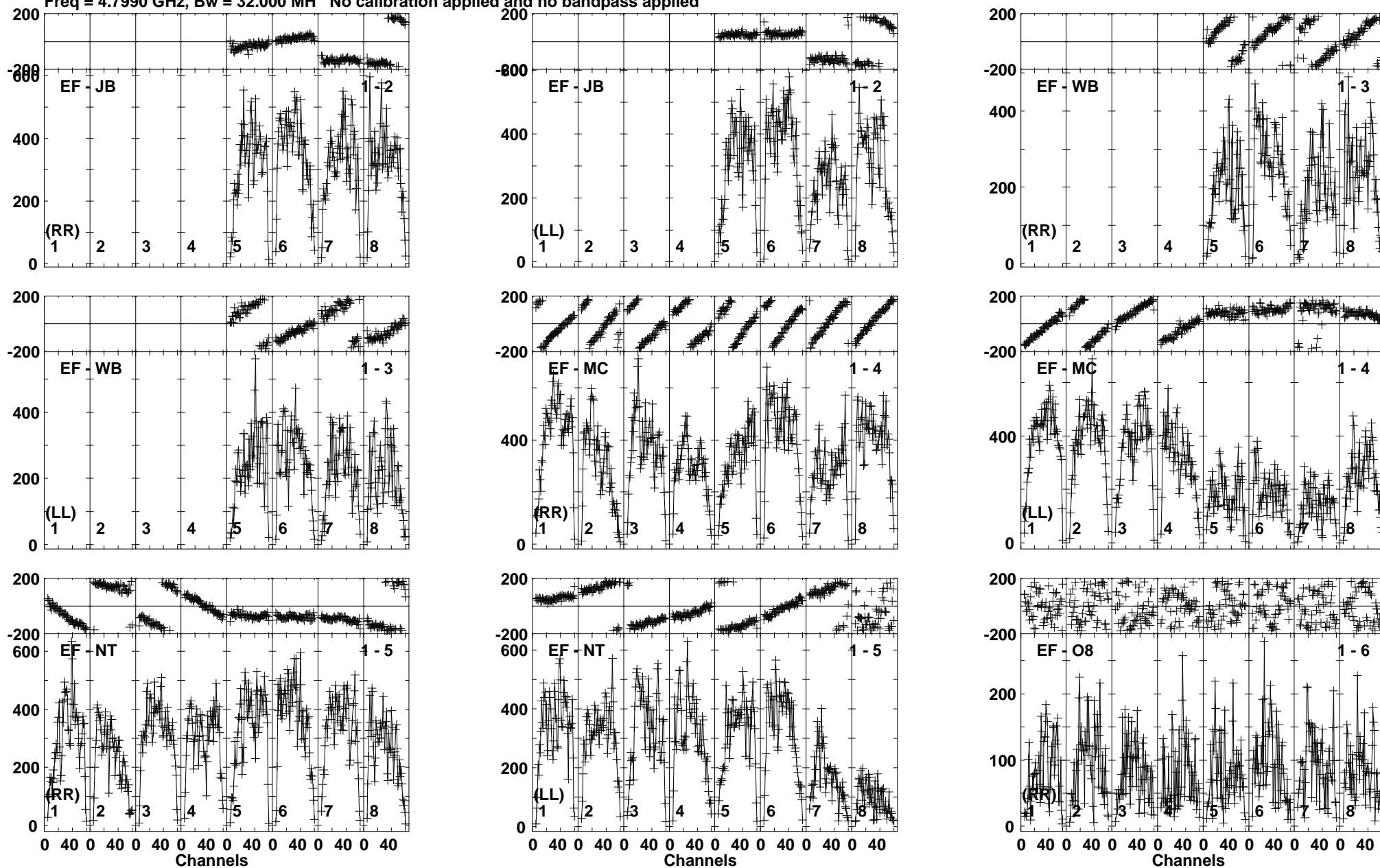

Lower frame: Micro Ampl Jy Top frame: Phas deg  
Vector averaged cross-power spectrum Baseline: EF (01) - JB (02)  
Timerange: 00/04:23:00 to 00/04:26:30

Plot file version 185 created 24-NOV-2017 10:10:21

J1112+4301 EG096D.UVDATA.1

Freq = 4.7990 GHz, Bw = 32.000 MH No calibration applied and no bandpass applied

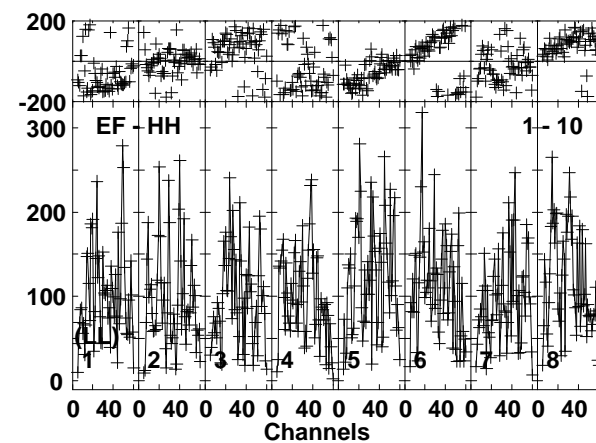
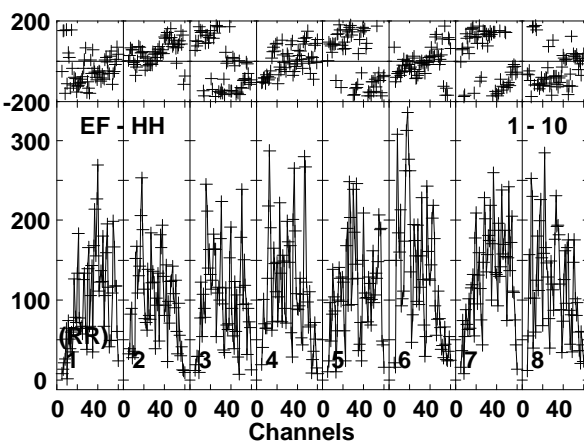
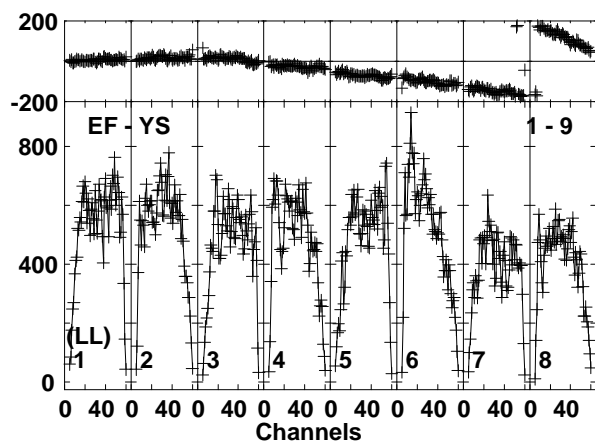
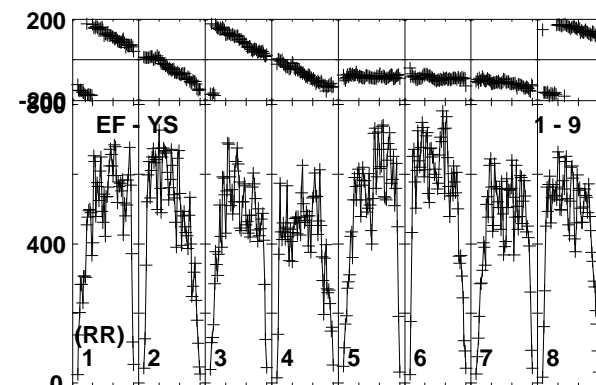
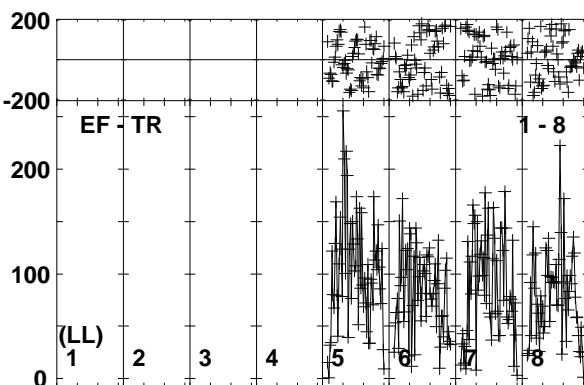
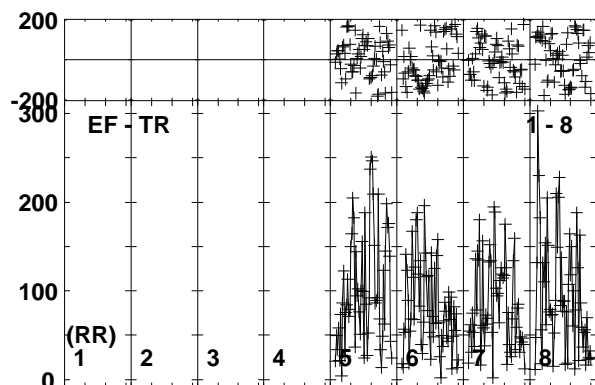
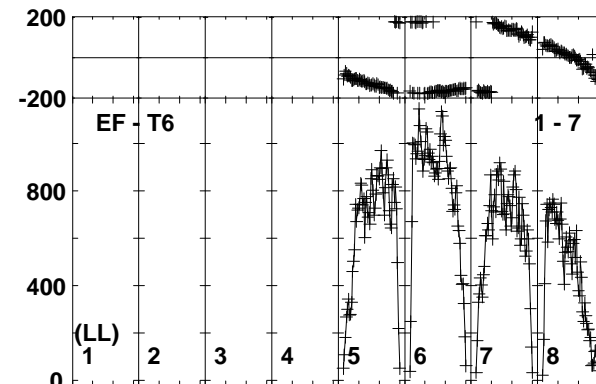
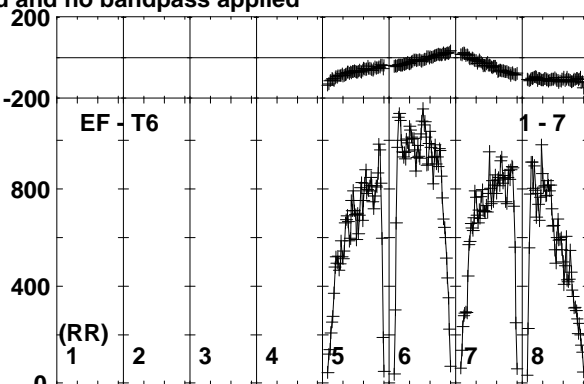
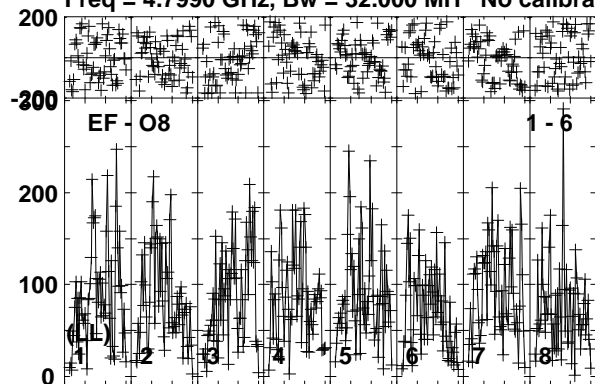

Lower frame: Micro Ampl Jy Top frame: Phas deg  
Vector averaged cross-power spectrum Baseline: EF (01) - O8 (06)  
Timerange: 00/04:23:00 to 00/04:26:30

Plot file version 186 created 24-NOV-2017 10:10:21  
J1112+4301 EG096D.UVDATA.1  
Freq = 4.7990 GHz, Bw = 32.000 MH No calibration applied and no bandpass applied

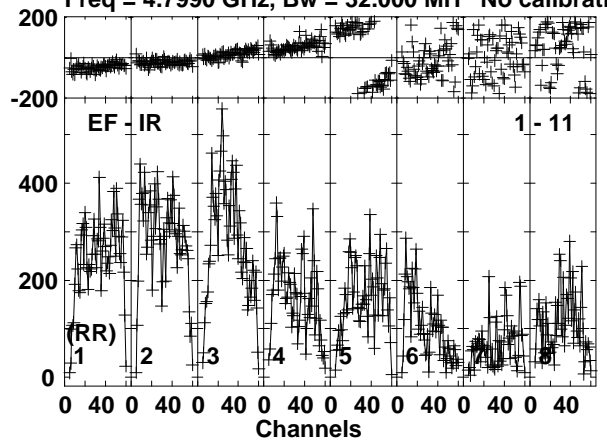

Lower frame: Micro Ampl Jy Top frame: Phas deg  
Vector averaged cross-power spectrum Baseline: EF (01) - IR (11)  
Timerange: 00/04:23:00 to 00/04:26:30



Plot file version 187 created 24-NOV-2017 10:10:22

J1108+4330 EG096D.UVDATA.1

Freq = 4.7990 GHz, Bw = 32.000 MH No calibration applied and no bandpass applied

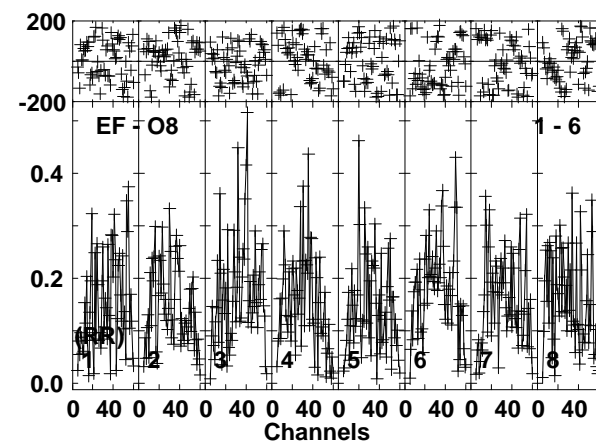
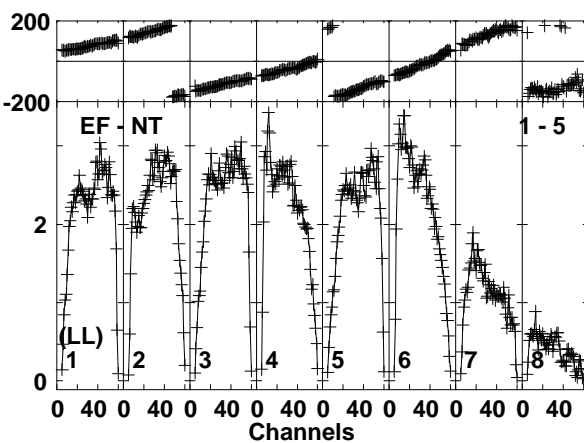
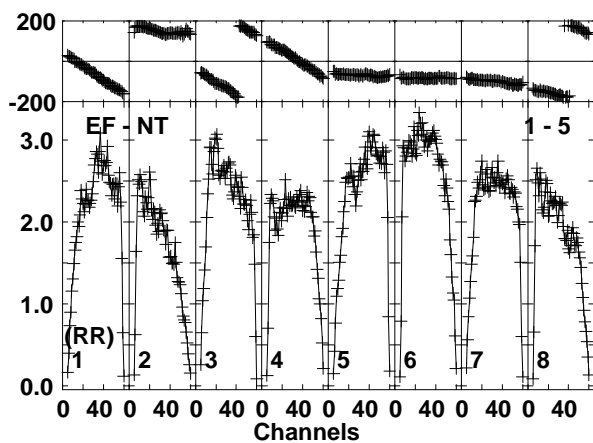
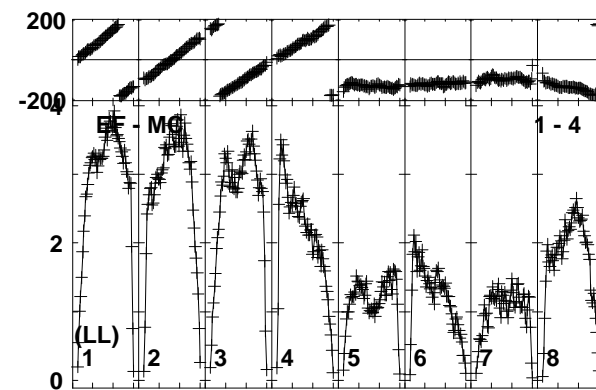
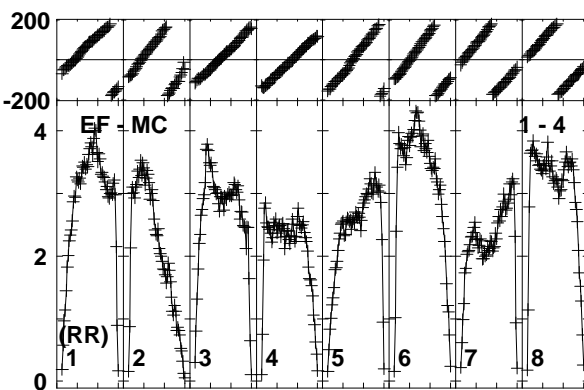
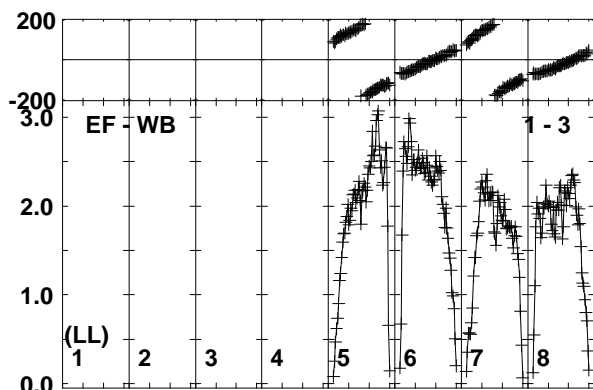
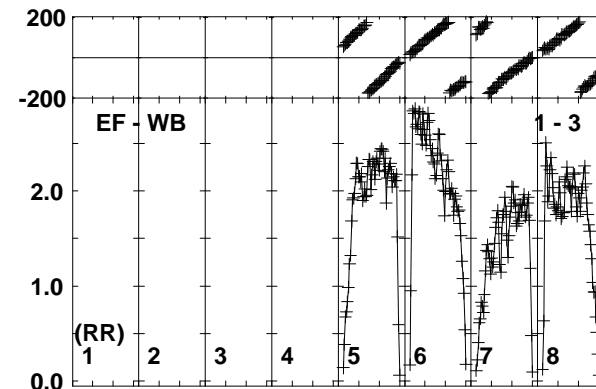
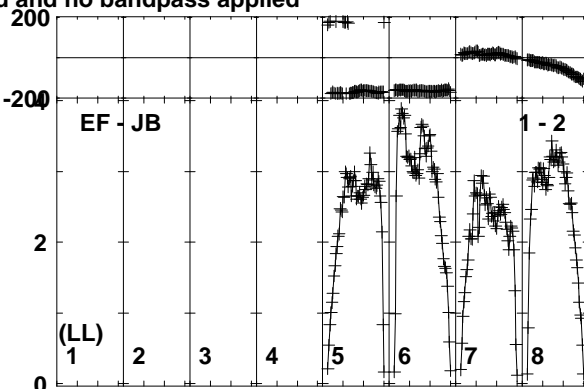
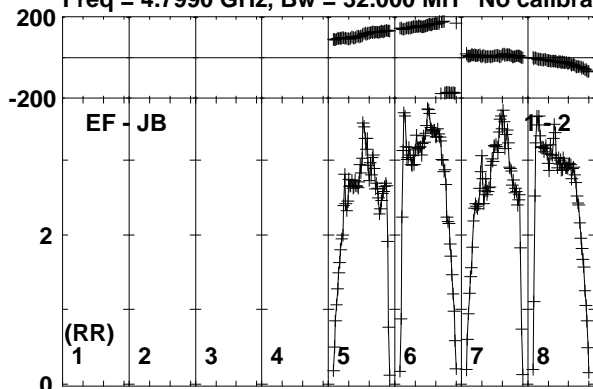

Lower frame: Milli Ampl Jy Top frame: Phas deg  
Vector averaged cross-power spectrum Baseline: EF (01) - JB (02)  
Timerange: 00/04:26:31 to 00/04:28:00

Plot file version 188 created 24-NOV-2017 10:10:22

J1108+4330 EG096D.UVDATA.1

Freq = 4.7990 GHz, Bw = 32.000 MH No calibration applied and no bandpass applied

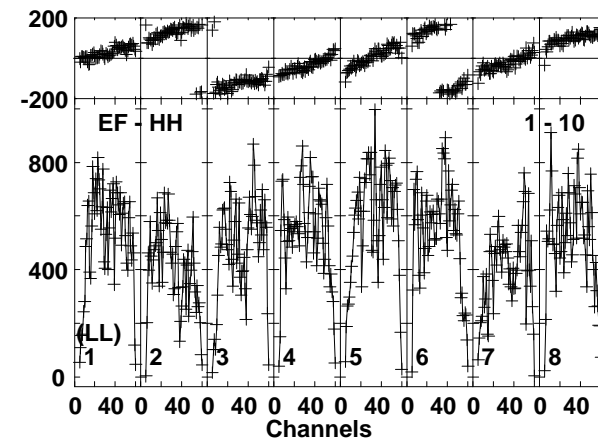
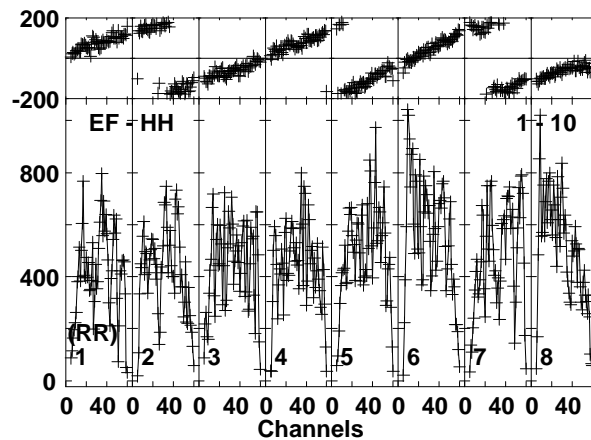
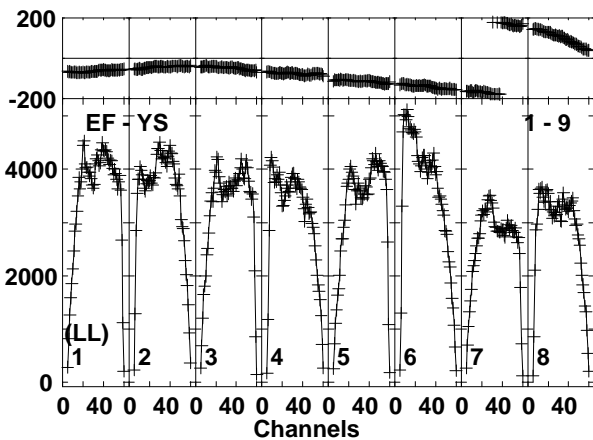
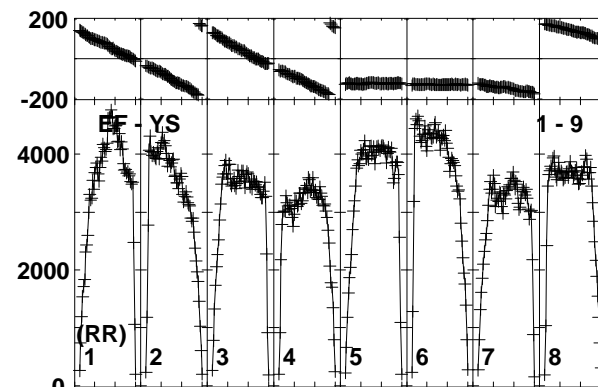
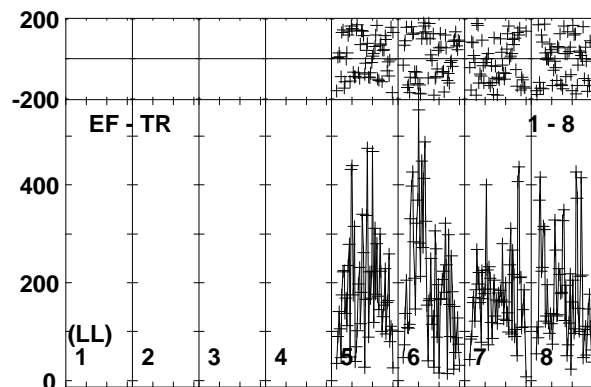
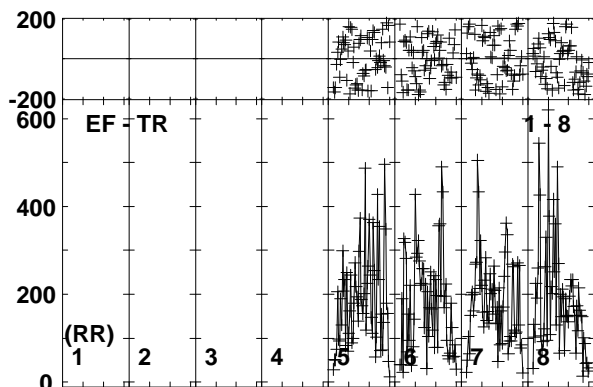
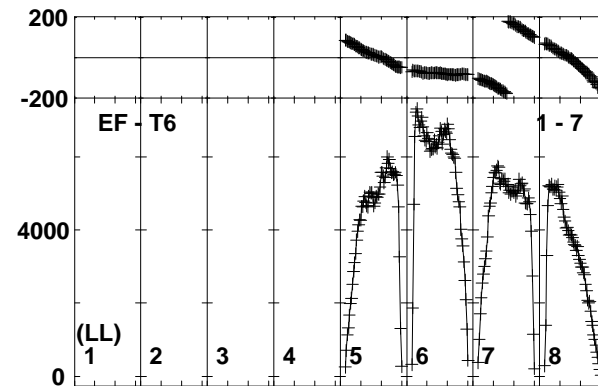
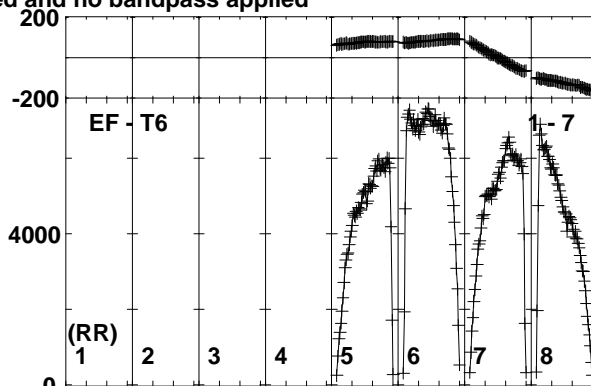
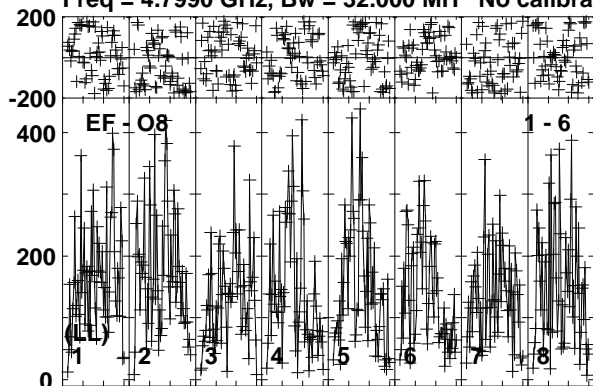

Lower frame: Micro Ampl Jy Top frame: Phas deg  
Vector averaged cross-power spectrum Baseline: EF (01) - O8 (06)  
Timerange: 00/04:26:31 to 00/04:28:00

Plot file version 189 created 24-NOV-2017 10:10:22  
J1108+4330 EG096D.UVDATA.1  
Freq = 4.7990 GHz, Bw = 32.000 MH No calibration applied and no bandpass applied

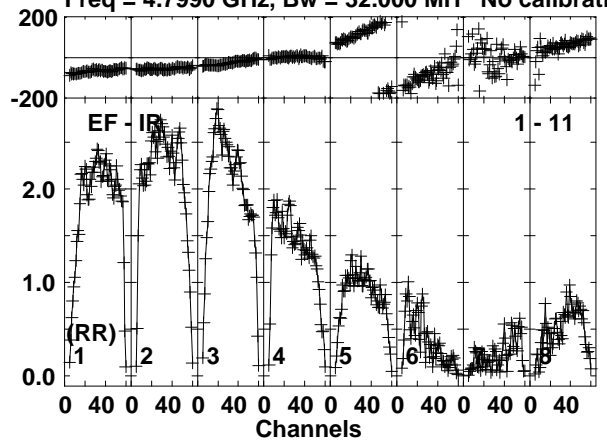

Lower frame: Milli Ampl Jy Top frame: Phas deg  
Vector averaged cross-power spectrum Baseline: EF (01) - IR (11)  
Timerange: 00/04:26:31 to 00/04:28:00

Plot file version 190 created 24-NOV-2017 10:10:22  
 ARUMA EG096D.UVDATA.1  
 Freq = 4.7990 GHz, Bw = 32.000 MH No calibration applied and no bandpass applied

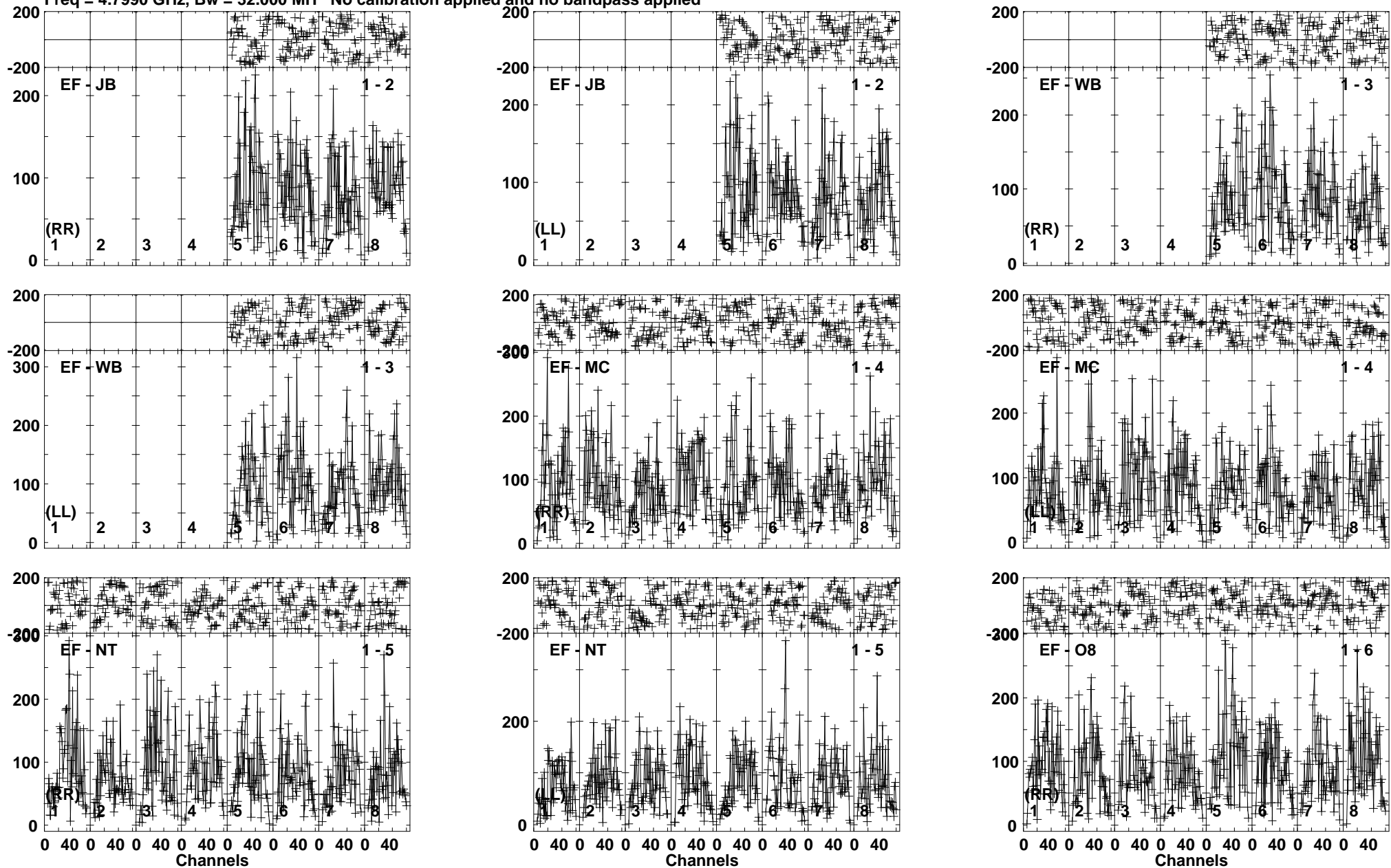

Lower frame: Micro Ampl Jy Top frame: Phas deg  
 Vector averaged cross-power spectrum Baseline: EF (01) - JB (02)  
 Timerange: 00/04:28:00 to 00/04:31:30

Plot file version 191 created 24-NOV-2017 10:10:22

ARUMA EG096D.UVDATA.1

Freq = 4.7990 GHz, Bw = 32.000 MH No calibration applied and no bandpass applied

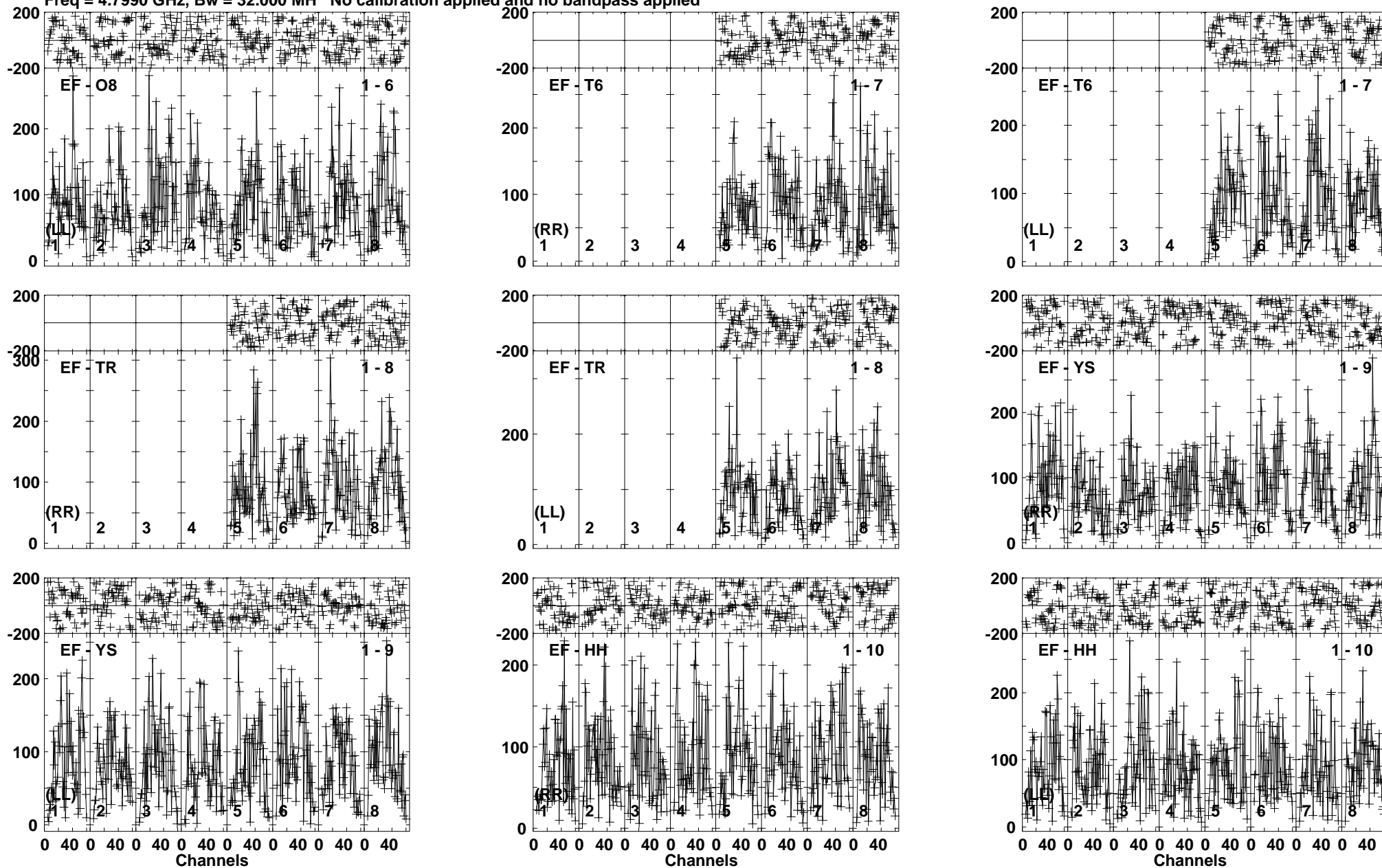

Lower frame: Micro Ampl Jy Top frame: Phas deg  
Vector averaged cross-power spectrum Baseline: EF (01) - O8 (06)  
Timerange: 00/04:28:00 to 00/04:31:30

Plot file version 192 created 24-NOV-2017 10:10:23  
ARUMA EG096D.UVDATA.1  
Freq = 4.7990 GHz, Bw = 32.000 MH No calibration applied and no bandpass applied

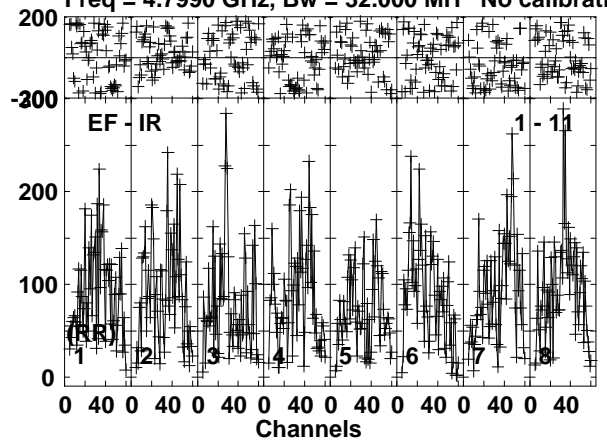

Lower frame: Micro Ampl Jy Top frame: Phas deg  
Vector averaged cross-power spectrum Baseline: EF (01) - IR (11)  
Timerange: 00/04:28:00 to 00/04:31:30

Plot file version 193 created 24-NOV-2017 10:10:23

J1108+4330 EG096D.UVDATA.1

Freq = 4.7990 GHz, Bw = 32.000 MH No calibration applied and no bandpass applied

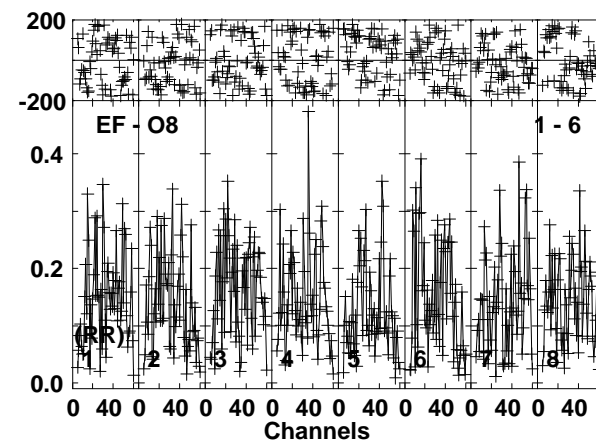
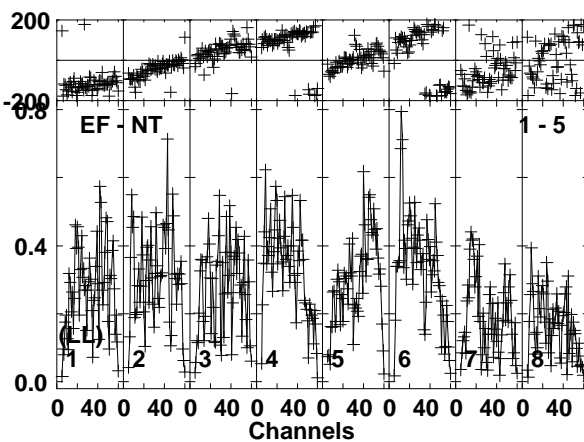
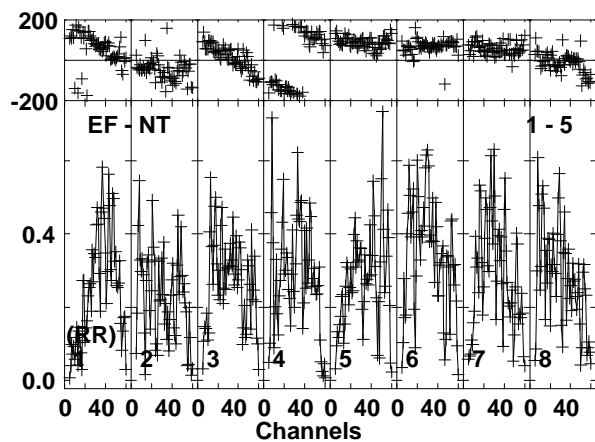
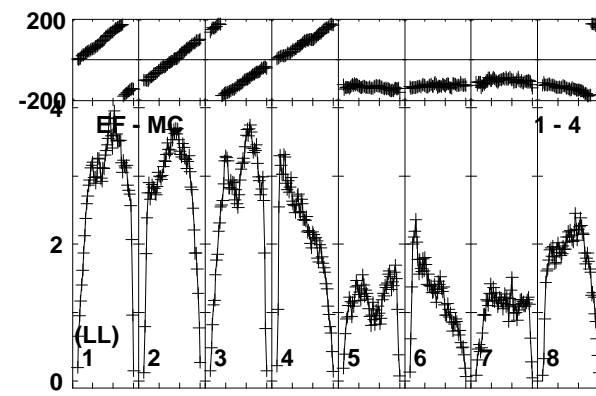
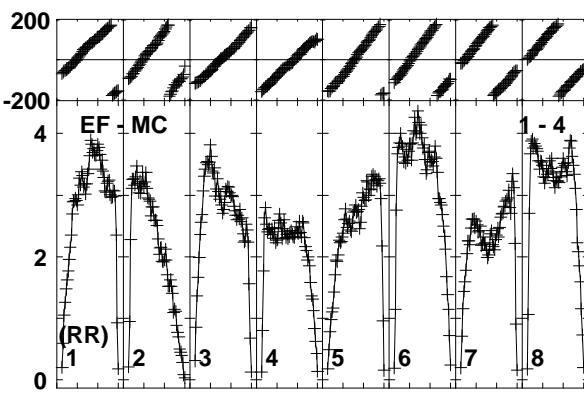
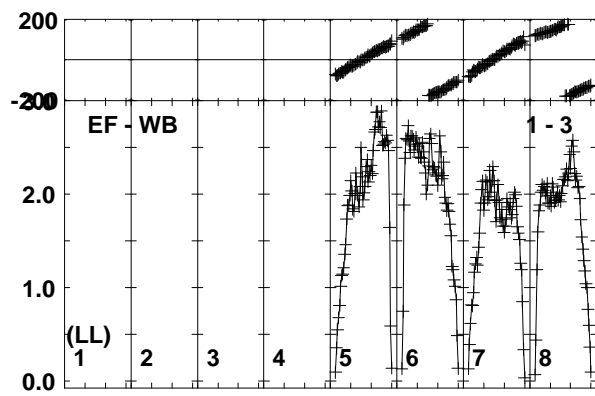
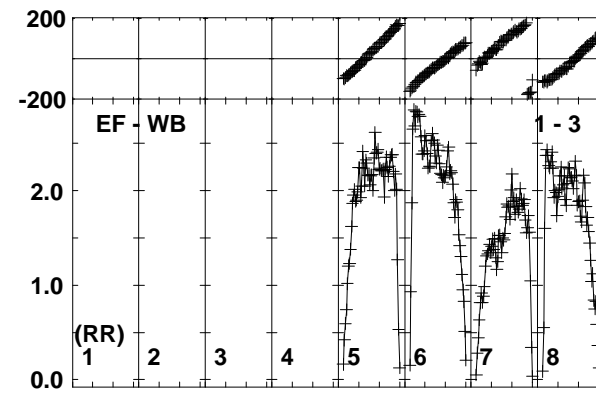
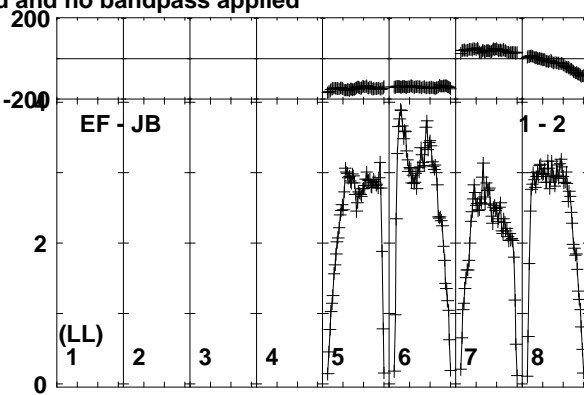
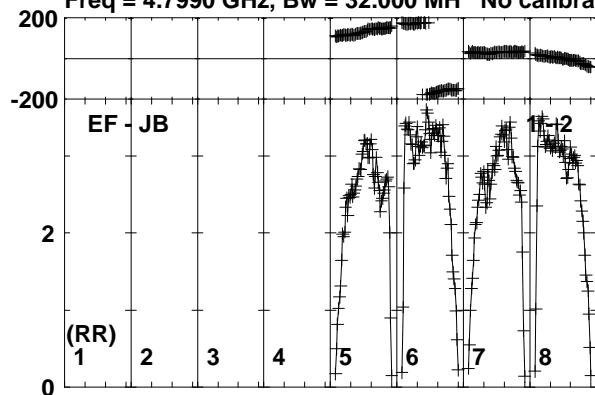

Lower frame: Milli Ampl Jy Top frame: Phas deg  
Vector averaged cross-power spectrum Baseline: EF (01) - JB (02)  
Timerange: 00/04:32:11 to 00/04:33:10

Plot file version 194 created 24-NOV-2017 10:10:23

J1108+4330 EG096D.UVDATA.1

Freq = 4.7990 GHz, Bw = 32.000 MH No calibration applied and no bandpass applied

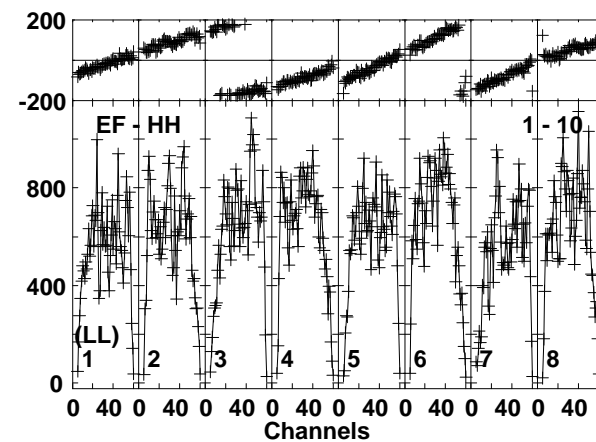
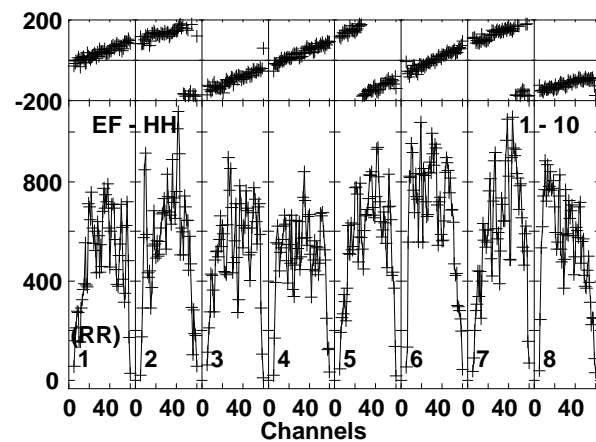
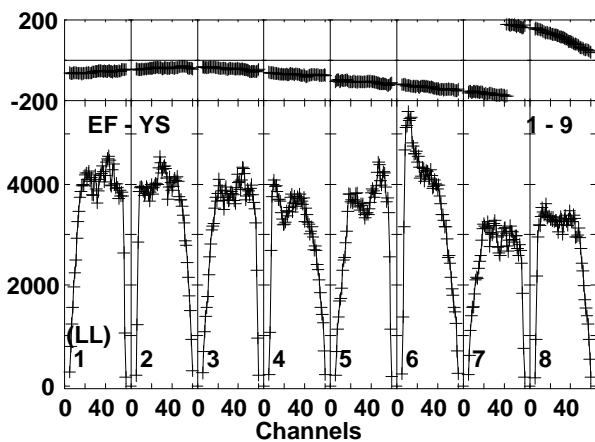
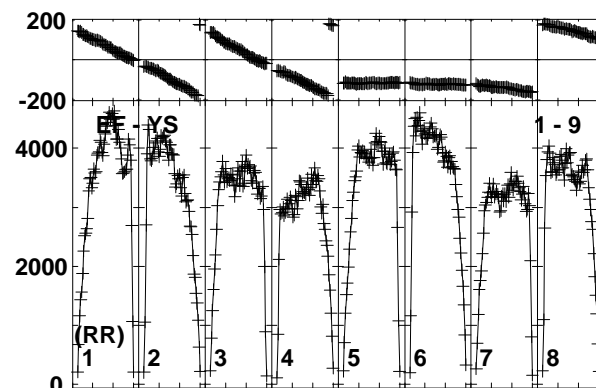
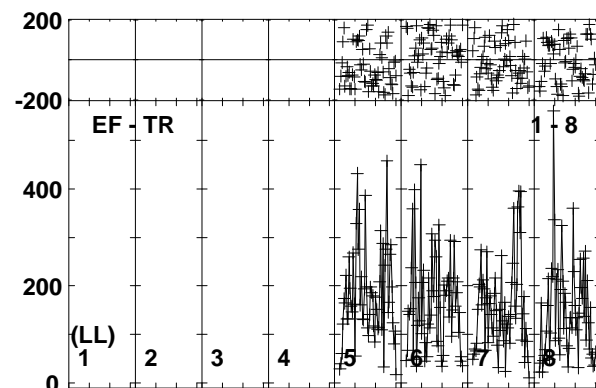
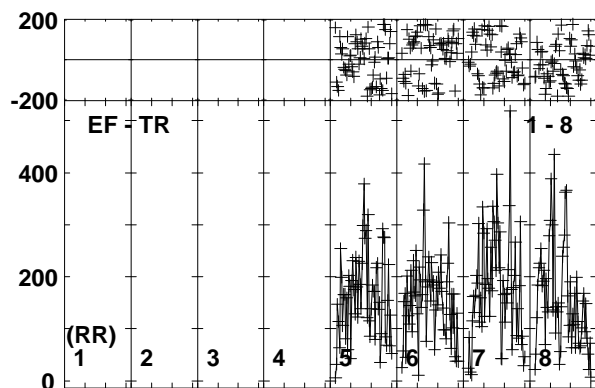
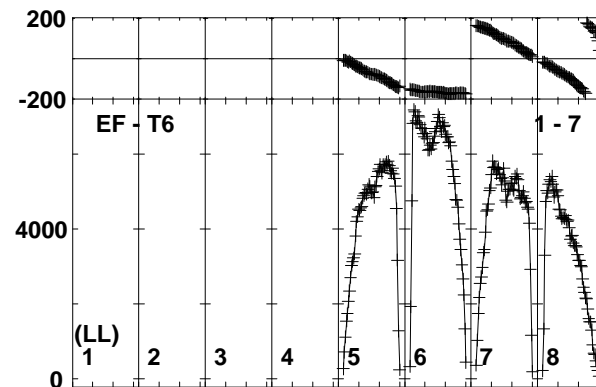
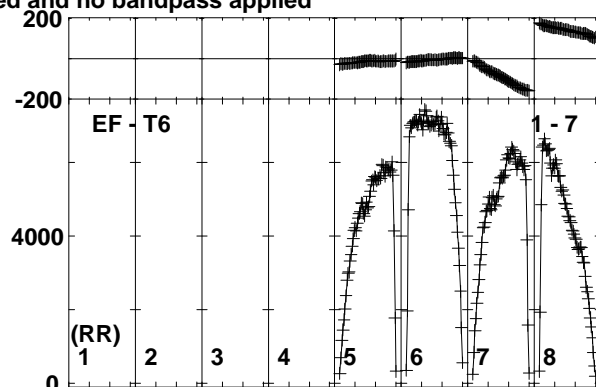
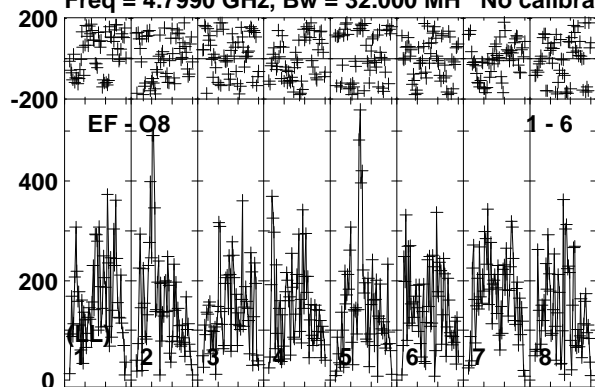

Lower frame: Micro Ampl Jy Top frame: Phas deg  
Vector averaged cross-power spectrum Baseline: EF (01) - O8 (06)  
Timerange: 00/04:32:11 to 00/04:33:10



Plot file version 195 created 24-NOV-2017 10:10:23

J1108+4330 EG096D.UVDATA.1

Freq = 4.7990 GHz, Bw = 32.000 MH No calibration applied and no bandpass applied

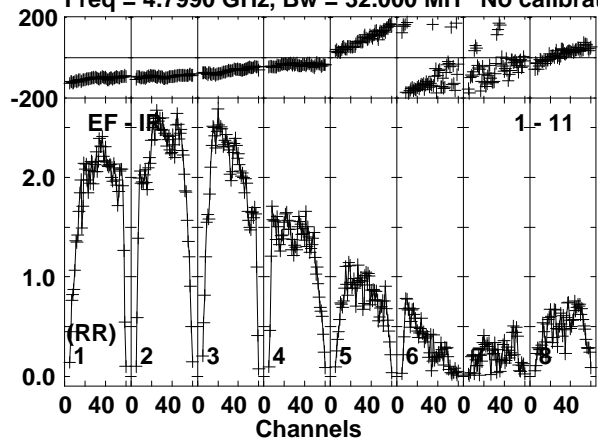

Lower frame: Milli Ampl Jy Top frame: Phas deg  
Vector averaged cross-power spectrum Baseline: EF (01) - IR (11)  
Timerange: 00/04:32:11 to 00/04:33:10

Plot file version 196 created 24-NOV-2017 10:10:23

ARUMA EG096D.UVDATA.1

Freq = 4.7990 GHz, Bw = 32.000 MH No calibration applied and no bandpass applied

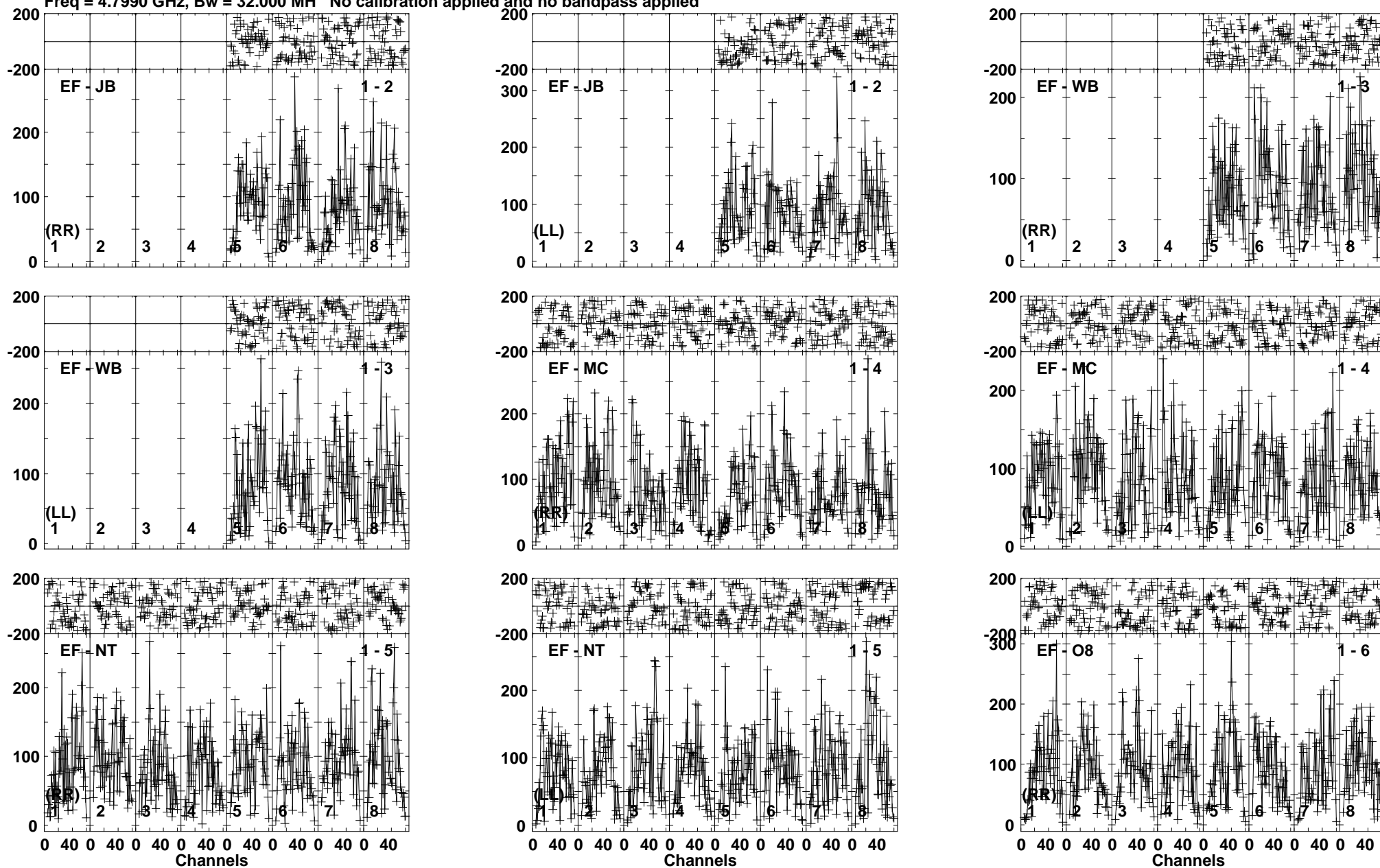

Lower frame: Micro Ampl Jy Top frame: Phas deg  
Vector averaged cross-power spectrum Baseline: EF (01) - JB (02)  
Timerange: 00/04:33:10 to 00/04:36:40

Plot file version 197 created 24-NOV-2017 10:10:24

ARUMA EG096D.UVDATA.1

Freq = 4.7990 GHz, Bw = 32.000 MH No calibration applied and no bandpass applied

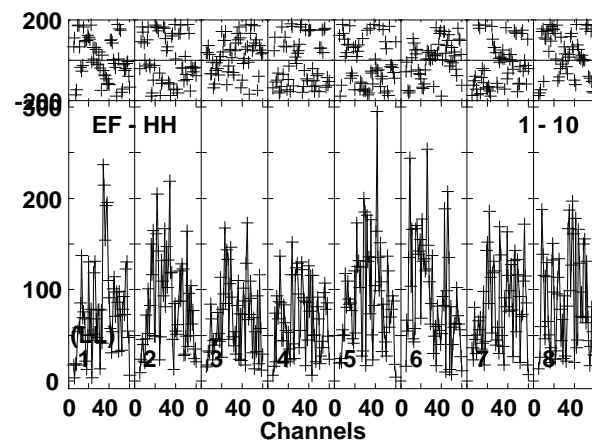
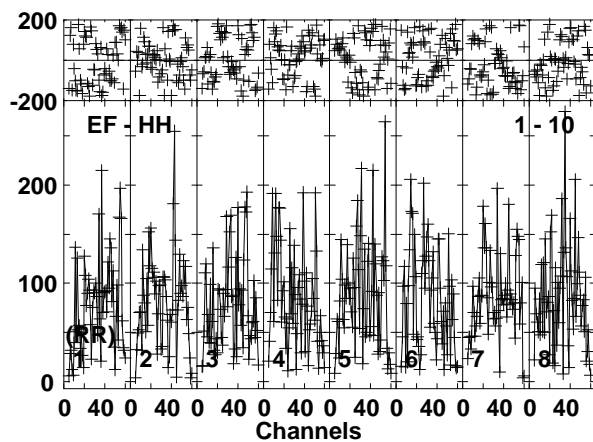
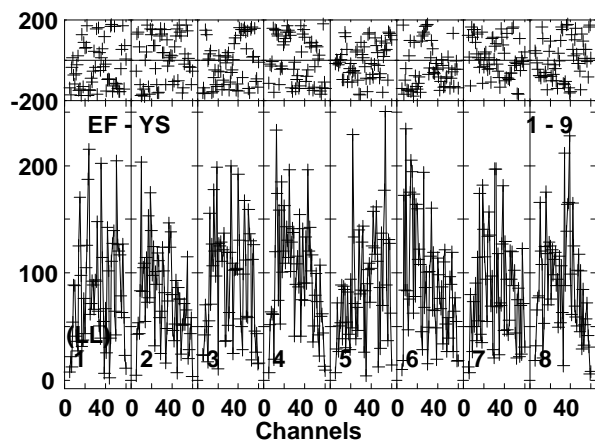
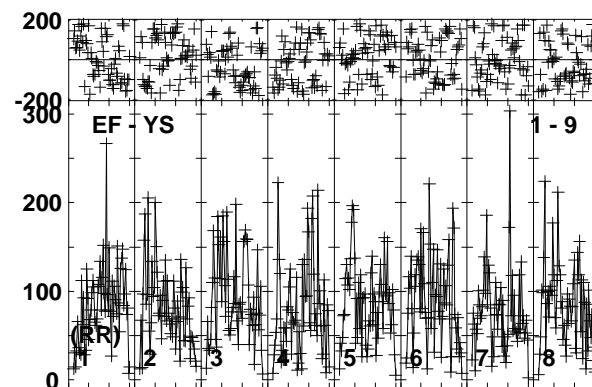
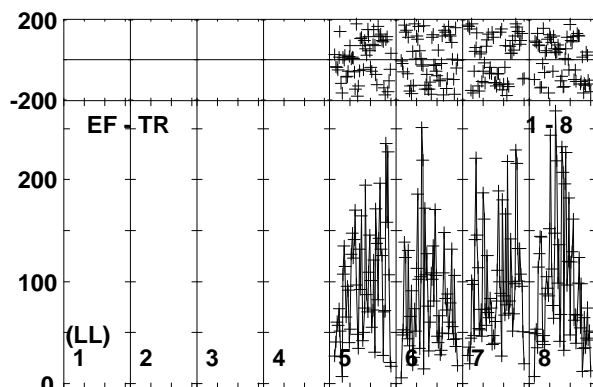
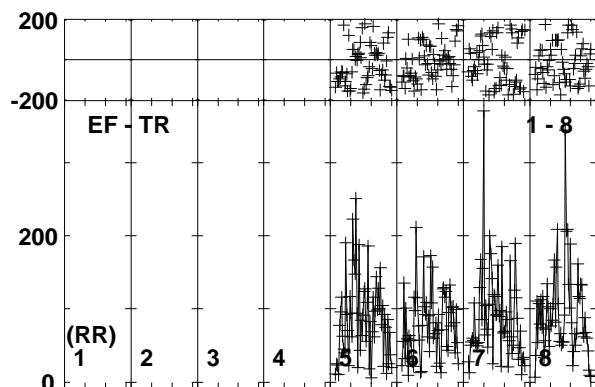
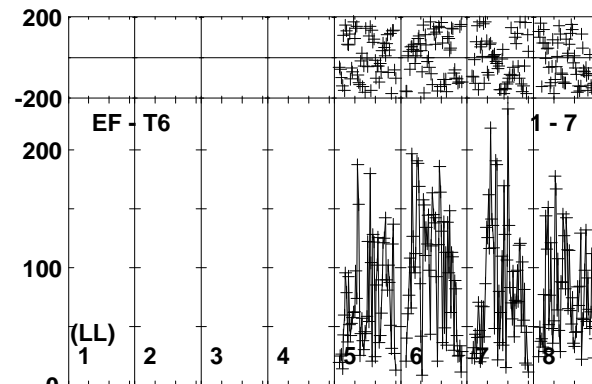
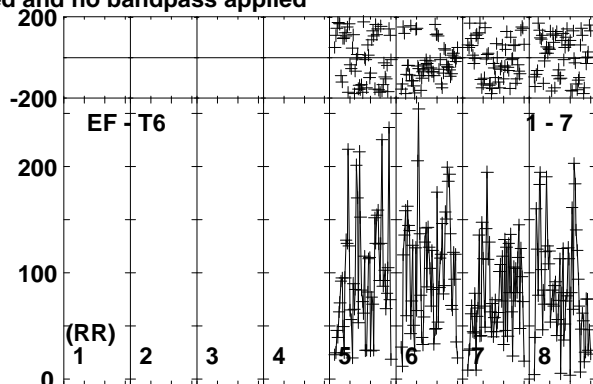
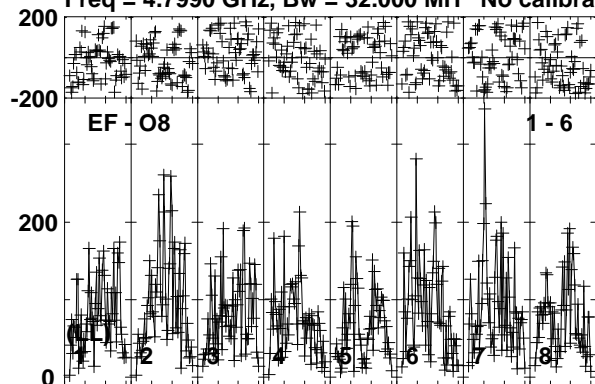

Lower frame: Micro Ampl Jy Top frame: Phas deg  
Vector averaged cross-power spectrum Baseline: EF (01) - O8 (06)  
Timerange: 00/04:33:10 to 00/04:36:40

Plot file version 198 created 24-NOV-2017 10:10:24  
ARUMA EG096D.UVDATA.1  
Freq = 4.7990 GHz, Bw = 32.000 MH No calibration applied and no bandpass applied

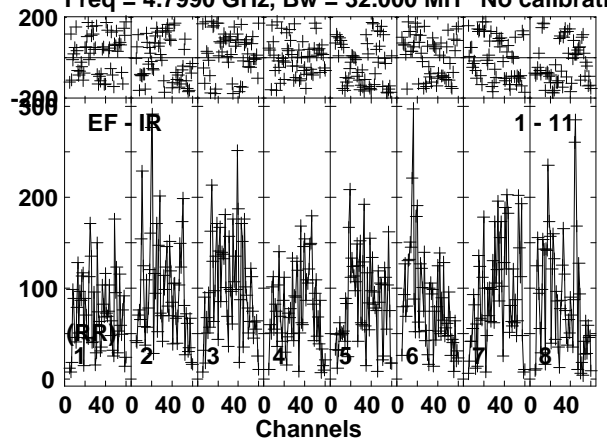

Lower frame: Micro Ampl Jy Top frame: Phas deg  
Vector averaged cross-power spectrum Baseline: EF (01) - IR (11)  
Timerange: 00/04:33:10 to 00/04:36:40

Plot file version 199 created 24-NOV-2017 10:10:24

J1108+4330 EG096D.UVDATA.1

Freq = 4.7990 GHz, Bw = 32.000 MH No calibration applied and no bandpass applied

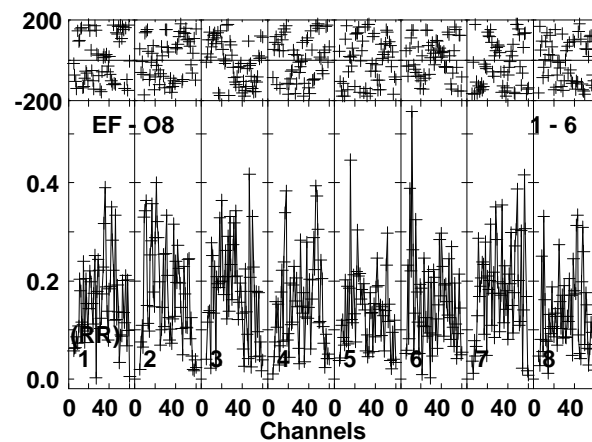
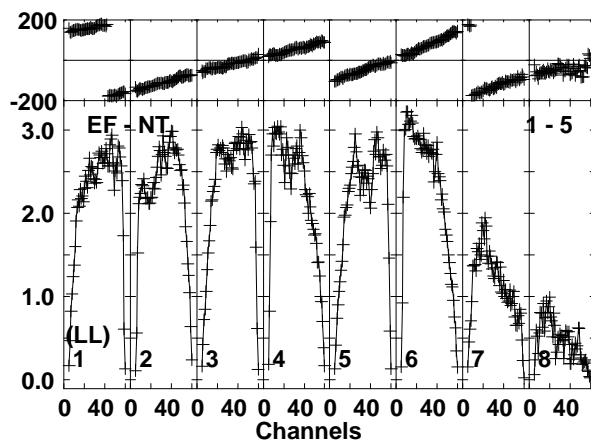
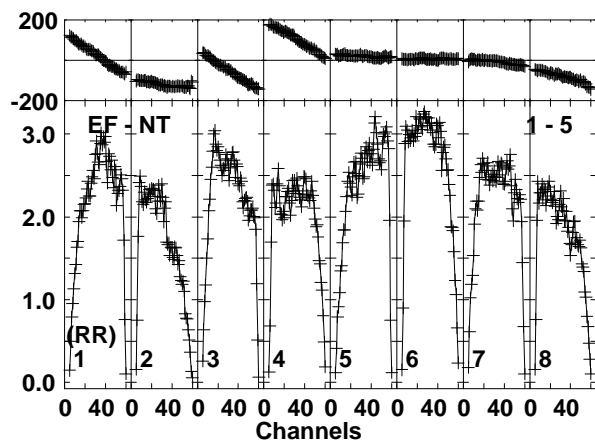
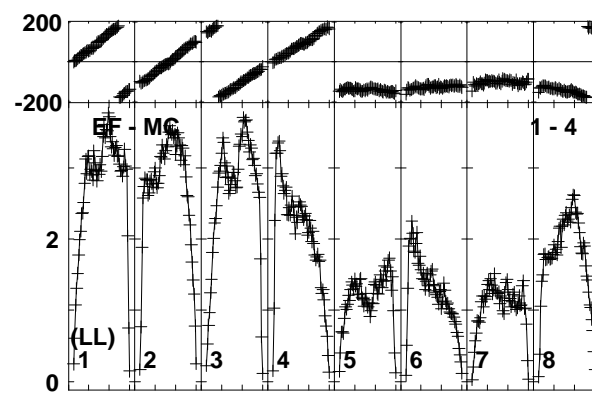
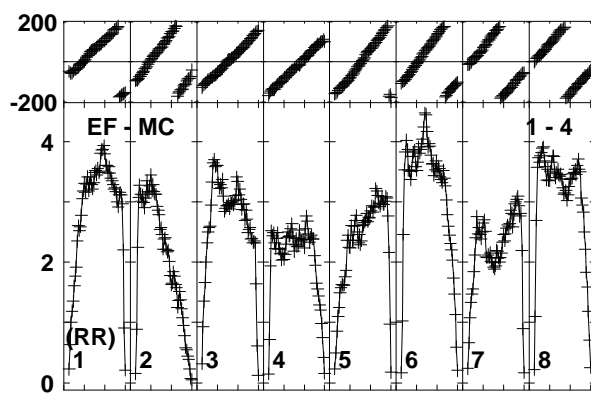
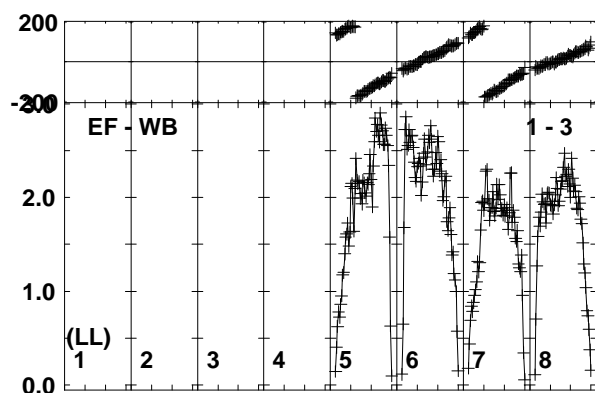
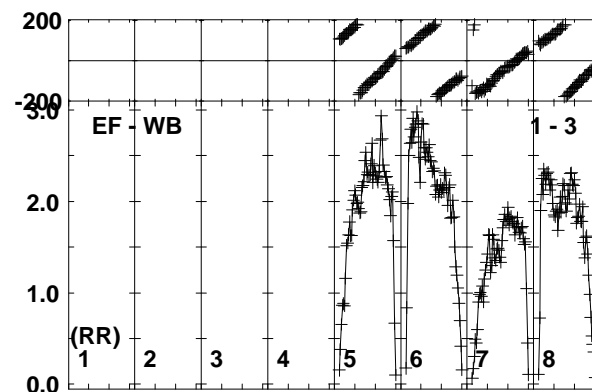
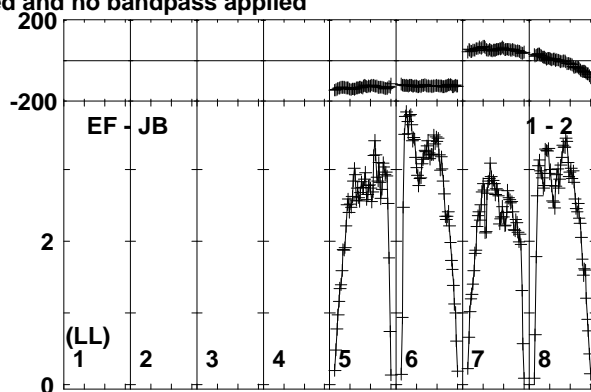
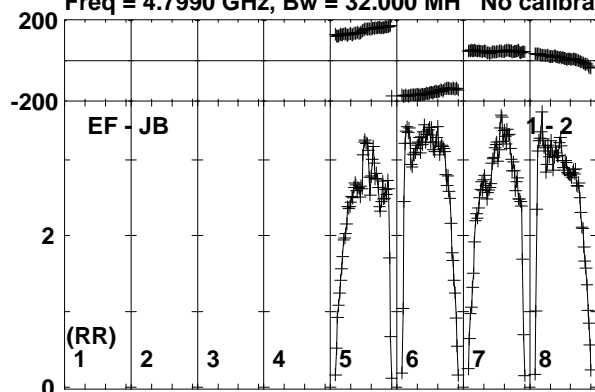

Lower frame: Milli Ampl Jy Top frame: Phas deg  
Vector averaged cross-power spectrum Baseline: EF (01) - JB (02)  
Timerange: 00/04:36:40 to 00/04:38:09

Plot file version 200 created 24-NOV-2017 10:10:24

J1108+4330 EG096D.UVDATA.1

Freq = 4.7990 GHz, Bw = 32.000 MH No calibration applied and no bandpass applied

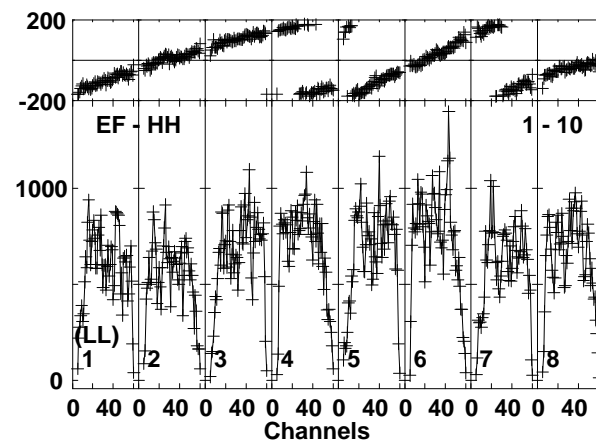
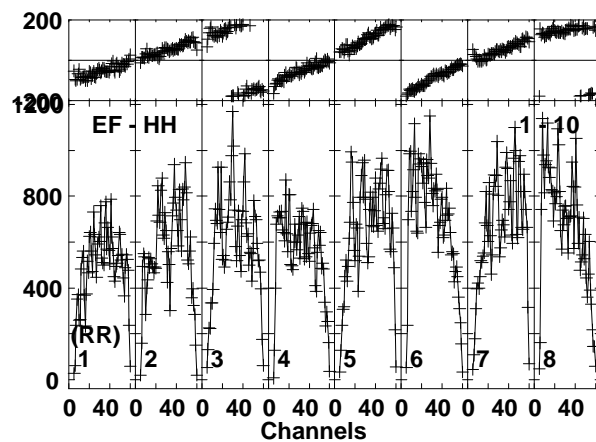
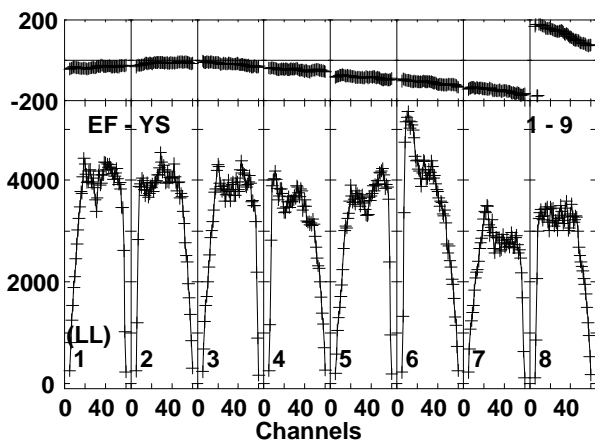
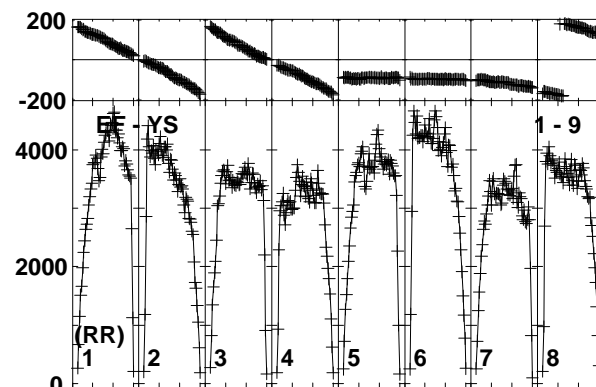
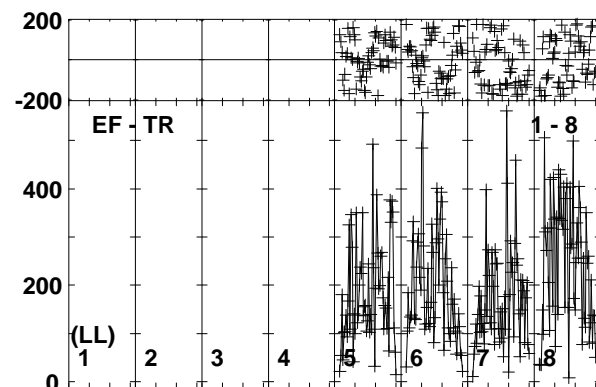
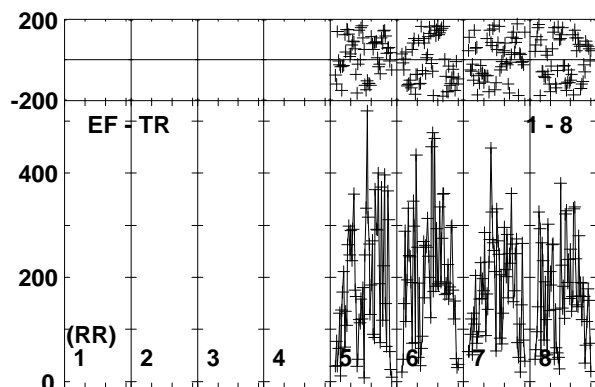
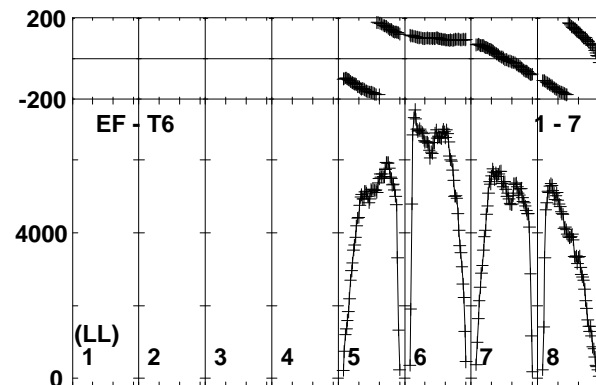
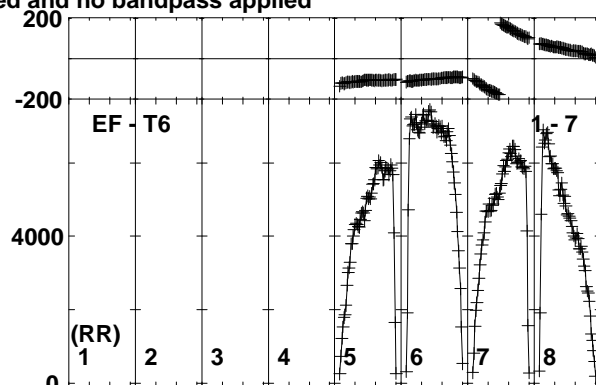
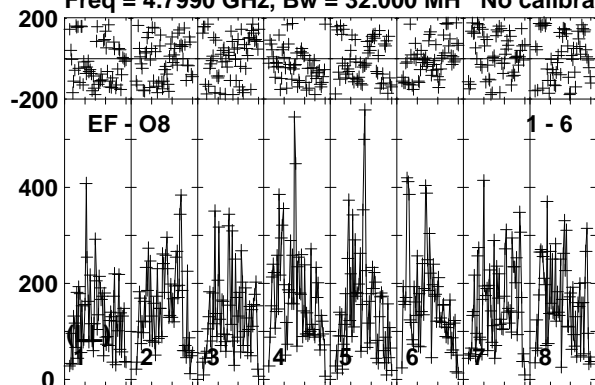

Lower frame: Micro Ampl Jy Top frame: Phas deg  
Vector averaged cross-power spectrum Baseline: EF (01) - O8 (06)  
Timerange: 00/04:36:40 to 00/04:38:09

Plot file version 201 created 24-NOV-2017 10:10:25  
J1108+4330 EG096D.UVDATA.1  
Freq = 4.7990 GHz, Bw = 32.000 MH No calibration applied and no bandpass applied

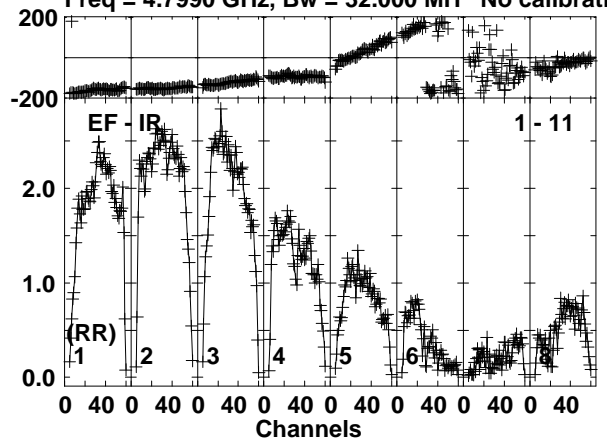

Lower frame: Milli Ampl Jy Top frame: Phas deg  
Vector averaged cross-power spectrum Baseline: EF (01) - IR (11)  
Timerange: 00/04:36:40 to 00/04:38:09

Plot file version 202 created 24-NOV-2017 10:10:25

ARUMA EG096D.UVDATA.1

Freq = 4.7990 GHz, Bw = 32.000 MH No calibration applied and no bandpass applied

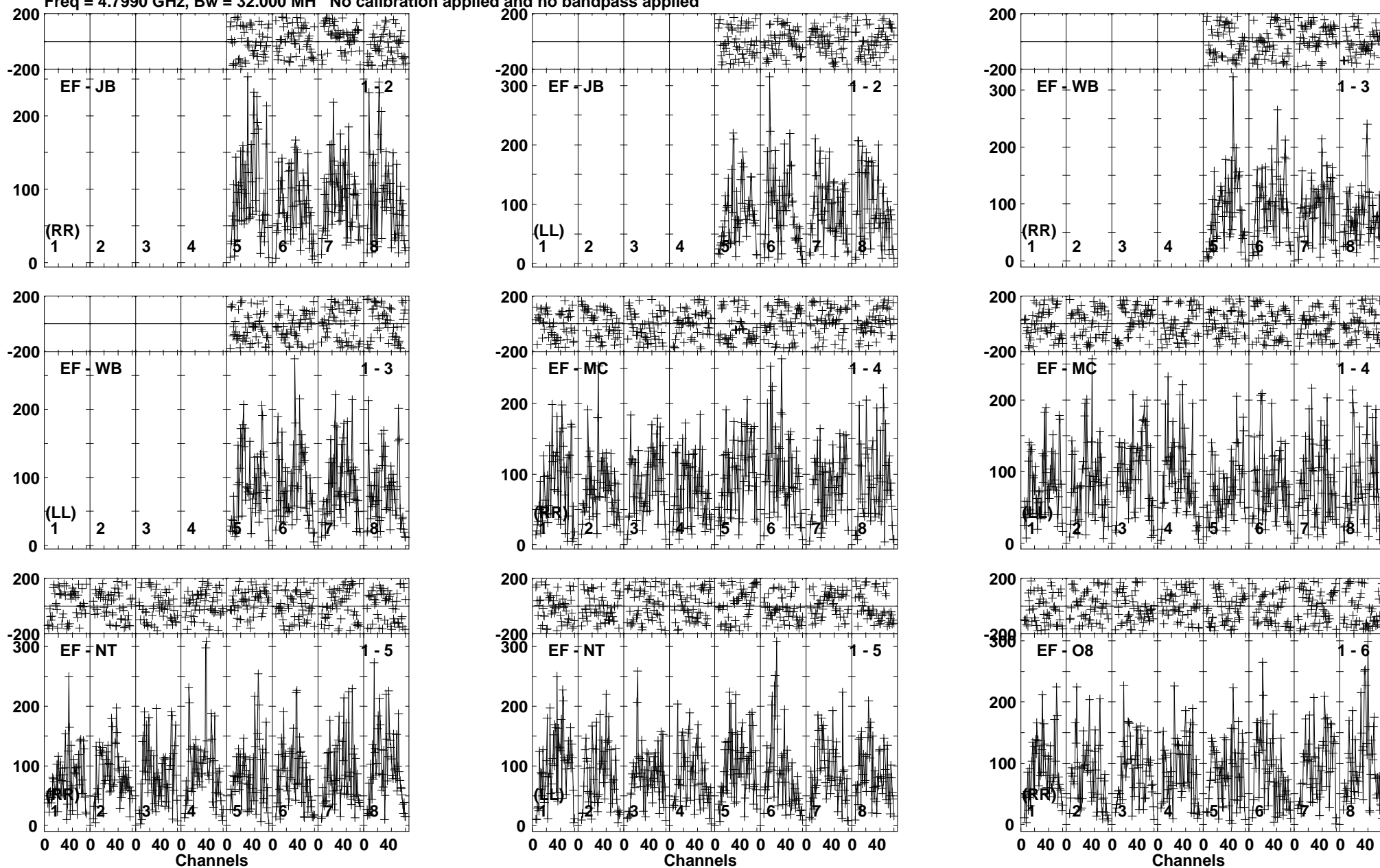

Lower frame: Micro Ampl Jy Top frame: Phas deg  
Vector averaged cross-power spectrum Baseline: EF (01) - JB (02)  
Timerange: 00/04:38:10 to 00/04:41:39



Plot file version 203 created 24-NOV-2017 10:10:25

ARUMA EG096D.UVDATA.1

Freq = 4.7990 GHz, Bw = 32.000 MH No calibration applied and no bandpass applied

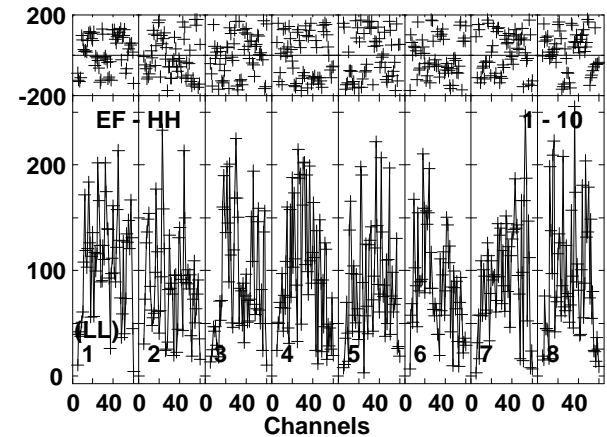
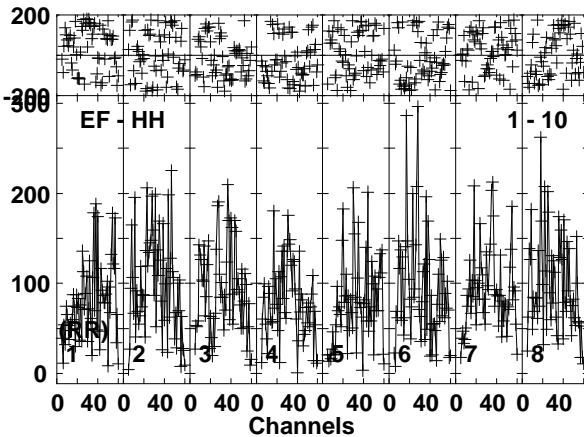
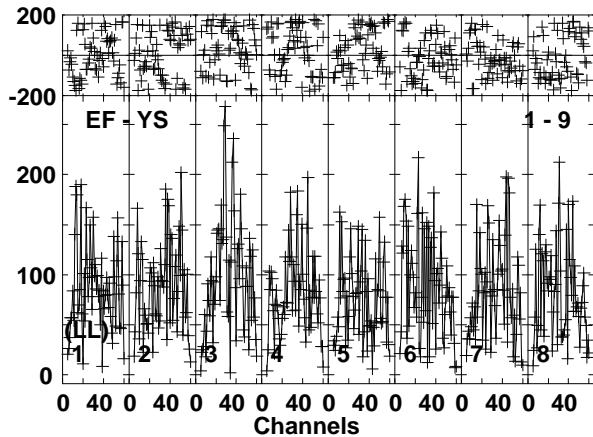
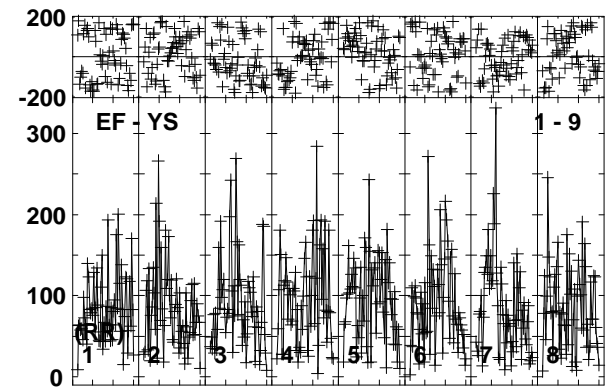
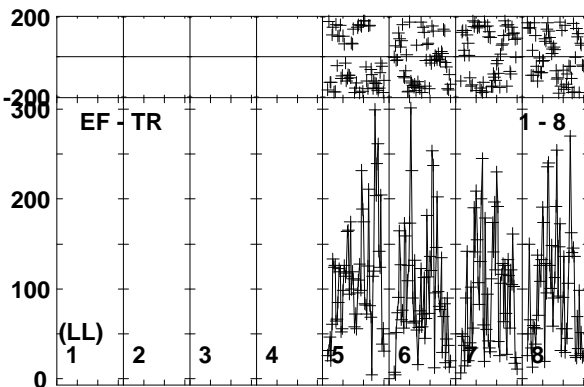
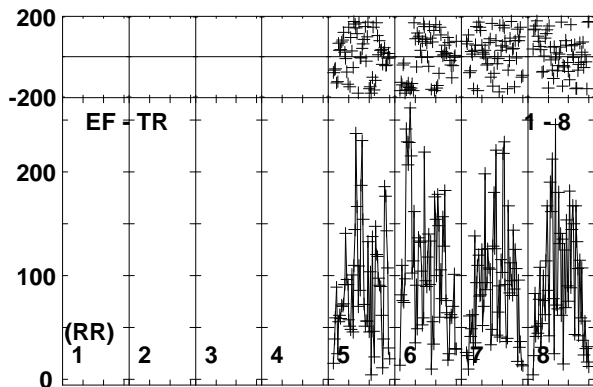
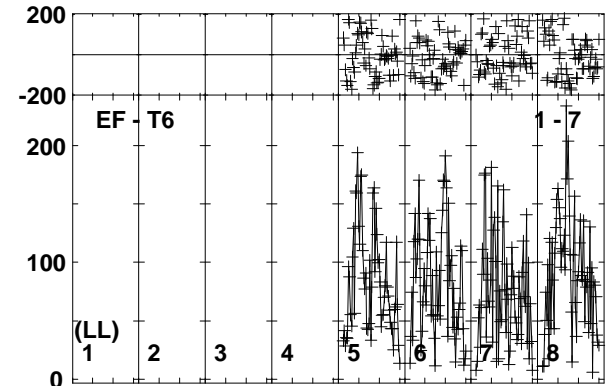
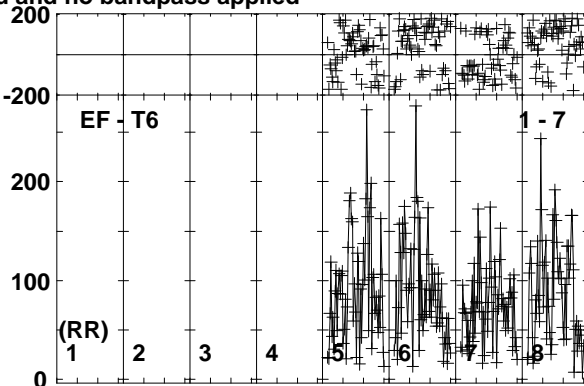
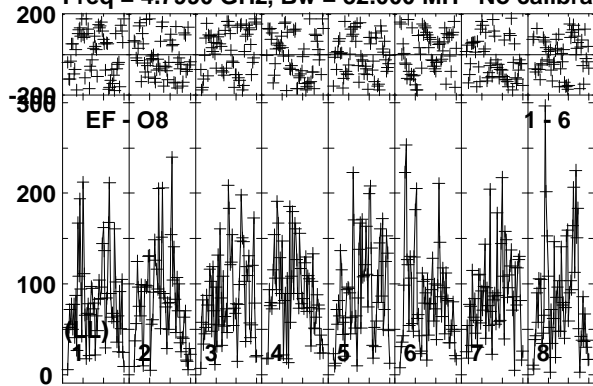

Lower frame: Micro Ampl Jy Top frame: Phas deg  
Vector averaged cross-power spectrum Baseline: EF (01) - O8 (06)  
Timerange: 00/04:38:10 to 00/04:41:39

Plot file version 204 created 24-NOV-2017 10:10:26  
ARUMA EG096D.UVDATA.1  
Freq = 4.7990 GHz, Bw = 32.000 MH No calibration applied and no bandpass applied

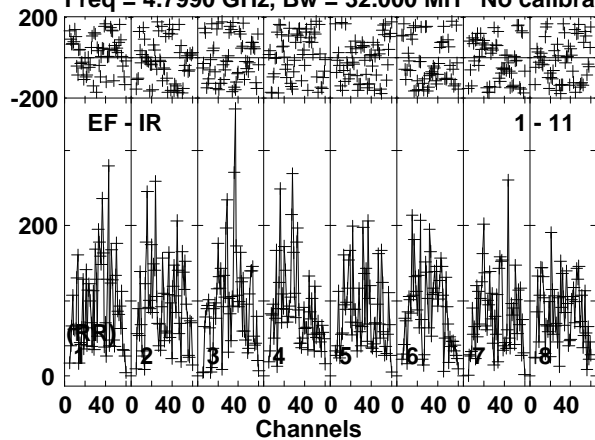

Lower frame: Micro Ampl Jy Top frame: Phas deg  
Vector averaged cross-power spectrum Baseline: EF (01) - IR (11)  
Timerange: 00/04:38:10 to 00/04:41:39

Plot file version 205 created 24-NOV-2017 10:10:26

J1108+4330 EG096D.UVDATA.1

Freq = 4.7990 GHz, Bw = 32.000 MH No calibration applied and no bandpass applied

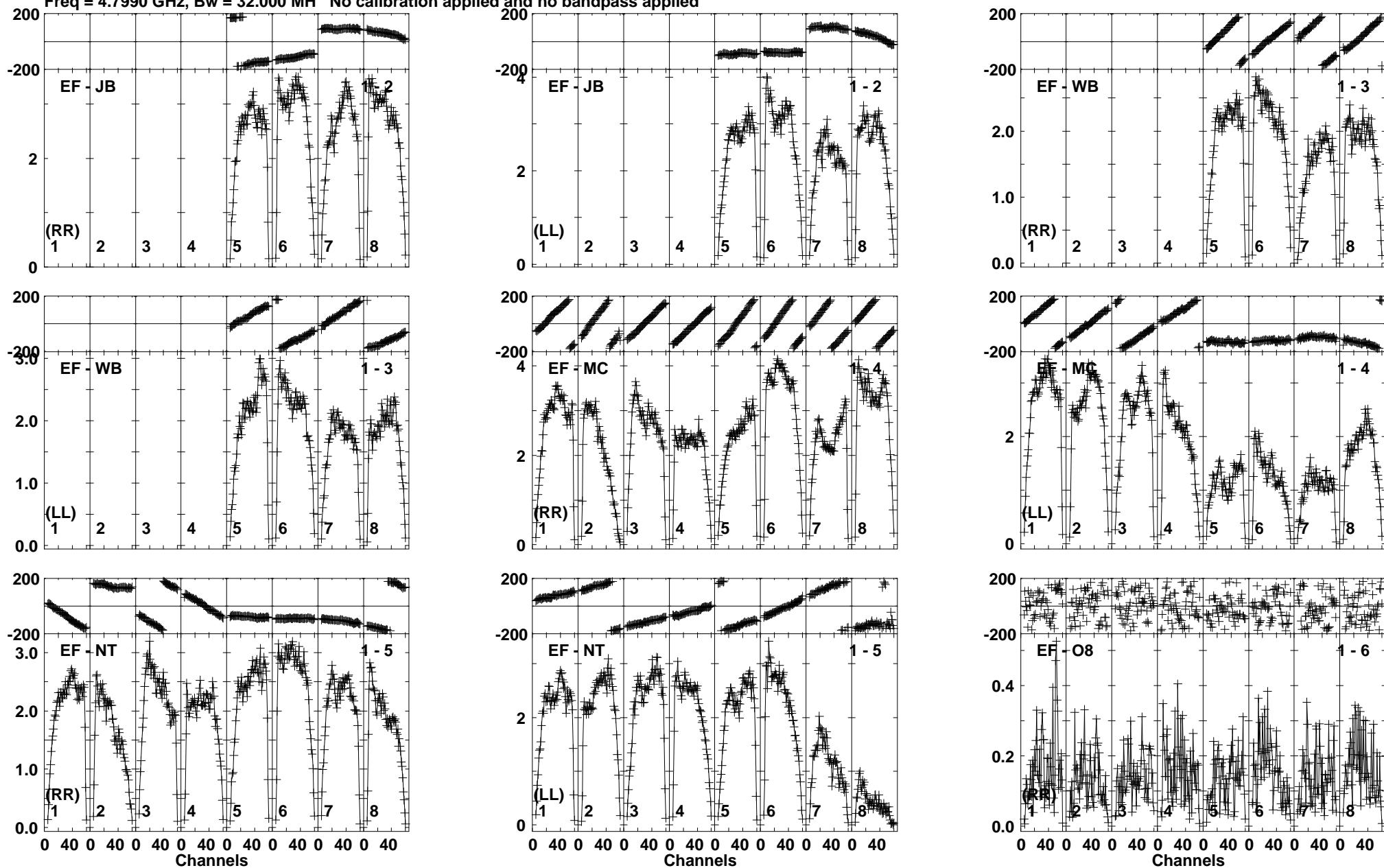

Lower frame: Milli Ampl Jy Top frame: Phas deg  
Vector averaged cross-power spectrum Baseline: EF (01) - JB (02)  
Timerange: 00/04:42:20 to 00/04:43:19

Plot file version 206 created 24-NOV-2017 10:10:26

J1108+4330 EG096D.UVDATA.1

Freq = 4.7990 GHz, Bw = 32.000 MH No calibration applied and no bandpass applied

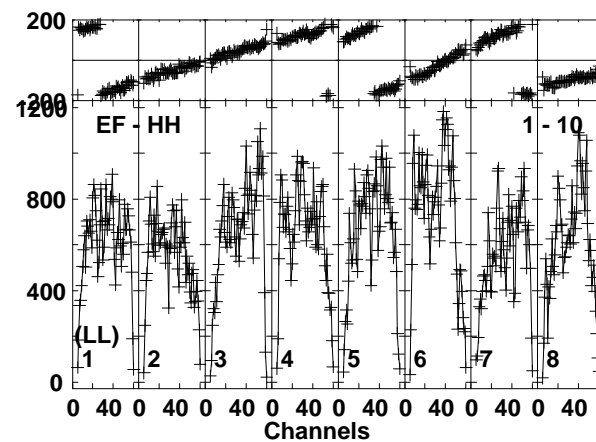
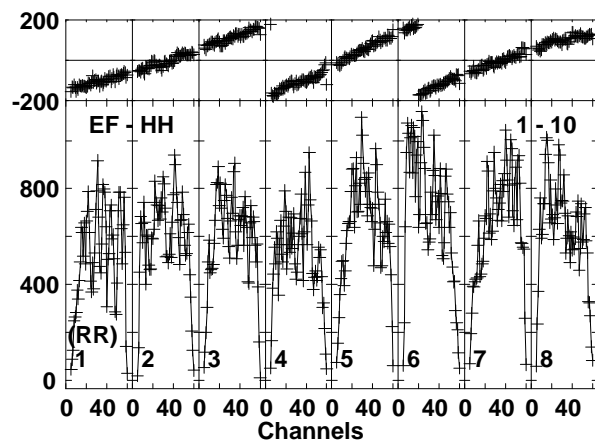
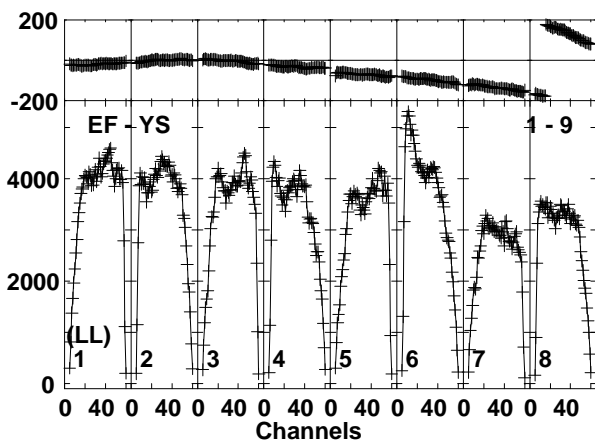
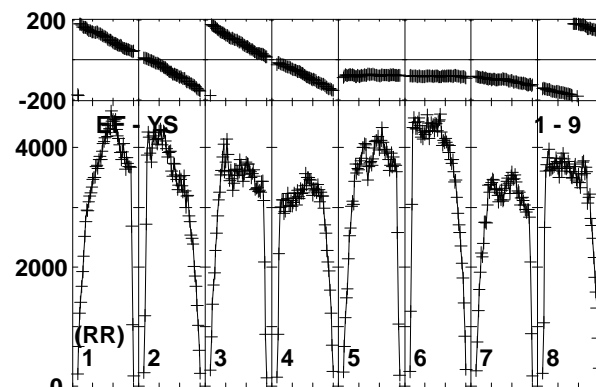
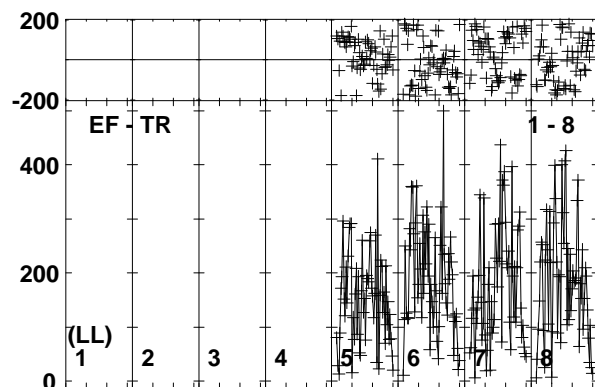
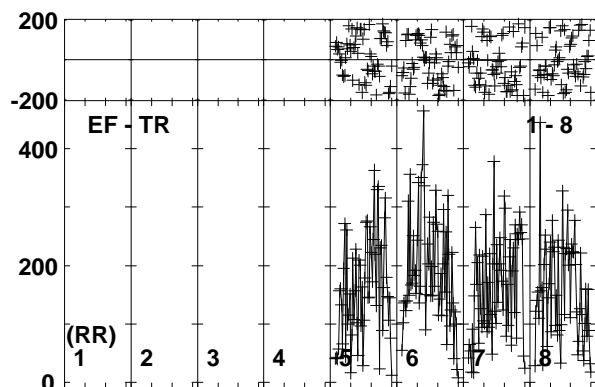
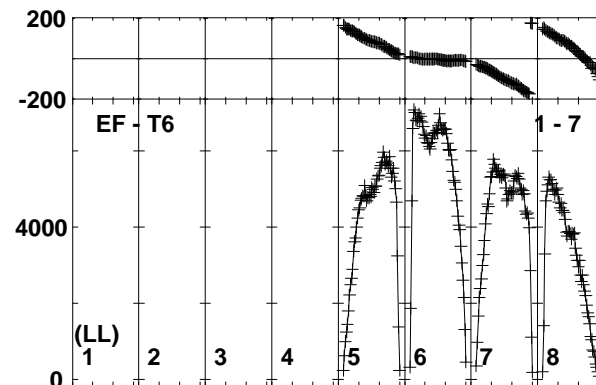
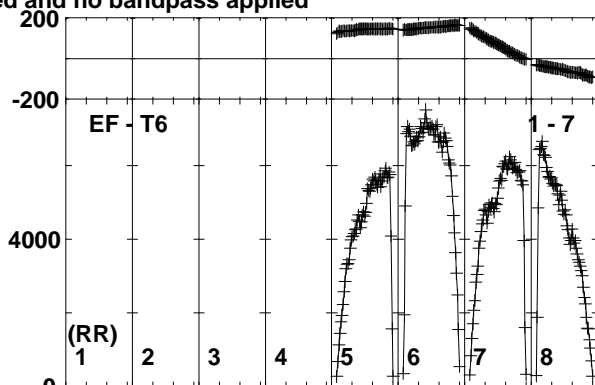
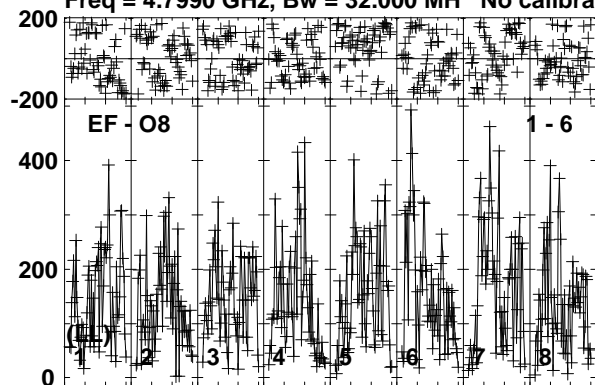

Lower frame: Micro Ampl Jy Top frame: Phas deg  
Vector averaged cross-power spectrum Baseline: EF (01) - O8 (06)  
Timerange: 00/04:42:20 to 00/04:43:19

Plot file version 207 created 24-NOV-2017 10:10:26

J1108+4330 EG096D.UVDATA.1

Freq = 4.7990 GHz, Bw = 32.000 MH No calibration applied and no bandpass applied

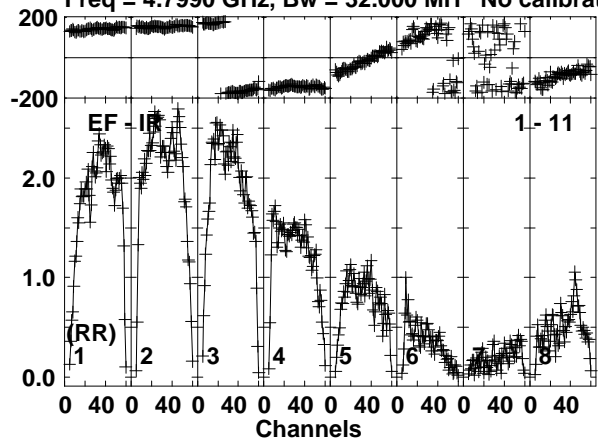

Lower frame: Milli Ampl Jy Top frame: Phas deg  
Vector averaged cross-power spectrum Baseline: EF (01) - IR (11)  
Timerange: 00/04:42:20 to 00/04:43:19

Plot file version 208 created 24-NOV-2017 10:10:26

ARUMA EG096D.UVDATA.1

Freq = 4.7990 GHz, Bw = 32.000 MH No calibration applied and no bandpass applied

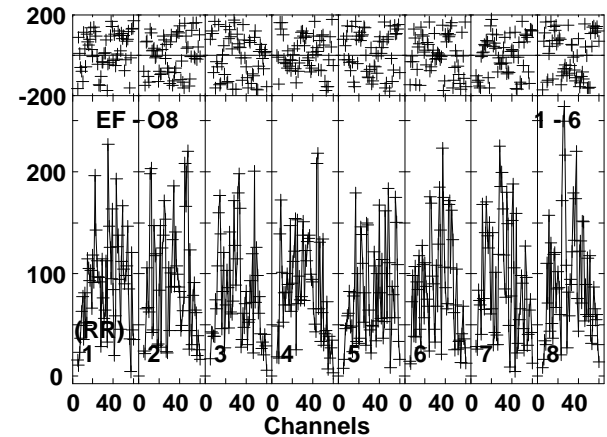
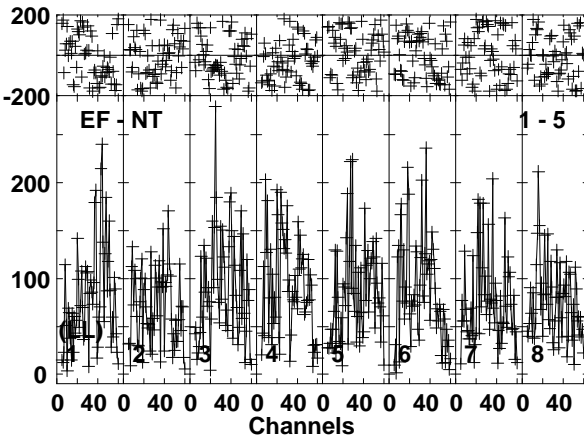
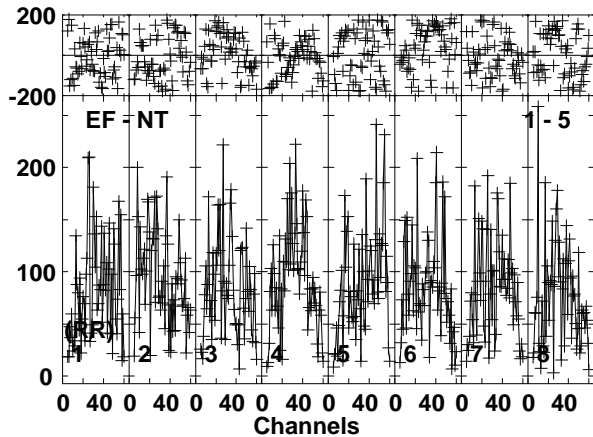
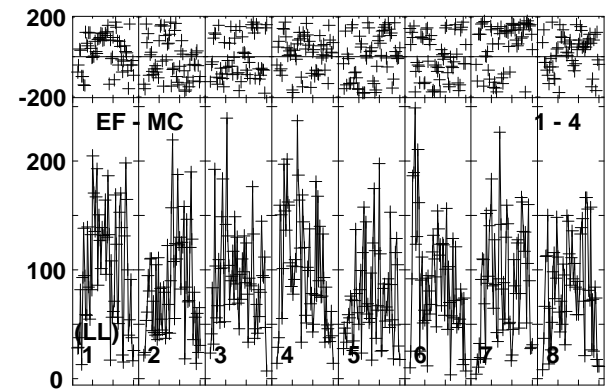
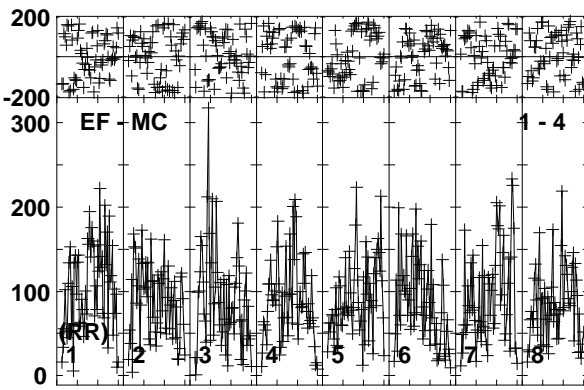
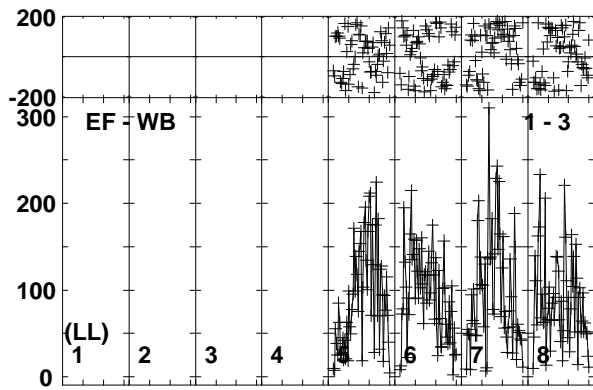
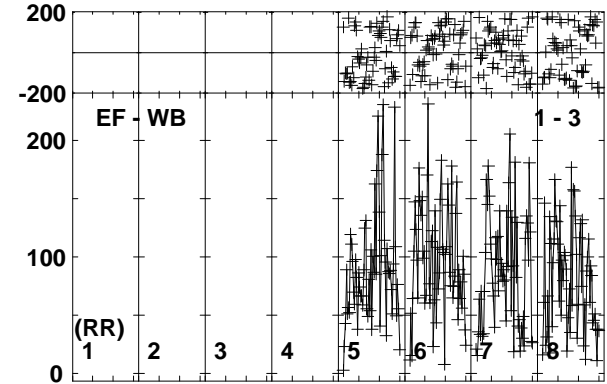
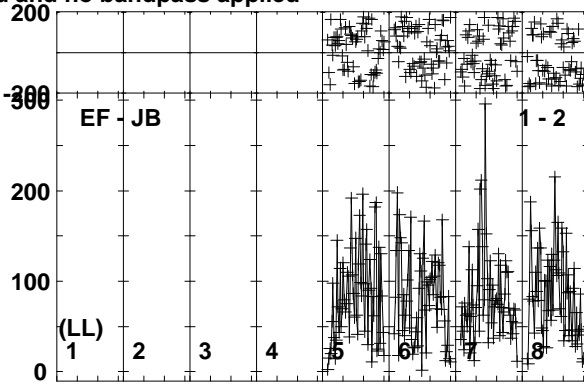
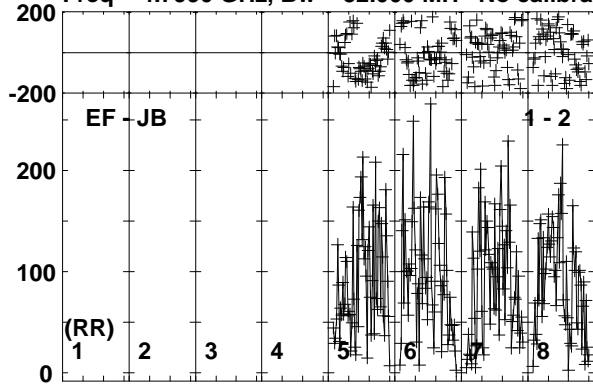

Lower frame: Micro Ampl Jy Top frame: Phas deg  
Vector averaged cross-power spectrum Baseline: EF (01) - JB (02)  
Timerange: 00/04:43:20 to 00/04:46:49

Plot file version 209 created 24-NOV-2017 10:10:27

ARUMA EG096D.UVDATA.1

Freq = 4.7990 GHz, Bw = 32.000 MH No calibration applied and no bandpass applied

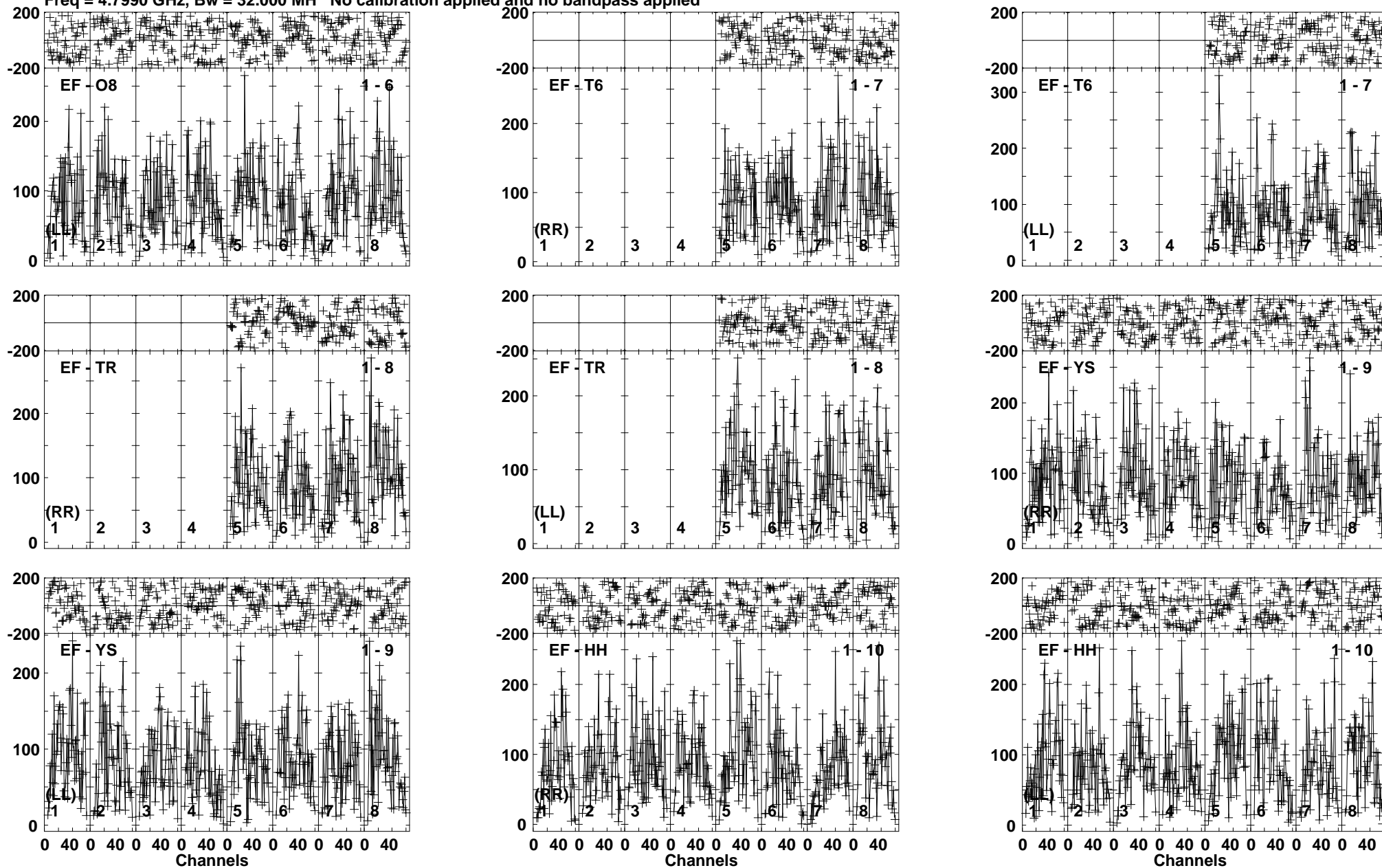

Lower frame: Micro Ampl Jy Top frame: Phas deg  
Vector averaged cross-power spectrum Baseline: EF (01) - O8 (06)  
Timerange: 00/04:43:20 to 00/04:46:49

Plot file version 210 created 24-NOV-2017 10:10:27  
ARUMA EG096D.UVDATA.1  
Freq = 4.7990 GHz, Bw = 32.000 MH No calibration applied and no bandpass applied

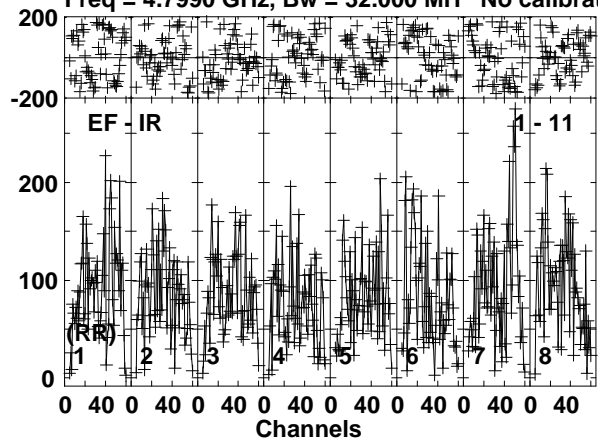

Lower frame: Micro Ampl Jy Top frame: Phas deg  
Vector averaged cross-power spectrum Baseline: EF (01) - IR (11)  
Timerange: 00/04:43:20 to 00/04:46:49



Plot file version 211 created 24-NOV-2017 10:10:27

J1108+4330 EG096D.UVDATA.1

Freq = 4.7990 GHz, Bw = 32.000 MH No calibration applied and no bandpass applied

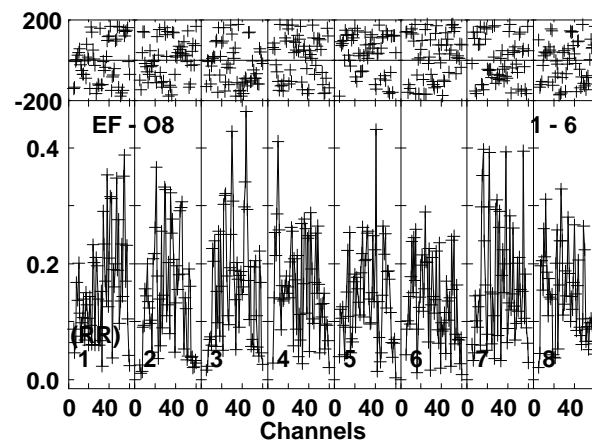
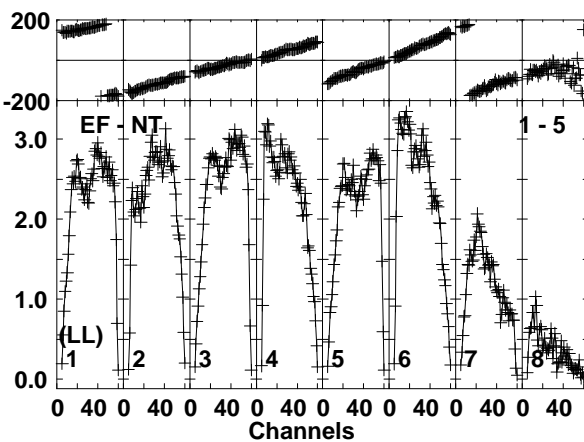
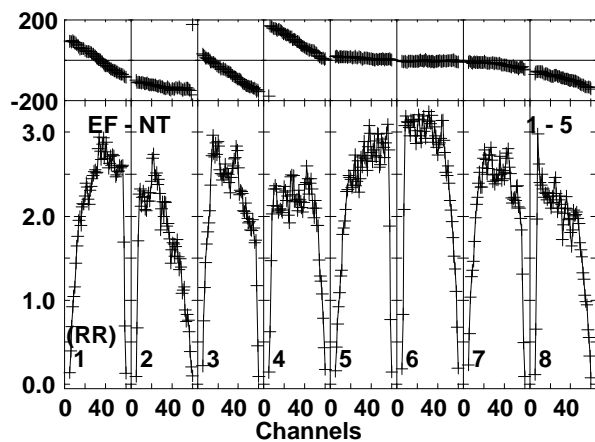
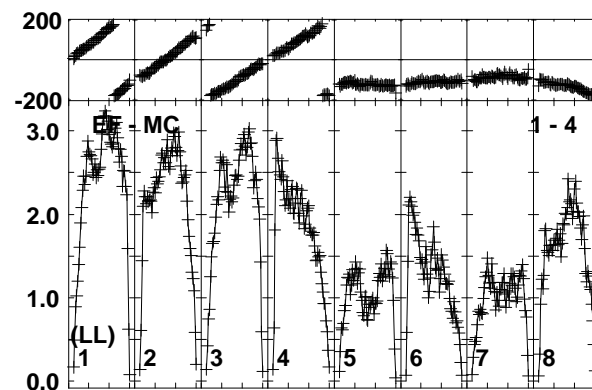
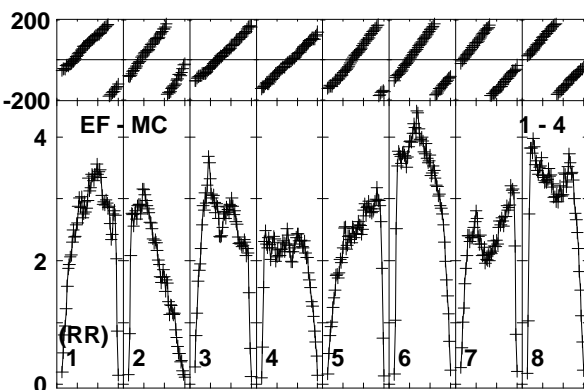
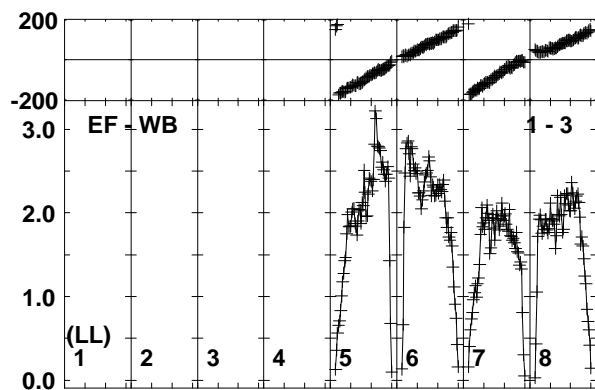
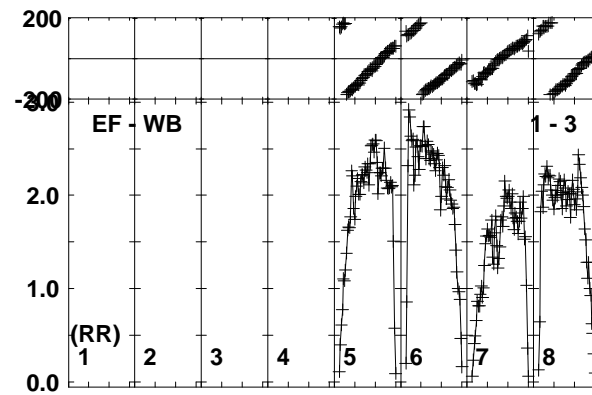
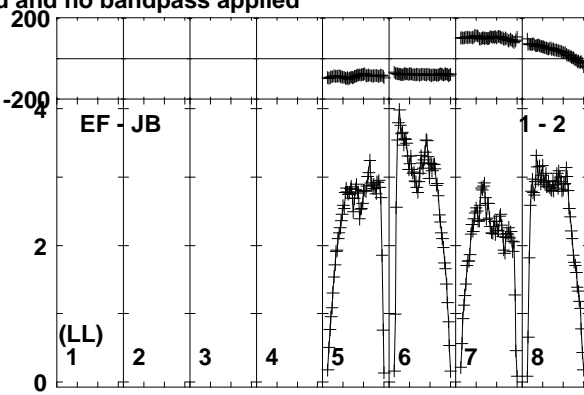
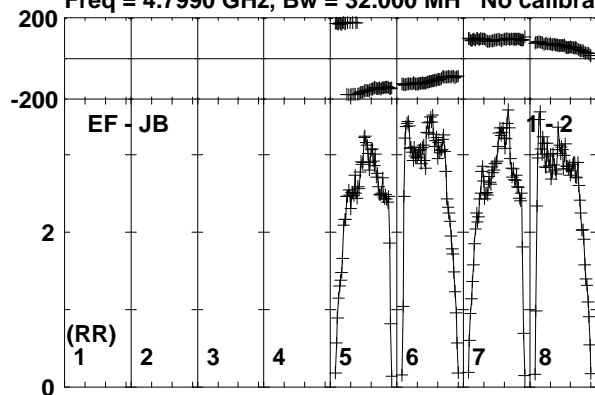

Lower frame: Milli Ampl Jy Top frame: Phas deg  
Vector averaged cross-power spectrum Baseline: EF (01) - JB (02)  
Timerange: 00/04:46:51 to 00/04:48:19

Plot file version 212 created 24-NOV-2017 10:10:27

J1108+4330 EG096D.UVDATA.1

Freq = 4.7990 GHz, Bw = 32.000 MH No calibration applied and no bandpass applied

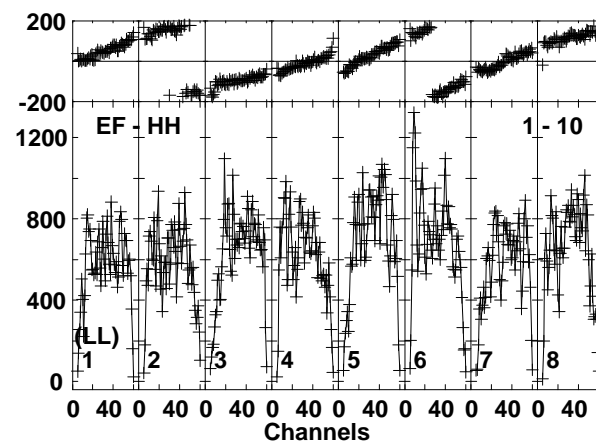
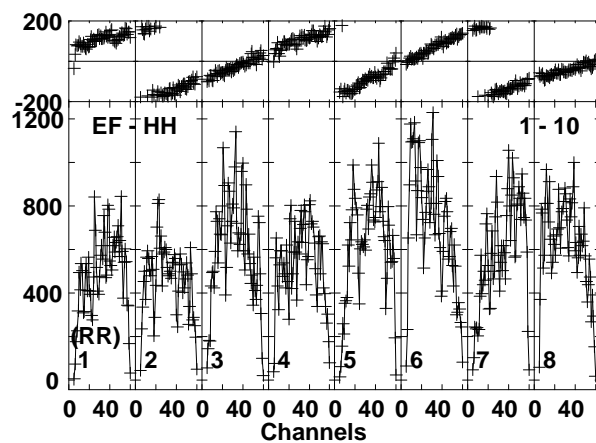
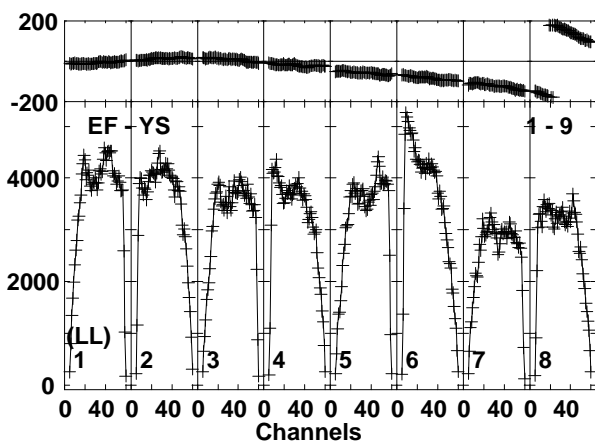
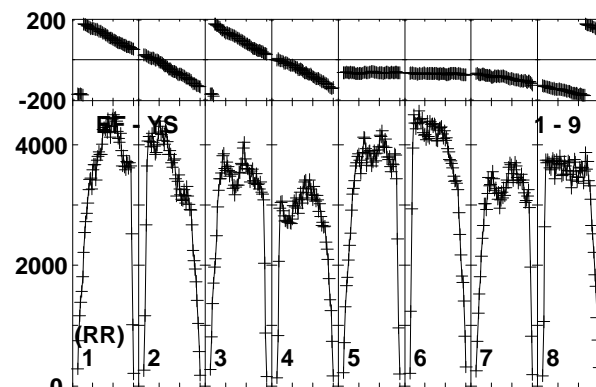
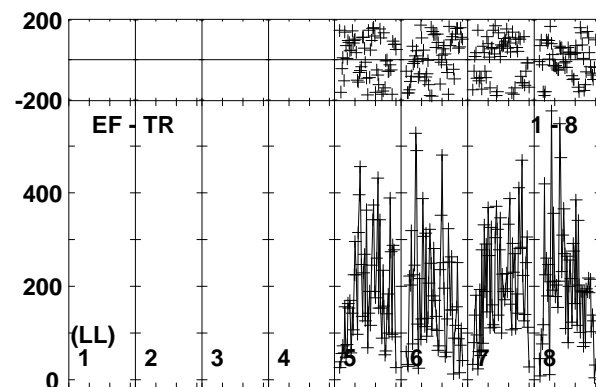
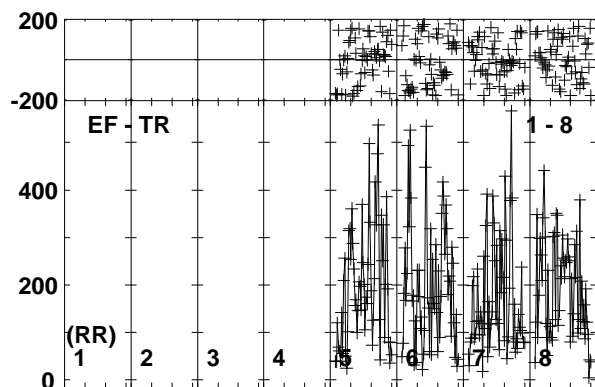
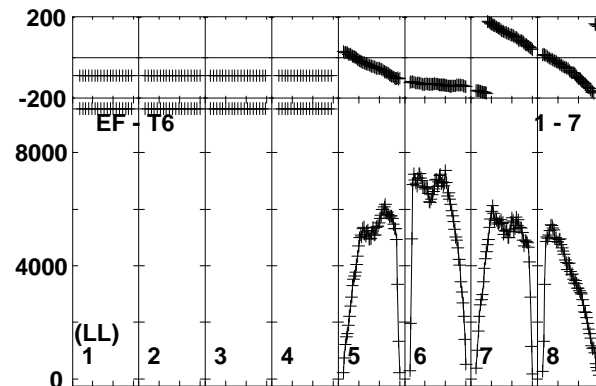
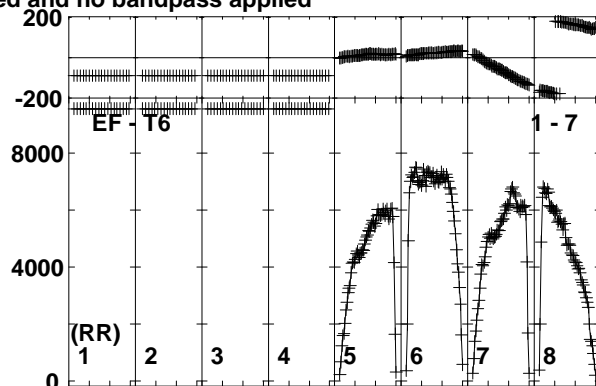
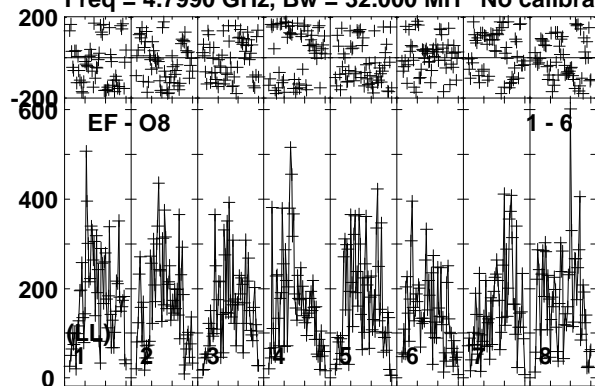

Lower frame: Micro Ampl Jy Top frame: Phas deg  
Vector averaged cross-power spectrum Baseline: EF (01) - O8 (06)  
Timerange: 00/04:46:51 to 00/04:48:19

Plot file version 213 created 24-NOV-2017 10:10:28

J1108+4330 EG096D.UVDATA.1

Freq = 4.7990 GHz, Bw = 32.000 MH No calibration applied and no bandpass applied

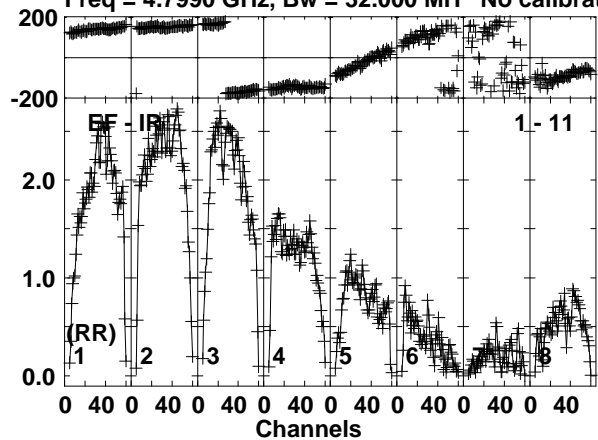

Lower frame: Milli Ampl Jy Top frame: Phas deg

Vector averaged cross-power spectrum Baseline: EF (01) - IR (11)

Timerange: 00/04:46:51 to 00/04:48:19

Plot file version 214 created 24-NOV-2017 10:10:28

ARUMA EG096D.UVDATA.1

Freq = 4.7990 GHz, Bw = 32.000 MH No calibration applied and no bandpass applied

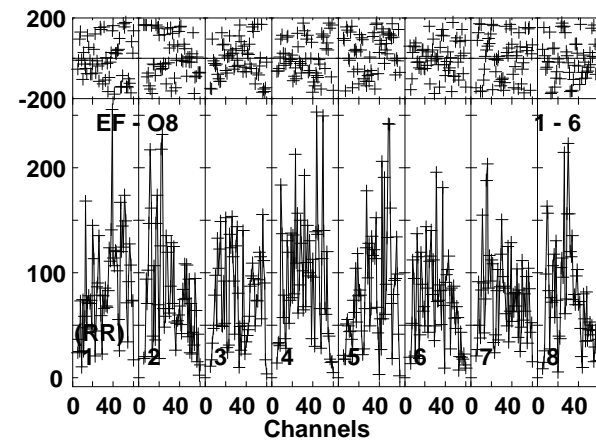
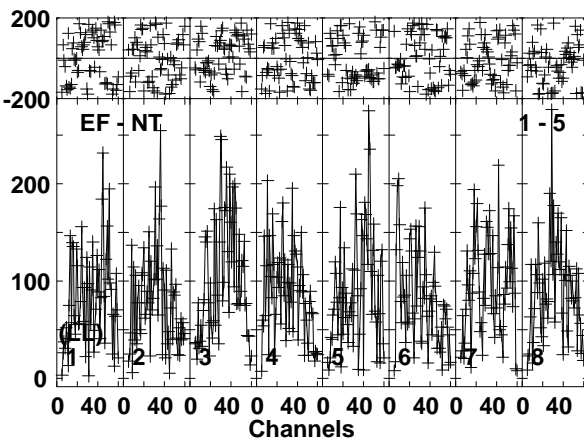
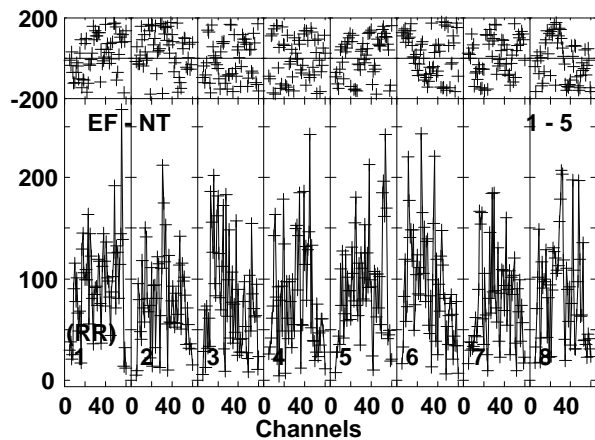
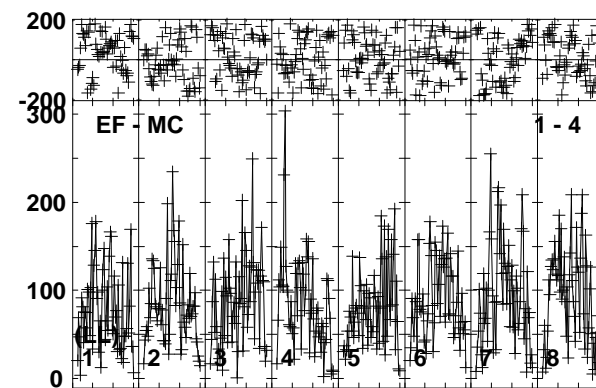
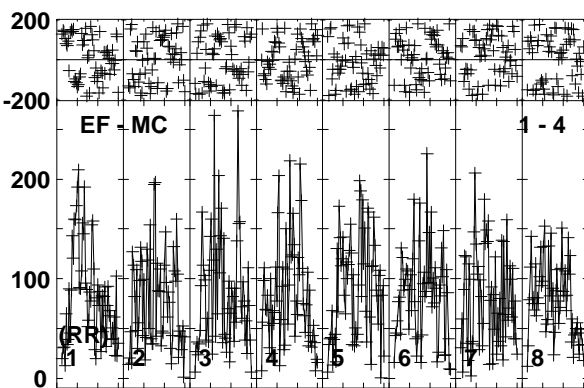
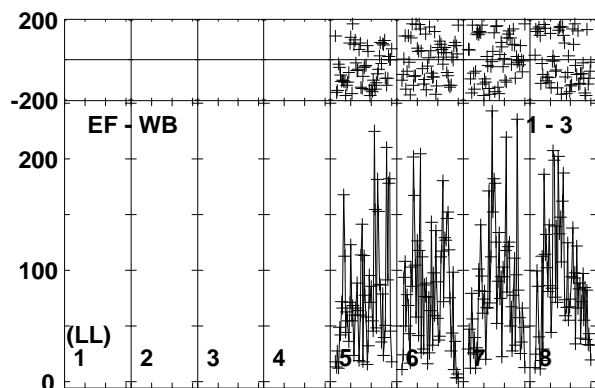
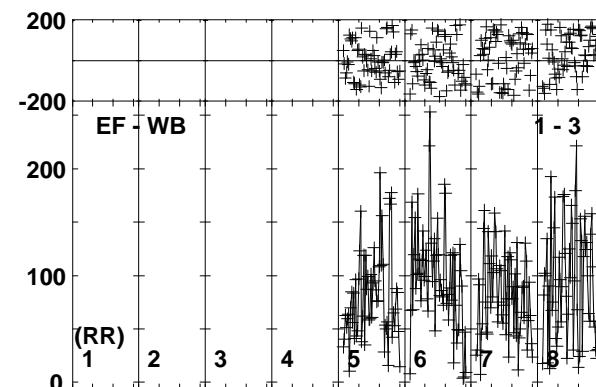
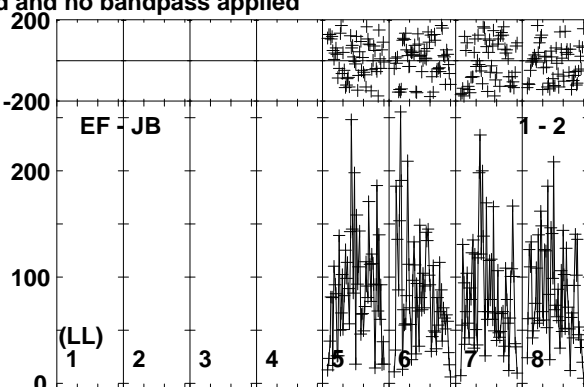
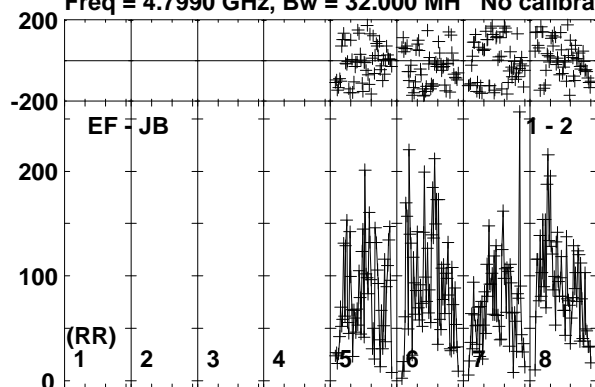

Lower frame: Micro Ampl Jy Top frame: Phas deg  
Vector averaged cross-power spectrum Baseline: EF (01) - JB (02)  
Timerange: 00/04:48:21 to 00/04:51:50

Plot file version 215 created 24-NOV-2017 10:10:28

ARUMA EG096D.UVDATA.1

Freq = 4.7990 GHz, Bw = 32.000 MH No calibration applied and no bandpass applied

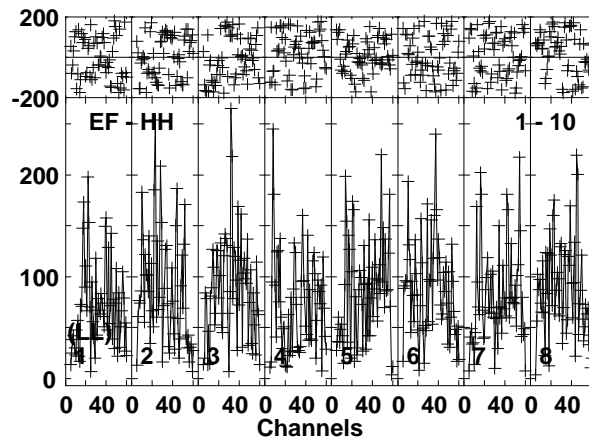
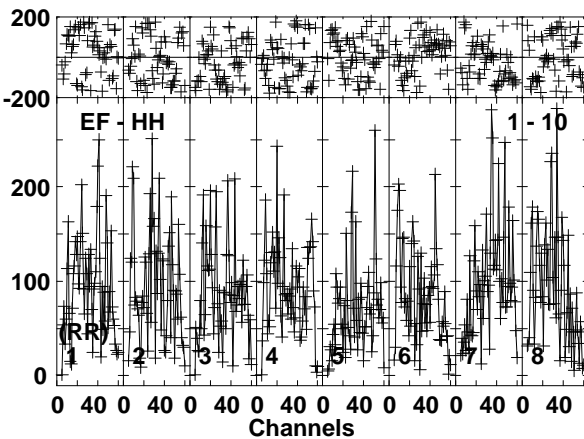
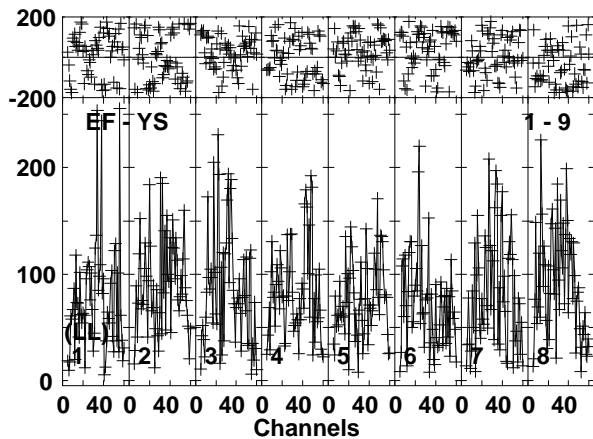
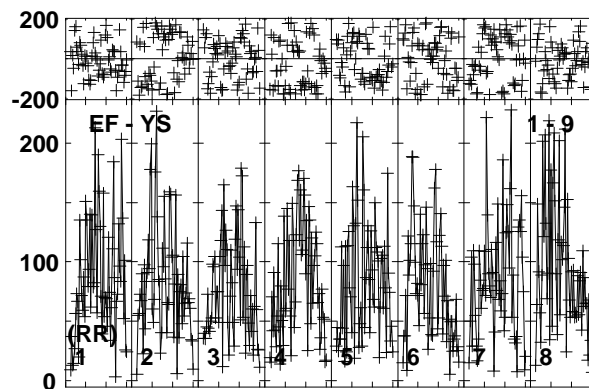
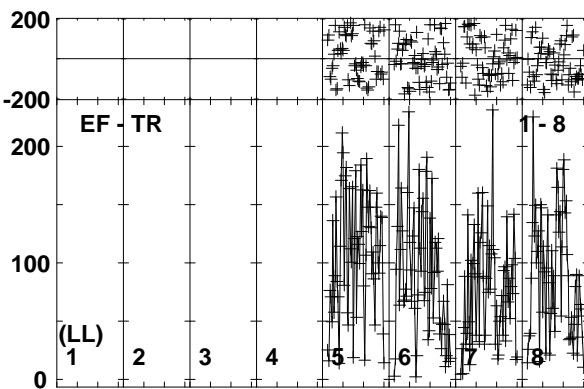
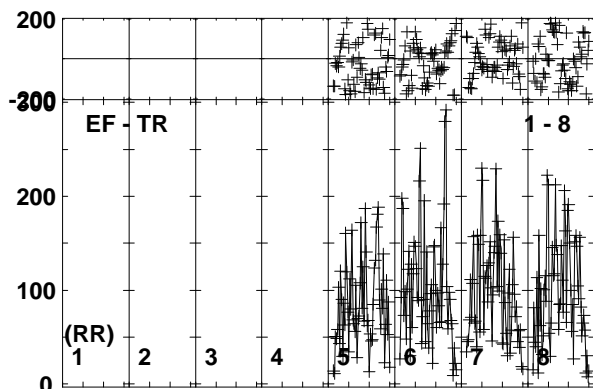
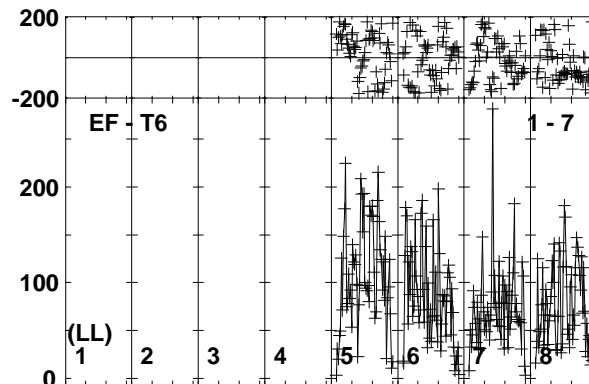
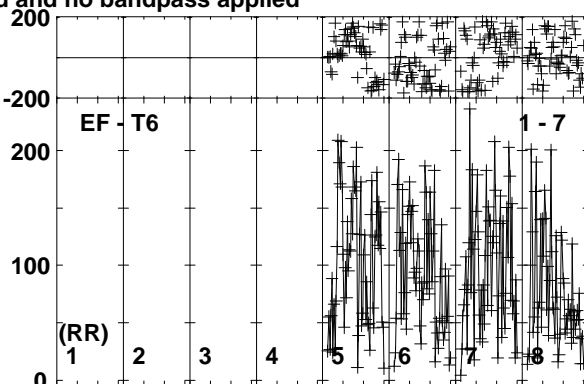
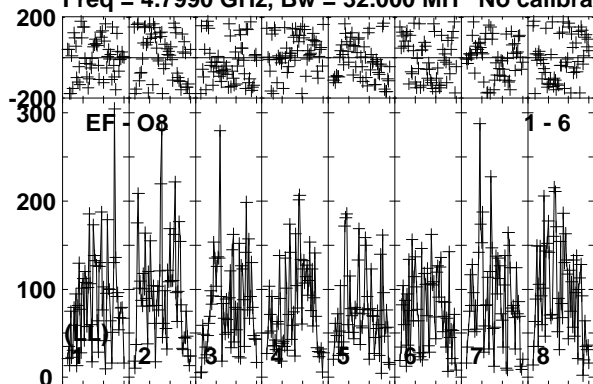

Lower frame: Micro Ampl Jy Top frame: Phas deg  
Vector averaged cross-power spectrum Baseline: EF (01) - O8 (06)  
Timerange: 00/04:48:21 to 00/04:51:50

Plot file version 216 created 24-NOV-2017 10:10:28  
ARUMA EG096D.UVDATA.1  
Freq = 4.7990 GHz, Bw = 32.000 MH No calibration applied and no bandpass applied

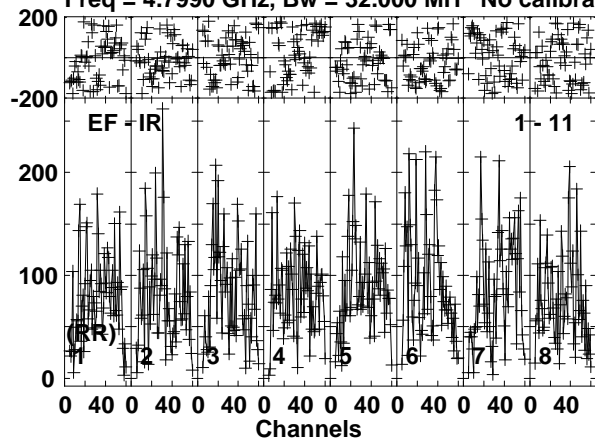

Lower frame: Micro Ampl Jy Top frame: Phas deg  
Vector averaged cross-power spectrum Baseline: EF (01) - IR (11)  
Timerange: 00/04:48:21 to 00/04:51:50

Plot file version 217 created 24-NOV-2017 10:10:28

J1108+4330 EG096D.UVDATA.1

Freq = 4.7990 GHz, Bw = 32.000 MH No calibration applied and no bandpass applied

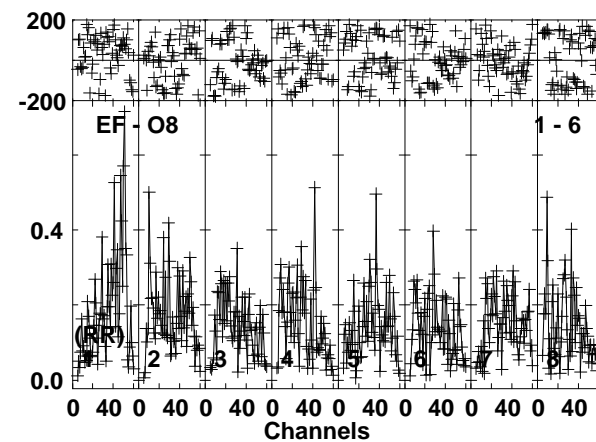
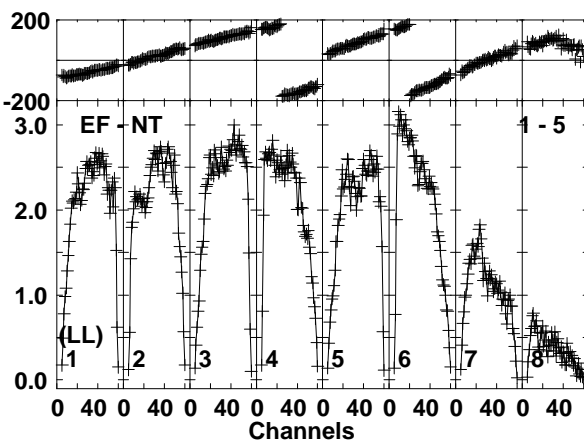
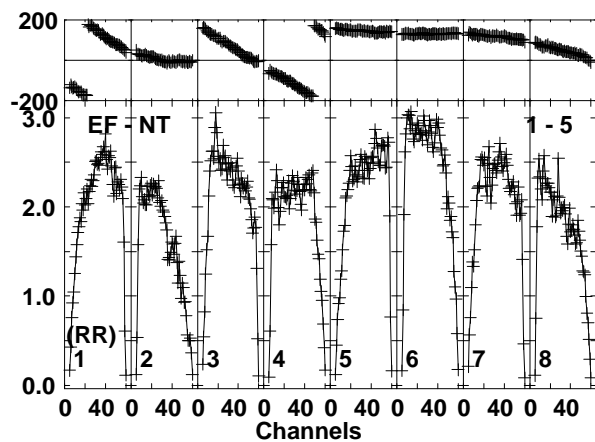
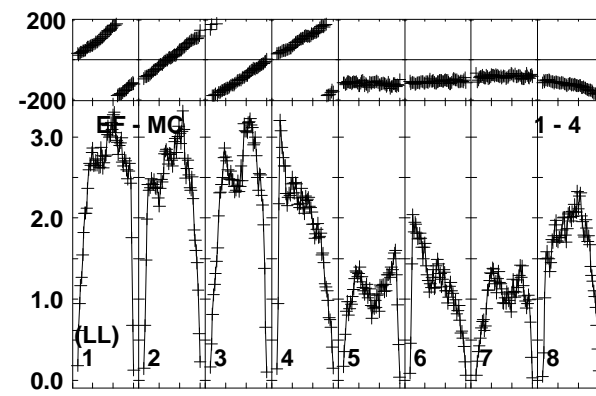
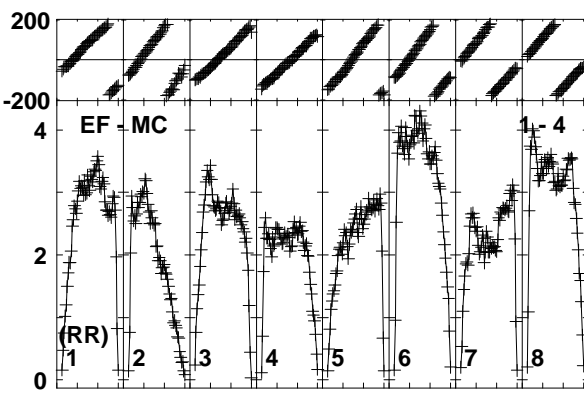
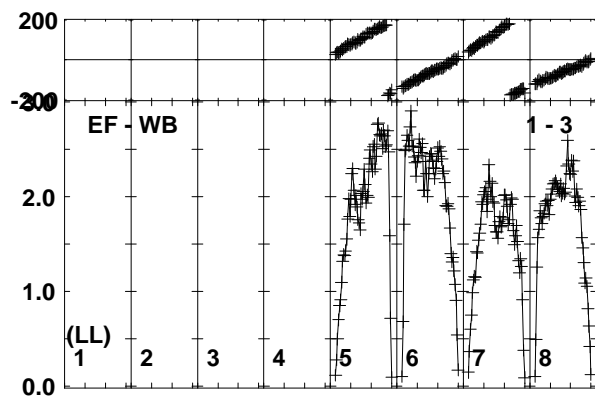
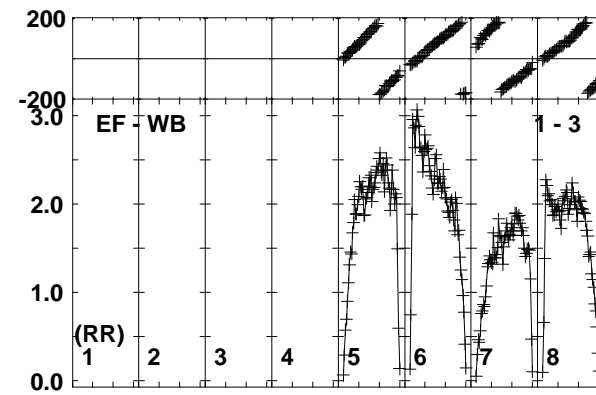
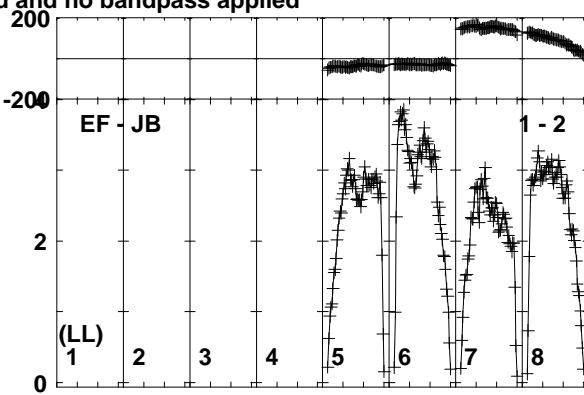
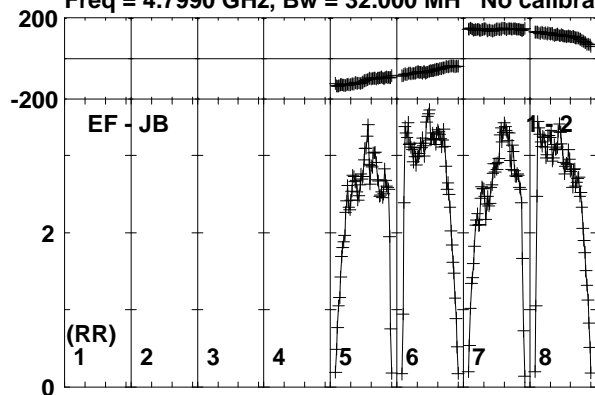

Lower frame: Milli Ampl Jy Top frame: Phas deg  
Vector averaged cross-power spectrum Baseline: EF (01) - JB (02)  
Timerange: 00/04:52:30 to 00/04:53:30

Plot file version 218 created 24-NOV-2017 10:10:29

J1108+4330 EG096D.UVDATA.1

Freq = 4.7990 GHz, Bw = 32.000 MH No calibration applied and no bandpass applied

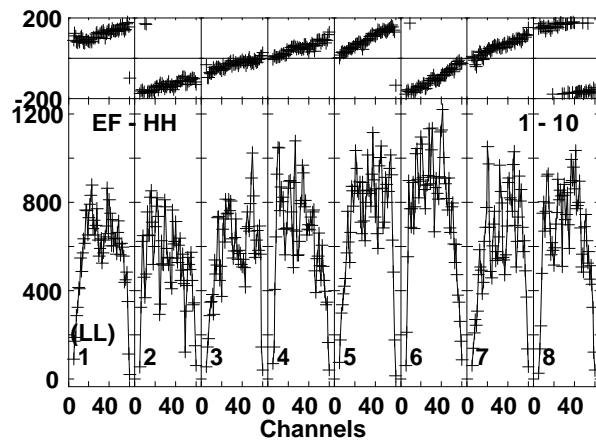
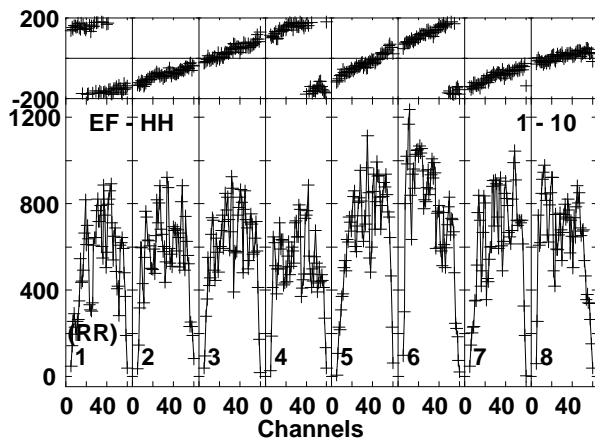
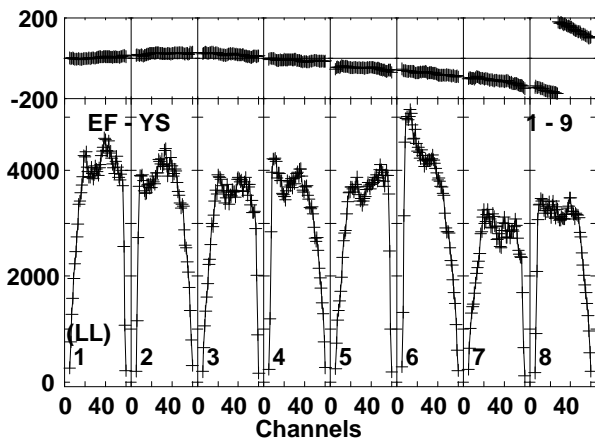
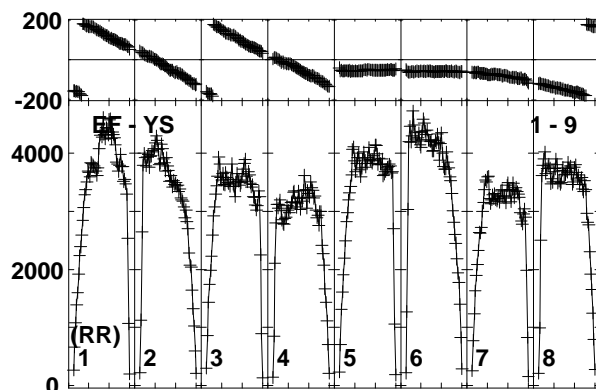
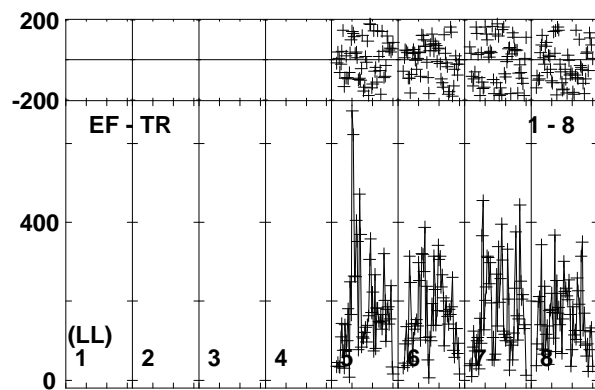
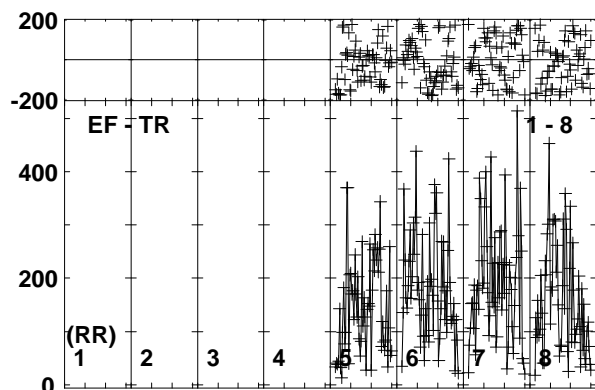
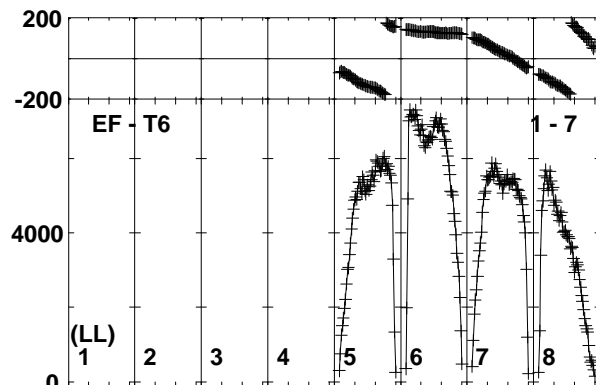
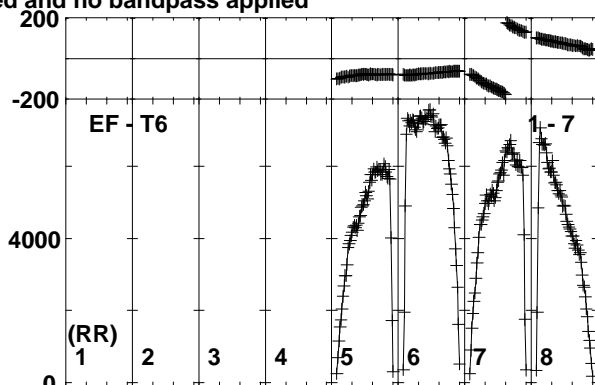
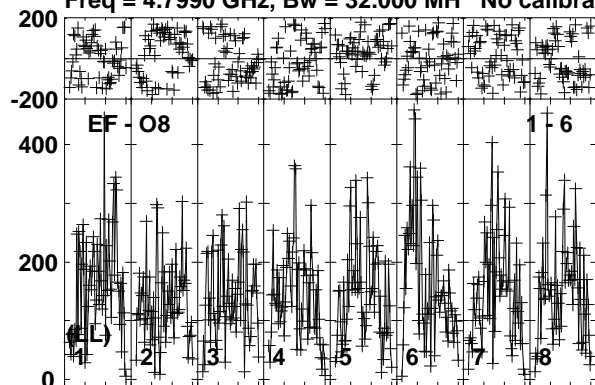

Lower frame: Micro Ampl Jy Top frame: Phas deg  
Vector averaged cross-power spectrum Baseline: EF (01) - O8 (06)  
Timerange: 00/04:52:30 to 00/04:53:30



Plot file version 219 created 24-NOV-2017 10:10:29

J1108+4330 EG096D.UVDATA.1

Freq = 4.7990 GHz, Bw = 32.000 MH No calibration applied and no bandpass applied

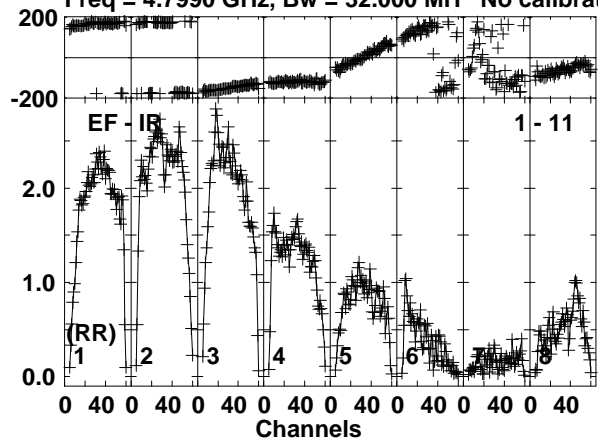

Lower frame: Milli Ampl Jy Top frame: Phas deg  
Vector averaged cross-power spectrum Baseline: EF (01) - IR (11)  
Timerange: 00/04:52:30 to 00/04:53:30

Plot file version 220 created 24-NOV-2017 10:10:29

J1112+4301 EG096D.UVDATA.1

Freq = 4.7990 GHz, Bw = 32.000 MH No calibration applied and no bandpass applied

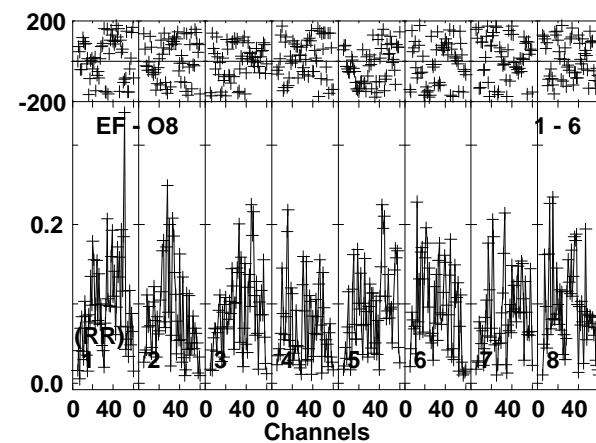
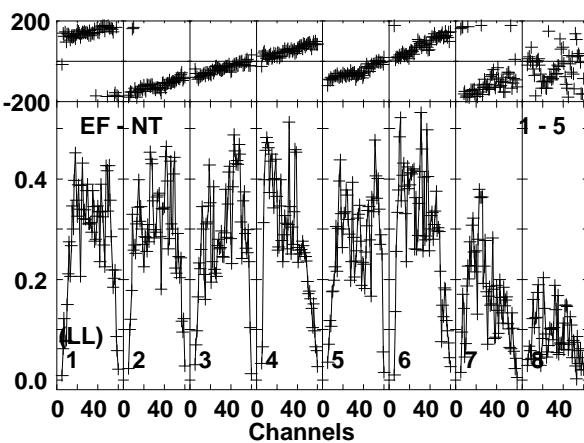
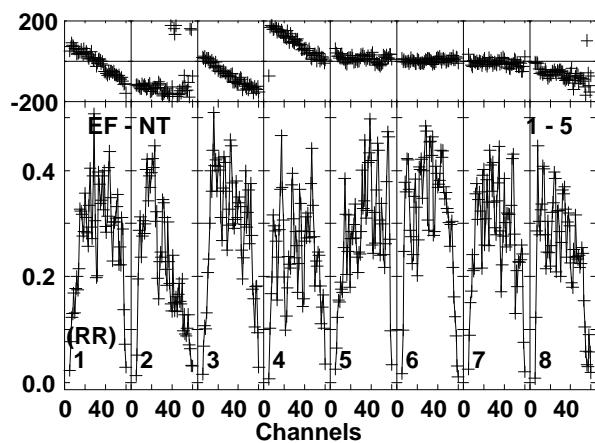
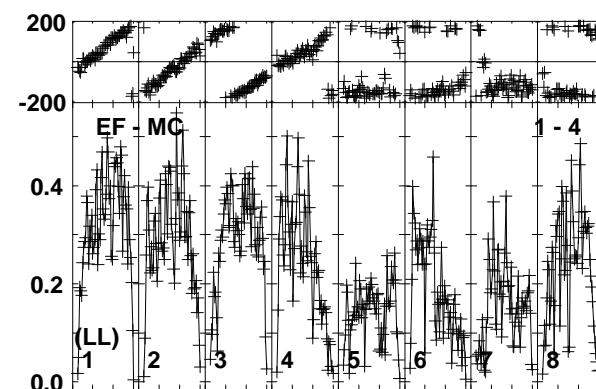
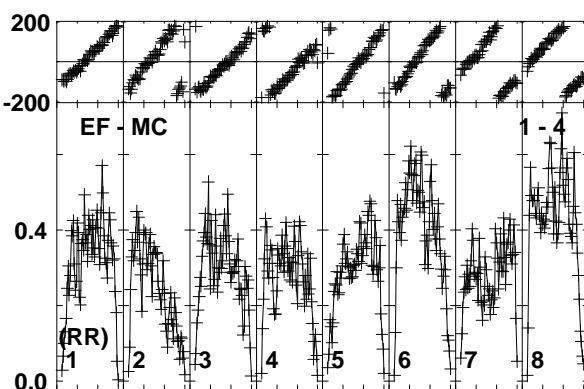
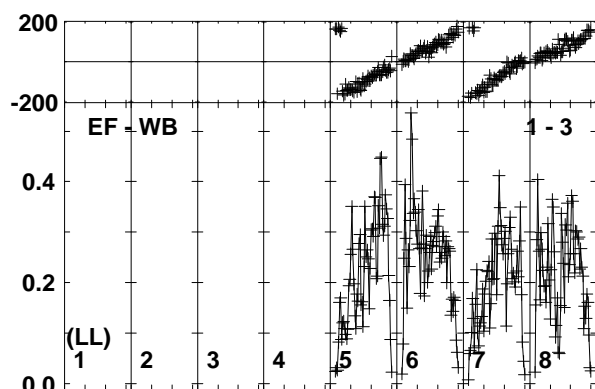
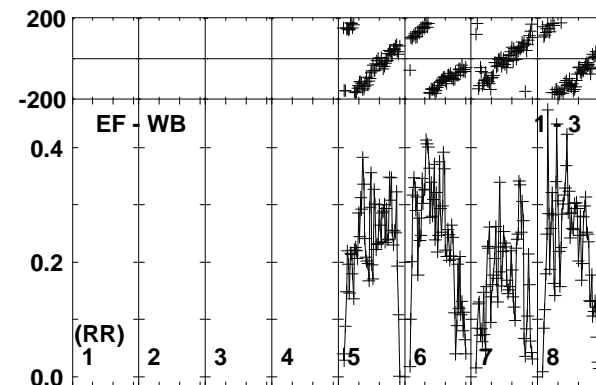
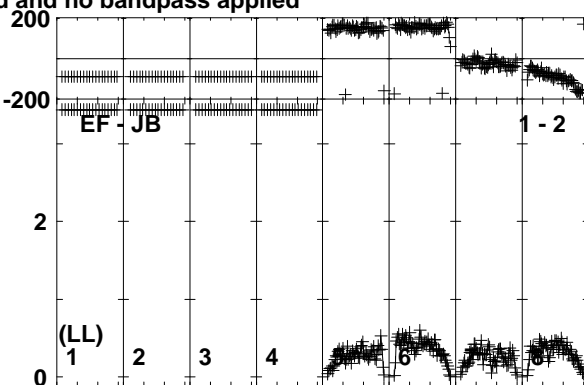
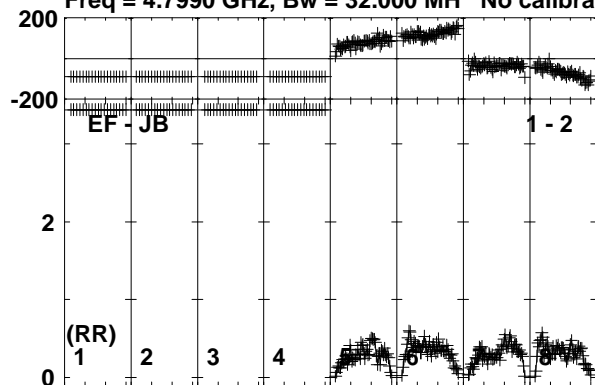

Lower frame: Milli Ampl Jy Top frame: Phas deg  
Vector averaged cross-power spectrum Baseline: EF (01) - JB (02)  
Timerange: 00/04:53:31 to 00/04:57:00

Plot file version 221 created 24-NOV-2017 10:10:29

J1112+4301 EG096D.UVDATA.1

Freq = 4.7990 GHz, Bw = 32.000 MH No calibration applied and no bandpass applied

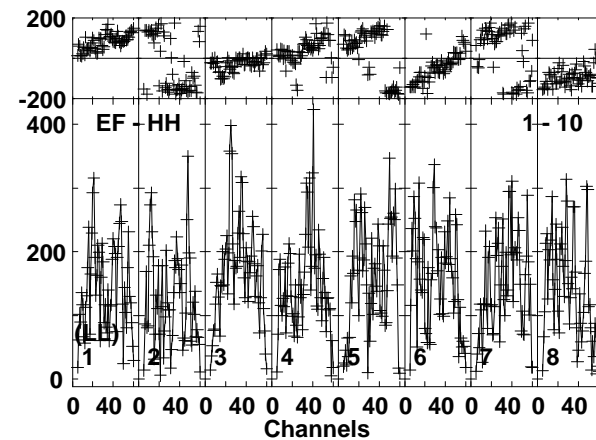
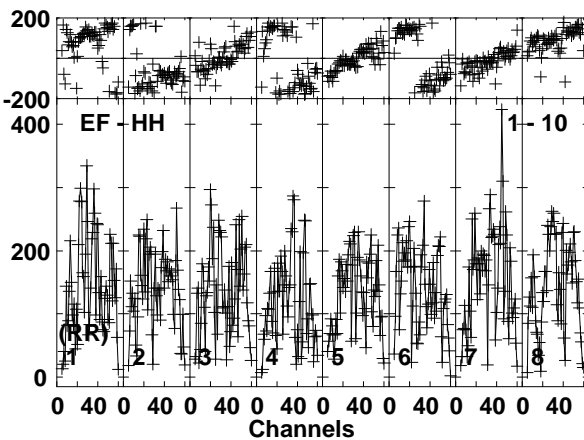
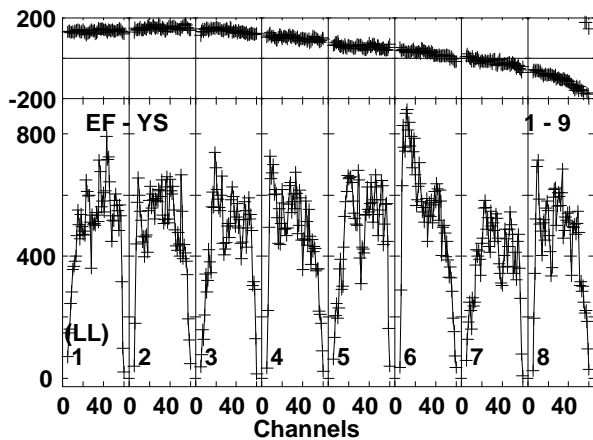
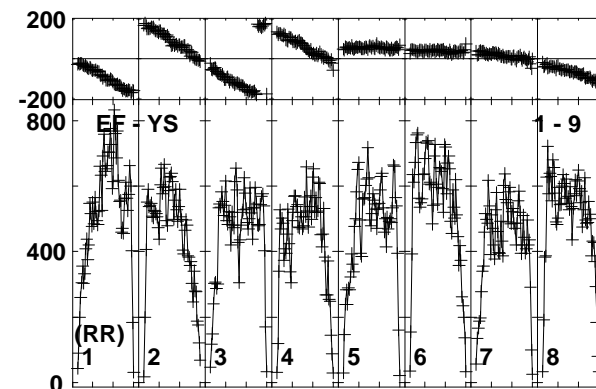
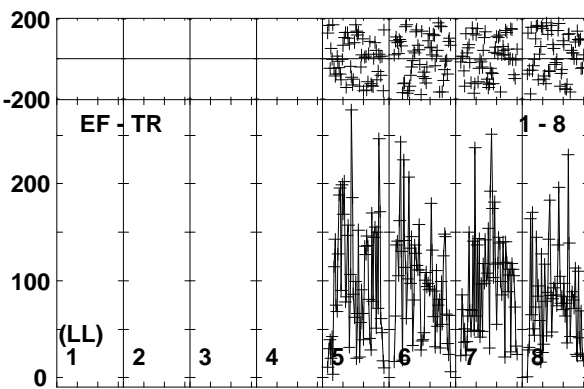
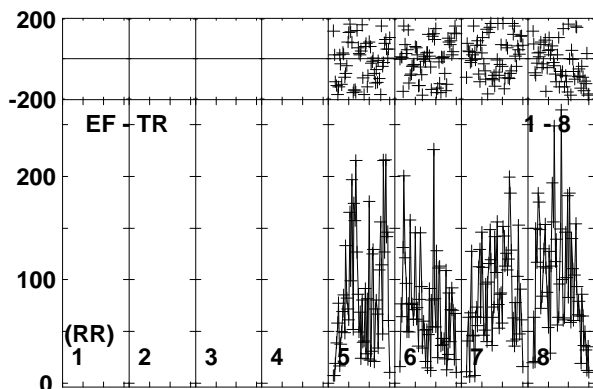
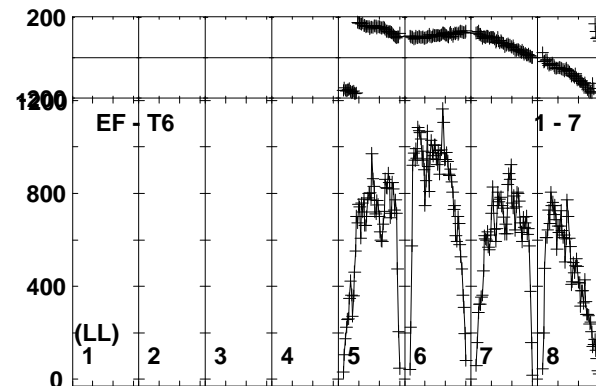
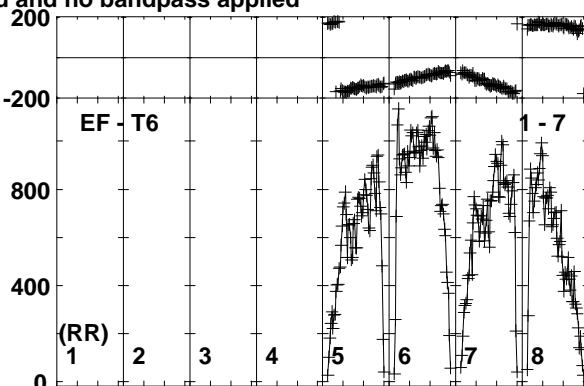
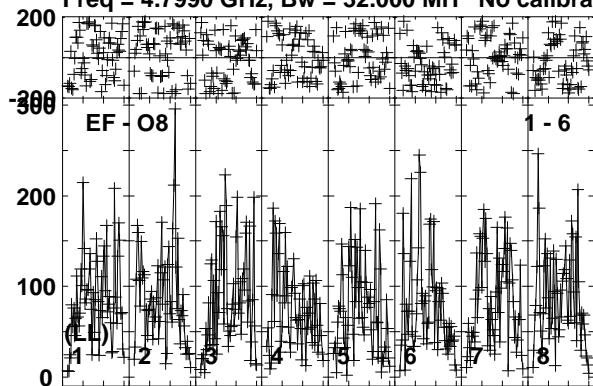

Lower frame: Micro Ampl Jy Top frame: Phas deg  
Vector averaged cross-power spectrum Baseline: EF (01) - O8 (06)  
Timerange: 00/04:53:31 to 00/04:57:00

Plot file version 222 created 24-NOV-2017 10:10:30  
J1112+4301 EG096D.UVDATA.1  
Freq = 4.7990 GHz, Bw = 32.000 MH No calibration applied and no bandpass applied

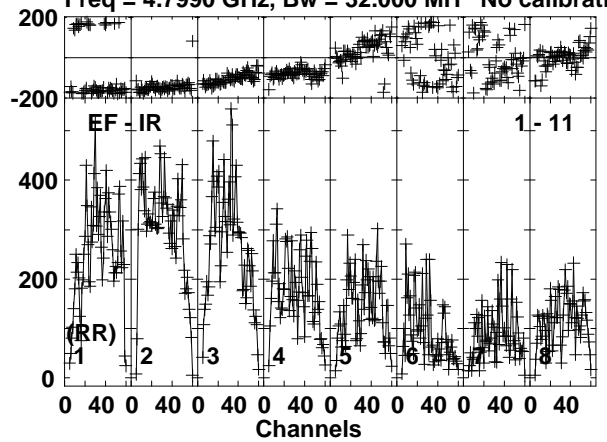

Lower frame: Micro Ampl Jy Top frame: Phas deg  
Vector averaged cross-power spectrum Baseline: EF (01) - IR (11)  
Timerange: 00/04:53:31 to 00/04:57:00

Plot file version 223 created 24-NOV-2017 10:10:30

J1108+4330 EG096D.UVDATA.1

Freq = 4.7990 GHz, Bw = 32.000 MH No calibration applied and no bandpass applied

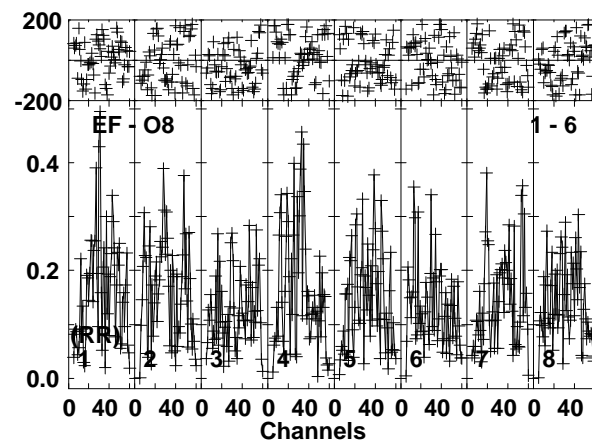
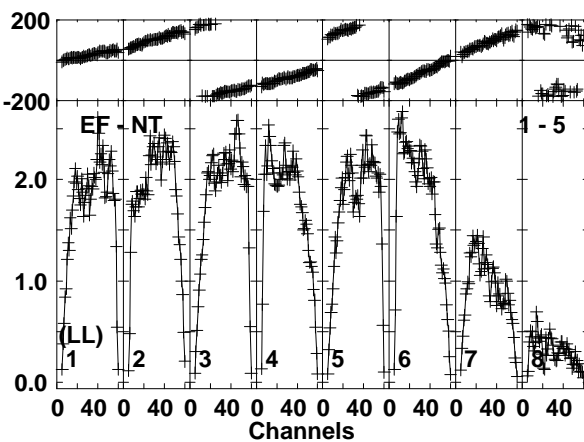
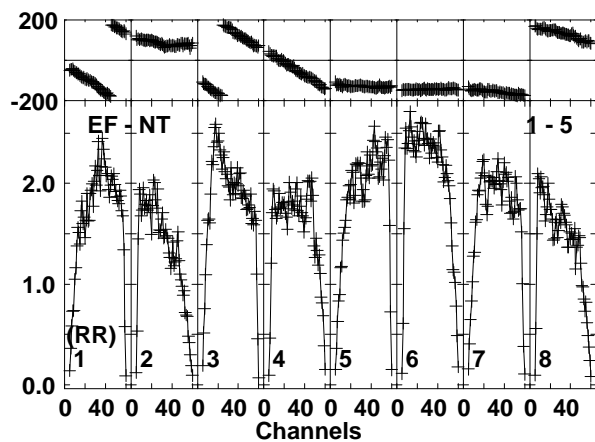
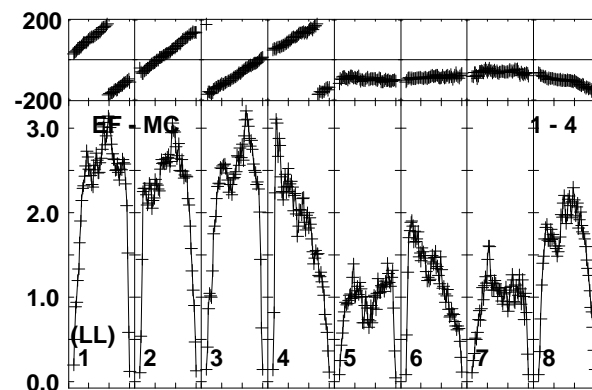
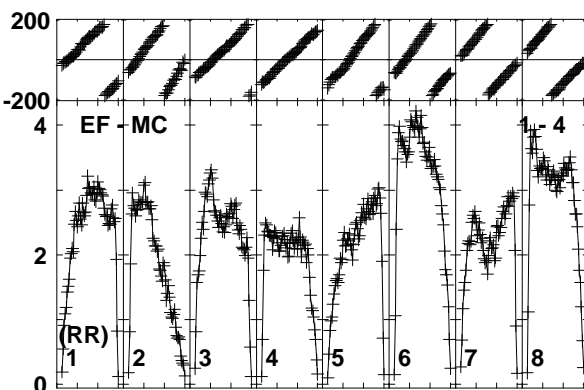
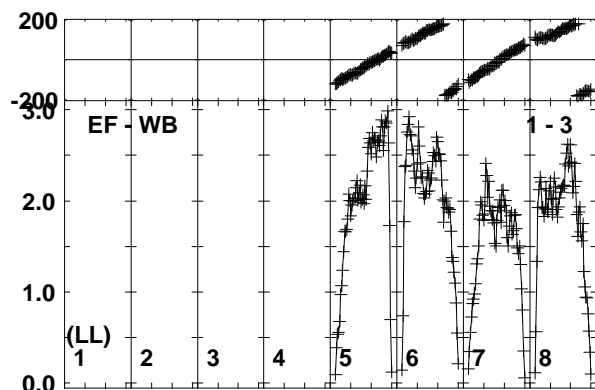
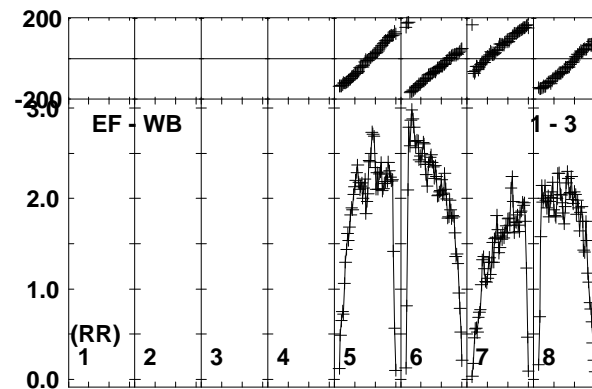
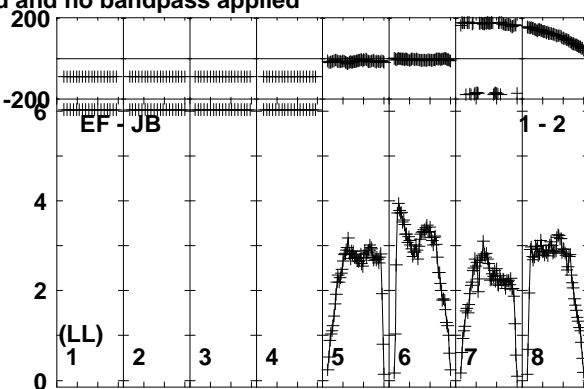
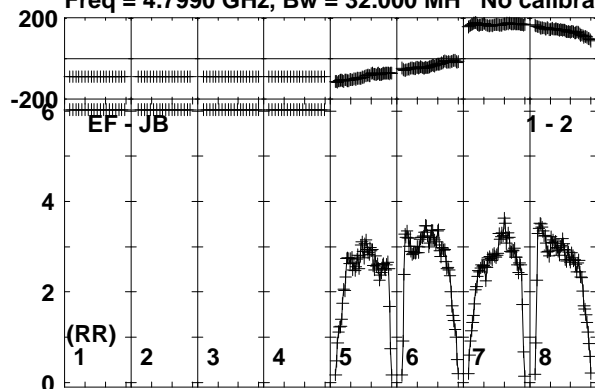

Lower frame: Milli Ampl Jy Top frame: Phas deg  
Vector averaged cross-power spectrum Baseline: EF (01) - JB (02)  
Timerange: 00/04:57:01 to 00/04:58:30

Plot file version 224 created 24-NOV-2017 10:10:30

J1108+4330 EG096D.UVDATA.1

Freq = 4.7990 GHz, Bw = 32.000 MH No calibration applied and no bandpass applied

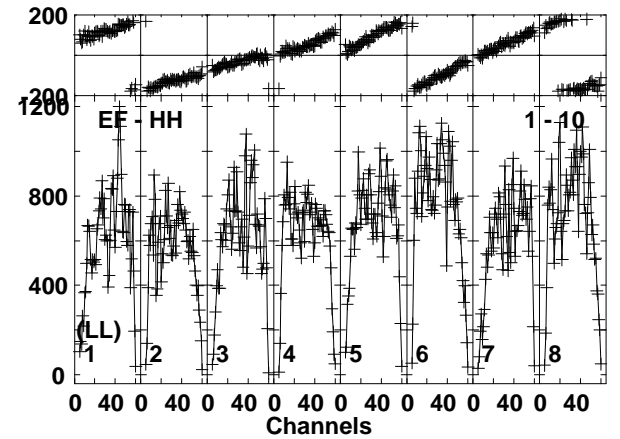
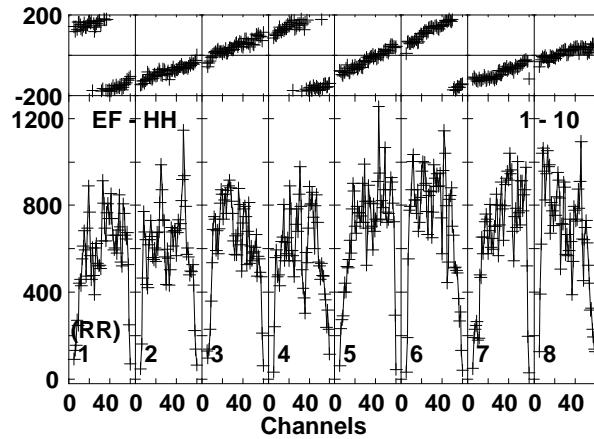
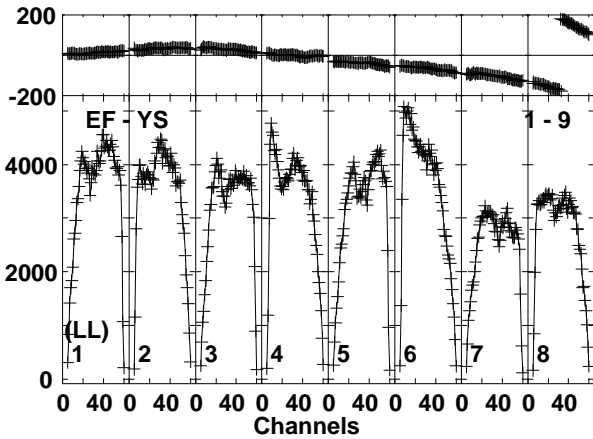
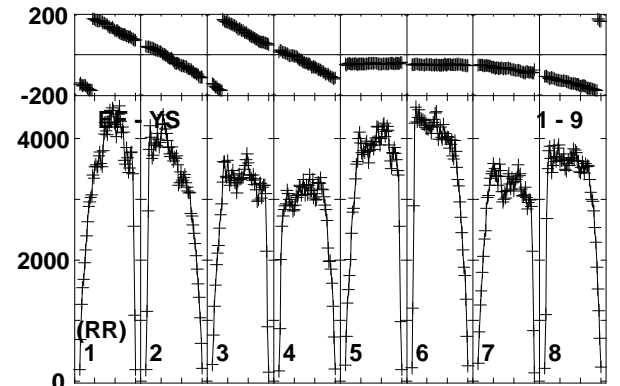
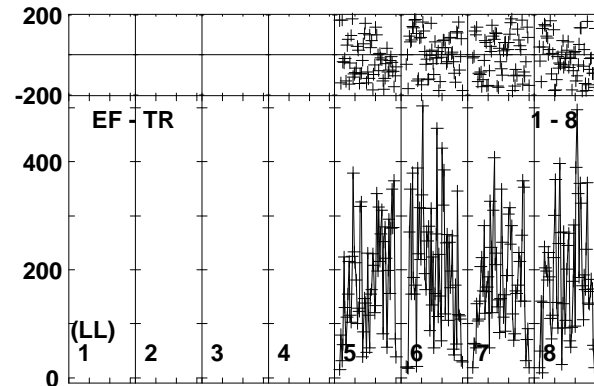
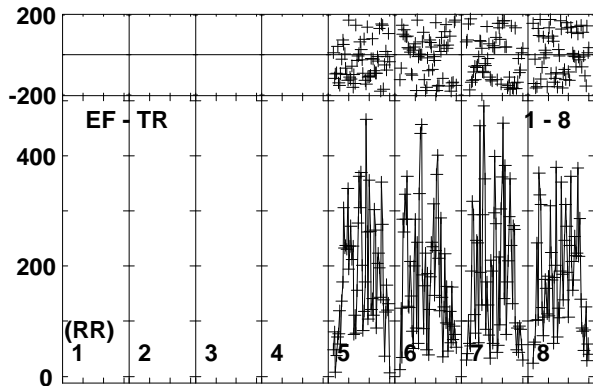
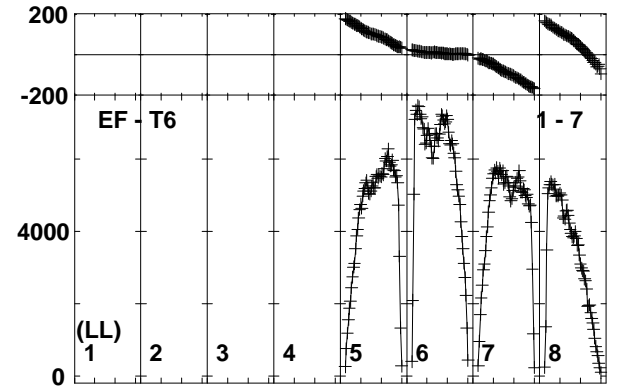
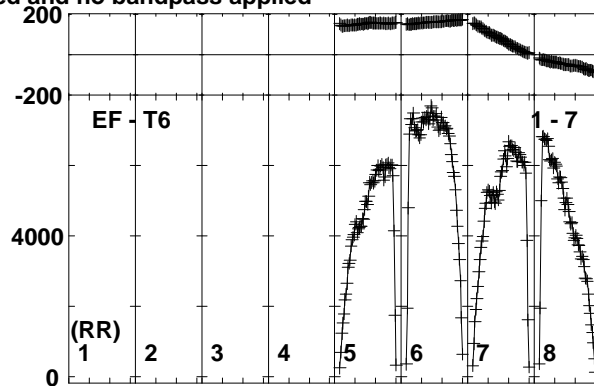
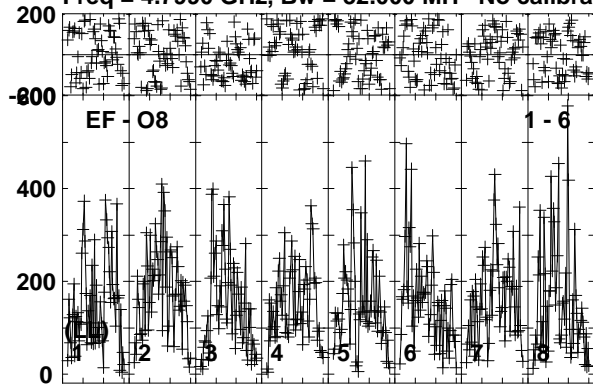

Lower frame: Micro Ampl Jy Top frame: Phas deg  
Vector averaged cross-power spectrum Baseline: EF (01) - O8 (06)  
Timerange: 00/04:57:01 to 00/04:58:30

Plot file version 225 created 24-NOV-2017 10:10:30  
J1108+4330 EG096D.UVDATA.1  
Freq = 4.7990 GHz, Bw = 32.000 MH No calibration applied and no bandpass applied

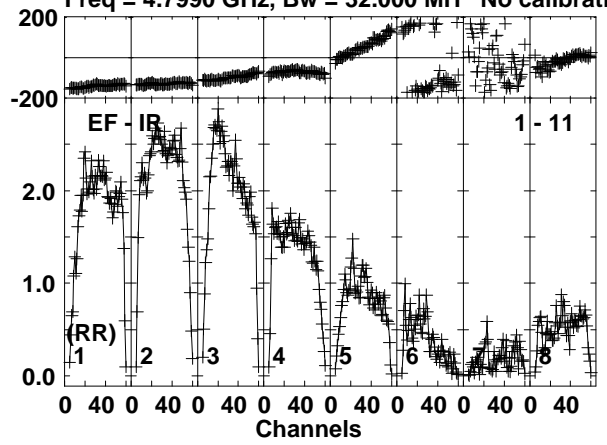

Lower frame: Milli Ampl Jy Top frame: Phas deg  
Vector averaged cross-power spectrum Baseline: EF (01) - IR (11)  
Timerange: 00/04:57:01 to 00/04:58:30

Plot file version 226 created 24-NOV-2017 10:10:30  
 ARUMA EG096D.UVDATA.1  
 Freq = 4.7990 GHz, Bw = 32.000 MH No calibration applied and no bandpass applied

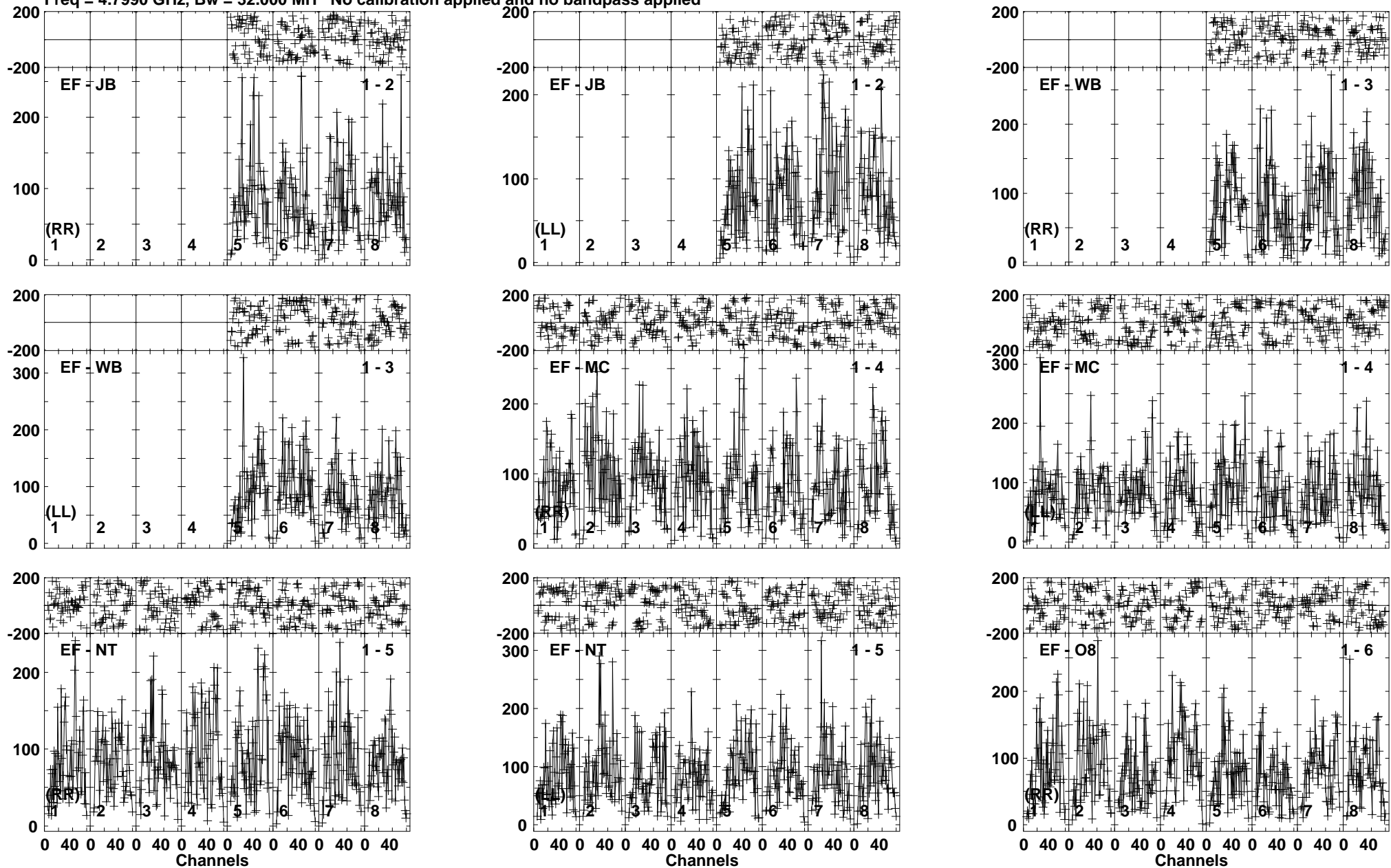

Lower frame: Micro Ampl Jy Top frame: Phas deg  
 Vector averaged cross-power spectrum Baseline: EF (01) - JB (02)  
 Timerange: 00/04:58:30 to 00/05:02:00



Plot file version 227 created 24-NOV-2017 10:10:31

ARUMA EG096D.UVDATA.1

Freq = 4.7990 GHz, Bw = 32.000 MH No calibration applied and no bandpass applied

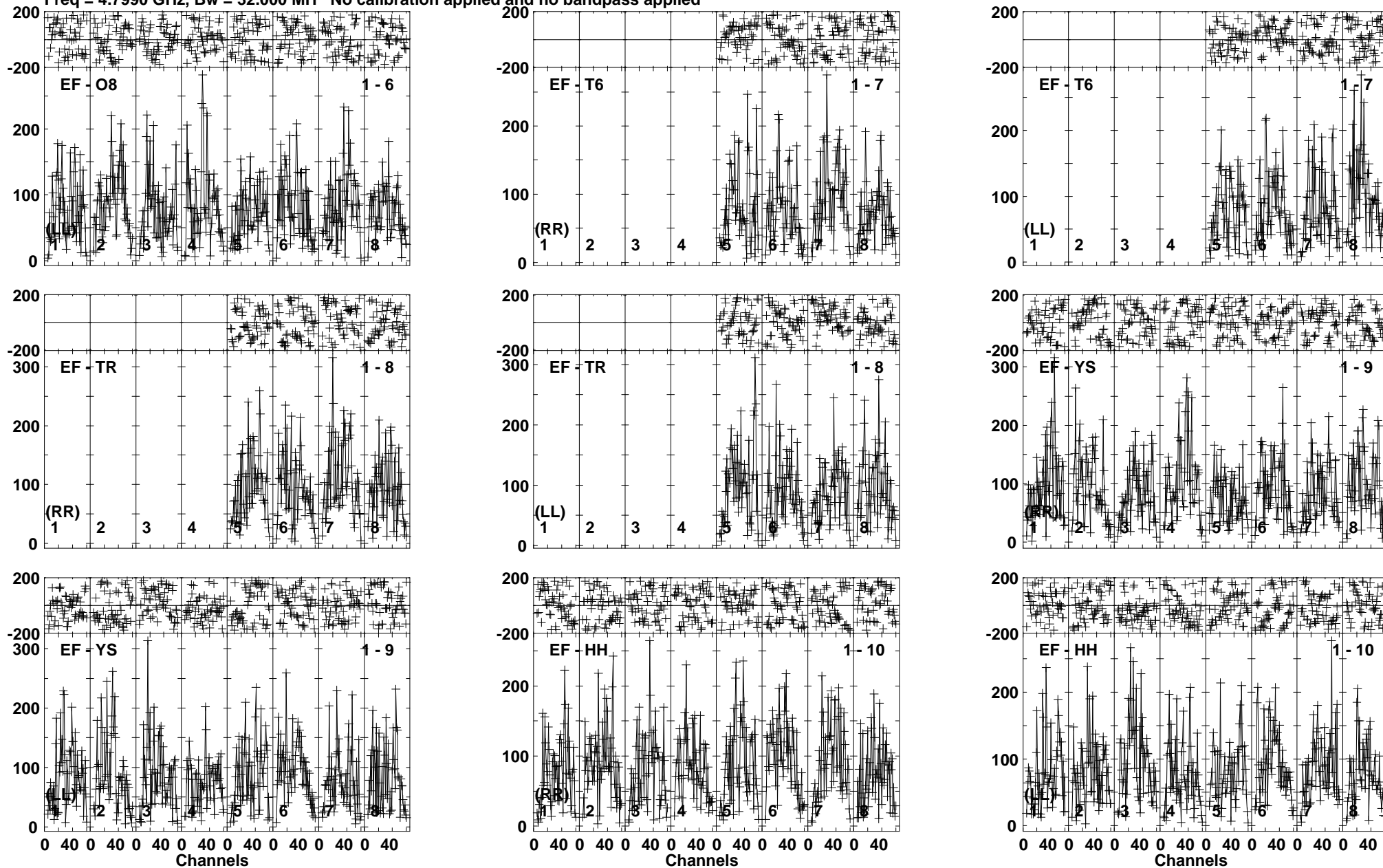

Lower frame: Micro Ampl Jy Top frame: Phas deg  
Vector averaged cross-power spectrum Baseline: EF (01) - O8 (06)  
Timerange: 00/04:58:30 to 00/05:02:00

Plot file version 228 created 24-NOV-2017 10:10:31  
ARUMA EG096D.UVDATA.1  
Freq = 4.7990 GHz, Bw = 32.000 MH No calibration applied and no bandpass applied

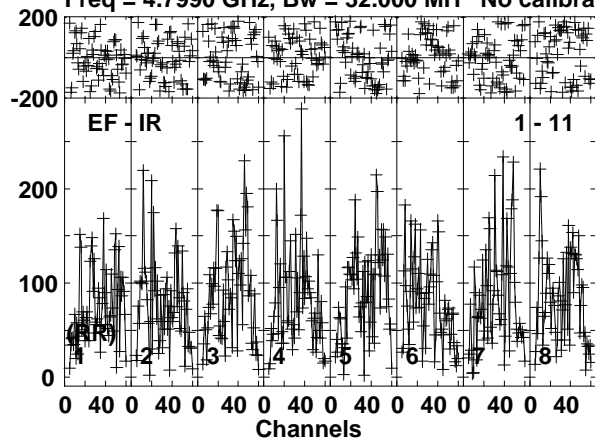

Lower frame: Micro Ampl Jy Top frame: Phas deg  
Vector averaged cross-power spectrum Baseline: EF (01) - IR (11)  
Timerange: 00/04:58:30 to 00/05:02:00

Plot file version 229 created 24-NOV-2017 10:10:31

J1108+4330 EG096D.UVDATA.1

Freq = 4.7990 GHz, Bw = 32.000 MH No calibration applied and no bandpass applied

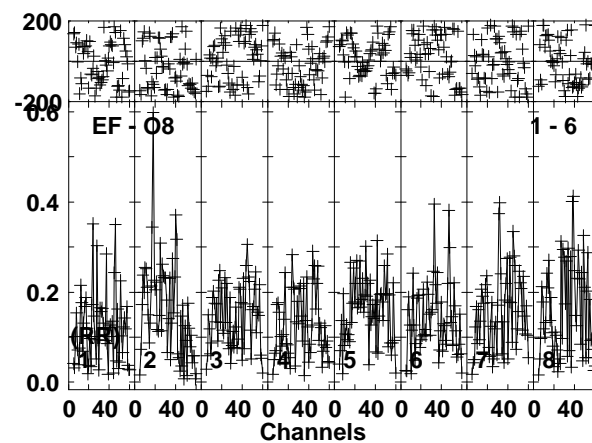
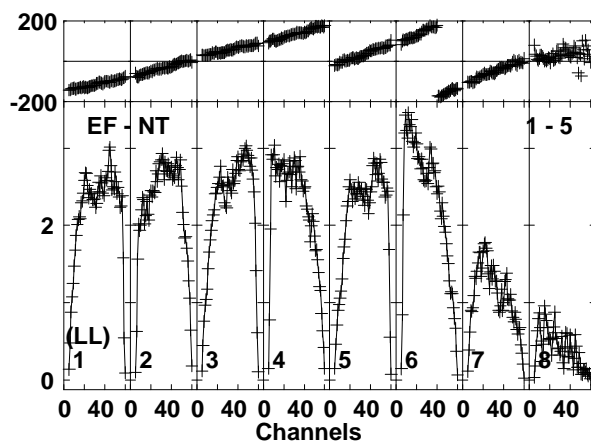
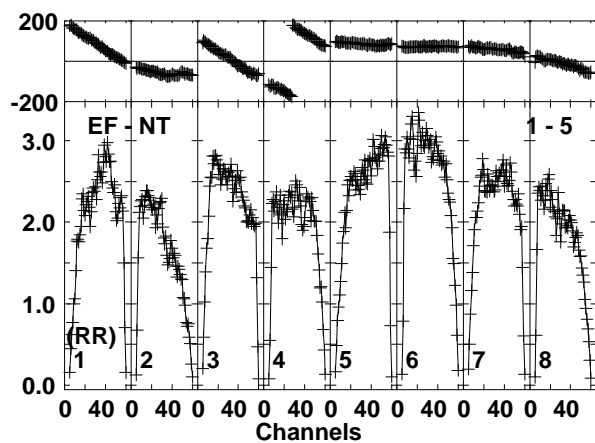
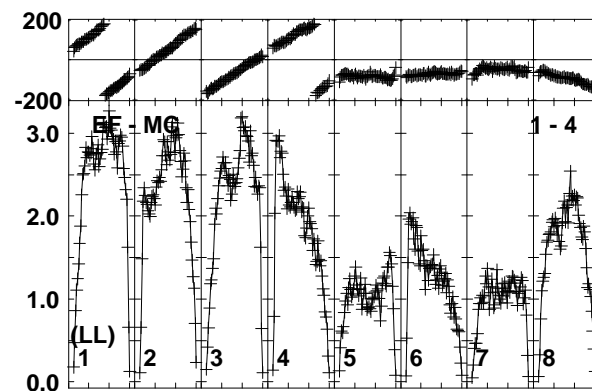
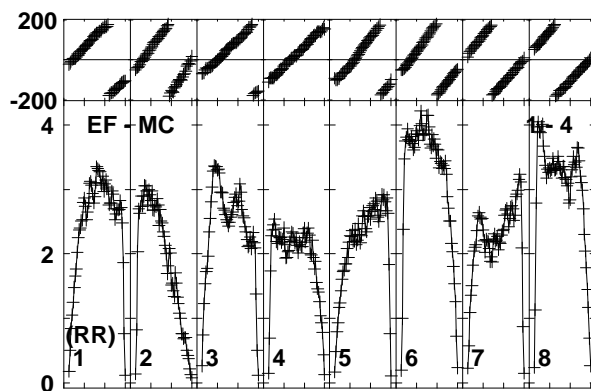
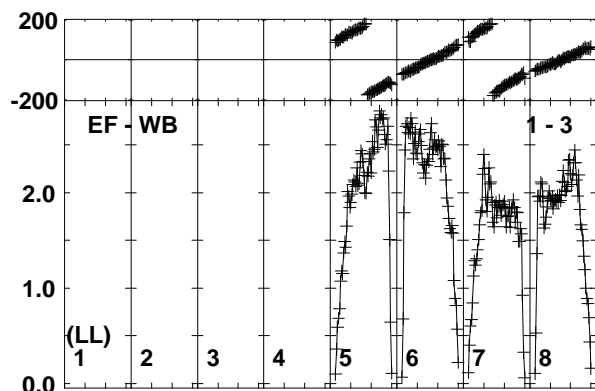
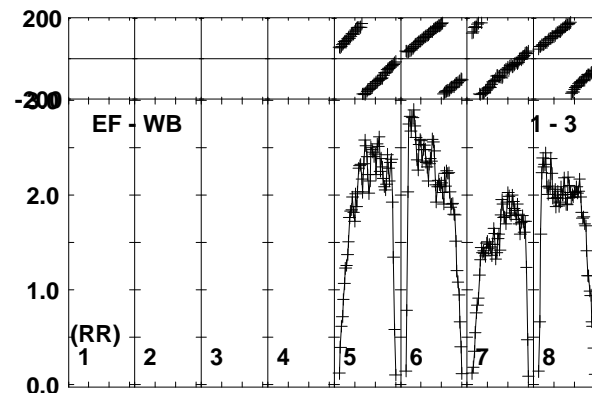
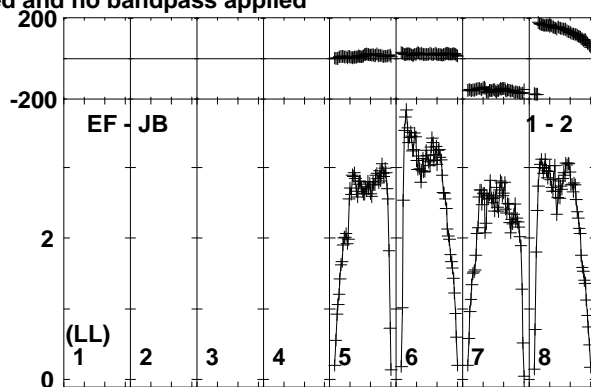
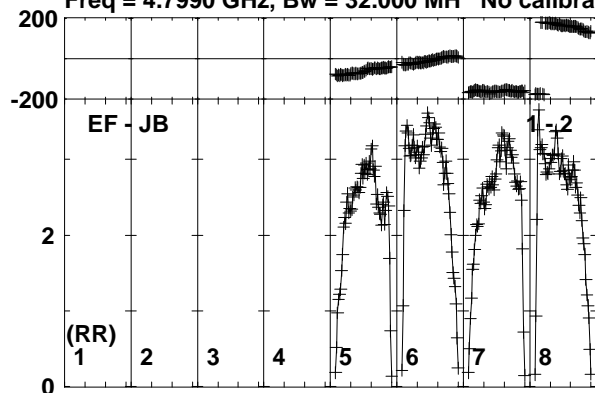

Lower frame: Milli Ampl Jy Top frame: Phas deg  
Vector averaged cross-power spectrum Baseline: EF (01) - JB (02)  
Timerange: 00/05:02:40 to 00/05:03:39

Plot file version 230 created 24-NOV-2017 10:10:31

J1108+4330 EG096D.UVDATA.1

Freq = 4.7990 GHz, Bw = 32.000 MH No calibration applied and no bandpass applied

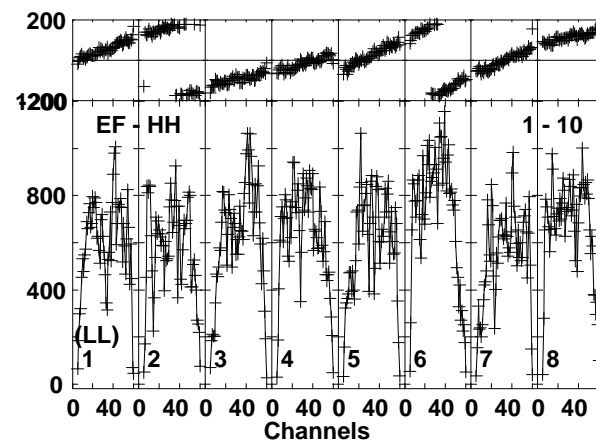
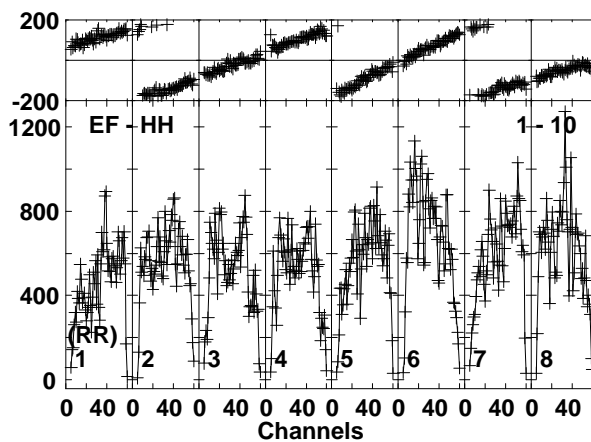
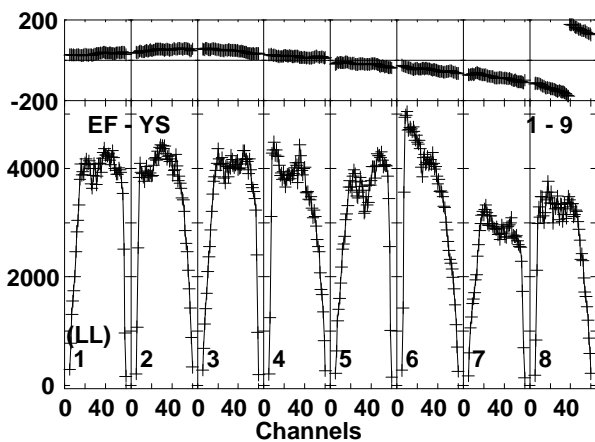
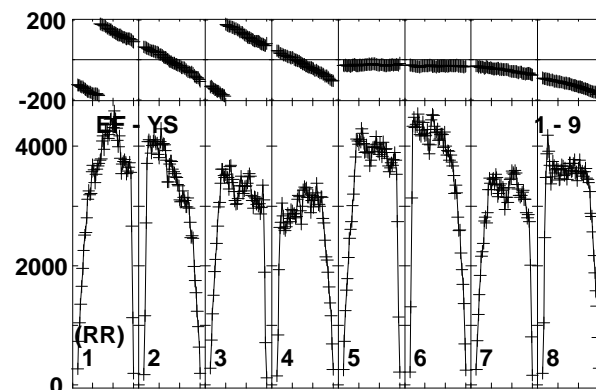
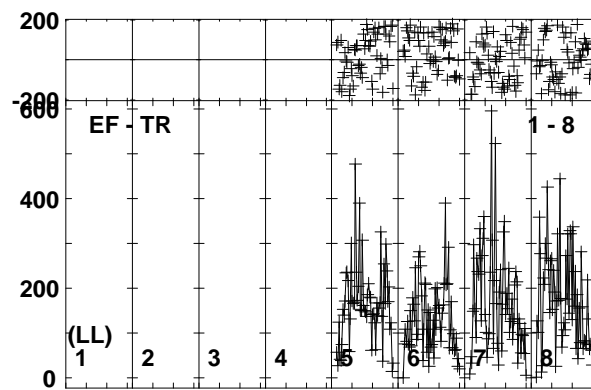
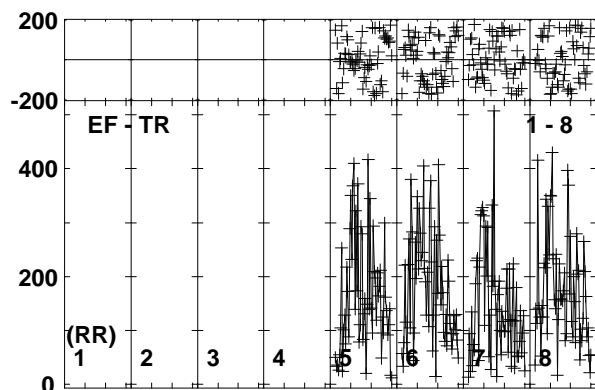
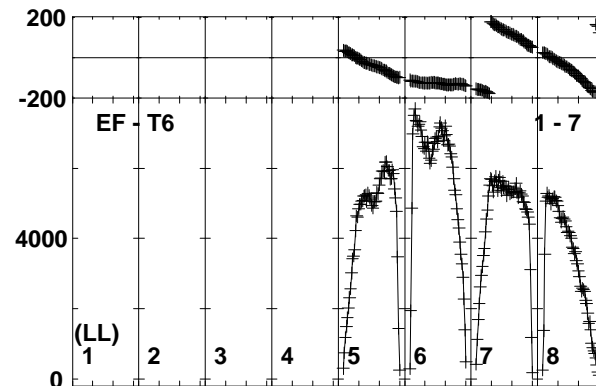
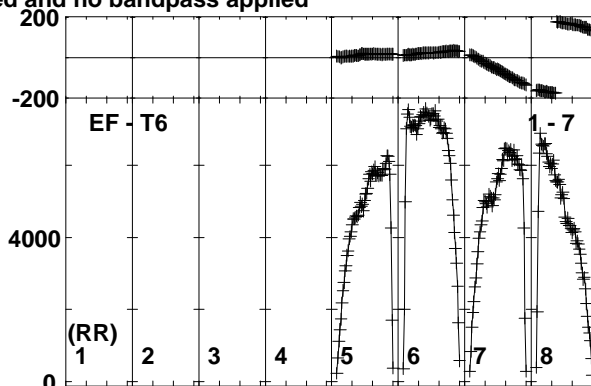
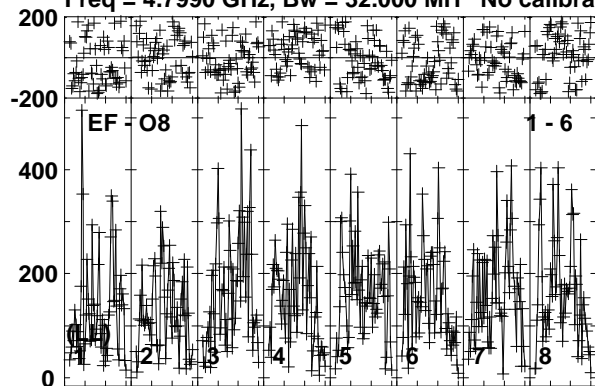

Lower frame: Micro Ampl Jy Top frame: Phas deg  
Vector averaged cross-power spectrum Baseline: EF (01) - O8 (06)  
Timerange: 00/05:02:40 to 00/05:03:39

Plot file version 231 created 24-NOV-2017 10:10:32  
J1108+4330 EG096D.UVDATA.1  
Freq = 4.7990 GHz, Bw = 32.000 MH No calibration applied and no bandpass applied

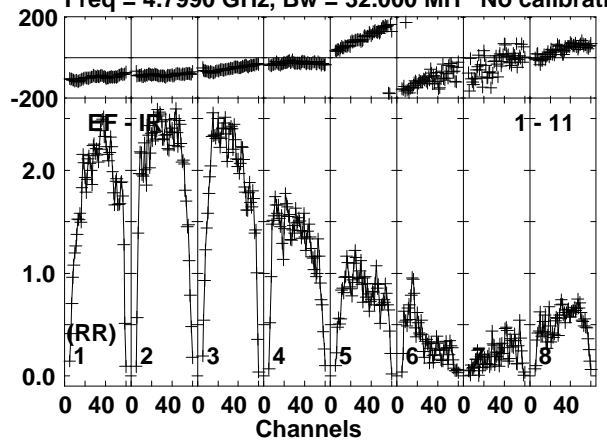

Lower frame: Milli Ampl Jy Top frame: Phas deg  
Vector averaged cross-power spectrum Baseline: EF (01) - IR (11)  
Timerange: 00/05:02:40 to 00/05:03:39

Plot file version 232 created 24-NOV-2017 10:10:32

ARUMA EG096D.UVDATA.1

Freq = 4.7990 GHz, Bw = 32.000 MH No calibration applied and no bandpass applied

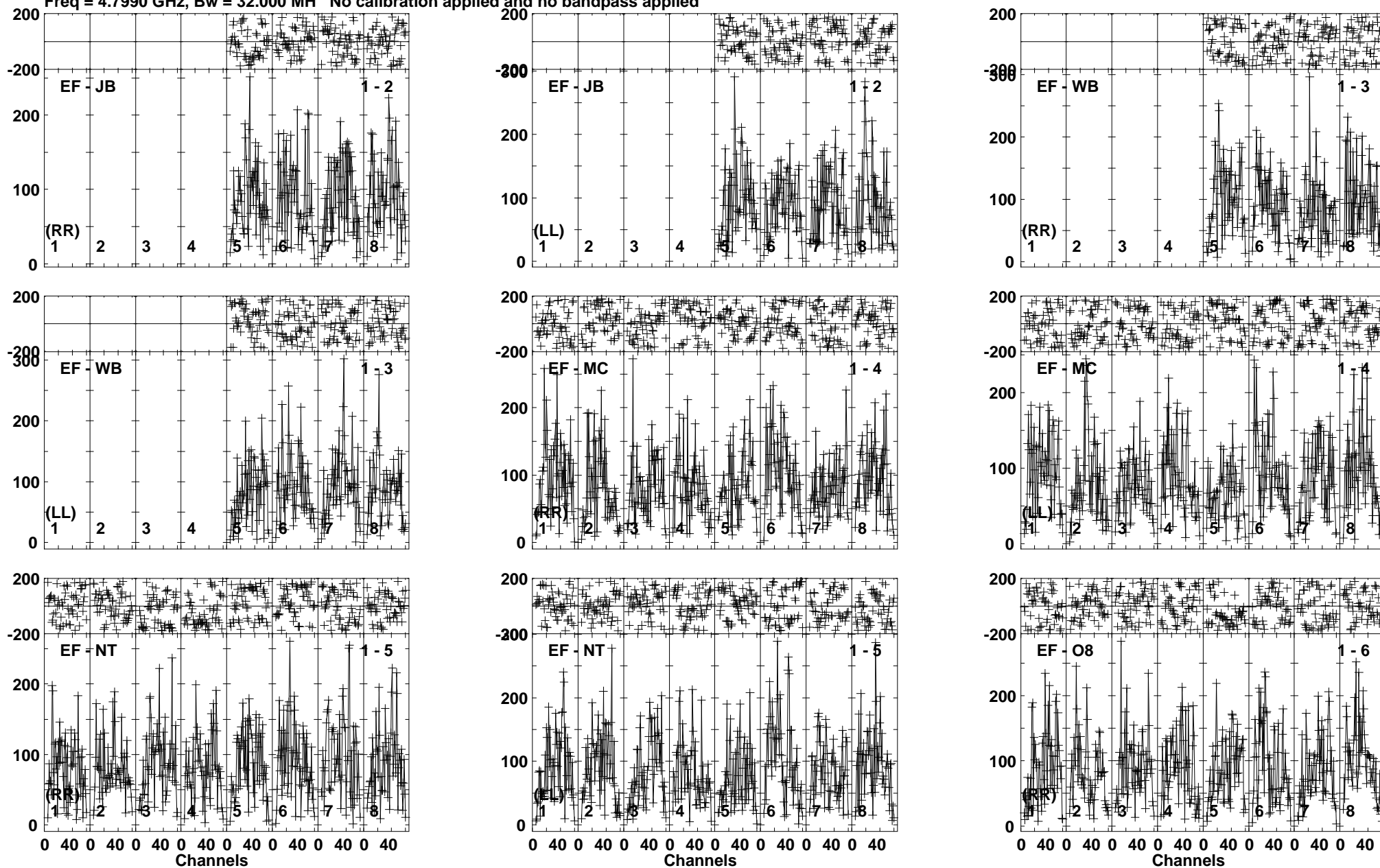

Lower frame: Micro Ampl Jy Top frame: Phas deg  
Vector averaged cross-power spectrum Baseline: EF (01) - JB (02)  
Timerange: 00/05:03:40 to 00/05:07:10

Plot file version 233 created 24-NOV-2017 10:10:32

ARUMA EG096D.UVDATA.1

Freq = 4.7990 GHz, Bw = 32.000 MH No calibration applied and no bandpass applied

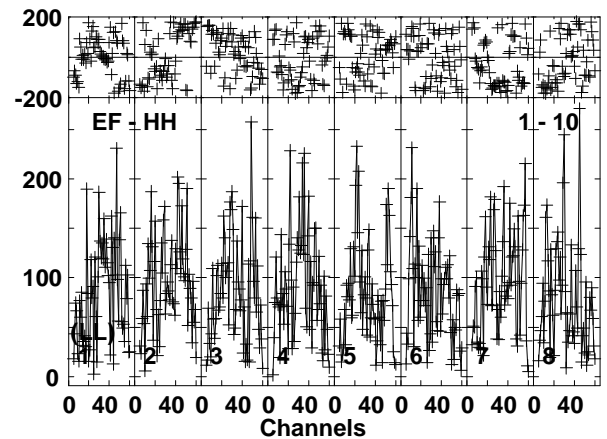
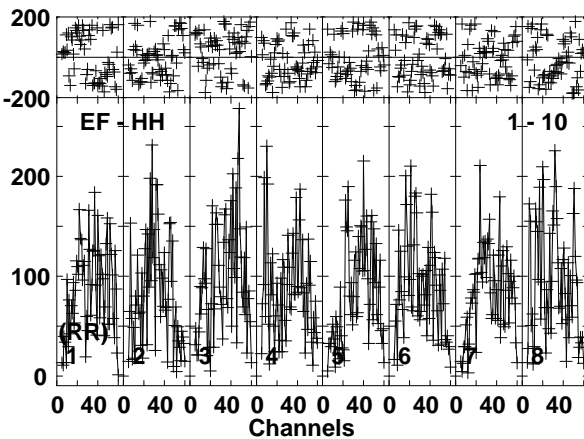
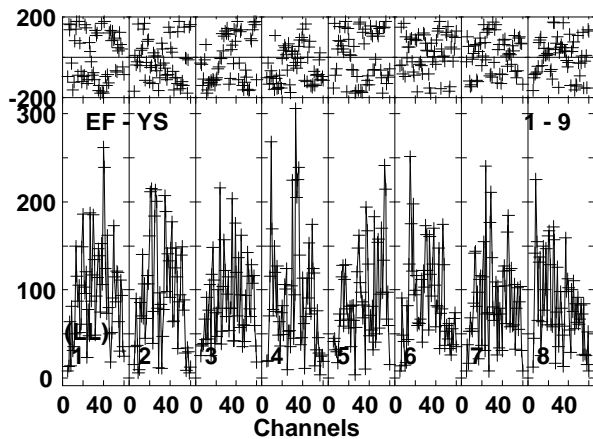
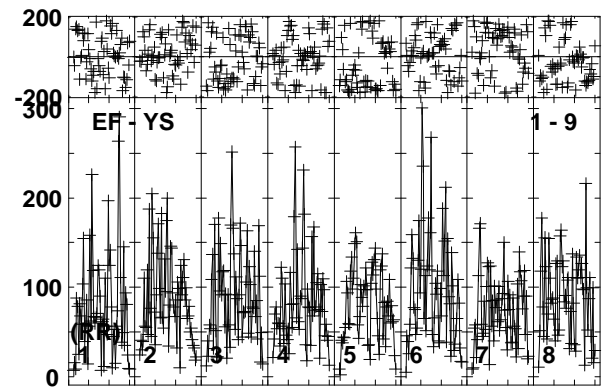
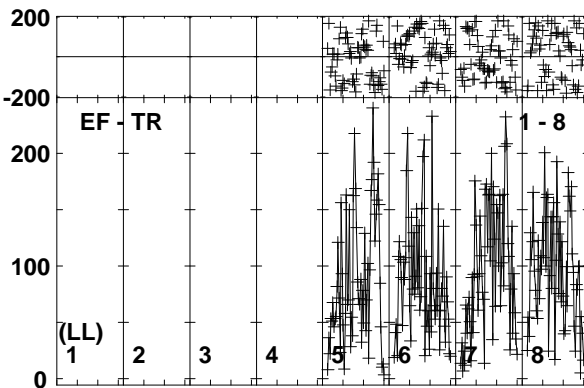
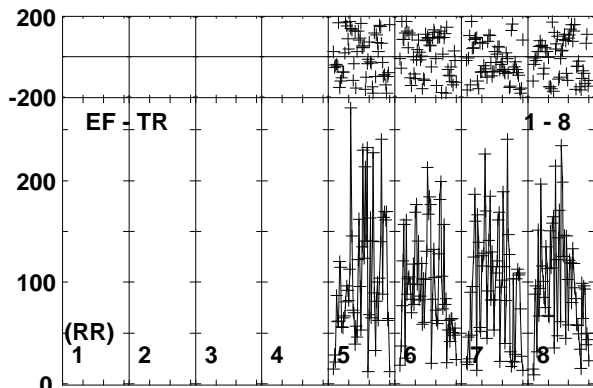
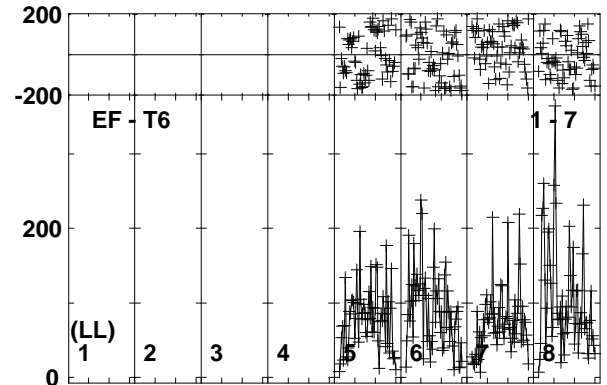
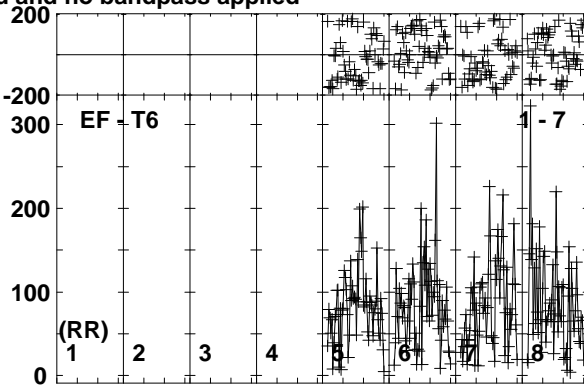
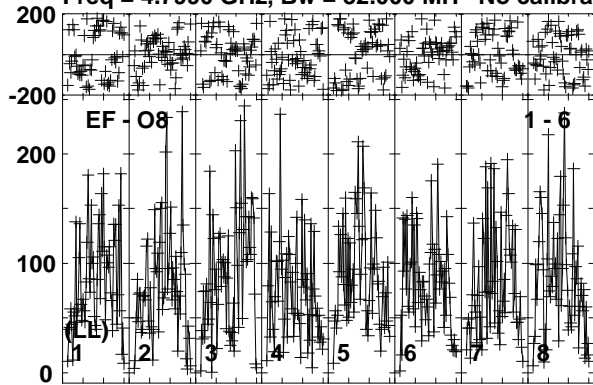

Lower frame: Micro Ampl Jy Top frame: Phas deg  
Vector averaged cross-power spectrum Baseline: EF (01) - O8 (06)  
Timerange: 00/05:03:40 to 00/05:07:10

Plot file version 234 created 24-NOV-2017 10:10:32  
ARUMA EG096D.UVDATA.1  
Freq = 4.7990 GHz, Bw = 32.000 MH No calibration applied and no bandpass applied

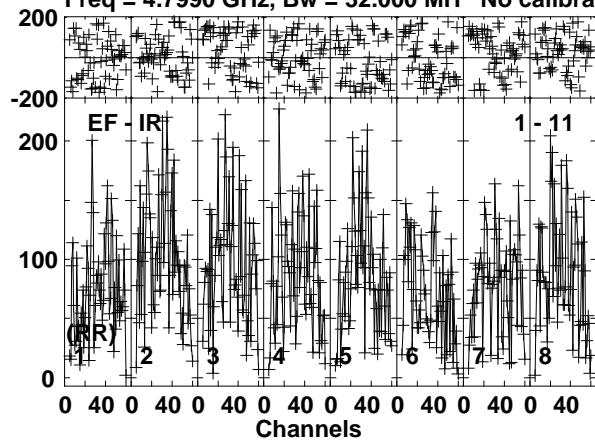

Lower frame: Micro Ampl Jy Top frame: Phas deg  
Vector averaged cross-power spectrum Baseline: EF (01) - IR (11)  
Timerange: 00/05:03:40 to 00/05:07:10



Plot file version 235 created 24-NOV-2017 10:10:32

J1108+4330 EG096D.UVDATA.1

Freq = 4.7990 GHz, Bw = 32.000 MH No calibration applied and no bandpass applied

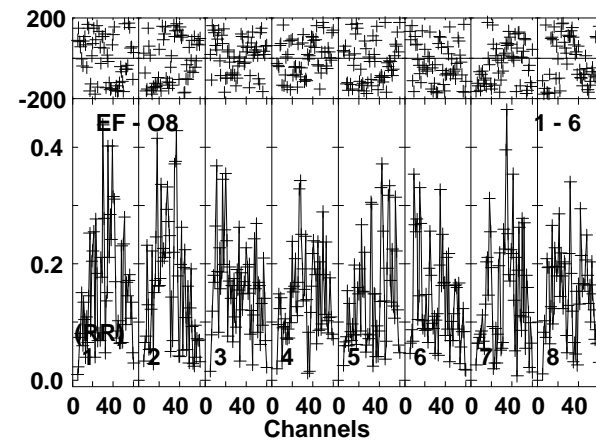
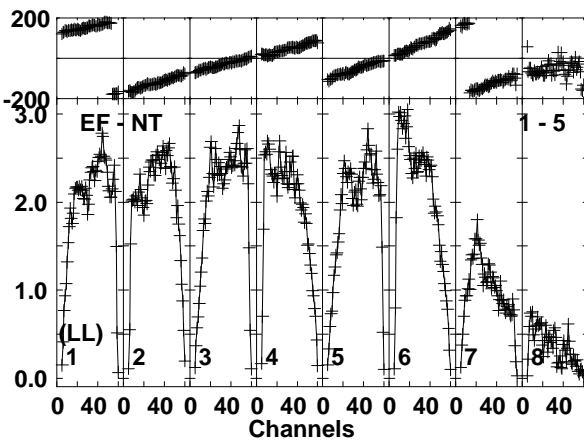
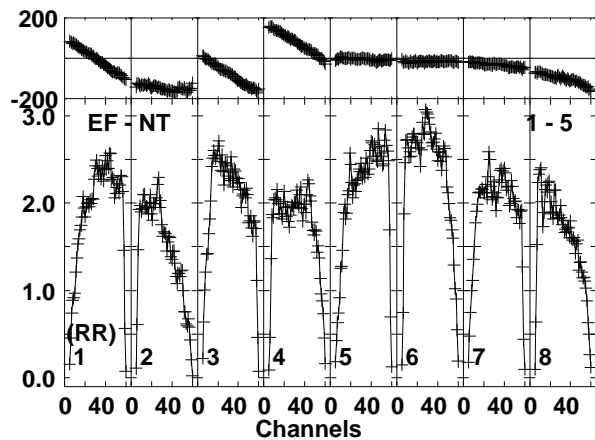
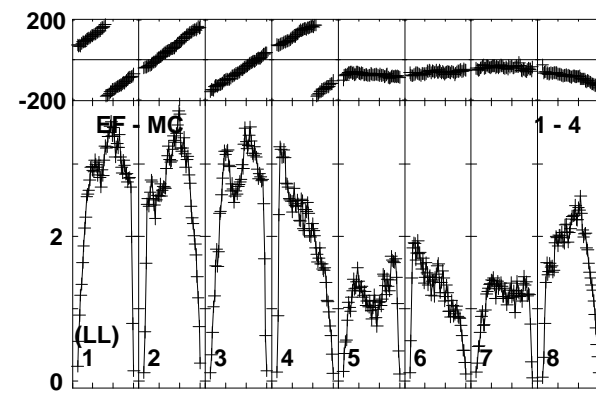
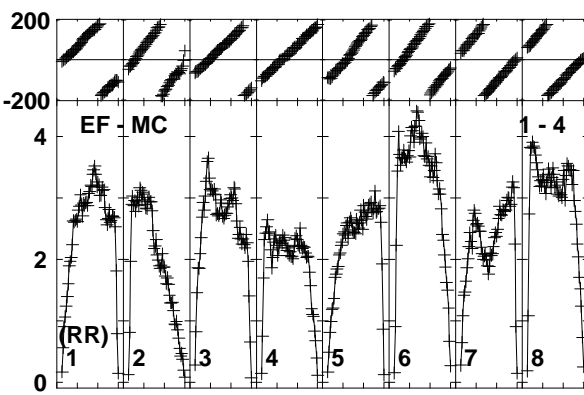
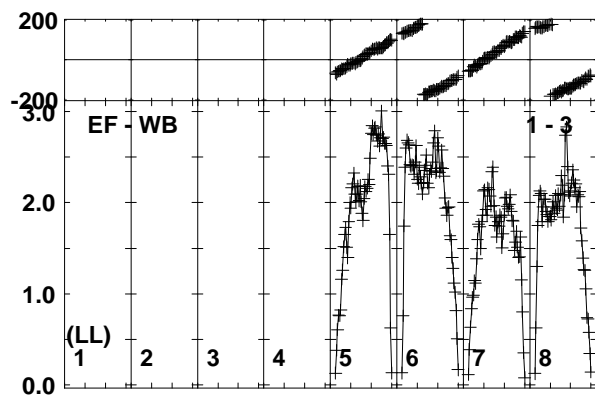
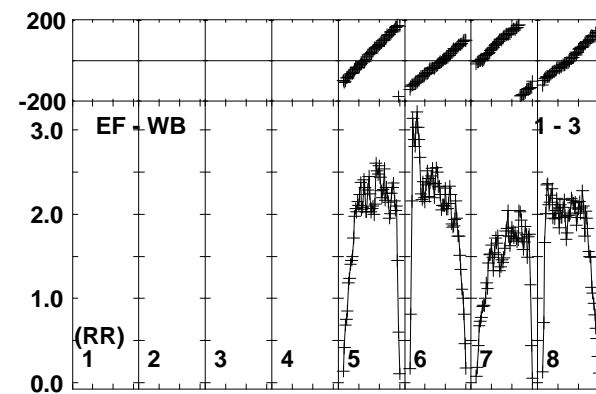
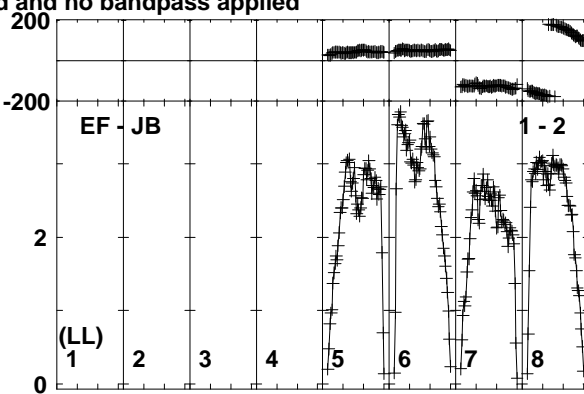
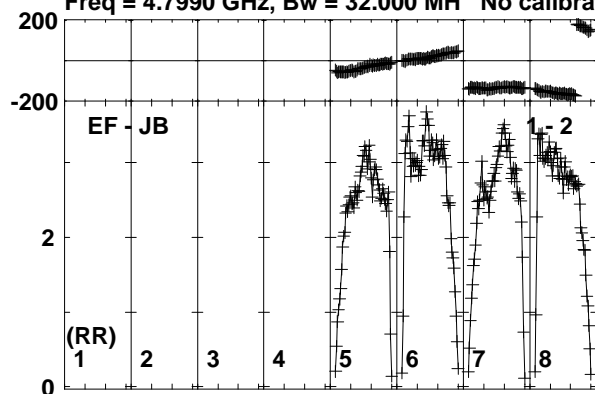

Lower frame: Milli Ampl Jy Top frame: Phas deg  
Vector averaged cross-power spectrum Baseline: EF (01) - JB (02)  
Timerange: 00/05:07:11 to 00/05:08:40

Plot file version 236 created 24-NOV-2017 10:10:33

J1108+4330 EG096D.UVDATA.1

Freq = 4.7990 GHz, Bw = 32.000 MH No calibration applied and no bandpass applied

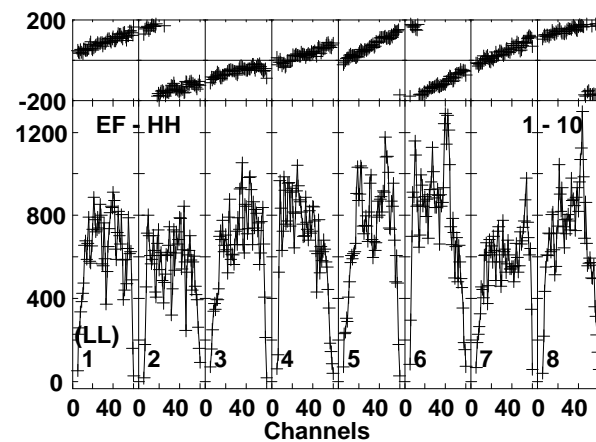
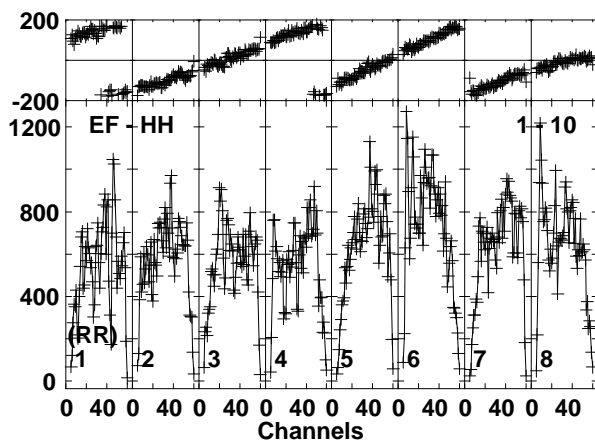
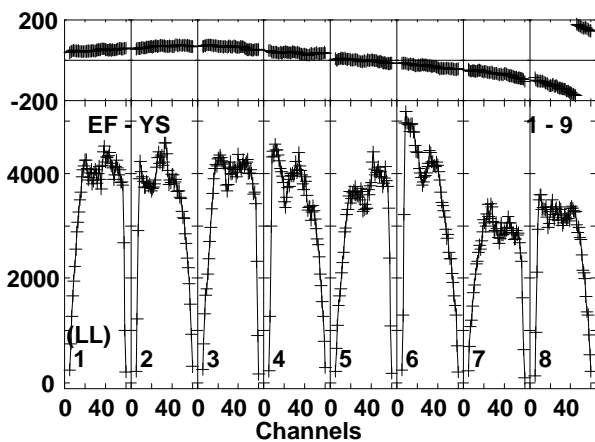
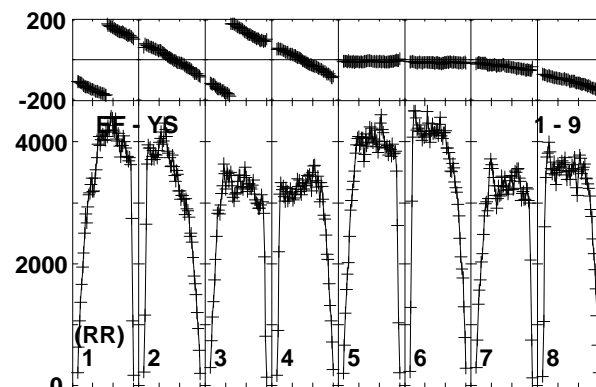
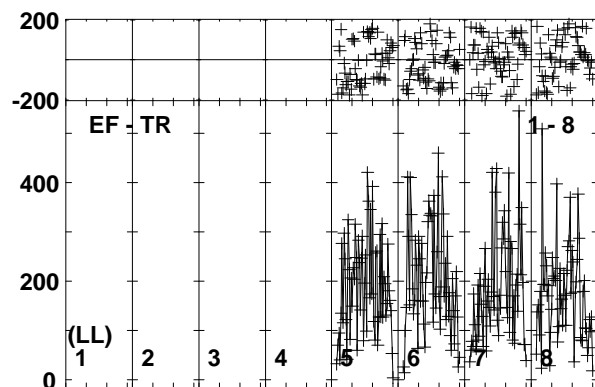
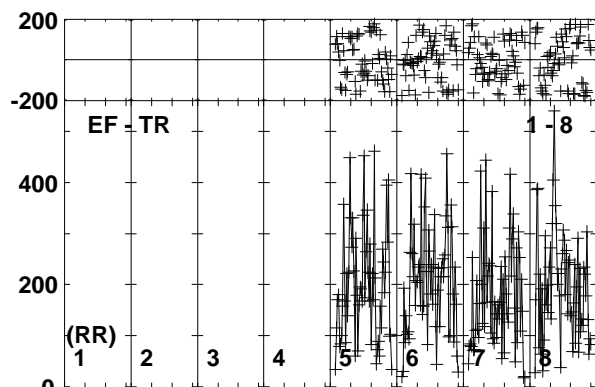
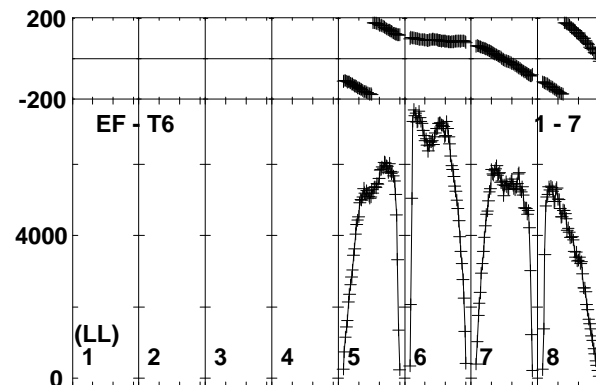
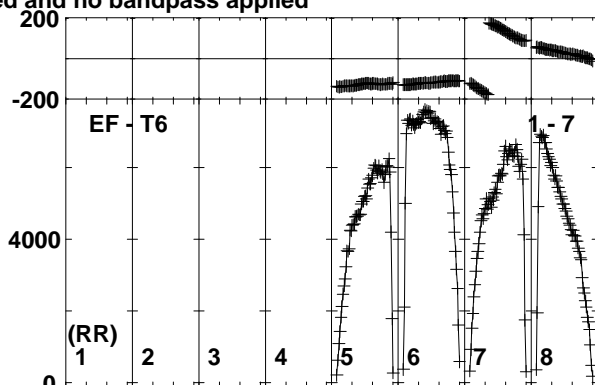
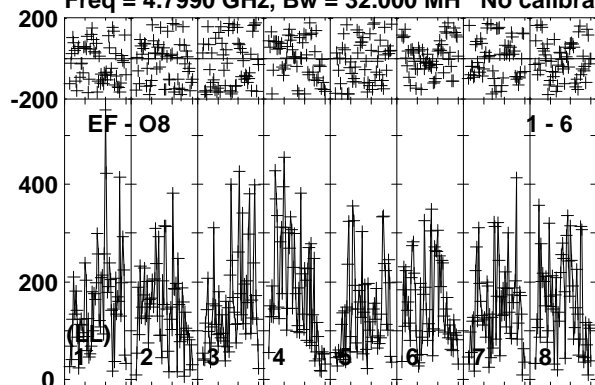

Lower frame: Micro Ampl Jy Top frame: Phas deg  
Vector averaged cross-power spectrum Baseline: EF (01) - O8 (06)  
Timerange: 00/05:07:11 to 00/05:08:40

Plot file version 237 created 24-NOV-2017 10:10:33  
J1108+4330 EG096D.UVDATA.1  
Freq = 4.7990 GHz, Bw = 32.000 MH No calibration applied and no bandpass applied

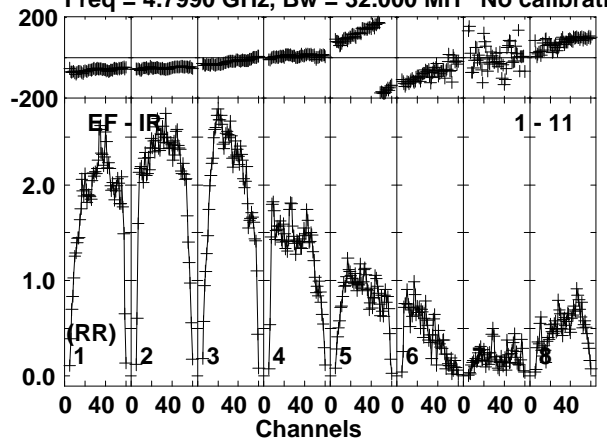

Lower frame: Milli Ampl Jy Top frame: Phas deg  
Vector averaged cross-power spectrum Baseline: EF (01) - IR (11)  
Timerange: 00/05:07:11 to 00/05:08:40

Plot file version 238 created 24-NOV-2017 10:10:33

ARUMA EG096D.UVDATA.1

Freq = 4.7990 GHz, Bw = 32.000 MH No calibration applied and no bandpass applied

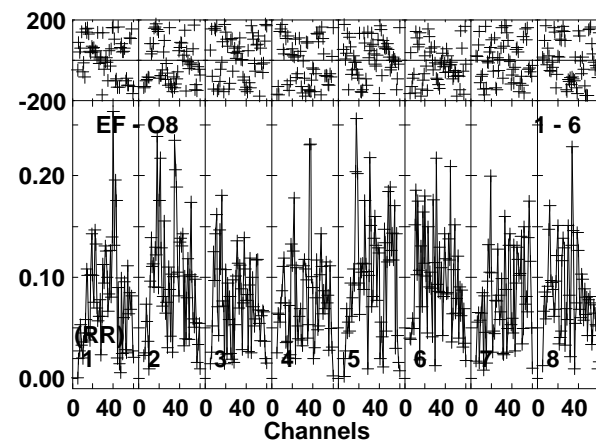
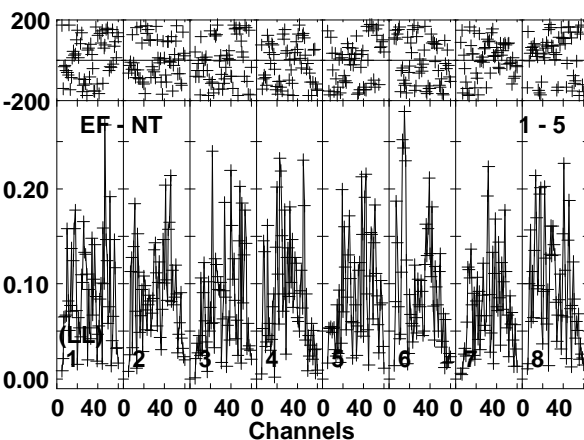
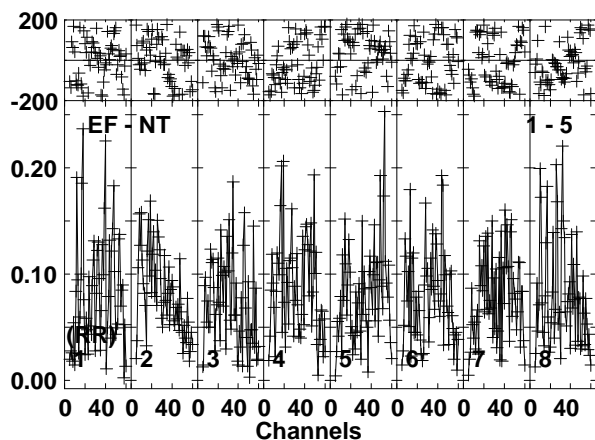
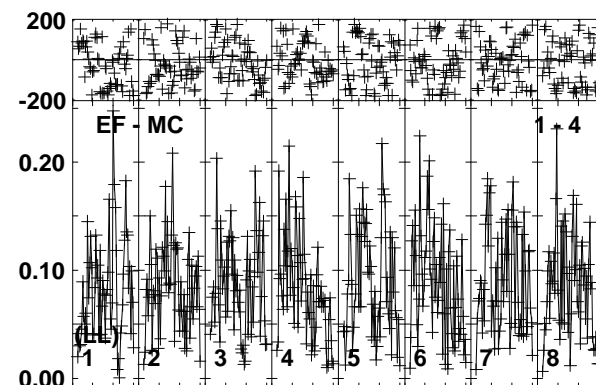
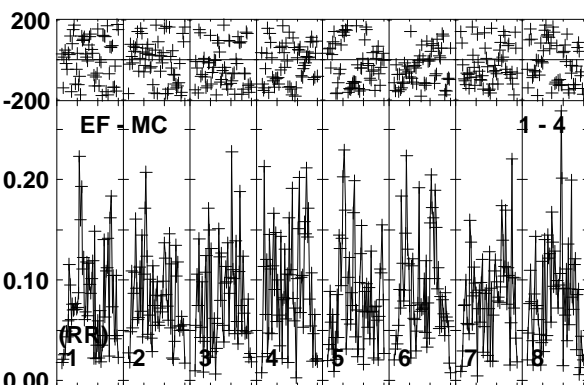
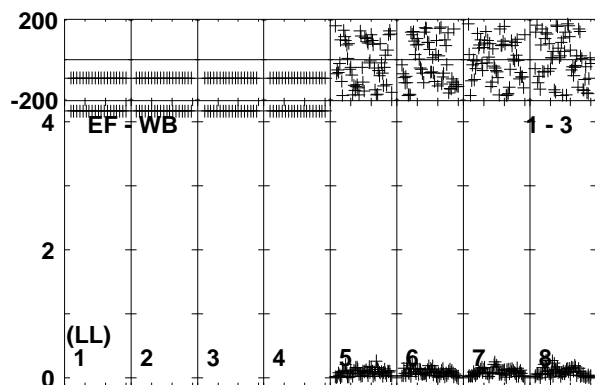
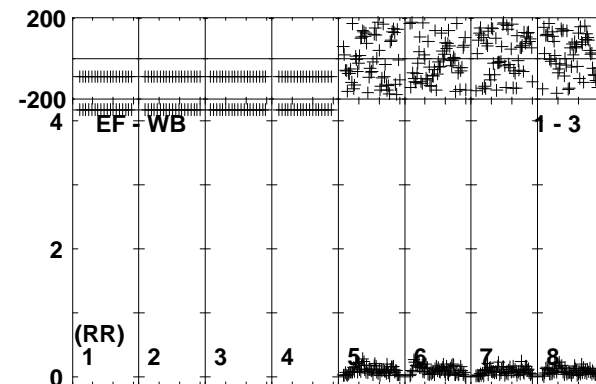
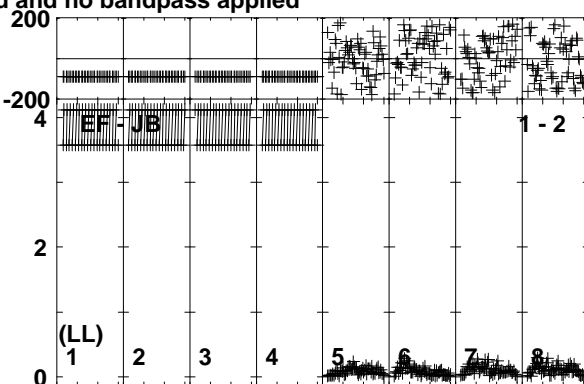
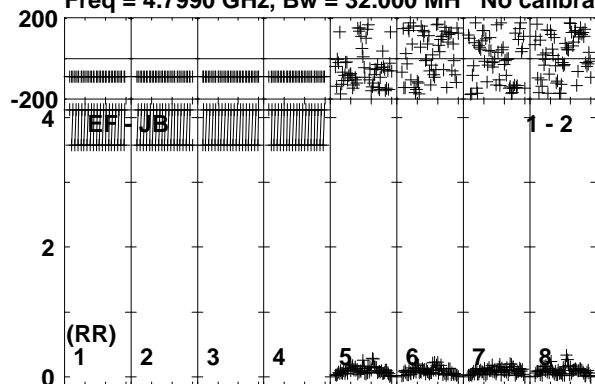

Lower frame: Milli Ampl Jy Top frame: Phas deg  
Vector averaged cross-power spectrum Baseline: EF (01) - JB (02)  
Timerange: 00/05:08:41 to 00/05:12:10

Plot file version 239 created 24-NOV-2017 10:10:33

ARUMA EG096D.UVDATA.1

Freq = 4.7990 GHz, Bw = 32.000 MH No calibration applied and no bandpass applied

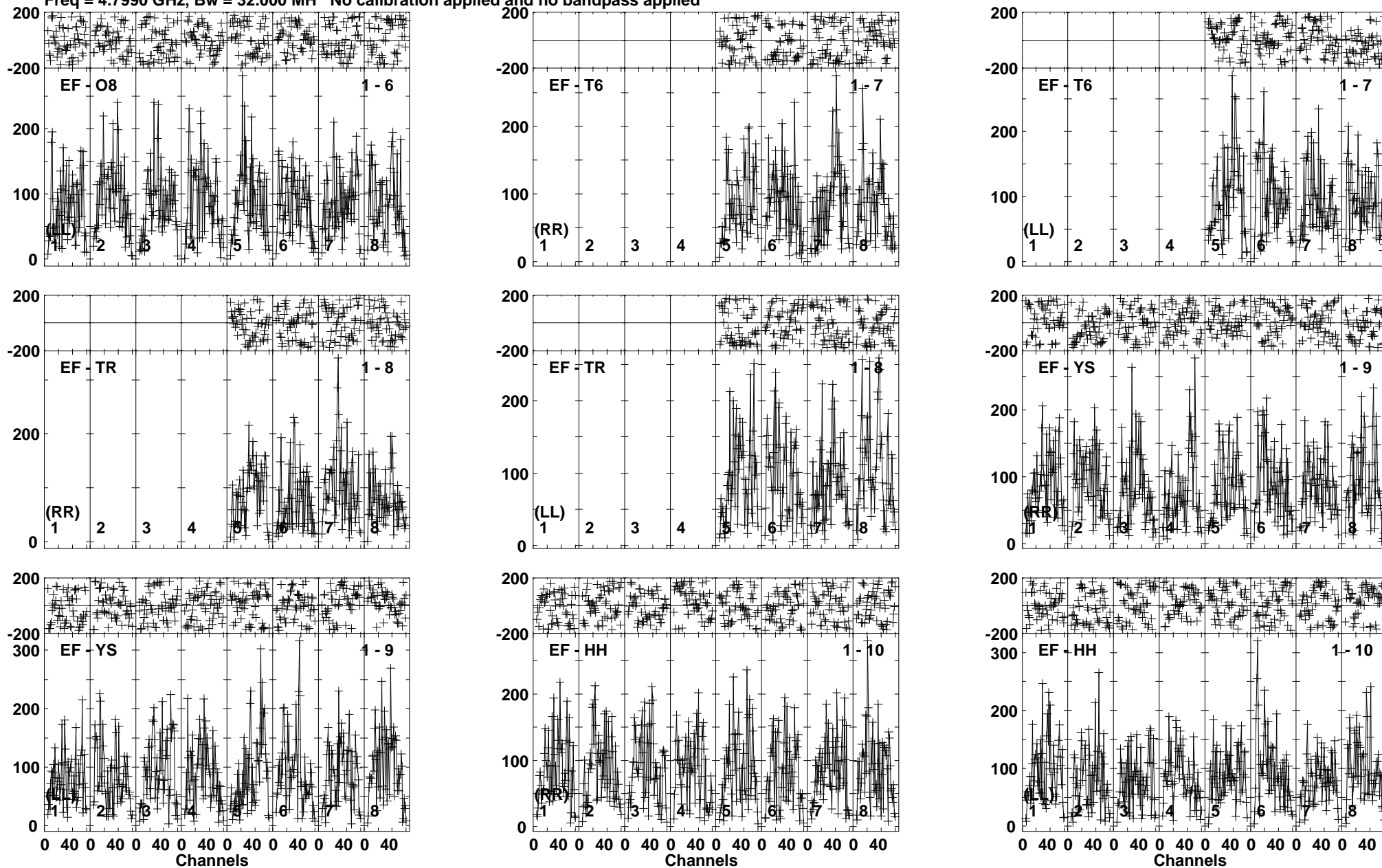

Lower frame: Micro Ampl Jy Top frame: Phas deg  
Vector averaged cross-power spectrum Baseline: EF (01) - O8 (06)  
Timerange: 00/05:08:41 to 00/05:12:10

Plot file version 240 created 24-NOV-2017 10:10:34  
ARUMA EG096D.UVDATA.1  
Freq = 4.7990 GHz, Bw = 32.000 MH No calibration applied and no bandpass applied

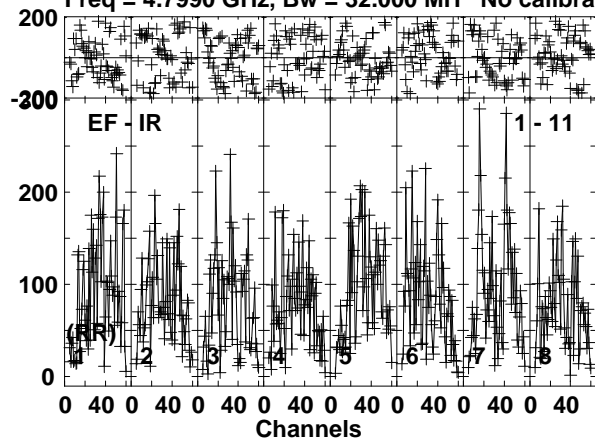

Lower frame: Micro Ampl Jy Top frame: Phas deg  
Vector averaged cross-power spectrum Baseline: EF (01) - IR (11)  
Timerange: 00/05:08:41 to 00/05:12:10

Plot file version 241 created 24-NOV-2017 10:10:34

J1108+4330 EG096D.UVDATA.1

Freq = 4.7990 GHz, Bw = 32.000 MH No calibration applied and no bandpass applied

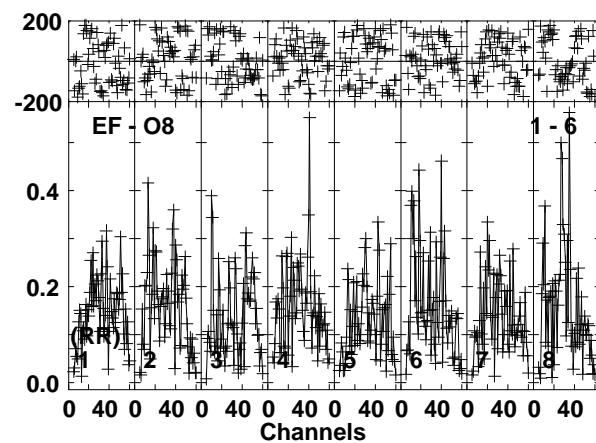
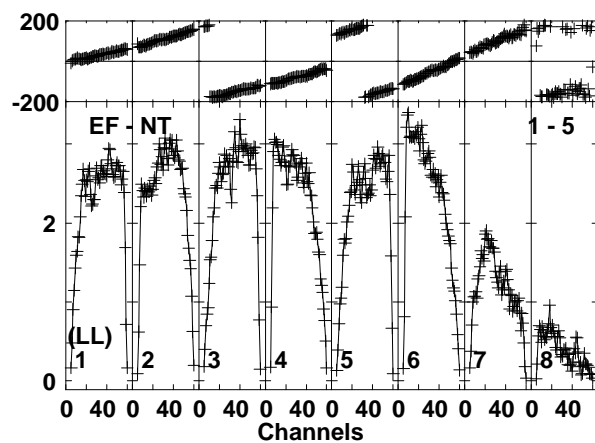
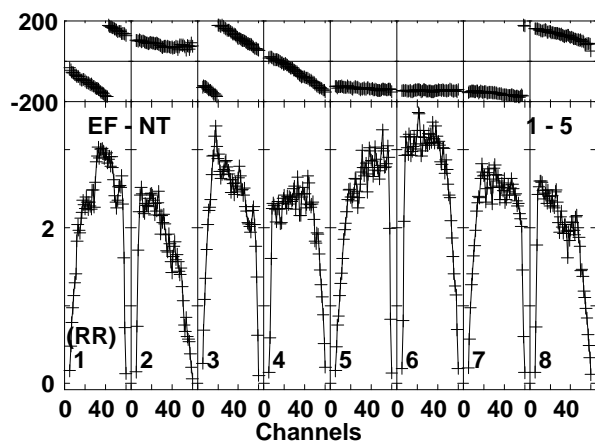
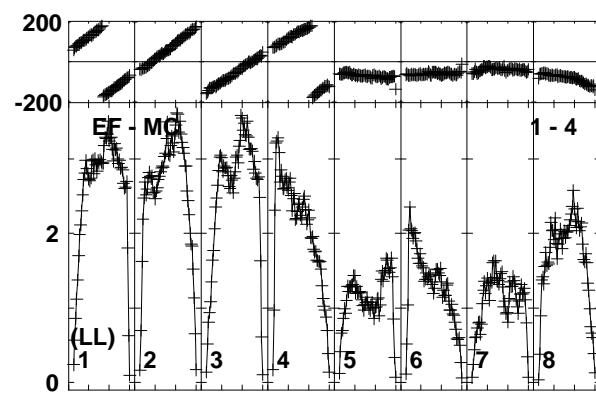
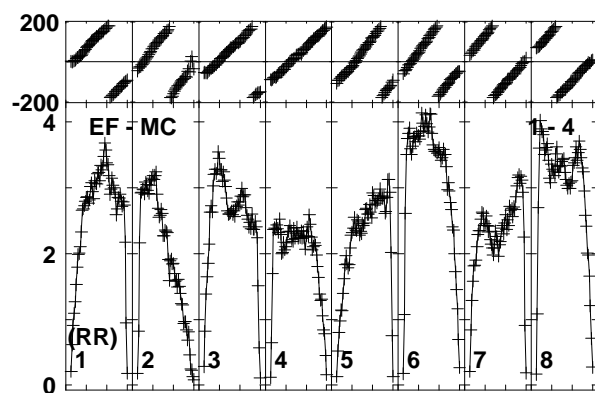
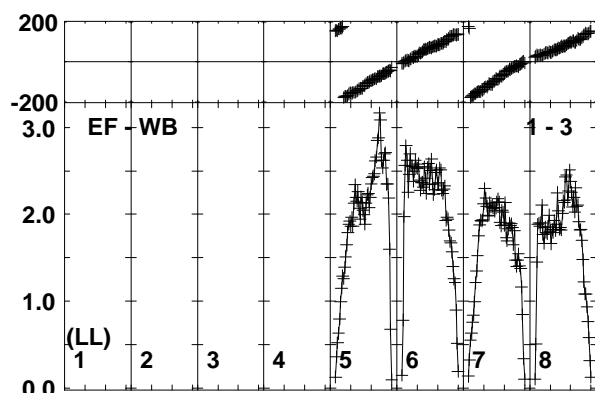
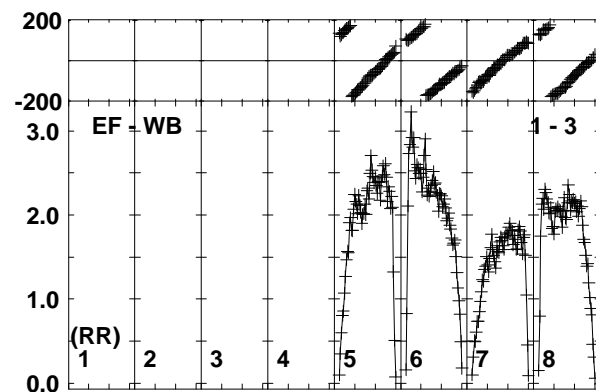
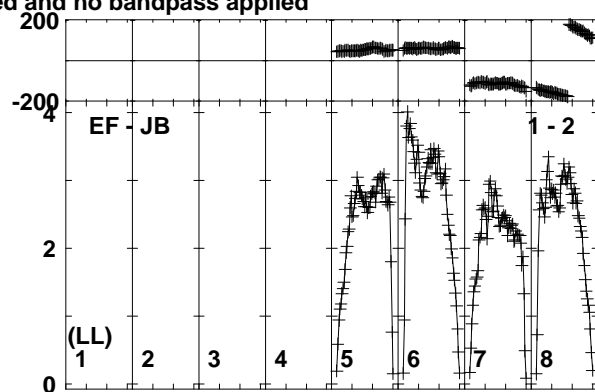
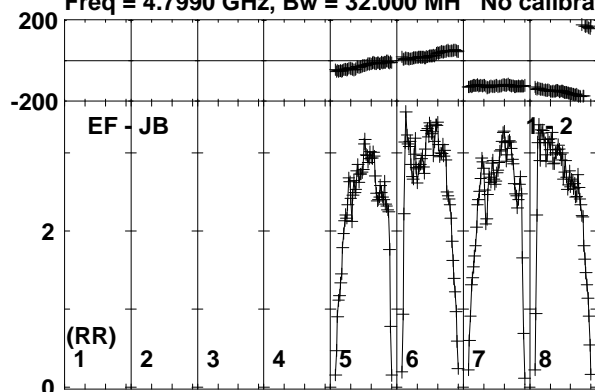

Lower frame: Milli Ampl Jy Top frame: Phas deg  
Vector averaged cross-power spectrum Baseline: EF (01) - JB (02)  
Timerange: 00/05:12:50 to 00/05:13:50

Plot file version 242 created 24-NOV-2017 10:10:34

J1108+4330 EG096D.UVDATA.1

Freq = 4.7990 GHz, Bw = 32.000 MH No calibration applied and no bandpass applied

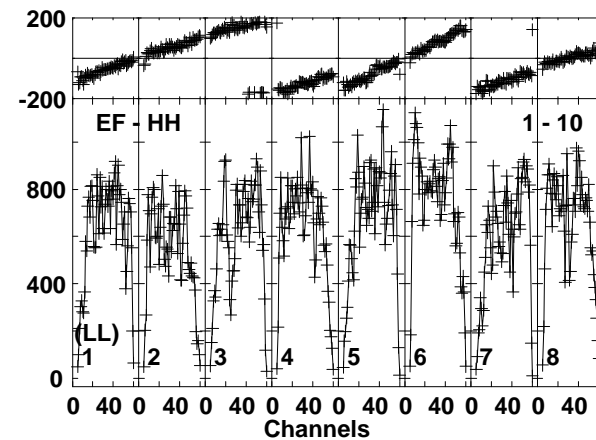
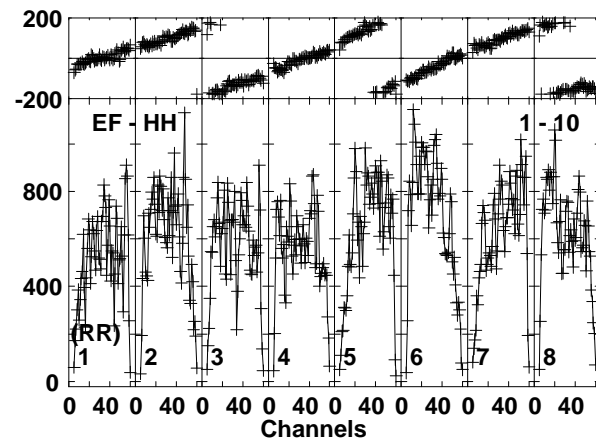
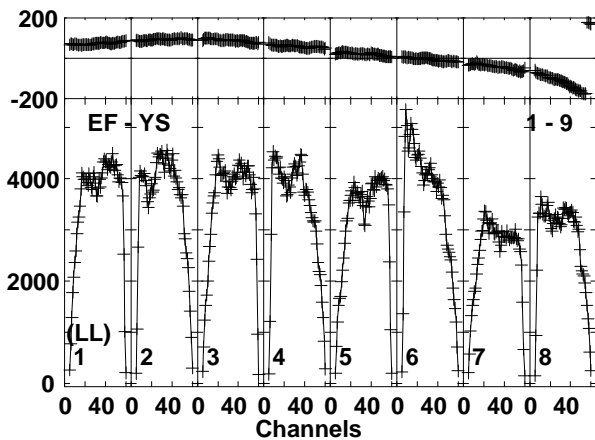
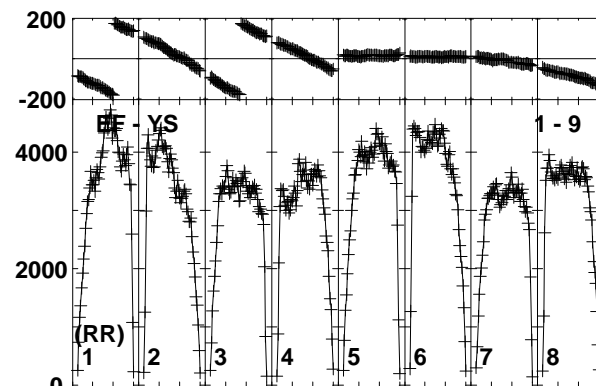
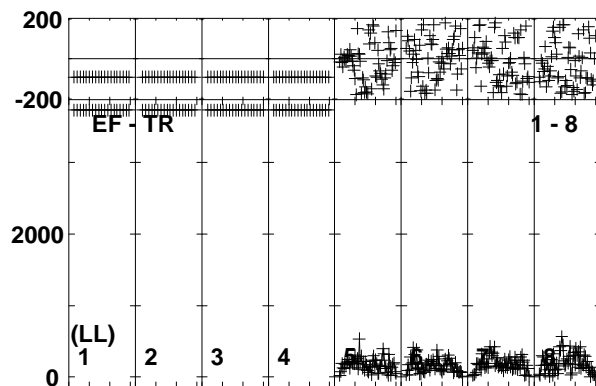
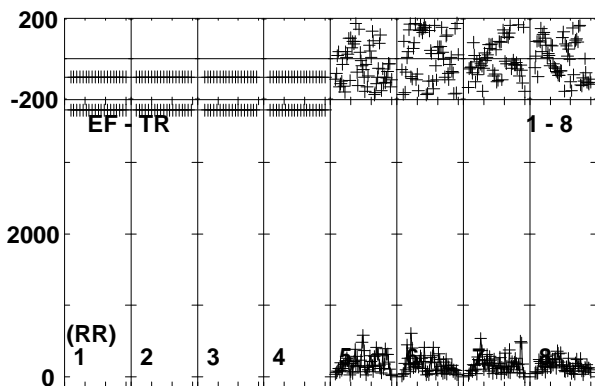
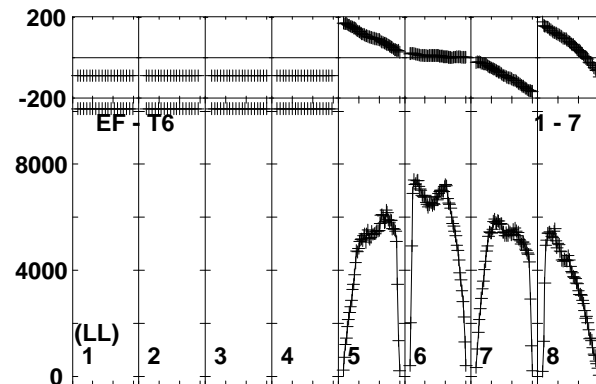
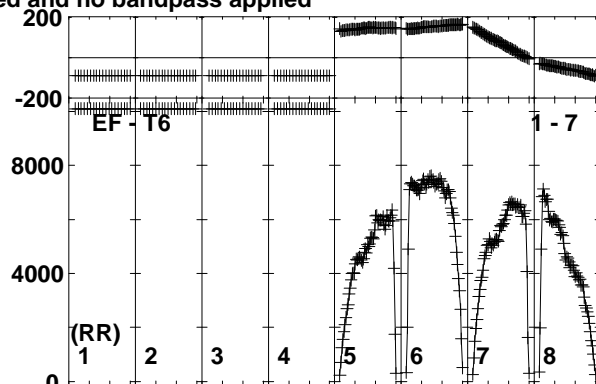
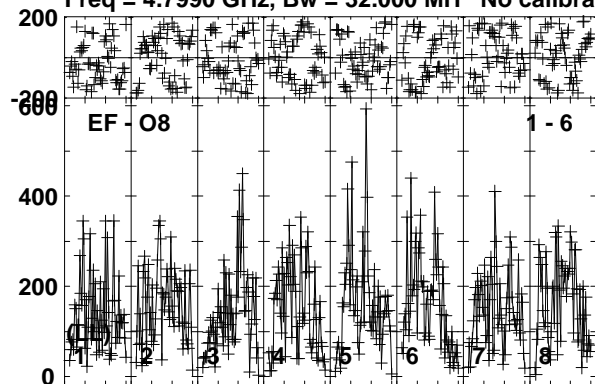

Lower frame: Micro Ampl Jy Top frame: Phas deg  
Vector averaged cross-power spectrum Baseline: EF (01) - O8 (06)  
Timerange: 00/05:12:50 to 00/05:13:50



Plot file version 243 created 24-NOV-2017 10:10:34  
J1108+4330 EG096D.UVDATA.1  
Freq = 4.7990 GHz, Bw = 32.000 MH No calibration applied and no bandpass applied

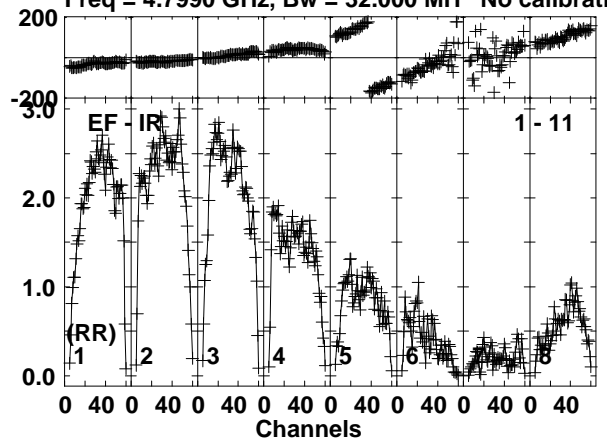

Lower frame: Milli Ampl Jy Top frame: Phas deg  
Vector averaged cross-power spectrum Baseline: EF (01) - IR (11)  
Timerange: 00/05:12:50 to 00/05:13:50

Plot file version 244 created 24-NOV-2017 10:10:34

ARUMA EG096D.UVDATA.1

Freq = 4.7990 GHz, Bw = 32.000 MH No calibration applied and no bandpass applied

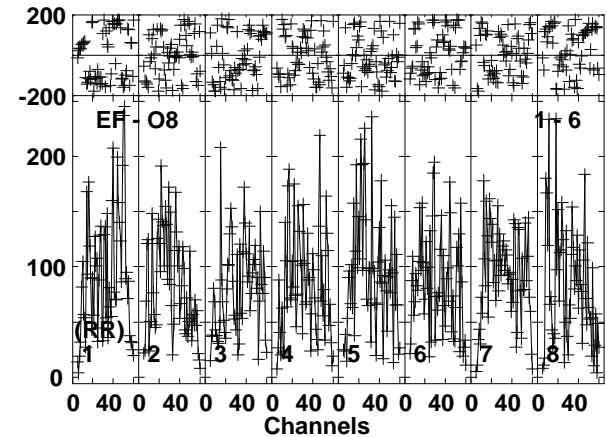
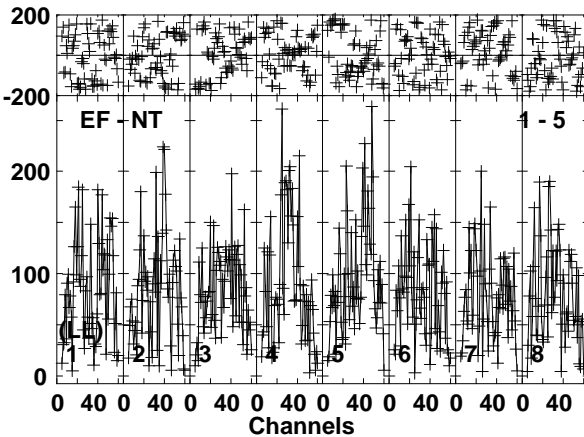
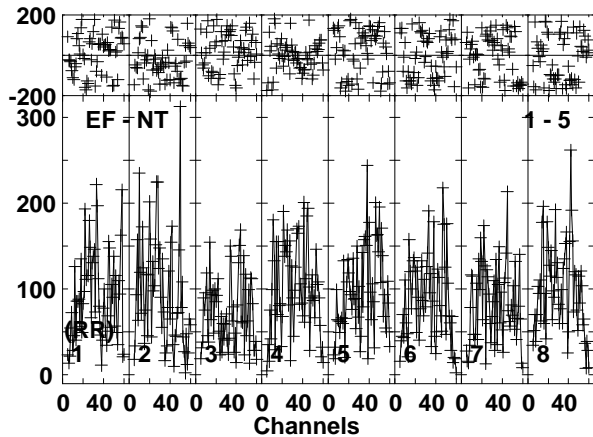
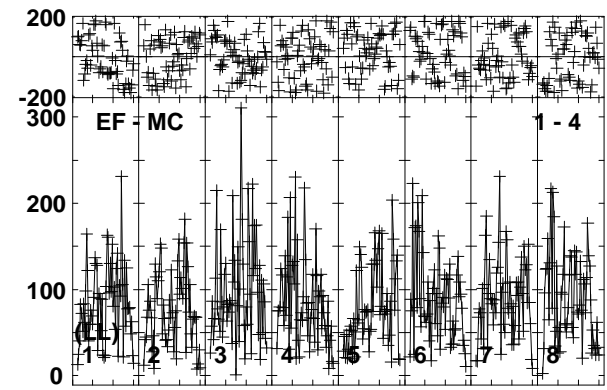
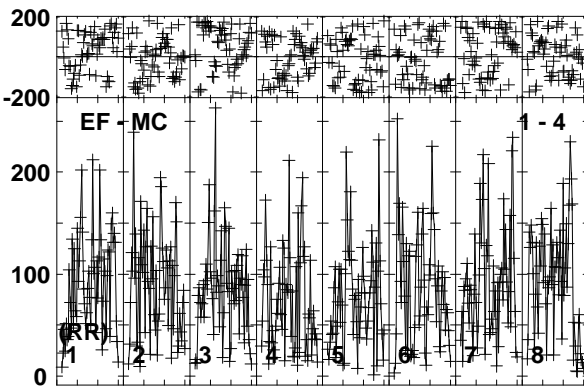
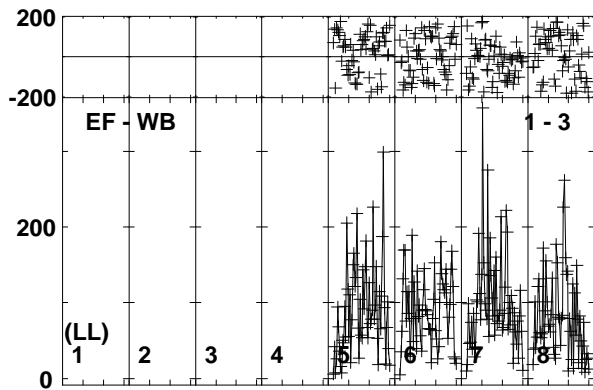
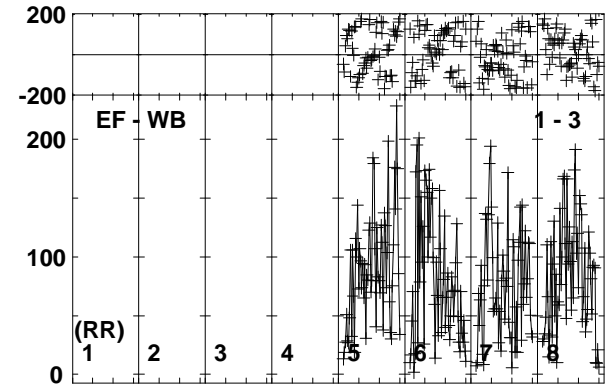
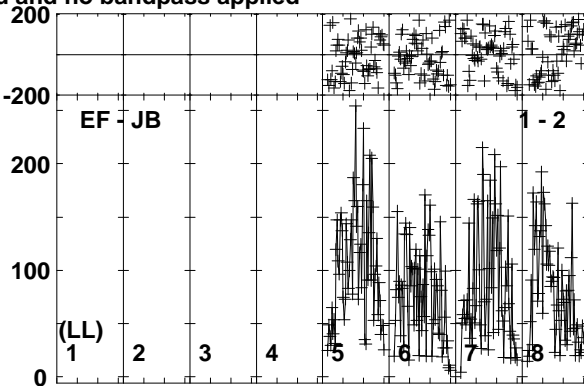
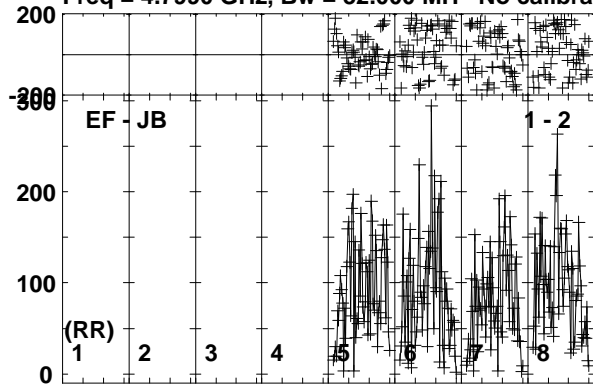

Lower frame: Micro Ampl Jy Top frame: Phas deg  
Vector averaged cross-power spectrum Baseline: EF (01) - JB (02)  
Timerange: 00/05:13:51 to 00/05:17:20

Plot file version 245 created 24-NOV-2017 10:10:35  
 ARUMA EG096D.UVDATA.1  
 Freq = 4.7990 GHz, Bw = 32.000 MH No calibration applied and no bandpass applied

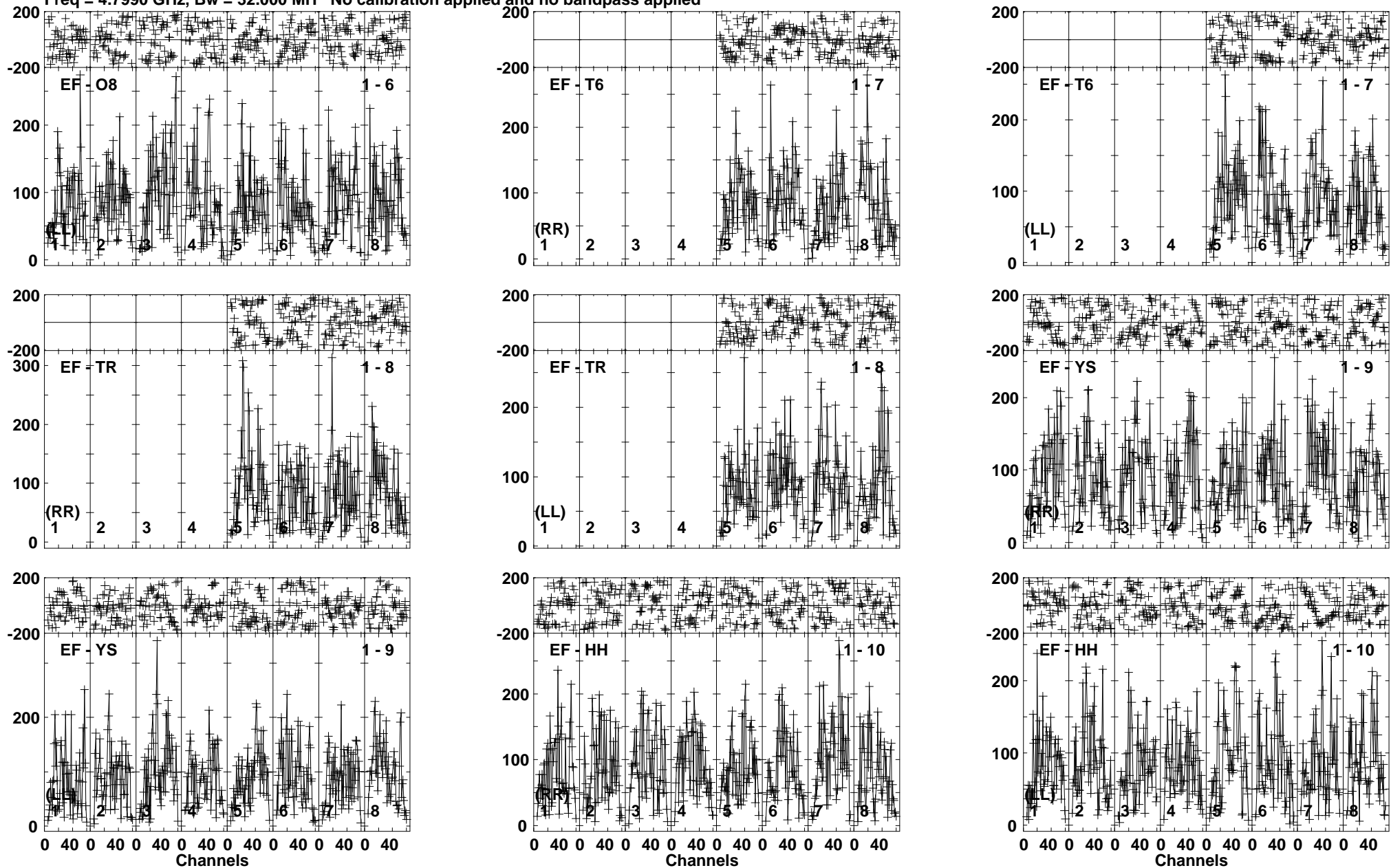

Lower frame: Micro Ampl Jy Top frame: Phas deg  
 Vector averaged cross-power spectrum Baseline: EF (01) - O8 (06)  
 Timerange: 00/05:13:51 to 00/05:17:20

Plot file version 246 created 24-NOV-2017 10:10:35  
ARUMA EG096D.UVDATA.1  
Freq = 4.7990 GHz, Bw = 32.000 MH No calibration applied and no bandpass applied

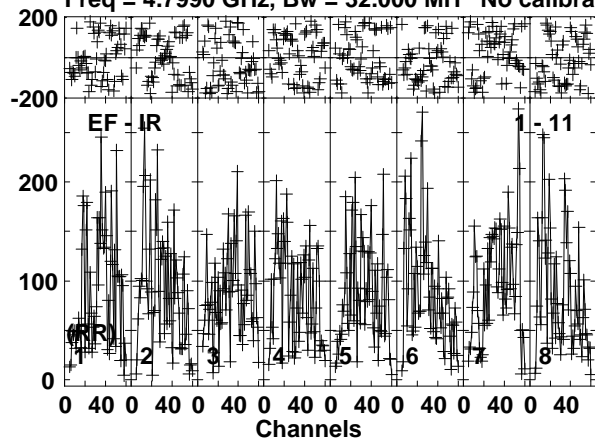

Lower frame: Micro Ampl Jy Top frame: Phas deg  
Vector averaged cross-power spectrum Baseline: EF (01) - IR (11)  
Timerange: 00/05:13:51 to 00/05:17:20

Plot file version 247 created 24-NOV-2017 10:10:35

J1108+4330 EG096D.UVDATA.1

Freq = 4.7990 GHz, Bw = 32.000 MH No calibration applied and no bandpass applied

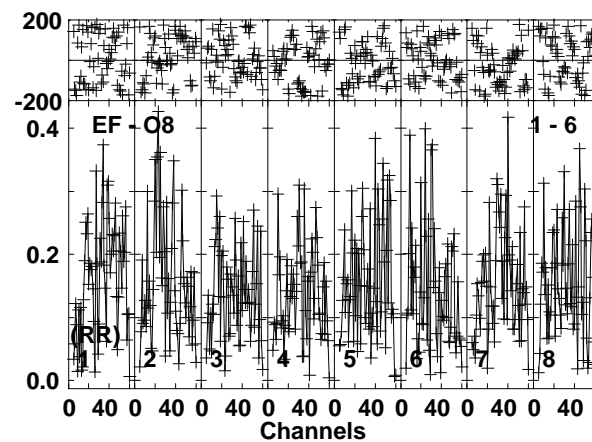
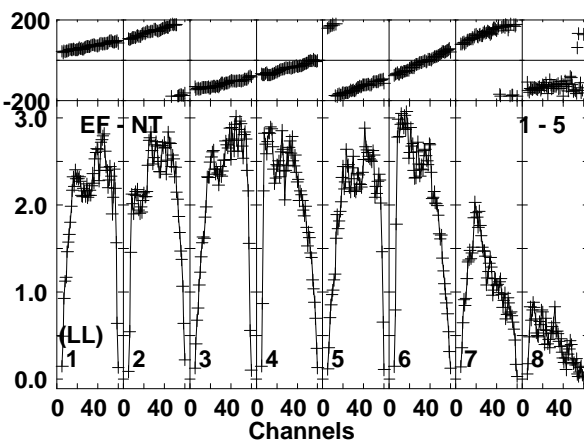
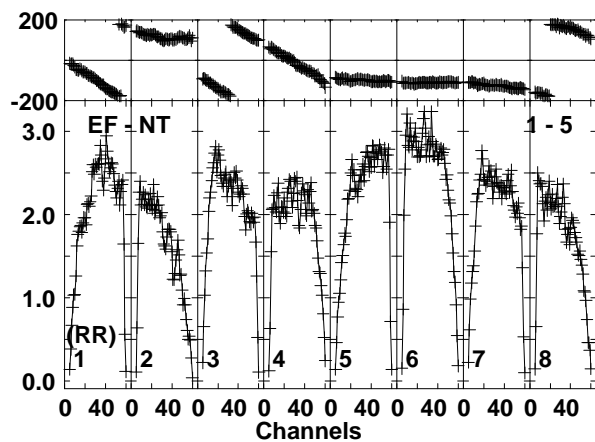
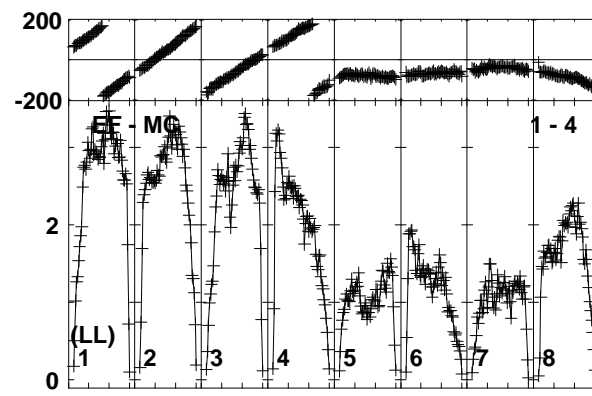
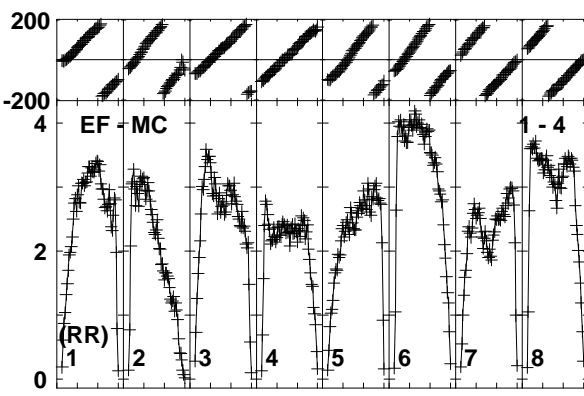
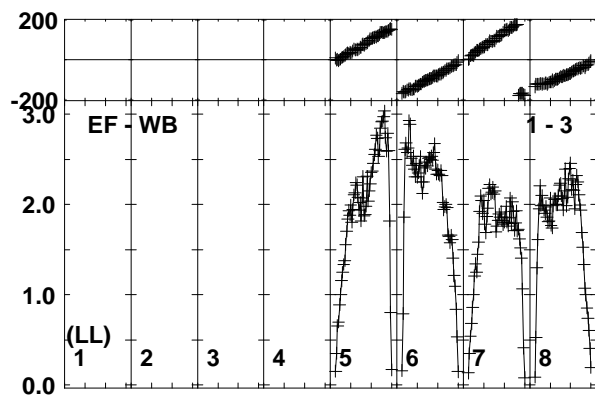
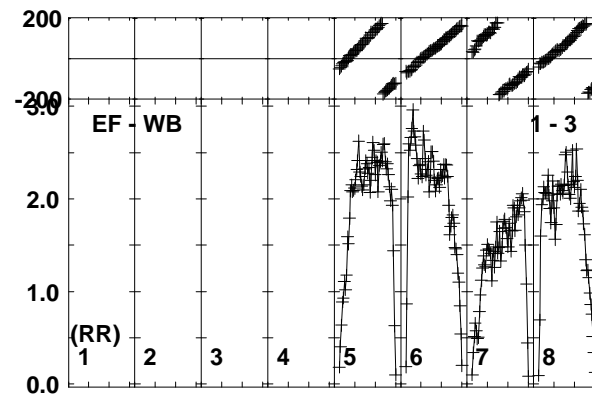
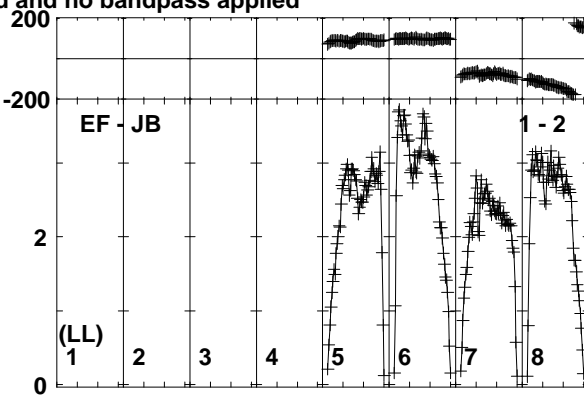
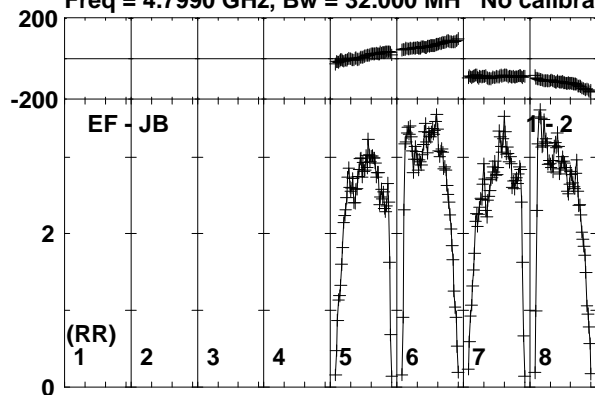

Lower frame: Milli Ampl Jy Top frame: Phas deg  
Vector averaged cross-power spectrum Baseline: EF (01) - JB (02)  
Timerange: 00/05:17:21 to 00/05:18:50

Plot file version 248 created 24-NOV-2017 10:10:35

J1108+4330 EG096D.UVDATA.1

Freq = 4.7990 GHz, Bw = 32.000 MH No calibration applied and no bandpass applied

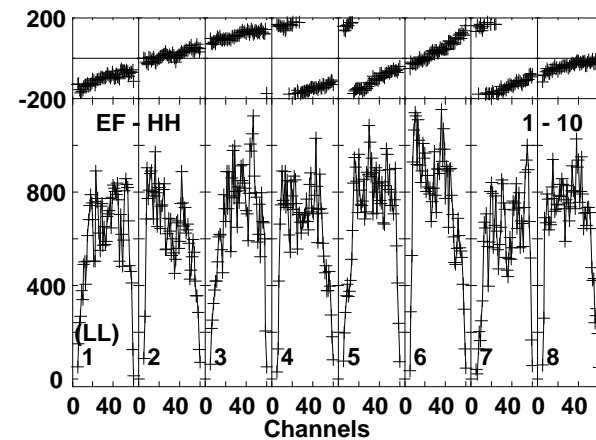
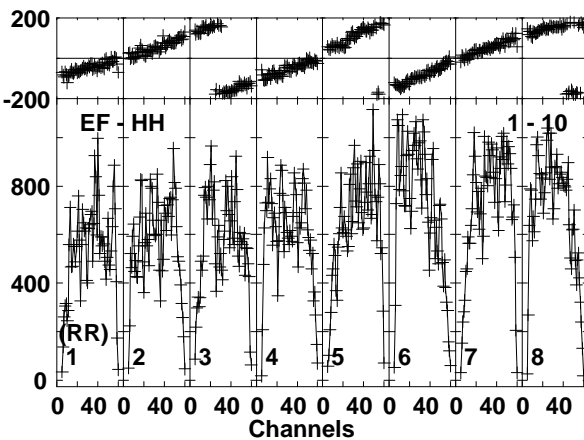
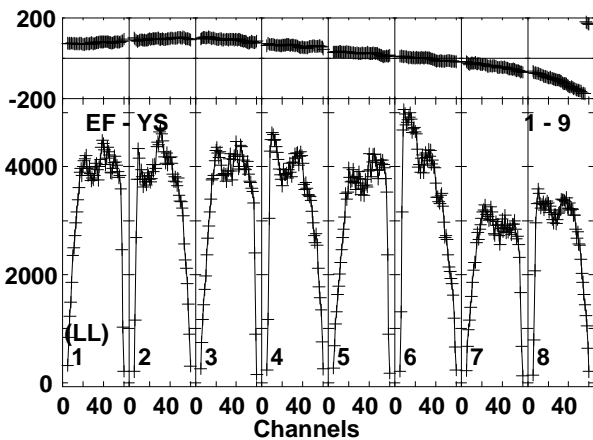
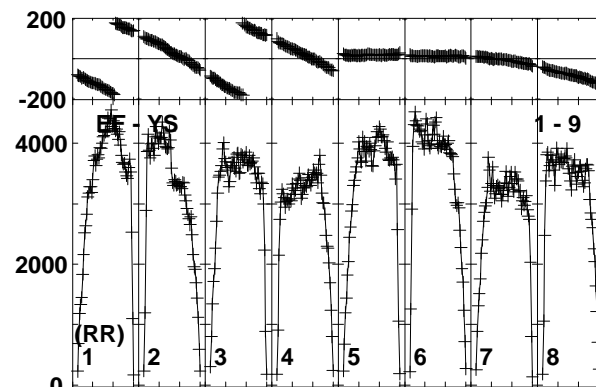
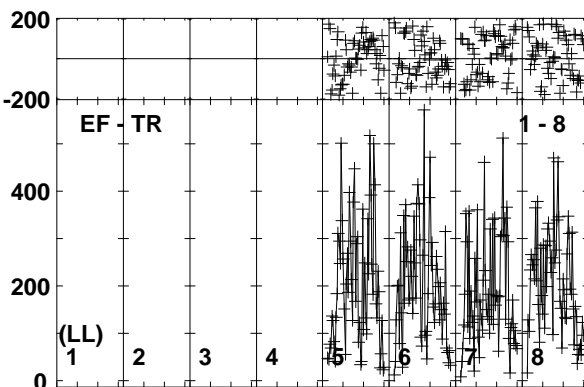
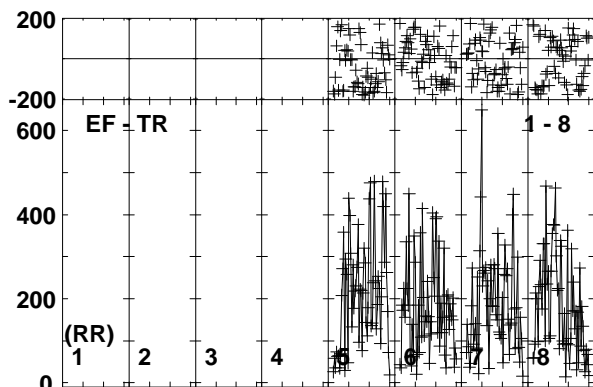
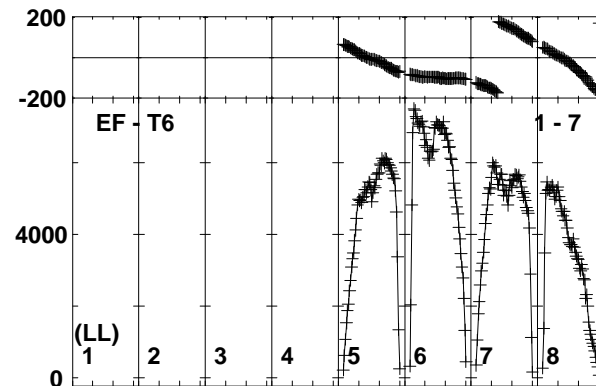
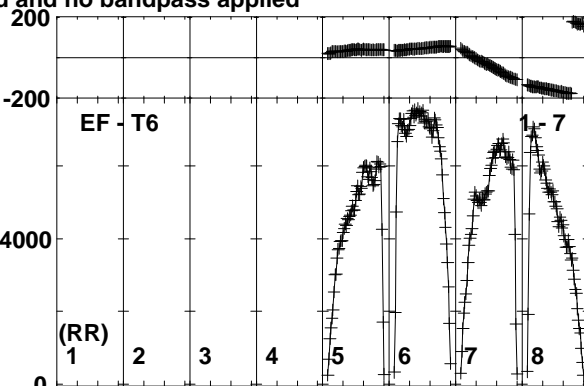
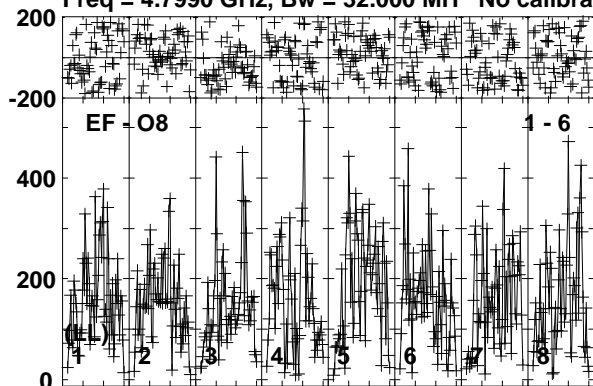

Lower frame: Micro Ampl Jy Top frame: Phas deg  
Vector averaged cross-power spectrum Baseline: EF (01) - O8 (06)  
Timerange: 00/05:17:21 to 00/05:18:50

Plot file version 249 created 24-NOV-2017 10:10:36  
J1108+4330 EG096D.UVDATA.1  
Freq = 4.7990 GHz, Bw = 32.000 MH No calibration applied and no bandpass applied

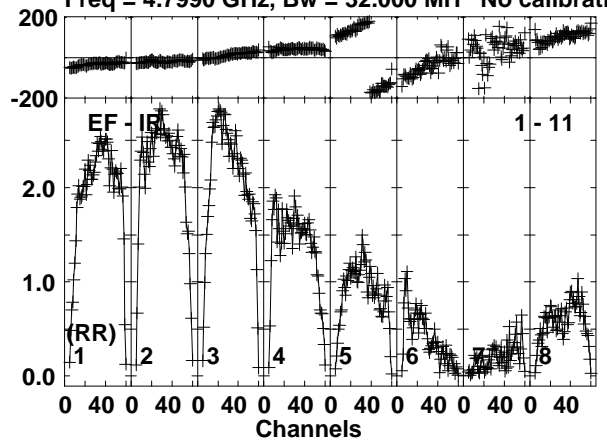

Lower frame: Milli Ampl Jy Top frame: Phas deg  
Vector averaged cross-power spectrum Baseline: EF (01) - IR (11)  
Timerange: 00/05:17:21 to 00/05:18:50

Plot file version 250 created 24-NOV-2017 10:10:36

ARUMA EG096D.UVDATA.1

Freq = 4.7990 GHz, Bw = 32.000 MH No calibration applied and no bandpass applied

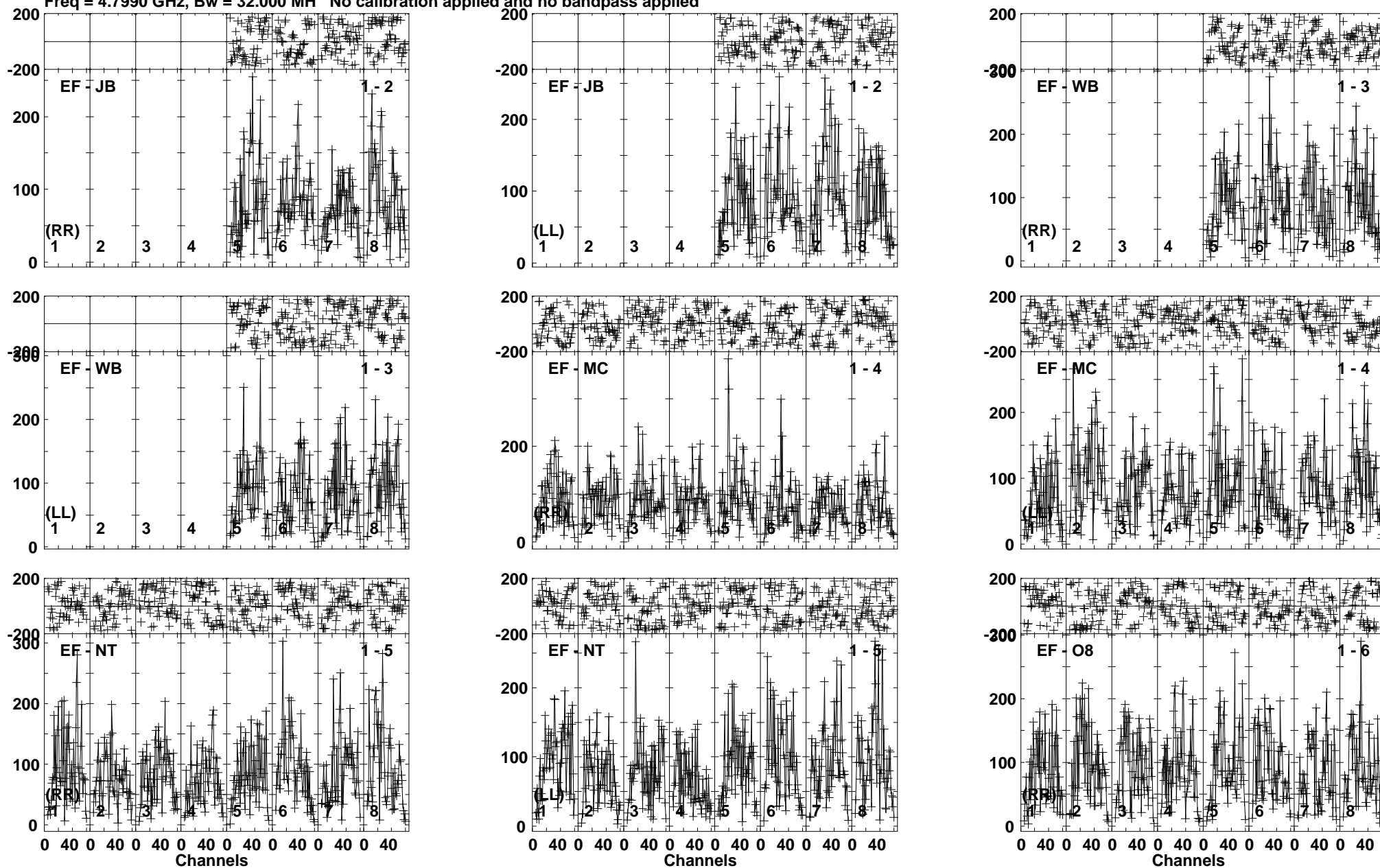

Lower frame: Micro Ampl Jy Top frame: Phas deg  
Vector averaged cross-power spectrum Baseline: EF (01) - JB (02)  
Timerange: 00/05:18:51 to 00/05:22:20



Plot file version 251 created 24-NOV-2017 10:10:36

ARUMA EG096D.UVDATA.1

Freq = 4.7990 GHz, Bw = 32.000 MH No calibration applied and no bandpass applied

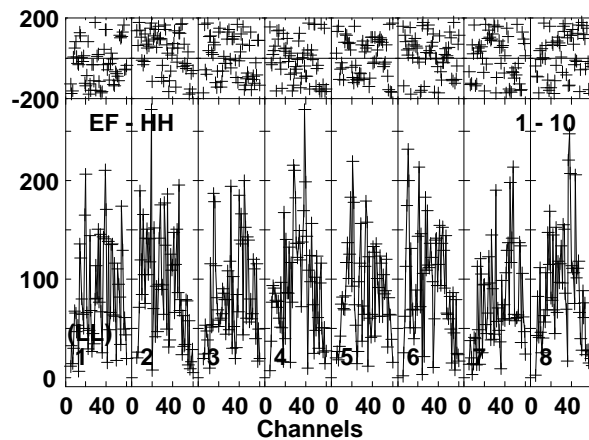
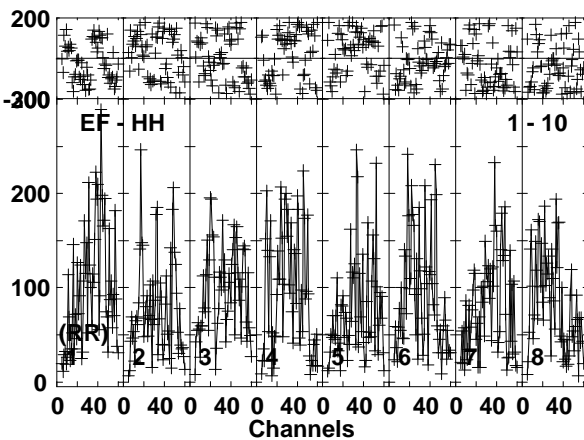
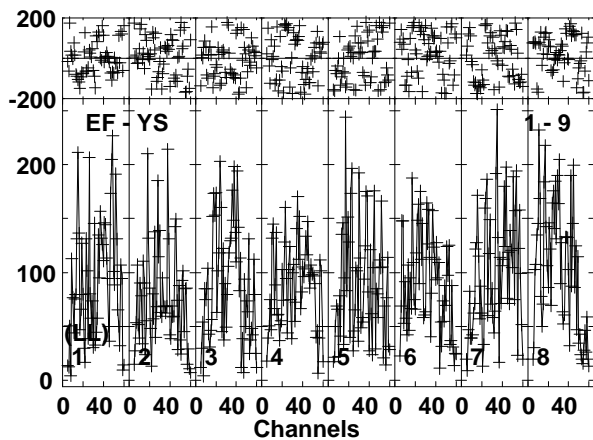
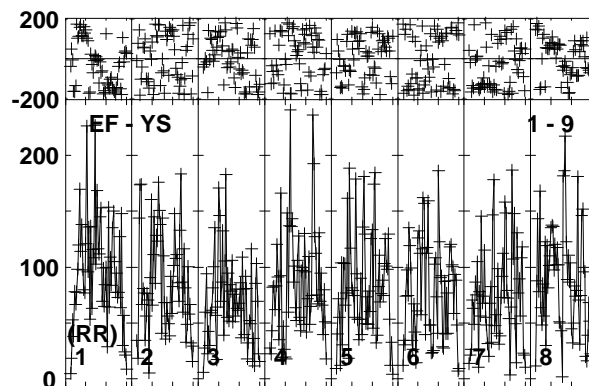
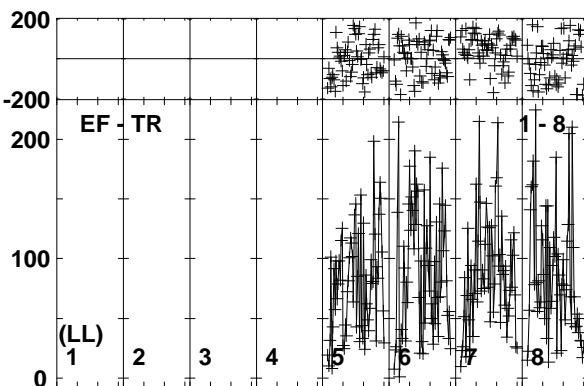
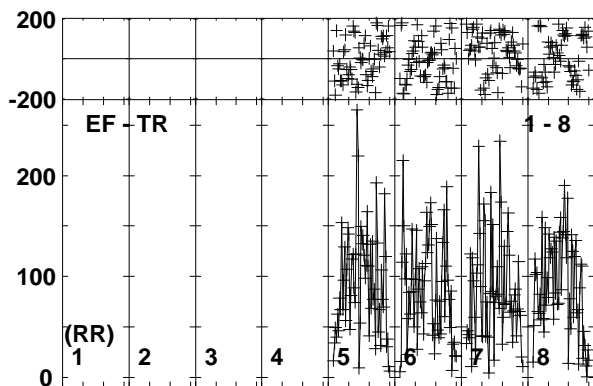
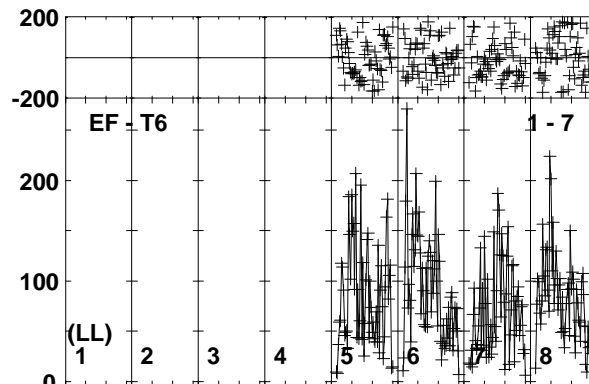
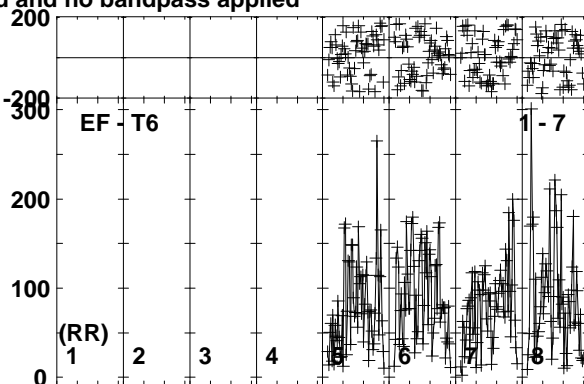
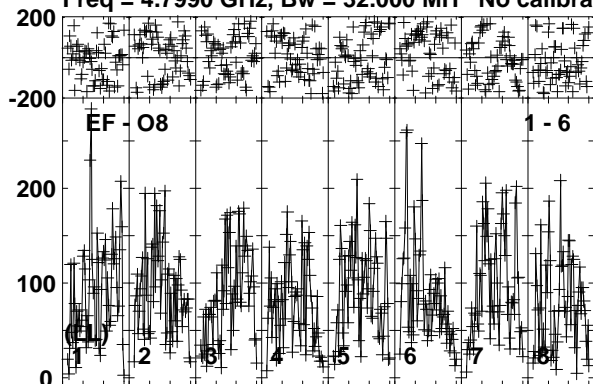

Lower frame: Micro Ampl Jy Top frame: Phas deg  
Vector averaged cross-power spectrum Baseline: EF (01) - O8 (06)  
Timerange: 00/05:18:51 to 00/05:22:20

Plot file version 252 created 24-NOV-2017 10:10:36  
ARUMA EG096D.UVDATA.1  
Freq = 4.7990 GHz, Bw = 32.000 MH No calibration applied and no bandpass applied

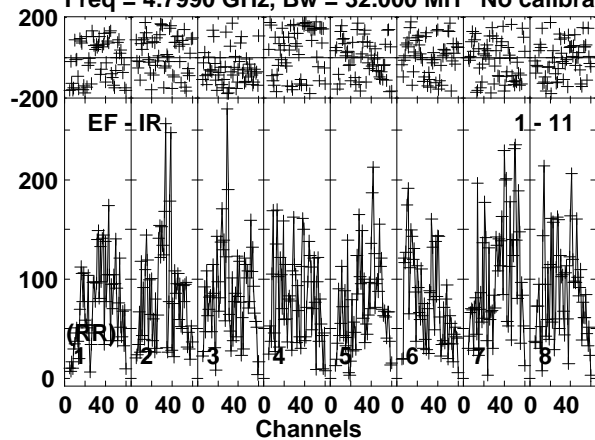

Lower frame: Micro Ampl Jy Top frame: Phas deg  
Vector averaged cross-power spectrum Baseline: EF (01) - IR (11)  
Timerange: 00/05:18:51 to 00/05:22:20

Plot file version 253 created 24-NOV-2017 10:10:36

J1108+4330 EG096D.UVDATA.1

Freq = 4.7990 GHz, Bw = 32.000 MH No calibration applied and no bandpass applied

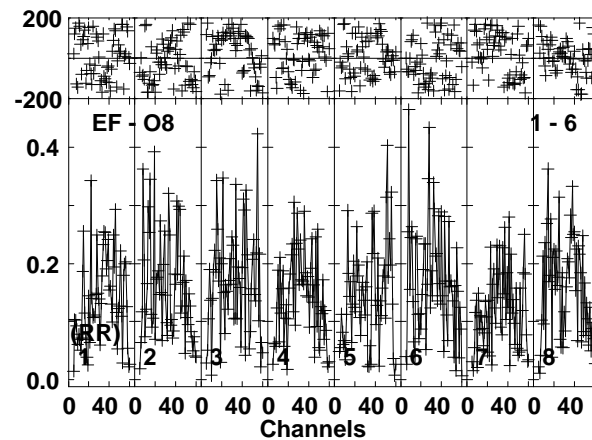
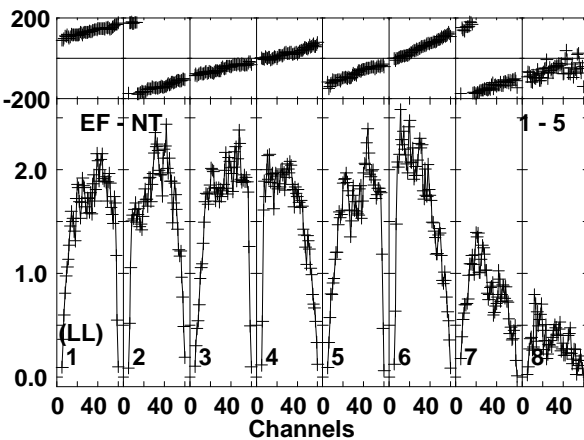
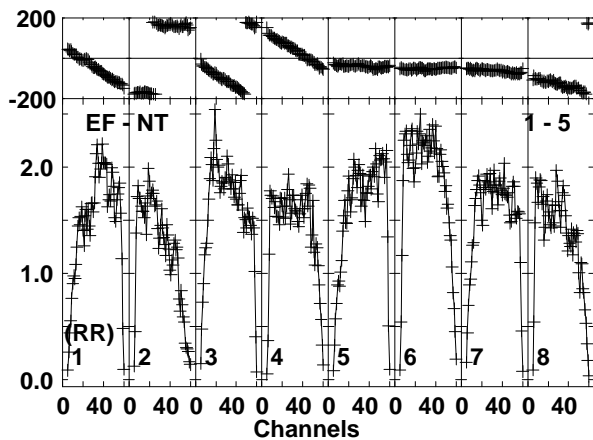
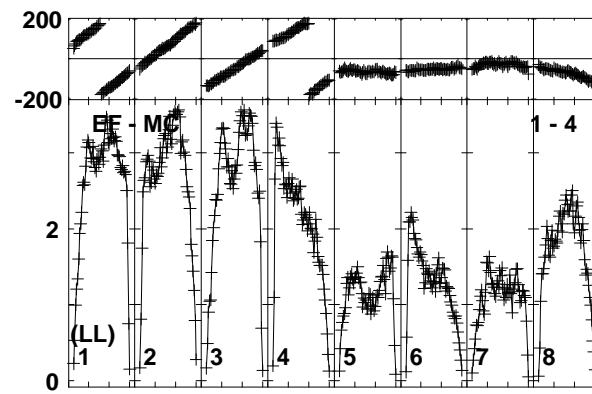
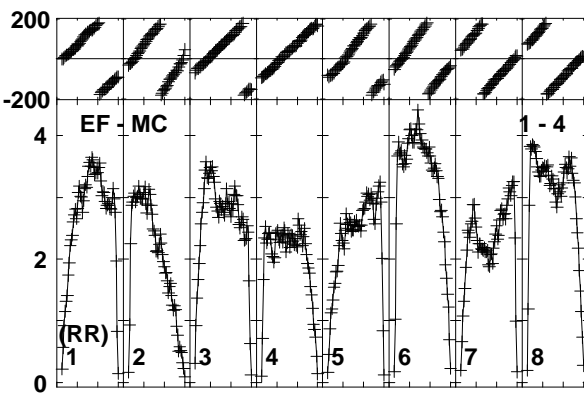
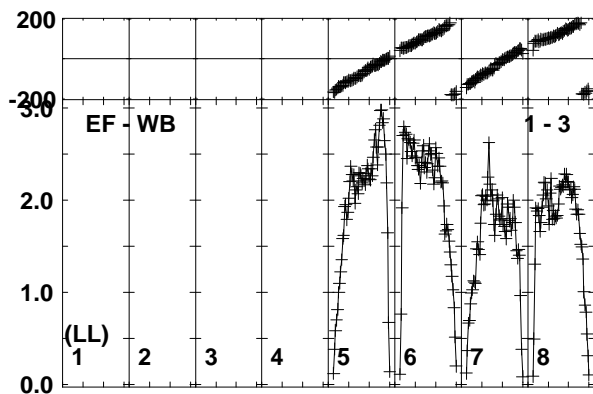
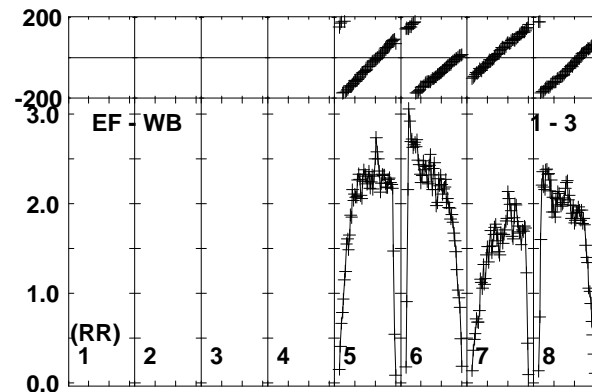
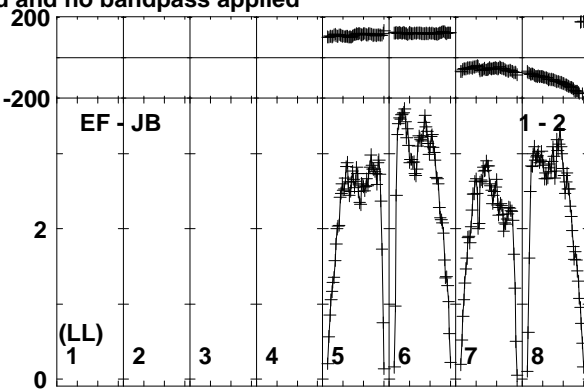
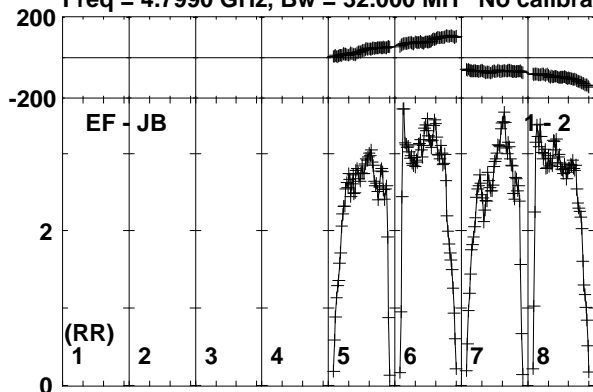

Lower frame: Milli Ampl Jy Top frame: Phas deg  
Vector averaged cross-power spectrum Baseline: EF (01) - JB (02)  
Timerange: 00/05:23:00 to 00/05:24:00

Plot file version 254 created 24-NOV-2017 10:10:37

J1108+4330 EG096D.UVDATA.1

Freq = 4.7990 GHz, Bw = 32.000 MH No calibration applied and no bandpass applied

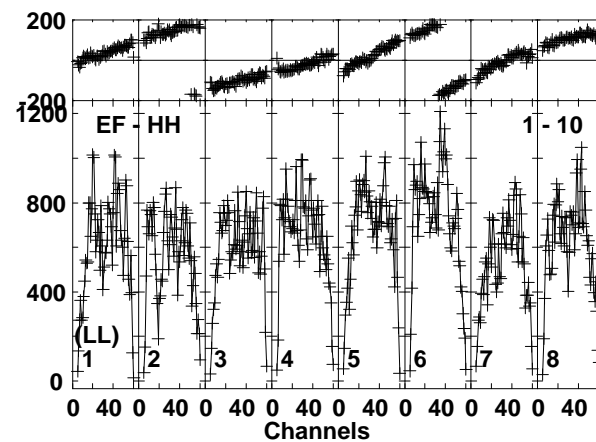
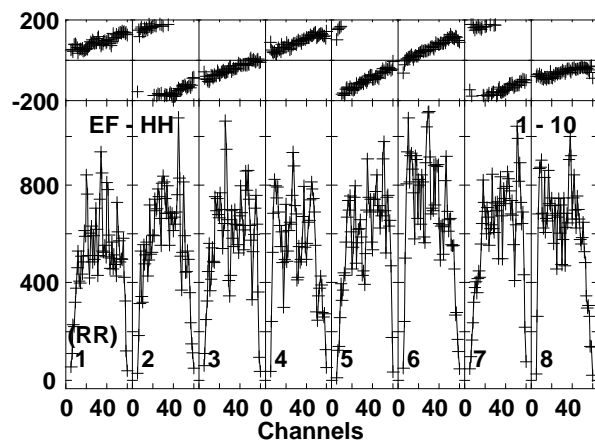
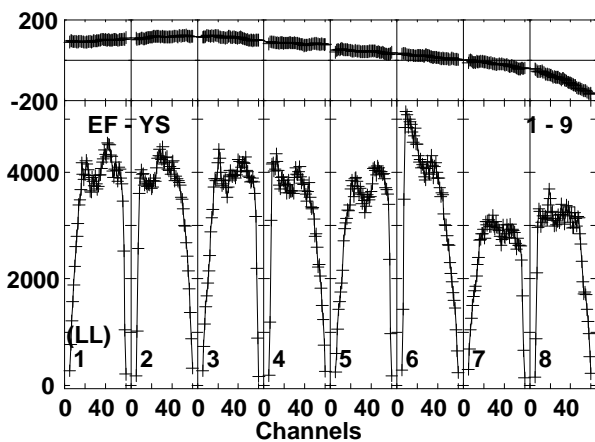
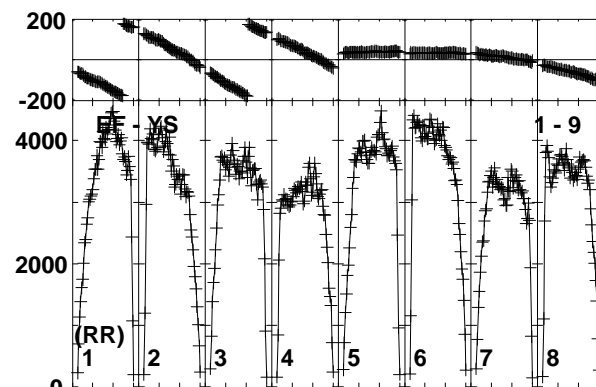
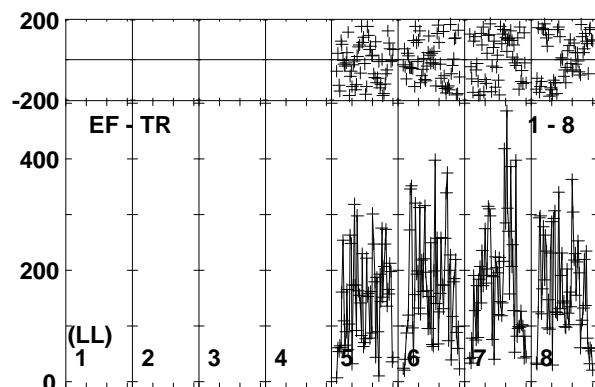
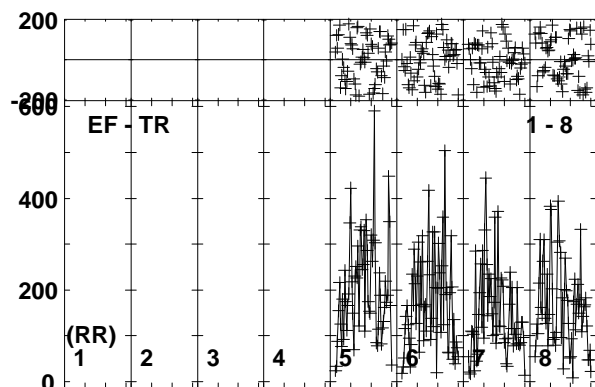
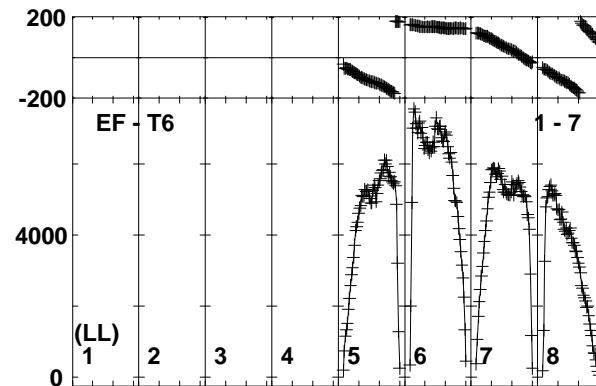
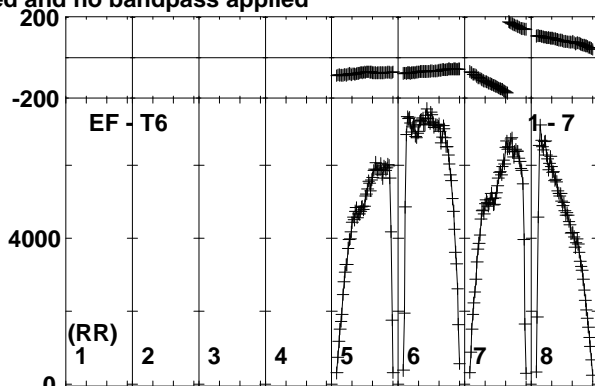
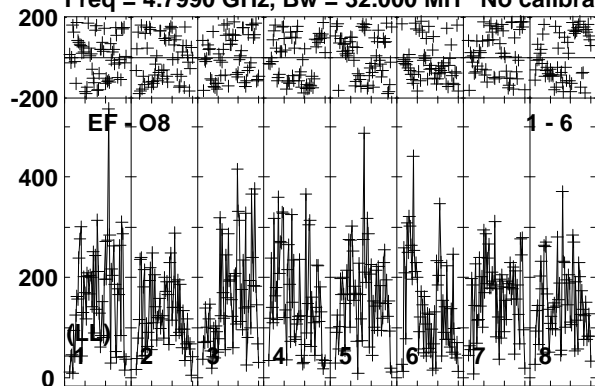

Lower frame: Micro Ampl Jy Top frame: Phas deg  
Vector averaged cross-power spectrum Baseline: EF (01) - O8 (06)  
Timerange: 00/05:23:00 to 00/05:24:00

Plot file version 255 created 24-NOV-2017 10:10:37  
J1108+4330 EG096D.UVDATA.1  
Freq = 4.7990 GHz, Bw = 32.000 MH No calibration applied and no bandpass applied

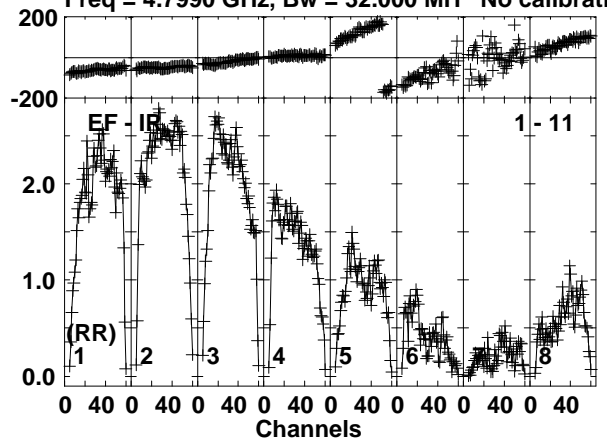

Lower frame: Milli Ampl Jy Top frame: Phas deg  
Vector averaged cross-power spectrum Baseline: EF (01) - IR (11)  
Timerange: 00/05:23:00 to 00/05:24:00

Plot file version 256 created 24-NOV-2017 10:10:37

J1112+4301 EG096D.UVDATA.1

Freq = 4.7990 GHz, Bw = 32.000 MH No calibration applied and no bandpass applied

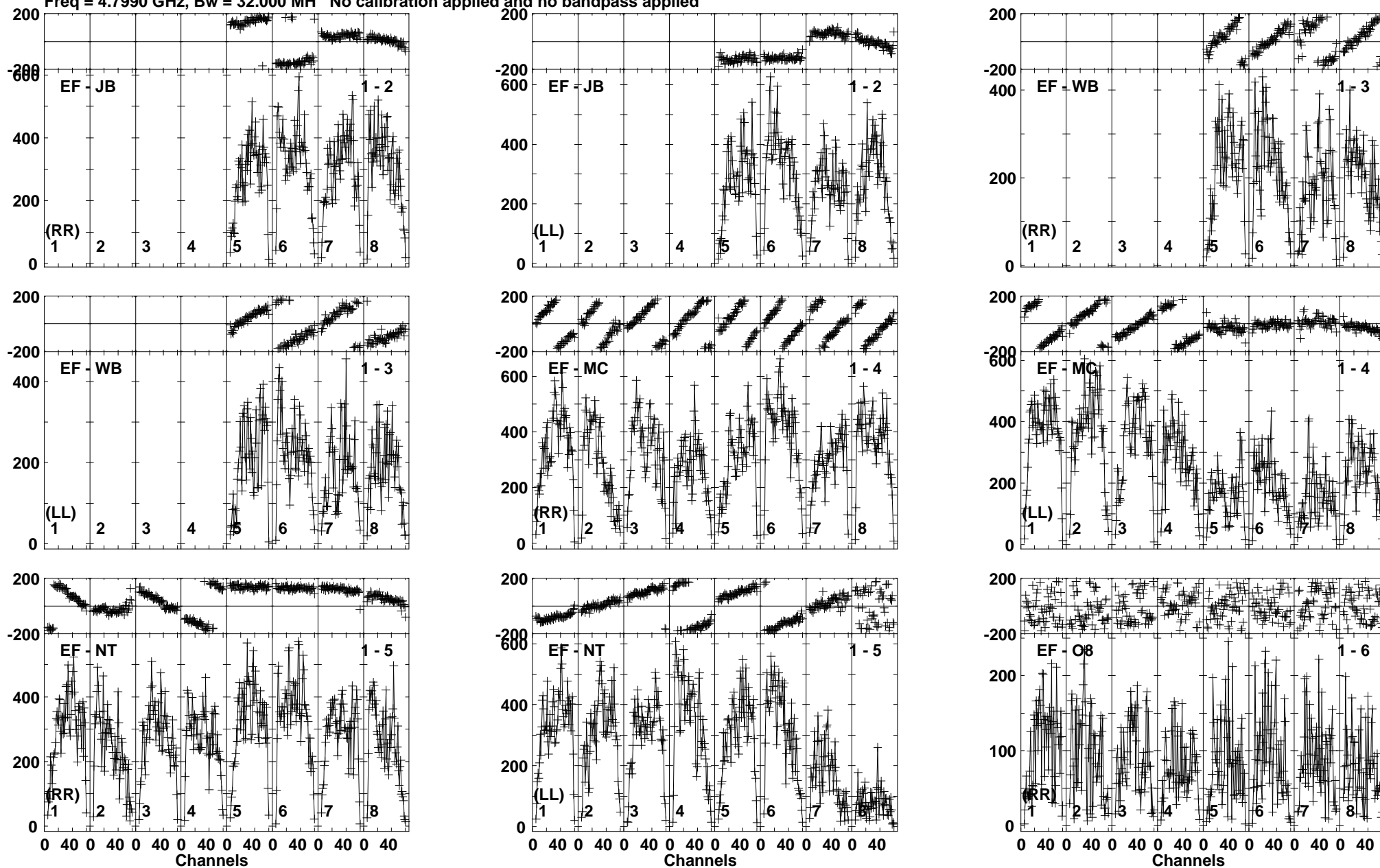

Lower frame: Micro Ampl Jy Top frame: Phas deg  
Vector averaged cross-power spectrum Baseline: EF (01) - JB (02)  
Timerange: 00/05:24:00 to 00/05:27:30

Plot file version 257 created 24-NOV-2017 10:10:37

J1112+4301 EG096D.UVDATA.1

Freq = 4.7990 GHz, Bw = 32.000 MH No calibration applied and no bandpass applied

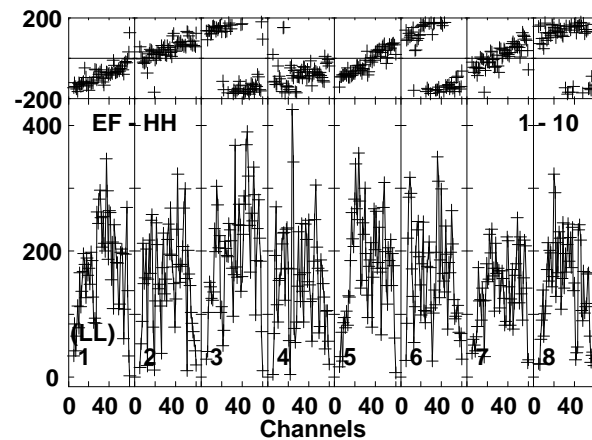
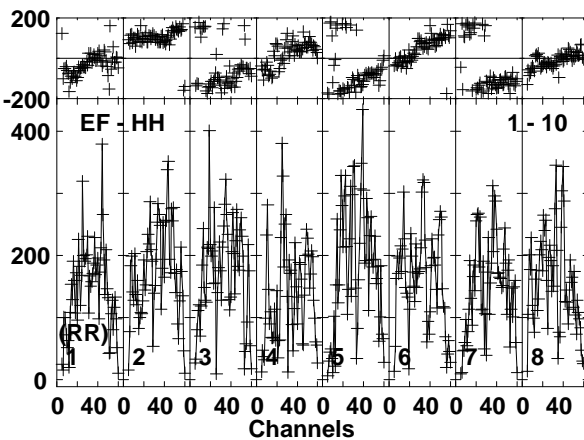
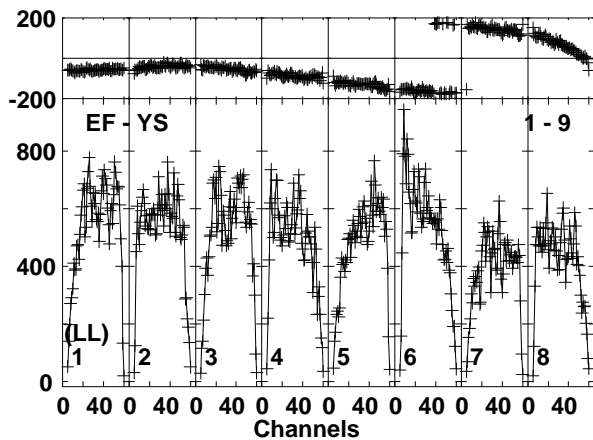
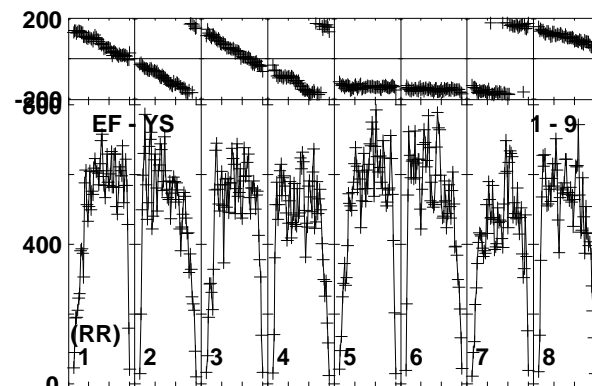
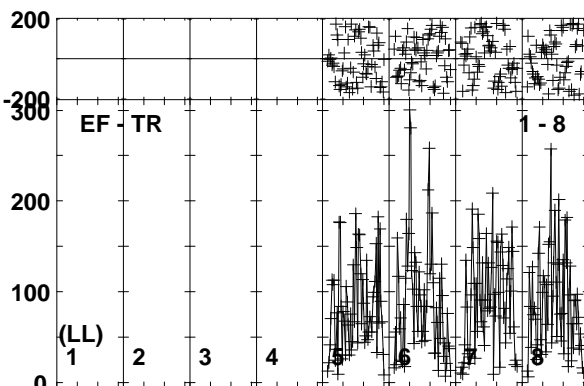
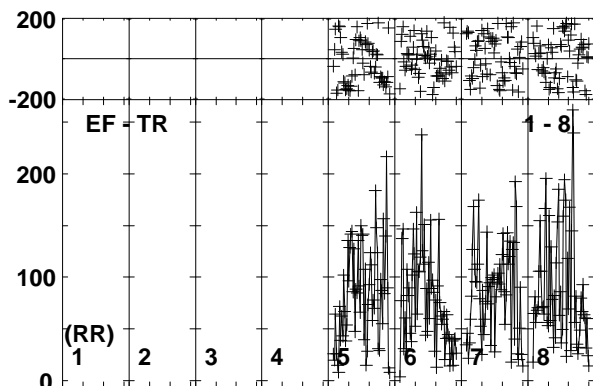
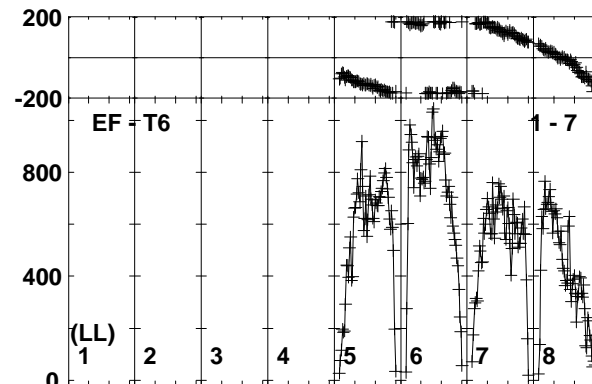
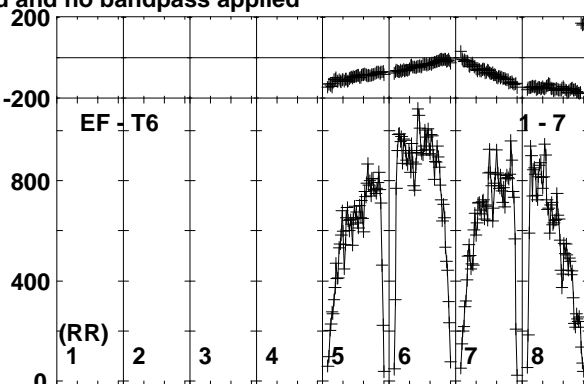
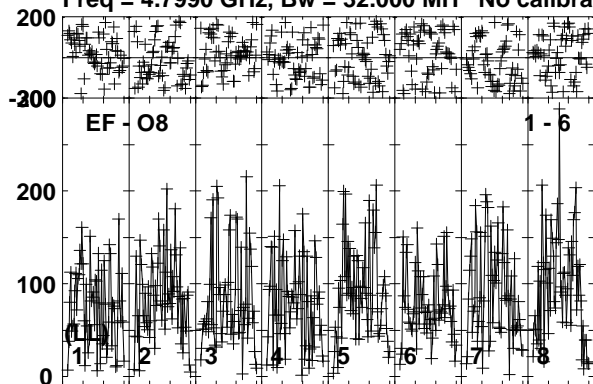

Lower frame: Micro Ampl Jy Top frame: Phas deg  
Vector averaged cross-power spectrum Baseline: EF (01) - O8 (06)  
Timerange: 00/05:24:00 to 00/05:27:30

Plot file version 258 created 24-NOV-2017 10:10:38

J1112+4301 EG096D.UVDATA.1

Freq = 4.7990 GHz, Bw = 32.000 MH No calibration applied and no bandpass applied

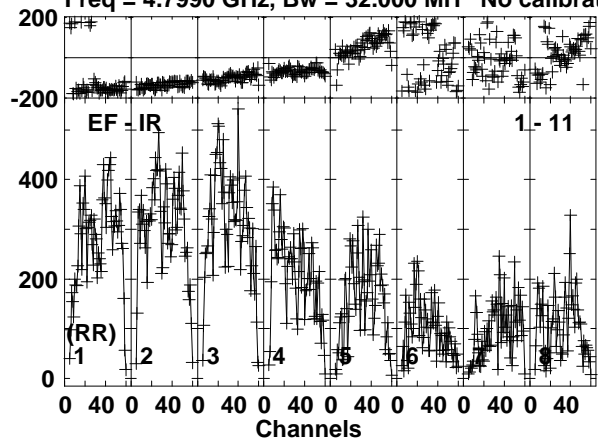

Lower frame: Micro Ampl Jy Top frame: Phas deg  
Vector averaged cross-power spectrum Baseline: EF (01) - IR (11)  
Timerange: 00/05:24:00 to 00/05:27:30



Plot file version 259 created 24-NOV-2017 10:10:38

J1108+4330 EG096D.UVDATA.1

Freq = 4.7990 GHz, Bw = 32.000 MH No calibration applied and no bandpass applied

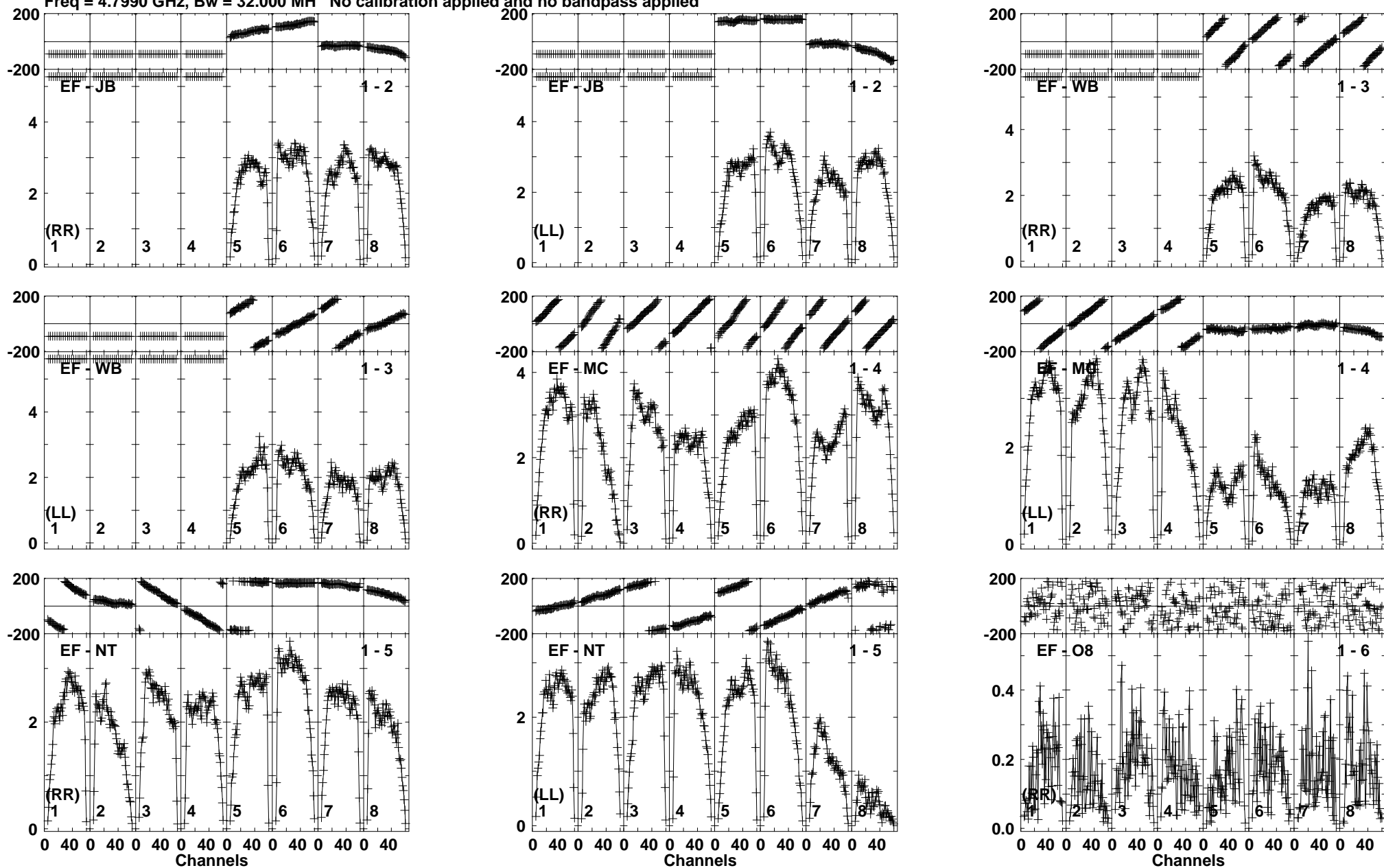

Lower frame: Milli Ampl Jy Top frame: Phas deg  
Vector averaged cross-power spectrum Baseline: EF (01) - JB (02)  
Timerange: 00/05:27:31 to 00/05:28:59

Plot file version 260 created 24-NOV-2017 10:10:38

J1108+4330 EG096D.UVDATA.1

Freq = 4.7990 GHz, Bw = 32.000 MH No calibration applied and no bandpass applied

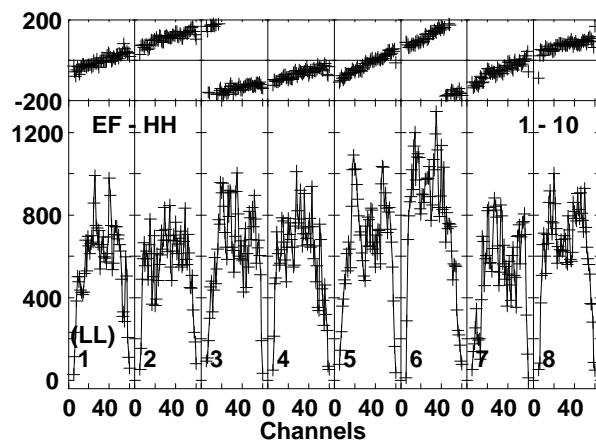
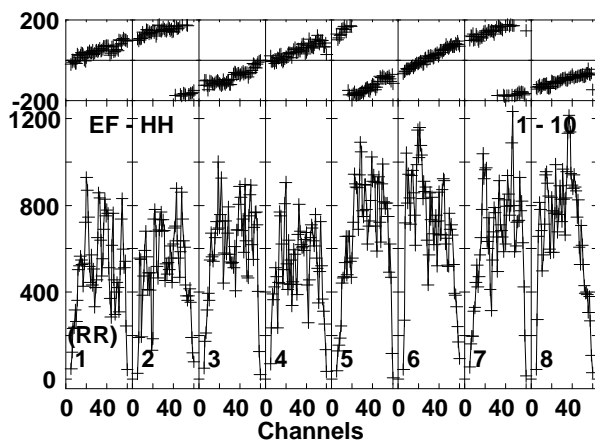
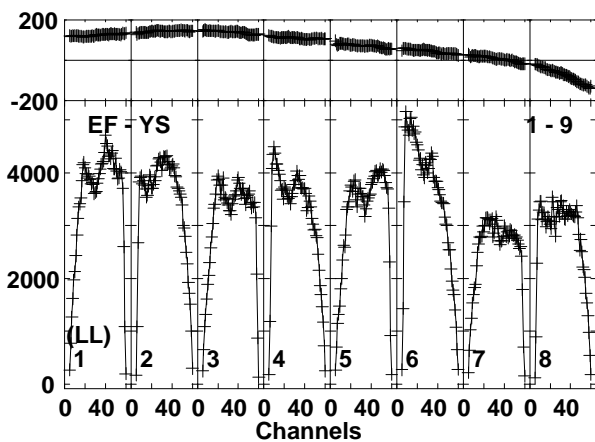
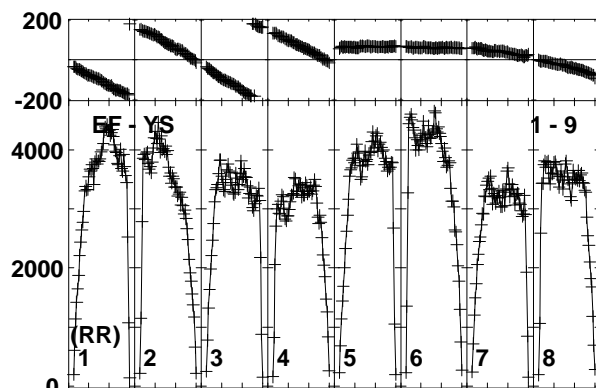
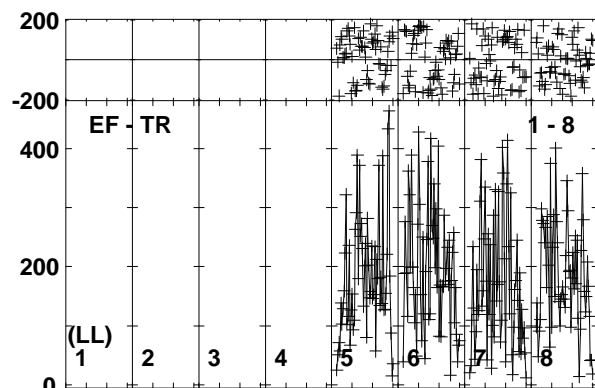
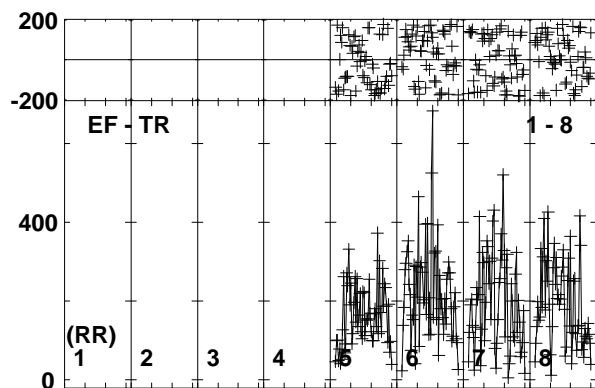
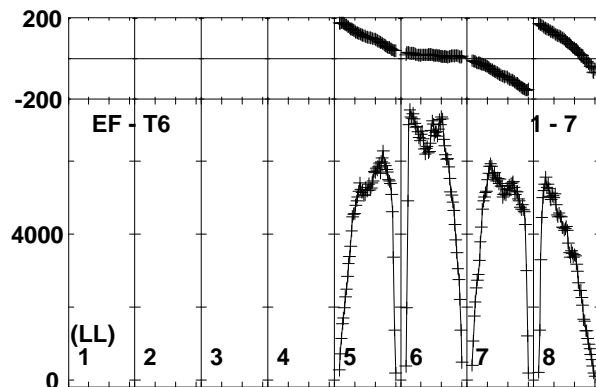
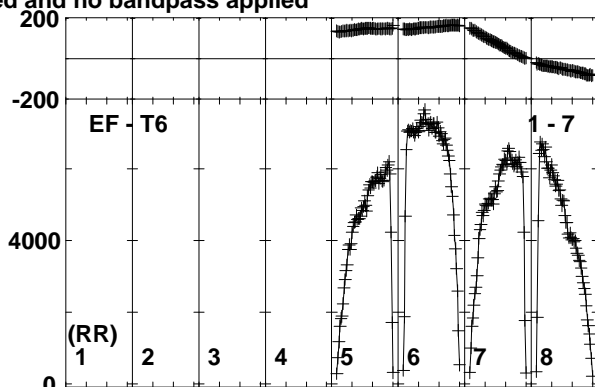
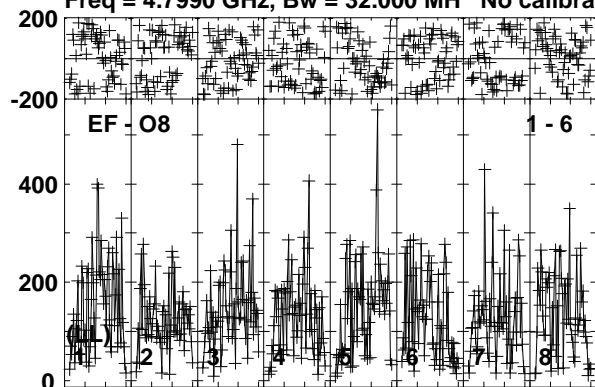

Lower frame: Micro Ampl Jy Top frame: Phas deg  
Vector averaged cross-power spectrum Baseline: EF (01) - O8 (06)  
Timerange: 00/05:27:31 to 00/05:28:59

Plot file version 261 created 24-NOV-2017 10:10:38

J1108+4330 EG096D.UVDATA.1

Freq = 4.7990 GHz, Bw = 32.000 MH No calibration applied and no bandpass applied

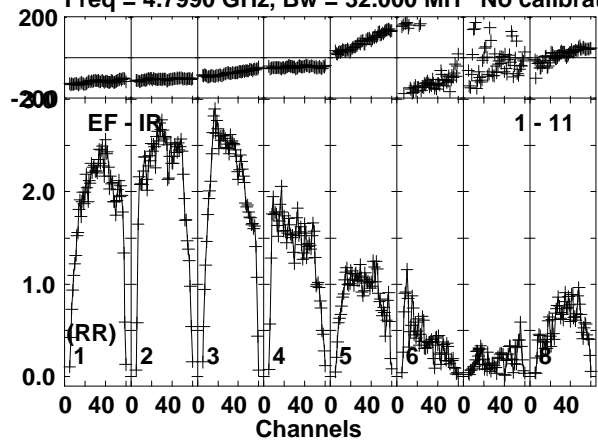

Lower frame: Milli Ampl Jy Top frame: Phas deg  
Vector averaged cross-power spectrum Baseline: EF (01) - IR (11)  
Timerange: 00/05:27:31 to 00/05:28:59

Plot file version 262 created 24-NOV-2017 10:10:38

ARUMA EG096D.UVDATA.1

Freq = 4.7990 GHz, Bw = 32.000 MH No calibration applied and no bandpass applied

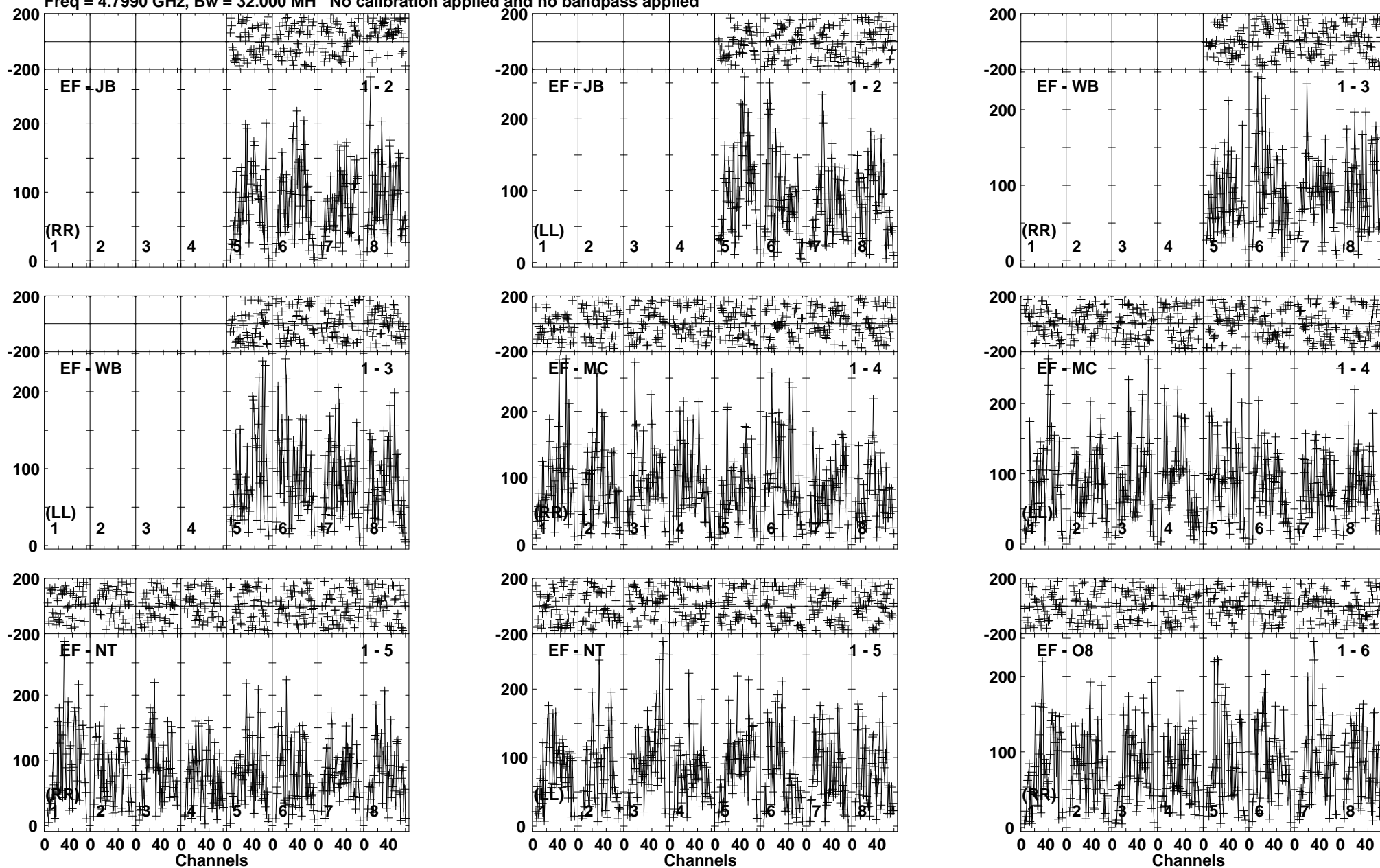

Lower frame: Micro Ampl Jy Top frame: Phas deg  
Vector averaged cross-power spectrum Baseline: EF (01) - JB (02)  
Timerange: 00/05:29:01 to 00/05:32:30

Plot file version 263 created 24-NOV-2017 10:10:39

ARUMA EG096D.UVDATA.1

Freq = 4.7990 GHz, Bw = 32.000 MH No calibration applied and no bandpass applied

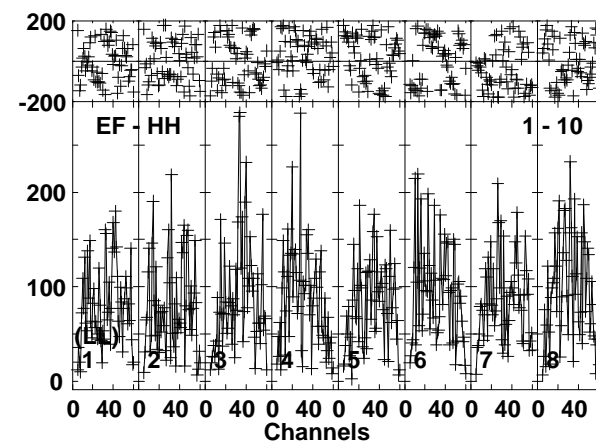
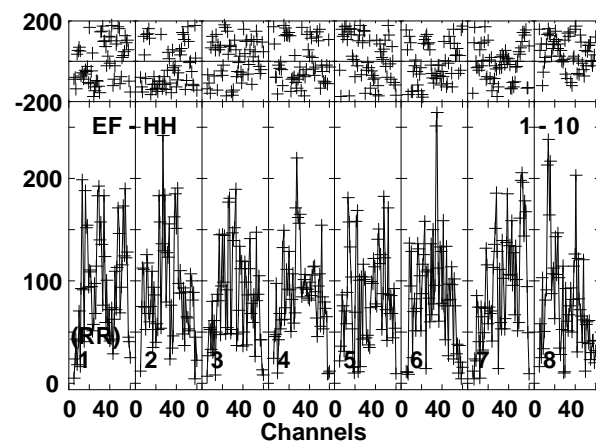
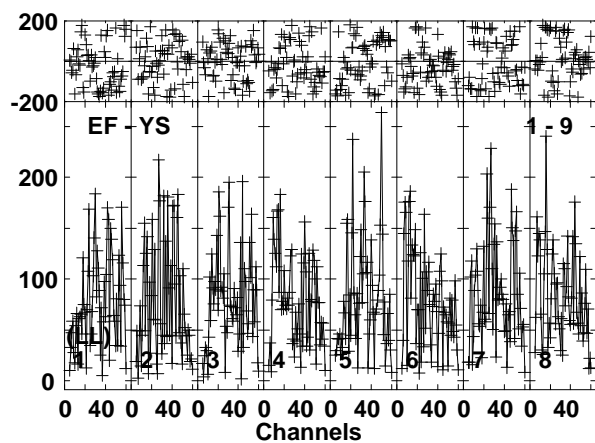
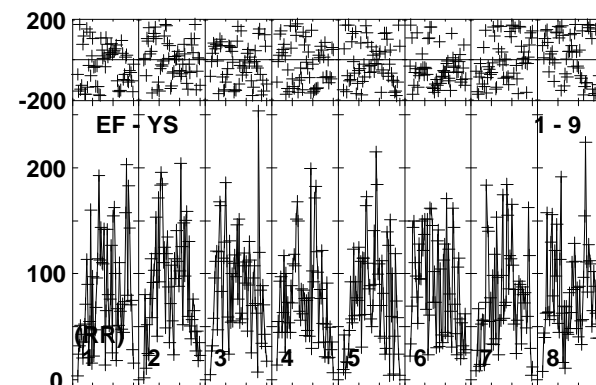
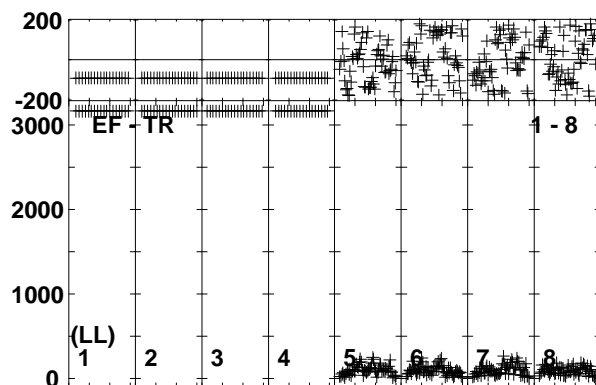
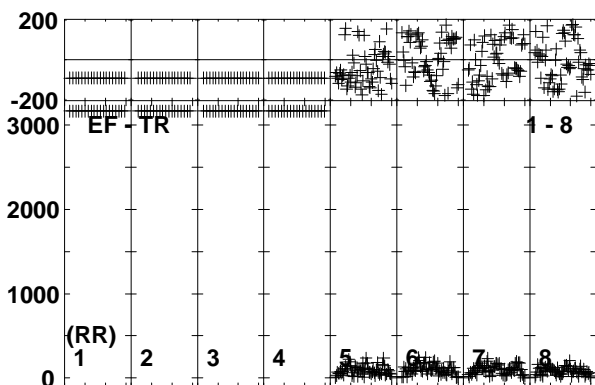
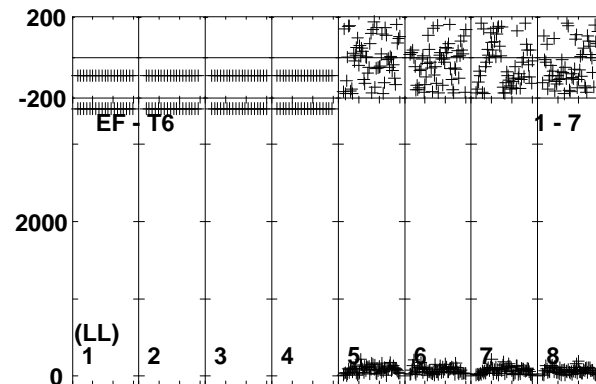
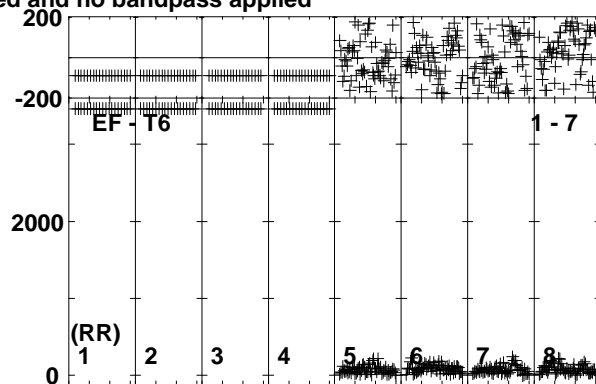
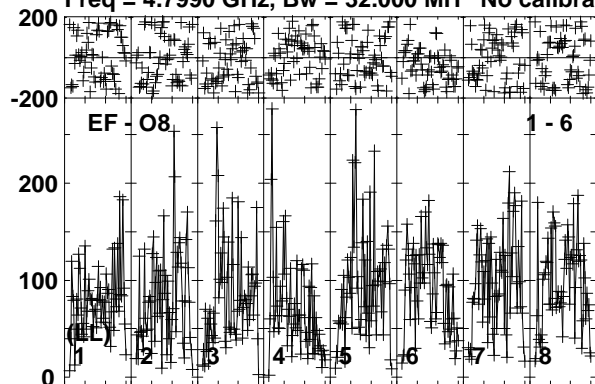

Lower frame: Micro Ampl Jy Top frame: Phas deg  
Vector averaged cross-power spectrum Baseline: EF (01) - O8 (06)  
Timerange: 00/05:29:01 to 00/05:32:30

Plot file version 264 created 24-NOV-2017 10:10:39  
ARUMA EG096D.UVDATA.1  
Freq = 4.7990 GHz, Bw = 32.000 MH No calibration applied and no bandpass applied

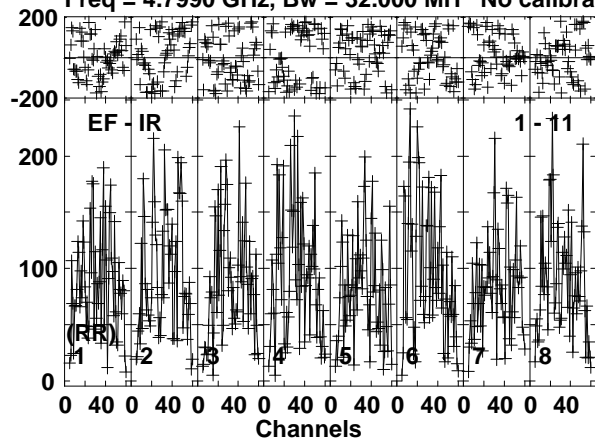

Lower frame: Micro Ampl Jy Top frame: Phas deg  
Vector averaged cross-power spectrum Baseline: EF (01) - IR (11)  
Timerange: 00/05:29:01 to 00/05:32:30

Plot file version 265 created 24-NOV-2017 10:10:39

J1108+4330 EG096D.UVDATA.1

Freq = 4.7990 GHz, Bw = 32.000 MH No calibration applied and no bandpass applied

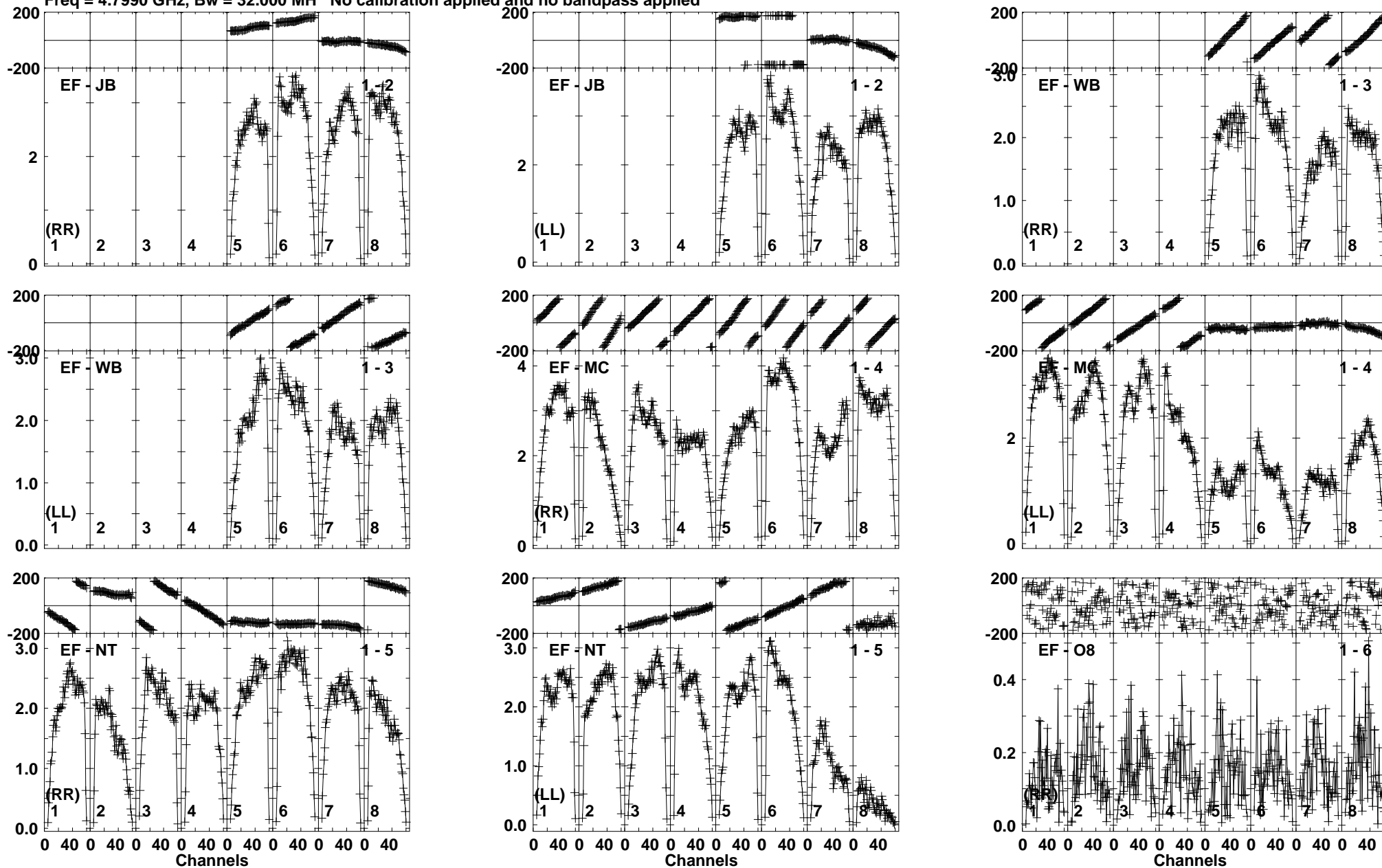

Lower frame: Milli Ampl Jy Top frame: Phas deg  
Vector averaged cross-power spectrum Baseline: EF (01) - JB (02)  
Timerange: 00/05:33:10 to 00/05:34:10

Plot file version 266 created 24-NOV-2017 10:10:40

J1108+4330 EG096D.UVDATA.1

Freq = 4.7990 GHz, Bw = 32.000 MH No calibration applied and no bandpass applied

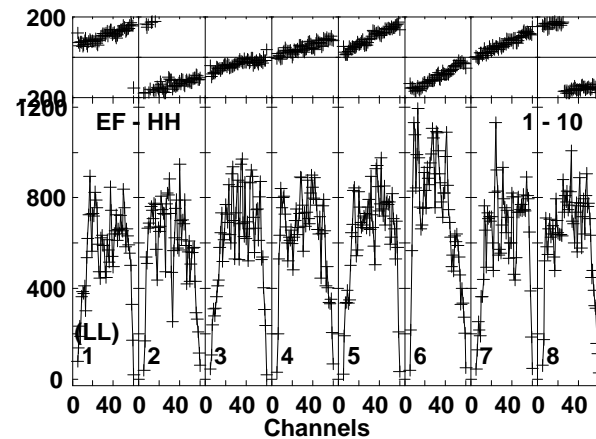
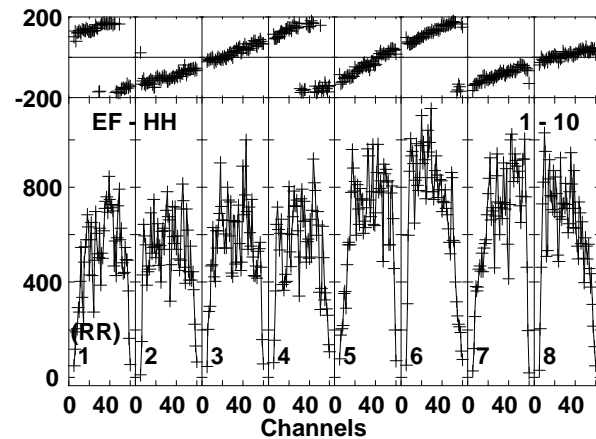
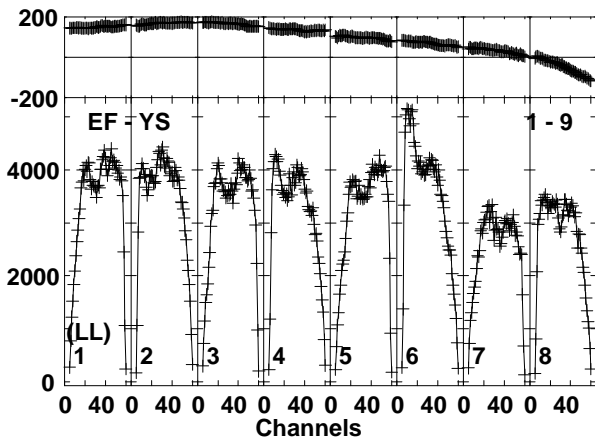
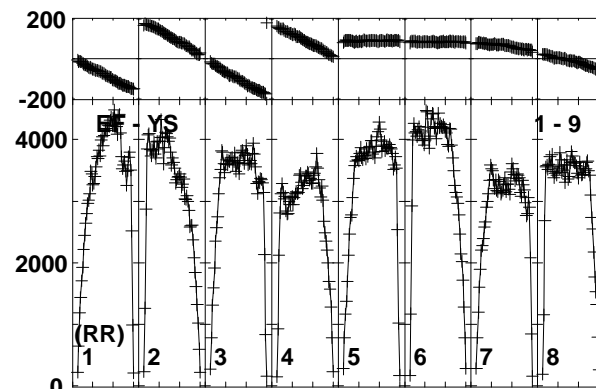
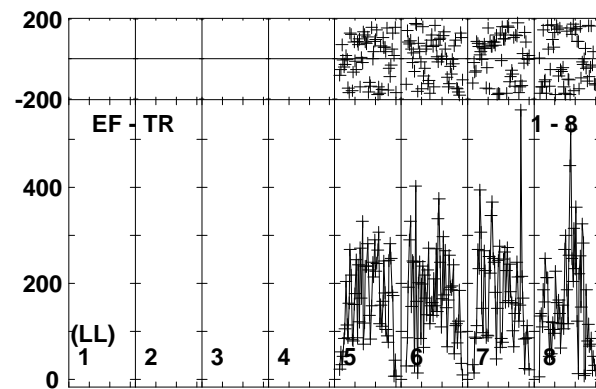
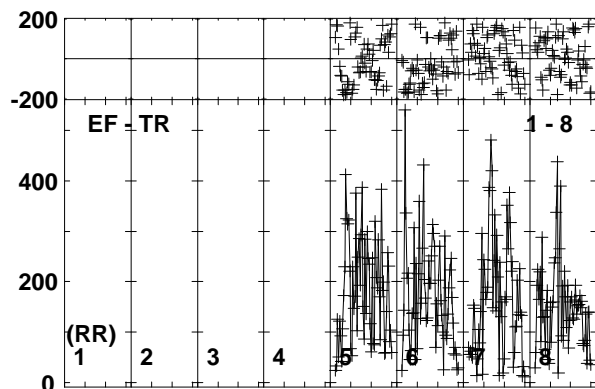
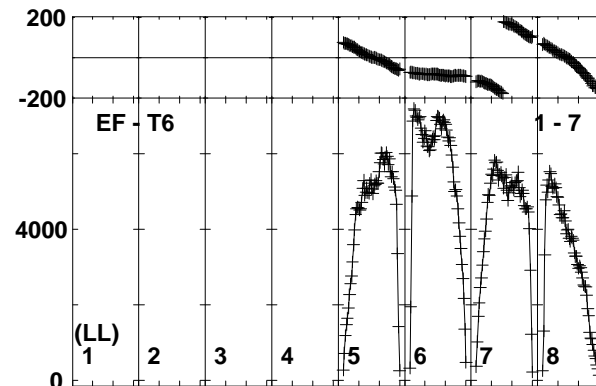
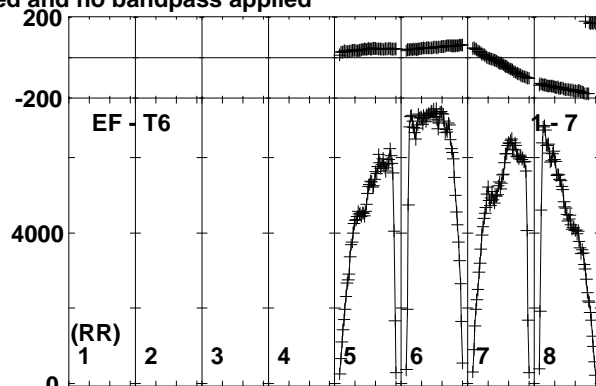
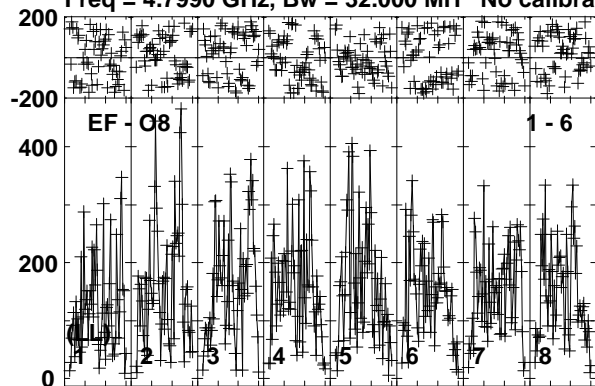

Lower frame: Micro Ampl Jy Top frame: Phas deg  
Vector averaged cross-power spectrum Baseline: EF (01) - O8 (06)  
Timerange: 00/05:33:10 to 00/05:34:10



Plot file version 267 created 24-NOV-2017 10:10:40  
J1108+4330 EG096D.UVDATA.1  
Freq = 4.7990 GHz, Bw = 32.000 MH No calibration applied and no bandpass applied

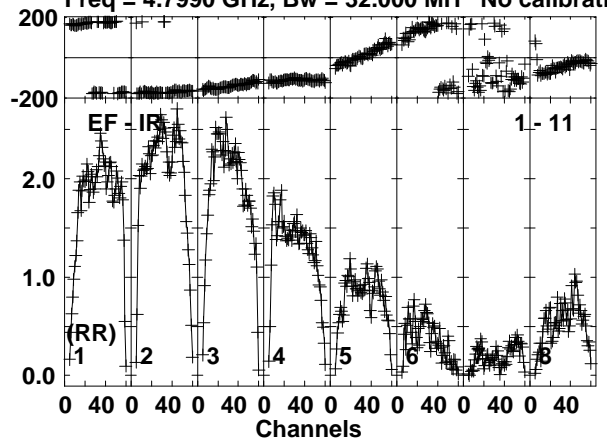

Lower frame: Milli Ampl Jy Top frame: Phas deg  
Vector averaged cross-power spectrum Baseline: EF (01) - IR (11)  
Timerange: 00/05:33:10 to 00/05:34:10

Plot file version 268 created 24-NOV-2017 10:10:40

ARUMA EG096D.UVDATA.1

Freq = 4.7990 GHz, Bw = 32.000 MH No calibration applied and no bandpass applied

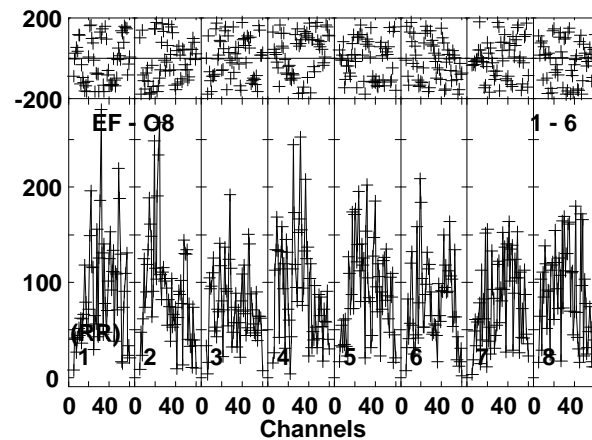
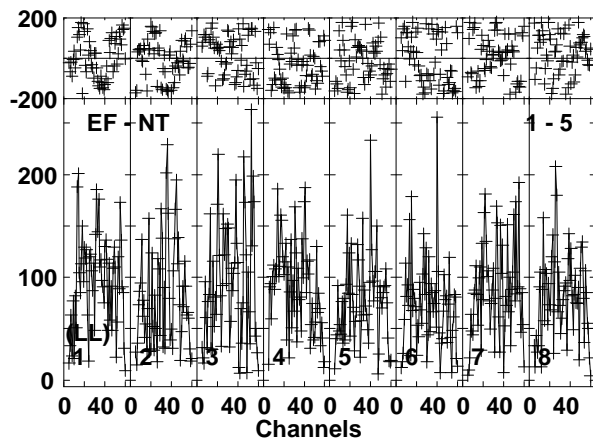
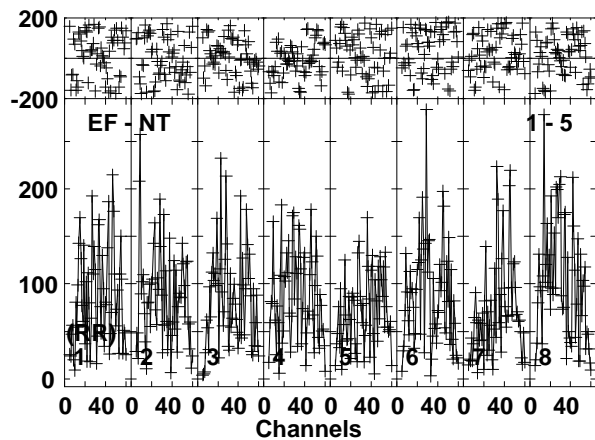
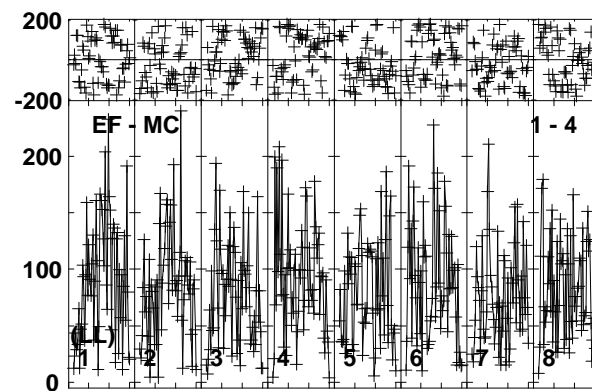
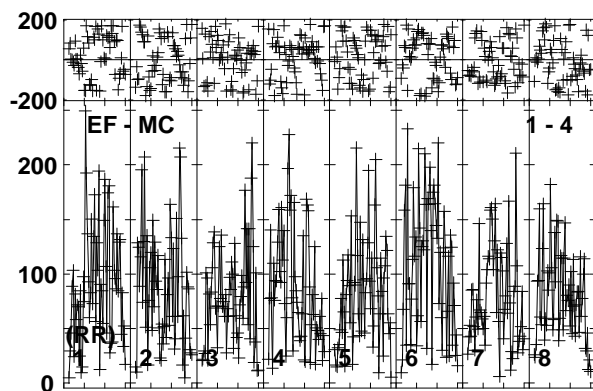
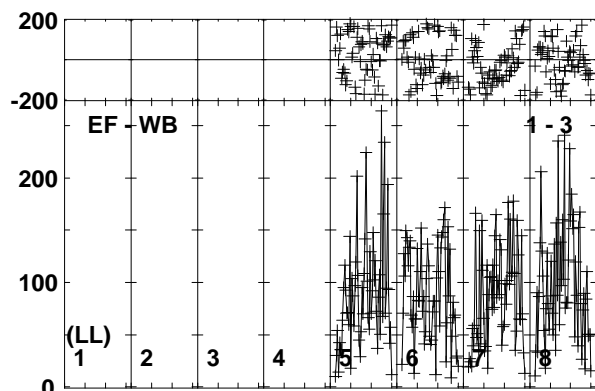
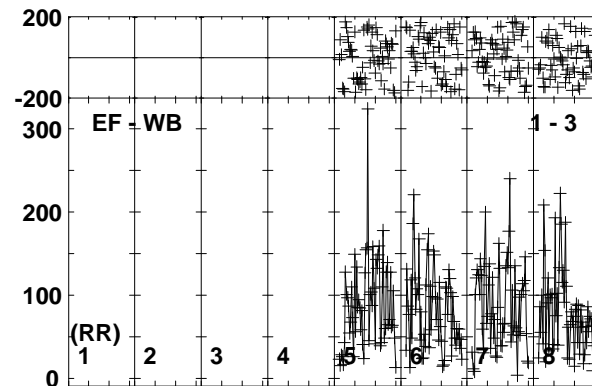
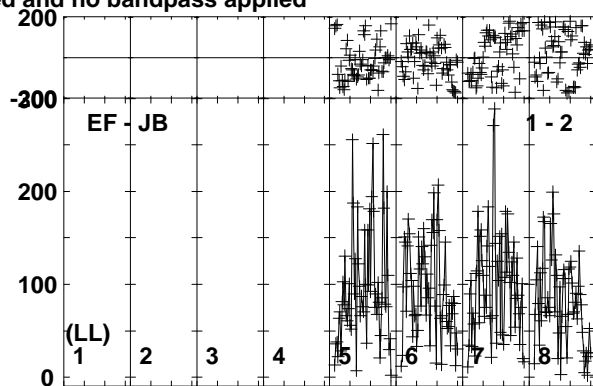
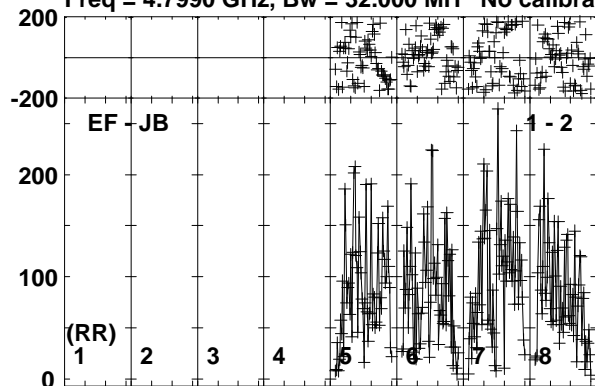

Lower frame: Micro Ampl Jy Top frame: Phas deg  
Vector averaged cross-power spectrum Baseline: EF (01) - JB (02)  
Timerange: 00/05:34:11 to 00/05:37:40

Plot file version 269 created 24-NOV-2017 10:10:40

ARUMA EG096D.UVDATA.1

Freq = 4.7990 GHz, Bw = 32.000 MH No calibration applied and no bandpass applied

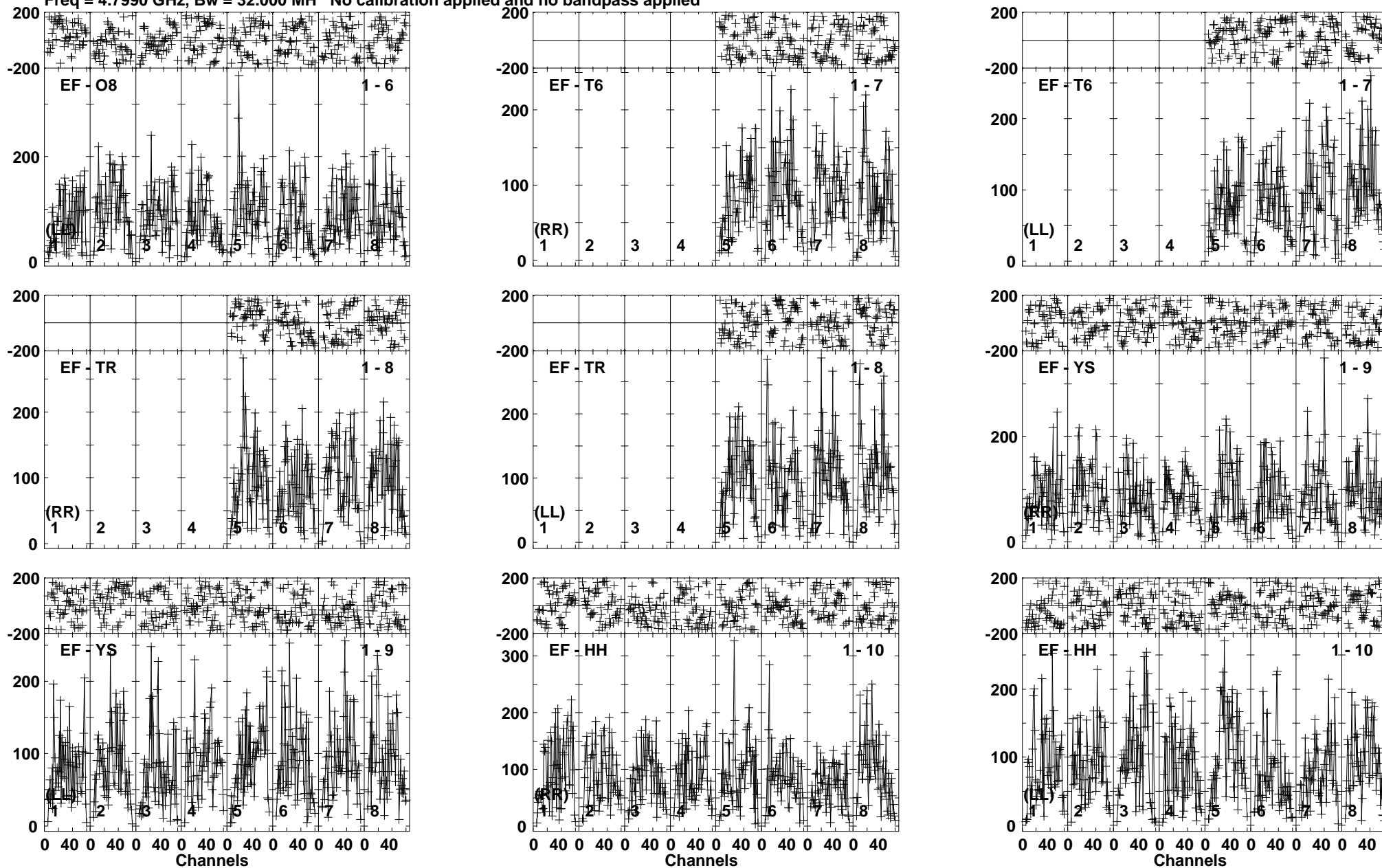

Lower frame: Micro Ampl Jy Top frame: Phas deg  
Vector averaged cross-power spectrum Baseline: EF (01) - O8 (06)  
Timerange: 00/05:34:11 to 00/05:37:40

Plot file version 270 created 24-NOV-2017 10:10:41  
ARUMA EG096D.UVDATA.1  
Freq = 4.7990 GHz, Bw = 32.000 MH No calibration applied and no bandpass applied

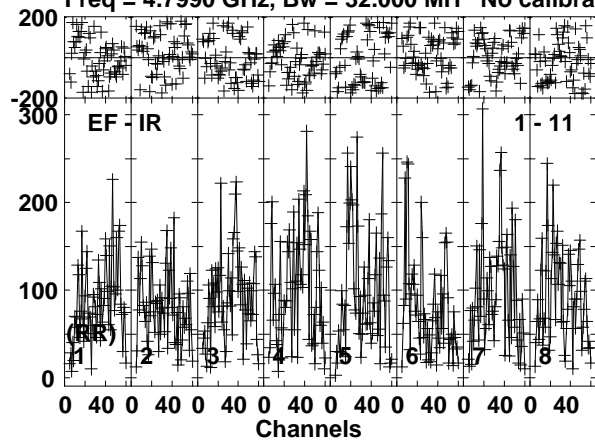

Lower frame: Micro Ampl Jy Top frame: Phas deg  
Vector averaged cross-power spectrum Baseline: EF (01) - IR (11)  
Timerange: 00/05:34:11 to 00/05:37:40

Plot file version 271 created 24-NOV-2017 10:10:41

J1108+4330 EG096D.UVDATA.1

Freq = 4.7990 GHz, Bw = 32.000 MH No calibration applied and no bandpass applied

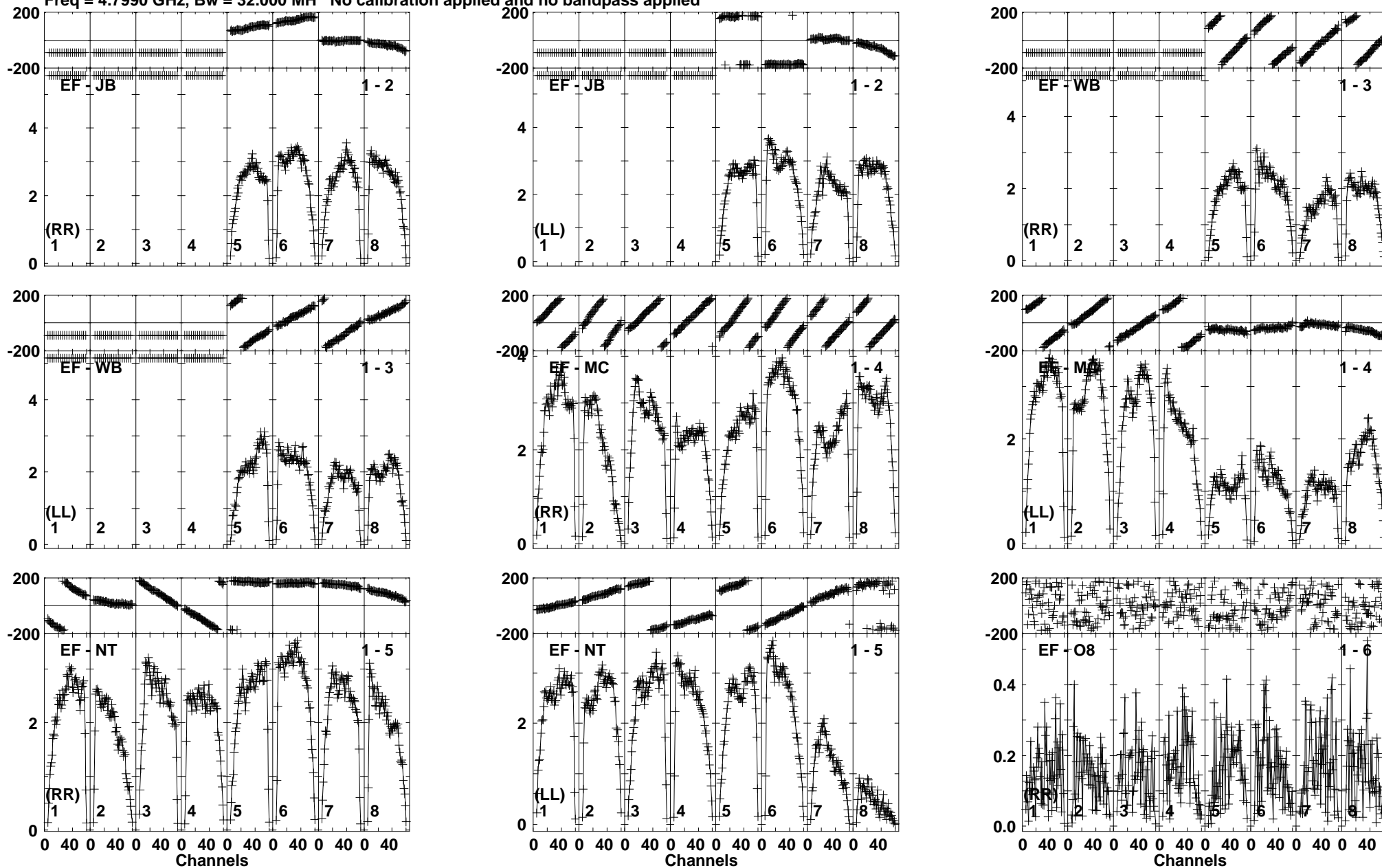

Lower frame: Milli Ampl Jy Top frame: Phas deg  
Vector averaged cross-power spectrum Baseline: EF (01) - JB (02)  
Timerange: 00/05:37:41 to 00/05:39:09

Plot file version 272 created 24-NOV-2017 10:10:41

J1108+4330 EG096D.UVDATA.1

Freq = 4.7990 GHz, Bw = 32.000 MH No calibration applied and no bandpass applied

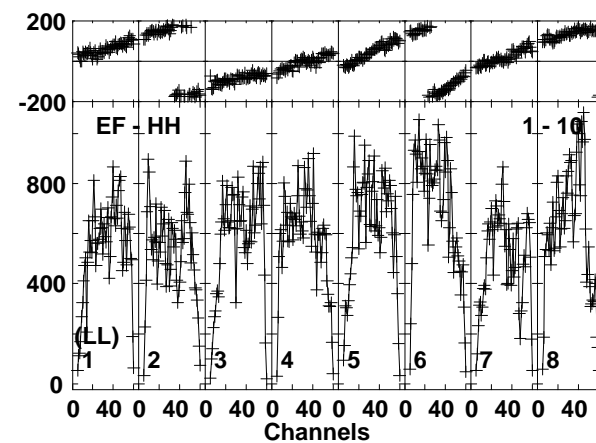
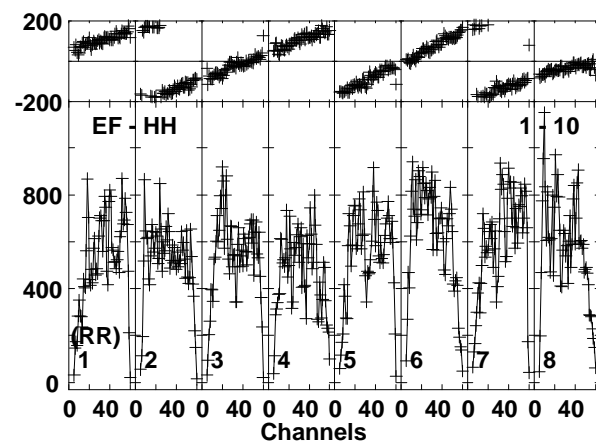
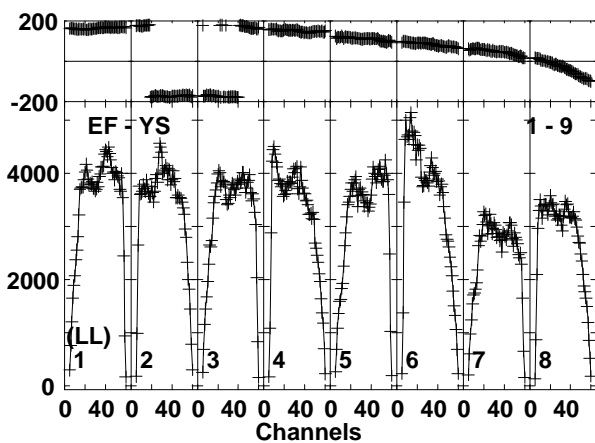
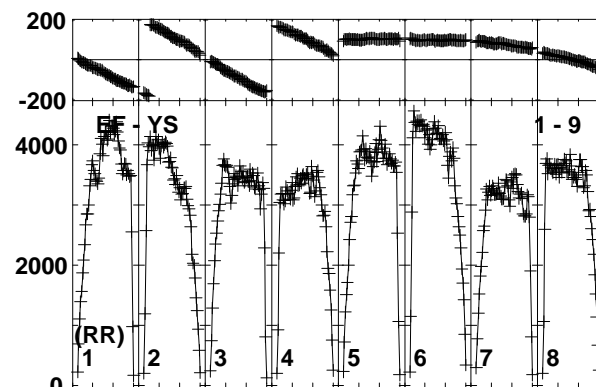
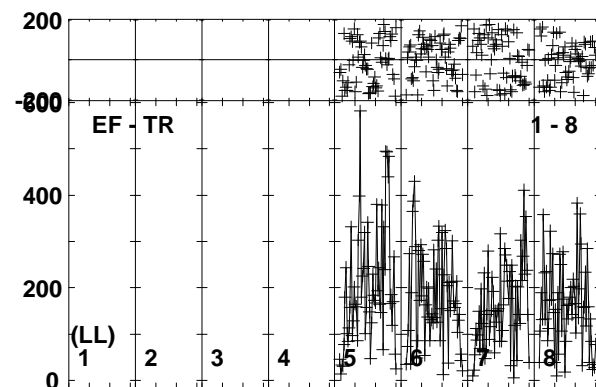
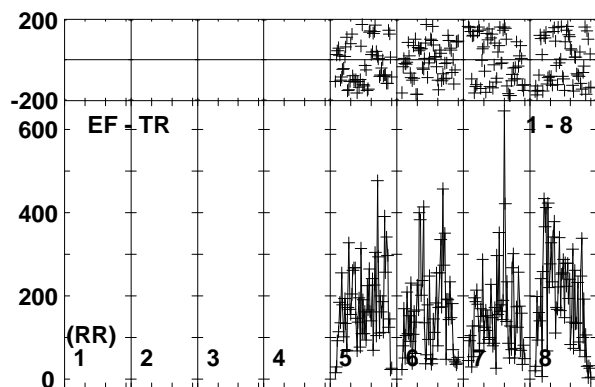
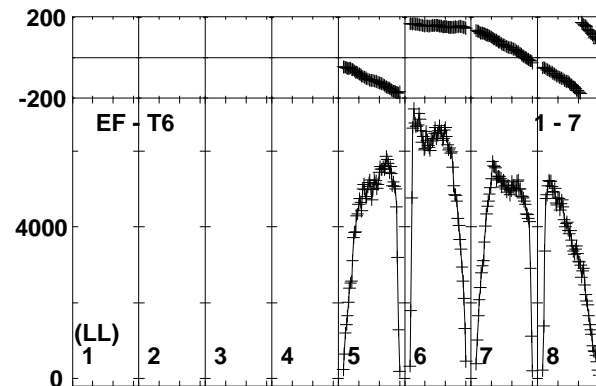
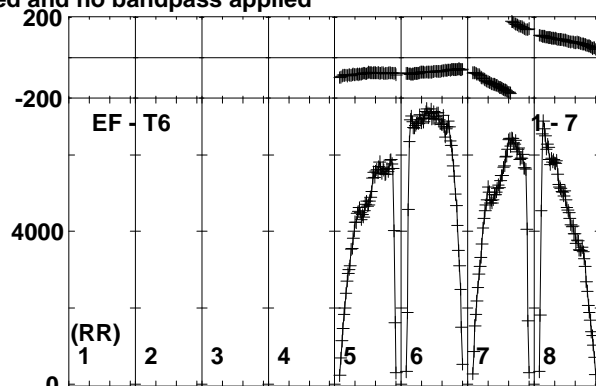
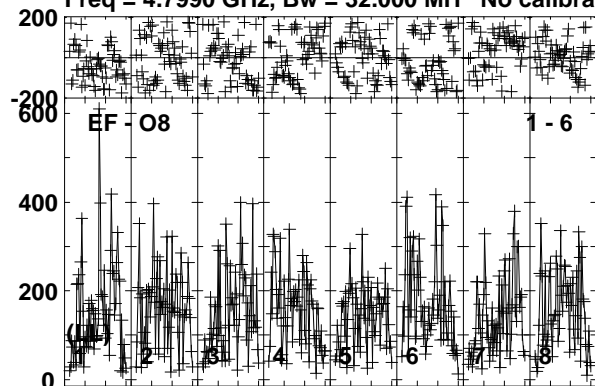

Lower frame: Micro Ampl Jy Top frame: Phas deg  
Vector averaged cross-power spectrum Baseline: EF (01) - O8 (06)  
Timerange: 00/05:37:41 to 00/05:39:09

Plot file version 273 created 24-NOV-2017 10:10:41

J1108+4330 EG096D.UVDATA.1

Freq = 4.7990 GHz, Bw = 32.000 MH No calibration applied and no bandpass applied

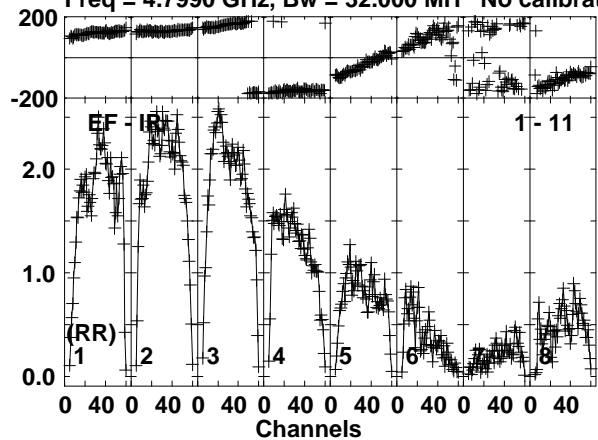

Lower frame: Milli Ampl Jy Top frame: Phas deg  
Vector averaged cross-power spectrum Baseline: EF (01) - IR (11)  
Timerange: 00/05:37:41 to 00/05:39:09

Plot file version 274 created 24-NOV-2017 10:10:42

ARUMA EG096D.UVDATA.1

Freq = 4.7990 GHz, Bw = 32.000 MH No calibration applied and no bandpass applied

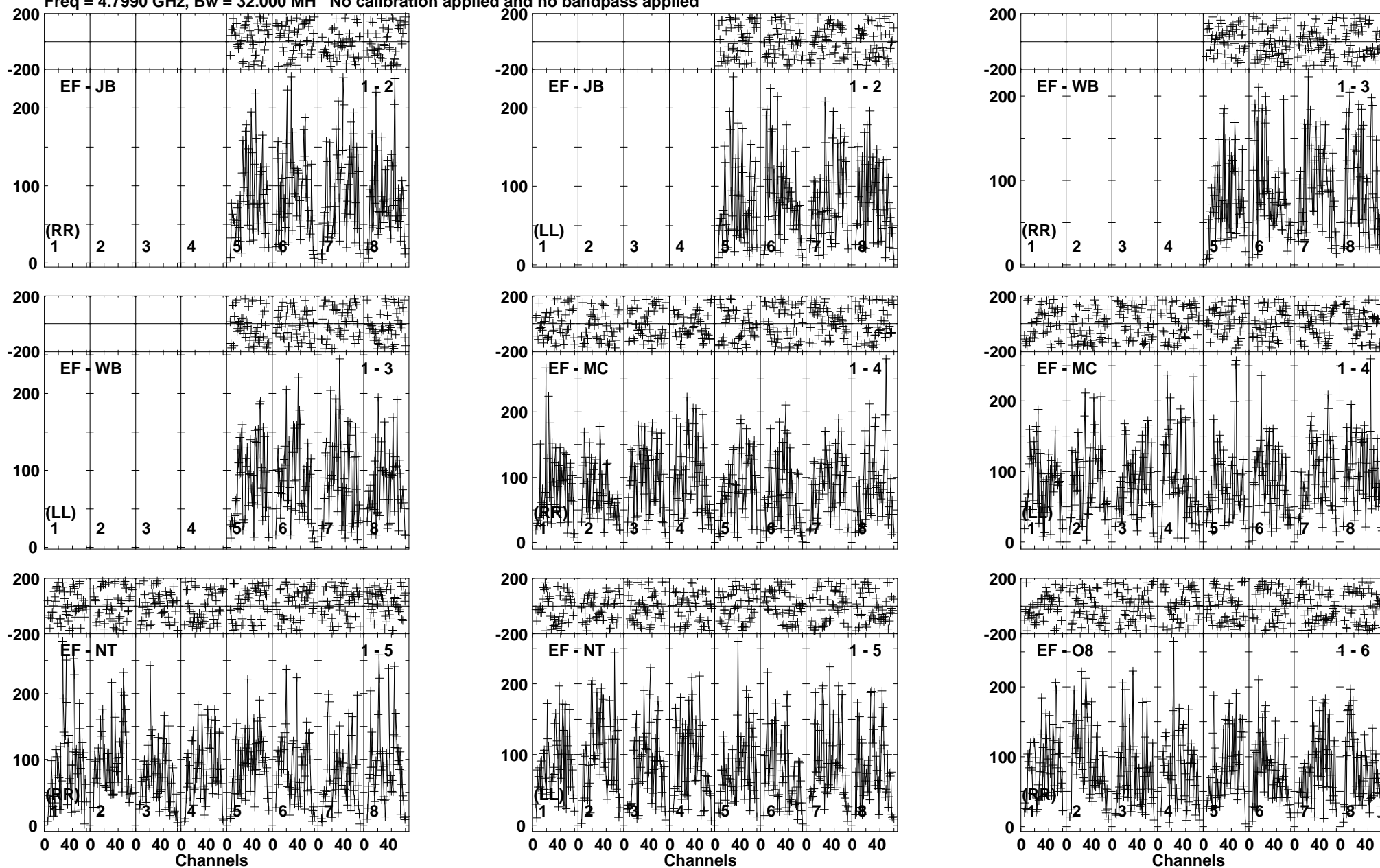

Lower frame: Micro Ampl Jy Top frame: Phas deg  
Vector averaged cross-power spectrum Baseline: EF (01) - JB (02)  
Timerange: 00/05:39:10 to 00/05:42:40



Plot file version 275 created 24-NOV-2017 10:10:42

ARUMA EG096D.UVDATA.1

Freq = 4.7990 GHz, Bw = 32.000 MH No calibration applied and no bandpass applied

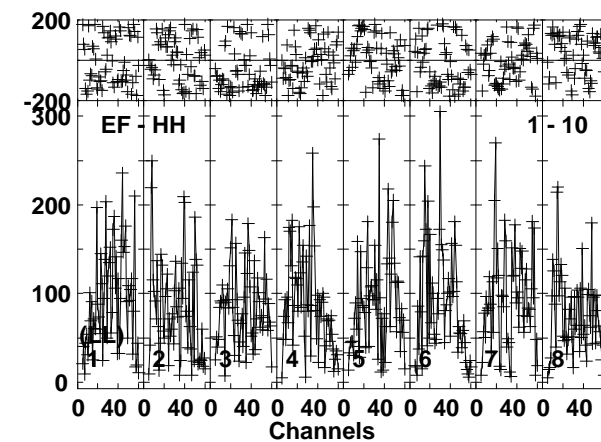
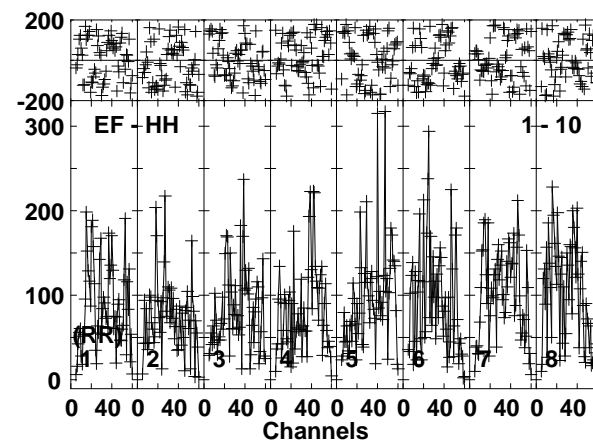
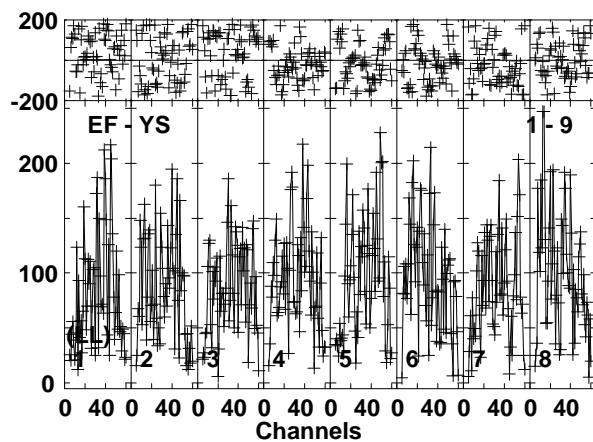
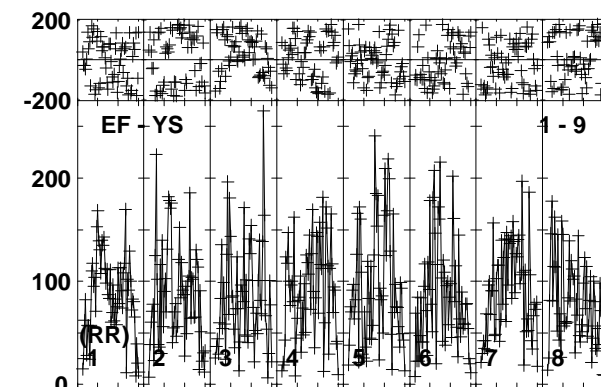
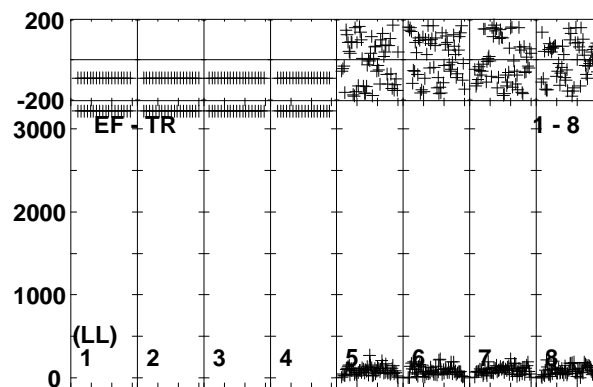
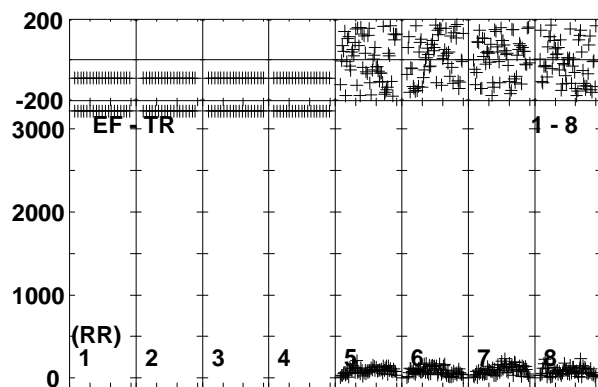
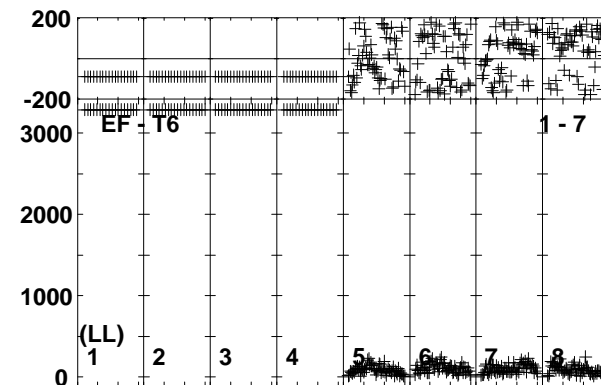
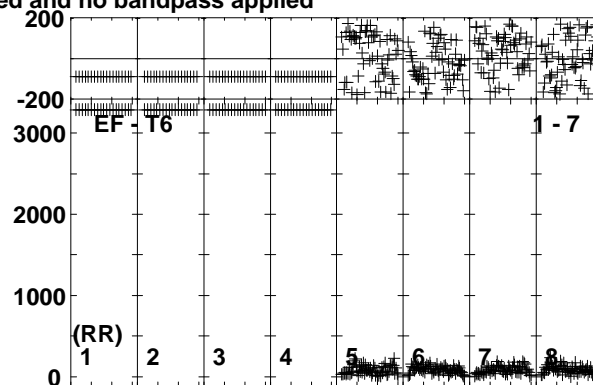
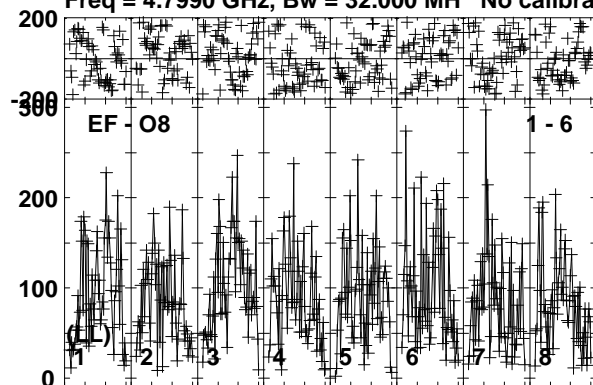

Lower frame: Micro Ampl Jy Top frame: Phas deg  
Vector averaged cross-power spectrum Baseline: EF (01) - O8 (06)  
Timerange: 00/05:39:10 to 00/05:42:40

Plot file version 276 created 24-NOV-2017 10:10:42  
ARUMA EG096D.UVDATA.1  
Freq = 4.7990 GHz, Bw = 32.000 MH No calibration applied and no bandpass applied

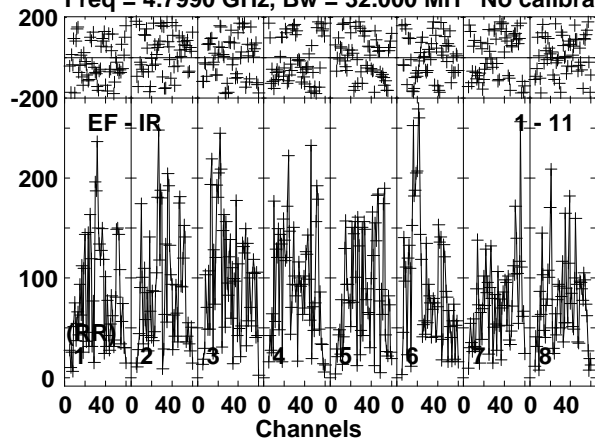

Lower frame: Micro Ampl Jy Top frame: Phas deg  
Vector averaged cross-power spectrum Baseline: EF (01) - IR (11)  
Timerange: 00/05:39:10 to 00/05:42:40

Plot file version 277 created 24-NOV-2017 10:10:42

J1108+4330 EG096D.UVDATA.1

Freq = 4.7990 GHz, Bw = 32.000 MH No calibration applied and no bandpass applied

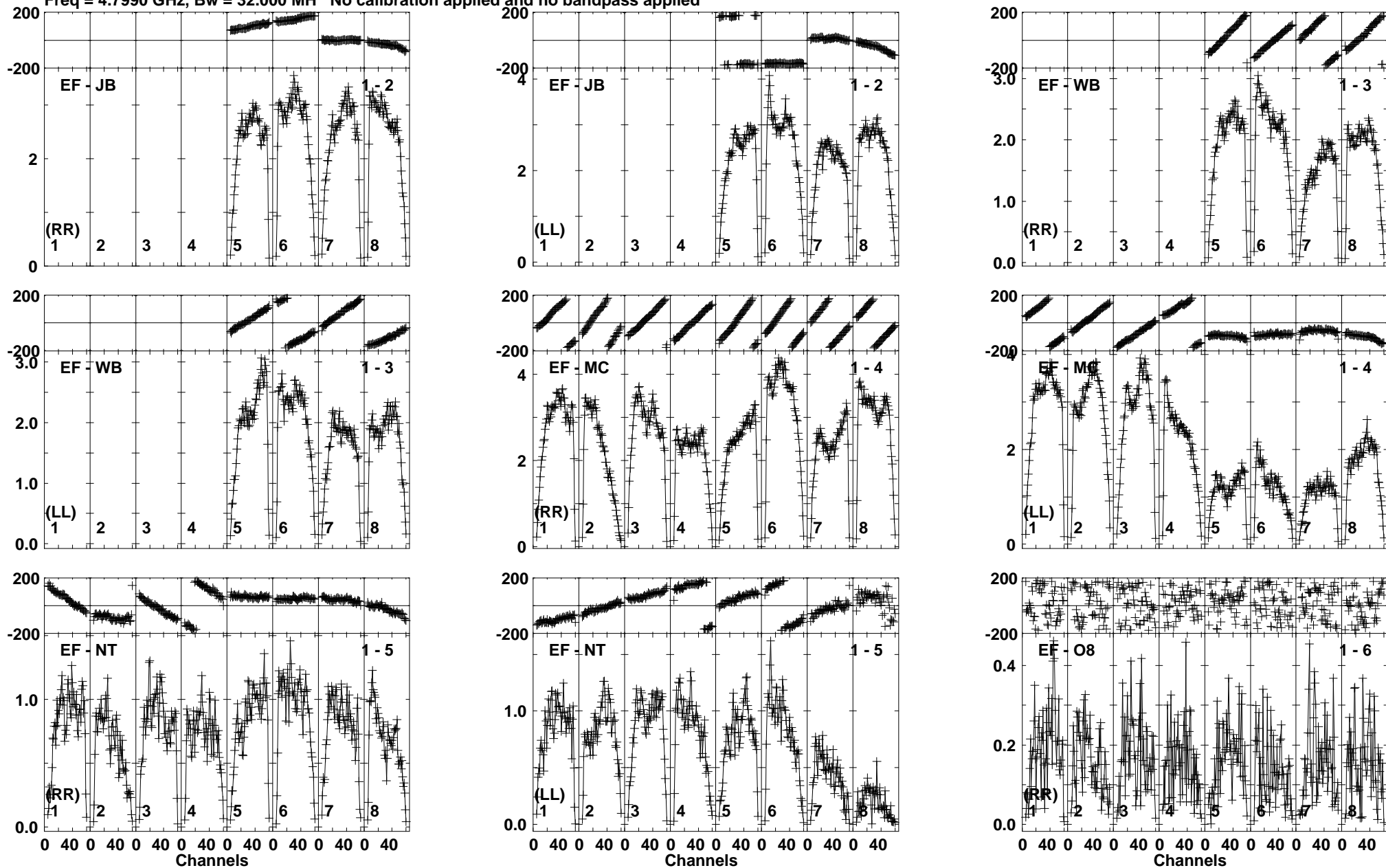

Lower frame: Milli Ampl Jy Top frame: Phas deg  
Vector averaged cross-power spectrum Baseline: EF (01) - JB (02)  
Timerange: 00/05:43:20 to 00/05:44:19

Plot file version 278 created 24-NOV-2017 10:10:43

J1108+4330 EG096D.UVDATA.1

Freq = 4.7990 GHz, Bw = 32.000 MH No calibration applied and no bandpass applied

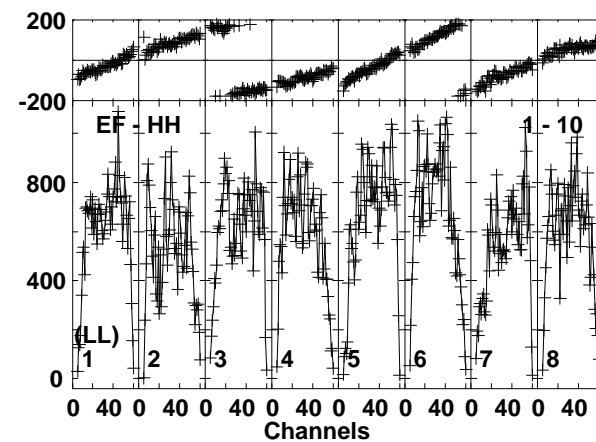
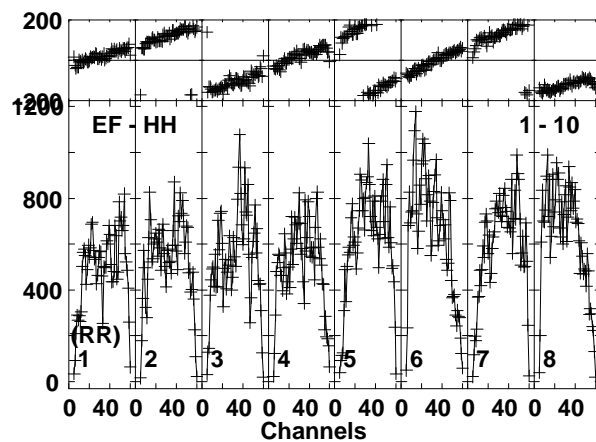
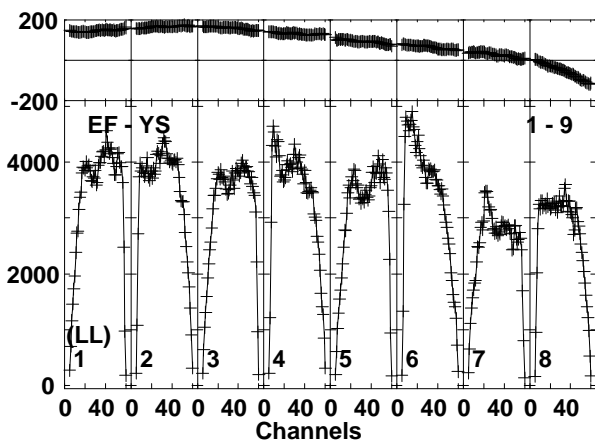
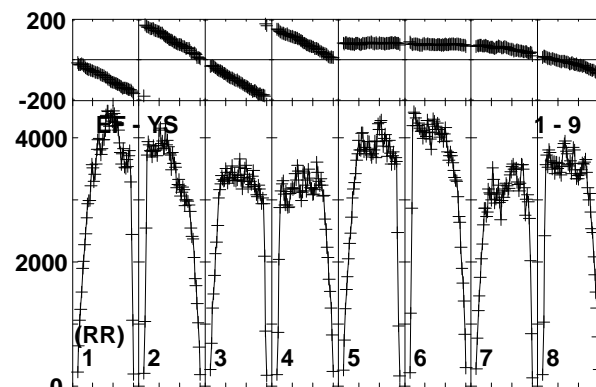
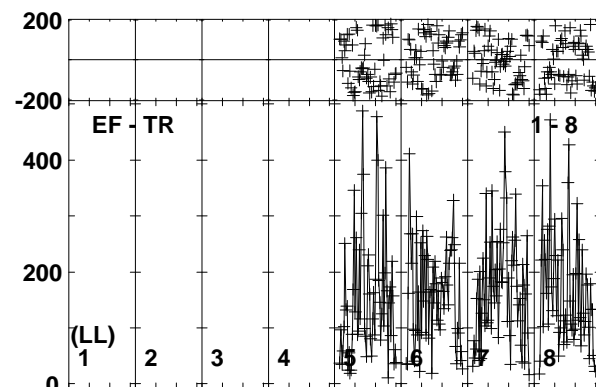
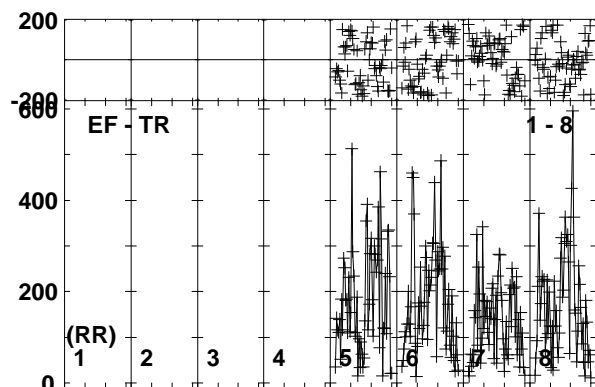
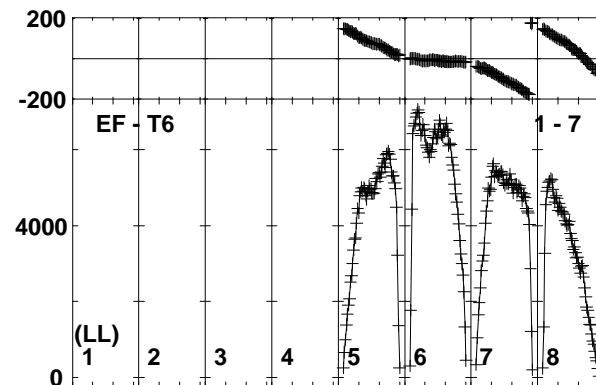
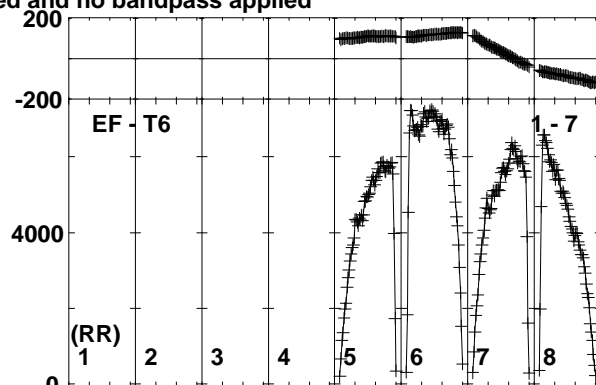
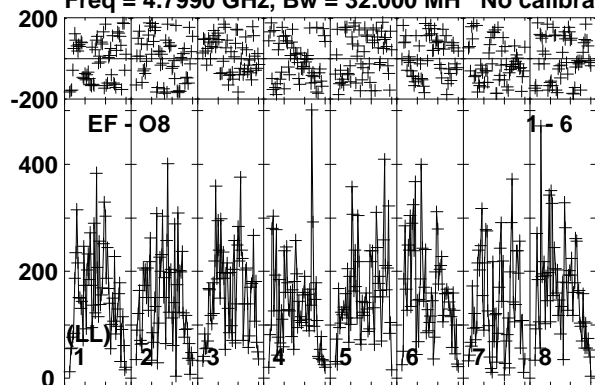

Lower frame: Micro Ampl Jy Top frame: Phas deg  
Vector averaged cross-power spectrum Baseline: EF (01) - O8 (06)  
Timerange: 00/05:43:20 to 00/05:44:19

Plot file version 279 created 24-NOV-2017 10:10:43  
J1108+4330 EG096D.UVDATA.1  
Freq = 4.7990 GHz, Bw = 32.000 MH No calibration applied and no bandpass applied

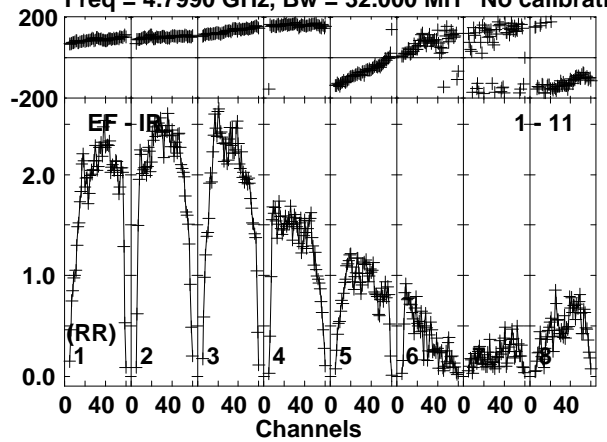

Lower frame: Milli Ampl Jy Top frame: Phas deg  
Vector averaged cross-power spectrum Baseline: EF (01) - IR (11)  
Timerange: 00/05:43:20 to 00/05:44:19

Plot file version 280 created 24-NOV-2017 10:10:43

ARUMA EG096D.UVDATA.1

Freq = 4.7990 GHz, Bw = 32.000 MH No calibration applied and no bandpass applied

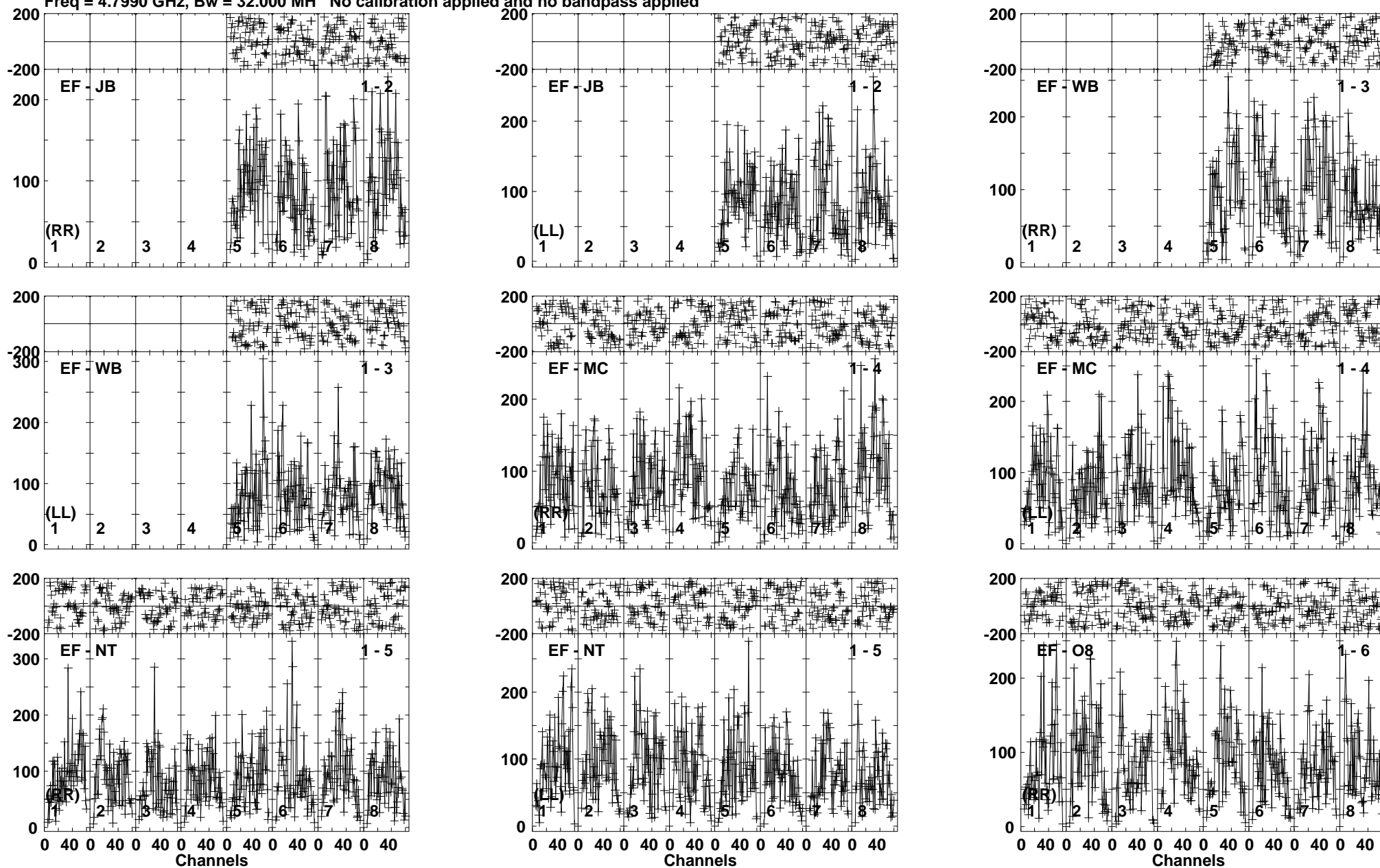

Lower frame: Micro Ampl Jy Top frame: Phas deg  
Vector averaged cross-power spectrum Baseline: EF (01) - JB (02)  
Timerange: 00/05:44:20 to 00/05:47:50



Plot file version 282 created 24-NOV-2017 10:10:44  
ARUMA EG096D.UVDATA.1  
Freq = 4.7990 GHz, Bw = 32.000 MH No calibration applied and no bandpass applied

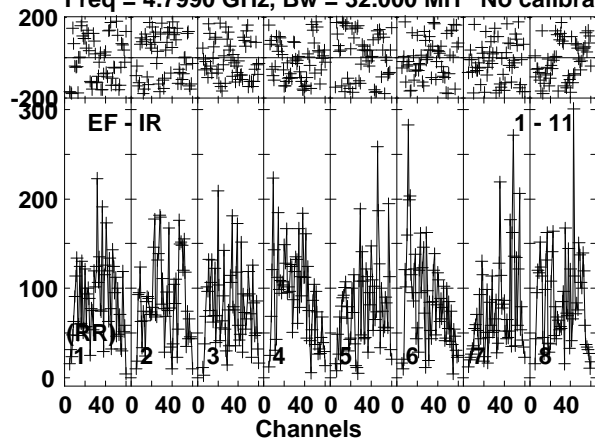

Lower frame: Micro Ampl Jy Top frame: Phas deg  
Vector averaged cross-power spectrum Baseline: EF (01) - IR (11)  
Timerange: 00/05:44:20 to 00/05:47:50



Plot file version 283 created 24-NOV-2017 10:10:44

J1108+4330 EG096D.UVDATA.1

Freq = 4.7990 GHz, Bw = 32.000 MH No calibration applied and no bandpass applied

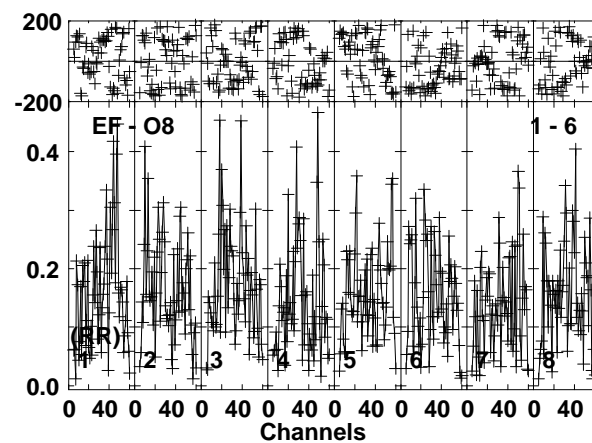
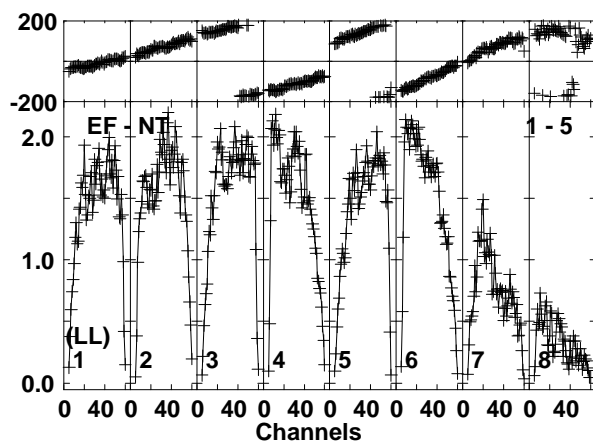
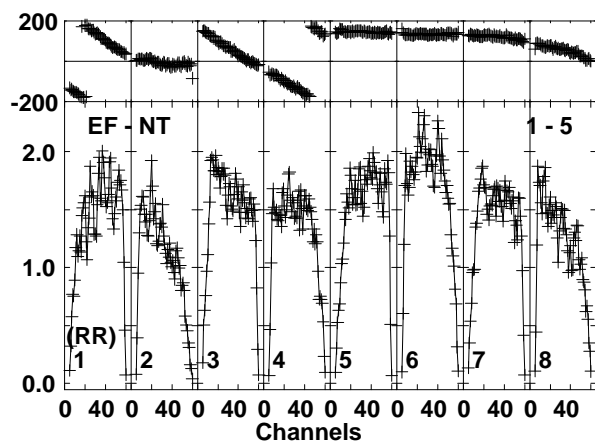
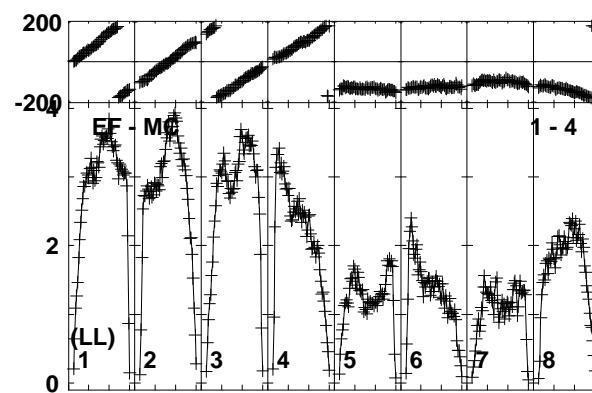
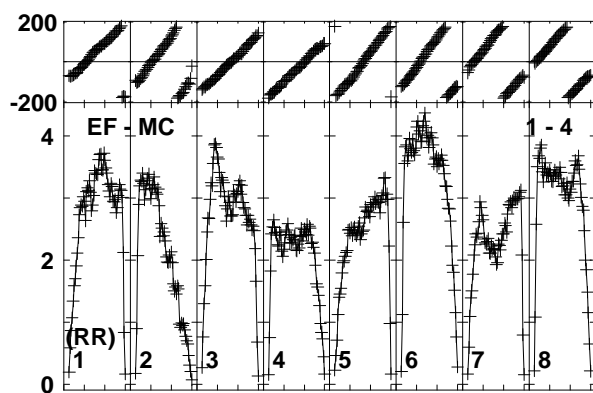
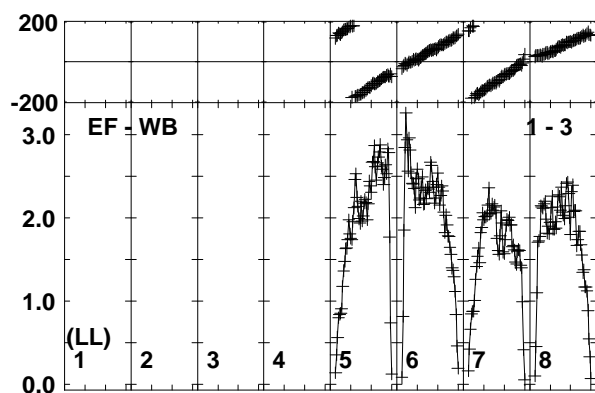
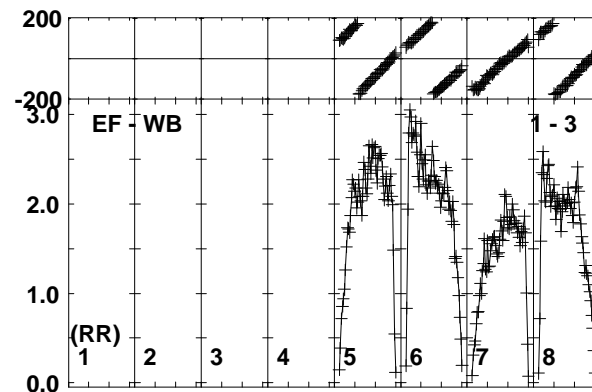
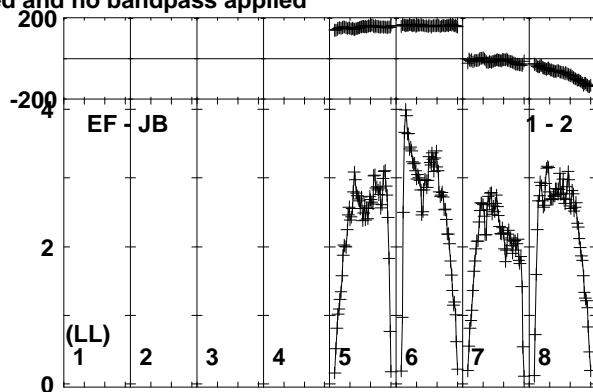
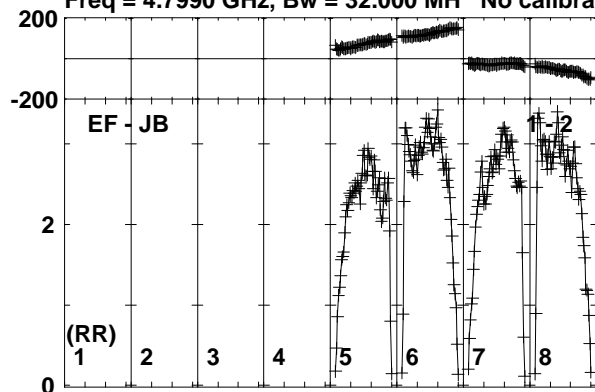

Lower frame: Milli Ampl Jy Top frame: Phas deg  
Vector averaged cross-power spectrum Baseline: EF (01) - JB (02)  
Timerange: 00/05:47:51 to 00/05:49:20

Plot file version 284 created 24-NOV-2017 10:10:44

J1108+4330 EG096D.UVDATA.1

Freq = 4.7990 GHz, Bw = 32.000 MH No calibration applied and no bandpass applied

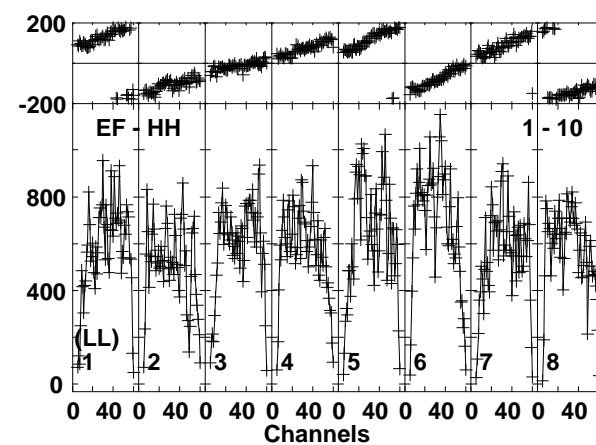
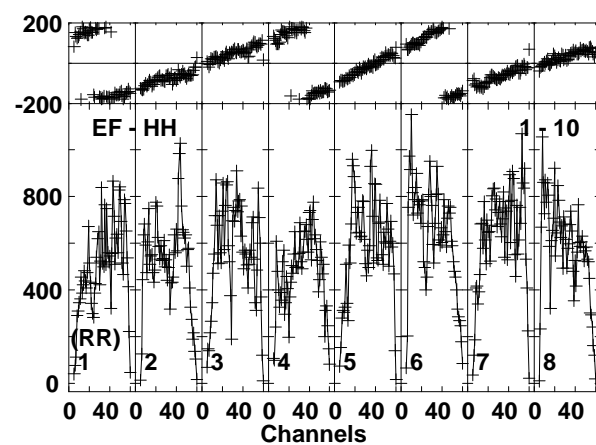
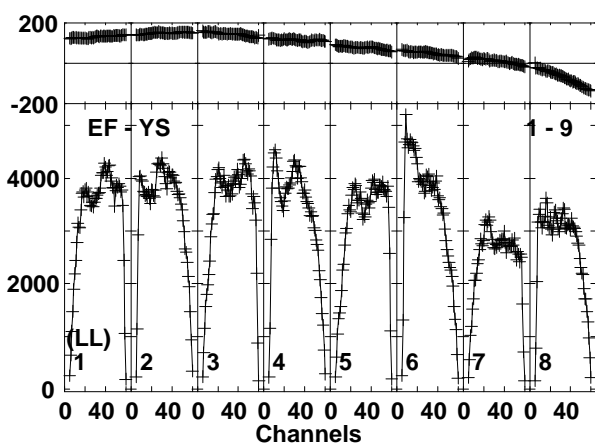
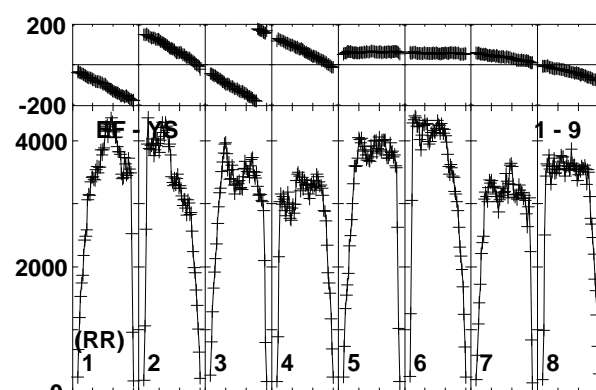
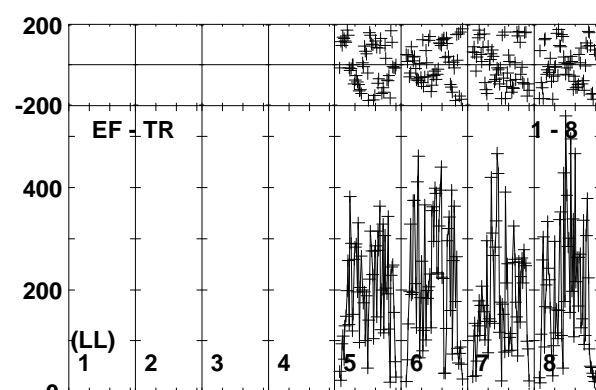
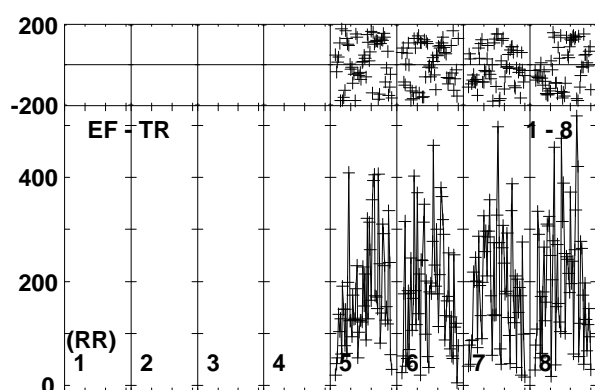
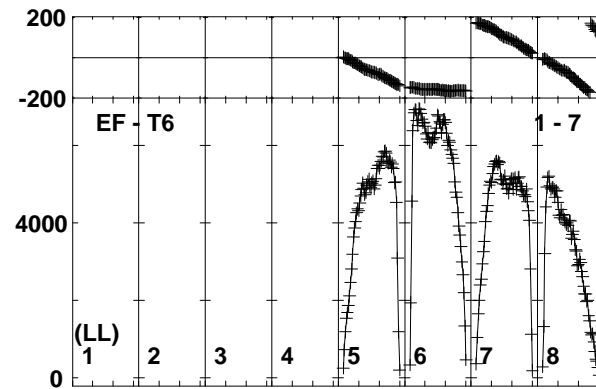
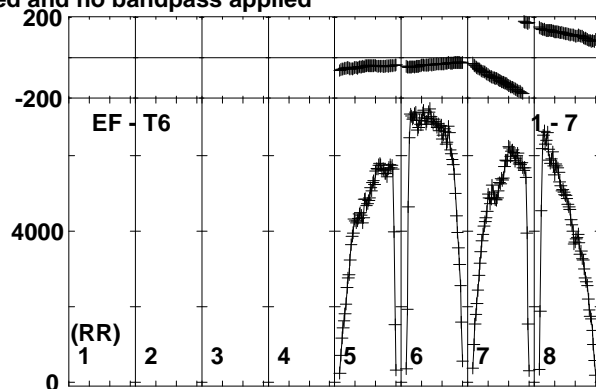
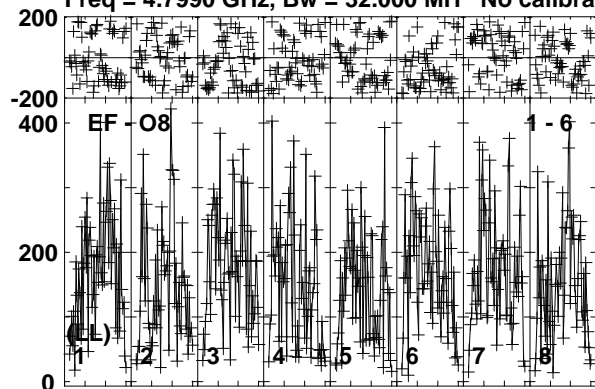

Lower frame: Micro Ampl Jy Top frame: Phas deg  
Vector averaged cross-power spectrum Baseline: EF (01) - O8 (06)  
Timerange: 00/05:47:51 to 00/05:49:20

Plot file version 285 created 24-NOV-2017 10:10:44  
J1108+4330 EG096D.UVDATA.1  
Freq = 4.7990 GHz, Bw = 32.000 MH No calibration applied and no bandpass applied

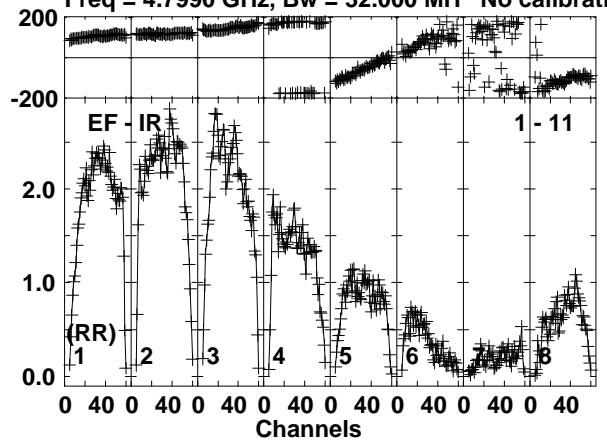

Lower frame: Milli Ampl Jy Top frame: Phas deg  
Vector averaged cross-power spectrum Baseline: EF (01) - IR (11)  
Timerange: 00/05:47:51 to 00/05:49:20

Plot file version 286 created 24-NOV-2017 10:10:44

ARUMA EG096D.UVDATA.1

Freq = 4.7990 GHz, Bw = 32.000 MH No calibration applied and no bandpass applied

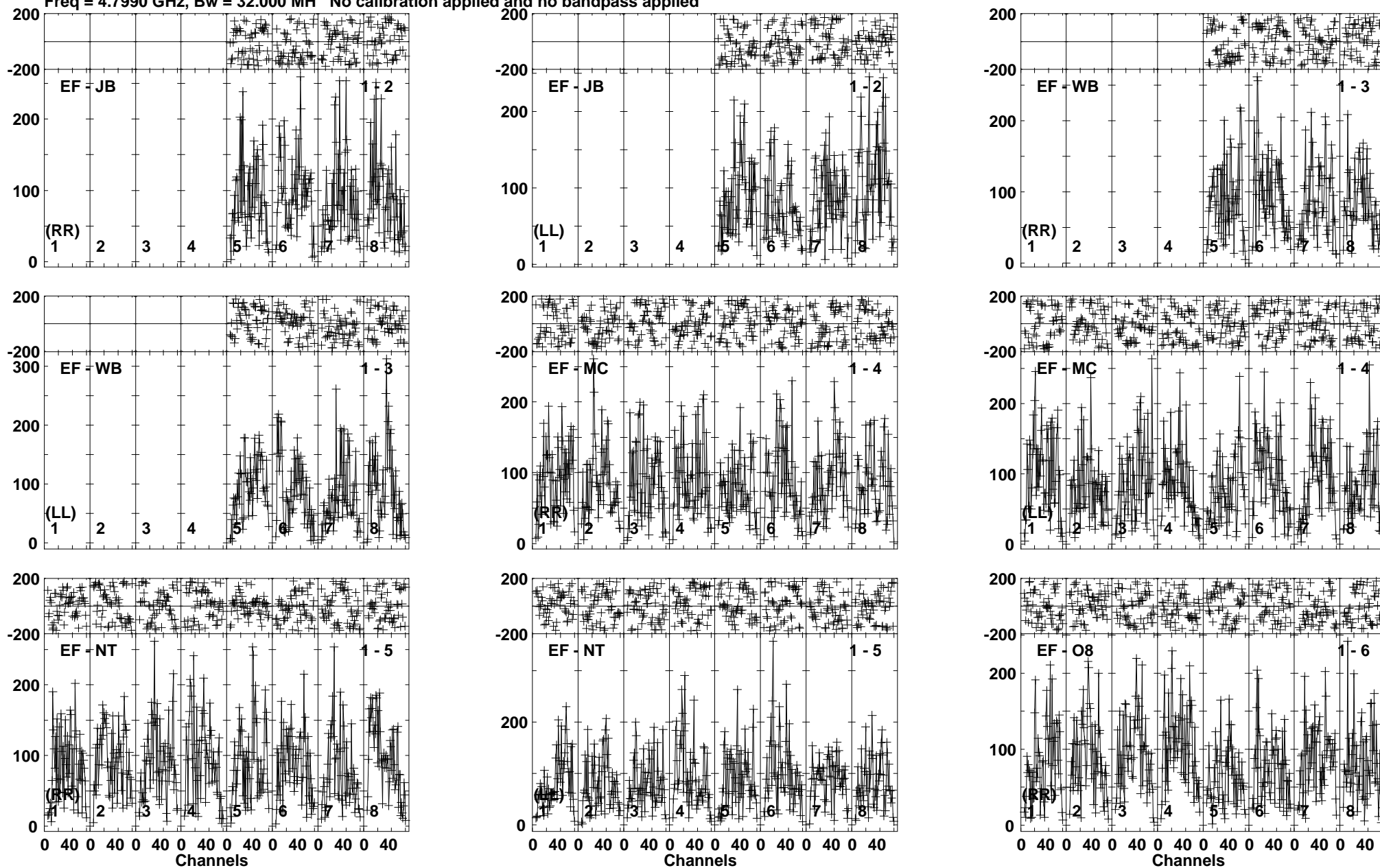

Lower frame: Micro Ampl Jy Top frame: Phas deg  
Vector averaged cross-power spectrum Baseline: EF (01) - JB (02)  
Timerange: 00/05:49:20 to 00/05:52:50

Plot file version 287 created 24-NOV-2017 10:10:45

ARUMA EG096D.UVDATA.1

Freq = 4.7990 GHz, Bw = 32.000 MH No calibration applied and no bandpass applied

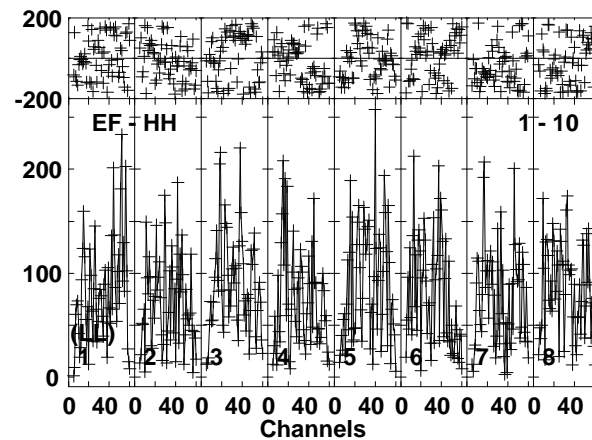
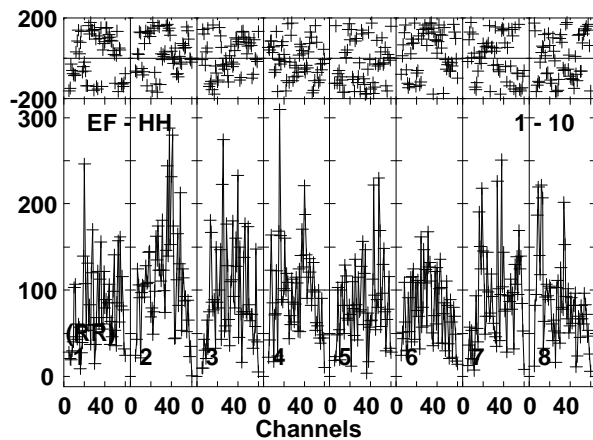
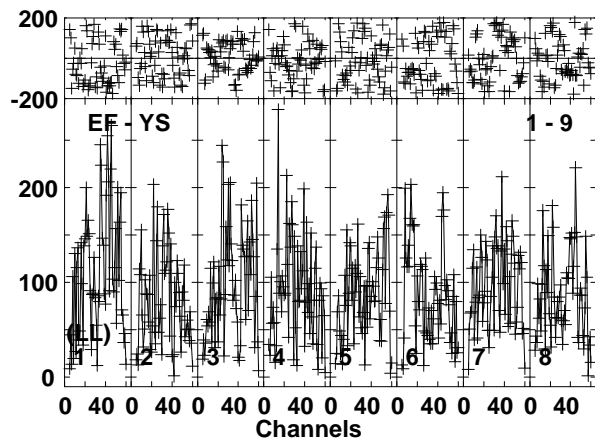
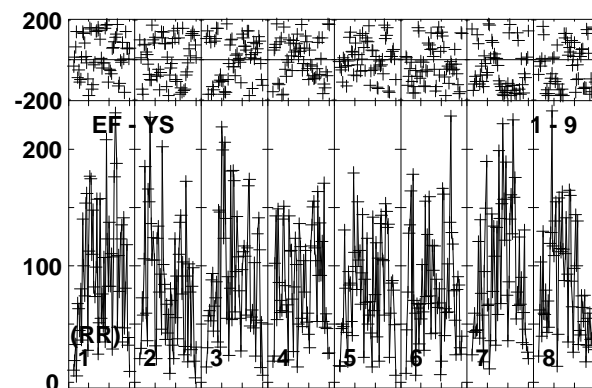
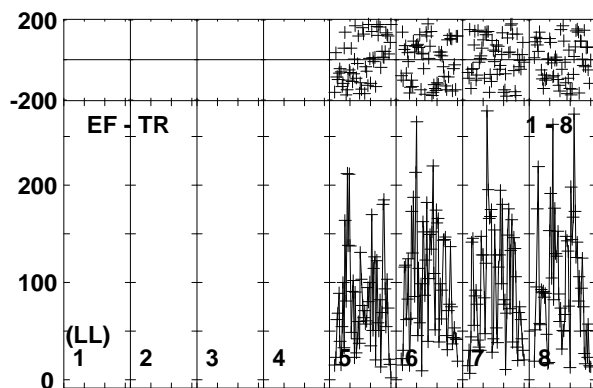
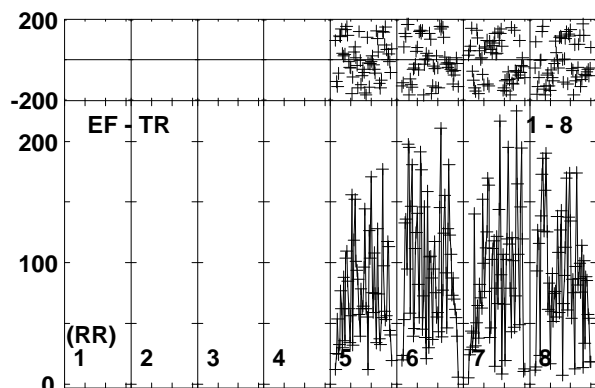
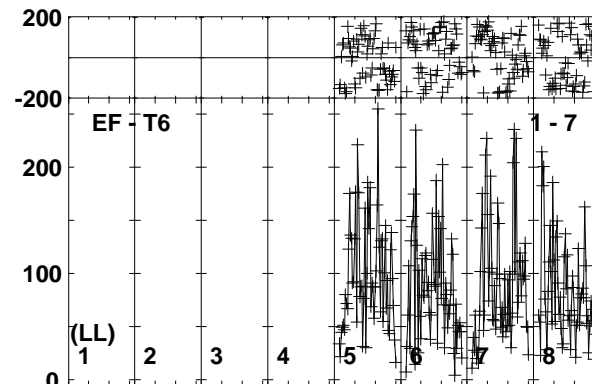
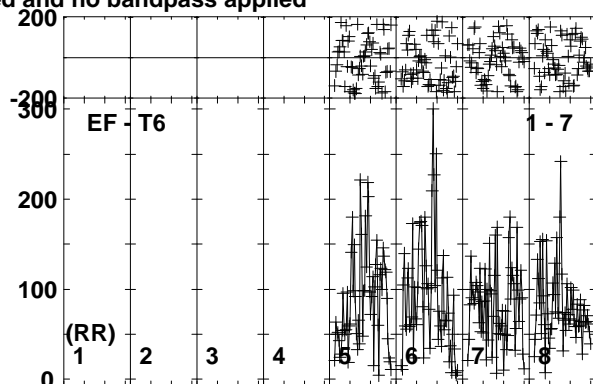
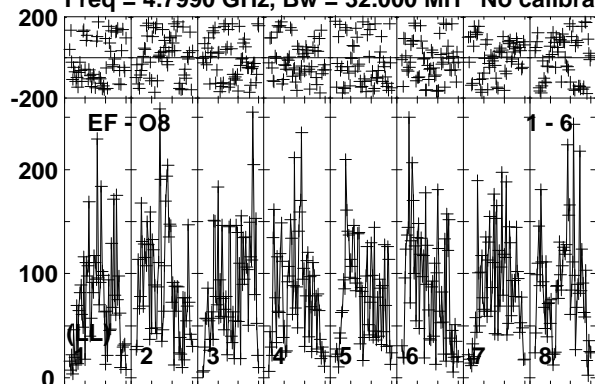

Lower frame: Micro Ampl Jy Top frame: Phas deg  
Vector averaged cross-power spectrum Baseline: EF (01) - O8 (06)  
Timerange: 00/05:49:20 to 00/05:52:50

Plot file version 288 created 24-NOV-2017 10:10:45  
ARUMA EG096D.UVDATA.1  
Freq = 4.7990 GHz, Bw = 32.000 MH No calibration applied and no bandpass applied

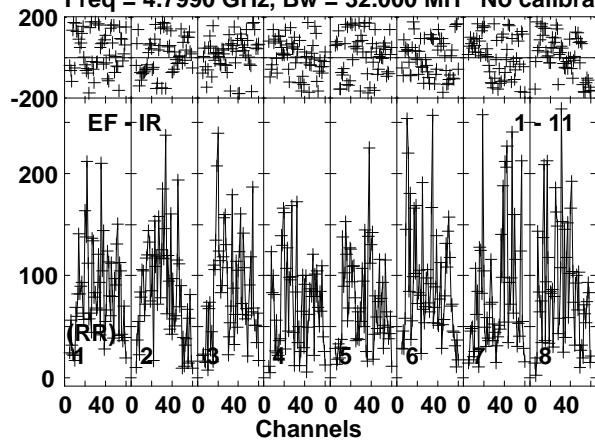

Lower frame: Micro Ampl Jy Top frame: Phas deg  
Vector averaged cross-power spectrum Baseline: EF (01) - IR (11)  
Timerange: 00/05:49:20 to 00/05:52:50

Plot file version 289 created 24-NOV-2017 10:10:45

J1108+4330 EG096D.UVDATA.1

Freq = 4.7990 GHz, Bw = 32.000 MH No calibration applied and no bandpass applied

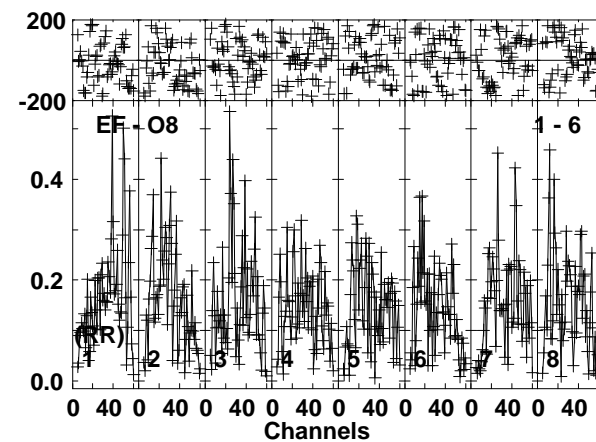
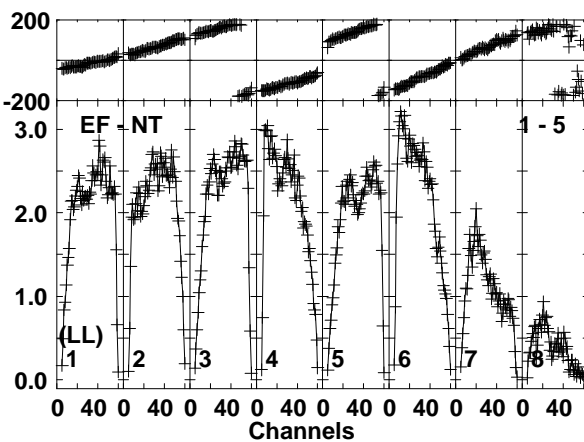
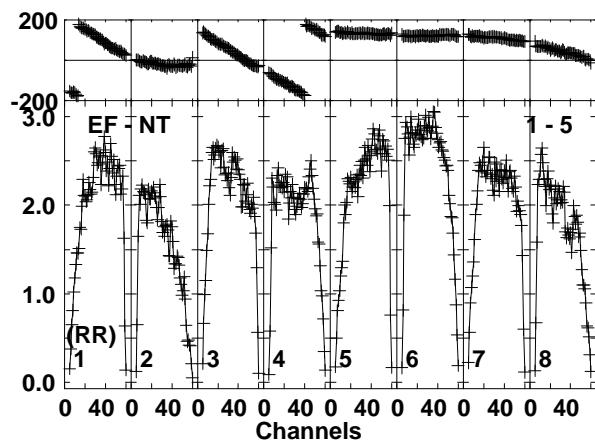
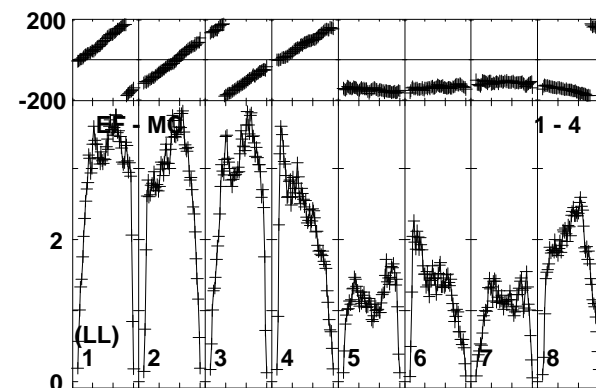
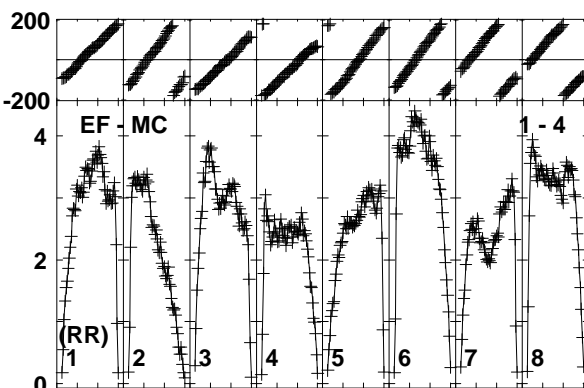
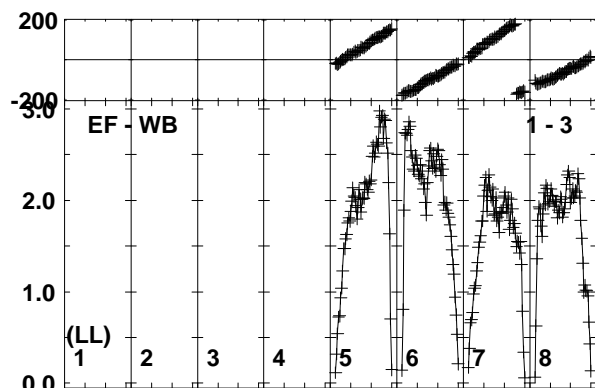
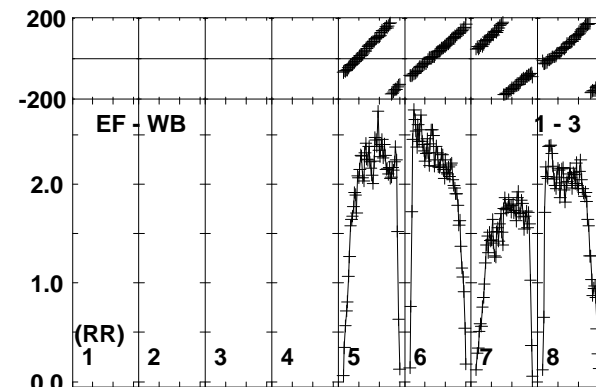
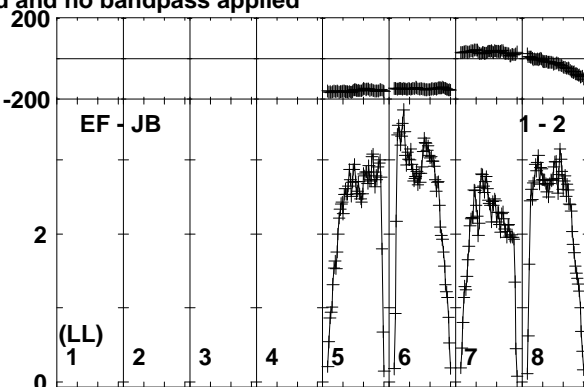
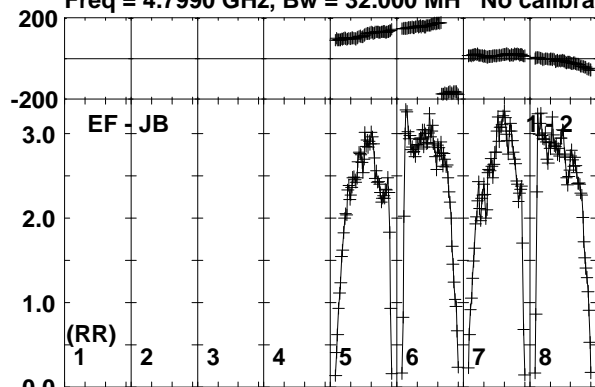

Lower frame: Milli Ampl Jy Top frame: Phas deg  
Vector averaged cross-power spectrum Baseline: EF (01) - JB (02)  
Timerange: 00/05:53:31 to 00/05:54:30

Plot file version 290 created 24-NOV-2017 10:10:45

J1108+4330 EG096D.UVDATA.1

Freq = 4.7990 GHz, Bw = 32.000 MH No calibration applied and no bandpass applied

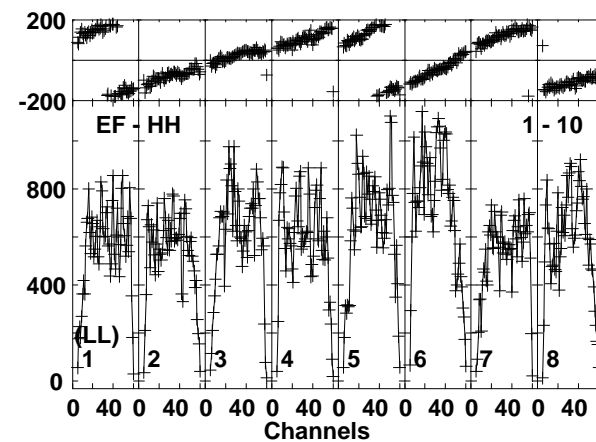
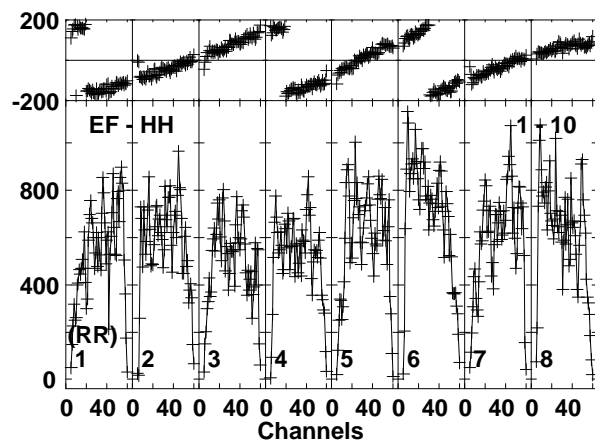
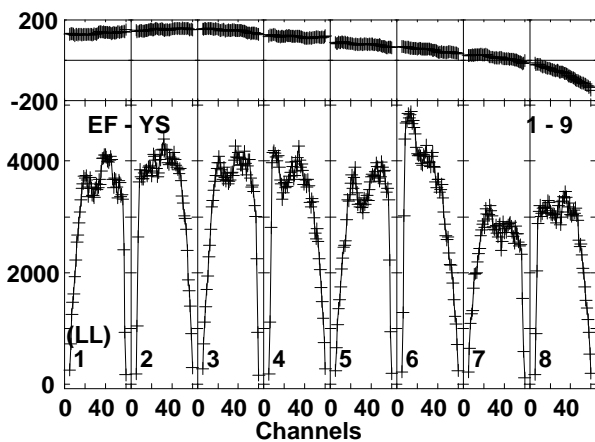
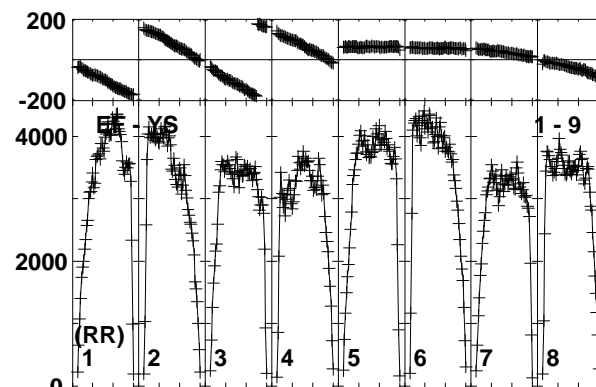
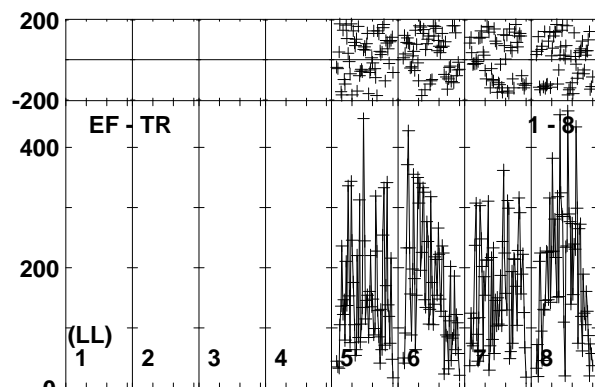
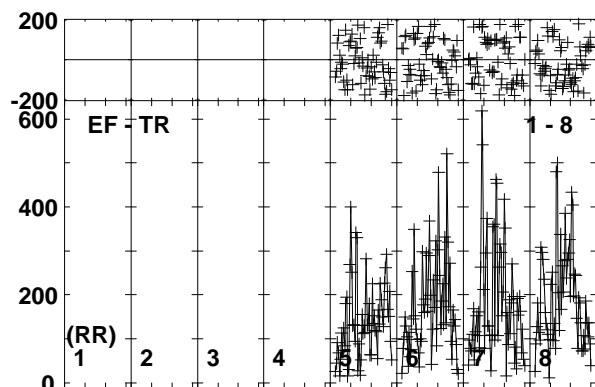
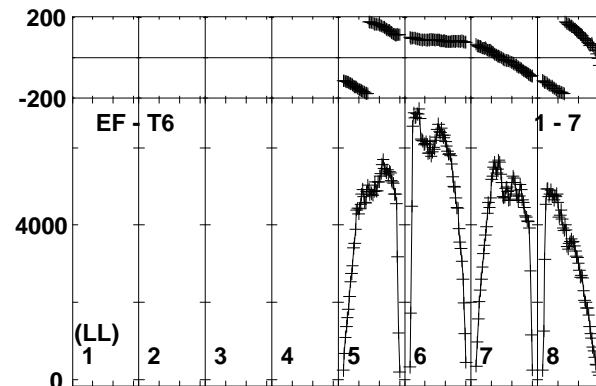
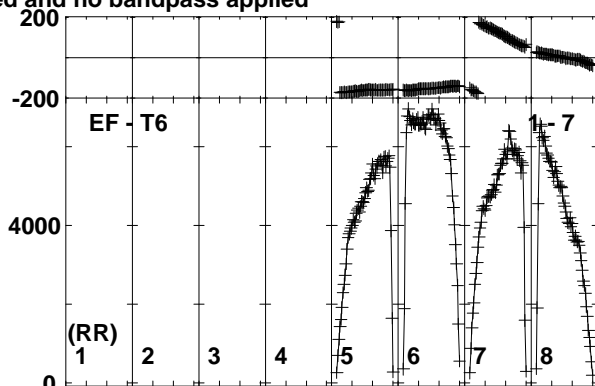
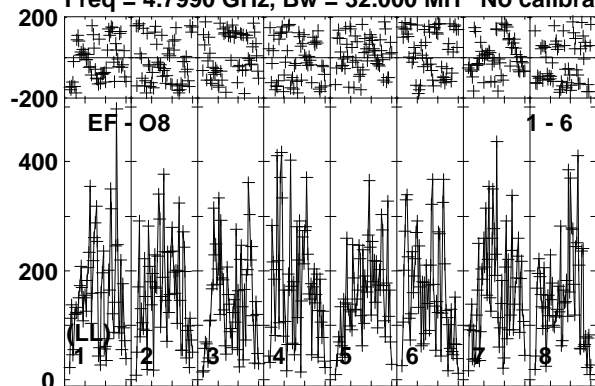

Lower frame: Micro Ampl Jy Top frame: Phas deg  
Vector averaged cross-power spectrum Baseline: EF (01) - O8 (06)  
Timerange: 00/05:53:31 to 00/05:54:30



Plot file version 291 created 24-NOV-2017 10:10:45  
J1108+4330 EG096D.UVDATA.1  
Freq = 4.7990 GHz, Bw = 32.000 MH No calibration applied and no bandpass applied

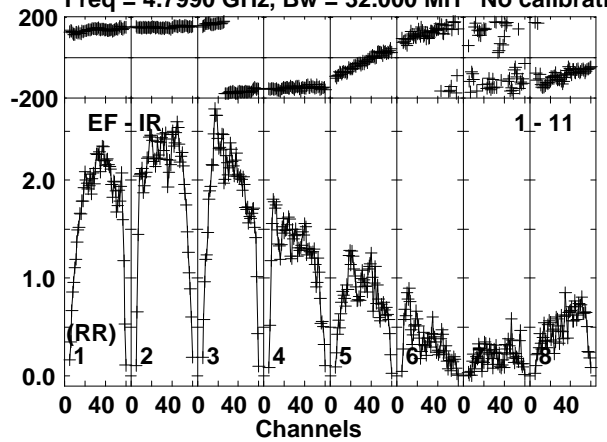

Lower frame: Milli Ampl Jy Top frame: Phas deg  
Vector averaged cross-power spectrum Baseline: EF (01) - IR (11)  
Timerange: 00/05:53:31 to 00/05:54:30

Plot file version 292 created 24-NOV-2017 10:10:46

J1112+4301 EG096D.UVDATA.1

Freq = 4.7990 GHz, Bw = 32.000 MH No calibration applied and no bandpass applied

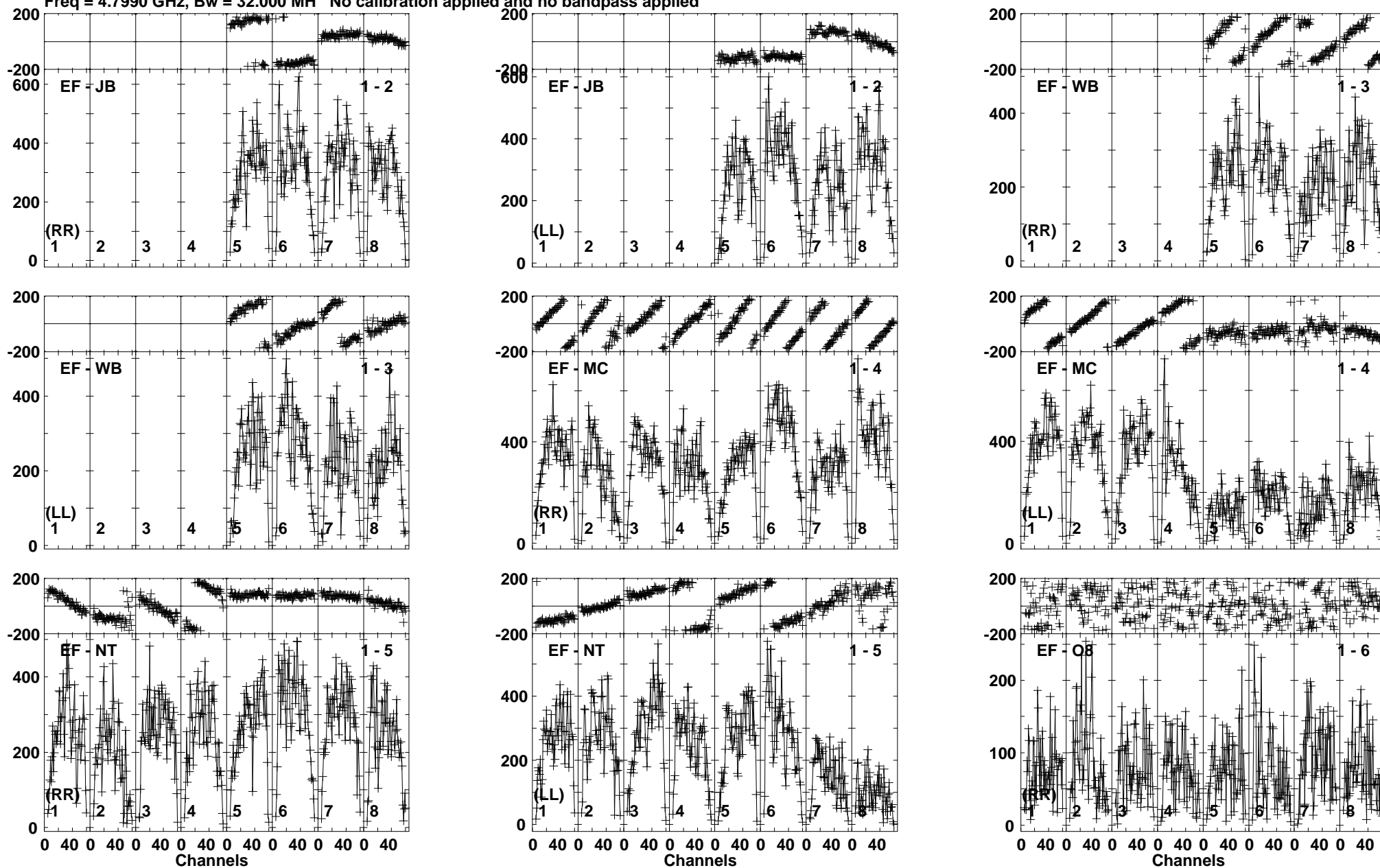

Lower frame: Micro Ampl Jy Top frame: Phas deg  
Vector averaged cross-power spectrum Baseline: EF (01) - JB (02)  
Timerange: 00/05:54:30 to 00/05:58:00

Plot file version 293 created 24-NOV-2017 10:10:46

J1112+4301 EG096D.UVDATA.1

Freq = 4.7990 GHz, Bw = 32.000 MH No calibration applied and no bandpass applied

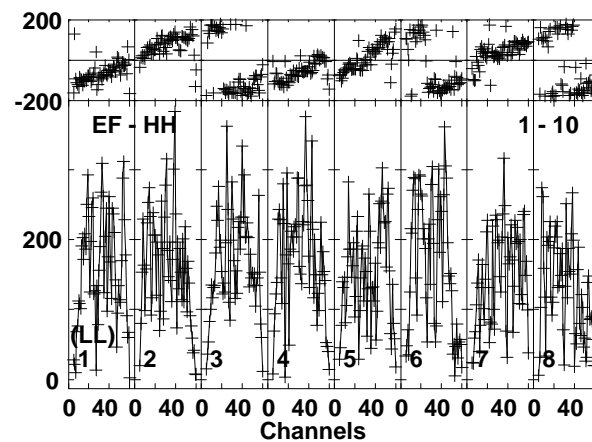
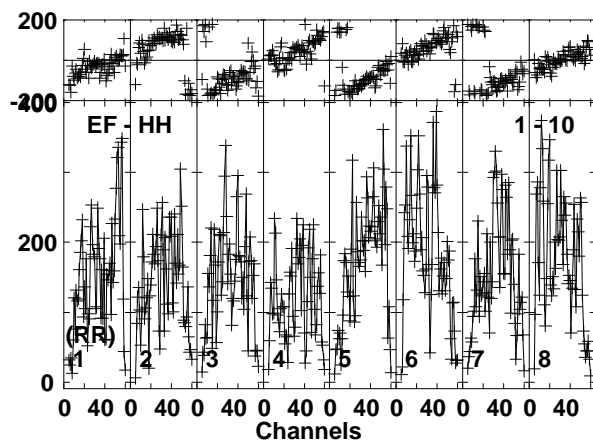
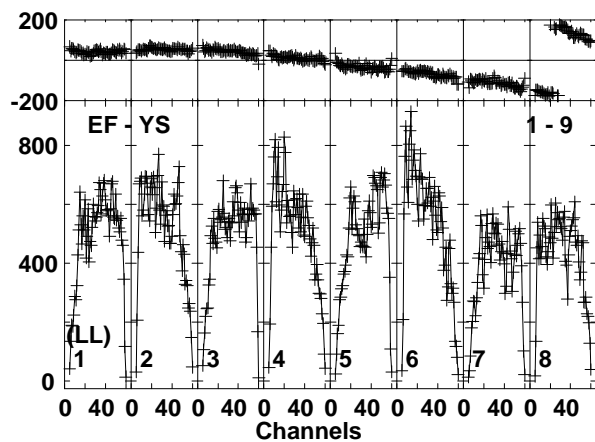
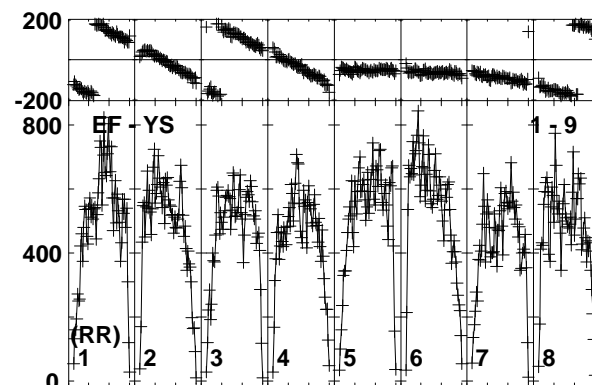
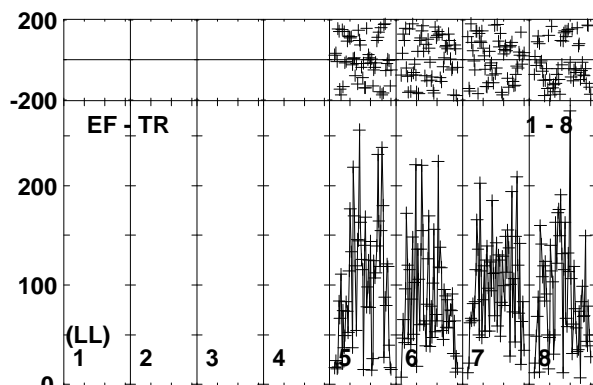
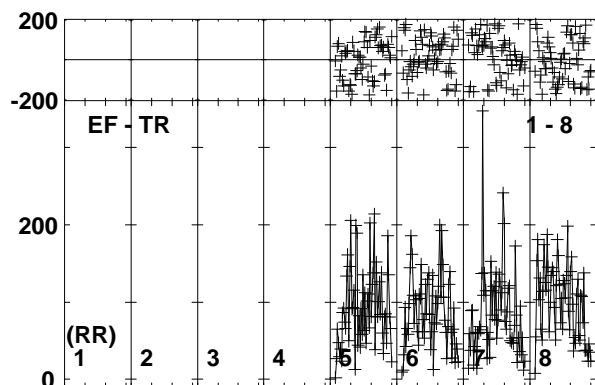
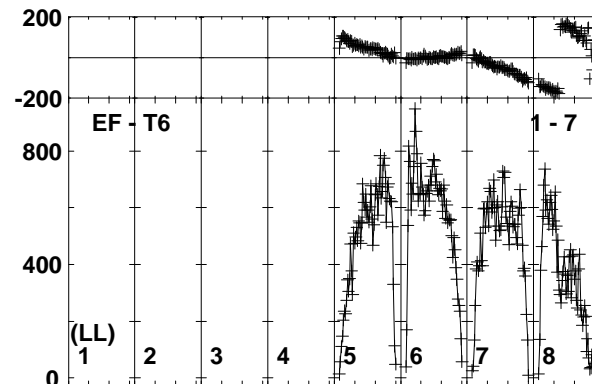
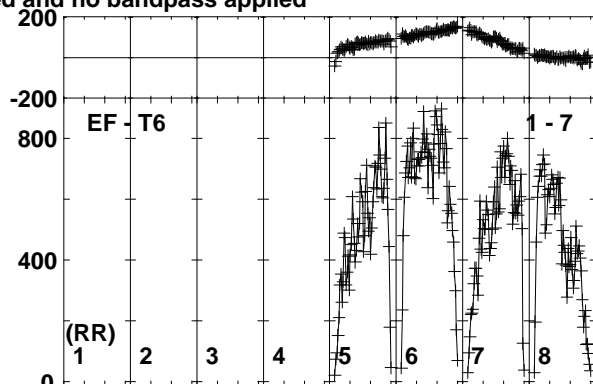
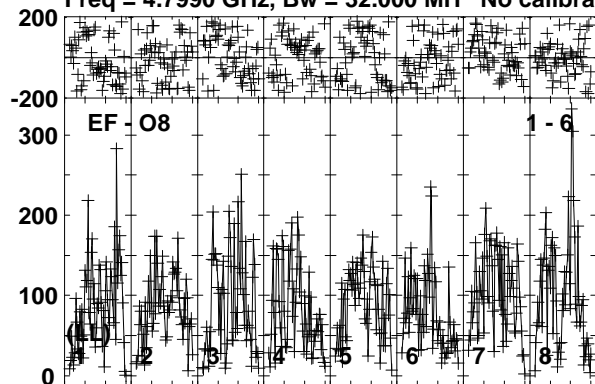

Lower frame: Micro Ampl Jy Top frame: Phas deg  
Vector averaged cross-power spectrum Baseline: EF (01) - O8 (06)  
Timerange: 00/05:54:30 to 00/05:58:00

Plot file version 294 created 24-NOV-2017 10:10:46

J1112+4301 EG096D.UVDATA.1

Freq = 4.7990 GHz, Bw = 32.000 MH No calibration applied and no bandpass applied

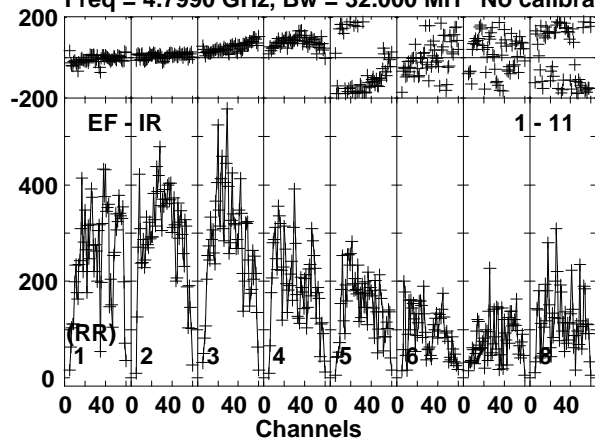

Lower frame: Micro Ampl Jy Top frame: Phas deg  
Vector averaged cross-power spectrum Baseline: EF (01) - IR (11)  
Timerange: 00/05:54:30 to 00/05:58:00

Plot file version 295 created 24-NOV-2017 10:10:46

J1108+4330 EG096D.UVDATA.1

Freq = 4.7990 GHz, Bw = 32.000 MH No calibration applied and no bandpass applied

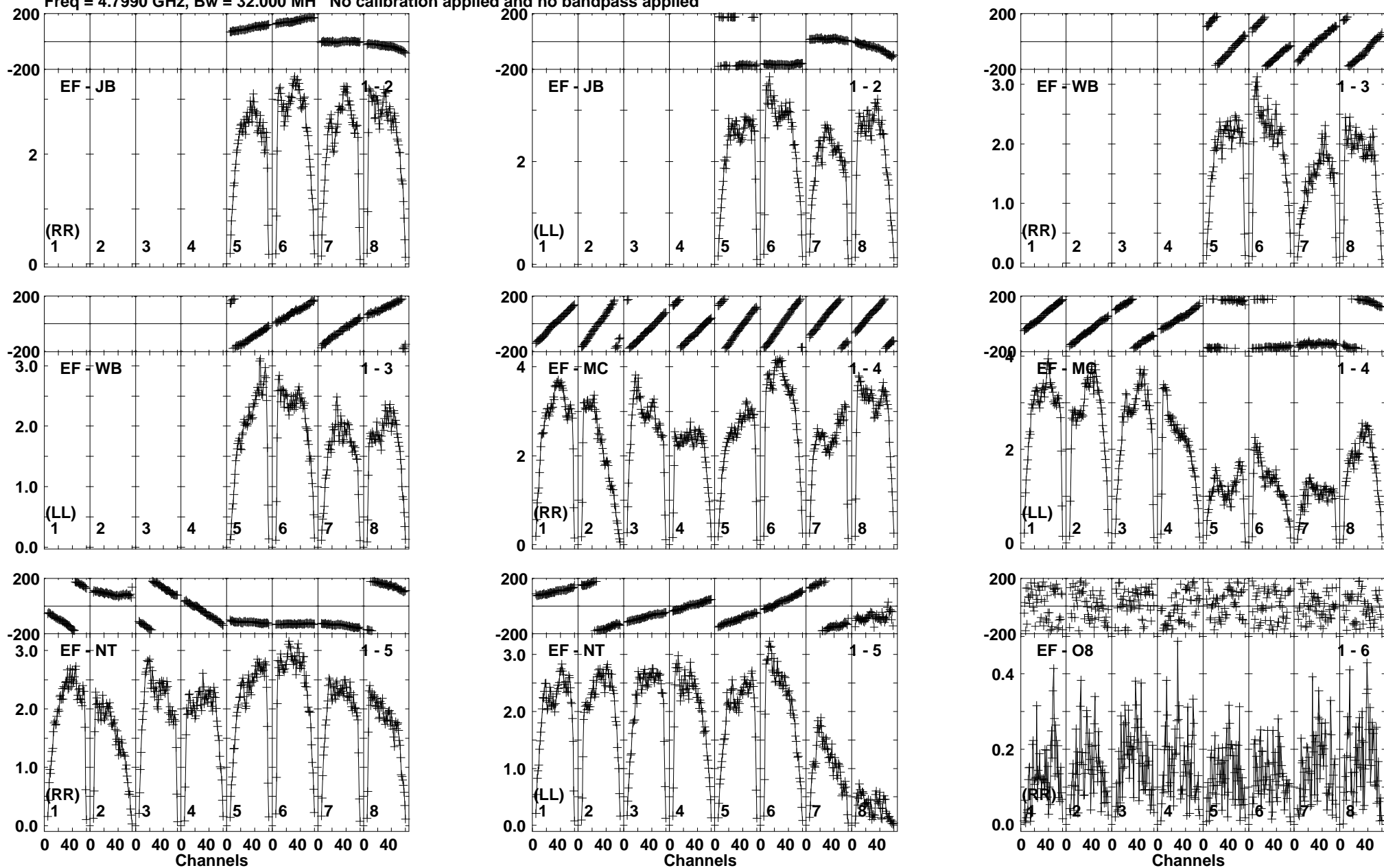

Lower frame: Milli Ampl Jy Top frame: Phas deg  
Vector averaged cross-power spectrum Baseline: EF (01) - JB (02)  
Timerange: 00/05:58:00 to 00/05:59:29

Plot file version 296 created 24-NOV-2017 10:10:47

J1108+4330 EG096D.UVDATA.1

Freq = 4.7990 GHz, Bw = 32.000 MH No calibration applied and no bandpass applied

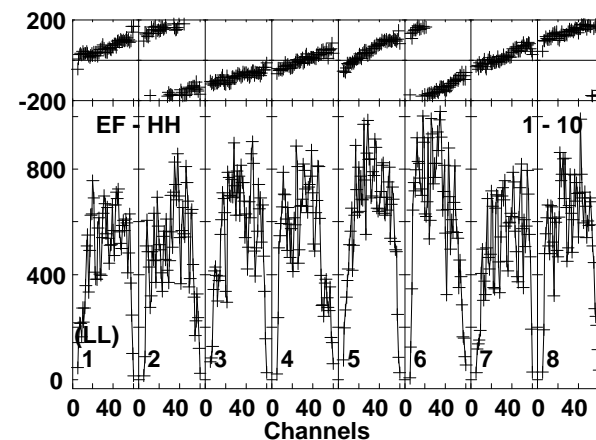
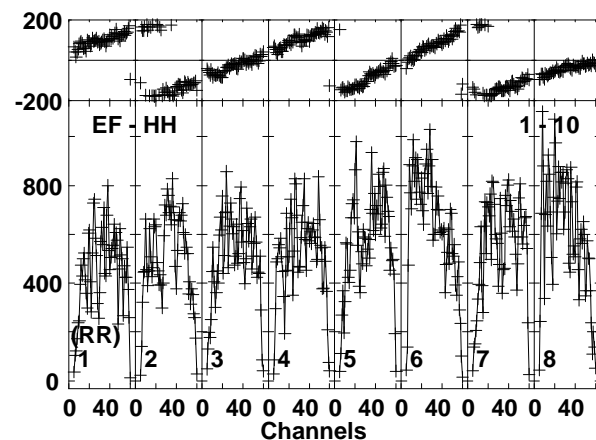
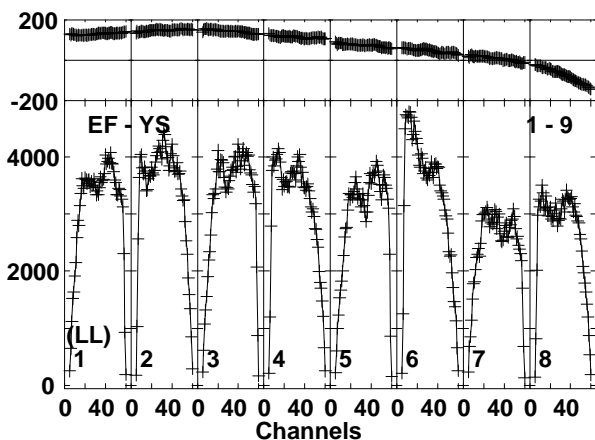
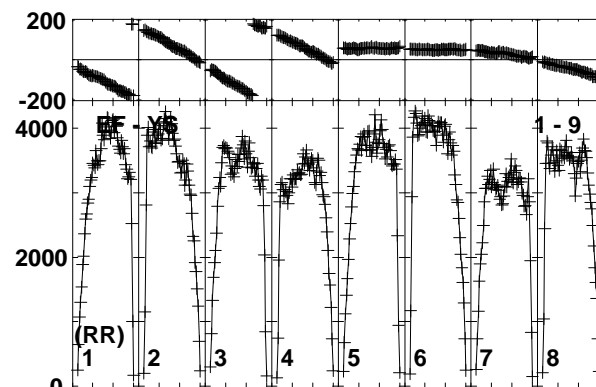
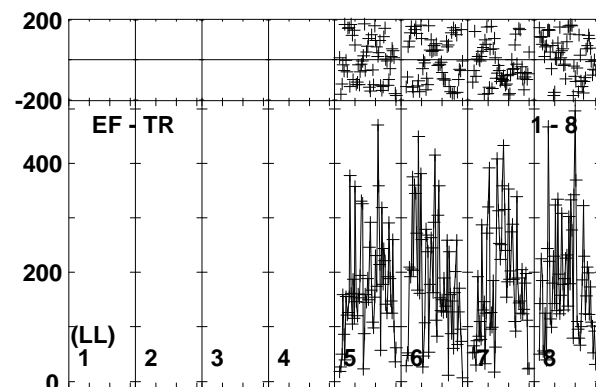
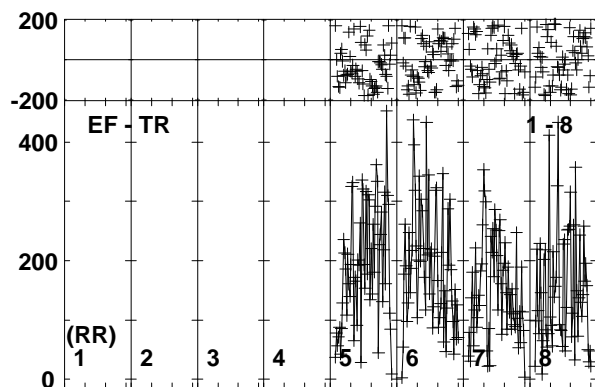
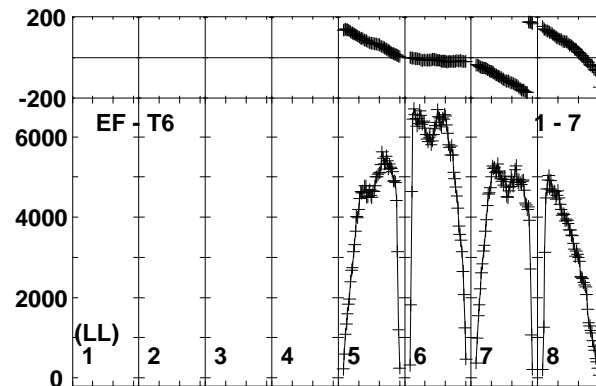
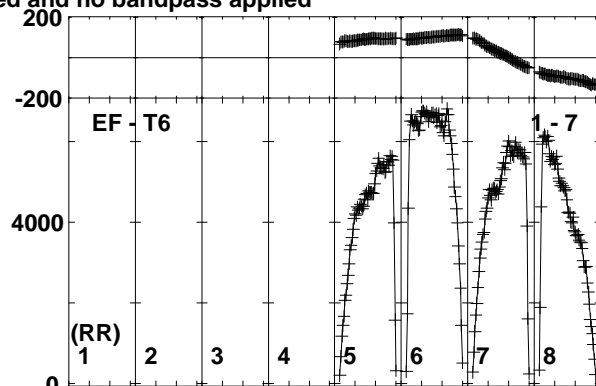
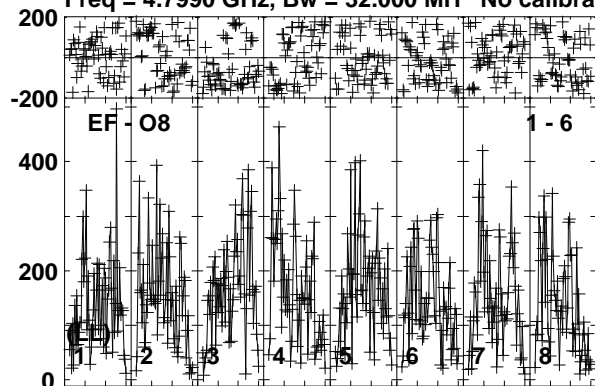

Lower frame: Micro Ampl Jy Top frame: Phas deg  
Vector averaged cross-power spectrum Baseline: EF (01) - O8 (06)  
Timerange: 00/05:58:00 to 00/05:59:29



Plot file version 298 created 24-NOV-2017 10:10:47

ARUMA EG096D.UVDATA.1

Freq = 4.7990 GHz, Bw = 32.000 MH No calibration applied and no bandpass applied

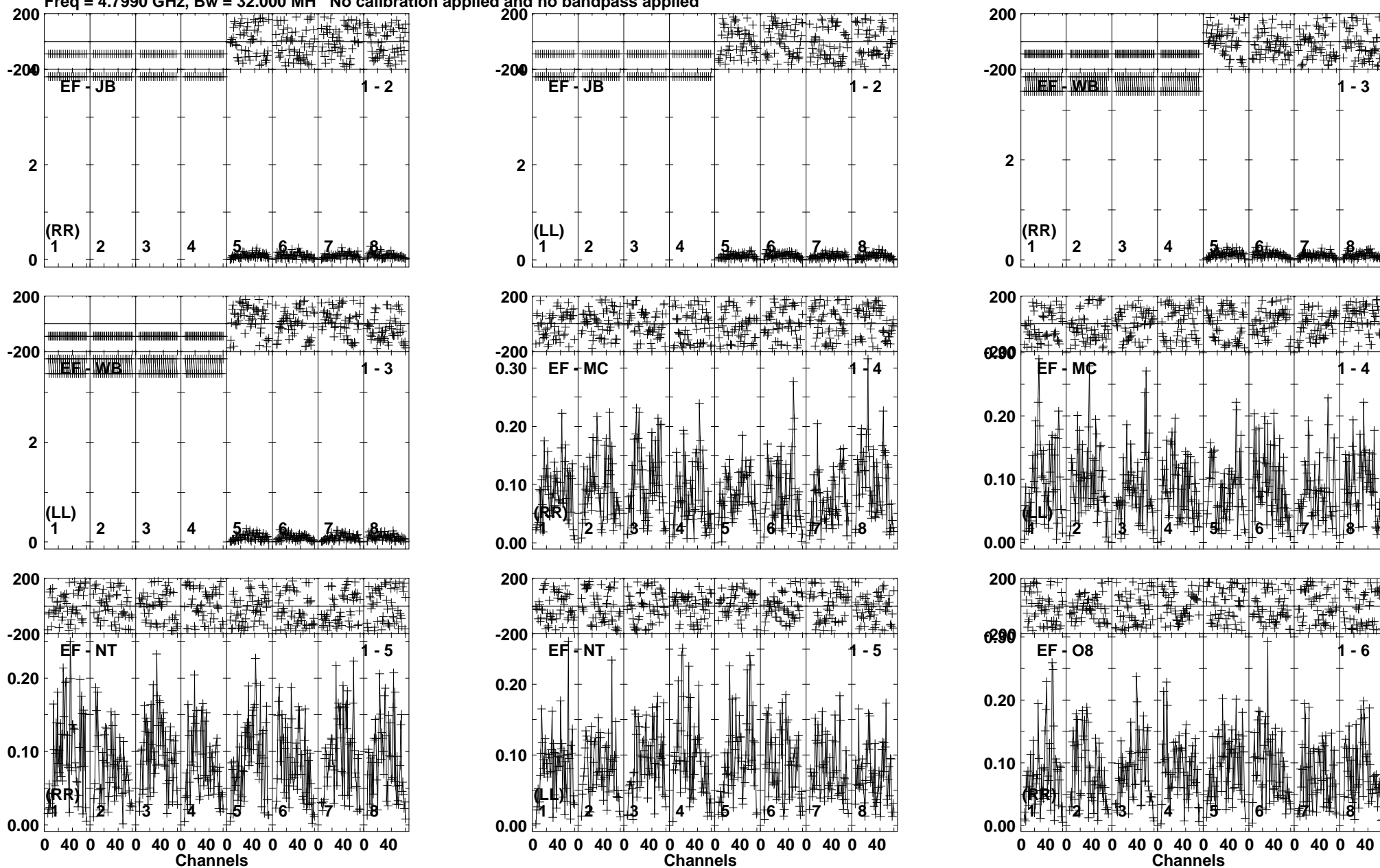

Lower frame: Milli Ampl Jy Top frame: Phas deg  
Vector averaged cross-power spectrum Baseline: EF (01) - JB (02)  
Timerange: 00/05:59:30 to 00/06:02:59





Plot file version 300 created 24-NOV-2017 10:10:48  
ARUMA EG096D.UVDATA.1  
Freq = 4.7990 GHz, Bw = 32.000 MH No calibration applied and no bandpass applied

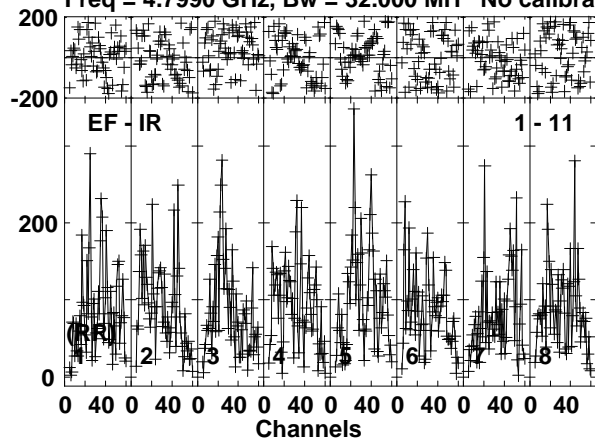

Lower frame: Micro Ampl Jy Top frame: Phas deg  
Vector averaged cross-power spectrum Baseline: EF (01) - IR (11)  
Timerange: 00/05:59:30 to 00/06:02:59

Plot file version 301 created 24-NOV-2017 10:10:48

J1108+4330 EG096D.UVDATA.1

Freq = 4.7990 GHz, Bw = 32.000 MH No calibration applied and no bandpass applied

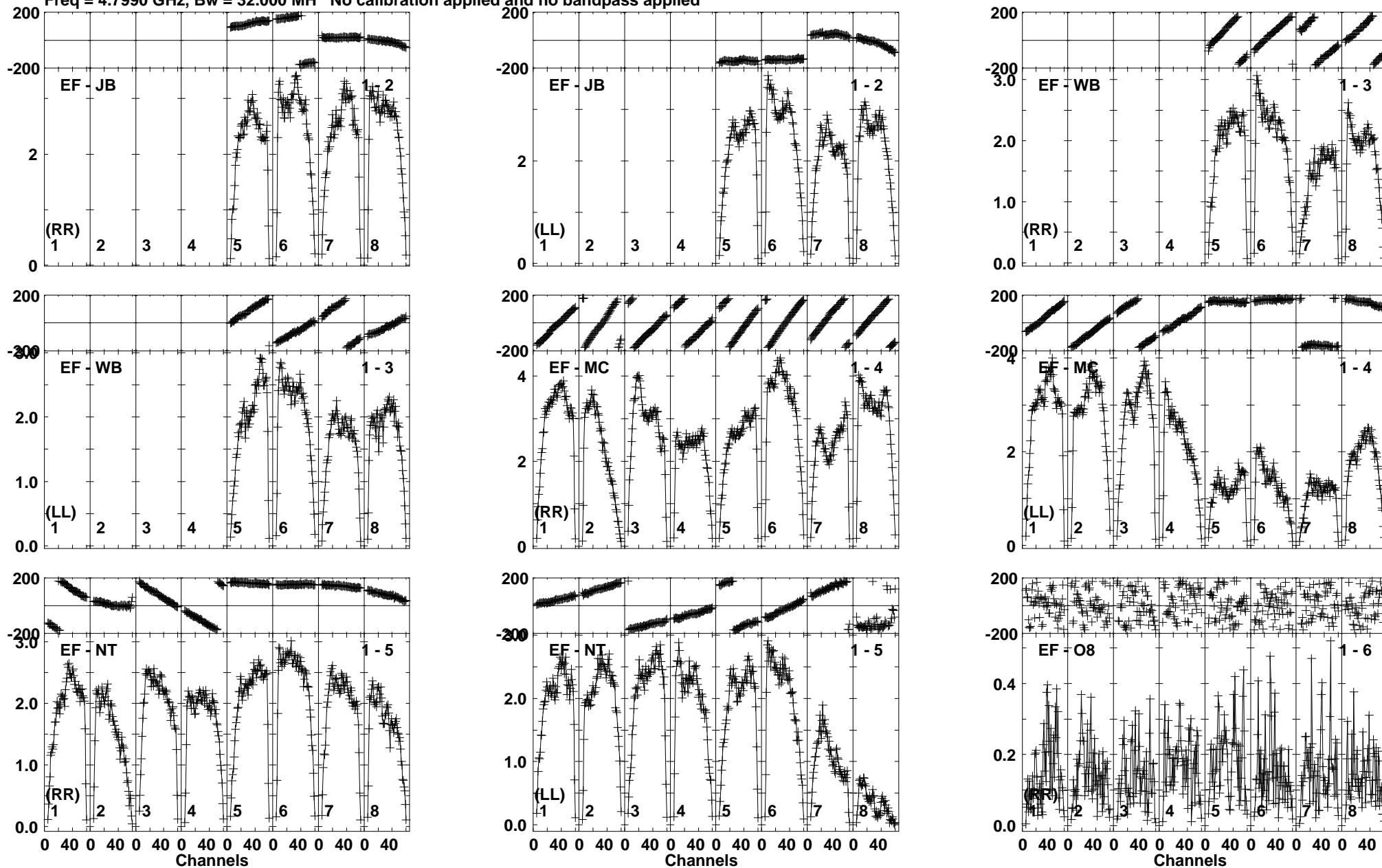

Lower frame: Milli Ampl Jy Top frame: Phas deg  
Vector averaged cross-power spectrum Baseline: EF (01) - JB (02)  
Timerange: 00/06:03:41 to 00/06:04:39

Plot file version 302 created 24-NOV-2017 10:10:48

J1108+4330 EG096D.UVDATA.1

Freq = 4.7990 GHz, Bw = 32.000 MH No calibration applied and no bandpass applied

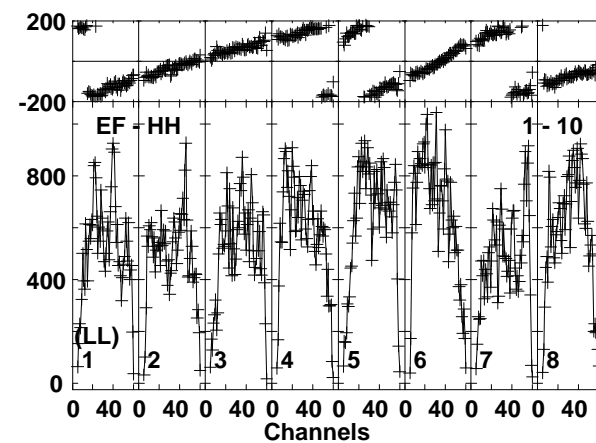
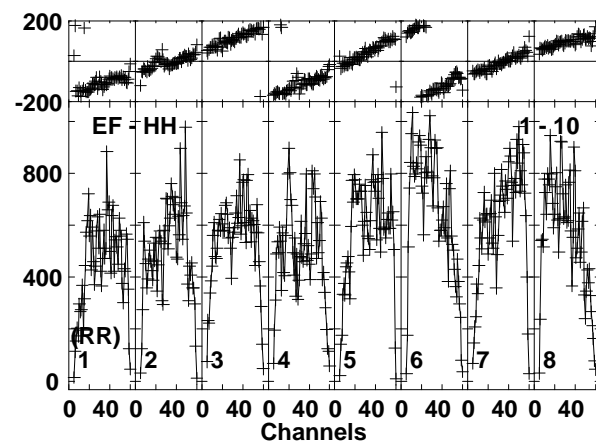
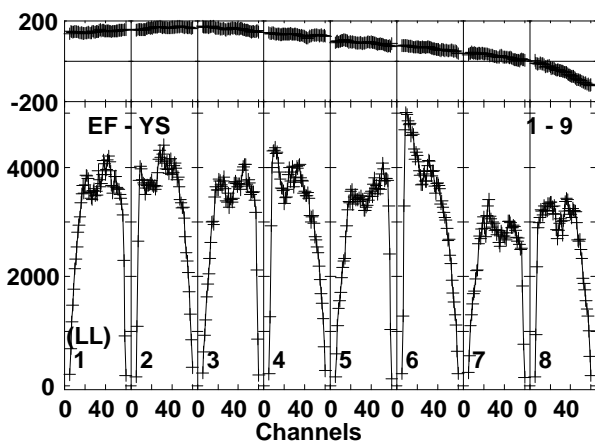
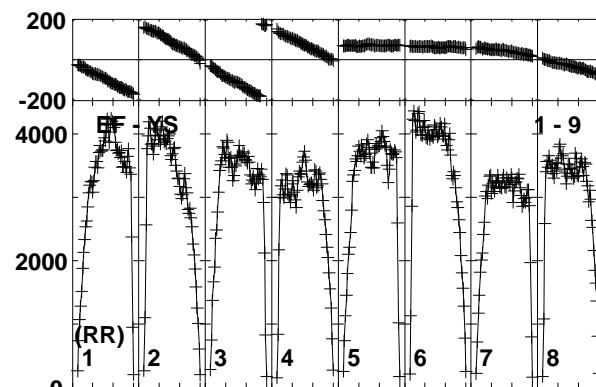
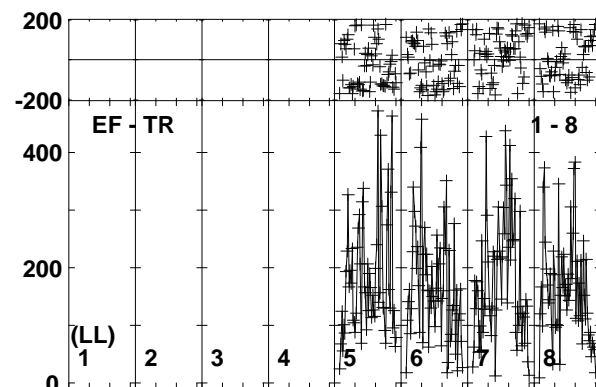
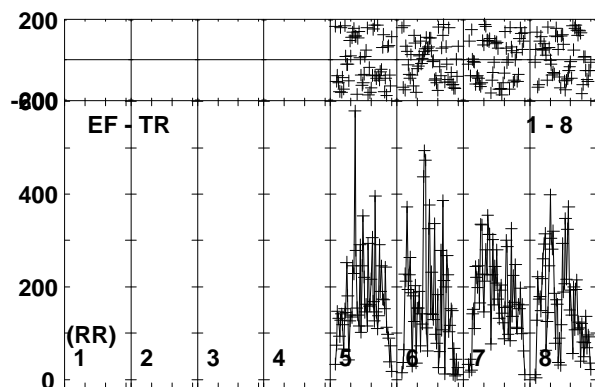
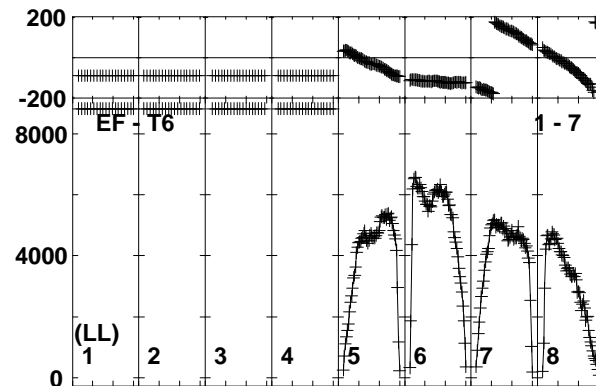
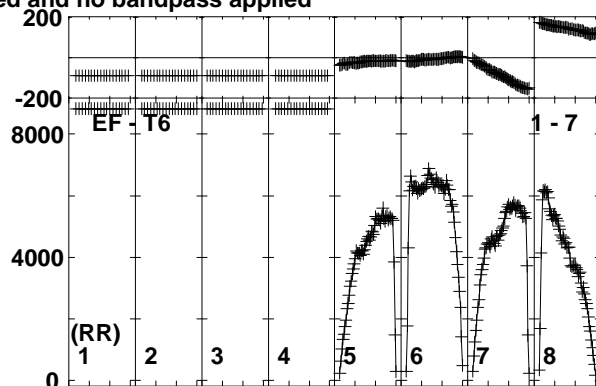
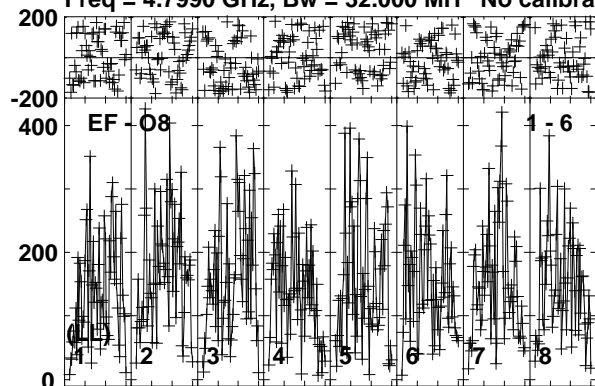

Lower frame: Micro Ampl Jy Top frame: Phas deg  
Vector averaged cross-power spectrum Baseline: EF (01) - O8 (06)  
Timerange: 00/06:03:41 to 00/06:04:39

Plot file version 303 created 24-NOV-2017 10:10:48

J1108+4330 EG096D.UVDATA.1

Freq = 4.7990 GHz, Bw = 32.000 MH No calibration applied and no bandpass applied

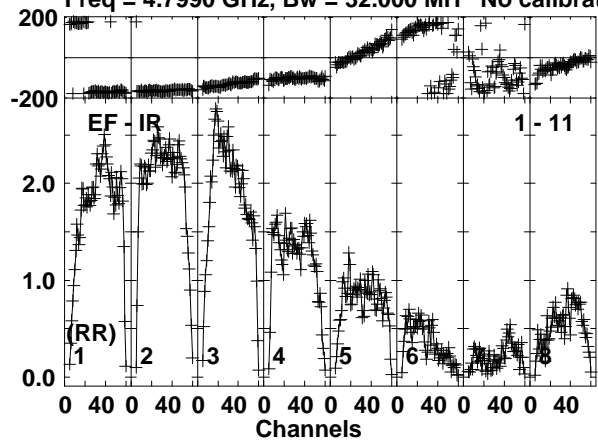

Lower frame: Milli Ampl Jy Top frame: Phas deg  
Vector averaged cross-power spectrum Baseline: EF (01) - IR (11)  
Timerange: 00/06:03:41 to 00/06:04:39

Plot file version 304 created 24-NOV-2017 10:10:48

ARUMA EG096D.UVDATA.1

Freq = 4.7990 GHz, Bw = 32.000 MH No calibration applied and no bandpass applied

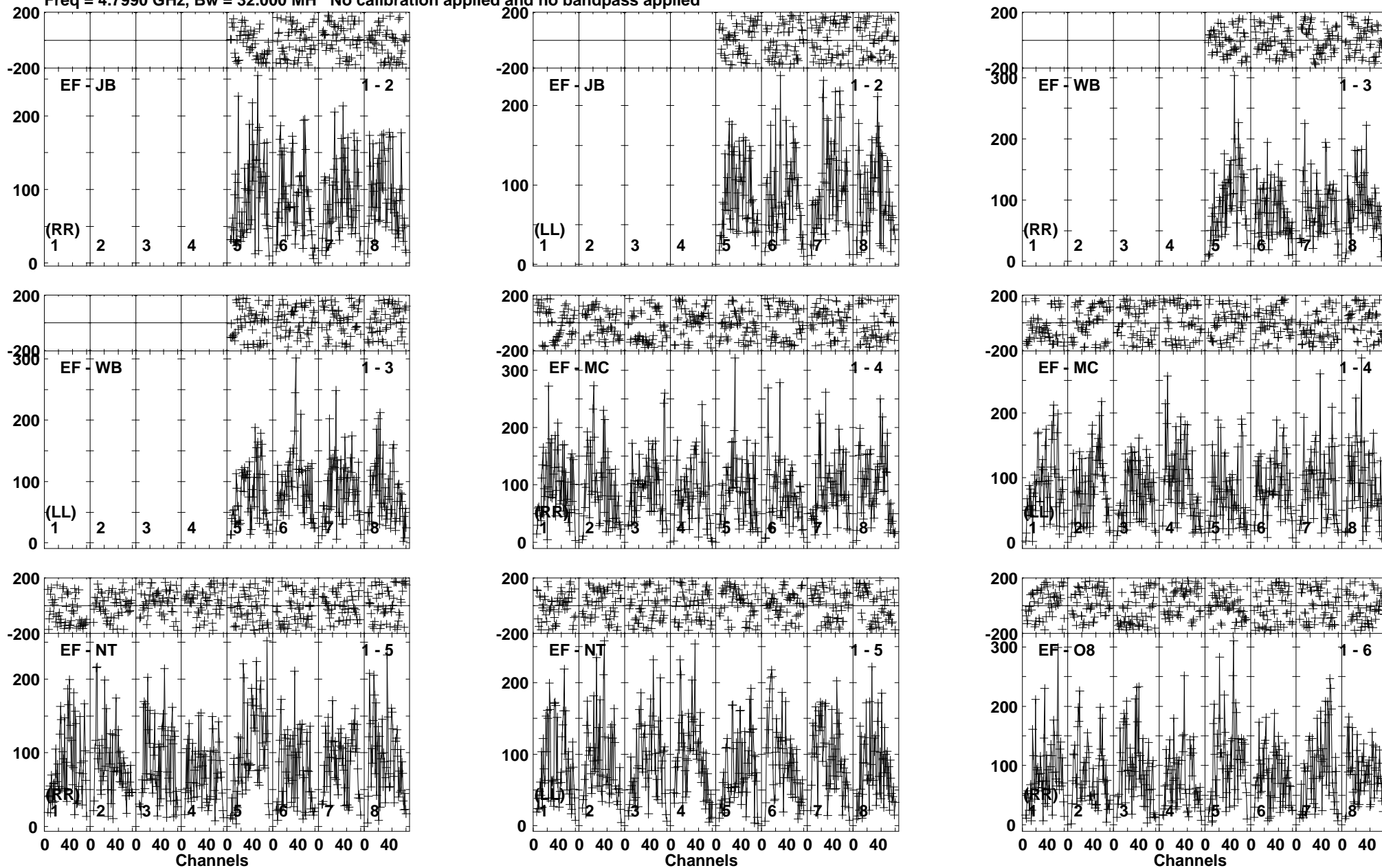

Lower frame: Micro Ampl Jy Top frame: Phas deg  
Vector averaged cross-power spectrum Baseline: EF (01) - JB (02)  
Timerange: 00/06:04:40 to 00/06:08:09

Plot file version 305 created 24-NOV-2017 10:10:49

ARUMA EG096D.UVDATA.1

Freq = 4.7990 GHz, Bw = 32.000 MH No calibration applied and no bandpass applied

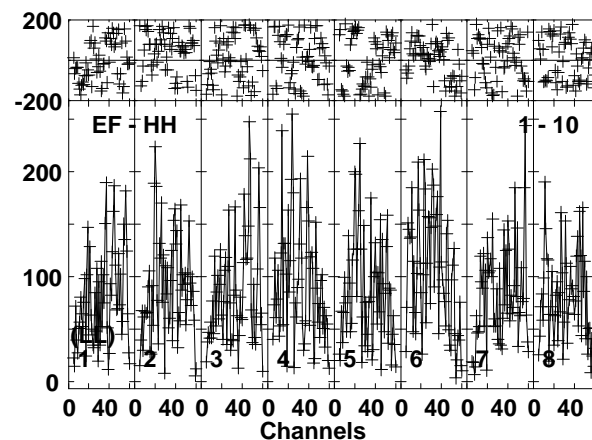
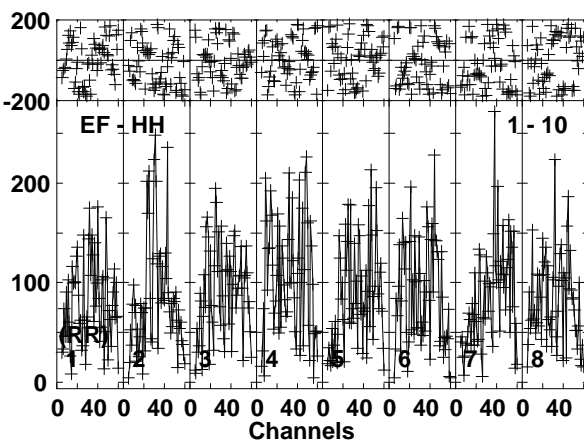
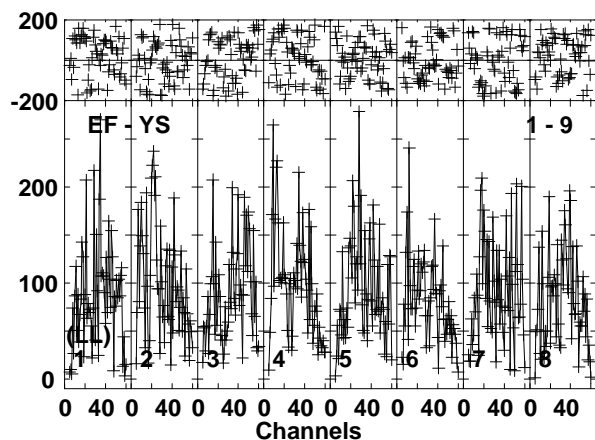
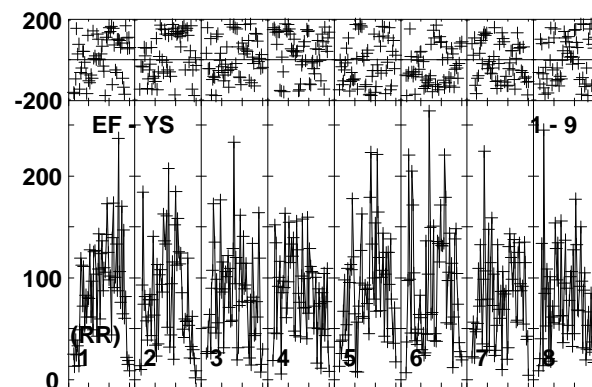
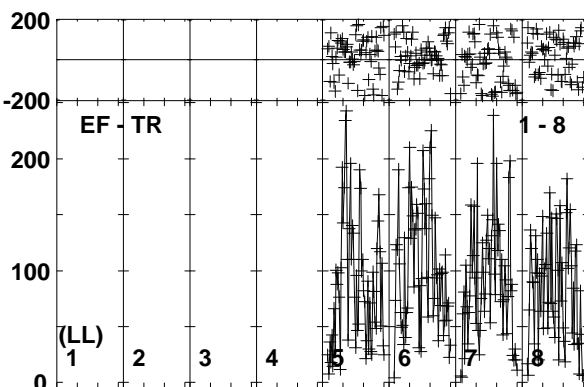
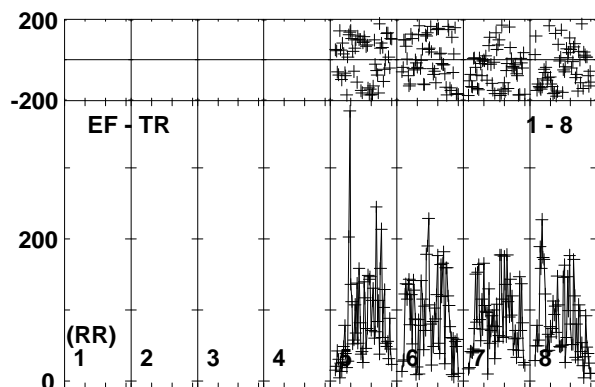
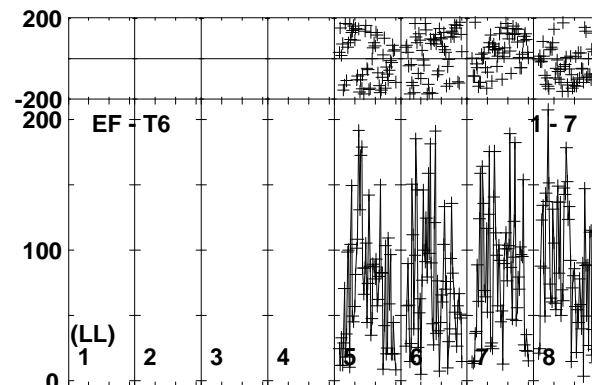
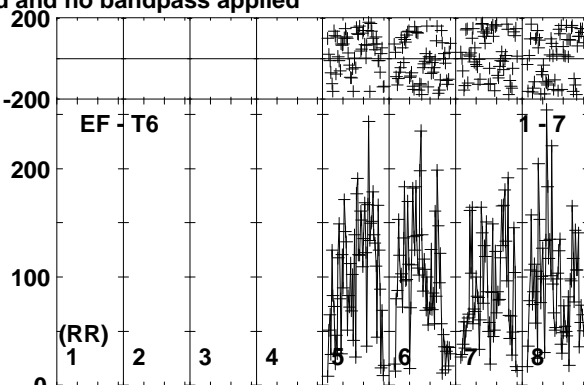
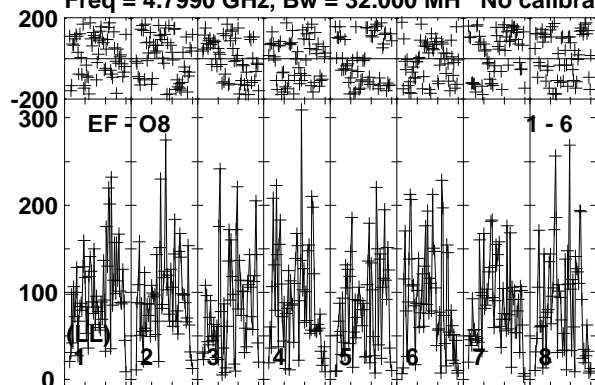

Lower frame: Micro Ampl Jy Top frame: Phas deg  
Vector averaged cross-power spectrum Baseline: EF (01) - O8 (06)  
Timerange: 00/06:04:40 to 00/06:08:09

Plot file version 306 created 24-NOV-2017 10:10:49  
ARUMA EG096D.UVDATA.1  
Freq = 4.7990 GHz, Bw = 32.000 MH No calibration applied and no bandpass applied

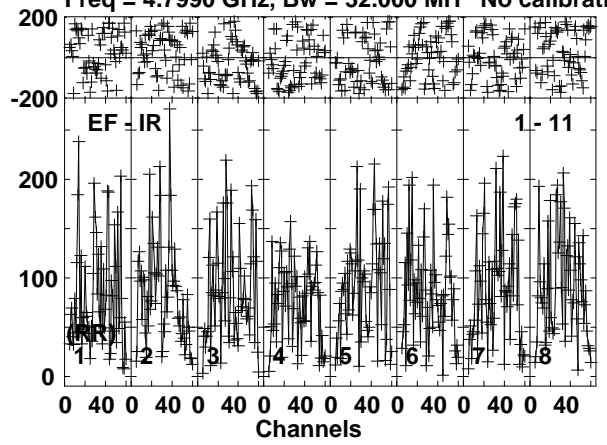

Lower frame: Micro Ampl Jy Top frame: Phas deg  
Vector averaged cross-power spectrum Baseline: EF (01) - IR (11)  
Timerange: 00/06:04:40 to 00/06:08:09



Plot file version 307 created 24-NOV-2017 10:10:49

J1108+4330 EG096D.UVDATA.1

Freq = 4.7990 GHz, Bw = 32.000 MH No calibration applied and no bandpass applied

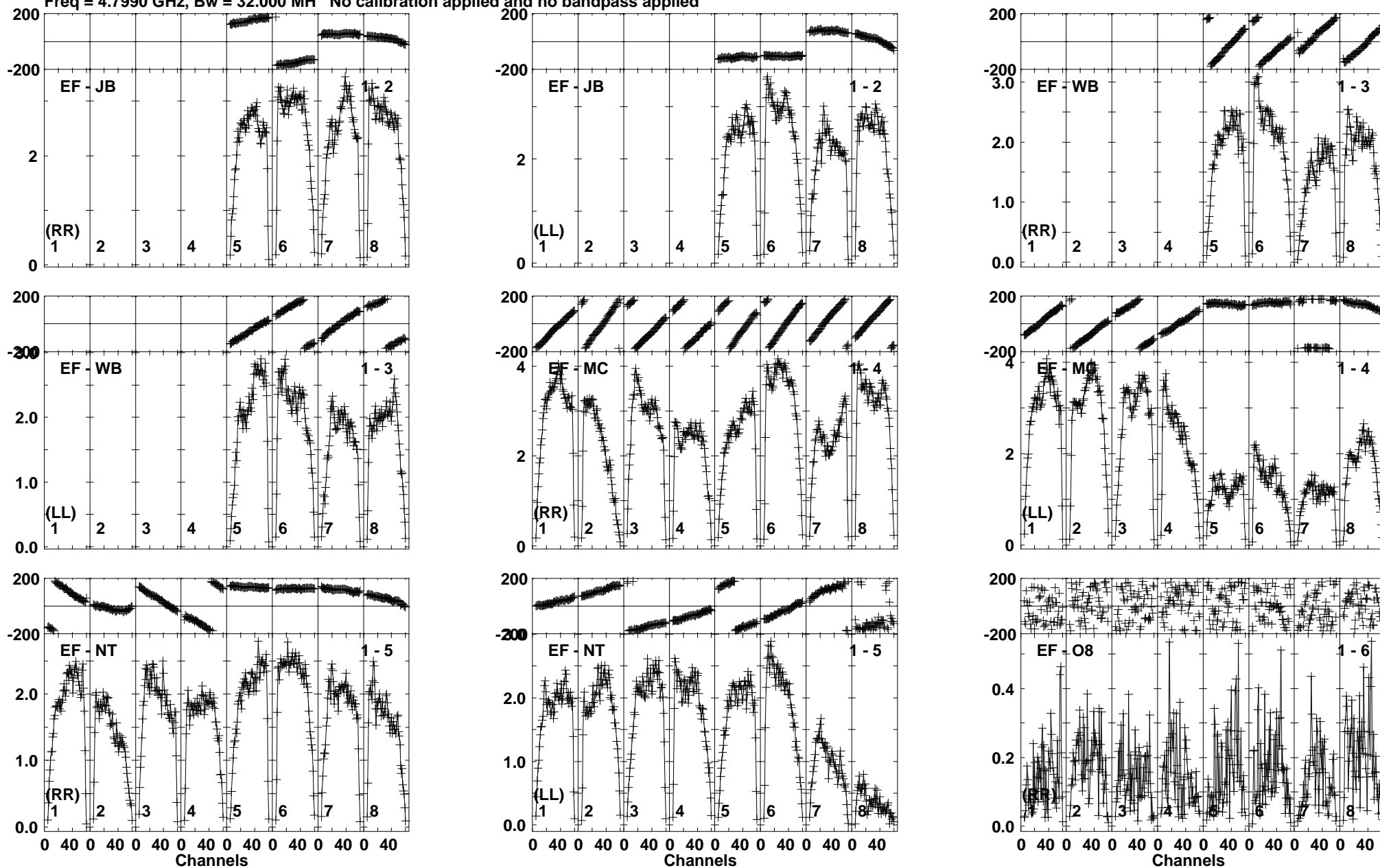

Lower frame: Milli Ampl Jy Top frame: Phas deg  
Vector averaged cross-power spectrum Baseline: EF (01) - JB (02)  
Timerange: 00/06:08:10 to 00/06:09:39

Plot file version 308 created 24-NOV-2017 10:10:49

J1108+4330 EG096D.UVDATA.1

Freq = 4.7990 GHz, Bw = 32.000 MH No calibration applied and no bandpass applied

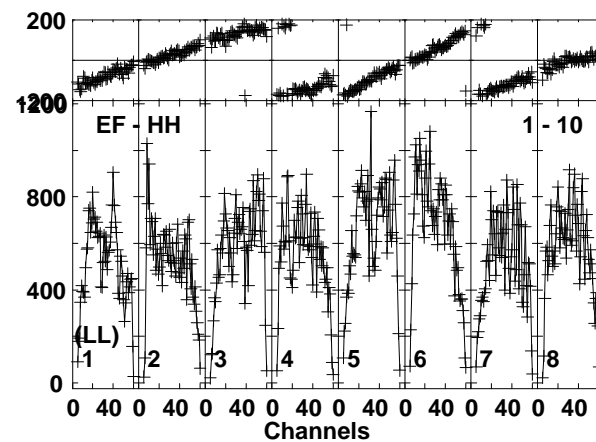
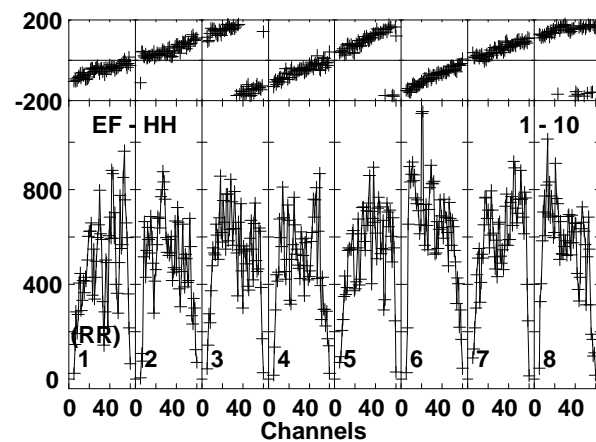
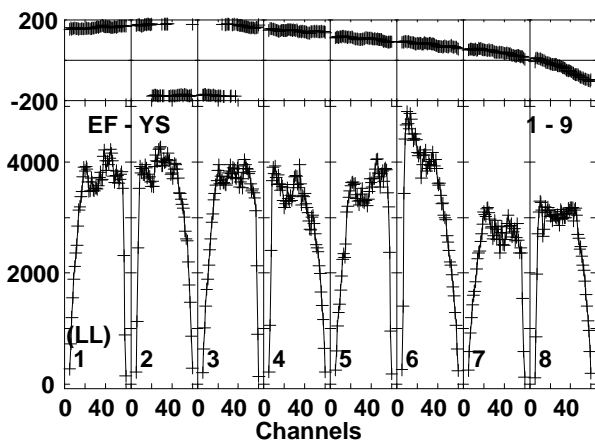
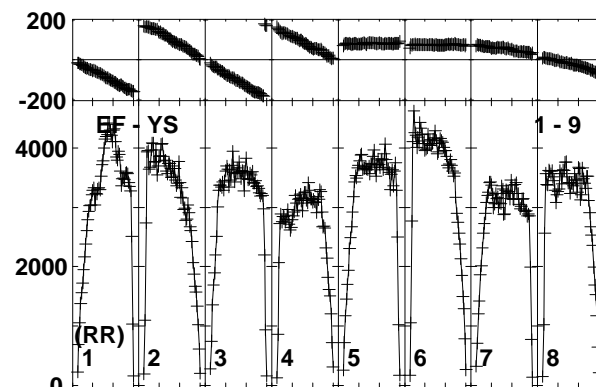
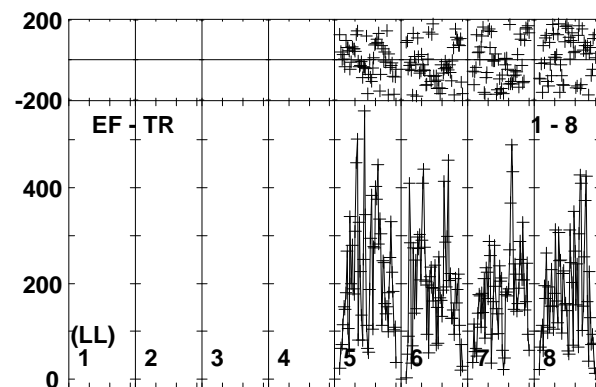
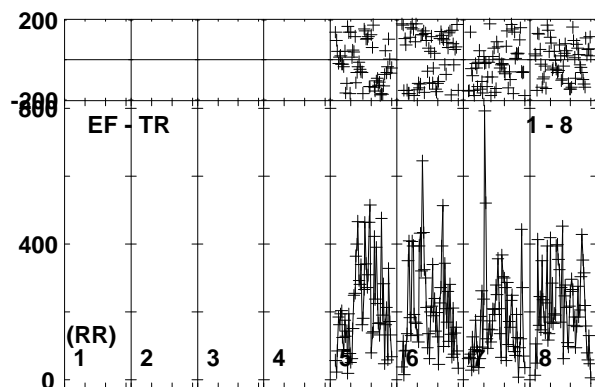
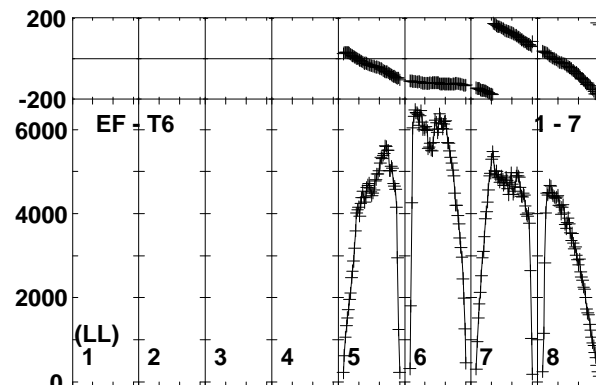
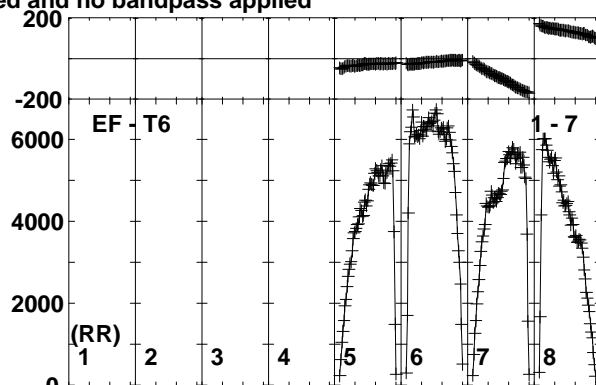
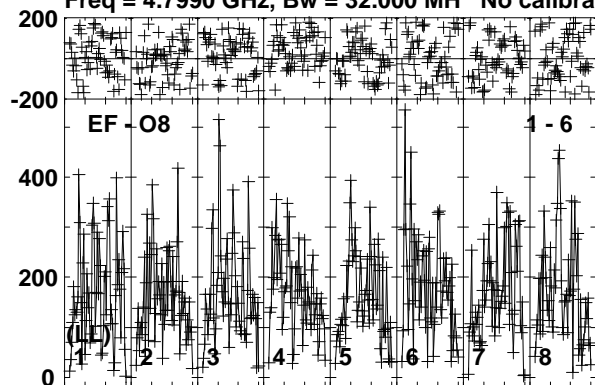

Lower frame: Micro Ampl Jy Top frame: Phas deg  
Vector averaged cross-power spectrum Baseline: EF (01) - O8 (06)  
Timerange: 00/06:08:10 to 00/06:09:39

Plot file version 309 created 24-NOV-2017 10:10:50  
J1108+4330 EG096D.UVDATA.1  
Freq = 4.7990 GHz, Bw = 32.000 MH No calibration applied and no bandpass applied

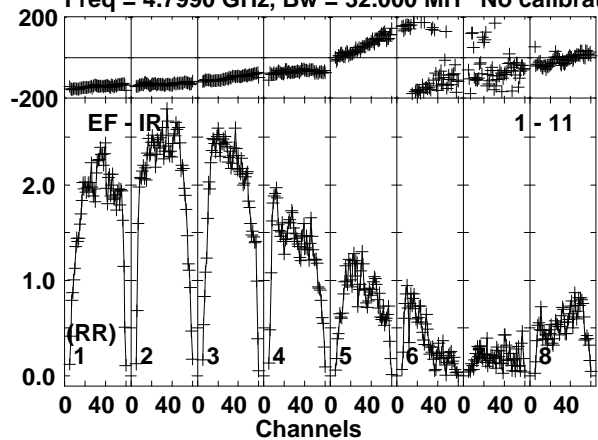

Lower frame: Milli Ampl Jy Top frame: Phas deg  
Vector averaged cross-power spectrum Baseline: EF (01) - IR (11)  
Timerange: 00/06:08:10 to 00/06:09:39



Plot file version 311 created 24-NOV-2017 10:10:50  
 ARUMA EG096D.UVDATA.1  
 Freq = 4.7990 GHz, Bw = 32.000 MH No calibration applied and no bandpass applied

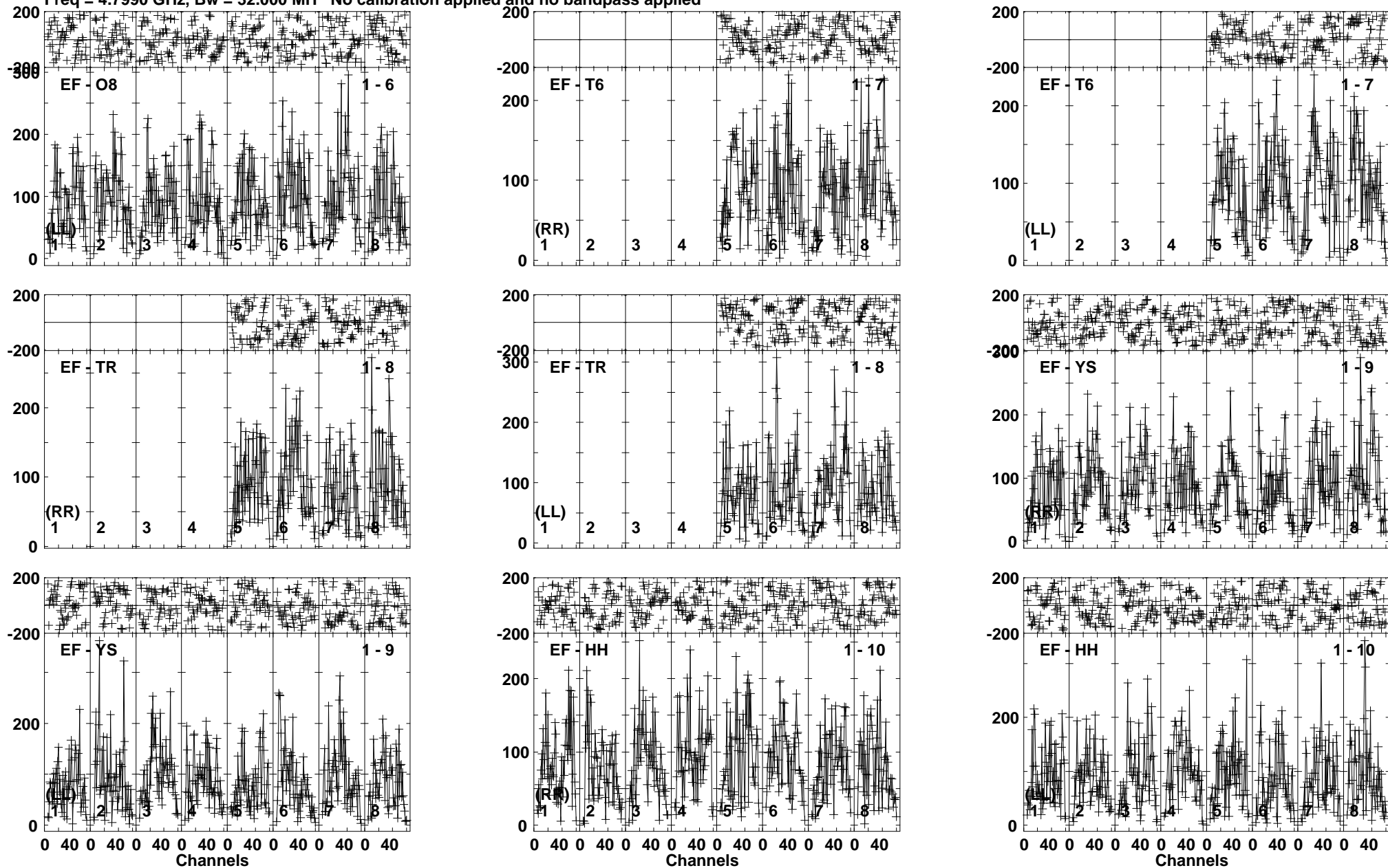

Lower frame: Micro Ampl Jy Top frame: Phas deg  
 Vector averaged cross-power spectrum Baseline: EF (01) - O8 (06)  
 Timerange: 00/06:09:41 to 00/06:13:10

Plot file version 312 created 24-NOV-2017 10:10:50  
ARUMA EG096D.UVDATA.1  
Freq = 4.7990 GHz, Bw = 32.000 MH No calibration applied and no bandpass applied

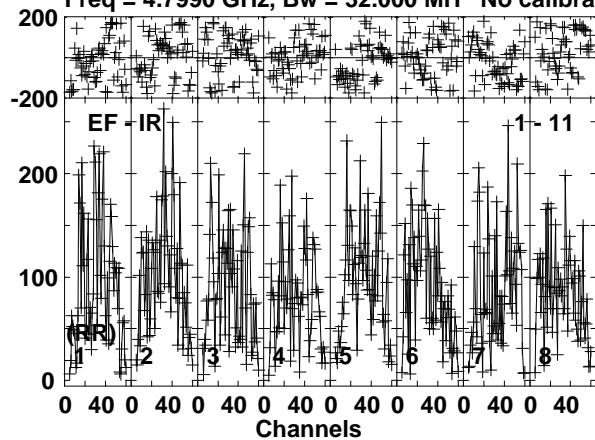

Lower frame: Micro Ampl Jy Top frame: Phas deg  
Vector averaged cross-power spectrum Baseline: EF (01) - IR (11)  
Timerange: 00/06:09:41 to 00/06:13:10

Plot file version 313 created 24-NOV-2017 10:10:50

J1108+4330 EG096D.UVDATA.1

Freq = 4.7990 GHz, Bw = 32.000 MH No calibration applied and no bandpass applied

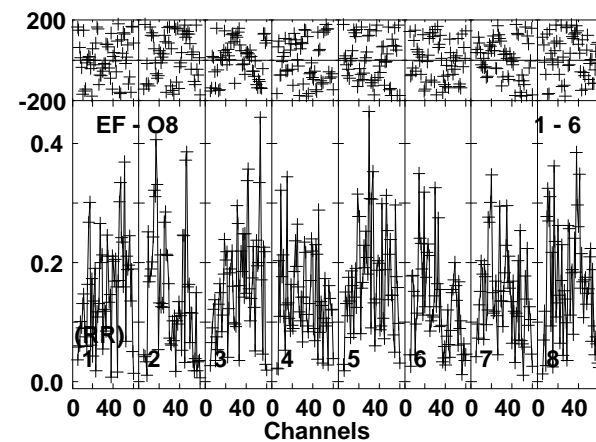
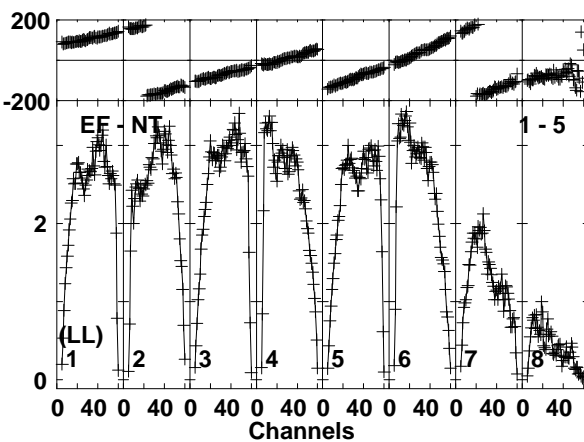
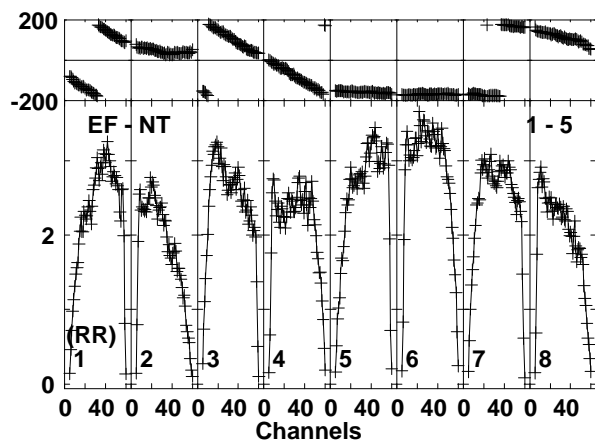
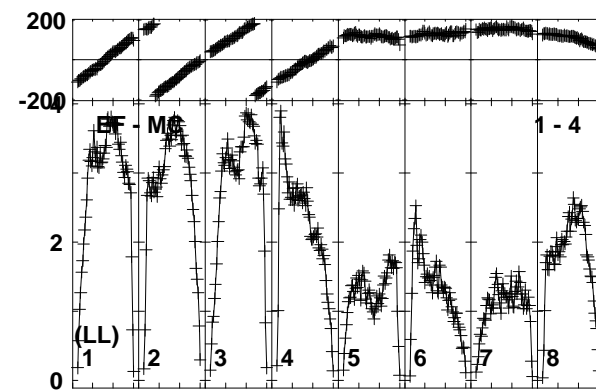
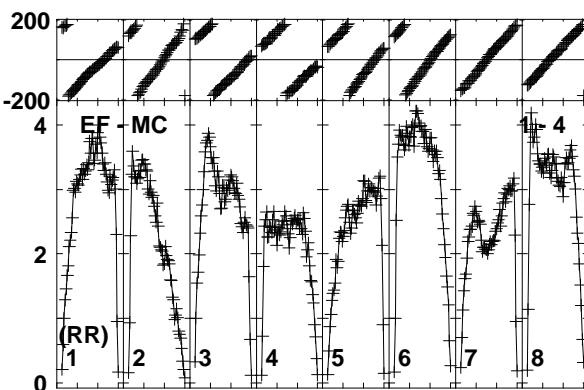
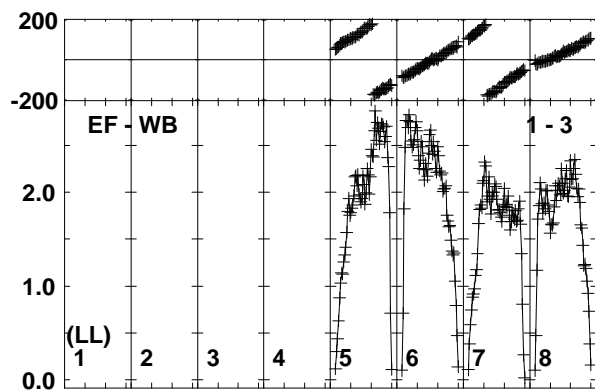
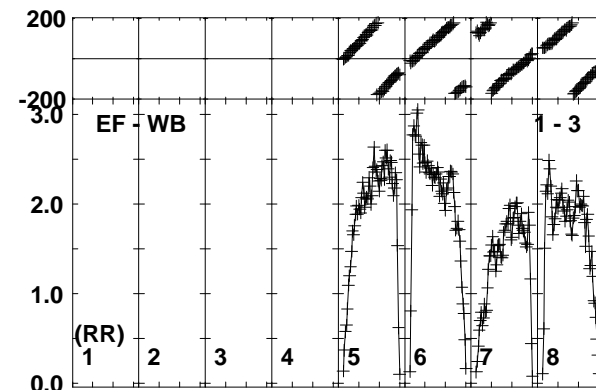
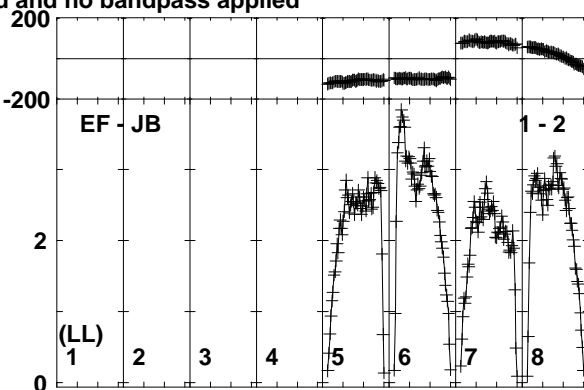
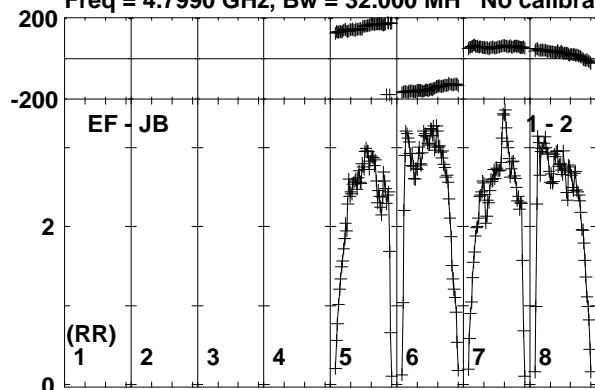

Lower frame: Milli Ampl Jy Top frame: Phas deg  
Vector averaged cross-power spectrum Baseline: EF (01) - JB (02)  
Timerange: 00/06:13:50 to 00/06:14:50

Plot file version 314 created 24-NOV-2017 10:10:51

J1108+4330 EG096D.UVDATA.1

Freq = 4.7990 GHz, Bw = 32.000 MH No calibration applied and no bandpass applied

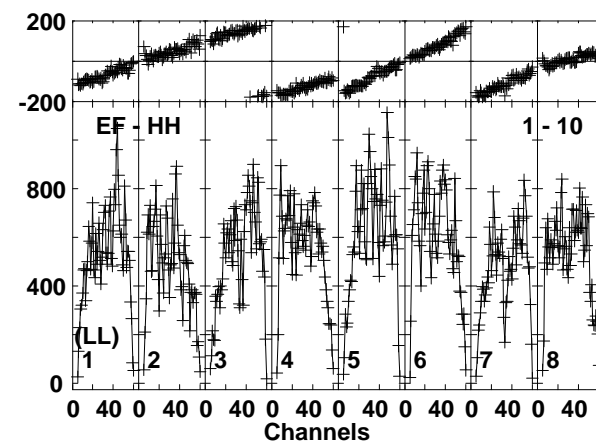
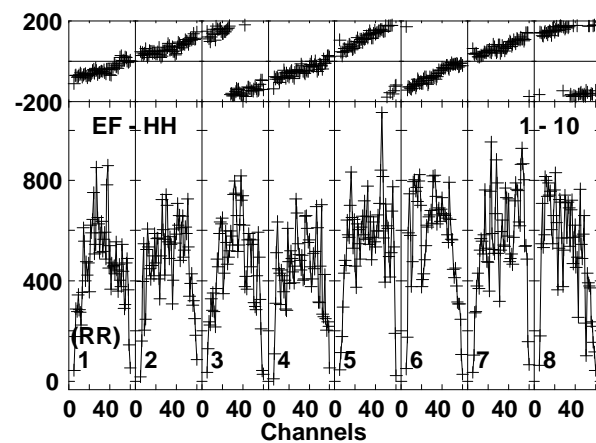
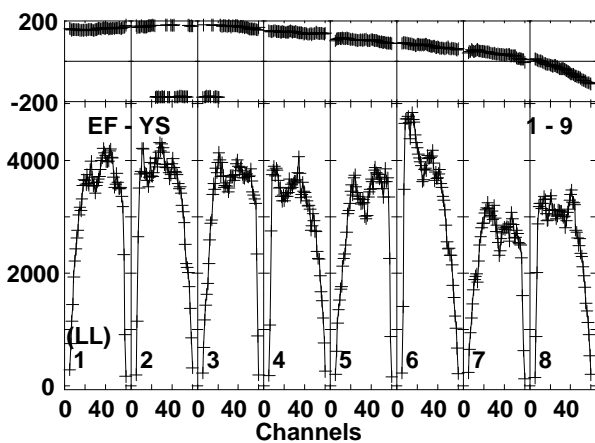
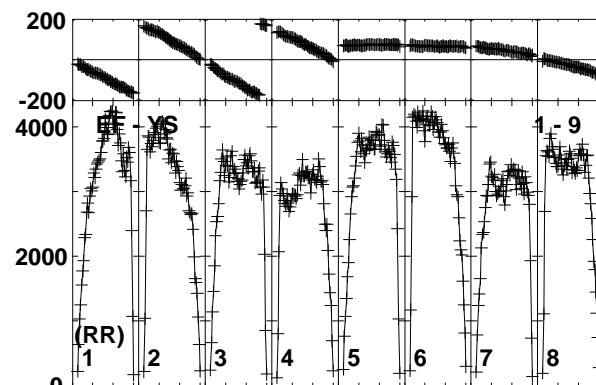
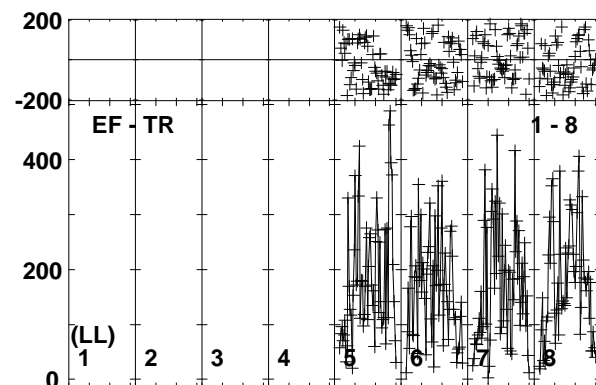
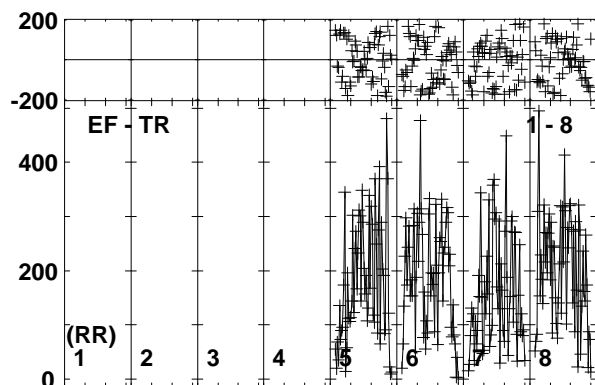
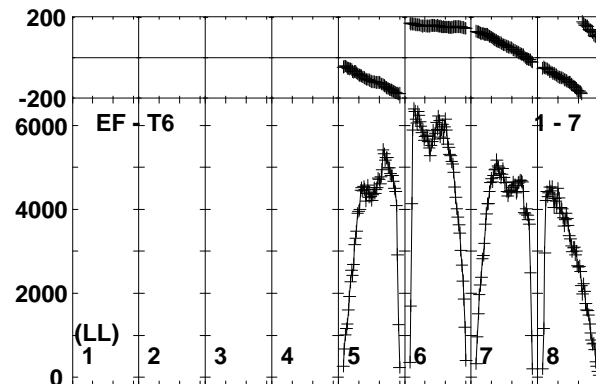
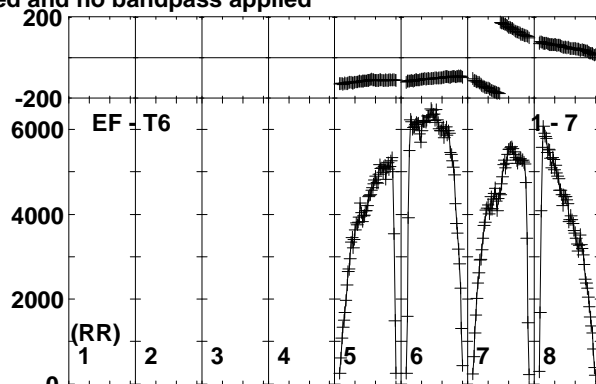
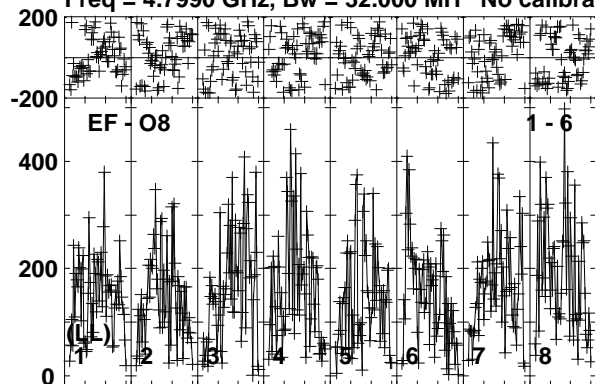

Lower frame: Micro Ampl Jy Top frame: Phas deg  
Vector averaged cross-power spectrum Baseline: EF (01) - O8 (06)  
Timerange: 00/06:13:50 to 00/06:14:50



Plot file version 315 created 24-NOV-2017 10:10:51  
J1108+4330 EG096D.UVDATA.1  
Freq = 4.7990 GHz, Bw = 32.000 MH No calibration applied and no bandpass applied

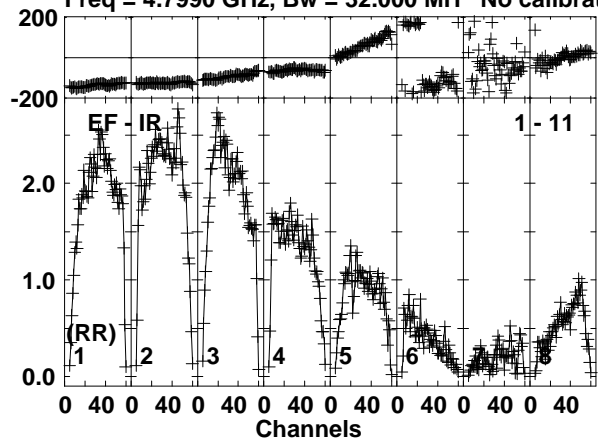

Lower frame: Milli Ampl Jy Top frame: Phas deg  
Vector averaged cross-power spectrum Baseline: EF (01) - IR (11)  
Timerange: 00/06:13:50 to 00/06:14:50

Plot file version 316 created 24-NOV-2017 10:10:51

ARUMA EG096D.UVDATA.1

Freq = 4.7990 GHz, Bw = 32.000 MH No calibration applied and no bandpass applied

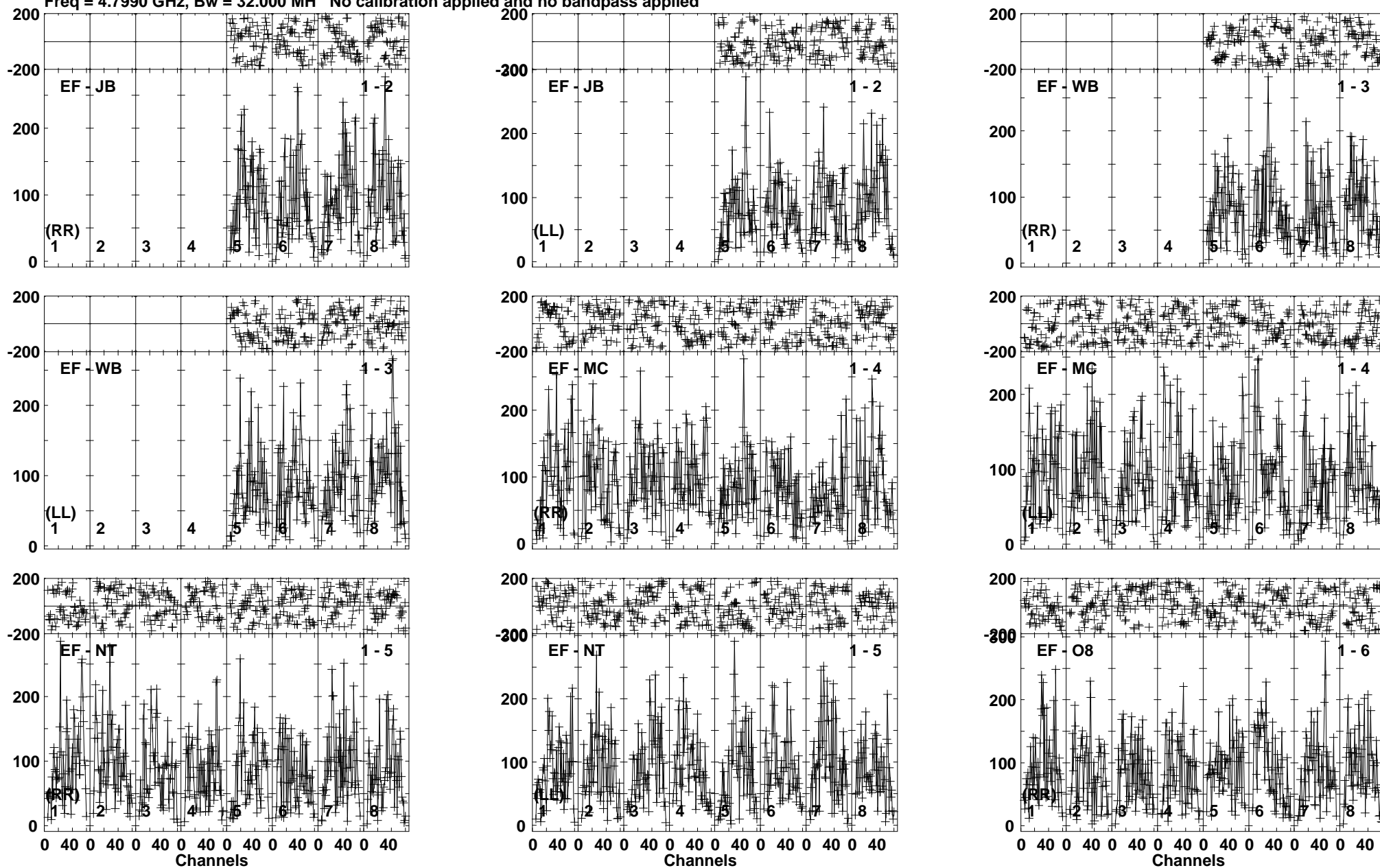

Lower frame: Micro Ampl Jy Top frame: Phas deg  
Vector averaged cross-power spectrum Baseline: EF (01) - JB (02)  
Timerange: 00/06:14:51 to 00/06:18:20

Plot file version 317 created 24-NOV-2017 10:10:51

ARUMA EG096D.UVDATA.1

Freq = 4.7990 GHz, Bw = 32.000 MH No calibration applied and no bandpass applied

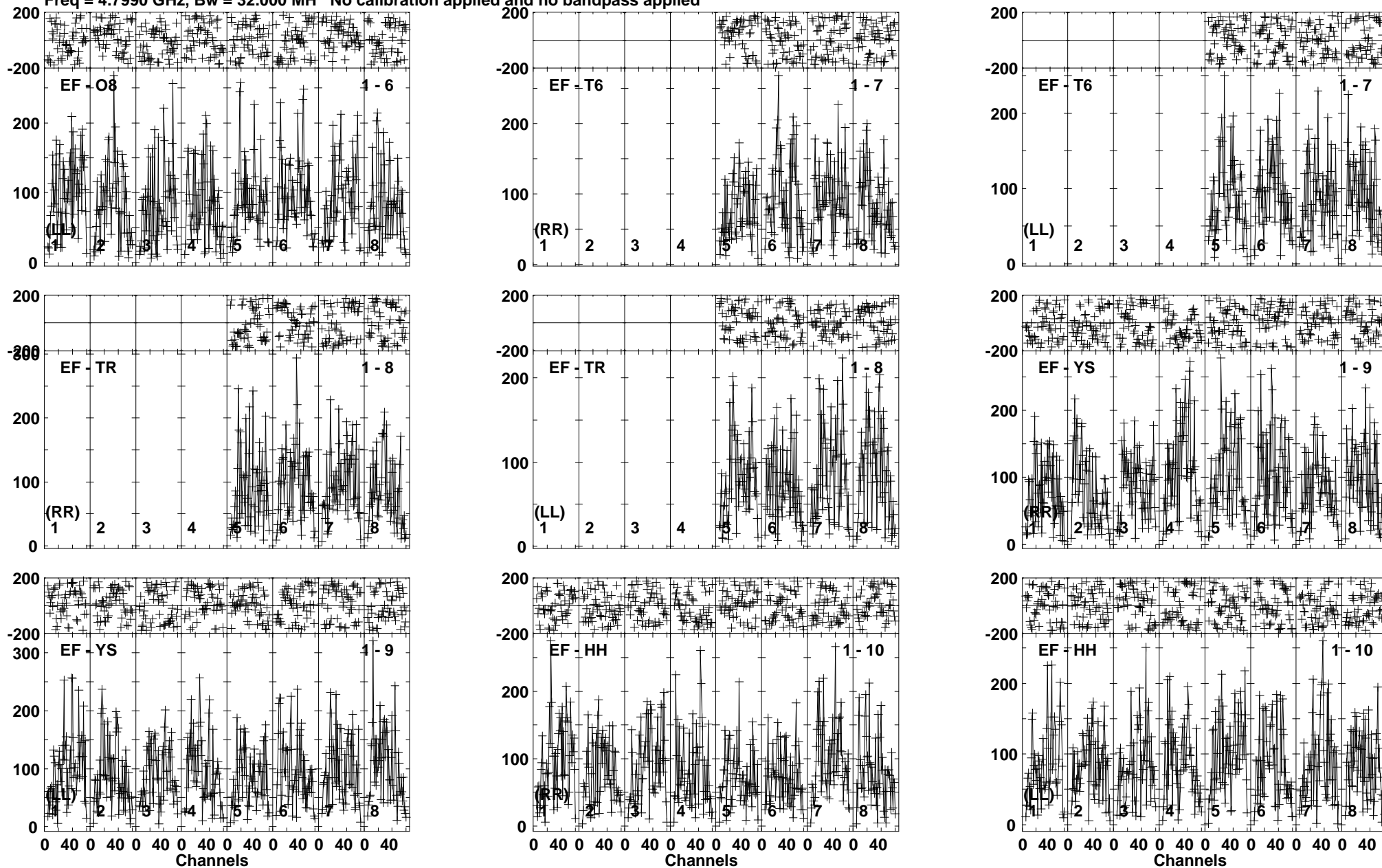

Lower frame: Micro Ampl Jy Top frame: Phas deg  
Vector averaged cross-power spectrum Baseline: EF (01) - O8 (06)  
Timerange: 00/06:14:51 to 00/06:18:20

Plot file version 318 created 24-NOV-2017 10:10:52  
ARUMA EG096D.UVDATA.1  
Freq = 4.7990 GHz, Bw = 32.000 MH No calibration applied and no bandpass applied

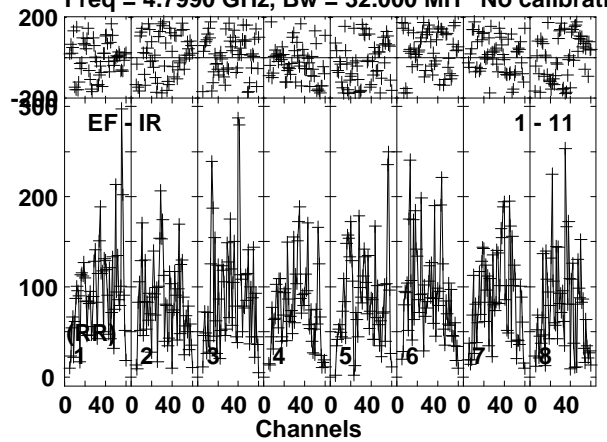

Lower frame: Micro Ampl Jy Top frame: Phas deg  
Vector averaged cross-power spectrum Baseline: EF (01) - IR (11)  
Timerange: 00/06:14:51 to 00/06:18:20

Plot file version 319 created 24-NOV-2017 10:10:52

J1108+4330 EG096D.UVDATA.1

Freq = 4.7990 GHz, Bw = 32.000 MH No calibration applied and no bandpass applied

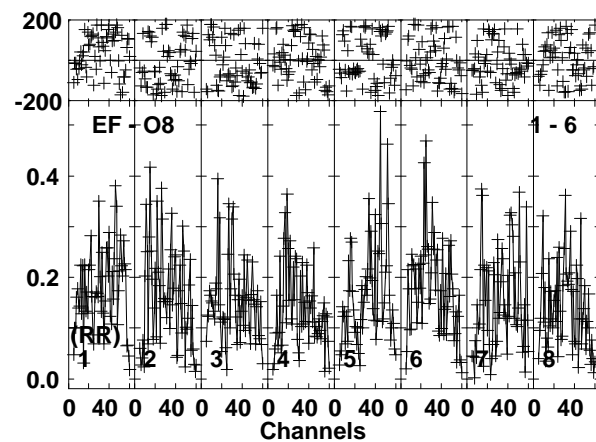
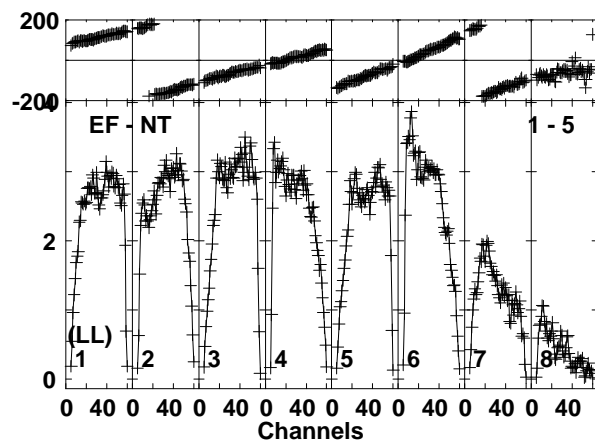
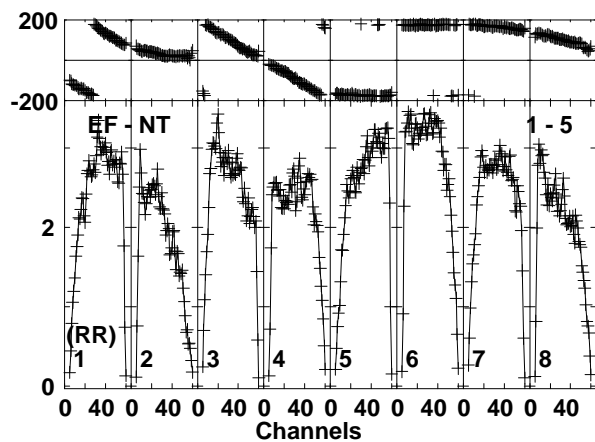
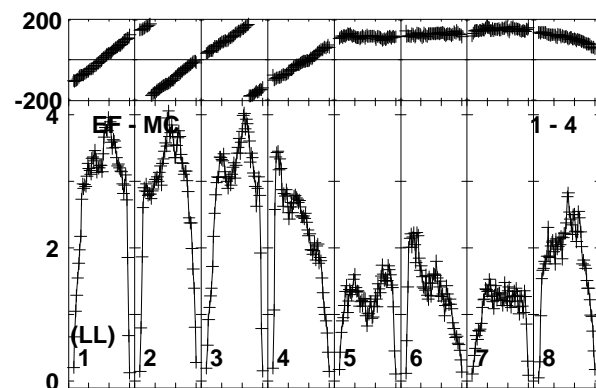
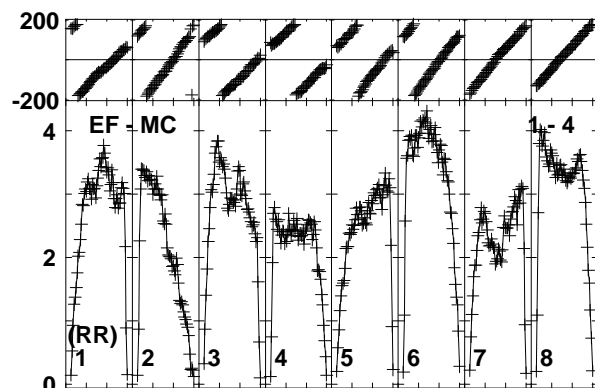
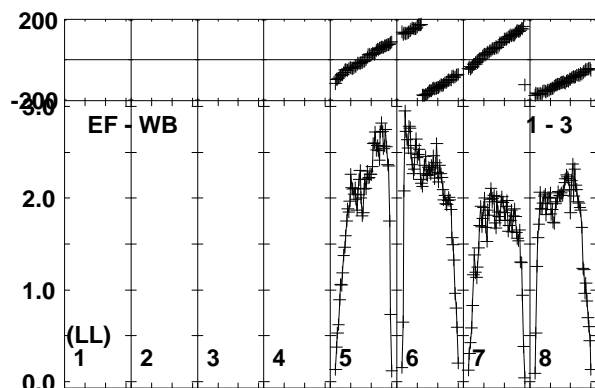
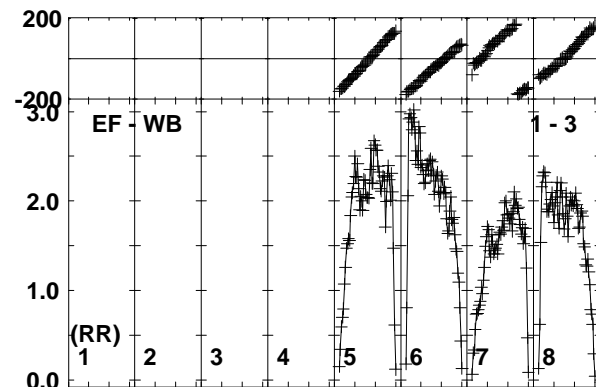
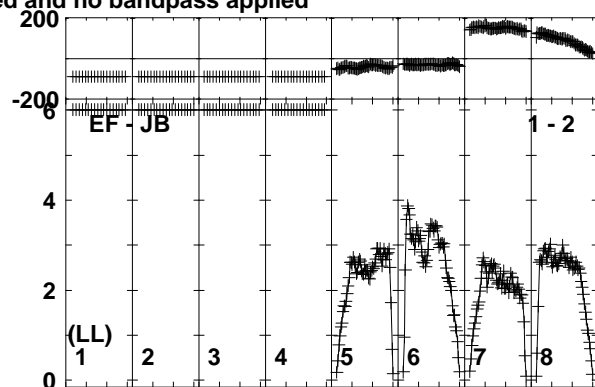
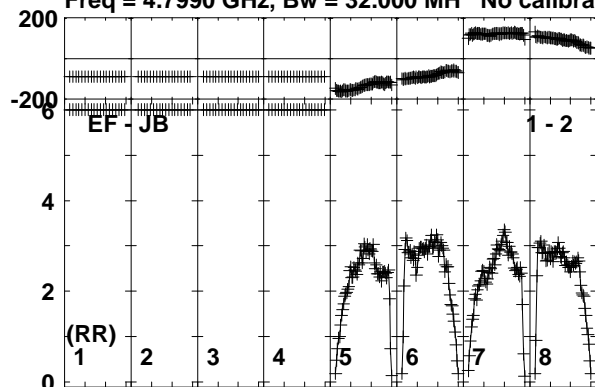

Lower frame: Milli Ampl Jy Top frame: Phas deg  
Vector averaged cross-power spectrum Baseline: EF (01) - JB (02)  
Timerange: 00/06:18:21 to 00/06:19:50

Plot file version 320 created 24-NOV-2017 10:10:52

J1108+4330 EG096D.UVDATA.1

Freq = 4.7990 GHz, Bw = 32.000 MH No calibration applied and no bandpass applied

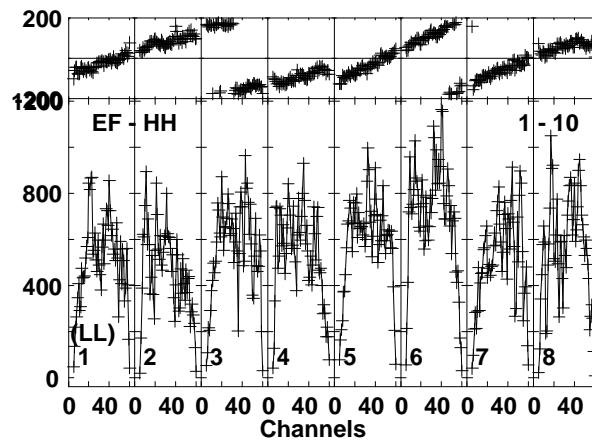
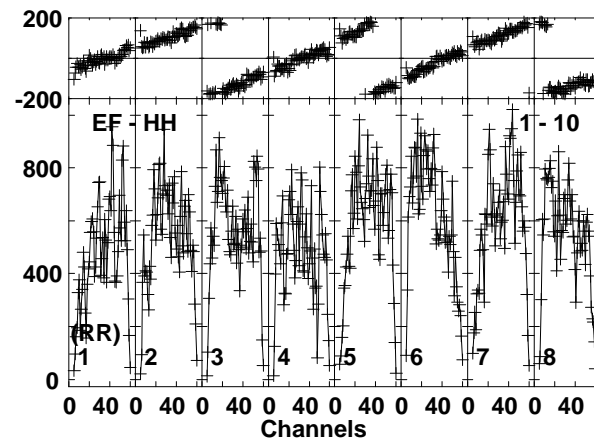
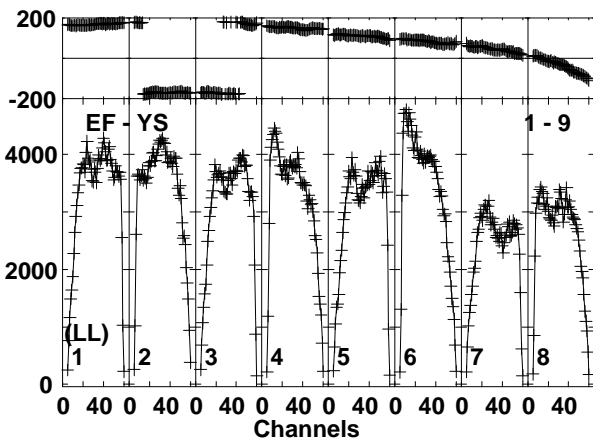
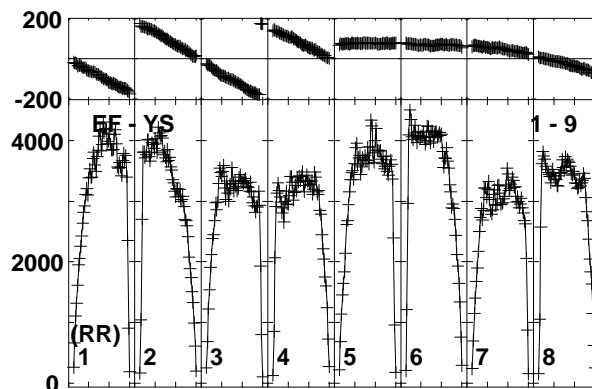
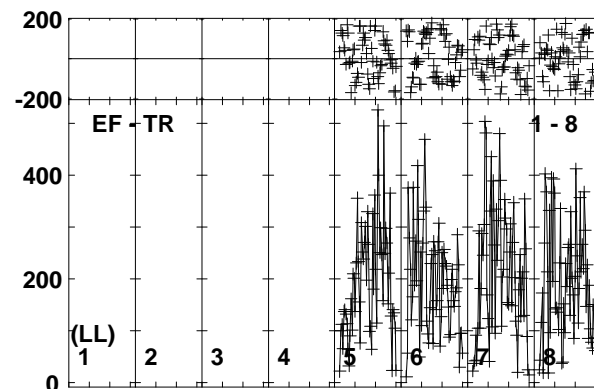
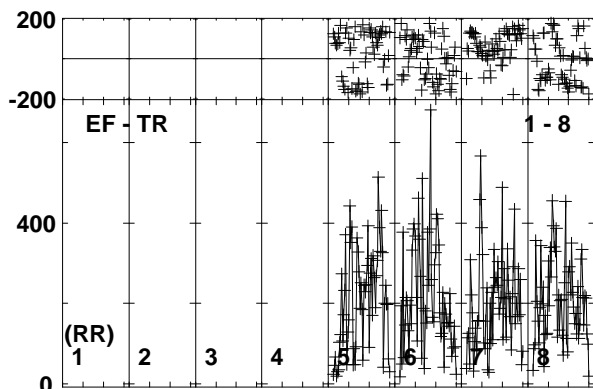
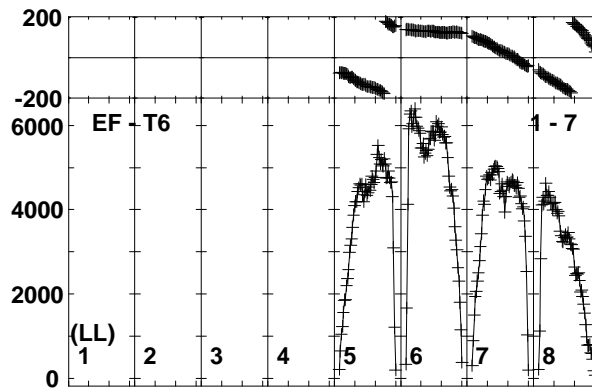
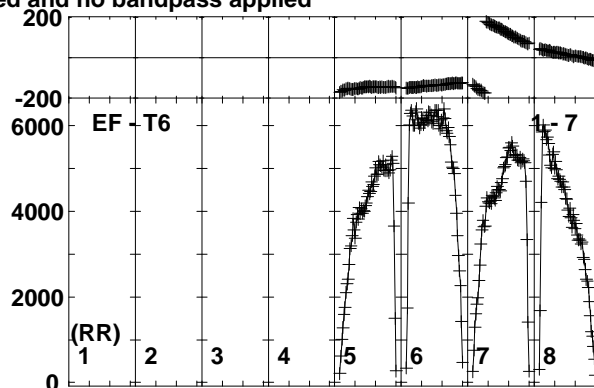
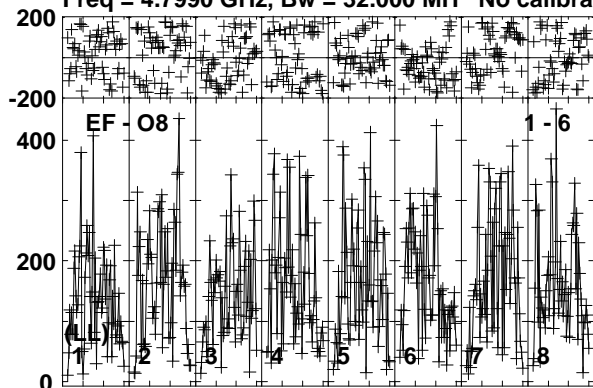

Lower frame: Micro Ampl Jy Top frame: Phas deg  
Vector averaged cross-power spectrum Baseline: EF (01) - O8 (06)  
Timerange: 00/06:18:21 to 00/06:19:50

Plot file version 321 created 24-NOV-2017 10:10:52  
J1108+4330 EG096D.UVDATA.1  
Freq = 4.7990 GHz, Bw = 32.000 MH No calibration applied and no bandpass applied

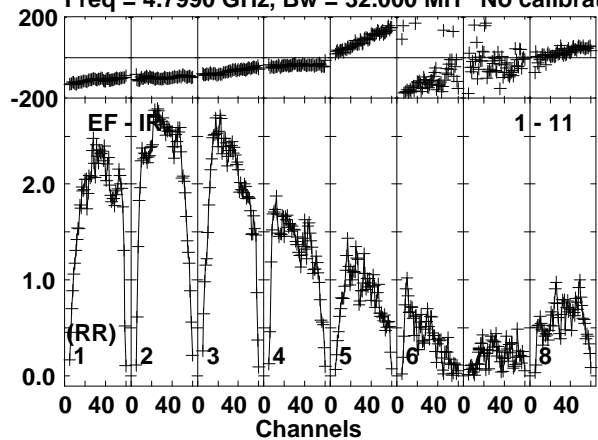

Lower frame: Milli Ampl Jy Top frame: Phas deg  
Vector averaged cross-power spectrum Baseline: EF (01) - IR (11)  
Timerange: 00/06:18:21 to 00/06:19:50





Plot file version 323 created 24-NOV-2017 10:10:53

ARUMA EG096D.UVDATA.1

Freq = 4.7990 GHz, Bw = 32.000 MH No calibration applied and no bandpass applied

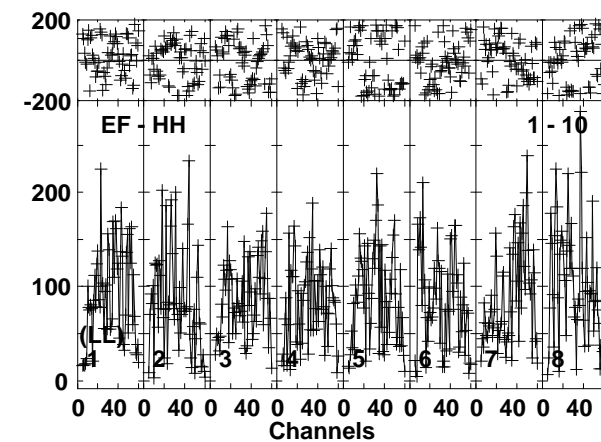
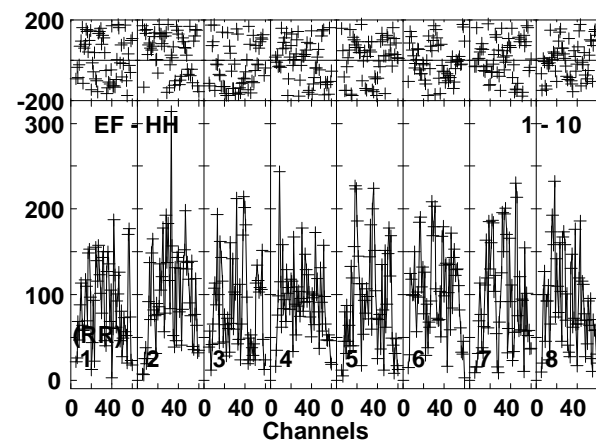
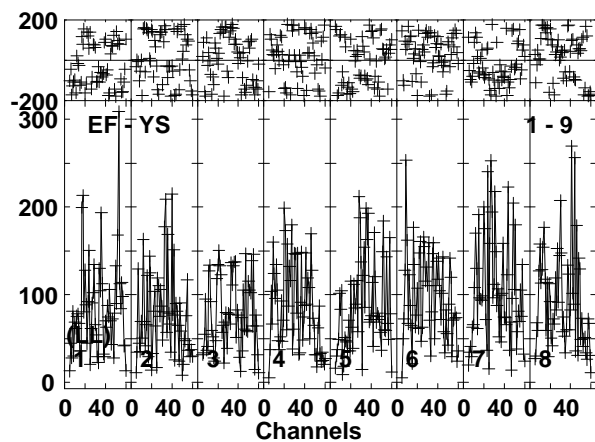
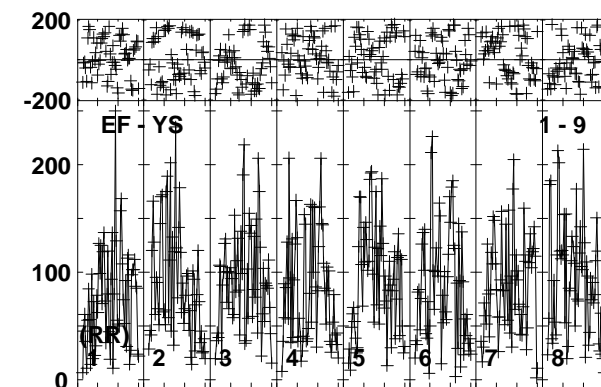
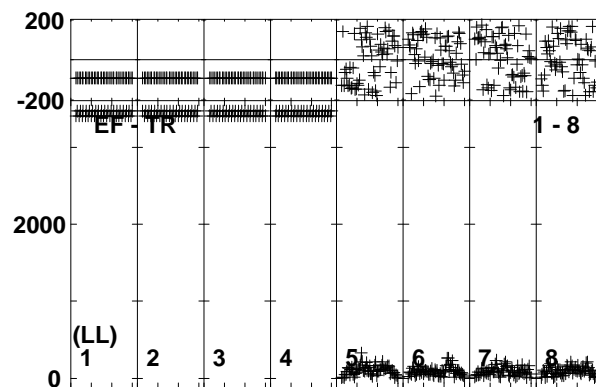
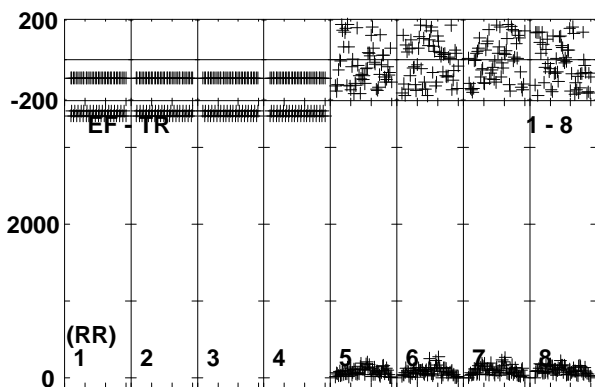
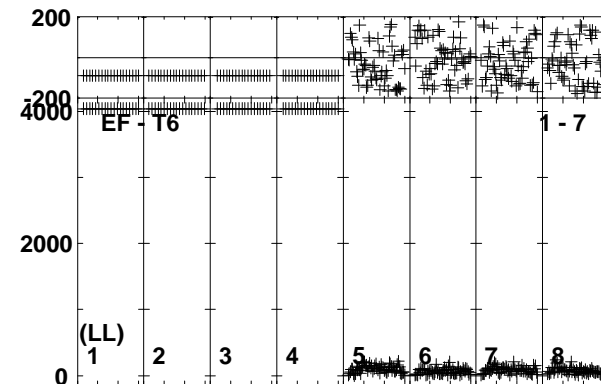
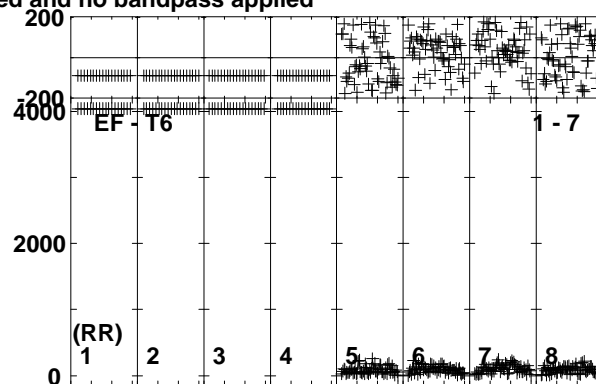
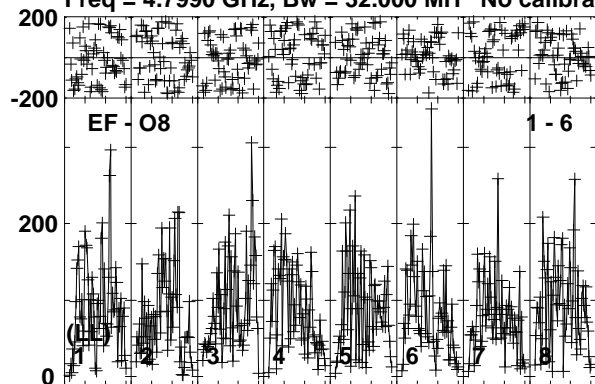

Lower frame: Micro Ampl Jy Top frame: Phas deg  
Vector averaged cross-power spectrum Baseline: EF (01) - O8 (06)  
Timerange: 00/06:19:50 to 00/06:23:20

Plot file version 324 created 24-NOV-2017 10:10:53  
ARUMA EG096D.UVDATA.1  
Freq = 4.7990 GHz, Bw = 32.000 MH No calibration applied and no bandpass applied

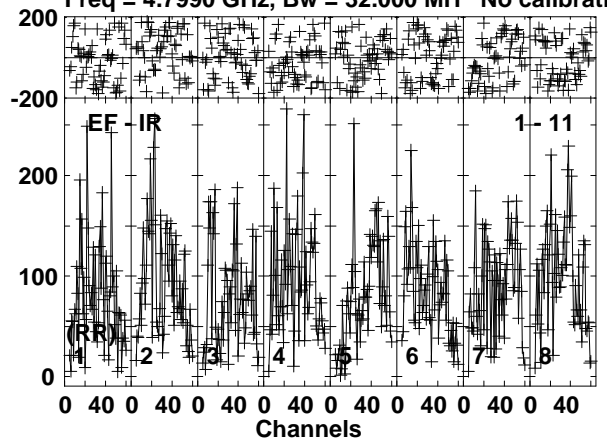

Lower frame: Micro Ampl Jy Top frame: Phas deg  
Vector averaged cross-power spectrum Baseline: EF (01) - IR (11)  
Timerange: 00/06:19:50 to 00/06:23:20

Plot file version 325 created 24-NOV-2017 10:10:53

J1108+4330 EG096D.UVDATA.1

Freq = 4.7990 GHz, Bw = 32.000 MH No calibration applied and no bandpass applied

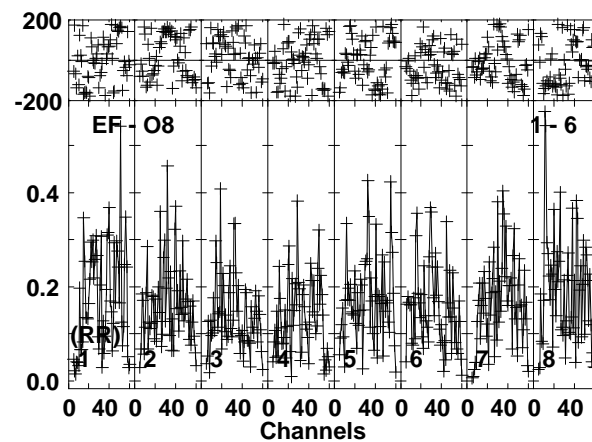
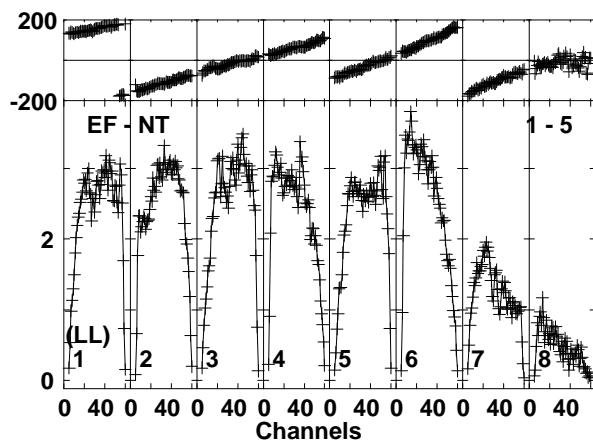
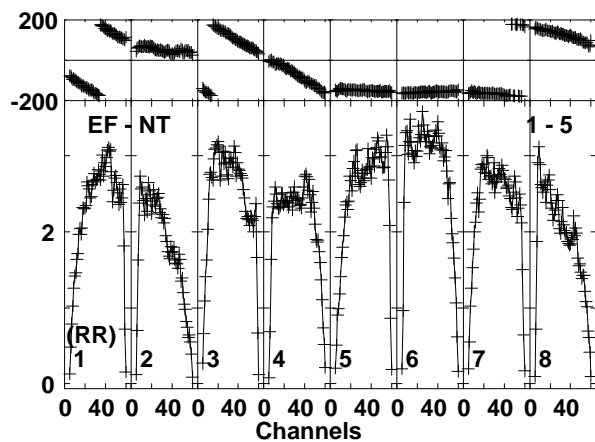
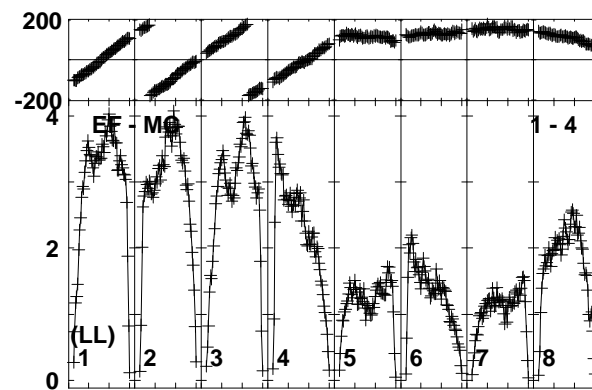
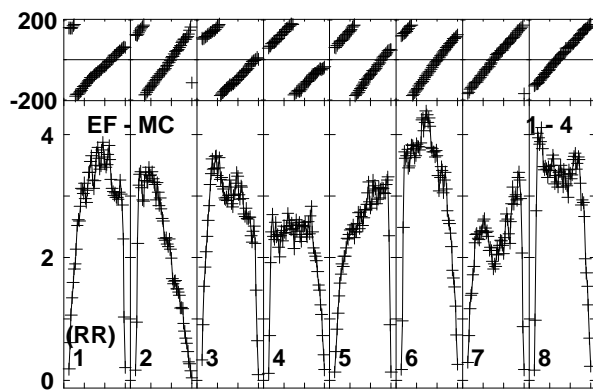
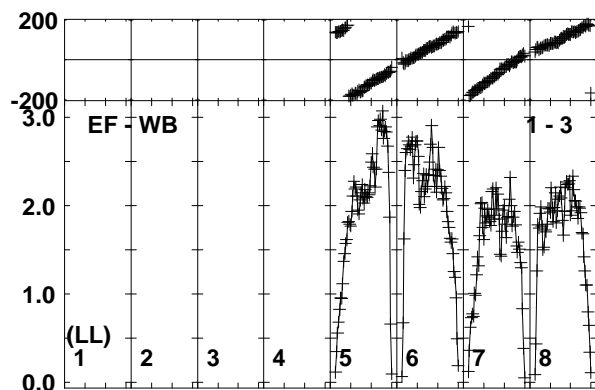
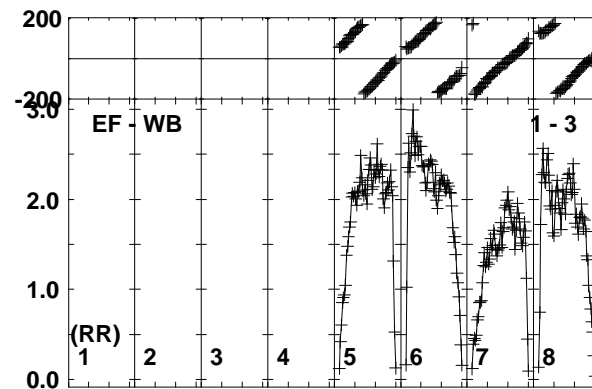
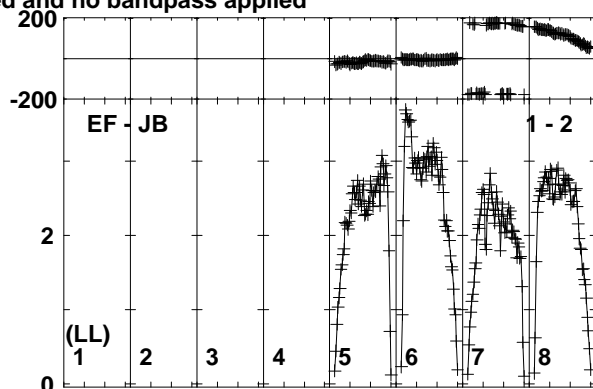
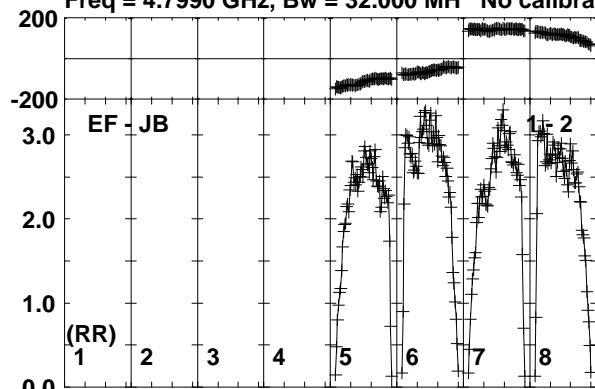

Lower frame: Milli Ampl Jy Top frame: Phas deg  
Vector averaged cross-power spectrum Baseline: EF (01) - JB (02)  
Timerange: 00/06:23:20 to 00/06:24:49

Plot file version 326 created 24-NOV-2017 10:10:53

J1108+4330 EG096D.UVDATA.1

Freq = 4.7990 GHz, Bw = 32.000 MH No calibration applied and no bandpass applied

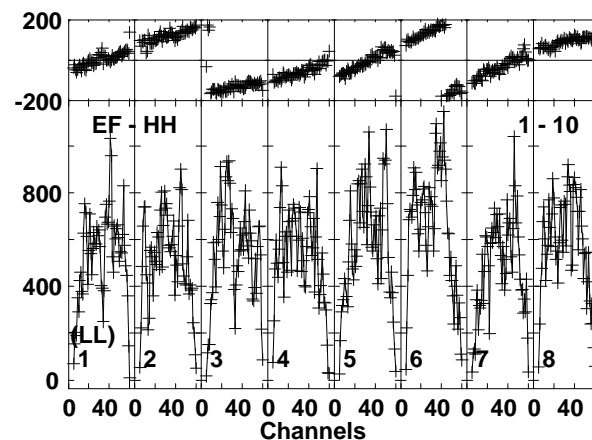
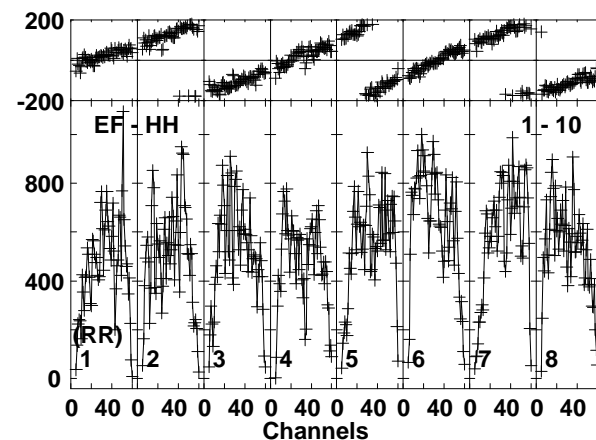
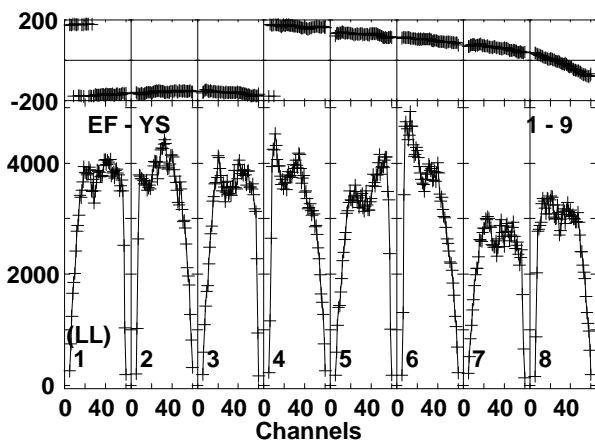
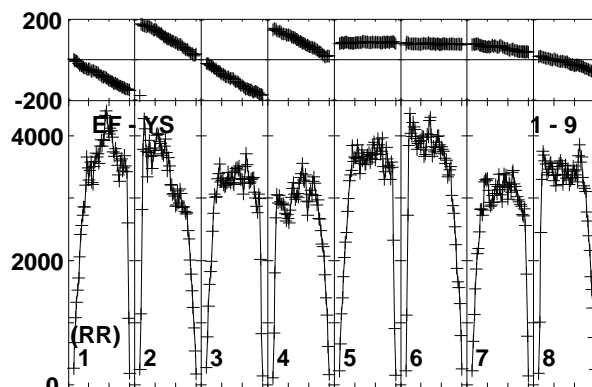
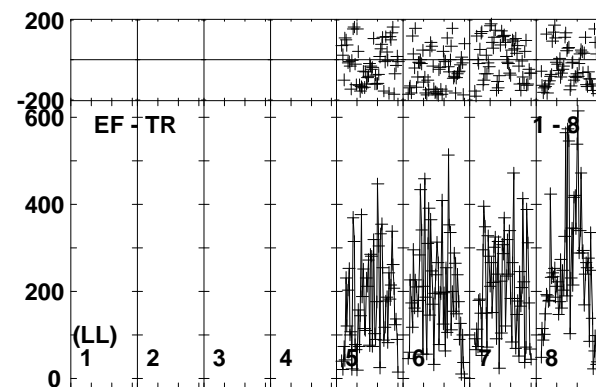
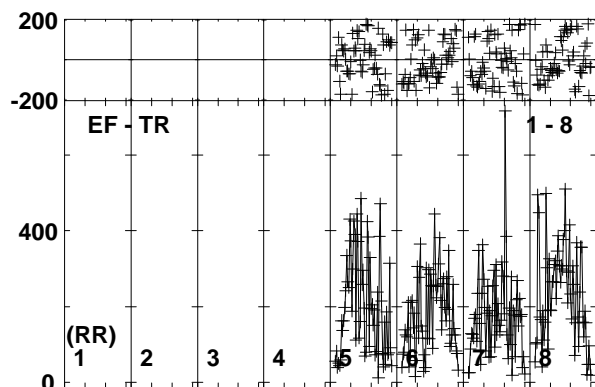
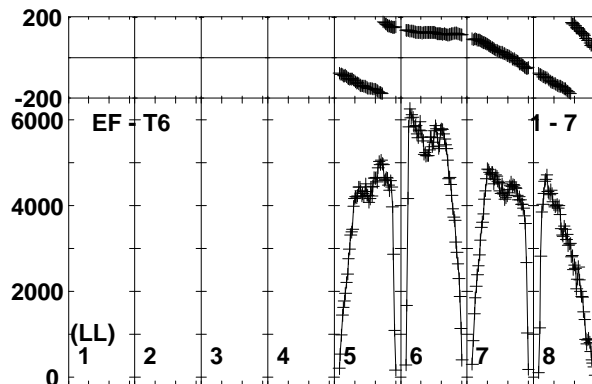
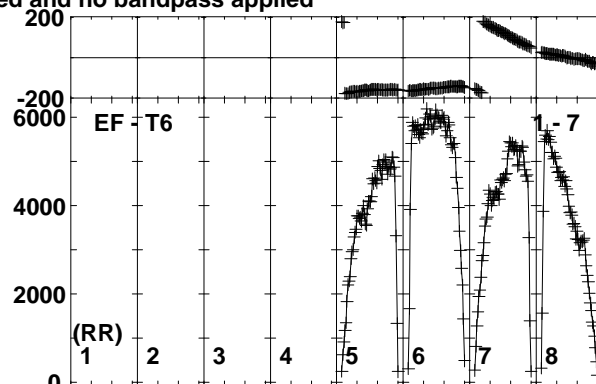
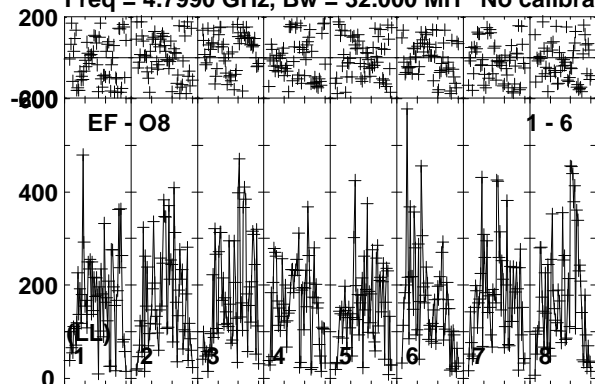

Lower frame: Micro Ampl Jy Top frame: Phas deg  
Vector averaged cross-power spectrum Baseline: EF (01) - O8 (06)  
Timerange: 00/06:23:20 to 00/06:24:49

Plot file version 327 created 24-NOV-2017 10:10:53  
J1108+4330 EG096D.UVDATA.1  
Freq = 4.7990 GHz, Bw = 32.000 MH No calibration applied and no bandpass applied

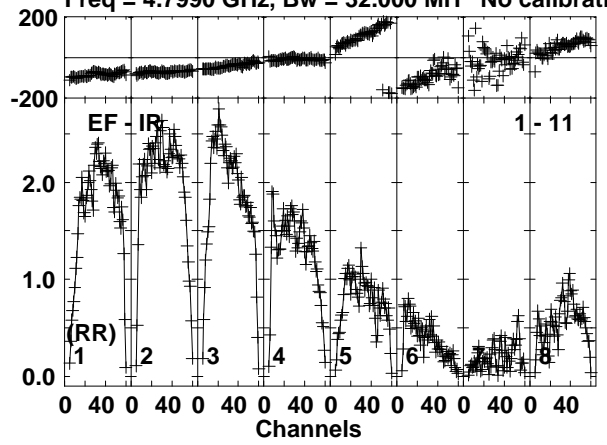

Lower frame: Milli Ampl Jy Top frame: Phas deg  
Vector averaged cross-power spectrum Baseline: EF (01) - IR (11)  
Timerange: 00/06:23:20 to 00/06:24:49

Plot file version 328 created 24-NOV-2017 10:10:53

J1310+3220 EG096D.UVDATA.1

Freq = 4.7990 GHz, Bw = 32.000 MH No calibration applied and no bandpass applied

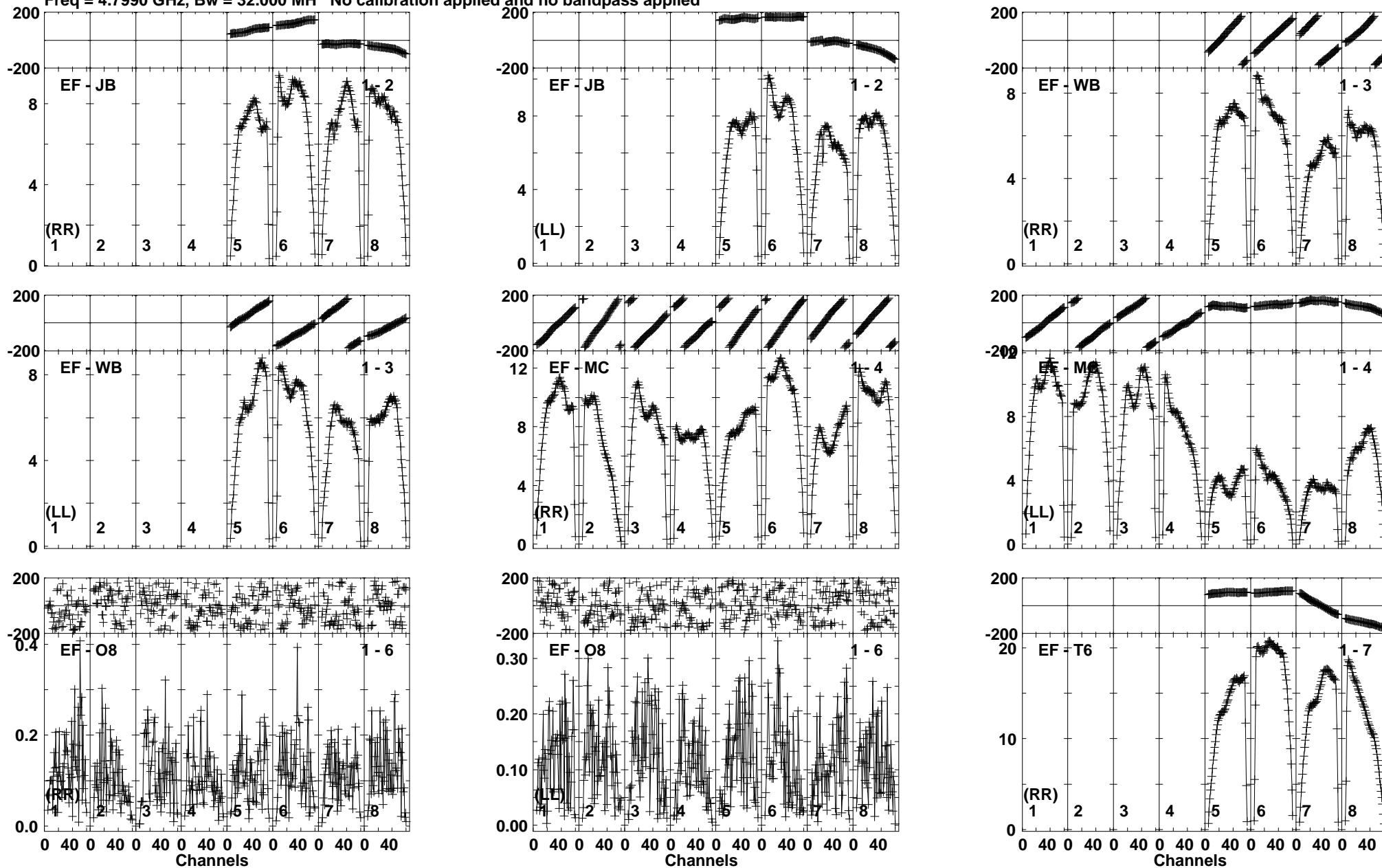

Lower frame: Milli Ampl Jy Top frame: Phas deg  
Vector averaged cross-power spectrum Baseline: EF (01) - JB (02)  
Timerange: 00/06:26:50 to 00/06:28:50

Plot file version 329 created 24-NOV-2017 10:10:54

J1310+3220 EG096D.UVDATA.1

Freq = 4.7990 GHz, Bw = 32.000 MH No calibration applied and no bandpass applied

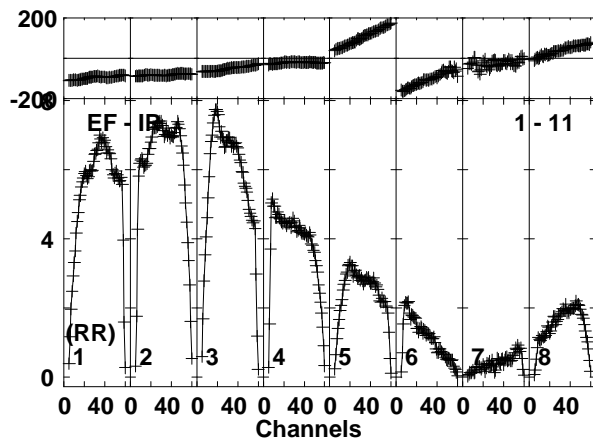
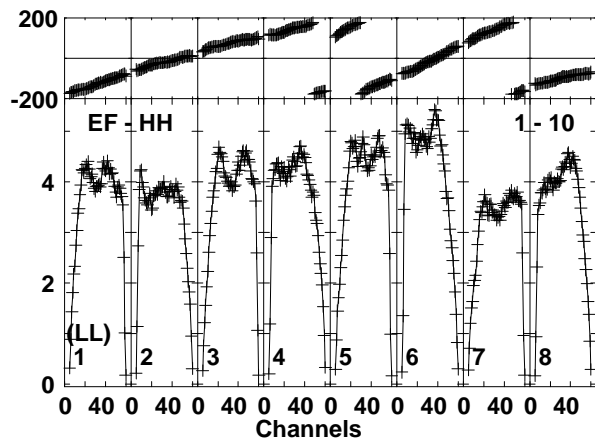
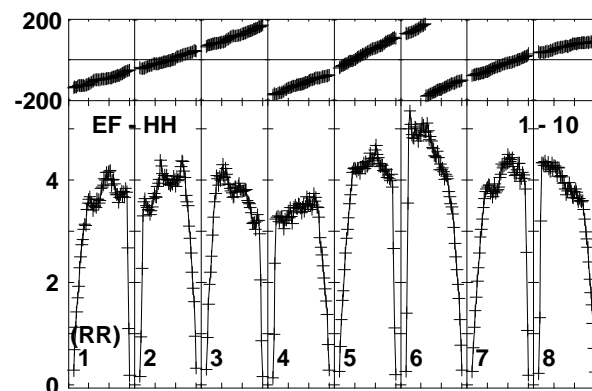
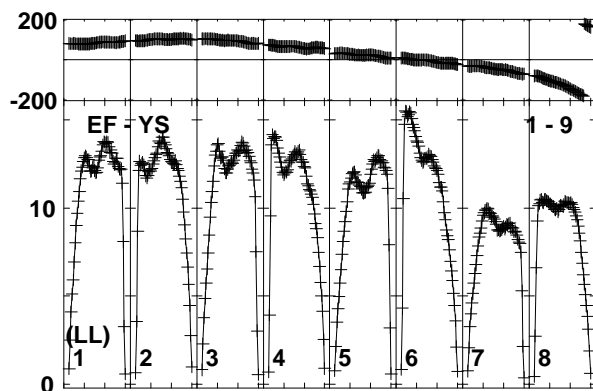
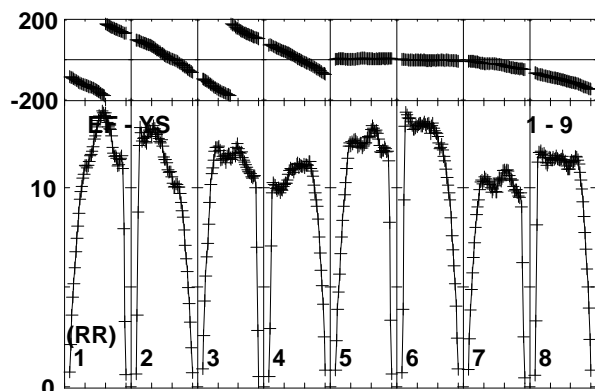
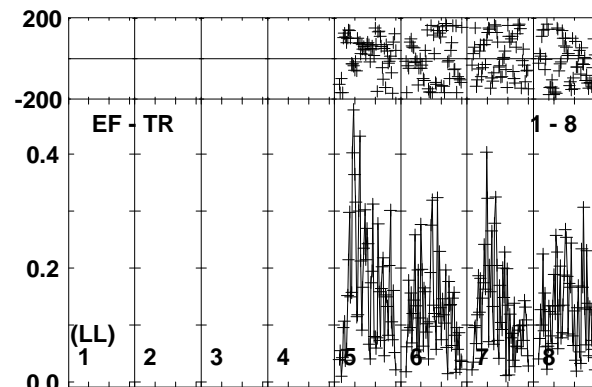
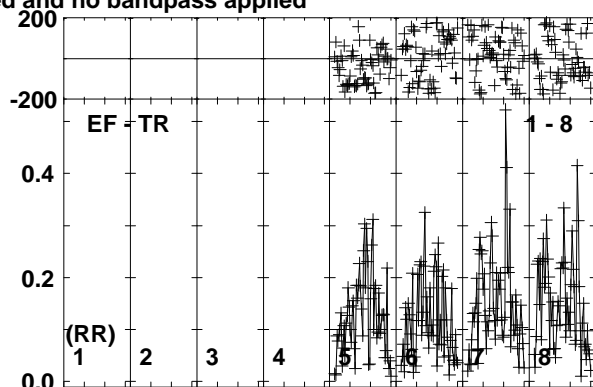
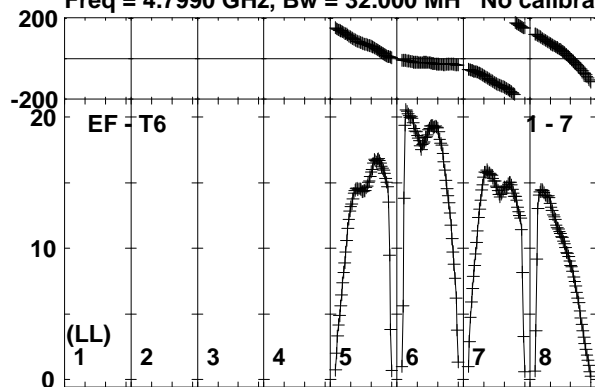

Lower frame: Milli Ampl Jy Top frame: Phas deg  
Vector averaged cross-power spectrum Baseline: EF (01) - T6 (07)  
Timerange: 00/06:26:50 to 00/06:28:50