

Plot file version 1 created 20-APR-2018 10:31:33

J0530+1331 EG102C.UVDATA.1

Freq = 4.7995 GHz, Bw = 32.000 MH No calibration applied and no bandpass applied

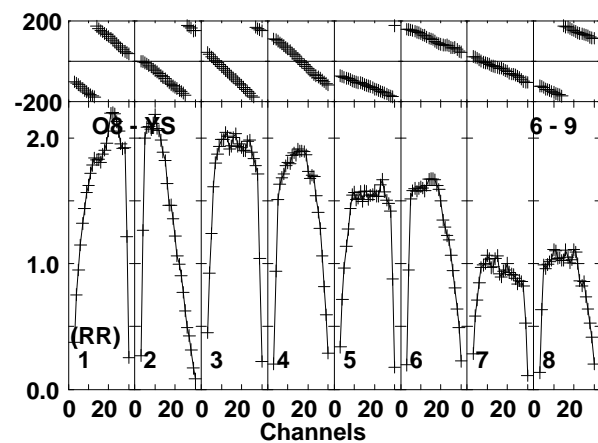
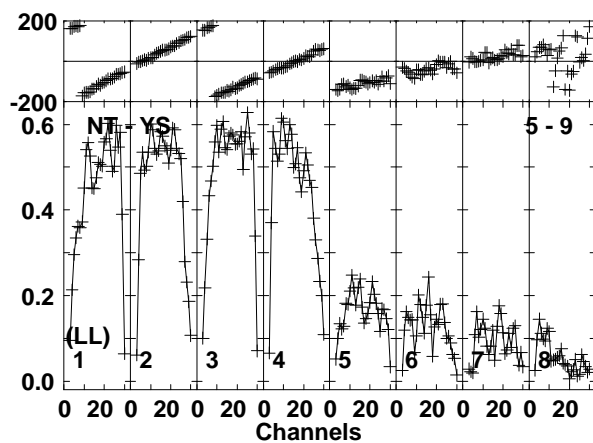
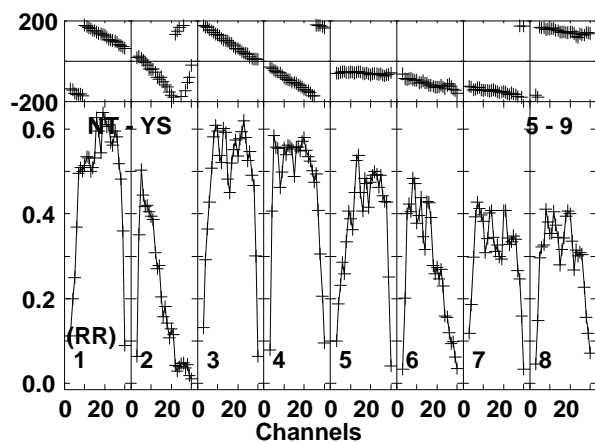
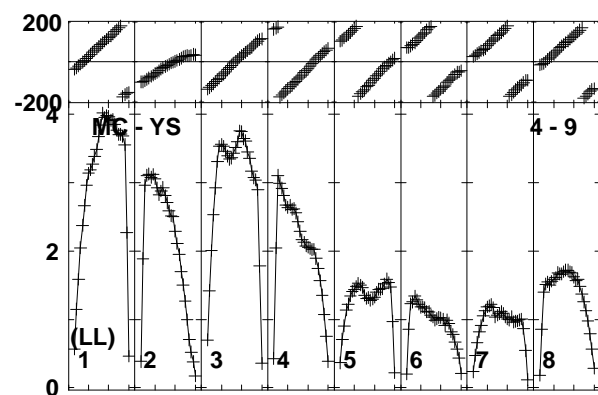
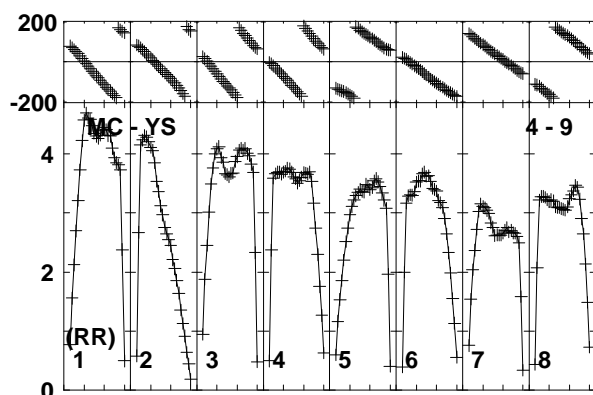
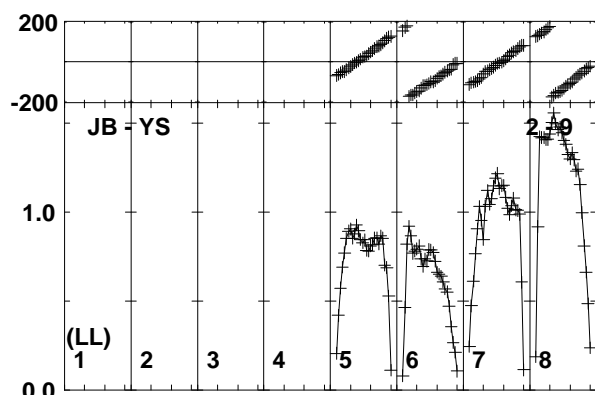
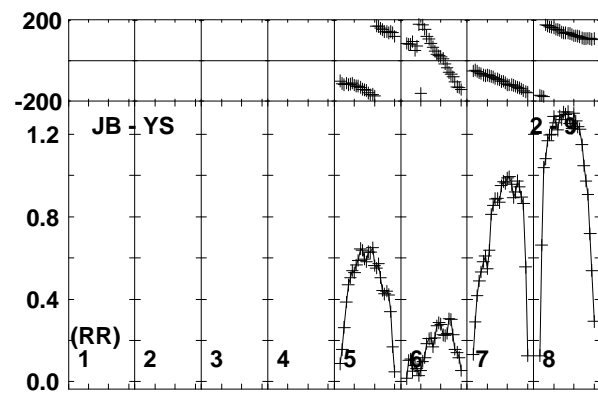
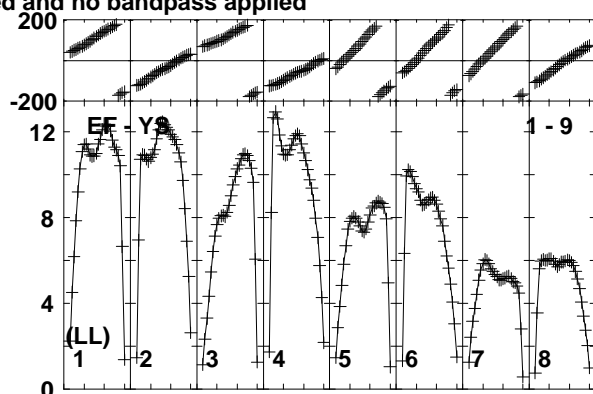
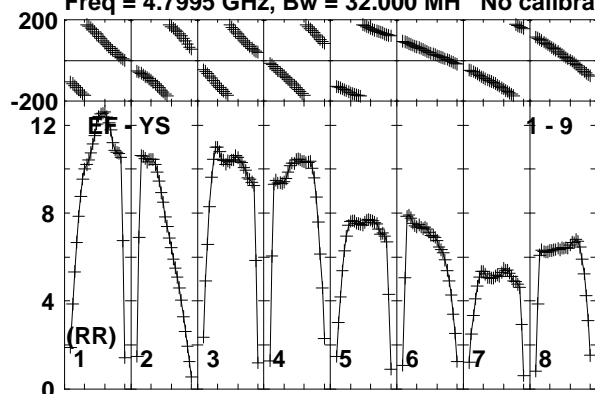

Lower frame: Milli Ampl Jy Top frame: Phas deg
Vector averaged cross-power spectrum Baseline: EF (01) - YS (09)
Timerange: 00/13:55:07 to 00/13:59:59

Plot file version 2 created 20-APR-2018 10:31:33

J0530+1331 EG102C.UVDATA.1

Freq = 4.7995 GHz, Bw = 32.000 MH No calibration applied and no bandpass applied

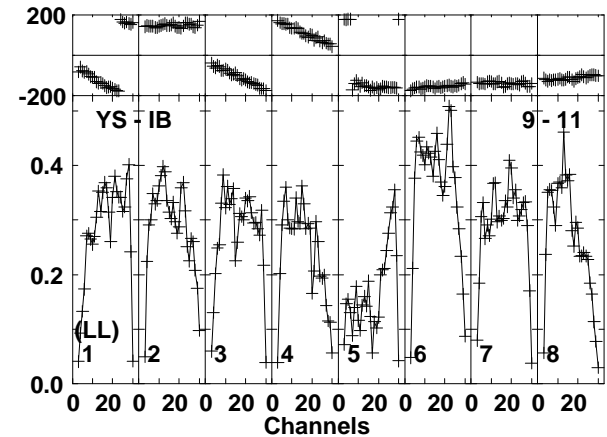
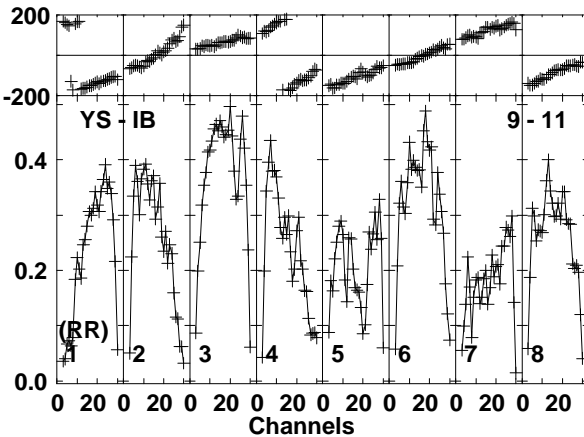
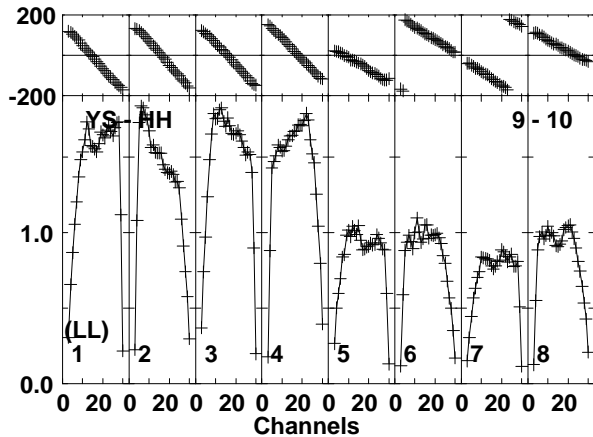
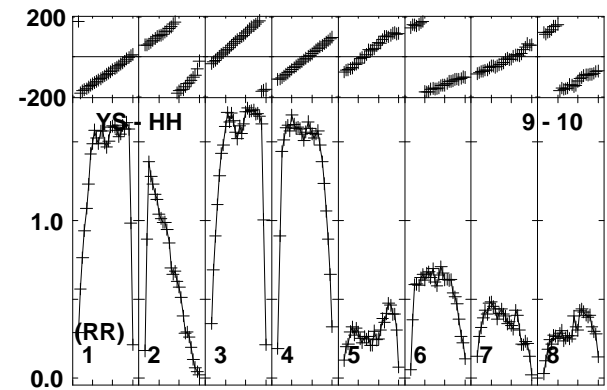
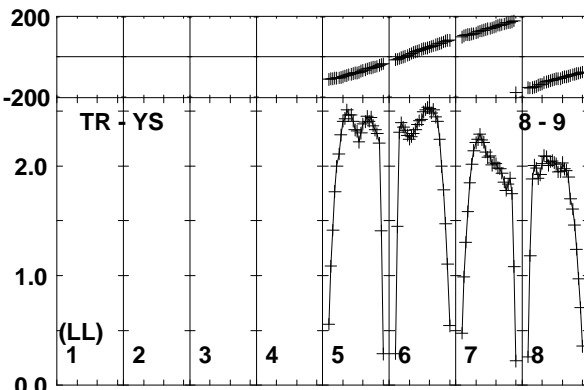
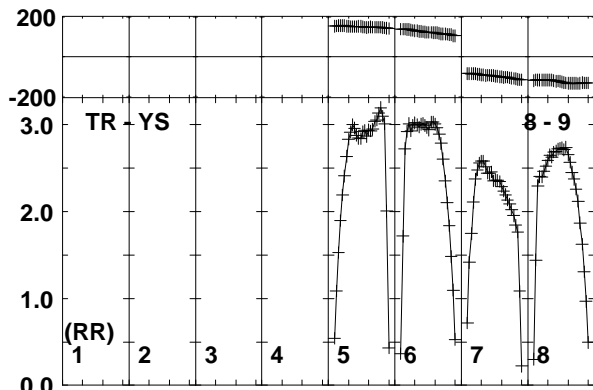
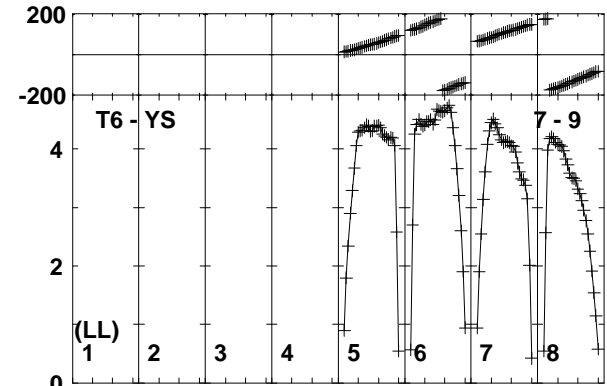
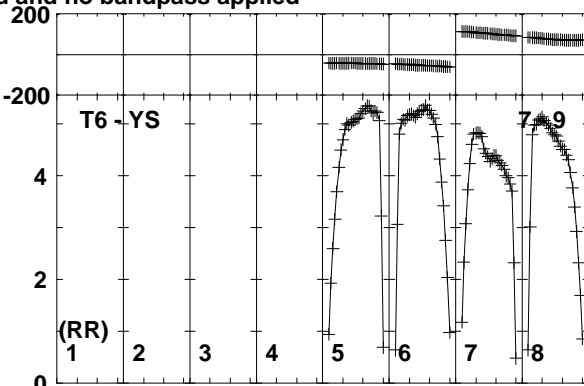
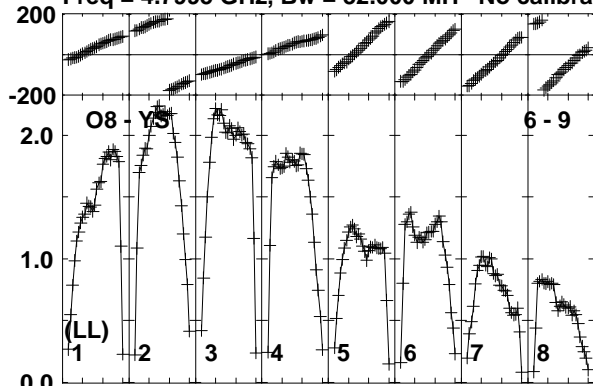

Lower frame: Milli Ampl Jy Top frame: Phas deg
Vector averaged cross-power spectrum Baseline: O8 (06) - YS (09)
Timerange: 00/13:55:07 to 00/13:59:59

Plot file version 3 created 20-APR-2018 10:31:34

J0915+0745 EG102C.UVDATA.1

Freq = 4.7995 GHz, Bw = 32.000 MH No calibration applied and no bandpass applied

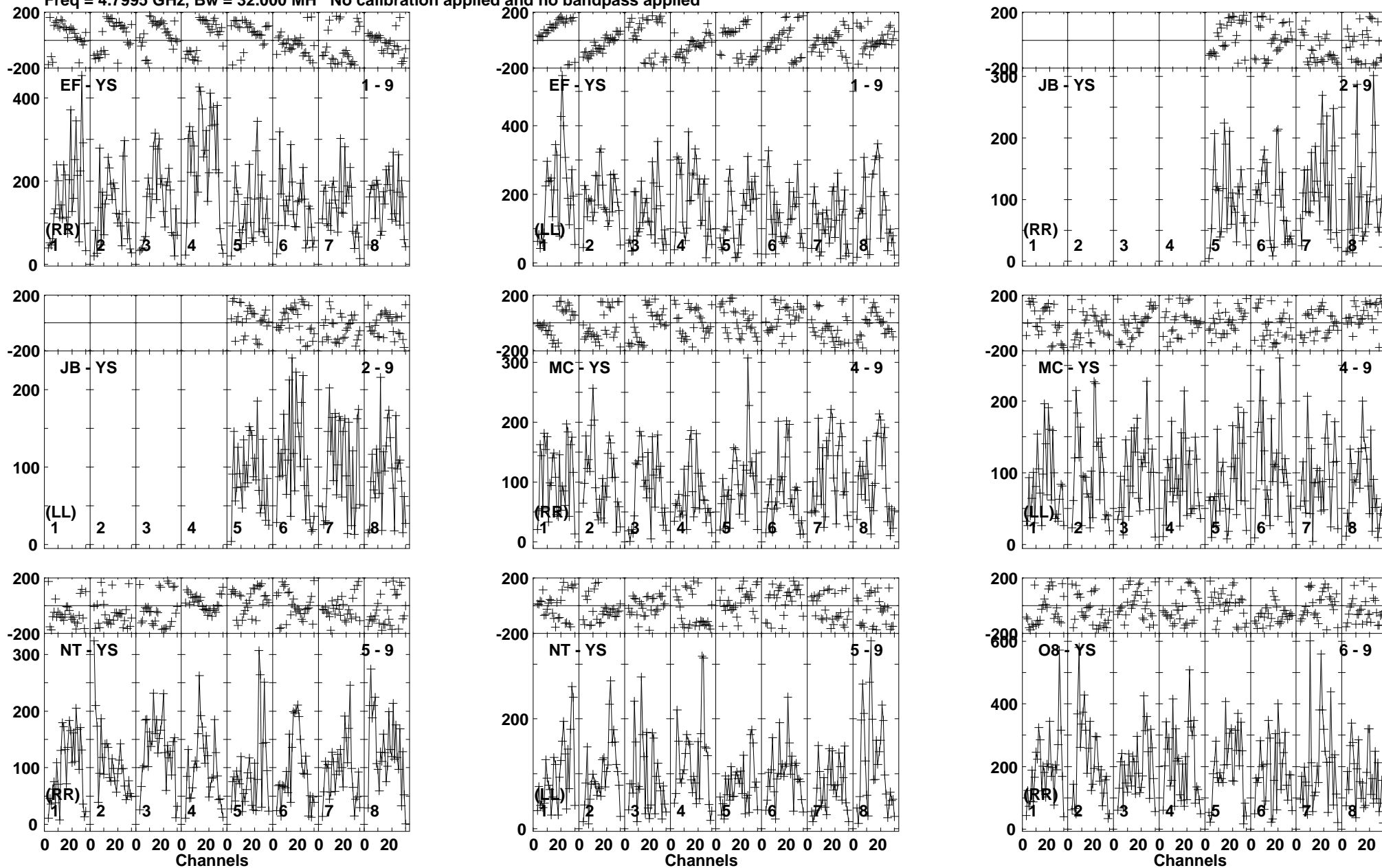

Lower frame: Micro Ampl Jy Top frame: Phas deg
Vector averaged cross-power spectrum Baseline: EF (01) - YS (09)
Timerange: 00/14:12:51 to 00/14:14:19

Plot file version 4 created 20-APR-2018 10:31:34

J0915+0745 EG102C.UVDATA.1

Freq = 4.7995 GHz, Bw = 32.000 MH No calibration applied and no bandpass applied

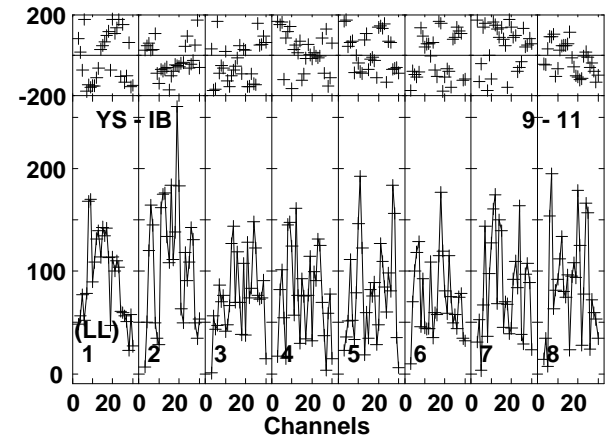
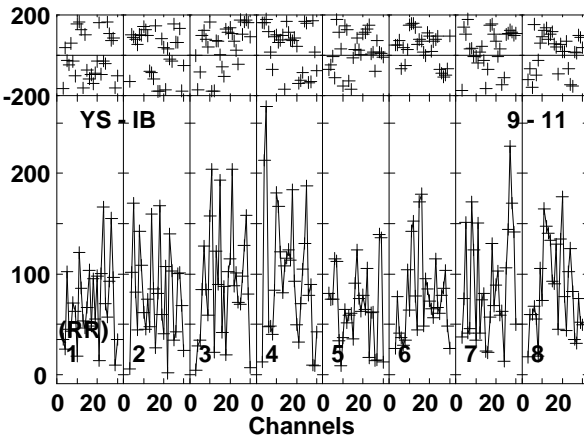
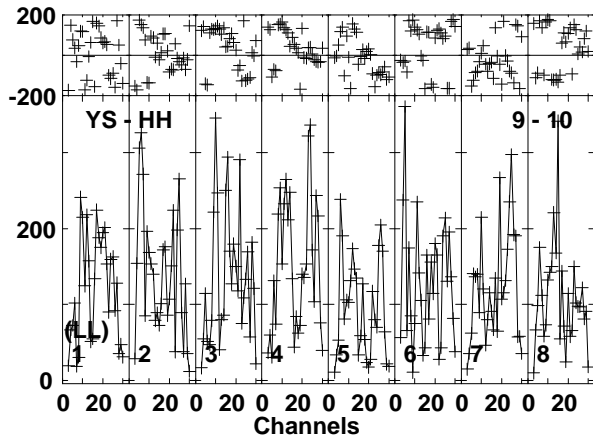
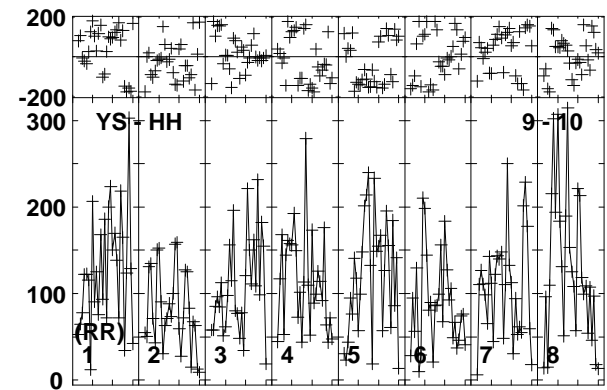
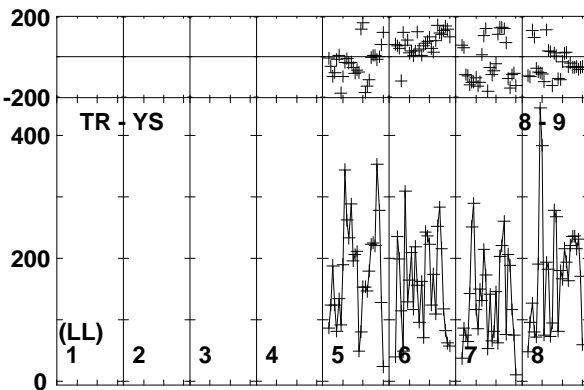
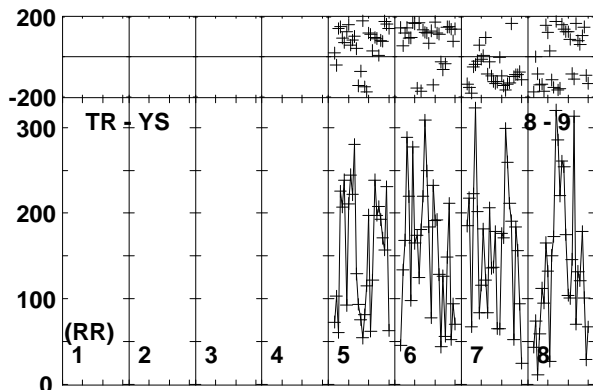
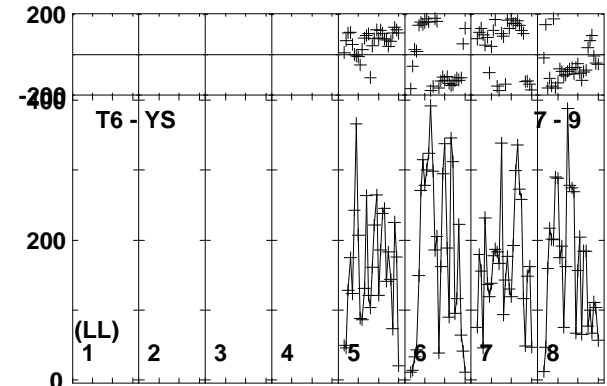
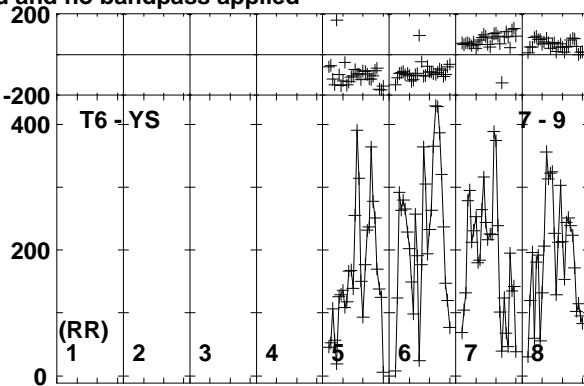
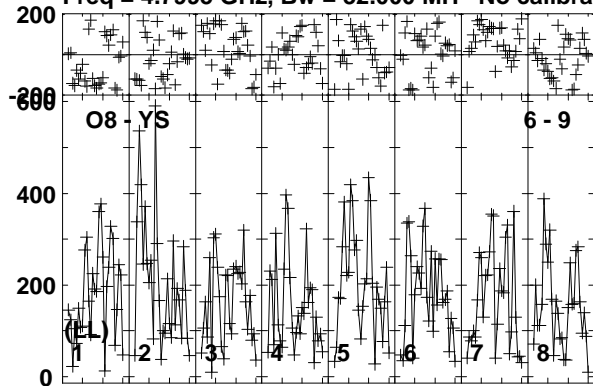

Lower frame: Micro Ampl Jy Top frame: Phas deg
Vector averaged cross-power spectrum Baseline: O8 (06) - YS (09)
Timerange: 00/14:12:51 to 00/14:14:19

Plot file version 5 created 20-APR-2018 10:31:34

J0915+0745 EG102C.UVDATA.1

Freq = 4.7995 GHz, Bw = 32.000 MH No calibration applied and no bandpass applied

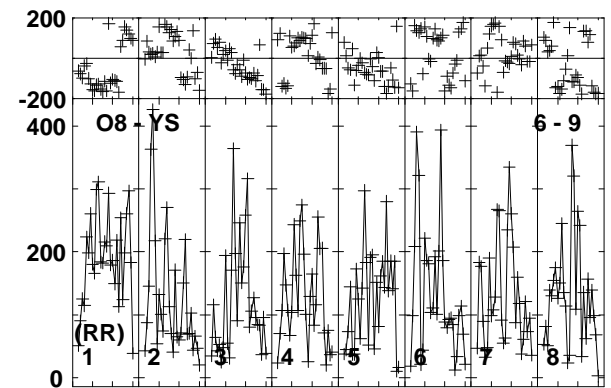
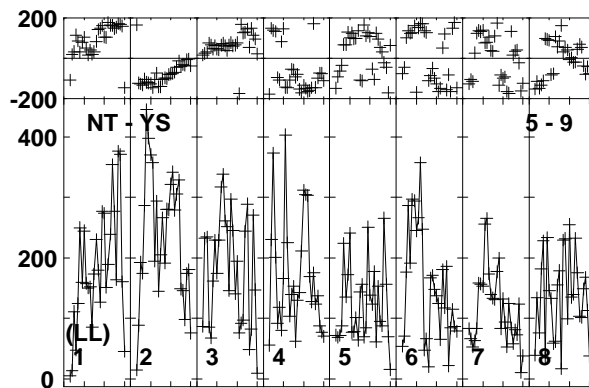
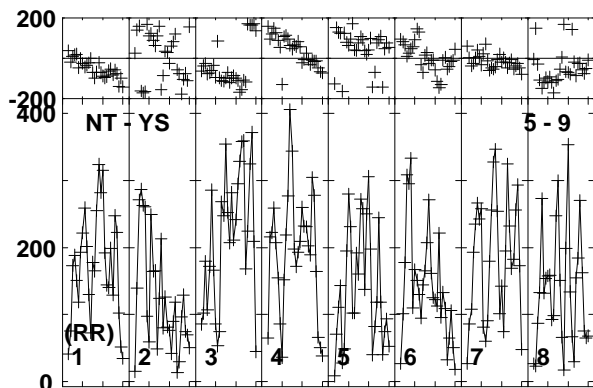
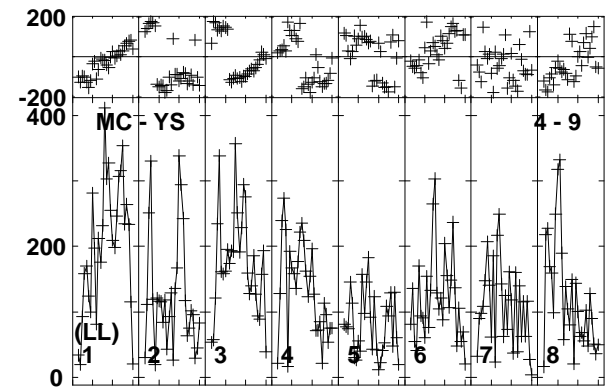
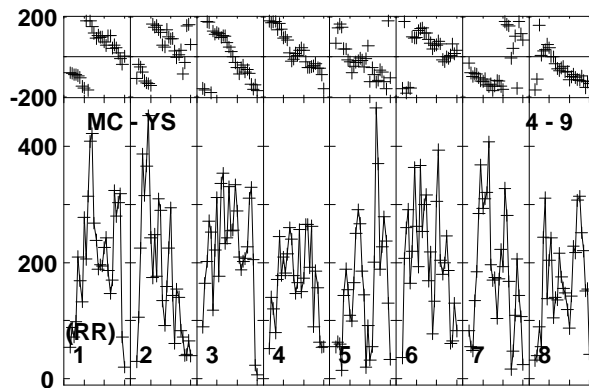
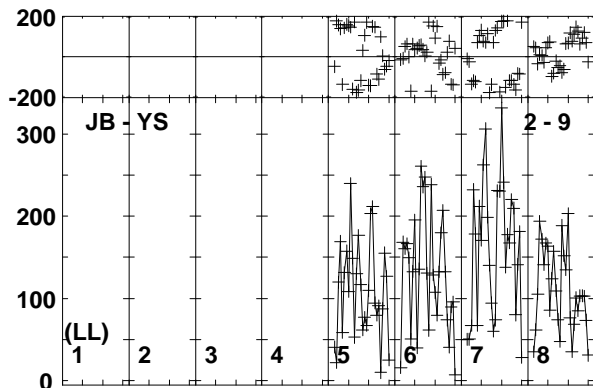
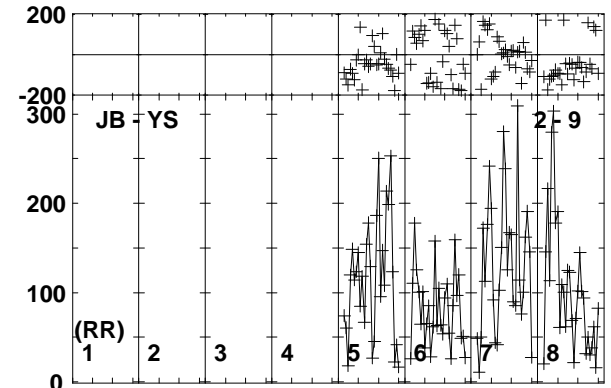
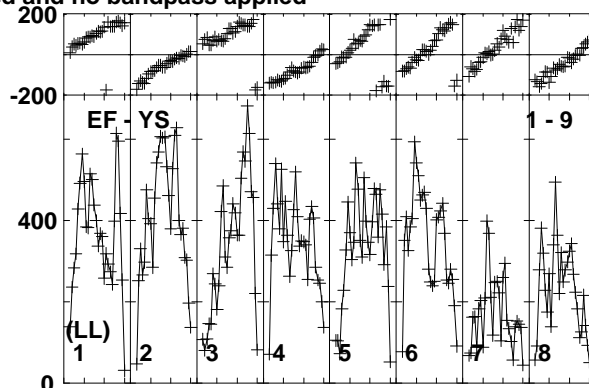
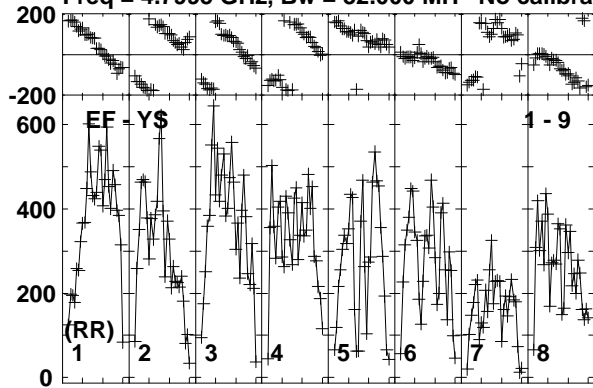

Lower frame: Micro Ampl Jy Top frame: Phas deg
Vector averaged cross-power spectrum Baseline: EF (01) - YS (09)
Timerange: 00/14:18:31 to 00/14:19:29

Plot file version 6 created 20-APR-2018 10:31:34

J0915+0745 EG102C.UVDATA.1

Freq = 4.7995 GHz, Bw = 32.000 MH No calibration applied and no bandpass applied

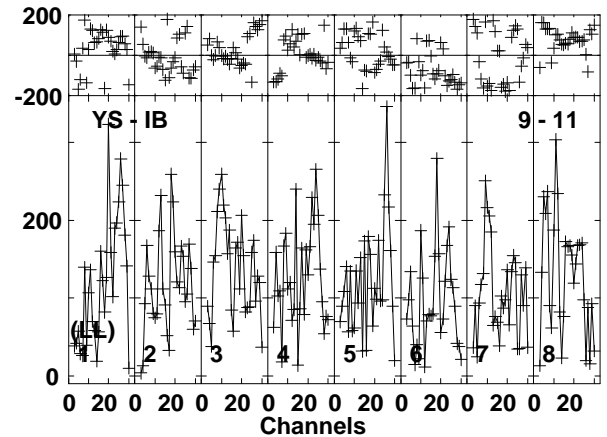
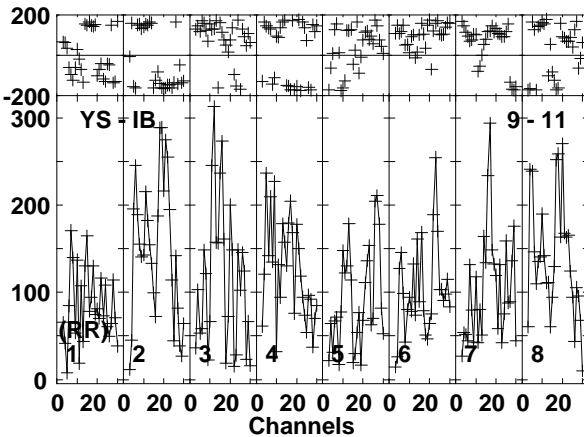
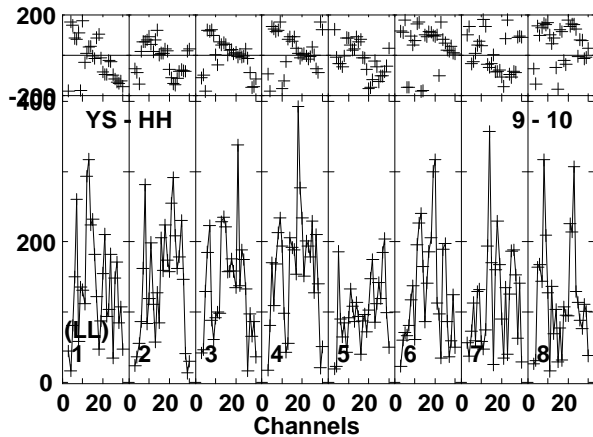
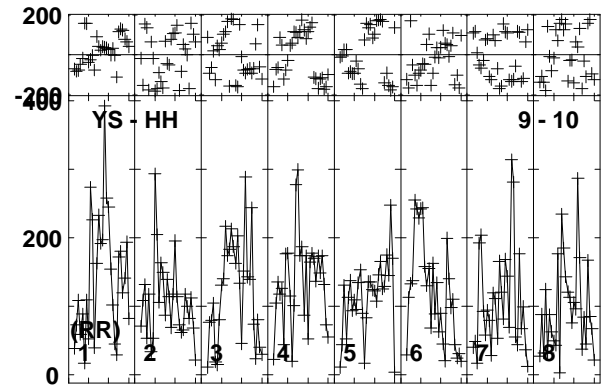
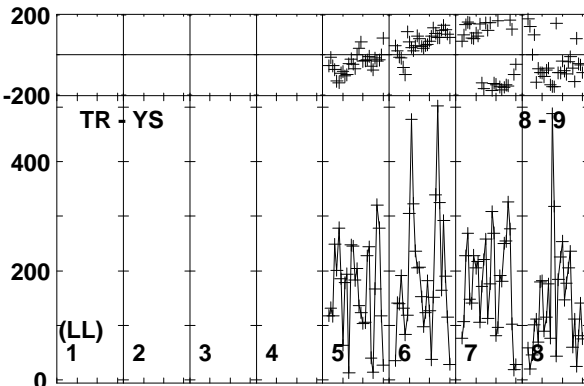
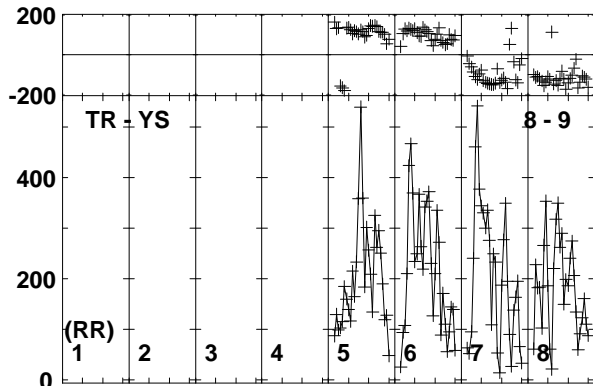
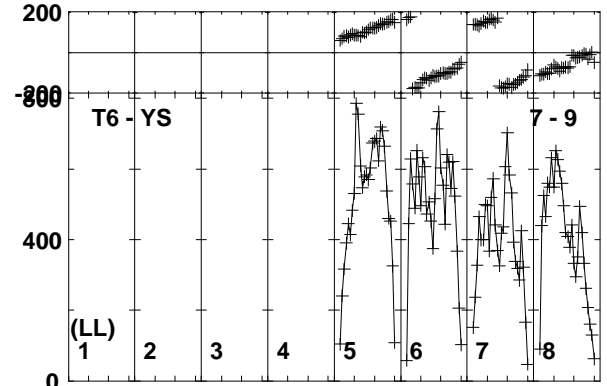
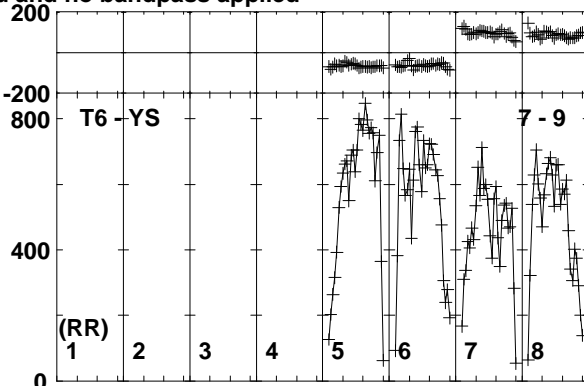
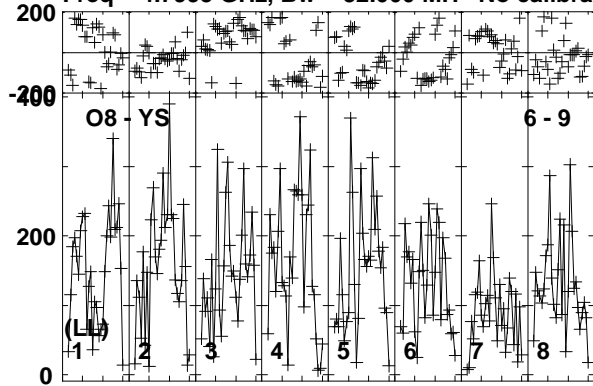

Lower frame: Micro Ampl Jy Top frame: Phas deg
Vector averaged cross-power spectrum Baseline: O8 (06) - YS (09)
Timerange: 00/14:18:31 to 00/14:19:29

Plot file version 7 created 20-APR-2018 10:31:34

B0915+068 EG102C.UVDATA.1

Freq = 4.7995 GHz, Bw = 32.000 MH No calibration applied and no bandpass applied

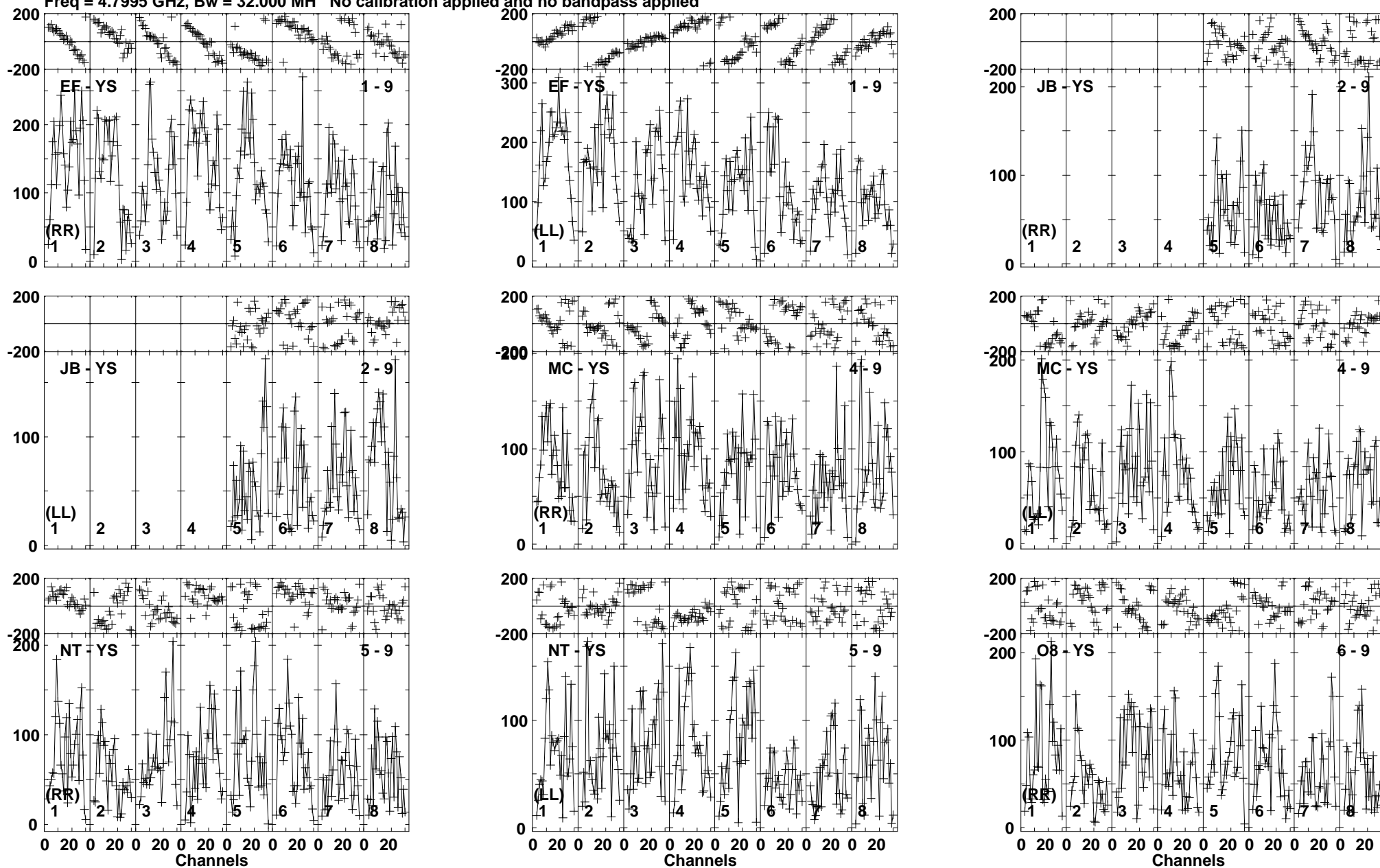

Lower frame: Micro Ampl Jy Top frame: Phas deg
Vector averaged cross-power spectrum Baseline: EF (01) - YS (09)
Timerange: 00/14:19:31 to 00/14:22:59

Plot file version 8 created 20-APR-2018 10:31:34

B0915+068 EG102C.UVDATA.1

Freq = 4.7995 GHz, Bw = 32.000 MH No calibration applied and no bandpass applied

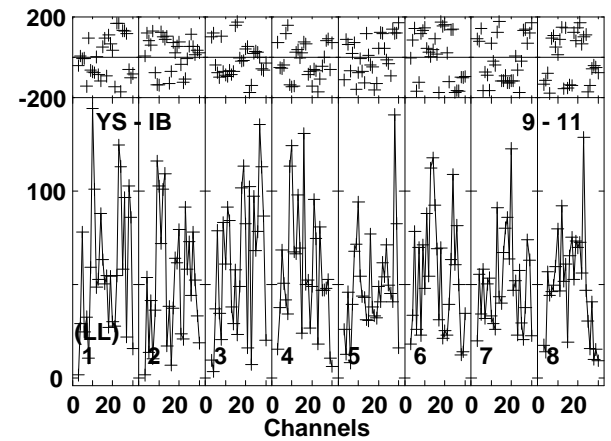
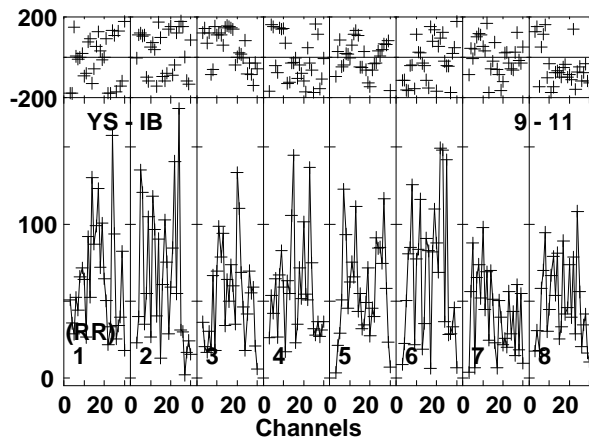
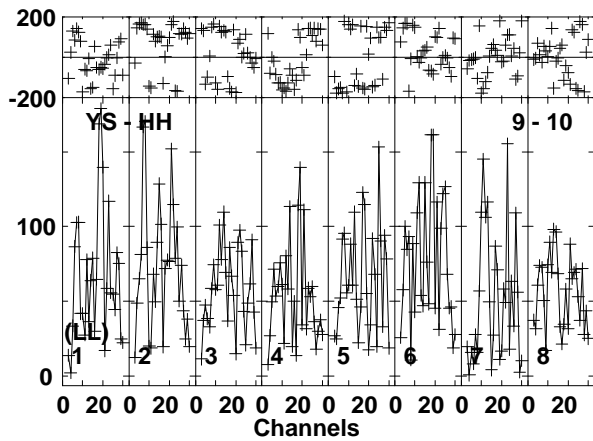
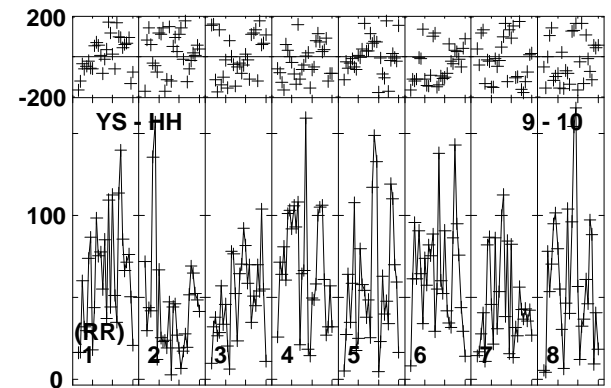
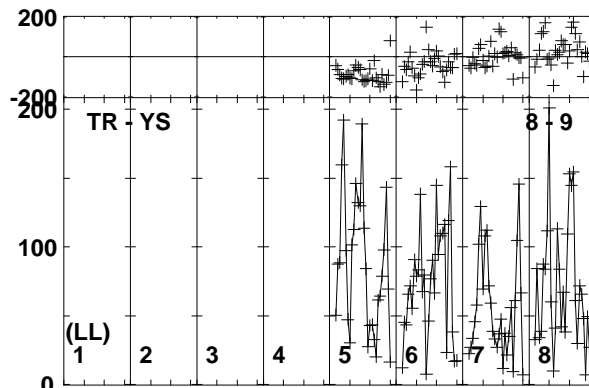
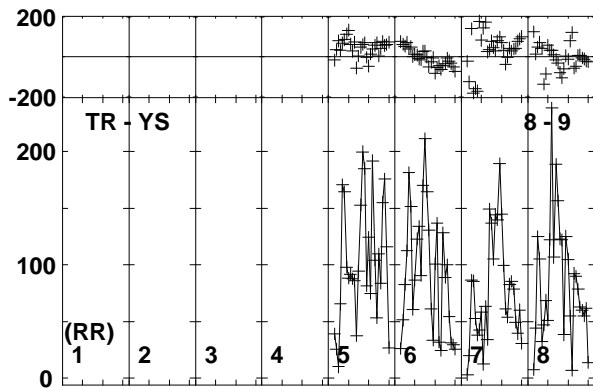
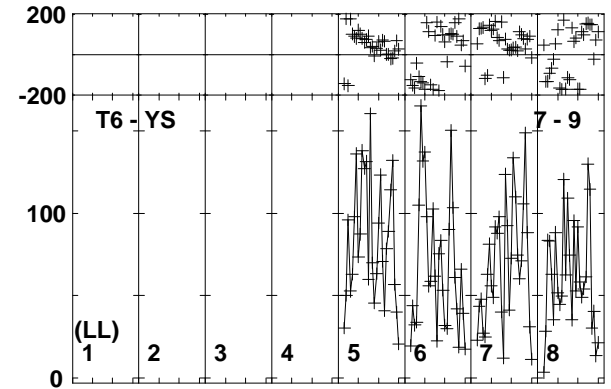
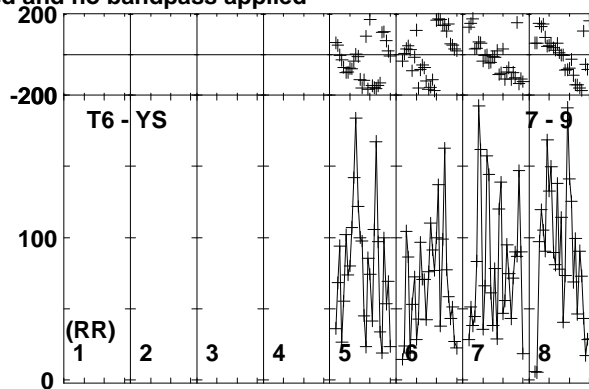
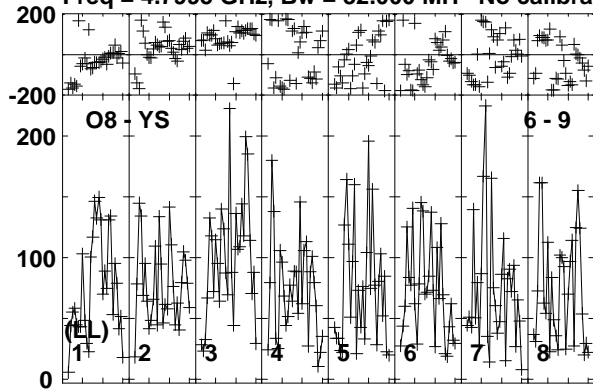

Lower frame: Micro Ampl Jy Top frame: Phas deg
Vector averaged cross-power spectrum Baseline: O8 (06) - YS (09)
Timerange: 00/14:19:31 to 00/14:22:59

Plot file version 9 created 20-APR-2018 10:31:35

J0915+0745 EG102C.UVDATA.1

Freq = 4.7995 GHz, Bw = 32.000 MH No calibration applied and no bandpass applied

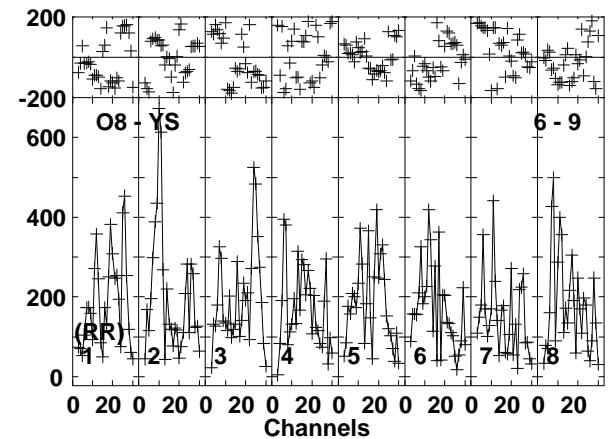
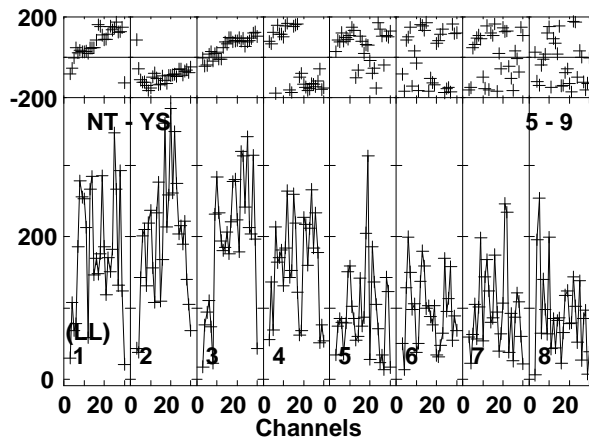
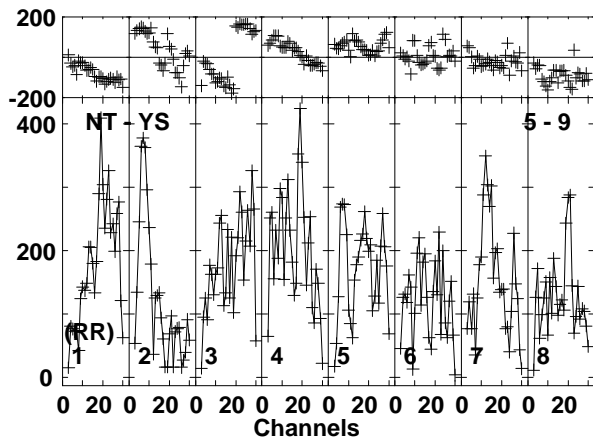
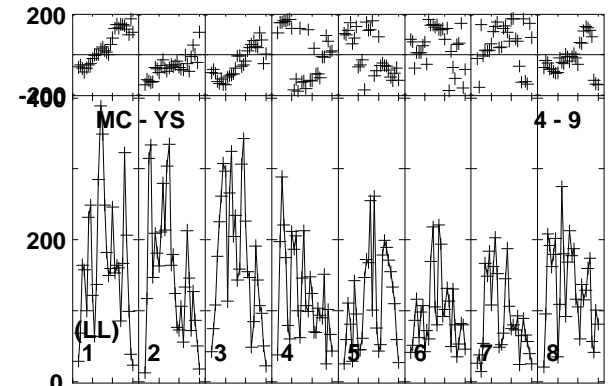
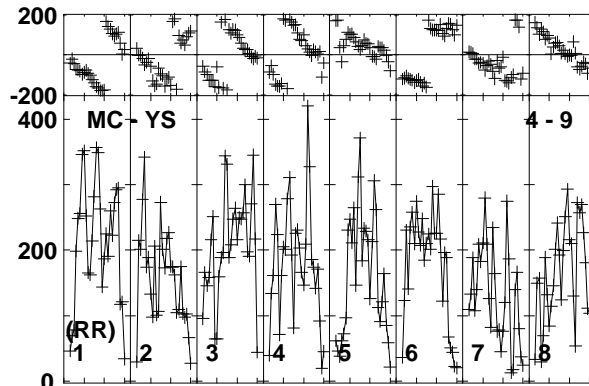
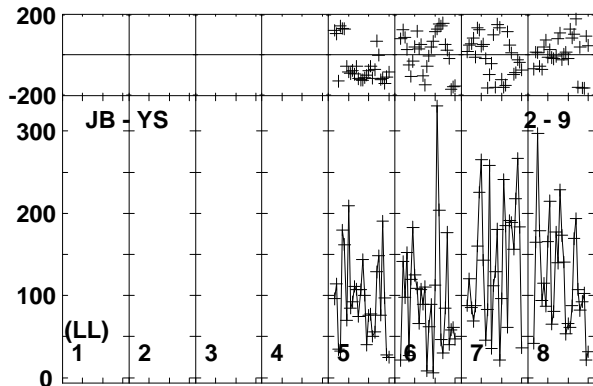
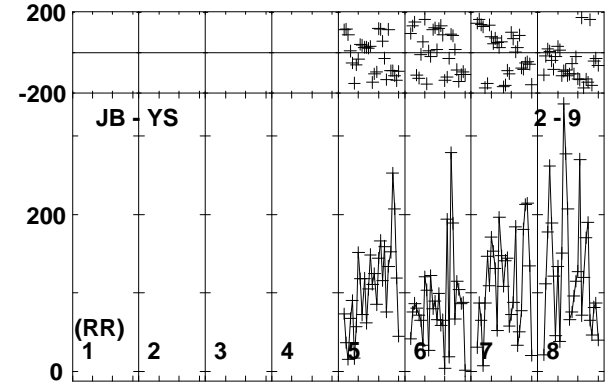
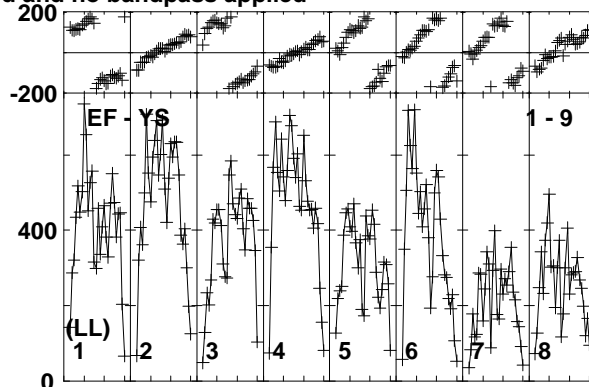
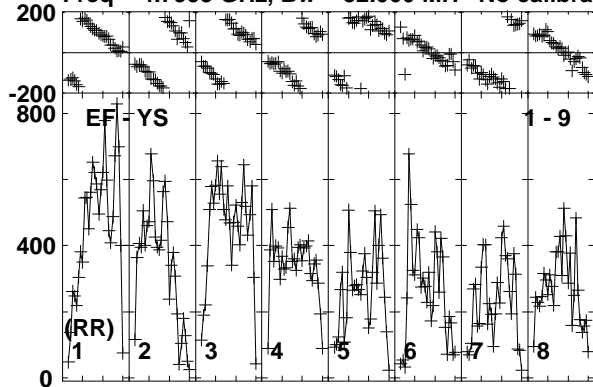

Lower frame: Micro Ampl Jy Top frame: Phas deg
Vector averaged cross-power spectrum Baseline: EF (01) - YS (09)
Timerange: 00/14:23:01 to 00/14:24:29

Plot file version 10 created 20-APR-2018 10:31:35

J0915+0745 EG102C.UVDATA.1

Freq = 4.7995 GHz, Bw = 32.000 MH No calibration applied and no bandpass applied

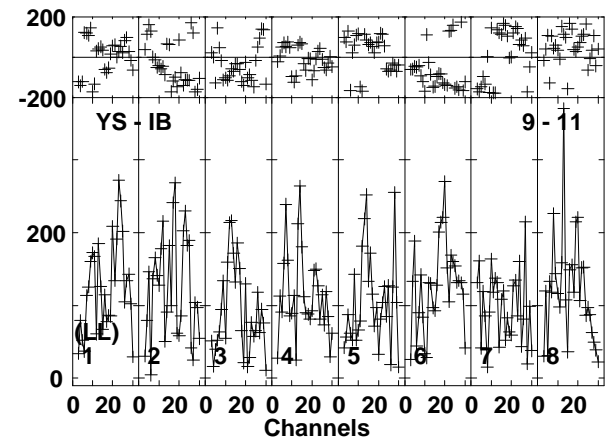
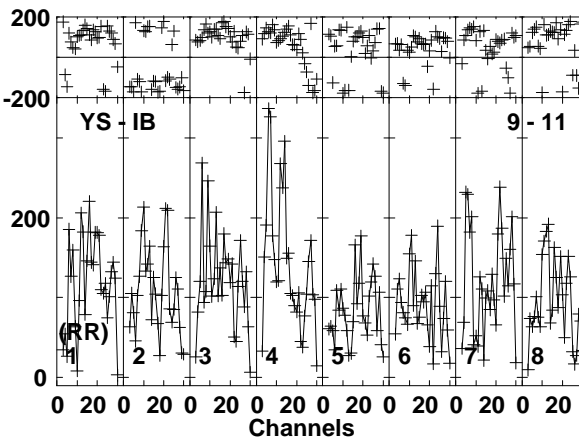
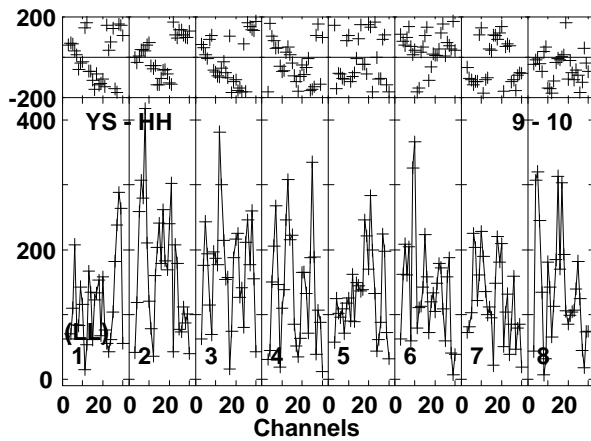
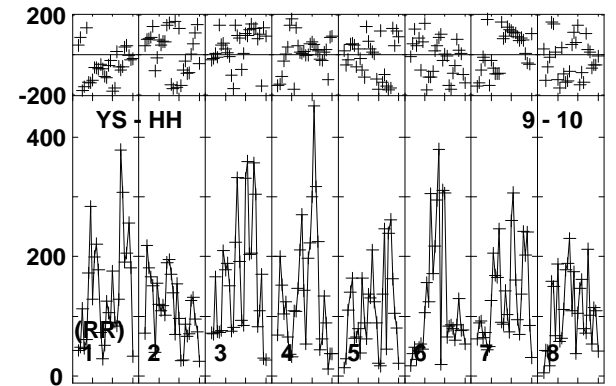
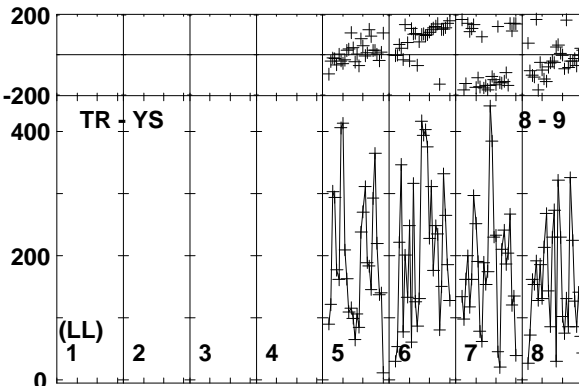
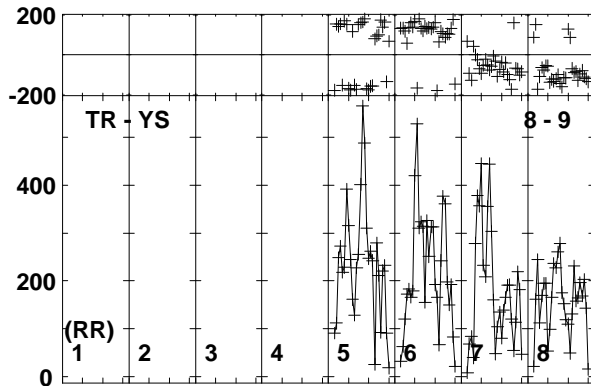
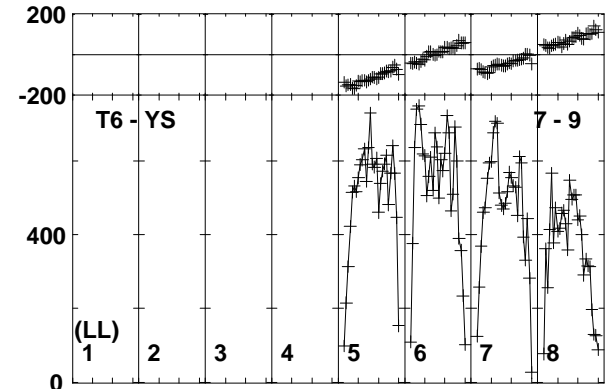
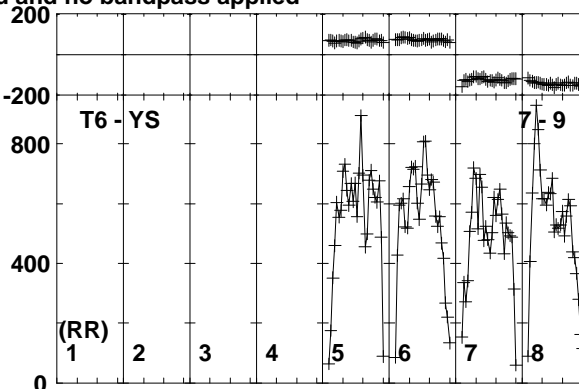
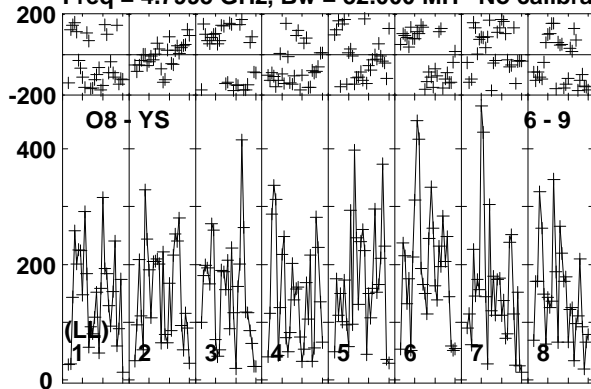

Lower frame: Micro Ampl Jy Top frame: Phas deg
Vector averaged cross-power spectrum Baseline: O8 (06) - YS (09)
Timerange: 00/14:23:01 to 00/14:24:29

Plot file version 11 created 20-APR-2018 10:31:35

B0915+068 EG102C.UVDATA.1

Freq = 4.7995 GHz, Bw = 32.000 MH No calibration applied and no bandpass applied

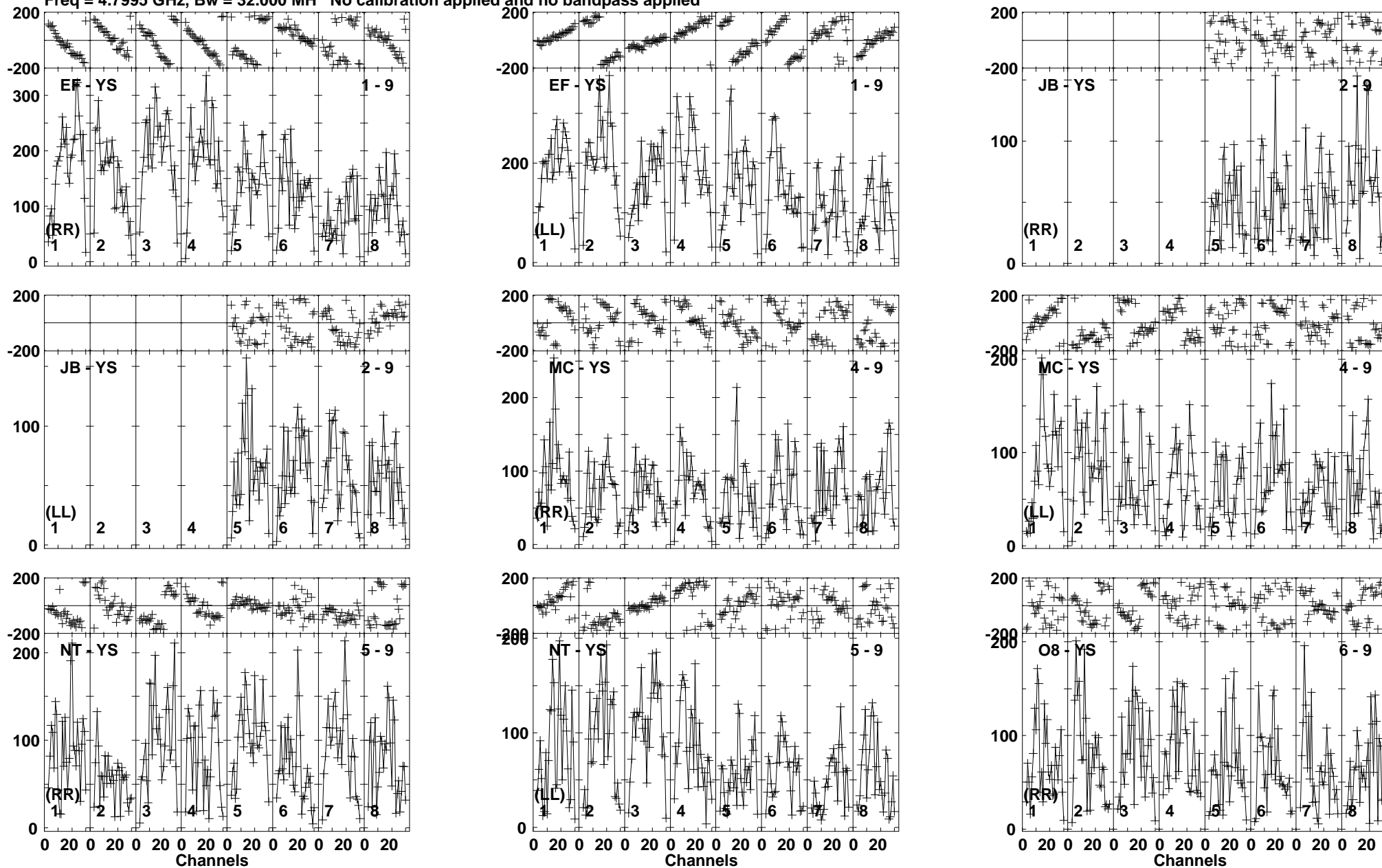

Lower frame: Micro Ampl Jy Top frame: Phas deg
Vector averaged cross-power spectrum Baseline: EF (01) - YS (09)
Timerange: 00/14:24:31 to 00/14:27:59

Plot file version 12 created 20-APR-2018 10:31:35

B0915+068 EG102C.UVDATA.1

Freq = 4.7995 GHz, Bw = 32.000 MH No calibration applied and no bandpass applied

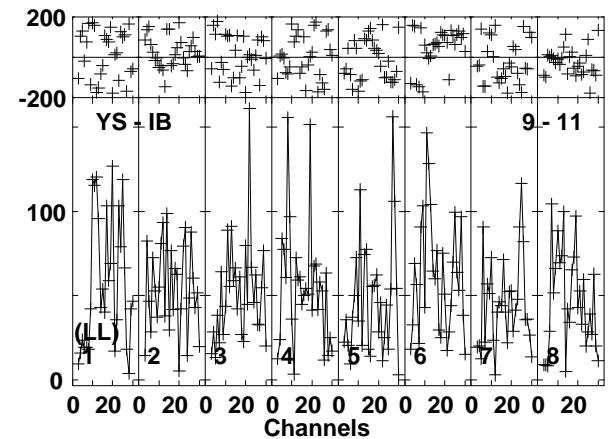
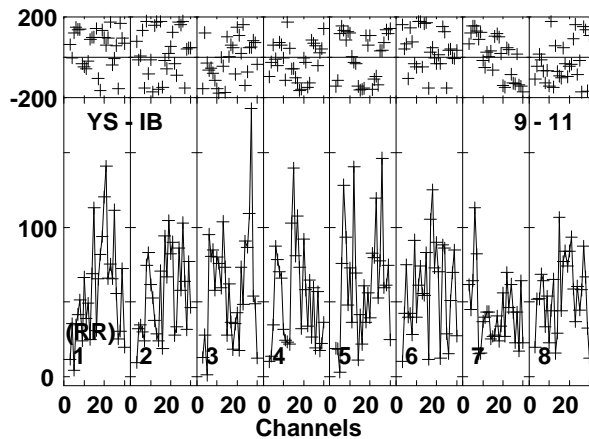
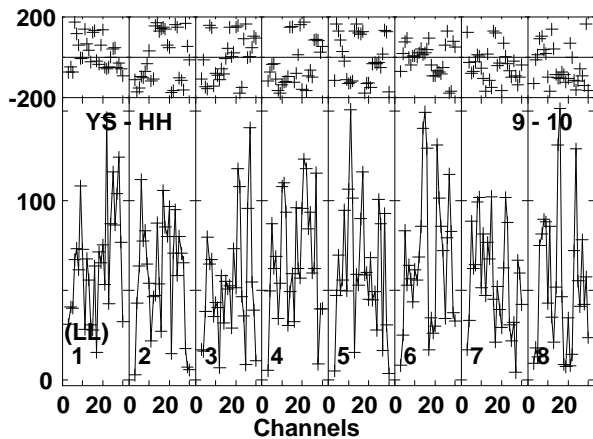
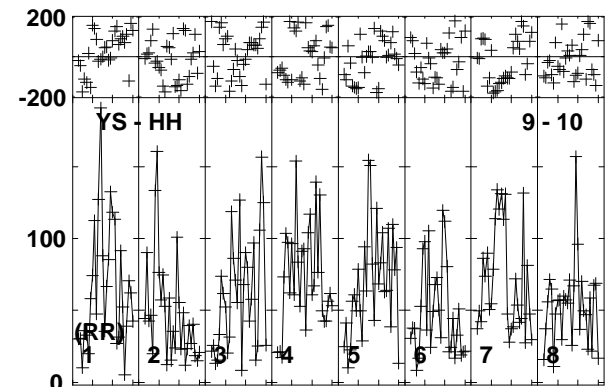
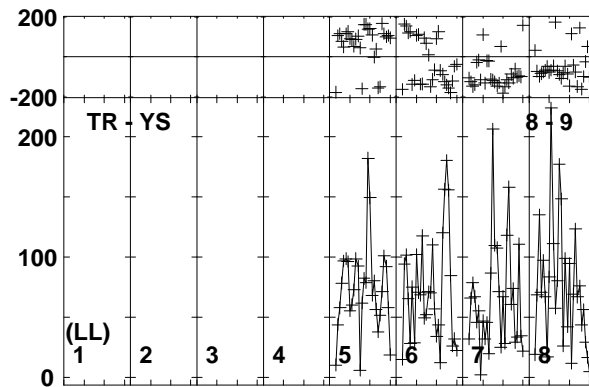
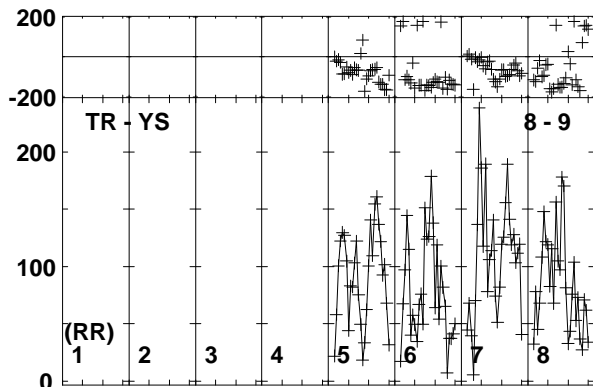
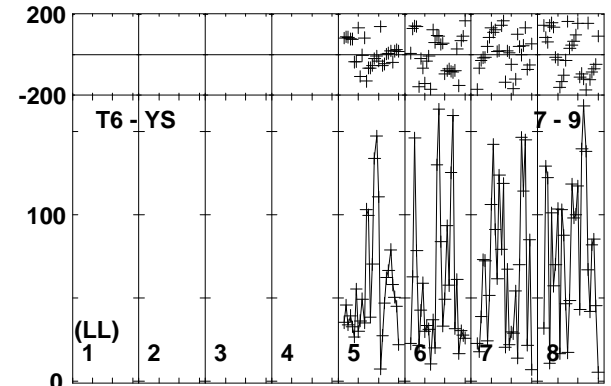
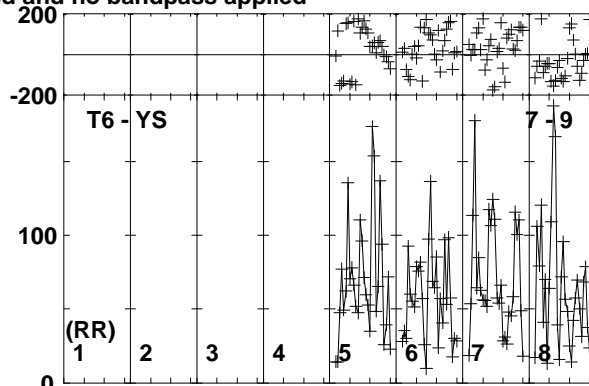
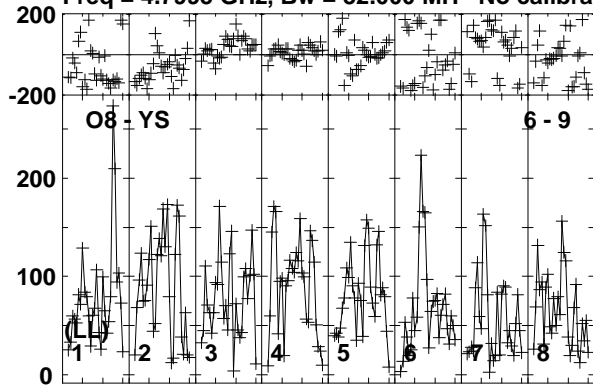

Lower frame: Micro Ampl Jy Top frame: Phas deg
Vector averaged cross-power spectrum Baseline: O8 (06) - YS (09)
Timerange: 00/14:24:31 to 00/14:27:59

Plot file version 13 created 20-APR-2018 10:31:35

J0915+0745 EG102C.UVDATA.1

Freq = 4.7995 GHz, Bw = 32.000 MH No calibration applied and no bandpass applied

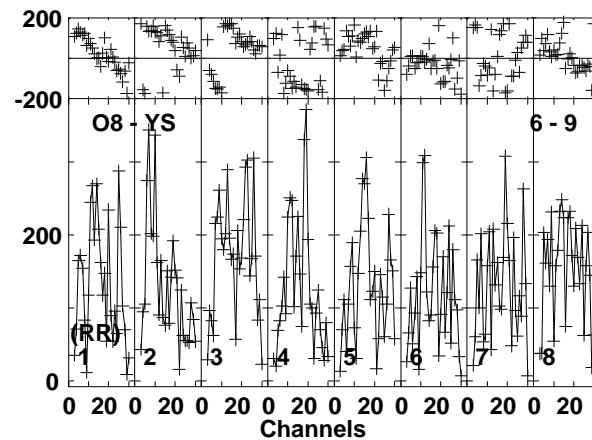
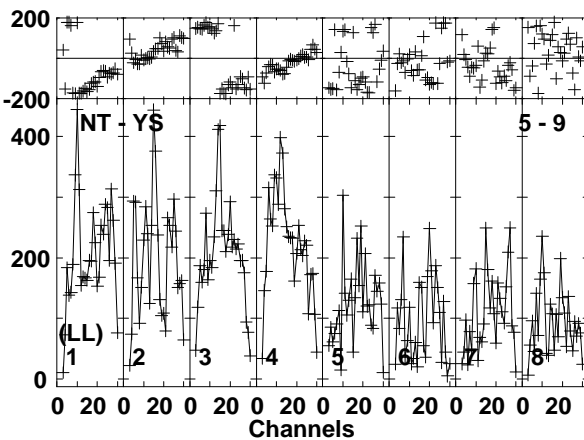
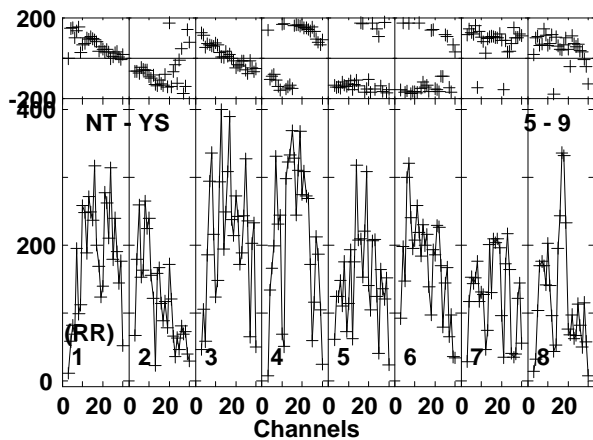
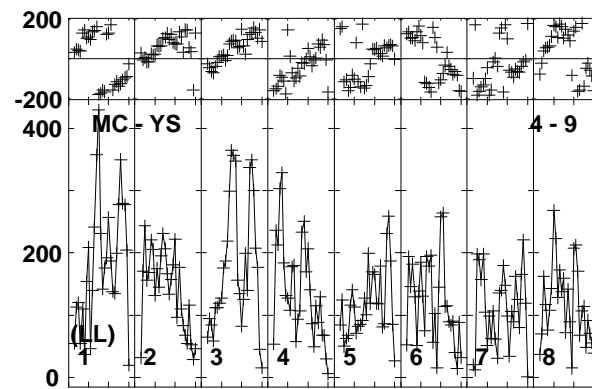
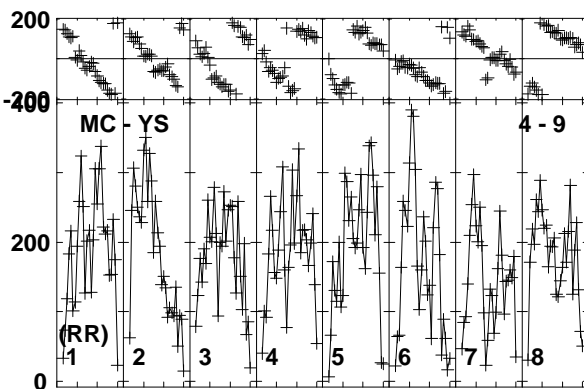
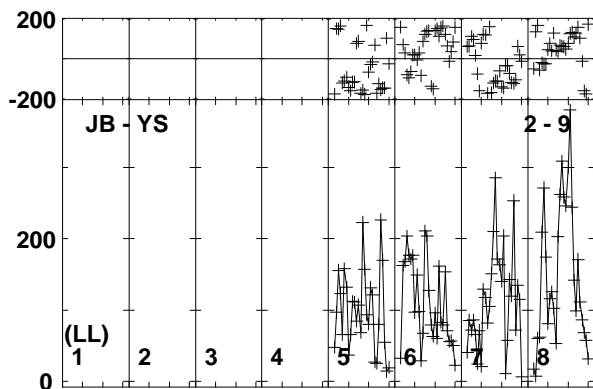
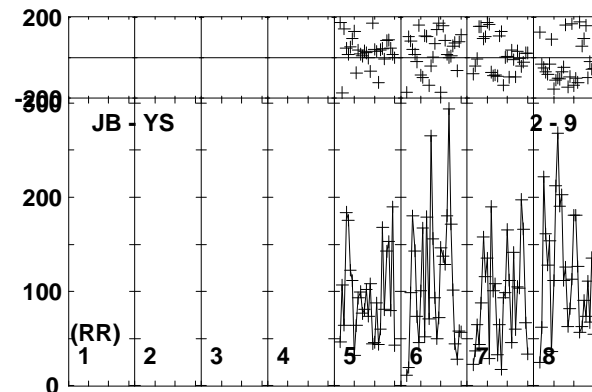
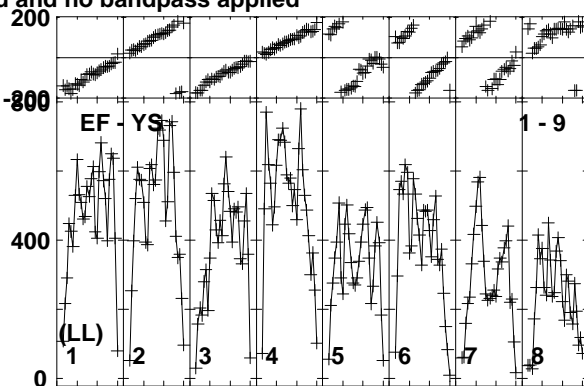
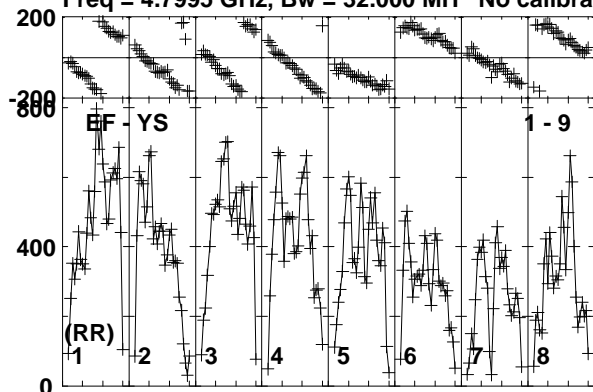

Lower frame: Micro Ampl Jy Top frame: Phas deg
Vector averaged cross-power spectrum Baseline: EF (01) - YS (09)
Timerange: 00/14:28:01 to 00/14:29:29

Plot file version 14 created 20-APR-2018 10:31:35

J0915+0745 EG102C.UVDATA.1

Freq = 4.7995 GHz, Bw = 32.000 MH No calibration applied and no bandpass applied

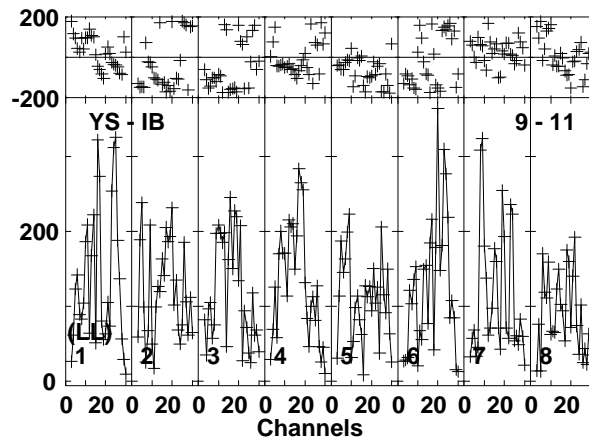
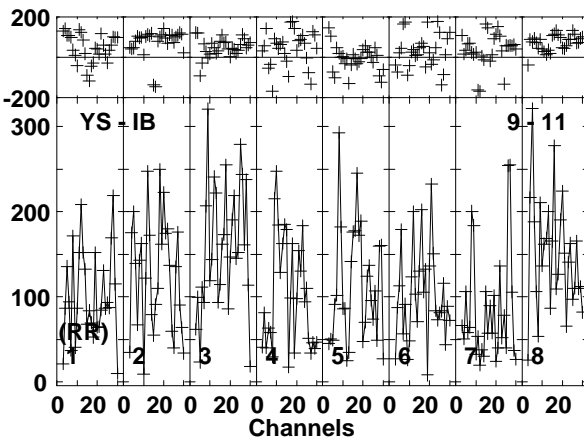
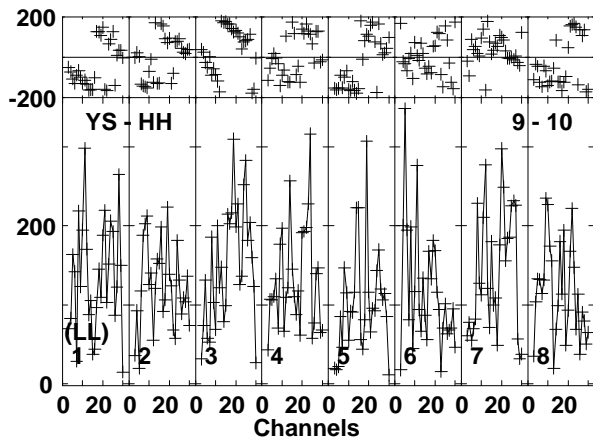
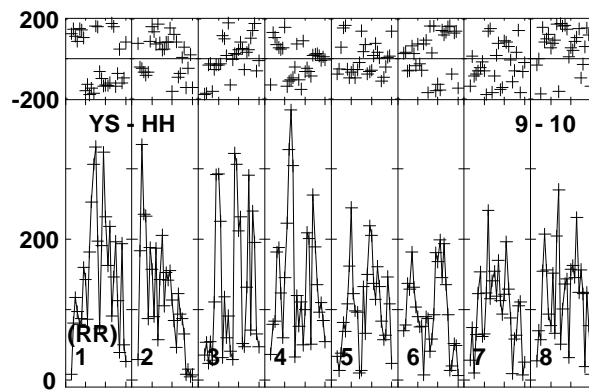
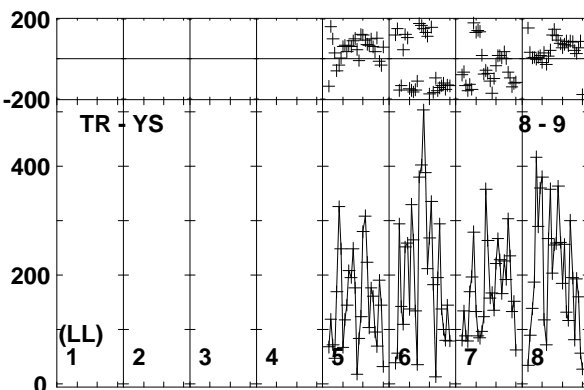
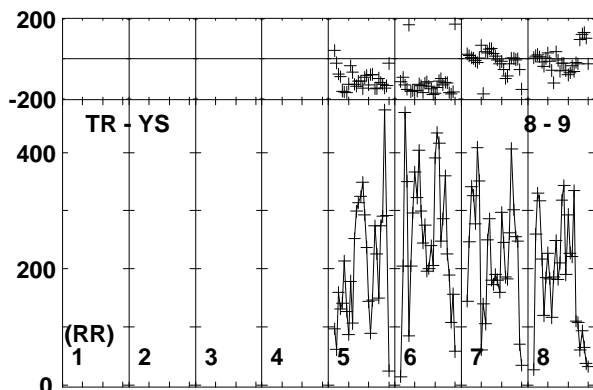
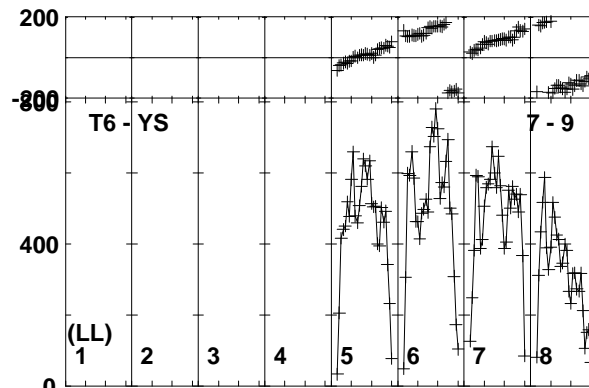
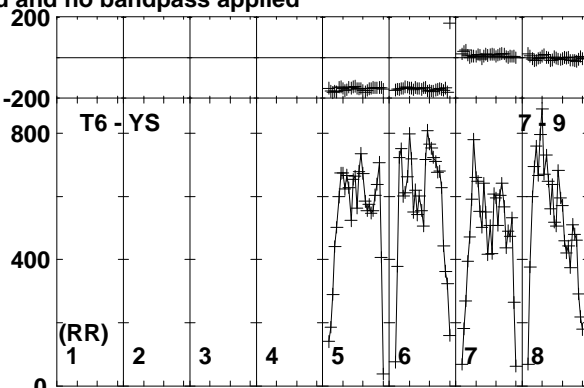
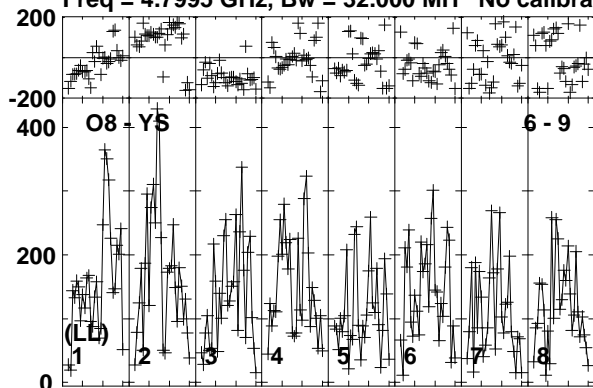

Lower frame: Micro Ampl Jy Top frame: Phas deg
Vector averaged cross-power spectrum Baseline: O8 (06) - YS (09)
Timerange: 00/14:28:01 to 00/14:29:29

Plot file version 15 created 20-APR-2018 10:31:35

B0915+068 EG102C.UVDATA.1

Freq = 4.7995 GHz, Bw = 32.000 MH No calibration applied and no bandpass applied

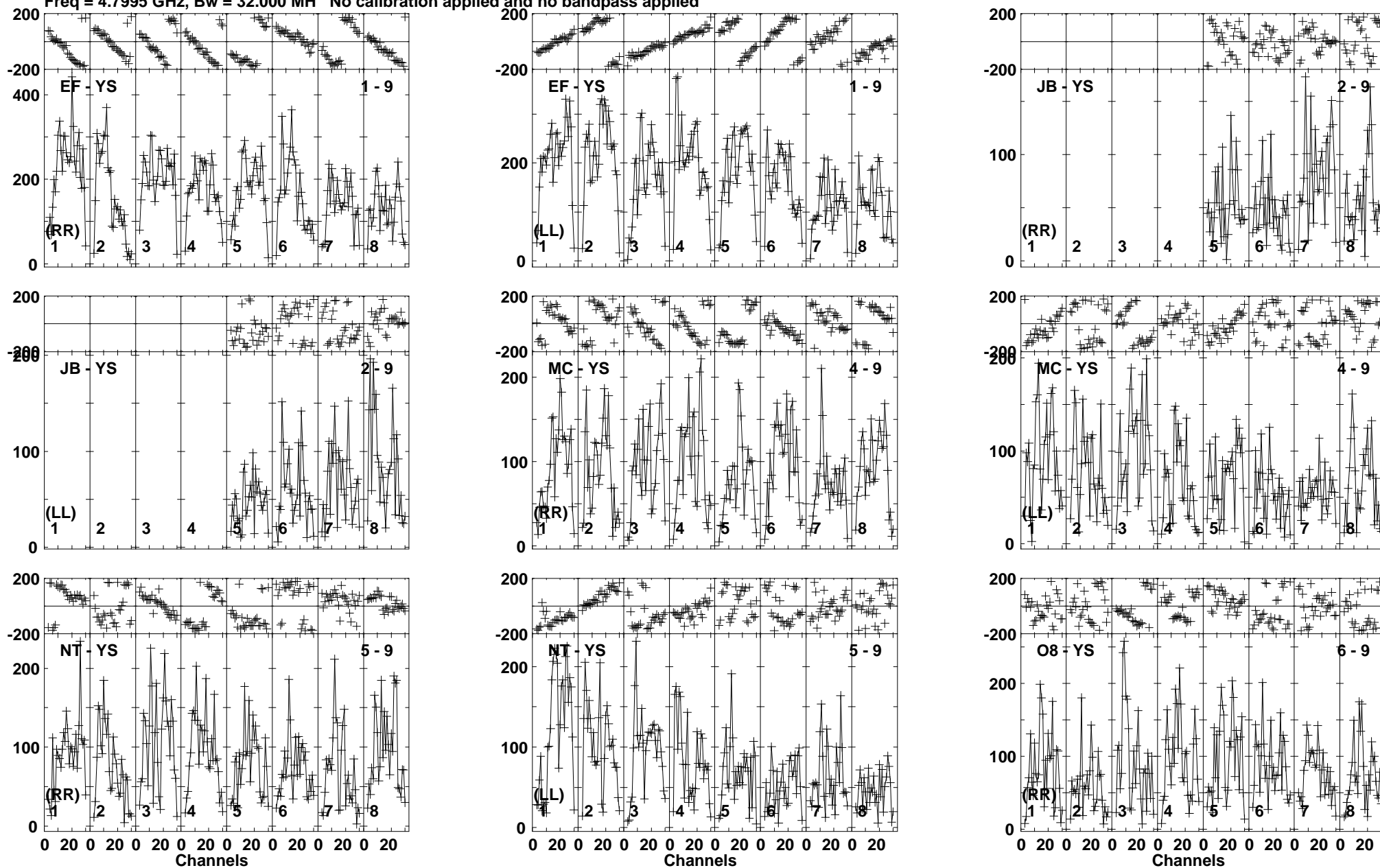

Lower frame: Micro Ampl Jy Top frame: Phas deg
Vector averaged cross-power spectrum Baseline: EF (01) - YS (09)
Timerange: 00/14:29:31 to 00/14:32:59

Plot file version 16 created 20-APR-2018 10:31:35
 B0915+068 EG102C.UVDATA.1
 Freq = 4.7995 GHz, Bw = 32.000 MH No calibration applied and no bandpass applied

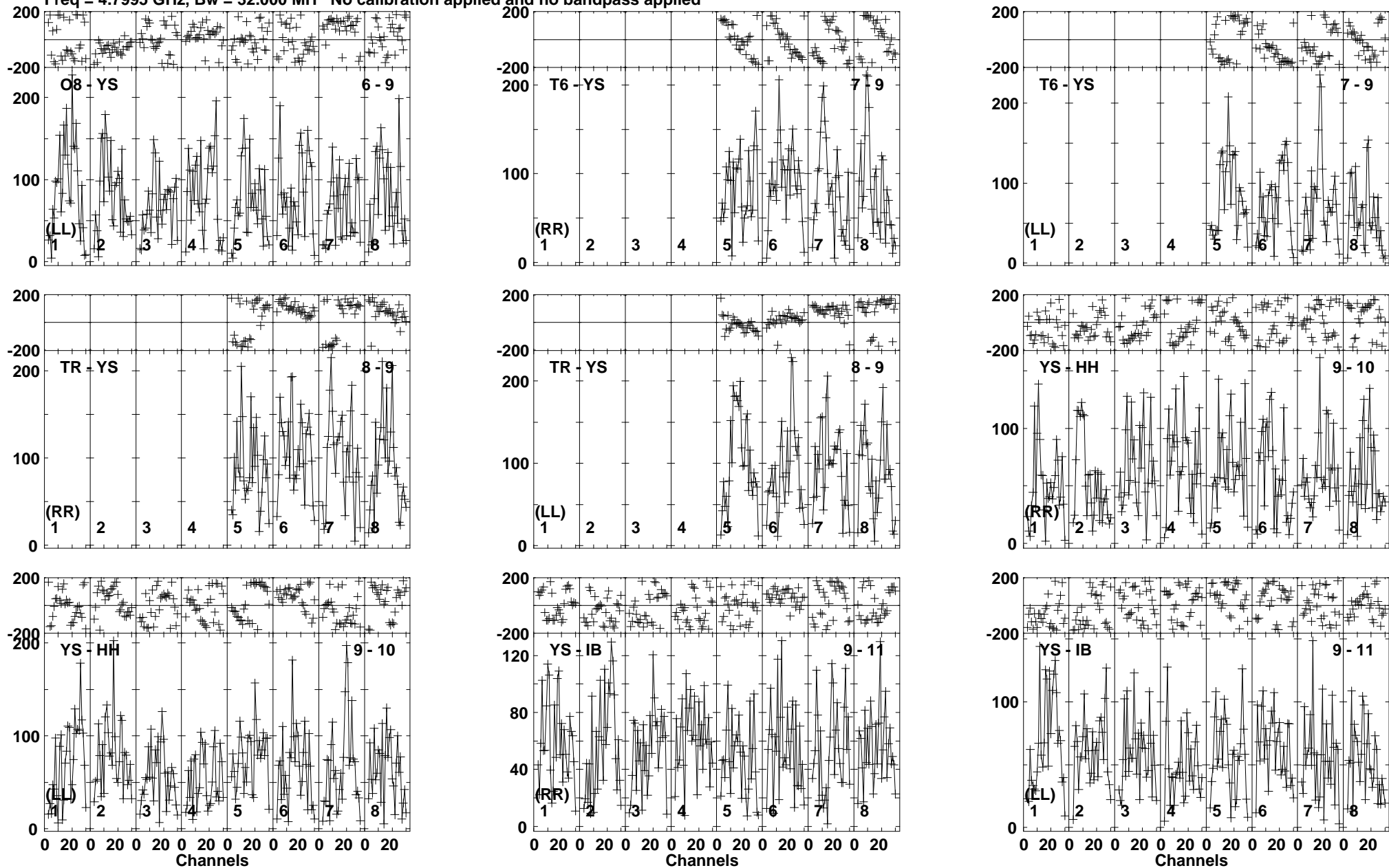

Lower frame: Micro Ampl Jy Top frame: Phas deg
 Vector averaged cross-power spectrum Baseline: O8 (06) - YS (09)
 Timerange: 00/14:29:31 to 00/14:32:59

Plot file version 17 created 20-APR-2018 10:31:35

J0915+0745 EG102C.UVDATA.1

Freq = 4.7995 GHz, Bw = 32.000 MH No calibration applied and no bandpass applied

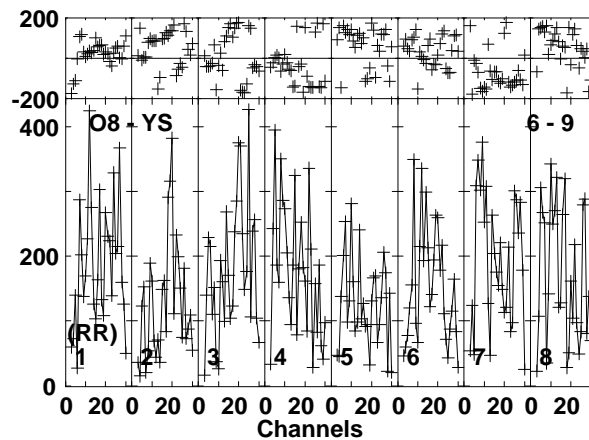
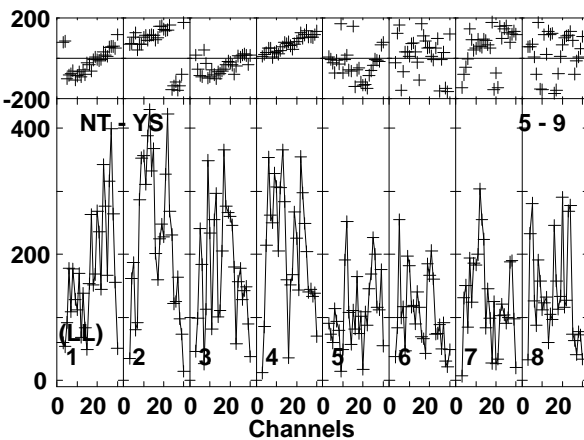
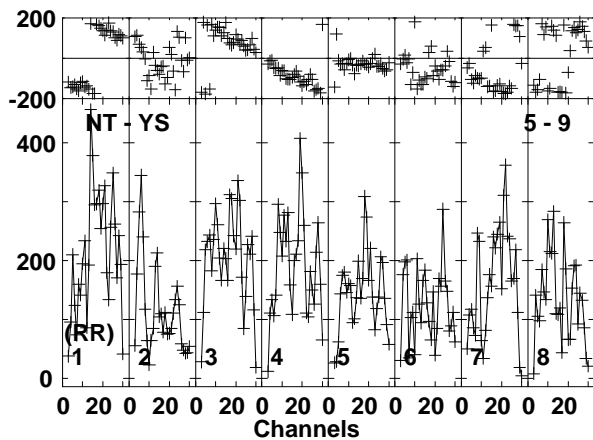
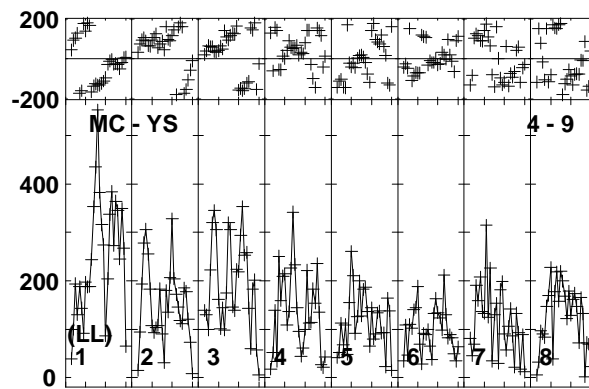
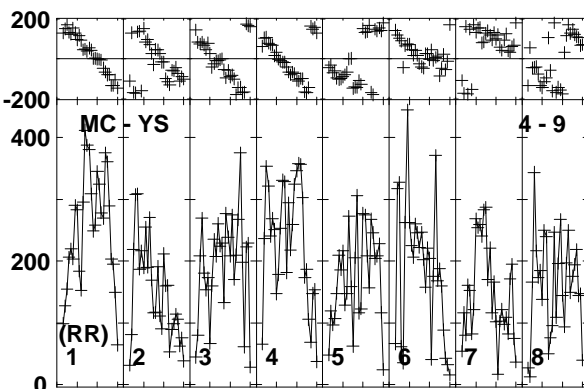
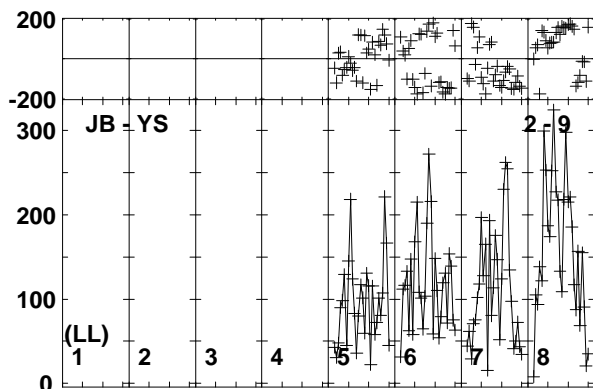
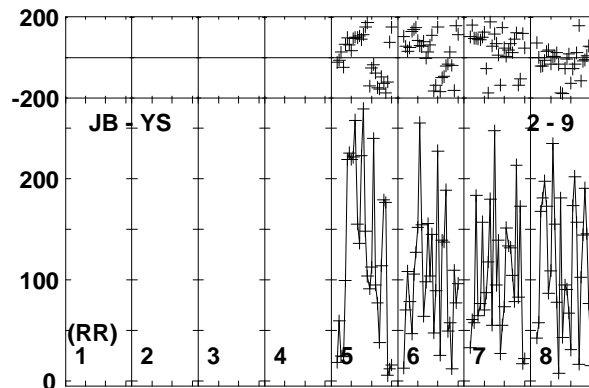
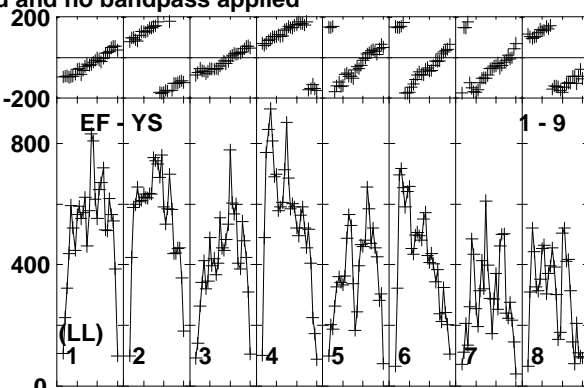
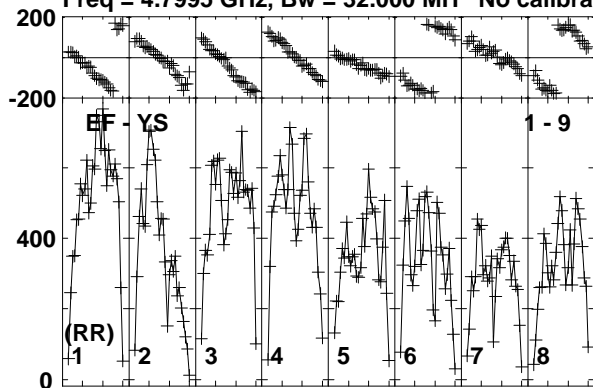

Lower frame: Micro Ampl Jy Top frame: Phas deg
Vector averaged cross-power spectrum Baseline: EF (01) - YS (09)
Timerange: 00/14:33:41 to 00/14:34:39

Plot file version 18 created 20-APR-2018 10:31:36

J0915+0745 EG102C.UVDATA.1

Freq = 4.7995 GHz, Bw = 32.000 MH No calibration applied and no bandpass applied

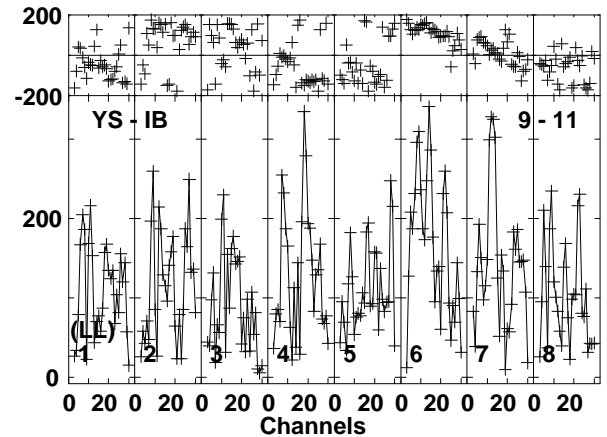
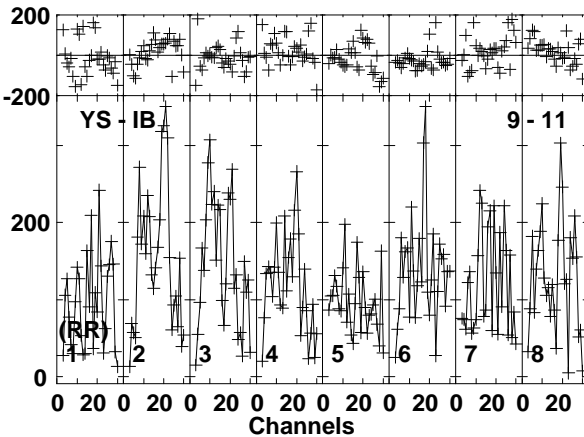
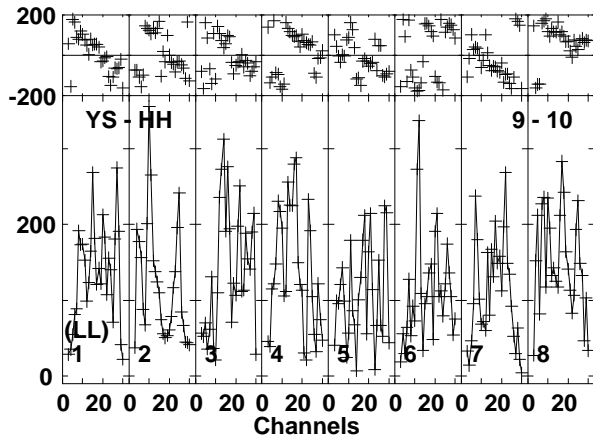
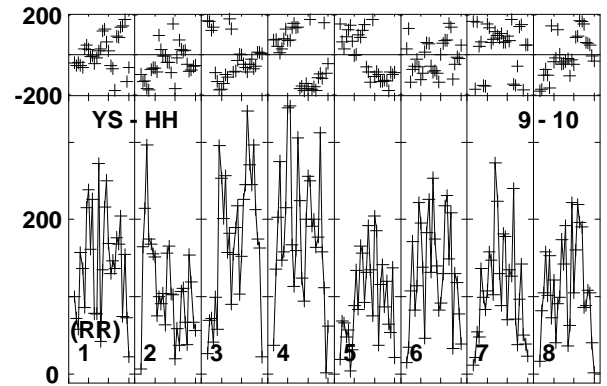
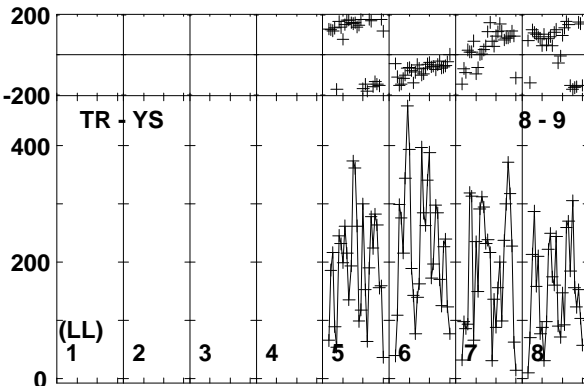
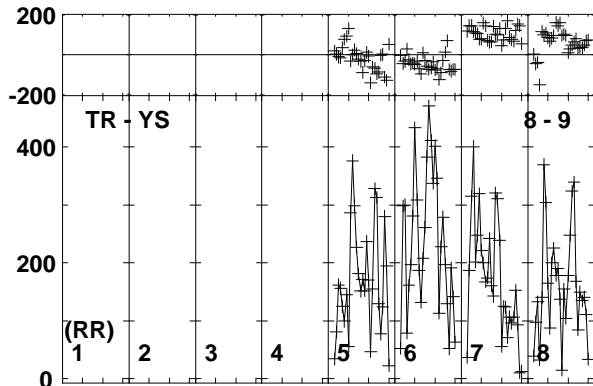
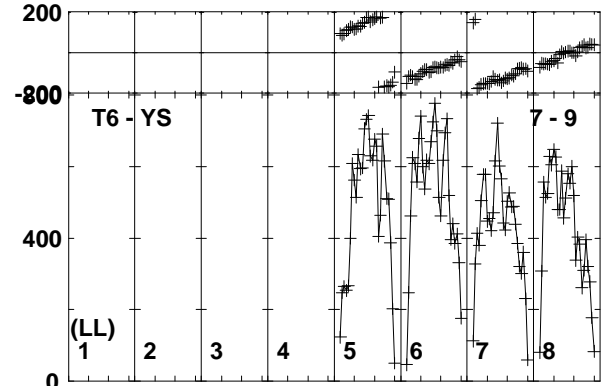
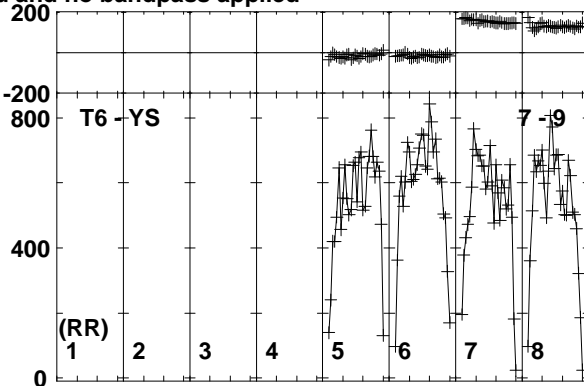
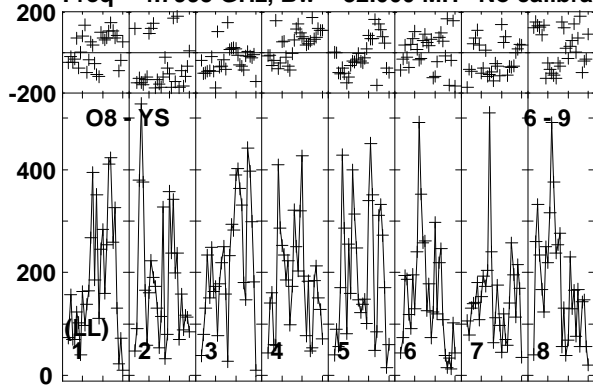

Lower frame: Micro Ampl Jy Top frame: Phas deg
Vector averaged cross-power spectrum Baseline: O8 (06) - YS (09)
Timerange: 00/14:33:41 to 00/14:34:39

Plot file version 19 created 20-APR-2018 10:31:36

B0915+068 EG102C.UVDATA.1

Freq = 4.7995 GHz, Bw = 32.000 MH No calibration applied and no bandpass applied

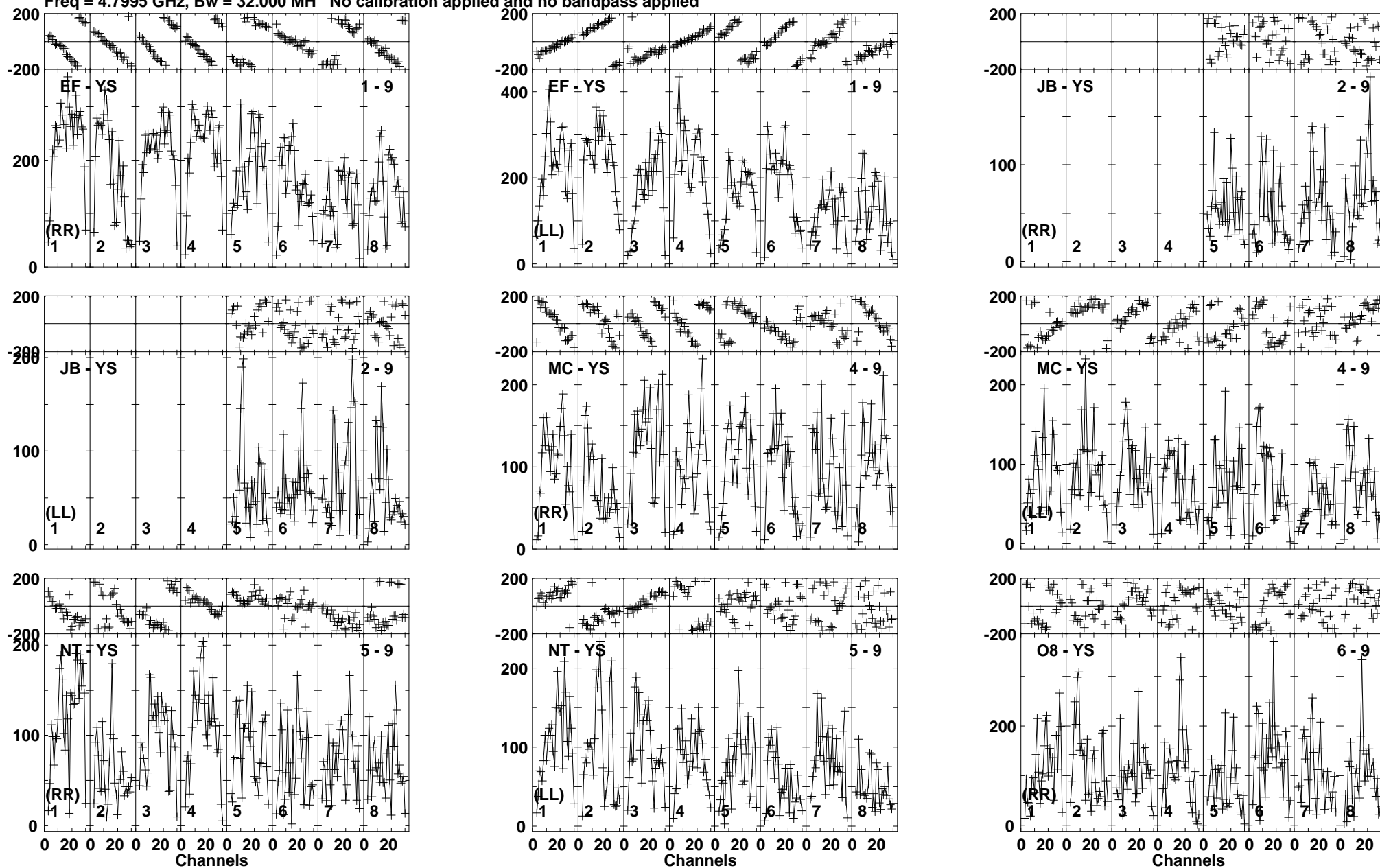

Lower frame: Micro Ampl Jy Top frame: Phas deg
Vector averaged cross-power spectrum Baseline: EF (01) - YS (09)
Timerange: 00/14:34:41 to 00/14:38:09

Plot file version 20 created 20-APR-2018 10:31:36

B0915+068 EG102C.UVDATA.1

Freq = 4.7995 GHz, Bw = 32.000 MH No calibration applied and no bandpass applied

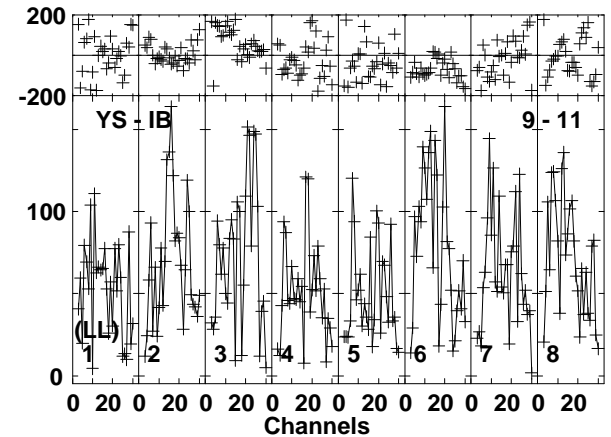
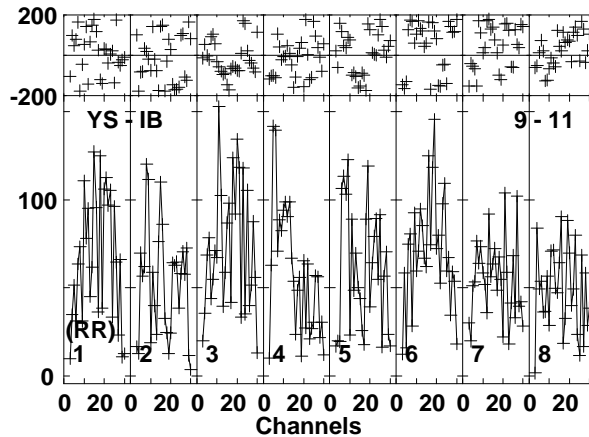
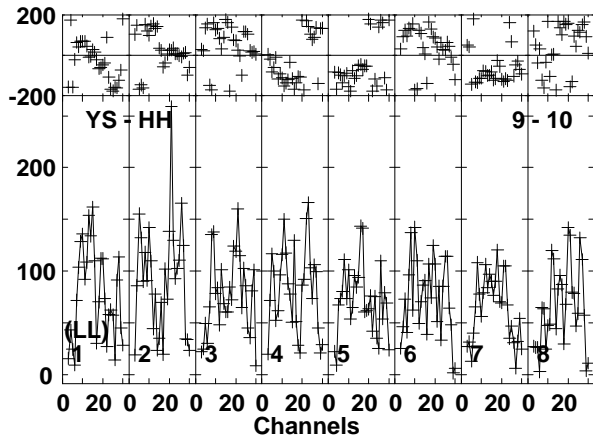
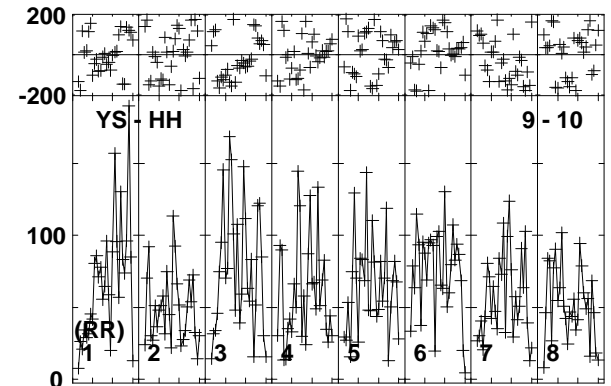
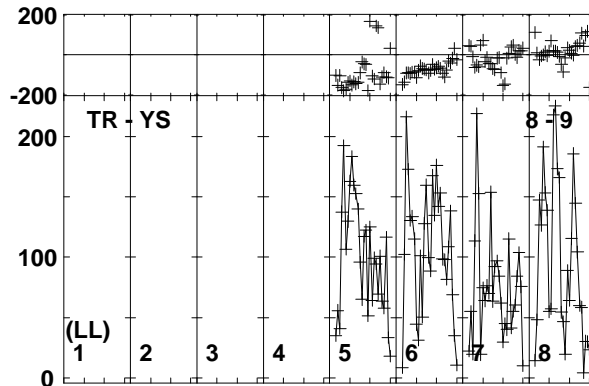
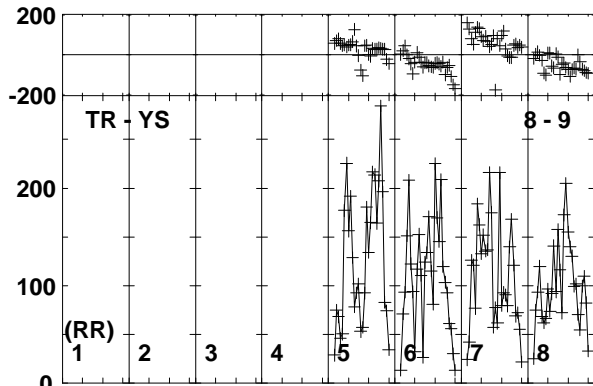
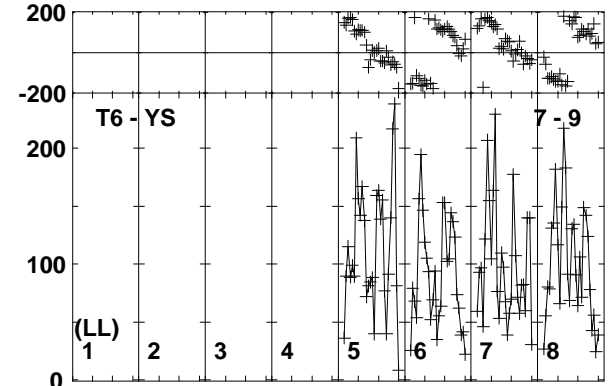
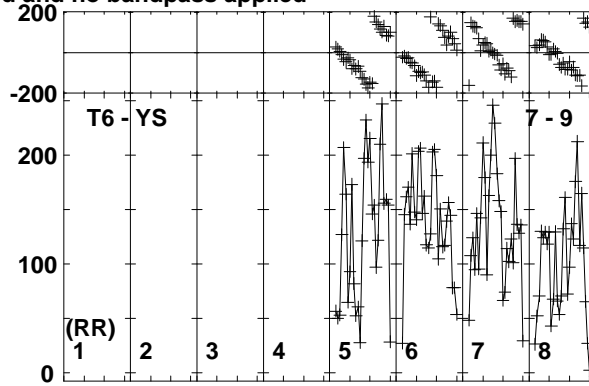
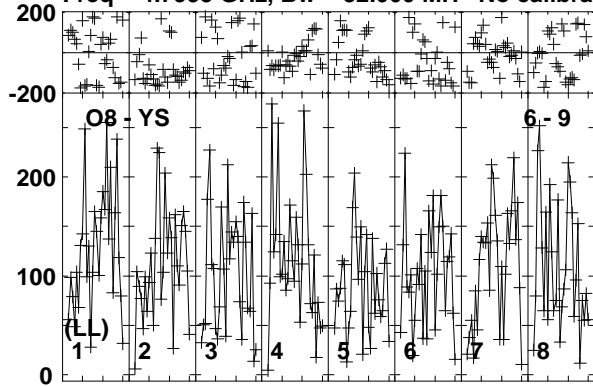

Lower frame: Micro Ampl Jy Top frame: Phas deg
Vector averaged cross-power spectrum Baseline: O8 (06) - YS (09)
Timerange: 00/14:34:41 to 00/14:38:09

Plot file version 21 created 20-APR-2018 10:31:36

J0915+0745 EG102C.UVDATA.1

Freq = 4.7995 GHz, Bw = 32.000 MH No calibration applied and no bandpass applied

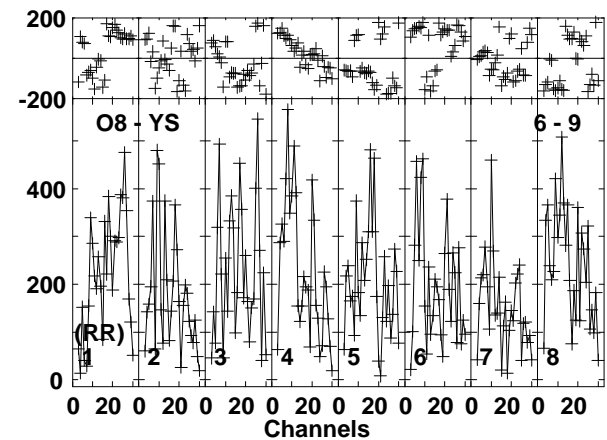
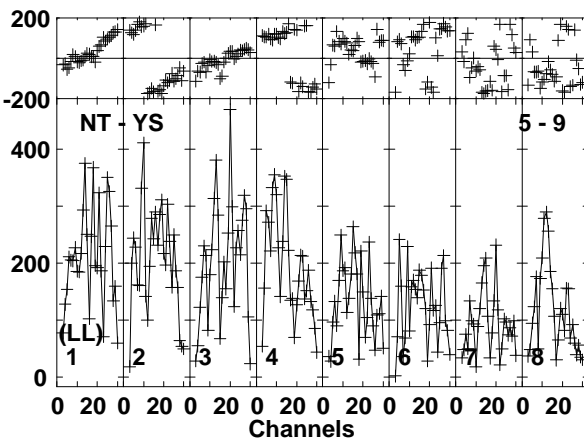
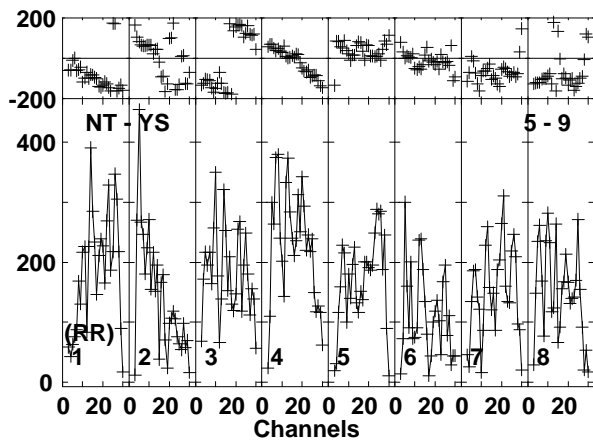
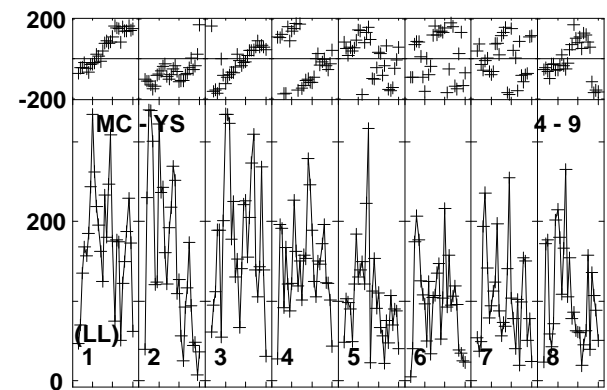
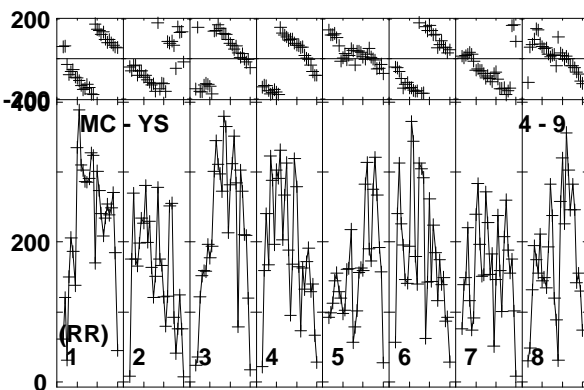
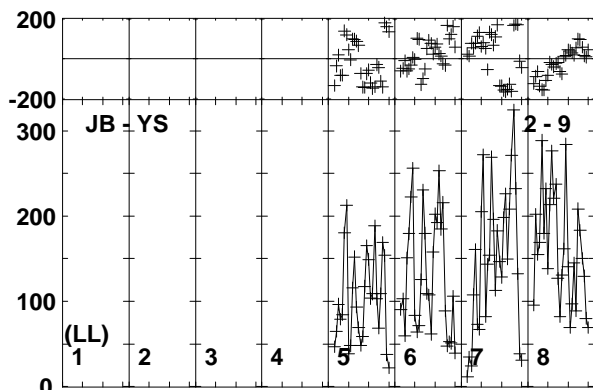
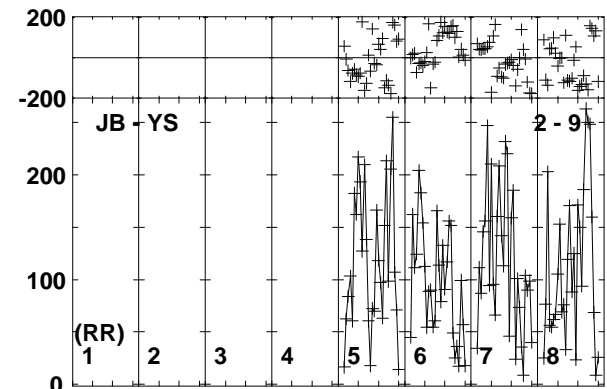
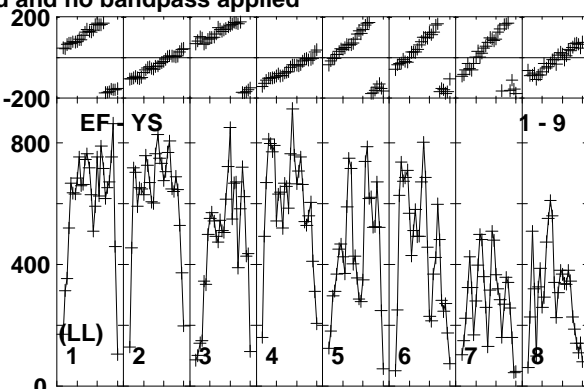
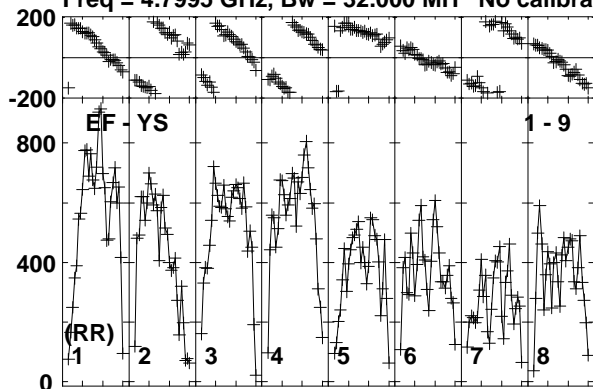

Lower frame: Micro Ampl Jy Top frame: Phas deg
Vector averaged cross-power spectrum Baseline: EF (01) - YS (09)
Timerange: 00/14:38:11 to 00/14:39:39

Plot file version 22 created 20-APR-2018 10:31:36

J0915+0745 EG102C.UVDATA.1

Freq = 4.7995 GHz, Bw = 32.000 MH No calibration applied and no bandpass applied

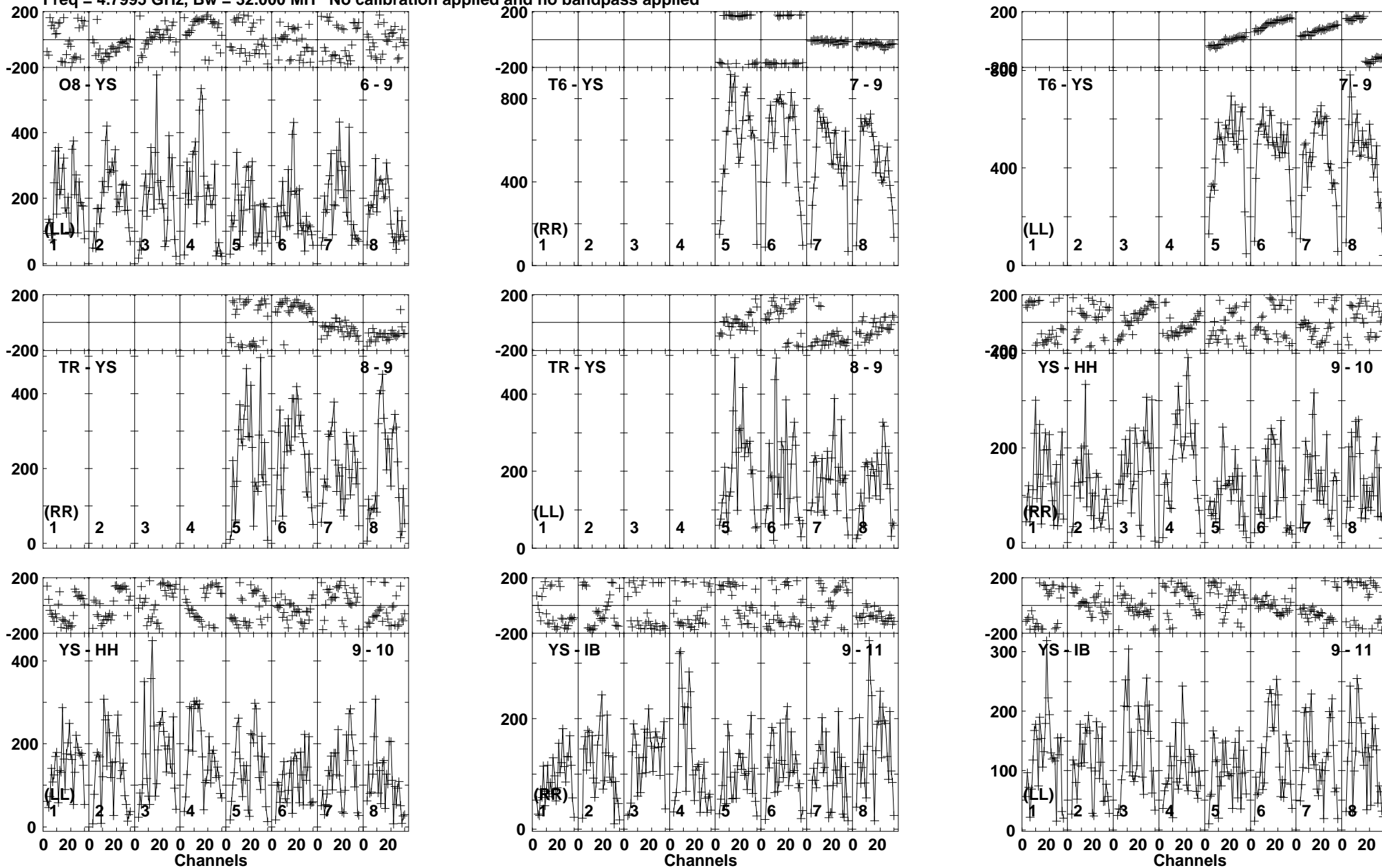

Lower frame: Micro Ampl Jy Top frame: Phas deg
Vector averaged cross-power spectrum Baseline: O8 (06) - YS (09)
Timerange: 00/14:38:11 to 00/14:39:39

Plot file version 23 created 20-APR-2018 10:31:36

B0915+068 EG102C.UVDATA.1

Freq = 4.7995 GHz, Bw = 32.000 MH No calibration applied and no bandpass applied

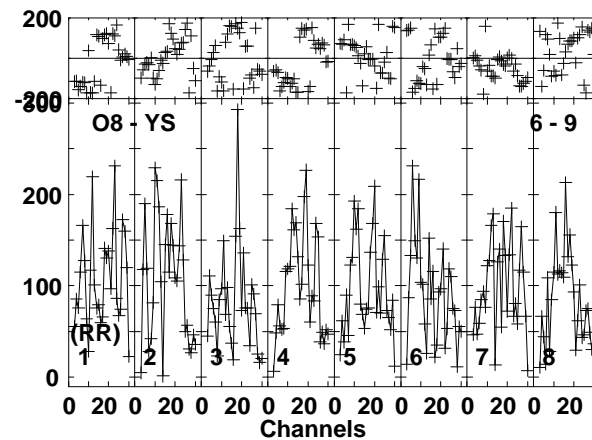
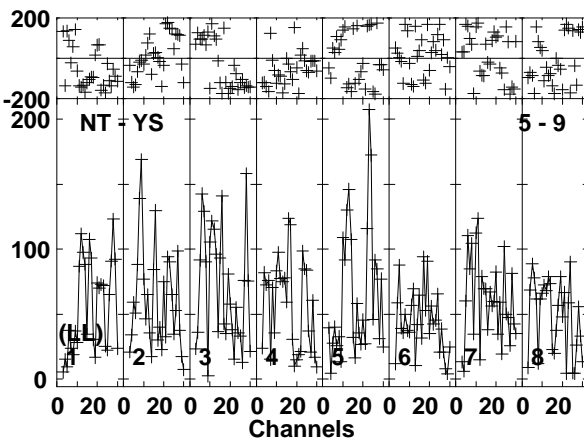
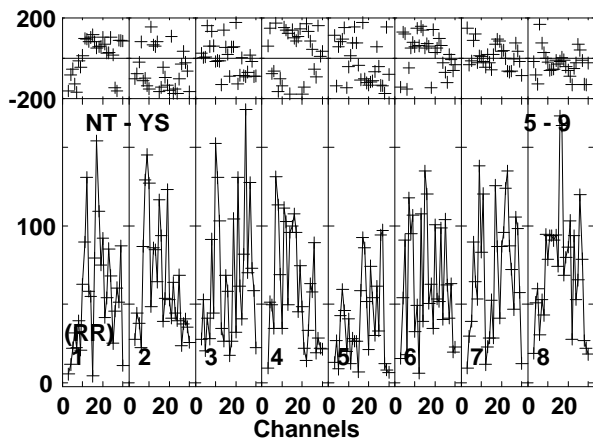
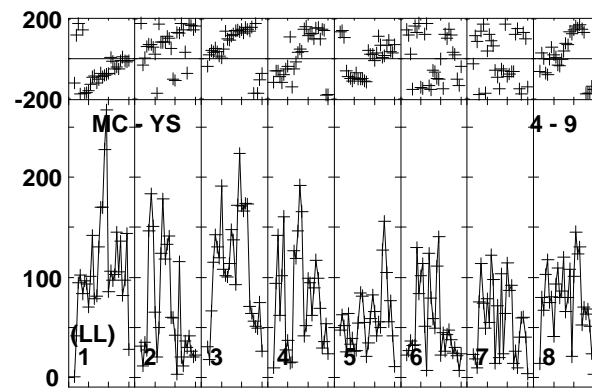
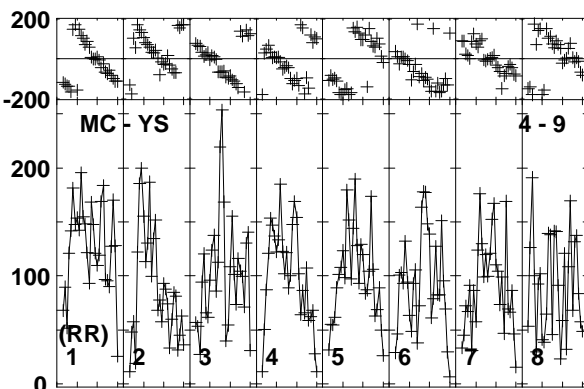
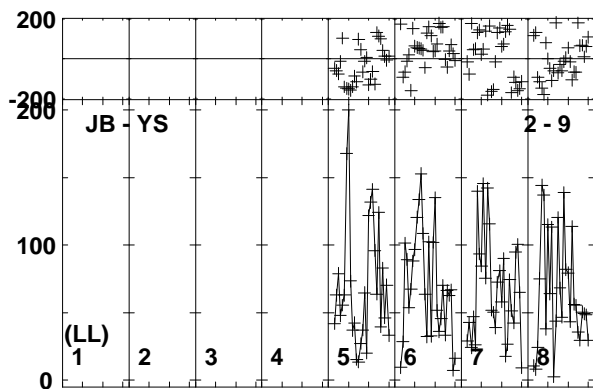
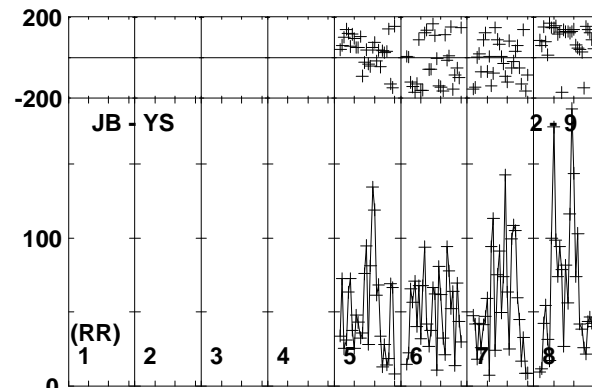
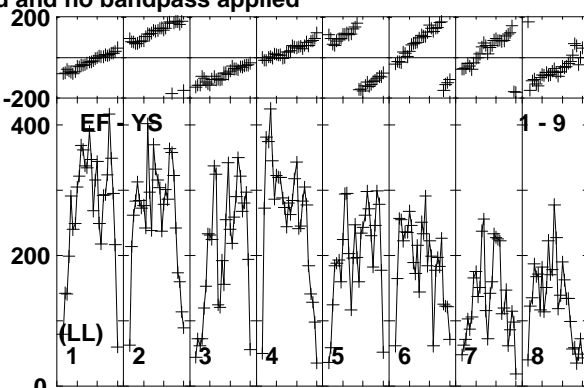
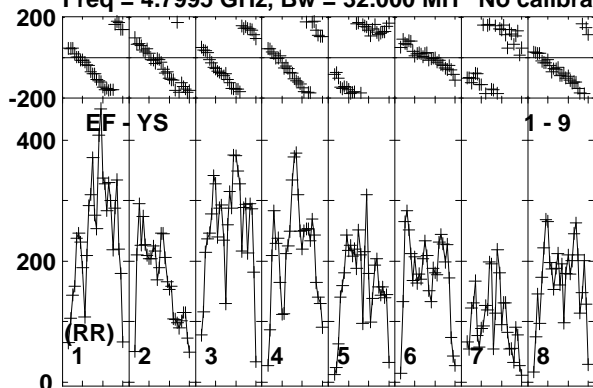

Lower frame: Micro Ampl Jy Top frame: Phas deg
Vector averaged cross-power spectrum Baseline: EF (01) - YS (09)
Timerange: 00/14:39:41 to 00/14:43:09

Plot file version 24 created 20-APR-2018 10:31:36

B0915+068 EG102C.UVDATA.1

Freq = 4.7995 GHz, Bw = 32.000 MH No calibration applied and no bandpass applied

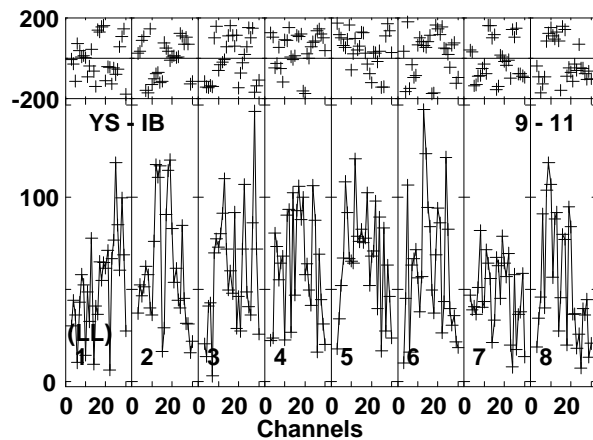
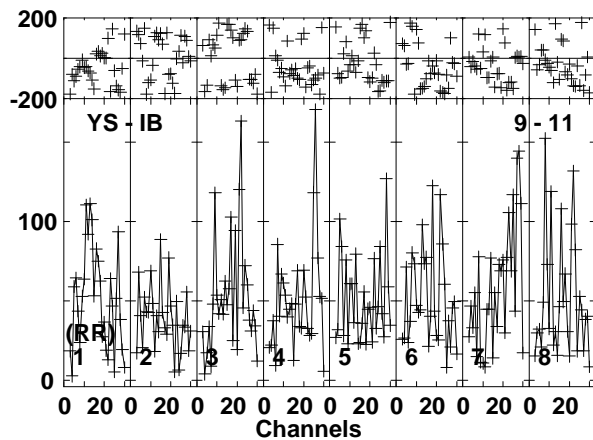
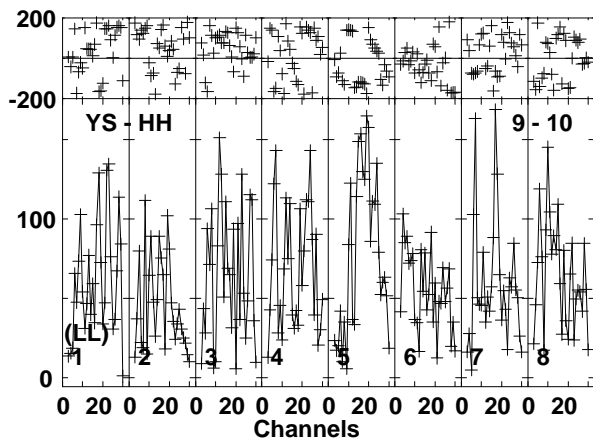
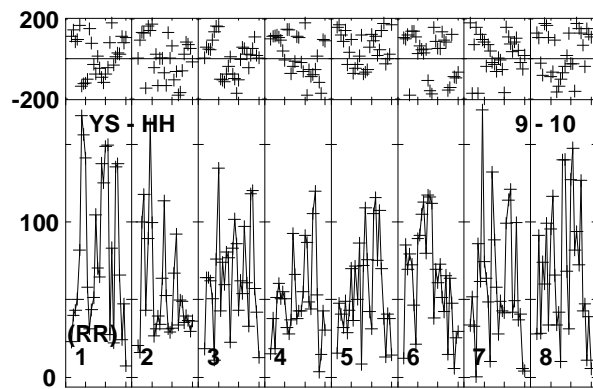
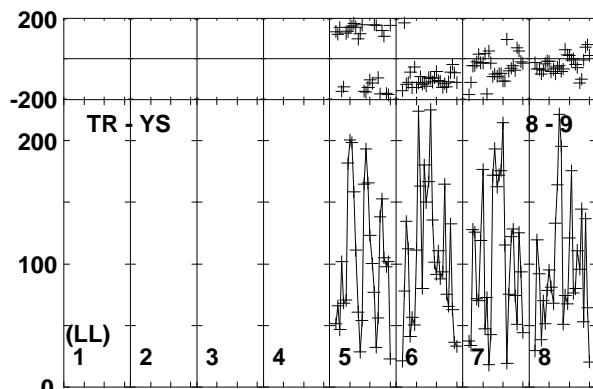
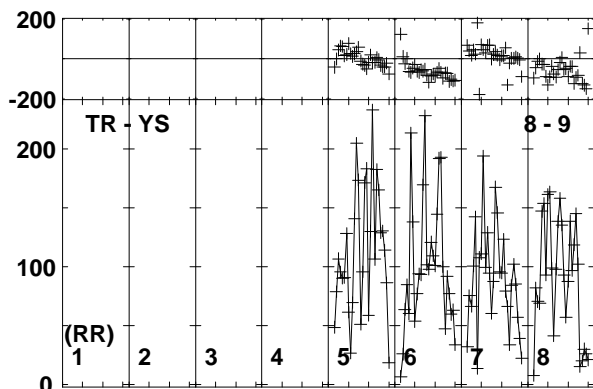
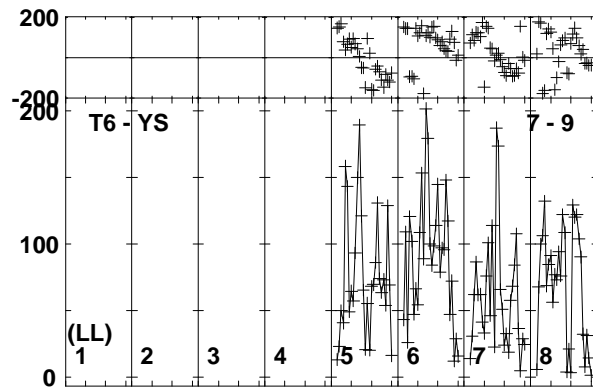
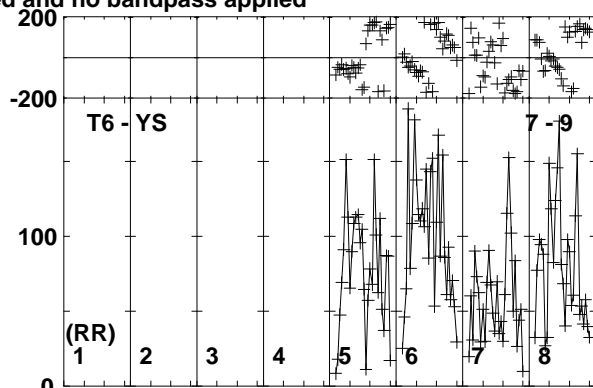
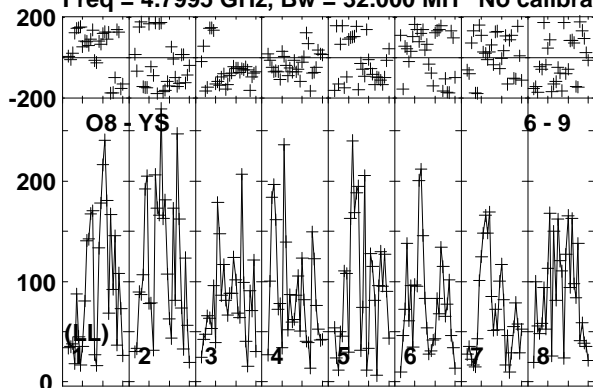

Lower frame: Micro Ampl Jy Top frame: Phas deg
Vector averaged cross-power spectrum Baseline: O8 (06) - YS (09)
Timerange: 00/14:39:41 to 00/14:43:09

Plot file version 25 created 20-APR-2018 10:31:36

J0915+0745 EG102C.UVDATA.1

Freq = 4.7995 GHz, Bw = 32.000 MH No calibration applied and no bandpass applied

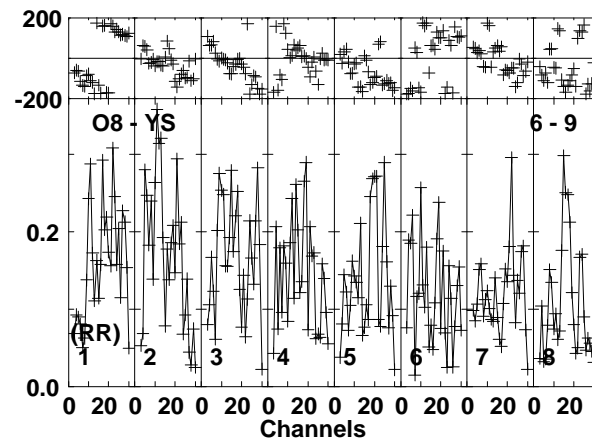
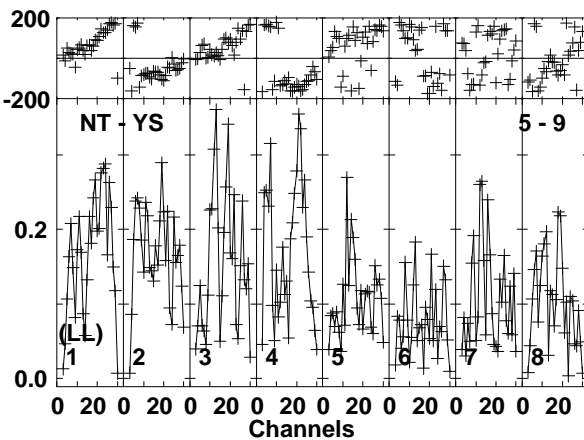
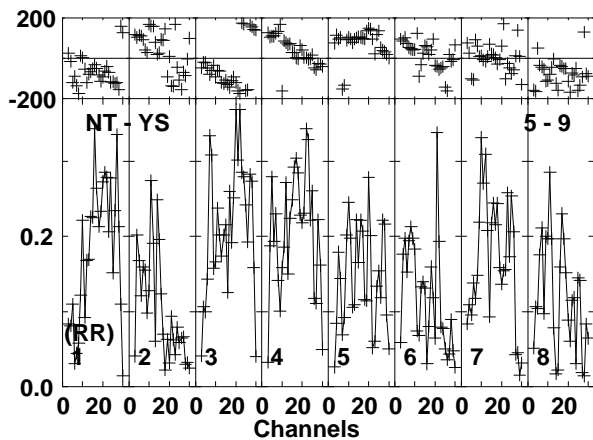
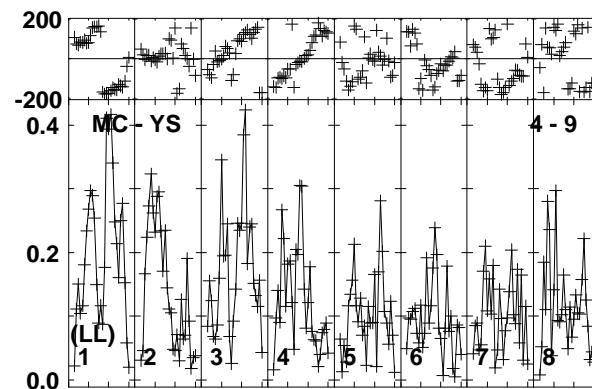
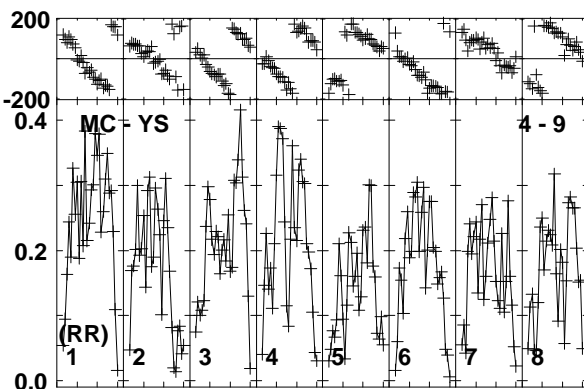
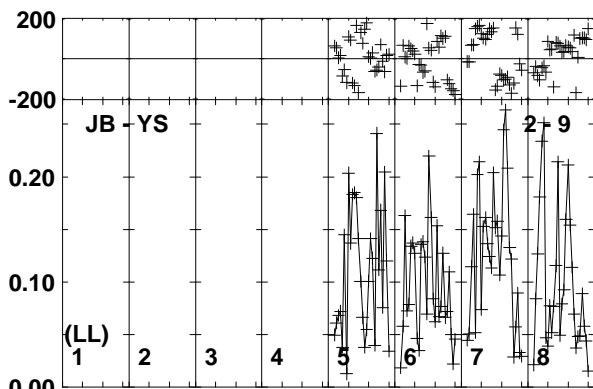
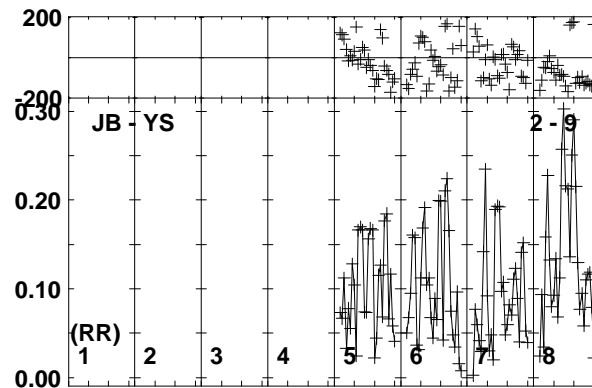
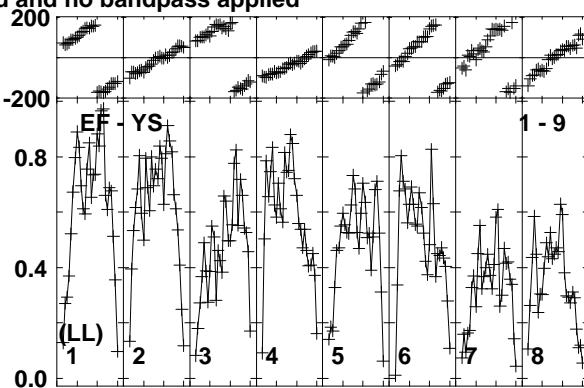
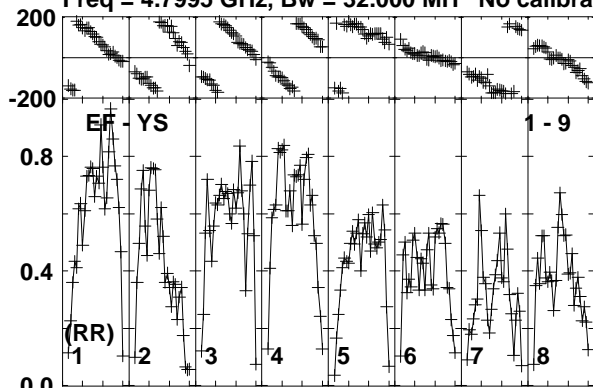

Lower frame: Milli Ampl Jy Top frame: Phas deg
Vector averaged cross-power spectrum Baseline: EF (01) - YS (09)
Timerange: 00/14:43:11 to 00/14:44:39

Plot file version 26 created 20-APR-2018 10:31:36

J0915+0745 EG102C.UVDATA.1

Freq = 4.7995 GHz, Bw = 32.000 MH No calibration applied and no bandpass applied

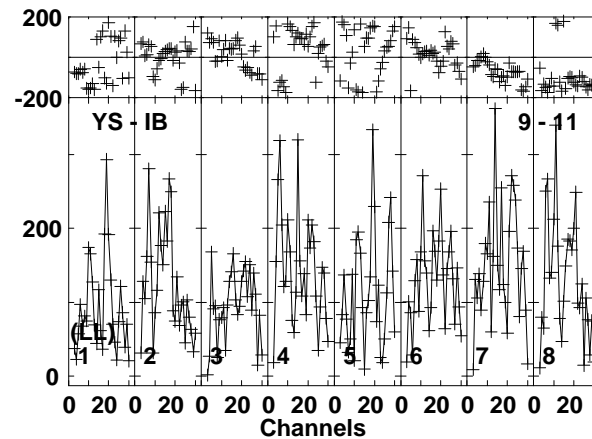
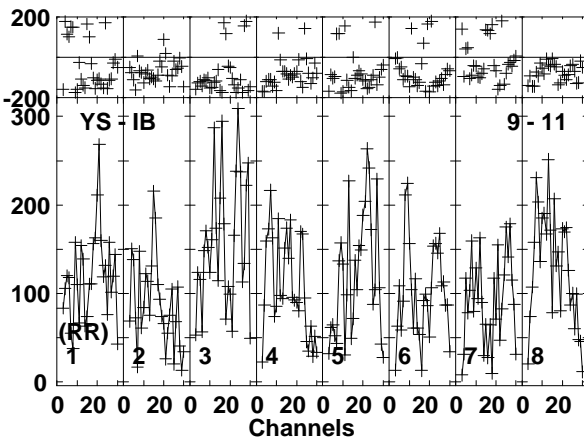
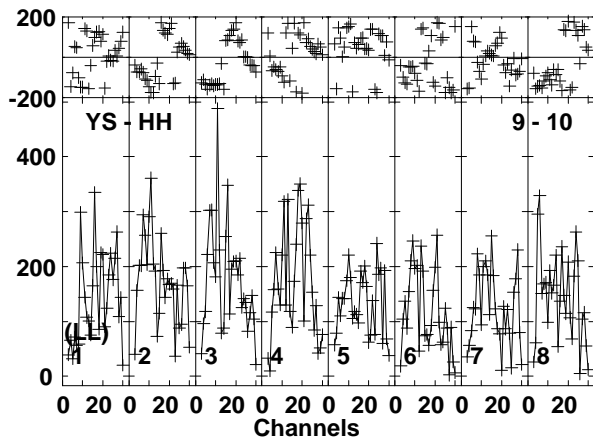
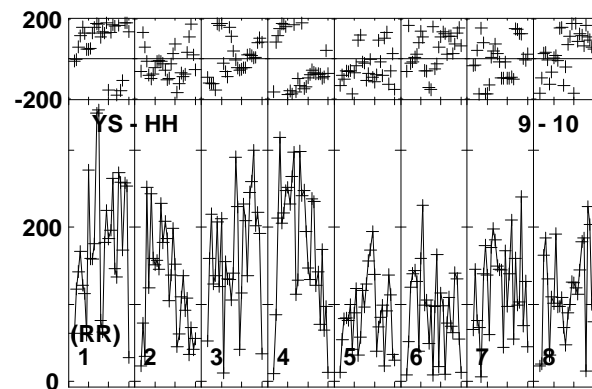
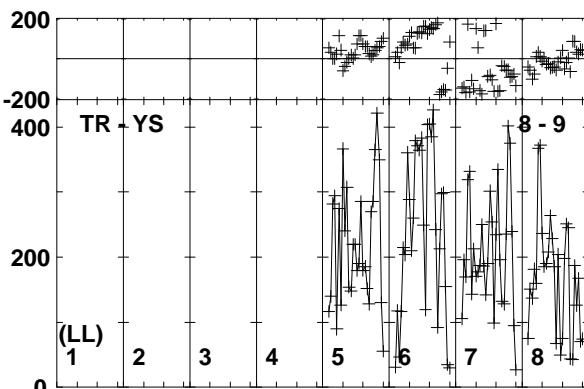
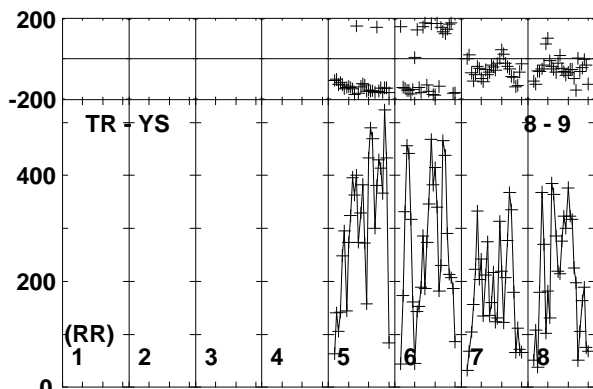
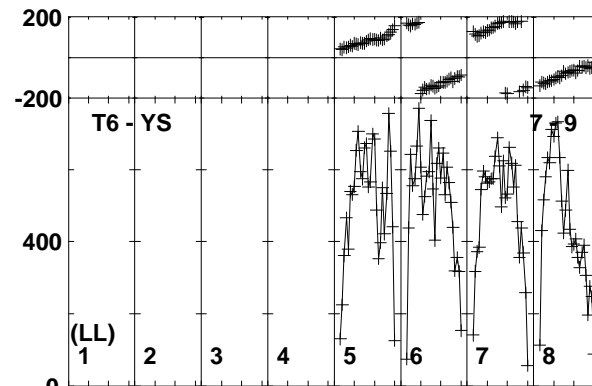
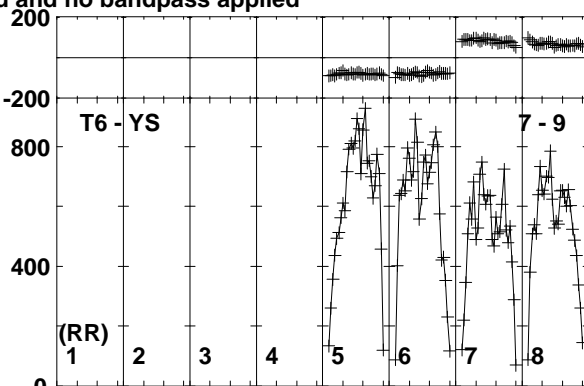
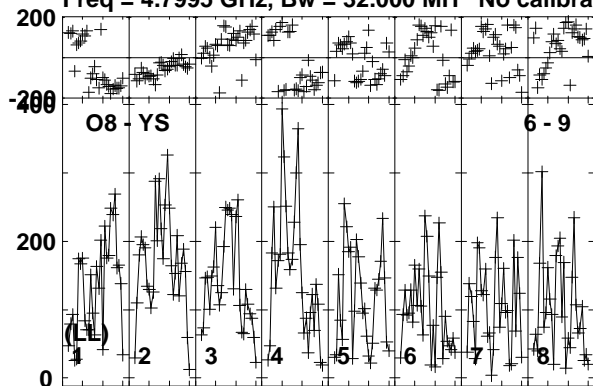

Lower frame: Micro Ampl Jy Top frame: Phas deg
Vector averaged cross-power spectrum Baseline: O8 (06) - YS (09)
Timerange: 00/14:43:11 to 00/14:44:39

Plot file version 27 created 20-APR-2018 10:31:36

B0915+068 EG102C.UVDATA.1

Freq = 4.7995 GHz, Bw = 32.000 MH No calibration applied and no bandpass applied

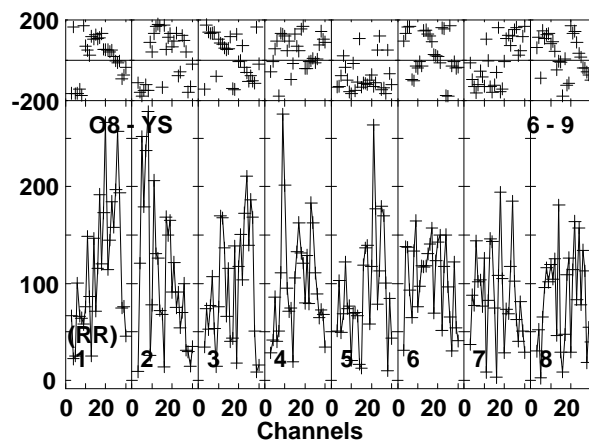
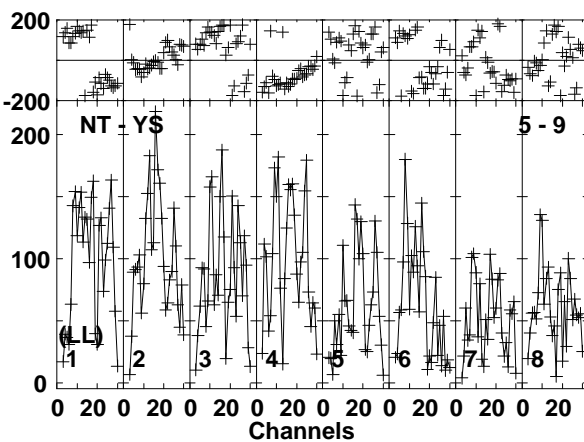
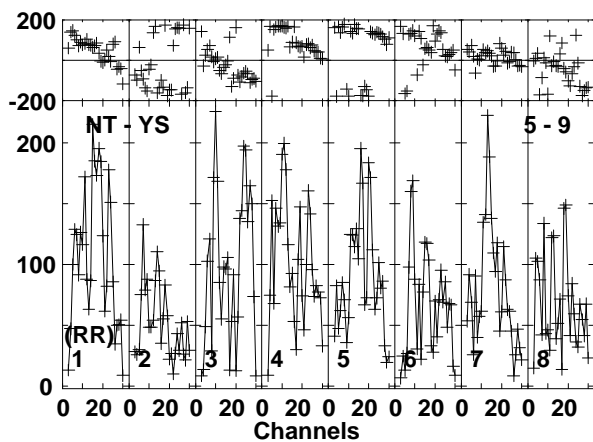
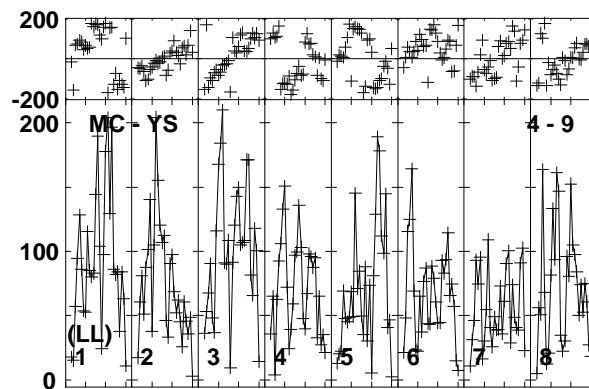
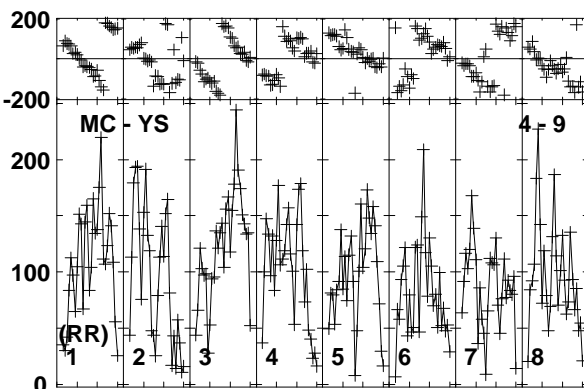
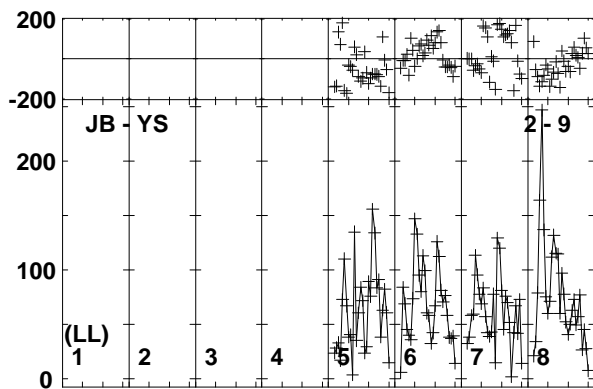
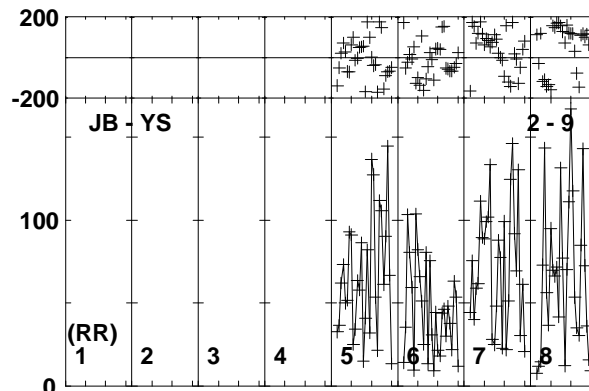
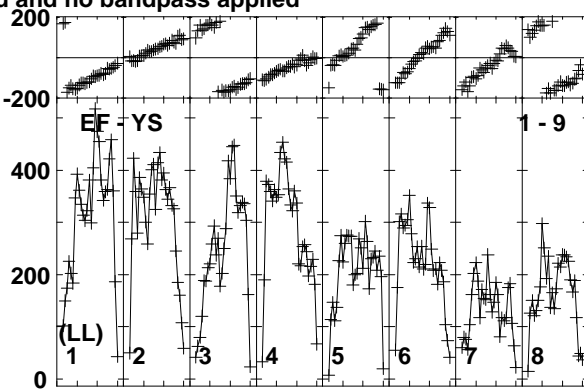
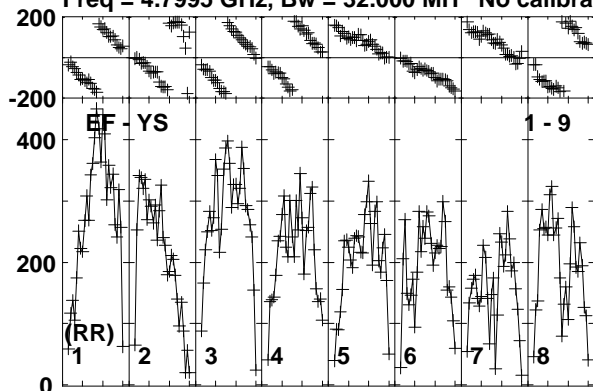

Lower frame: Micro Ampl Jy Top frame: Phas deg
Vector averaged cross-power spectrum Baseline: EF (01) - YS (09)
Timerange: 00/14:44:41 to 00/14:48:09

Plot file version 28 created 20-APR-2018 10:31:36

B0915+068 EG102C.UVDATA.1

Freq = 4.7995 GHz, Bw = 32.000 MH No calibration applied and no bandpass applied

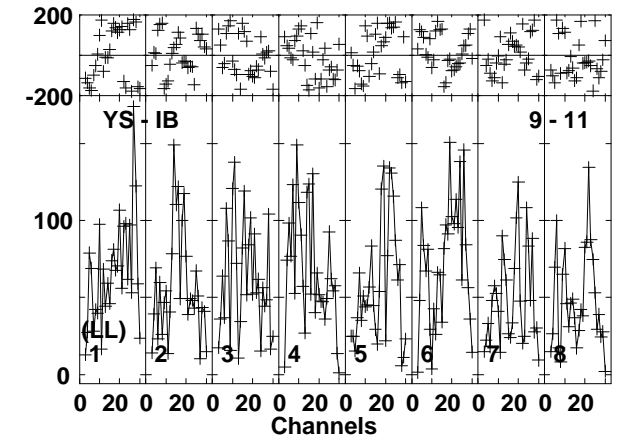
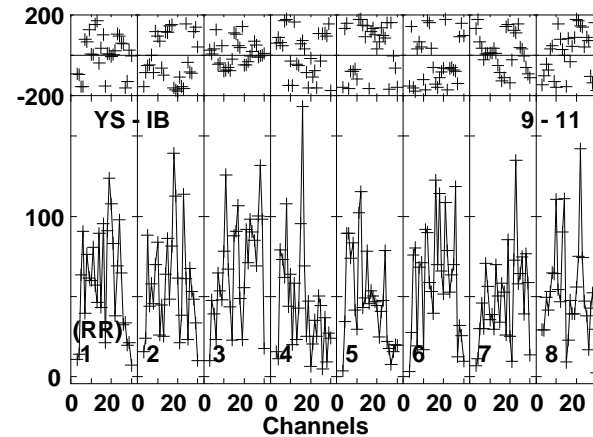
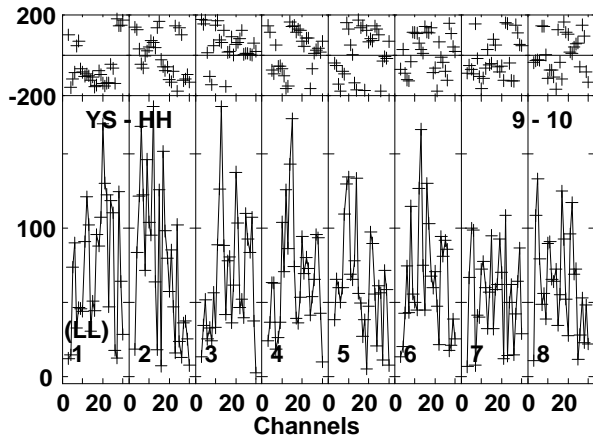
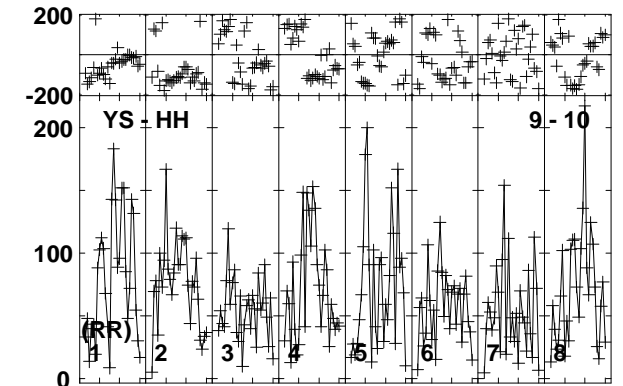
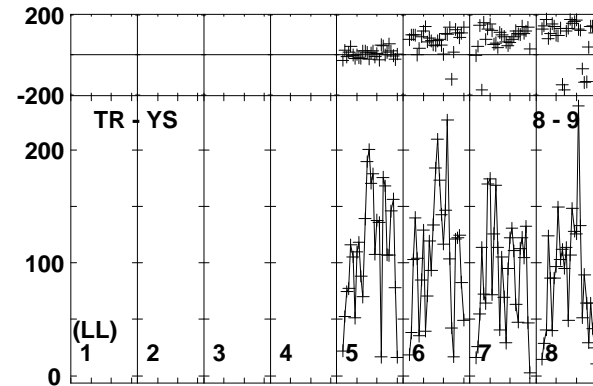
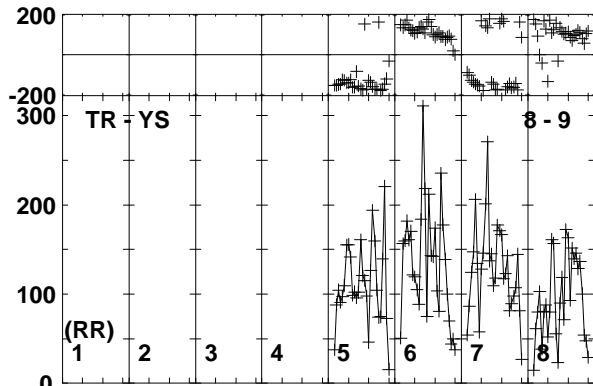
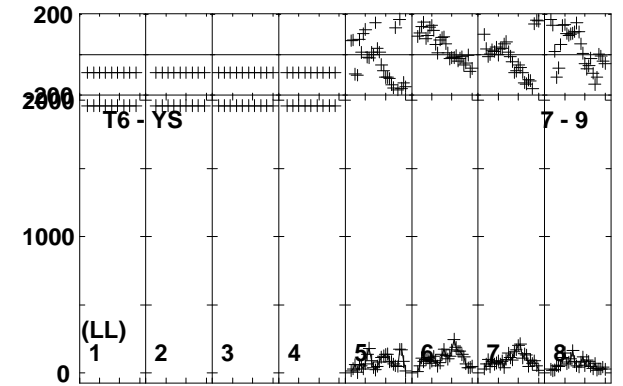
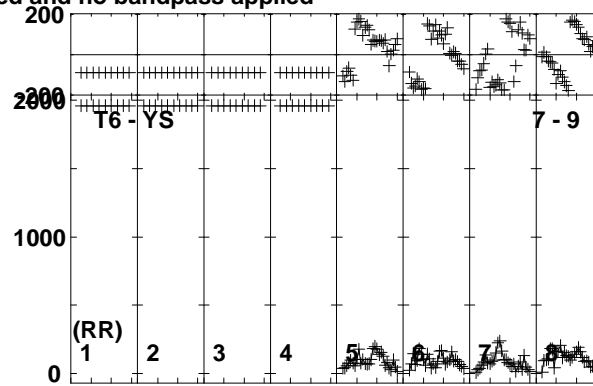
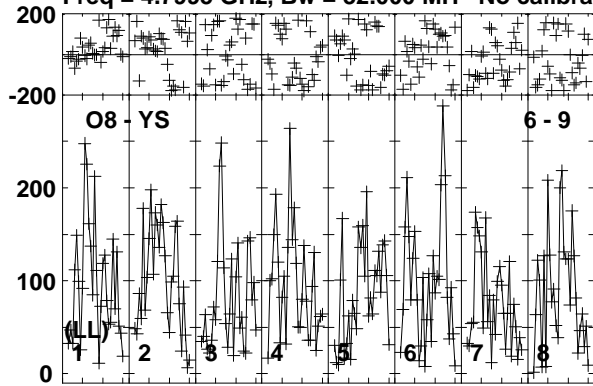

Lower frame: Micro Ampl Jy Top frame: Phas deg
Vector averaged cross-power spectrum Baseline: O8 (06) - YS (09)
Timerange: 00/14:44:41 to 00/14:48:09

Plot file version 29 created 20-APR-2018 10:31:37

J0915+0745 EG102C.UVDATA.1

Freq = 4.7995 GHz, Bw = 32.000 MH No calibration applied and no bandpass applied

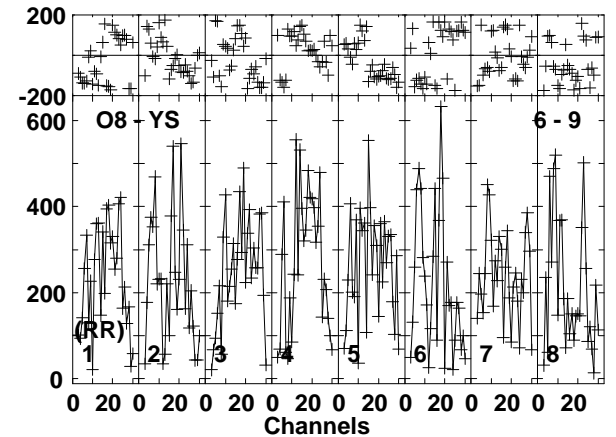
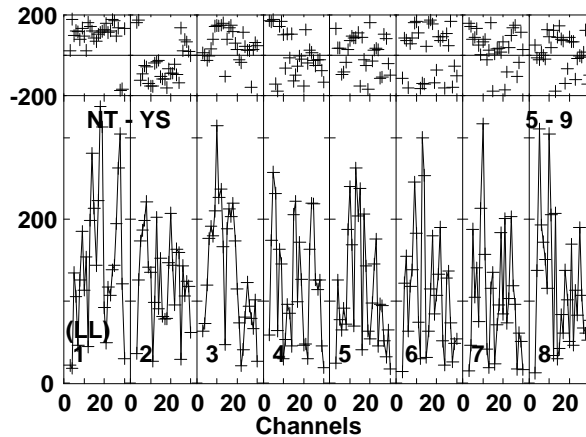
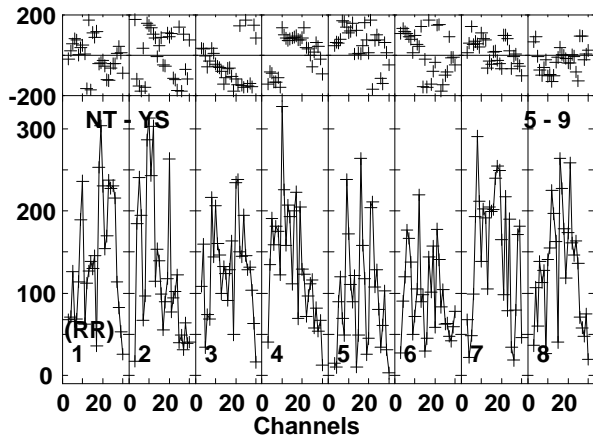
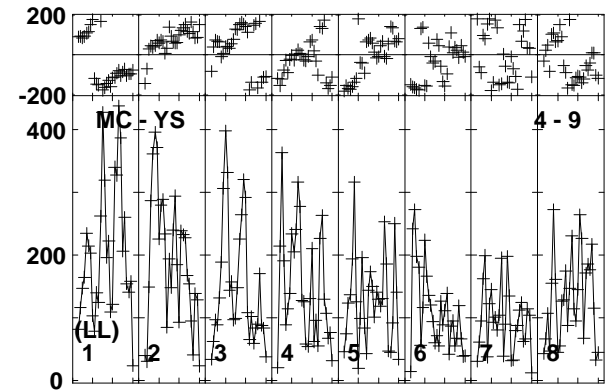
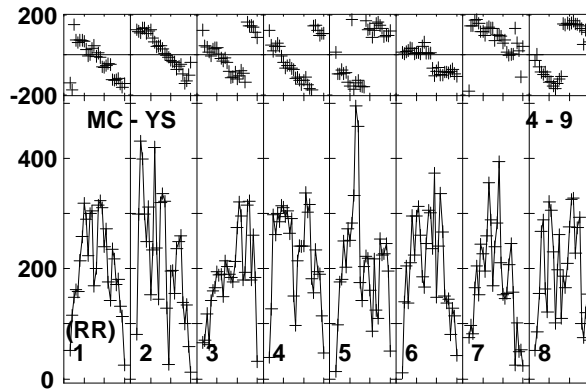
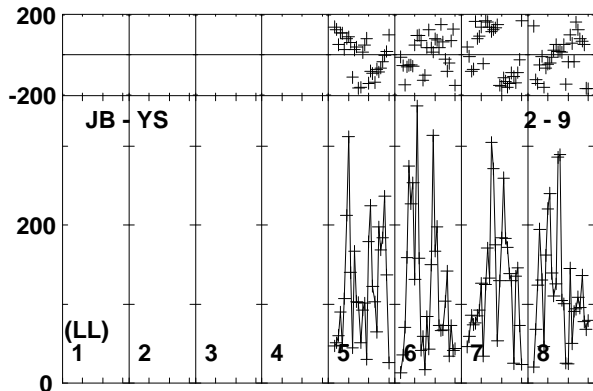
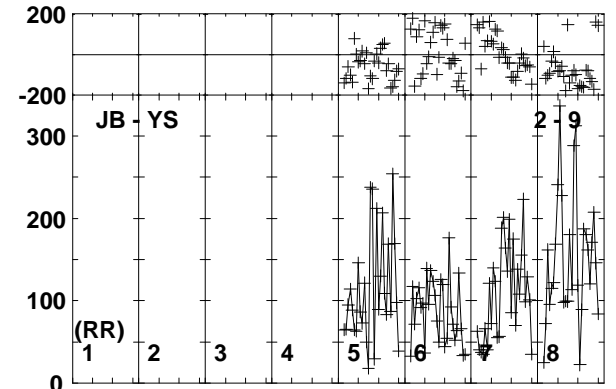
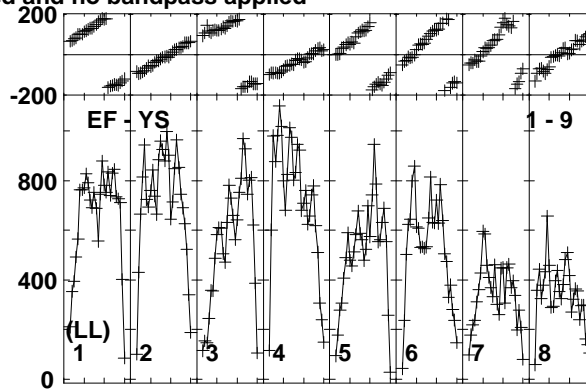
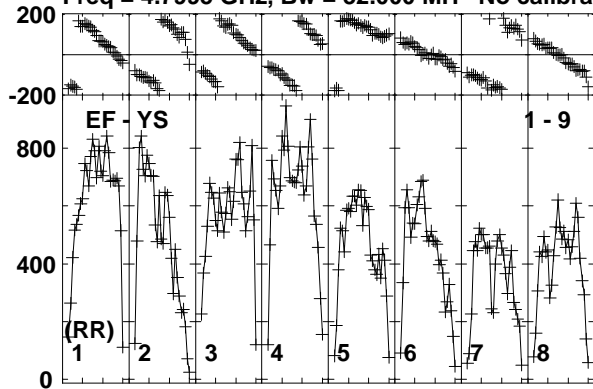

Lower frame: Micro Ampl Jy Top frame: Phas deg
Vector averaged cross-power spectrum Baseline: EF (01) - YS (09)
Timerange: 00/14:48:51 to 00/14:49:49

Plot file version 30 created 20-APR-2018 10:31:37

J0915+0745 EG102C.UVDATA.1

Freq = 4.7995 GHz, Bw = 32.000 MH No calibration applied and no bandpass applied

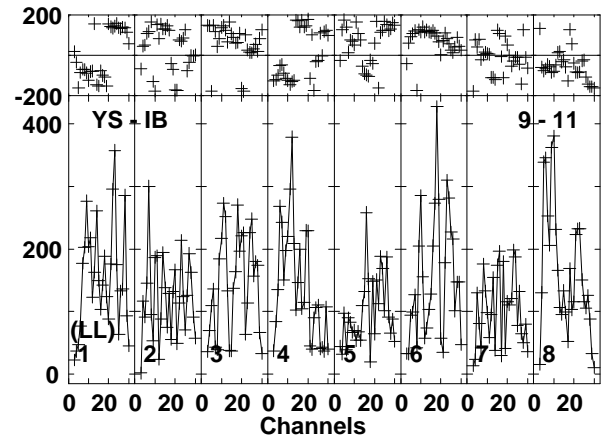
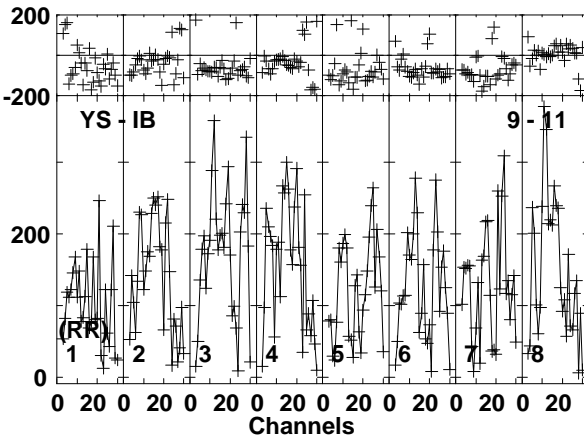
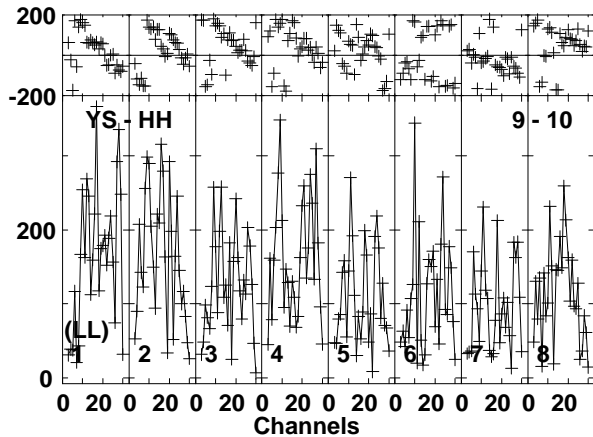
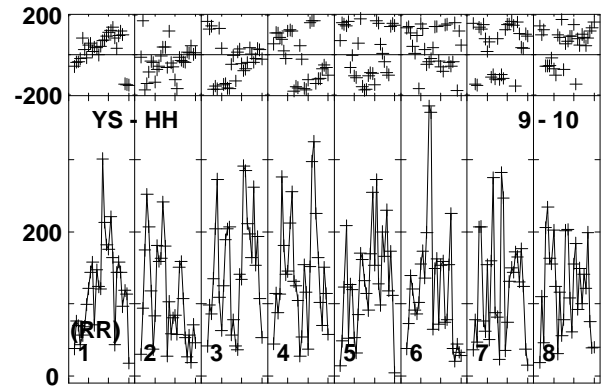
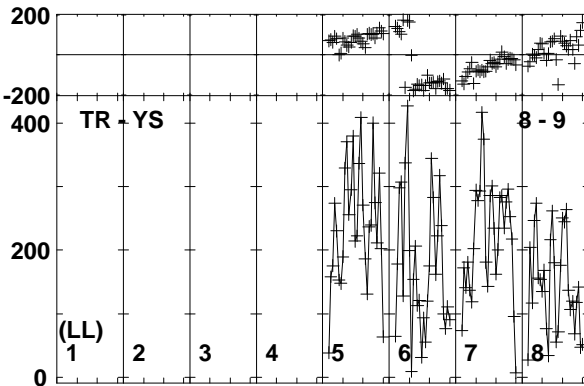
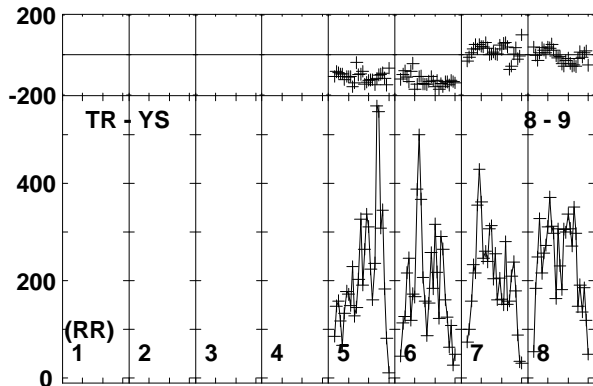
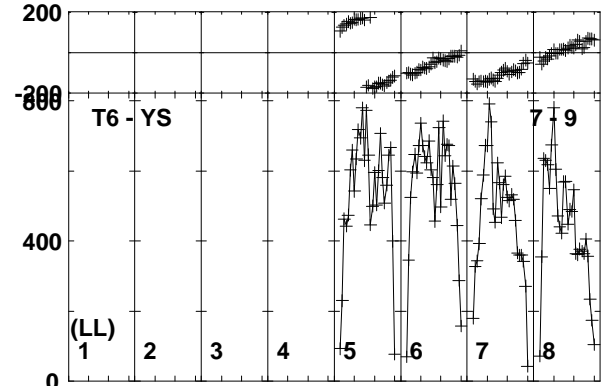
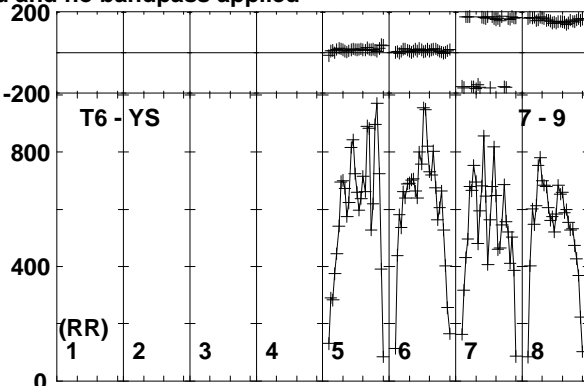
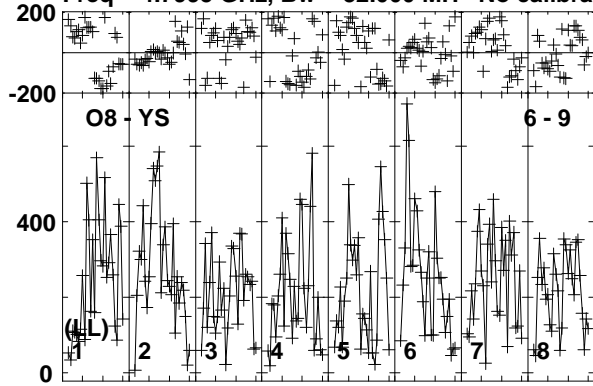

Lower frame: Micro Ampl Jy Top frame: Phas deg
Vector averaged cross-power spectrum Baseline: O8 (06) - YS (09)
Timerange: 00/14:48:51 to 00/14:49:49

Plot file version 31 created 20-APR-2018 10:31:37

B0915+068 EG102C.UVDATA.1

Freq = 4.7995 GHz, Bw = 32.000 MH No calibration applied and no bandpass applied

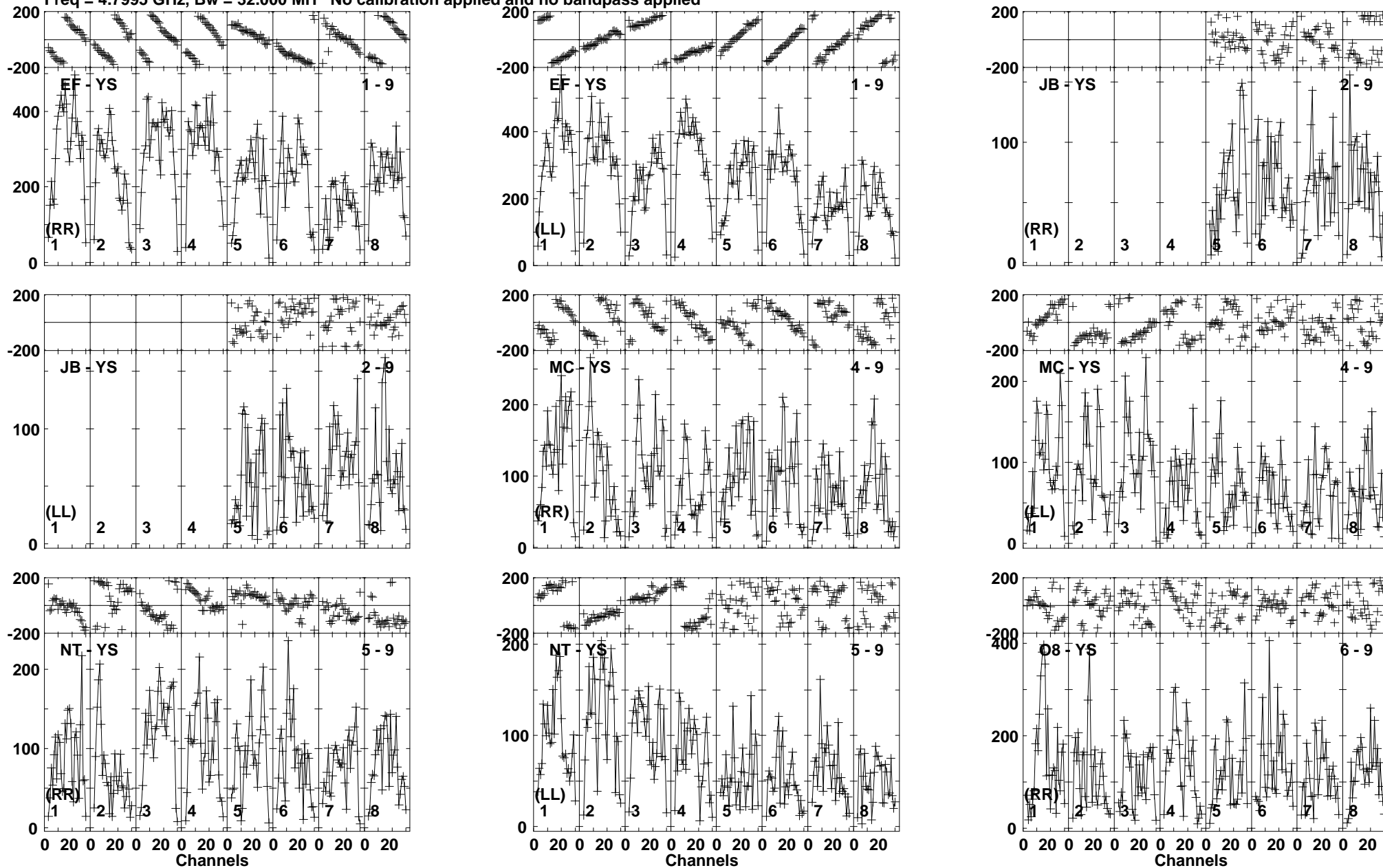

Lower frame: Micro Ampl Jy Top frame: Phas deg
Vector averaged cross-power spectrum Baseline: EF (01) - YS (09)
Timerange: 00/14:49:51 to 00/14:53:19

Plot file version 32 created 20-APR-2018 10:31:37

B0915+068 EG102C.UVDATA.1

Freq = 4.7995 GHz, Bw = 32.000 MH No calibration applied and no bandpass applied

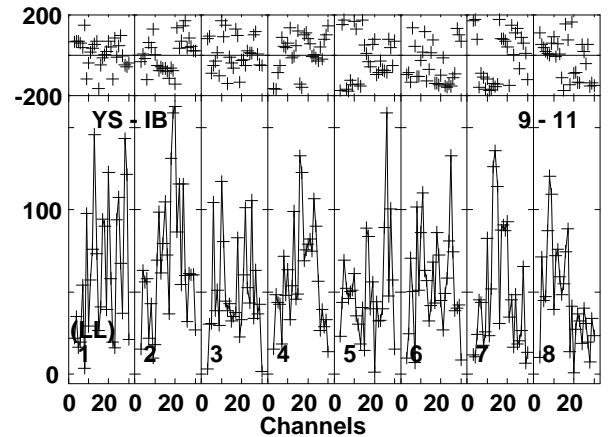
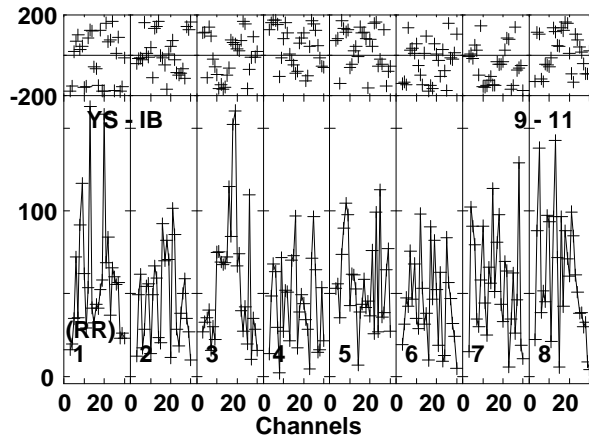
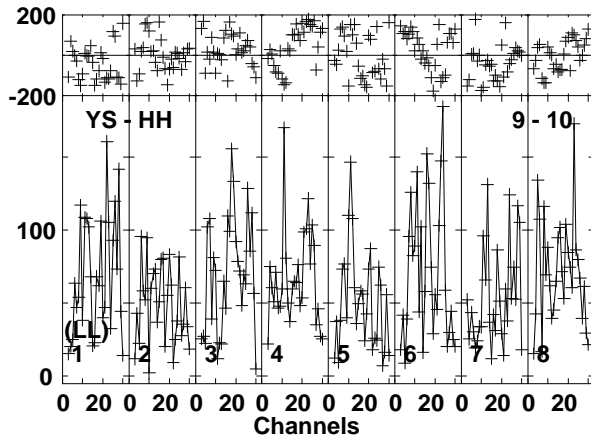
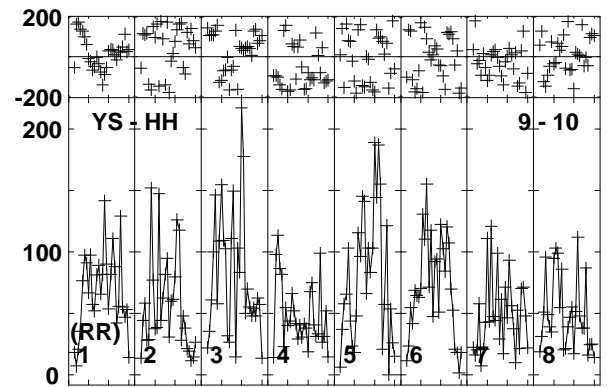
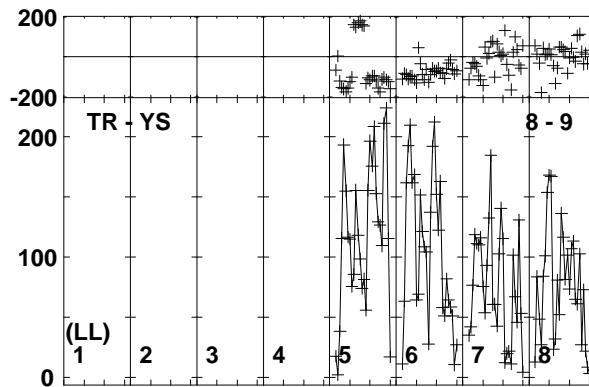
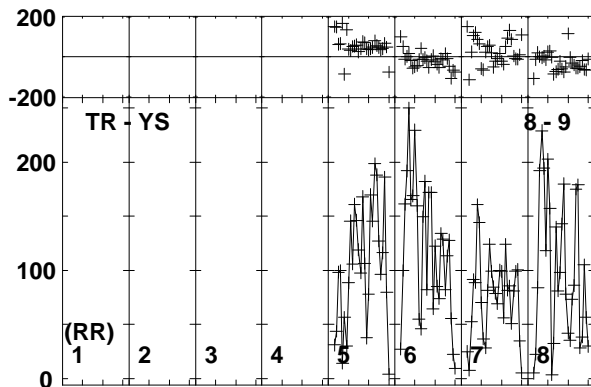
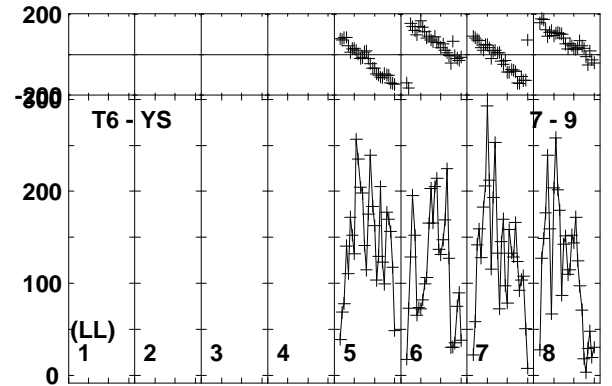
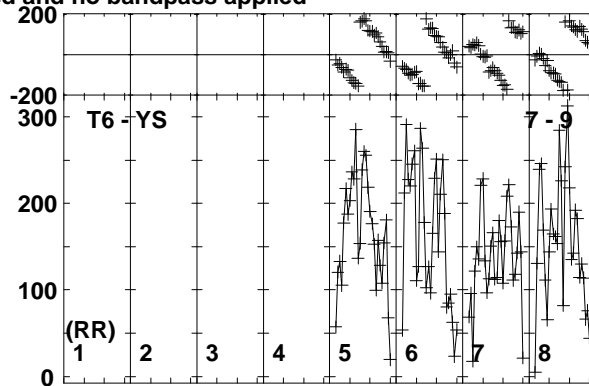
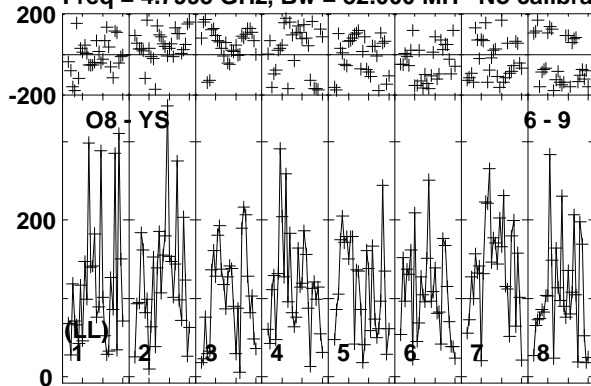

Lower frame: Micro Ampl Jy Top frame: Phas deg
Vector averaged cross-power spectrum Baseline: O8 (06) - YS (09)
Timerange: 00/14:49:51 to 00/14:53:19

Plot file version 33 created 20-APR-2018 10:31:37

J0915+0745 EG102C.UVDATA.1

Freq = 4.7995 GHz, Bw = 32.000 MH No calibration applied and no bandpass applied

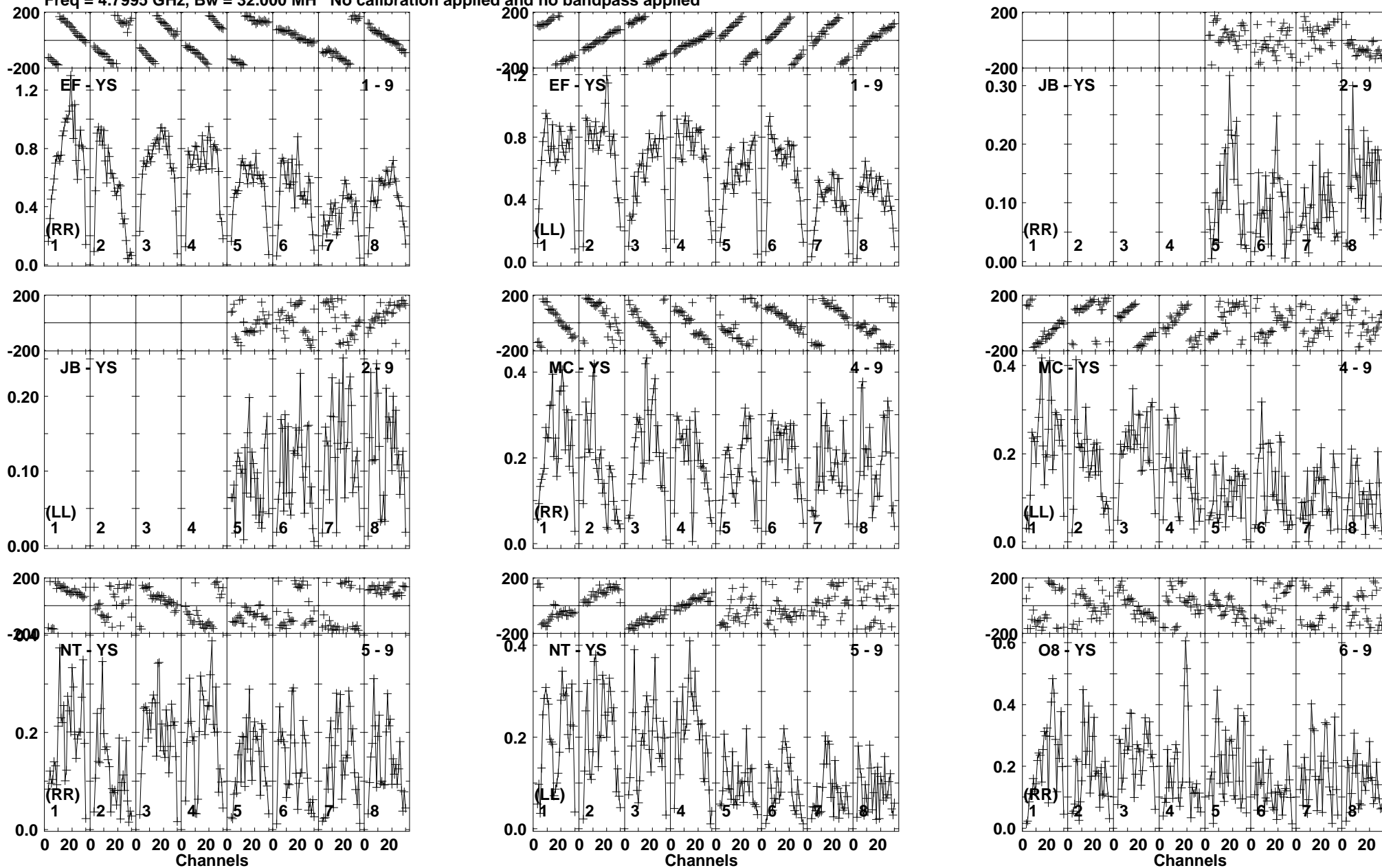

Lower frame: Milli Ampl Jy Top frame: Phas deg
Vector averaged cross-power spectrum Baseline: EF (01) - YS (09)
Timerange: 00/14:53:21 to 00/14:54:49

Plot file version 34 created 20-APR-2018 10:31:37

J0915+0745 EG102C.UVDATA.1

Freq = 4.7995 GHz, Bw = 32.000 MH No calibration applied and no bandpass applied

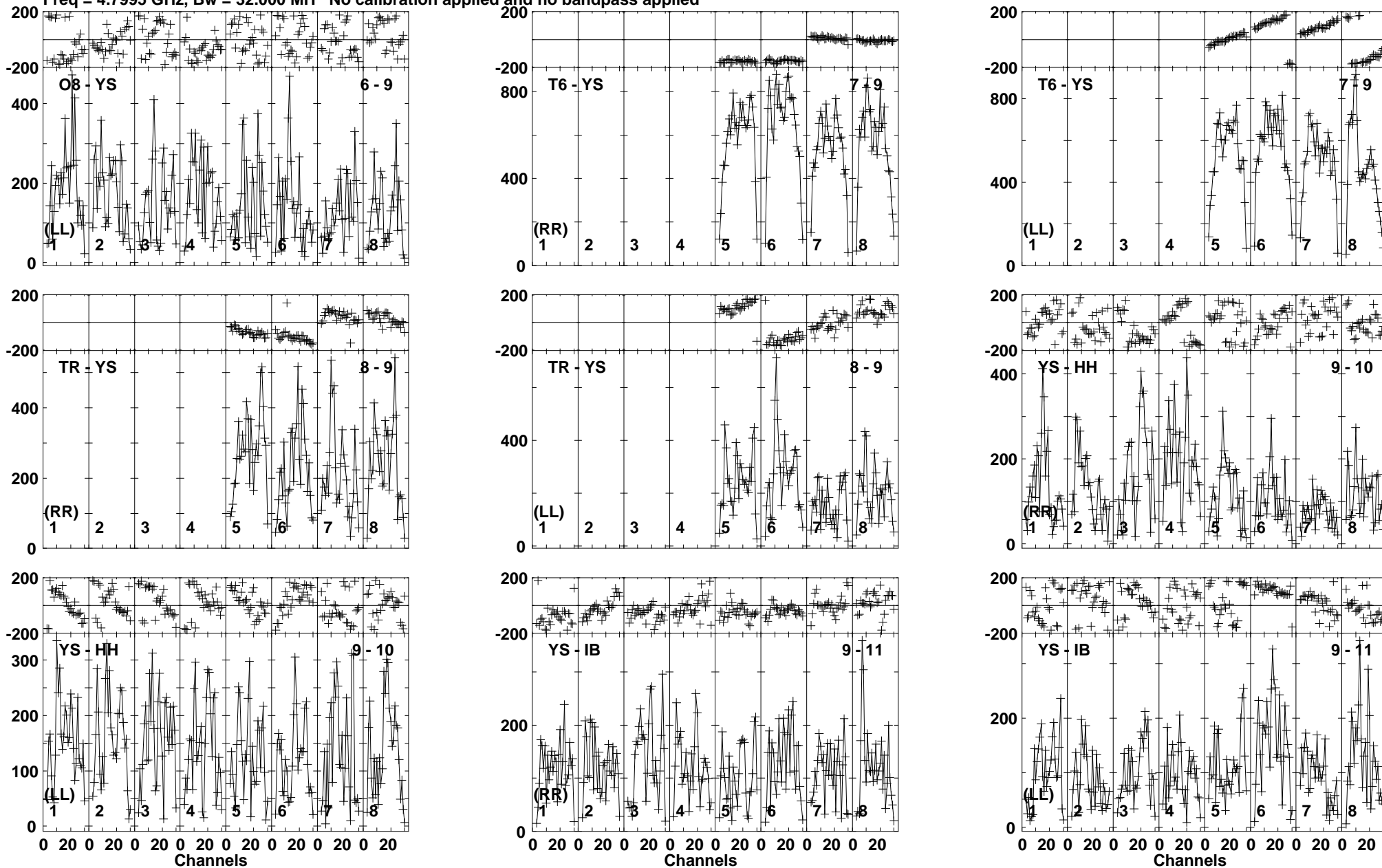

Lower frame: Micro Ampl Jy Top frame: Phas deg
Vector averaged cross-power spectrum Baseline: O8 (06) - YS (09)
Timerange: 00/14:53:21 to 00/14:54:49

Plot file version 35 created 20-APR-2018 10:31:37

B0915+068 EG102C.UVDATA.1

Freq = 4.7995 GHz, Bw = 32.000 MH No calibration applied and no bandpass applied

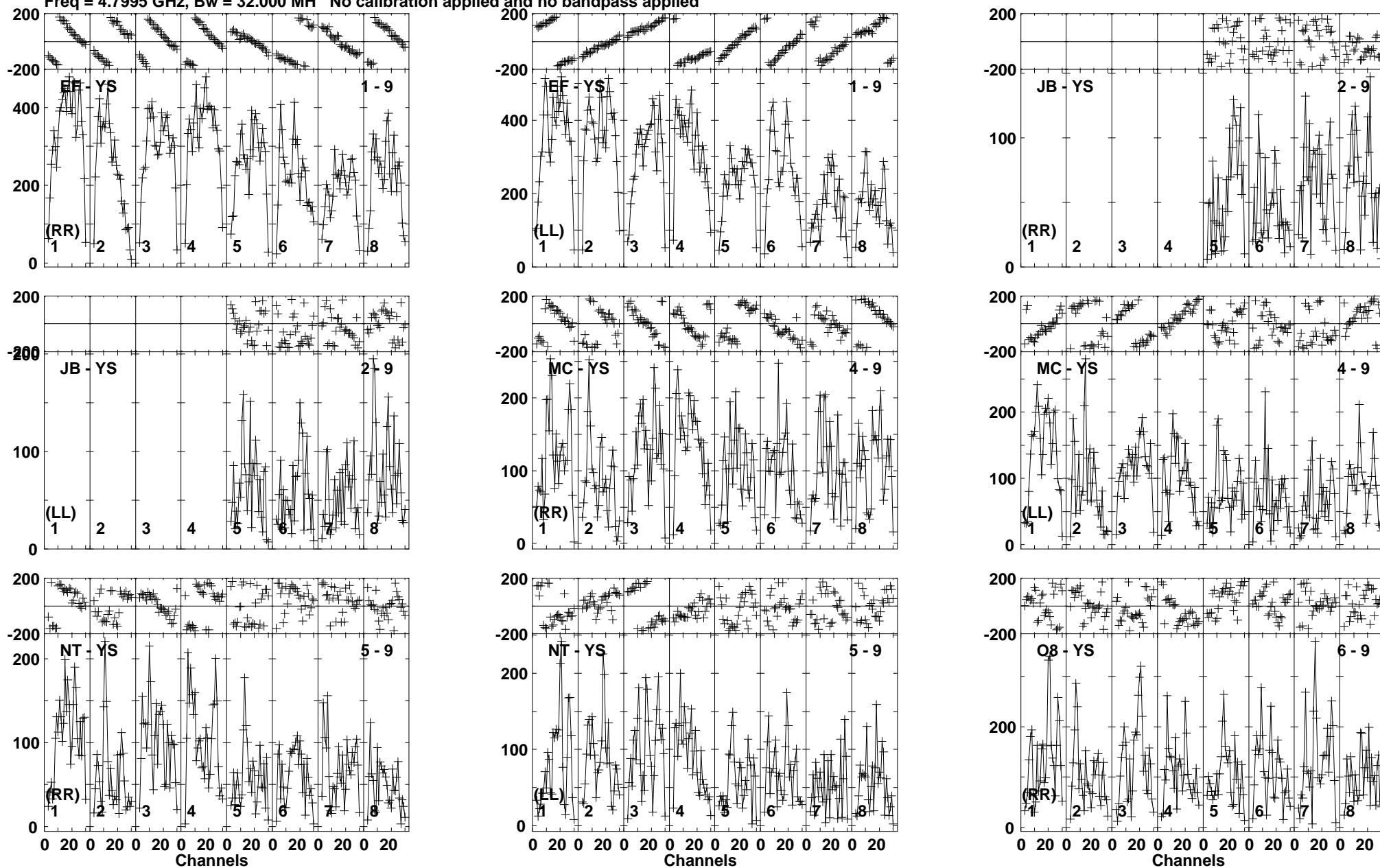

Lower frame: Micro Ampl Jy Top frame: Phas deg
Vector averaged cross-power spectrum Baseline: EF (01) - YS (09)
Timerange: 00/14:54:51 to 00/14:58:19

Plot file version 36 created 20-APR-2018 10:31:37

B0915+068 EG102C.UVDATA.1

Freq = 4.7995 GHz, Bw = 32.000 MH No calibration applied and no bandpass applied

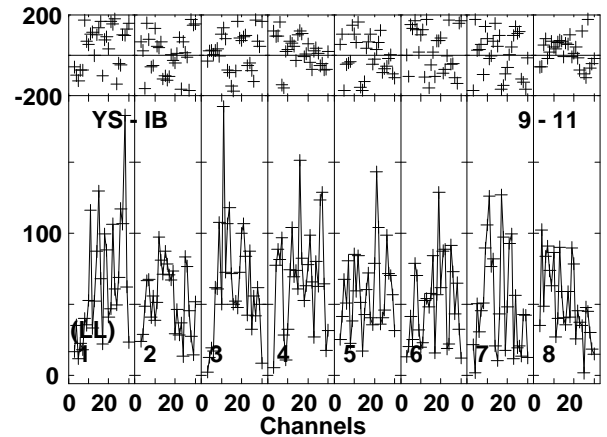
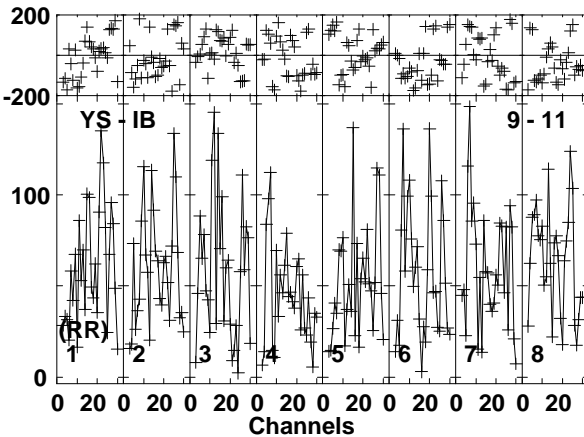
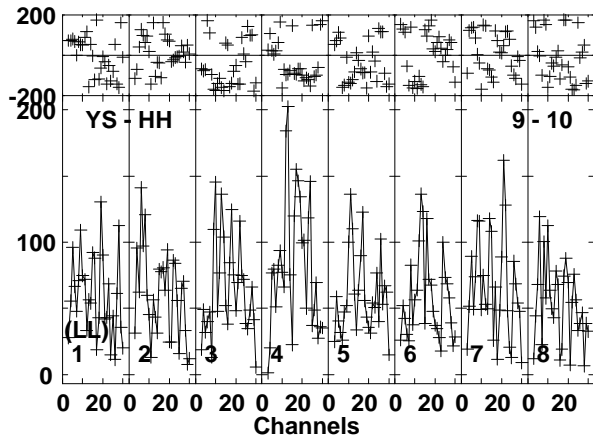
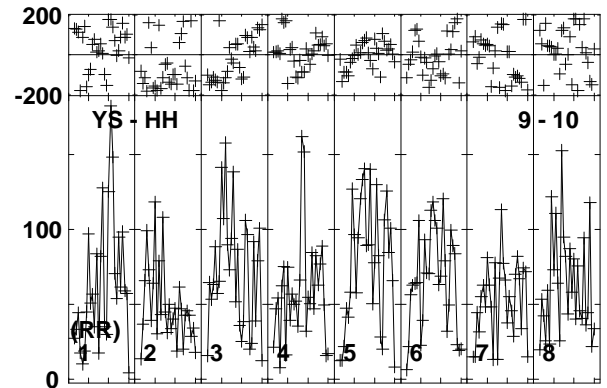
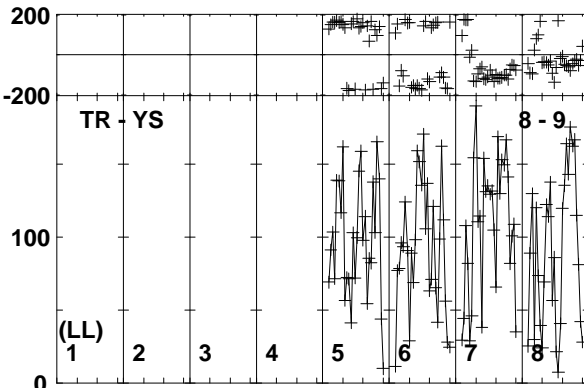
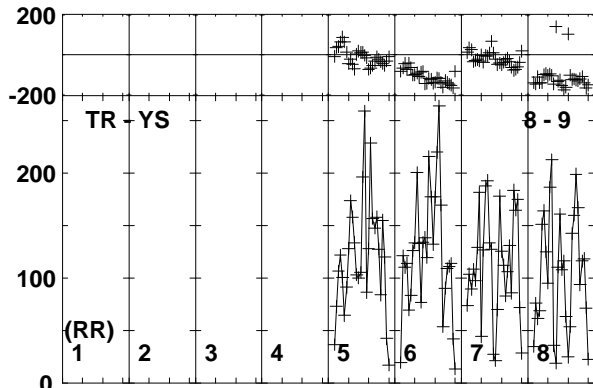
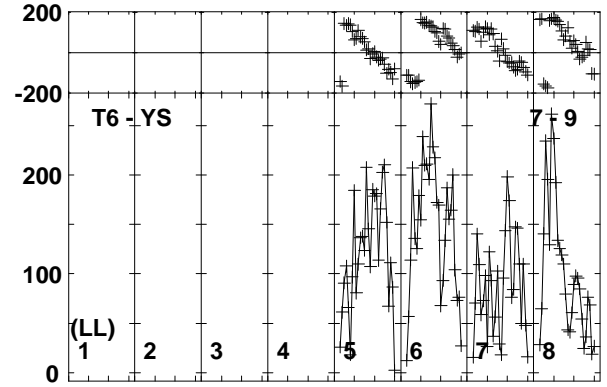
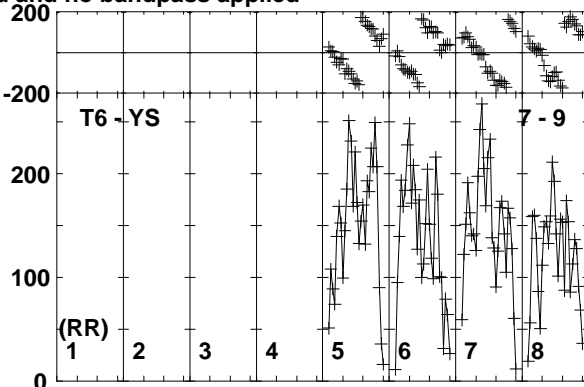
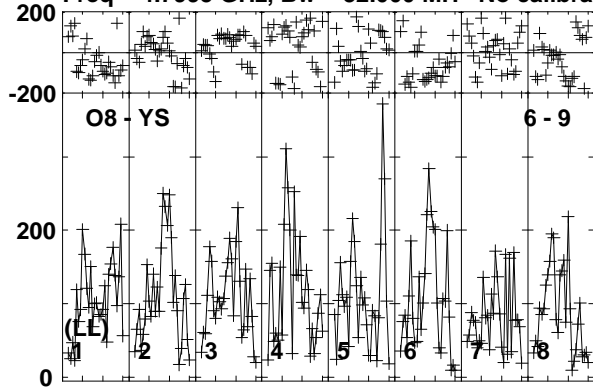

Lower frame: Micro Ampl Jy Top frame: Phas deg
Vector averaged cross-power spectrum Baseline: O8 (06) - YS (09)
Timerange: 00/14:54:51 to 00/14:58:19

Plot file version 37 created 20-APR-2018 10:31:37

J0915+0745 EG102C.UVDATA.1

Freq = 4.7995 GHz, Bw = 32.000 MH No calibration applied and no bandpass applied

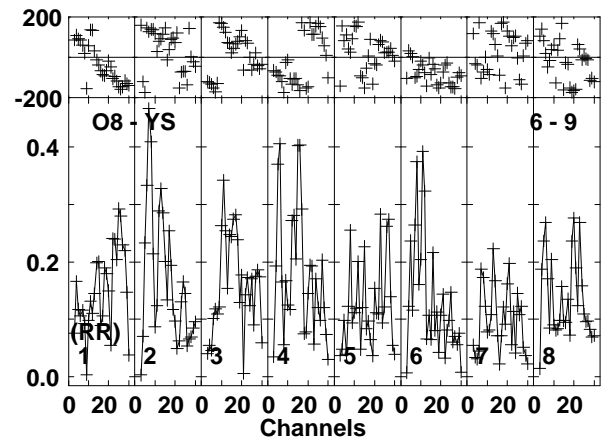
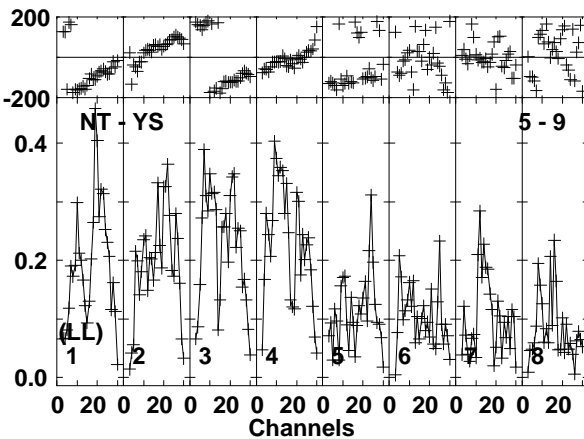
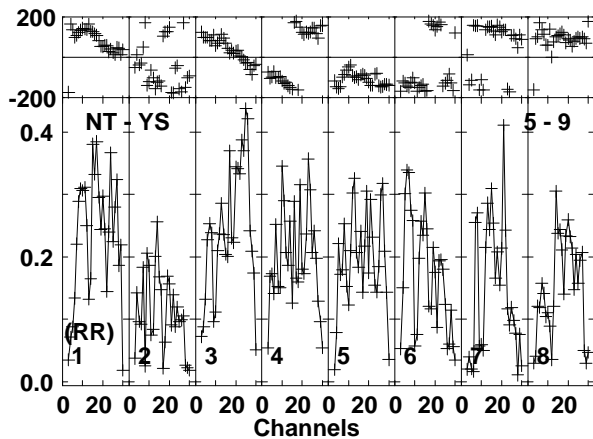
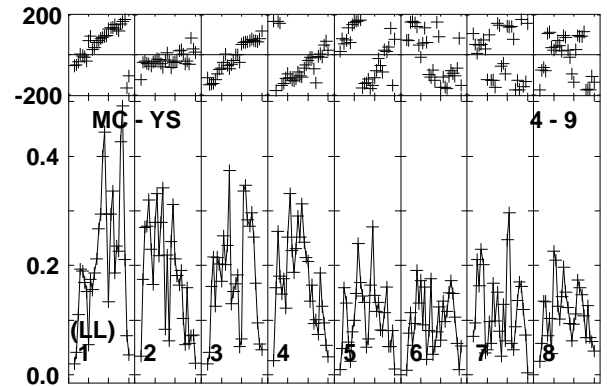
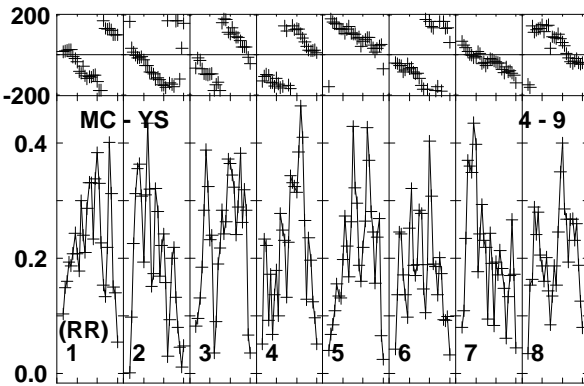
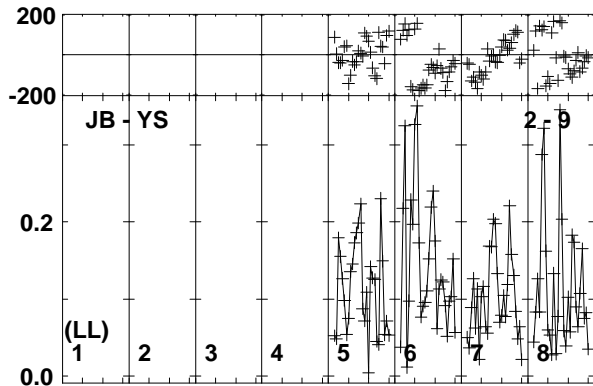
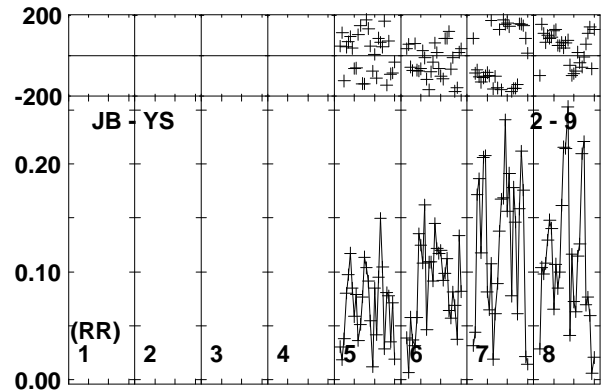
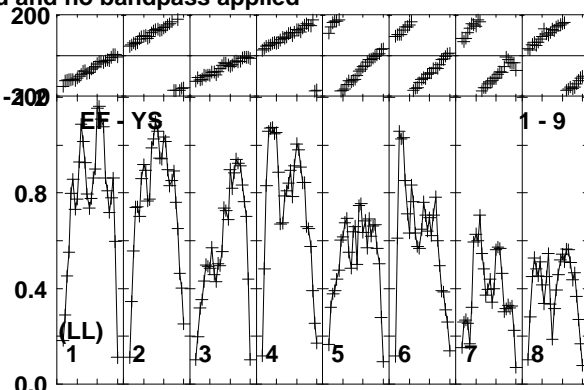
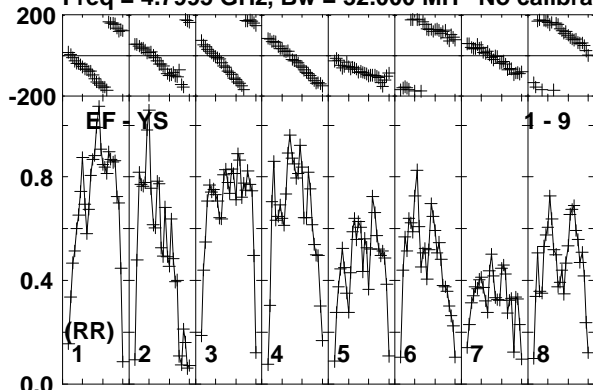

Lower frame: Milli Ampl Jy Top frame: Phas deg
Vector averaged cross-power spectrum Baseline: EF (01) - YS (09)
Timerange: 00/14:58:21 to 00/14:59:49

Plot file version 38 created 20-APR-2018 10:31:37

J0915+0745 EG102C.UVDATA.1

Freq = 4.7995 GHz, Bw = 32.000 MH No calibration applied and no bandpass applied

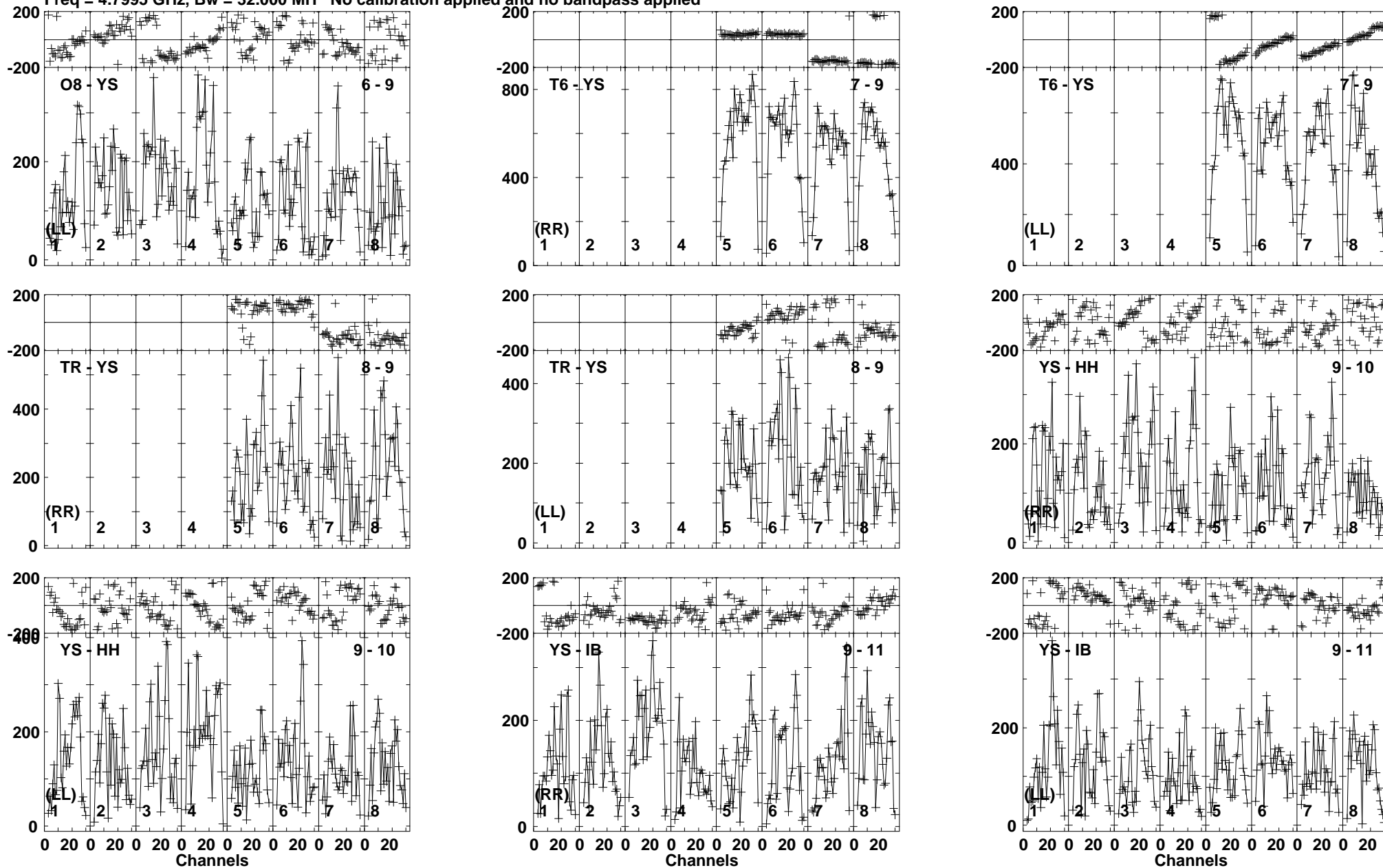

Lower frame: Micro Ampl Jy Top frame: Phas deg
Vector averaged cross-power spectrum Baseline: O8 (06) - YS (09)
Timerange: 00/14:58:21 to 00/14:59:49

Plot file version 39 created 20-APR-2018 10:31:38

B0915+068 EG102C.UVDATA.1

Freq = 4.7995 GHz, Bw = 32.000 MH No calibration applied and no bandpass applied

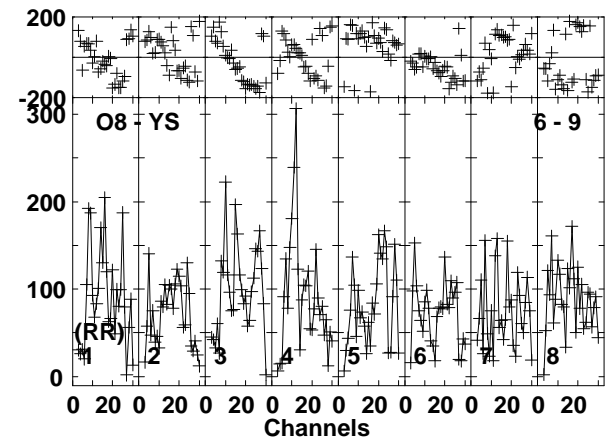
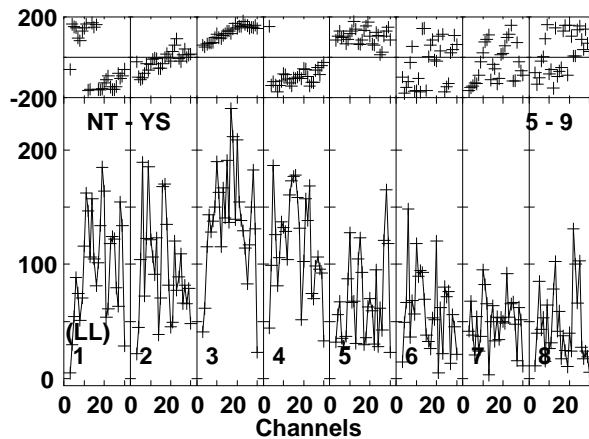
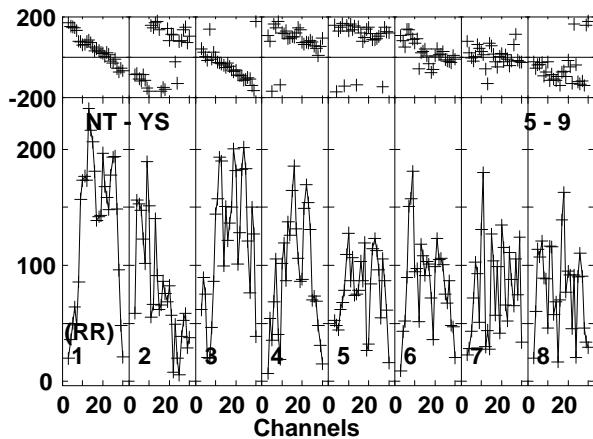
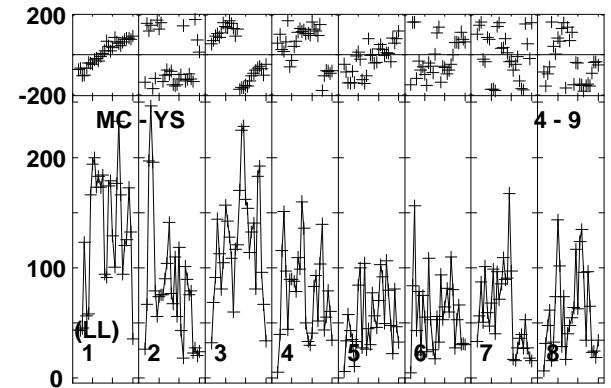
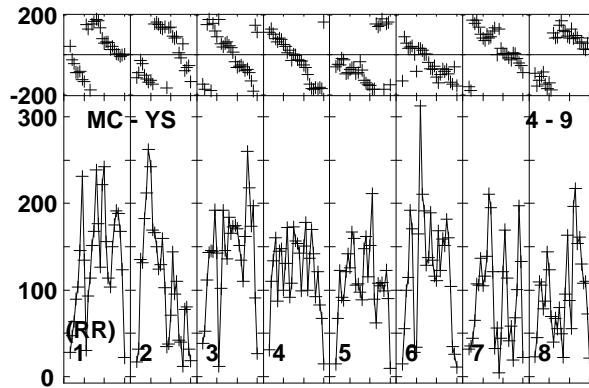
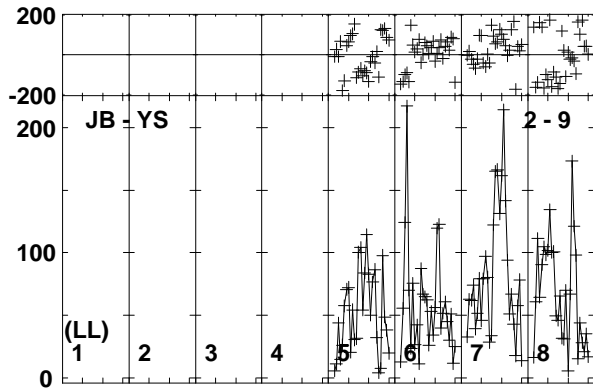
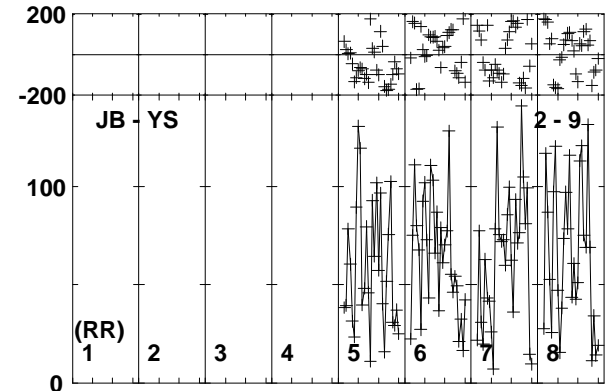
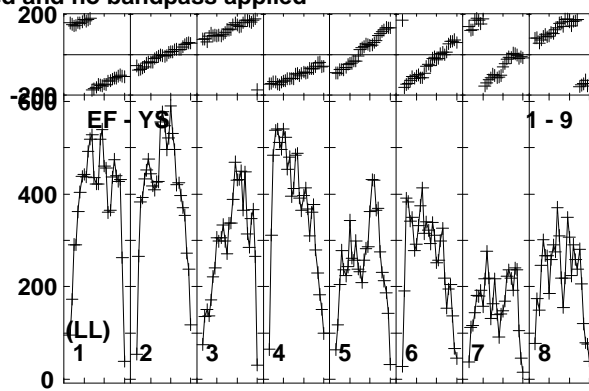
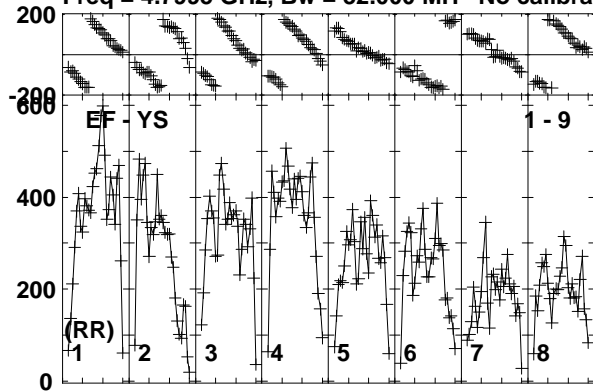

Lower frame: Micro Ampl Jy Top frame: Phas deg
Vector averaged cross-power spectrum Baseline: EF (01) - YS (09)
Timerange: 00/14:59:51 to 00/15:03:19

Plot file version 40 created 20-APR-2018 10:31:38

B0915+068 EG102C.UVDATA.1

Freq = 4.7995 GHz, Bw = 32.000 MH No calibration applied and no bandpass applied

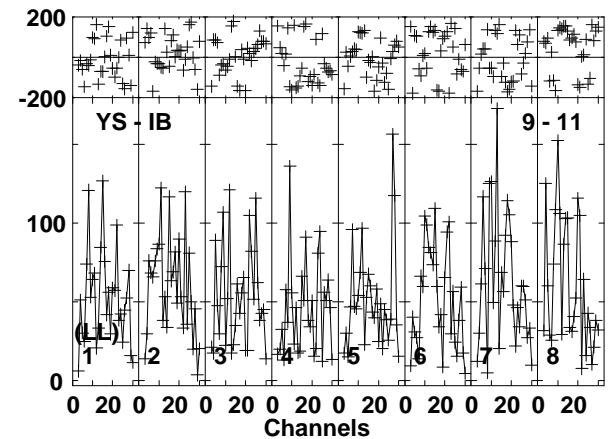
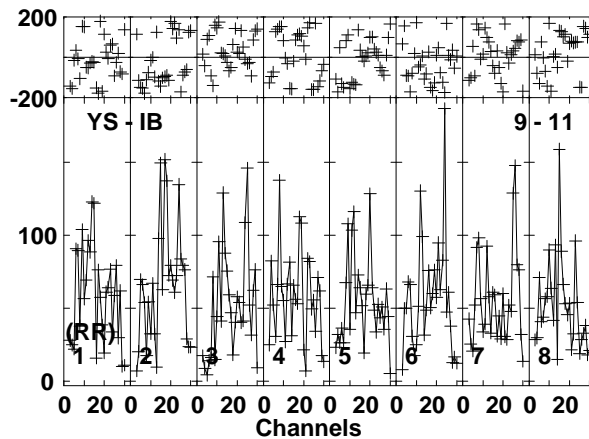
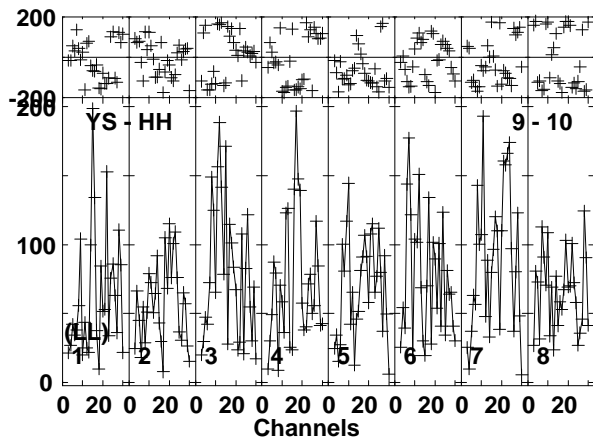
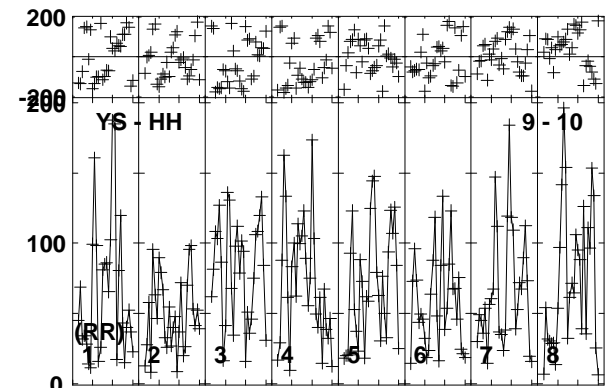
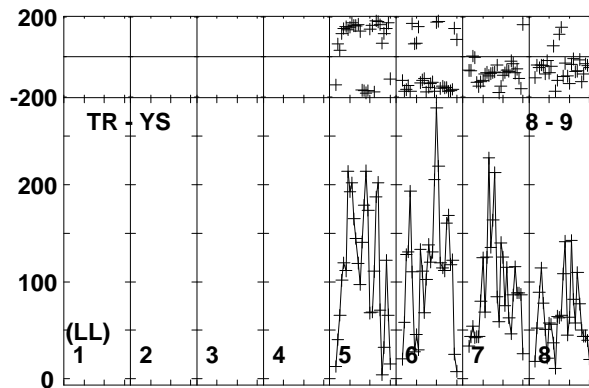
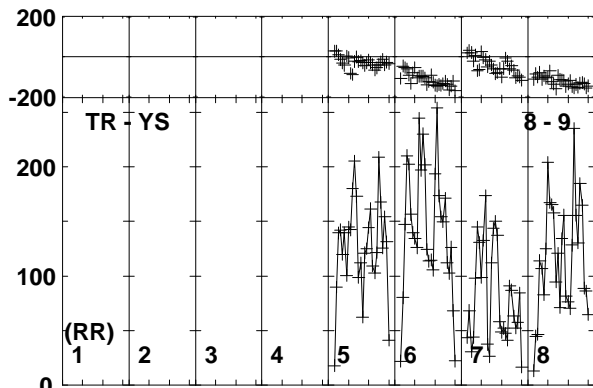
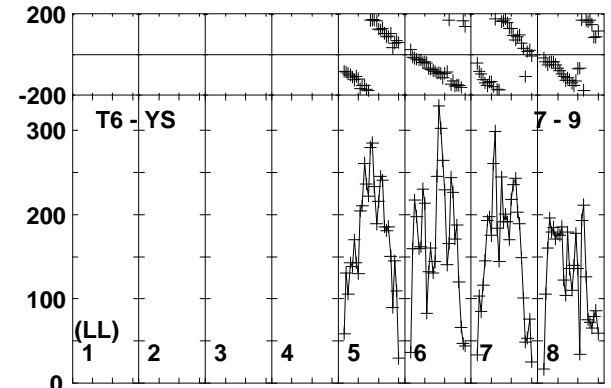
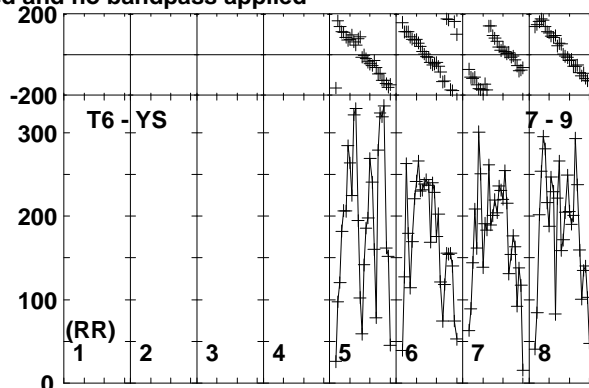
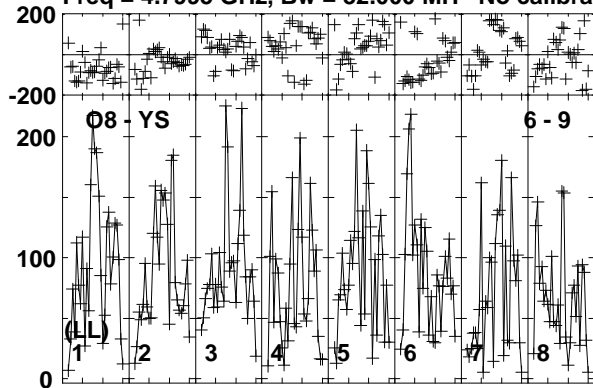

Lower frame: Micro Ampl Jy Top frame: Phas deg
Vector averaged cross-power spectrum Baseline: O8 (06) - YS (09)
Timerange: 00/14:59:51 to 00/15:03:19

Plot file version 41 created 20-APR-2018 10:31:38

J0915+0745 EG102C.UVDATA.1

Freq = 4.7995 GHz, Bw = 32.000 MH No calibration applied and no bandpass applied

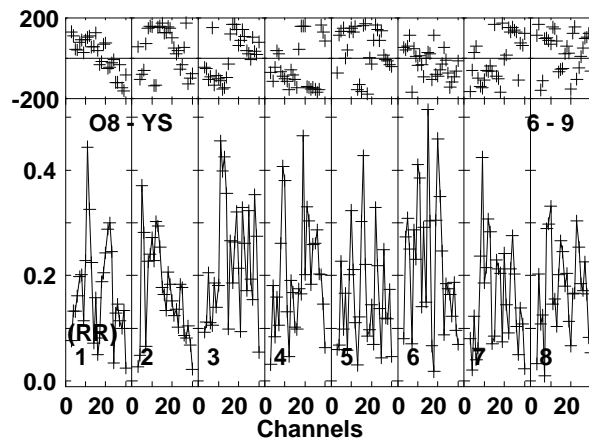
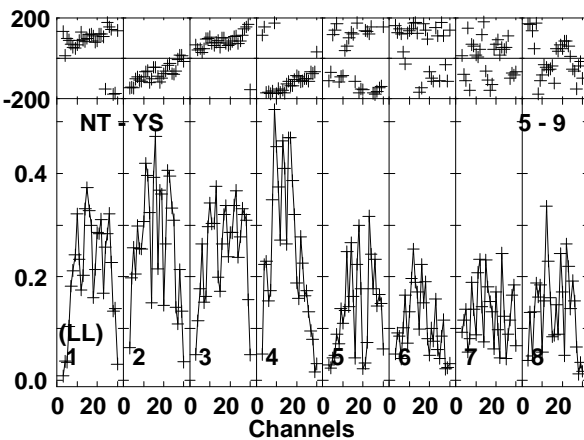
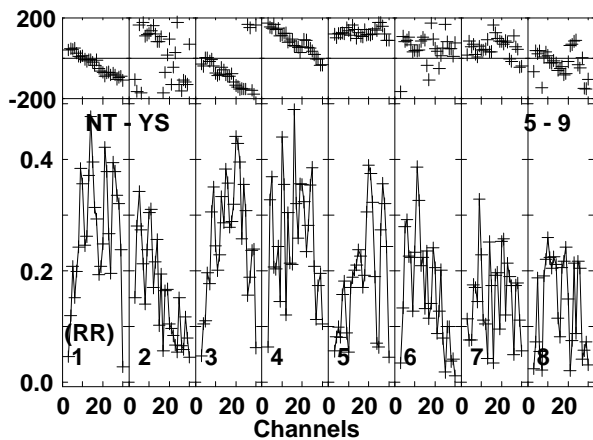
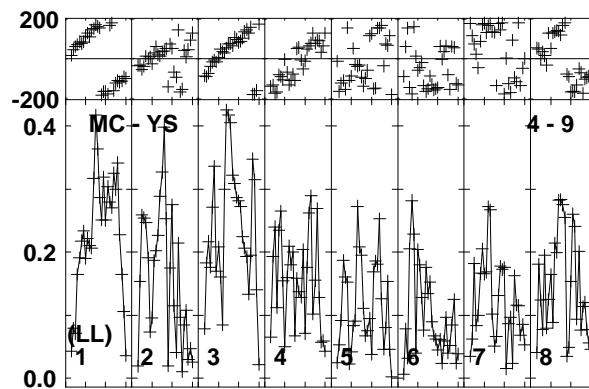
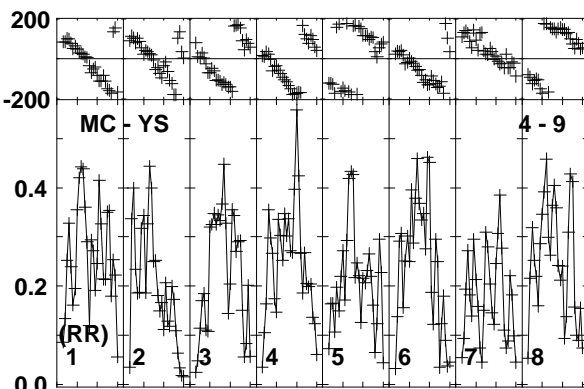
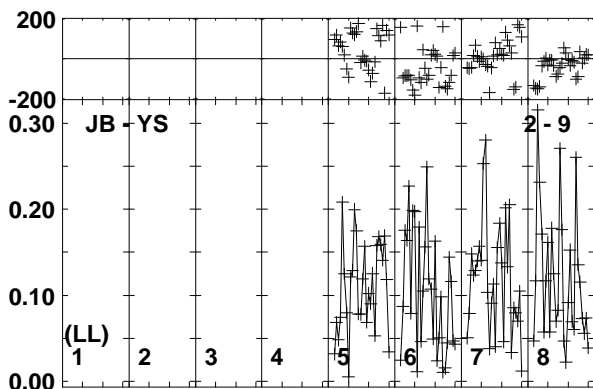
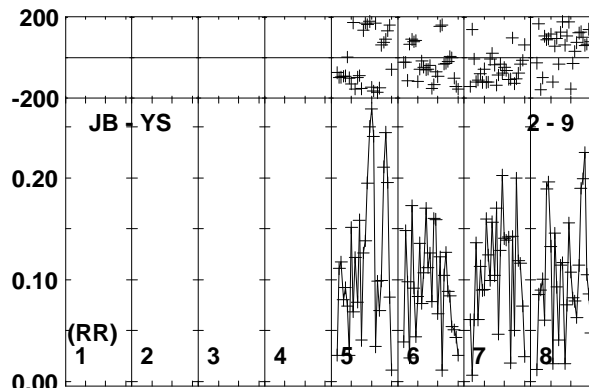
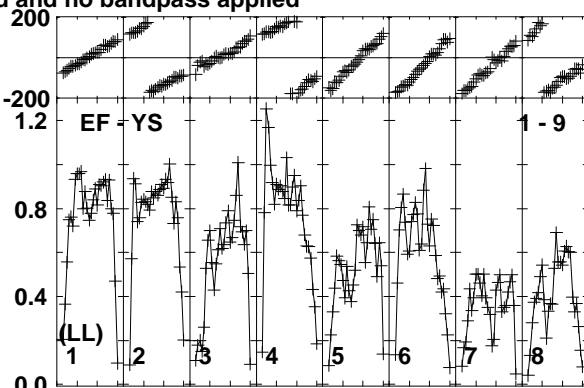
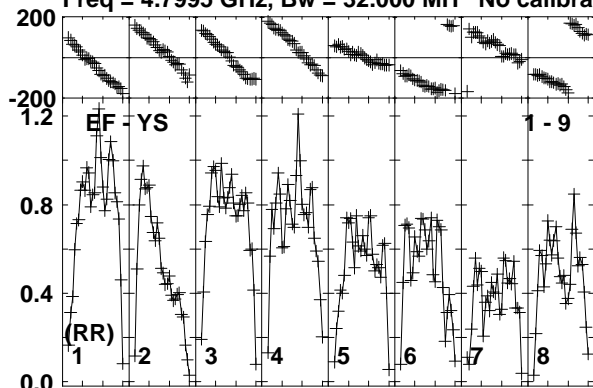

Lower frame: Milli Ampl Jy Top frame: Phas deg
Vector averaged cross-power spectrum Baseline: EF (01) - YS (09)
Timerange: 00/15:04:01 to 00/15:04:59

Plot file version 42 created 20-APR-2018 10:31:38

J0915+0745 EG102C.UVDATA.1

Freq = 4.7995 GHz, Bw = 32.000 MH No calibration applied and no bandpass applied

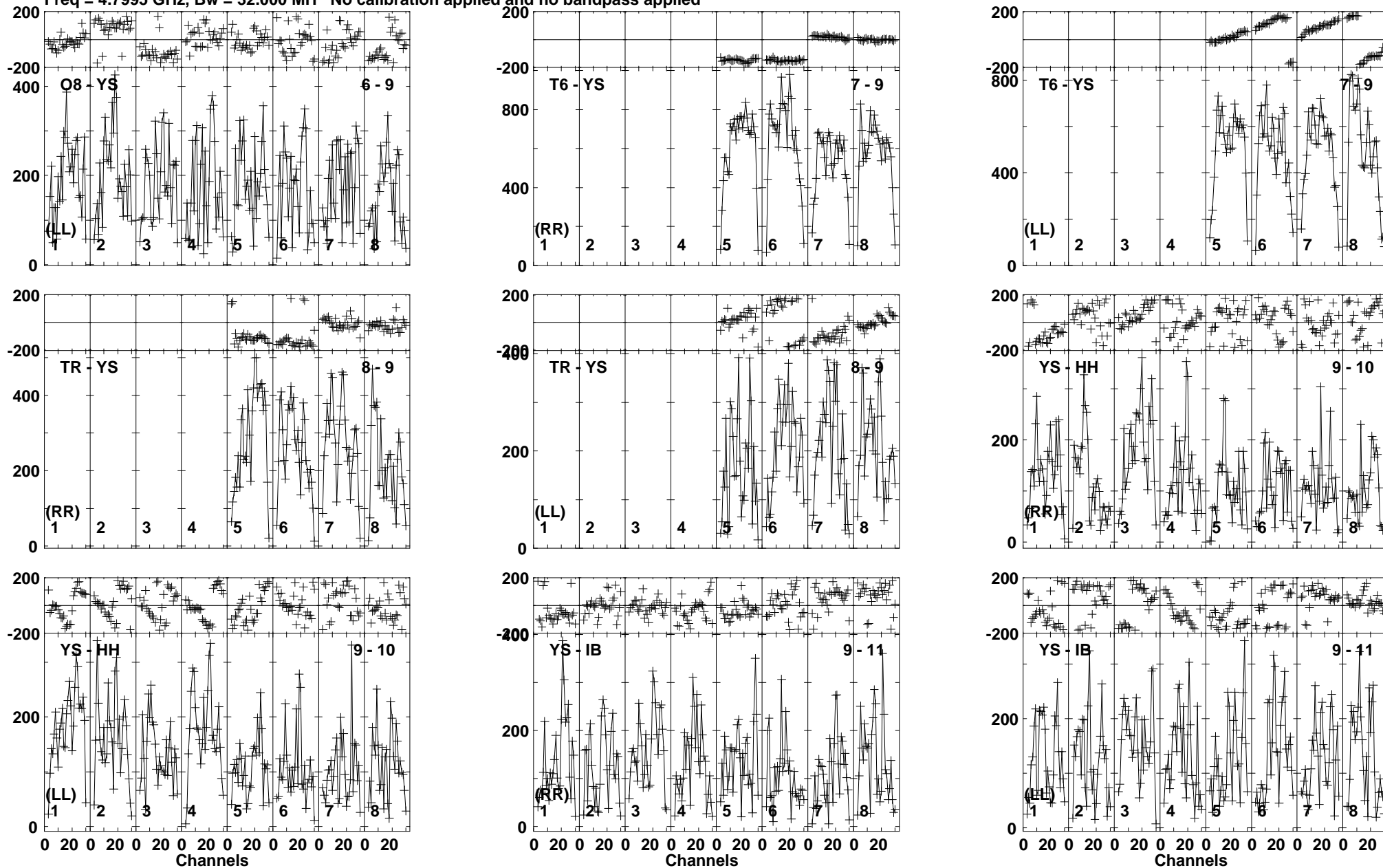

Lower frame: Micro Ampl Jy Top frame: Phas deg
Vector averaged cross-power spectrum Baseline: O8 (06) - YS (09)
Timerange: 00/15:04:01 to 00/15:04:59

Plot file version 43 created 20-APR-2018 10:31:38

B0915+068 EG102C.UVDATA.1

Freq = 4.7995 GHz, Bw = 32.000 MH No calibration applied and no bandpass applied

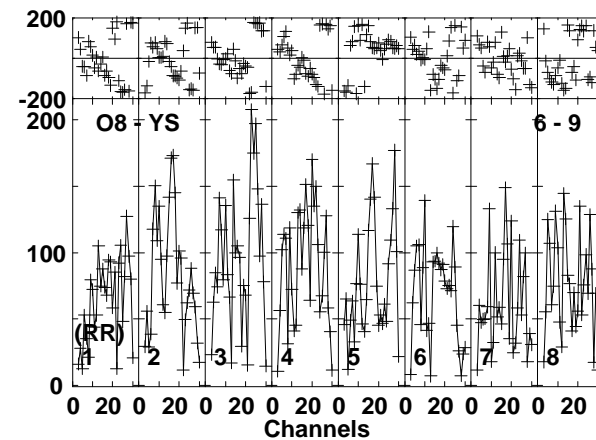
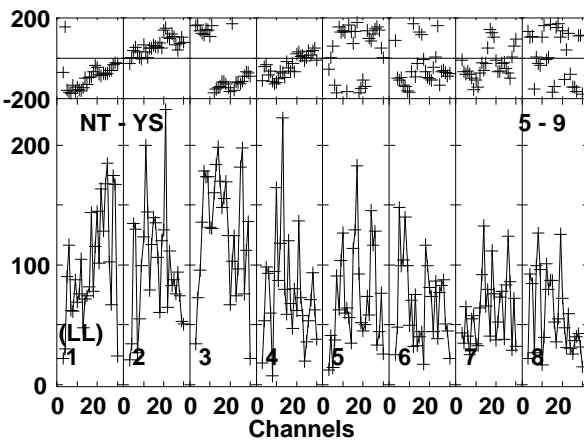
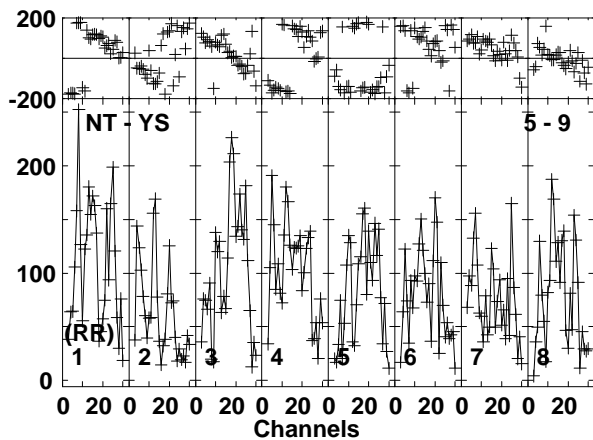
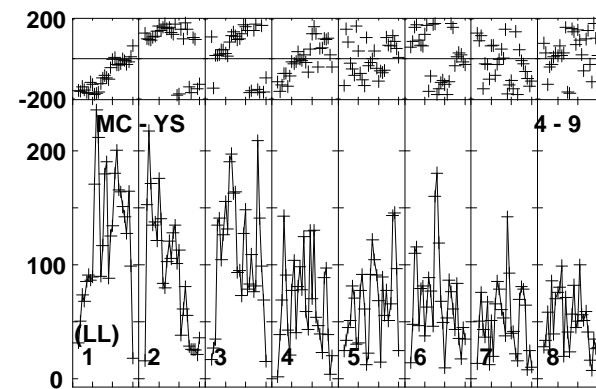
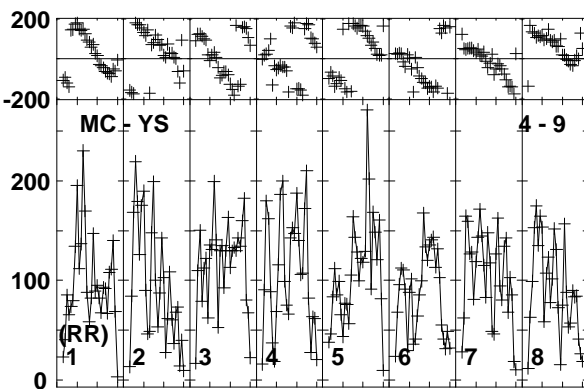
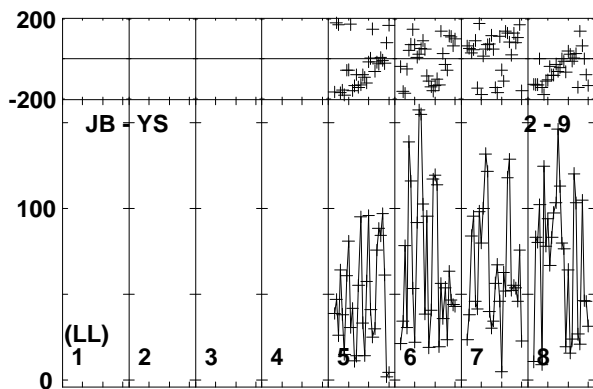
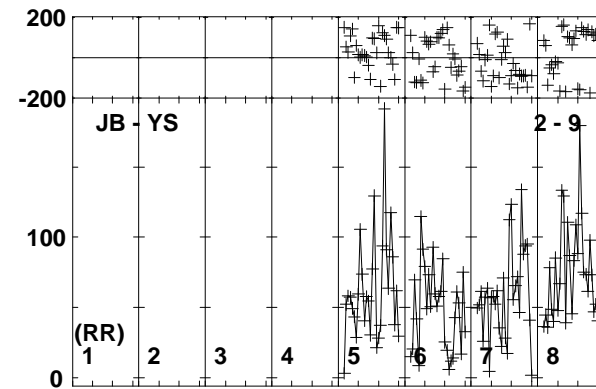
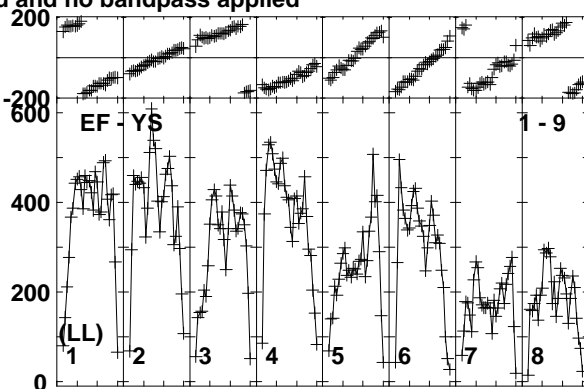
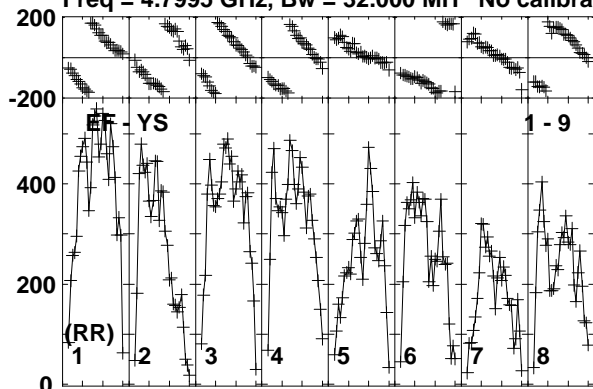

Lower frame: Micro Ampl Jy Top frame: Phas deg
Vector averaged cross-power spectrum Baseline: EF (01) - YS (09)
Timerange: 00/15:05:01 to 00/15:08:29

Plot file version 44 created 20-APR-2018 10:31:38

B0915+068 EG102C.UVDATA.1

Freq = 4.7995 GHz, Bw = 32.000 MH No calibration applied and no bandpass applied

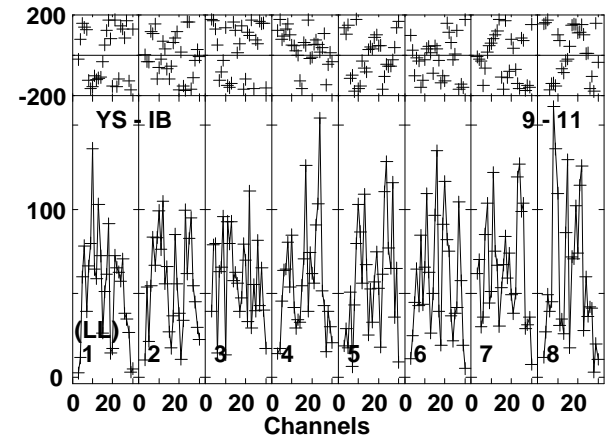
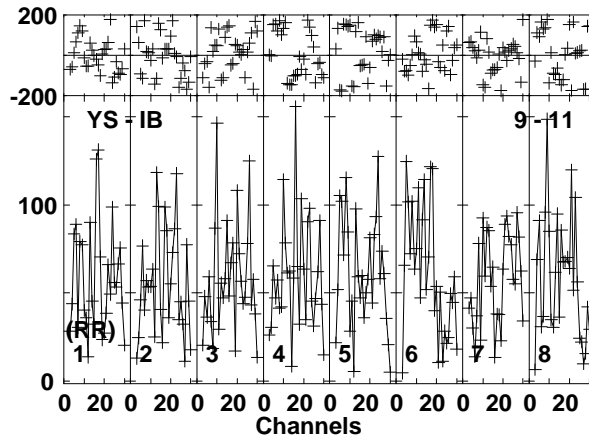
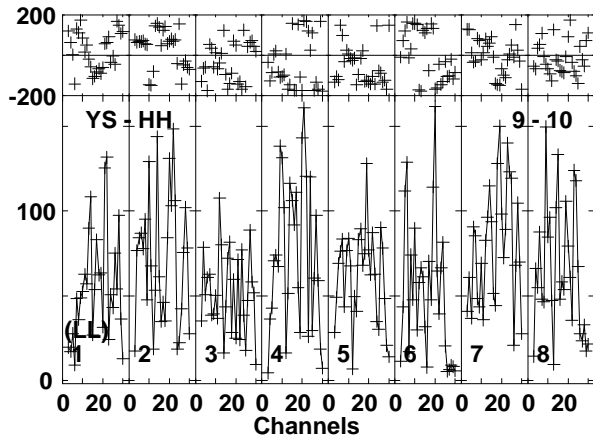
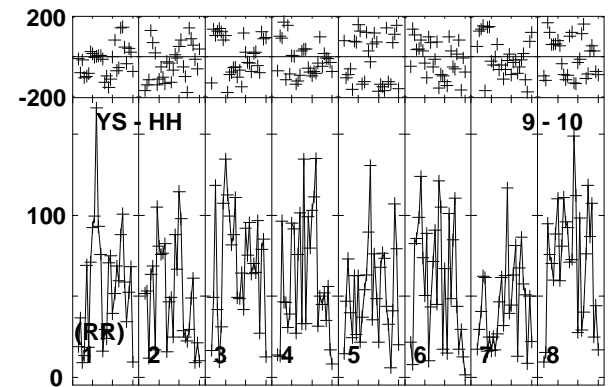
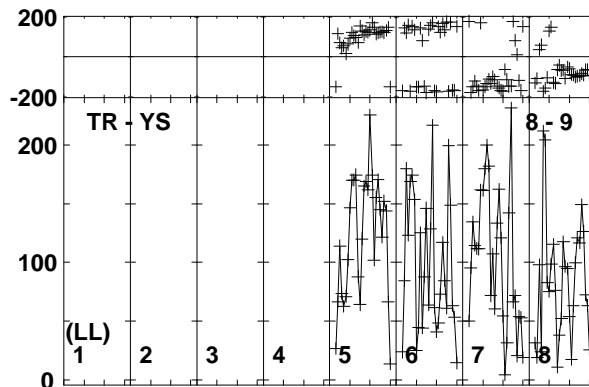
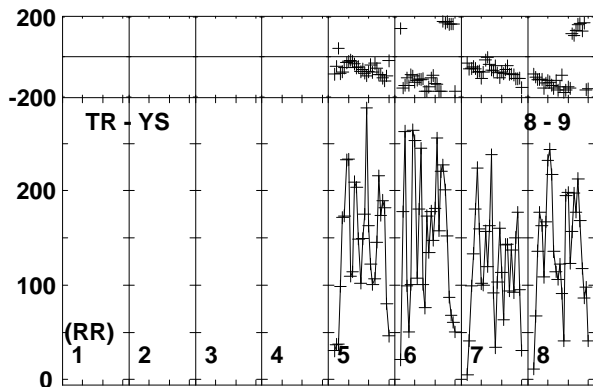
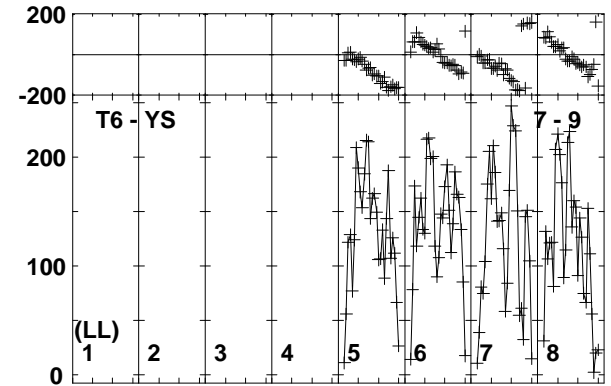
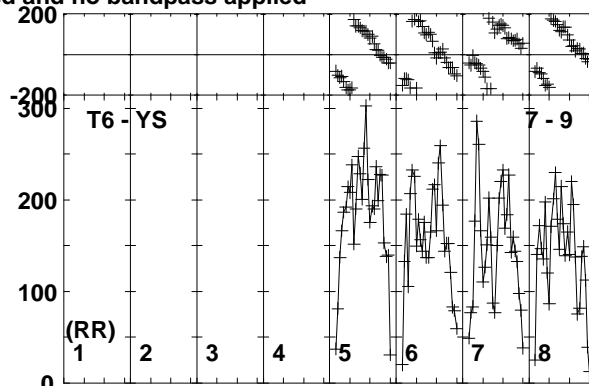
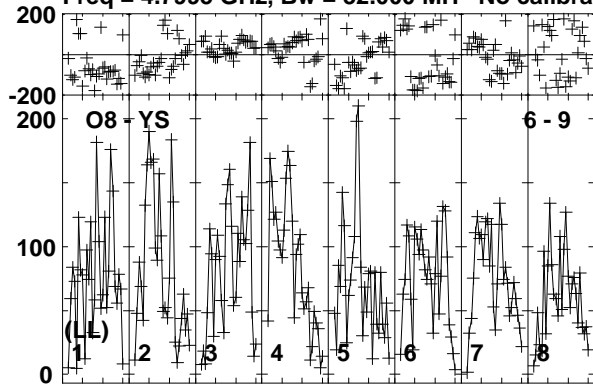

Lower frame: Micro Ampl Jy Top frame: Phas deg
Vector averaged cross-power spectrum Baseline: O8 (06) - YS (09)
Timerange: 00/15:05:01 to 00/15:08:29

Plot file version 45 created 20-APR-2018 10:31:38

J0915+0745 EG102C.UVDATA.1

Freq = 4.7995 GHz, Bw = 32.000 MH No calibration applied and no bandpass applied

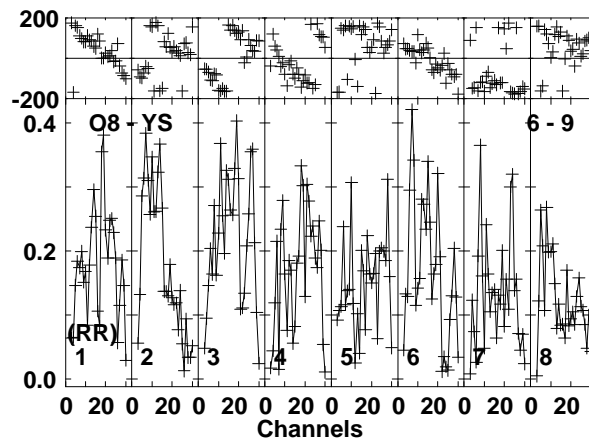
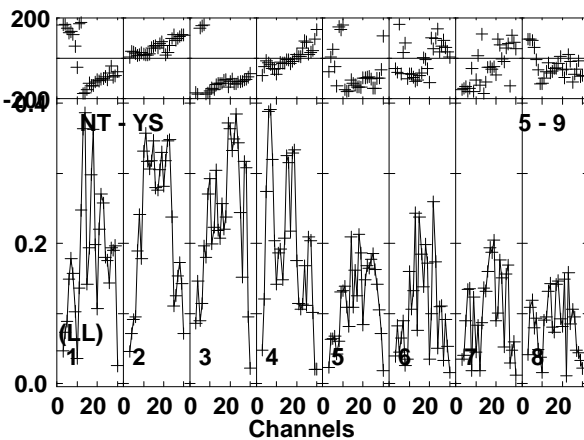
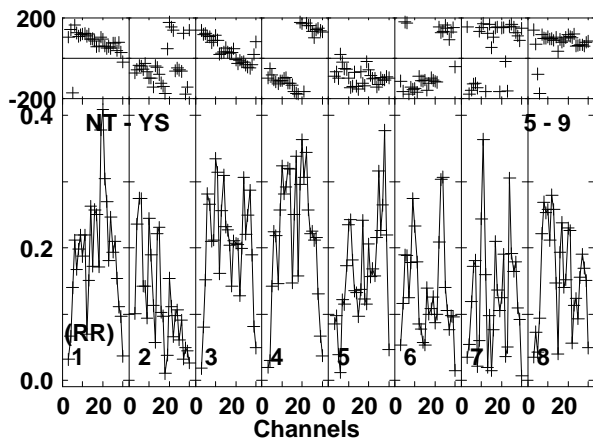
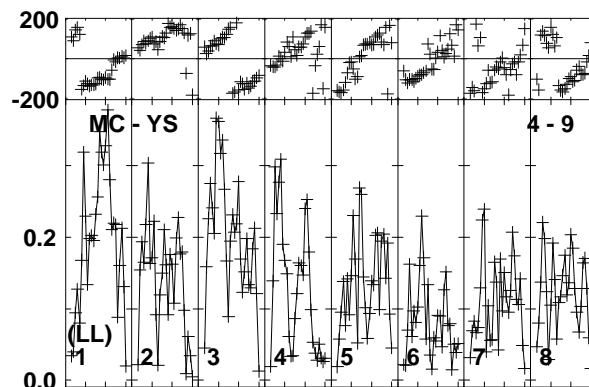
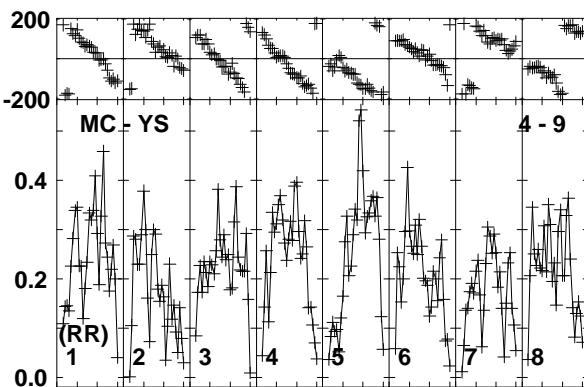
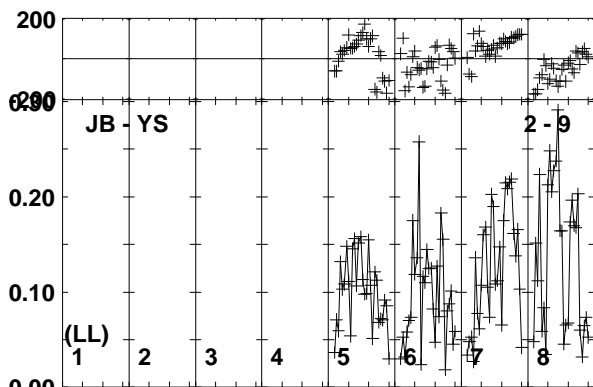
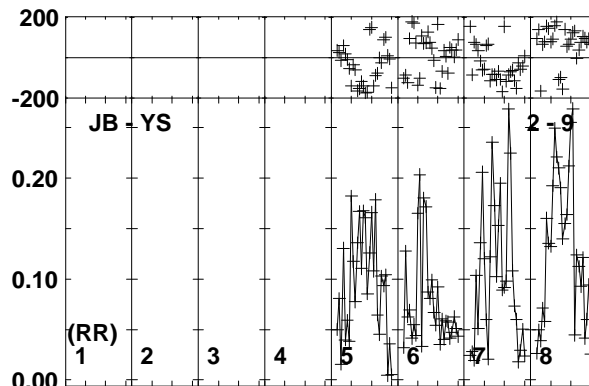
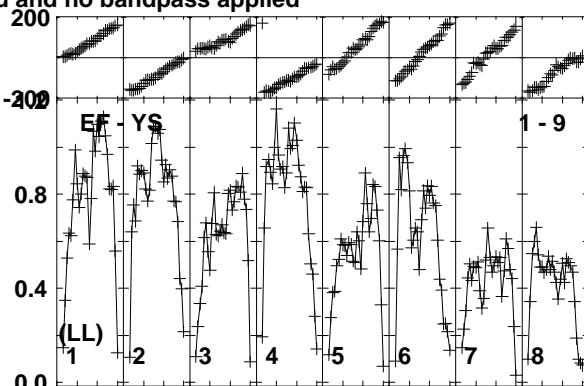
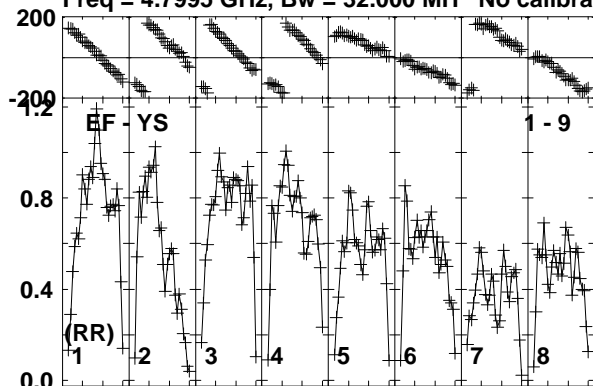

Lower frame: Milli Ampl Jy Top frame: Phas deg
Vector averaged cross-power spectrum Baseline: EF (01) - YS (09)
Timerange: 00/15:08:31 to 00/15:09:59

Plot file version 46 created 20-APR-2018 10:31:38

J0915+0745 EG102C.UVDATA.1

Freq = 4.7995 GHz, Bw = 32.000 MH No calibration applied and no bandpass applied

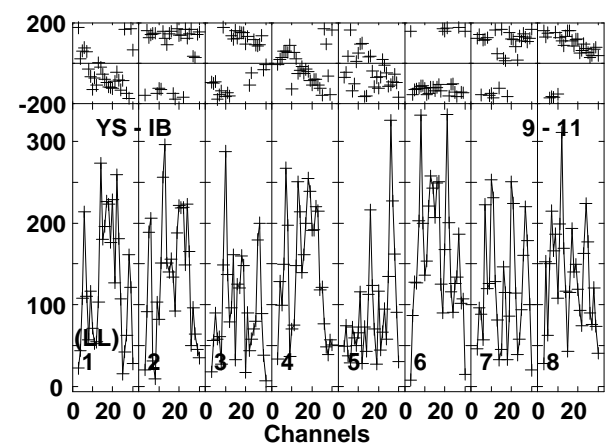
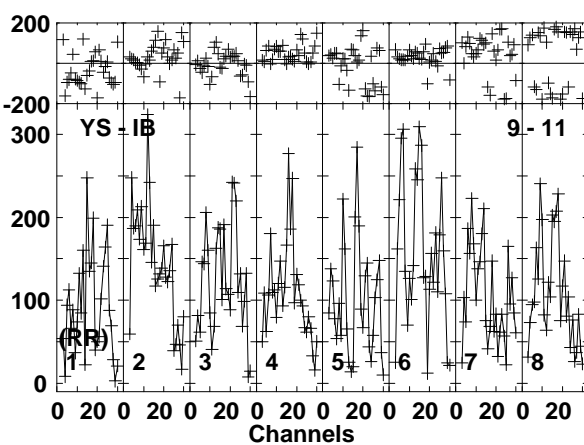
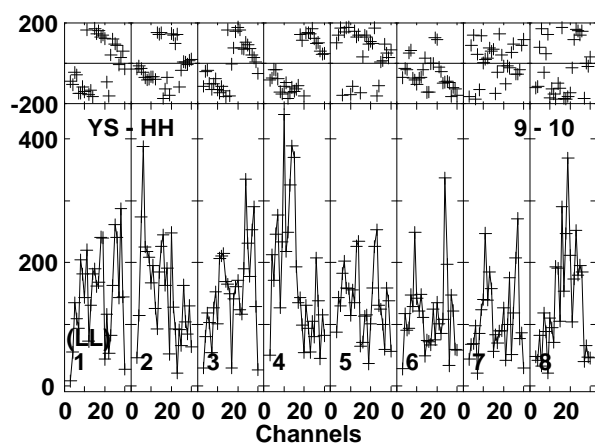
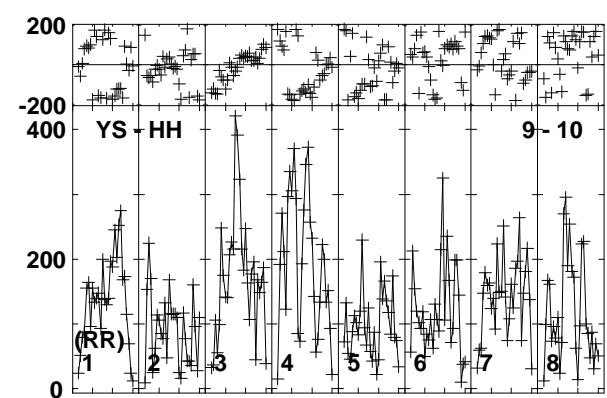
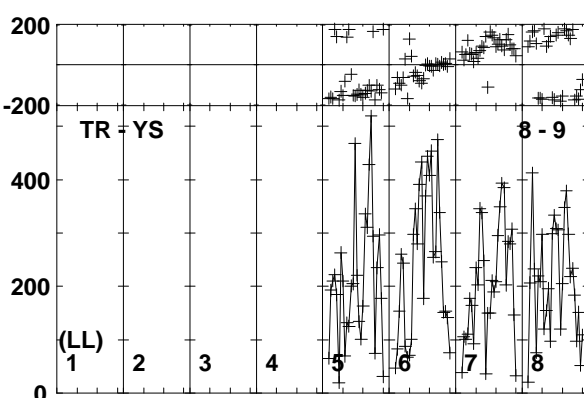
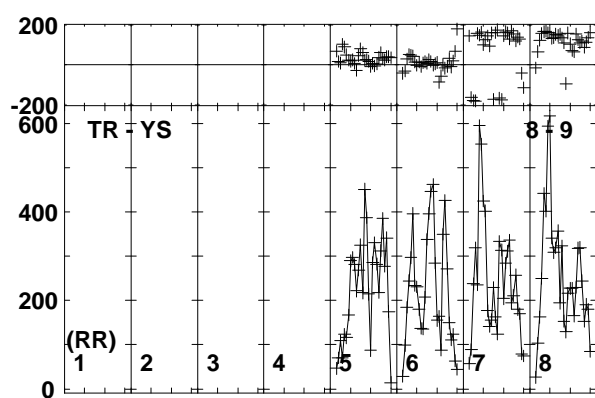
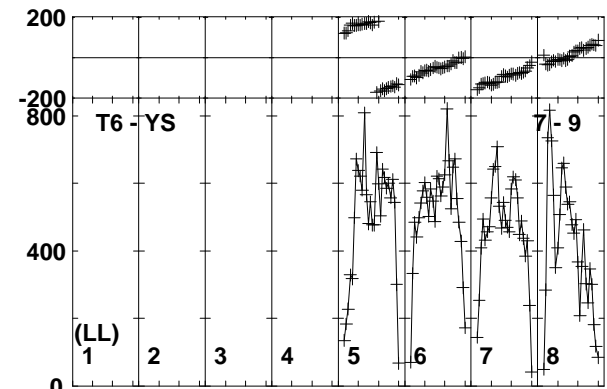
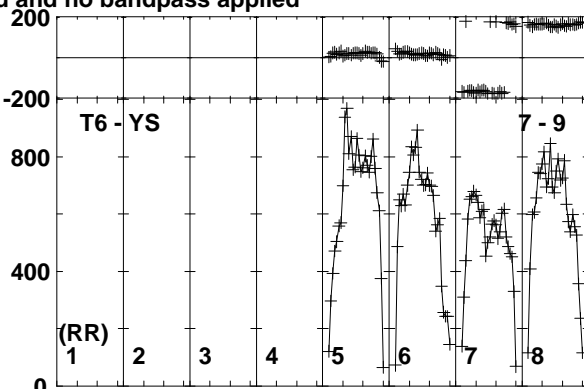
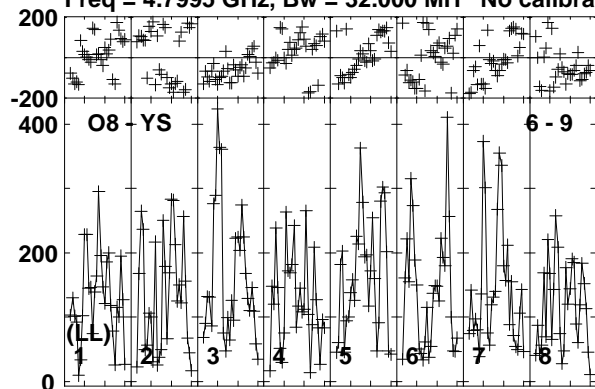

Lower frame: Micro Ampl Jy Top frame: Phas deg
Vector averaged cross-power spectrum Baseline: O8 (06) - YS (09)
Timerange: 00/15:08:31 to 00/15:09:59

Plot file version 47 created 20-APR-2018 10:31:38

B0915+068 EG102C.UVDATA.1

Freq = 4.7995 GHz, Bw = 32.000 MH No calibration applied and no bandpass applied

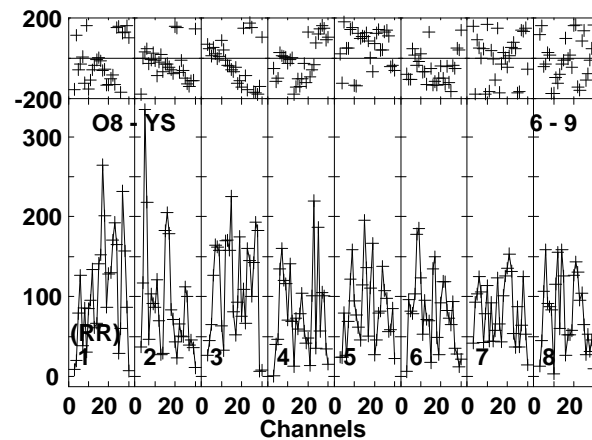
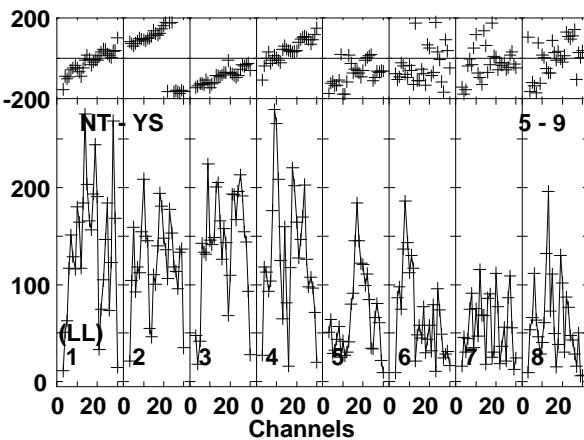
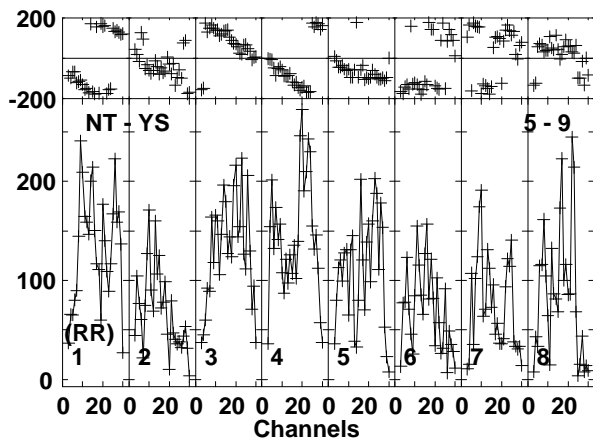
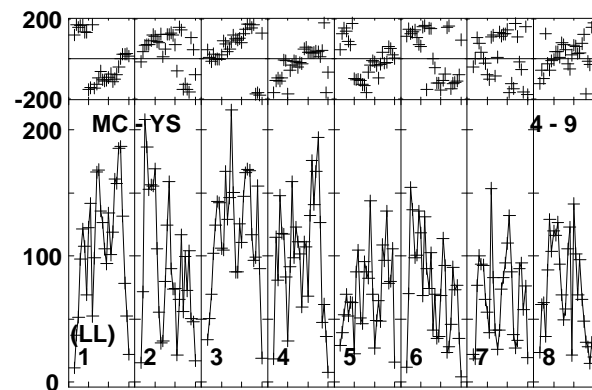
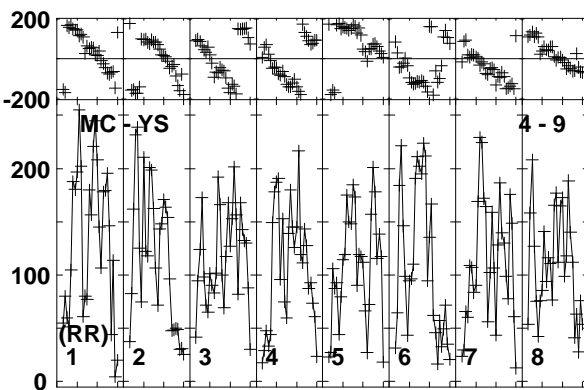
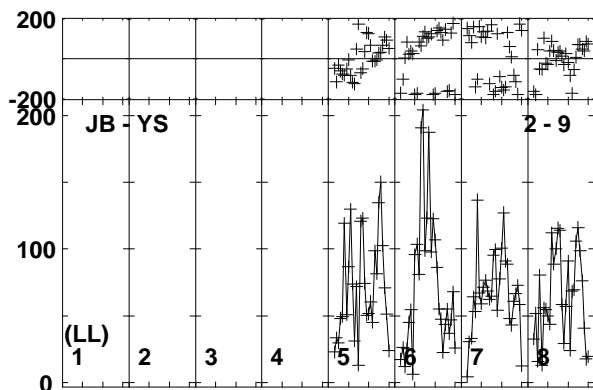
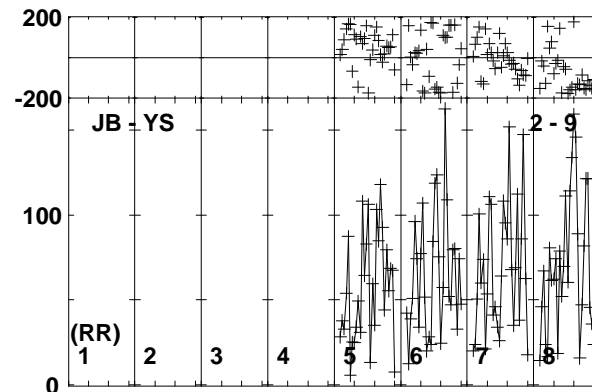
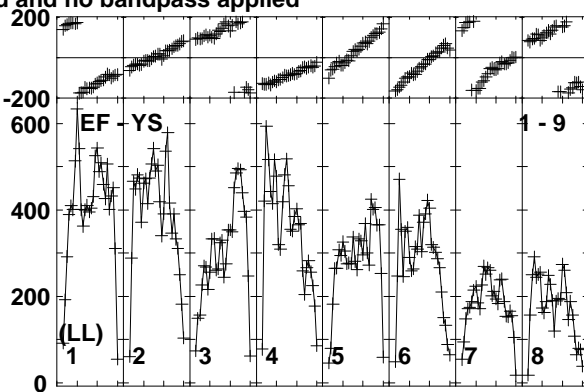
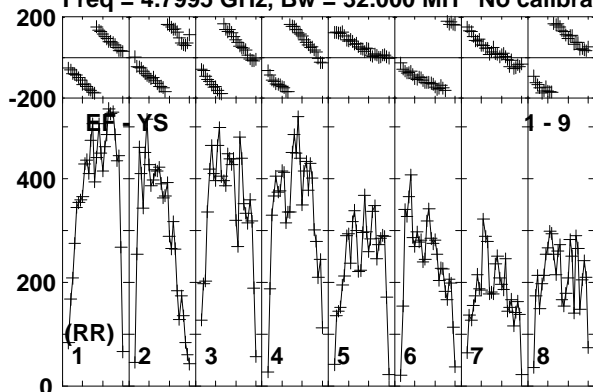

Lower frame: Micro Ampl Jy Top frame: Phas deg
Vector averaged cross-power spectrum Baseline: EF (01) - YS (09)
Timerange: 00/15:10:01 to 00/15:13:29

Plot file version 48 created 20-APR-2018 10:31:38

B0915+068 EG102C.UVDATA.1

Freq = 4.7995 GHz, Bw = 32.000 MH No calibration applied and no bandpass applied

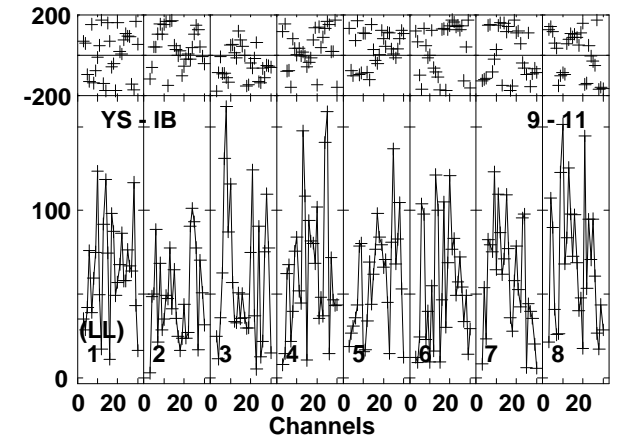
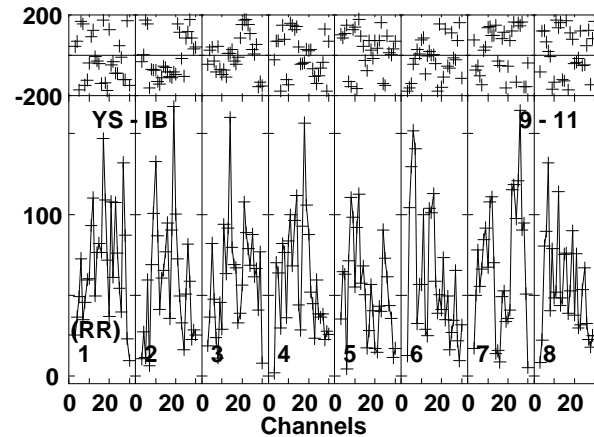
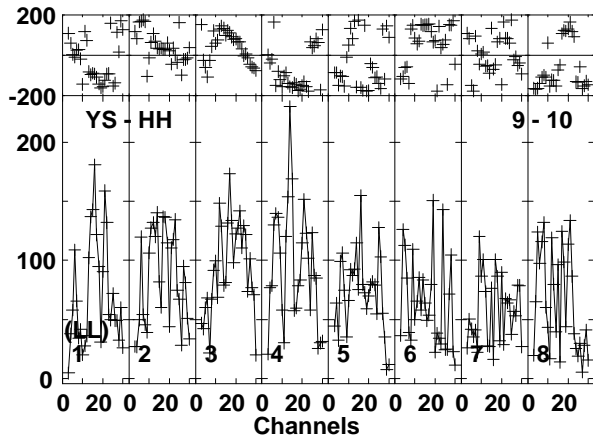
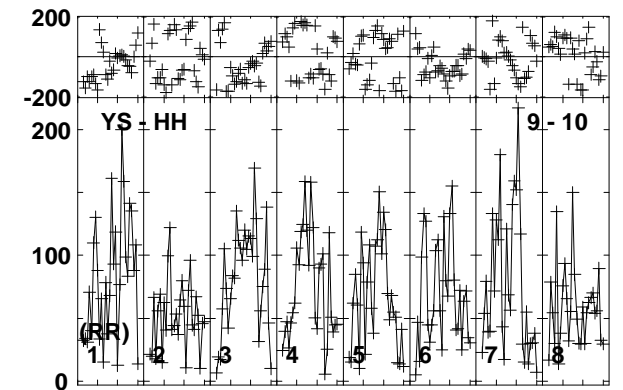
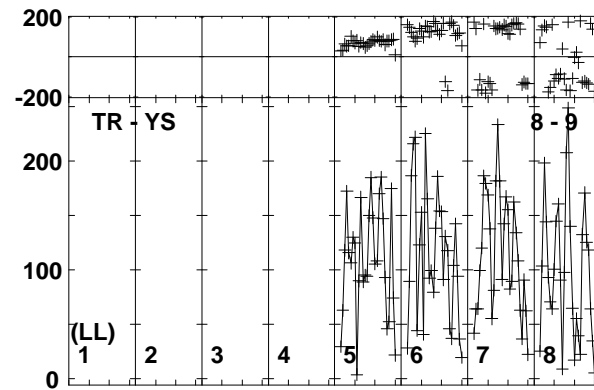
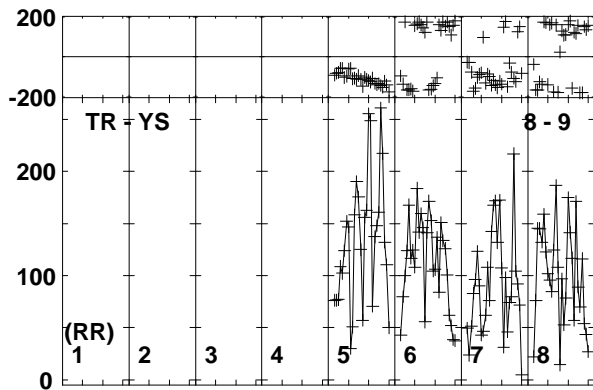
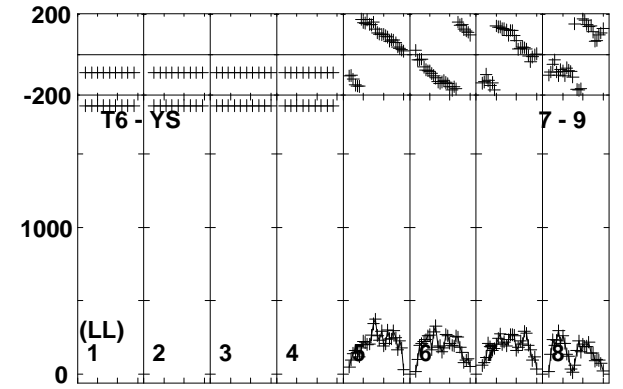
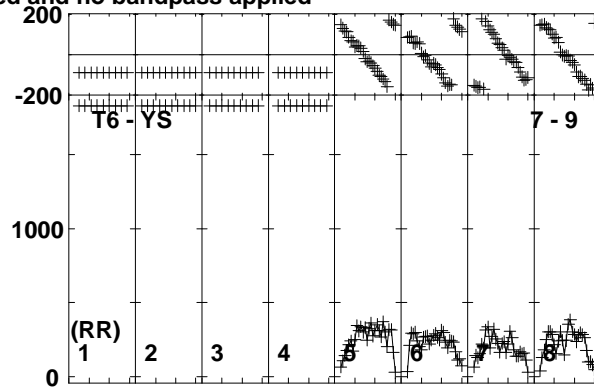
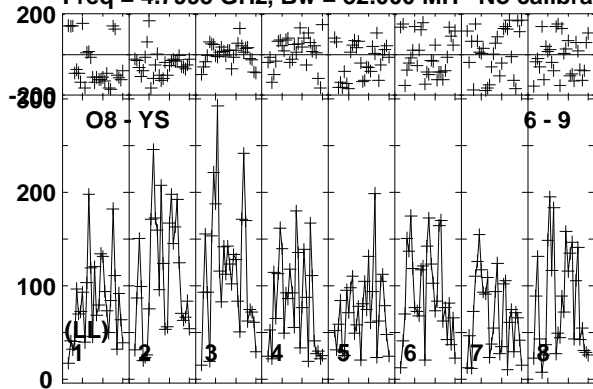

Lower frame: Micro Ampl Jy Top frame: Phas deg
Vector averaged cross-power spectrum Baseline: O8 (06) - YS (09)
Timerange: 00/15:10:01 to 00/15:13:29

Plot file version 49 created 20-APR-2018 10:31:39

J0915+0745 EG102C.UVDATA.1

Freq = 4.7995 GHz, Bw = 32.000 MH No calibration applied and no bandpass applied

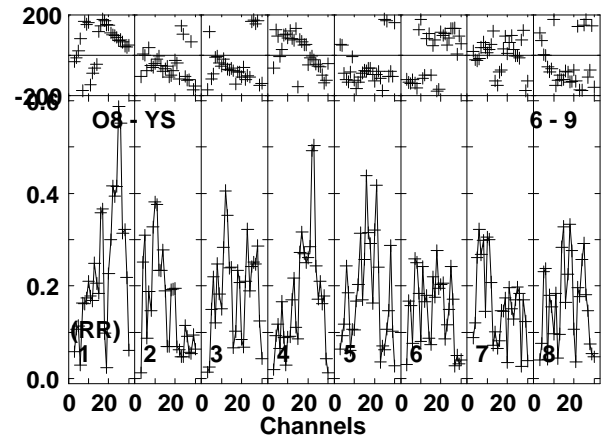
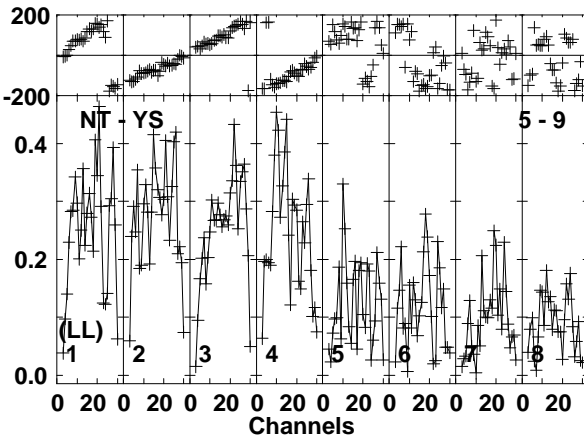
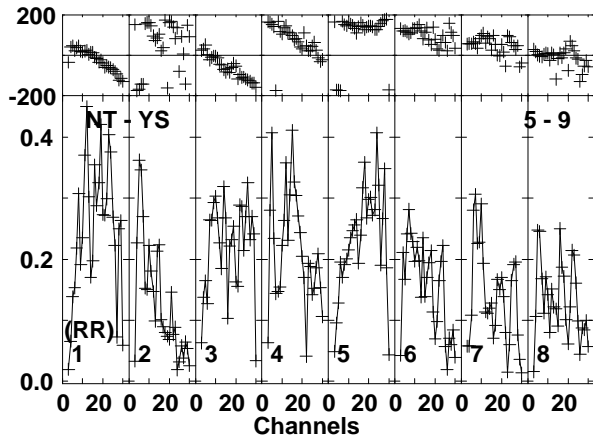
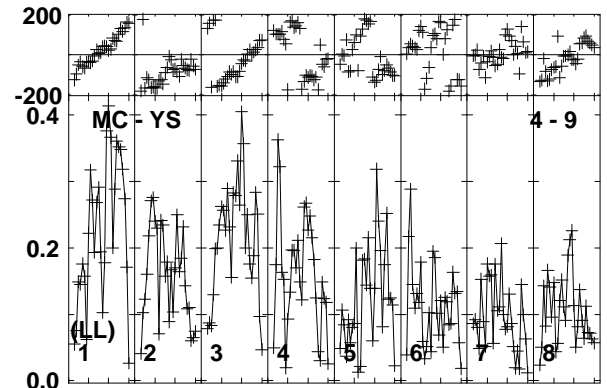
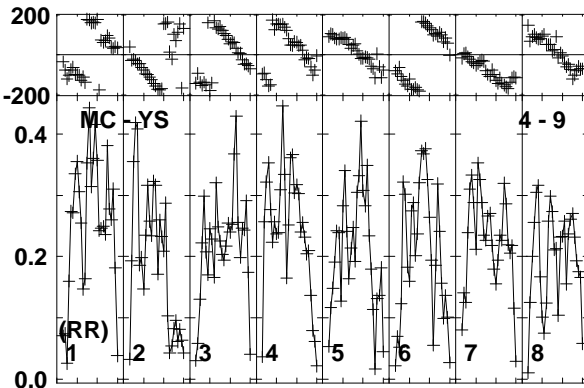
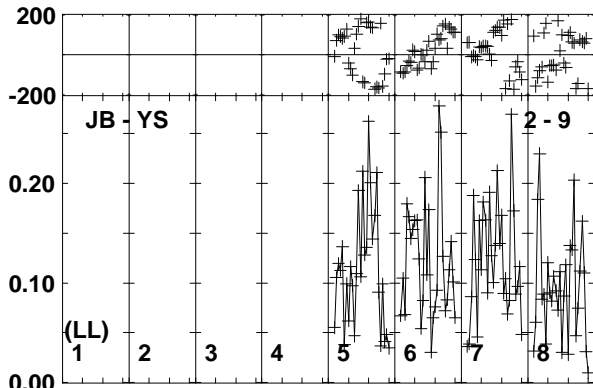
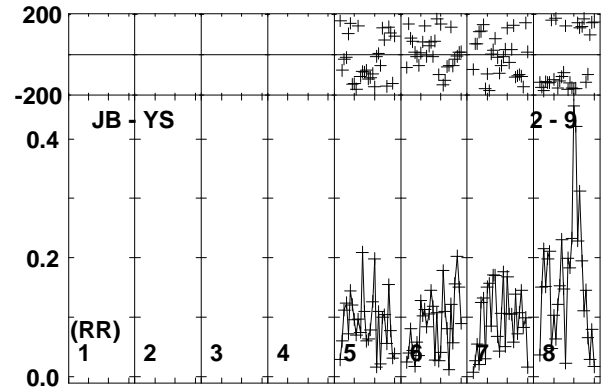
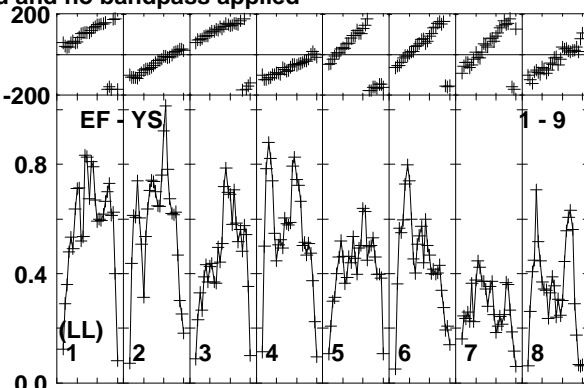
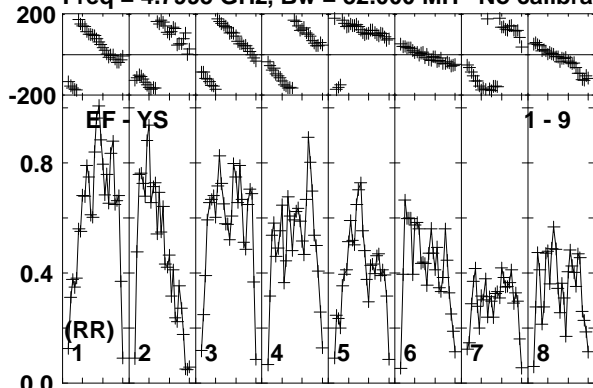

Lower frame: Milli Ampl Jy Top frame: Phas deg
Vector averaged cross-power spectrum Baseline: EF (01) - YS (09)
Timerange: 00/15:13:31 to 00/15:14:59

Plot file version 50 created 20-APR-2018 10:31:39

J0915+0745 EG102C.UVDATA.1

Freq = 4.7995 GHz, Bw = 32.000 MH No calibration applied and no bandpass applied

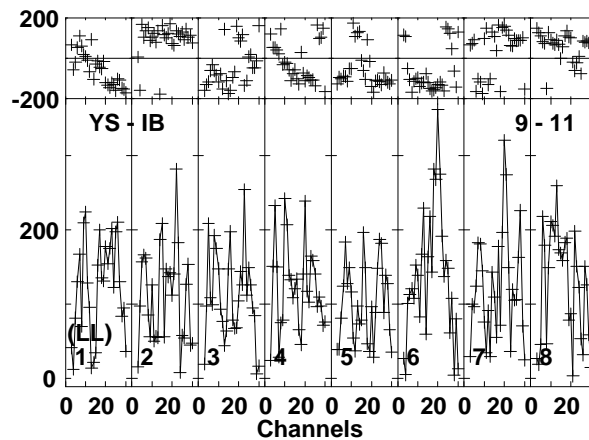
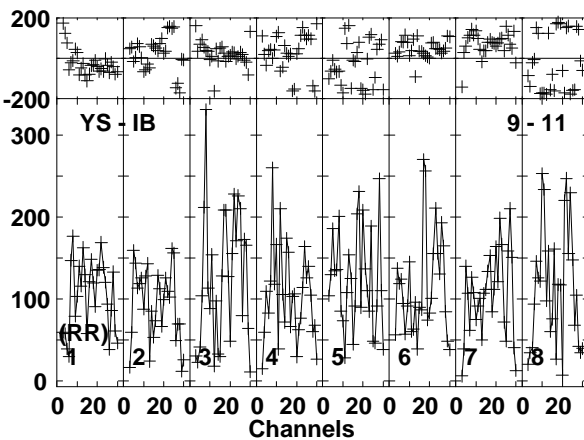
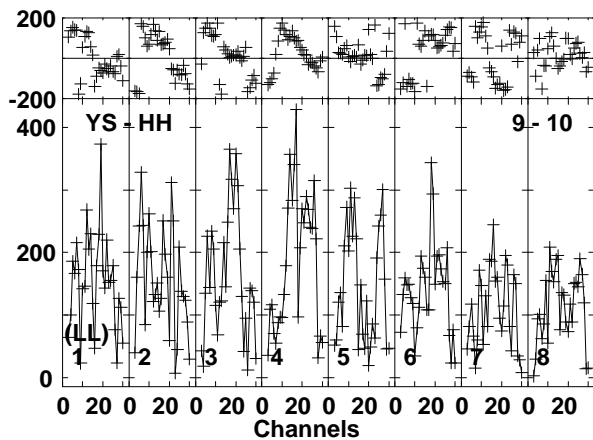
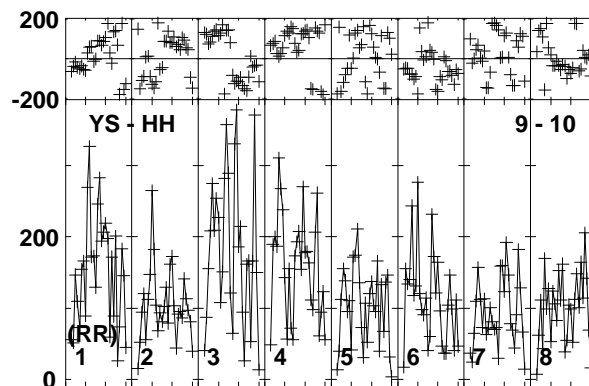
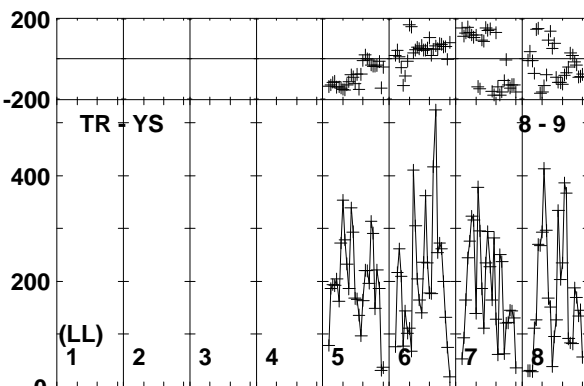
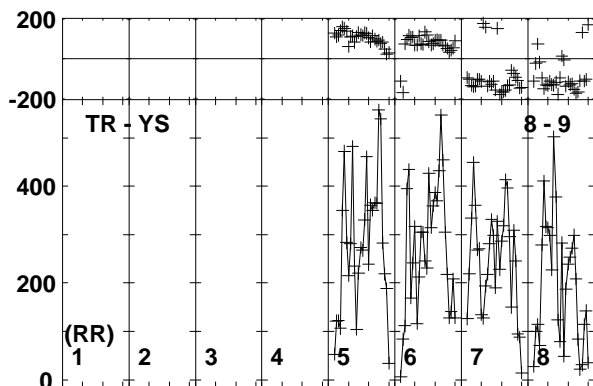
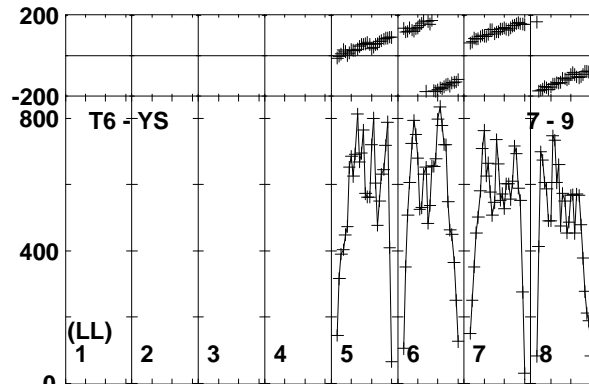
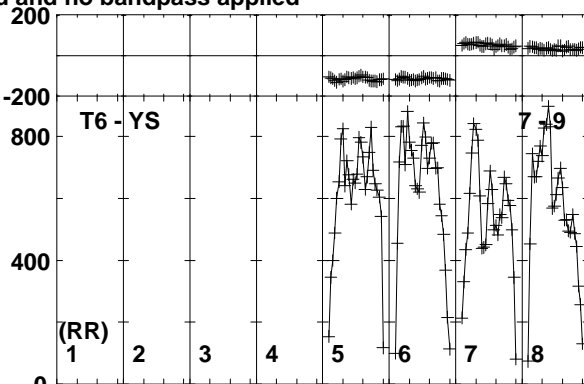
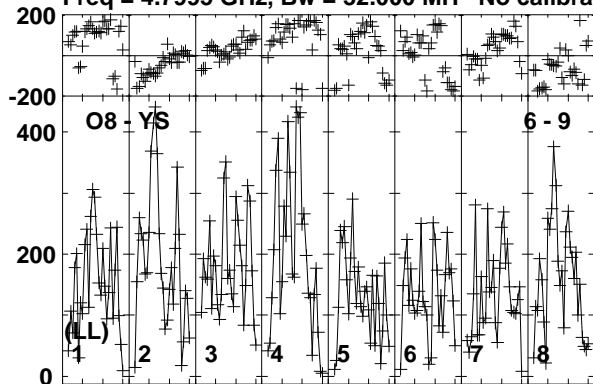

Lower frame: Micro Ampl Jy Top frame: Phas deg
Vector averaged cross-power spectrum Baseline: O8 (06) - YS (09)
Timerange: 00/15:13:31 to 00/15:14:59

Plot file version 51 created 20-APR-2018 10:31:39

B0915+068 EG102C.UVDATA.1

Freq = 4.7995 GHz, Bw = 32.000 MH No calibration applied and no bandpass applied

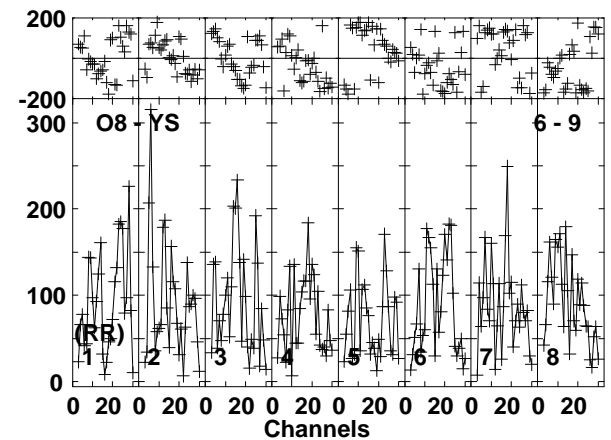
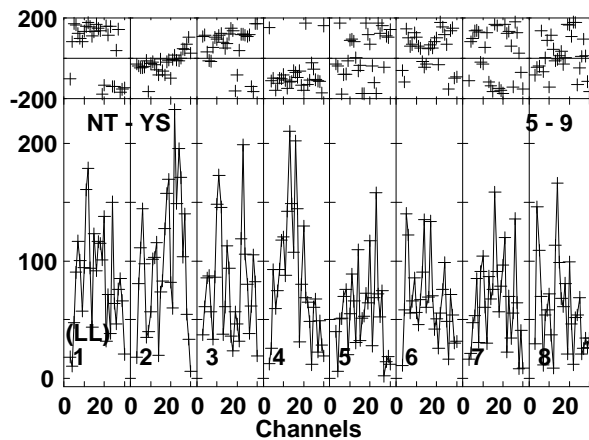
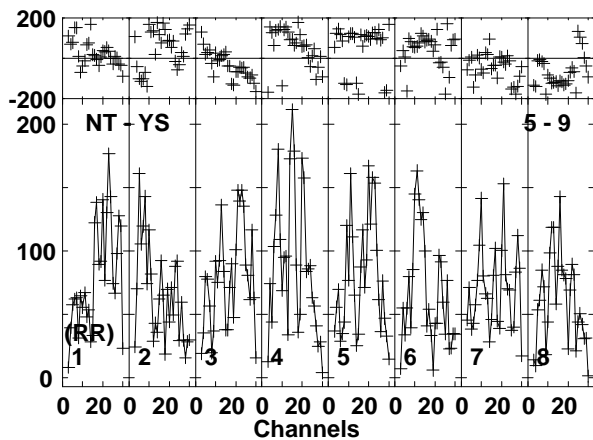
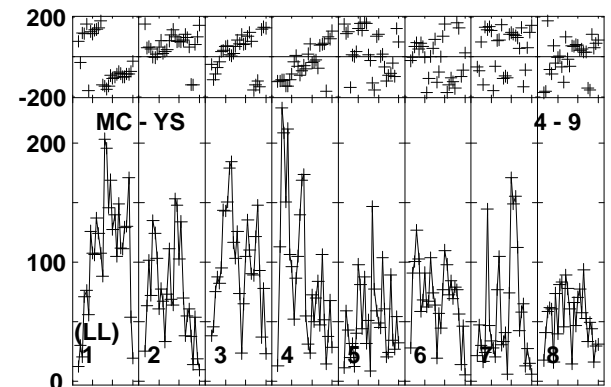
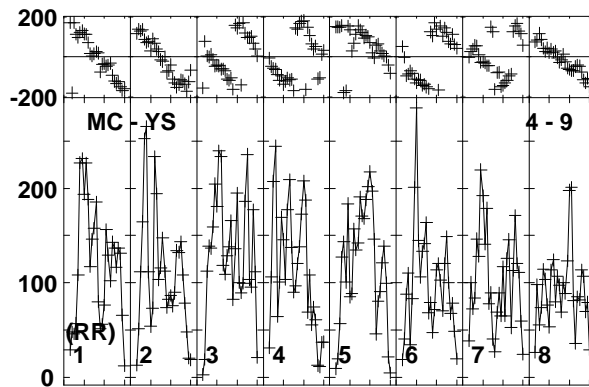
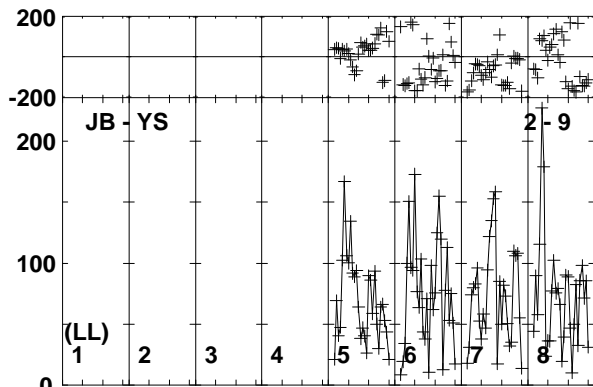
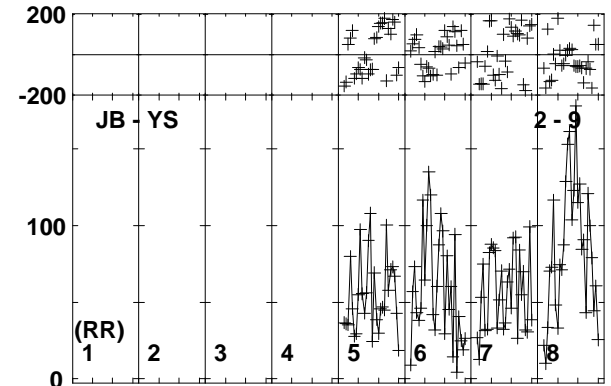
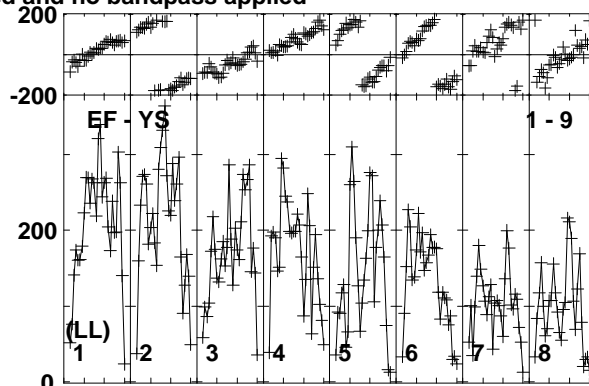
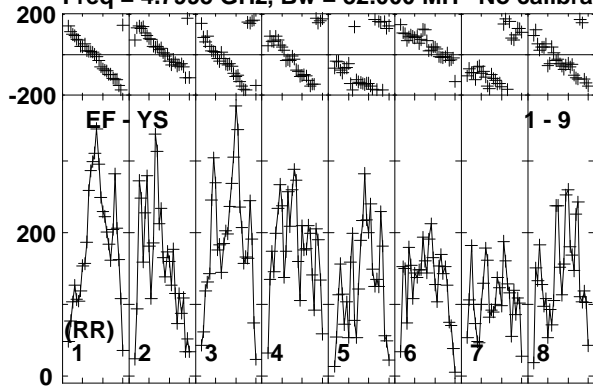

Lower frame: Micro Ampl Jy Top frame: Phas deg
Vector averaged cross-power spectrum Baseline: EF (01) - YS (09)
Timerange: 00/15:15:01 to 00/15:18:29

Plot file version 52 created 20-APR-2018 10:31:39

B0915+068 EG102C.UVDATA.1

Freq = 4.7995 GHz, Bw = 32.000 MH No calibration applied and no bandpass applied

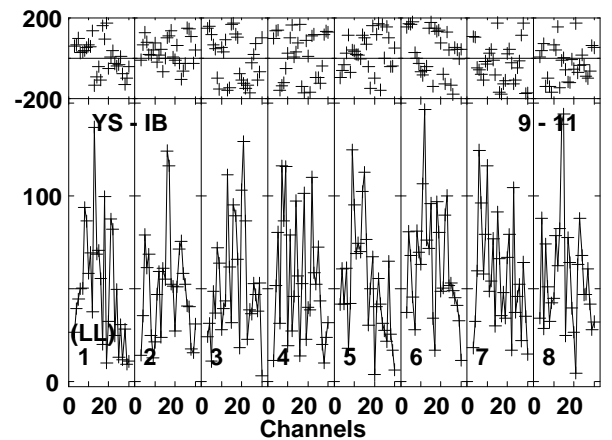
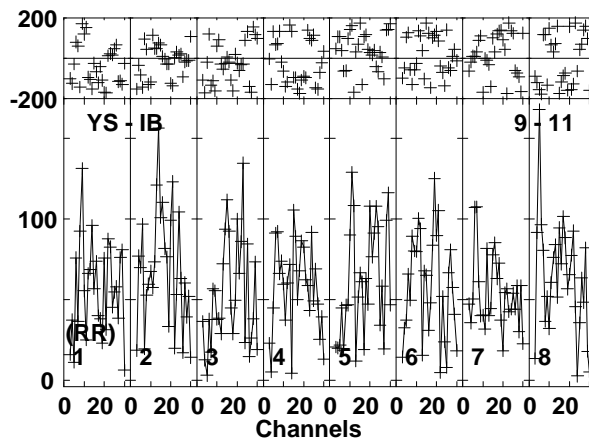
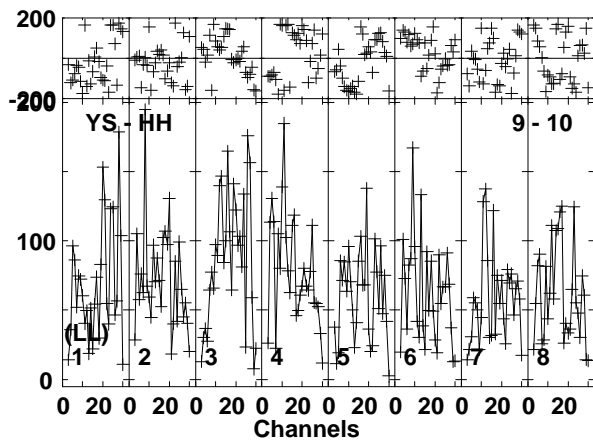
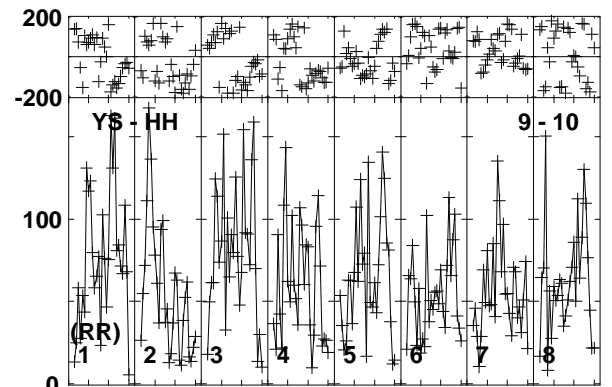
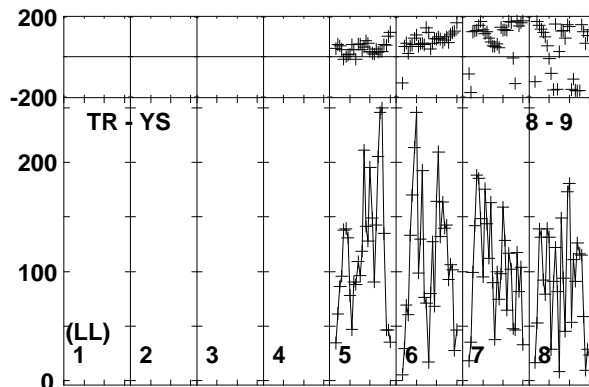
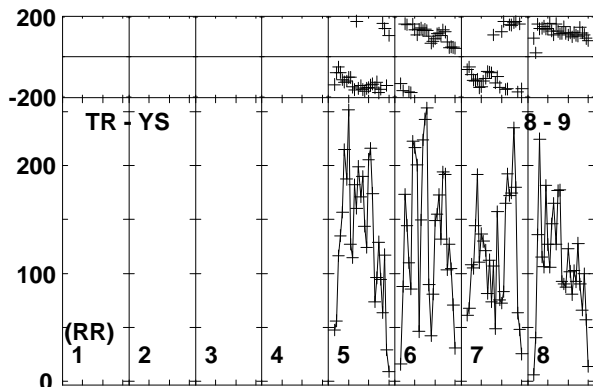
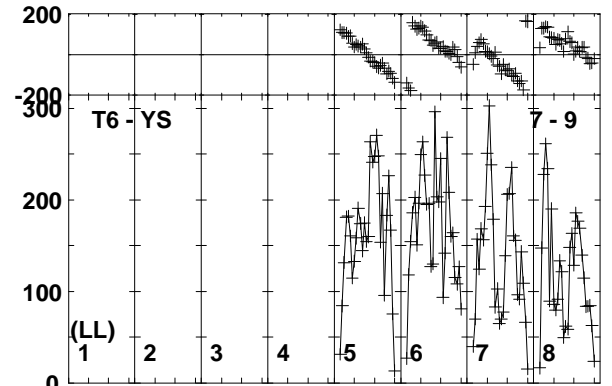
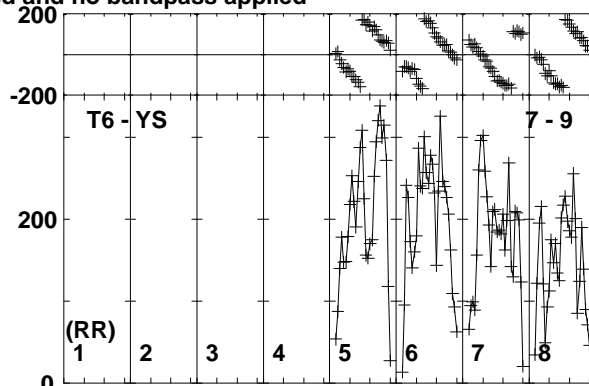
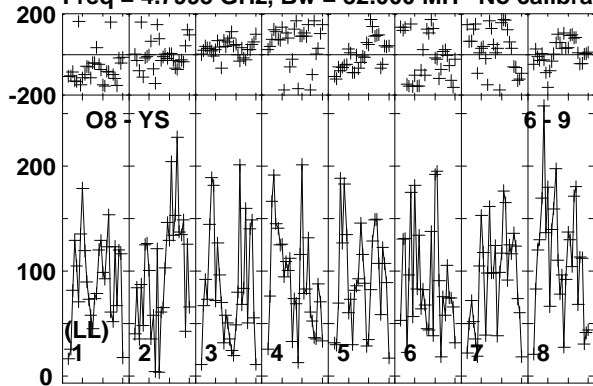

Lower frame: Micro Ampl Jy Top frame: Phas deg
Vector averaged cross-power spectrum Baseline: O8 (06) - YS (09)
Timerange: 00/15:15:01 to 00/15:18:29

Plot file version 53 created 20-APR-2018 10:31:39

J0915+0745 EG102C.UVDATA.1

Freq = 4.7995 GHz, Bw = 32.000 MH No calibration applied and no bandpass applied

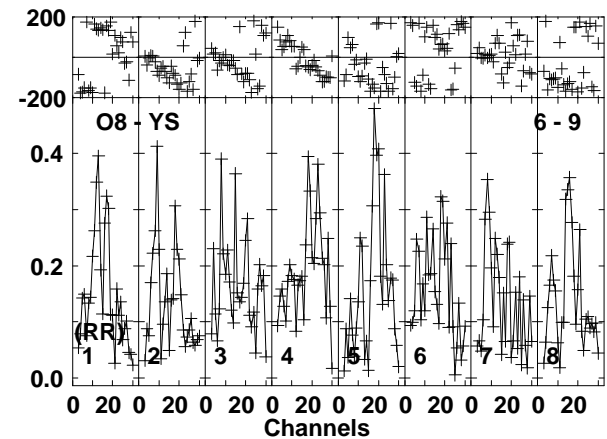
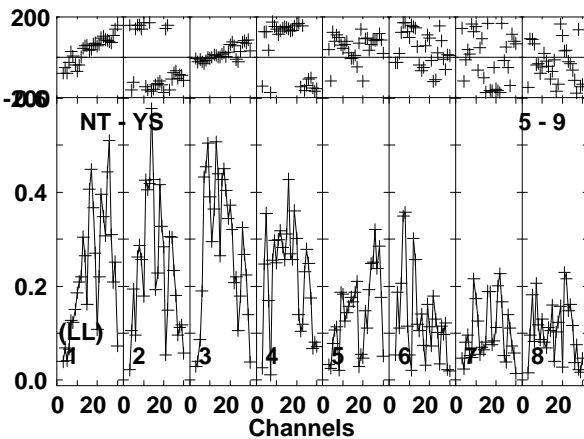
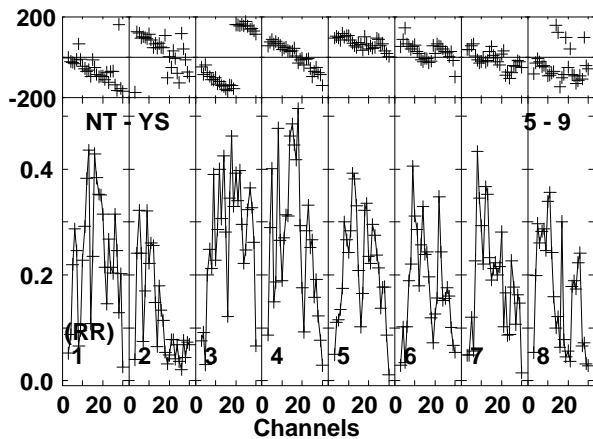
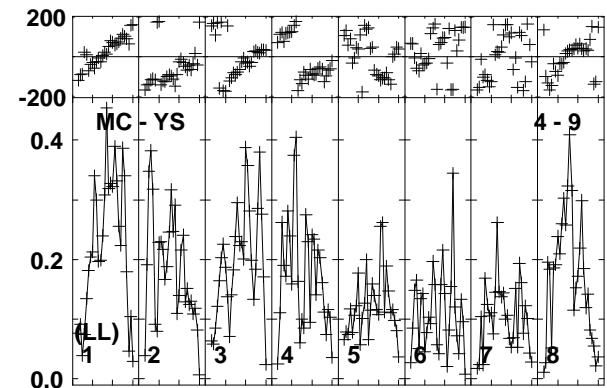
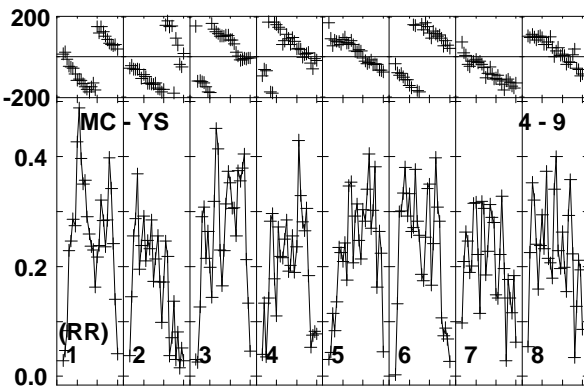
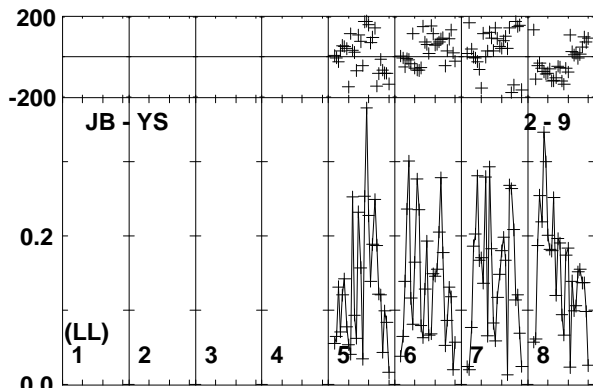
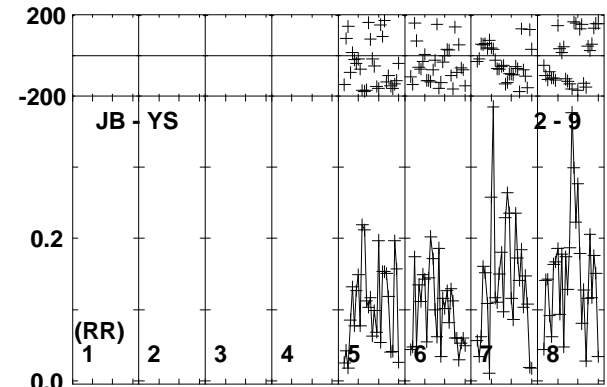
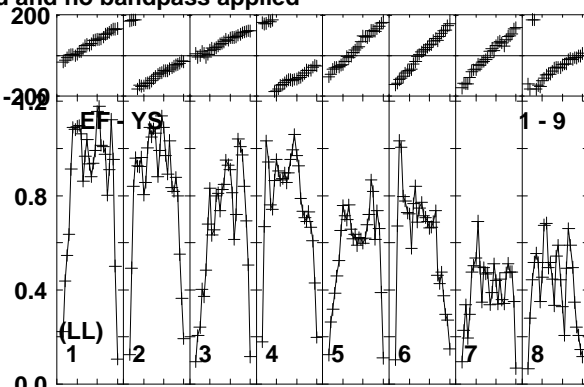
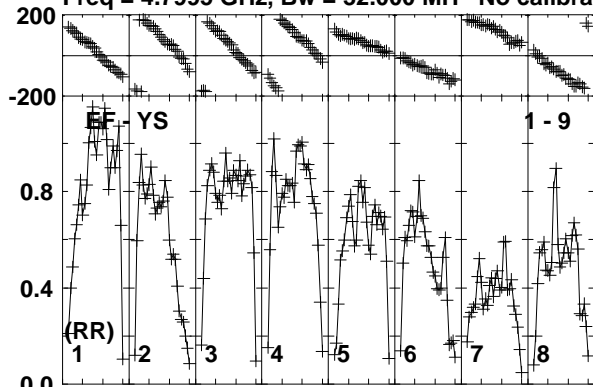

Lower frame: Milli Ampl Jy Top frame: Phas deg
Vector averaged cross-power spectrum Baseline: EF (01) - YS (09)
Timerange: 00/15:19:11 to 00/15:20:09

Plot file version 54 created 20-APR-2018 10:31:39

J0915+0745 EG102C.UVDATA.1

Freq = 4.7995 GHz, Bw = 32.000 MH No calibration applied and no bandpass applied

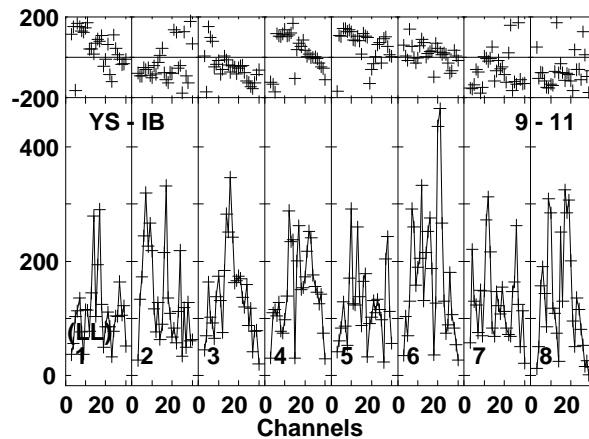
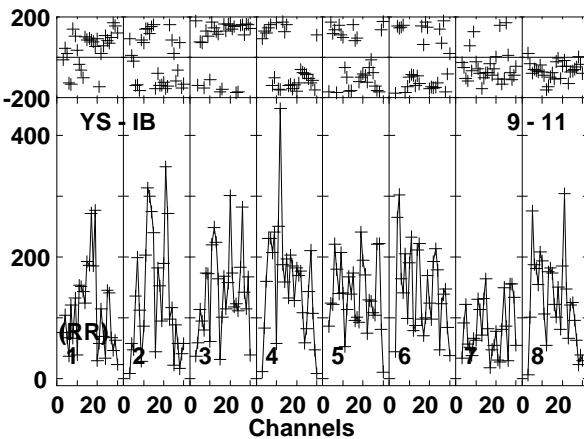
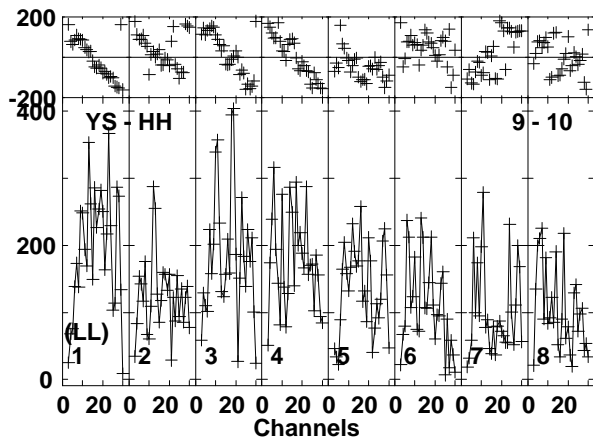
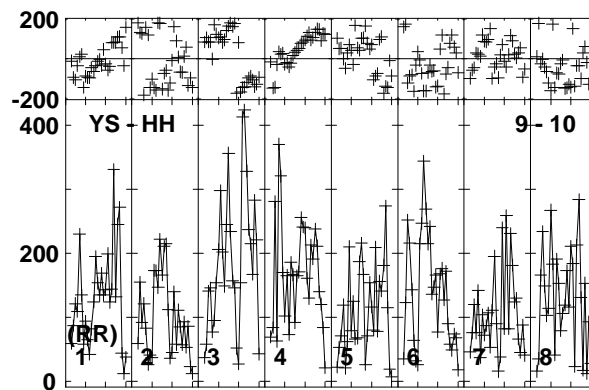
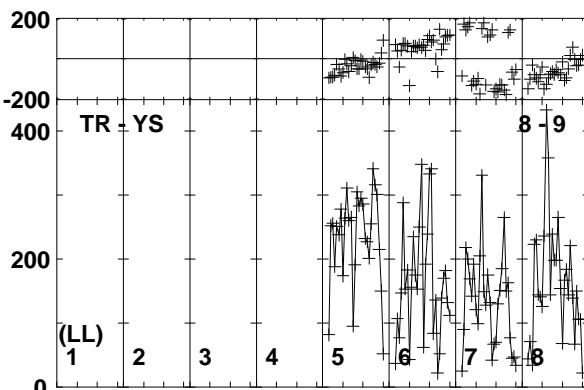
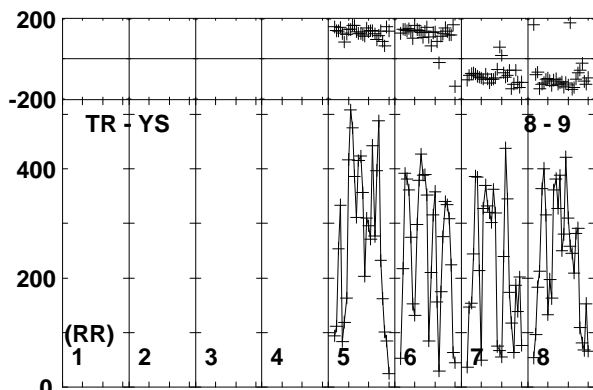
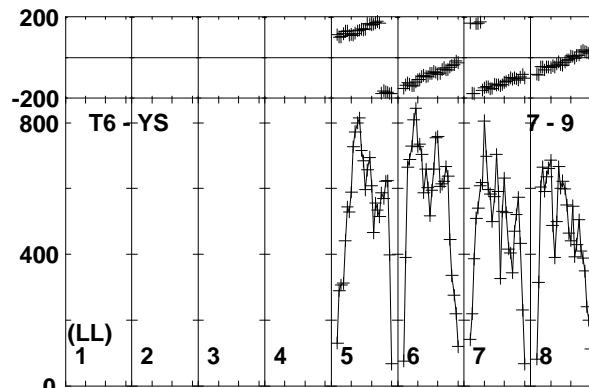
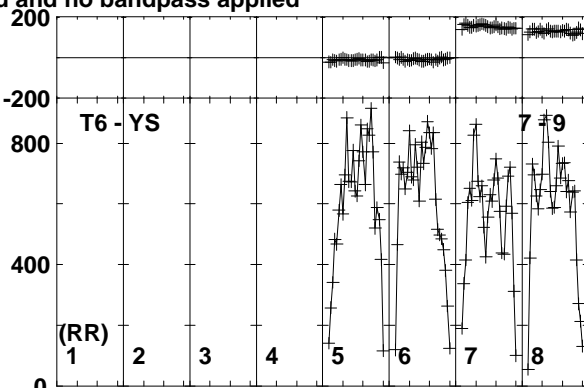
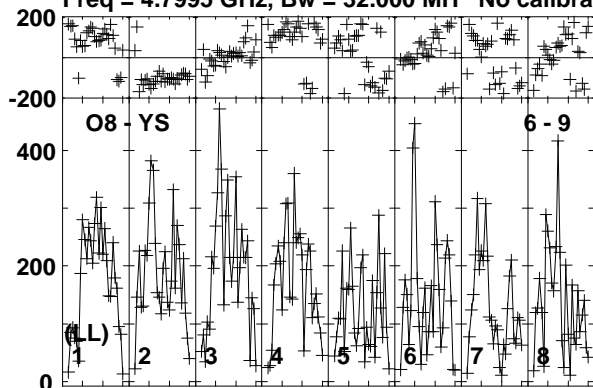

Lower frame: Micro Ampl Jy Top frame: Phas deg
Vector averaged cross-power spectrum Baseline: O8 (06) - YS (09)
Timerange: 00/15:19:11 to 00/15:20:09

Plot file version 55 created 20-APR-2018 10:31:39

B0915+068 EG102C.UVDATA.1

Freq = 4.7995 GHz, Bw = 32.000 MH No calibration applied and no bandpass applied

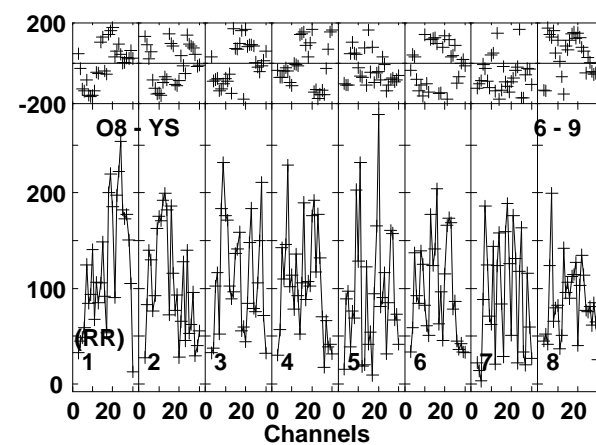
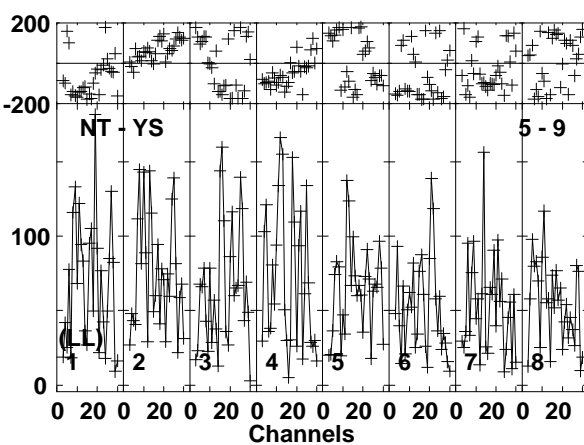
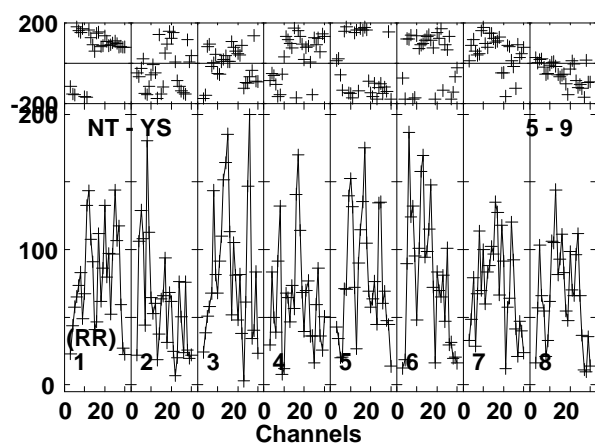
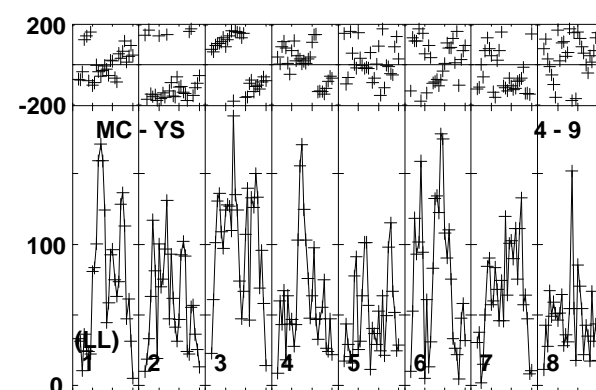
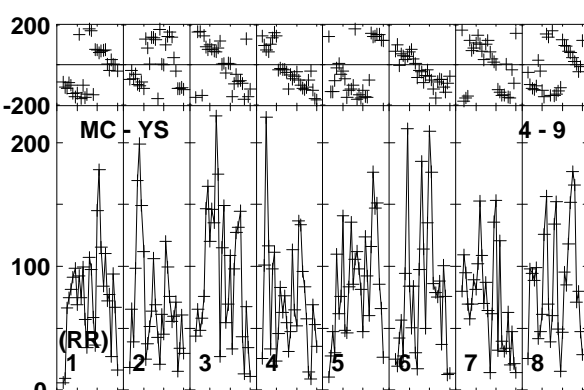
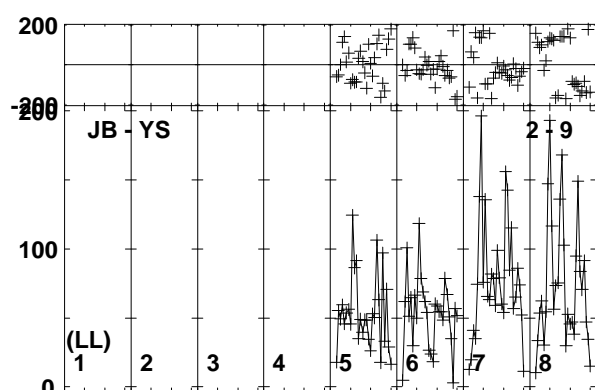
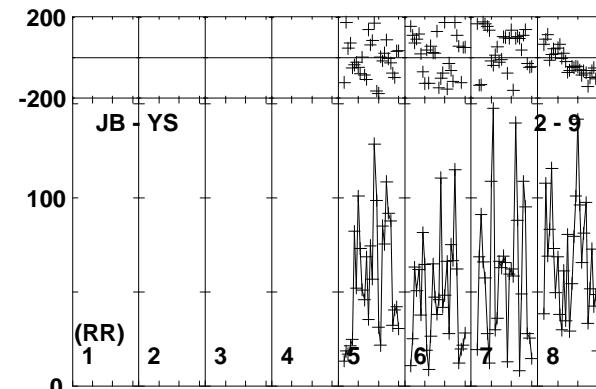
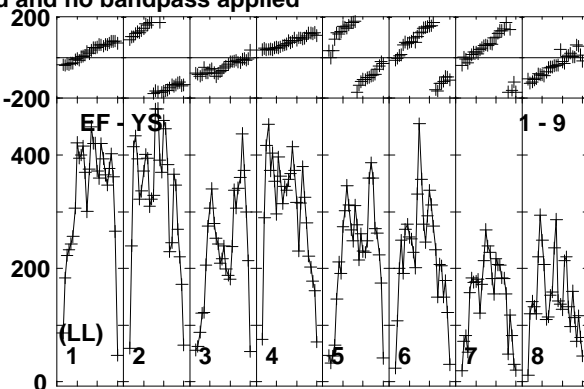
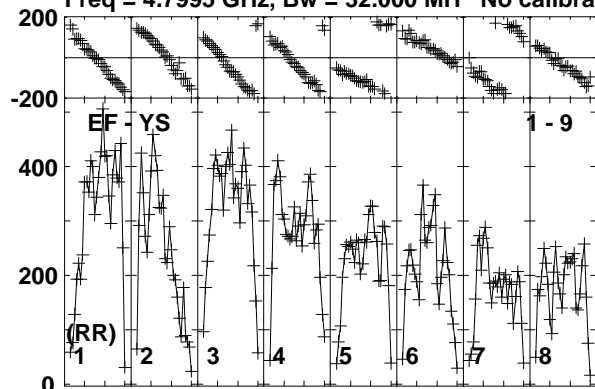

Lower frame: Micro Ampl Jy Top frame: Phas deg
Vector averaged cross-power spectrum Baseline: EF (01) - YS (09)
Timerange: 00/15:20:11 to 00/15:23:39

Plot file version 56 created 20-APR-2018 10:31:39

B0915+068 EG102C.UVDATA.1

Freq = 4.7995 GHz, Bw = 32.000 MH No calibration applied and no bandpass applied

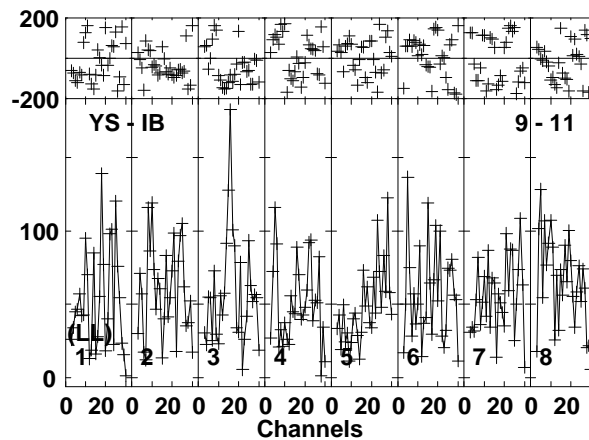
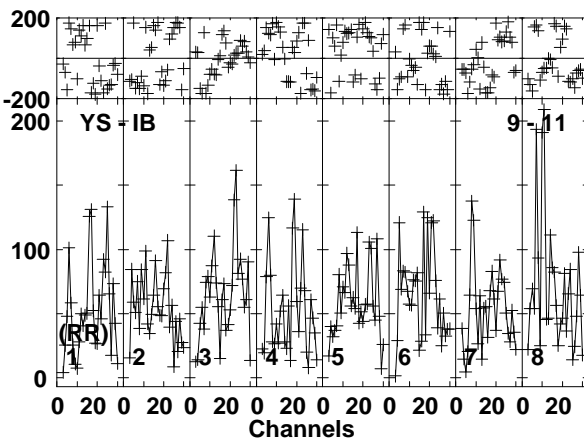
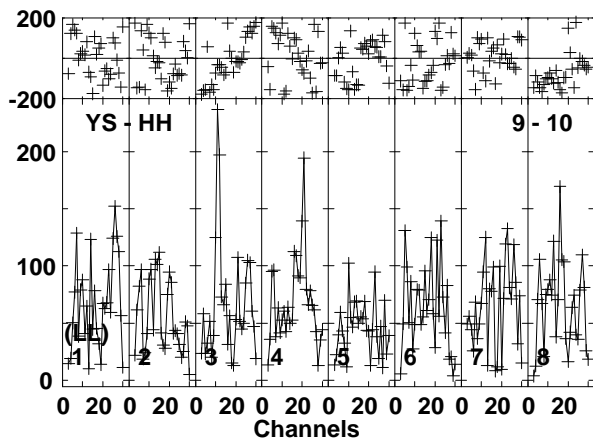
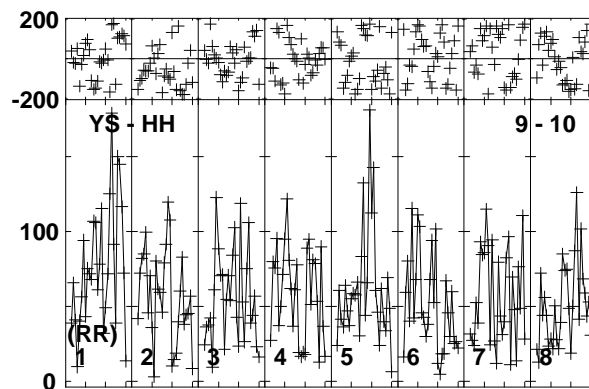
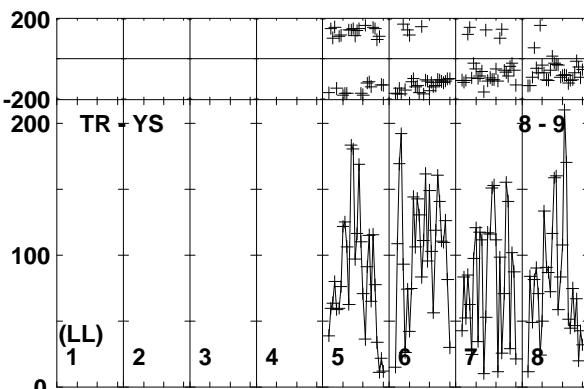
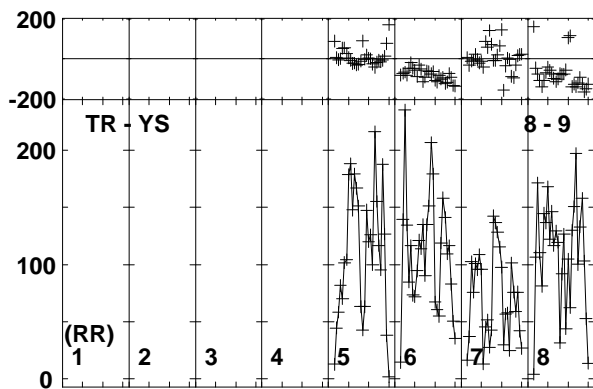
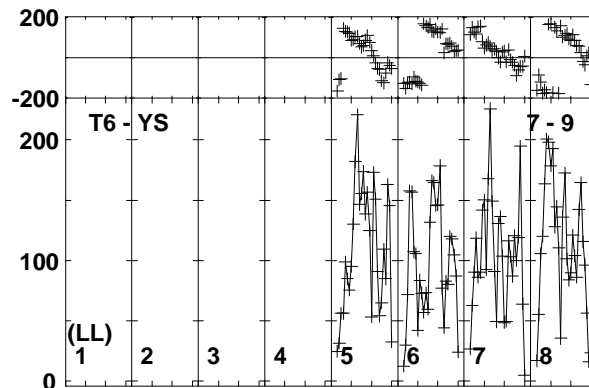
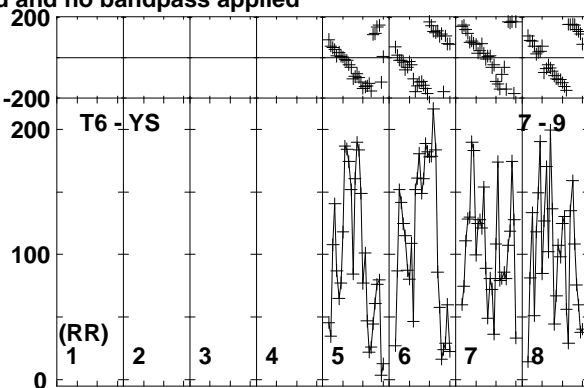
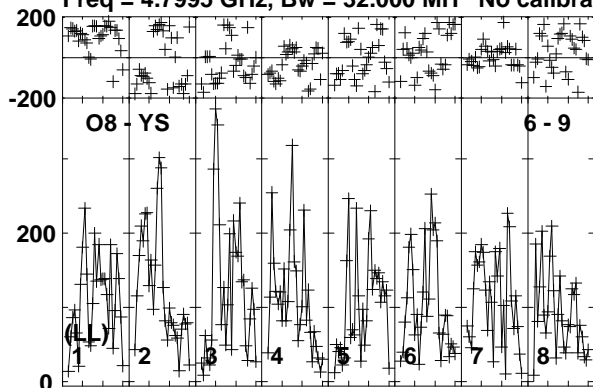

Lower frame: Micro Ampl Jy Top frame: Phas deg
Vector averaged cross-power spectrum Baseline: O8 (06) - YS (09)
Timerange: 00/15:20:11 to 00/15:23:39

Plot file version 57 created 20-APR-2018 10:31:39

J0915+0745 EG102C.UVDATA.1

Freq = 4.7995 GHz, Bw = 32.000 MH No calibration applied and no bandpass applied

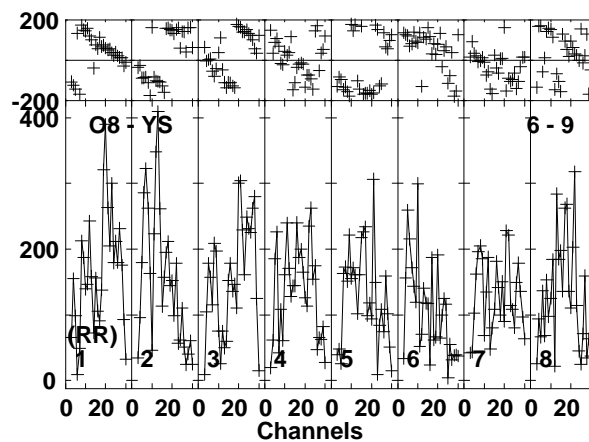
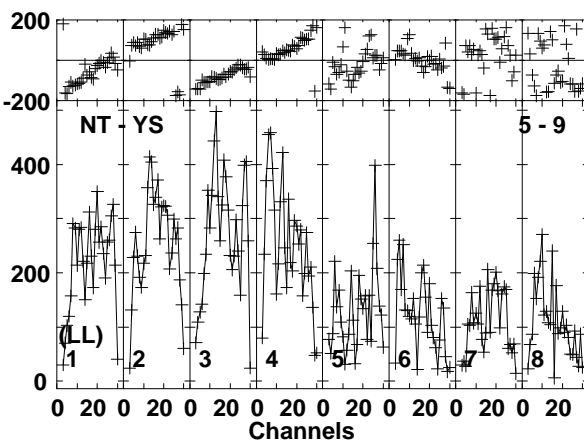
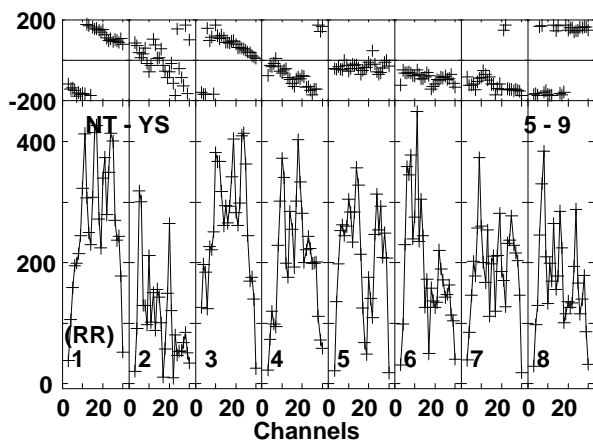
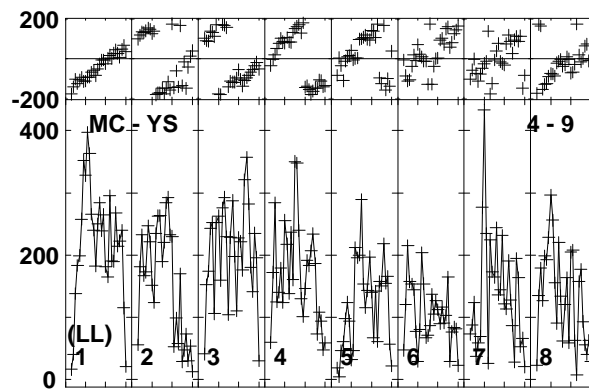
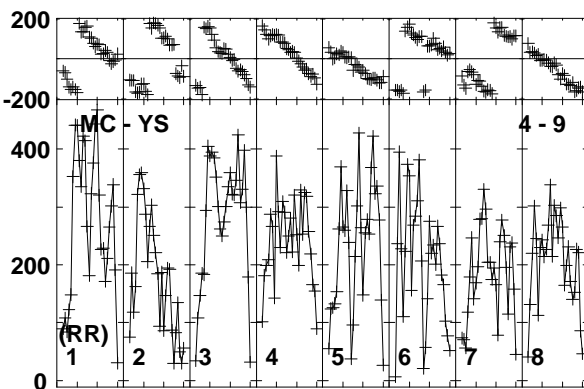
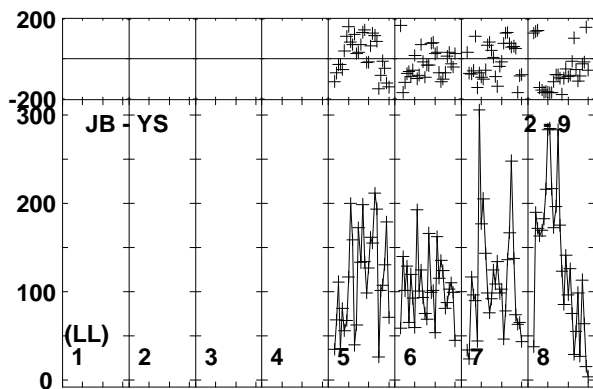
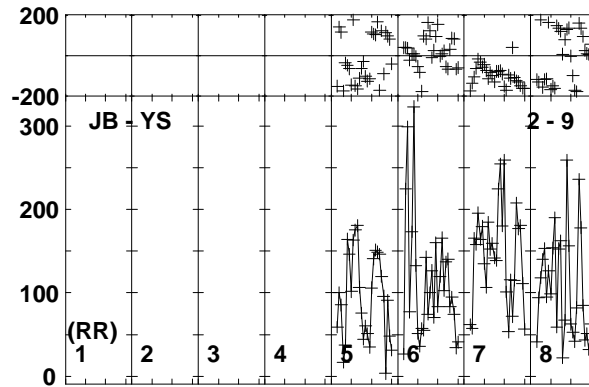
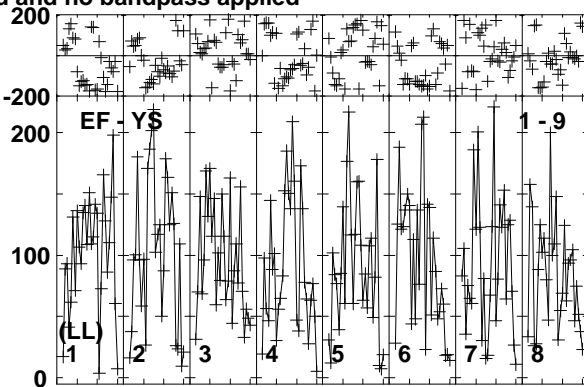
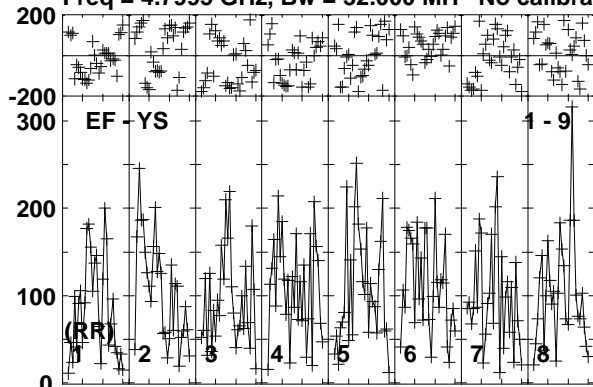

Lower frame: Micro Ampl Jy Top frame: Phas deg
Vector averaged cross-power spectrum Baseline: EF (01) - YS (09)
Timerange: 00/15:23:41 to 00/15:25:09

Plot file version 58 created 20-APR-2018 10:31:40

J0915+0745 EG102C.UVDATA.1

Freq = 4.7995 GHz, Bw = 32.000 MH No calibration applied and no bandpass applied

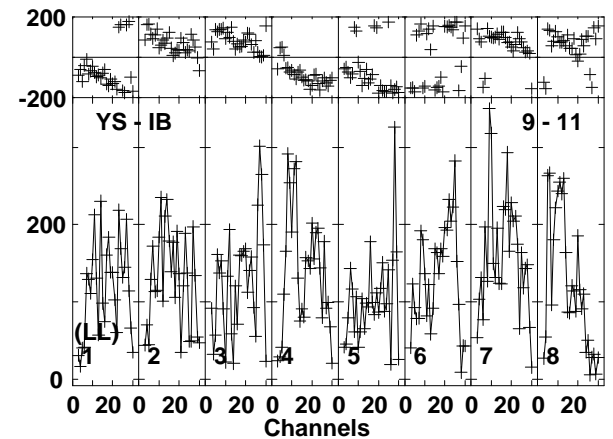
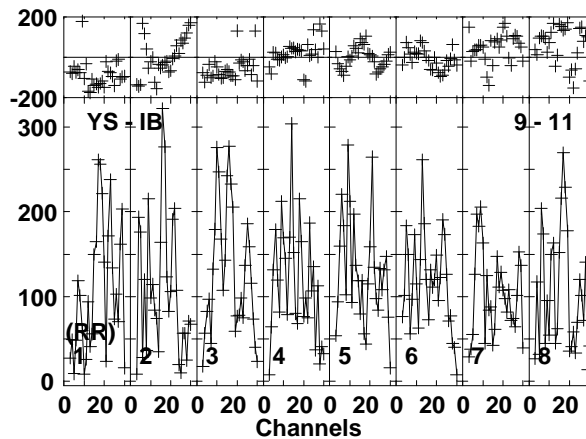
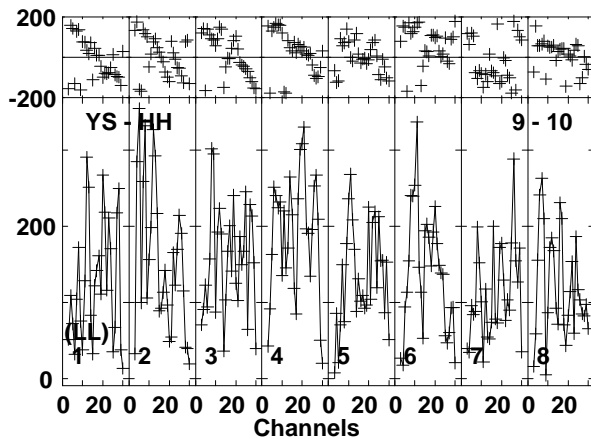
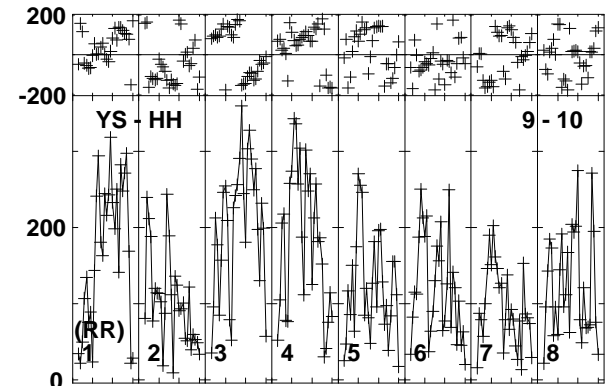
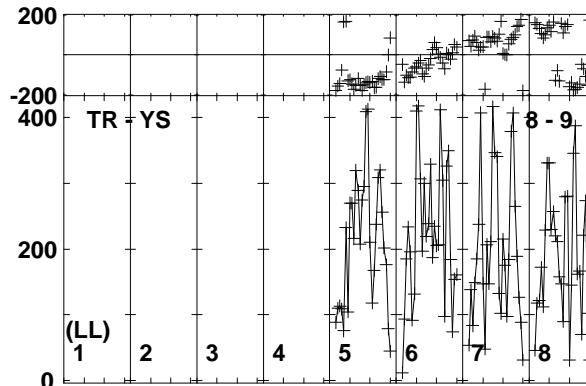
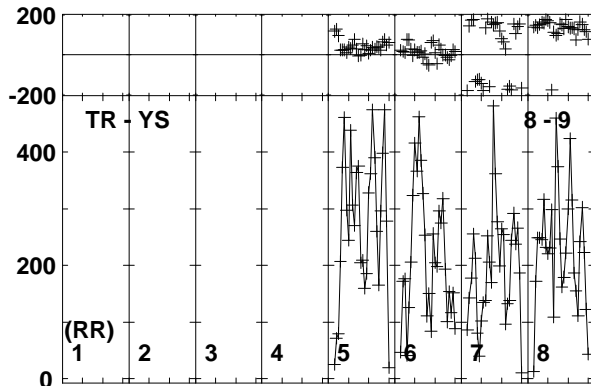
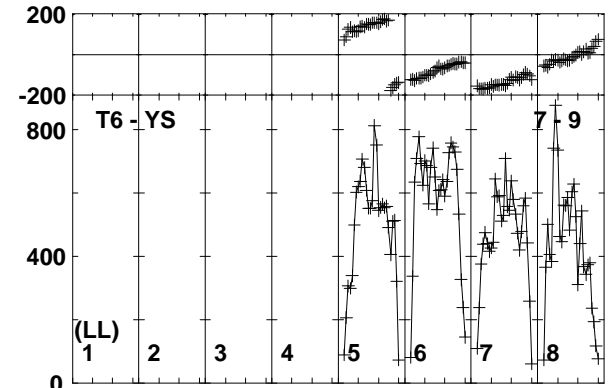
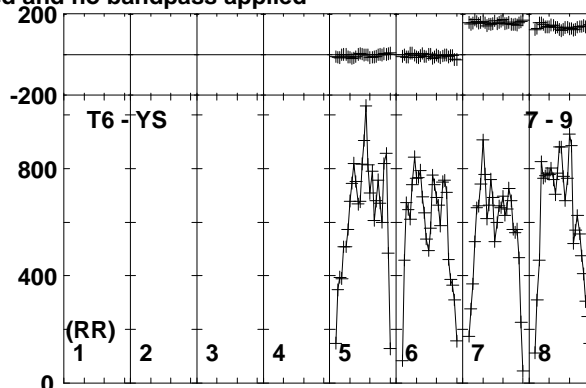
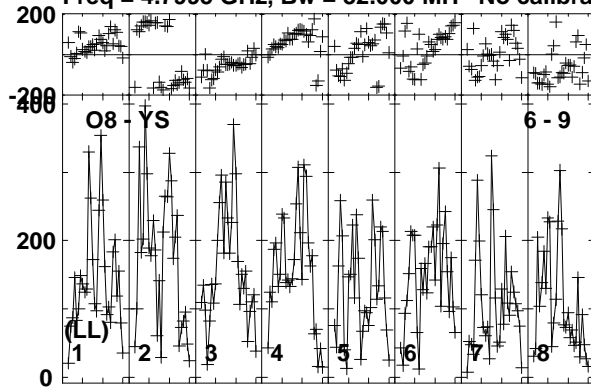

Lower frame: Micro Ampl Jy Top frame: Phas deg
Vector averaged cross-power spectrum Baseline: O8 (06) - YS (09)
Timerange: 00/15:23:41 to 00/15:25:09

Plot file version 59 created 20-APR-2018 10:31:40

B0915+068 EG102C.UVDATA.1

Freq = 4.7995 GHz, Bw = 32.000 MH No calibration applied and no bandpass applied

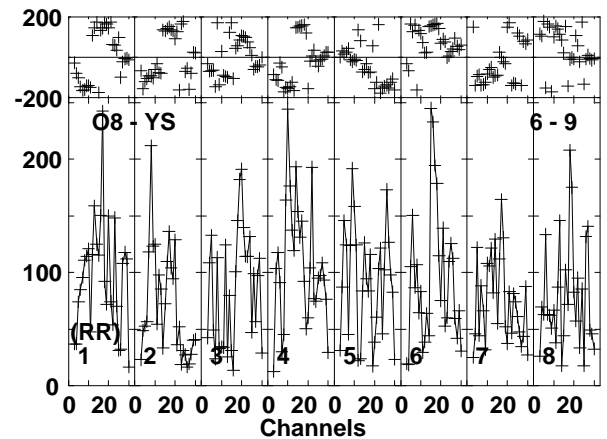
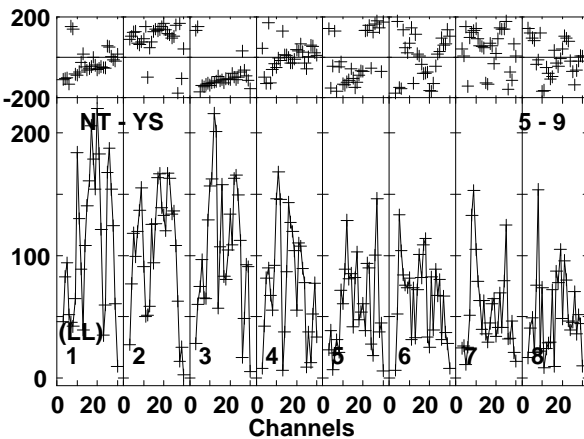
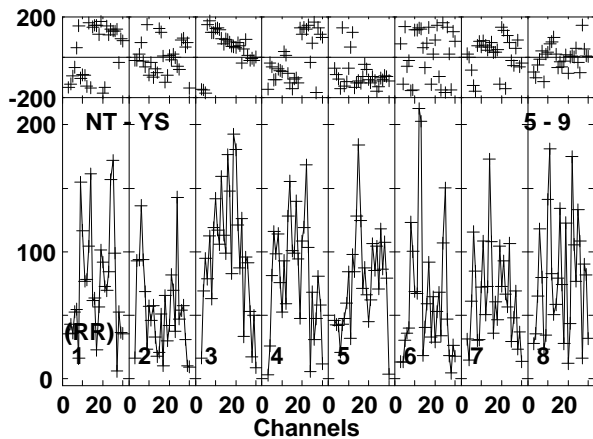
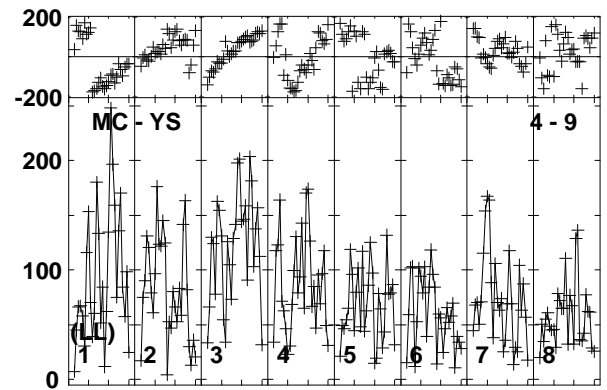
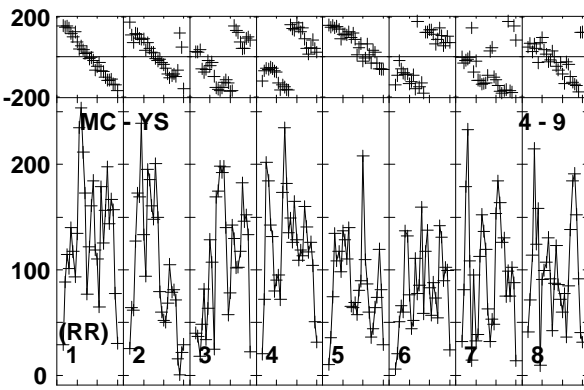
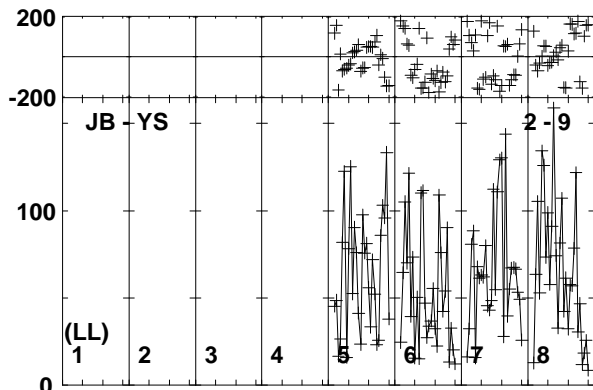
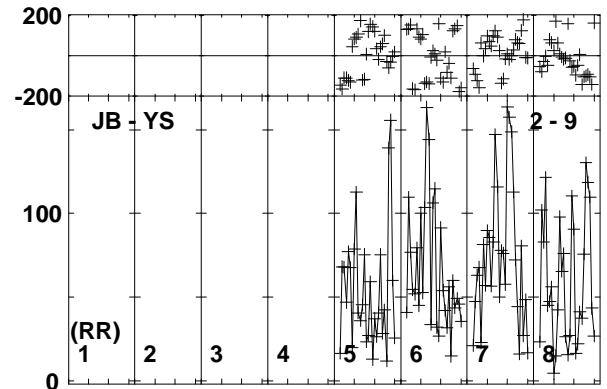
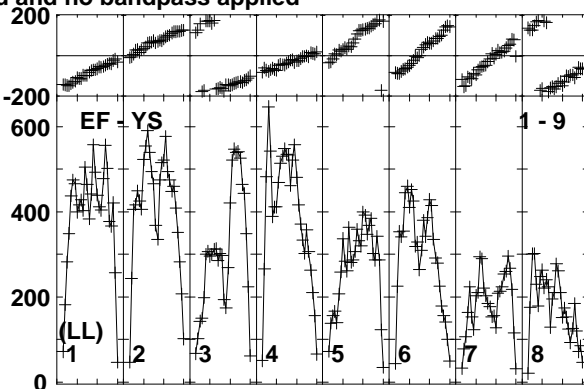
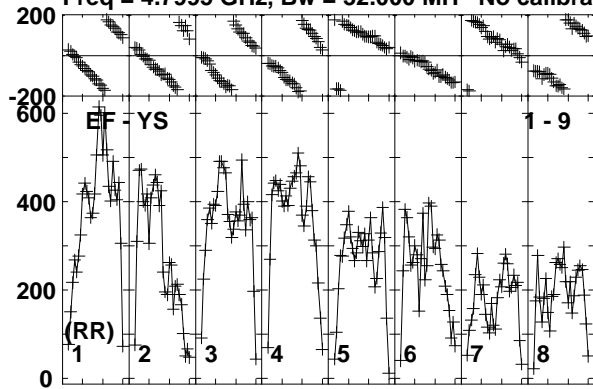

Lower frame: Micro Ampl Jy Top frame: Phas deg
Vector averaged cross-power spectrum Baseline: EF (01) - YS (09)
Timerange: 00/15:25:11 to 00/15:28:39

Plot file version 60 created 20-APR-2018 10:31:40

B0915+068 EG102C.UVDATA.1

Freq = 4.7995 GHz, Bw = 32.000 MH No calibration applied and no bandpass applied

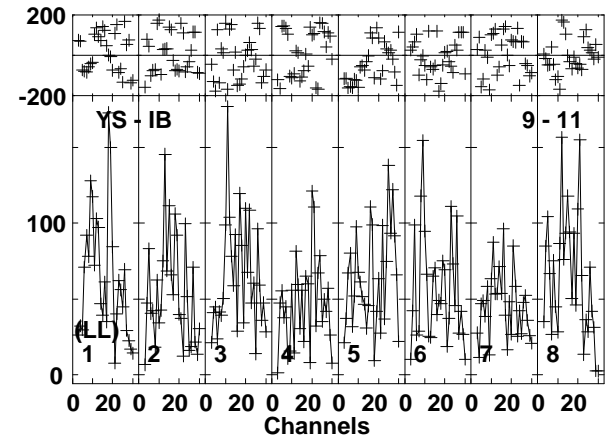
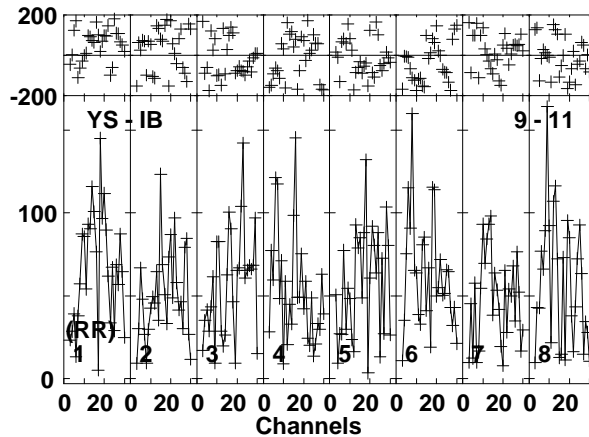
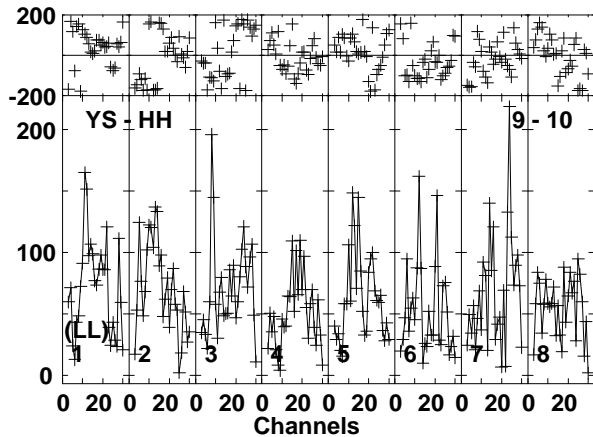
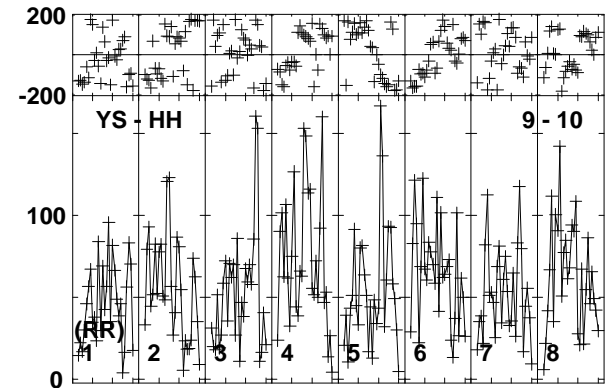
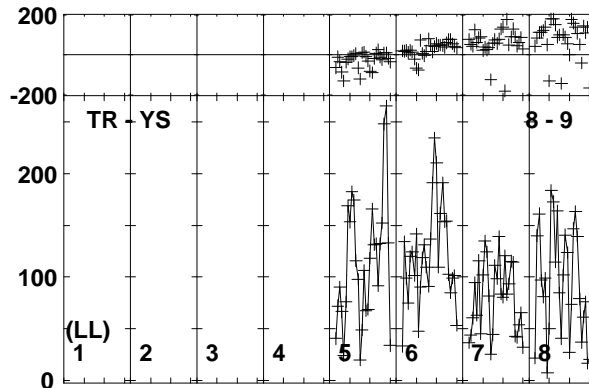
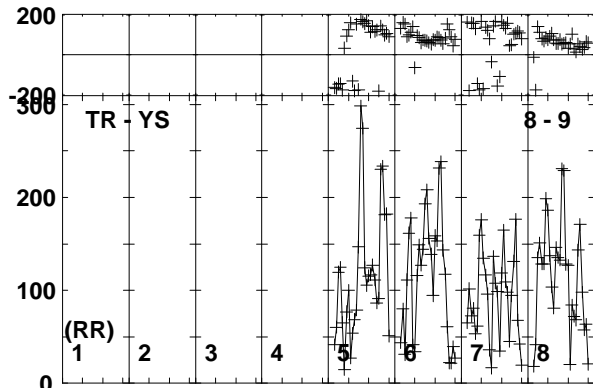
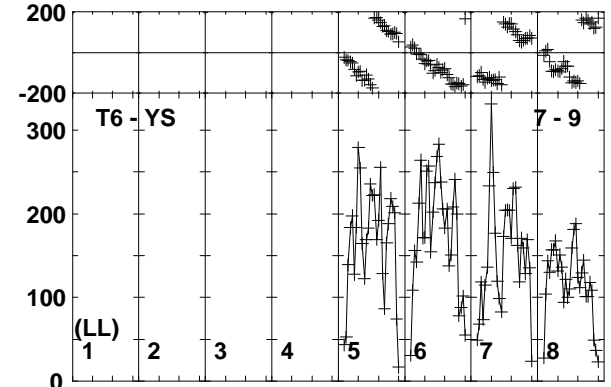
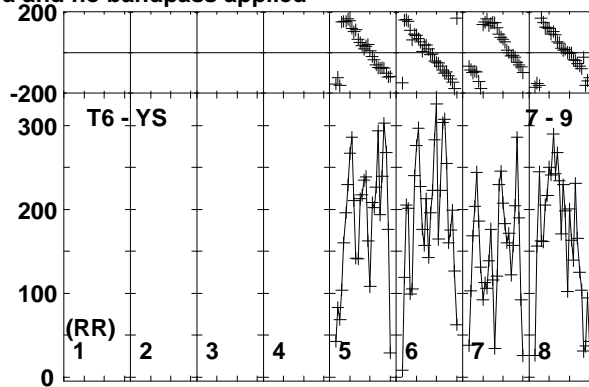
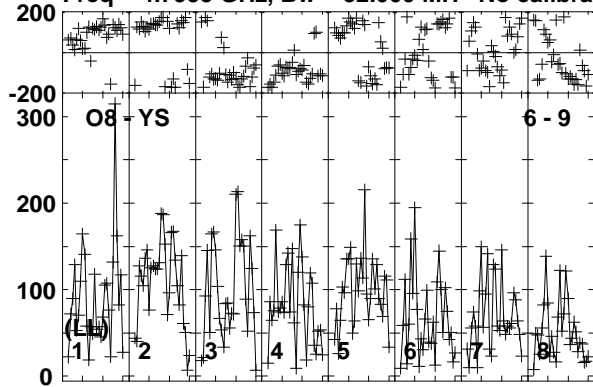

Lower frame: Micro Ampl Jy Top frame: Phas deg
Vector averaged cross-power spectrum Baseline: O8 (06) - YS (09)
Timerange: 00/15:25:11 to 00/15:28:39

Plot file version 61 created 20-APR-2018 10:31:40

J0915+0745 EG102C.UVDATA.1

Freq = 4.7995 GHz, Bw = 32.000 MH No calibration applied and no bandpass applied

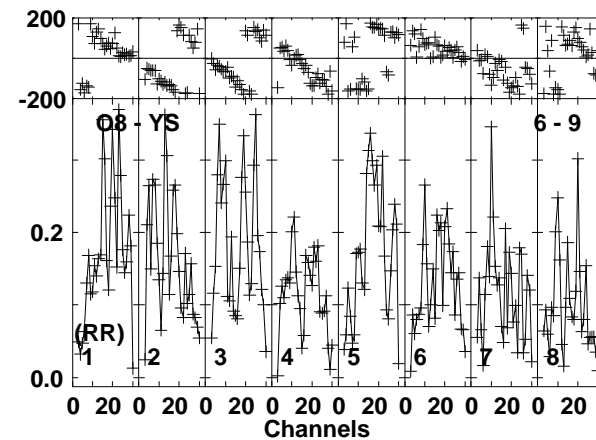
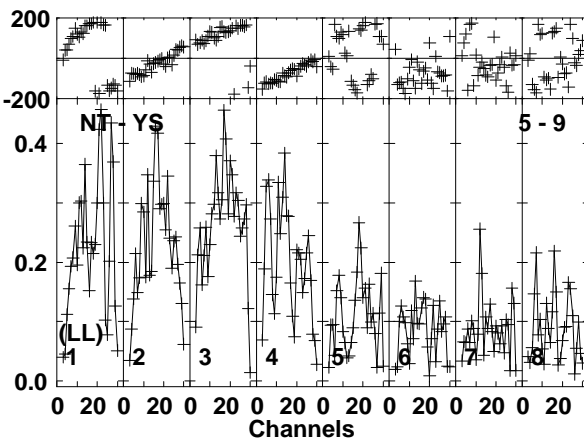
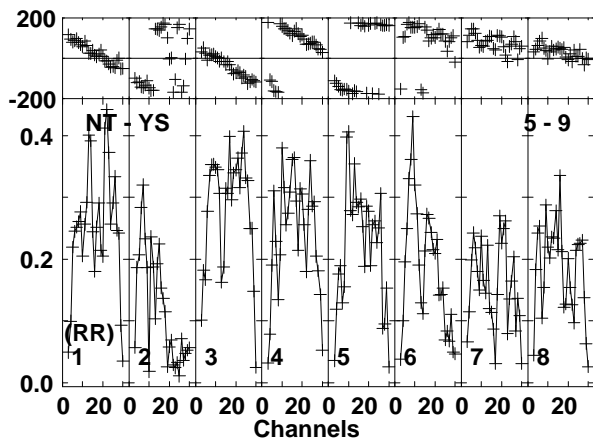
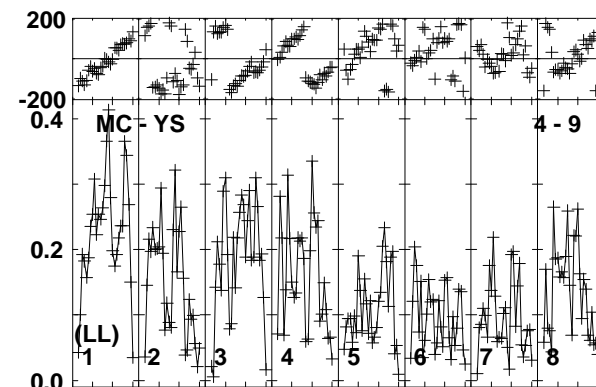
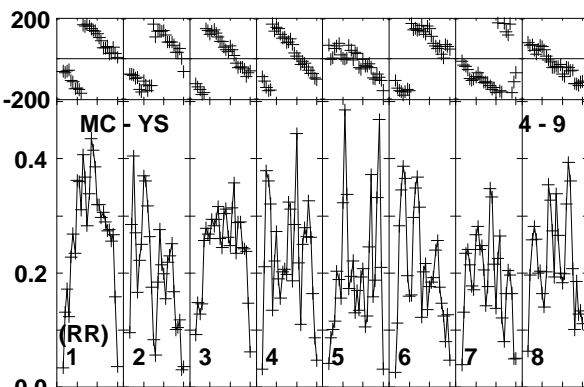
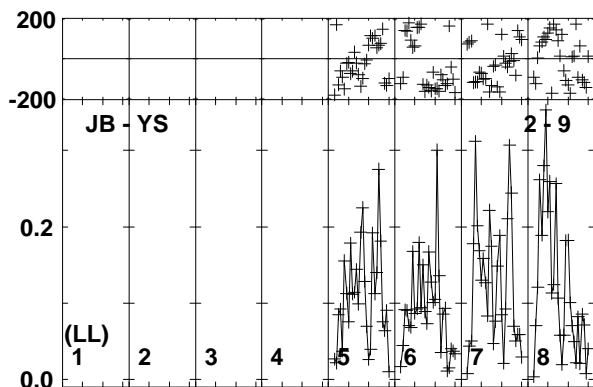
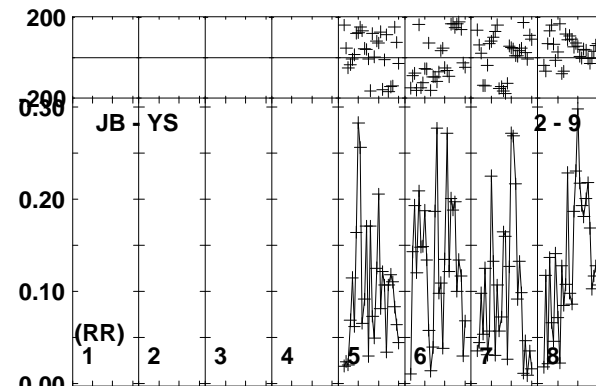
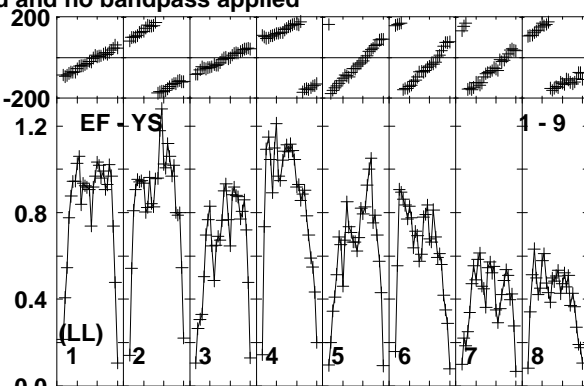
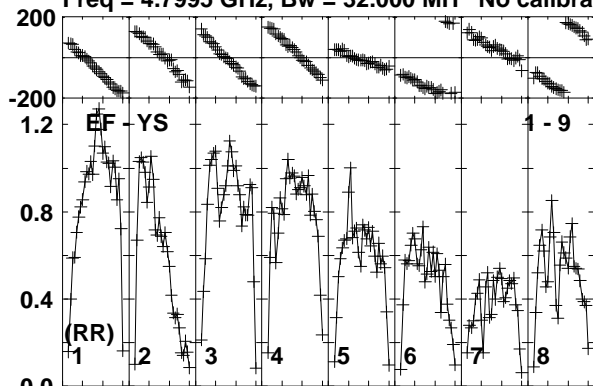

Lower frame: Milli Ampl Jy Top frame: Phas deg
Vector averaged cross-power spectrum Baseline: EF (01) - YS (09)
Timerange: 00/15:28:41 to 00/15:30:09

Plot file version 62 created 20-APR-2018 10:31:40

J0915+0745 EG102C.UVDATA.1

Freq = 4.7995 GHz, Bw = 32.000 MH No calibration applied and no bandpass applied

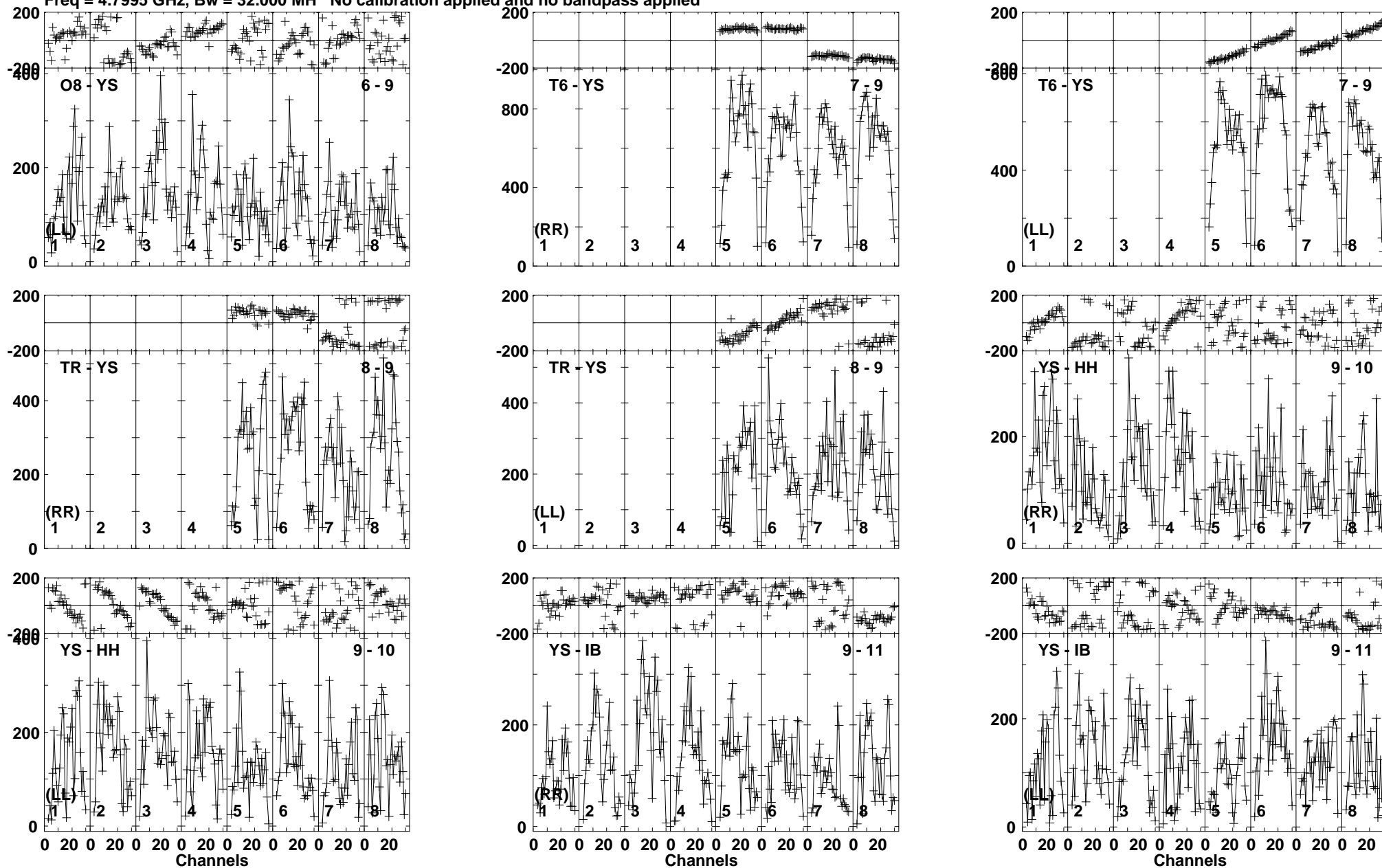

Lower frame: Micro Ampl Jy Top frame: Phas deg
Vector averaged cross-power spectrum Baseline: O8 (06) - YS (09)
Timerange: 00/15:28:41 to 00/15:30:09

Plot file version 63 created 20-APR-2018 10:31:40
 B0915+068 EG102C.UVDATA.1
 Freq = 4.7995 GHz, Bw = 32.000 MH No calibration applied and no bandpass applied

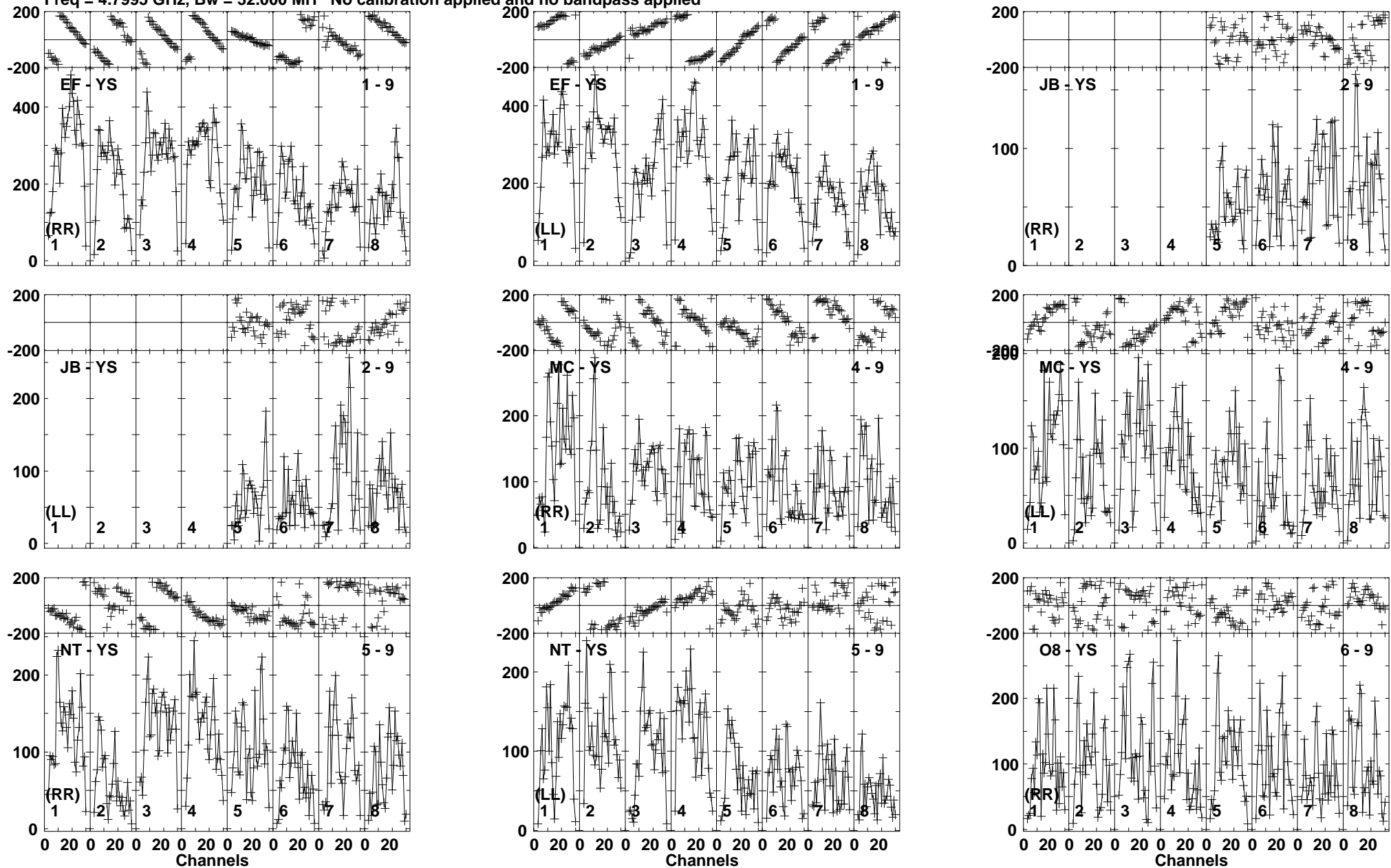

Lower frame: Micro Ampl Jy Top frame: Phas deg
 Vector averaged cross-power spectrum Baseline: EF (01) - YS (09)
 Timerange: 00/15:30:11 to 00/15:33:39

Plot file version 64 created 20-APR-2018 10:31:40
 B0915+068 EG102C.UVDATA.1
 Freq = 4.7995 GHz, Bw = 32.000 MH No calibration applied and no bandpass applied

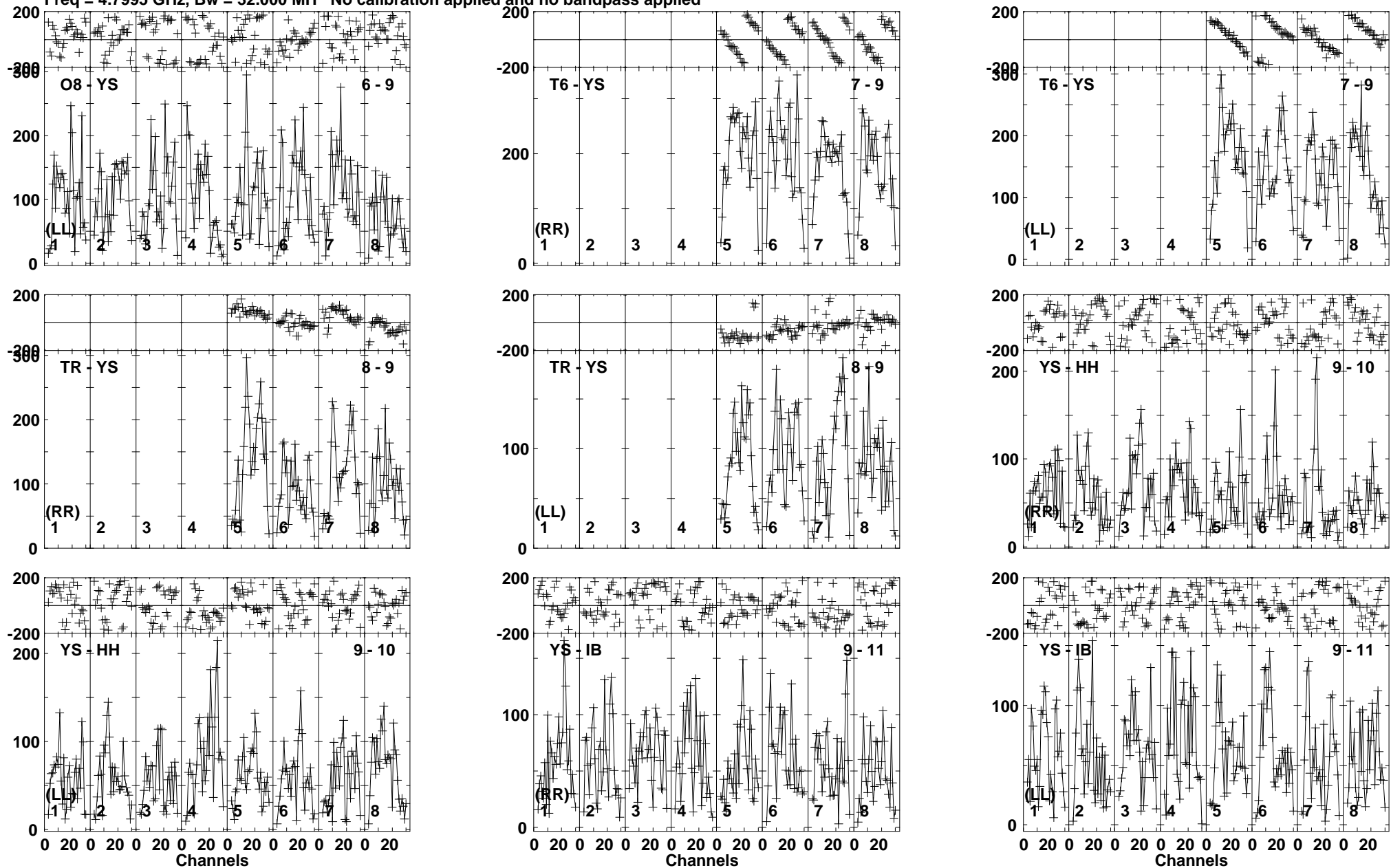

Lower frame: Micro Ampl Jy Top frame: Phas deg
 Vector averaged cross-power spectrum Baseline: O8 (06) - YS (09)
 Timerange: 00/15:30:11 to 00/15:33:39

Plot file version 65 created 20-APR-2018 10:31:40

J0915+0745 EG102C.UVDATA.1

Freq = 4.7995 GHz, Bw = 32.000 MH No calibration applied and no bandpass applied

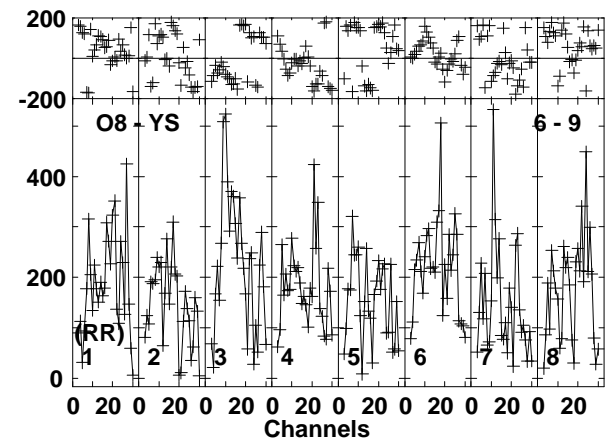
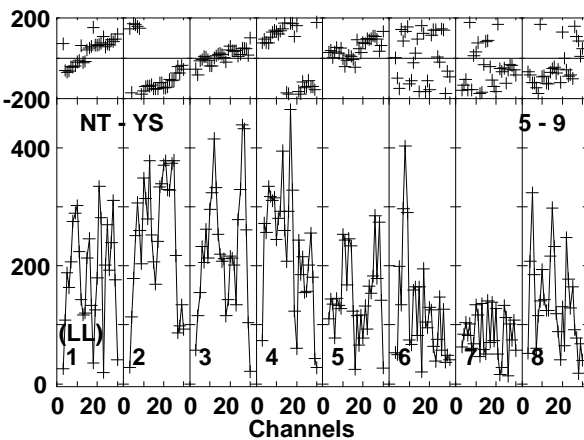
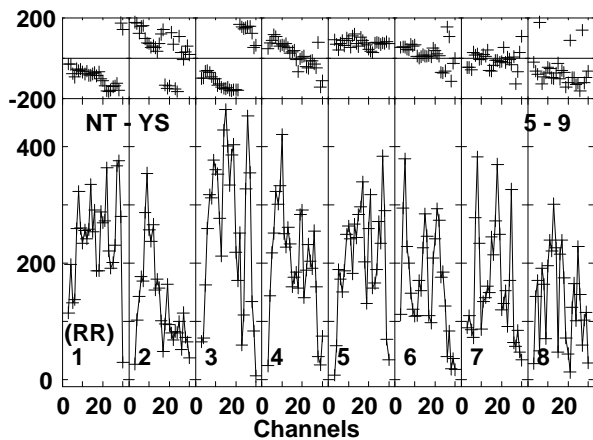
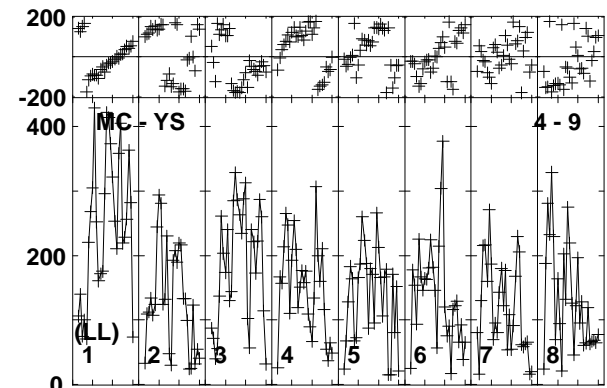
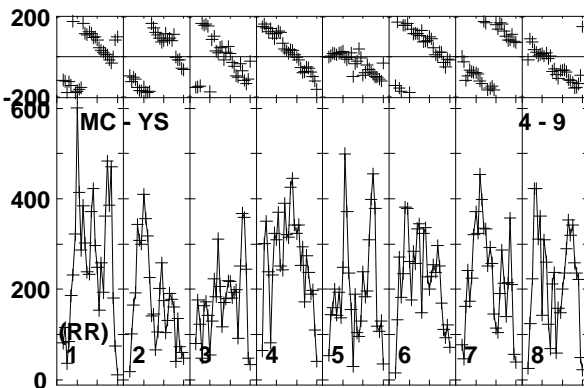
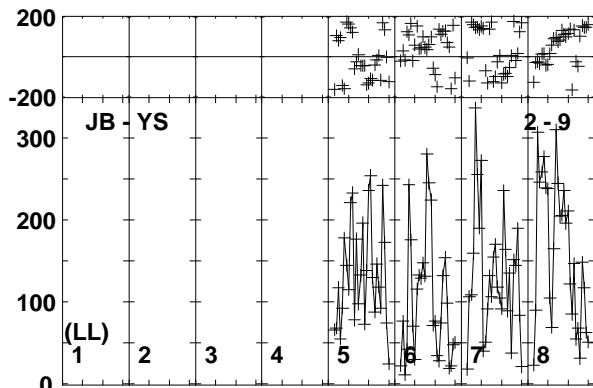
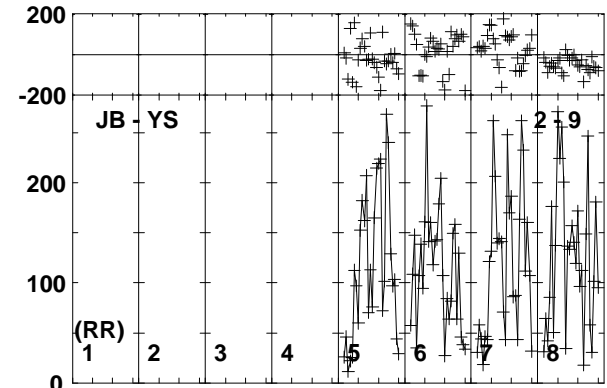
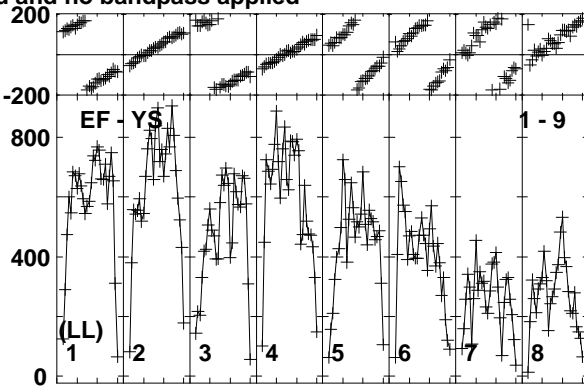
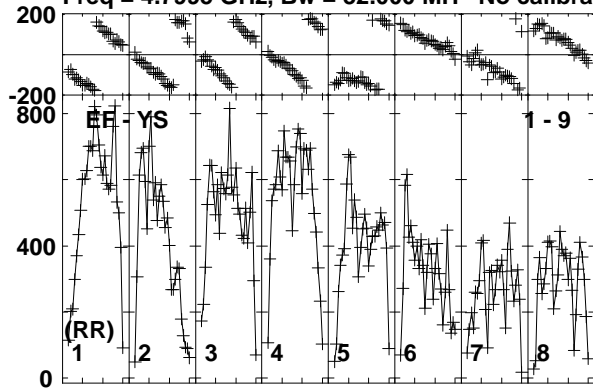

Lower frame: Micro Ampl Jy Top frame: Phas deg
Vector averaged cross-power spectrum Baseline: EF (01) - YS (09)
Timerange: 00/15:34:21 to 00/15:35:19

Plot file version 66 created 20-APR-2018 10:31:40

J0915+0745 EG102C.UVDATA.1

Freq = 4.7995 GHz, Bw = 32.000 MH No calibration applied and no bandpass applied

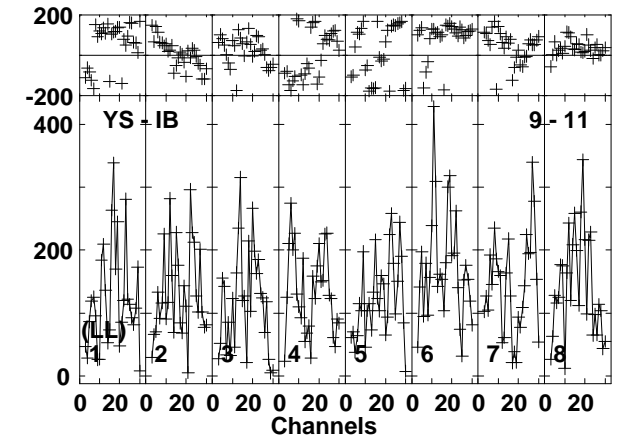
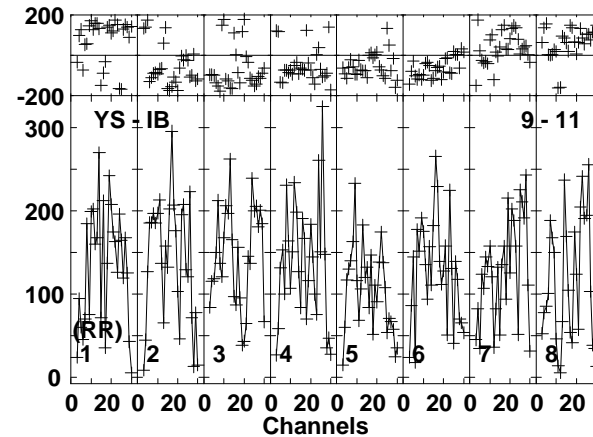
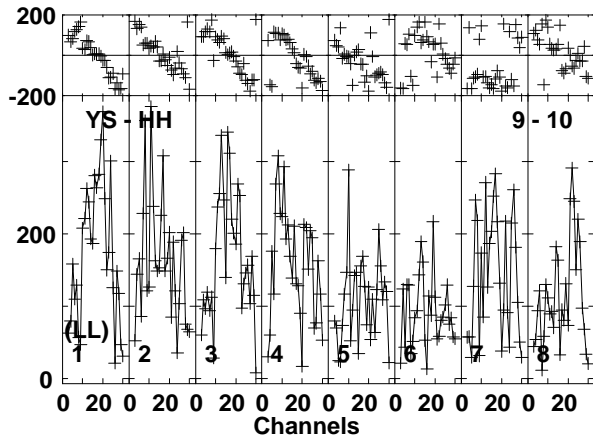
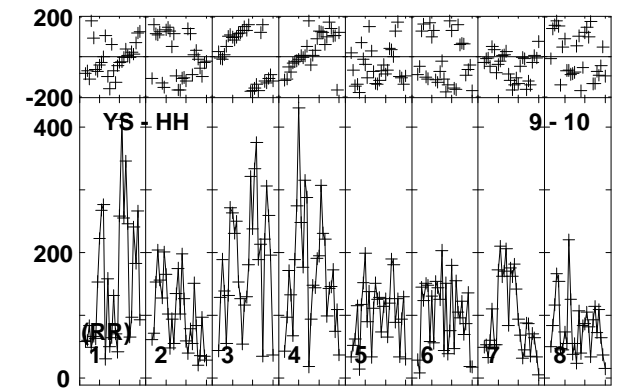
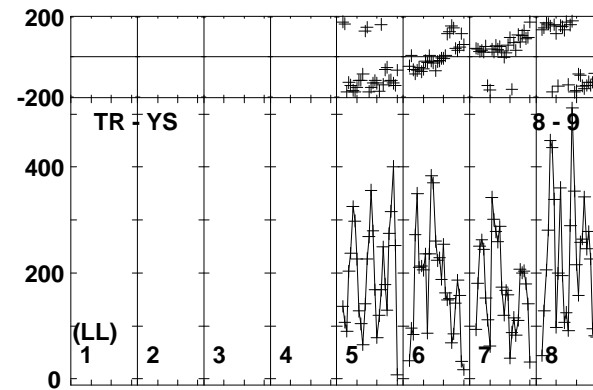
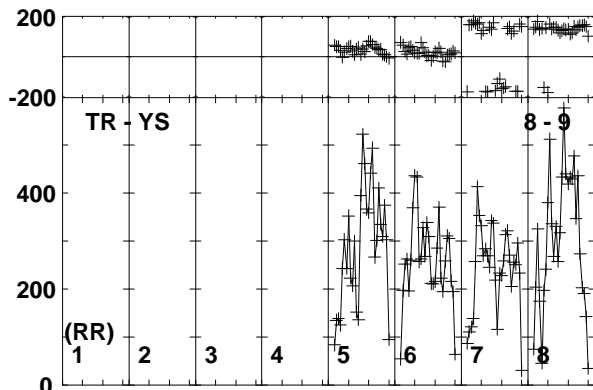
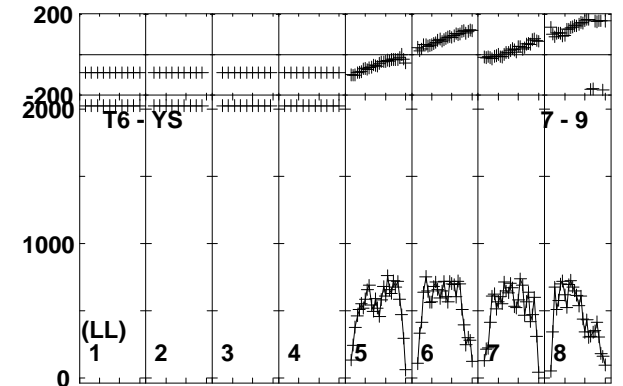
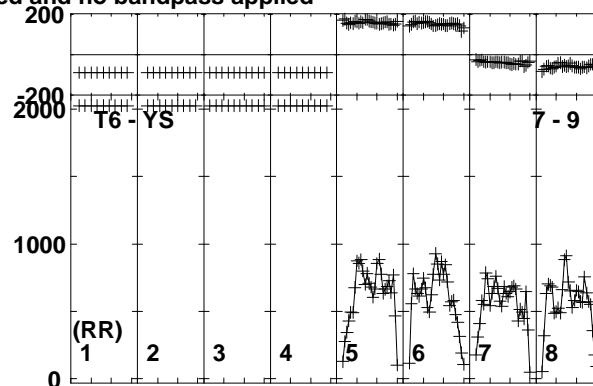
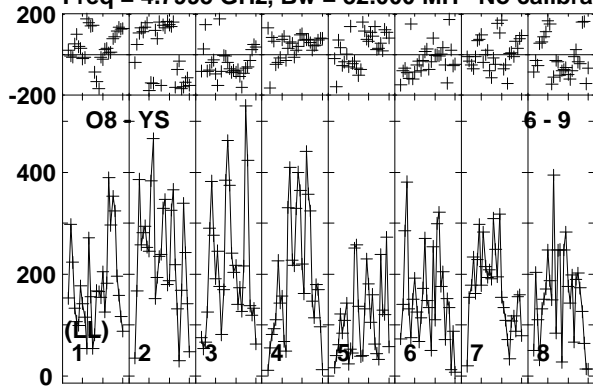

Lower frame: Micro Ampl Jy Top frame: Phas deg
Vector averaged cross-power spectrum Baseline: O8 (06) - YS (09)
Timerange: 00/15:34:21 to 00/15:35:19

Plot file version 67 created 20-APR-2018 10:31:41

B0915+068 EG102C.UVDATA.1

Freq = 4.7995 GHz, Bw = 32.000 MH No calibration applied and no bandpass applied

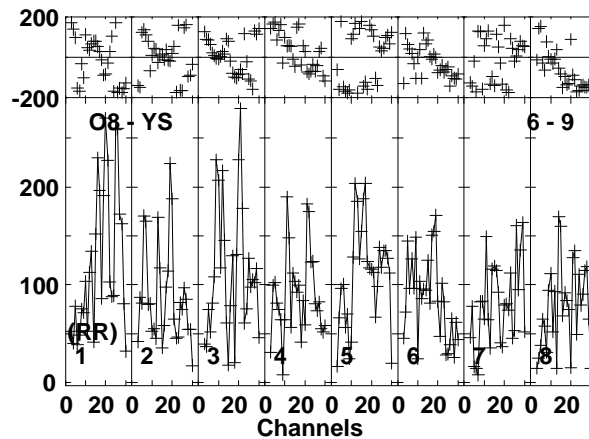
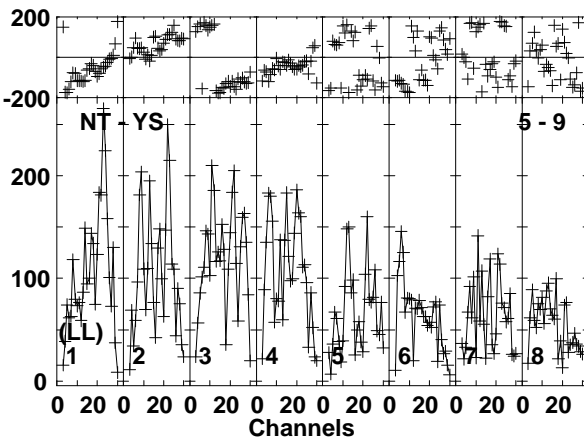
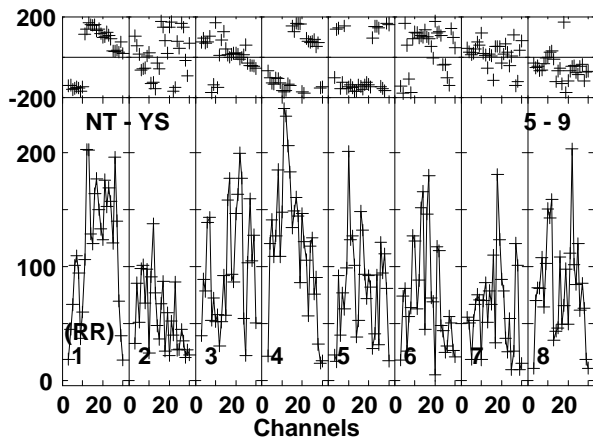
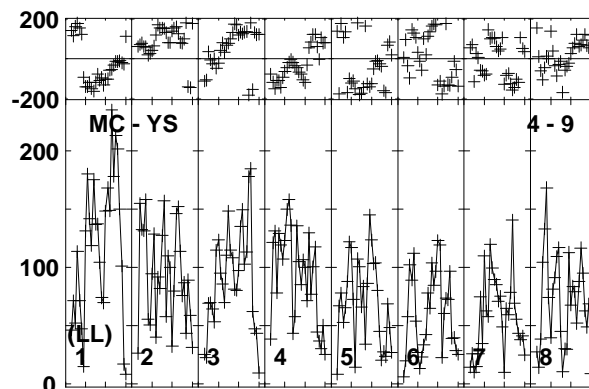
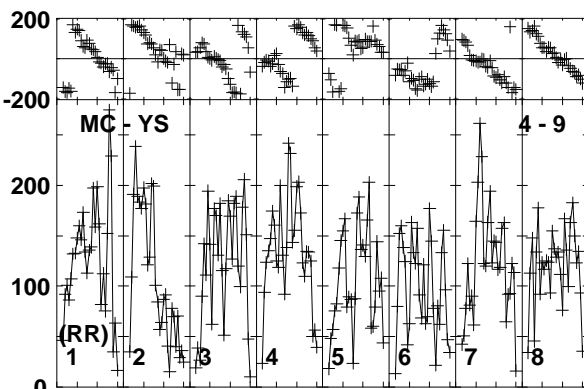
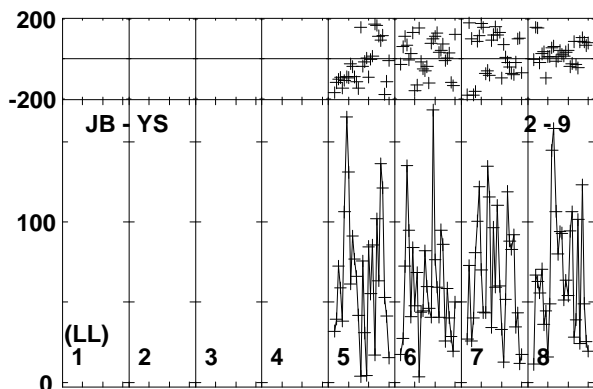
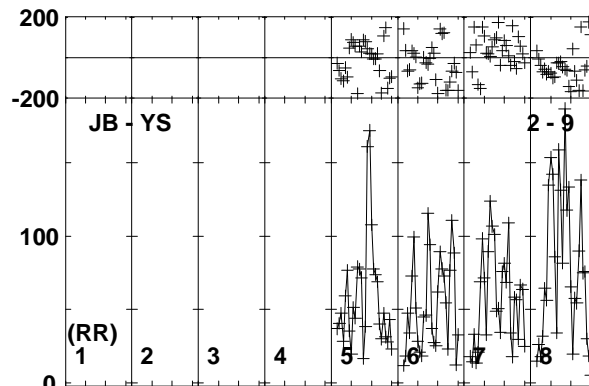
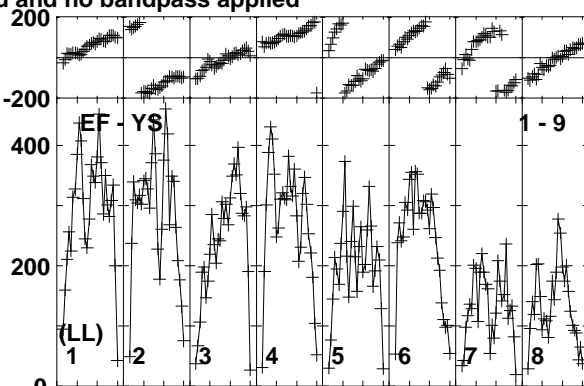
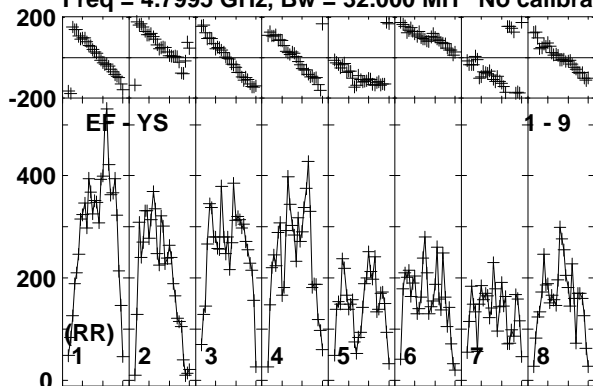

Lower frame: Micro Ampl Jy Top frame: Phas deg
Vector averaged cross-power spectrum Baseline: EF (01) - YS (09)
Timerange: 00/15:35:21 to 00/15:38:49

Plot file version 68 created 20-APR-2018 10:31:41

B0915+068 EG102C.UVDATA.1

Freq = 4.7995 GHz, Bw = 32.000 MH No calibration applied and no bandpass applied

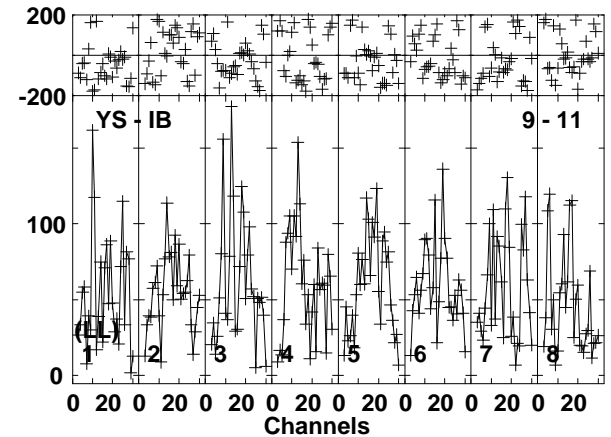
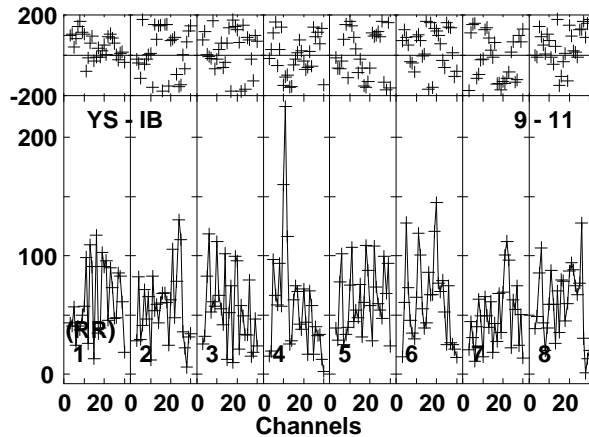
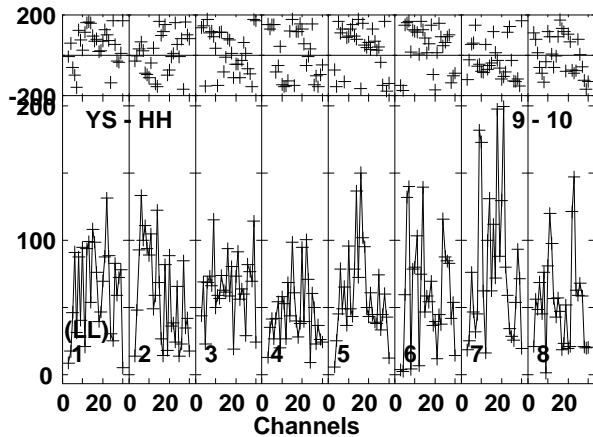
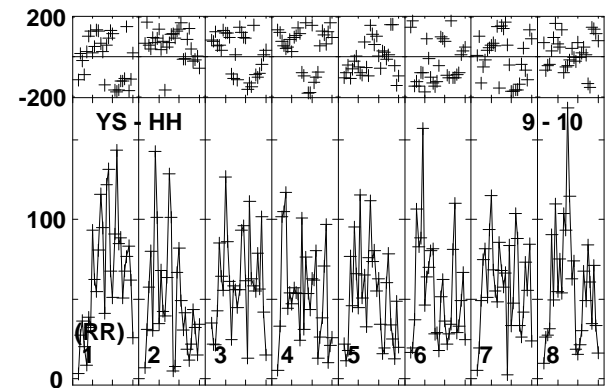
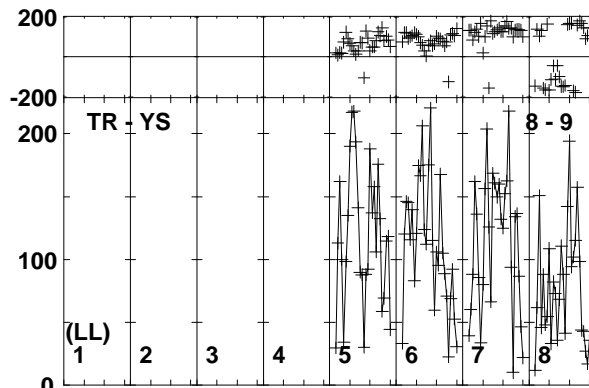
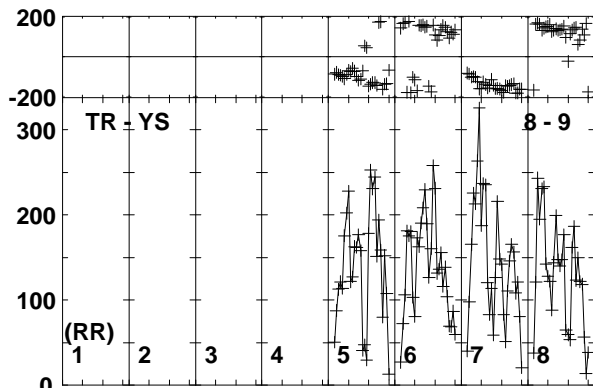
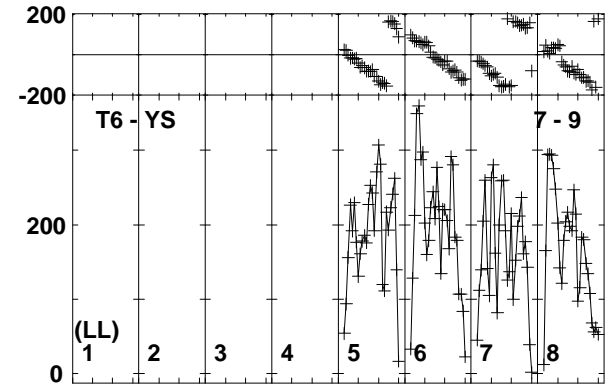
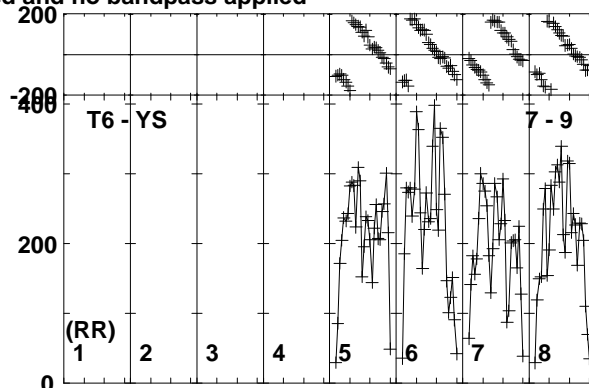
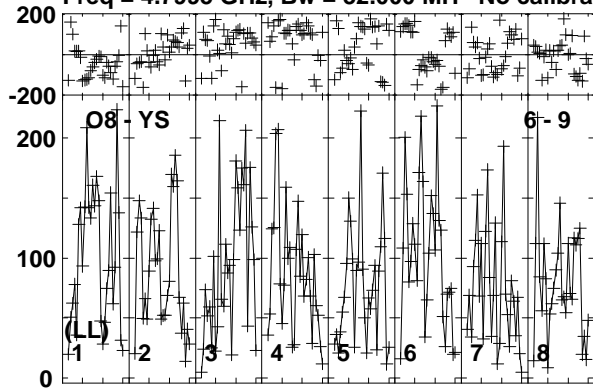

Lower frame: Micro Ampl Jy Top frame: Phas deg
Vector averaged cross-power spectrum Baseline: O8 (06) - YS (09)
Timerange: 00/15:35:21 to 00/15:38:49

Plot file version 69 created 20-APR-2018 10:31:41

J0915+0745 EG102C.UVDATA.1

Freq = 4.7995 GHz, Bw = 32.000 MH No calibration applied and no bandpass applied

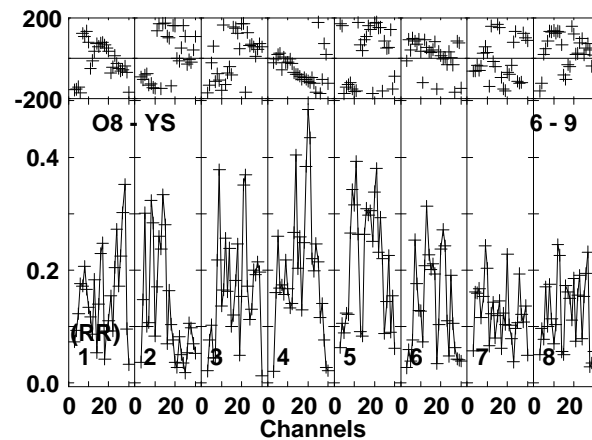
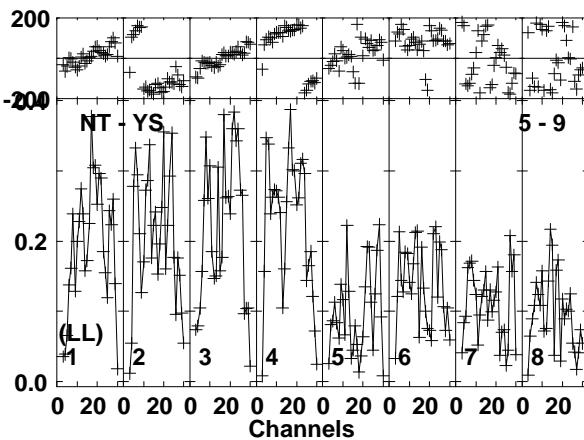
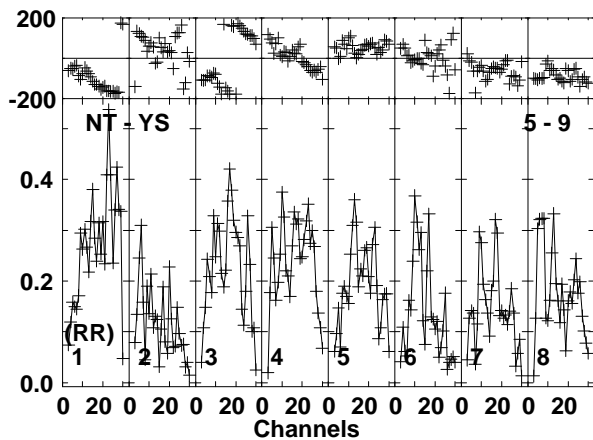
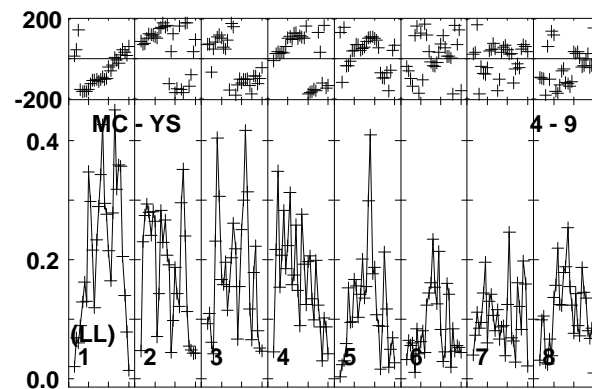
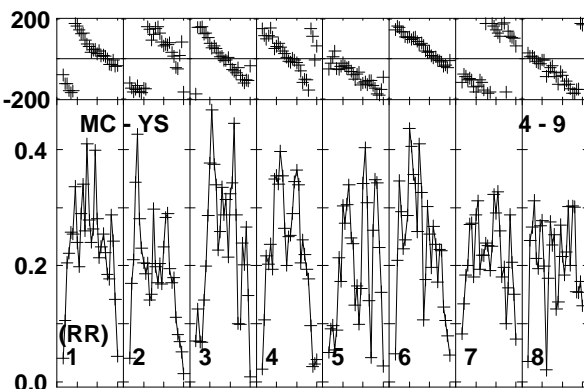
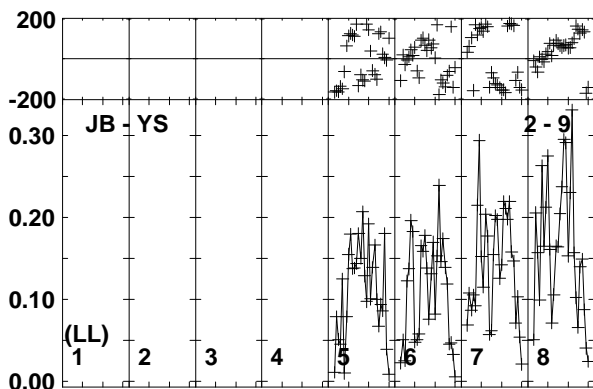
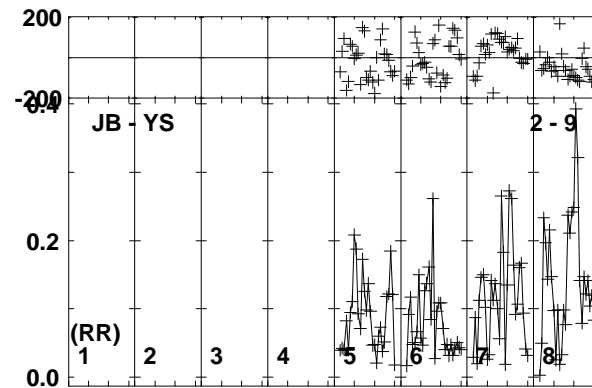
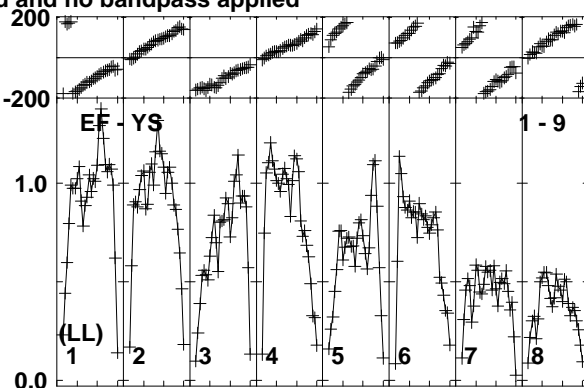
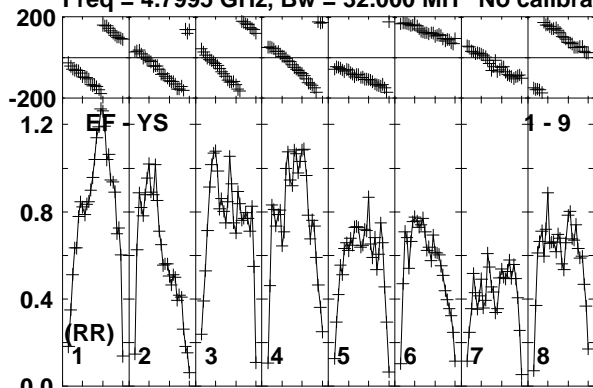

Lower frame: Milli Ampl Jy Top frame: Phas deg
Vector averaged cross-power spectrum Baseline: EF (01) - YS (09)
Timerange: 00/15:38:51 to 00/15:40:19

Plot file version 70 created 20-APR-2018 10:31:41

J0915+0745 EG102C.UVDATA.1

Freq = 4.7995 GHz, Bw = 32.000 MH No calibration applied and no bandpass applied

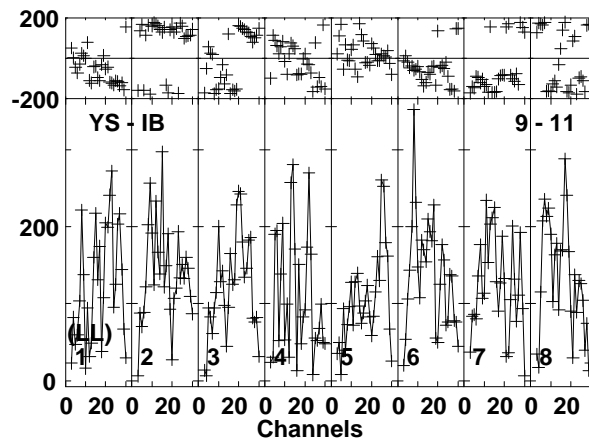
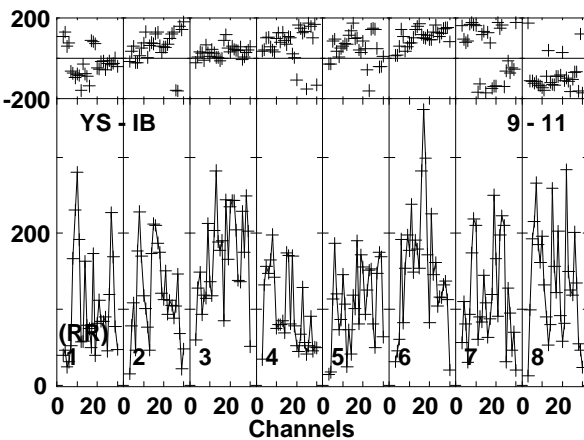
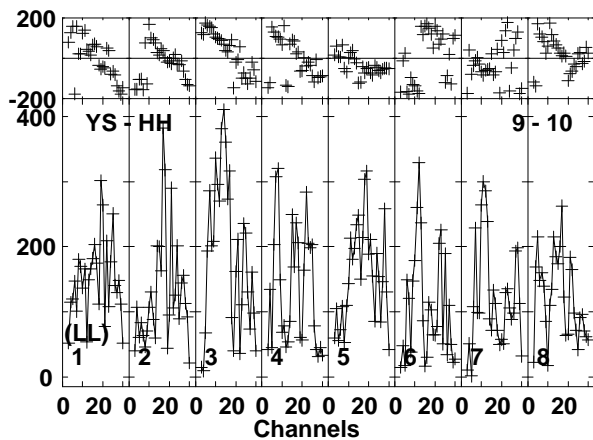
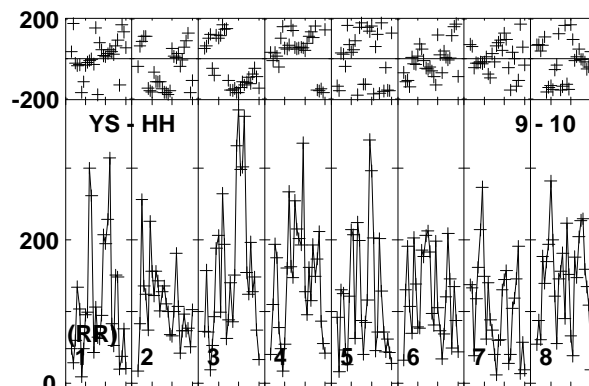
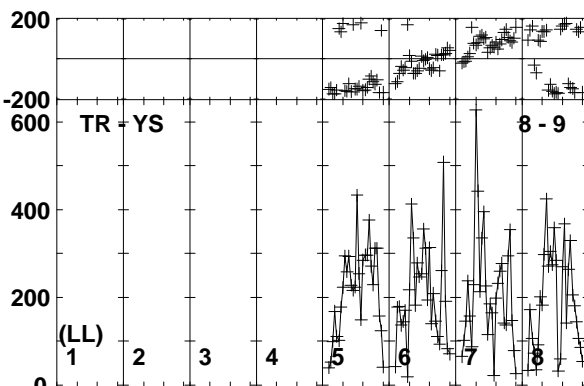
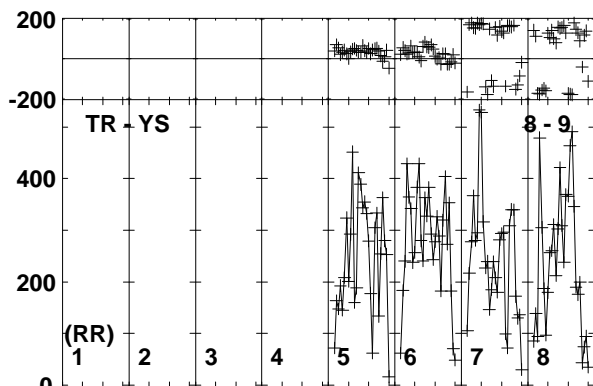
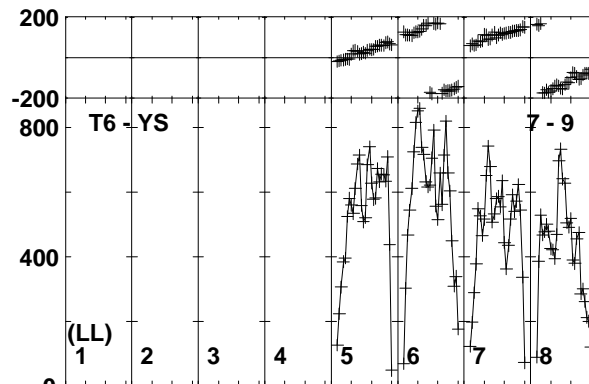
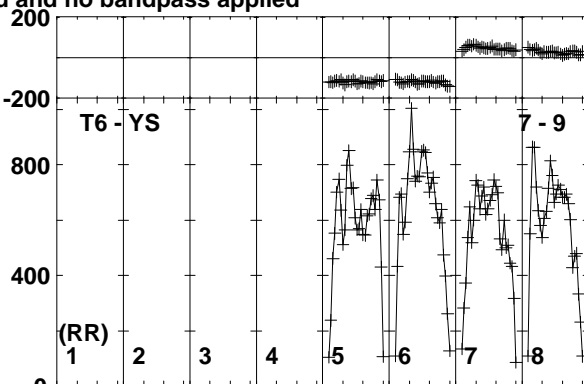
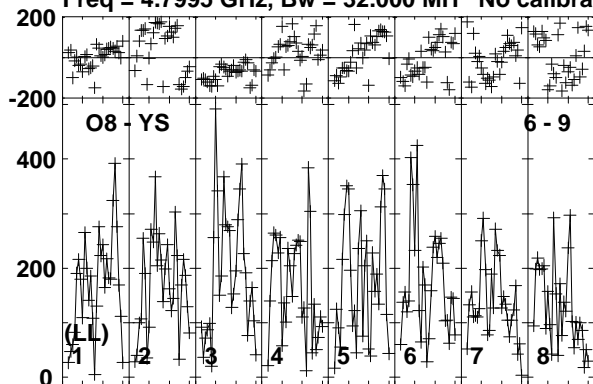

Lower frame: Micro Ampl Jy Top frame: Phas deg
Vector averaged cross-power spectrum Baseline: O8 (06) - YS (09)
Timerange: 00/15:38:51 to 00/15:40:19

Plot file version 71 created 20-APR-2018 10:31:41

B0915+068 EG102C.UVDATA.1

Freq = 4.7995 GHz, Bw = 32.000 MH No calibration applied and no bandpass applied

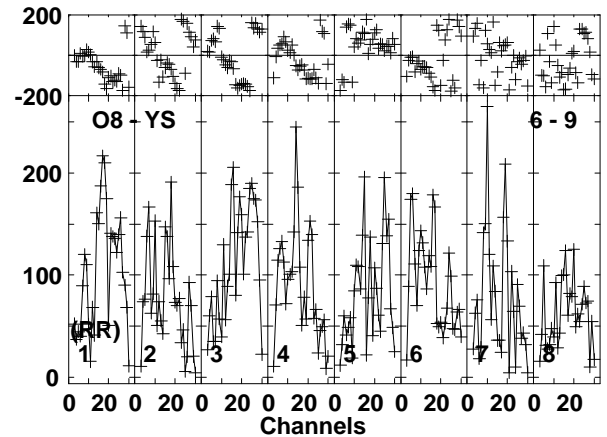
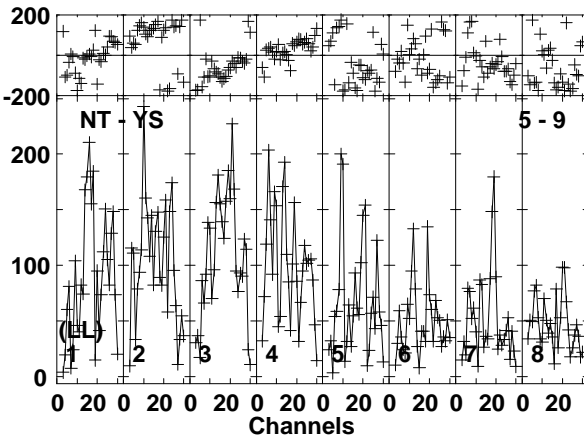
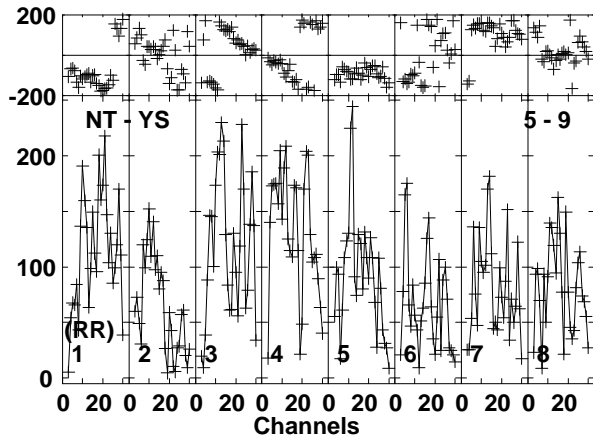
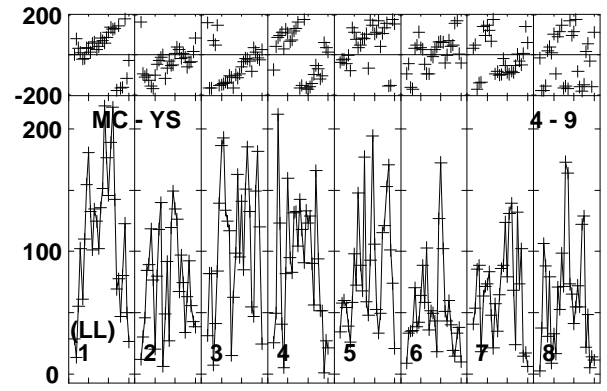
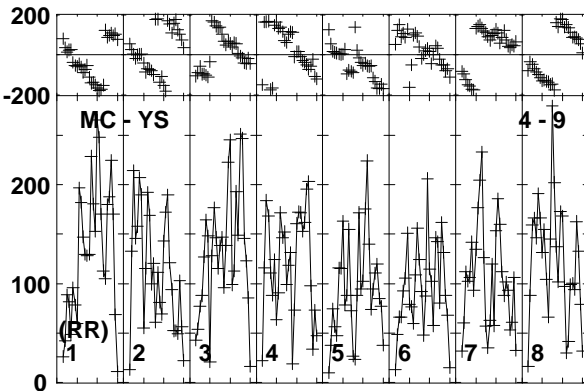
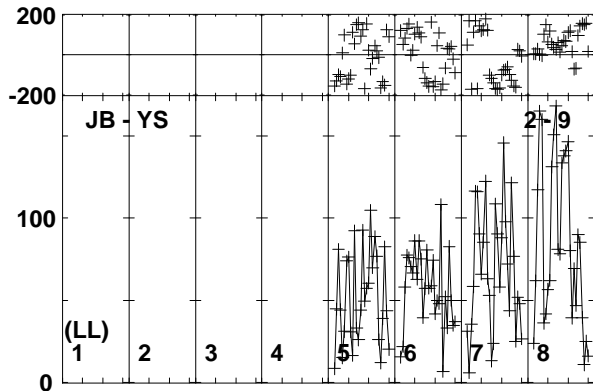
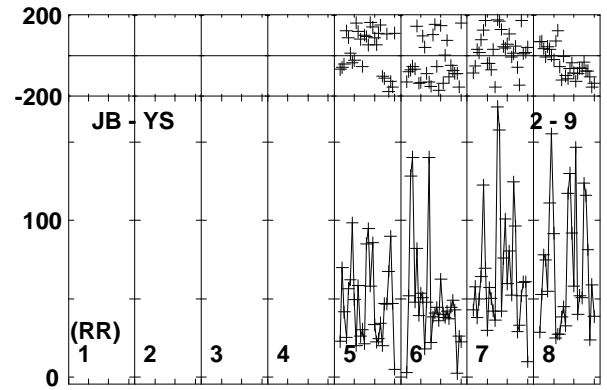
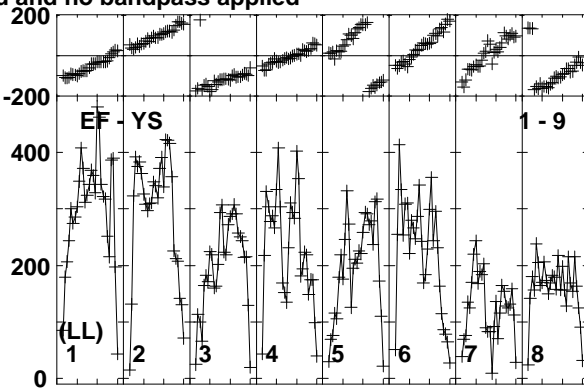
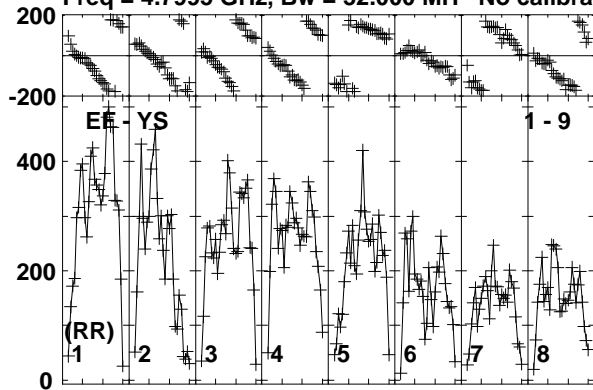

Lower frame: Micro Ampl Jy Top frame: Phas deg
Vector averaged cross-power spectrum Baseline: EF (01) - YS (09)
Timerange: 00/15:40:21 to 00/15:43:49

Plot file version 72 created 20-APR-2018 10:31:41

B0915+068 EG102C.UVDATA.1

Freq = 4.7995 GHz, Bw = 32.000 MH No calibration applied and no bandpass applied

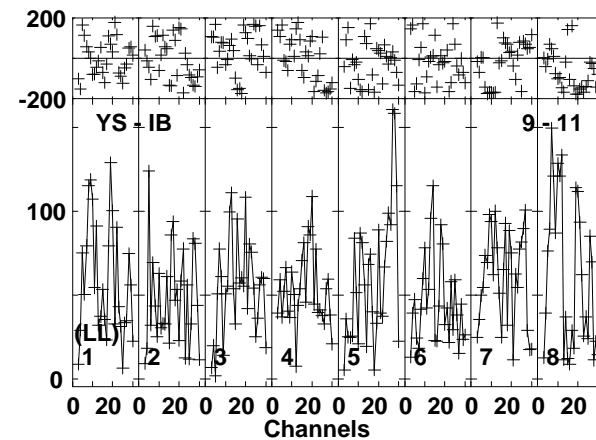
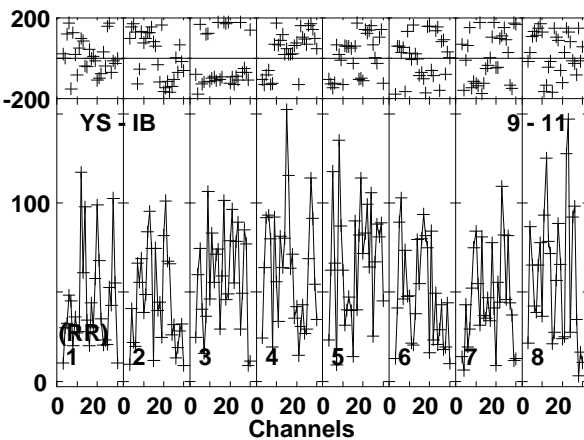
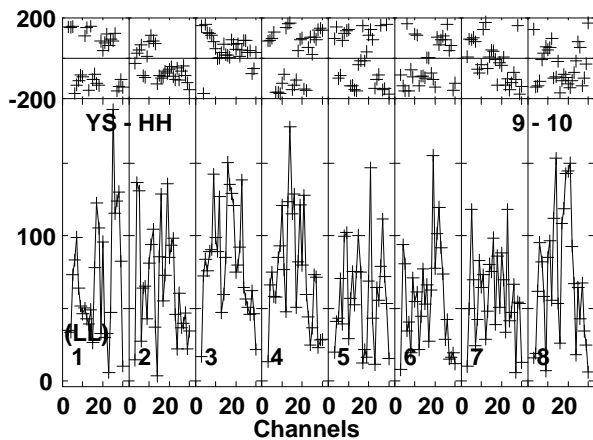
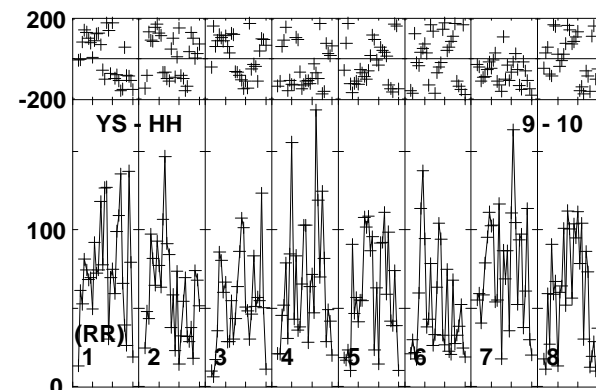
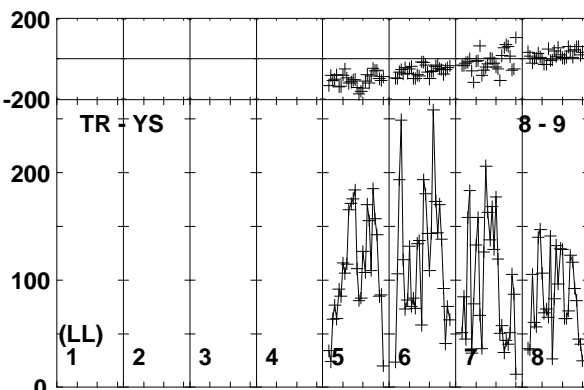
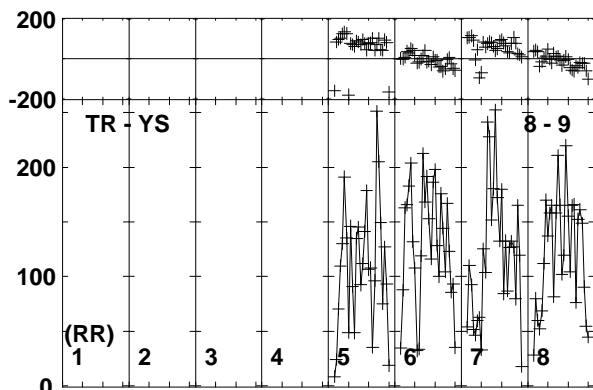
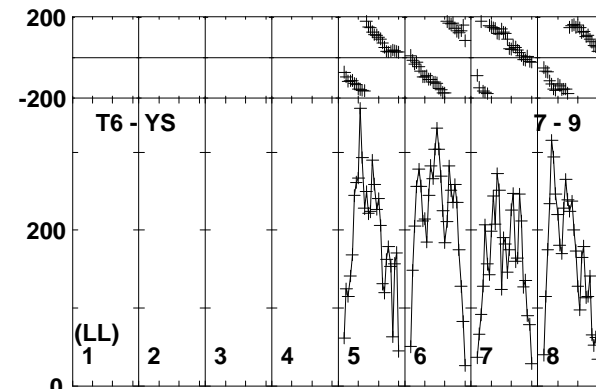
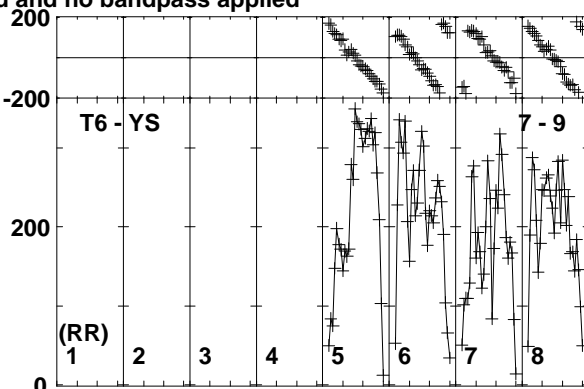
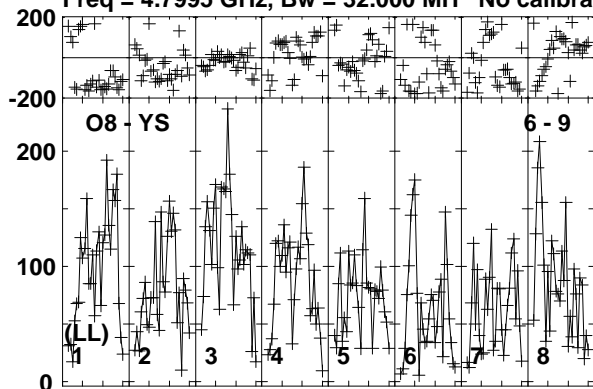

Lower frame: Micro Ampl Jy Top frame: Phas deg
Vector averaged cross-power spectrum Baseline: O8 (06) - YS (09)
Timerange: 00/15:40:21 to 00/15:43:49

Plot file version 73 created 20-APR-2018 10:31:41

J0915+0745 EG102C.UVDATA.1

Freq = 4.7995 GHz, Bw = 32.000 MH No calibration applied and no bandpass applied

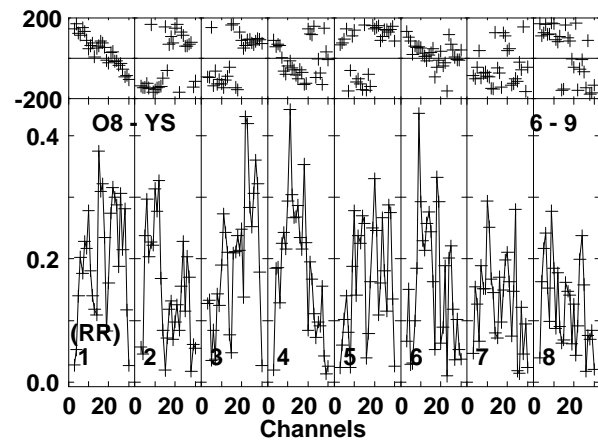
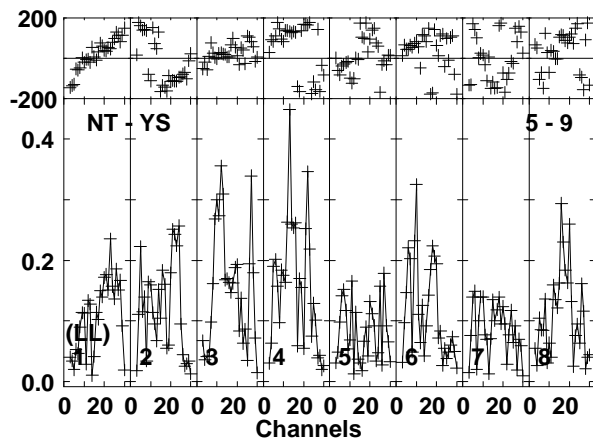
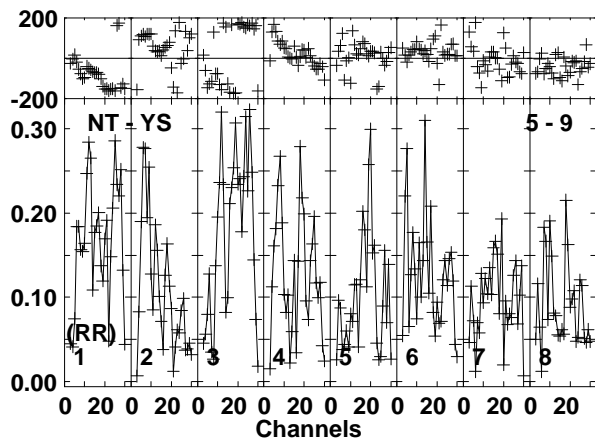
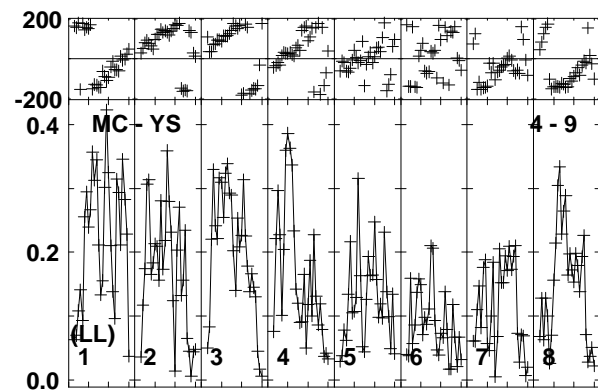
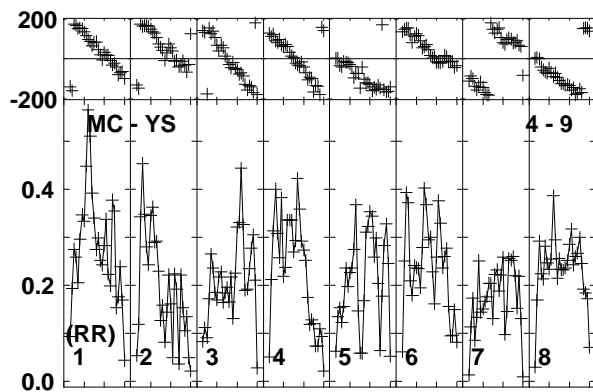
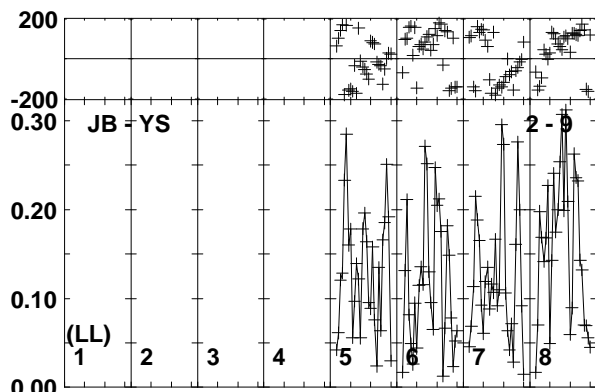
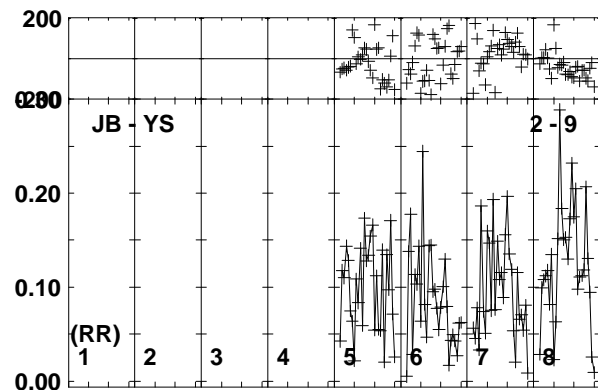
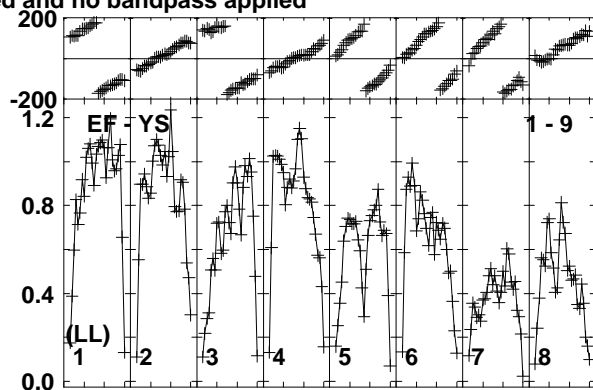
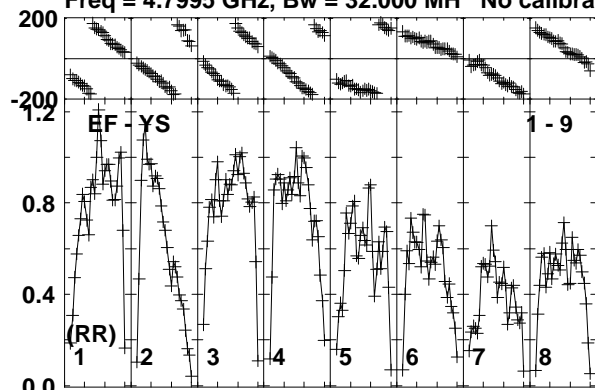

Lower frame: Milli Ampl Jy Top frame: Phas deg
Vector averaged cross-power spectrum Baseline: EF (01) - YS (09)
Timerange: 00/15:43:51 to 00/15:45:19

Plot file version 74 created 20-APR-2018 10:31:41

J0915+0745 EG102C.UVDATA.1

Freq = 4.7995 GHz, Bw = 32.000 MH No calibration applied and no bandpass applied

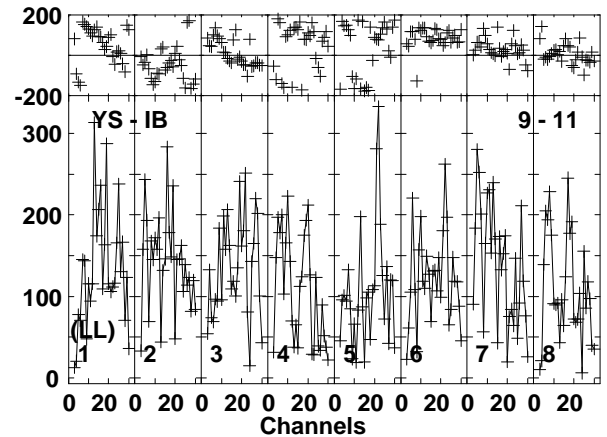
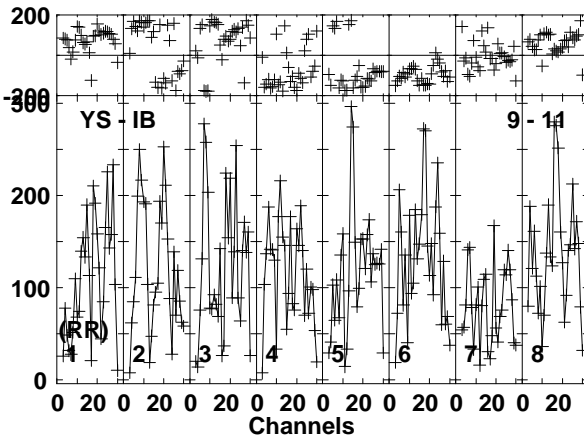
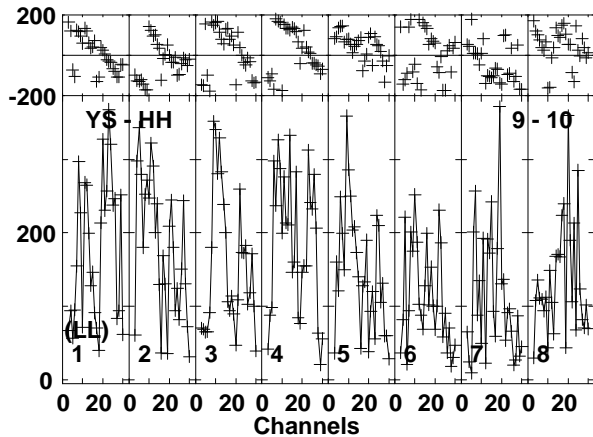
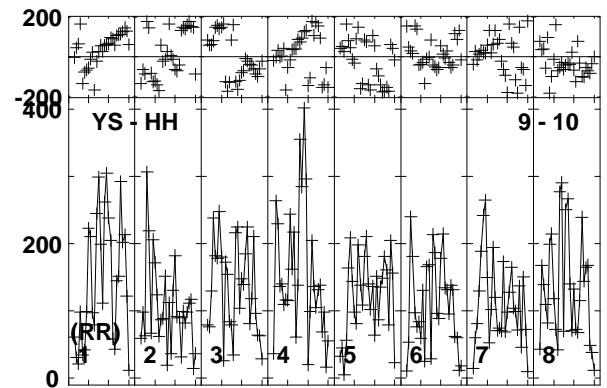
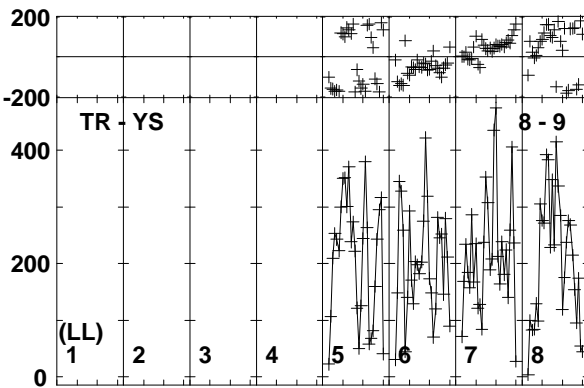
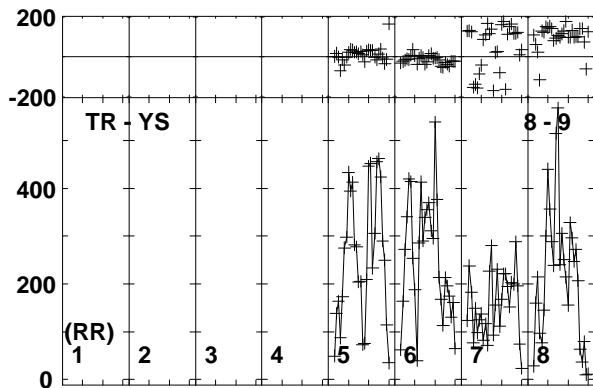
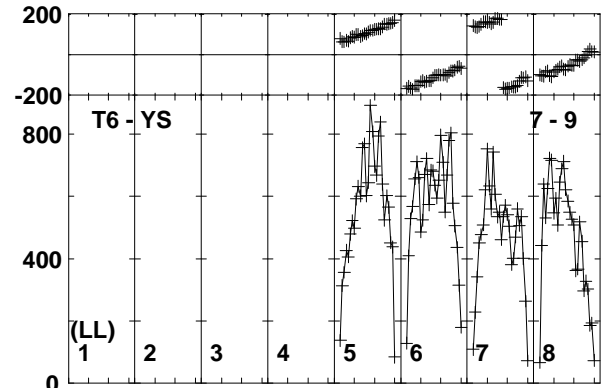
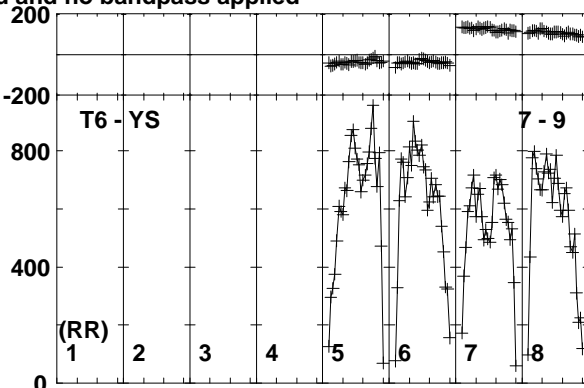
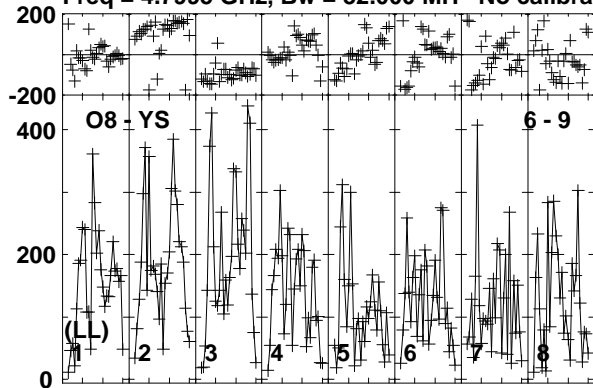

Lower frame: Micro Ampl Jy Top frame: Phas deg
Vector averaged cross-power spectrum Baseline: O8 (06) - YS (09)
Timerange: 00/15:43:51 to 00/15:45:19

Plot file version 75 created 20-APR-2018 10:31:41

B0915+068 EG102C.UVDATA.1

Freq = 4.7995 GHz, Bw = 32.000 MH No calibration applied and no bandpass applied

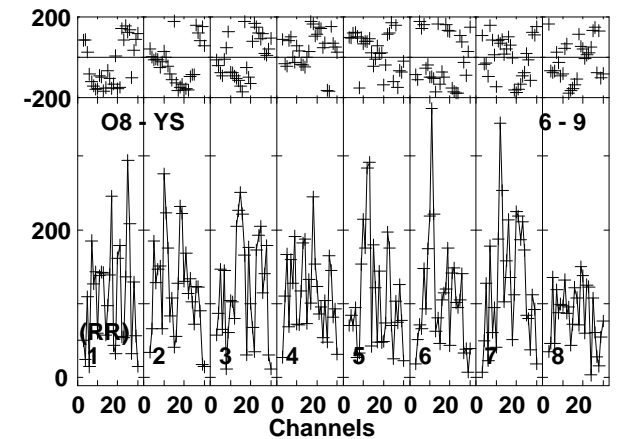
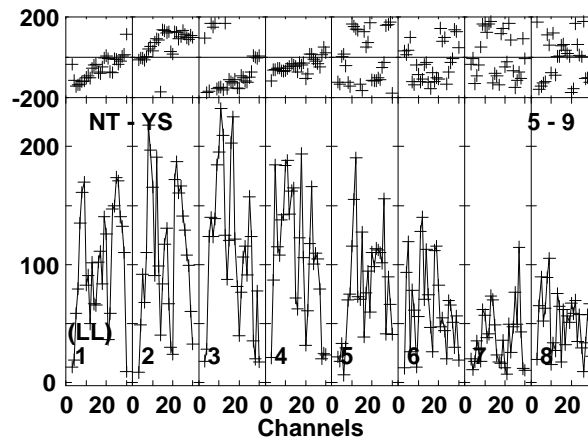
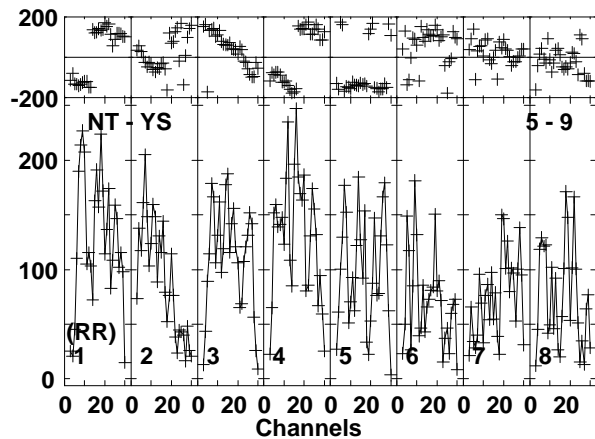
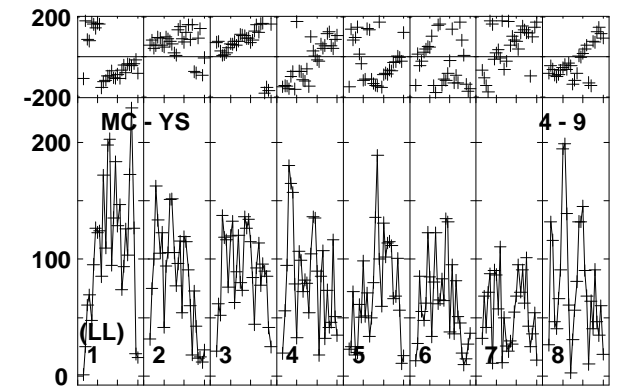
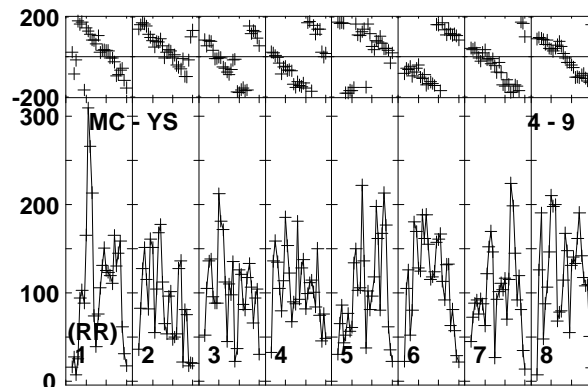
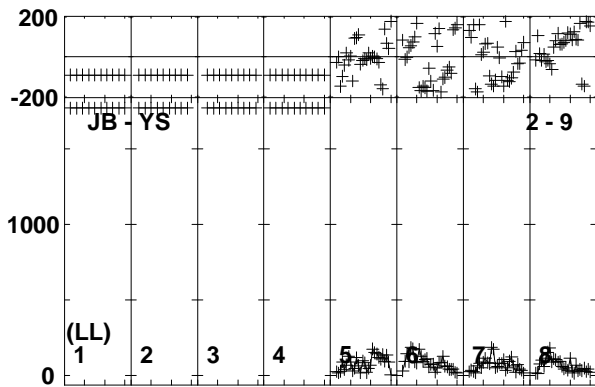
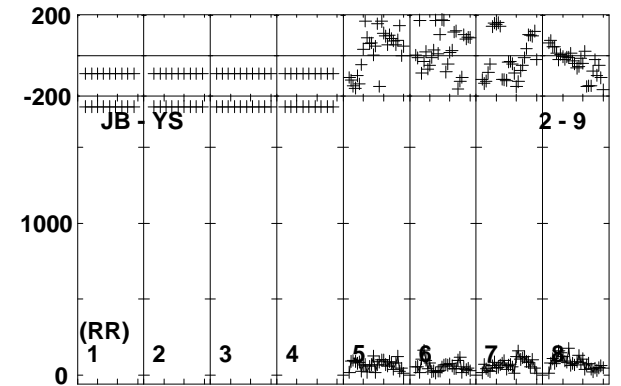
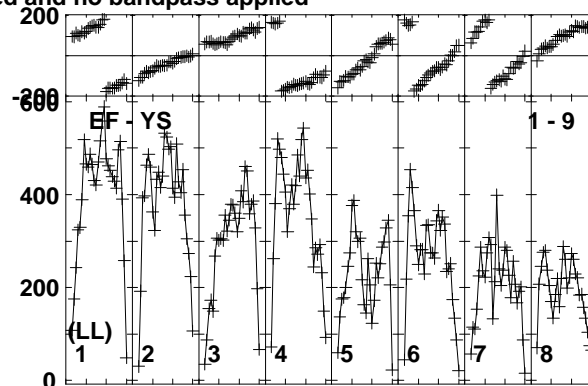
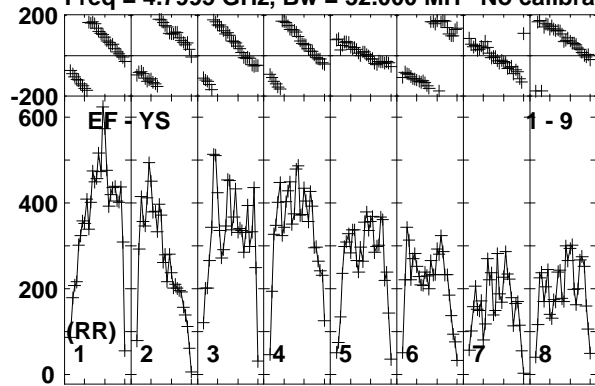

Lower frame: Micro Ampl Jy Top frame: Phas deg
Vector averaged cross-power spectrum Baseline: EF (01) - YS (09)
Timerange: 00/15:45:21 to 00/15:48:49

Plot file version 76 created 20-APR-2018 10:31:42

B0915+068 EG102C.UVDATA.1

Freq = 4.7995 GHz, Bw = 32.000 MH No calibration applied and no bandpass applied

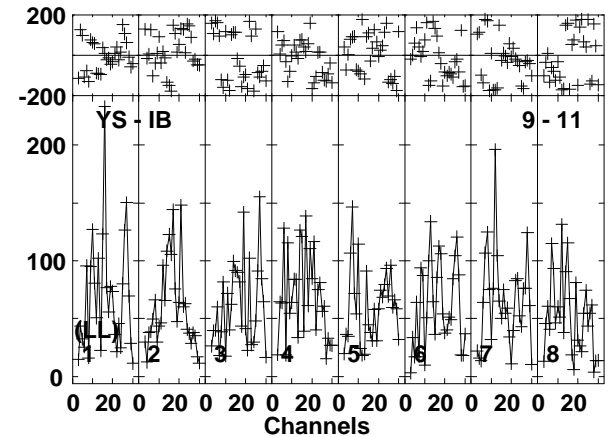
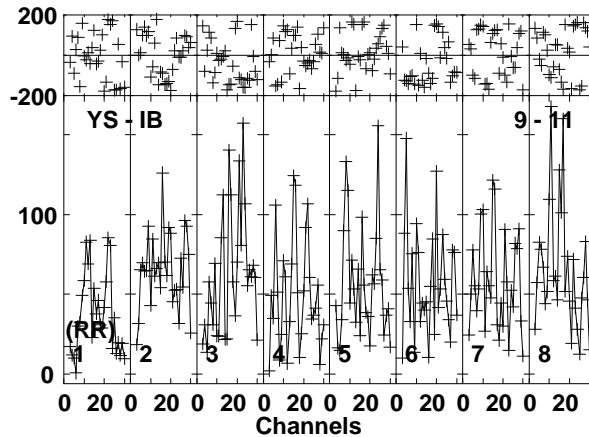
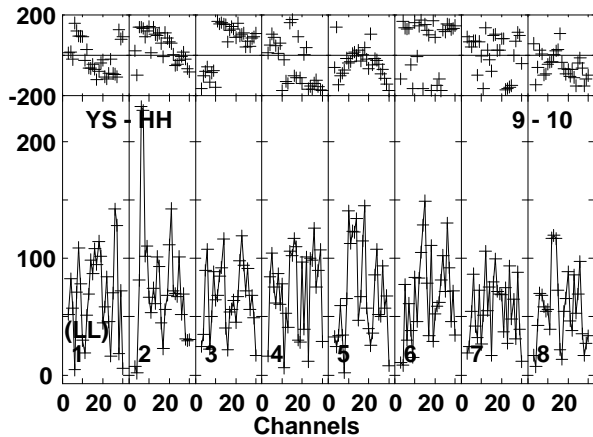
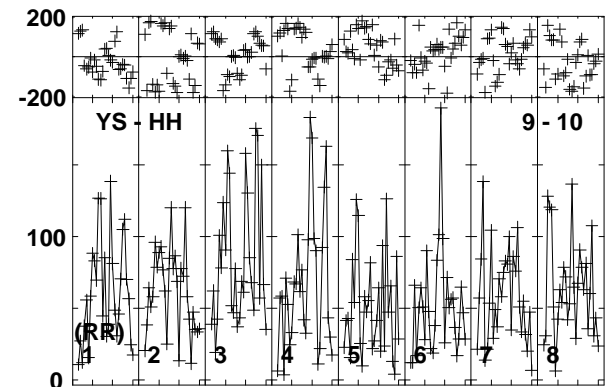
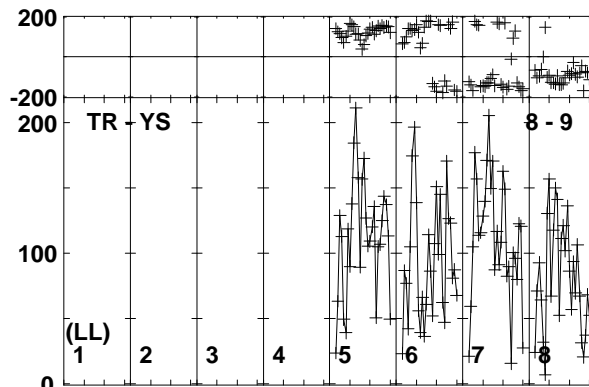
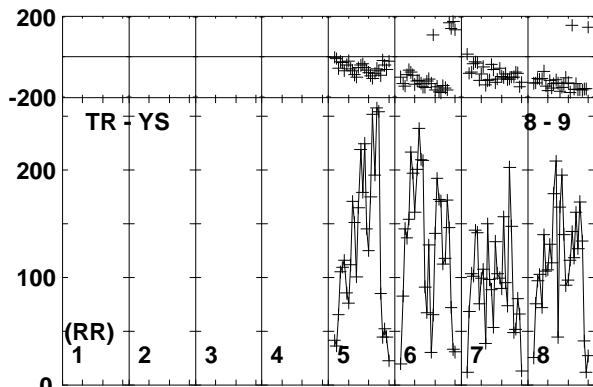
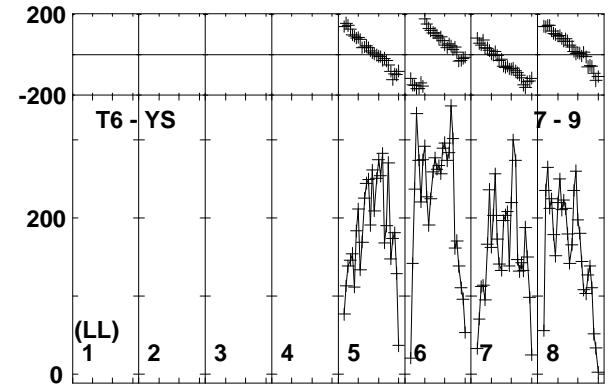
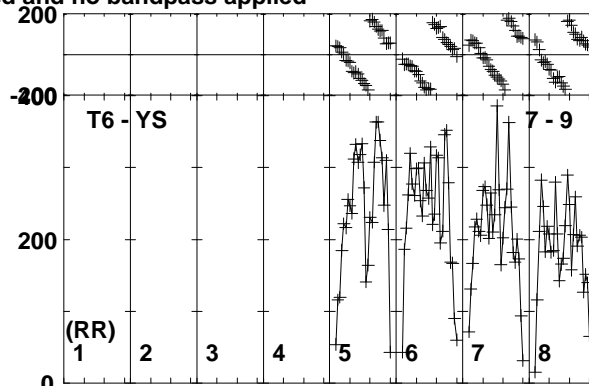
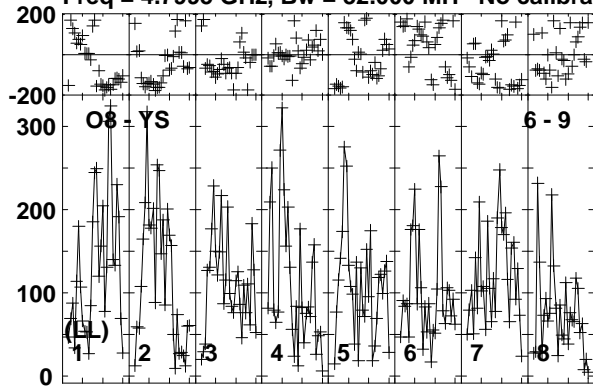

Lower frame: Micro Ampl Jy Top frame: Phas deg
Vector averaged cross-power spectrum Baseline: O8 (06) - YS (09)
Timerange: 00/15:45:21 to 00/15:48:49

Plot file version 77 created 20-APR-2018 10:31:42

J0915+0745 EG102C.UVDATA.1

Freq = 4.7995 GHz, Bw = 32.000 MH No calibration applied and no bandpass applied

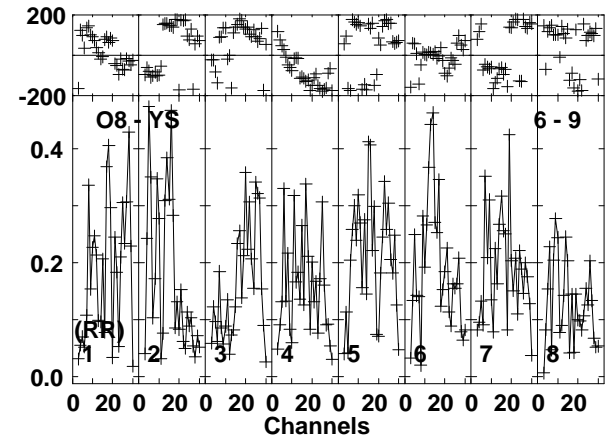
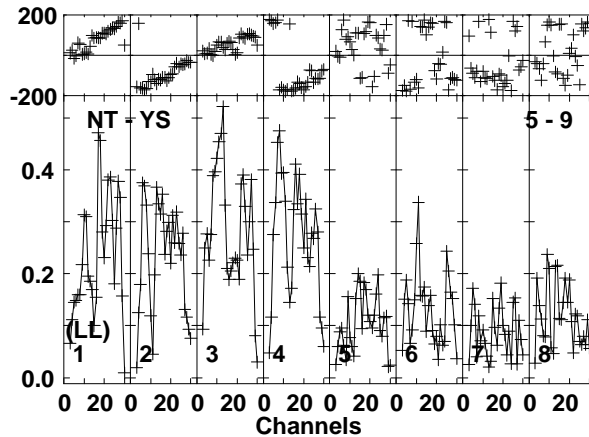
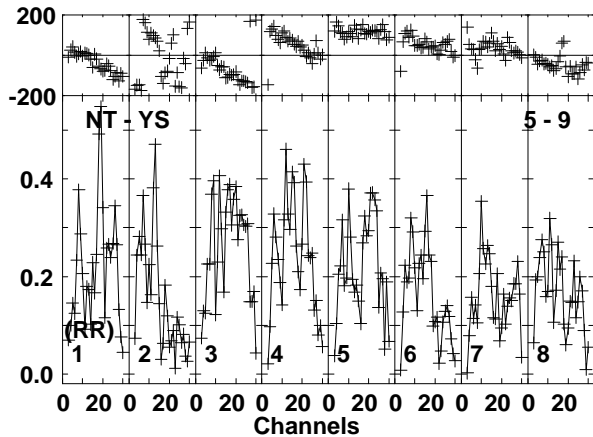
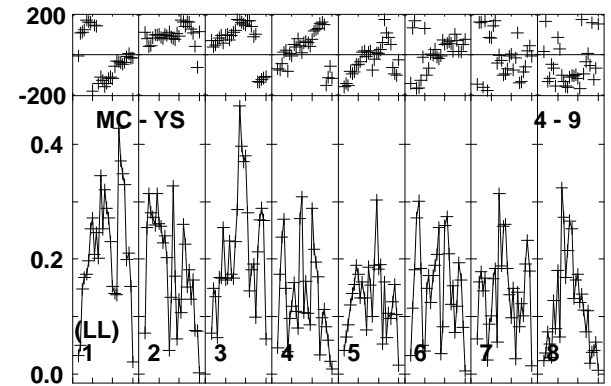
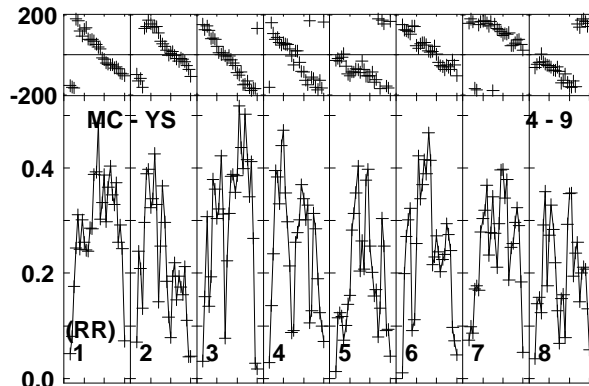
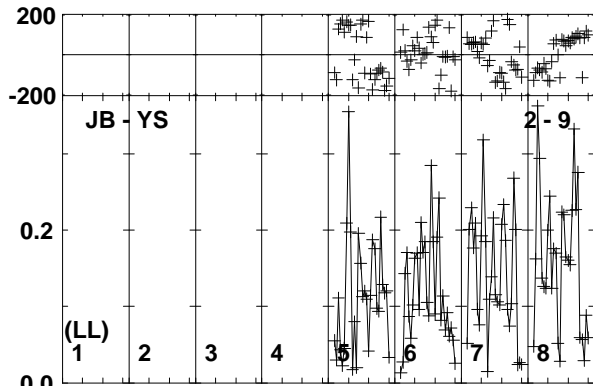
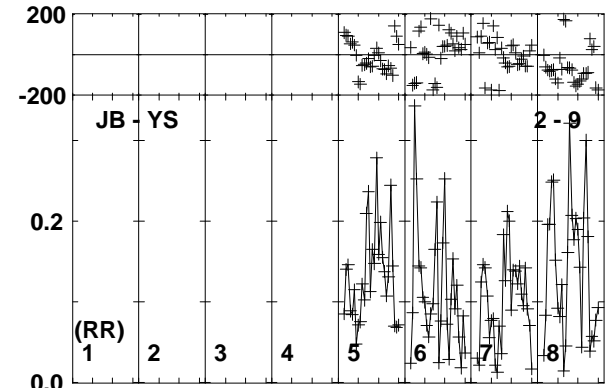
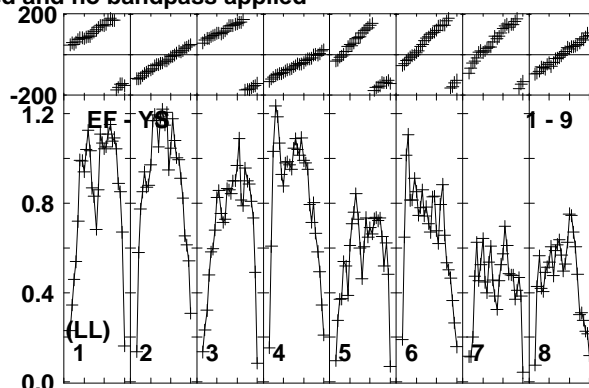
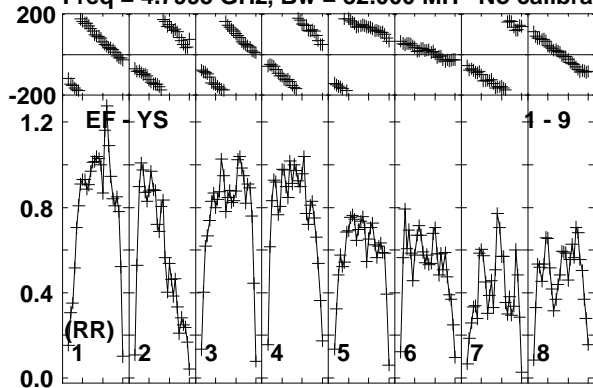

Lower frame: Milli Ampl Jy Top frame: Phas deg
Vector averaged cross-power spectrum Baseline: EF (01) - YS (09)
Timerange: 00/15:49:31 to 00/15:50:29

Plot file version 78 created 20-APR-2018 10:31:42

J0915+0745 EG102C.UVDATA.1

Freq = 4.7995 GHz, Bw = 32.000 MH No calibration applied and no bandpass applied

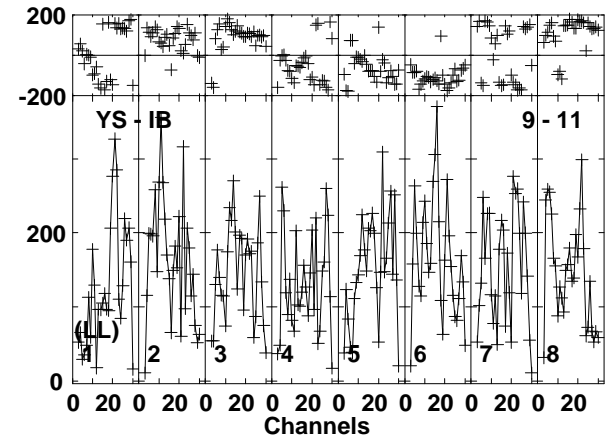
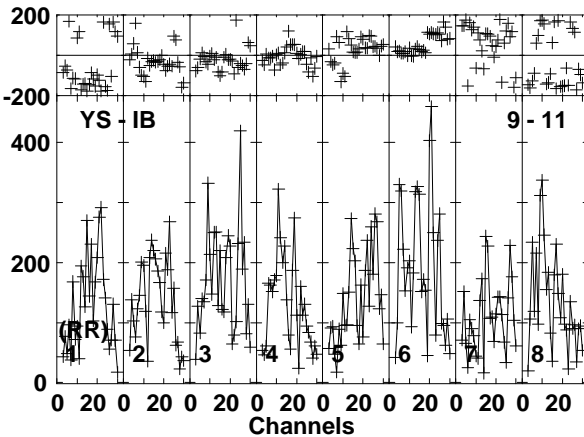
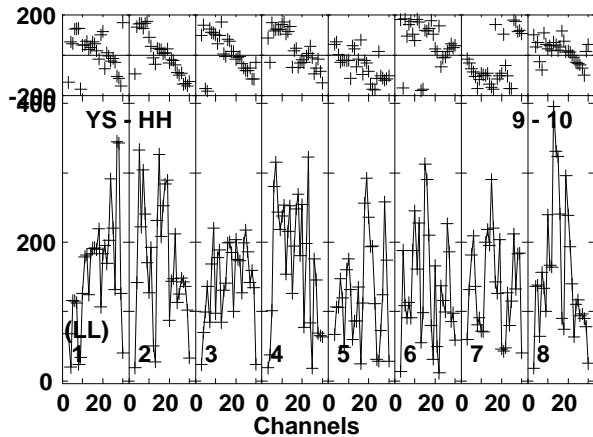
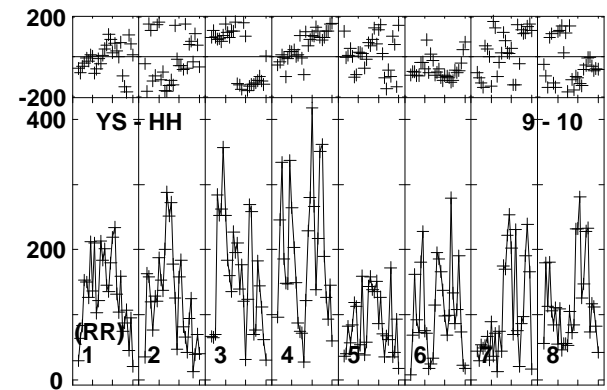
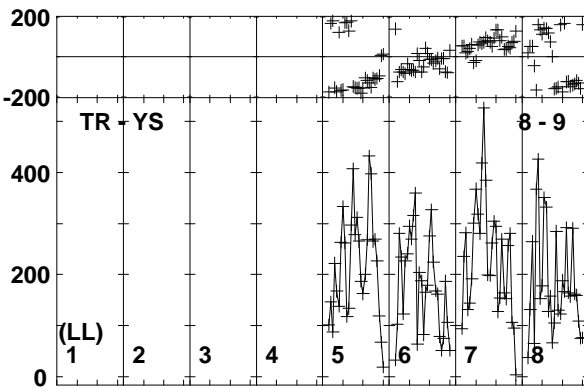
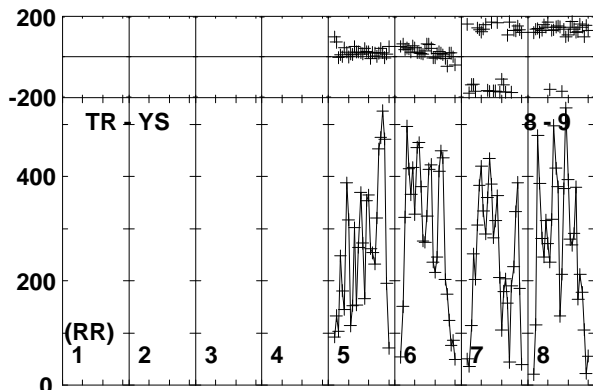
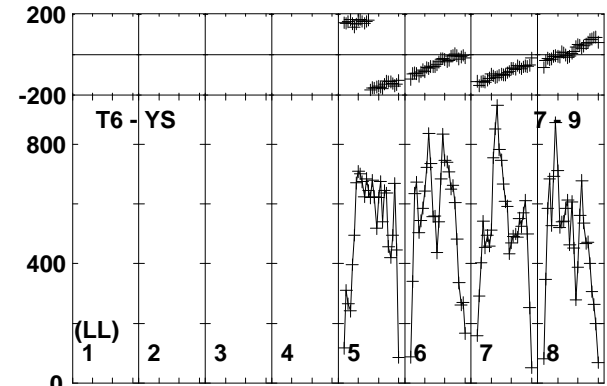
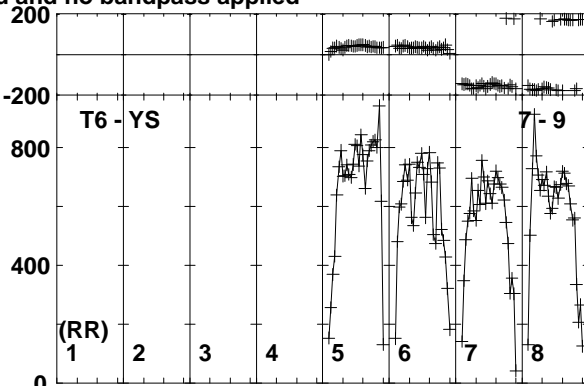
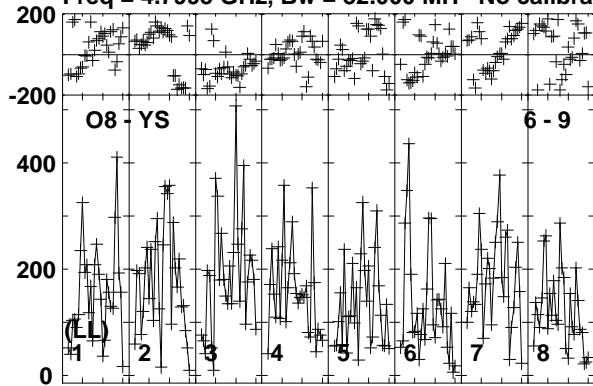

Lower frame: Micro Ampl Jy Top frame: Phas deg
Vector averaged cross-power spectrum Baseline: O8 (06) - YS (09)
Timerange: 00/15:49:31 to 00/15:50:29

Plot file version 79 created 20-APR-2018 10:31:42

B0915+068 EG102C.UVDATA.1

Freq = 4.7995 GHz, Bw = 32.000 MH No calibration applied and no bandpass applied

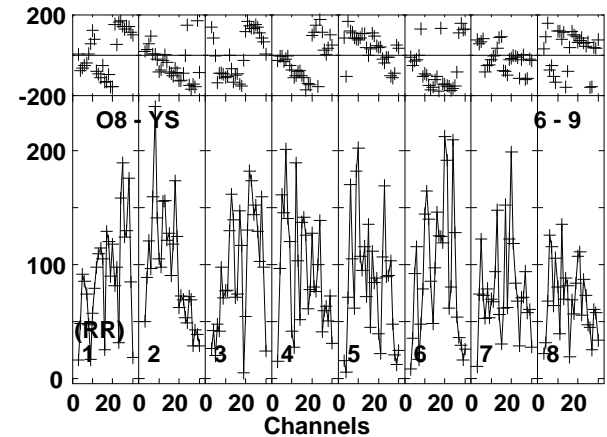
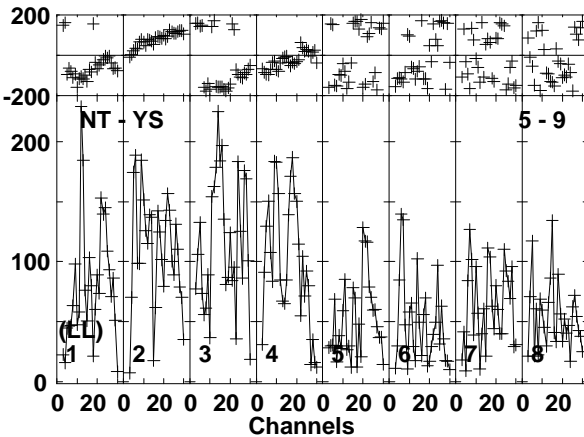
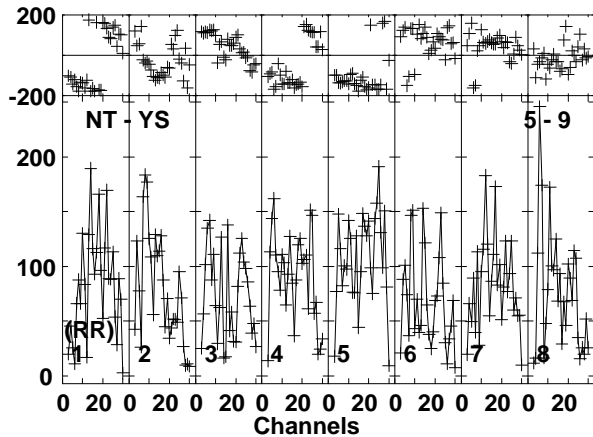
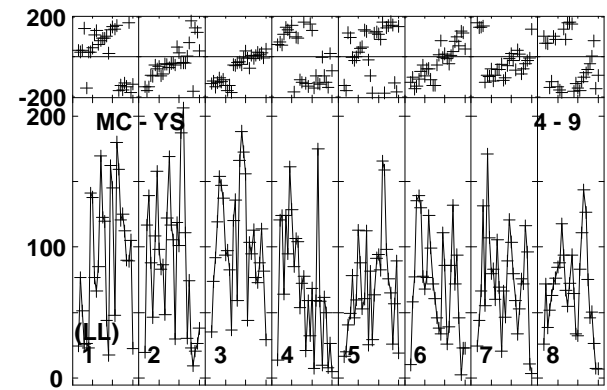
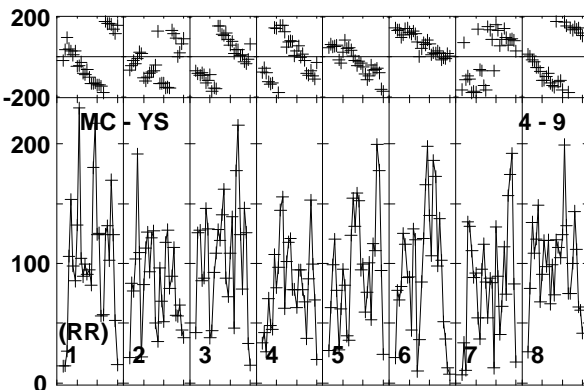
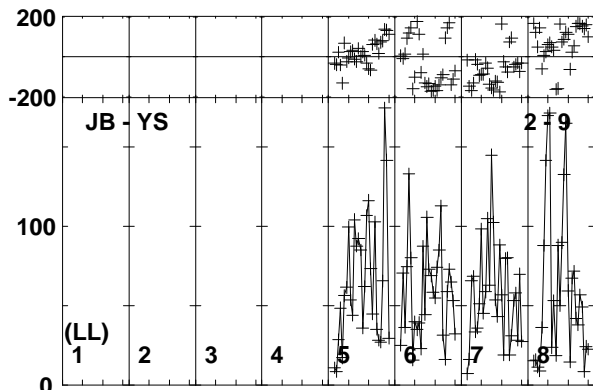
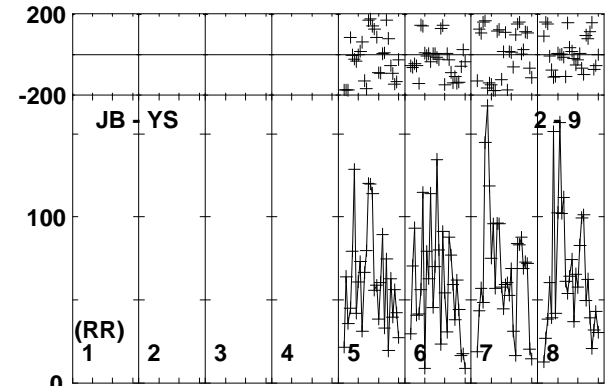
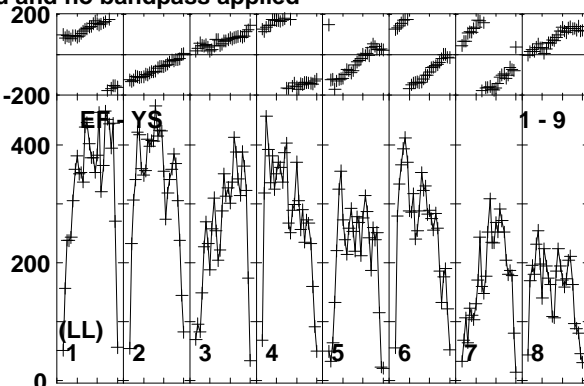
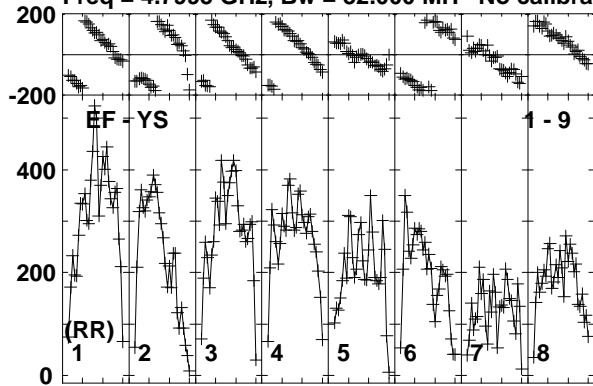

Lower frame: Micro Ampl Jy Top frame: Phas deg
Vector averaged cross-power spectrum Baseline: EF (01) - YS (09)
Timerange: 00:15:50:31 to 00:15:53:59

Plot file version 80 created 20-APR-2018 10:31:42

B0915+068 EG102C.UVDATA.1

Freq = 4.7995 GHz, Bw = 32.000 MH No calibration applied and no bandpass applied

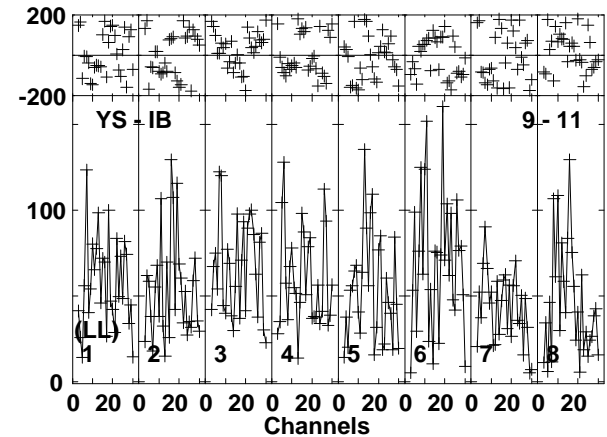
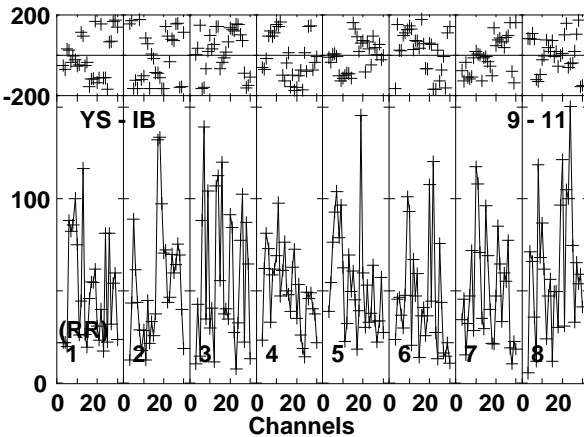
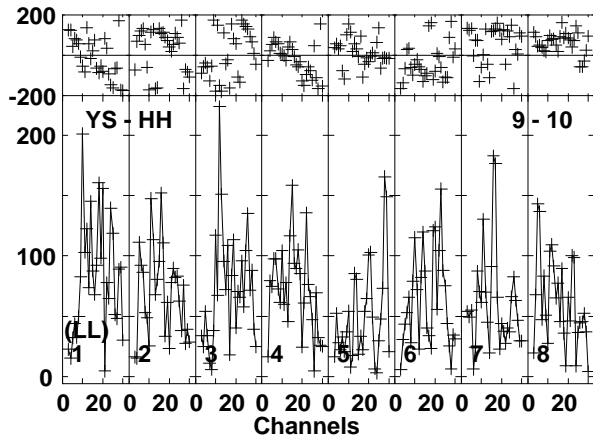
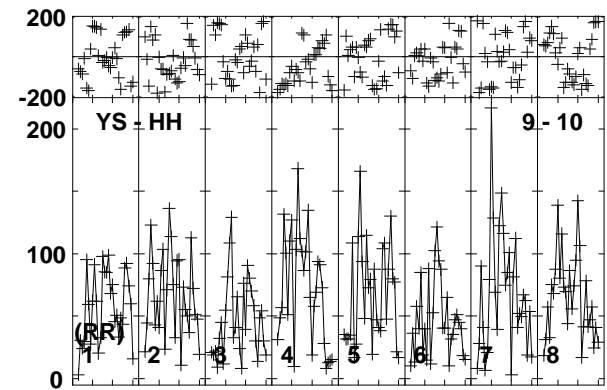
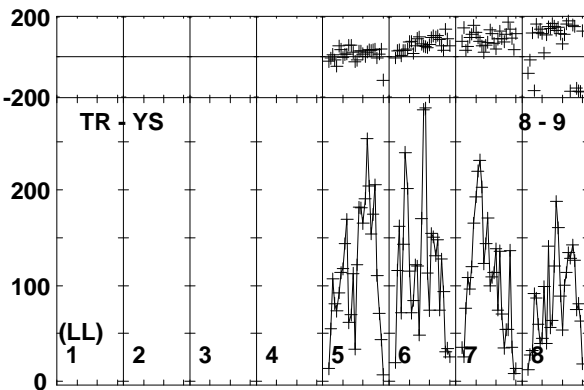
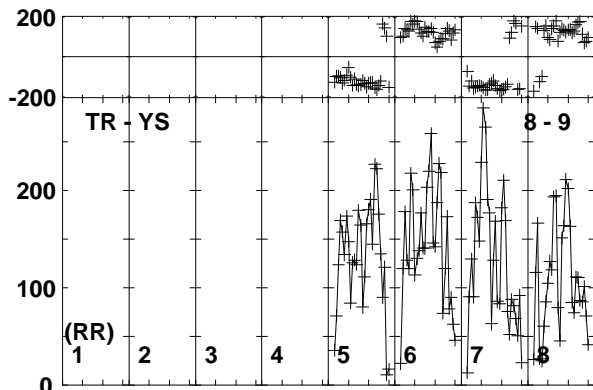
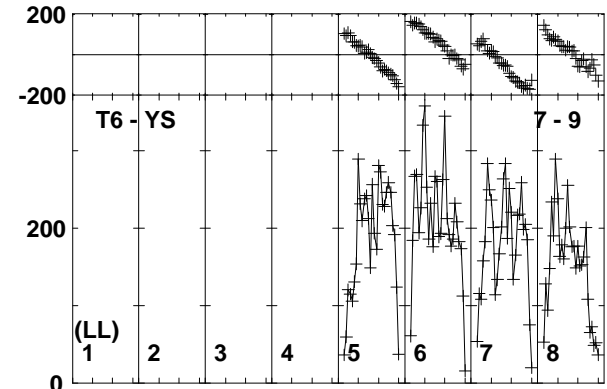
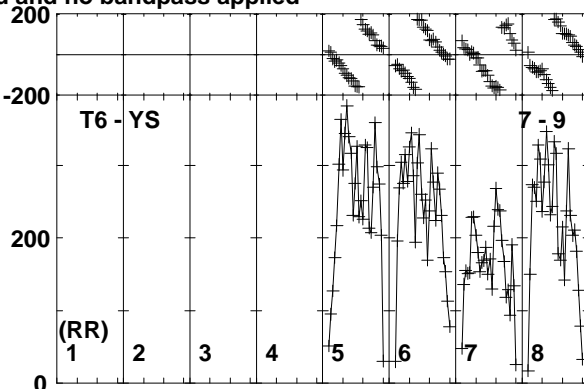
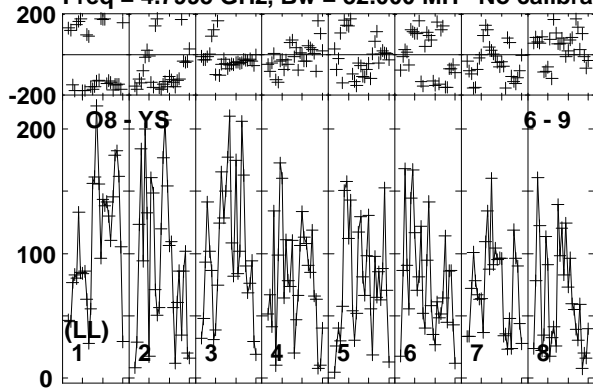

Lower frame: Micro Ampl Jy Top frame: Phas deg
Vector averaged cross-power spectrum Baseline: O8 (06) - YS (09)
Timerange: 00/15:50:31 to 00/15:53:59

Plot file version 81 created 20-APR-2018 10:31:42

J0915+0745 EG102C.UVDATA.1

Freq = 4.7995 GHz, Bw = 32.000 MH No calibration applied and no bandpass applied

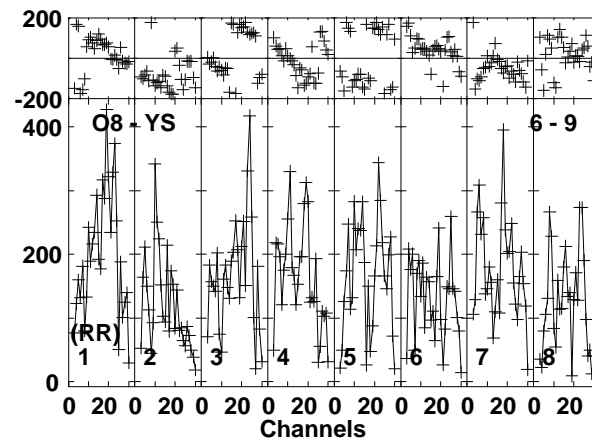
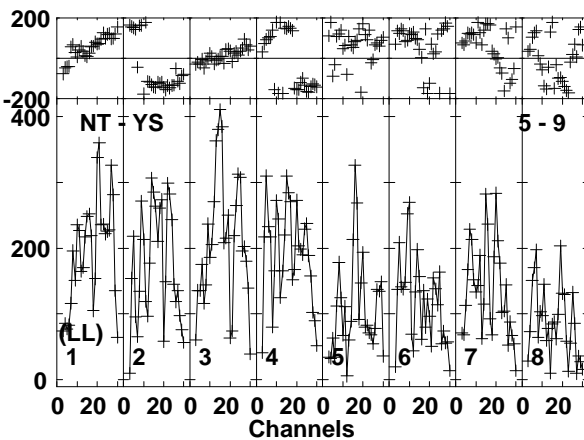
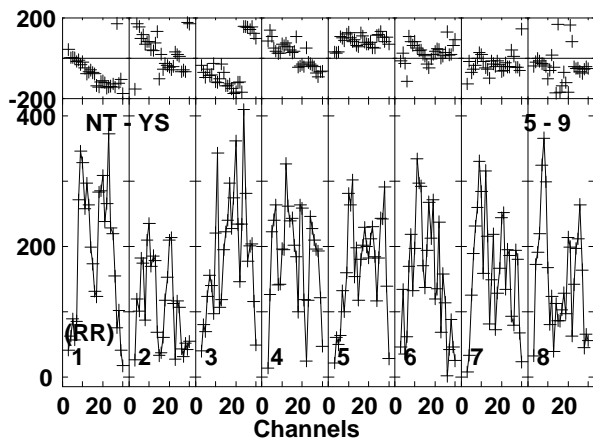
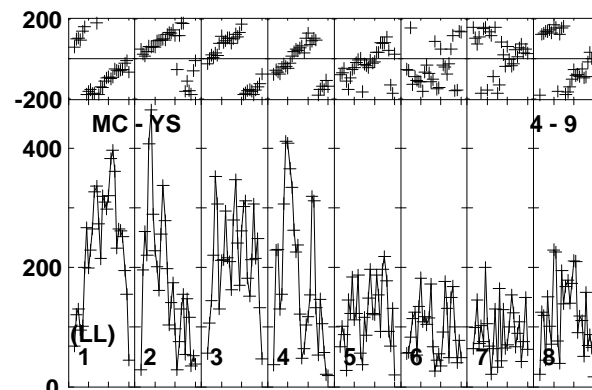
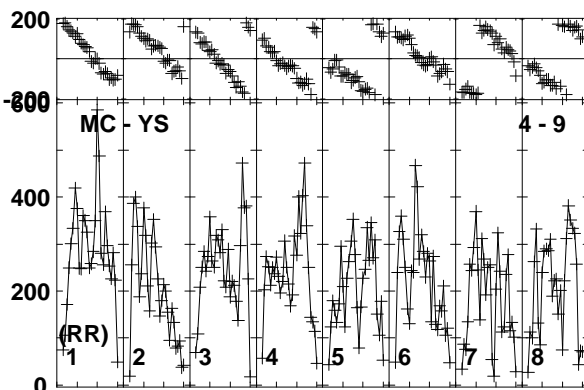
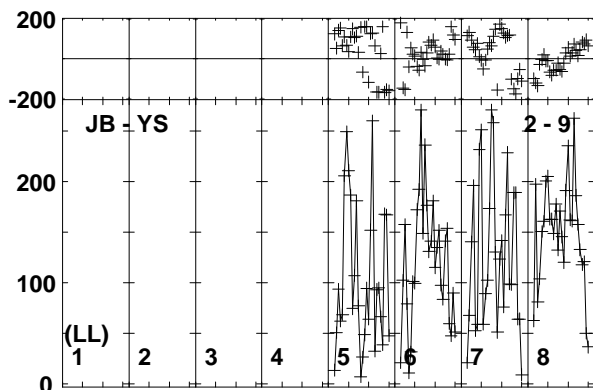
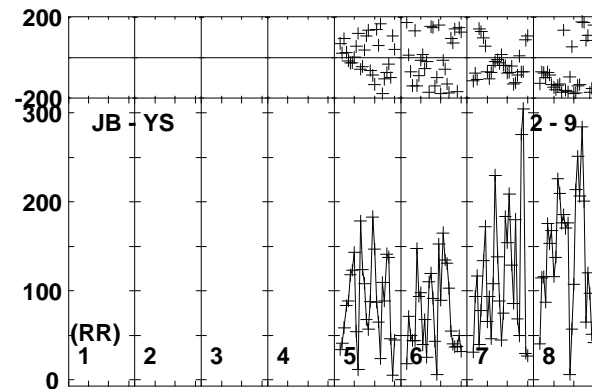
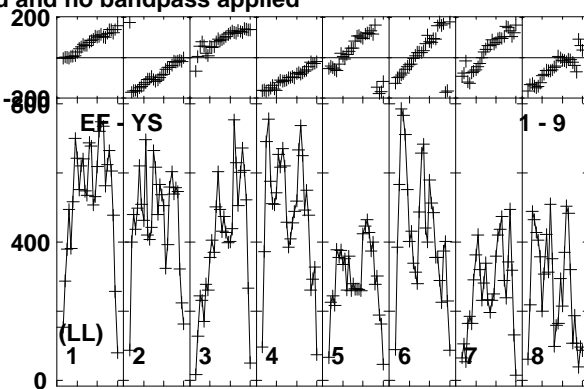
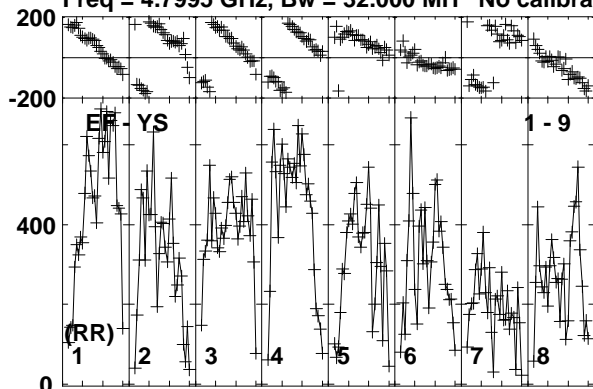

Lower frame: Micro Ampl Jy Top frame: Phas deg
Vector averaged cross-power spectrum Baseline: EF (01) - YS (09)
Timerange: 00/15:54:01 to 00/15:55:29

Plot file version 82 created 20-APR-2018 10:31:42

J0915+0745 EG102C.UVDATA.1

Freq = 4.7995 GHz, Bw = 32.000 MH No calibration applied and no bandpass applied

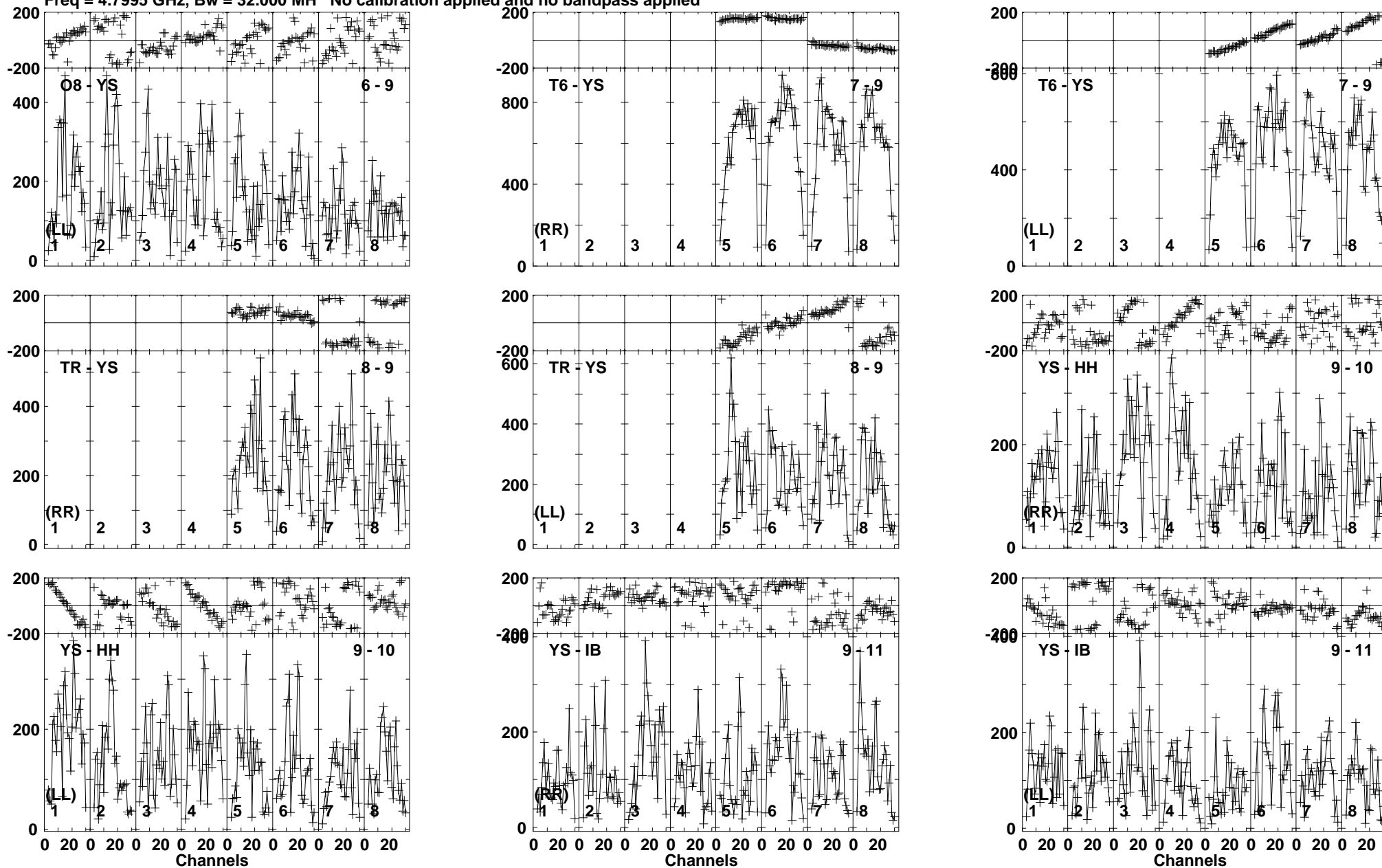

Plot file version 83 created 20-APR-2018 10:31:42

B0915+068 EG102C.UVDATA.1

Freq = 4.7995 GHz, Bw = 32.000 MH No calibration applied and no bandpass applied

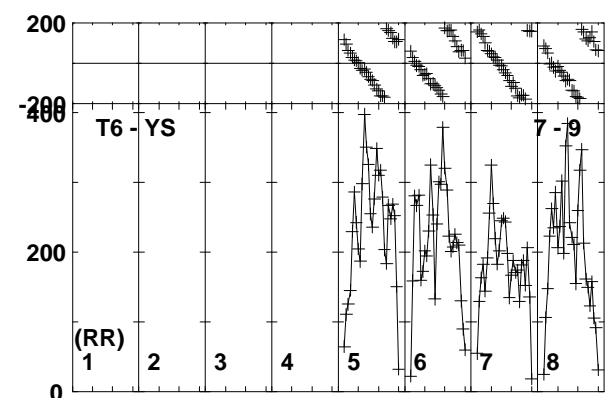
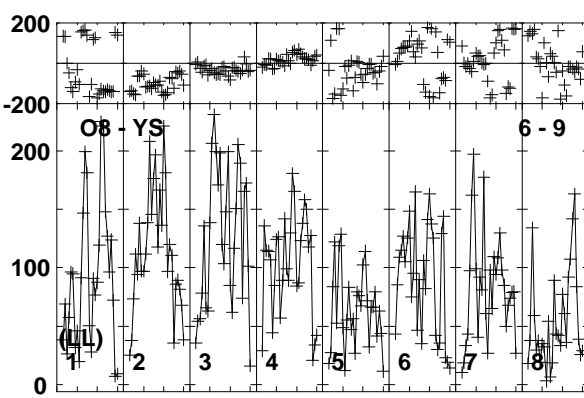
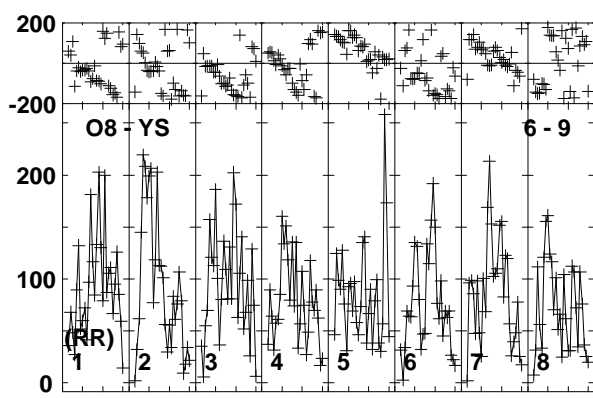
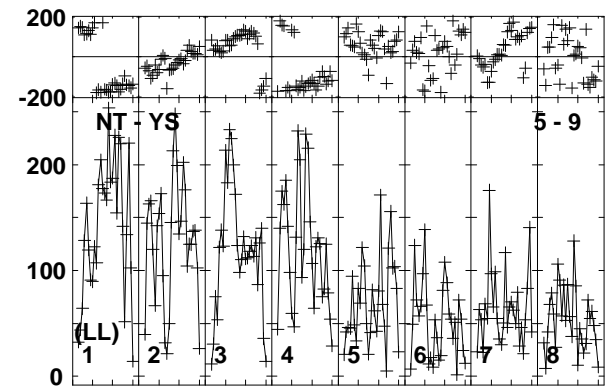
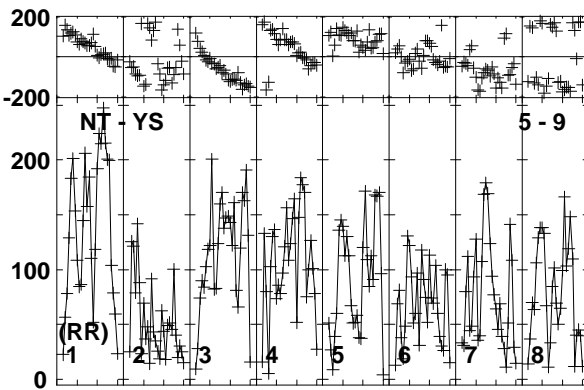
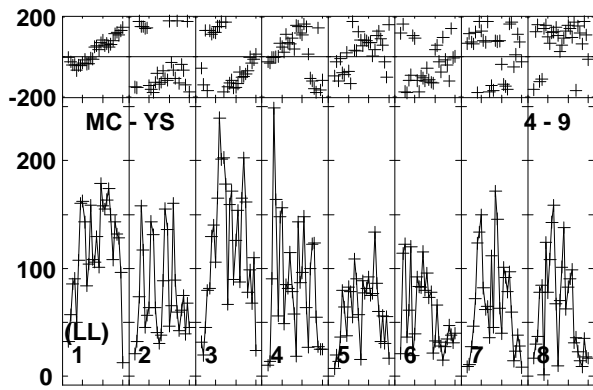
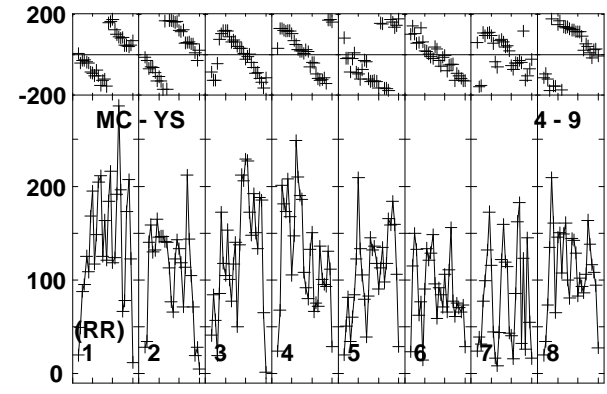
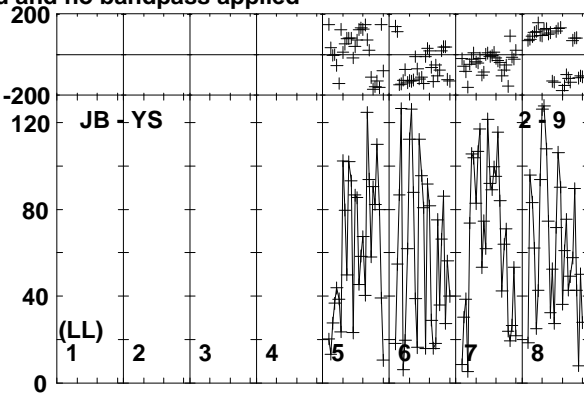
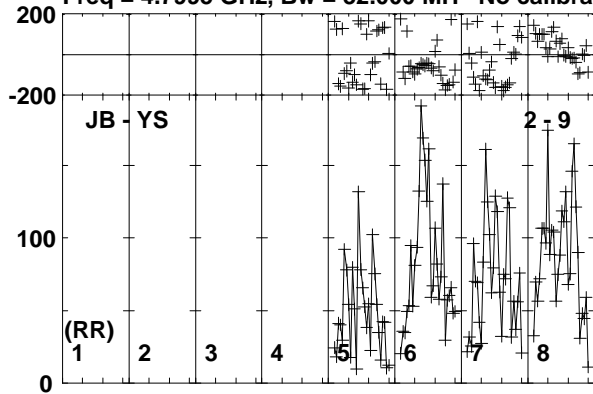

Lower frame: Micro Ampl Jy Top frame: Phas deg
Vector averaged cross-power spectrum Baseline: JB (02) - YS (09)
Timerange: 00/15:55:31 to 00/15:58:59

Plot file version 84 created 20-APR-2018 10:31:42
 B0915+068 EG102C.UVDATA.1
 Freq = 4.7995 GHz, Bw = 32.000 MH No calibration applied and no bandpass applied

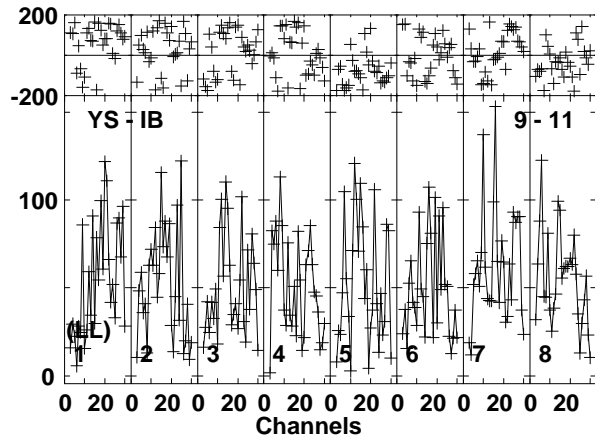
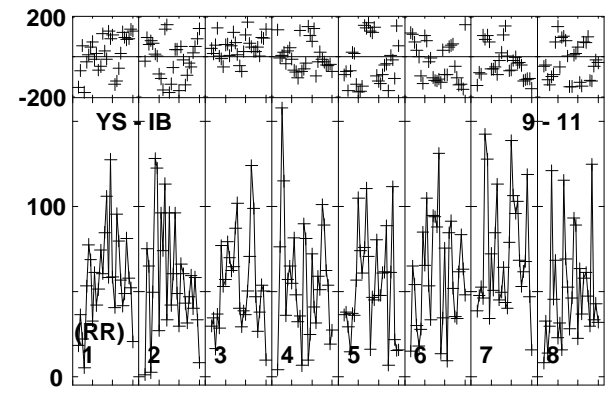
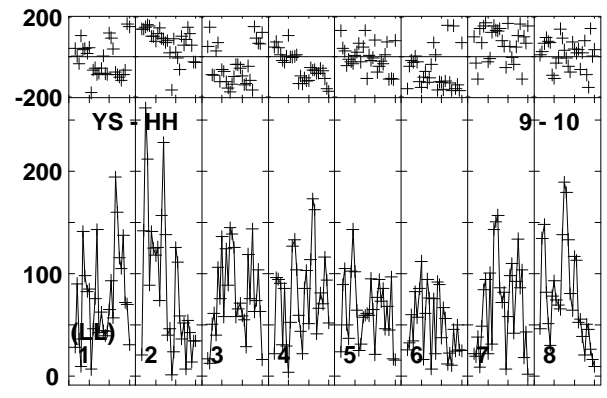
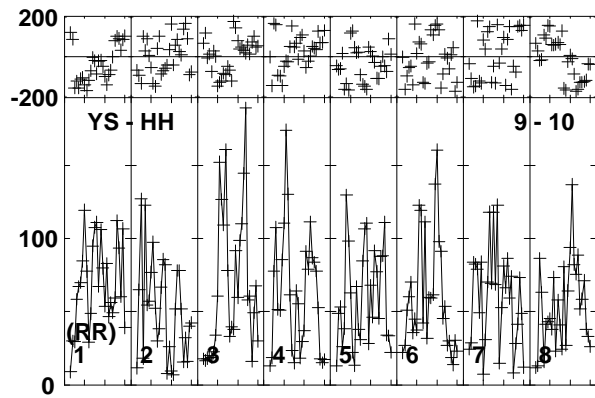
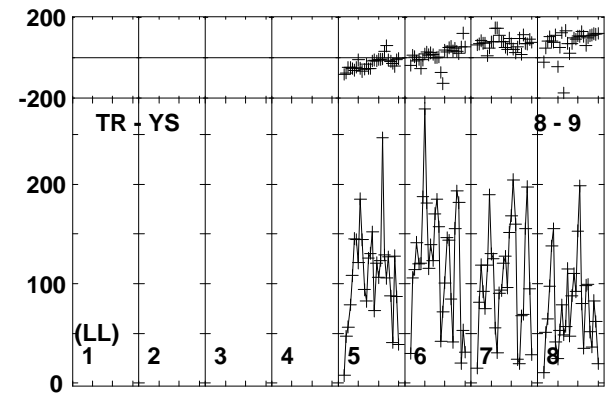
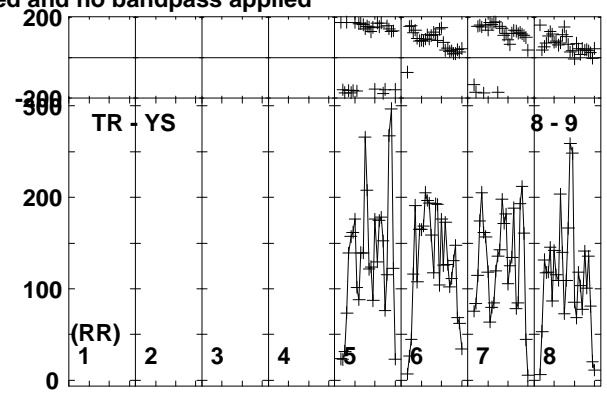
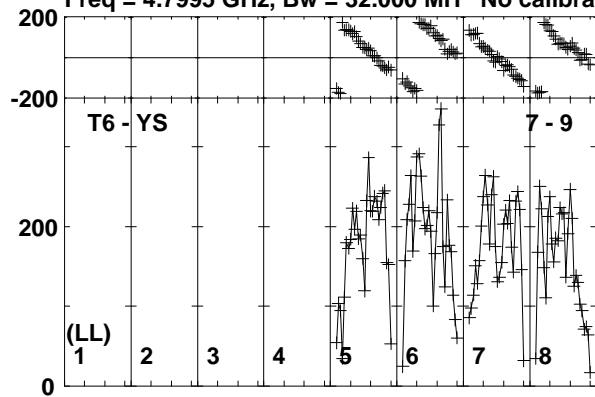

Lower frame: Micro Ampl Jy Top frame: Phas deg
 Vector averaged cross-power spectrum Baseline: T6 (07) - YS (09)
 Timerange: 00/15:55:31 to 00/15:58:59

Plot file version 85 created 20-APR-2018 10:31:43

J0915+0745 EG102C.UVDATA.1

Freq = 4.7995 GHz, Bw = 32.000 MH No calibration applied and no bandpass applied

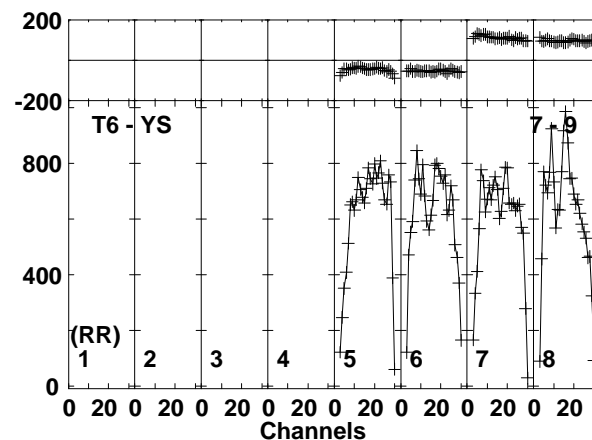
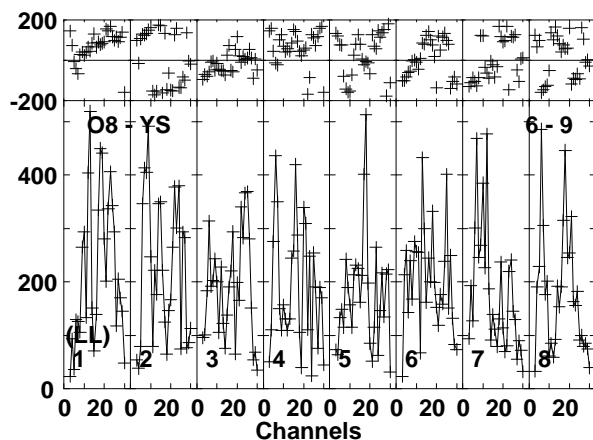
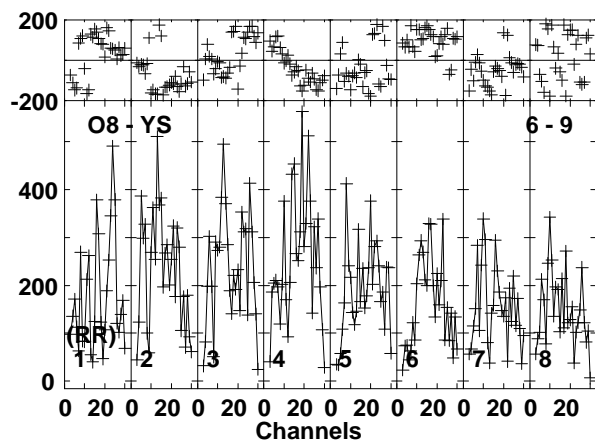
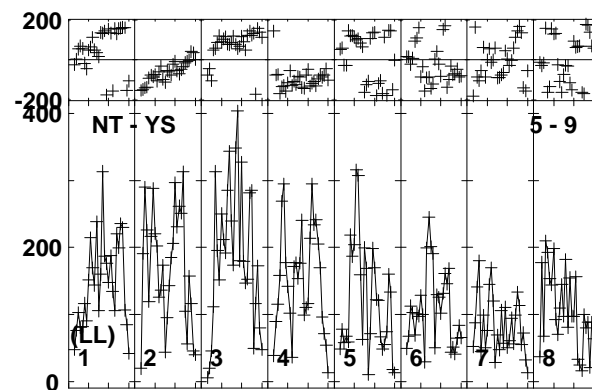
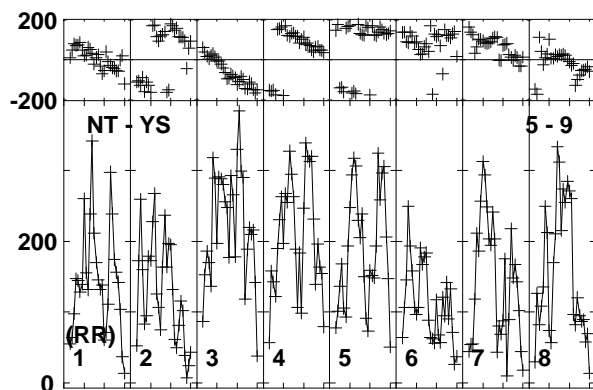
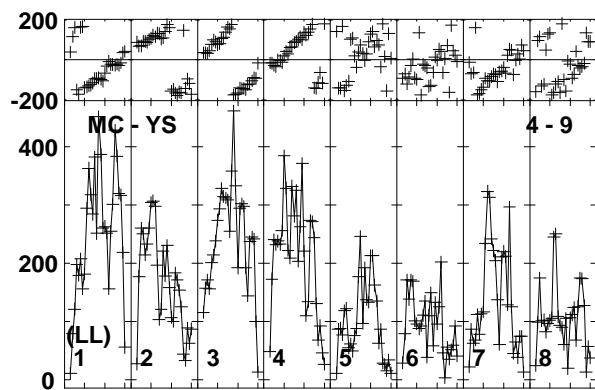
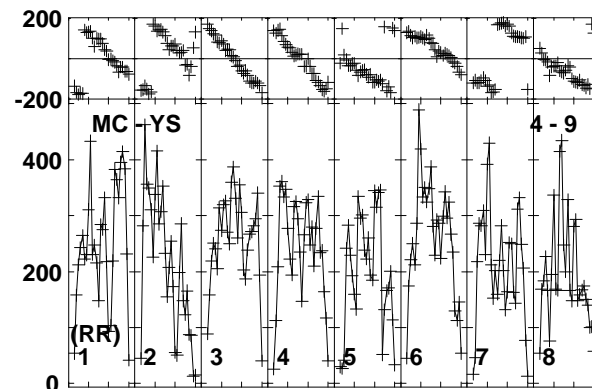
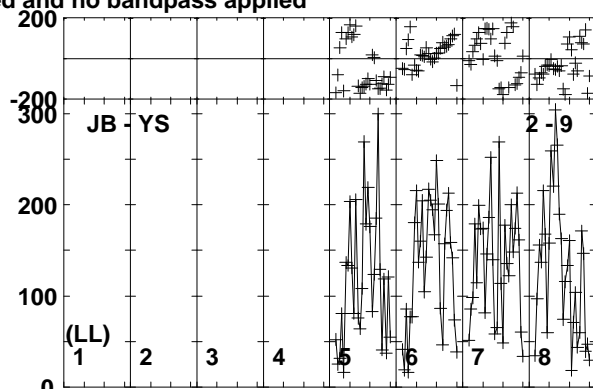
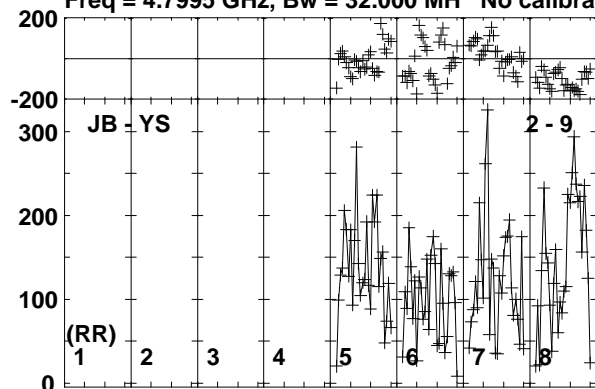

Lower frame: Micro Ampl Jy Top frame: Phas deg
Vector averaged cross-power spectrum Baseline: JB (02) - YS (09)
Timerange: 00/15:59:01 to 00/16:00:29

Plot file version 86 created 20-APR-2018 10:31:43

J0915+0745 EG102C.UVDATA.1

Freq = 4.7995 GHz, Bw = 32.000 MH No calibration applied and no bandpass applied

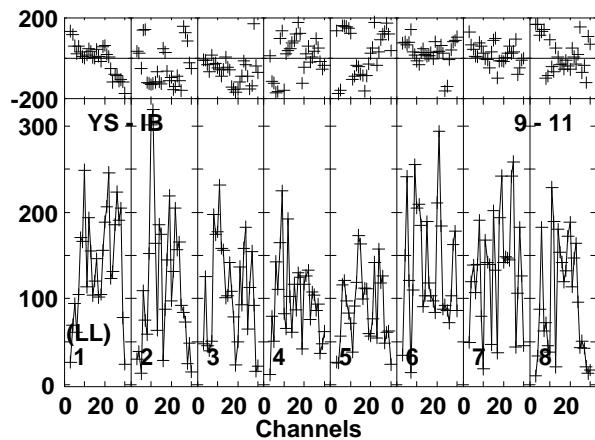
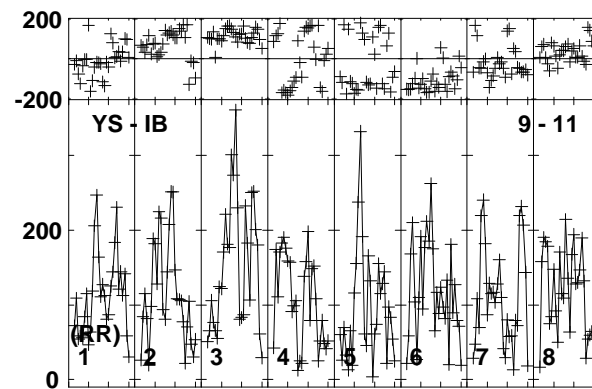
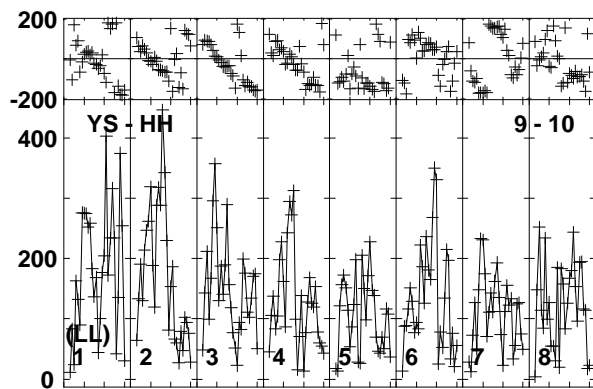
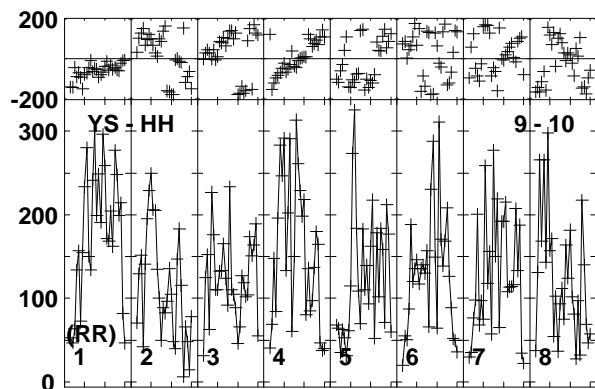
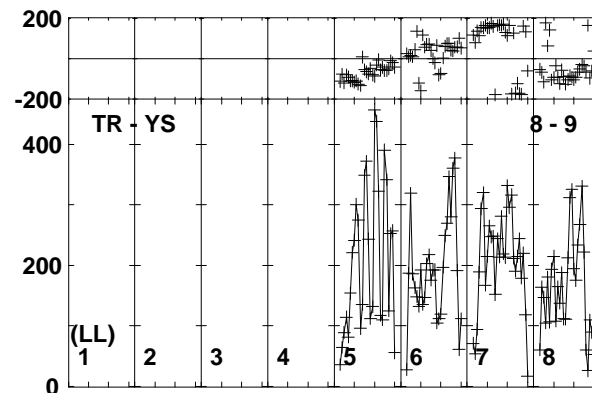
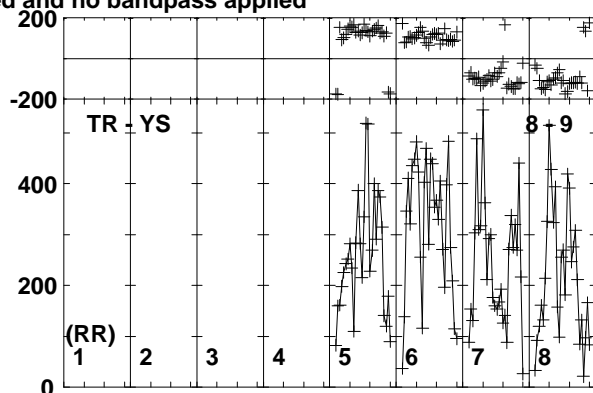
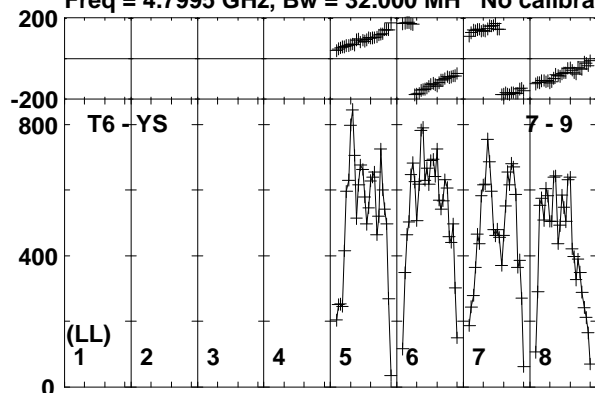

Lower frame: Micro Ampl Jy Top frame: Phas deg
Vector averaged cross-power spectrum Baseline: T6 (07) - YS (09)
Timerange: 00/15:59:01 to 00/16:00:29

Plot file version 87 created 20-APR-2018 10:31:43

B0915+068 EG102C.UVDATA.1

Freq = 4.7995 GHz, Bw = 32.000 MH No calibration applied and no bandpass applied

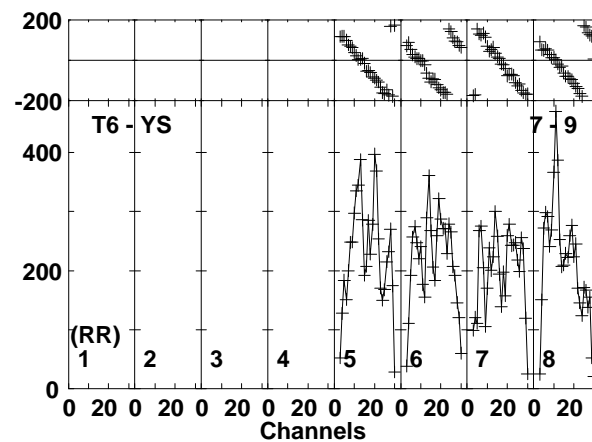
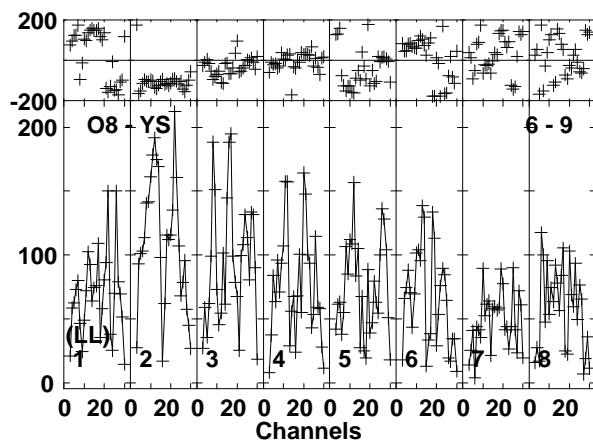
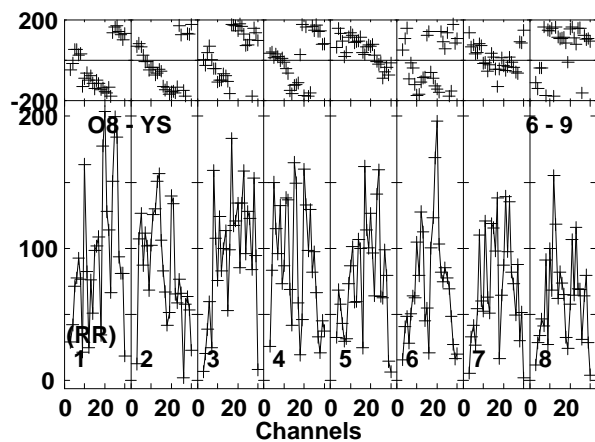
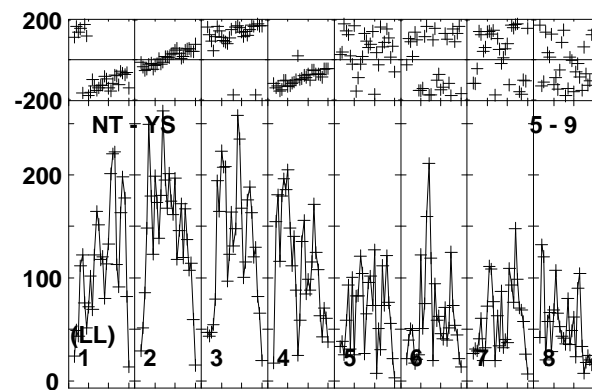
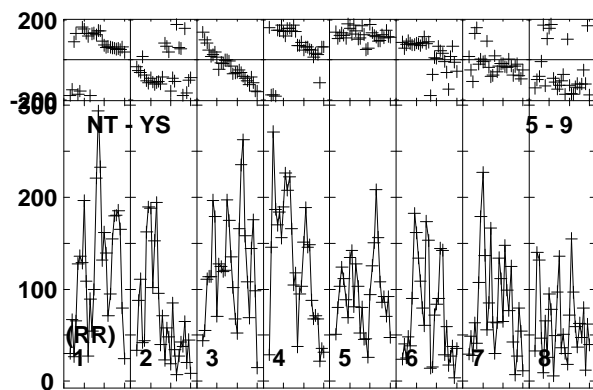
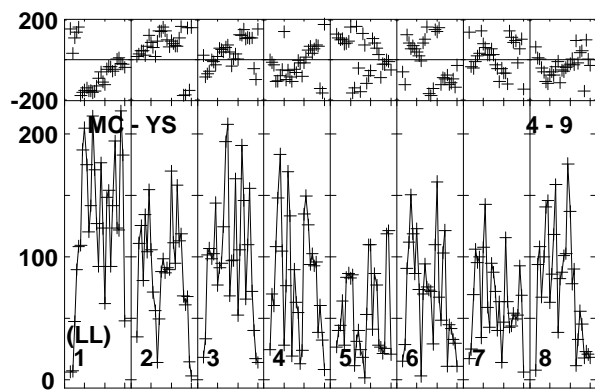
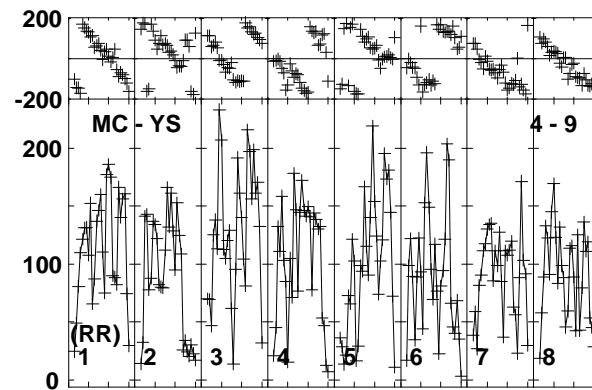
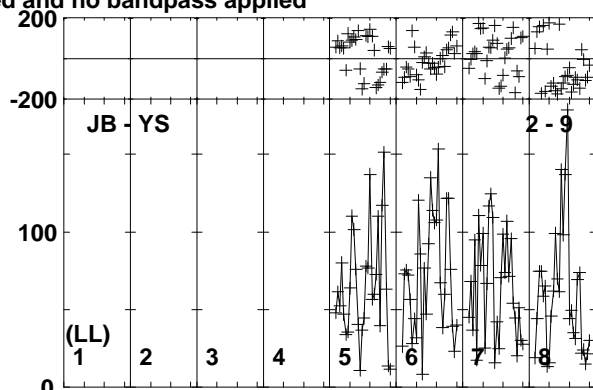
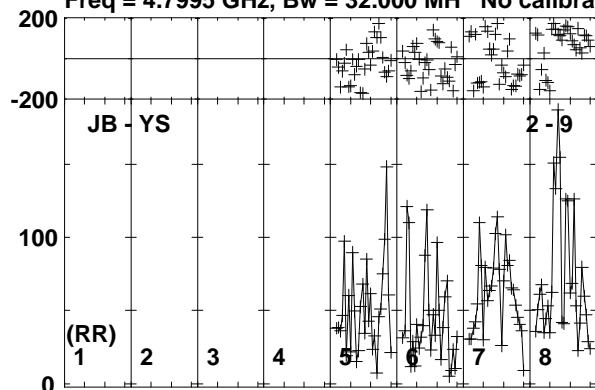

Lower frame: Micro Ampl Jy Top frame: Phas deg
Vector averaged cross-power spectrum Baseline: JB (02) - YS (09)
Timerange: 00/16:00:31 to 00/16:03:59

Plot file version 88 created 20-APR-2018 10:31:43
 B0915+068 EG102C.UVDATA.1
 Freq = 4.7995 GHz, Bw = 32.000 MH No calibration applied and no bandpass applied

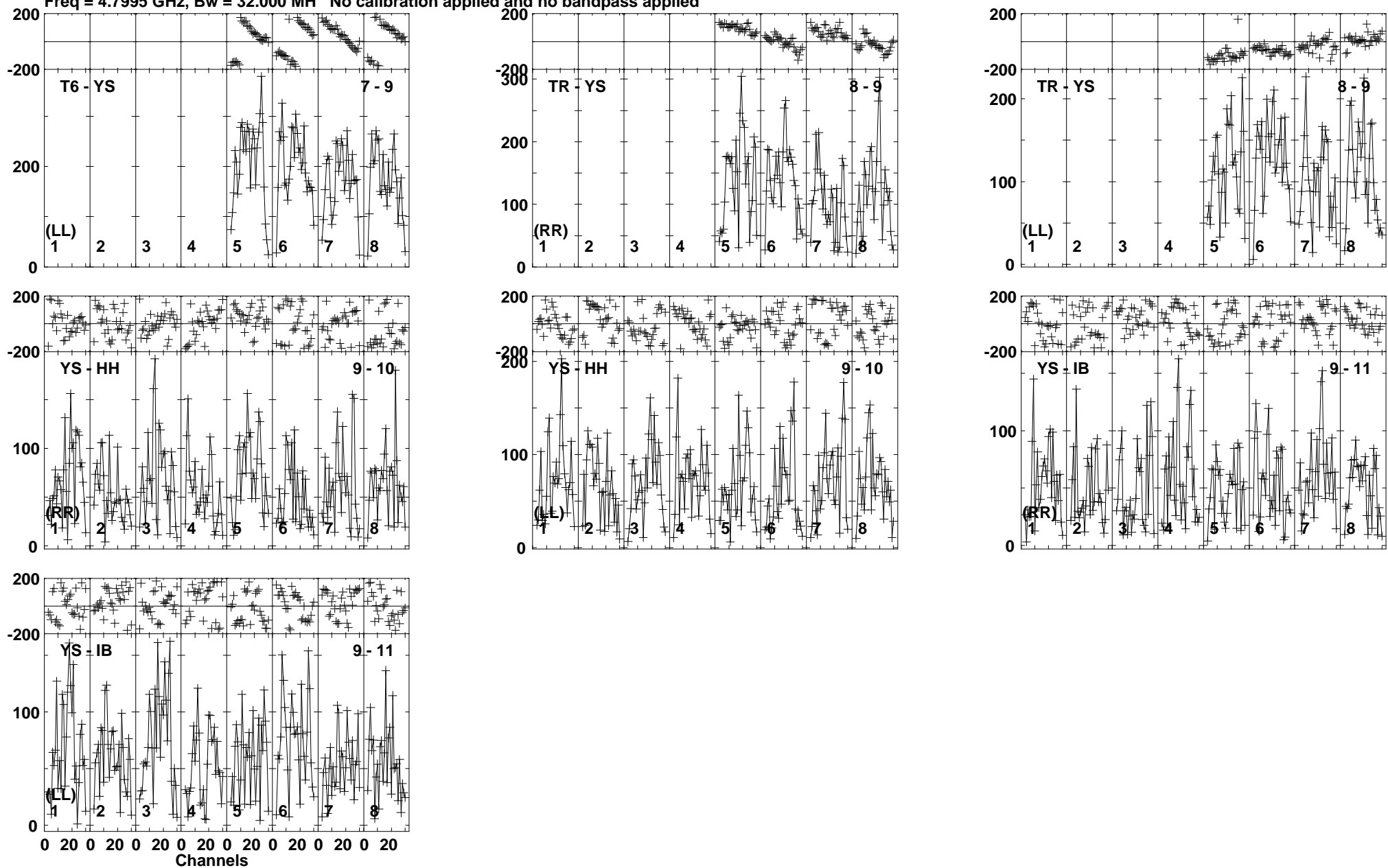

Lower frame: Micro Ampl Jy Top frame: Phas deg
 Vector averaged cross-power spectrum Baseline: T6 (07) - YS (09)
 Timerange: 00/16:00:31 to 00/16:03:59

Plot file version 89 created 20-APR-2018 10:31:43

J0915+0745 EG102C.UVDATA.1

Freq = 4.7995 GHz, Bw = 32.000 MH No calibration applied and no bandpass applied

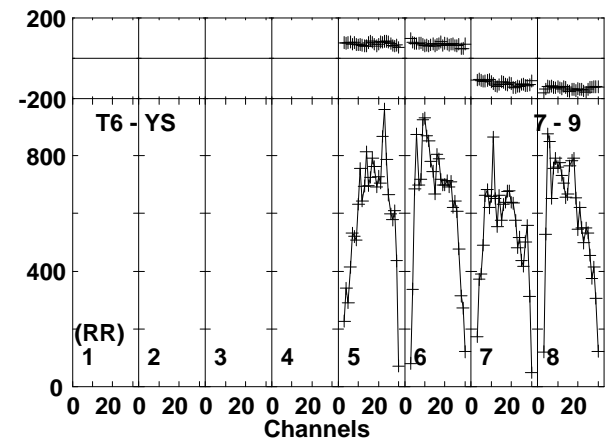
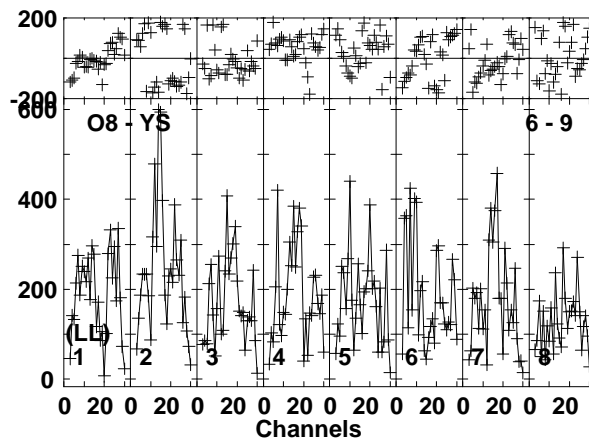
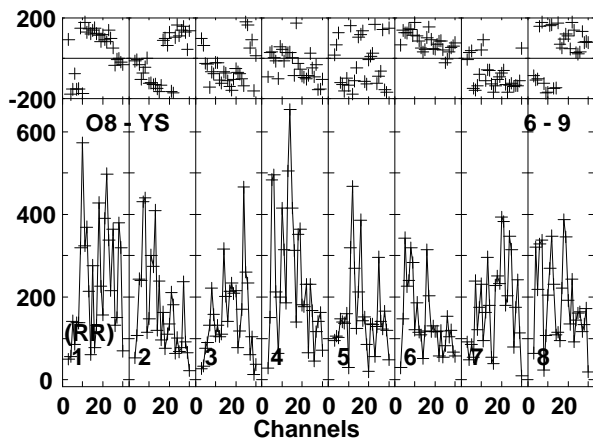
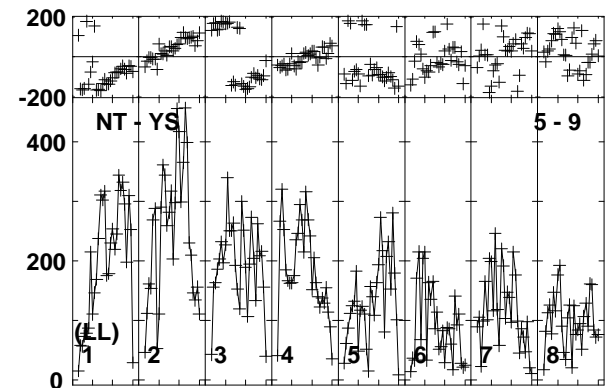
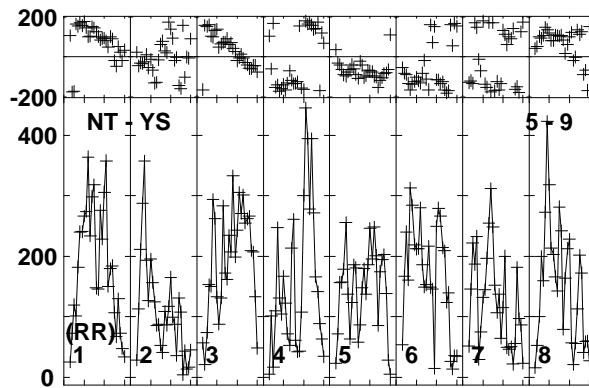
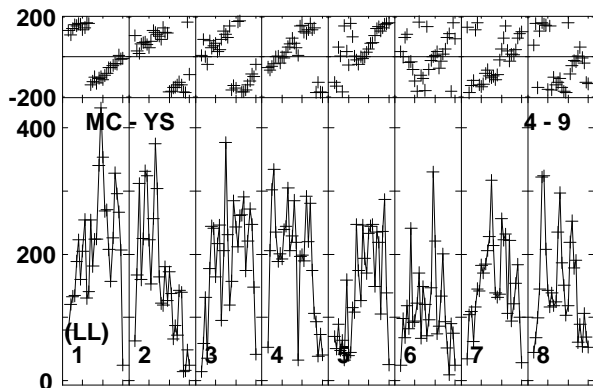
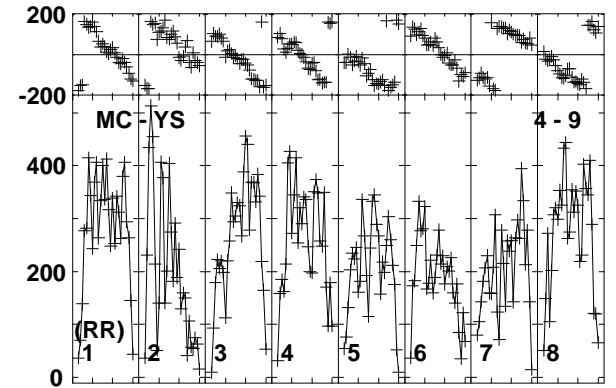
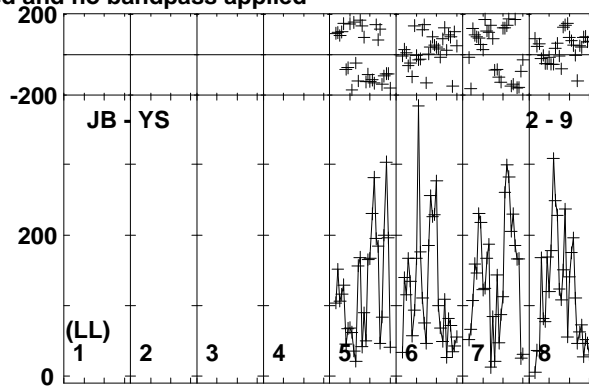
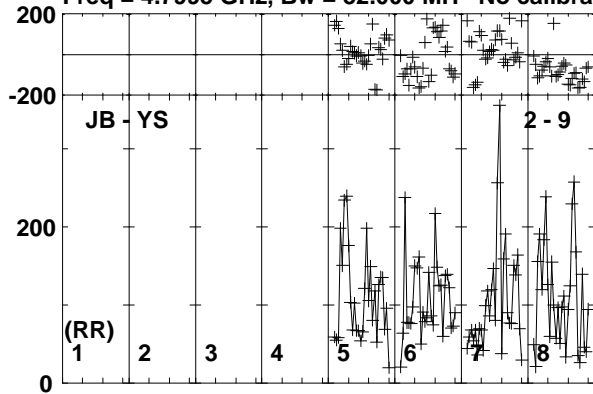

Lower frame: Micro Ampl Jy Top frame: Phas deg
Vector averaged cross-power spectrum Baseline: JB (02) - YS (09)
Timerange: 00/16:04:41 to 00/16:05:39

Plot file version 90 created 20-APR-2018 10:31:43

J0915+0745 EG102C.UVDATA.1

Freq = 4.7995 GHz, Bw = 32.000 MH No calibration applied and no bandpass applied

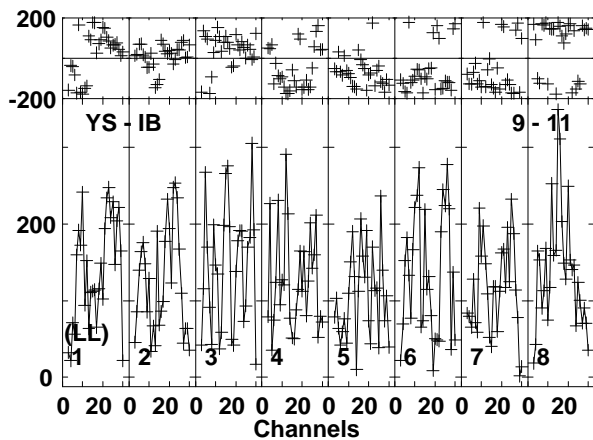
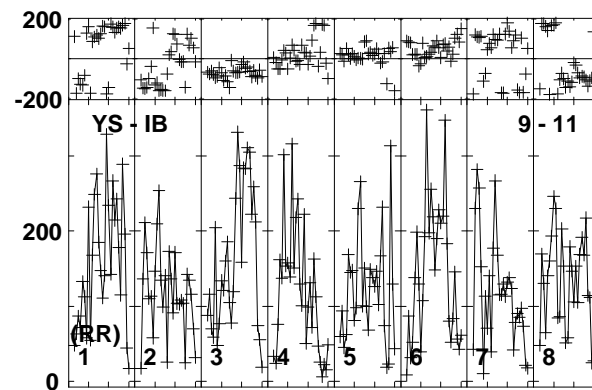
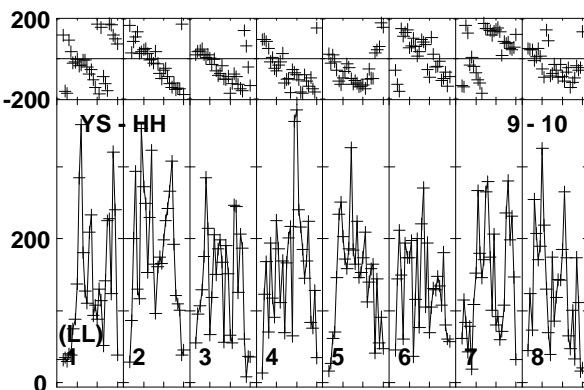
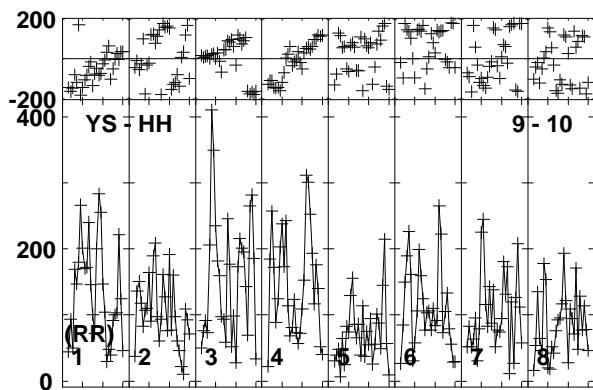
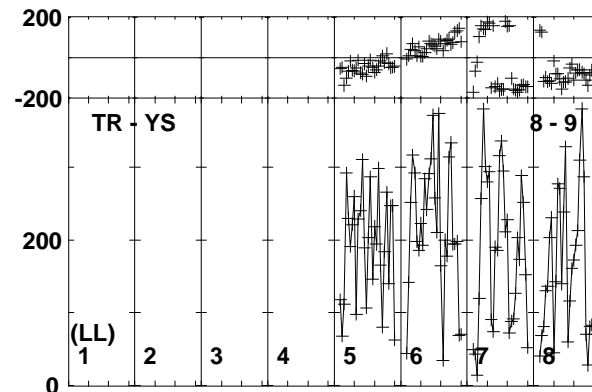
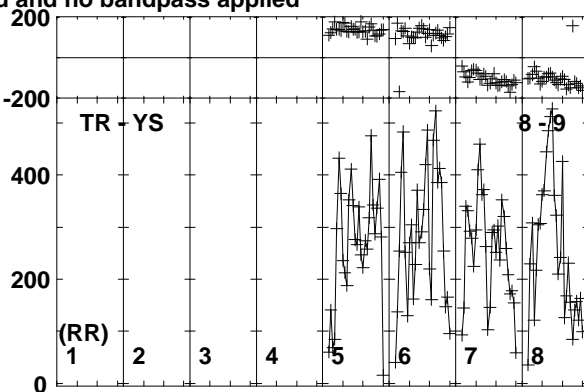
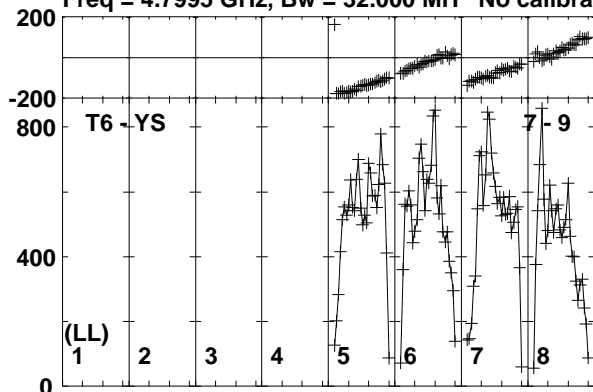

Lower frame: Micro Ampl Jy Top frame: Phas deg
Vector averaged cross-power spectrum Baseline: T6 (07) - YS (09)
Timerange: 00/16:04:41 to 00/16:05:39

Plot file version 91 created 20-APR-2018 10:31:43

B0915+068 EG102C.UVDATA.1

Freq = 4.7995 GHz, Bw = 32.000 MH No calibration applied and no bandpass applied

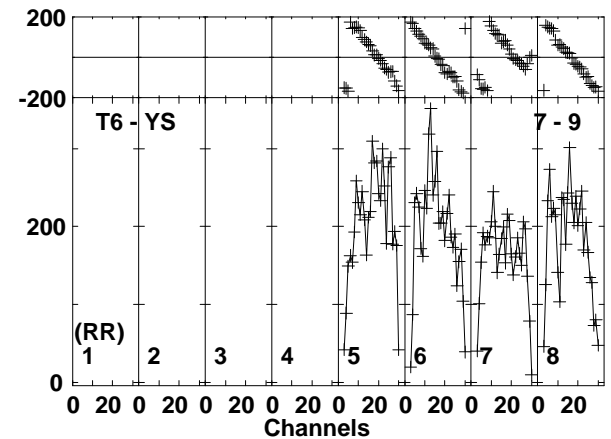
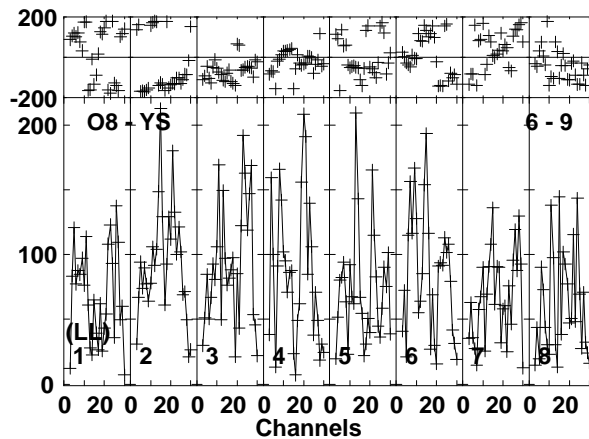
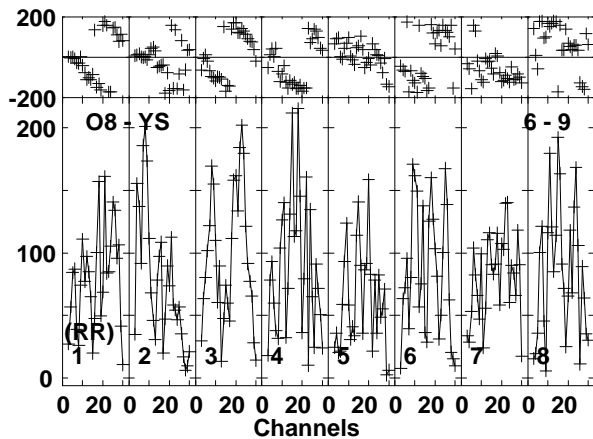
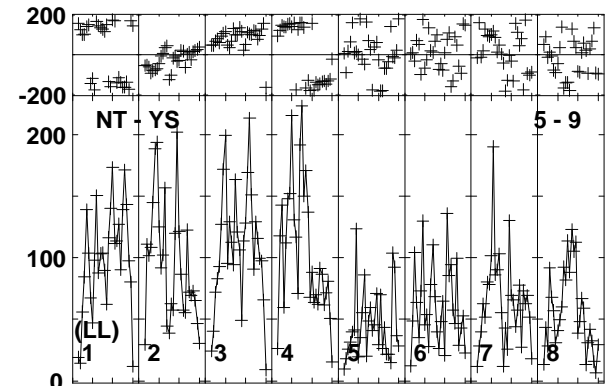
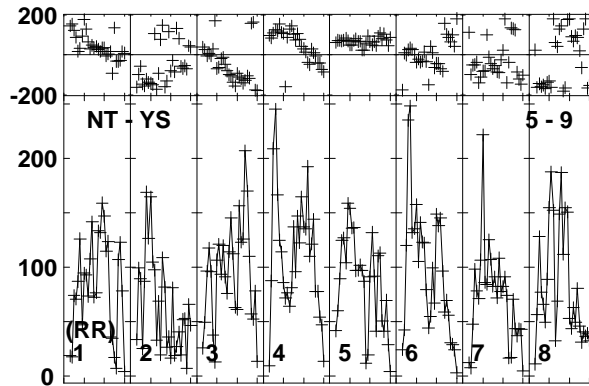
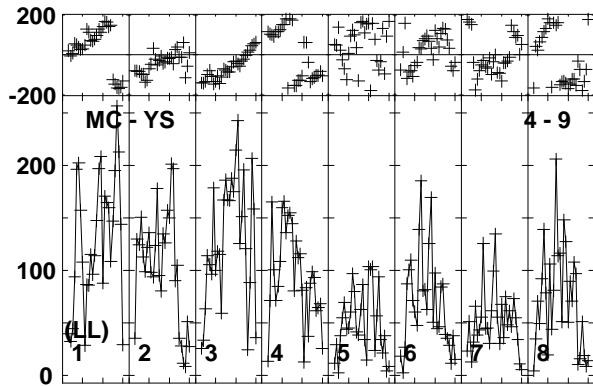
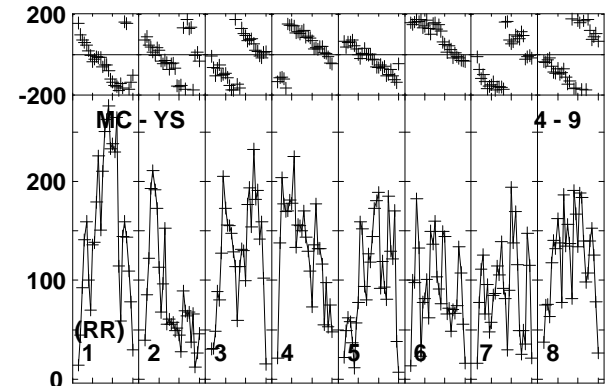
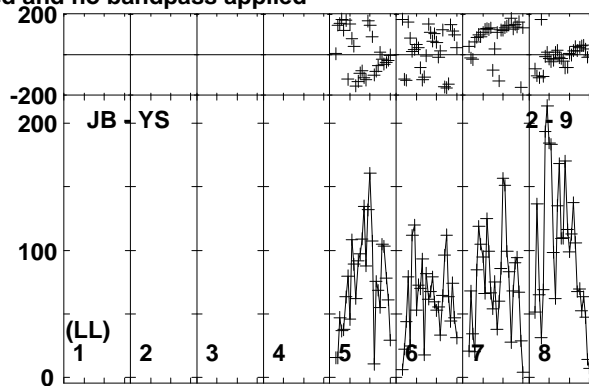
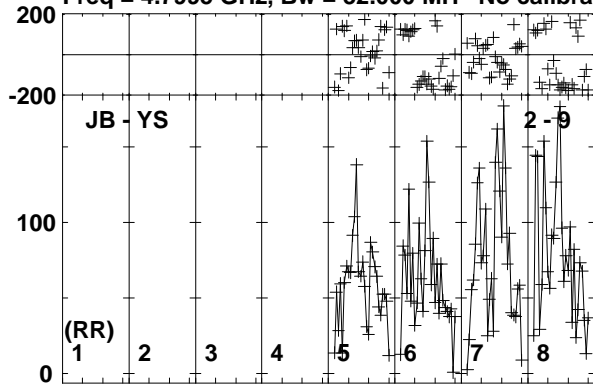

Lower frame: Micro Ampl Jy Top frame: Phas deg
Vector averaged cross-power spectrum Baseline: JB (02) - YS (09)
Timerange: 00/16:05:41 to 00/16:09:09

Plot file version 92 created 20-APR-2018 10:31:43

B0915+068 EG102C.UVDATA.1

Freq = 4.7995 GHz, Bw = 32.000 MH No calibration applied and no bandpass applied

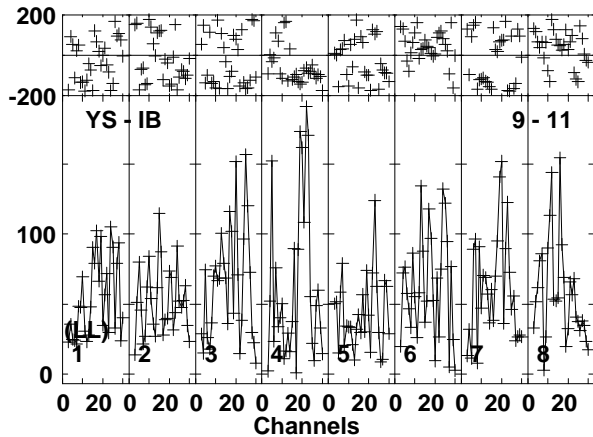
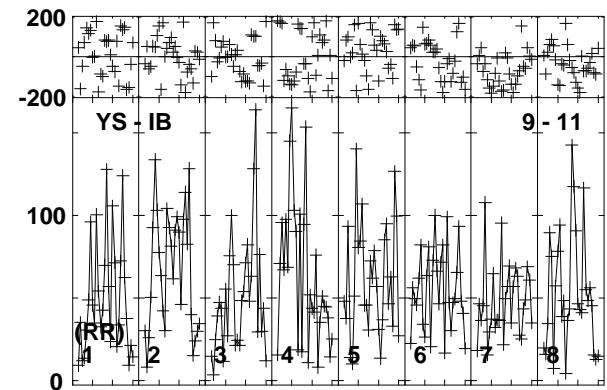
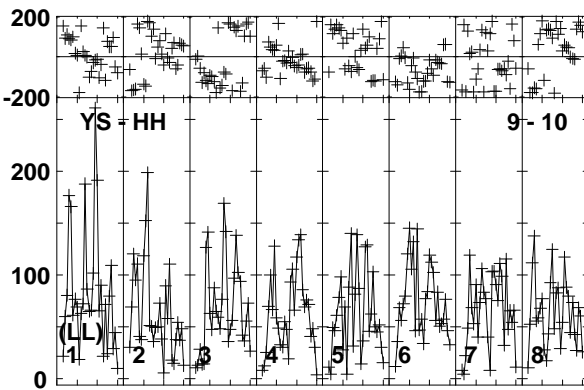
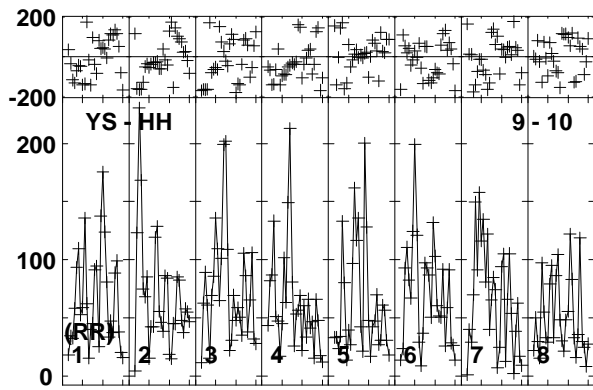
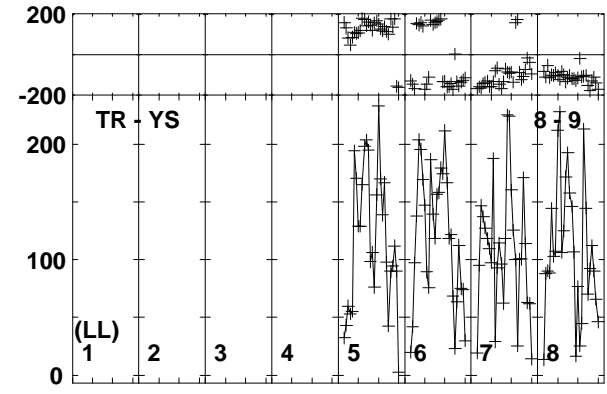
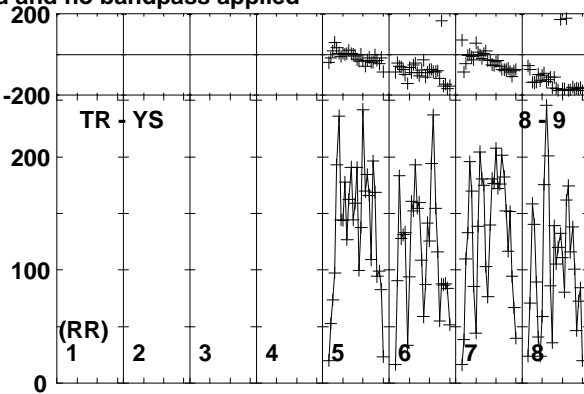
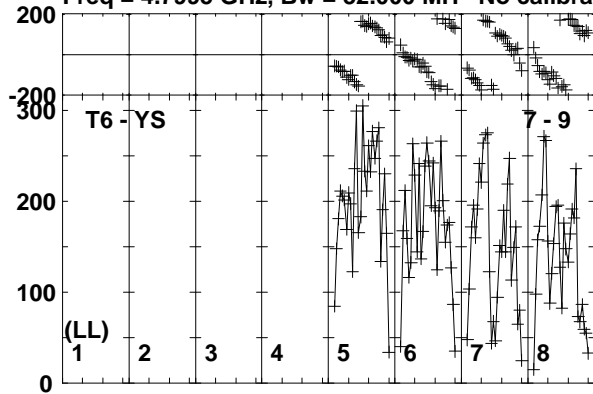

Lower frame: Micro Ampl Jy Top frame: Phas deg
Vector averaged cross-power spectrum Baseline: T6 (07) - YS (09)
Timerange: 00/16:05:41 to 00/16:09:09

Plot file version 93 created 20-APR-2018 10:31:43

J0915+0745 EG102C.UVDATA.1

Freq = 4.7995 GHz, Bw = 32.000 MH No calibration applied and no bandpass applied

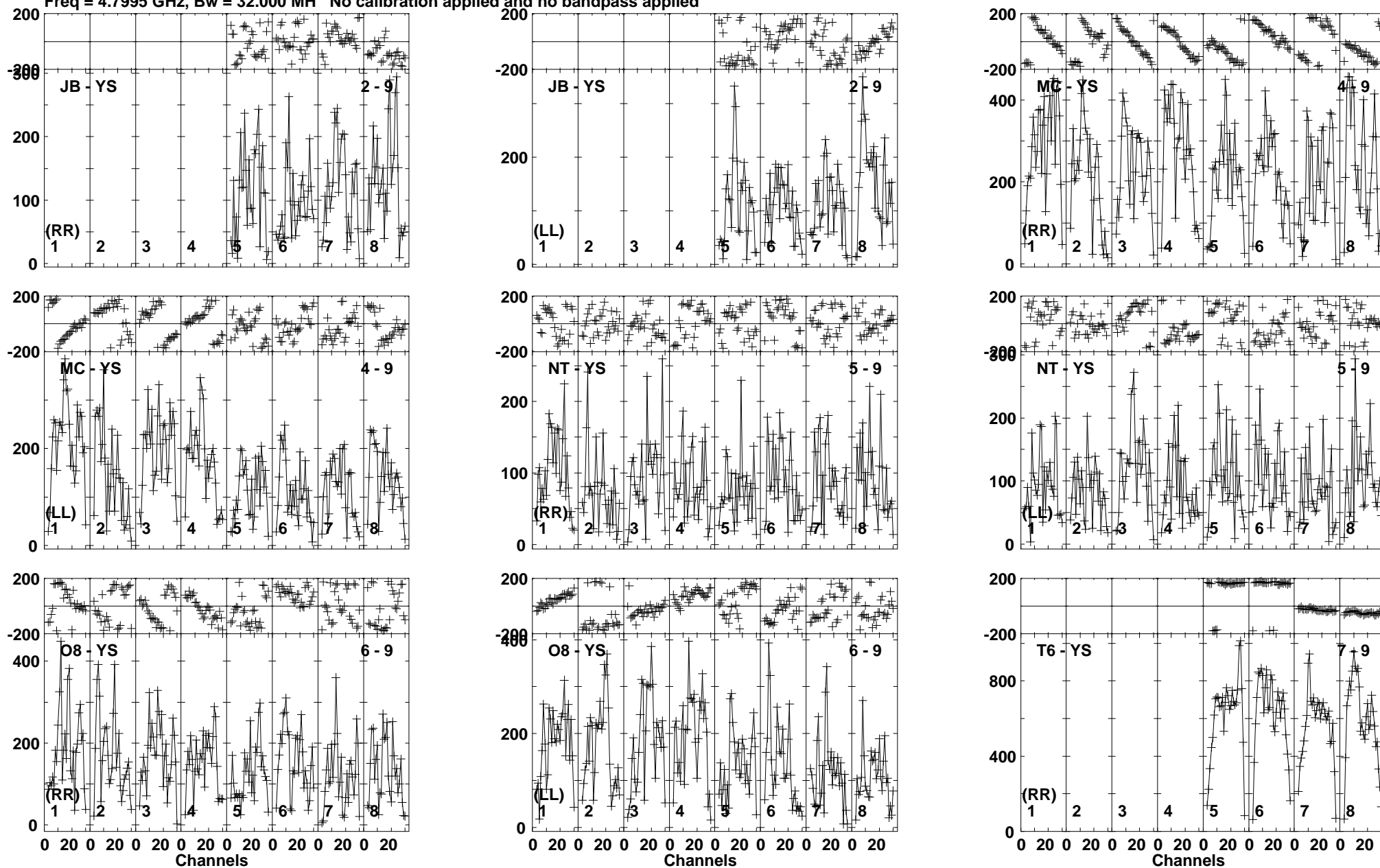

Lower frame: Micro Ampl Jy Top frame: Phas deg
Vector averaged cross-power spectrum Baseline: JB (02) - YS (09)
Timerange: 00/16:09:11 to 00/16:10:39

Plot file version 94 created 20-APR-2018 10:31:43

J0915+0745 EG102C.UVDATA.1

Freq = 4.7995 GHz, Bw = 32.000 MH No calibration applied and no bandpass applied

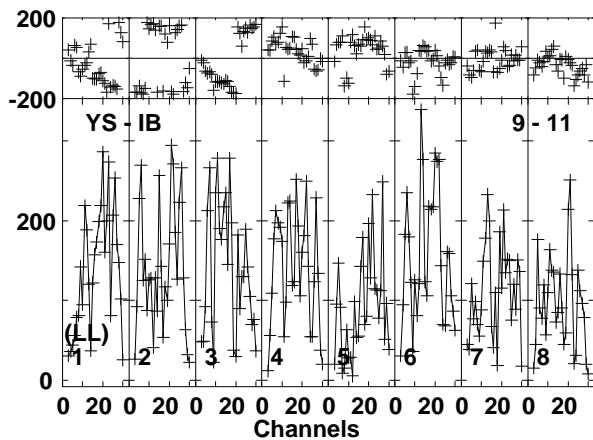
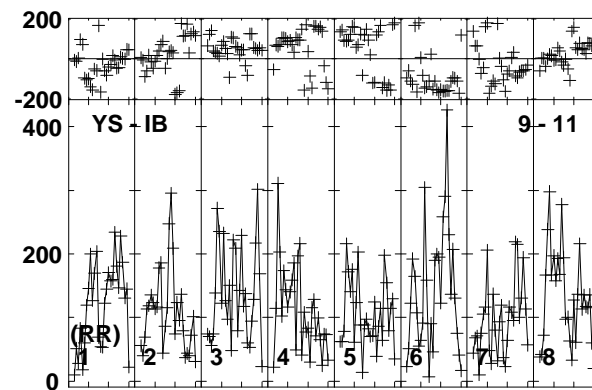
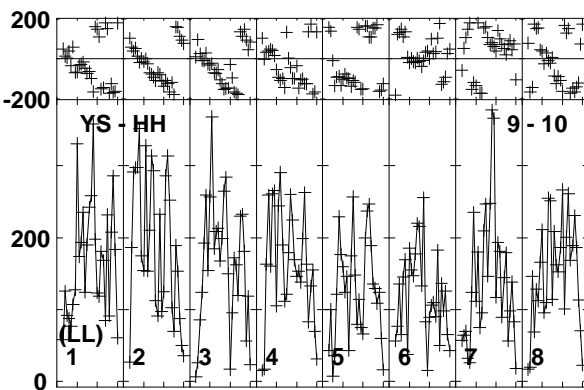
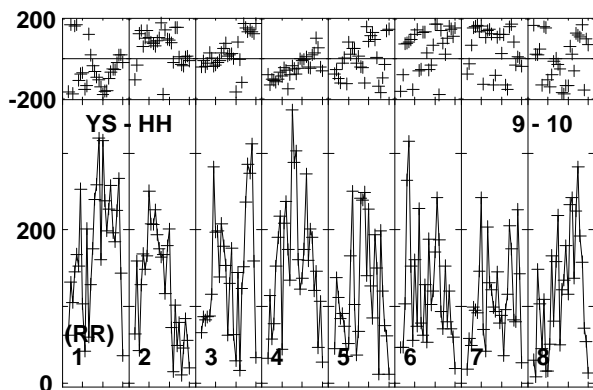
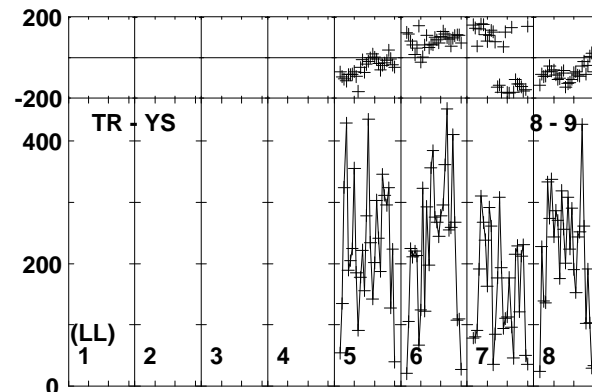
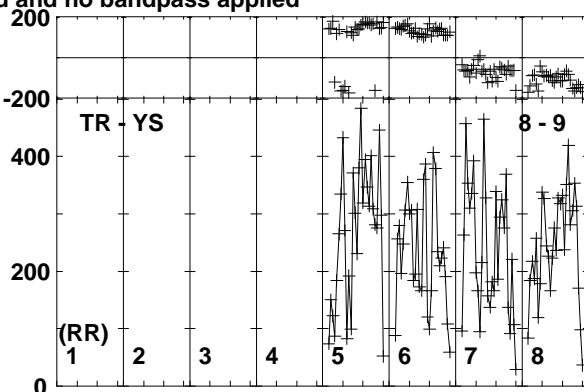
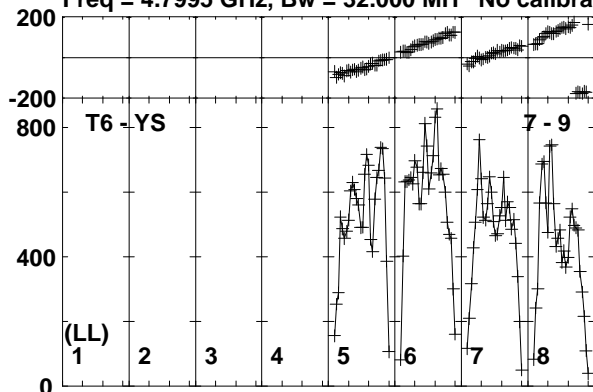

Lower frame: Micro Ampl Jy Top frame: Phas deg
Vector averaged cross-power spectrum Baseline: T6 (07) - YS (09)
Timerange: 00/16:09:11 to 00/16:10:39

Plot file version 95 created 20-APR-2018 10:31:44

B0915+068 EG102C.UVDATA.1

Freq = 4.7995 GHz, Bw = 32.000 MH No calibration applied and no bandpass applied

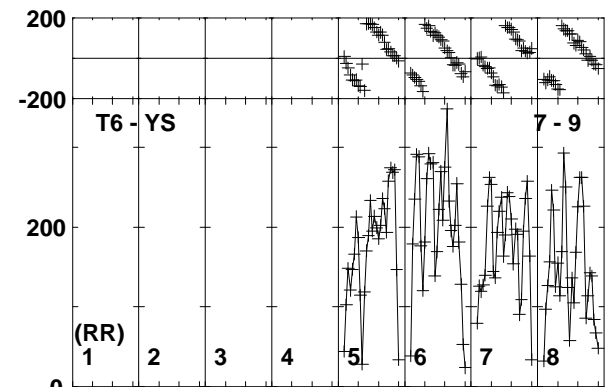
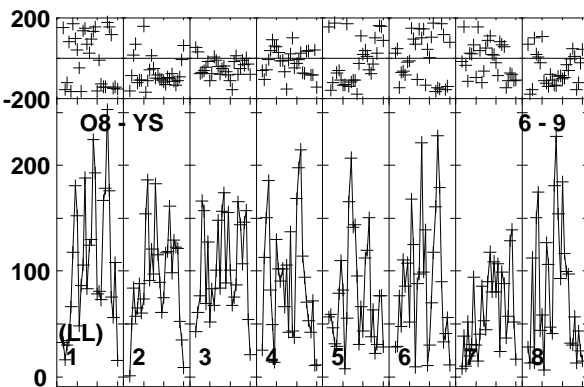
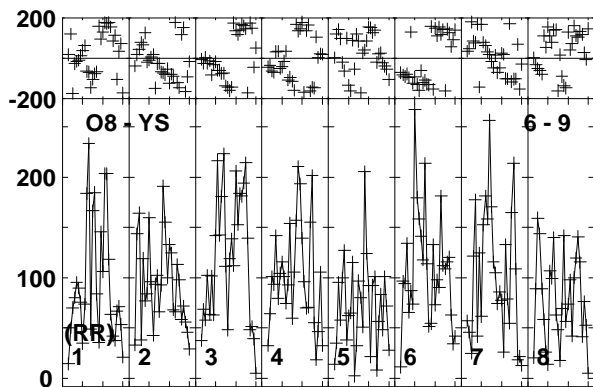
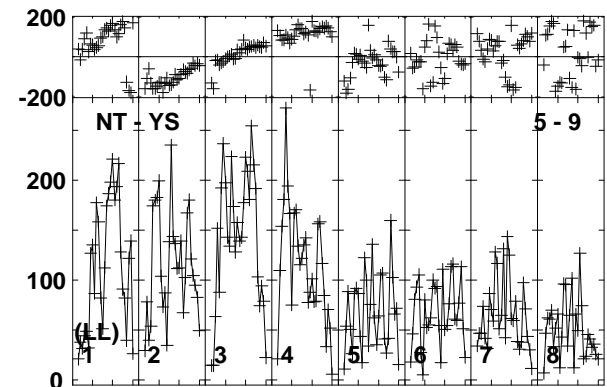
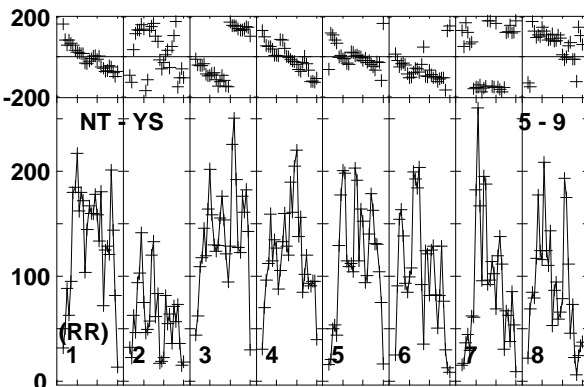
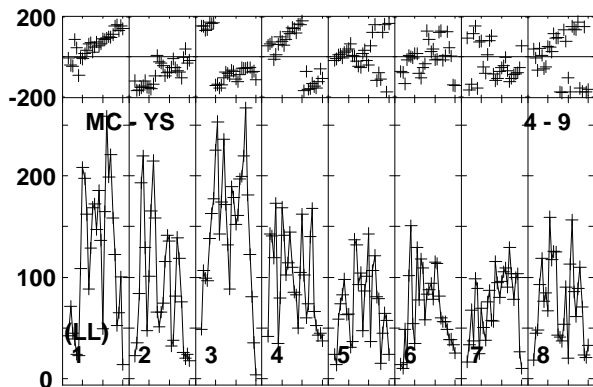
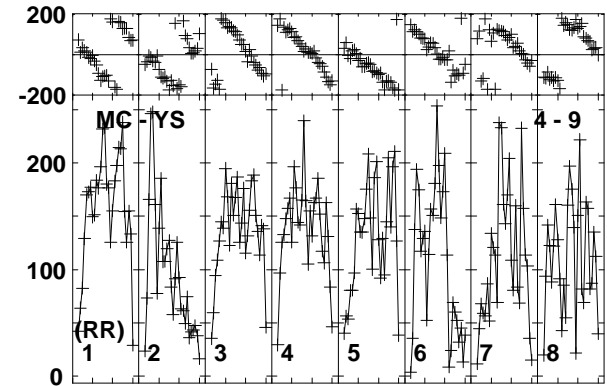
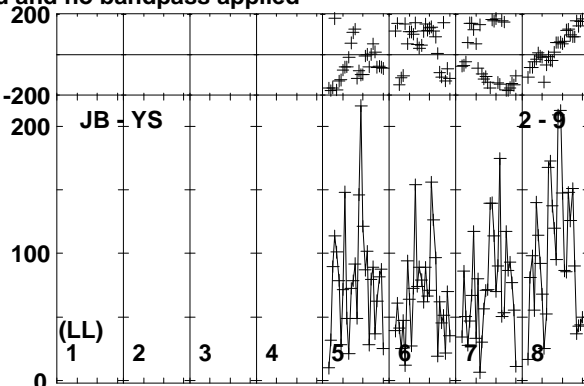
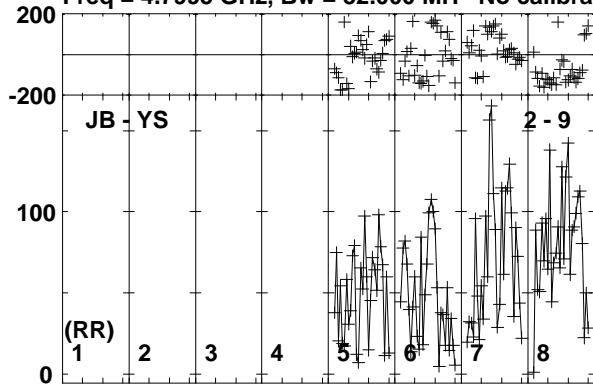

Lower frame: Micro Ampl Jy Top frame: Phas deg
Vector averaged cross-power spectrum Baseline: JB (02) - YS (09)
Timerange: 00/16:10:41 to 00/16:14:09

Plot file version 96 created 20-APR-2018 10:31:44

B0915+068 EG102C.UVDATA.1

Freq = 4.7995 GHz, Bw = 32.000 MH No calibration applied and no bandpass applied

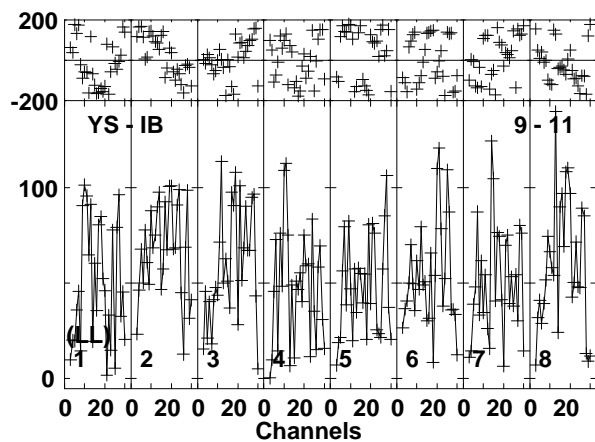
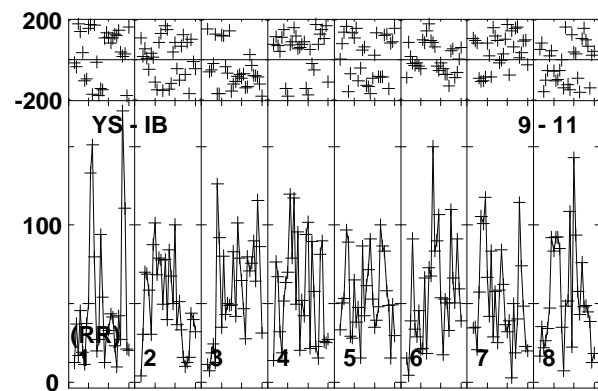
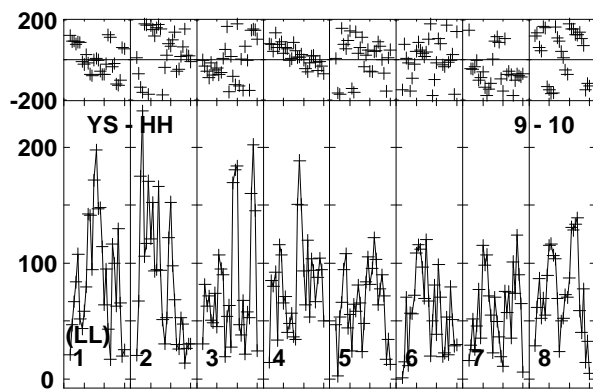
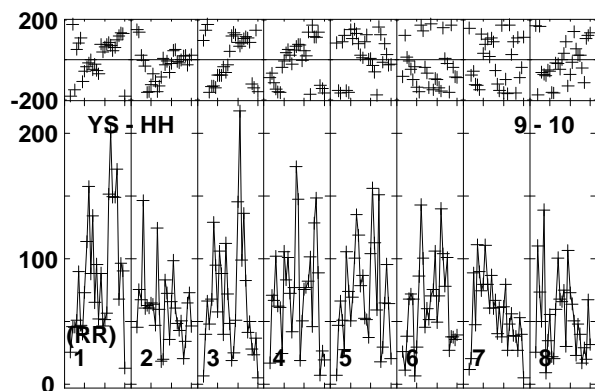
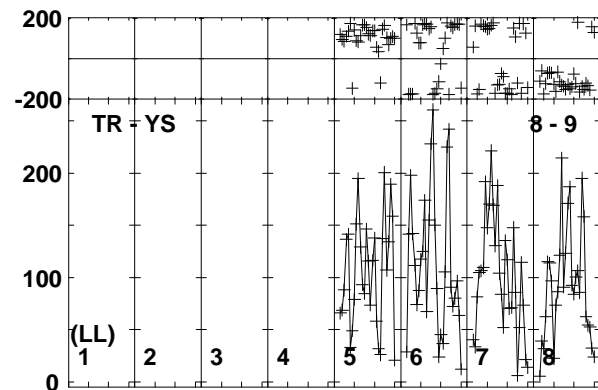
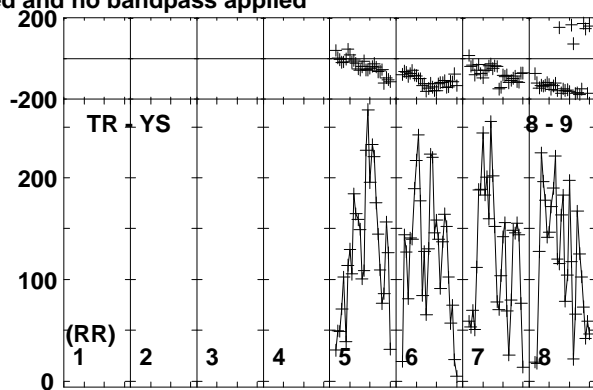
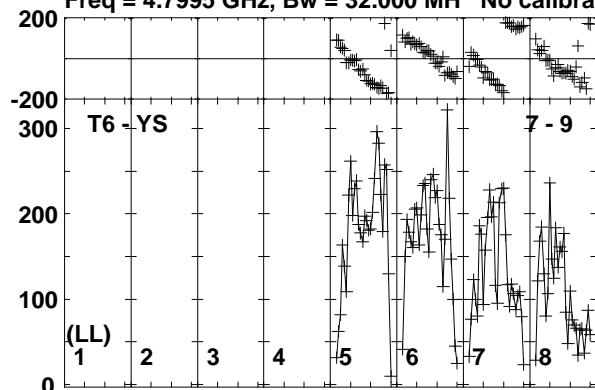

Lower frame: Micro Ampl Jy Top frame: Phas deg
Vector averaged cross-power spectrum Baseline: T6 (07) - YS (09)
Timerange: 00/16:10:41 to 00/16:14:09

Plot file version 97 created 20-APR-2018 10:31:44

J0915+0745 EG102C.UVDATA.1

Freq = 4.7995 GHz, Bw = 32.000 MH No calibration applied and no bandpass applied

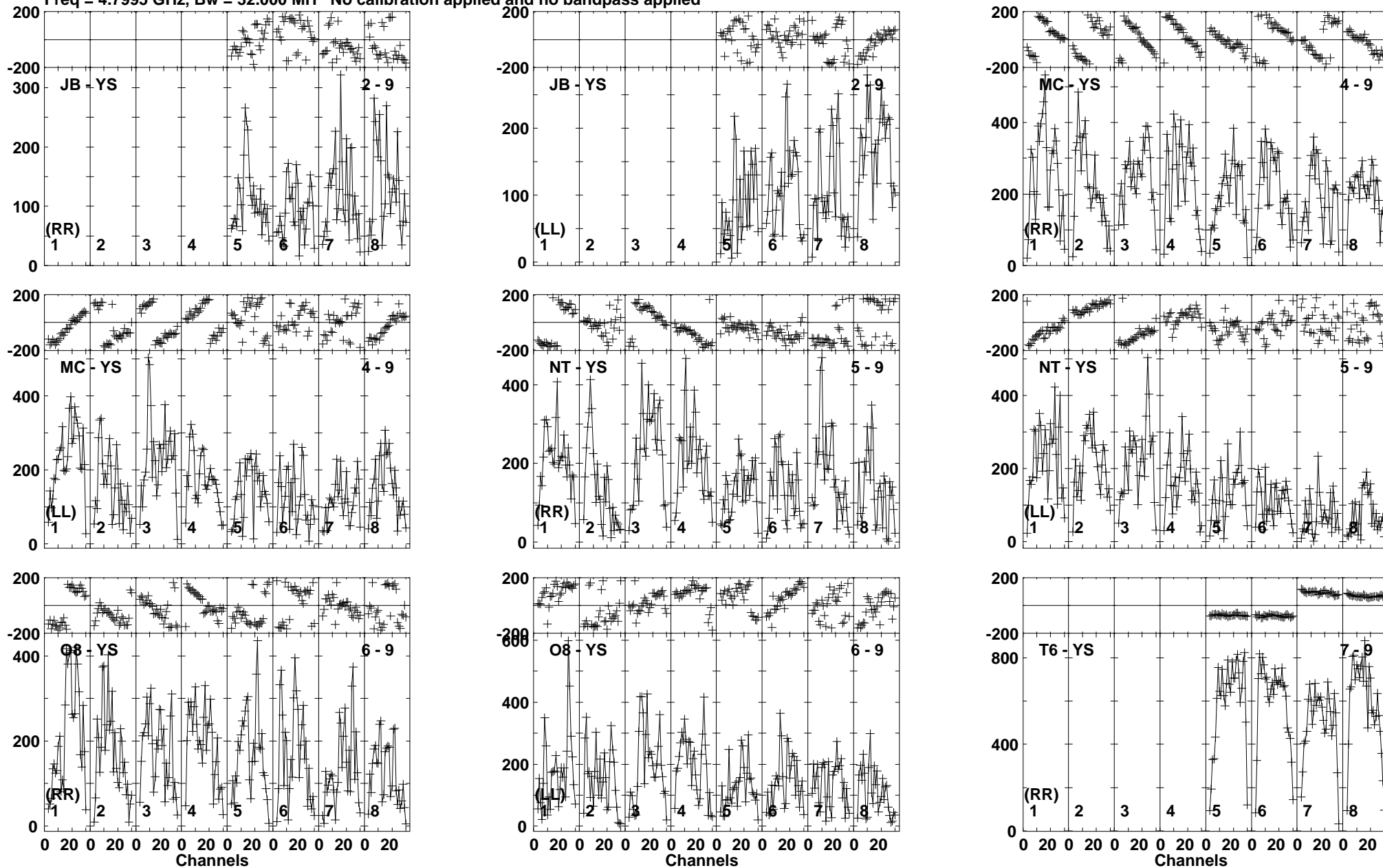

Lower frame: Micro Ampl Jy Top frame: Phas deg
Vector averaged cross-power spectrum Baseline: JB (02) - YS (09)
Timerange: 00/16:14:11 to 00/16:15:39

Plot file version 98 created 20-APR-2018 10:31:44

J0915+0745 EG102C.UVDATA.1

Freq = 4.7995 GHz, Bw = 32.000 MH No calibration applied and no bandpass applied

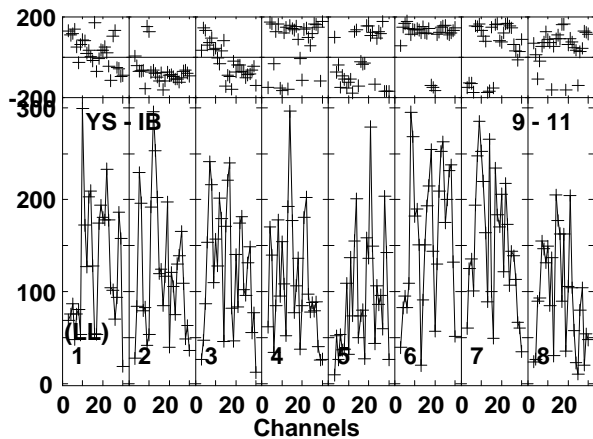
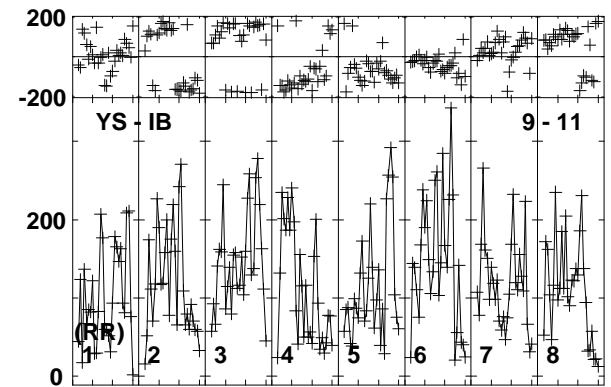
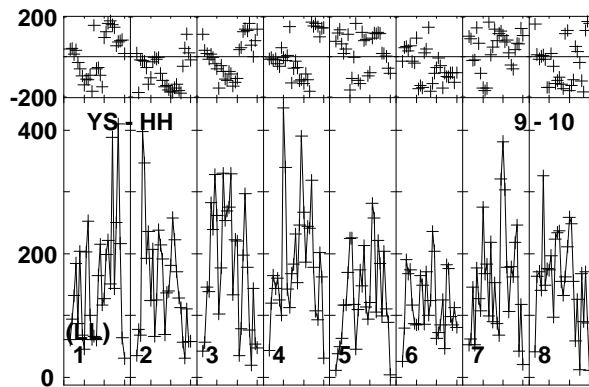
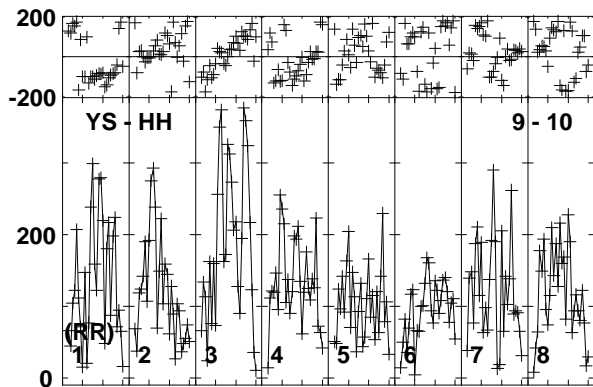
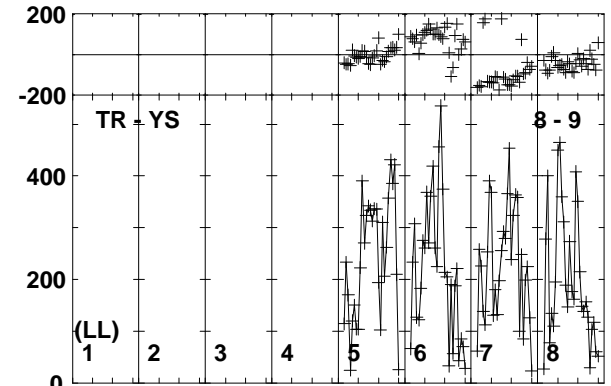
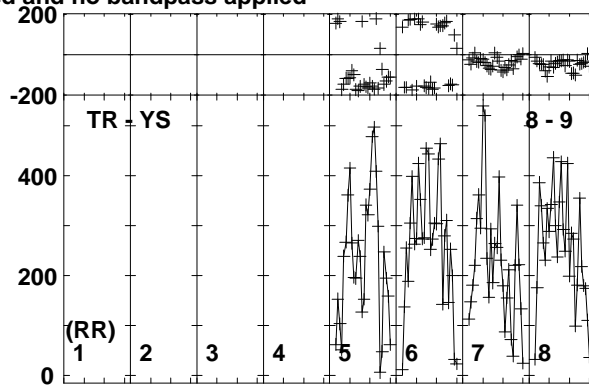
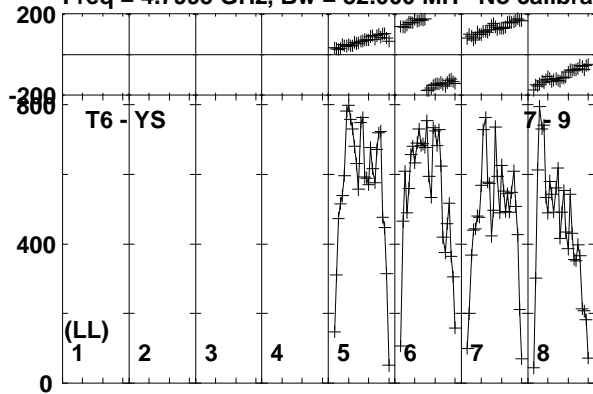

Lower frame: Micro Ampl Jy Top frame: Phas deg
Vector averaged cross-power spectrum Baseline: T6 (07) - YS (09)
Timerange: 00/16:14:11 to 00/16:15:39

Plot file version 99 created 20-APR-2018 10:31:44

B0915+068 EG102C.UVDATA.1

Freq = 4.7995 GHz, Bw = 32.000 MH No calibration applied and no bandpass applied

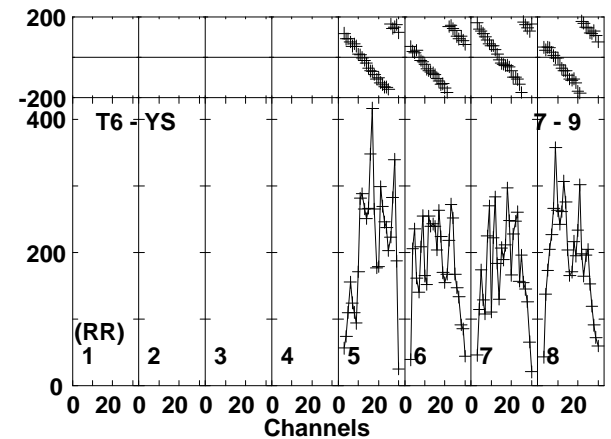
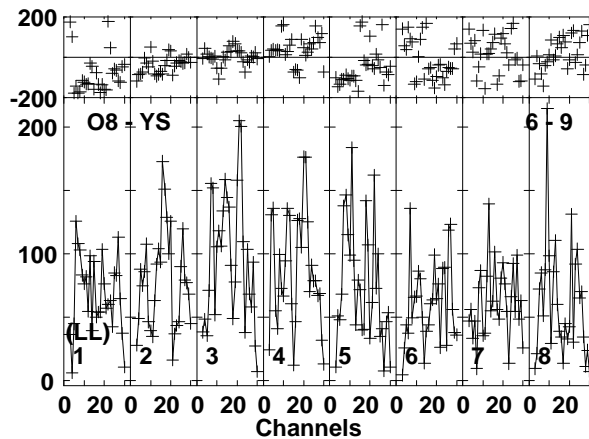
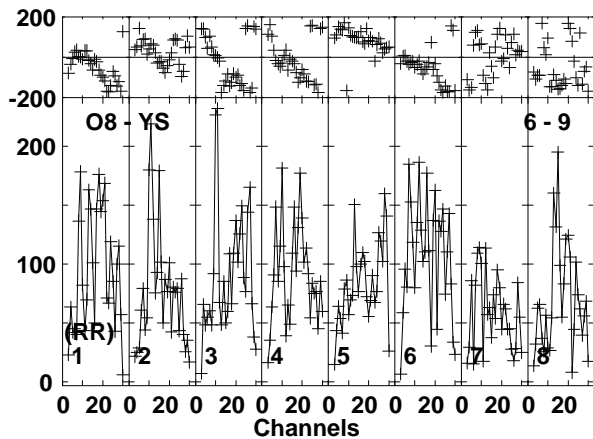
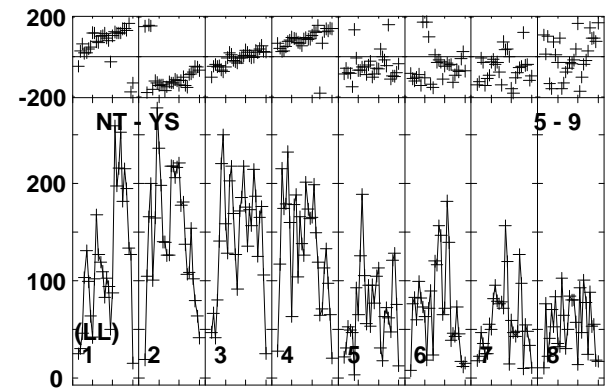
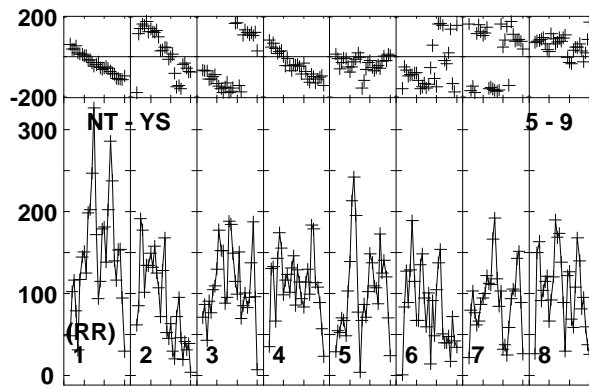
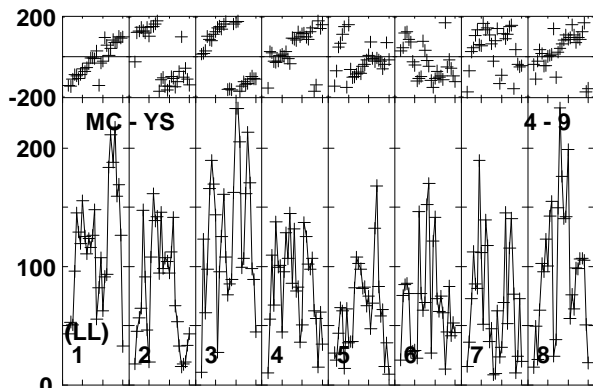
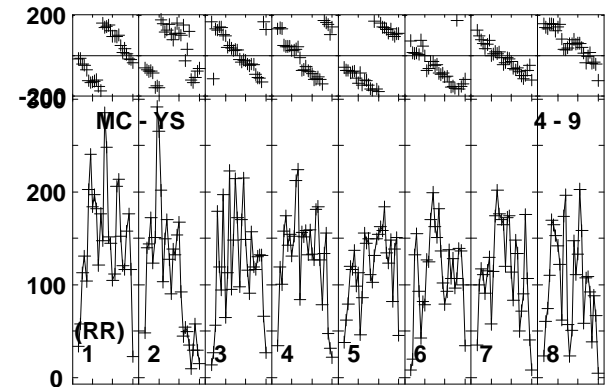
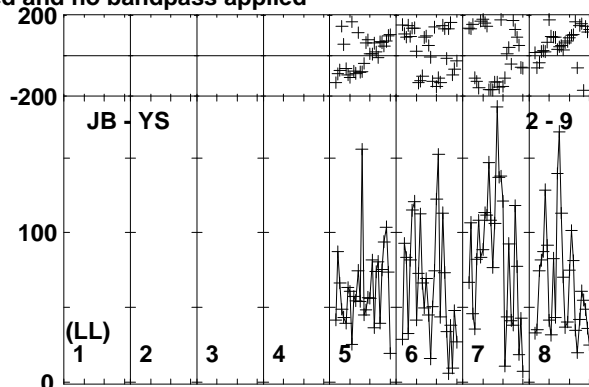
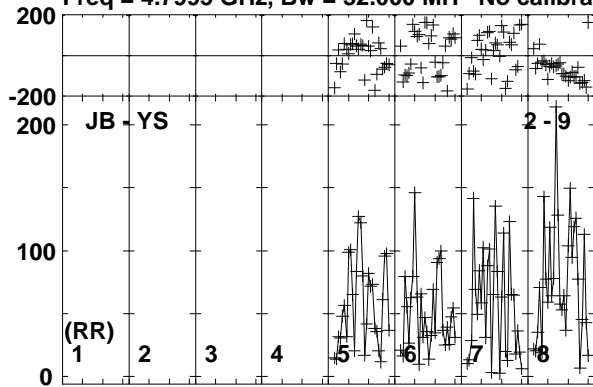

Lower frame: Micro Ampl Jy Top frame: Phas deg
Vector averaged cross-power spectrum Baseline: JB (02) - YS (09)
Timerange: 00/16:15:41 to 00/16:19:09

Plot file version 100 created 20-APR-2018 10:31:44

B0915+068 EG102C.UVDATA.1

Freq = 4.7995 GHz, Bw = 32.000 MH No calibration applied and no bandpass applied

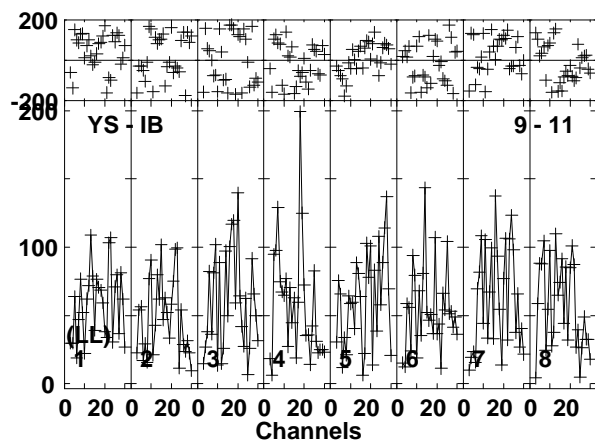
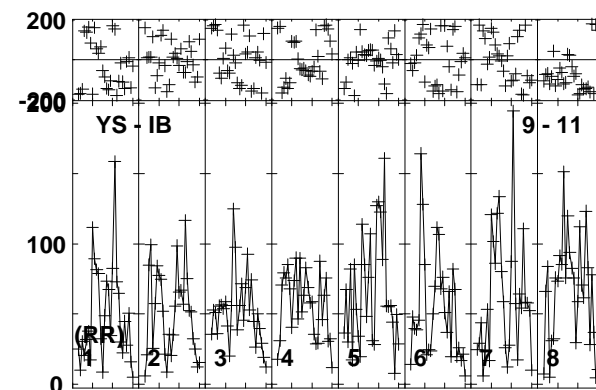
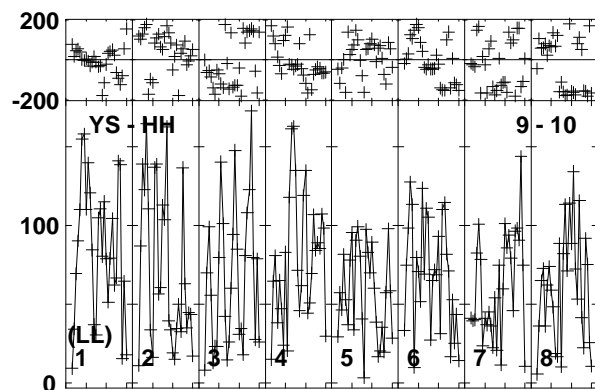
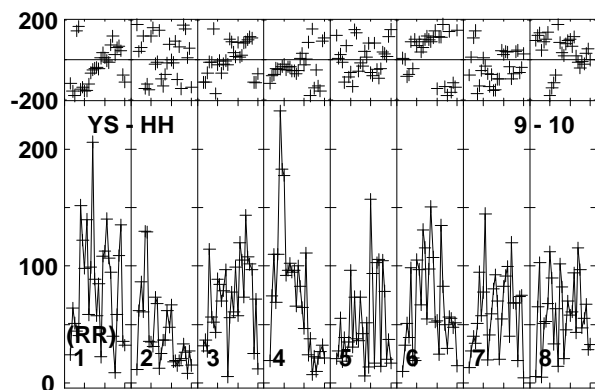
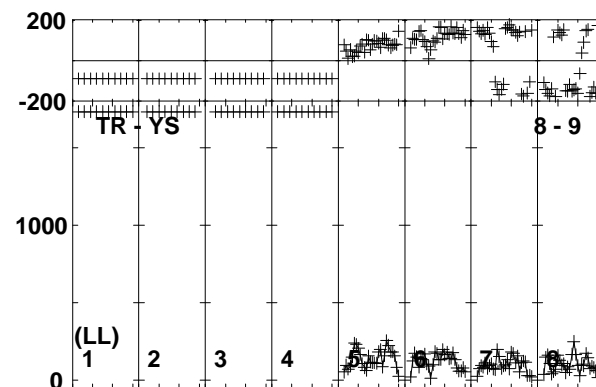
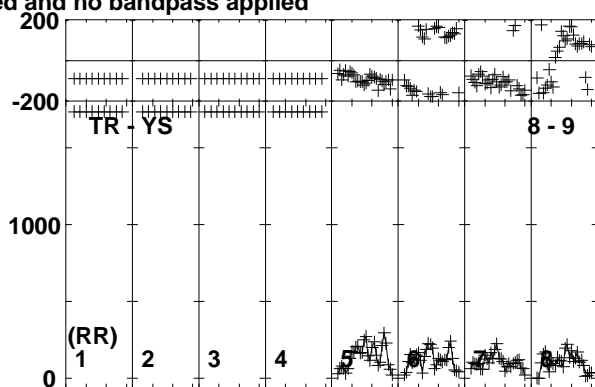
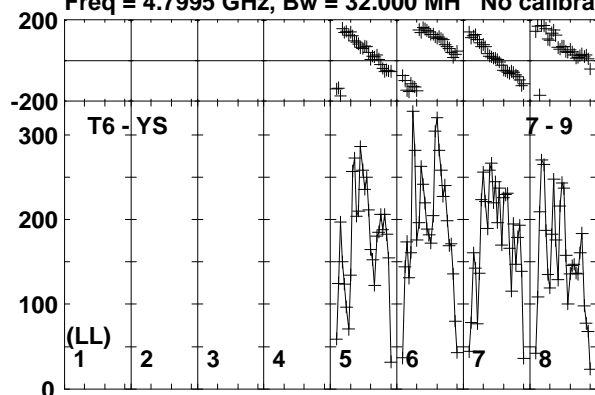

Lower frame: Micro Ampl Jy Top frame: Phas deg
Vector averaged cross-power spectrum Baseline: T6 (07) - YS (09)
Timerange: 00/16:15:41 to 00/16:19:09

Plot file version 101 created 20-APR-2018 10:31:44

J0915+0745 EG102C.UVDATA.1

Freq = 4.7995 GHz, Bw = 32.000 MH No calibration applied and no bandpass applied

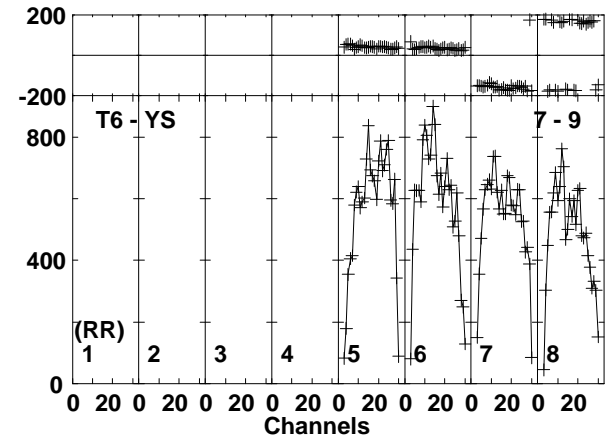
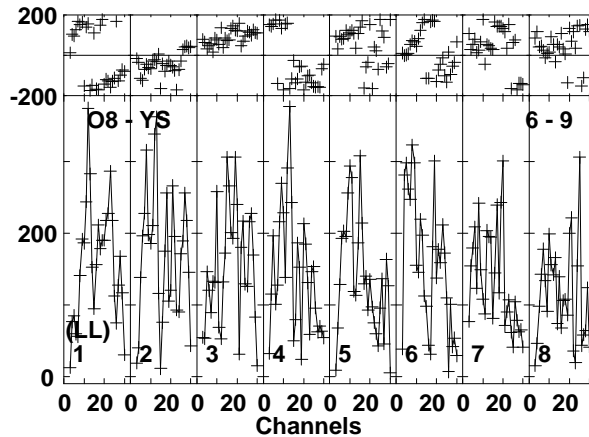
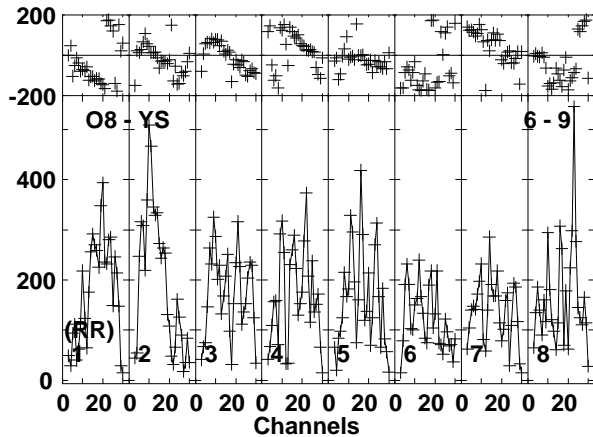
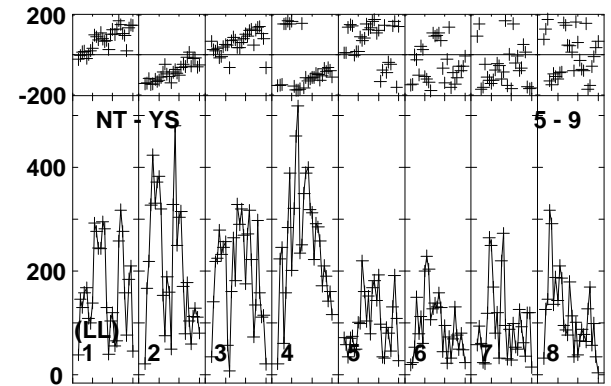
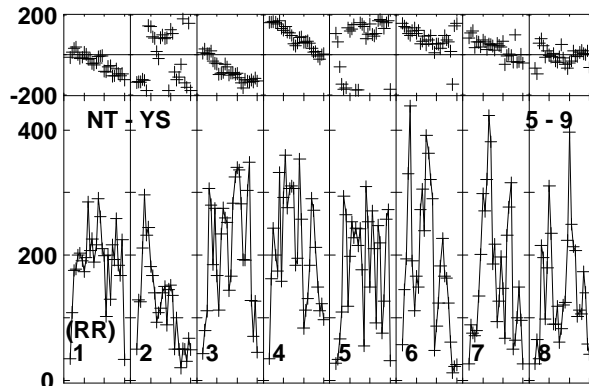
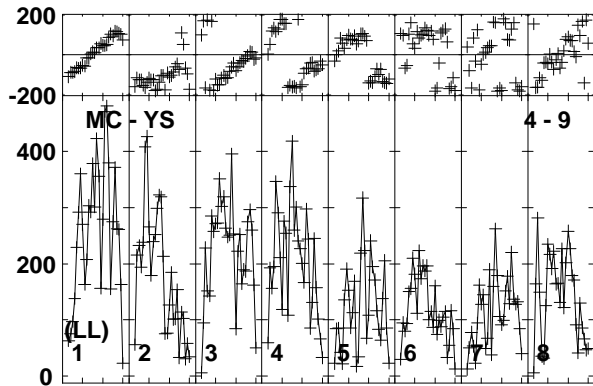
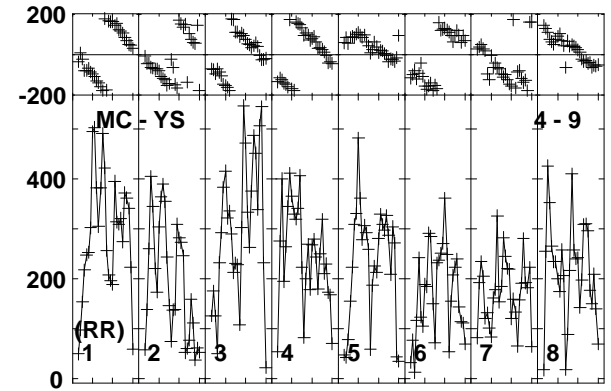
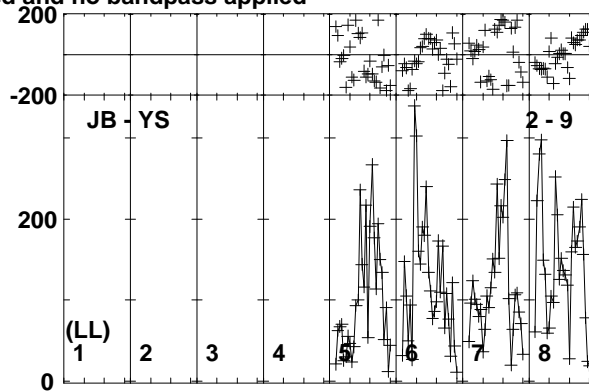
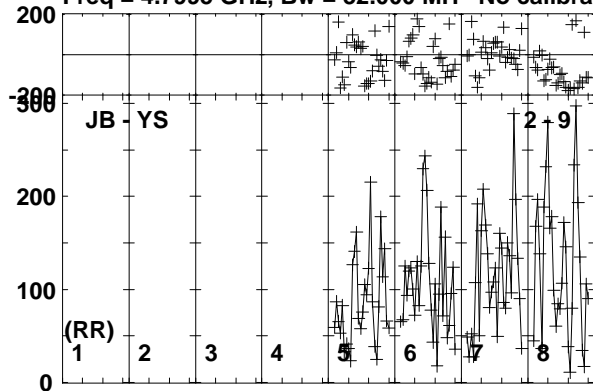

Lower frame: Micro Ampl Jy Top frame: Phas deg
Vector averaged cross-power spectrum Baseline: JB (02) - YS (09)
Timerange: 00/16:19:51 to 00/16:20:49

Plot file version 102 created 20-APR-2018 10:31:44

J0915+0745 EG102C.UVDATA.1

Freq = 4.7995 GHz, Bw = 32.000 MH No calibration applied and no bandpass applied

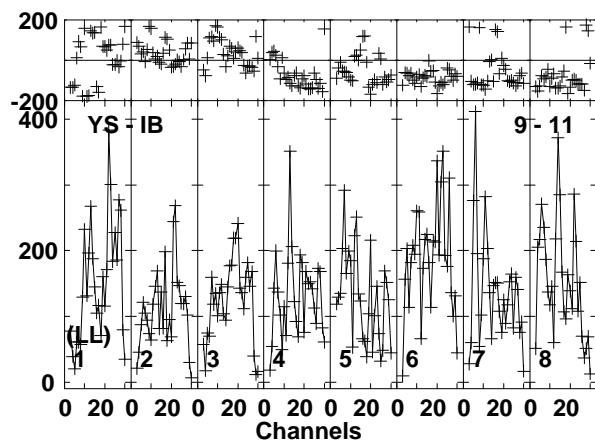
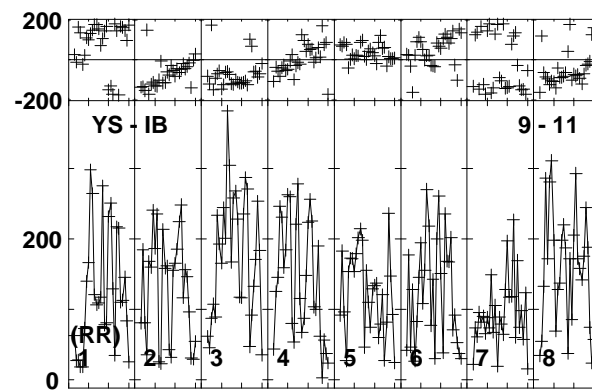
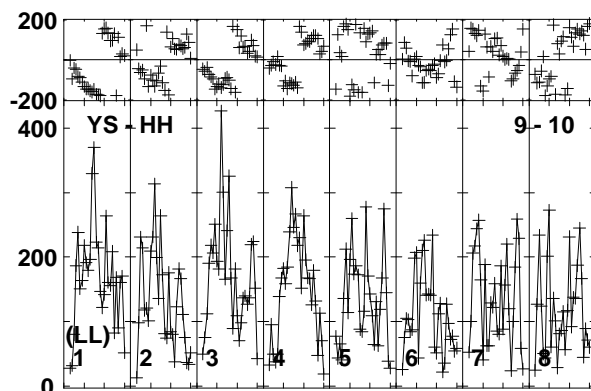
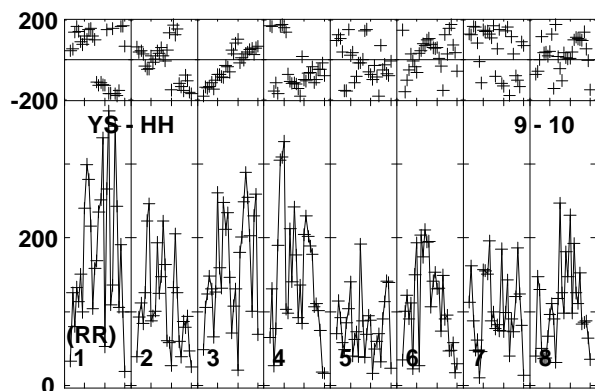
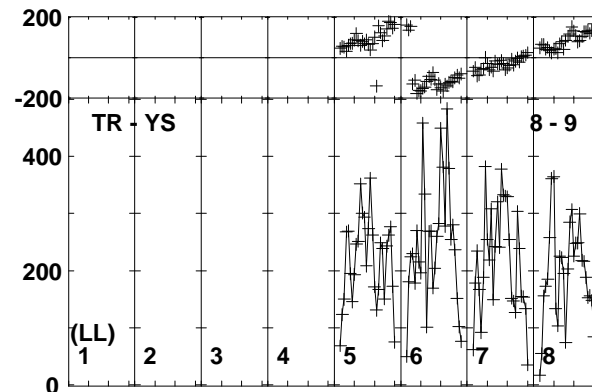
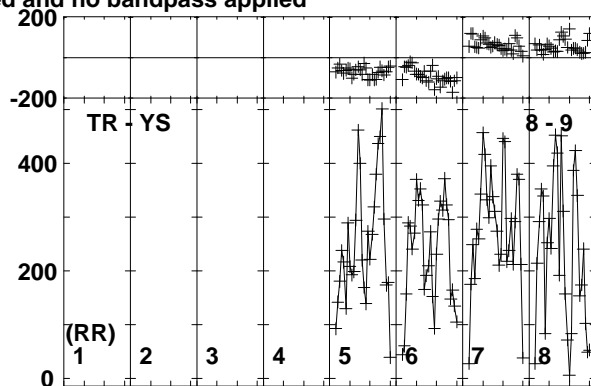
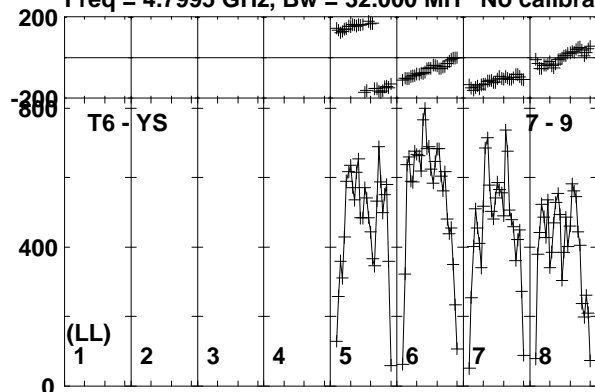

Lower frame: Micro Ampl Jy Top frame: Phas deg
Vector averaged cross-power spectrum Baseline: T6 (07) - YS (09)
Timerange: 00/16:19:51 to 00/16:20:49

Plot file version 103 created 20-APR-2018 10:31:44

B0915+068 EG102C.UVDATA.1

Freq = 4.7995 GHz, Bw = 32.000 MH No calibration applied and no bandpass applied

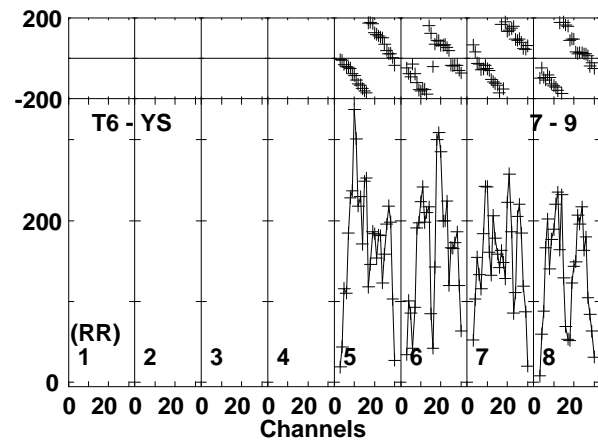
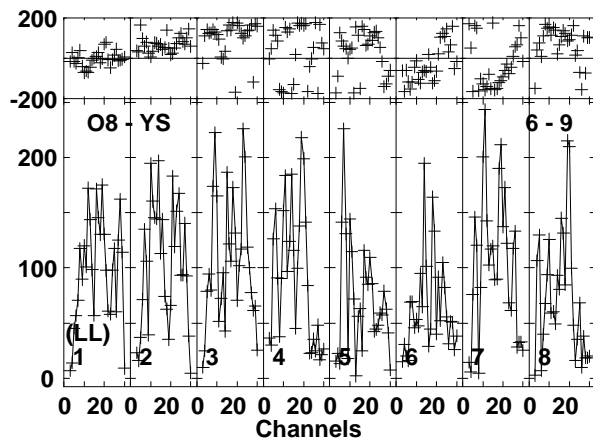
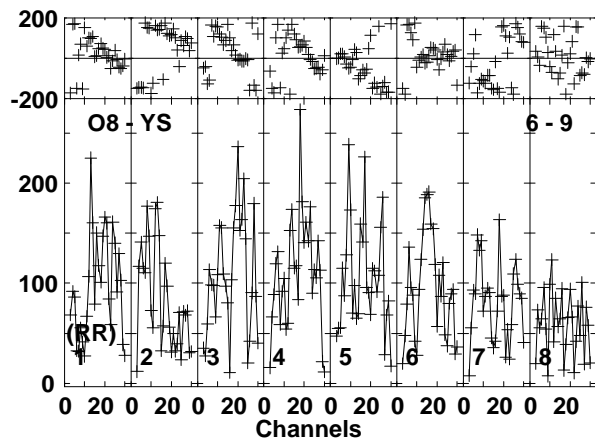
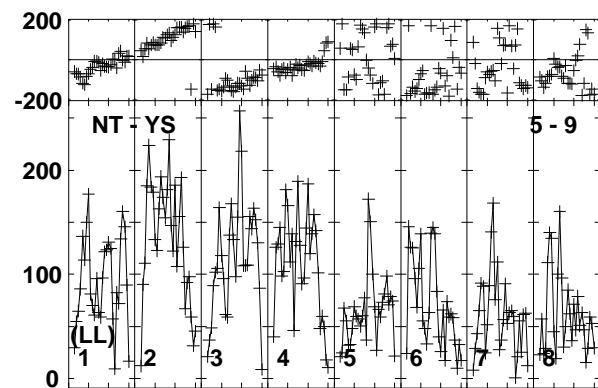
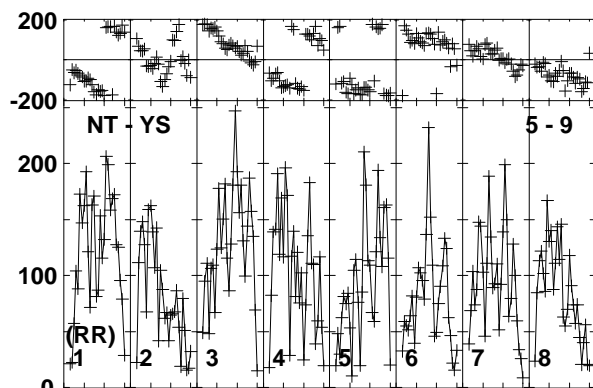
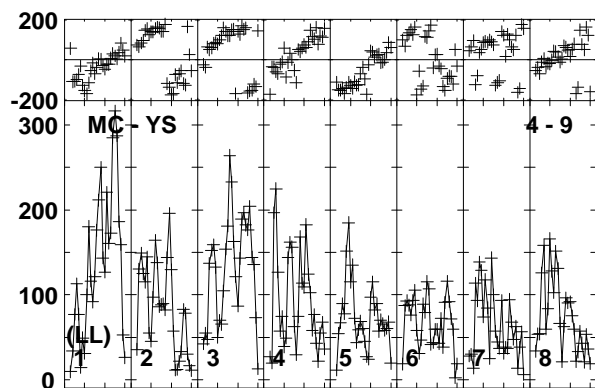
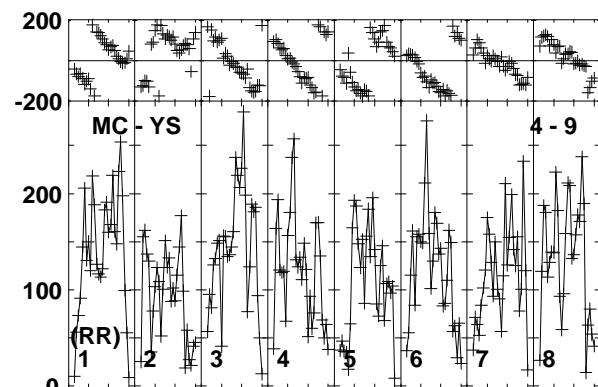
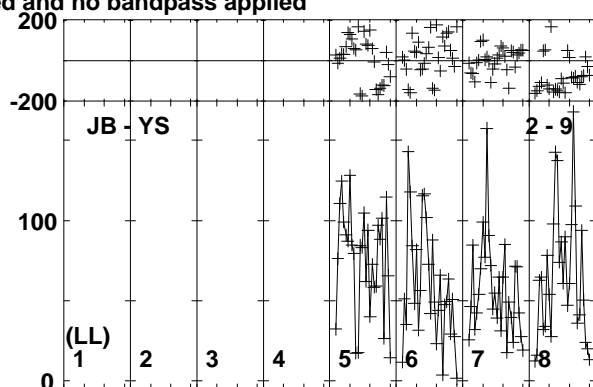
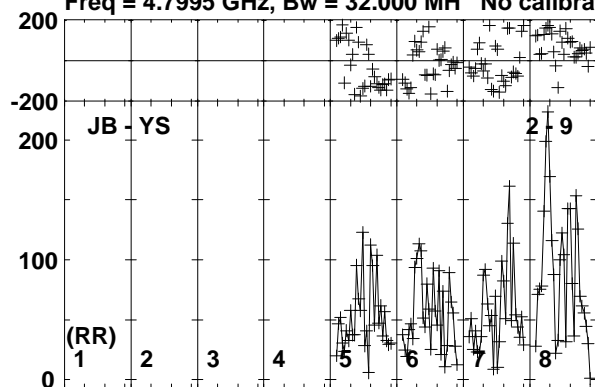

Lower frame: Micro Ampl Jy Top frame: Phas deg
Vector averaged cross-power spectrum Baseline: JB (02) - YS (09)
Timerange: 00/16:20:51 to 00/16:24:19

Plot file version 104 created 20-APR-2018 10:31:45

B0915+068 EG102C.UVDATA.1

Freq = 4.7995 GHz, Bw = 32.000 MH No calibration applied and no bandpass applied

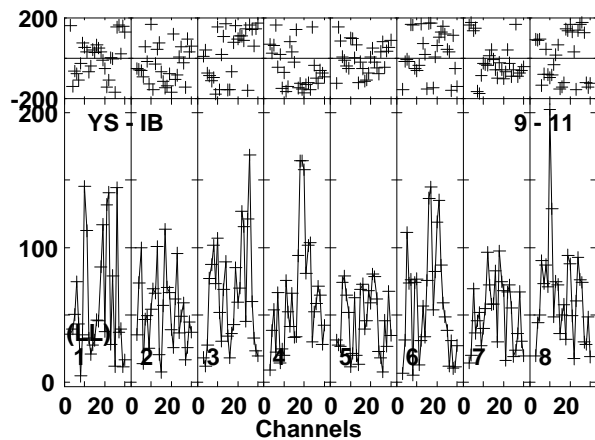
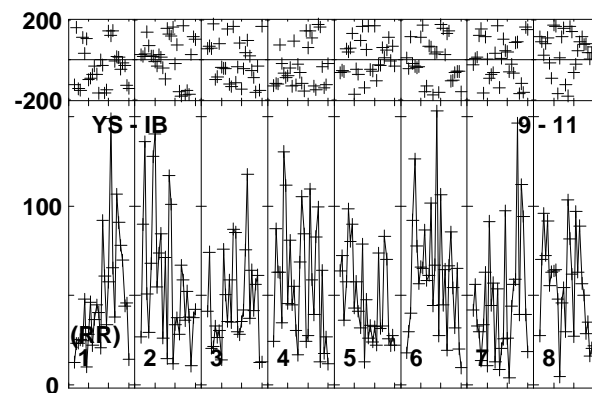
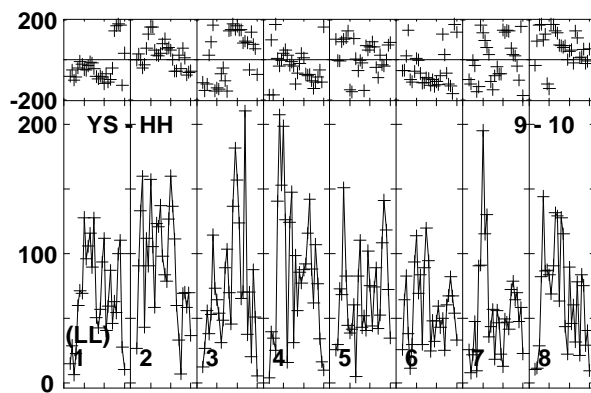
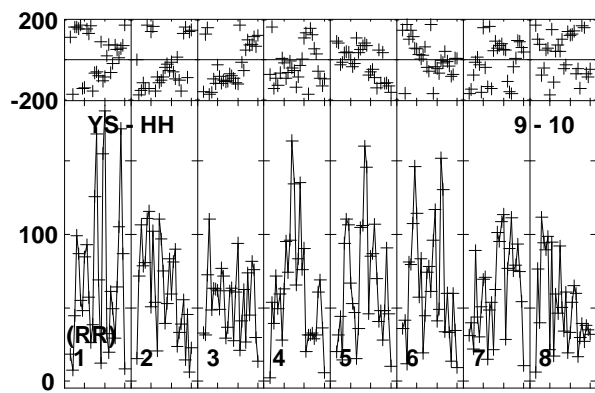
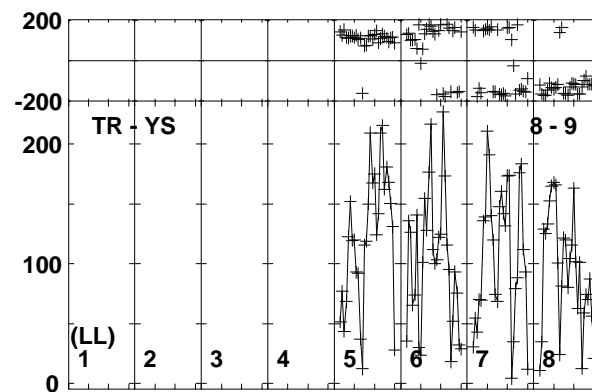
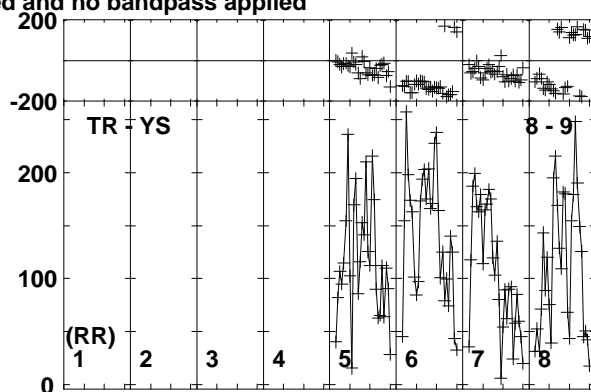
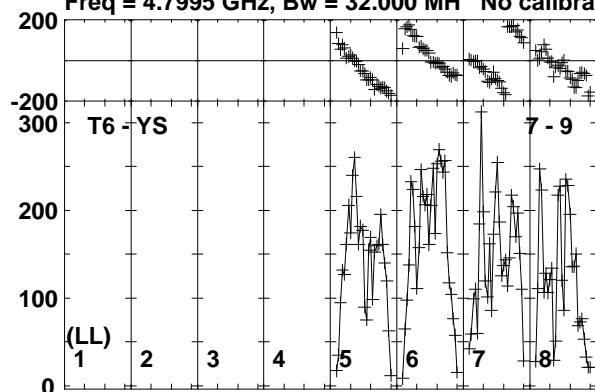

Lower frame: Micro Ampl Jy Top frame: Phas deg
Vector averaged cross-power spectrum Baseline: T6 (07) - YS (09)
Timerange: 00/16:20:51 to 00/16:24:19

Plot file version 105 created 20-APR-2018 10:31:45

J0915+0745 EG102C.UVDATA.1

Freq = 4.7995 GHz, Bw = 32.000 MH No calibration applied and no bandpass applied

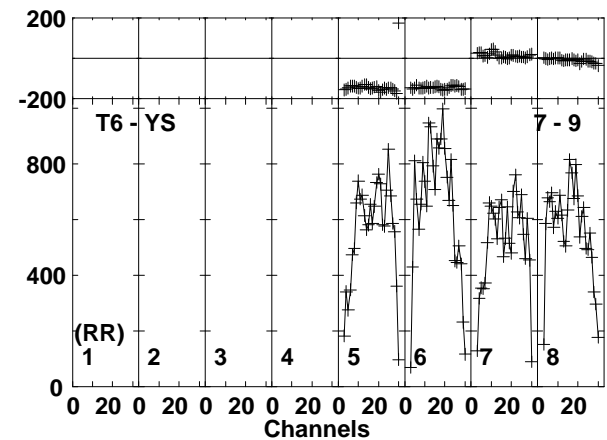
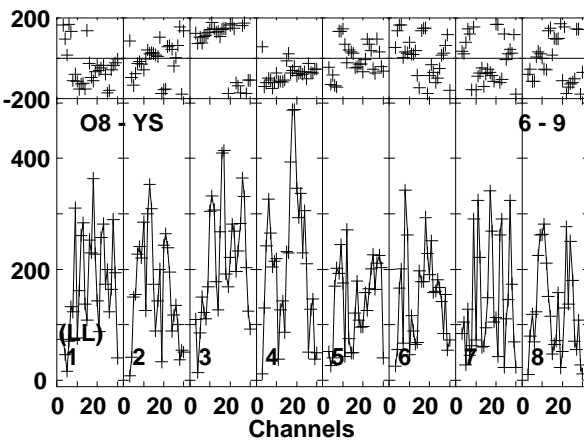
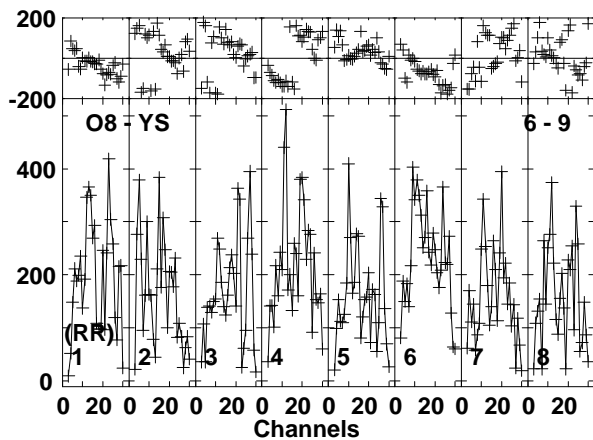
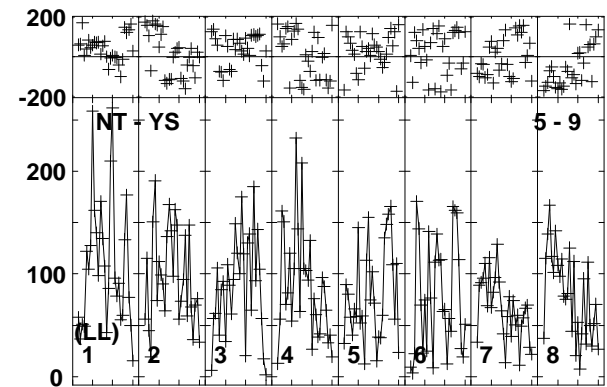
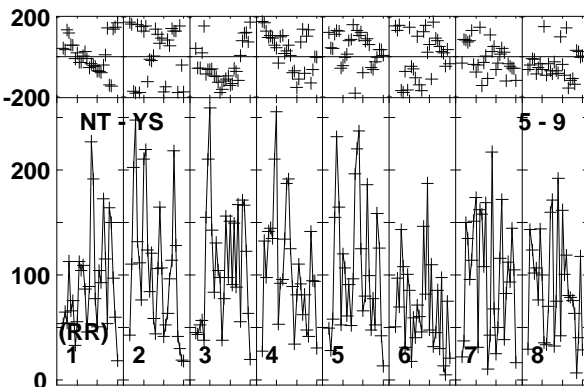
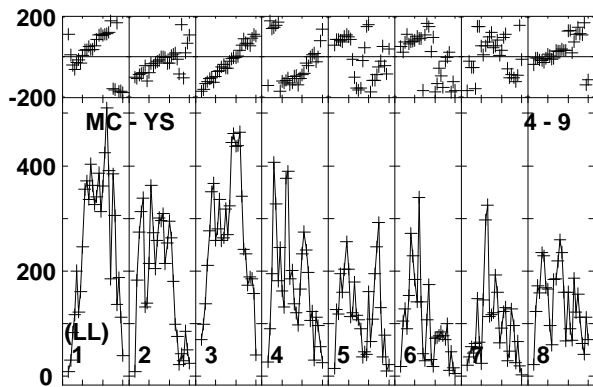
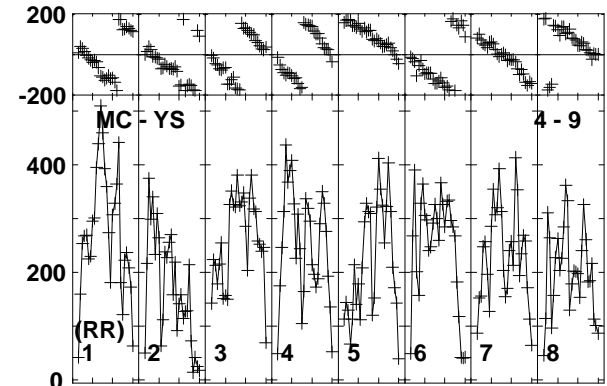
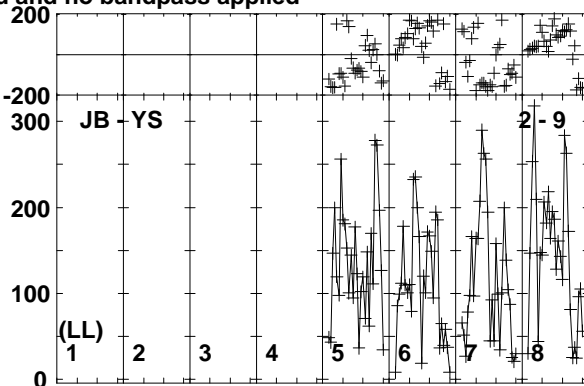
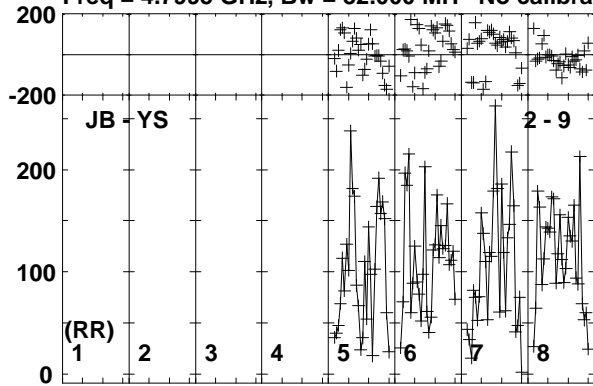

Lower frame: Micro Ampl Jy Top frame: Phas deg
Vector averaged cross-power spectrum Baseline: JB (02) - YS (09)
Timerange: 00/16:24:21 to 00/16:25:49

Plot file version 106 created 20-APR-2018 10:31:45

J0915+0745 EG102C.UVDATA.1

Freq = 4.7995 GHz, Bw = 32.000 MH No calibration applied and no bandpass applied

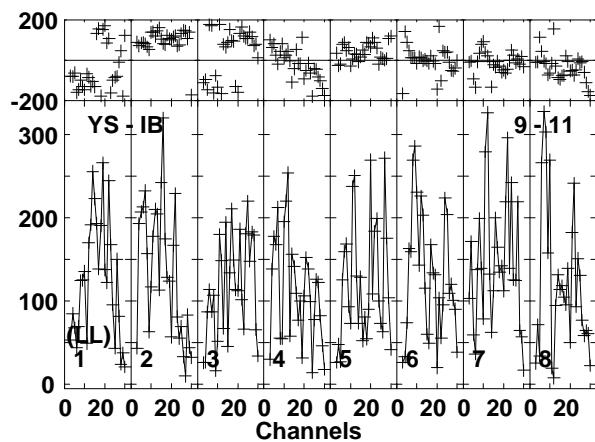
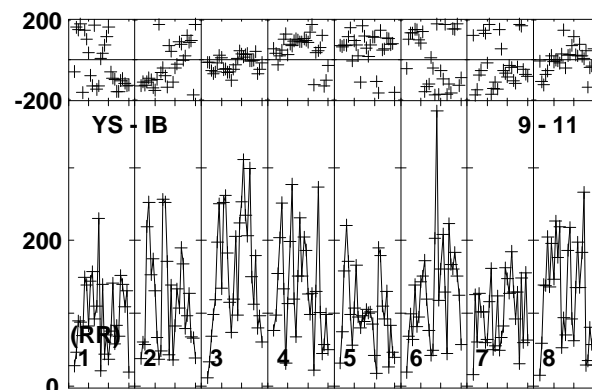
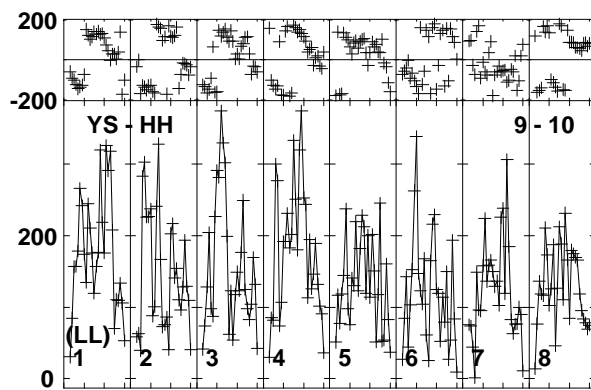
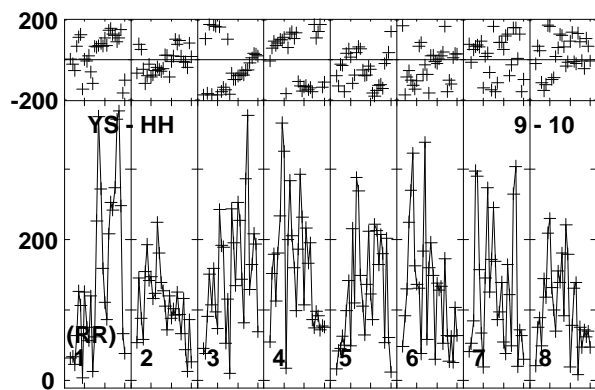
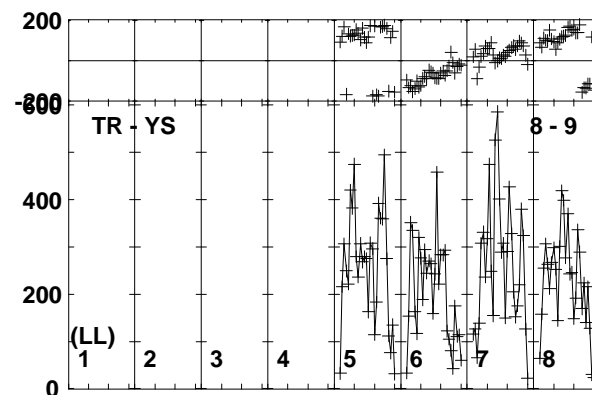
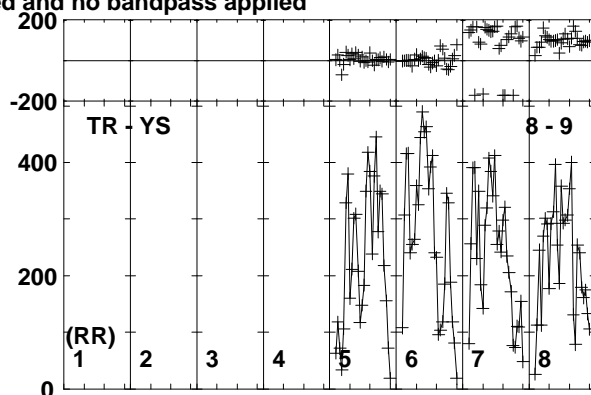
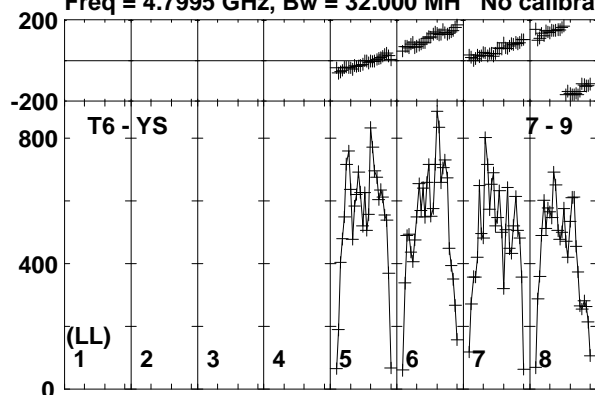

Lower frame: Micro Ampl Jy Top frame: Phas deg
Vector averaged cross-power spectrum Baseline: T6 (07) - YS (09)
Timerange: 00/16:24:21 to 00/16:25:49

Plot file version 107 created 20-APR-2018 10:31:45

B0915+068 EG102C.UVDATA.1

Freq = 4.7995 GHz, Bw = 32.000 MH No calibration applied and no bandpass applied

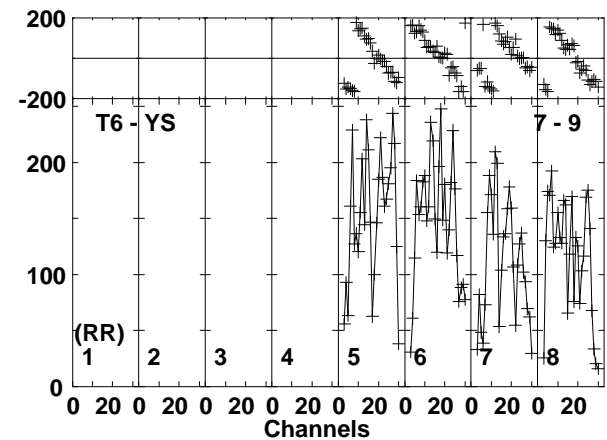
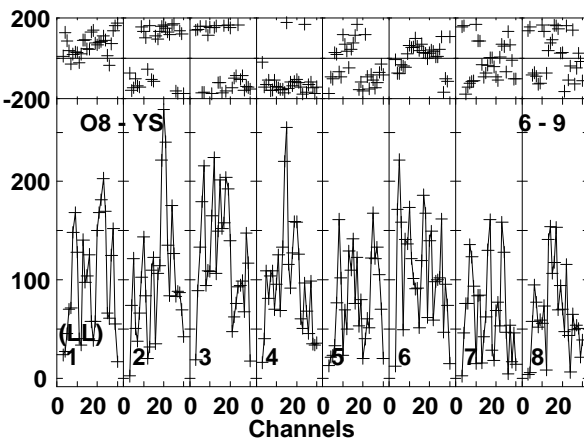
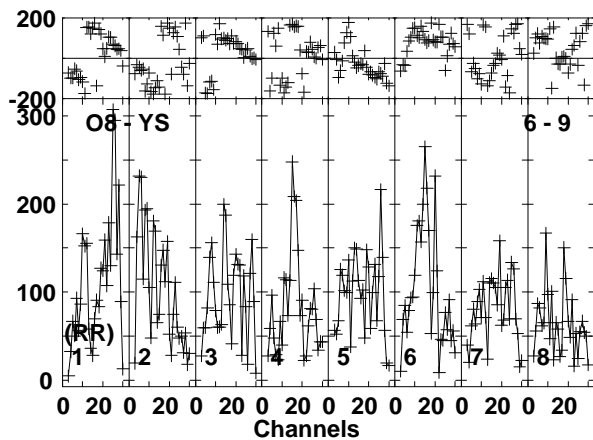
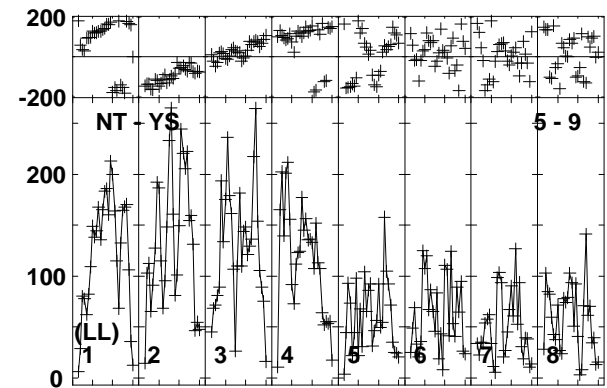
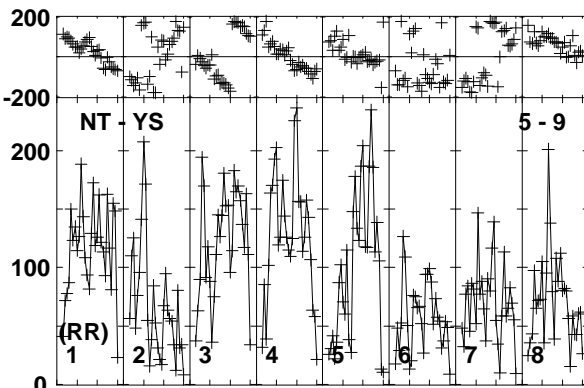
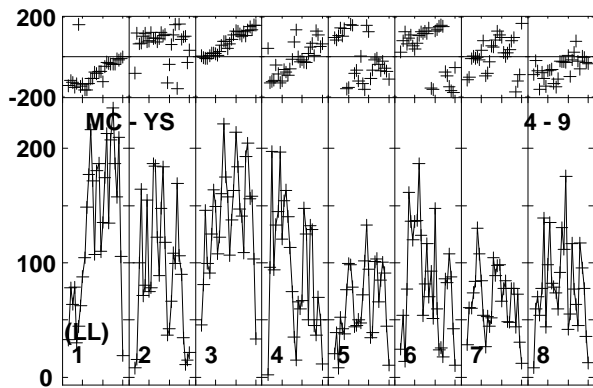
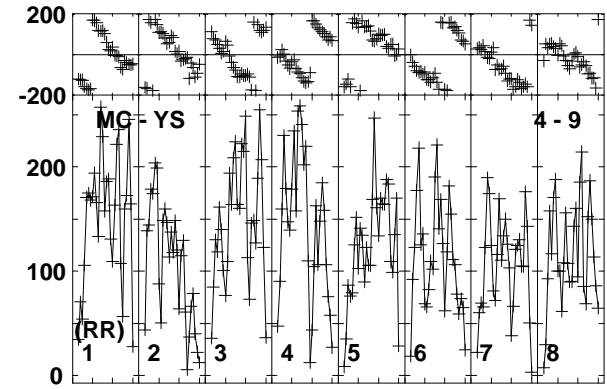
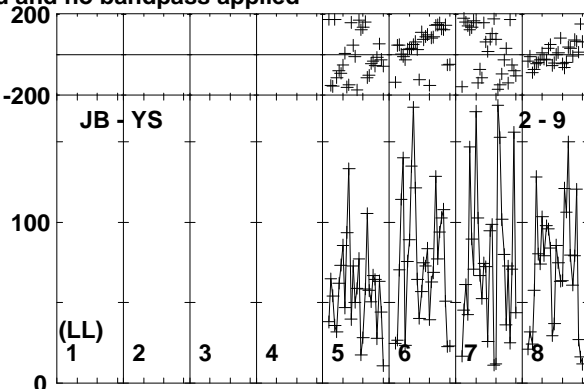
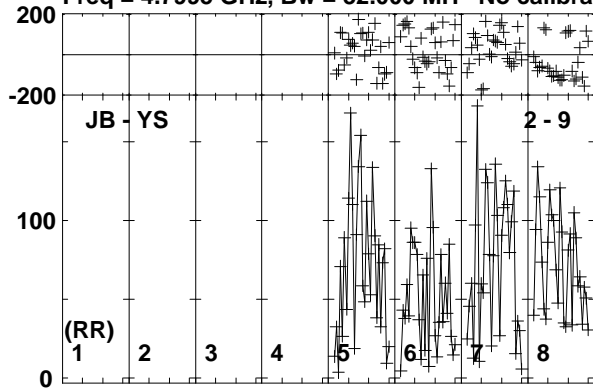

Lower frame: Micro Ampl Jy Top frame: Phas deg
Vector averaged cross-power spectrum Baseline: JB (02) - YS (09)
Timerange: 00/16:25:51 to 00/16:29:19

Plot file version 108 created 20-APR-2018 10:31:45

B0915+068 EG102C.UVDATA.1

Freq = 4.7995 GHz, Bw = 32.000 MH No calibration applied and no bandpass applied

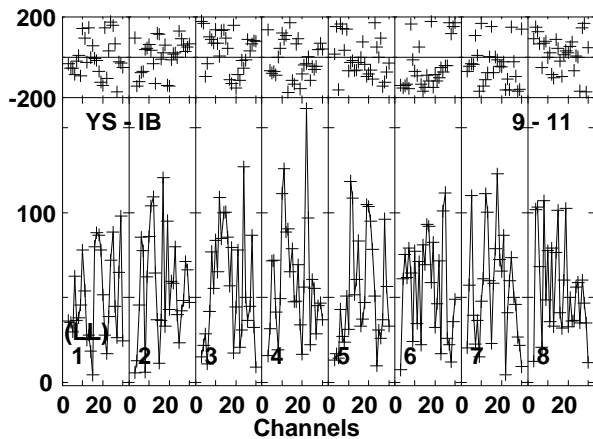
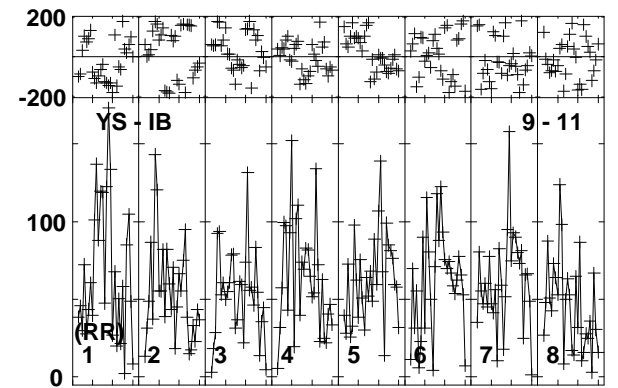
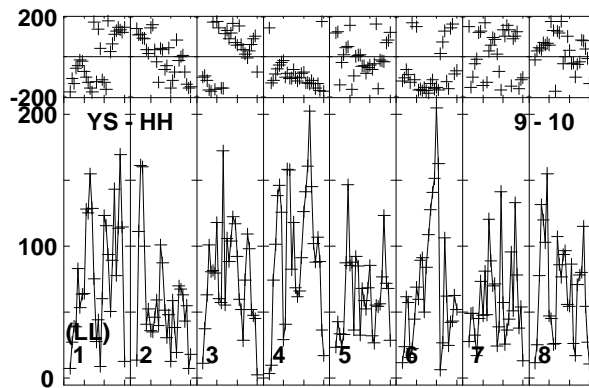
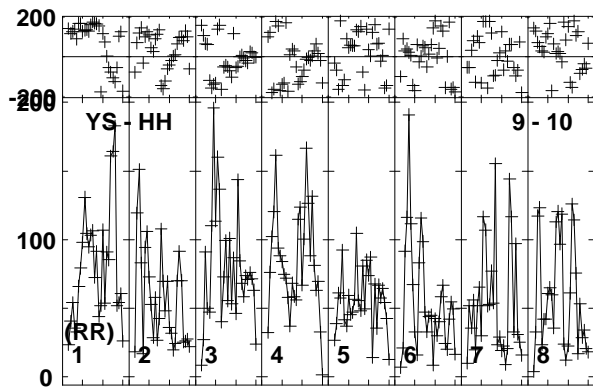
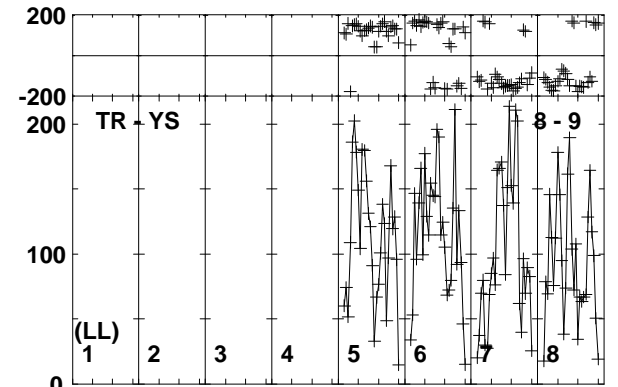
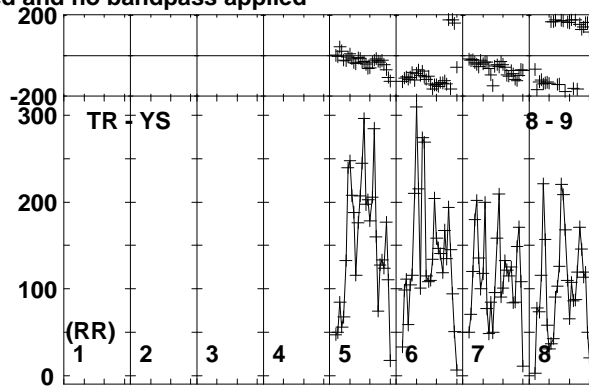
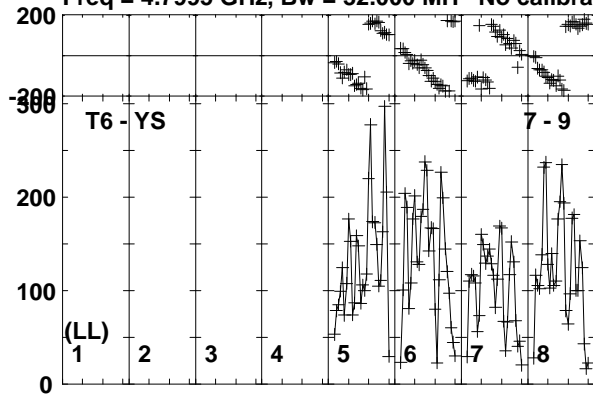

Lower frame: Micro Ampl Jy Top frame: Phas deg
Vector averaged cross-power spectrum Baseline: T6 (07) - YS (09)
Timerange: 00/16:25:51 to 00/16:29:19

Plot file version 109 created 20-APR-2018 10:31:45

J0915+0745 EG102C.UVDATA.1

Freq = 4.7995 GHz, Bw = 32.000 MH No calibration applied and no bandpass applied

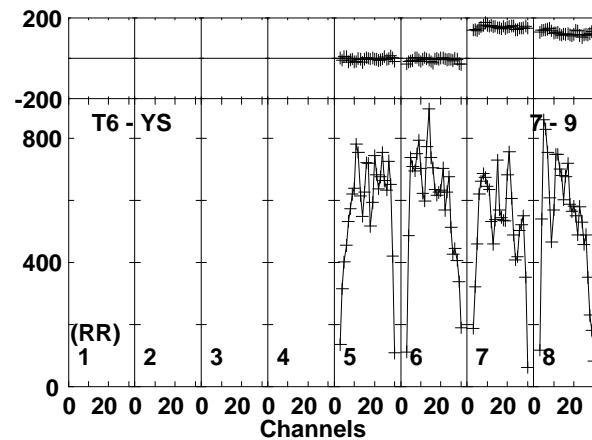
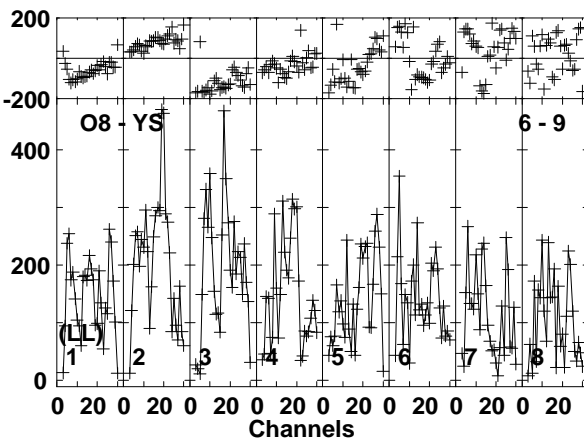
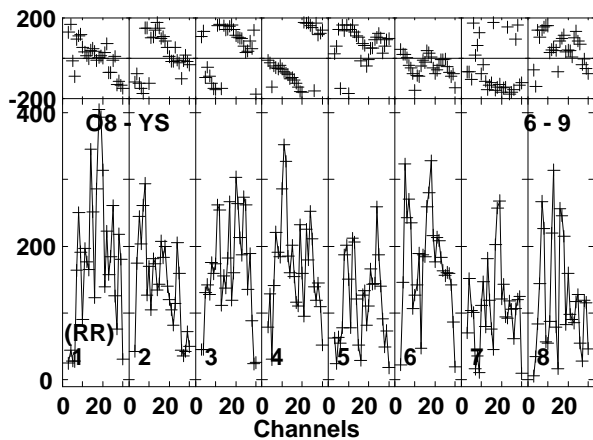
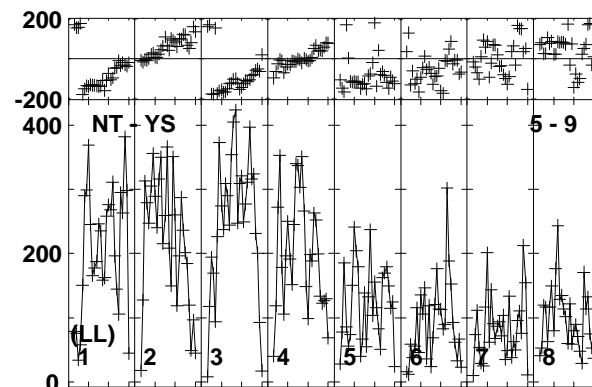
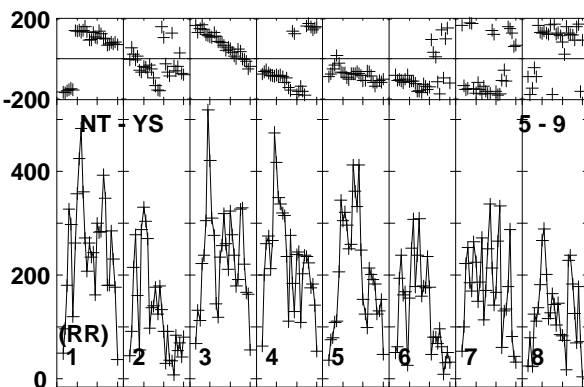
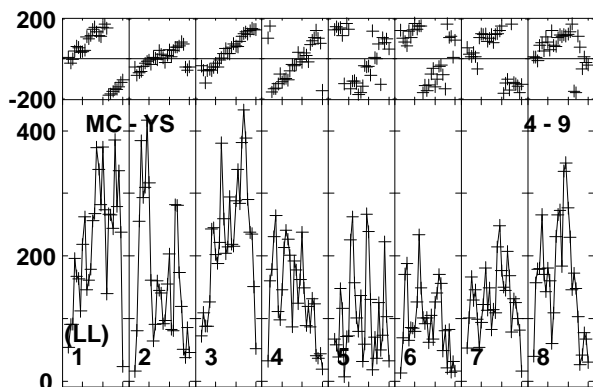
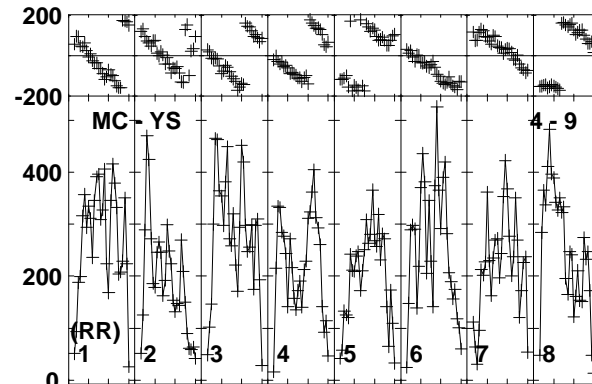
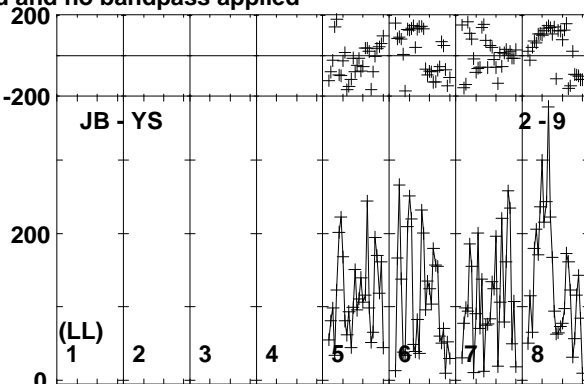
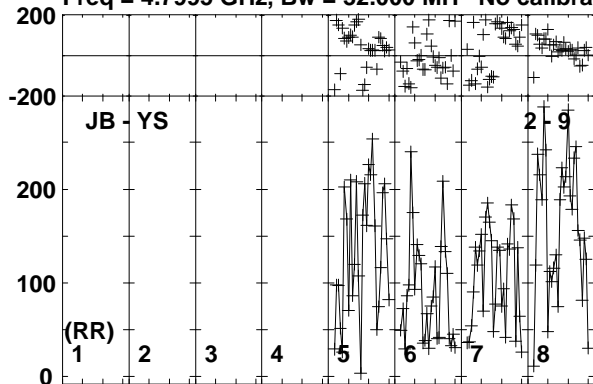

Lower frame: Micro Ampl Jy Top frame: Phas deg
Vector averaged cross-power spectrum Baseline: JB (02) - YS (09)
Timerange: 00/16:29:21 to 00/16:30:49

Plot file version 110 created 20-APR-2018 10:31:45

J0915+0745 EG102C.UVDATA.1

Freq = 4.7995 GHz, Bw = 32.000 MH No calibration applied and no bandpass applied

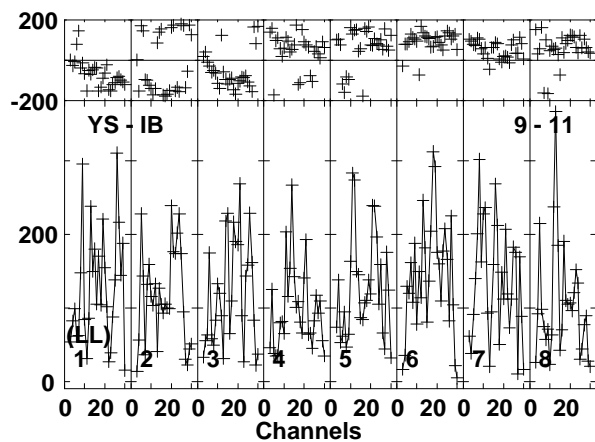
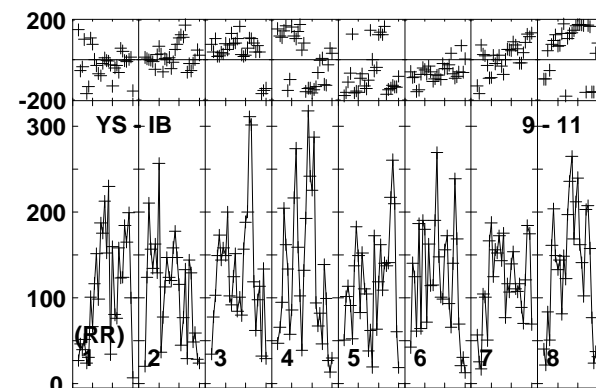
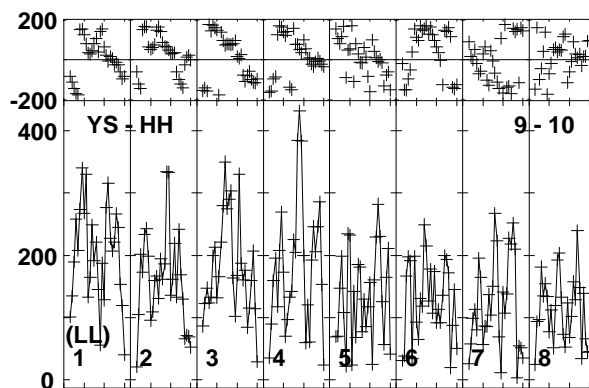
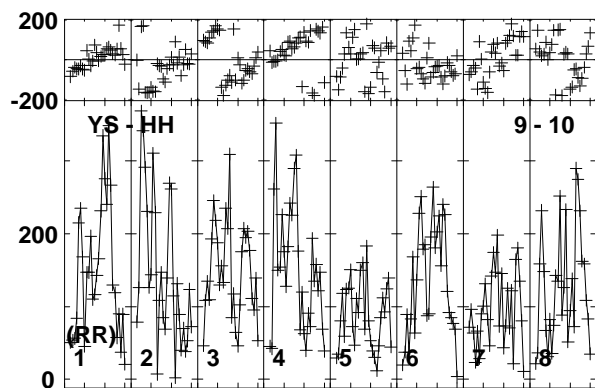
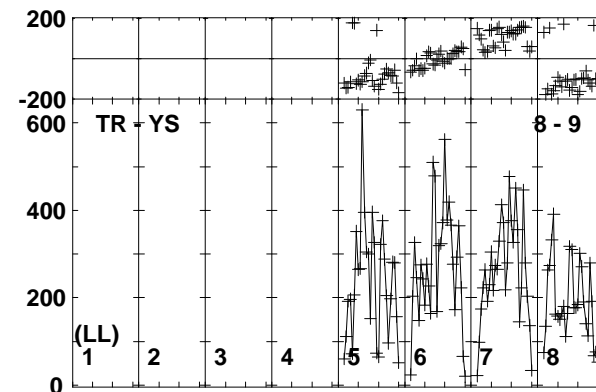
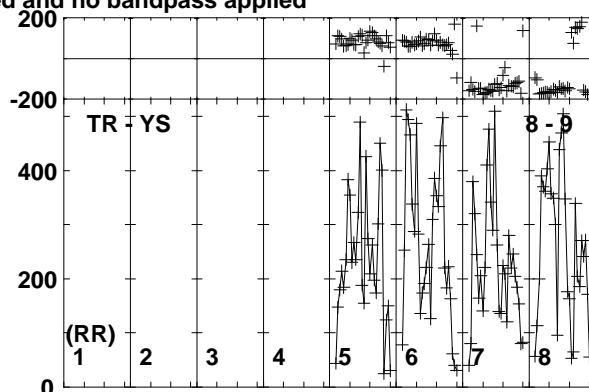
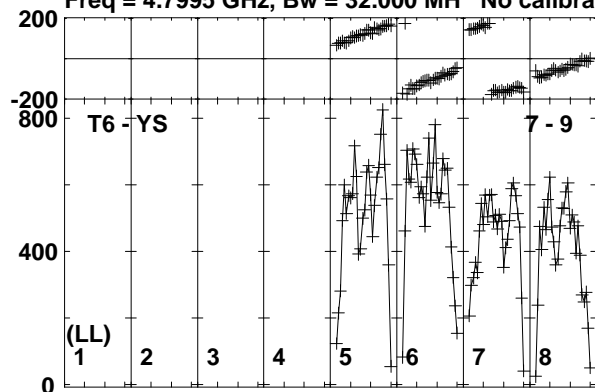

Lower frame: Micro Ampl Jy Top frame: Phas deg
Vector averaged cross-power spectrum Baseline: T6 (07) - YS (09)
Timerange: 00/16:29:21 to 00/16:30:49

Plot file version 111 created 20-APR-2018 10:31:45

B0915+068 EG102C.UVDATA.1

Freq = 4.7995 GHz, Bw = 32.000 MH No calibration applied and no bandpass applied

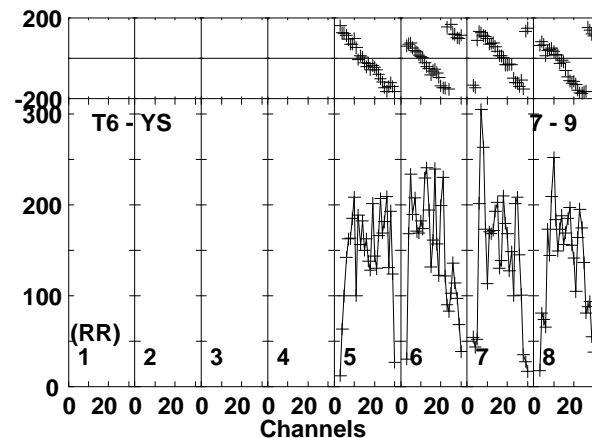
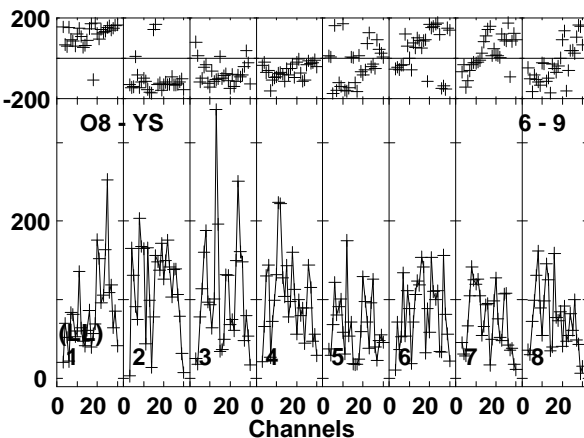
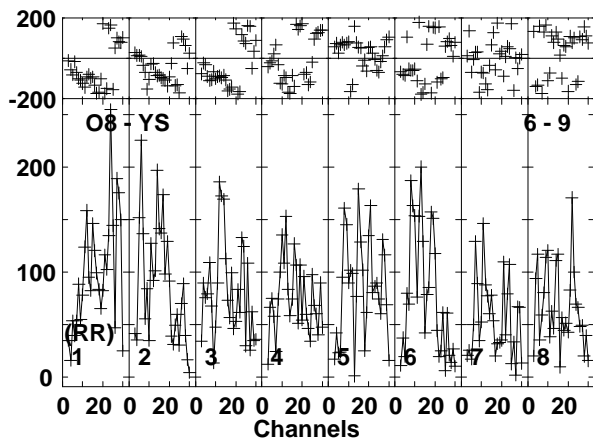
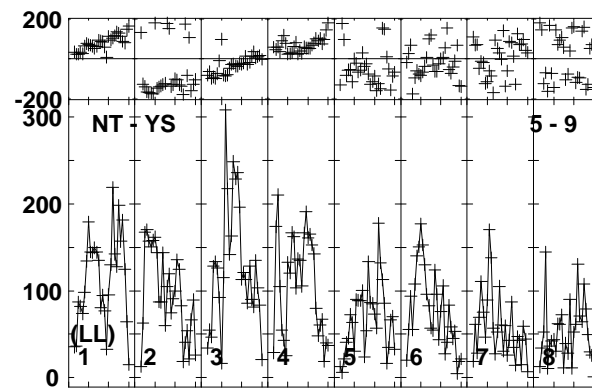
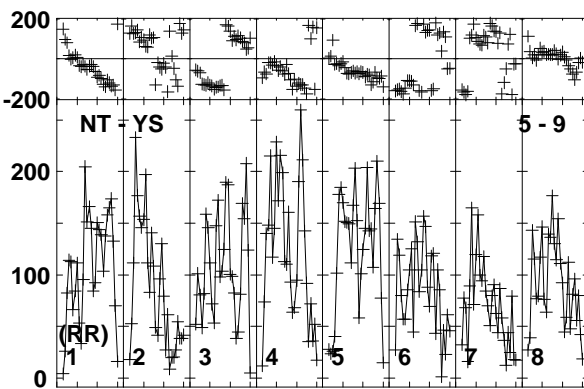
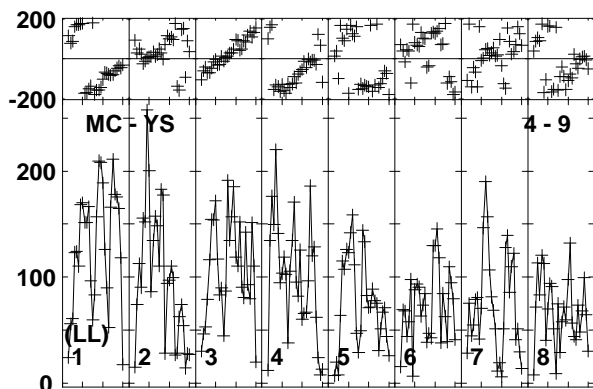
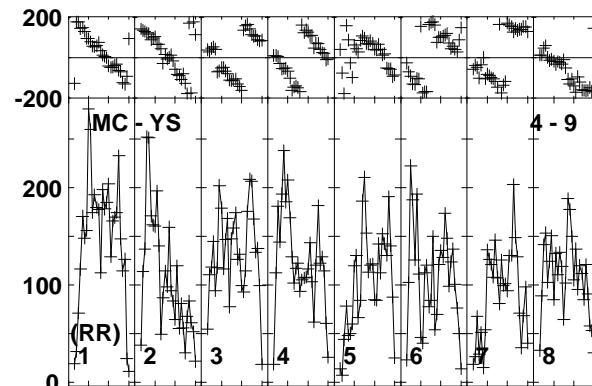
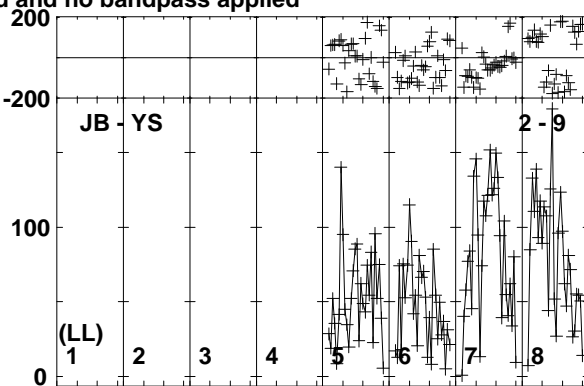
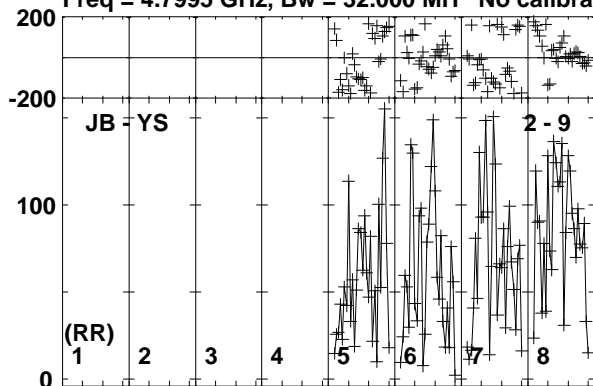

Lower frame: Micro Ampl Jy Top frame: Phas deg
Vector averaged cross-power spectrum Baseline: JB (02) - YS (09)
Timerange: 00/16:30:51 to 00/16:34:19

Plot file version 112 created 20-APR-2018 10:31:45

B0915+068 EG102C.UVDATA.1

Freq = 4.7995 GHz, Bw = 32.000 MH No calibration applied and no bandpass applied

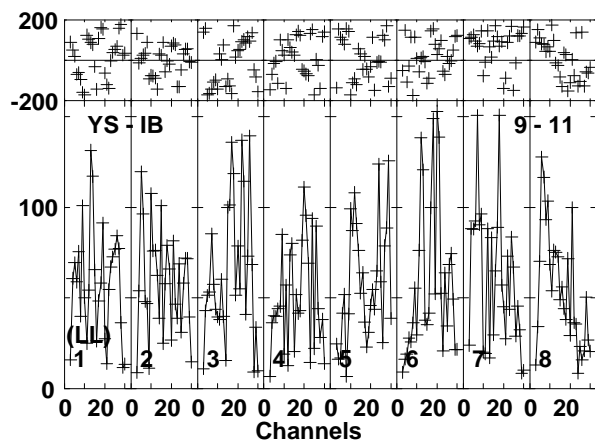
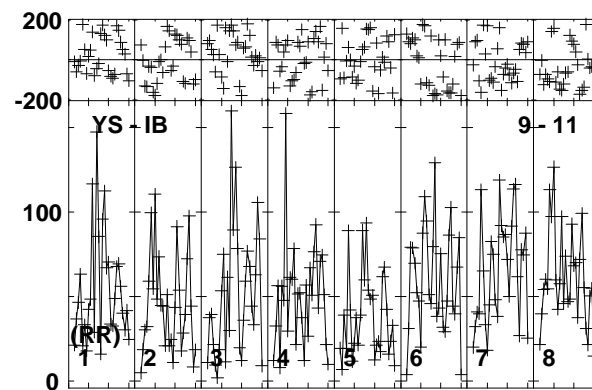
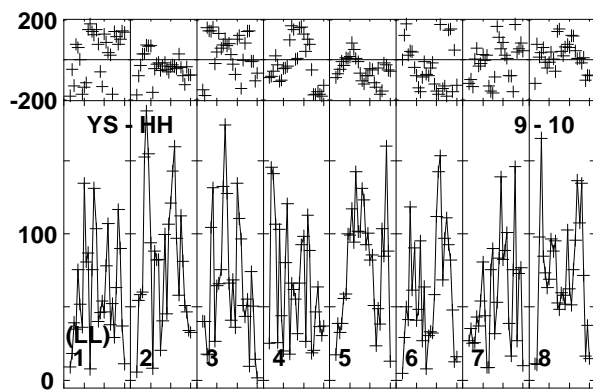
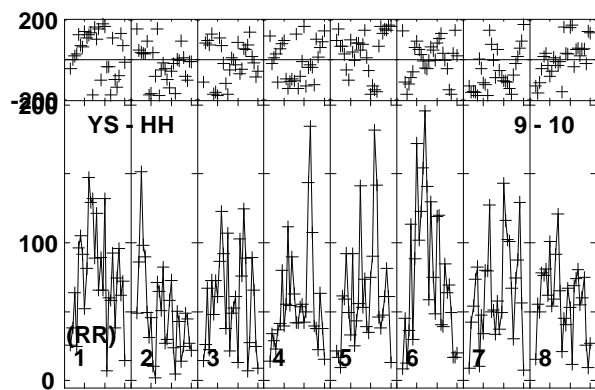
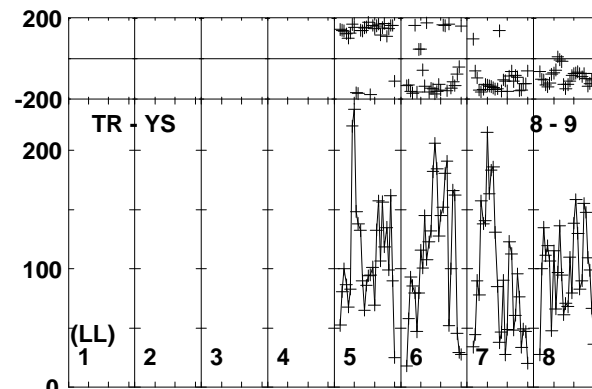
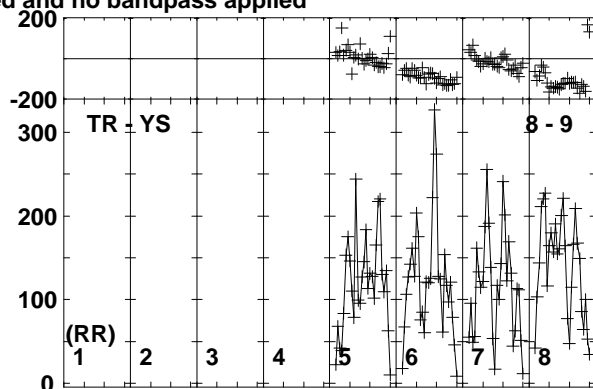
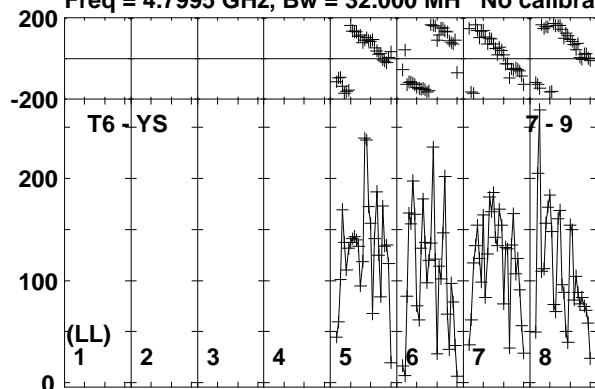

Lower frame: Micro Ampl Jy Top frame: Phas deg
Vector averaged cross-power spectrum Baseline: T6 (07) - YS (09)
Timerange: 00/16:30:51 to 00/16:34:19

Plot file version 113 created 20-APR-2018 10:31:46

J0915+0745 EG102C.UVDATA.1

Freq = 4.7995 GHz, Bw = 32.000 MH No calibration applied and no bandpass applied

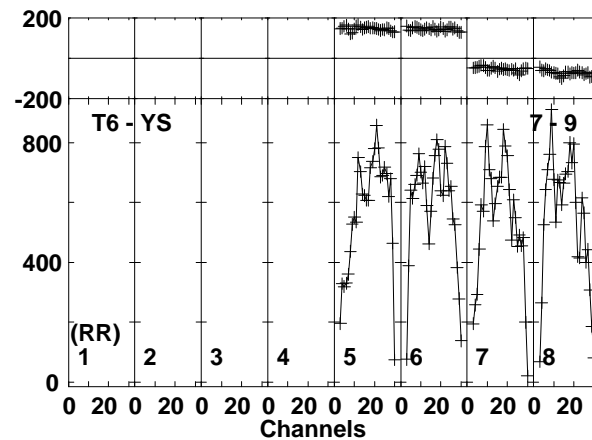
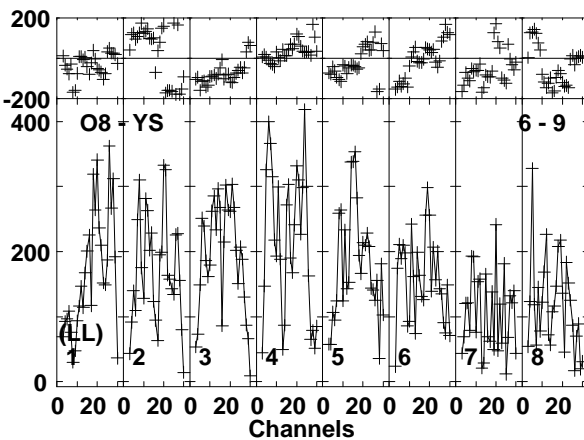
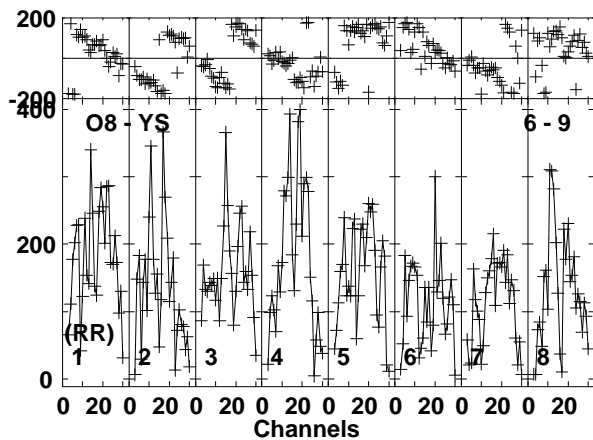
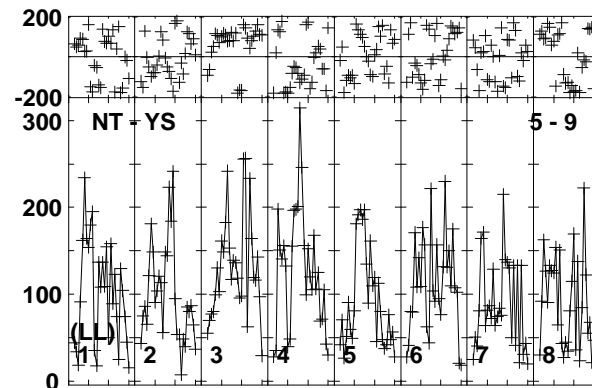
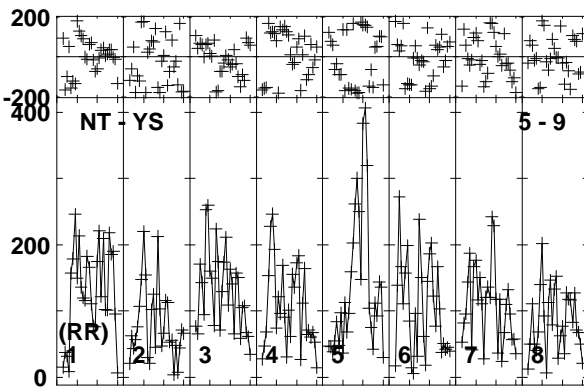
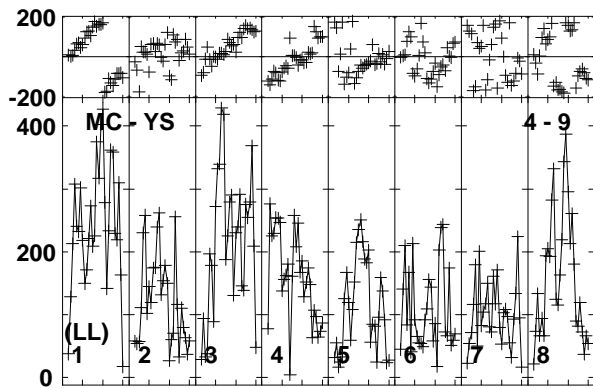
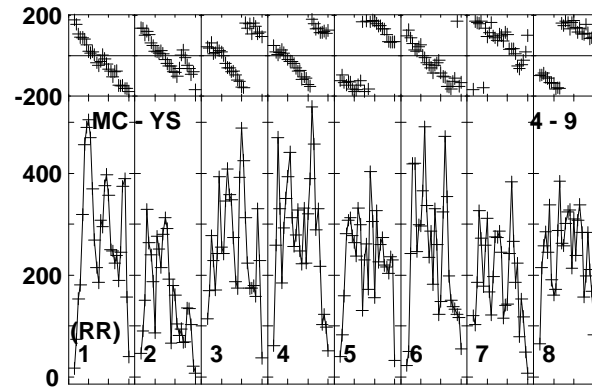
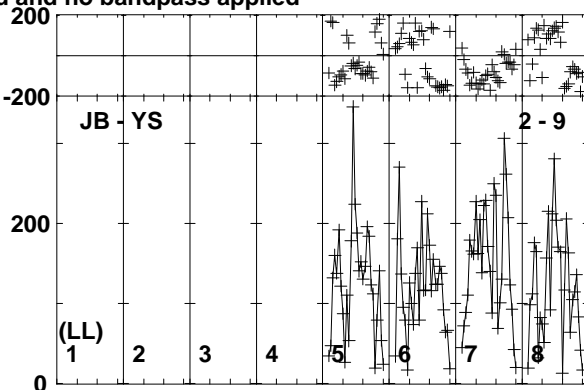
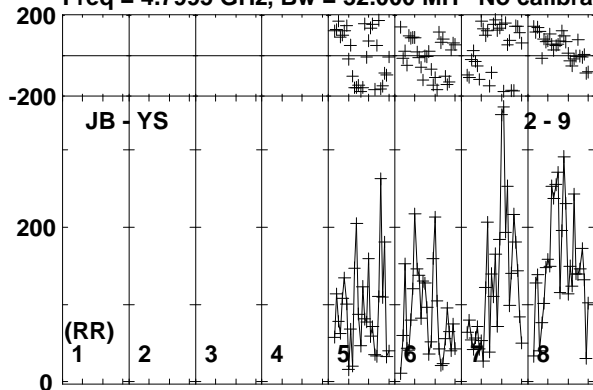

Lower frame: Micro Ampl Jy Top frame: Phas deg
Vector averaged cross-power spectrum Baseline: JB (02) - YS (09)
Timerange: 00/16:35:01 to 00/16:35:59

Plot file version 114 created 20-APR-2018 10:31:46

J0915+0745 EG102C.UVDATA.1

Freq = 4.7995 GHz, Bw = 32.000 MH No calibration applied and no bandpass applied

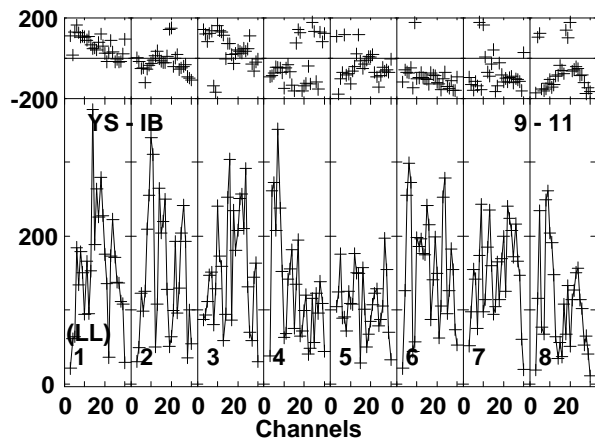
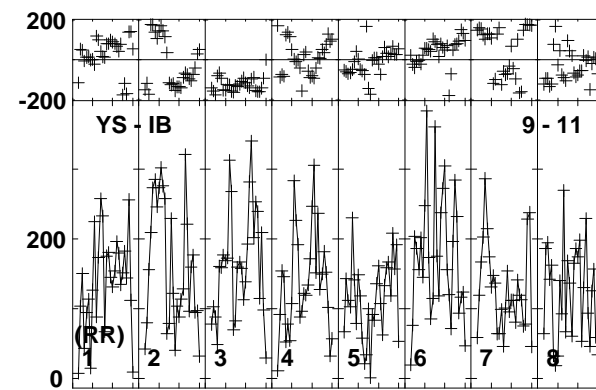
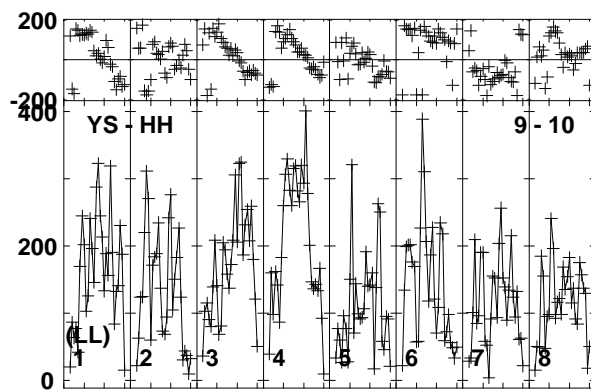
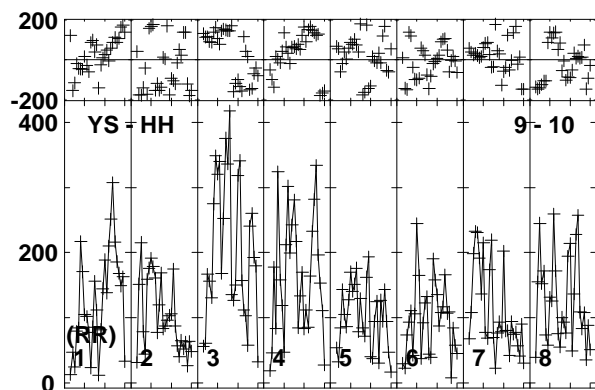
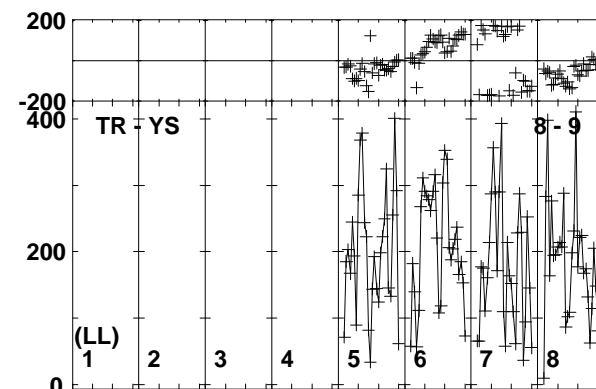
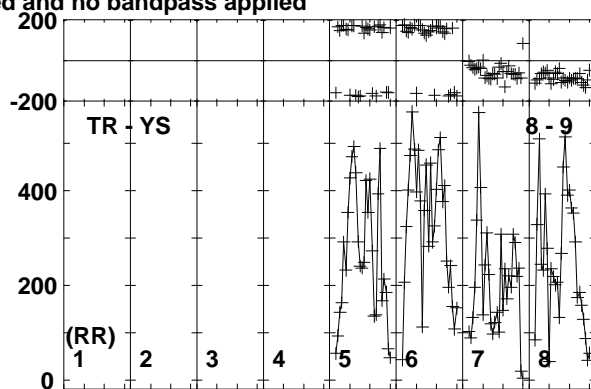
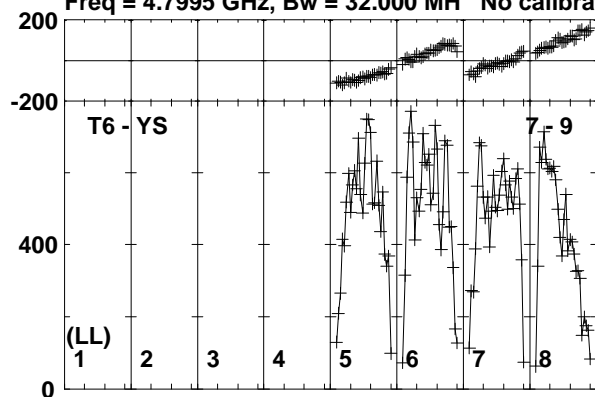

Lower frame: Micro Ampl Jy Top frame: Phas deg
Vector averaged cross-power spectrum Baseline: T6 (07) - YS (09)
Timerange: 00/16:35:01 to 00/16:35:59

Plot file version 115 created 20-APR-2018 10:31:46

B0915+068 EG102C.UVDATA.1

Freq = 4.7995 GHz, Bw = 32.000 MH No calibration applied and no bandpass applied

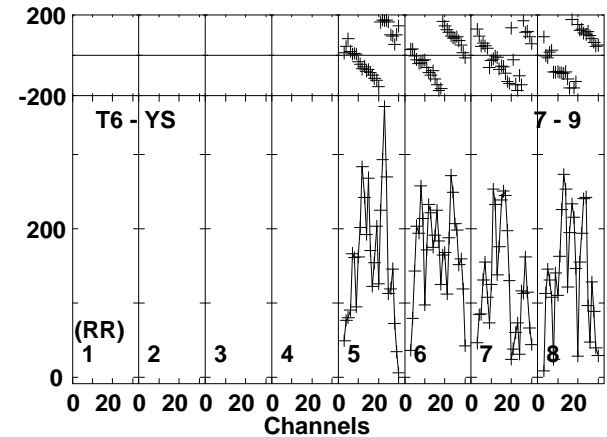
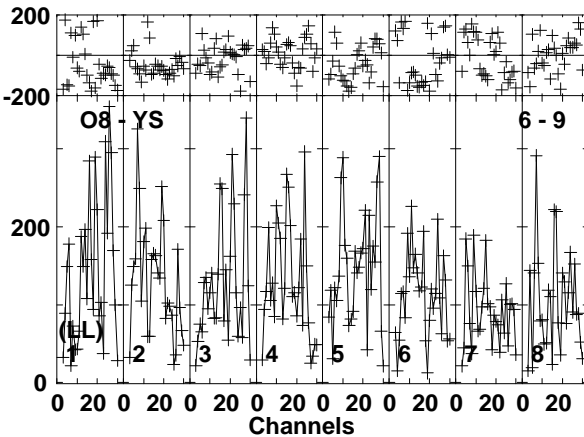
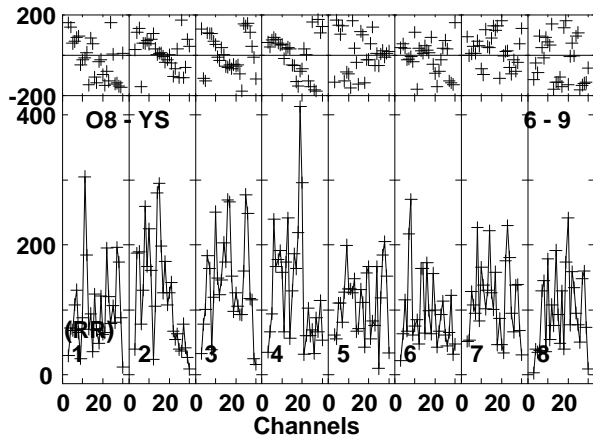
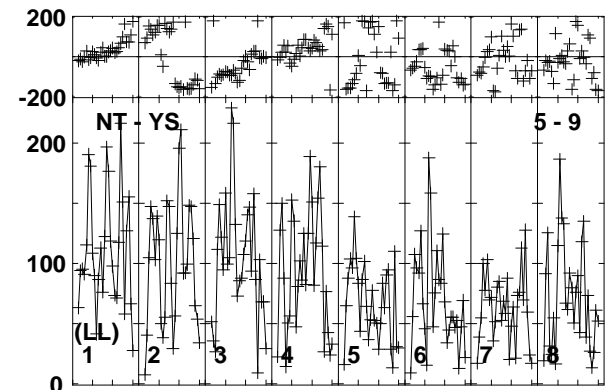
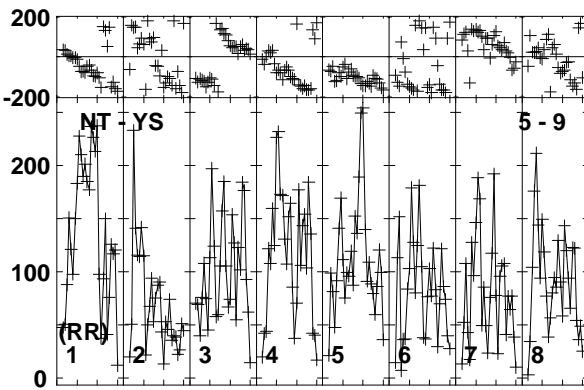
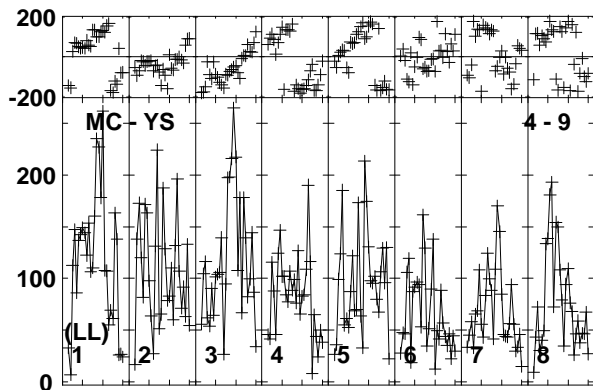
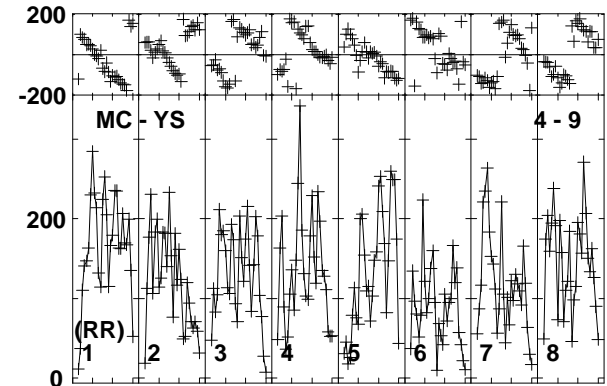
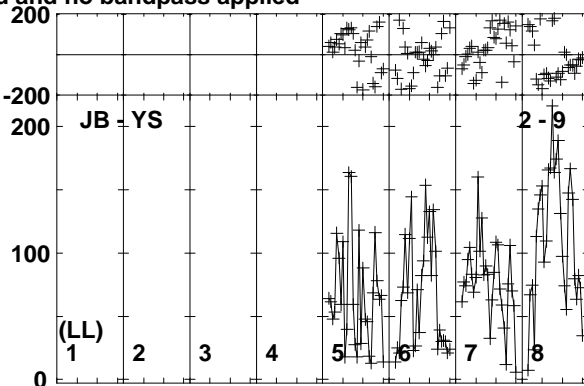
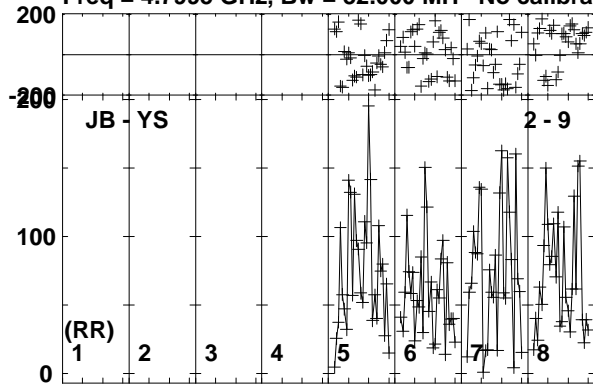

Lower frame: Micro Ampl Jy Top frame: Phas deg
Vector averaged cross-power spectrum Baseline: JB (02) - YS (09)
Timerange: 00/16:36:01 to 00/16:39:29

Plot file version 116 created 20-APR-2018 10:31:46

B0915+068 EG102C.UVDATA.1

Freq = 4.7995 GHz, Bw = 32.000 MH No calibration applied and no bandpass applied

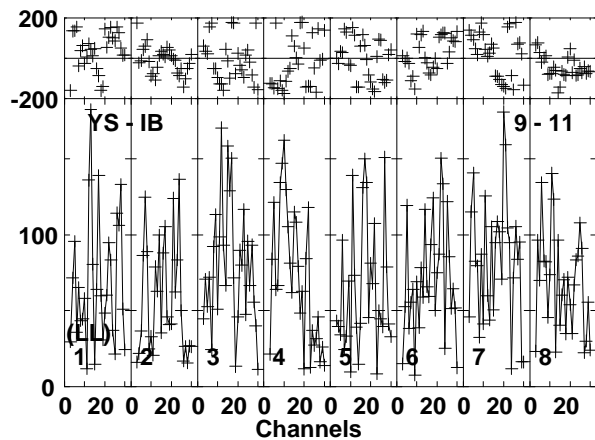
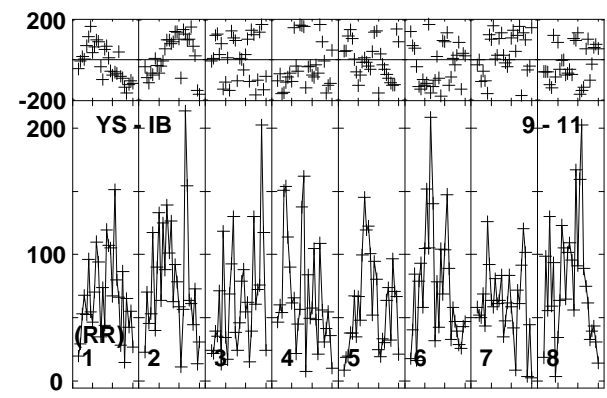
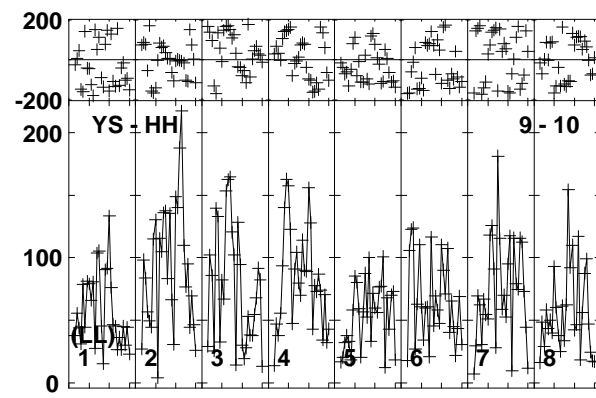
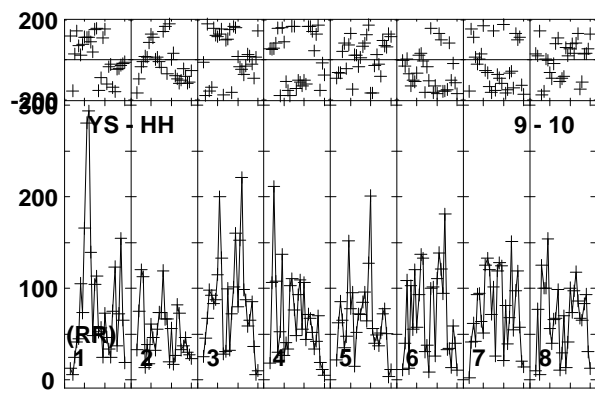
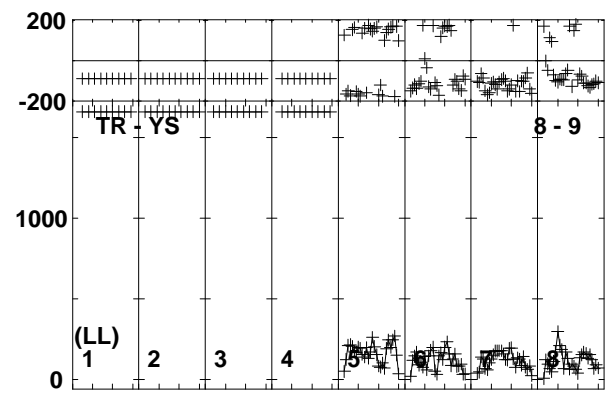
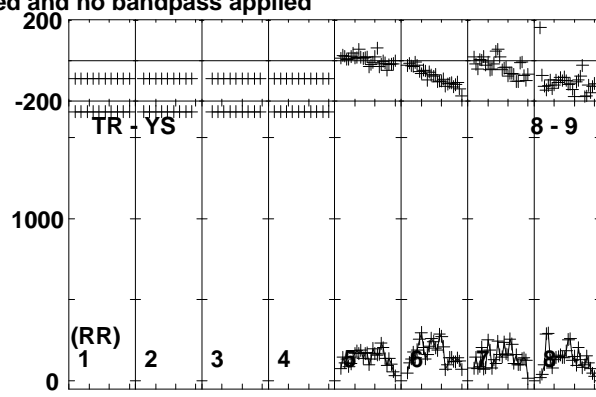
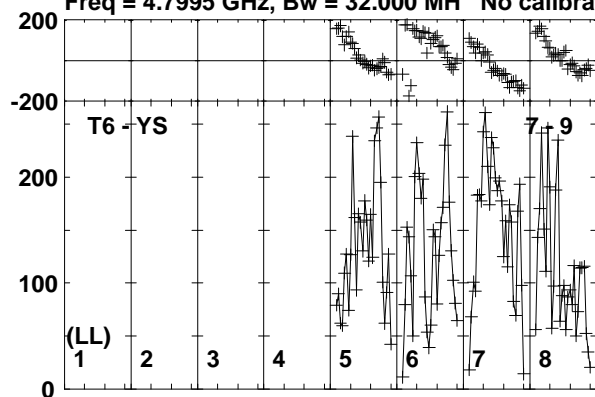

Lower frame: Micro Ampl Jy Top frame: Phas deg
Vector averaged cross-power spectrum Baseline: T6 (07) - YS (09)
Timerange: 00/16:36:01 to 00/16:39:29

Plot file version 117 created 20-APR-2018 10:31:46

J0915+0745 EG102C.UVDATA.1

Freq = 4.7995 GHz, Bw = 32.000 MH No calibration applied and no bandpass applied

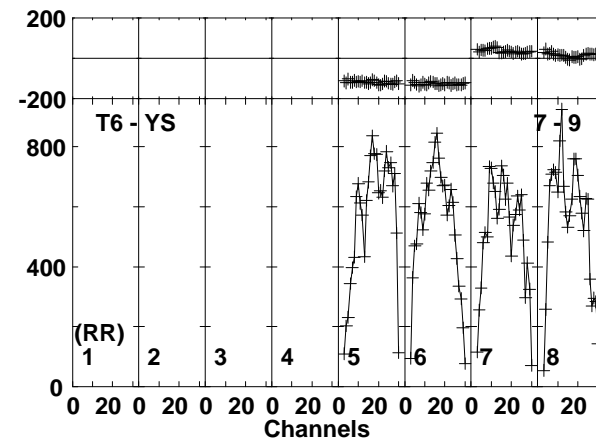
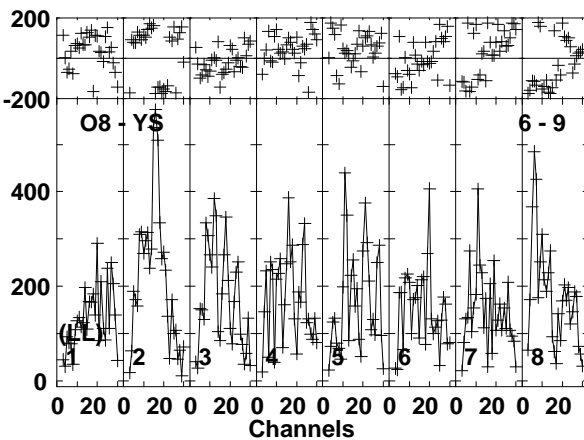
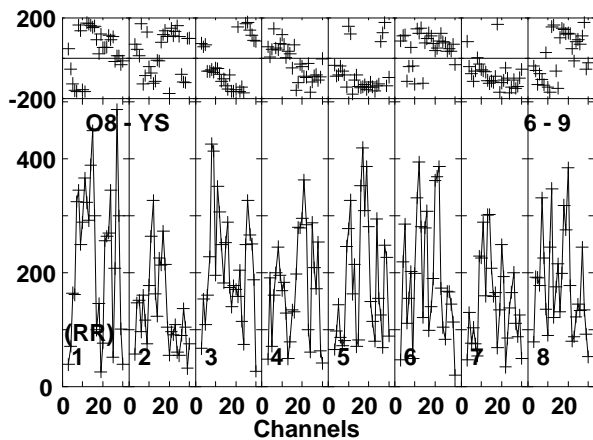
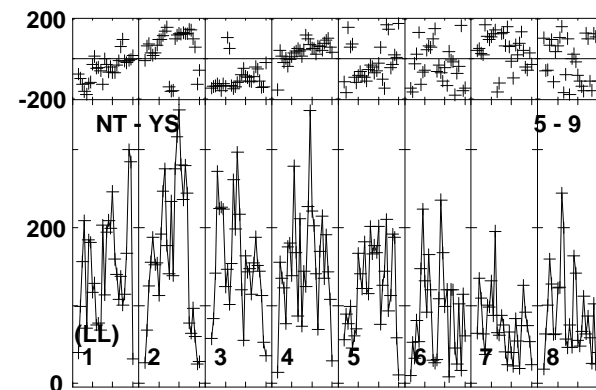
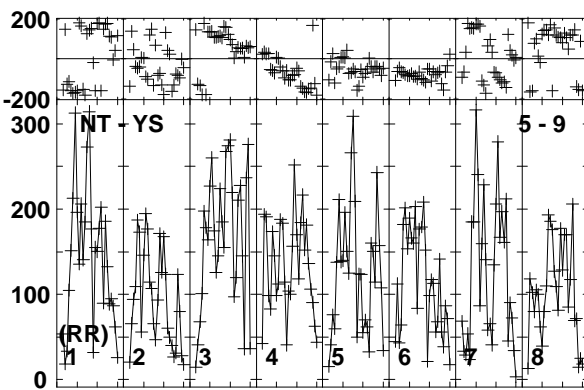
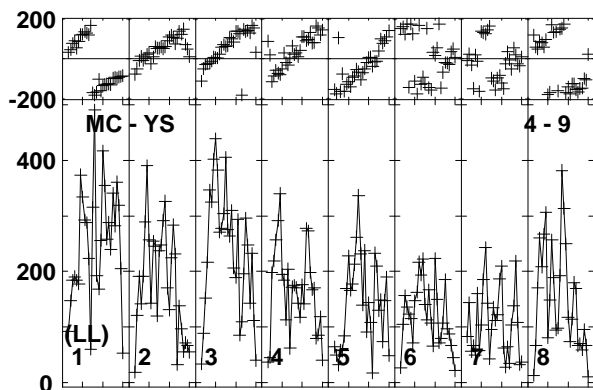
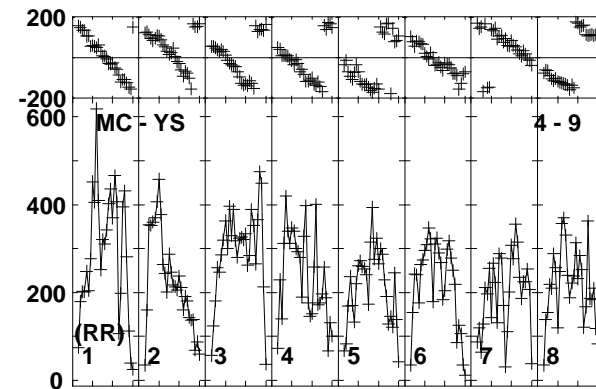
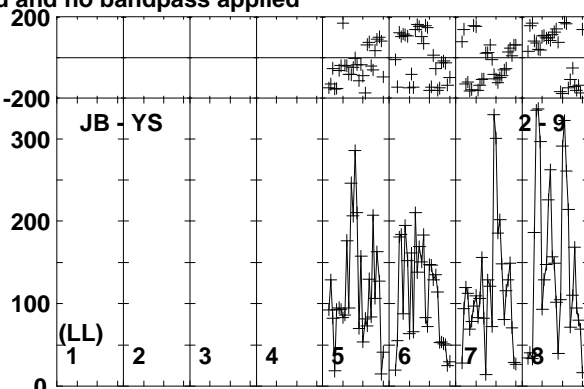
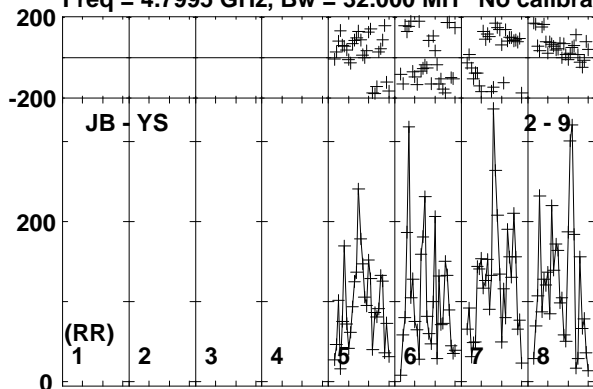

Lower frame: Micro Ampl Jy Top frame: Phas deg
Vector averaged cross-power spectrum Baseline: JB (02) - YS (09)
Timerange: 00/16:39:31 to 00/16:40:59

Plot file version 118 created 20-APR-2018 10:31:46

J0915+0745 EG102C.UVDATA.1

Freq = 4.7995 GHz, Bw = 32.000 MH No calibration applied and no bandpass applied

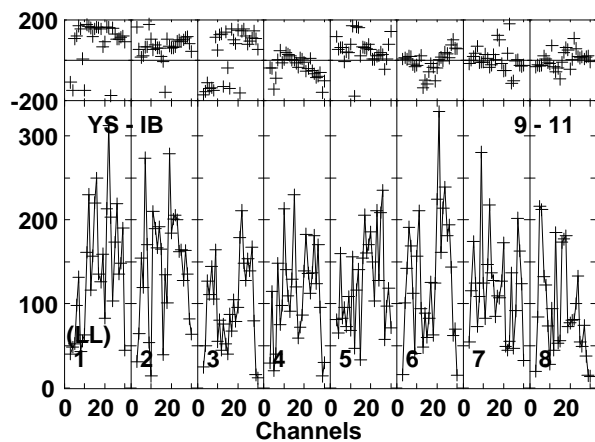
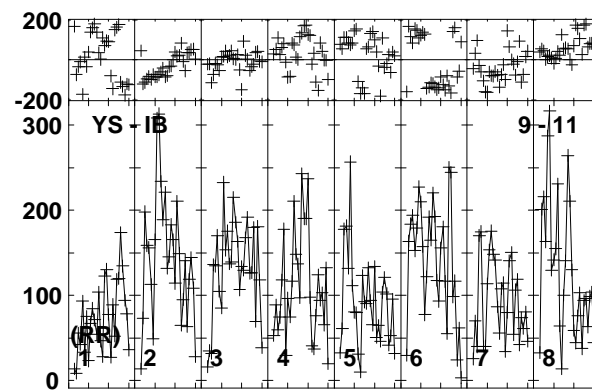
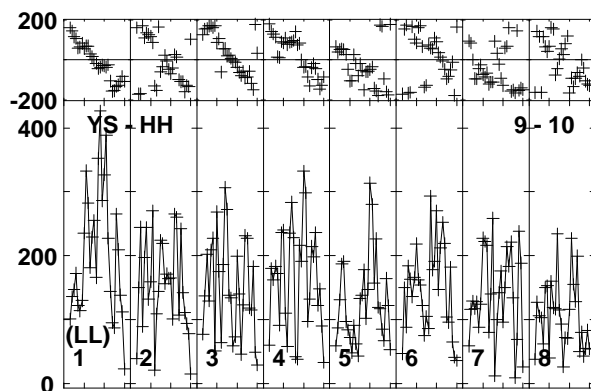
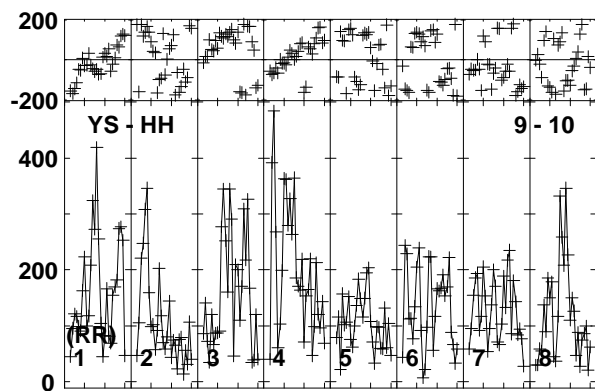
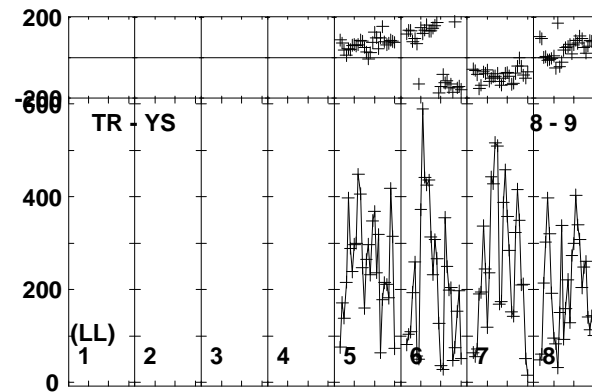
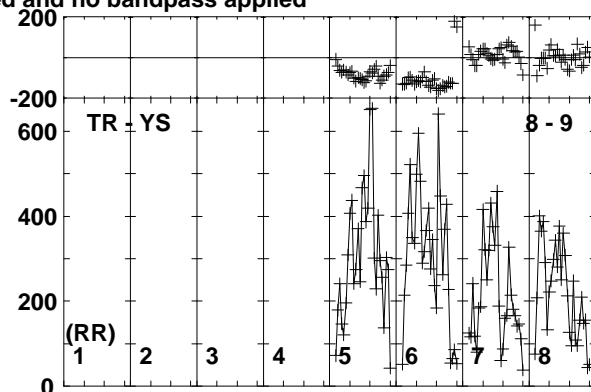
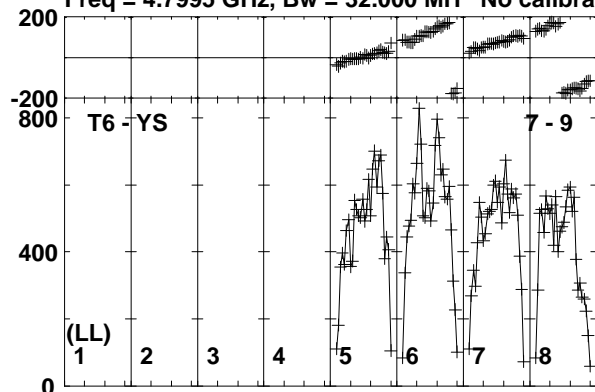

Lower frame: Micro Ampl Jy Top frame: Phas deg
Vector averaged cross-power spectrum Baseline: T6 (07) - YS (09)
Timerange: 00/16:39:31 to 00/16:40:59

Plot file version 119 created 20-APR-2018 10:31:46

B0915+068 EG102C.UVDATA.1

Freq = 4.7995 GHz, Bw = 32.000 MH No calibration applied and no bandpass applied

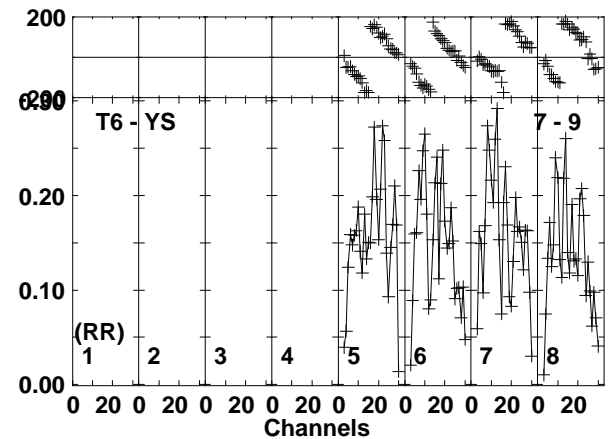
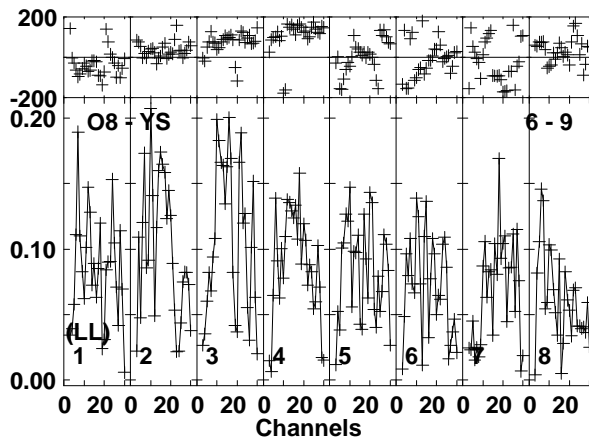
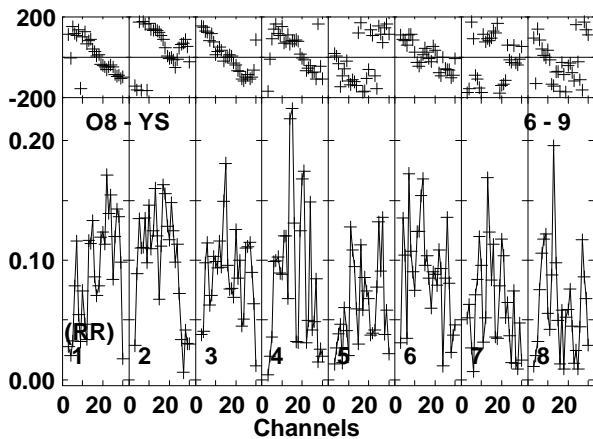
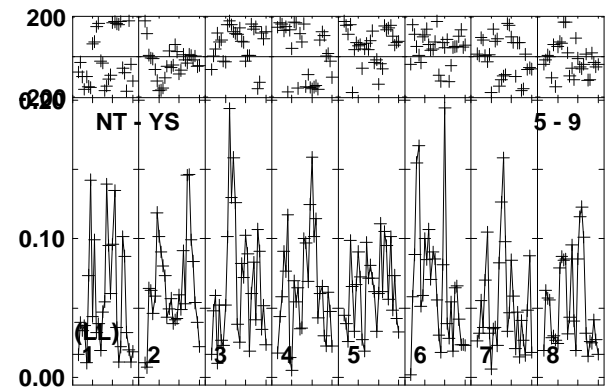
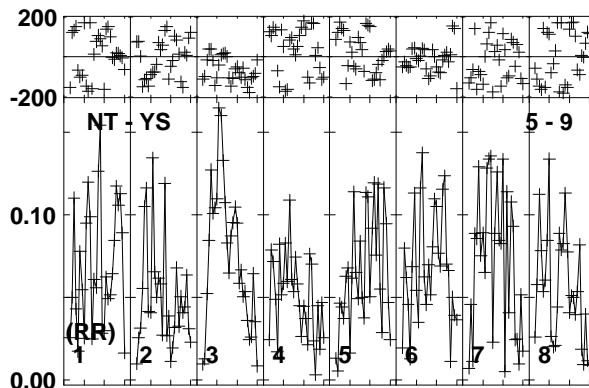
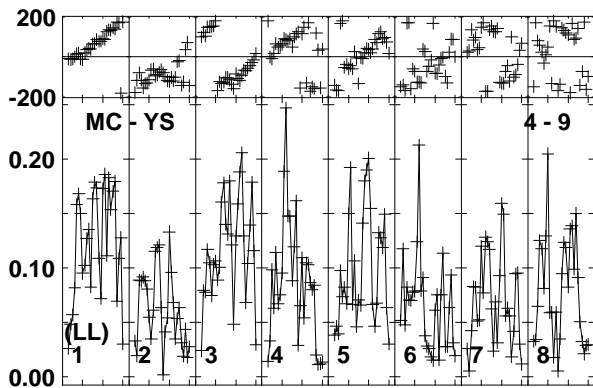
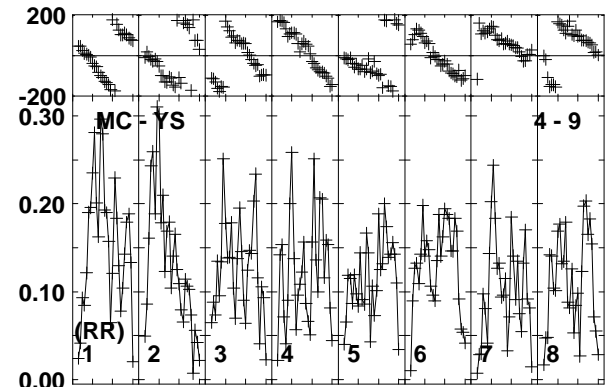
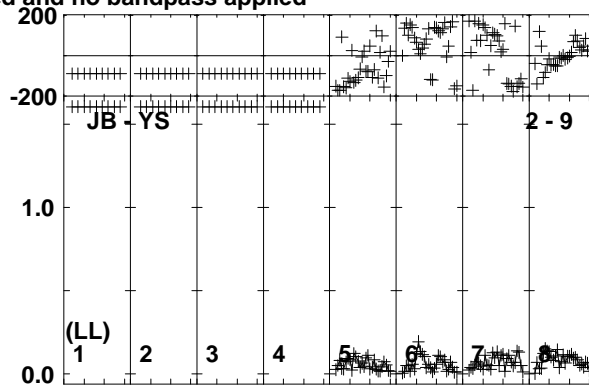
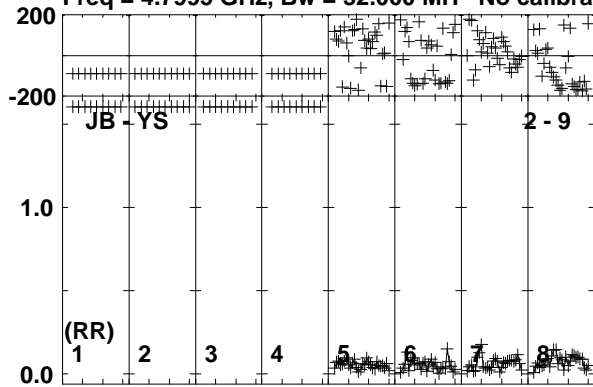

Lower frame: Milli Ampl Jy Top frame: Phas deg
Vector averaged cross-power spectrum Baseline: JB (02) - YS (09)
Timerange: 00/16:41:01 to 00/16:44:29

Plot file version 120 created 20-APR-2018 10:31:46

B0915+068 EG102C.UVDATA.1

Freq = 4.7995 GHz, Bw = 32.000 MH No calibration applied and no bandpass applied

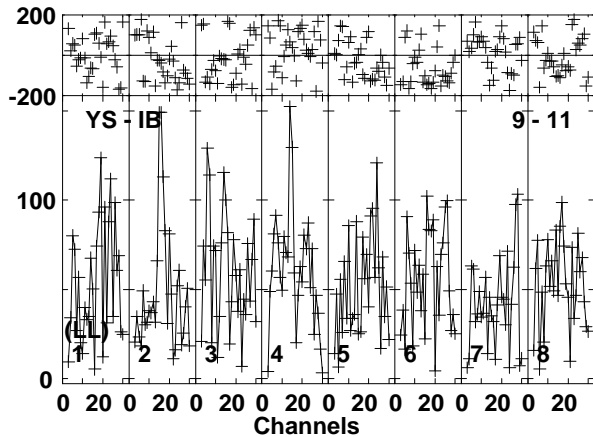
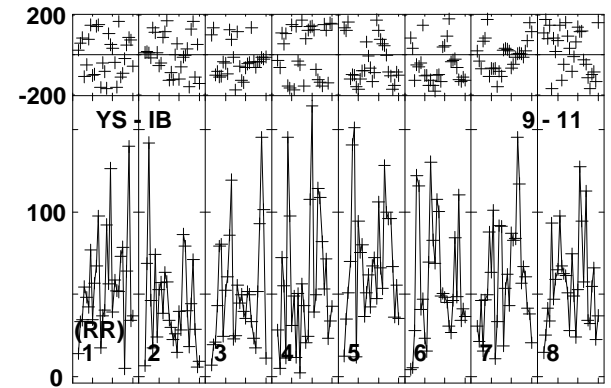
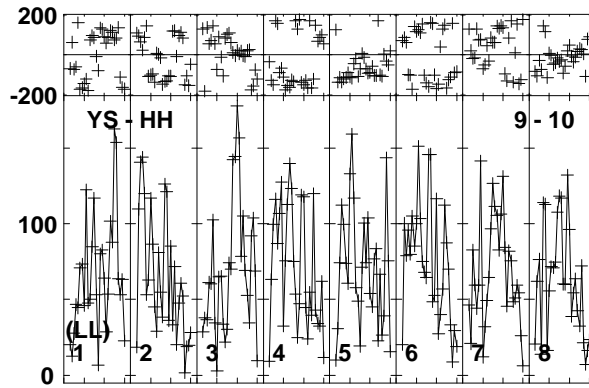
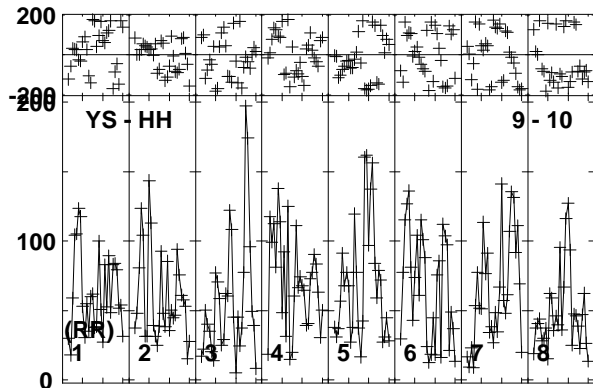
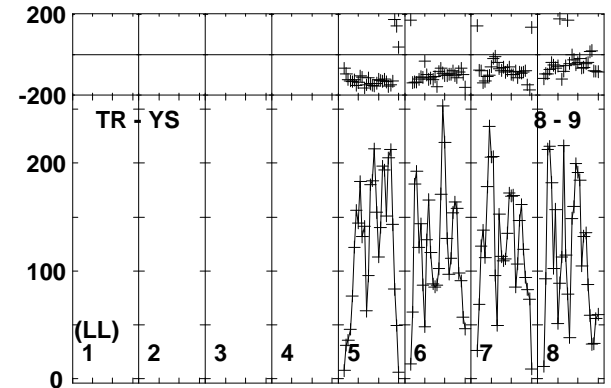
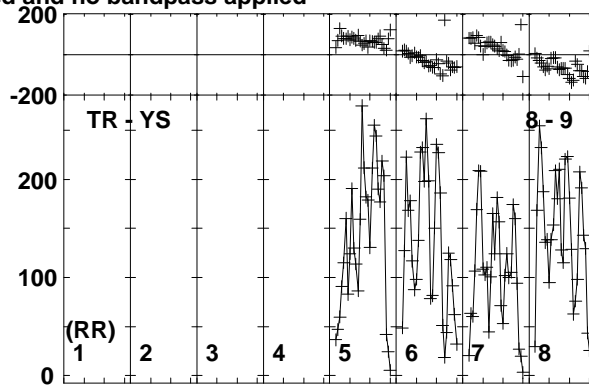
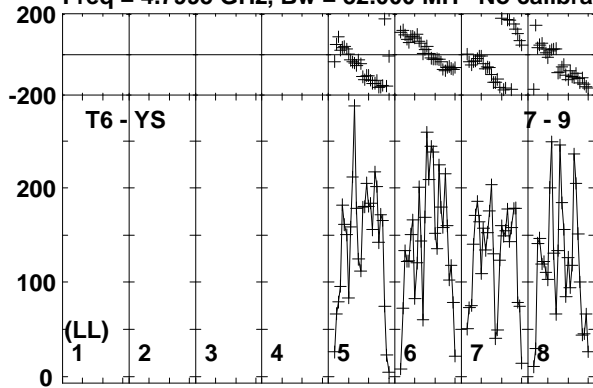

Lower frame: Micro Ampl Jy Top frame: Phas deg
Vector averaged cross-power spectrum Baseline: T6 (07) - YS (09)
Timerange: 00/16:41:01 to 00/16:44:29

Plot file version 121 created 20-APR-2018 10:31:46

J0915+0745 EG102C.UVDATA.1

Freq = 4.7995 GHz, Bw = 32.000 MH No calibration applied and no bandpass applied

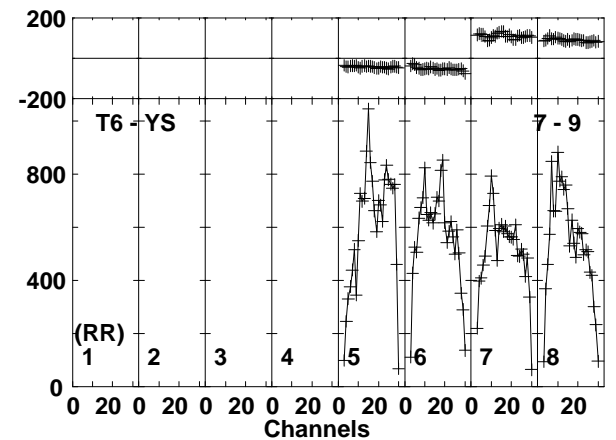
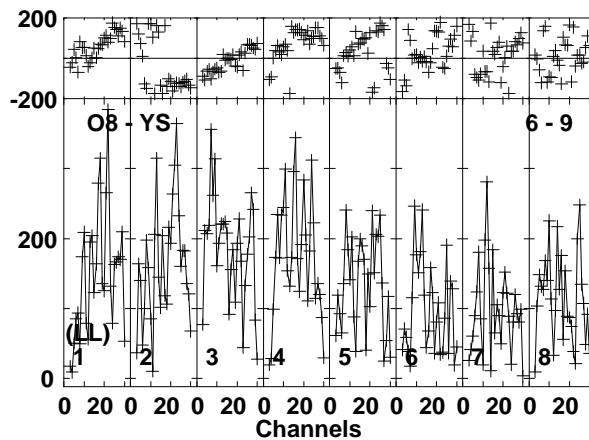
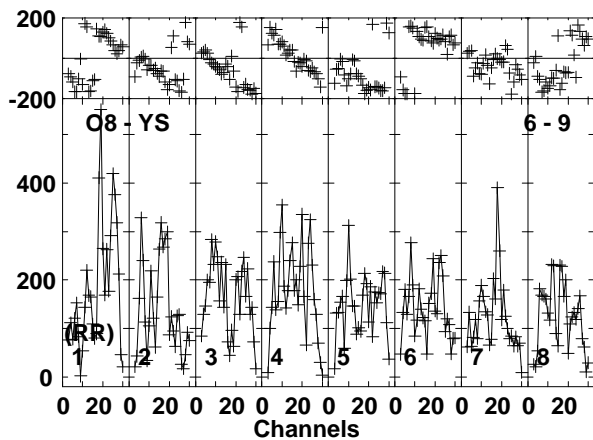
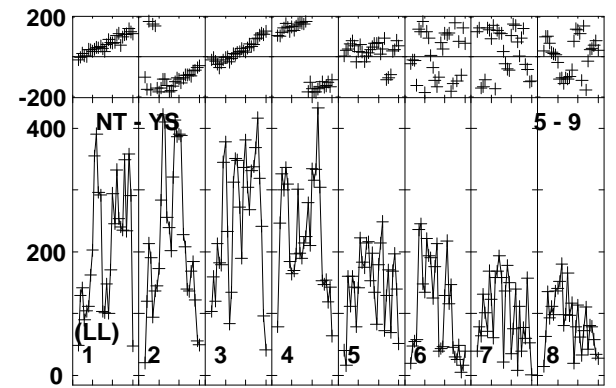
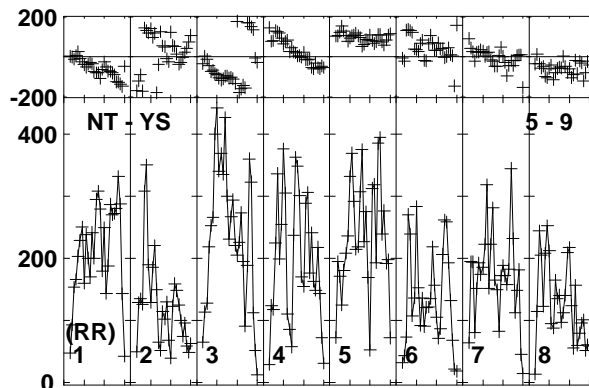
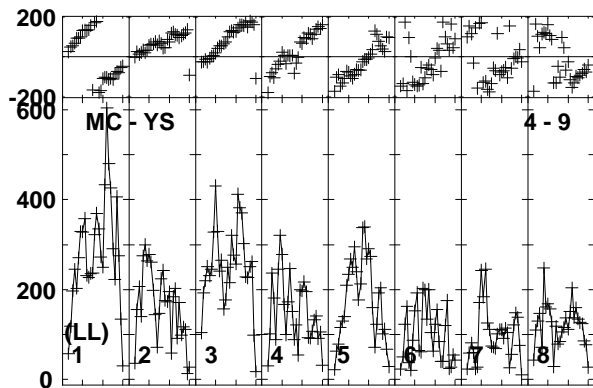
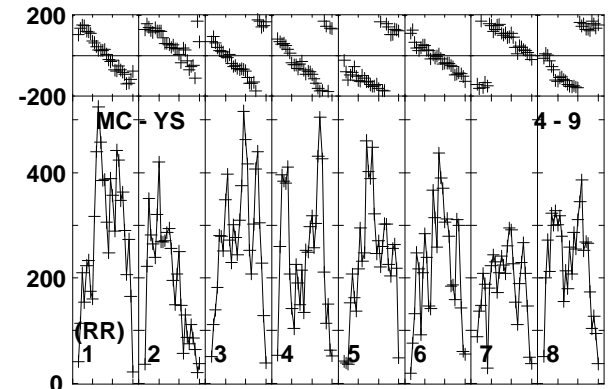
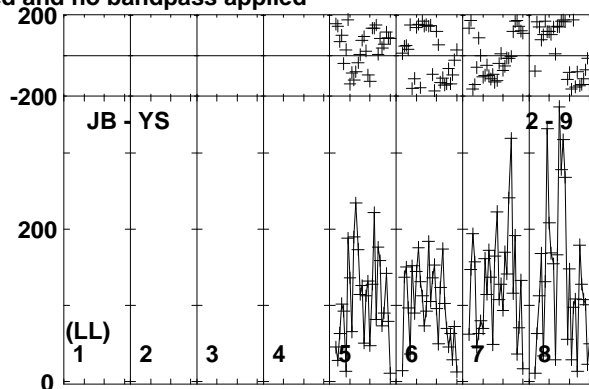
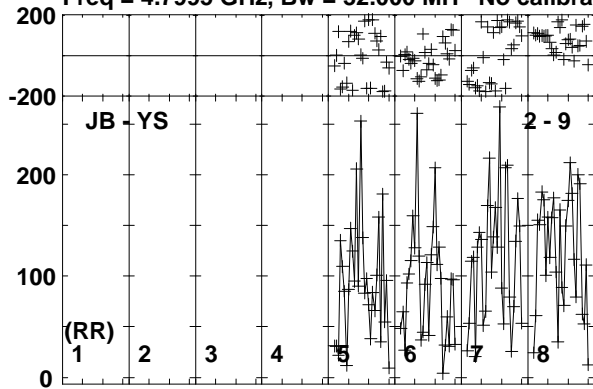

Lower frame: Micro Ampl Jy Top frame: Phas deg
Vector averaged cross-power spectrum Baseline: JB (02) - YS (09)
Timerange: 00/16:44:31 to 00/16:45:59

Plot file version 122 created 20-APR-2018 10:31:46

J0915+0745 EG102C.UVDATA.1

Freq = 4.7995 GHz, Bw = 32.000 MH No calibration applied and no bandpass applied

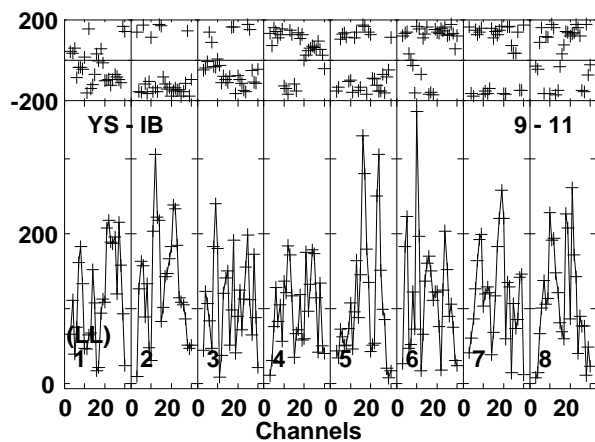
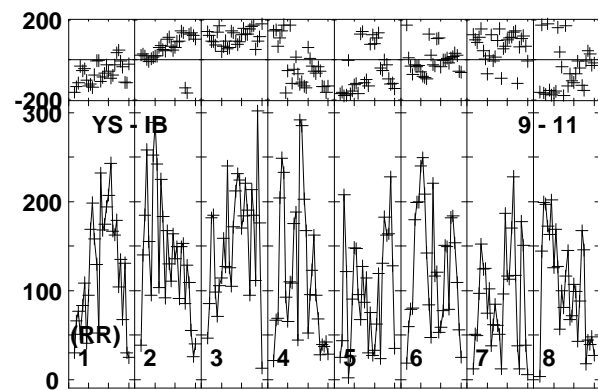
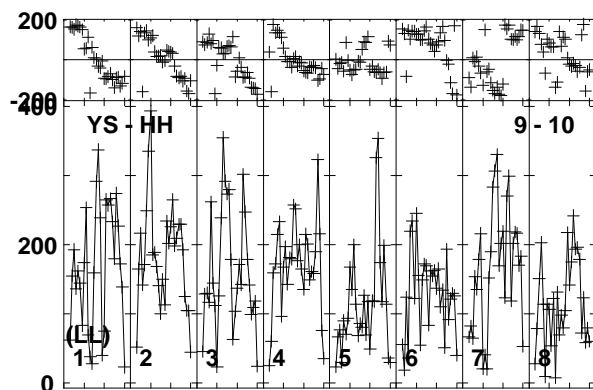
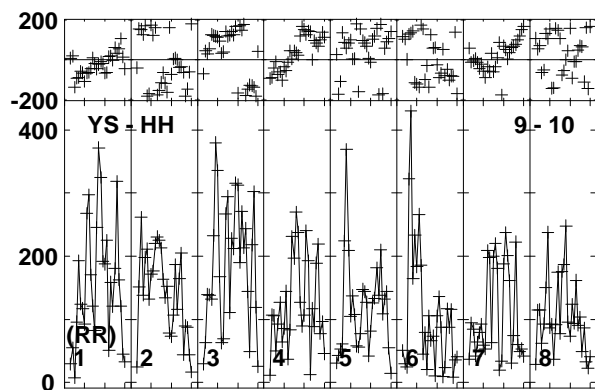
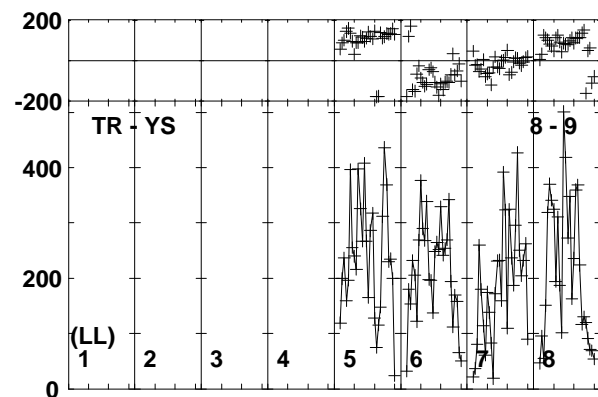
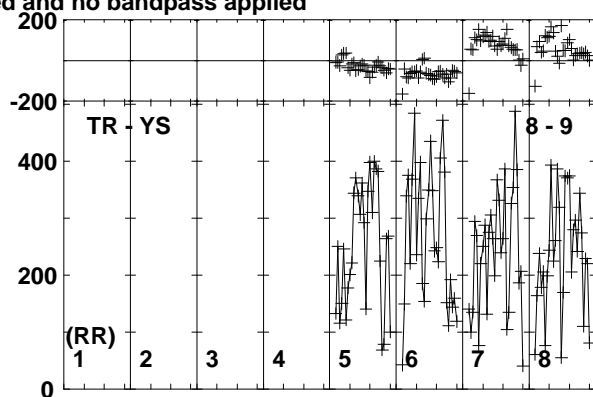
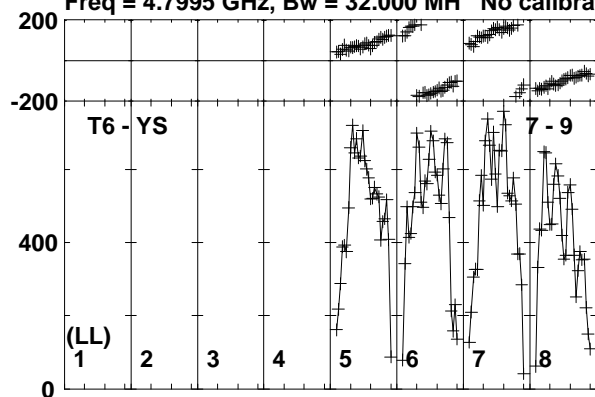

Lower frame: Micro Ampl Jy Top frame: Phas deg
Vector averaged cross-power spectrum Baseline: T6 (07) - YS (09)
Timerange: 00/16:44:31 to 00/16:45:59

Plot file version 123 created 20-APR-2018 10:31:46

B0915+068 EG102C.UVDATA.1

Freq = 4.7995 GHz, Bw = 32.000 MH No calibration applied and no bandpass applied

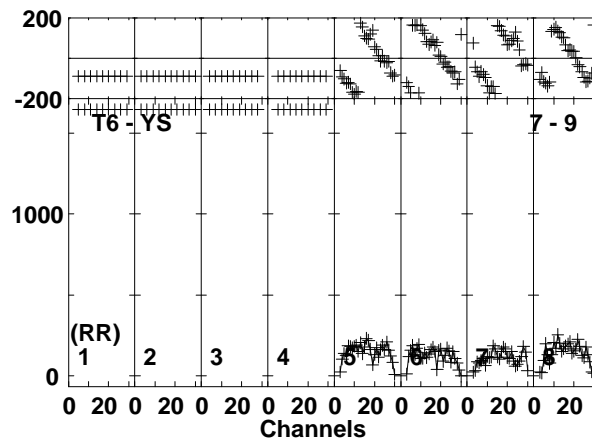
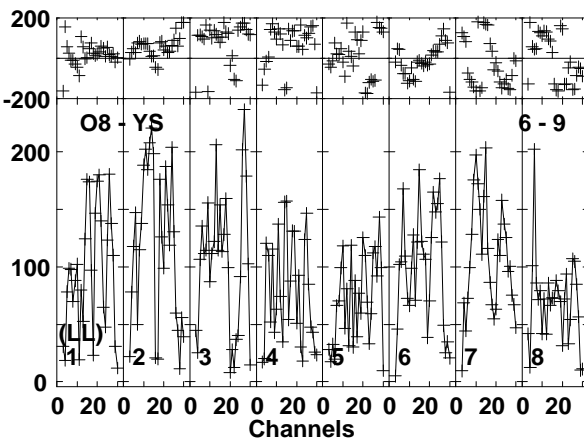
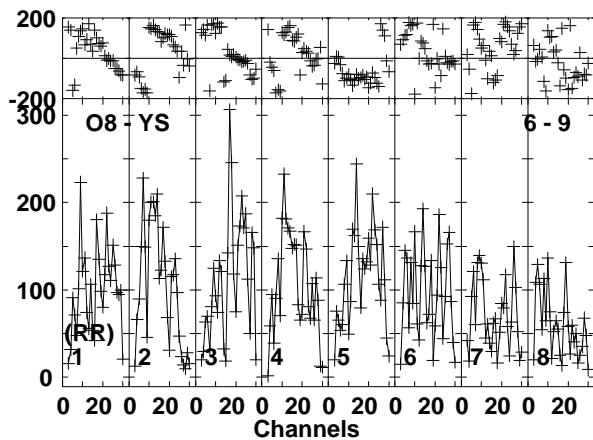
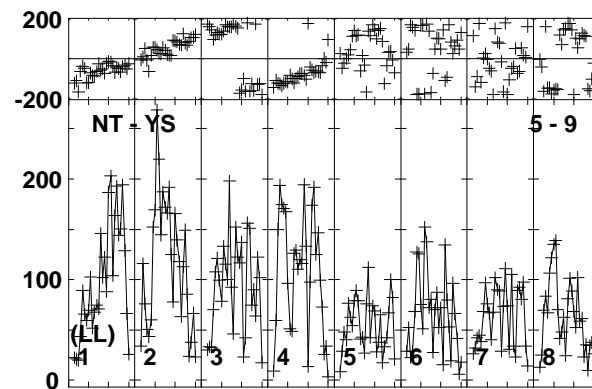
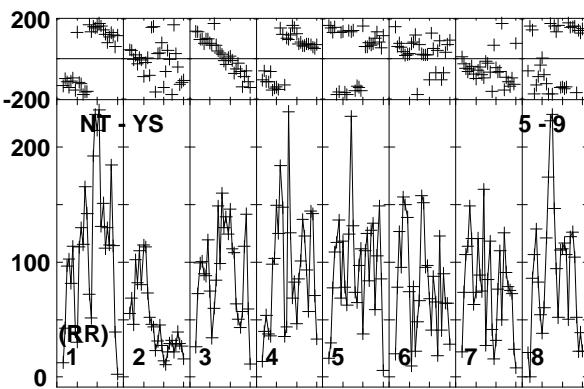
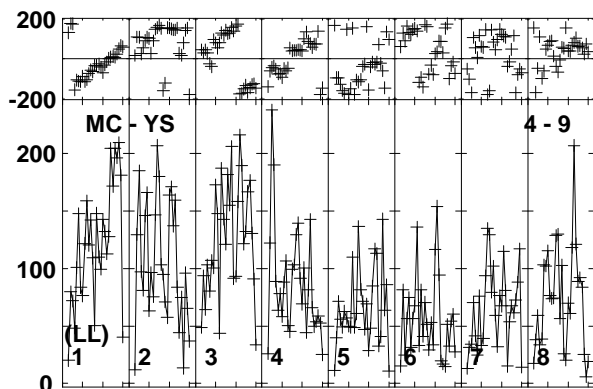
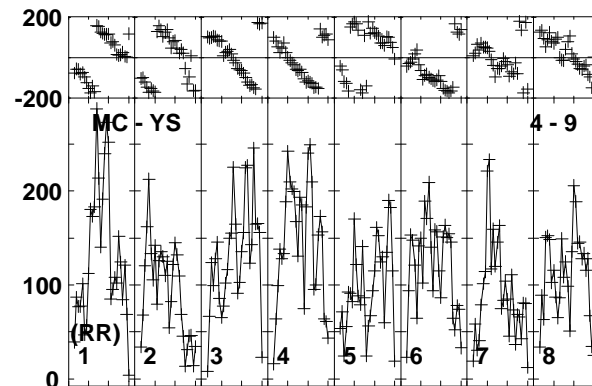
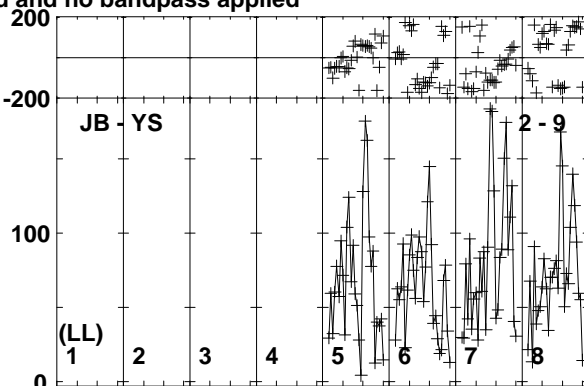
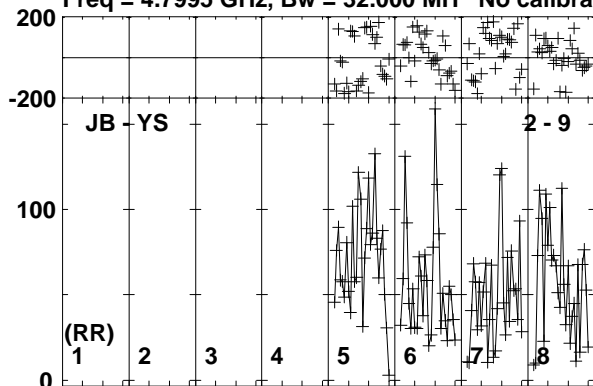

Lower frame: Micro Ampl Jy Top frame: Phas deg
Vector averaged cross-power spectrum Baseline: JB (02) - YS (09)
Timerange: 00/16:46:01 to 00/16:49:29

Plot file version 124 created 20-APR-2018 10:31:47

B0915+068 EG102C.UVDATA.1

Freq = 4.7995 GHz, Bw = 32.000 MH No calibration applied and no bandpass applied

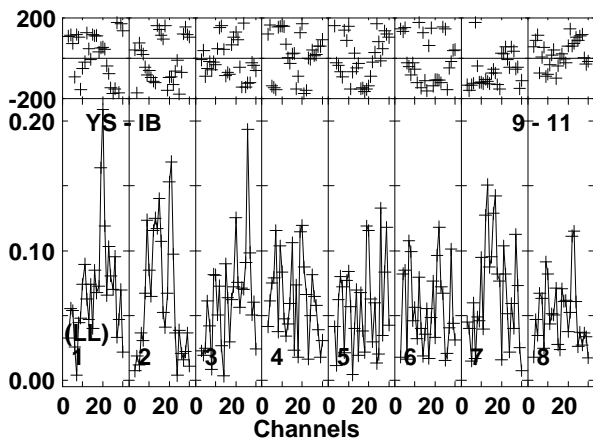
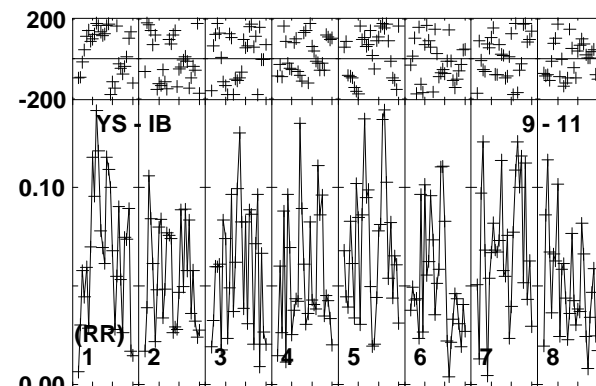
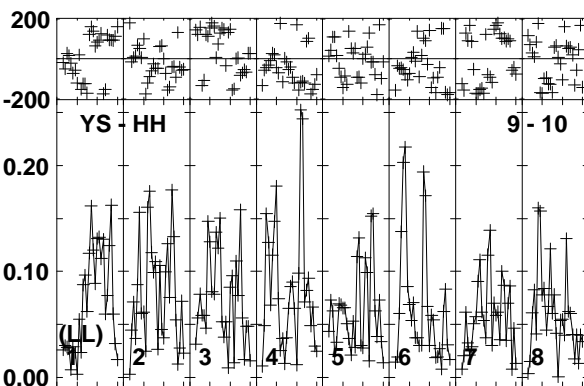
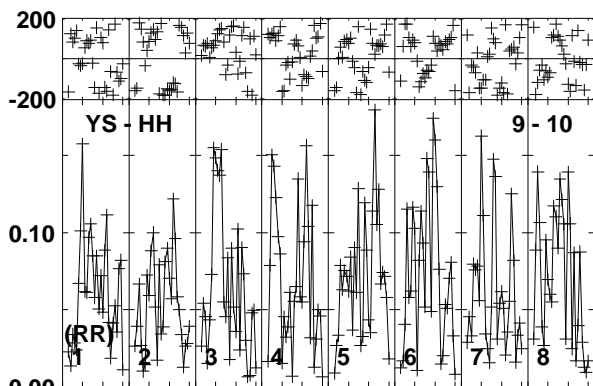
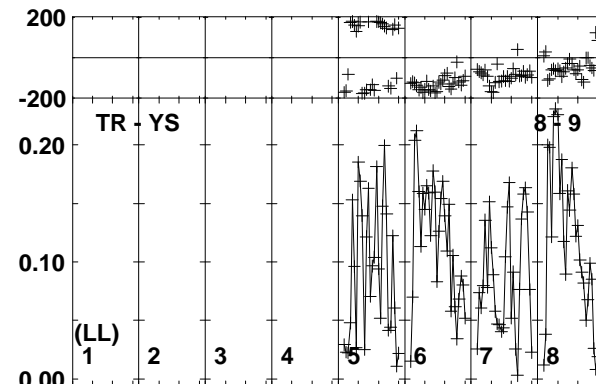
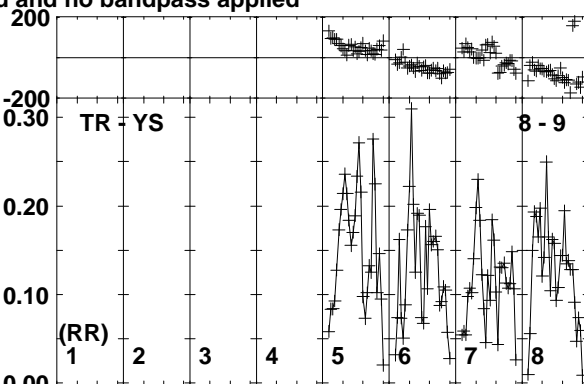
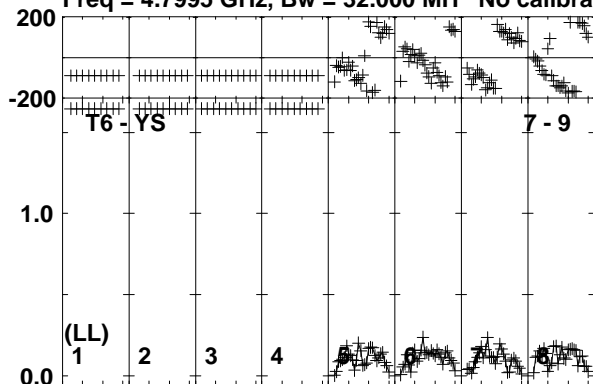

Lower frame: Milli Ampl Jy Top frame: Phas deg
Vector averaged cross-power spectrum Baseline: T6 (07) - YS (09)
Timerange: 00/16:46:01 to 00/16:49:29

Plot file version 125 created 20-APR-2018 10:31:47

J0915+0745 EG102C.UVDATA.1

Freq = 4.7995 GHz, Bw = 32.000 MH No calibration applied and no bandpass applied

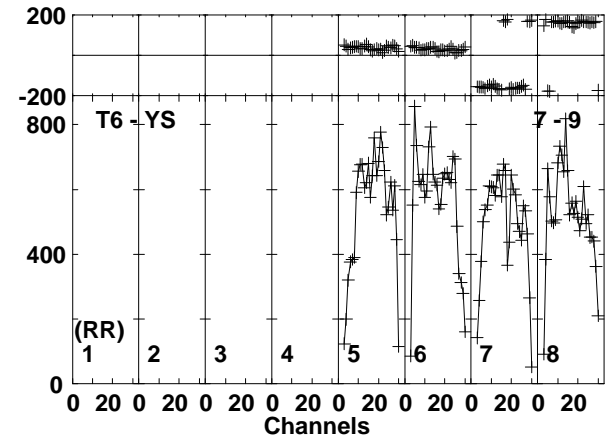
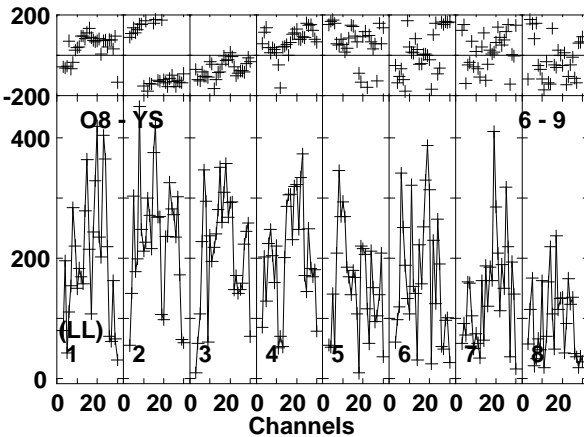
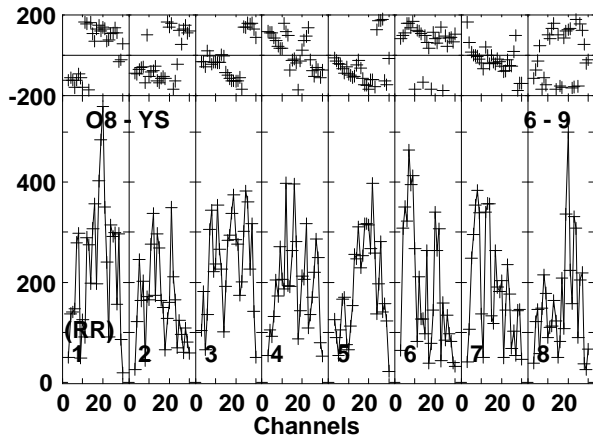
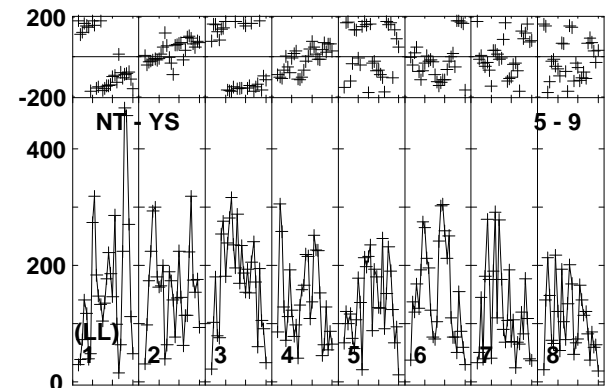
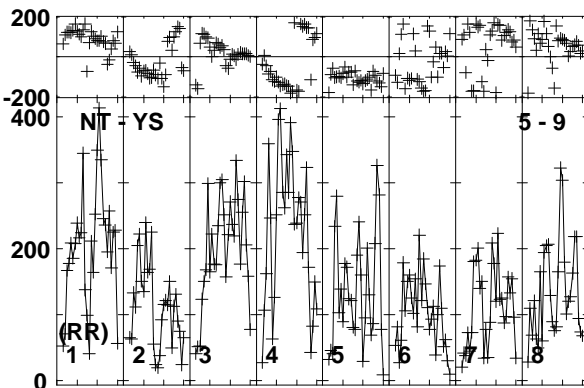
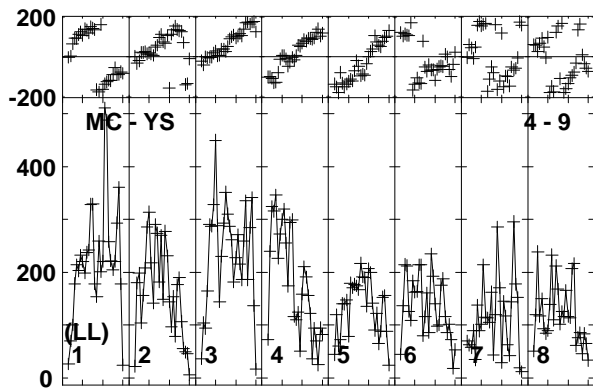
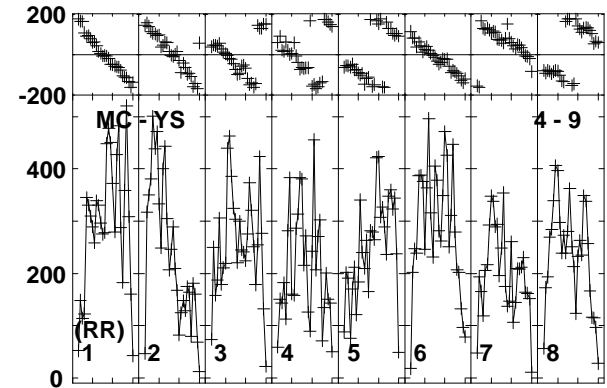
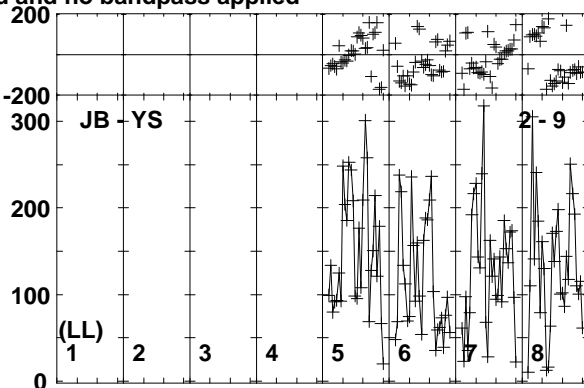
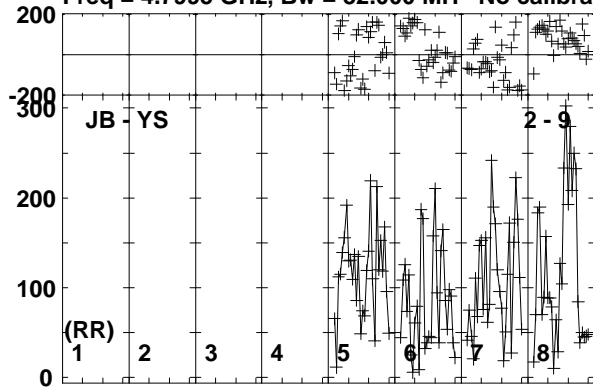

Lower frame: Micro Ampl Jy Top frame: Phas deg
Vector averaged cross-power spectrum Baseline: JB (02) - YS (09)
Timerange: 00/16:50:11 to 00/16:51:09

Plot file version 126 created 20-APR-2018 10:31:47

J0915+0745 EG102C.UVDATA.1

Freq = 4.7995 GHz, Bw = 32.000 MH No calibration applied and no bandpass applied

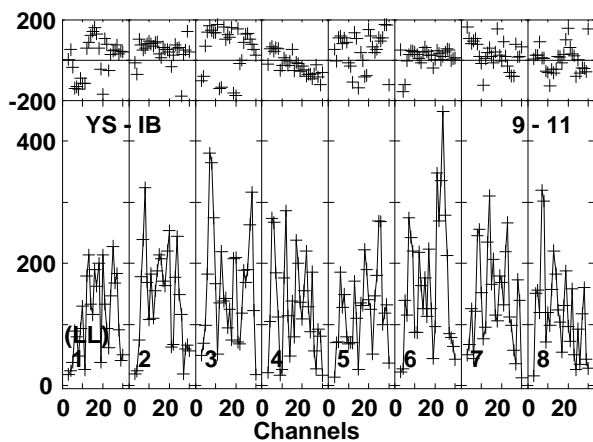
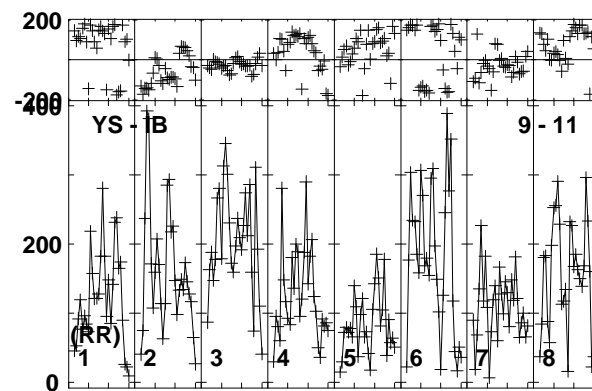
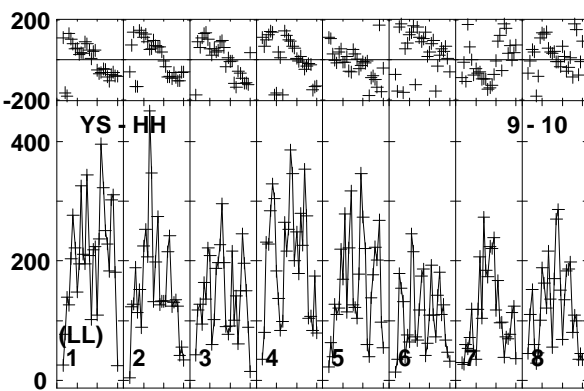
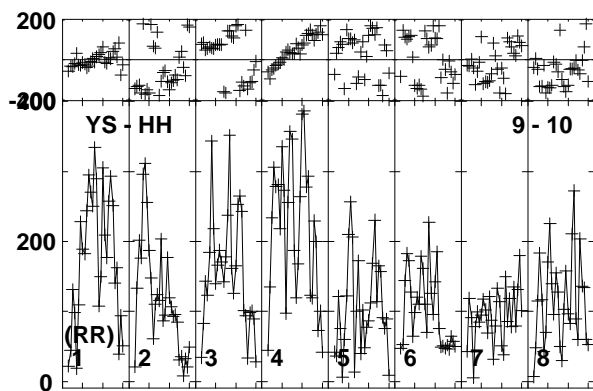
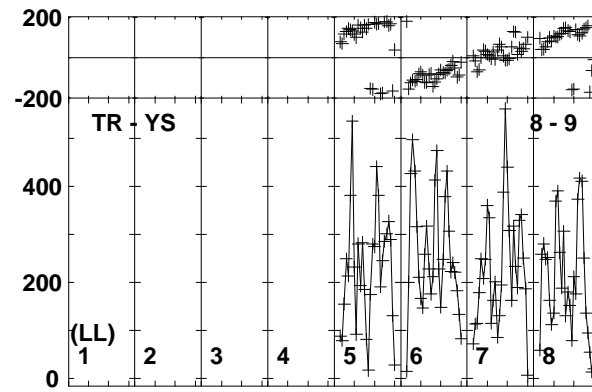
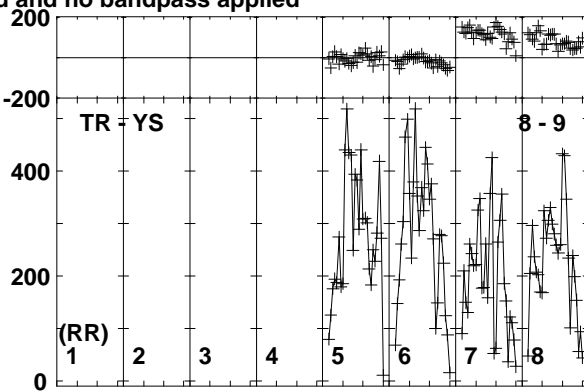
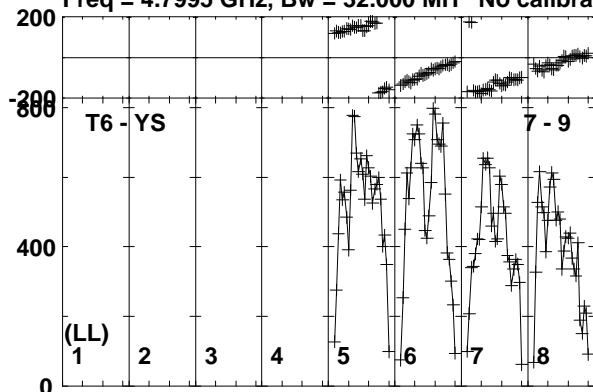

Lower frame: Micro Ampl Jy Top frame: Phas deg
Vector averaged cross-power spectrum Baseline: T6 (07) - YS (09)
Timerange: 00/16:50:11 to 00/16:51:09

Plot file version 127 created 20-APR-2018 10:31:47

B0915+068 EG102C.UVDATA.1

Freq = 4.7995 GHz, Bw = 32.000 MH No calibration applied and no bandpass applied

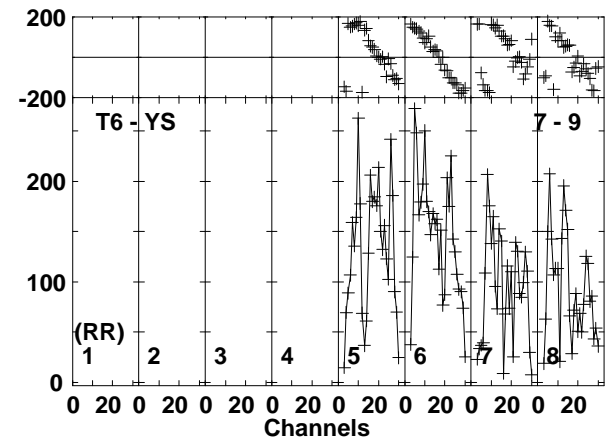
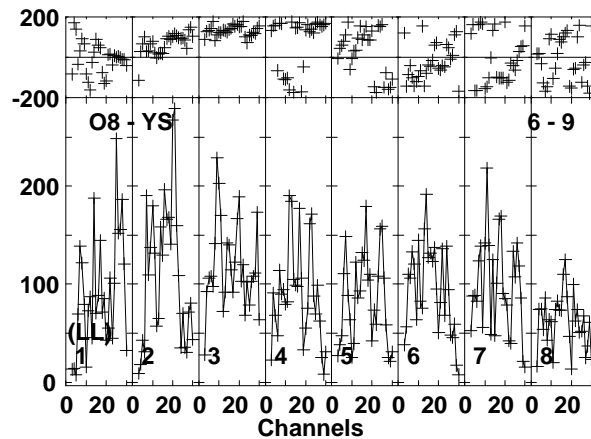
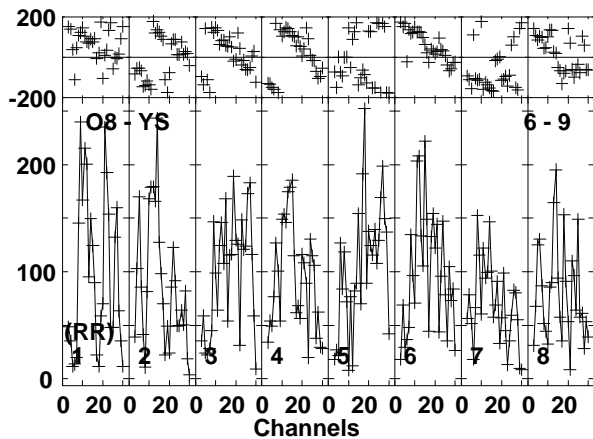
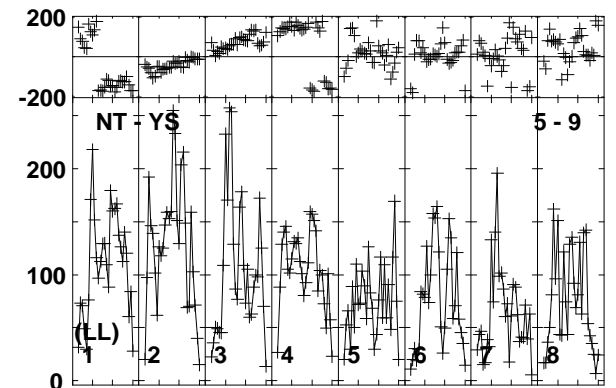
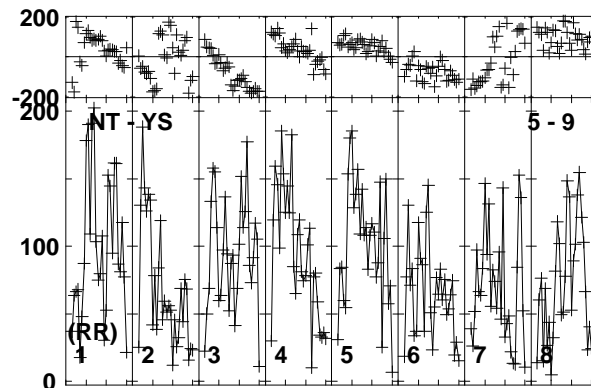
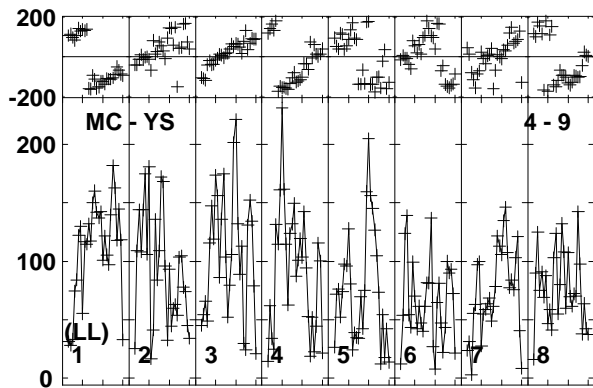
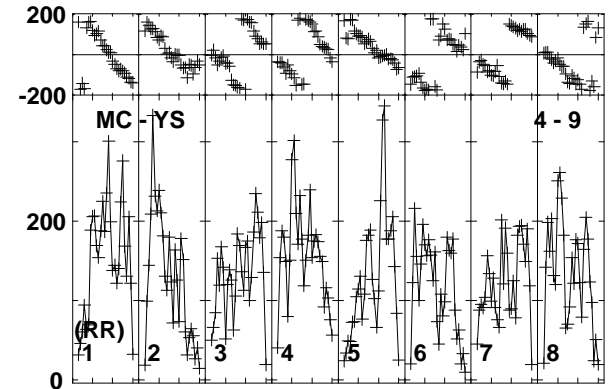
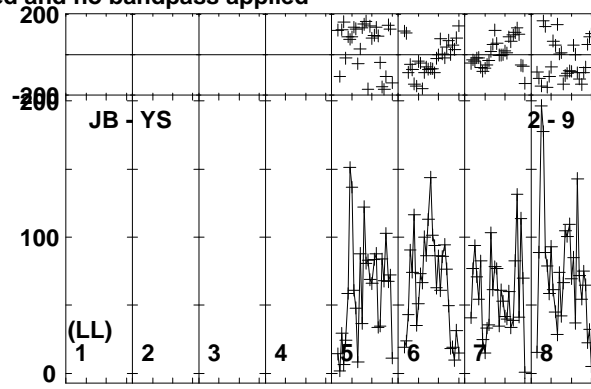
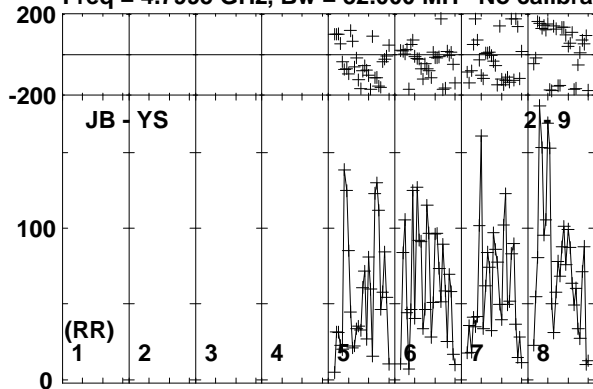

Lower frame: Micro Ampl Jy Top frame: Phas deg
Vector averaged cross-power spectrum Baseline: JB (02) - YS (09)
Timerange: 00/16:51:11 to 00/16:54:39

Plot file version 128 created 20-APR-2018 10:31:47

B0915+068 EG102C.UVDATA.1

Freq = 4.7995 GHz, Bw = 32.000 MH No calibration applied and no bandpass applied

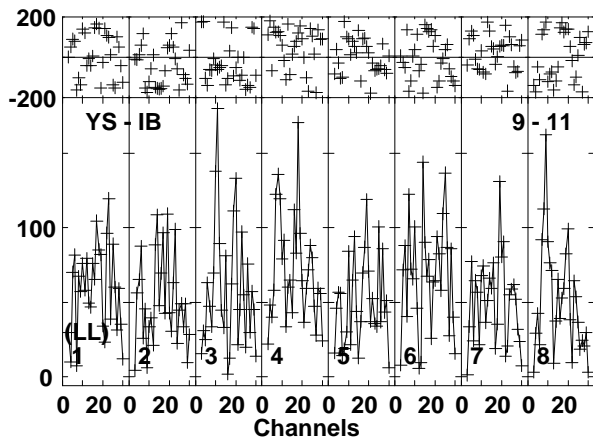
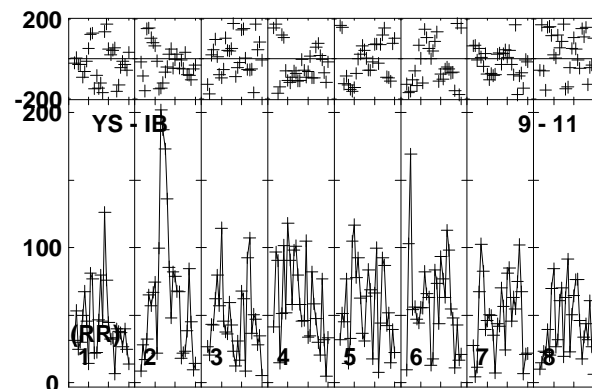
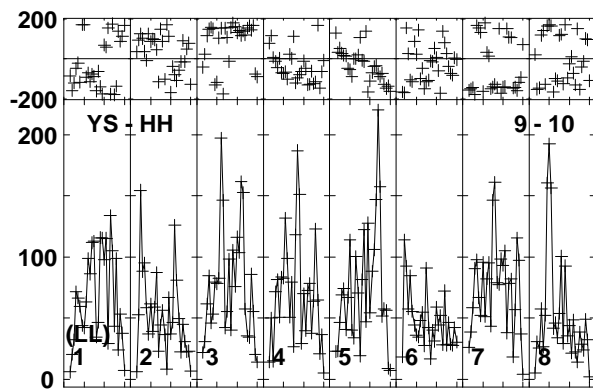
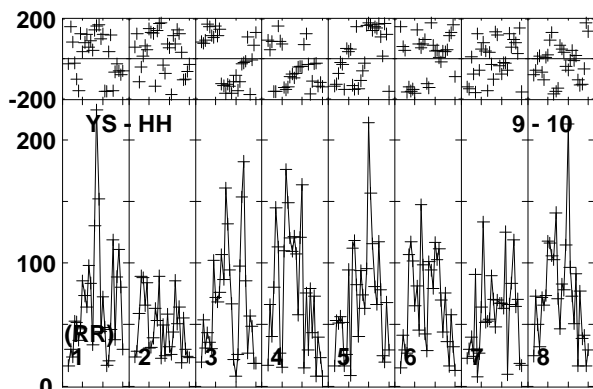
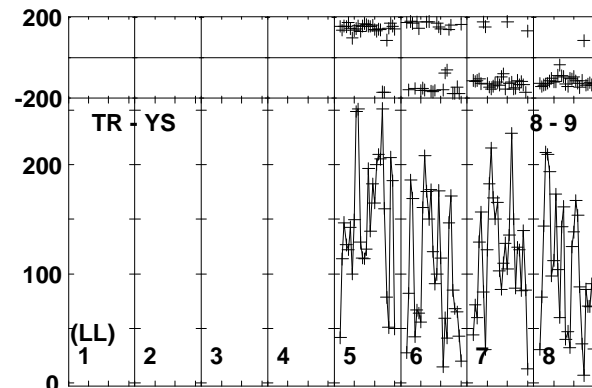
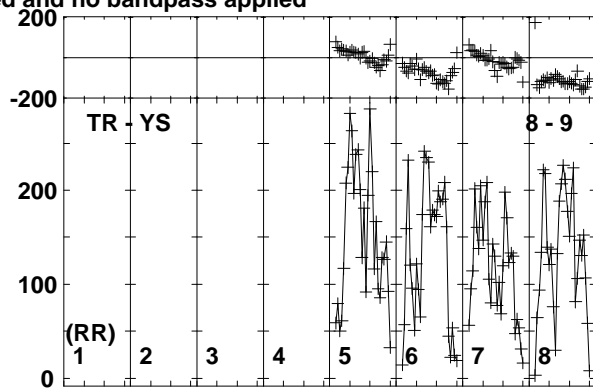
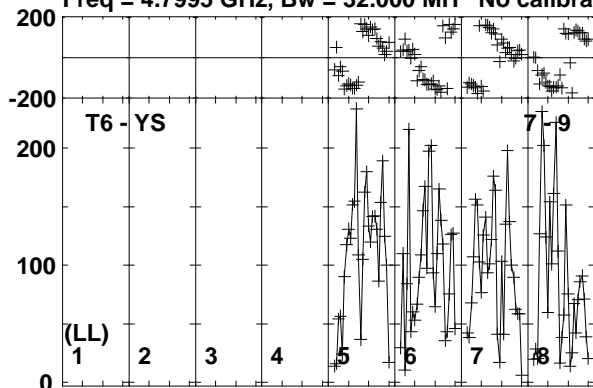

Lower frame: Micro Ampl Jy Top frame: Phas deg
Vector averaged cross-power spectrum Baseline: T6 (07) - YS (09)
Timerange: 00/16:51:11 to 00/16:54:39

Plot file version 129 created 20-APR-2018 10:31:47

J0915+0745 EG102C.UVDATA.1

Freq = 4.7995 GHz, Bw = 32.000 MH No calibration applied and no bandpass applied

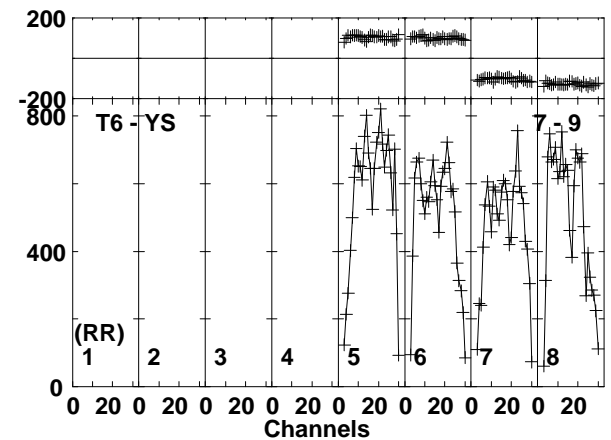
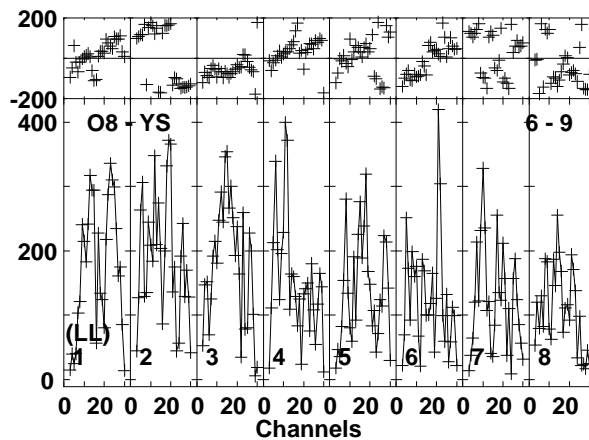
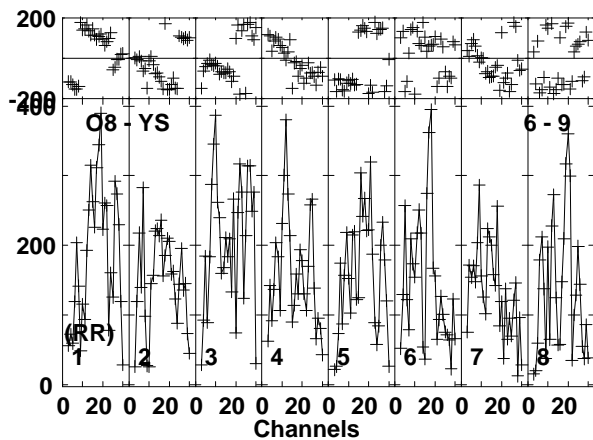
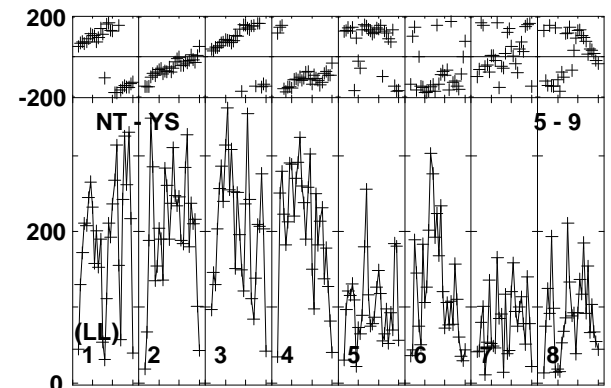
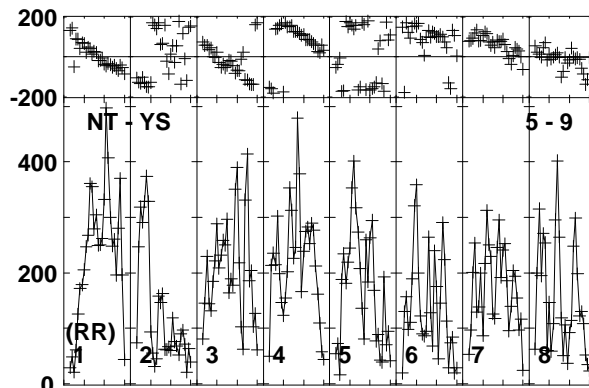
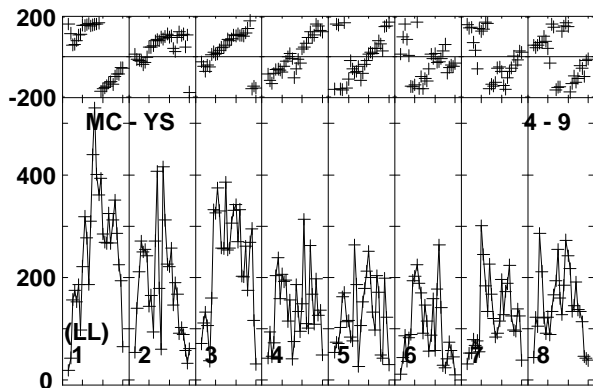
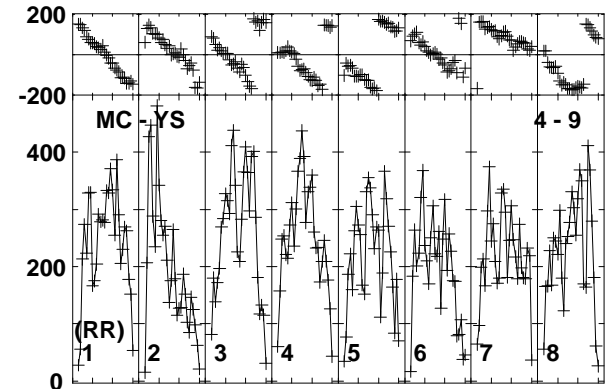
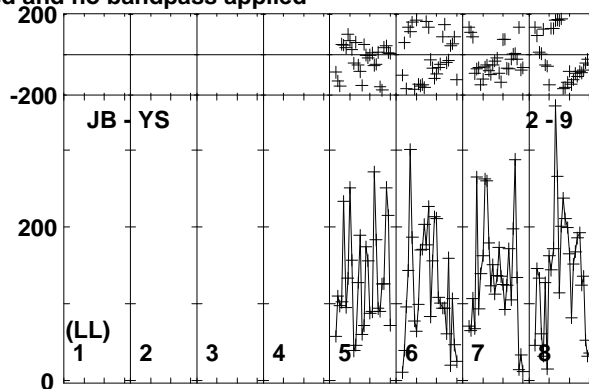
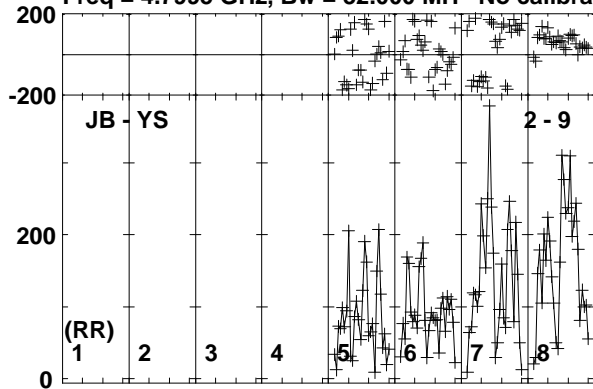

Lower frame: Micro Ampl Jy Top frame: Phas deg
Vector averaged cross-power spectrum Baseline: JB (02) - YS (09)
Timerange: 00/16:54:41 to 00/16:56:09

Plot file version 130 created 20-APR-2018 10:31:47

J0915+0745 EG102C.UVDATA.1

Freq = 4.7995 GHz, Bw = 32.000 MH No calibration applied and no bandpass applied

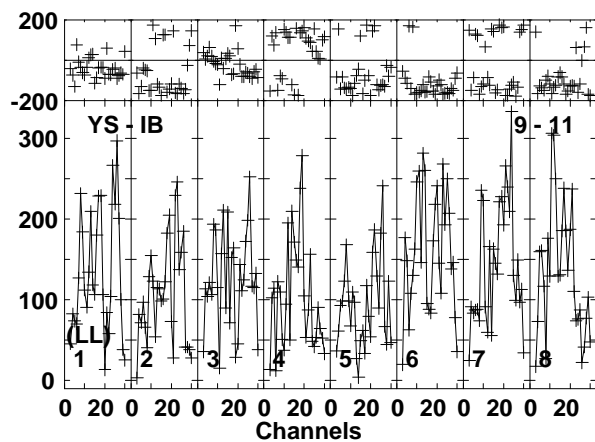
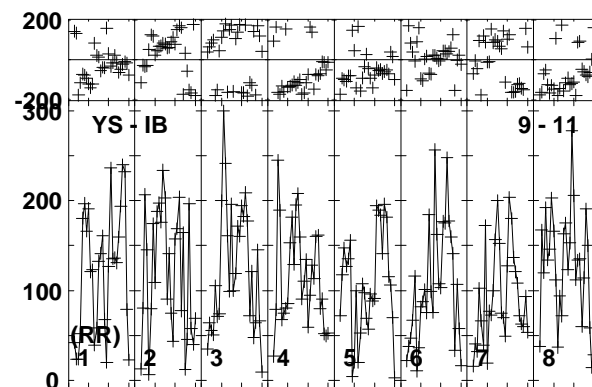
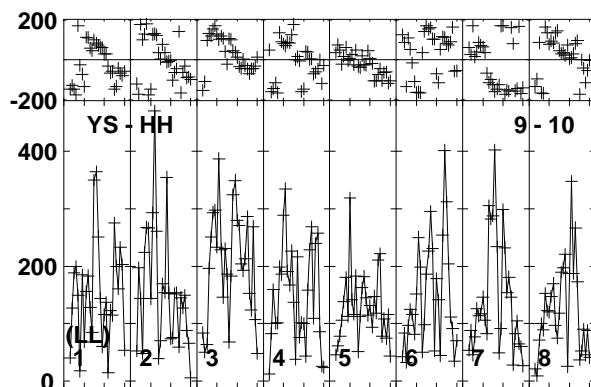
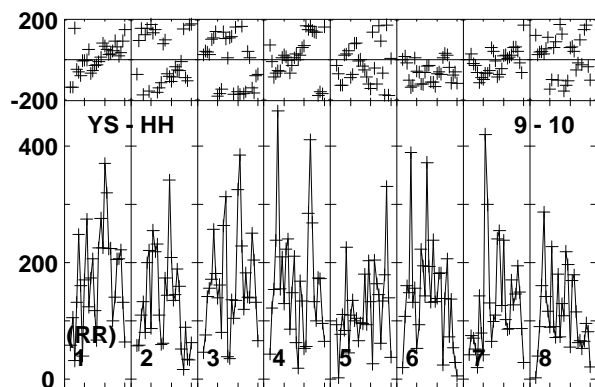
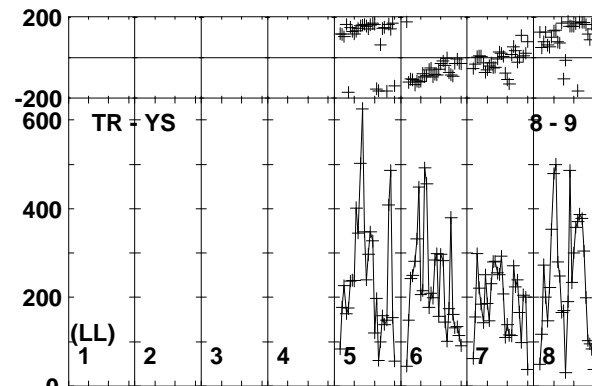
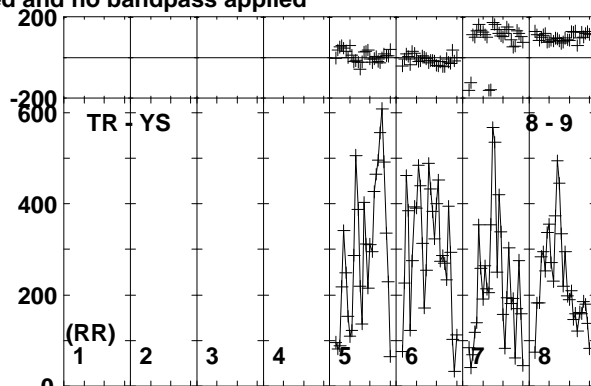
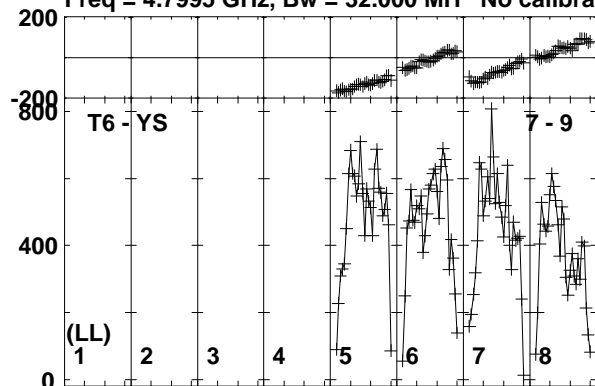

Lower frame: Micro Ampl Jy Top frame: Phas deg
Vector averaged cross-power spectrum Baseline: T6 (07) - YS (09)
Timerange: 00/16:54:41 to 00/16:56:09

Plot file version 131 created 20-APR-2018 10:31:47

B0915+068 EG102C.UVDATA.1

Freq = 4.7995 GHz, Bw = 32.000 MH No calibration applied and no bandpass applied

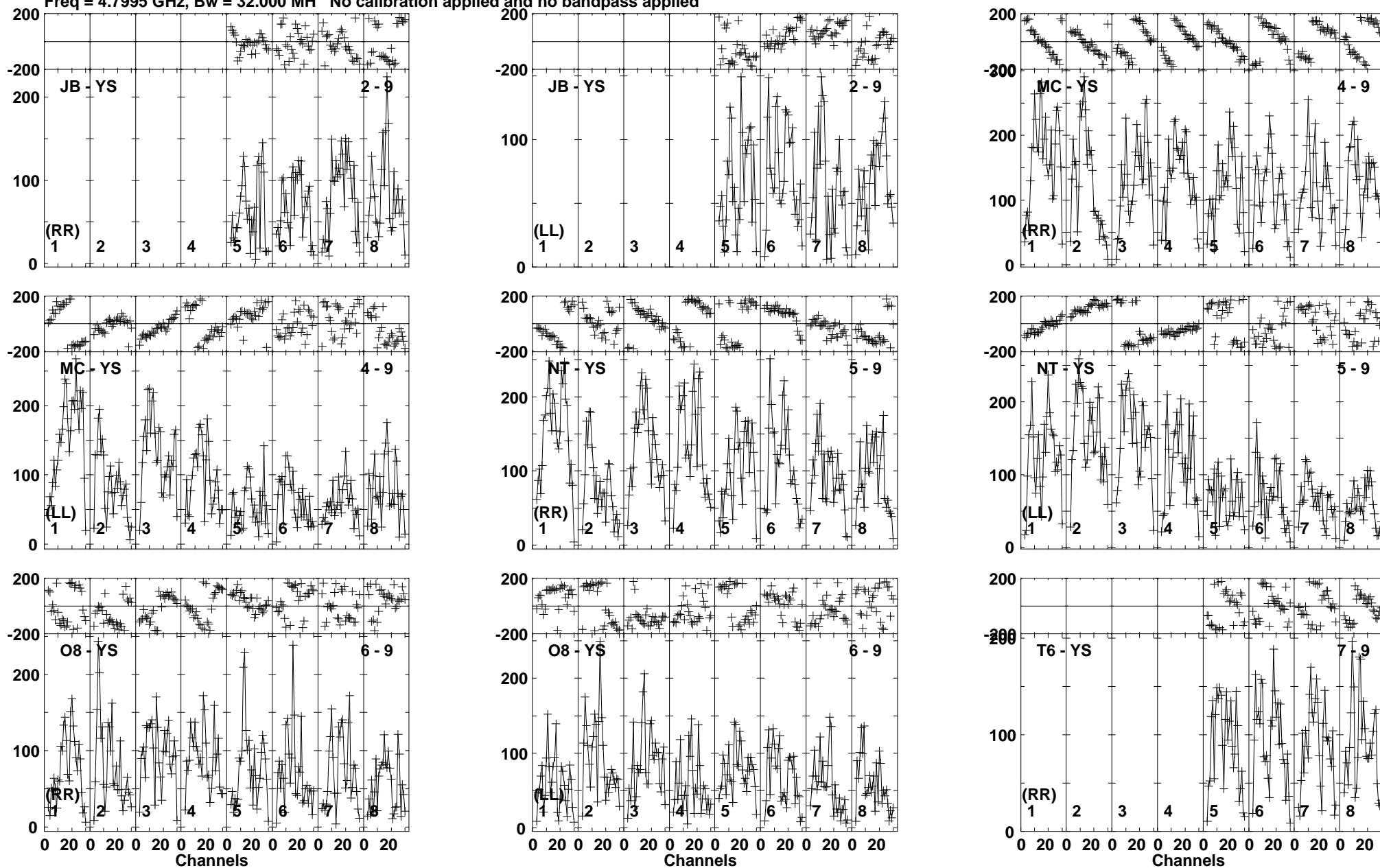

Lower frame: Micro Ampl Jy Top frame: Phas deg
Vector averaged cross-power spectrum Baseline: JB (02) - YS (09)
Timerange: 00/16:56:11 to 00/16:59:39

Plot file version 132 created 20-APR-2018 10:31:47

B0915+068 EG102C.UVDATA.1

Freq = 4.7995 GHz, Bw = 32.000 MH No calibration applied and no bandpass applied

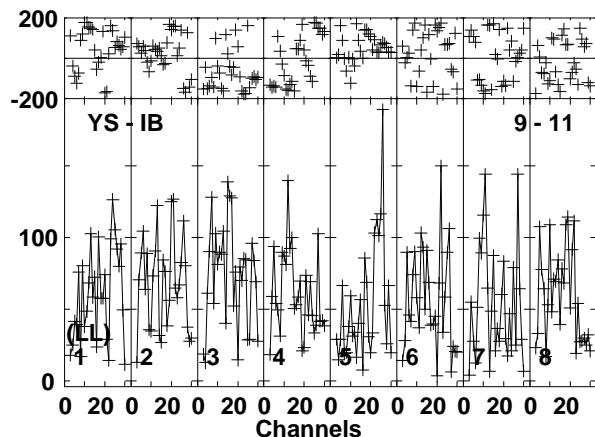
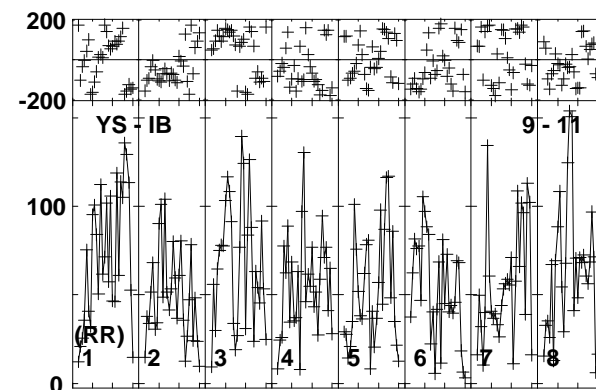
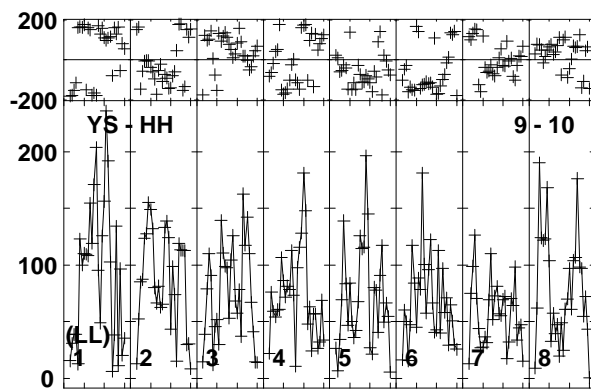
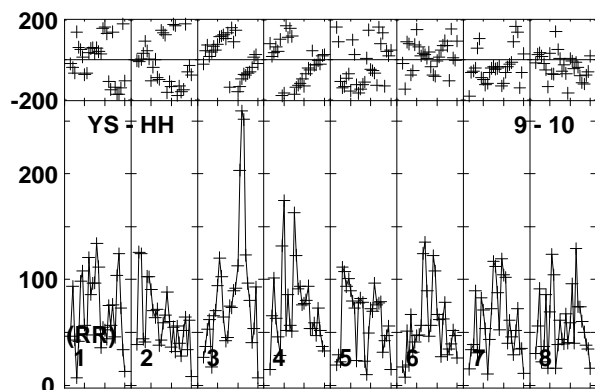
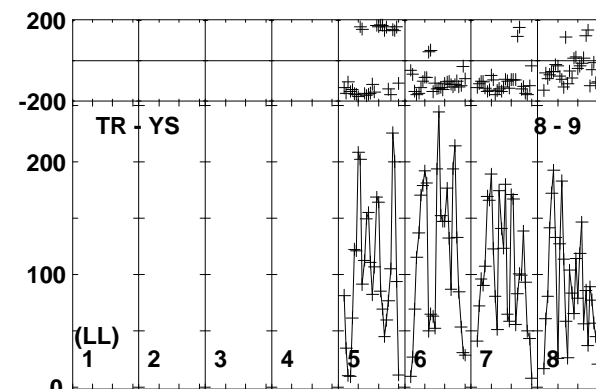
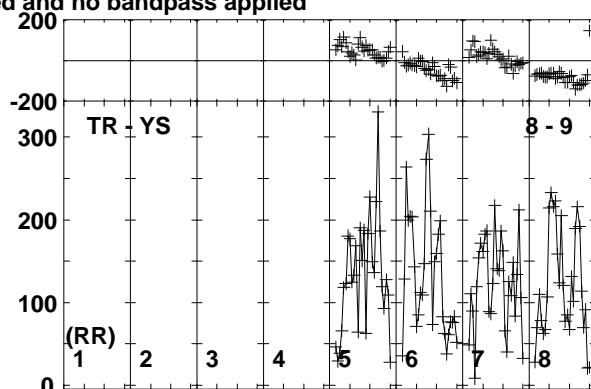
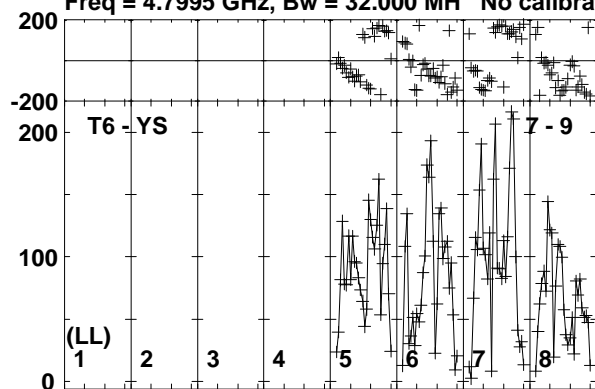

Lower frame: Micro Ampl Jy Top frame: Phas deg
Vector averaged cross-power spectrum Baseline: T6 (07) - YS (09)
Timerange: 00/16:56:11 to 00/16:59:39

Plot file version 133 created 20-APR-2018 10:31:48

J0915+0745 EG102C.UVDATA.1

Freq = 4.7995 GHz, Bw = 32.000 MH No calibration applied and no bandpass applied

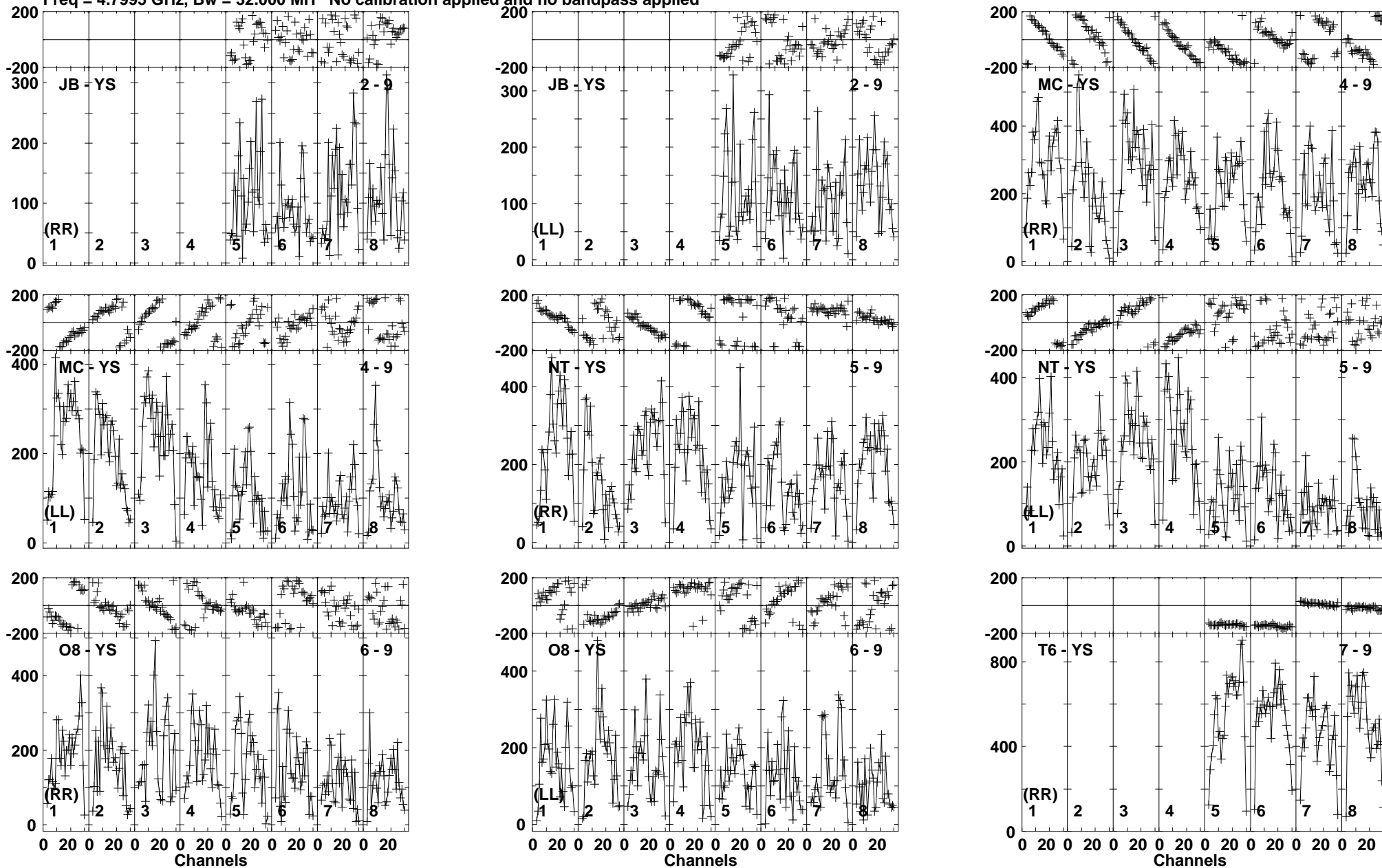

Lower frame: Micro Ampl Jy Top frame: Phas deg
Vector averaged cross-power spectrum Baseline: JB (02) - YS (09)
Timerange: 00/16:59:41 to 00/17:01:09

Plot file version 134 created 20-APR-2018 10:31:48

J0915+0745 EG102C.UVDATA.1

Freq = 4.7995 GHz, Bw = 32.000 MH No calibration applied and no bandpass applied

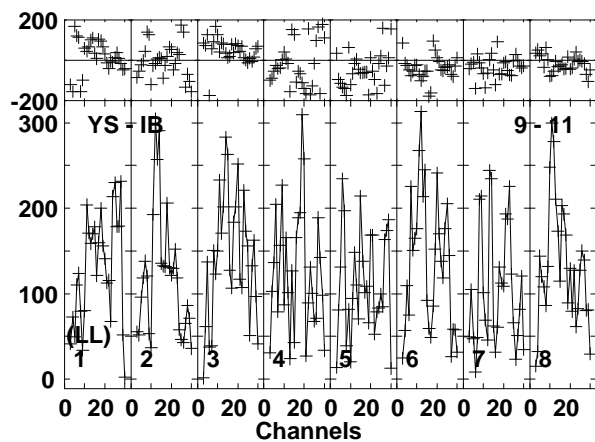
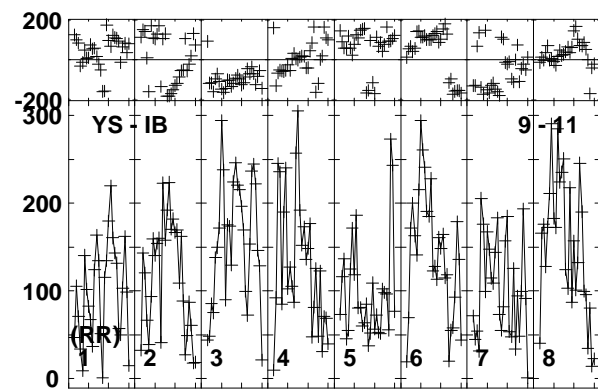
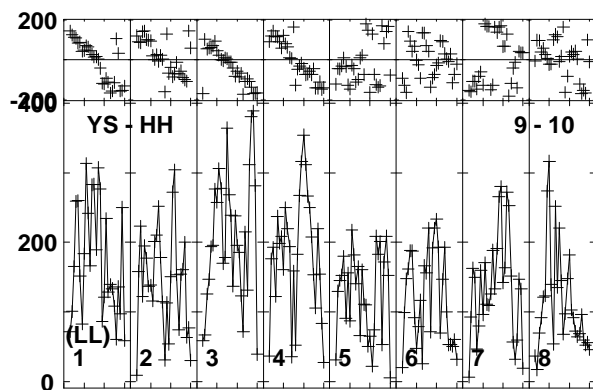
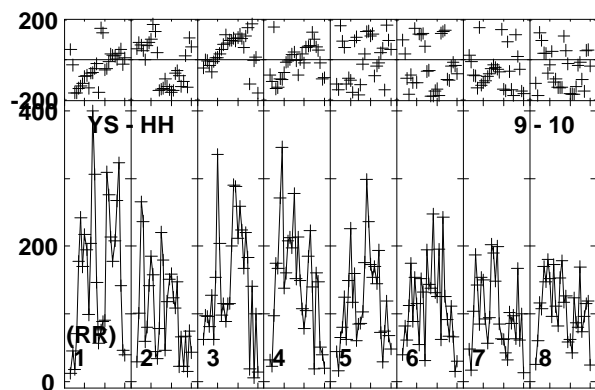
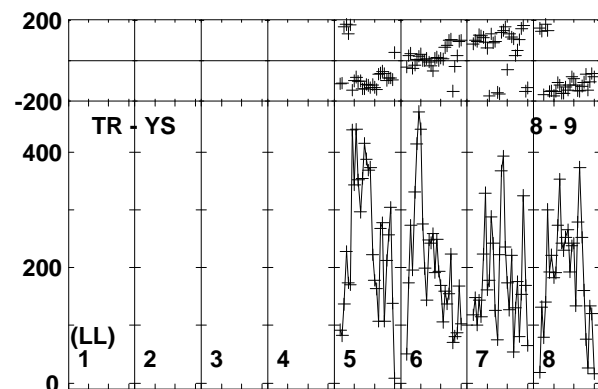
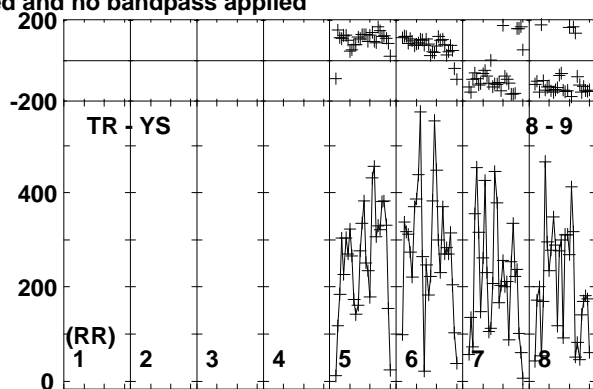
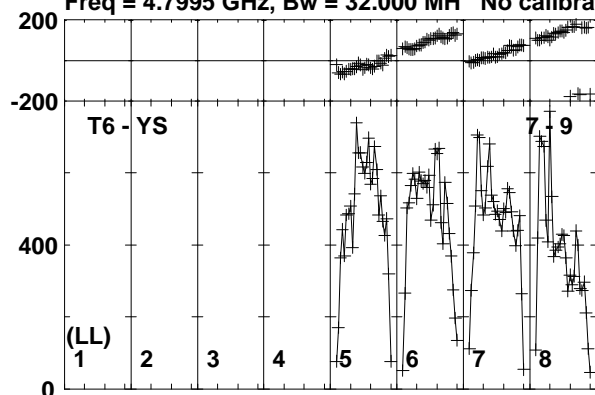

Lower frame: Micro Ampl Jy Top frame: Phas deg
Vector averaged cross-power spectrum Baseline: T6 (07) - YS (09)
Timerange: 00/16:59:41 to 00/17:01:09

Plot file version 135 created 20-APR-2018 10:31:48

B0915+068 EG102C.UVDATA.1

Freq = 4.7995 GHz, Bw = 32.000 MH No calibration applied and no bandpass applied

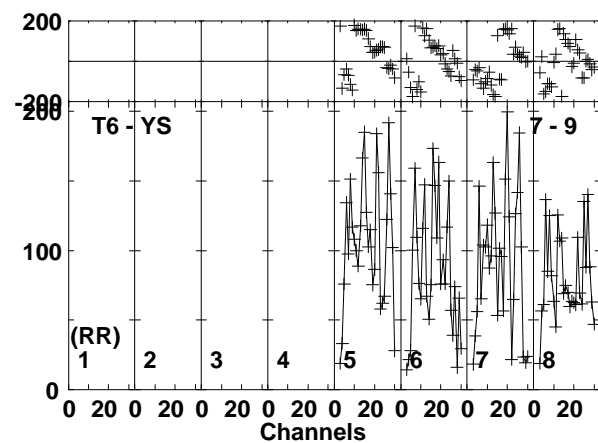
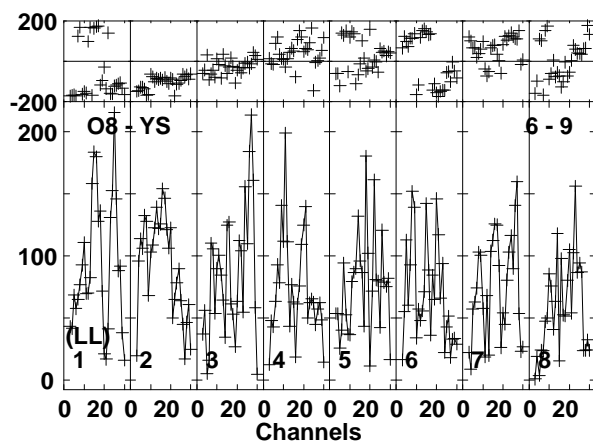
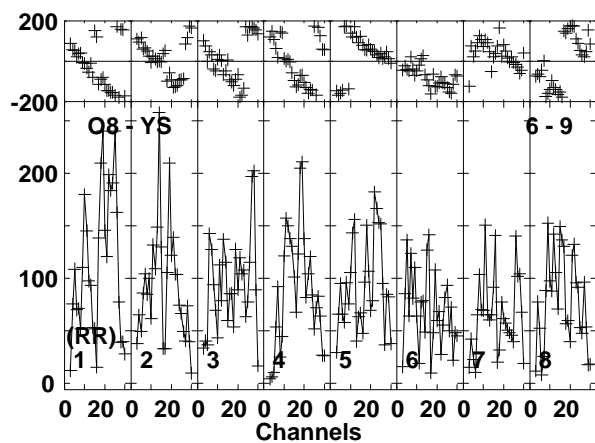
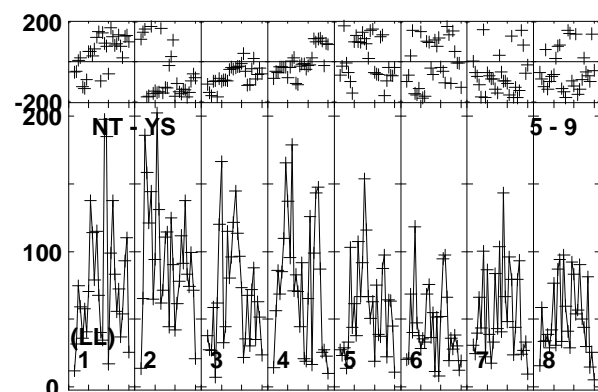
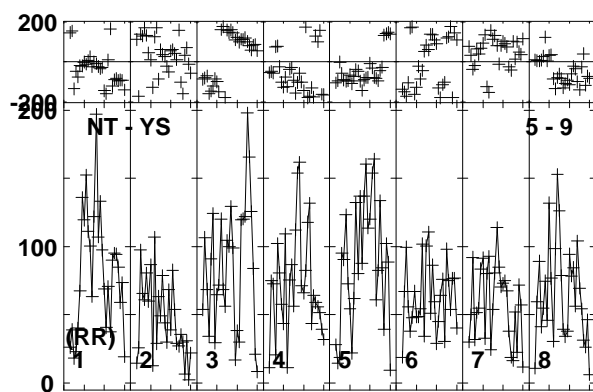
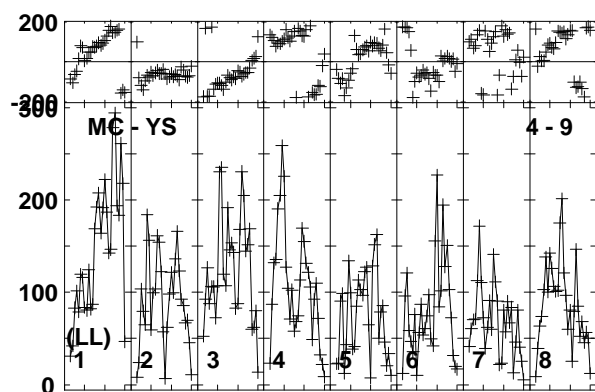
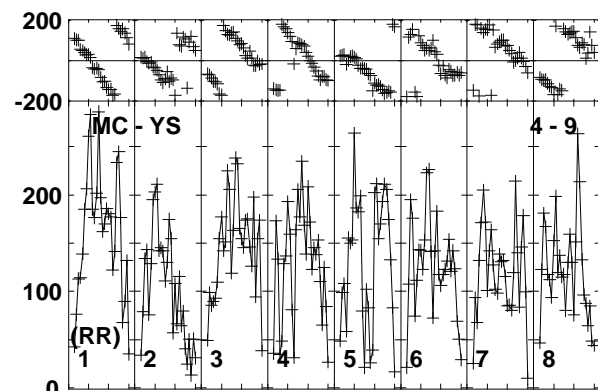
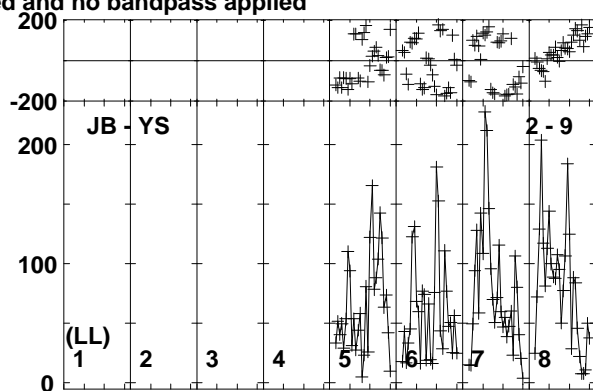
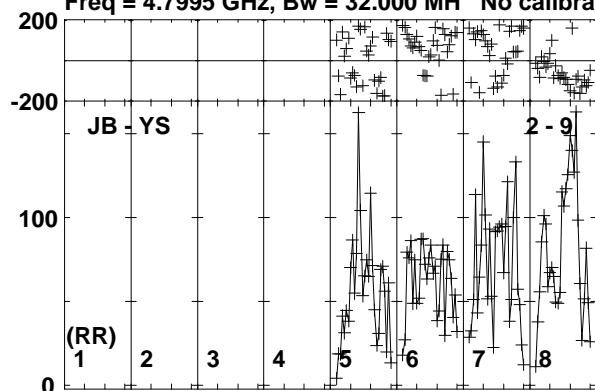

Lower frame: Micro Ampl Jy Top frame: Phas deg
Vector averaged cross-power spectrum Baseline: JB (02) - YS (09)
Timerange: 00/17:01:11 to 00/17:04:39

Plot file version 136 created 20-APR-2018 10:31:48

B0915+068 EG102C.UVDATA.1

Freq = 4.7995 GHz, Bw = 32.000 MH No calibration applied and no bandpass applied

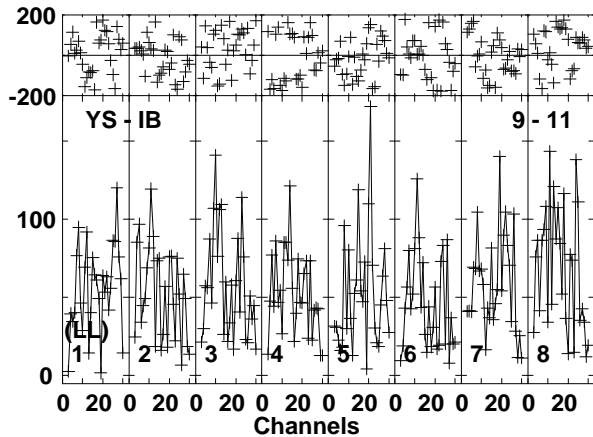
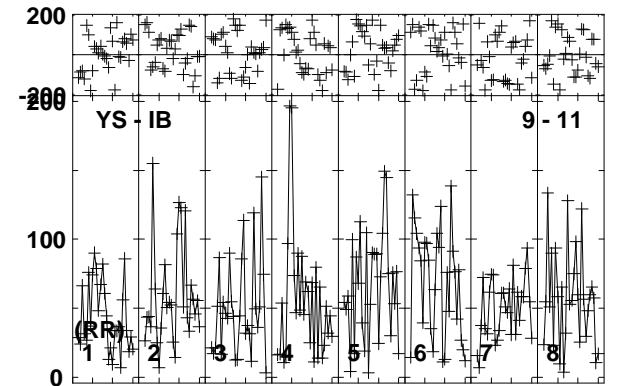
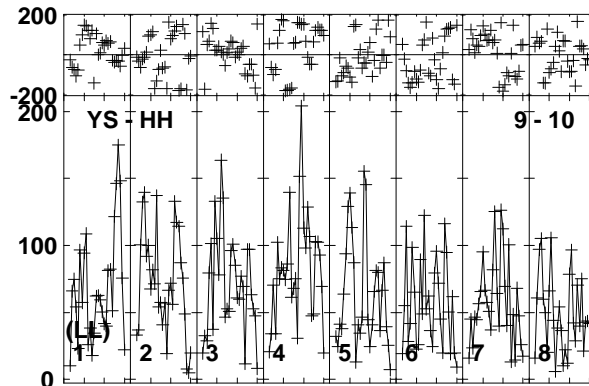
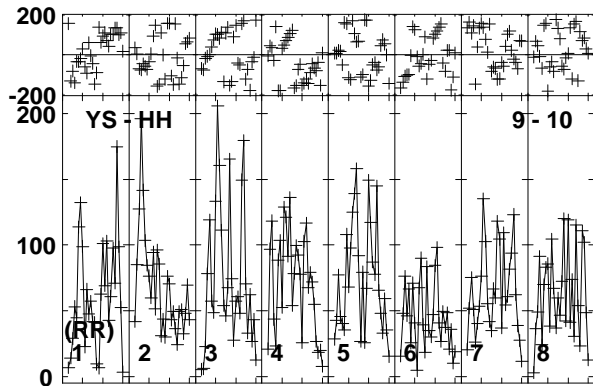
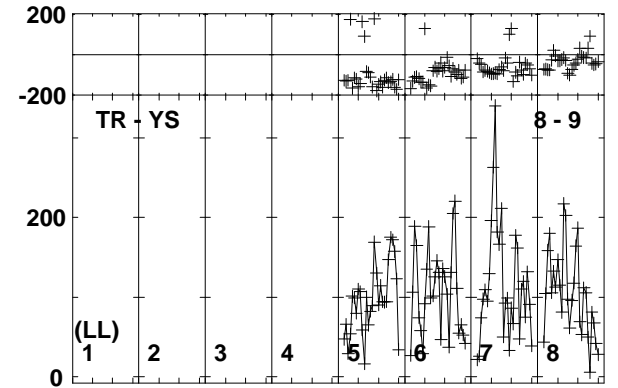
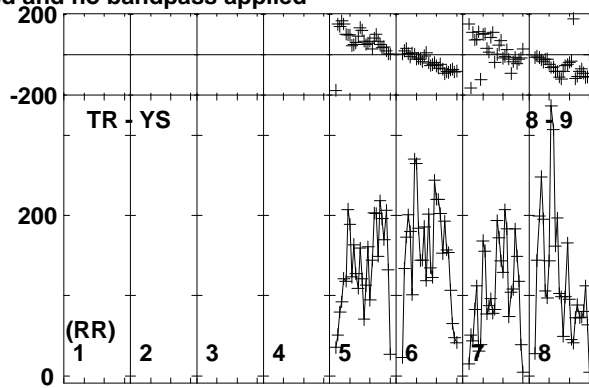
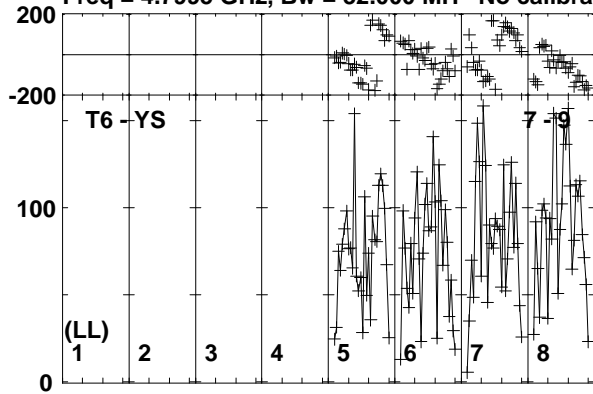

Lower frame: Micro Ampl Jy Top frame: Phas deg
Vector averaged cross-power spectrum Baseline: T6 (07) - YS (09)
Timerange: 00/17:01:11 to 00/17:04:39

Plot file version 137 created 20-APR-2018 10:31:48

J0915+0745 EG102C.UVDATA.1

Freq = 4.7995 GHz, Bw = 32.000 MH No calibration applied and no bandpass applied

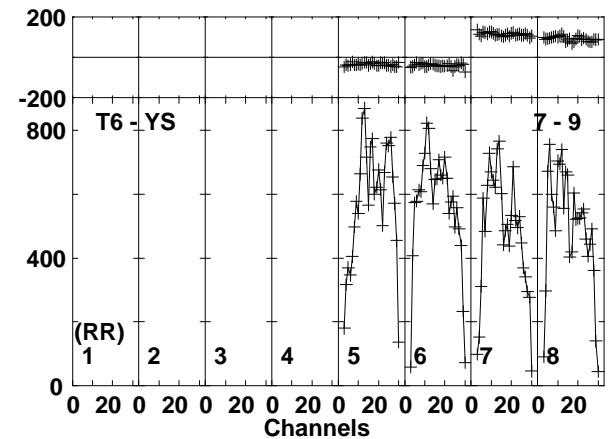
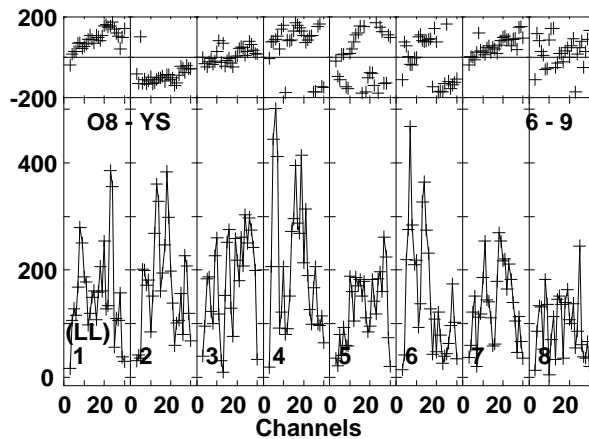
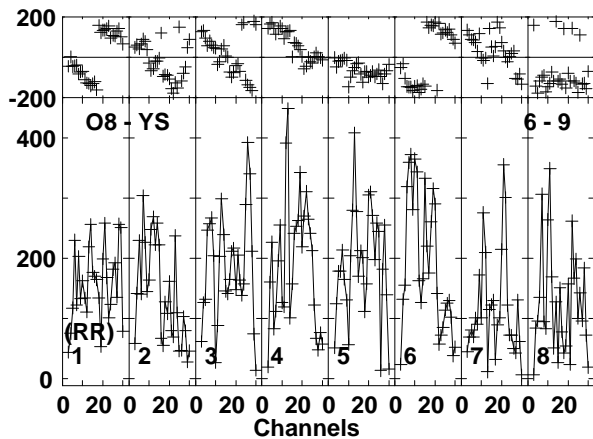
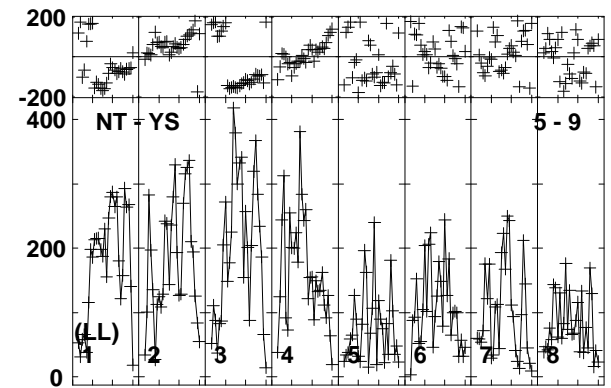
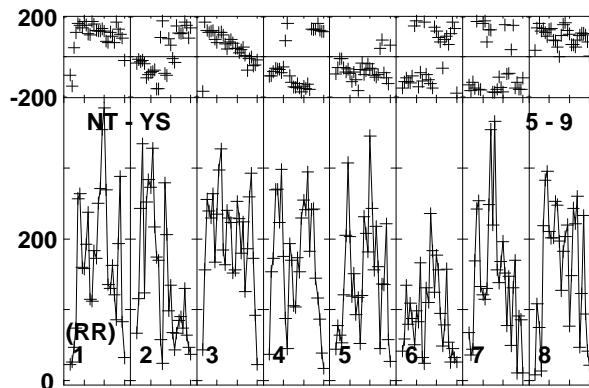
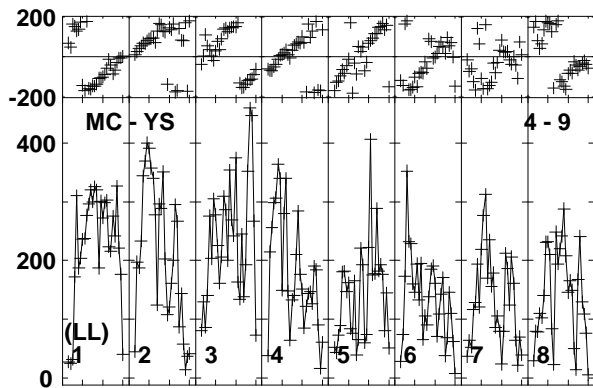
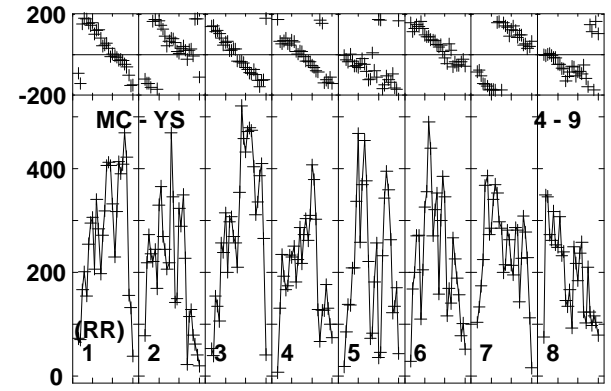
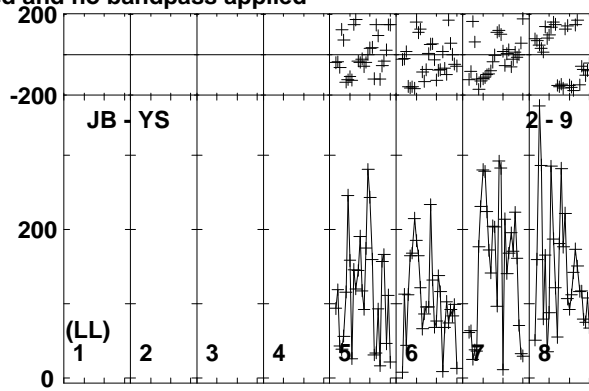
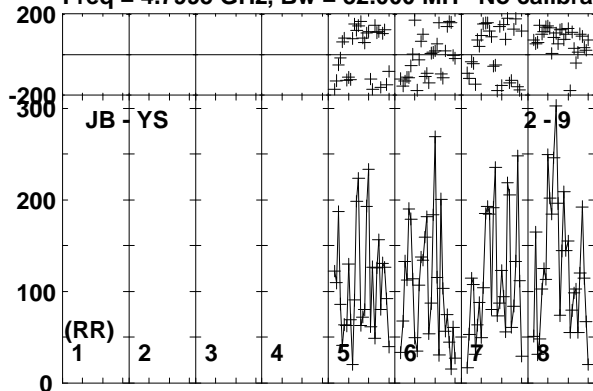

Lower frame: Micro Ampl Jy Top frame: Phas deg
Vector averaged cross-power spectrum Baseline: JB (02) - YS (09)
Timerange: 00/17:05:21 to 00/17:06:19

Plot file version 138 created 20-APR-2018 10:31:48

J0915+0745 EG102C.UVDATA.1

Freq = 4.7995 GHz, Bw = 32.000 MH No calibration applied and no bandpass applied

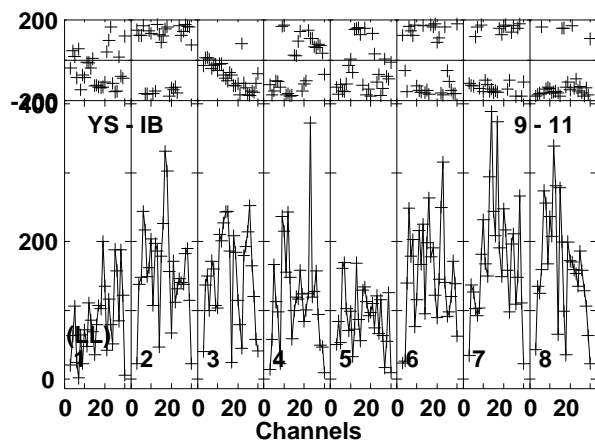
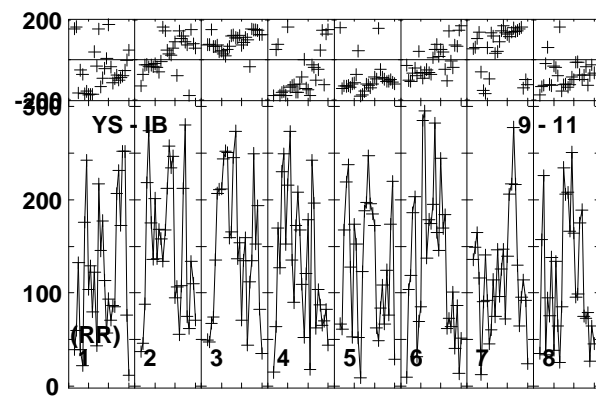
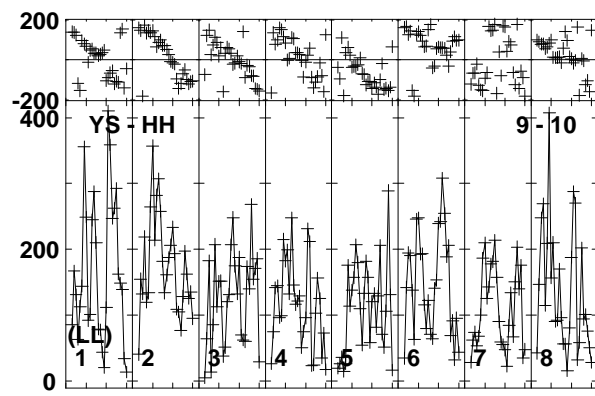
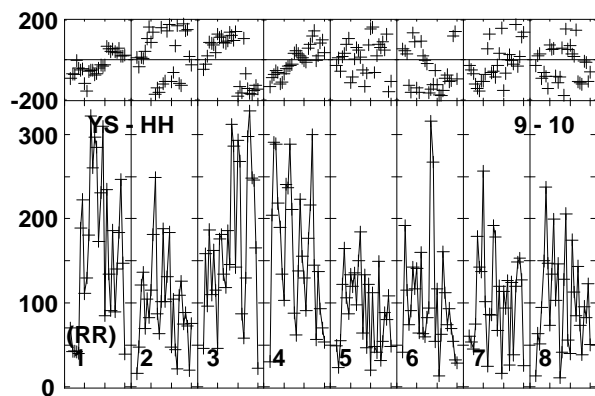
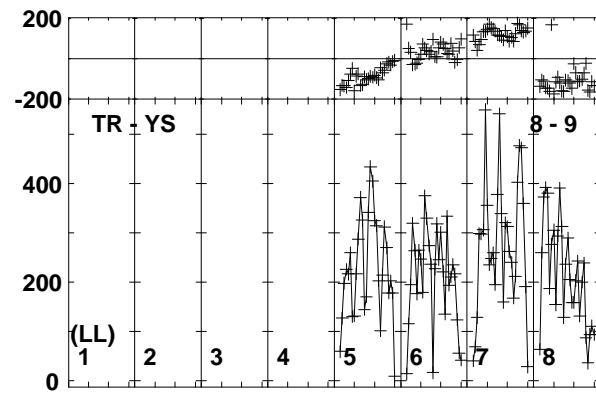
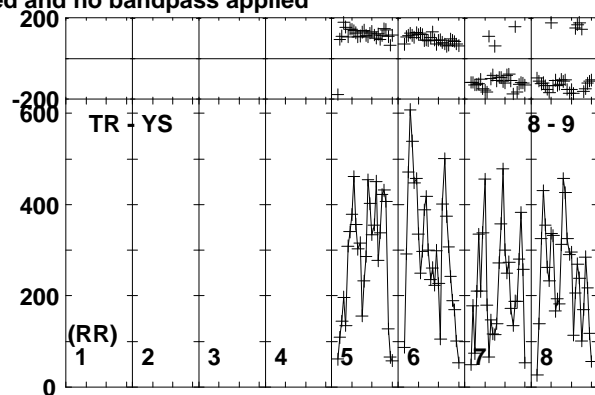
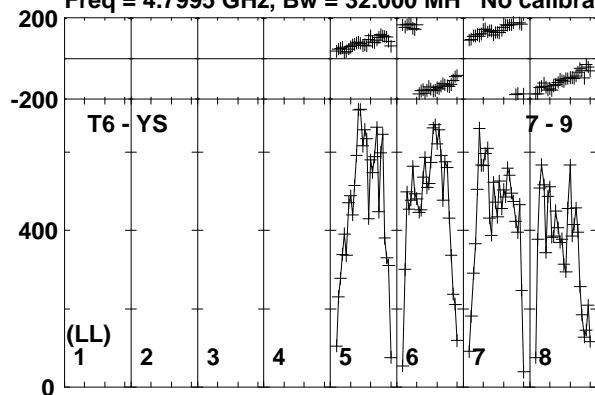

Lower frame: Micro Ampl Jy Top frame: Phas deg
Vector averaged cross-power spectrum Baseline: T6 (07) - YS (09)
Timerange: 00/17:05:21 to 00/17:06:19

Plot file version 139 created 20-APR-2018 10:31:48

B0915+068 EG102C.UVDATA.1

Freq = 4.7995 GHz, Bw = 32.000 MH No calibration applied and no bandpass applied

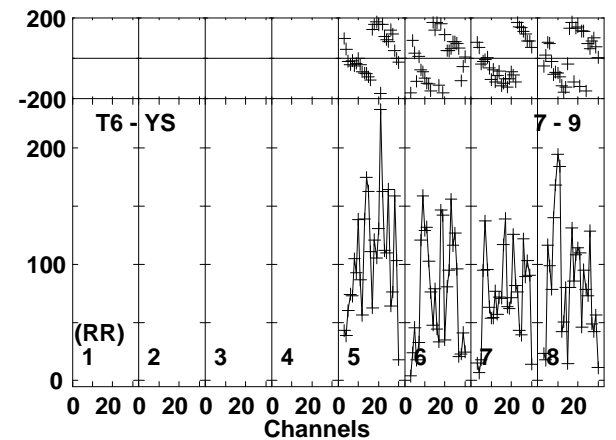
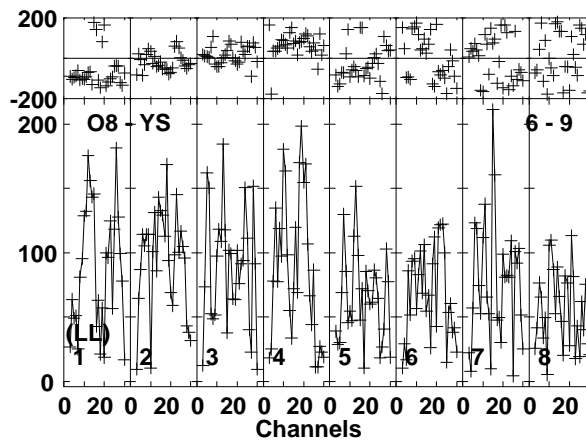
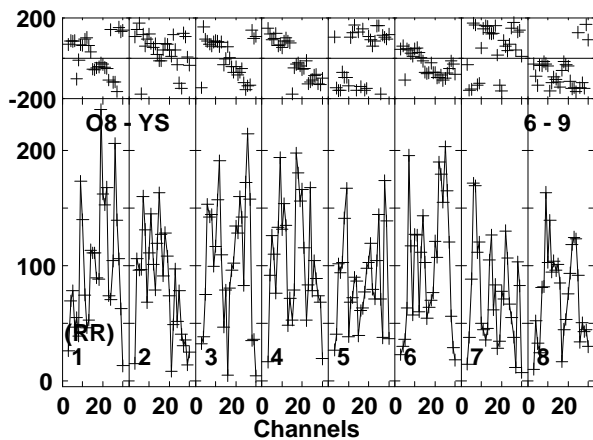
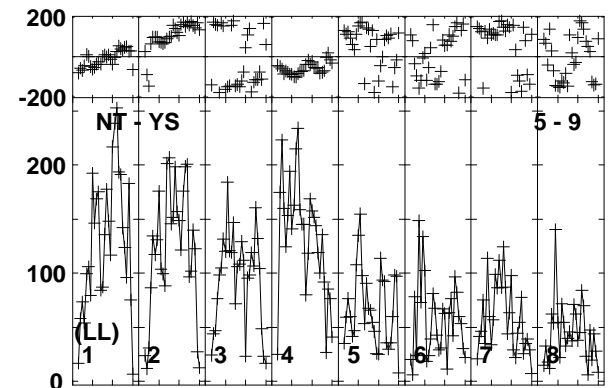
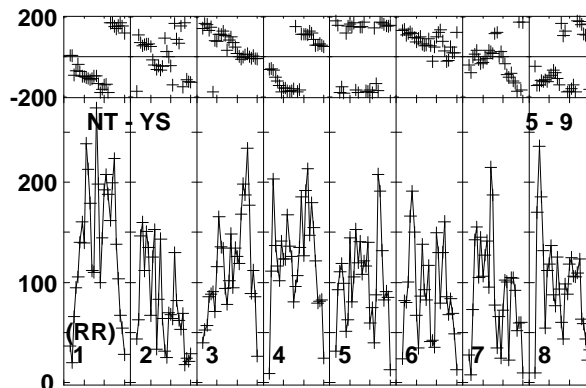
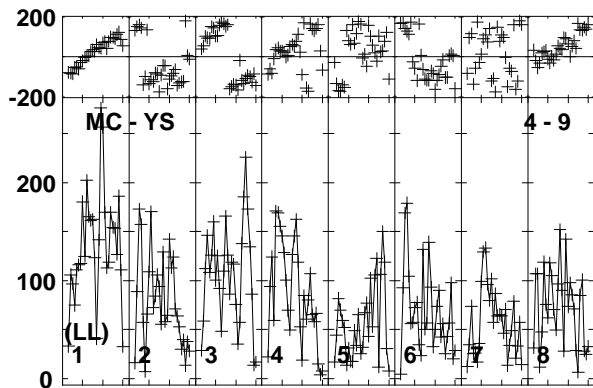
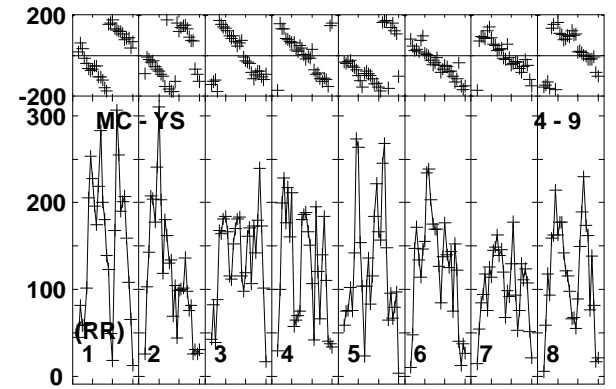
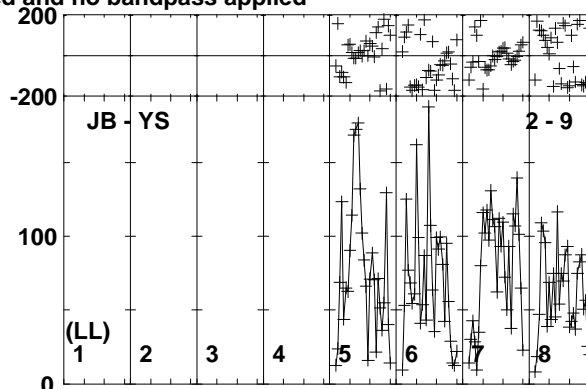
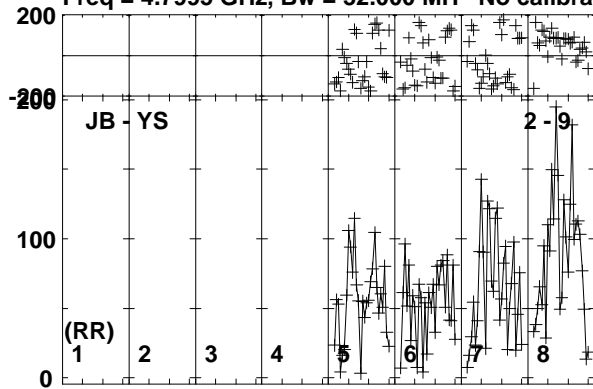

Lower frame: Micro Ampl Jy Top frame: Phas deg
Vector averaged cross-power spectrum Baseline: JB (02) - YS (09)
Timerange: 00/17:06:21 to 00/17:09:49

Plot file version 140 created 20-APR-2018 10:31:48

B0915+068 EG102C.UVDATA.1

Freq = 4.7995 GHz, Bw = 32.000 MH No calibration applied and no bandpass applied

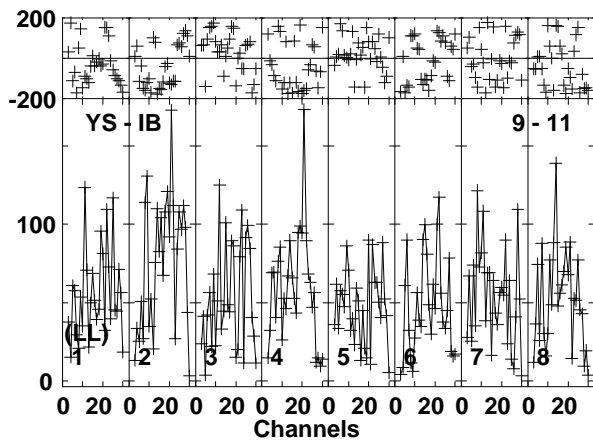
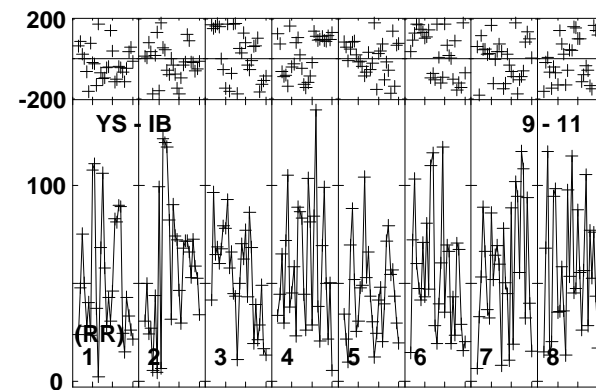
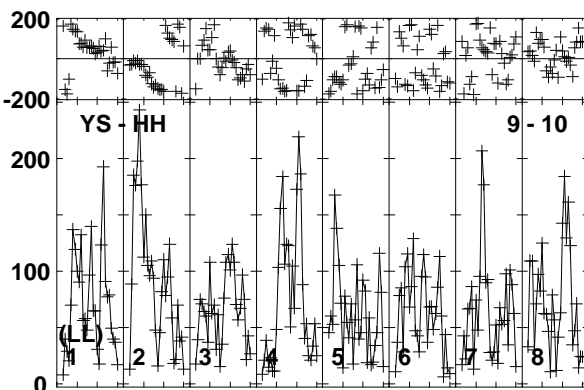
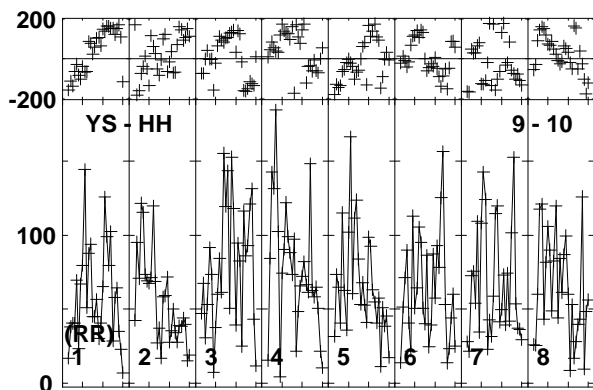
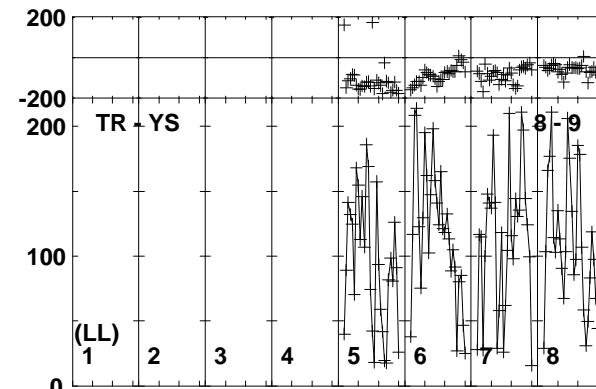
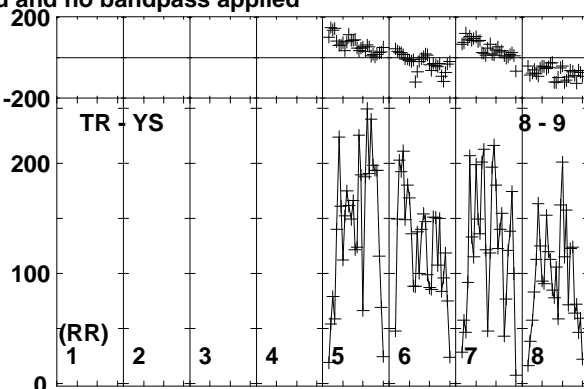
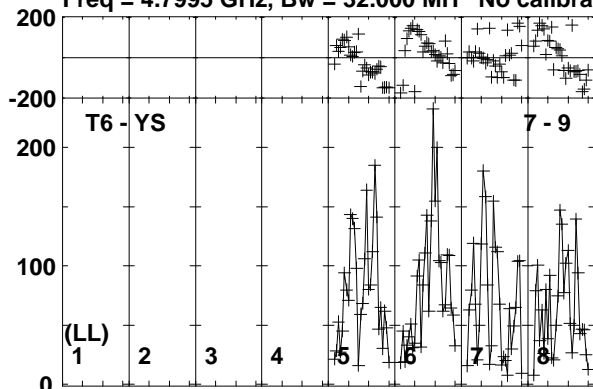

Lower frame: Micro Ampl Jy Top frame: Phas deg
Vector averaged cross-power spectrum Baseline: T6 (07) - YS (09)
Timerange: 00/17:06:21 to 00/17:09:49

Plot file version 141 created 20-APR-2018 10:31:48

J0915+0745 EG102C.UVDATA.1

Freq = 4.7995 GHz, Bw = 32.000 MH No calibration applied and no bandpass applied

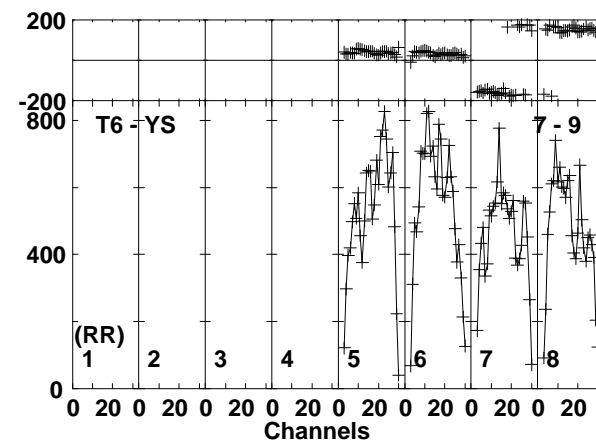
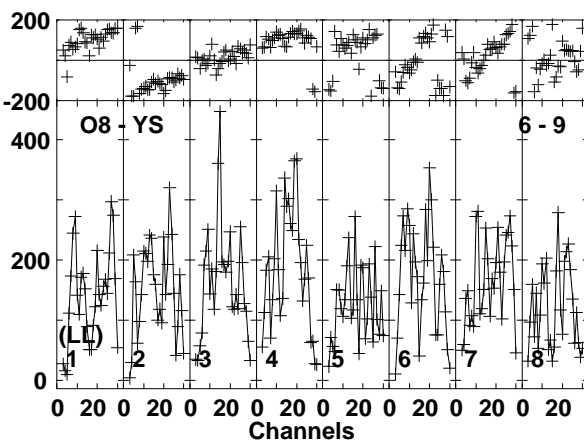
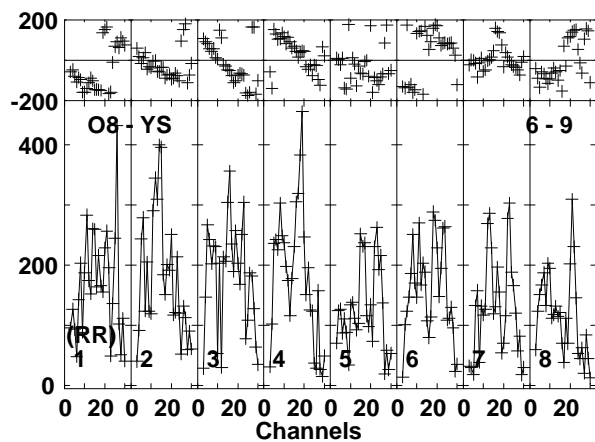
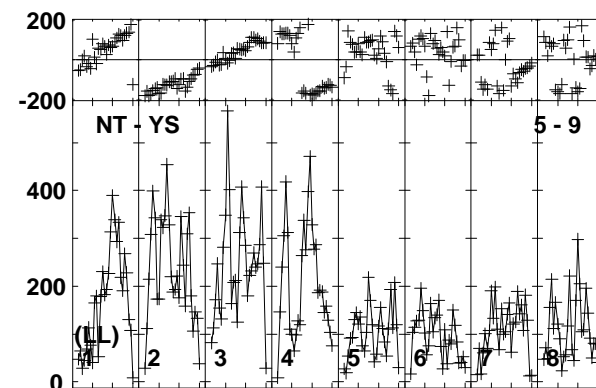
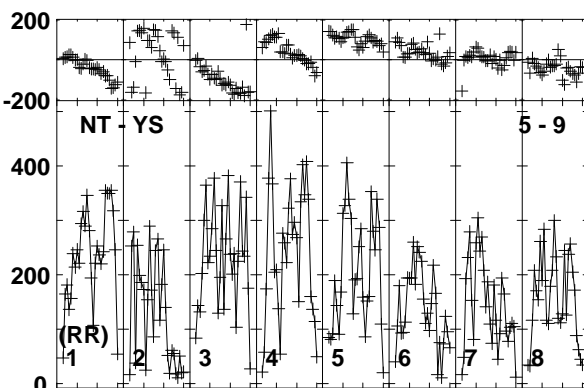
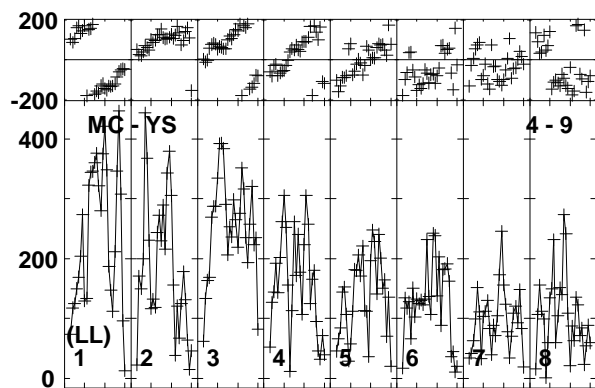
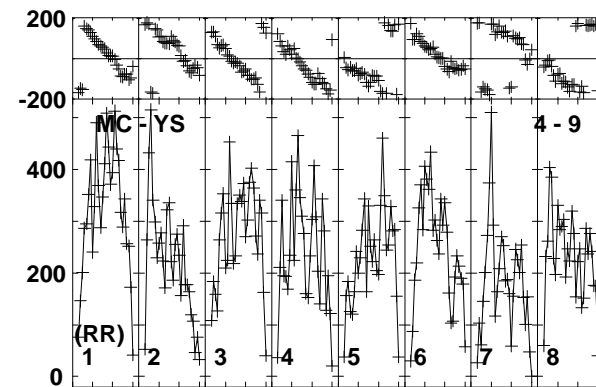
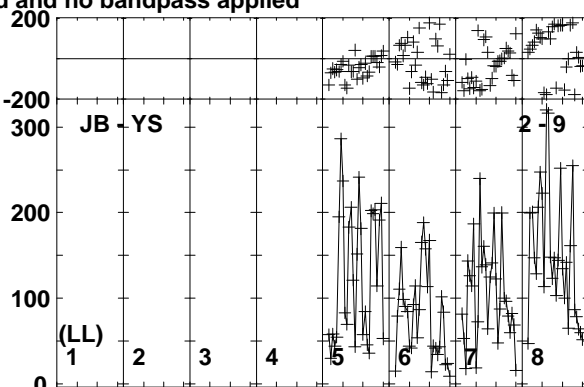
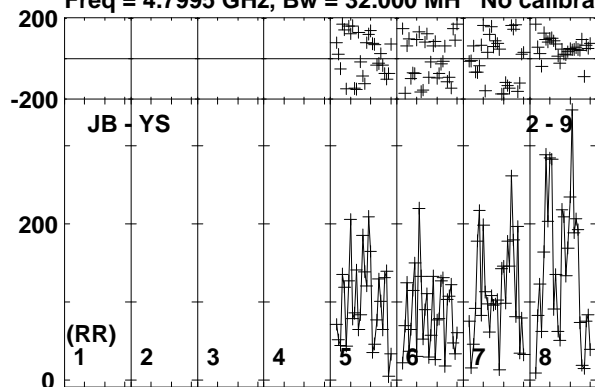

Lower frame: Micro Ampl Jy Top frame: Phas deg
Vector averaged cross-power spectrum Baseline: JB (02) - YS (09)
Timerange: 00:17:09:51 to 00:17:11:19

Plot file version 142 created 20-APR-2018 10:31:48

J0915+0745 EG102C.UVDATA.1

Freq = 4.7995 GHz, Bw = 32.000 MH No calibration applied and no bandpass applied

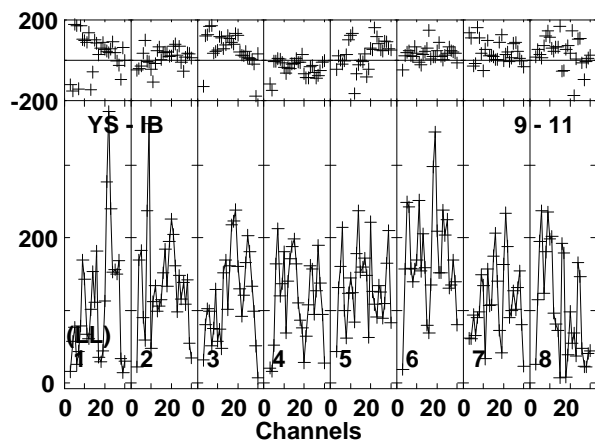
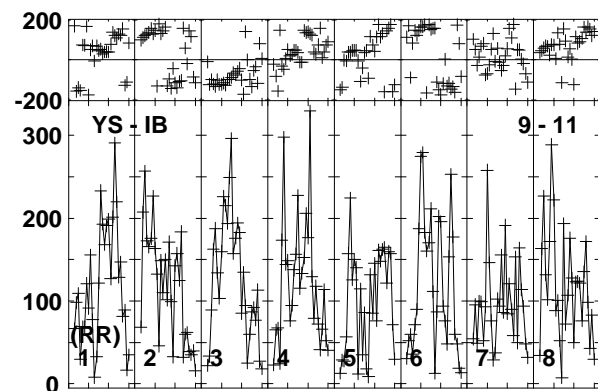
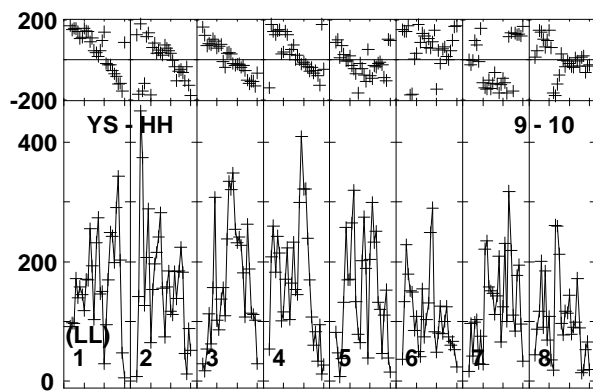
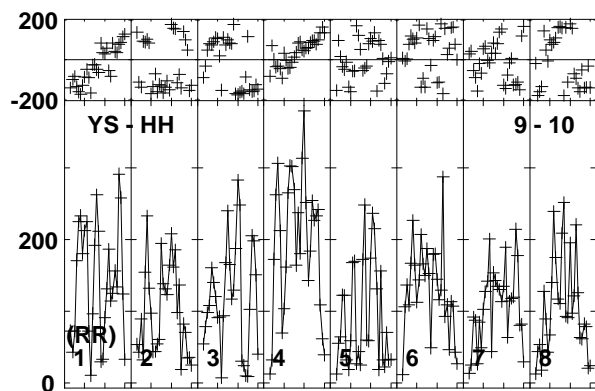
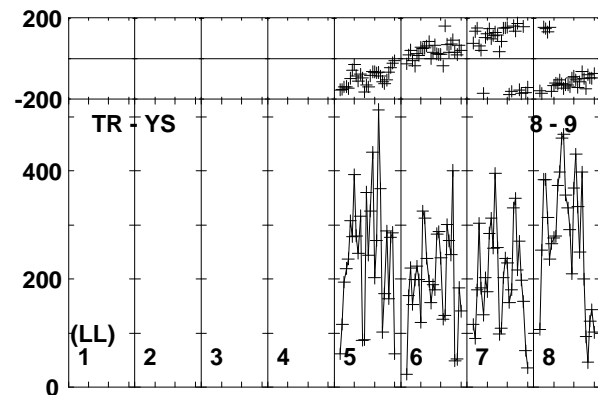
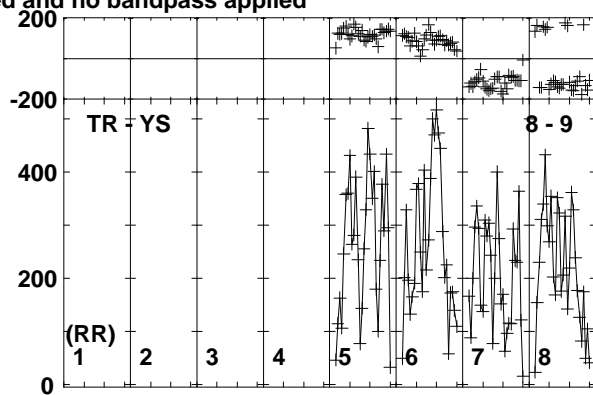
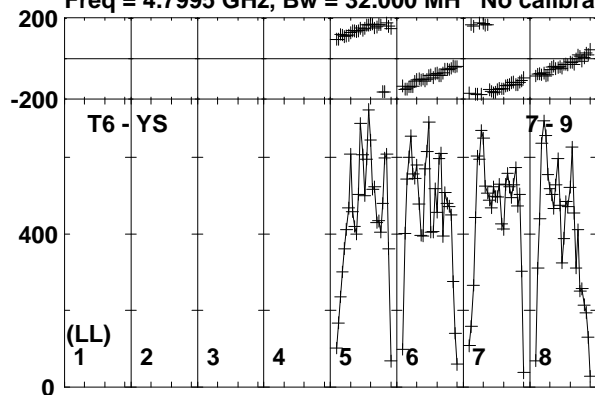

Lower frame: Micro Ampl Jy Top frame: Phas deg
Vector averaged cross-power spectrum Baseline: T6 (07) - YS (09)
Timerange: 00/17:09:51 to 00/17:11:19

Plot file version 143 created 20-APR-2018 10:31:49

B0915+068 EG102C.UVDATA.1

Freq = 4.7995 GHz, Bw = 32.000 MH No calibration applied and no bandpass applied

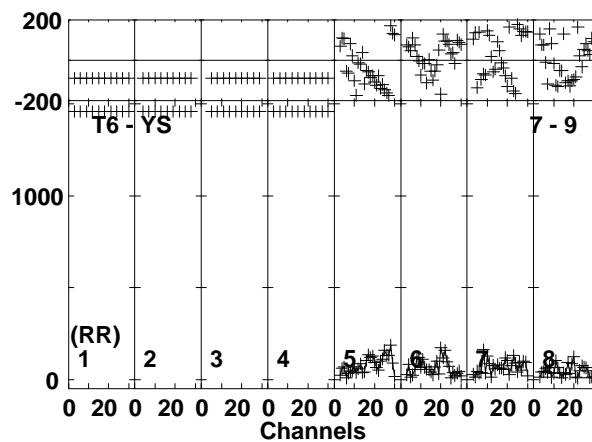
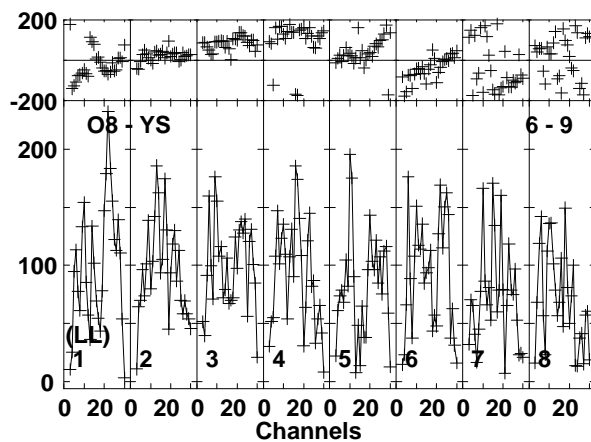
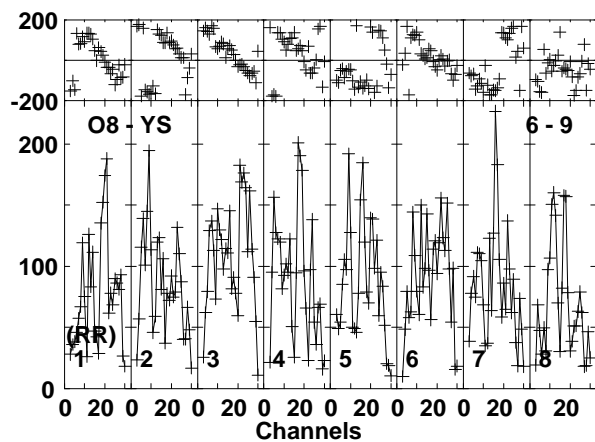
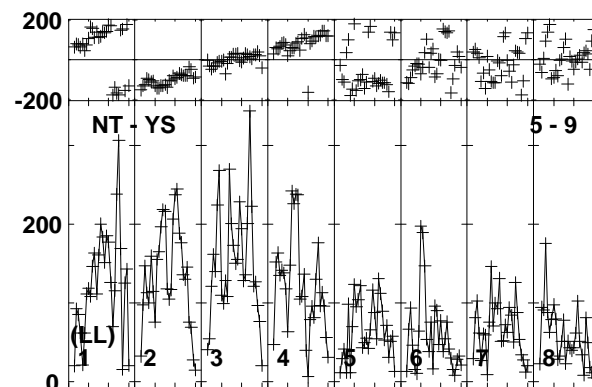
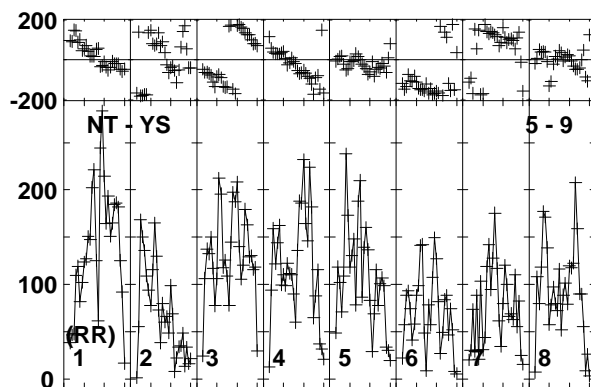
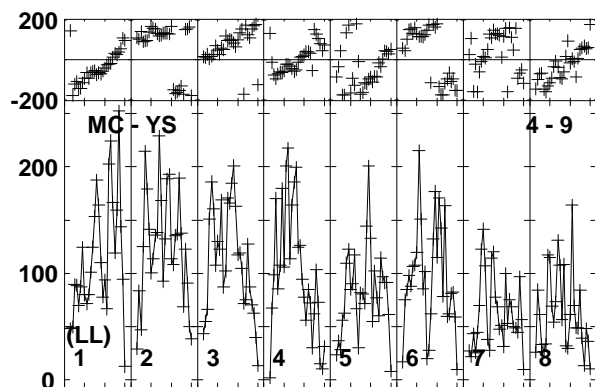
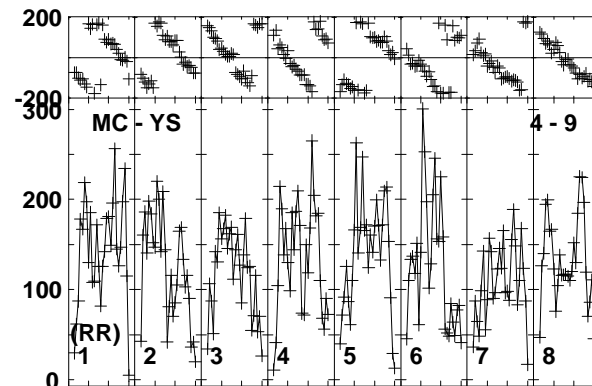
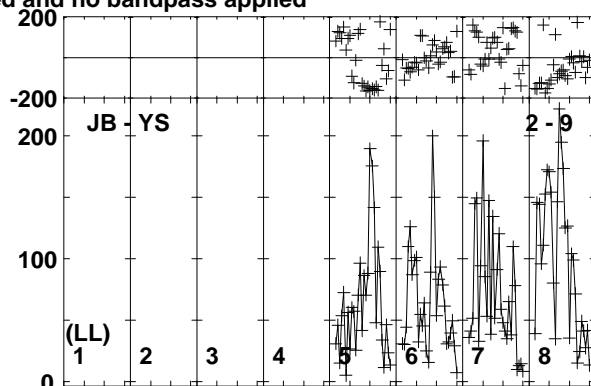
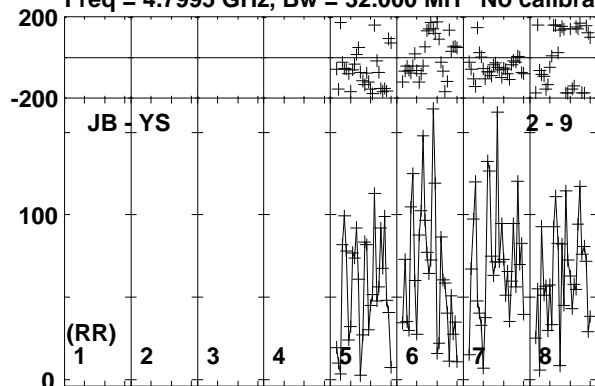

Lower frame: Micro Ampl Jy Top frame: Phas deg
Vector averaged cross-power spectrum Baseline: JB (02) - YS (09)
Timerange: 00/17:11:21 to 00/17:14:49

Plot file version 144 created 20-APR-2018 10:31:49

B0915+068 EG102C.UVDATA.1

Freq = 4.7995 GHz, Bw = 32.000 MH No calibration applied and no bandpass applied

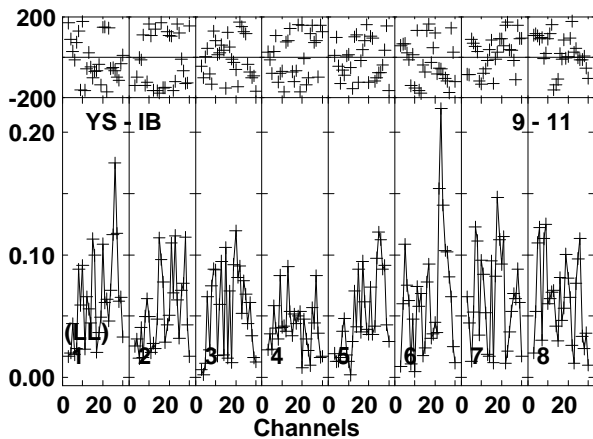
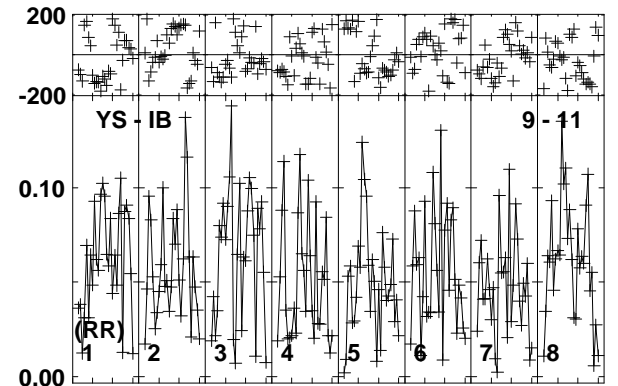
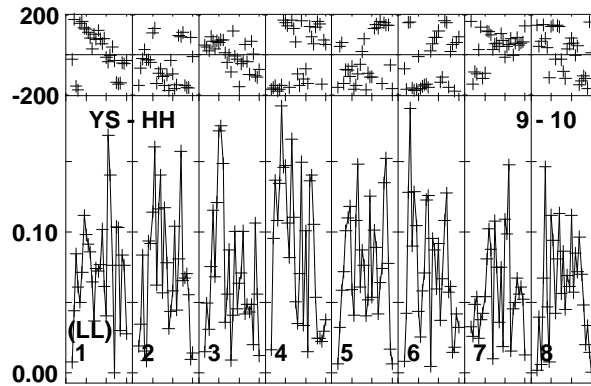
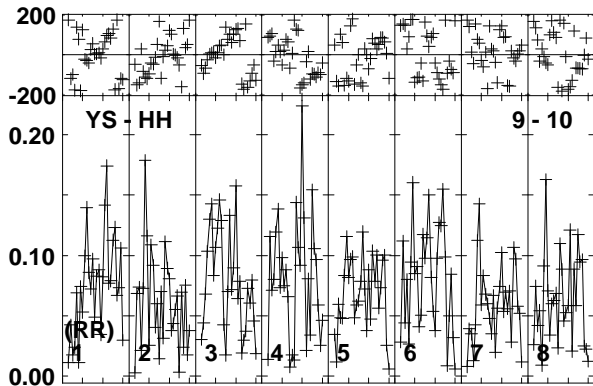
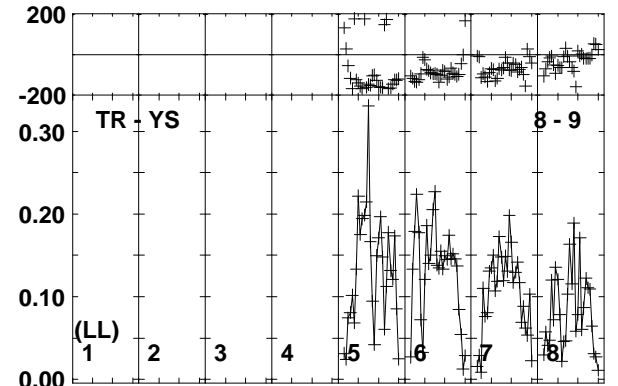
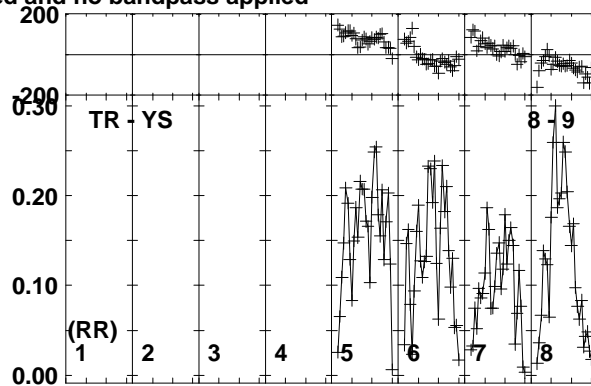
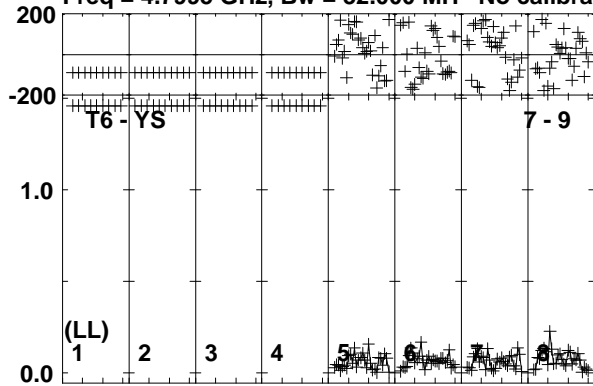

Lower frame: Milli Ampl Jy Top frame: Phas deg
Vector averaged cross-power spectrum Baseline: T6 (07) - YS (09)
Timerange: 00/17:11:21 to 00/17:14:49

Plot file version 145 created 20-APR-2018 10:31:49

J0915+0745 EG102C.UVDATA.1

Freq = 4.7995 GHz, Bw = 32.000 MH No calibration applied and no bandpass applied

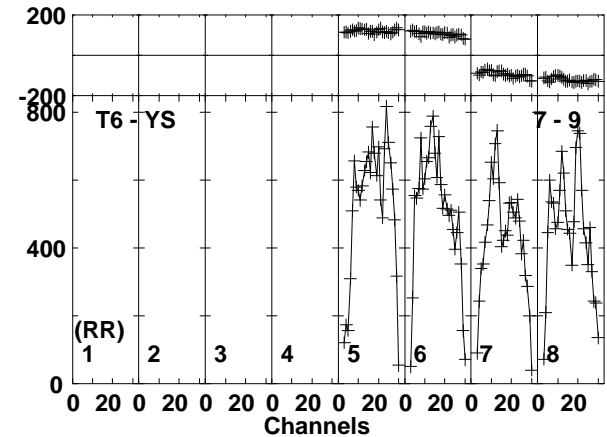
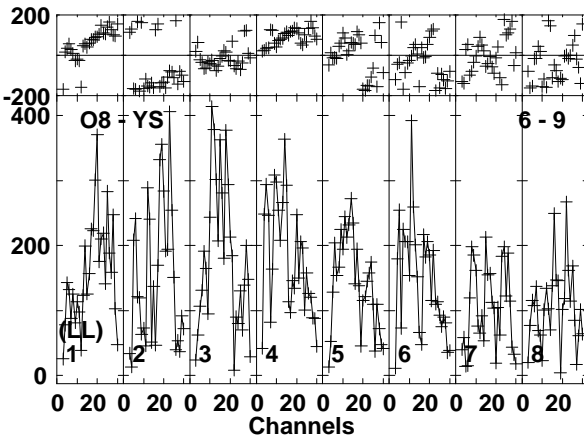
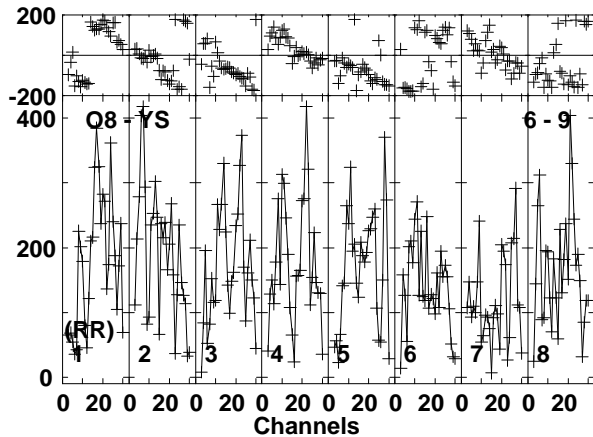
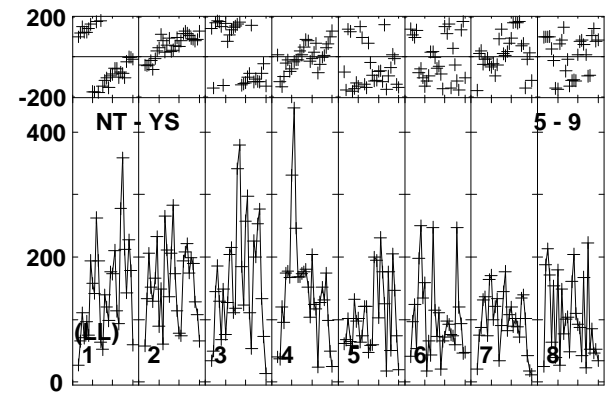
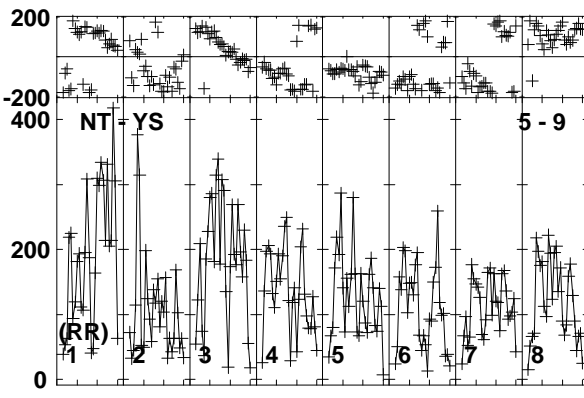
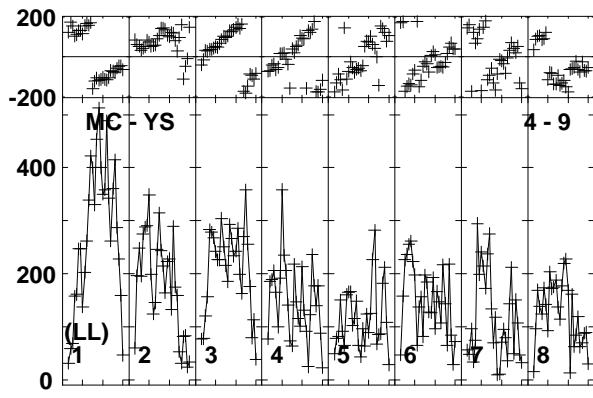
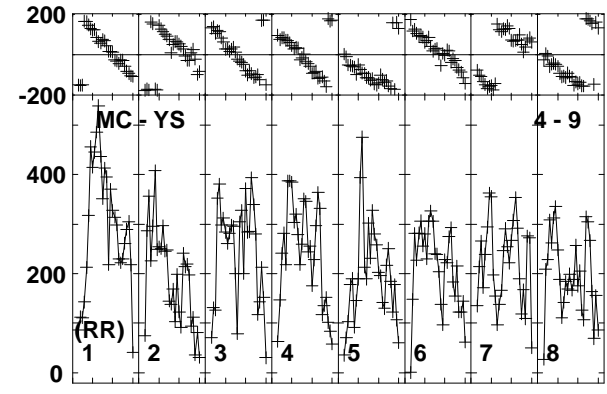
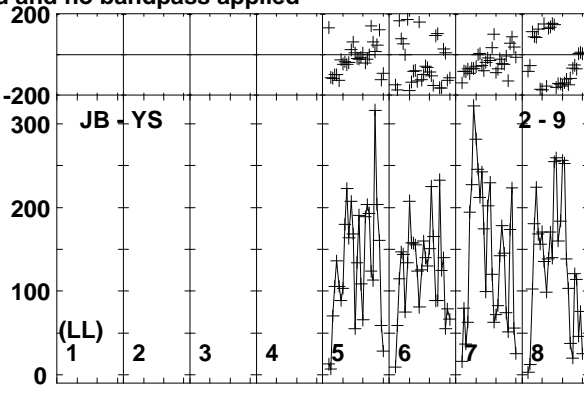
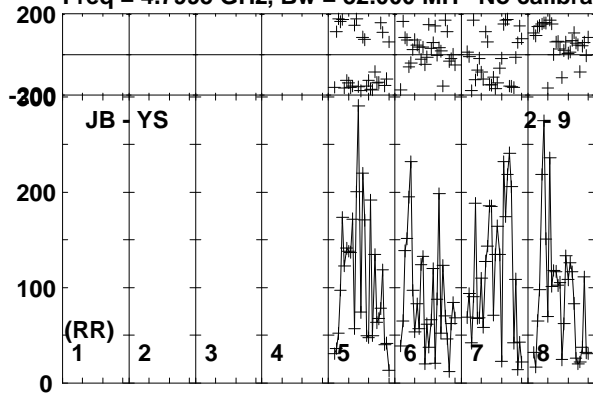

Lower frame: Micro Ampl Jy Top frame: Phas deg
Vector averaged cross-power spectrum Baseline: JB (02) - YS (09)
Timerange: 00/17:14:51 to 00/17:16:19

Plot file version 146 created 20-APR-2018 10:31:49

J0915+0745 EG102C.UVDATA.1

Freq = 4.7995 GHz, Bw = 32.000 MH No calibration applied and no bandpass applied

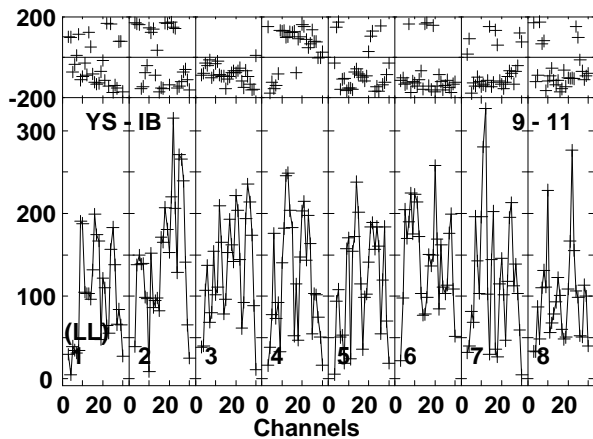
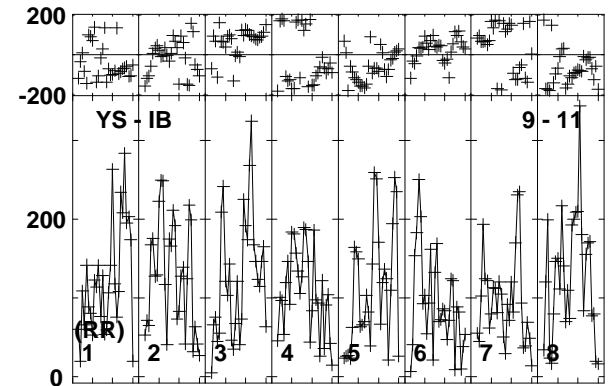
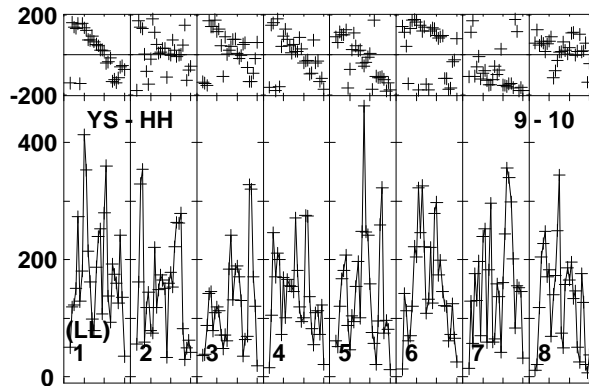
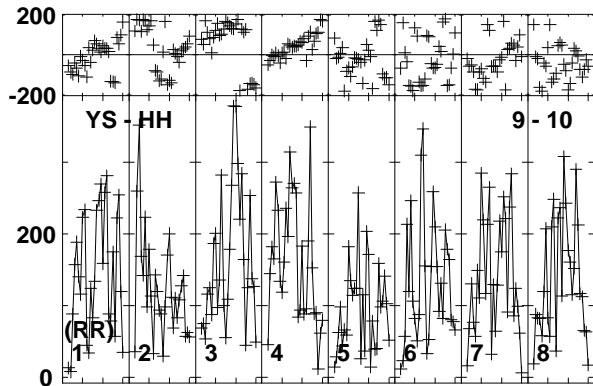
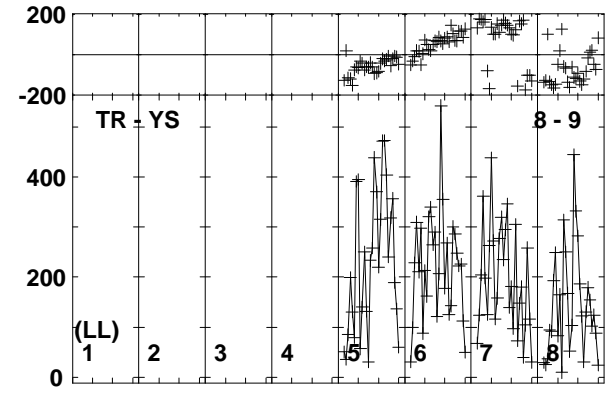
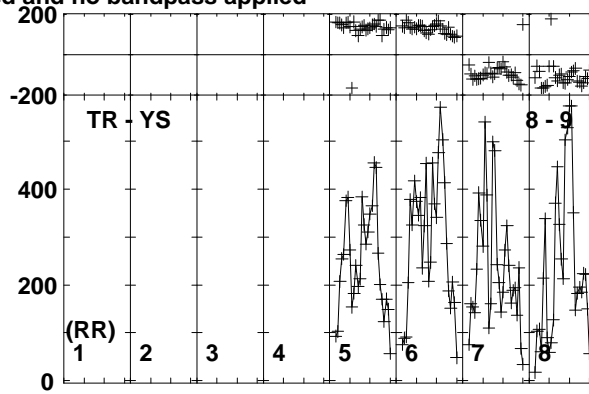
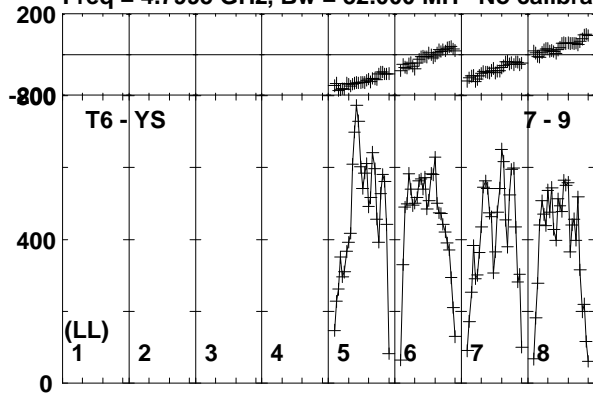

Lower frame: Micro Ampl Jy Top frame: Phas deg
Vector averaged cross-power spectrum Baseline: T6 (07) - YS (09)
Timerange: 00/17:14:51 to 00/17:16:19

Plot file version 147 created 20-APR-2018 10:31:49

B0915+068 EG102C.UVDATA.1

Freq = 4.7995 GHz, Bw = 32.000 MH No calibration applied and no bandpass applied

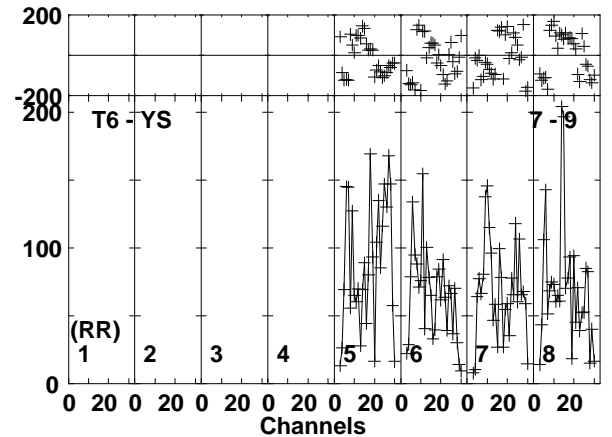
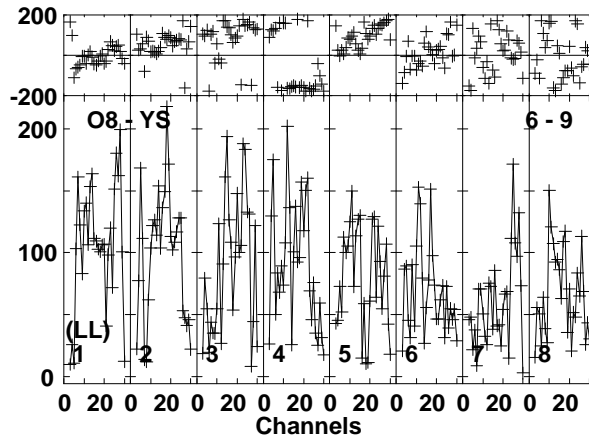
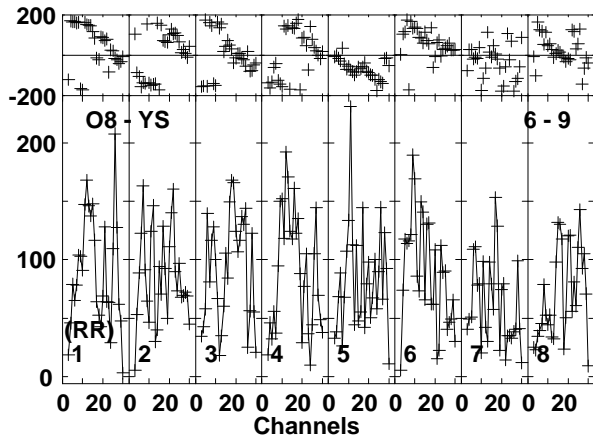
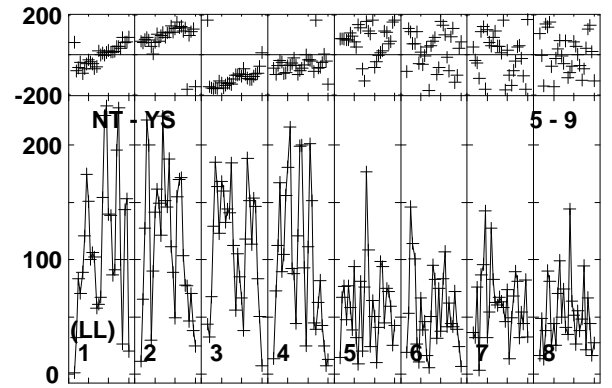
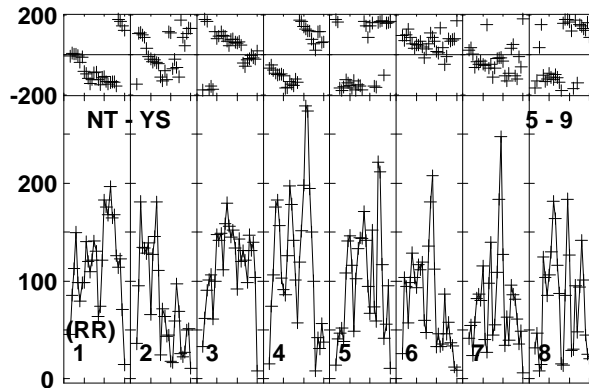
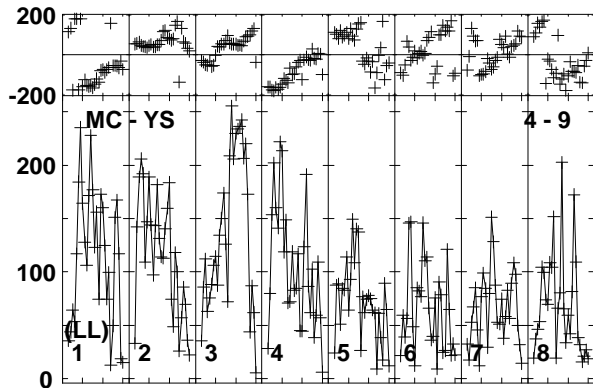
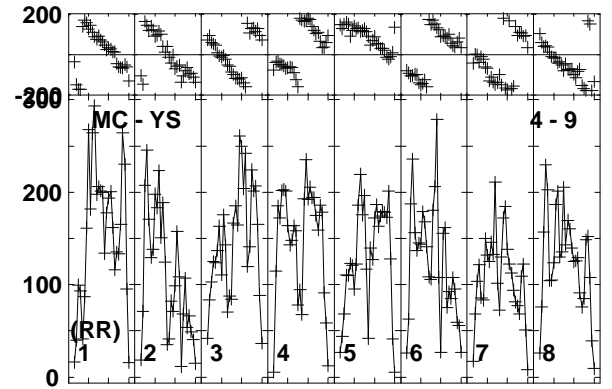
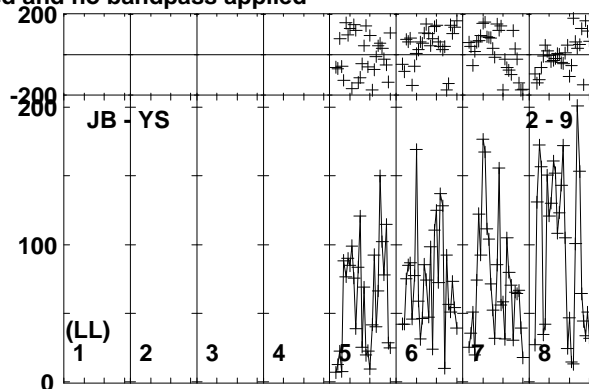
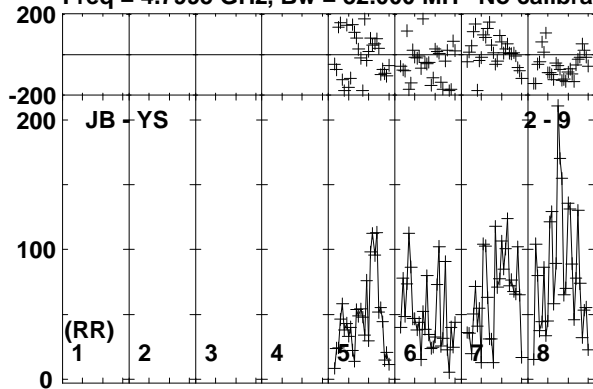

Lower frame: Micro Ampl Jy Top frame: Phas deg
Vector averaged cross-power spectrum Baseline: JB (02) - YS (09)
Timerange: 00/17:16:21 to 00/17:19:49

Plot file version 148 created 20-APR-2018 10:31:49

B0915+068 EG102C.UVDATA.1

Freq = 4.7995 GHz, Bw = 32.000 MH No calibration applied and no bandpass applied

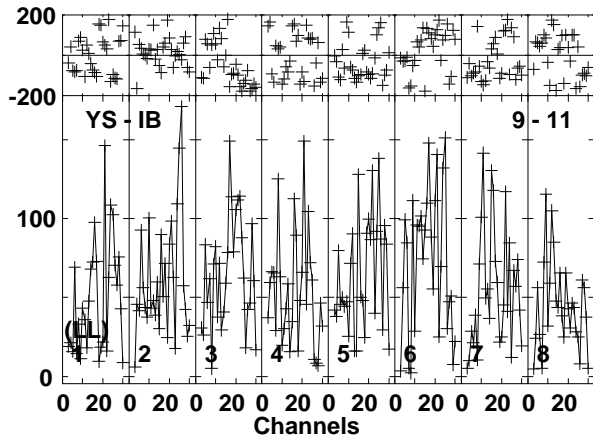
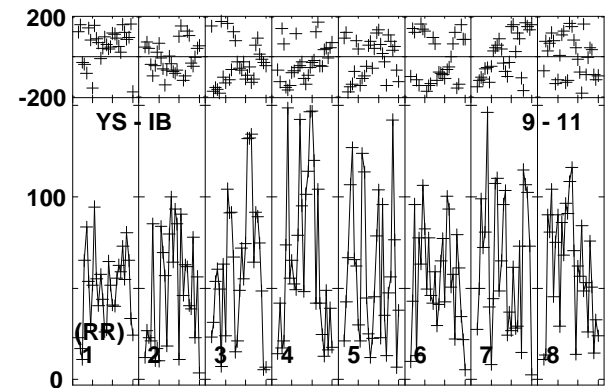
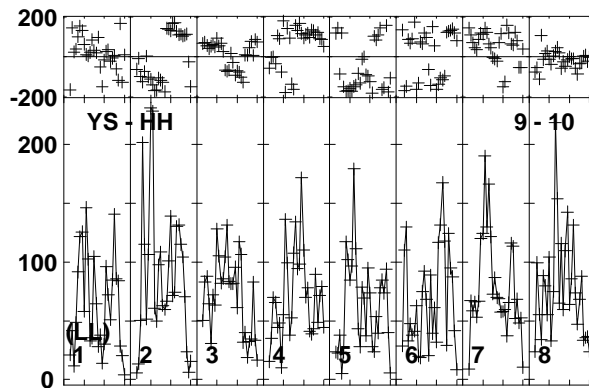
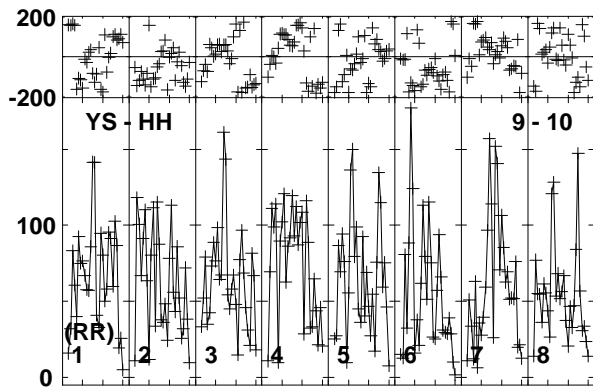
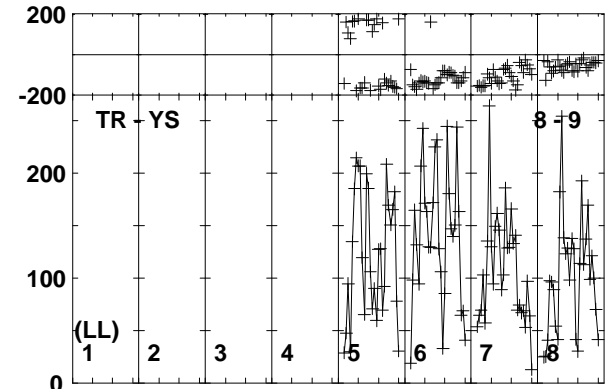
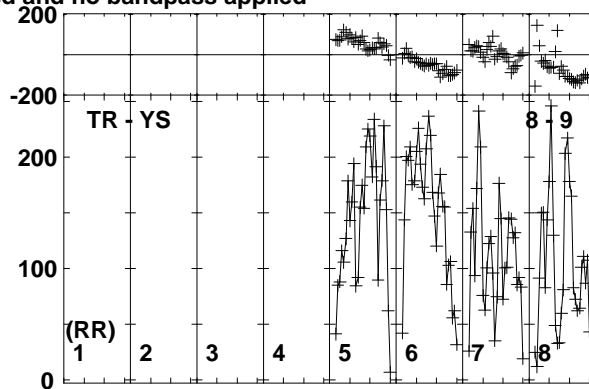
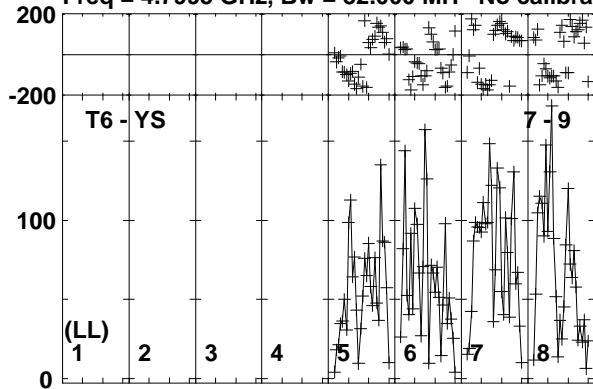

Lower frame: Micro Ampl Jy Top frame: Phas deg
Vector averaged cross-power spectrum Baseline: T6 (07) - YS (09)
Timerange: 00/17:16:21 to 00/17:19:49

Plot file version 149 created 20-APR-2018 10:31:49

J0915+0745 EG102C.UVDATA.1

Freq = 4.7995 GHz, Bw = 32.000 MH No calibration applied and no bandpass applied

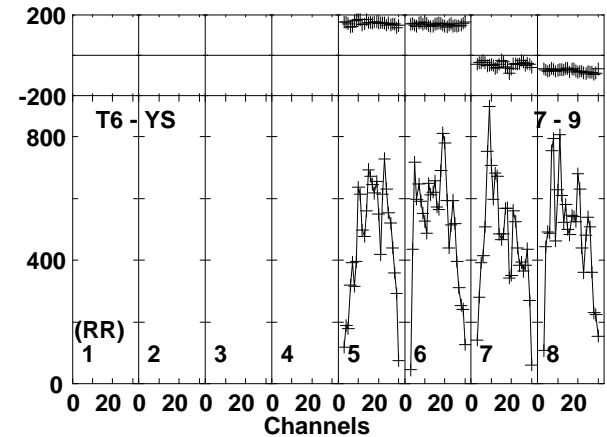
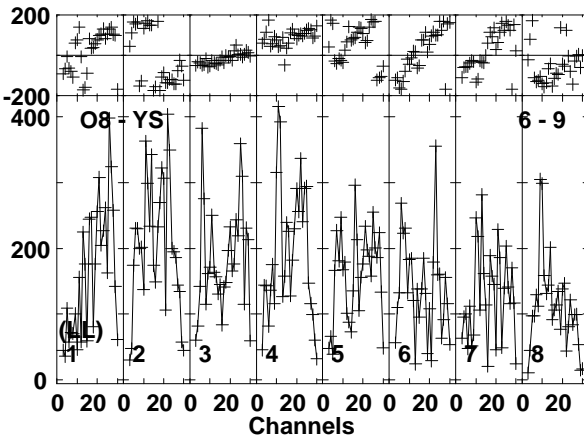
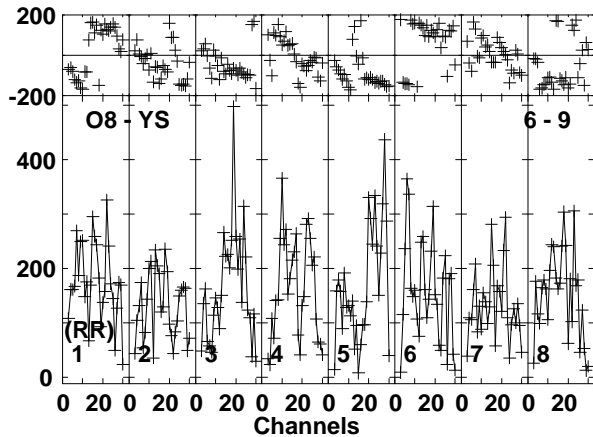
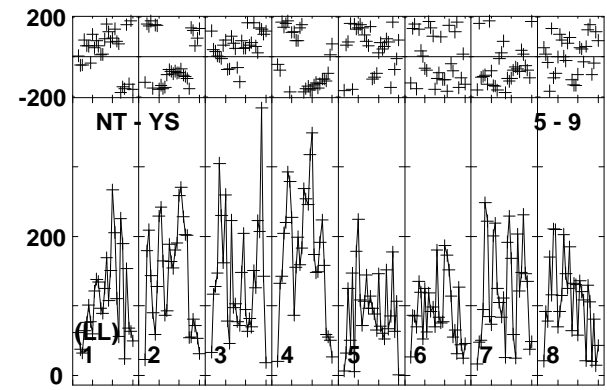
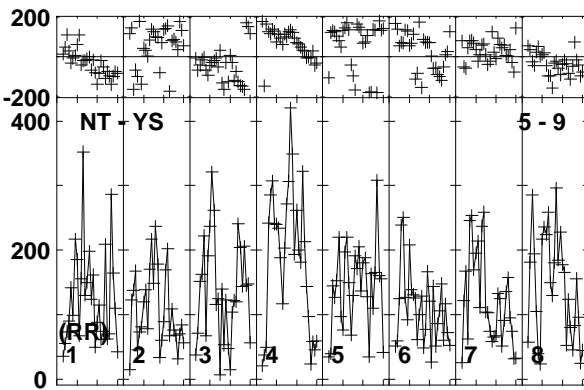
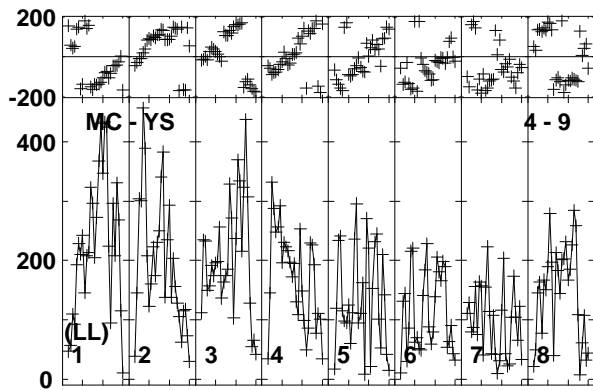
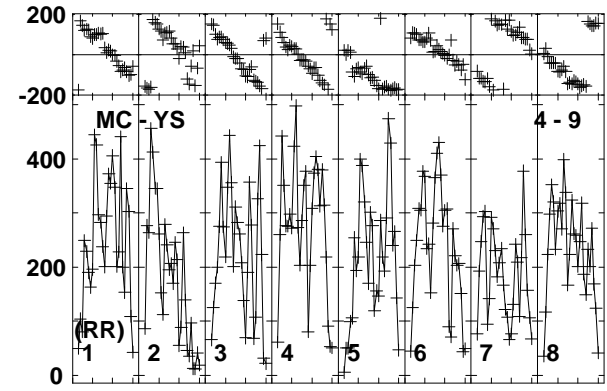
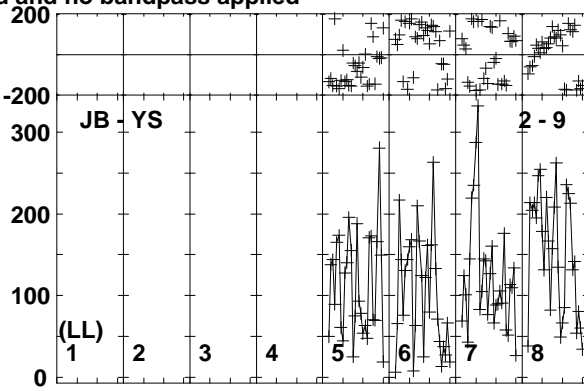
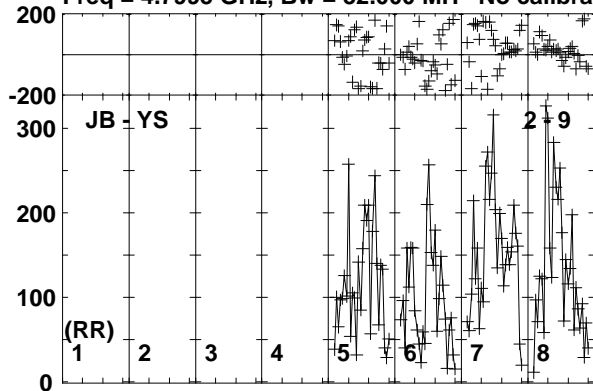

Lower frame: Micro Ampl Jy Top frame: Phas deg
Vector averaged cross-power spectrum Baseline: JB (02) - YS (09)
Timerange: 00/17:20:31 to 00/17:21:29

Plot file version 150 created 20-APR-2018 10:31:49

J0915+0745 EG102C.UVDATA.1

Freq = 4.7995 GHz, Bw = 32.000 MH No calibration applied and no bandpass applied

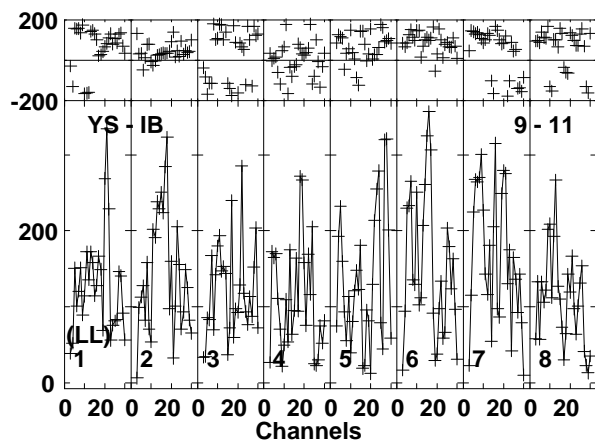
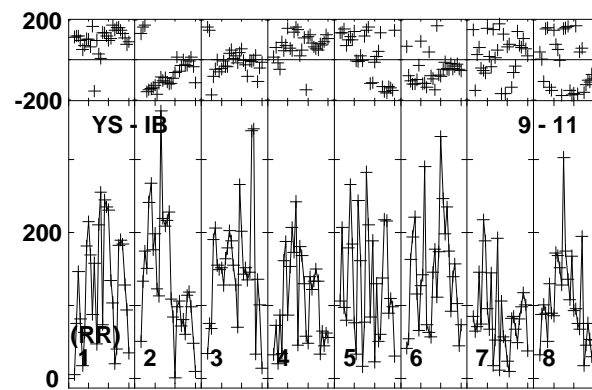
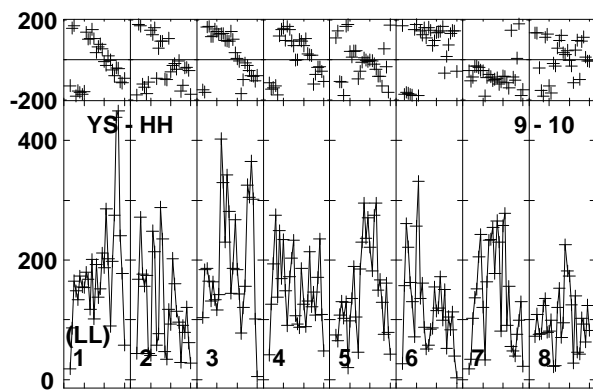
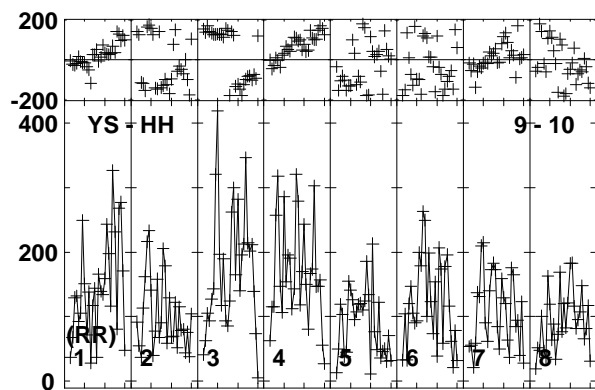
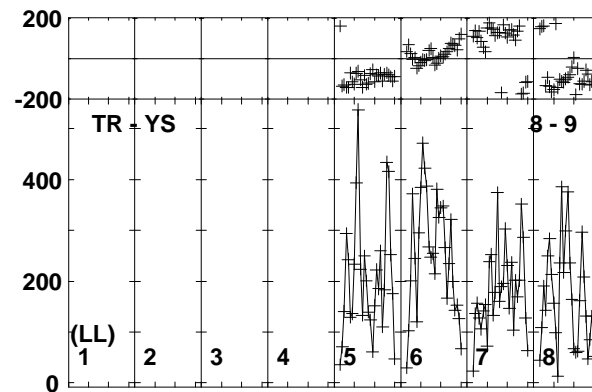
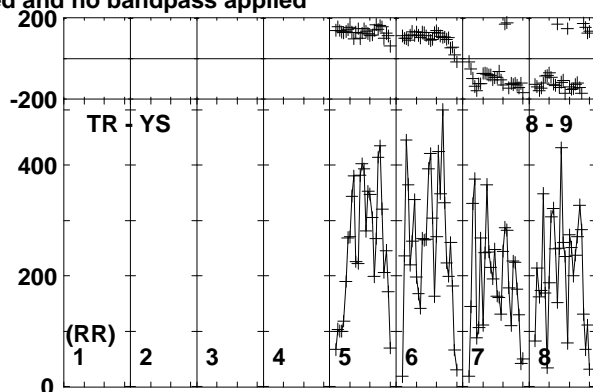
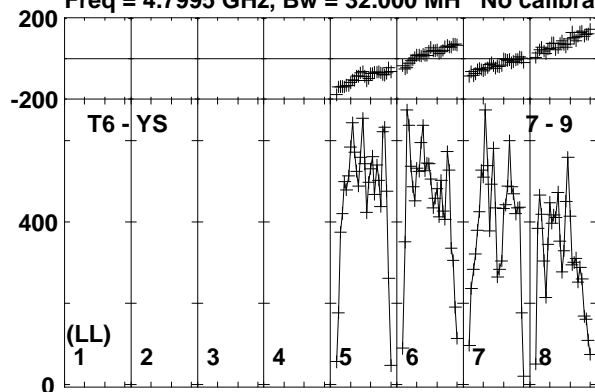

Lower frame: Micro Ampl Jy Top frame: Phas deg
Vector averaged cross-power spectrum Baseline: T6 (07) - YS (09)
Timerange: 00/17:20:31 to 00/17:21:29

Plot file version 151 created 20-APR-2018 10:31:49

B0915+068 EG102C.UVDATA.1

Freq = 4.7995 GHz, Bw = 32.000 MH No calibration applied and no bandpass applied

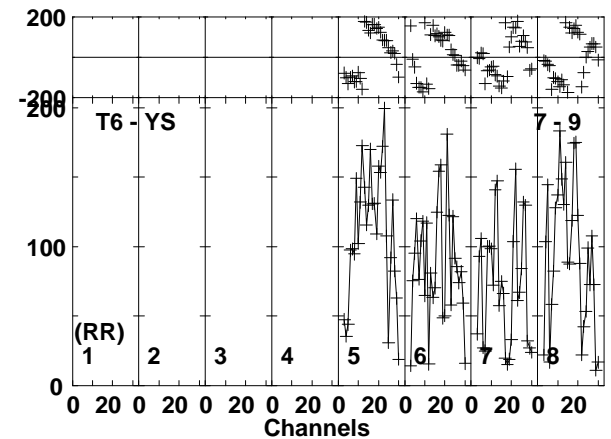
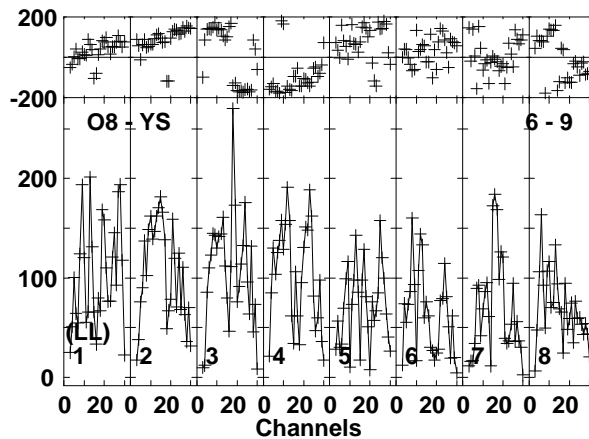
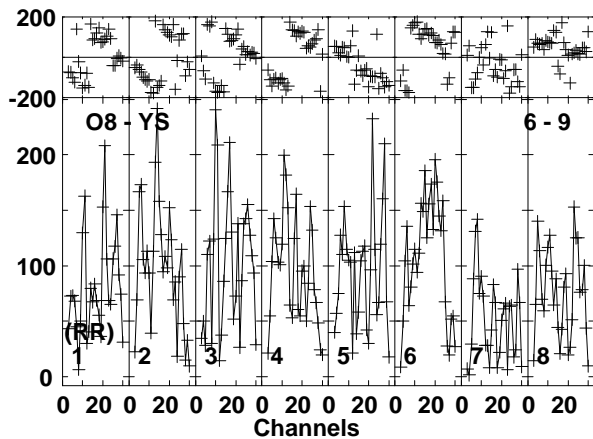
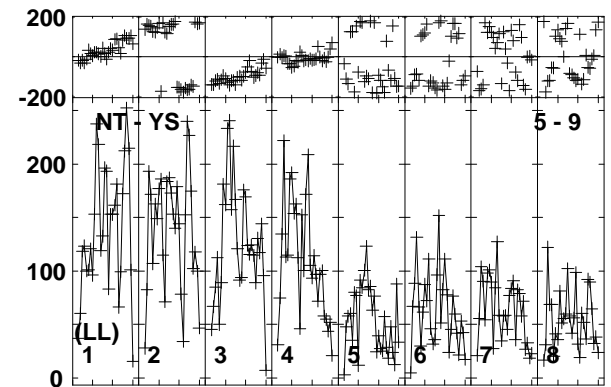
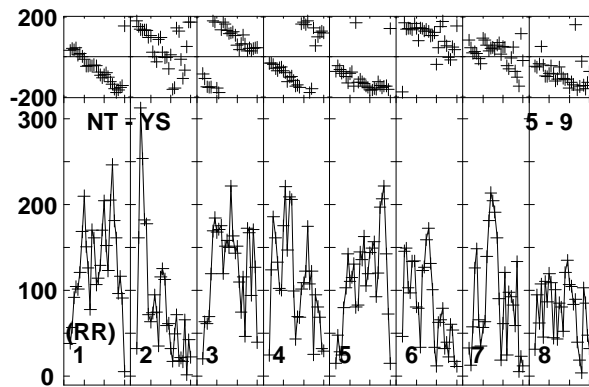
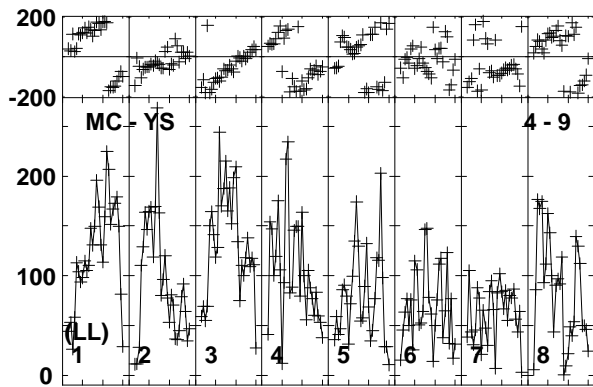
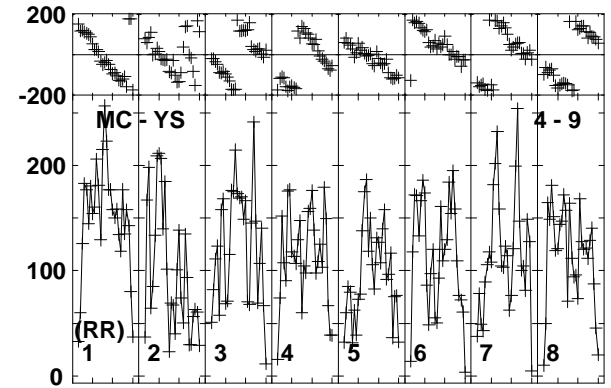
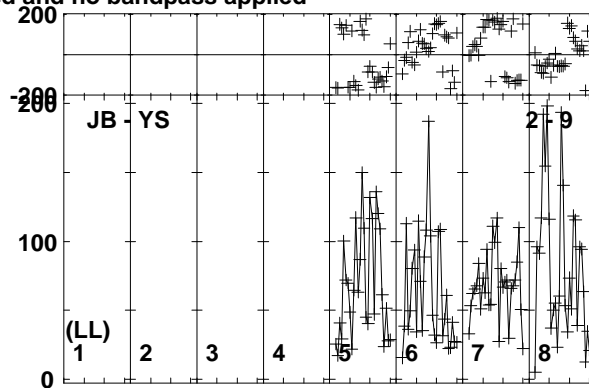
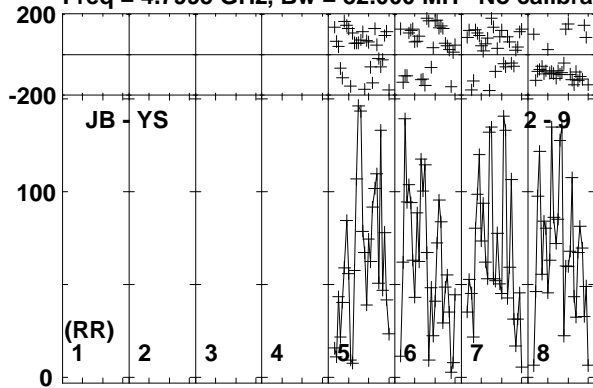

Lower frame: Micro Ampl Jy Top frame: Phas deg
Vector averaged cross-power spectrum Baseline: JB (02) - YS (09)
Timerange: 00/17:21:31 to 00/17:24:59

Plot file version 152 created 20-APR-2018 10:31:50

B0915+068 EG102C.UVDATA.1

Freq = 4.7995 GHz, Bw = 32.000 MH No calibration applied and no bandpass applied

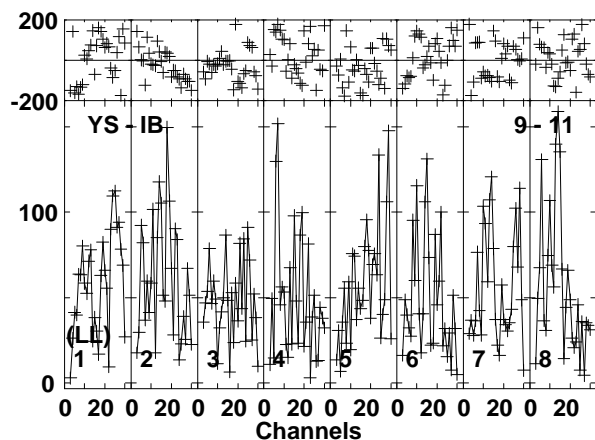
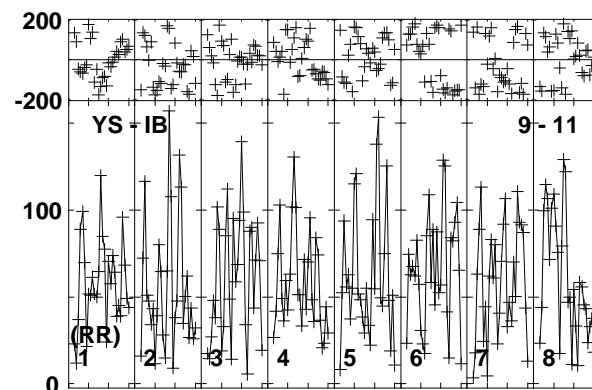
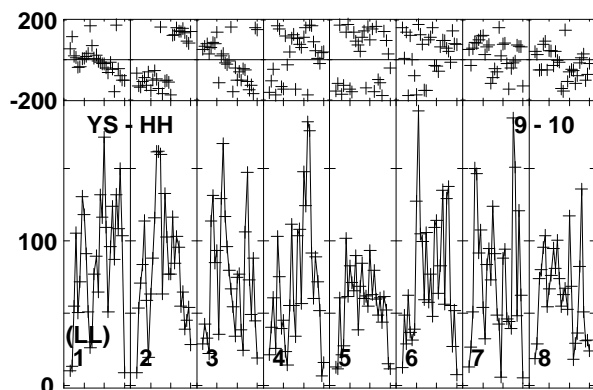
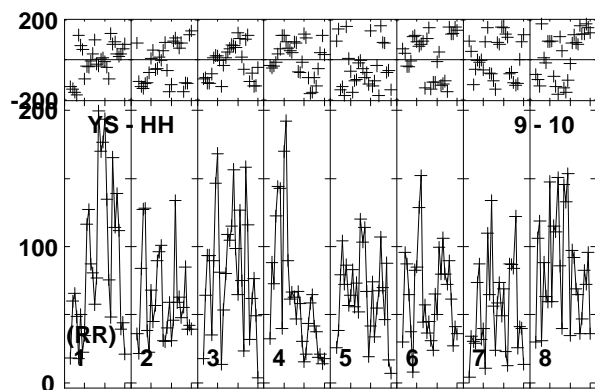
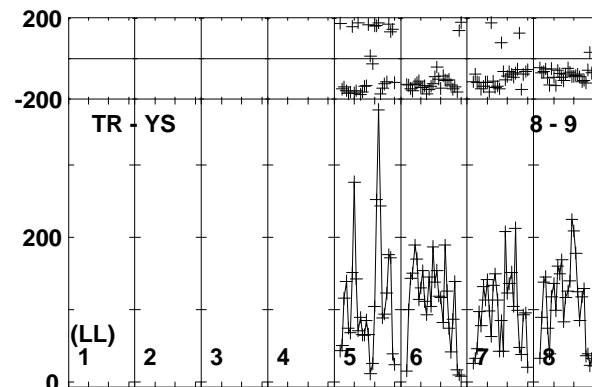
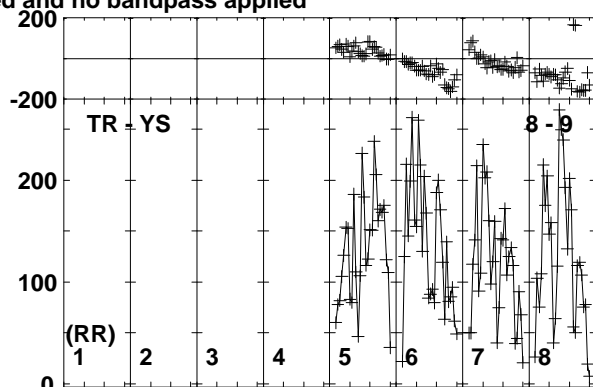
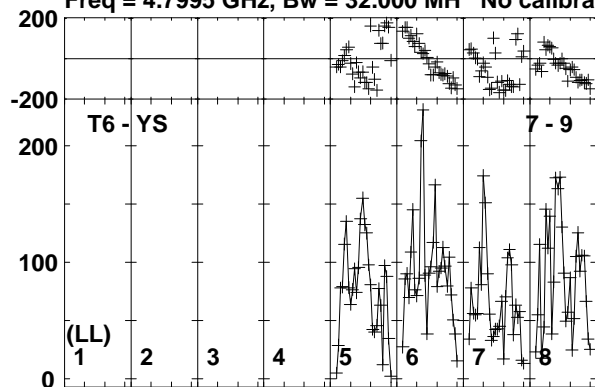

Lower frame: Micro Ampl Jy Top frame: Phas deg
Vector averaged cross-power spectrum Baseline: T6 (07) - YS (09)
Timerange: 00/17:21:31 to 00/17:24:59

Plot file version 153 created 20-APR-2018 10:31:50

J0915+0745 EG102C.UVDATA.1

Freq = 4.7995 GHz, Bw = 32.000 MH No calibration applied and no bandpass applied

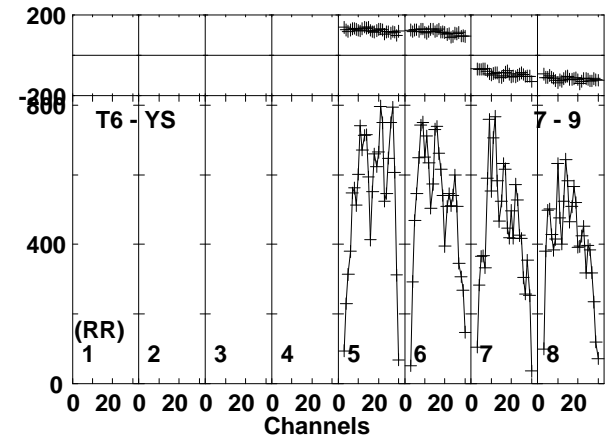
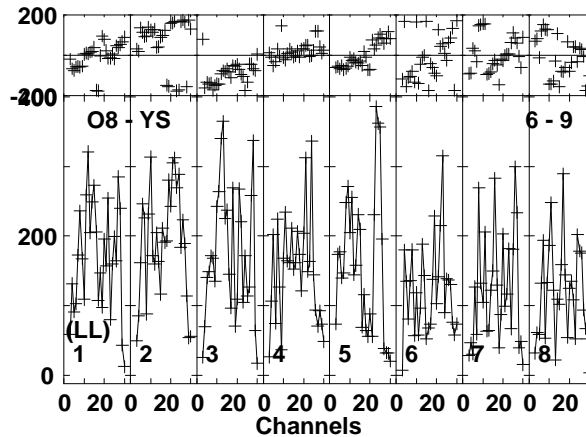
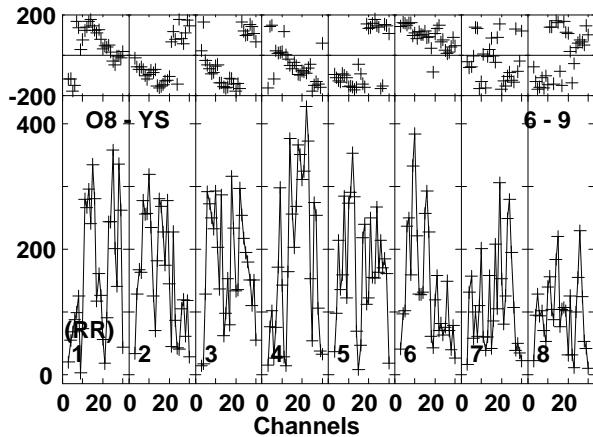
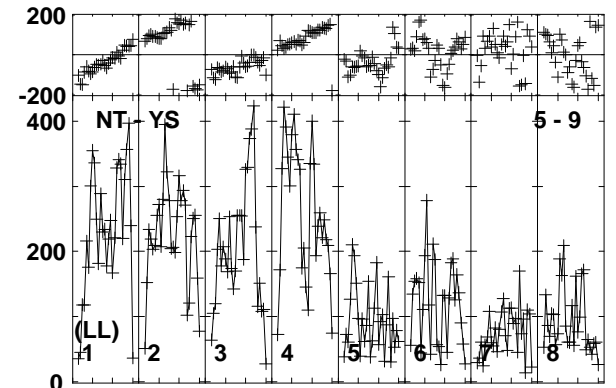
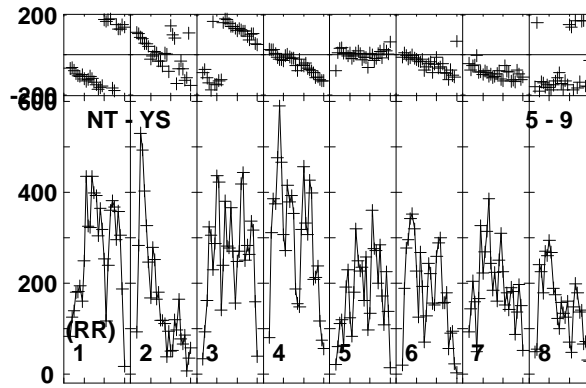
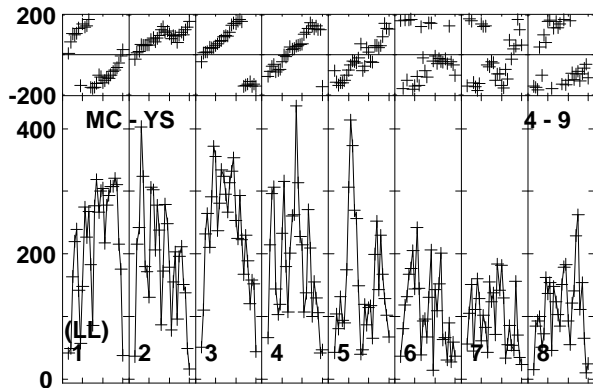
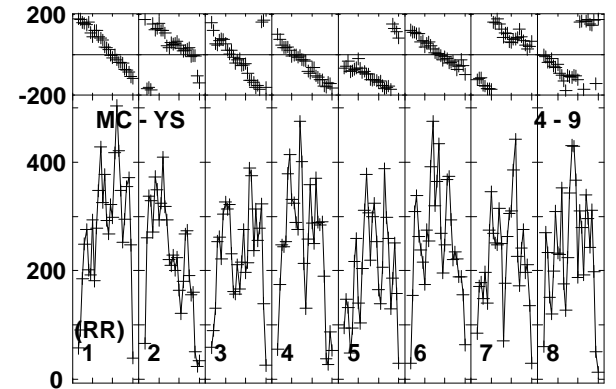
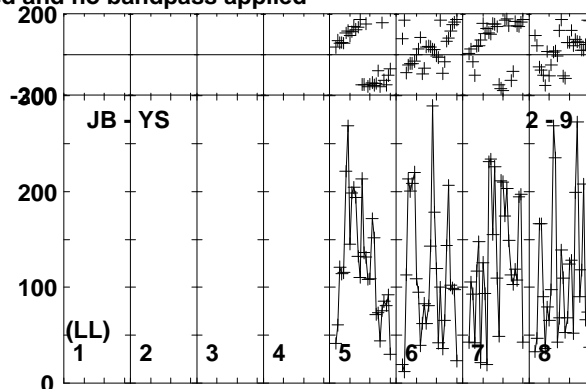
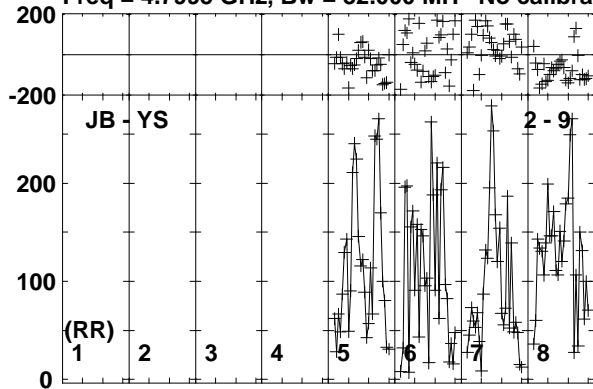

Lower frame: Micro Ampl Jy Top frame: Phas deg
Vector averaged cross-power spectrum Baseline: JB (02) - YS (09)
Timerange: 00/17:25:01 to 00/17:26:29

Plot file version 154 created 20-APR-2018 10:31:50

J0915+0745 EG102C.UVDATA.1

Freq = 4.7995 GHz, Bw = 32.000 MH No calibration applied and no bandpass applied

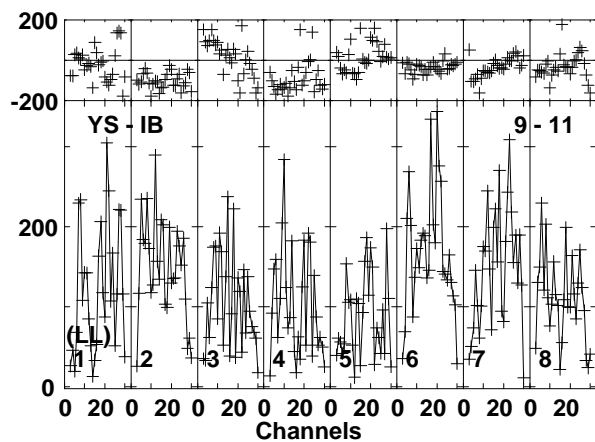
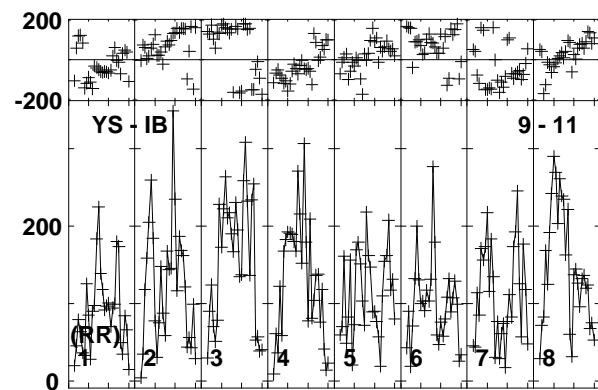
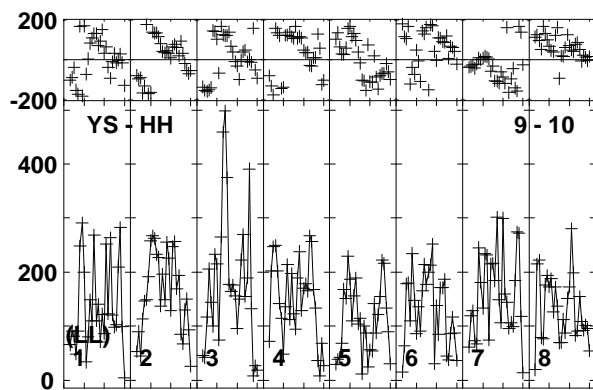
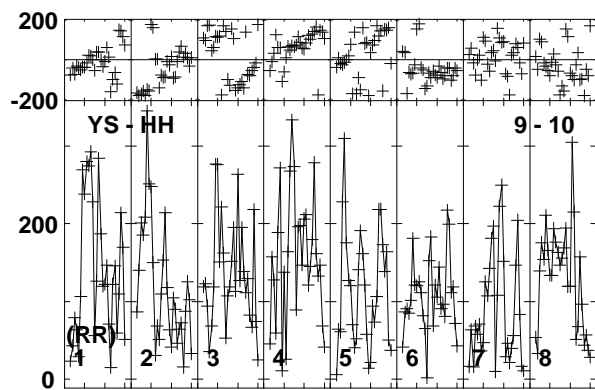
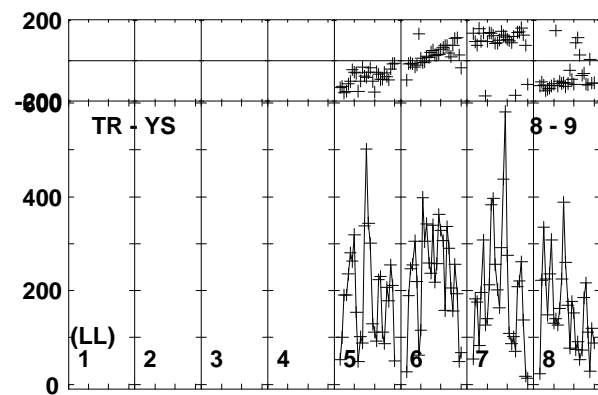
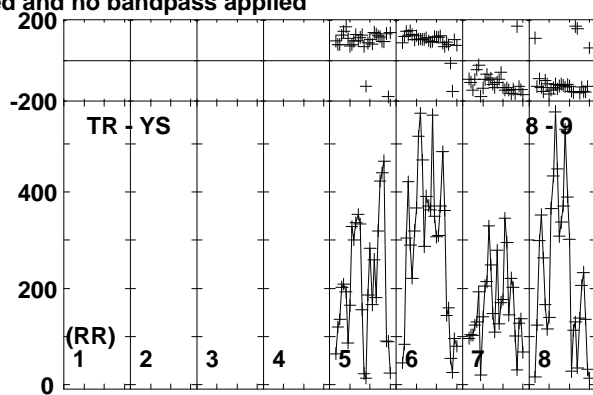
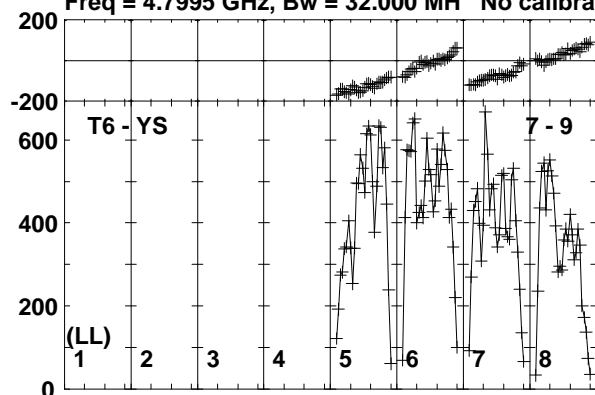

Lower frame: Micro Ampl Jy Top frame: Phas deg
Vector averaged cross-power spectrum Baseline: T6 (07) - YS (09)
Timerange: 00/17:25:01 to 00/17:26:29

Plot file version 155 created 20-APR-2018 10:31:50

B0915+068 EG102C.UVDATA.1

Freq = 4.7995 GHz, Bw = 32.000 MH No calibration applied and no bandpass applied

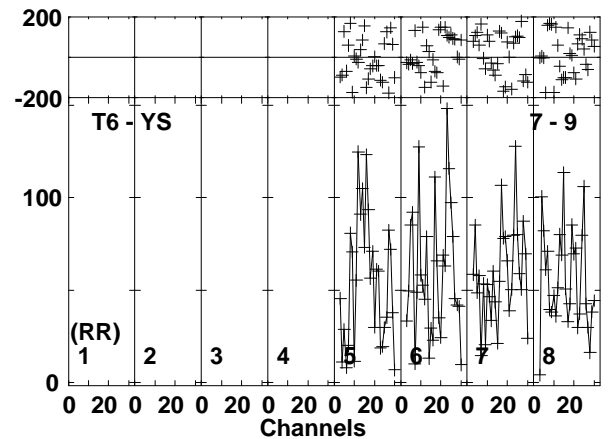
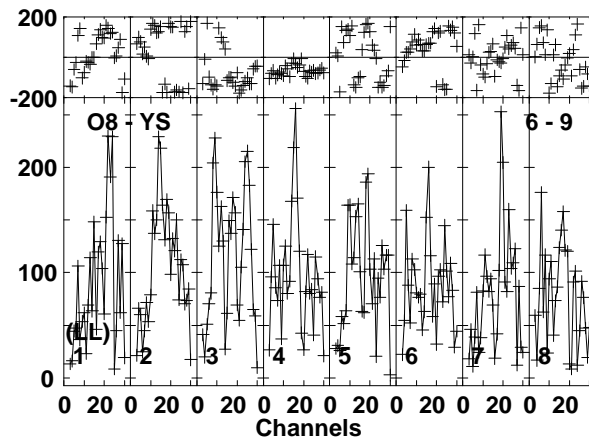
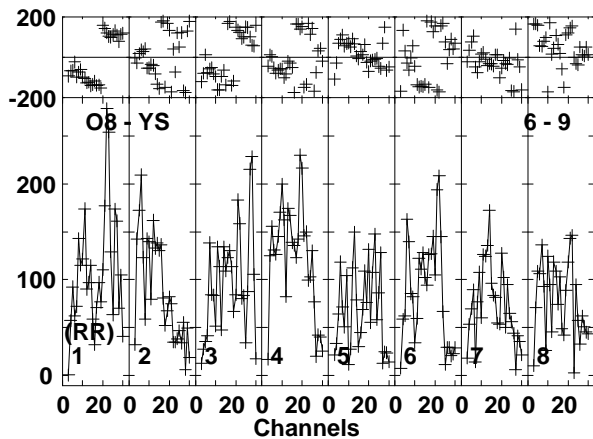
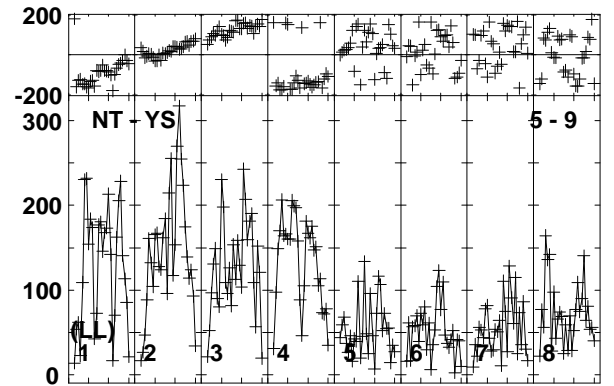
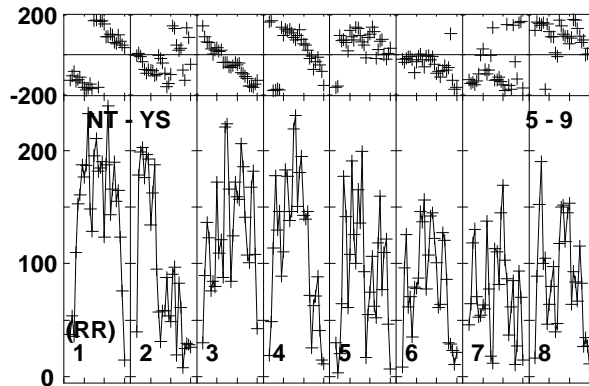
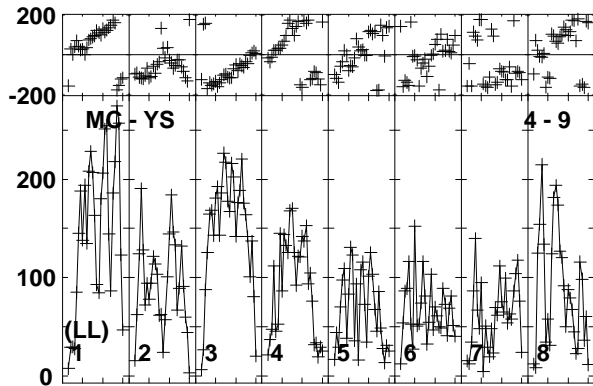
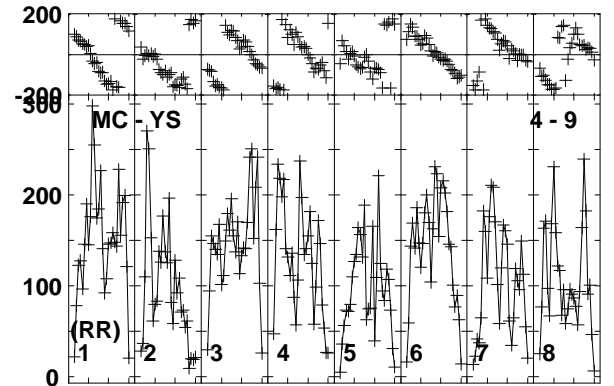
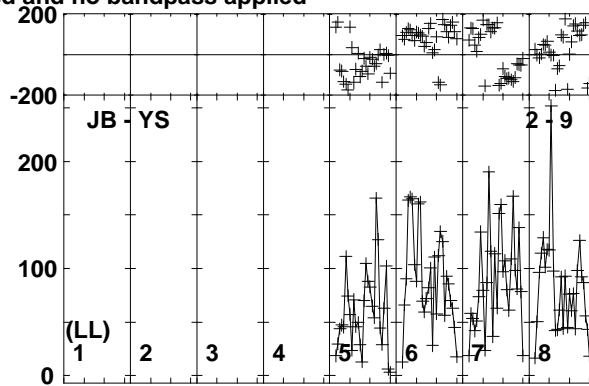
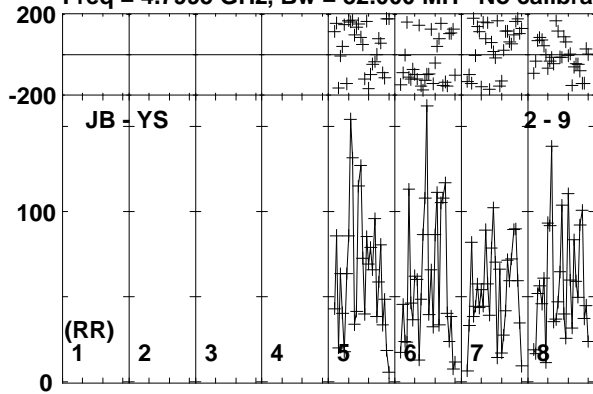

Lower frame: Micro Ampl Jy Top frame: Phas deg
Vector averaged cross-power spectrum Baseline: JB (02) - YS (09)
Timerange: 00/17:26:31 to 00/17:29:59

Plot file version 156 created 20-APR-2018 10:31:50

B0915+068 EG102C.UVDATA.1

Freq = 4.7995 GHz, Bw = 32.000 MH No calibration applied and no bandpass applied

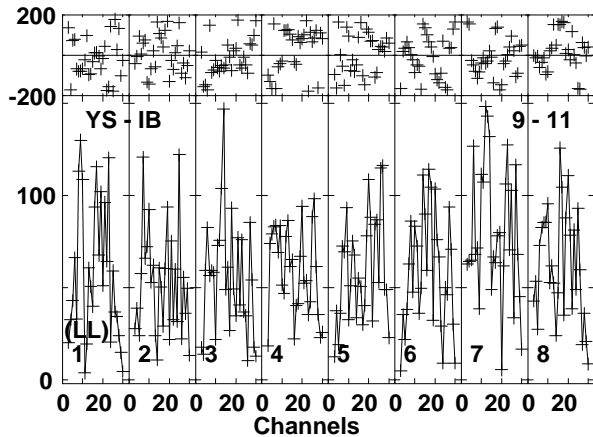
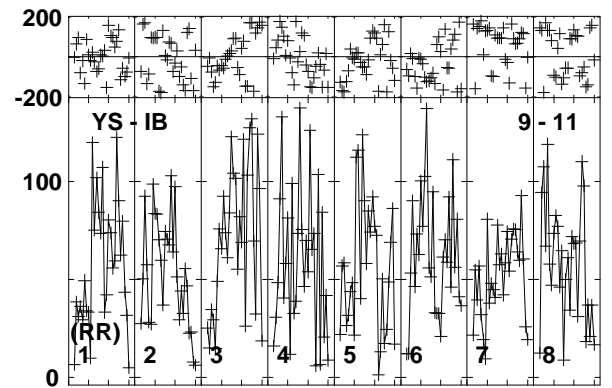
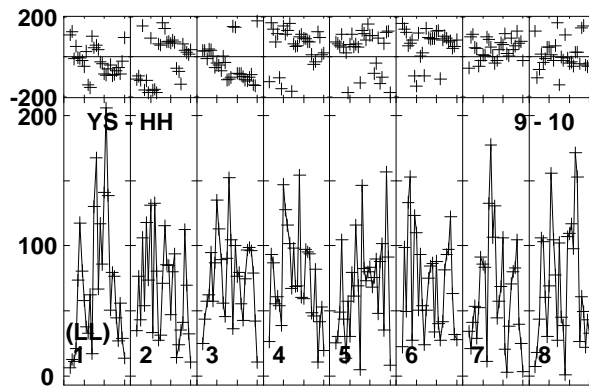
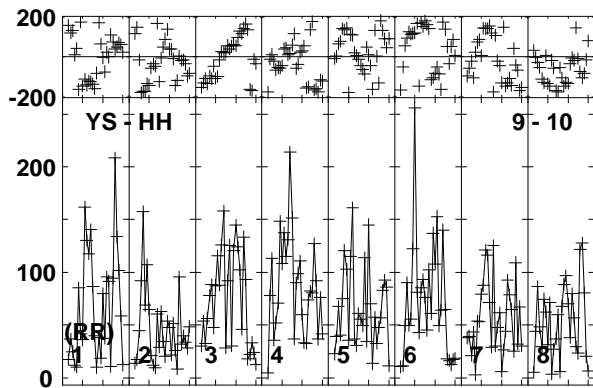
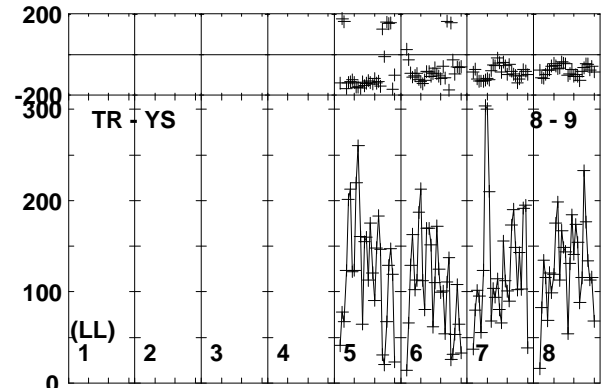
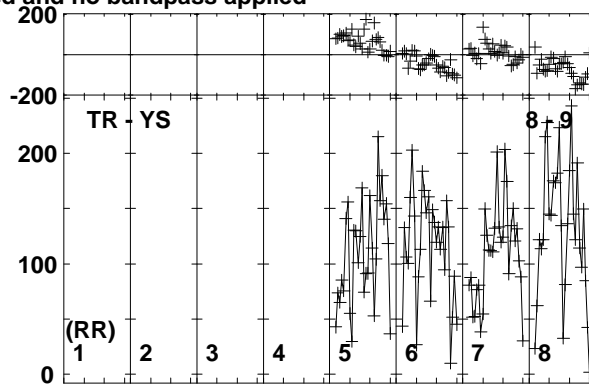
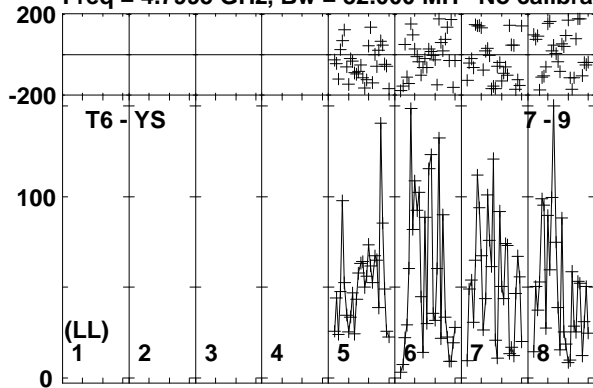

Lower frame: Micro Ampl Jy Top frame: Phas deg
Vector averaged cross-power spectrum Baseline: T6 (07) - YS (09)
Timerange: 00/17:26:31 to 00/17:29:59

Plot file version 157 created 20-APR-2018 10:31:50

J0915+0745 EG102C.UVDATA.1

Freq = 4.7995 GHz, Bw = 32.000 MH No calibration applied and no bandpass applied

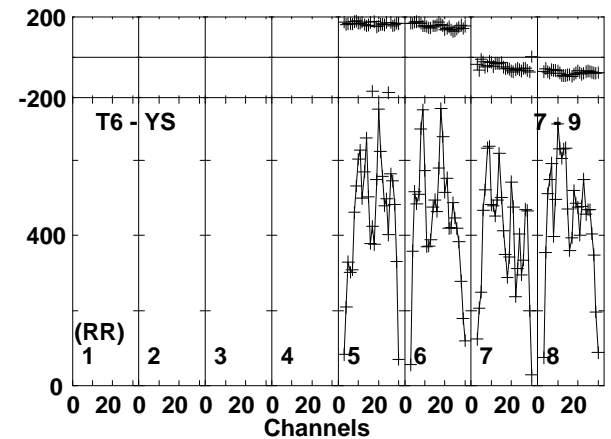
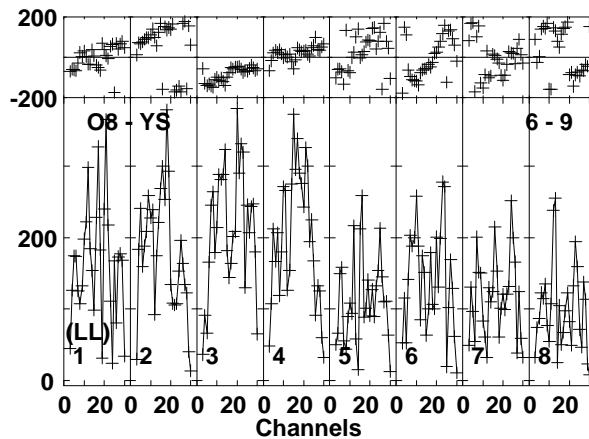
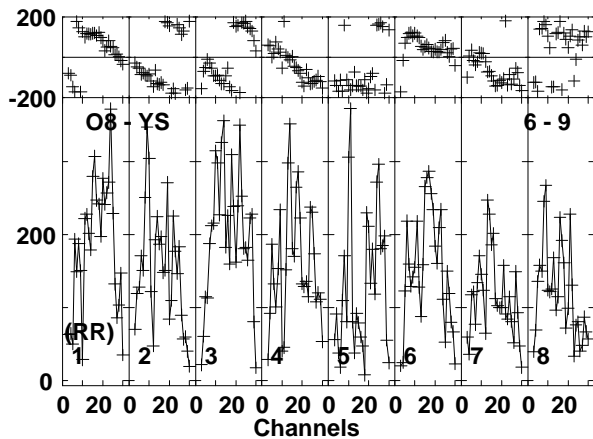
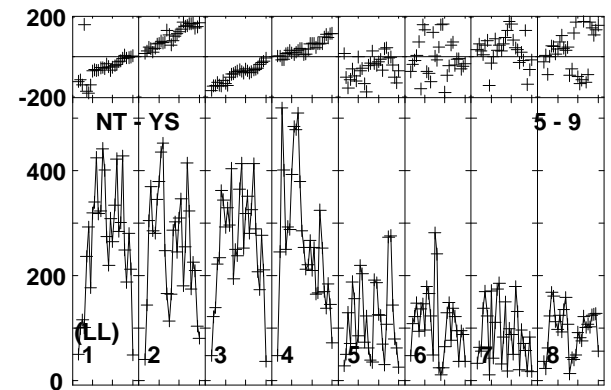
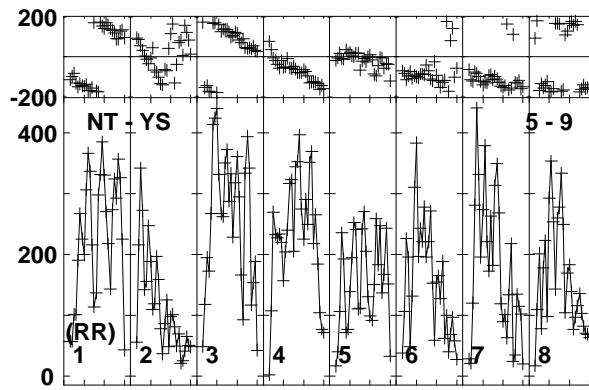
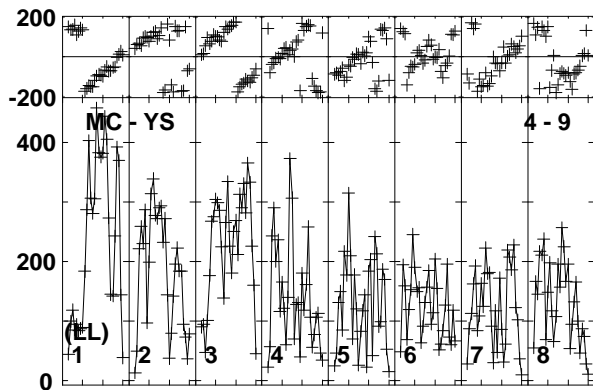
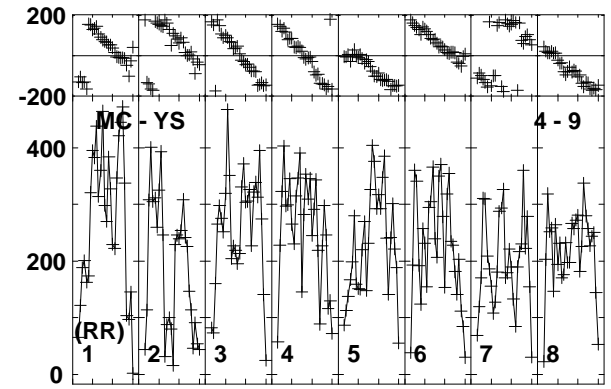
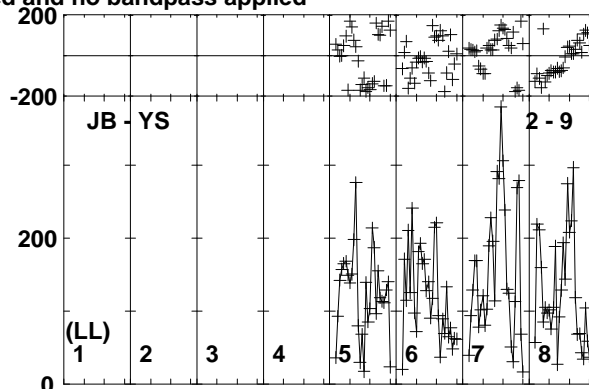
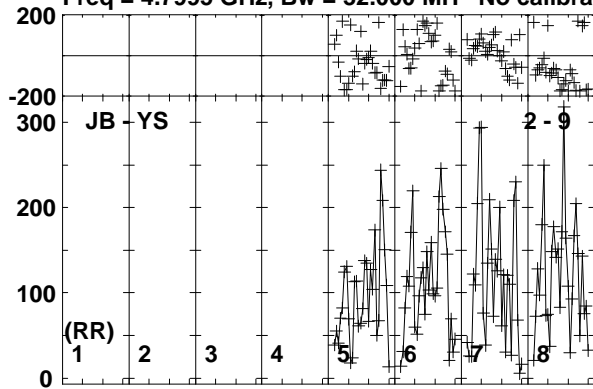

Lower frame: Micro Ampl Jy Top frame: Phas deg
Vector averaged cross-power spectrum Baseline: JB (02) - YS (09)
Timerange: 00/17:30:01 to 00/17:31:29

Plot file version 158 created 20-APR-2018 10:31:50

J0915+0745 EG102C.UVDATA.1

Freq = 4.7995 GHz, Bw = 32.000 MH No calibration applied and no bandpass applied

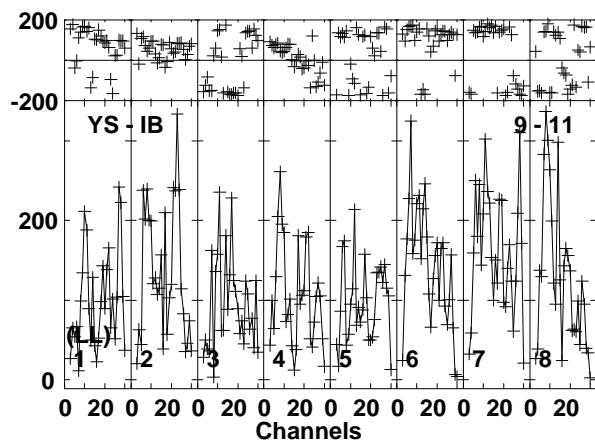
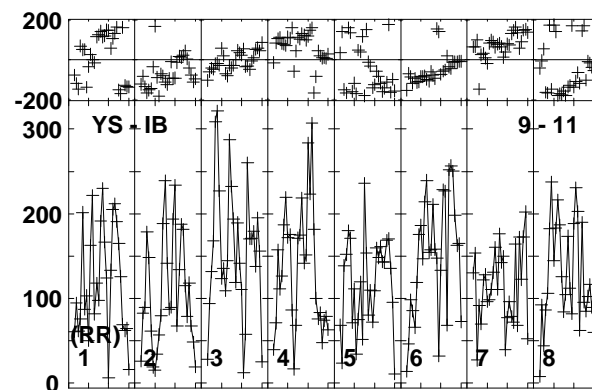
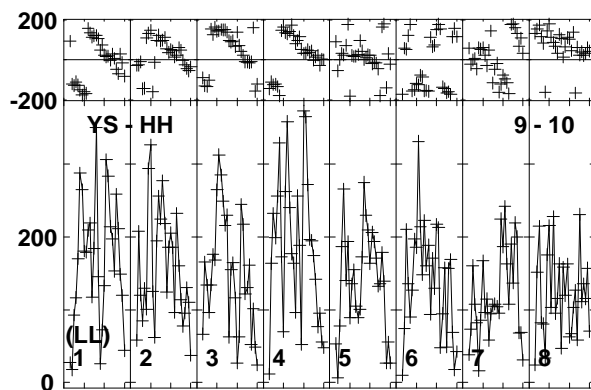
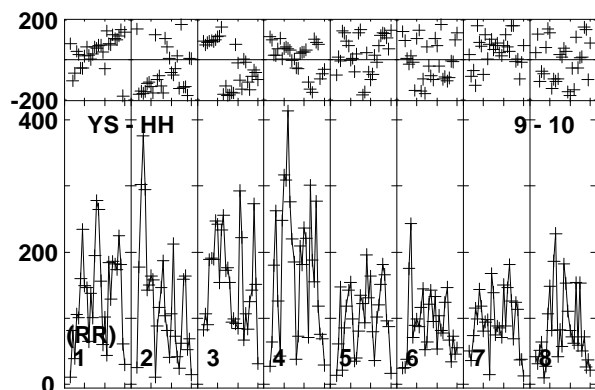
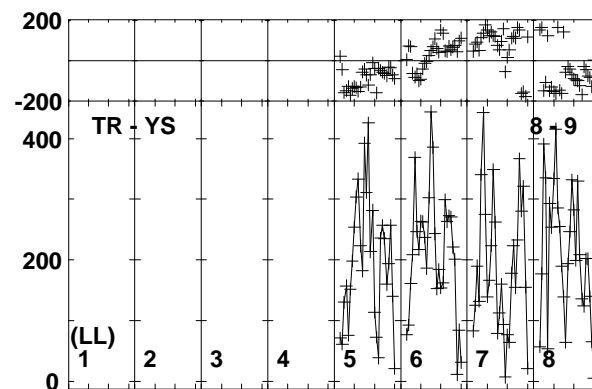
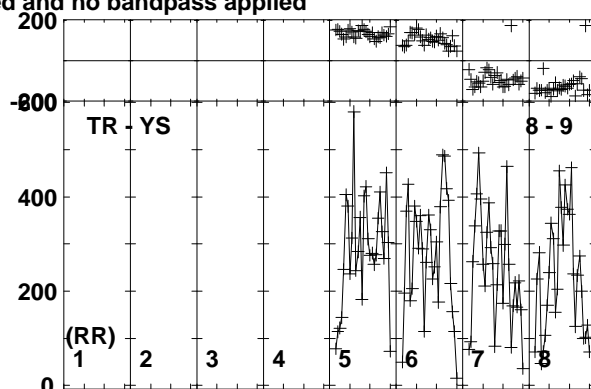
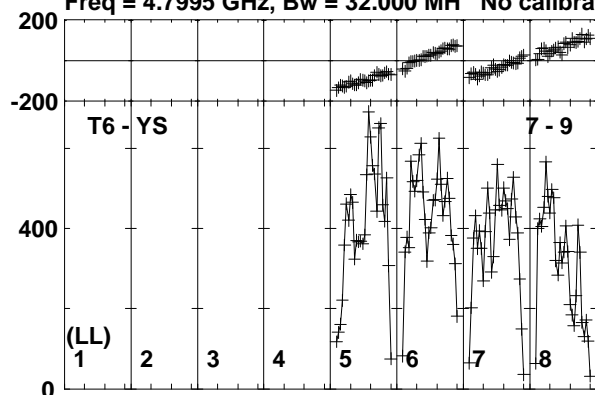

Lower frame: Micro Ampl Jy Top frame: Phas deg
Vector averaged cross-power spectrum Baseline: T6 (07) - YS (09)
Timerange: 00/17:30:01 to 00/17:31:29

Plot file version 159 created 20-APR-2018 10:31:50

B0915+068 EG102C.UVDATA.1

Freq = 4.7995 GHz, Bw = 32.000 MH No calibration applied and no bandpass applied

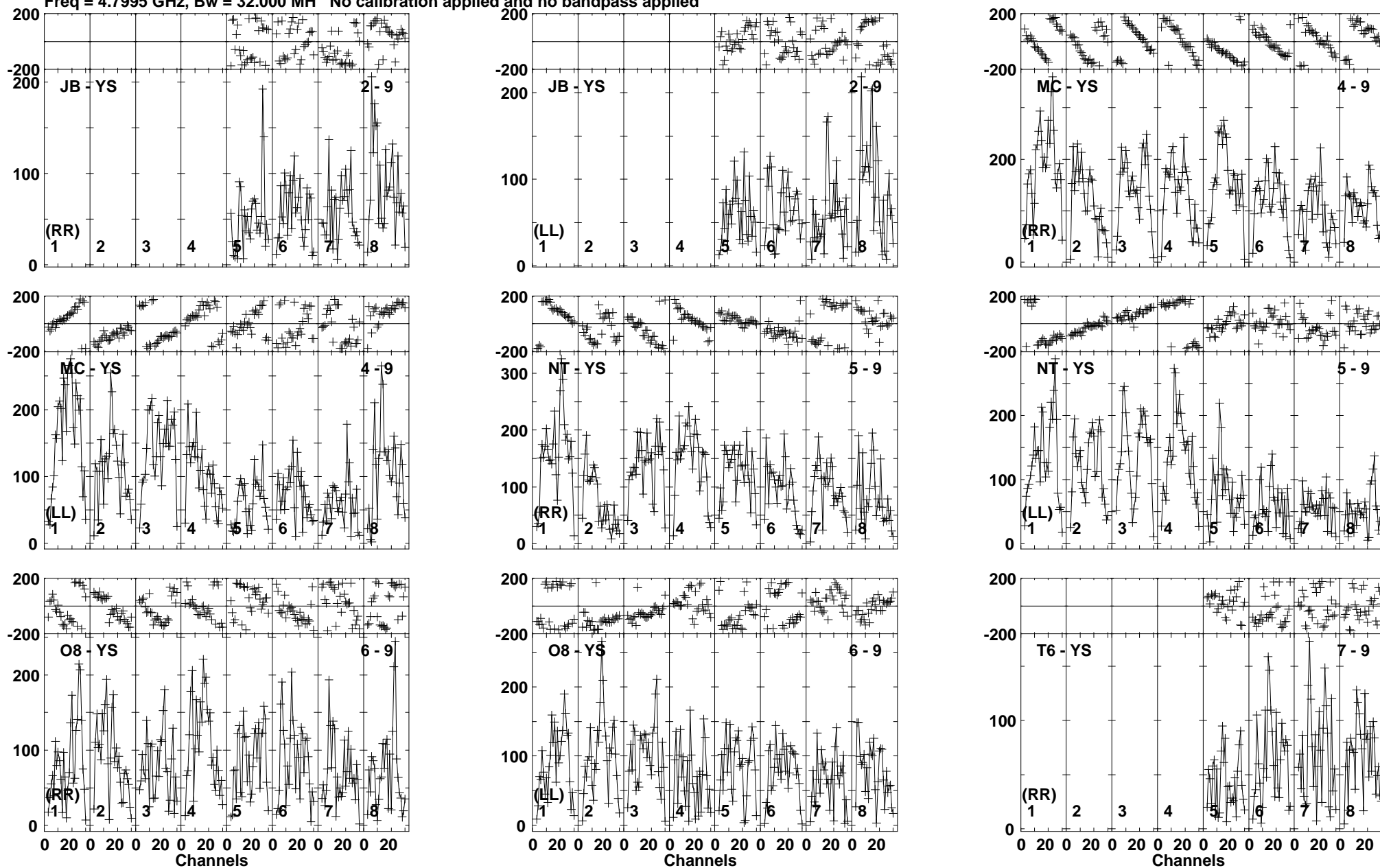

Lower frame: Micro Ampl Jy Top frame: Phas deg
Vector averaged cross-power spectrum Baseline: JB (02) - YS (09)
Timerange: 00/17:31:31 to 00/17:34:59

Plot file version 160 created 20-APR-2018 10:31:50

B0915+068 EG102C.UVDATA.1

Freq = 4.7995 GHz, Bw = 32.000 MH No calibration applied and no bandpass applied

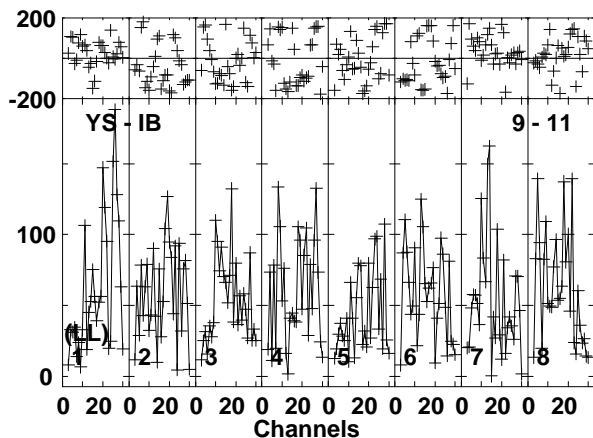
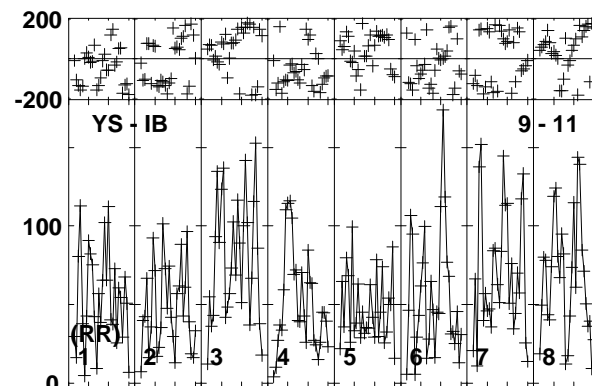
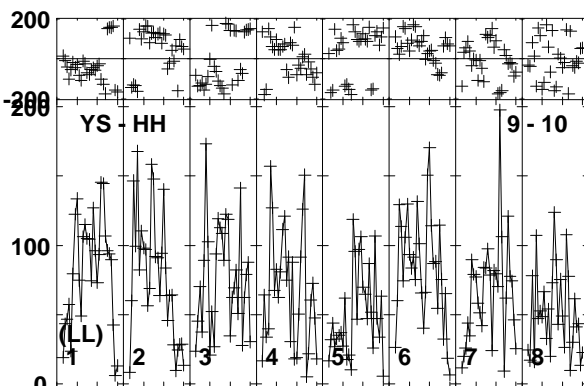
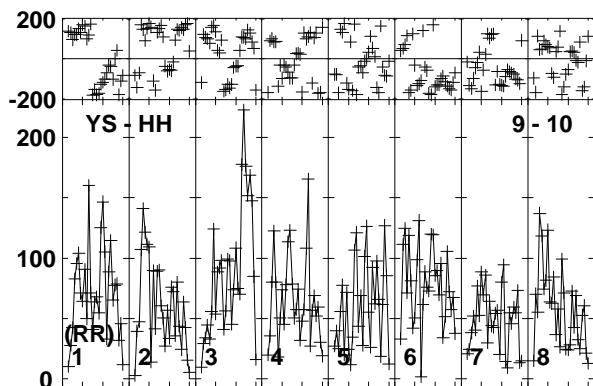
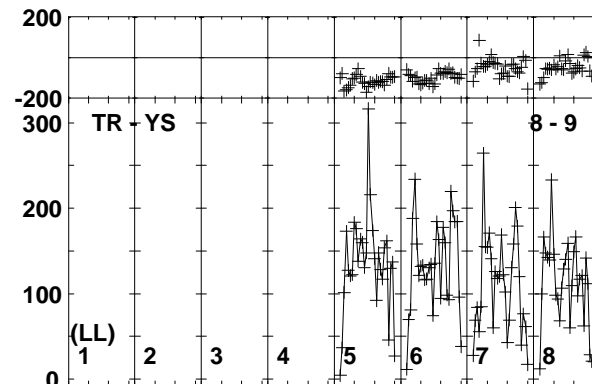
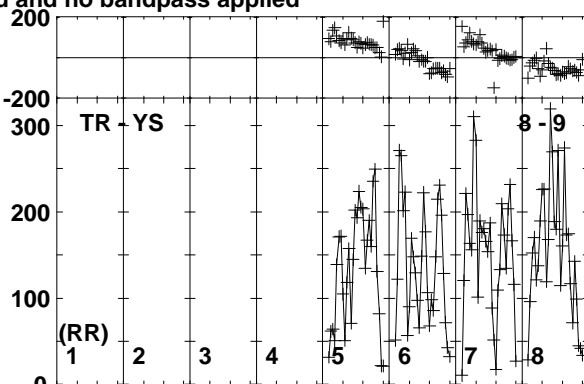
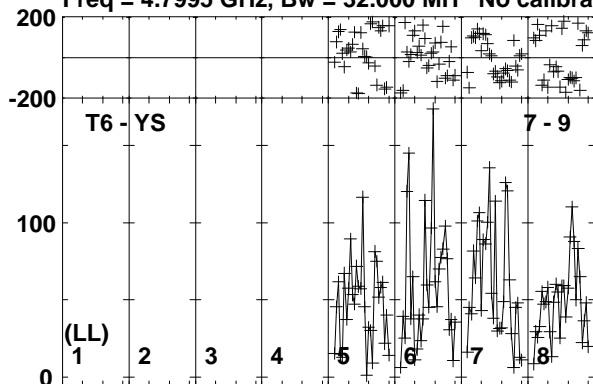

Lower frame: Micro Ampl Jy Top frame: Phas deg
Vector averaged cross-power spectrum Baseline: T6 (07) - YS (09)
Timerange: 00/17:31:31 to 00/17:34:59

Plot file version 161 created 20-APR-2018 10:31:50

J0915+0745 EG102C.UVDATA.1

Freq = 4.7995 GHz, Bw = 32.000 MH No calibration applied and no bandpass applied

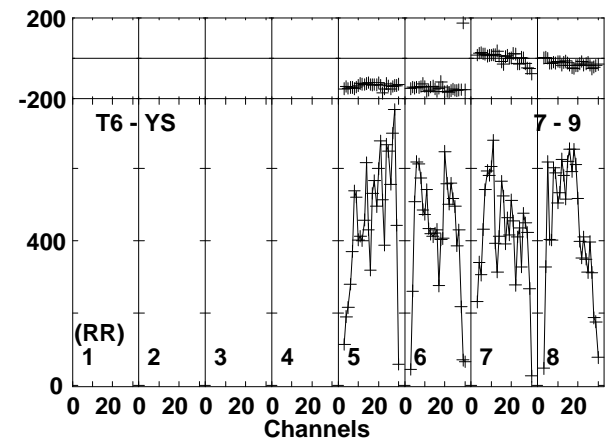
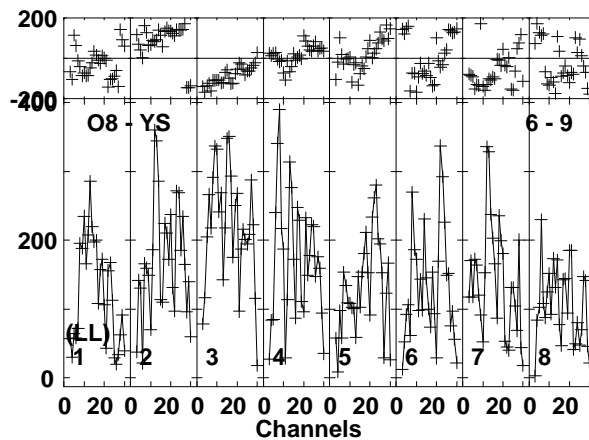
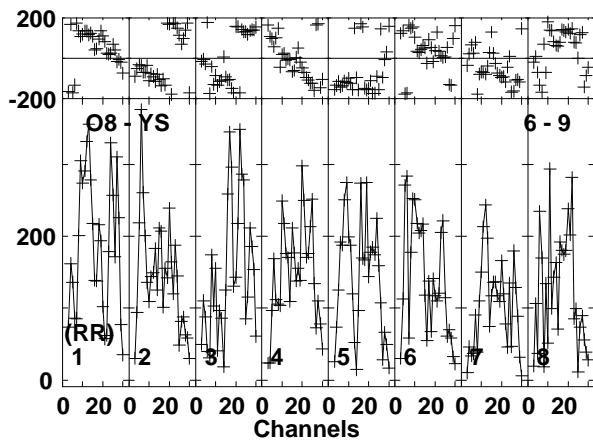
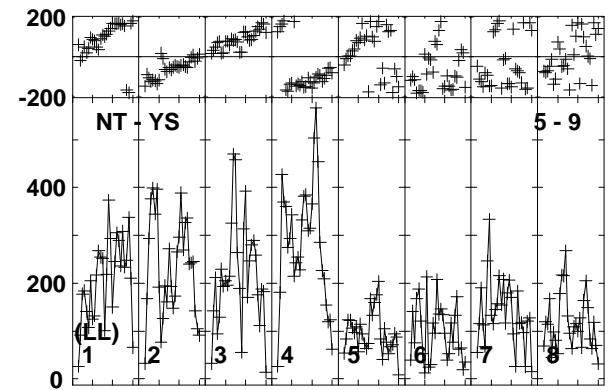
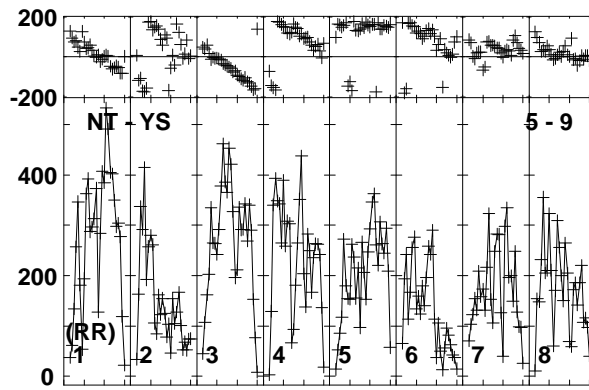
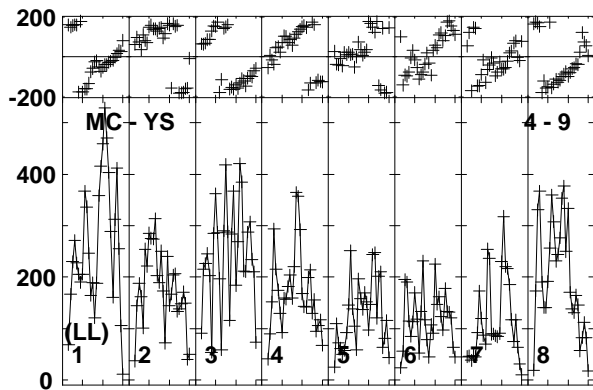
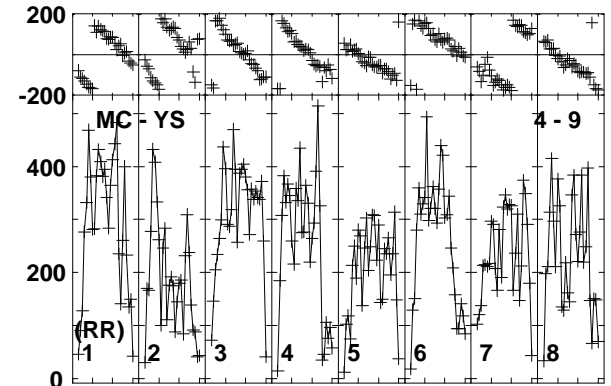
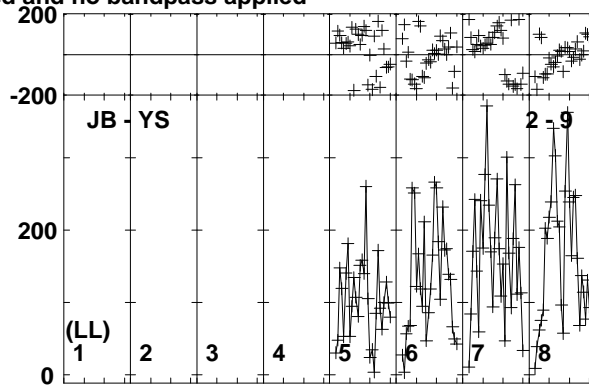
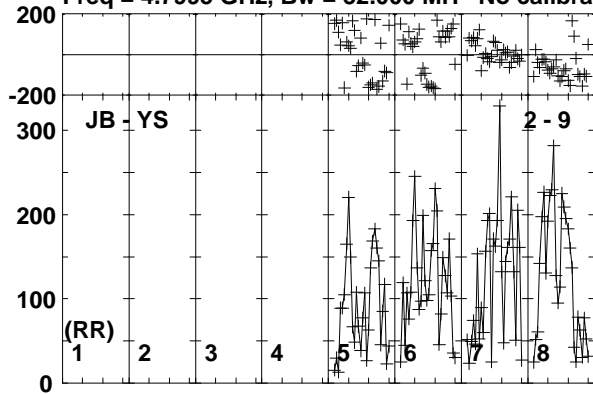

Lower frame: Micro Ampl Jy Top frame: Phas deg
Vector averaged cross-power spectrum Baseline: JB (02) - YS (09)
Timerange: 00/17:35:41 to 00/17:36:39

Plot file version 162 created 20-APR-2018 10:31:51

J0915+0745 EG102C.UVDATA.1

Freq = 4.7995 GHz, Bw = 32.000 MH No calibration applied and no bandpass applied

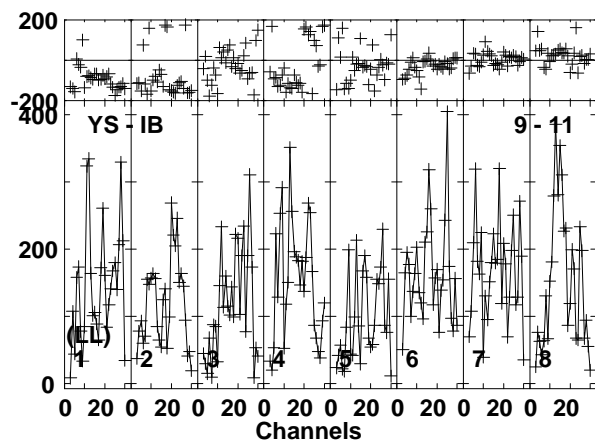
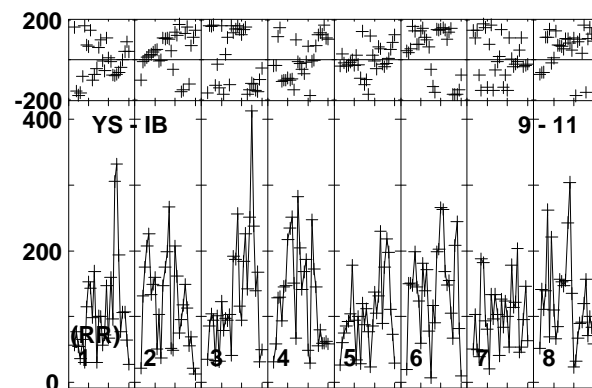
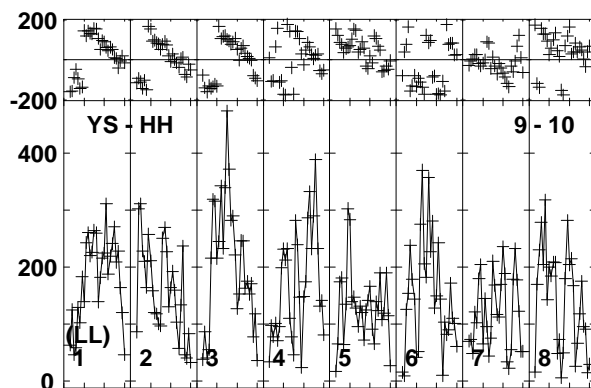
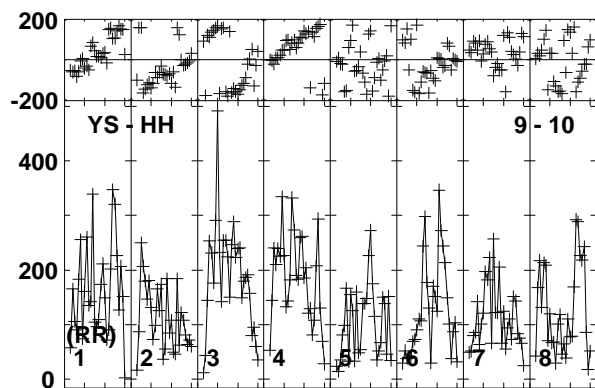
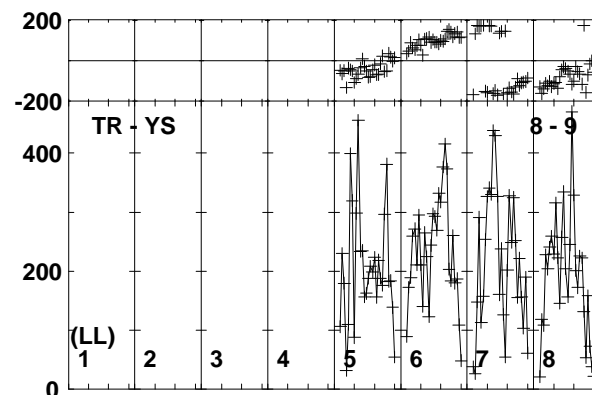
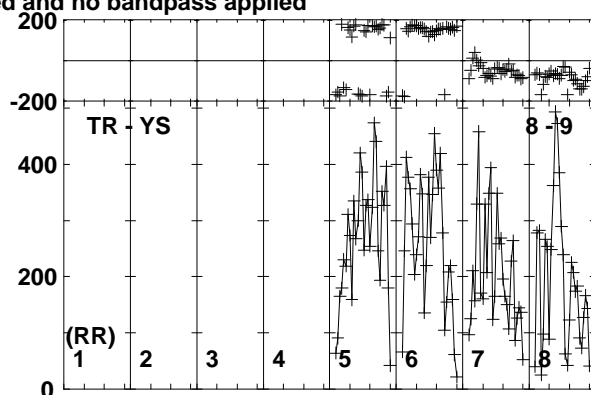
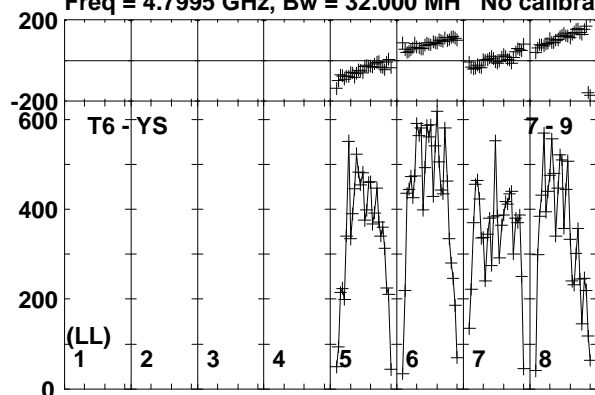

Lower frame: Micro Ampl Jy Top frame: Phas deg
Vector averaged cross-power spectrum Baseline: T6 (07) - YS (09)
Timerange: 00/17:35:41 to 00/17:36:39

Plot file version 163 created 20-APR-2018 10:31:51

B0915+068 EG102C.UVDATA.1

Freq = 4.7995 GHz, Bw = 32.000 MH No calibration applied and no bandpass applied

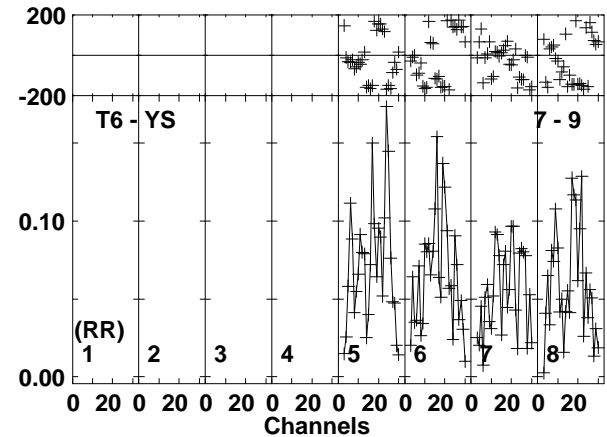
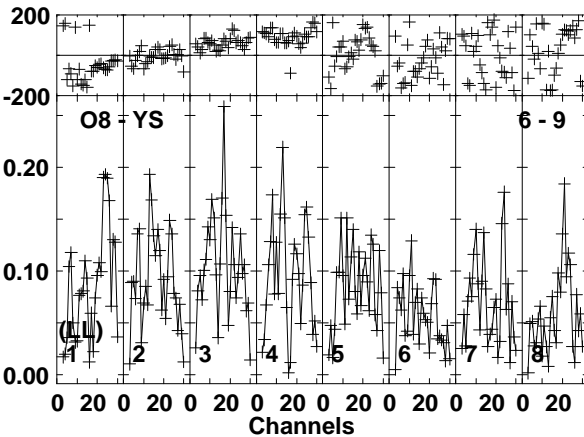
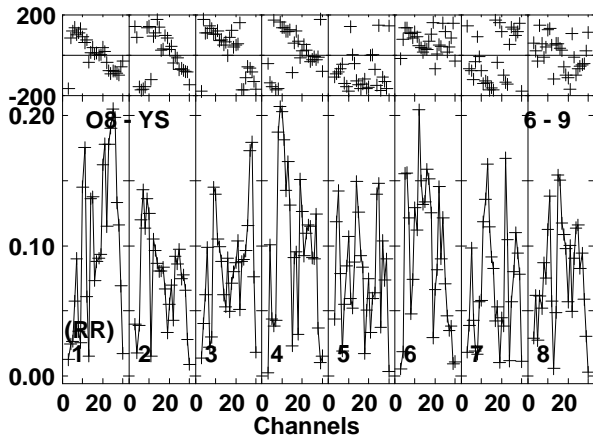
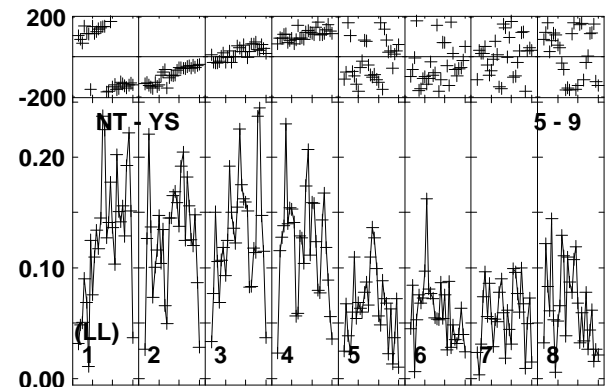
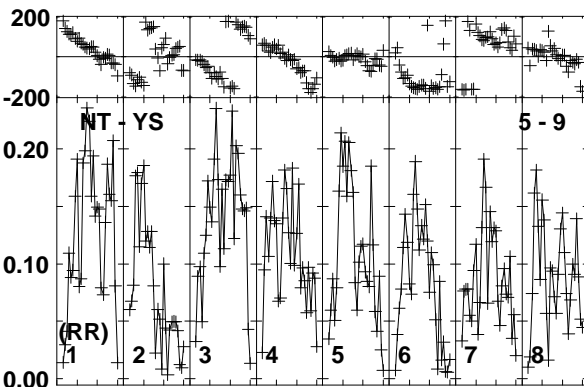
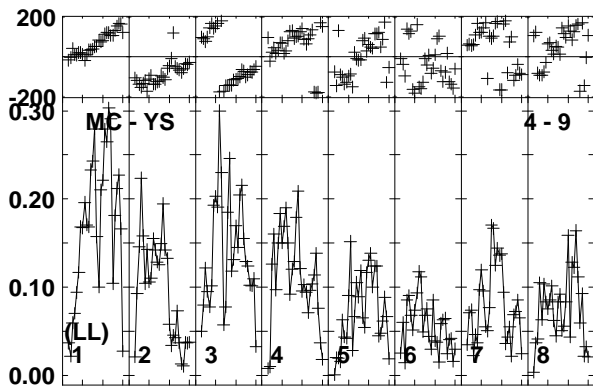
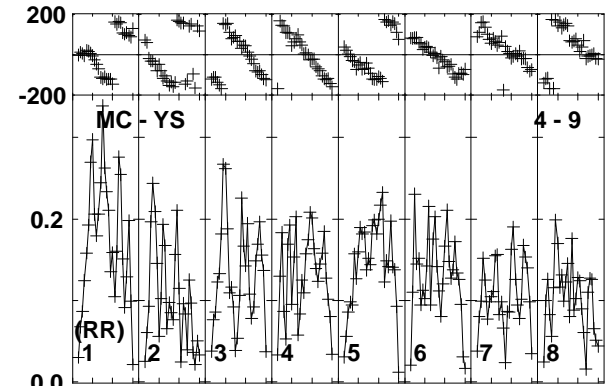
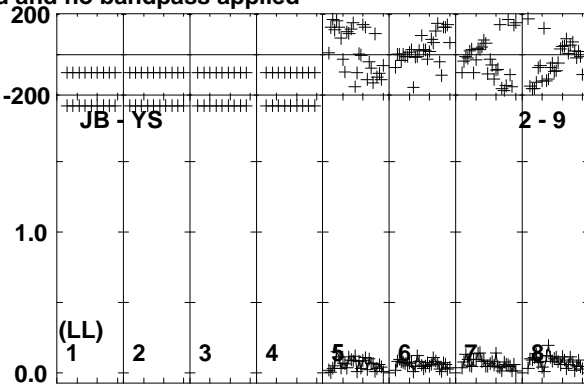
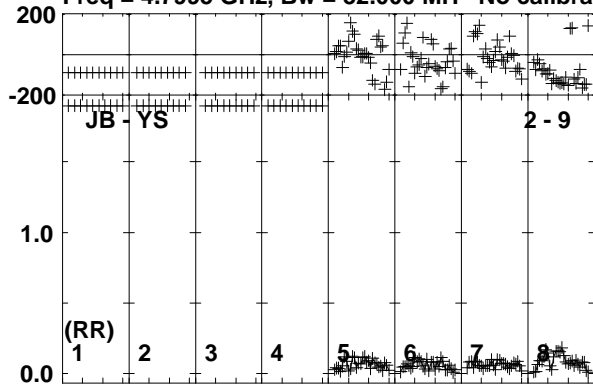

Lower frame: Milli Ampl Jy Top frame: Phas deg
Vector averaged cross-power spectrum Baseline: JB (02) - YS (09)
Timerange: 00/17:36:41 to 00/17:40:09

Plot file version 164 created 20-APR-2018 10:31:51

B0915+068 EG102C.UVDATA.1

Freq = 4.7995 GHz, Bw = 32.000 MH No calibration applied and no bandpass applied

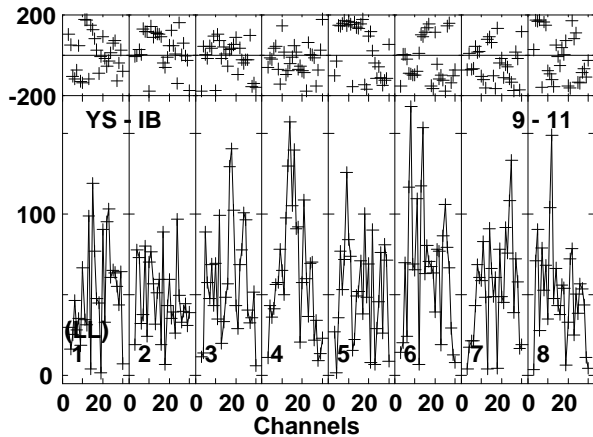
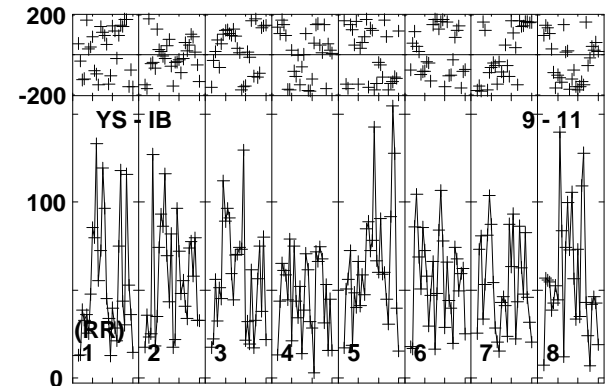
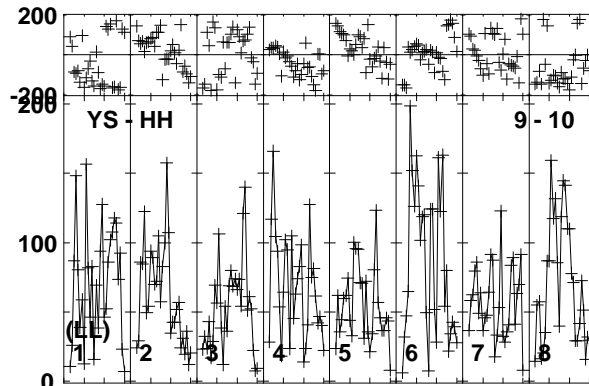
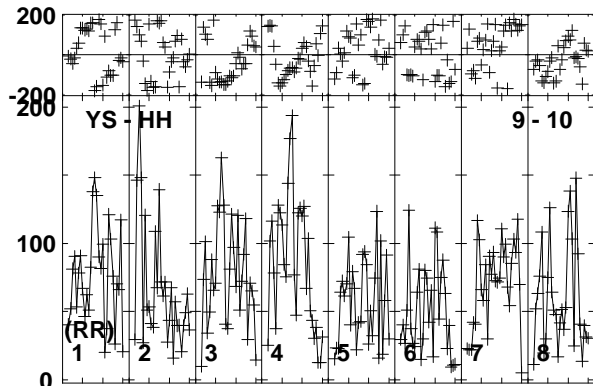
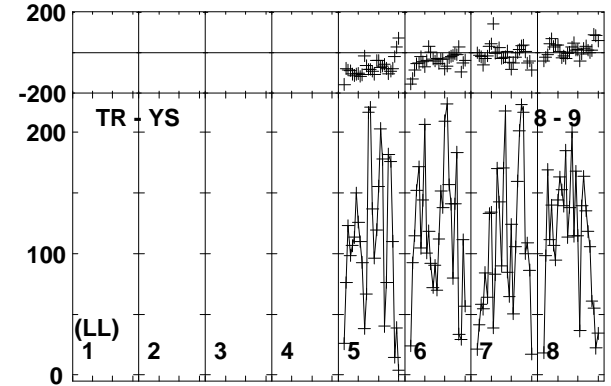
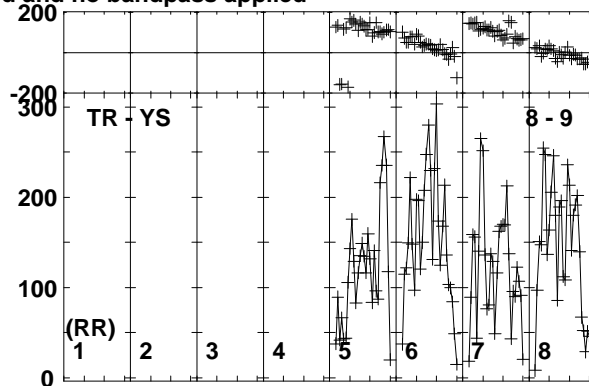
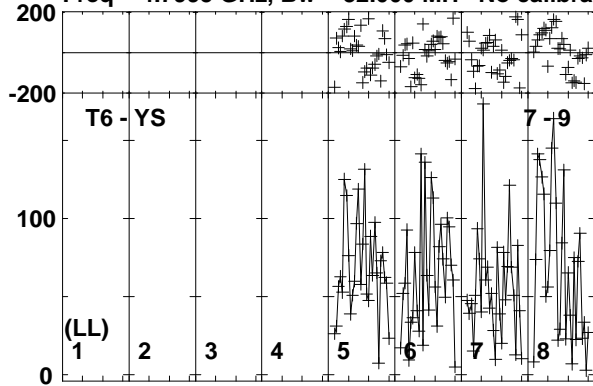

Lower frame: Micro Ampl Jy Top frame: Phas deg
Vector averaged cross-power spectrum Baseline: T6 (07) - YS (09)
Timerange: 00/17:36:41 to 00/17:40:09

Plot file version 165 created 20-APR-2018 10:31:51

J0915+0745 EG102C.UVDATA.1

Freq = 4.7995 GHz, Bw = 32.000 MH No calibration applied and no bandpass applied

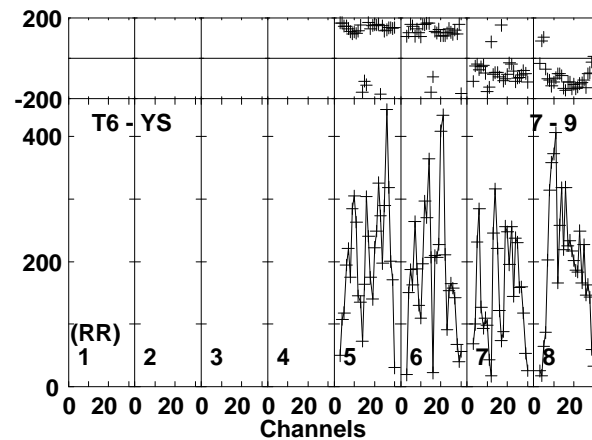
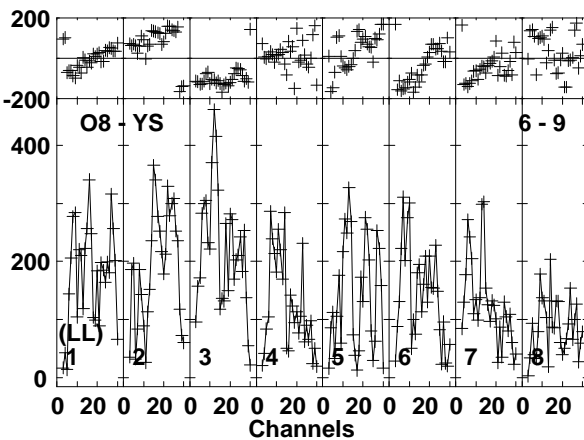
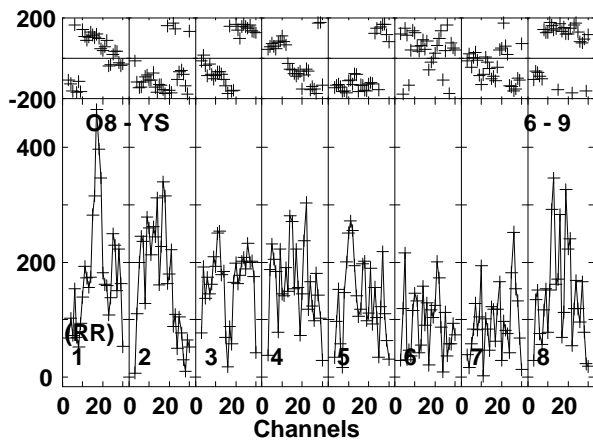
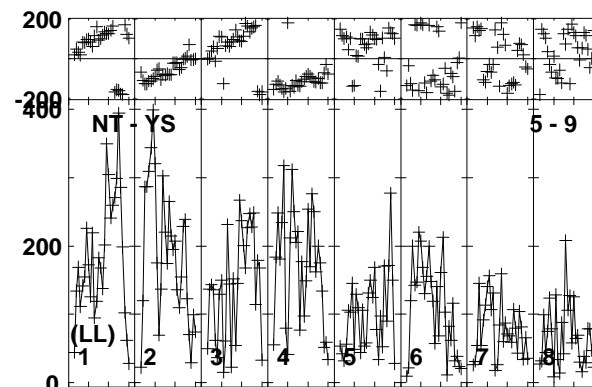
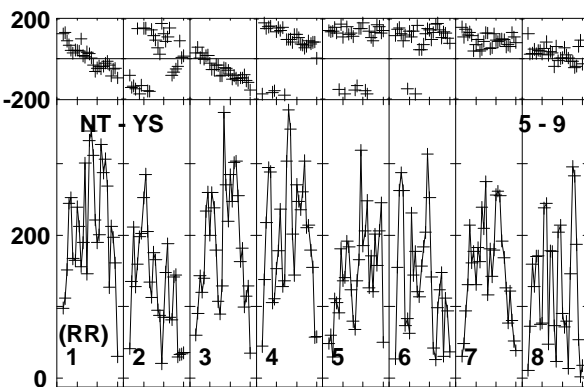
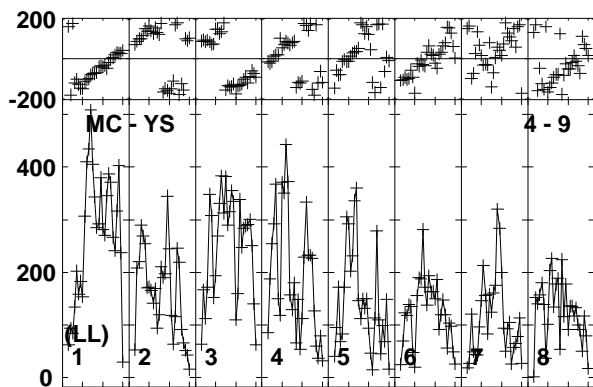
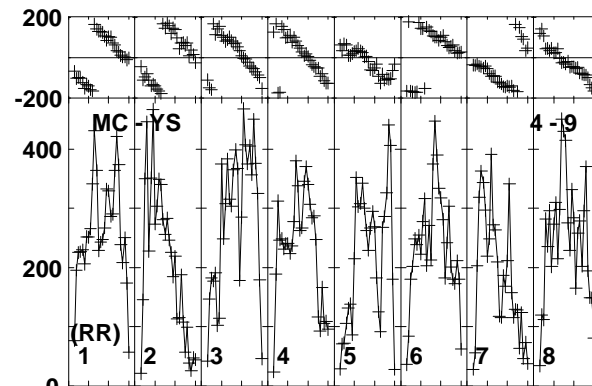
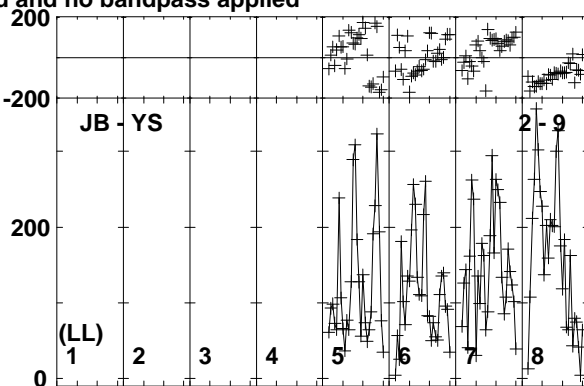
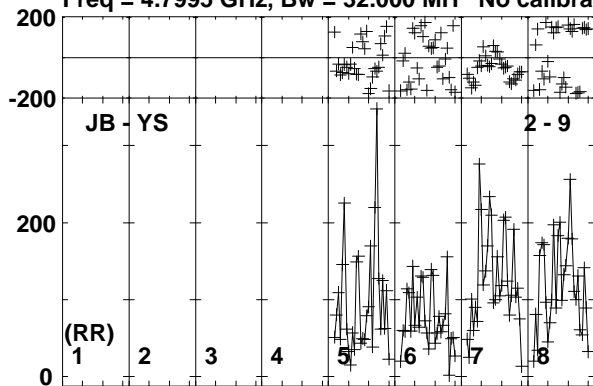

Lower frame: Micro Ampl Jy Top frame: Phas deg
Vector averaged cross-power spectrum Baseline: JB (02) - YS (09)
Timerange: 00/17:40:11 to 00/17:41:39

Plot file version 166 created 20-APR-2018 10:31:51

J0915+0745 EG102C.UVDATA.1

Freq = 4.7995 GHz, Bw = 32.000 MH No calibration applied and no bandpass applied

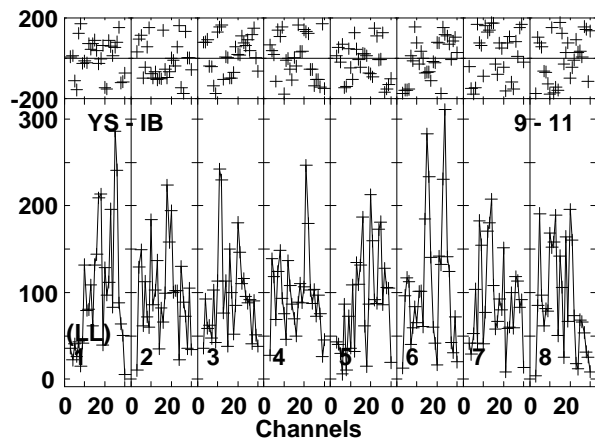
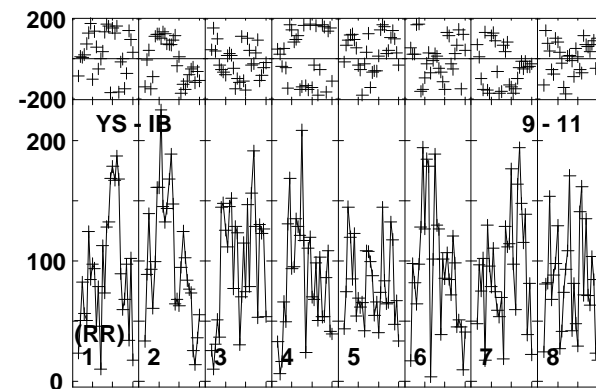
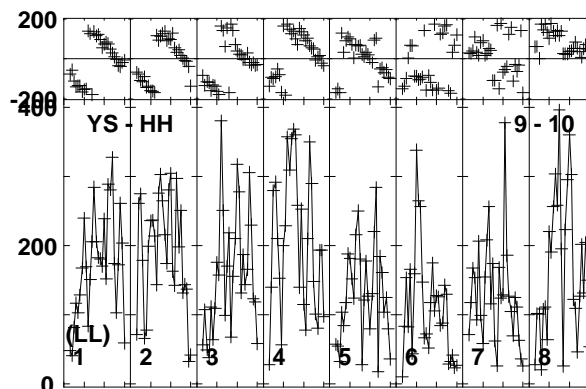
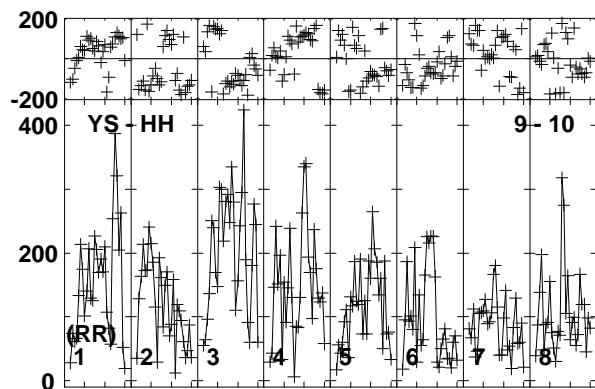
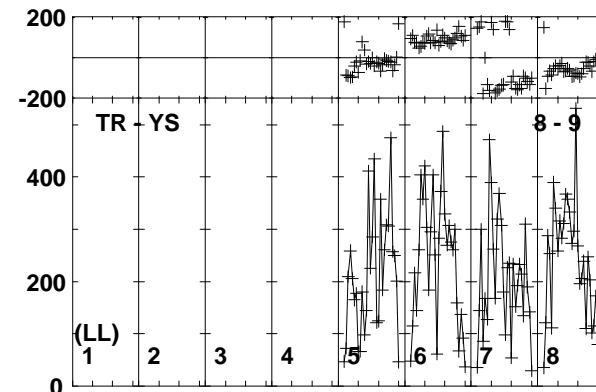
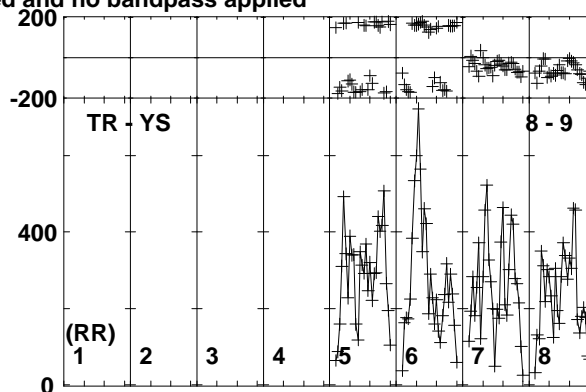
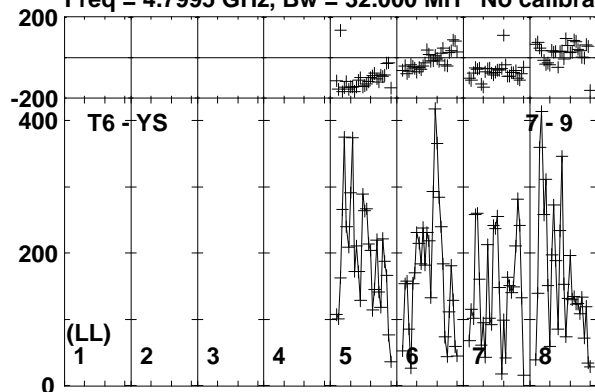

Lower frame: Micro Ampl Jy Top frame: Phas deg
Vector averaged cross-power spectrum Baseline: T6 (07) - YS (09)
Timerange: 00/17:40:11 to 00/17:41:39

Plot file version 167 created 20-APR-2018 10:31:51

B0915+068 EG102C.UVDATA.1

Freq = 4.7995 GHz, Bw = 32.000 MH No calibration applied and no bandpass applied

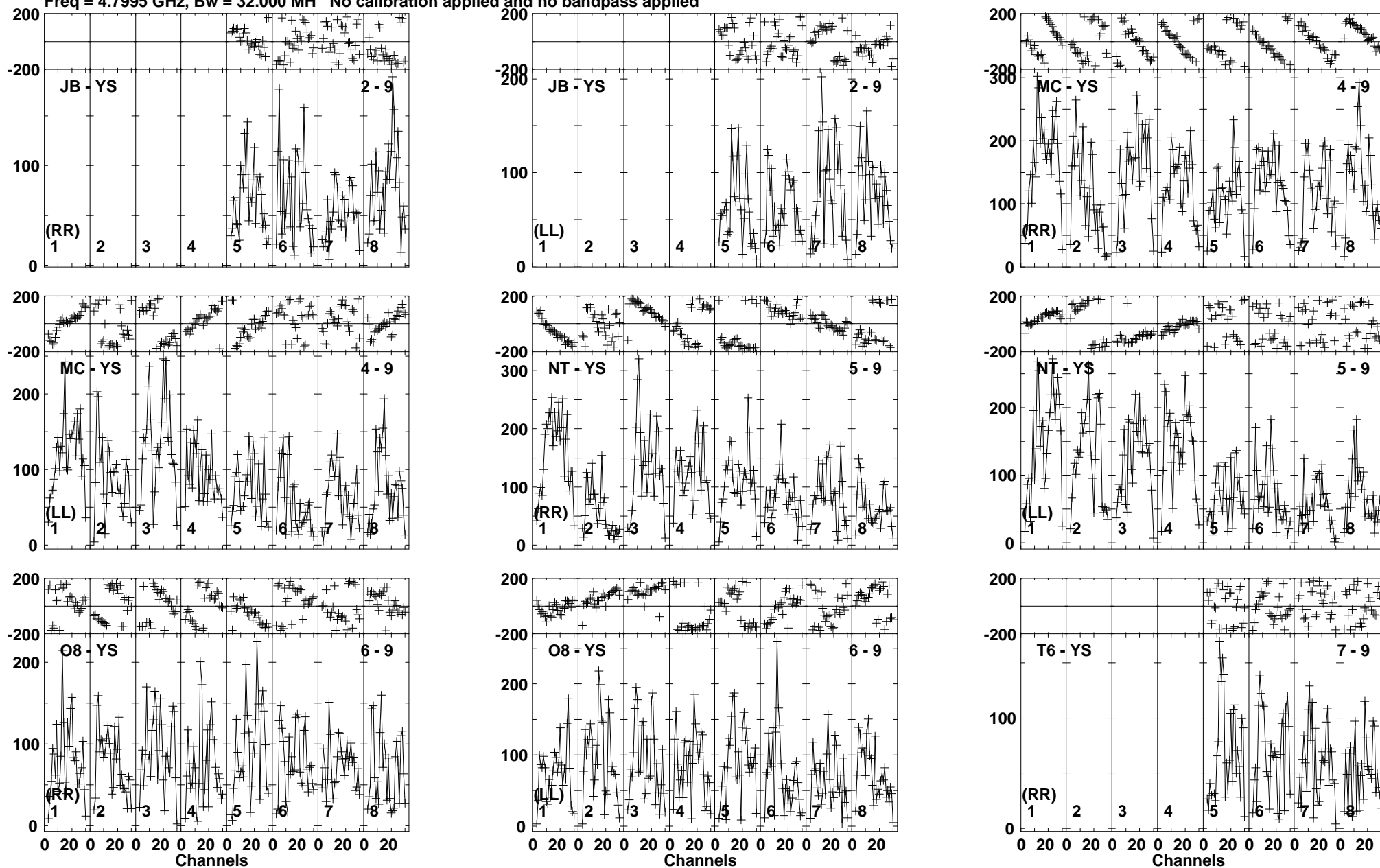

Lower frame: Micro Ampl Jy Top frame: Phas deg
Vector averaged cross-power spectrum Baseline: JB (02) - YS (09)
Timerange: 00/17:41:41 to 00/17:45:09

Plot file version 168 created 20-APR-2018 10:31:51

B0915+068 EG102C.UVDATA.1

Freq = 4.7995 GHz, Bw = 32.000 MH No calibration applied and no bandpass applied

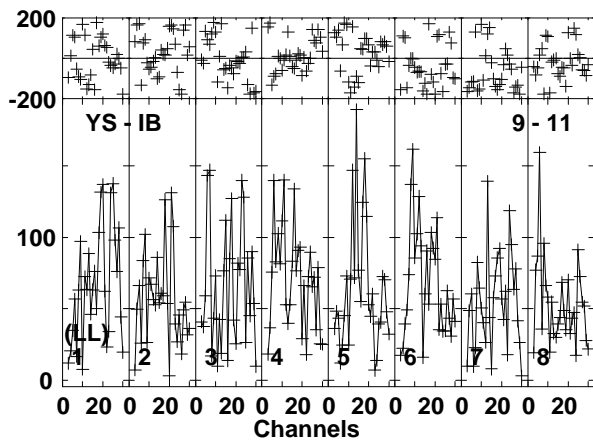
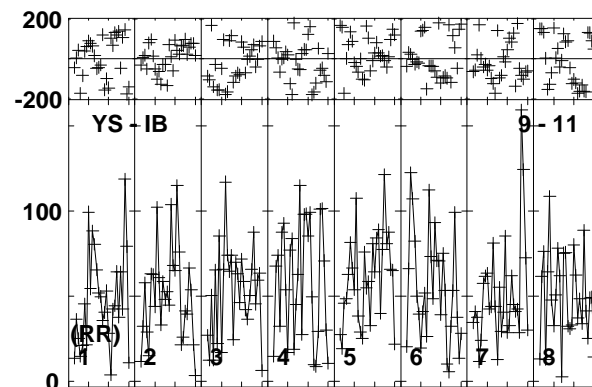
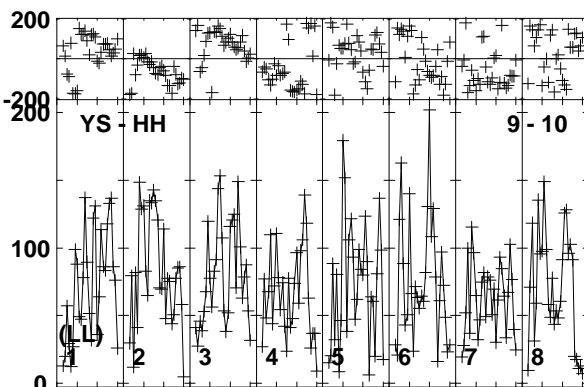
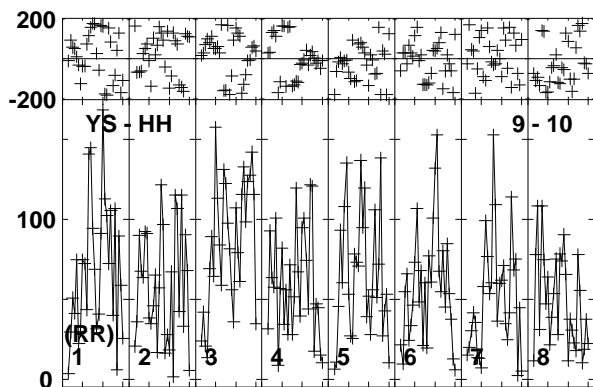
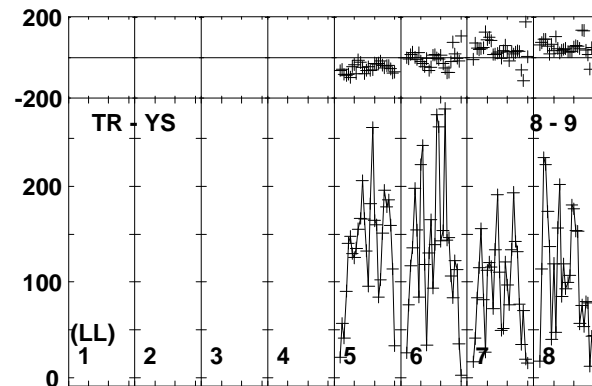
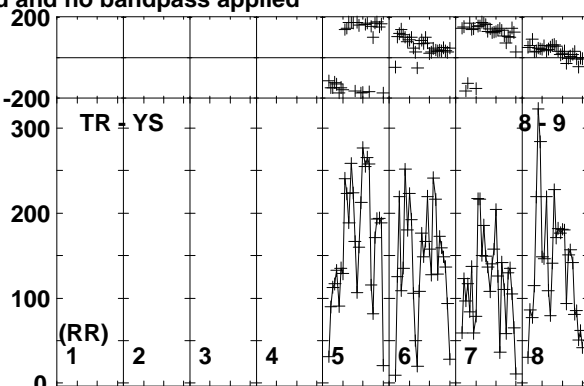
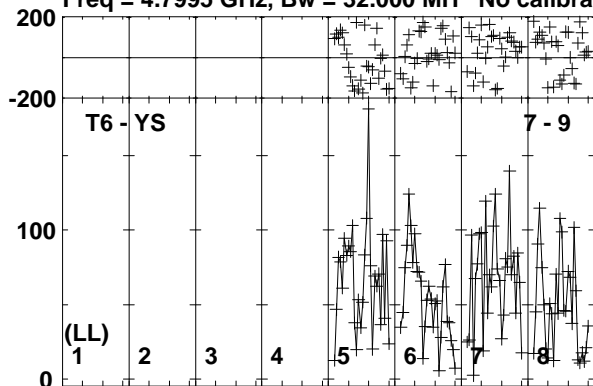

Lower frame: Micro Ampl Jy Top frame: Phas deg
Vector averaged cross-power spectrum Baseline: T6 (07) - YS (09)
Timerange: 00/17:41:41 to 00/17:45:09

Plot file version 169 created 20-APR-2018 10:31:51

J0915+0745 EG102C.UVDATA.1

Freq = 4.7995 GHz, Bw = 32.000 MH No calibration applied and no bandpass applied

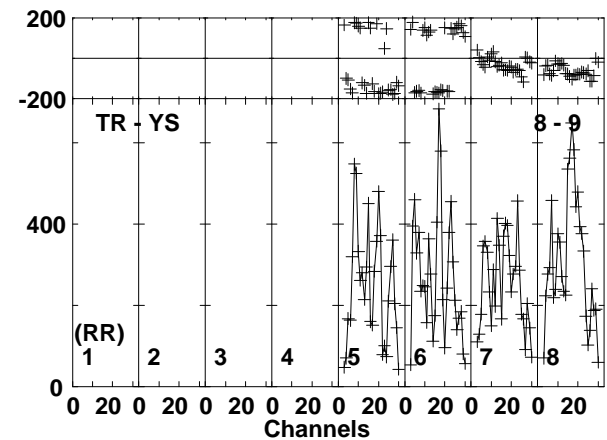
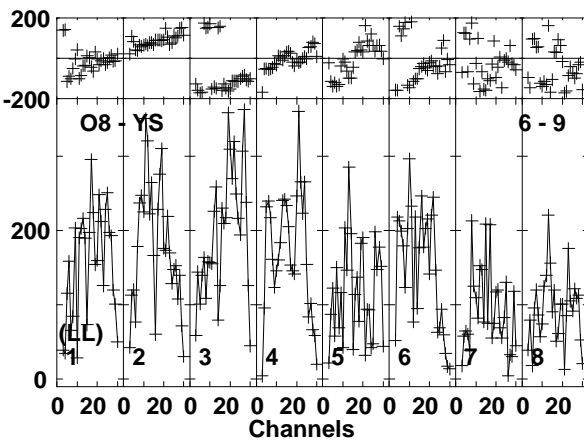
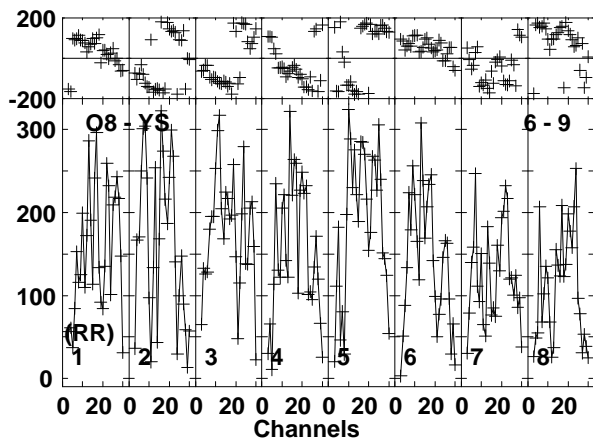
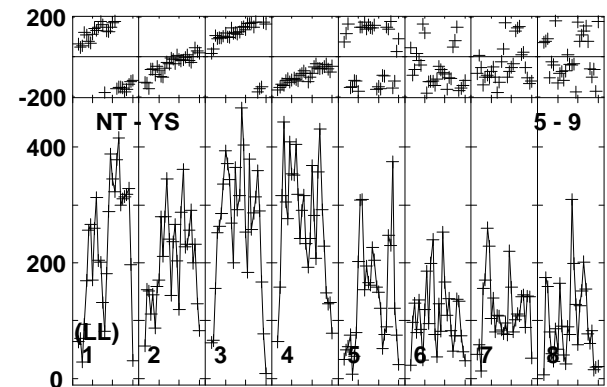
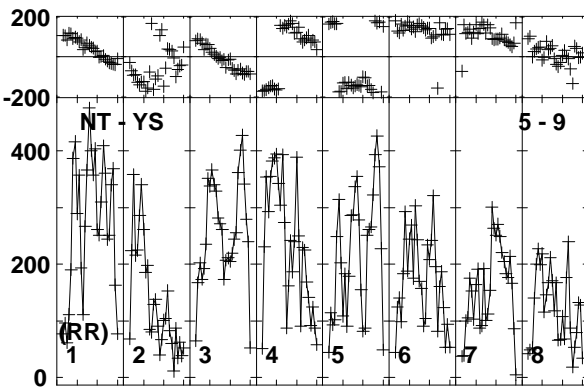
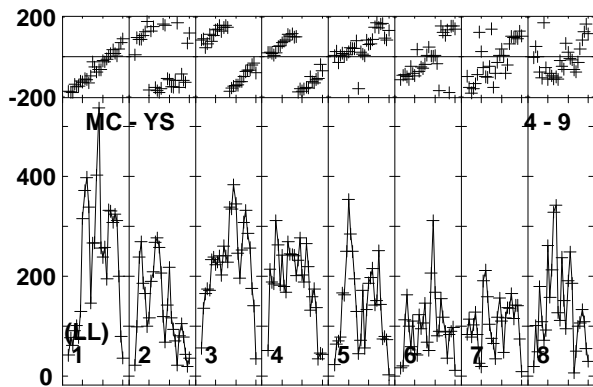
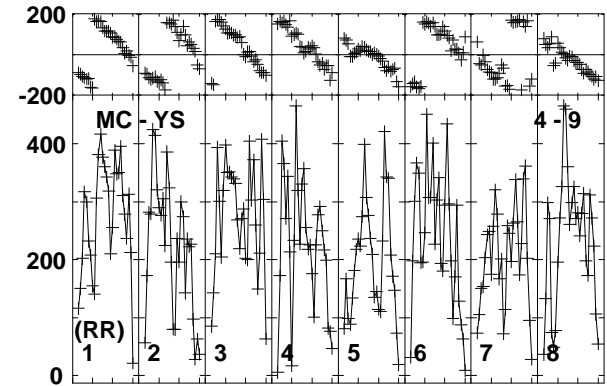
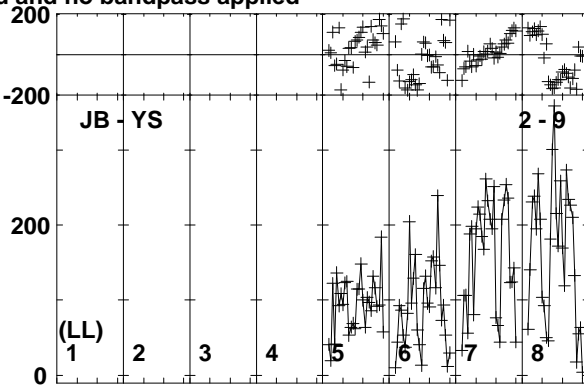
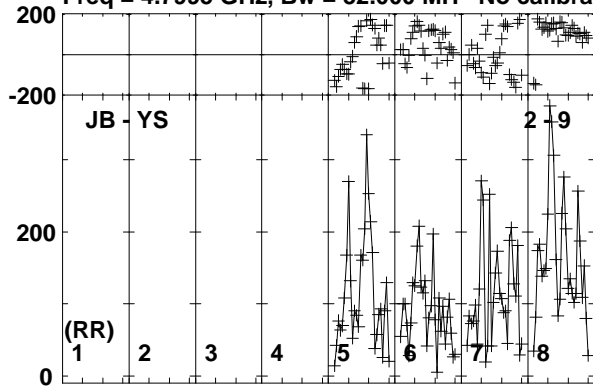

Lower frame: Micro Ampl Jy Top frame: Phas deg
Vector averaged cross-power spectrum Baseline: JB (02) - YS (09)
Timerange: 00:17:45:11 to 00:17:46:39

Plot file version 170 created 20-APR-2018 10:31:51

J0915+0745 EG102C.UVDATA.1

Freq = 4.7995 GHz, Bw = 32.000 MH No calibration applied and no bandpass applied

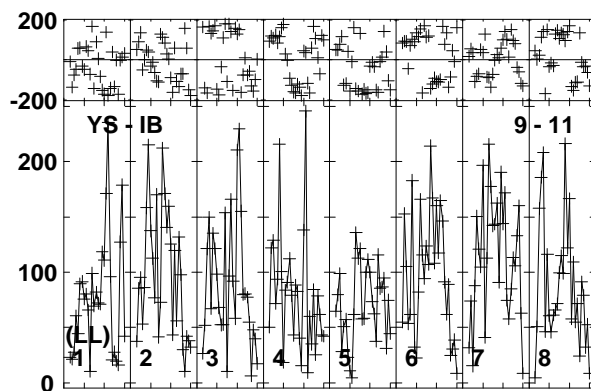
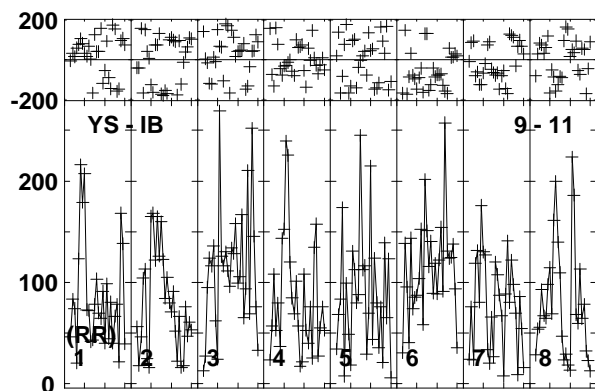
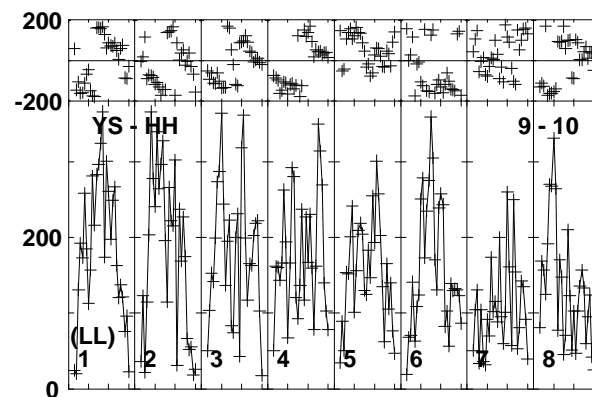
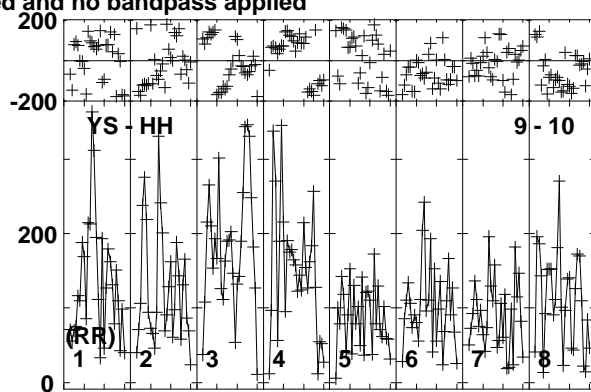
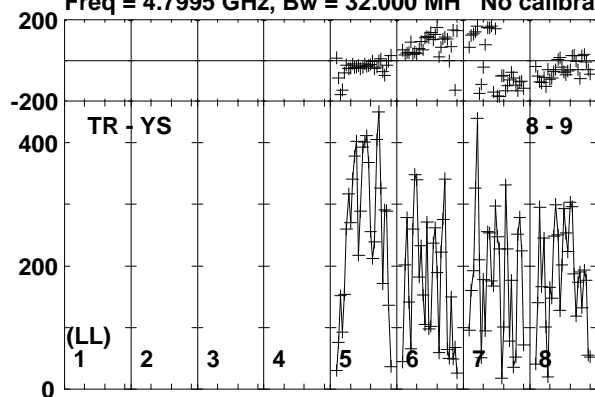

Lower frame: Micro Ampl Jy Top frame: Phas deg
Vector averaged cross-power spectrum Baseline: TR (08) - YS (09)
Timerange: 00/17:45:11 to 00/17:46:39

Plot file version 171 created 20-APR-2018 10:31:51

J1041+0610 EG102C.UVDATA.1

Freq = 4.7995 GHz, Bw = 32.000 MH No calibration applied and no bandpass applied

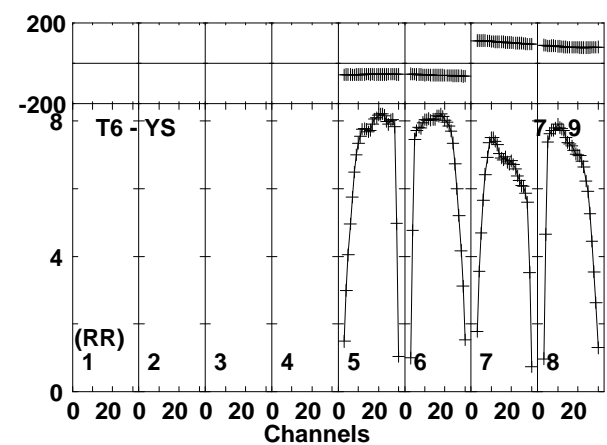
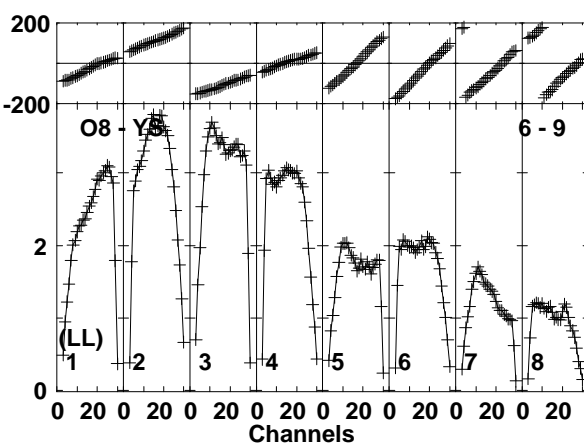
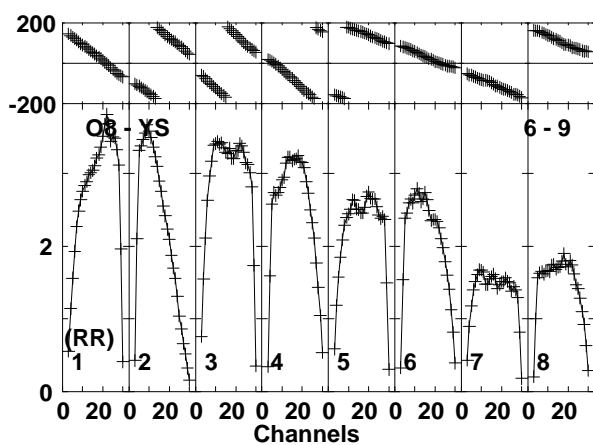
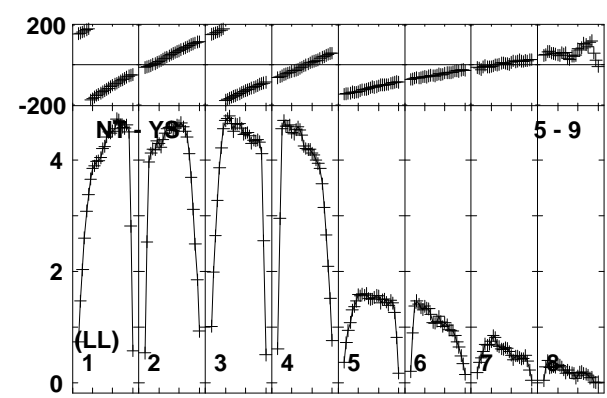
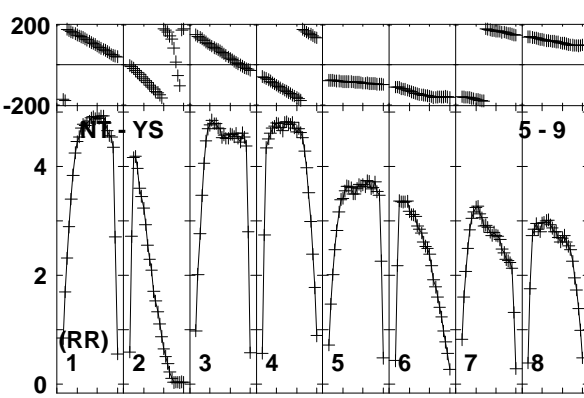
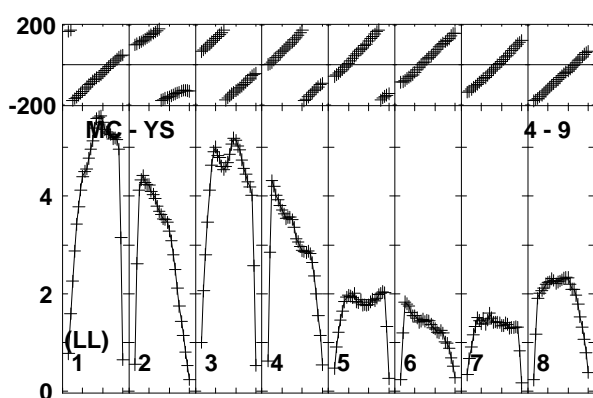
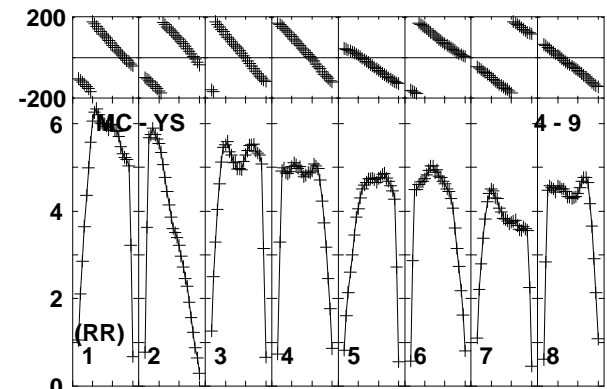
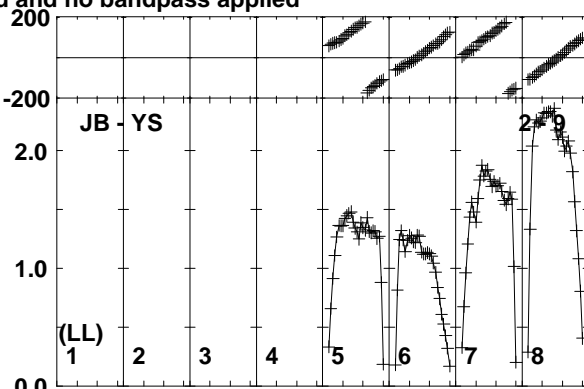
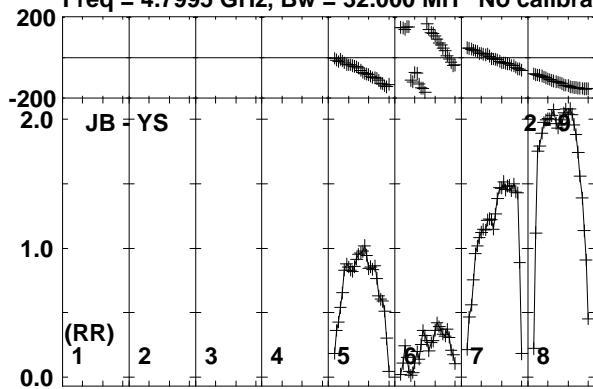

Lower frame: Milli Ampl Jy Top frame: Phas deg
Vector averaged cross-power spectrum Baseline: JB (02) - YS (09)
Timerange: 00/17:48:21 to 00/17:51:19

Plot file version 172 created 20-APR-2018 10:31:52

J1041+0610 EG102C.UVDATA.1

Freq = 4.7995 GHz, Bw = 32.000 MH No calibration applied and no bandpass applied

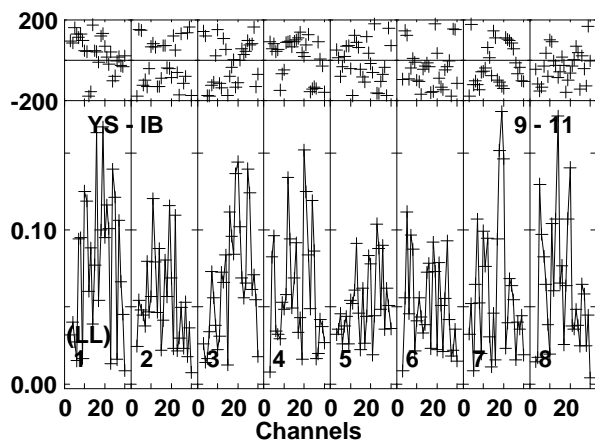
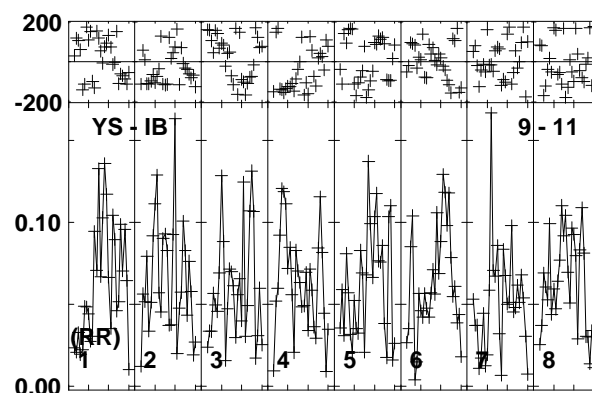
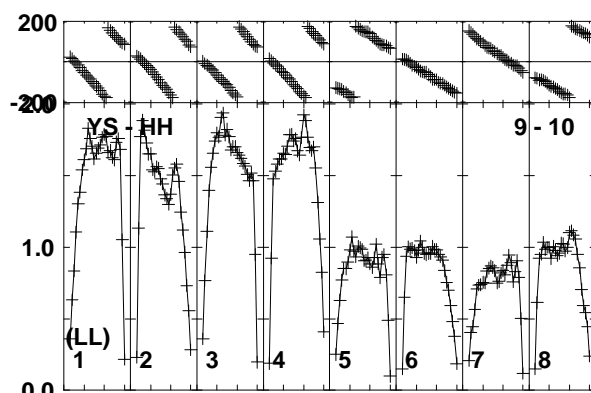
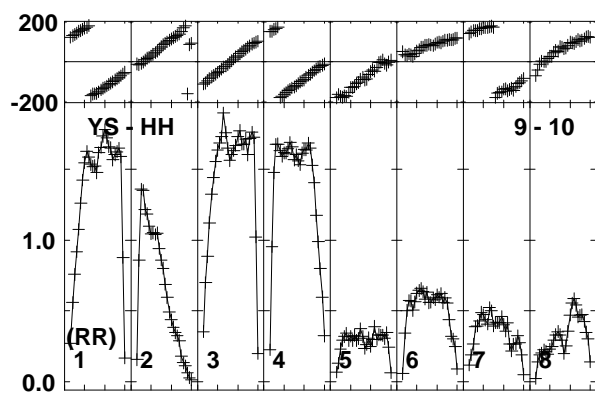
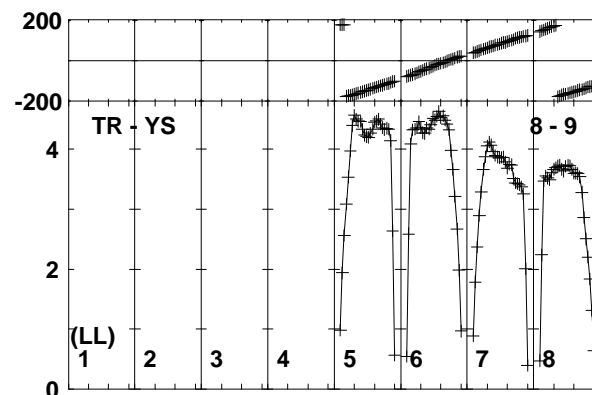
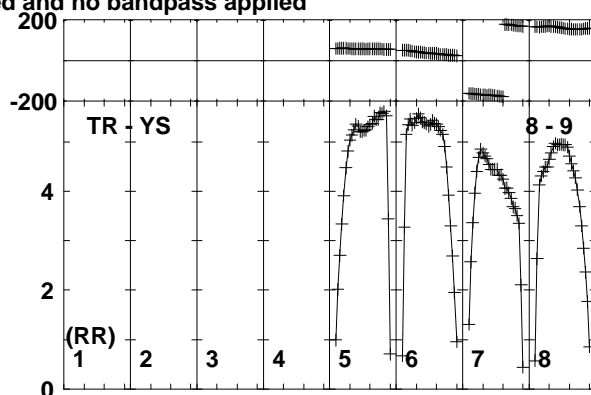
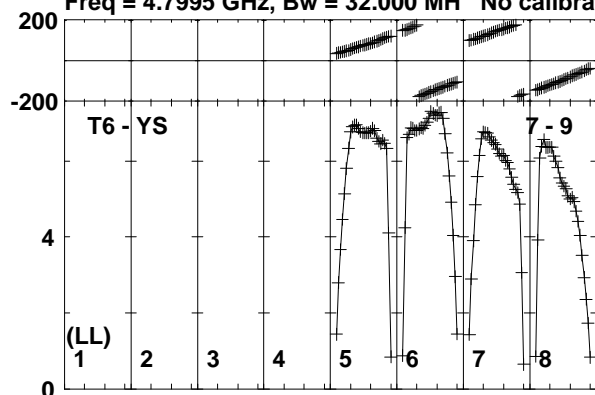

Lower frame: Milli Ampl Jy Top frame: Phas deg
Vector averaged cross-power spectrum Baseline: T6 (07) - YS (09)
Timerange: 00/17:48:21 to 00/17:51:19