

Plot file version 1 created 11-NOV-2019 15:07:15

3C345 EK040B.UVDATA.1

Freq = 4.7990 GHz, Bw = 32.000 MH No calibration applied and no bandpass applied

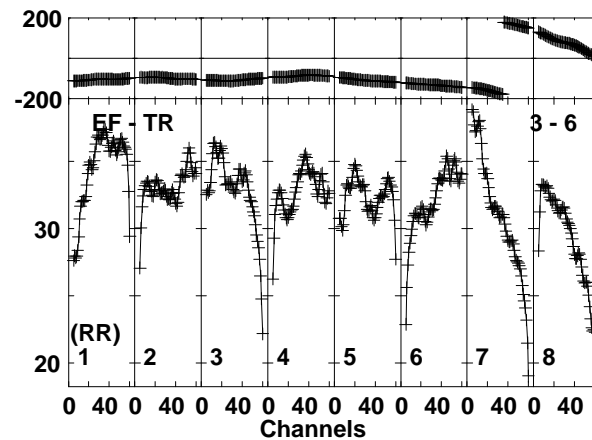
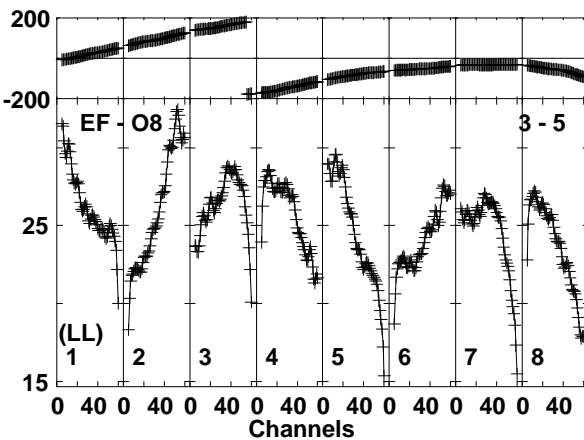
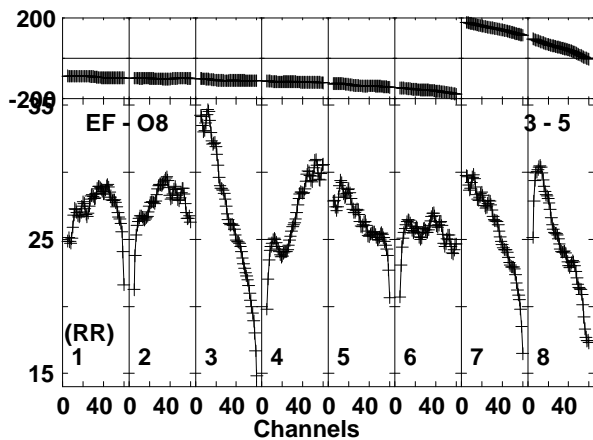
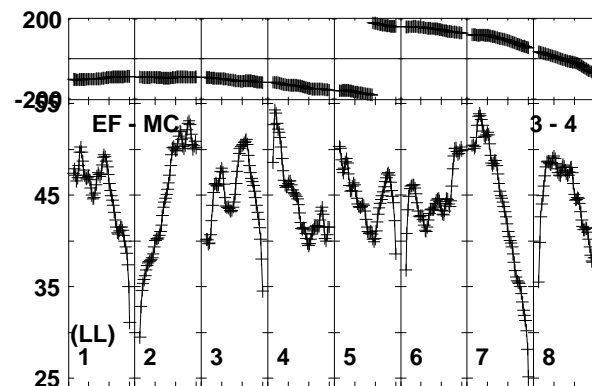
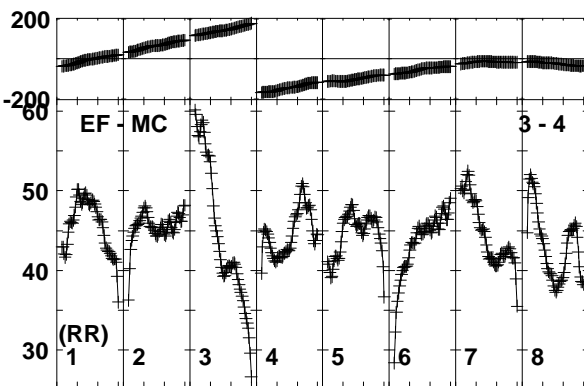
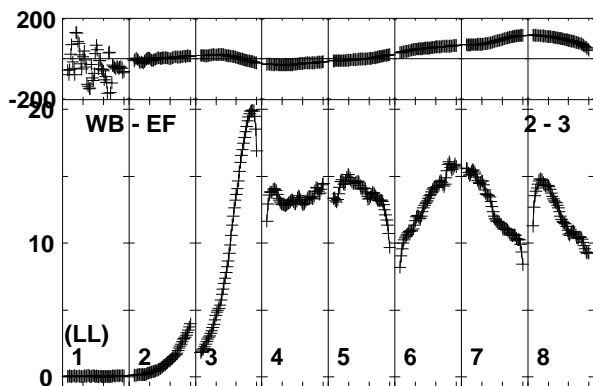
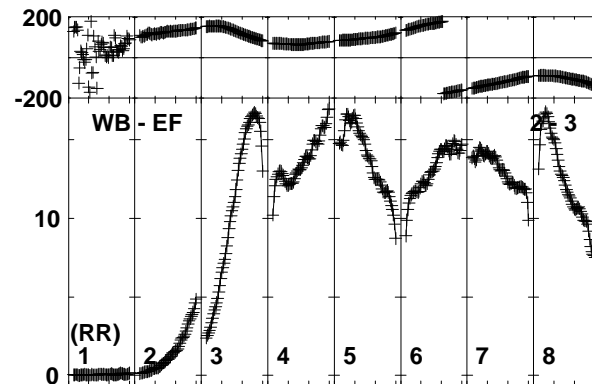
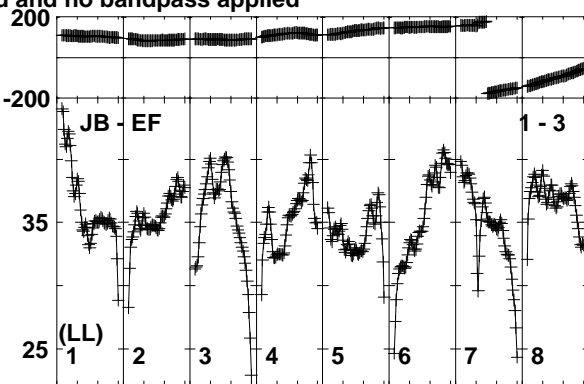
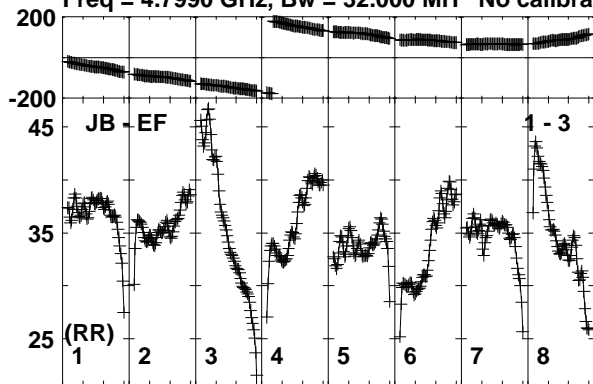

Lower frame: Milli Ampl Jy Top frame: Phas deg  
Vector averaged cross-power spectrum Baseline: JB (01) - EF (03)  
Timerange: 00/21:00:01 to 00/21:07:59

Plot file version 2 created 11-NOV-2019 15:07:16

3C345 EK040B.UVDATA.1

Freq = 4.7990 GHz, Bw = 32.000 MH No calibration applied and no bandpass applied

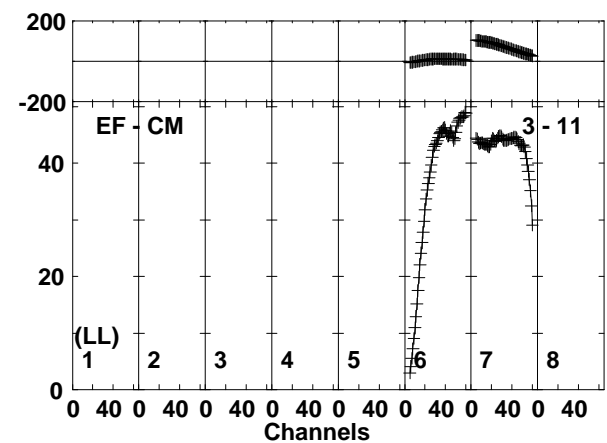
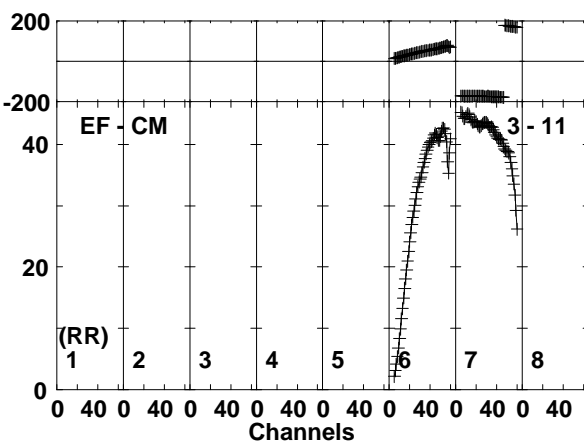
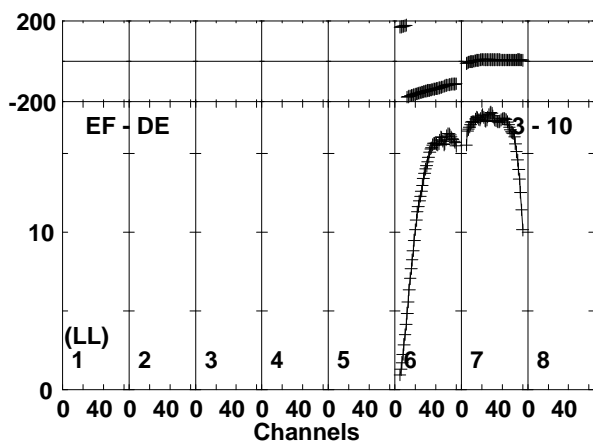
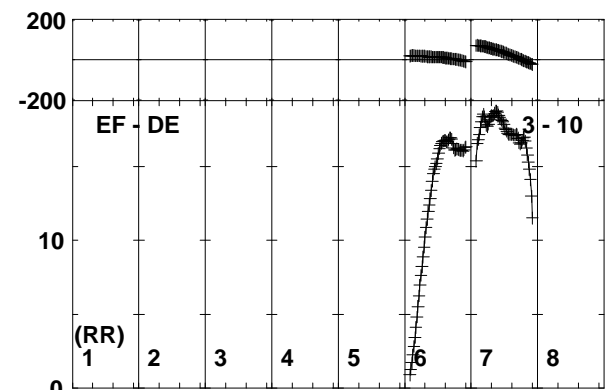
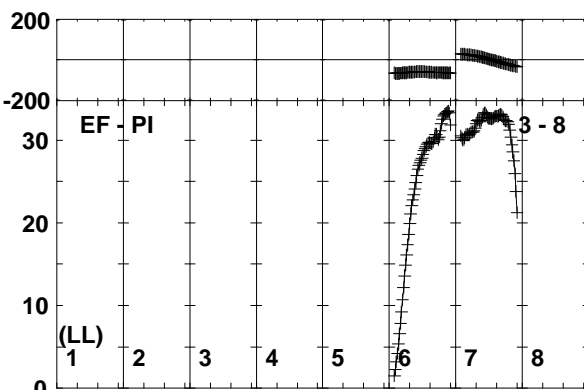
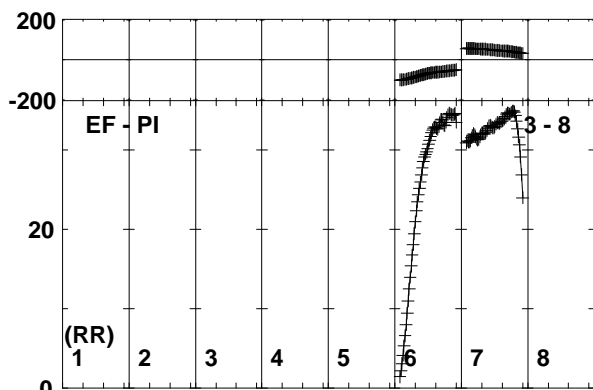
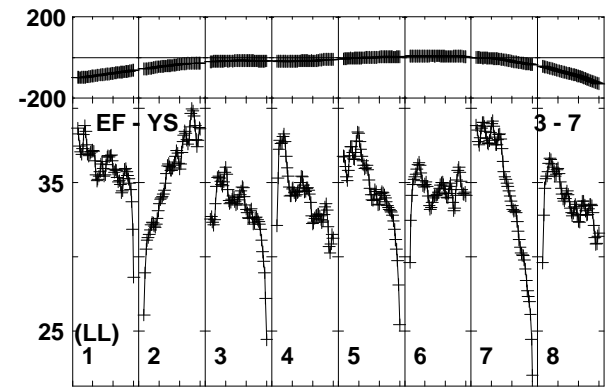
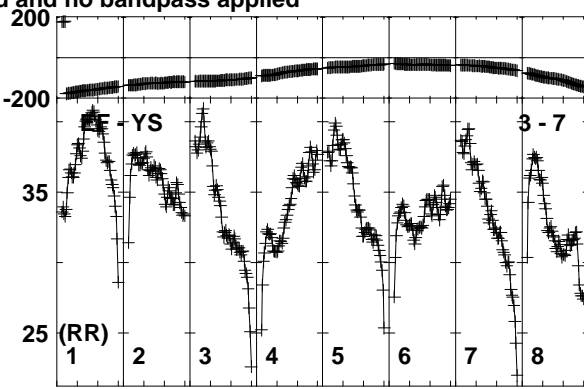
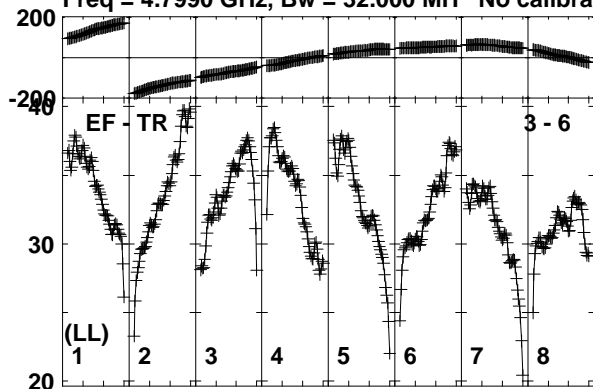

Lower frame: Milli Ampl Jy Top frame: Phas deg  
Vector averaged cross-power spectrum Baseline: EF (03) - TR (06)  
Timerange: 00/21:00:01 to 00/21:07:59



Plot file version 3 created 11-NOV-2019 15:07:16

3C345 EK040B.UVDATA.1

Freq = 4.7990 GHz, Bw = 32.000 MH No calibration applied and no bandpass applied

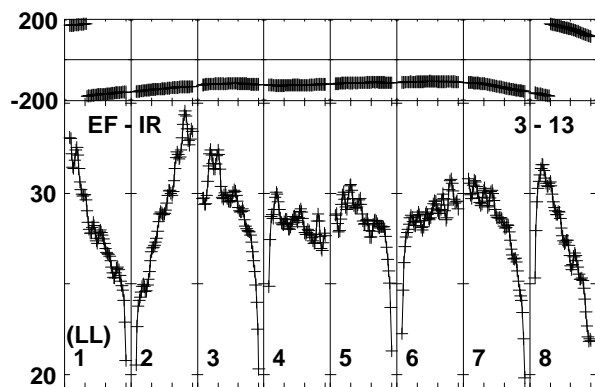
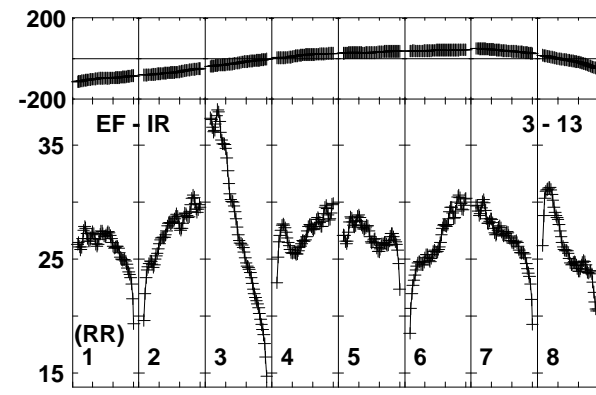
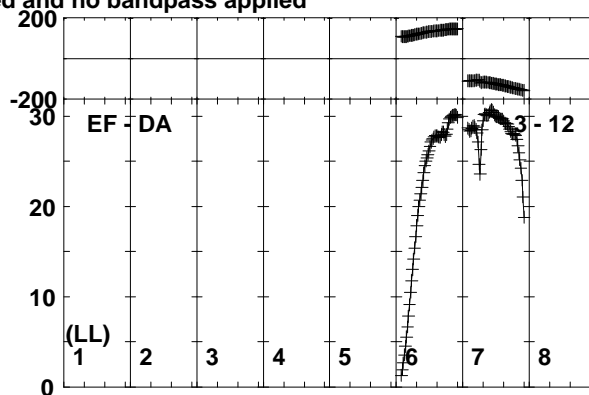
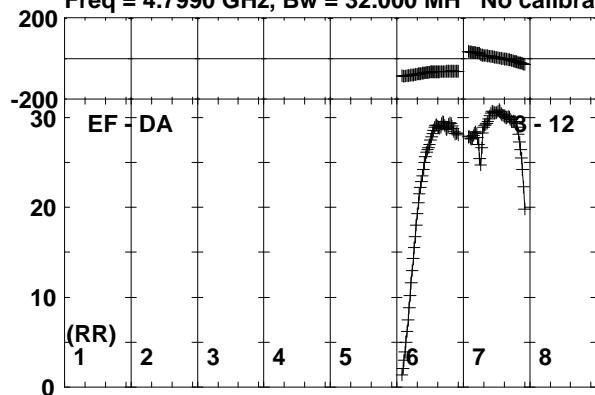

Lower frame: Milli Ampl Jy Top frame: Phas deg  
Vector averaged cross-power spectrum Baseline: EF (03) - DA (12)  
Timerange: 00/21:00:01 to 00/21:07:59

Plot file version 4 created 11-NOV-2019 15:07:16

J1826+0149 EK040B.UVDATA.1

Freq = 4.7990 GHz, Bw = 32.000 MH No calibration applied and no bandpass applied

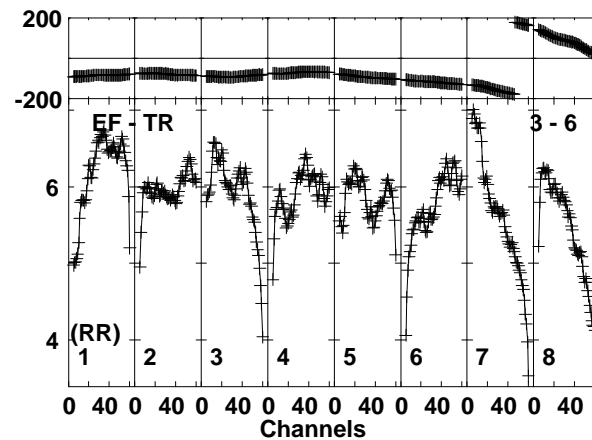
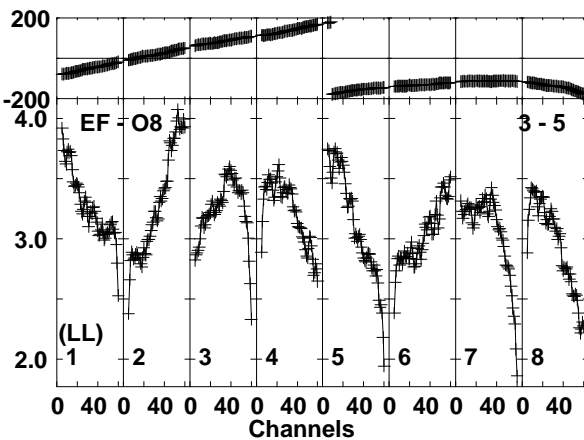
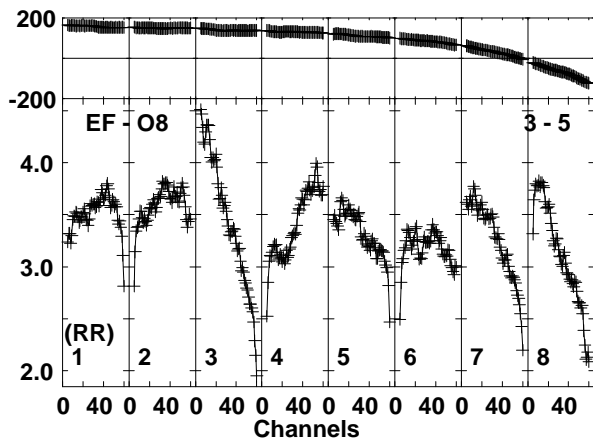
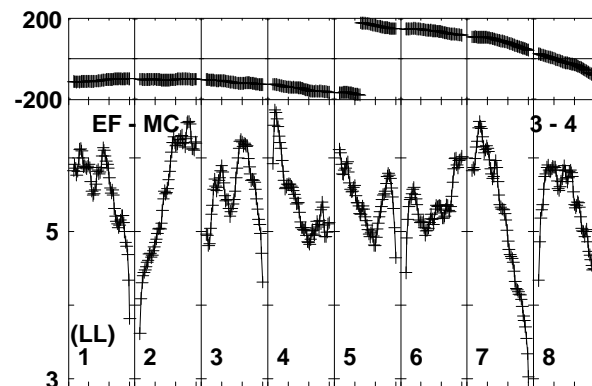
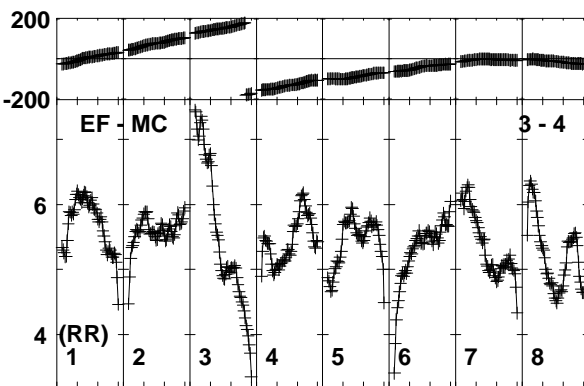
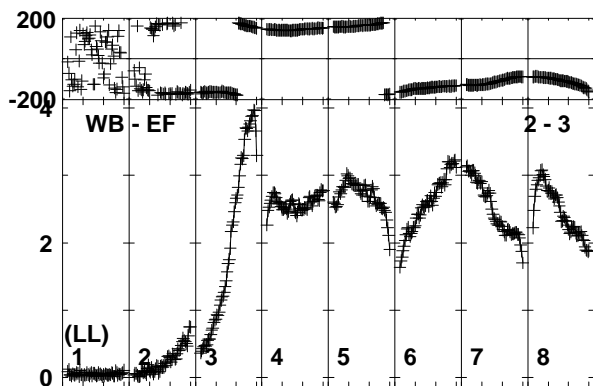
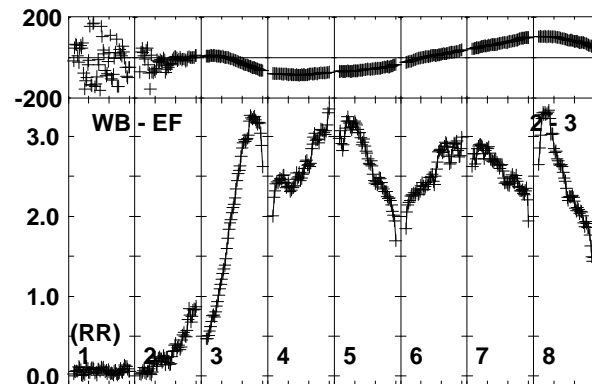
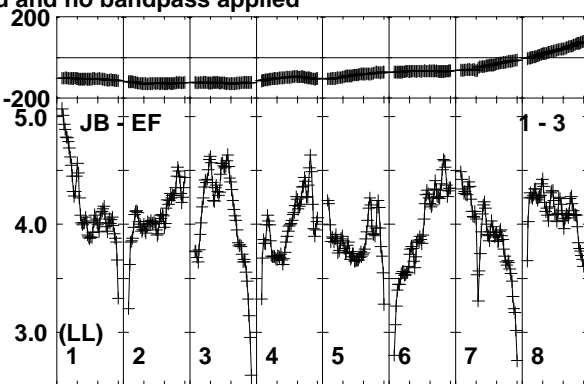
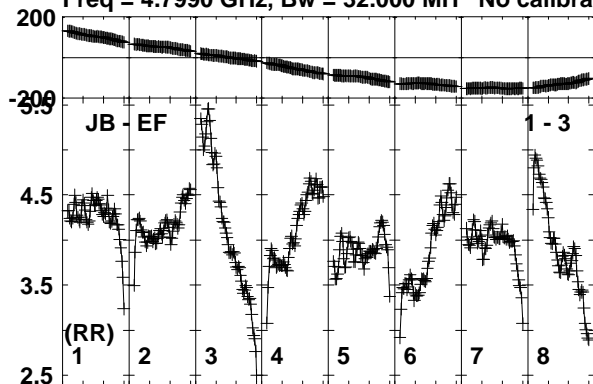

Lower frame: Milli Ampl Jy Top frame: Phas deg  
Vector averaged cross-power spectrum Baseline: JB (01) - EF (03)  
Timerange: 00/21:12:01 to 00/21:15:19

Plot file version 5 created 11-NOV-2019 15:07:16

J1826+0149 EK040B.UVDATA.1

Freq = 4.7990 GHz, Bw = 32.000 MH No calibration applied and no bandpass applied

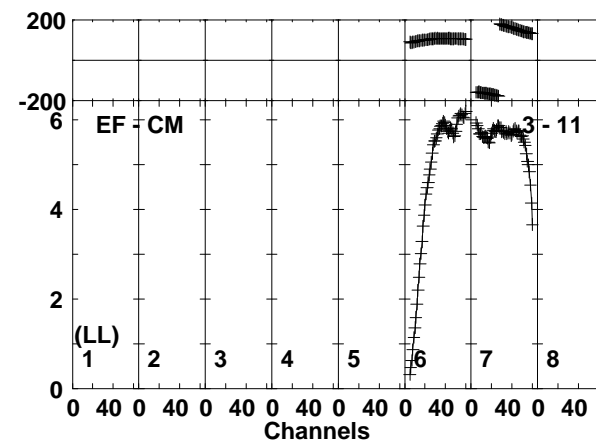
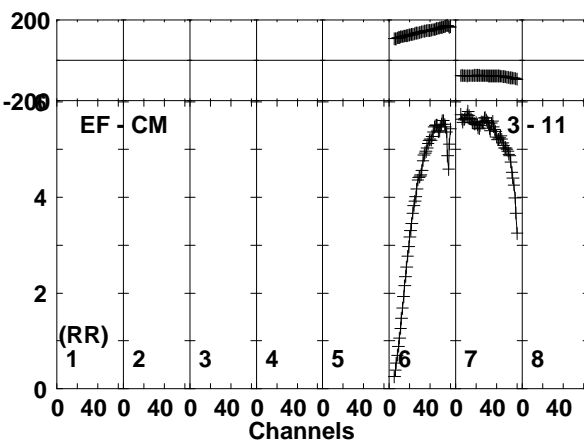
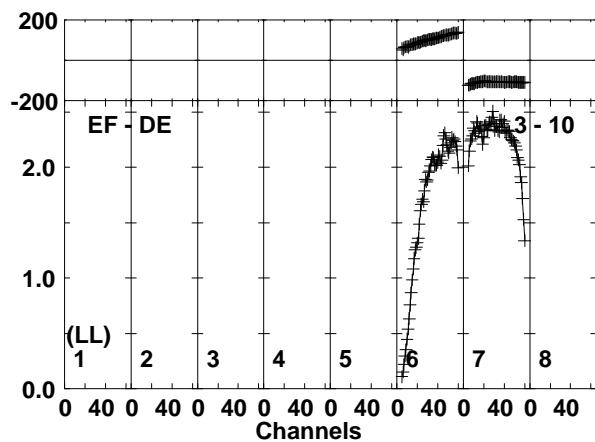
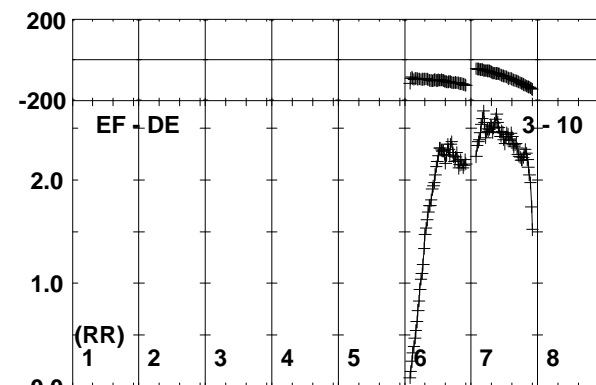
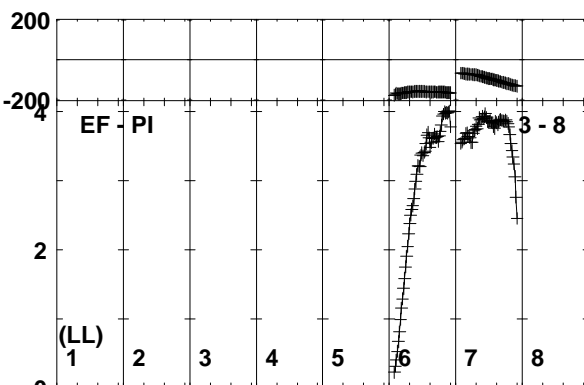
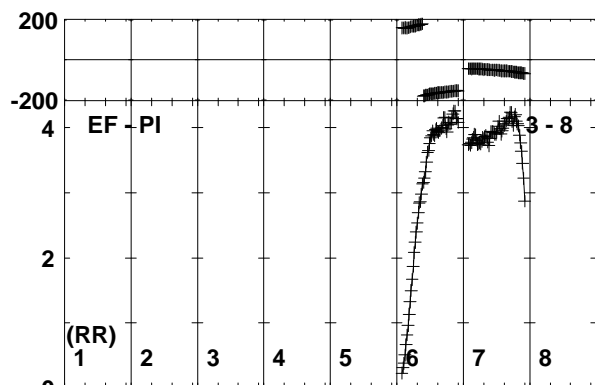
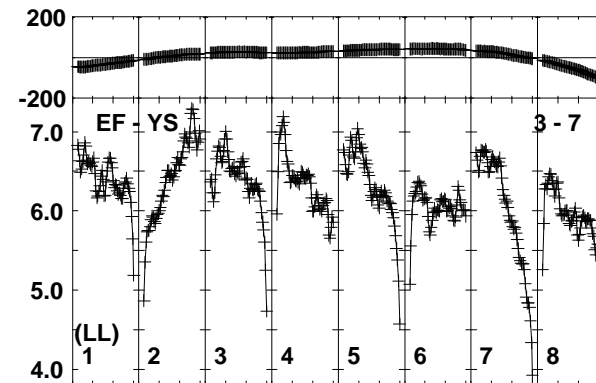
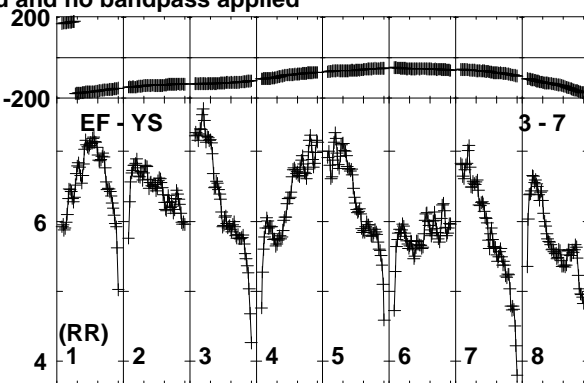
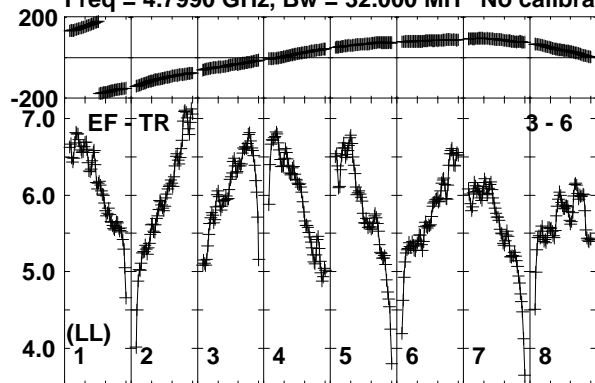

Lower frame: Milli Ampl Jy Top frame: Phas deg  
Vector averaged cross-power spectrum Baseline: EF (03) - TR (06)  
Timerange: 00/21:12:01 to 00/21:15:19

Plot file version 6 created 11-NOV-2019 15:07:16

J1826+0149 EK040B.UVDATA.1

Freq = 4.7990 GHz, Bw = 32.000 MH No calibration applied and no bandpass applied

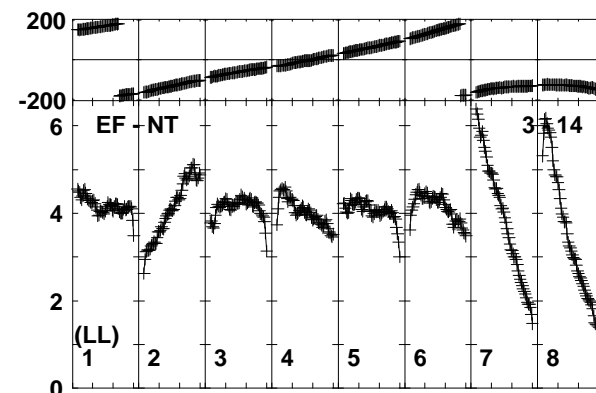
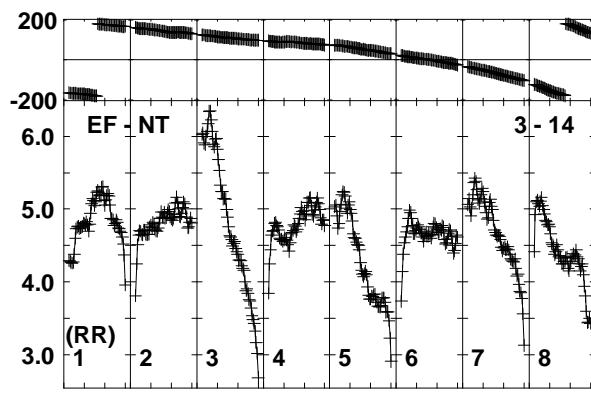
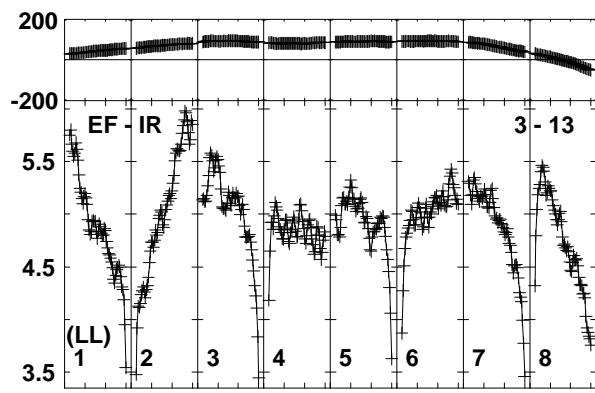
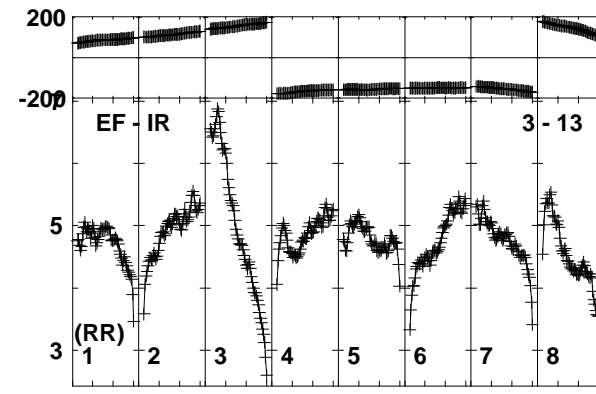
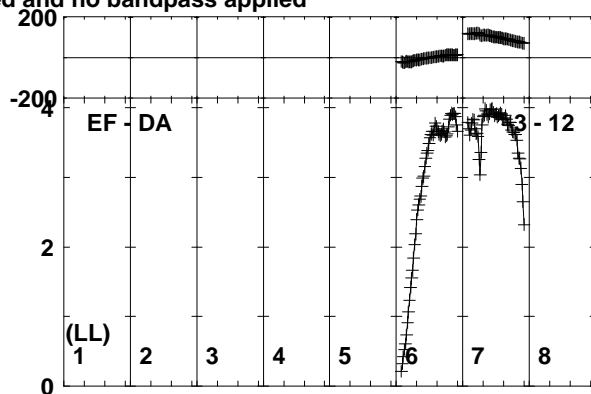
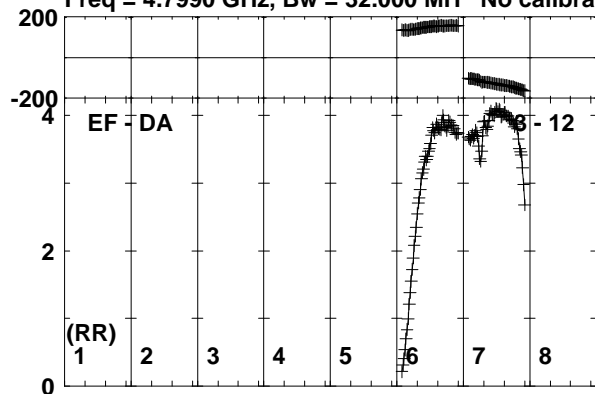

Channels

Lower frame: Milli Ampl Jy Top frame: Phas deg  
Vector averaged cross-power spectrum Baseline: EF (03) - DA (12)  
Timerange: 00/21:12:01 to 00/21:15:19

Plot file version 7 created 11-NOV-2019 15:07:16

SER8NJ EK040B.UVDATA.1

Freq = 4.7990 GHz, Bw = 32.000 MH No calibration applied and no bandpass applied

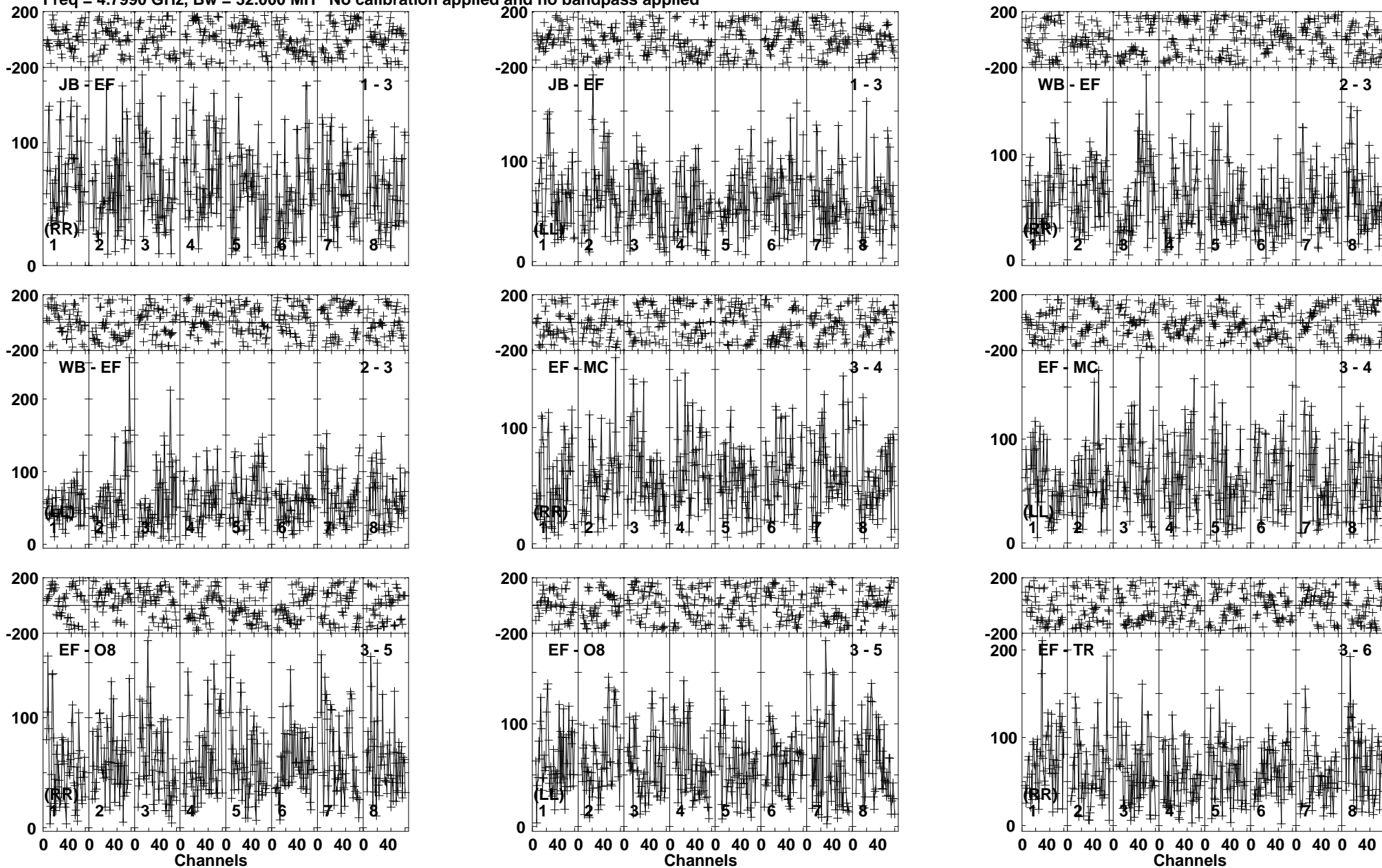

Lower frame: Micro Ampl Jy Top frame: Phas deg  
Vector averaged cross-power spectrum Baseline: JB (01) - EF (03)  
Timerange: 00/21:15:21 to 00/21:19:19

Plot file version 8 created 11-NOV-2019 15:07:17  
SER8NJ EK040B.UVDATA.1

Freq = 4.7990 GHz, Bw = 32.000 MH No calibration applied and no bandpass applied

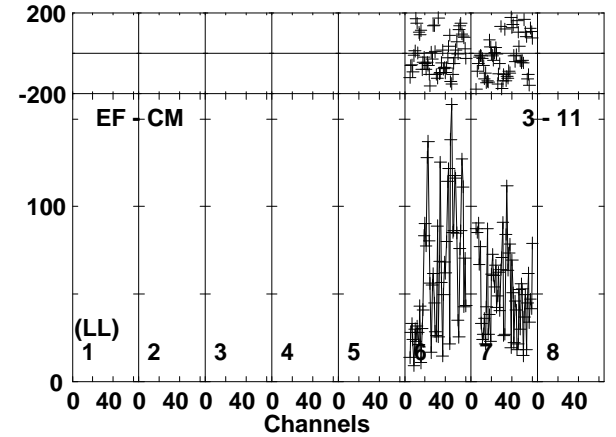
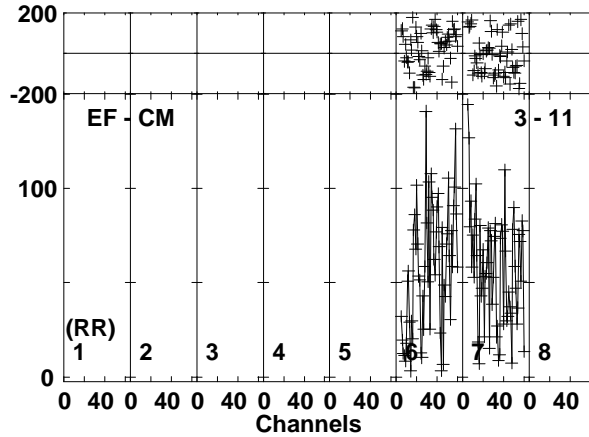
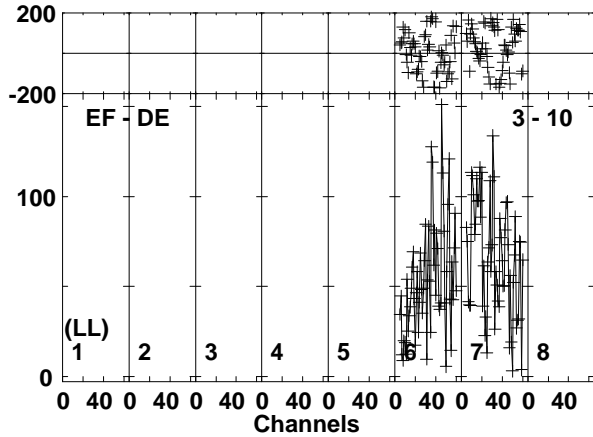
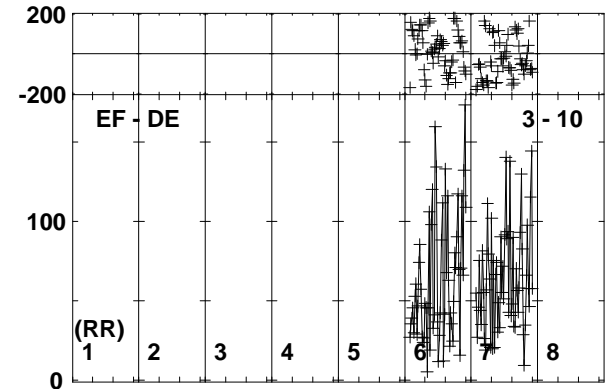
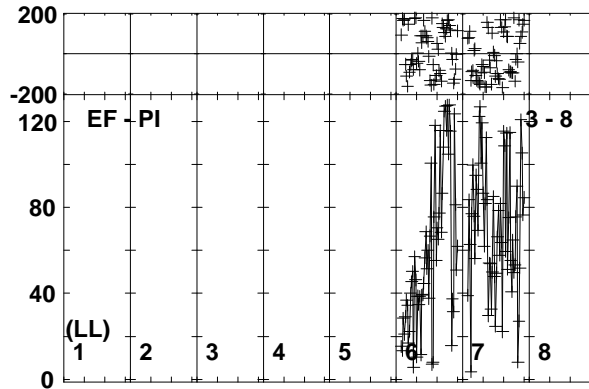
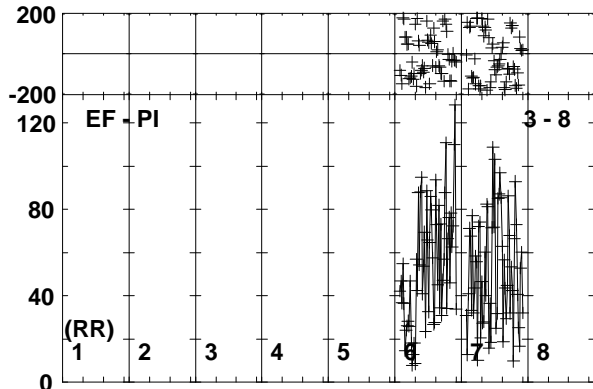
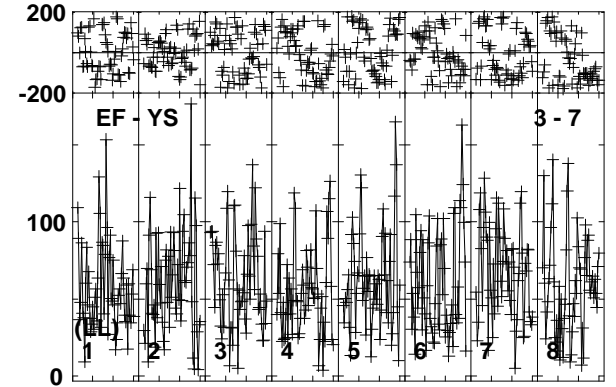
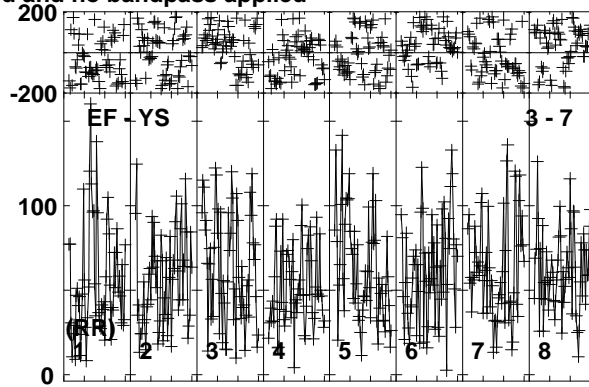
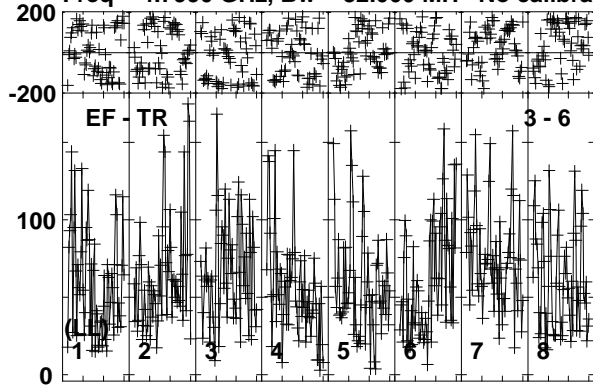

Lower frame: Micro Ampl Jy Top frame: Phas deg  
Vector averaged cross-power spectrum Baseline: EF (03) - TR (06)  
Timerange: 00/21:15:21 to 00/21:19:19

Plot file version 9 created 11-NOV-2019 15:07:17

SER8NJ EK040B.UVDATA.1

Freq = 4.7990 GHz, Bw = 32.000 MH No calibration applied and no bandpass applied

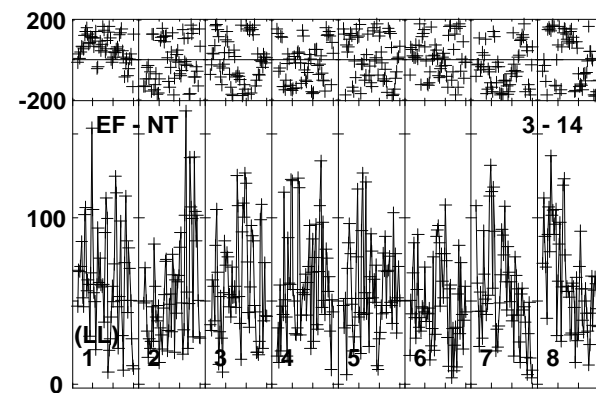
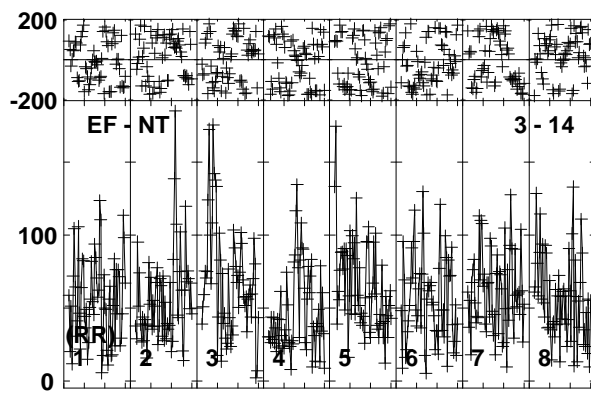
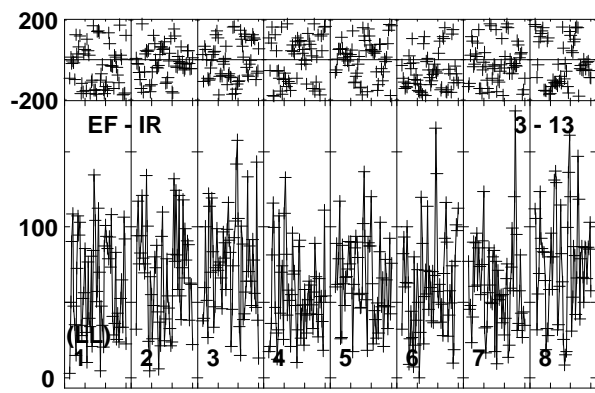
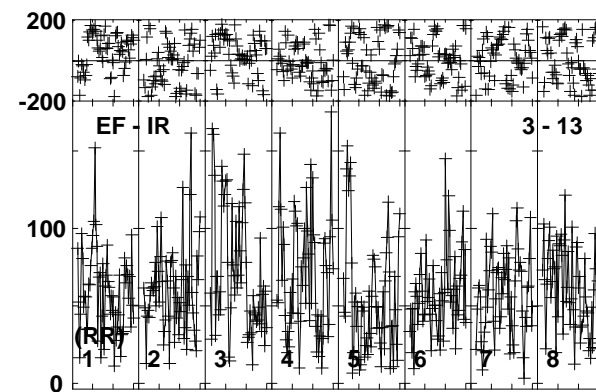
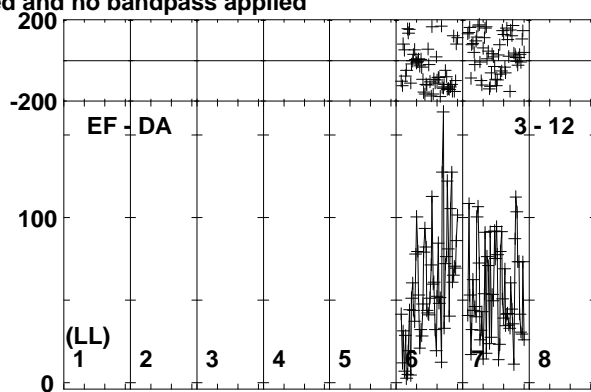
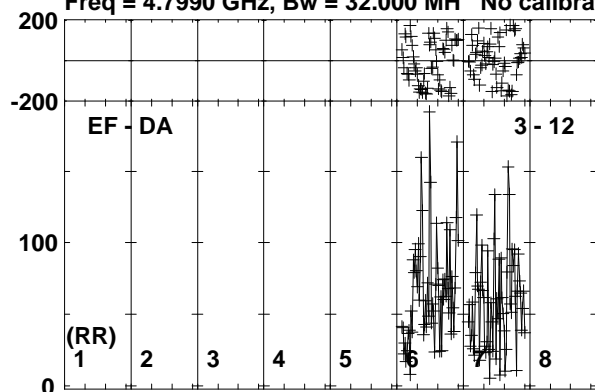

0 40 0 40 0 40 0 40 0 40 0 40 0 40 0 40 0 40 0 40

Channels

Lower frame: Micro Ampl Jy Top frame: Phas deg  
Vector averaged cross-power spectrum Baseline: EF (03) - DA (12)  
Timerange: 00/21:15:21 to 00/21:19:19

Plot file version 10 created 11-NOV-2019 15:07:17

J1826+0149 EK040B.UVDATA.1

Freq = 4.7990 GHz, Bw = 32.000 MH No calibration applied and no bandpass applied

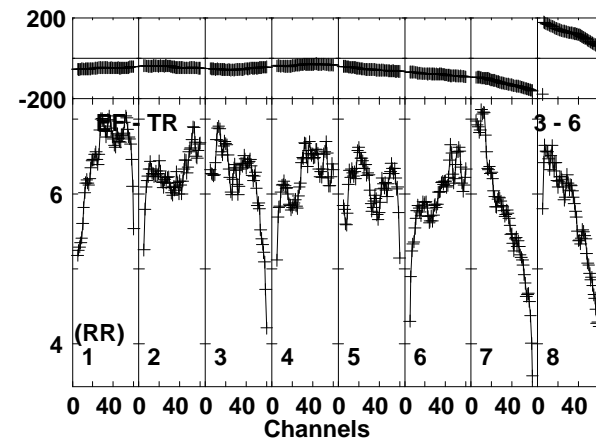
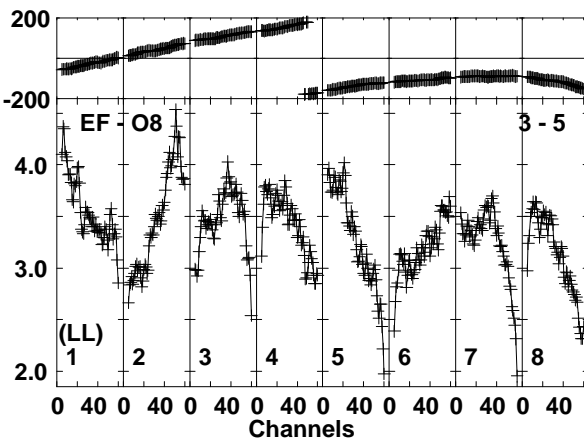
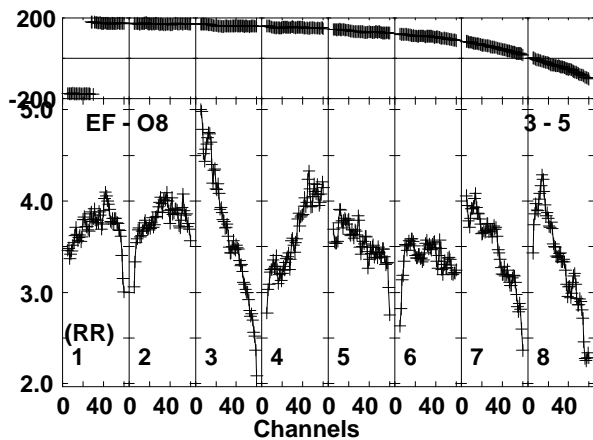
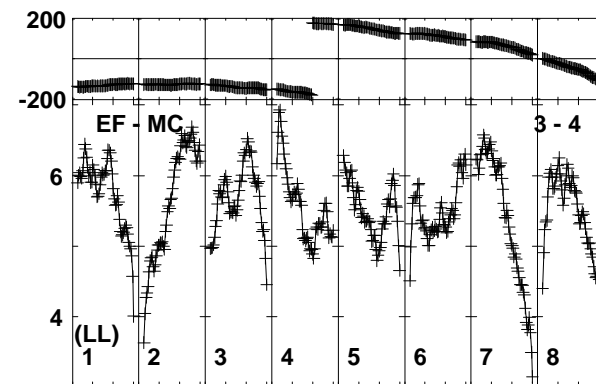
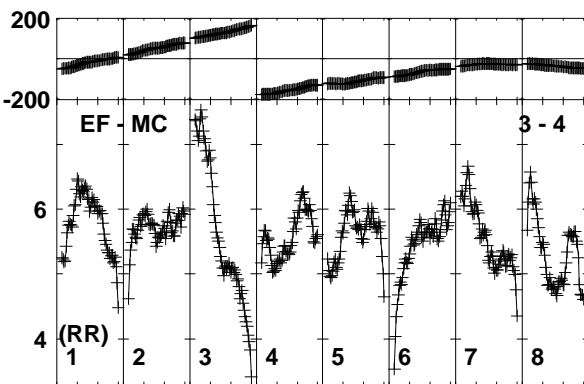
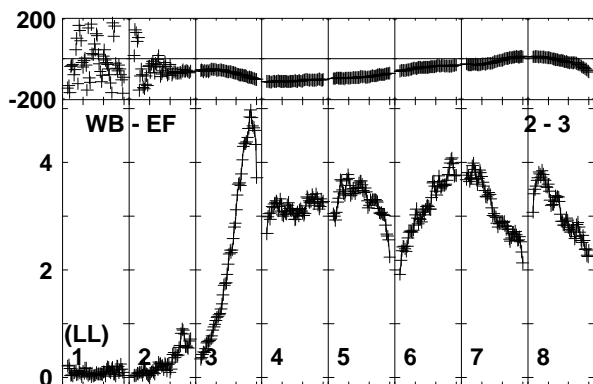
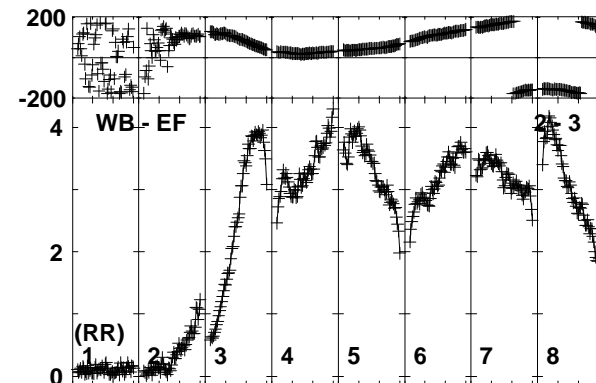
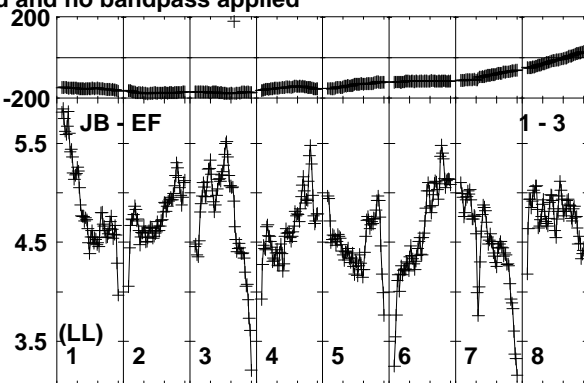
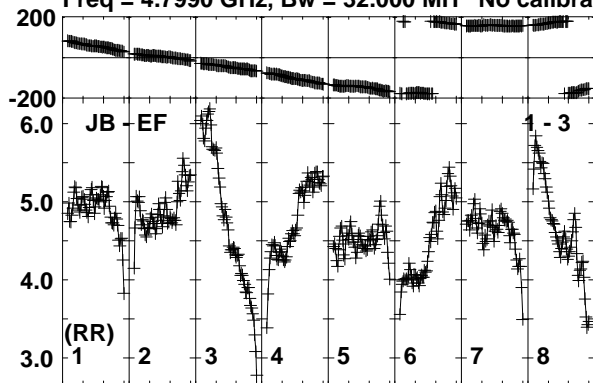

Lower frame: Milli Ampl Jy Top frame: Phas deg  
Vector averaged cross-power spectrum Baseline: JB (01) - EF (03)  
Timerange: 00/21:19:23 to 00/21:20:49



Plot file version 11 created 11-NOV-2019 15:07:17

J1826+0149 EK040B.UVDATA.1

Freq = 4.7990 GHz, Bw = 32.000 MH No calibration applied and no bandpass applied

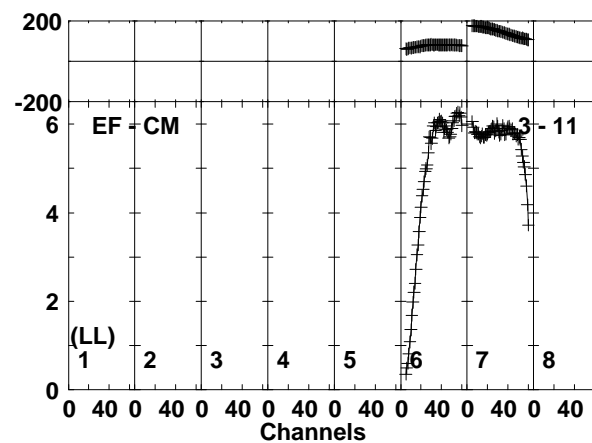
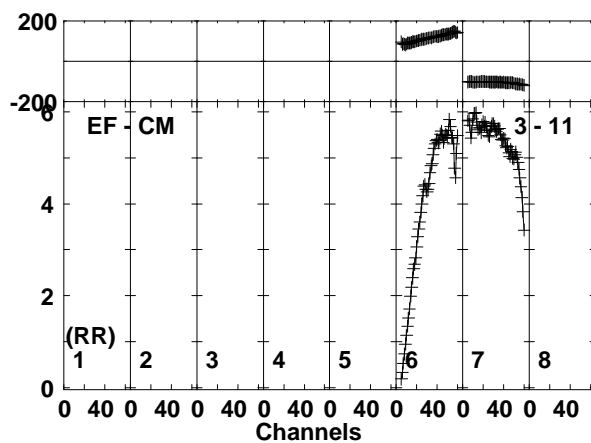
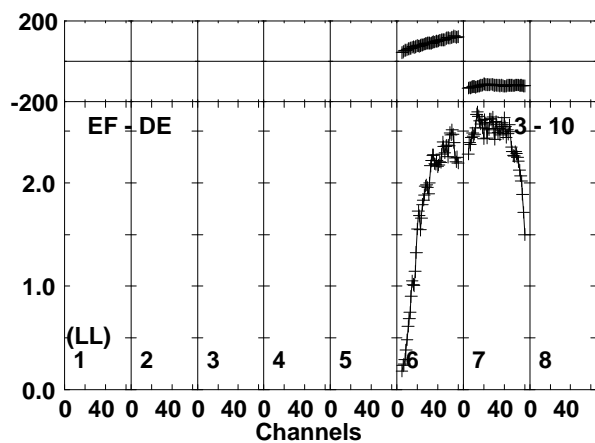
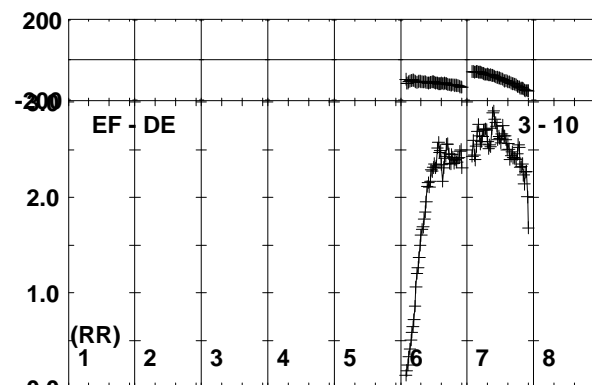
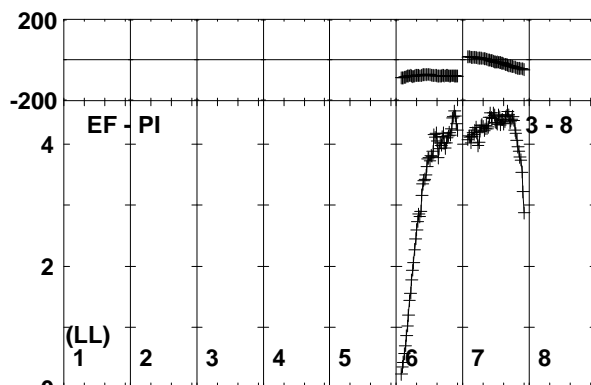
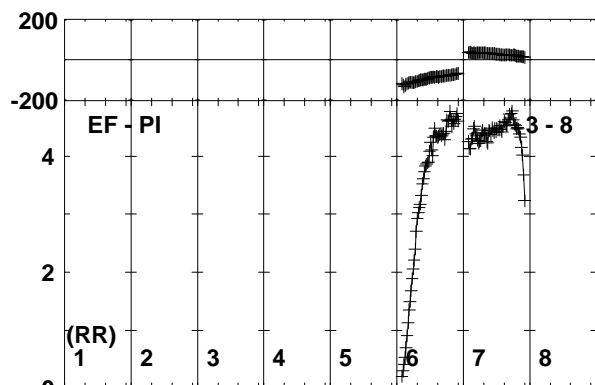
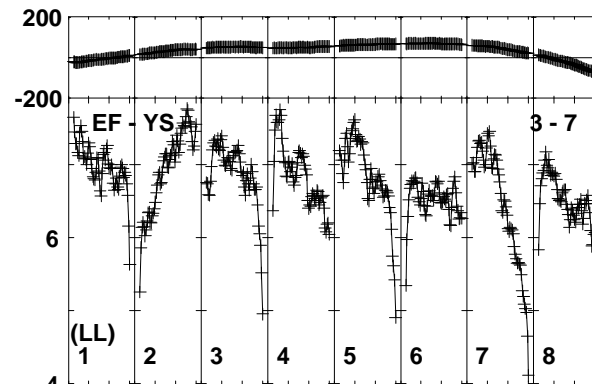
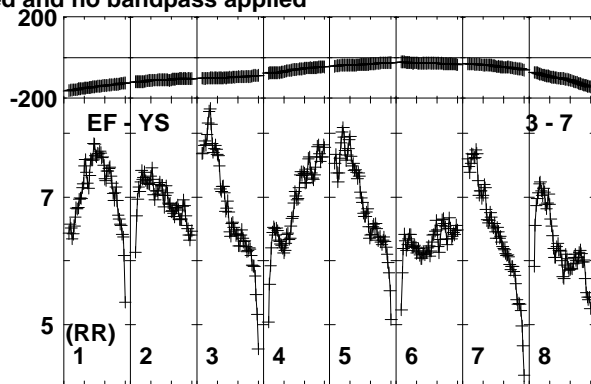
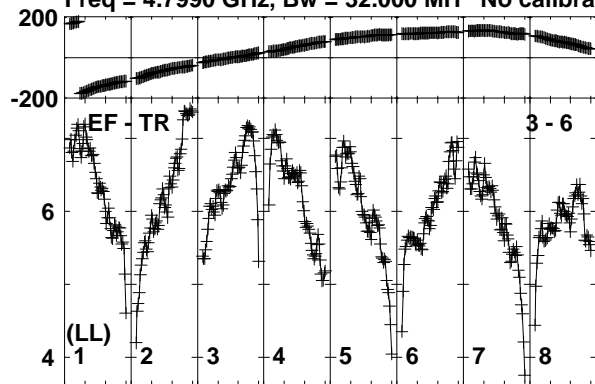

Lower frame: Milli Ampl Jy Top frame: Phas deg  
Vector averaged cross-power spectrum Baseline: EF (03) - TR (06)  
Timerange: 00/21:19:23 to 00/21:20:49

Plot file version 12 created 11-NOV-2019 15:07:17

J1826+0149 EK040B.UVDATA.1

Freq = 4.7990 GHz, Bw = 32.000 MH No calibration applied and no bandpass applied

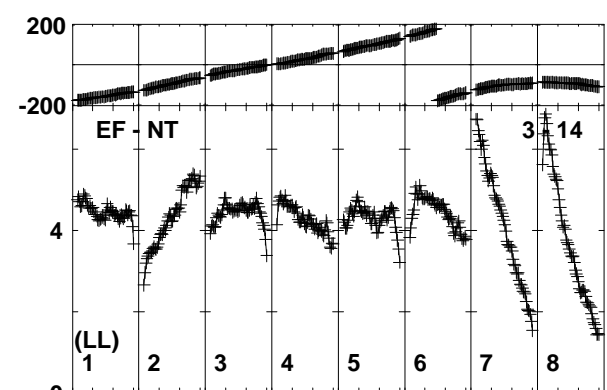
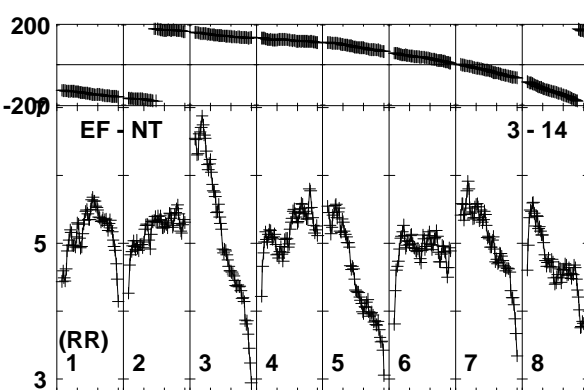
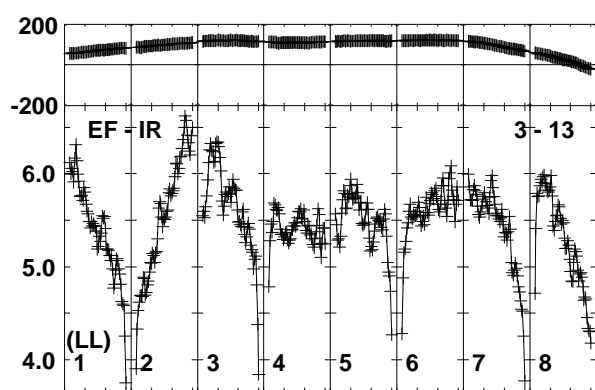
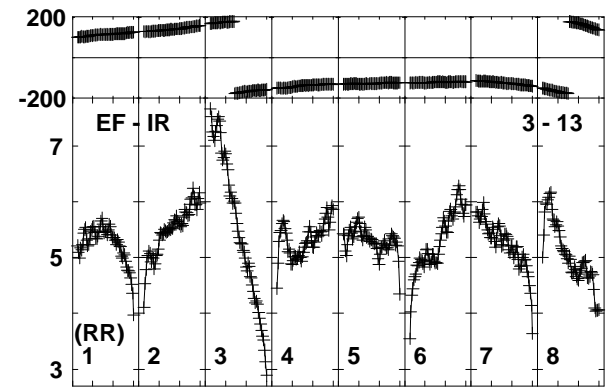
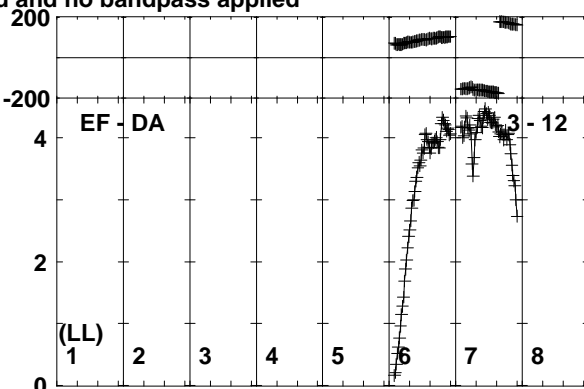
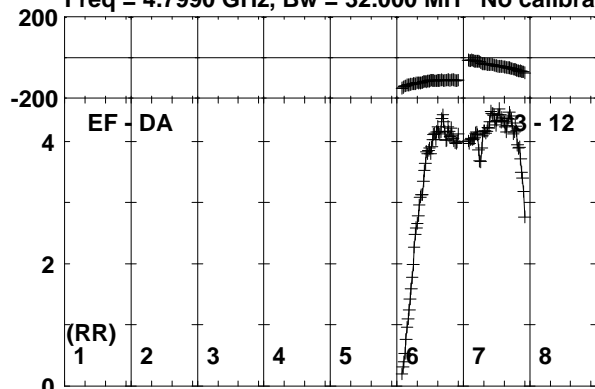

Channels

Lower frame: Milli Ampl Jy Top frame: Phas deg  
Vector averaged cross-power spectrum Baseline: EF (03) - DA (12)  
Timerange: 00/21:19:23 to 00/21:20:49

Plot file version 13 created 11-NOV-2019 15:07:17

SER8NJ EK040B.UVDATA.1

Freq = 4.7990 GHz, Bw = 32.000 MH No calibration applied and no bandpass applied

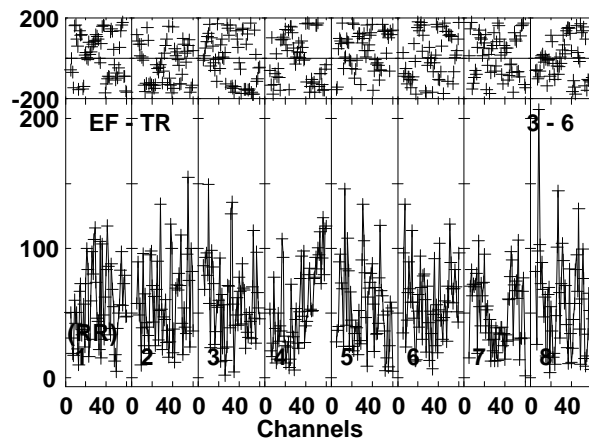
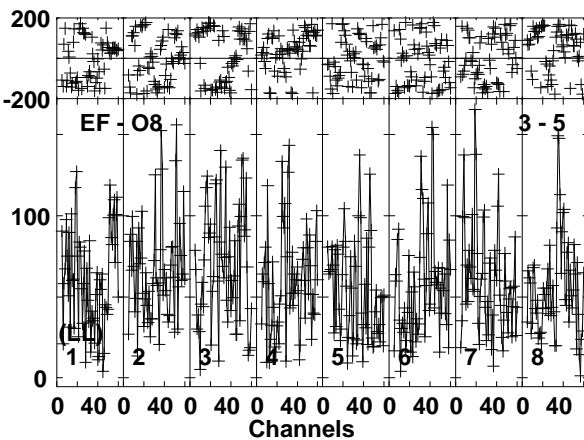
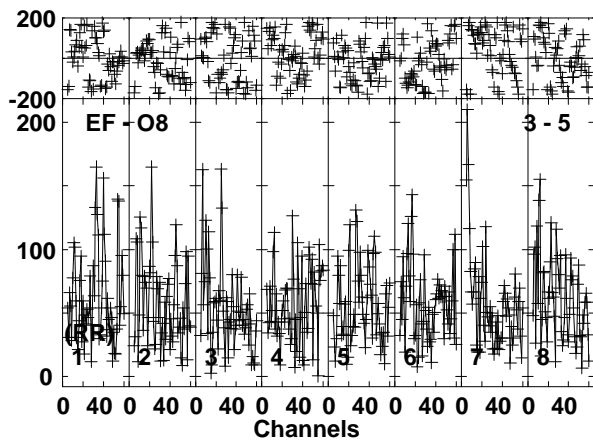
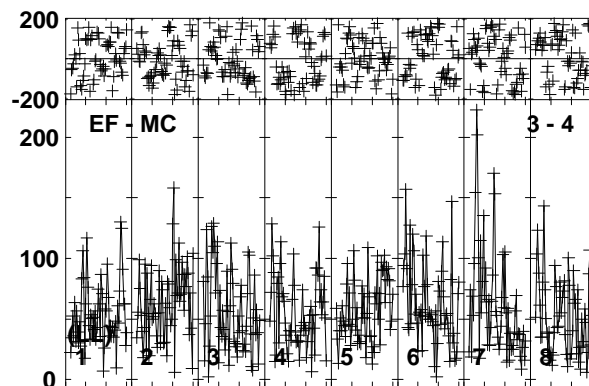
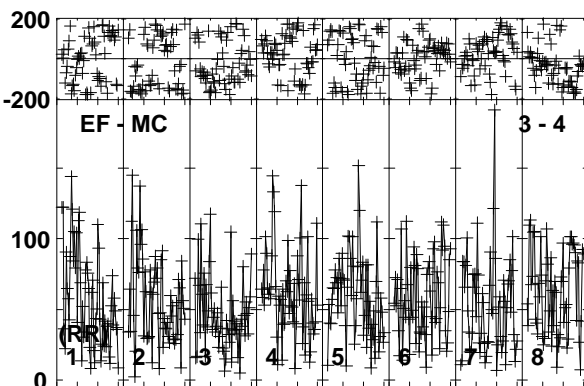
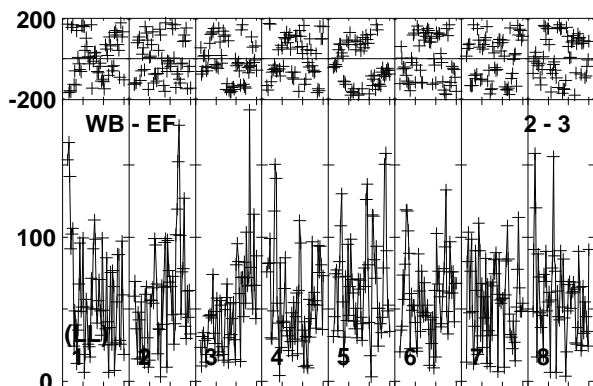
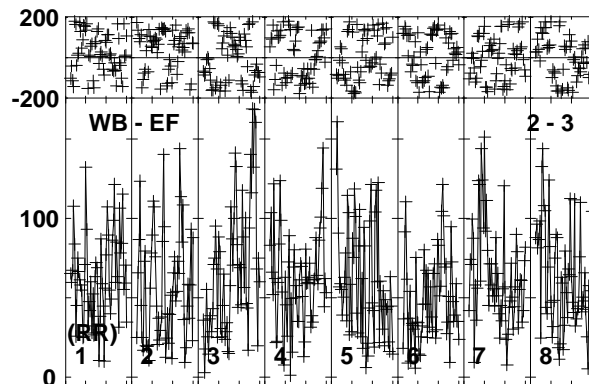
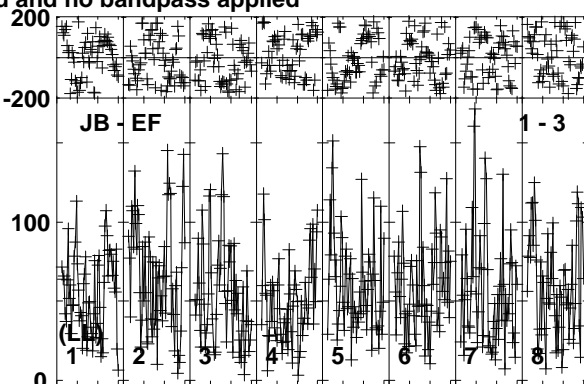
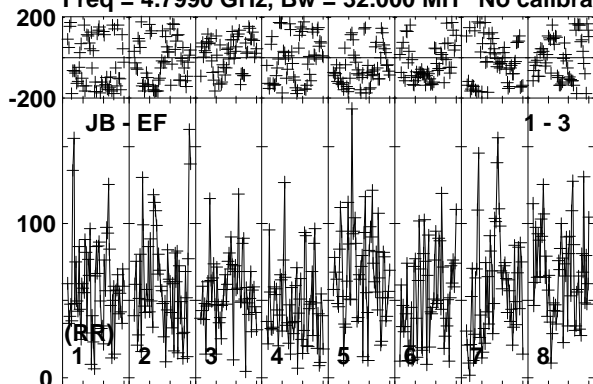

Lower frame: Micro Ampl Jy Top frame: Phas deg  
Vector averaged cross-power spectrum Baseline: JB (01) - EF (03)  
Timerange: 00/21:20:51 to 00/21:24:49

Plot file version 14 created 11-NOV-2019 15:07:17

SER8NJ EK040B.UVDATA.1

Freq = 4.7990 GHz, Bw = 32.000 MH No calibration applied and no bandpass applied

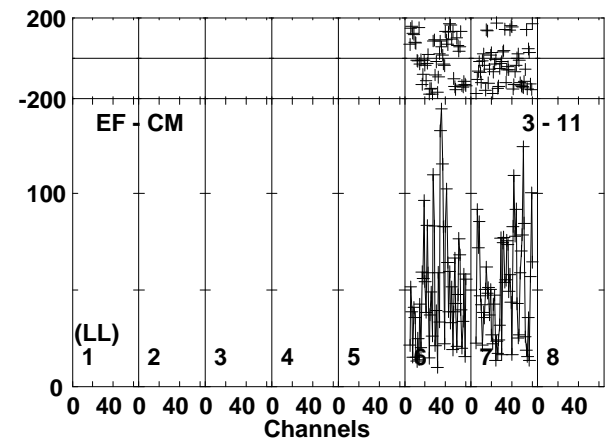
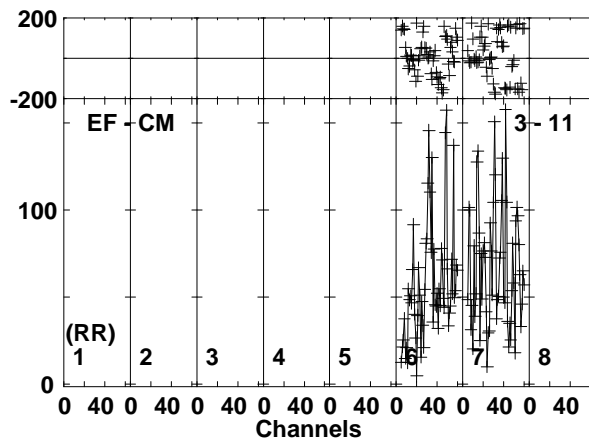
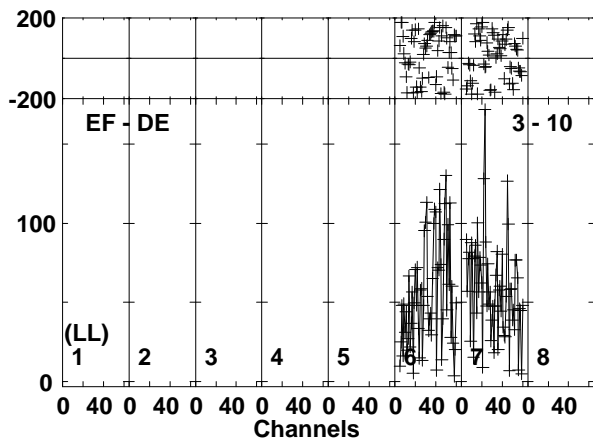
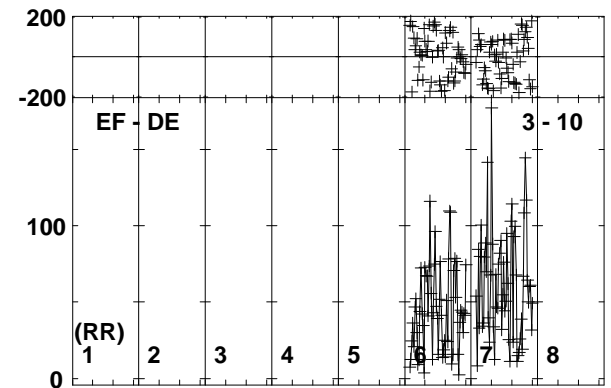
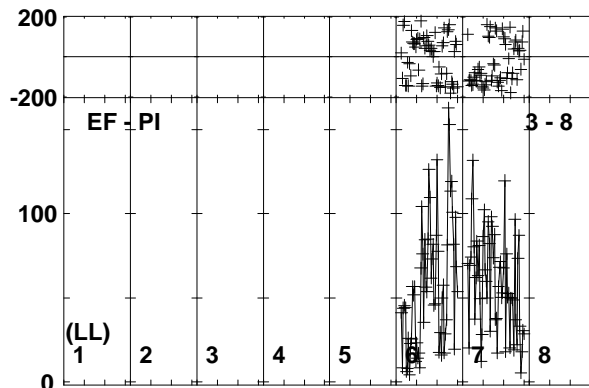
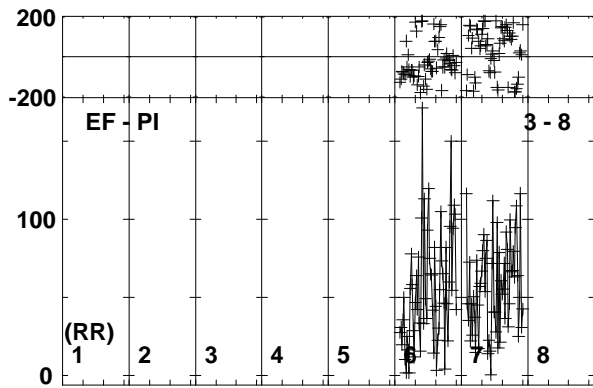
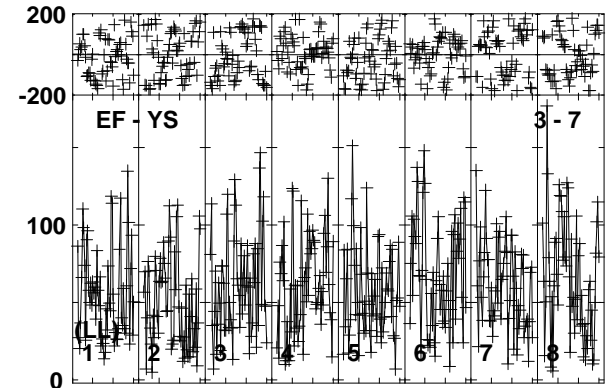
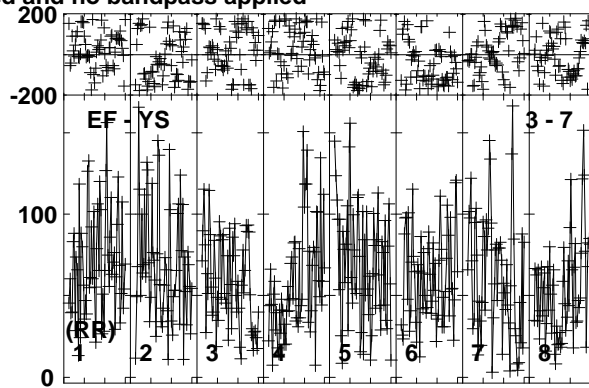
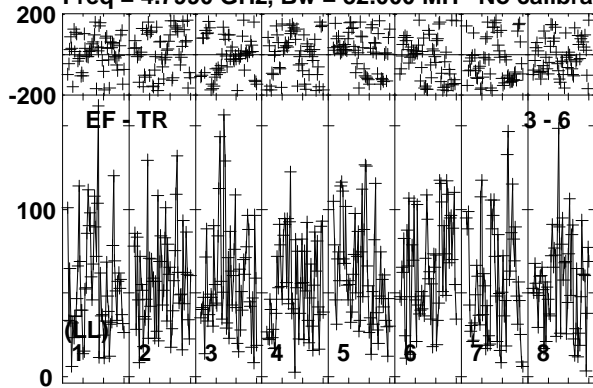

Lower frame: Micro Ampl Jy Top frame: Phas deg  
Vector averaged cross-power spectrum Baseline: EF (03) - TR (06)  
Timerange: 00/21:20:51 to 00/21:24:49

Plot file version 15 created 11-NOV-2019 15:07:18

SER8NJ EK040B.UVDATA.1

Freq = 4.7990 GHz, Bw = 32.000 MH No calibration applied and no bandpass applied

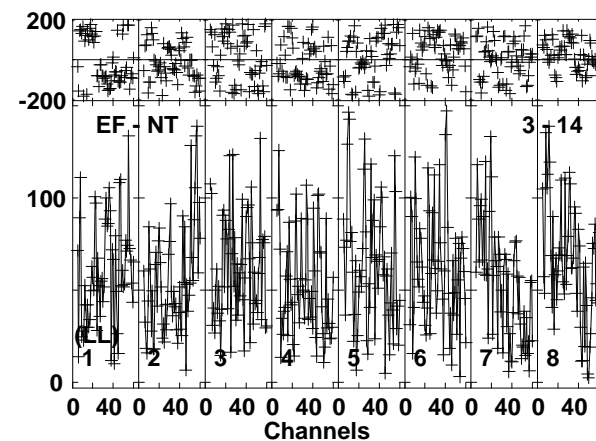
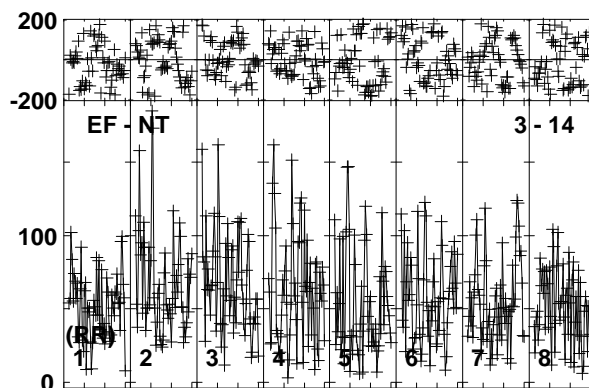
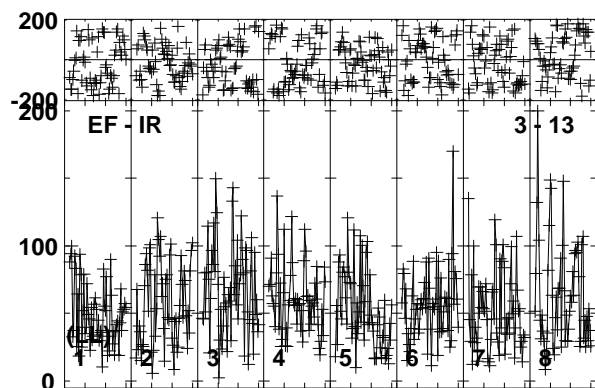
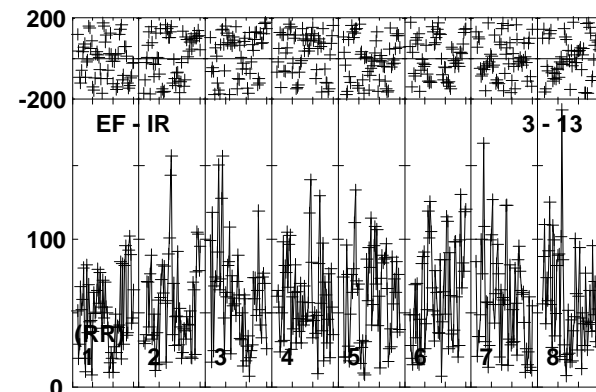
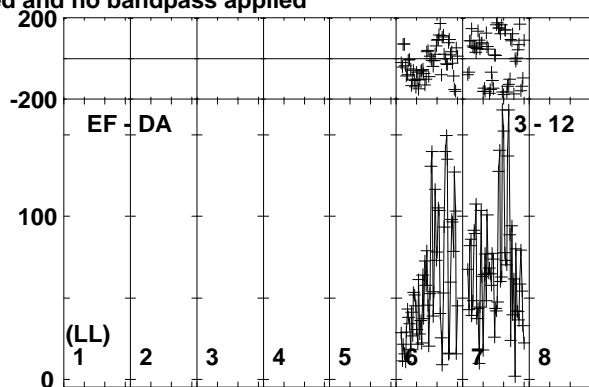
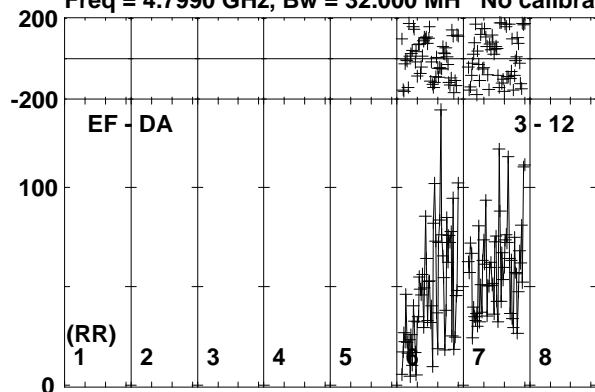

Lower frame: Micro Ampl Jy Top frame: Phas deg  
Vector averaged cross-power spectrum Baseline: EF (03) - DA (12)  
Timerange: 00/21:20:51 to 00/21:24:49

Plot file version 16 created 11-NOV-2019 15:07:18

J1826+0149 EK040B.UVDATA.1

Freq = 4.7990 GHz, Bw = 32.000 MH No calibration applied and no bandpass applied

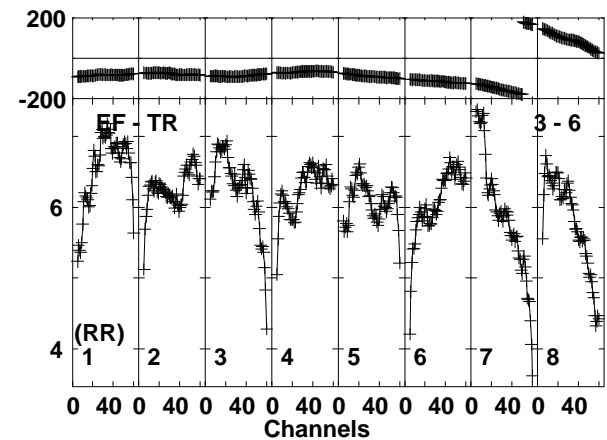
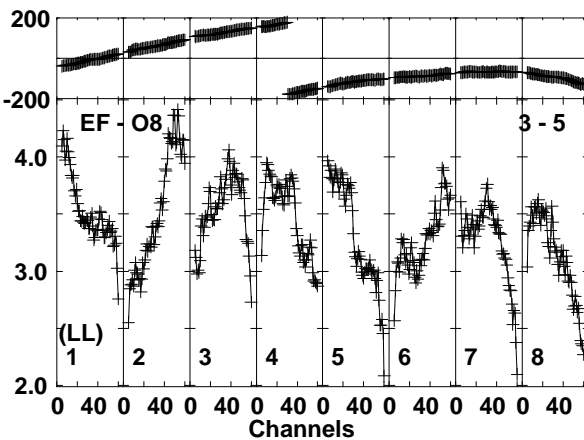
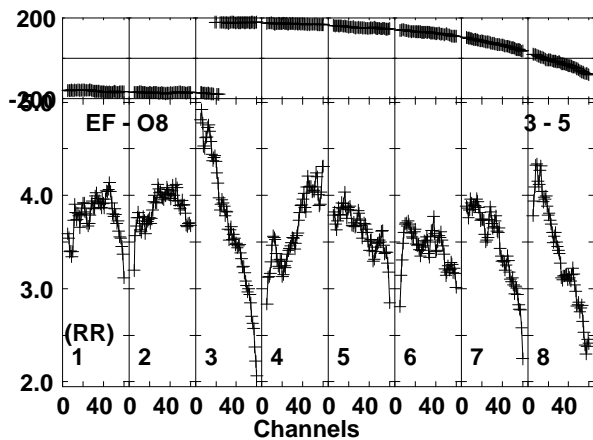
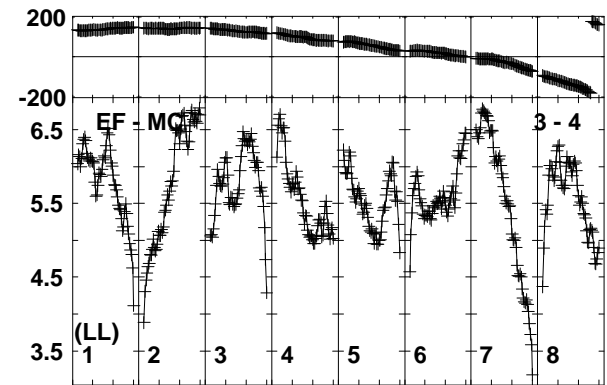
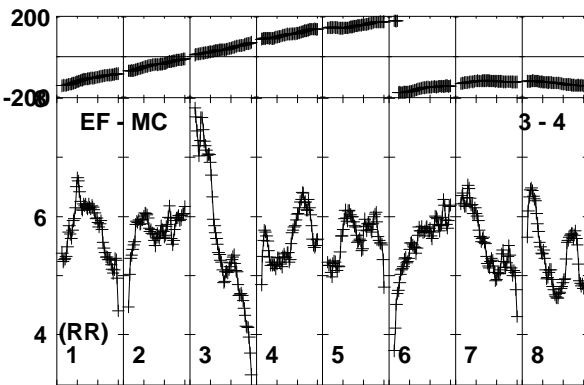
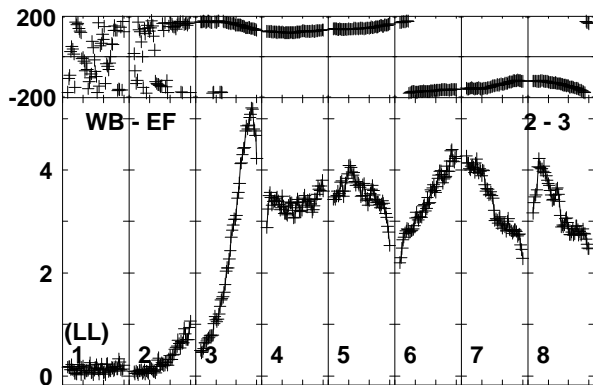
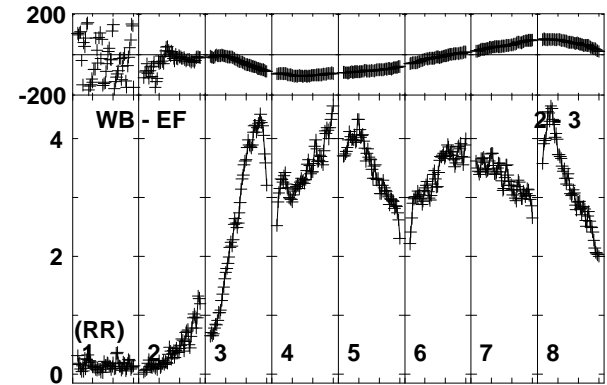
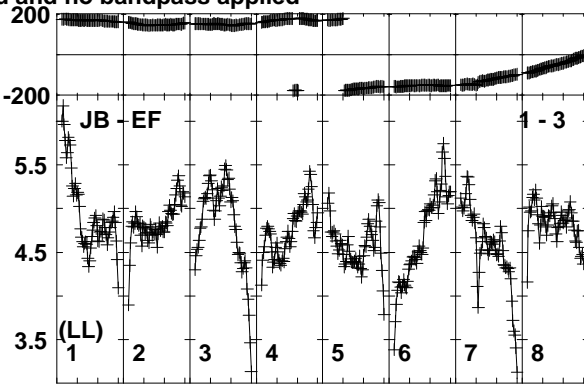
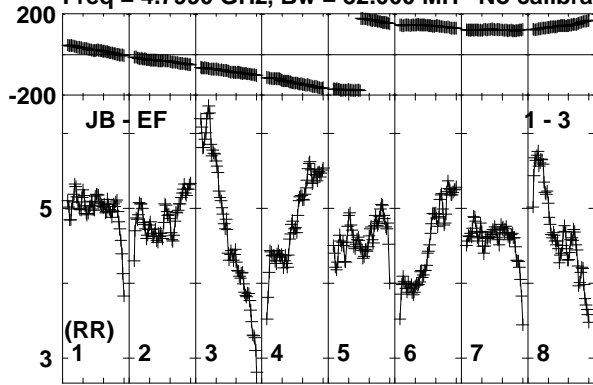

Lower frame: Milli Ampl Jy Top frame: Phas deg  
Vector averaged cross-power spectrum Baseline: JB (01) - EF (03)  
Timerange: 00/21:25:31 to 00/21:26:29

Plot file version 17 created 11-NOV-2019 15:07:18

J1826+0149 EK040B.UVDATA.1

Freq = 4.7990 GHz, Bw = 32.000 MH No calibration applied and no bandpass applied

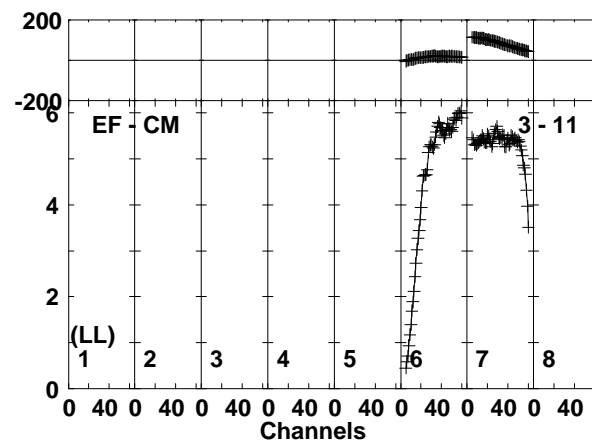
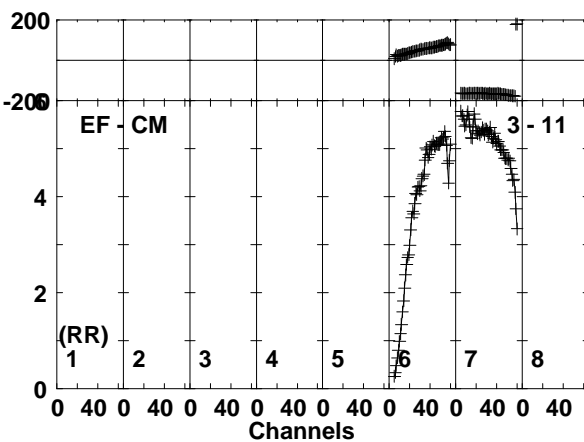
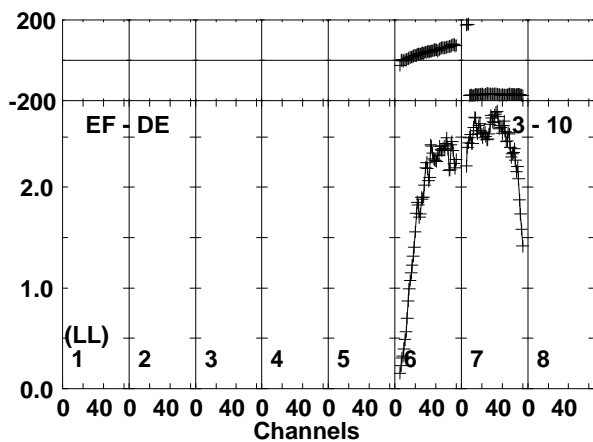
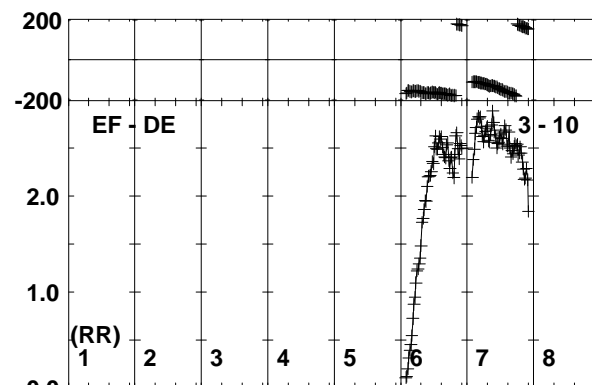
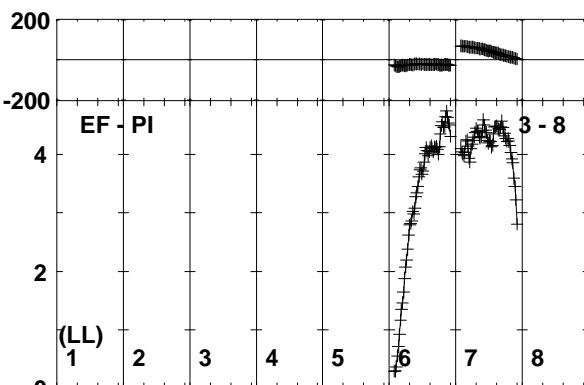
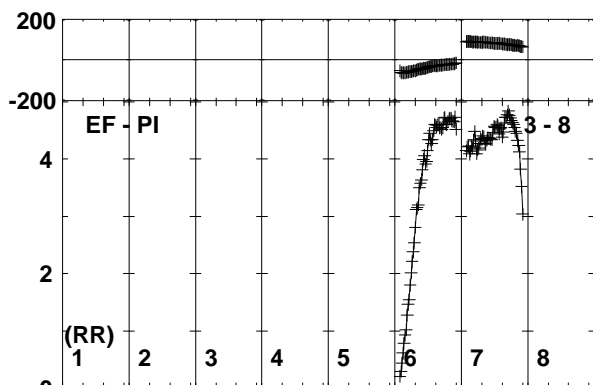
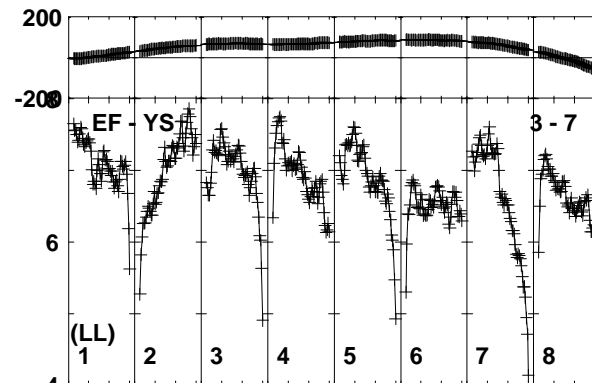
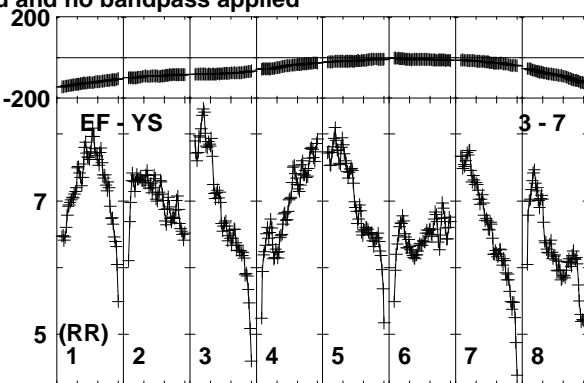
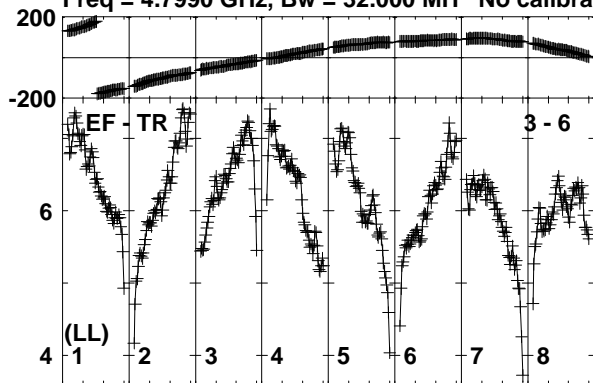

Lower frame: Milli Ampl Jy Top frame: Phas deg  
Vector averaged cross-power spectrum Baseline: EF (03) - TR (06)  
Timerange: 00/21:25:31 to 00/21:26:29

Plot file version 18 created 11-NOV-2019 15:07:18

J1826+0149 EK040B.UVDATA.1

Freq = 4.7990 GHz, Bw = 32.000 MH No calibration applied and no bandpass applied

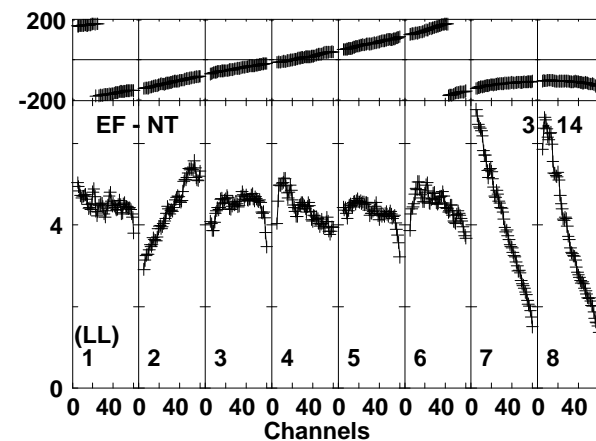
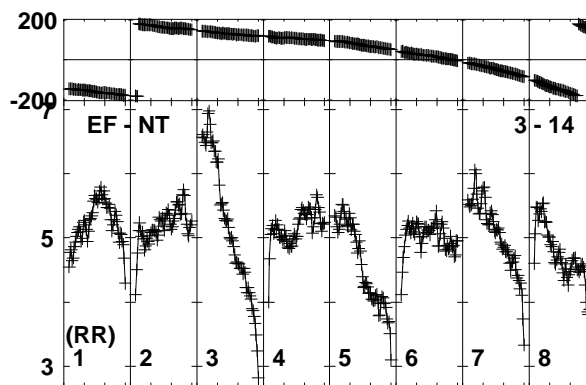
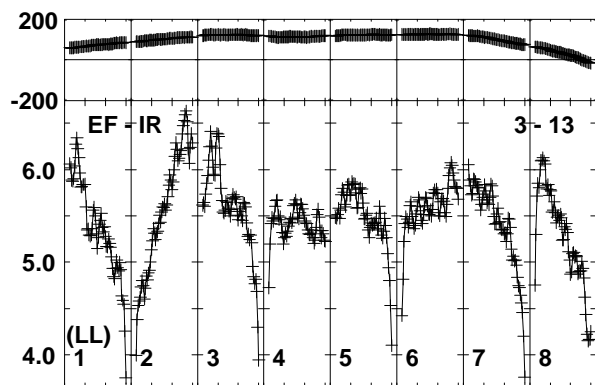
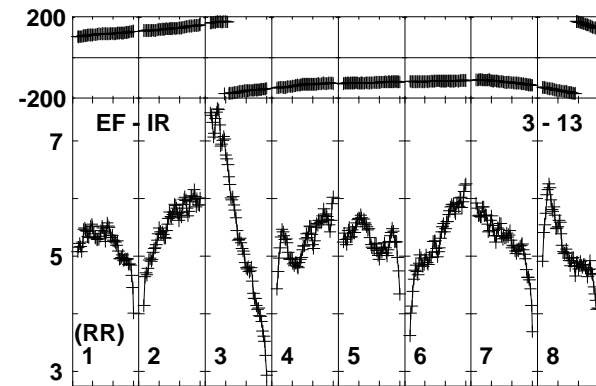
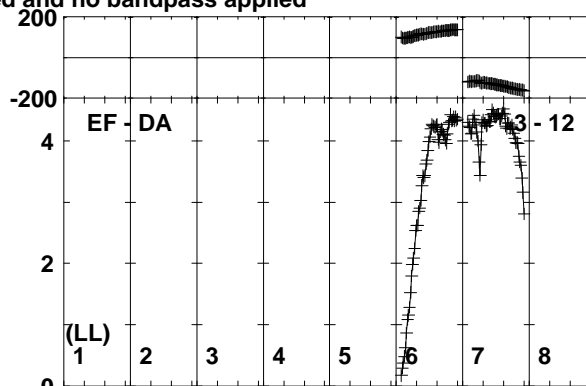
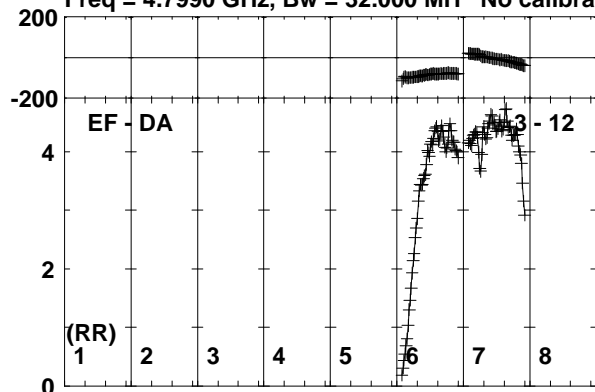

Lower frame: Milli Ampl Jy Top frame: Phas deg  
Vector averaged cross-power spectrum Baseline: EF (03) - DA (12)  
Timerange: 00/21:25:31 to 00/21:26:29



Plot file version 19 created 11-NOV-2019 15:07:18

SER8NJ EK040B.UVDATA.1

Freq = 4.7990 GHz, Bw = 32.000 MH No calibration applied and no bandpass applied

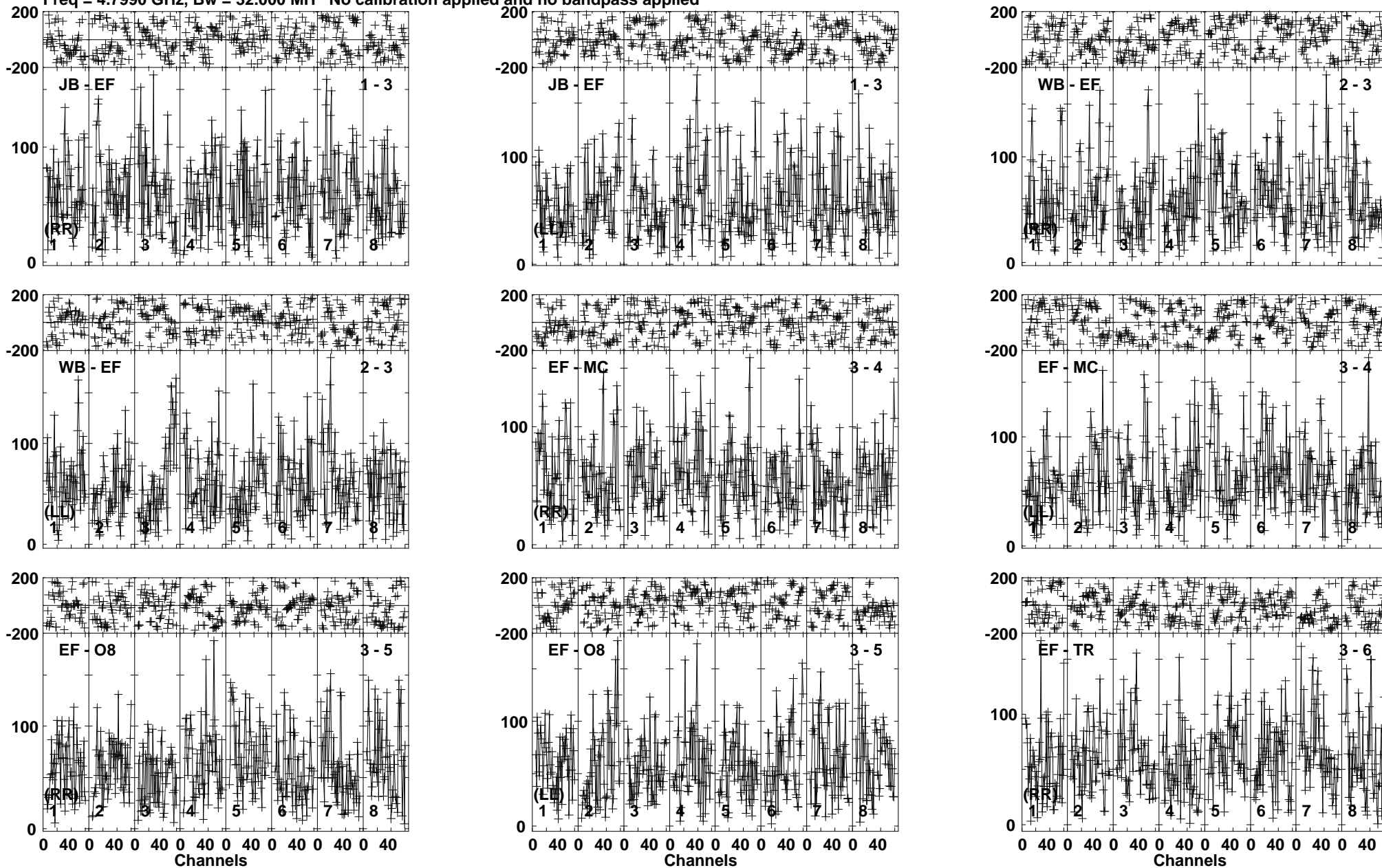

Lower frame: Micro Ampl Jy Top frame: Phas deg  
Vector averaged cross-power spectrum Baseline: JB (01) - EF (03)  
Timerange: 00/21:26:33 to 00/21:30:29

Plot file version 20 created 11-NOV-2019 15:07:18

SER8NJ EK040B.UVDATA.1

Freq = 4.7990 GHz, Bw = 32.000 MH No calibration applied and no bandpass applied

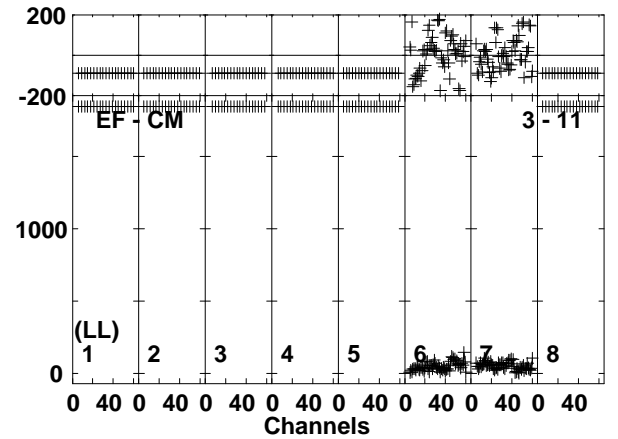
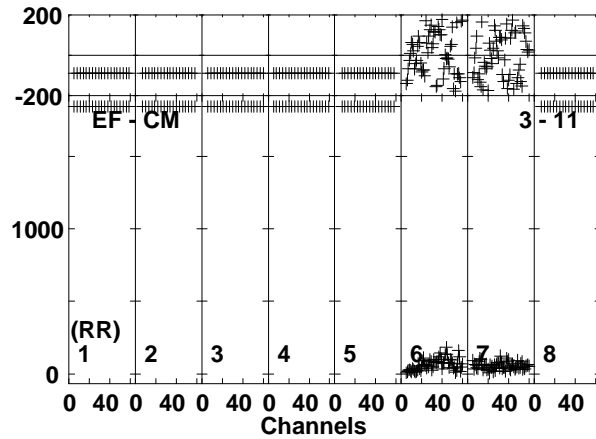
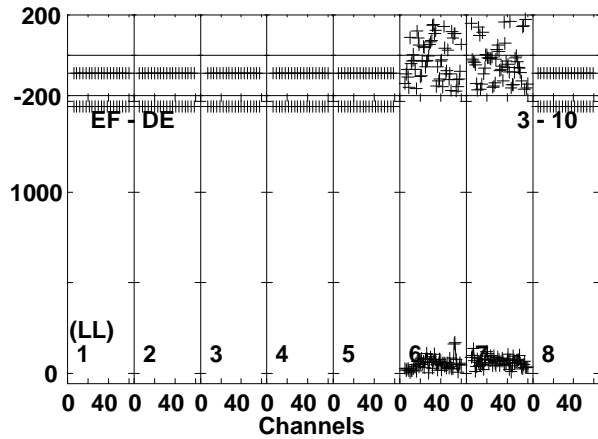
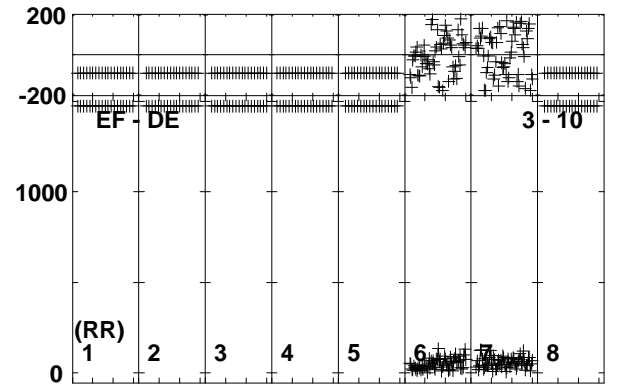
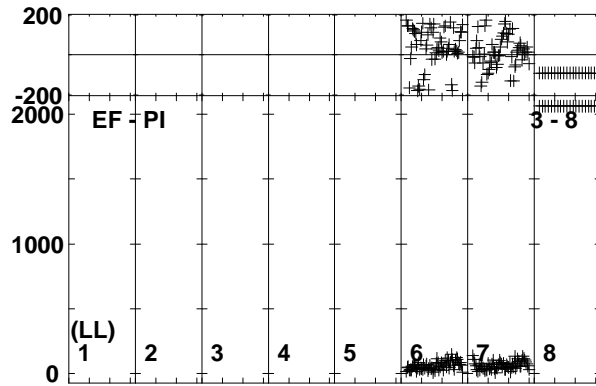
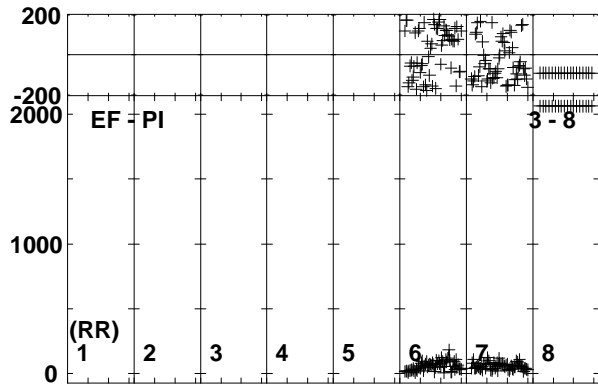
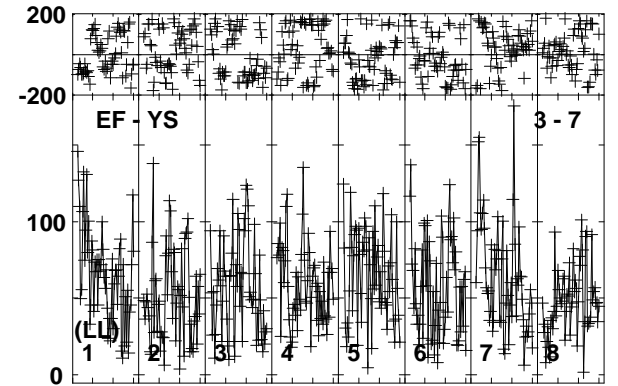
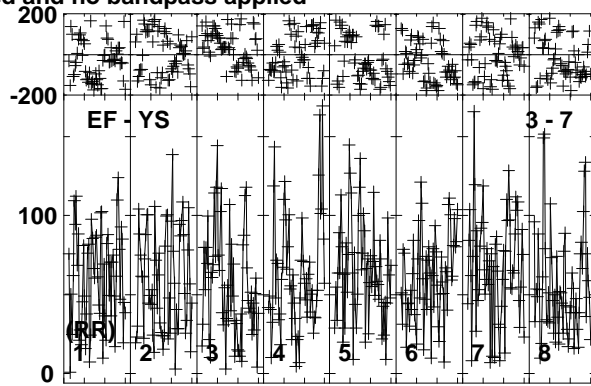
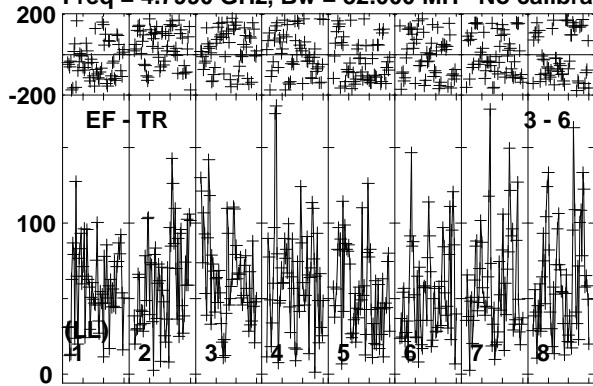

Lower frame: Micro Ampl Jy Top frame: Phas deg  
Vector averaged cross-power spectrum Baseline: EF (03) - TR (06)  
Timerange: 00/21:26:33 to 00/21:30:29

Plot file version 21 created 11-NOV-2019 15:07:18

SER8NJ EK040B.UVDATA.1

Freq = 4.7990 GHz, Bw = 32.000 MH No calibration applied and no bandpass applied

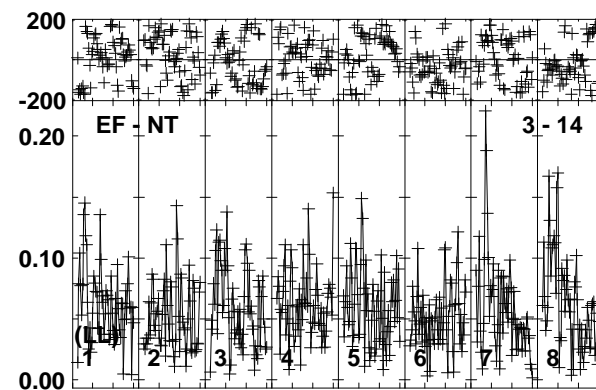
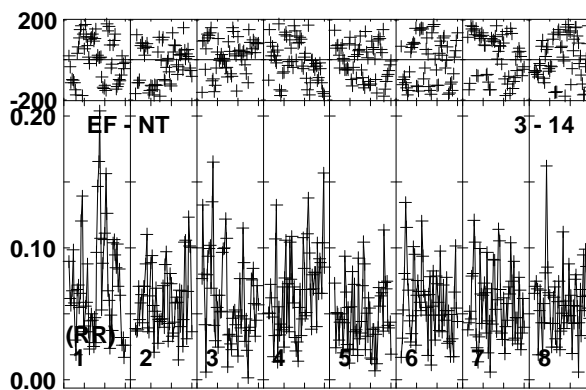
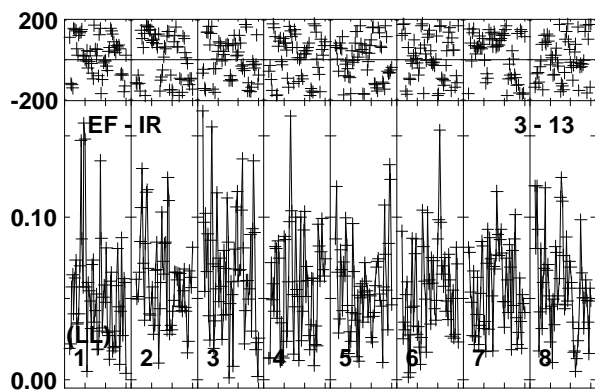
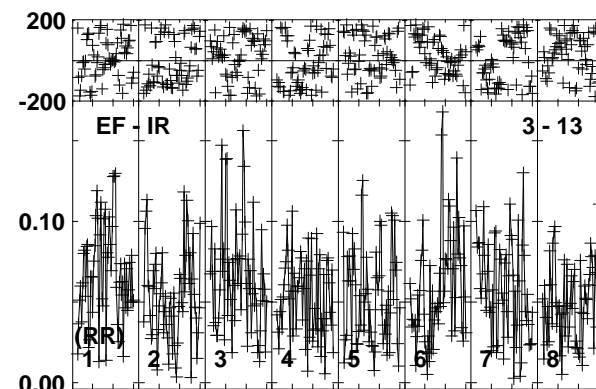
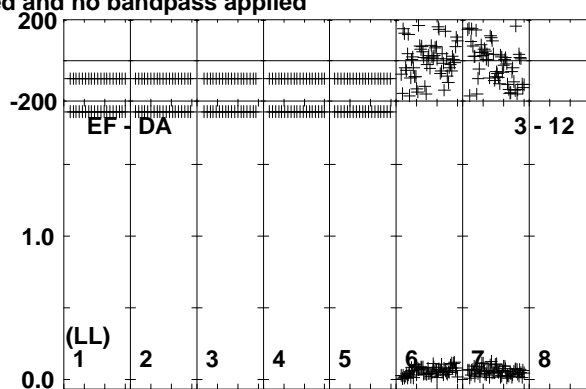
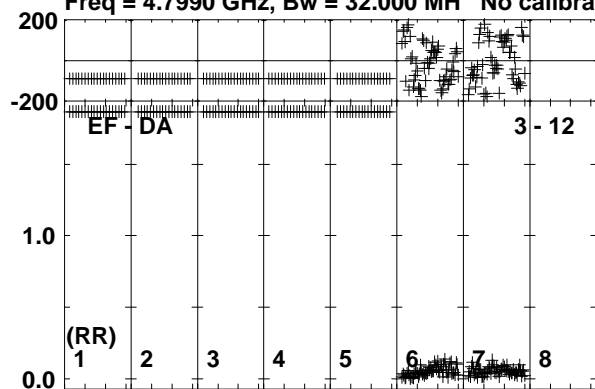

0 40 0 40 0 40 0 40 0 40 0 40 0 40 0 40 0 40 0 40  
Channels

Lower frame: Milli Ampl Jy Top frame: Phas deg  
Vector averaged cross-power spectrum Baseline: EF (03) - DA (12)  
Timerange: 00/21:26:33 to 00/21:30:29

Plot file version 22 created 11-NOV-2019 15:07:18

J1826+0149 EK040B.UVDATA.1

Freq = 4.7990 GHz, Bw = 32.000 MH No calibration applied and no bandpass applied

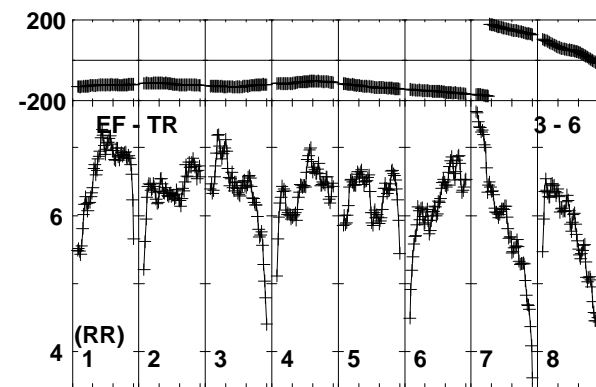
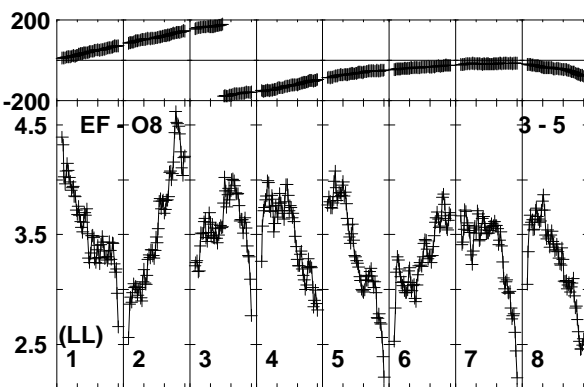
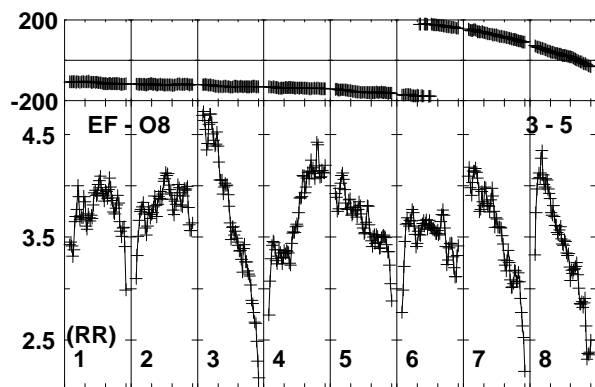
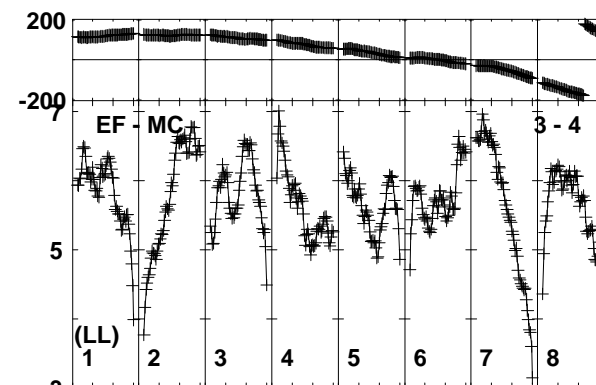
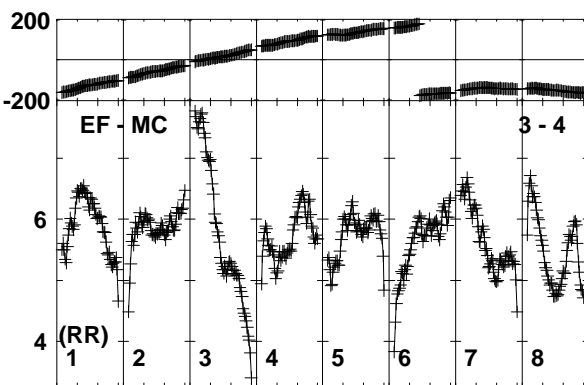
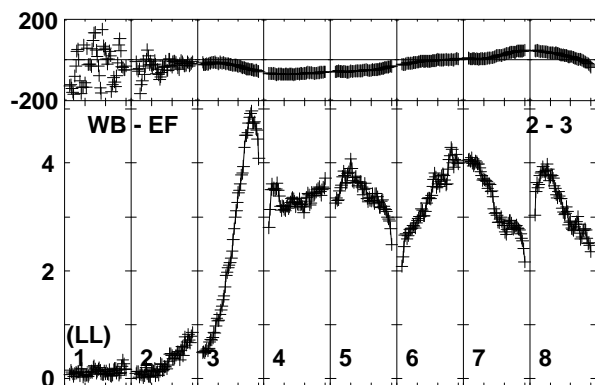
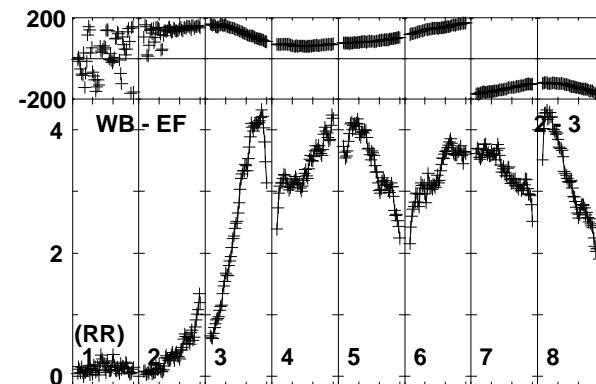
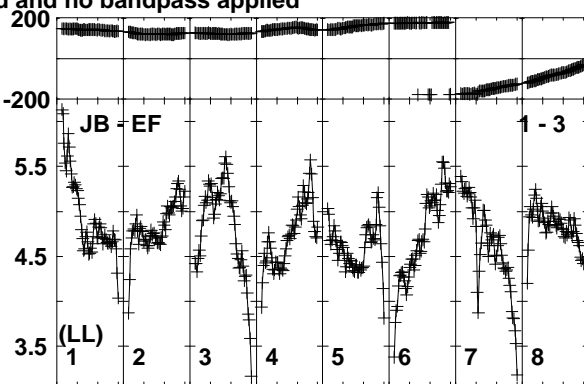
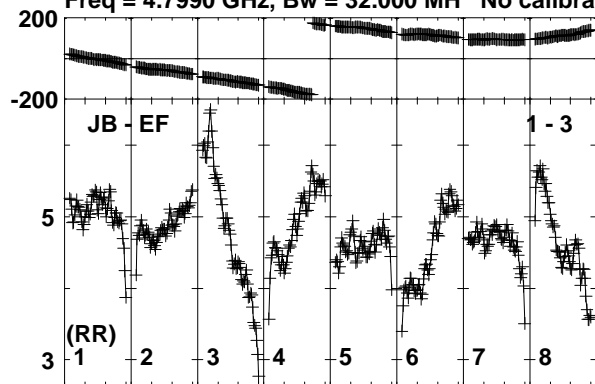

Lower frame: Milli Ampl Jy Top frame: Phas deg

Vector averaged cross-power spectrum Baseline: JB (01) - EF (03)

Timerange: 00/21:30:33 to 00/21:31:59

Plot file version 23 created 11-NOV-2019 15:07:18

J1826+0149 EK040B.UVDATA.1

Freq = 4.7990 GHz, Bw = 32.000 MH No calibration applied and no bandpass applied

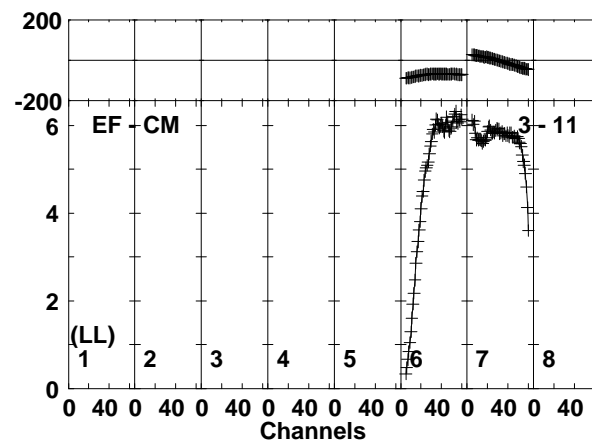
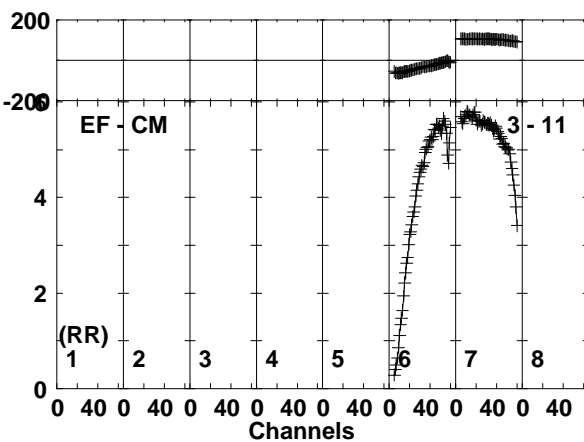
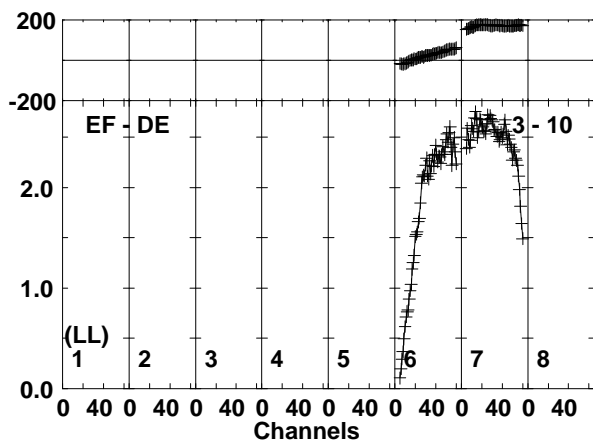
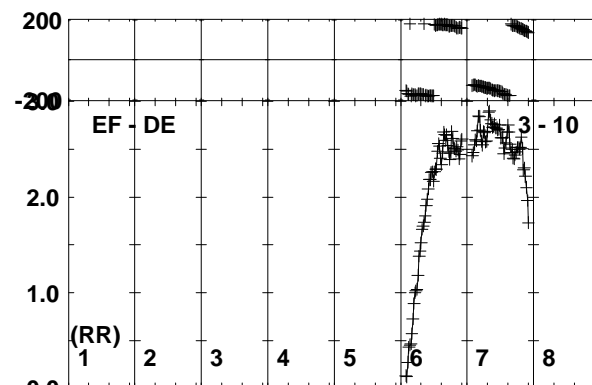
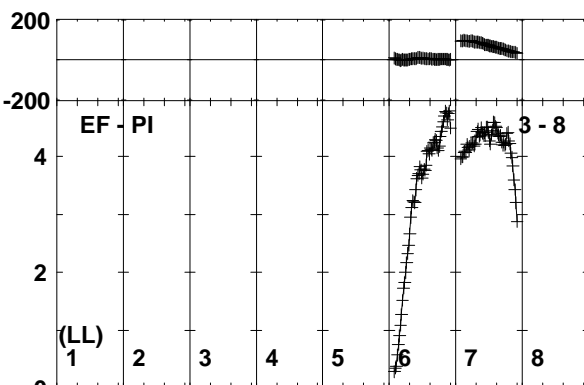
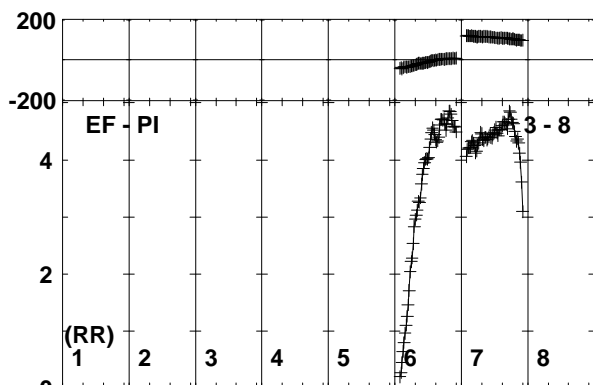
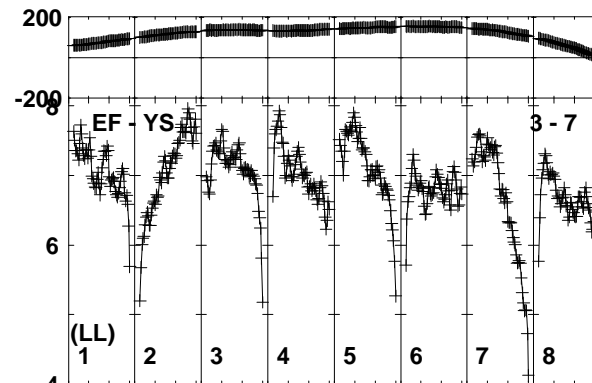
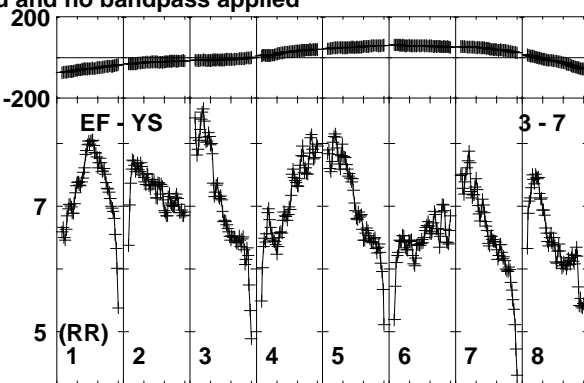
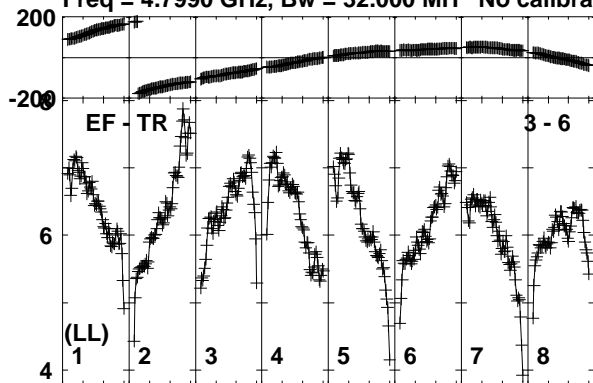

Lower frame: Milli Ampl Jy Top frame: Phas deg  
Vector averaged cross-power spectrum Baseline: EF (03) - TR (06)  
Timerange: 00/21:30:33 to 00/21:31:59

Plot file version 24 created 11-NOV-2019 15:07:19

J1826+0149 EK040B.UVDATA.1

Freq = 4.7990 GHz, Bw = 32.000 MH No calibration applied and no bandpass applied

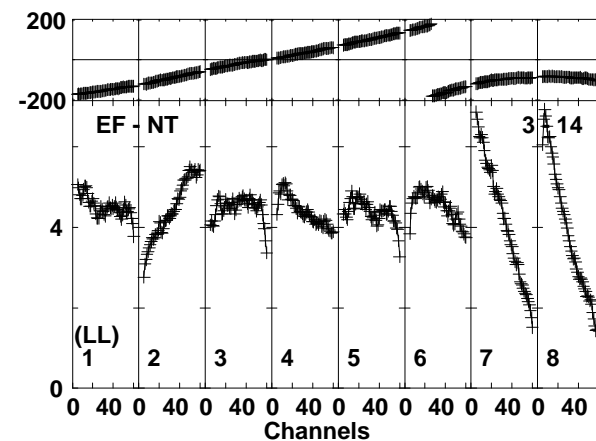
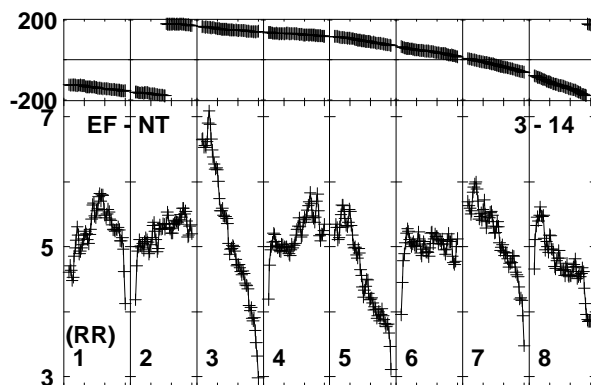
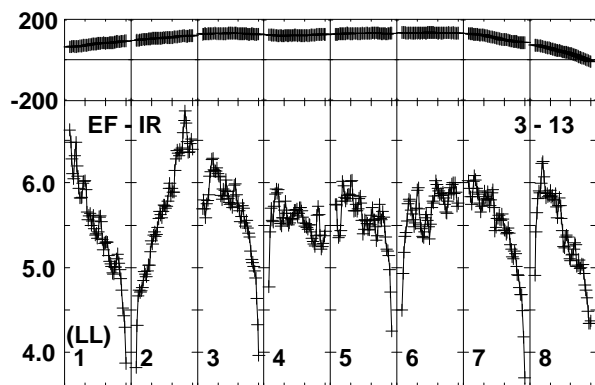
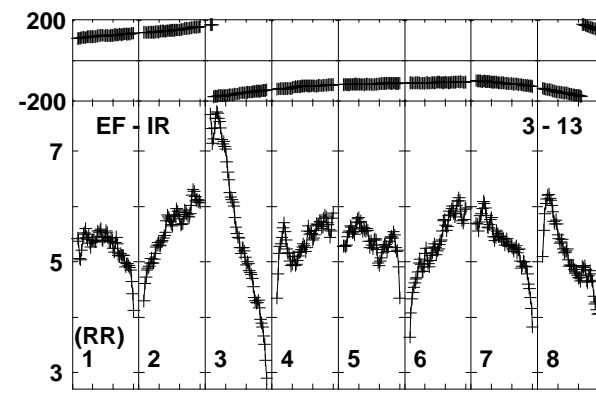
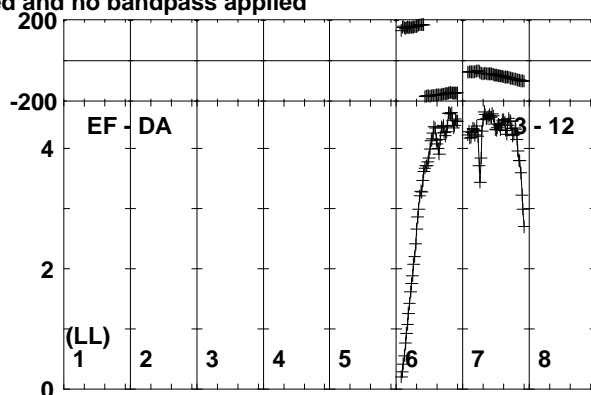
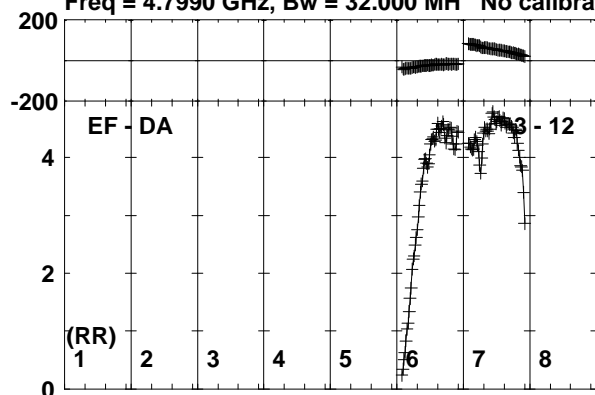

Lower frame: Milli Ampl Jy Top frame: Phas deg  
Vector averaged cross-power spectrum Baseline: EF (03) - DA (12)  
Timerange: 00/21:30:33 to 00/21:31:59

Plot file version 25 created 11-NOV-2019 15:07:19

SER8NJ EK040B.UVDATA.1

Freq = 4.7990 GHz, Bw = 32.000 MH No calibration applied and no bandpass applied

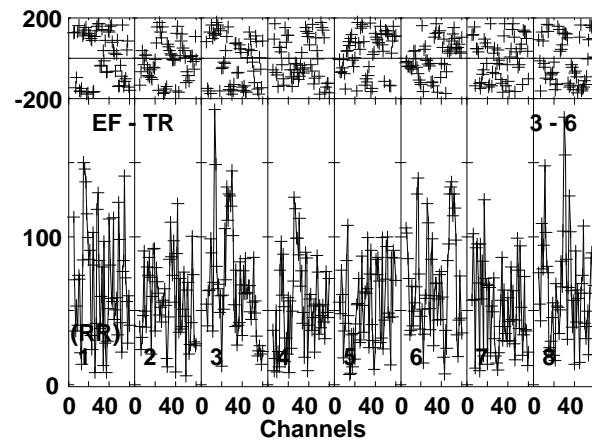
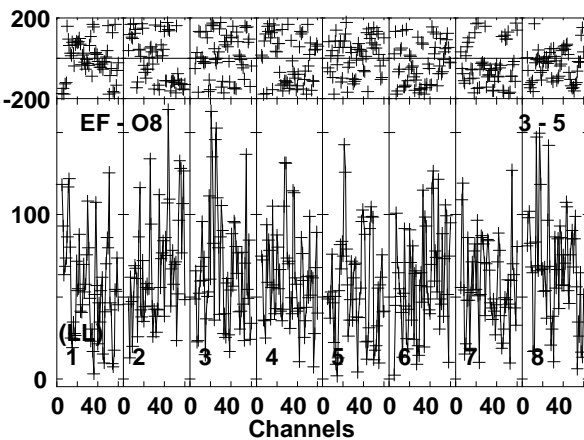
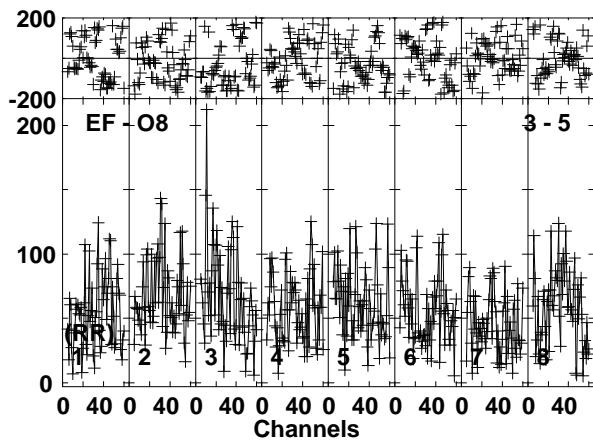
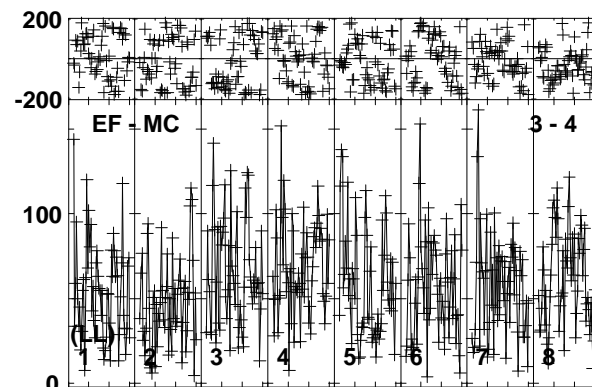
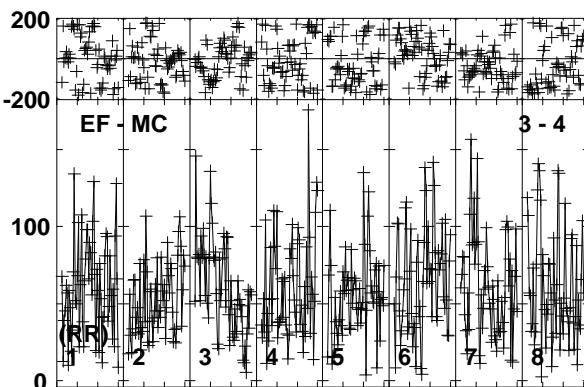
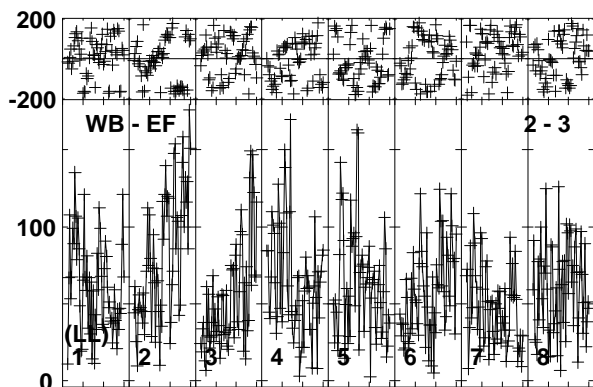
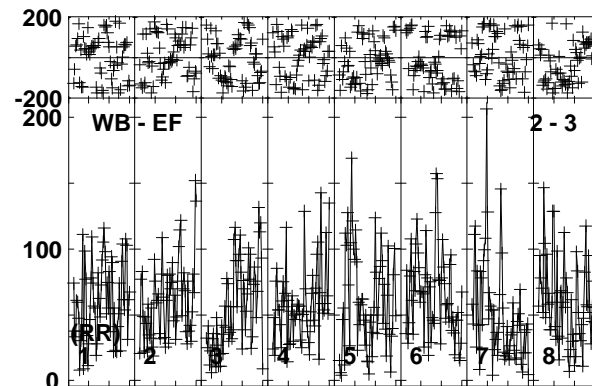
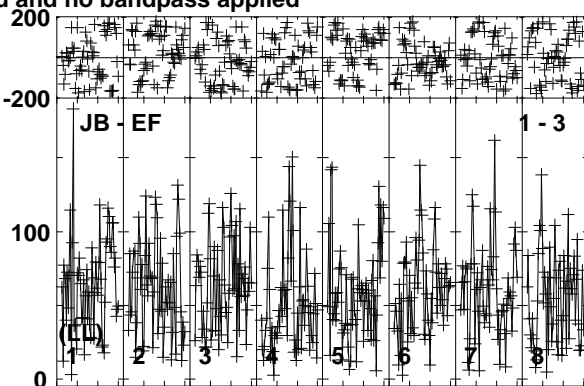
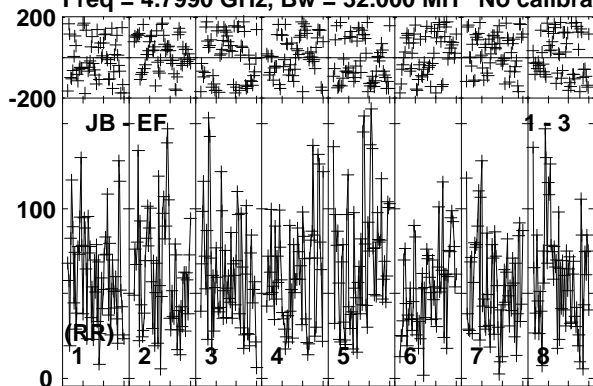

Lower frame: Micro Ampl Jy Top frame: Phas deg  
Vector averaged cross-power spectrum Baseline: JB (01) - EF (03)  
Timerange: 00/21:32:01 to 00/21:35:59

Plot file version 26 created 11-NOV-2019 15:07:19

SER8NJ EK040B.UVDATA.1

Freq = 4.7990 GHz, Bw = 32.000 MH No calibration applied and no bandpass applied

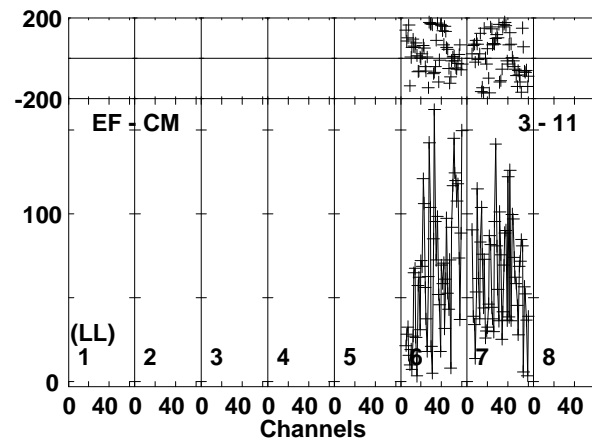
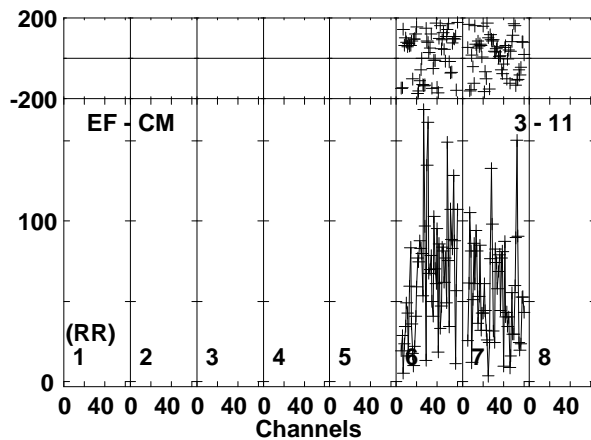
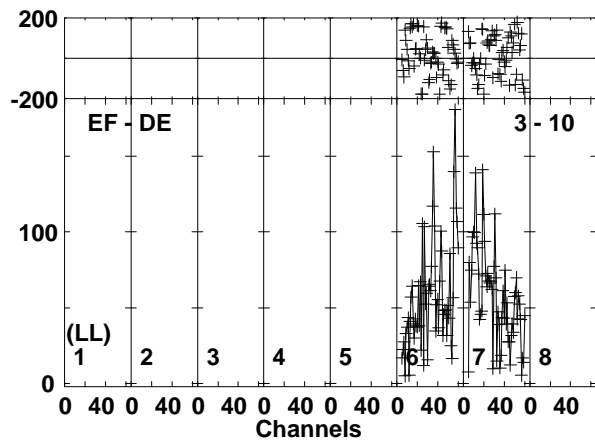
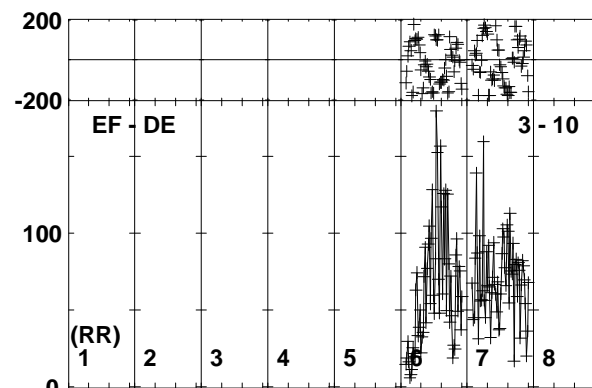
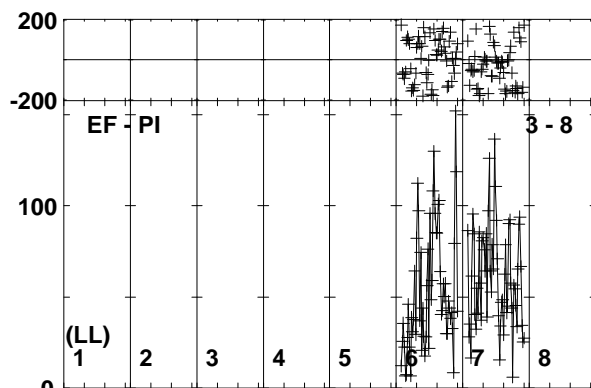
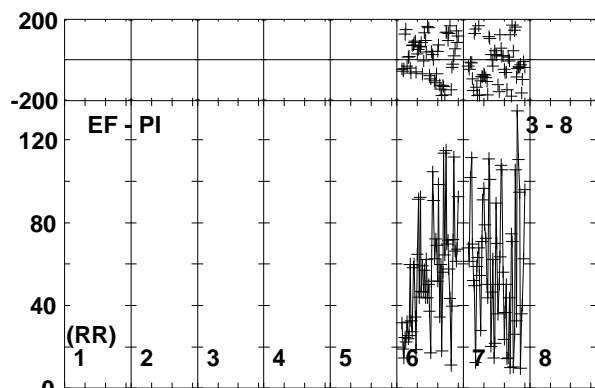
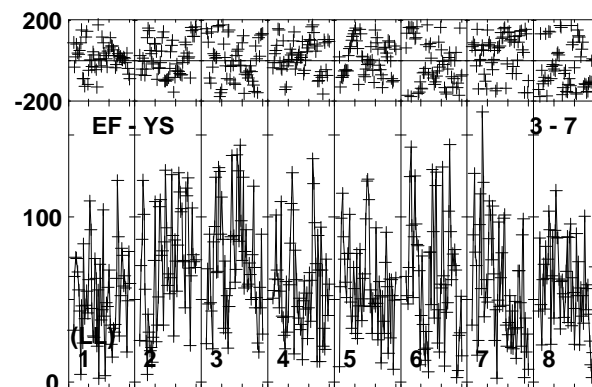
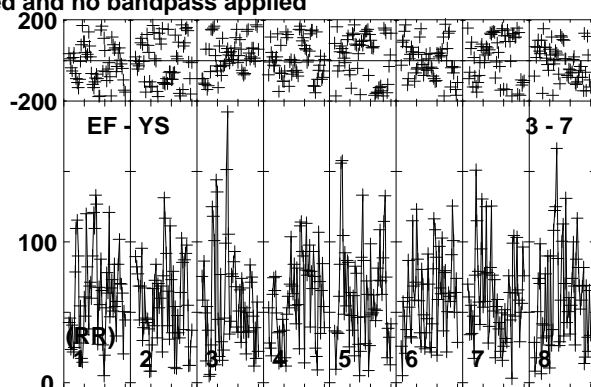
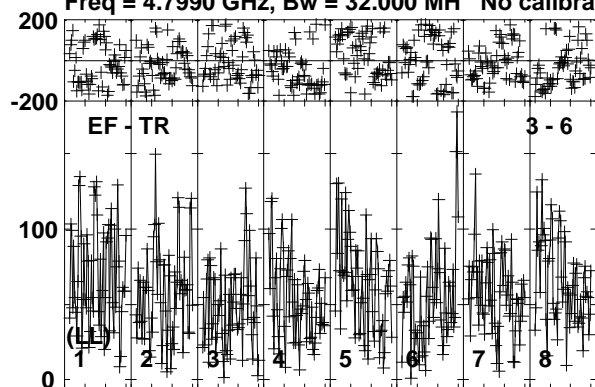

Lower frame: Micro Ampl Jy Top frame: Phas deg  
Vector averaged cross-power spectrum Baseline: EF (03) - TR (06)  
Timerange: 00/21:32:01 to 00/21:35:59



Plot file version 27 created 11-NOV-2019 15:07:19

SER8NJ EK040B.UVDATA.1

Freq = 4.7990 GHz, Bw = 32.000 MH No calibration applied and no bandpass applied

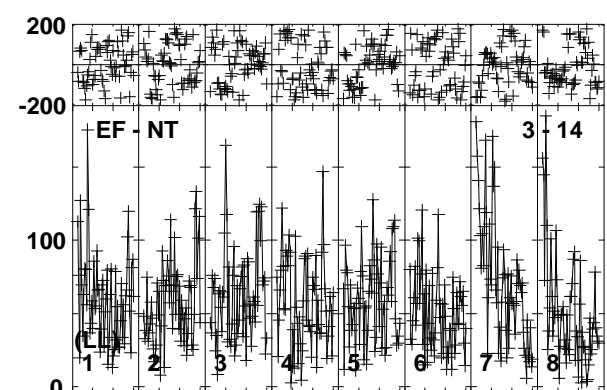
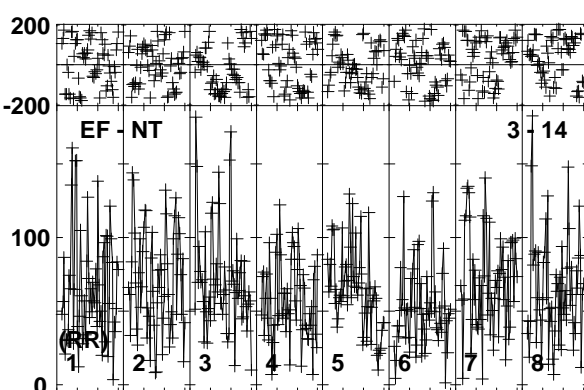
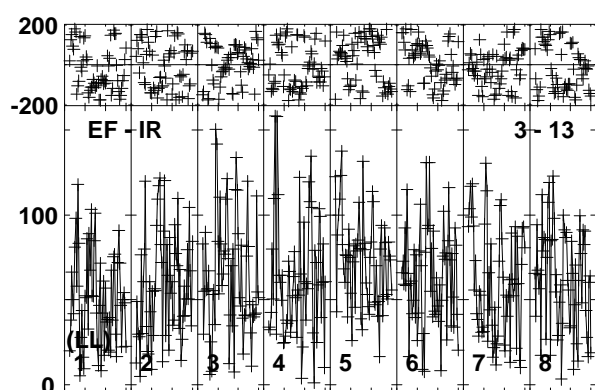
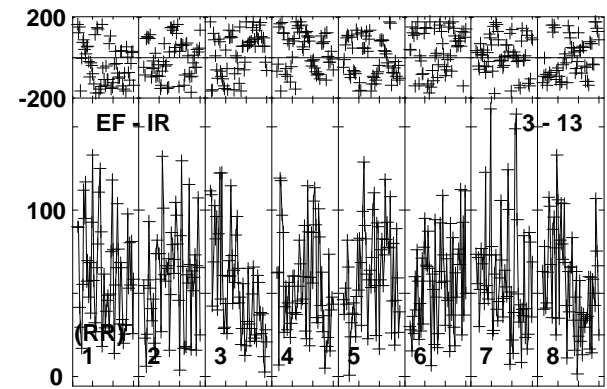
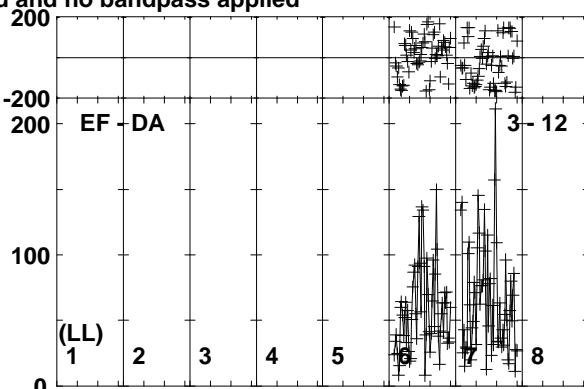
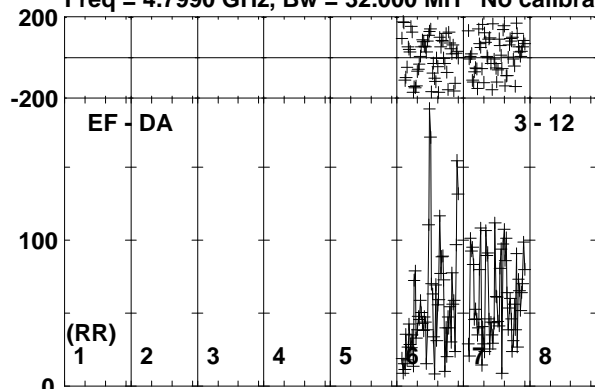

0 40 0 40 0 40 0 40 0 40 0 40 0 40 0 40 0 40 0 40  
Channels

Lower frame: Micro Ampl Jy Top frame: Phas deg  
Vector averaged cross-power spectrum Baseline: EF (03) - DA (12)  
Timerange: 00/21:32:01 to 00/21:35:59

Plot file version 28 created 11-NOV-2019 15:07:19

J1826+0149 EK040B.UVDATA.1

Freq = 4.7990 GHz, Bw = 32.000 MH No calibration applied and no bandpass applied

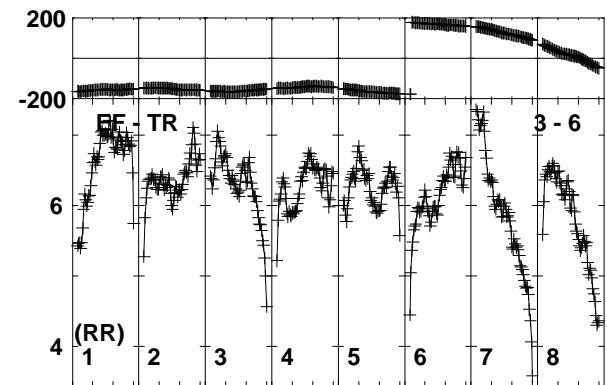
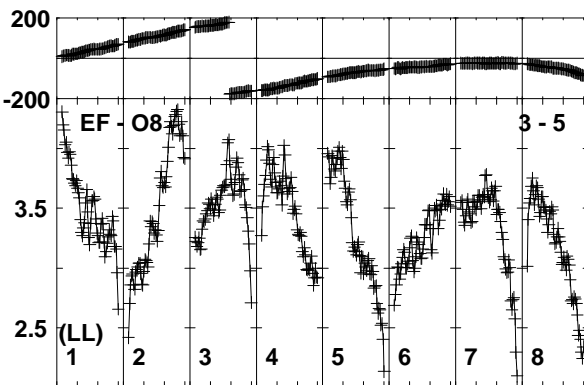
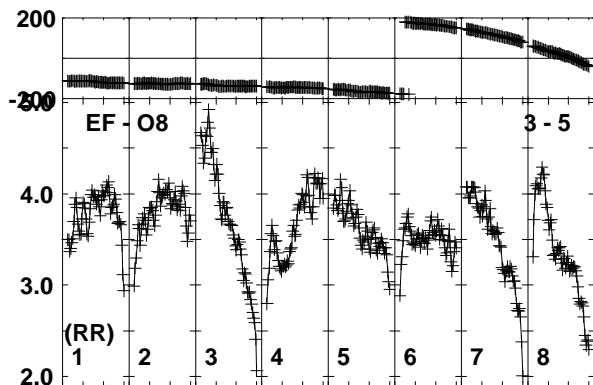
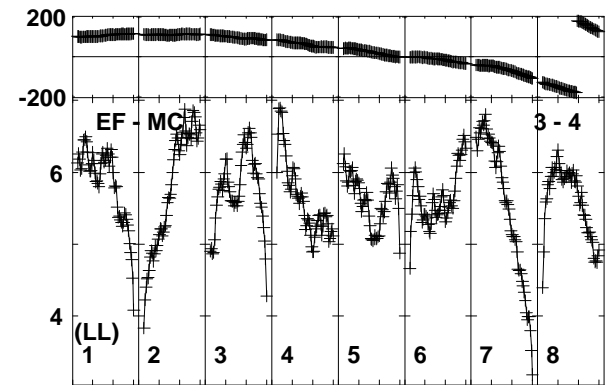
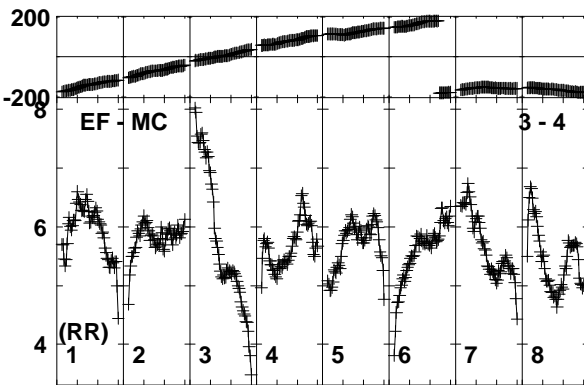
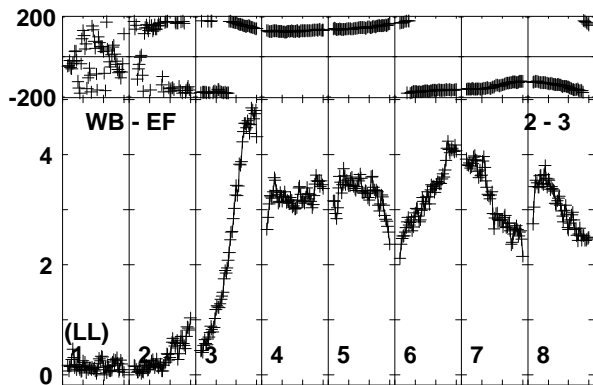
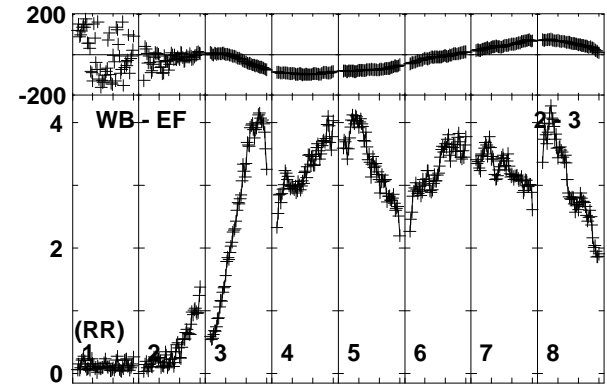
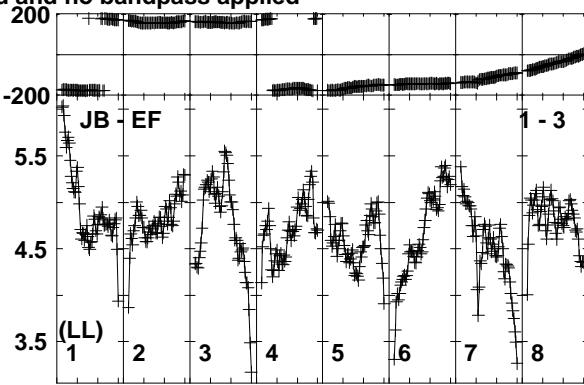
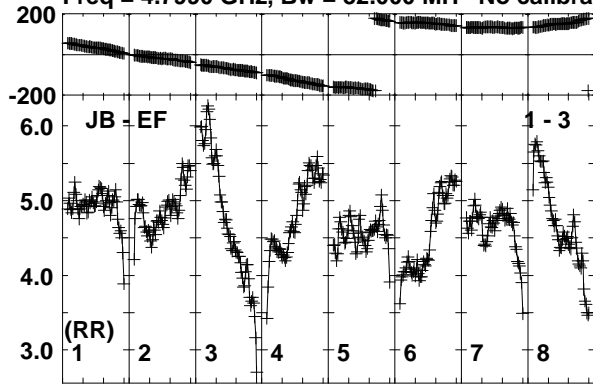

Lower frame: Milli Ampl Jy Top frame: Phas deg  
Vector averaged cross-power spectrum Baseline: JB (01) - EF (03)  
Timerange: 00/21:36:41 to 00/21:37:39

Plot file version 29 created 11-NOV-2019 15:07:19

J1826+0149 EK040B.UVDATA.1

Freq = 4.7990 GHz, Bw = 32.000 MH No calibration applied and no bandpass applied

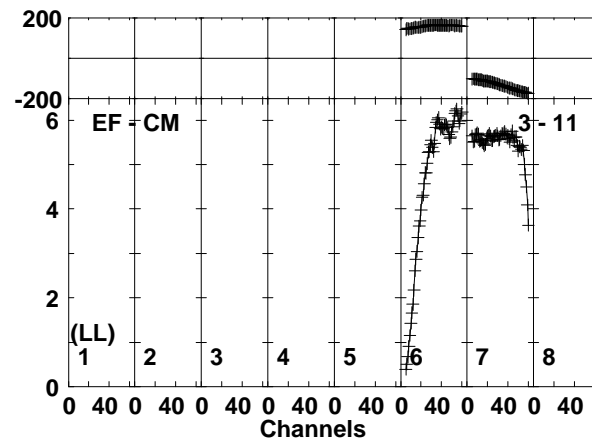
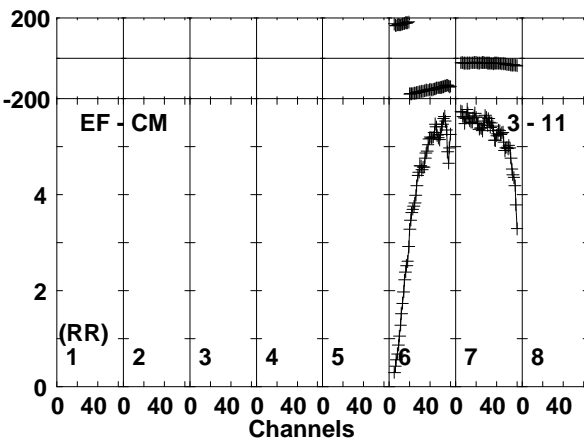
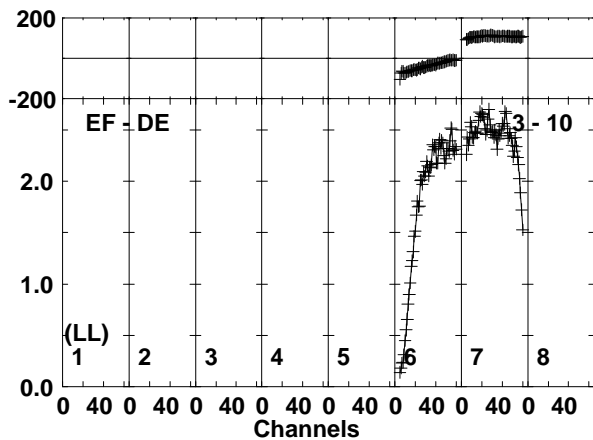
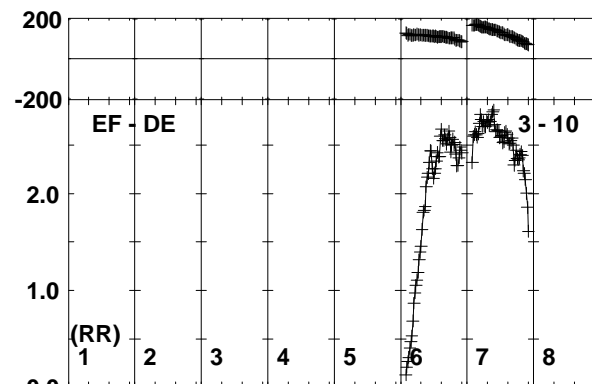
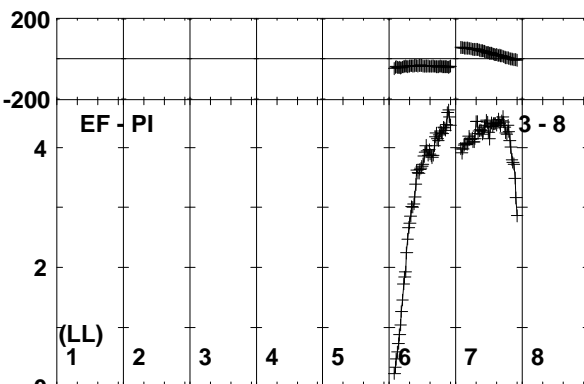
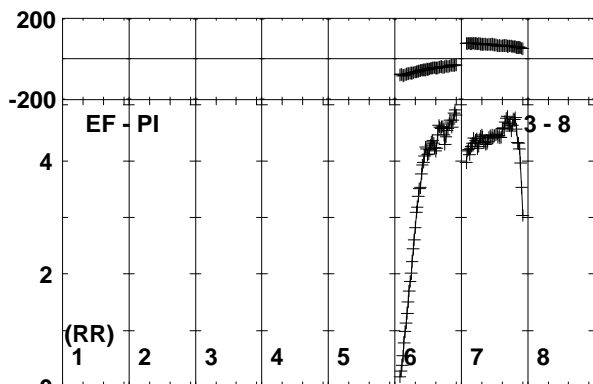
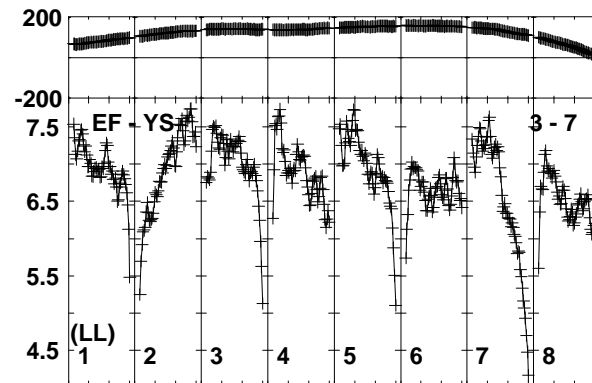
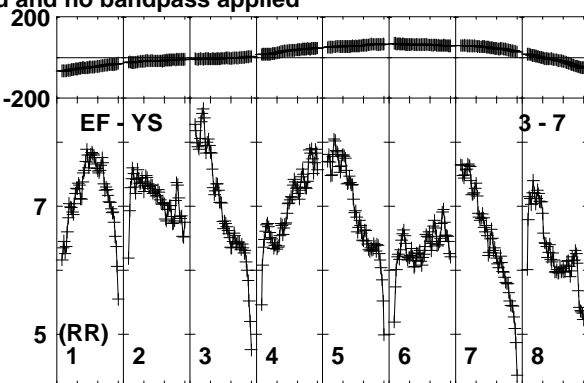
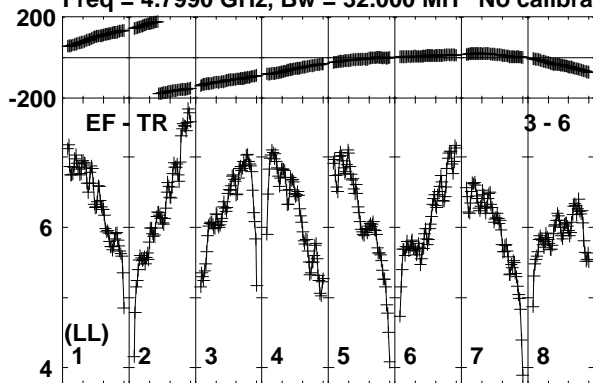

Lower frame: Milli Ampl Jy Top frame: Phas deg  
Vector averaged cross-power spectrum Baseline: EF (03) - TR (06)  
Timerange: 00/21:36:41 to 00/21:37:39

Plot file version 30 created 11-NOV-2019 15:07:19

J1826+0149 EK040B.UVDATA.1

Freq = 4.7990 GHz, Bw = 32.000 MH No calibration applied and no bandpass applied

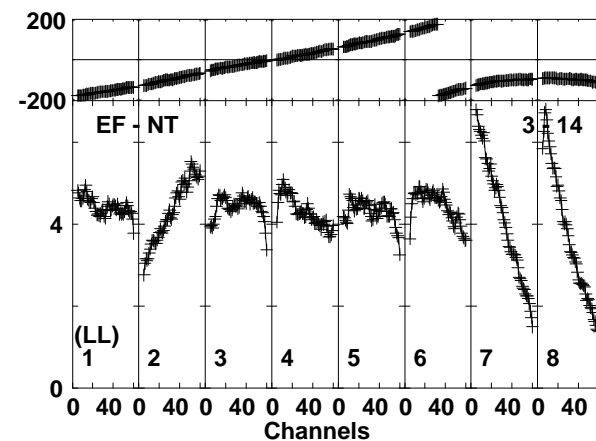
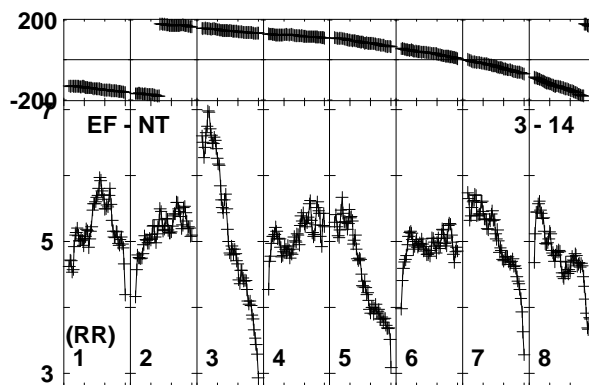
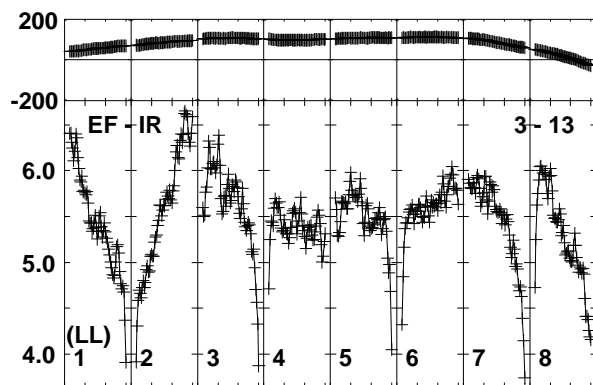
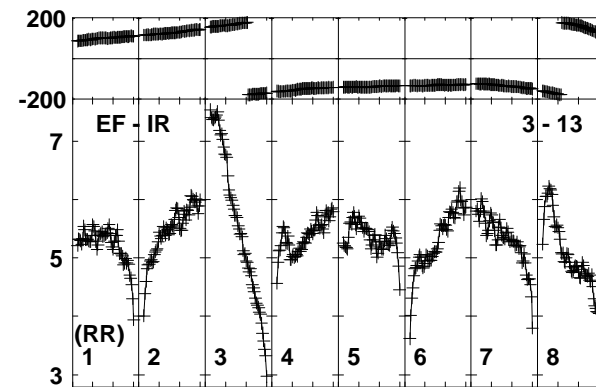
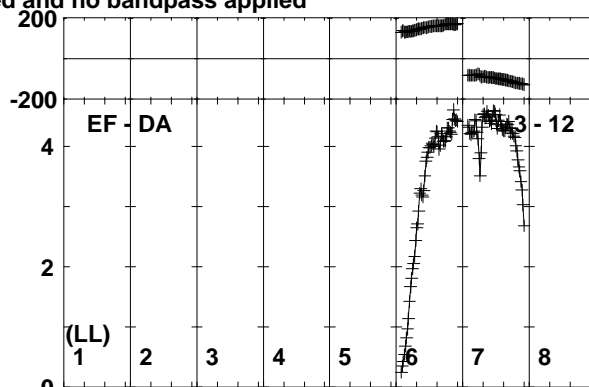
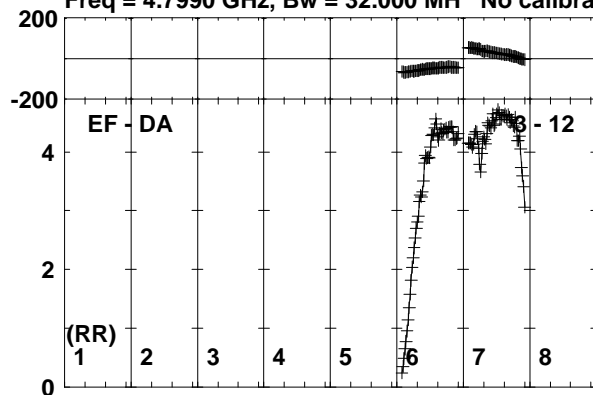

Lower frame: Milli Ampl Jy Top frame: Phas deg  
Vector averaged cross-power spectrum Baseline: EF (03) - DA (12)  
Timerange: 00/21:36:41 to 00/21:37:39

Plot file version 31 created 11-NOV-2019 15:07:19

SER8NJ EK040B.UVDATA.1

Freq = 4.7990 GHz, Bw = 32.000 MH No calibration applied and no bandpass applied

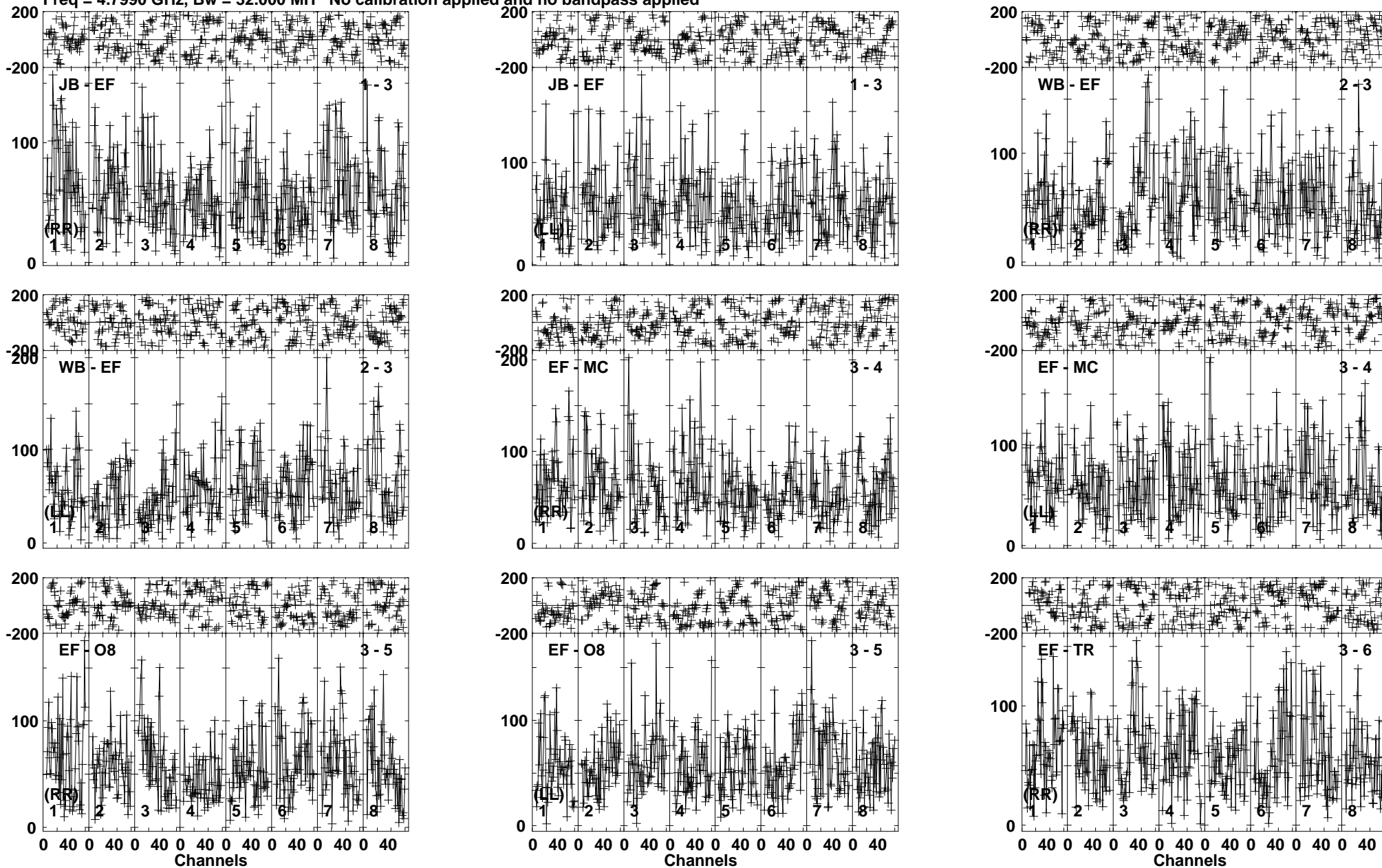

Lower frame: Micro Ampl Jy Top frame: Phas deg  
Vector averaged cross-power spectrum Baseline: JB (01) - EF (03)  
Timerange: 00:21:37:41 to 00:21:41:39

Plot file version 32 created 11-NOV-2019 15:07:19

SER8NJ EK040B.UVDATA.1

Freq = 4.7990 GHz, Bw = 32.000 MH No calibration applied and no bandpass applied

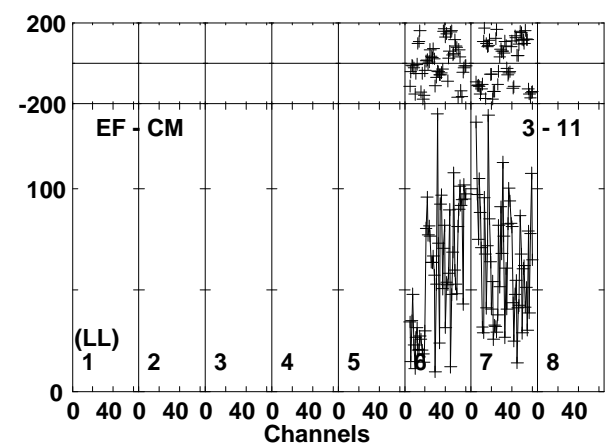
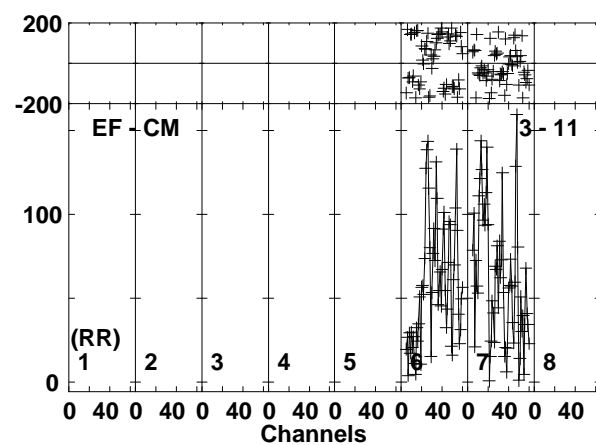
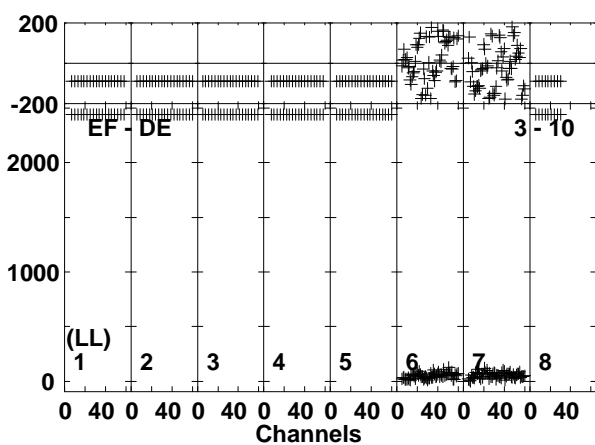
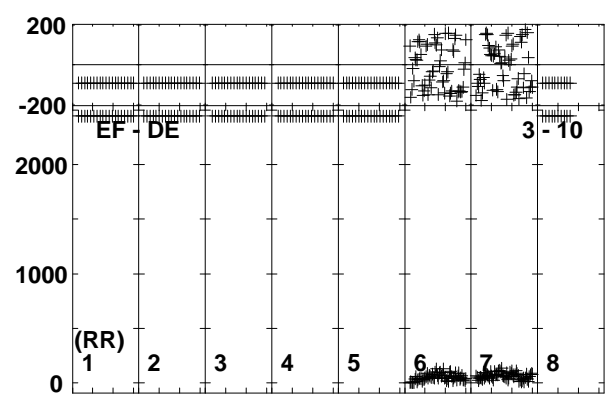
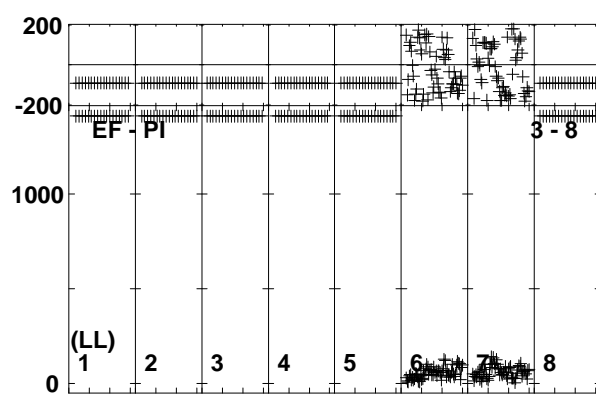
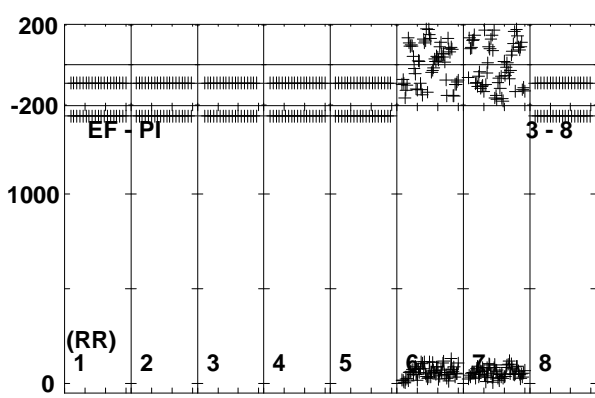
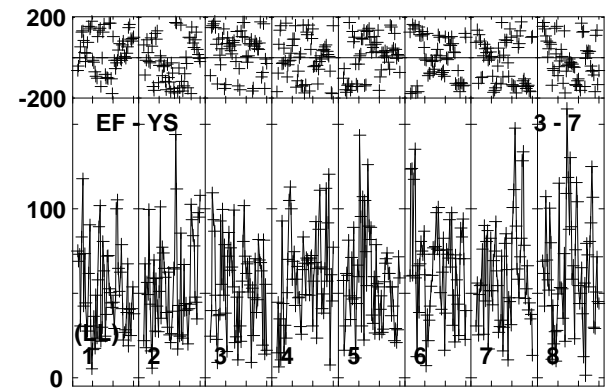
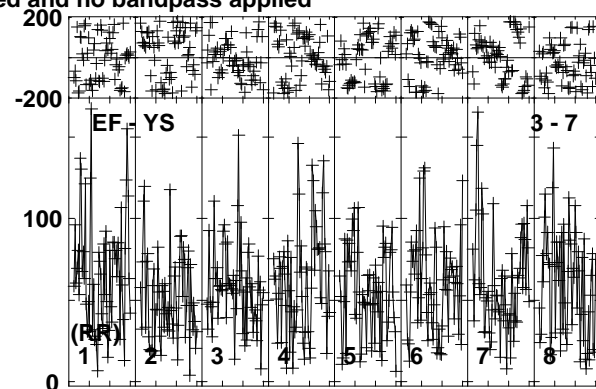
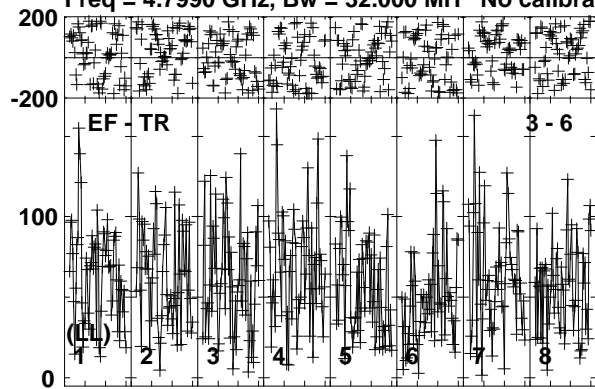

Lower frame: Micro Ampl Jy Top frame: Phas deg  
Vector averaged cross-power spectrum Baseline: EF (03) - TR (06)  
Timerange: 00/21:37:41 to 00/21:41:39

Plot file version 33 created 11-NOV-2019 15:07:20

SER8NJ EK040B.UVDATA.1

Freq = 4.7990 GHz, Bw = 32.000 MH No calibration applied and no bandpass applied

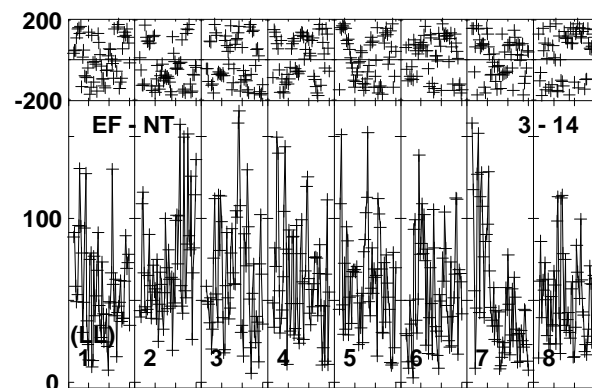
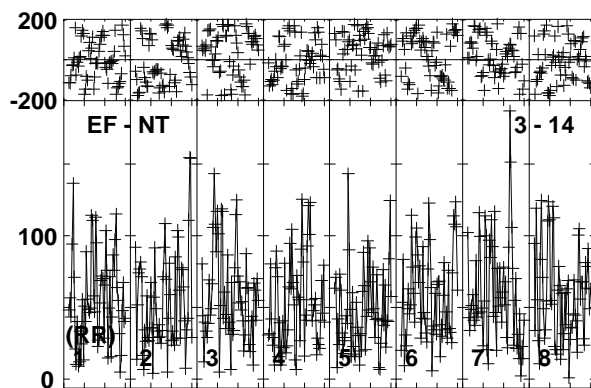
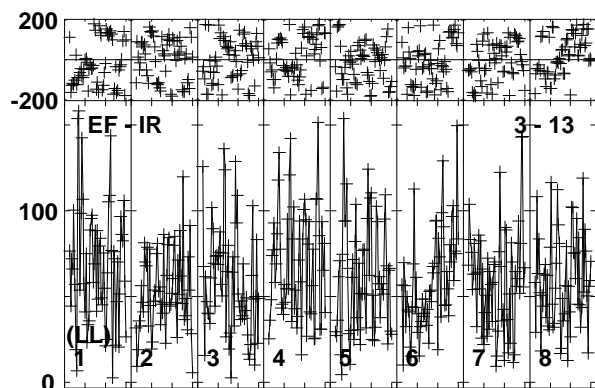
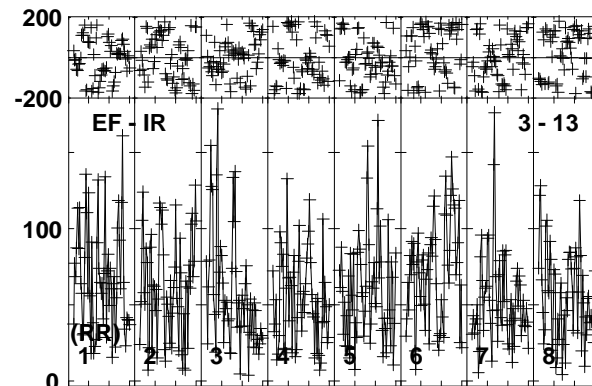
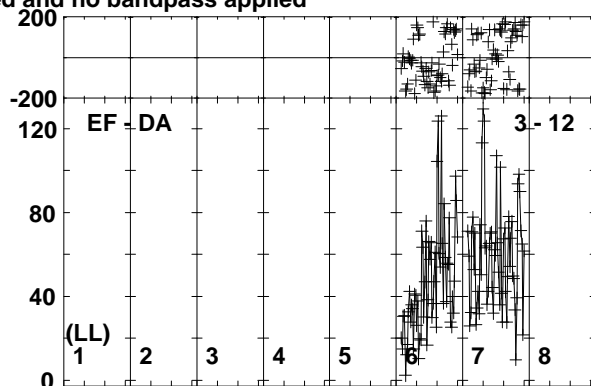
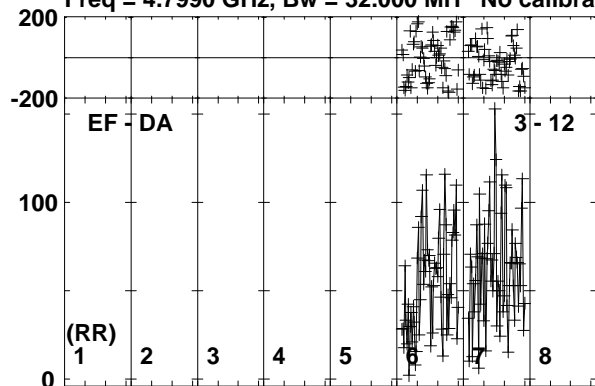

0 40 0 40 0 40 0 40 0 40 0 40 0 40 0 40 0 40 0 40  
Channels

Lower frame: Micro Ampl Jy Top frame: Phas deg  
Vector averaged cross-power spectrum Baseline: EF (03) - DA (12)  
Timerange: 00/21:37:41 to 00/21:41:39

Plot file version 34 created 11-NOV-2019 15:07:20

J1826+0149 EK040B.UVDATA.1

Freq = 4.7990 GHz, Bw = 32.000 MH No calibration applied and no bandpass applied

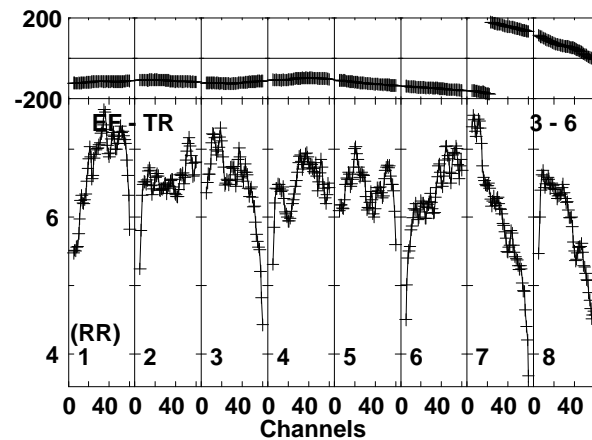
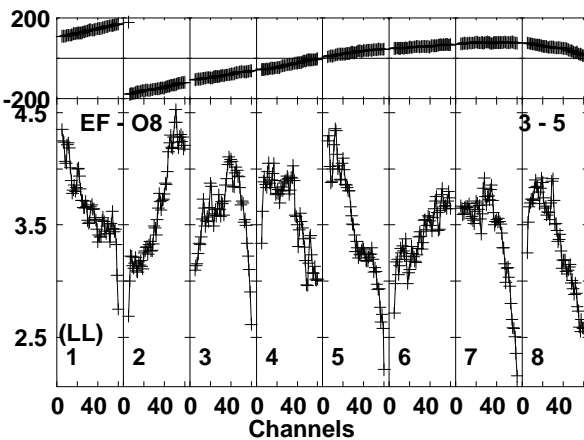
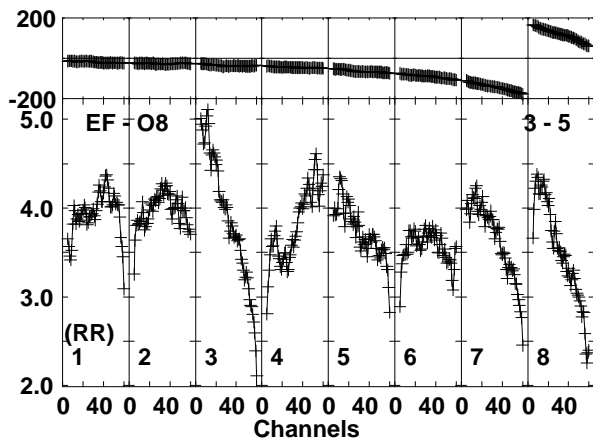
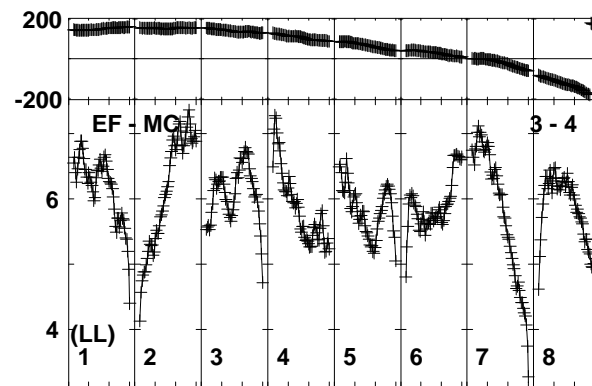
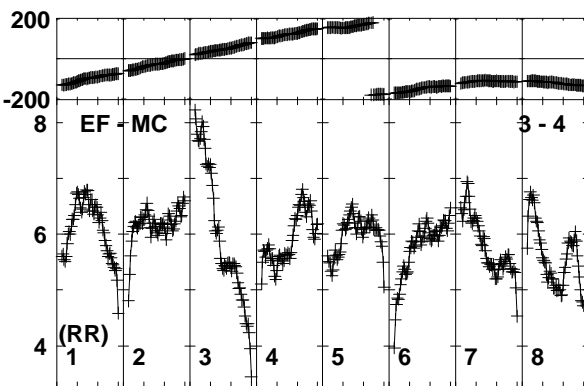
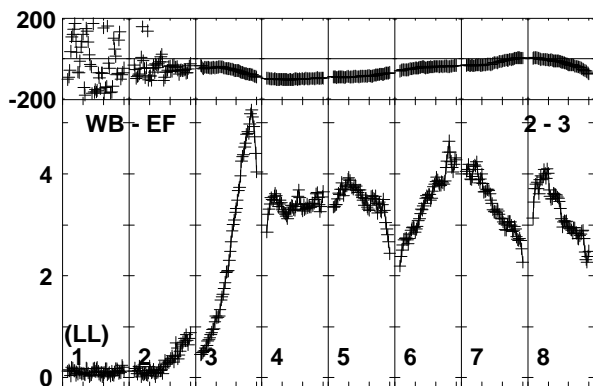
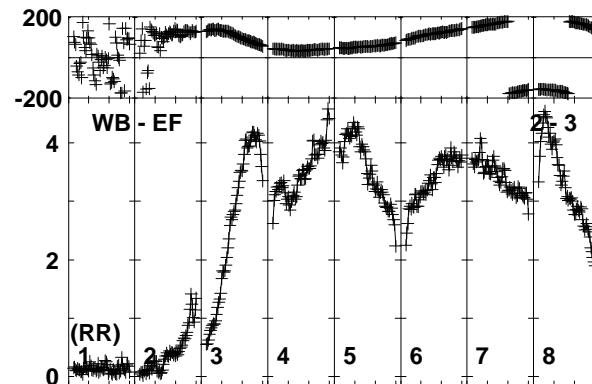
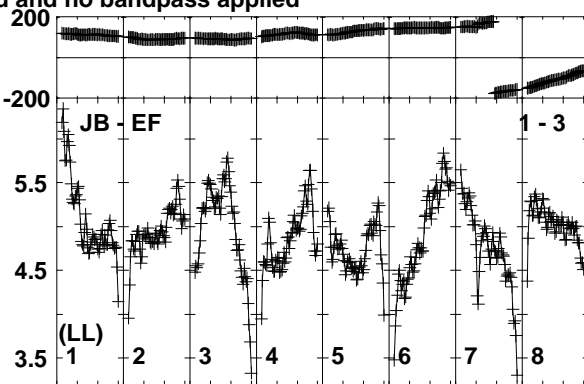
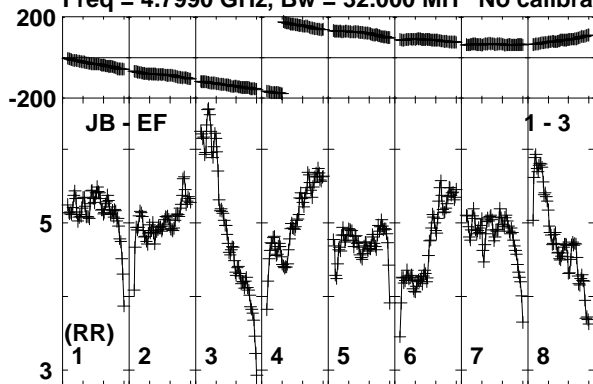

Lower frame: Milli Ampl Jy Top frame: Phas deg  
Vector averaged cross-power spectrum Baseline: JB (01) - EF (03)  
Timerange: 00/21:41:41 to 00/21:43:09



Plot file version 35 created 11-NOV-2019 15:07:20

J1826+0149 EK040B.UVDATA.1

Freq = 4.7990 GHz, Bw = 32.000 MH No calibration applied and no bandpass applied

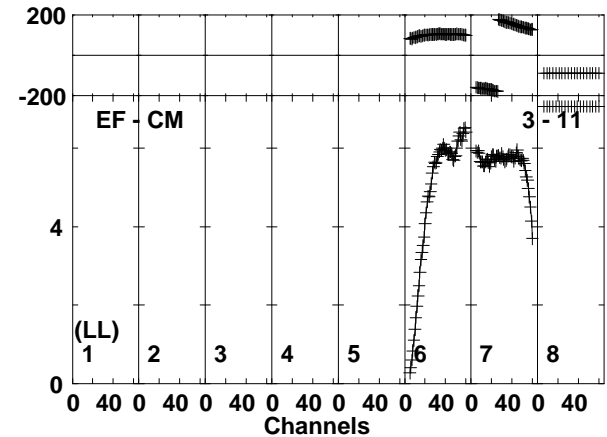
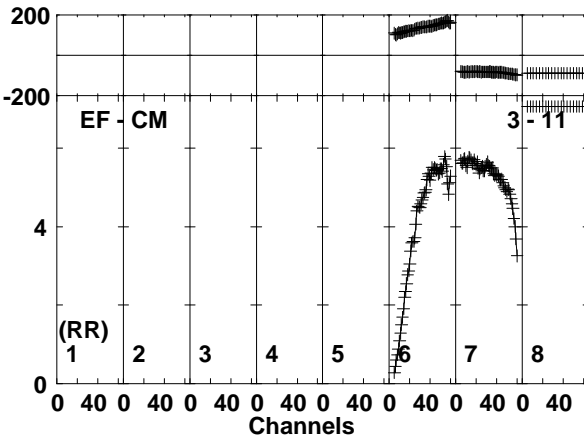
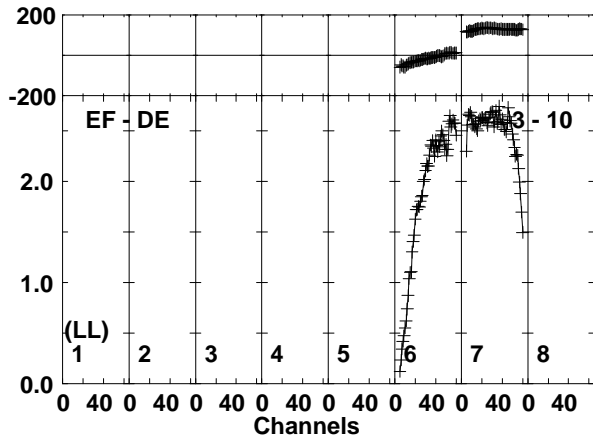
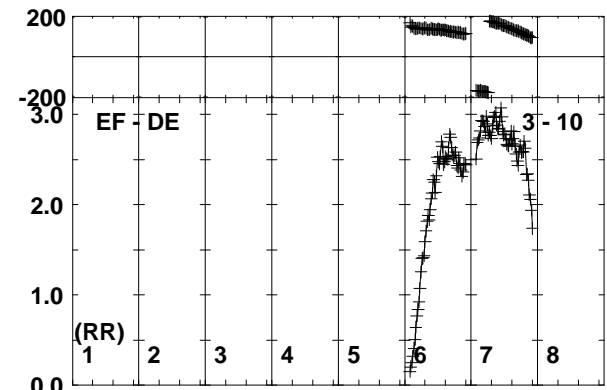
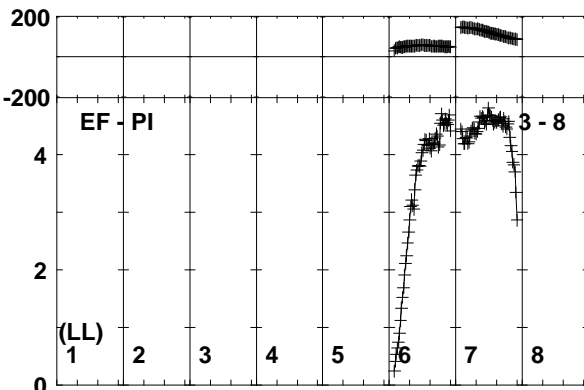
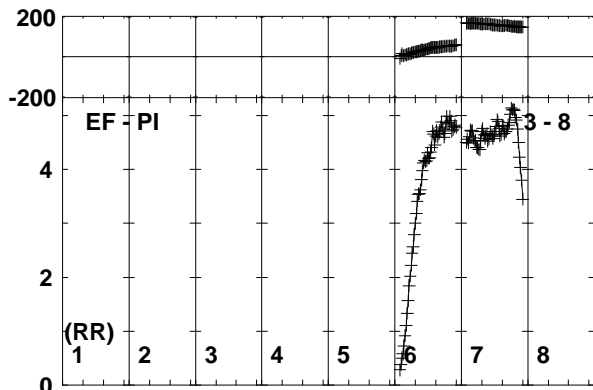
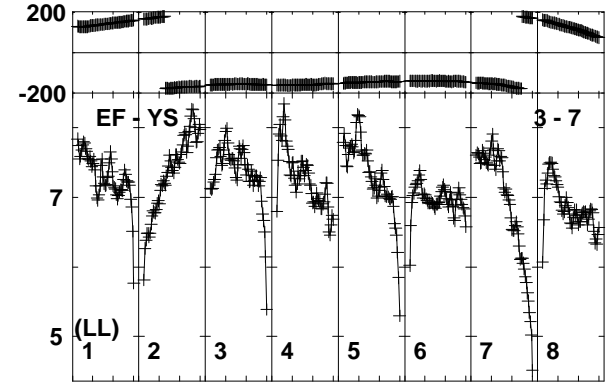
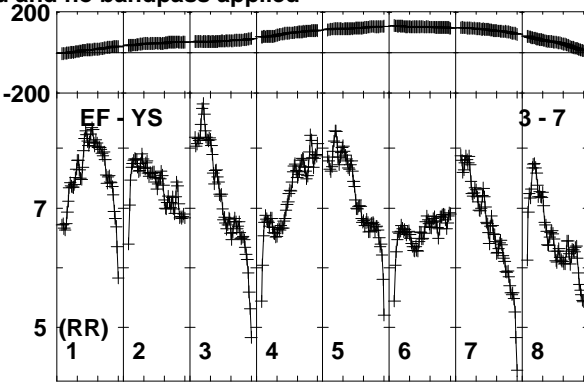
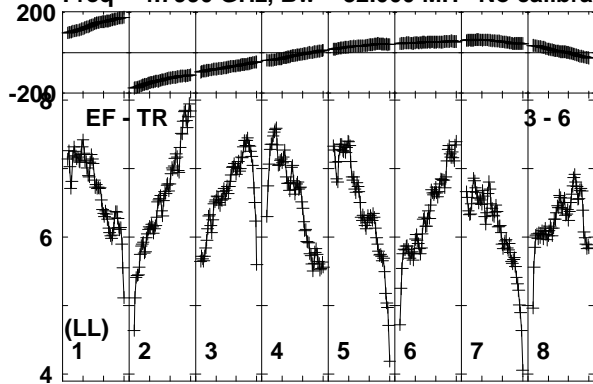

Lower frame: Milli Ampl Jy Top frame: Phas deg  
 Vector averaged cross-power spectrum Baseline: EF (03) - TR (06)  
 Timerange: 00/21:41:41 to 00/21:43:09

Plot file version 36 created 11-NOV-2019 15:07:20

J1826+0149 EK040B.UVDATA.1

Freq = 4.7990 GHz, Bw = 32.000 MH No calibration applied and no bandpass applied

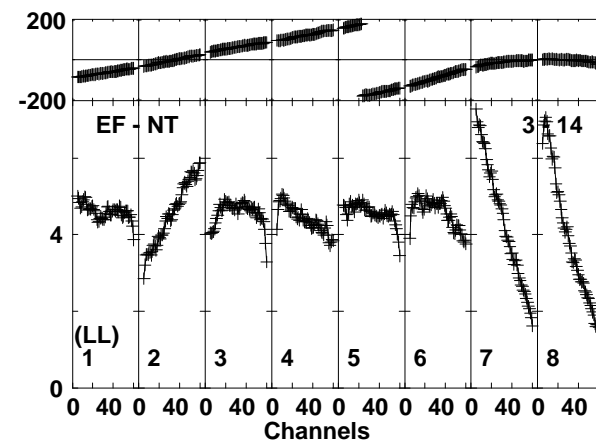
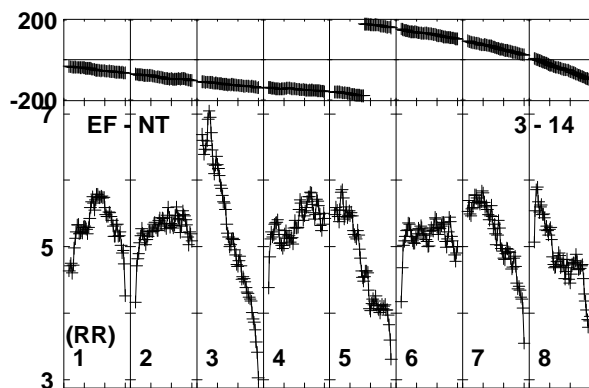
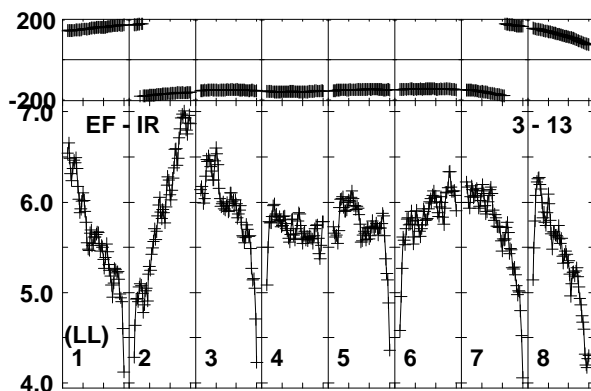
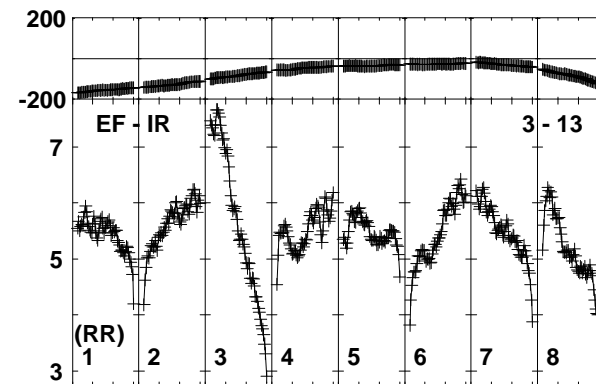
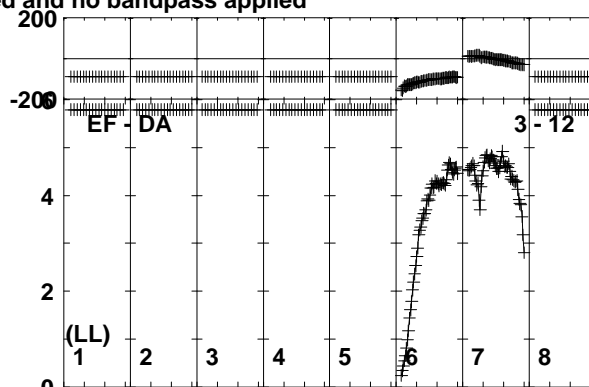
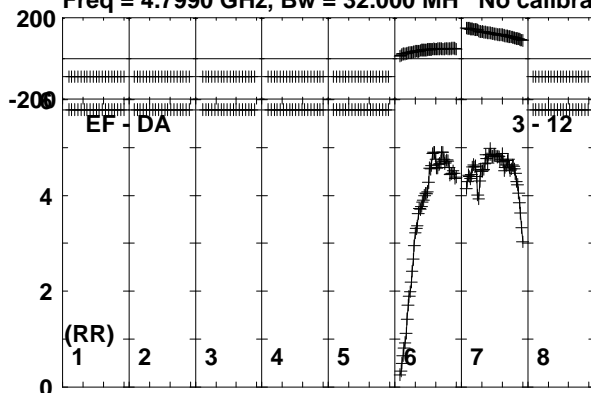

Lower frame: Milli Ampl Jy Top frame: Phas deg  
Vector averaged cross-power spectrum Baseline: EF (03) - DA (12)  
Timerange: 00/21:41:41 to 00/21:43:09

Plot file version 37 created 11-NOV-2019 15:07:20

SER8NJ\_EK040B.UVDATA.1

Freq = 4.7990 GHz, Bw = 32.000 MH No calibration applied and no bandpass applied

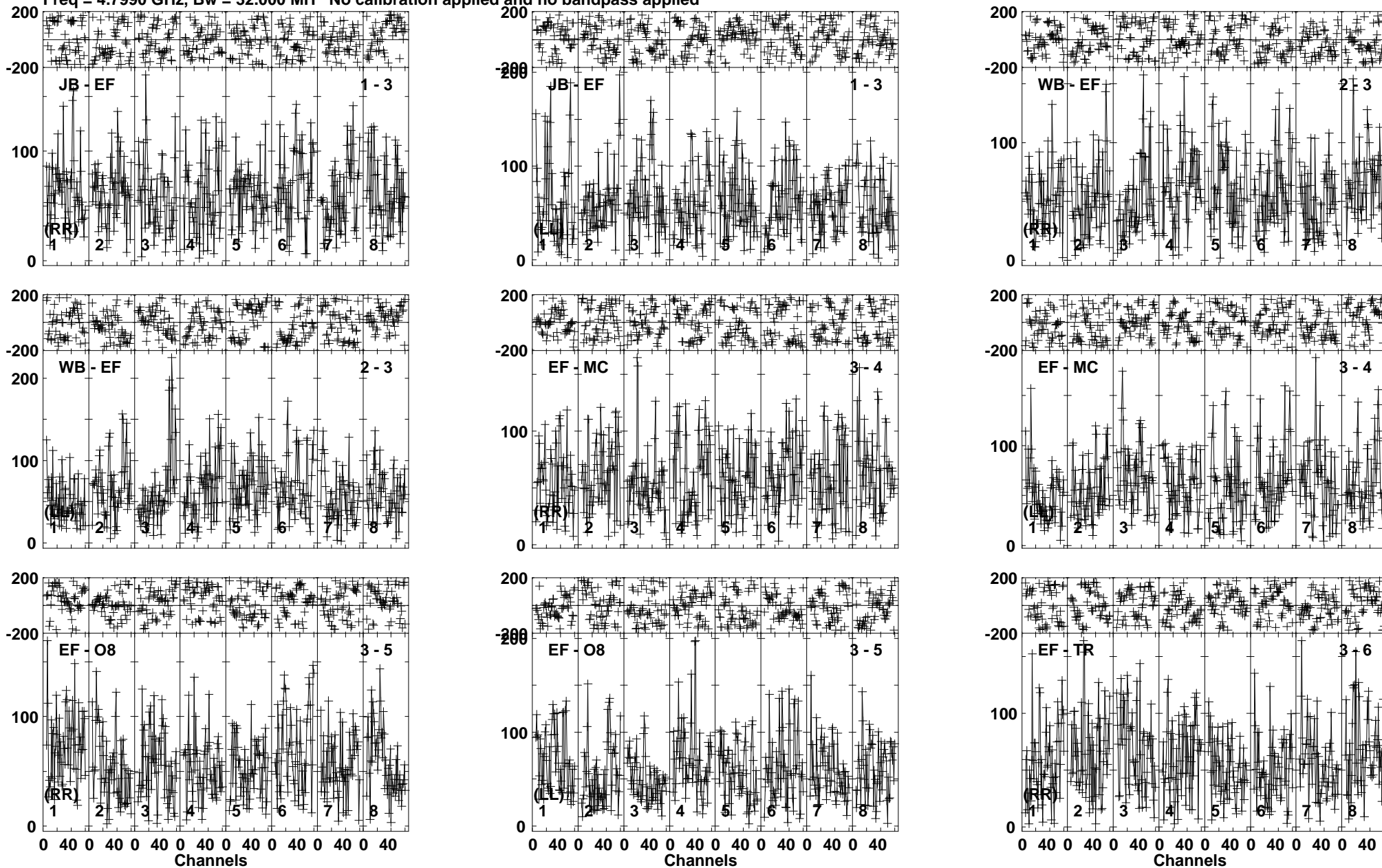

Lower frame: Micro Ampl Jy Top frame: Phas deg  
 Vector averaged cross-power spectrum Baseline: JB (01) - EF (03)  
 Timerange: 00/21:43:13 to 00/21:47:09

Plot file version 38 created 11-NOV-2019 15:07:20  
 SER8NJ EK040B.UVDATA.1  
 Freq = 4.7990 GHz, Bw = 32.000 MH No calibration applied and no bandpass applied

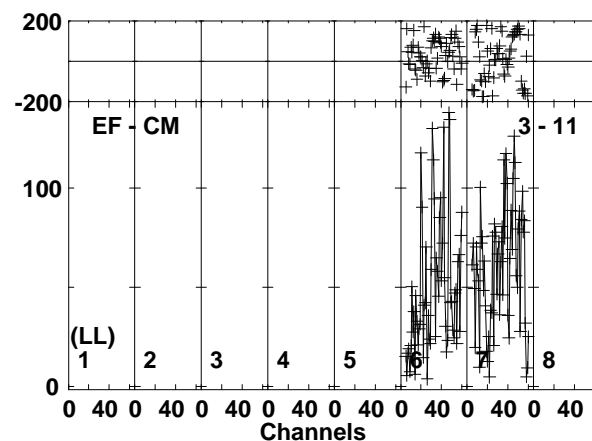
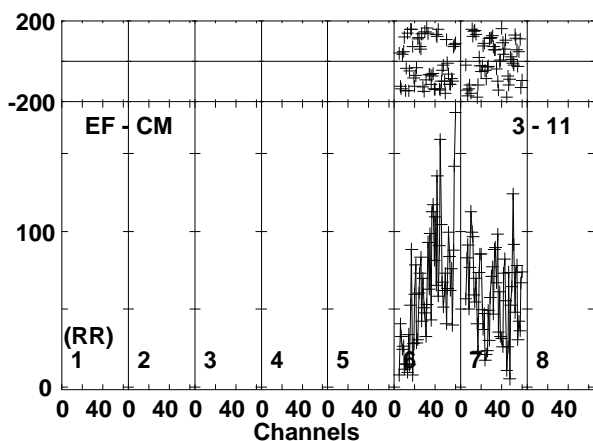
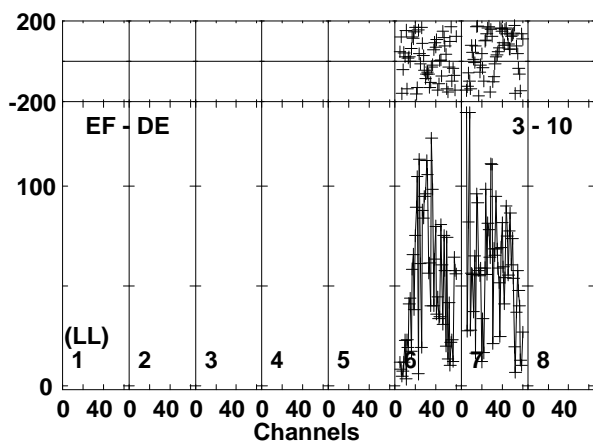
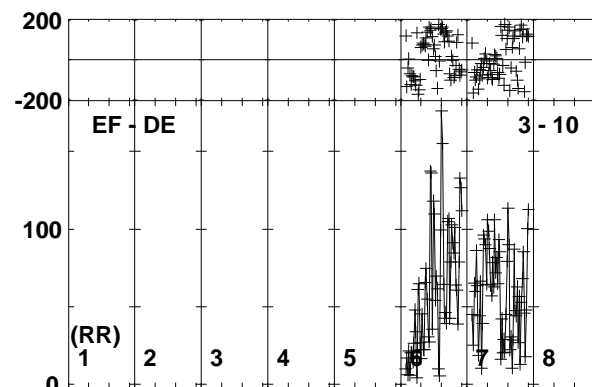
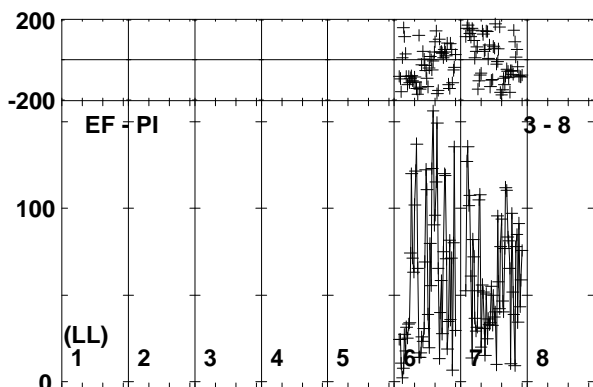
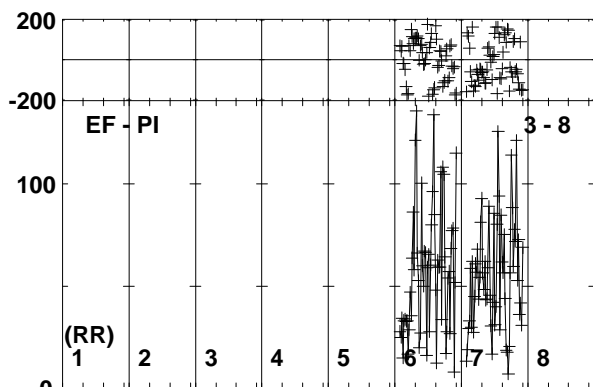
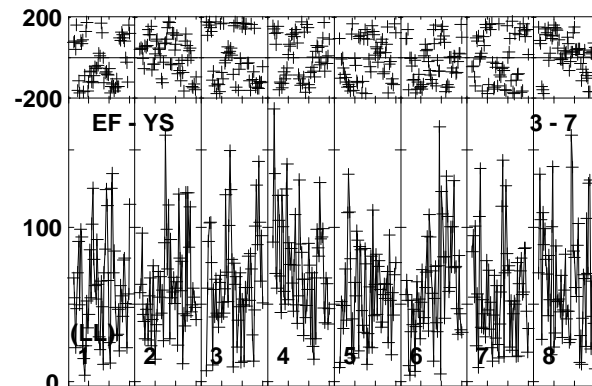
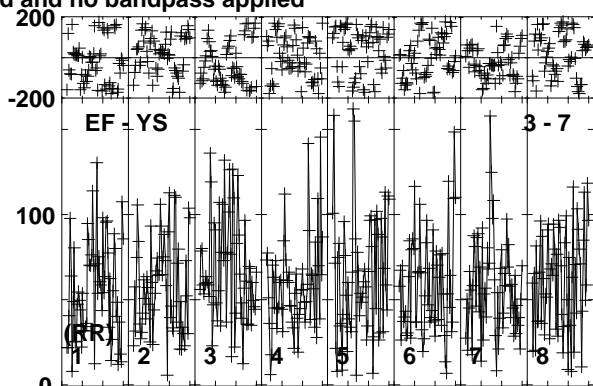
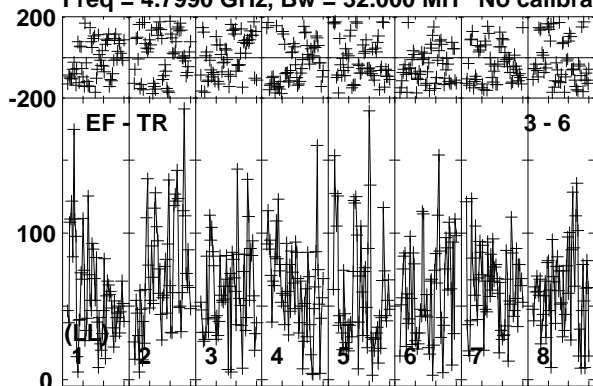

Lower frame: Micro Ampl Jy Top frame: Phas deg  
 Vector averaged cross-power spectrum Baseline: EF (03) - TR (06)  
 Timerange: 00/21:43:13 to 00/21:47:09

Plot file version 39 created 11-NOV-2019 15:07:20

SER8NJ EK040B.UVDATA.1

Freq = 4.7990 GHz, Bw = 32.000 MH No calibration applied and no bandpass applied

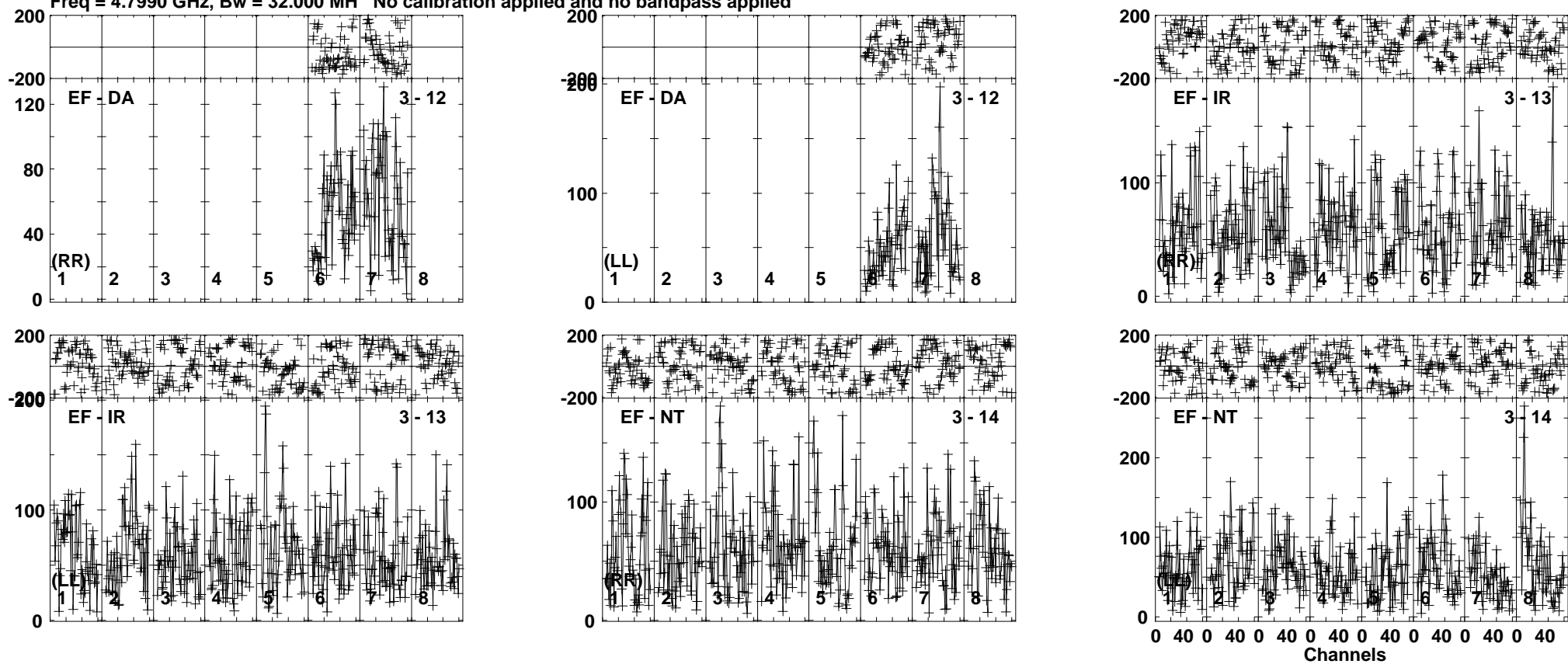

Lower frame: Micro Ampl Jy Top frame: Phas deg  
Vector averaged cross-power spectrum Baseline: EF (03) - DA (12)  
Timerange: 00/21:43:13 to 00/21:47:09

Plot file version 40 created 11-NOV-2019 15:07:20

J1826+0149 EK040B.UVDATA.1

Freq = 4.7990 GHz, Bw = 32.000 MH No calibration applied and no bandpass applied

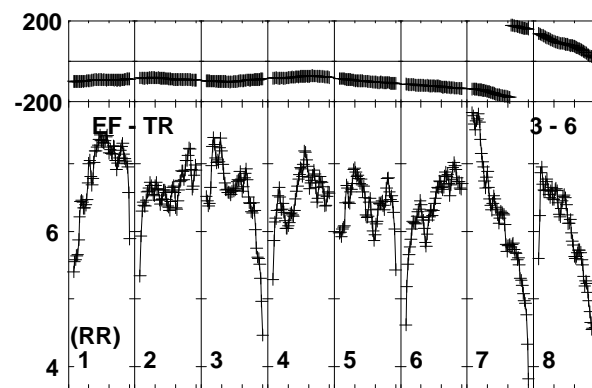
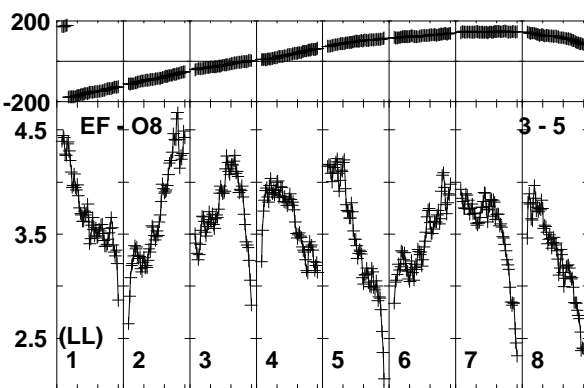
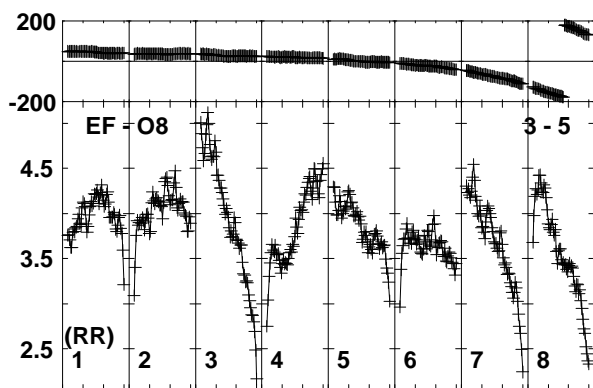
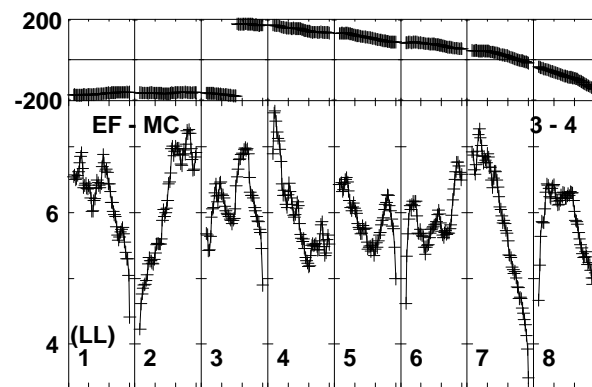
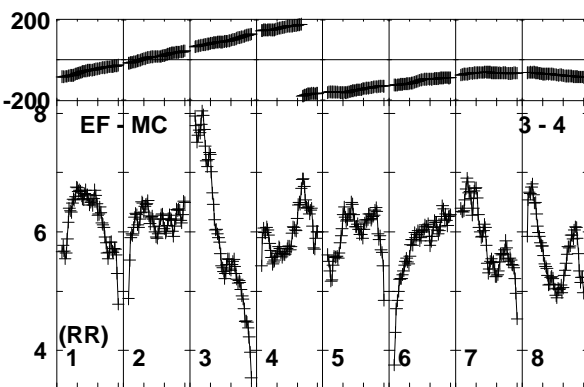
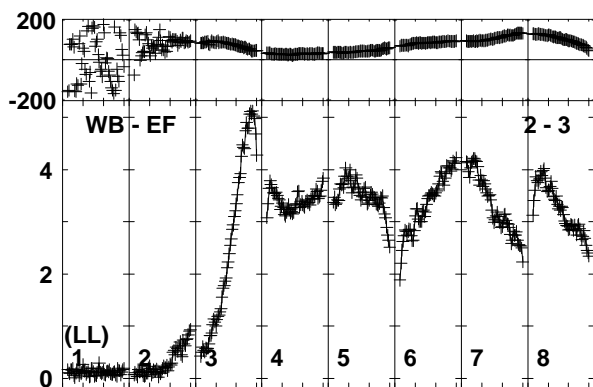
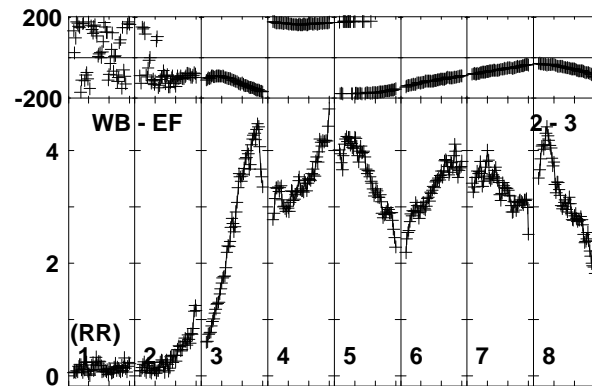
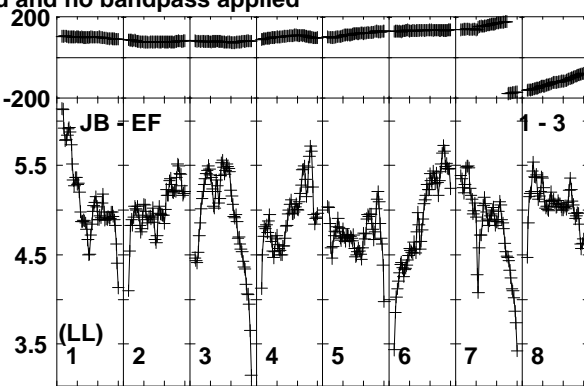
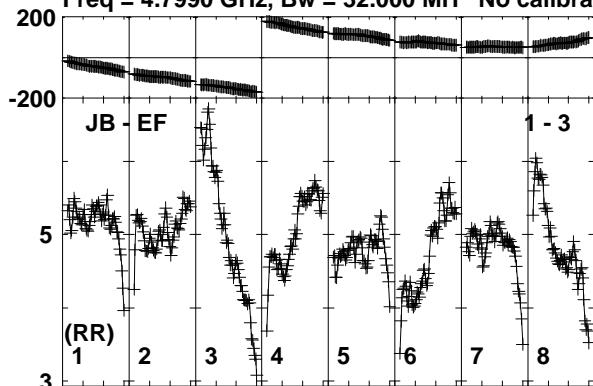

Lower frame: Milli Ampl Jy Top frame: Phas deg

Vector averaged cross-power spectrum Baseline: JB (01) - EF (03)

Timerange: 00/21:47:51 to 00/21:48:49

Plot file version 41 created 11-NOV-2019 15:07:20

J1826+0149 EK040B.UVDATA.1

Freq = 4.7990 GHz, Bw = 32.000 MH No calibration applied and no bandpass applied

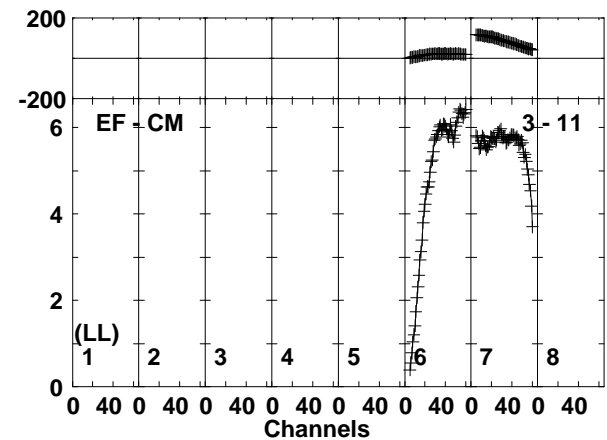
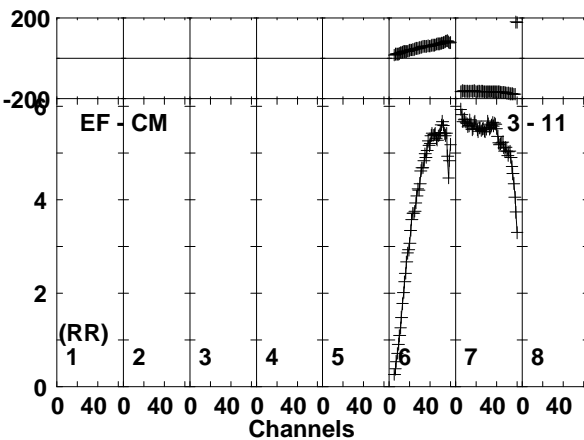
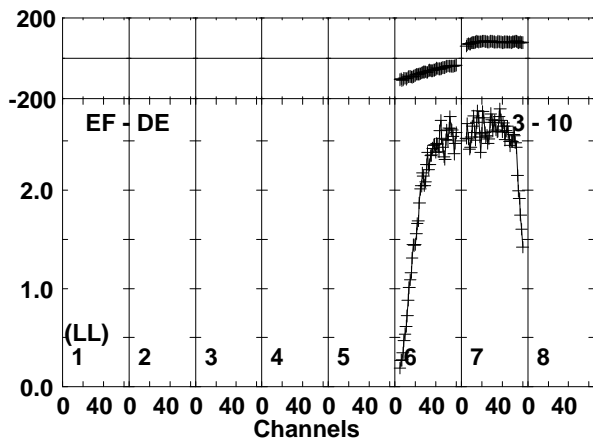
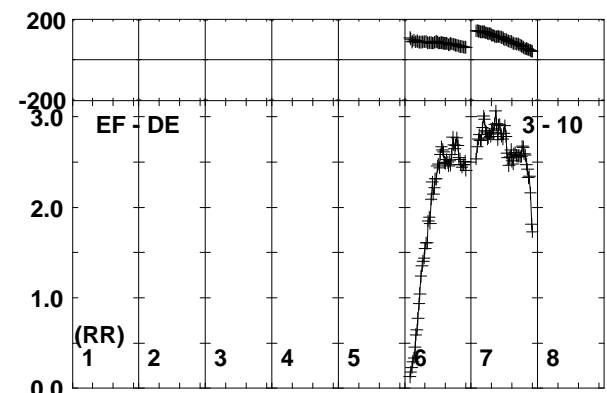
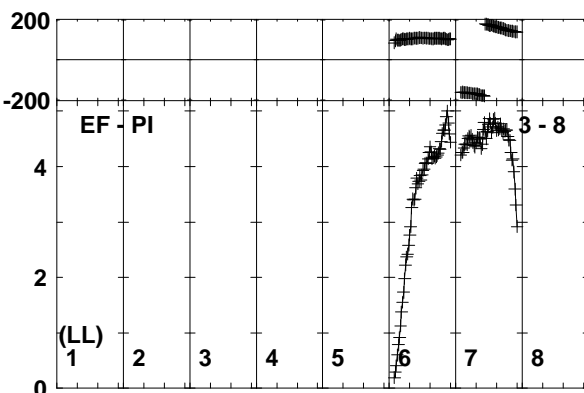
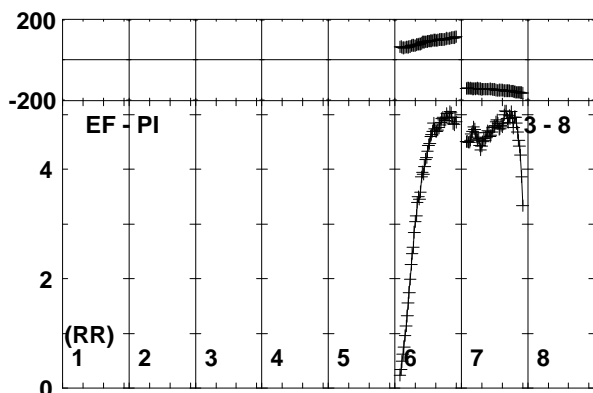
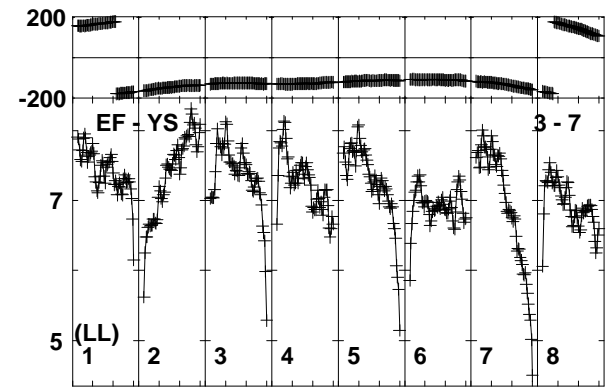
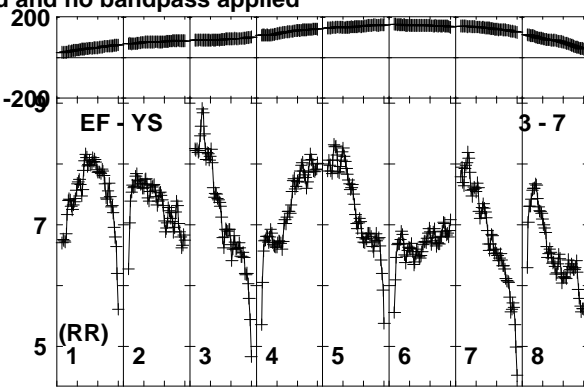
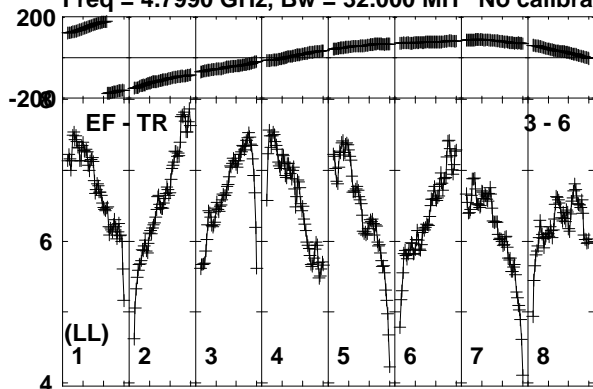

Lower frame: Milli Ampl Jy Top frame: Phas deg  
Vector averaged cross-power spectrum Baseline: EF (03) - TR (06)  
Timerange: 00/21:47:51 to 00/21:48:49

Plot file version 42 created 11-NOV-2019 15:07:20

J1826+0149 EK040B.UVDATA.1

Freq = 4.7990 GHz, Bw = 32.000 MH No calibration applied and no bandpass applied

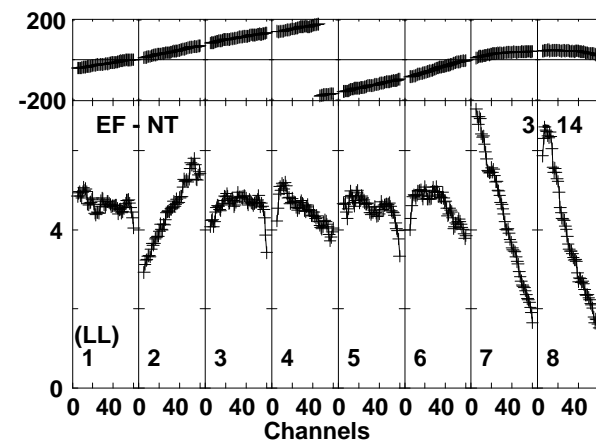
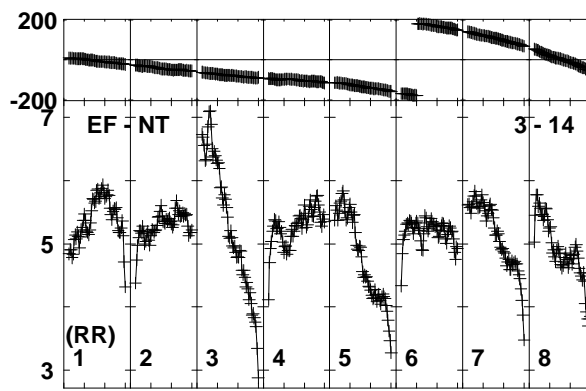
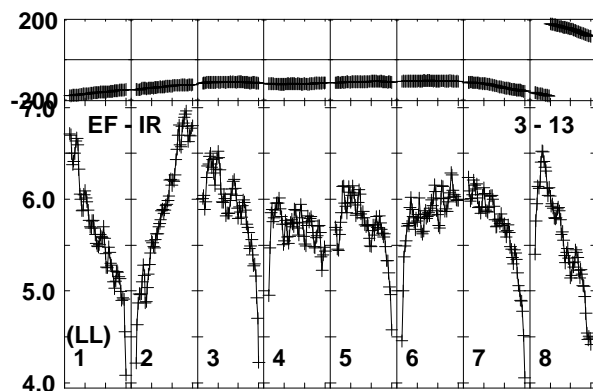
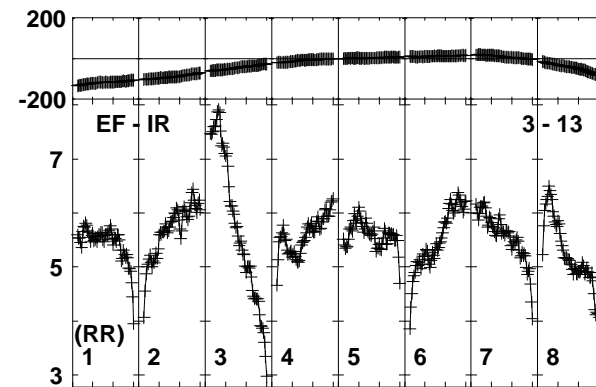
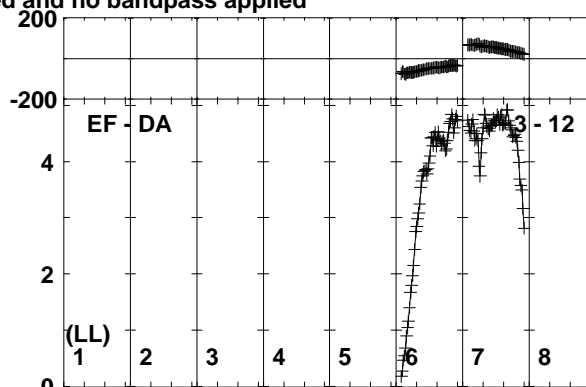
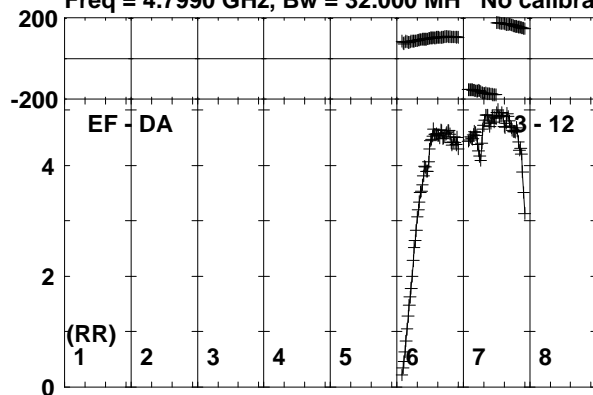

Lower frame: Milli Ampl Jy Top frame: Phas deg  
Vector averaged cross-power spectrum Baseline: EF (03) - DA (12)  
Timerange: 00:21:47:51 to 00:21:48:49



Plot file version 43 created 11-NOV-2019 15:07:21

SER8NJ EK040B.UVDATA.1

Freq = 4.7990 GHz, Bw = 32.000 MH No calibration applied and no bandpass applied

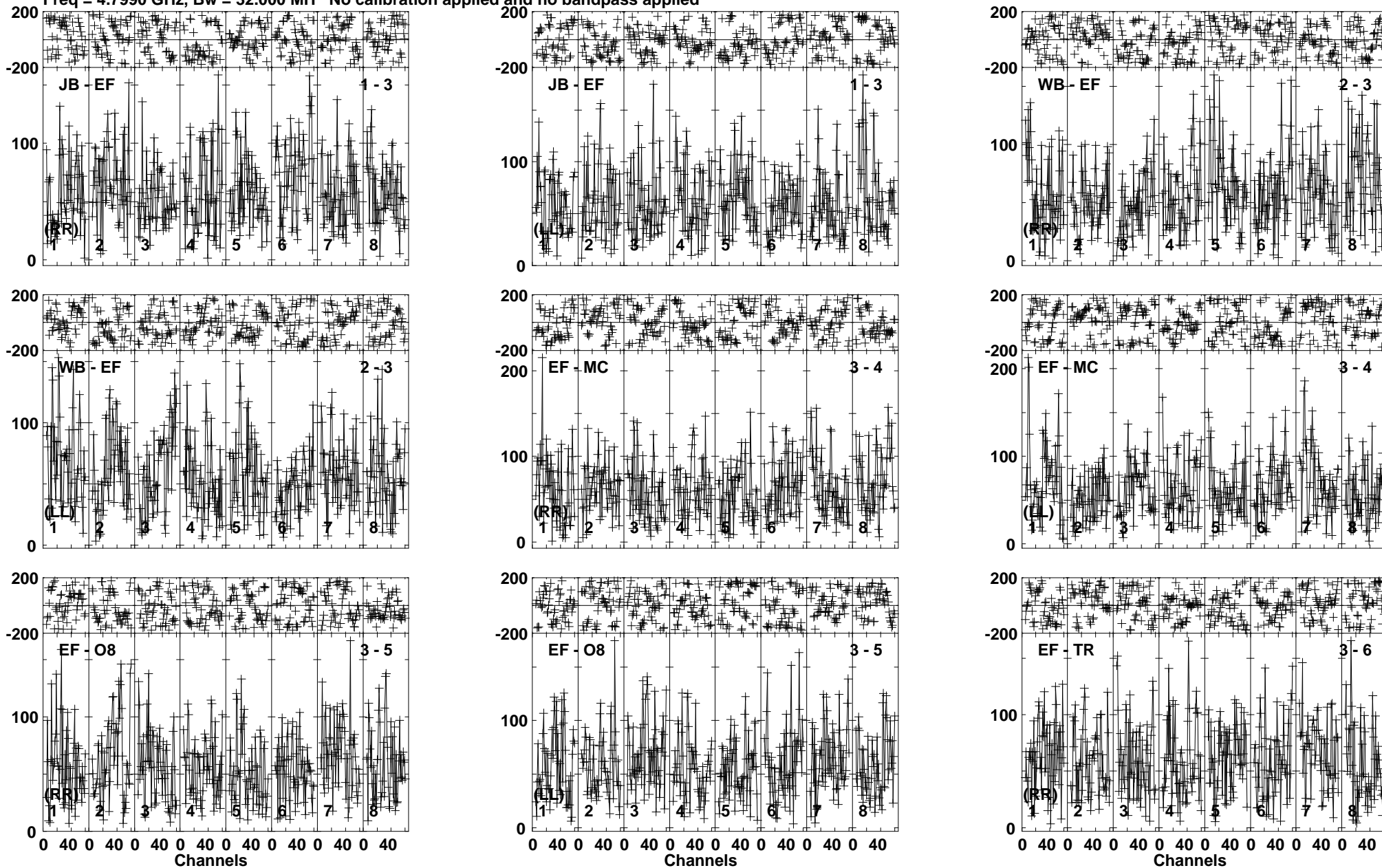

Lower frame: Micro Ampl Jy Top frame: Phas deg  
Vector averaged cross-power spectrum Baseline: JB (01) - EF (03)  
Timerange: 00:21:48:53 to 00:21:52:49

Plot file version 44 created 11-NOV-2019 15:07:21

SER8NJ EK040B.UVDATA.1

Freq = 4.7990 GHz, Bw = 32.000 MH No calibration applied and no bandpass applied

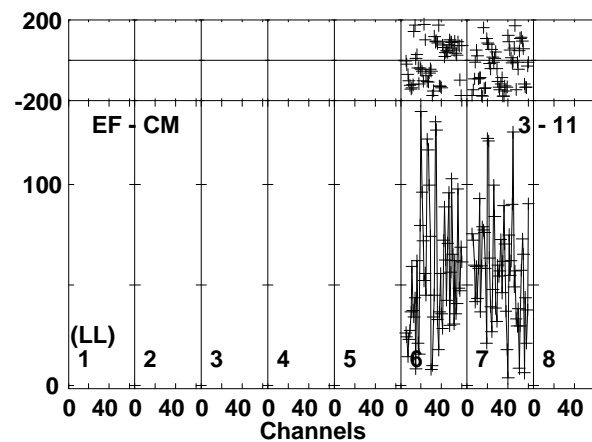
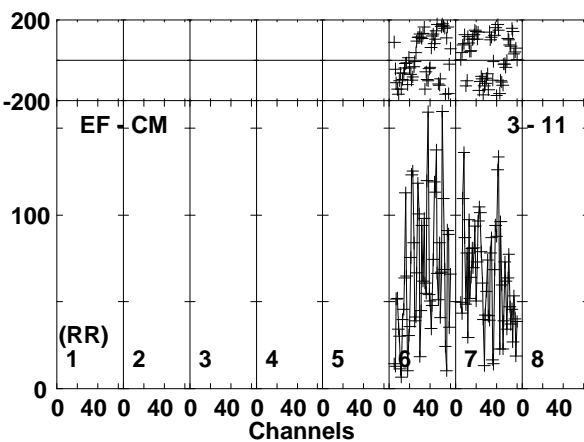
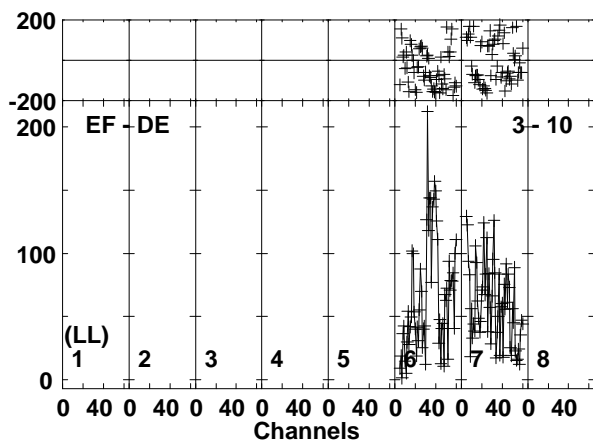
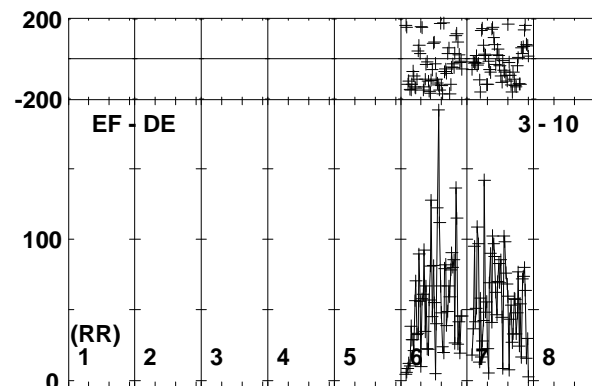
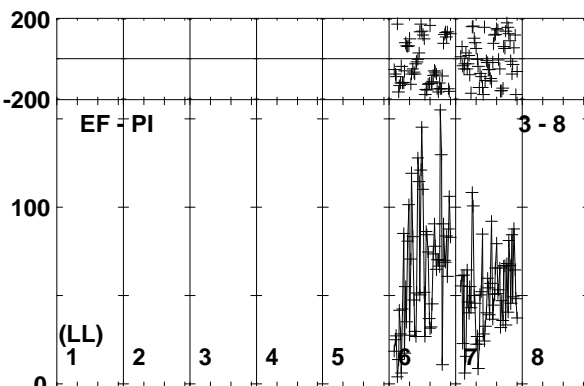
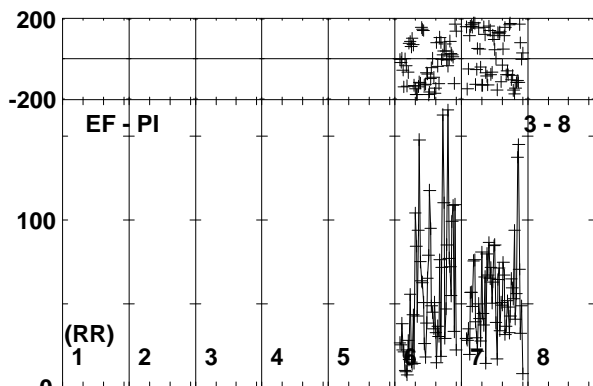
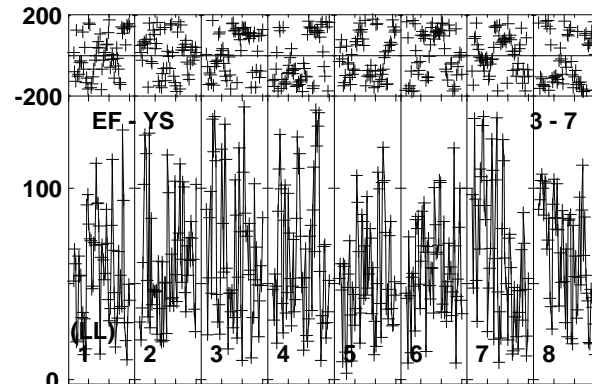
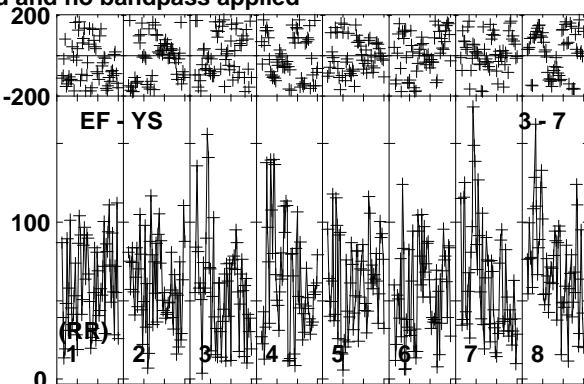
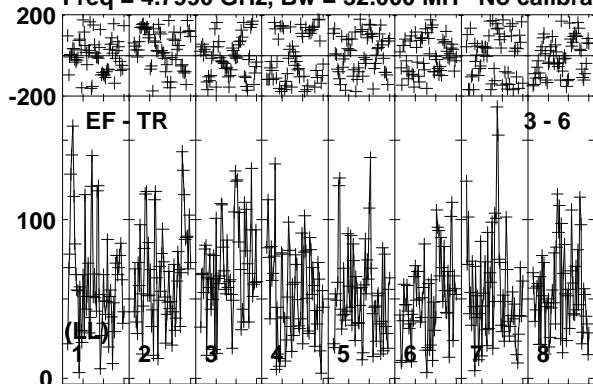

Lower frame: Micro Ampl Jy Top frame: Phas deg  
Vector averaged cross-power spectrum Baseline: EF (03) - TR (06)  
Timerange: 00/21:48:53 to 00/21:52:49

Plot file version 45 created 11-NOV-2019 15:07:21

SER8NJ EK040B.UVDATA.1

Freq = 4.7990 GHz, Bw = 32.000 MH No calibration applied and no bandpass applied

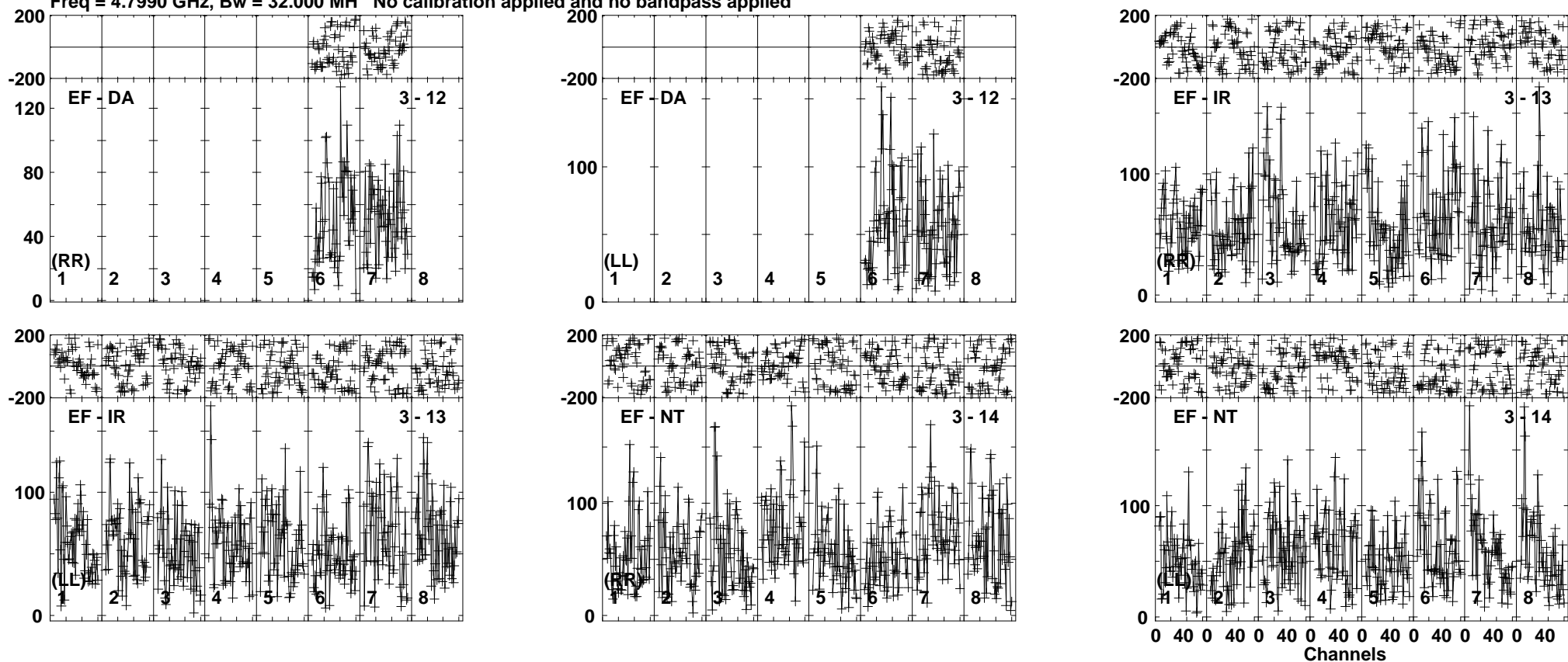

Lower frame: Micro Ampl Jy Top frame: Phas deg  
Vector averaged cross-power spectrum Baseline: EF (03) - DA (12)  
Timerange: 00/21:48:53 to 00/21:52:49

Plot file version 46 created 11-NOV-2019 15:07:21

J1826+0149 EK040B.UVDATA.1

Freq = 4.7990 GHz, Bw = 32.000 MH No calibration applied and no bandpass applied

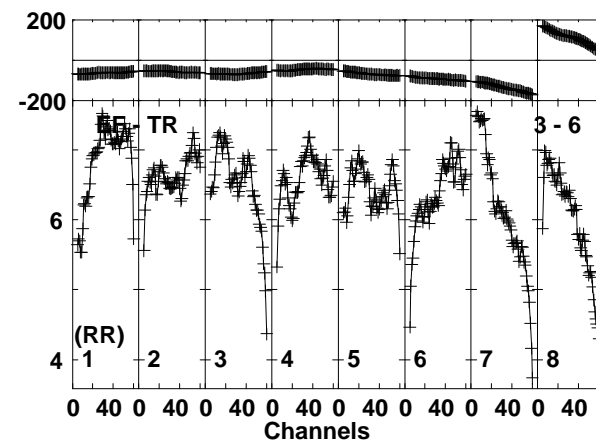
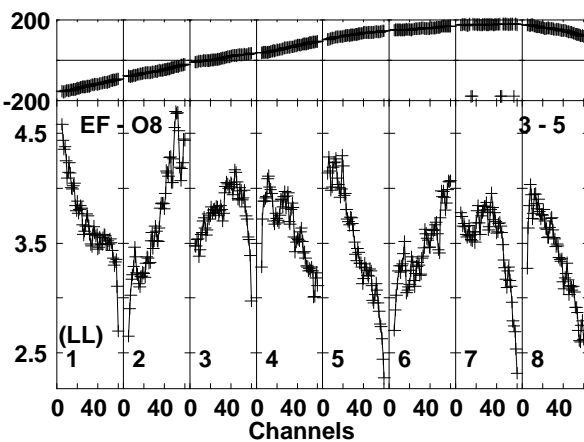
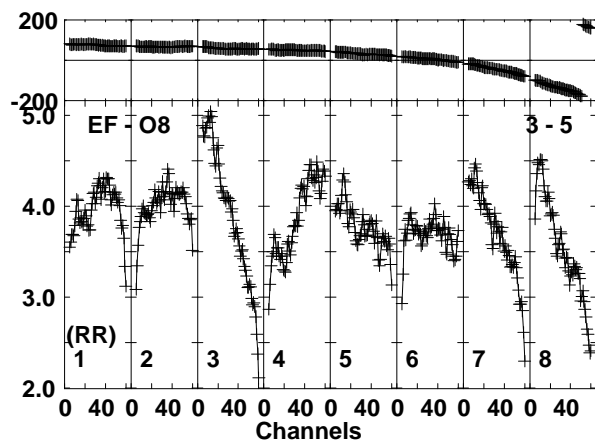
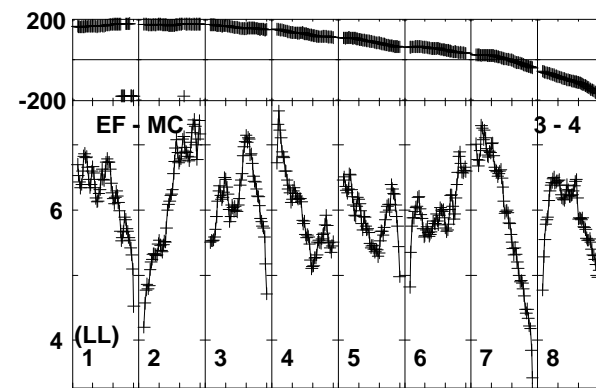
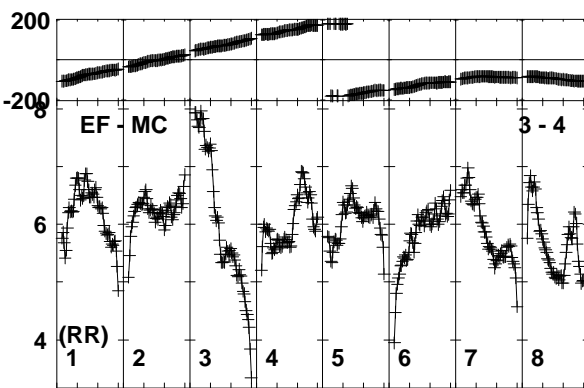
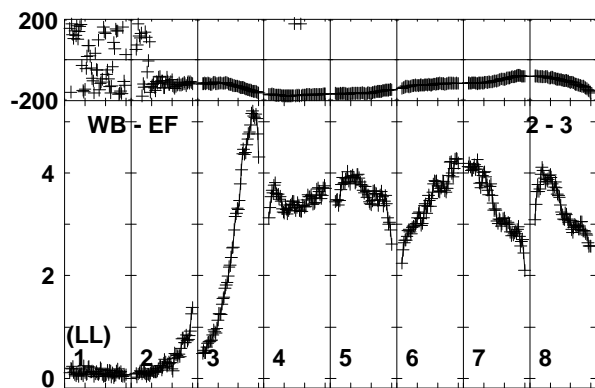
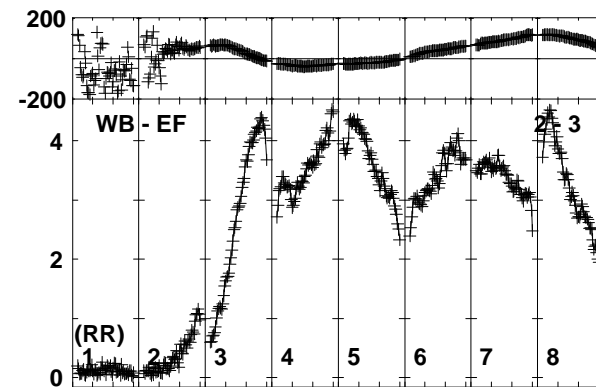
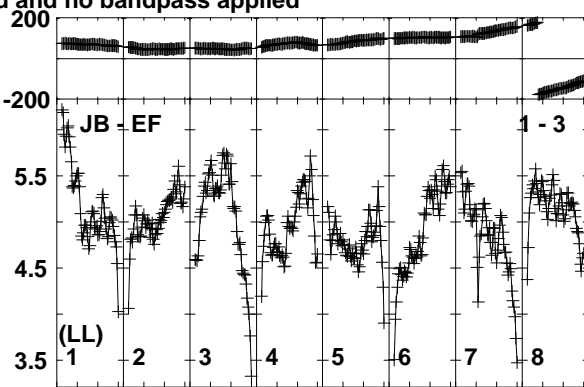
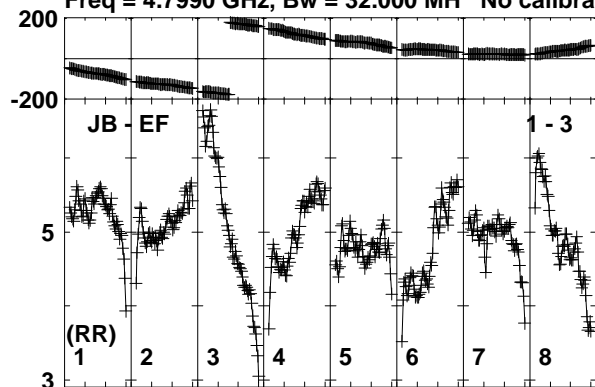

Lower frame: Milli Ampl Jy Top frame: Phas deg  
Vector averaged cross-power spectrum Baseline: JB (01) - EF (03)  
Timerange: 00/21:52:51 to 00/21:54:19

Plot file version 47 created 11-NOV-2019 15:07:21

J1826+0149 EK040B.UVDATA.1

Freq = 4.7990 GHz, Bw = 32.000 MH No calibration applied and no bandpass applied

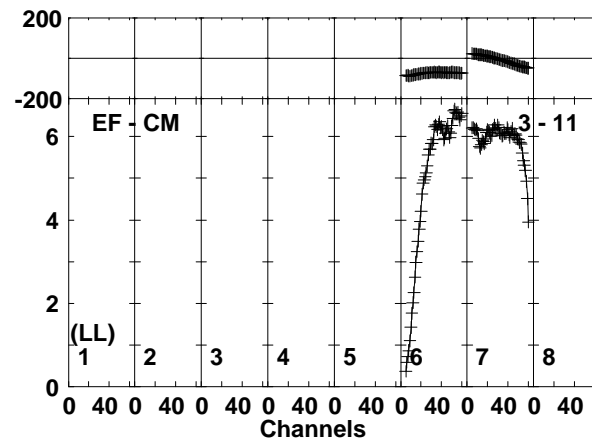
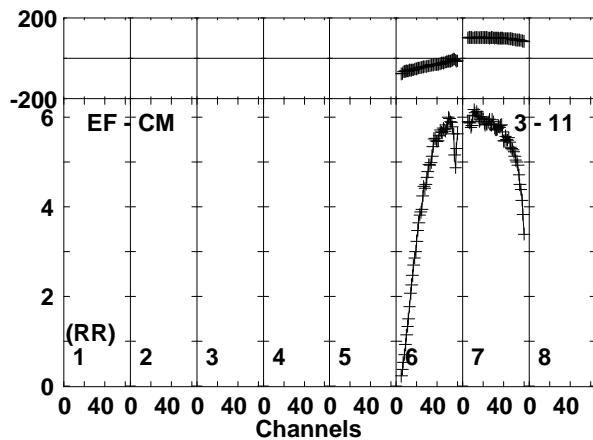
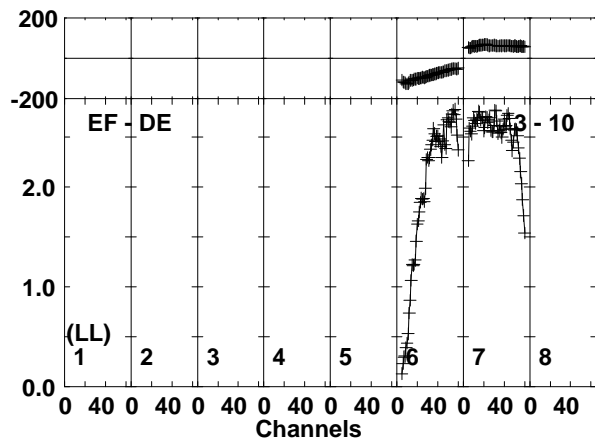
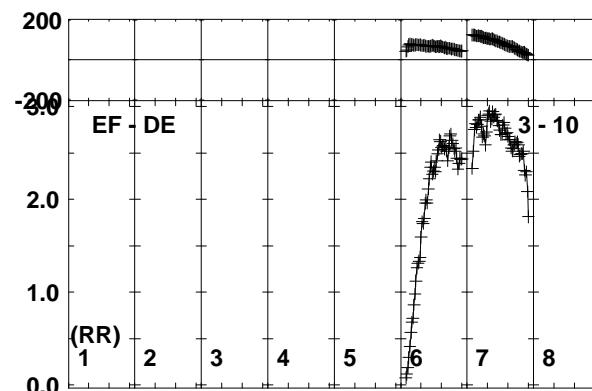
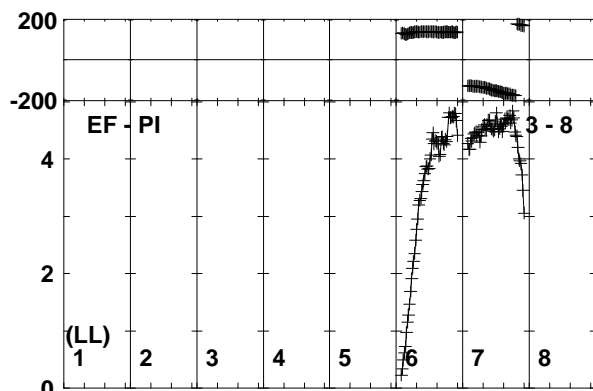
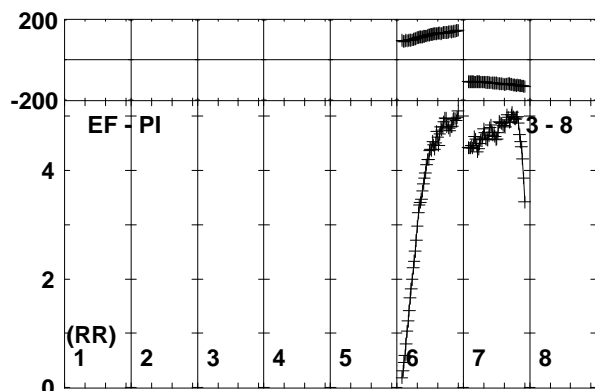
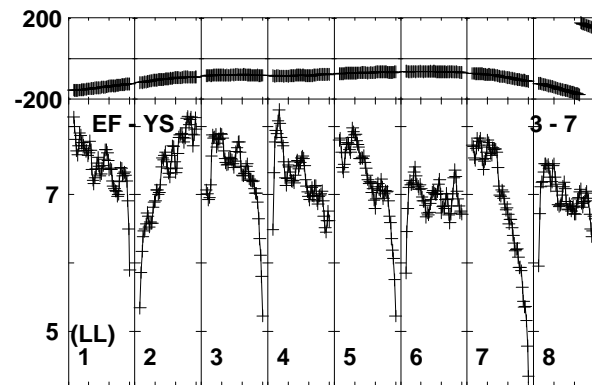
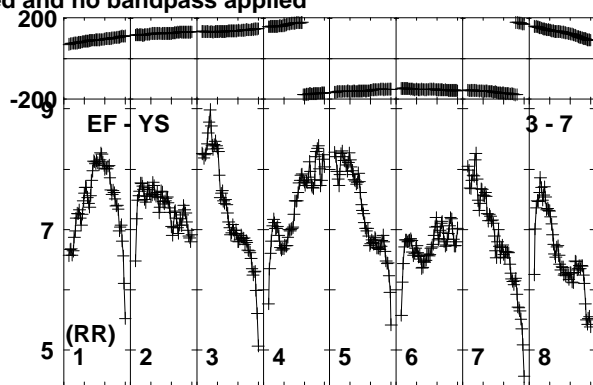
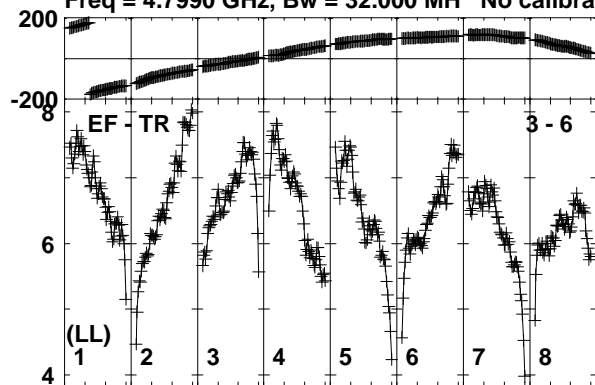

Lower frame: Milli Ampl Jy Top frame: Phas deg  
Vector averaged cross-power spectrum Baseline: EF (03) - TR (06)  
Timerange: 00/21:52:51 to 00/21:54:19

Plot file version 48 created 11-NOV-2019 15:07:21

J1826+0149 EK040B.UVDATA.1

Freq = 4.7990 GHz, Bw = 32.000 MH No calibration applied and no bandpass applied

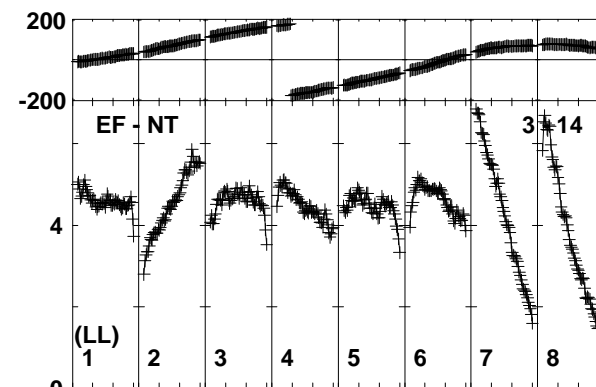
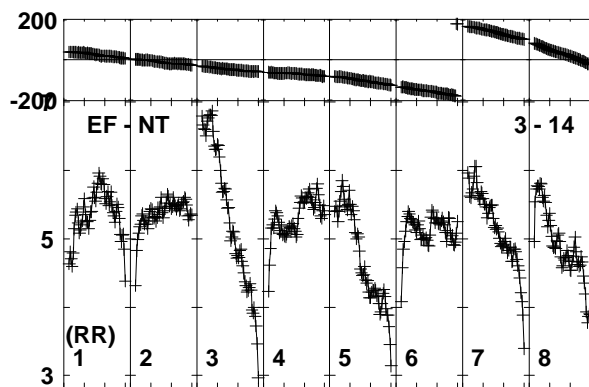
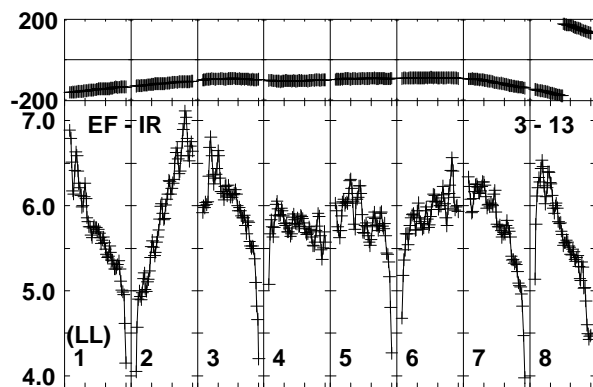
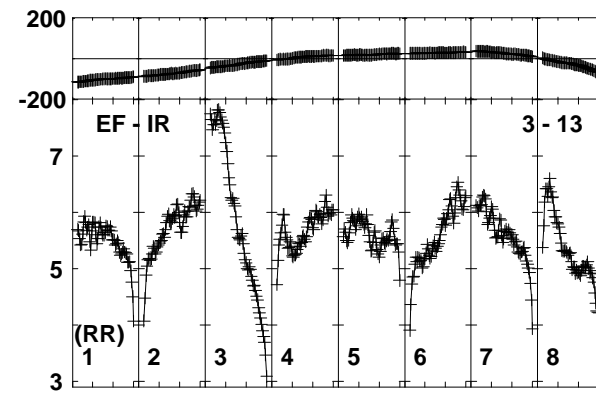
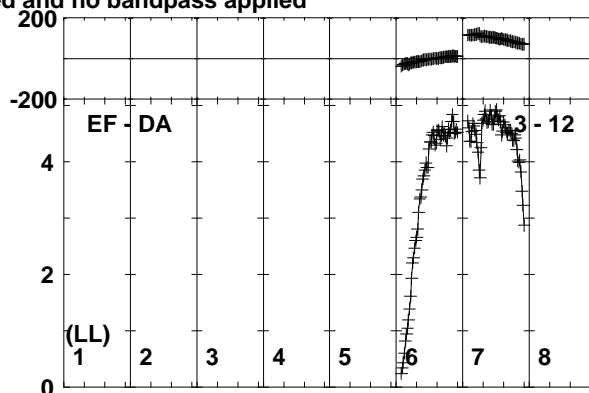
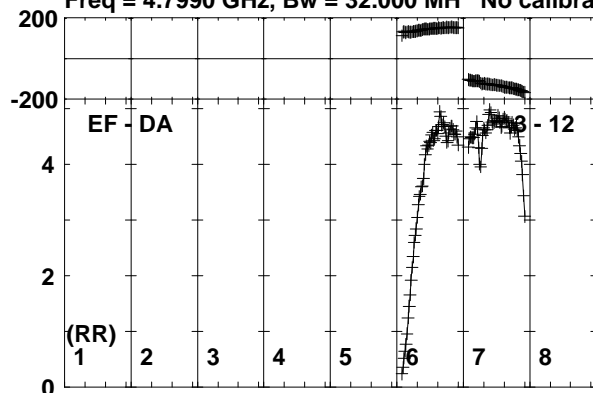

Channels

Lower frame: Milli Ampl Jy Top frame: Phas deg  
Vector averaged cross-power spectrum Baseline: EF (03) - DA (12)  
Timerange: 00/21:52:51 to 00/21:54:19

Plot file version 49 created 11-NOV-2019 15:07:21

SER8NJ EK040B.UVDATA.1

Freq = 4.7990 GHz, Bw = 32.000 MH No calibration applied and no bandpass applied

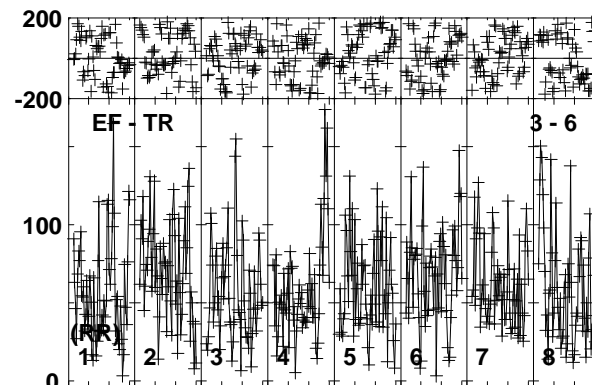
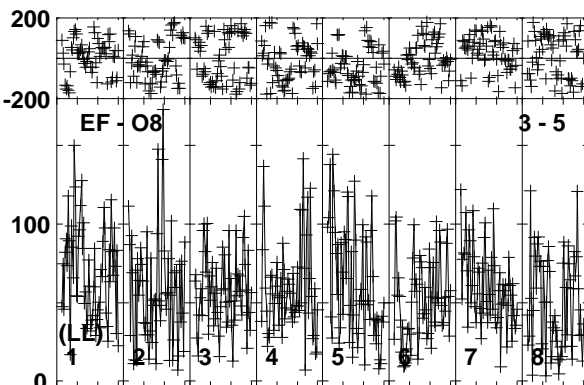
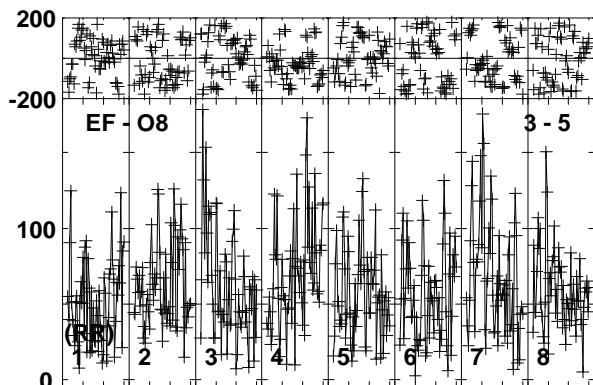
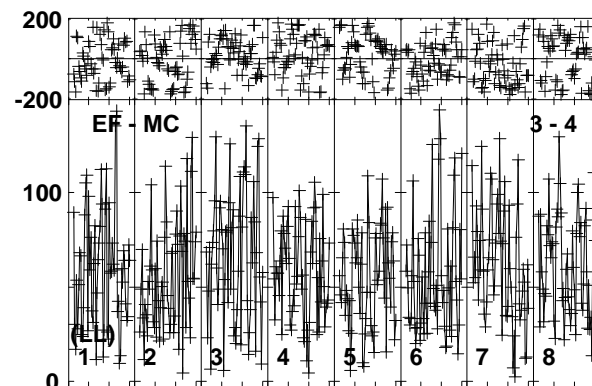
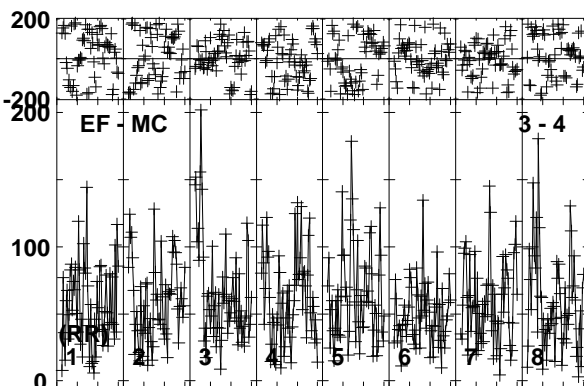
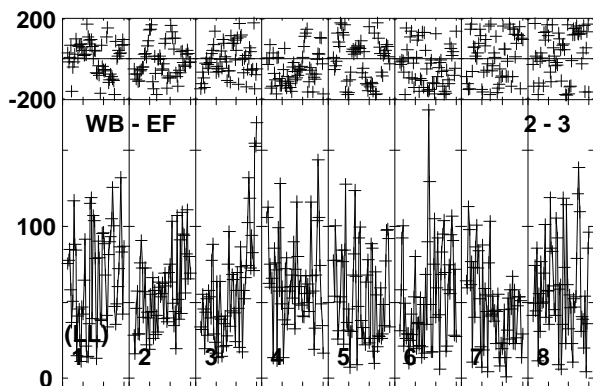
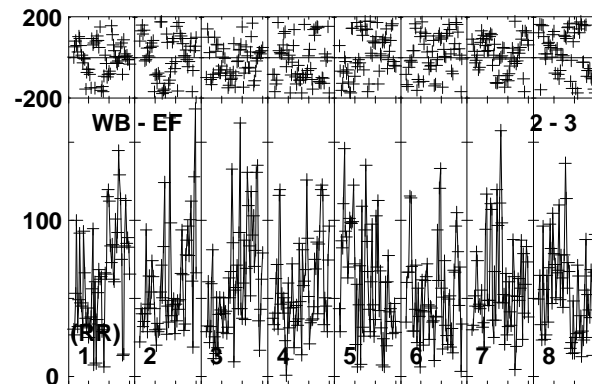
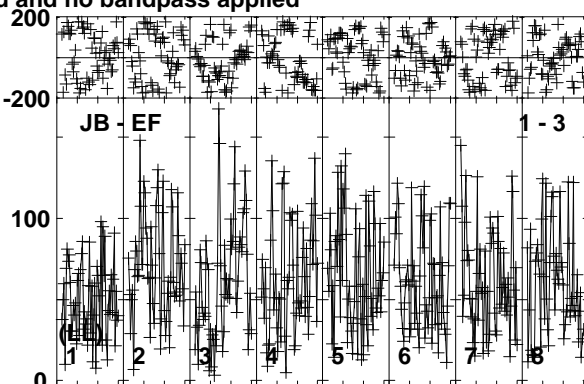
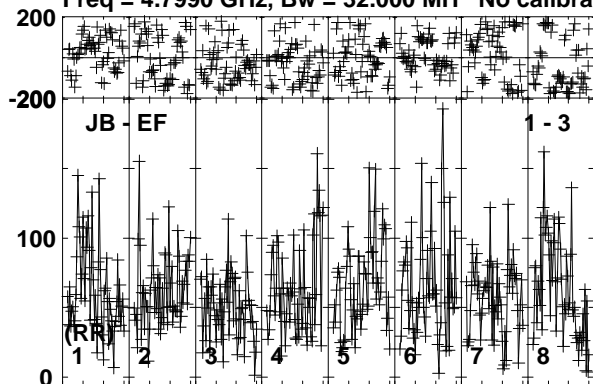

Lower frame: Micro Ampl Jy Top frame: Phas deg  
Vector averaged cross-power spectrum Baseline: JB (01) - EF (03)  
Timerange: 00/21:54:23 to 00/21:58:19

Plot file version 50 created 11-NOV-2019 15:07:21

SER8NJ EK040B.UVDATA.1

Freq = 4.7990 GHz, Bw = 32.000 MH No calibration applied and no bandpass applied

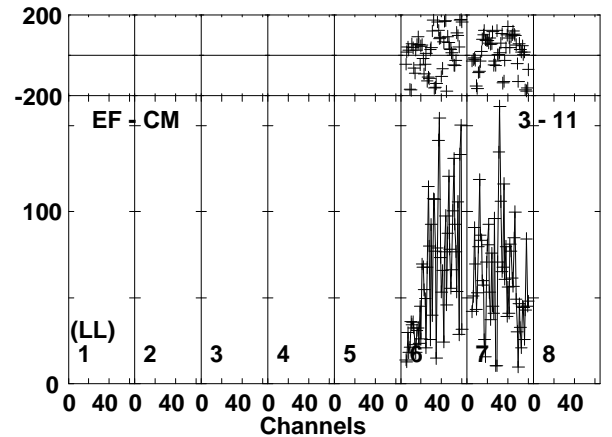
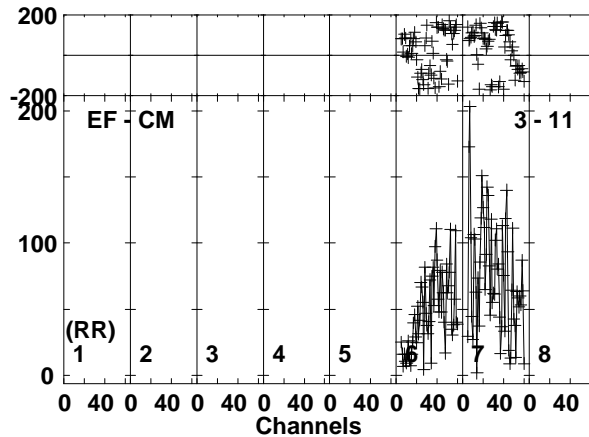
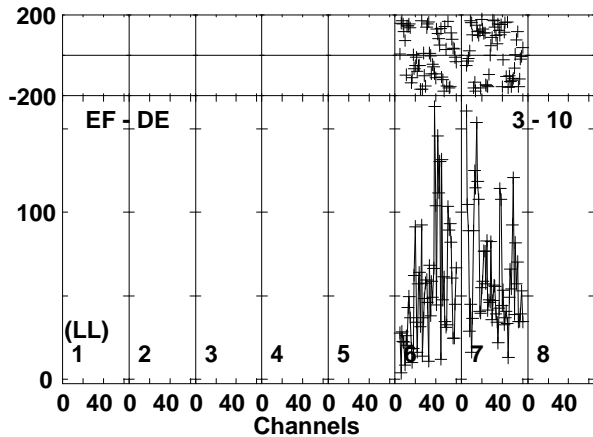
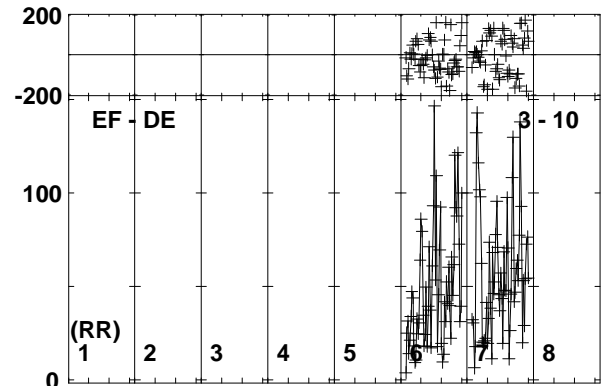
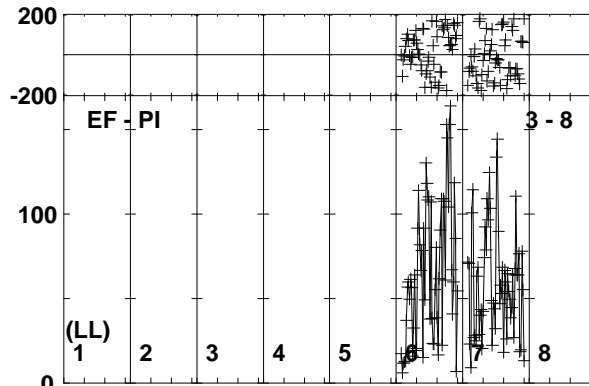
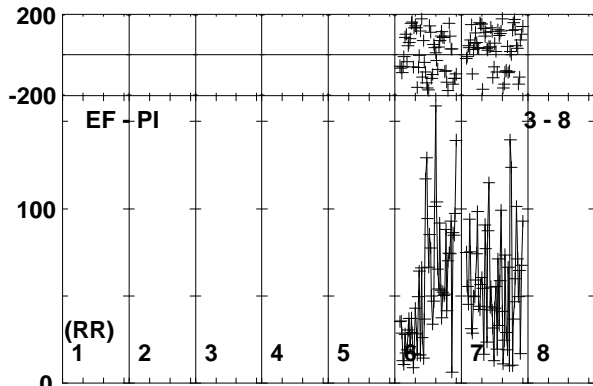
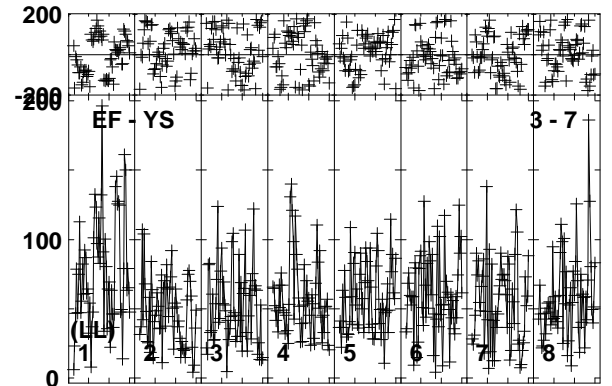
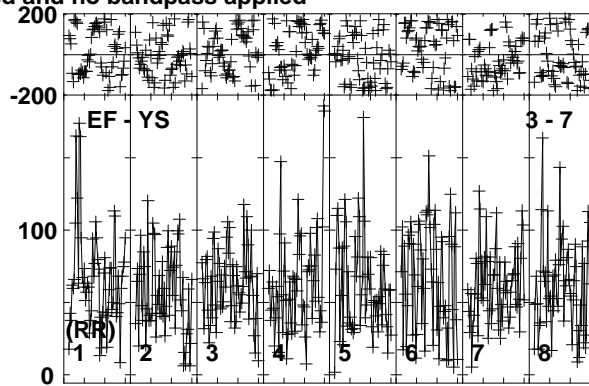
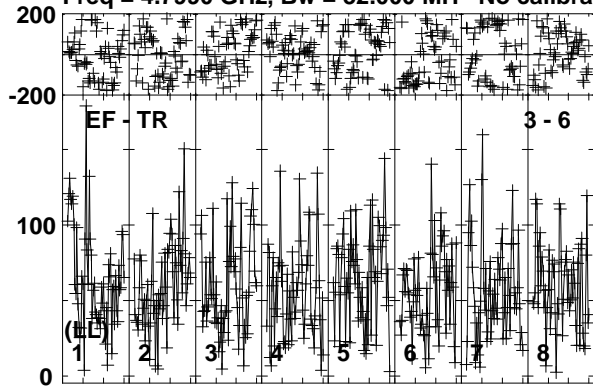

Lower frame: Micro Ampl Jy Top frame: Phas deg  
Vector averaged cross-power spectrum Baseline: EF (03) - TR (06)  
Timerange: 00/21:54:23 to 00/21:58:19



Plot file version 51 created 11-NOV-2019 15:07:22  
SER8NJ EK040B.UVDATA.1  
Freq = 4.7990 GHz, Bw = 32.000 MH No calibration applied and no bandpass applied

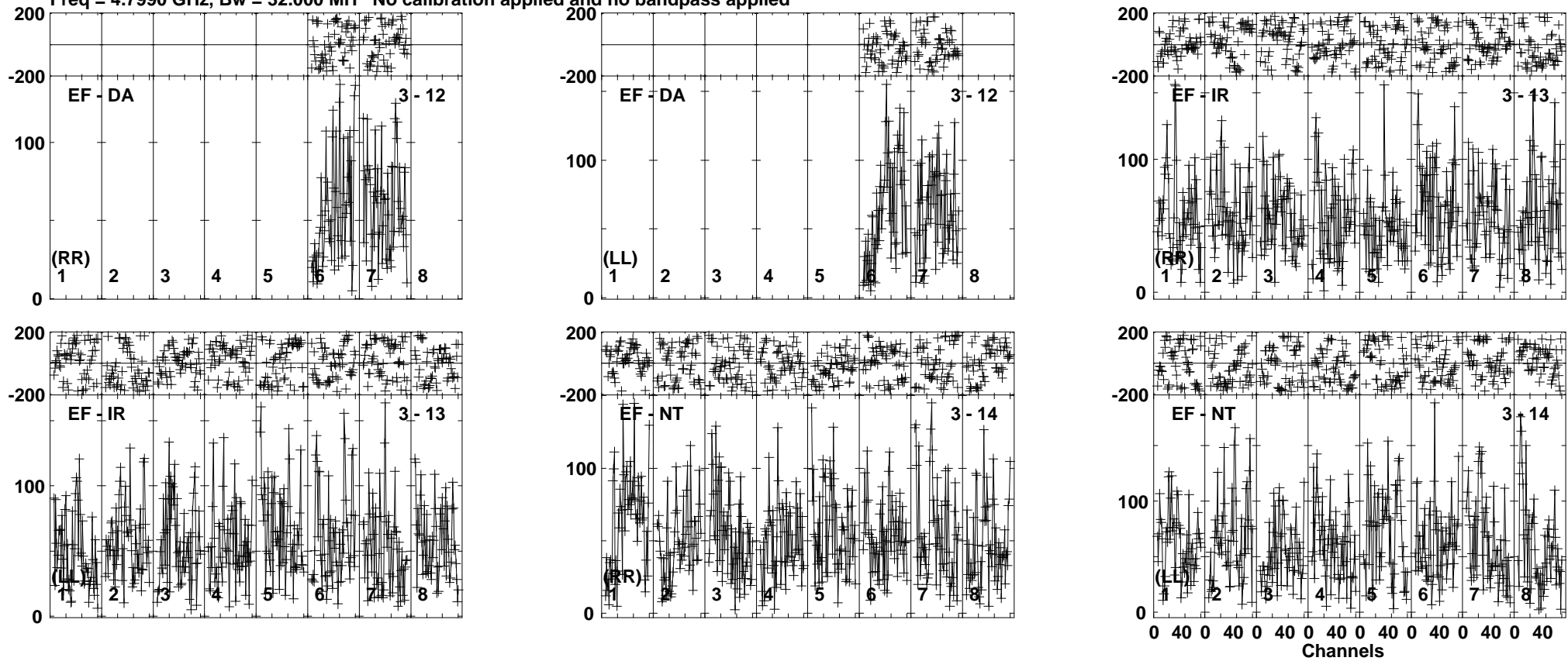

Lower frame: Micro Ampl Jy Top frame: Phas deg  
Vector averaged cross-power spectrum Baseline: EF (03) - DA (12)  
Timerange: 00/21:54:23 to 00/21:58:19

Plot file version 52 created 11-NOV-2019 15:07:22

J1826+0149 EK040B.UVDATA.1

Freq = 4.7990 GHz, Bw = 32.000 MH No calibration applied and no bandpass applied

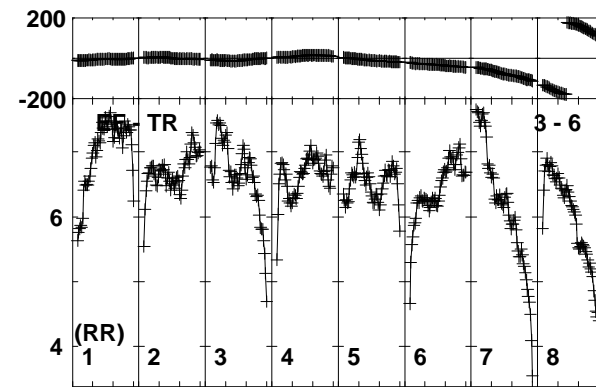
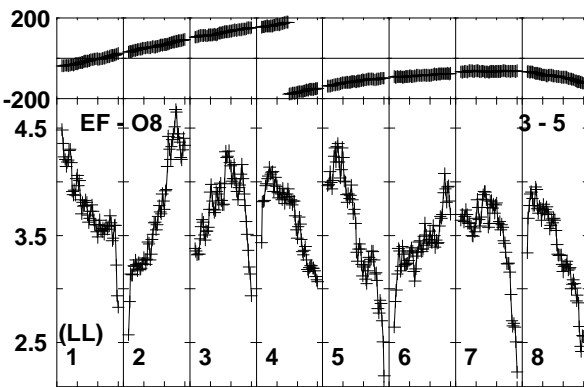
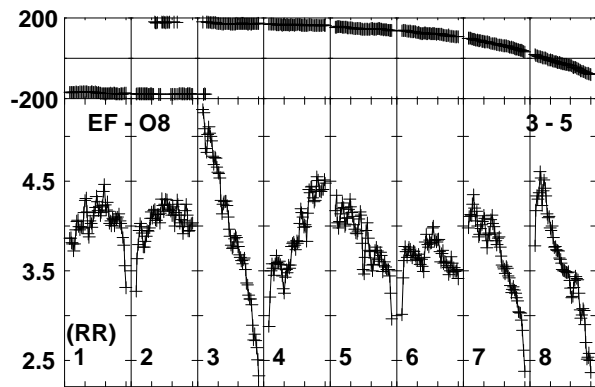
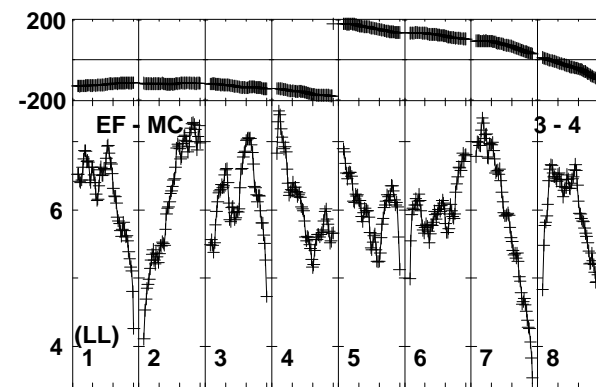
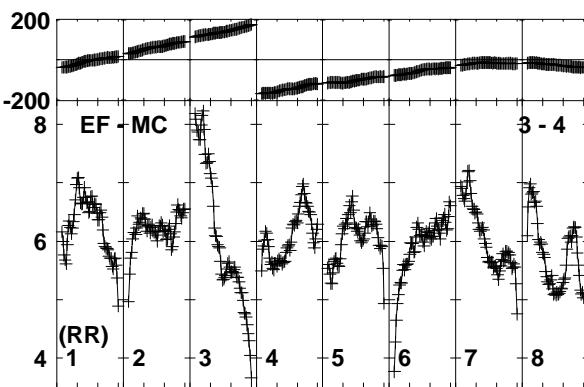
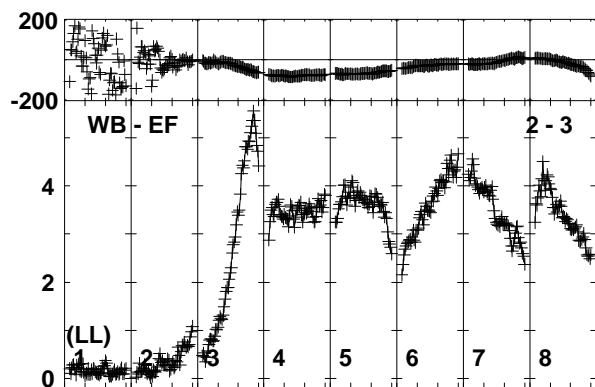
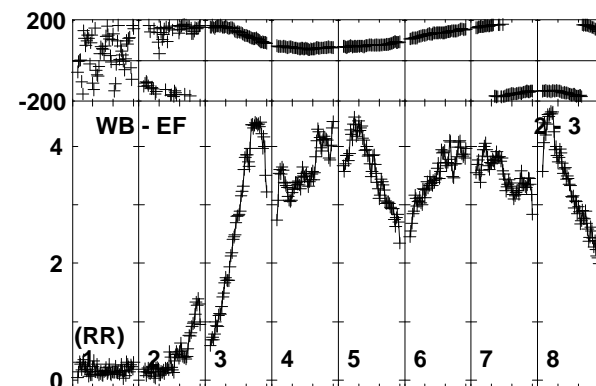
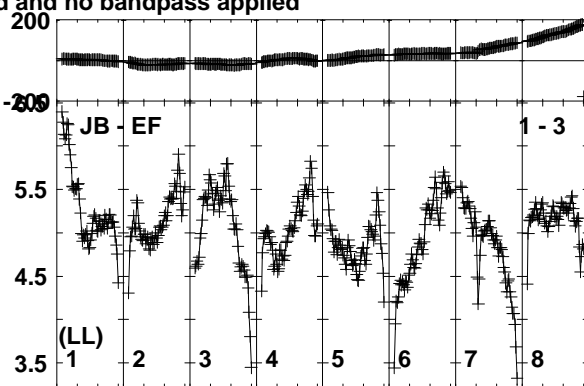
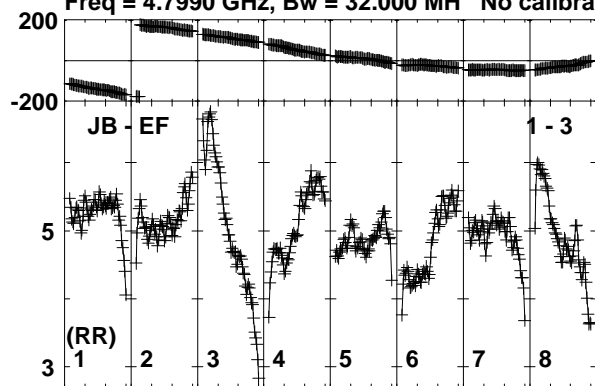

Lower frame: Milli Ampl Jy Top frame: Phas deg  
Vector averaged cross-power spectrum Baseline: JB (01) - EF (03)  
Timerange: 00/21:59:01 to 00/21:59:59

Plot file version 53 created 11-NOV-2019 15:07:22

J1826+0149 EK040B.UVDATA.1

Freq = 4.7990 GHz, Bw = 32.000 MH No calibration applied and no bandpass applied

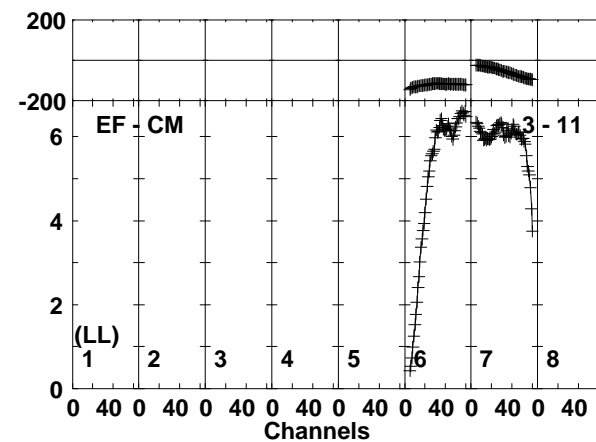
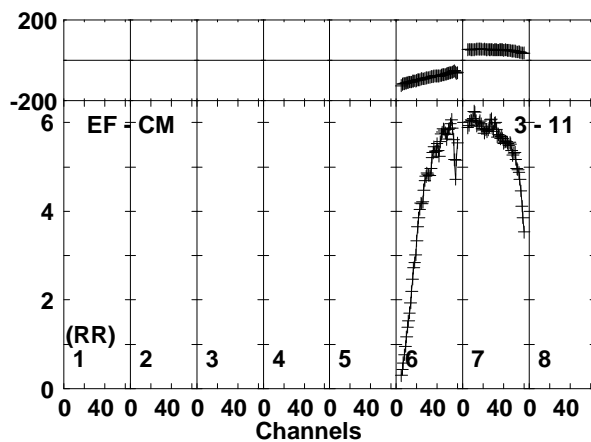
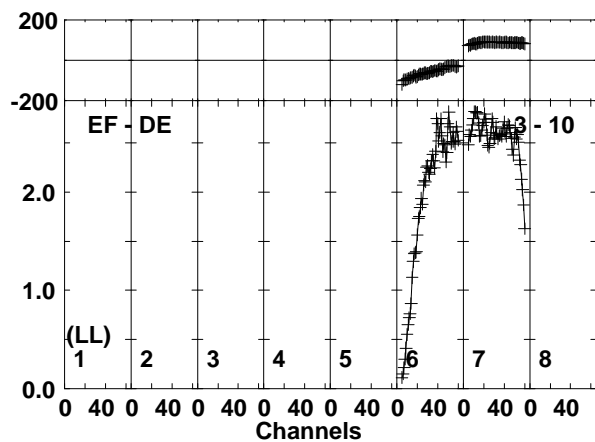
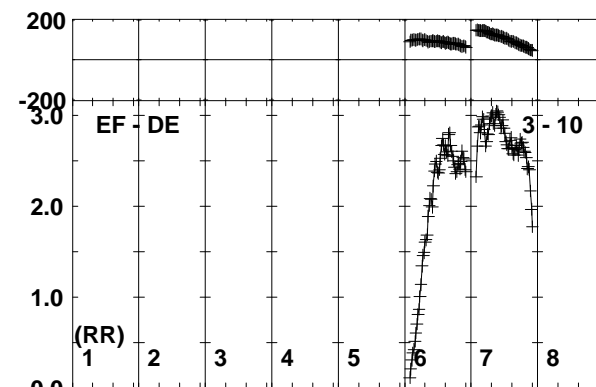
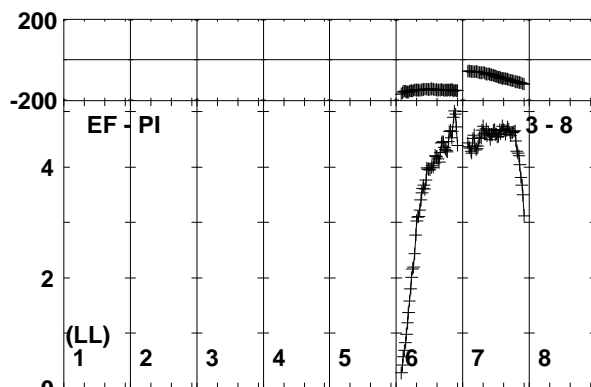
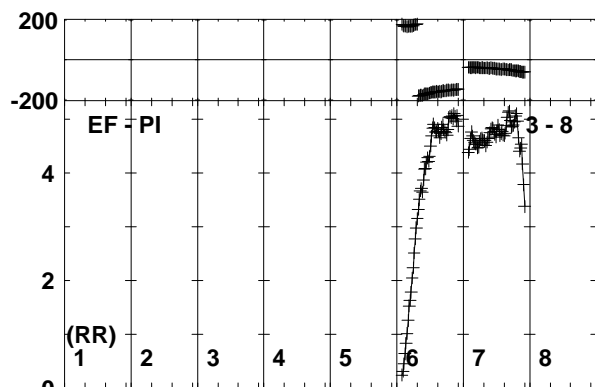
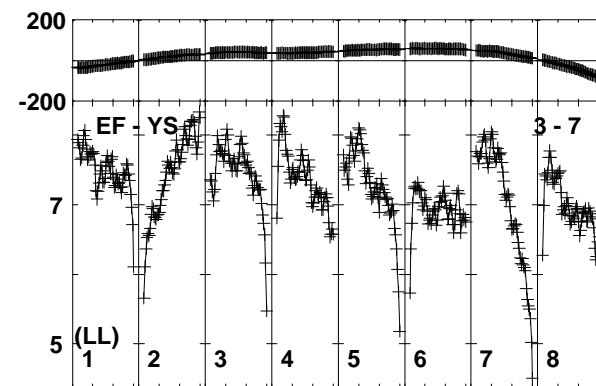
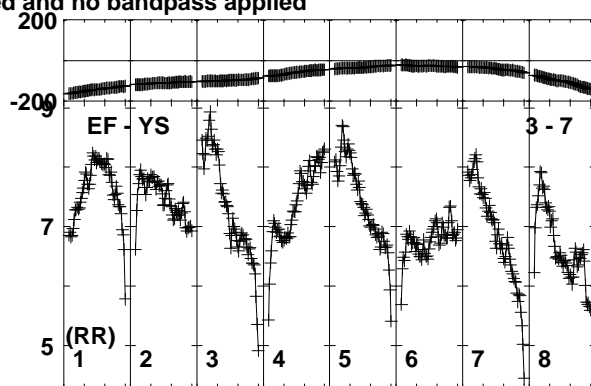
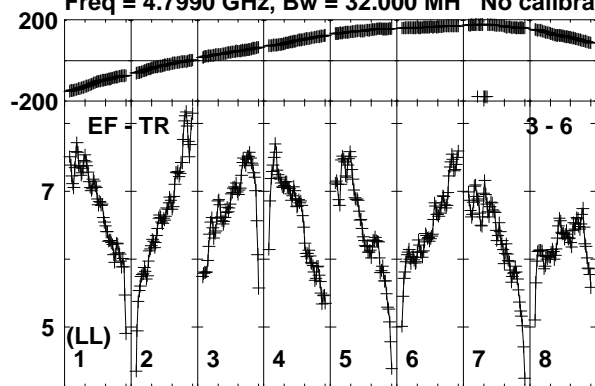

Lower frame: Milli Ampl Jy Top frame: Phas deg  
Vector averaged cross-power spectrum Baseline: EF (03) - TR (06)  
Timerange: 00/21:59:01 to 00/21:59:59

Plot file version 54 created 11-NOV-2019 15:07:22

J1826+0149 EK040B.UVDATA.1

Freq = 4.7990 GHz, Bw = 32.000 MH No calibration applied and no bandpass applied

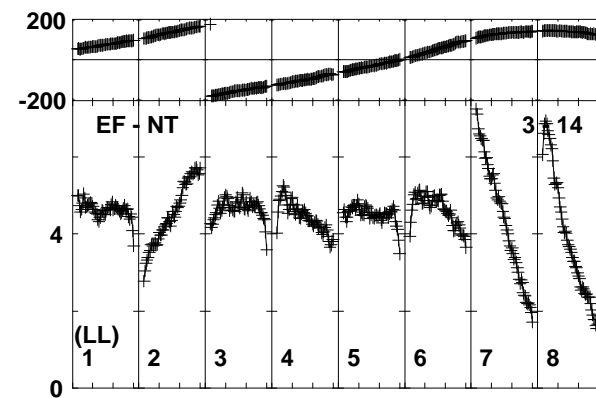
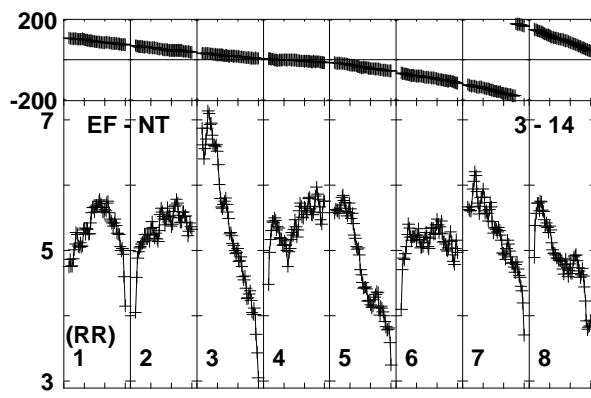
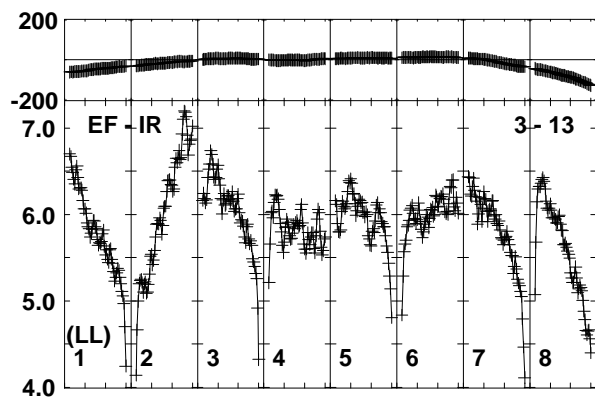
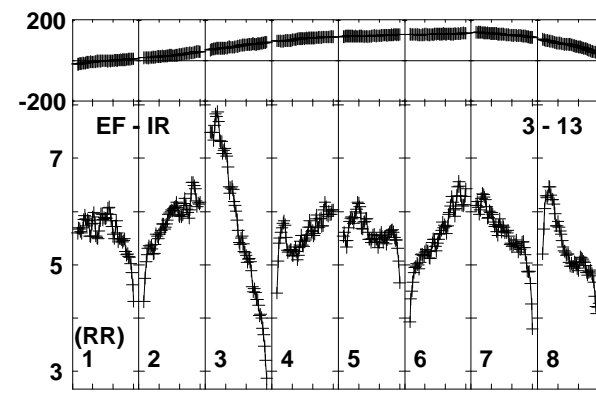
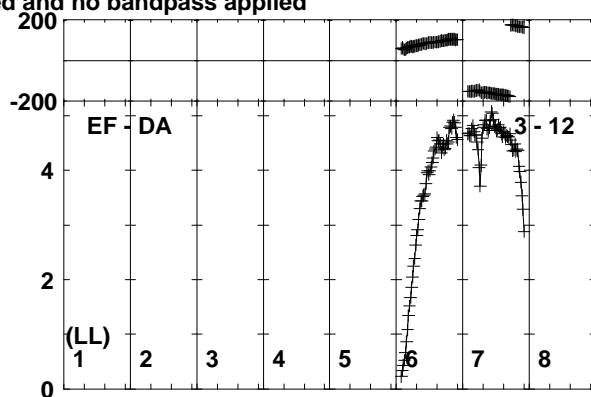
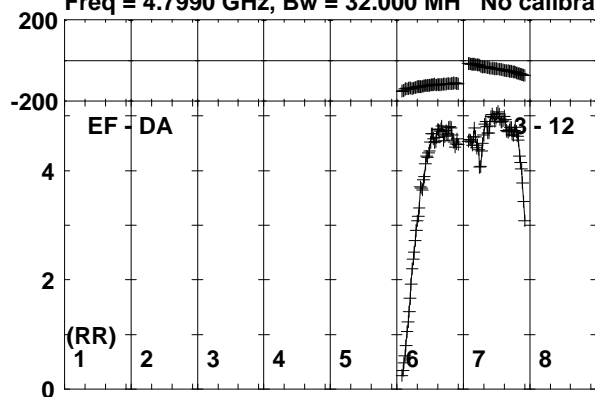

Lower frame: Milli Ampl Jy Top frame: Phas deg  
Vector averaged cross-power spectrum Baseline: EF (03) - DA (12)  
Timerange: 00/21:59:01 to 00/21:59:59

Plot file version 55 created 11-NOV-2019 15:07:22

SER8NJ EK040B.UVDATA.1

Freq = 4.7990 GHz, Bw = 32.000 MH No calibration applied and no bandpass applied

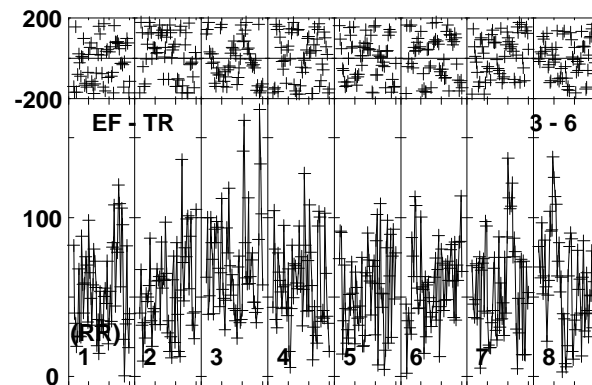
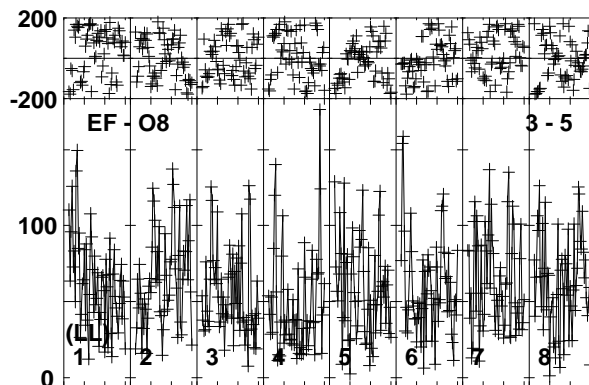
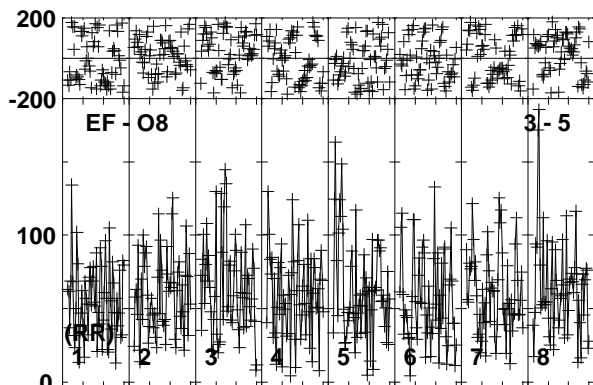
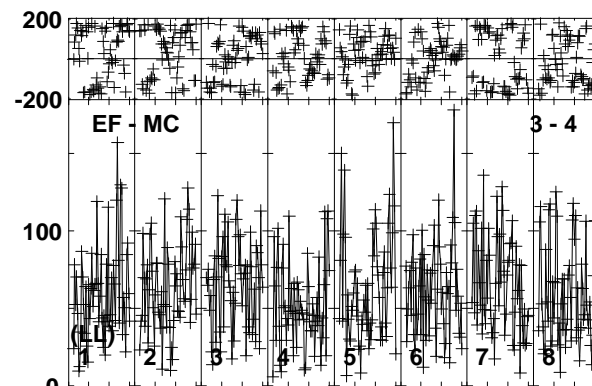
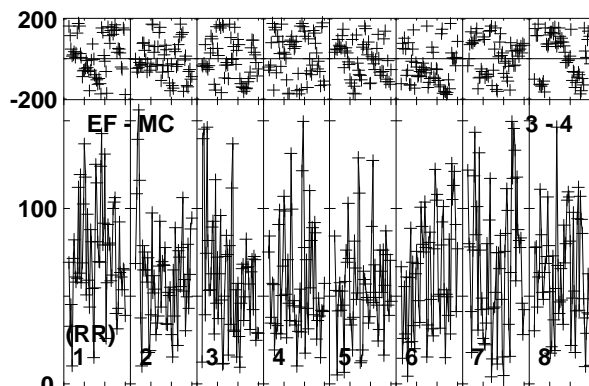
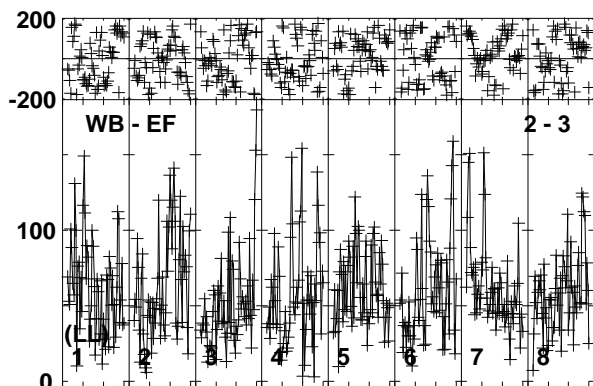
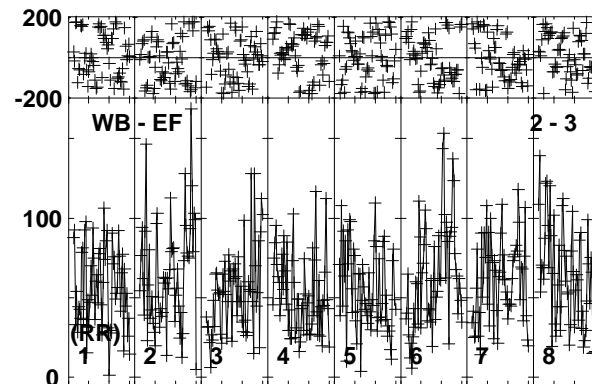
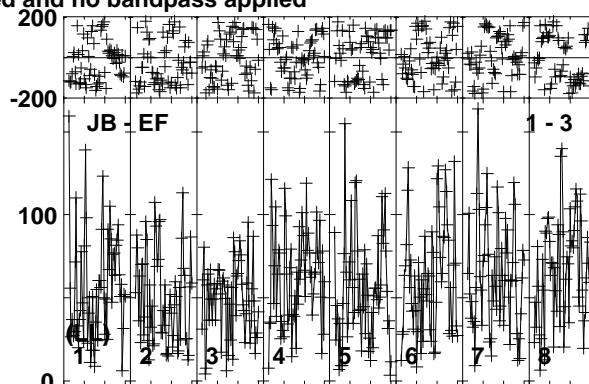
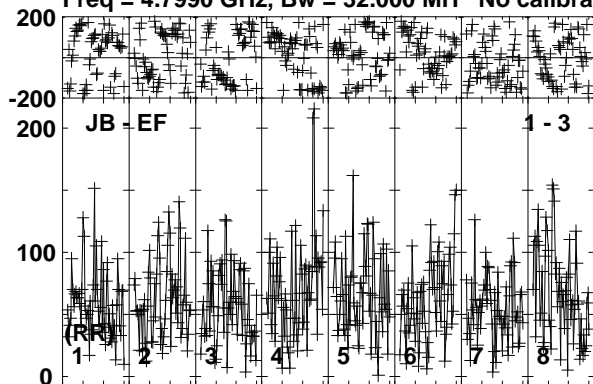

Lower frame: Micro Ampl Jy Top frame: Phas deg  
Vector averaged cross-power spectrum Baseline: JB (01) - EF (03)  
Timerange: 00:22:00:03 to 00:22:03:59

Plot file version 56 created 11-NOV-2019 15:07:22

SER8NJ EK040B.UVDATA.1

Freq = 4.7990 GHz, Bw = 32.000 MH No calibration applied and no bandpass applied

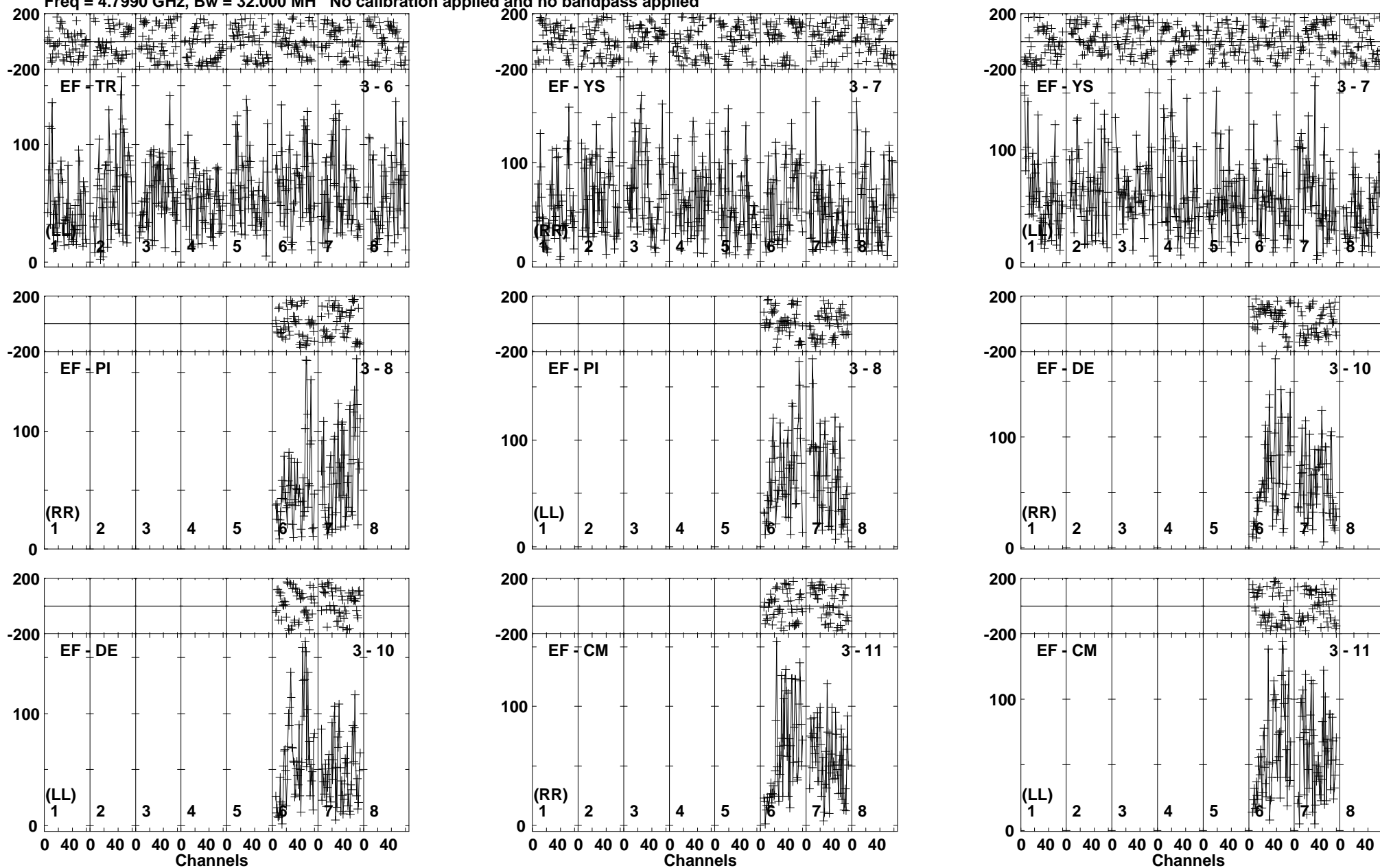

Lower frame: Micro Ampl Jy Top frame: Phas deg  
Vector averaged cross-power spectrum Baseline: EF (03) - TR (06)  
Timerange: 00/22:00:03 to 00/22:03:59

Plot file version 57 created 11-NOV-2019 15:07:22

SER8NJ EK040B.UVDATA.1

Freq = 4.7990 GHz, Bw = 32.000 MH No calibration applied and no bandpass applied

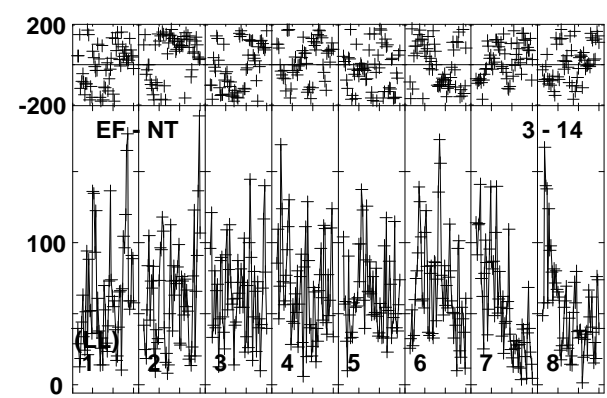
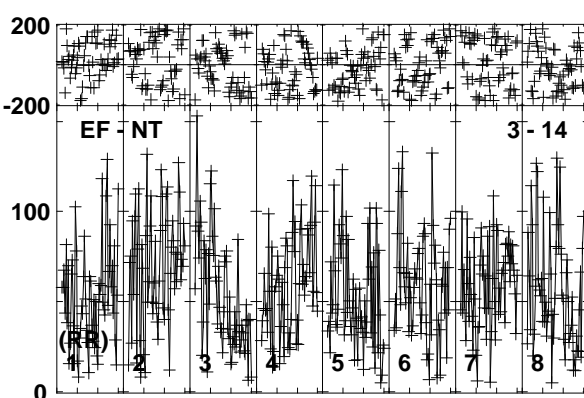
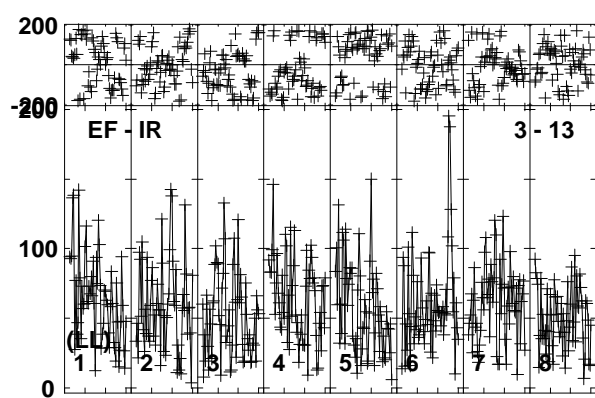
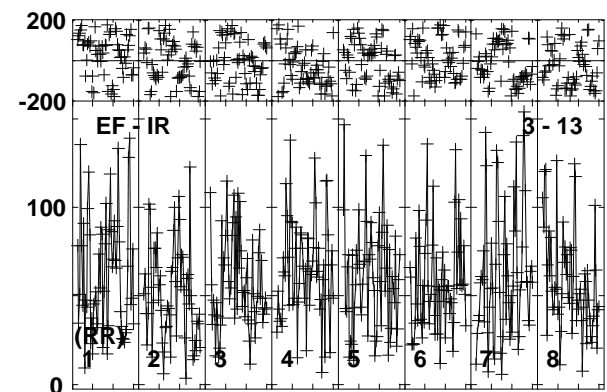
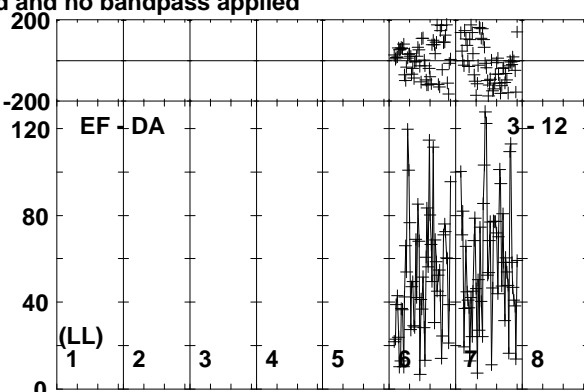
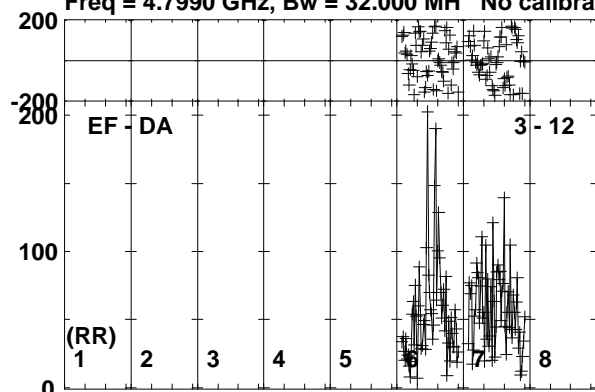

0 40 0 40 0 40 0 40 0 40 0 40 0 40 0 40 0 40 0 40  
Channels

Lower frame: Micro Ampl Jy Top frame: Phas deg  
Vector averaged cross-power spectrum Baseline: EF (03) - DA (12)  
Timerange: 00/22:00:03 to 00/22:03:59

Plot file version 58 created 11-NOV-2019 15:07:22

J1826+0149 EK040B.UVDATA.1

Freq = 4.7990 GHz, Bw = 32.000 MH No calibration applied and no bandpass applied

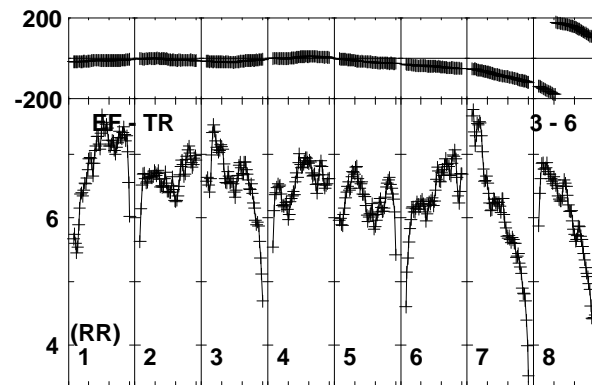
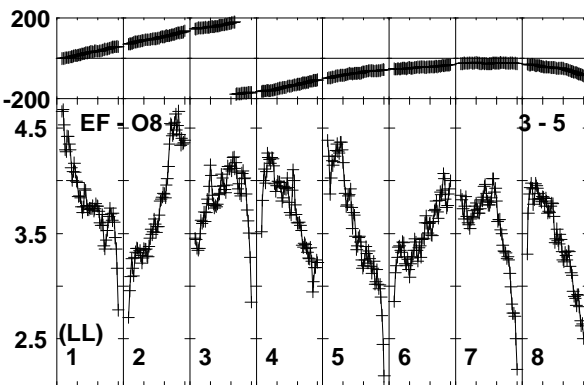
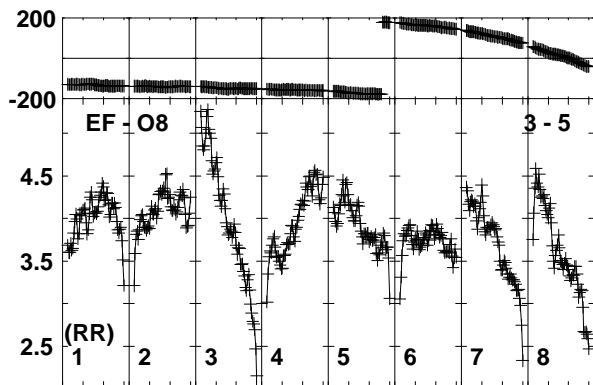
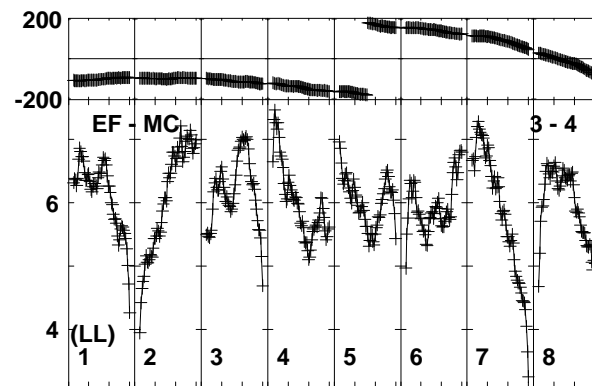
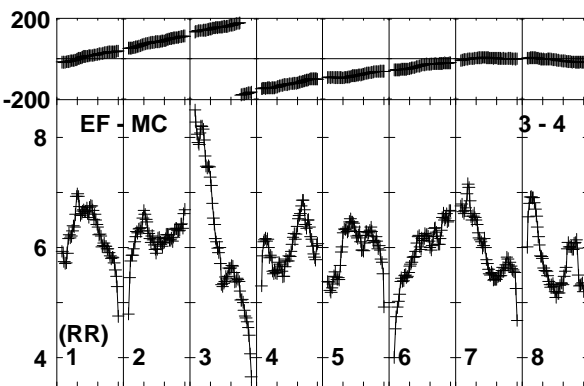
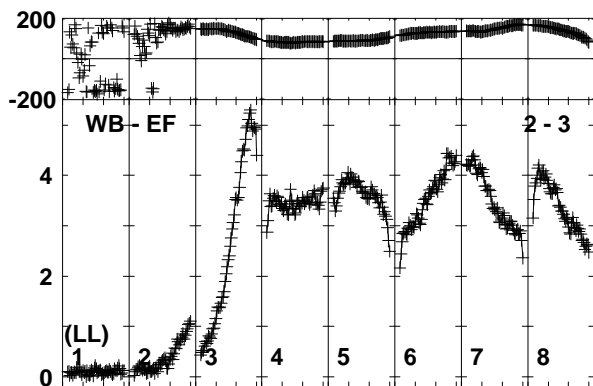
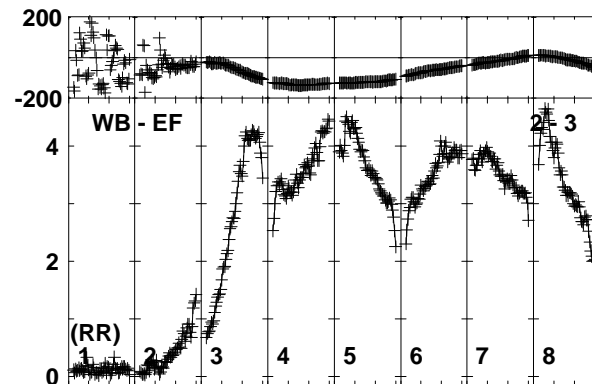
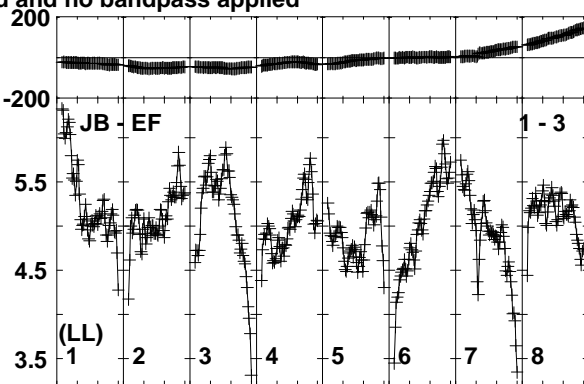
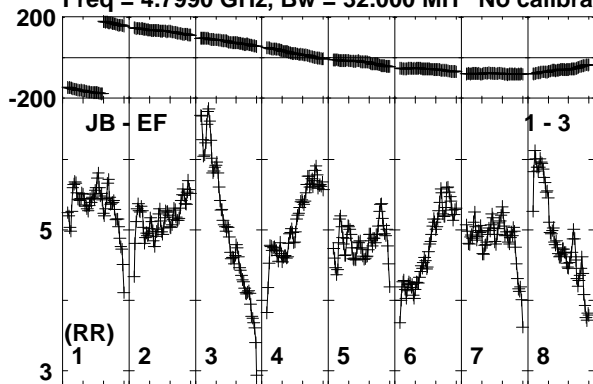

Lower frame: Milli Ampl Jy Top frame: Phas deg  
Vector averaged cross-power spectrum Baseline: JB (01) - EF (03)  
Timerange: 00/22:04:03 to 00/22:05:29



Plot file version 59 created 11-NOV-2019 15:07:22

J1826+0149 EK040B.UVDATA.1

Freq = 4.7990 GHz, Bw = 32.000 MH No calibration applied and no bandpass applied

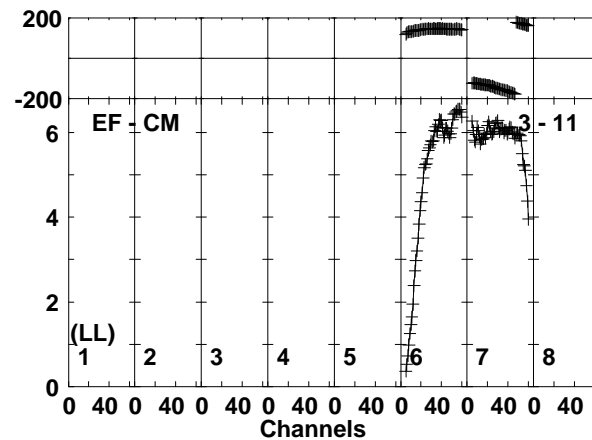
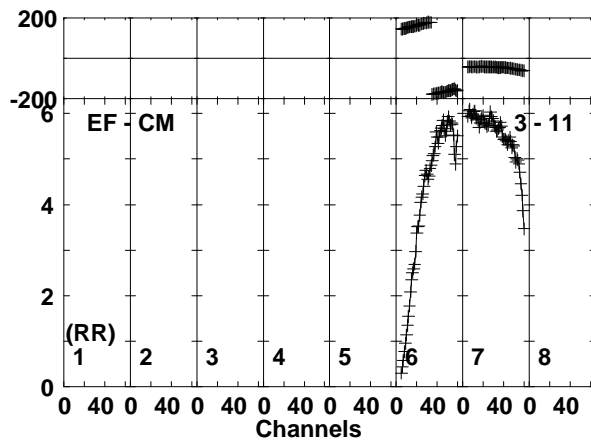
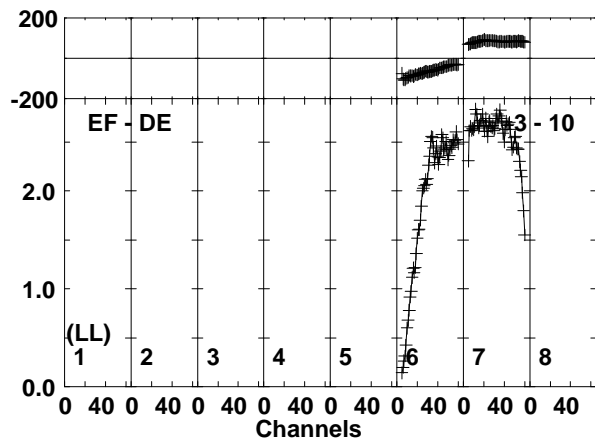
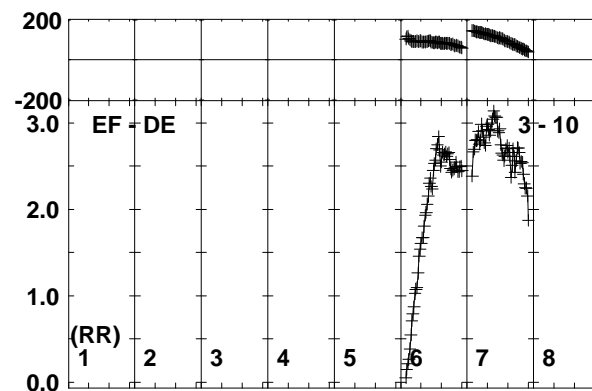
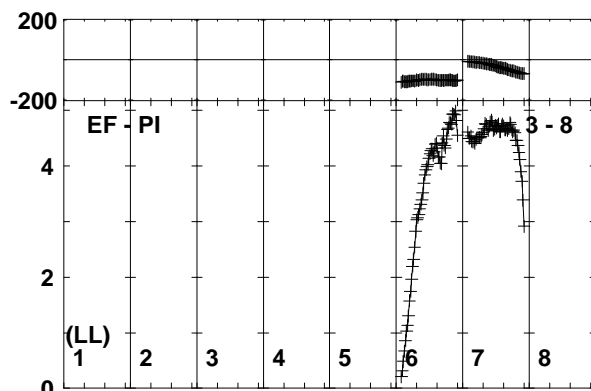
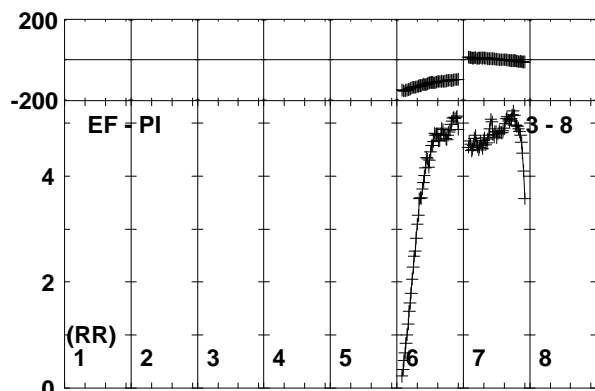
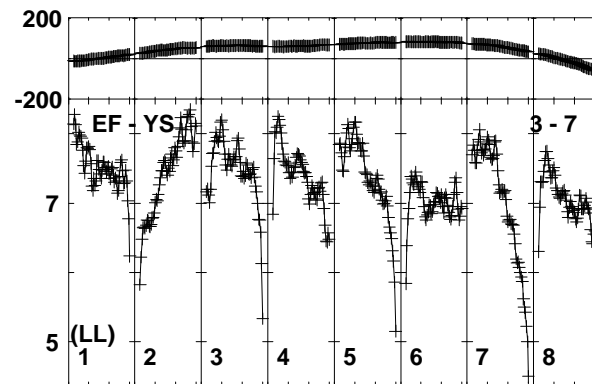
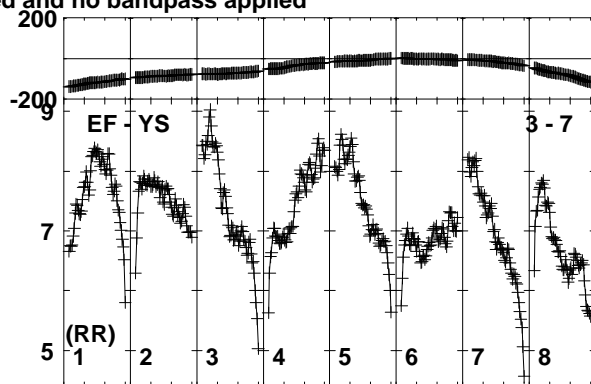
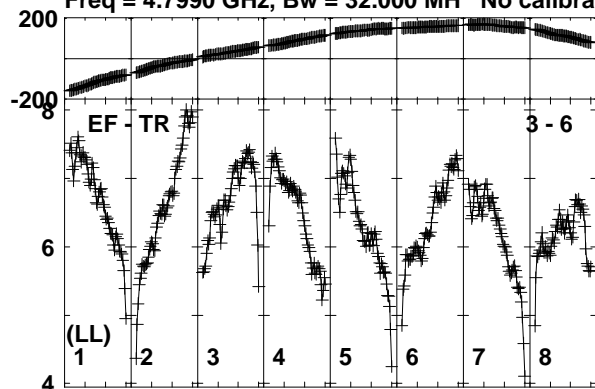

Lower frame: Milli Ampl Jy Top frame: Phas deg  
Vector averaged cross-power spectrum Baseline: EF (03) - TR (06)  
Timerange: 00/22:04:03 to 00/22:05:29

Plot file version 60 created 11-NOV-2019 15:07:22

J1826+0149 EK040B.UVDATA.1

Freq = 4.7990 GHz, Bw = 32.000 MH No calibration applied and no bandpass applied

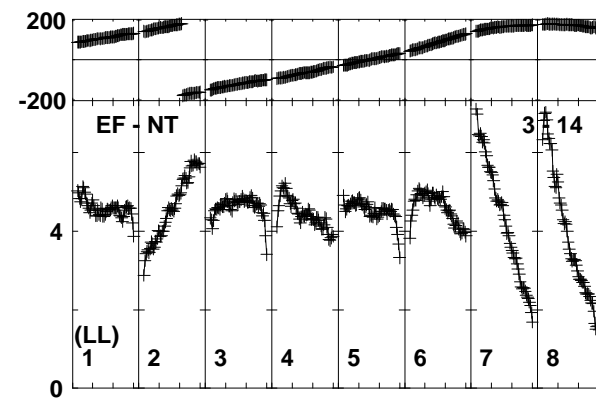
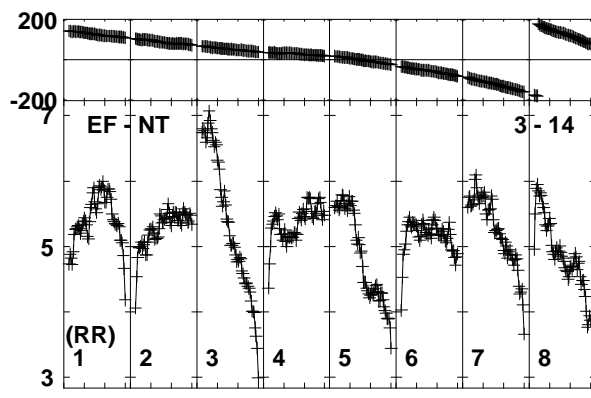
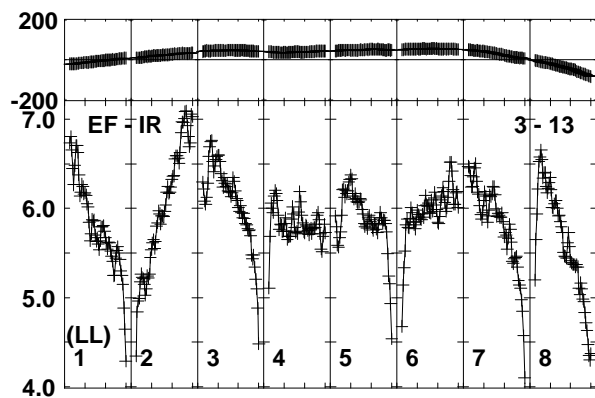
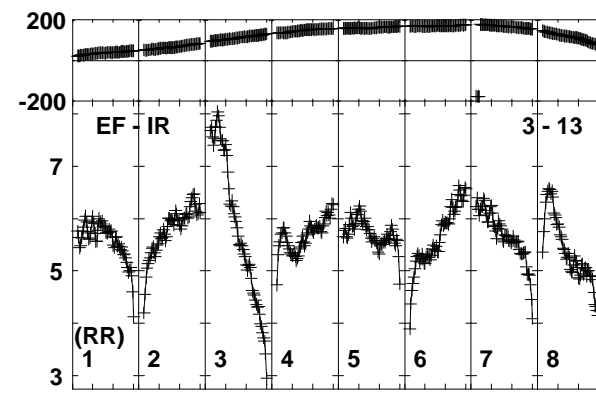
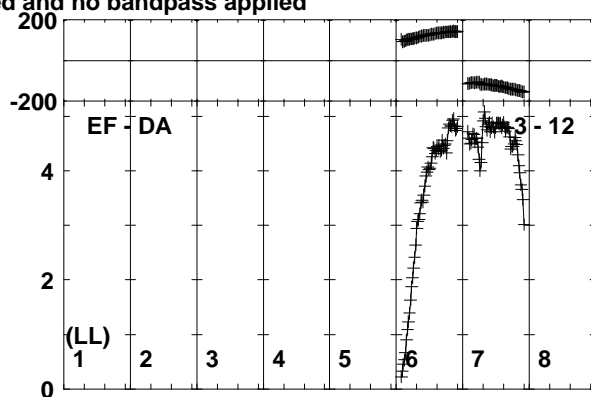
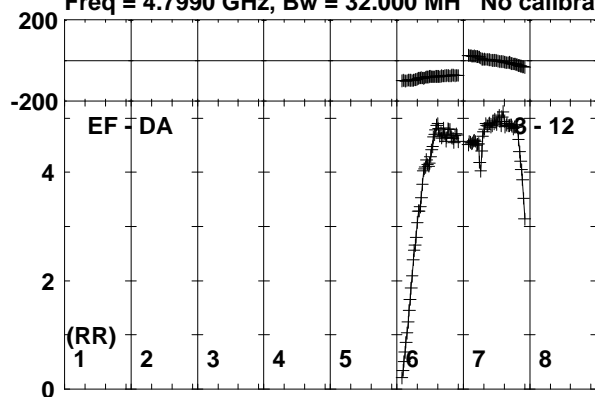

Channels

Lower frame: Milli Ampl Jy Top frame: Phas deg  
Vector averaged cross-power spectrum Baseline: EF (03) - DA (12)  
Timerange: 00/22:04:03 to 00/22:05:29

Plot file version 61 created 11-NOV-2019 15:07:23

SER8NJ EK040B.UVDATA.1

Freq = 4.7990 GHz, Bw = 32.000 MH No calibration applied and no bandpass applied

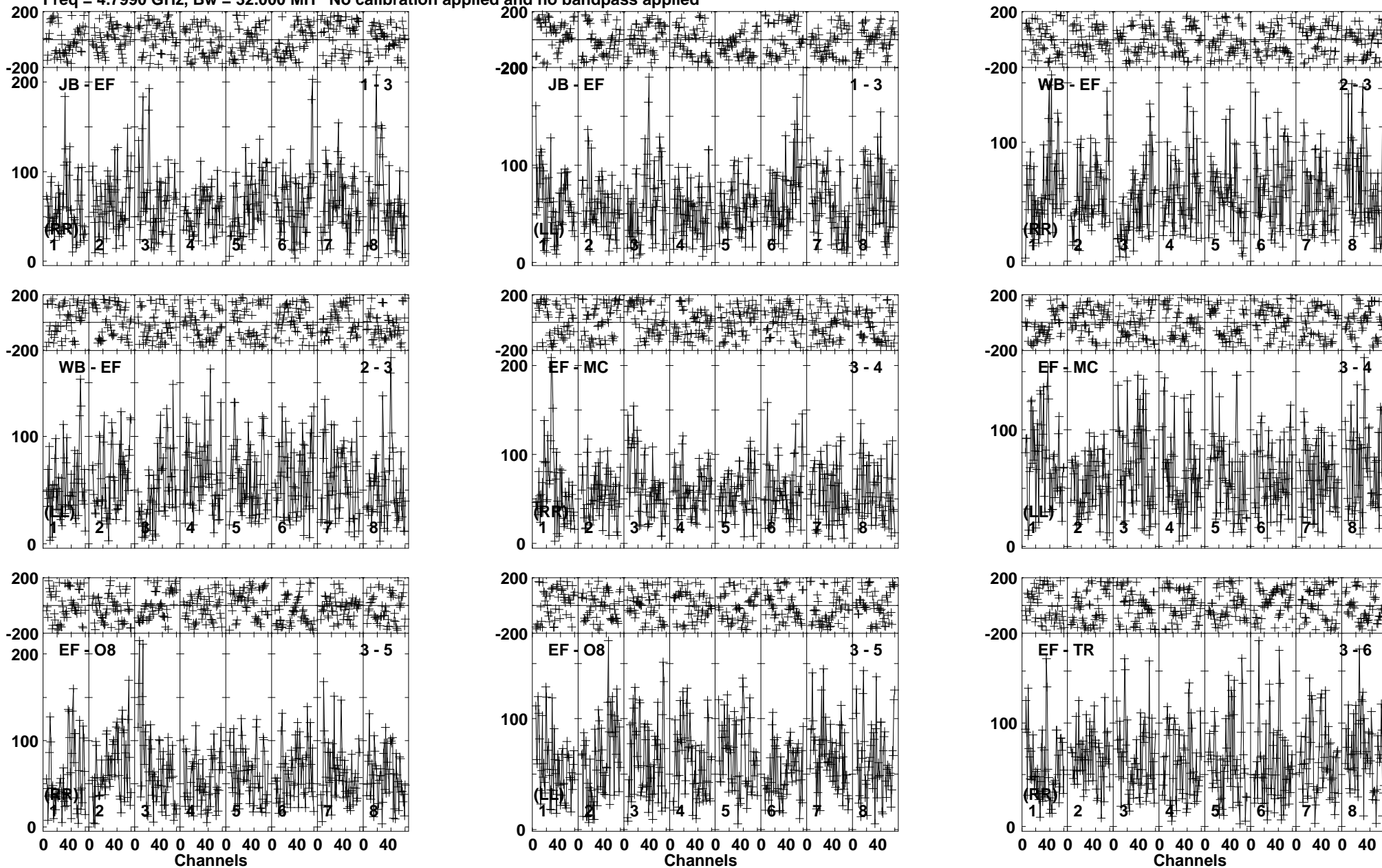

Lower frame: Micro Ampl Jy Top frame: Phas deg  
Vector average cross-power spectrum Baseline: JB (01) - EF (03)  
Timerange: 00/22:05:31 to 00/22:09:29

Plot file version 62 created 11-NOV-2019 15:07:23

SER8NJ EK040B.UVDATA.1

Freq = 4.7990 GHz, Bw = 32.000 MH No calibration applied and no bandpass applied

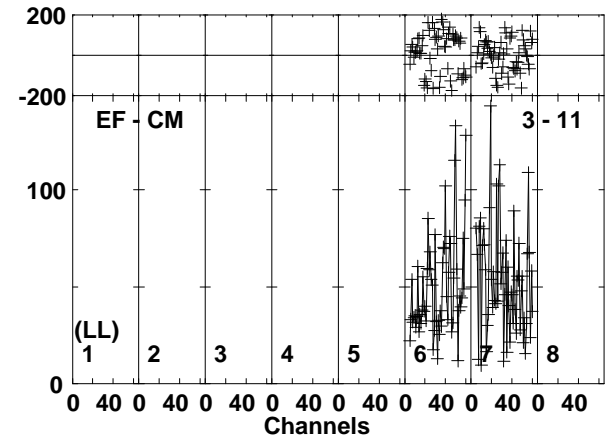
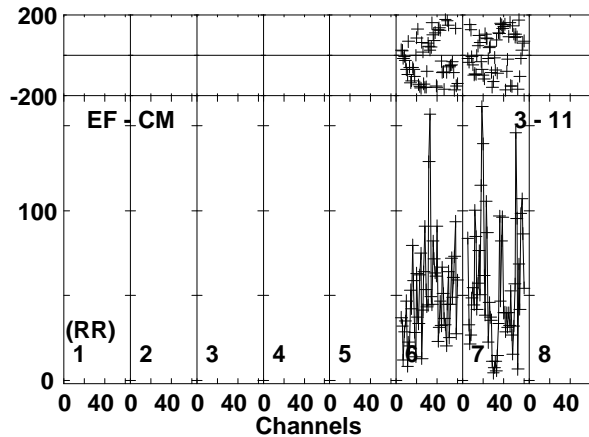
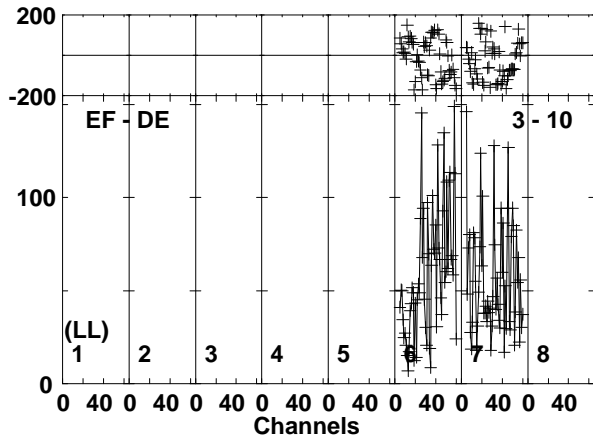
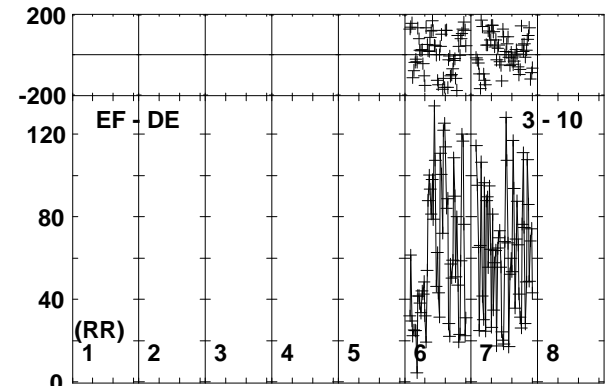
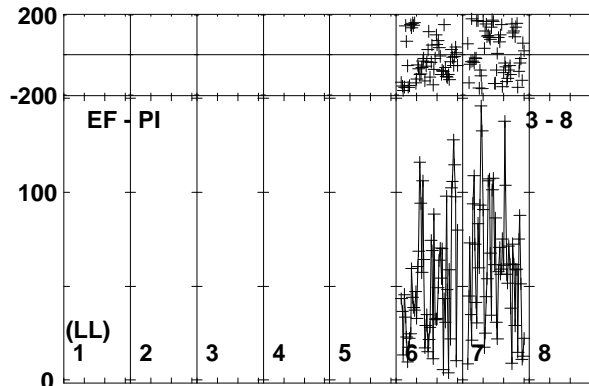
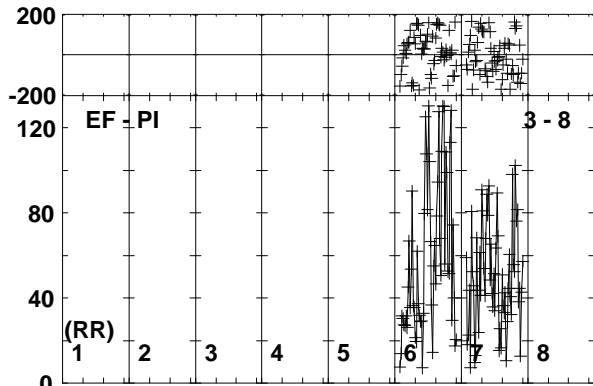
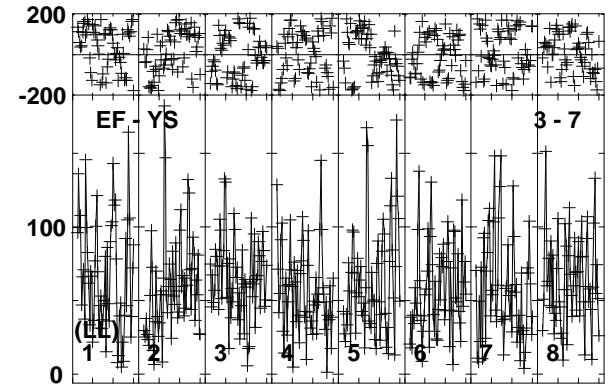
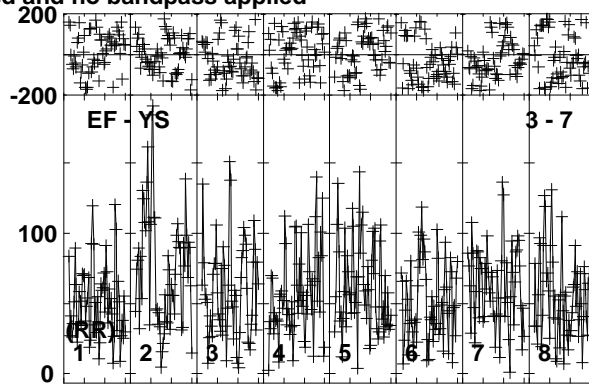
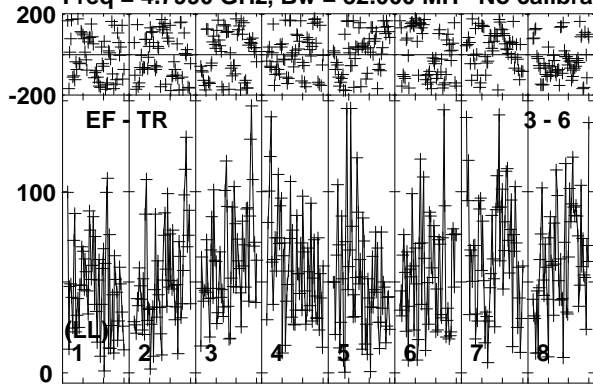

Lower frame: Micro Ampl Jy Top frame: Phas deg  
Vector averaged cross-power spectrum Baseline: EF (03) - TR (06)  
Timerange: 00/22:05:31 to 00/22:09:29

Plot file version 63 created 11-NOV-2019 15:07:23  
 SER8NJ EK040B.UVDATA.1  
 Freq = 4.7990 GHz, Bw = 32.000 MH No calibration applied and no bandpass applied

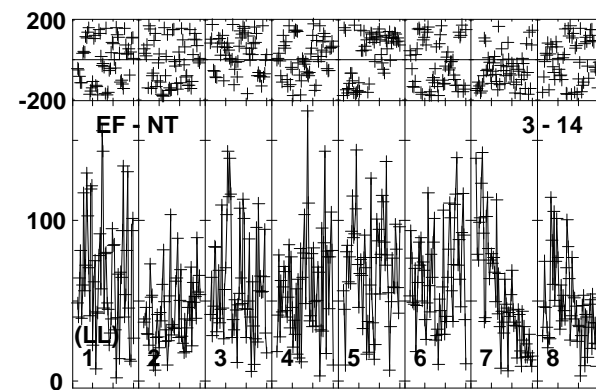
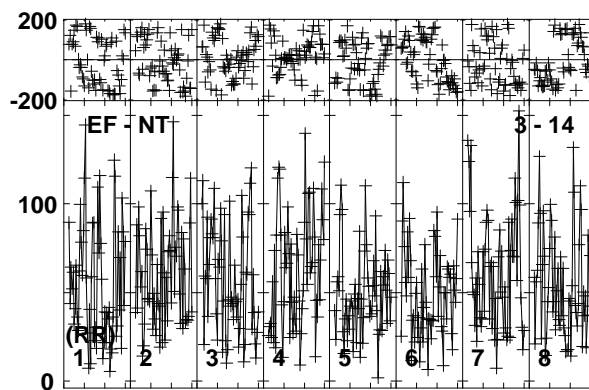
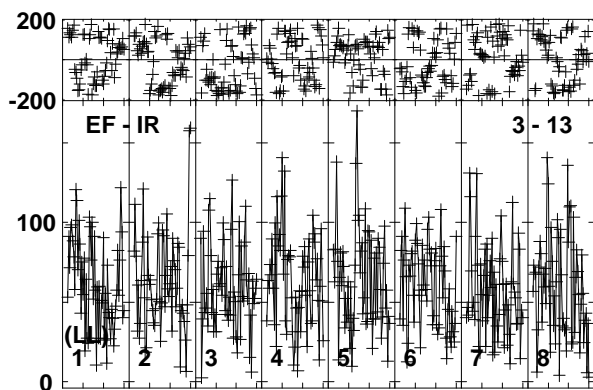
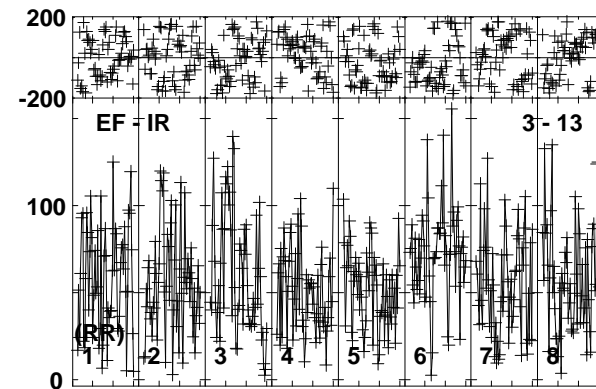
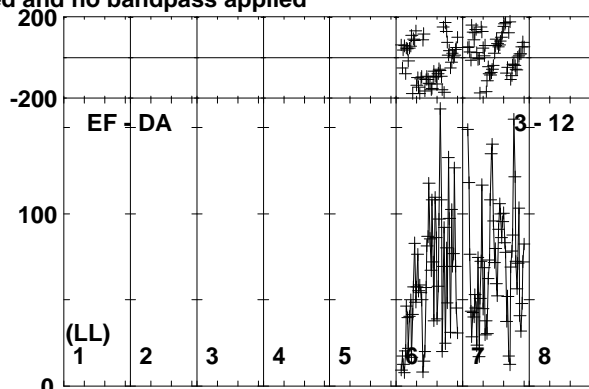
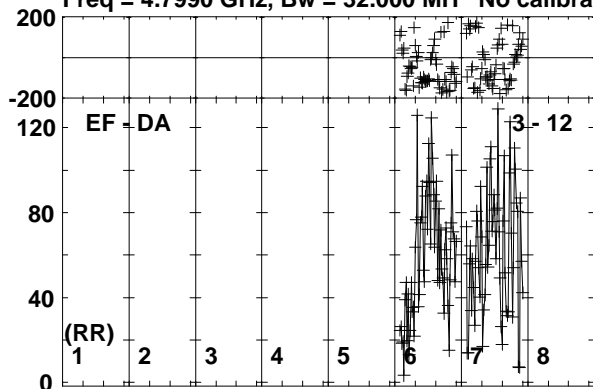

0 40 0 40 0 40 0 40 0 40 0 40 0 40 0 40 0 40  
 Channels

Lower frame: Micro Ampl Jy Top frame: Phas deg  
 Vector averaged cross-power spectrum Baseline: EF (03) - DA (12)  
 Timerange: 00/22:05:31 to 00/22:09:29

Plot file version 64 created 11-NOV-2019 15:07:23

J1826+0149 EK040B.UVDATA.1

Freq = 4.7990 GHz, Bw = 32.000 MH No calibration applied and no bandpass applied

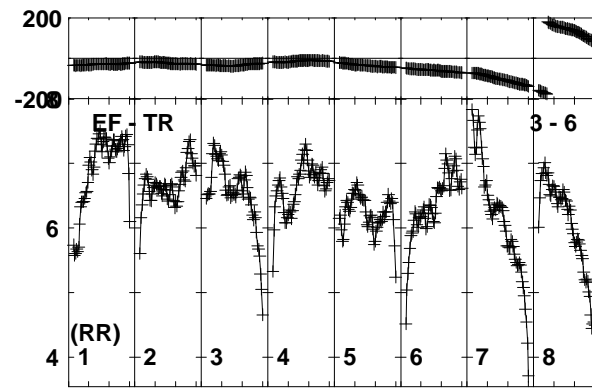
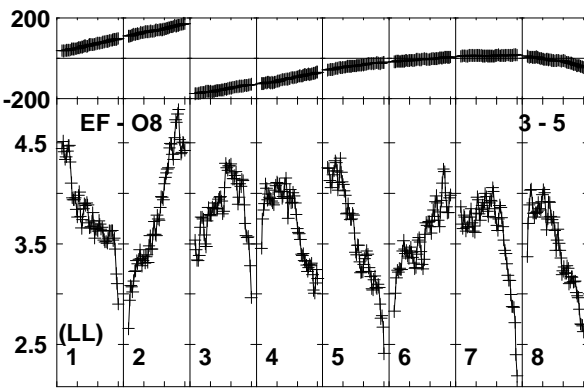
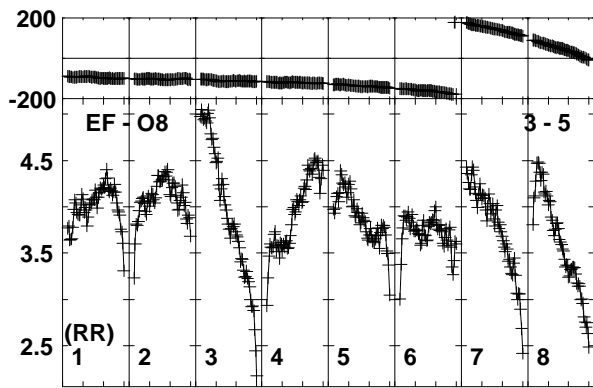
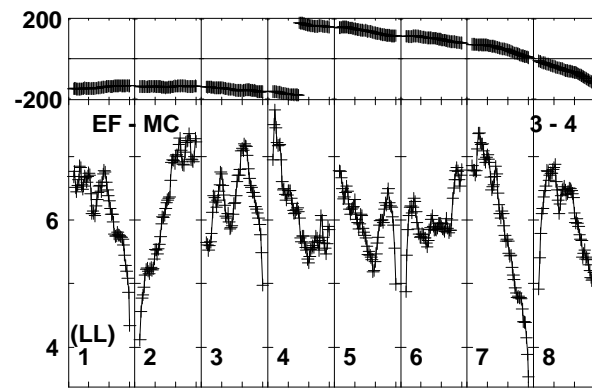
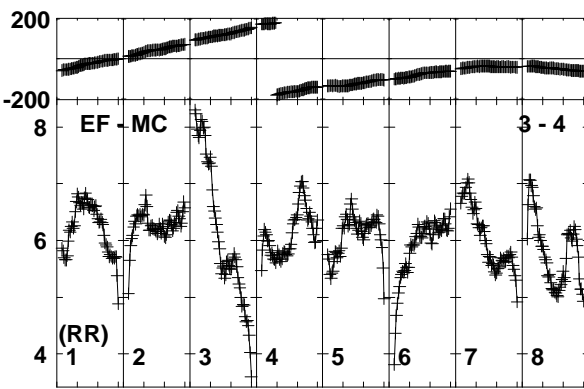
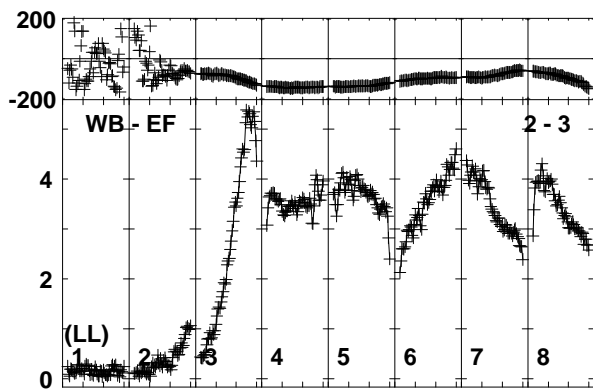
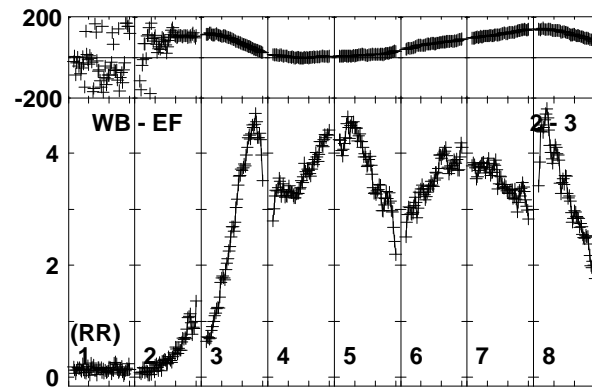
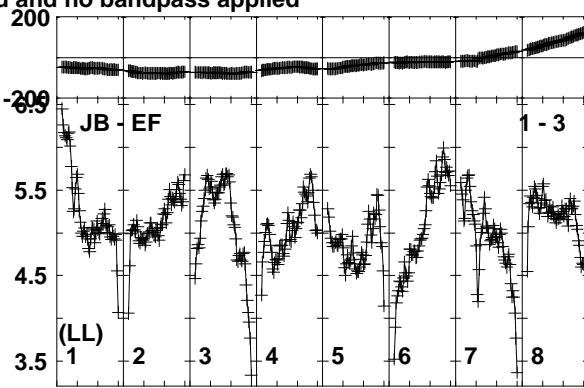
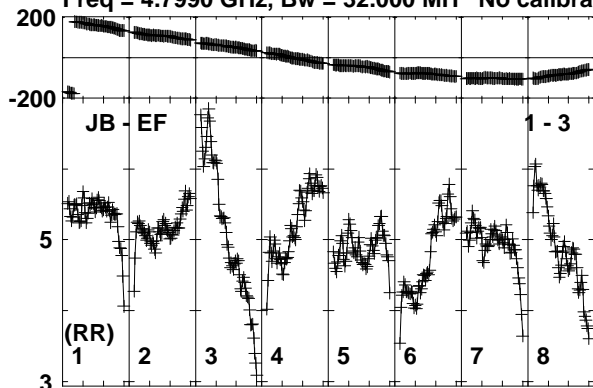

Lower frame: Milli Ampl Jy Top frame: Phas deg  
Vector averaged cross-power spectrum Baseline: JB (01) - EF (03)  
Timerange: 00/22:10:11 to 00/22:11:09

Plot file version 65 created 11-NOV-2019 15:07:23

J1826+0149 EK040B.UVDATA.1

Freq = 4.7990 GHz, Bw = 32.000 MH No calibration applied and no bandpass applied

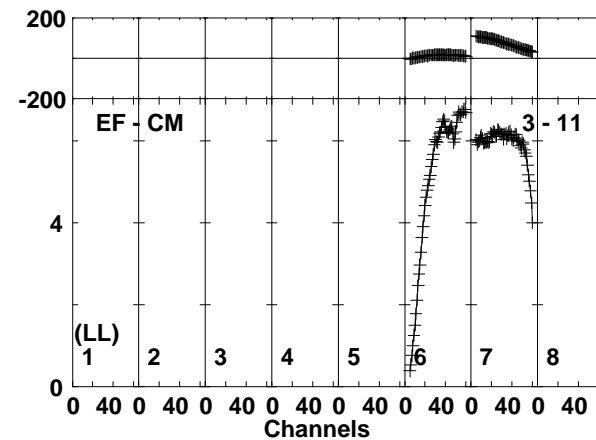
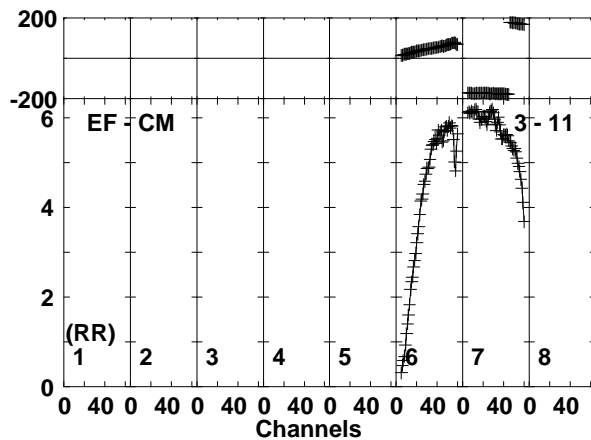
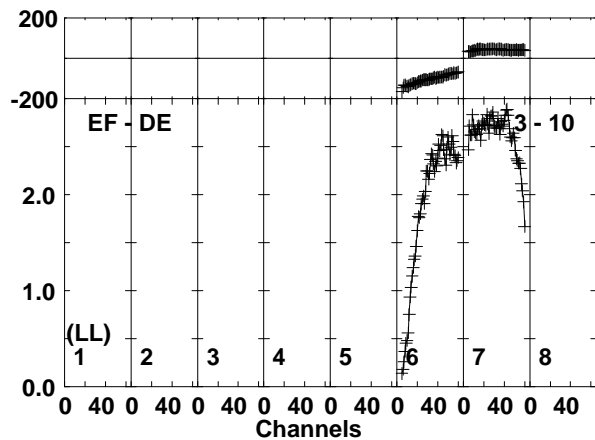
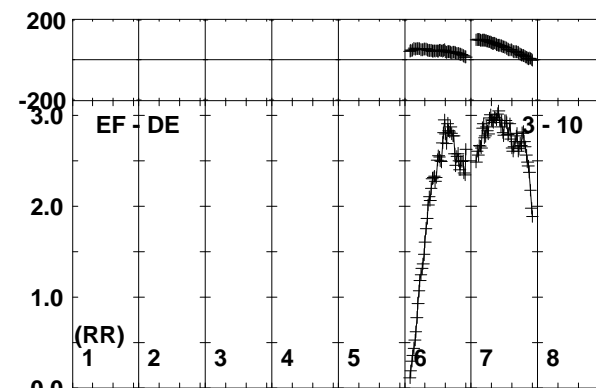
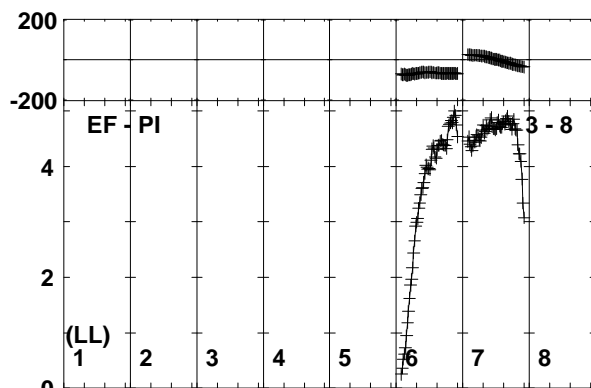
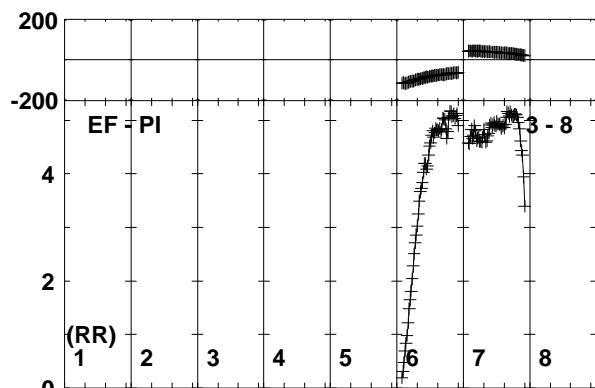
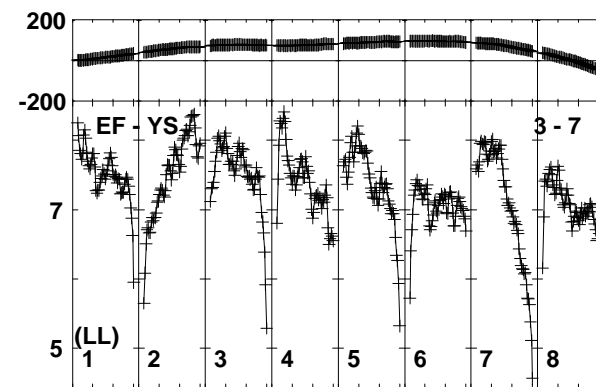
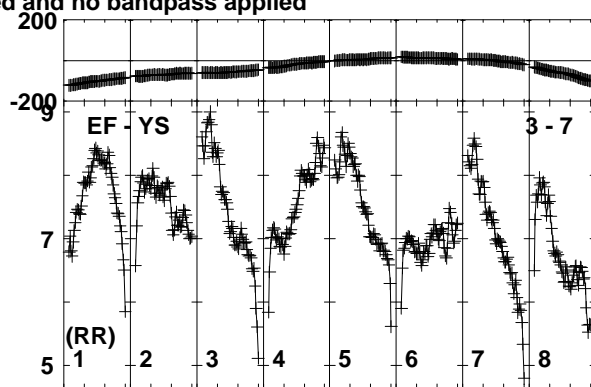
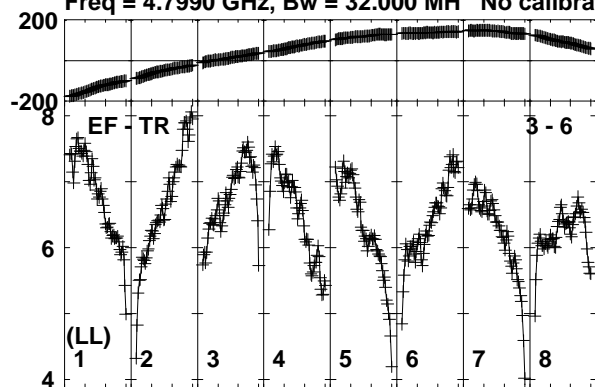

Lower frame: Milli Ampl Jy Top frame: Phas deg  
Vector averaged cross-power spectrum Baseline: EF (03) - TR (06)  
Timerange: 00/22:10:11 to 00/22:11:09

Plot file version 66 created 11-NOV-2019 15:07:23

J1826+0149 EK040B.UVDATA.1

Freq = 4.7990 GHz, Bw = 32.000 MH No calibration applied and no bandpass applied

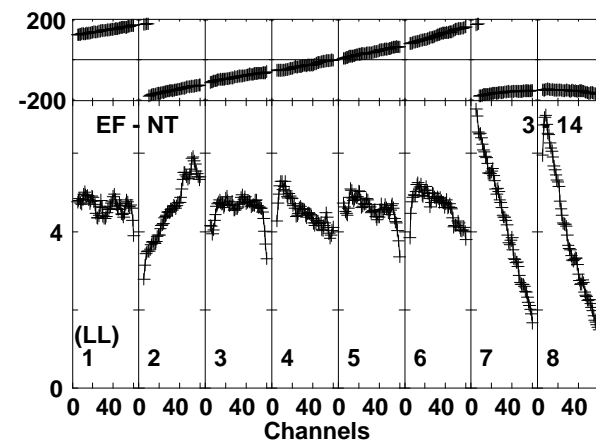
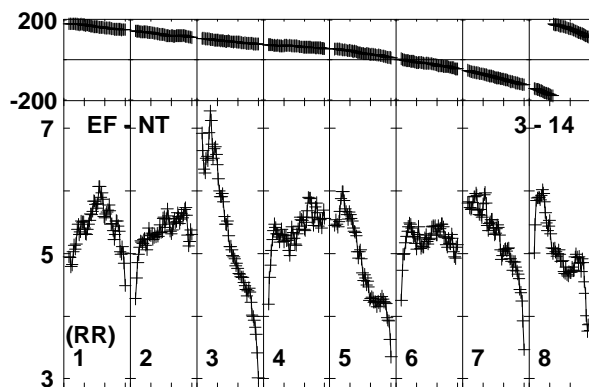
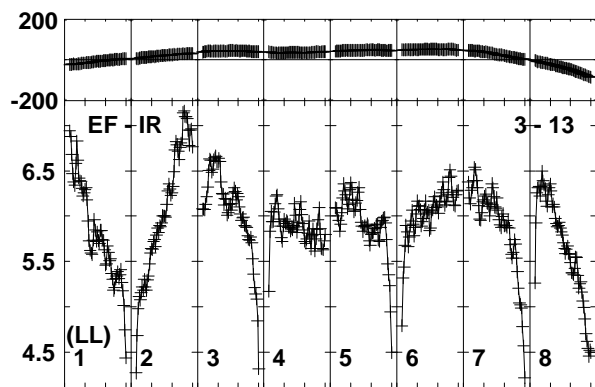
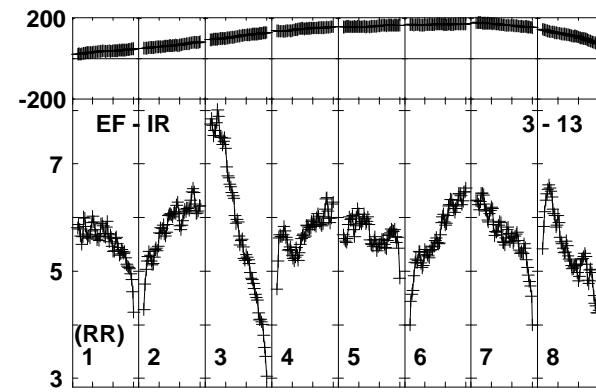
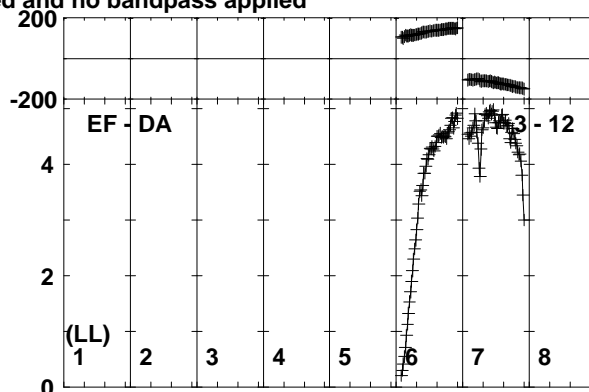
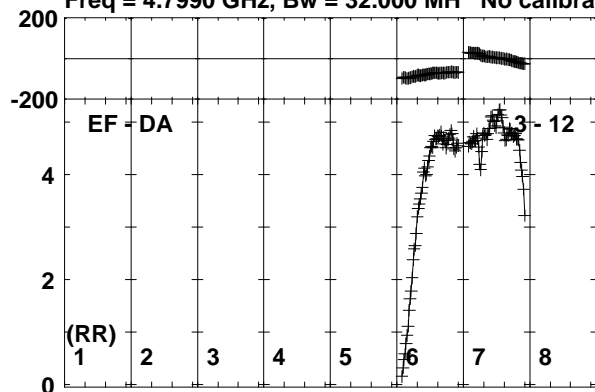

Lower frame: Milli Ampl Jy Top frame: Phas deg  
Vector averaged cross-power spectrum Baseline: EF (03) - DA (12)  
Timerange: 00/22:10:11 to 00/22:11:09



Plot file version 67 created 11-NOV-2019 15:07:23

SER8NJ EK040B.UVDATA.1

Freq = 4.7990 GHz, Bw = 32.000 MH No calibration applied and no bandpass applied

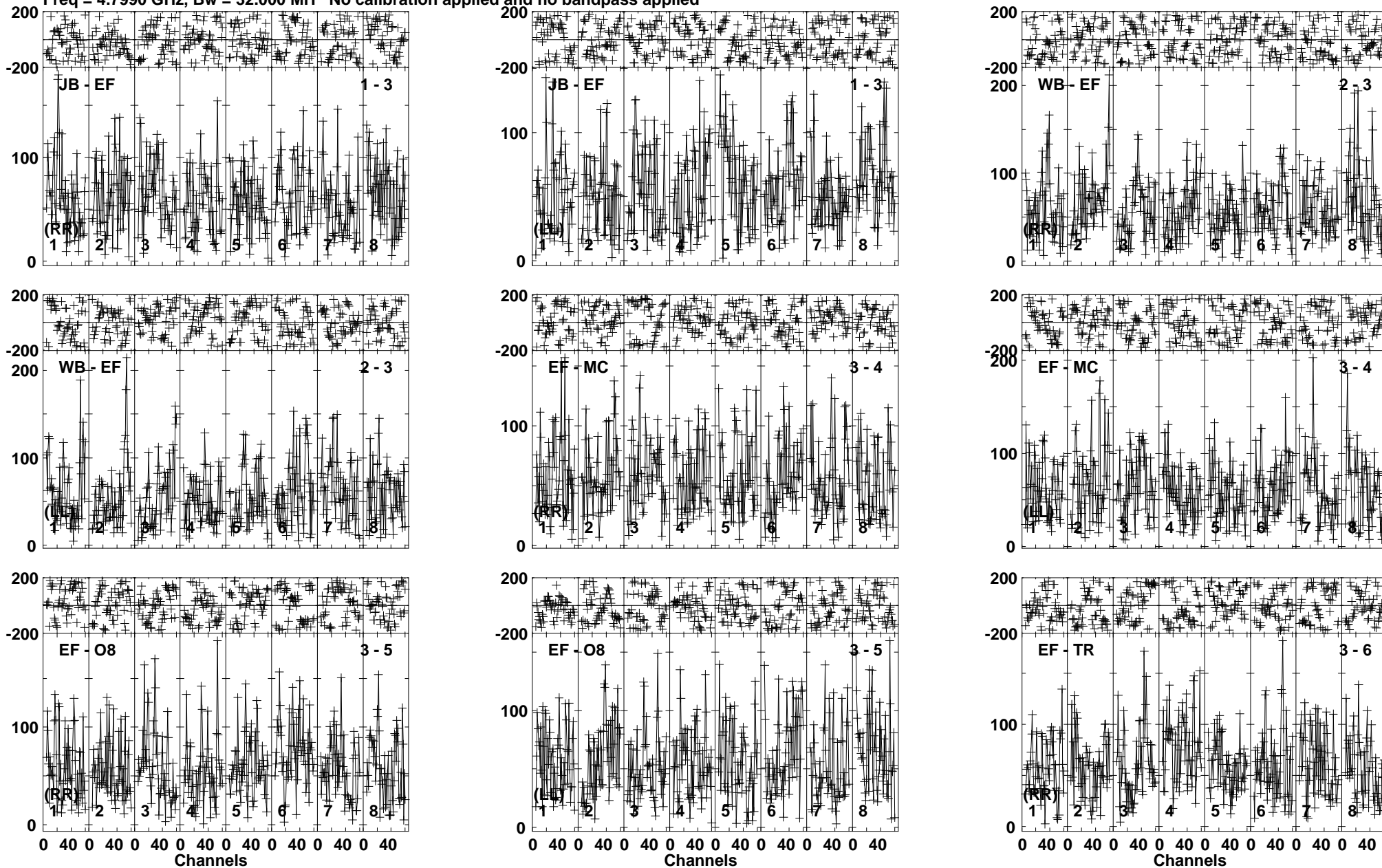

Lower frame: Micro Ampl Jy Top frame: Phas deg  
Vector averaged cross-power spectrum Baseline: JB (01) - EF (03)  
Timerange: 00:22:11:11 to 00:22:15:09

Plot file version 68 created 11-NOV-2019 15:07:23

SER8NJ EK040B.UVDATA.1

Freq = 4.7990 GHz, Bw = 32.000 MH No calibration applied and no bandpass applied

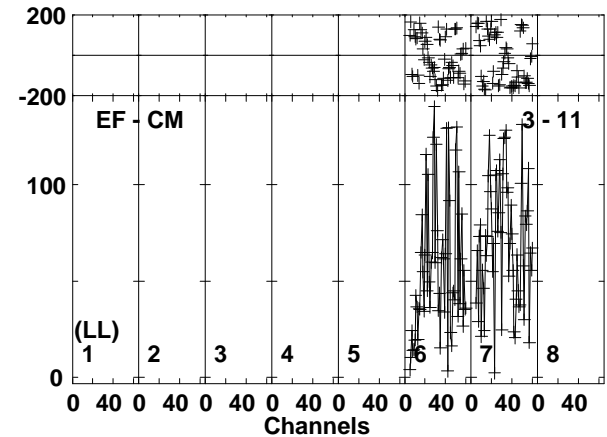
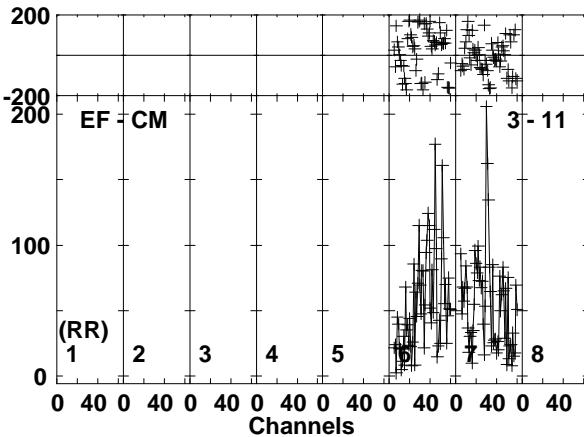
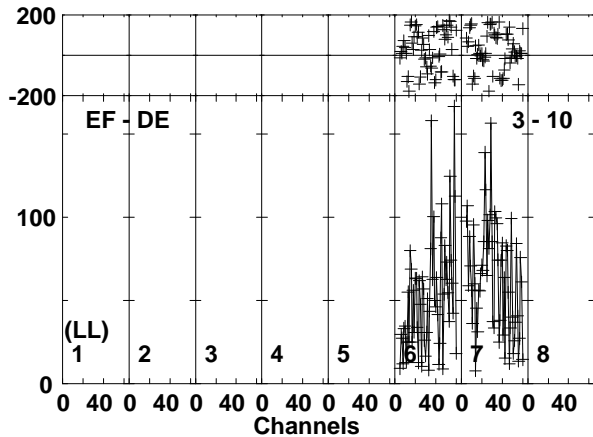
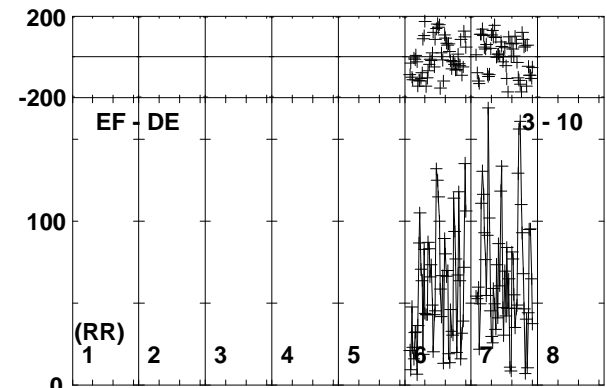
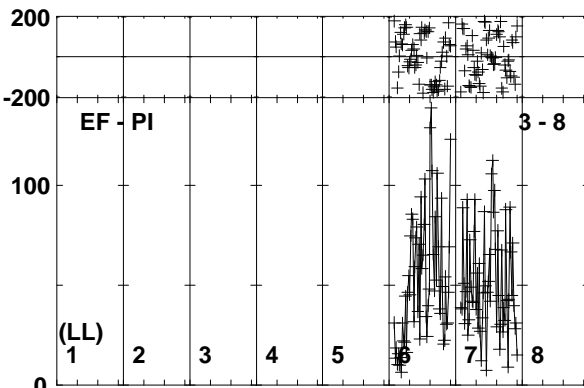
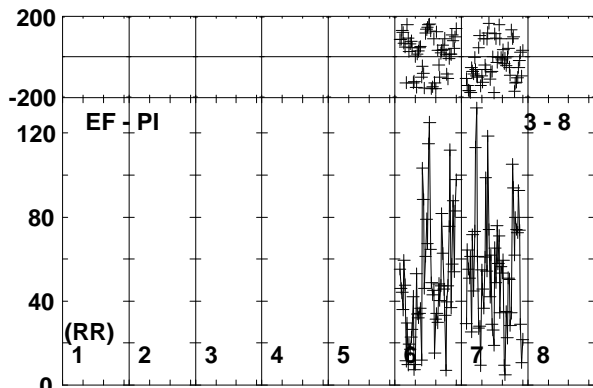
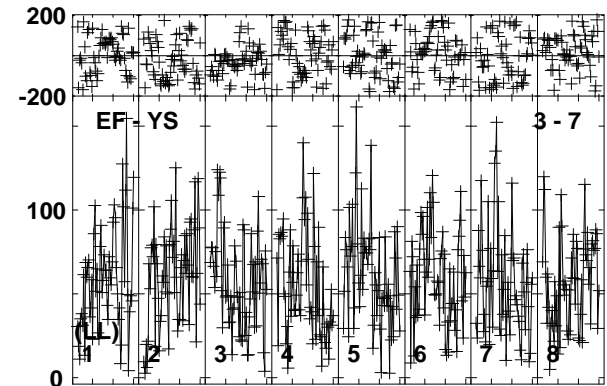
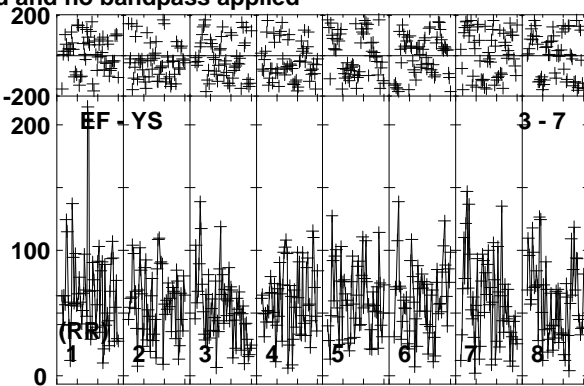
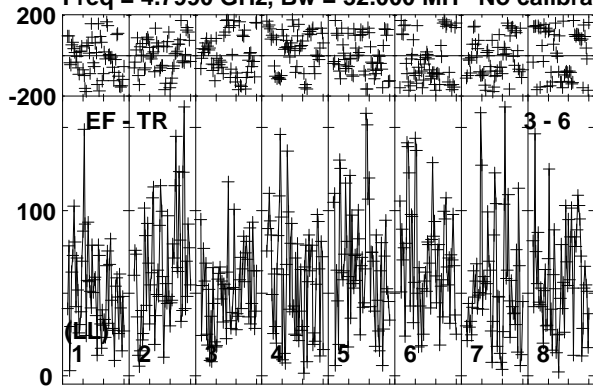

Lower frame: Micro Ampl Jy Top frame: Phas deg  
Vector averaged cross-power spectrum Baseline: EF (03) - TR (06)  
Timerange: 00:22:11:11 to 00:22:15:09

Plot file version 69 created 11-NOV-2019 15:07:24

SER8NJ EK040B.UVDATA.1

Freq = 4.7990 GHz, Bw = 32.000 MH No calibration applied and no bandpass applied

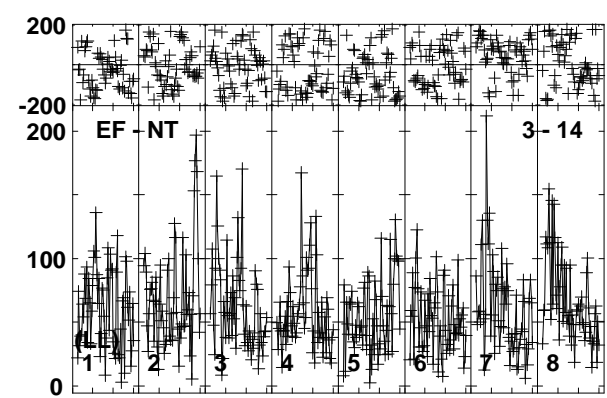
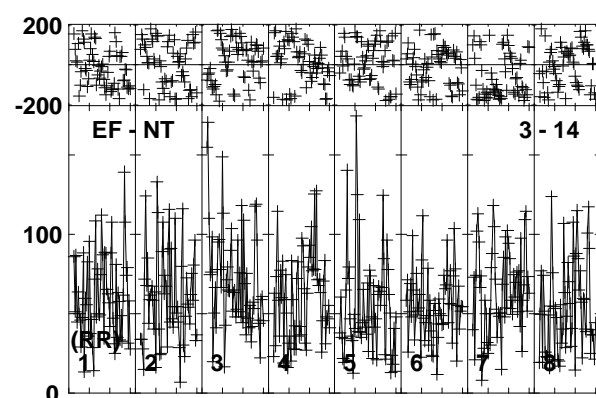
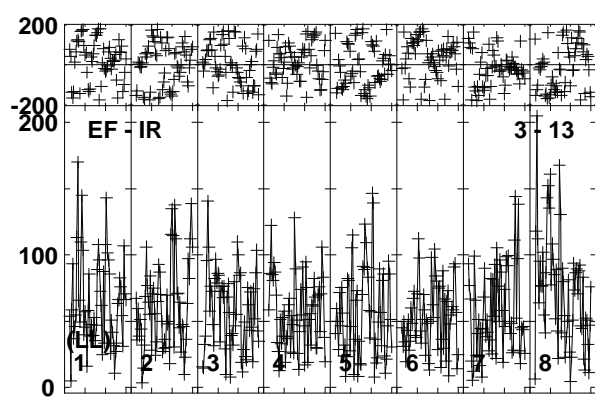
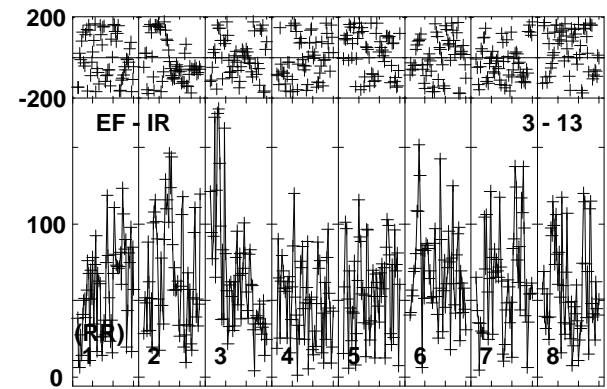
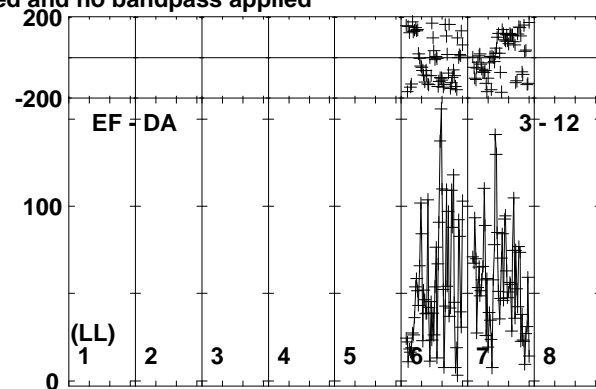
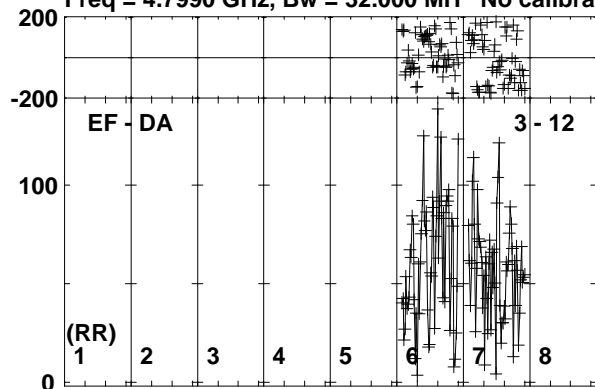

0 40 0 40 0 40 0 40 0 40 0 40 0 40 0 40 0 40 0 40  
Channels

Lower frame: Micro Ampl Jy Top frame: Phas deg  
Vector averaged cross-power spectrum Baseline: EF (03) - DA (12)  
Timerange: 00/22:11:11 to 00/22:15:09

Plot file version 70 created 11-NOV-2019 15:07:24

J1826+0149 EK040B.UVDATA.1

Freq = 4.7990 GHz, Bw = 32.000 MH No calibration applied and no bandpass applied

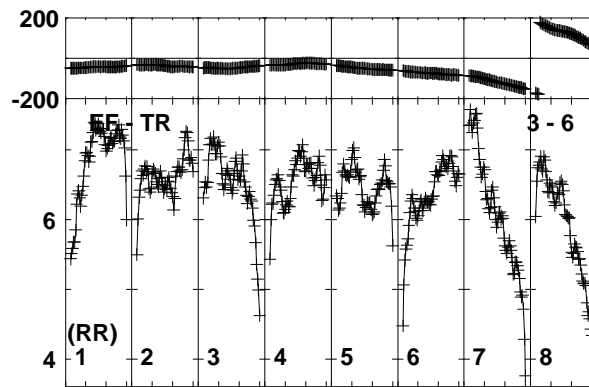
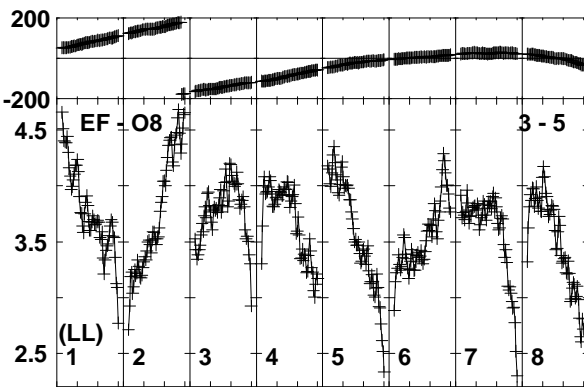
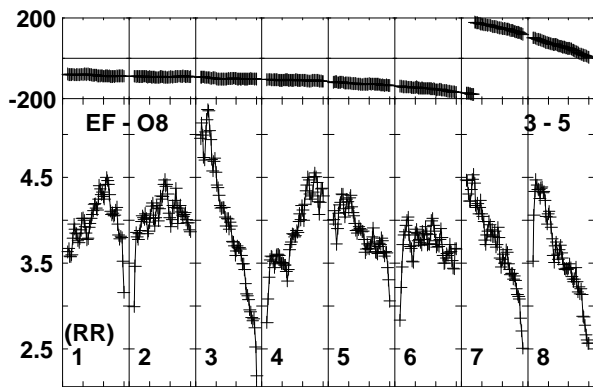
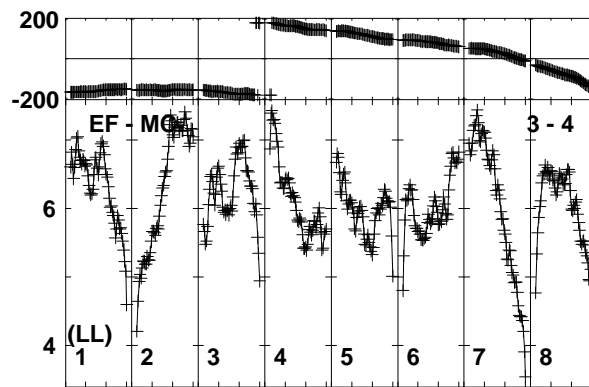
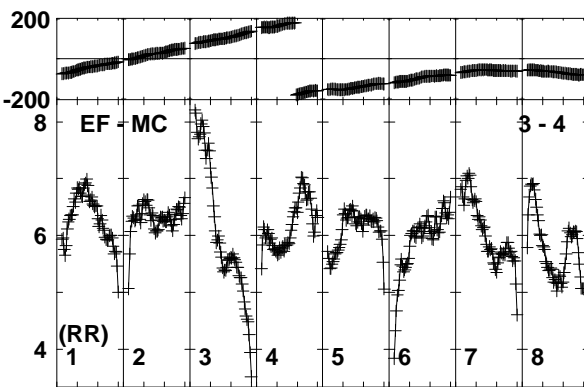
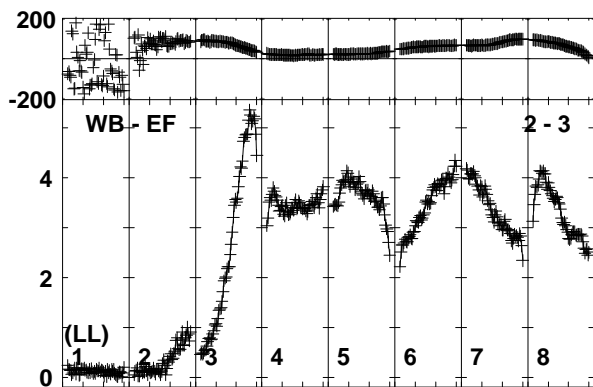
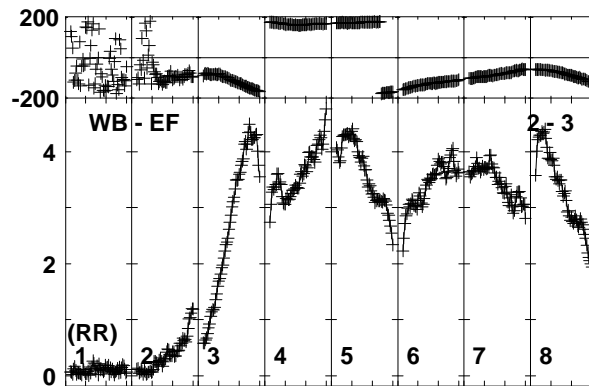
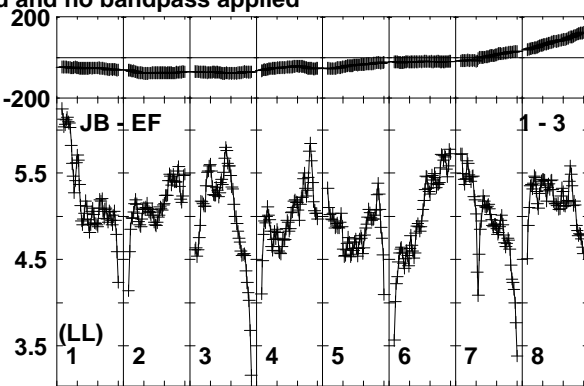
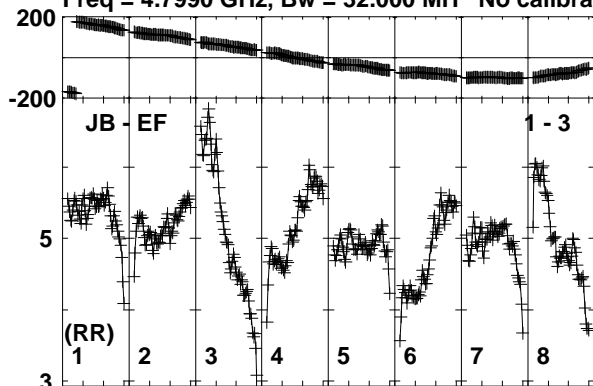

Lower frame: Milli Ampl Jy Top frame: Phas deg  
Vector averaged cross-power spectrum Baseline: JB (01) - EF (03)  
Timerange: 00/22:15:11 to 00/22:16:39

Plot file version 71 created 11-NOV-2019 15:07:24

J1826+0149 EK040B.UVDATA.1

Freq = 4.7990 GHz, Bw = 32.000 MH No calibration applied and no bandpass applied

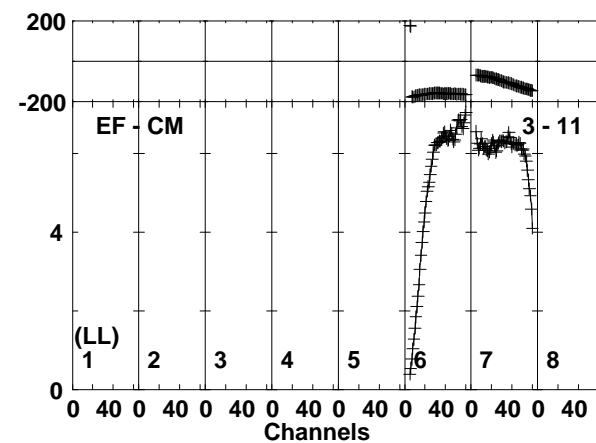
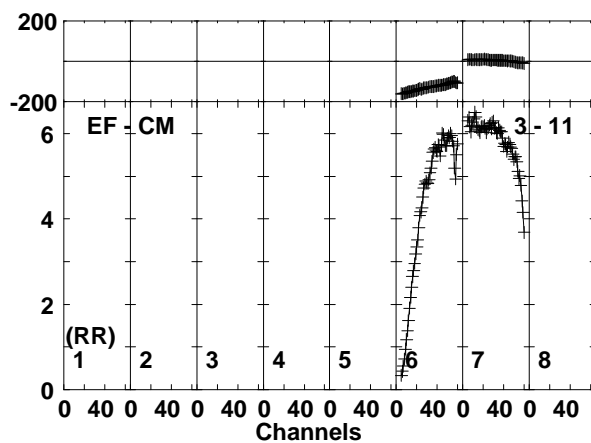
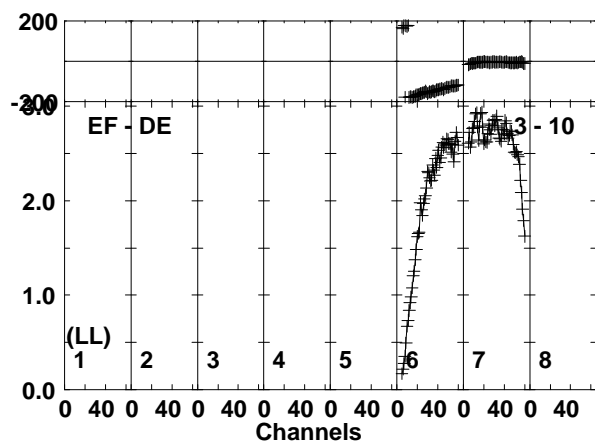
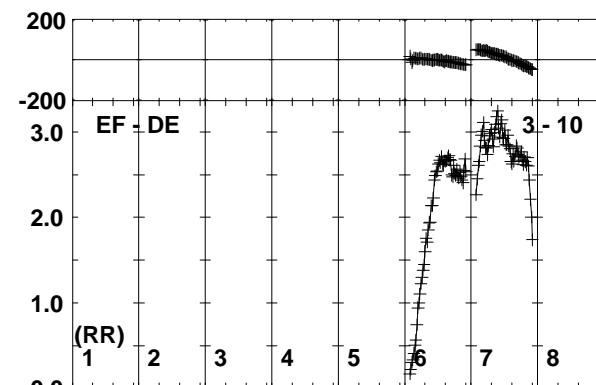
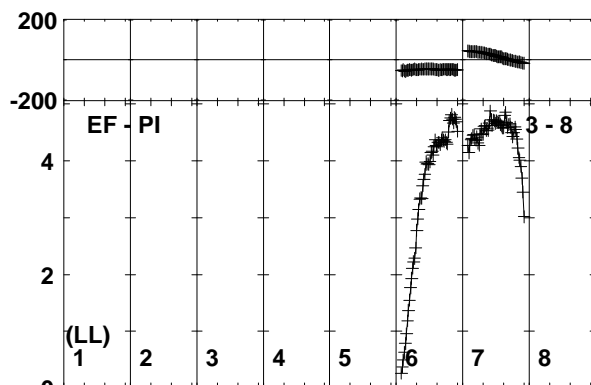
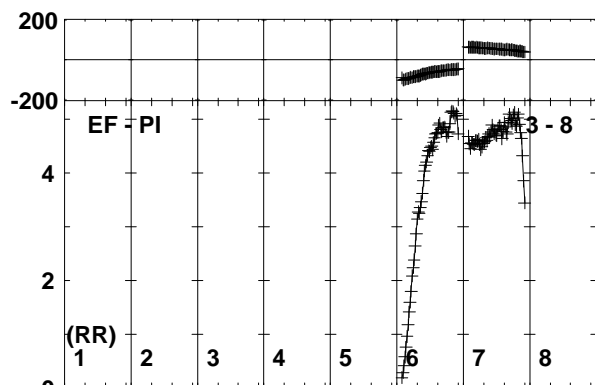
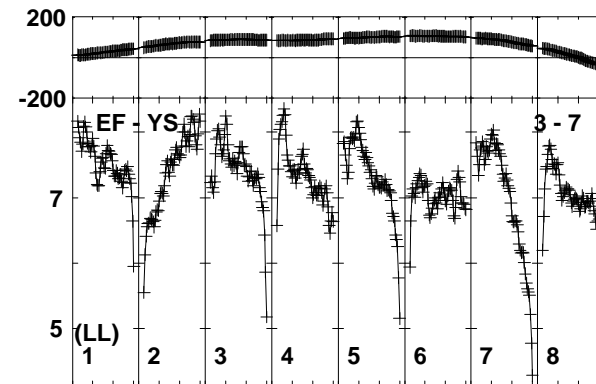
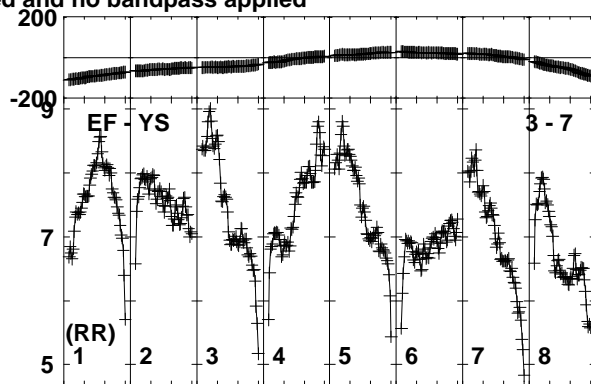
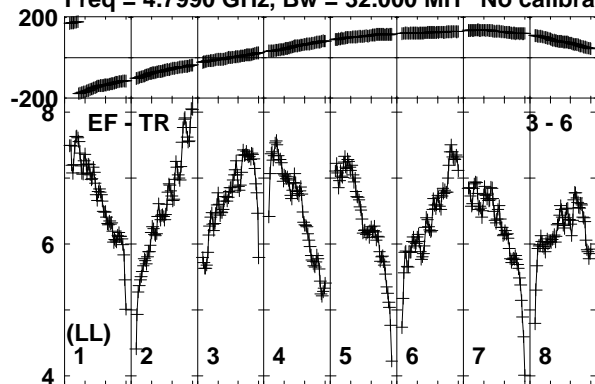

Lower frame: Milli Ampl Jy Top frame: Phas deg  
Vector averaged cross-power spectrum Baseline: EF (03) - TR (06)  
Timerange: 00/22:15:11 to 00/22:16:39

Plot file version 72 created 11-NOV-2019 15:07:24

J1826+0149 EK040B.UVDATA.1

Freq = 4.7990 GHz, Bw = 32.000 MH No calibration applied and no bandpass applied

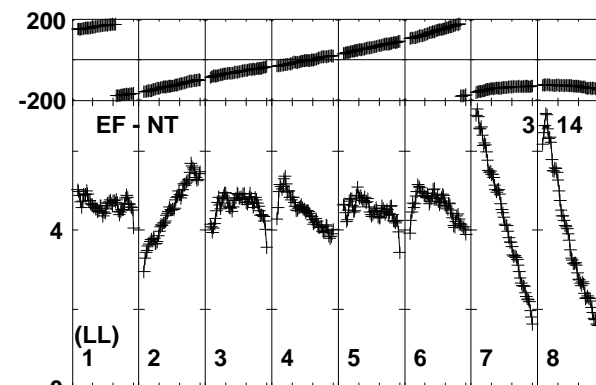
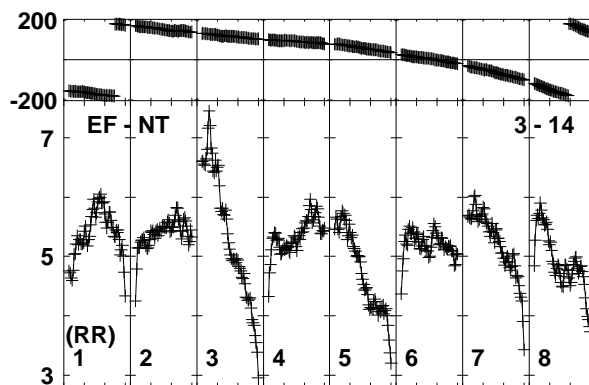
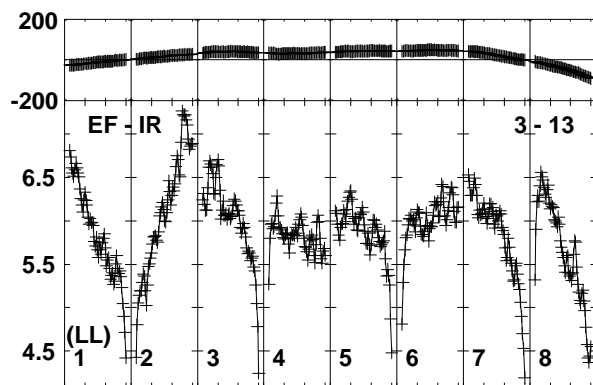
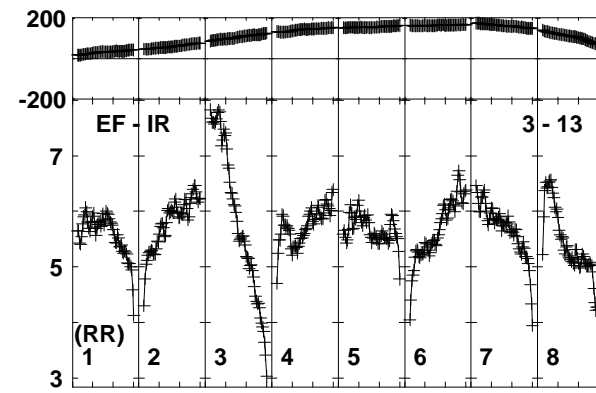
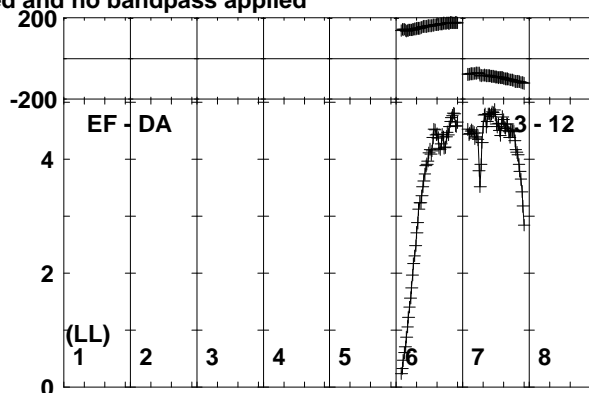
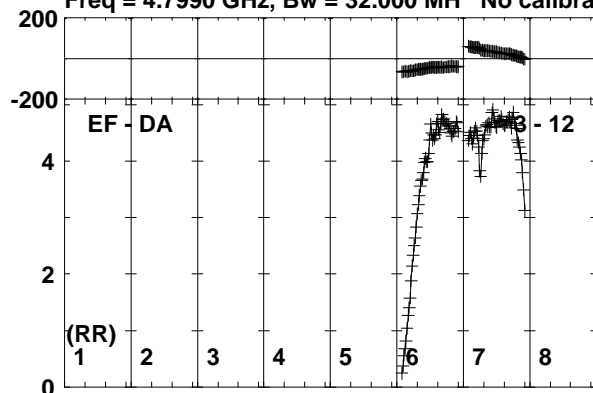

Channels

Lower frame: Milli Ampl Jy Top frame: Phas deg  
Vector averaged cross-power spectrum Baseline: EF (03) - DA (12)  
Timerange: 00/22:15:11 to 00/22:16:39

Plot file version 73 created 11-NOV-2019 15:07:24

SER8NJ EK040B.UVDATA.1

Freq = 4.7990 GHz, Bw = 32.000 MH No calibration applied and no bandpass applied

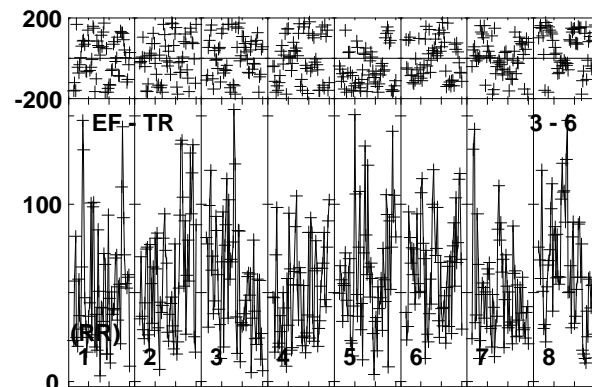
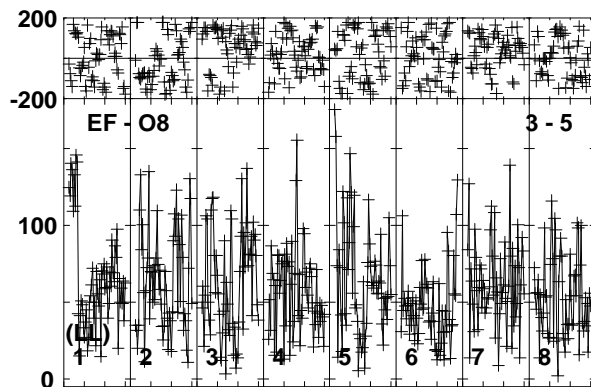
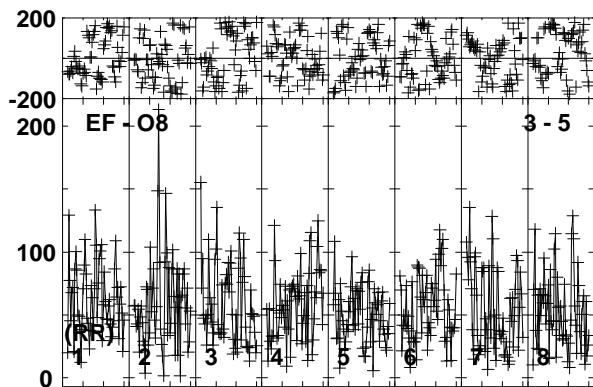
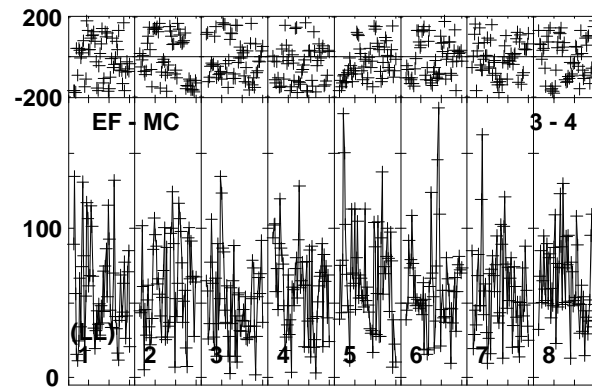
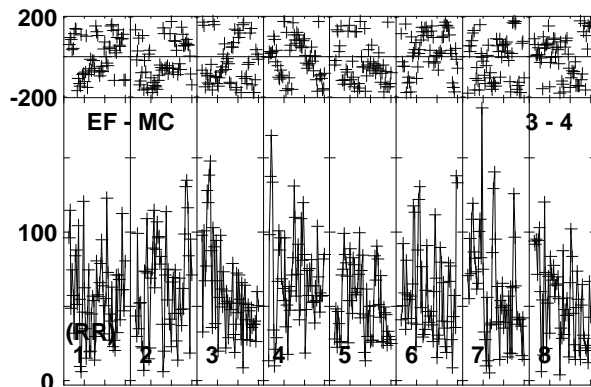
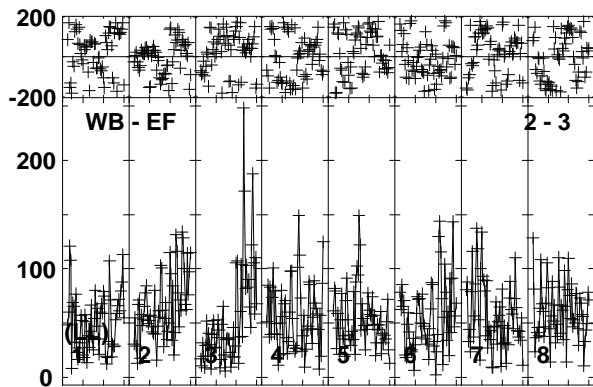
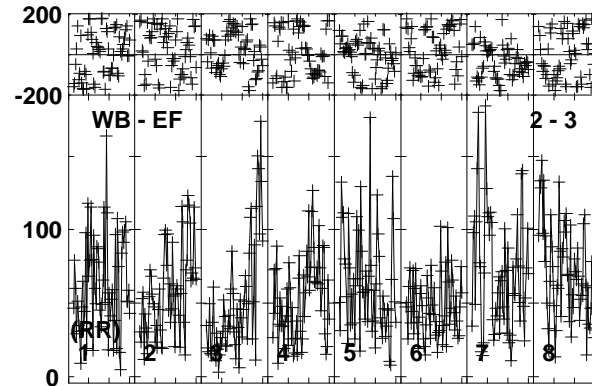
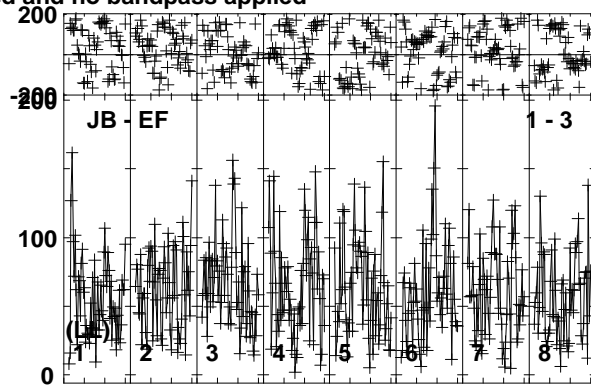
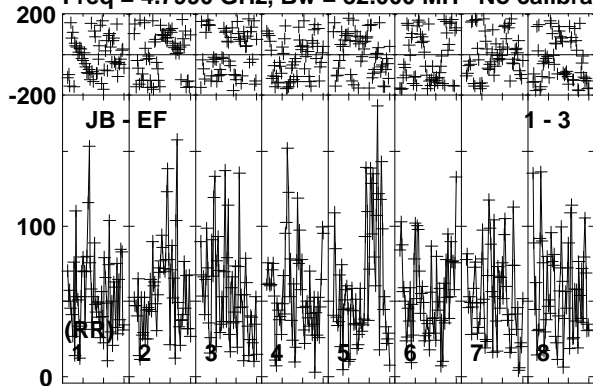

Lower frame: Micro Ampl Jy Top frame: Phas deg  
Vector averaged cross-power spectrum Baseline: JB (01) - EF (03)  
Timerange: 00:22:16:43 to 00:22:20:39

Plot file version 74 created 11-NOV-2019 15:07:24  
SER8NJ\_EK040B.UVDATA.1

Freq = 4.7990 GHz, Bw = 32.000 MH No calibration applied and no bandpass applied

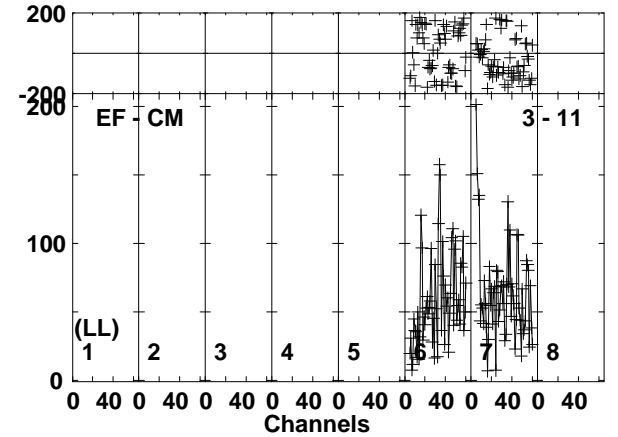
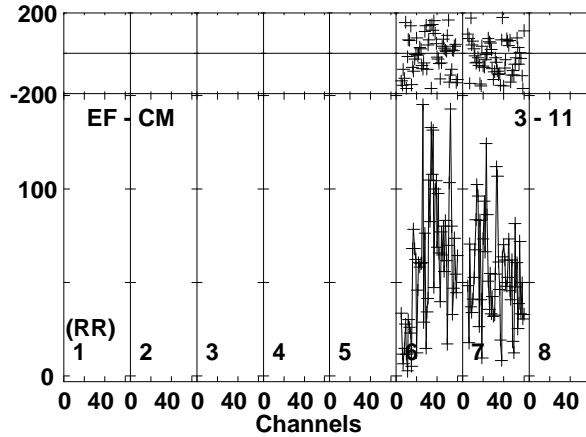
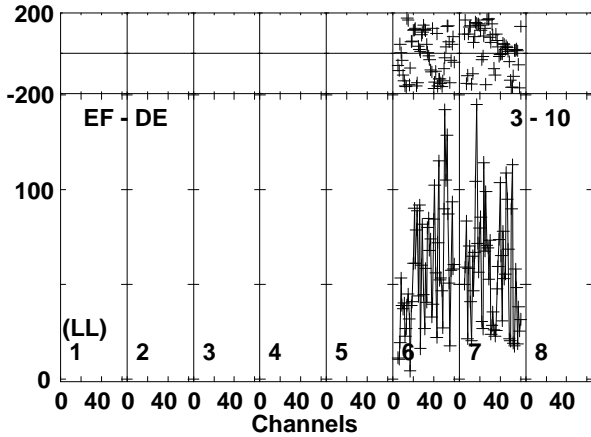
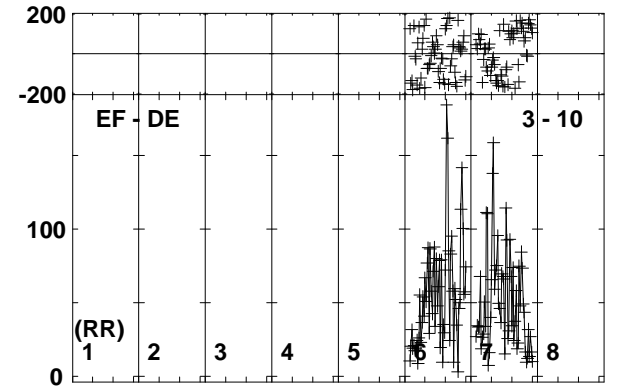
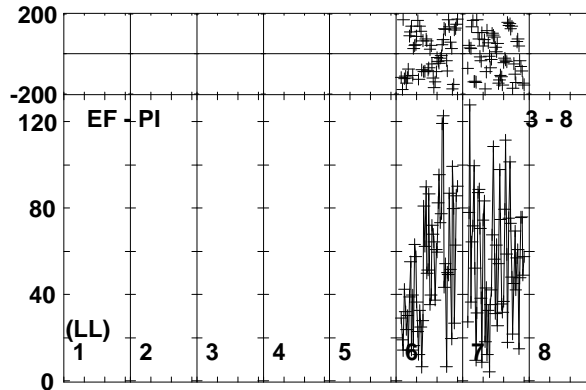
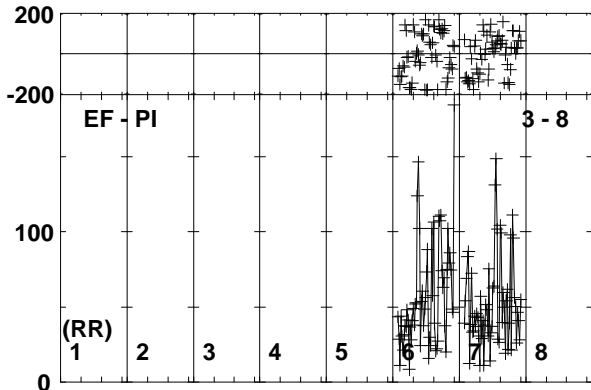
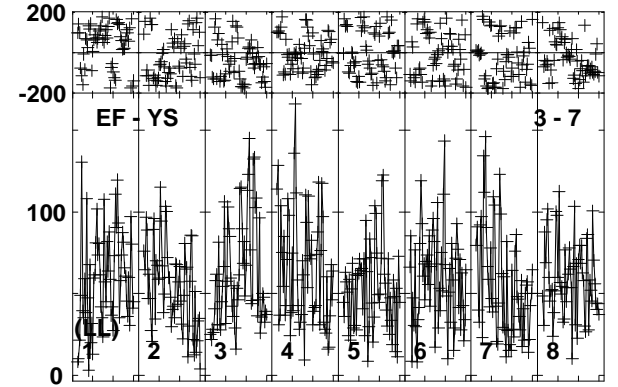
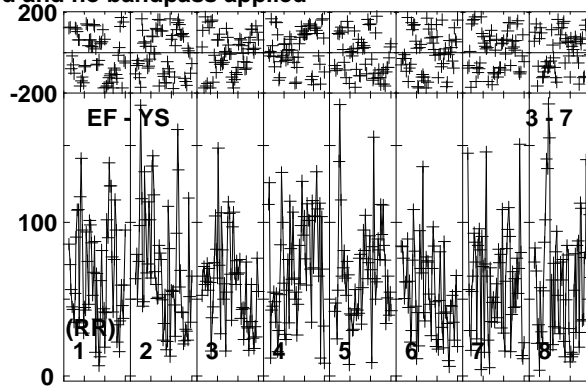
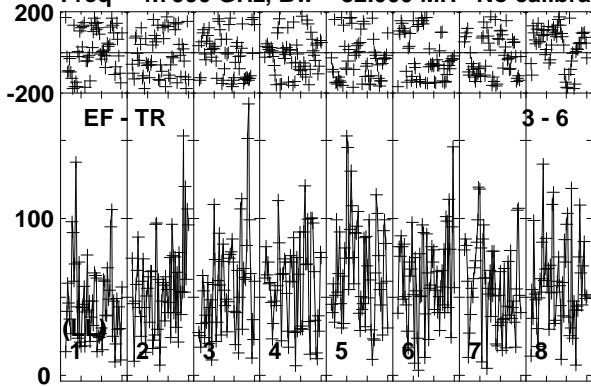

Lower frame: Micro Ampl Jy Top frame: Phas deg  
Vector averaged cross-power spectrum Baseline: EF (03) - TR (06)  
Timerange: 00/22:16:43 to 00/22:20:39



Plot file version 75 created 11-NOV-2019 15:07:24

SER8NJ EK040B.UVDATA.1

Freq = 4.7990 GHz, Bw = 32.000 MH No calibration applied and no bandpass applied

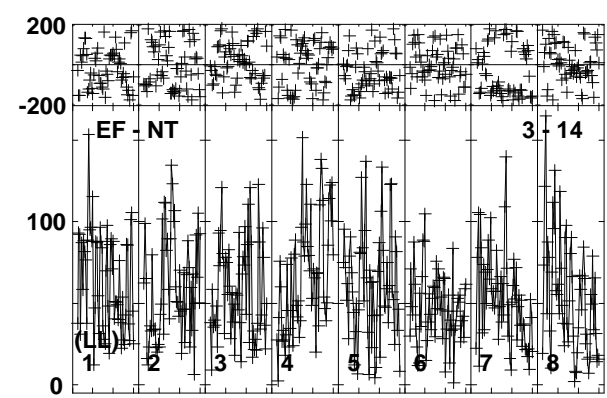
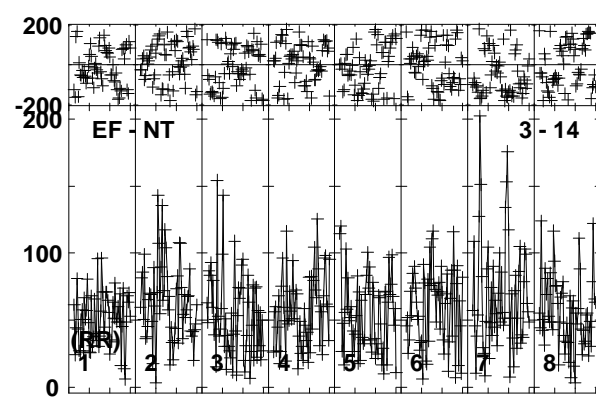
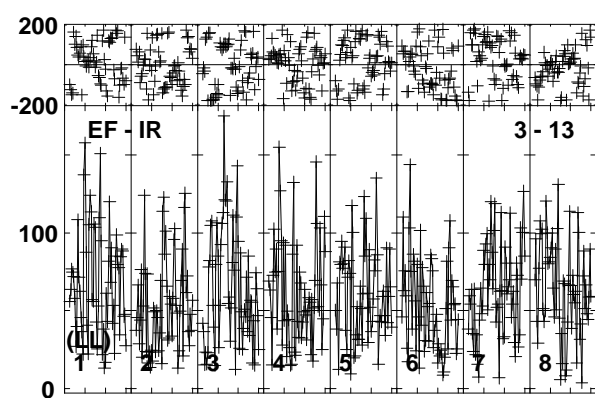
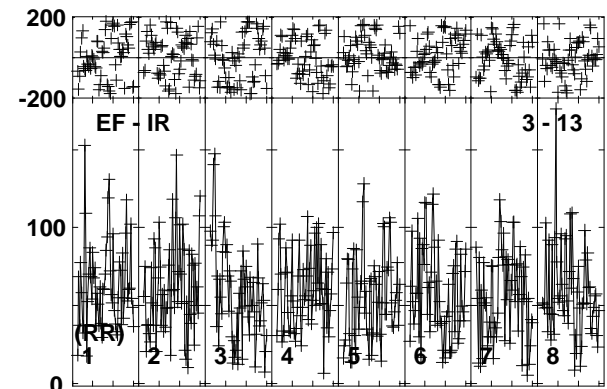
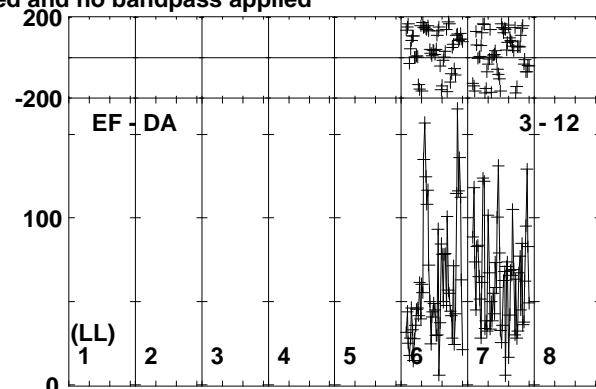
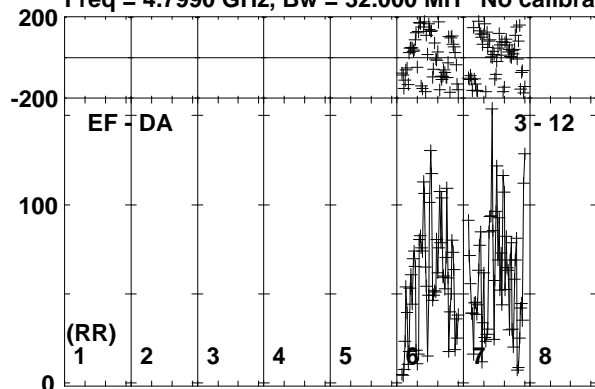

0 40 0 40 0 40 0 40 0 40 0 40 0 40 0 40 0 40 0 40  
Channels

Lower frame: Micro Ampl Jy Top frame: Phas deg  
Vector averaged cross-power spectrum Baseline: EF (03) - DA (12)  
Timerange: 00/22:16:43 to 00/22:20:39

Plot file version 76 created 11-NOV-2019 15:07:24

J1826+0149 EK040B.UVDATA.1

Freq = 4.7990 GHz, Bw = 32.000 MH No calibration applied and no bandpass applied

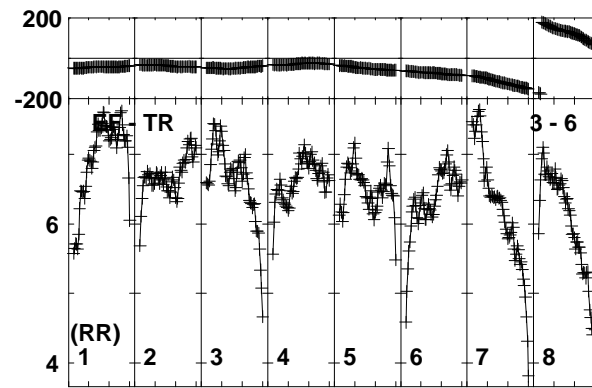
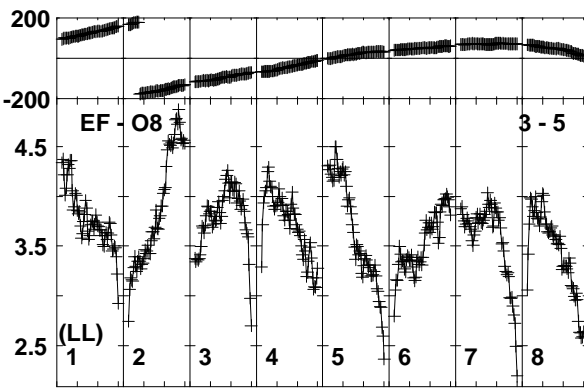
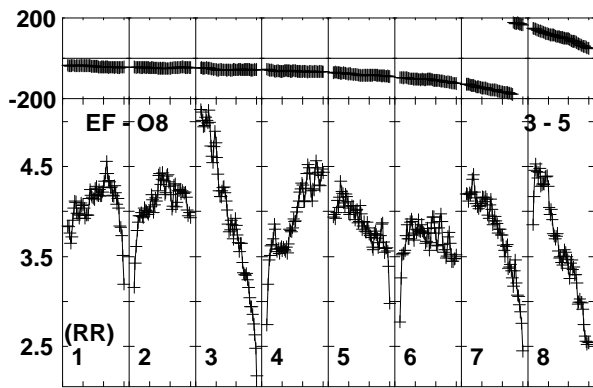
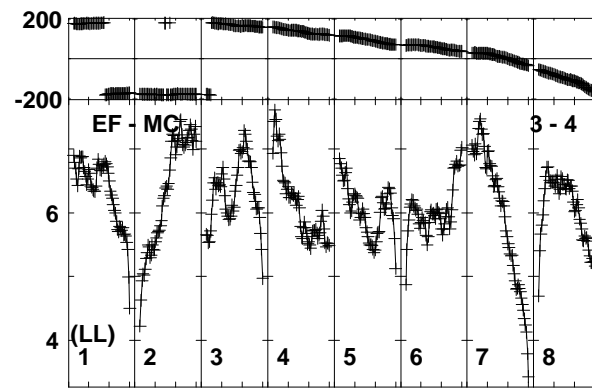
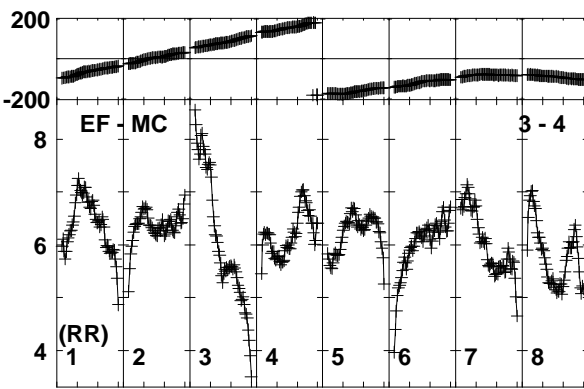
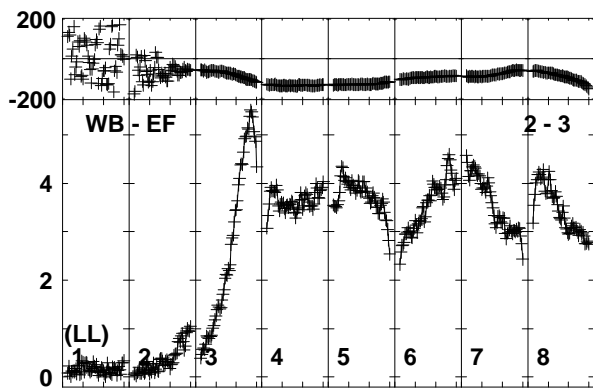
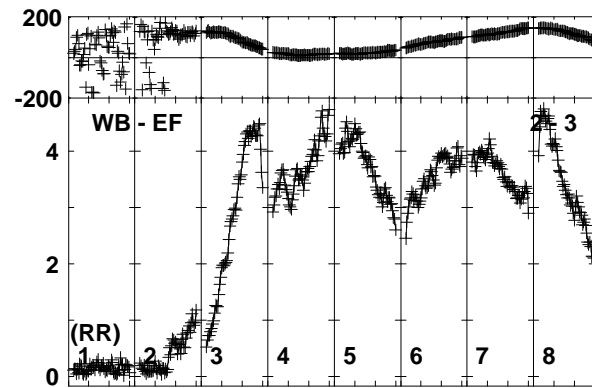
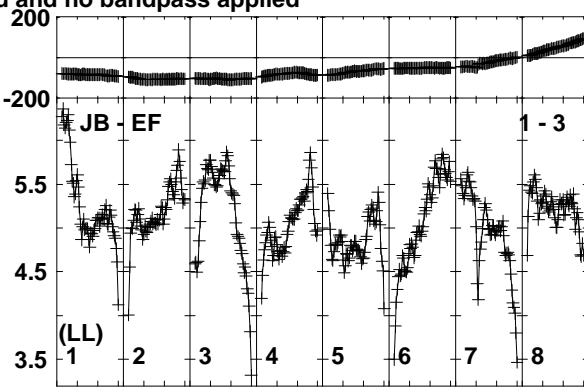
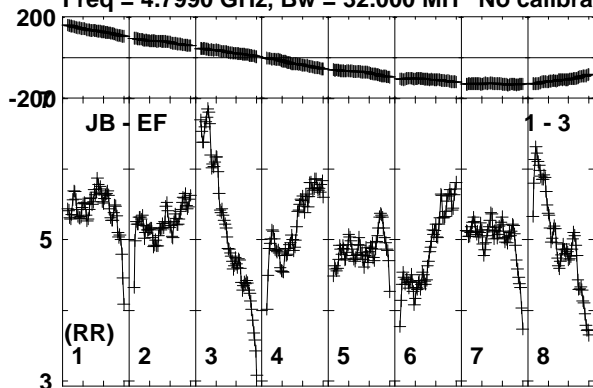

Lower frame: Milli Ampl Jy Top frame: Phas deg  
Vector averaged cross-power spectrum Baseline: JB (01) - EF (03)  
Timerange: 00/22:21:21 to 00/22:22:19

Plot file version 77 created 11-NOV-2019 15:07:25

J1826+0149 EK040B.UVDATA.1

Freq = 4.7990 GHz, Bw = 32.000 MH No calibration applied and no bandpass applied

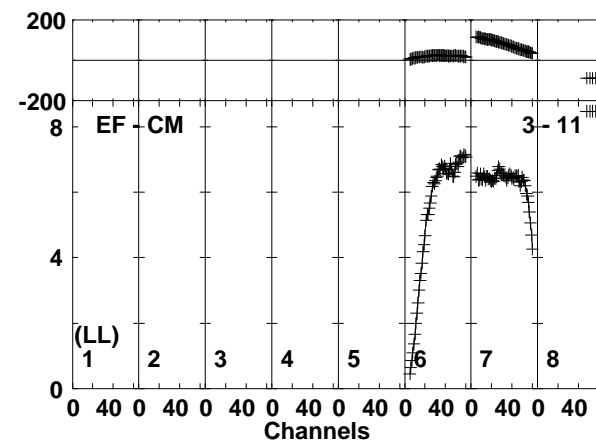
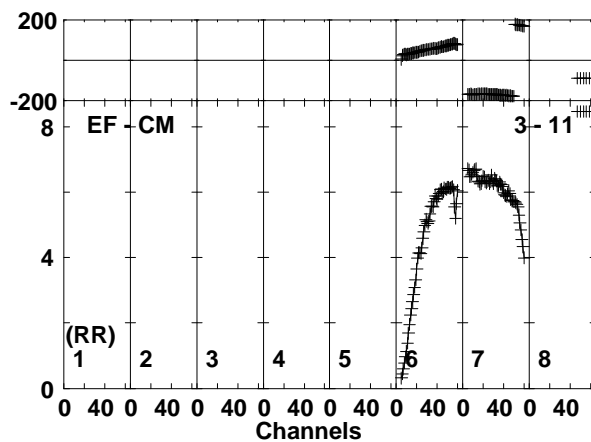
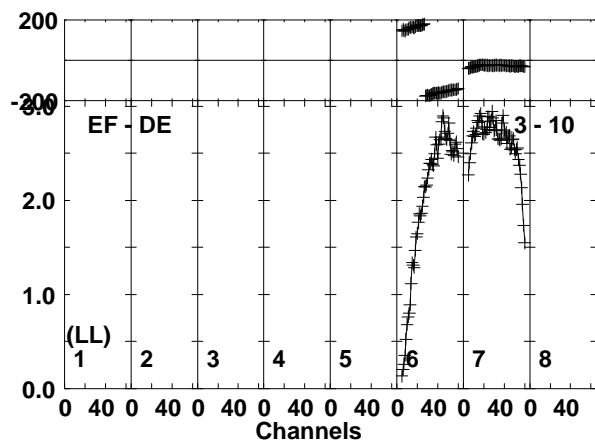
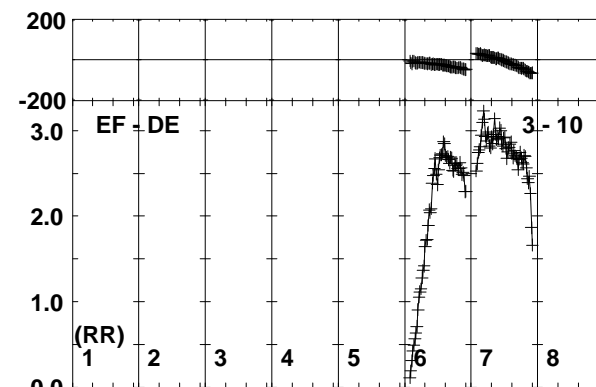
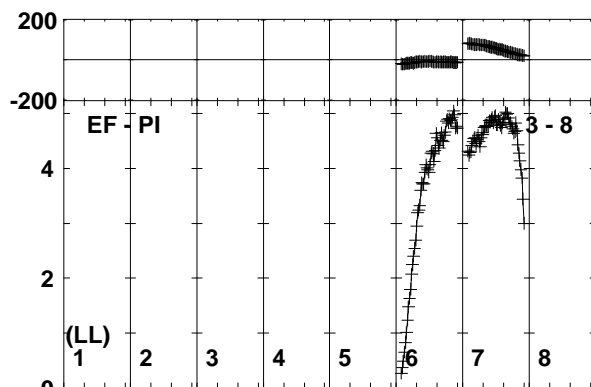
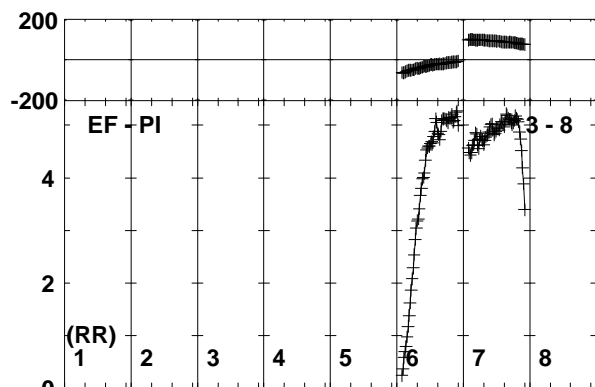
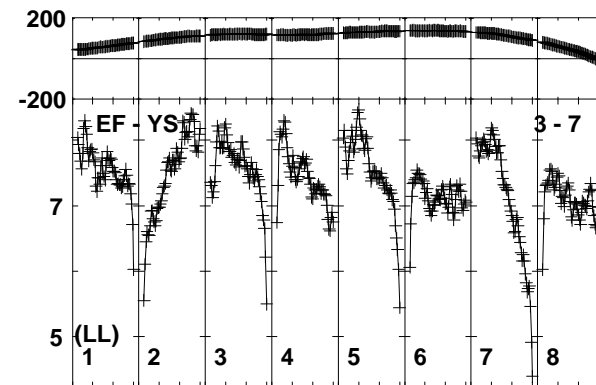
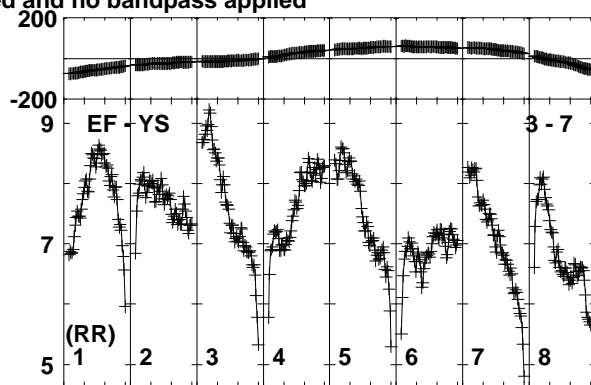
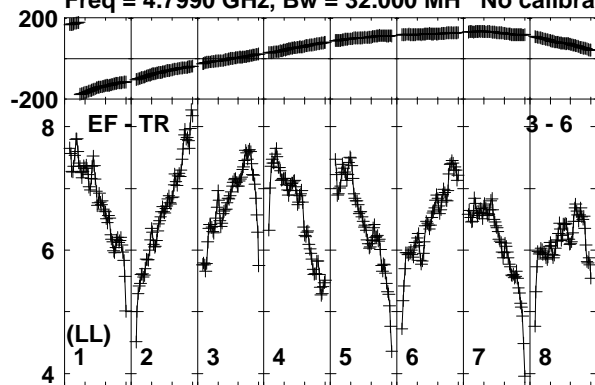

Lower frame: Milli Ampl Jy Top frame: Phas deg  
Vector averaged cross-power spectrum Baseline: EF (03) - TR (06)  
Timerange: 00/22:21:21 to 00/22:22:19

Plot file version 78 created 11-NOV-2019 15:07:25

J1826+0149 EK040B.UVDATA.1

Freq = 4.7990 GHz, Bw = 32.000 MH No calibration applied and no bandpass applied

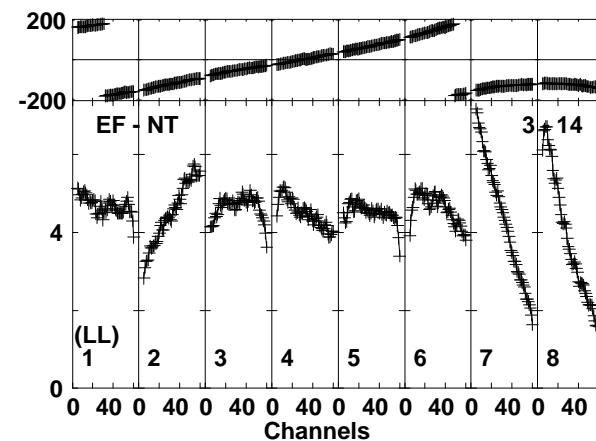
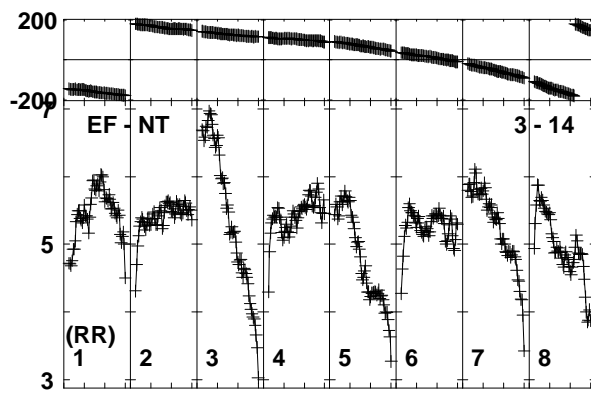
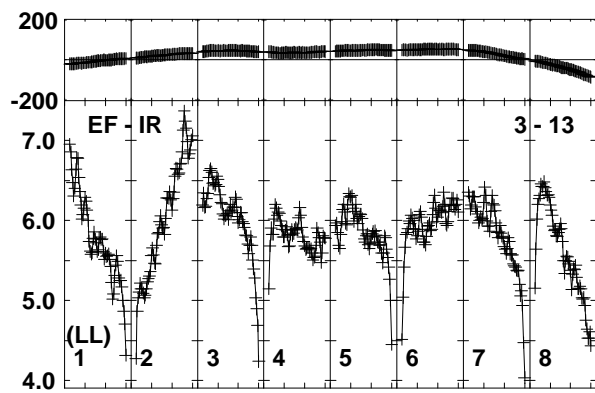
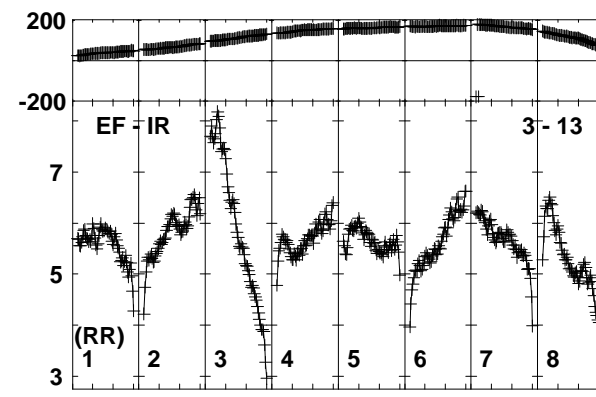
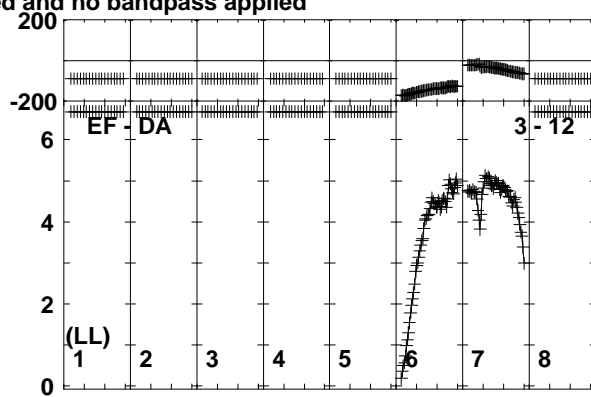
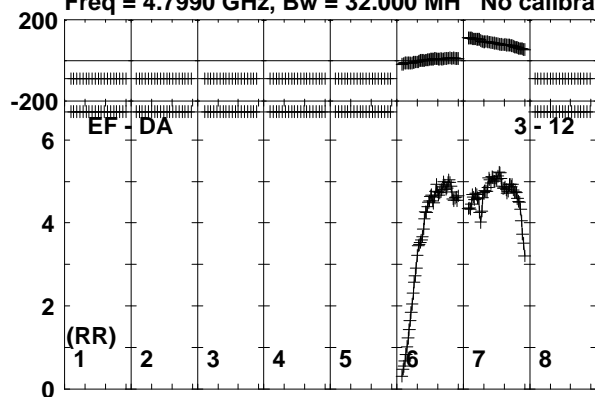

Lower frame: Milli Ampl Jy Top frame: Phas deg  
Vector averaged cross-power spectrum Baseline: EF (03) - DA (12)  
Timerange: 00:22:21:21 to 00:22:22:19

Plot file version 79 created 11-NOV-2019 15:07:25

SER8NJ EK040B.UVDATA.1

Freq = 4.7990 GHz, Bw = 32.000 MH No calibration applied and no bandpass applied

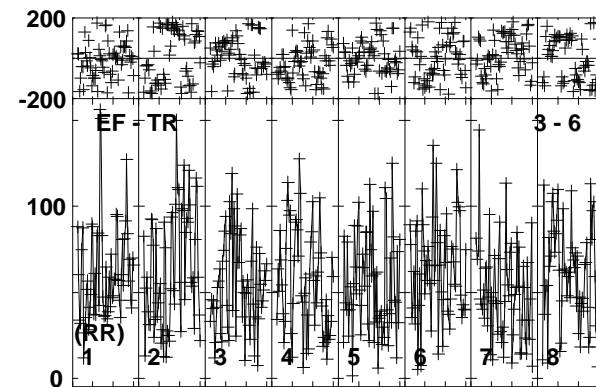
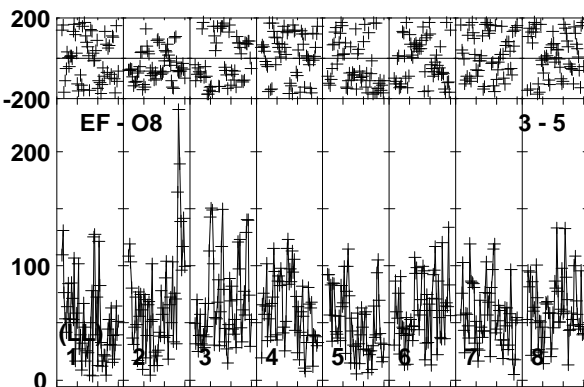
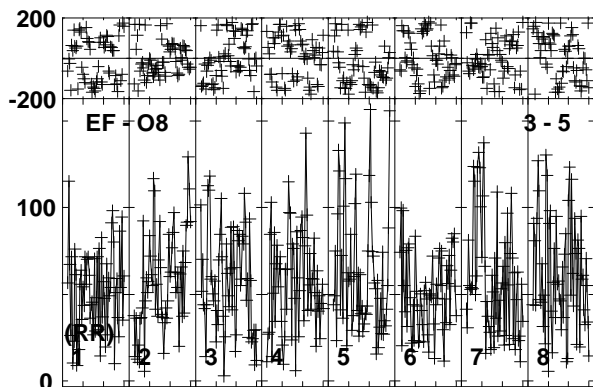
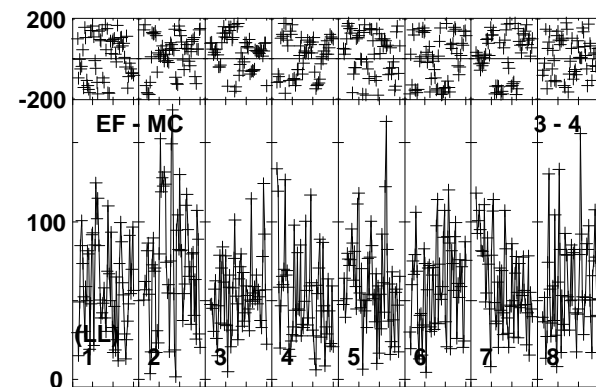
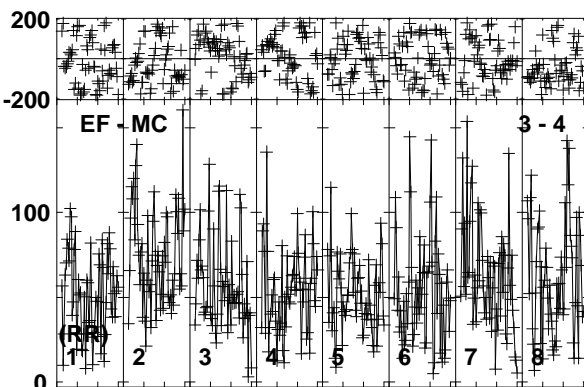
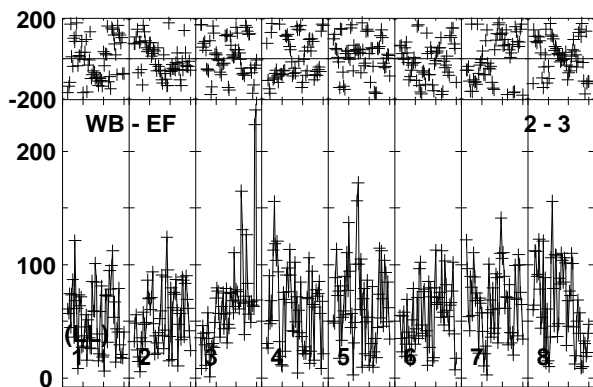
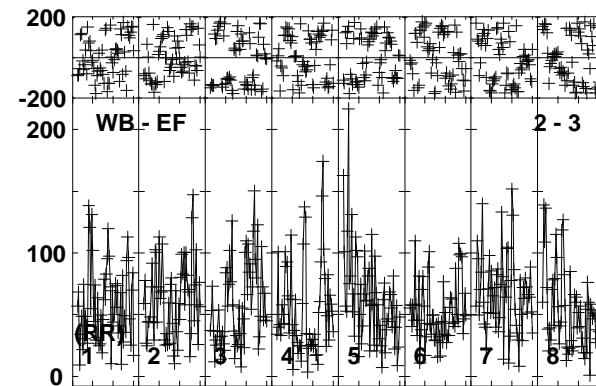
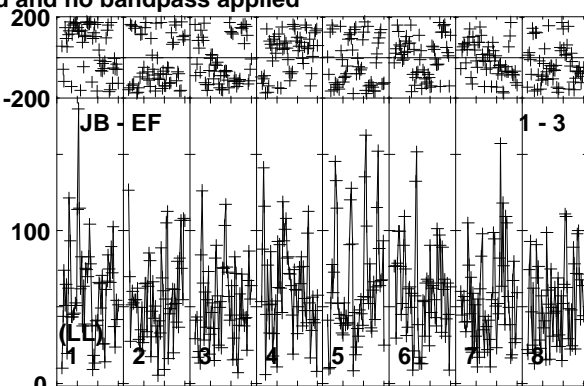
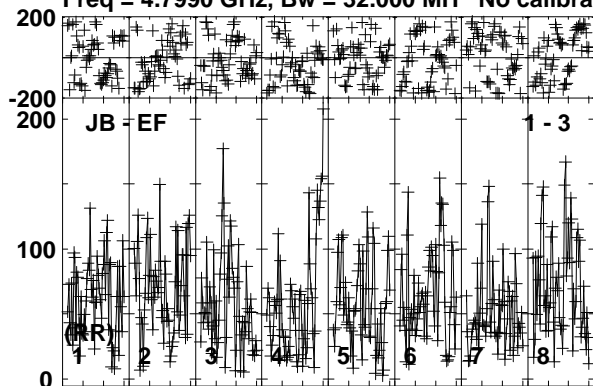

Lower frame: Micro Ampl Jy Top frame: Phas deg  
Vector averaged cross-power spectrum Baseline: JB (01) - EF (03)  
Timerange: 00/22:22:23 to 00/22:26:19

Plot file version 80 created 11-NOV-2019 15:07:25

SER8NJ EK040B.UVDATA.1

Freq = 4.7990 GHz, Bw = 32.000 MH No calibration applied and no bandpass applied

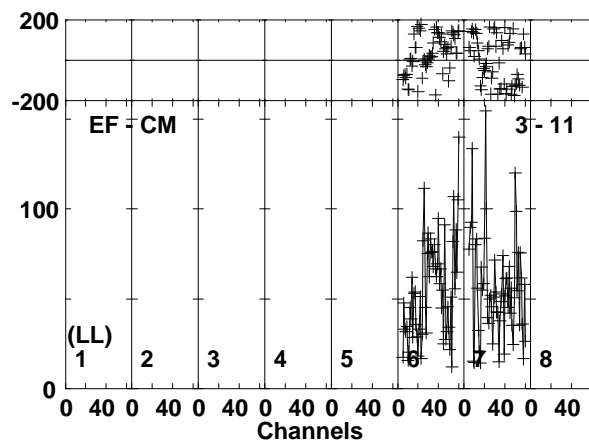
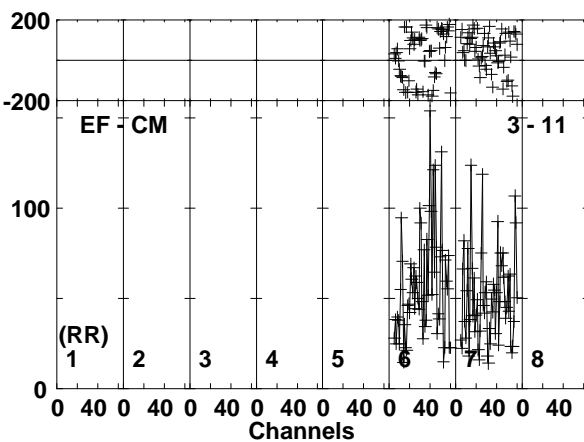
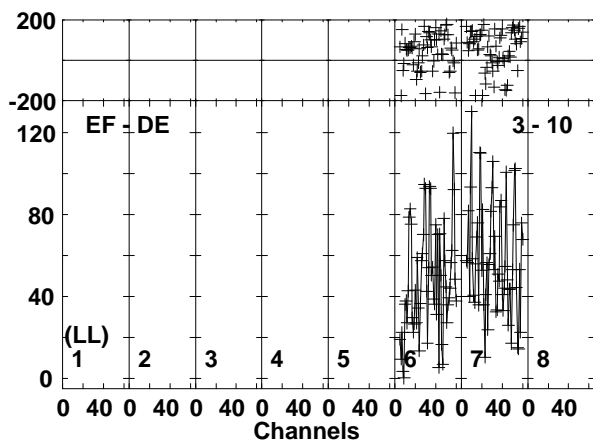
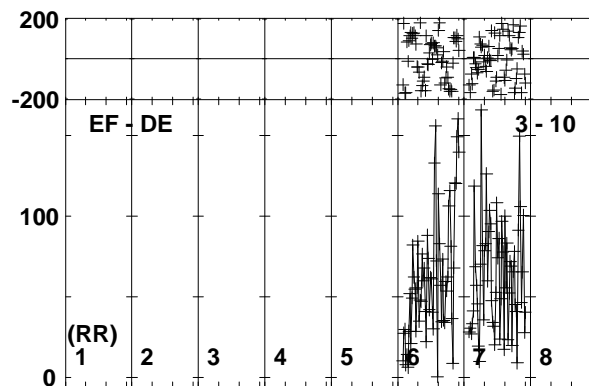
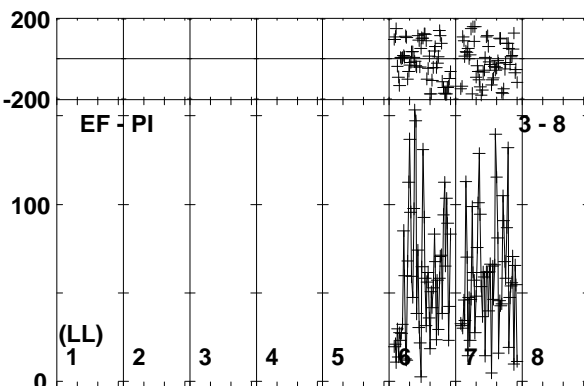
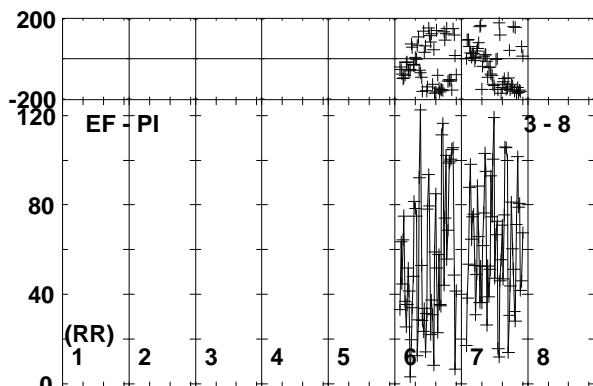
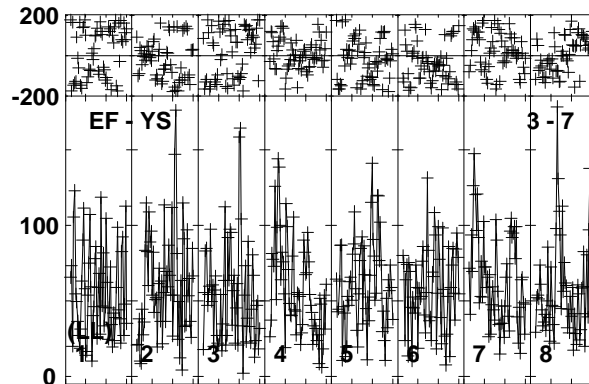
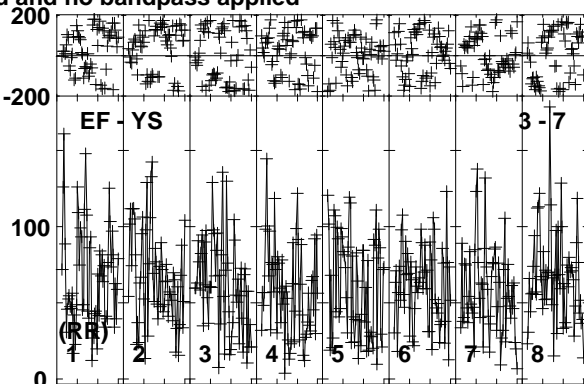
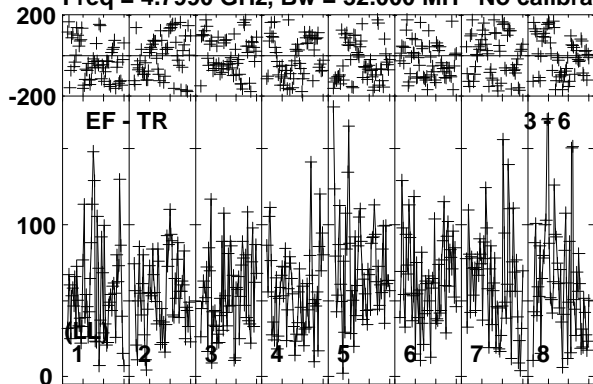

Lower frame: Micro Ampl Jy Top frame: Phas deg  
Vector averaged cross-power spectrum Baseline: EF (03) - TR (06)  
Timerange: 00/22:22:23 to 00/22:26:19

Plot file version 81 created 11-NOV-2019 15:07:25

SER8NJ EK040B.UVDATA.1

Freq = 4.7990 GHz, Bw = 32.000 MH No calibration applied and no bandpass applied

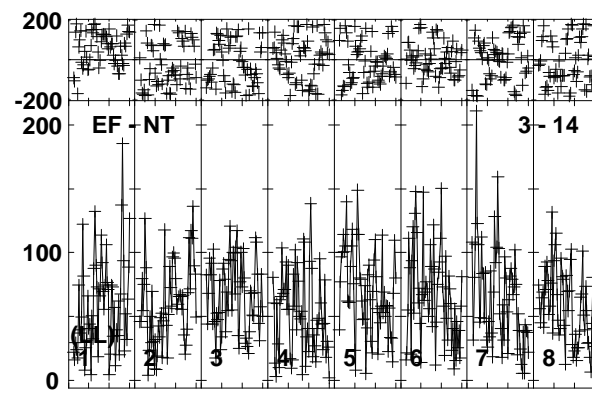
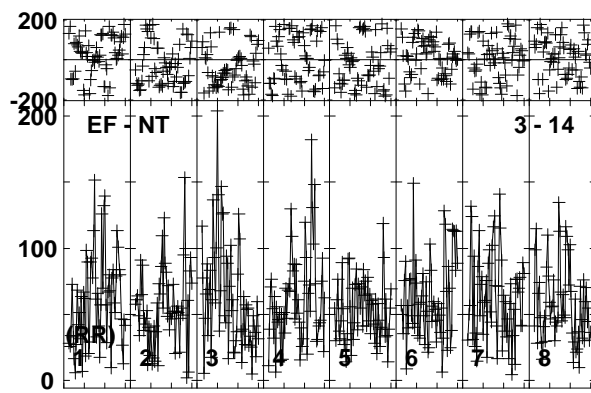
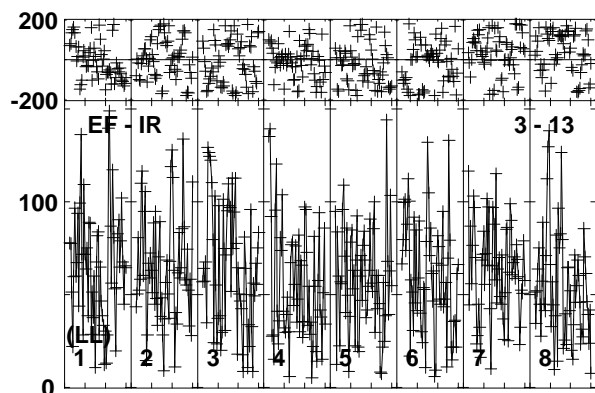
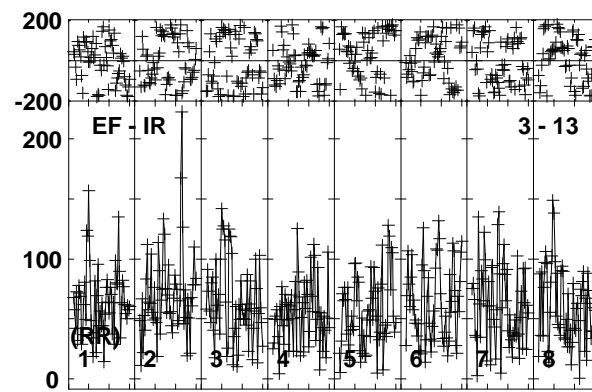
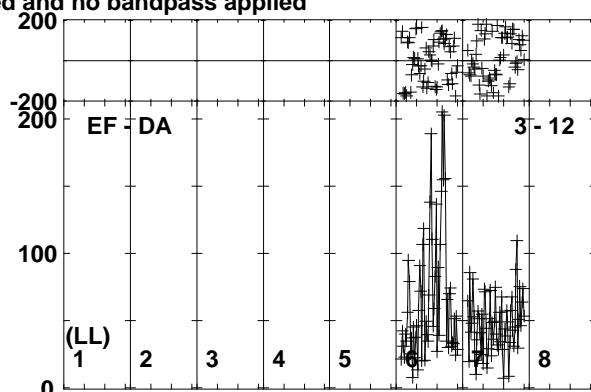
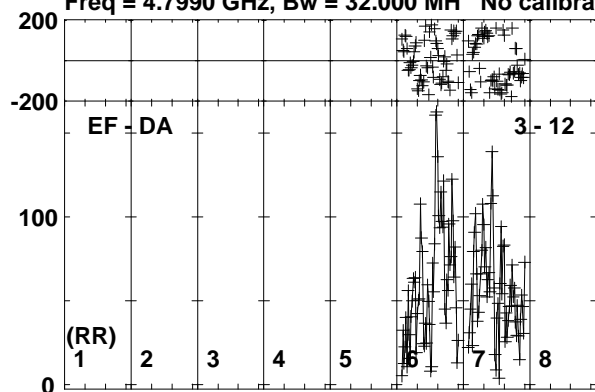

0 40 0 40 0 40 0 40 0 40 0 40 0 40 0 40 0 40 0 40  
Channels

Lower frame: Micro Ampl Jy Top frame: Phas deg  
Vector averaged cross-power spectrum Baseline: EF (03) - DA (12)  
Timerange: 00/22:22:23 to 00/22:26:19

Plot file version 82 created 11-NOV-2019 15:07:25

J1826+0149 EK040B.UVDATA.1

Freq = 4.7990 GHz, Bw = 32.000 MH No calibration applied and no bandpass applied

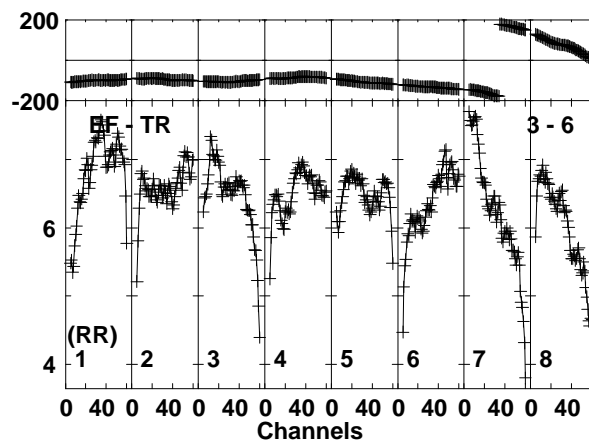
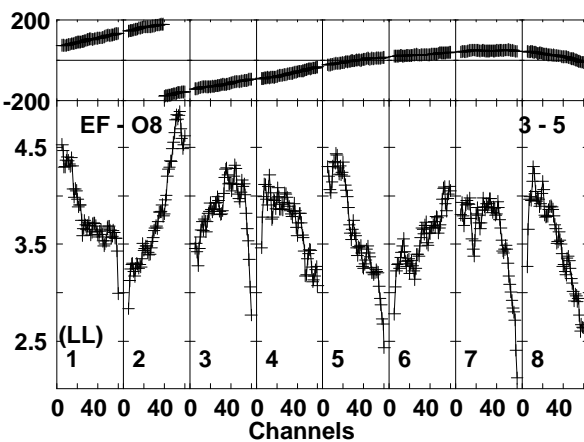
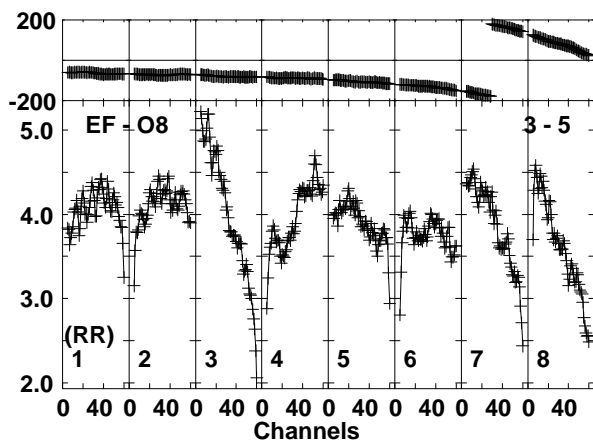
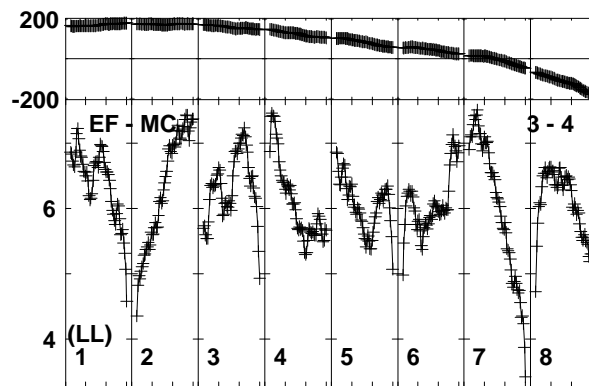
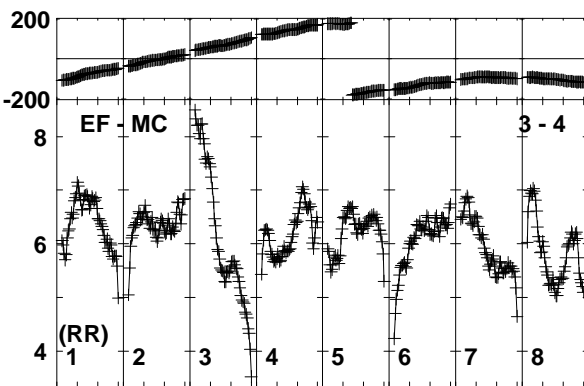
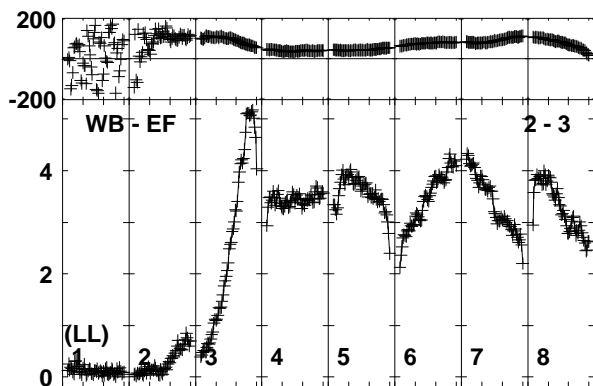
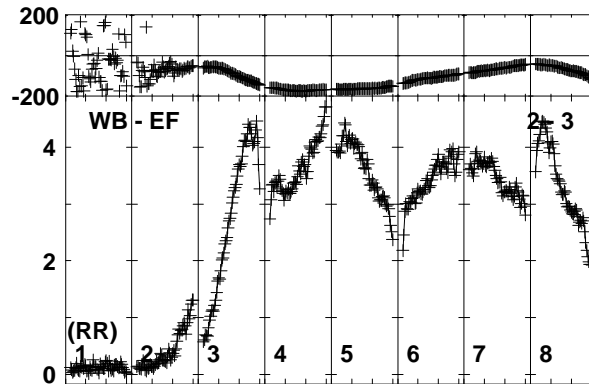
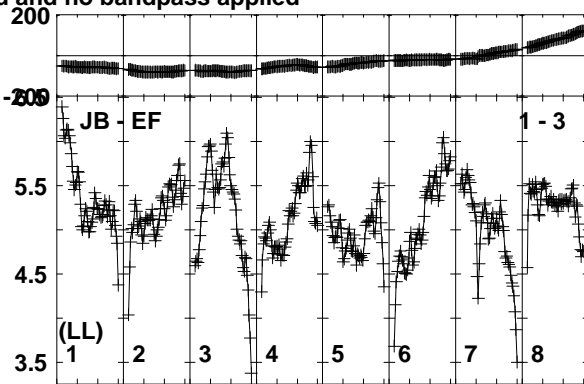
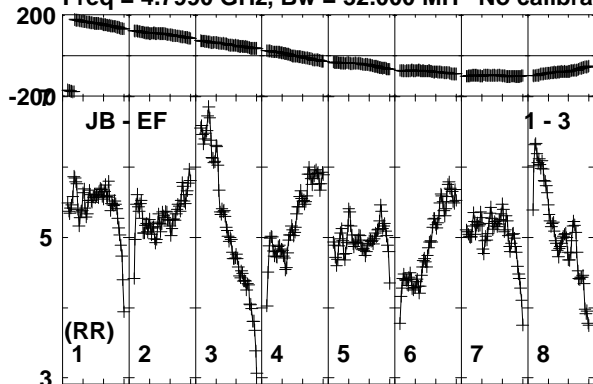

Lower frame: Milli Ampl Jy Top frame: Phas deg  
Vector averaged cross-power spectrum Baseline: JB (01) - EF (03)  
Timerange: 00:22:26:23 to 00:22:27:49



Plot file version 83 created 11-NOV-2019 15:07:25

J1826+0149 EK040B.UVDATA.1

Freq = 4.7990 GHz, Bw = 32.000 MH No calibration applied and no bandpass applied

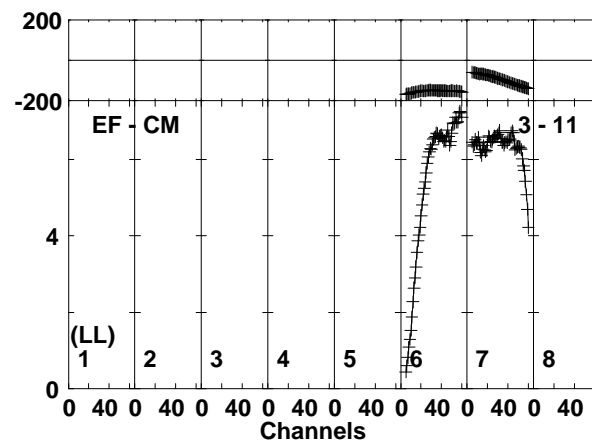
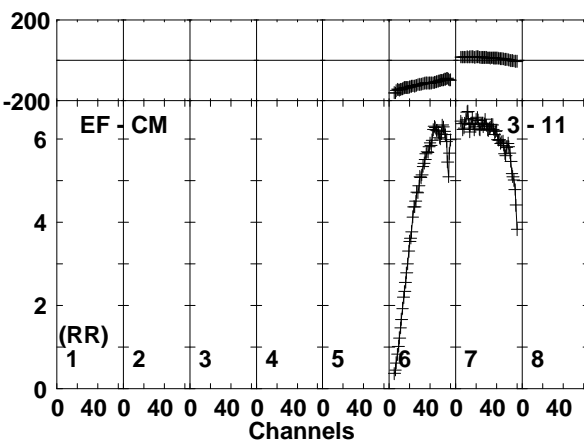
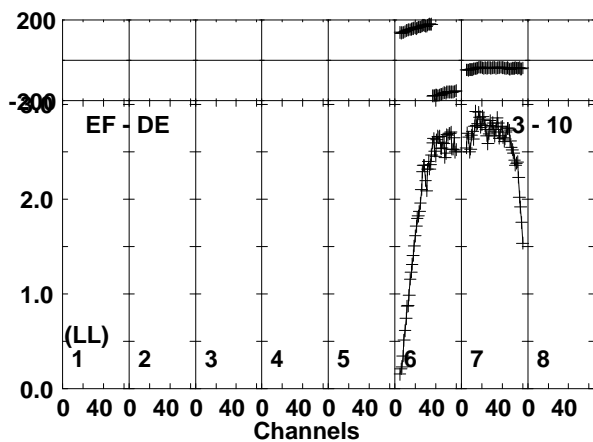
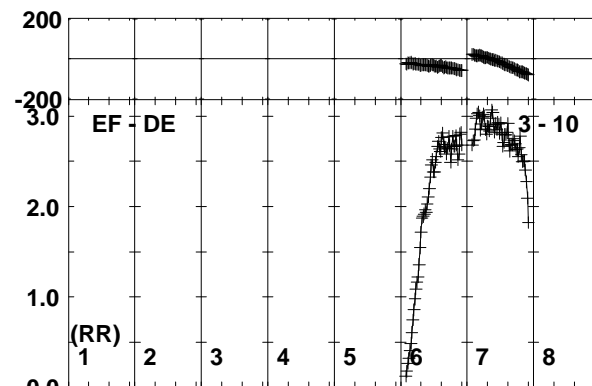
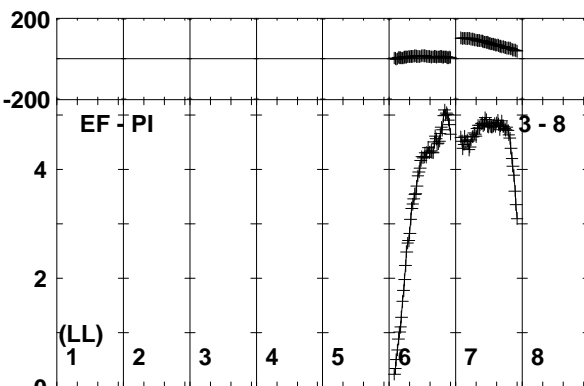
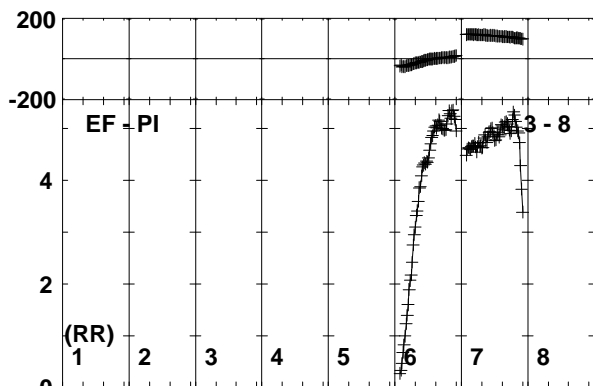
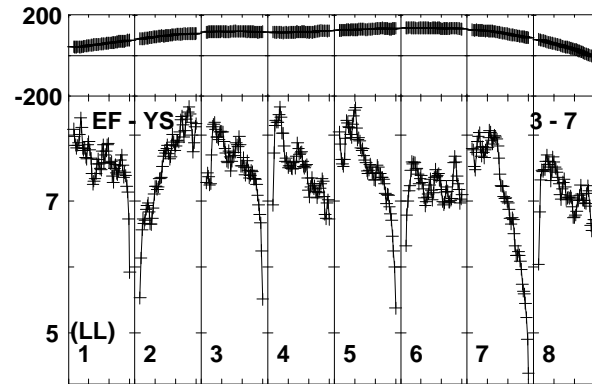
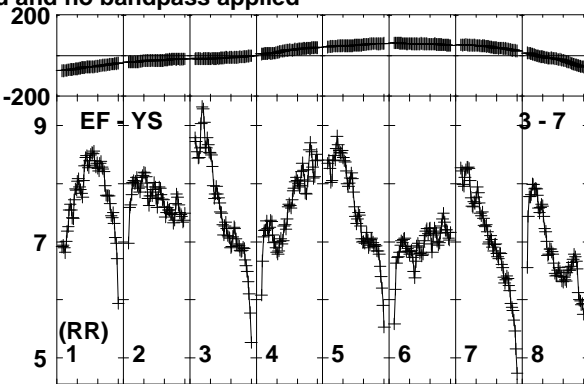
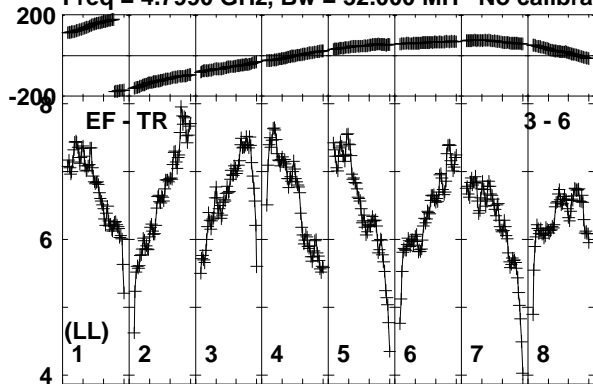

Lower frame: Milli Ampl Jy Top frame: Phas deg  
Vector averaged cross-power spectrum Baseline: EF (03) - TR (06)  
Timerange: 00/22:26:23 to 00/22:27:49

Plot file version 84 created 11-NOV-2019 15:07:25

J1826+0149 EK040B.UVDATA.1

Freq = 4.7990 GHz, Bw = 32.000 MH No calibration applied and no bandpass applied

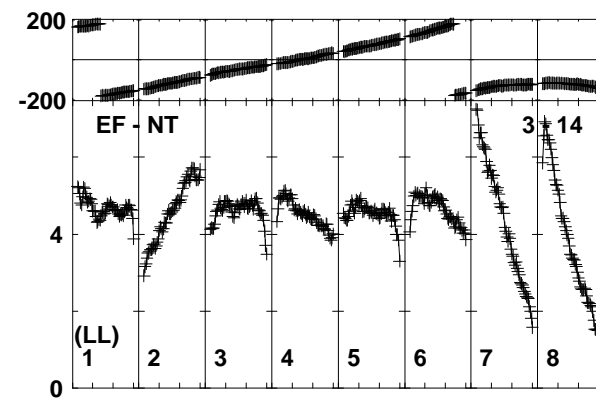
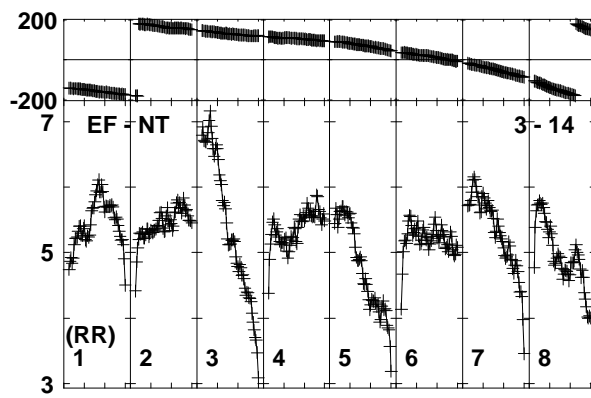
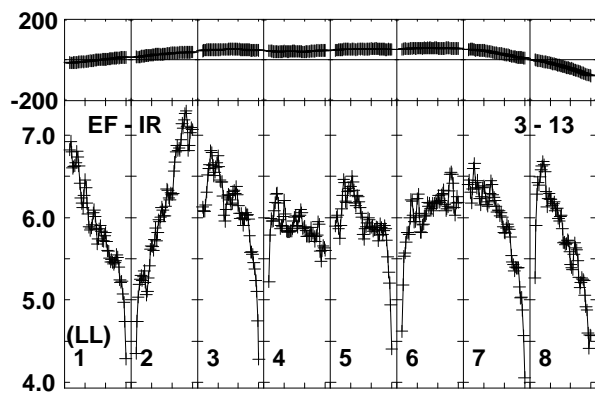
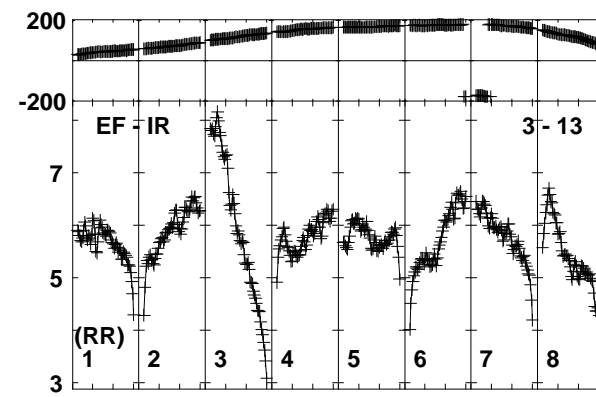
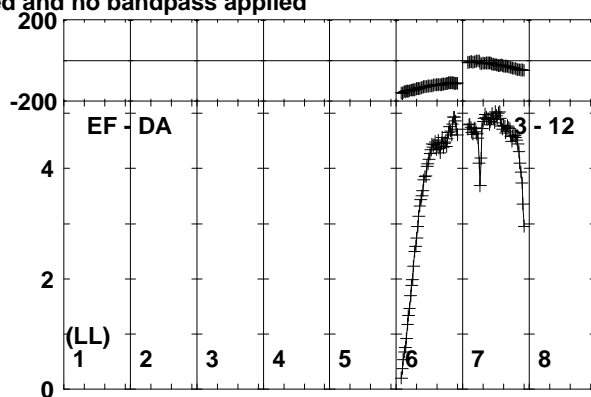
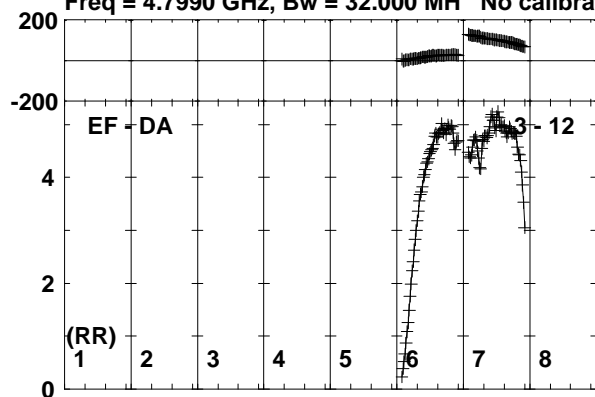

Lower frame: Milli Ampl Jy Top frame: Phas deg  
Vector averaged cross-power spectrum Baseline: EF (03) - DA (12)  
Timerange: 00/22:26:23 to 00/22:27:49

Plot file version 85 created 11-NOV-2019 15:07:25

SER8NJ EK040B.UVDATA.1

Freq = 4.7990 GHz, Bw = 32.000 MH No calibration applied and no bandpass applied

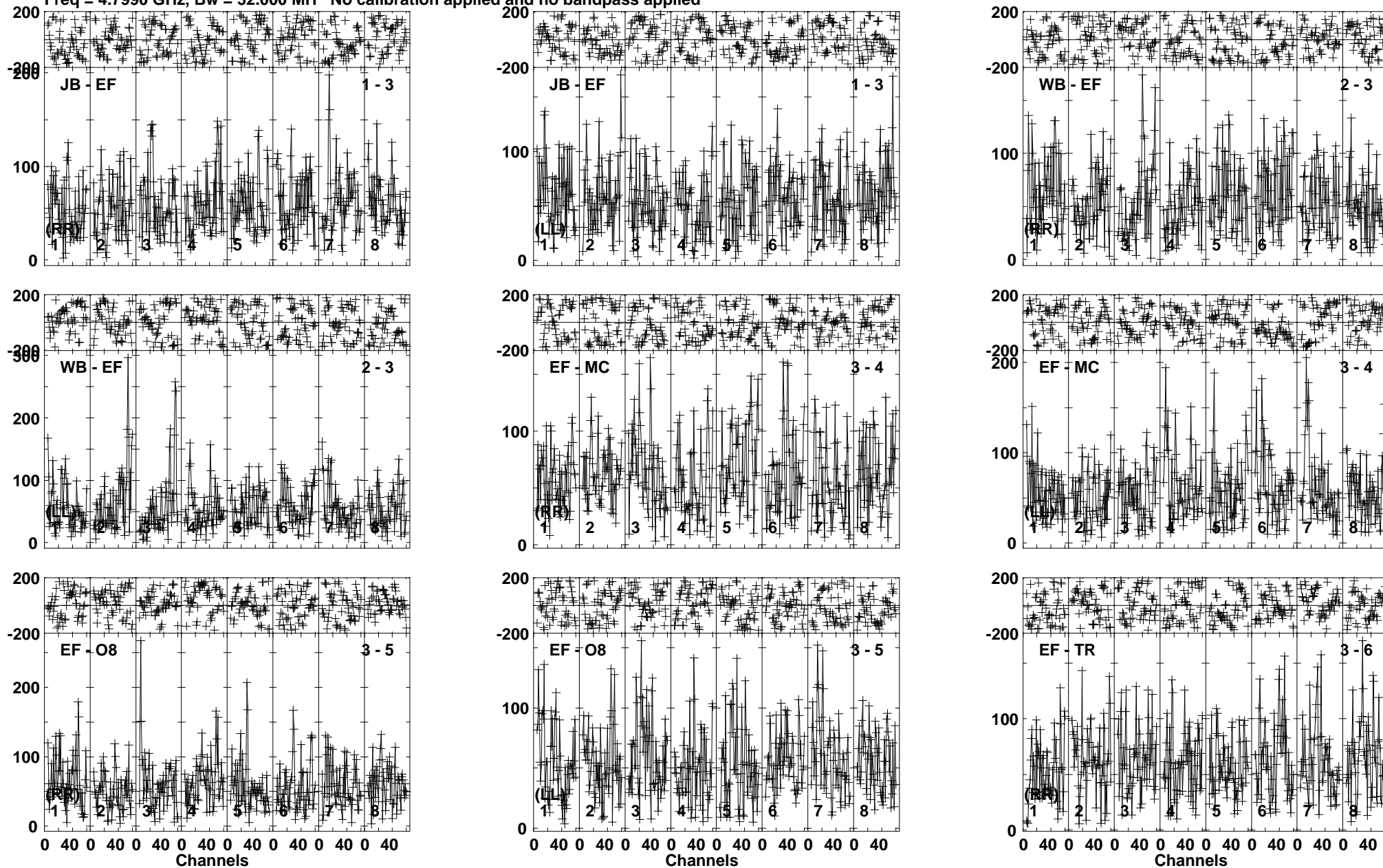

Lower frame: Micro Ampl Jy Top frame: Phas deg  
Vector averaged cross-power spectrum Baseline: JB (01) - EF (03)  
Timerange: 00:22:27:53 to 00:22:31:49

Plot file version 86 created 11-NOV-2019 15:07:26

SER8NJ EK040B.UVDATA.1

Freq = 4.7990 GHz, Bw = 32.000 MH No calibration applied and no bandpass applied

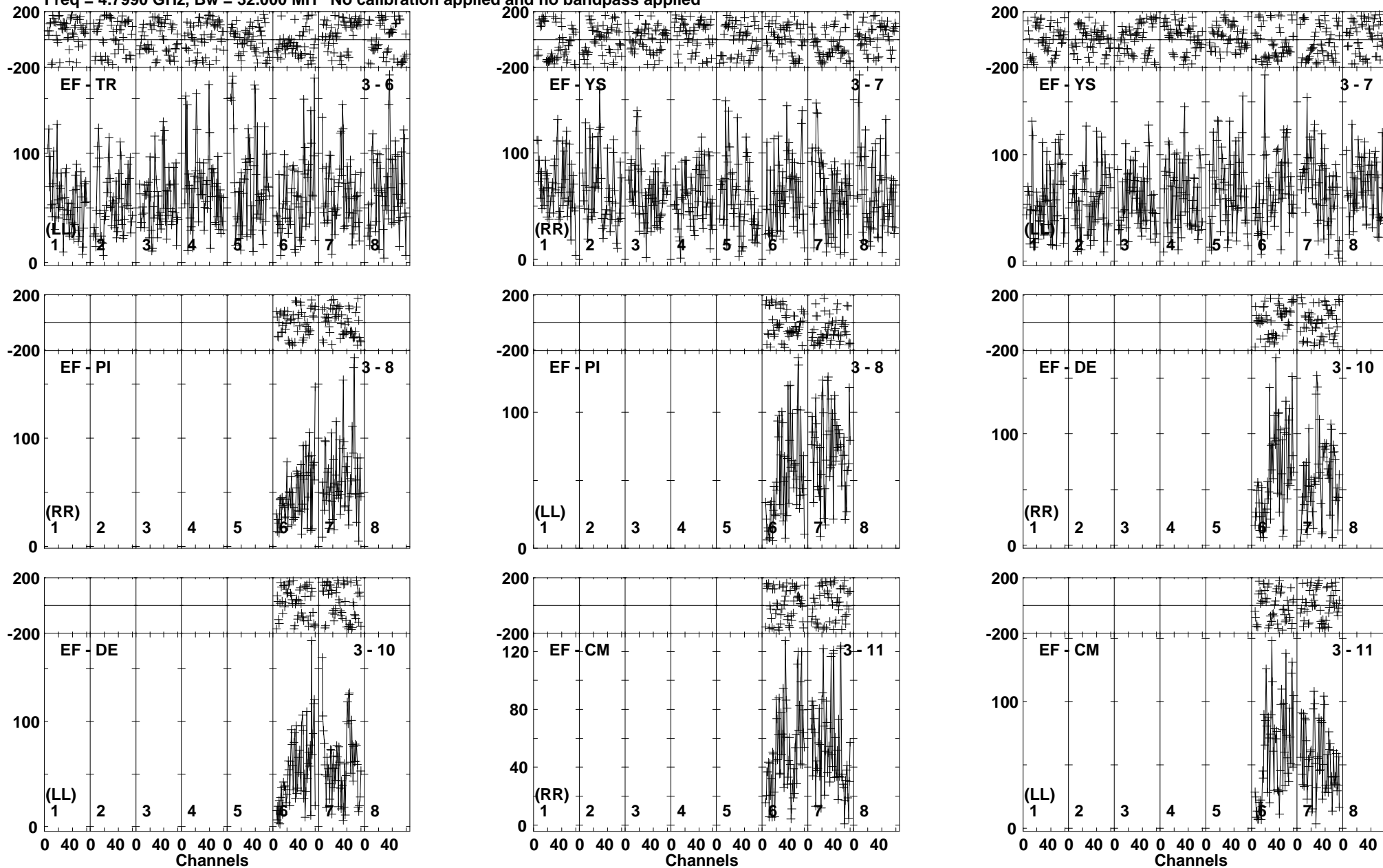

Lower frame: Micro Ampl Jy Top frame: Phas deg  
Vector averaged cross-power spectrum Baseline: EF (03) - TR (06)  
Timerange: 00/22:27:53 to 00/22:31:49

Plot file version 87 created 11-NOV-2019 15:07:26  
 SER8NJ EK040B.UVDATA.1  
 Freq = 4.7990 GHz, Bw = 32.000 MH No calibration applied and no bandpass applied

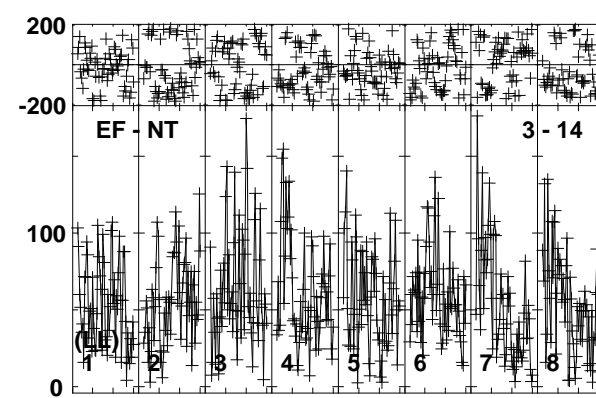
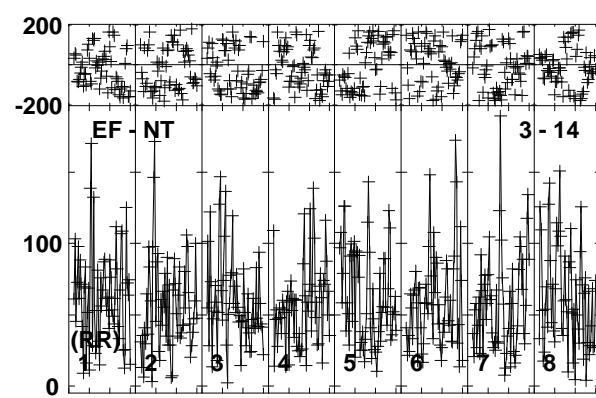
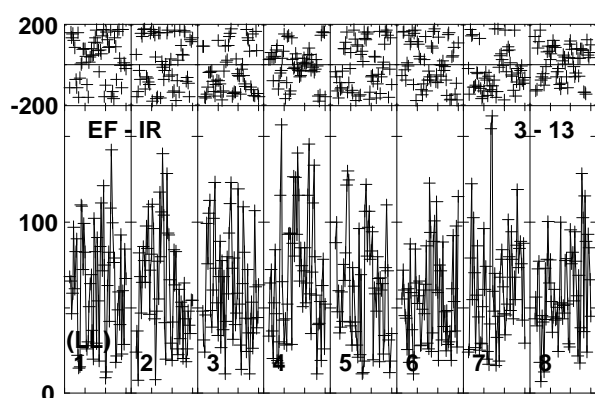
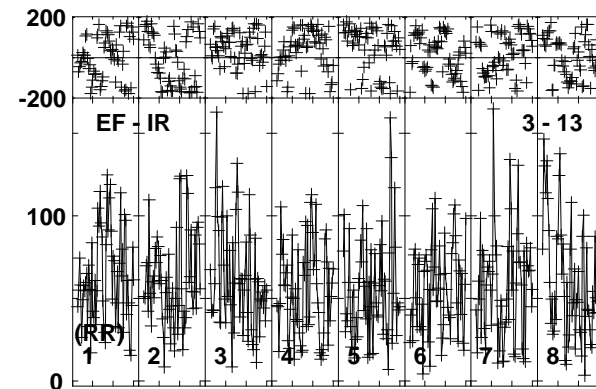
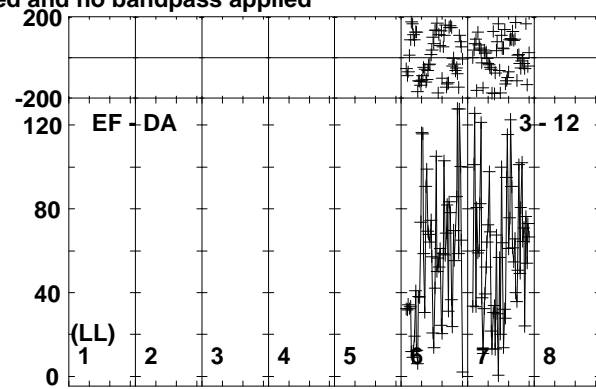
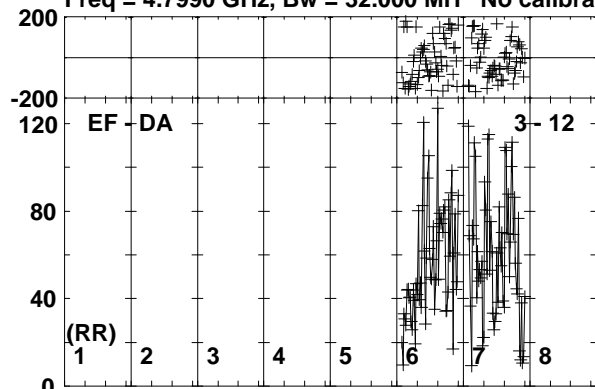

0 40 0 40 0 40 0 40 0 40 0 40 0 40 0 40 0 40  
 Channels

Lower frame: Micro Ampl Jy Top frame: Phas deg  
 Vector averaged cross-power spectrum Baseline: EF (03) - DA (12)  
 Timerange: 00/22:27:53 to 00/22:31:49

Plot file version 88 created 11-NOV-2019 15:07:26

J1826+0149 EK040B.UVDATA.1

Freq = 4.7990 GHz, Bw = 32.000 MH No calibration applied and no bandpass applied

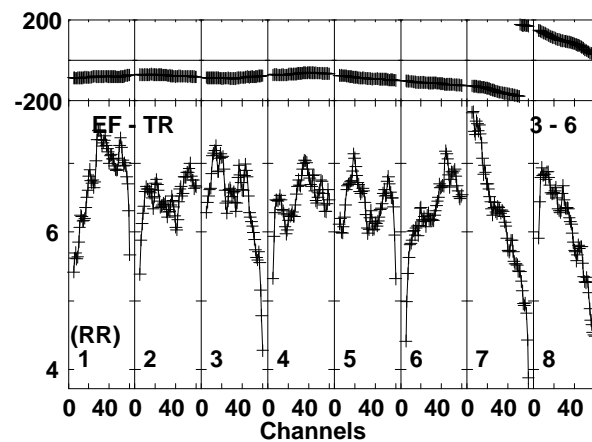
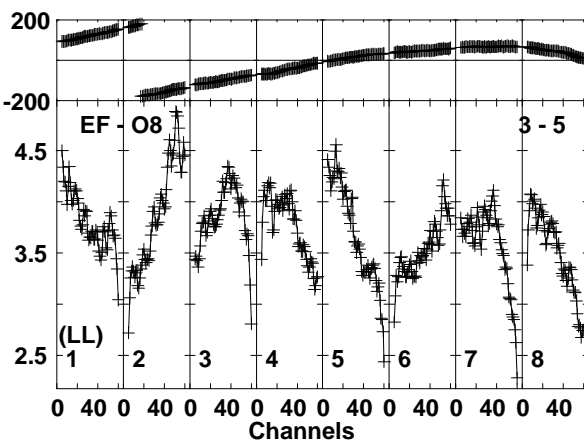
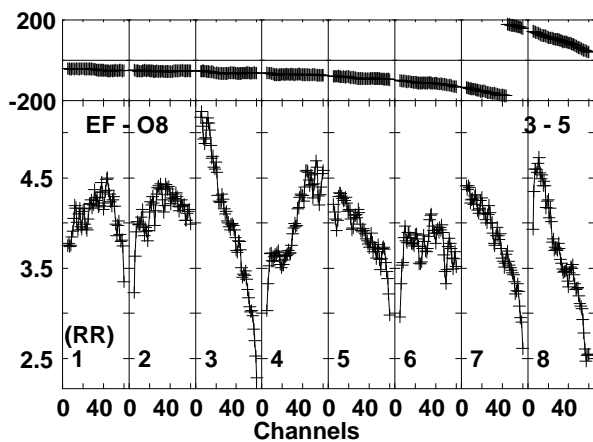
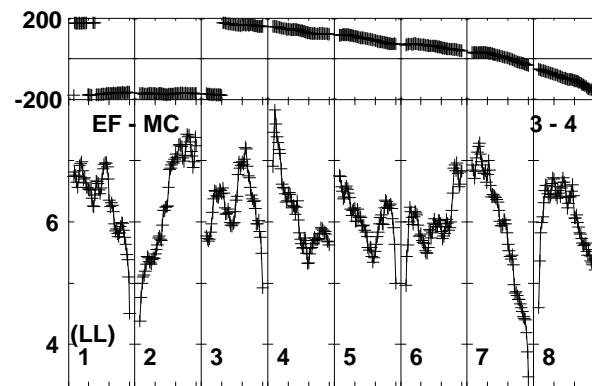
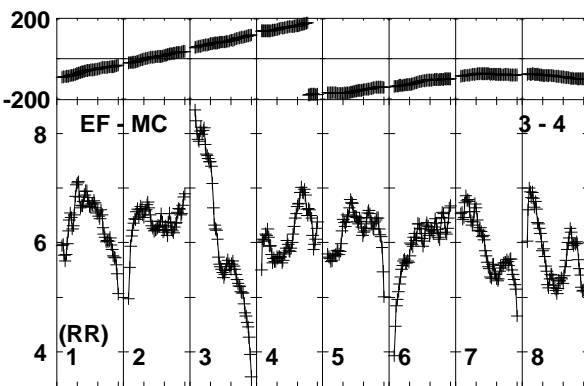
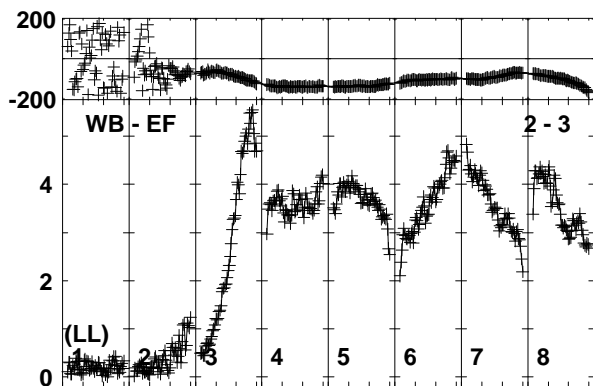
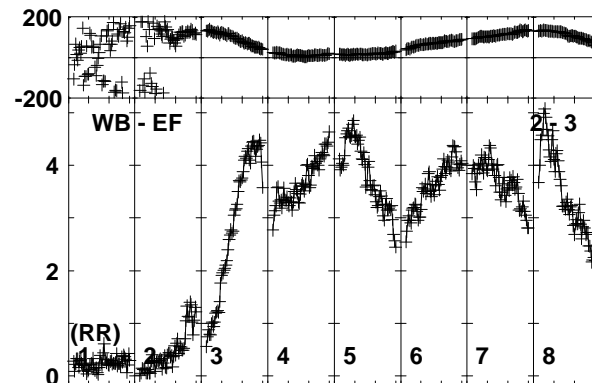
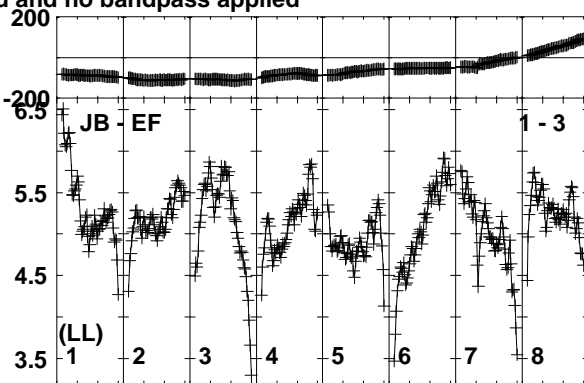
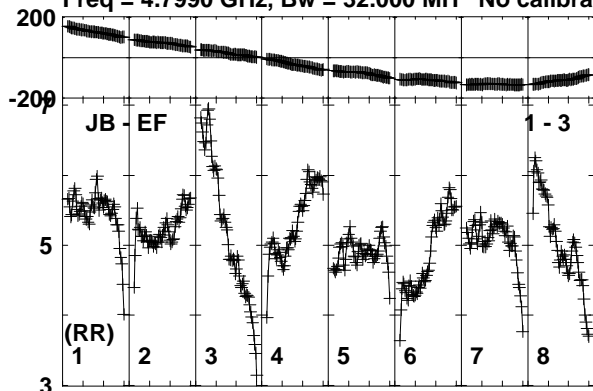

Lower frame: Milli Ampl Jy Top frame: Phas deg  
Vector averaged cross-power spectrum Baseline: JB (01) - EF (03)  
Timerange: 00/22:32:31 to 00/22:33:29

Plot file version 89 created 11-NOV-2019 15:07:26

J1826+0149 EK040B.UVDATA.1

Freq = 4.7990 GHz, Bw = 32.000 MH No calibration applied and no bandpass applied

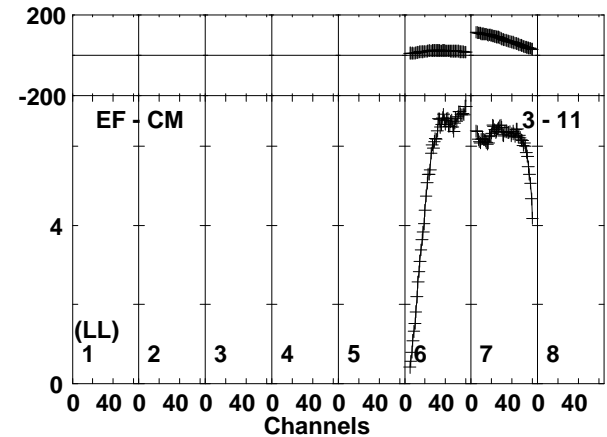
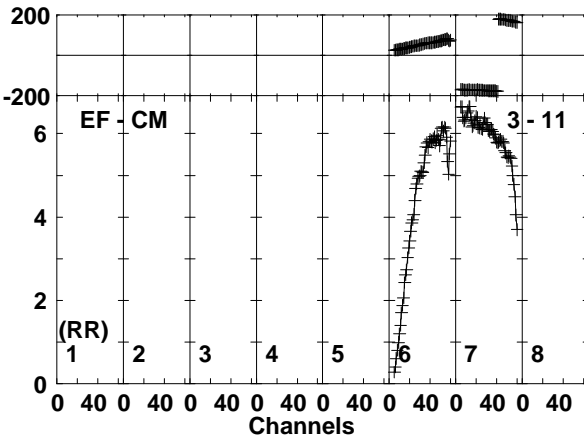
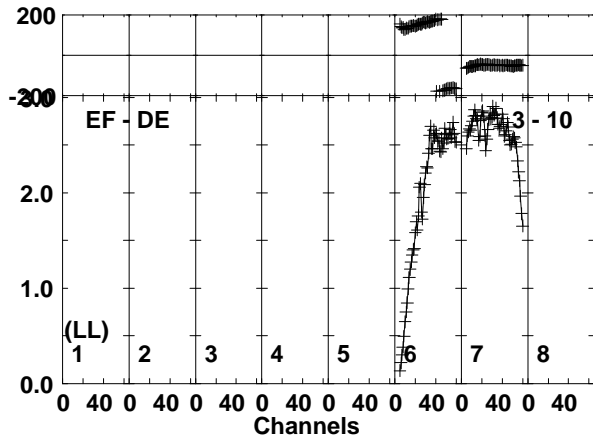
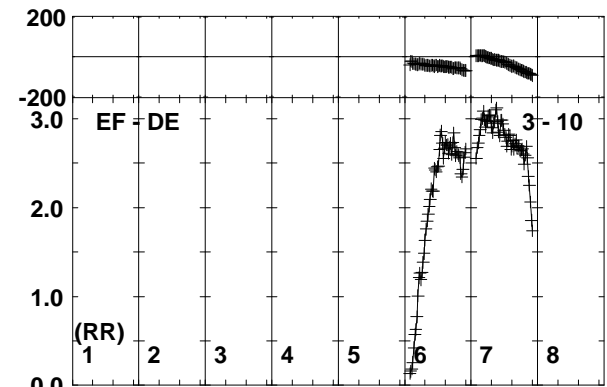
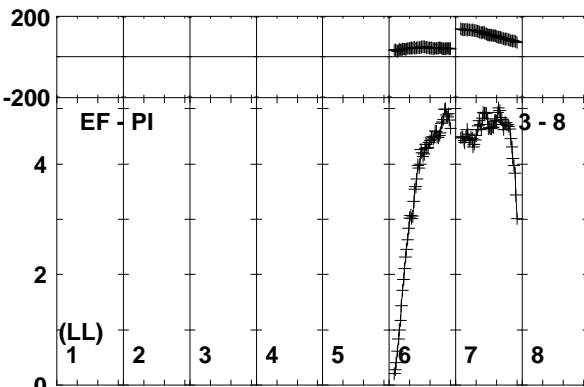
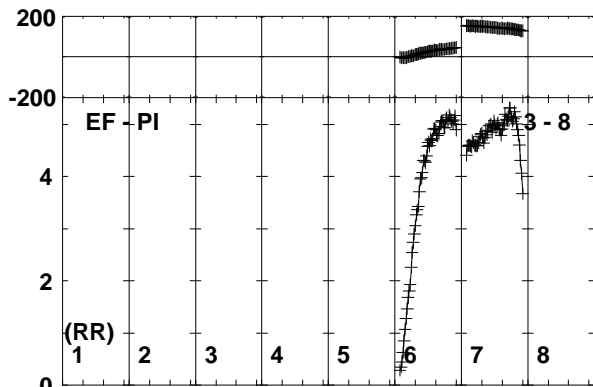
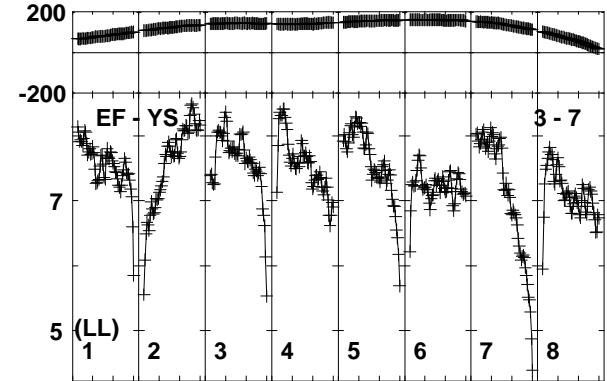
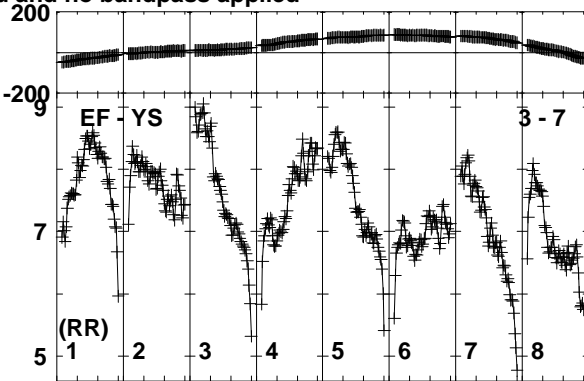
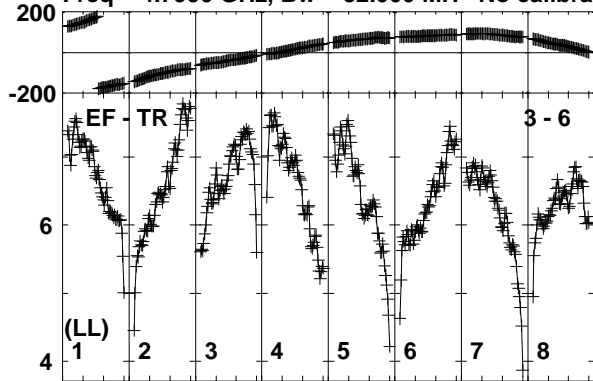

Lower frame: Milli Ampl Jy Top frame: Phas deg  
Vector averaged cross-power spectrum Baseline: EF (03) - TR (06)  
Timerange: 00/22:32:31 to 00/22:33:29

Plot file version 90 created 11-NOV-2019 15:07:26

J1826+0149 EK040B.UVDATA.1

Freq = 4.7990 GHz, Bw = 32.000 MH No calibration applied and no bandpass applied

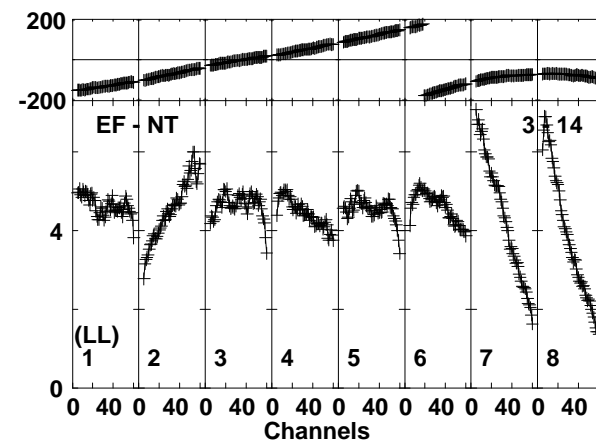
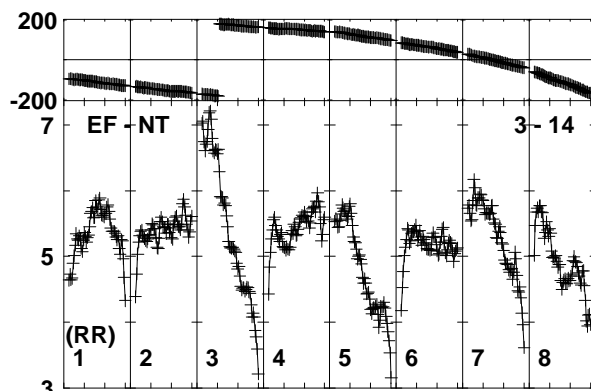
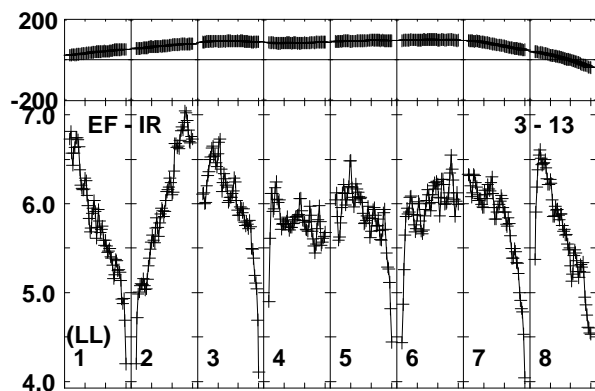
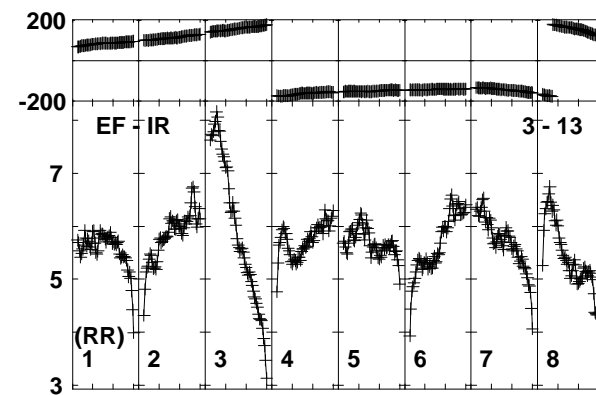
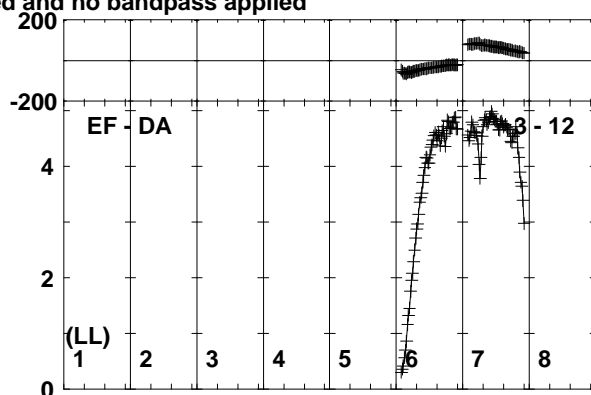
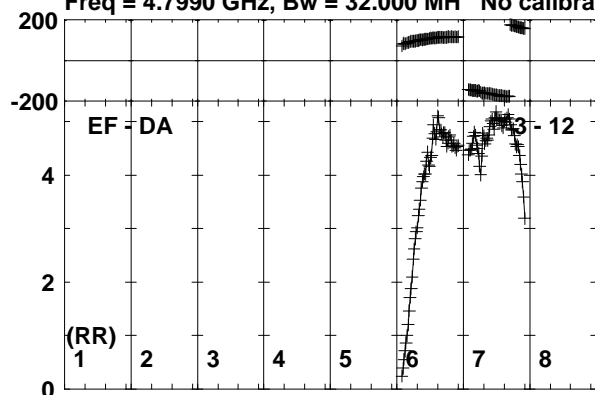

Lower frame: Milli Ampl Jy Top frame: Phas deg  
Vector averaged cross-power spectrum Baseline: EF (03) - DA (12)  
Timerange: 00/22:32:31 to 00/22:33:29



Plot file version 91 created 11-NOV-2019 15:07:26

SER8NJ EK040B.UVDATA.1

Freq = 4.7990 GHz, Bw = 32.000 MH No calibration applied and no bandpass applied

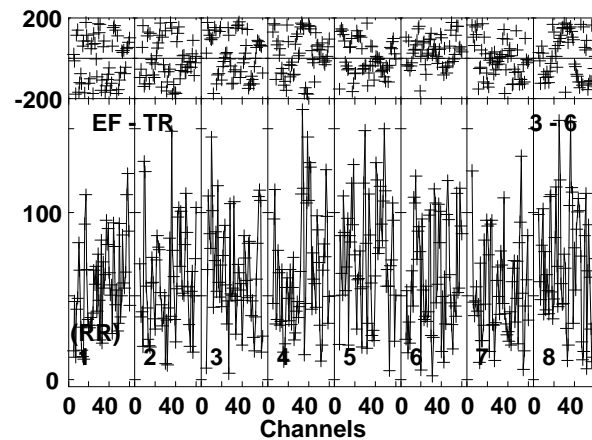
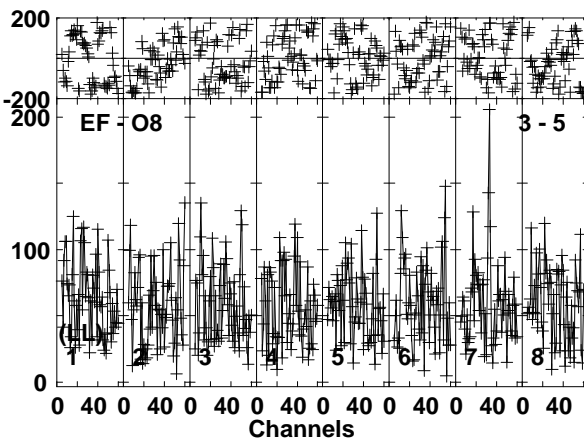
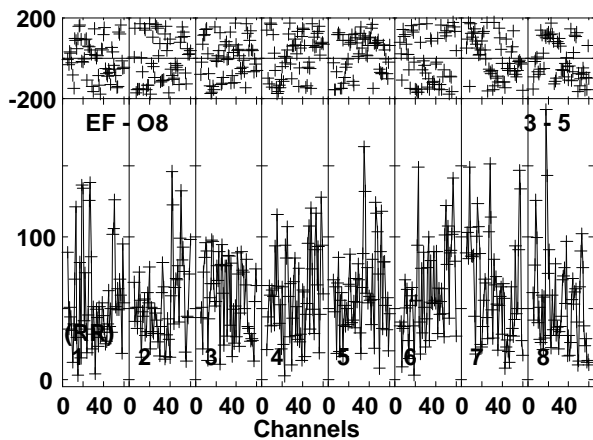
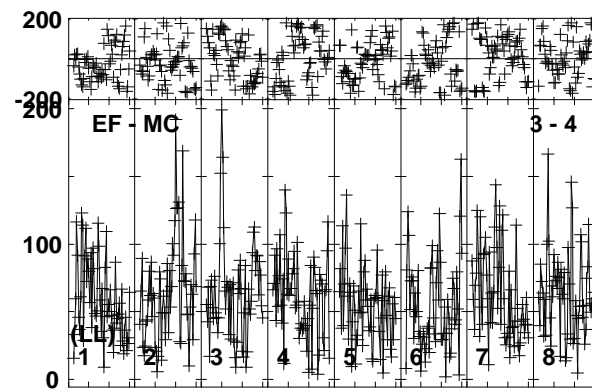
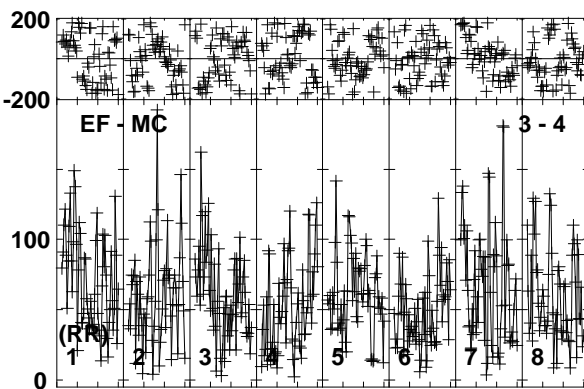
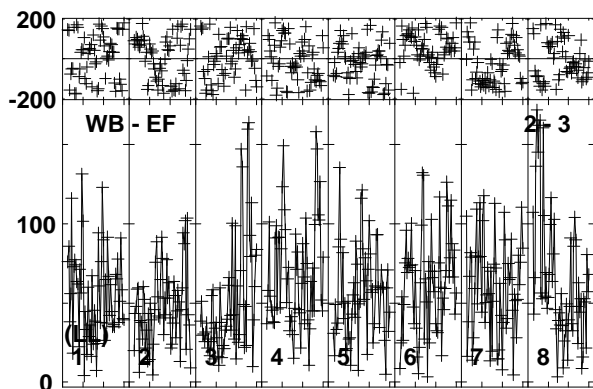
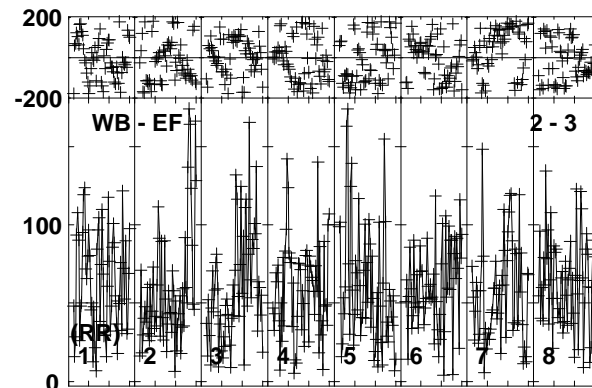
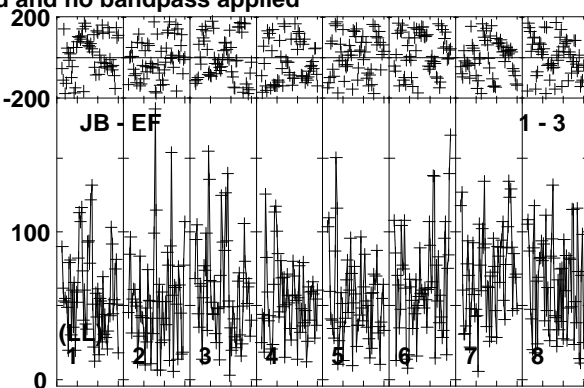
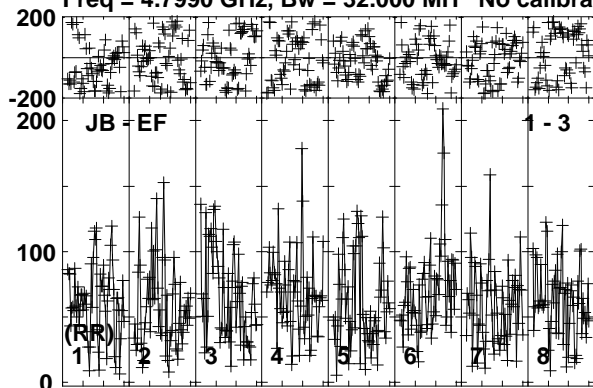

Lower frame: Micro Ampl Jy Top frame: Phas deg  
Vector averaged cross-power spectrum Baseline: JB (01) - EF (03)  
Timerange: 00/22:33:31 to 00/22:37:29

Plot file version 92 created 11-NOV-2019 15:07:26

SER8NJ EK040B.UVDATA.1

Freq = 4.7990 GHz, Bw = 32.000 MH No calibration applied and no bandpass applied

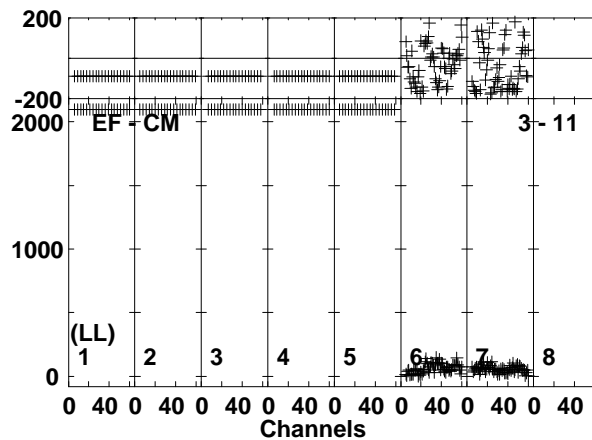
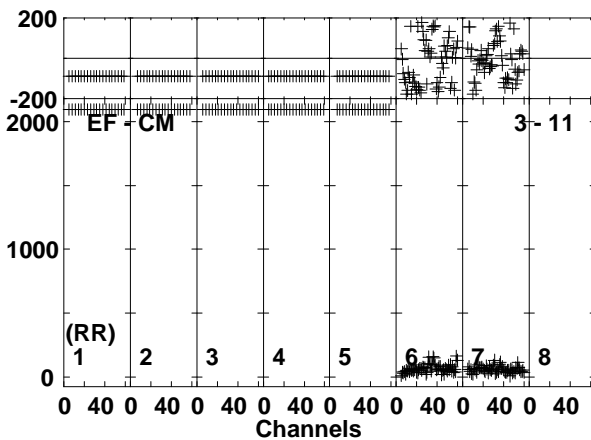
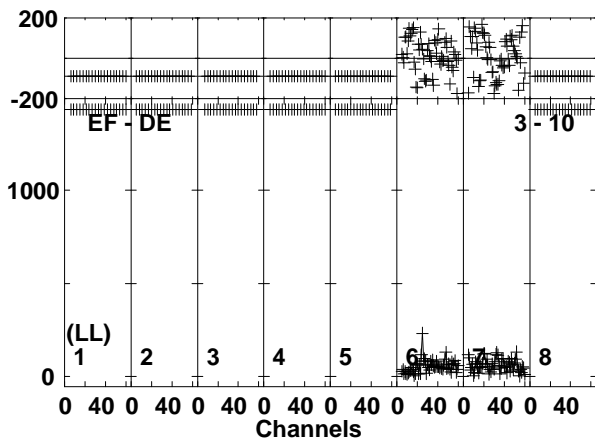
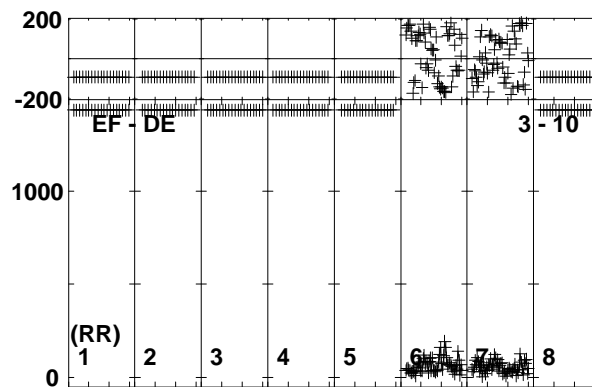
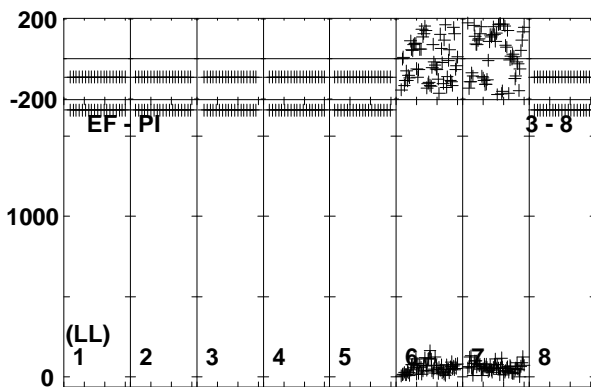
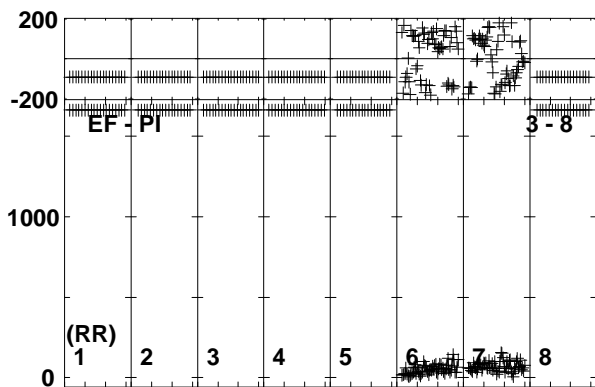
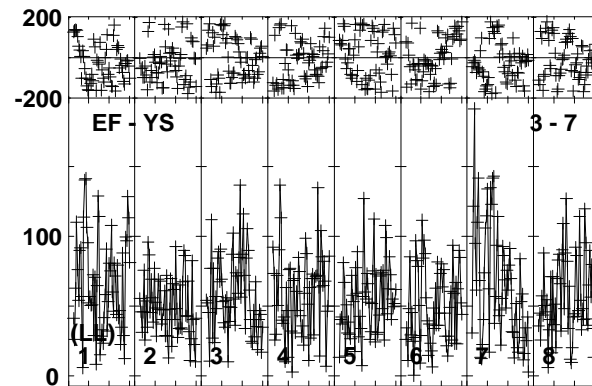
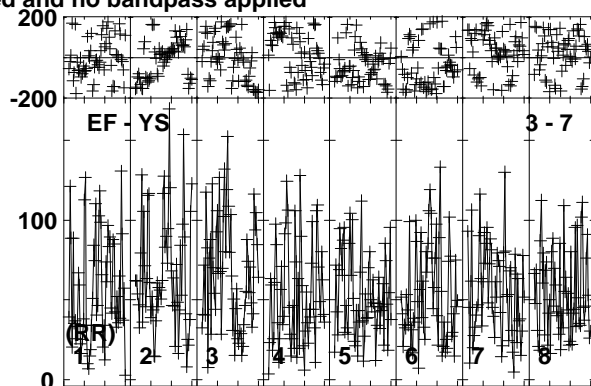
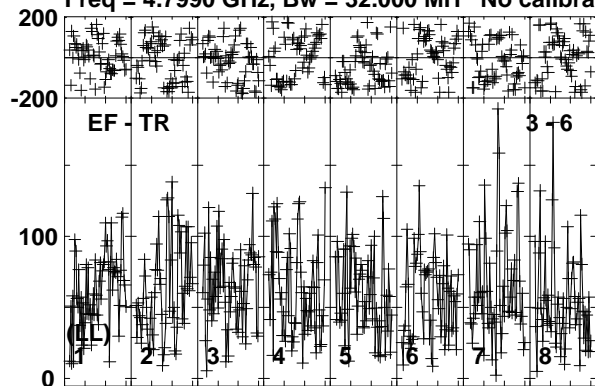

Lower frame: Micro Ampl Jy Top frame: Phas deg  
Vector averaged cross-power spectrum Baseline: EF (03) - TR (06)  
Timerange: 00:22:33:31 to 00:22:37:29

Plot file version 93 created 11-NOV-2019 15:07:26

SER8NJ EK040B.UVDATA.1

Freq = 4.7990 GHz, Bw = 32.000 MH No calibration applied and no bandpass applied

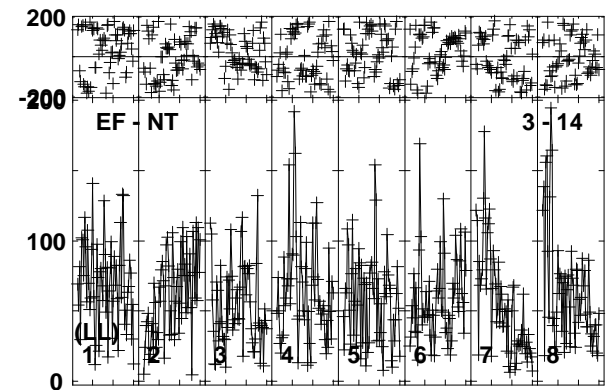
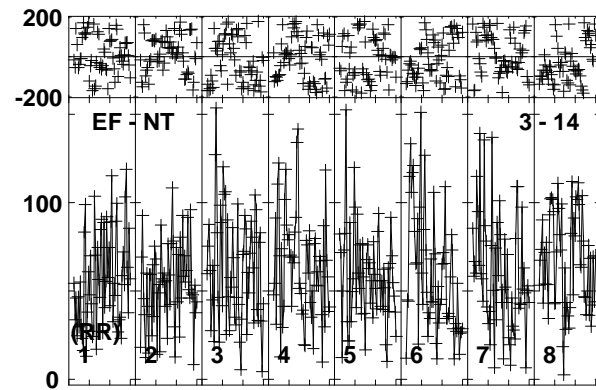
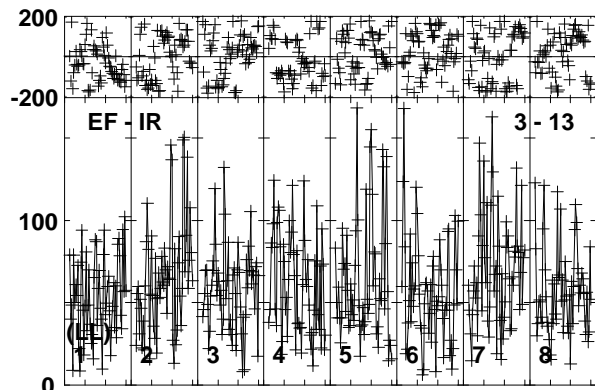
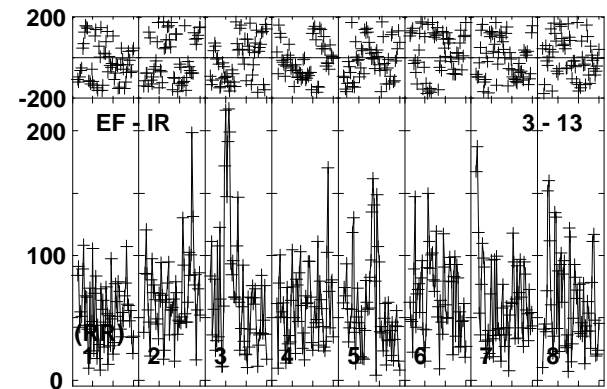
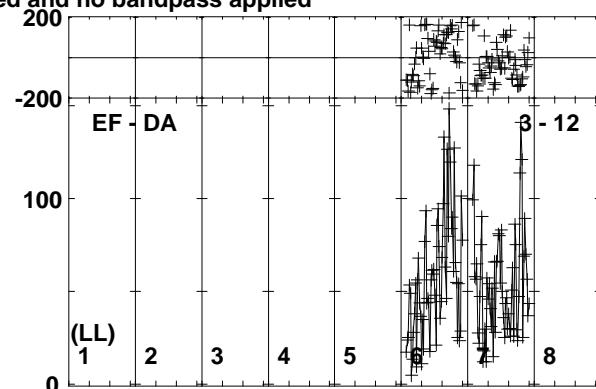
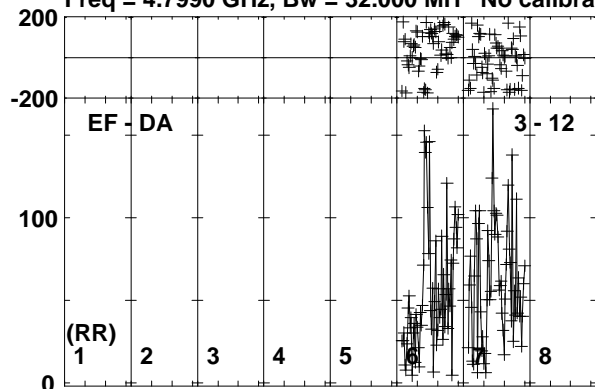

Channels

Lower frame: Micro Ampl Jy Top frame: Phas deg  
Vector averaged cross-power spectrum Baseline: EF (03) - DA (12)  
Timerange: 00/22:33:31 to 00/22:37:29

Plot file version 94 created 11-NOV-2019 15:07:26

J1826+0149 EK040B.UVDATA.1

Freq = 4.7990 GHz, Bw = 32.000 MH No calibration applied and no bandpass applied

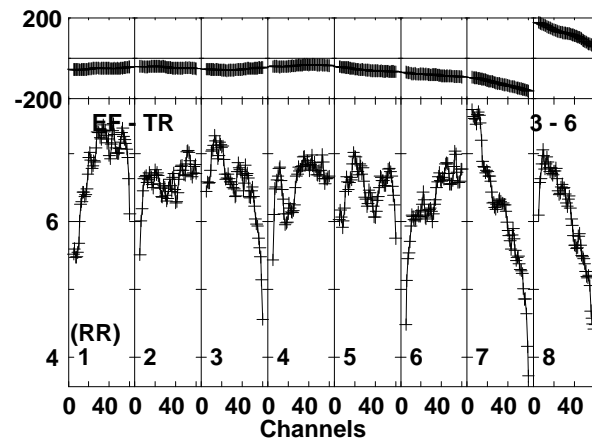
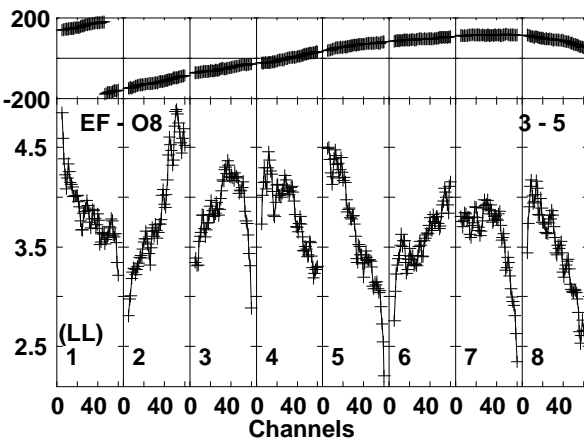
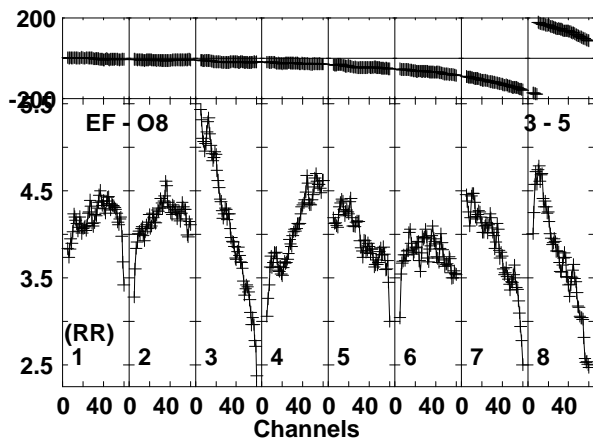
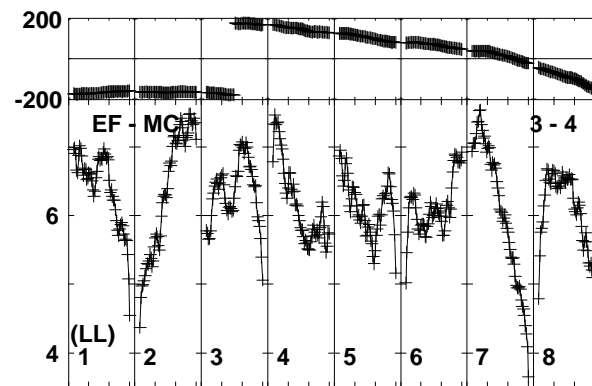
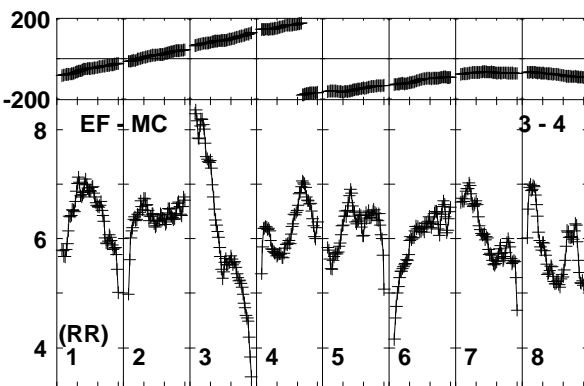
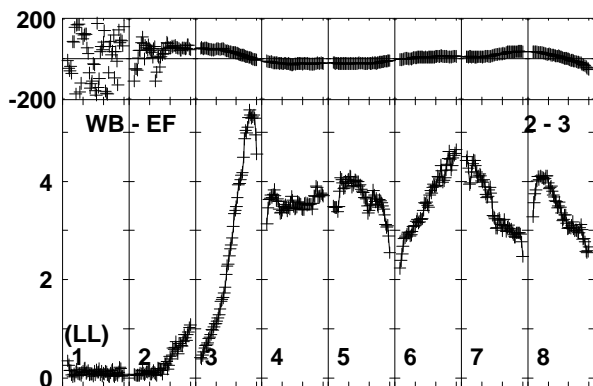
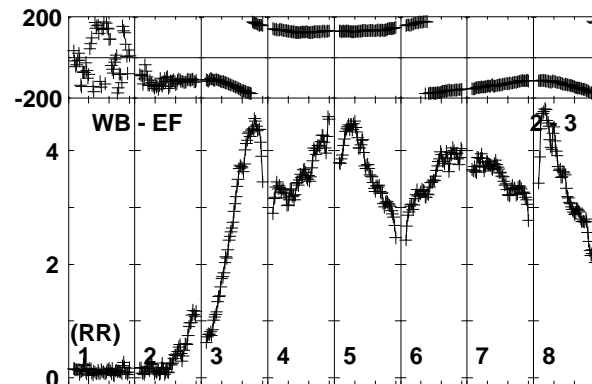
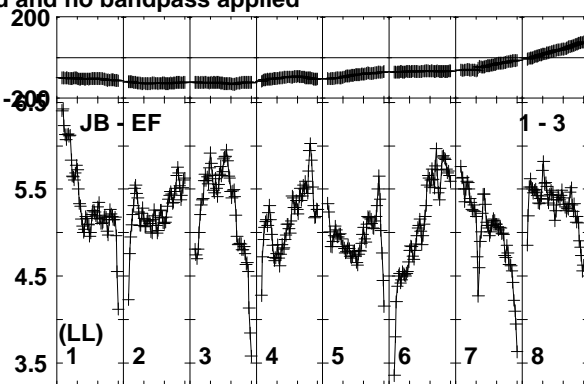
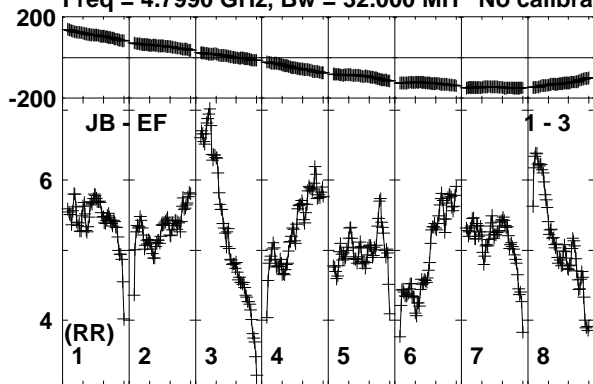

Lower frame: Milli Ampl Jy Top frame: Phas deg  
Vector averaged cross-power spectrum Baseline: JB (01) - EF (03)  
Timerange: 00/22:37:33 to 00/22:38:59

Plot file version 95 created 11-NOV-2019 15:07:27

J1826+0149 EK040B.UVDATA.1

Freq = 4.7990 GHz, Bw = 32.000 MH No calibration applied and no bandpass applied

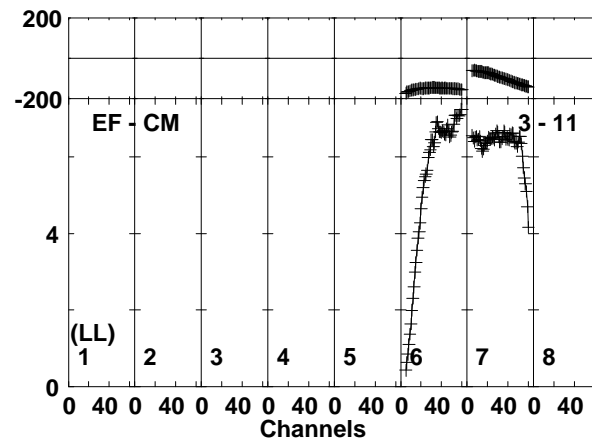
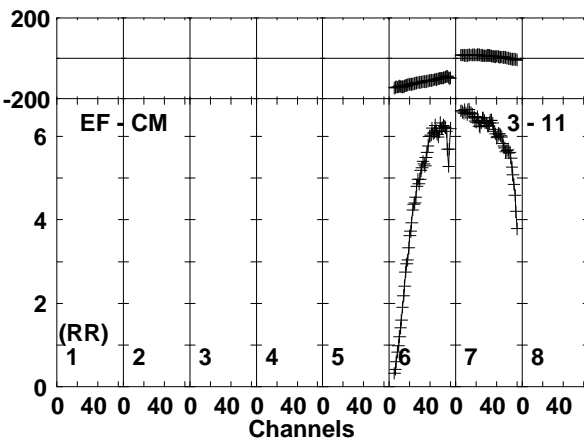
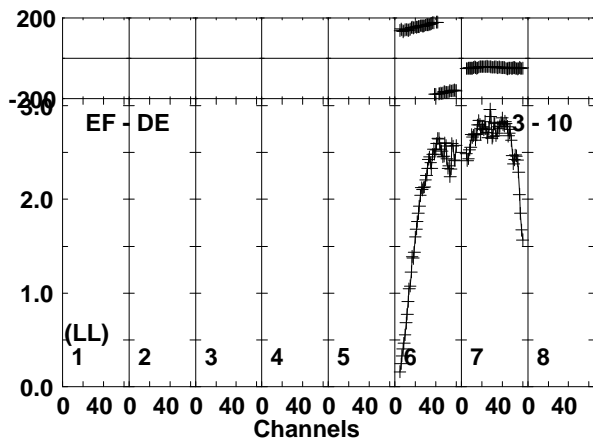
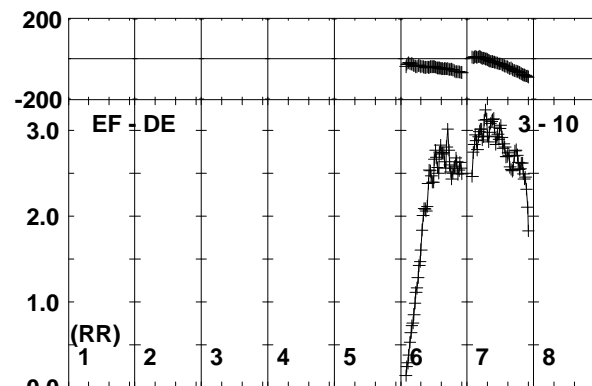
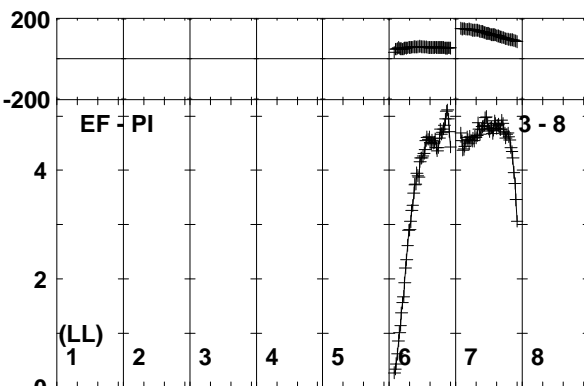
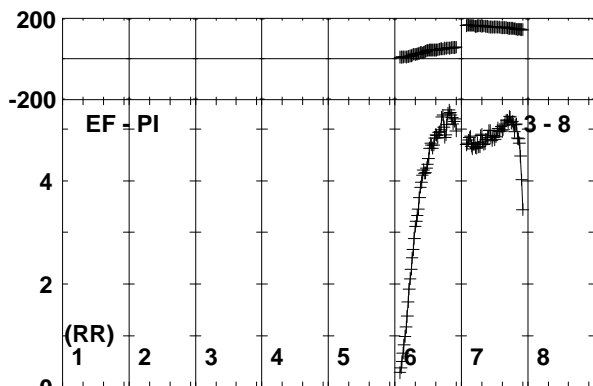
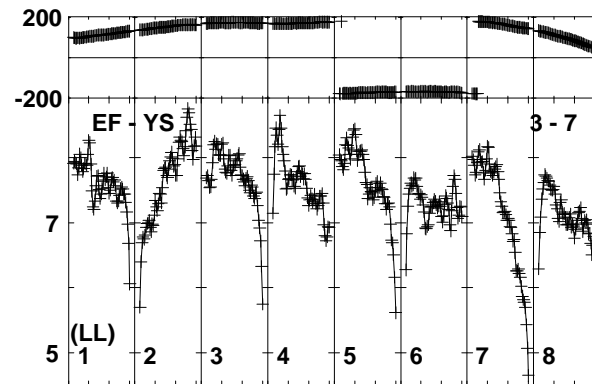
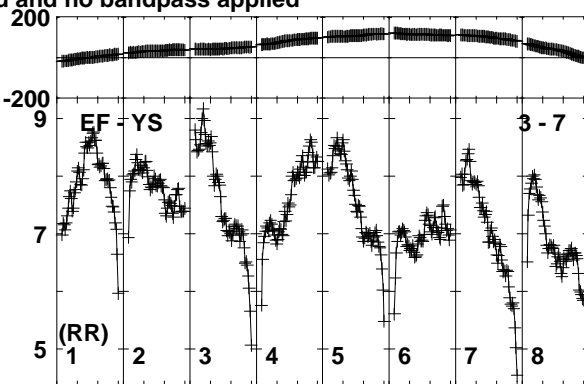
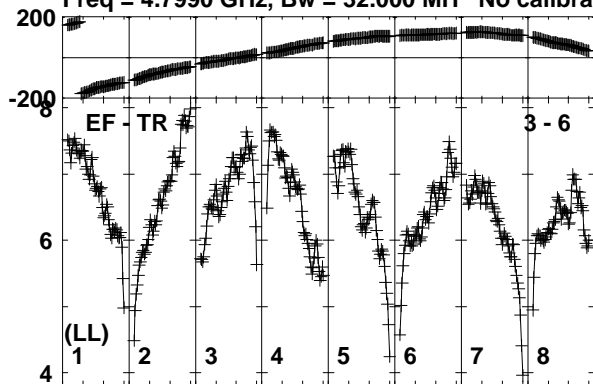

Lower frame: Milli Ampl Jy Top frame: Phas deg  
Vector averaged cross-power spectrum Baseline: EF (03) - TR (06)  
Timerange: 00/22:37:33 to 00/22:38:59

Plot file version 96 created 11-NOV-2019 15:07:27  
 J1826+0149 EK040B.UVDATA.1  
 Freq = 4.7990 GHz, Bw = 32.000 MH No calibration applied and no bandpass applied

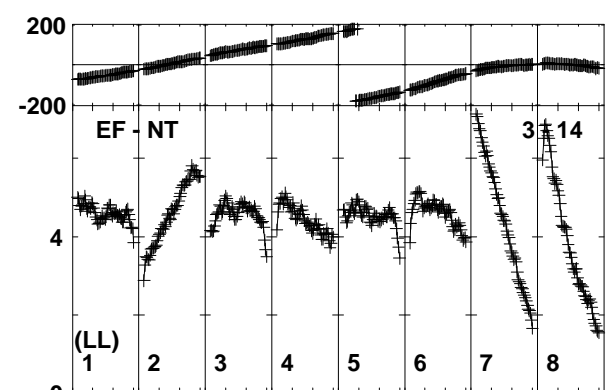
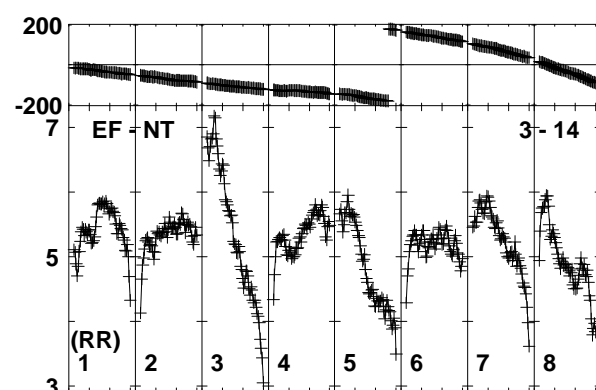
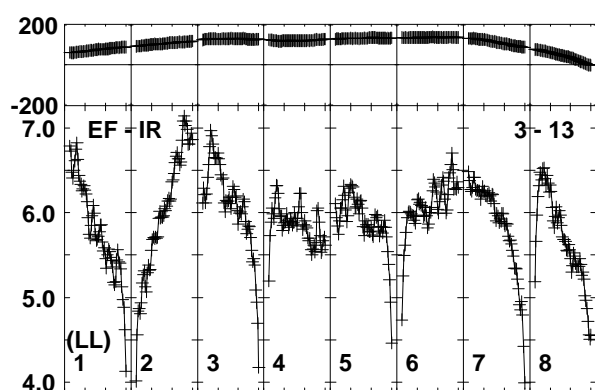
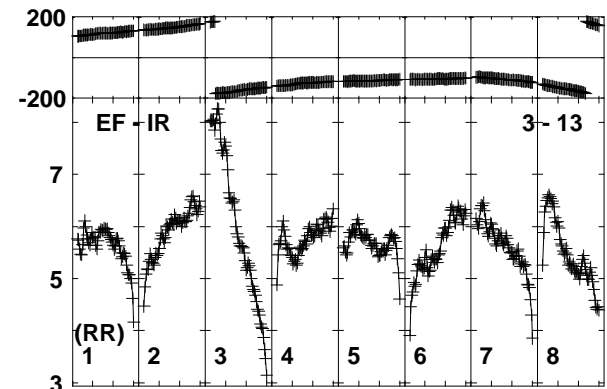
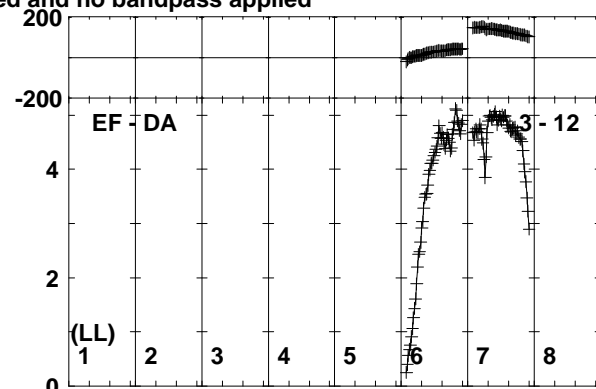
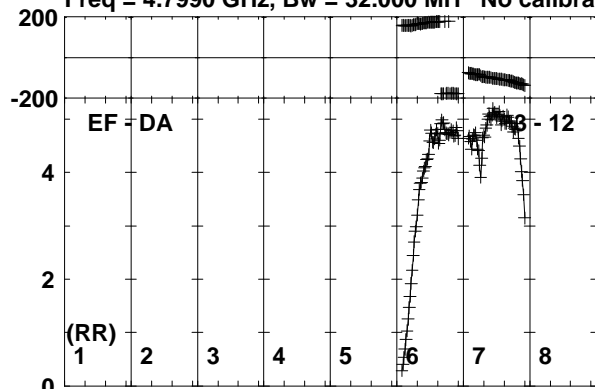

Channels

Lower frame: Milli Ampl Jy Top frame: Phas deg  
 Vector averaged cross-power spectrum Baseline: EF (03) - DA (12)  
 Timerange: 00:22:37:33 to 00:22:38:59

Plot file version 97 created 11-NOV-2019 15:07:27

SER8NJ EK040B.UVDATA.1

Freq = 4.7990 GHz, Bw = 32.000 MH No calibration applied and no bandpass applied

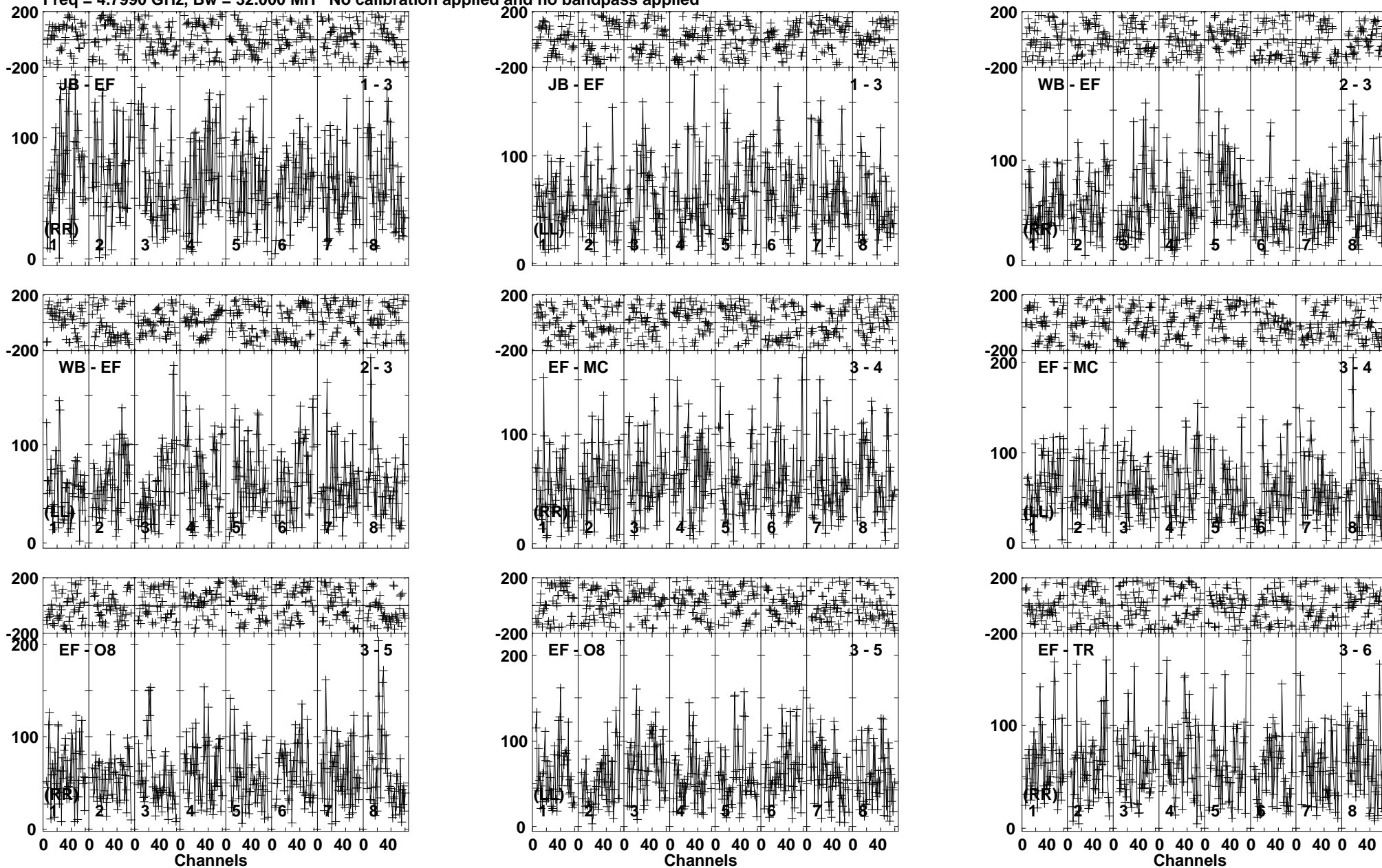

Lower frame: Micro Ampl Jy Top frame: Phas deg  
Vector averaged cross-power spectrum Baseline: JB (01) - EF (03)  
Timerange: 00:22:39:01 to 00:22:42:59

Plot file version 98 created 11-NOV-2019 15:07:27

SER8NJ EK040B.UVDATA.1

Freq = 4.7990 GHz, Bw = 32.000 MH No calibration applied and no bandpass applied

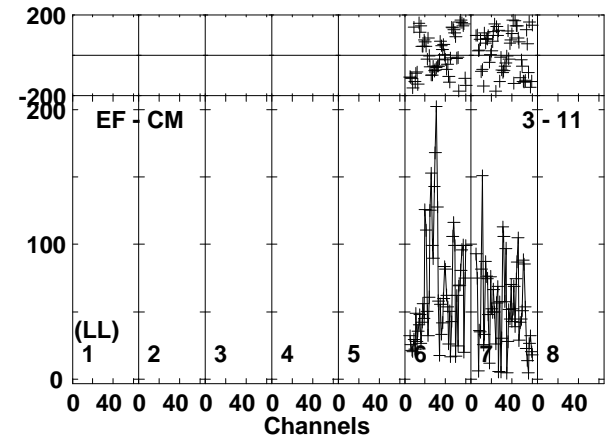
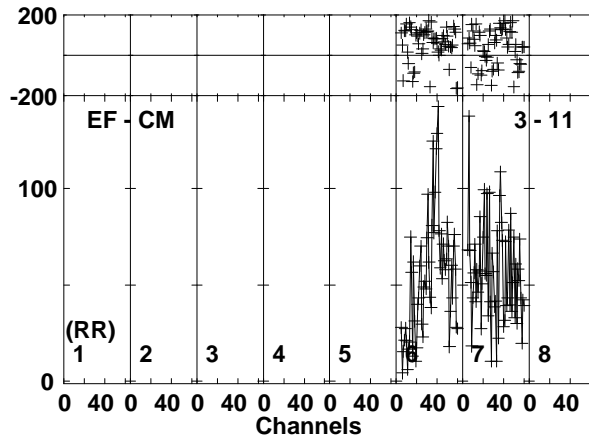
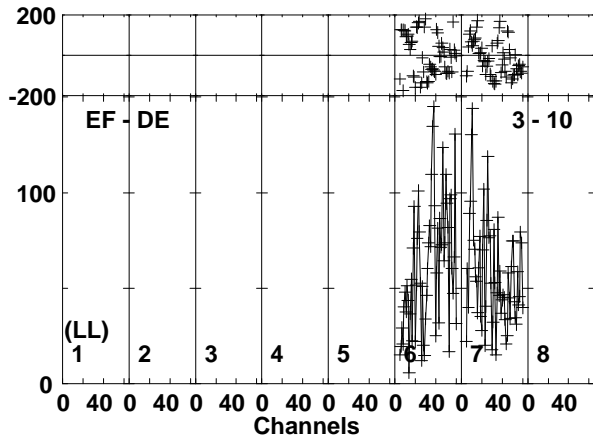
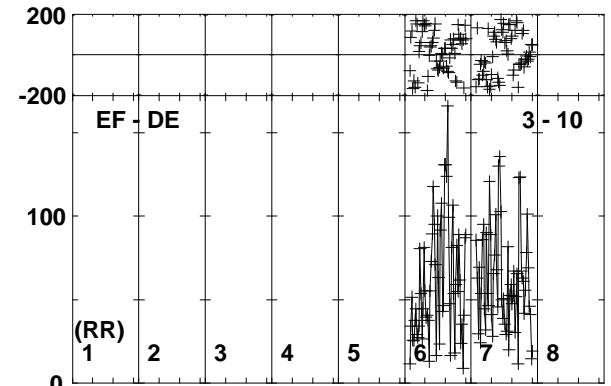
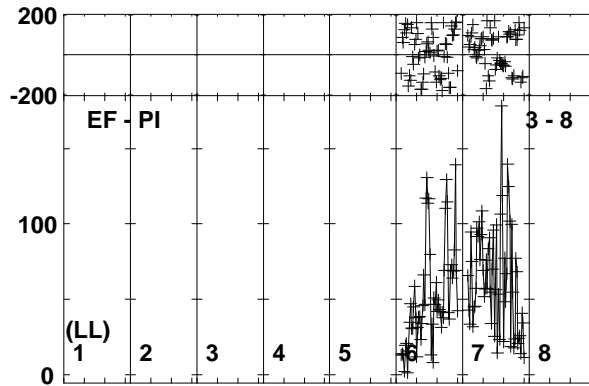
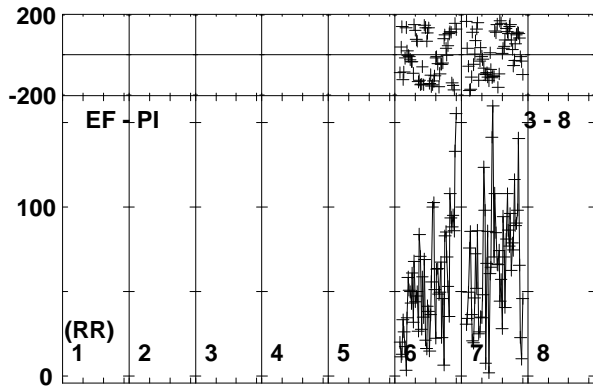
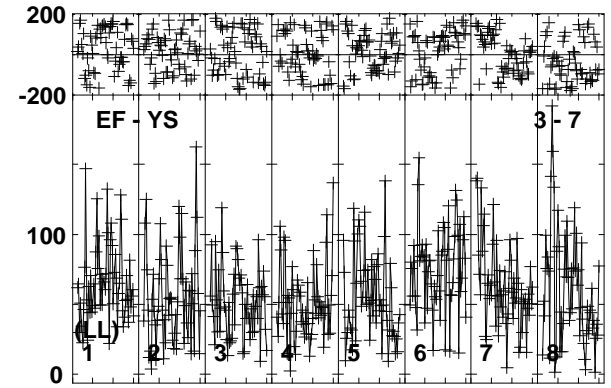
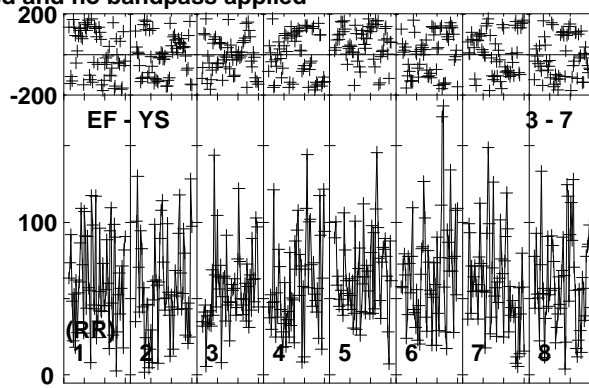
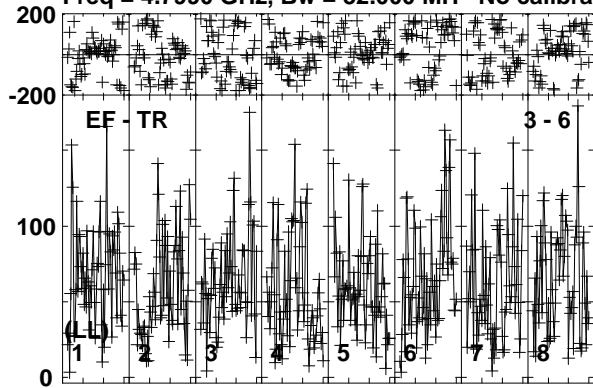

Lower frame: Micro Ampl Jy Top frame: Phas deg  
Vector averaged cross-power spectrum Baseline: EF (03) - TR (06)  
Timerange: 00/22:39:01 to 00/22:42:59



Plot file version 99 created 11-NOV-2019 15:07:27

SER8NJ EK040B.UVDATA.1

Freq = 4.7990 GHz, Bw = 32.000 MH No calibration applied and no bandpass applied

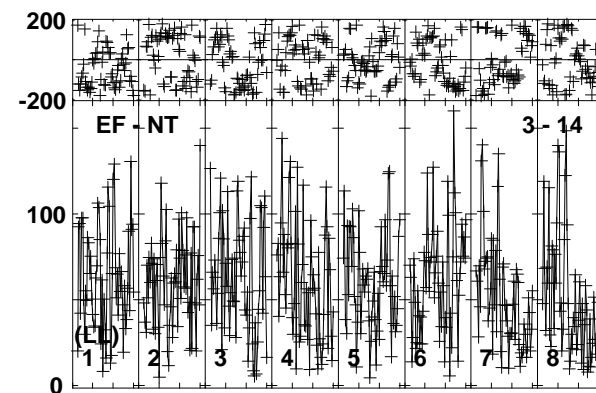
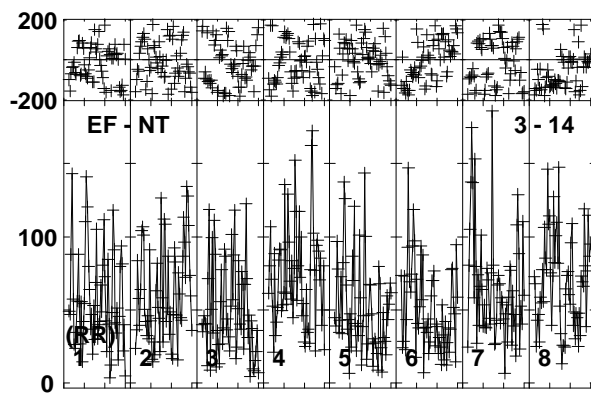
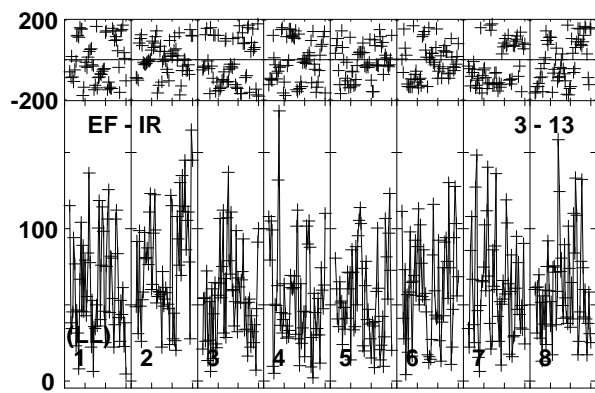
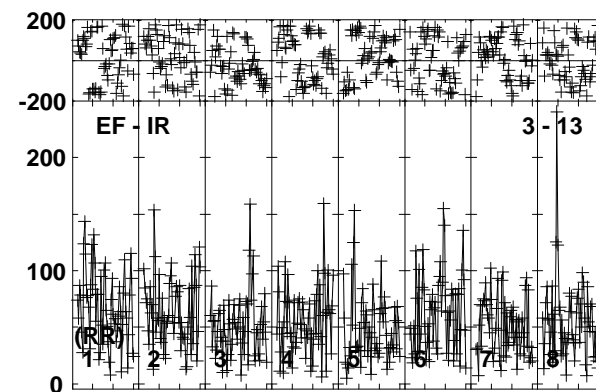
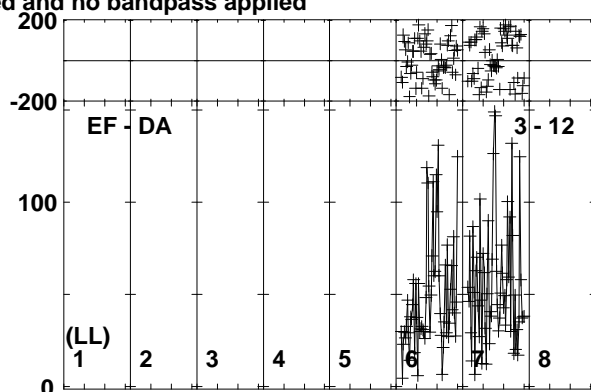
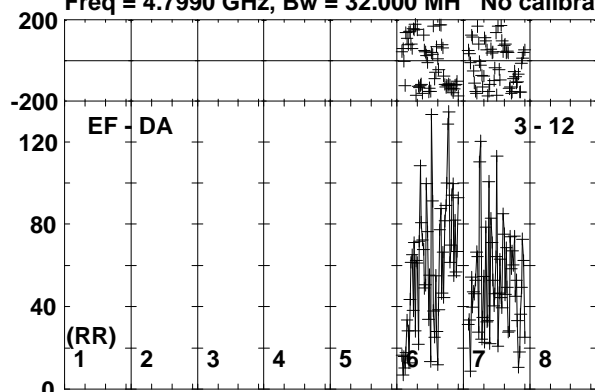

Channels

Lower frame: Micro Ampl Jy Top frame: Phas deg  
Vector averaged cross-power spectrum Baseline: EF (03) - DA (12)  
Timerange: 00:22:39:01 to 00:22:42:59

Plot file version 100 created 11-NOV-2019 15:07:27

J1826+0149 EK040B.UVDATA.1

Freq = 4.7990 GHz, Bw = 32.000 MH No calibration applied and no bandpass applied

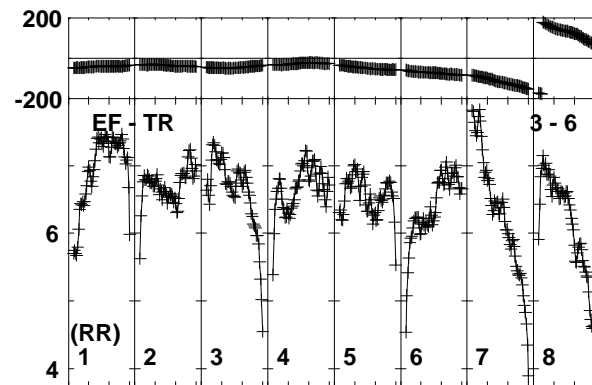
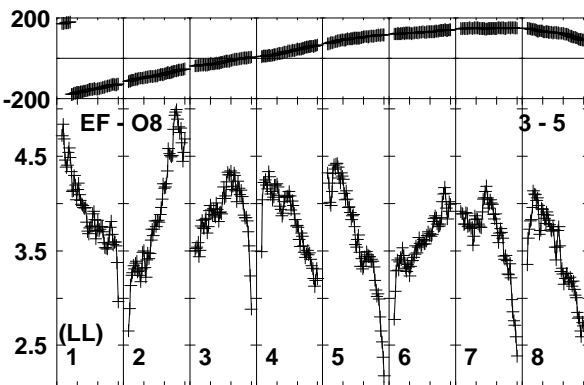
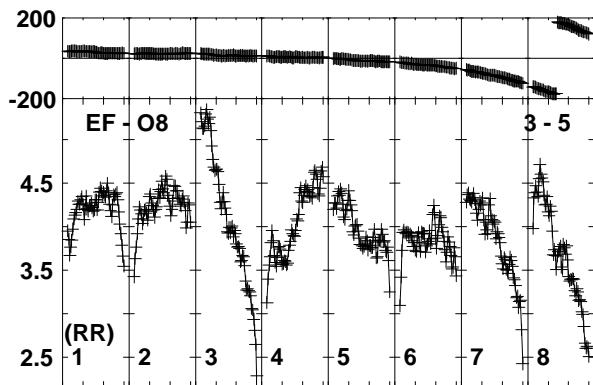
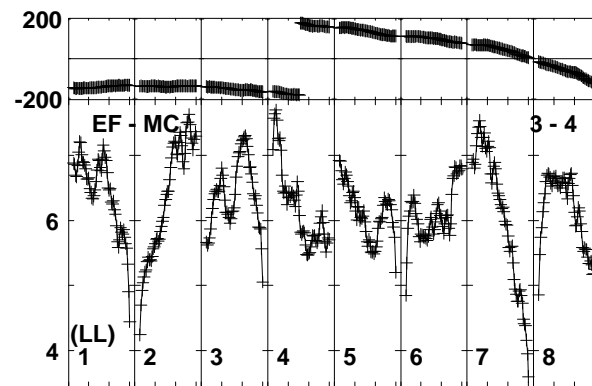
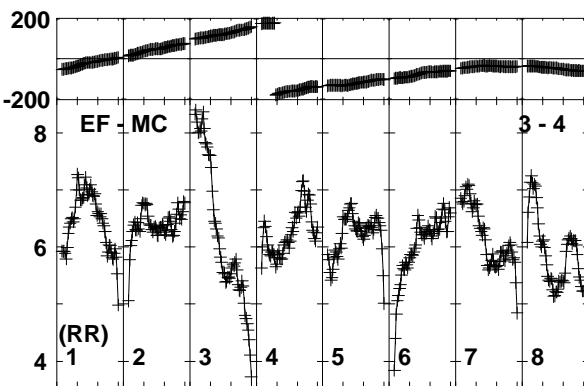
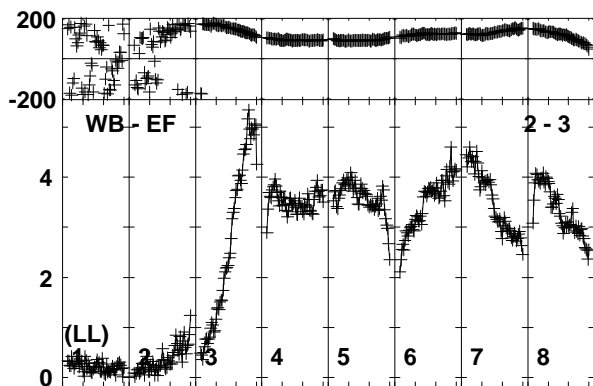
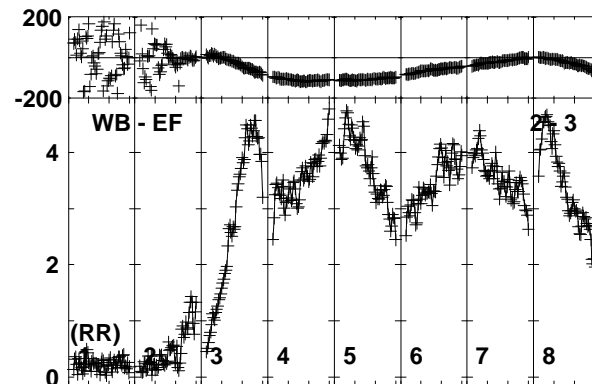
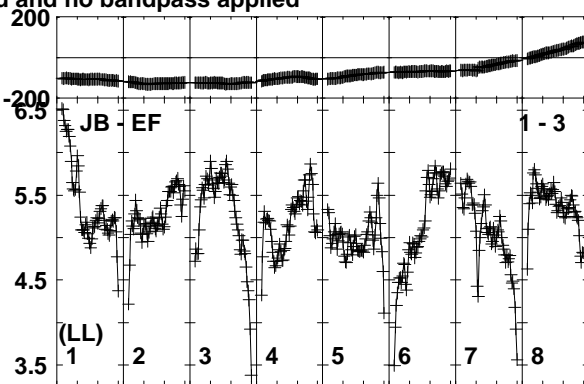
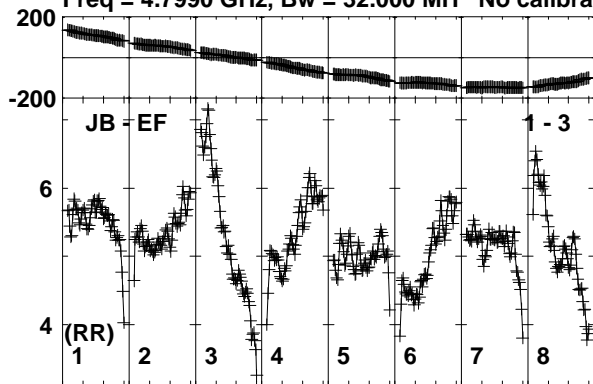

Lower frame: Milli Ampl Jy Top frame: Phas deg  
Vector averaged cross-power spectrum Baseline: JB (01) - EF (03)  
Timerange: 00/22:43:41 to 00/22:44:39

Plot file version 101 created 11-NOV-2019 15:07:27

J1826+0149 EK040B.UVDATA.1

Freq = 4.7990 GHz, Bw = 32.000 MH No calibration applied and no bandpass applied

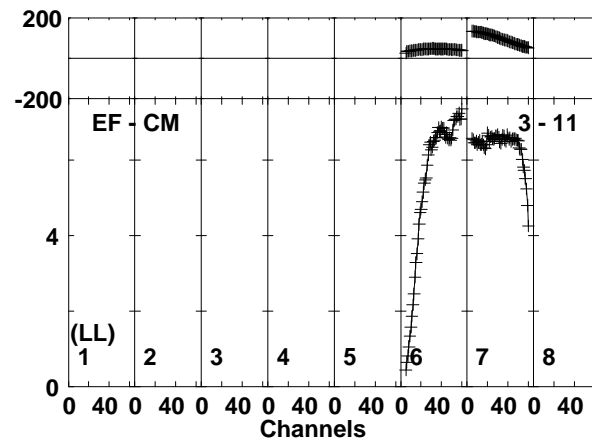
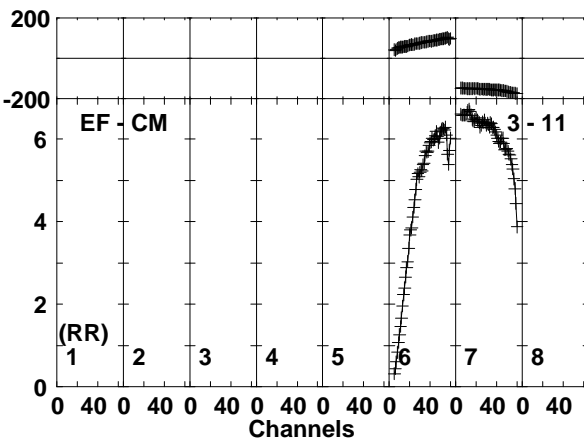
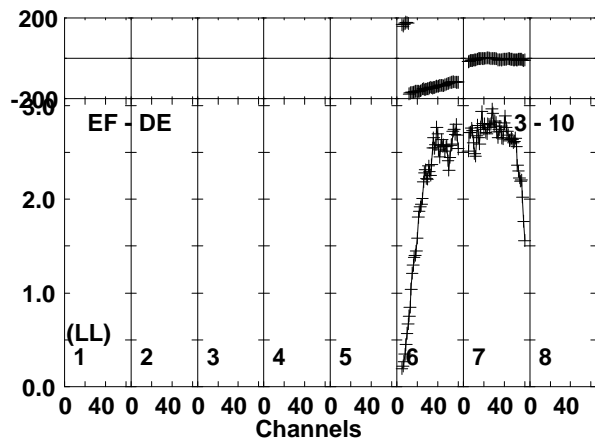
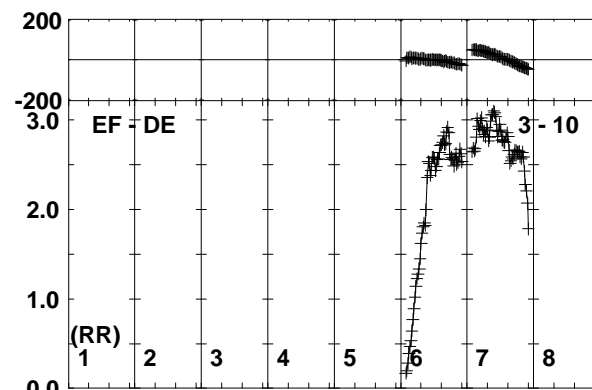
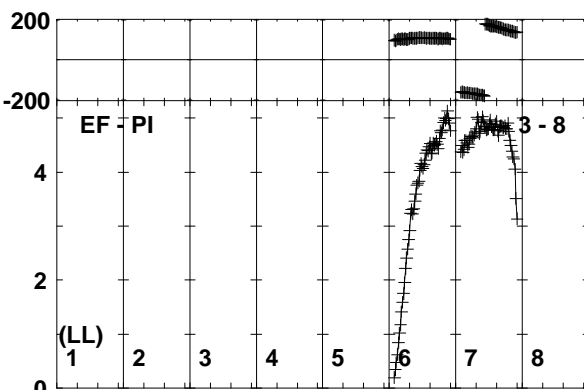
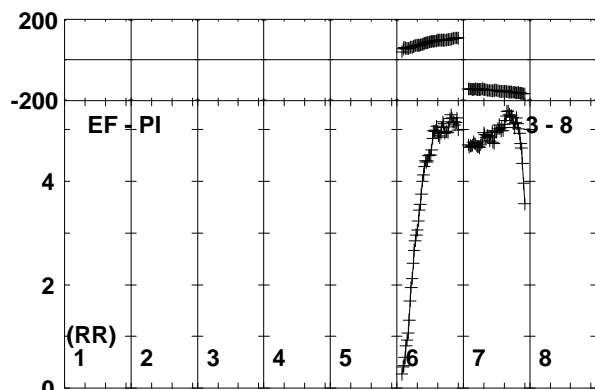
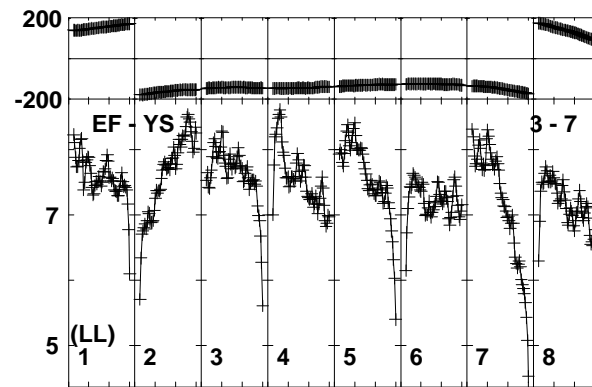
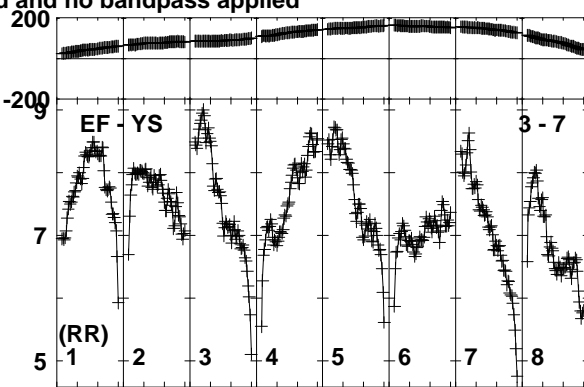
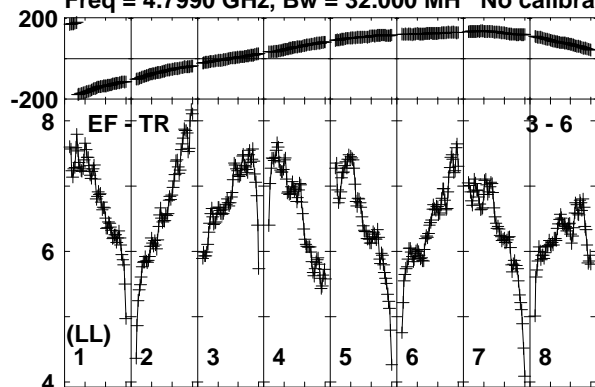

Lower frame: Milli Ampl Jy Top frame: Phas deg  
Vector averaged cross-power spectrum Baseline: EF (03) - TR (06)  
Timerange: 00/22:43:41 to 00/22:44:39

Plot file version 102 created 11-NOV-2019 15:07:27

J1826+0149 EK040B.UVDATA.1

Freq = 4.7990 GHz, Bw = 32.000 MH No calibration applied and no bandpass applied

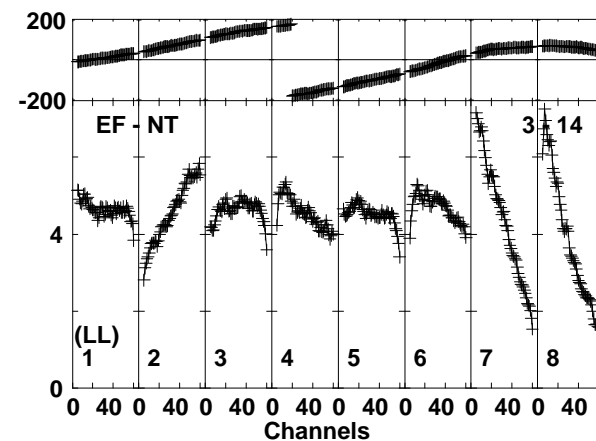
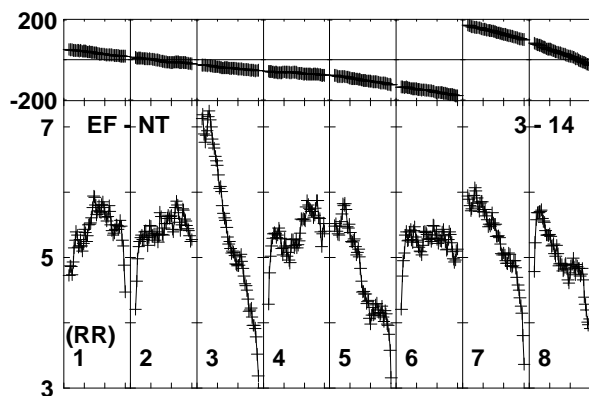
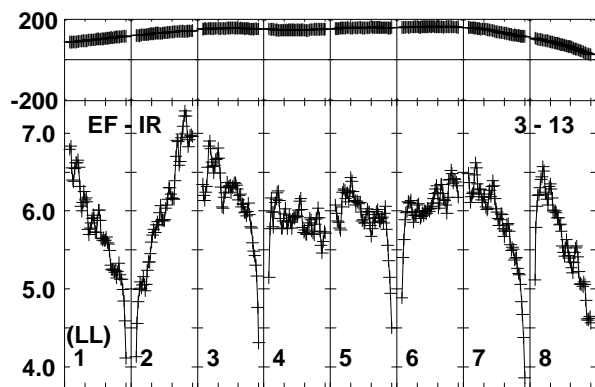
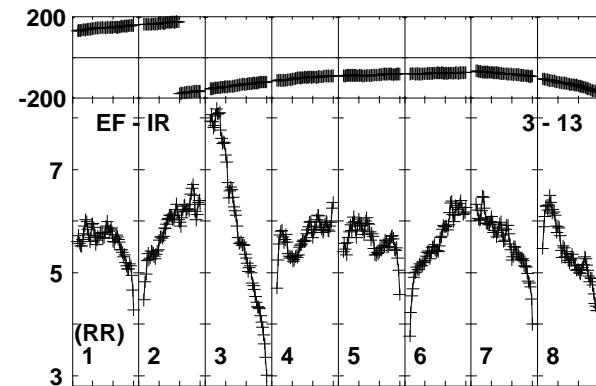
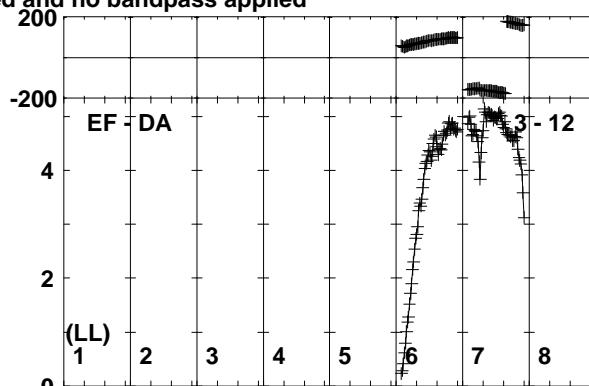
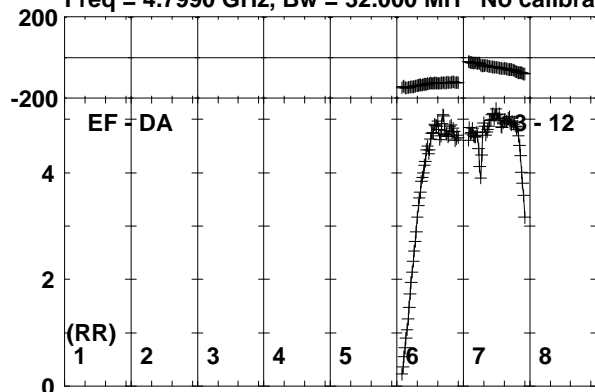

Lower frame: Milli Ampl Jy Top frame: Phas deg  
Vector averaged cross-power spectrum Baseline: EF (03) - DA (12)  
Timerange: 00:22:43:41 to 00:22:44:39

Plot file version 103 created 11-NOV-2019 15:07:27

SER8NJ EK040B.UVDATA.1

Freq = 4.7990 GHz, Bw = 32.000 MH No calibration applied and no bandpass applied

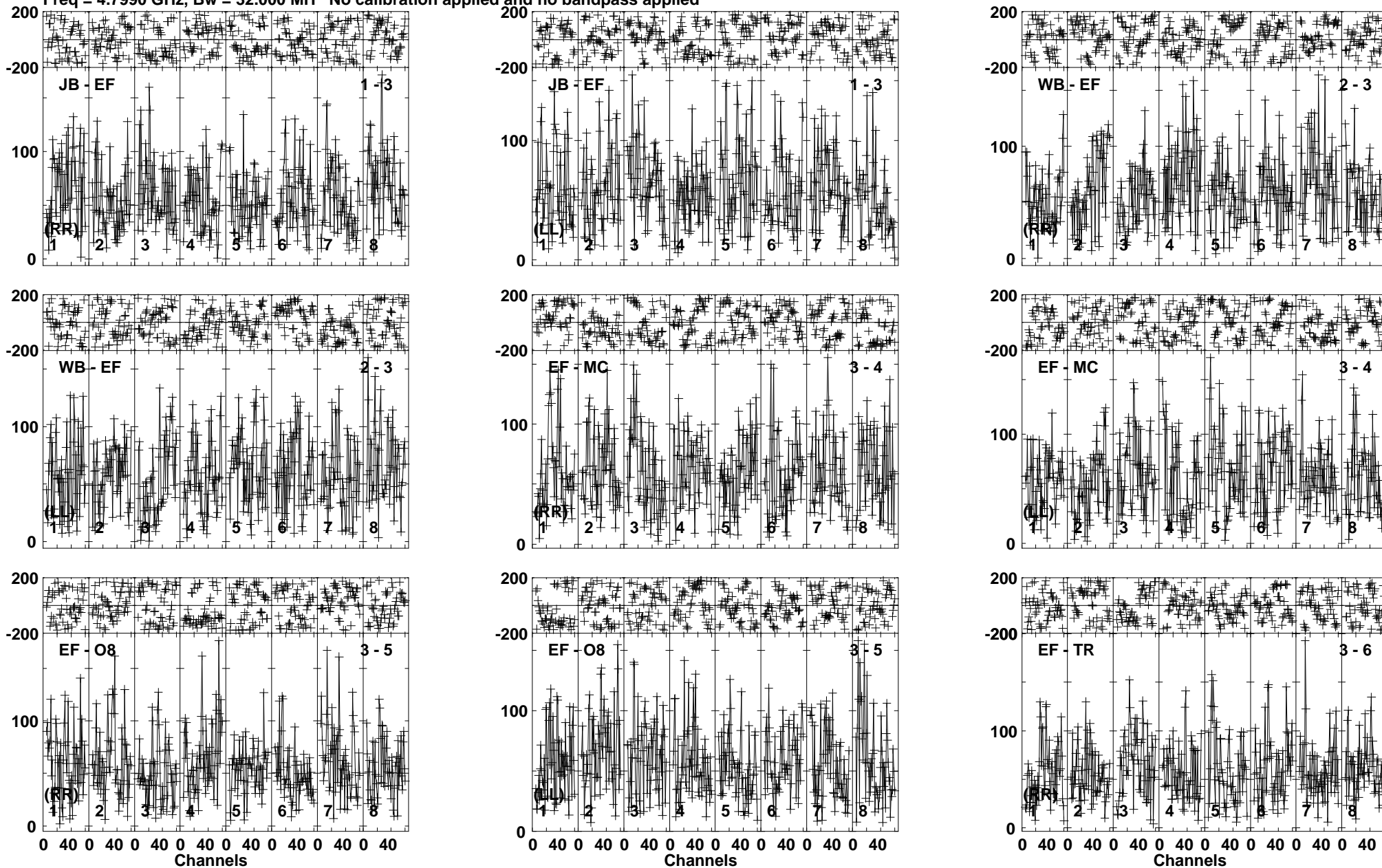

Lower frame: Micro Ampl Jy Top frame: Phas deg  
Vector averaged cross-power spectrum Baseline: JB (01) - EF (03)  
Timerange: 00:22:44:43 to 00:22:48:39

Plot file version 104 created 11-NOV-2019 15:07:28

SER8NJ EK040B.UVDATA.1

Freq = 4.7990 GHz, Bw = 32.000 MH No calibration applied and no bandpass applied

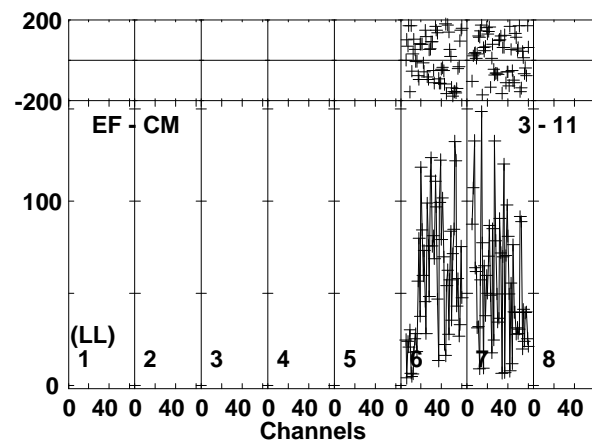
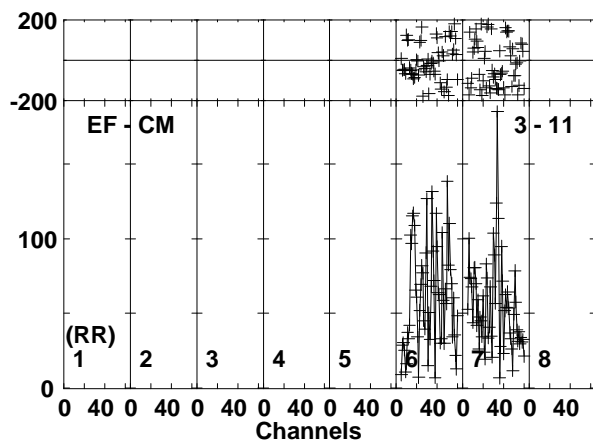
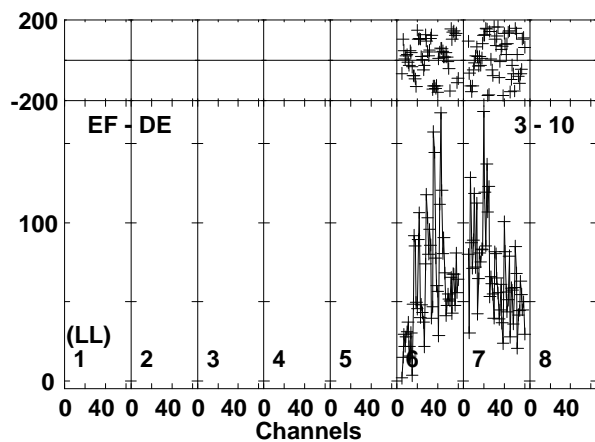
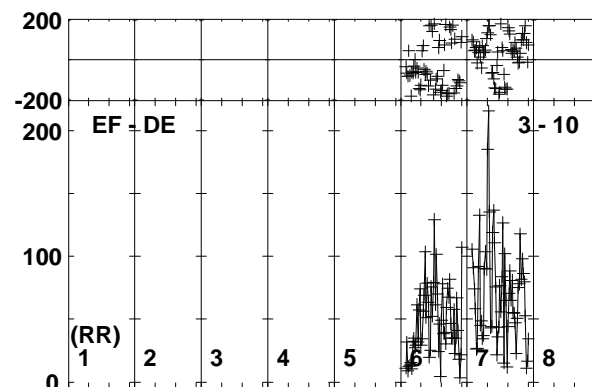
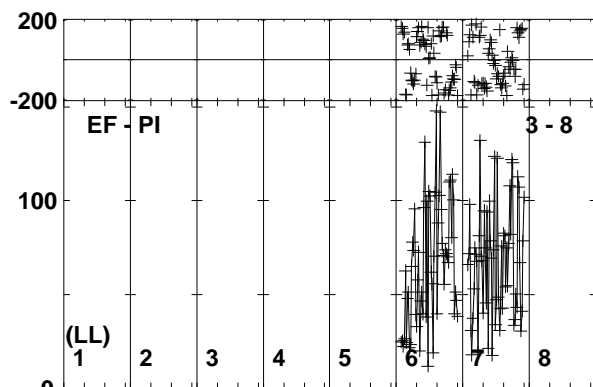
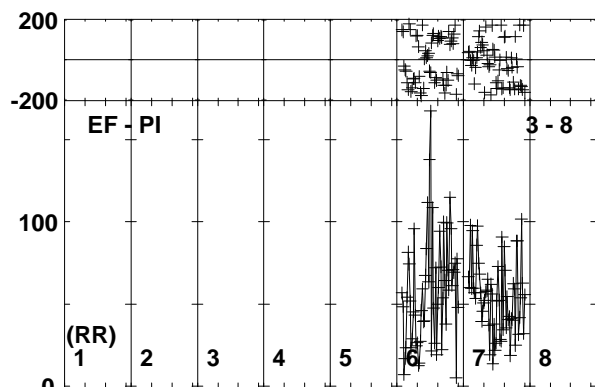
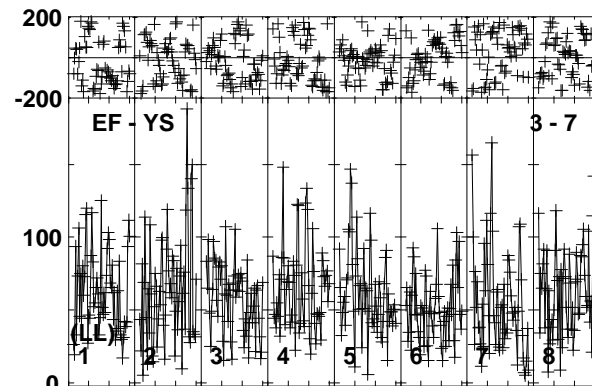
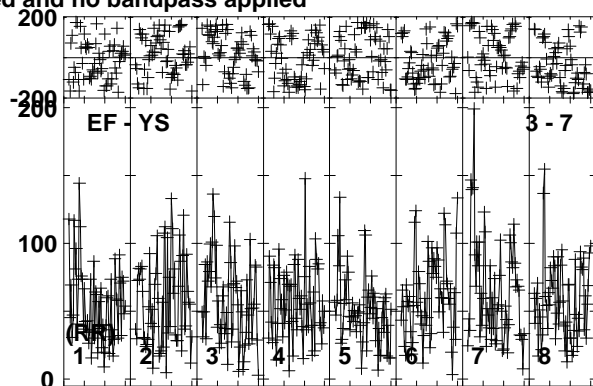
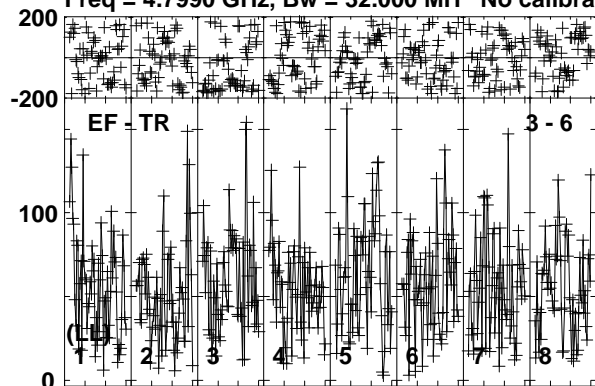

Lower frame: Micro Ampl Jy Top frame: Phas deg  
Vector averaged cross-power spectrum Baseline: EF (03) - TR (06)  
Timerange: 00/22:44:43 to 00/22:48:39

Plot file version 105 created 11-NOV-2019 15:07:28

SER8NJ EK040B.UVDATA.1

Freq = 4.7990 GHz, Bw = 32.000 MH No calibration applied and no bandpass applied

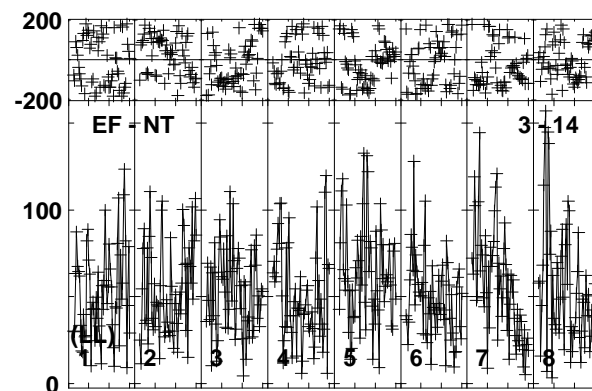
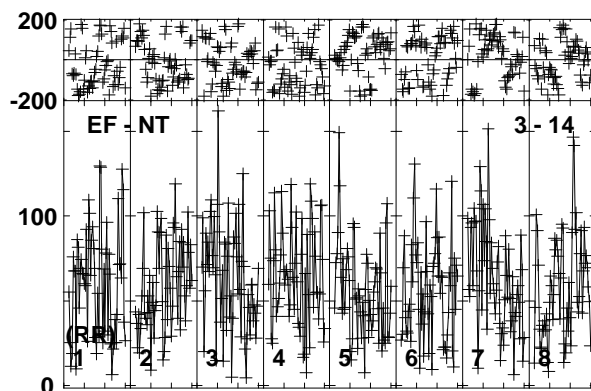
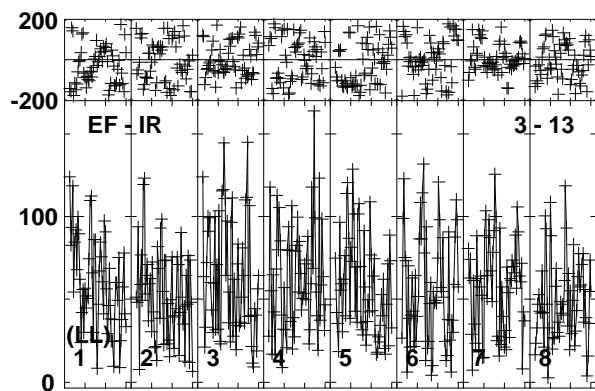
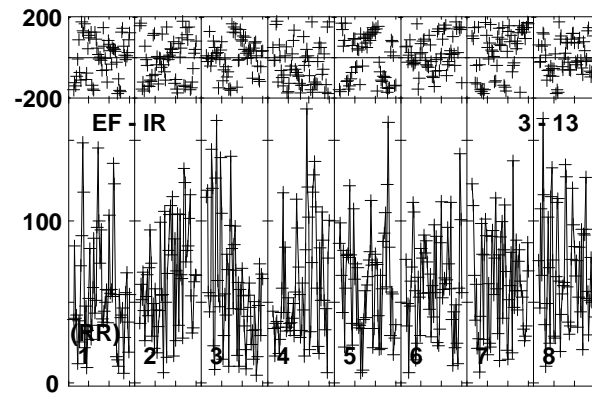
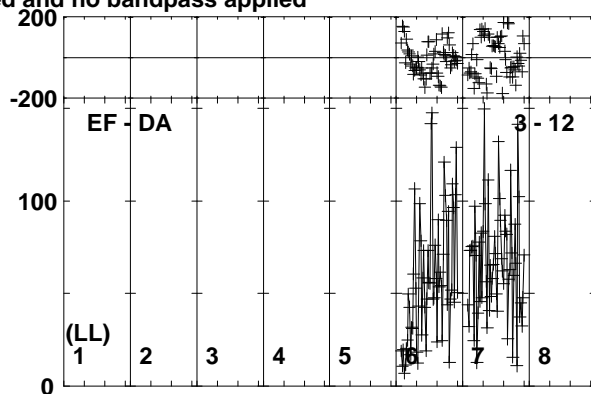
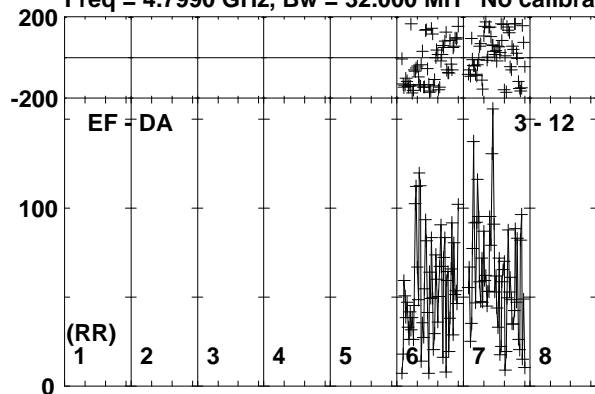

0 40 0 40 0 40 0 40 0 40 0 40 0 40 0 40 0 40 0 40  
Channels

Lower frame: Micro Ampl Jy Top frame: Phas deg  
Vector averaged cross-power spectrum Baseline: EF (03) - DA (12)  
Timerange: 00:22:44:43 to 00:22:48:39

Plot file version 106 created 11-NOV-2019 15:07:28

J1826+0149 EK040B.UVDATA.1

Freq = 4.7990 GHz, Bw = 32.000 MH No calibration applied and no bandpass applied

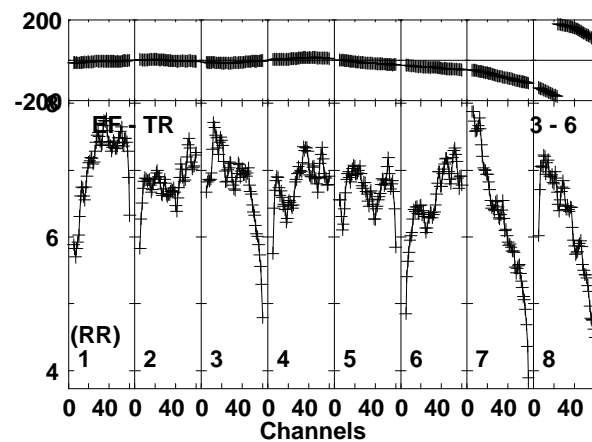
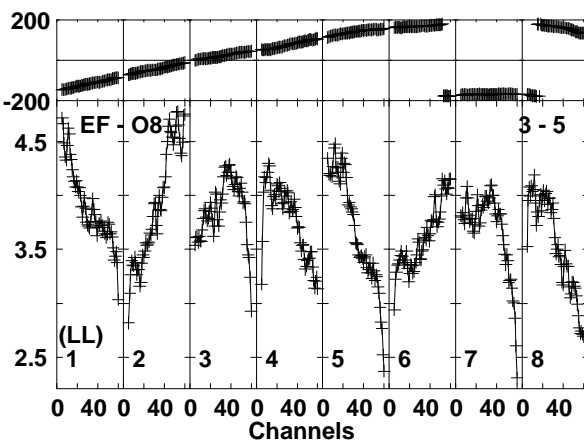
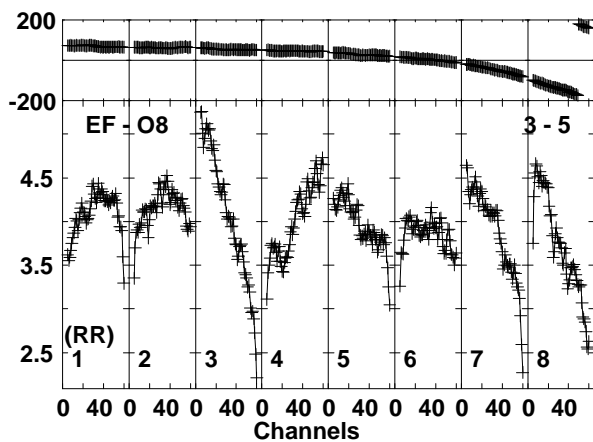
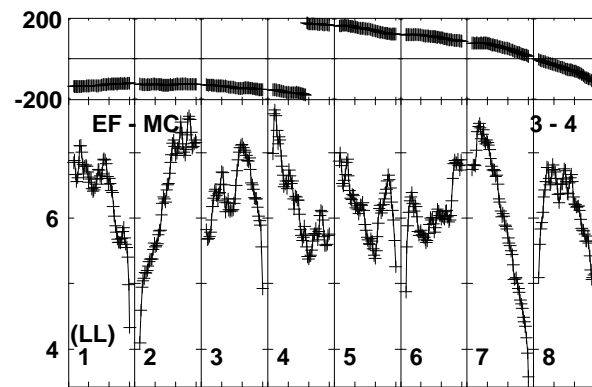
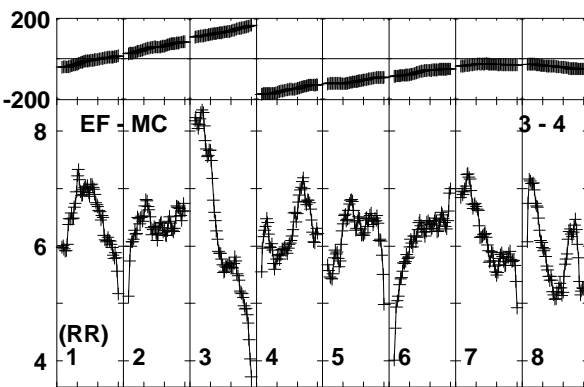
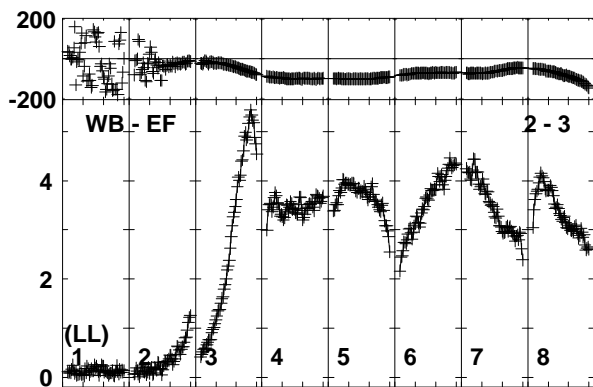
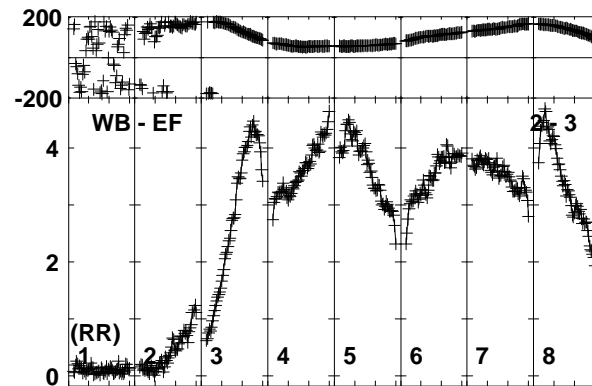
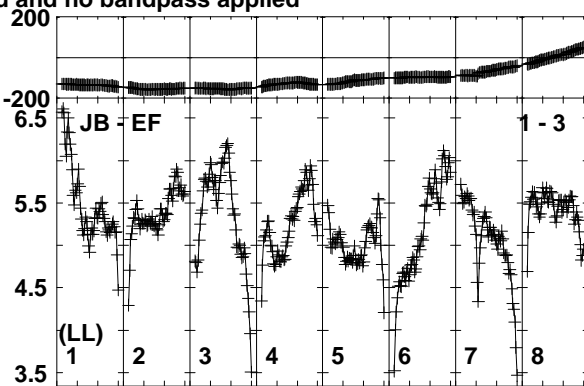
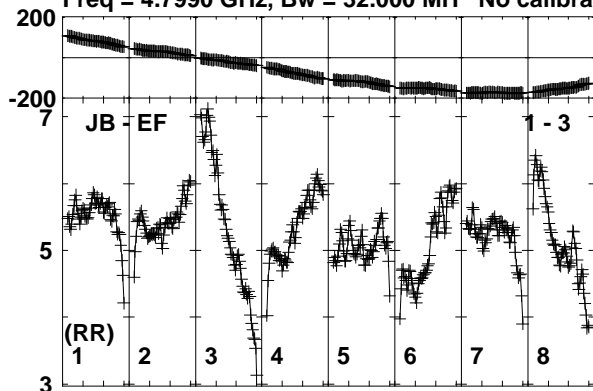

Lower frame: Milli Ampl Jy Top frame: Phas deg  
Vector averaged cross-power spectrum Baseline: JB (01) - EF (03)  
Timerange: 00:22:48:43 to 00:22:50:09



Plot file version 107 created 11-NOV-2019 15:07:28

J1826+0149 EK040B.UVDATA.1

Freq = 4.7990 GHz, Bw = 32.000 MH No calibration applied and no bandpass applied

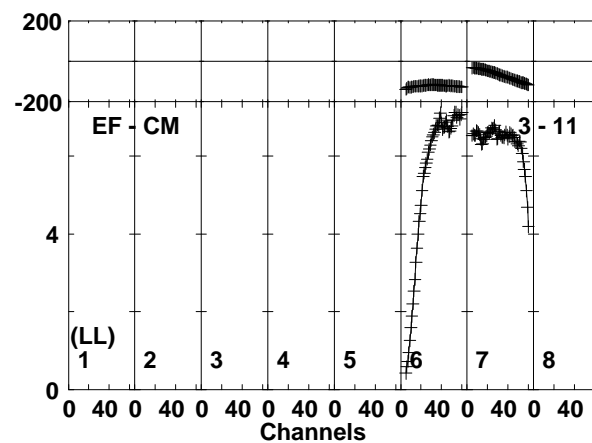
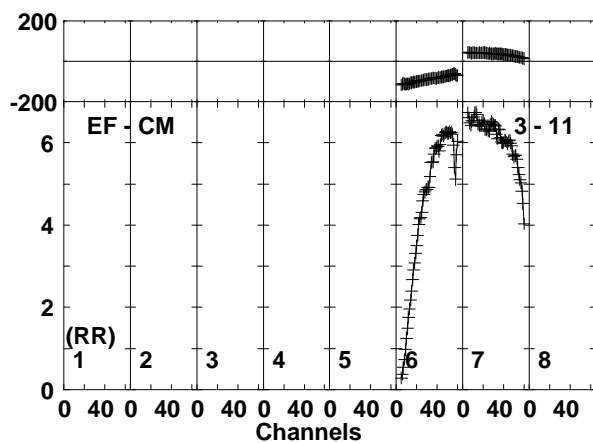
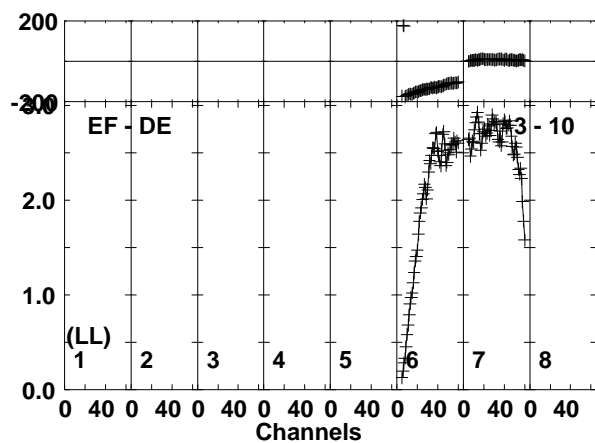
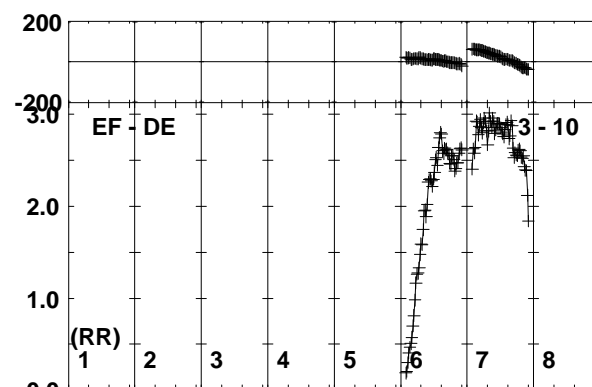
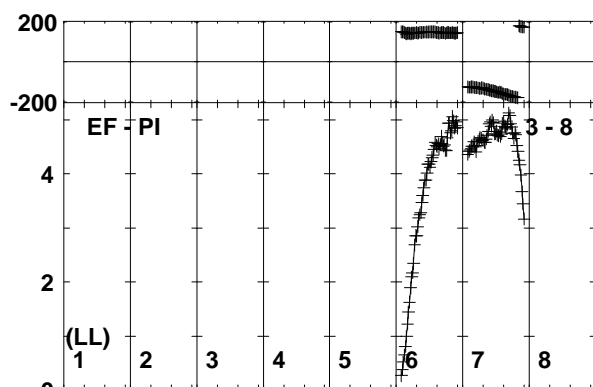
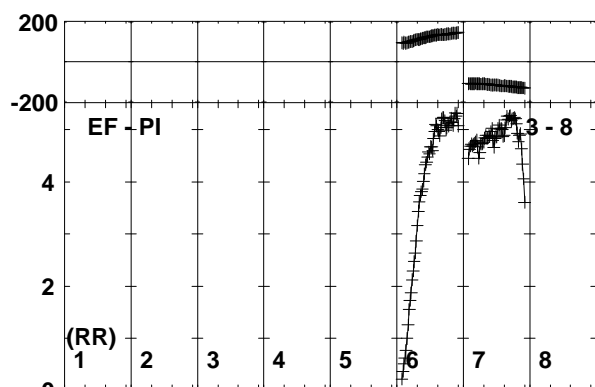
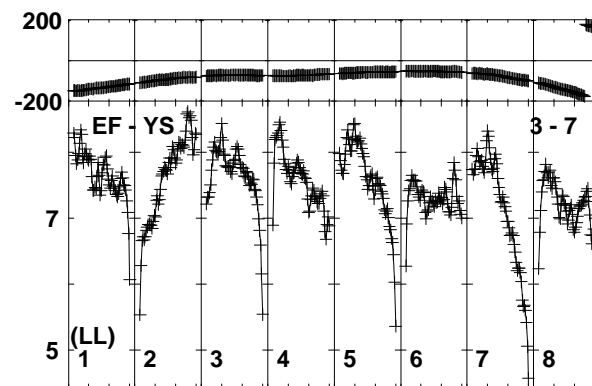
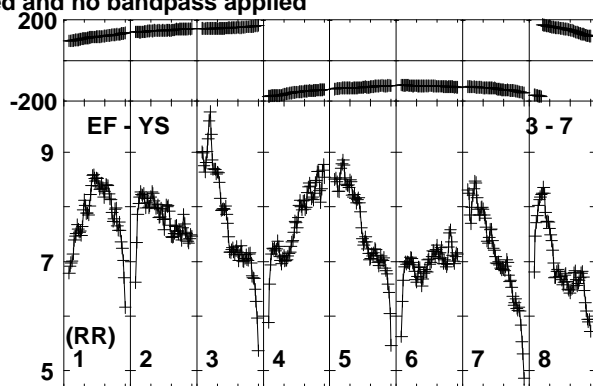
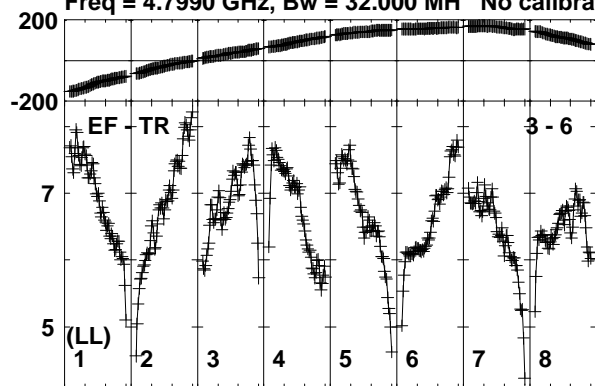

Lower frame: Milli Ampl Jy Top frame: Phas deg  
Vector averaged cross-power spectrum Baseline: EF (03) - TR (06)  
Timerange: 00/22:48:43 to 00/22:50:09

Plot file version 108 created 11-NOV-2019 15:07:28

J1826+0149 EK040B.UVDATA.1

Freq = 4.7990 GHz, Bw = 32.000 MH No calibration applied and no bandpass applied

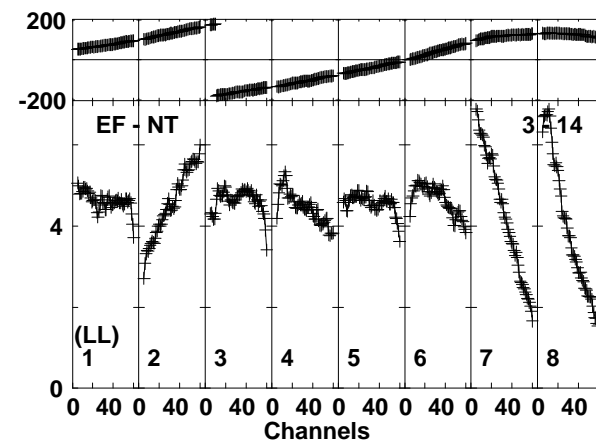
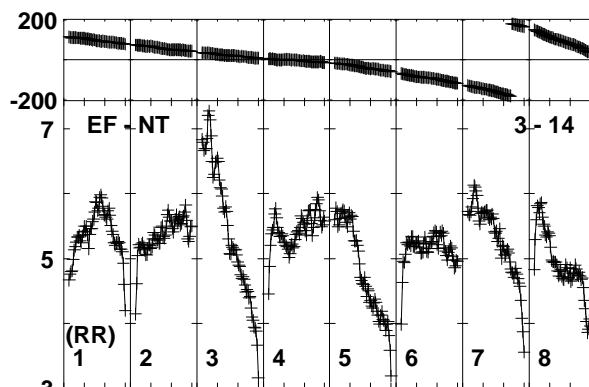
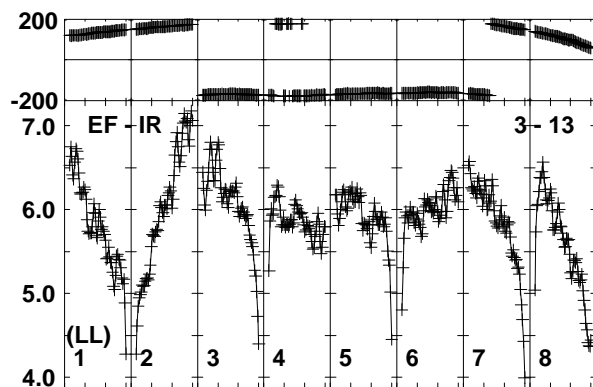
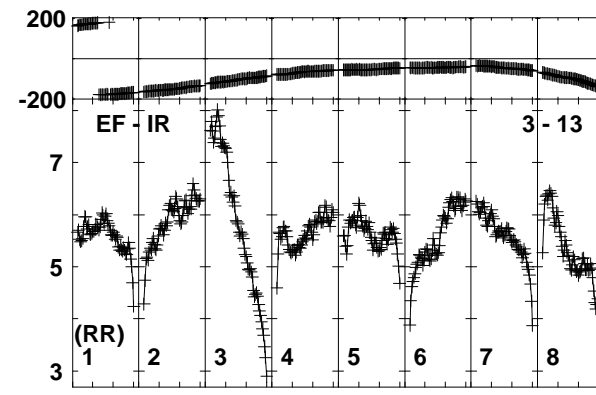
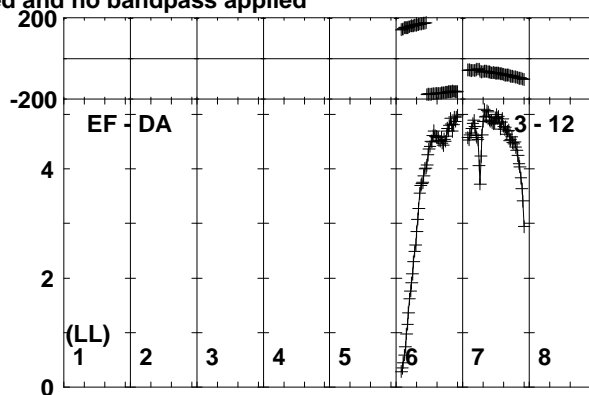
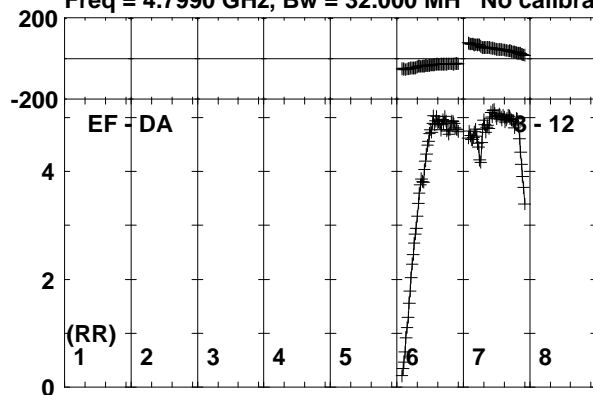

Lower frame: Milli Ampl Jy Top frame: Phas deg  
Vector averaged cross-power spectrum Baseline: EF (03) - DA (12)  
Timerange: 00:22:48:43 to 00:22:50:09

Plot file version 109 created 11-NOV-2019 15:07:28

SER8NJ EK040B.UVDATA.1

Freq = 4.7990 GHz, Bw = 32.000 MH No calibration applied and no bandpass applied

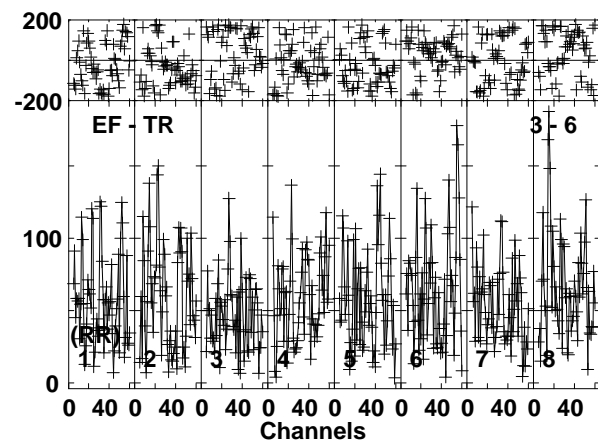
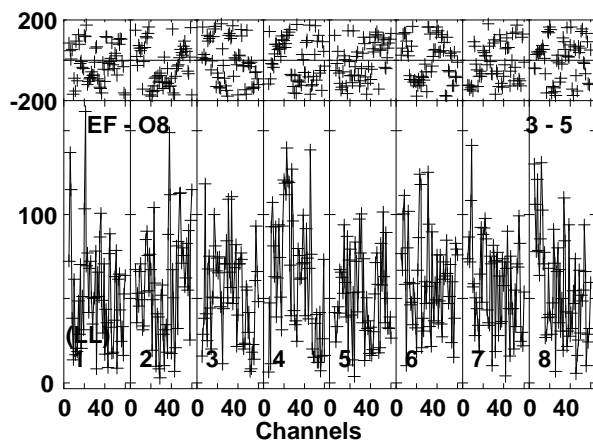
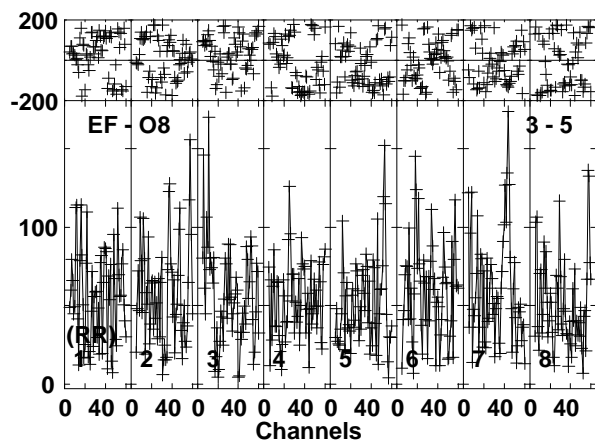
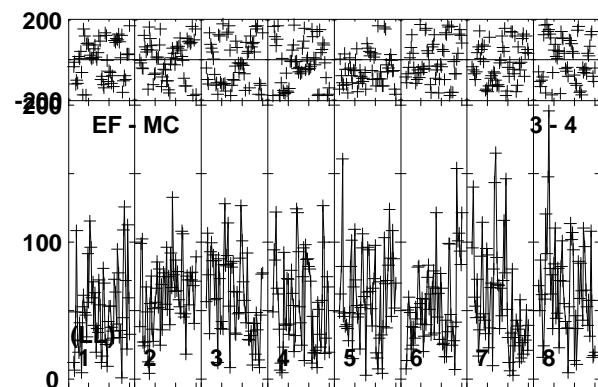
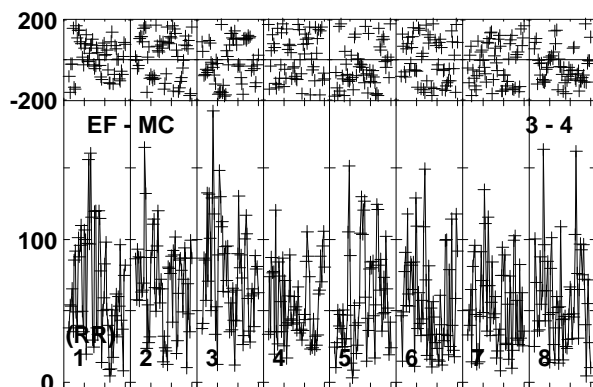
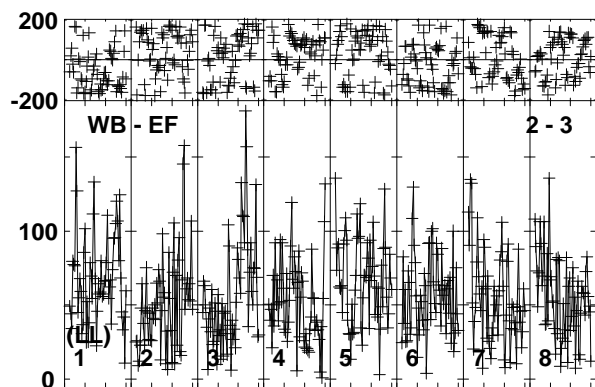
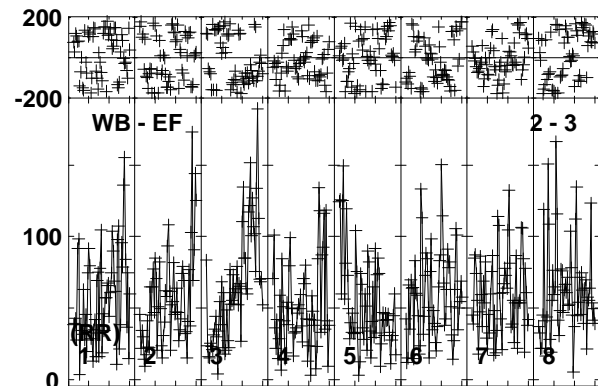
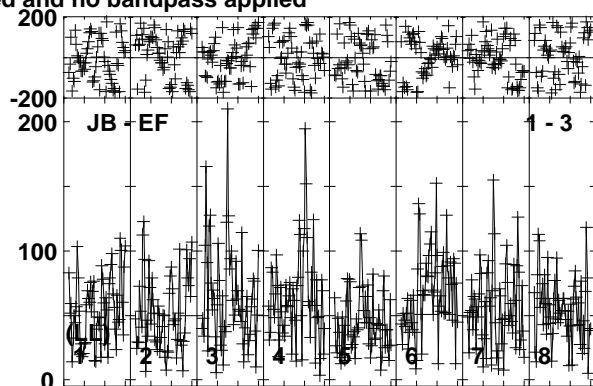
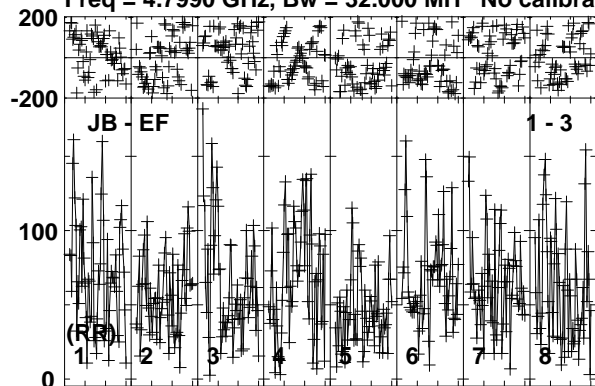

Lower frame: Micro Ampl Jy Top frame: Phas deg  
Vector averaged cross-power spectrum Baseline: JB (01) - EF (03)  
Timerange: 00:22:50:11 to 00:22:54:09

Plot file version 110 created 11-NOV-2019 15:07:28

SER8NJ EK040B.UVDATA.1

Freq = 4.7990 GHz, Bw = 32.000 MH No calibration applied and no bandpass applied

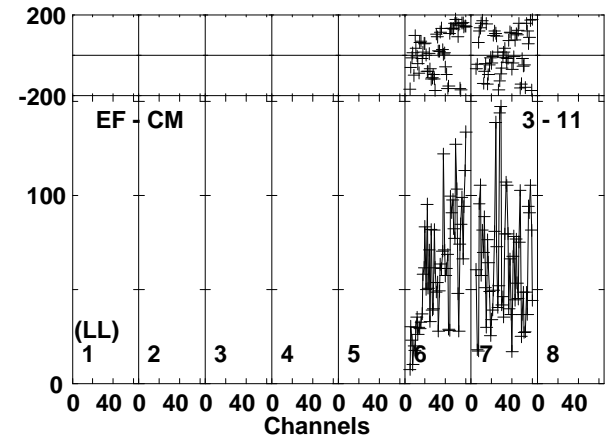
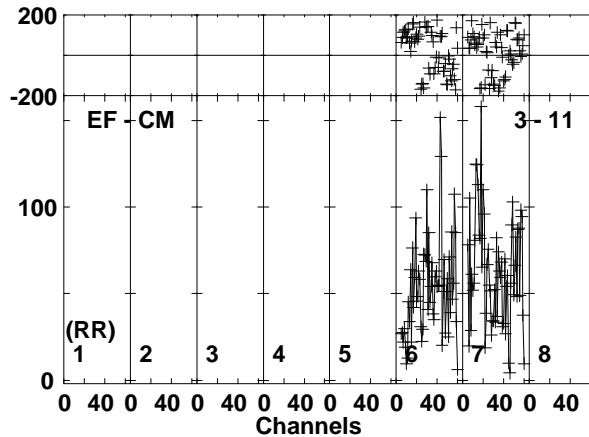
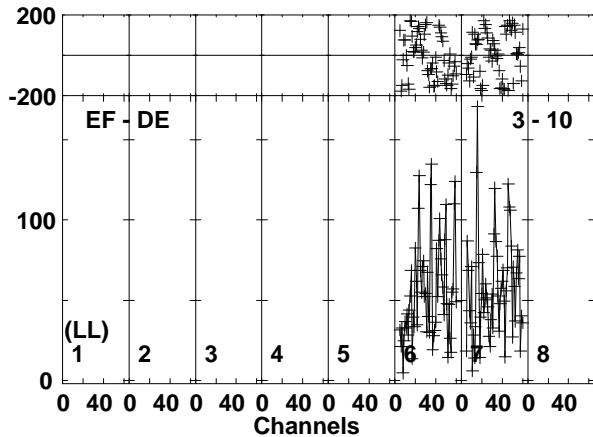
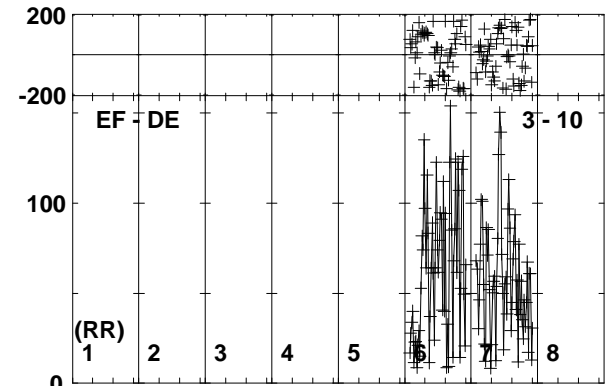
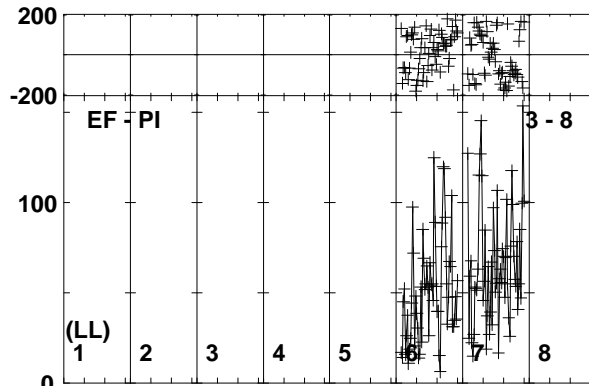
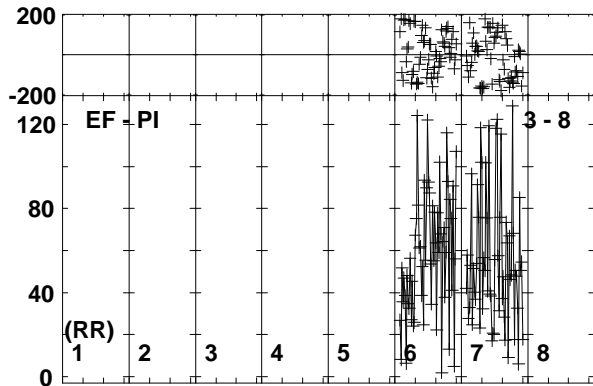
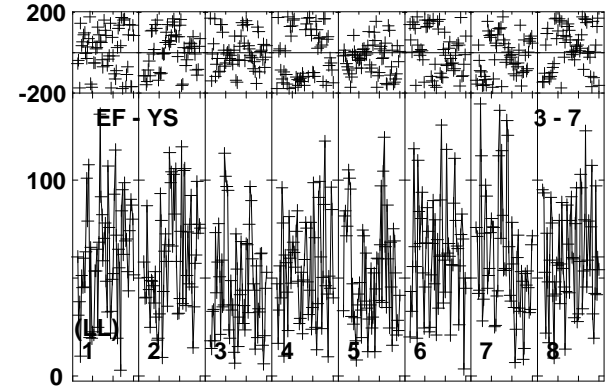
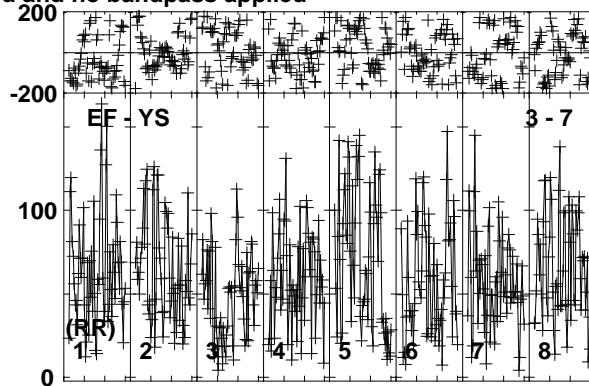
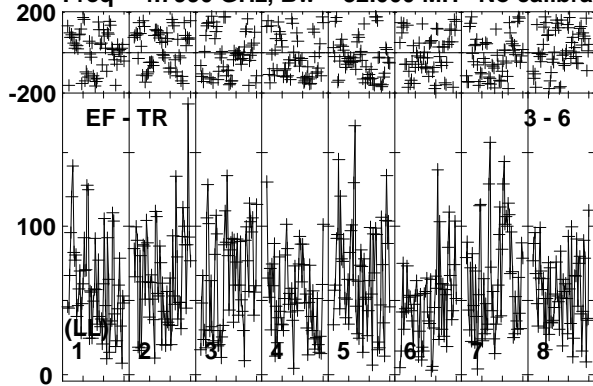

Lower frame: Micro Ampl Jy Top frame: Phas deg  
Vector averaged cross-power spectrum Baseline: EF (03) - TR (06)  
Timerange: 00:22:50:11 to 00:22:54:09

Plot file version 111 created 11-NOV-2019 15:07:28

SER8NJ EK040B.UVDATA.1

Freq = 4.7990 GHz, Bw = 32.000 MH No calibration applied and no bandpass applied

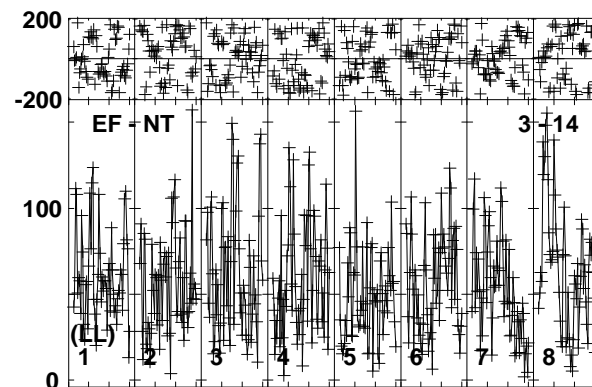
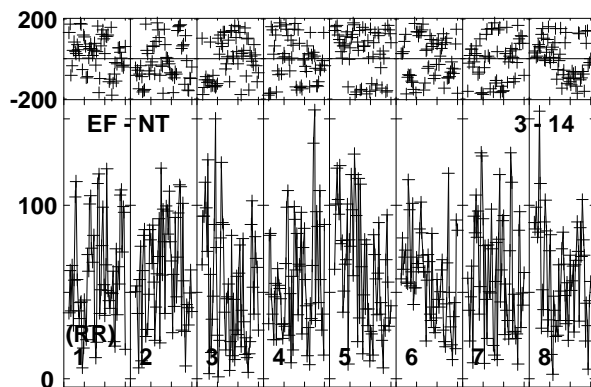
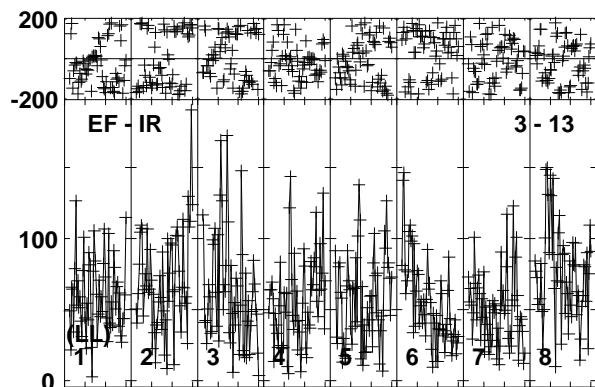
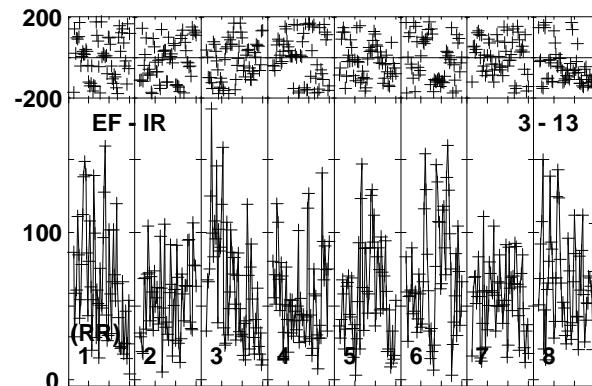
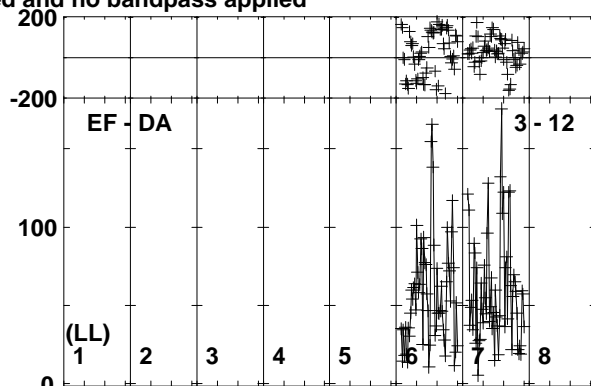
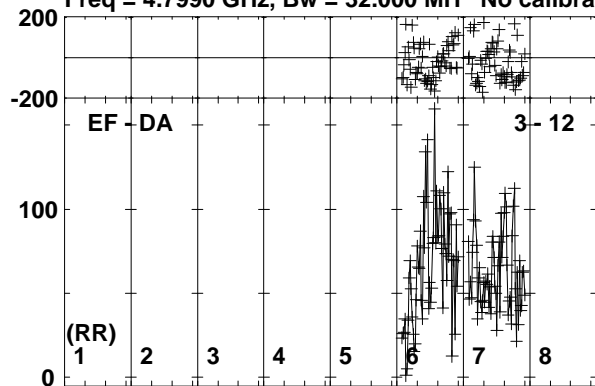

0 40 0 40 0 40 0 40 0 40 0 40 0 40 0 40 0 40  
Channels

Lower frame: Micro Ampl Jy Top frame: Phas deg  
Vector averaged cross-power spectrum Baseline: EF (03) - DA (12)  
Timerange: 00:22:50:11 to 00:22:54:09

Plot file version 112 created 11-NOV-2019 15:07:28

J1826+0149 EK040B.UVDATA.1

Freq = 4.7990 GHz, Bw = 32.000 MH No calibration applied and no bandpass applied

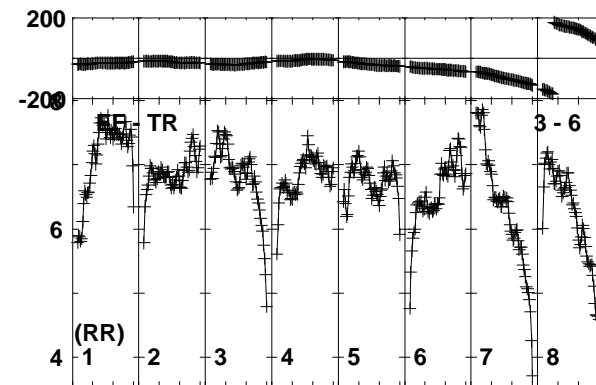
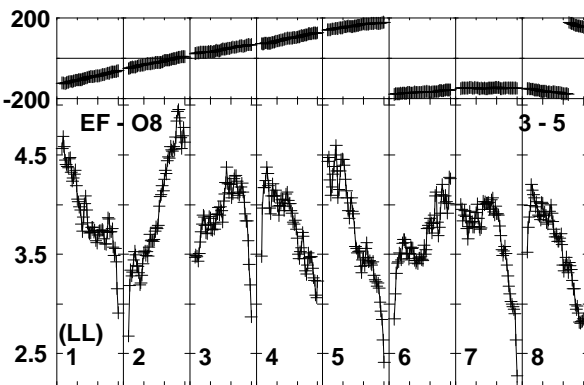
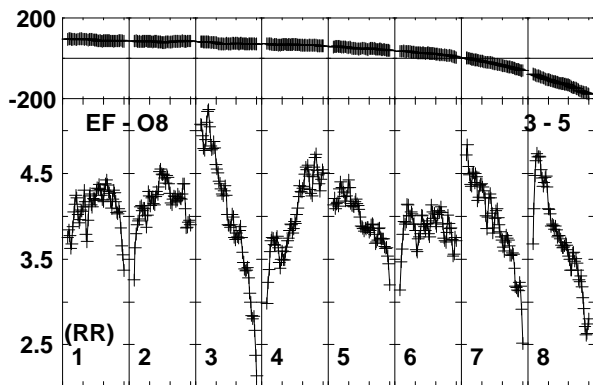
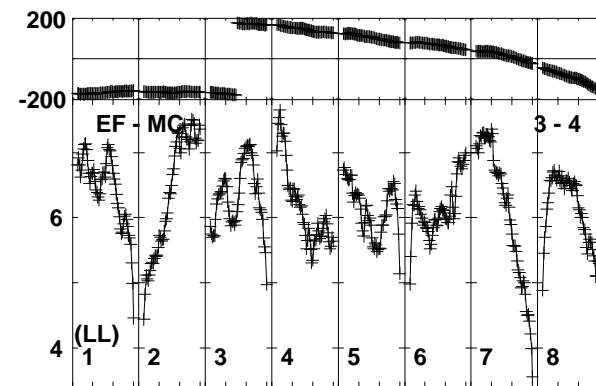
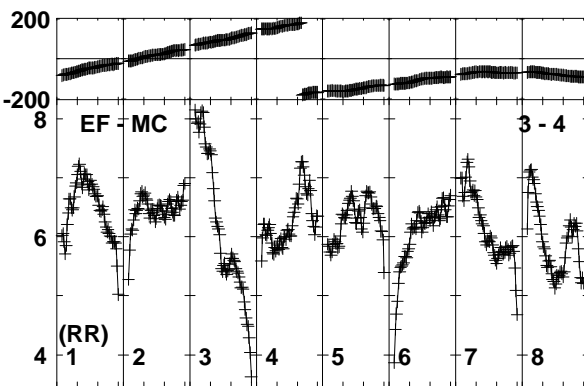
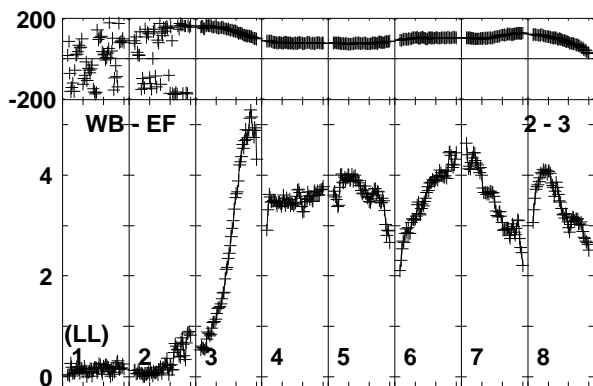
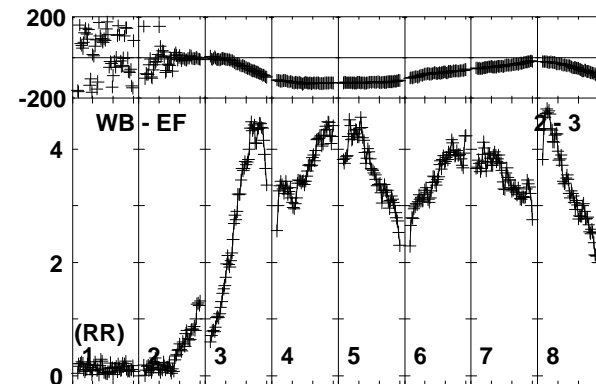
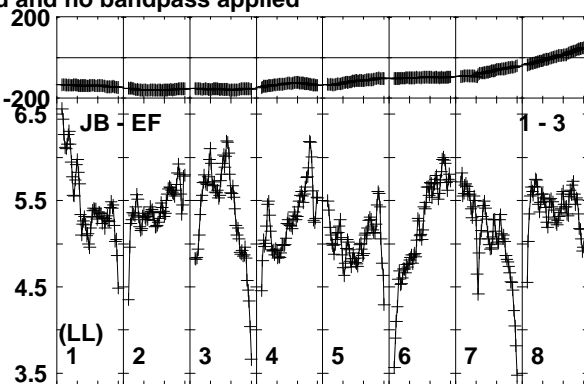
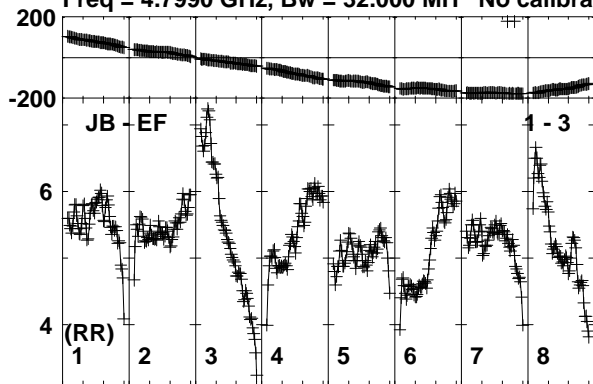

Lower frame: Milli Ampl Jy Top frame: Phas deg  
Vector averaged cross-power spectrum Baseline: JB (01) - EF (03)  
Timerange: 00:22:54:51 to 00:22:55:49

Plot file version 113 created 11-NOV-2019 15:07:29

J1826+0149 EK040B.UVDATA.1

Freq = 4.7990 GHz, Bw = 32.000 MH No calibration applied and no bandpass applied

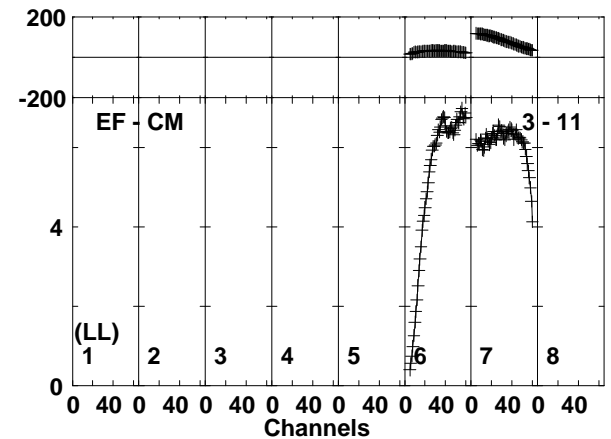
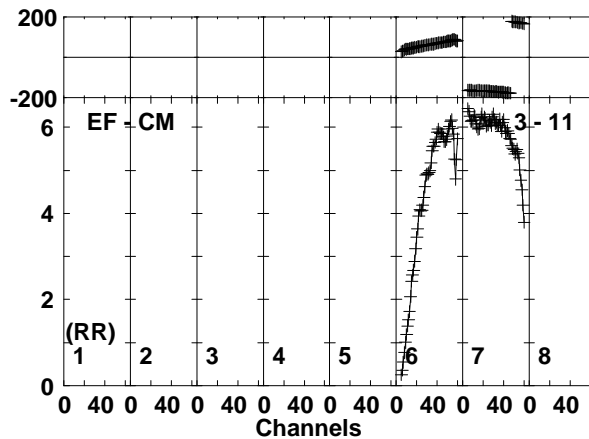
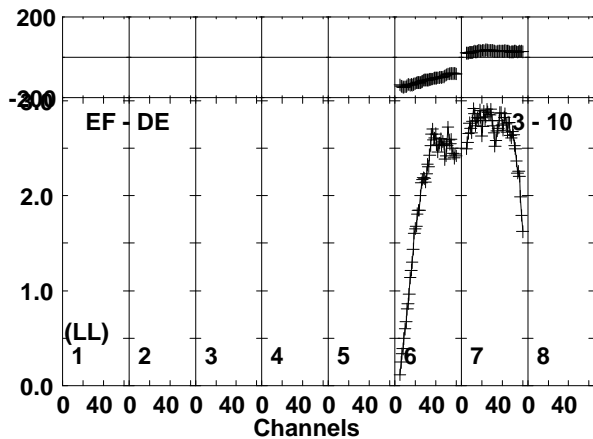
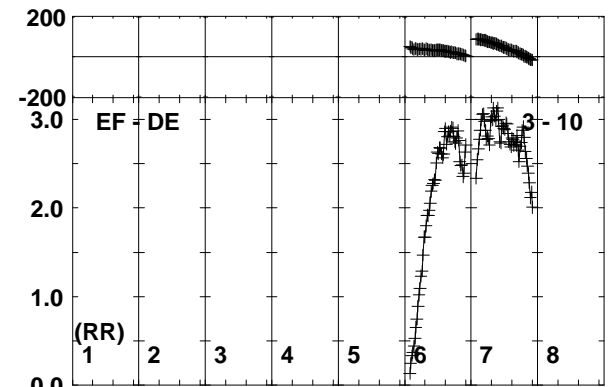
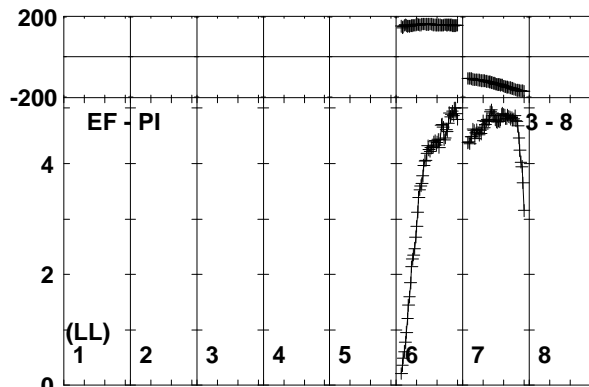
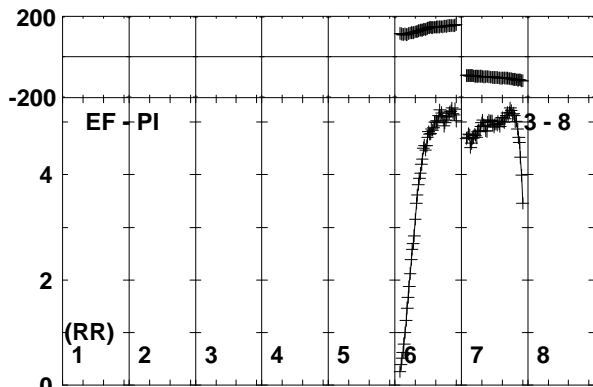
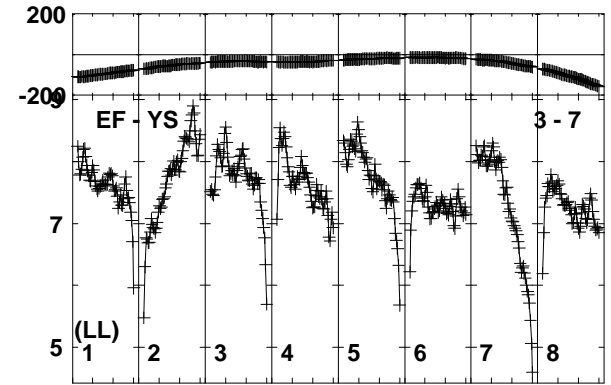
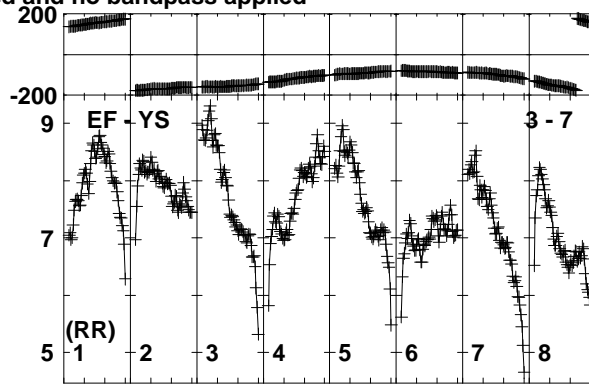
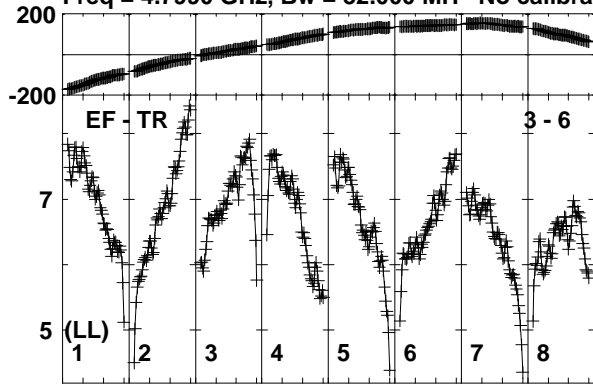

Lower frame: Milli Ampl Jy Top frame: Phas deg  
Vector averaged cross-power spectrum Baseline: EF (03) - TR (06)  
Timerange: 00/22:54:51 to 00/22:55:49

Plot file version 114 created 11-NOV-2019 15:07:29

J1826+0149 EK040B.UVDATA.1

Freq = 4.7990 GHz, Bw = 32.000 MH No calibration applied and no bandpass applied

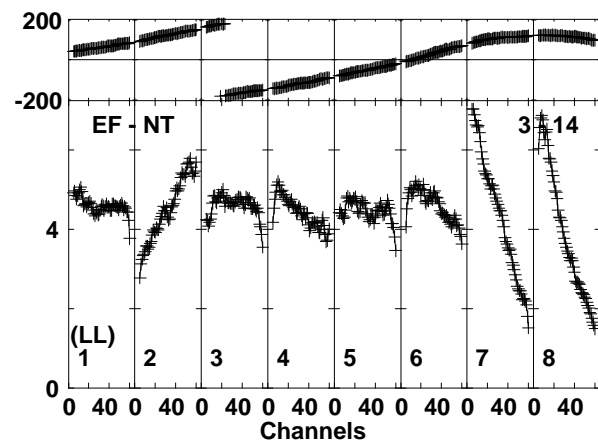
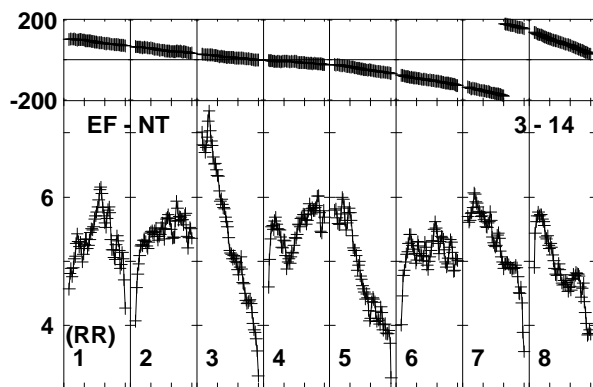
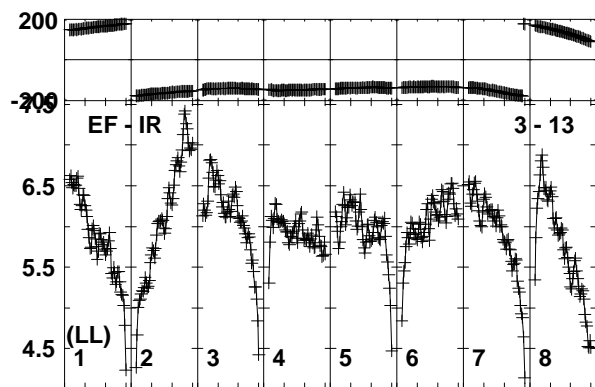
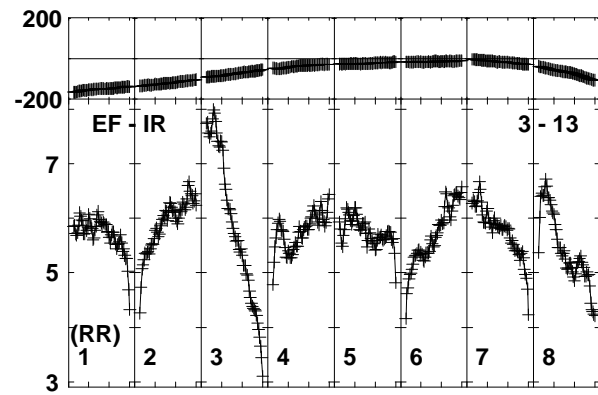
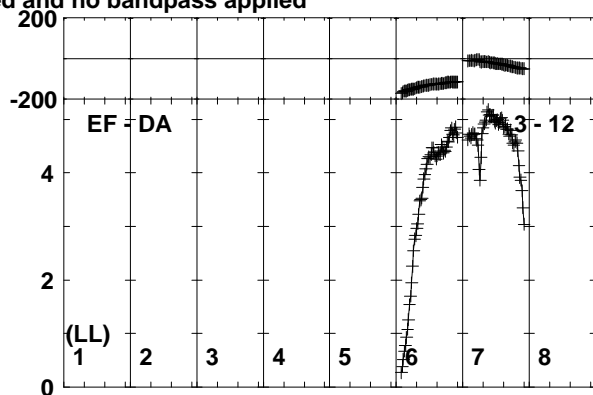
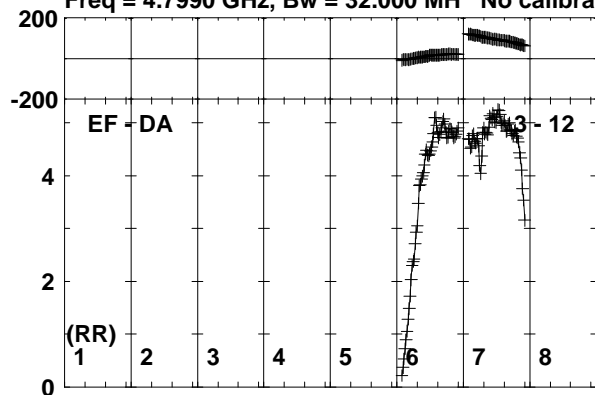

Lower frame: Milli Ampl Jy Top frame: Phas deg  
Vector averaged cross-power spectrum Baseline: EF (03) - DA (12)  
Timerange: 00/22:54:51 to 00/22:55:49



Plot file version 115 created 11-NOV-2019 15:07:29

SER8NJ EK040B.UVDATA.1

Freq = 4.7990 GHz, Bw = 32.000 MH No calibration applied and no bandpass applied

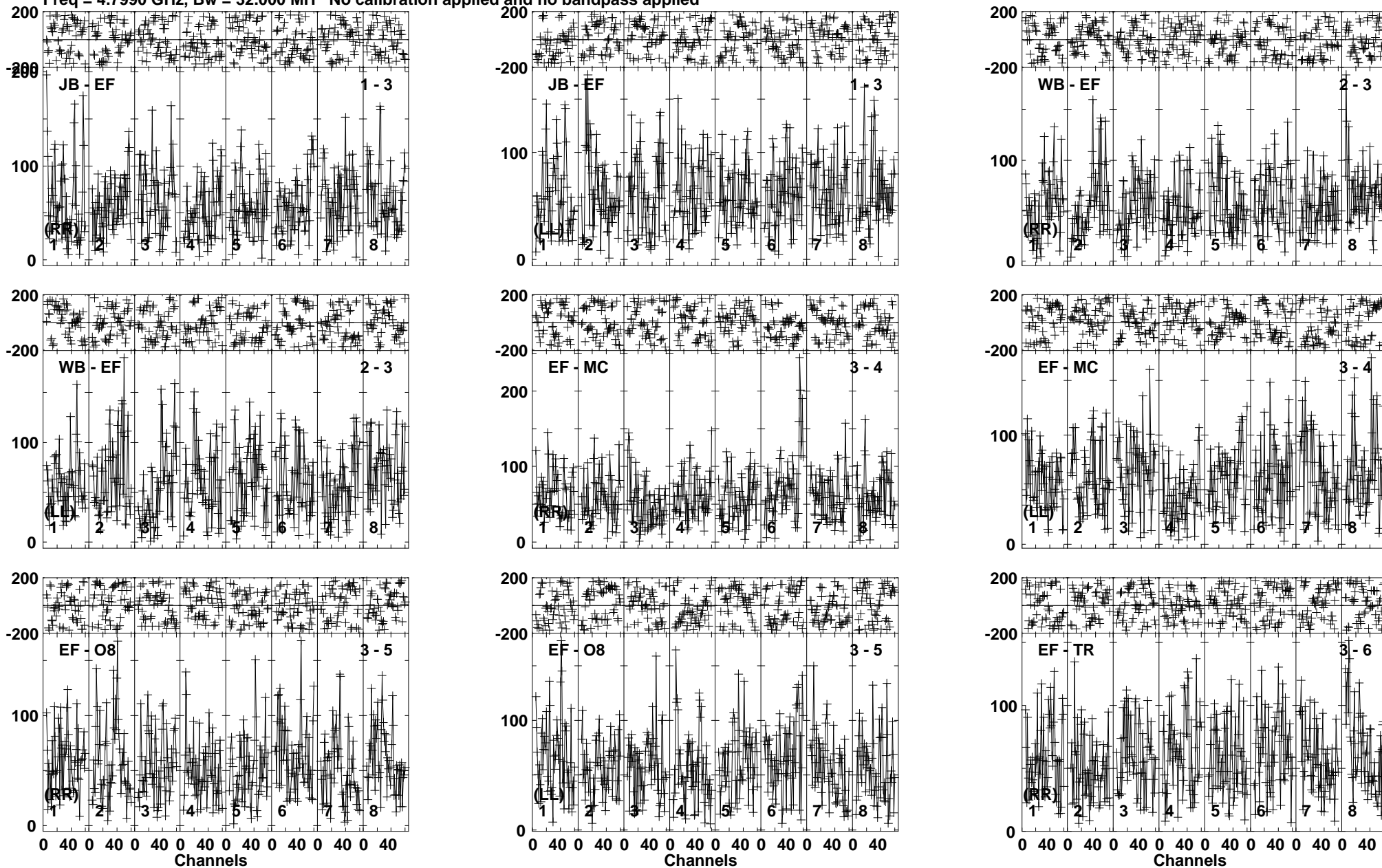

Lower frame: Micro Ampl Jy Top frame: Phas deg  
Vector averaged cross-power spectrum Baseline: JB (01) - EF (03)  
Timerange: 00/22:55:53 to 00/22:59:49

Plot file version 116 created 11-NOV-2019 15:07:29

SER8NJ EK040B.UVDATA.1

Freq = 4.7990 GHz, Bw = 32.000 MH No calibration applied and no bandpass applied

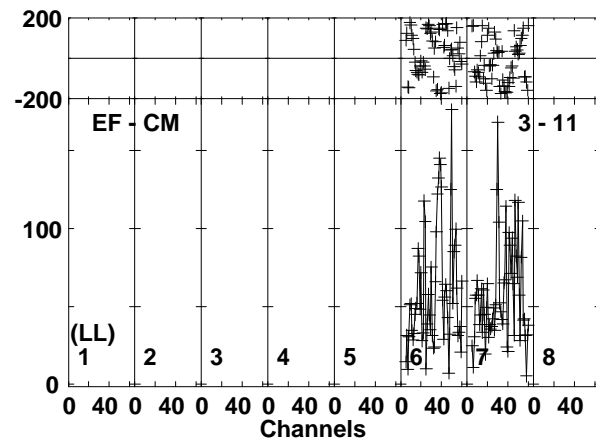
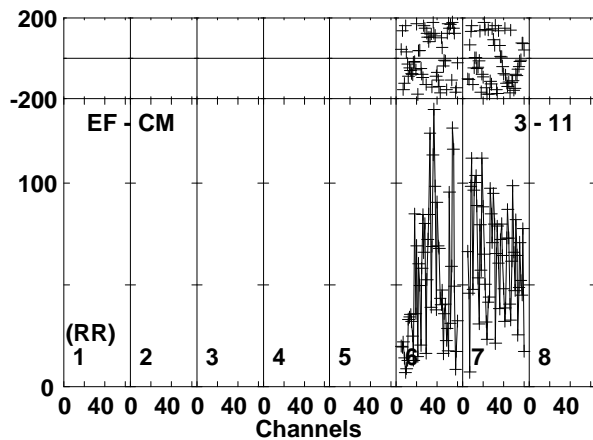
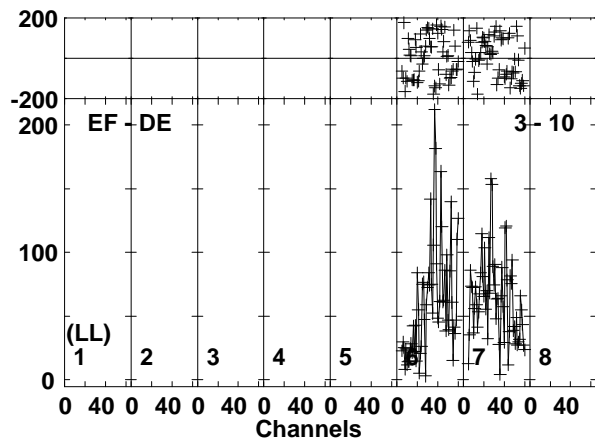
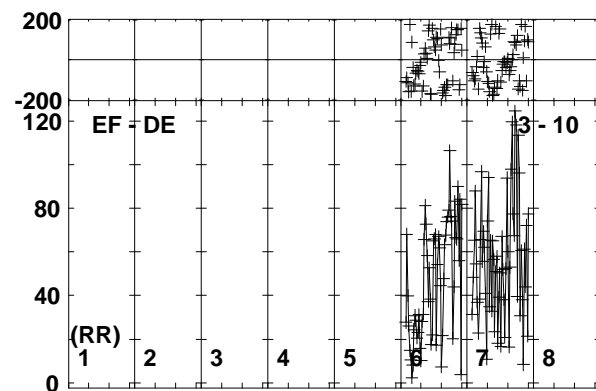
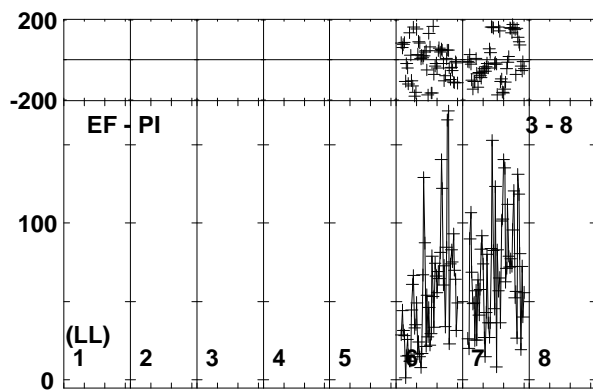
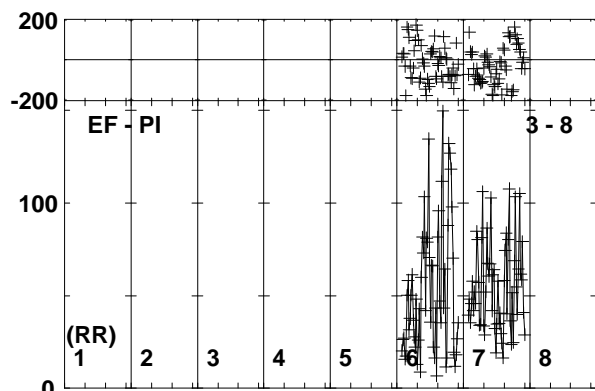
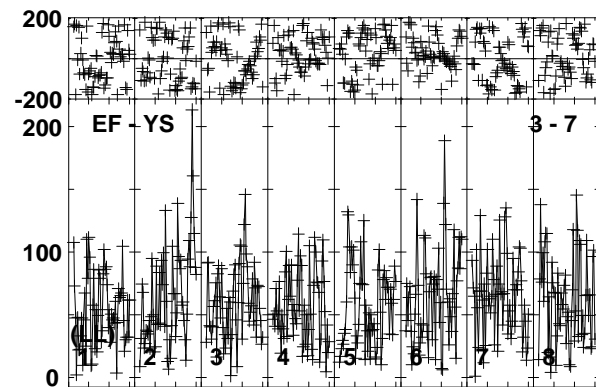
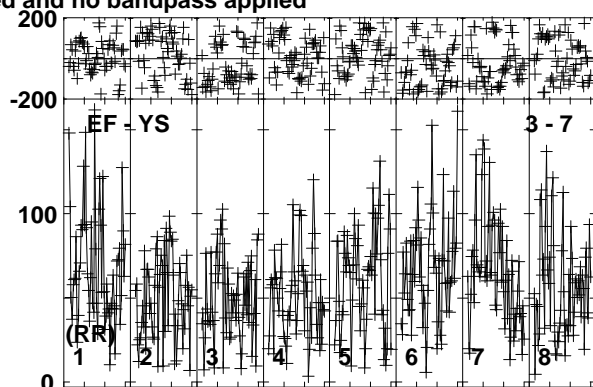
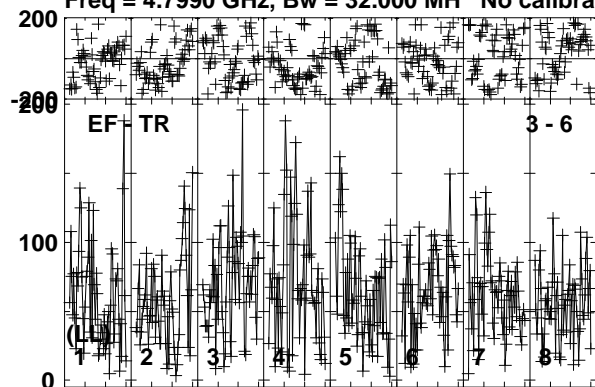

Lower frame: Micro Ampl Jy Top frame: Phas deg  
Vector averaged cross-power spectrum Baseline: EF (03) - TR (06)  
Timerange: 00:22:55:53 to 00:22:59:49

Plot file version 117 created 11-NOV-2019 15:07:29  
 SER8NJ EK040B.UVDATA.1  
 Freq = 4.7990 GHz, Bw = 32.000 MH No calibration applied and no bandpass applied

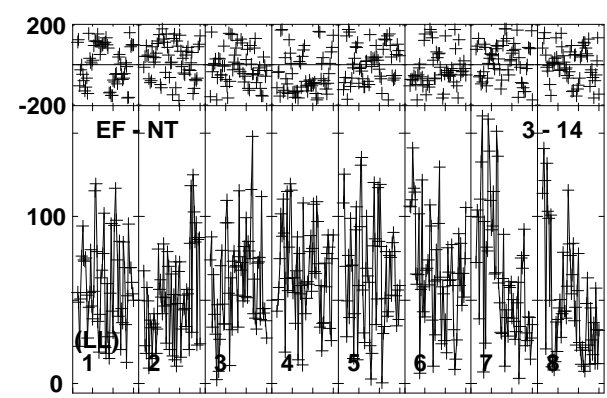
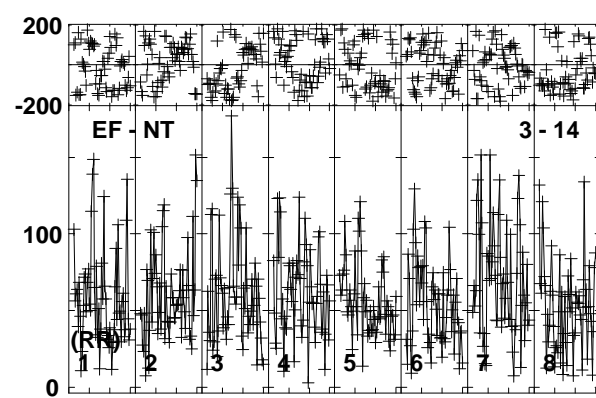
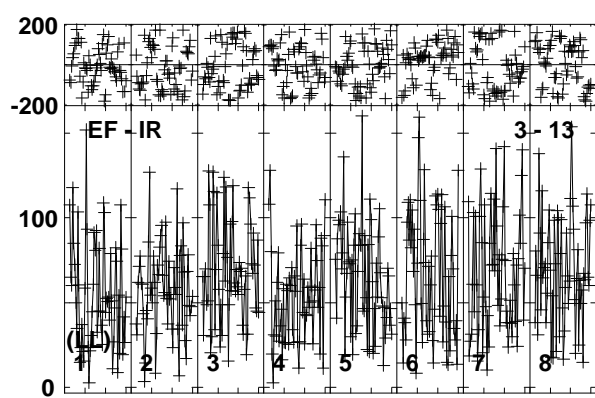
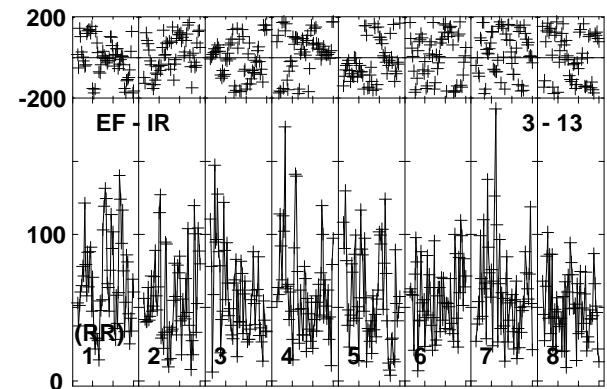
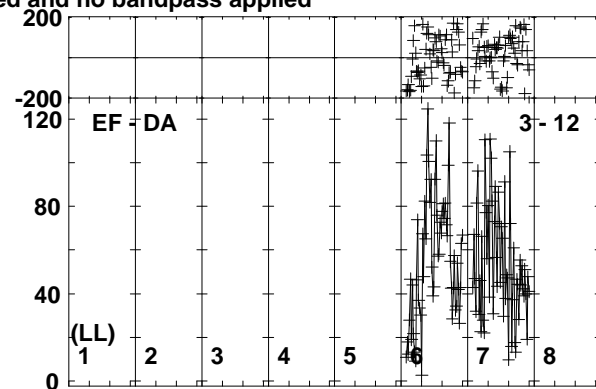
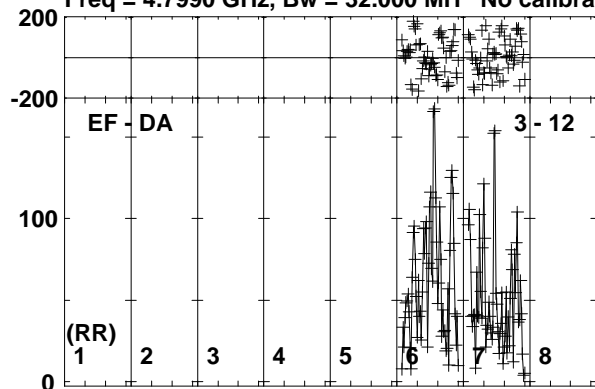

0 40 0 40 0 40 0 40 0 40 0 40 0 40 0 40 0 40 0 40  
 Channels

Lower frame: Micro Ampl Jy Top frame: Phas deg  
 Vector averaged cross-power spectrum Baseline: EF (03) - DA (12)  
 Timerange: 00/22:55:53 to 00/22:59:49

Plot file version 118 created 11-NOV-2019 15:07:29

J1826+0149 EK040B.UVDATA.1

Freq = 4.7990 GHz, Bw = 32.000 MH No calibration applied and no bandpass applied

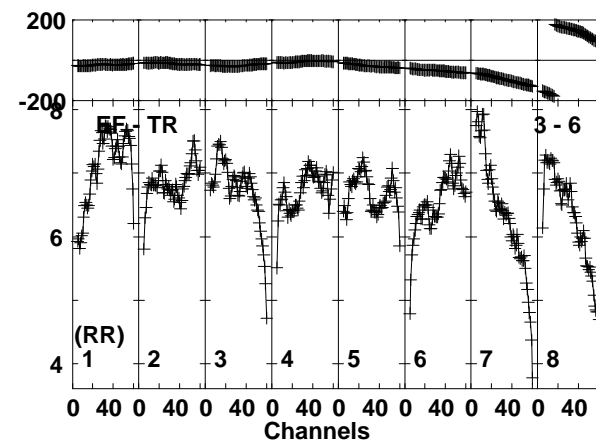
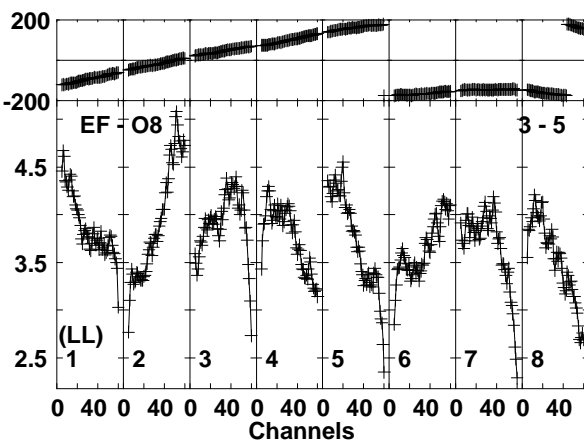
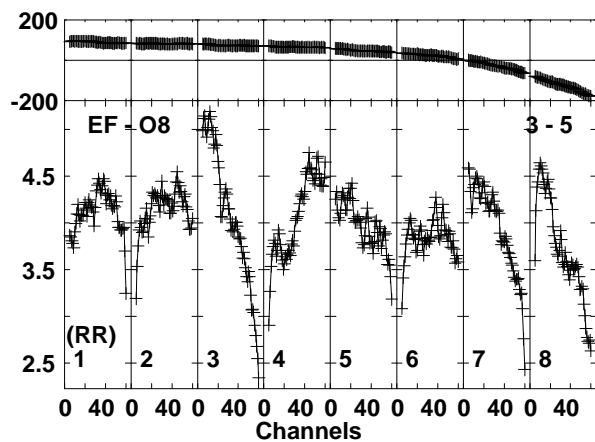
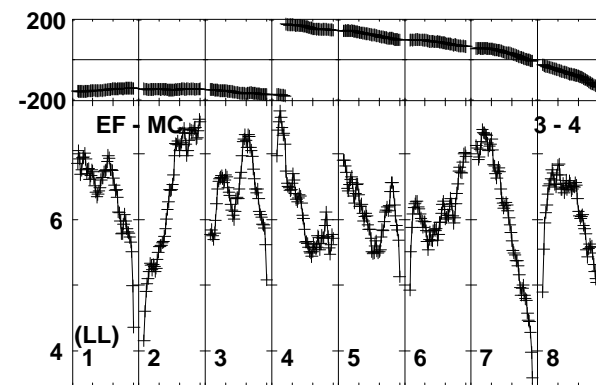
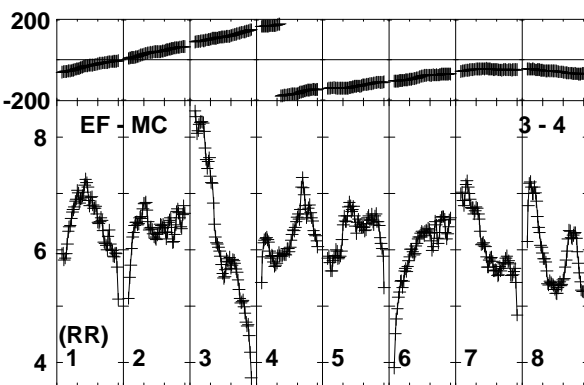
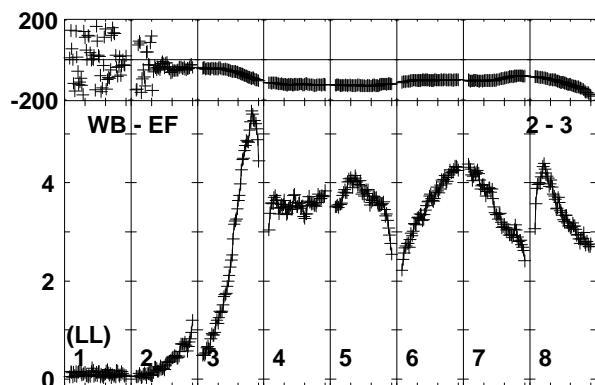
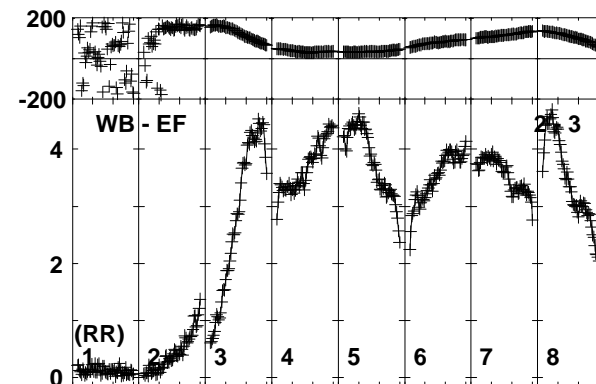
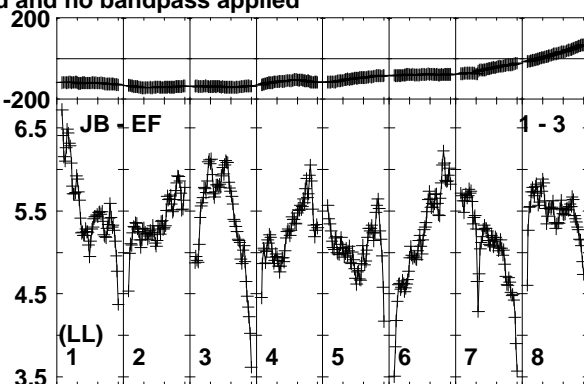
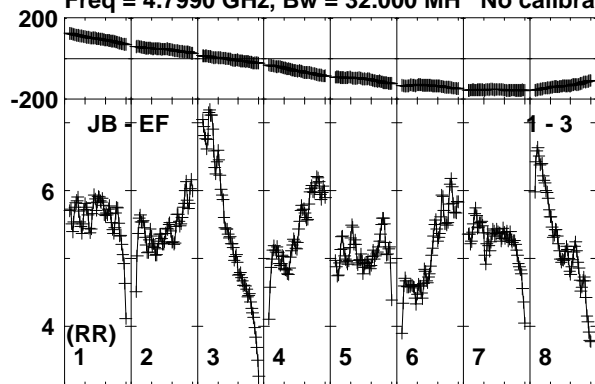

Lower frame: Milli Ampl Jy Top frame: Phas deg  
Vector averaged cross-power spectrum Baseline: JB (01) - EF (03)  
Timerange: 00:22:59:53 to 00:23:01:19

Plot file version 119 created 11-NOV-2019 15:07:29

J1826+0149 EK040B.UVDATA.1

Freq = 4.7990 GHz, Bw = 32.000 MH No calibration applied and no bandpass applied

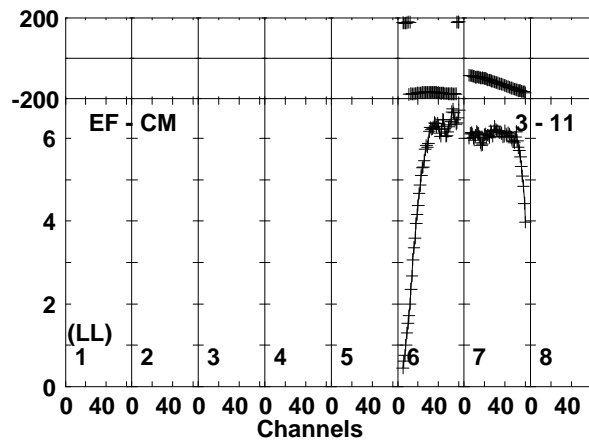
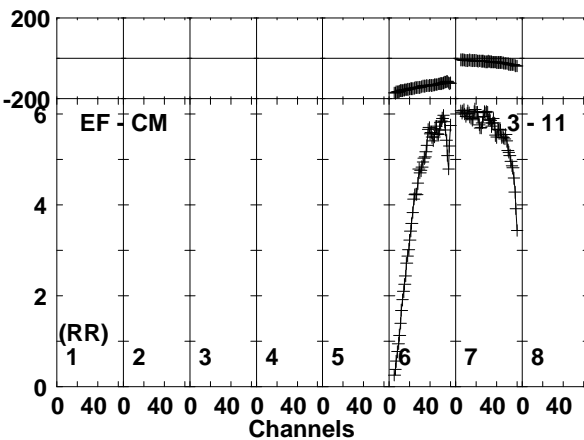
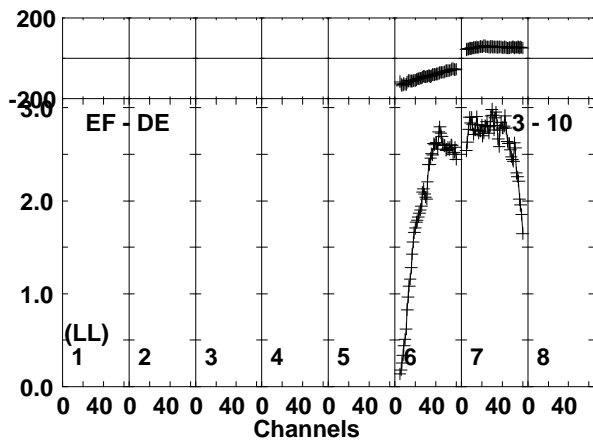
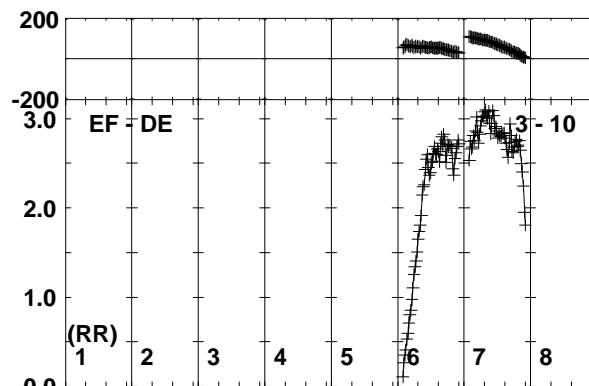
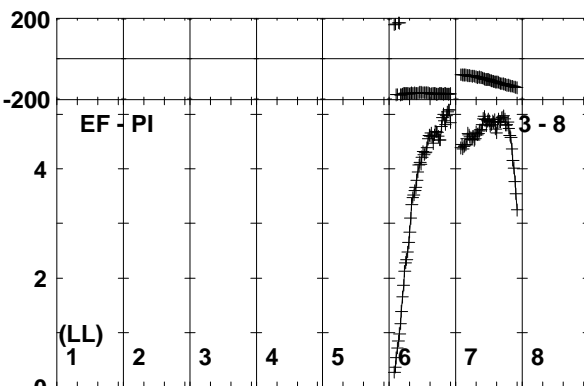
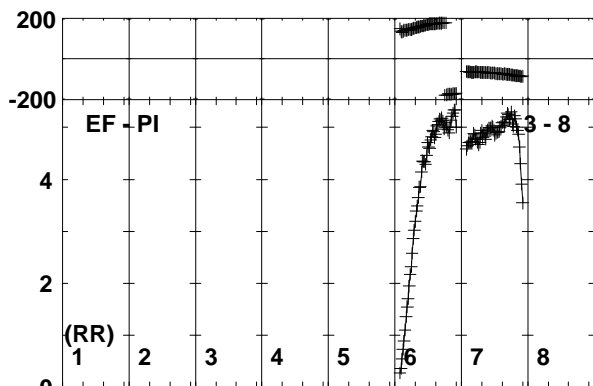
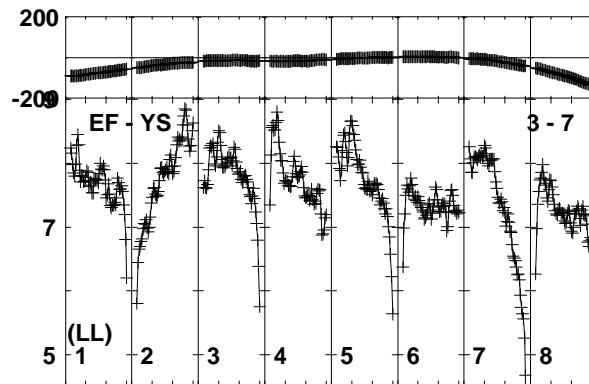
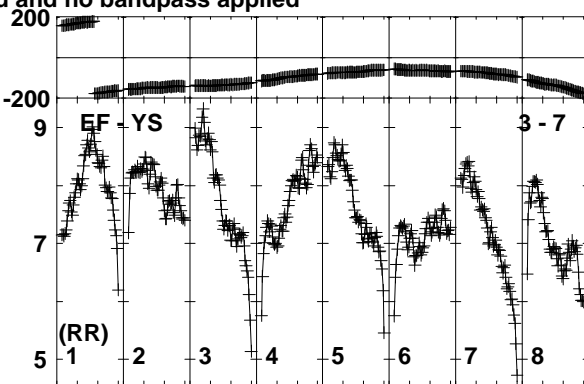
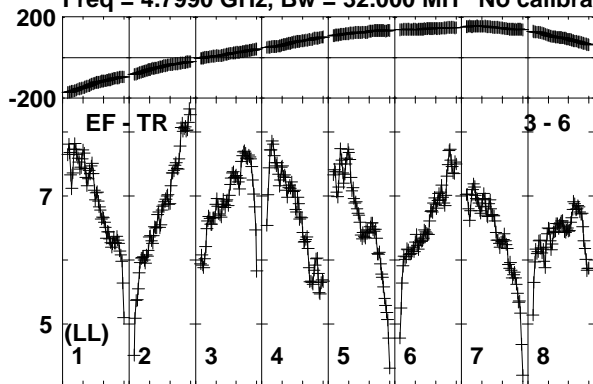

Lower frame: Milli Ampl Jy Top frame: Phas deg  
Vector averaged cross-power spectrum Baseline: EF (03) - TR (06)  
Timerange: 00/22:59:53 to 00/23:01:19

Plot file version 120 created 11-NOV-2019 15:07:29

J1826+0149 EK040B.UVDATA.1

Freq = 4.7990 GHz, Bw = 32.000 MH No calibration applied and no bandpass applied

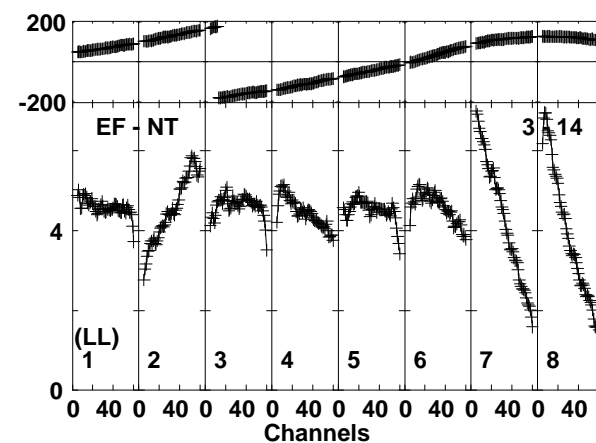
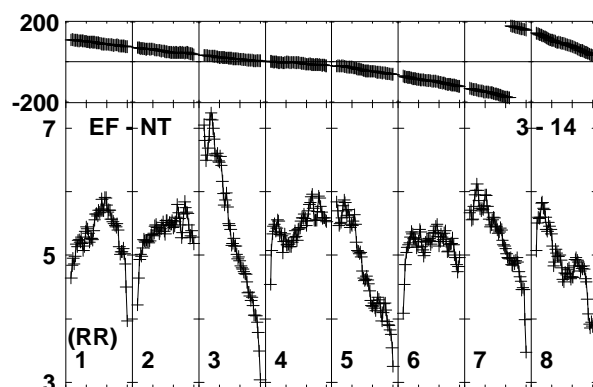
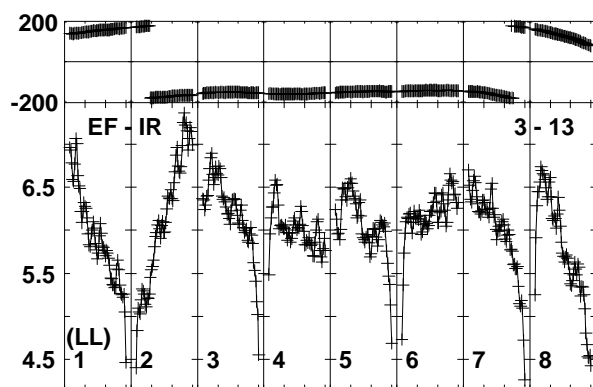
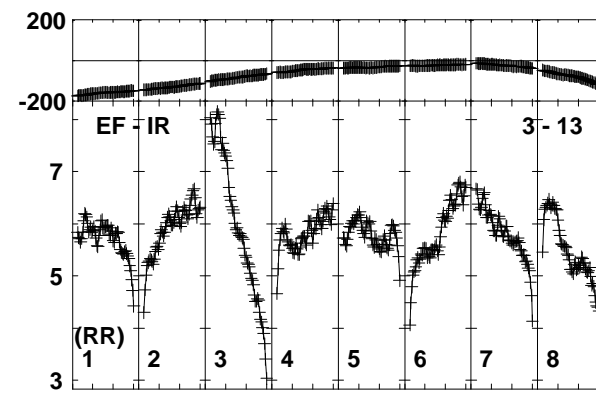
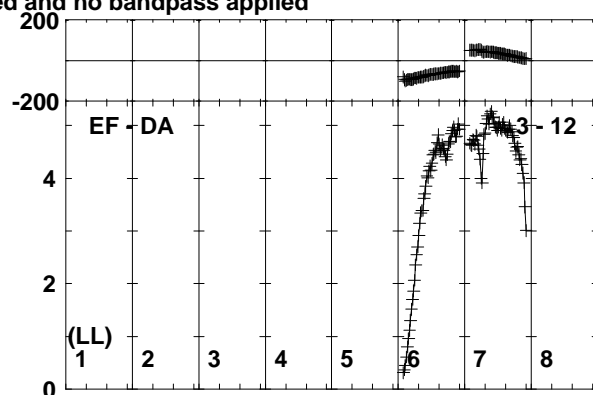
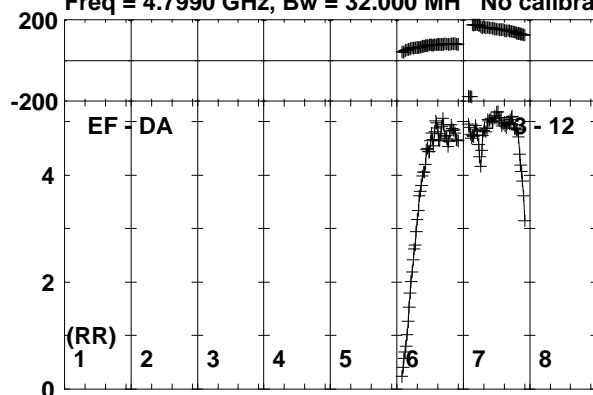

Lower frame: Milli Ampl Jy Top frame: Phas deg  
Vector averaged cross-power spectrum Baseline: EF (03) - DA (12)  
Timerange: 00/22:59:53 to 00/23:01:19

Plot file version 121 created 11-NOV-2019 15:07:29

SER8NJ EK040B.UVDATA.1

Freq = 4.7990 GHz, Bw = 32.000 MH No calibration applied and no bandpass applied

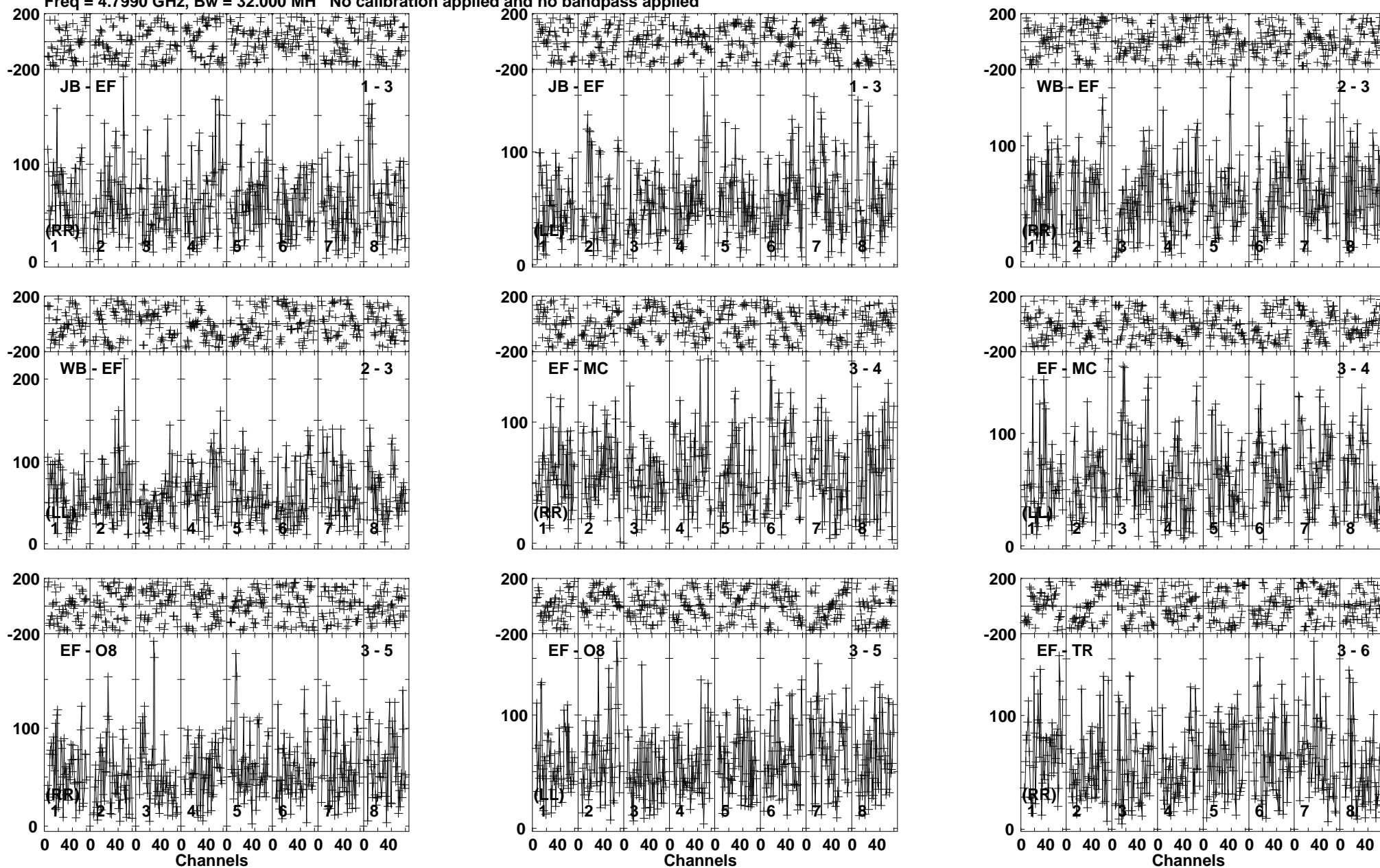

Lower frame: Micro Ampl Jy Top frame: Phas deg  
Vector averaged cross-power spectrum Baseline: JB (01) - EF (03)  
Timerange: 00/23:01:21 to 00/23:05:19

Plot file version 122 created 11-NOV-2019 15:07:30

SER8NJ EK040B.UVDATA.1

Freq = 4.7990 GHz, Bw = 32.000 MH No calibration applied and no bandpass applied

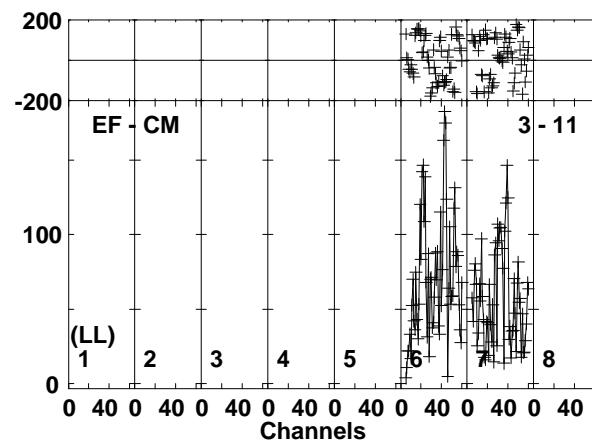
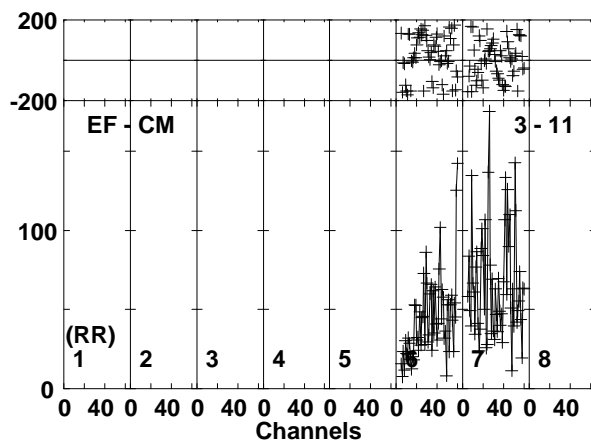
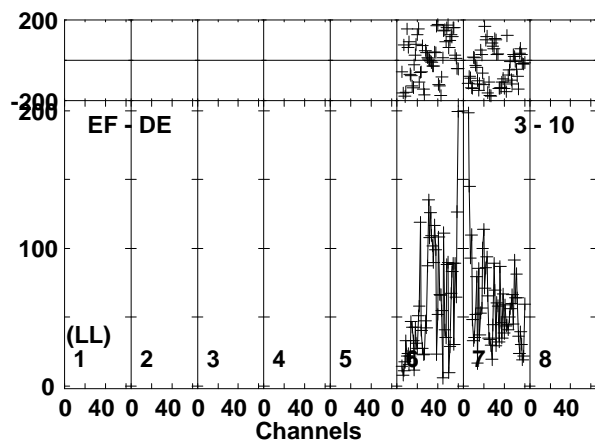
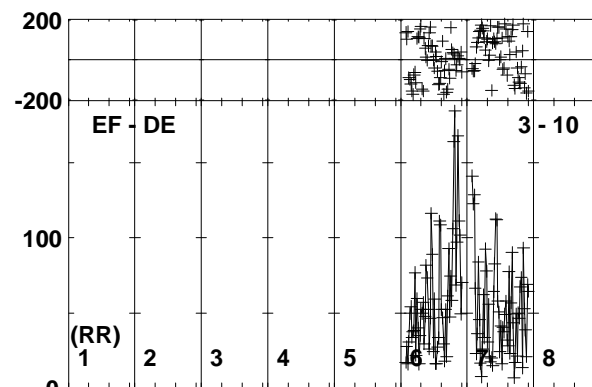
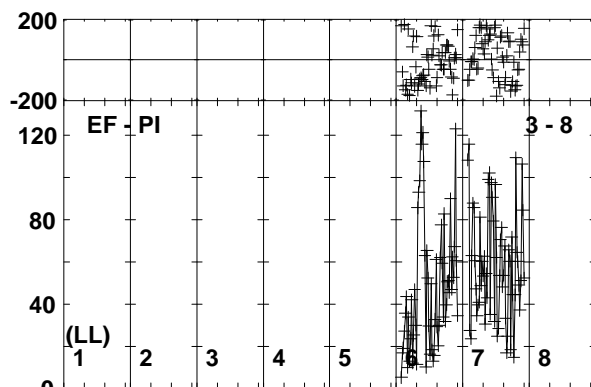
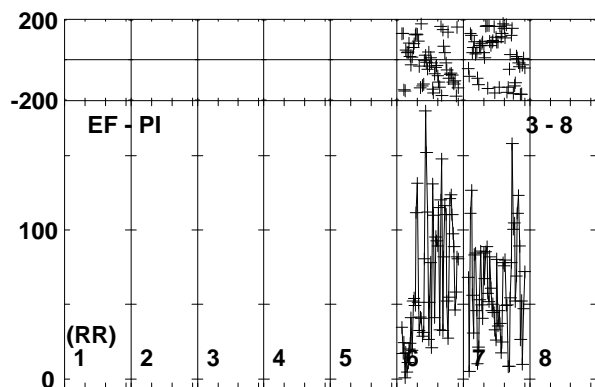
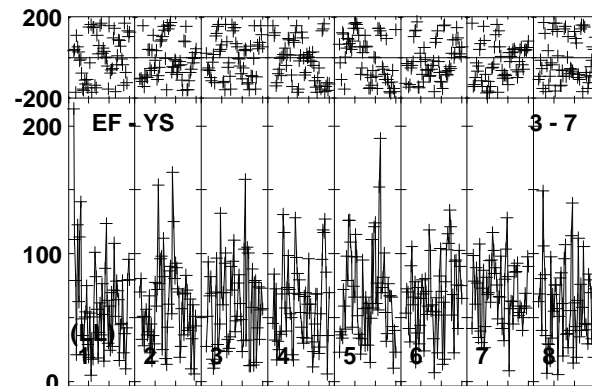
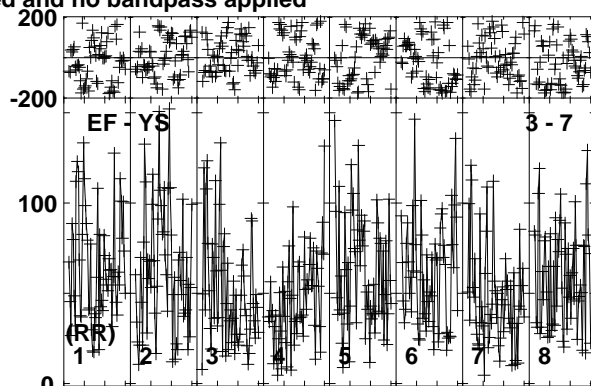
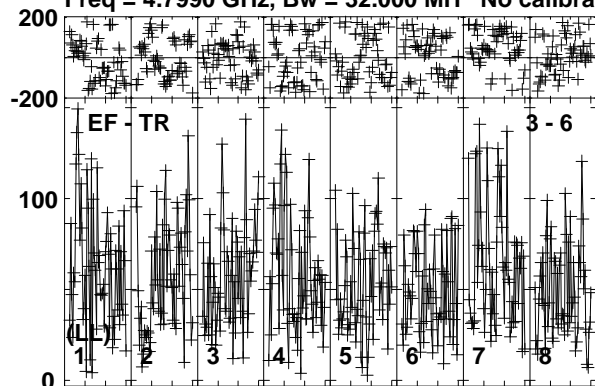

Lower frame: Micro Ampl Jy Top frame: Phas deg  
Vector averaged cross-power spectrum Baseline: EF (03) - TR (06)  
Timerange: 00/23:01:21 to 00/23:05:19



Plot file version 123 created 11-NOV-2019 15:07:30

SER8NJ EK040B.UVDATA.1

Freq = 4.7990 GHz, Bw = 32.000 MH No calibration applied and no bandpass applied

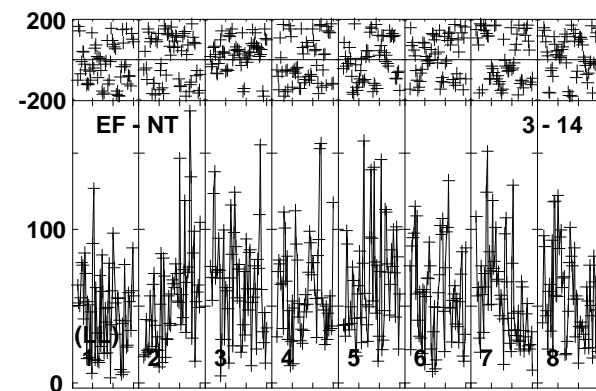
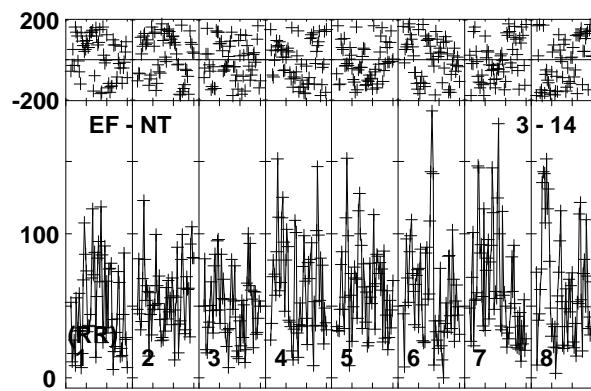
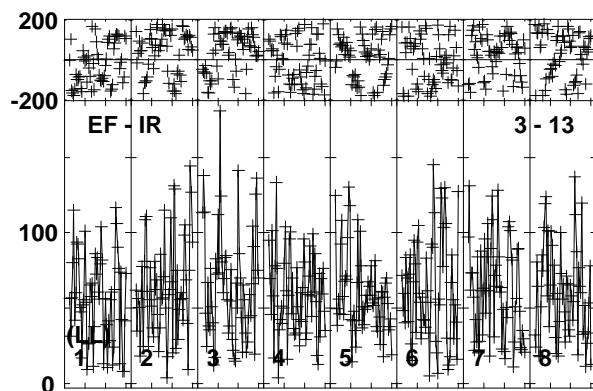
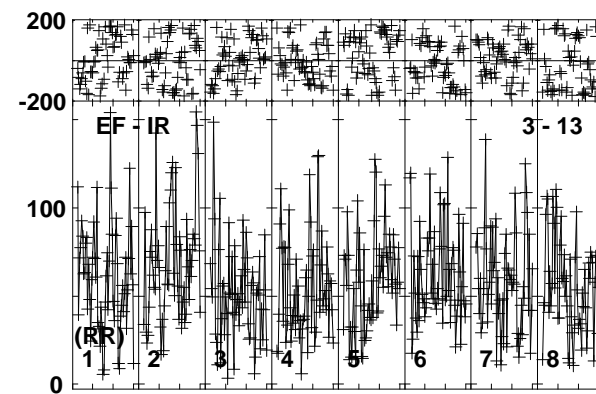
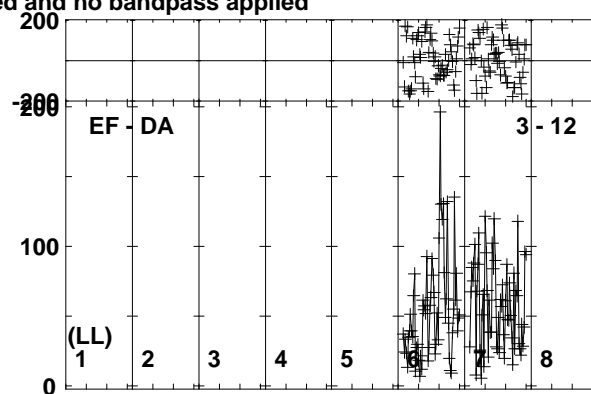
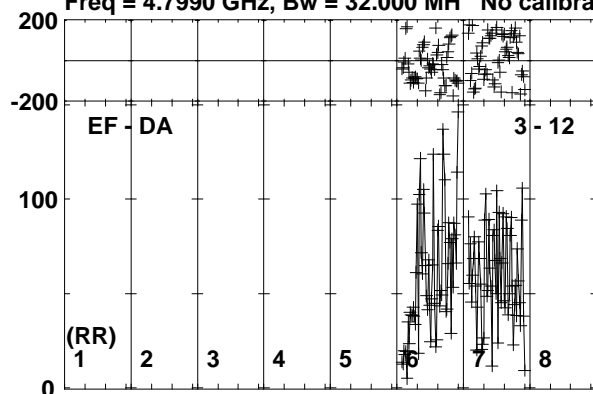

0 40 0 40 0 40 0 40 0 40 0 40 0 40 0 40 0 40 0 40  
Channels

Lower frame: Micro Ampl Jy Top frame: Phas deg  
Vector averaged cross-power spectrum Baseline: EF (03) - DA (12)  
Timerange: 00/23:01:21 to 00/23:05:19

Plot file version 124 created 11-NOV-2019 15:07:30

J1826+0149 EK040B.UVDATA.1

Freq = 4.7990 GHz, Bw = 32.000 MH No calibration applied and no bandpass applied

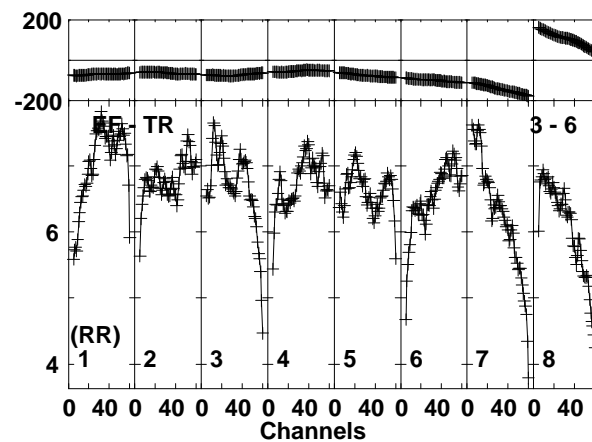
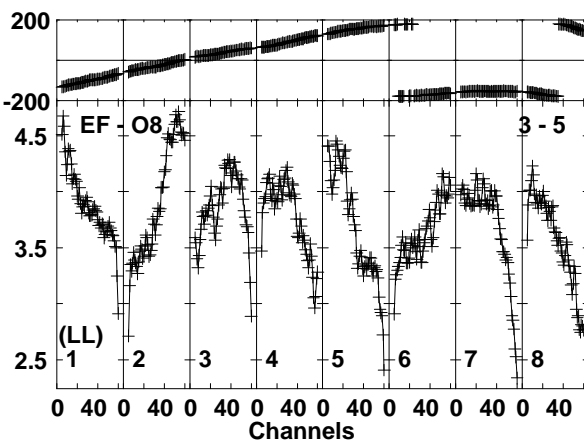
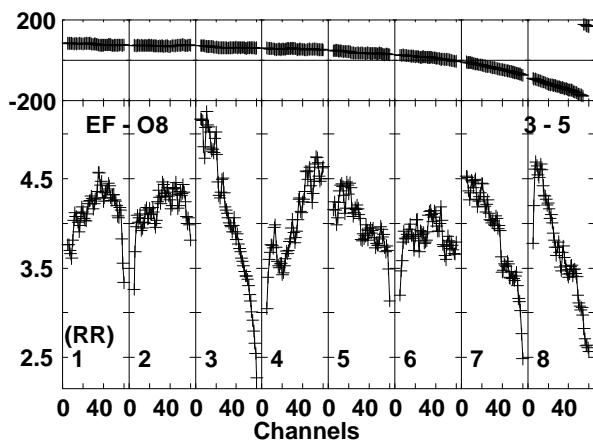
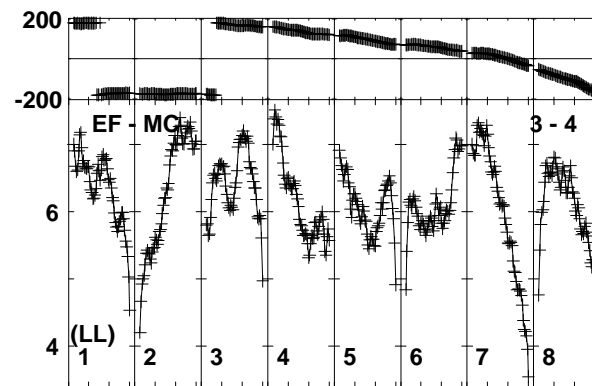
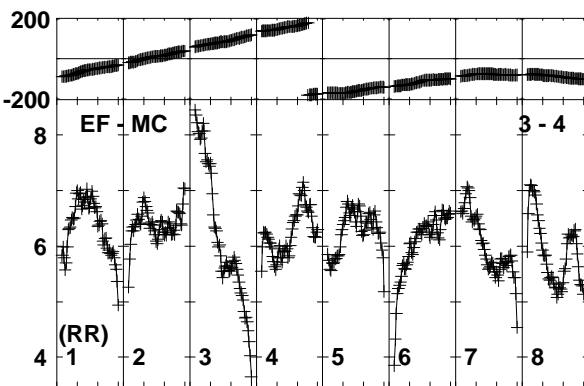
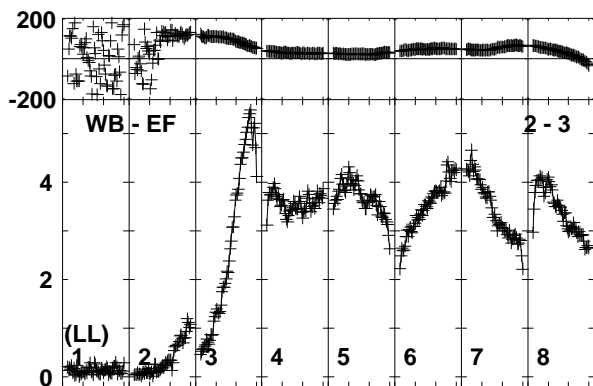
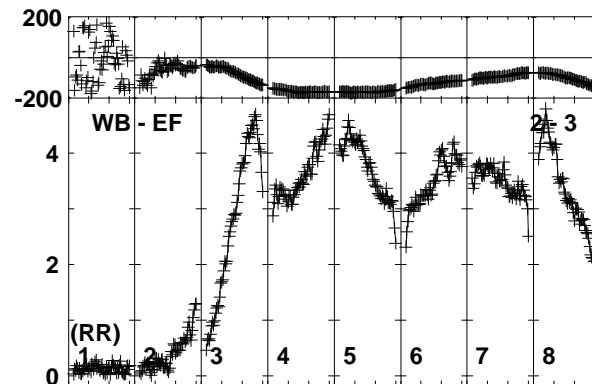
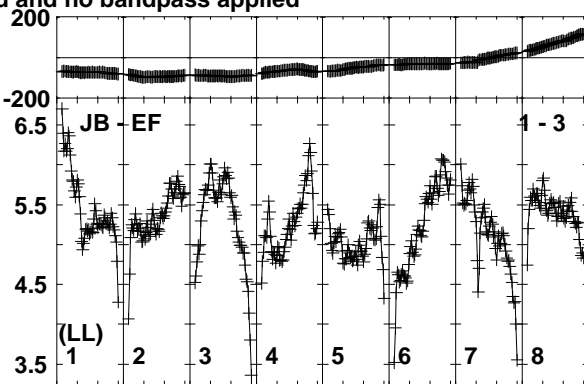
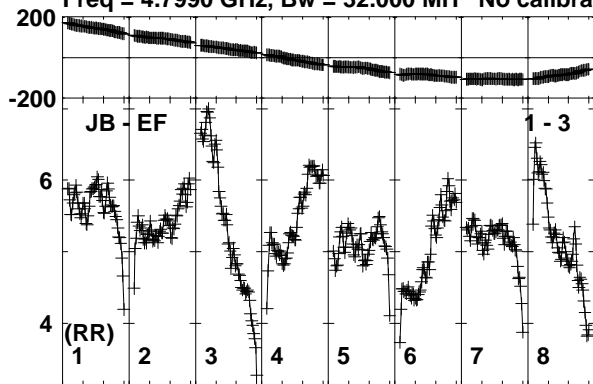

Lower frame: Milli Ampl Jy Top frame: Phas deg  
Vector averaged cross-power spectrum Baseline: JB (01) - EF (03)  
Timerange: 00/23:06:01 to 00/23:06:59

Plot file version 125 created 11-NOV-2019 15:07:30

J1826+0149 EK040B.UVDATA.1

Freq = 4.7990 GHz, Bw = 32.000 MH No calibration applied and no bandpass applied

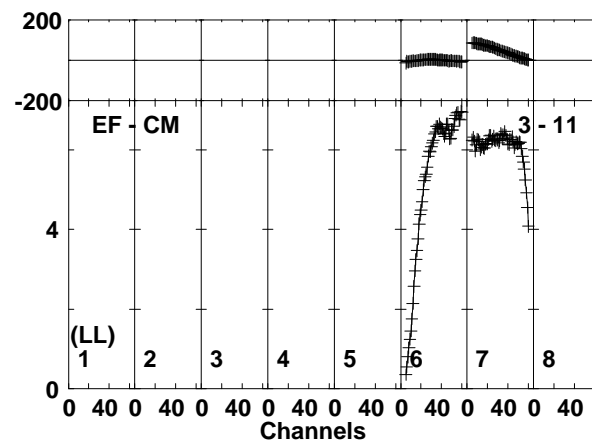
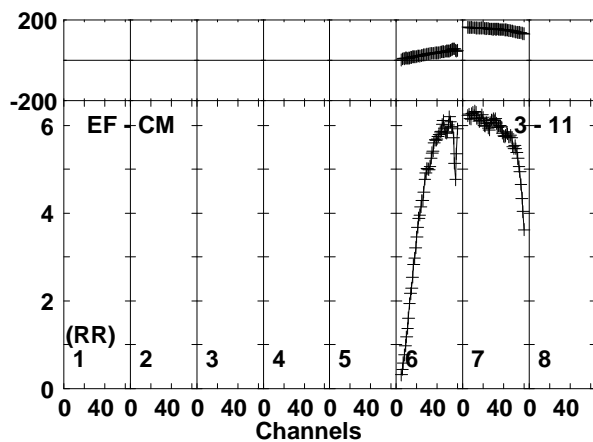
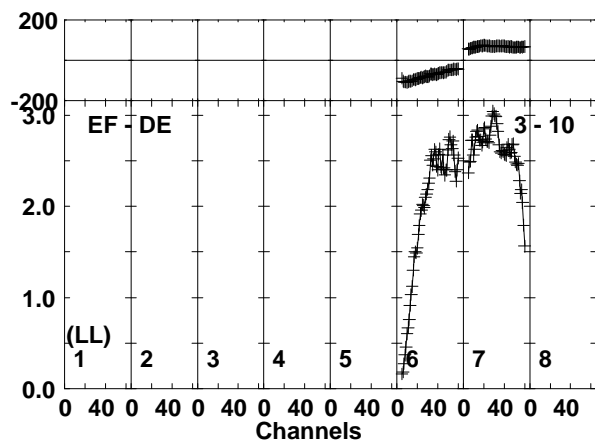
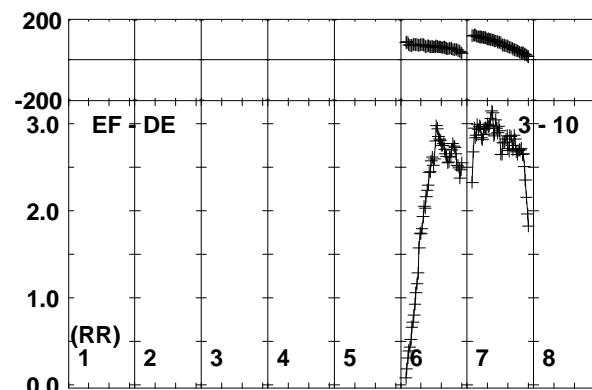
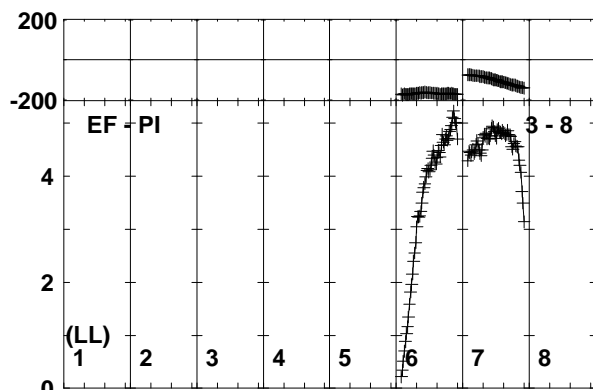
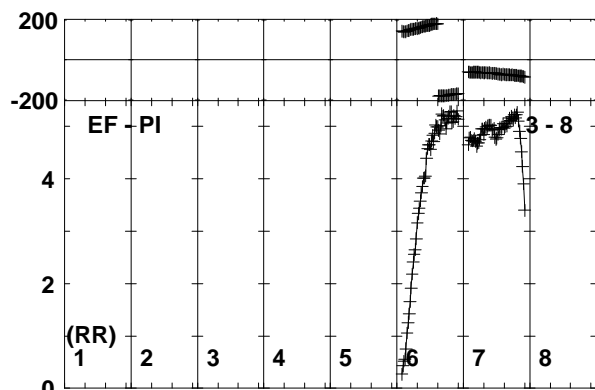
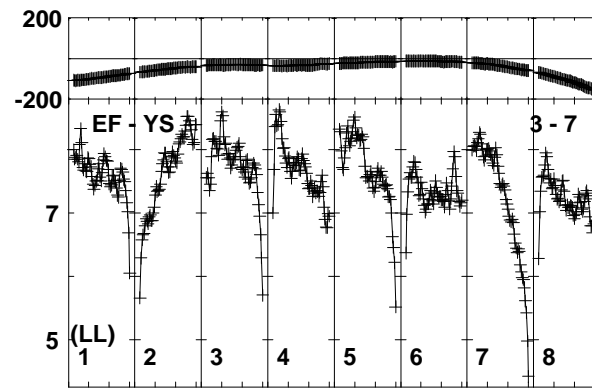
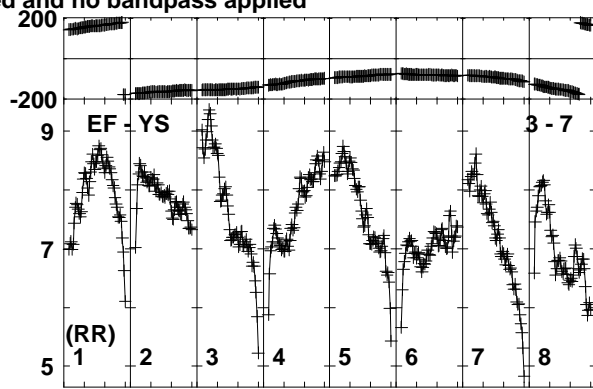
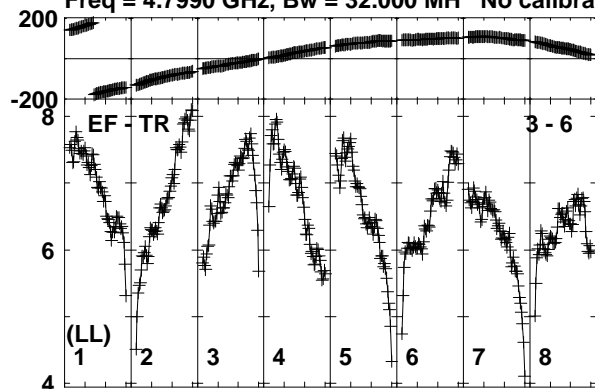

Lower frame: Milli Ampl Jy Top frame: Phas deg  
Vector averaged cross-power spectrum Baseline: EF (03) - TR (06)  
Timerange: 00/23:06:01 to 00/23:06:59

Plot file version 126 created 11-NOV-2019 15:07:30

J1826+0149 EK040B.UVDATA.1

Freq = 4.7990 GHz, Bw = 32.000 MH No calibration applied and no bandpass applied

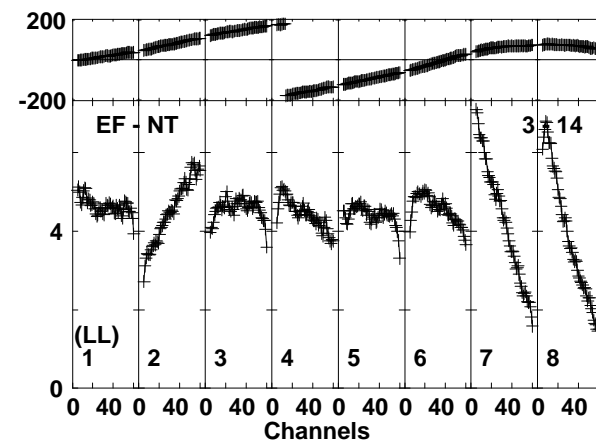
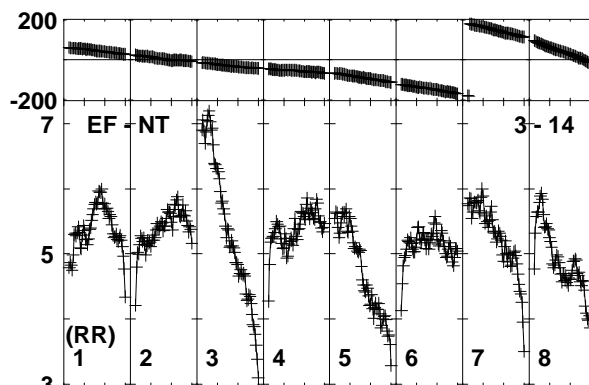
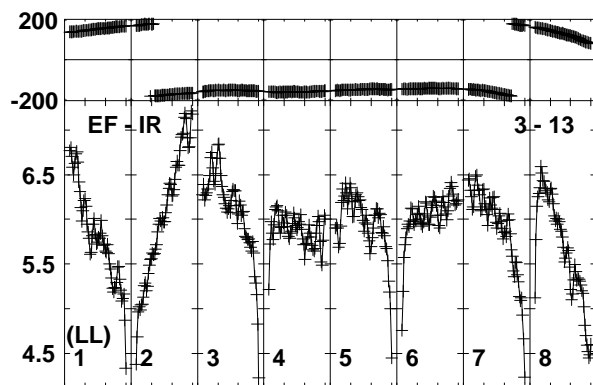
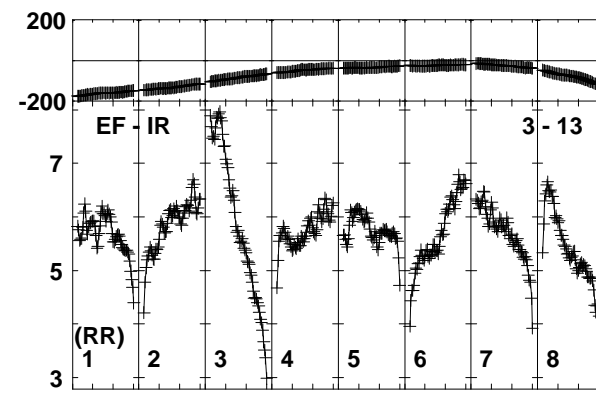
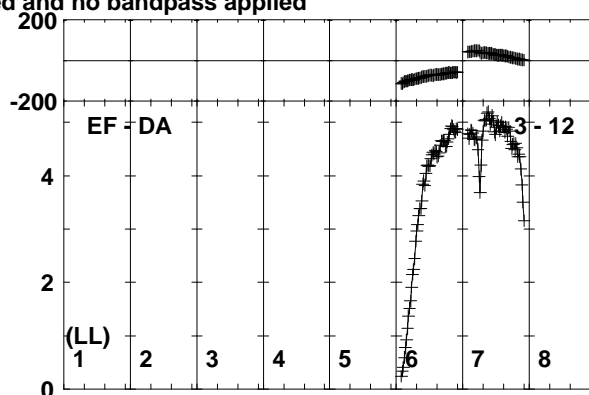
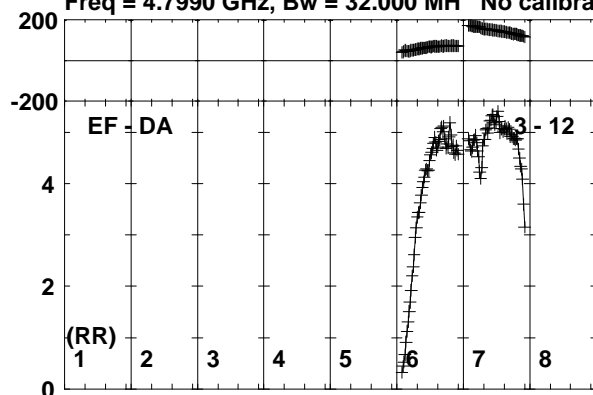

Lower frame: Milli Ampl Jy Top frame: Phas deg  
Vector averaged cross-power spectrum Baseline: EF (03) - DA (12)  
Timerange: 00/23:06:01 to 00/23:06:59

Plot file version 127 created 11-NOV-2019 15:07:30

SER8NJ EK040B.UVDATA.1

Freq = 4.7990 GHz, Bw = 32.000 MH No calibration applied and no bandpass applied

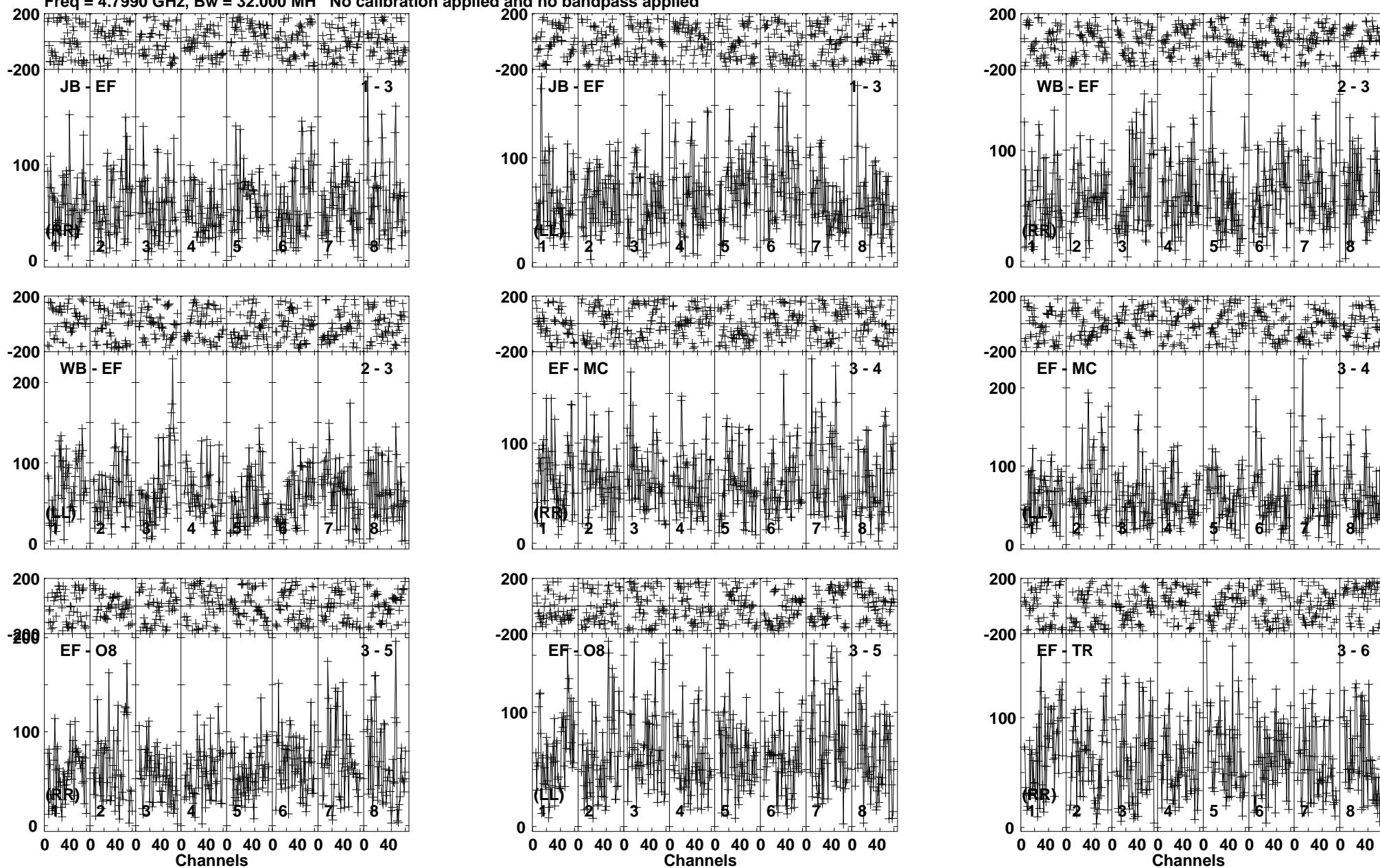

Lower frame: Micro Ampl Jy Top frame: Phas deg  
Vector averaged cross-power spectrum Baseline: JB (01) - EF (03)  
Timerange: 00/23:07:03 to 00/23:10:59

Plot file version 128 created 11-NOV-2019 15:07:30

SER8NJ EK040B.UVDATA.1

Freq = 4.7990 GHz, Bw = 32.000 MH No calibration applied and no bandpass applied

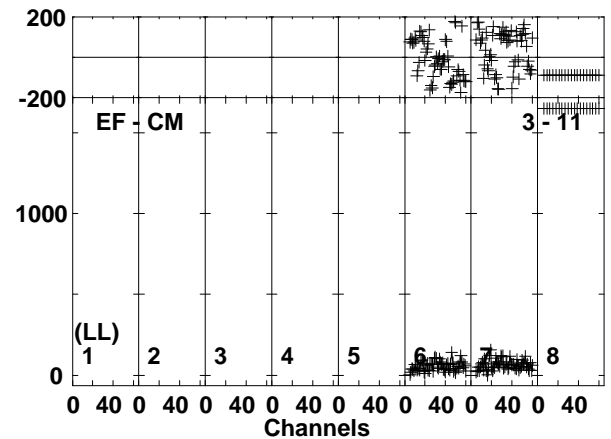
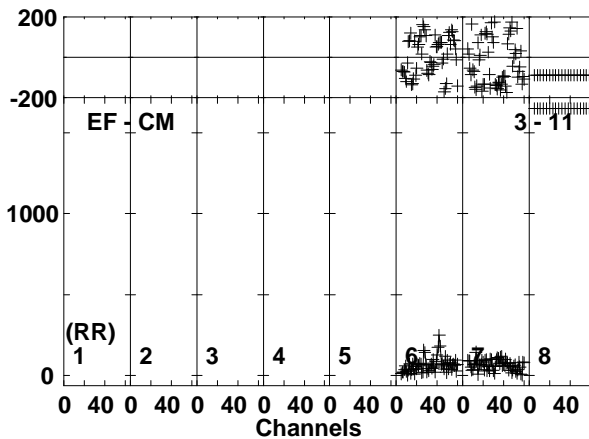
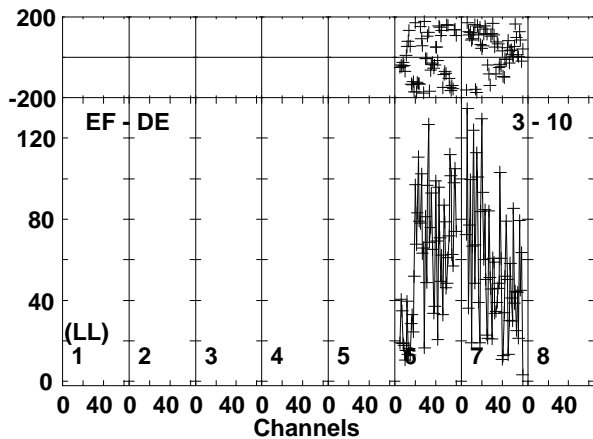
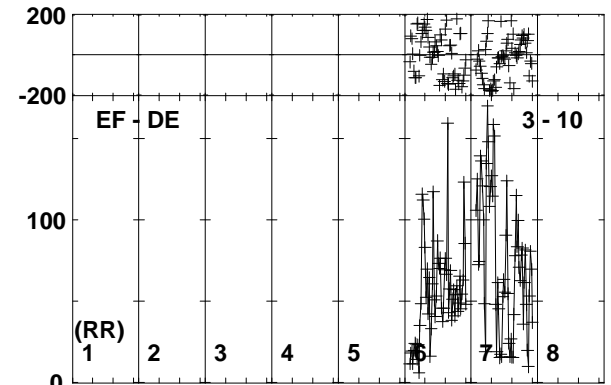
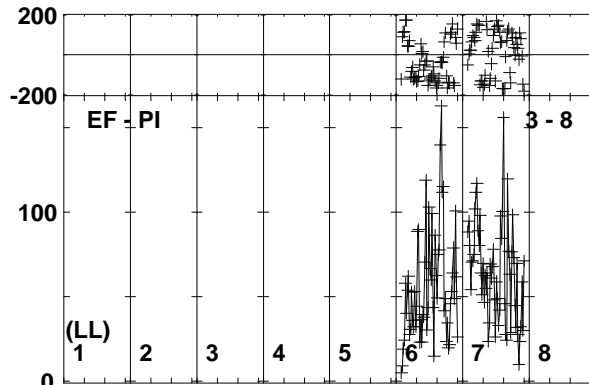
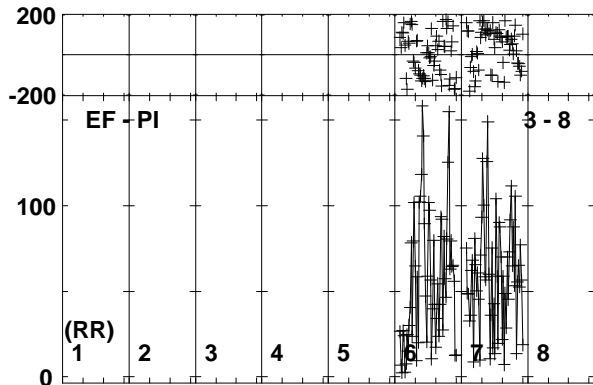
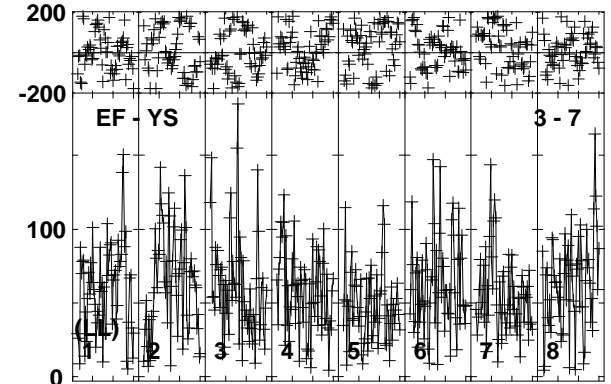
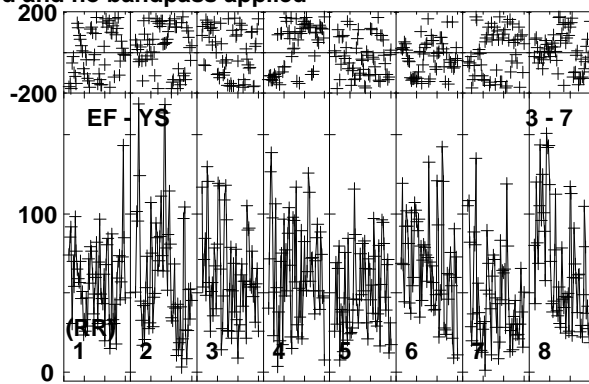
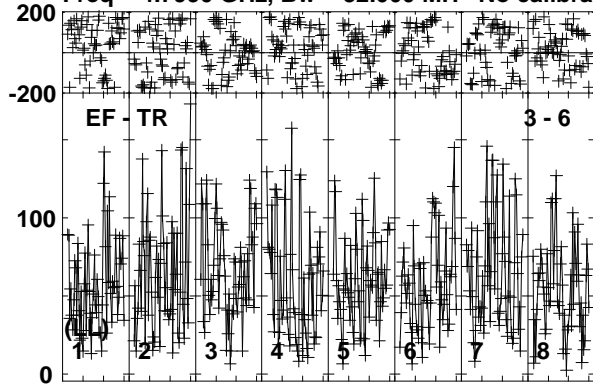

Lower frame: Micro Ampl Jy Top frame: Phas deg  
Vector averaged cross-power spectrum Baseline: EF (03) - TR (06)  
Timerange: 00/23:07:03 to 00/23:10:59

Plot file version 129 created 11-NOV-2019 15:07:30

SER8NJ EK040B.UVDATA.1

Freq = 4.7990 GHz, Bw = 32.000 MH No calibration applied and no bandpass applied

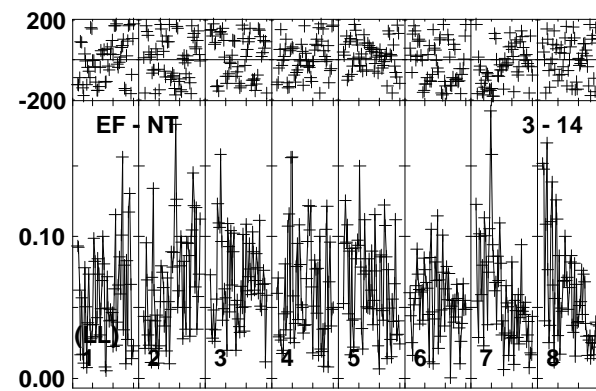
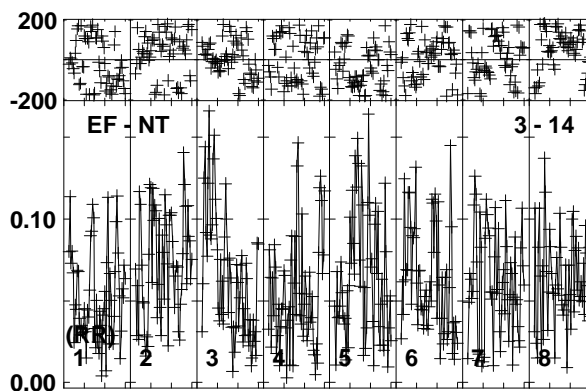
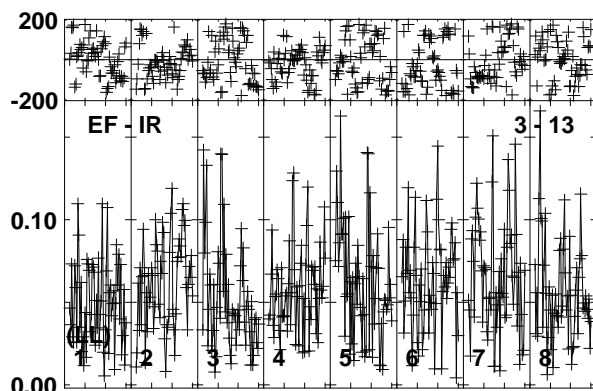
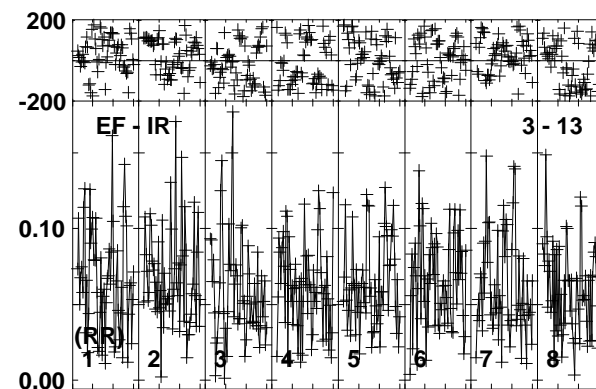
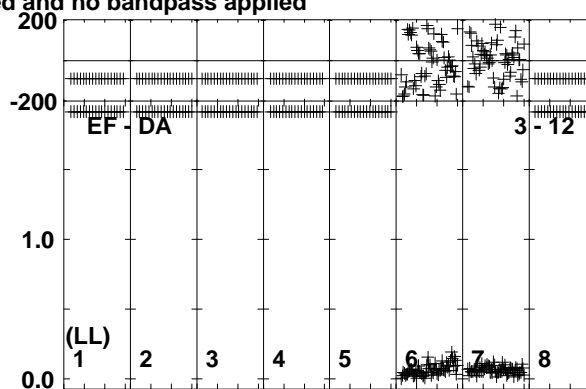
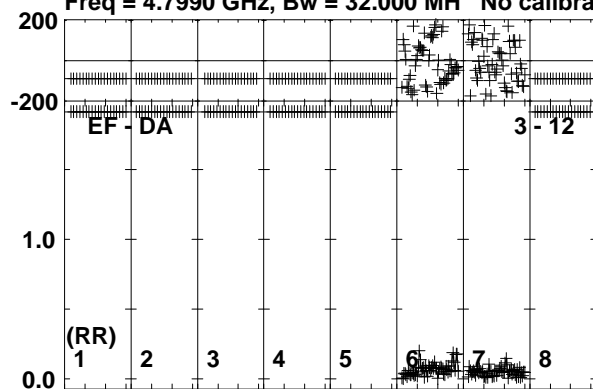

0 40 0 40 0 40 0 40 0 40 0 40 0 40 0 40 0 40 0 40  
Channels

Lower frame: Milli Ampl Jy Top frame: Phas deg  
Vector averaged cross-power spectrum Baseline: EF (03) - DA (12)  
Timerange: 00/23:07:03 to 00/23:10:59

Plot file version 130 created 11-NOV-2019 15:07:30

J1826+0149 EK040B.UVDATA.1

Freq = 4.7990 GHz, Bw = 32.000 MH No calibration applied and no bandpass applied

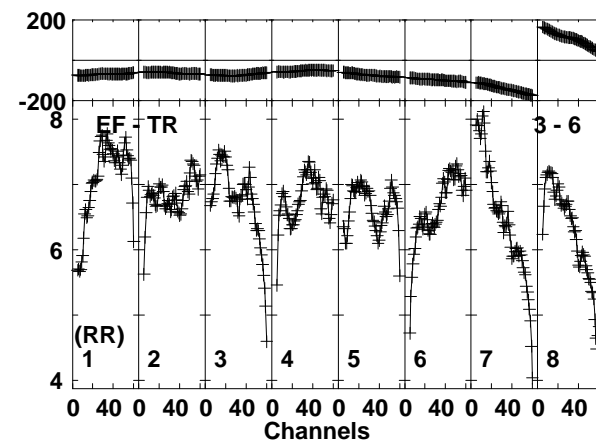
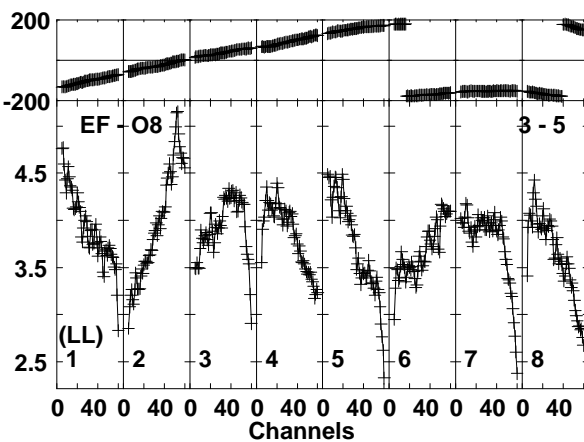
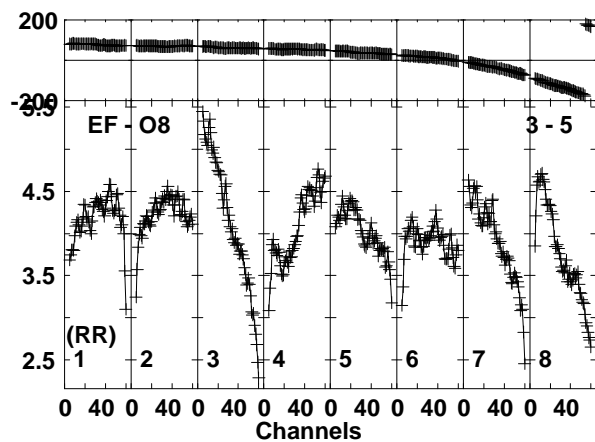
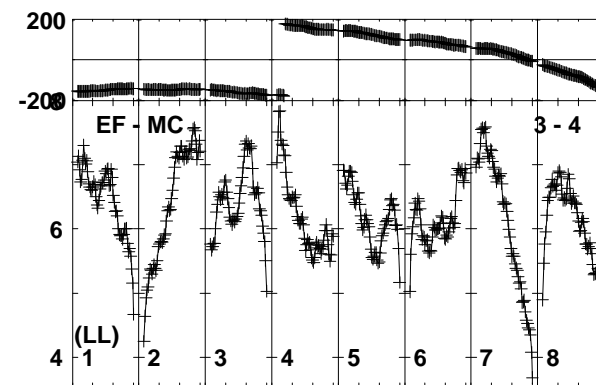
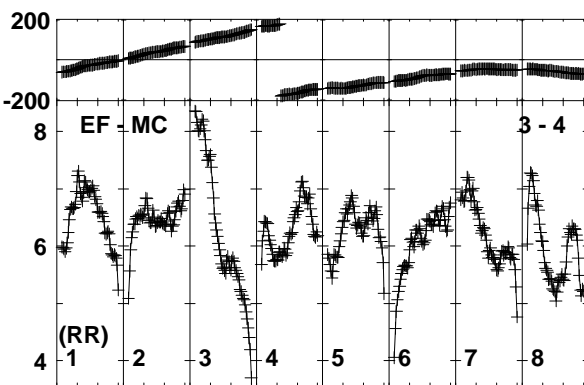
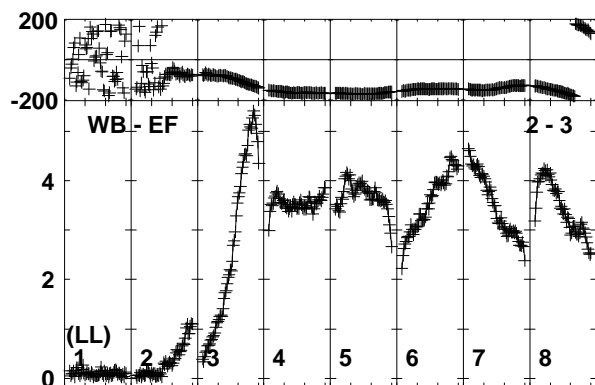
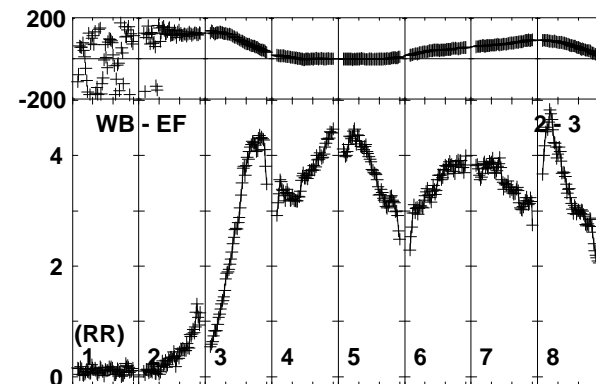
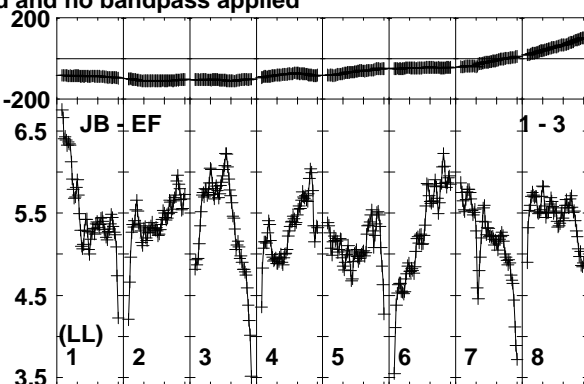
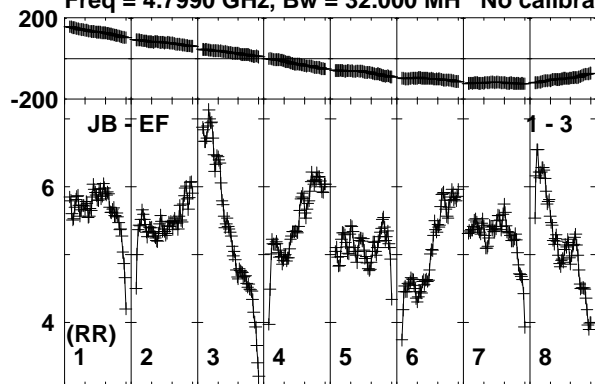

Lower frame: Milli Ampl Jy Top frame: Phas deg  
Vector averaged cross-power spectrum Baseline: JB (01) - EF (03)  
Timerange: 00/23:11:01 to 00/23:12:29



Plot file version 131 created 11-NOV-2019 15:07:31

J1826+0149 EK040B.UVDATA.1

Freq = 4.7990 GHz, Bw = 32.000 MH No calibration applied and no bandpass applied

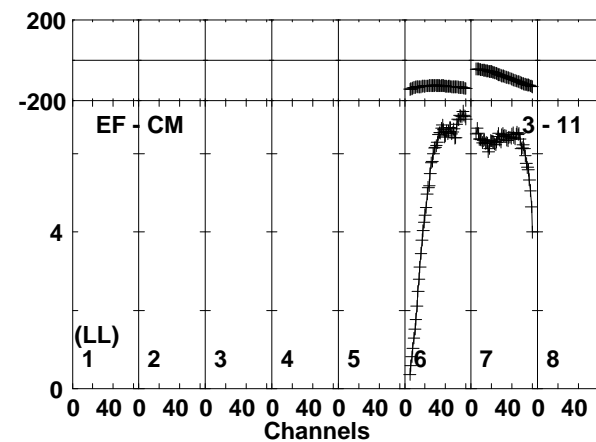
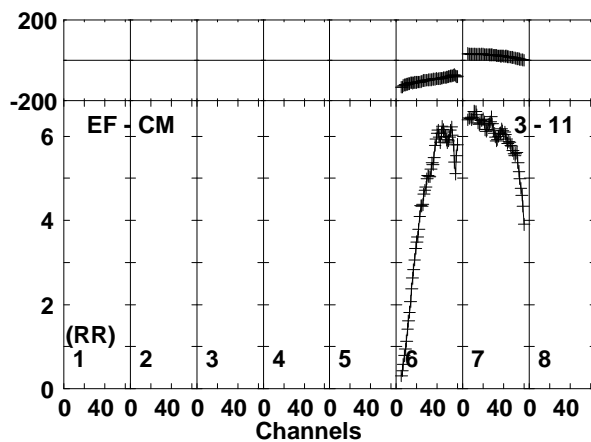
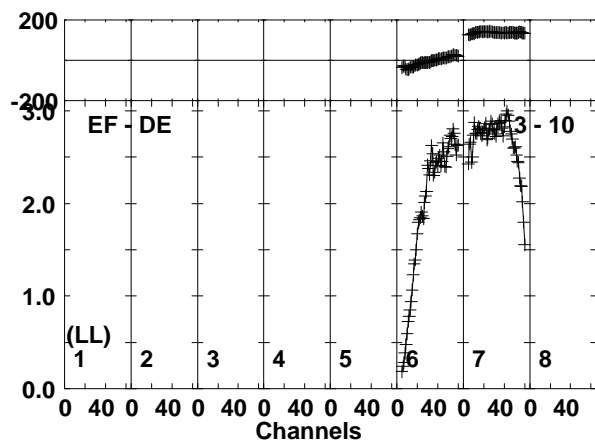
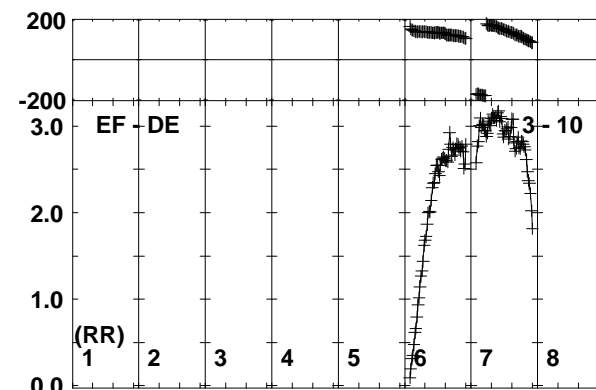
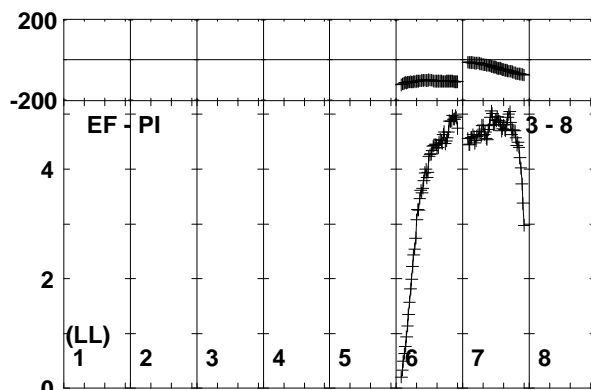
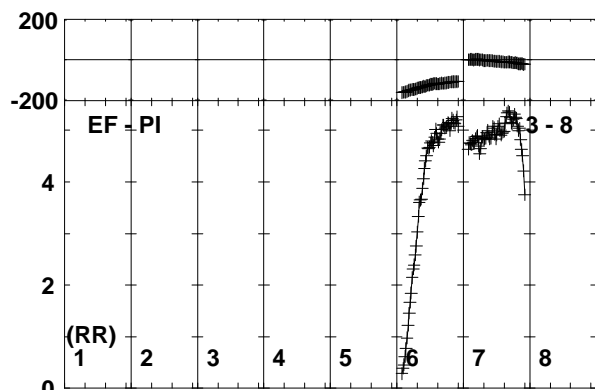
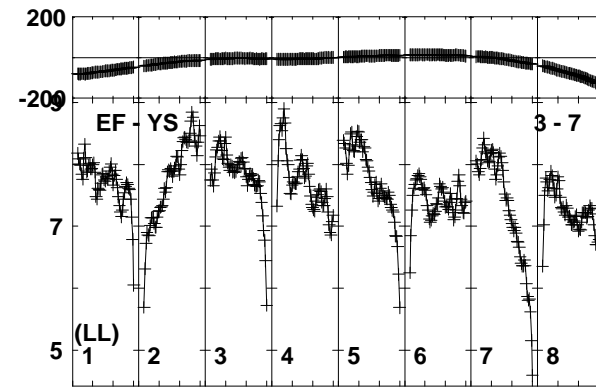
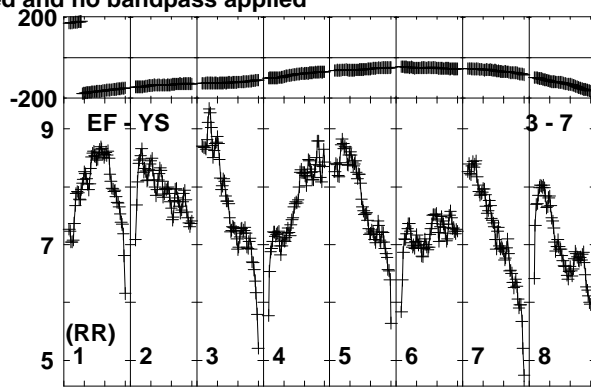
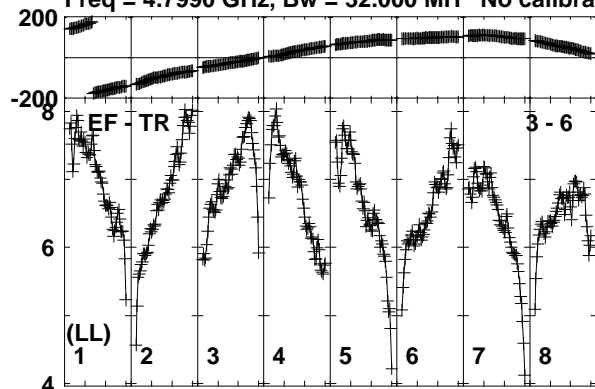

Lower frame: Milli Ampl Jy Top frame: Phas deg  
Vector averaged cross-power spectrum Baseline: EF (03) - TR (06)  
Timerange: 00/23:11:01 to 00/23:12:29

Plot file version 132 created 11-NOV-2019 15:07:31

J1826+0149 EK040B.UVDATA.1

Freq = 4.7990 GHz, Bw = 32.000 MH No calibration applied and no bandpass applied

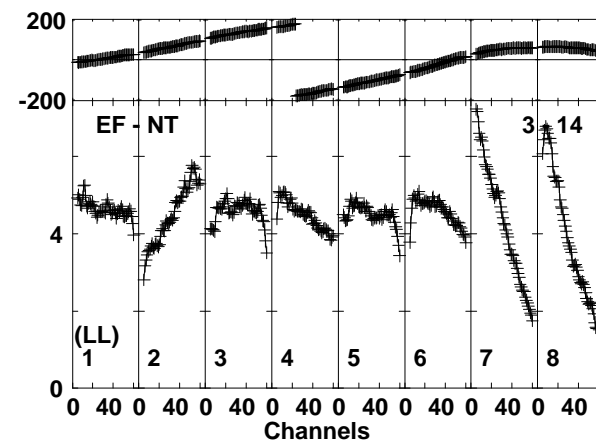
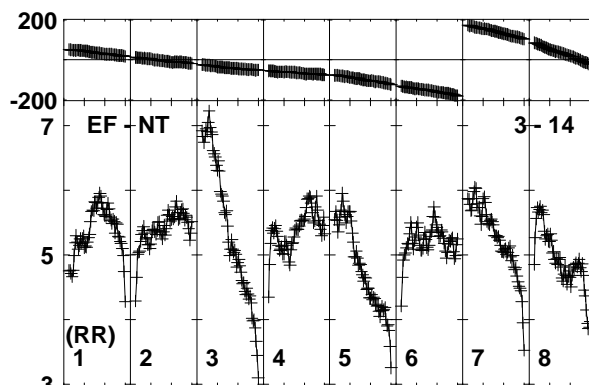
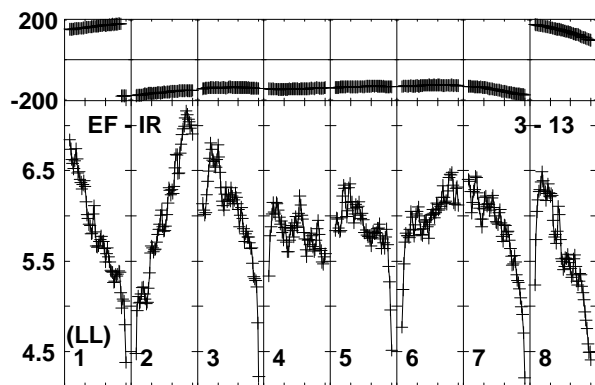
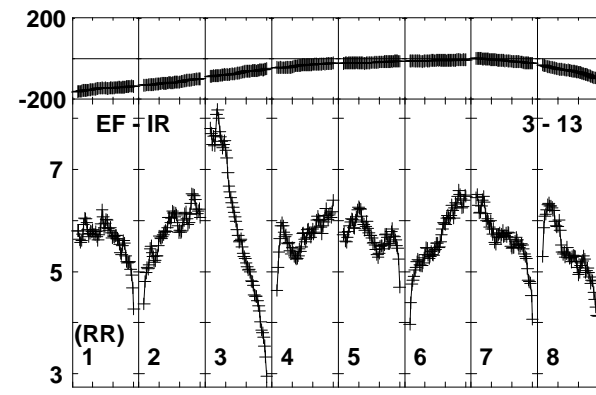
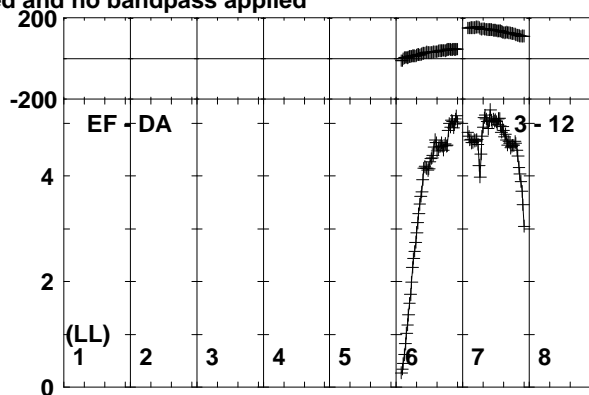
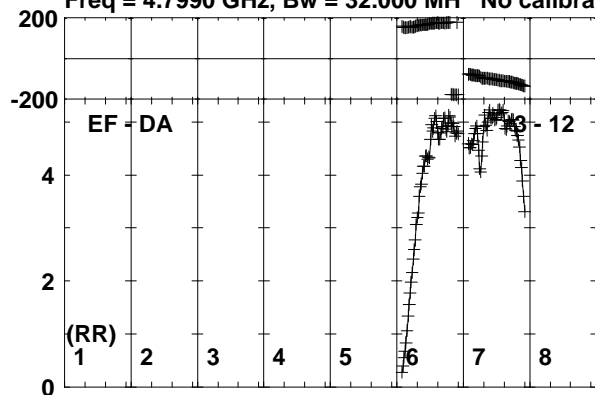

Lower frame: Milli Ampl Jy Top frame: Phas deg  
Vector averaged cross-power spectrum Baseline: EF (03) - DA (12)  
Timerange: 00/23:11:01 to 00/23:12:29

Plot file version 133 created 11-NOV-2019 15:07:31

SER8NJ EK040B.UVDATA.1

Freq = 4.7990 GHz, Bw = 32.000 MH No calibration applied and no bandpass applied

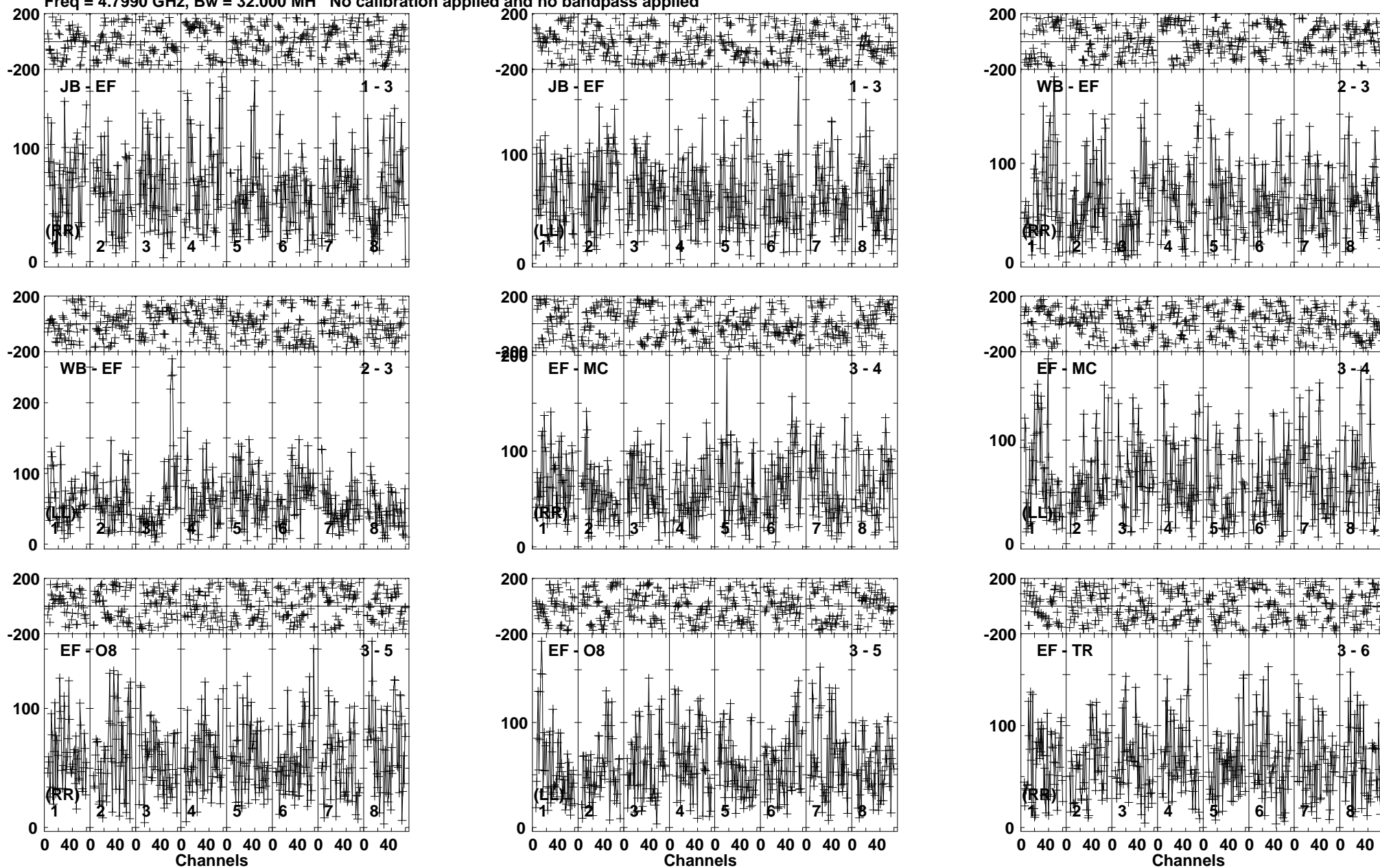

Lower frame: Micro Ampl Jy Top frame: Phas deg  
Vector averaged cross-power spectrum Baseline: JB (01) - EF (03)  
Timerange: 00/23:12:33 to 00/23:16:29

Plot file version 134 created 11-NOV-2019 15:07:31

SER8NJ EK040B.UVDATA.1

Freq = 4.7990 GHz, Bw = 32.000 MH No calibration applied and no bandpass applied

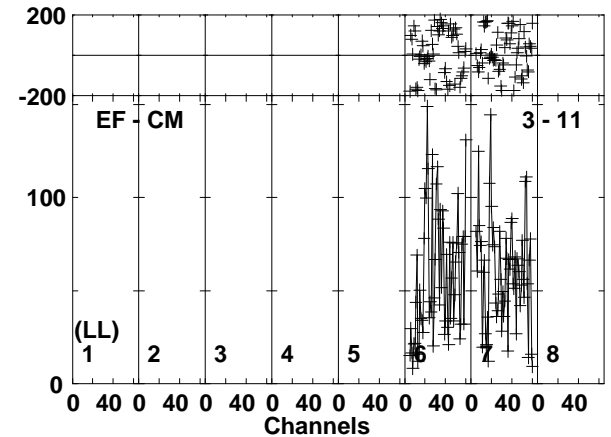
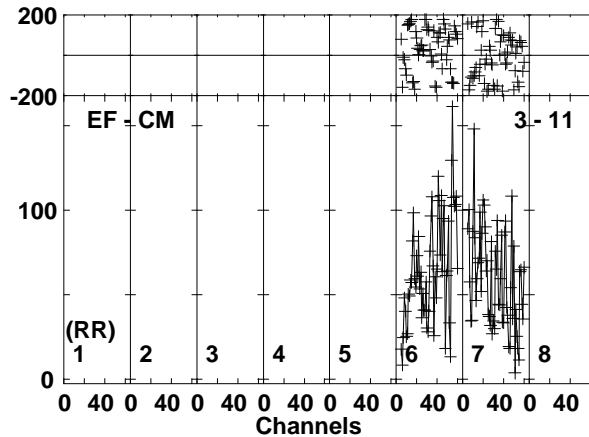
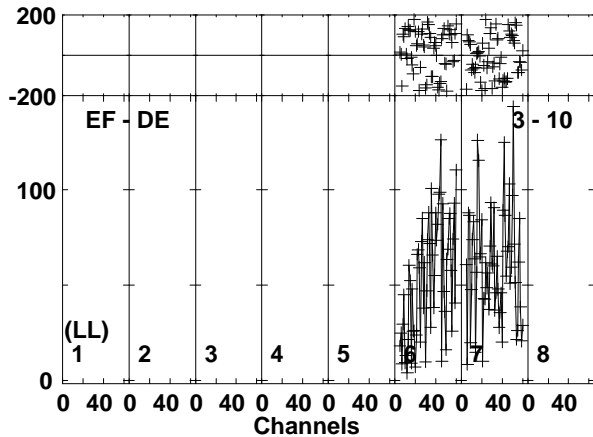
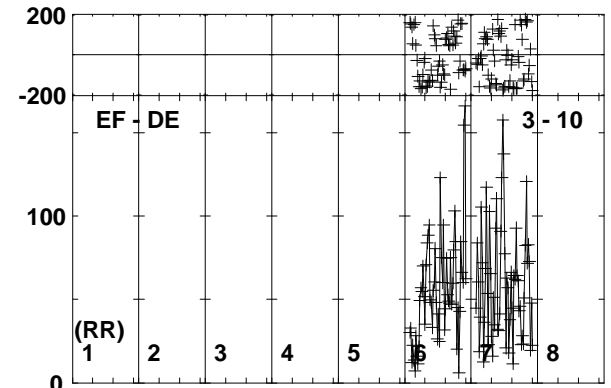
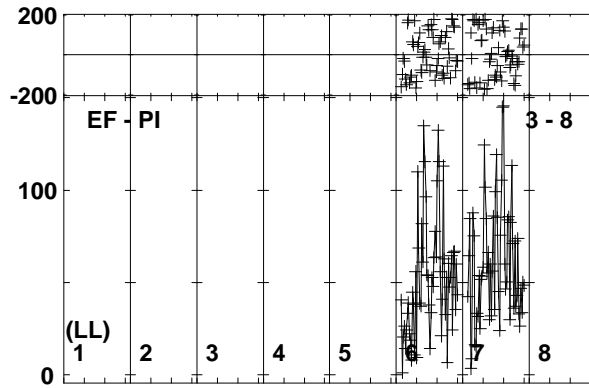
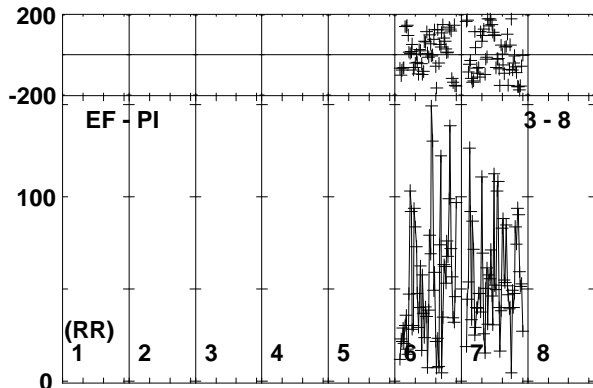
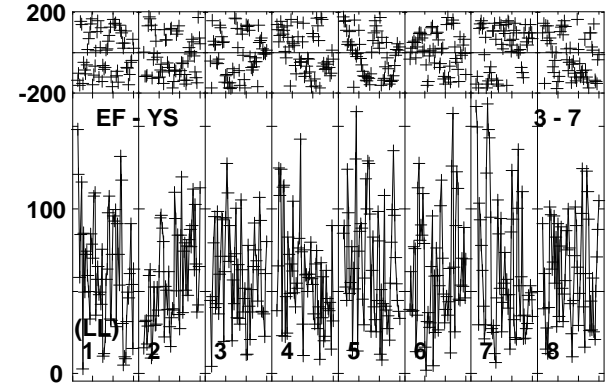
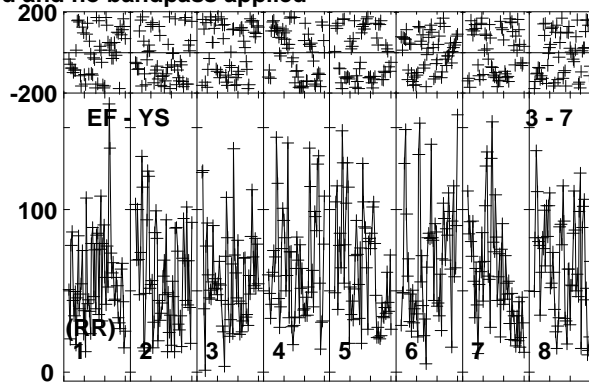
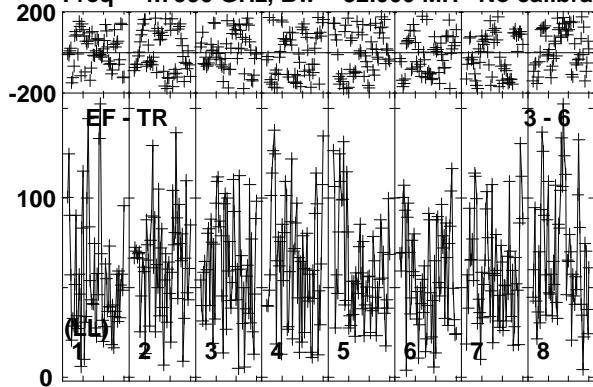

Lower frame: Micro Ampl Jy Top frame: Phas deg  
Vector averaged cross-power spectrum Baseline: EF (03) - TR (06)  
Timerange: 00/23:12:33 to 00/23:16:29

Plot file version 135 created 11-NOV-2019 15:07:31

SER8NJ EK040B.UVDATA.1

Freq = 4.7990 GHz, Bw = 32.000 MH No calibration applied and no bandpass applied

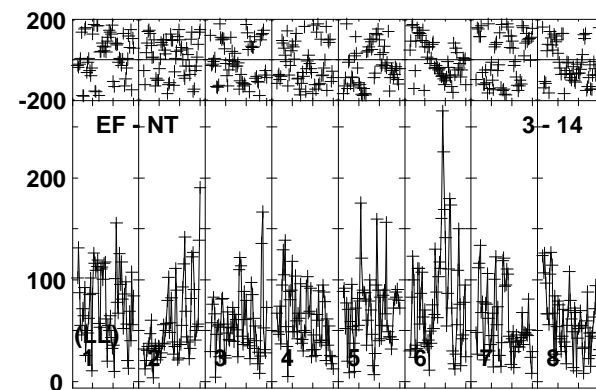
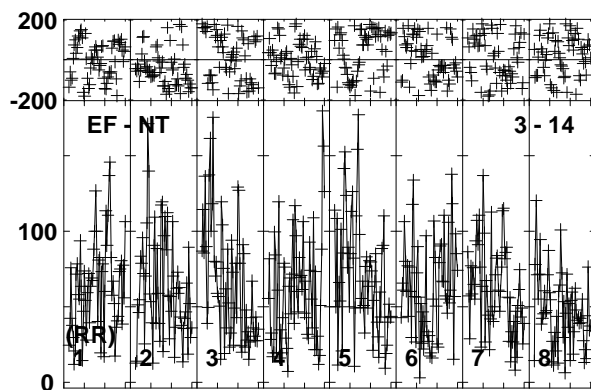
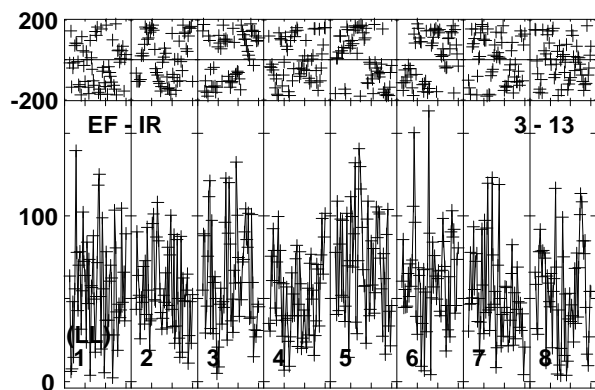
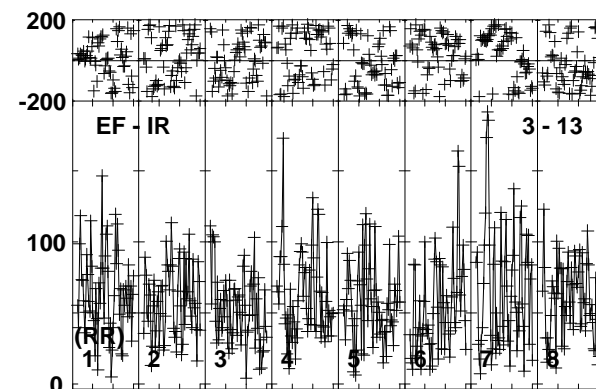
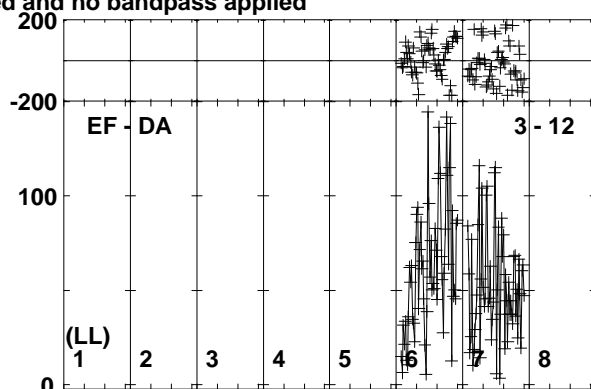
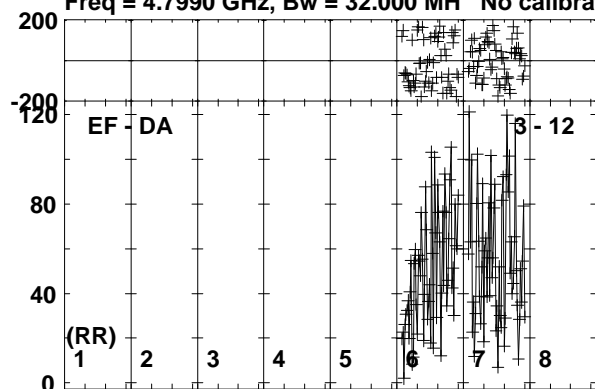

Channels

Lower frame: Micro Ampl Jy Top frame: Phas deg  
Vector averaged cross-power spectrum Baseline: EF (03) - DA (12)  
Timerange: 00/23:12:33 to 00/23:16:29

Plot file version 136 created 11-NOV-2019 15:07:31

J1826+0149 EK040B.UVDATA.1

Freq = 4.7990 GHz, Bw = 32.000 MH No calibration applied and no bandpass applied

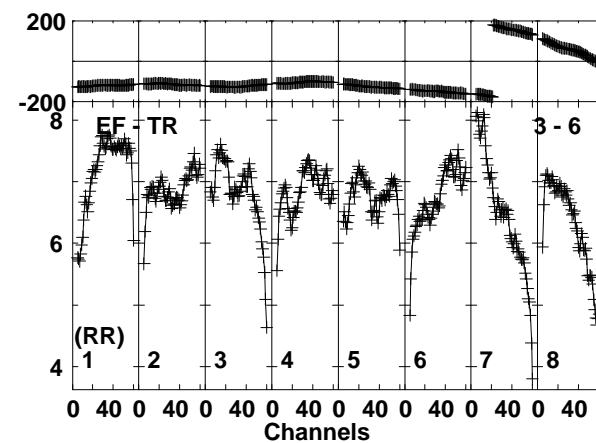
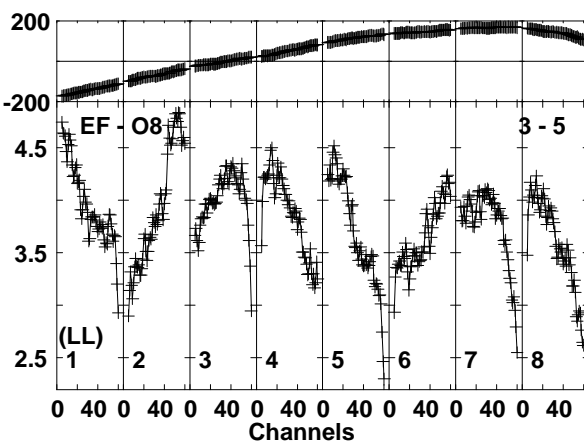
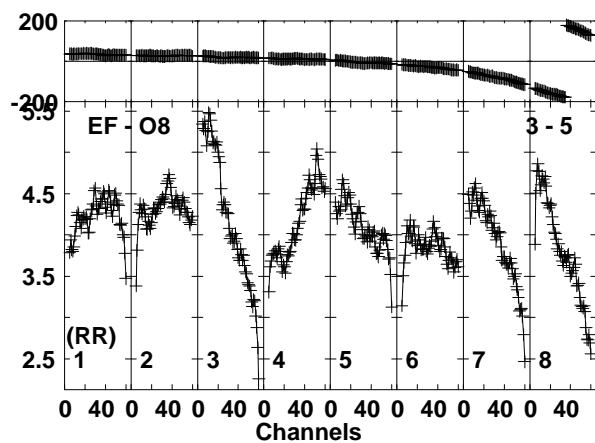
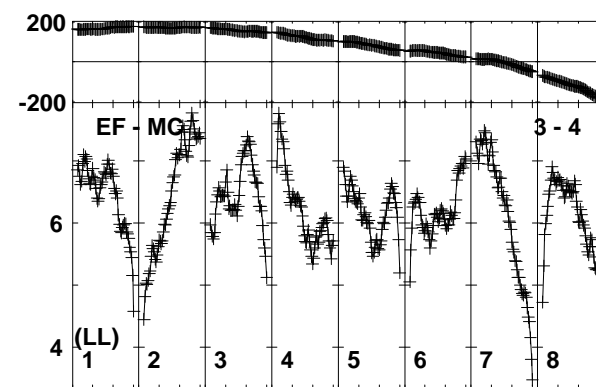
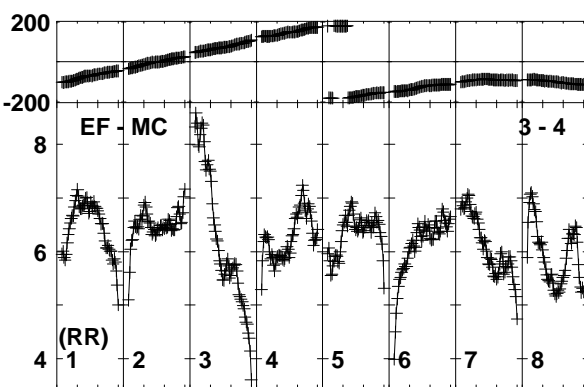
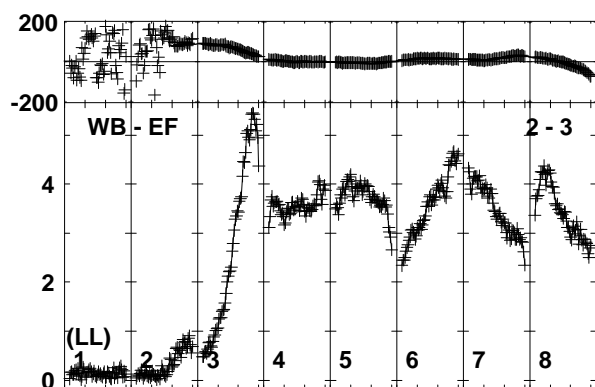
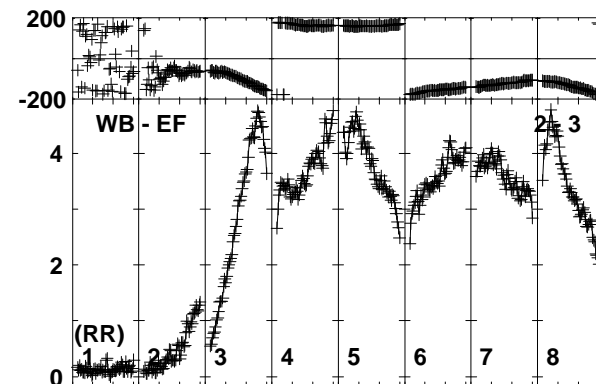
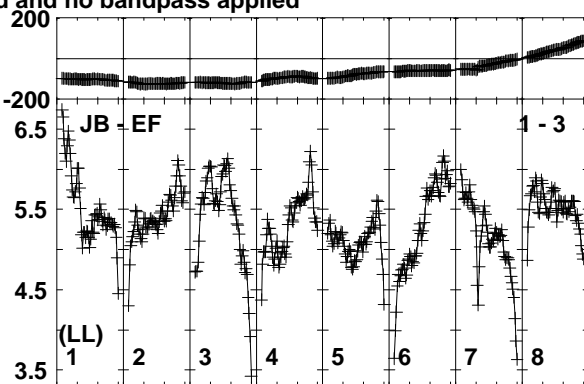
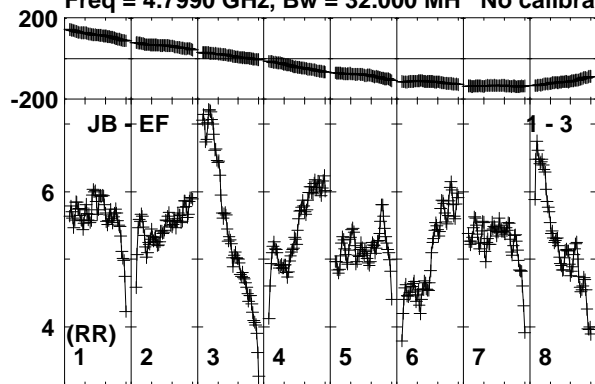

Lower frame: Milli Ampl Jy Top frame: Phas deg  
Vector averaged cross-power spectrum Baseline: JB (01) - EF (03)  
Timerange: 00/23:17:11 to 00/23:18:09

Plot file version 137 created 11-NOV-2019 15:07:31

J1826+0149 EK040B.UVDATA.1

Freq = 4.7990 GHz, Bw = 32.000 MH No calibration applied and no bandpass applied

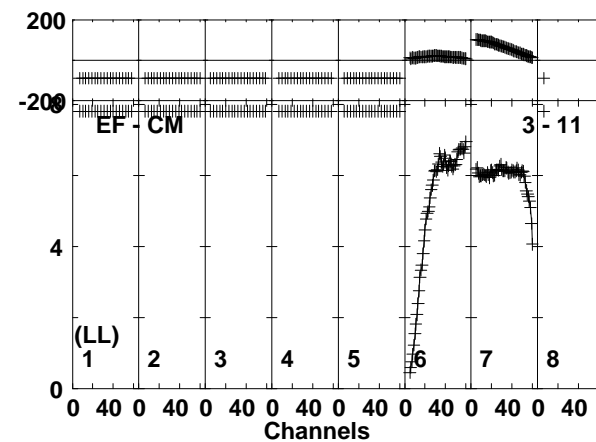
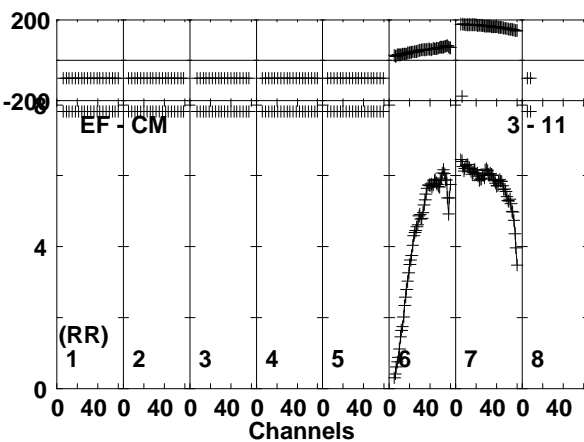
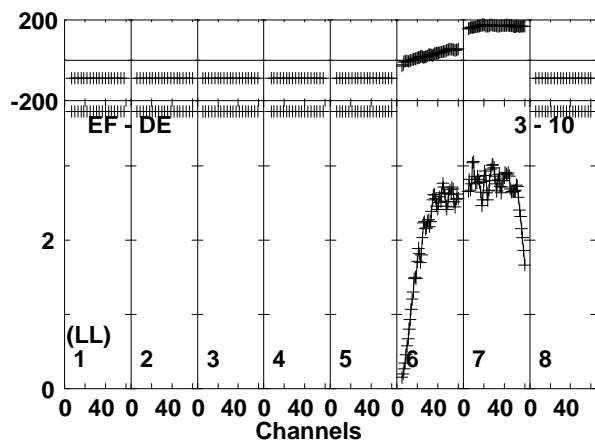
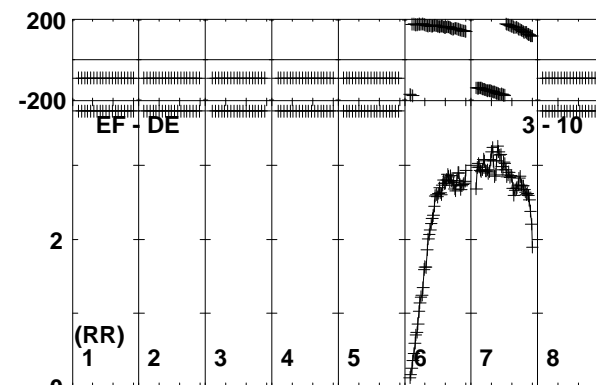
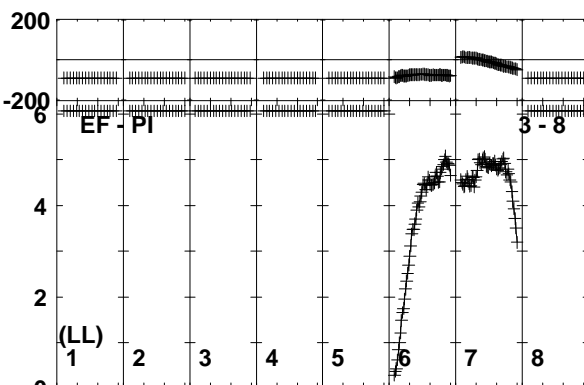
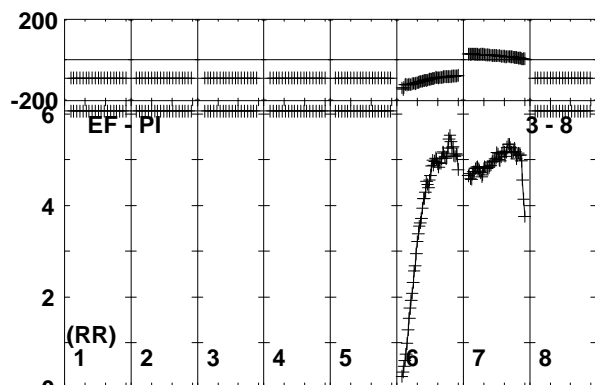
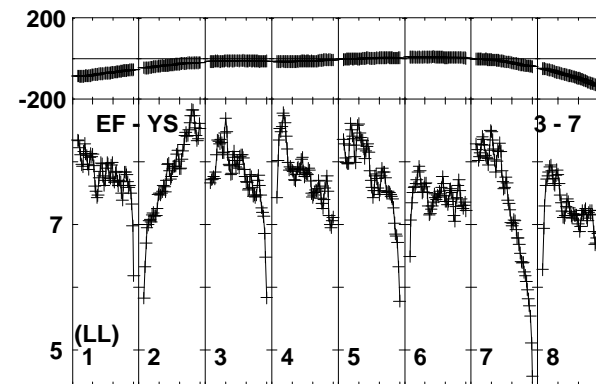
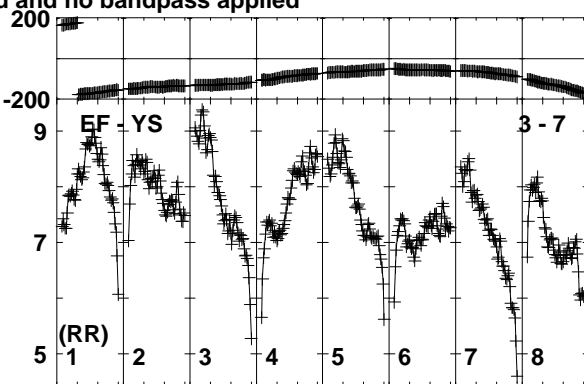
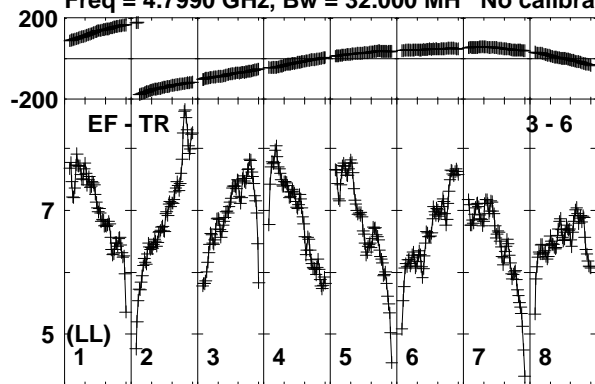

Lower frame: Milli Ampl Jy Top frame: Phas deg  
Vector averaged cross-power spectrum Baseline: EF (03) - TR (06)  
Timerange: 00/23:17:11 to 00/23:18:09

Plot file version 138 created 11-NOV-2019 15:07:31  
 J1826+0149 EK040B.UVDATA.1  
 Freq = 4.7990 GHz, Bw = 32.000 MH No calibration applied and no bandpass applied

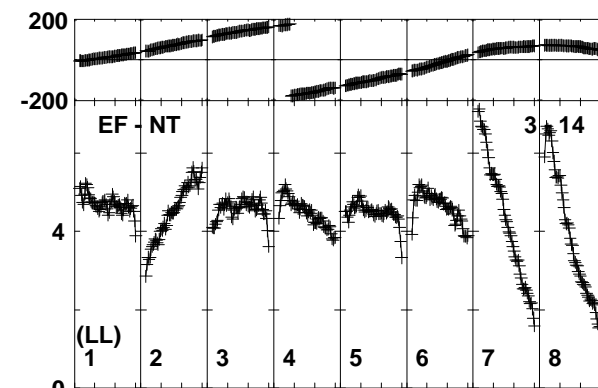
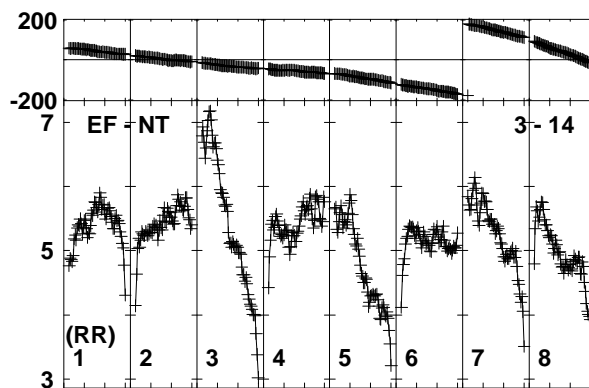
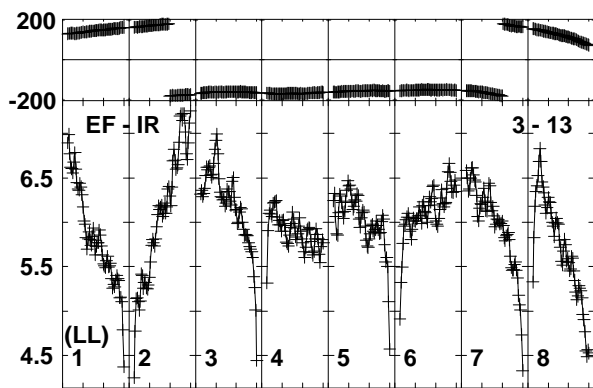
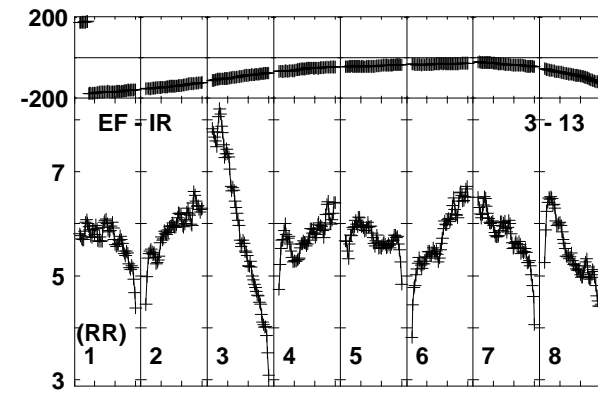
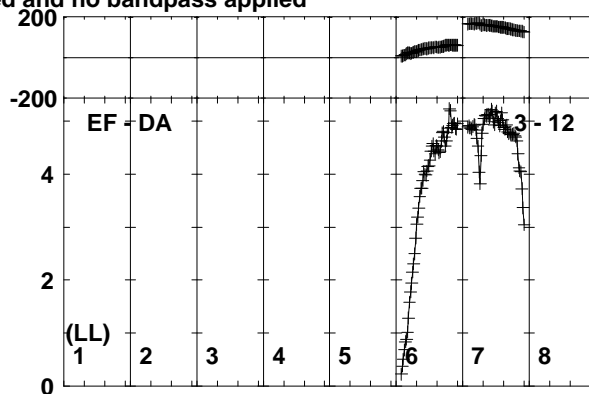
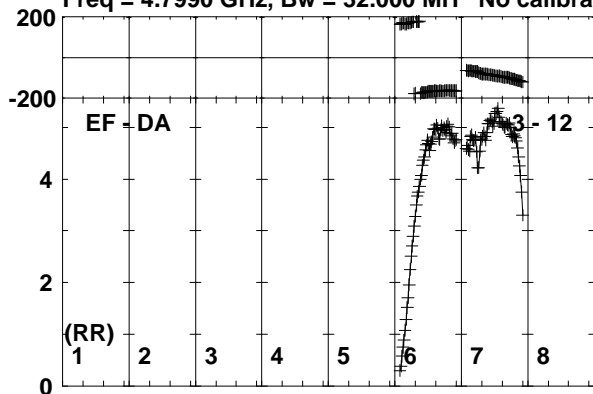

Channels

Lower frame: Milli Ampl Jy Top frame: Phas deg  
 Vector averaged cross-power spectrum Baseline: EF (03) - DA (12)  
 Timerange: 00/23:17:11 to 00/23:18:09



Plot file version 139 created 11-NOV-2019 15:07:31

SER8NJ EK040B.UVDATA.1

Freq = 4.7990 GHz, Bw = 32.000 MH No calibration applied and no bandpass applied

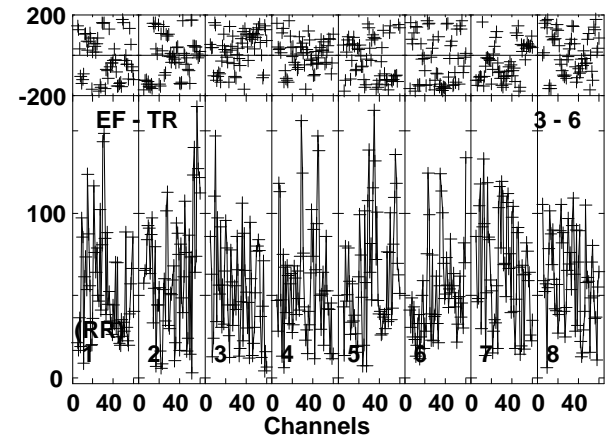
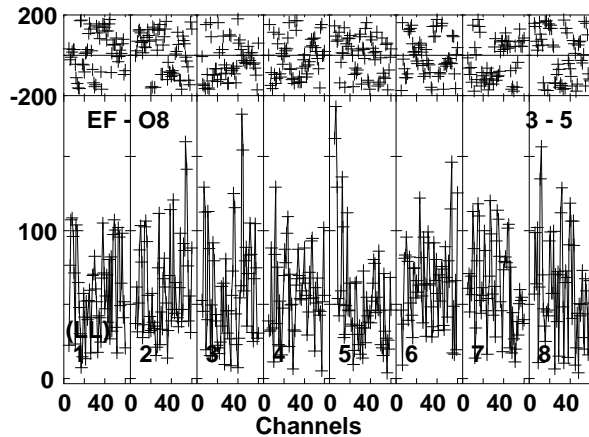
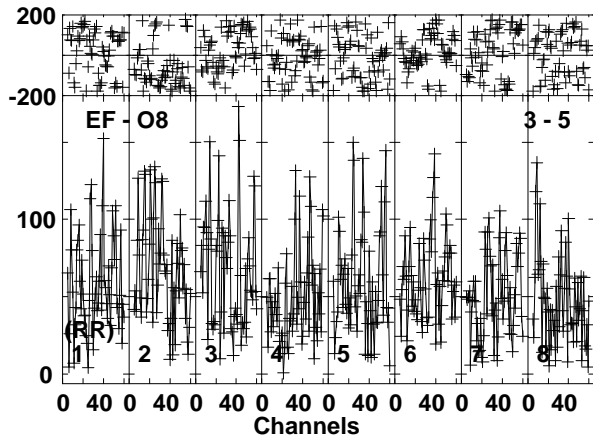
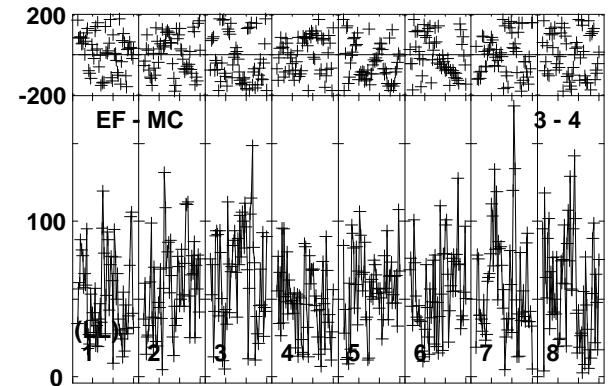
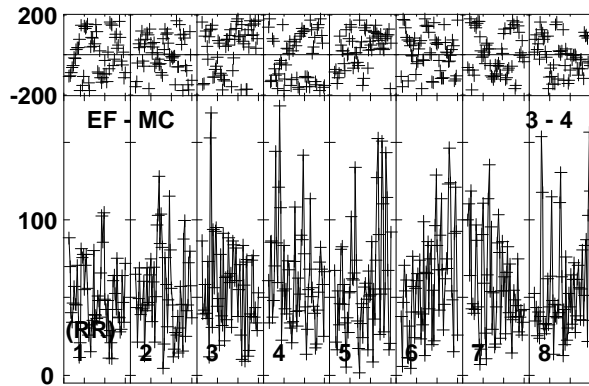
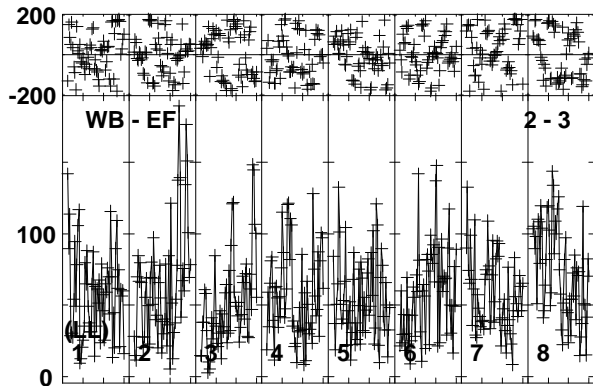
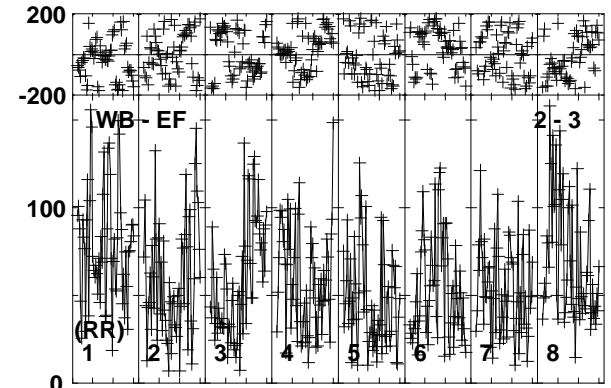
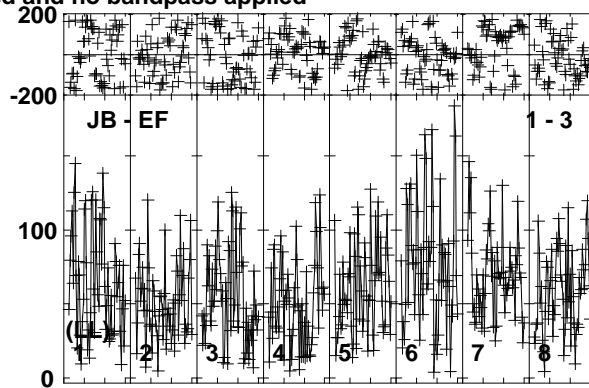
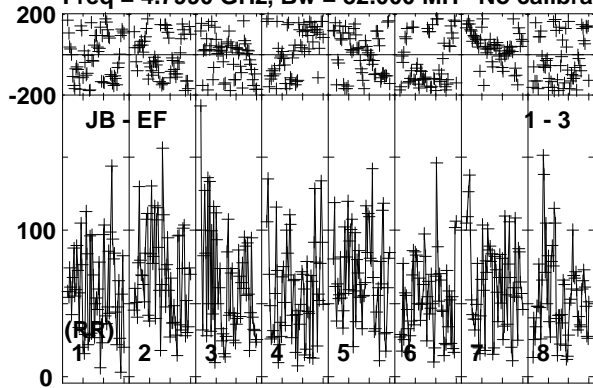

Lower frame: Micro Ampl Jy Top frame: Phas deg  
Vector averaged cross-power spectrum Baseline: JB (01) - EF (03)  
Timerange: 00/23:18:13 to 00/23:22:09

Plot file version 140 created 11-NOV-2019 15:07:32

SER8NJ EK040B.UVDATA.1

Freq = 4.7990 GHz, Bw = 32.000 MH No calibration applied and no bandpass applied

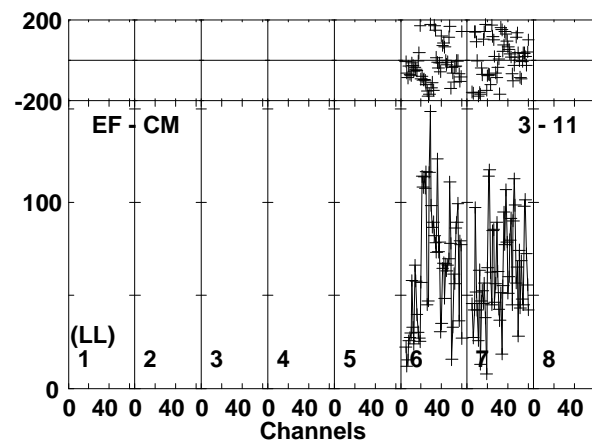
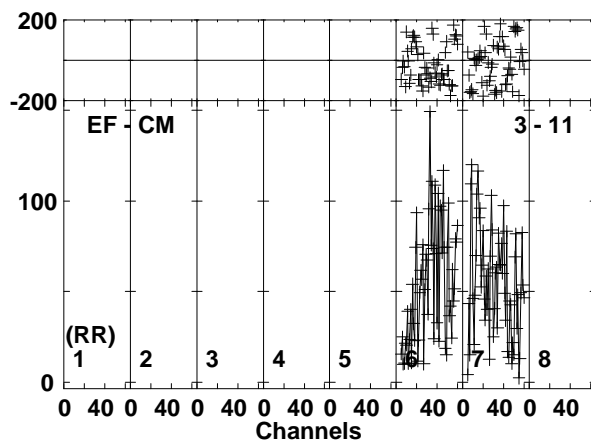
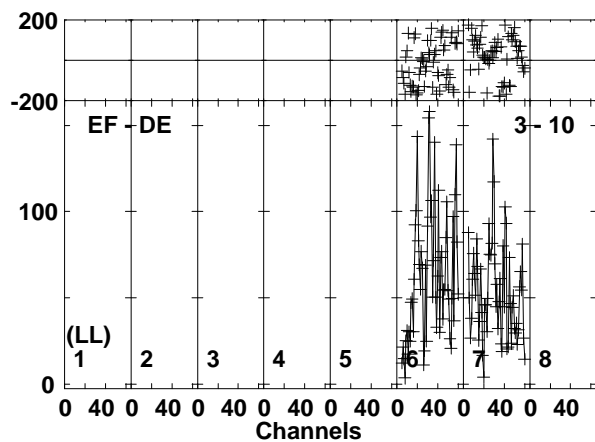
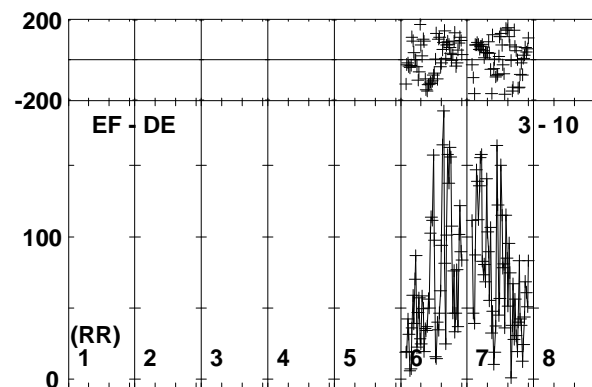
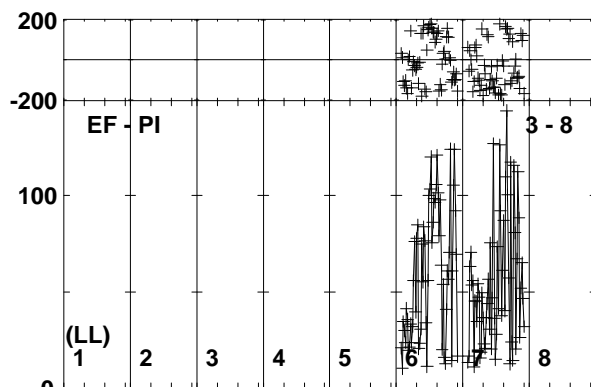
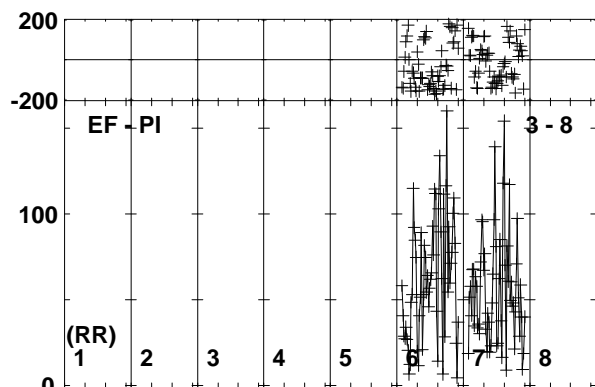
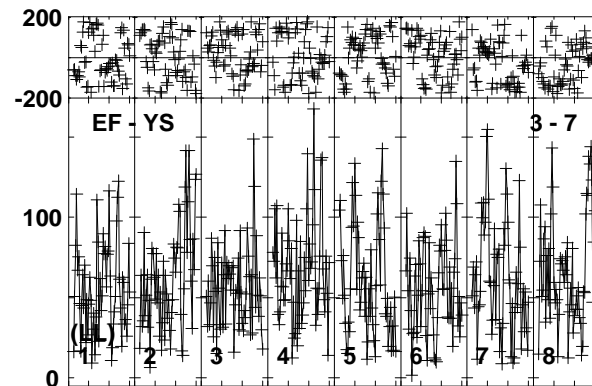
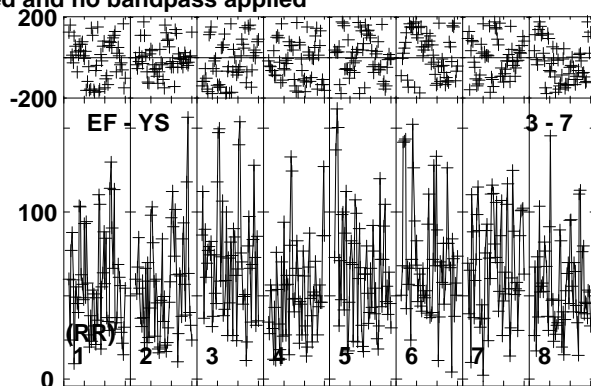
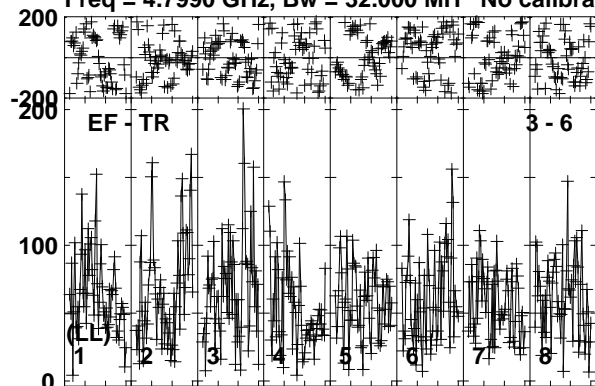

Lower frame: Micro Ampl Jy Top frame: Phas deg  
Vector averaged cross-power spectrum Baseline: EF (03) - TR (06)  
Timerange: 00/23:18:13 to 00/23:22:09



Plot file version 142 created 11-NOV-2019 15:07:32

J1826+0149 EK040B.UVDATA.1

Freq = 4.7990 GHz, Bw = 32.000 MH No calibration applied and no bandpass applied

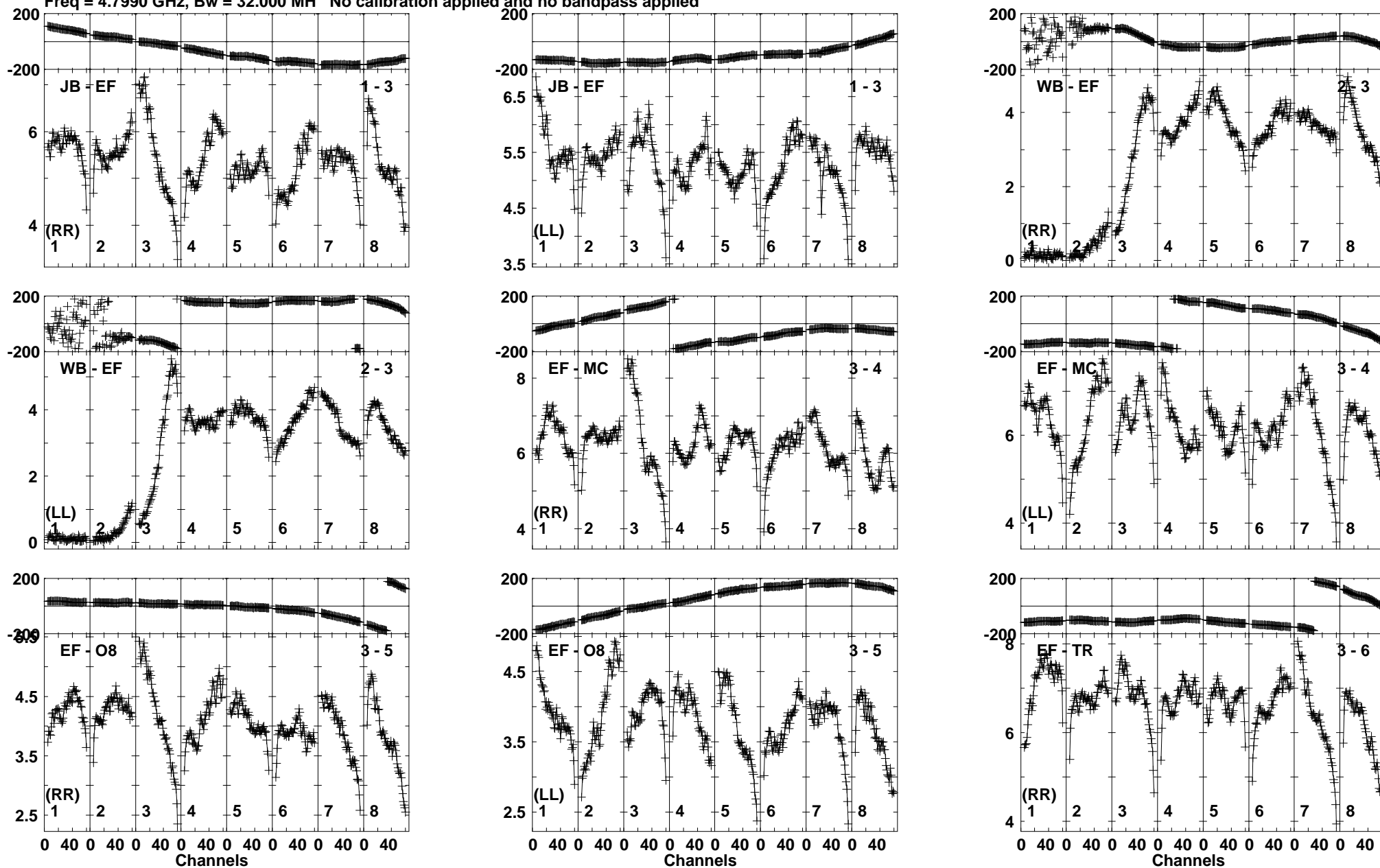

Lower frame: Milli Ampl Jy Top frame: Phas deg  
Vector averaged cross-power spectrum Baseline: JB (01) - EF (03)  
Timerange: 00/23:22:13 to 00/23:23:39

Plot file version 143 created 11-NOV-2019 15:07:32

J1826+0149 EK040B.UVDATA.1

Freq = 4.7990 GHz, Bw = 32.000 MH No calibration applied and no bandpass applied

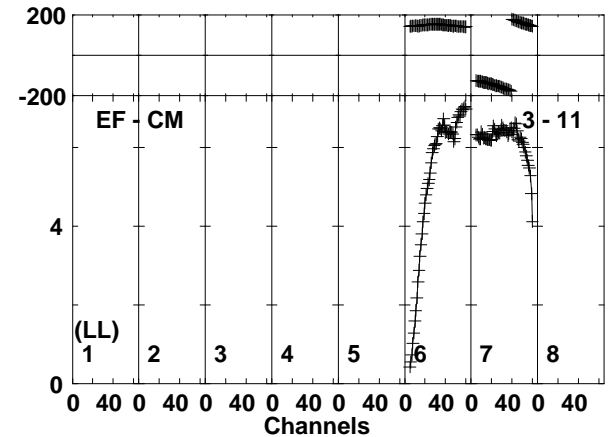
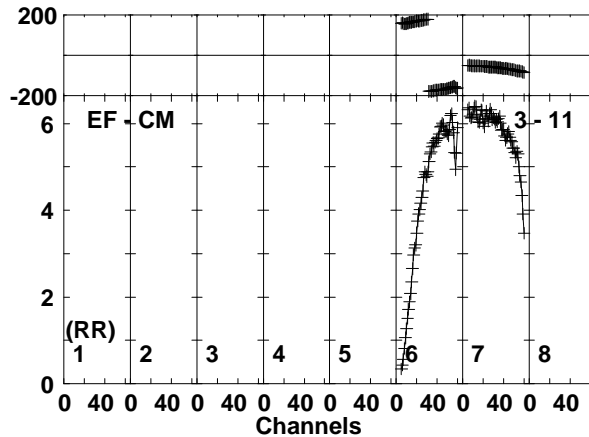
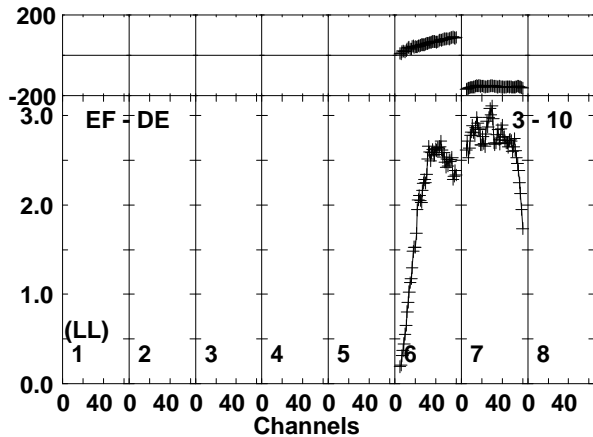
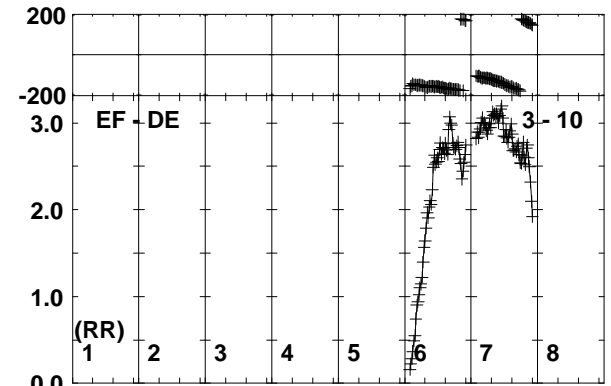
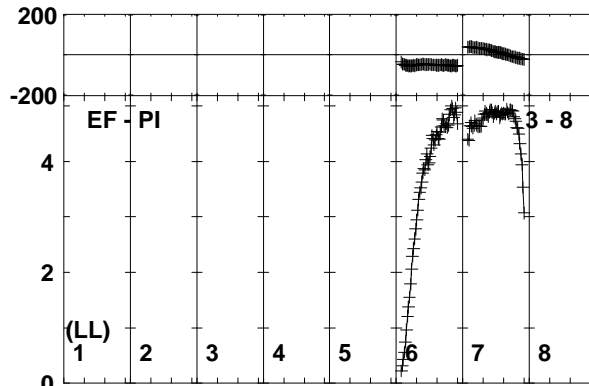
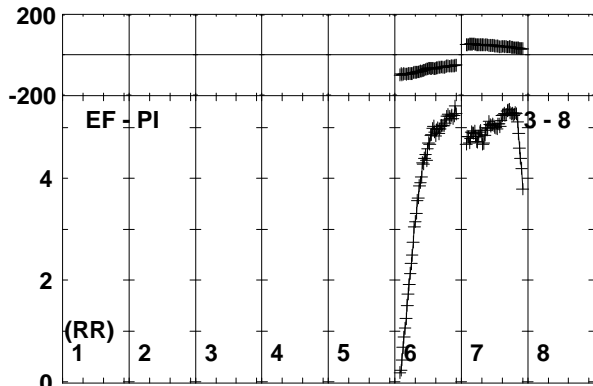
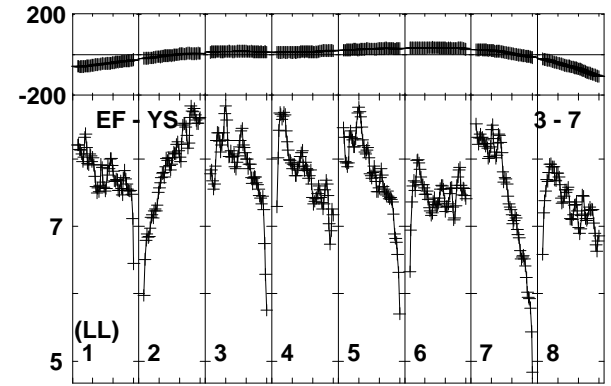
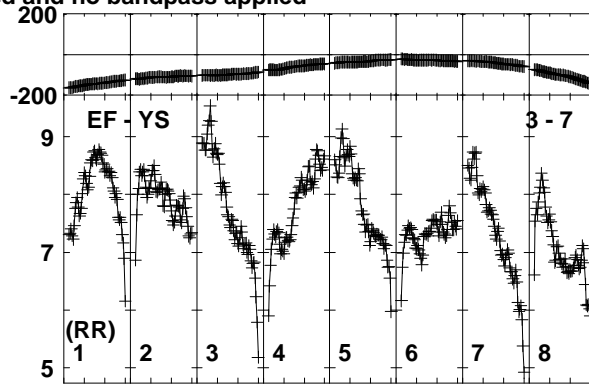
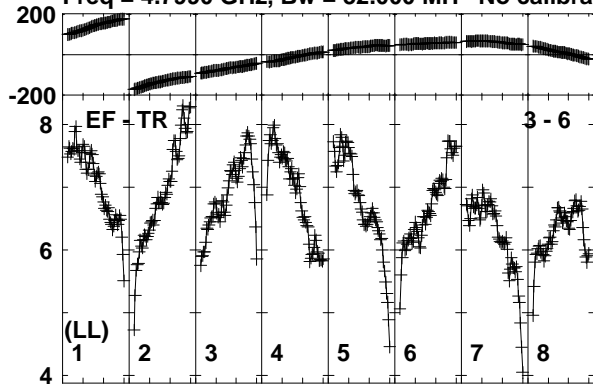

Lower frame: Milli Ampl Jy Top frame: Phas deg  
Vector averaged cross-power spectrum Baseline: EF (03) - TR (06)  
Timerange: 00/23:22:13 to 00/23:23:39

Plot file version 144 created 11-NOV-2019 15:07:32

J1826+0149 EK040B.UVDATA.1

Freq = 4.7990 GHz, Bw = 32.000 MH No calibration applied and no bandpass applied

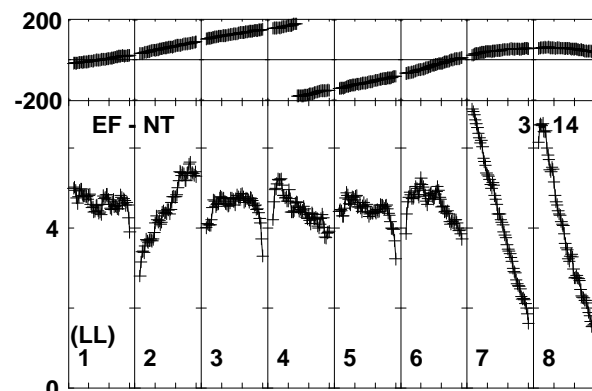
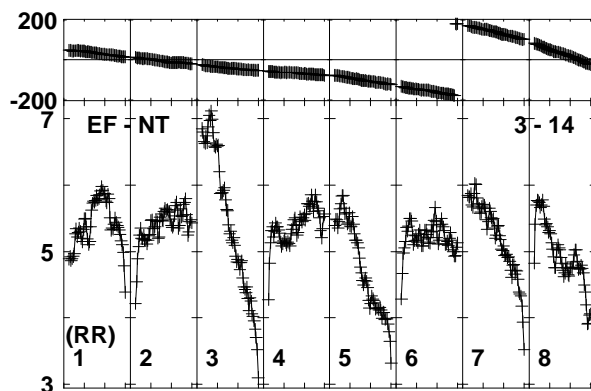
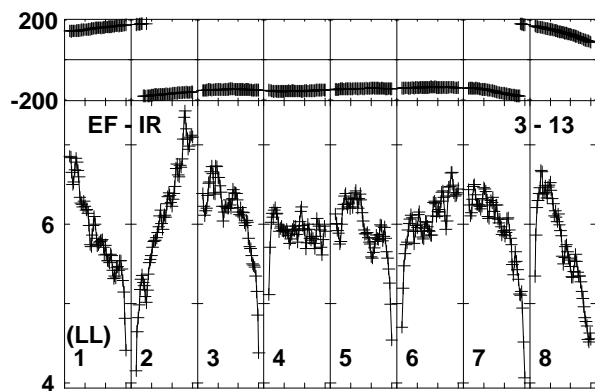
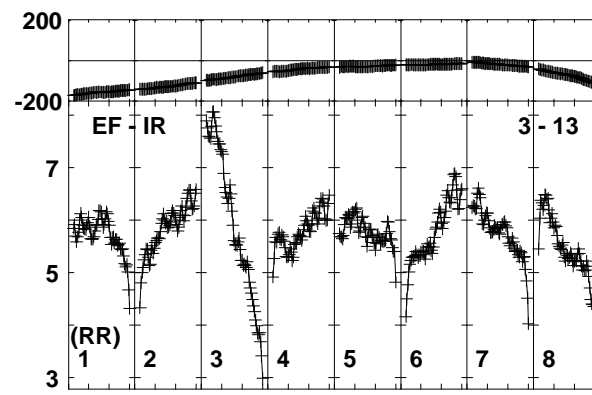
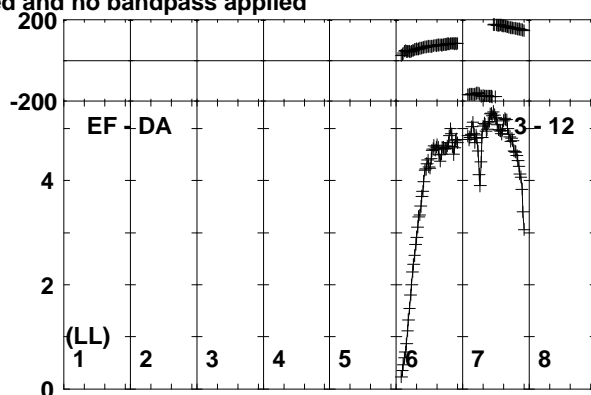
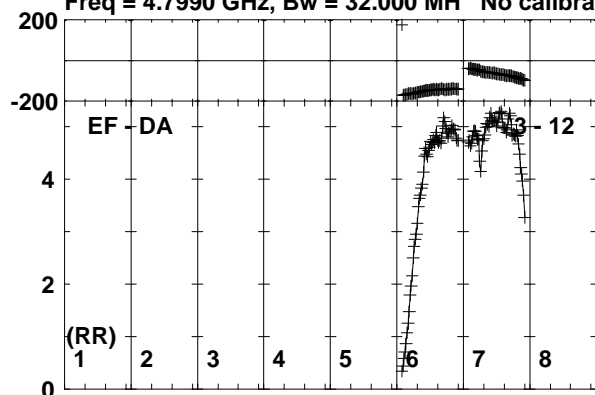

Lower frame: Milli Ampl Jy Top frame: Phas deg  
Vector averaged cross-power spectrum Baseline: EF (03) - DA (12)  
Timerange: 00/23:22:13 to 00/23:23:39

Plot file version 145 created 11-NOV-2019 15:07:32

SER8NJ EK040B.UVDATA.1

Freq = 4.7990 GHz, Bw = 32.000 MH No calibration applied and no bandpass applied

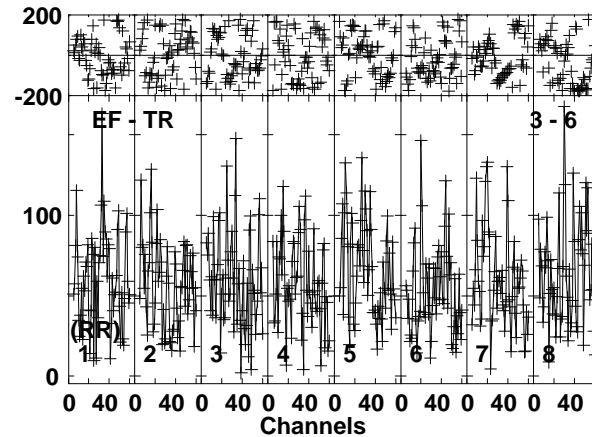
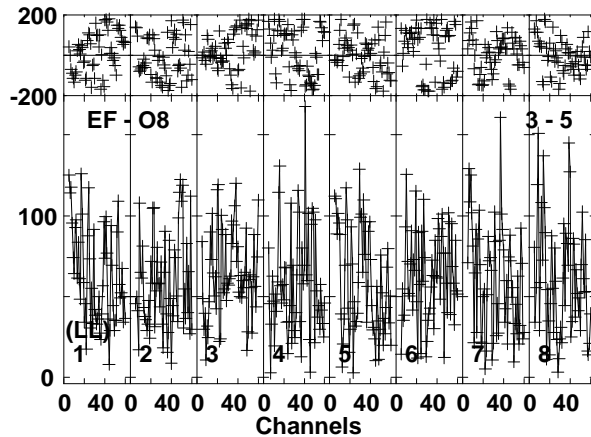
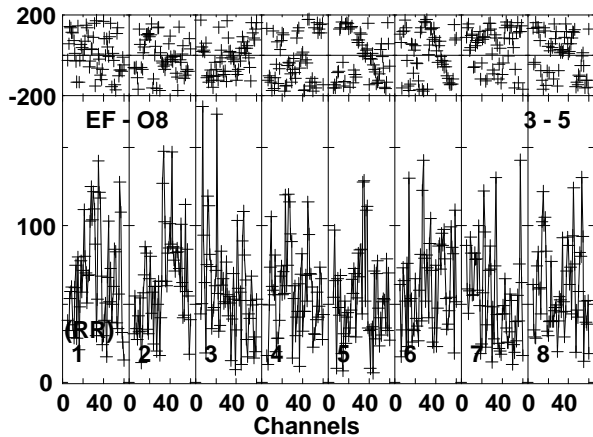
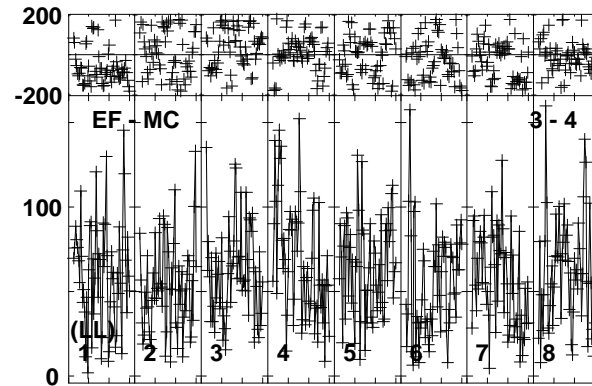
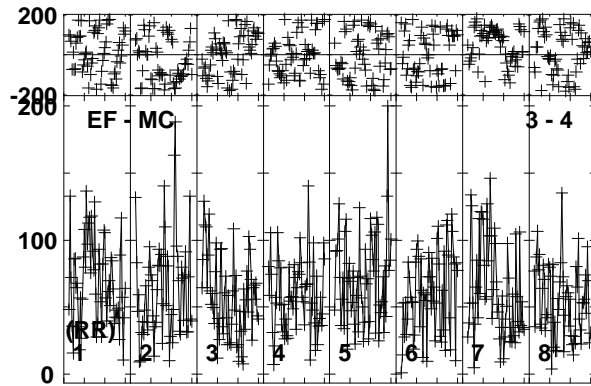
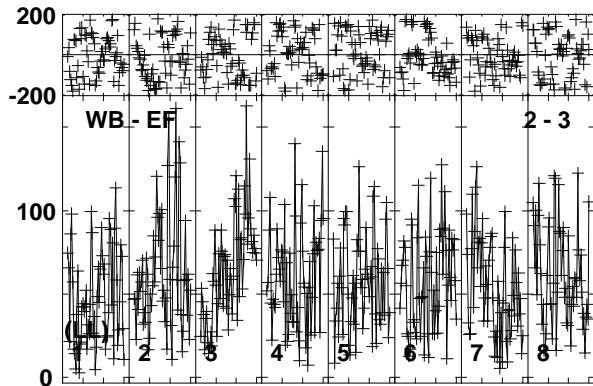
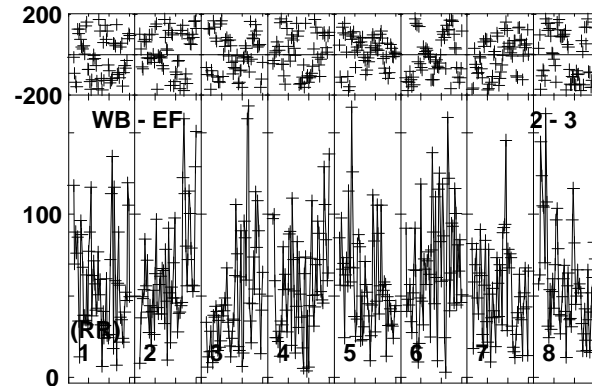
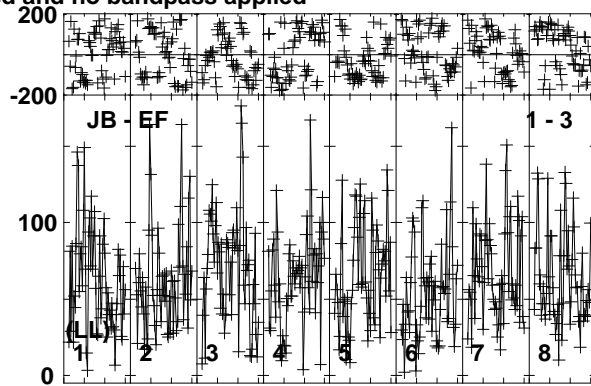
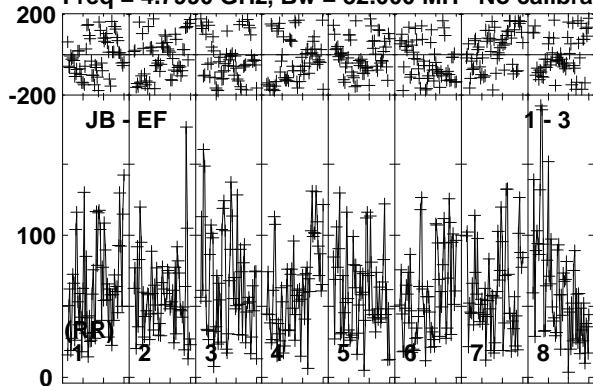

Lower frame: Micro Ampl Jy Top frame: Phas deg  
Vector averaged cross-power spectrum Baseline: JB (01) - EF (03)  
Timerange: 00/23:23:43 to 00/23:27:39

Plot file version 146 created 11-NOV-2019 15:07:32

SER8NJ EK040B.UVDATA.1

Freq = 4.7990 GHz, Bw = 32.000 MH No calibration applied and no bandpass applied

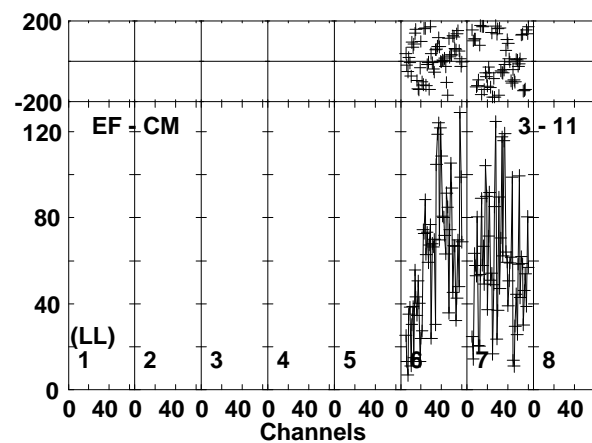
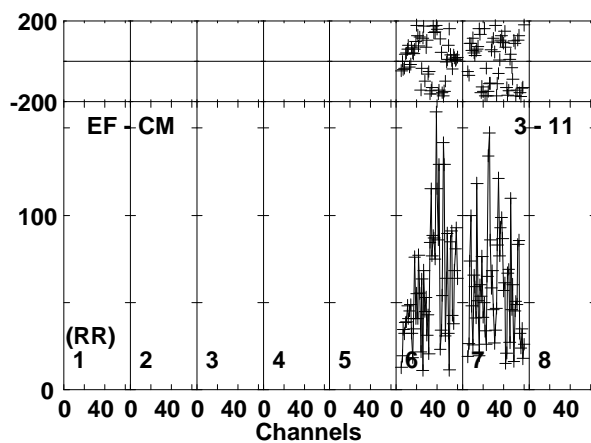
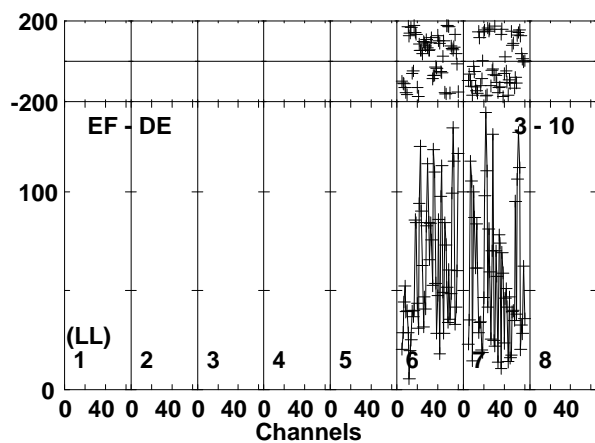
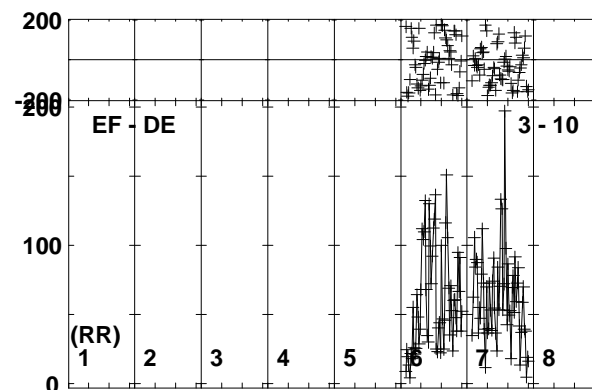
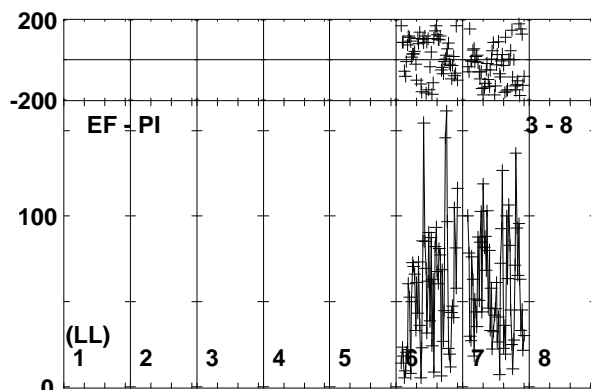
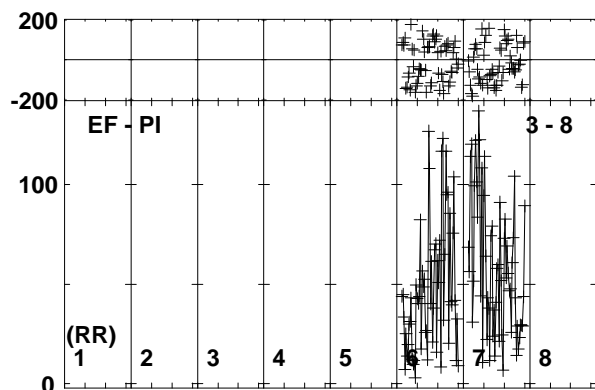
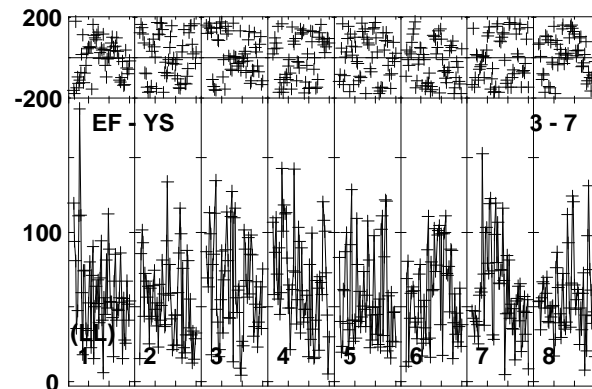
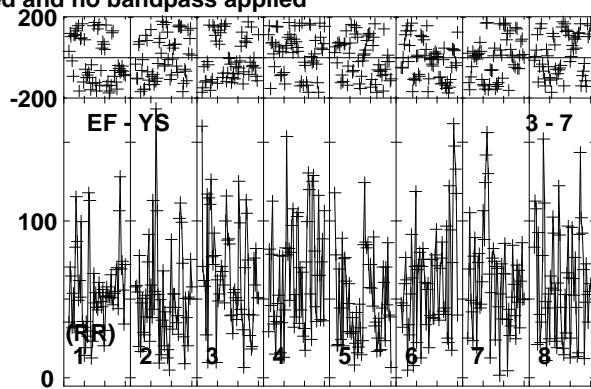
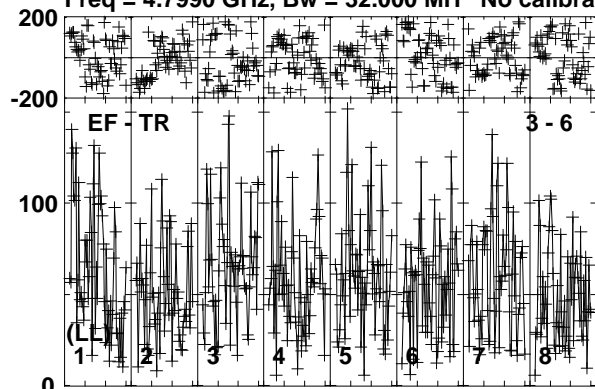

Lower frame: Micro Ampl Jy Top frame: Phas deg  
Vector averaged cross-power spectrum Baseline: EF (03) - TR (06)  
Timerange: 00/23:23:43 to 00/23:27:39



Plot file version 147 created 11-NOV-2019 15:07:32  
 SER8NJ EK040B.UVDATA.1  
 Freq = 4.7990 GHz, Bw = 32.000 MH No calibration applied and no bandpass applied

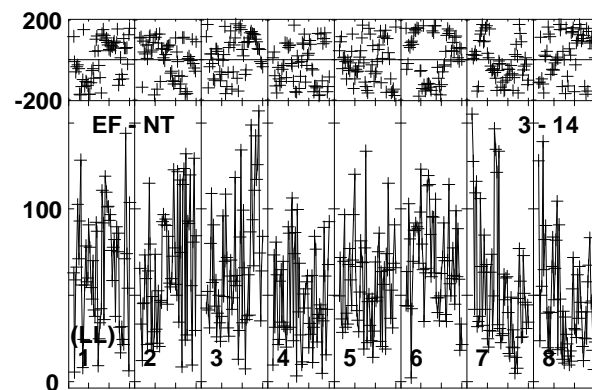
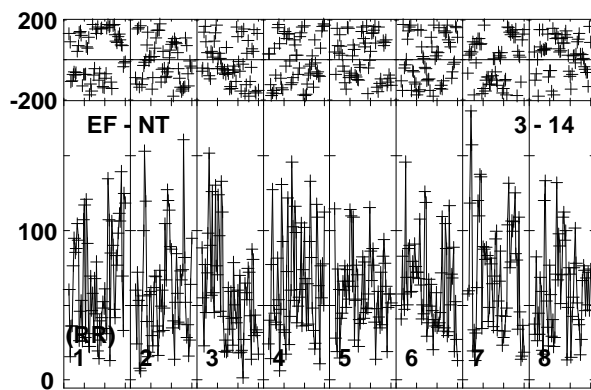
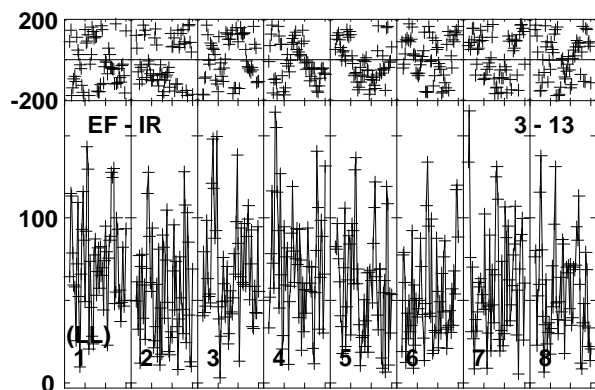
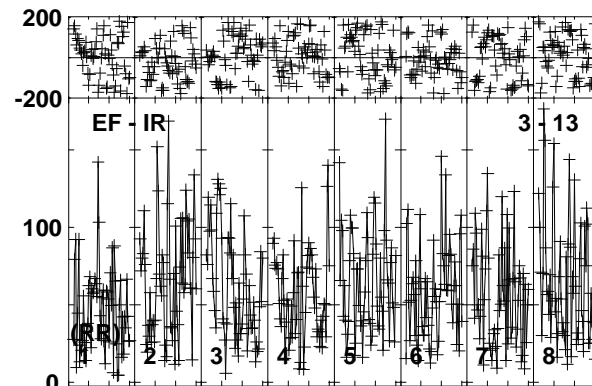
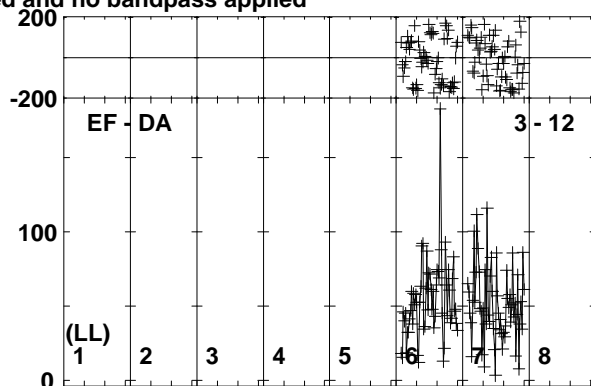
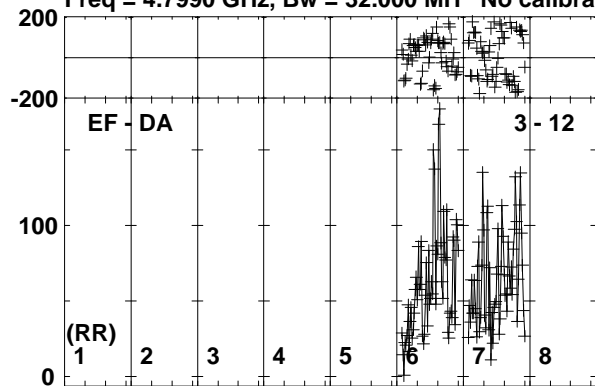

0 40 0 40 0 40 0 40 0 40 0 40 0 40 0 40 0 40 0 40  
 Channels

Lower frame: Micro Ampl Jy Top frame: Phas deg  
 Vector averaged cross-power spectrum Baseline: EF (03) - DA (12)  
 Timerange: 00/23:23:43 to 00/23:27:39

Plot file version 148 created 11-NOV-2019 15:07:32

J1826+0149 EK040B.UVDATA.1

Freq = 4.7990 GHz, Bw = 32.000 MH No calibration applied and no bandpass applied

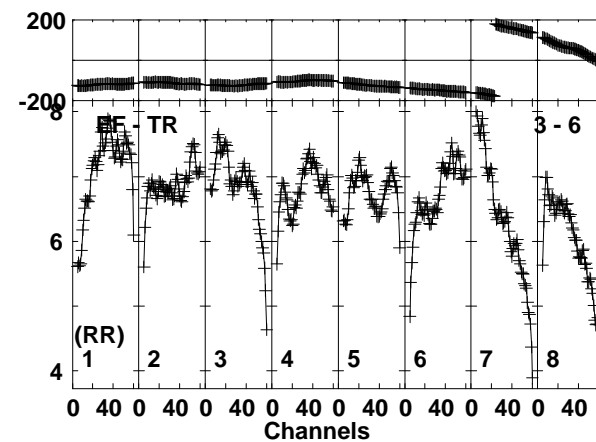
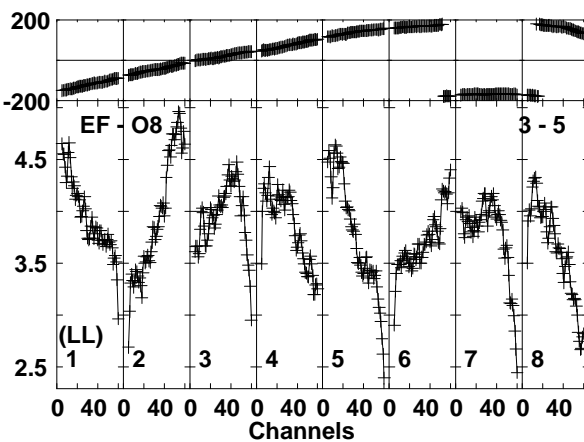
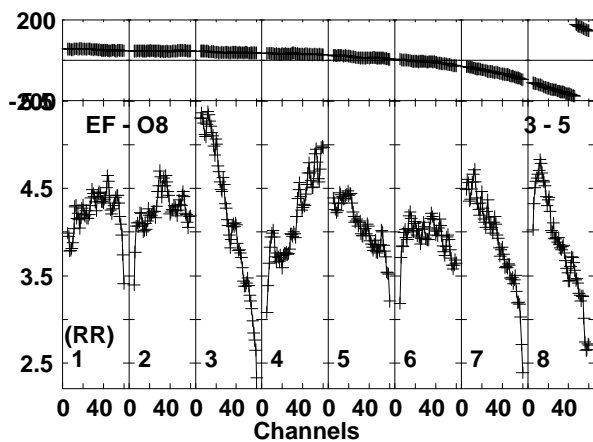
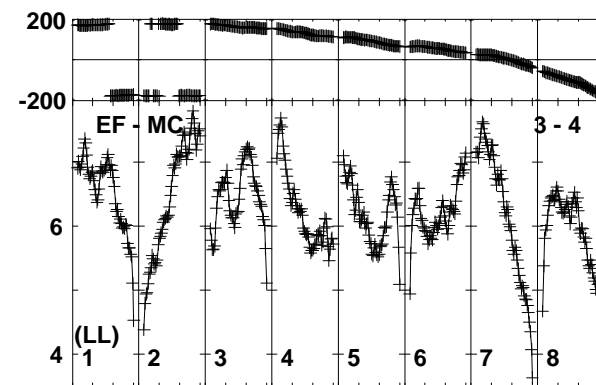
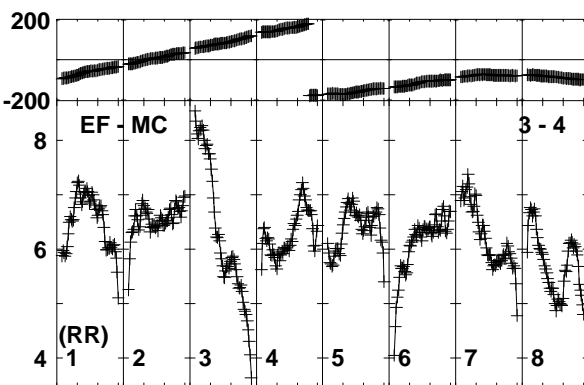
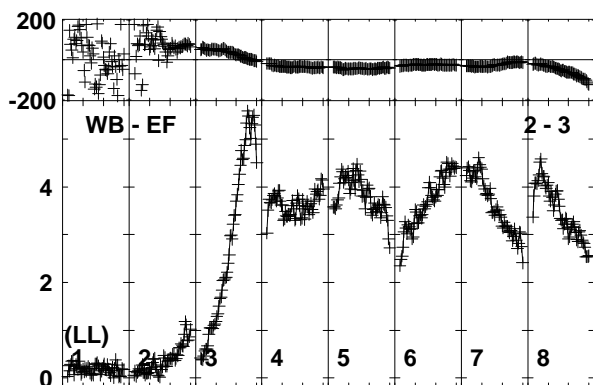
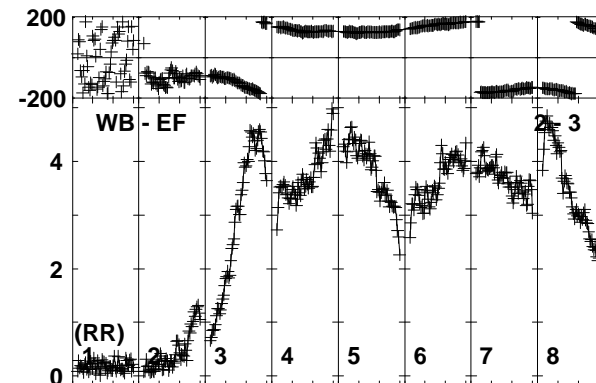
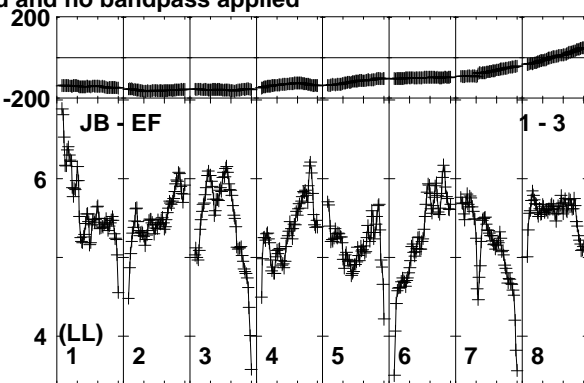
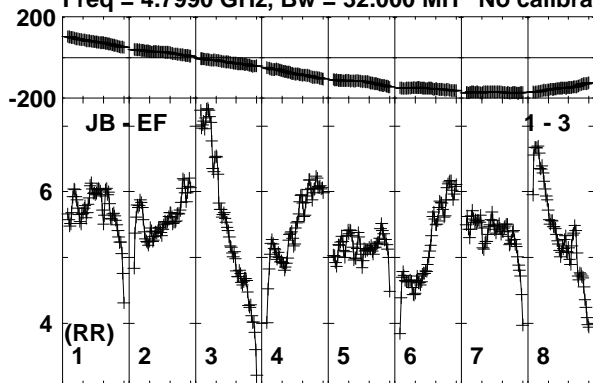

Lower frame: Milli Ampl Jy Top frame: Phas deg  
Vector averaged cross-power spectrum Baseline: JB (01) - EF (03)  
Timerange: 00/23:28:21 to 00/23:29:19

Plot file version 149 created 11-NOV-2019 15:07:33

J1826+0149 EK040B.UVDATA.1

Freq = 4.7990 GHz, Bw = 32.000 MH No calibration applied and no bandpass applied

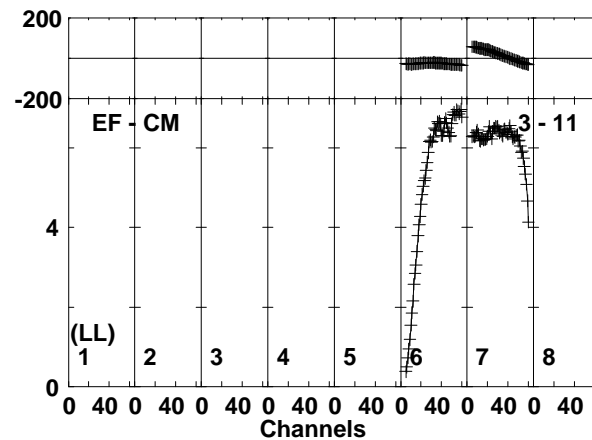
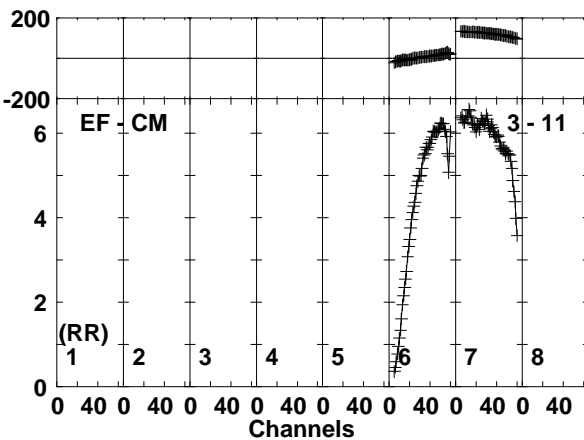
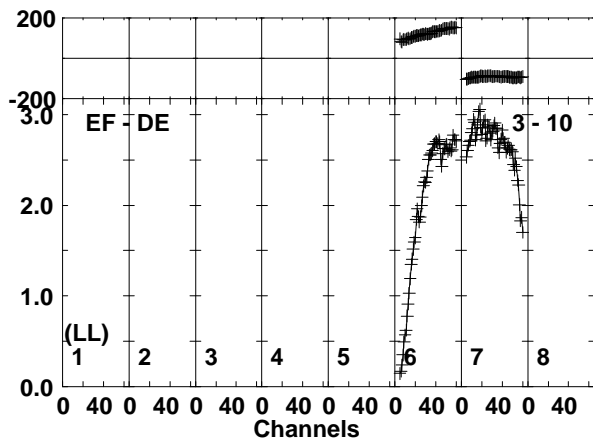
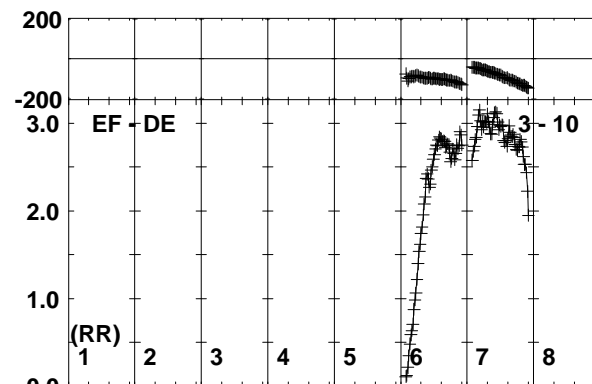
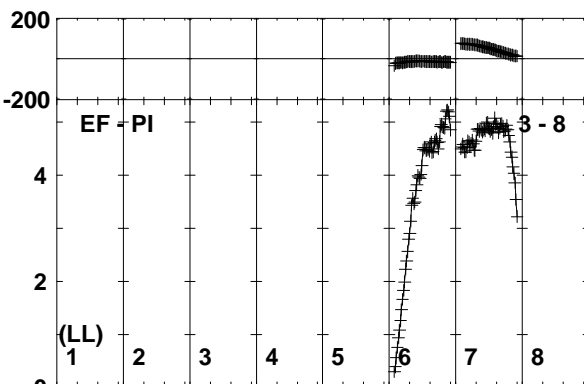
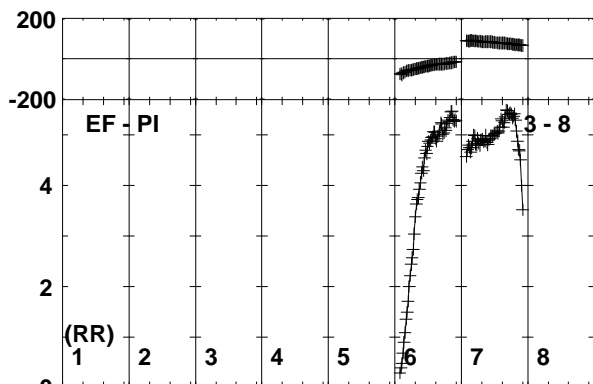
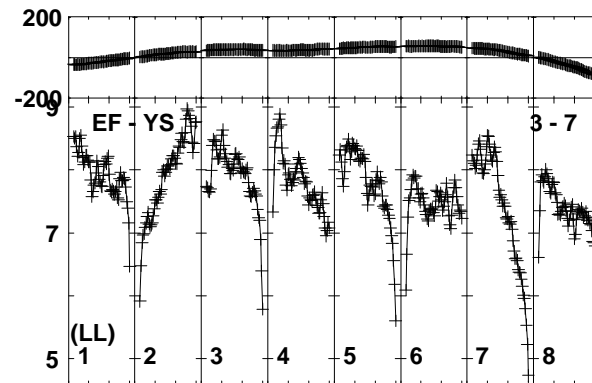
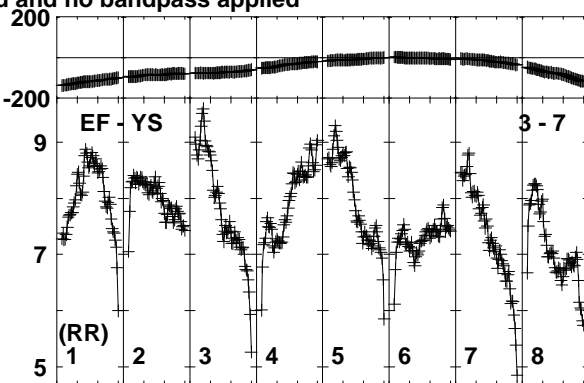
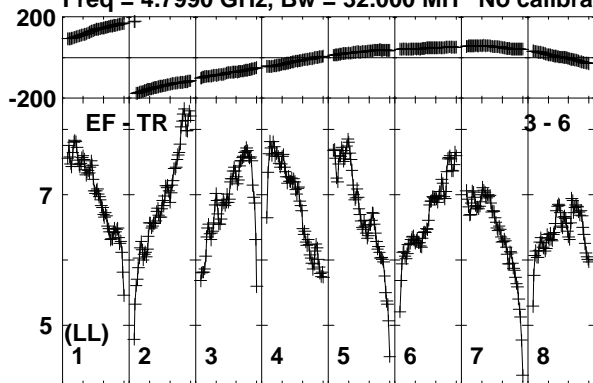

Lower frame: Milli Ampl Jy Top frame: Phas deg  
Vector averaged cross-power spectrum Baseline: EF (03) - TR (06)  
Timerange: 00/23:28:21 to 00/23:29:19

Plot file version 150 created 11-NOV-2019 15:07:33

J1826+0149 EK040B.UVDATA.1

Freq = 4.7990 GHz, Bw = 32.000 MH No calibration applied and no bandpass applied

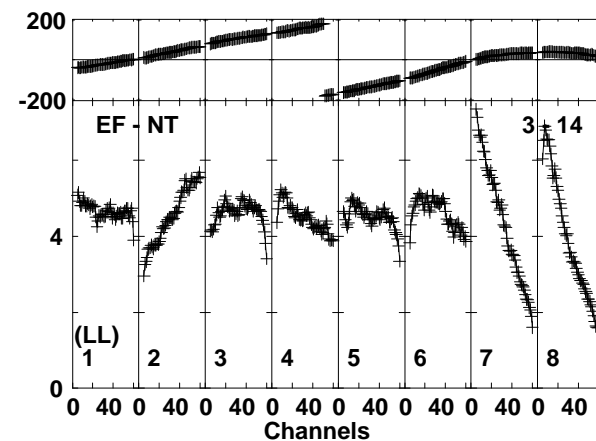
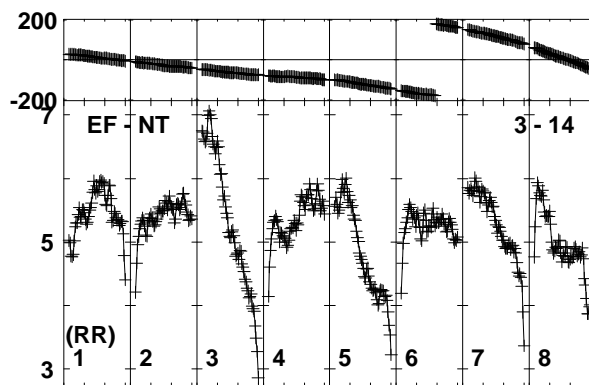
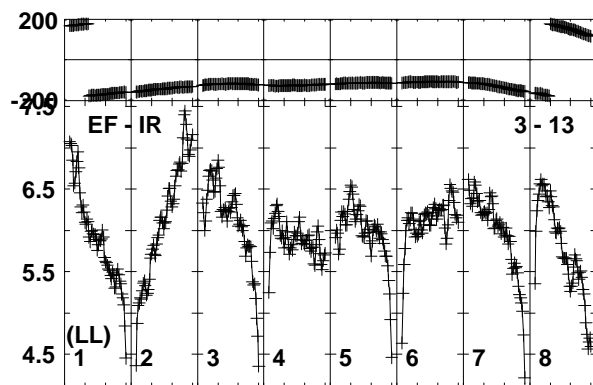
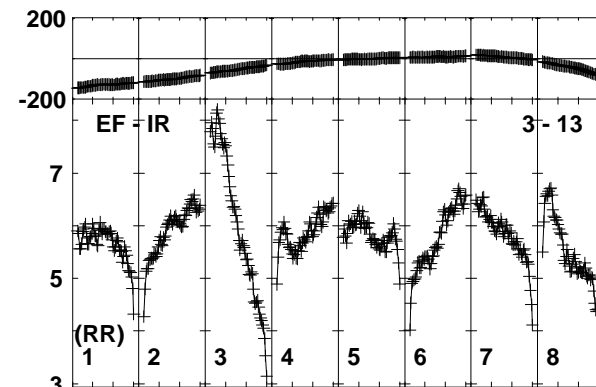
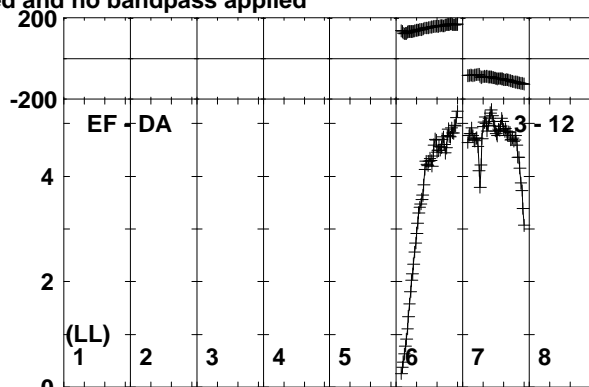
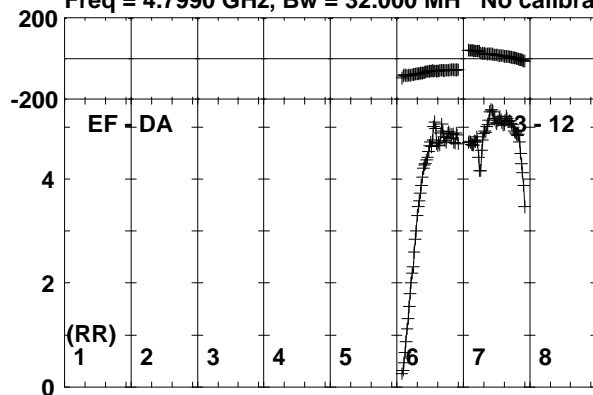

Lower frame: Milli Ampl Jy Top frame: Phas deg  
Vector averaged cross-power spectrum Baseline: EF (03) - DA (12)  
Timerange: 00/23:28:21 to 00/23:29:19

Plot file version 151 created 11-NOV-2019 15:07:33

SER8NJ EK040B.UVDATA.1

Freq = 4.7990 GHz, Bw = 32.000 MH No calibration applied and no bandpass applied

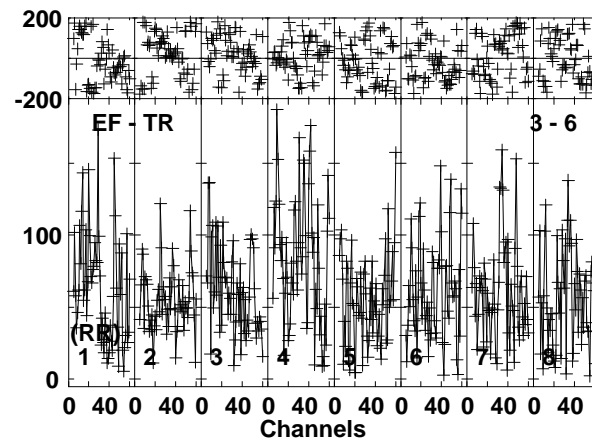
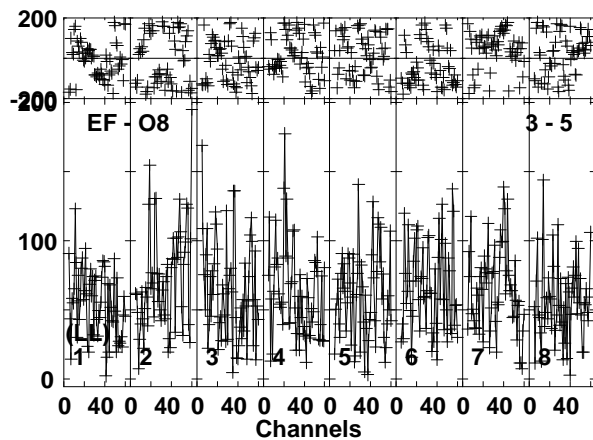
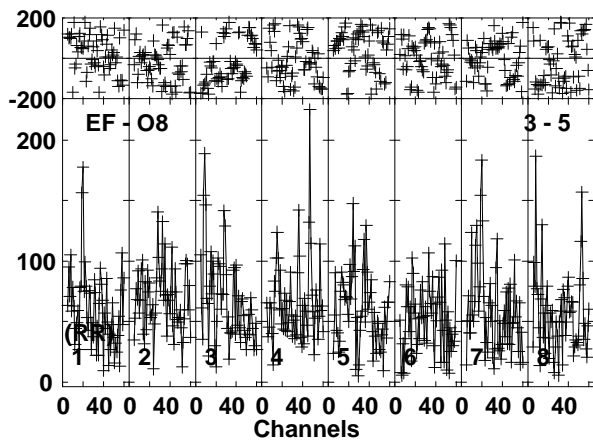
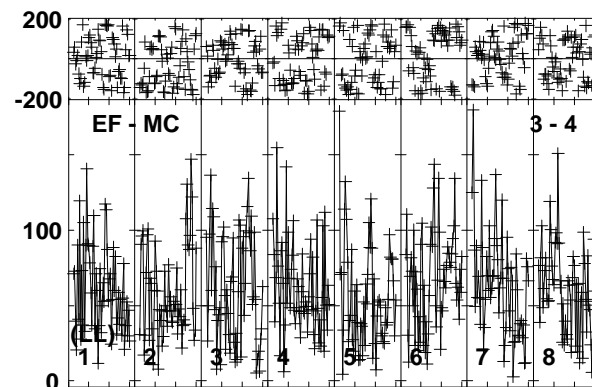
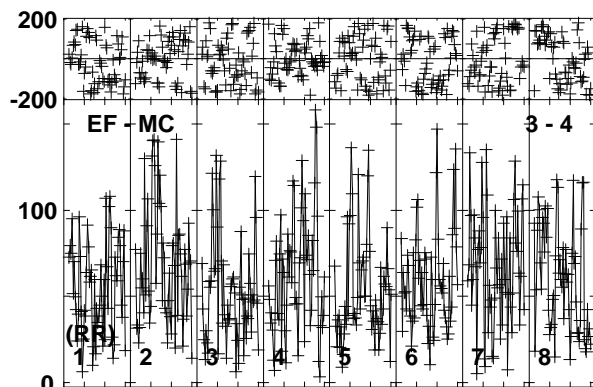
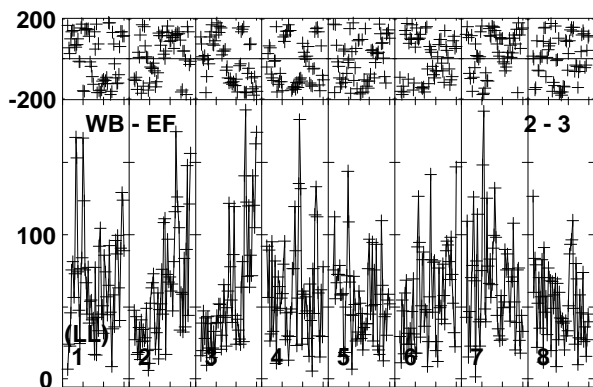
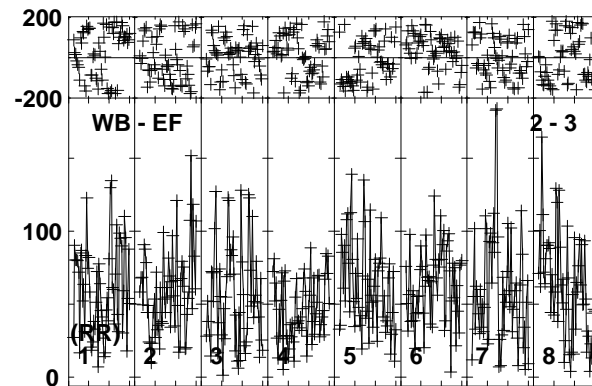
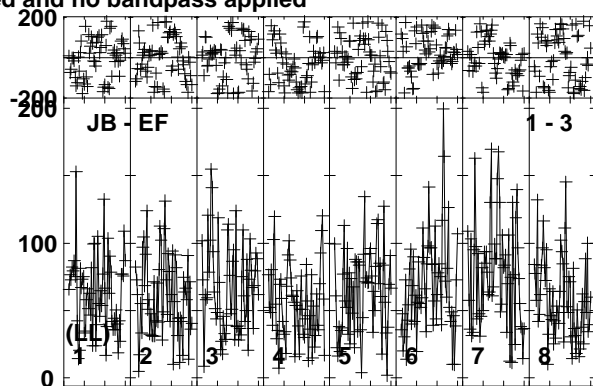
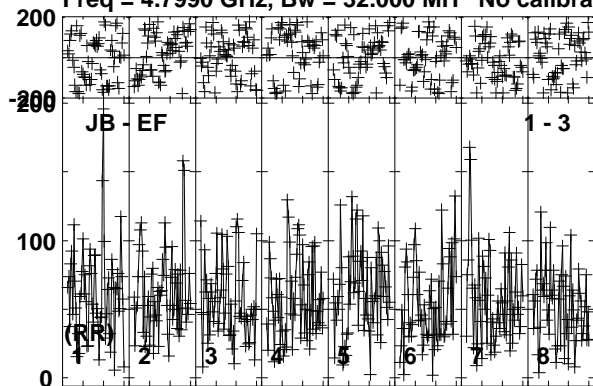

Lower frame: Micro Ampl Jy Top frame: Phas deg  
Vector averaged cross-power spectrum Baseline: JB (01) - EF (03)  
Timerange: 00/23:29:21 to 00/23:33:19

Plot file version 152 created 11-NOV-2019 15:07:33

SER8NJ EK040B.UVDATA.1

Freq = 4.7990 GHz, Bw = 32.000 MH No calibration applied and no bandpass applied

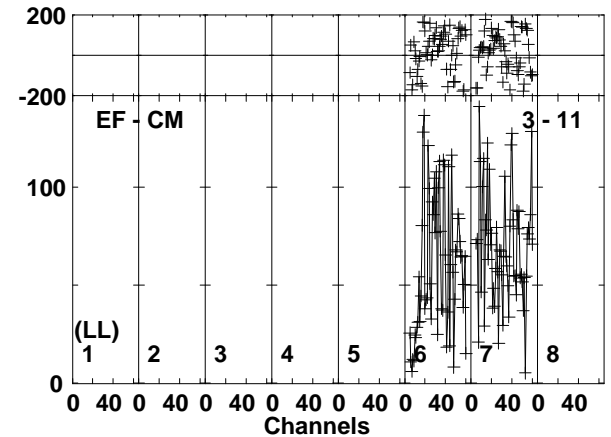
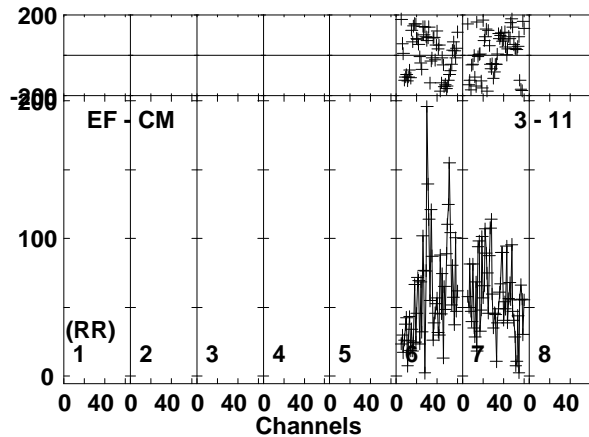
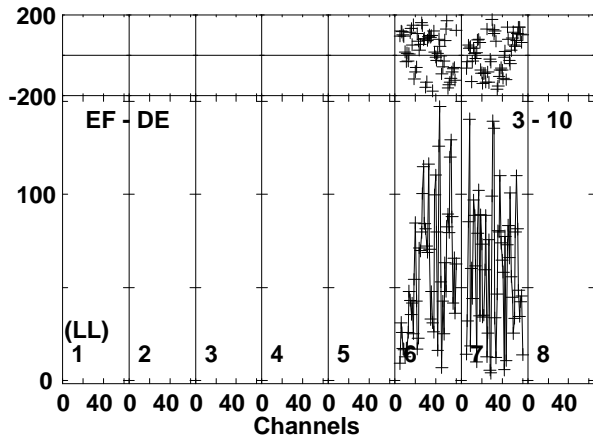
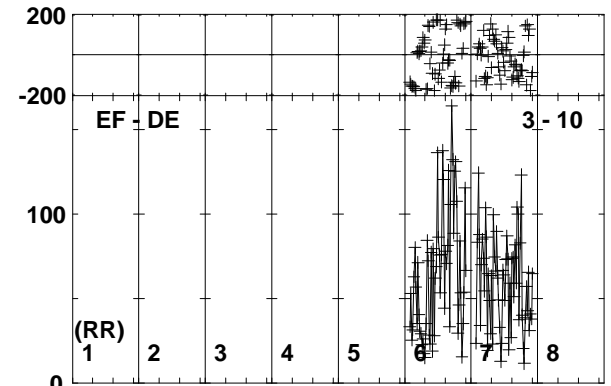
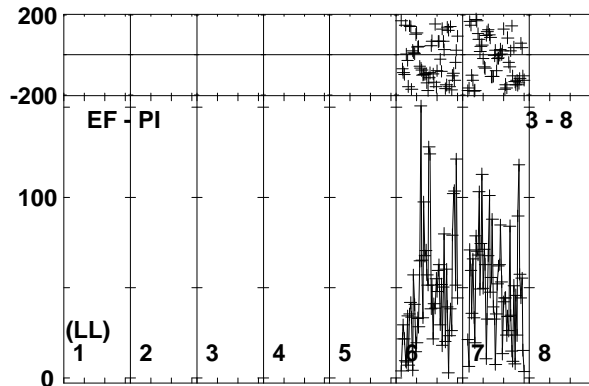
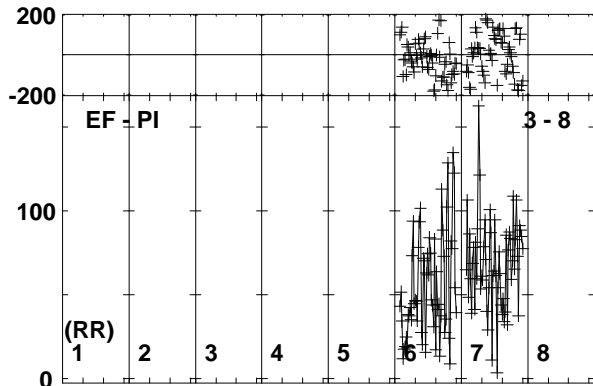
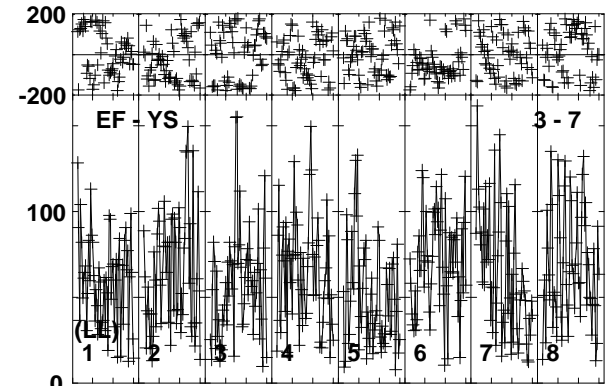
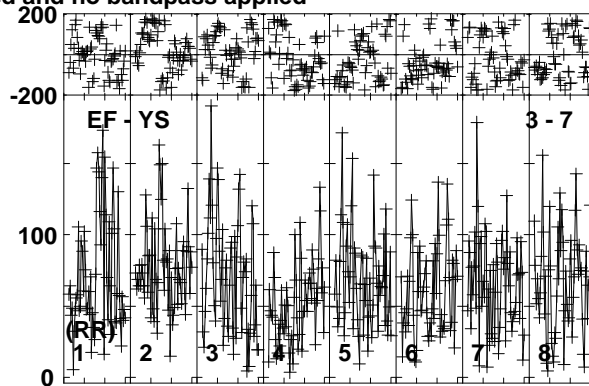
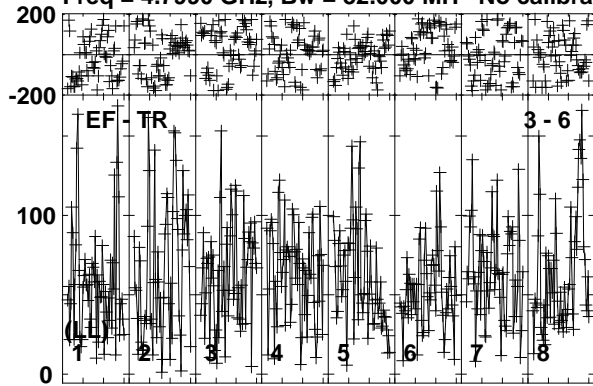

Lower frame: Micro Ampl Jy Top frame: Phas deg  
Vector averaged cross-power spectrum Baseline: EF (03) - TR (06)  
Timerange: 00/23:29:21 to 00/23:33:19

Plot file version 153 created 11-NOV-2019 15:07:33

SER8NJ EK040B.UVDATA.1

Freq = 4.7990 GHz, Bw = 32.000 MH No calibration applied and no bandpass applied

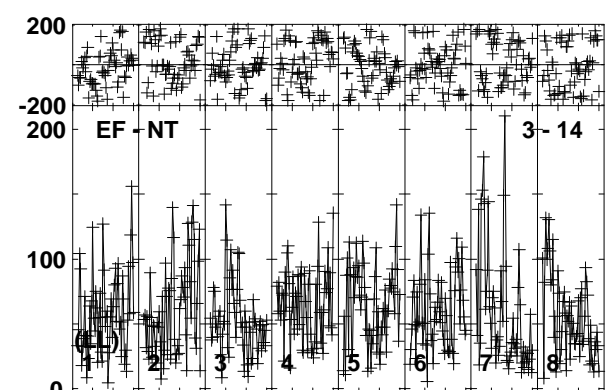
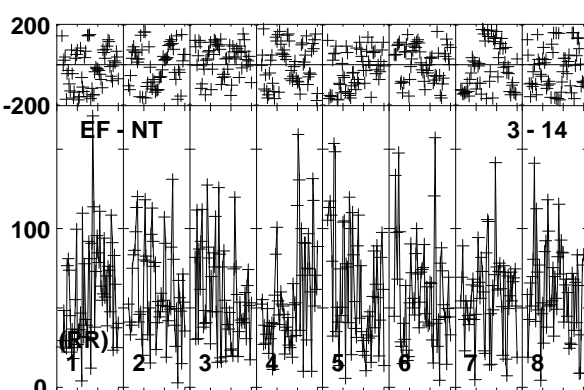
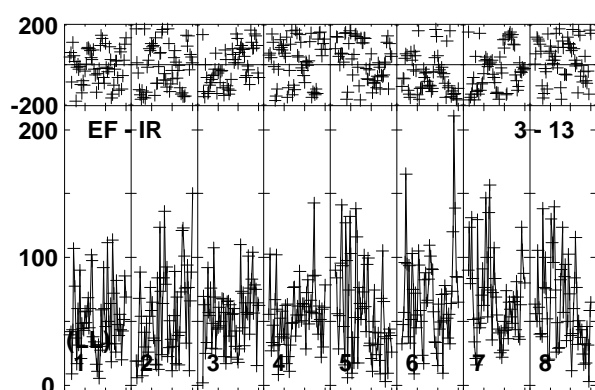
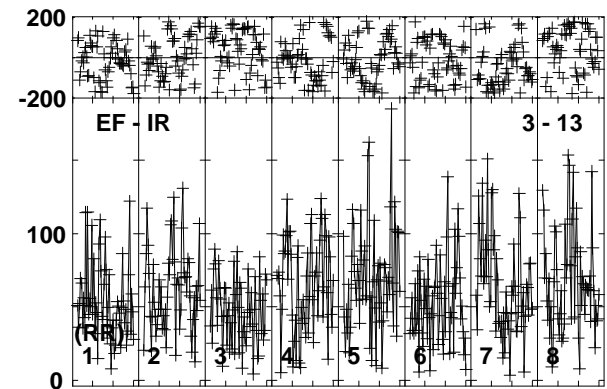
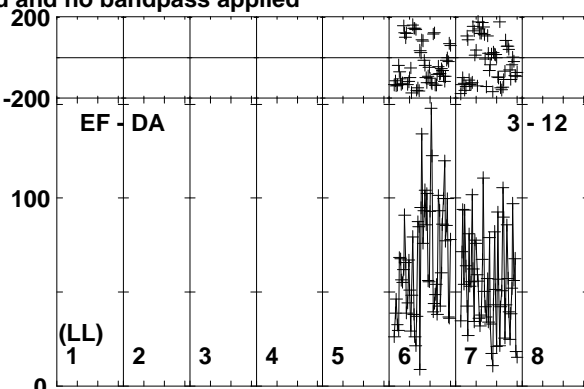
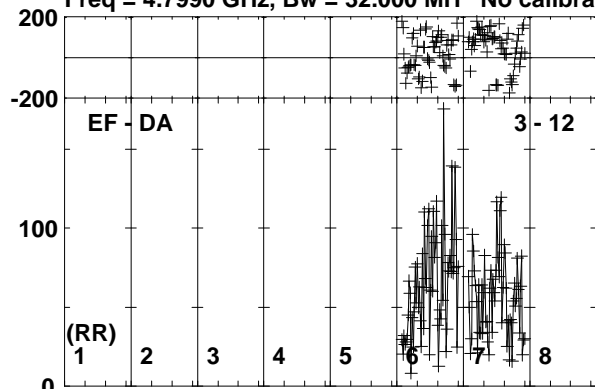

0 40 0 40 0 40 0 40 0 40 0 40 0 40 0 40 0 40 0 40  
Channels

Lower frame: Micro Ampl Jy Top frame: Phas deg  
Vector averaged cross-power spectrum Baseline: EF (03) - DA (12)  
Timerange: 00/23:29:21 to 00/23:33:19

Plot file version 154 created 11-NOV-2019 15:07:33

J1826+0149 EK040B.UVDATA.1

Freq = 4.7990 GHz, Bw = 32.000 MH No calibration applied and no bandpass applied

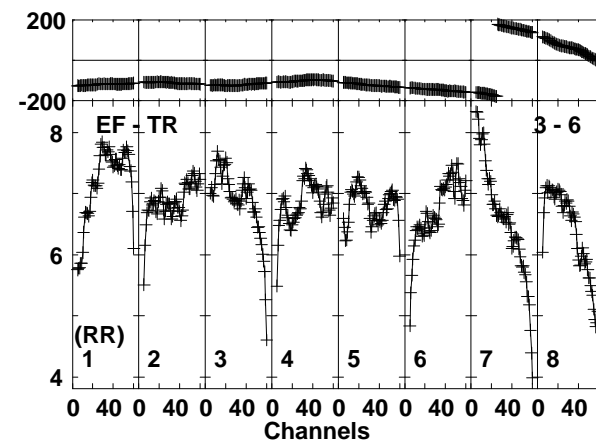
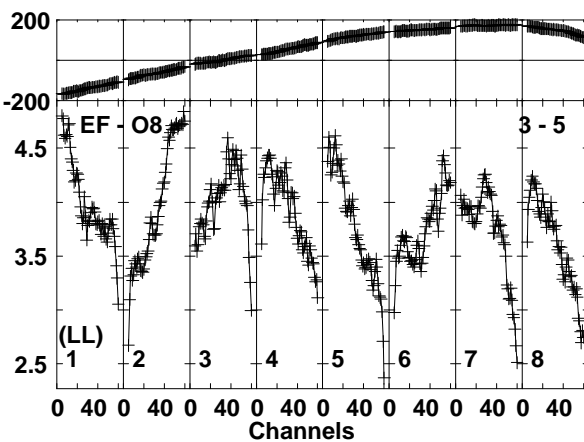
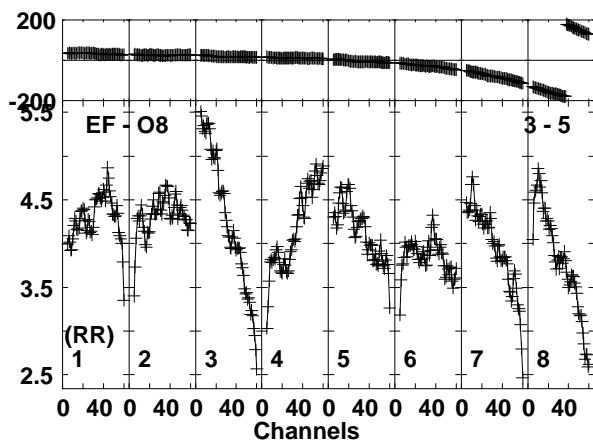
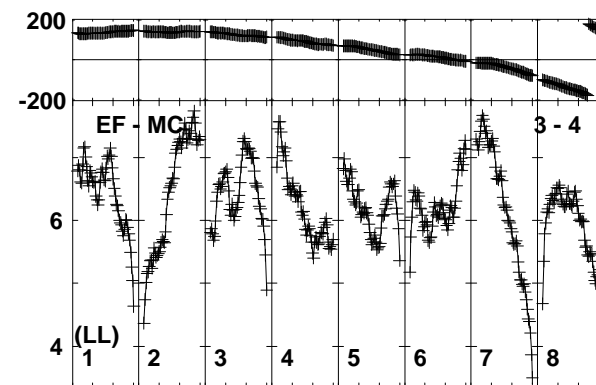
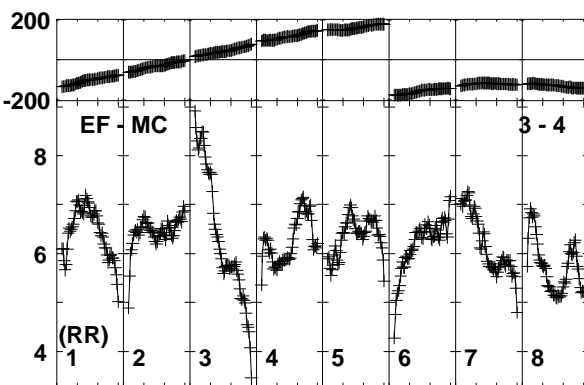
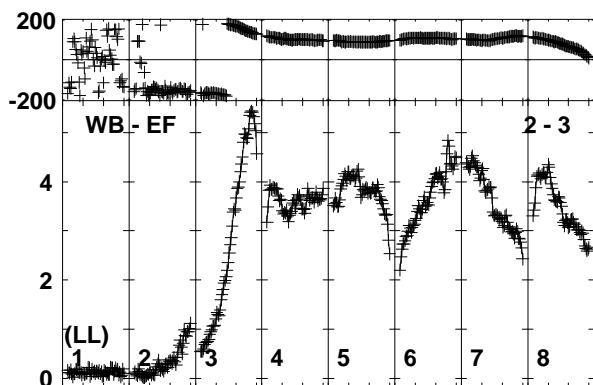
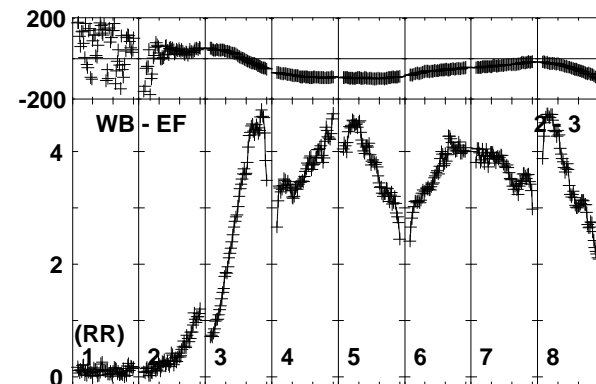
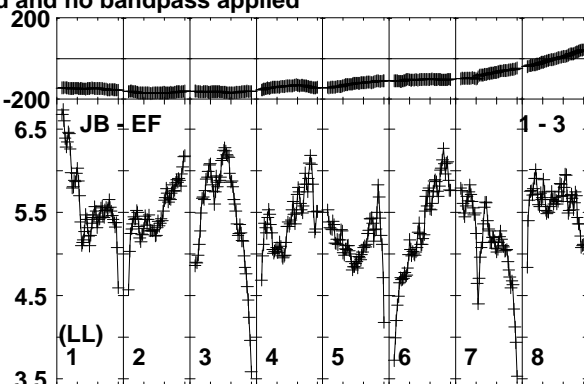
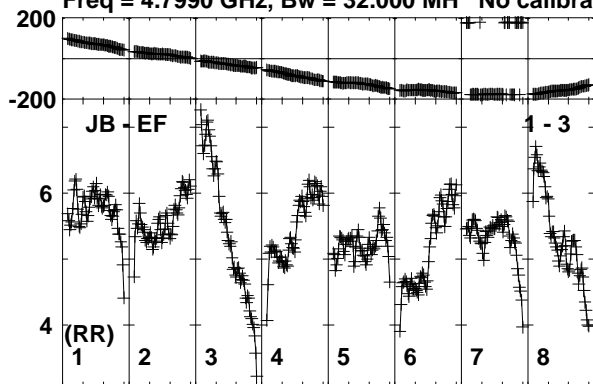

Lower frame: Milli Ampl Jy Top frame: Phas deg  
Vector averaged cross-power spectrum Baseline: JB (01) - EF (03)  
Timerange: 00/23:33:21 to 00/23:34:49



Plot file version 155 created 11-NOV-2019 15:07:33

J1826+0149 EK040B.UVDATA.1

Freq = 4.7990 GHz, Bw = 32.000 MH No calibration applied and no bandpass applied

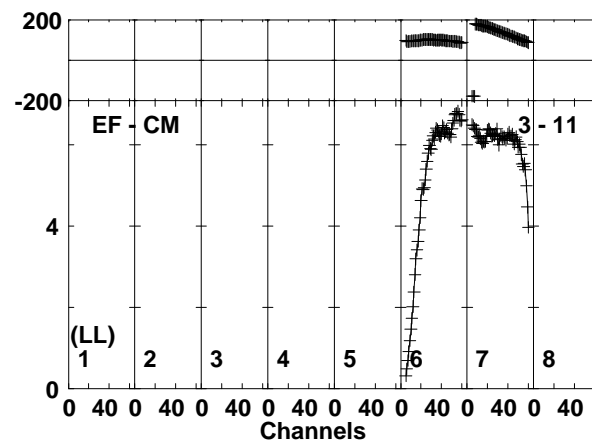
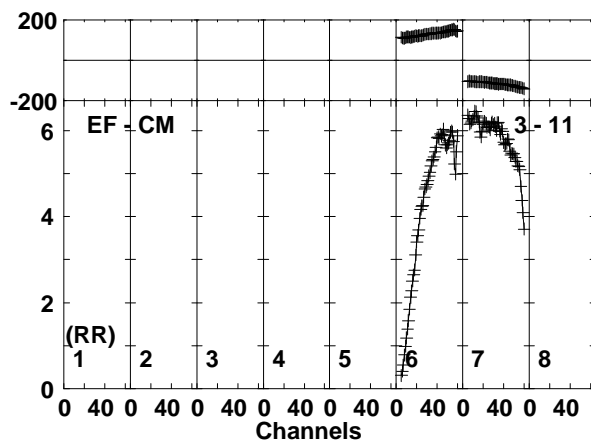
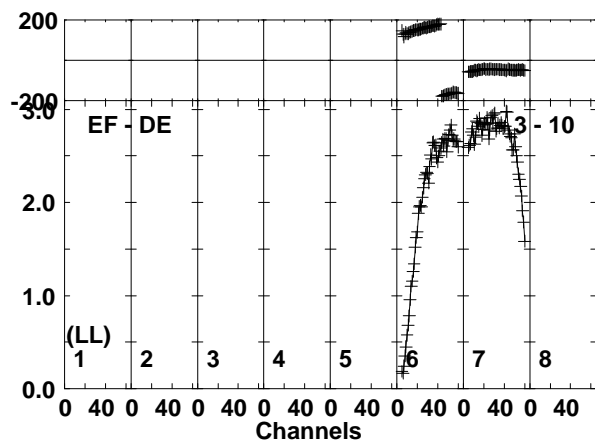
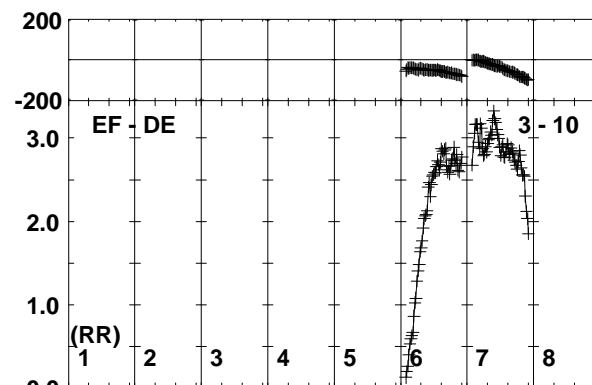
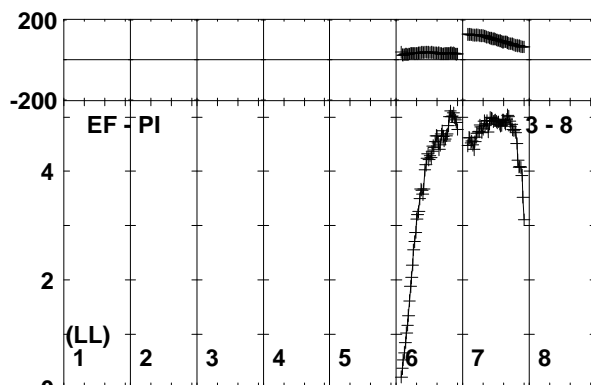
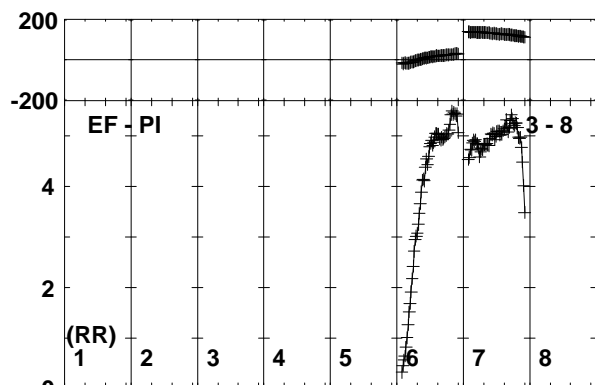
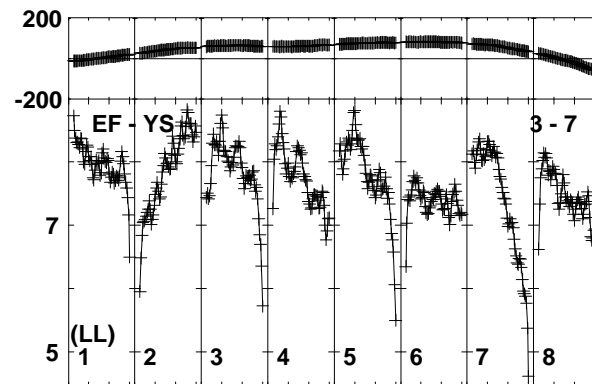
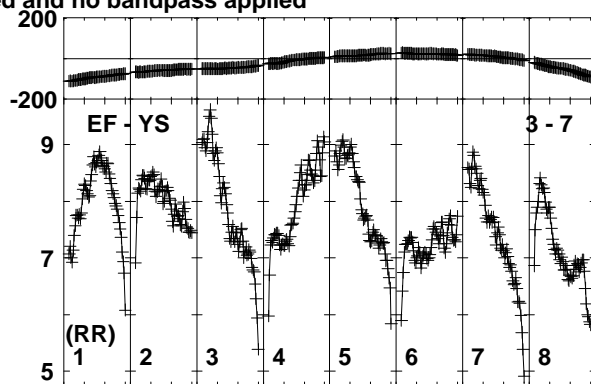
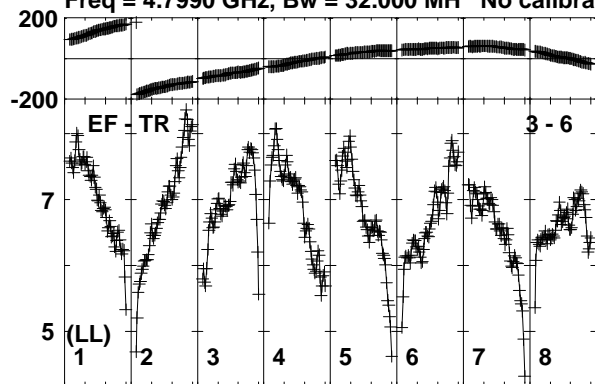

Lower frame: Milli Ampl Jy Top frame: Phas deg  
Vector averaged cross-power spectrum Baseline: EF (03) - TR (06)  
Timerange: 00/23:33:21 to 00/23:34:49

Plot file version 156 created 11-NOV-2019 15:07:33

J1826+0149 EK040B.UVDATA.1

Freq = 4.7990 GHz, Bw = 32.000 MH No calibration applied and no bandpass applied

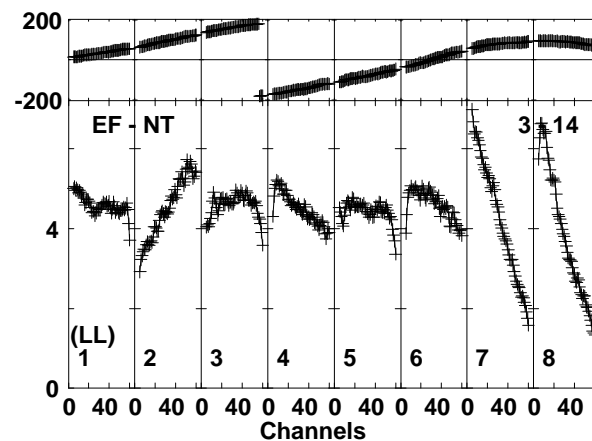
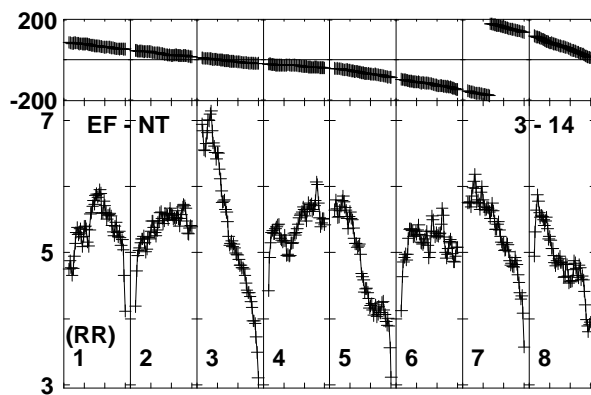
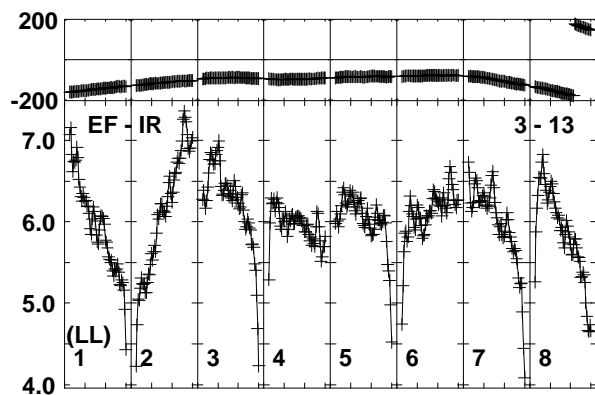
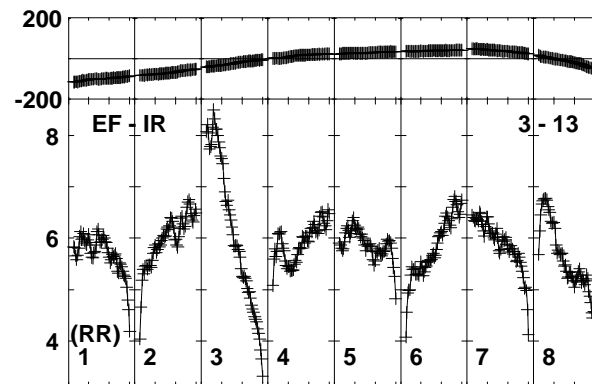
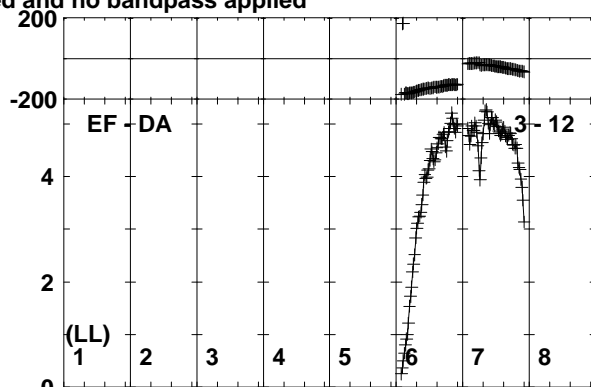
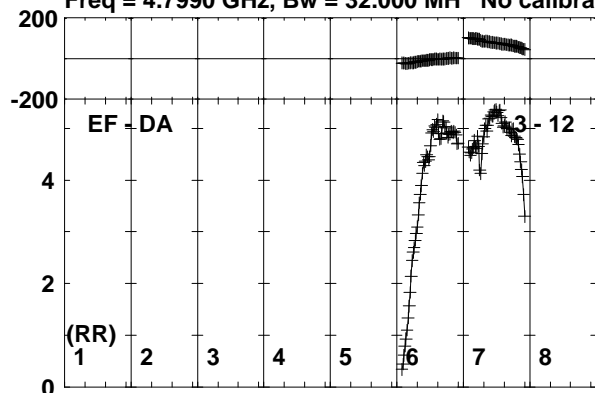

Lower frame: Milli Ampl Jy Top frame: Phas deg  
Vector averaged cross-power spectrum Baseline: EF (03) - DA (12)  
Timerange: 00/23:33:21 to 00/23:34:49

Plot file version 157 created 11-NOV-2019 15:07:33

SER8NJ EK040B.UVDATA.1

Freq = 4.7990 GHz, Bw = 32.000 MH No calibration applied and no bandpass applied

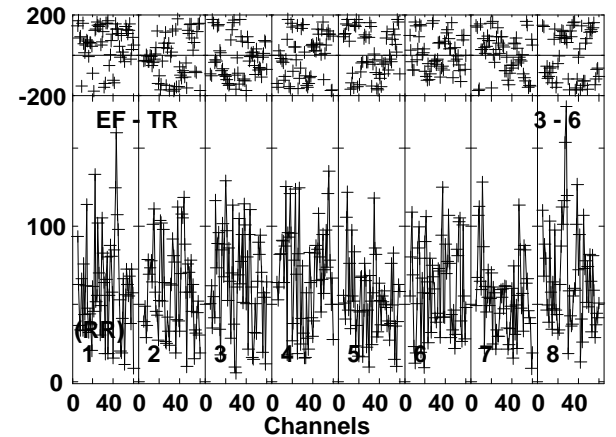
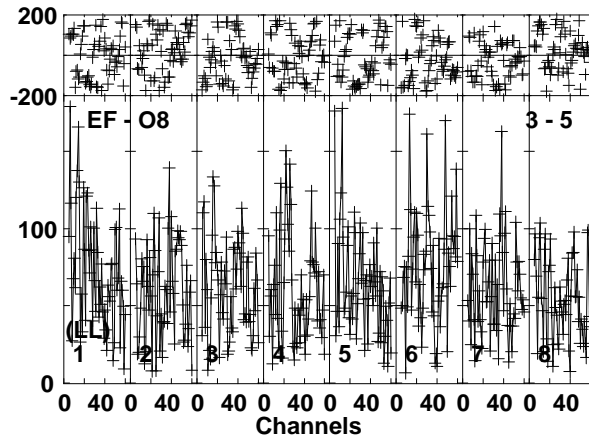
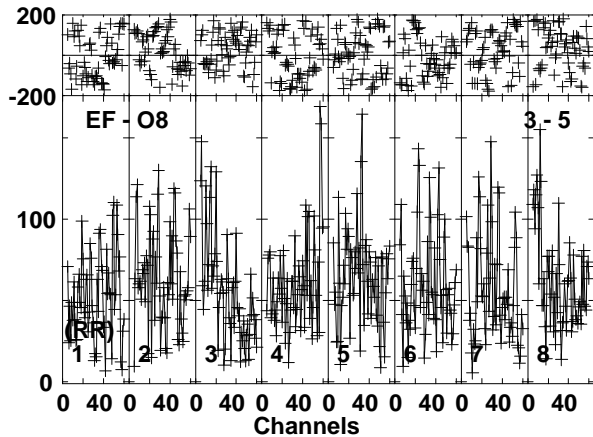
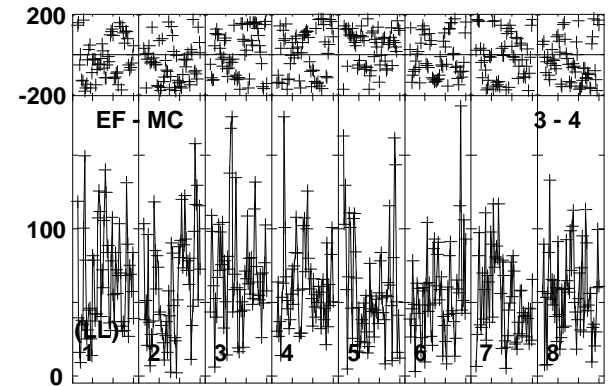
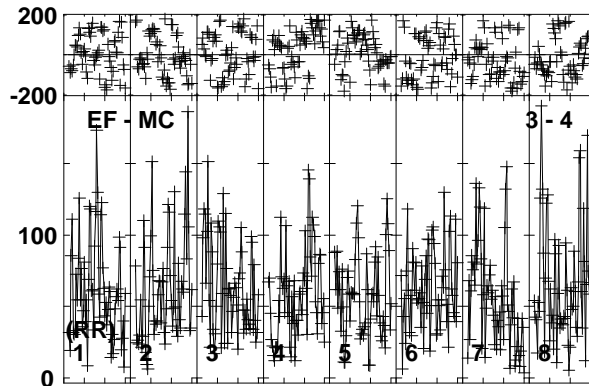
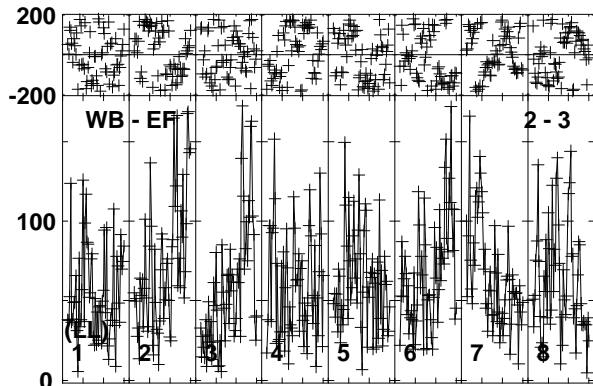
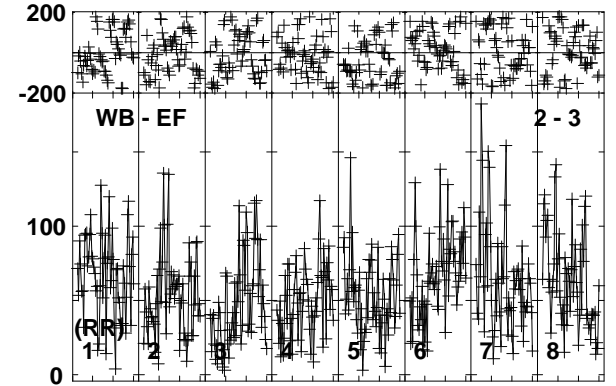
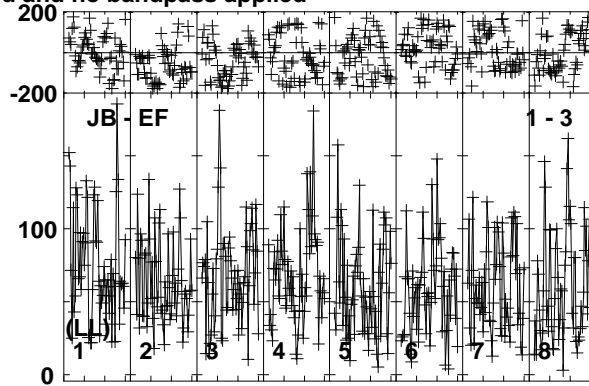
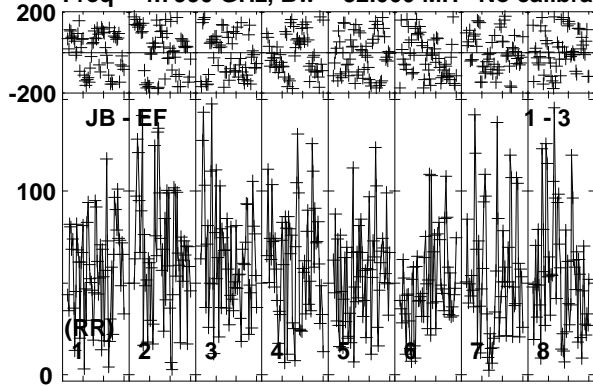

Lower frame: Micro Ampl Jy Top frame: Phas deg  
Vector averaged cross-power spectrum Baseline: JB (01) - EF (03)  
Timerange: 00/23:34:51 to 00/23:38:49

Plot file version 158 created 11-NOV-2019 15:07:34

SER8NJ EK040B.UVDATA.1

Freq = 4.7990 GHz, Bw = 32.000 MH No calibration applied and no bandpass applied

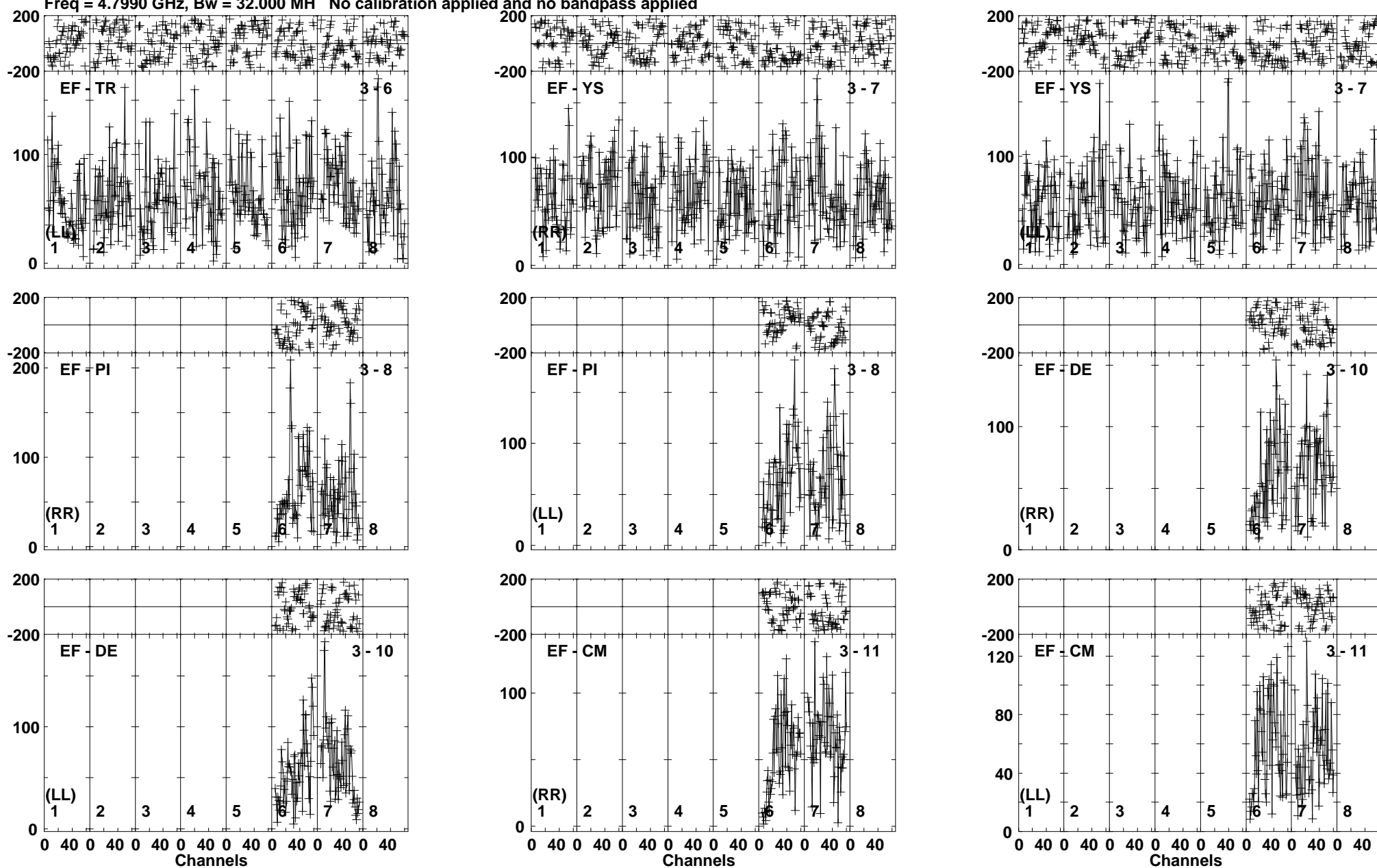

Lower frame: Micro Ampl Jy Top frame: Phas deg  
Vector averaged cross-power spectrum Baseline: EF (03) - TR (06)  
Timerange: 00:23:34:51 to 00:23:38:49



Plot file version 160 created 11-NOV-2019 15:07:34

J1826+0149 EK040B.UVDATA.1

Freq = 4.7990 GHz, Bw = 32.000 MH No calibration applied and no bandpass applied

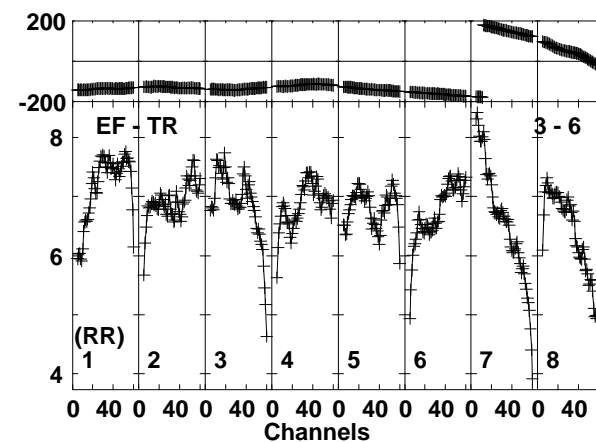
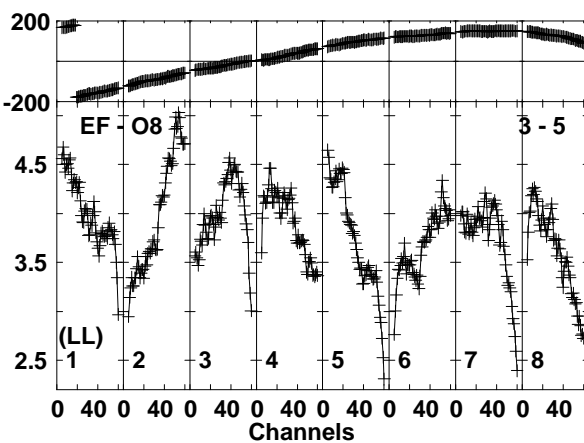
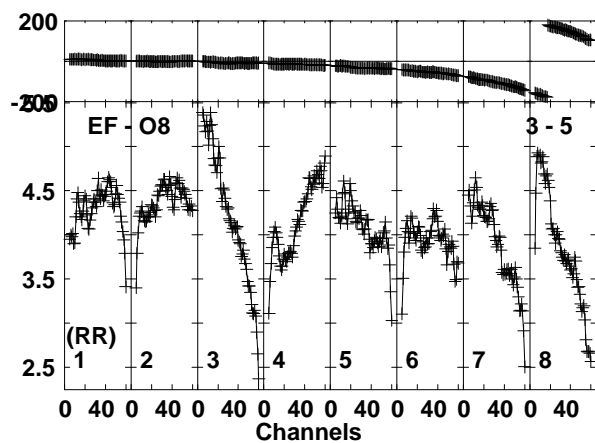
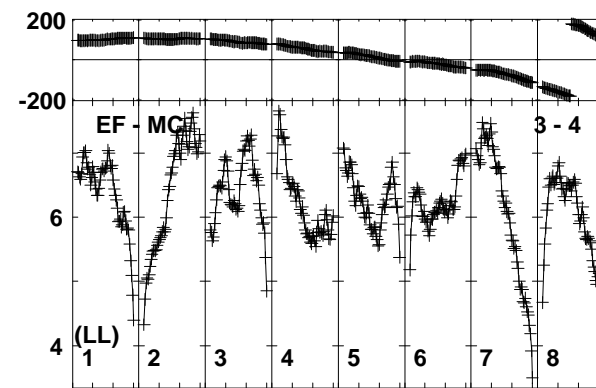
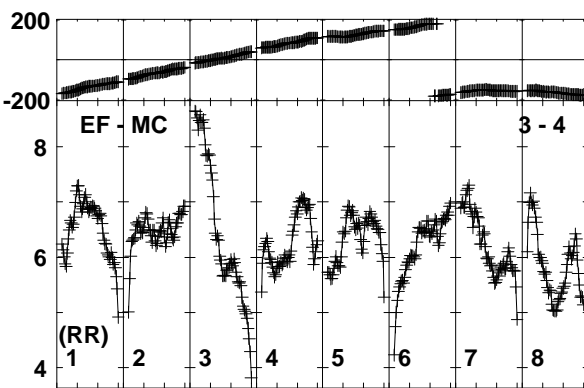
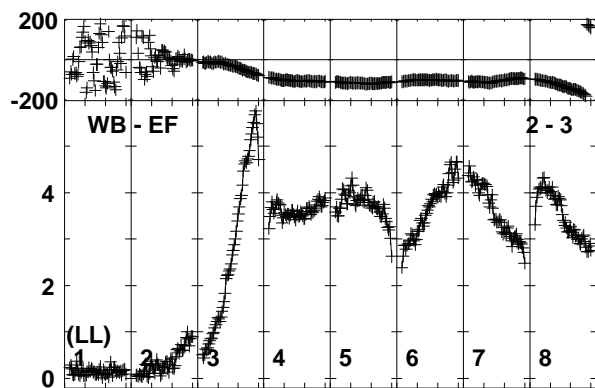
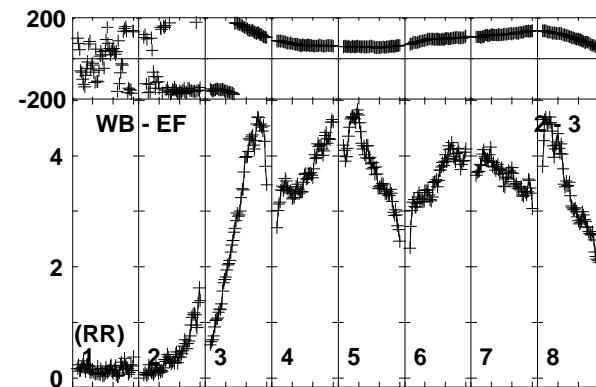
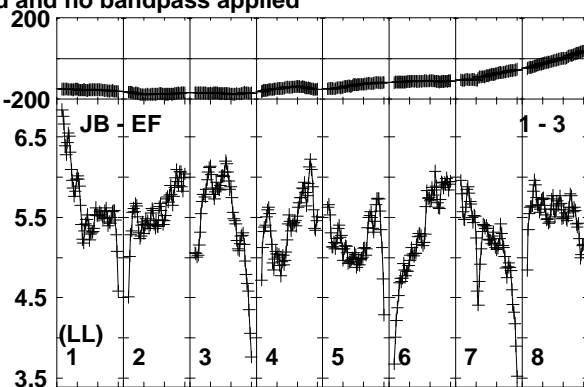
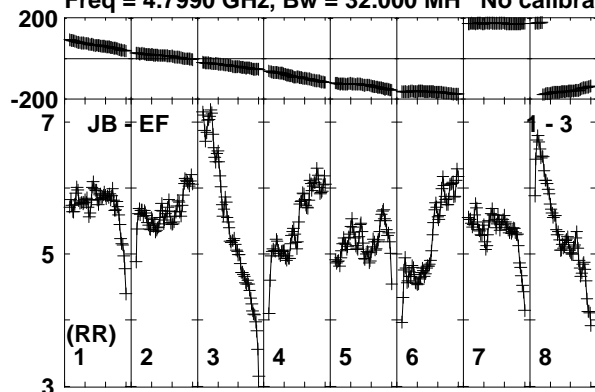

Lower frame: Milli Ampl Jy Top frame: Phas deg  
Vector averaged cross-power spectrum Baseline: JB (01) - EF (03)  
Timerange: 00/23:39:31 to 00/23:40:29

Plot file version 161 created 11-NOV-2019 15:07:34

J1826+0149 EK040B.UVDATA.1

Freq = 4.7990 GHz, Bw = 32.000 MH No calibration applied and no bandpass applied

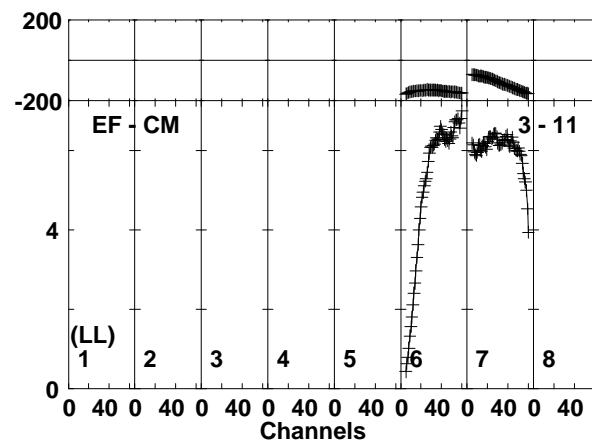
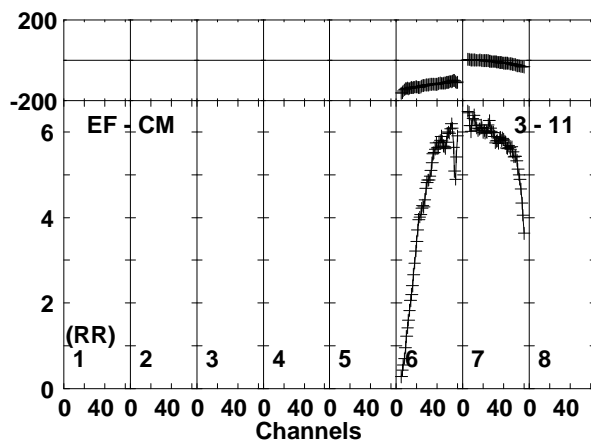
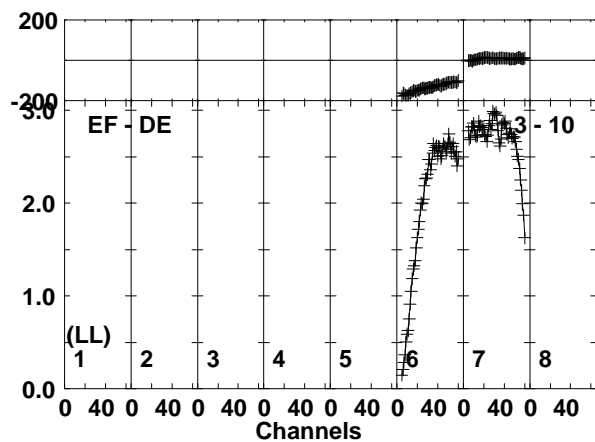
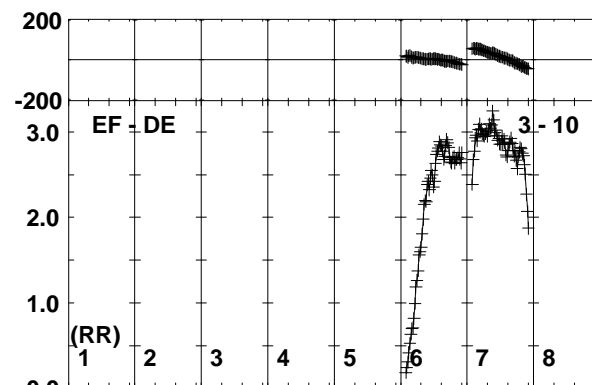
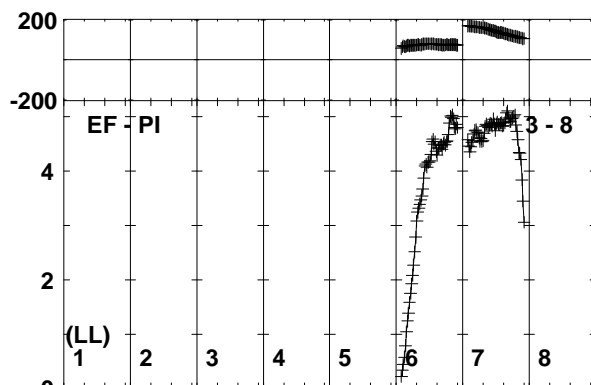
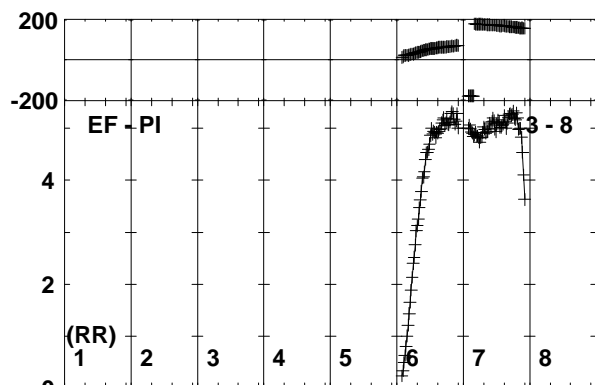
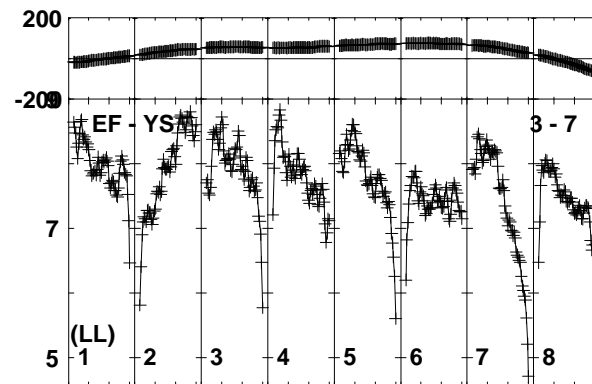
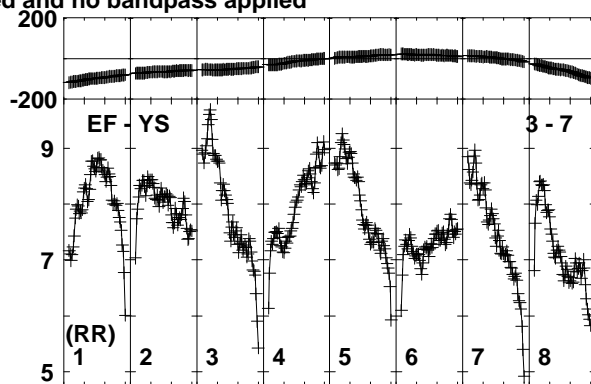
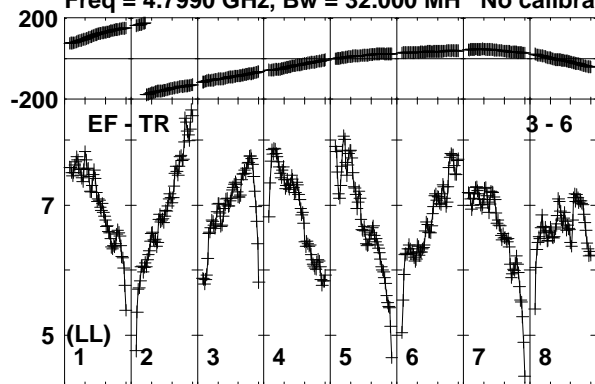

Lower frame: Milli Ampl Jy Top frame: Phas deg  
Vector averaged cross-power spectrum Baseline: EF (03) - TR (06)  
Timerange: 00/23:39:31 to 00/23:40:29

Plot file version 162 created 11-NOV-2019 15:07:34

J1826+0149 EK040B.UVDATA.1

Freq = 4.7990 GHz, Bw = 32.000 MH No calibration applied and no bandpass applied

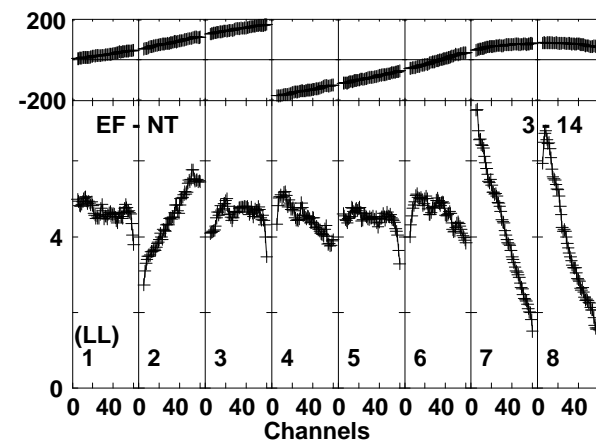
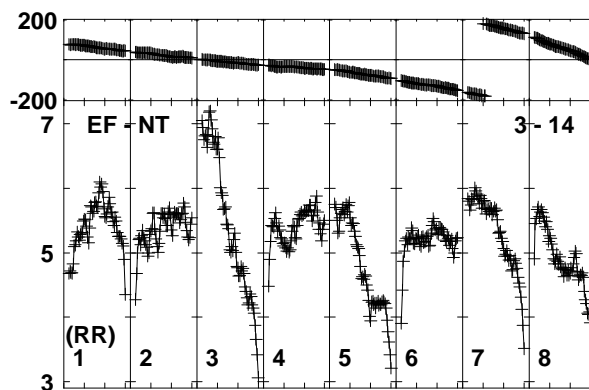
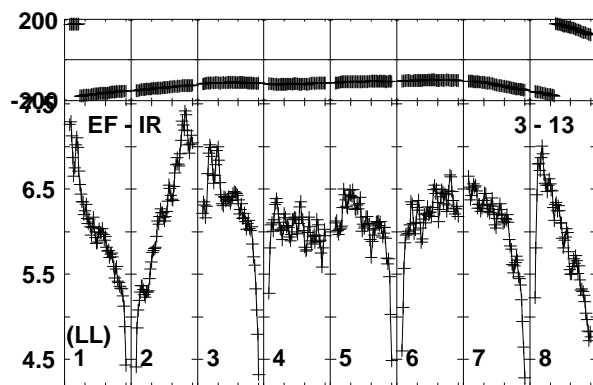
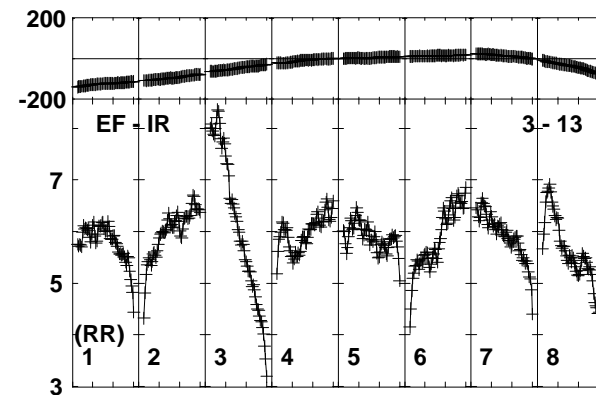
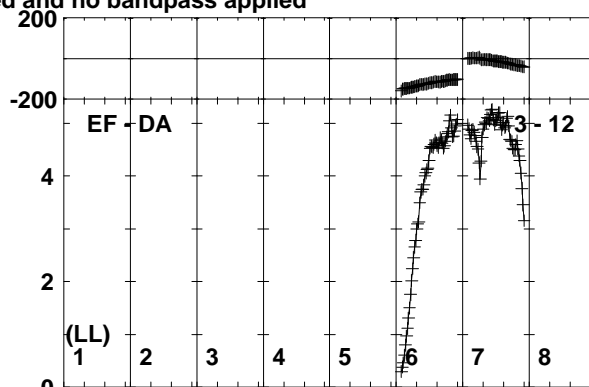
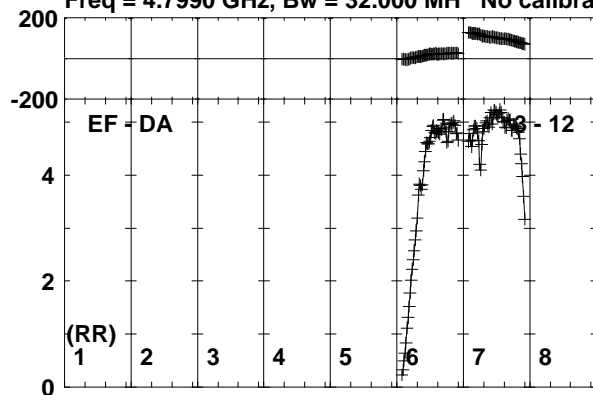

Lower frame: Milli Ampl Jy Top frame: Phas deg  
Vector averaged cross-power spectrum Baseline: EF (03) - DA (12)  
Timerange: 00/23:39:31 to 00/23:40:29



Plot file version 163 created 11-NOV-2019 15:07:34

SER8NJ EK040B.UVDATA.1

Freq = 4.7990 GHz, Bw = 32.000 MH No calibration applied and no bandpass applied

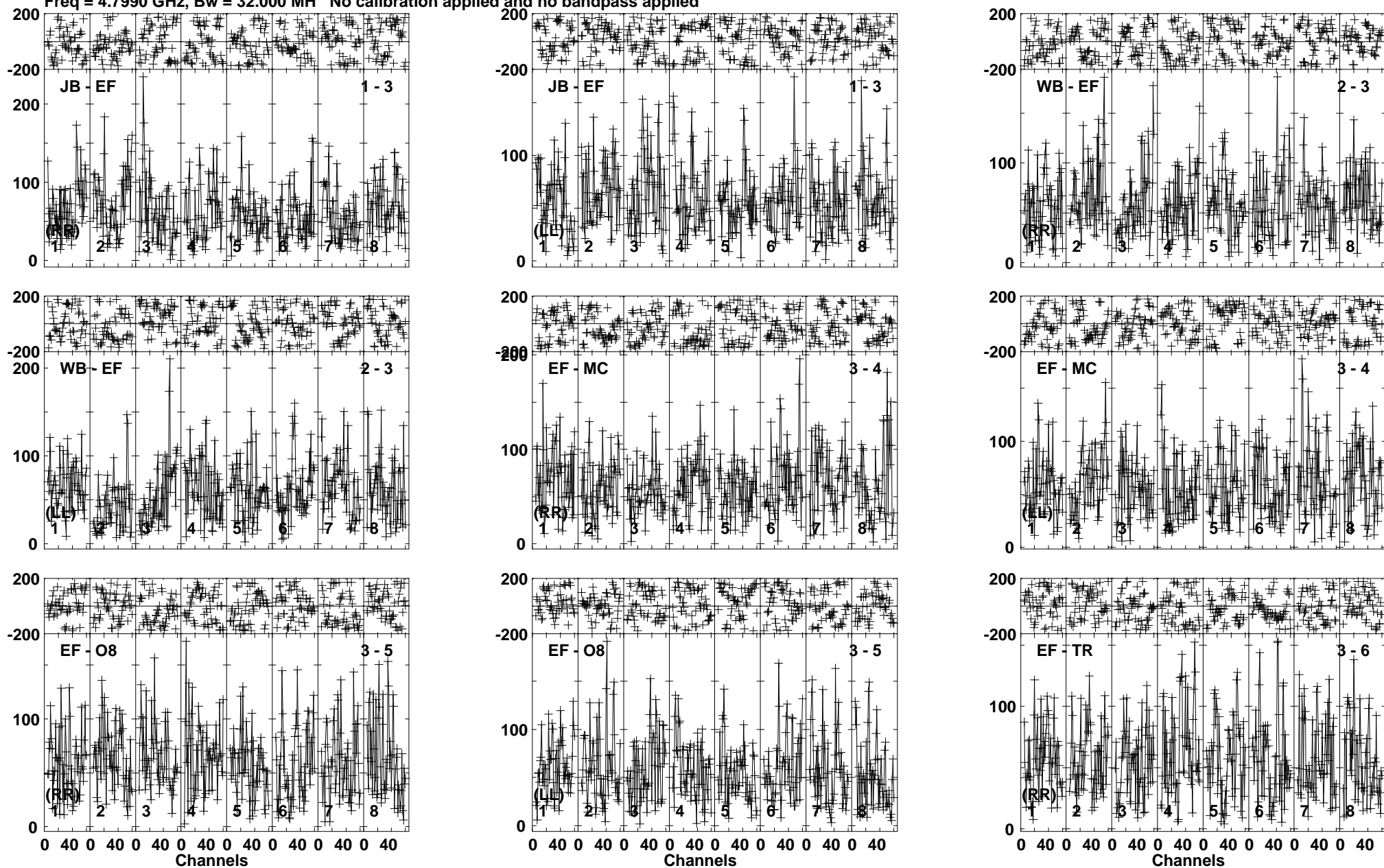

Lower frame: Micro Ampl Jy Top frame: Phas deg  
Vector averaged cross-power spectrum Baseline: JB (01) - EF (03)  
Timerange: 00/23:40:33 to 00/23:44:29

Plot file version 164 created 11-NOV-2019 15:07:34

SER8NJ EK040B.UVDATA.1

Freq = 4.7990 GHz, Bw = 32.000 MH No calibration applied and no bandpass applied

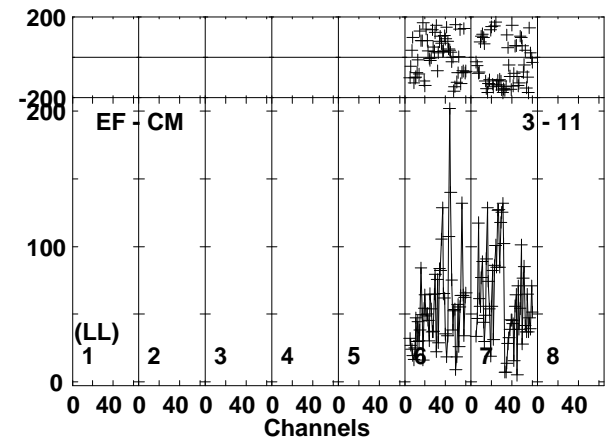
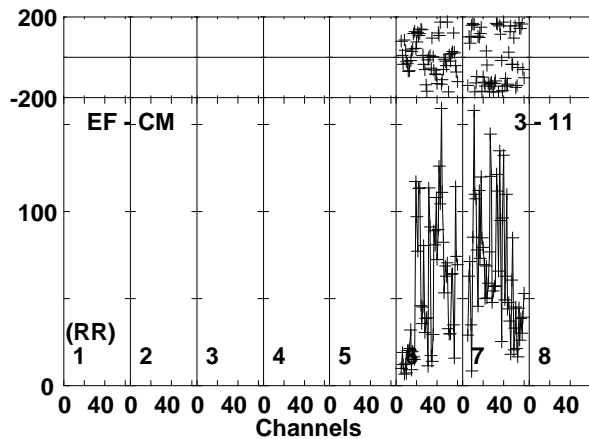
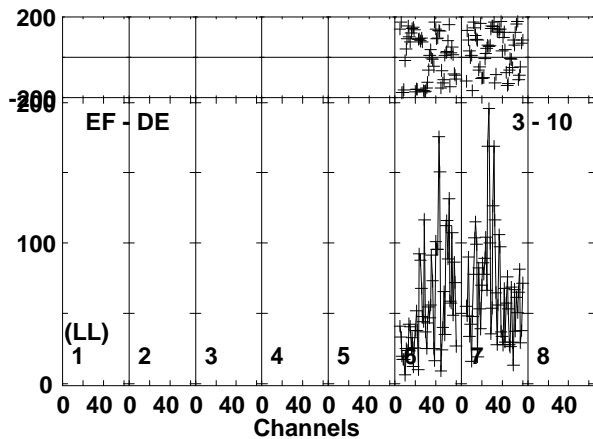
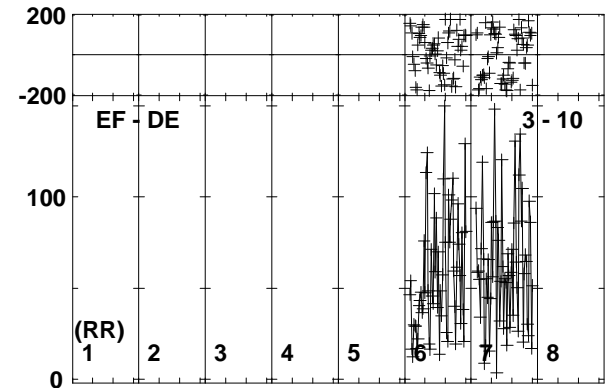
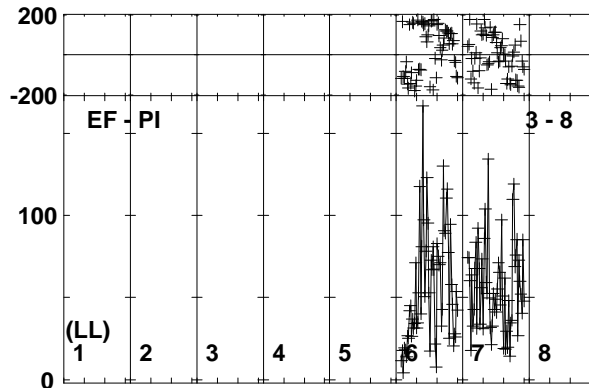
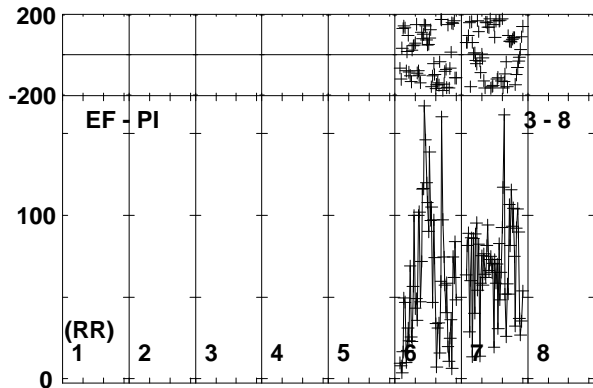
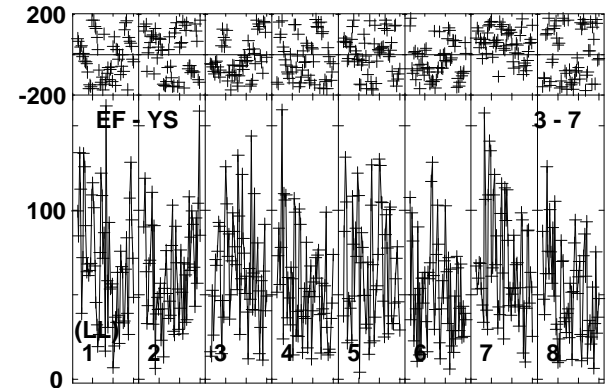
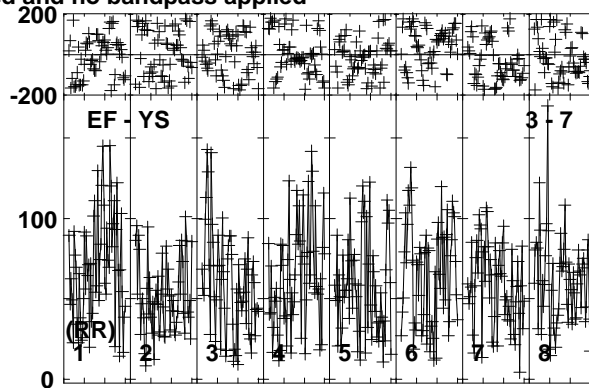
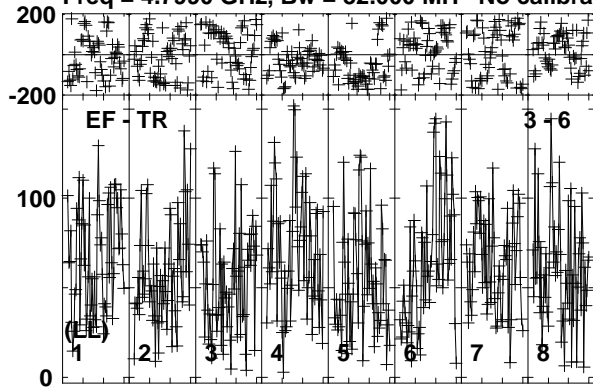

Lower frame: Micro Ampl Jy Top frame: Phas deg  
Vector averaged cross-power spectrum Baseline: EF (03) - TR (06)  
Timerange: 00/23:40:33 to 00/23:44:29

Plot file version 165 created 11-NOV-2019 15:07:34  
SER8NJ EK040B.UVDATA.1

Freq = 4.7990 GHz, Bw = 32.000 MH No calibration applied and no bandpass applied

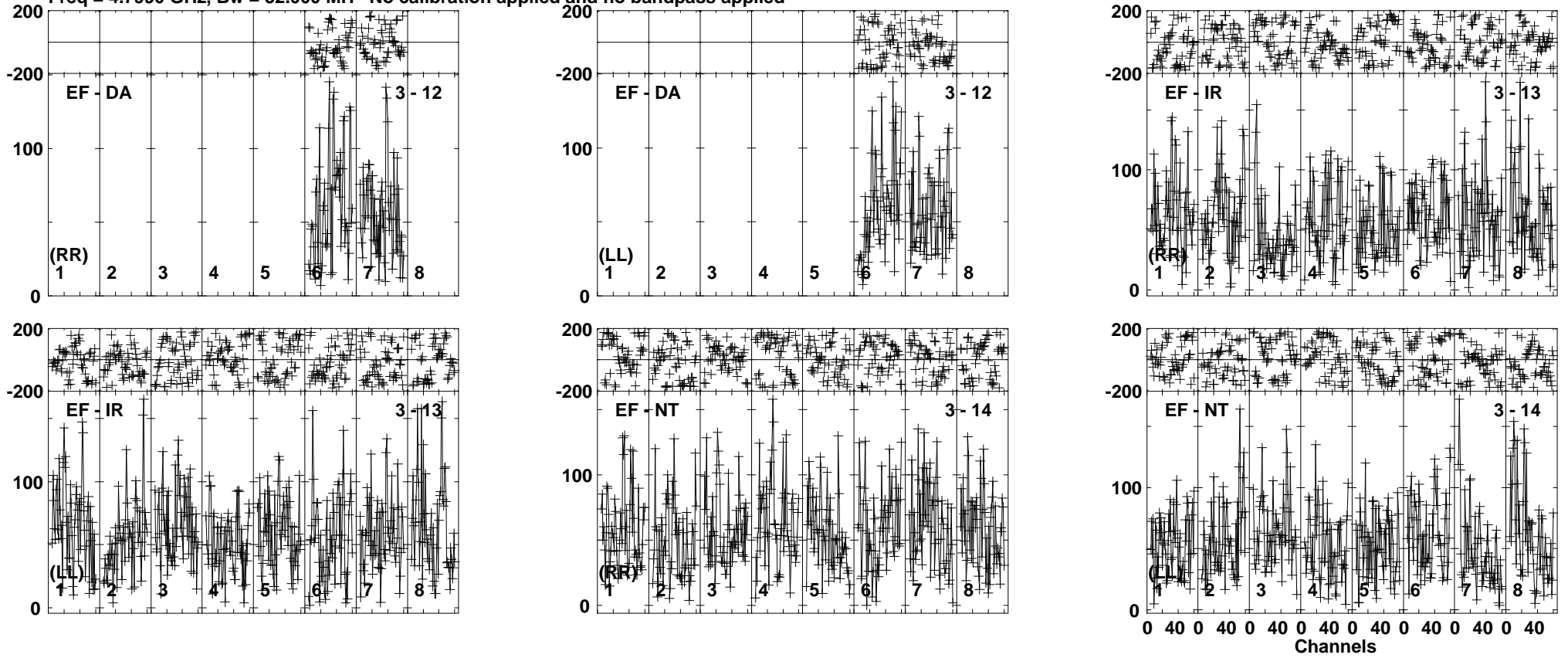

Lower frame: Micro Ampl Jy Top frame: Phas deg  
Vector averaged cross-power spectrum Baseline: EF (03) - DA (12)  
Timerange: 00/23:40:33 to 00/23:44:29

Plot file version 166 created 11-NOV-2019 15:07:34

J1826+0149 EK040B.UVDATA.1

Freq = 4.7990 GHz, Bw = 32.000 MH No calibration applied and no bandpass applied

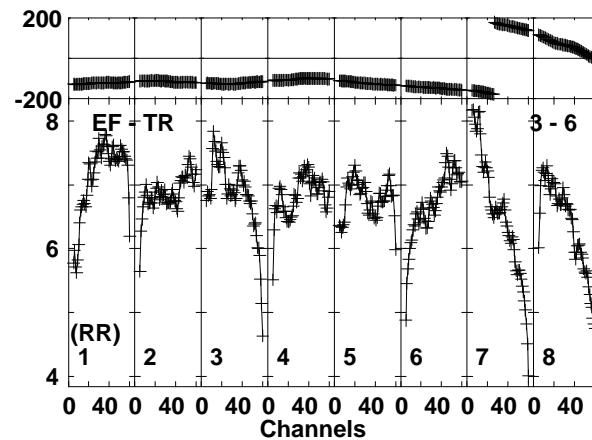
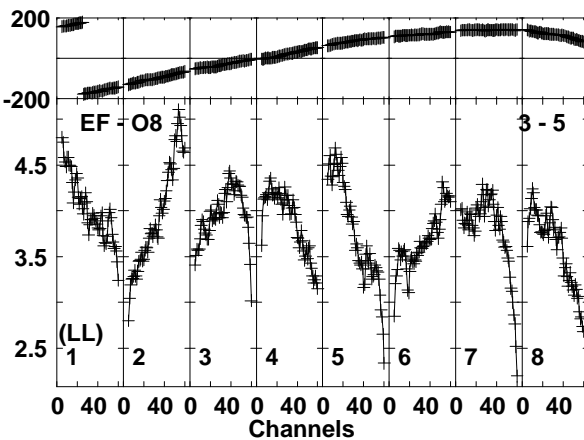
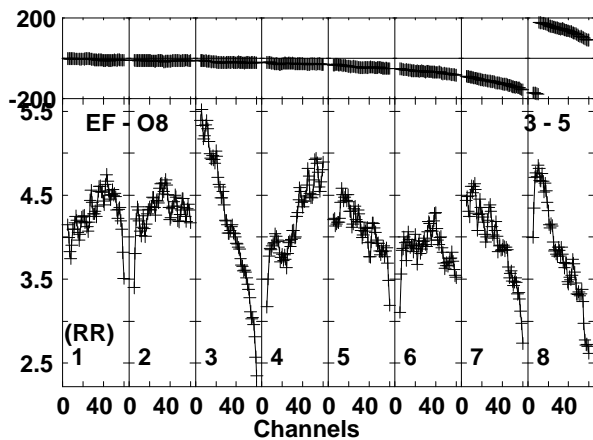
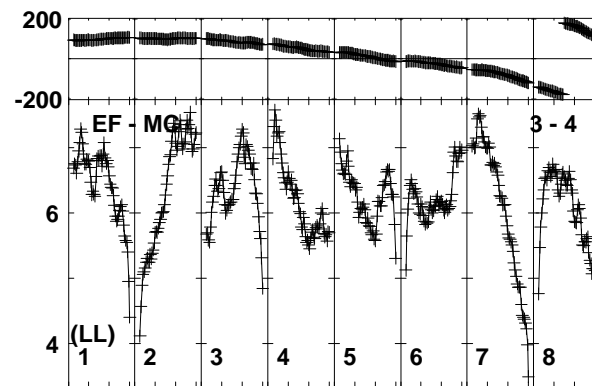
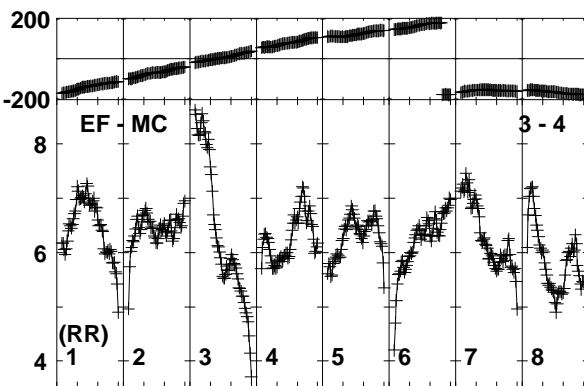
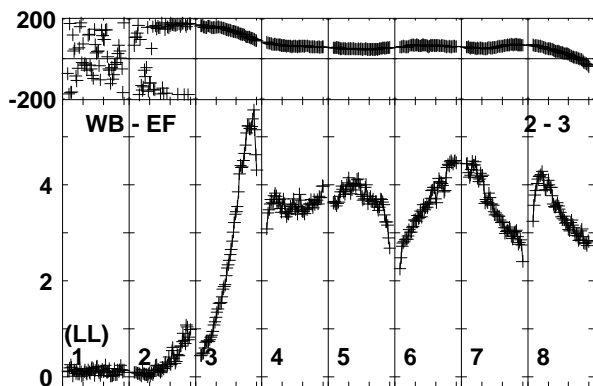
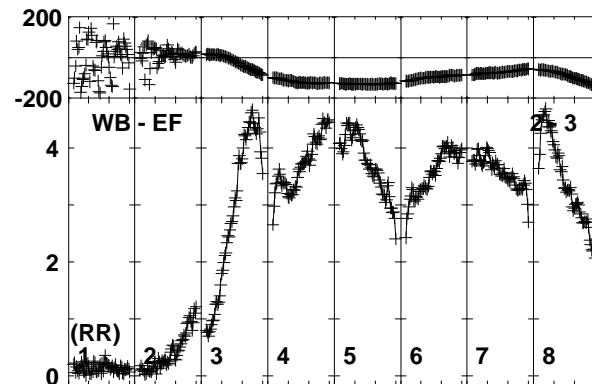
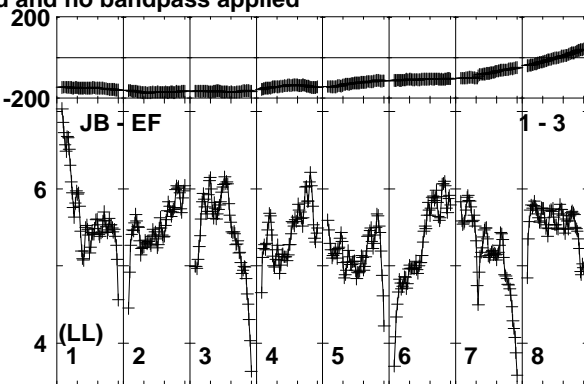
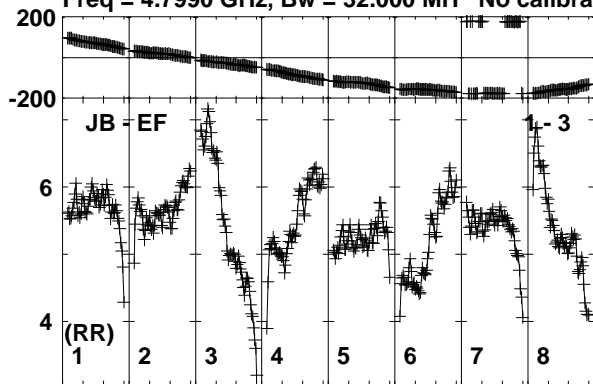

Lower frame: Milli Ampl Jy Top frame: Phas deg  
Vector averaged cross-power spectrum Baseline: JB (01) - EF (03)  
Timerange: 00/23:44:33 to 00/23:45:59

Plot file version 167 created 11-NOV-2019 15:07:35

J1826+0149 EK040B.UVDATA.1

Freq = 4.7990 GHz, Bw = 32.000 MH No calibration applied and no bandpass applied

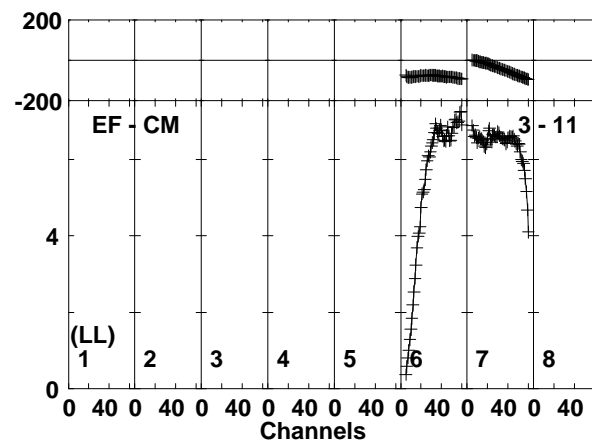
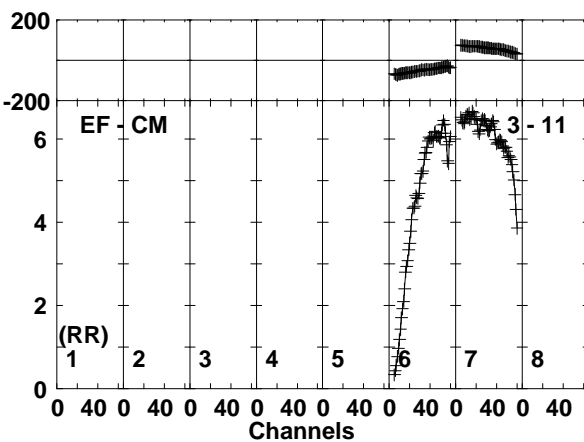
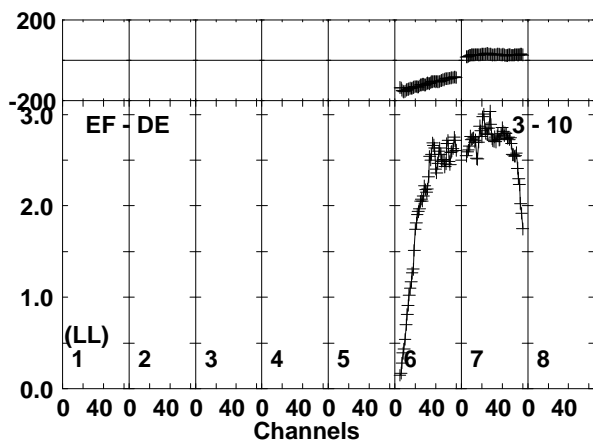
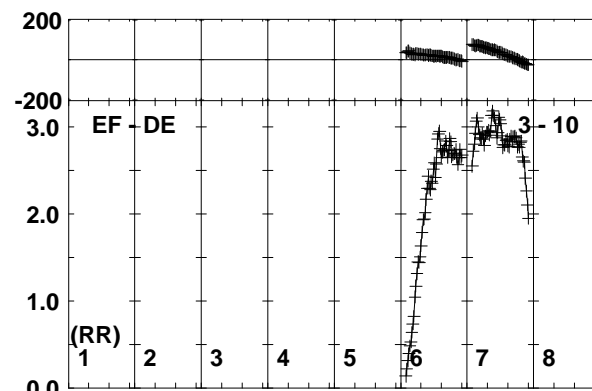
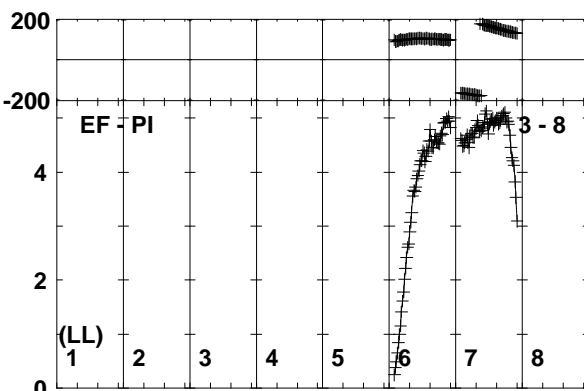
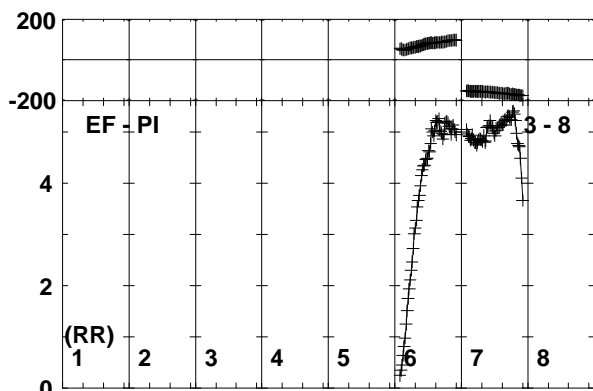
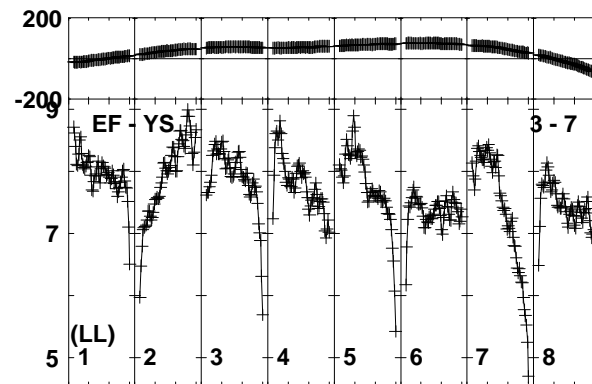
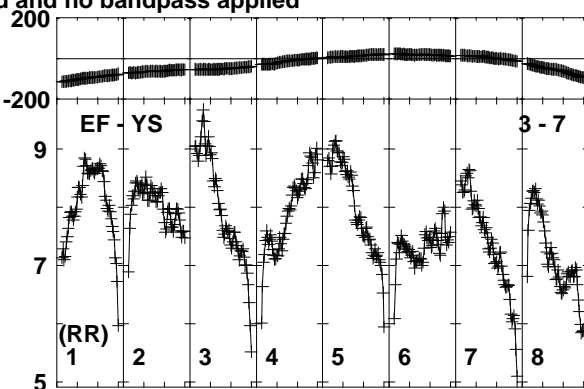
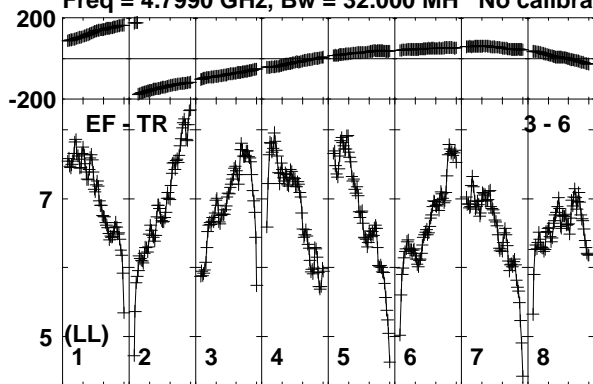

Lower frame: Milli Ampl Jy Top frame: Phas deg  
Vector averaged cross-power spectrum Baseline: EF (03) - TR (06)  
Timerange: 00/23:44:33 to 00/23:45:59

Plot file version 168 created 11-NOV-2019 15:07:35

J1826+0149 EK040B.UVDATA.1

Freq = 4.7990 GHz, Bw = 32.000 MH No calibration applied and no bandpass applied

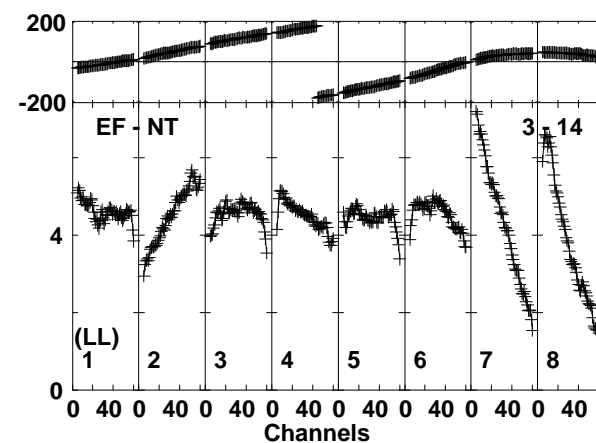
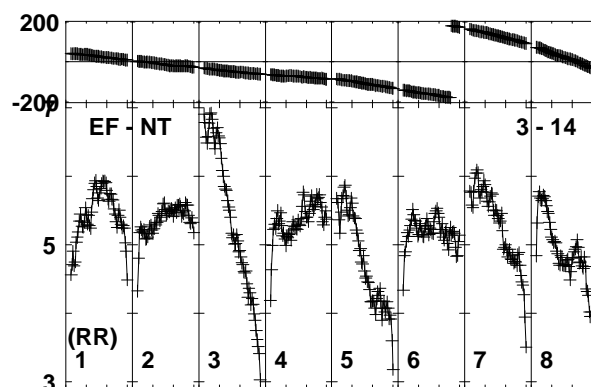
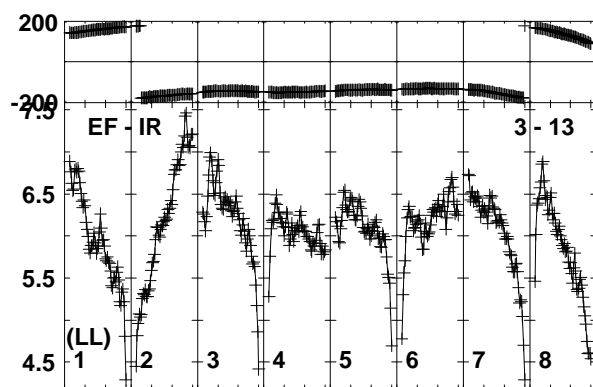
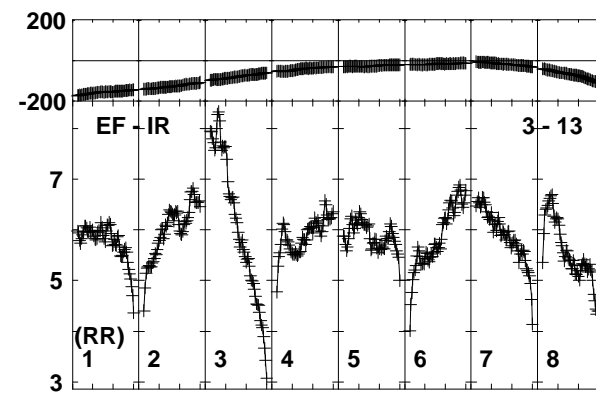
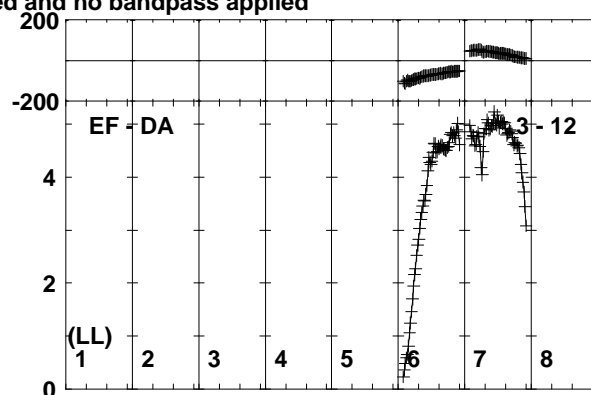
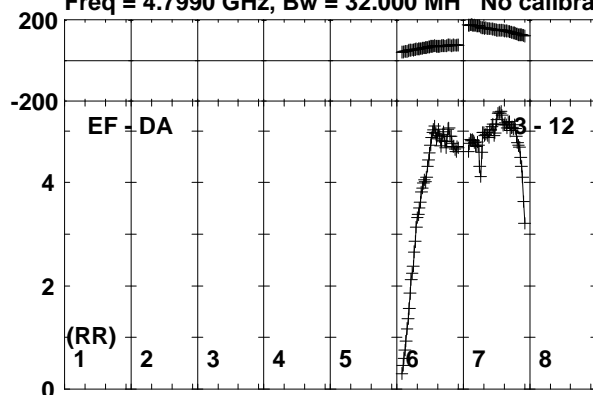

Lower frame: Milli Ampl Jy Top frame: Phas deg  
Vector averaged cross-power spectrum Baseline: EF (03) - DA (12)  
Timerange: 00/23:44:33 to 00/23:45:59

Plot file version 169 created 11-NOV-2019 15:07:35

SER8NJ EK040B.UVDATA.1

Freq = 4.7990 GHz, Bw = 32.000 MH No calibration applied and no bandpass applied

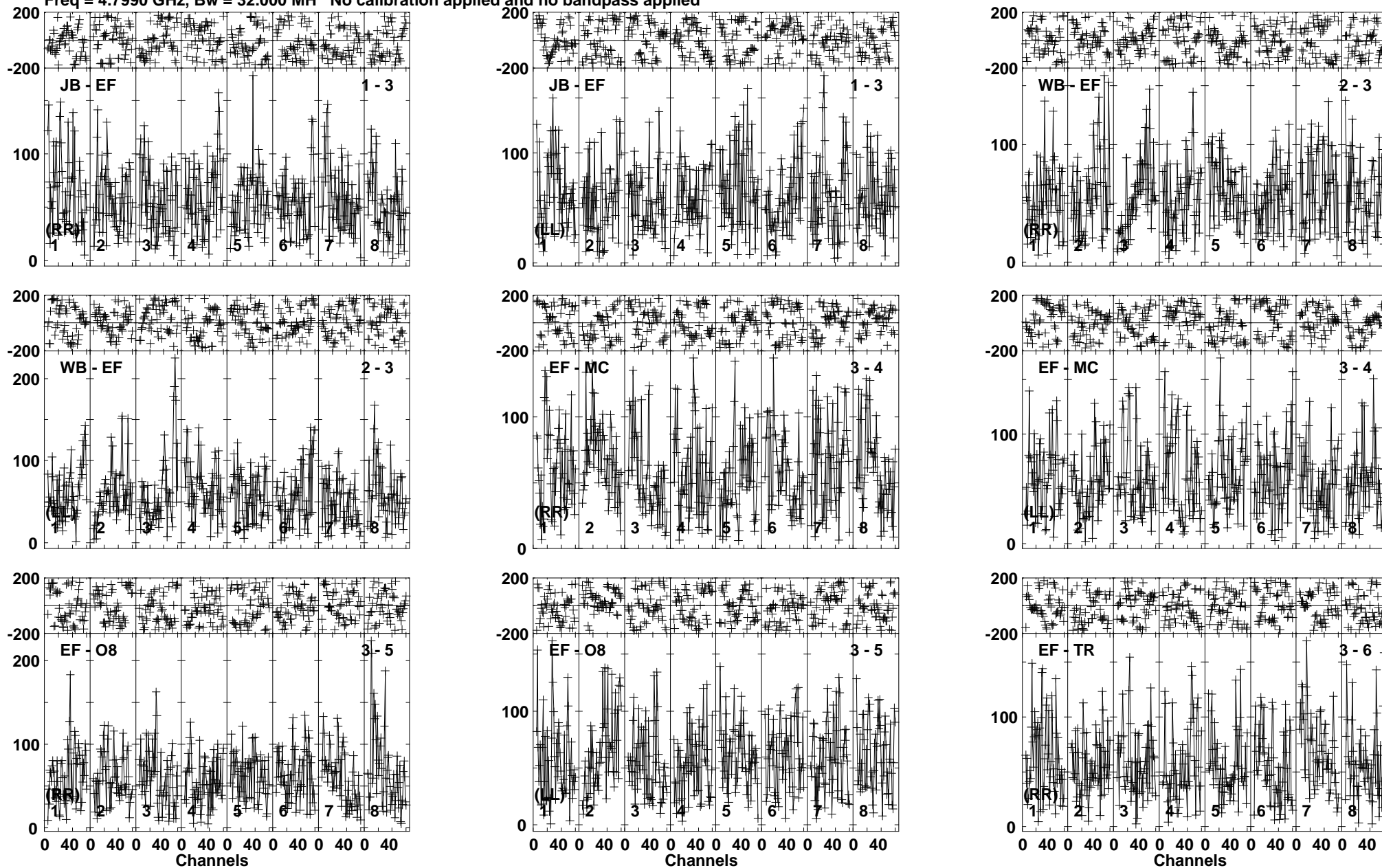

Lower frame: Micro Ampl Jy Top frame: Phas deg  
Vector averaged cross-power spectrum Baseline: JB (01) - EF (03)  
Timerange: 00:23:46:01 to 00:23:49:59

Plot file version 170 created 11-NOV-2019 15:07:35

SER8NJ EK040B.UVDATA.1

Freq = 4.7990 GHz, Bw = 32.000 MH No calibration applied and no bandpass applied

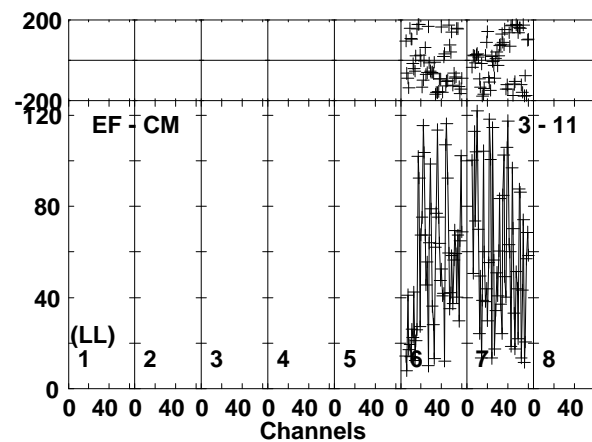
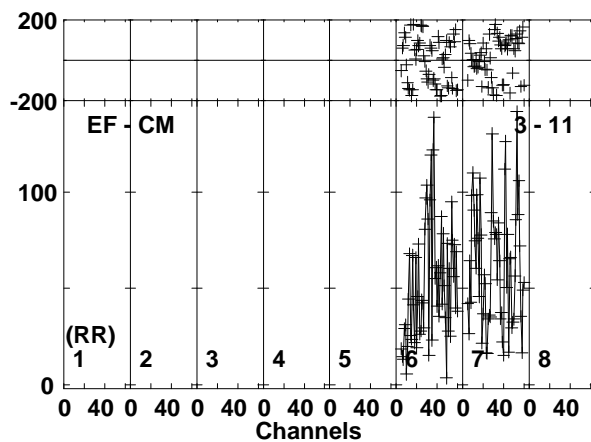
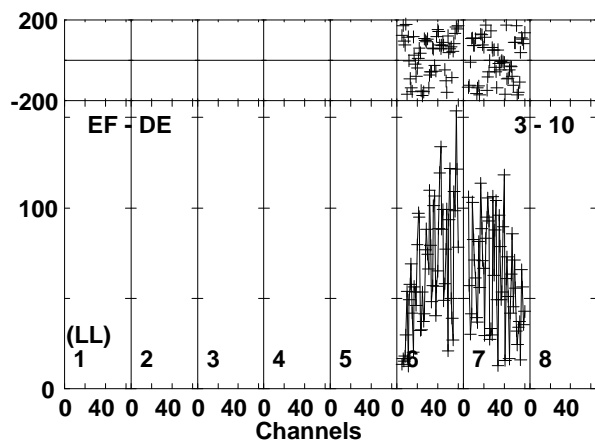
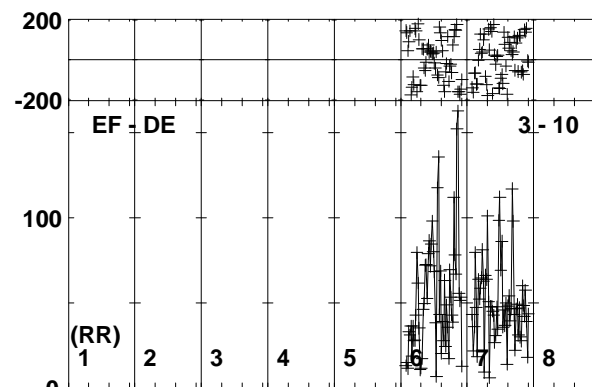
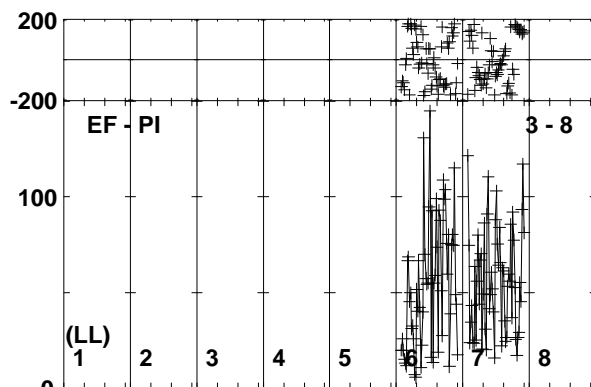
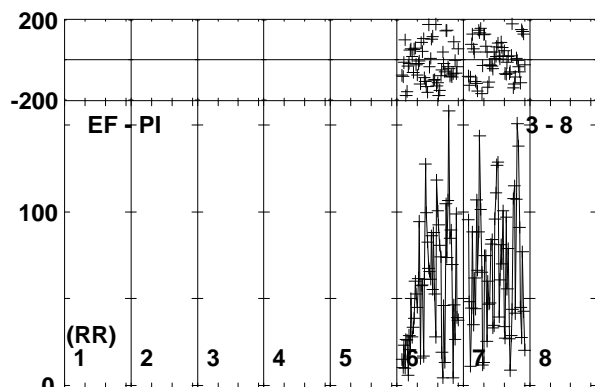
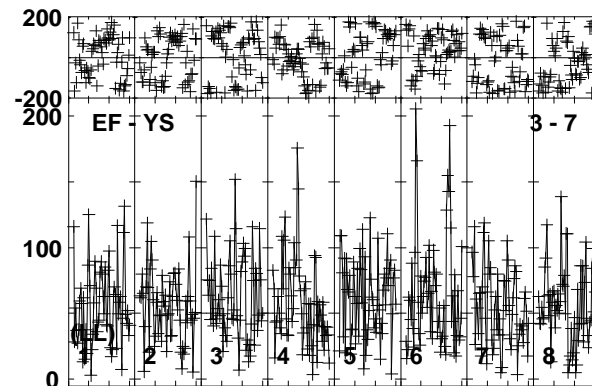
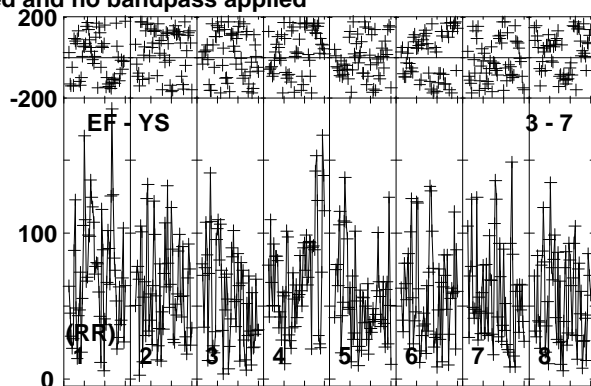
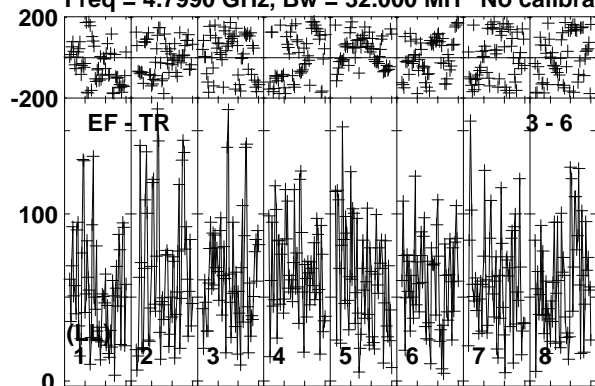

Lower frame: Micro Ampl Jy Top frame: Phas deg  
Vector averaged cross-power spectrum Baseline: EF (03) - TR (06)  
Timerange: 00/23:46:01 to 00/23:49:59



Plot file version 171 created 11-NOV-2019 15:07:35

SER8NJ EK040B.UVDATA.1

Freq = 4.7990 GHz, Bw = 32.000 MH No calibration applied and no bandpass applied

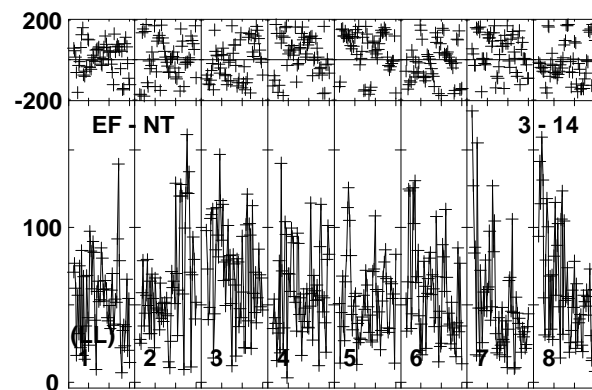
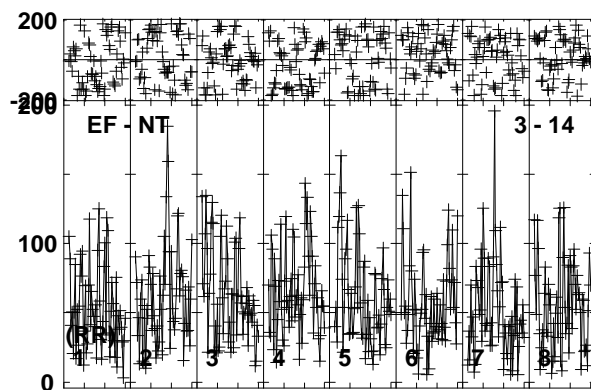
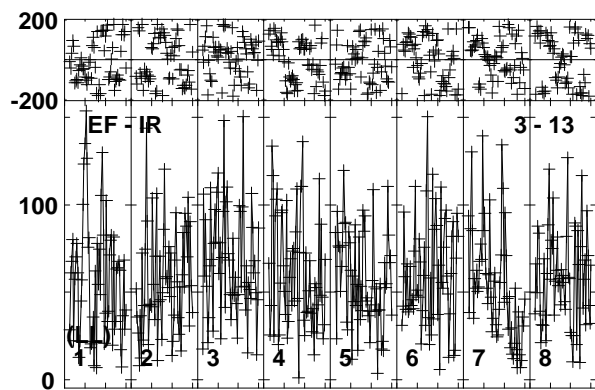
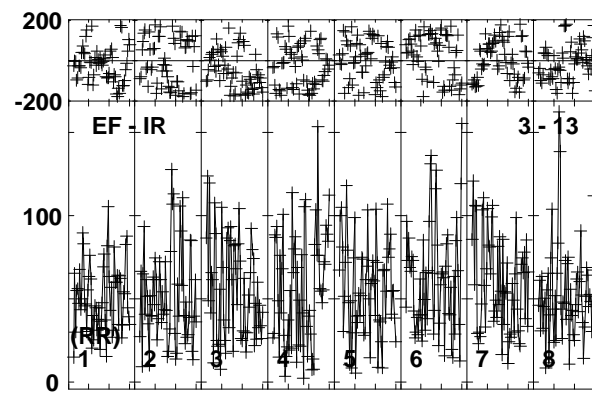
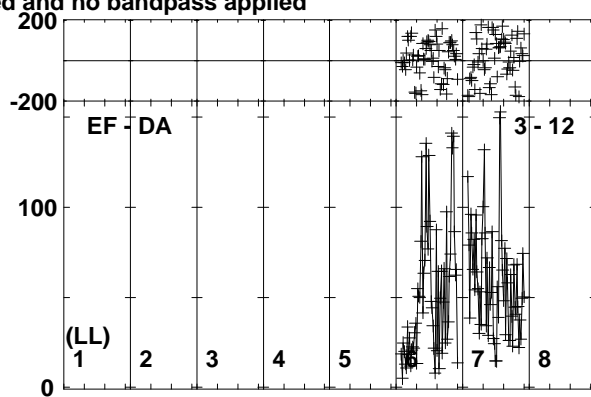
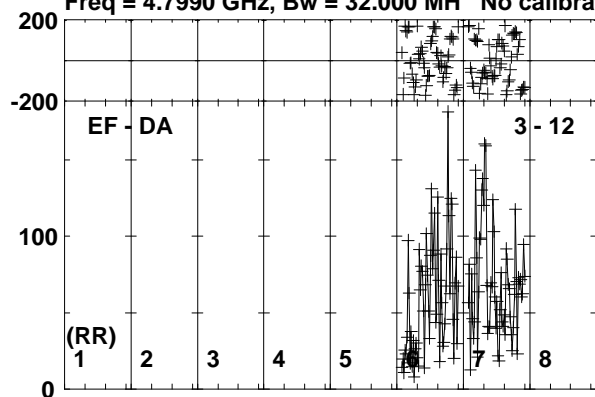

0 40 0 40 0 40 0 40 0 40 0 40 0 40 0 40 0 40 0 40  
Channels

Lower frame: Micro Ampl Jy Top frame: Phas deg  
Vector averaged cross-power spectrum Baseline: EF (03) - DA (12)  
Timerange: 00/23:46:01 to 00/23:49:59

Plot file version 172 created 11-NOV-2019 15:07:35

J1826+0149 EK040B.UVDATA.1

Freq = 4.7990 GHz, Bw = 32.000 MH No calibration applied and no bandpass applied

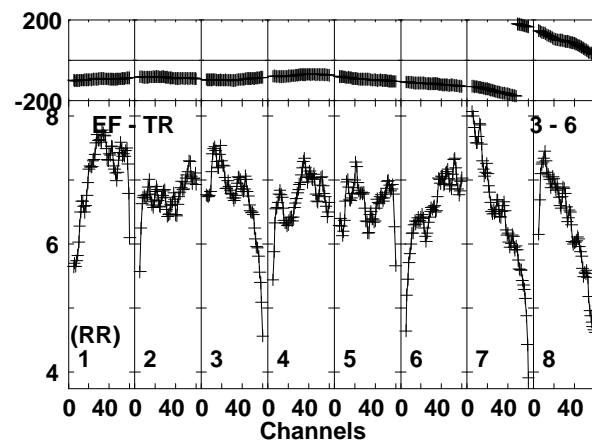
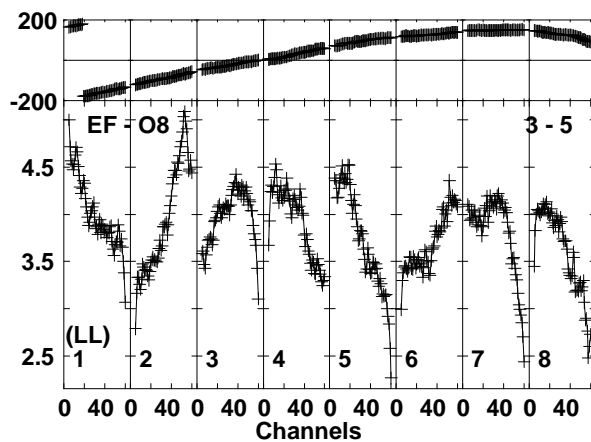
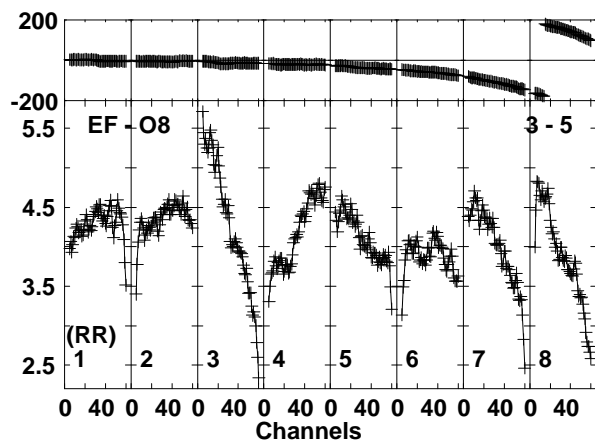
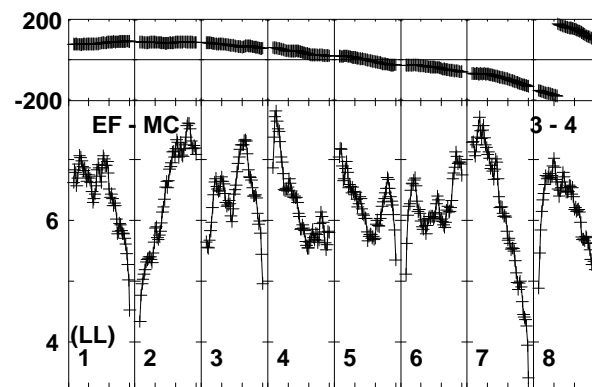
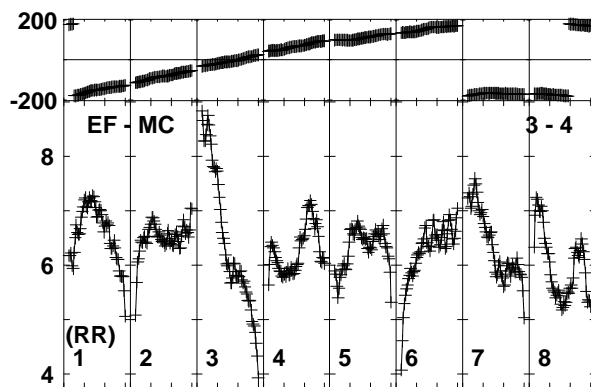
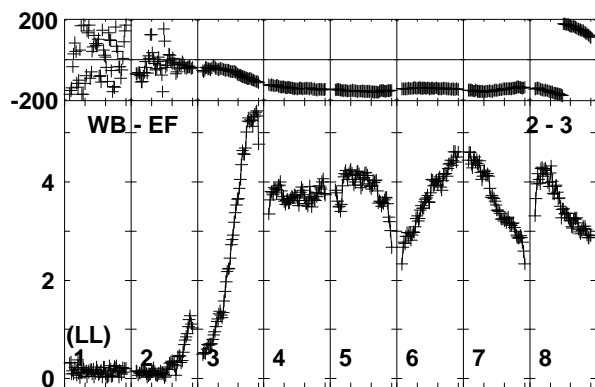
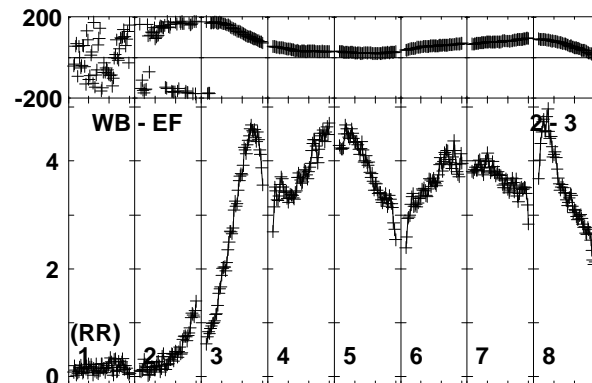
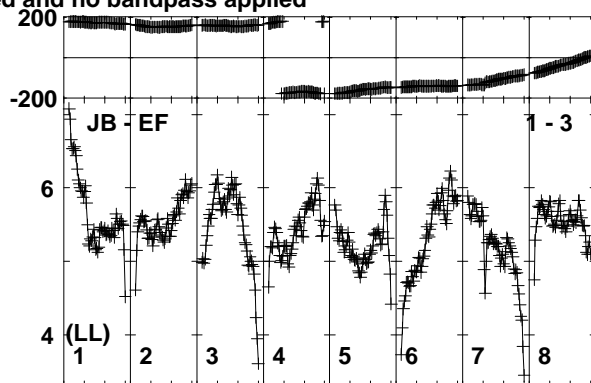
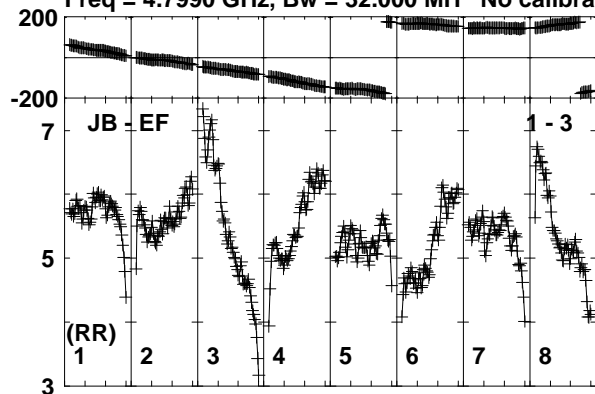

Lower frame: Milli Ampl Jy Top frame: Phas deg  
Vector averaged cross-power spectrum Baseline: JB (01) - EF (03)  
Timerange: 00/23:50:41 to 00/23:51:39

Plot file version 173 created 11-NOV-2019 15:07:35

J1826+0149 EK040B.UVDATA.1

Freq = 4.7990 GHz, Bw = 32.000 MH No calibration applied and no bandpass applied

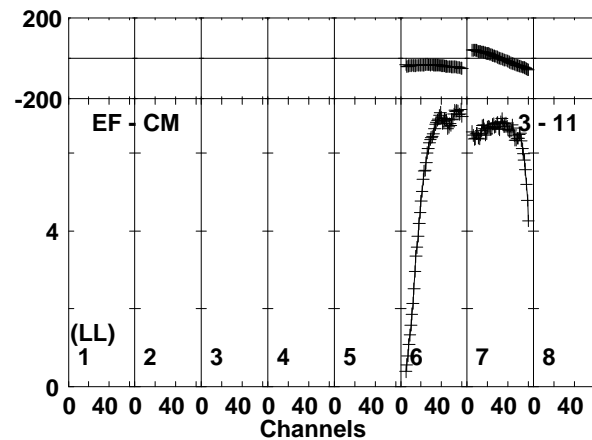
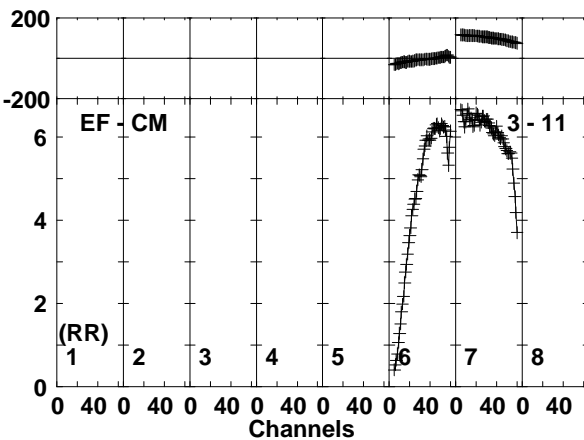
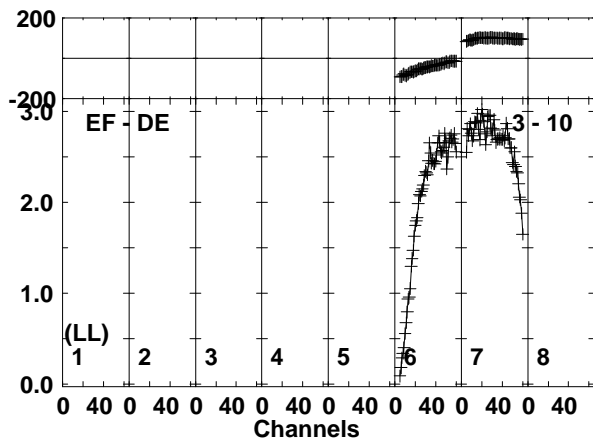
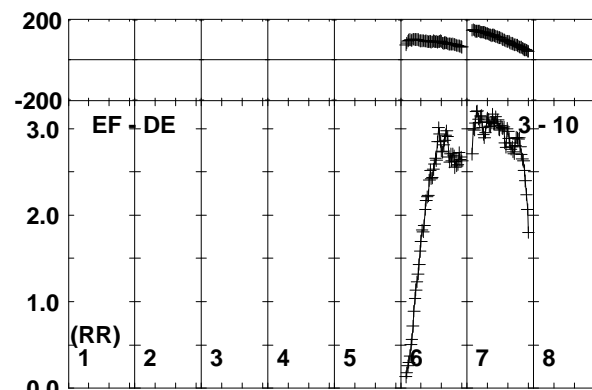
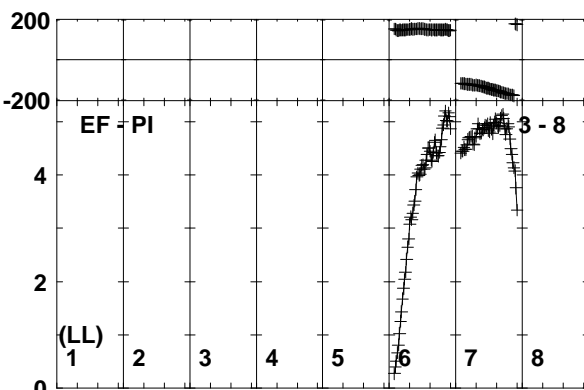
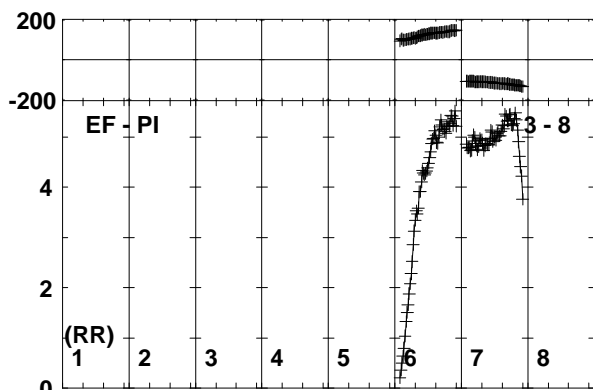
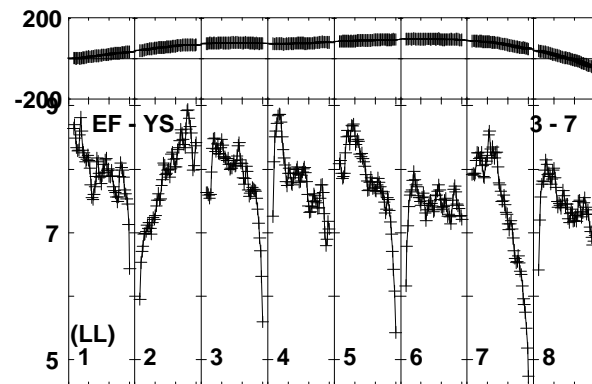
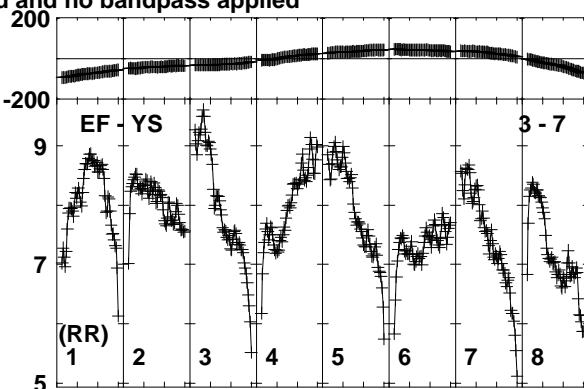
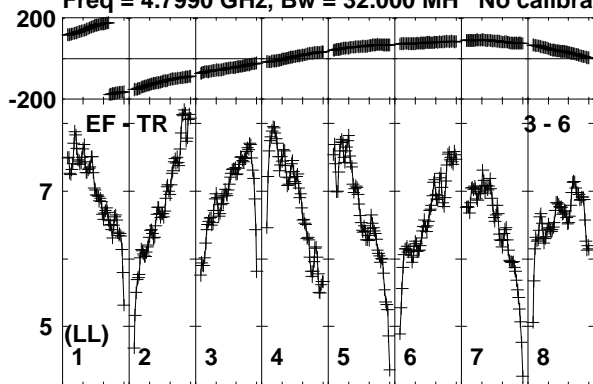

Lower frame: Milli Ampl Jy Top frame: Phas deg  
Vector averaged cross-power spectrum Baseline: EF (03) - TR (06)  
Timerange: 00/23:50:41 to 00/23:51:39

Plot file version 174 created 11-NOV-2019 15:07:35

J1826+0149 EK040B.UVDATA.1

Freq = 4.7990 GHz, Bw = 32.000 MH No calibration applied and no bandpass applied

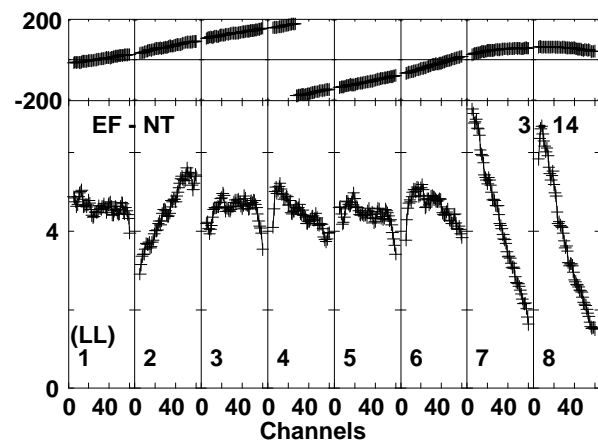
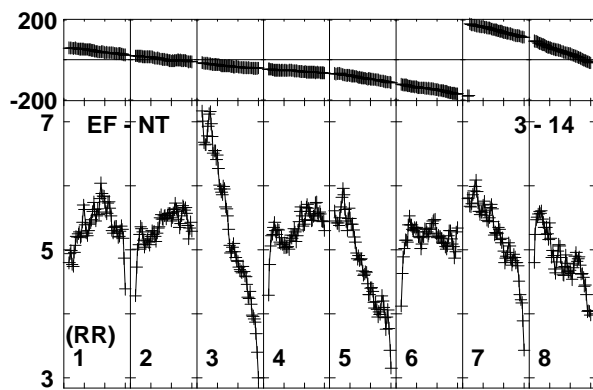
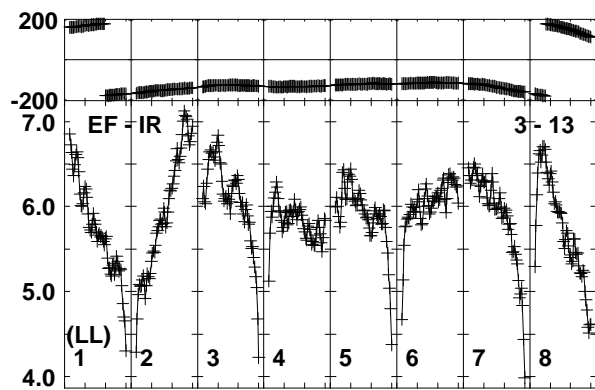
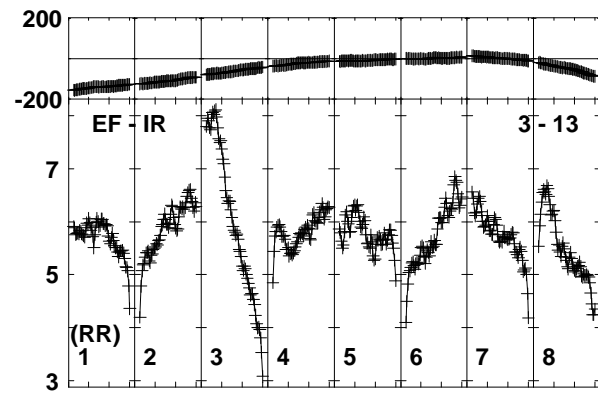
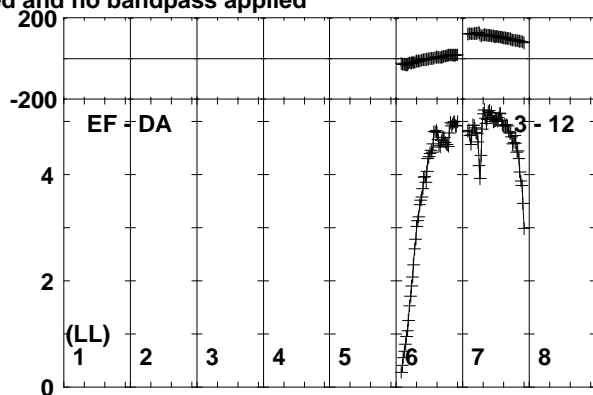
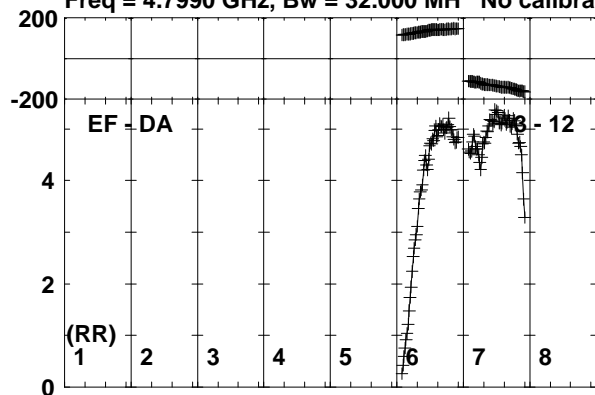

Lower frame: Milli Ampl Jy Top frame: Phas deg  
Vector averaged cross-power spectrum Baseline: EF (03) - DA (12)  
Timerange: 00/23:50:41 to 00/23:51:39

Plot file version 175 created 11-NOV-2019 15:07:35

J1751+0939 EK040B.UVDATA.1

Freq = 4.7990 GHz, Bw = 32.000 MH No calibration applied and no bandpass applied

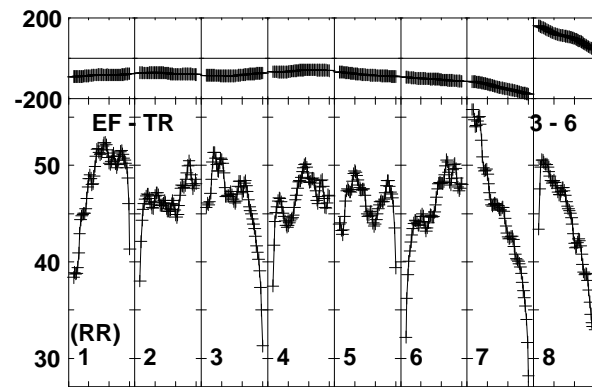
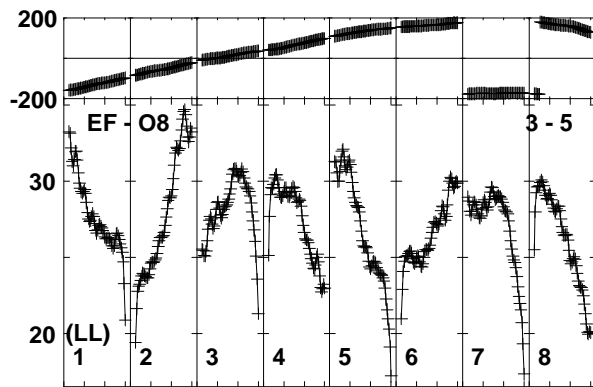
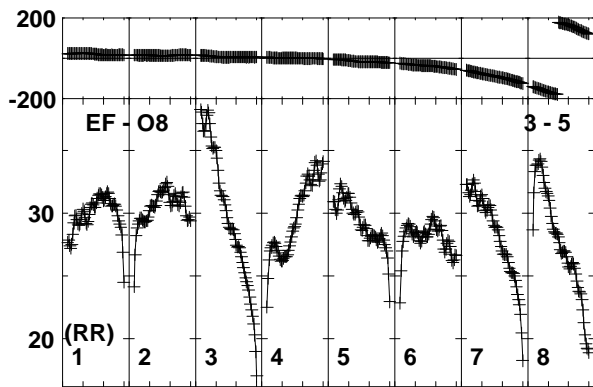
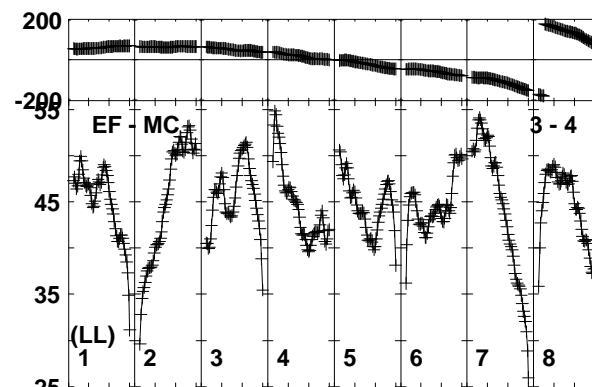
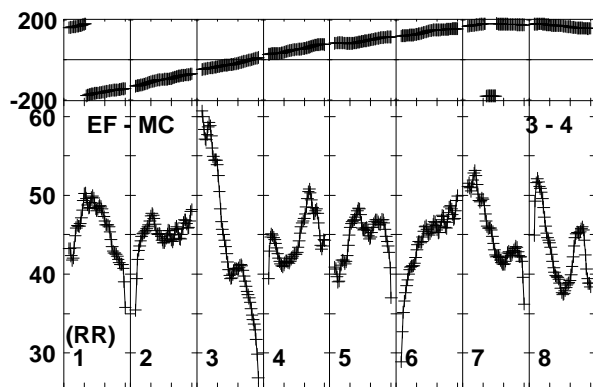
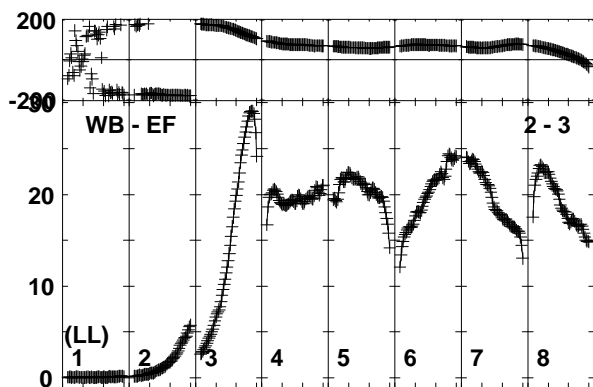
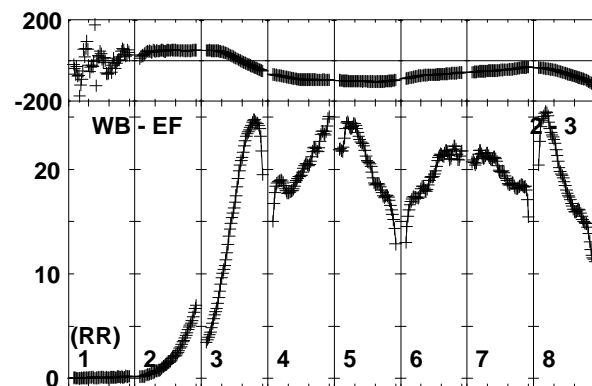
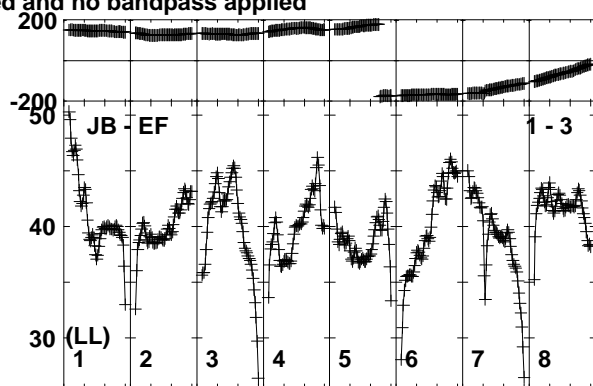
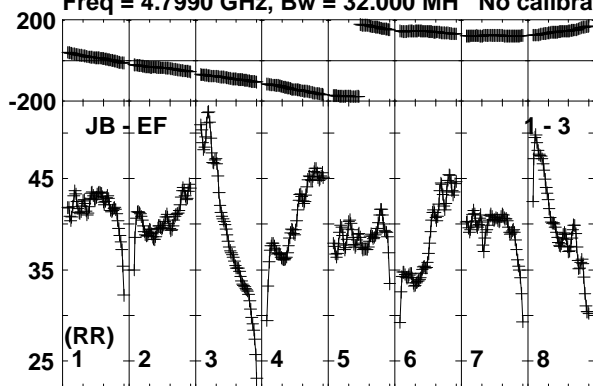

Lower frame: Milli Ampl Jy Top frame: Phas deg  
Vector averaged cross-power spectrum Baseline: JB (01) - EF (03)  
Timerange: 00/23:53:11 to 00/23:58:09

Plot file version 176 created 11-NOV-2019 15:07:36

J1751+0939 EK040B.UVDATA.1

Freq = 4.7990 GHz, Bw = 32.000 MH No calibration applied and no bandpass applied

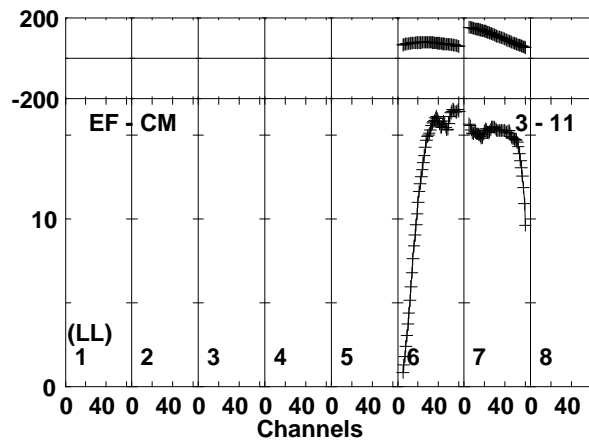
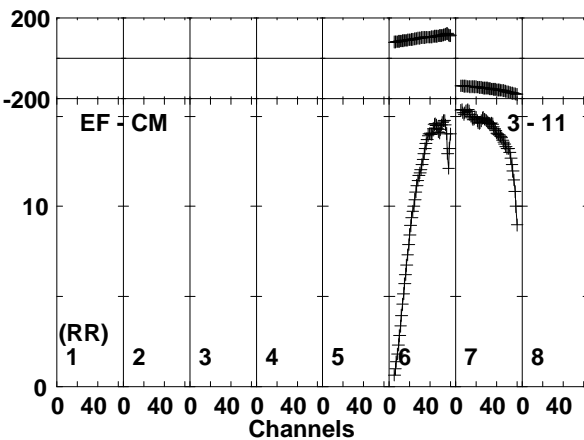
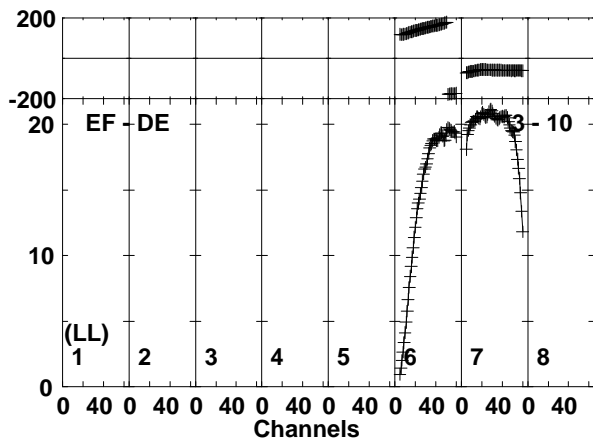
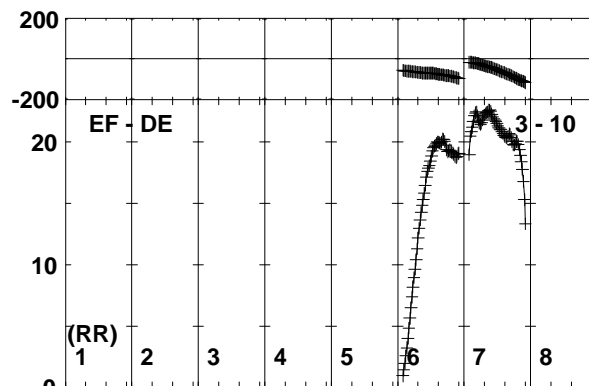
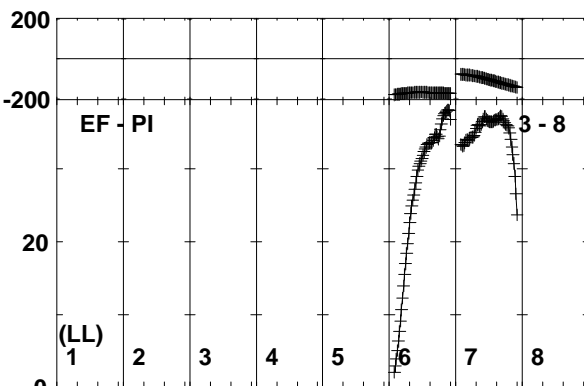
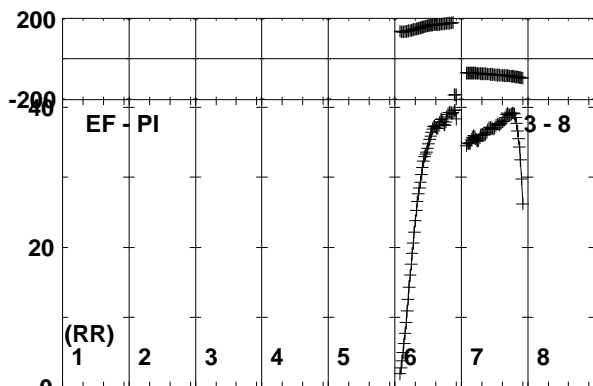
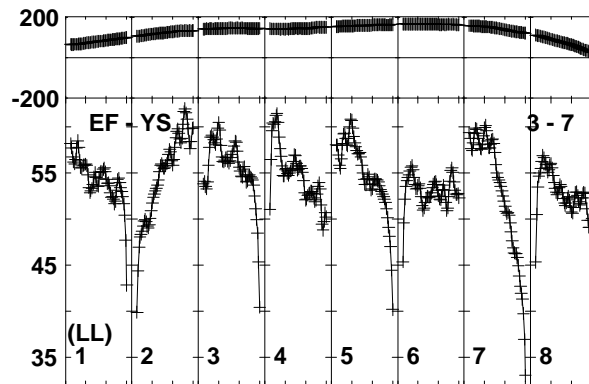
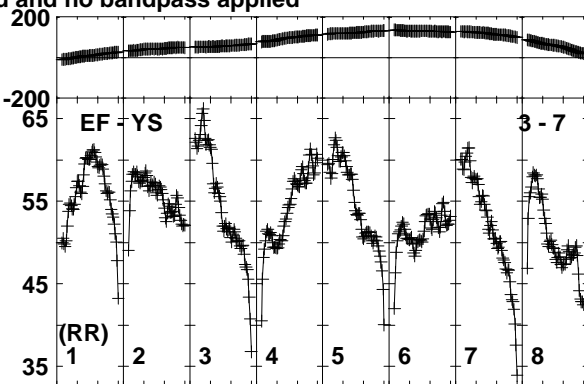
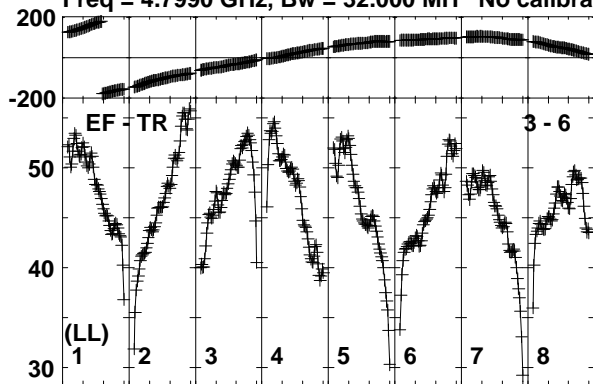

Lower frame: Milli Ampl Jy Top frame: Phas deg  
Vector averaged cross-power spectrum Baseline: EF (03) - TR (06)  
Timerange: 00/23:53:11 to 00/23:58:09

Plot file version 177 created 11-NOV-2019 15:07:36

J1751+0939 EK040B.UVDATA.1

Freq = 4.7990 GHz, Bw = 32.000 MH No calibration applied and no bandpass applied

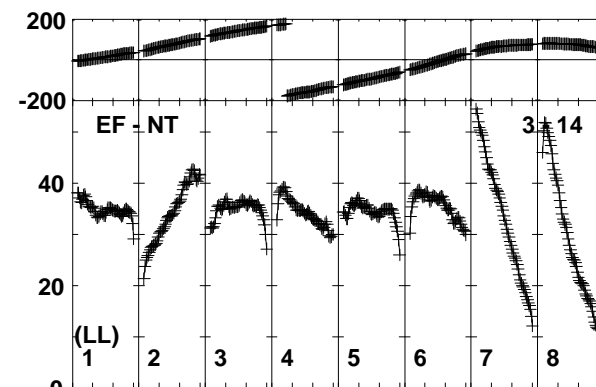
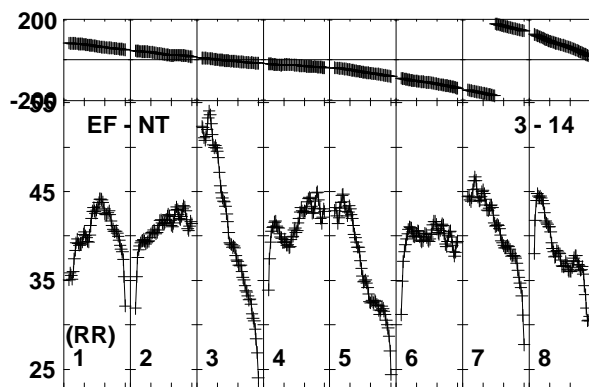
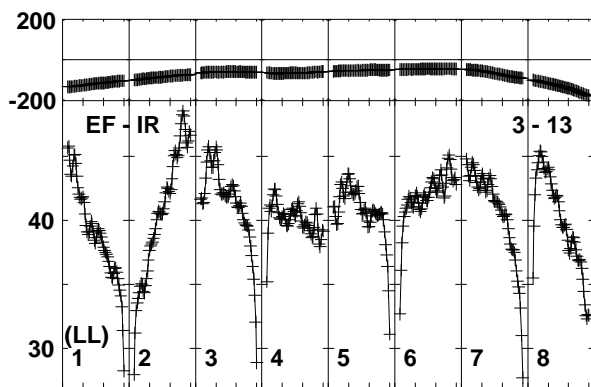
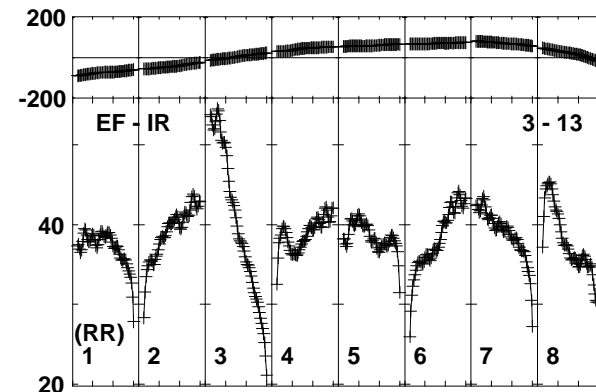
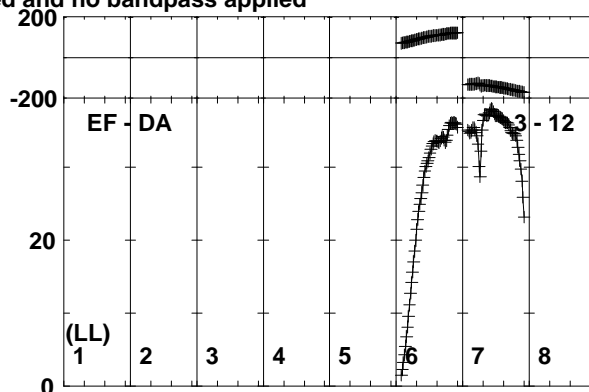
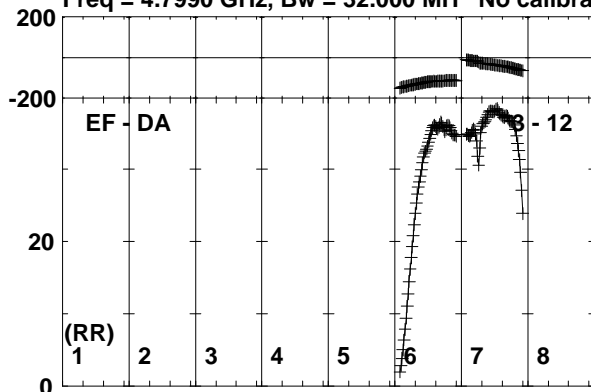

Channels

Lower frame: Milli Ampl Jy Top frame: Phas deg  
Vector averaged cross-power spectrum Baseline: EF (03) - DA (12)  
Timerange: 00/23:53:11 to 00/23:58:09

Plot file version 178 created 11-NOV-2019 15:07:36

J1826+0149 EK040B.UVDATA.1

Freq = 4.7990 GHz, Bw = 32.000 MH No calibration applied and no bandpass applied

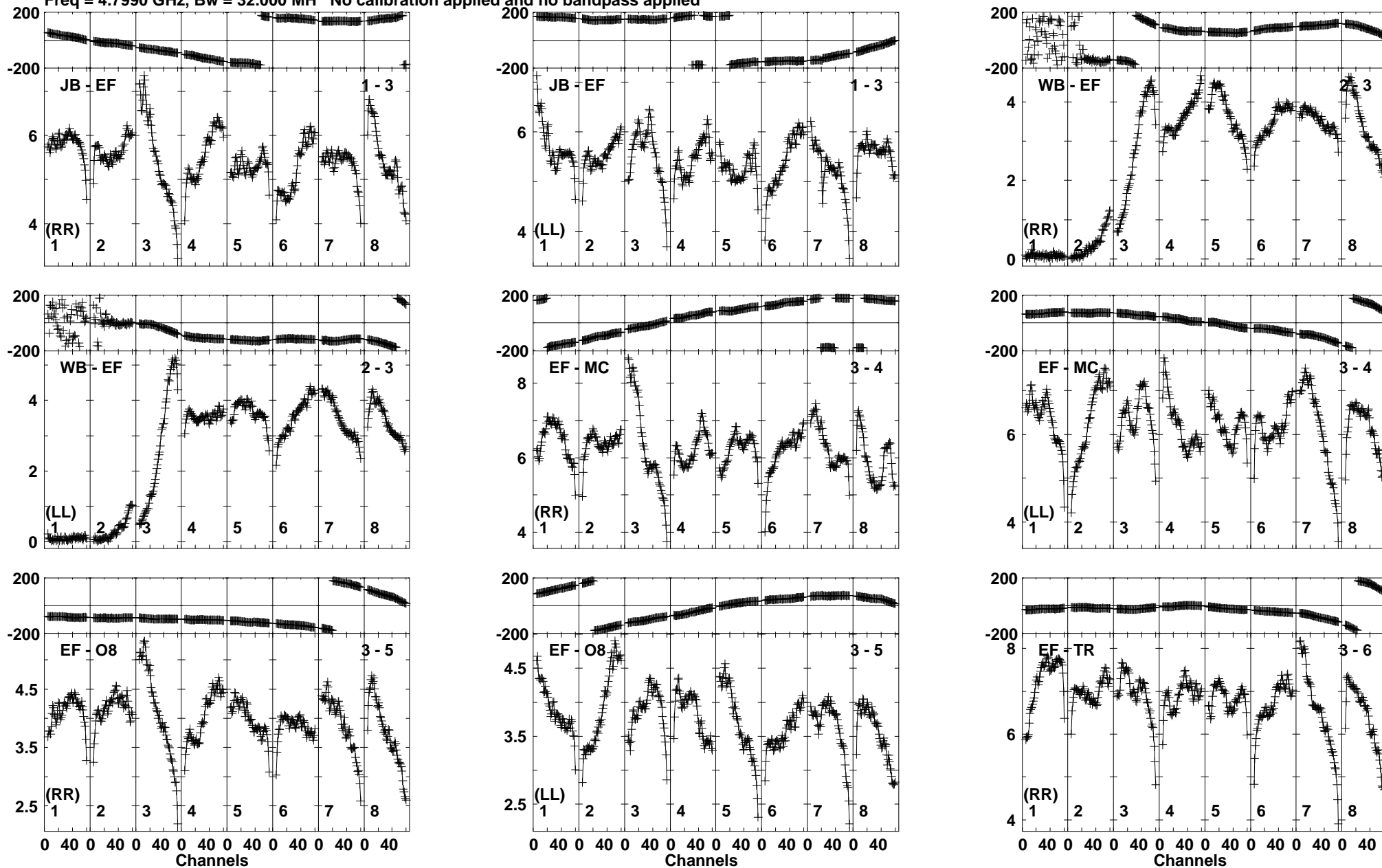

Lower frame: Milli Ampl Jy Top frame: Phas deg  
Vector averaged cross-power spectrum Baseline: JB (01) - EF (03)  
Timerange: 00/23:59:41 to 01/00:01:39



Plot file version 179 created 11-NOV-2019 15:07:36

J1826+0149 EK040B.UVDATA.1

Freq = 4.7990 GHz, Bw = 32.000 MH No calibration applied and no bandpass applied

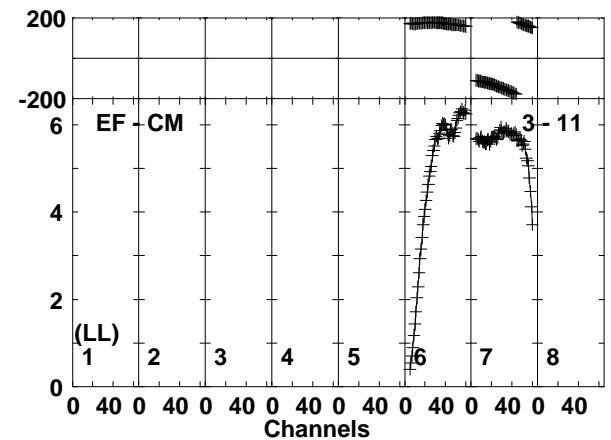
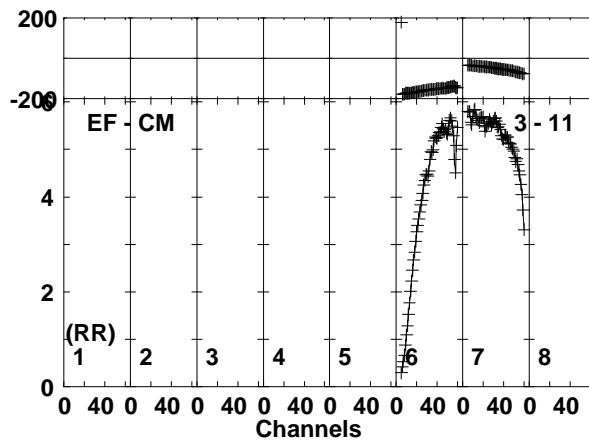
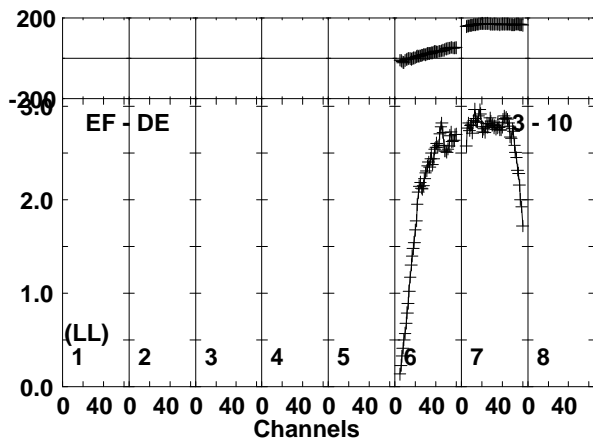
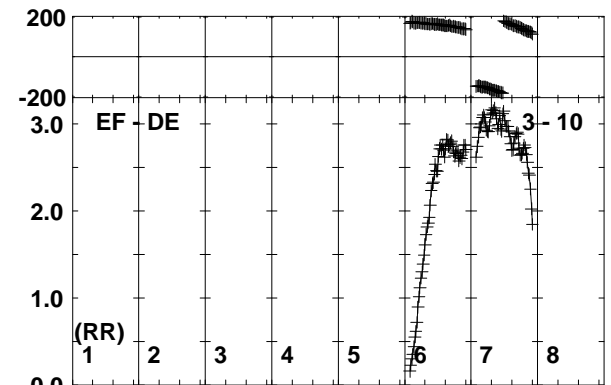
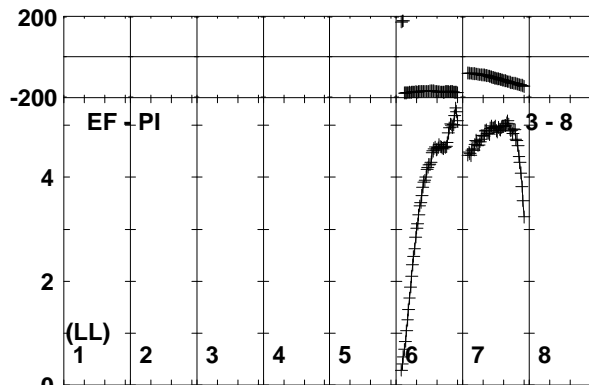
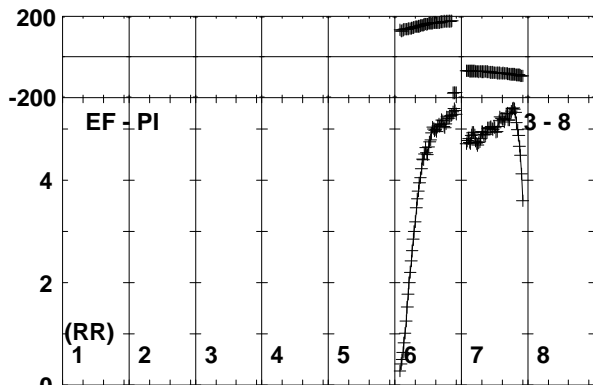
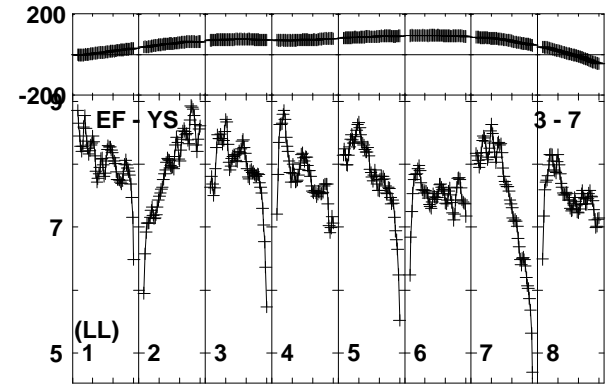
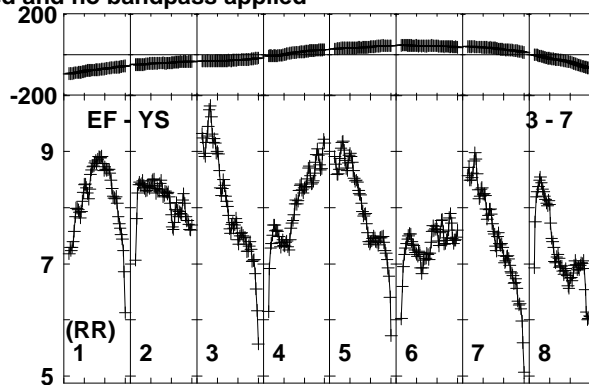
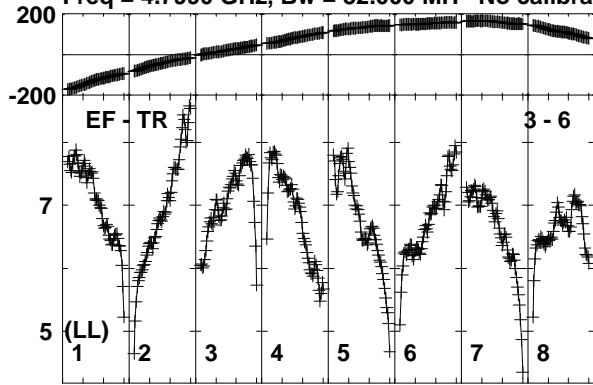

Lower frame: Milli Ampl Jy Top frame: Phas deg  
Vector averaged cross-power spectrum Baseline: EF (03) - TR (06)  
Timerange: 00/23:59:41 to 01/00:01:39

Plot file version 180 created 11-NOV-2019 15:07:36

J1826+0149 EK040B.UVDATA.1

Freq = 4.7990 GHz, Bw = 32.000 MH No calibration applied and no bandpass applied

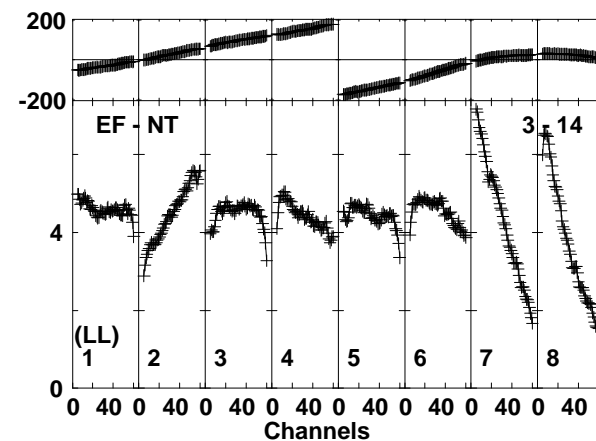
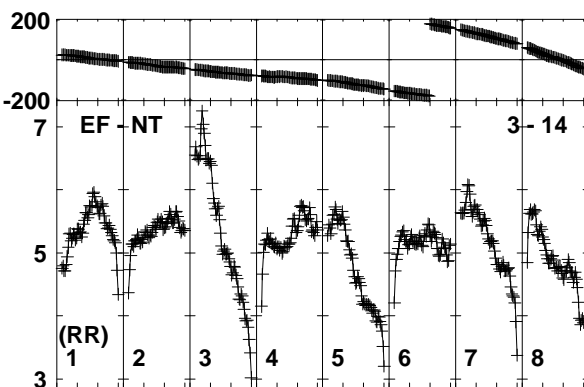
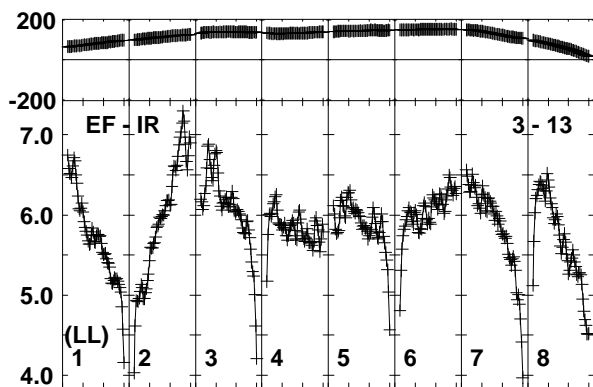
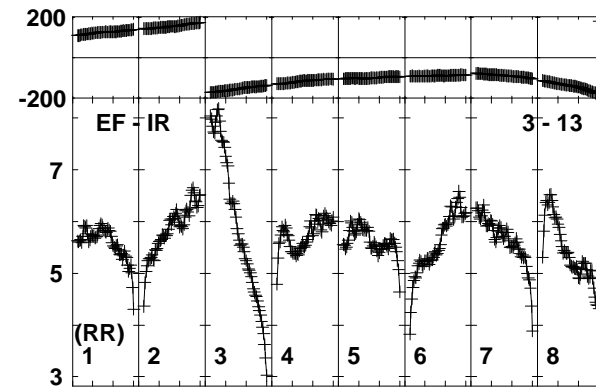
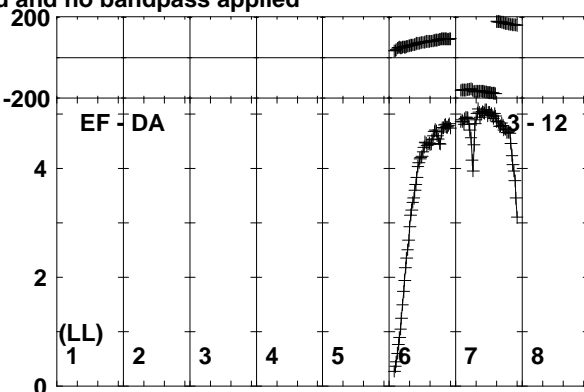
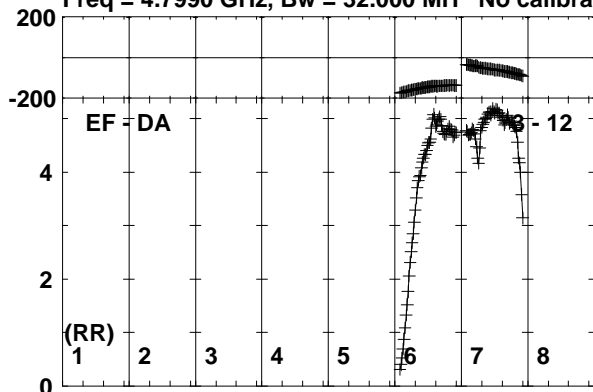

Lower frame: Milli Ampl Jy Top frame: Phas deg  
Vector averaged cross-power spectrum Baseline: EF (03) - DA (12)  
Timerange: 00/23:59:41 to 01/00:01:39

Plot file version 181 created 11-NOV-2019 15:07:36

SER8NJ EK040B.UVDATA.1

Freq = 4.7990 GHz, Bw = 32.000 MH No calibration applied and no bandpass applied

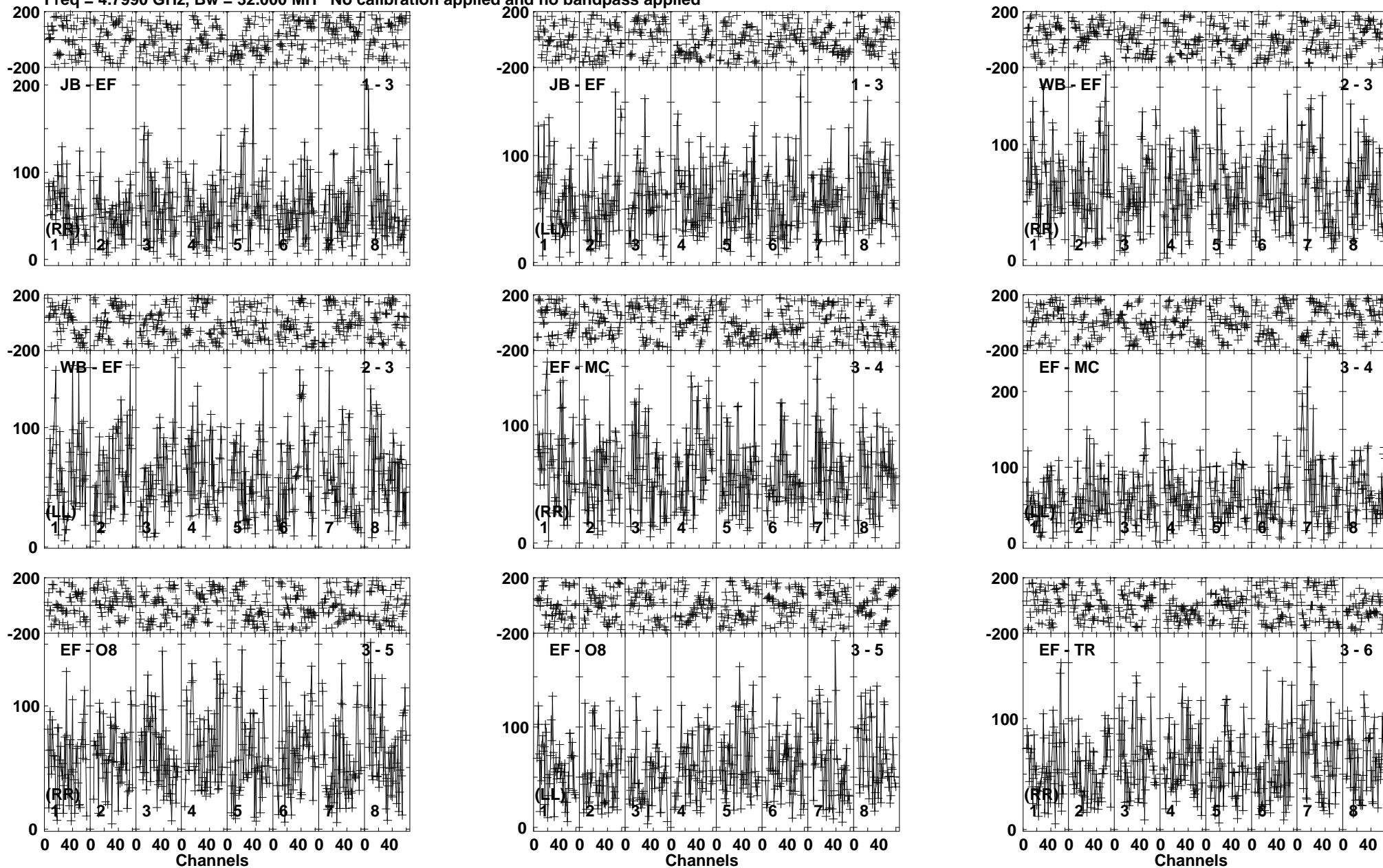

Lower frame: Micro Ampl Jy Top frame: Phas deg  
Vector averaged cross-power spectrum Baseline: JB (01) - EF (03)  
Timerange: 01/00:01:41 to 01/00:05:39

Plot file version 182 created 11-NOV-2019 15:07:36

SER8NJ EK040B.UVDATA.1

Freq = 4.7990 GHz, Bw = 32.000 MH No calibration applied and no bandpass applied

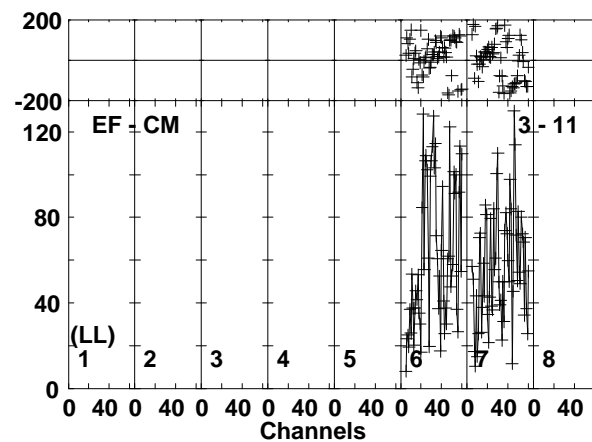
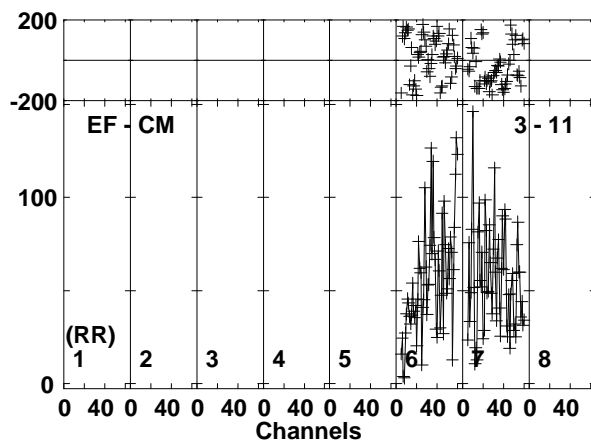
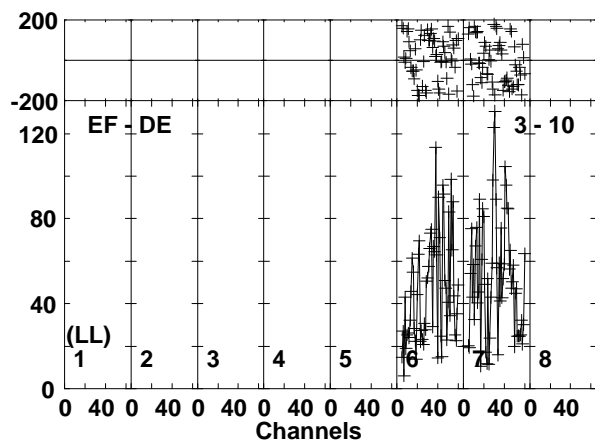
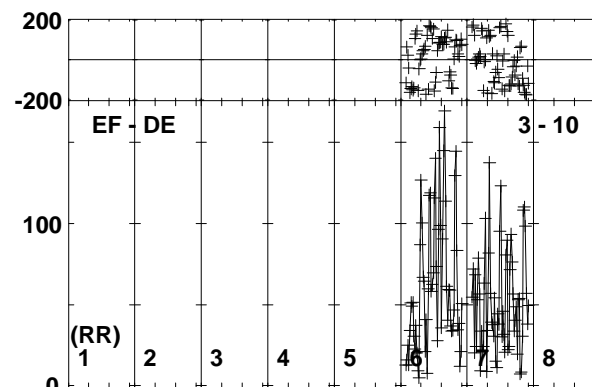
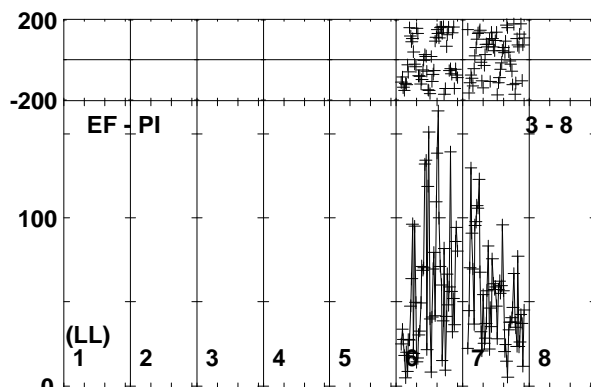
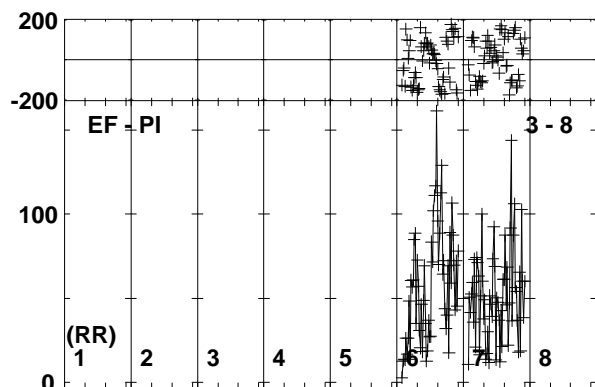
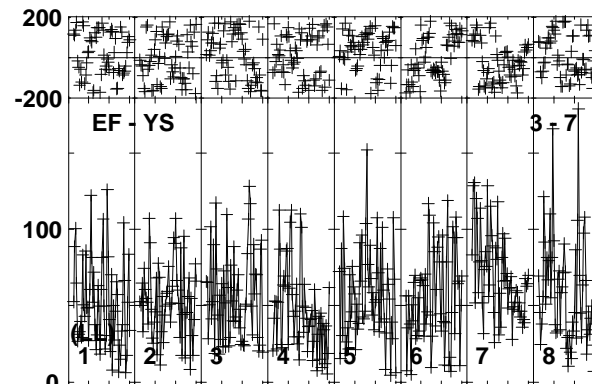
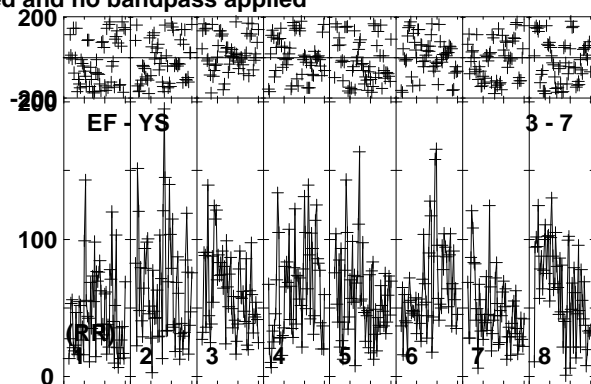
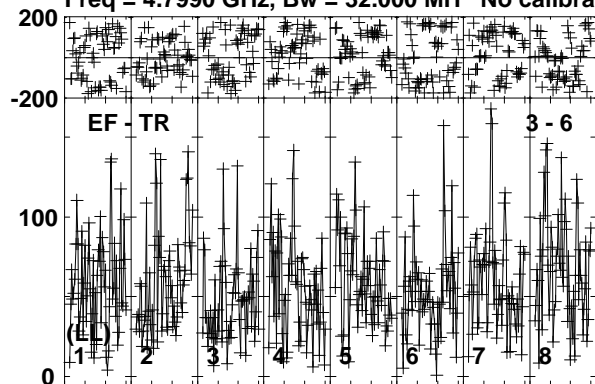

Lower frame: Micro Ampl Jy Top frame: Phas deg  
Vector averaged cross-power spectrum Baseline: EF (03) - TR (06)  
Timerange: 01/00:01:41 to 01/00:05:39

Plot file version 183 created 11-NOV-2019 15:07:37

SER8NJ EK040B.UVDATA.1

Freq = 4.7990 GHz, Bw = 32.000 MH No calibration applied and no bandpass applied

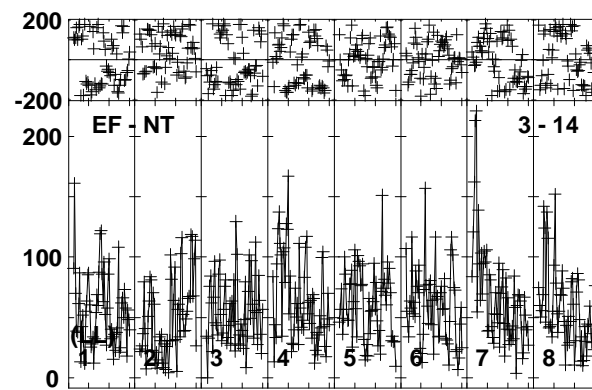
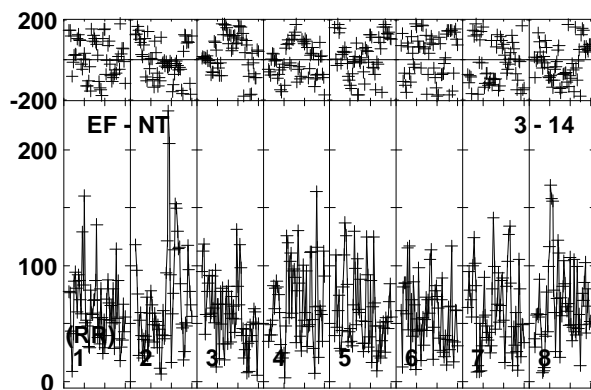
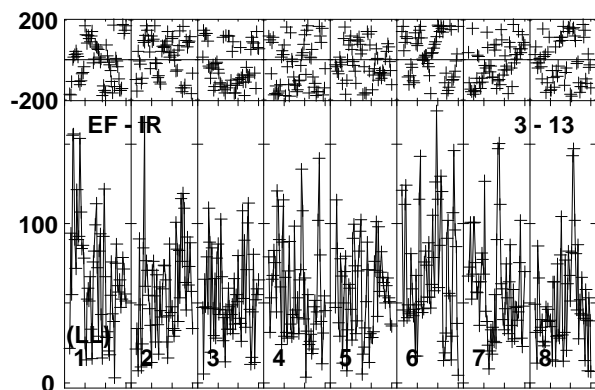
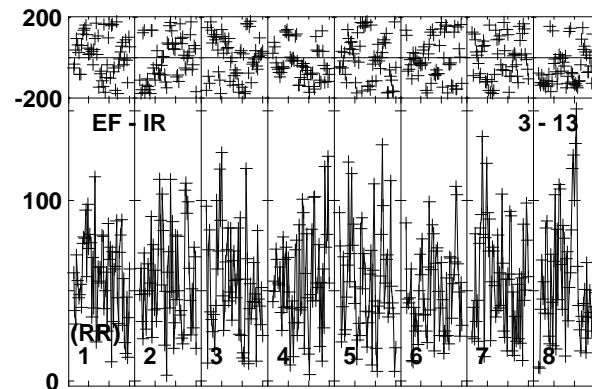
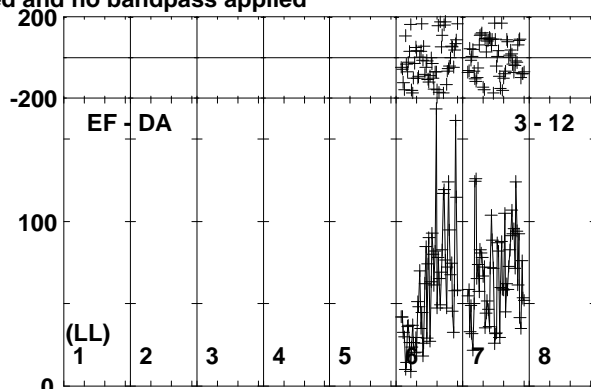
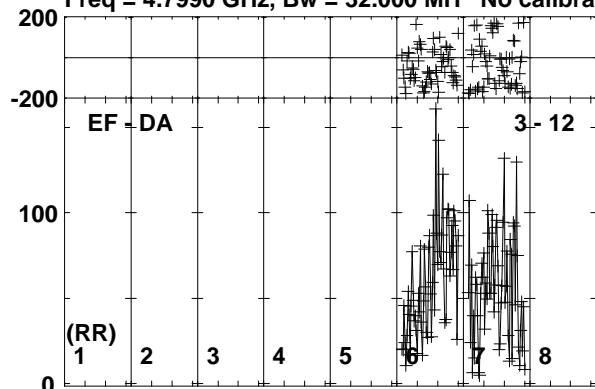

0 40 0 40 0 40 0 40 0 40 0 40 0 40 0 40 0 40 0 40  
Channels

Lower frame: Micro Ampl Jy Top frame: Phas deg  
Vector averaged cross-power spectrum Baseline: EF (03) - DA (12)  
Timerange: 01/00:01:41 to 01/00:05:39

Plot file version 184 created 11-NOV-2019 15:07:37

J1826+0149 EK040B.UVDATA.1

Freq = 4.7990 GHz, Bw = 32.000 MH No calibration applied and no bandpass applied

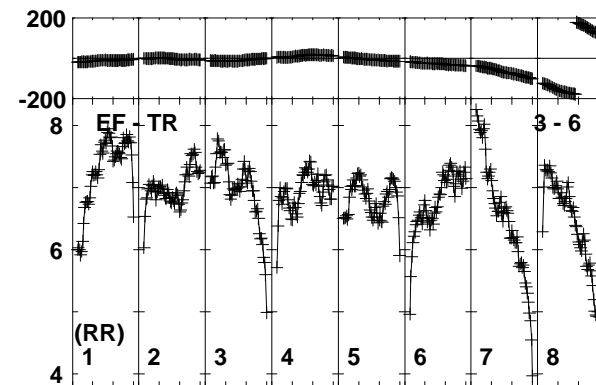
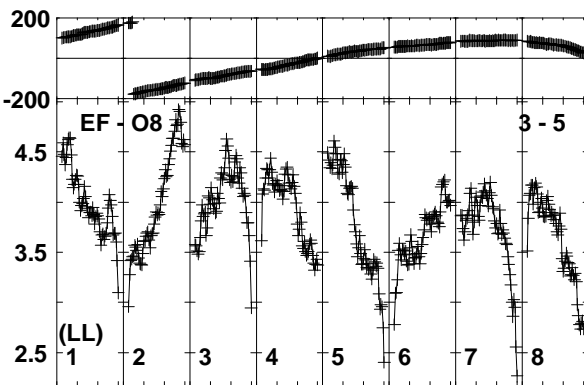
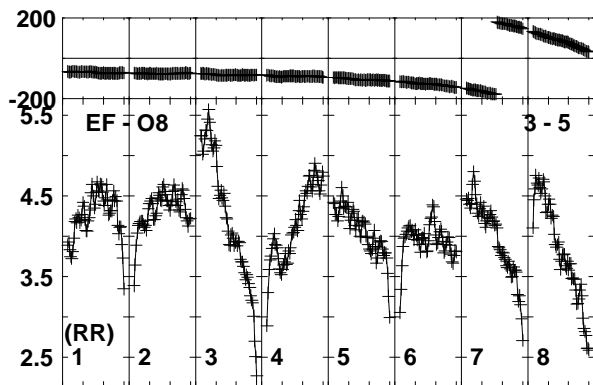
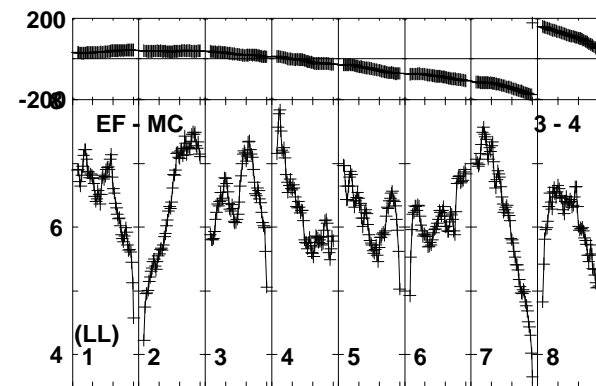
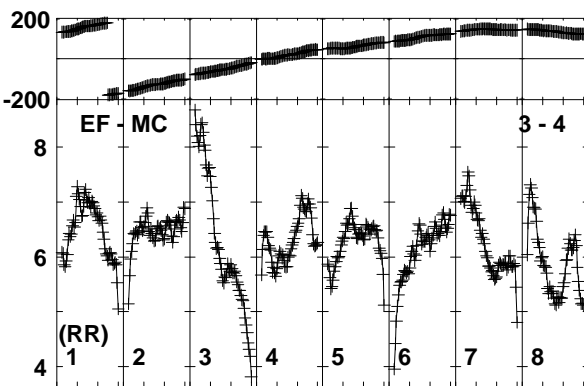
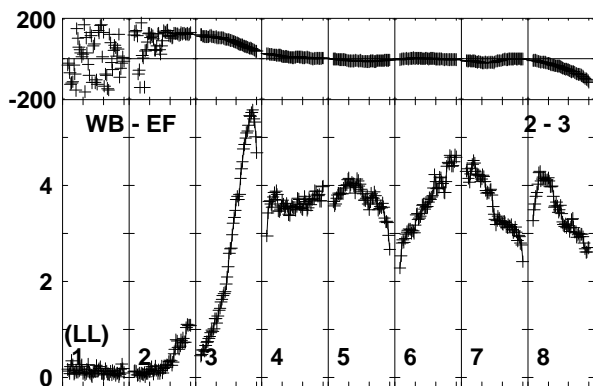
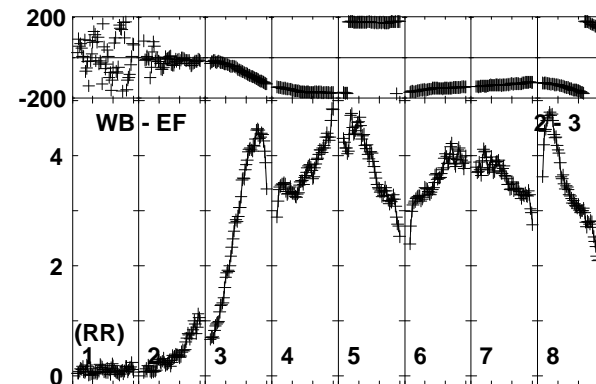
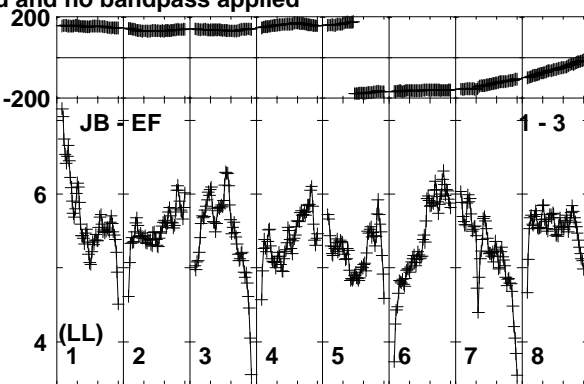
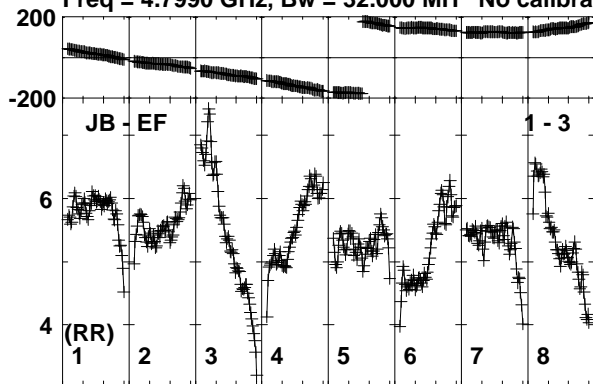

Lower frame: Milli Ampl Jy Top frame: Phas deg  
Vector averaged cross-power spectrum Baseline: JB (01) - EF (03)  
Timerange: 01/00:05:41 to 01/00:07:09

Plot file version 185 created 11-NOV-2019 15:07:37

J1826+0149 EK040B.UVDATA.1

Freq = 4.7990 GHz, Bw = 32.000 MH No calibration applied and no bandpass applied

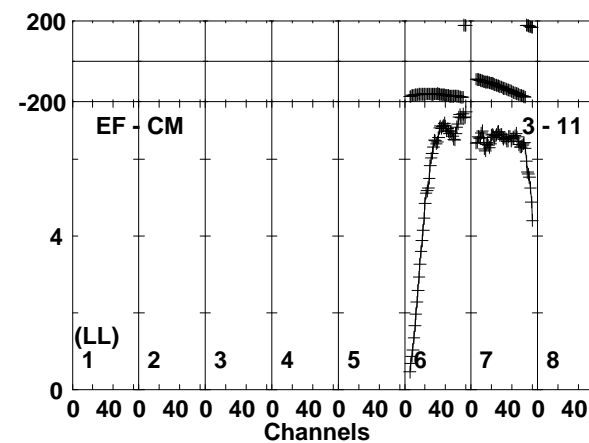
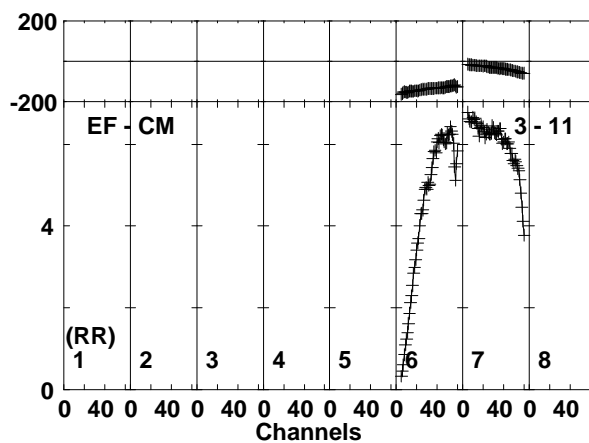
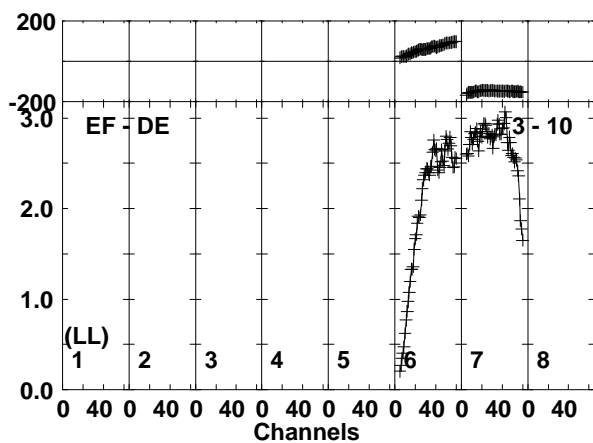
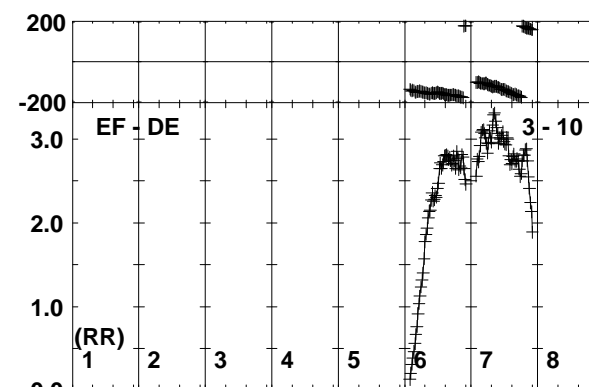
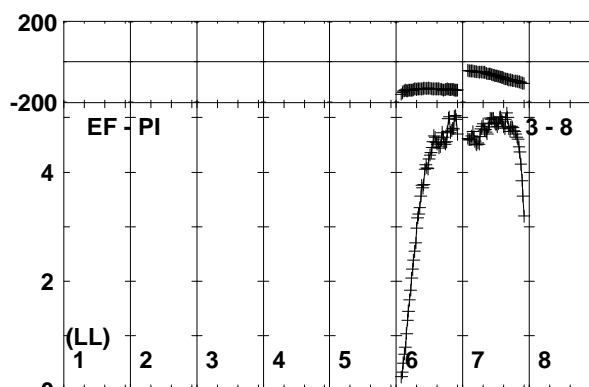
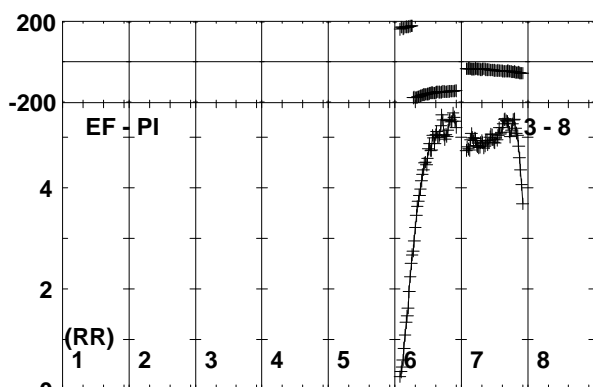
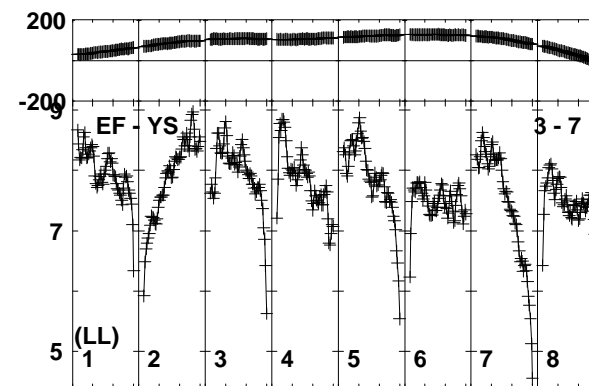
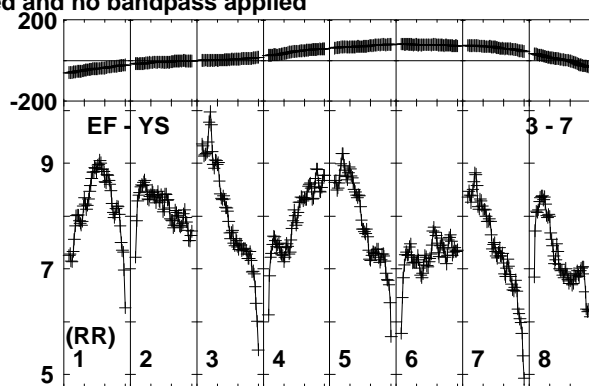
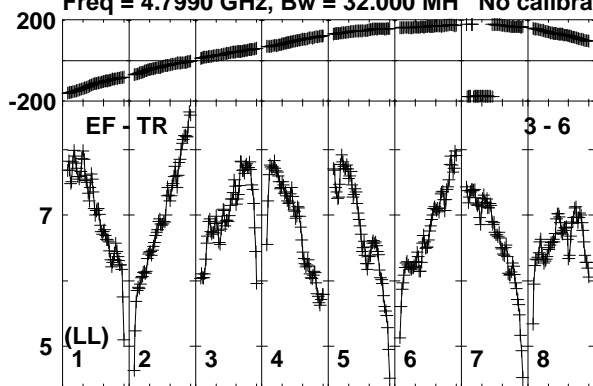

Lower frame: Milli Ampl Jy Top frame: Phas deg  
Vector averaged cross-power spectrum Baseline: EF (03) - TR (06)  
Timerange: 01/00:05:41 to 01/00:07:09

Plot file version 186 created 11-NOV-2019 15:07:37  
 J1826+0149 EK040B.UVDATA.1  
 Freq = 4.7990 GHz, Bw = 32.000 MH No calibration applied and no bandpass applied

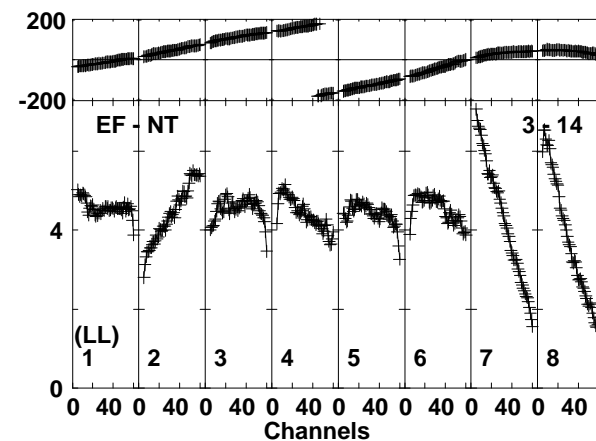
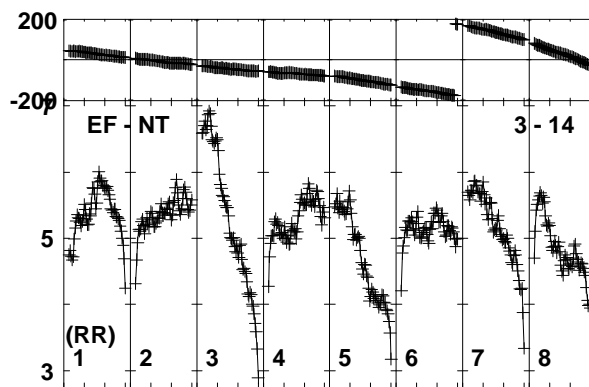
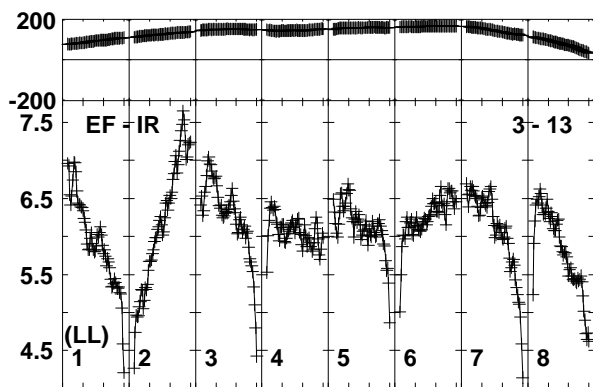
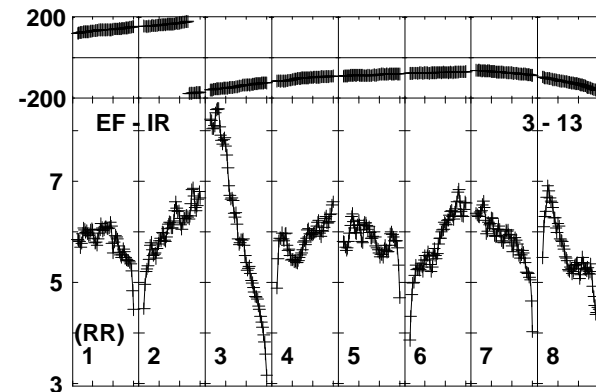
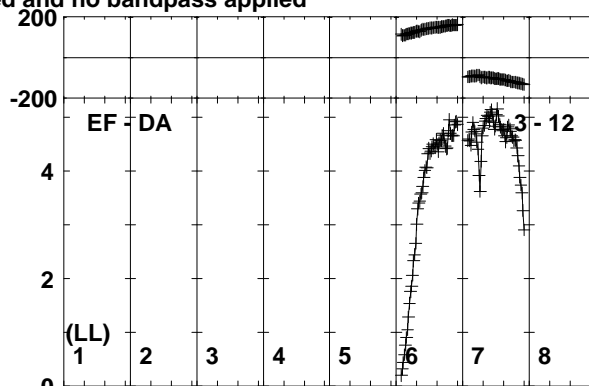
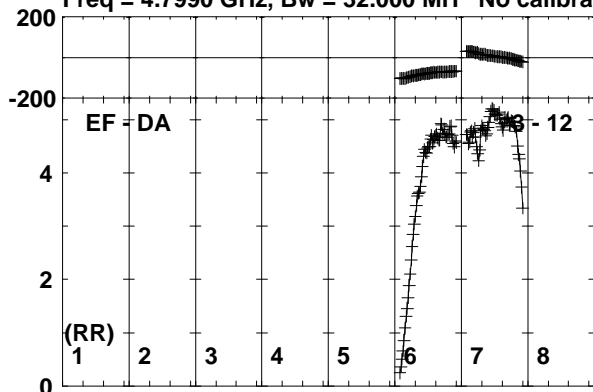

Lower frame: Milli Ampl Jy Top frame: Phas deg  
 Vector averaged cross-power spectrum Baseline: EF (03) - DA (12)  
 Timerange: 01/00:05:41 to 01/00:07:09



Plot file version 187 created 11-NOV-2019 15:07:37

SER8NJ EK040B.UVDATA.1

Freq = 4.7990 GHz, Bw = 32.000 MH No calibration applied and no bandpass applied

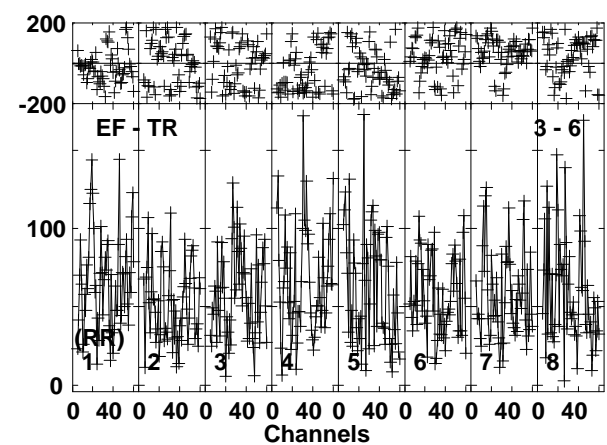
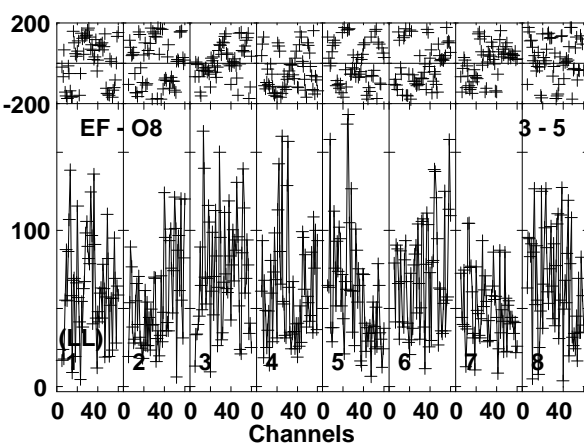
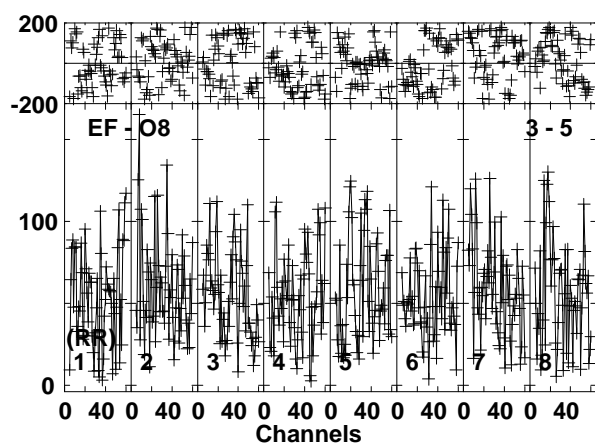
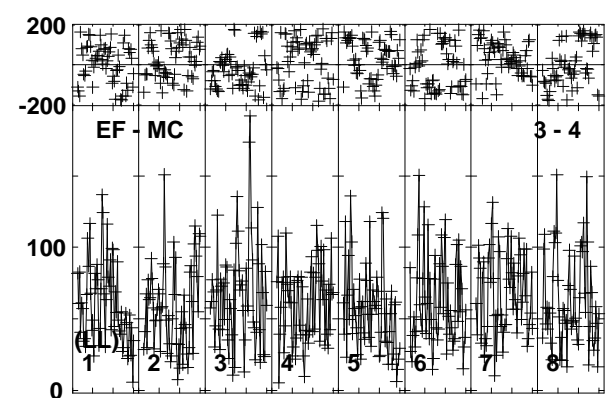
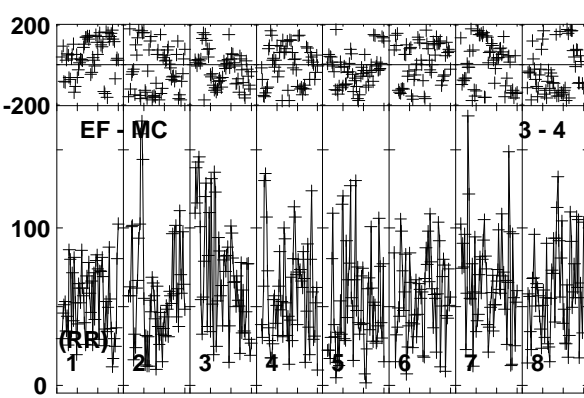
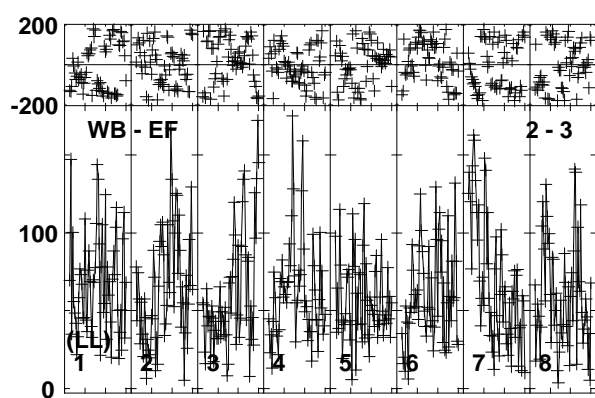
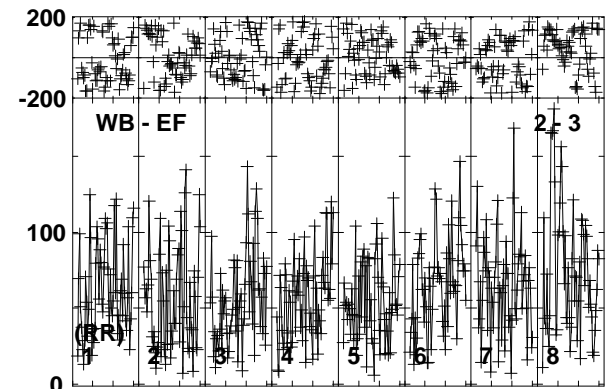
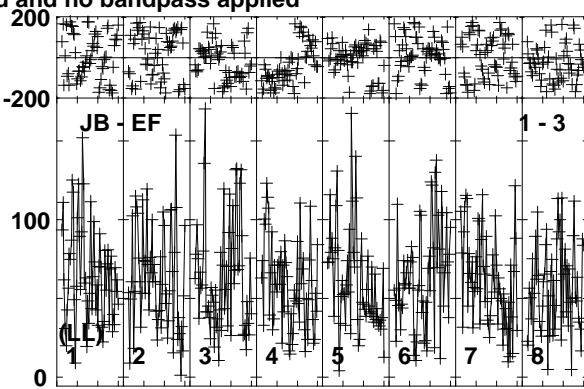
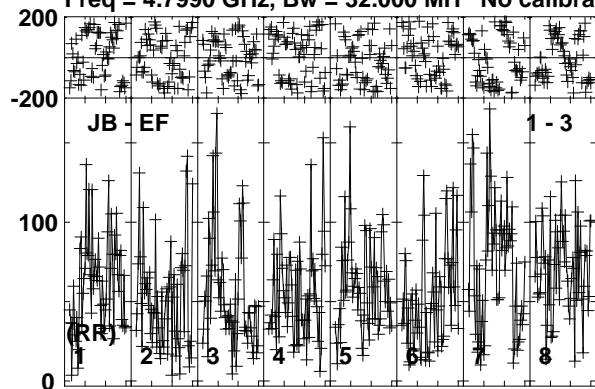

Lower frame: Micro Ampl Jy Top frame: Phas deg  
Vector averaged cross-power spectrum Baseline: JB (01) - EF (03)  
Timerange: 01/00:07:13 to 01/00:11:09

Plot file version 188 created 11-NOV-2019 15:07:37

SER8NJ EK040B.UVDATA.1

Freq = 4.7990 GHz, Bw = 32.000 MH No calibration applied and no bandpass applied

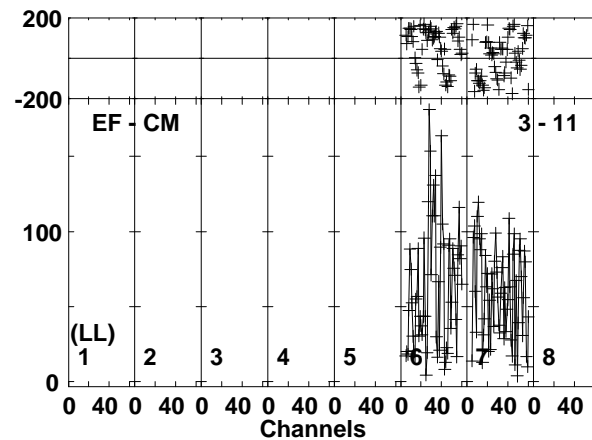
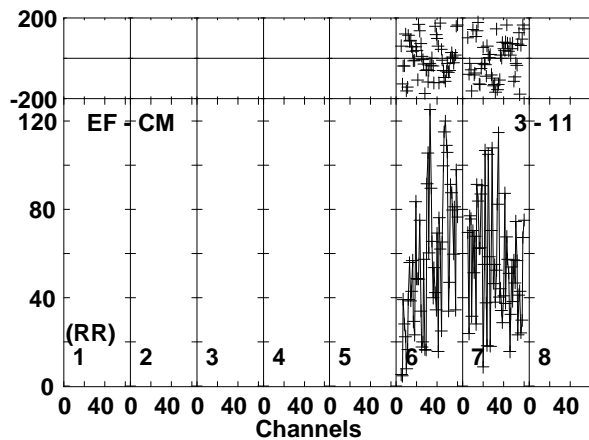
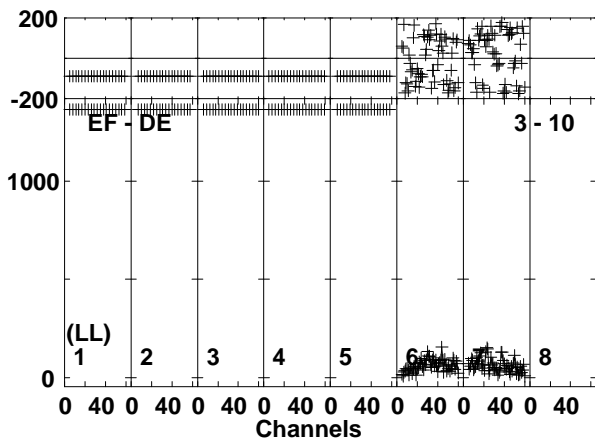
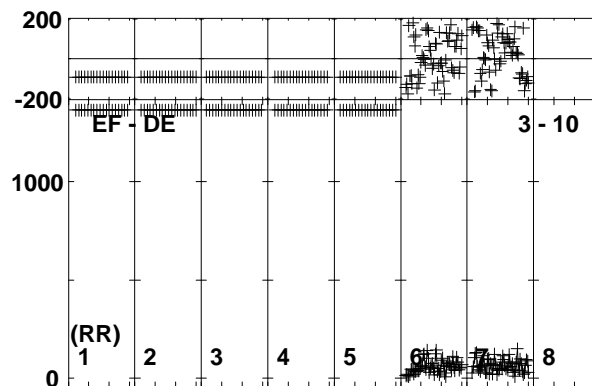
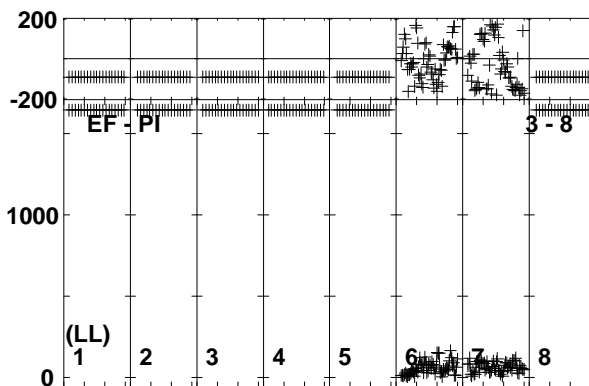
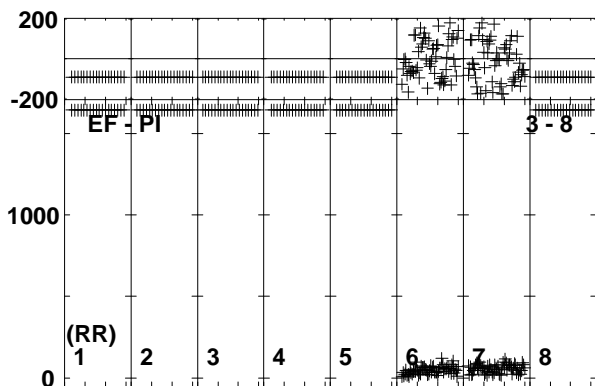
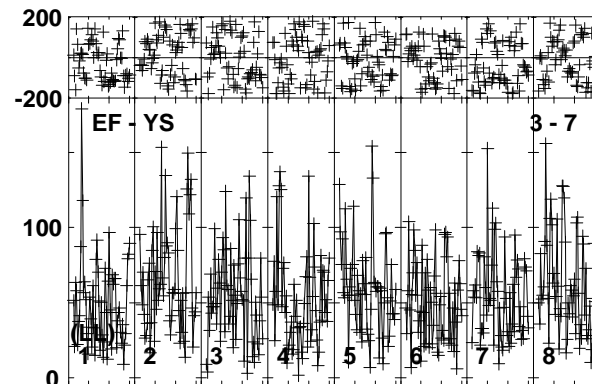
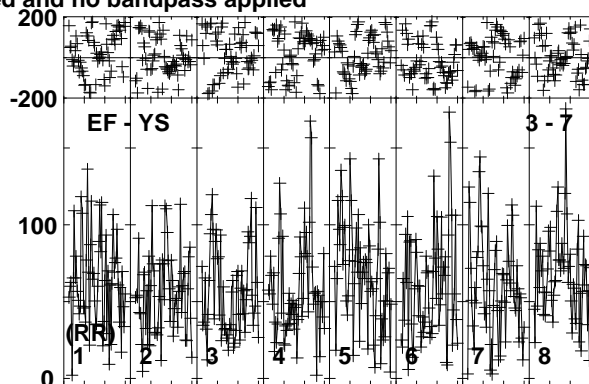
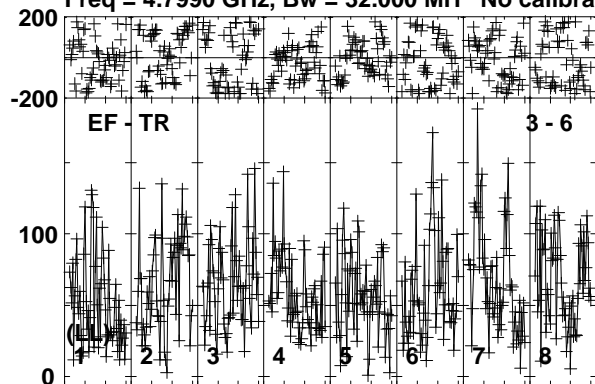

Lower frame: Micro Ampl Jy Top frame: Phas deg  
Vector averaged cross-power spectrum Baseline: EF (03) - TR (06)  
Timerange: 01/00:07:13 to 01/00:11:09

Plot file version 189 created 11-NOV-2019 15:07:37

SER8NJ EK040B.UVDATA.1

Freq = 4.7990 GHz, Bw = 32.000 MH No calibration applied and no bandpass applied

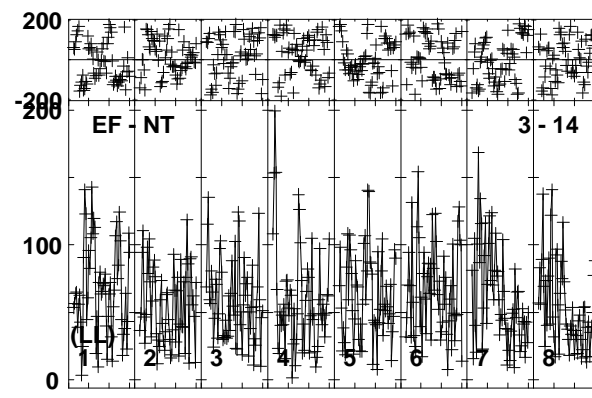
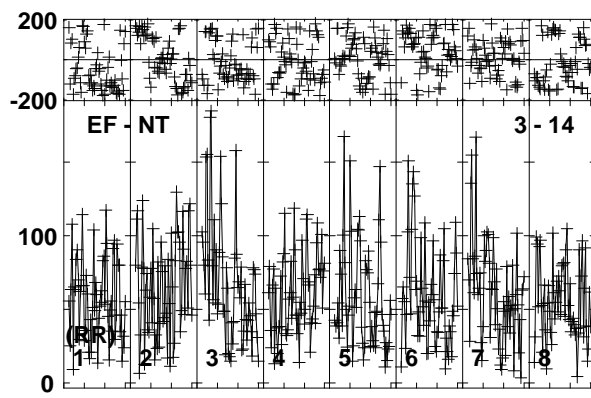
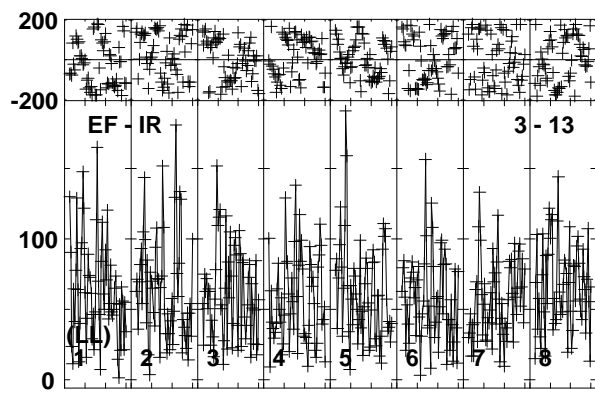
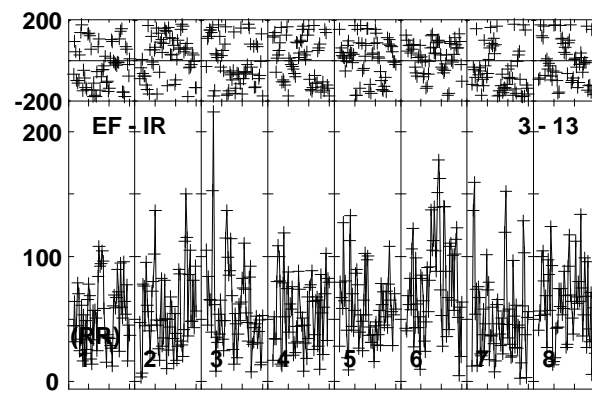
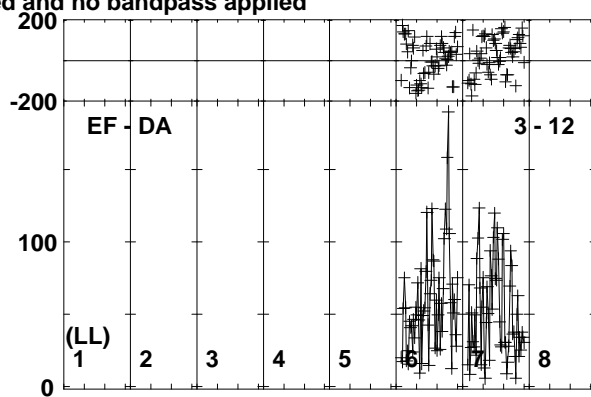
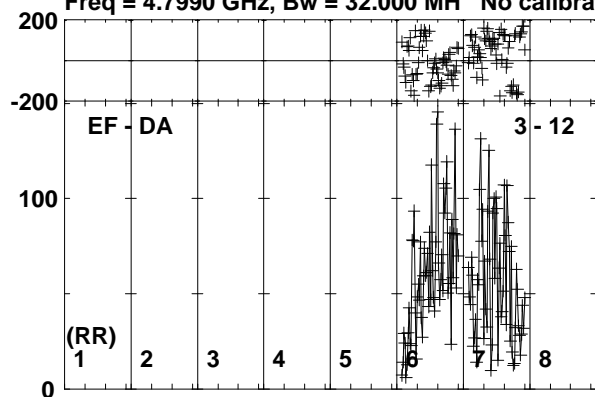

0 40 0 40 0 40 0 40 0 40 0 40 0 40 0 40 0 40 0 40  
Channels

Lower frame: Micro Ampl Jy Top frame: Phas deg  
Vector averaged cross-power spectrum Baseline: EF (03) - DA (12)  
Timerange: 01/00:07:13 to 01/00:11:09

Plot file version 190 created 11-NOV-2019 15:07:37

J1826+0149 EK040B.UVDATA.1

Freq = 4.7990 GHz, Bw = 32.000 MH No calibration applied and no bandpass applied

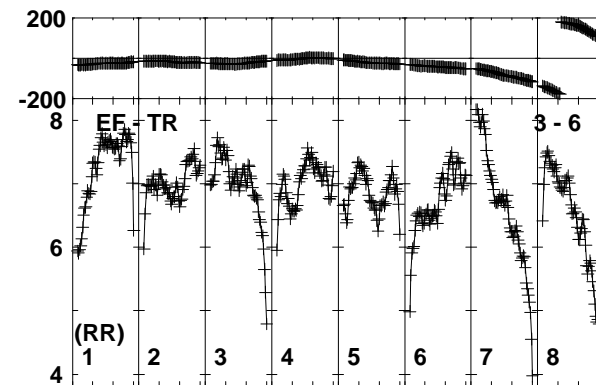
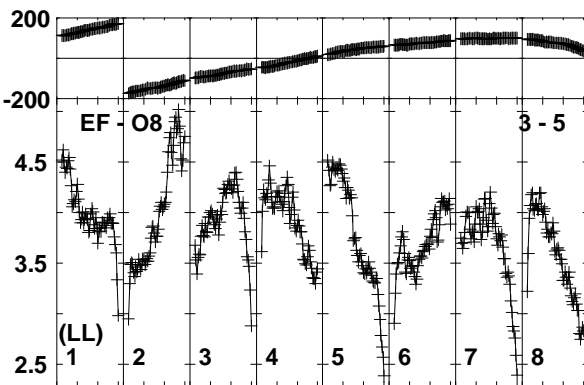
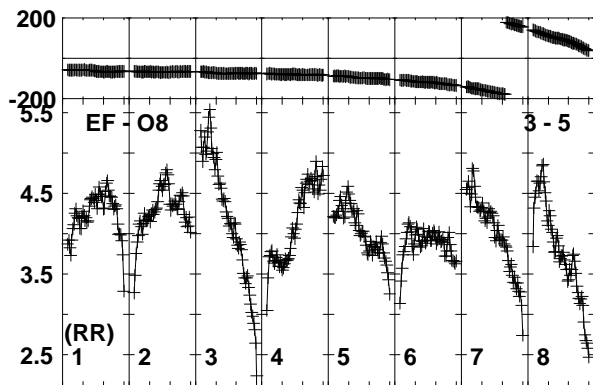
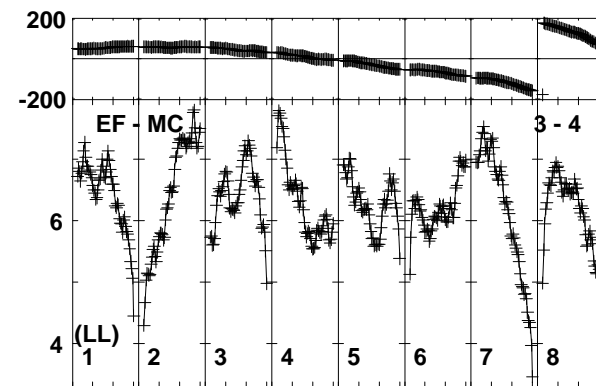
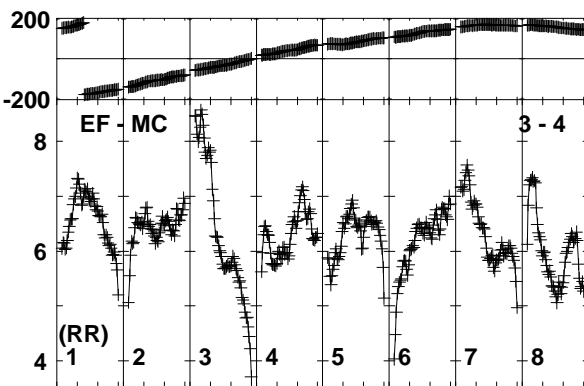
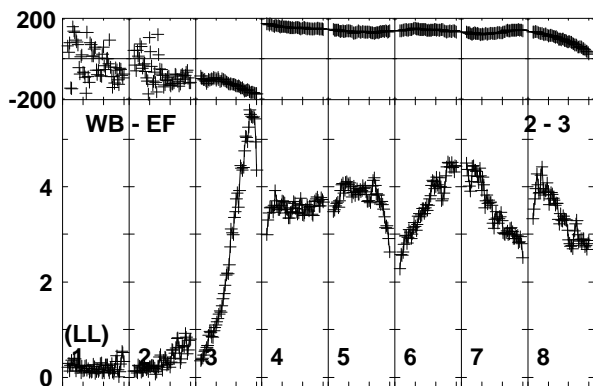
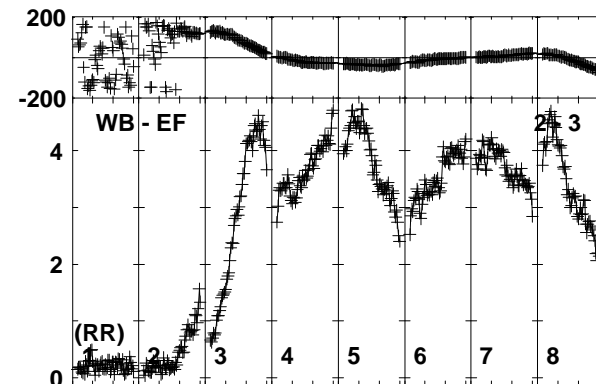
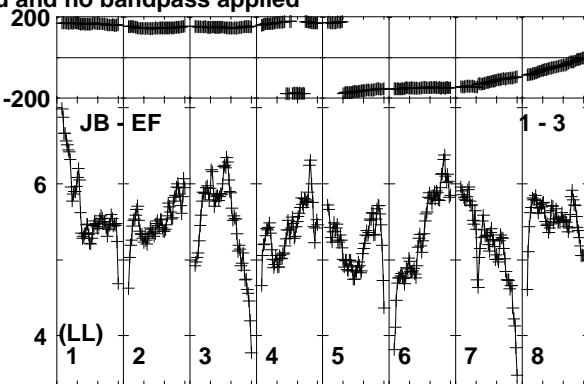
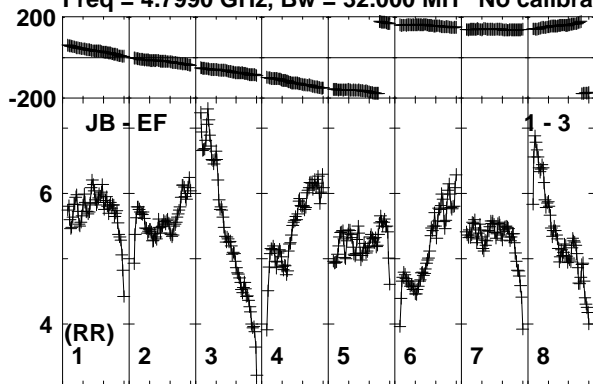

Lower frame: Milli Ampl Jy Top frame: Phas deg  
Vector averaged cross-power spectrum Baseline: JB (01) - EF (03)  
Timerange: 01/00:11:51 to 01/00:12:49

Plot file version 191 created 11-NOV-2019 15:07:37

J1826+0149 EK040B.UVDATA.1

Freq = 4.7990 GHz, Bw = 32.000 MH No calibration applied and no bandpass applied

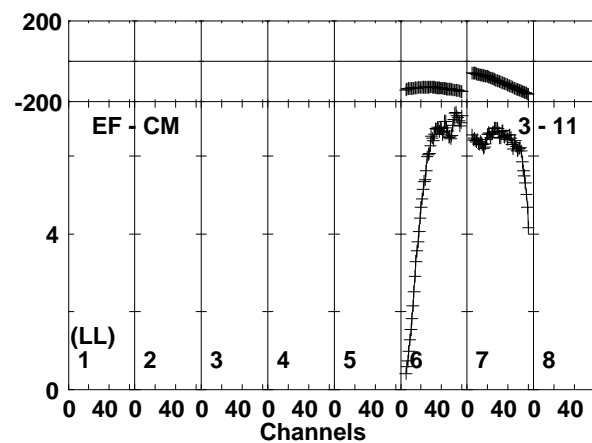
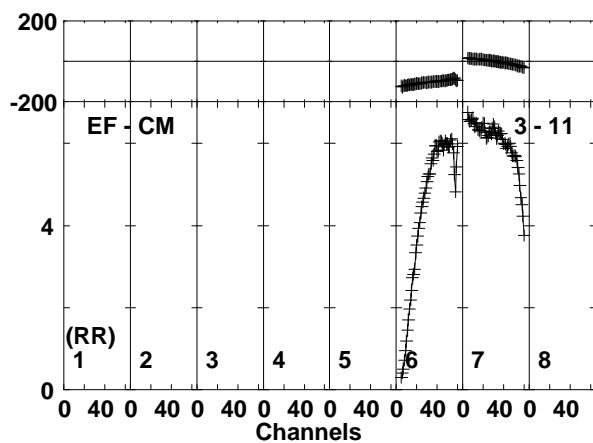
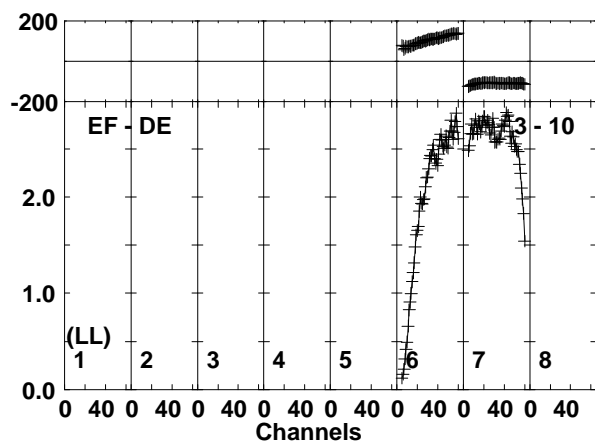
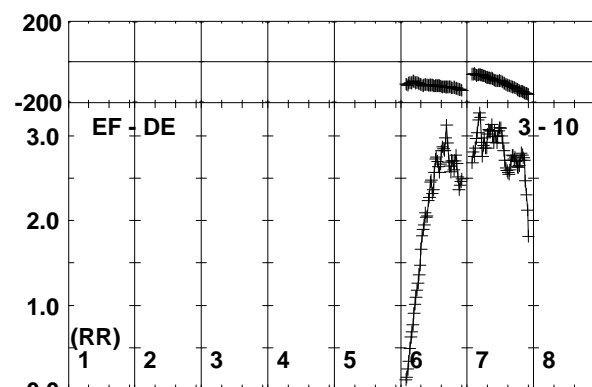
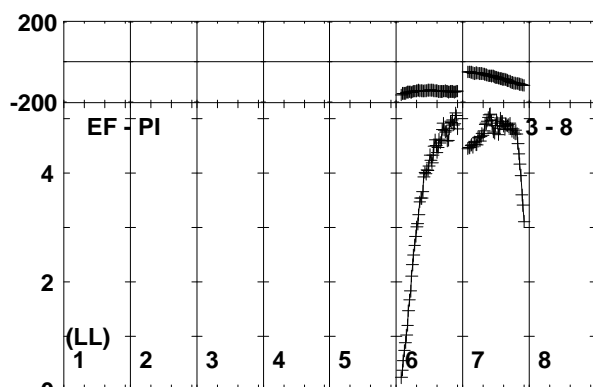
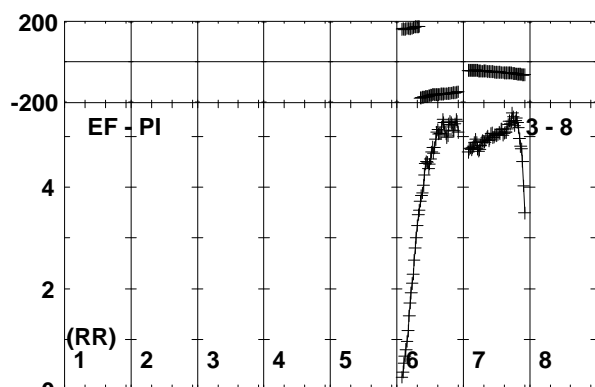
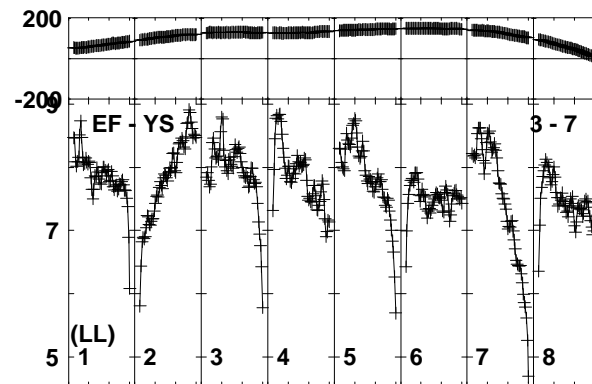
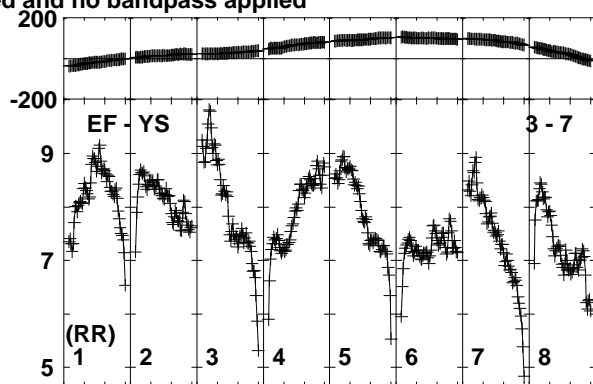
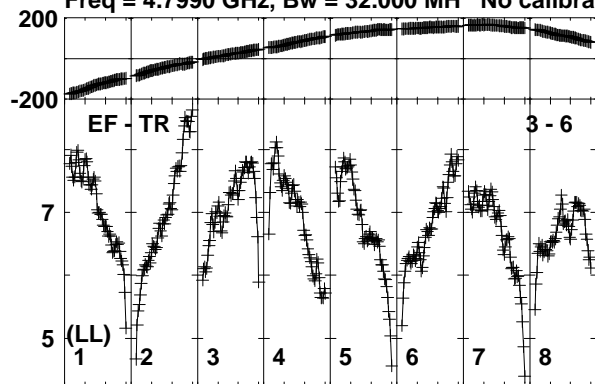

Lower frame: Milli Ampl Jy Top frame: Phas deg  
Vector averaged cross-power spectrum Baseline: EF (03) - TR (06)  
Timerange: 01/00:11:51 to 01/00:12:49

Plot file version 192 created 11-NOV-2019 15:07:37

J1826+0149 EK040B.UVDATA.1

Freq = 4.7990 GHz, Bw = 32.000 MH No calibration applied and no bandpass applied

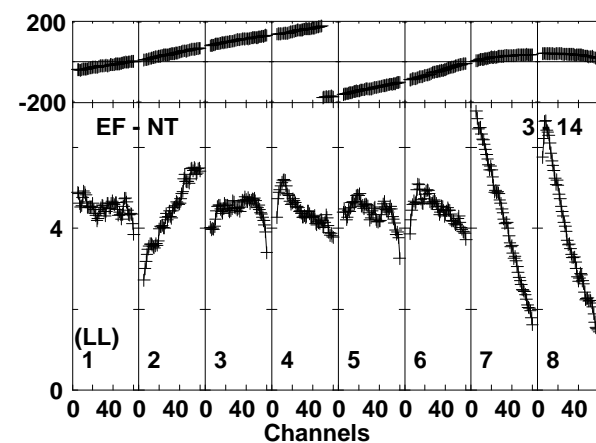
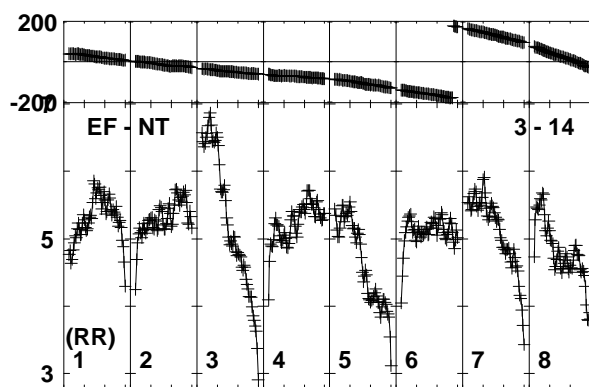
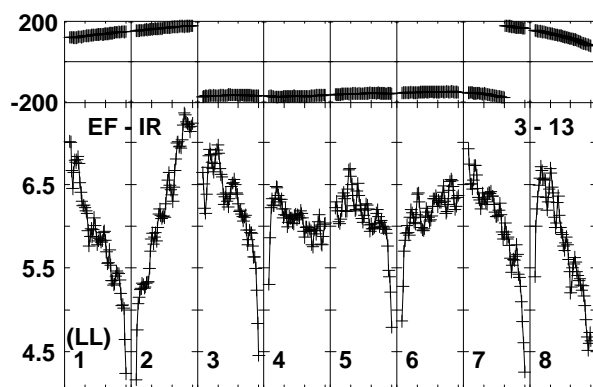
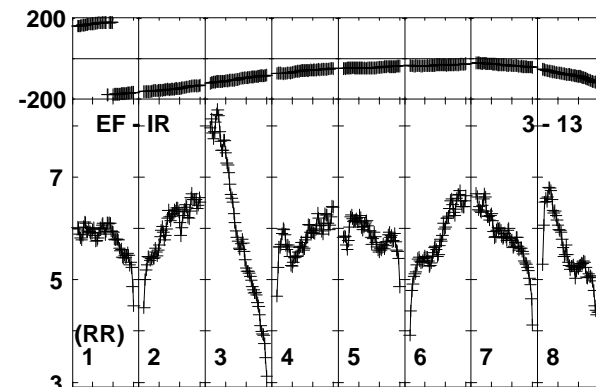
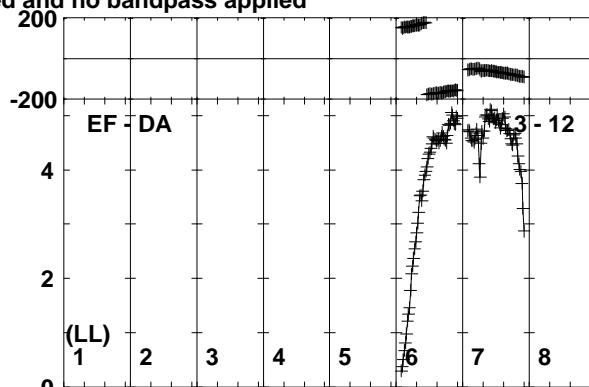
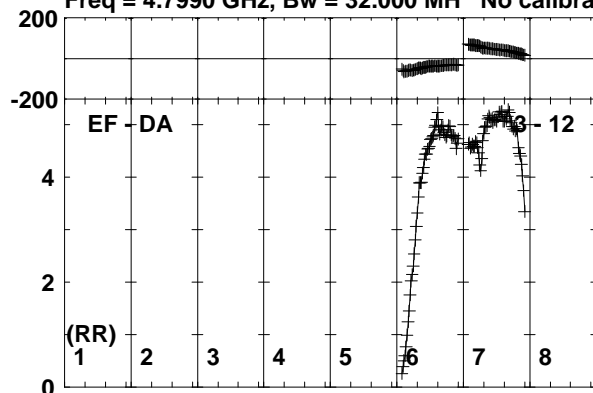

Lower frame: Milli Ampl Jy Top frame: Phas deg  
Vector averaged cross-power spectrum Baseline: EF (03) - DA (12)  
Timerange: 01/00:11:51 to 01/00:12:49

Plot file version 193 created 11-NOV-2019 15:07:38

SER8NJ EK040B.UVDATA.1

Freq = 4.7990 GHz, Bw = 32.000 MH No calibration applied and no bandpass applied

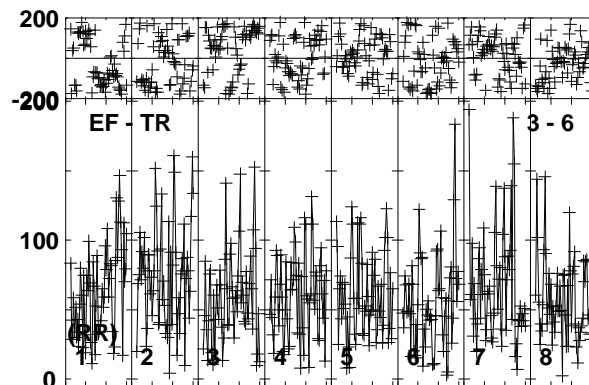
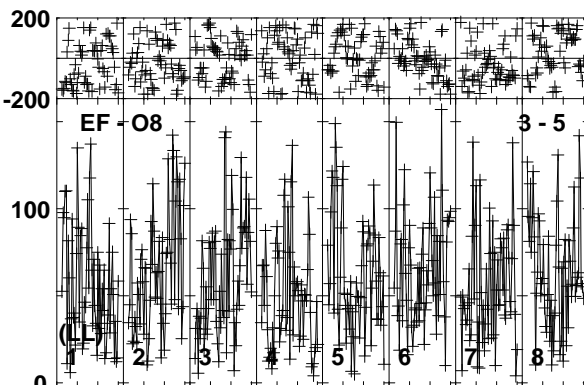
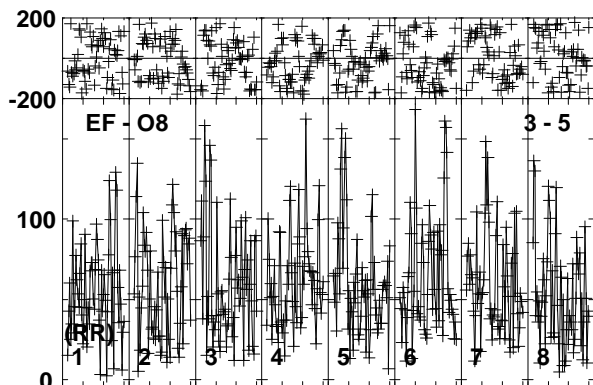
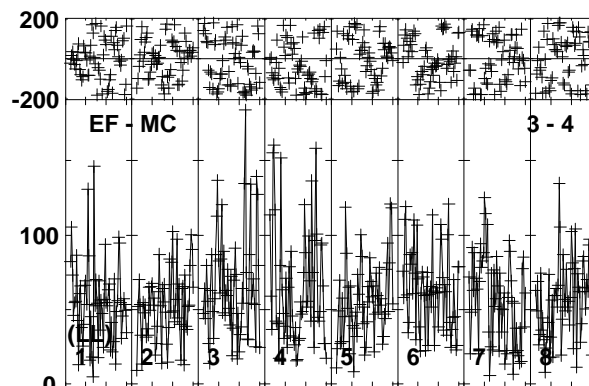
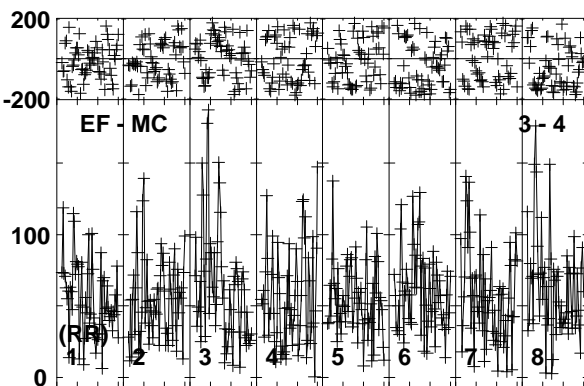
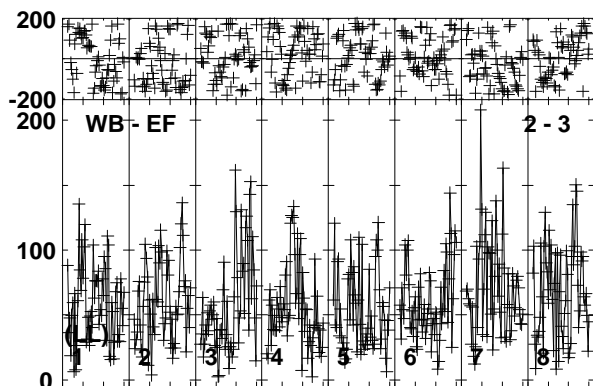
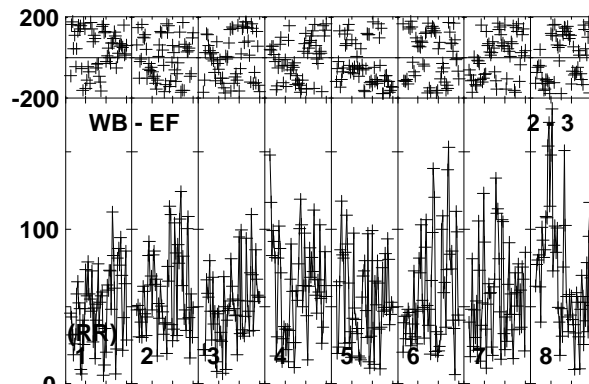
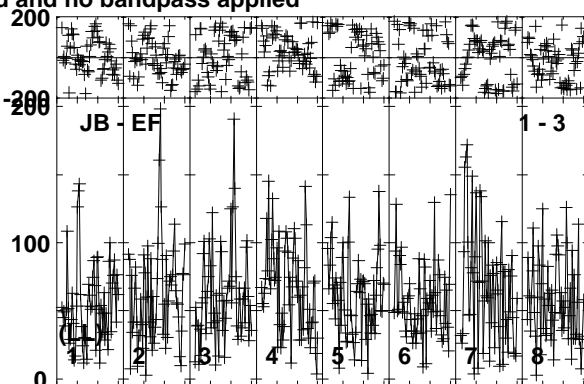
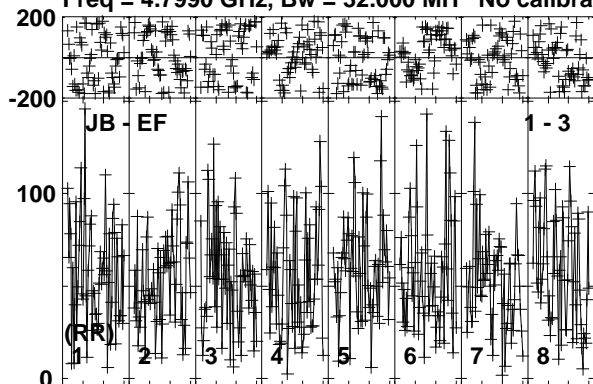

Lower frame: Micro Ampl Jy Top frame: Phas deg  
Vector averaged cross-power spectrum Baseline: JB (01) - EF (03)  
Timerange: 01/00:12:51 to 01/00:16:49

Plot file version 194 created 11-NOV-2019 15:07:38  
SER8NJ EK040B.UVDATA.1  
Freq = 4.7990 GHz, Bw = 32.000 MH No calibration applied and no bandpass applied

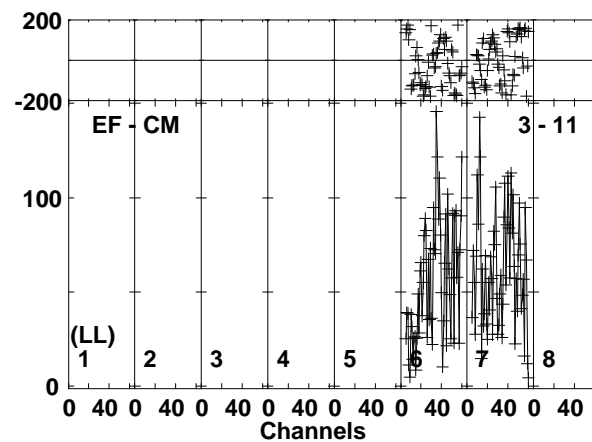
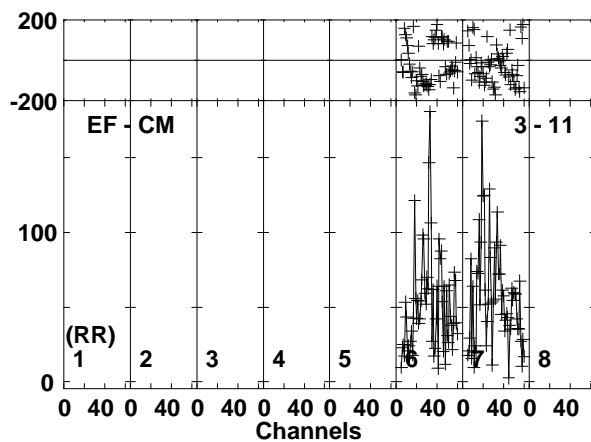
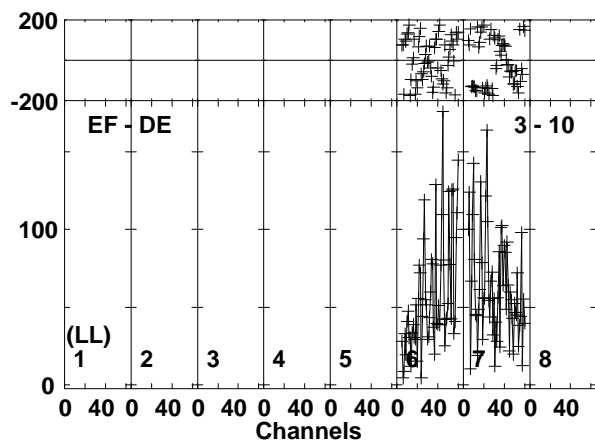
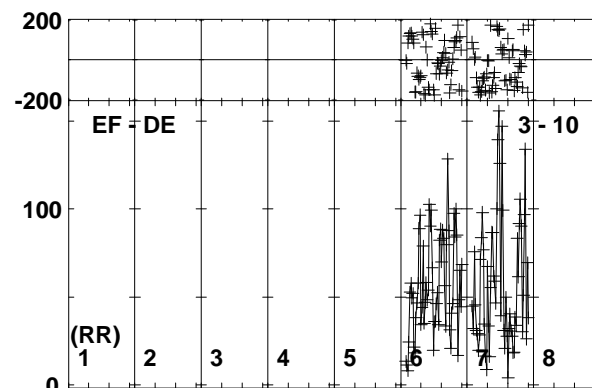
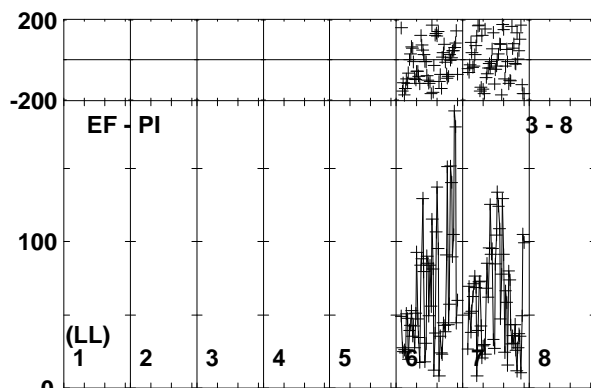
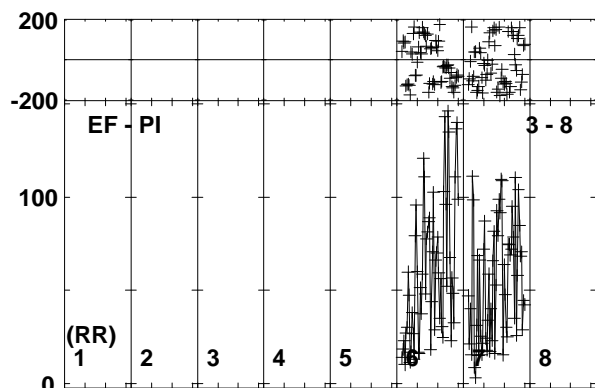
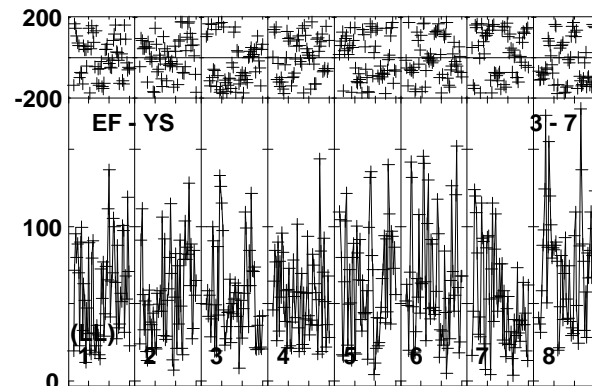
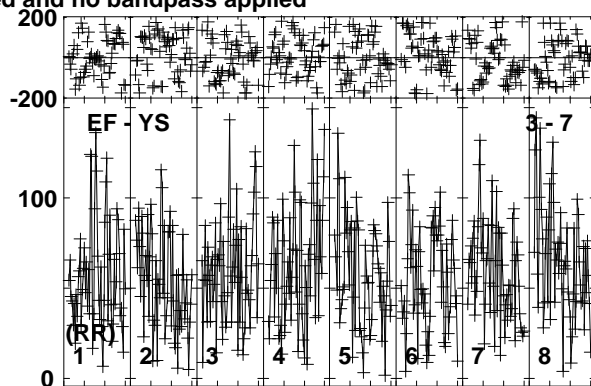
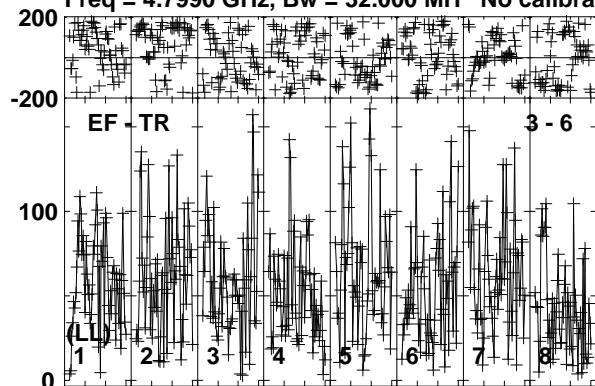

Lower frame: Micro Ampl Jy Top frame: Phas deg  
Vector averaged cross-power spectrum Baseline: EF (03) - TR (06)  
Timerange: 01/00:12:51 to 01/00:16:49



Plot file version 195 created 11-NOV-2019 15:07:38

SER8NJ EK040B.UVDATA.1

Freq = 4.7990 GHz, Bw = 32.000 MH No calibration applied and no bandpass applied

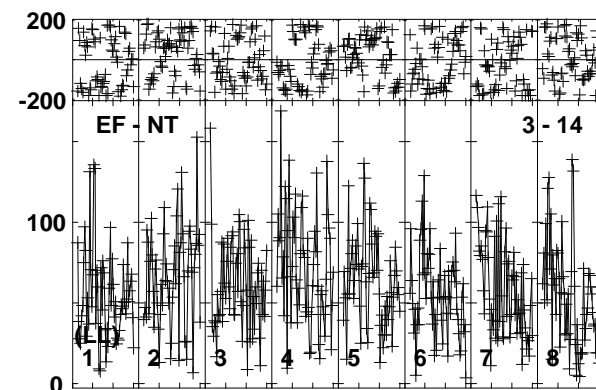
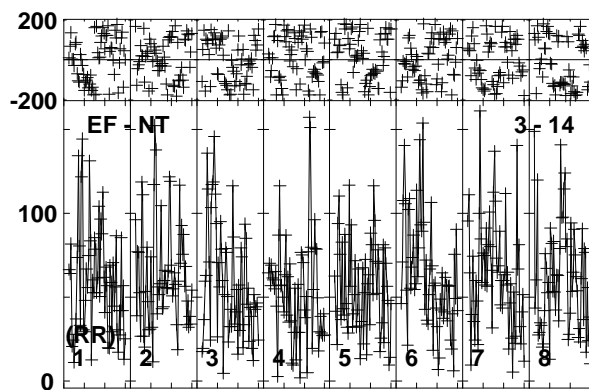
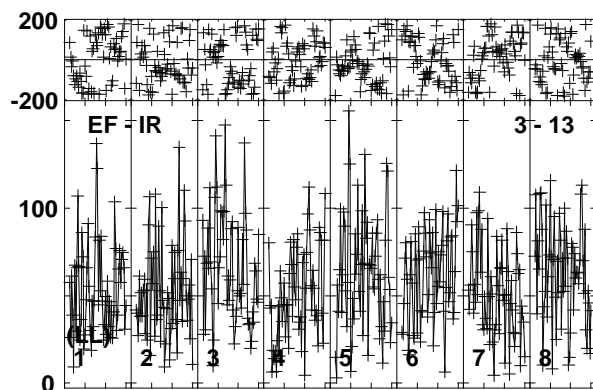
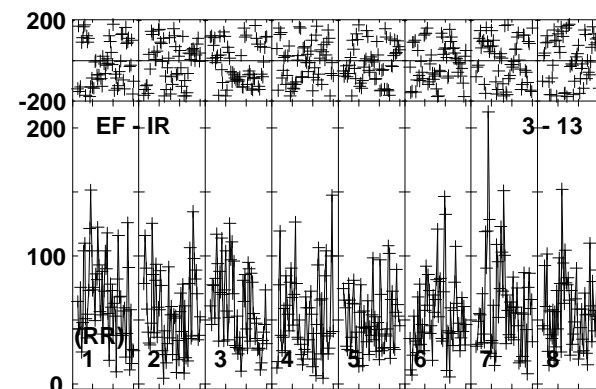
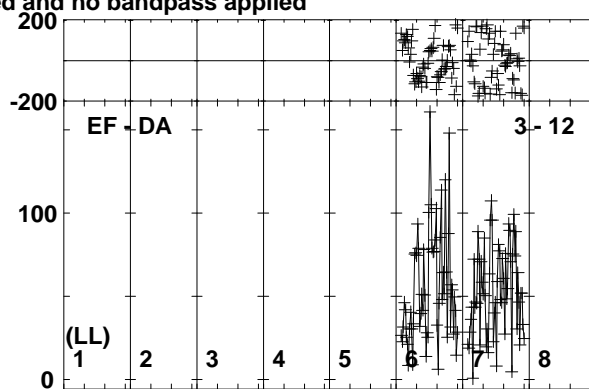
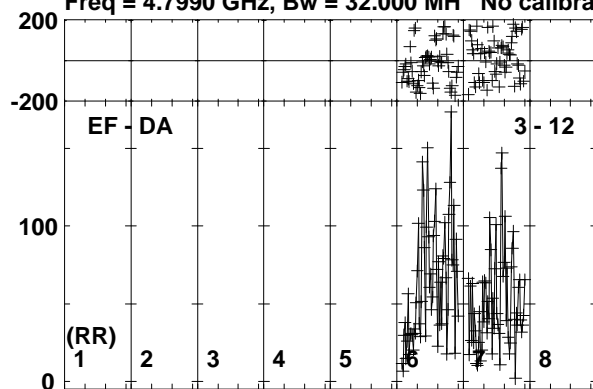

0 40 0 40 0 40 0 40 0 40 0 40 0 40 0 40 0 40  
Channels

Lower frame: Micro Ampl Jy Top frame: Phas deg  
Vector averaged cross-power spectrum Baseline: EF (03) - DA (12)  
Timerange: 01/00:12:51 to 01/00:16:49

Plot file version 196 created 11-NOV-2019 15:07:38

J1826+0149 EK040B.UVDATA.1

Freq = 4.7990 GHz, Bw = 32.000 MH No calibration applied and no bandpass applied

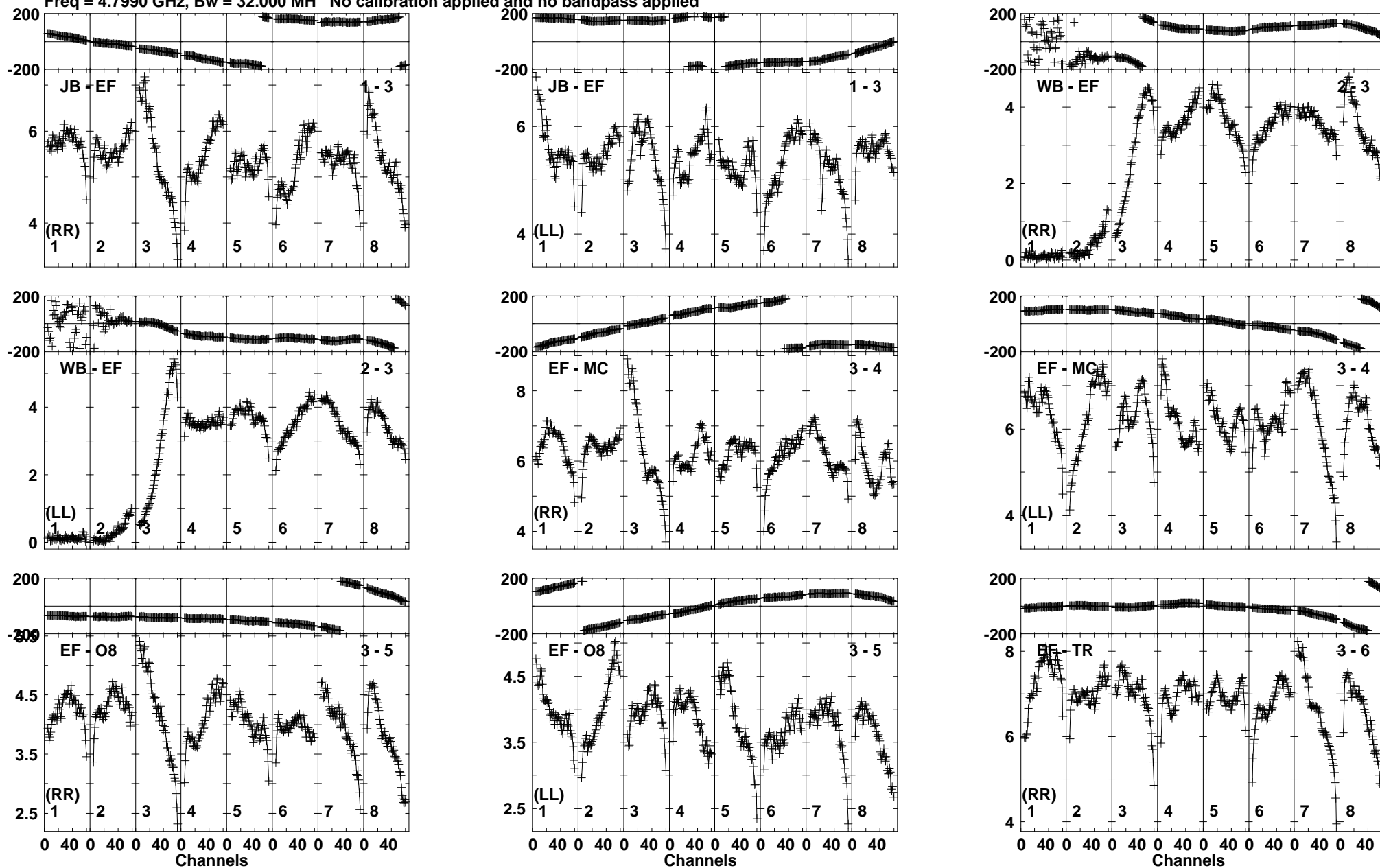

Lower frame: Milli Ampl Jy Top frame: Phas deg  
Vector averaged cross-power spectrum Baseline: JB (01) - EF (03)  
Timerange: 01/00:16:51 to 01/00:18:19

Plot file version 197 created 11-NOV-2019 15:07:38

J1826+0149 EK040B.UVDATA.1

Freq = 4.7990 GHz, Bw = 32.000 MH No calibration applied and no bandpass applied

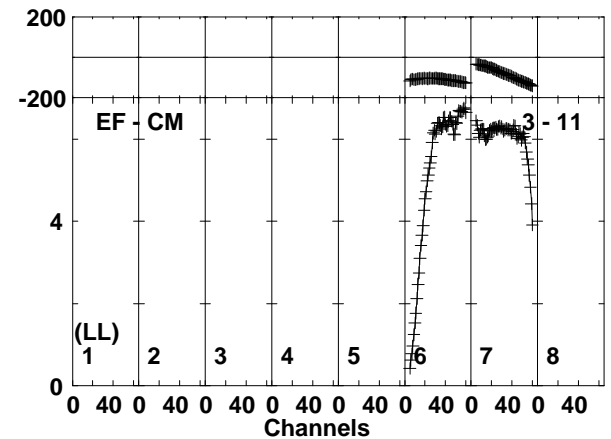
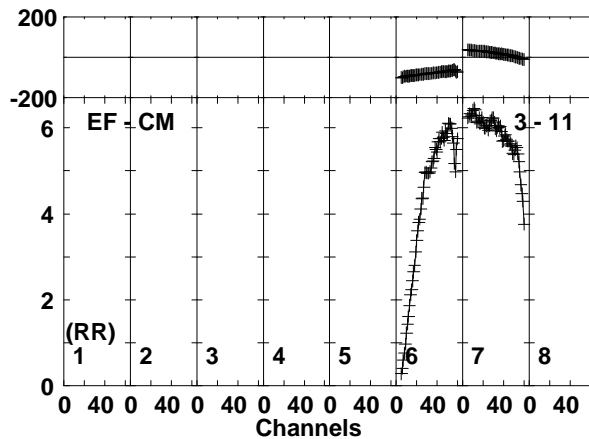
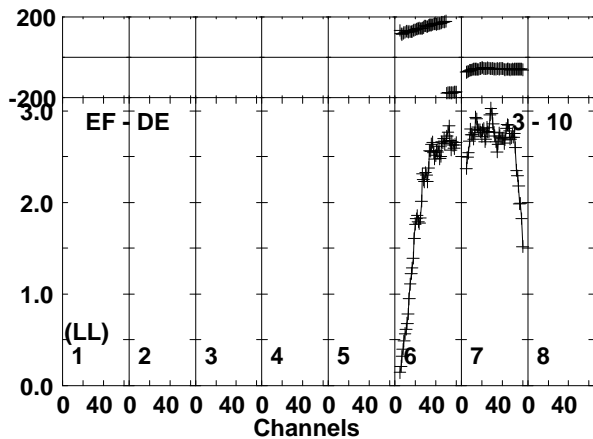
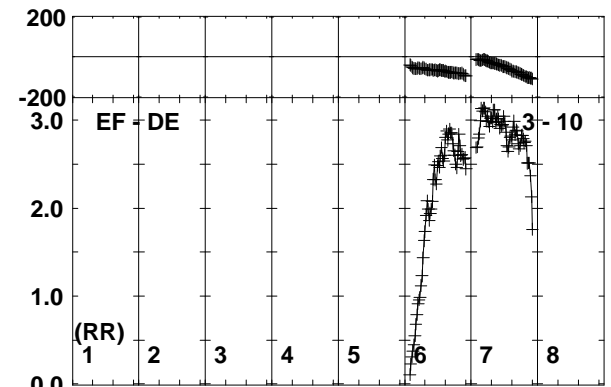
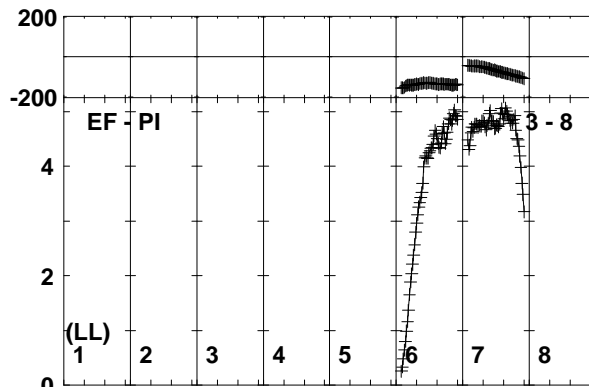
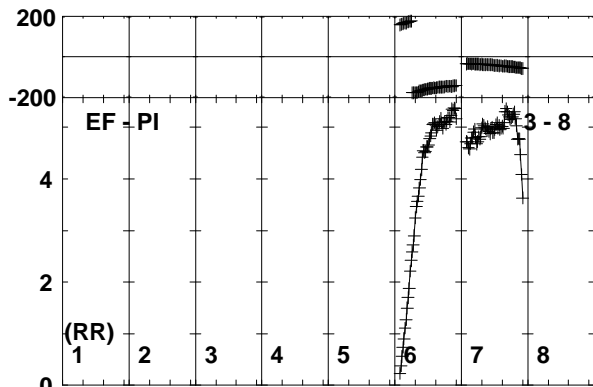
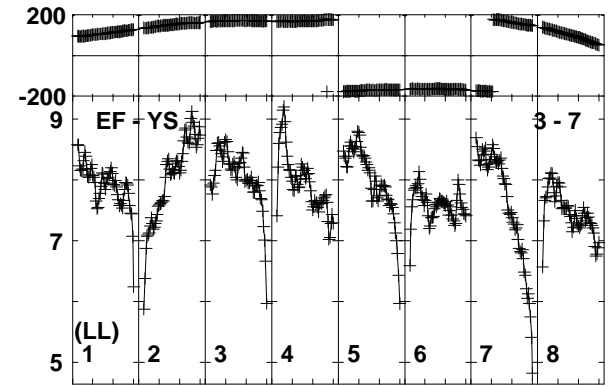
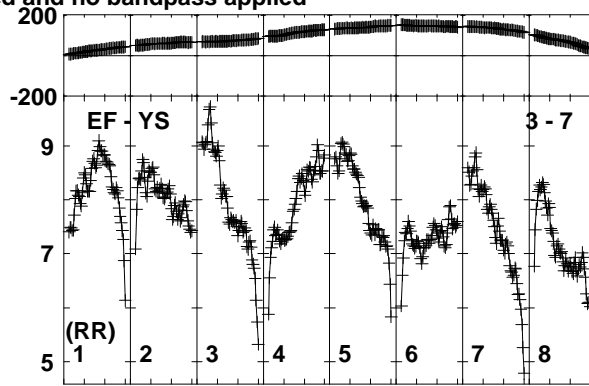
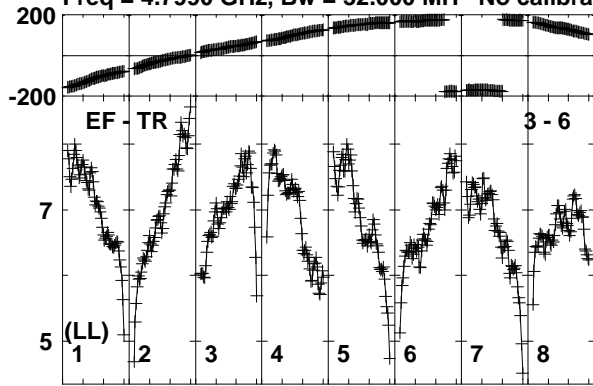

Lower frame: Milli Ampl Jy Top frame: Phas deg  
Vector averaged cross-power spectrum Baseline: EF (03) - TR (06)  
Timerange: 01/00:16:51 to 01/00:18:19

Plot file version 198 created 11-NOV-2019 15:07:38

J1826+0149 EK040B.UVDATA.1

Freq = 4.7990 GHz, Bw = 32.000 MH No calibration applied and no bandpass applied

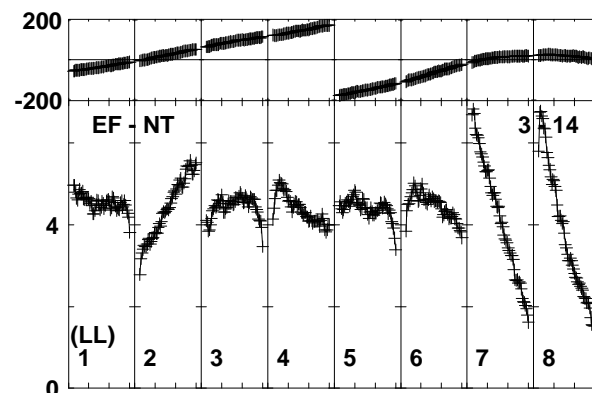
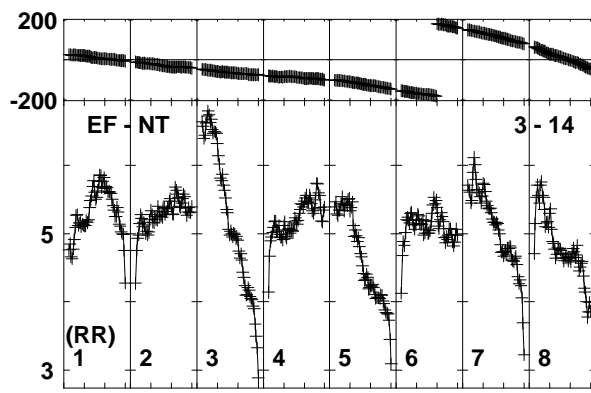
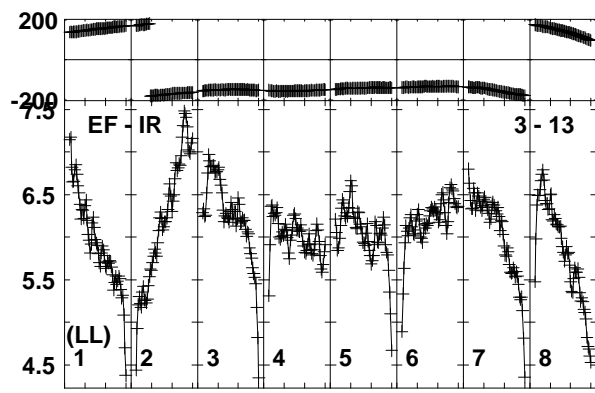
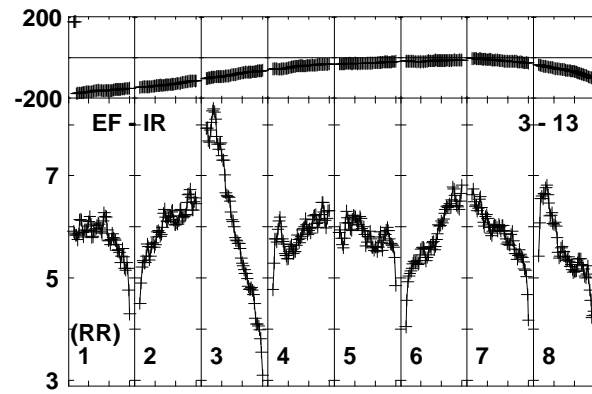
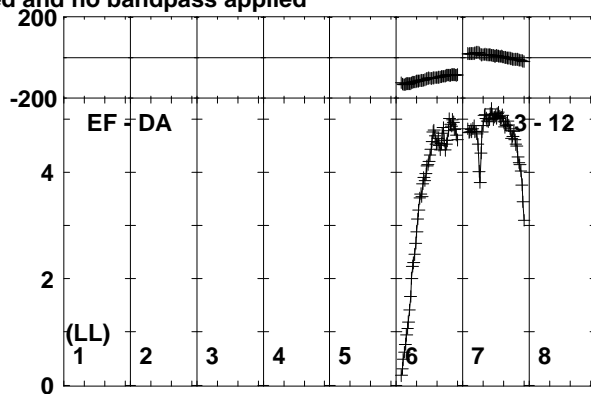
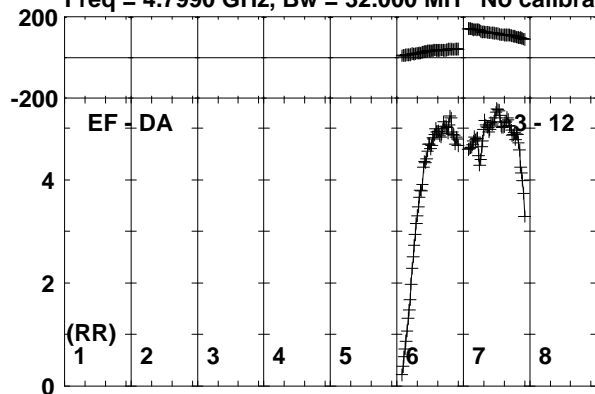

Channels

Lower frame: Milli Ampl Jy Top frame: Phas deg  
Vector averaged cross-power spectrum Baseline: EF (03) - DA (12)  
Timerange: 01/00:16:51 to 01/00:18:19

Plot file version 199 created 11-NOV-2019 15:07:38

SER8NJ EK040B.UVDATA.1

Freq = 4.7990 GHz, Bw = 32.000 MH No calibration applied and no bandpass applied

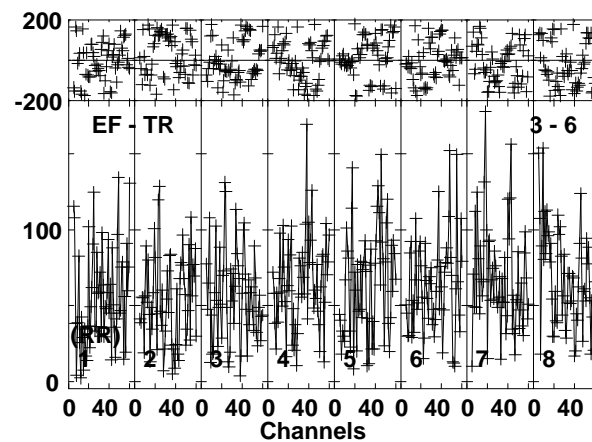
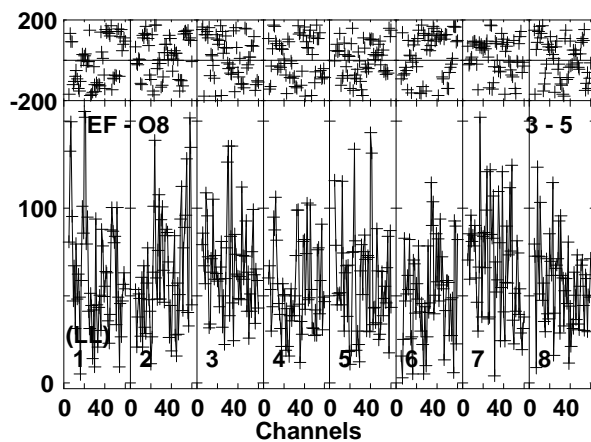
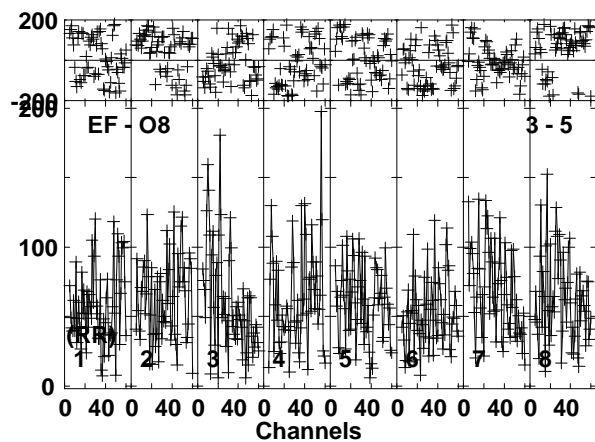
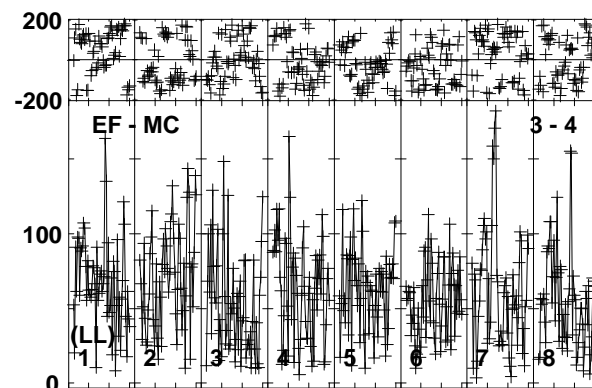
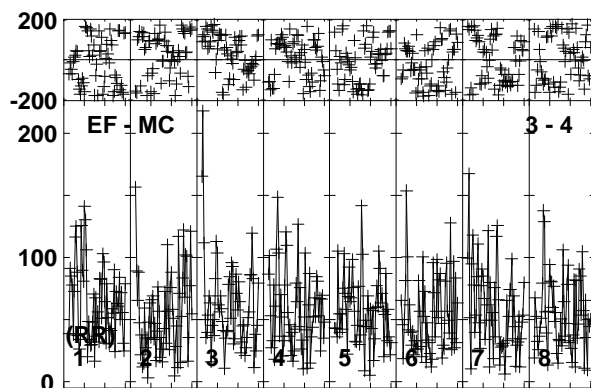
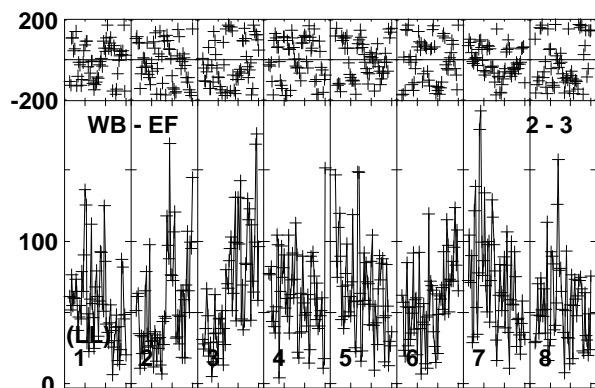
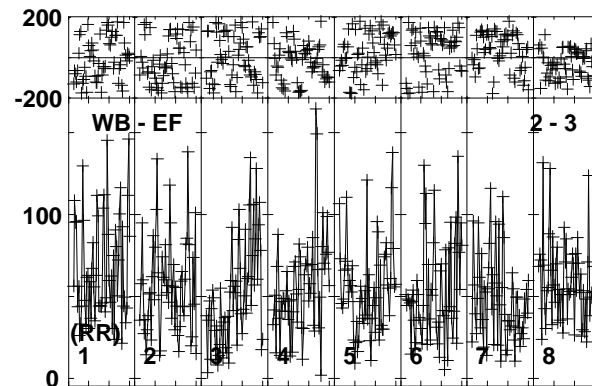
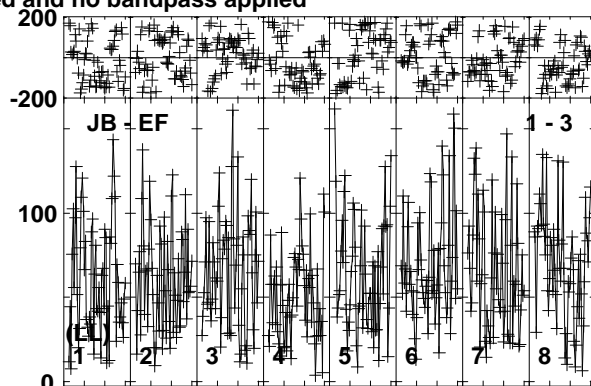
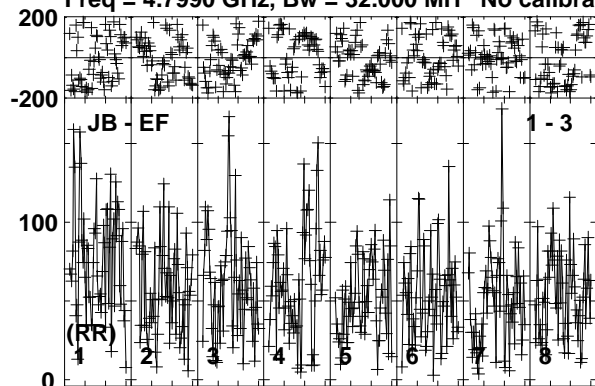

Lower frame: Micro Ampl Jy Top frame: Phas deg  
Vector averaged cross-power spectrum Baseline: JB (01) - EF (03)  
Timerange: 01/00:18:23 to 01/00:22:19

Plot file version 200 created 11-NOV-2019 15:07:38

SER8NJ EK040B.UVDATA.1

Freq = 4.7990 GHz, Bw = 32.000 MH No calibration applied and no bandpass applied

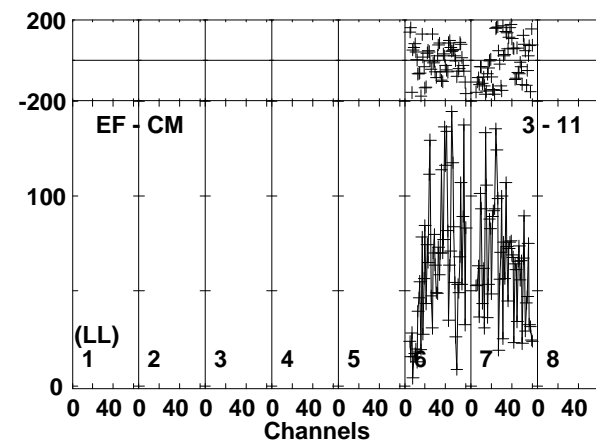
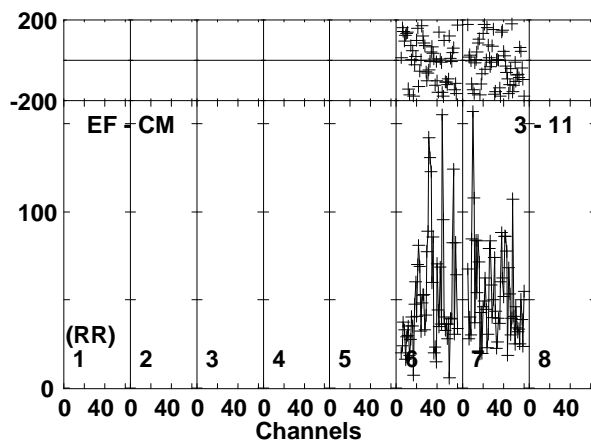
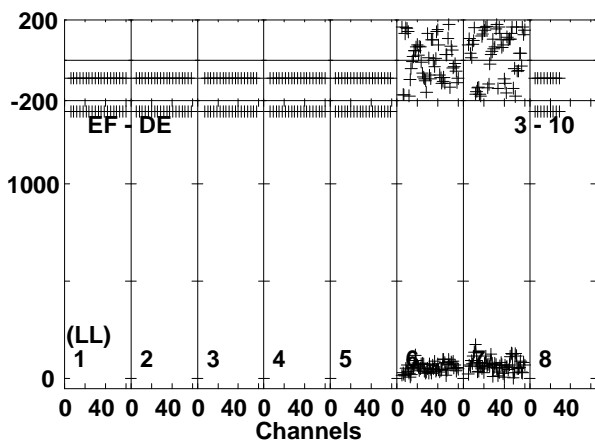
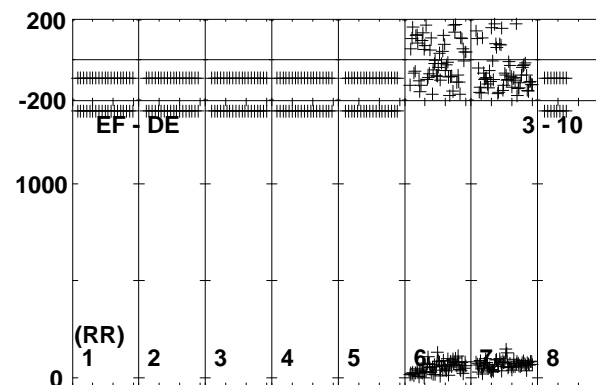
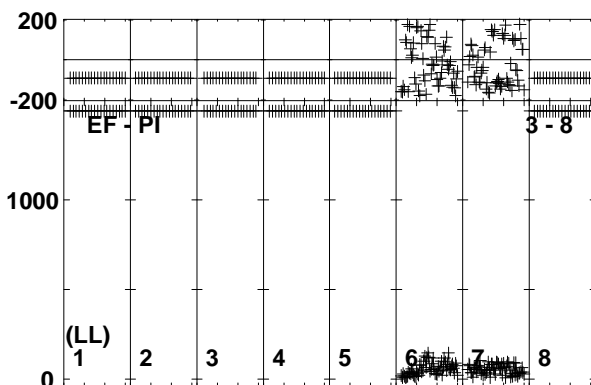
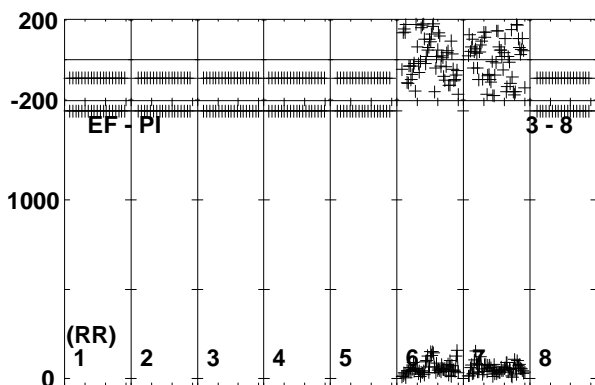
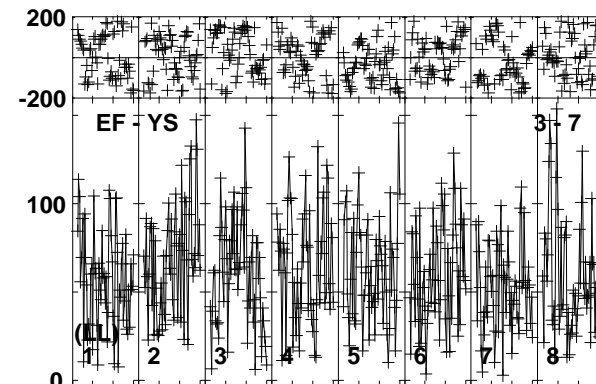
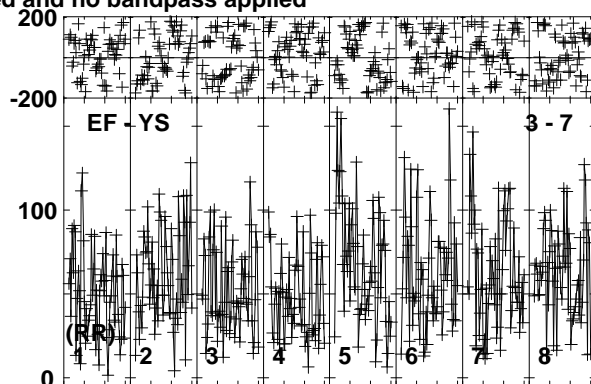
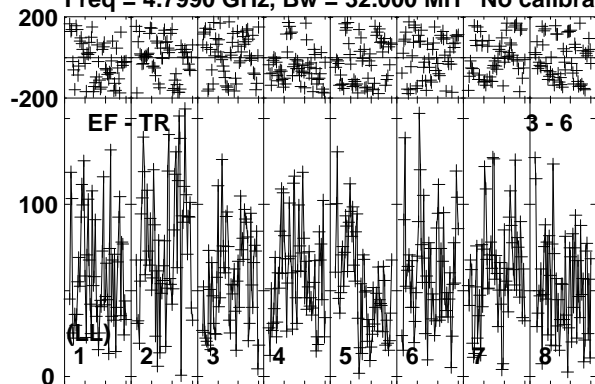

Lower frame: Micro Ampl Jy Top frame: Phas deg  
Vector averaged cross-power spectrum Baseline: EF (03) - TR (06)  
Timerange: 01/00:18:23 to 01/00:22:19

Plot file version 201 created 11-NOV-2019 15:07:39

SER8NJ EK040B.UVDATA.1

Freq = 4.7990 GHz, Bw = 32.000 MH No calibration applied and no bandpass applied

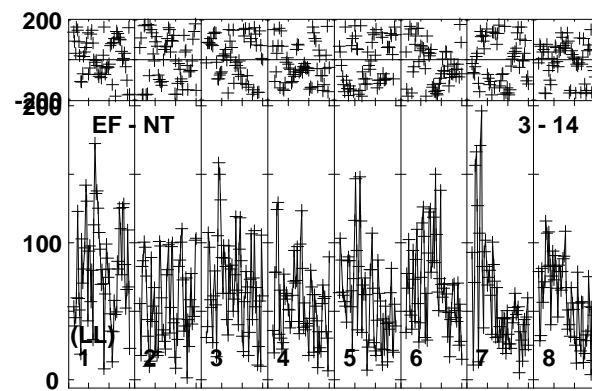
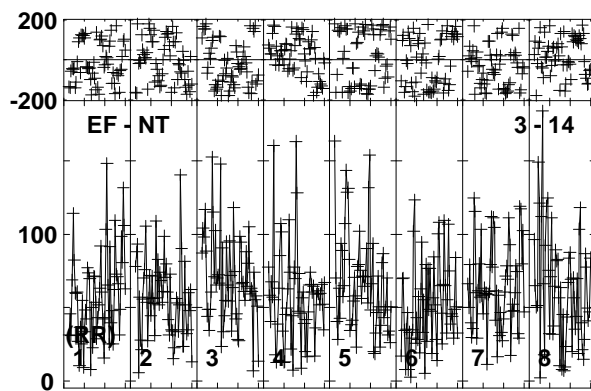
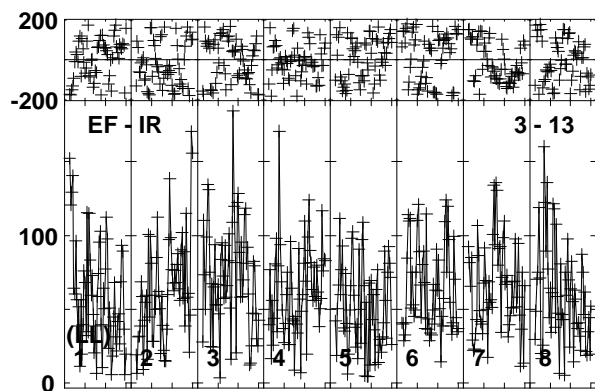
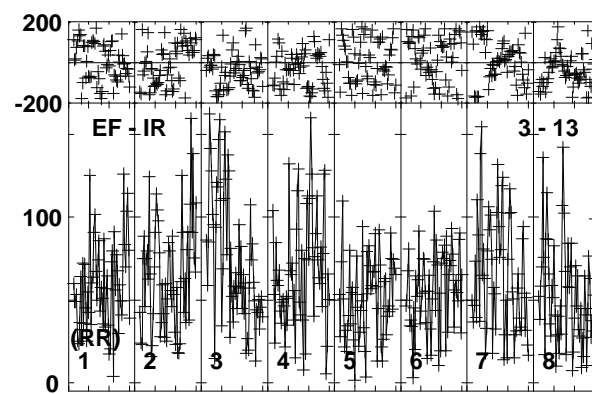
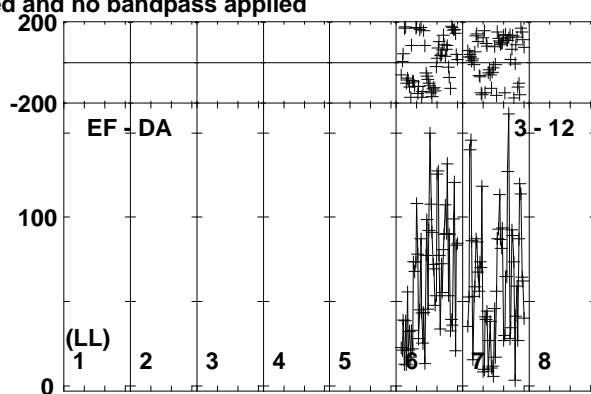
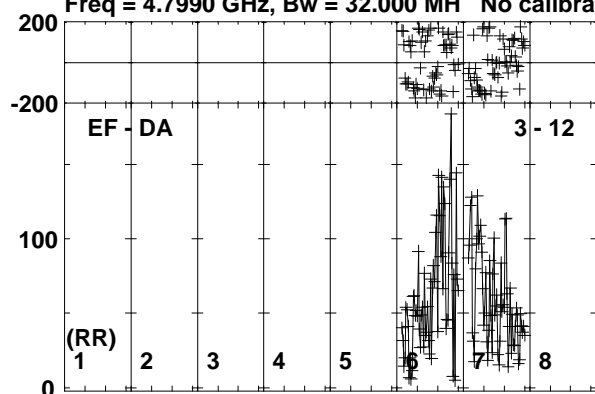

0 40 0 40 0 40 0 40 0 40 0 40 0 40 0 40 0 40 0 40  
Channels

Lower frame: Micro Ampl Jy Top frame: Phas deg  
Vector averaged cross-power spectrum Baseline: EF (03) - DA (12)  
Timerange: 01/00:18:23 to 01/00:22:19

Plot file version 202 created 11-NOV-2019 15:07:39

J1826+0149 EK040B.UVDATA.1

Freq = 4.7990 GHz, Bw = 32.000 MH No calibration applied and no bandpass applied

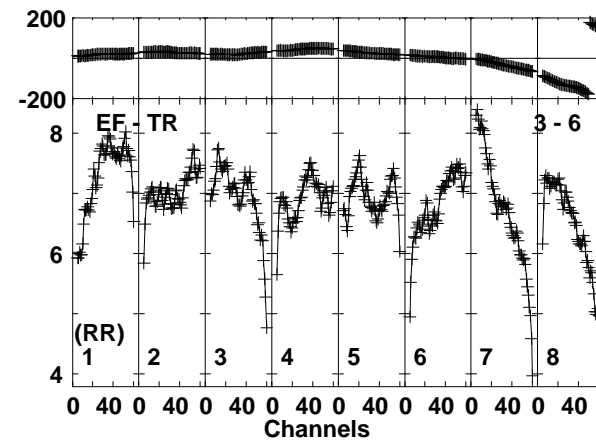
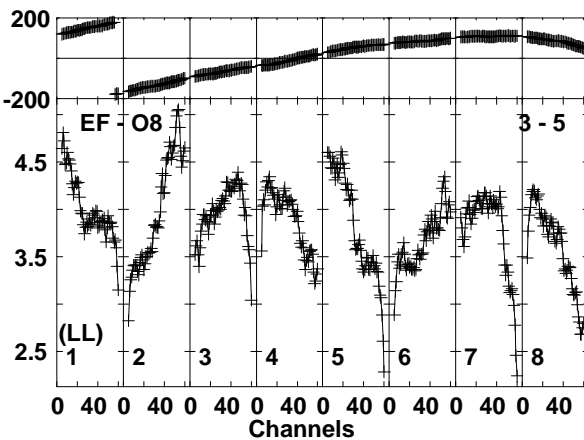
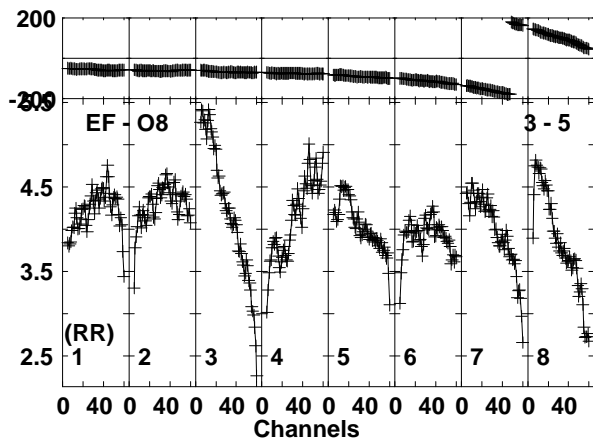
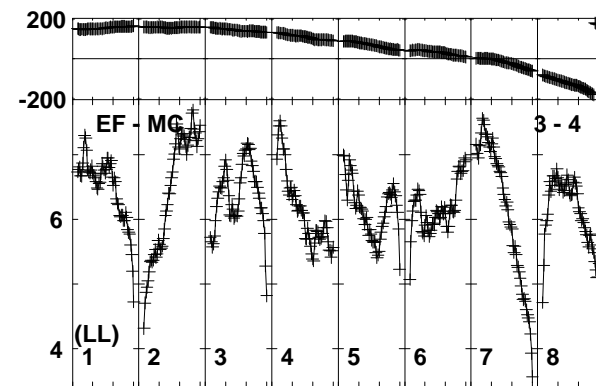
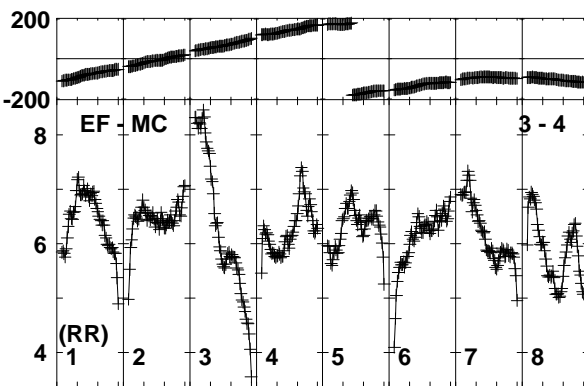
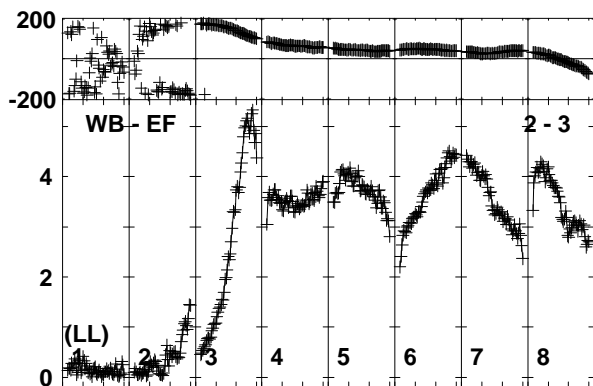
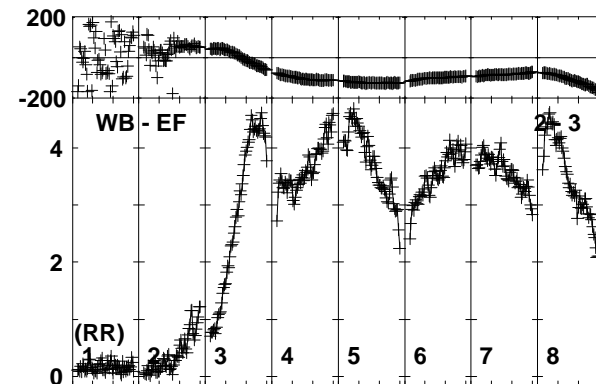
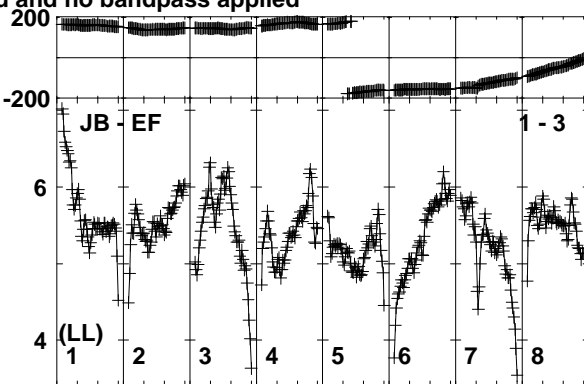
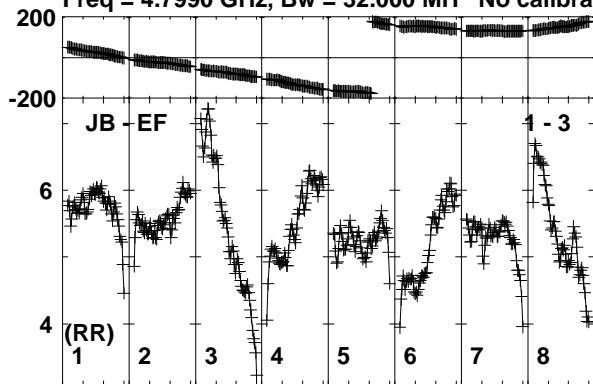

Lower frame: Milli Ampl Jy Top frame: Phas deg  
Vector averaged cross-power spectrum Baseline: JB (01) - EF (03)  
Timerange: 01/00:23:01 to 01/00:23:59



Plot file version 203 created 11-NOV-2019 15:07:39

J1826+0149 EK040B.UVDATA.1

Freq = 4.7990 GHz, Bw = 32.000 MH No calibration applied and no bandpass applied

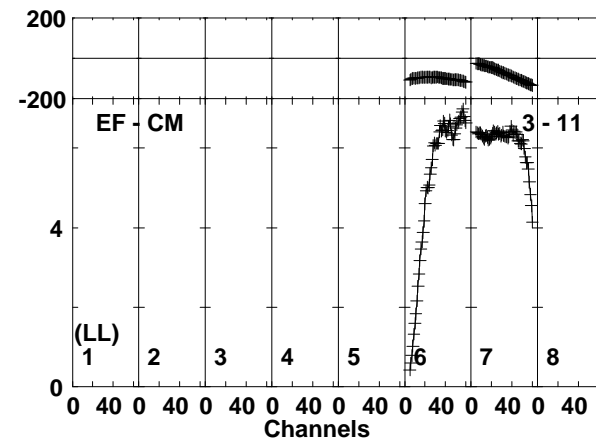
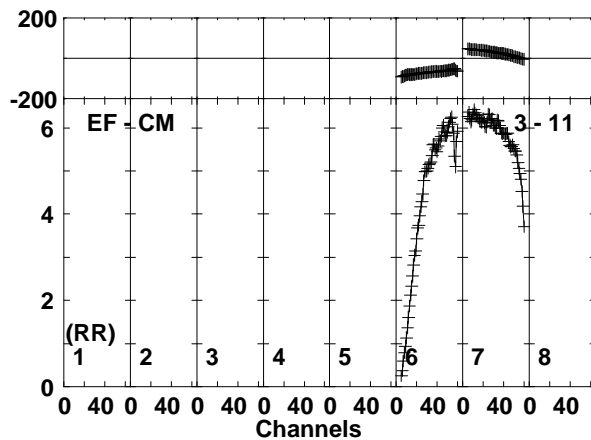
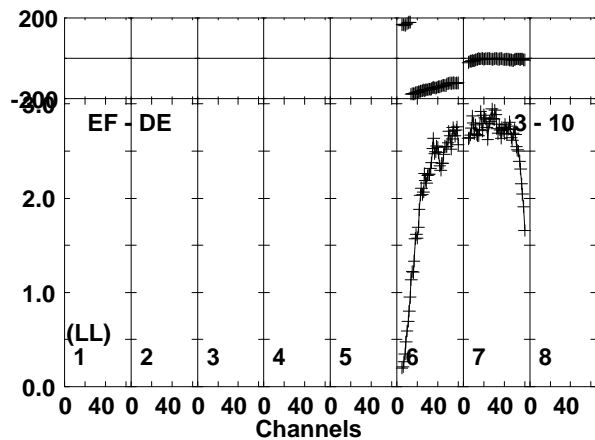
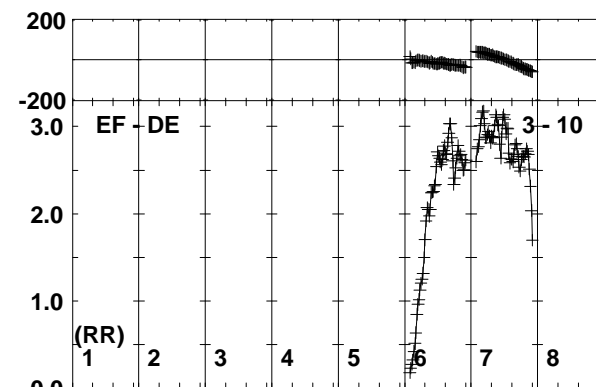
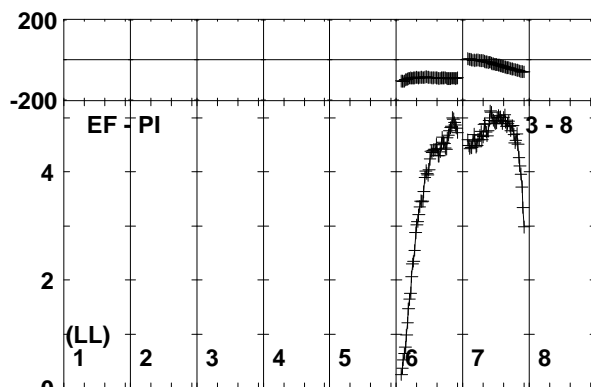
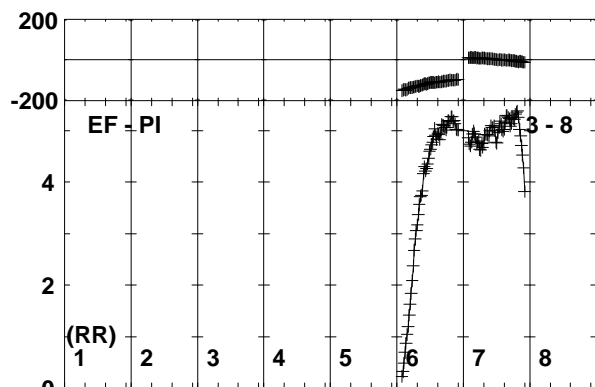
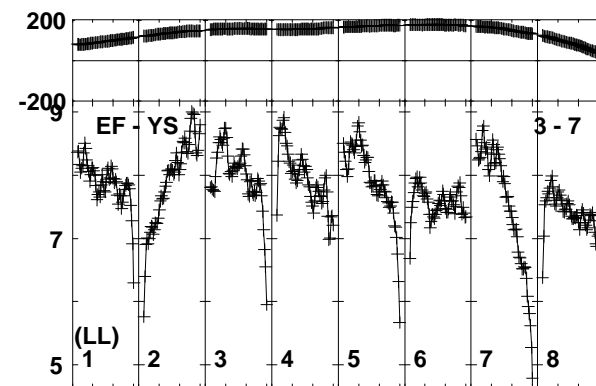
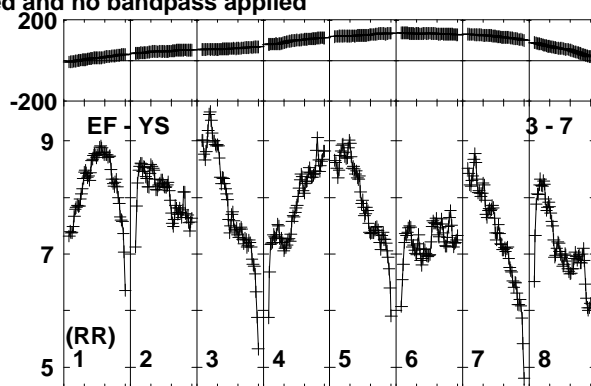
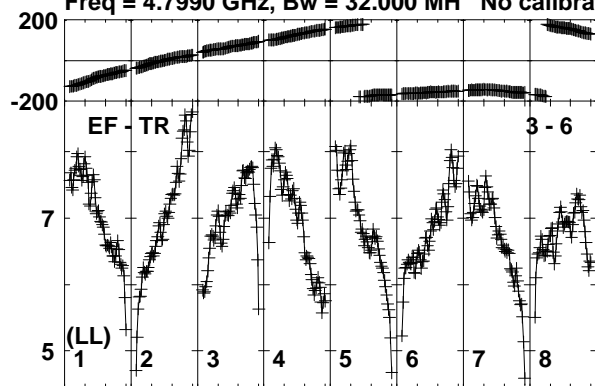

Lower frame: Milli Ampl Jy Top frame: Phas deg  
Vector averaged cross-power spectrum Baseline: EF (03) - TR (06)  
Timerange: 01/00:23:01 to 01/00:23:59

Plot file version 204 created 11-NOV-2019 15:07:39  
J1826+0149 EK040B.UVDATA.1

Freq = 4.7990 GHz, Bw = 32.000 MH No calibration applied and no bandpass applied

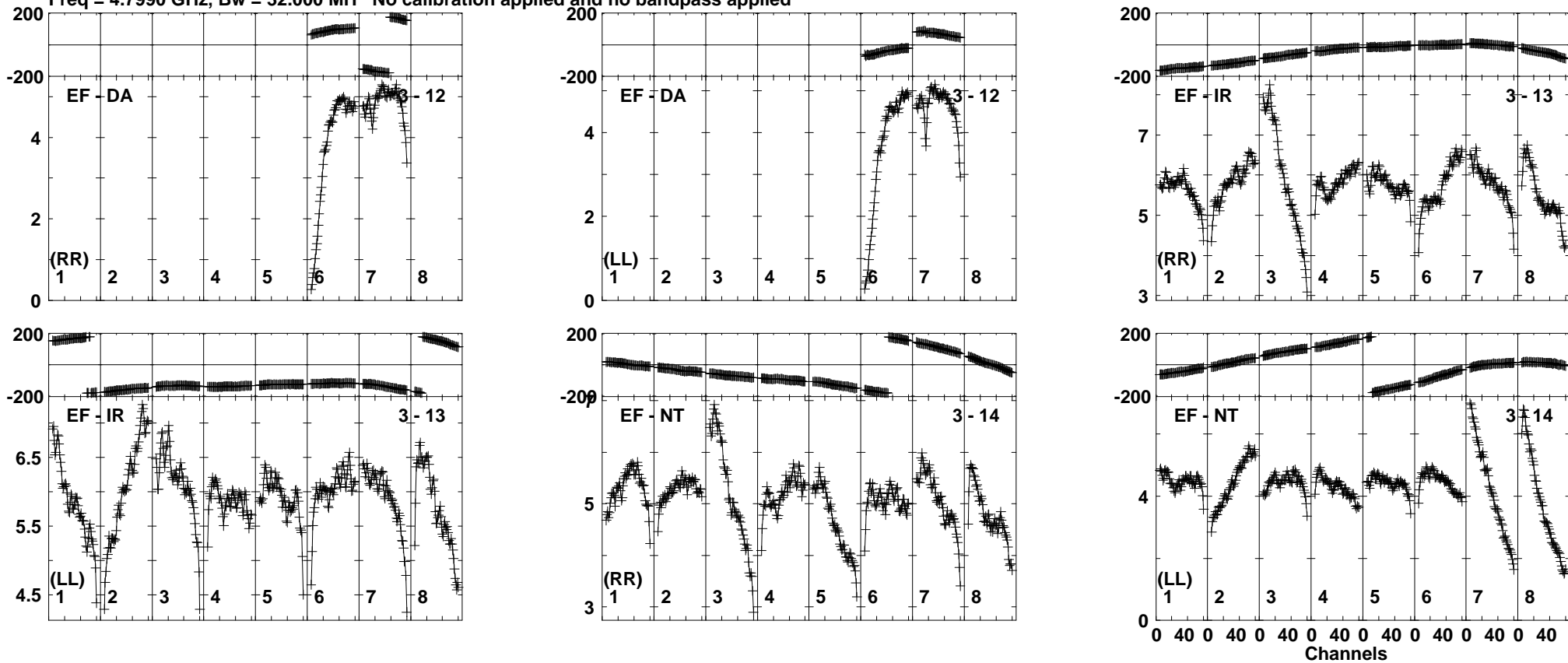

Lower frame: Milli Ampl Jy Top frame: Phas deg  
Vector averaged cross-power spectrum Baseline: EF (03) - DA (12)  
Timerange: 01/00:23:01 to 01/00:23:59

Plot file version 205 created 11-NOV-2019 15:07:39

SER8NJ EK040B.UVDATA.1

Freq = 4.7990 GHz, Bw = 32.000 MH No calibration applied and no bandpass applied

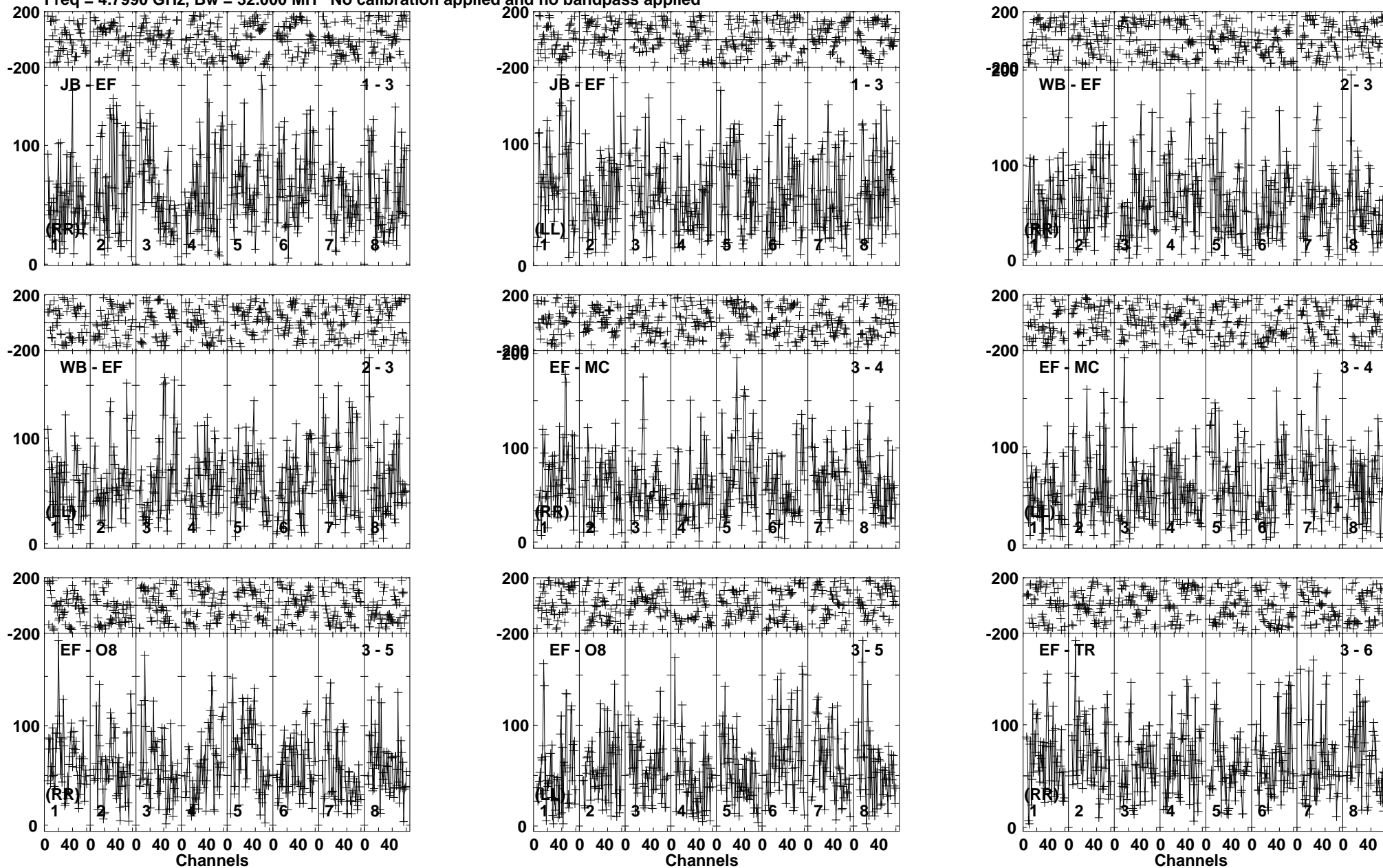

Lower frame: Micro Ampl Jy Top frame: Phas deg  
Vector averaged cross-power spectrum Baseline: JB (01) - EF (03)  
Timerange: 01/00:24:01 to 01/00:27:59

Plot file version 206 created 11-NOV-2019 15:07:39

SER8NJ EK040B.UVDATA.1

Freq = 4.7990 GHz, Bw = 32.000 MH No calibration applied and no bandpass applied

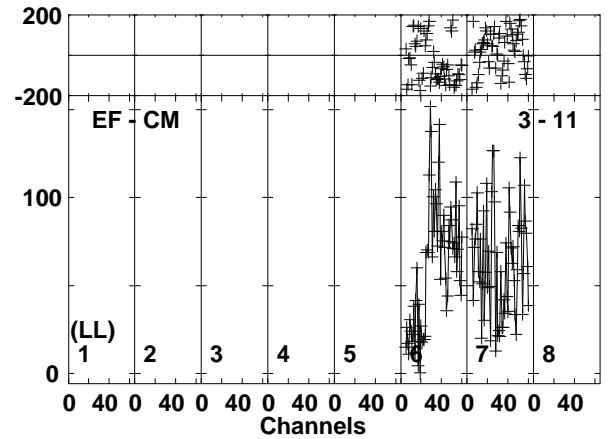
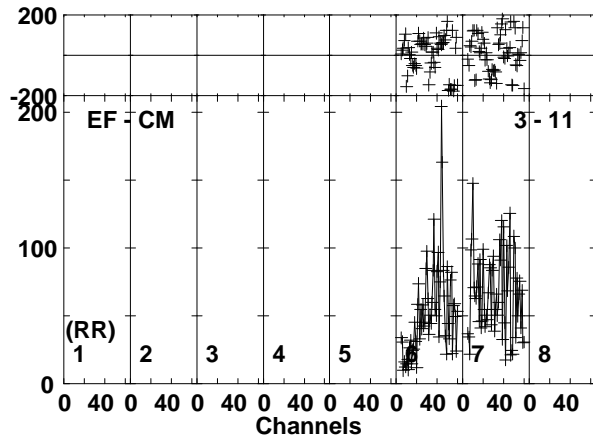
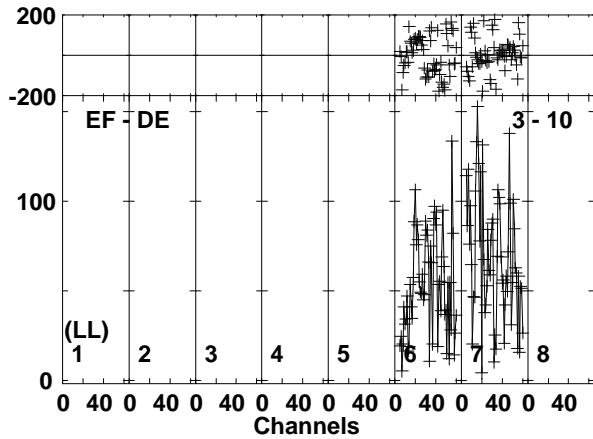
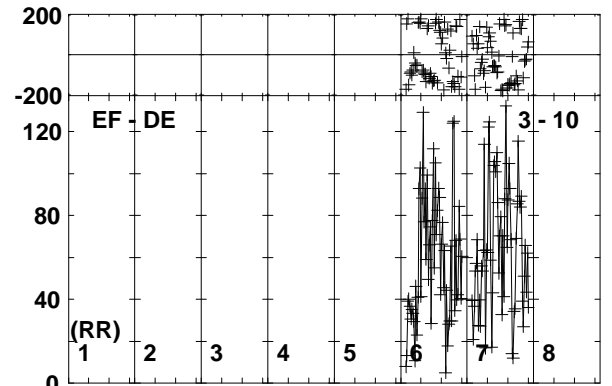
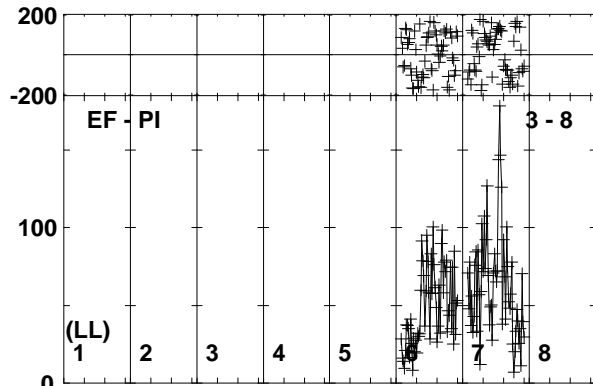
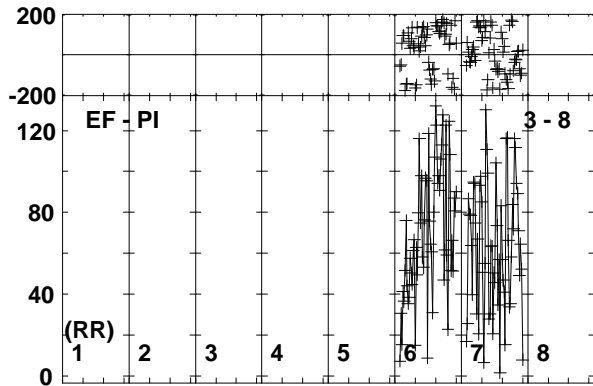
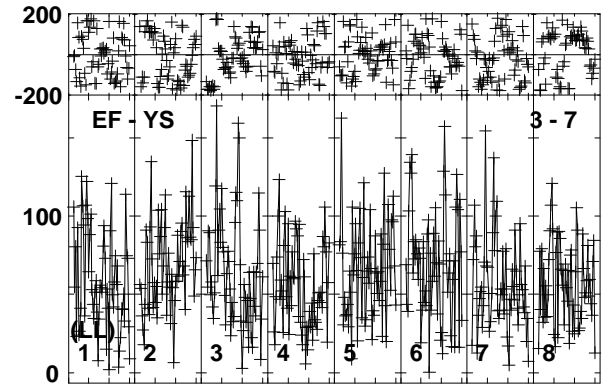
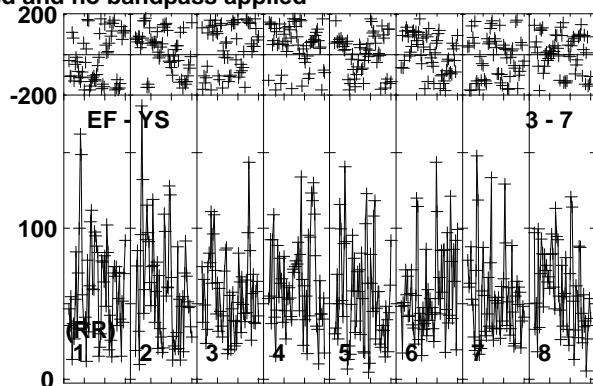
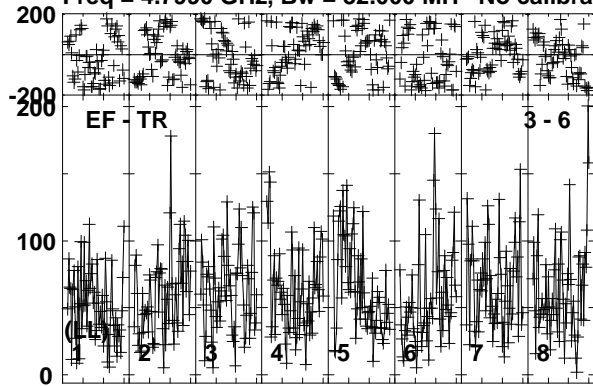

Lower frame: Micro Ampl Jy Top frame: Phas deg  
Vector averaged cross-power spectrum Baseline: EF (03) - TR (06)  
Timerange: 01/00:24:01 to 01/00:27:59

Plot file version 207 created 11-NOV-2019 15:07:39

SER8NJ EK040B.UVDATA.1

Freq = 4.7990 GHz, Bw = 32.000 MH No calibration applied and no bandpass applied

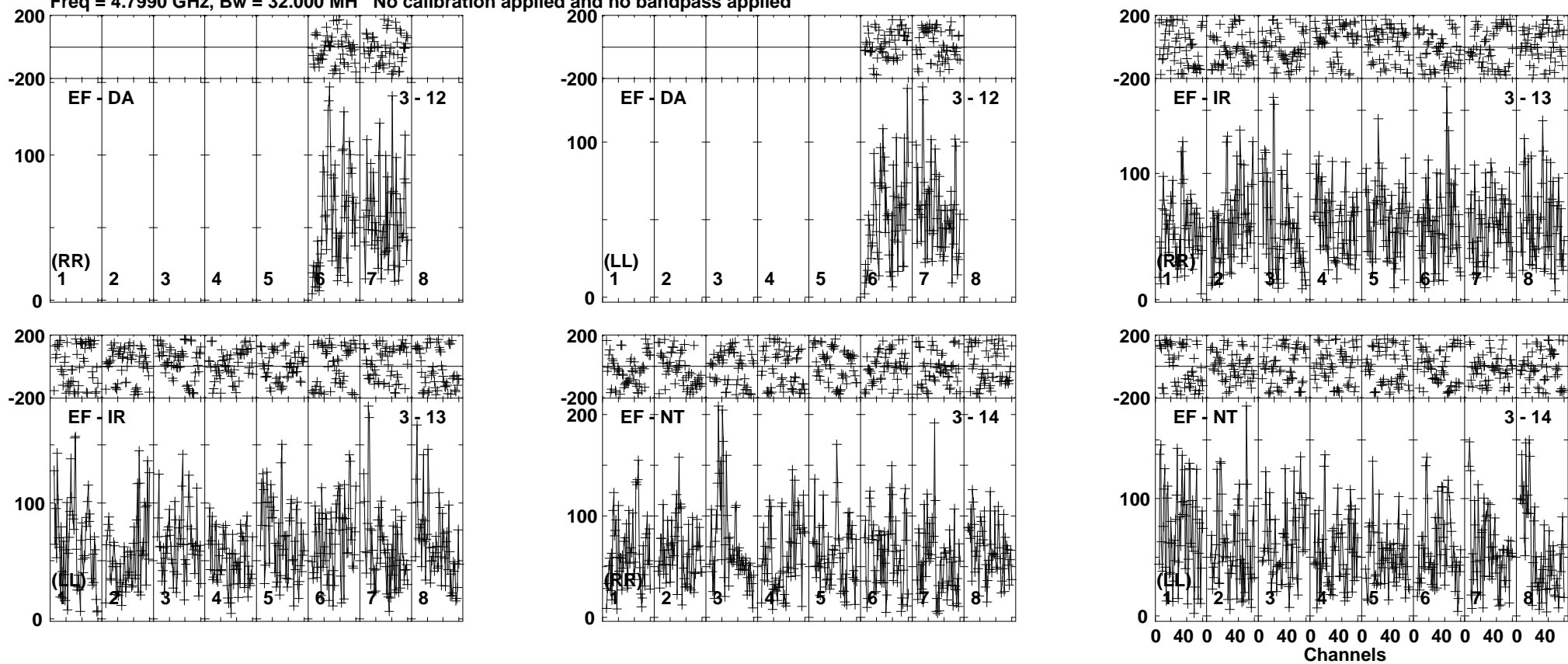

Lower frame: Micro Ampl Jy Top frame: Phas deg  
Vector averaged cross-power spectrum Baseline: EF (03) - DA (12)  
Timerange: 01/00:24:01 to 01/00:27:59

Plot file version 208 created 11-NOV-2019 15:07:39

J1826+0149 EK040B.UVDATA.1

Freq = 4.7990 GHz, Bw = 32.000 MH No calibration applied and no bandpass applied

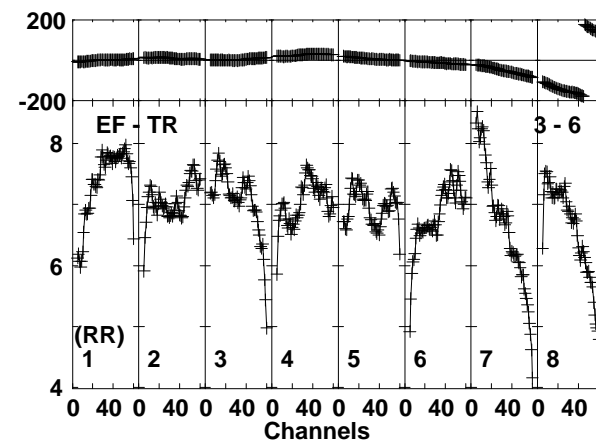
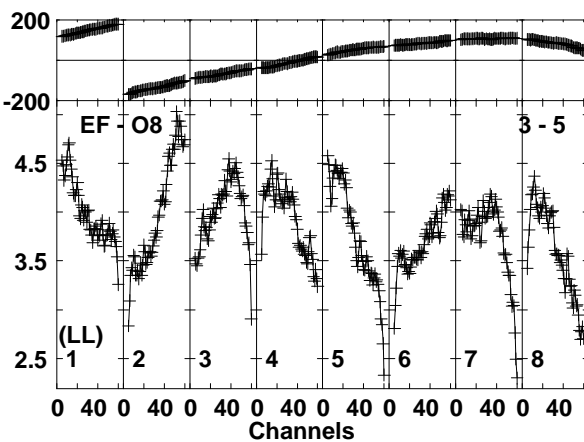
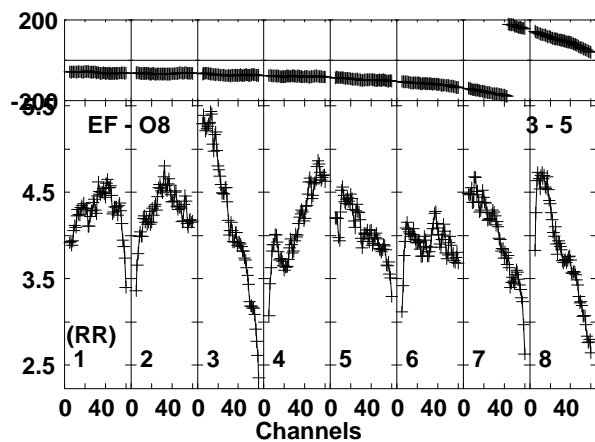
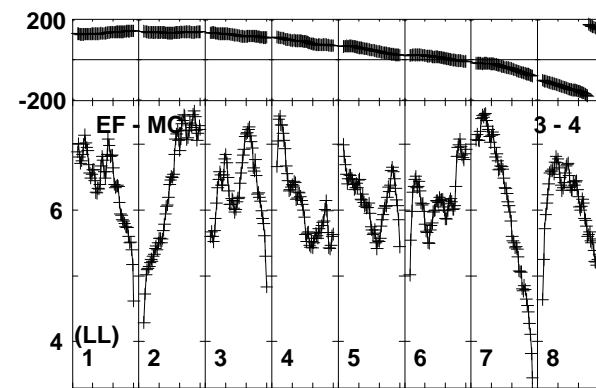
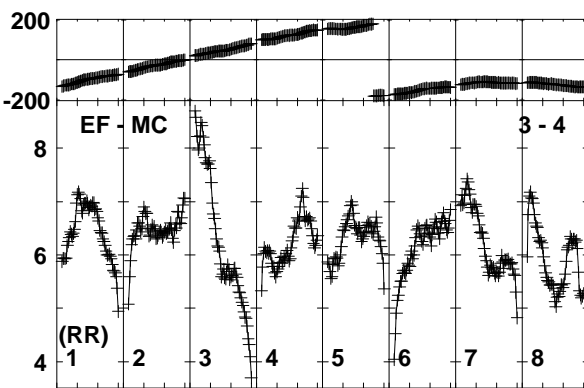
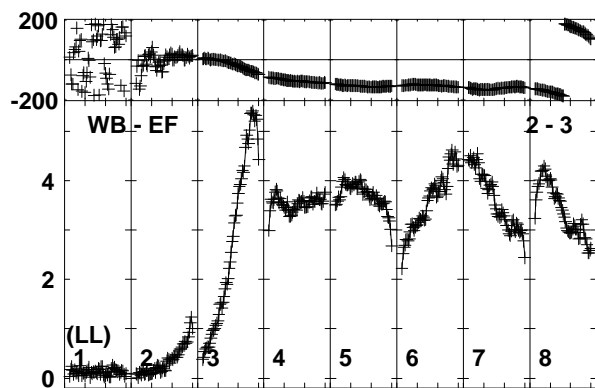
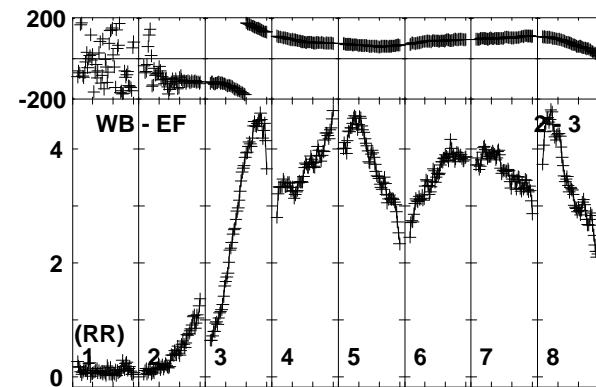
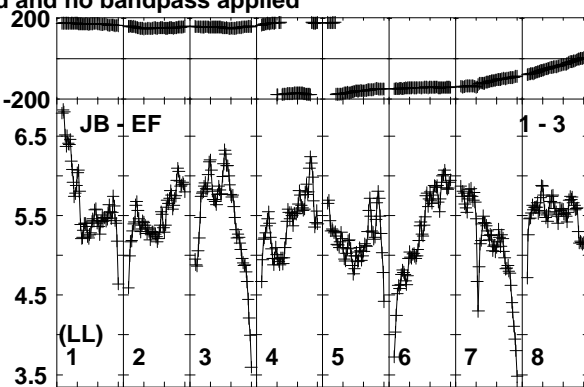
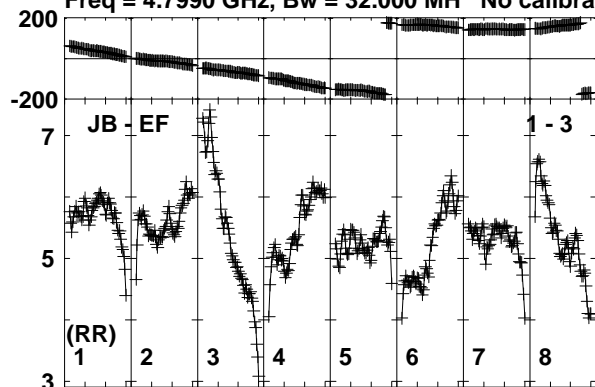

Lower frame: Milli Ampl Jy Top frame: Phas deg  
Vector averaged cross-power spectrum Baseline: JB (01) - EF (03)  
Timerange: 01/00:28:01 to 01/00:29:29

Plot file version 209 created 11-NOV-2019 15:07:39

J1826+0149 EK040B.UVDATA.1

Freq = 4.7990 GHz, Bw = 32.000 MH No calibration applied and no bandpass applied

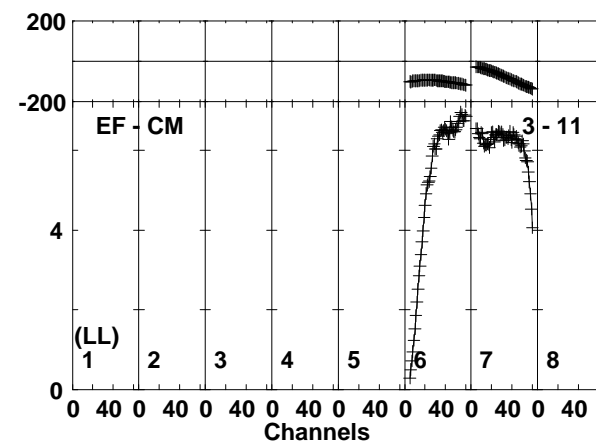
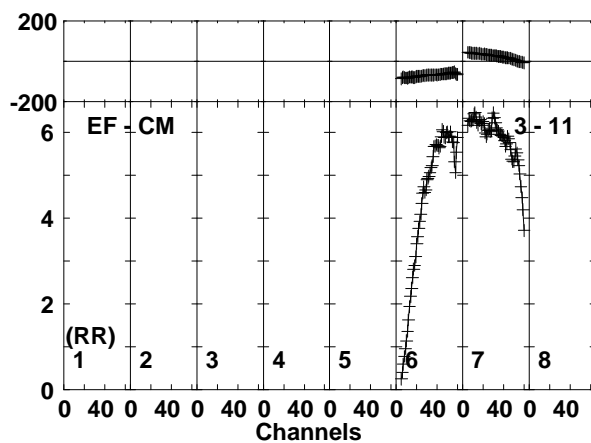
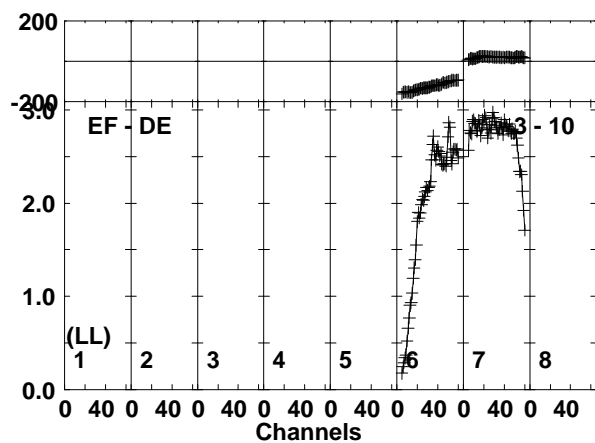
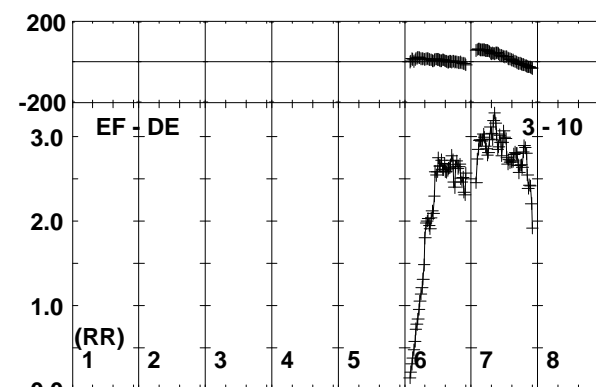
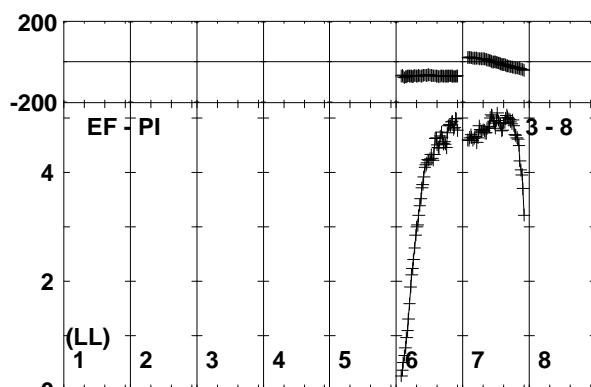
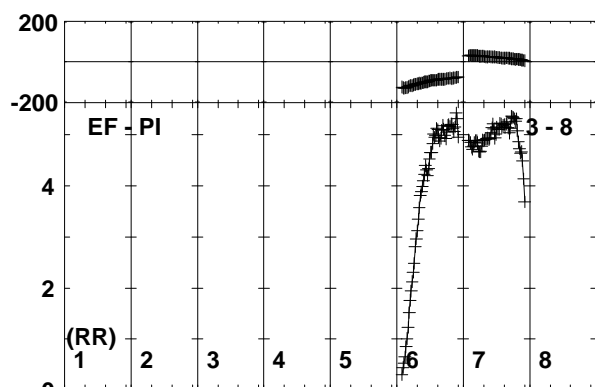
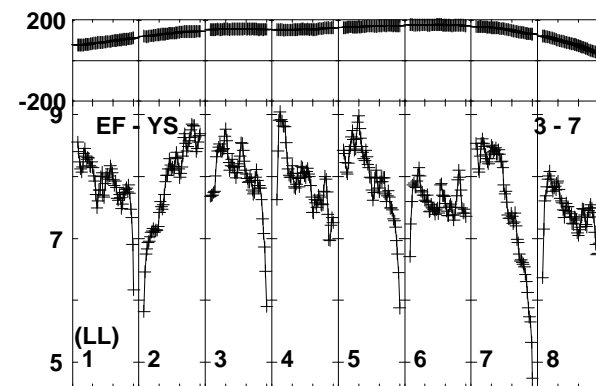
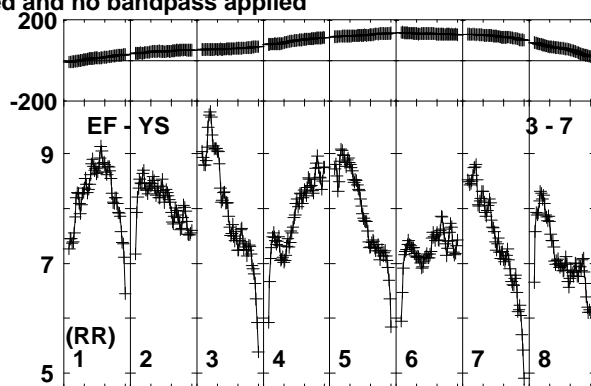
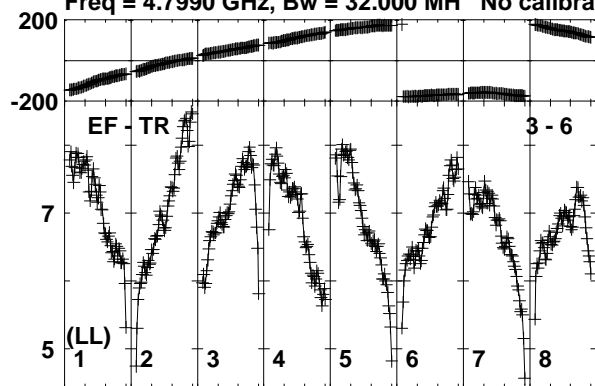

Lower frame: Milli Ampl Jy Top frame: Phas deg  
Vector averaged cross-power spectrum Baseline: EF (03) - TR (06)  
Timerange: 01/00:28:01 to 01/00:29:29

Plot file version 210 created 11-NOV-2019 15:07:40

J1826+0149 EK040B.UVDATA.1

Freq = 4.7990 GHz, Bw = 32.000 MH No calibration applied and no bandpass applied

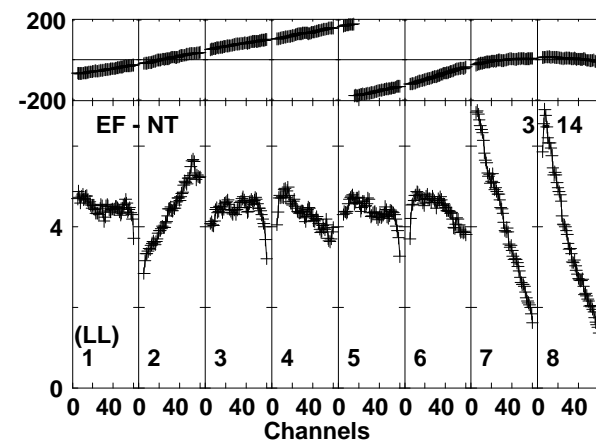
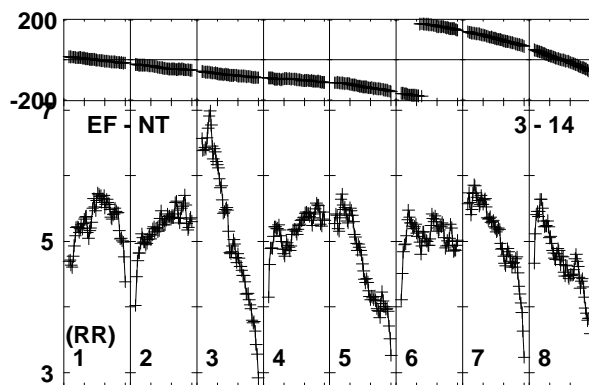
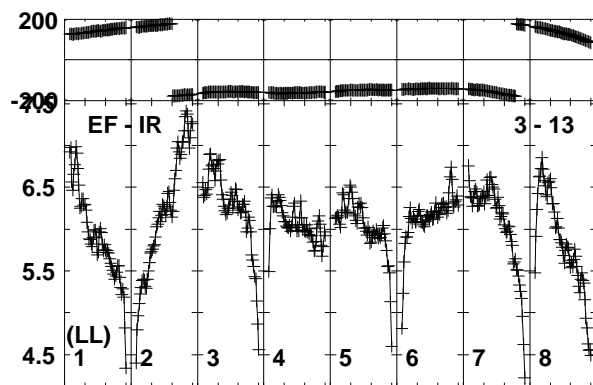
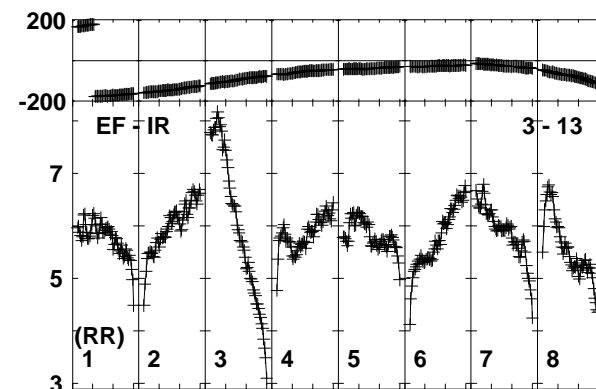
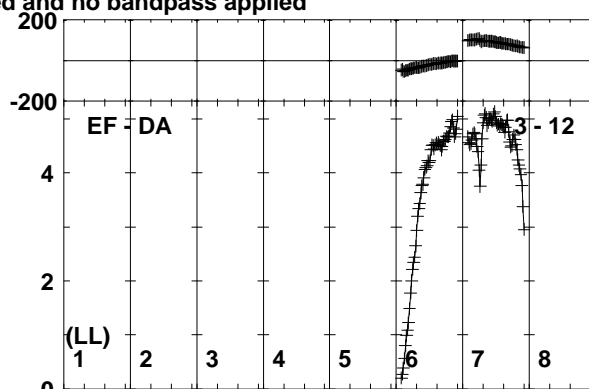
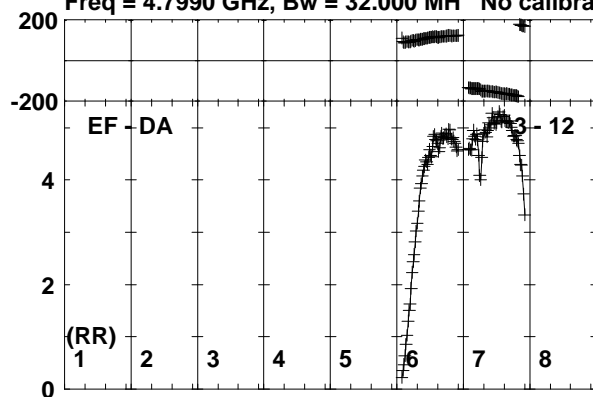

Lower frame: Milli Ampl Jy Top frame: Phas deg  
Vector averaged cross-power spectrum Baseline: EF (03) - DA (12)  
Timerange: 01/00:28:01 to 01/00:29:29



Plot file version 211 created 11-NOV-2019 15:07:40  
SER8NJ EK040B.UVDATA.1

Freq = 4.7990 GHz, Bw = 32.000 MH No calibration applied and no bandpass applied

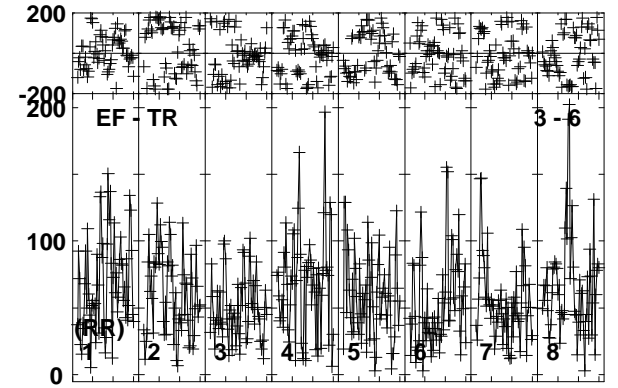
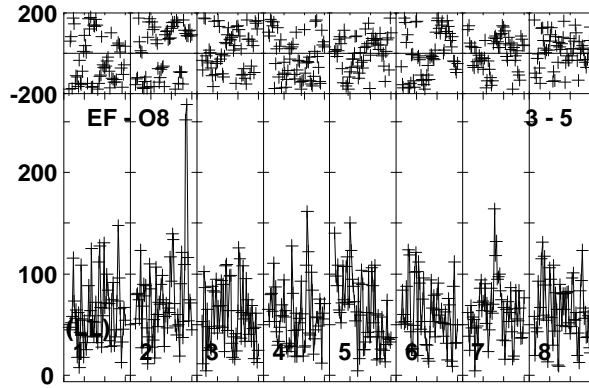
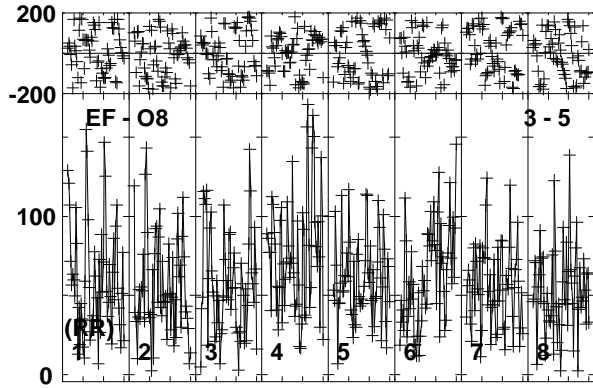
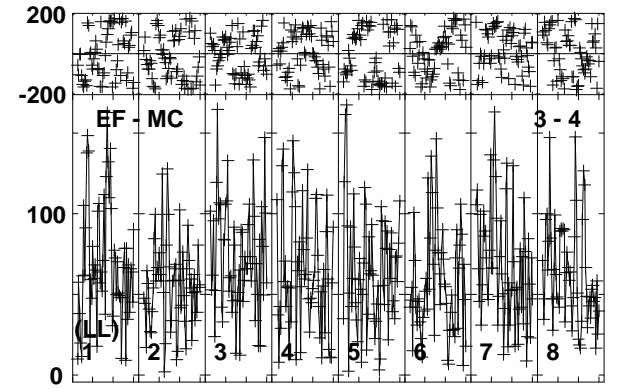
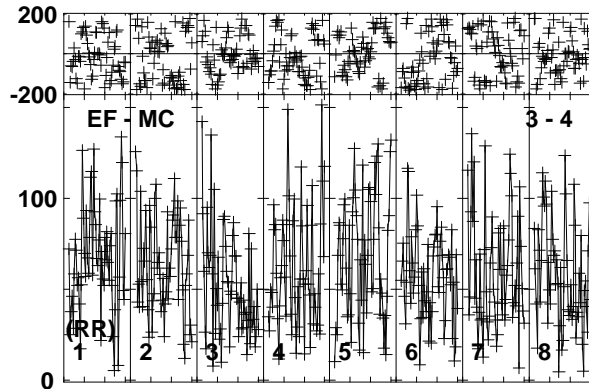
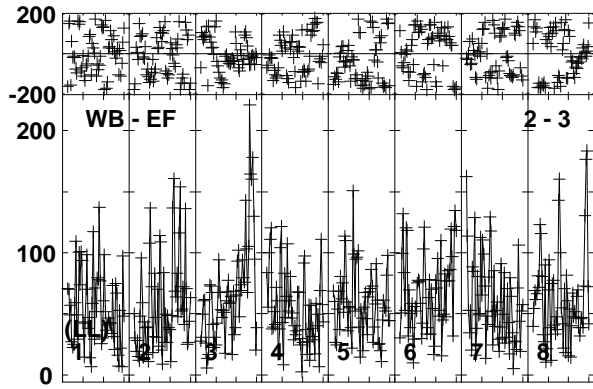
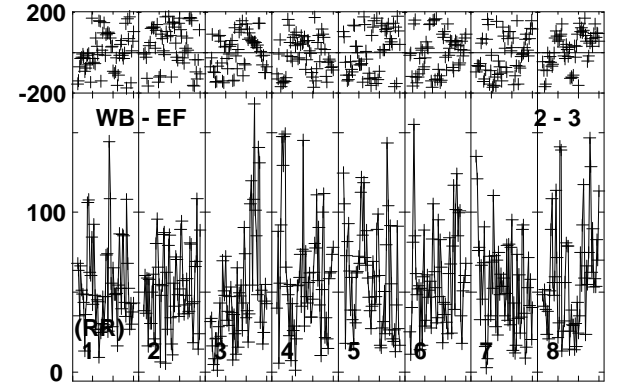
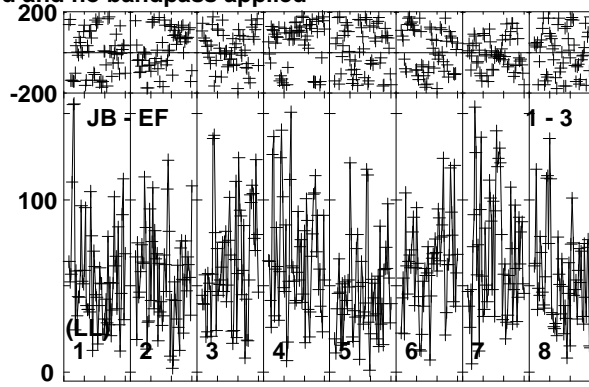
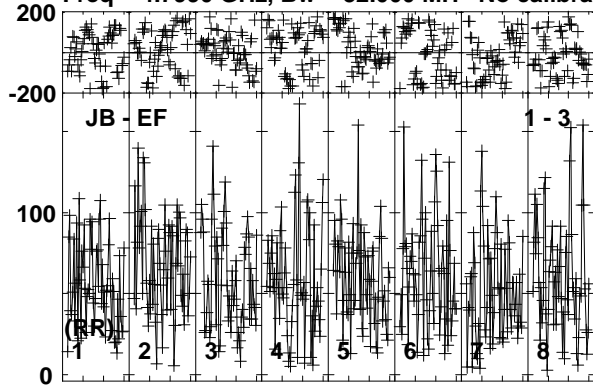

Lower frame: Micro Ampl Jy Top frame: Phas deg  
Vector averaged cross-power spectrum Baseline: JB (01) - EF (03)  
Timerange: 01/00:29:31 to 01/00:33:29

Plot file version 212 created 11-NOV-2019 15:07:40

SER8NJ EK040B.UVDATA.1

Freq = 4.7990 GHz, Bw = 32.000 MH No calibration applied and no bandpass applied

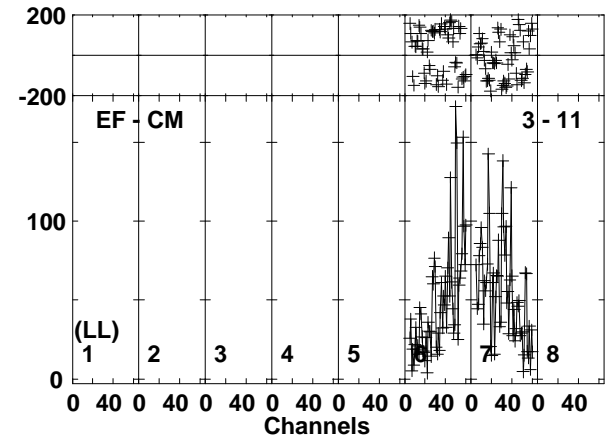
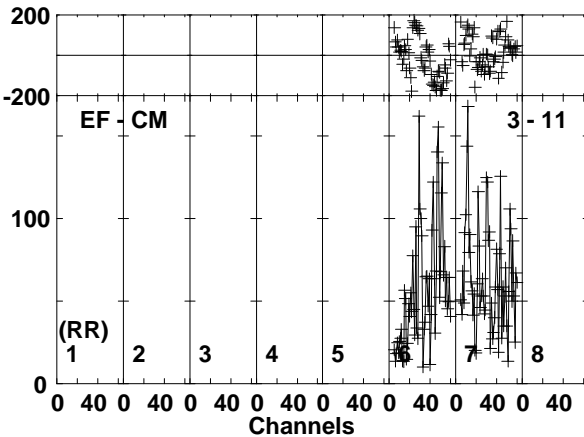
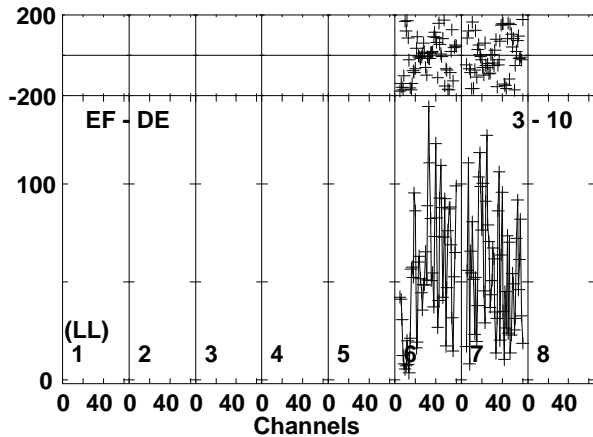
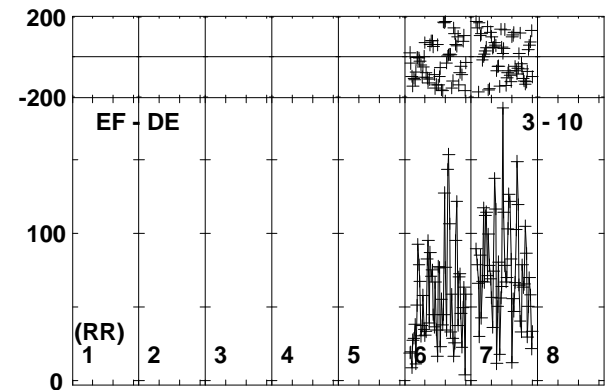
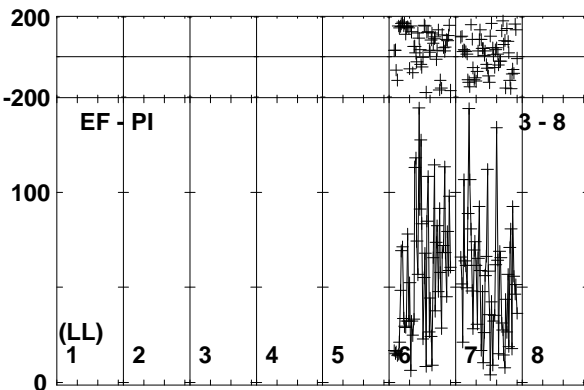
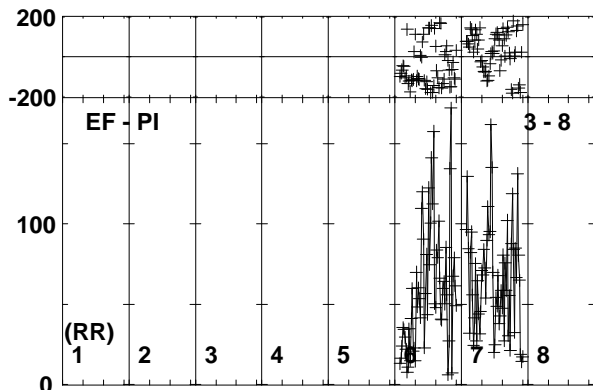
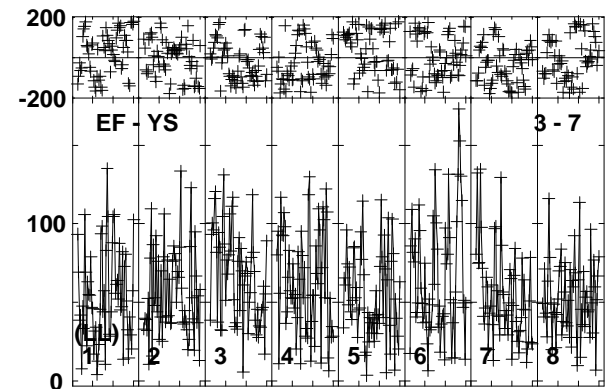
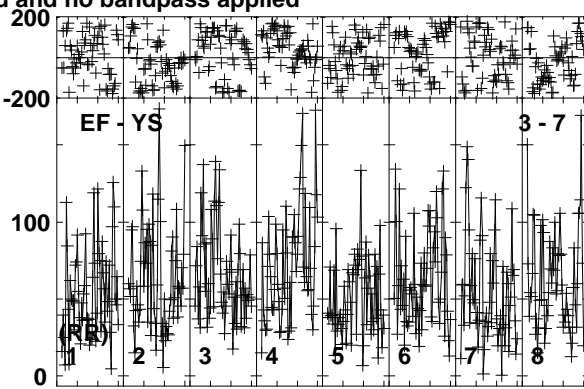
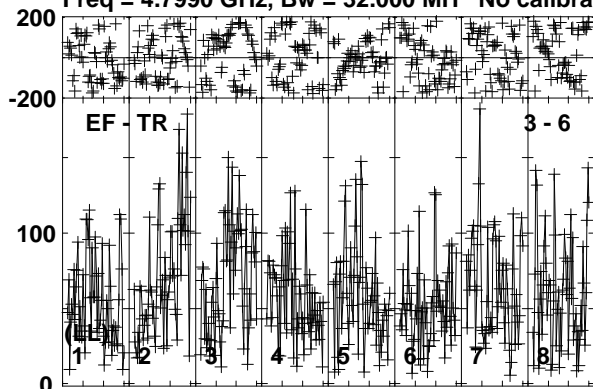

Lower frame: Micro Ampl Jy Top frame: Phas deg  
Vector averaged cross-power spectrum Baseline: EF (03) - TR (06)  
Timerange: 01/00:29:31 to 01/00:33:29

Plot file version 213 created 11-NOV-2019 15:07:40

SER8NJ EK040B.UVDATA.1

Freq = 4.7990 GHz, Bw = 32.000 MH No calibration applied and no bandpass applied

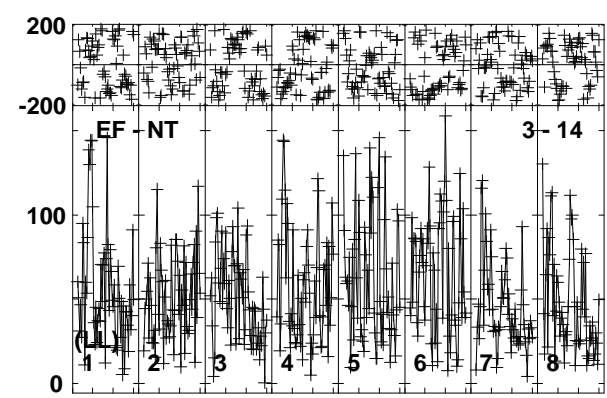
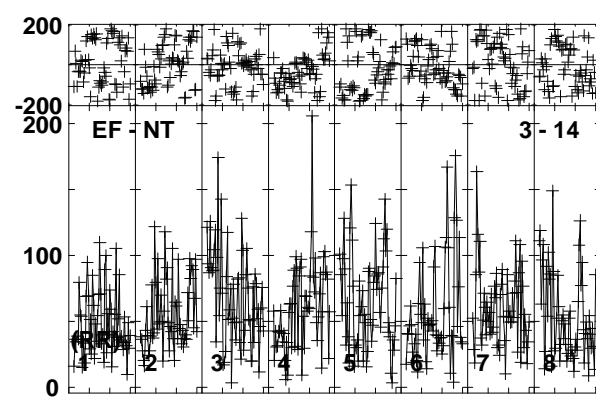
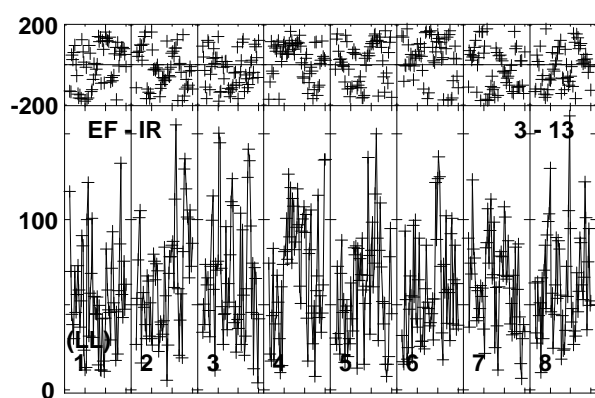
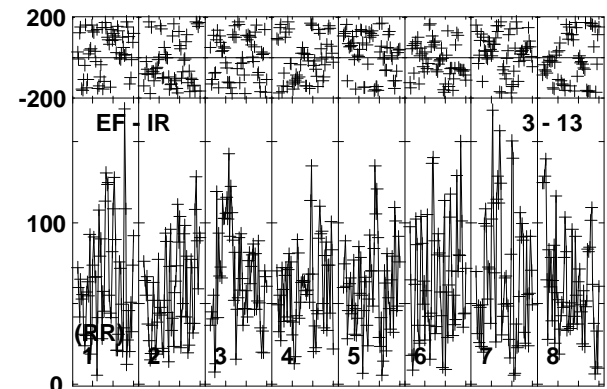
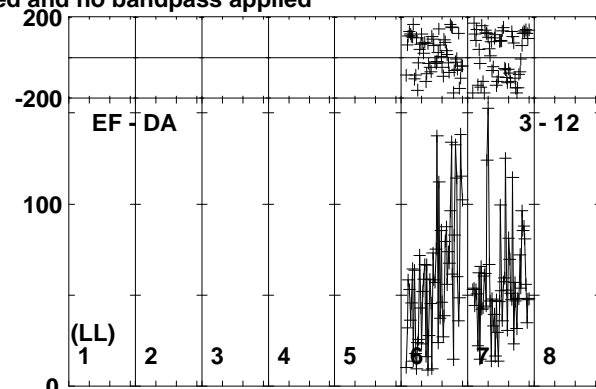
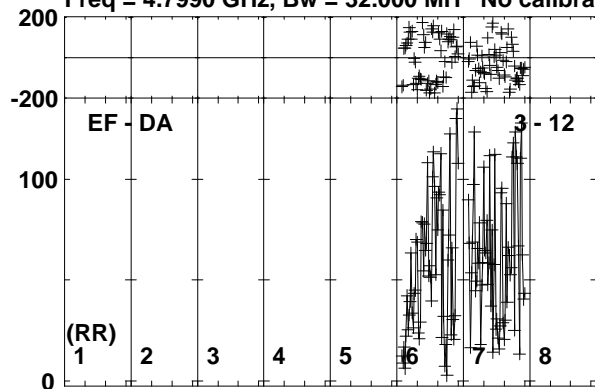

0 40 0 40 0 40 0 40 0 40 0 40 0 40 0 40 0 40  
Channels

Lower frame: Micro Ampl Jy Top frame: Phas deg  
Vector averaged cross-power spectrum Baseline: EF (03) - DA (12)  
Timerange: 01/00:29:31 to 01/00:33:29

Plot file version 214 created 11-NOV-2019 15:07:40

J1826+0149 EK040B.UVDATA.1

Freq = 4.7990 GHz, Bw = 32.000 MH No calibration applied and no bandpass applied

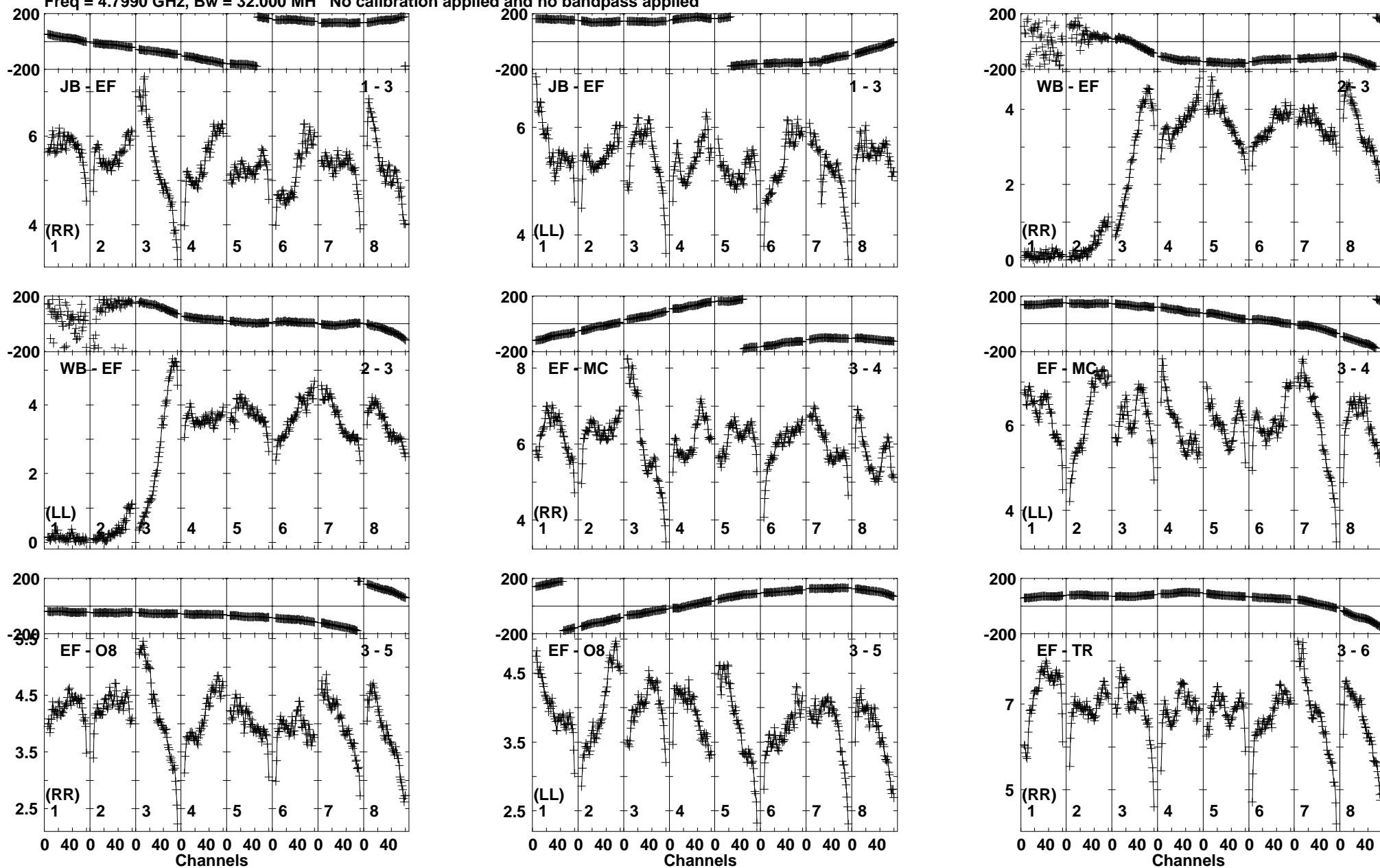

Lower frame: Milli Ampl Jy Top frame: Phas deg  
Vector averaged cross-power spectrum Baseline: JB (01) - EF (03)  
Timerange: 01/00:34:11 to 01/00:35:09

Plot file version 215 created 11-NOV-2019 15:07:40

J1826+0149 EK040B.UVDATA.1

Freq = 4.7990 GHz, Bw = 32.000 MH No calibration applied and no bandpass applied

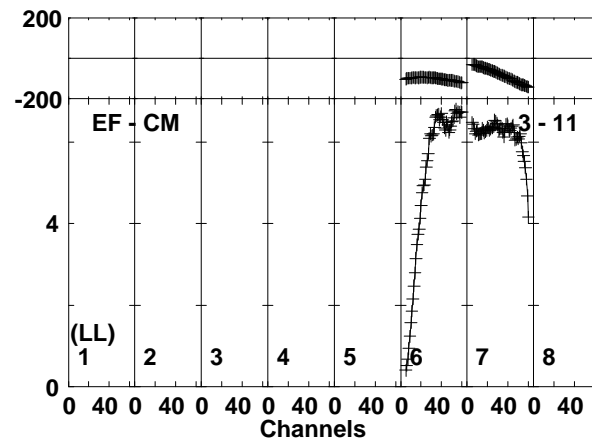
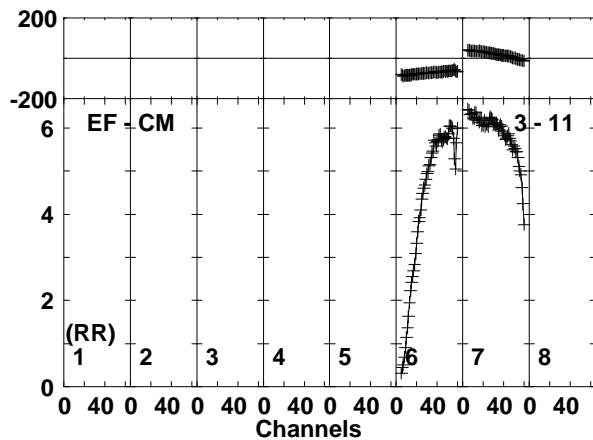
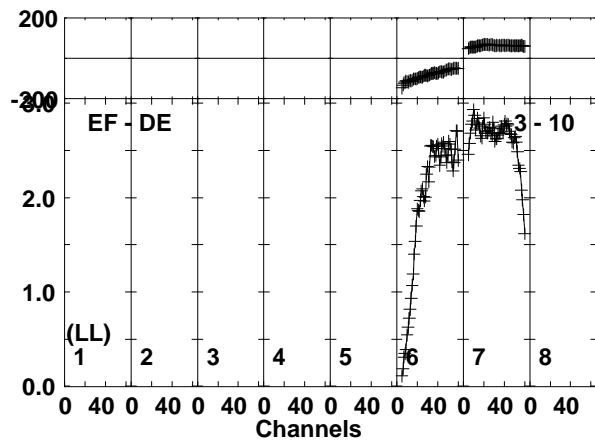
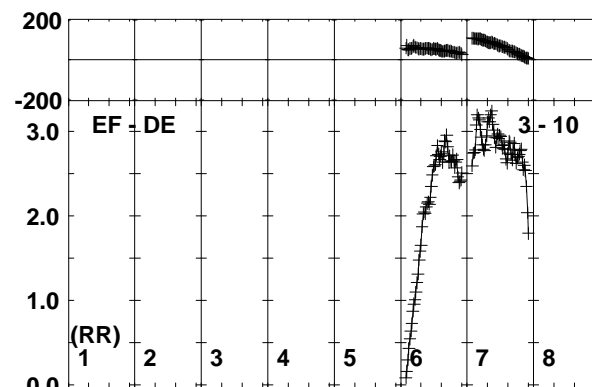
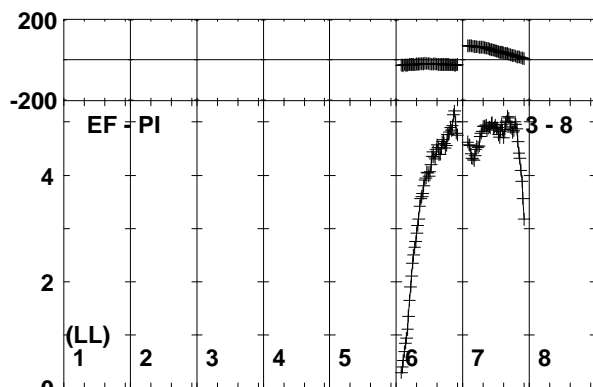
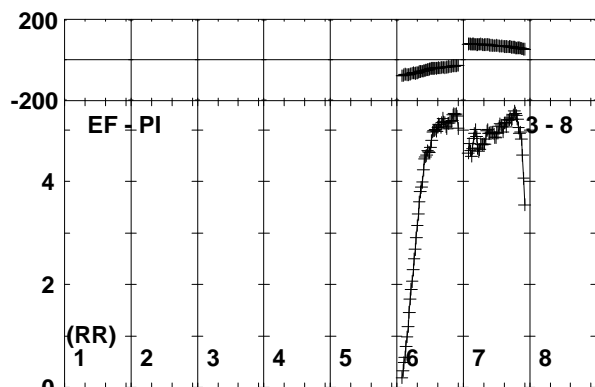
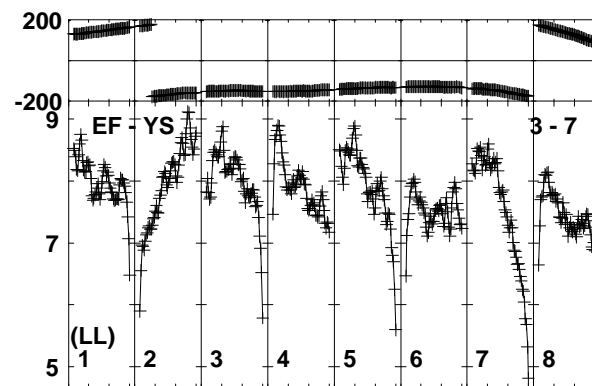
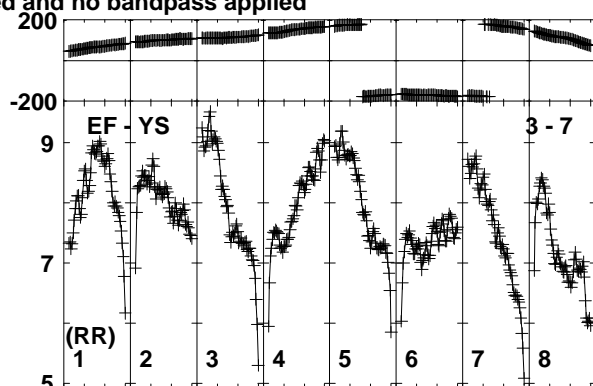
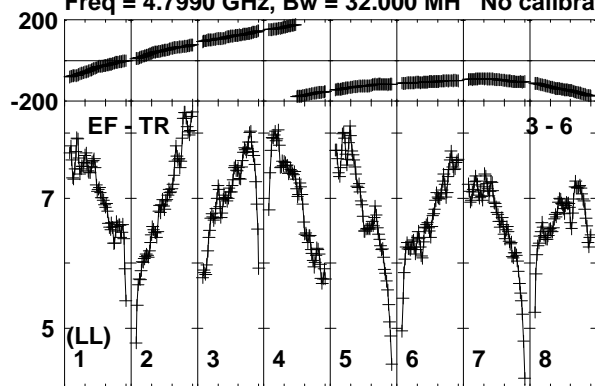

Lower frame: Milli Ampl Jy Top frame: Phas deg  
Vector averaged cross-power spectrum Baseline: EF (03) - TR (06)  
Timerange: 01/00:34:11 to 01/00:35:09

Plot file version 216 created 11-NOV-2019 15:07:40

J1826+0149 EK040B.UVDATA.1

Freq = 4.7990 GHz, Bw = 32.000 MH No calibration applied and no bandpass applied

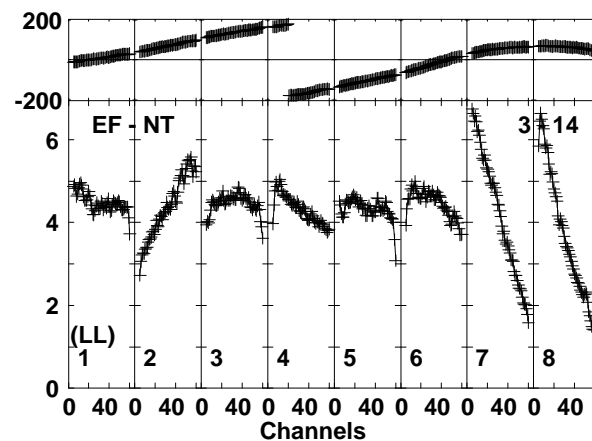
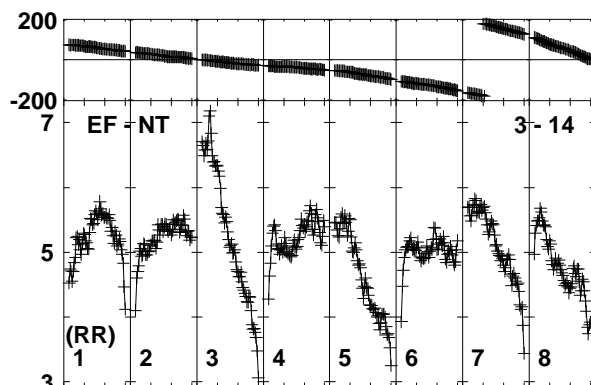
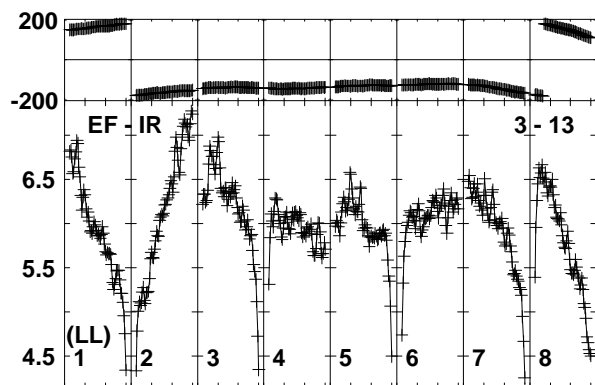
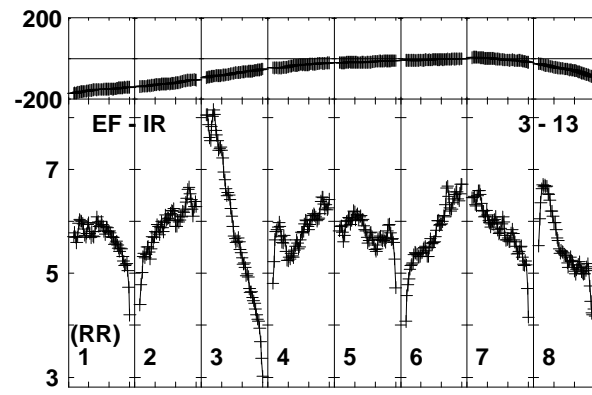
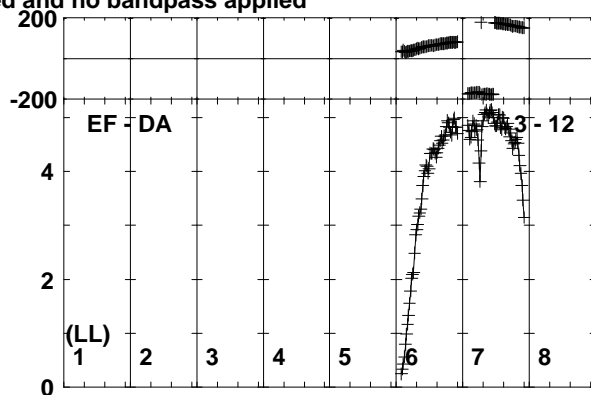
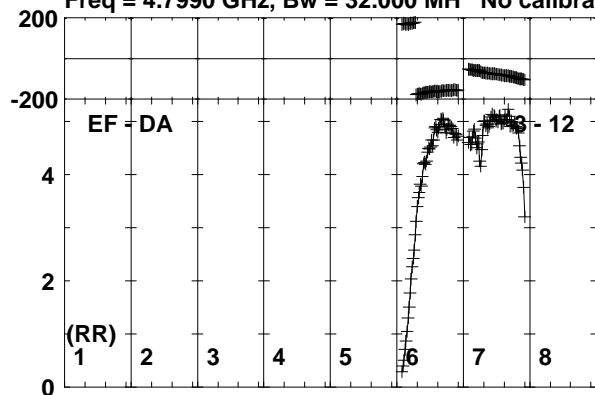

Lower frame: Milli Ampl Jy Top frame: Phas deg  
Vector averaged cross-power spectrum Baseline: EF (03) - DA (12)  
Timerange: 01/00:34:11 to 01/00:35:09

Plot file version 217 created 11-NOV-2019 15:07:40

SER8NJ EK040B.UVDATA.1

Freq = 4.7990 GHz, Bw = 32.000 MH No calibration applied and no bandpass applied

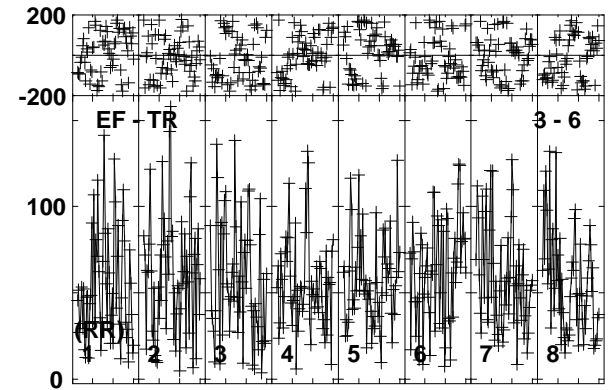
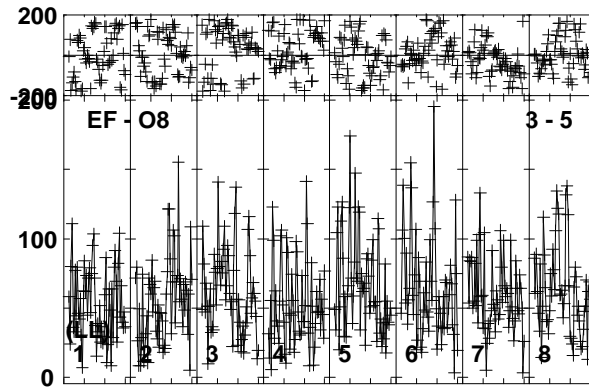
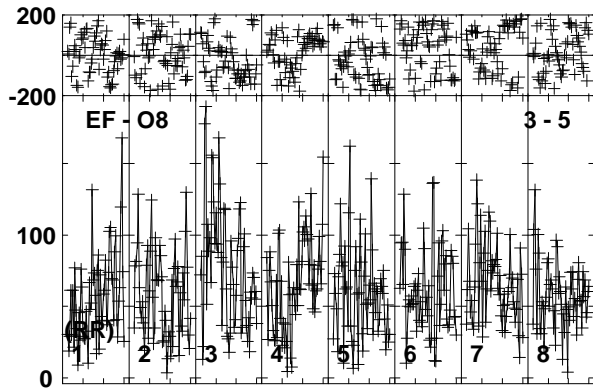
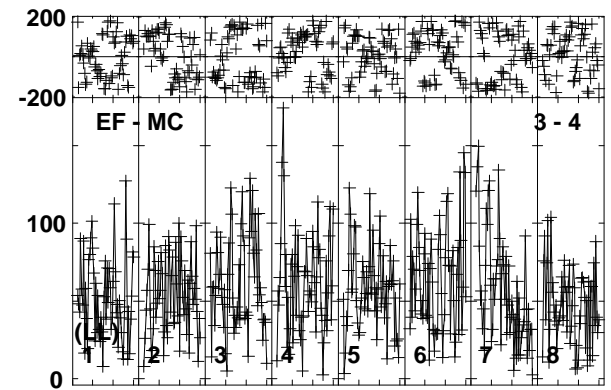
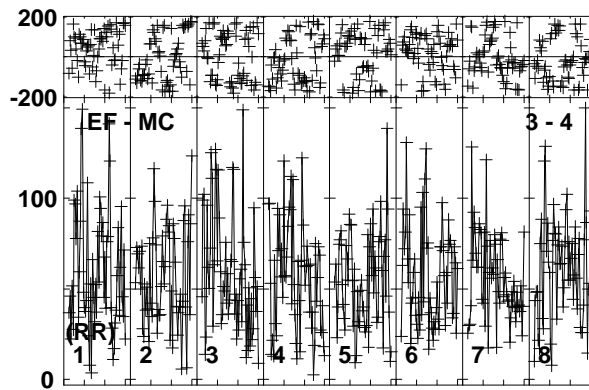
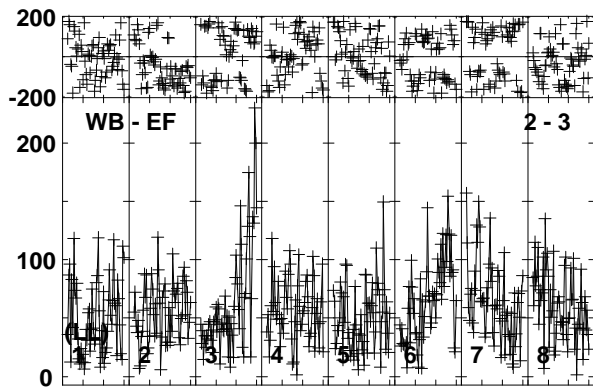
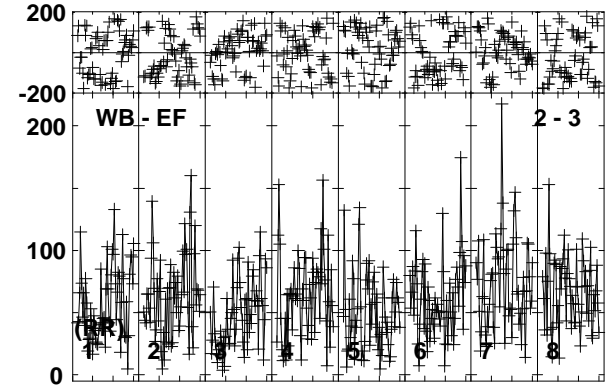
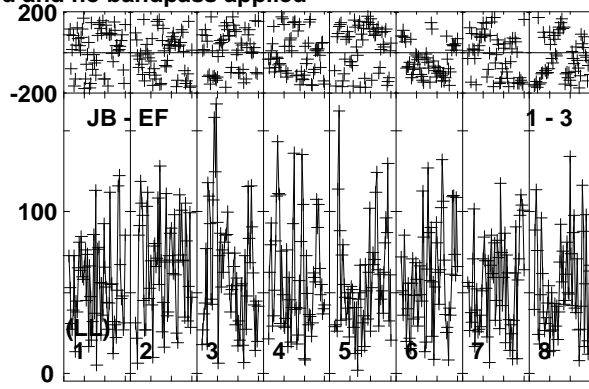
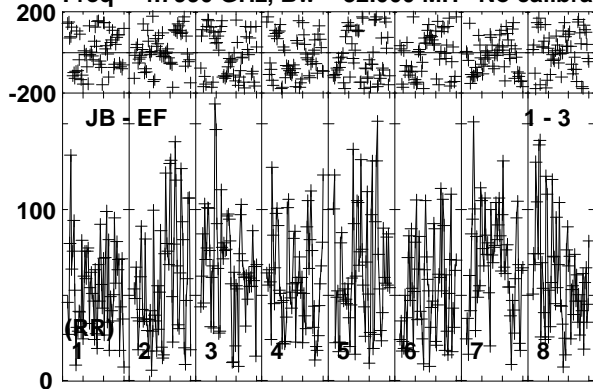

Lower frame: Micro Ampl Jy Top frame: Phas deg  
Vector averaged cross-power spectrum Baseline: JB (01) - EF (03)  
Timerange: 01/00:35:13 to 01/00:39:09

Plot file version 218 created 11-NOV-2019 15:07:41

SER8NJ EK040B.UVDATA.1

Freq = 4.7990 GHz, Bw = 32.000 MH No calibration applied and no bandpass applied

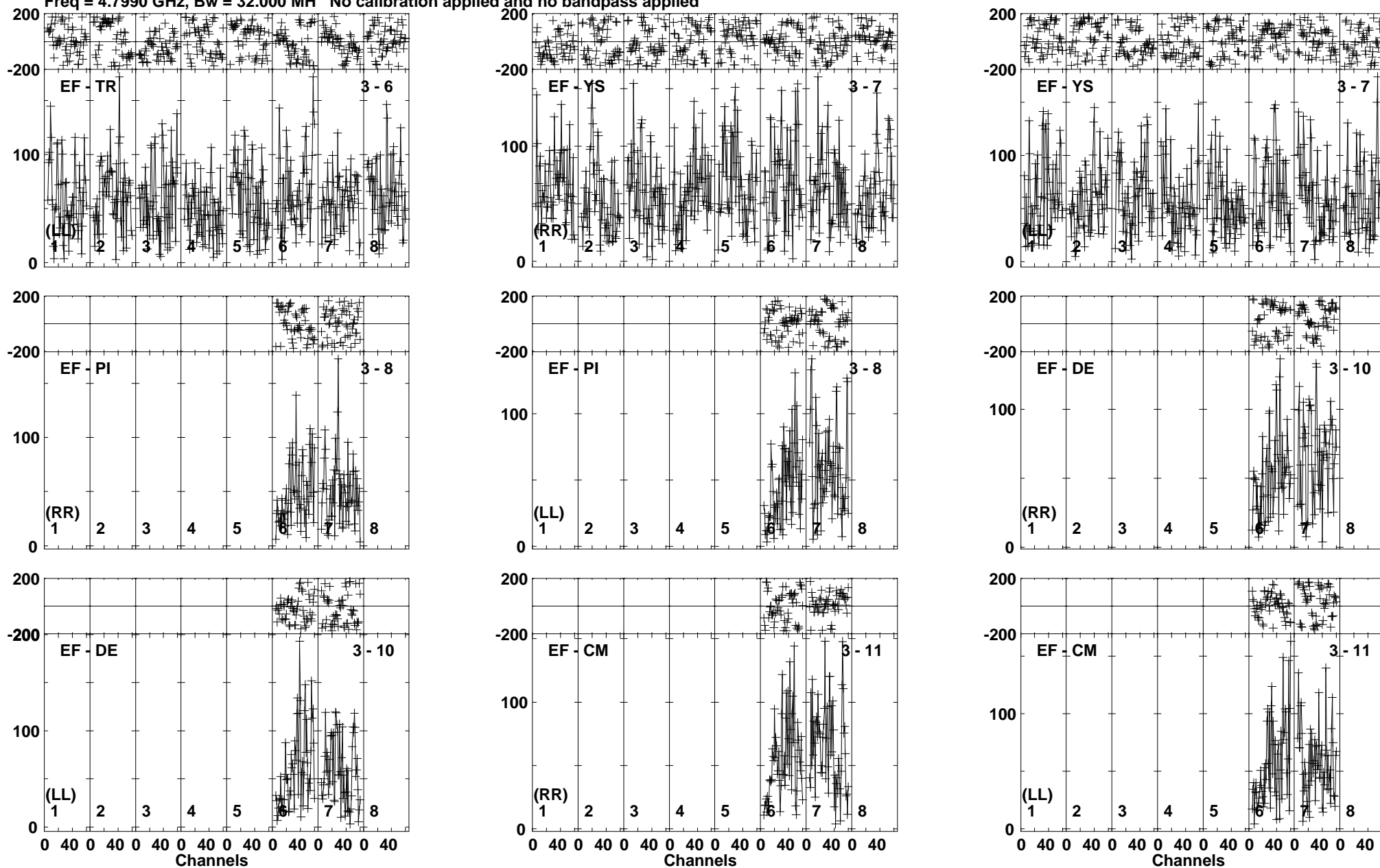

Lower frame: Micro Ampl Jy Top frame: Phas deg  
Vector average cross-power spectrum Baseline: EF (03) - TR (06)  
Timerange: 01/00:35:13 to 01/00:39:09



Plot file version 219 created 11-NOV-2019 15:07:41  
 SER8NJ EK040B.UVDATA.1  
 Freq = 4.7990 GHz, Bw = 32.000 MH No calibration applied and no bandpass applied

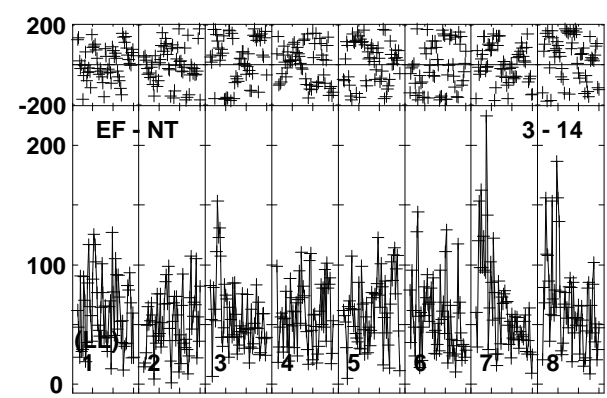
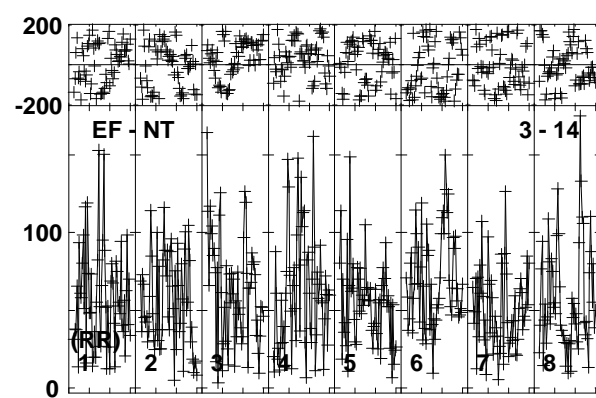
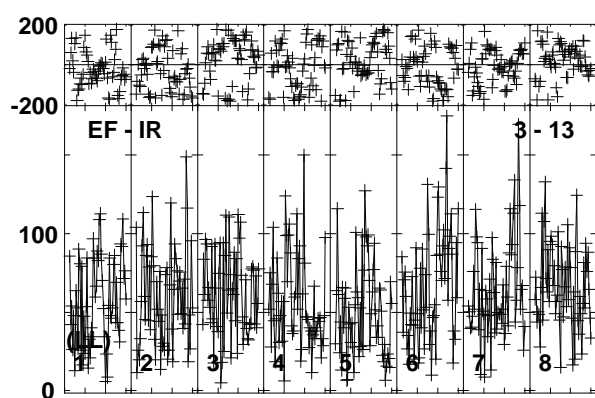
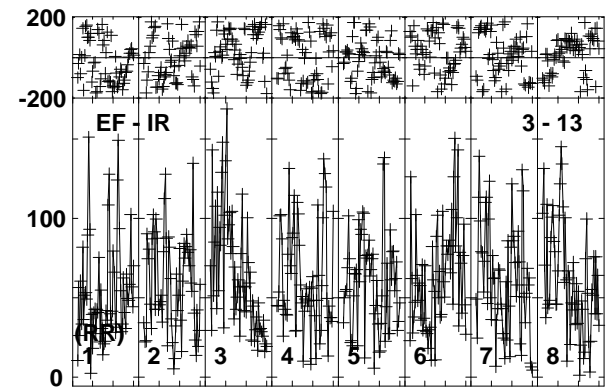
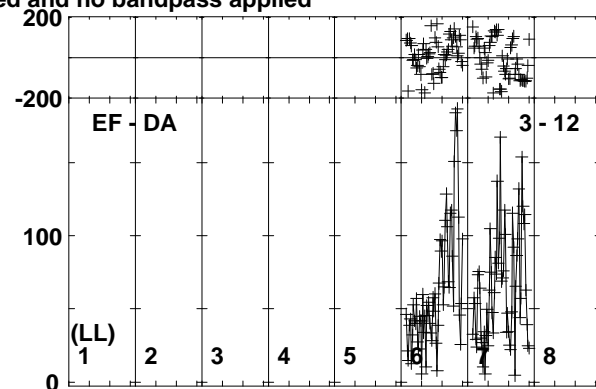
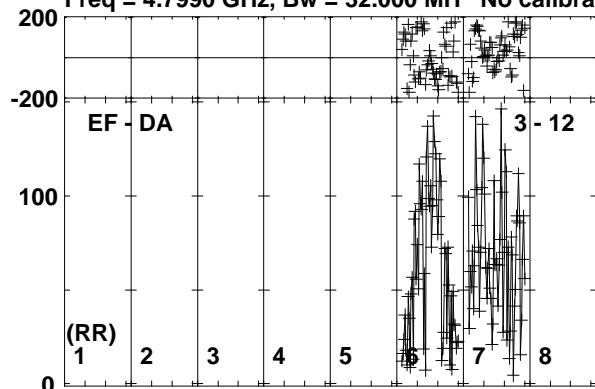

0 40 0 40 0 40 0 40 0 40 0 40 0 40 0 40 0 40  
 Channels

Lower frame: Micro Ampl Jy Top frame: Phas deg  
 Vector averaged cross-power spectrum Baseline: EF (03) - DA (12)  
 Timerange: 01/00:35:13 to 01/00:39:09

Plot file version 220 created 11-NOV-2019 15:07:41

J1826+0149 EK040B.UVDATA.1

Freq = 4.7990 GHz, Bw = 32.000 MH No calibration applied and no bandpass applied

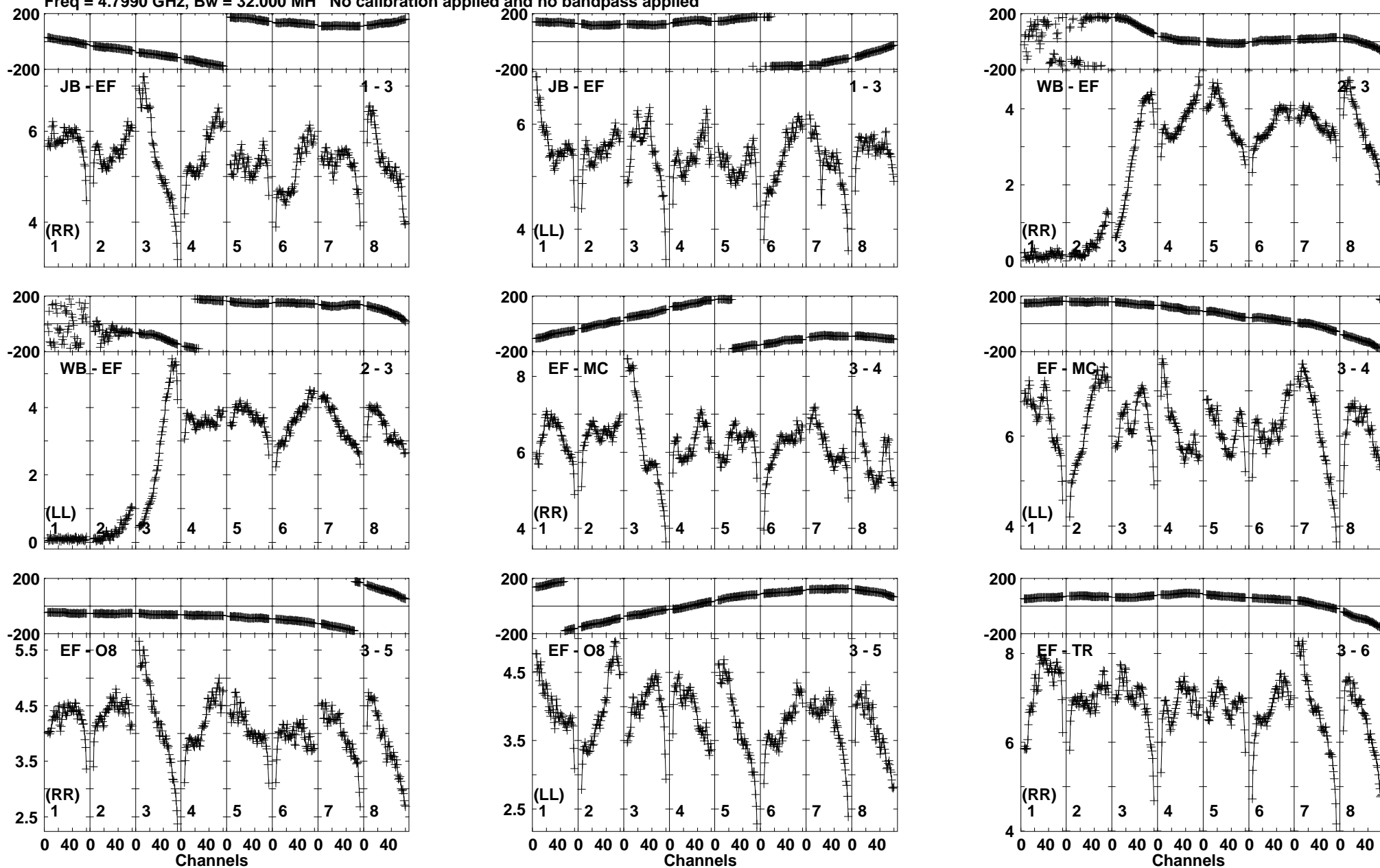

Lower frame: Milli Ampl Jy Top frame: Phas deg  
Vector averaged cross-power spectrum Baseline: JB (01) - EF (03)  
Timerange: 01/00:39:11 to 01/00:40:39

Plot file version 221 created 11-NOV-2019 15:07:41

J1826+0149 EK040B.UVDATA.1

Freq = 4.7990 GHz, Bw = 32.000 MH No calibration applied and no bandpass applied

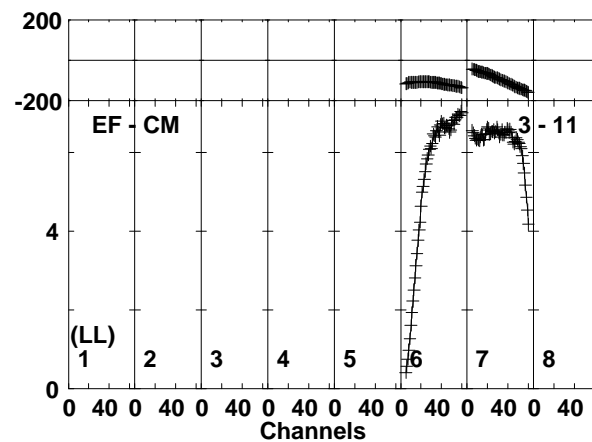
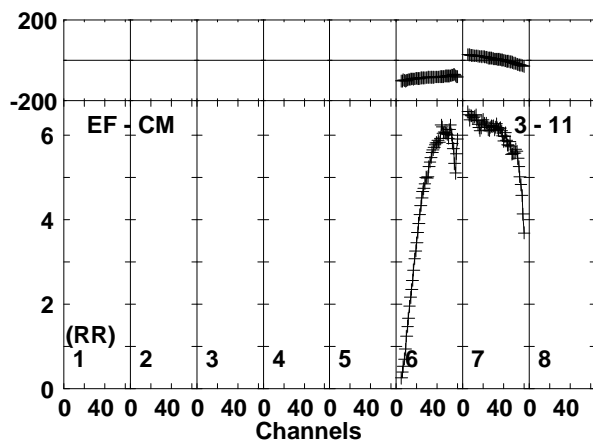
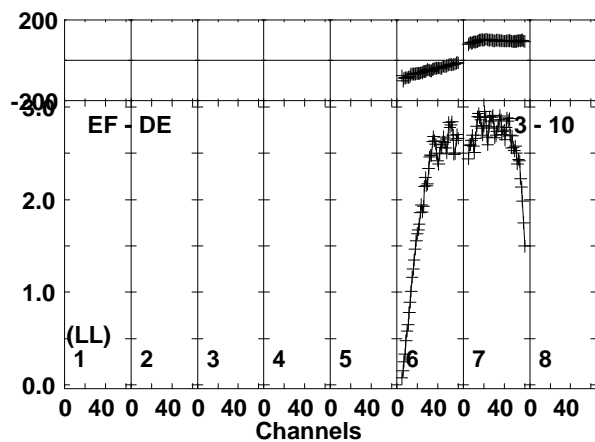
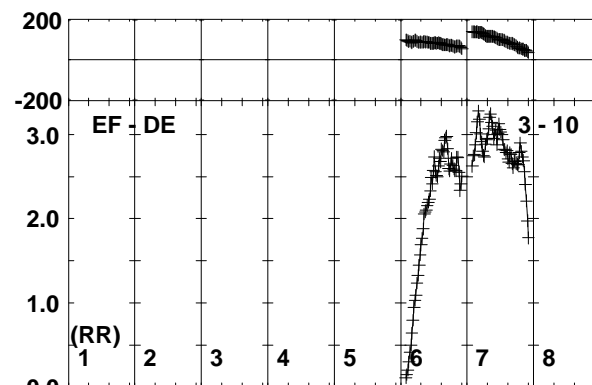
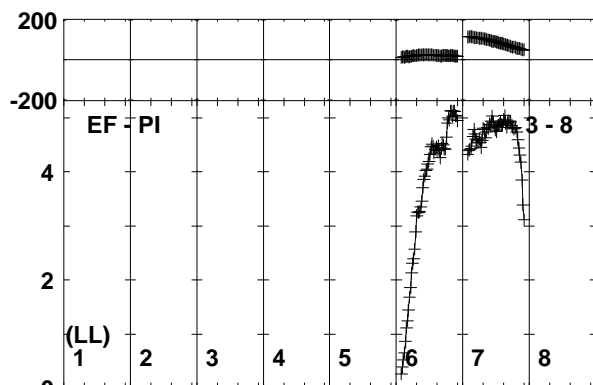
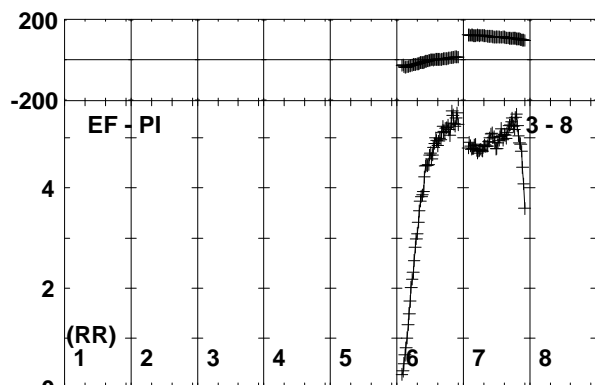
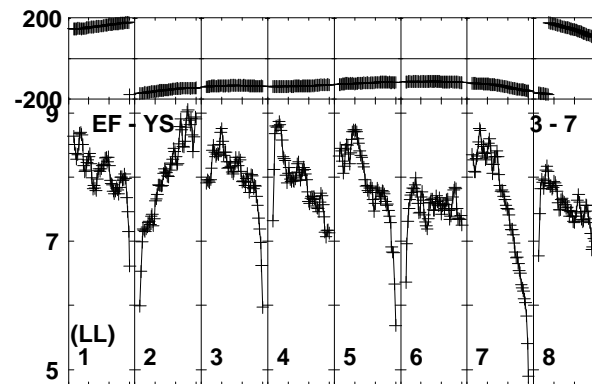
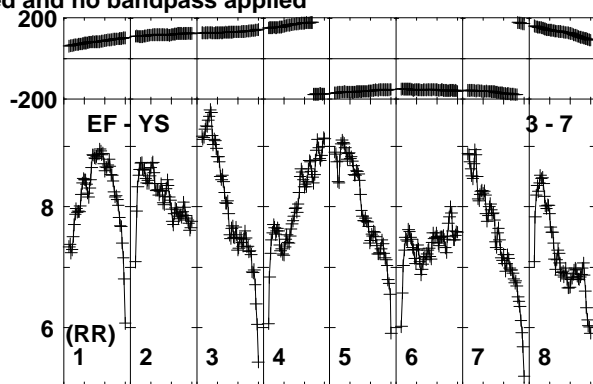
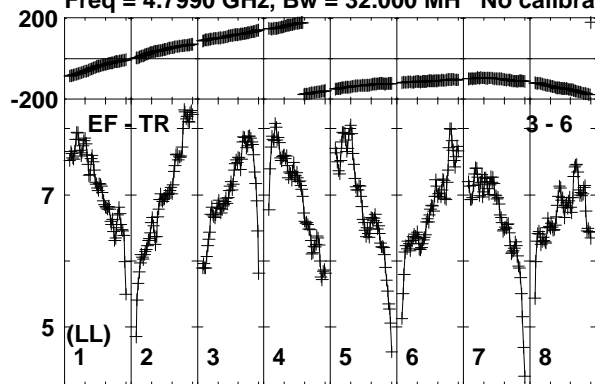

Lower frame: Milli Ampl Jy Top frame: Phas deg  
Vector averaged cross-power spectrum Baseline: EF (03) - TR (06)  
Timerange: 01/00:39:11 to 01/00:40:39

Plot file version 222 created 11-NOV-2019 15:07:41

J1826+0149 EK040B.UVDATA.1

Freq = 4.7990 GHz, Bw = 32.000 MH No calibration applied and no bandpass applied

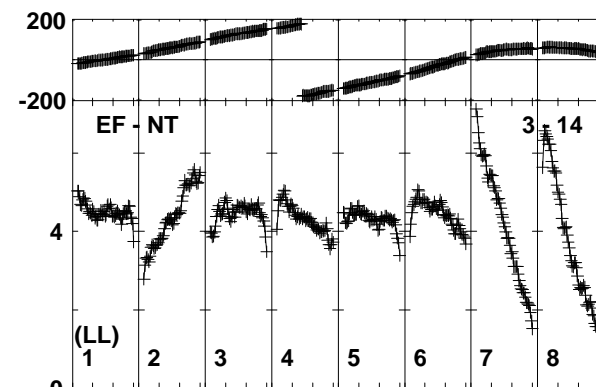
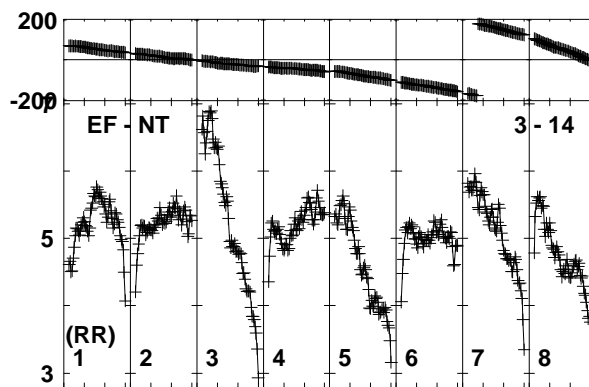
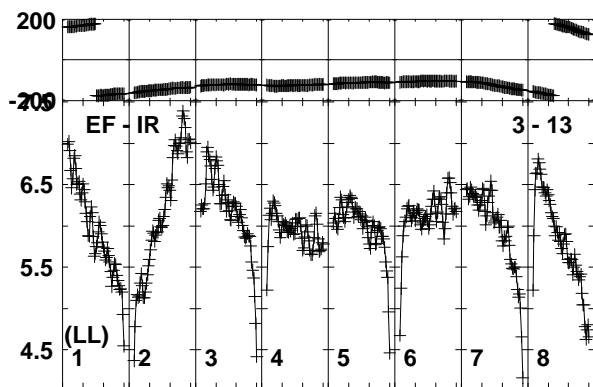
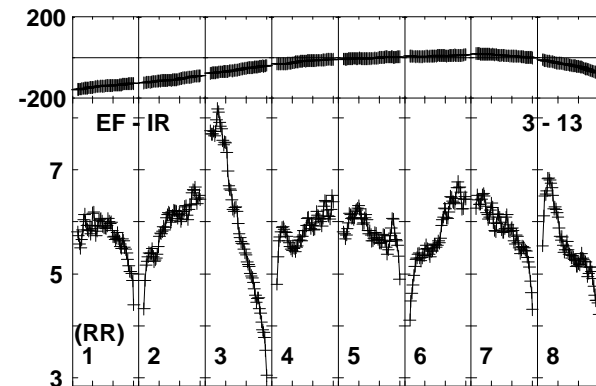
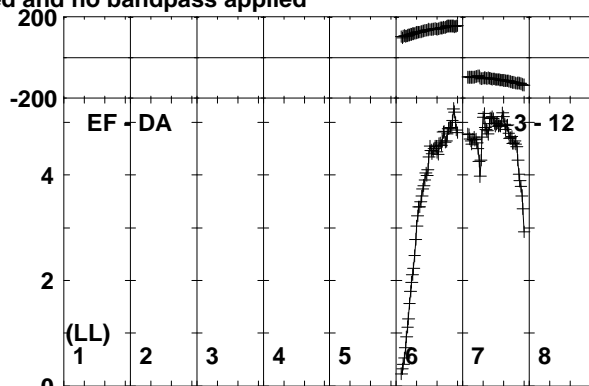
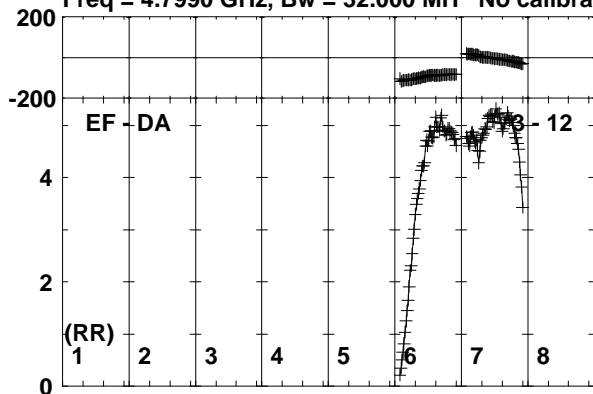

Channels

Lower frame: Milli Ampl Jy Top frame: Phas deg  
Vector averaged cross-power spectrum Baseline: EF (03) - DA (12)  
Timerange: 01/00:39:11 to 01/00:40:39

Plot file version 223 created 11-NOV-2019 15:07:41

SER8NJ EK040B.UVDATA.1

Freq = 4.7990 GHz, Bw = 32.000 MH No calibration applied and no bandpass applied

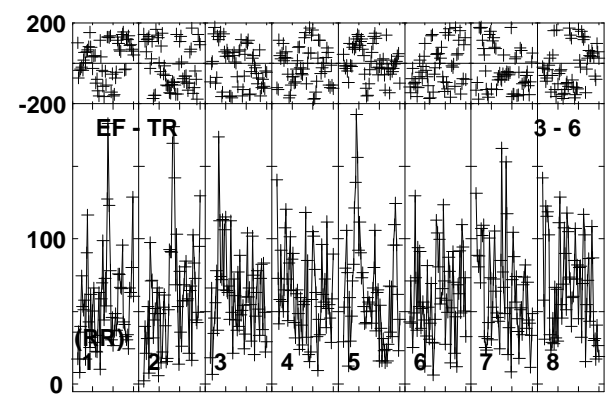
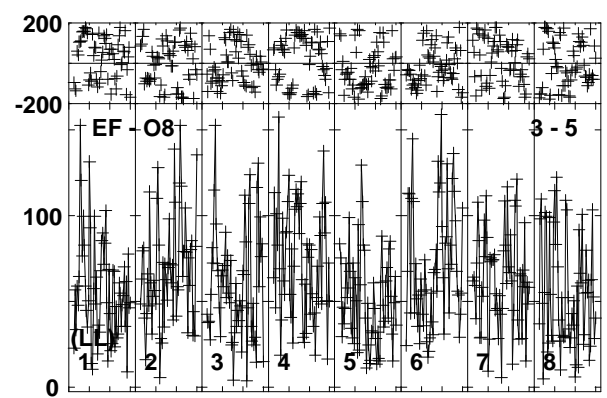
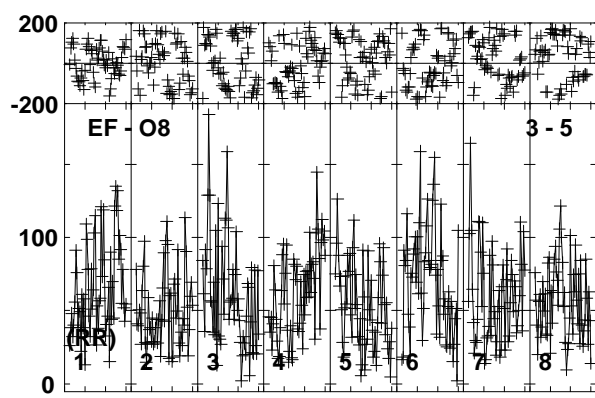
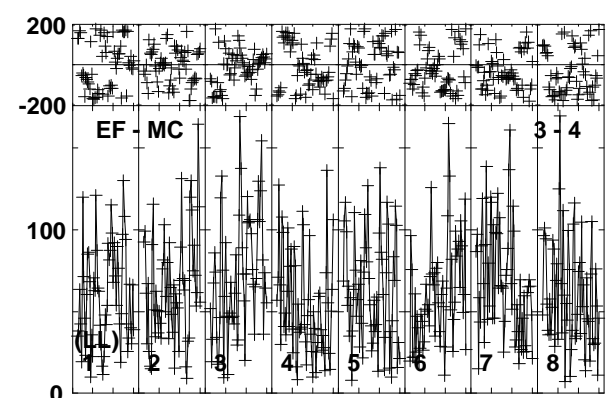
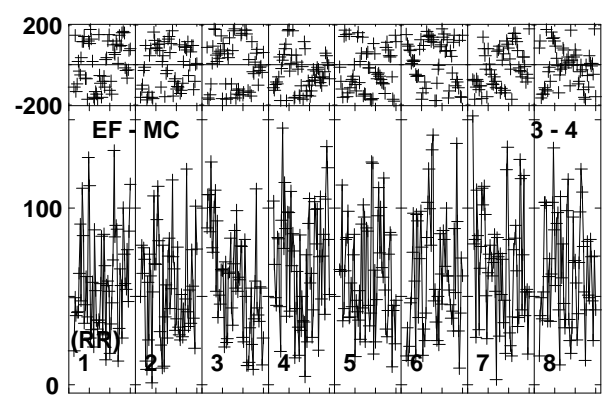
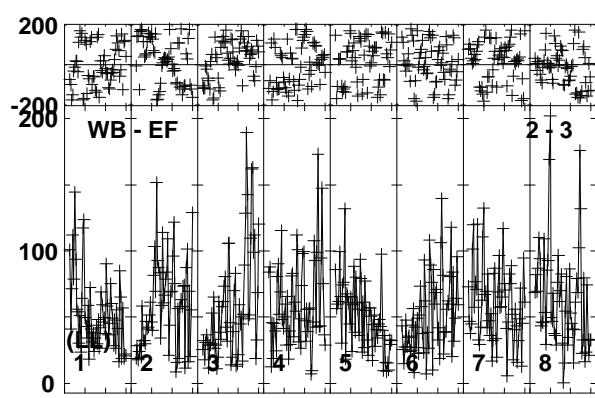
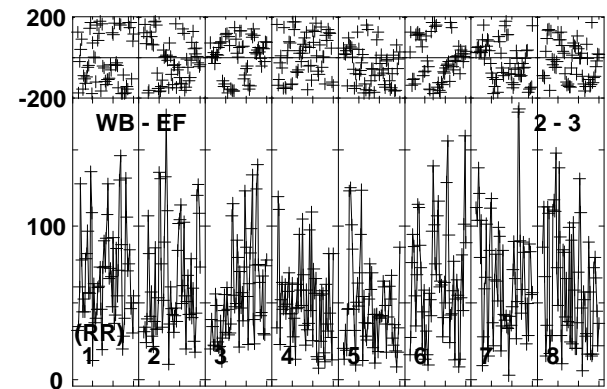
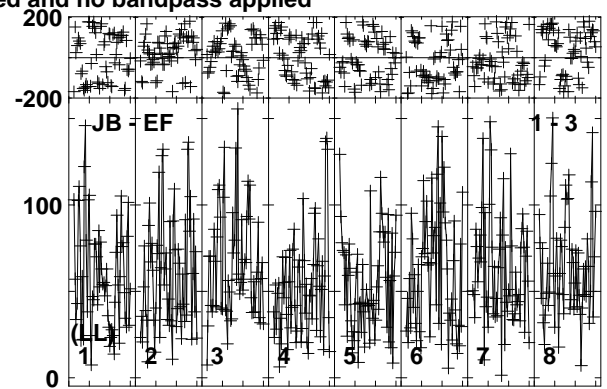
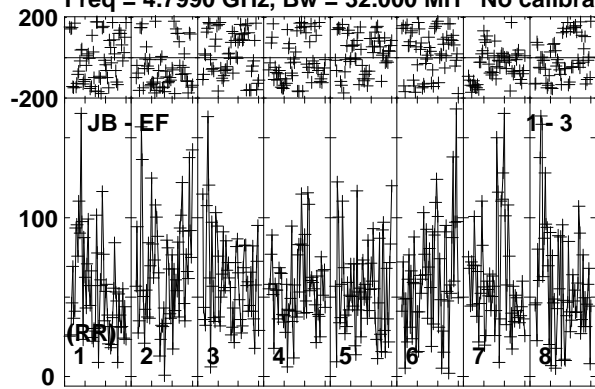

Lower frame: Micro Ampl Jy Top frame: Phas deg  
Vector averaged cross-power spectrum Baseline: JB (01) - EF (03)  
Timerange: 01/00:40:43 to 01/00:44:39

Plot file version 224 created 11-NOV-2019 15:07:41

SER8NJ EK040B.UVDATA.1

Freq = 4.7990 GHz, Bw = 32.000 MH No calibration applied and no bandpass applied

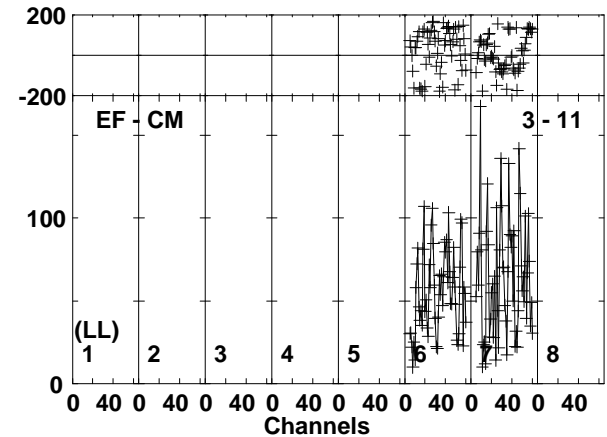
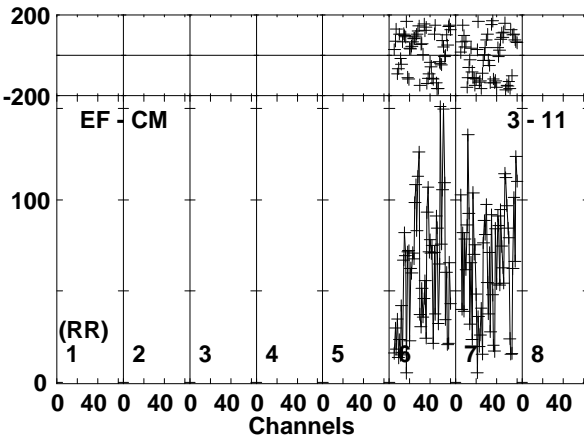
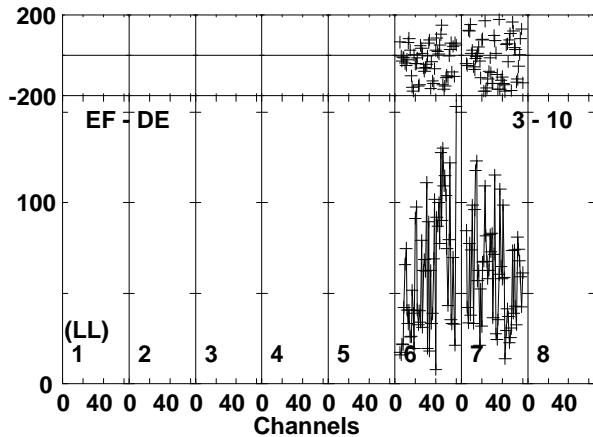
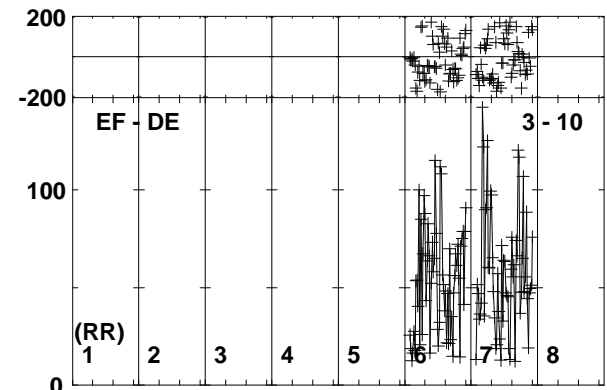
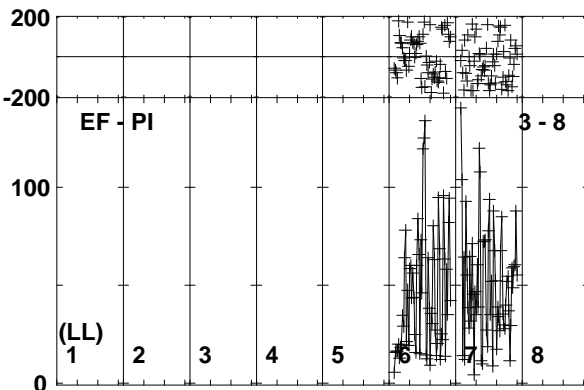
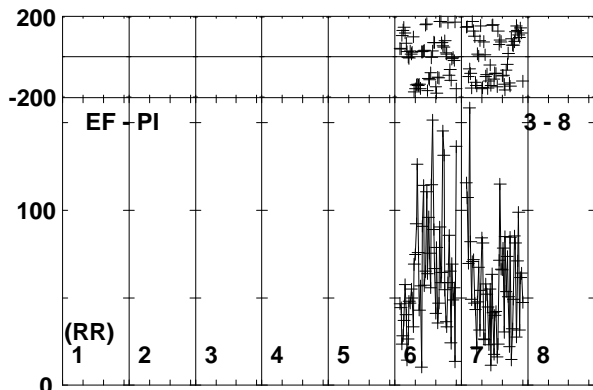
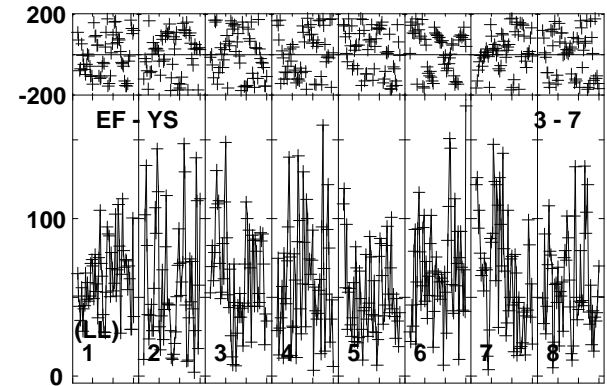
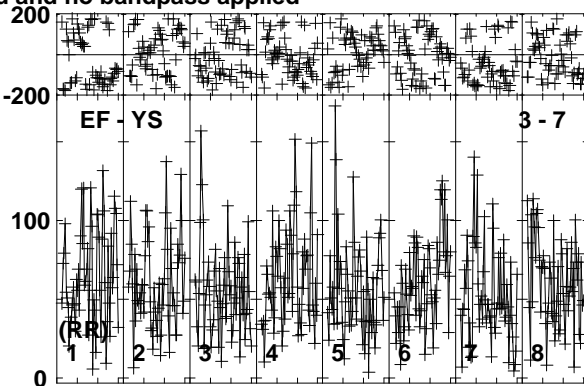
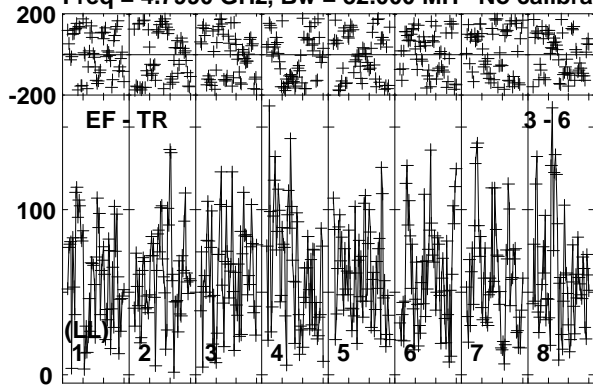

Lower frame: Micro Ampl Jy Top frame: Phas deg  
Vector averaged cross-power spectrum Baseline: EF (03) - TR (06)  
Timerange: 01/00:40:43 to 01/00:44:39

Plot file version 225 created 11-NOV-2019 15:07:41

SER8NJ EK040B.UVDATA.1

Freq = 4.7990 GHz, Bw = 32.000 MH No calibration applied and no bandpass applied

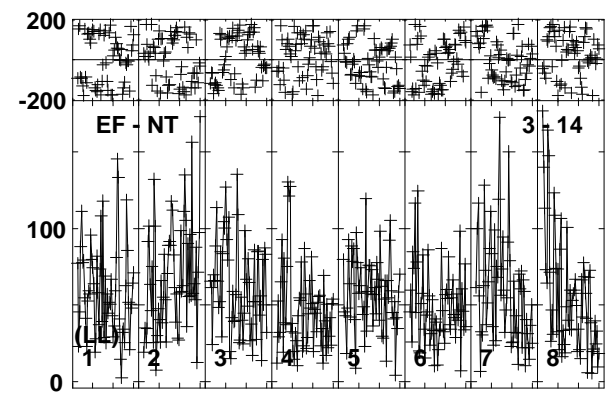
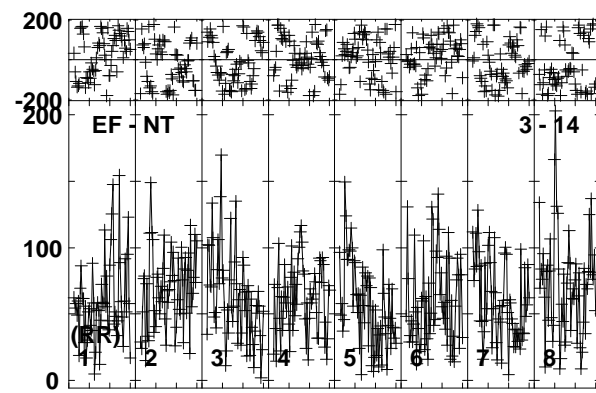
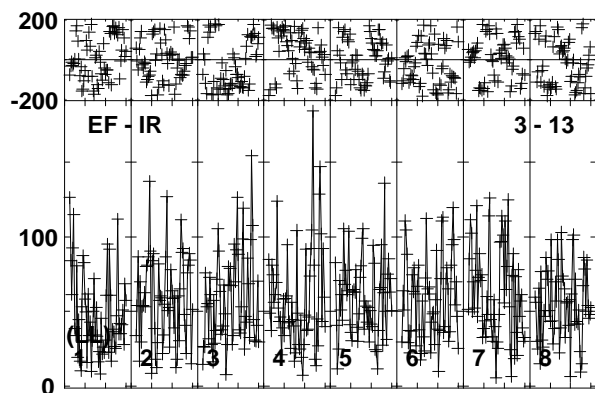
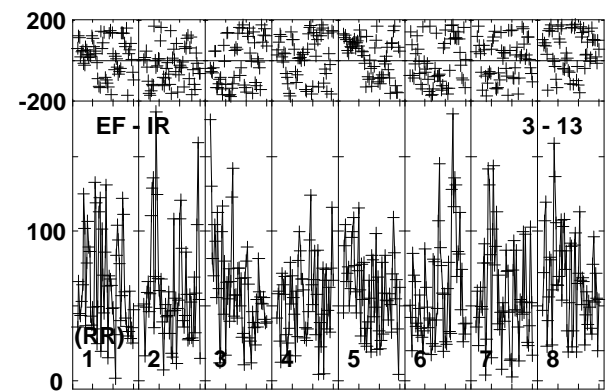
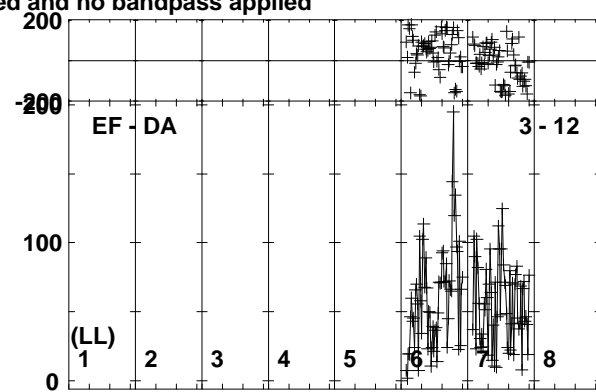
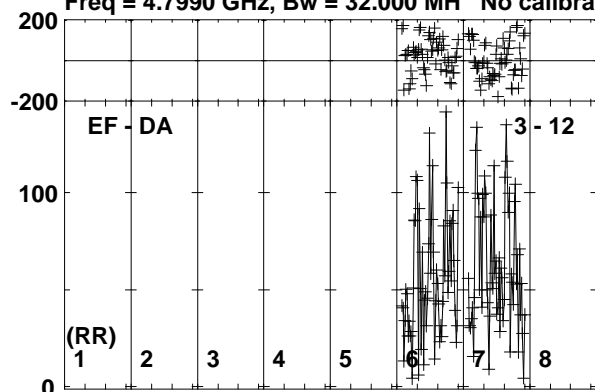

0 40 0 40 0 40 0 40 0 40 0 40 0 40 0 40 0 40  
Channels

Lower frame: Micro Ampl Jy Top frame: Phas deg  
Vector averaged cross-power spectrum Baseline: EF (03) - DA (12)  
Timerange: 01/00:40:43 to 01/00:44:39

Plot file version 226 created 11-NOV-2019 15:07:41

J1826+0149 EK040B.UVDATA.1

Freq = 4.7990 GHz, Bw = 32.000 MH No calibration applied and no bandpass applied

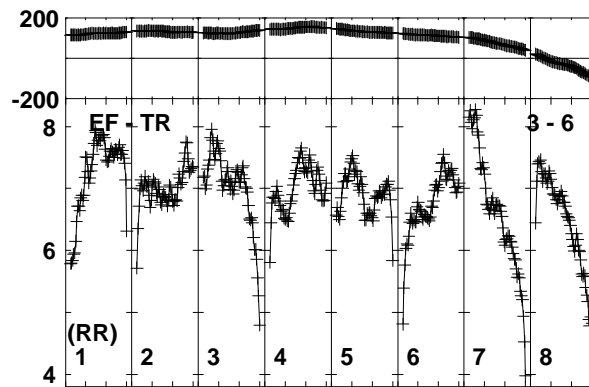
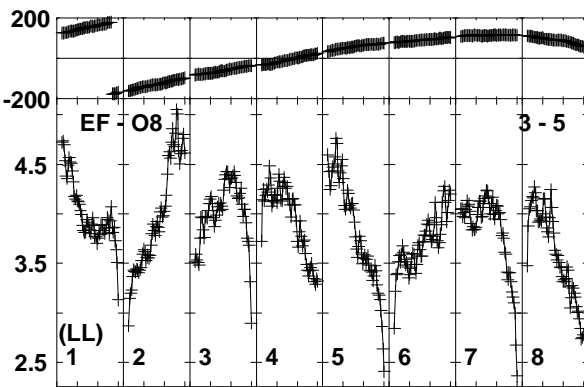
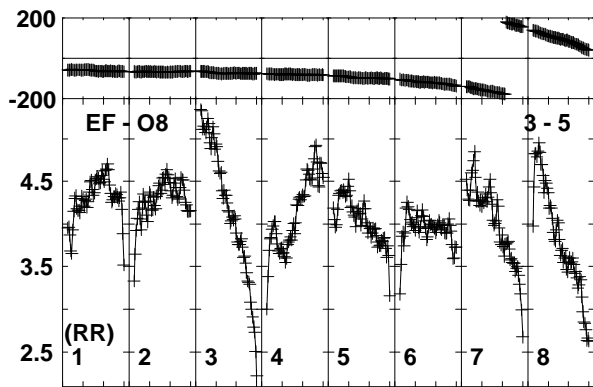
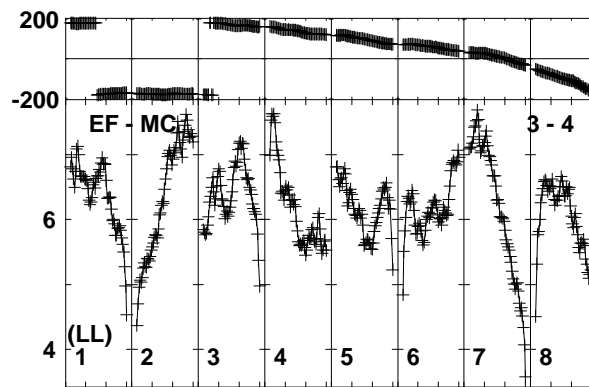
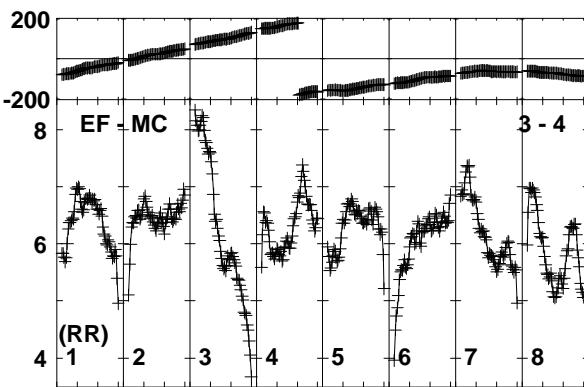
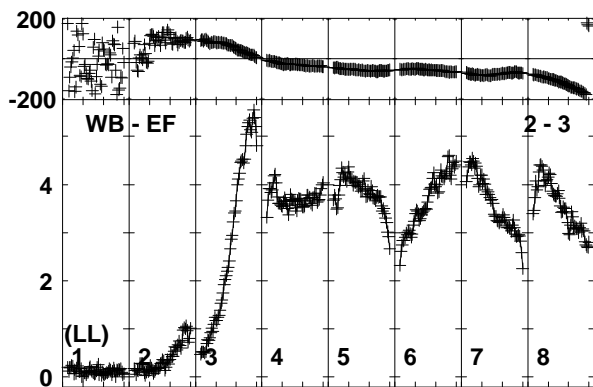
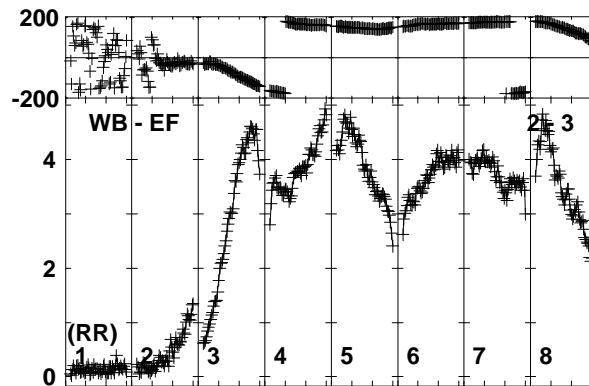
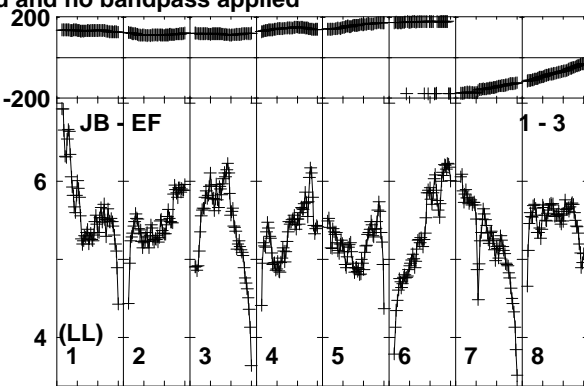
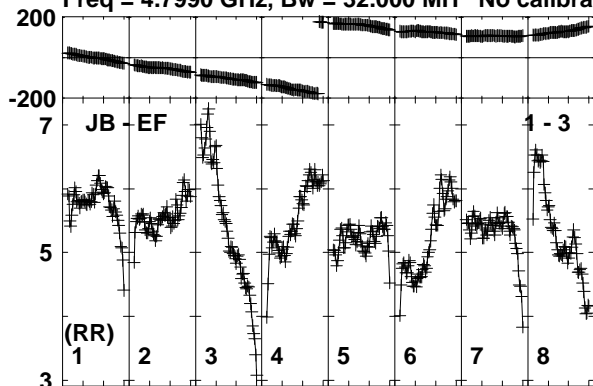

Lower frame: Milli Ampl Jy Top frame: Phas deg  
Vector averaged cross-power spectrum Baseline: JB (01) - EF (03)  
Timerange: 01/00:45:21 to 01/00:46:19



Plot file version 227 created 11-NOV-2019 15:07:42

J1826+0149 EK040B.UVDATA.1

Freq = 4.7990 GHz, Bw = 32.000 MH No calibration applied and no bandpass applied

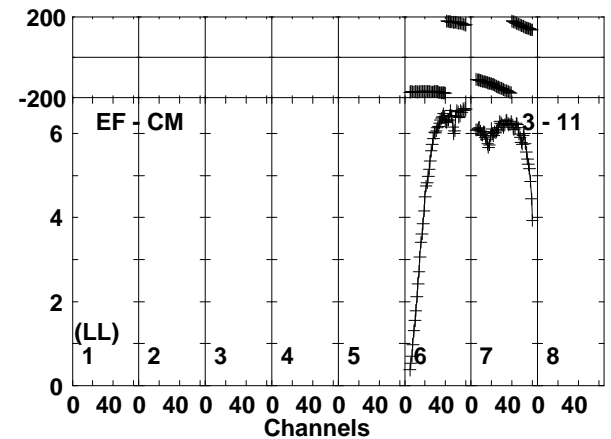
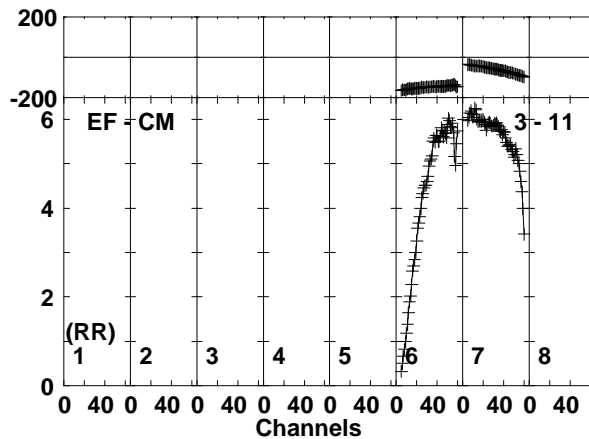
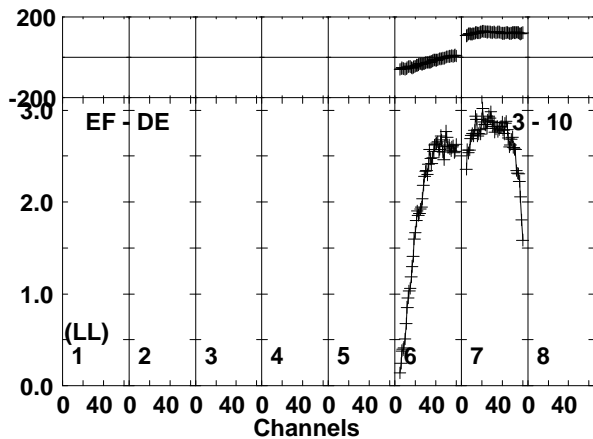
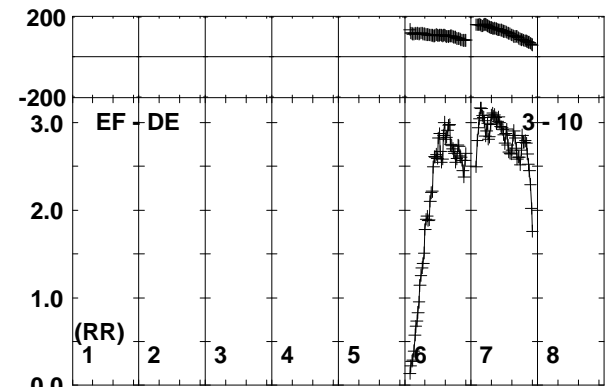
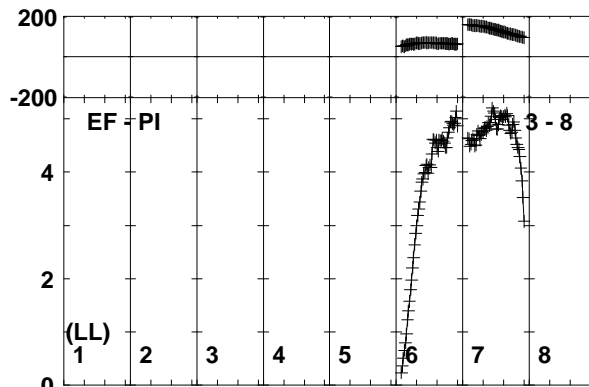
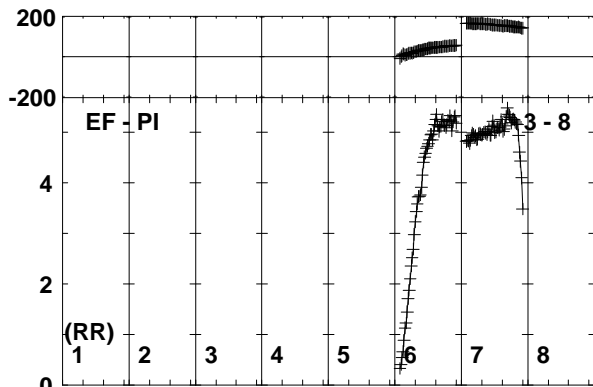
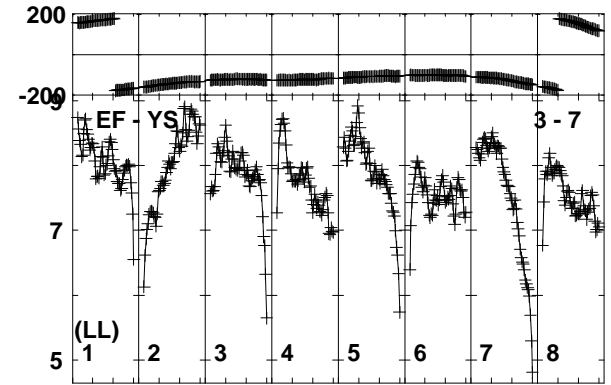
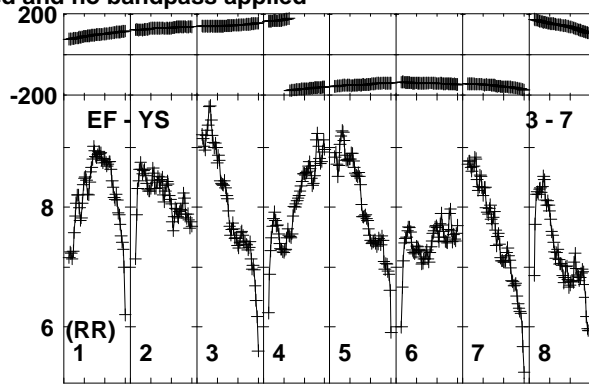
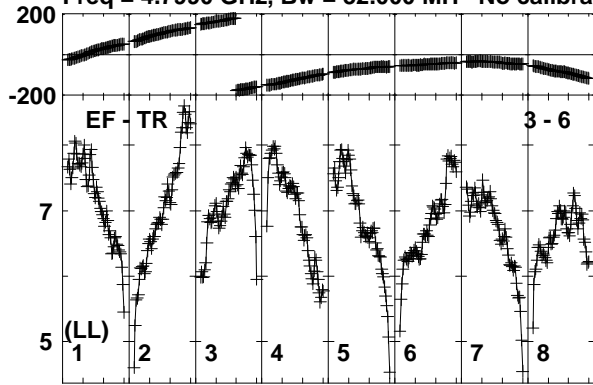

Lower frame: Milli Ampl Jy Top frame: Phas deg  
Vector averaged cross-power spectrum Baseline: EF (03) - TR (06)  
Timerange: 01/00:45:21 to 01/00:46:19

Plot file version 228 created 11-NOV-2019 15:07:42

J1826+0149 EK040B.UVDATA.1

Freq = 4.7990 GHz, Bw = 32.000 MH No calibration applied and no bandpass applied

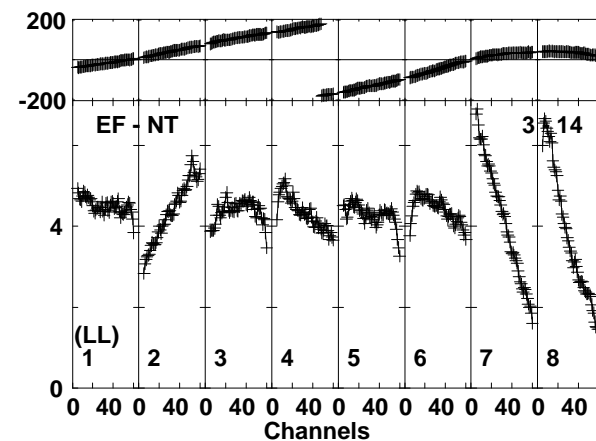
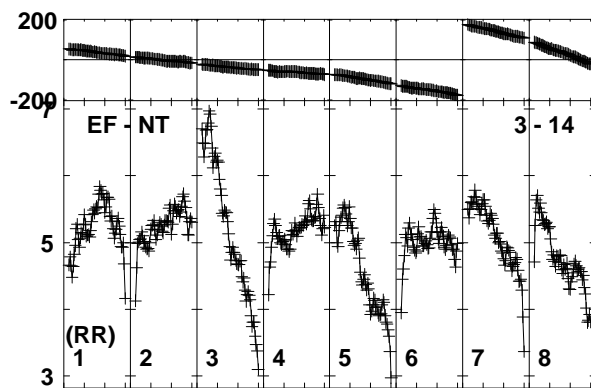
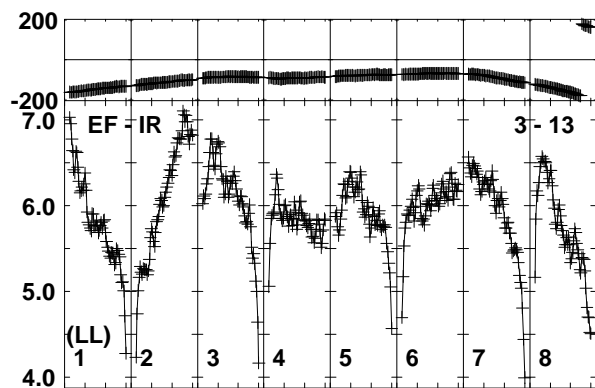
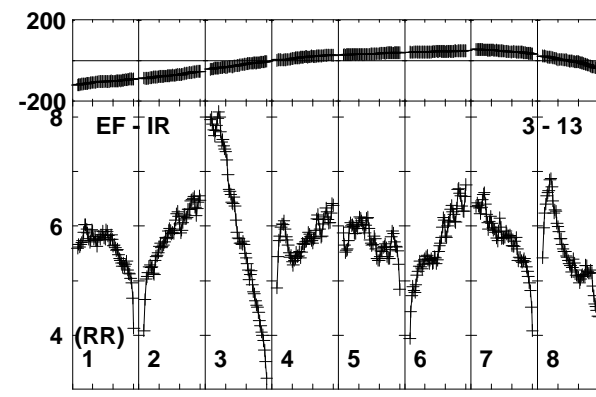
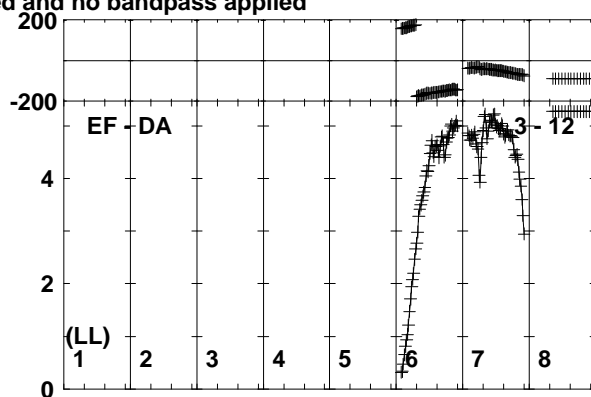
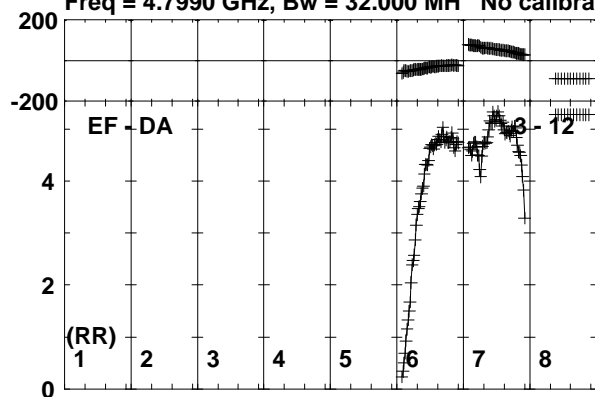

Lower frame: Milli Ampl Jy Top frame: Phas deg  
Vector averaged cross-power spectrum Baseline: EF (03) - DA (12)  
Timerange: 01/00:45:21 to 01/00:46:19

Plot file version 229 created 11-NOV-2019 15:07:42

SER8NJ EK040B.UVDATA.1

Freq = 4.7990 GHz, Bw = 32.000 MH No calibration applied and no bandpass applied

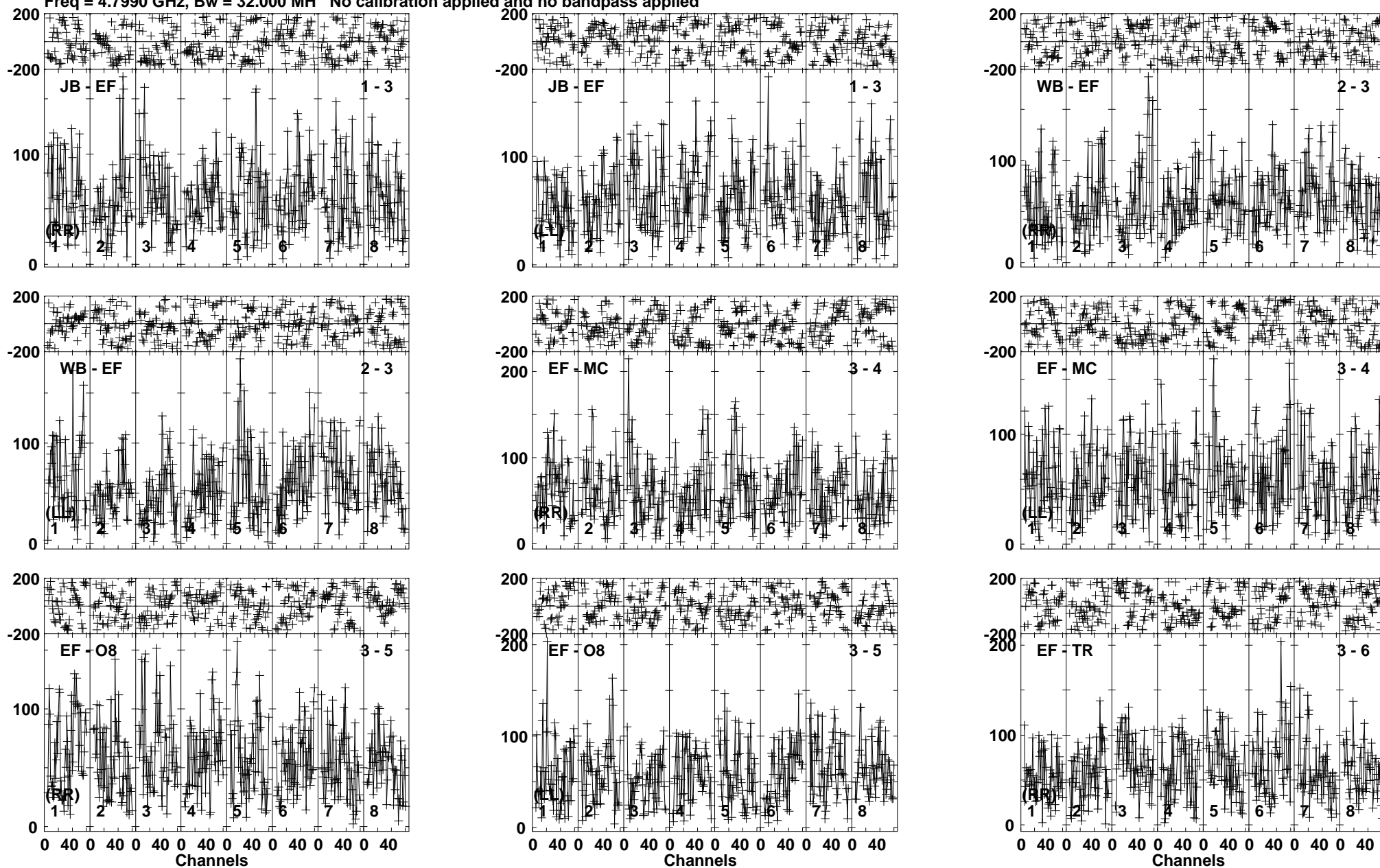

Lower frame: Micro Ampl Jy Top frame: Phas deg  
Vector averaged cross-power spectrum Baseline: JB (01) - EF (03)  
Timerange: 01/00:46:21 to 01/00:50:19

Plot file version 230 created 11-NOV-2019 15:07:42

SER8NJ EK040B.UVDATA.1

Freq = 4.7990 GHz, Bw = 32.000 MH No calibration applied and no bandpass applied

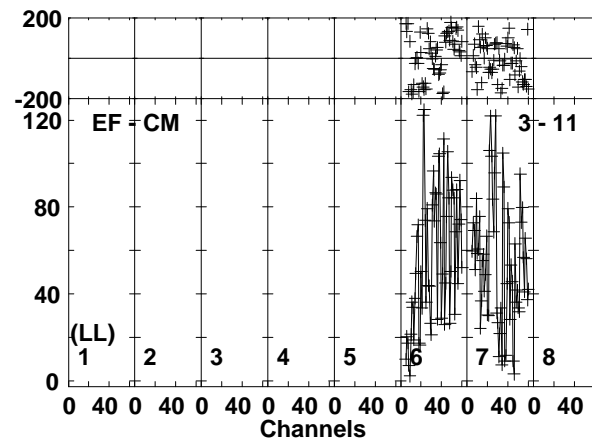
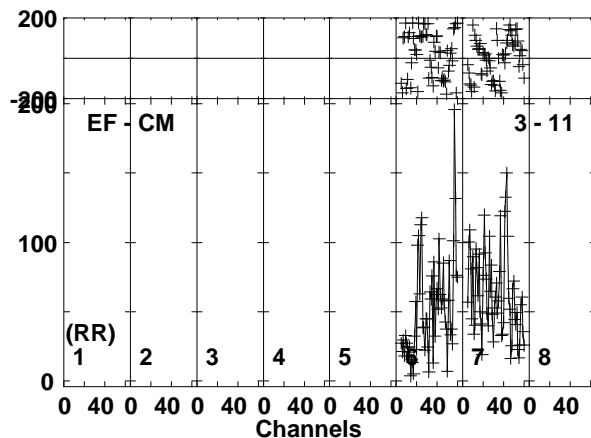
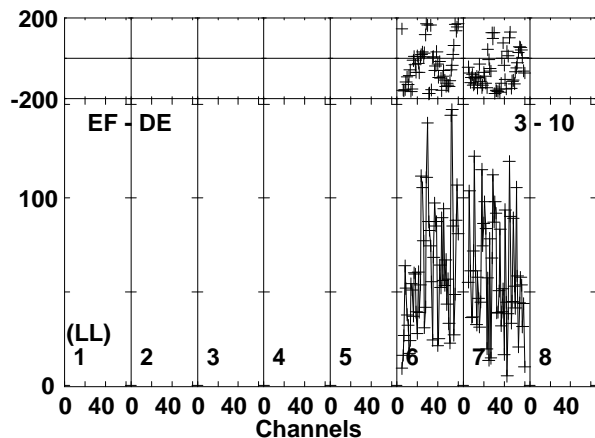
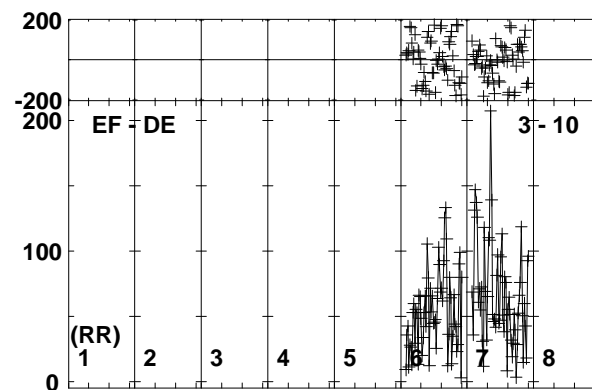
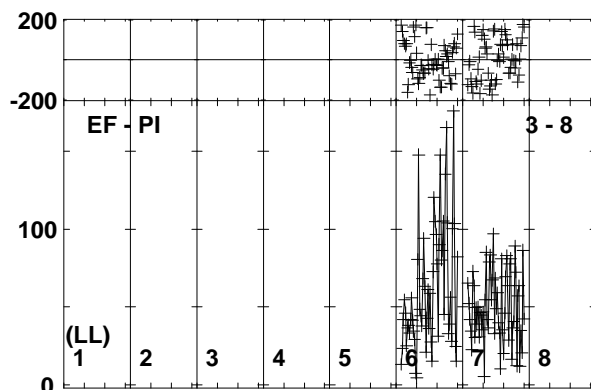
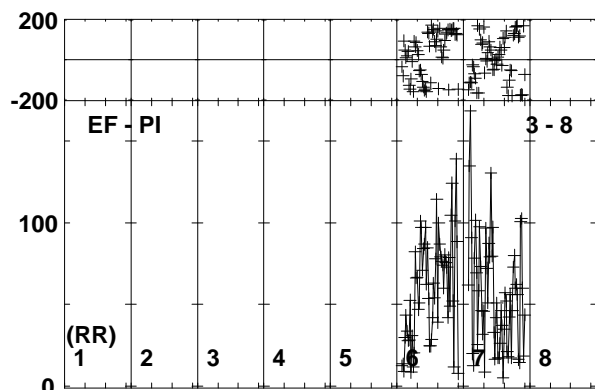
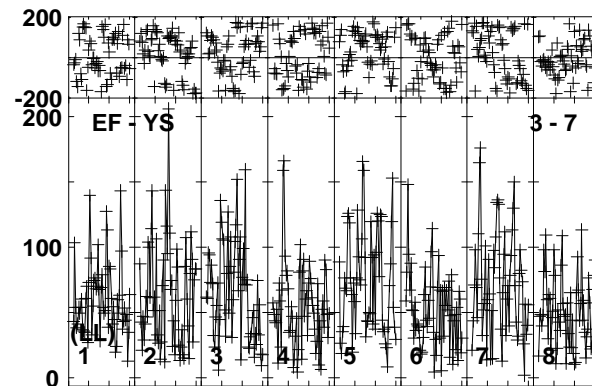
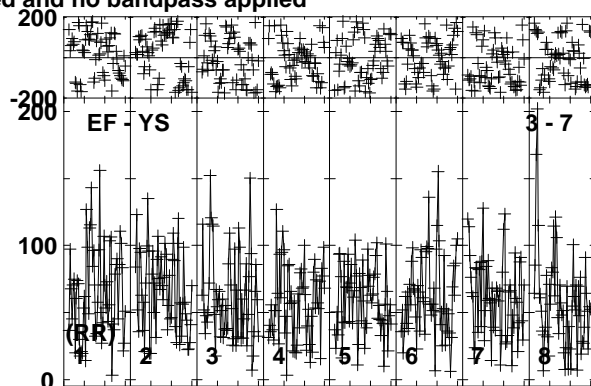
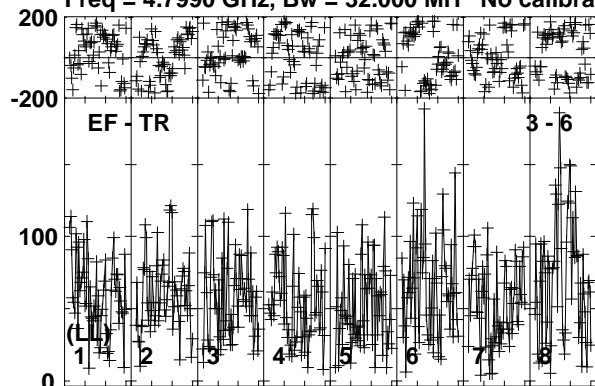

Lower frame: Micro Ampl Jy Top frame: Phas deg  
Vector averaged cross-power spectrum Baseline: EF (03) - TR (06)  
Timerange: 01/00:46:21 to 01/00:50:19

Plot file version 231 created 11-NOV-2019 15:07:42  
 SER8NJ EK040B.UVDATA.1  
 Freq = 4.7990 GHz, Bw = 32.000 MH No calibration applied and no bandpass applied

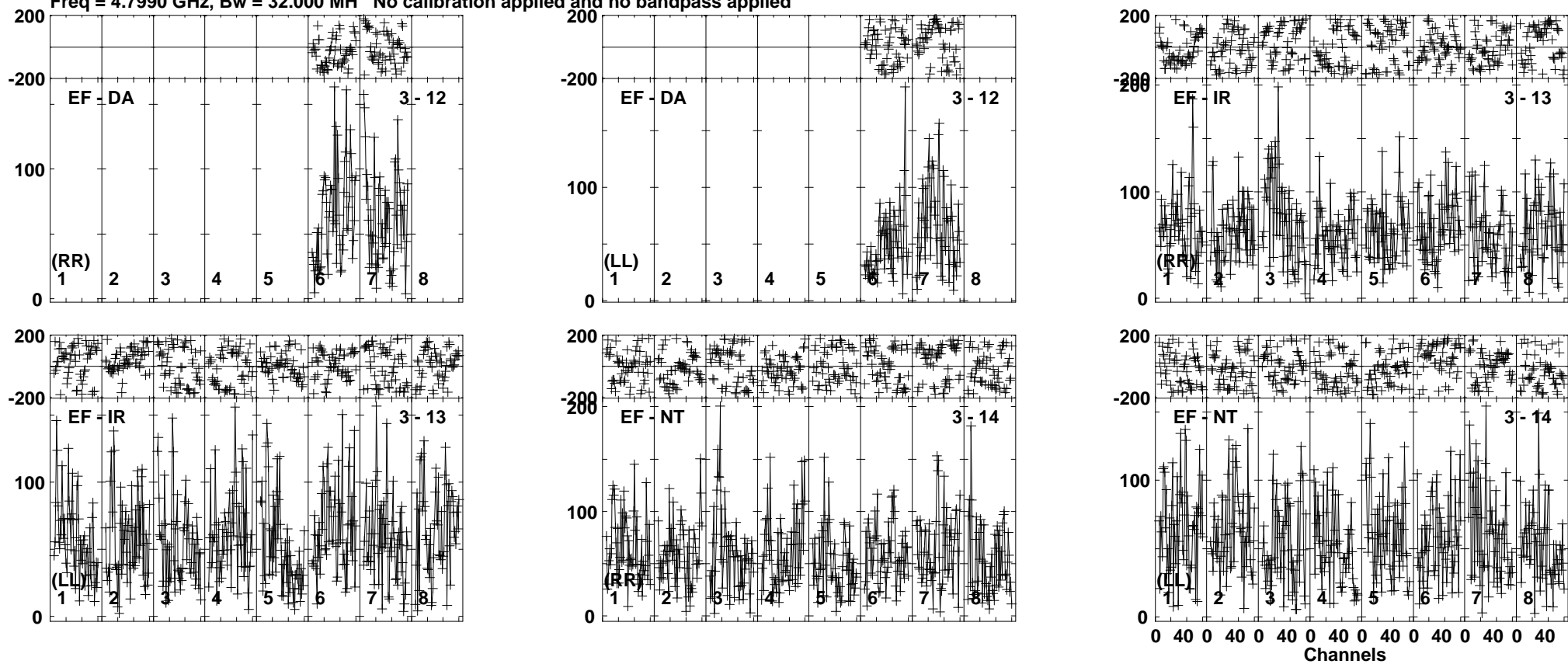

Lower frame: Micro Ampl Jy Top frame: Phas deg  
 Vector averaged cross-power spectrum Baseline: EF (03) - DA (12)  
 Timerange: 01/00:46:21 to 01/00:50:19

Plot file version 232 created 11-NOV-2019 15:07:42

J1826+0149 EK040B.UVDATA.1

Freq = 4.7990 GHz, Bw = 32.000 MH No calibration applied and no bandpass applied

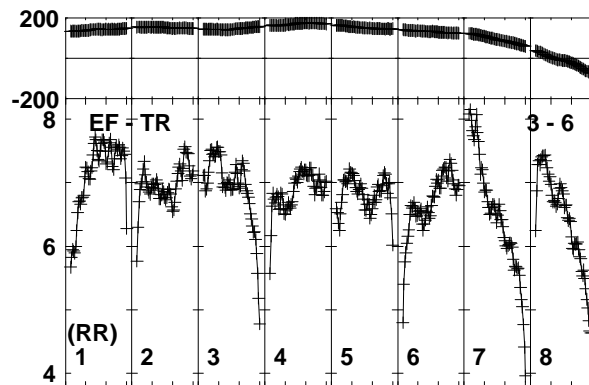
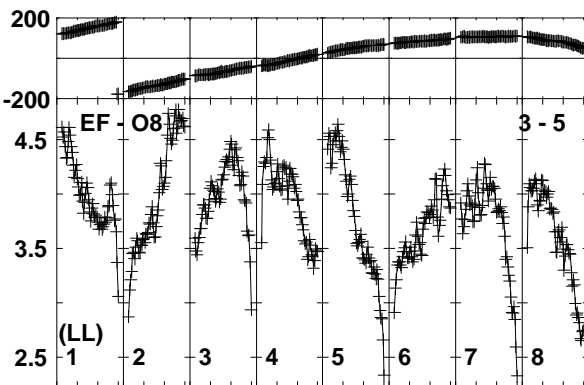
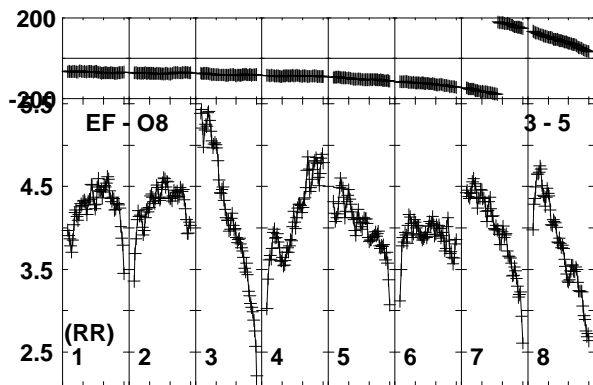
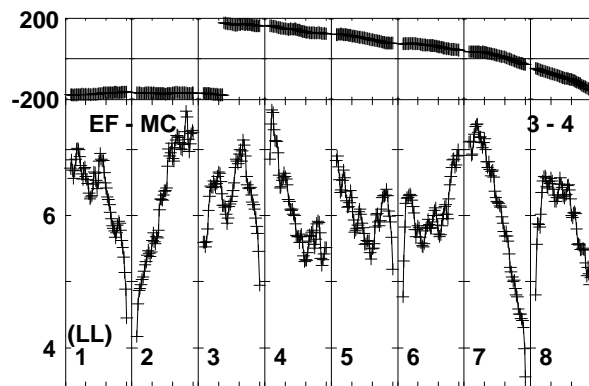
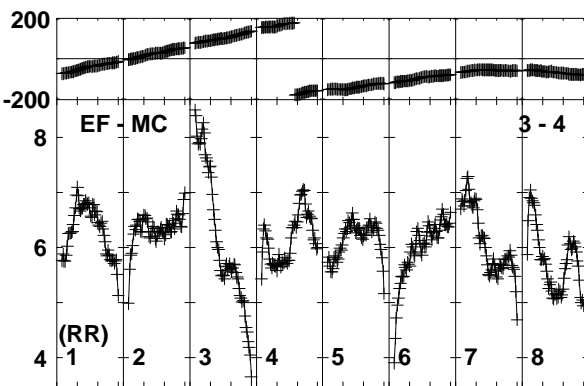
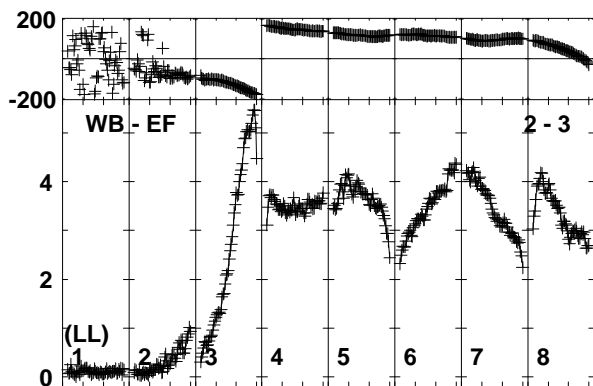
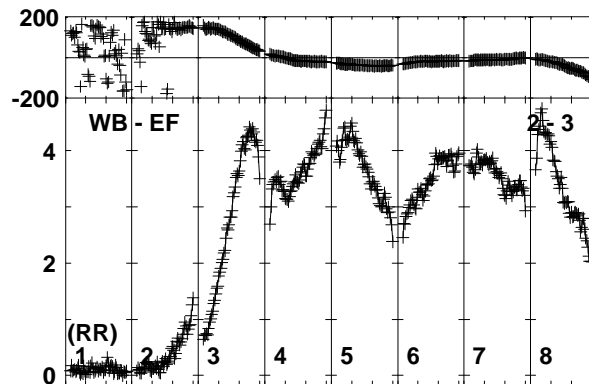
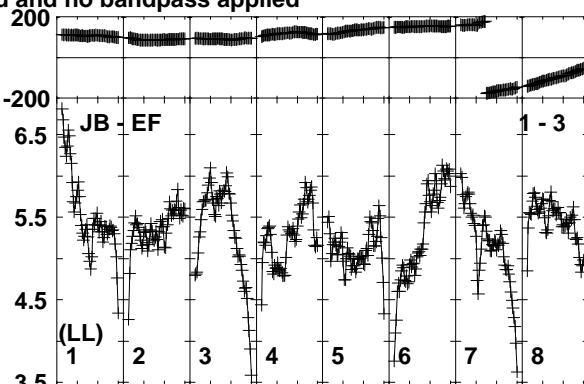
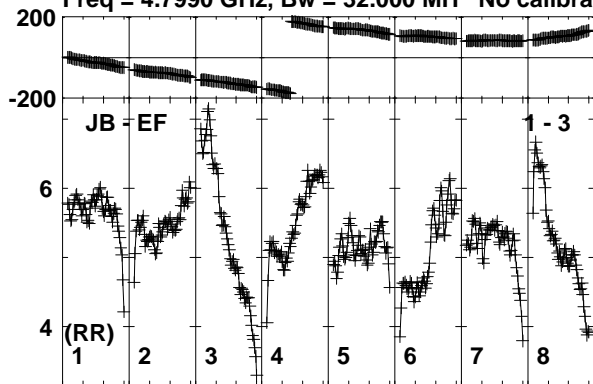

Lower frame: Milli Ampl Jy Top frame: Phas deg  
Vector averaged cross-power spectrum Baseline: JB (01) - EF (03)  
Timerange: 01/00:50:21 to 01/00:51:49

Plot file version 233 created 11-NOV-2019 15:07:42

J1826+0149 EK040B.UVDATA.1

Freq = 4.7990 GHz, Bw = 32.000 MH No calibration applied and no bandpass applied

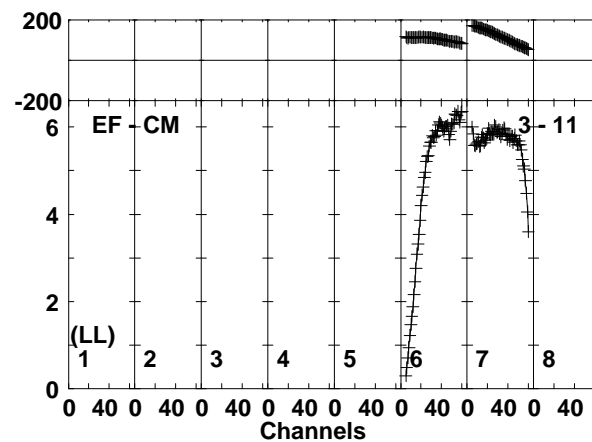
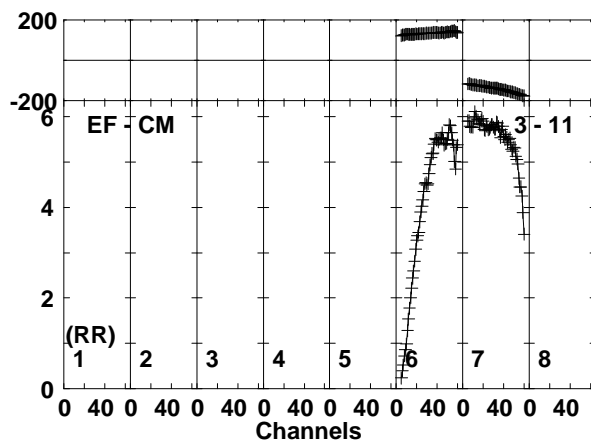
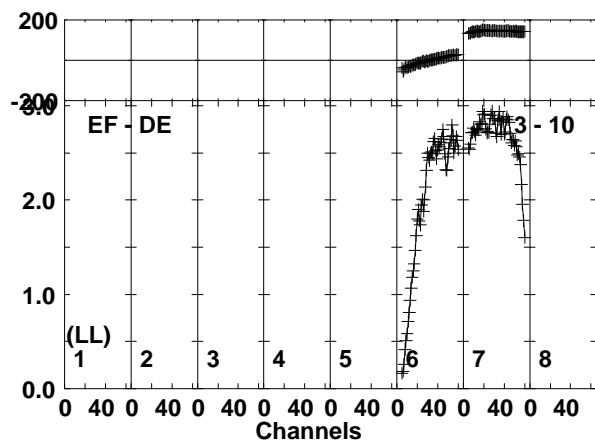
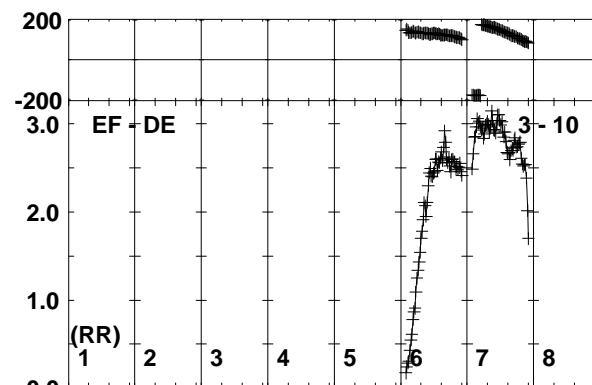
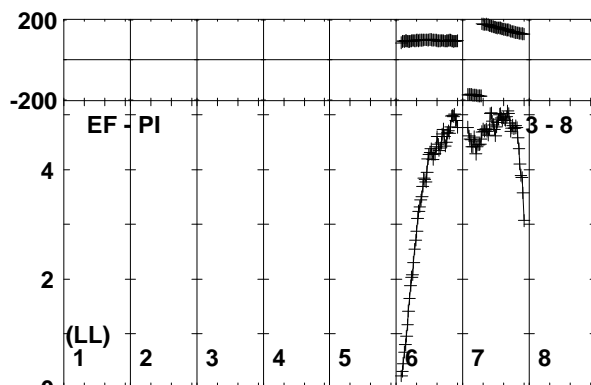
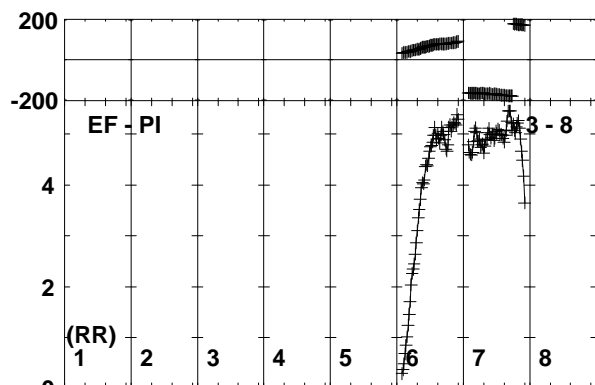
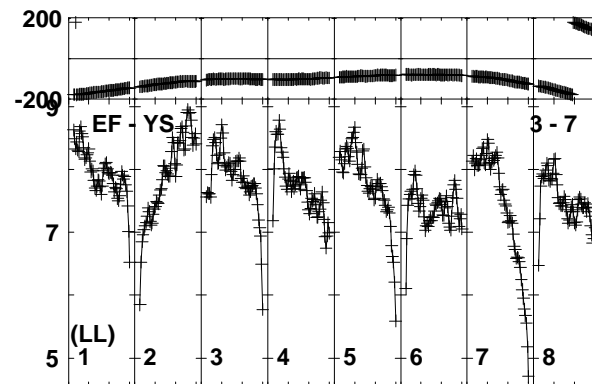
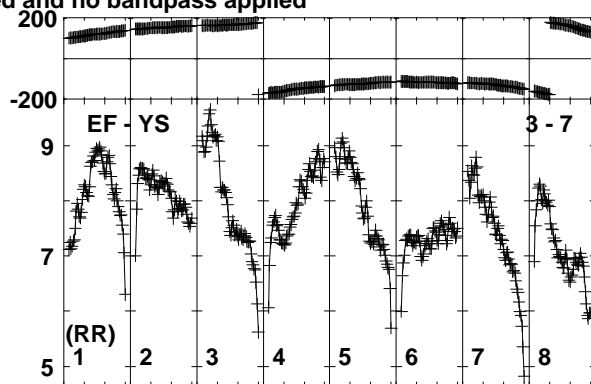
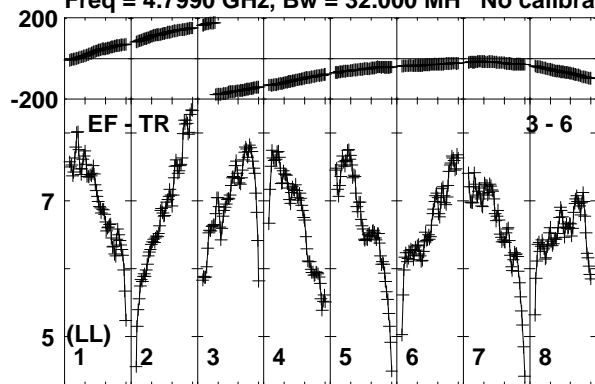

Lower frame: Milli Ampl Jy Top frame: Phas deg  
Vector averaged cross-power spectrum Baseline: EF (03) - TR (06)  
Timerange: 01/00:50:21 to 01/00:51:49

Plot file version 234 created 11-NOV-2019 15:07:42

J1826+0149 EK040B.UVDATA.1

Freq = 4.7990 GHz, Bw = 32.000 MH No calibration applied and no bandpass applied

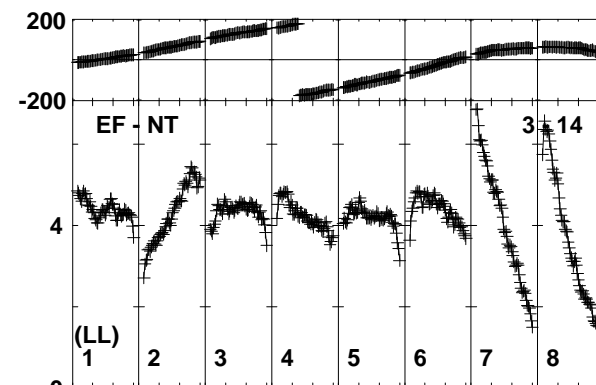
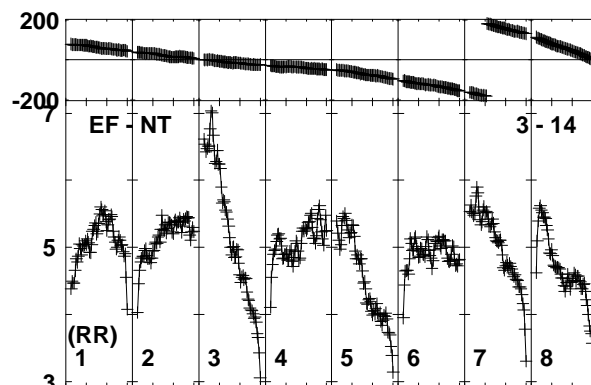
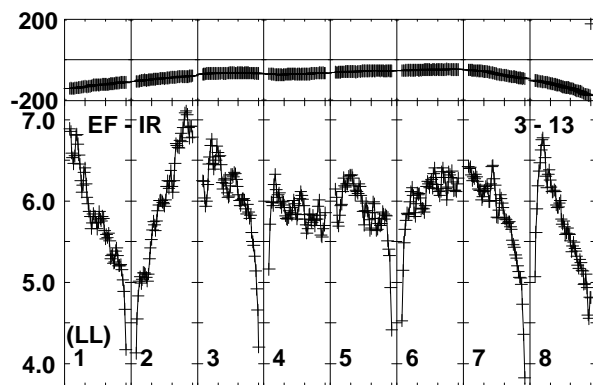
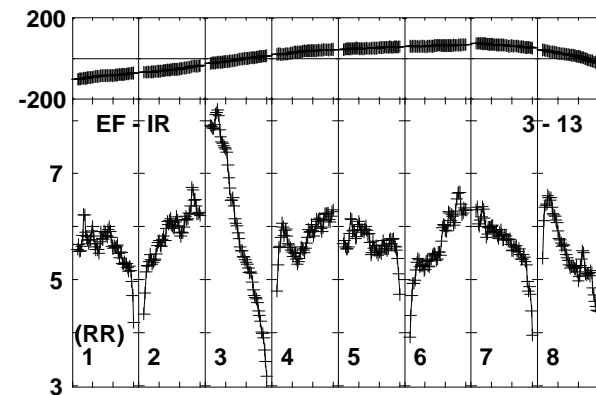
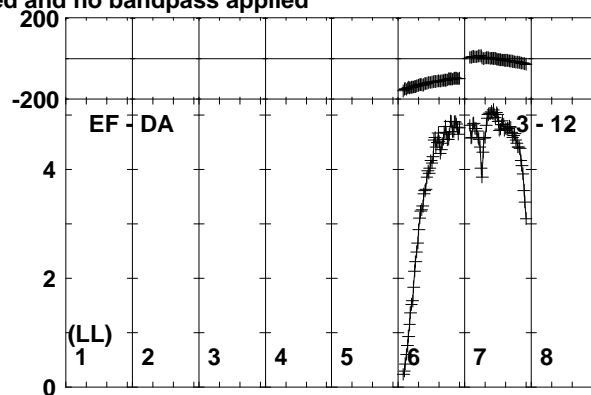
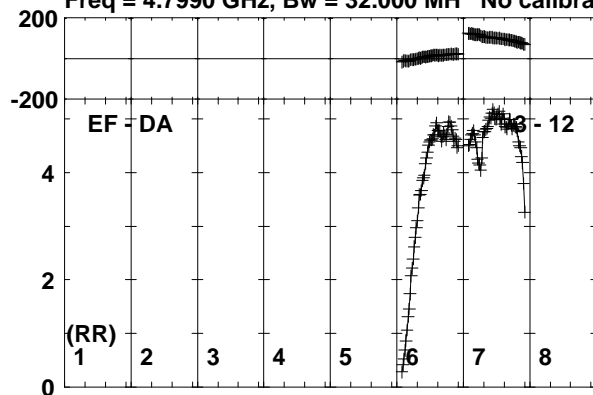

Lower frame: Milli Ampl Jy Top frame: Phas deg  
Vector averaged cross-power spectrum Baseline: EF (03) - DA (12)  
Timerange: 01/00:50:21 to 01/00:51:49



Plot file version 235 created 11-NOV-2019 15:07:42  
 SER8NJ EK040B.UVDATA.1

Freq = 4.7990 GHz, Bw = 32.000 MH No calibration applied and no bandpass applied

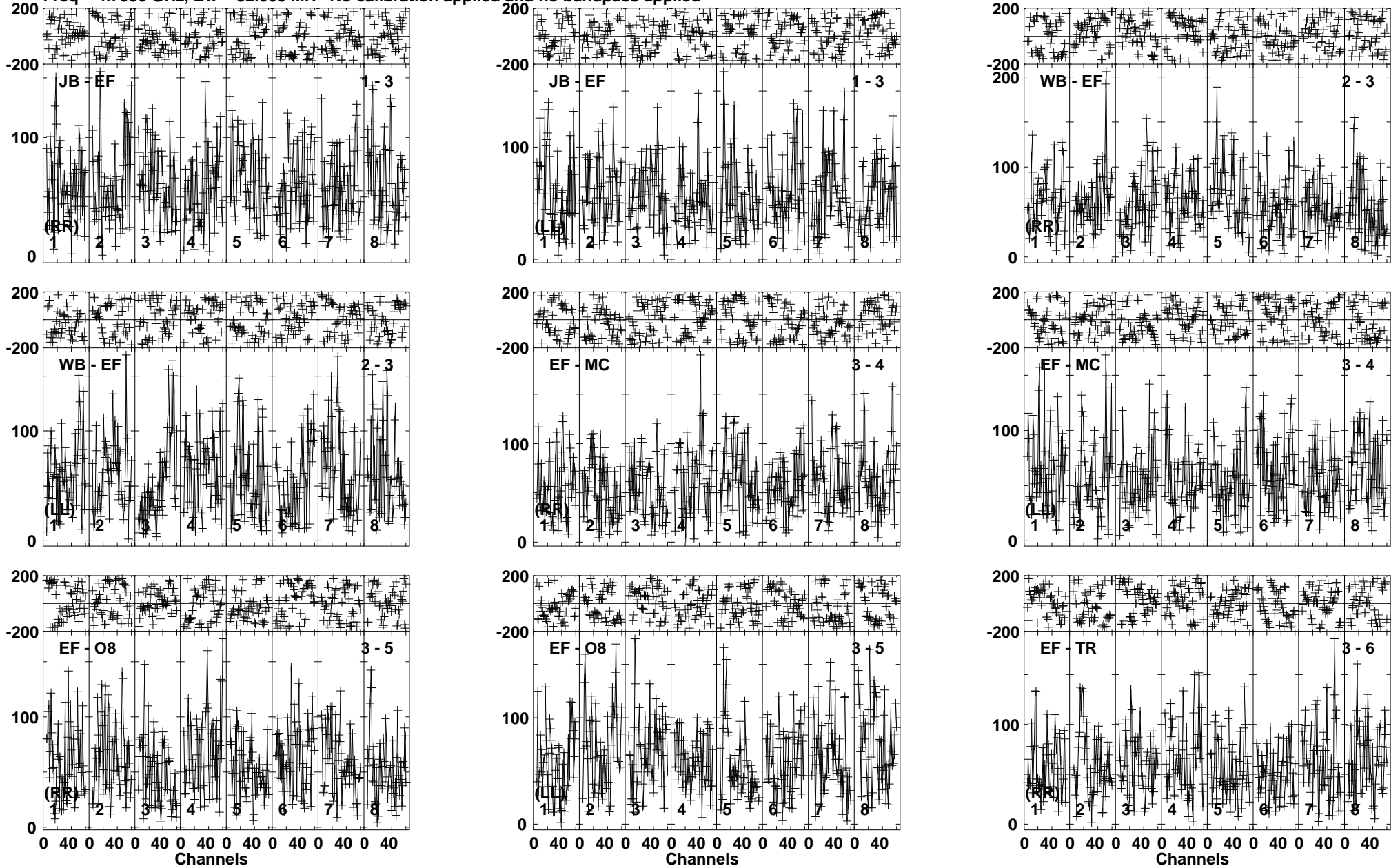

Lower frame: Micro Ampl Jy Top frame: Phas deg  
 Vector averaged cross-power spectrum Baseline: JB (01) - EF (03)  
 Timerange: 01/00:51:53 to 01/00:55:49

Plot file version 236 created 11-NOV-2019 15:07:43

SER8NJ EK040B.UVDATA.1

Freq = 4.7990 GHz, Bw = 32.000 MH No calibration applied and no bandpass applied

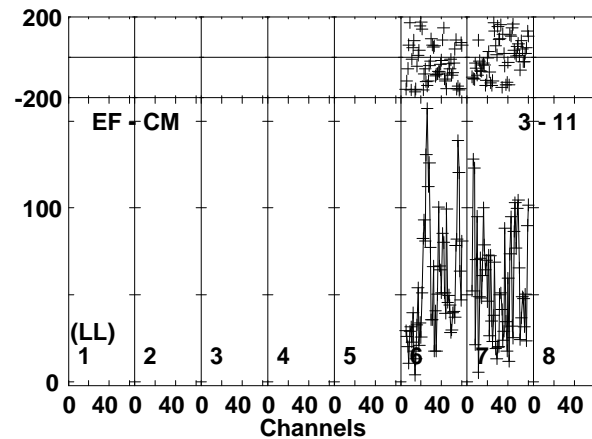
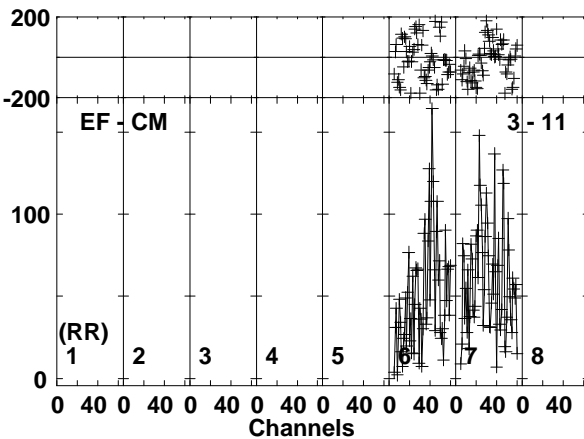
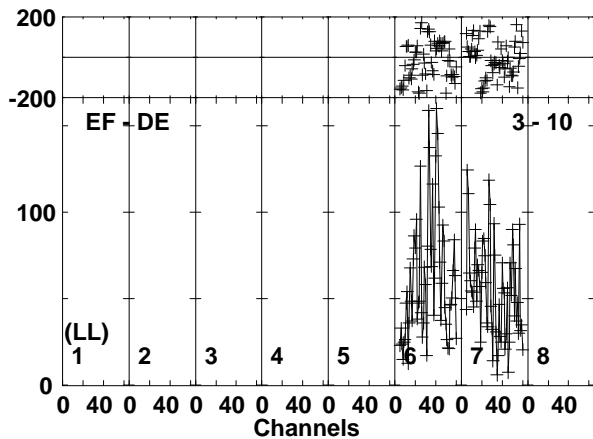
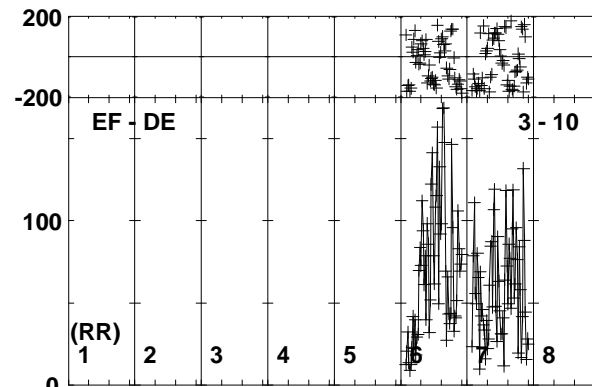
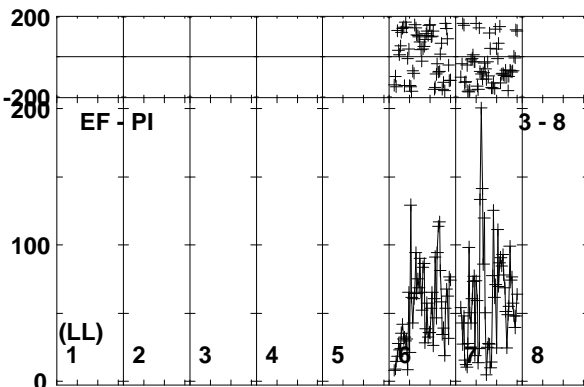
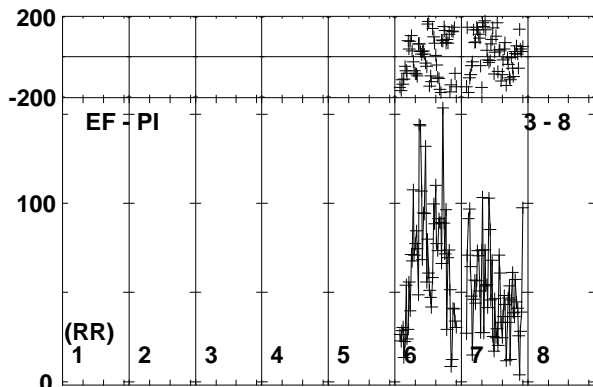
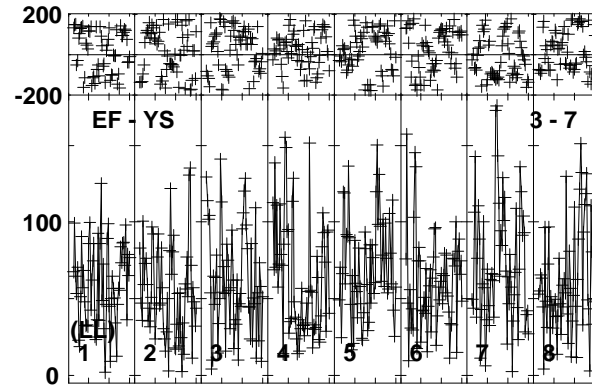
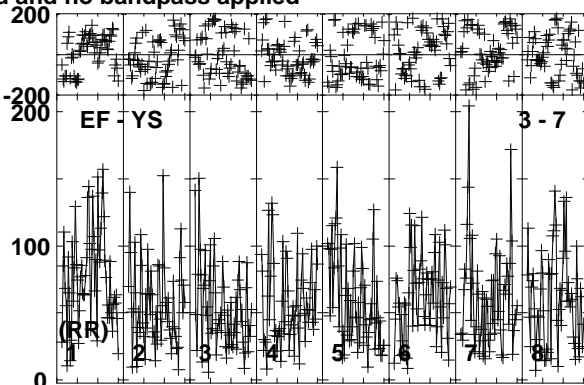
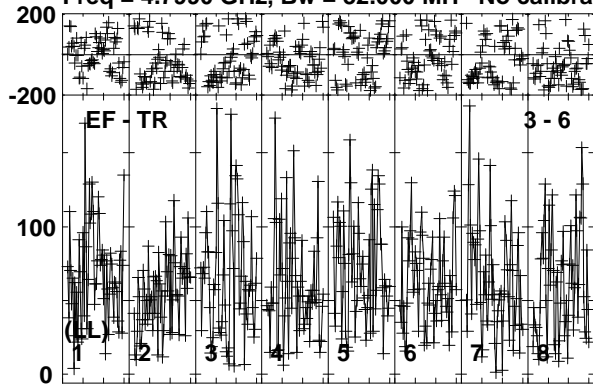

Lower frame: Micro Ampl Jy Top frame: Phas deg  
Vector averaged cross-power spectrum Baseline: EF (03) - TR (06)  
Timerange: 01/00:51:53 to 01/00:55:49

Plot file version 237 created 11-NOV-2019 15:07:43

SER8NJ EK040B.UVDATA.1

Freq = 4.7990 GHz, Bw = 32.000 MH No calibration applied and no bandpass applied

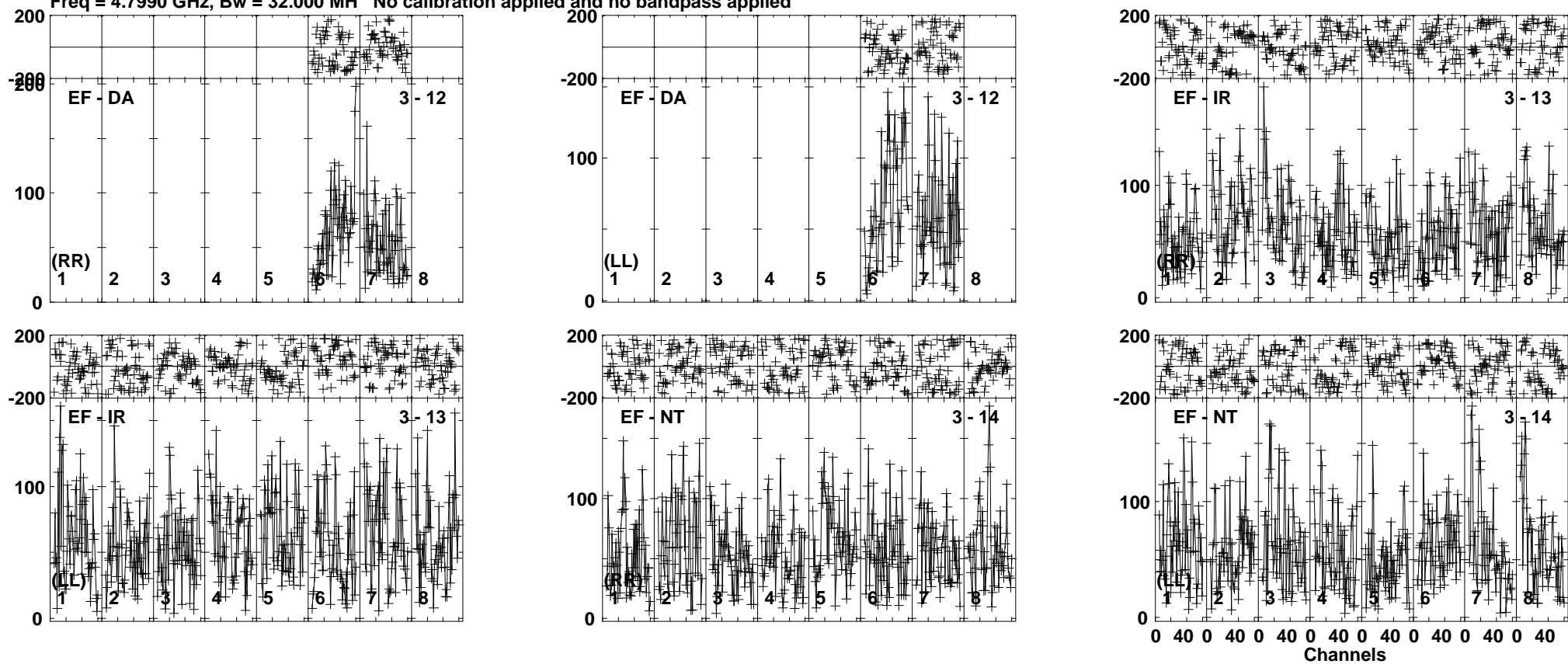

Lower frame: Micro Ampl Jy Top frame: Phas deg  
Vector averaged cross-power spectrum Baseline: EF (03) - DA (12)  
Timerange: 01/00:51:53 to 01/00:55:49

Plot file version 238 created 11-NOV-2019 15:07:43

J1826+0149 EK040B.UVDATA.1

Freq = 4.7990 GHz, Bw = 32.000 MH No calibration applied and no bandpass applied

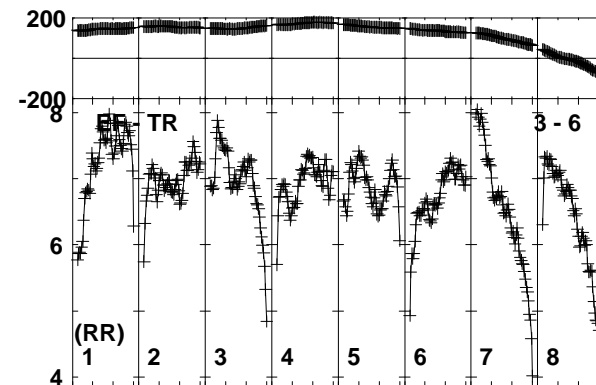
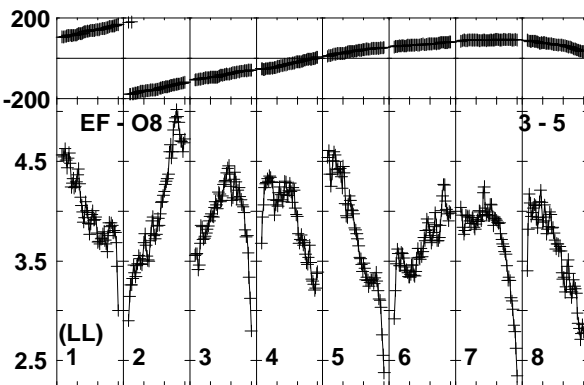
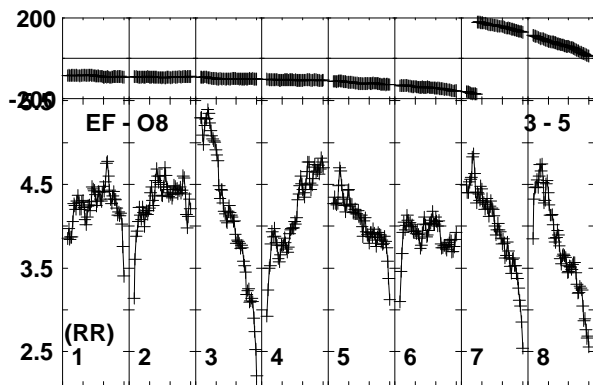
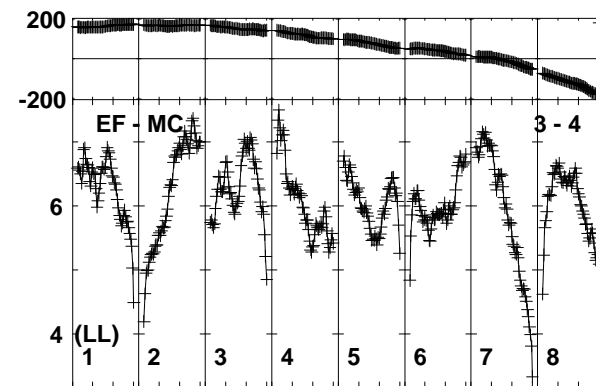
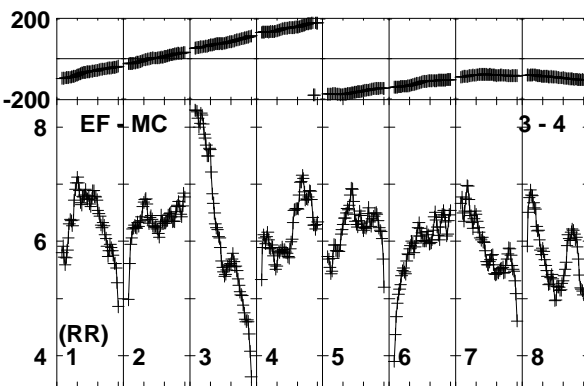
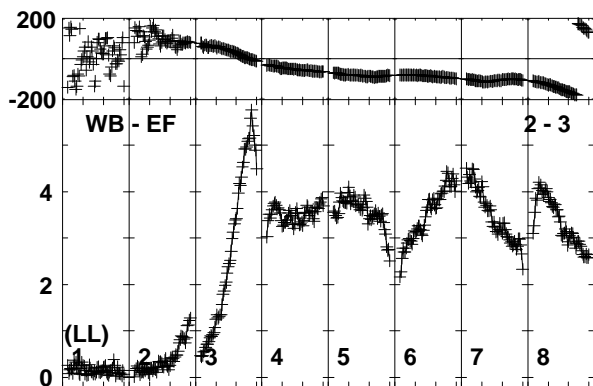
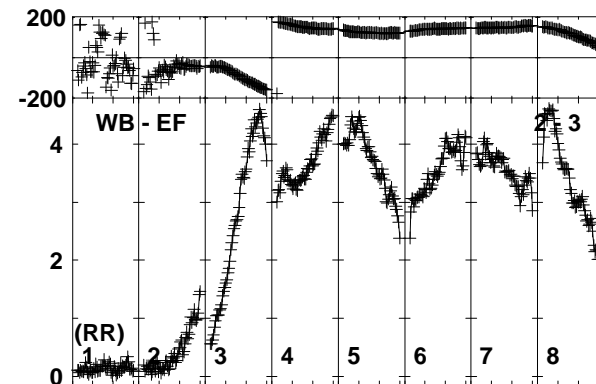
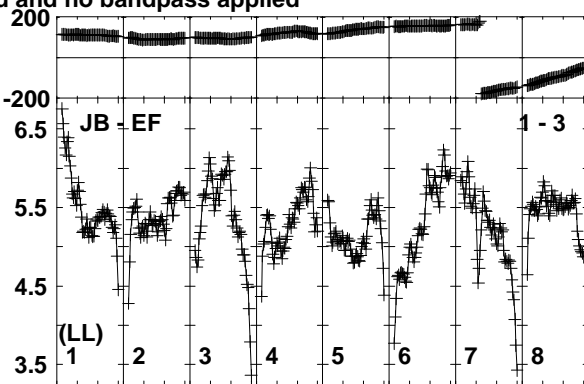
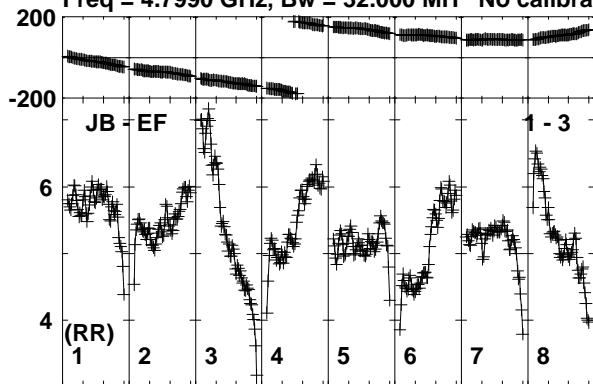

Lower frame: Milli Ampl Jy Top frame: Phas deg  
Vector averaged cross-power spectrum Baseline: JB (01) - EF (03)  
Timerange: 01/00:56:31 to 01/00:57:29

Plot file version 239 created 11-NOV-2019 15:07:43

J1826+0149 EK040B.UVDATA.1

Freq = 4.7990 GHz, Bw = 32.000 MH No calibration applied and no bandpass applied

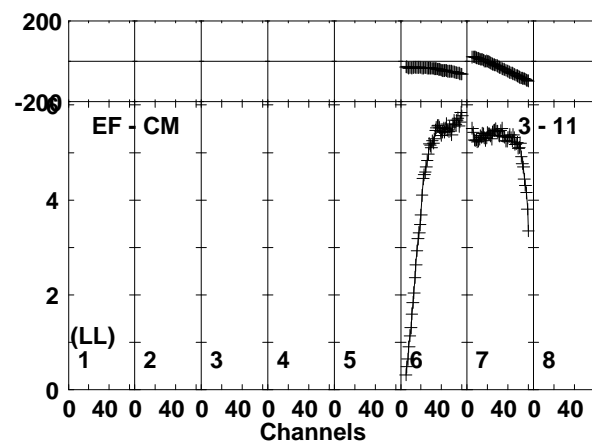
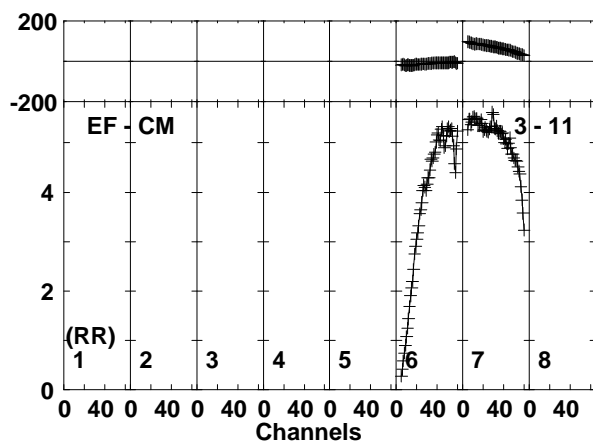
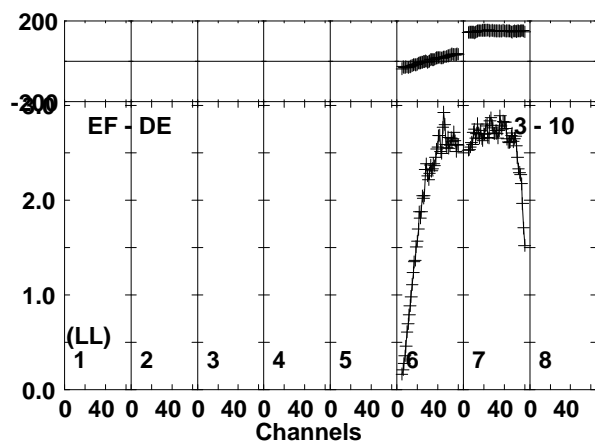
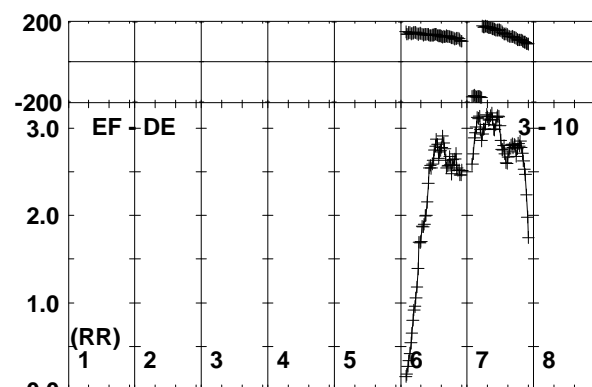
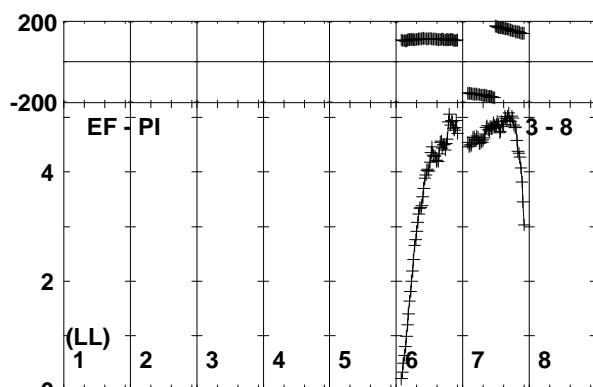
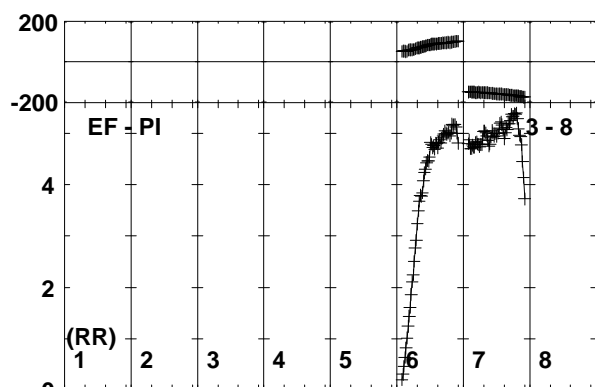
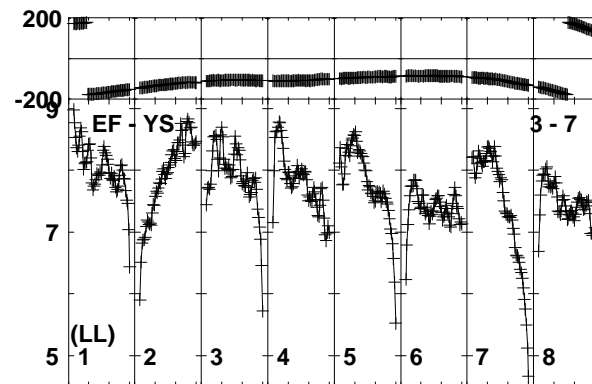
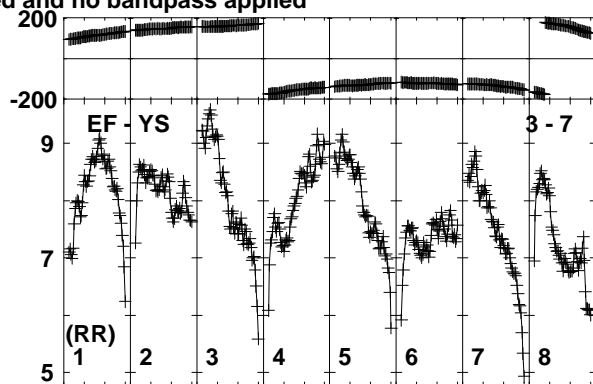
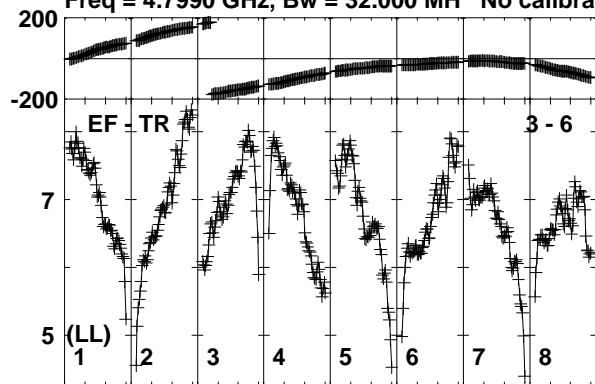

Lower frame: Milli Ampl Jy Top frame: Phas deg  
Vector averaged cross-power spectrum Baseline: EF (03) - TR (06)  
Timerange: 01/00:56:31 to 01/00:57:29

Plot file version 240 created 11-NOV-2019 15:07:43

J1826+0149 EK040B.UVDATA.1

Freq = 4.7990 GHz, Bw = 32.000 MH No calibration applied and no bandpass applied

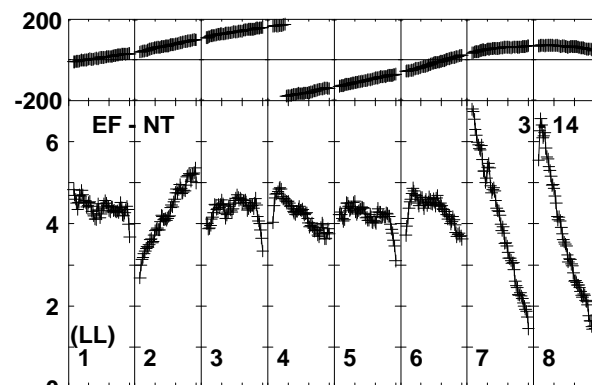
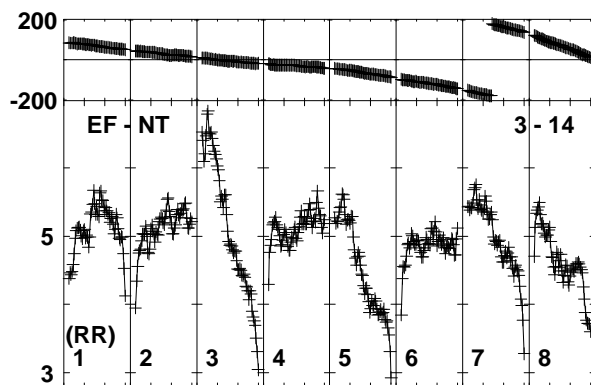
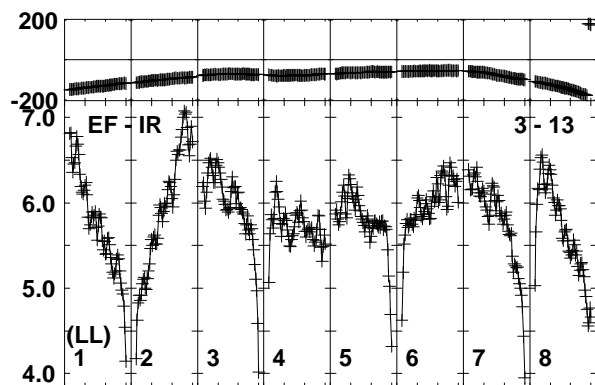
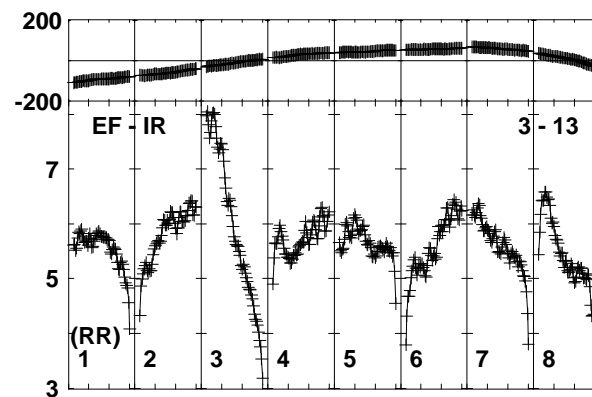
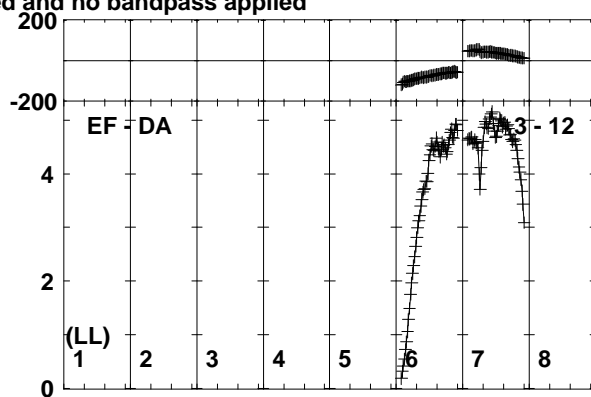
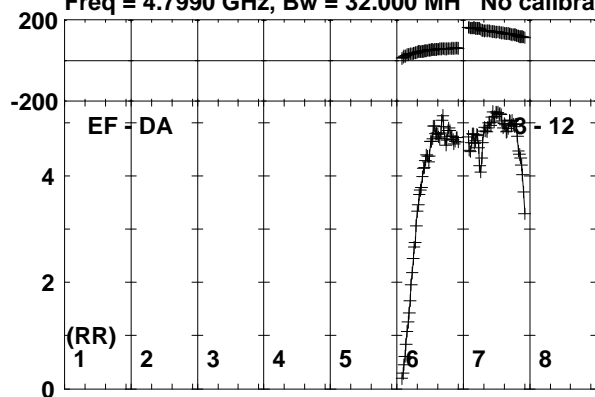

Channels

Lower frame: Milli Ampl Jy Top frame: Phas deg  
Vector averaged cross-power spectrum Baseline: EF (03) - DA (12)  
Timerange: 01/00:56:31 to 01/00:57:29

Plot file version 241 created 11-NOV-2019 15:07:43

SER8NJ EK040B.UVDATA.1

Freq = 4.7990 GHz, Bw = 32.000 MH No calibration applied and no bandpass applied

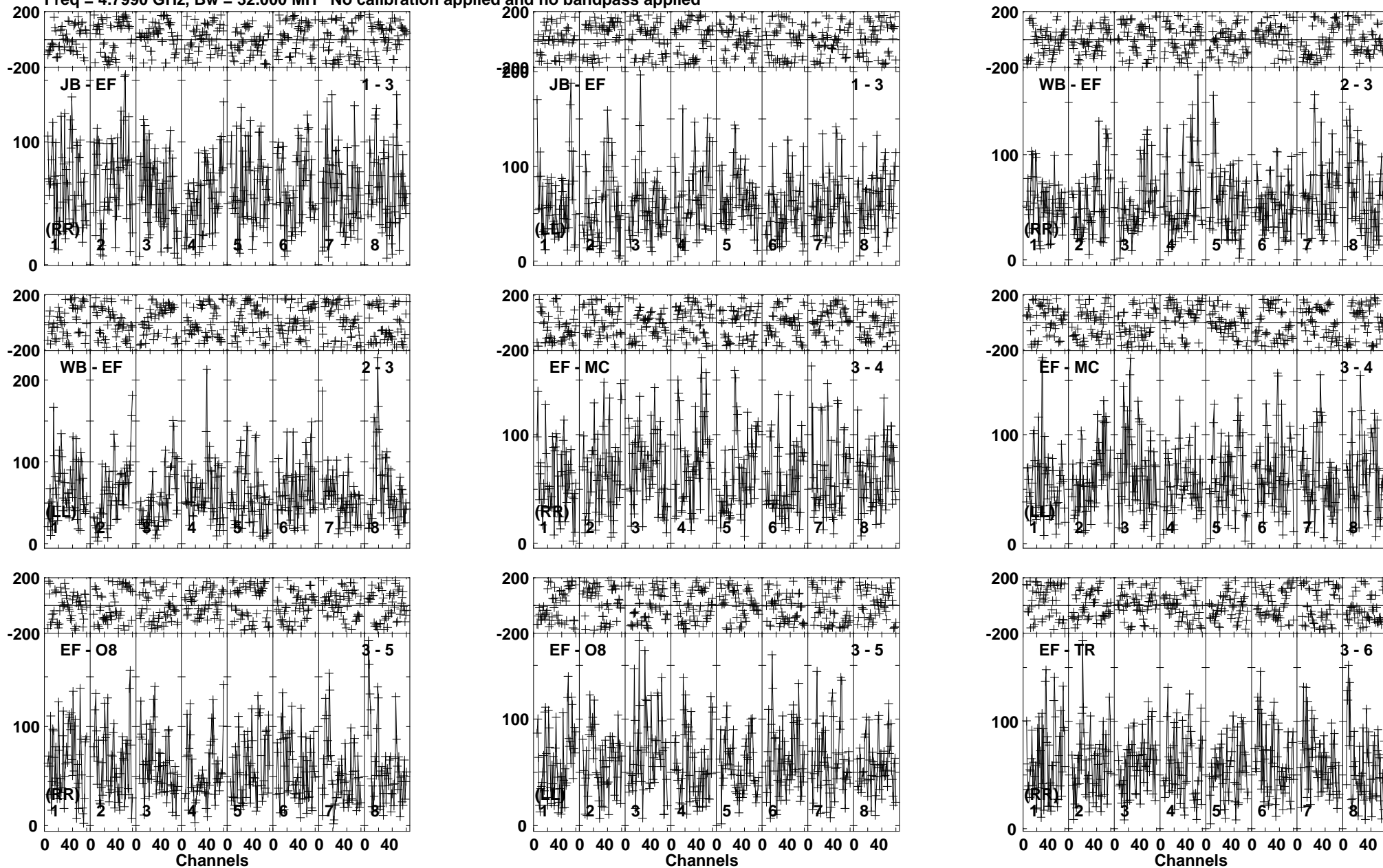

Lower frame: Micro Ampl Jy Top frame: Phas deg  
Vector averaged cross-power spectrum Baseline: JB (01) - EF (03)  
Timerange: 01/00:57:31 to 01/01:01:29

Plot file version 242 created 11-NOV-2019 15:07:43  
 SER8NJ EK040B.UVDATA.1

Freq = 4.7990 GHz, Bw = 32.000 MH No calibration applied and no bandpass applied

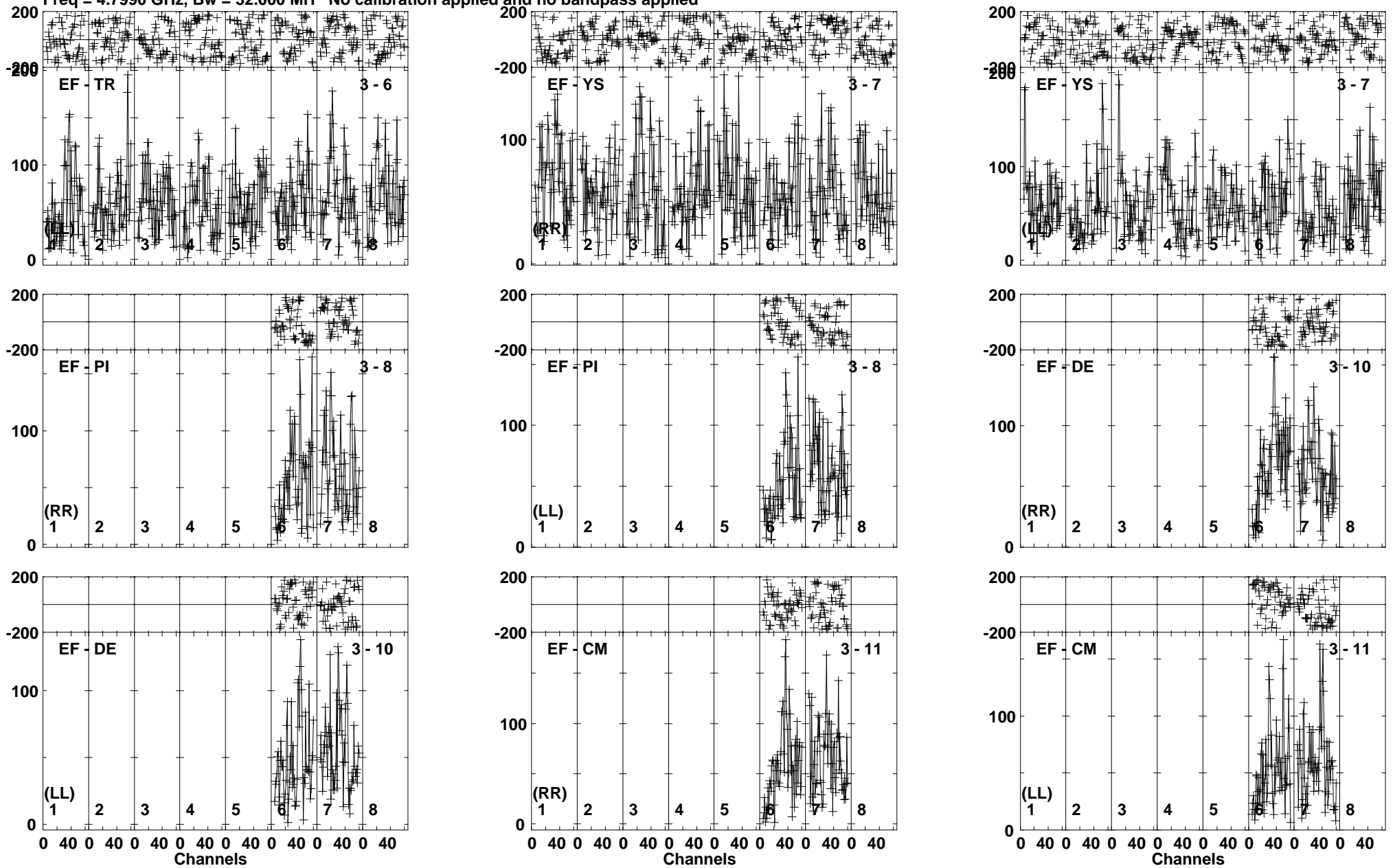

Lower frame: Micro Ampl Jy Top frame: Phas deg  
 Vector averaged cross-power spectrum Baseline: EF (03) - TR (06)  
 Timerange: 01/00:57:31 to 01/01:01:29



Plot file version 243 created 11-NOV-2019 15:07:43

SER8NJ EK040B.UVDATA.1

Freq = 4.7990 GHz, Bw = 32.000 MH No calibration applied and no bandpass applied

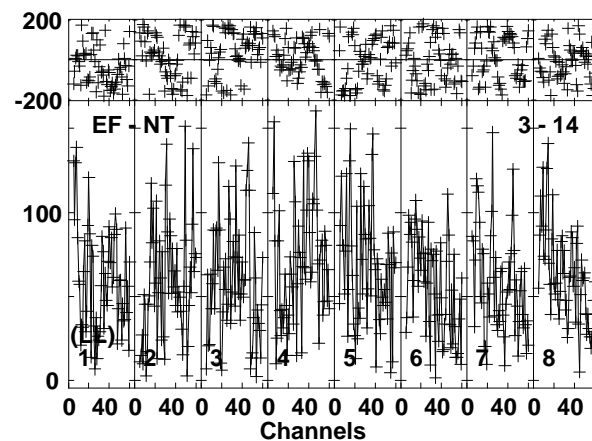
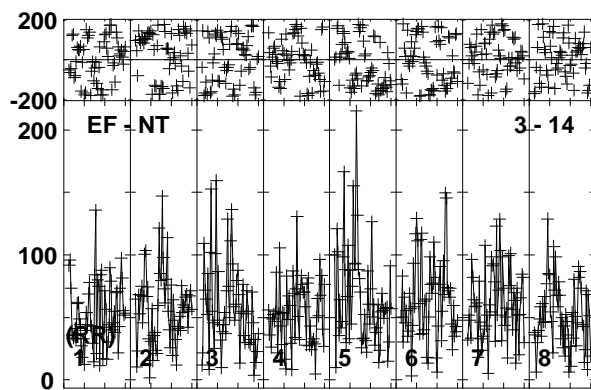
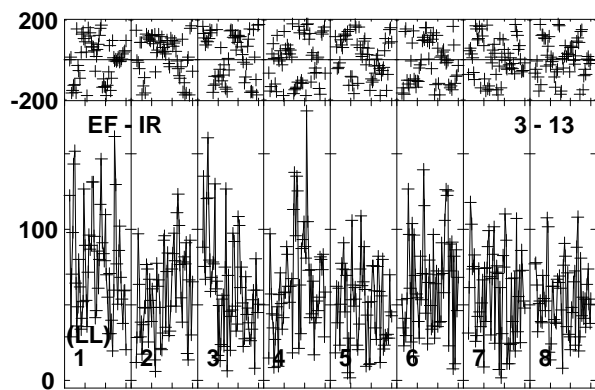
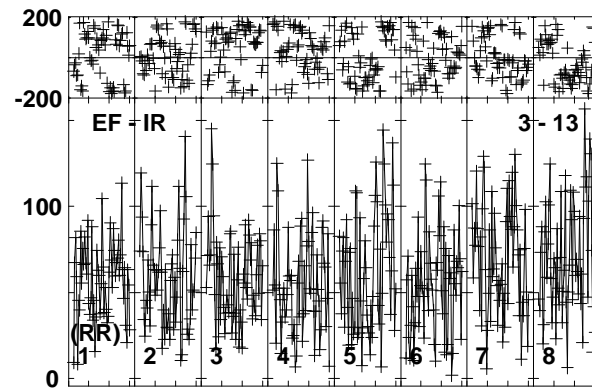
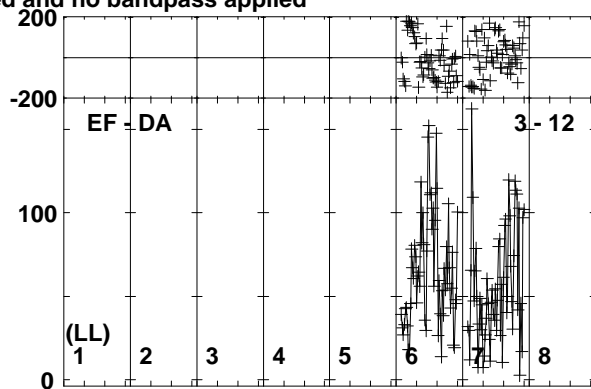
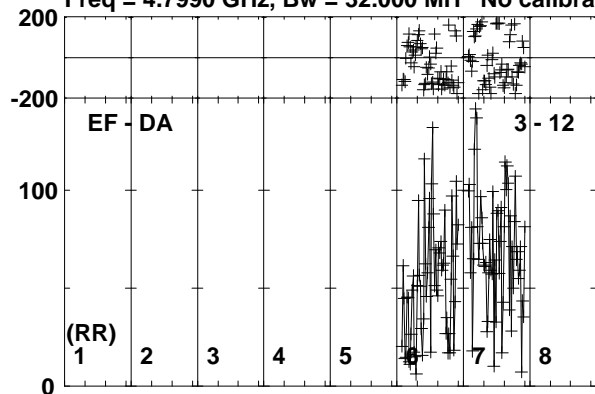

Lower frame: Micro Ampl Jy Top frame: Phas deg  
Vector averaged cross-power spectrum Baseline: EF (03) - DA (12)  
Timerange: 01/00:57:31 to 01/01:01:29

Plot file version 244 created 11-NOV-2019 15:07:44

J1826+0149 EK040B.UVDATA.1

Freq = 4.7990 GHz, Bw = 32.000 MH No calibration applied and no bandpass applied

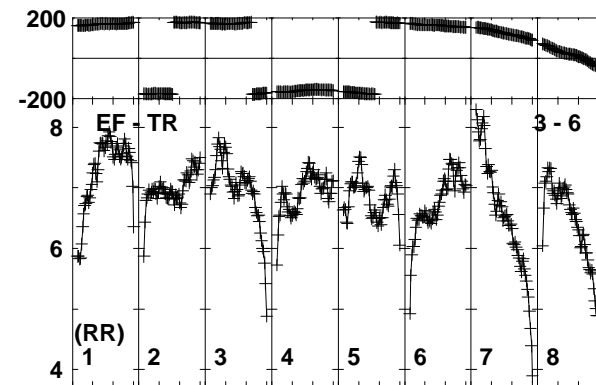
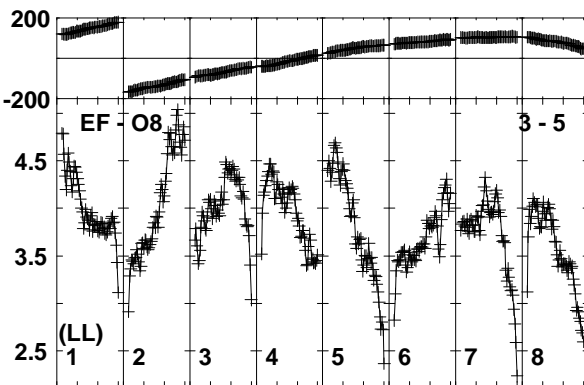
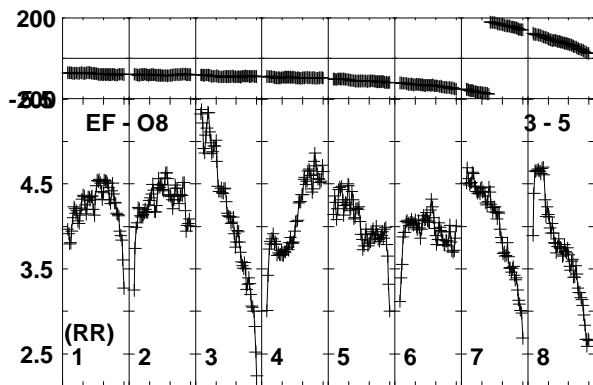
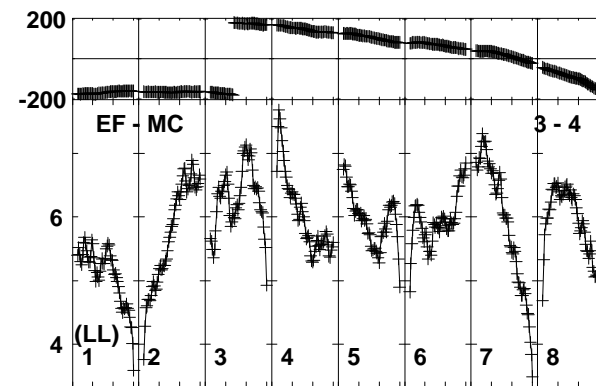
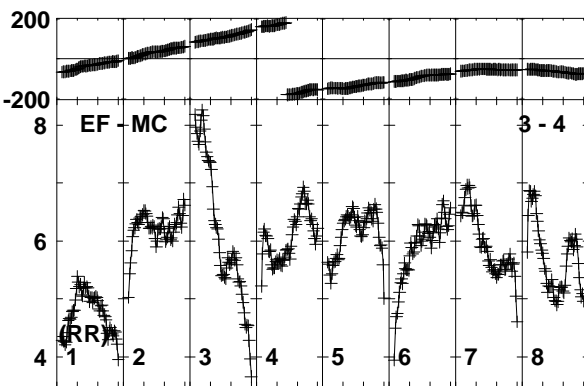
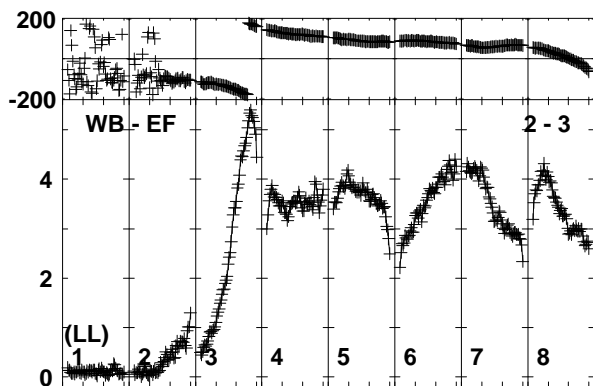
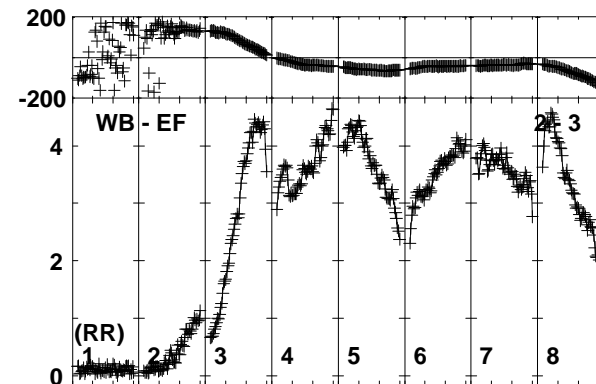
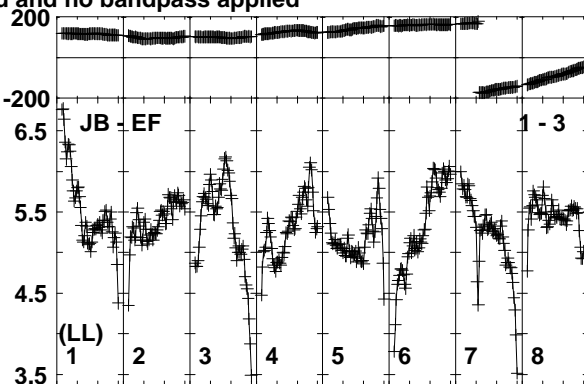
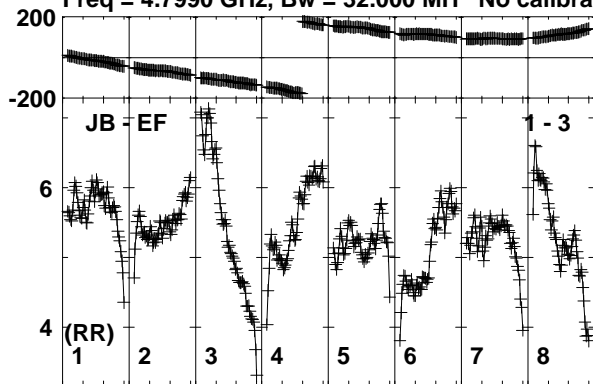

Lower frame: Milli Ampl Jy Top frame: Phas deg  
Vector averaged cross-power spectrum Baseline: JB (01) - EF (03)  
Timerange: 01/01:01:31 to 01/01:02:59

Plot file version 245 created 11-NOV-2019 15:07:44

J1826+0149 EK040B.UVDATA.1

Freq = 4.7990 GHz, Bw = 32.000 MH No calibration applied and no bandpass applied

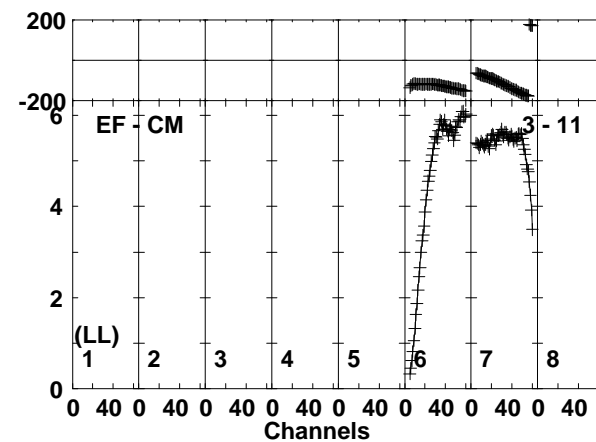
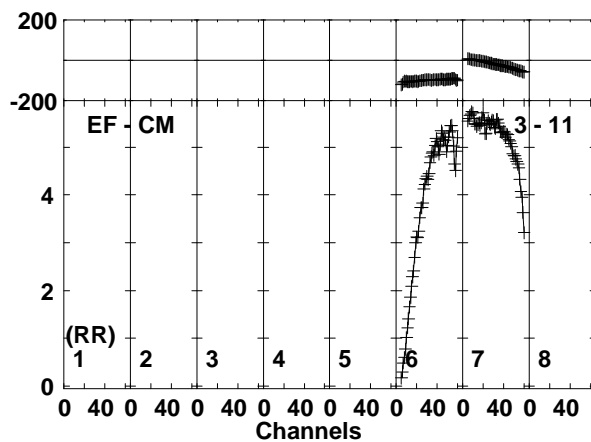
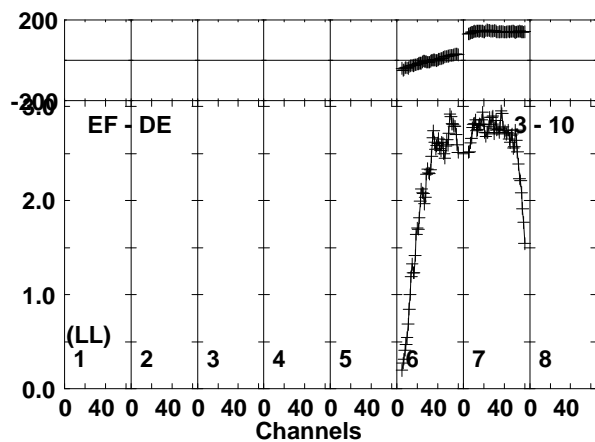
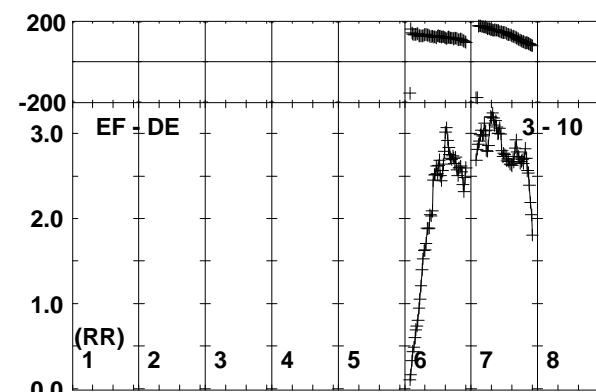
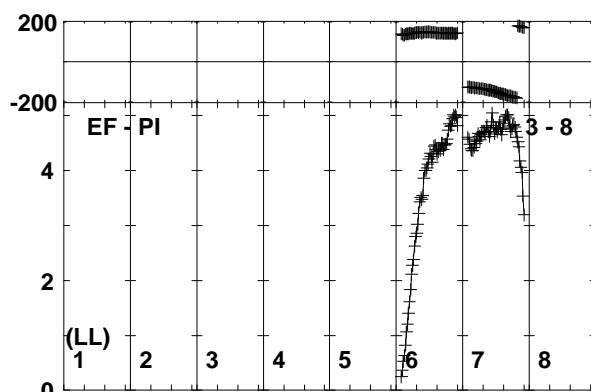
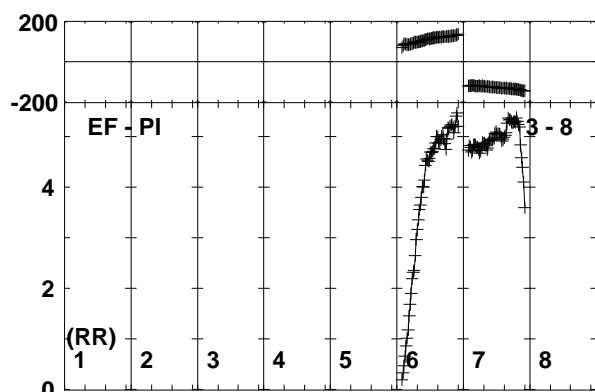
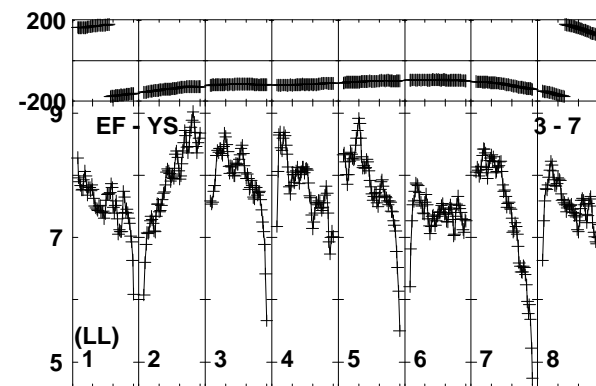
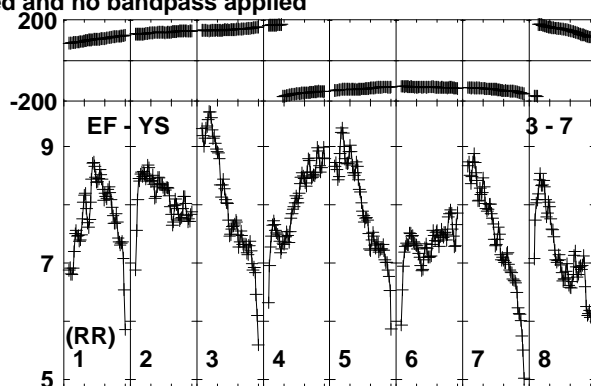
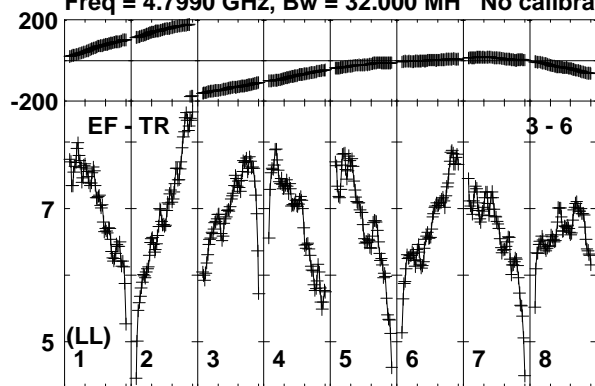

Lower frame: Milli Ampl Jy Top frame: Phas deg  
Vector averaged cross-power spectrum Baseline: EF (03) - TR (06)  
Timerange: 01/01:01:31 to 01/01:02:59

Plot file version 246 created 11-NOV-2019 15:07:44

J1826+0149 EK040B.UVDATA.1

Freq = 4.7990 GHz, Bw = 32.000 MH No calibration applied and no bandpass applied

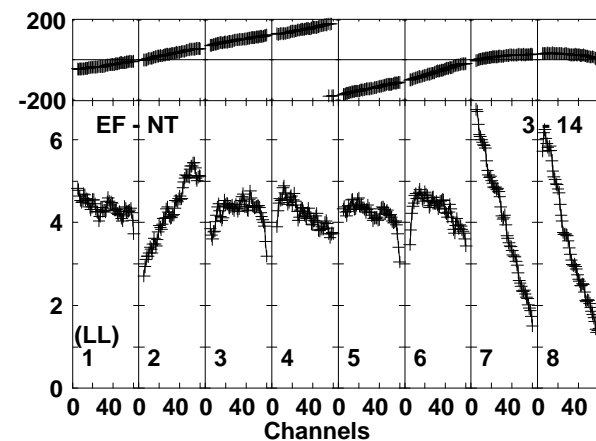
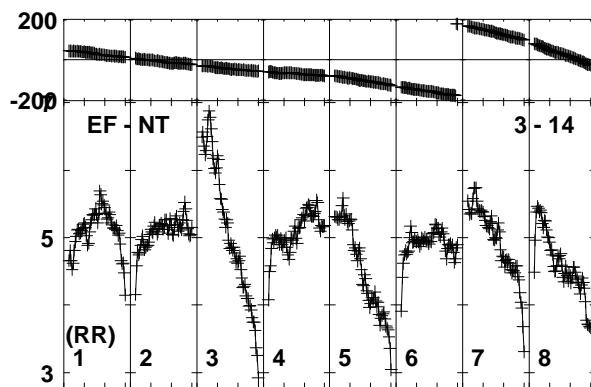
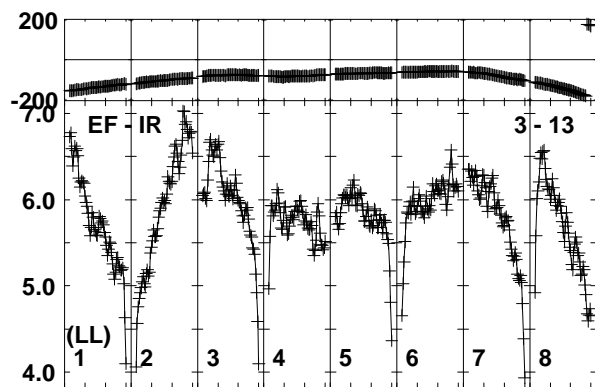
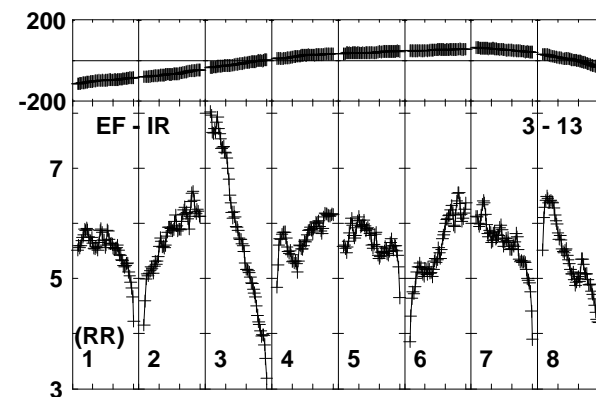
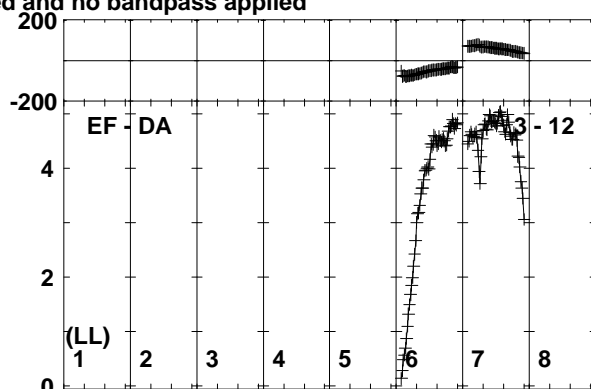
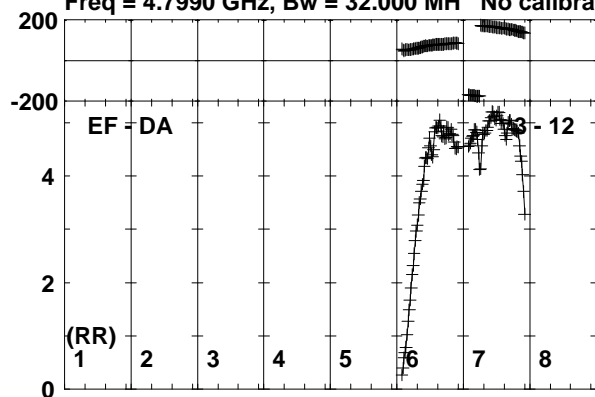

Lower frame: Milli Ampl Jy Top frame: Phas deg  
Vector averaged cross-power spectrum Baseline: EF (03) - DA (12)  
Timerange: 01/01:01:31 to 01/01:02:59

Plot file version 247 created 11-NOV-2019 15:07:44

SER8NJ EK040B.UVDATA.1

Freq = 4.7990 GHz, Bw = 32.000 MH No calibration applied and no bandpass applied

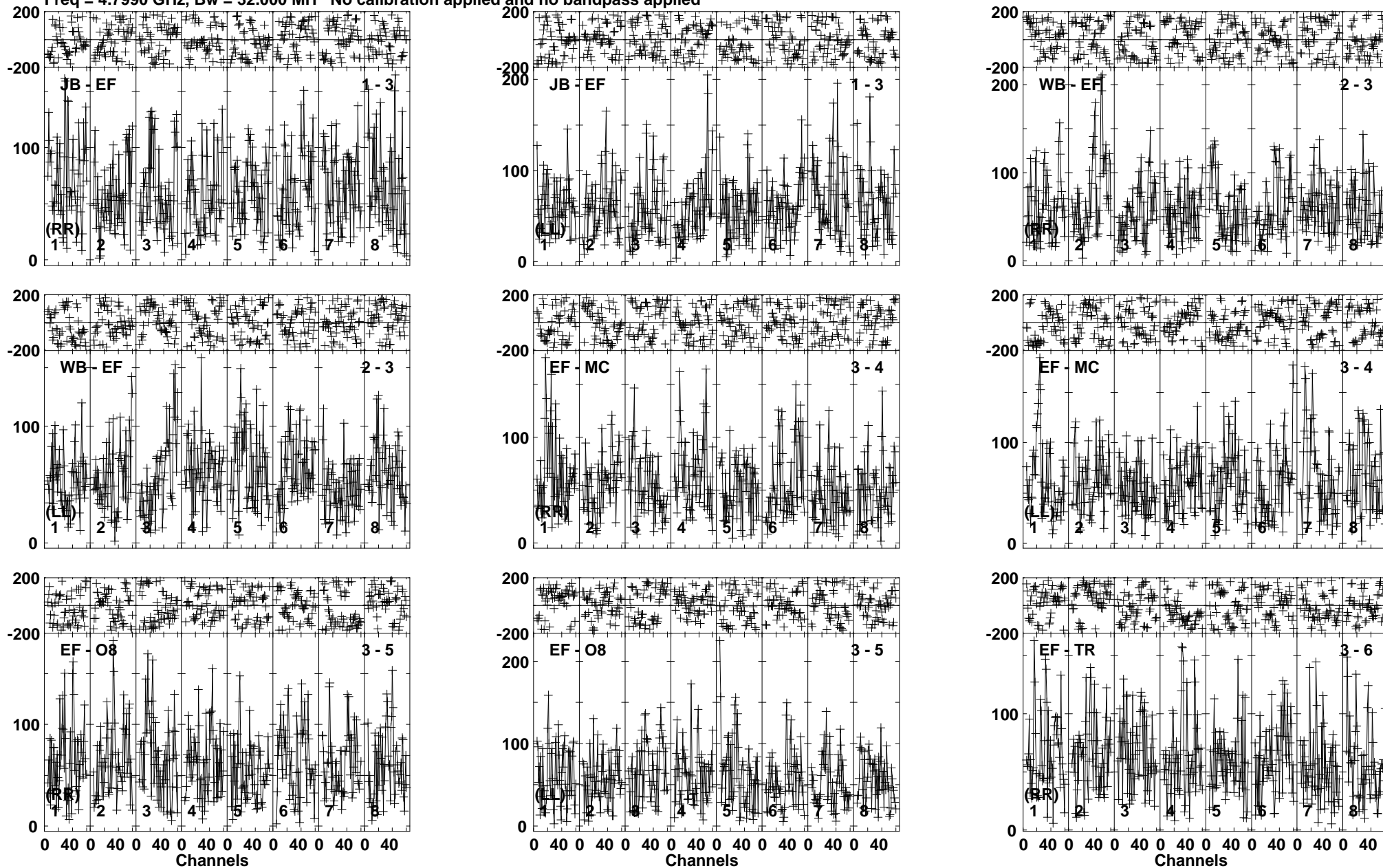

Lower frame: Micro Ampl Jy Top frame: Phas deg  
Vector averaged cross-power spectrum Baseline: JB (01) - EF (03)  
Timerange: 01/01:03:03 to 01/01:06:59

Plot file version 248 created 11-NOV-2019 15:07:44

SER8NJ EK040B.UVDATA.1

Freq = 4.7990 GHz, Bw = 32.000 MH No calibration applied and no bandpass applied

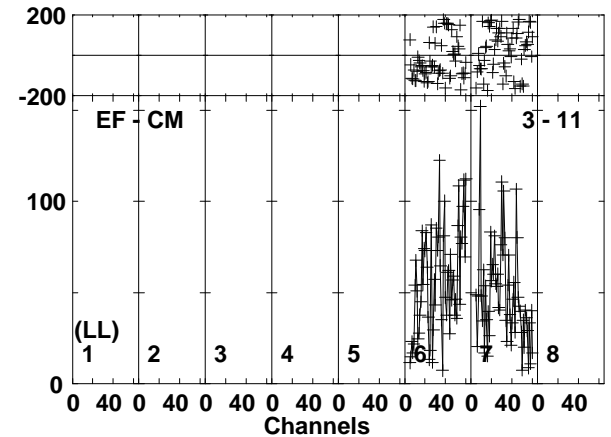
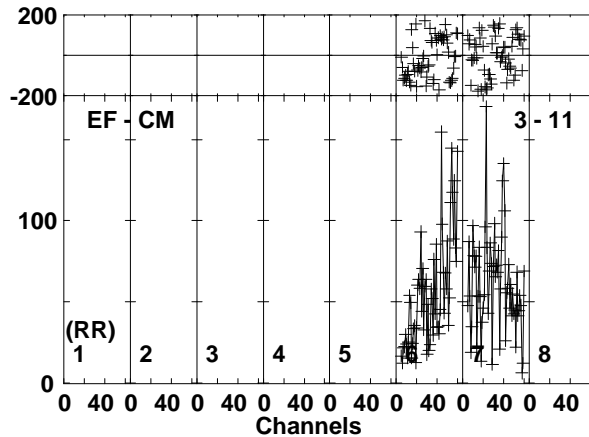
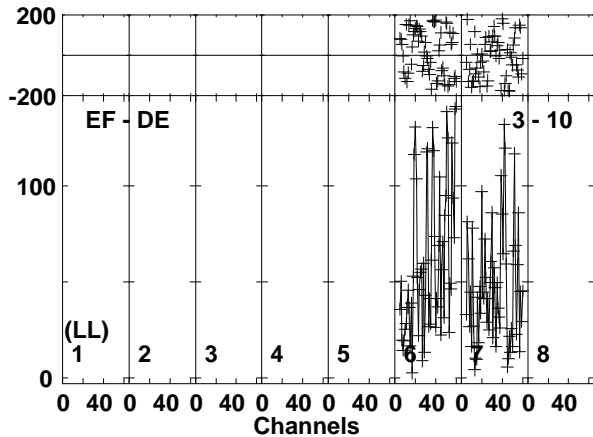
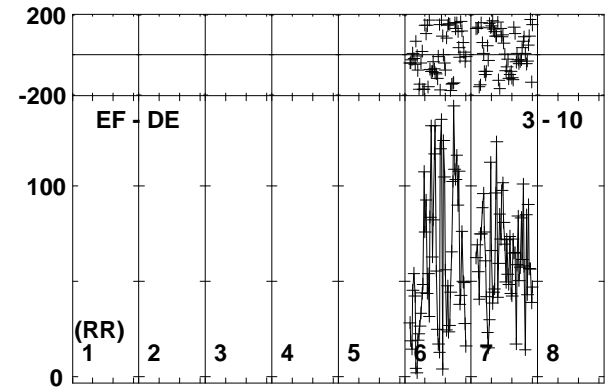
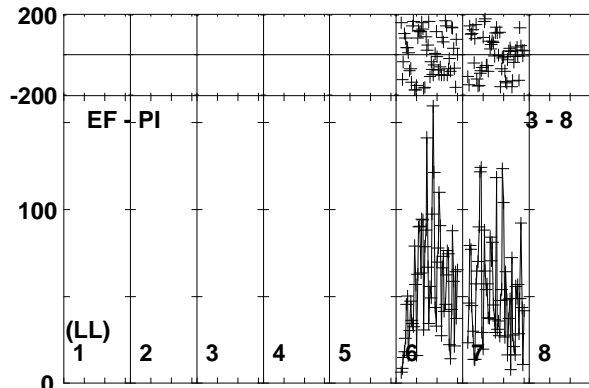
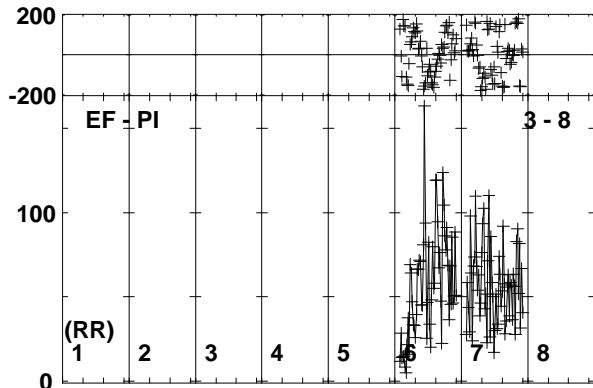
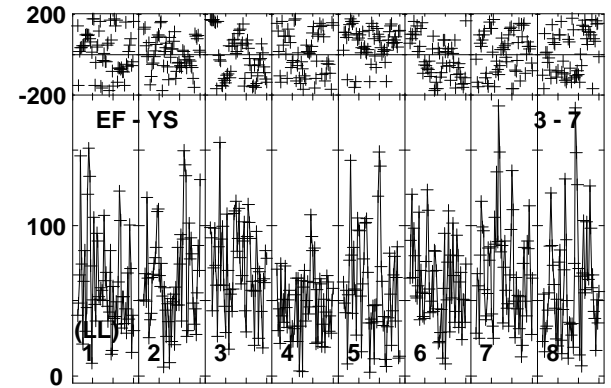
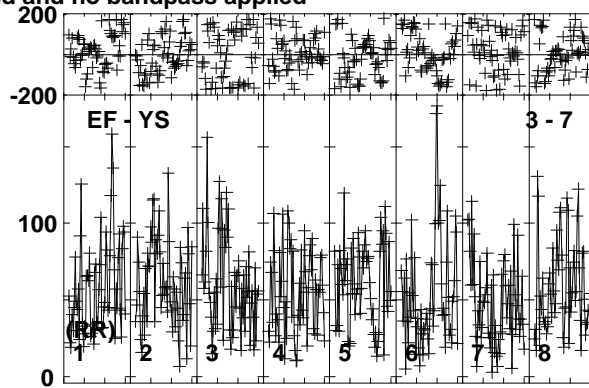
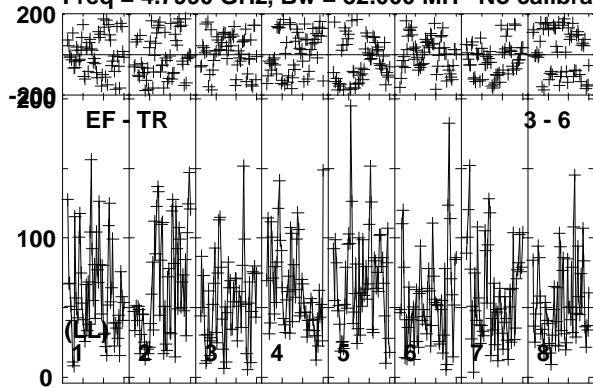

Lower frame: Micro Ampl Jy Top frame: Phas deg  
Vector averaged cross-power spectrum Baseline: EF (03) - TR (06)  
Timerange: 01/01:03:03 to 01/01:06:59

Plot file version 249 created 11-NOV-2019 15:07:44

SER8NJ EK040B.UVDATA.1

Freq = 4.7990 GHz, Bw = 32.000 MH No calibration applied and no bandpass applied

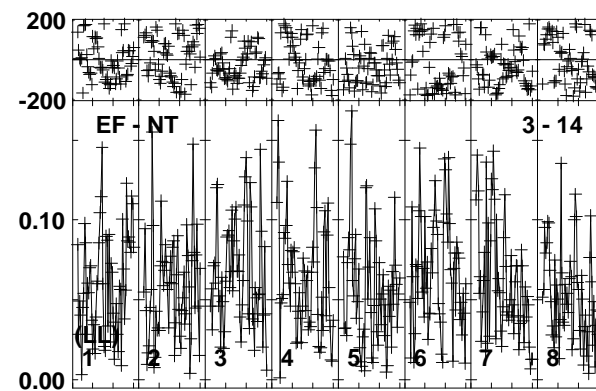
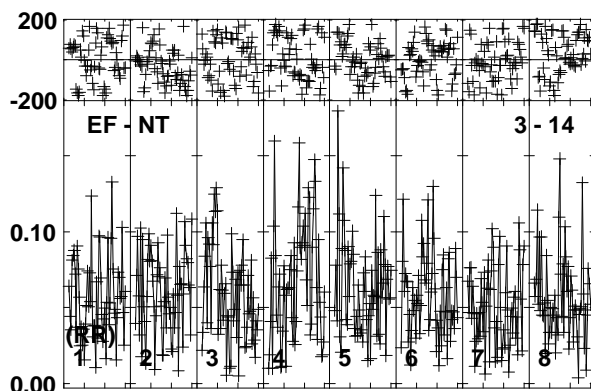
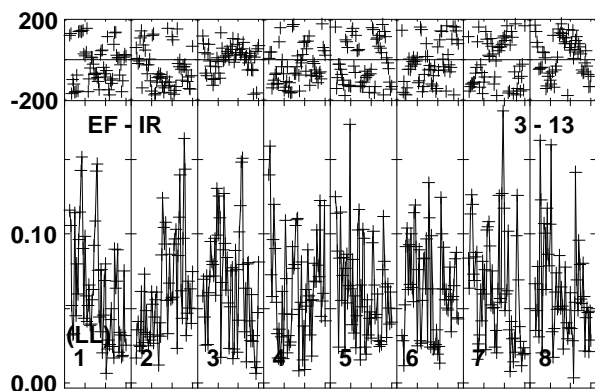
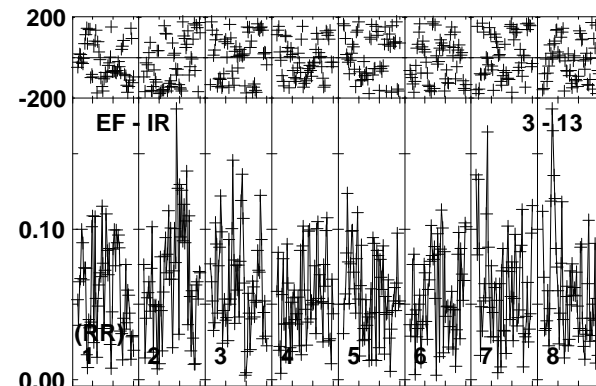
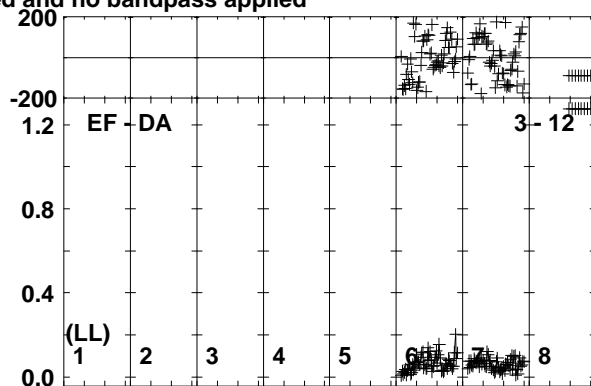
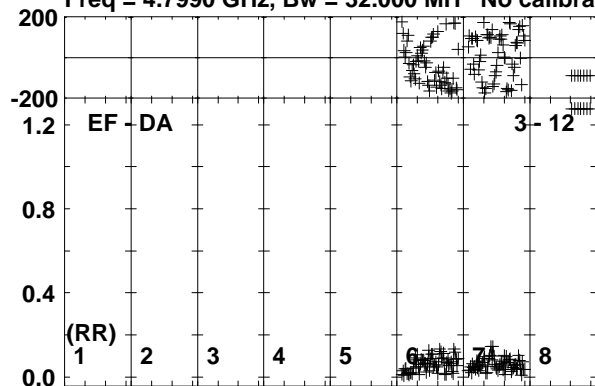

0 40 0 40 0 40 0 40 0 40 0 40 0 40 0 40 0 40 0 40  
Channels

Lower frame: Milli Ampl Jy Top frame: Phas deg  
Vector averaged cross-power spectrum Baseline: EF (03) - DA (12)  
Timerange: 01/01:03:03 to 01/01:06:59

Plot file version 250 created 11-NOV-2019 15:07:44

J1826+0149 EK040B.UVDATA.1

Freq = 4.7990 GHz, Bw = 32.000 MH No calibration applied and no bandpass applied

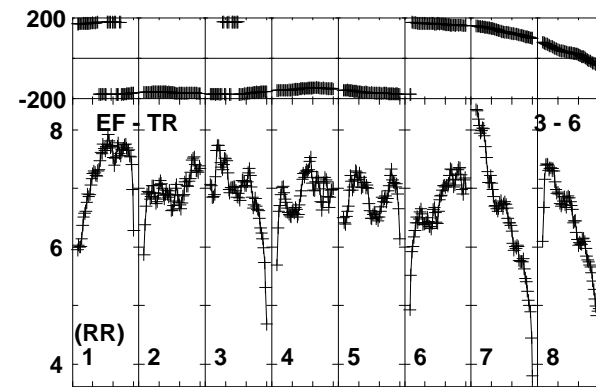
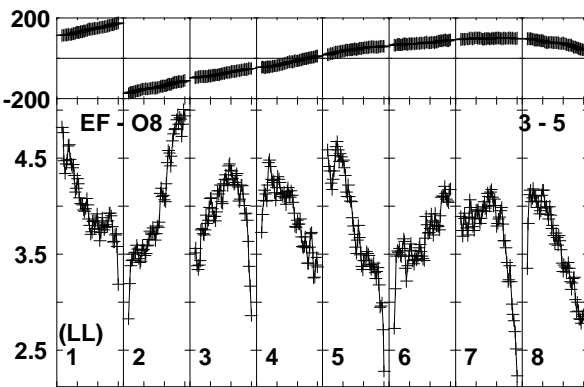
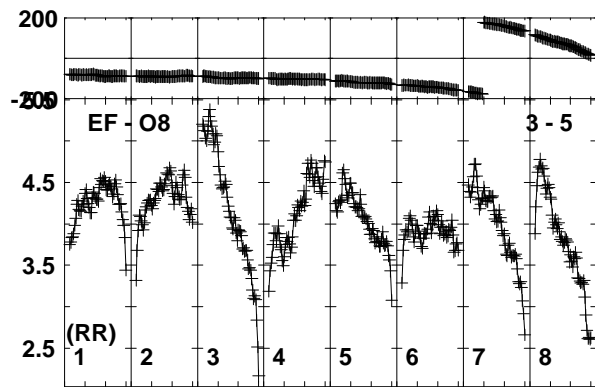
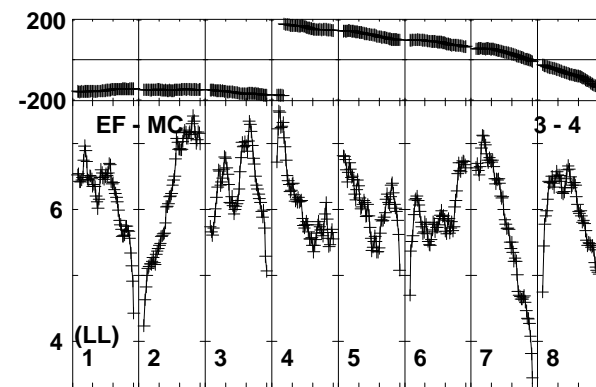
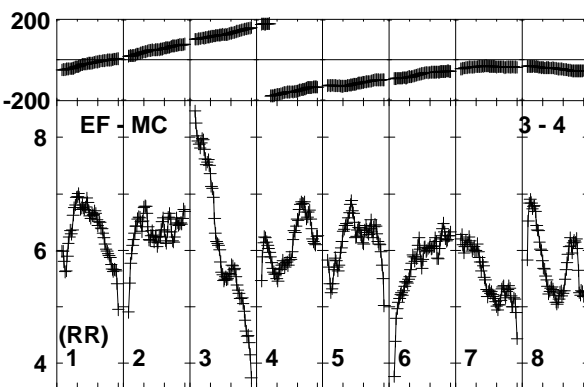
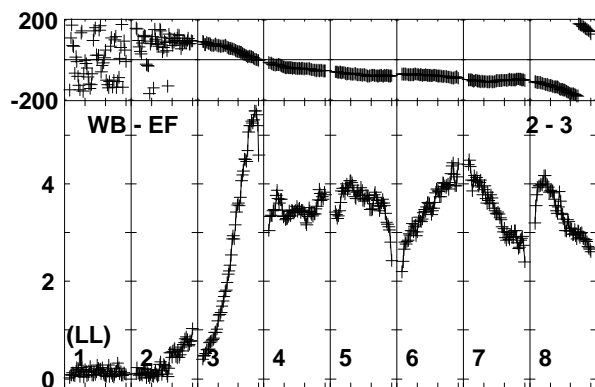
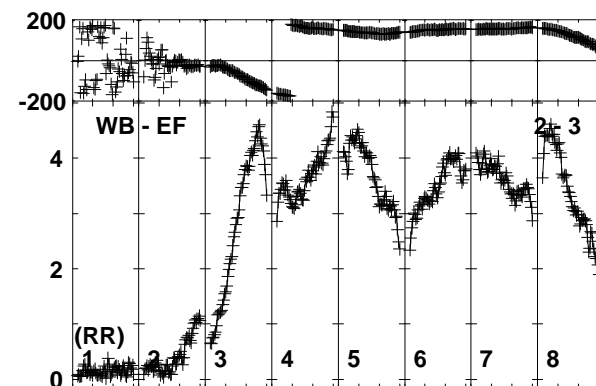
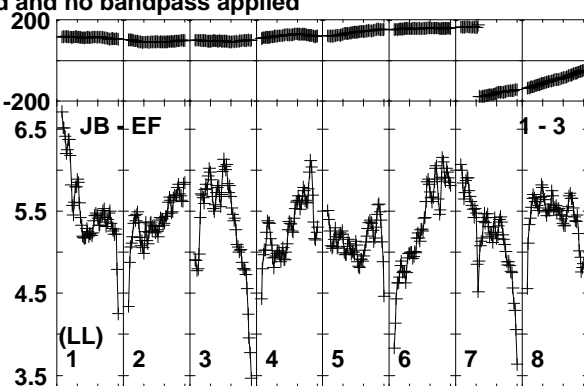
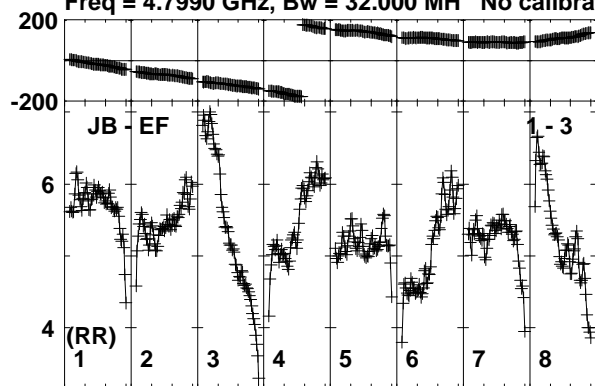

Lower frame: Milli Ampl Jy Top frame: Phas deg  
Vector averaged cross-power spectrum Baseline: JB (01) - EF (03)  
Timerange: 01/01:07:41 to 01/01:08:39



Plot file version 251 created 11-NOV-2019 15:07:44

J1826+0149 EK040B.UVDATA.1

Freq = 4.7990 GHz, Bw = 32.000 MH No calibration applied and no bandpass applied

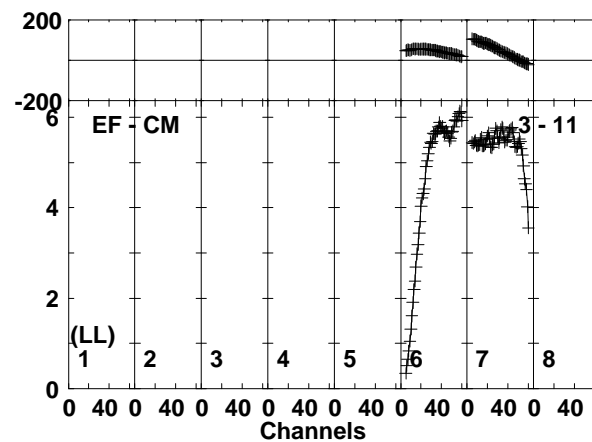
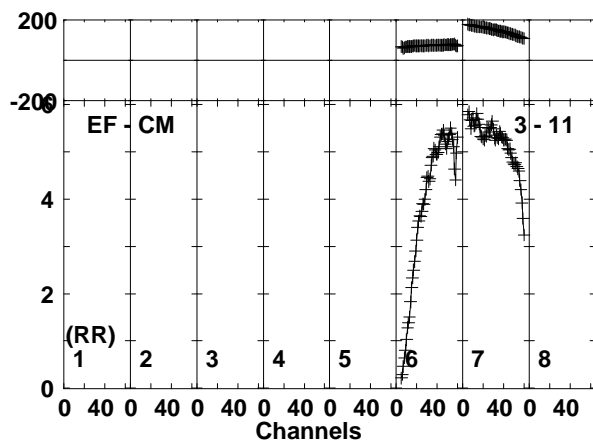
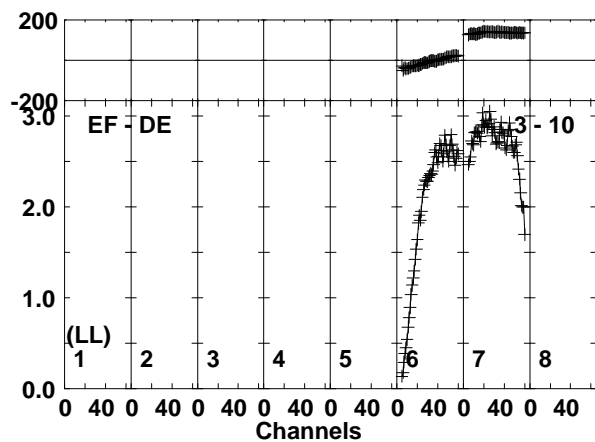
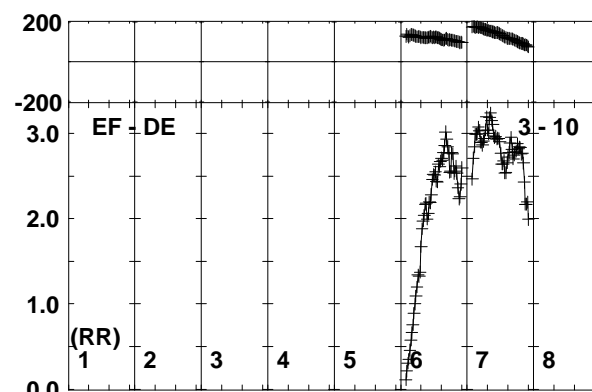
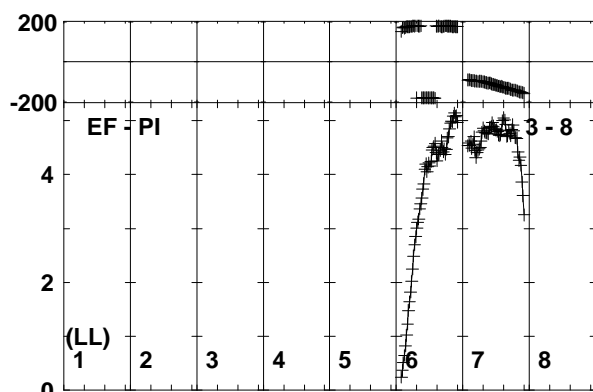
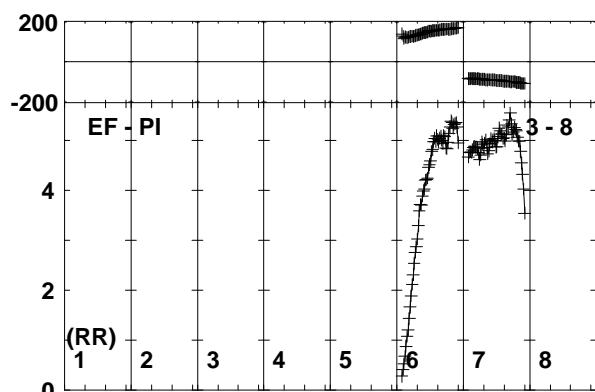
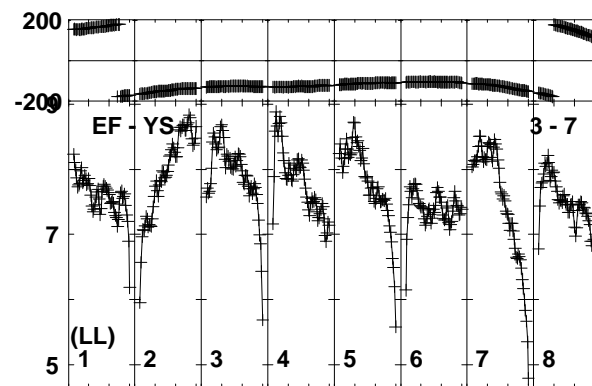
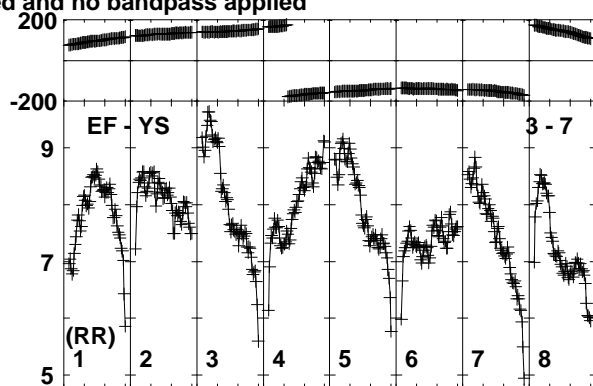
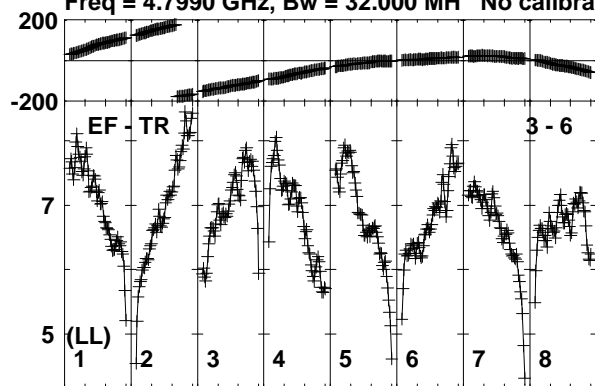

Lower frame: Milli Ampl Jy Top frame: Phas deg  
Vector averaged cross-power spectrum Baseline: EF (03) - TR (06)  
Timerange: 01/01:07:41 to 01/01:08:39

Plot file version 252 created 11-NOV-2019 15:07:45

J1826+0149 EK040B.UVDATA.1

Freq = 4.7990 GHz, Bw = 32.000 MH No calibration applied and no bandpass applied

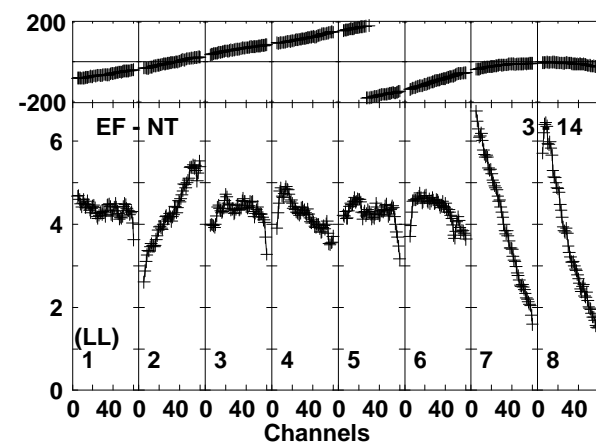
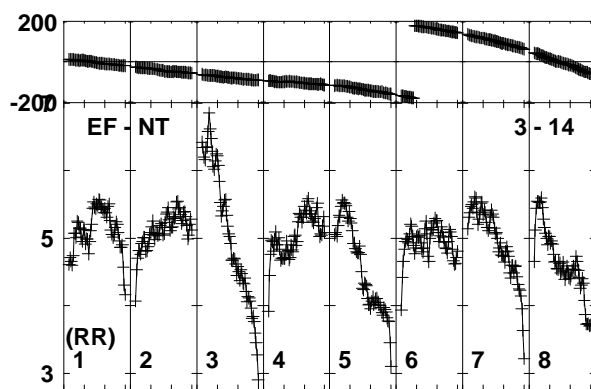
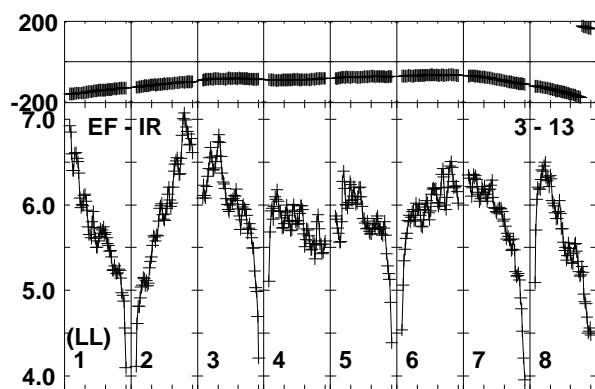
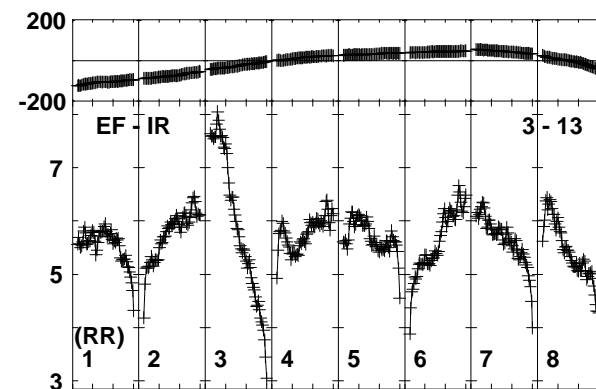
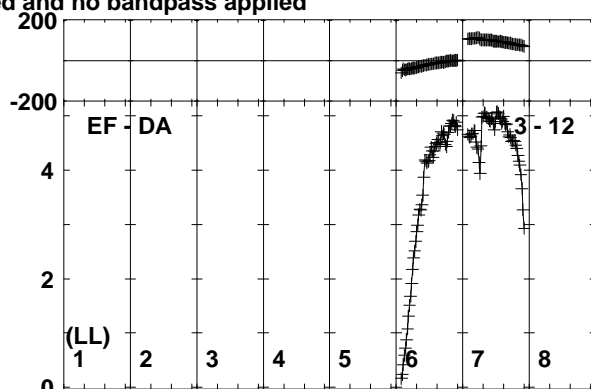
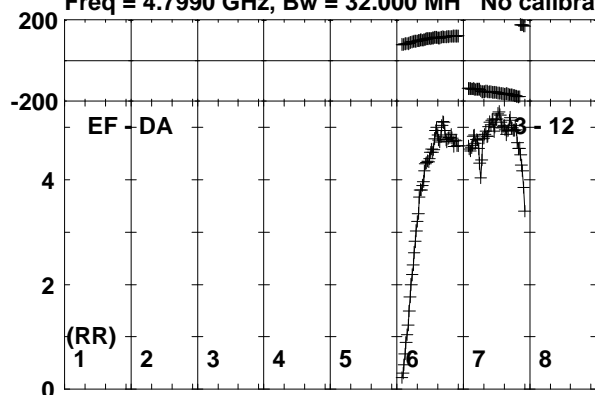

Lower frame: Milli Ampl Jy Top frame: Phas deg  
Vector averaged cross-power spectrum Baseline: EF (03) - DA (12)  
Timerange: 01/01:07:41 to 01/01:08:39

Plot file version 253 created 11-NOV-2019 15:07:45

SER8NJ EK040B.UVDATA.1

Freq = 4.7990 GHz, Bw = 32.000 MH No calibration applied and no bandpass applied

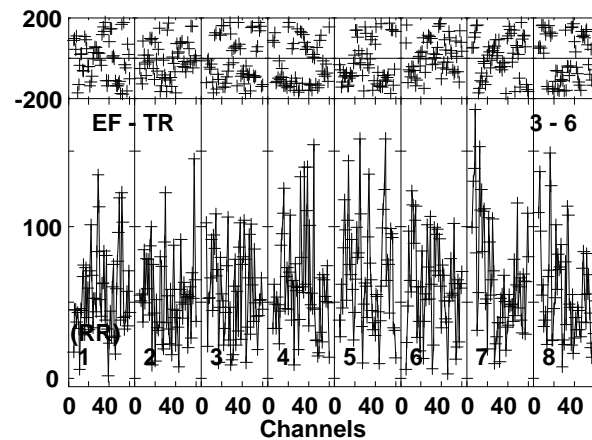
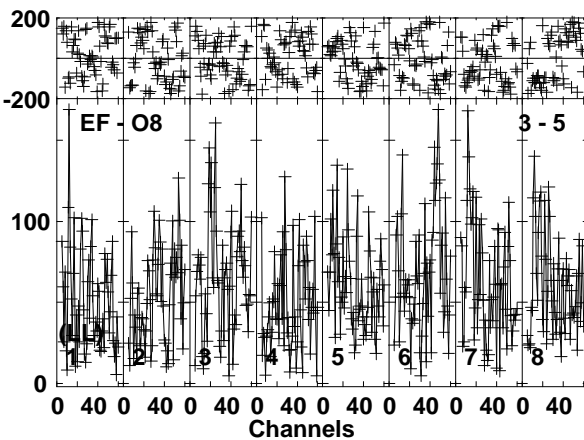
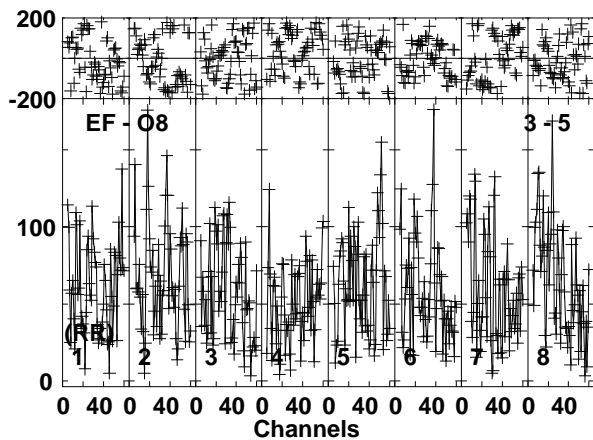
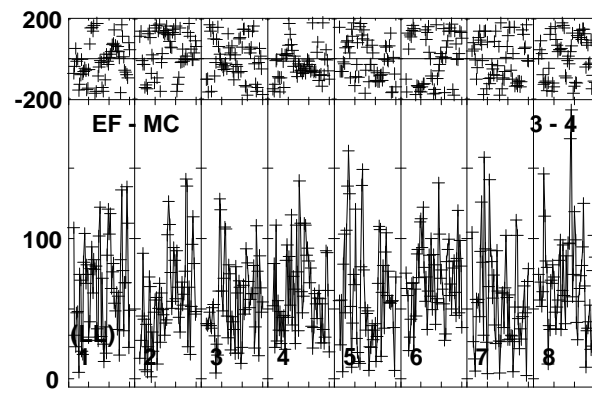
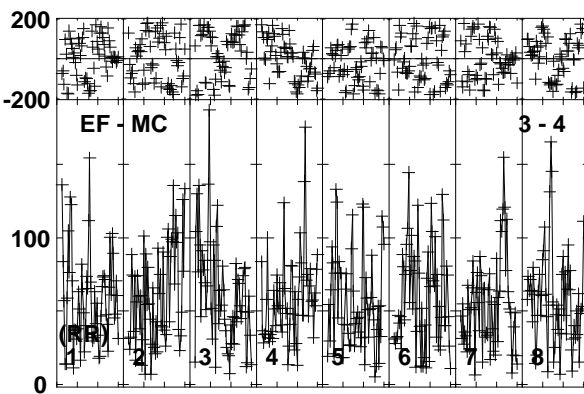
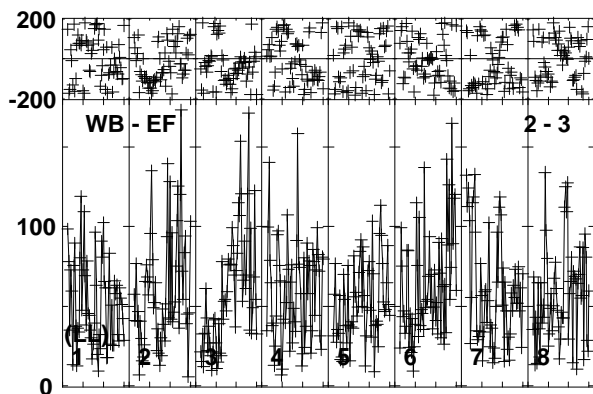
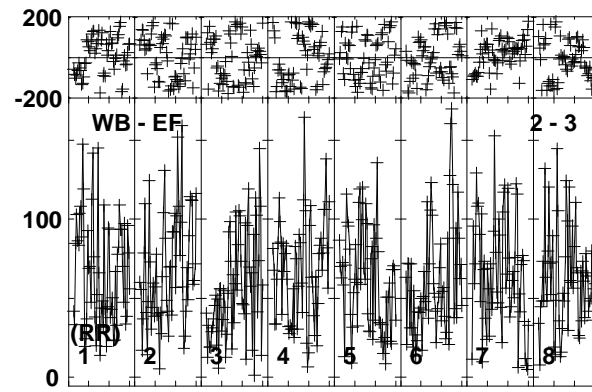
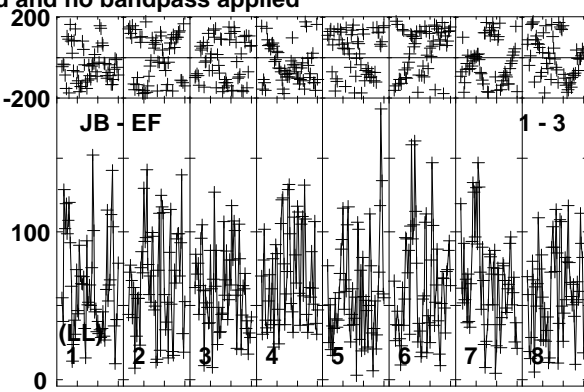
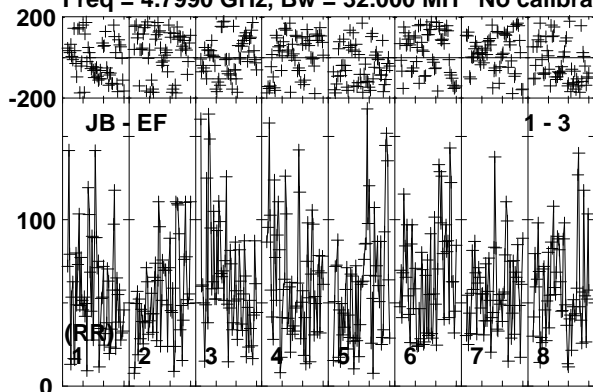

Lower frame: Micro Ampl Jy Top frame: Phas deg  
Vector averaged cross-power spectrum Baseline: JB (01) - EF (03)  
Timerange: 01/01:08:41 to 01/01:12:39

Plot file version 254 created 11-NOV-2019 15:07:45

SER8NJ EK040B.UVDATA.1

Freq = 4.7990 GHz, Bw = 32.000 MH No calibration applied and no bandpass applied

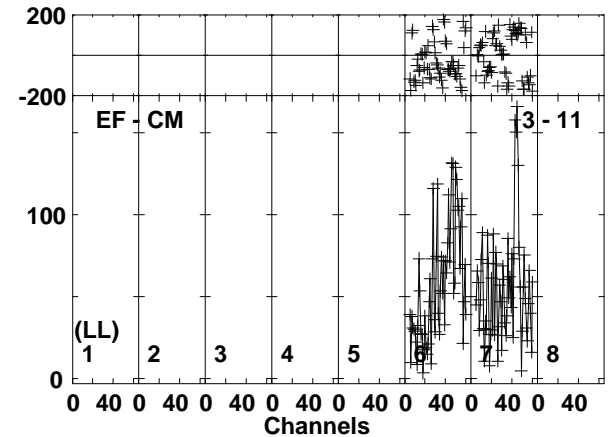
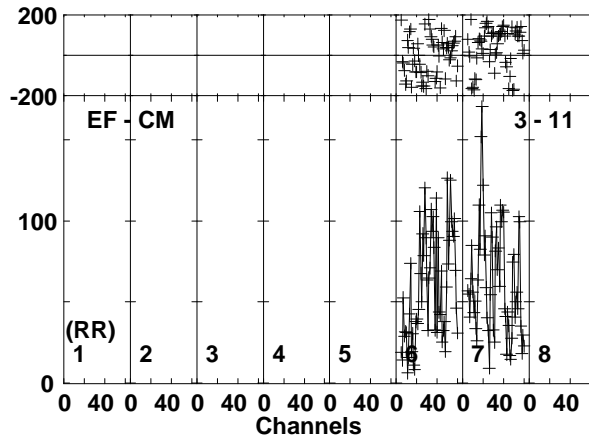
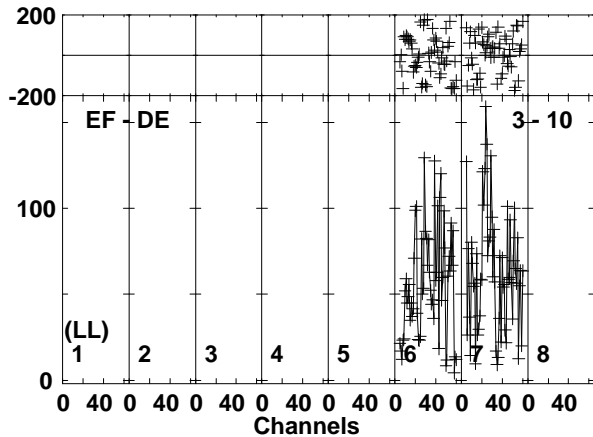
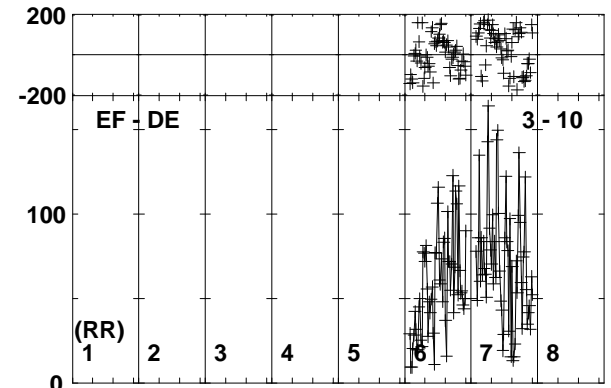
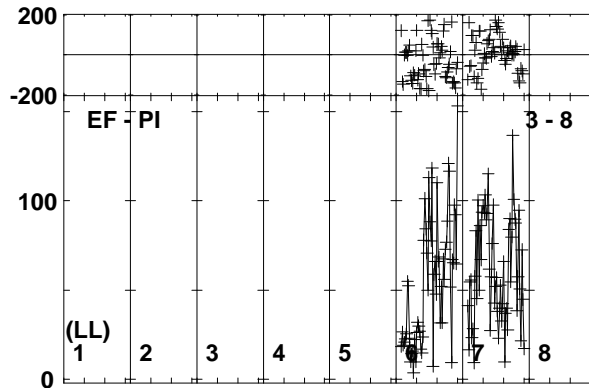
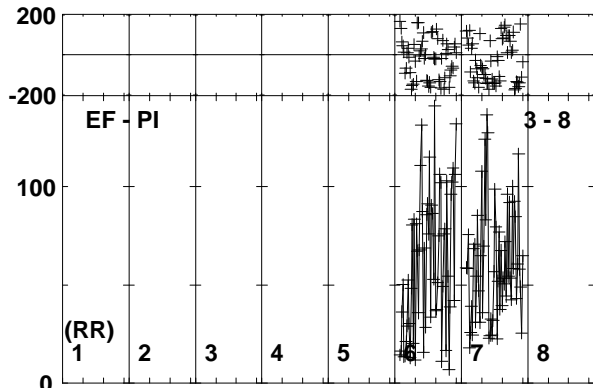
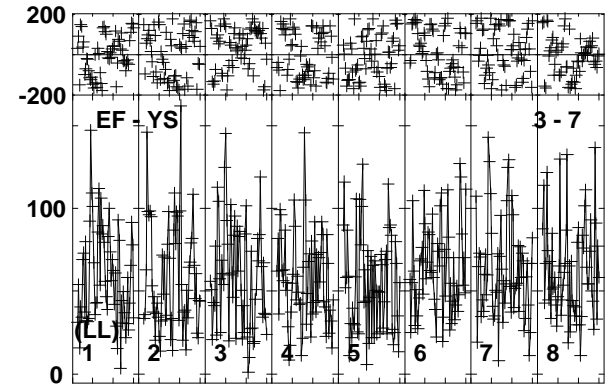
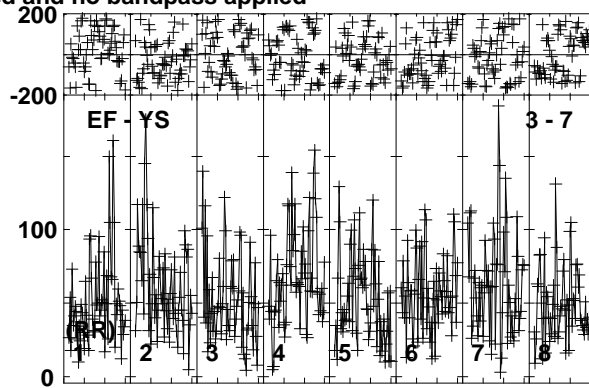
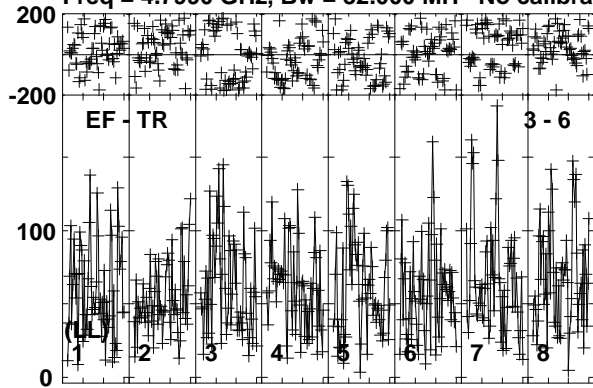

Lower frame: Micro Ampl Jy Top frame: Phas deg  
Vector averaged cross-power spectrum Baseline: EF (03) - TR (06)  
Timerange: 01/01:08:41 to 01/01:12:39

Plot file version 255 created 11-NOV-2019 15:07:45  
 SER8NJ EK040B.UVDATA.1  
 Freq = 4.7990 GHz, Bw = 32.000 MH No calibration applied and no bandpass applied

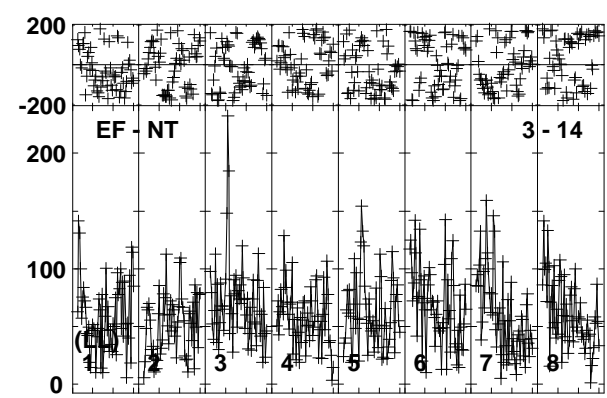
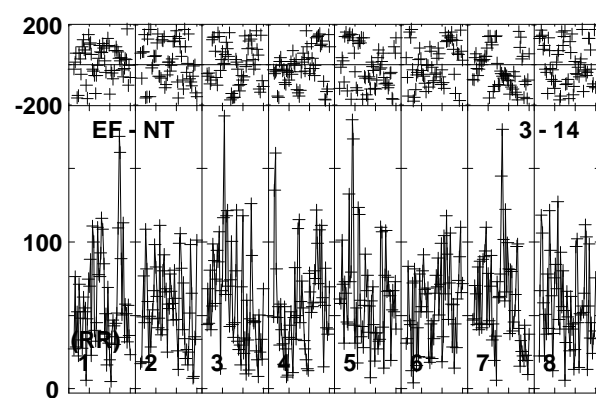
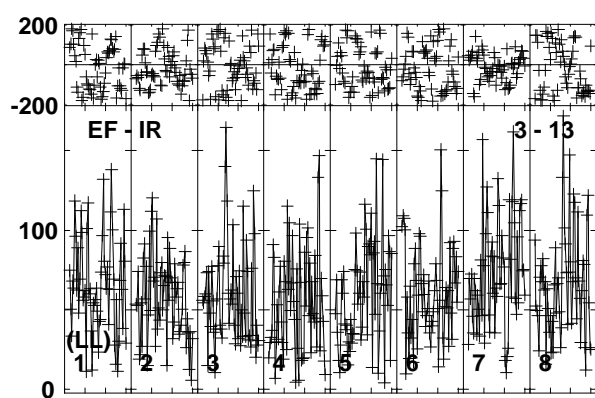
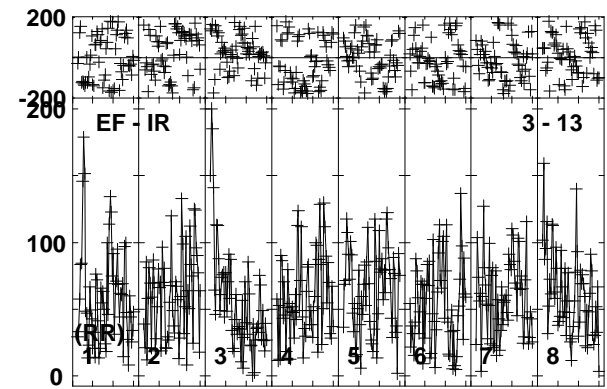
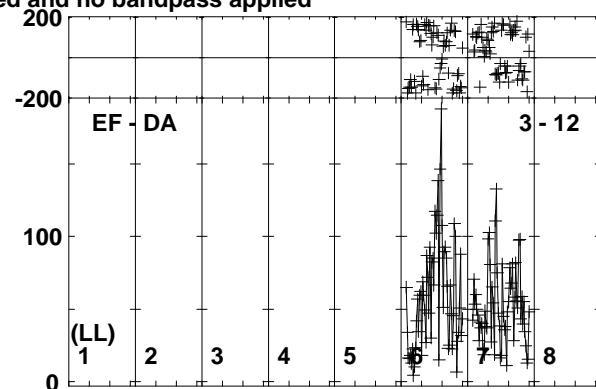
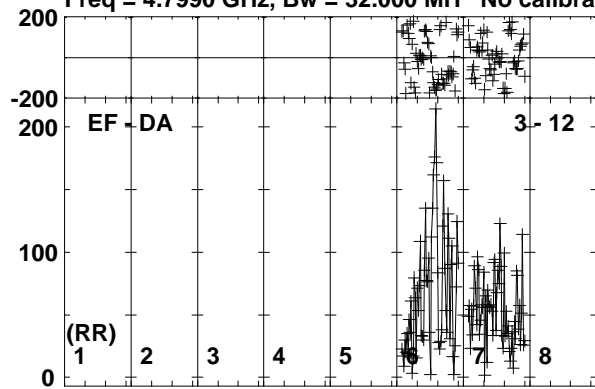

0 40 0 40 0 40 0 40 0 40 0 40 0 40 0 40 0 40  
 Channels

Lower frame: Micro Ampl Jy Top frame: Phas deg  
 Vector averaged cross-power spectrum Baseline: EF (03) - DA (12)  
 Timerange: 01/01:08:41 to 01/01:12:39

Plot file version 256 created 11-NOV-2019 15:07:45

J1826+0149 EK040B.UVDATA.1

Freq = 4.7990 GHz, Bw = 32.000 MH No calibration applied and no bandpass applied

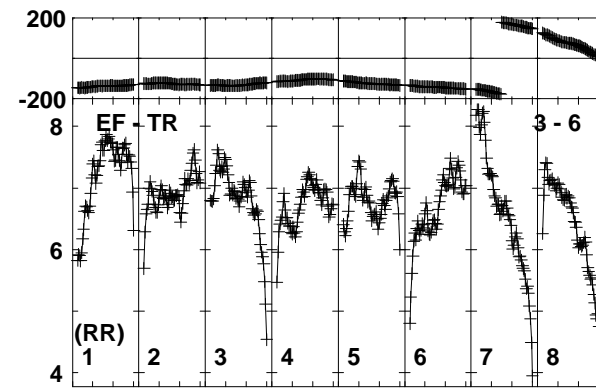
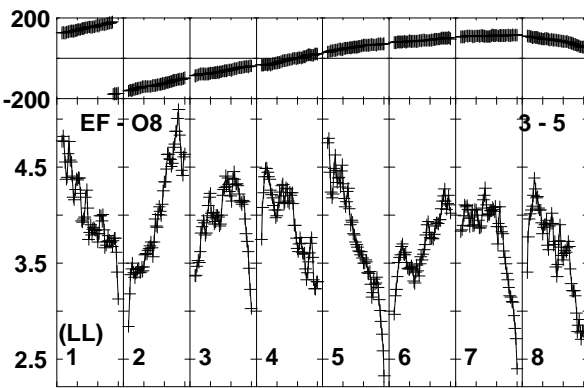
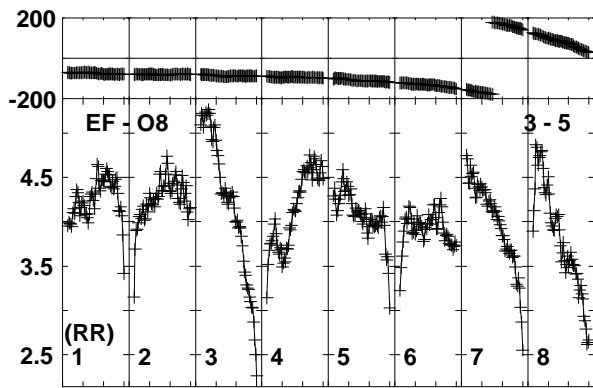
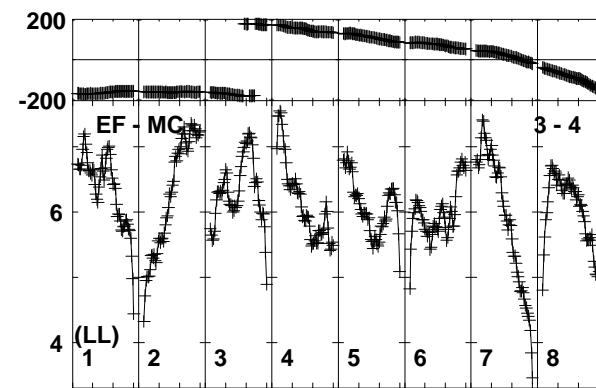
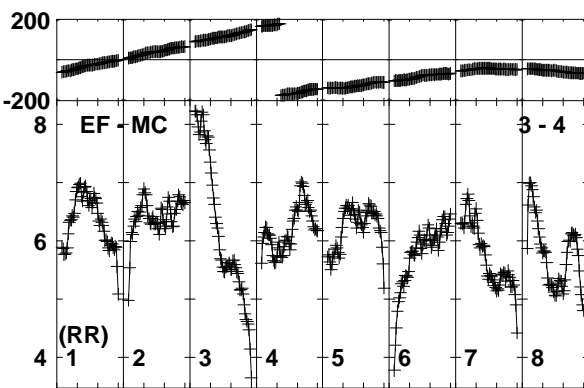
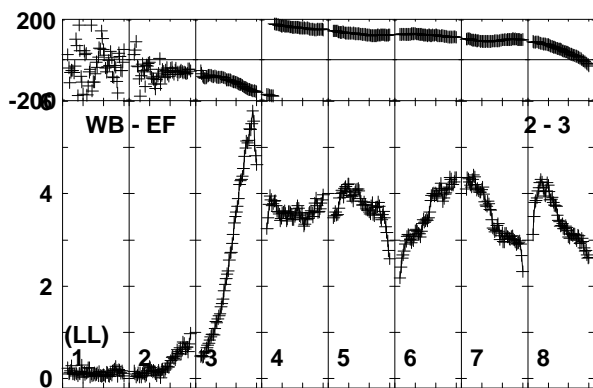
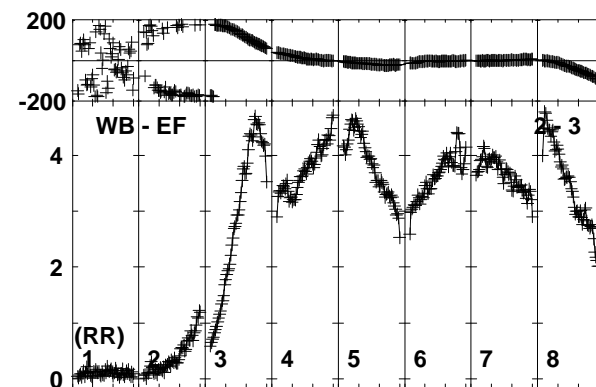
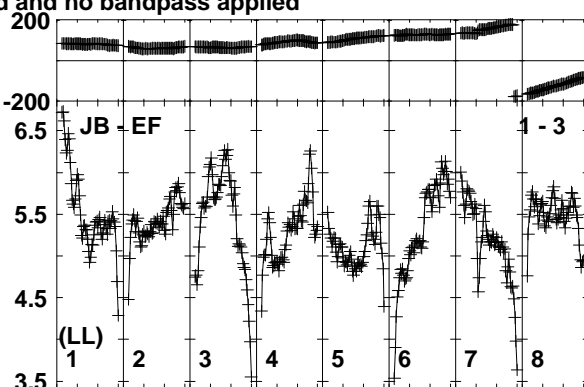
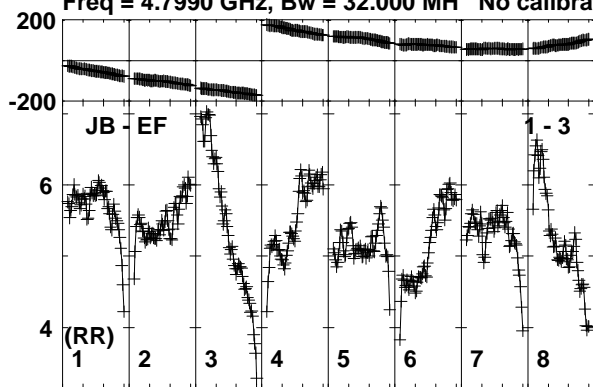

Lower frame: Milli Ampl Jy Top frame: Phas deg  
Vector averaged cross-power spectrum Baseline: JB (01) - EF (03)  
Timerange: 01/01:12:41 to 01/01:14:09

Plot file version 257 created 11-NOV-2019 15:07:45

J1826+0149 EK040B.UVDATA.1

Freq = 4.7990 GHz, Bw = 32.000 MH No calibration applied and no bandpass applied

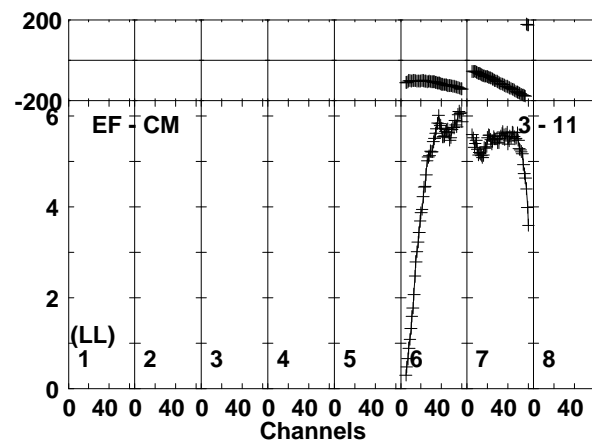
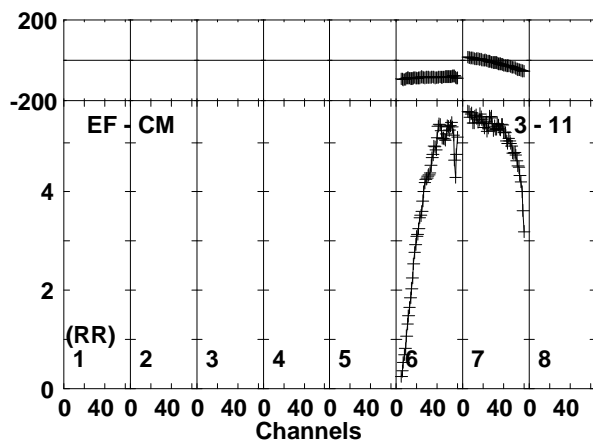
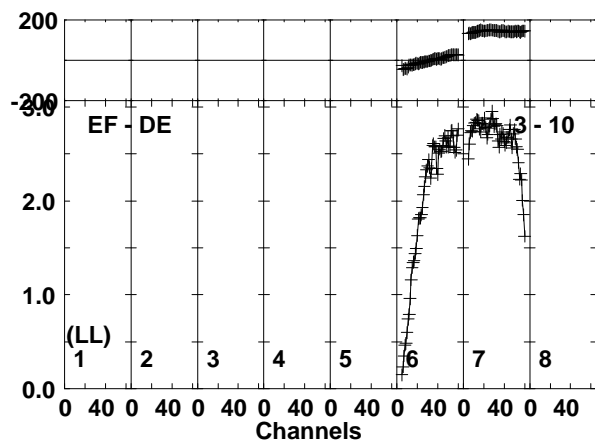
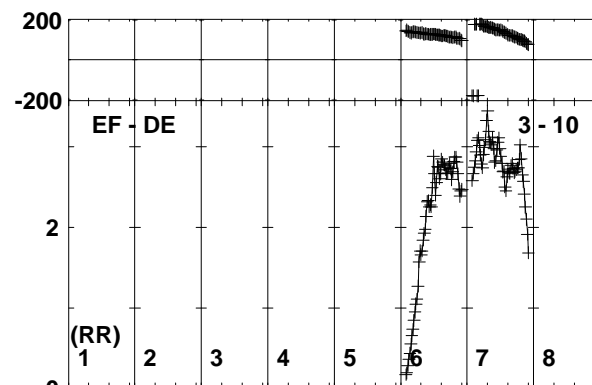
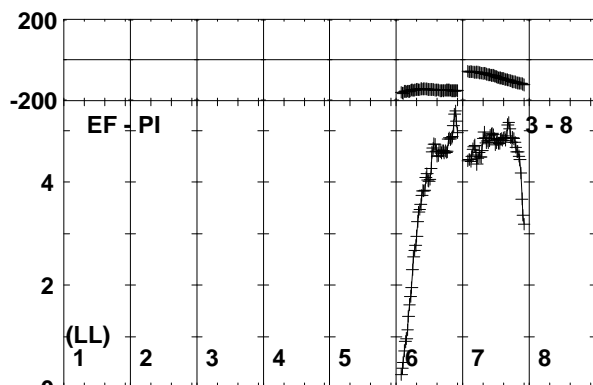
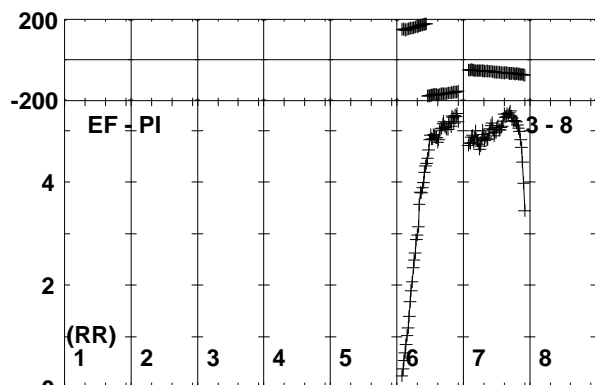
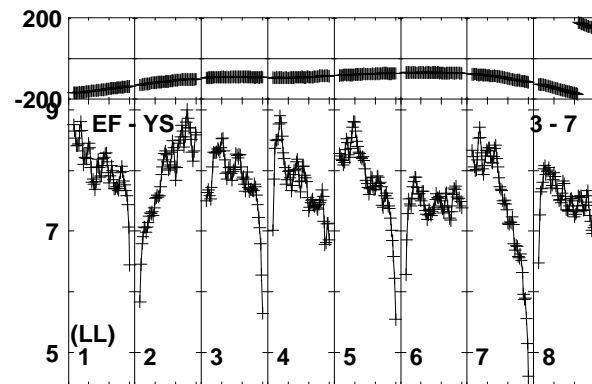
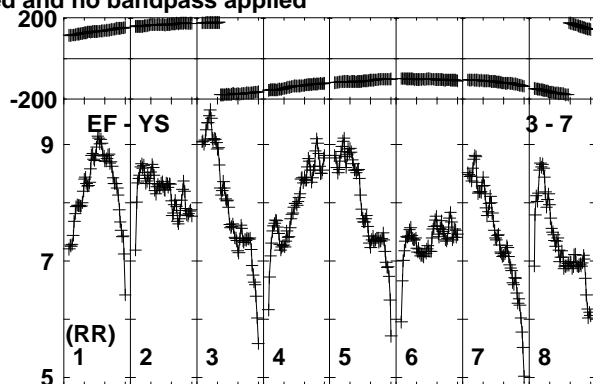
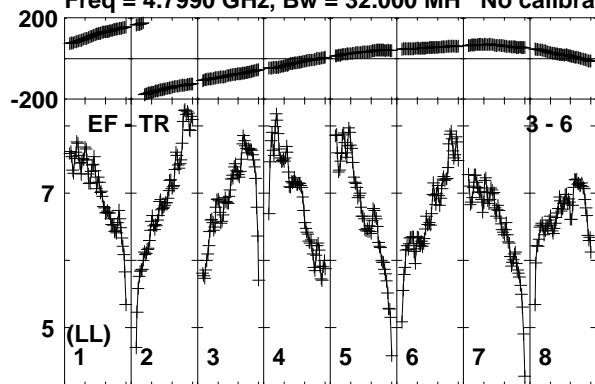

Lower frame: Milli Ampl Jy Top frame: Phas deg  
Vector averaged cross-power spectrum Baseline: EF (03) - TR (06)  
Timerange: 01/01:12:41 to 01/01:14:09

Plot file version 258 created 11-NOV-2019 15:07:45

J1826+0149 EK040B.UVDATA.1

Freq = 4.7990 GHz, Bw = 32.000 MH No calibration applied and no bandpass applied

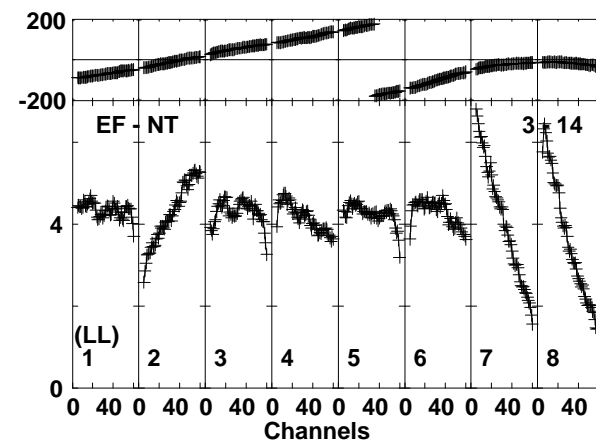
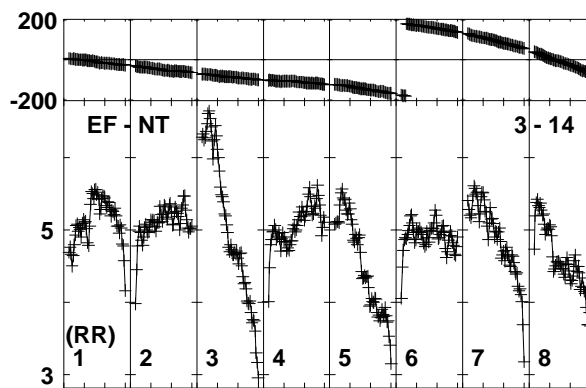
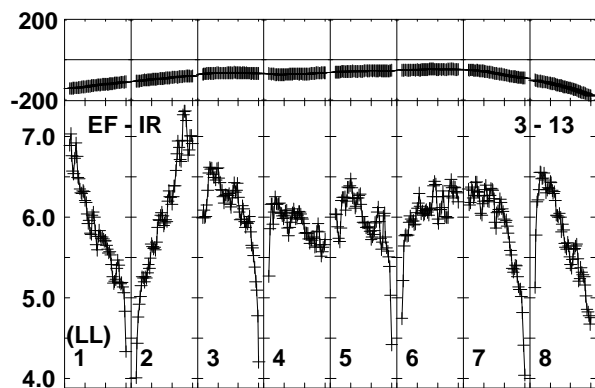
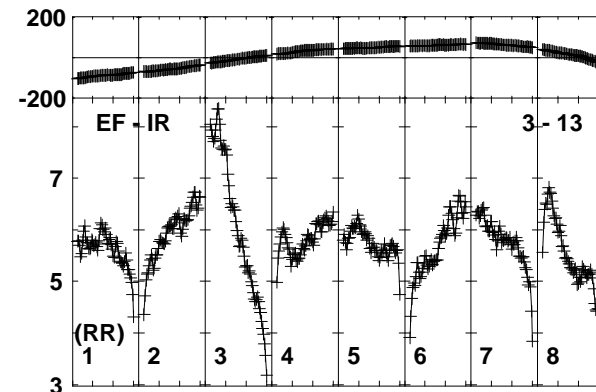
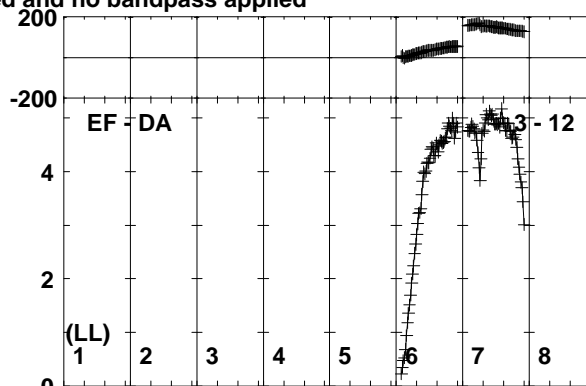
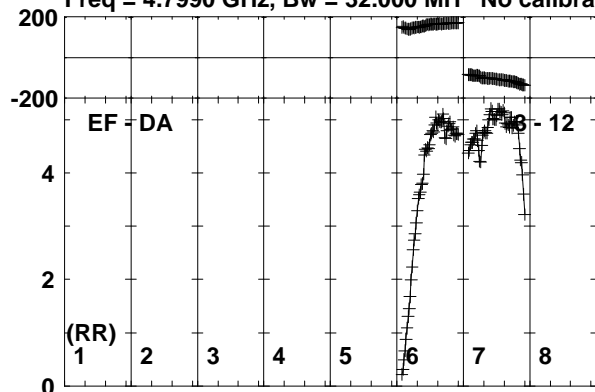

Lower frame: Milli Ampl Jy Top frame: Phas deg  
Vector averaged cross-power spectrum Baseline: EF (03) - DA (12)  
Timerange: 01/01:12:41 to 01/01:14:09



Plot file version 259 created 11-NOV-2019 15:07:45

SER8NJ EK040B.UVDATA.1

Freq = 4.7990 GHz, Bw = 32.000 MH No calibration applied and no bandpass applied

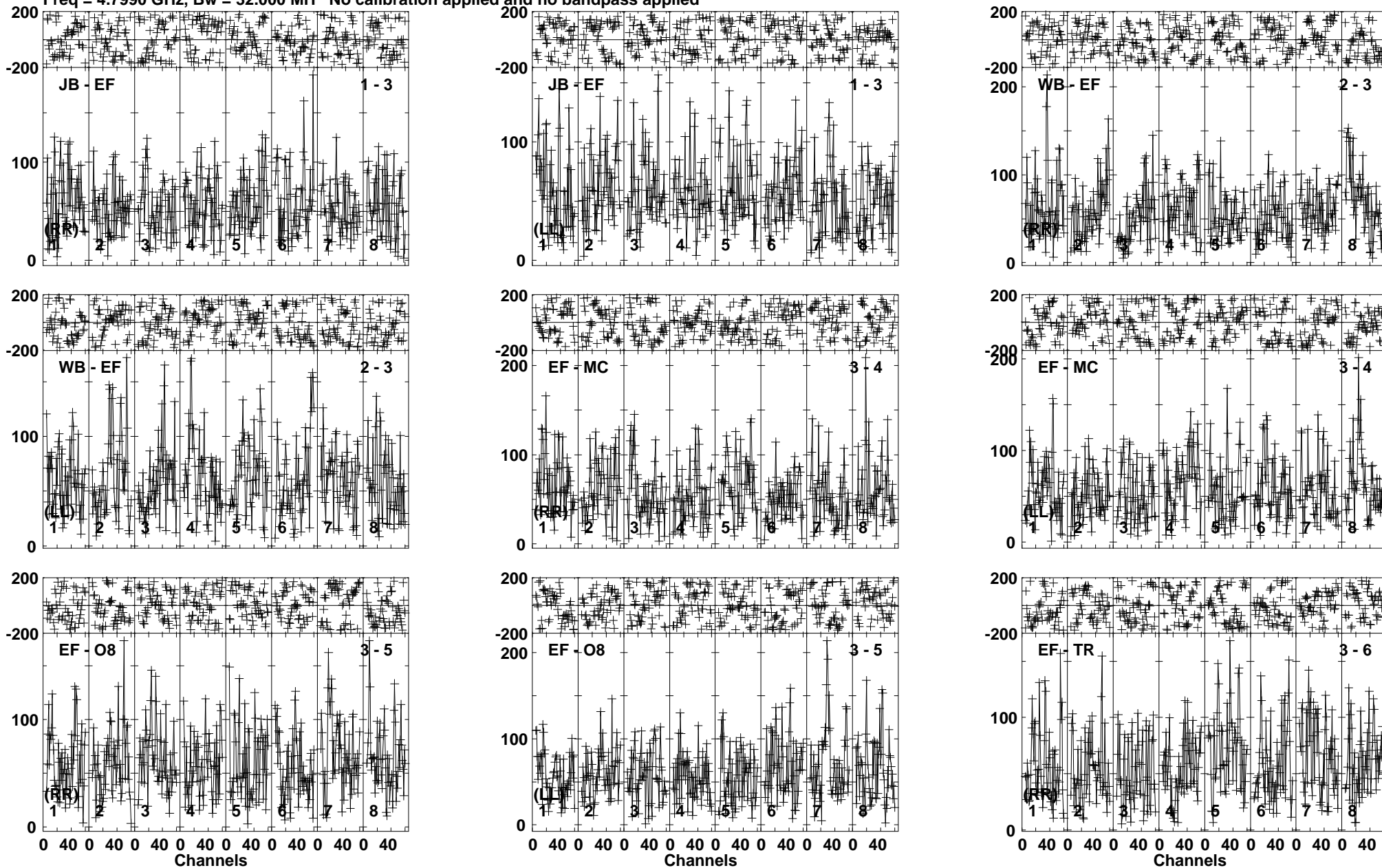

Lower frame: Micro Ampl Jy Top frame: Phas deg  
Vector averaged cross-power spectrum Baseline: JB (01) - EF (03)  
Timerange: 01/01:14:13 to 01/01:18:09

Plot file version 260 created 11-NOV-2019 15:07:45  
 SER8NJ EK040B.UVDATA.1  
 Freq = 4.7990 GHz, Bw = 32.000 MH No calibration applied and no bandpass applied

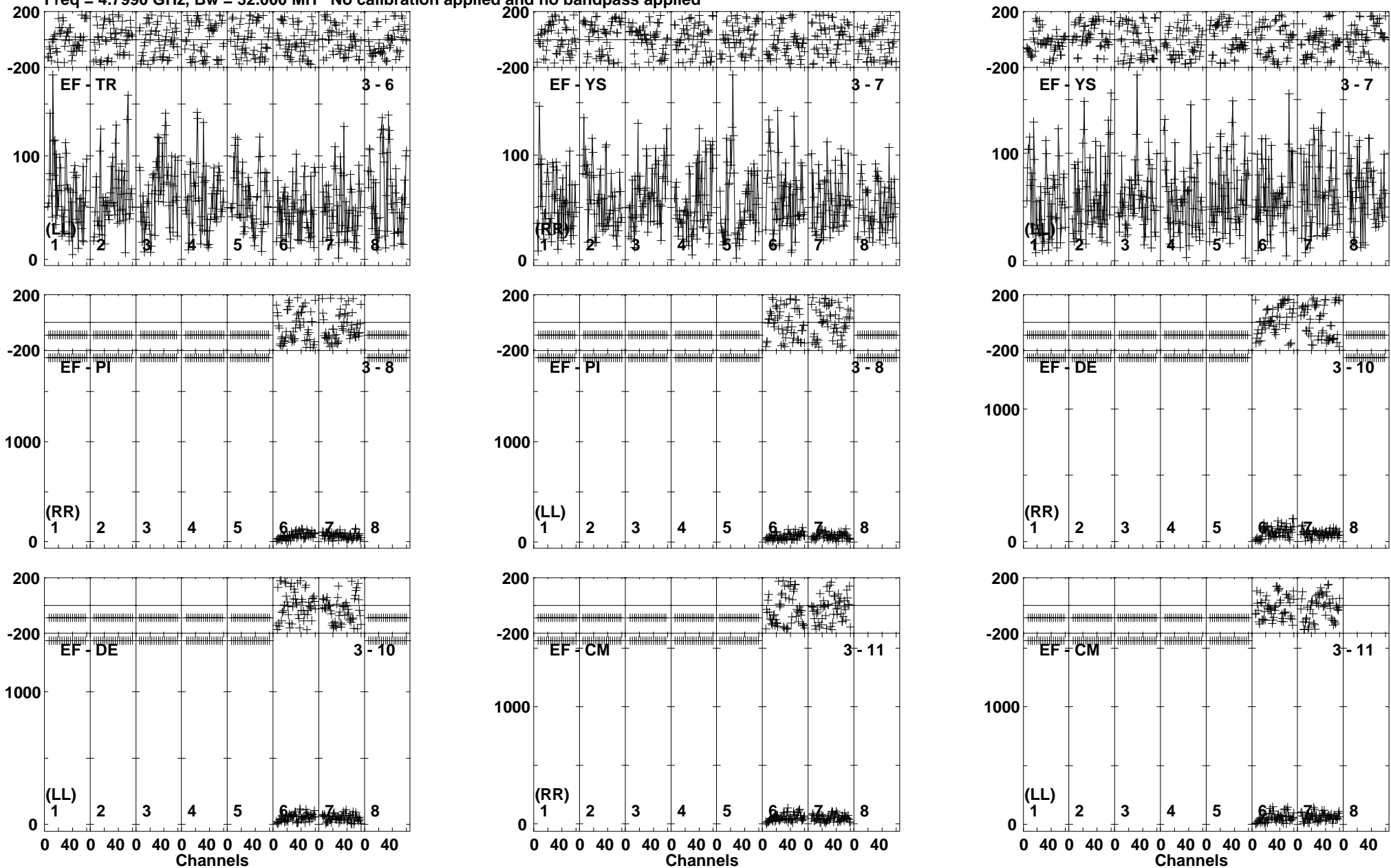

Lower frame: Micro Ampl Jy Top frame: Phas deg  
 Vector averaged cross-power spectrum Baseline: EF (03) - TR (06)  
 Timerange: 01/01:14:13 to 01/01:18:09

Plot file version 261 created 11-NOV-2019 15:07:46

SER8NJ EK040B.UVDATA.1

Freq = 4.7990 GHz, Bw = 32.000 MH No calibration applied and no bandpass applied

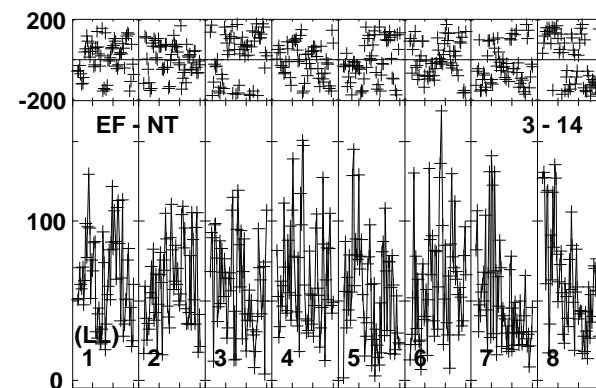
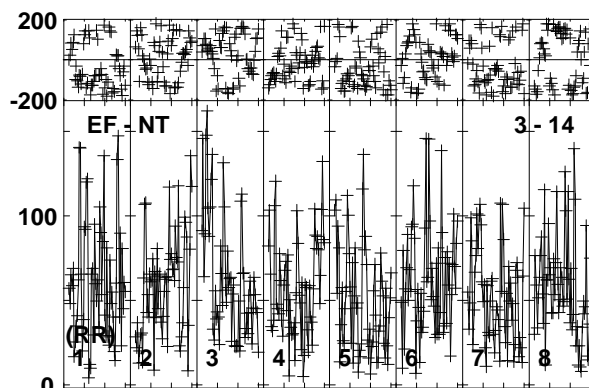
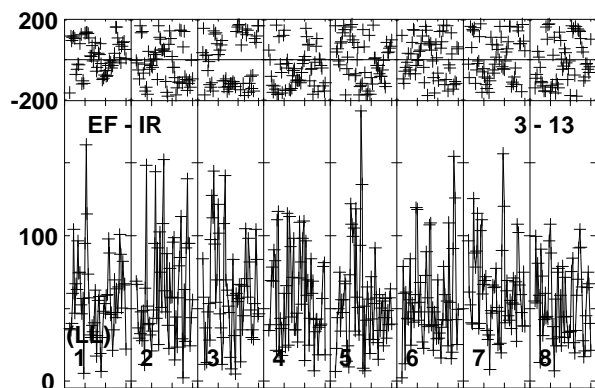
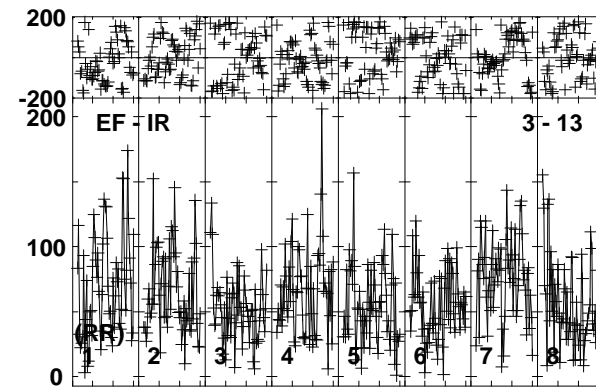
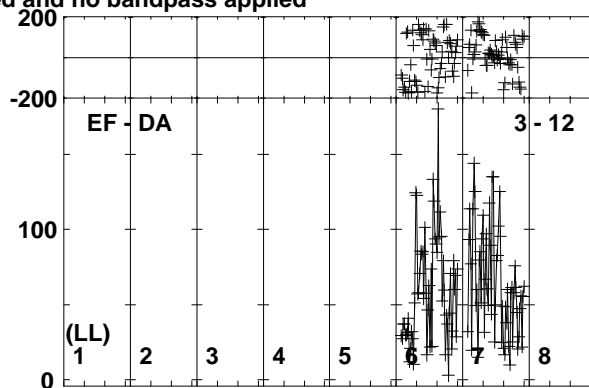
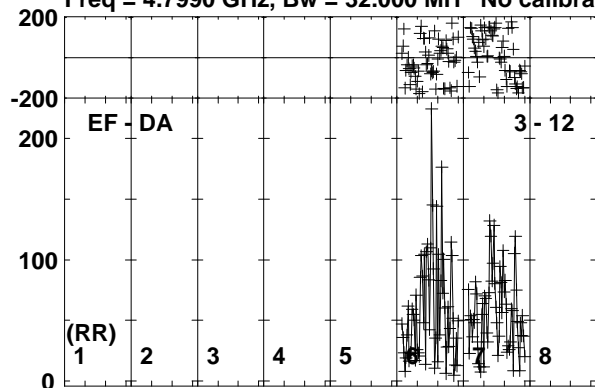

0 40 0 40 0 40 0 40 0 40 0 40 0 40 0 40 0 40 0 40  
Channels

Lower frame: Micro Ampl Jy Top frame: Phas deg  
Vector averaged cross-power spectrum Baseline: EF (03) - DA (12)  
Timerange: 01/01:14:13 to 01/01:18:09

Plot file version 262 created 11-NOV-2019 15:07:46

J1826+0149 EK040B.UVDATA.1

Freq = 4.7990 GHz, Bw = 32.000 MH No calibration applied and no bandpass applied

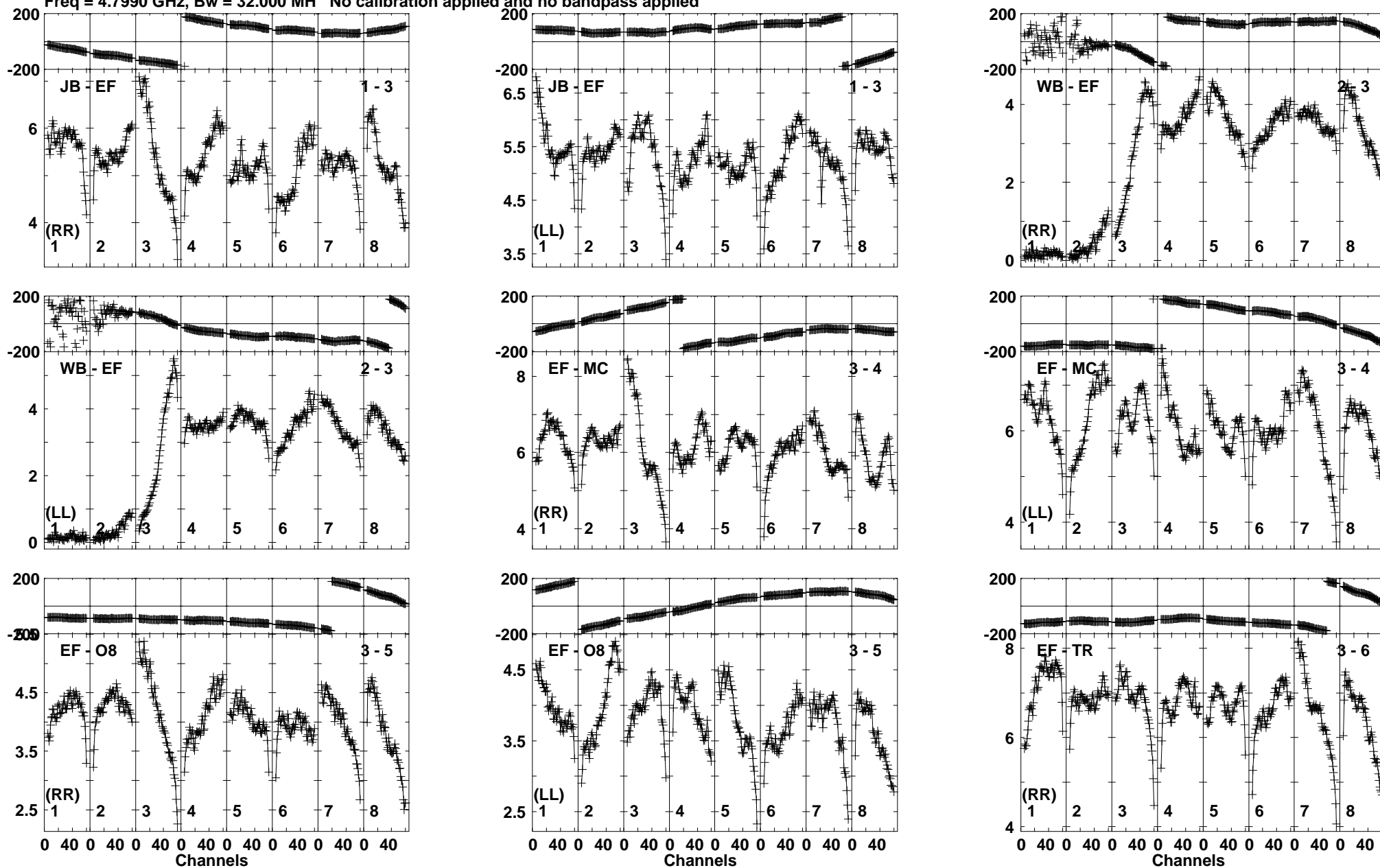

Lower frame: Milli Ampl Jy Top frame: Phas deg  
Vector averaged cross-power spectrum Baseline: JB (01) - EF (03)  
Timerange: 01/01:18:51 to 01/01:19:49

Plot file version 263 created 11-NOV-2019 15:07:46

J1826+0149 EK040B.UVDATA.1

Freq = 4.7990 GHz, Bw = 32.000 MH No calibration applied and no bandpass applied

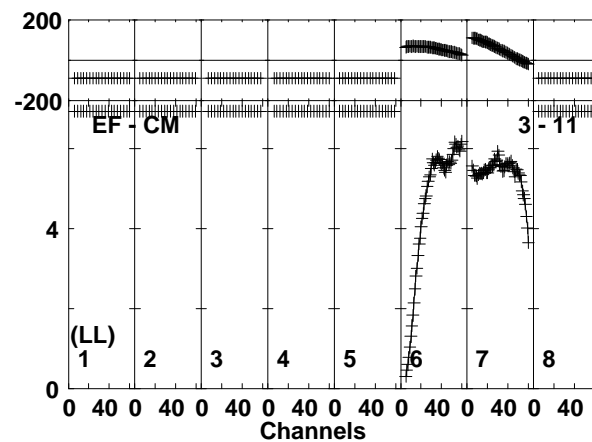
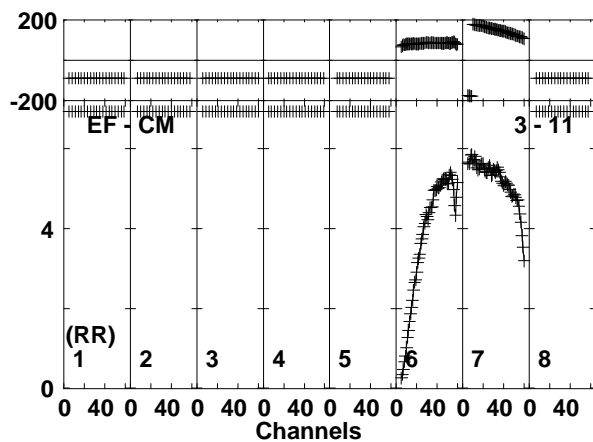
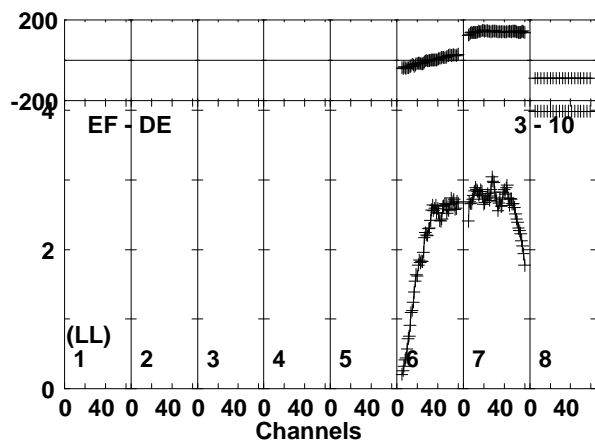
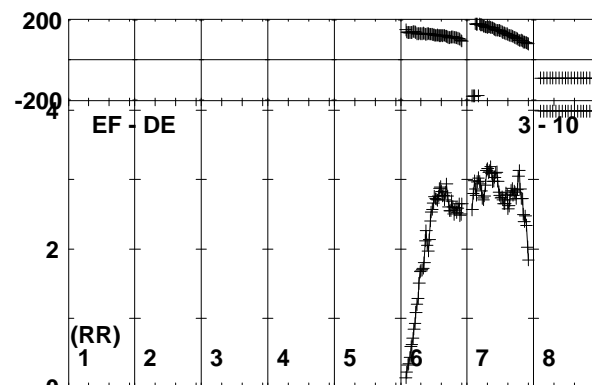
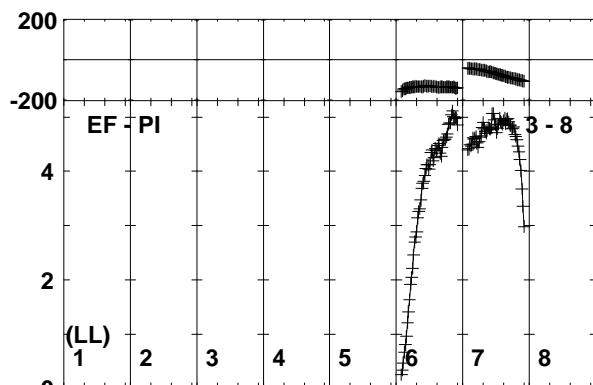
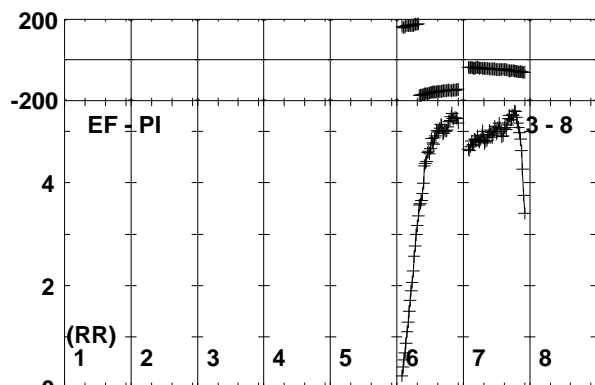
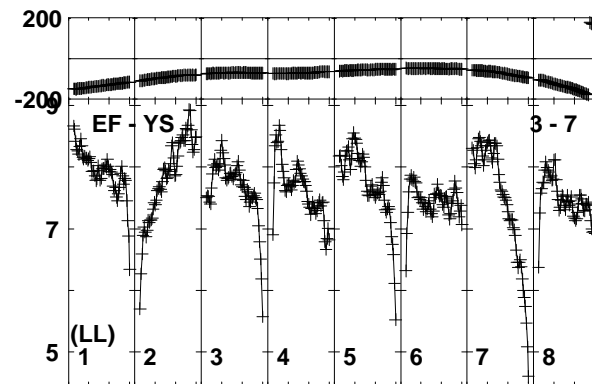
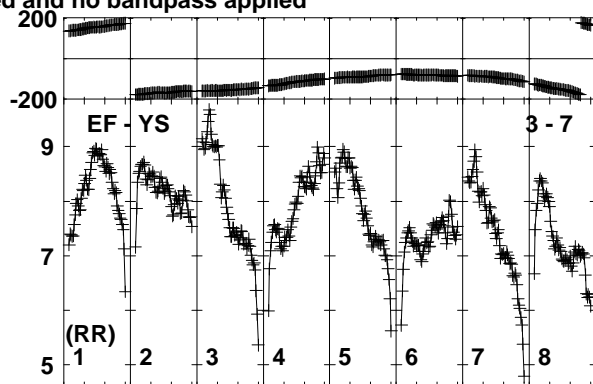
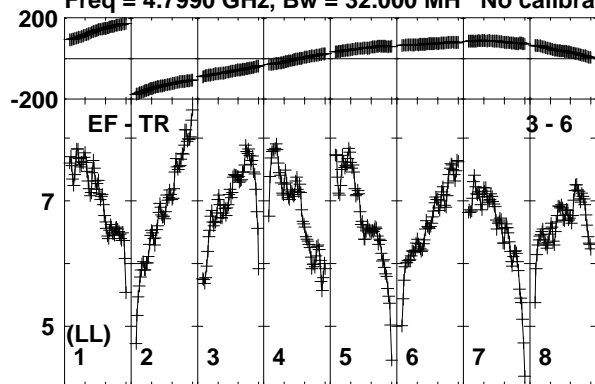

Lower frame: Milli Ampl Jy Top frame: Phas deg  
Vector averaged cross-power spectrum Baseline: EF (03) - TR (06)  
Timerange: 01/01:18:51 to 01/01:19:49

Plot file version 264 created 11-NOV-2019 15:07:46

J1826+0149 EK040B.UVDATA.1

Freq = 4.7990 GHz, Bw = 32.000 MH No calibration applied and no bandpass applied

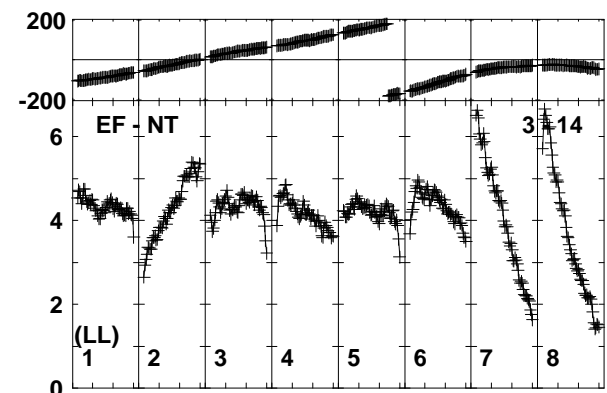
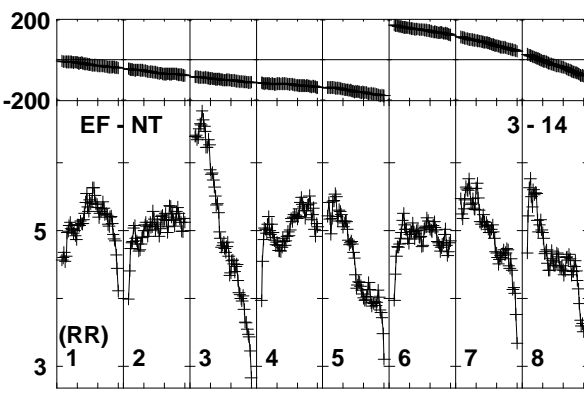
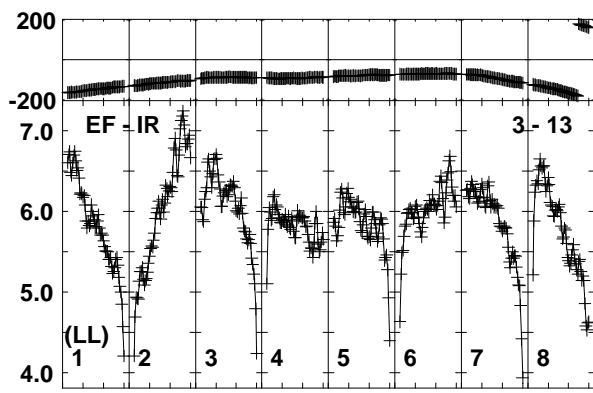
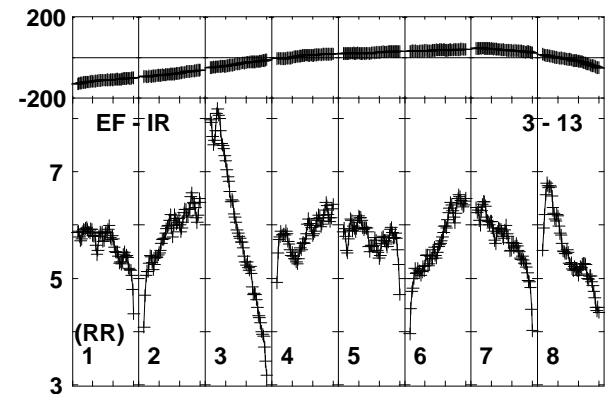
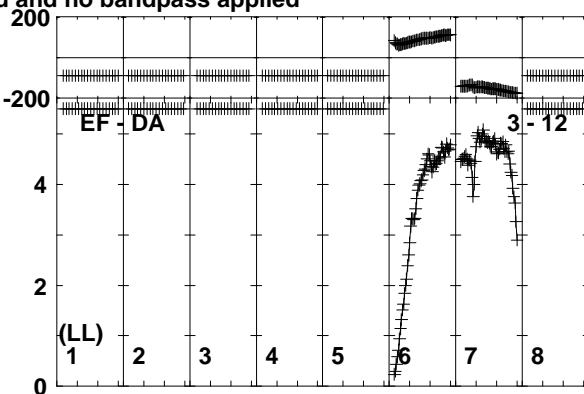
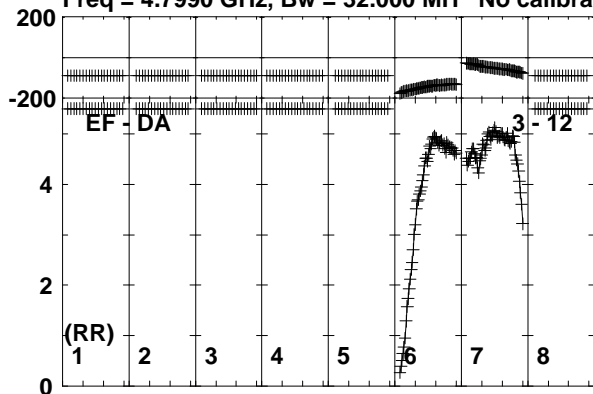

Lower frame: Milli Ampl Jy Top frame: Phas deg  
Vector averaged cross-power spectrum Baseline: EF (03) - DA (12)  
Timerange: 01/01:18:51 to 01/01:19:49

Plot file version 265 created 11-NOV-2019 15:07:46

SER8NJ EK040B.UVDATA.1

Freq = 4.7990 GHz, Bw = 32.000 MH No calibration applied and no bandpass applied

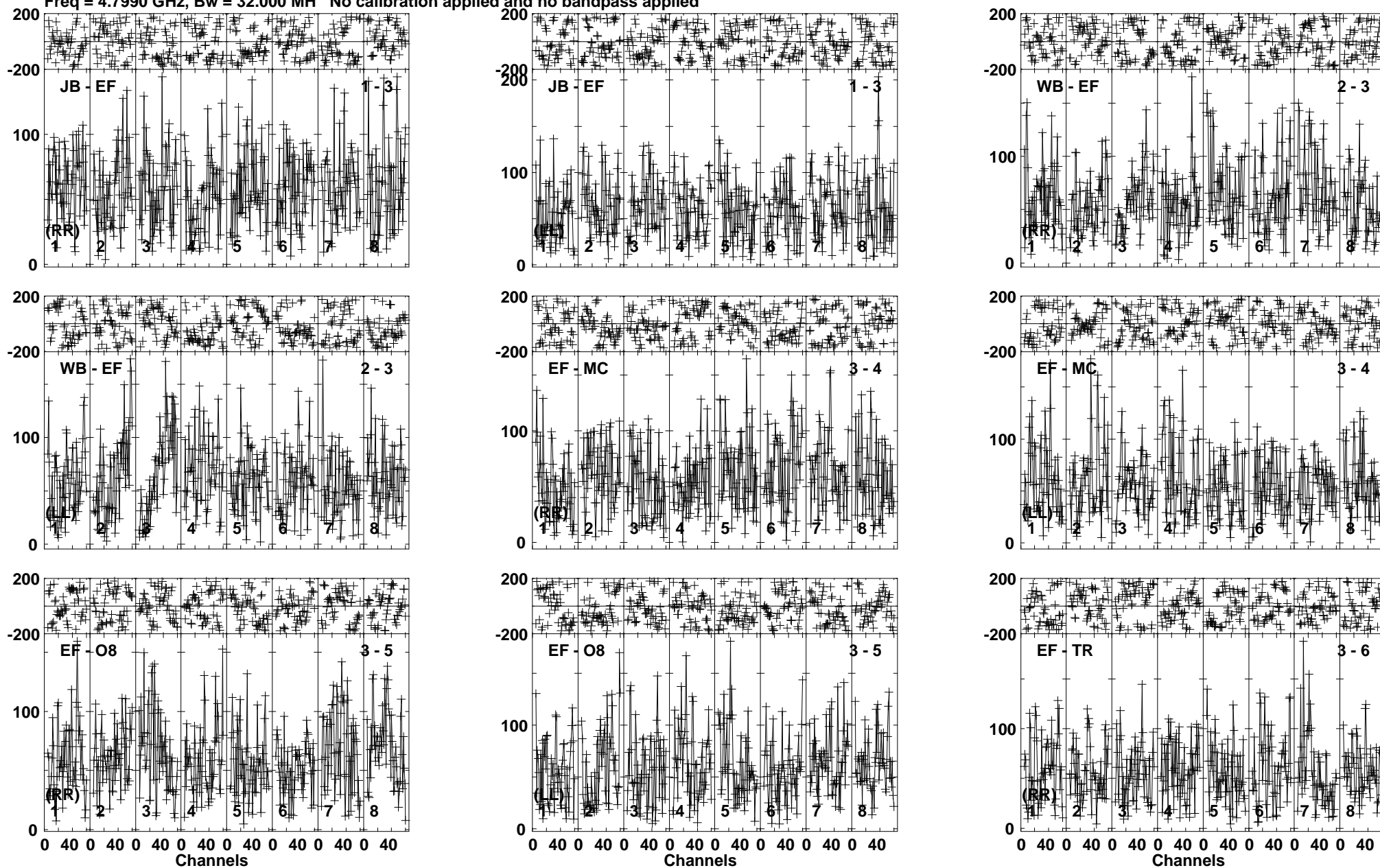

Lower frame: Micro Ampl Jy Top frame: Phas deg  
Vector averaged cross-power spectrum Baseline: JB (01) - EF (03)  
Timerange: 01/01:19:53 to 01/01:23:49

Plot file version 266 created 11-NOV-2019 15:07:46

SER8NJ EK040B.UVDATA.1

Freq = 4.7990 GHz, Bw = 32.000 MH No calibration applied and no bandpass applied

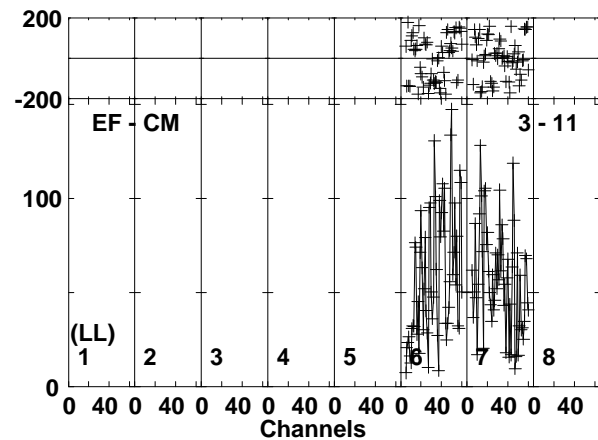
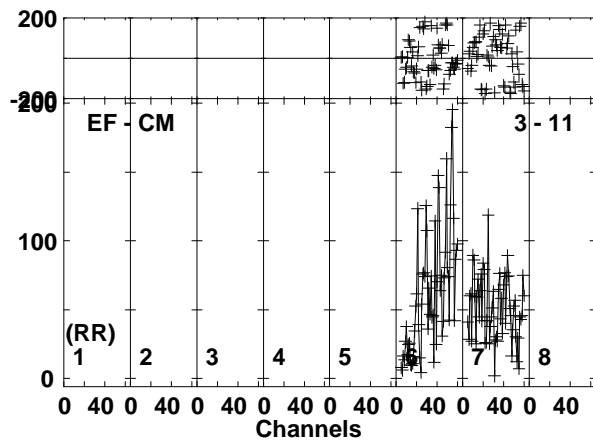
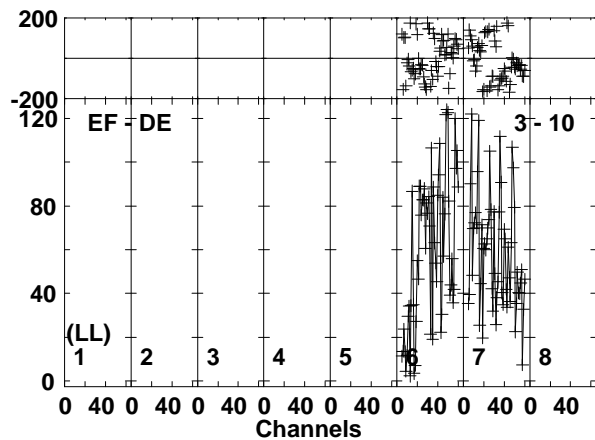
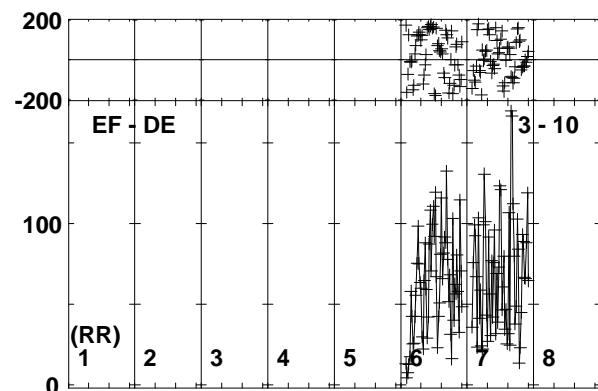
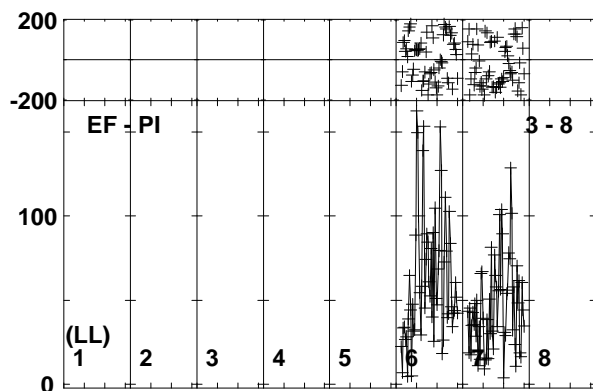
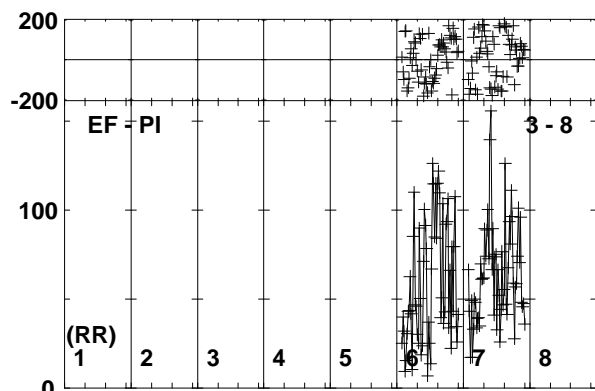
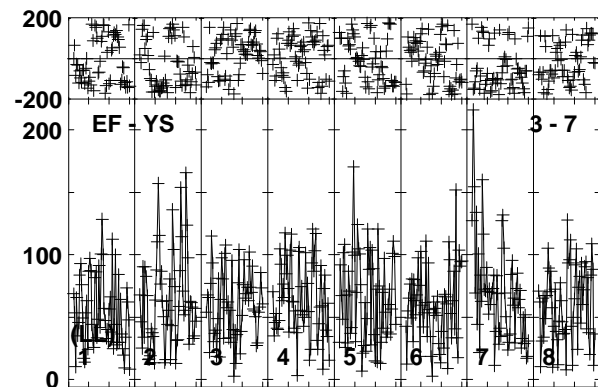
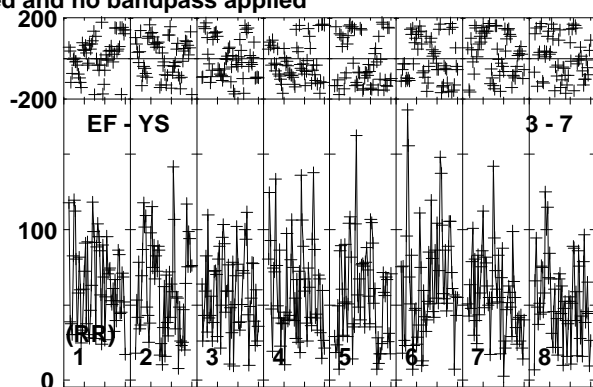
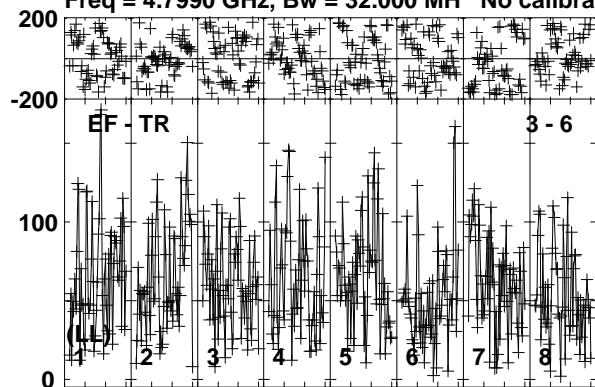

Lower frame: Micro Ampl Jy Top frame: Phas deg  
Vector averaged cross-power spectrum Baseline: EF (03) - TR (06)  
Timerange: 01/01:19:53 to 01/01:23:49



Plot file version 267 created 11-NOV-2019 15:07:46  
 SER8NJ EK040B.UVDATA.1  
 Freq = 4.7990 GHz, Bw = 32.000 MH No calibration applied and no bandpass applied

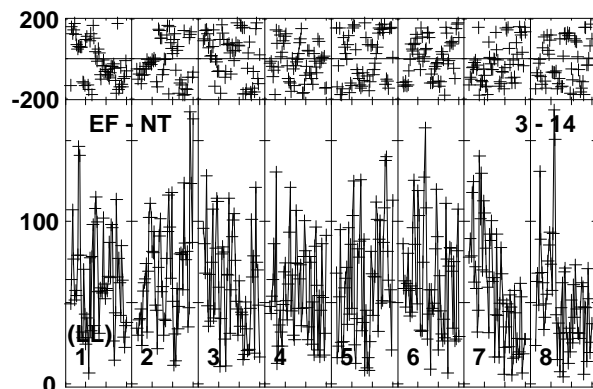
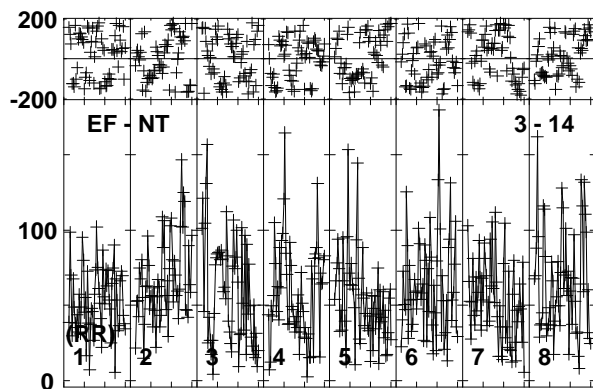
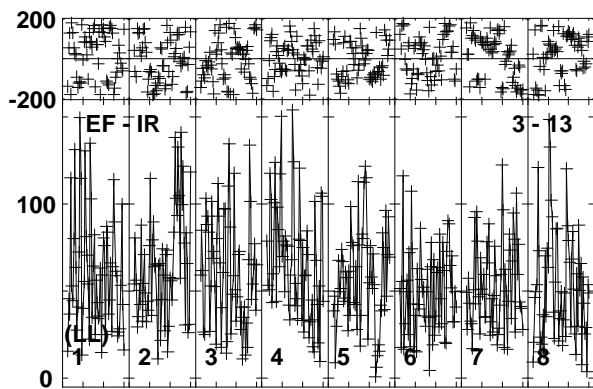
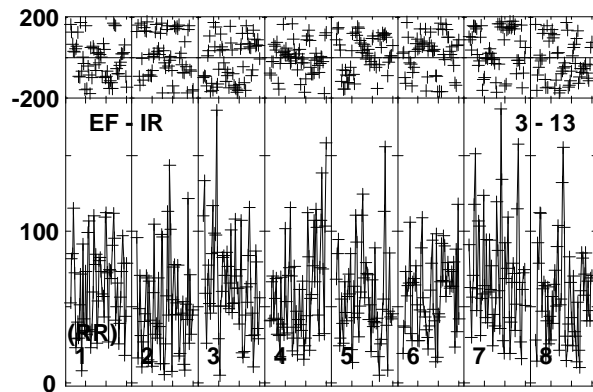
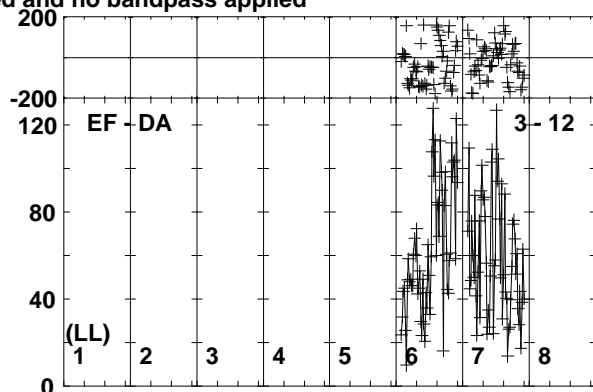
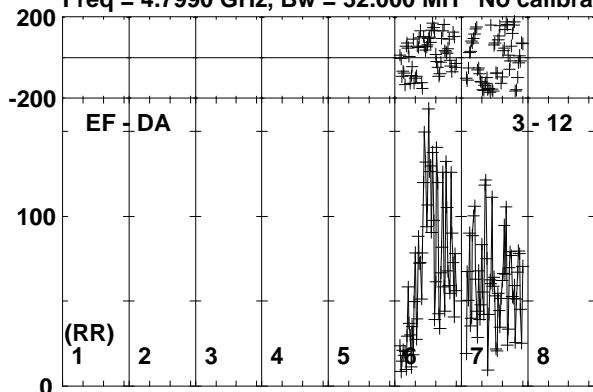

0 40 0 40 0 40 0 40 0 40 0 40 0 40 0 40 0 40  
 Channels

Lower frame: Micro Ampl Jy Top frame: Phas deg  
 Vector averaged cross-power spectrum Baseline: EF (03) - DA (12)  
 Timerange: 01/01:19:53 to 01/01:23:49

Plot file version 268 created 11-NOV-2019 15:07:47

J1826+0149 EK040B.UVDATA.1

Freq = 4.7990 GHz, Bw = 32.000 MH No calibration applied and no bandpass applied

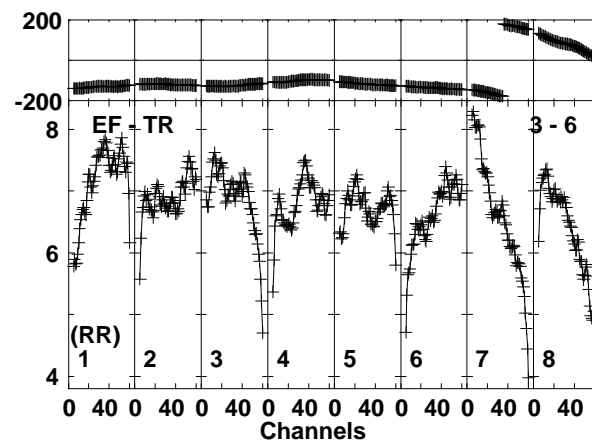
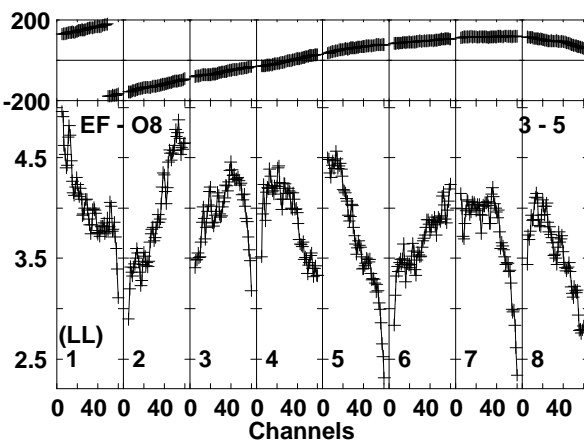
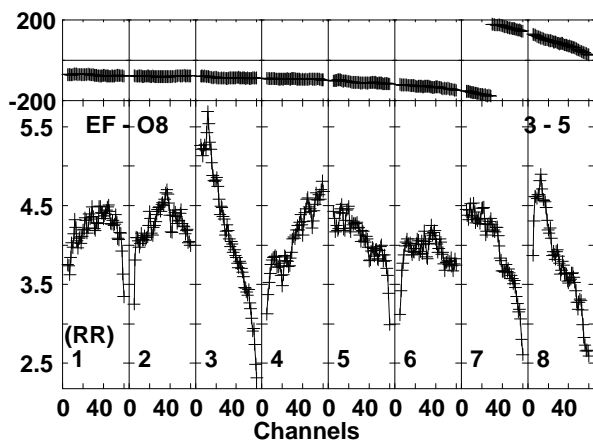
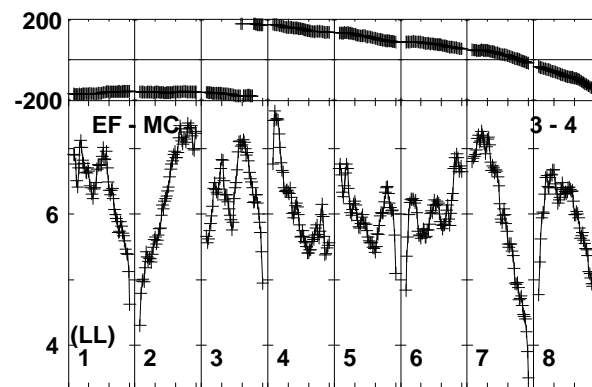
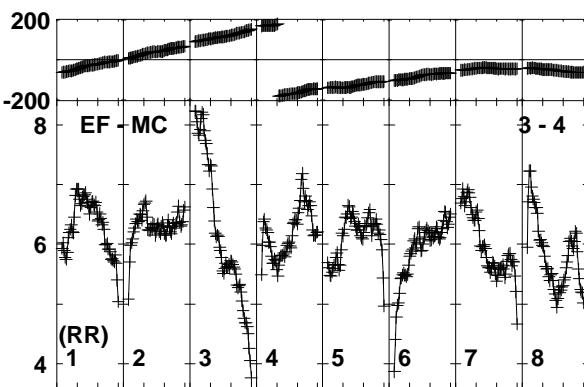
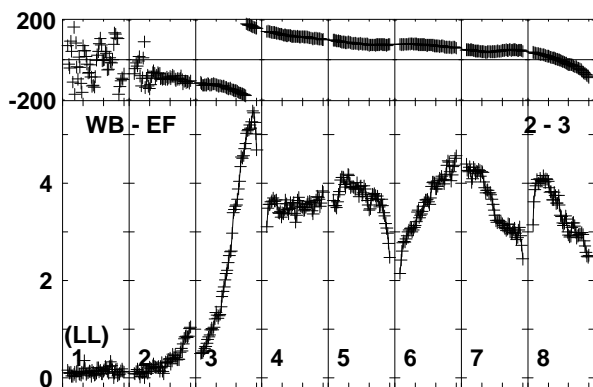
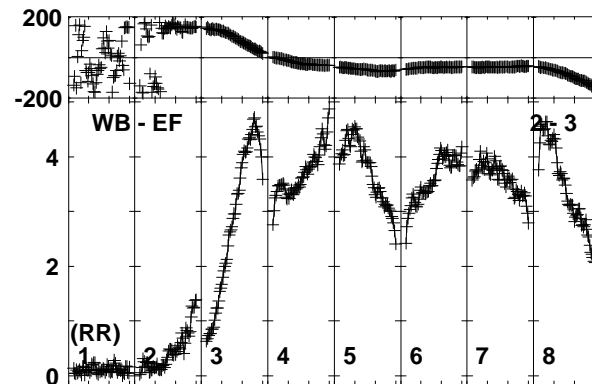
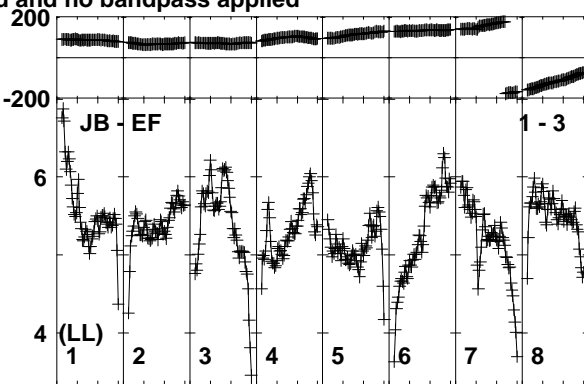
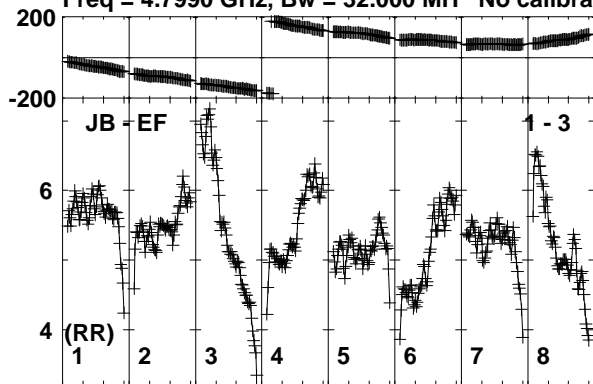

Lower frame: Milli Ampl Jy Top frame: Phas deg  
Vector averaged cross-power spectrum Baseline: JB (01) - EF (03)  
Timerange: 01/01:23:51 to 01/01:25:19

Plot file version 269 created 11-NOV-2019 15:07:47

J1826+0149 EK040B.UVDATA.1

Freq = 4.7990 GHz, Bw = 32.000 MH No calibration applied and no bandpass applied

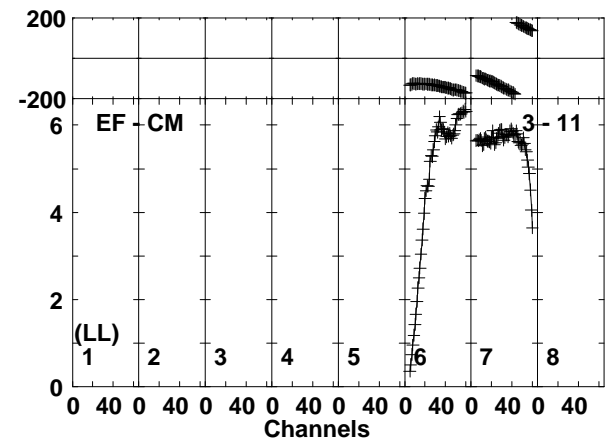
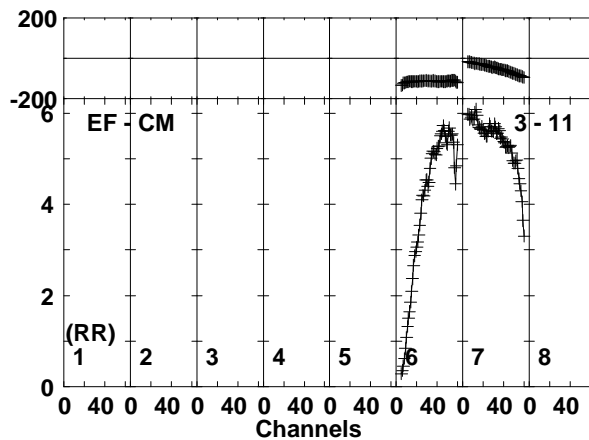
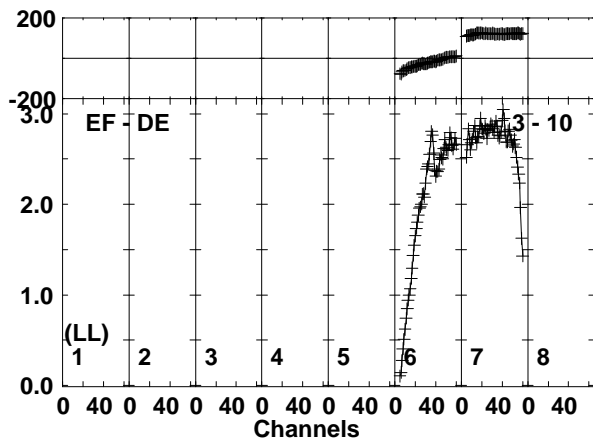
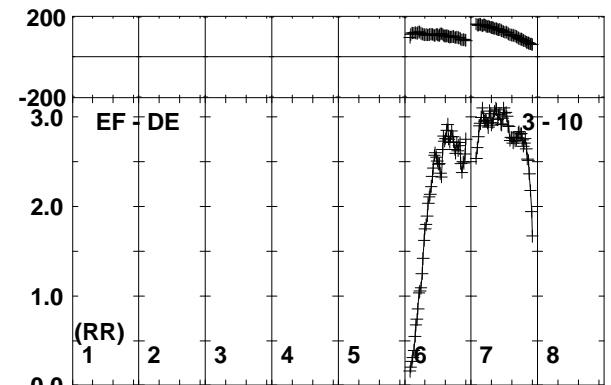
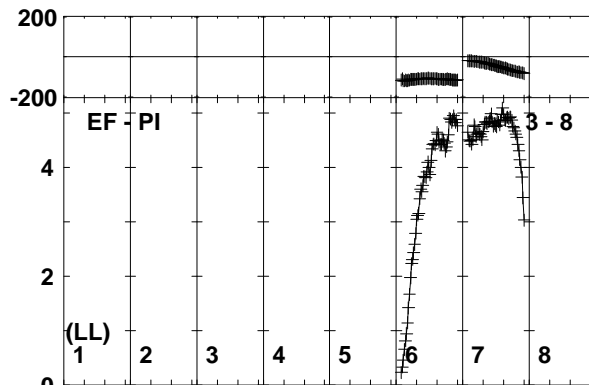
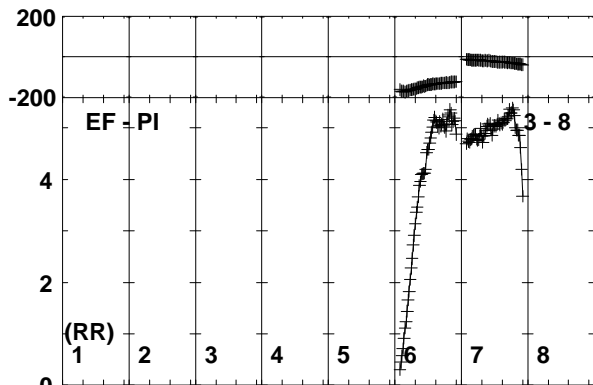
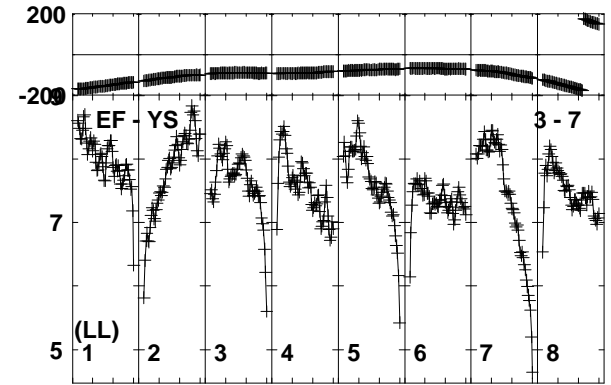
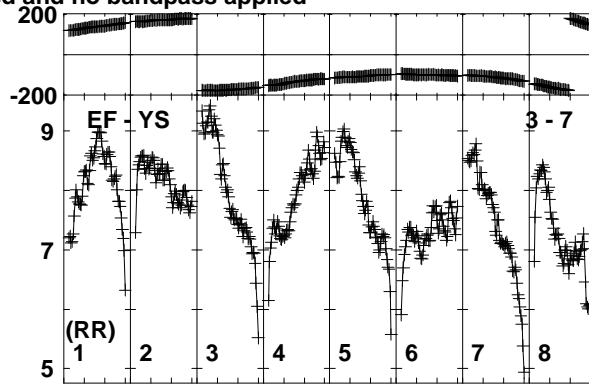
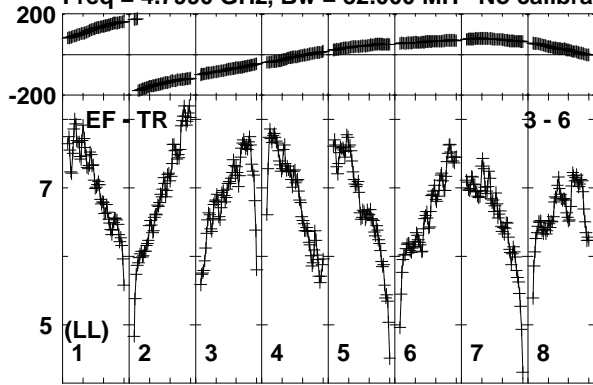

Lower frame: Milli Ampl Jy Top frame: Phas deg  
Vector averaged cross-power spectrum Baseline: EF (03) - TR (06)  
Timerange: 01/01:23:51 to 01/01:25:19

Plot file version 270 created 11-NOV-2019 15:07:47

J1826+0149 EK040B.UVDATA.1

Freq = 4.7990 GHz, Bw = 32.000 MH No calibration applied and no bandpass applied

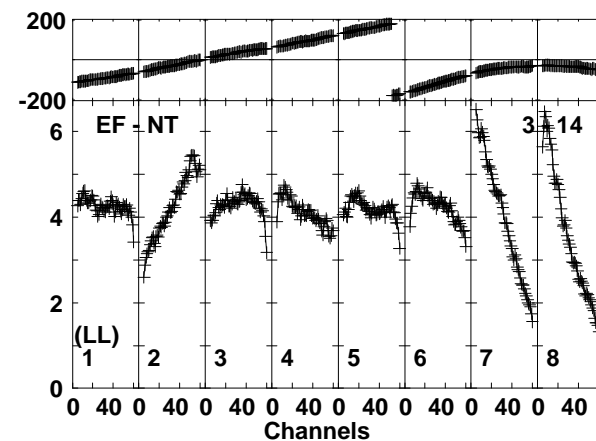
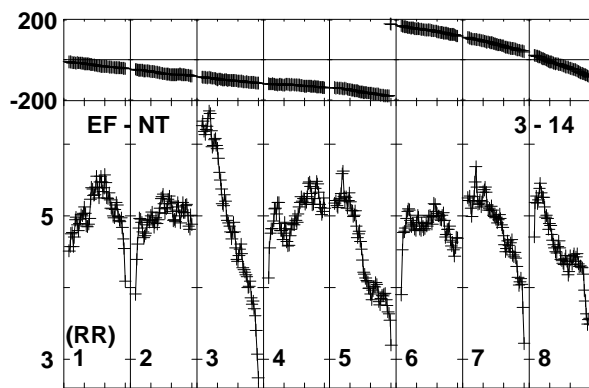
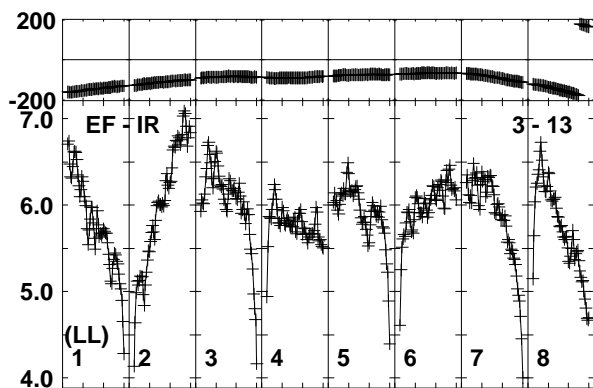
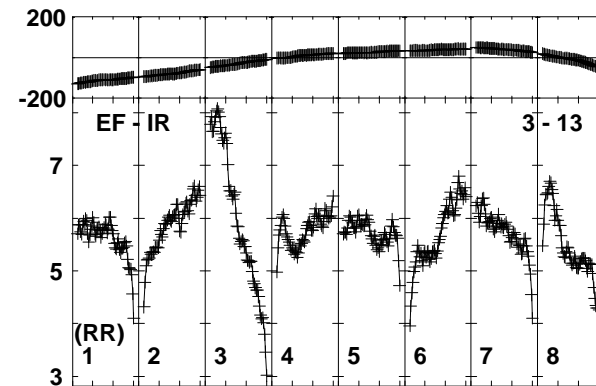
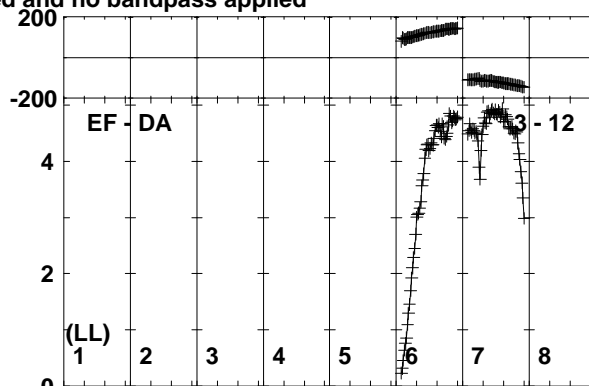
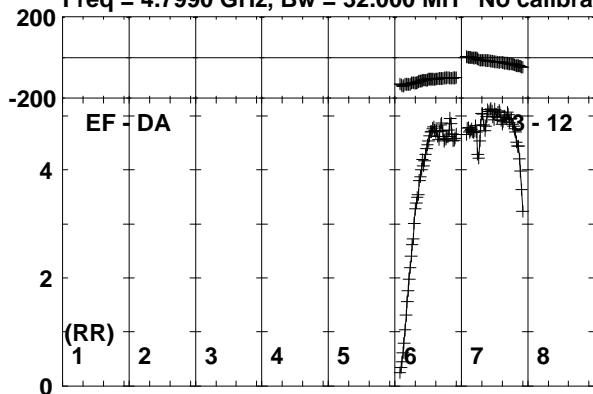

Lower frame: Milli Ampl Jy Top frame: Phas deg  
Vector averaged cross-power spectrum Baseline: EF (03) - DA (12)  
Timerange: 01/01:23:51 to 01/01:25:19

Plot file version 271 created 11-NOV-2019 15:07:47

SER8NJ EK040B.UVDATA.1

Freq = 4.7990 GHz, Bw = 32.000 MH No calibration applied and no bandpass applied

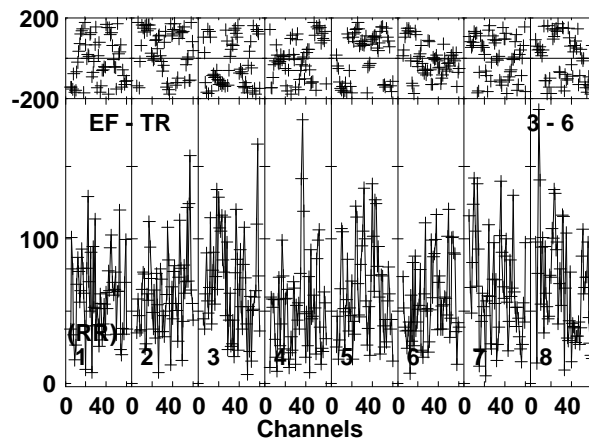
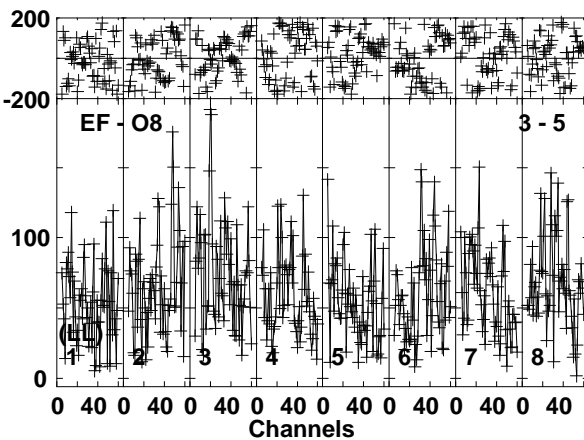
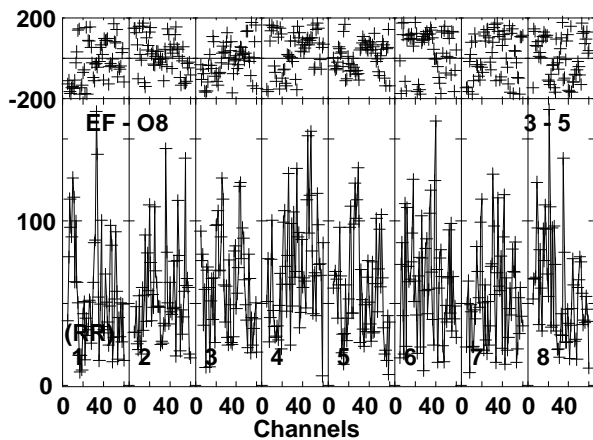
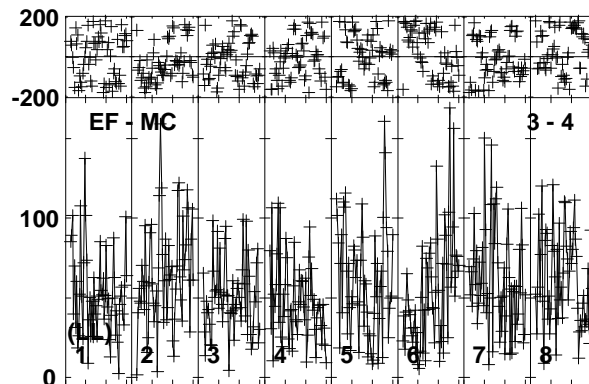
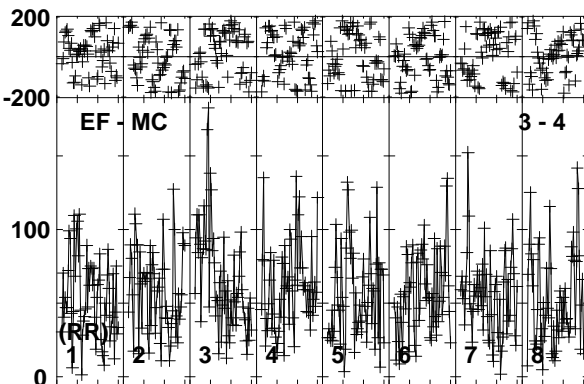
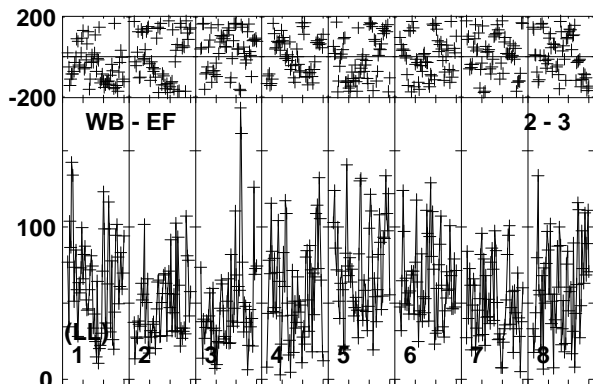
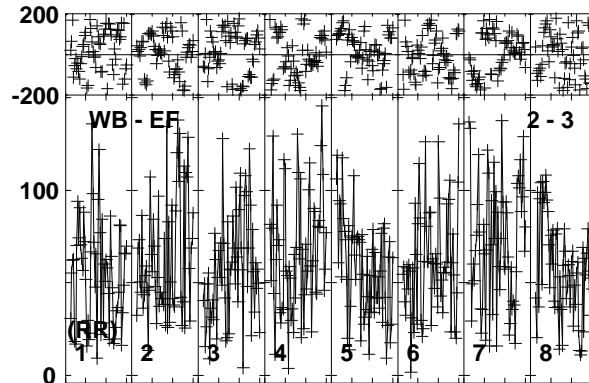
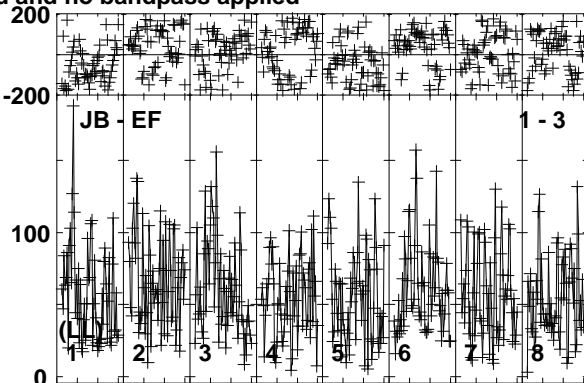
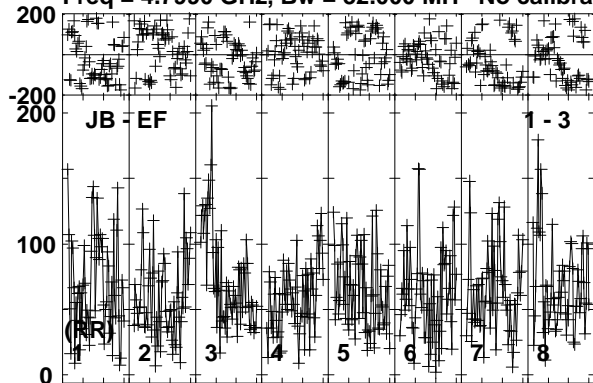

Lower frame: Micro Ampl Jy Top frame: Phas deg  
Vector averaged cross-power spectrum Baseline: JB (01) - EF (03)  
Timerange: 01/01:25:23 to 01/01:29:19

Plot file version 272 created 11-NOV-2019 15:07:47

SER8NJ EK040B.UVDATA.1

Freq = 4.7990 GHz, Bw = 32.000 MH No calibration applied and no bandpass applied

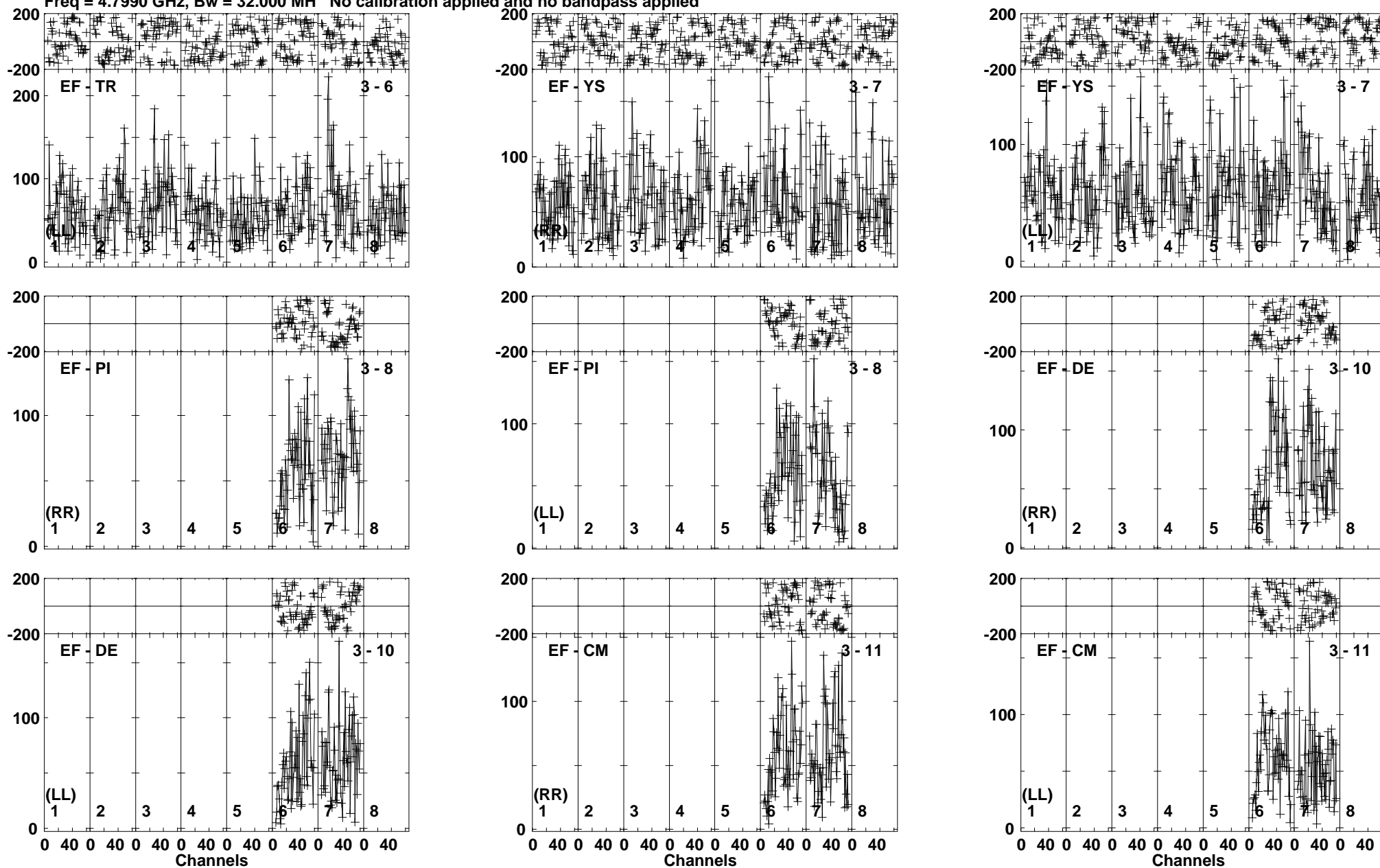

Lower frame: Micro Ampl Jy Top frame: Phas deg  
Vector averaged cross-power spectrum Baseline: EF (03) - TR (06)  
Timerange: 01/01:25:23 to 01/01:29:19

Plot file version 273 created 11-NOV-2019 15:07:47

SER8NJ EK040B.UVDATA.1

Freq = 4.7990 GHz, Bw = 32.000 MH No calibration applied and no bandpass applied

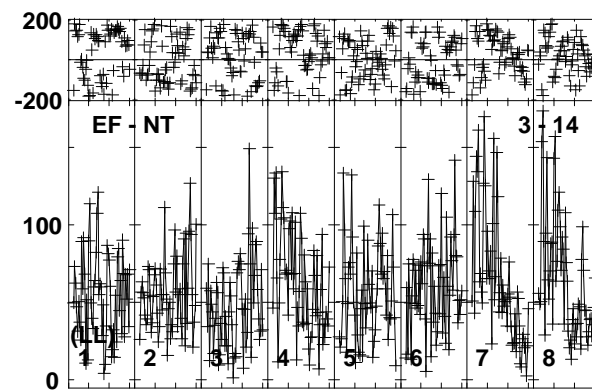
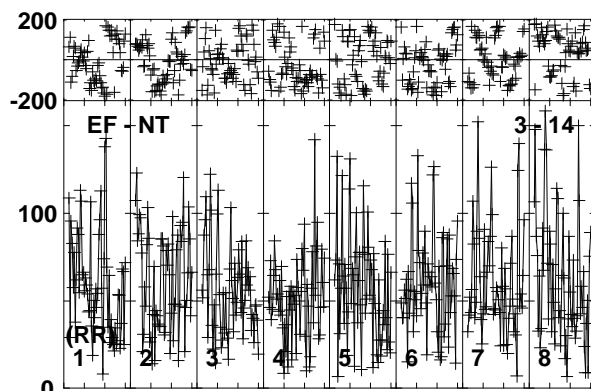
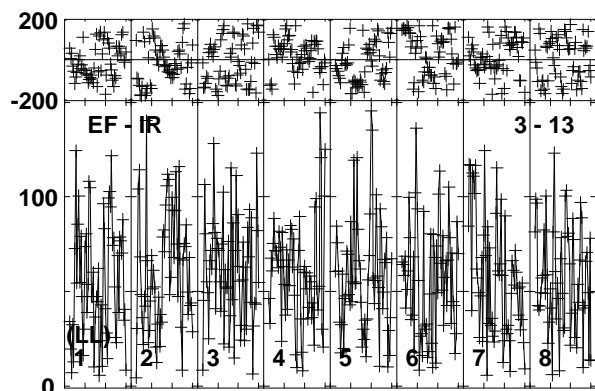
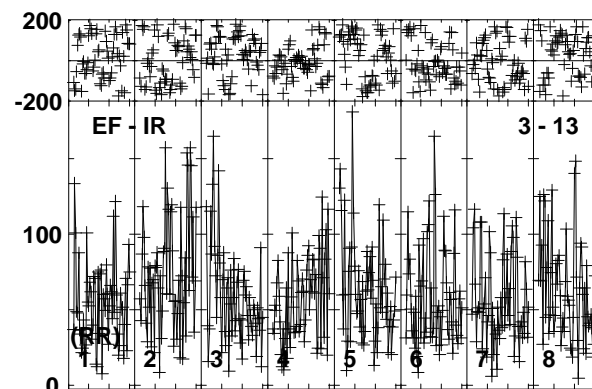
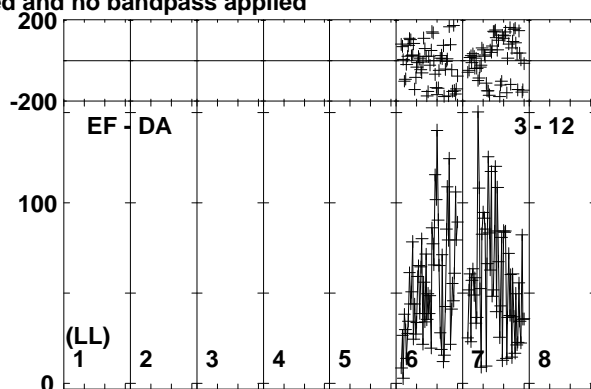
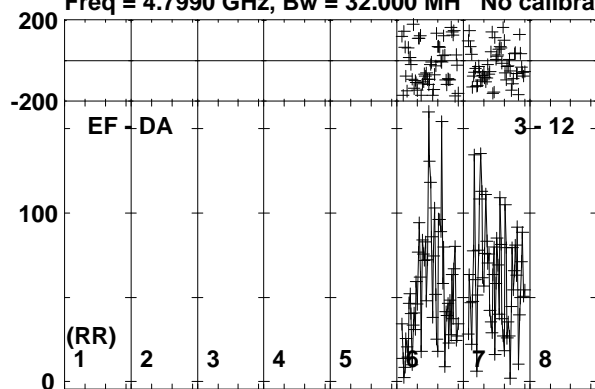

0 40 0 40 0 40 0 40 0 40 0 40 0 40 0 40 0 40 0 40  
Channels

Lower frame: Micro Ampl Jy Top frame: Phas deg  
Vector averaged cross-power spectrum Baseline: EF (03) - DA (12)  
Timerange: 01/01:25:23 to 01/01:29:19

Plot file version 274 created 11-NOV-2019 15:07:47

J1826+0149 EK040B.UVDATA.1

Freq = 4.7990 GHz, Bw = 32.000 MH No calibration applied and no bandpass applied

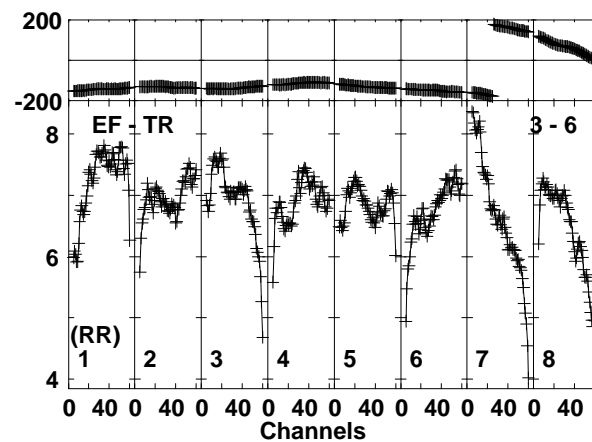
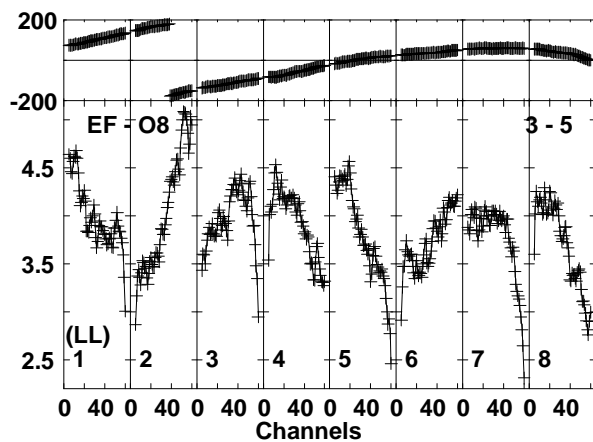
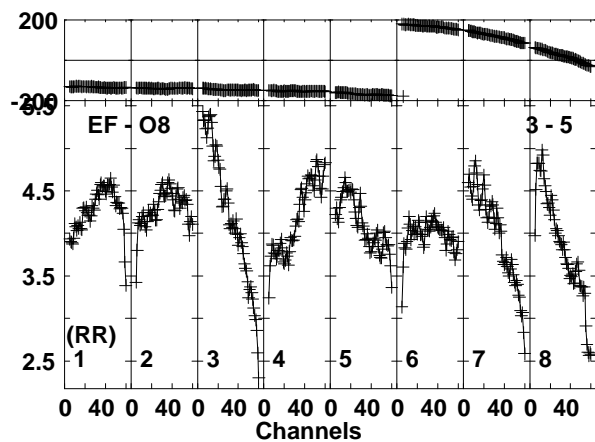
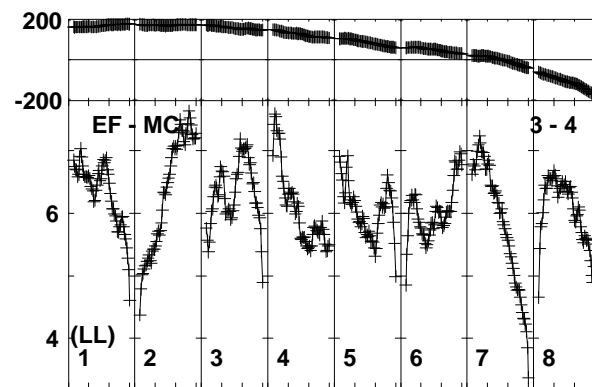
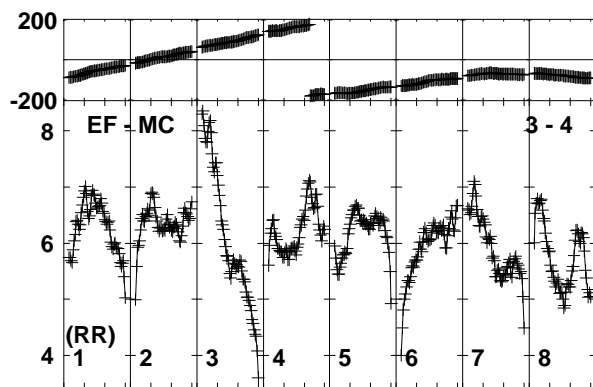
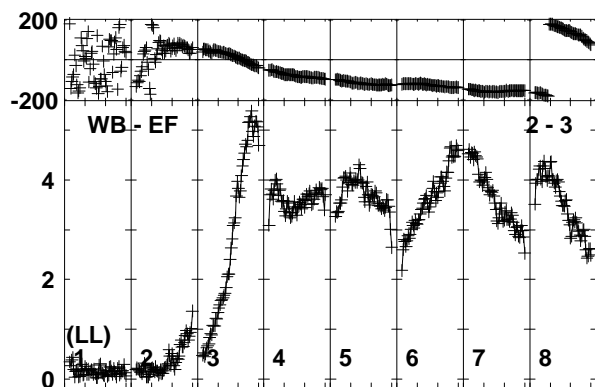
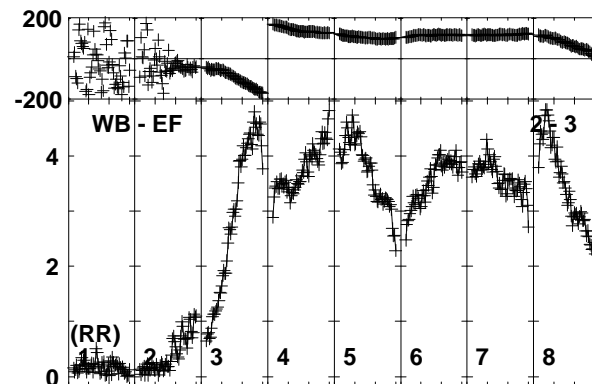
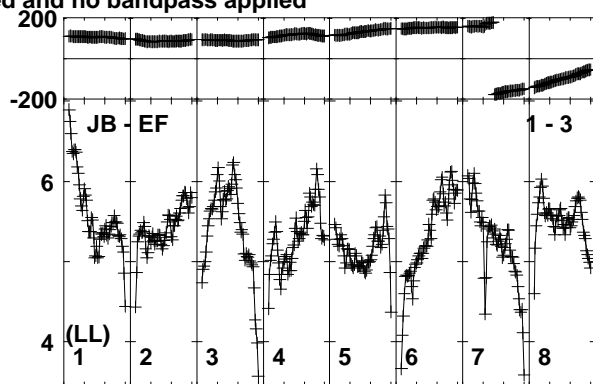
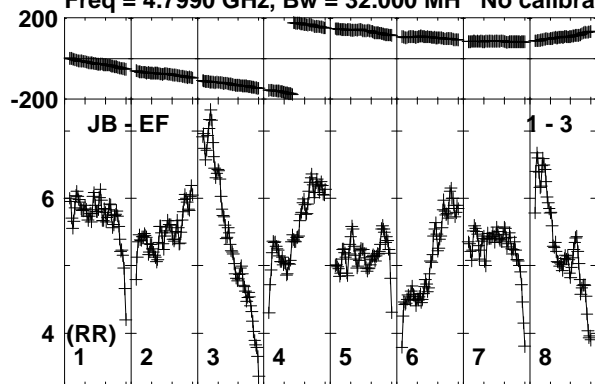

Lower frame: Milli Ampl Jy Top frame: Phas deg  
Vector averaged cross-power spectrum Baseline: JB (01) - EF (03)  
Timerange: 01/01:30:01 to 01/01:30:59



Plot file version 275 created 11-NOV-2019 15:07:47

J1826+0149 EK040B.UVDATA.1

Freq = 4.7990 GHz, Bw = 32.000 MH No calibration applied and no bandpass applied

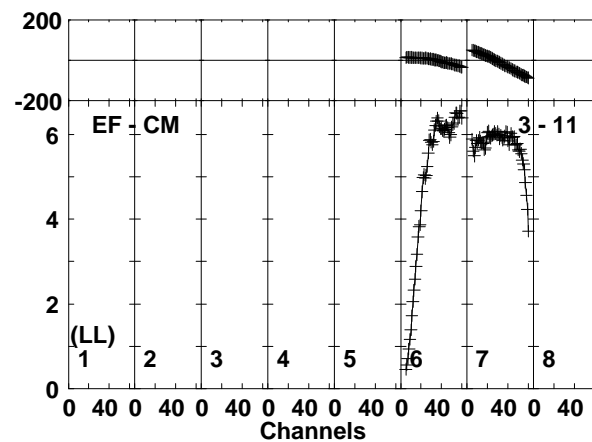
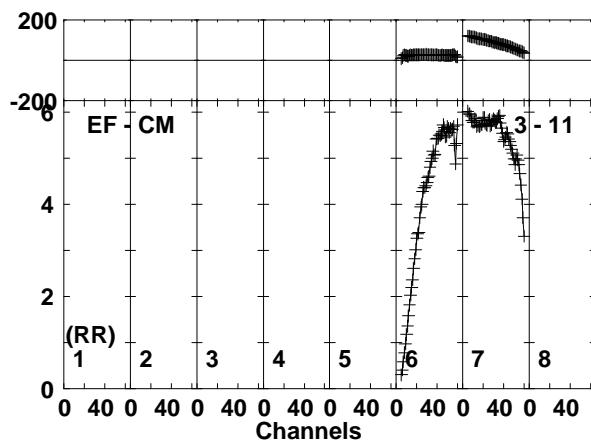
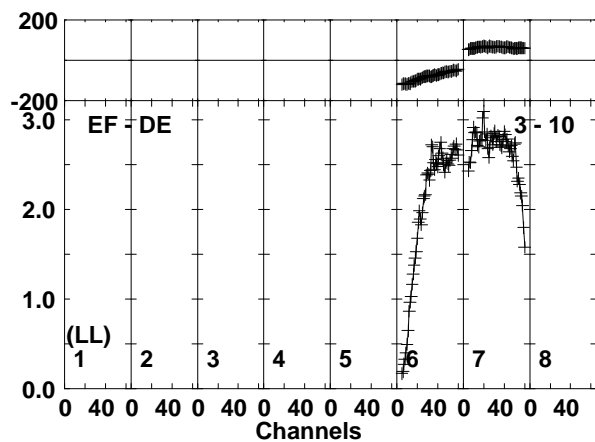
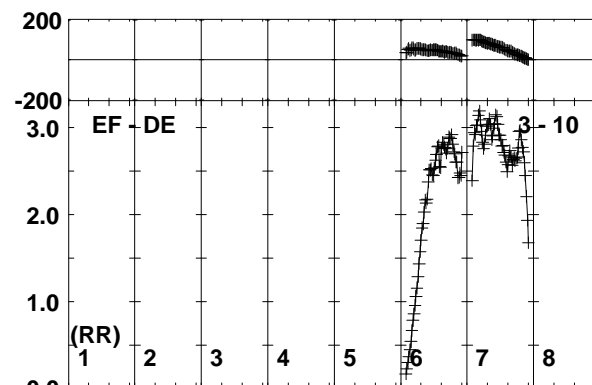
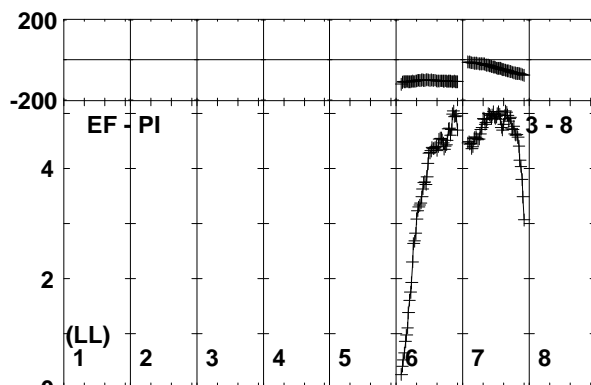
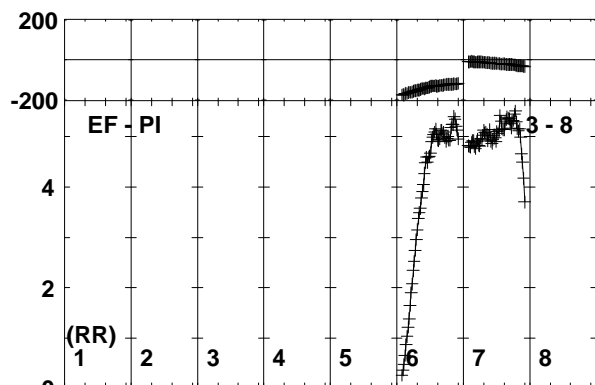
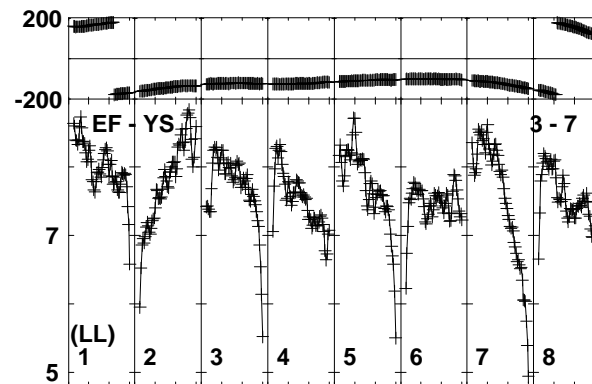
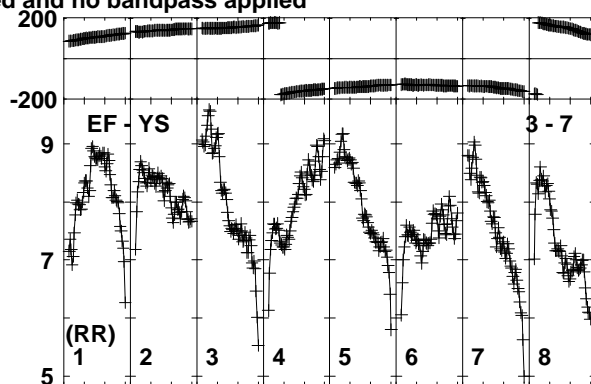
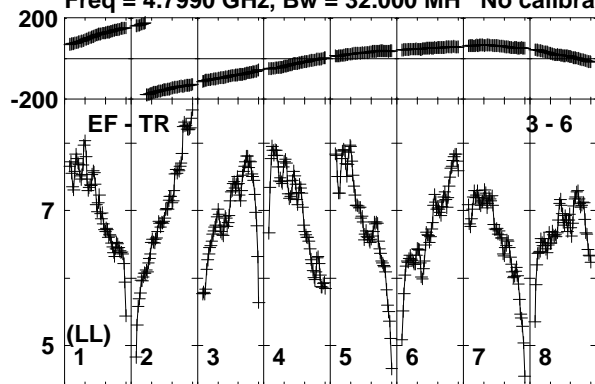

Lower frame: Milli Ampl Jy Top frame: Phas deg  
Vector averaged cross-power spectrum Baseline: EF (03) - TR (06)  
Timerange: 01/01:30:01 to 01/01:30:59

Plot file version 276 created 11-NOV-2019 15:07:47

J1826+0149 EK040B.UVDATA.1

Freq = 4.7990 GHz, Bw = 32.000 MH No calibration applied and no bandpass applied

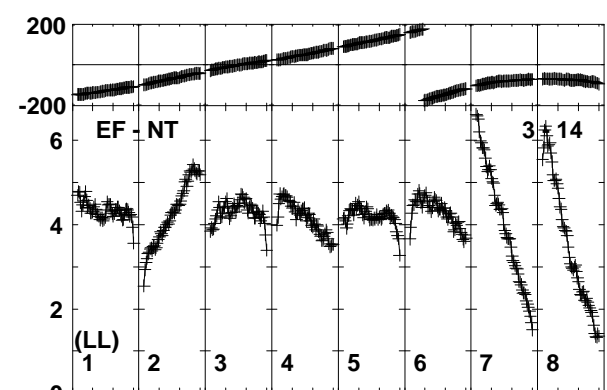
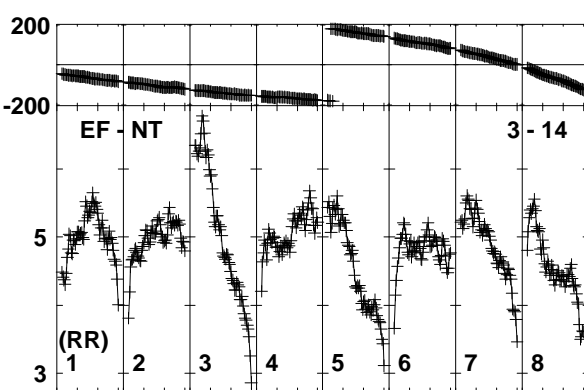
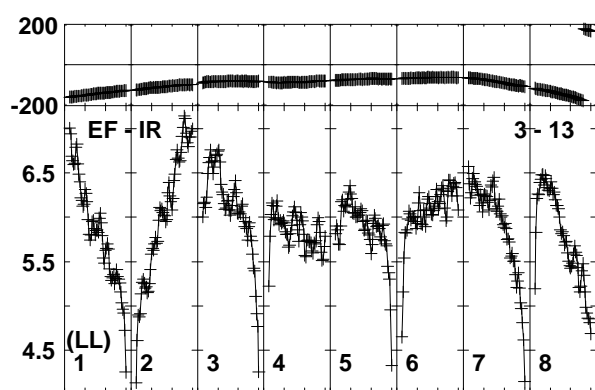
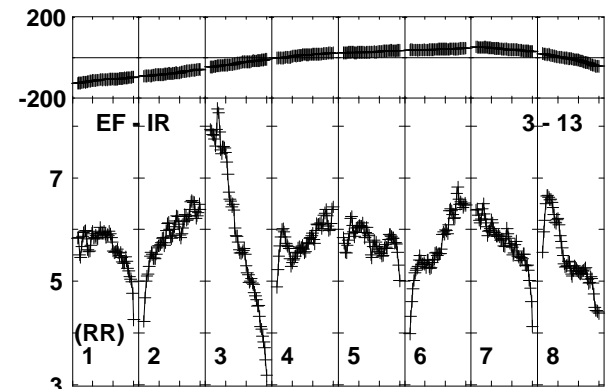
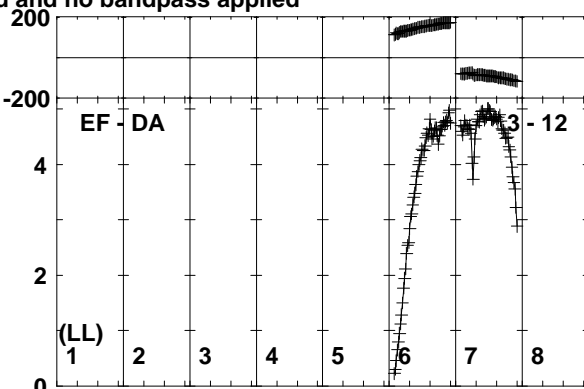
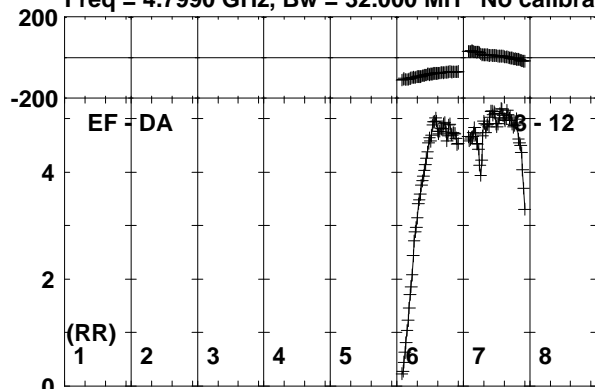

Lower frame: Milli Ampl Jy Top frame: Phas deg  
Vector averaged cross-power spectrum Baseline: EF (03) - DA (12)  
Timerange: 01/01:30:01 to 01/01:30:59

Plot file version 277 created 11-NOV-2019 15:07:48

SER8NJ EK040B.UVDATA.1

Freq = 4.7990 GHz, Bw = 32.000 MH No calibration applied and no bandpass applied

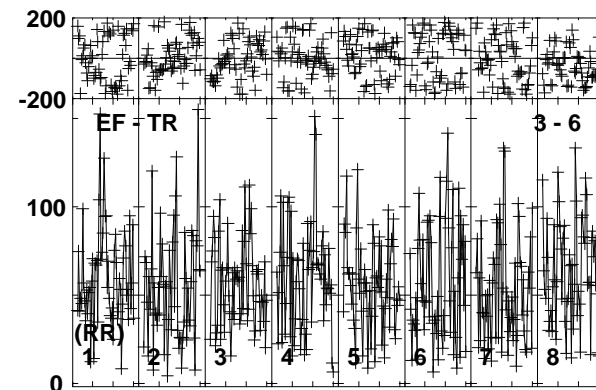
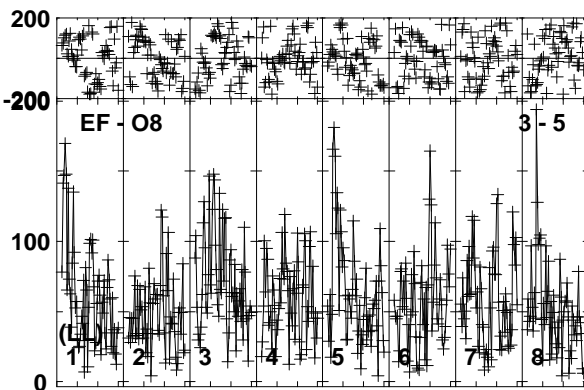
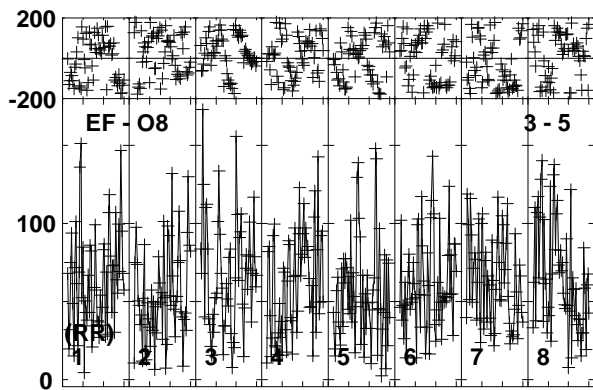
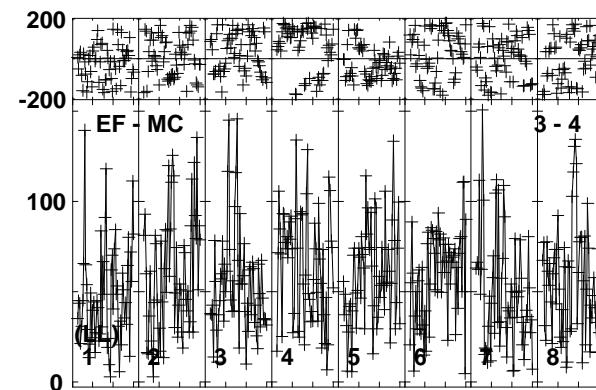
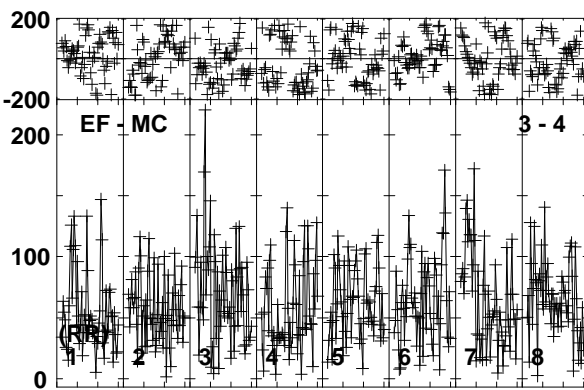
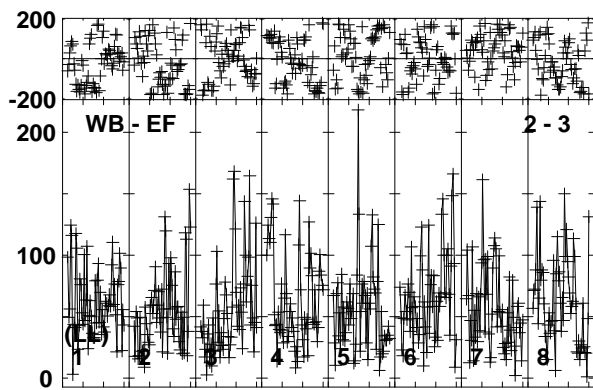
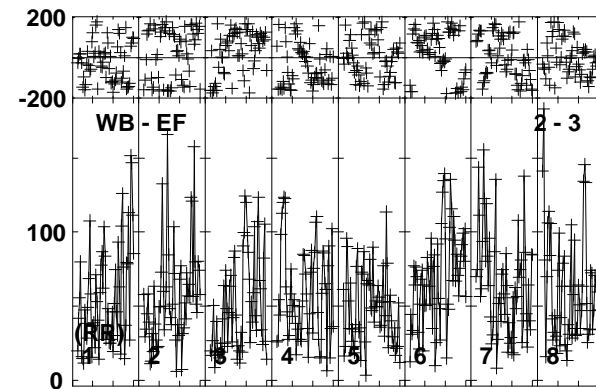
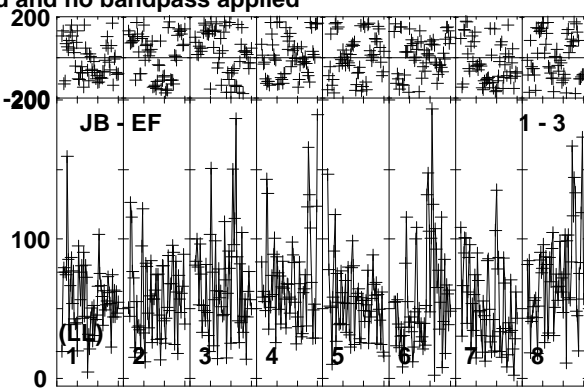
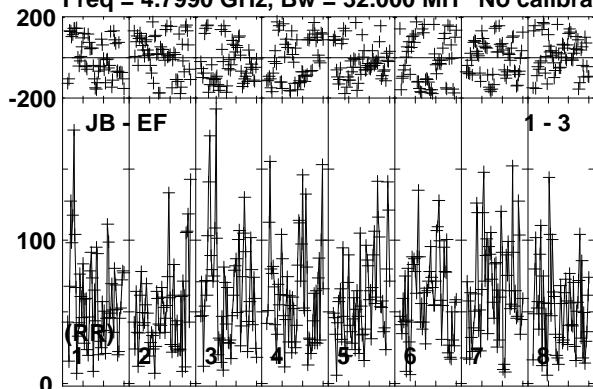

Lower frame: Micro Ampl Jy Top frame: Phas deg  
Vector averaged cross-power spectrum Baseline: JB (01) - EF (03)  
Timerange: 01/01:31:03 to 01/01:34:59

Plot file version 278 created 11-NOV-2019 15:07:48

SER8NJ EK040B.UVDATA.1

Freq = 4.7990 GHz, Bw = 32.000 MH No calibration applied and no bandpass applied

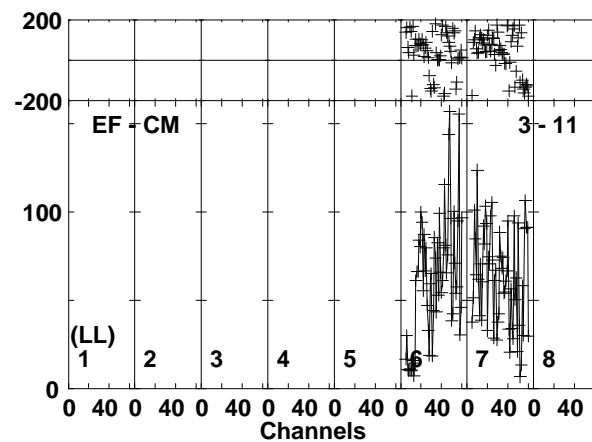
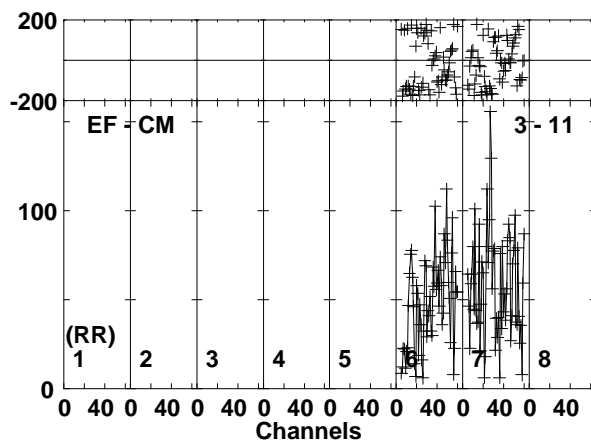
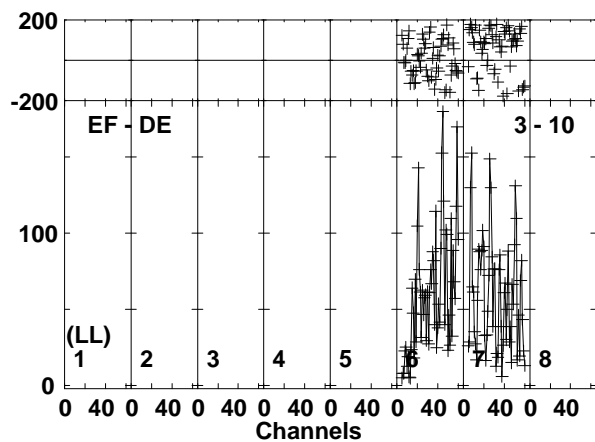
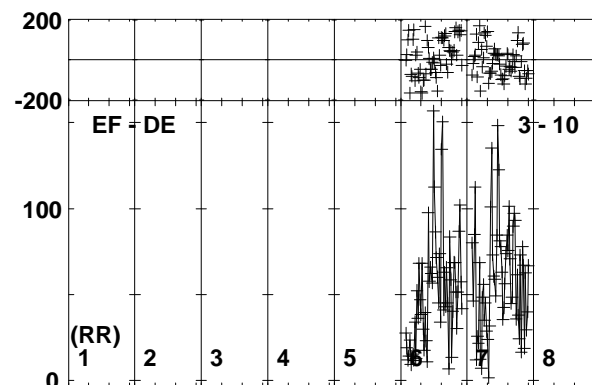
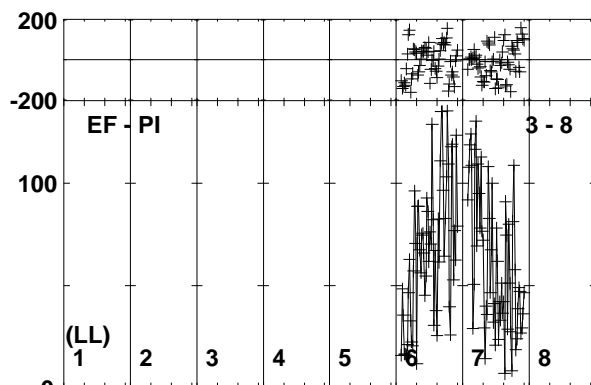
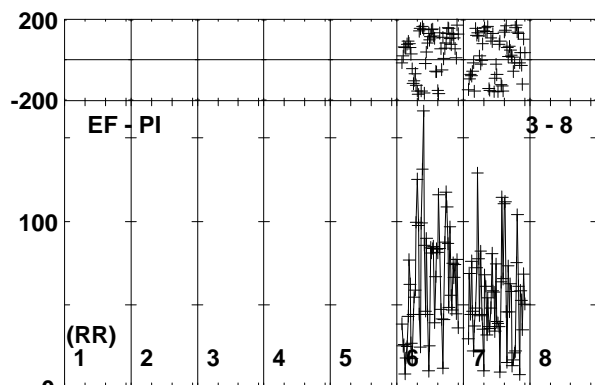
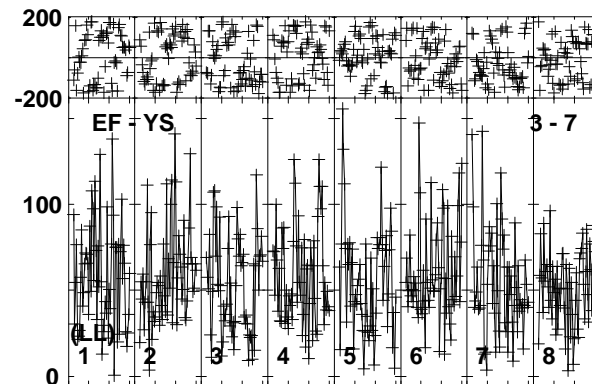
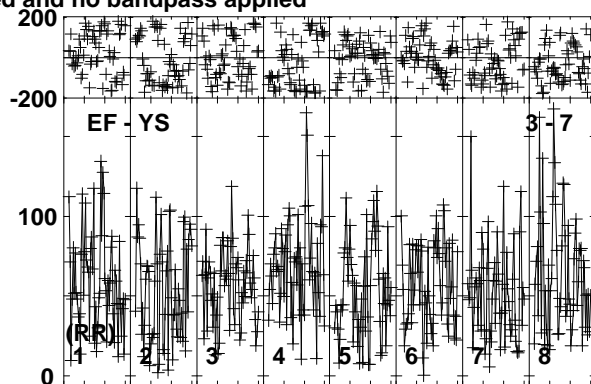
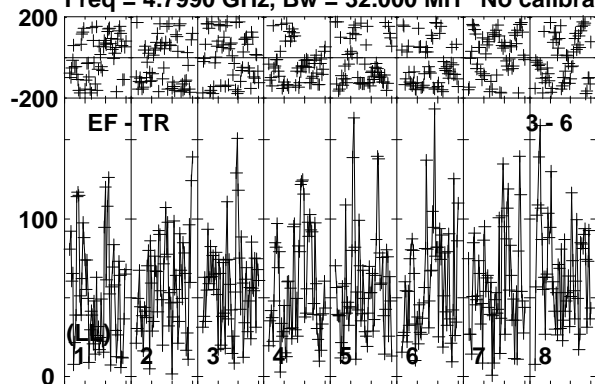

Lower frame: Micro Ampl Jy Top frame: Phas deg  
Vector averaged cross-power spectrum Baseline: EF (03) - TR (06)  
Timerange: 01/01:31:03 to 01/01:34:59

Plot file version 279 created 11-NOV-2019 15:07:48  
SER8NJ EK040B.UVDATA.1  
Freq = 4.7990 GHz, Bw = 32.000 MH No calibration applied and no bandpass applied

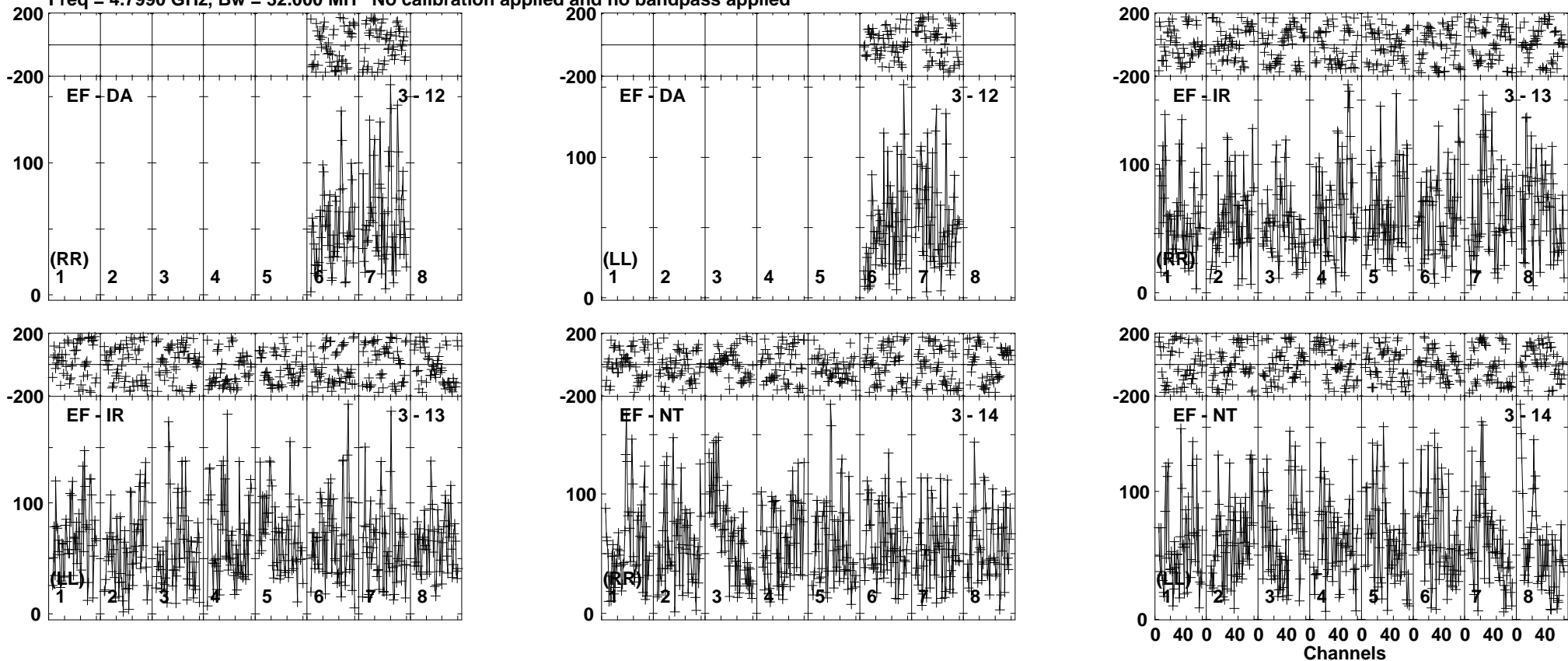

Lower frame: Micro Ampl Jy Top frame: Phas deg  
Vector averaged cross-power spectrum Baseline: EF (03) - DA (12)  
Timerange: 01/01:31:03 to 01/01:34:59

Plot file version 280 created 11-NOV-2019 15:07:48

J1826+0149 EK040B.UVDATA.1

Freq = 4.7990 GHz, Bw = 32.000 MH No calibration applied and no bandpass applied

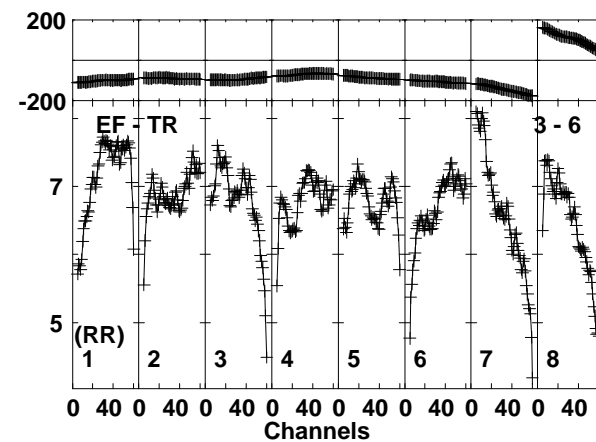
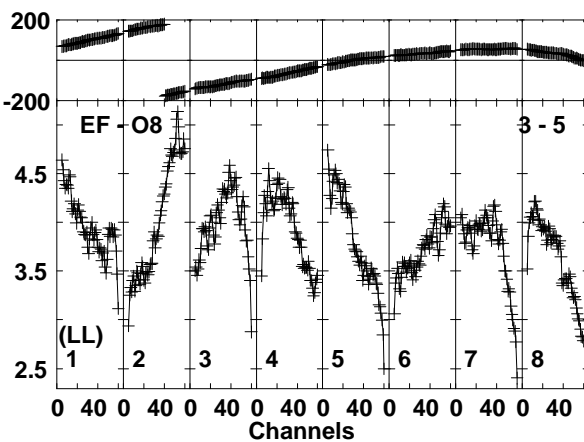
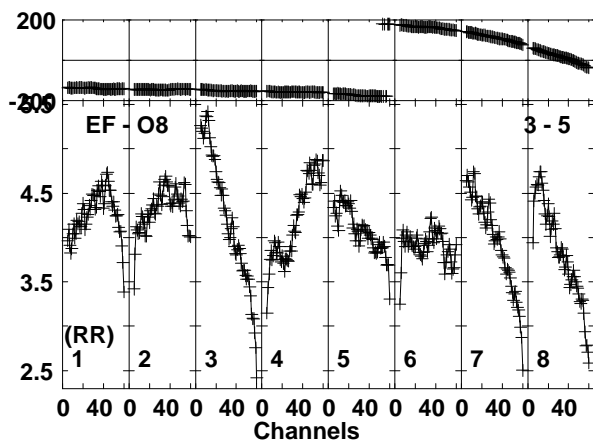
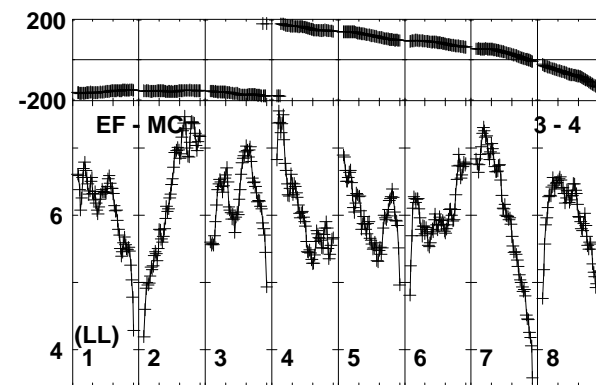
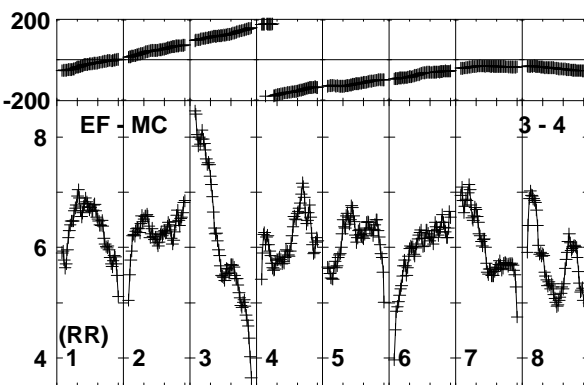
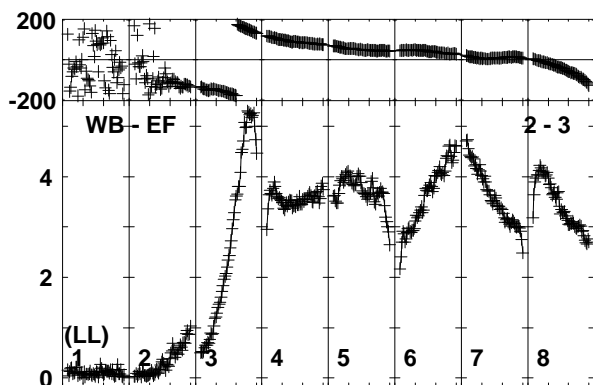
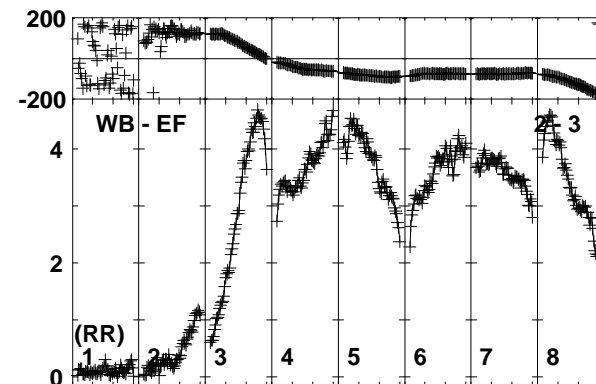
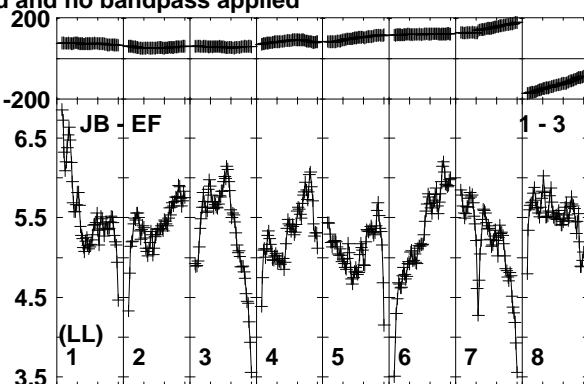
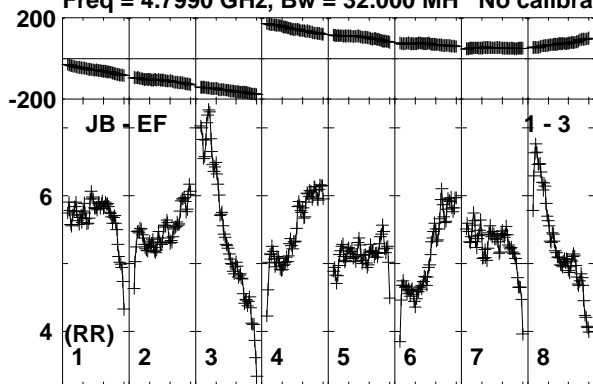

Lower frame: Milli Ampl Jy Top frame: Phas deg  
Vector averaged cross-power spectrum Baseline: JB (01) - EF (03)  
Timerange: 01/01:35:03 to 01/01:36:29

Plot file version 281 created 11-NOV-2019 15:07:48

J1826+0149 EK040B.UVDATA.1

Freq = 4.7990 GHz, Bw = 32.000 MH No calibration applied and no bandpass applied

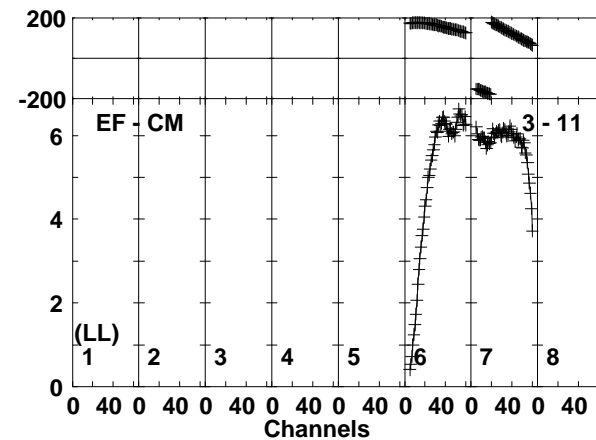
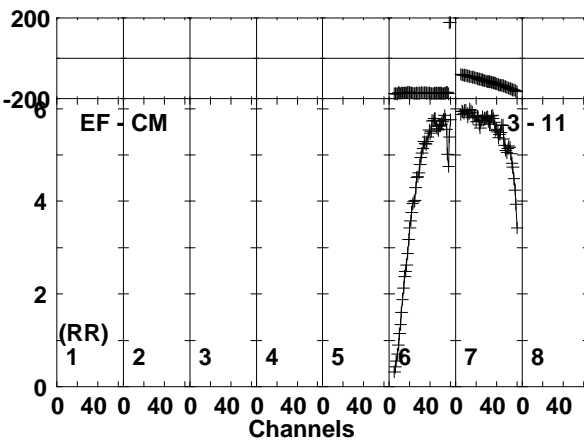
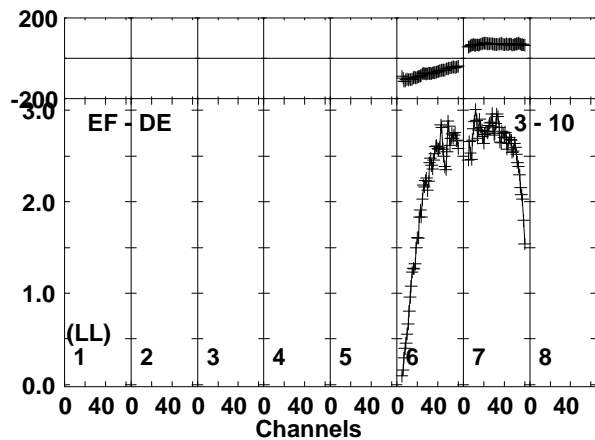
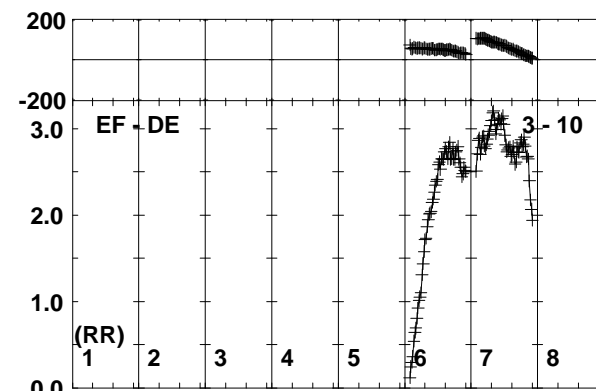
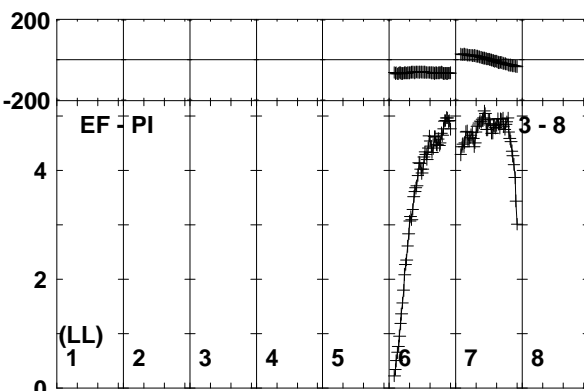
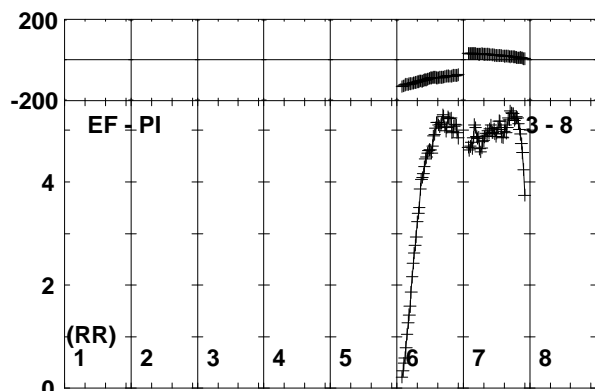
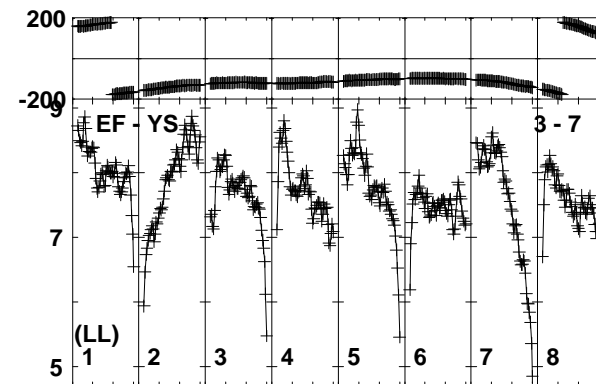
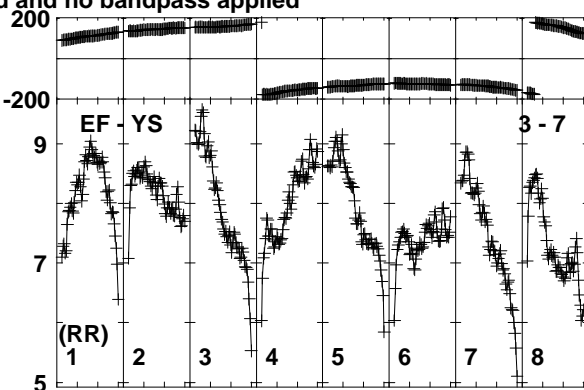
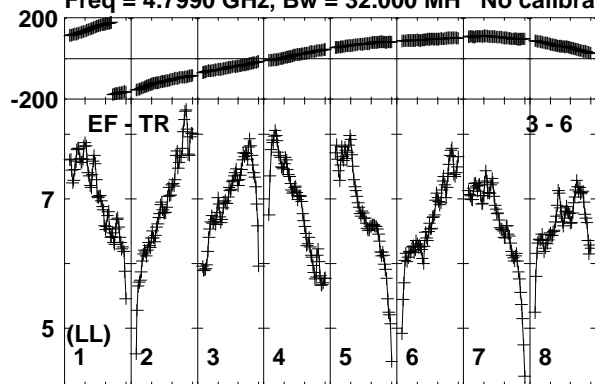

Lower frame: Milli Ampl Jy Top frame: Phas deg  
Vector averaged cross-power spectrum Baseline: EF (03) - TR (06)  
Timerange: 01/01:35:03 to 01/01:36:29

Plot file version 282 created 11-NOV-2019 15:07:48

J1826+0149 EK040B.UVDATA.1

Freq = 4.7990 GHz, Bw = 32.000 MH No calibration applied and no bandpass applied

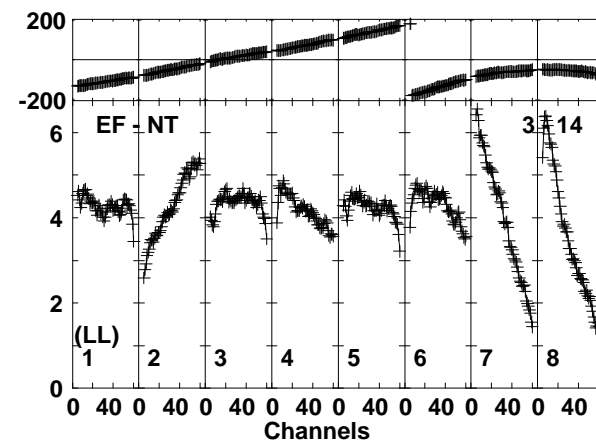
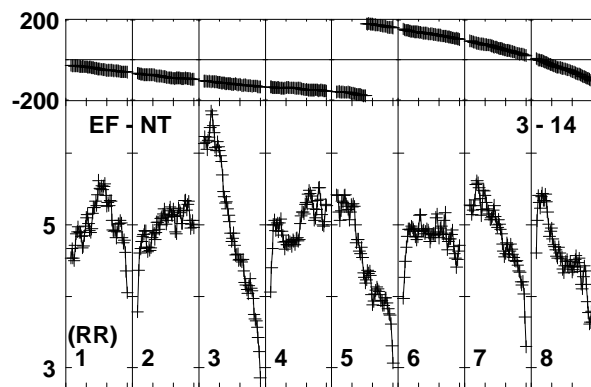
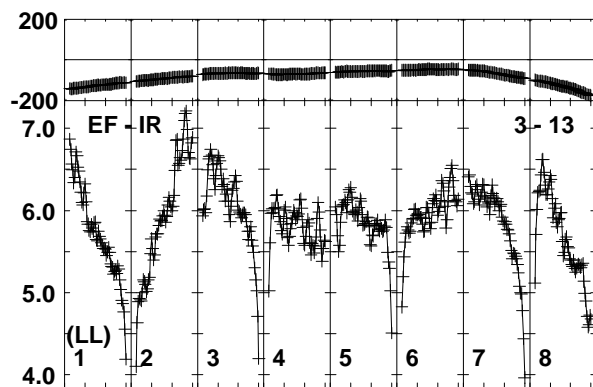
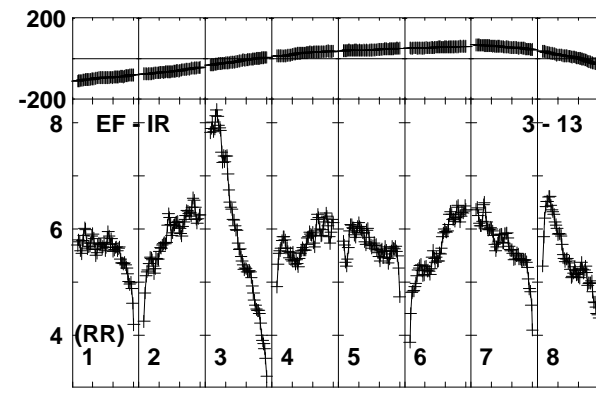
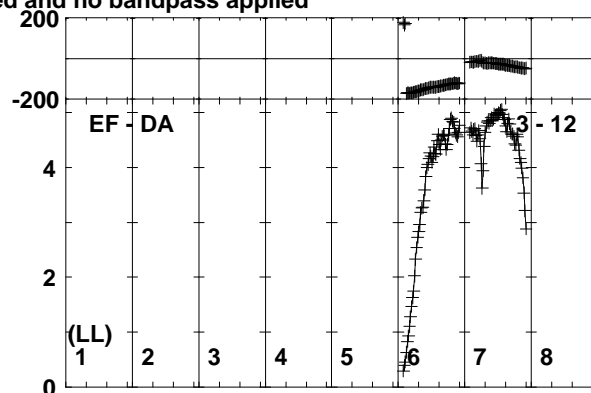
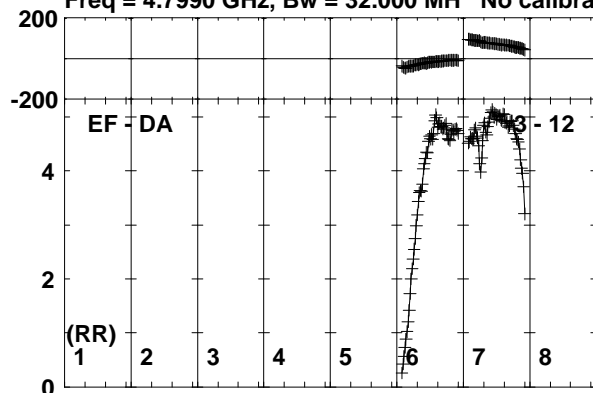

Lower frame: Milli Ampl Jy Top frame: Phas deg  
Vector averaged cross-power spectrum Baseline: EF (03) - DA (12)  
Timerange: 01/01:35:03 to 01/01:36:29



Plot file version 283 created 11-NOV-2019 15:07:48  
SER8NJ EK040B.UVDATA.1  
Freq = 4.7990 GHz, Bw = 32.000 MH No calibration applied and no bandpass applied

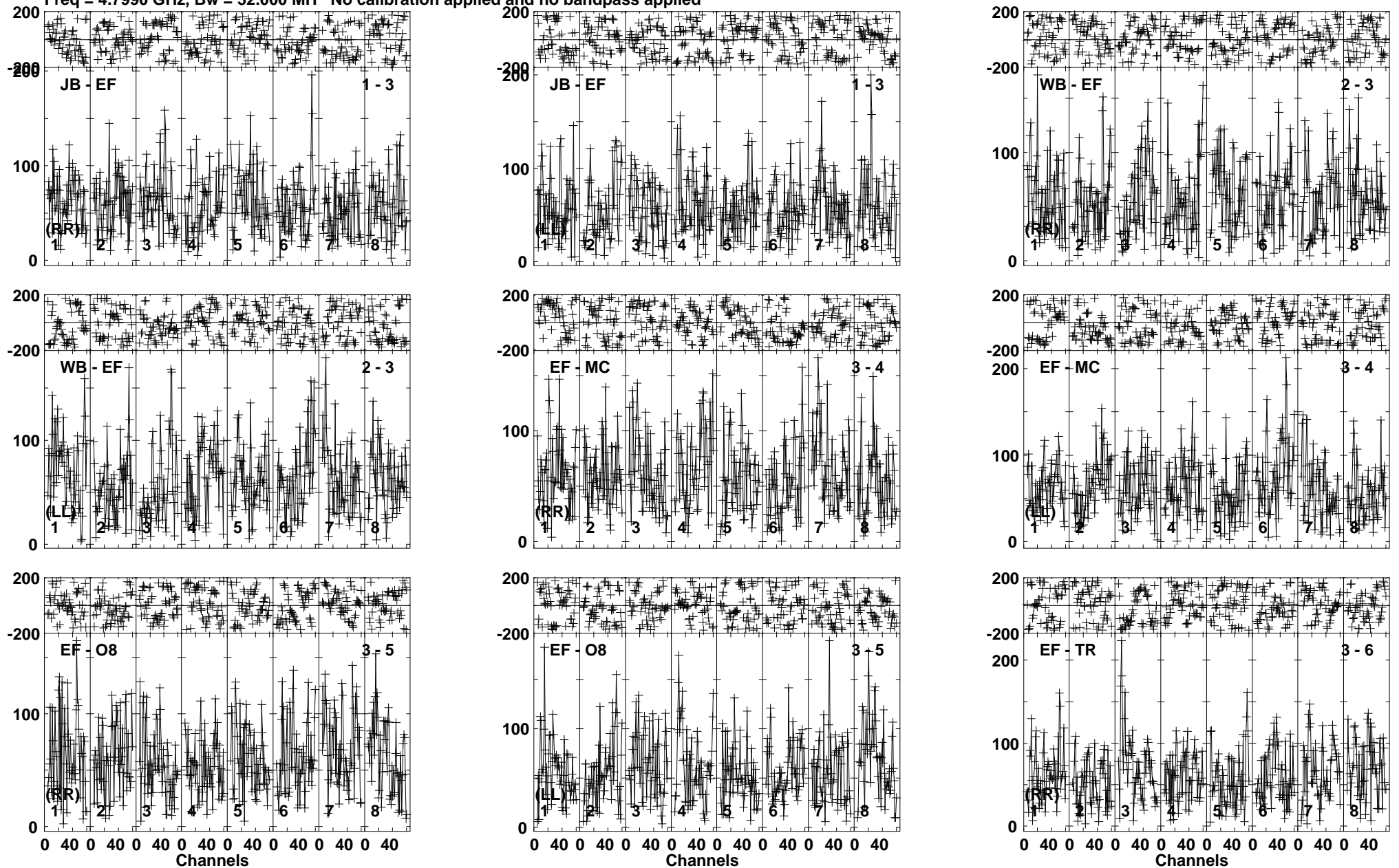

Lower frame: Micro Ampl Jy Top frame: Phas deg  
Vector averaged cross-power spectrum Baseline: JB (01) - EF (03)  
Timerange: 01/01:36:31 to 01/01:40:29

Plot file version 284 created 11-NOV-2019 15:07:48

SER8NJ EK040B.UVDATA.1

Freq = 4.7990 GHz, Bw = 32.000 MH No calibration applied and no bandpass applied

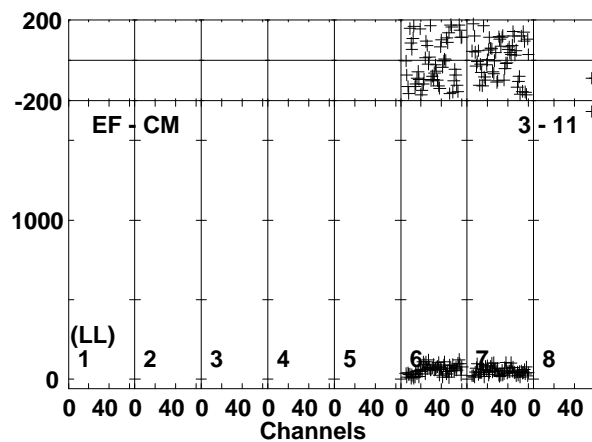
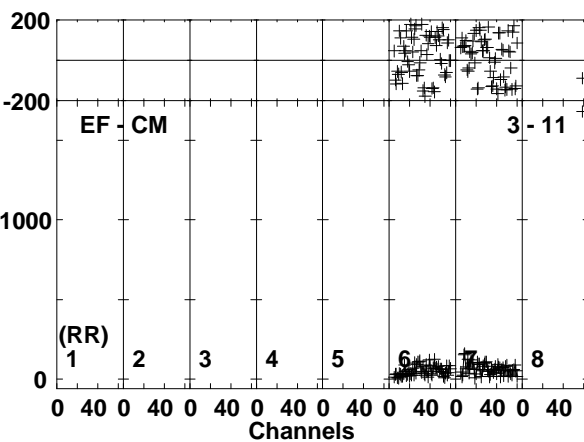
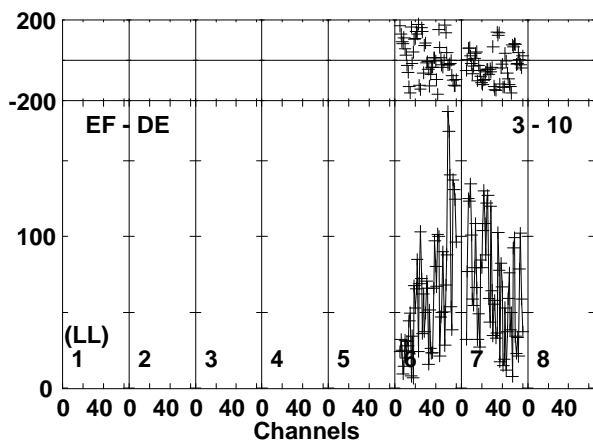
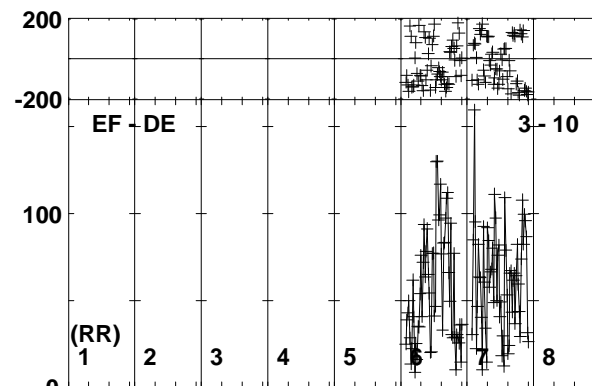
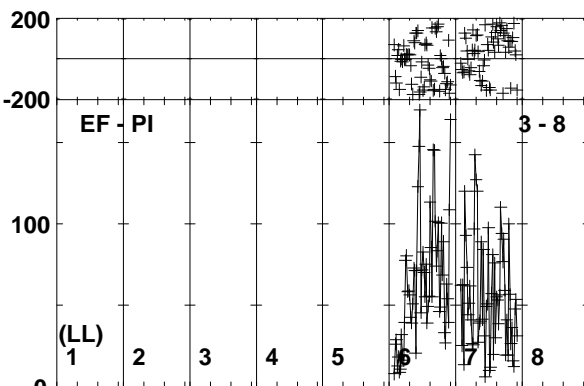
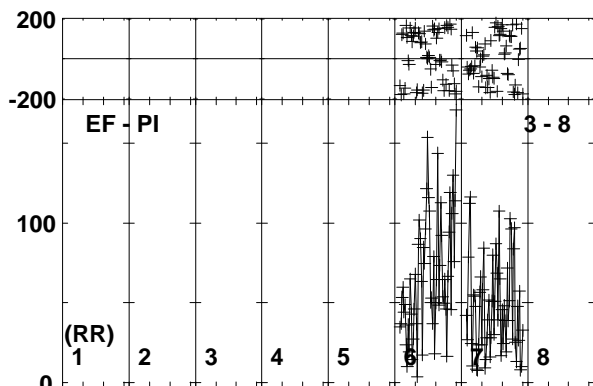
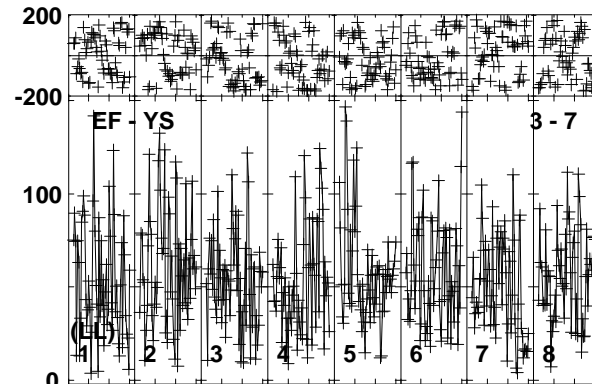
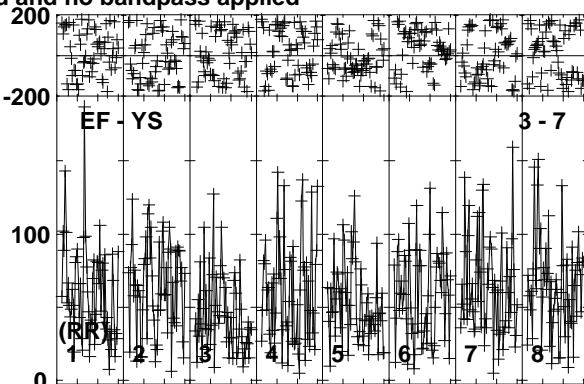
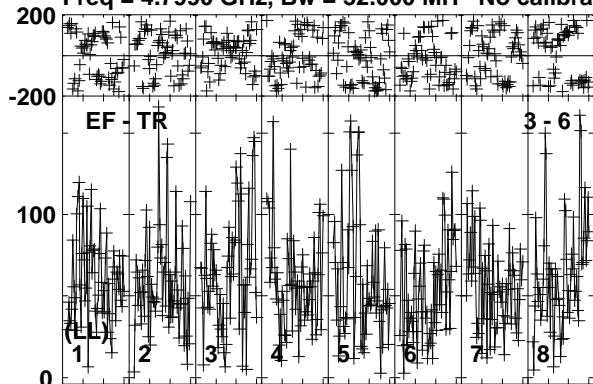

Lower frame: Micro Ampl Jy Top frame: Phas deg  
Vector averaged cross-power spectrum Baseline: EF (03) - TR (06)  
Timerange: 01/01:36:31 to 01/01:40:29

Plot file version 285 created 11-NOV-2019 15:07:49

SER8NJ EK040B.UVDATA.1

Freq = 4.7990 GHz, Bw = 32.000 MH No calibration applied and no bandpass applied

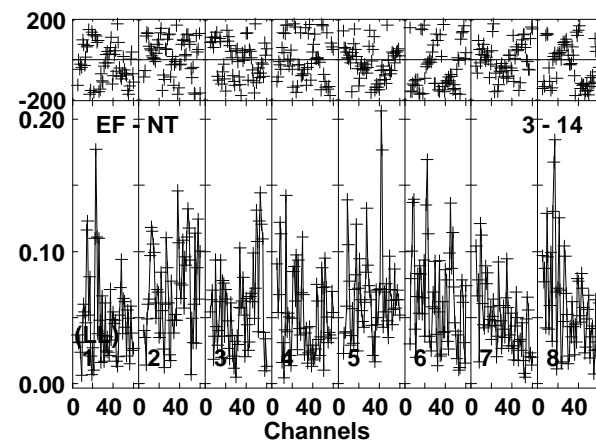
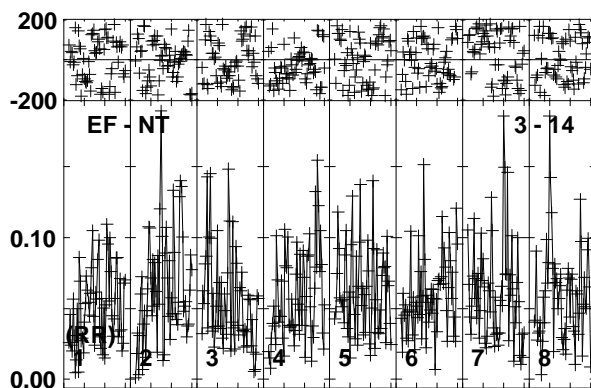
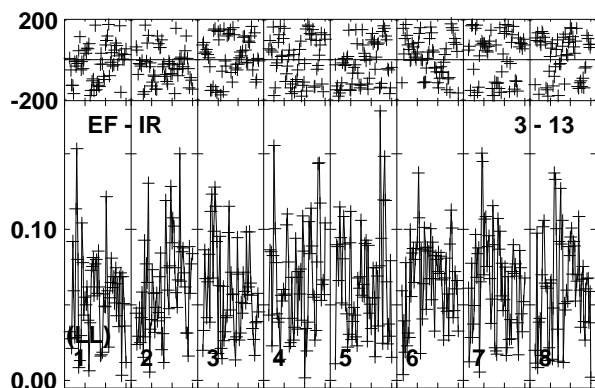
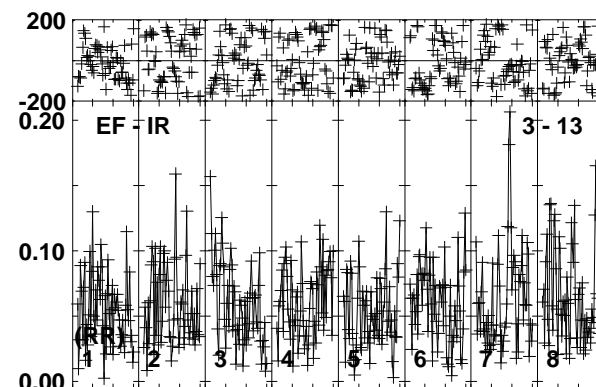
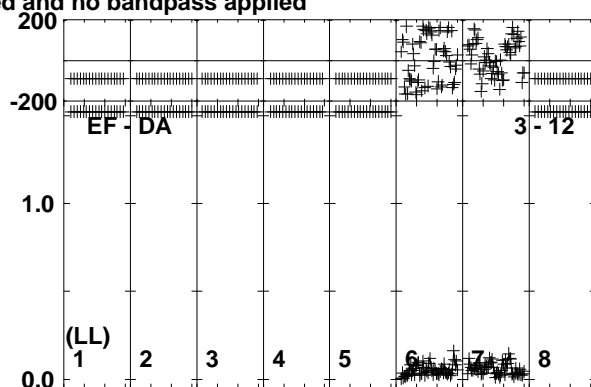
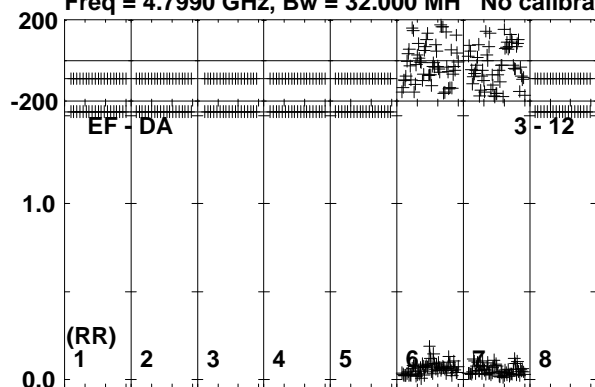

Lower frame: Milli Ampl Jy Top frame: Phas deg  
Vector averaged cross-power spectrum Baseline: EF (03) - DA (12)  
Timerange: 01/01:36:31 to 01/01:40:29

Plot file version 286 created 11-NOV-2019 15:07:49

J1826+0149 EK040B.UVDATA.1

Freq = 4.7990 GHz, Bw = 32.000 MH No calibration applied and no bandpass applied

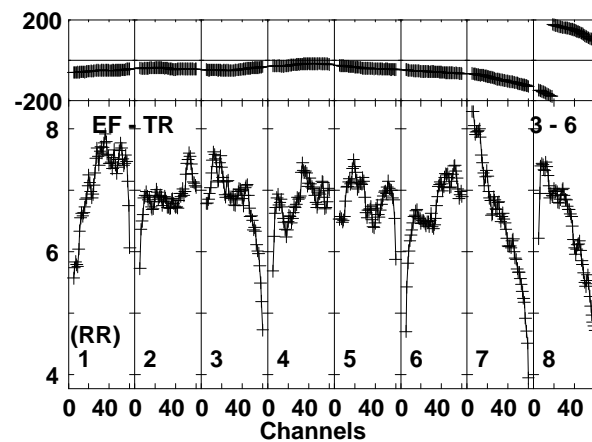
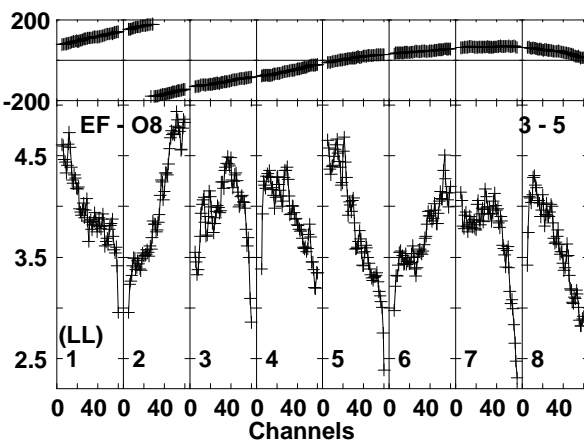
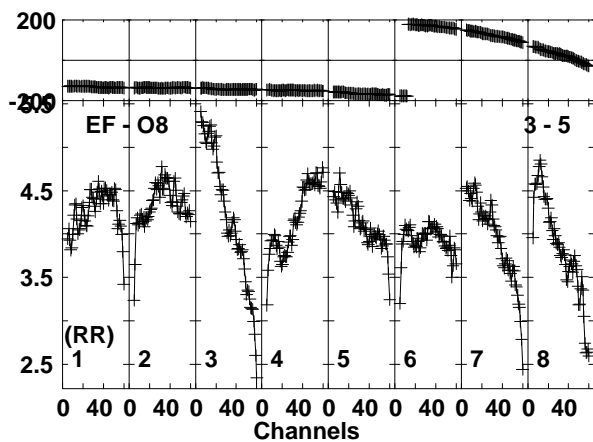
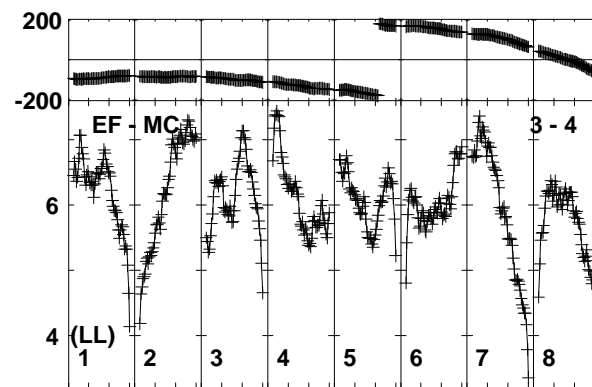
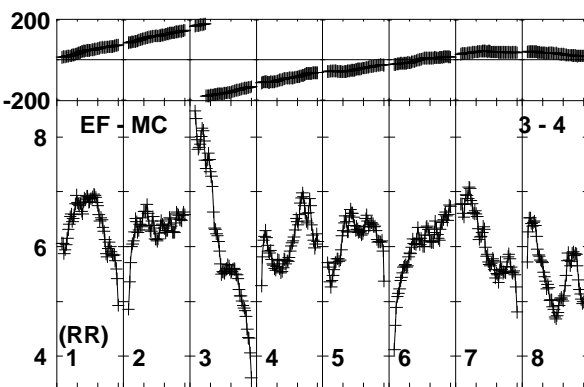
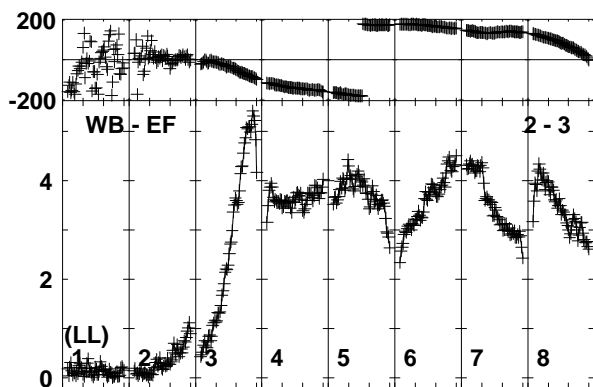
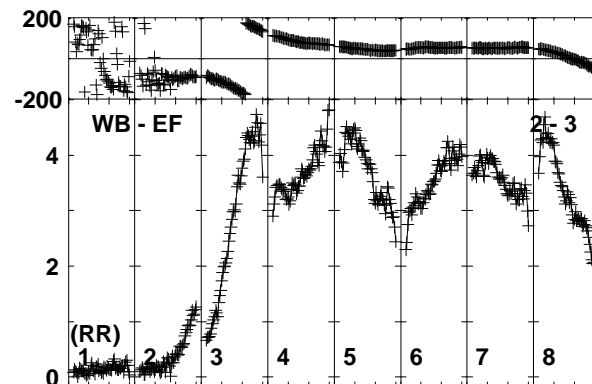
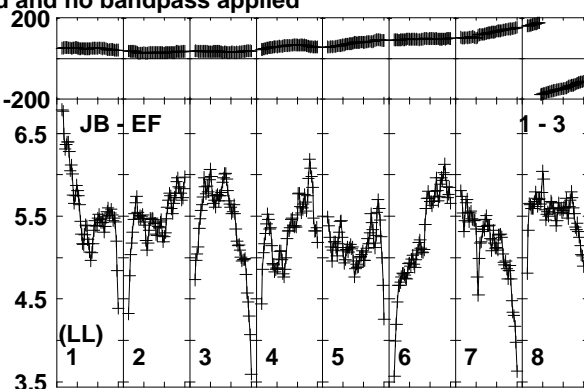
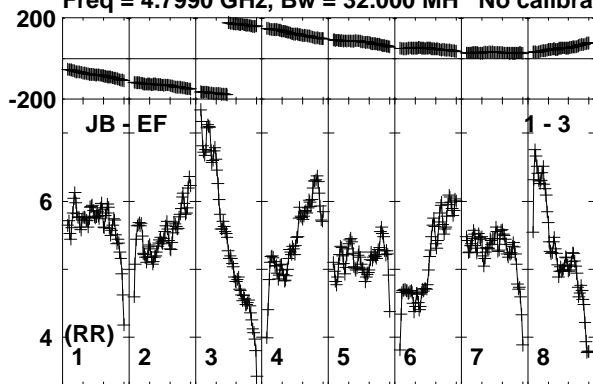

Lower frame: Milli Ampl Jy Top frame: Phas deg  
Vector averaged cross-power spectrum Baseline: JB (01) - EF (03)  
Timerange: 01/01:41:11 to 01/01:42:09

Plot file version 287 created 11-NOV-2019 15:07:49

J1826+0149 EK040B.UVDATA.1

Freq = 4.7990 GHz, Bw = 32.000 MH No calibration applied and no bandpass applied

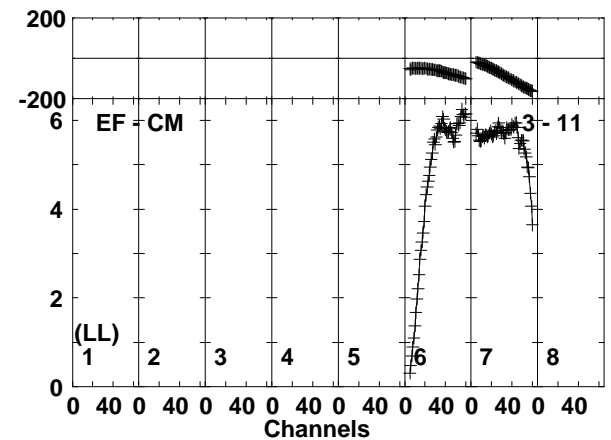
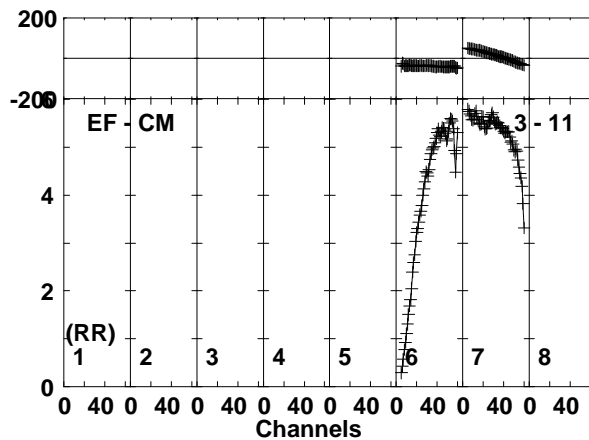
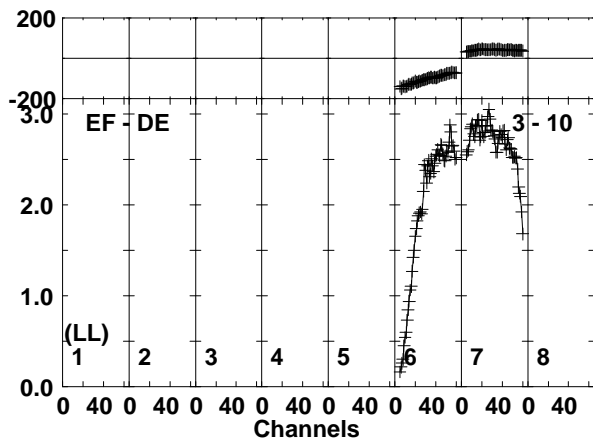
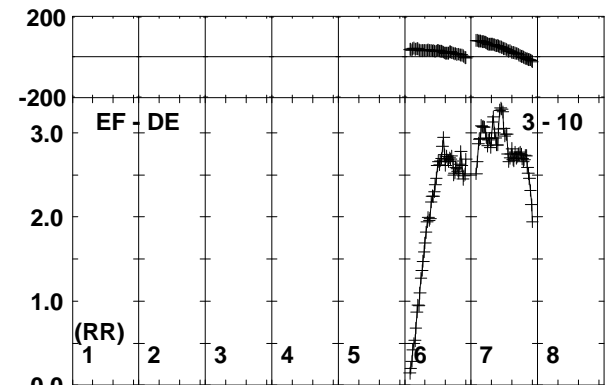
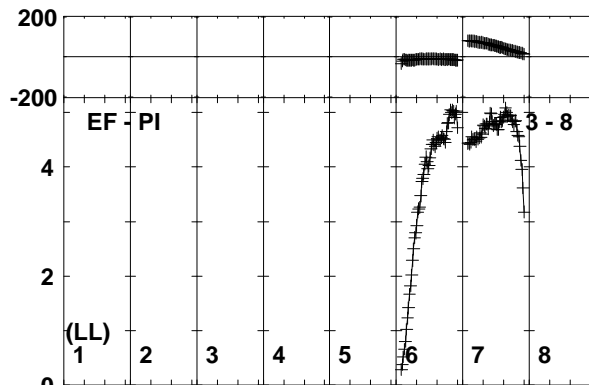
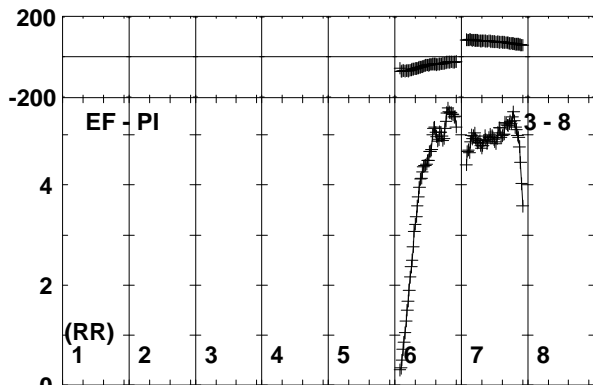
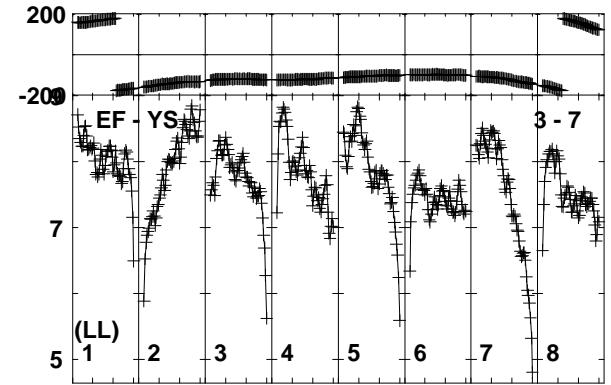
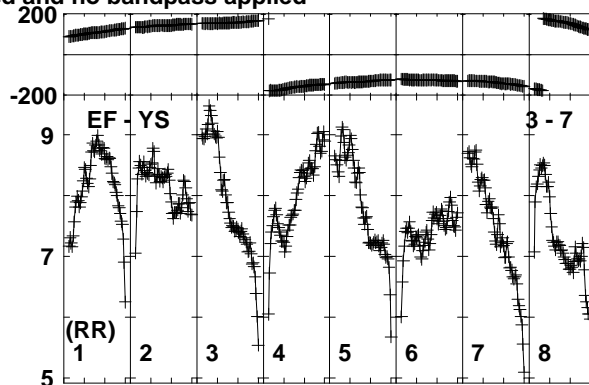
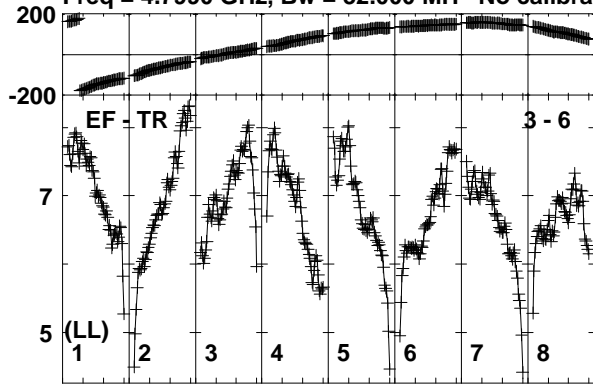

Lower frame: Milli Ampl Jy Top frame: Phas deg  
Vector averaged cross-power spectrum Baseline: EF (03) - TR (06)  
Timerange: 01/01:41:11 to 01/01:42:09

Plot file version 288 created 11-NOV-2019 15:07:49

J1826+0149 EK040B.UVDATA.1

Freq = 4.7990 GHz, Bw = 32.000 MH No calibration applied and no bandpass applied

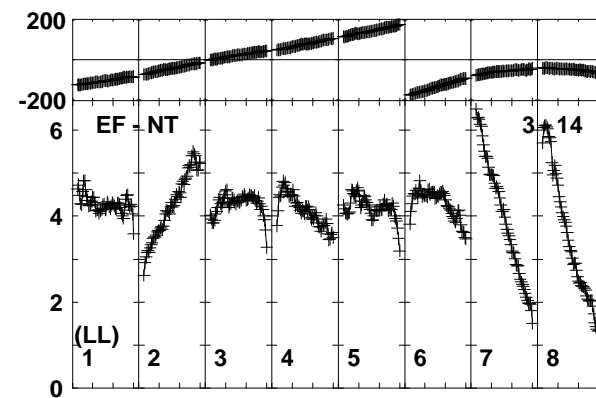
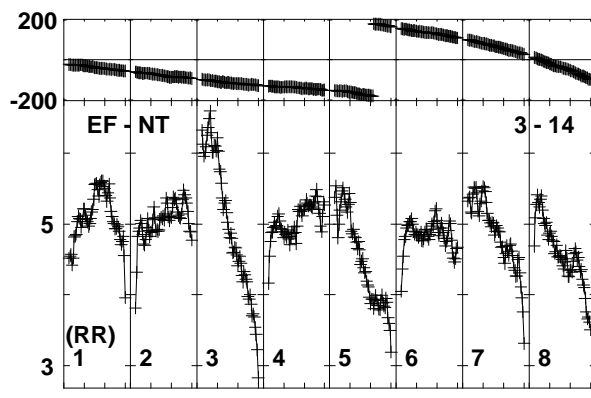
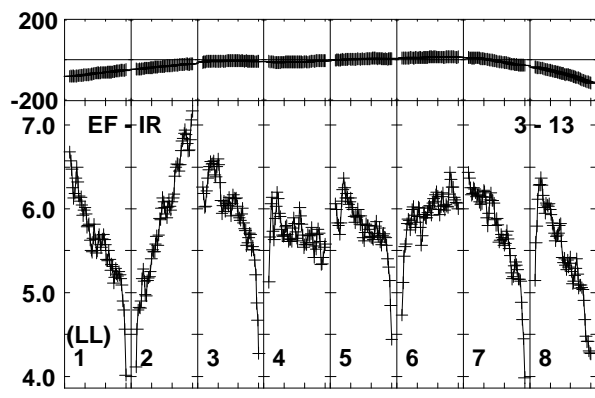
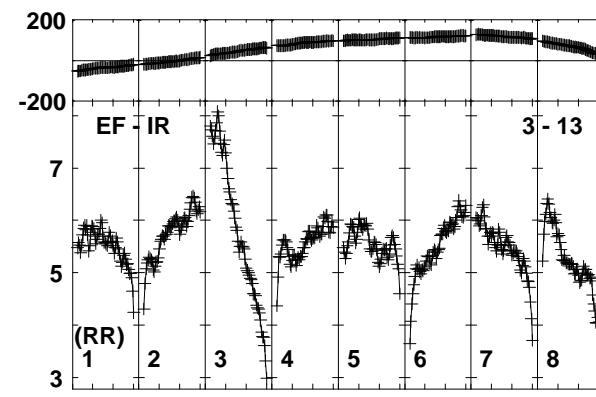
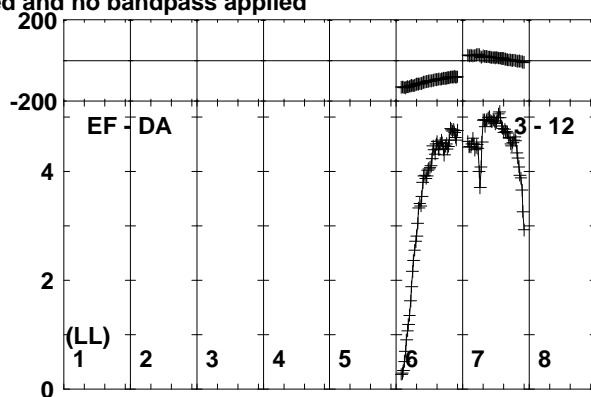
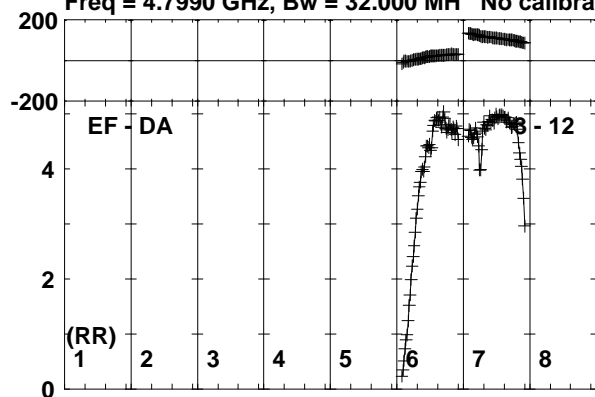

Channels

Lower frame: Milli Ampl Jy Top frame: Phas deg  
Vector averaged cross-power spectrum Baseline: EF (03) - DA (12)  
Timerange: 01/01:41:11 to 01/01:42:09

Plot file version 289 created 11-NOV-2019 15:07:49

SER8NJ EK040B.UVDATA.1

Freq = 4.7990 GHz, Bw = 32.000 MH No calibration applied and no bandpass applied

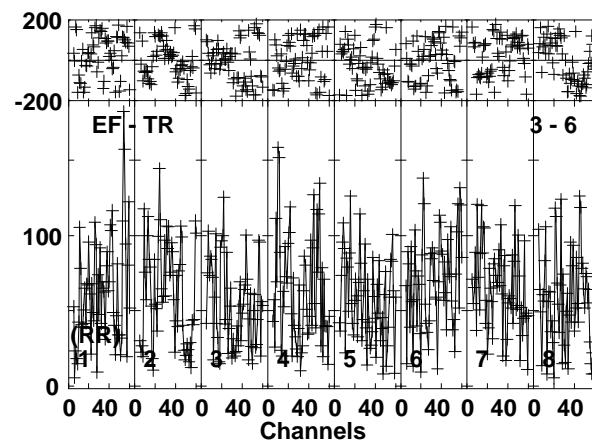
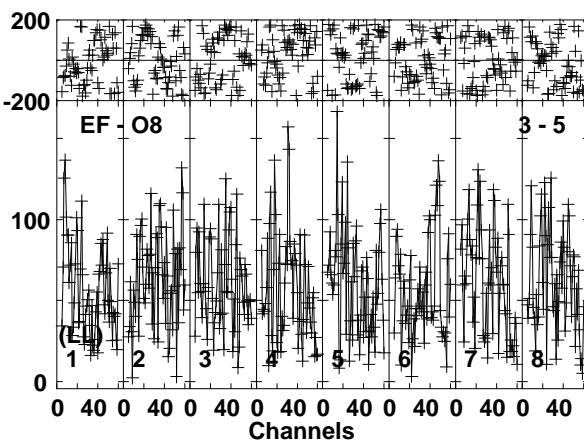
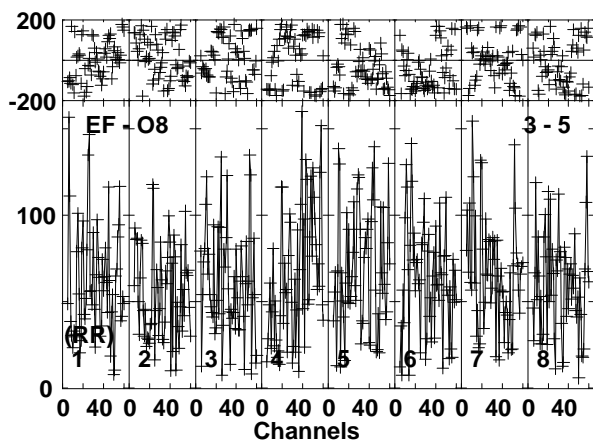
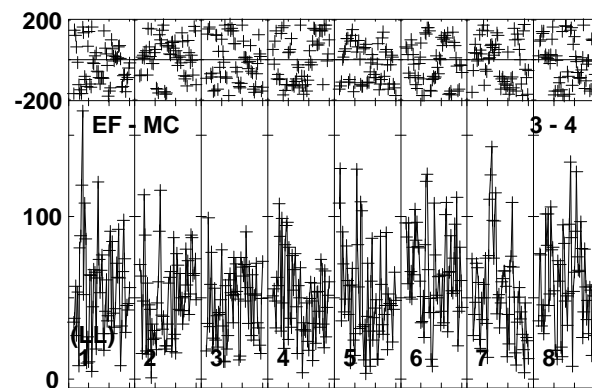
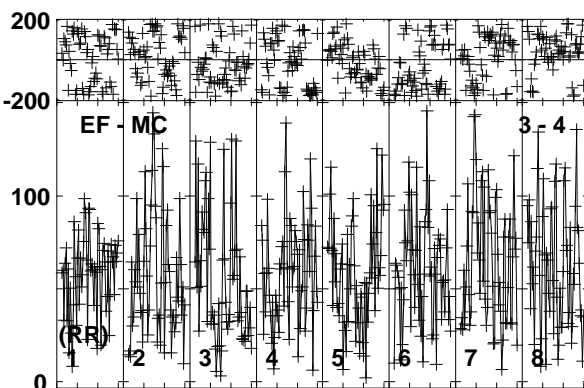
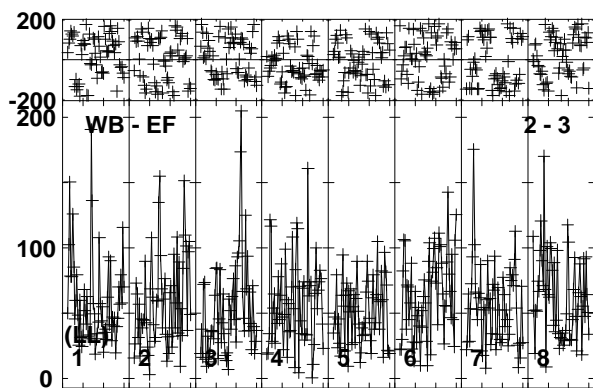
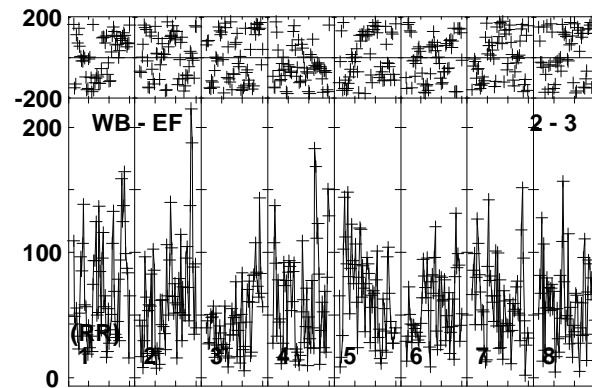
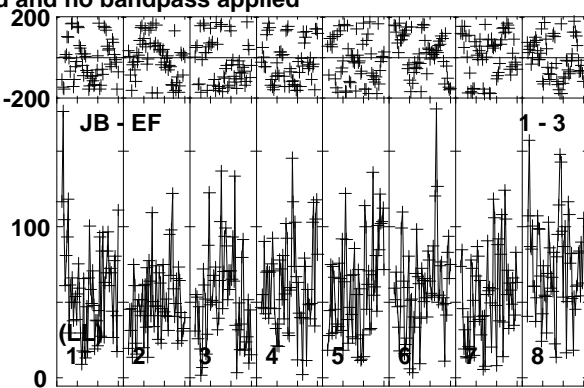
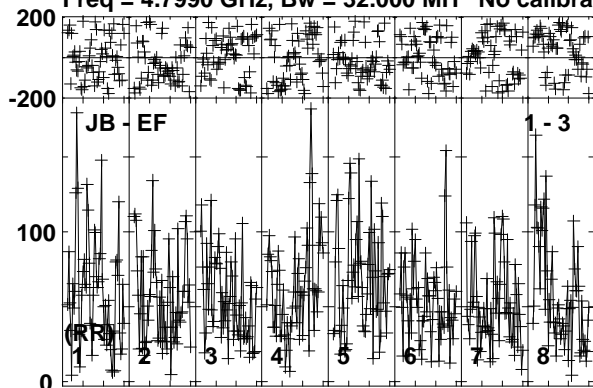

Lower frame: Micro Ampl Jy Top frame: Phas deg  
Vector averaged cross-power spectrum Baseline: JB (01) - EF (03)  
Timerange: 01/01:42:13 to 01/01:46:09

Plot file version 290 created 11-NOV-2019 15:07:49

SER8NJ EK040B.UVDATA.1

Freq = 4.7990 GHz, Bw = 32.000 MH No calibration applied and no bandpass applied

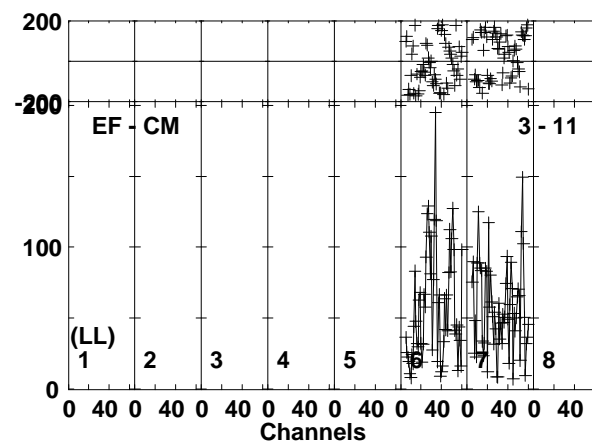
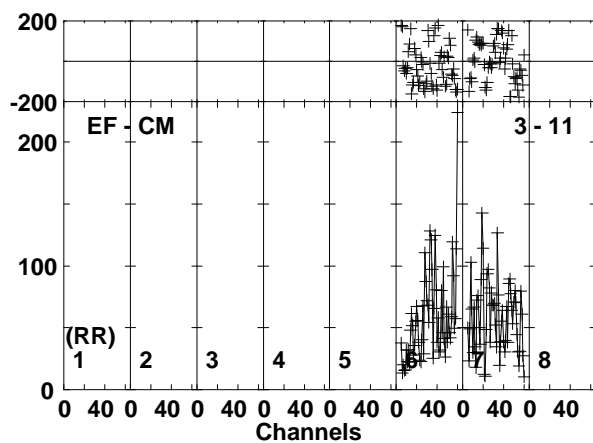
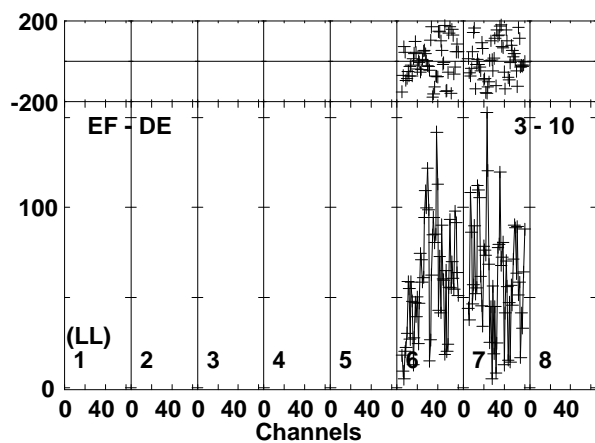
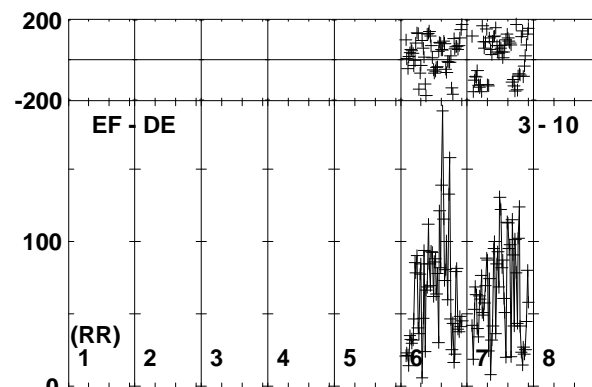
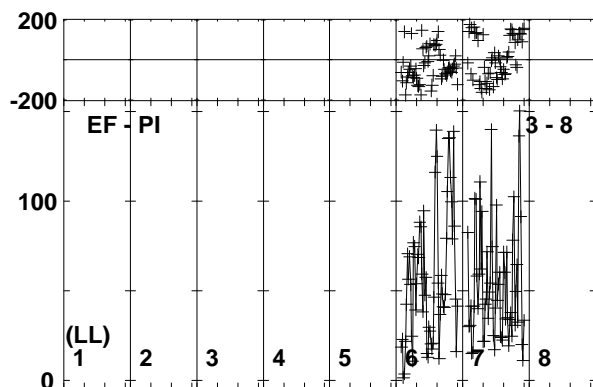
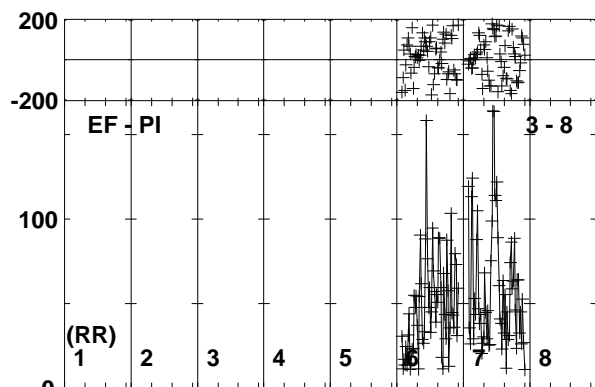
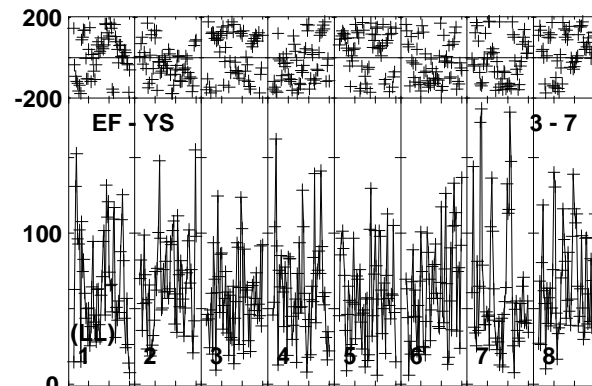
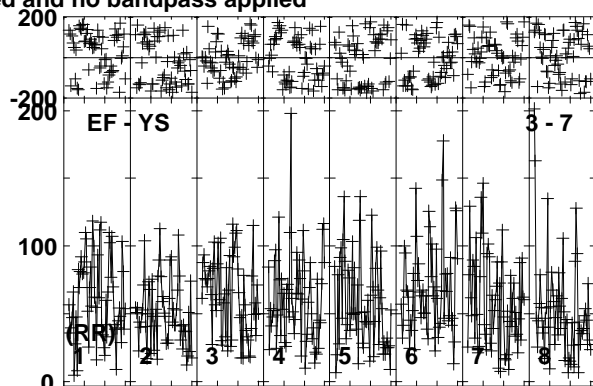
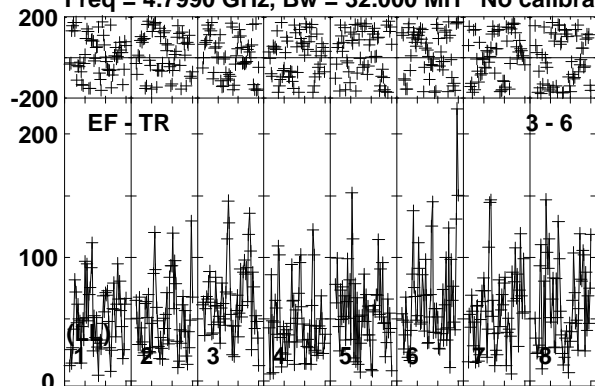

Lower frame: Micro Ampl Jy Top frame: Phas deg  
Vector averaged cross-power spectrum Baseline: EF (03) - TR (06)  
Timerange: 01/01:42:13 to 01/01:46:09



Plot file version 291 created 11-NOV-2019 15:07:49

SER8NJ EK040B.UVDATA.1

Freq = 4.7990 GHz, Bw = 32.000 MH No calibration applied and no bandpass applied

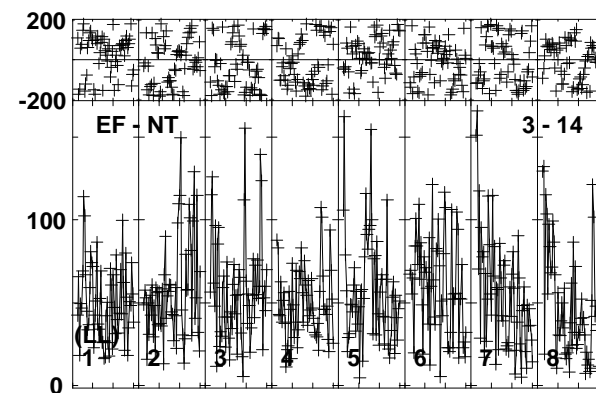
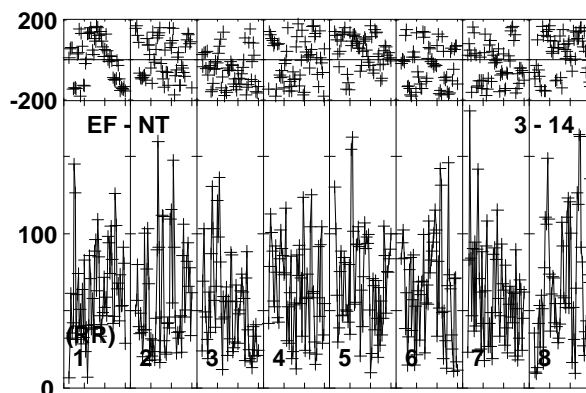
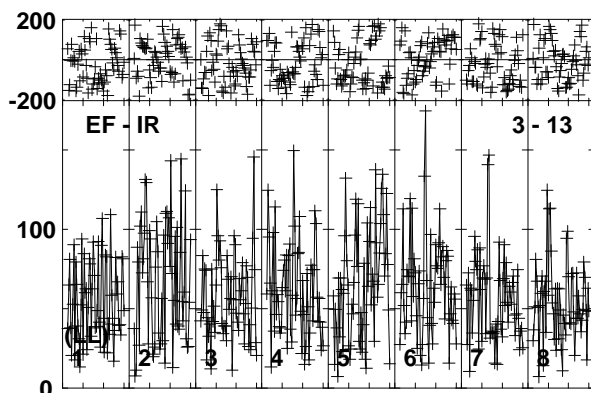
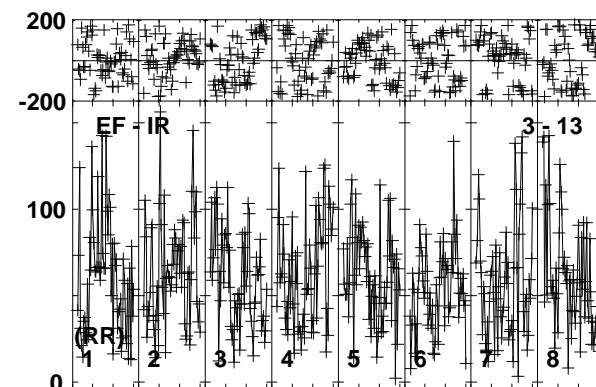
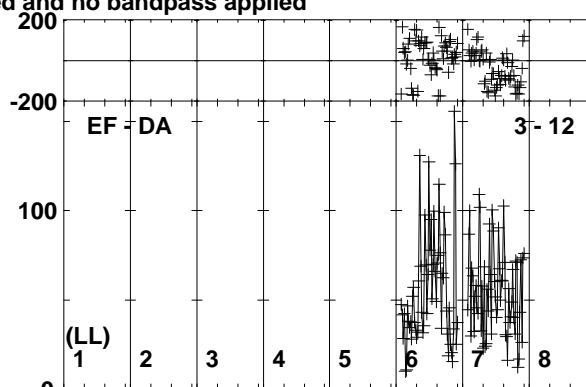
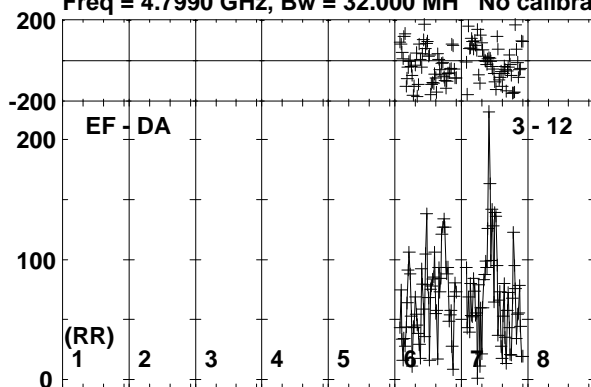

0 40 0 40 0 40 0 40 0 40 0 40 0 40 0 40 0 40 0 40

Lower frame: Micro Ampl Jy Top frame: Phas deg  
Vector averaged cross-power spectrum Baseline: EF (03) - DA (12)  
Timerange: 01/01:42:13 to 01/01:46:09

Plot file version 292 created 11-NOV-2019 15:07:49

J1826+0149 EK040B.UVDATA.1

Freq = 4.7990 GHz, Bw = 32.000 MH No calibration applied and no bandpass applied

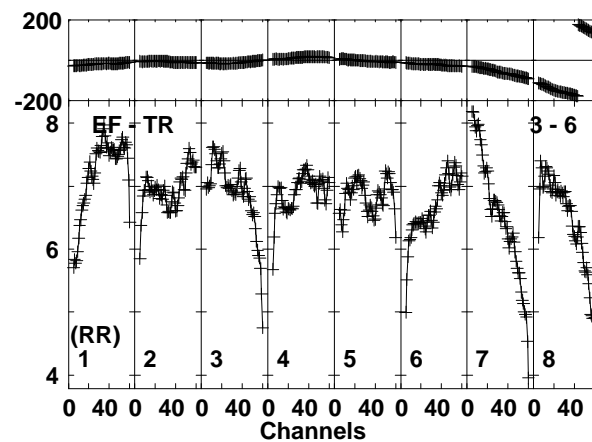
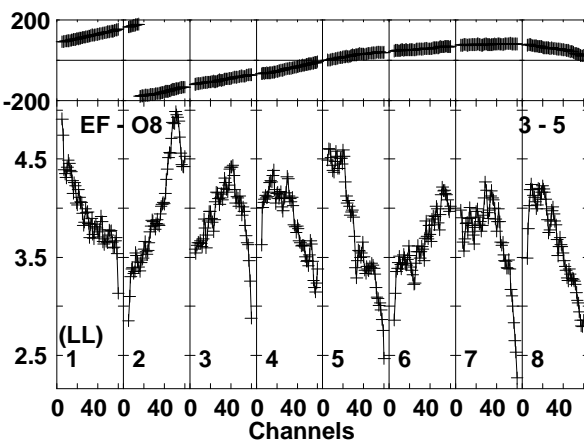
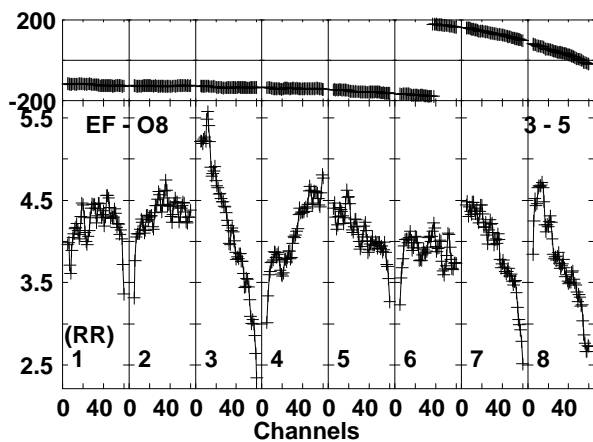
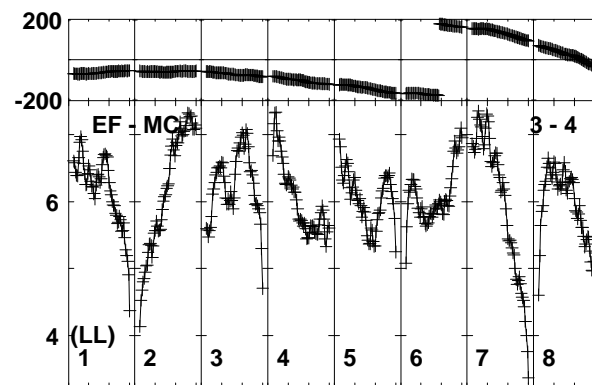
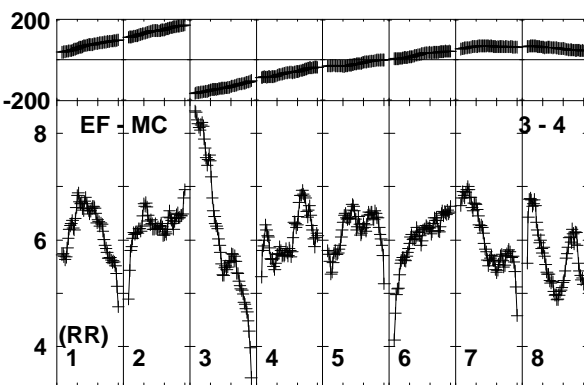
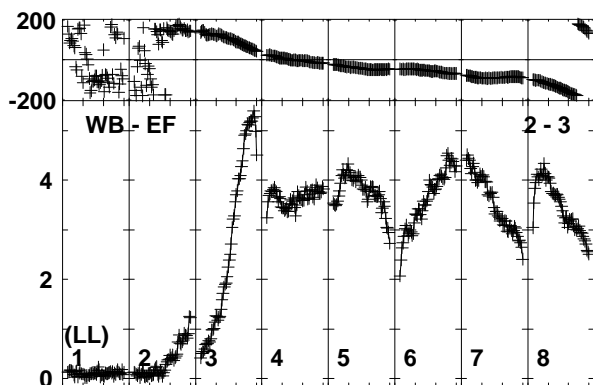
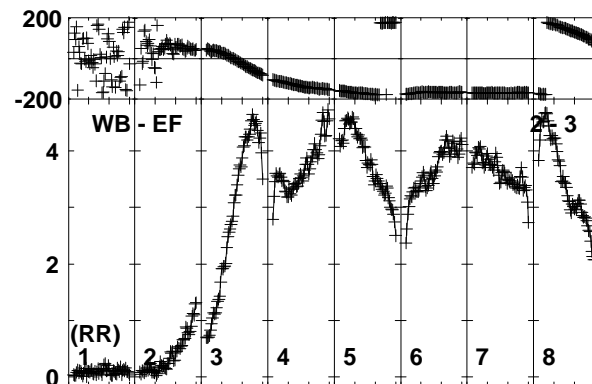
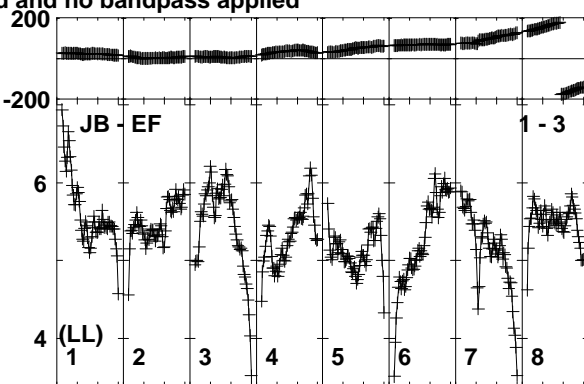
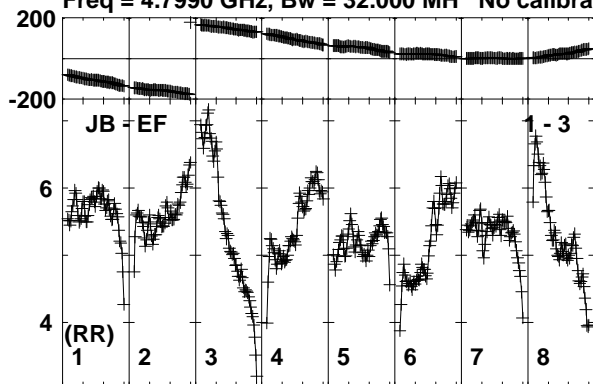

Lower frame: Milli Ampl Jy Top frame: Phas deg  
Vector averaged cross-power spectrum Baseline: JB (01) - EF (03)  
Timerange: 01/01:46:13 to 01/01:47:39

Plot file version 293 created 11-NOV-2019 15:07:49

J1826+0149 EK040B.UVDATA.1

Freq = 4.7990 GHz, Bw = 32.000 MH No calibration applied and no bandpass applied

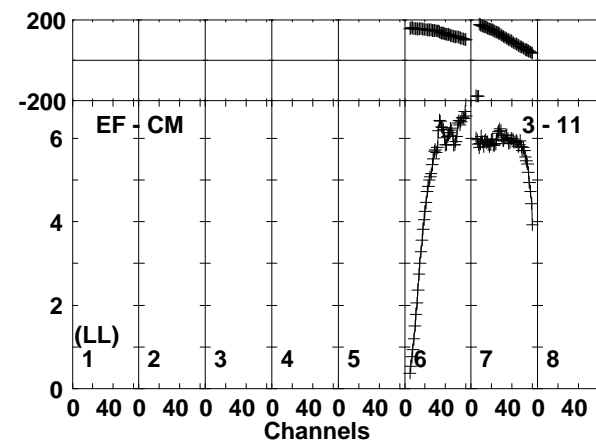
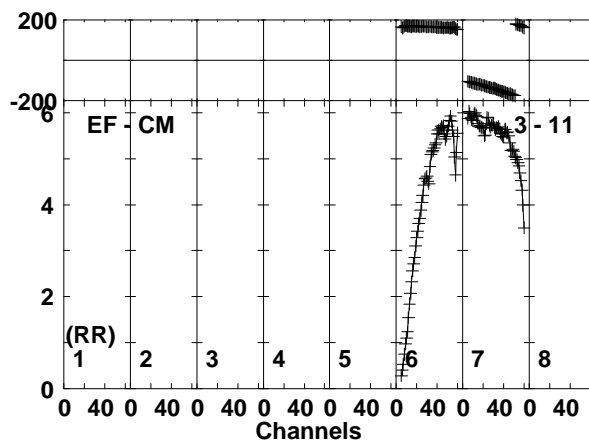
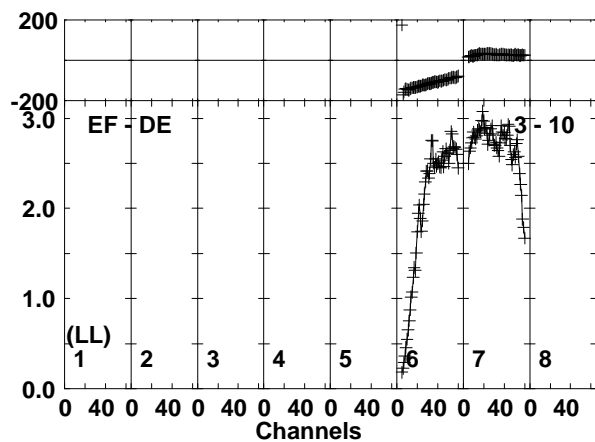
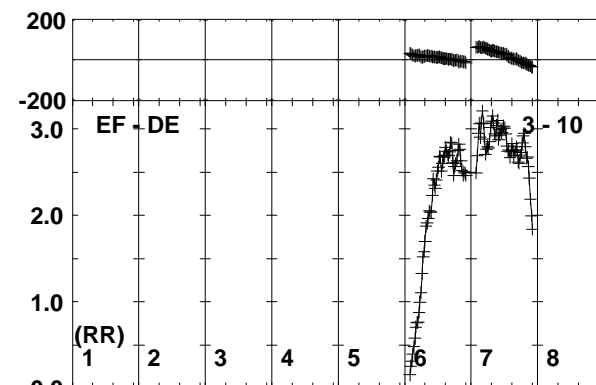
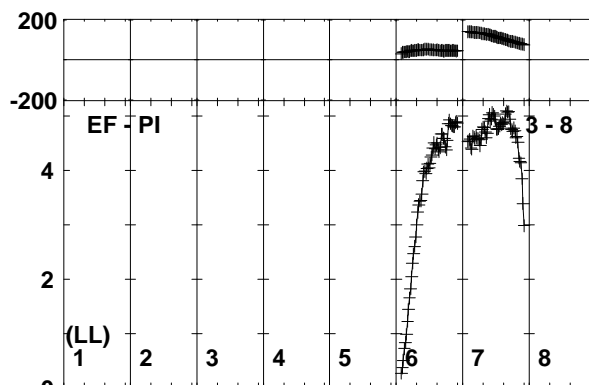
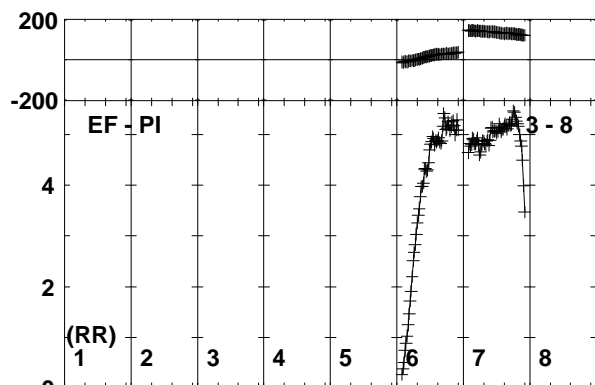
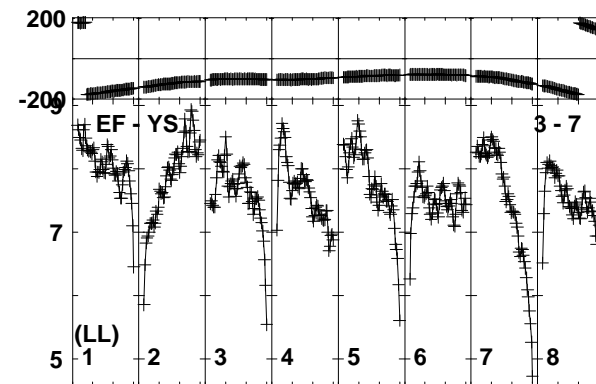
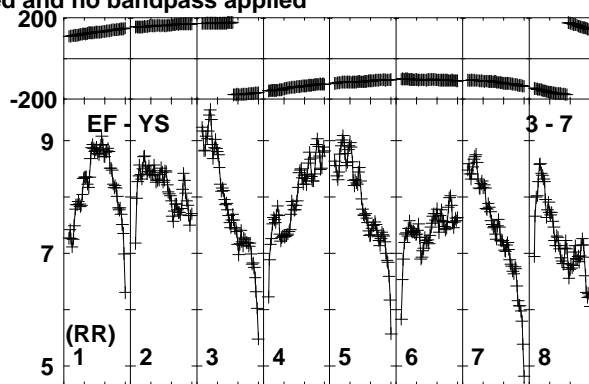
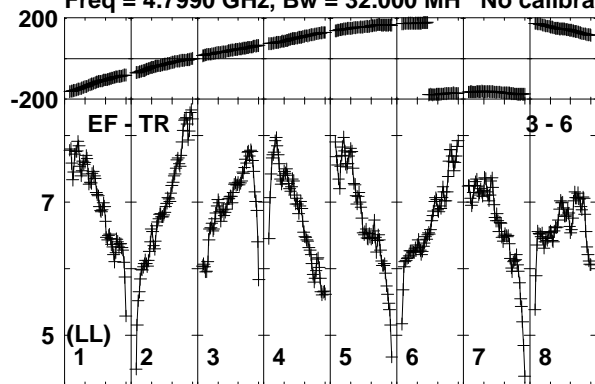

Lower frame: Milli Ampl Jy Top frame: Phas deg  
Vector averaged cross-power spectrum Baseline: EF (03) - TR (06)  
Timerange: 01/01:46:13 to 01/01:47:39

Plot file version 294 created 11-NOV-2019 15:07:50

J1826+0149 EK040B.UVDATA.1

Freq = 4.7990 GHz, Bw = 32.000 MH No calibration applied and no bandpass applied

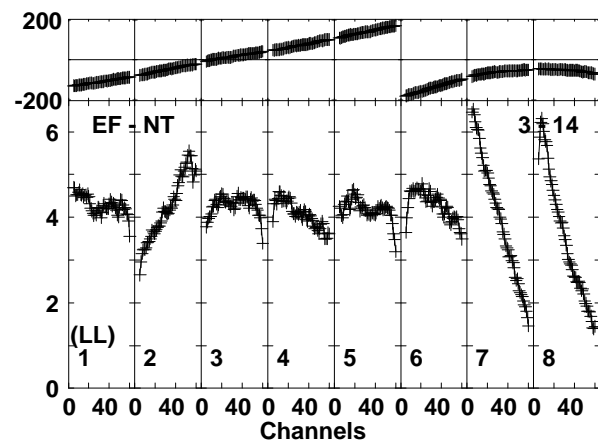
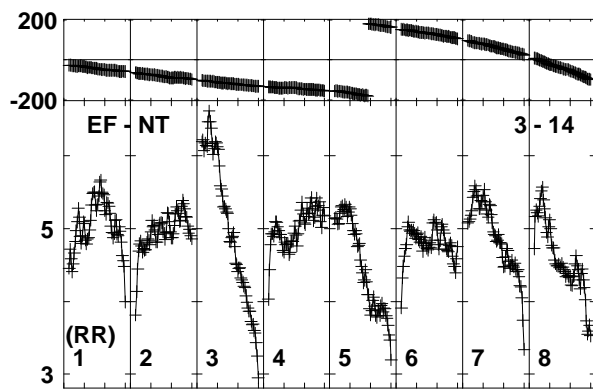
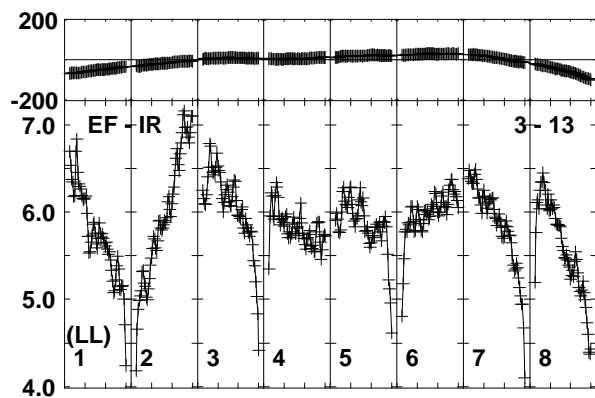
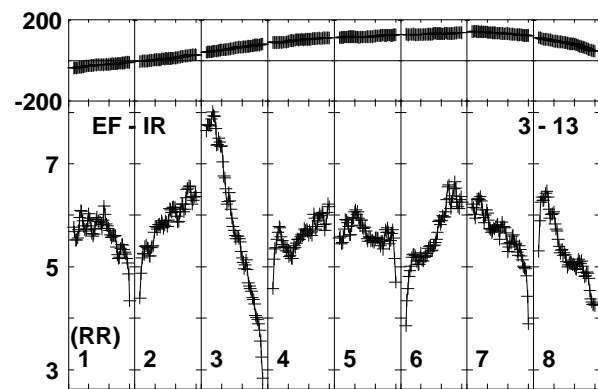
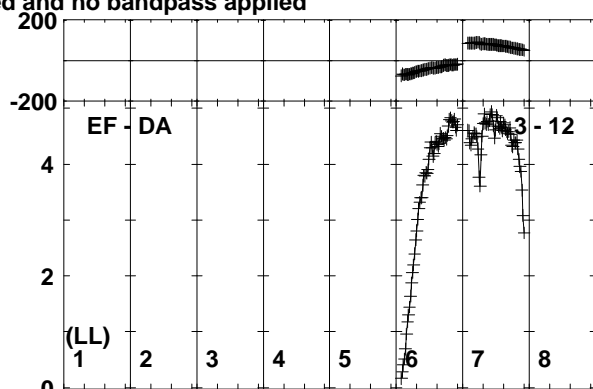
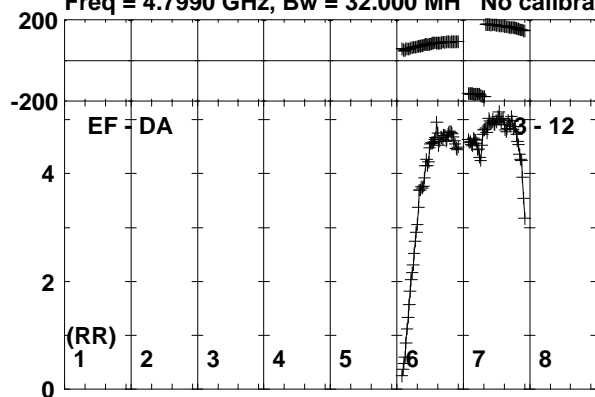

Lower frame: Milli Ampl Jy Top frame: Phas deg  
Vector averaged cross-power spectrum Baseline: EF (03) - DA (12)  
Timerange: 01/01:46:13 to 01/01:47:39

Plot file version 295 created 11-NOV-2019 15:07:50

SER8NJ EK040B.UVDATA.1

Freq = 4.7990 GHz, Bw = 32.000 MH No calibration applied and no bandpass applied

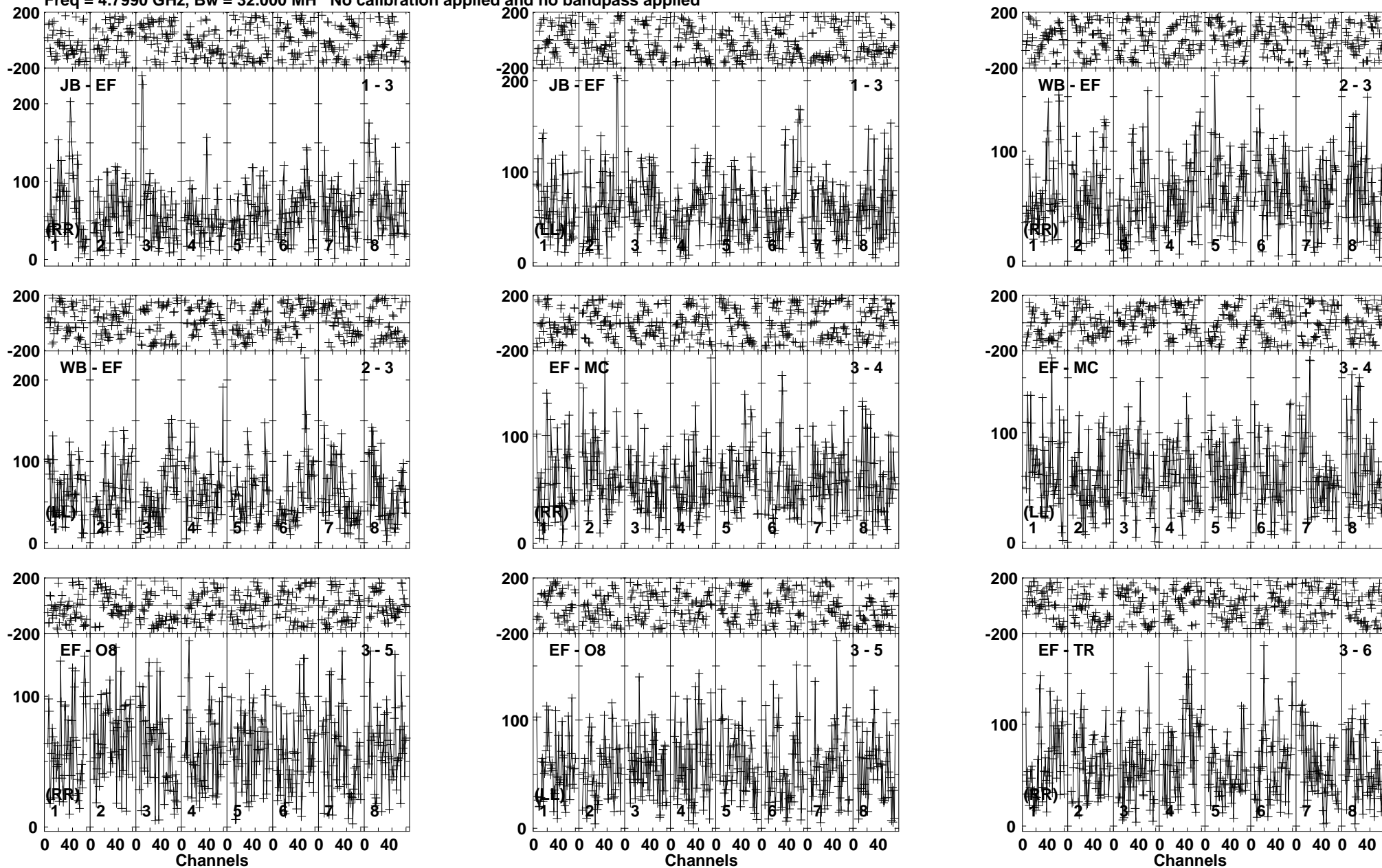

Lower frame: Micro Ampl Jy Top frame: Phas deg  
Vector averaged cross-power spectrum Baseline: JB (01) - EF (03)  
Timerange: 01/01:47:41 to 01/01:51:39

Plot file version 296 created 11-NOV-2019 15:07:50

SER8NJ EK040B.UVDATA.1

Freq = 4.7990 GHz, Bw = 32.000 MH No calibration applied and no bandpass applied

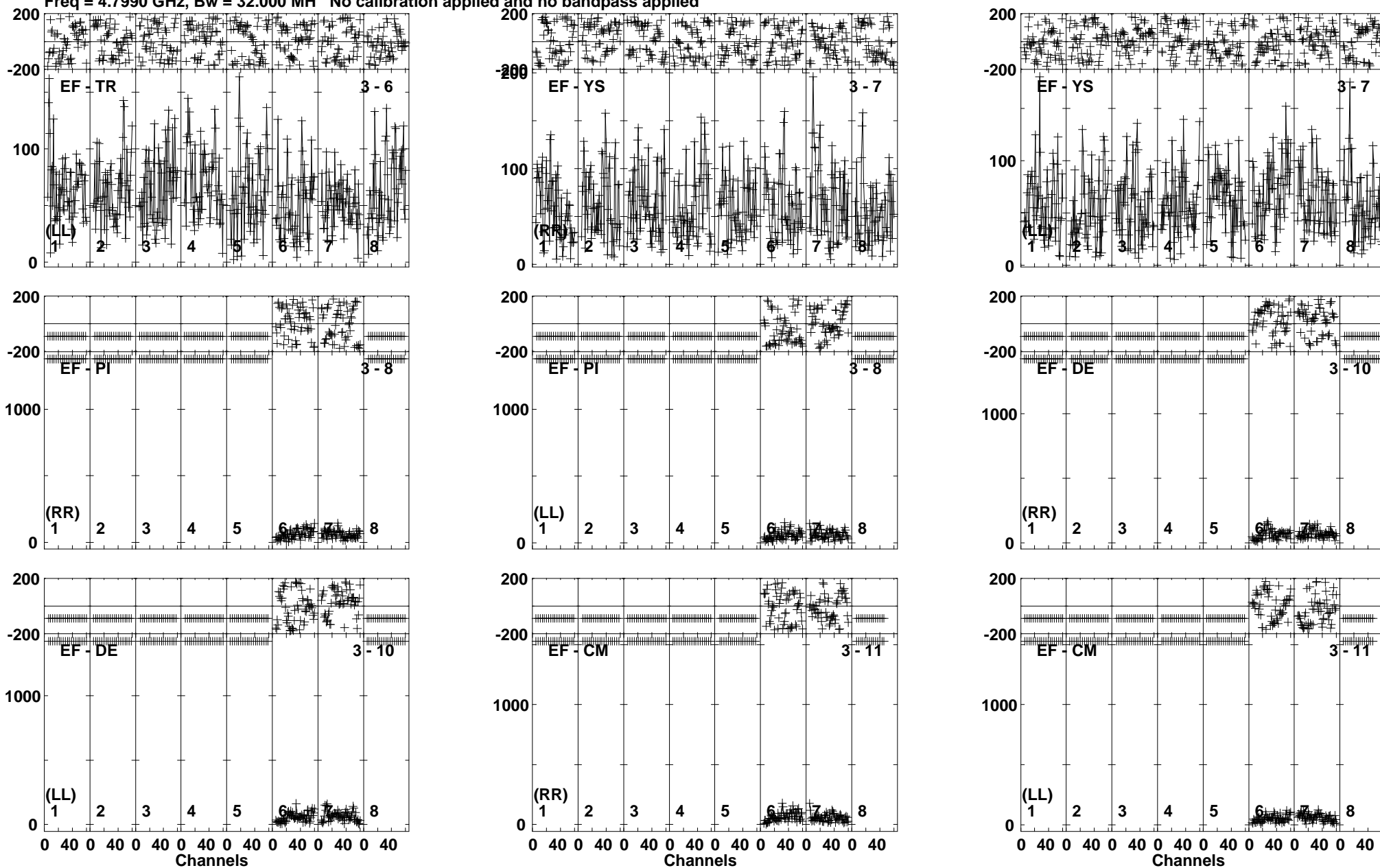

Lower frame: Micro Ampl Jy Top frame: Phas deg  
Vector averaged cross-power spectrum Baseline: EF (03) - TR (06)  
Timerange: 01/01:47:41 to 01/01:51:39

Plot file version 297 created 11-NOV-2019 15:07:50

SER8NJ EK040B.UVDATA.1

Freq = 4.7990 GHz, Bw = 32.000 MH No calibration applied and no bandpass applied

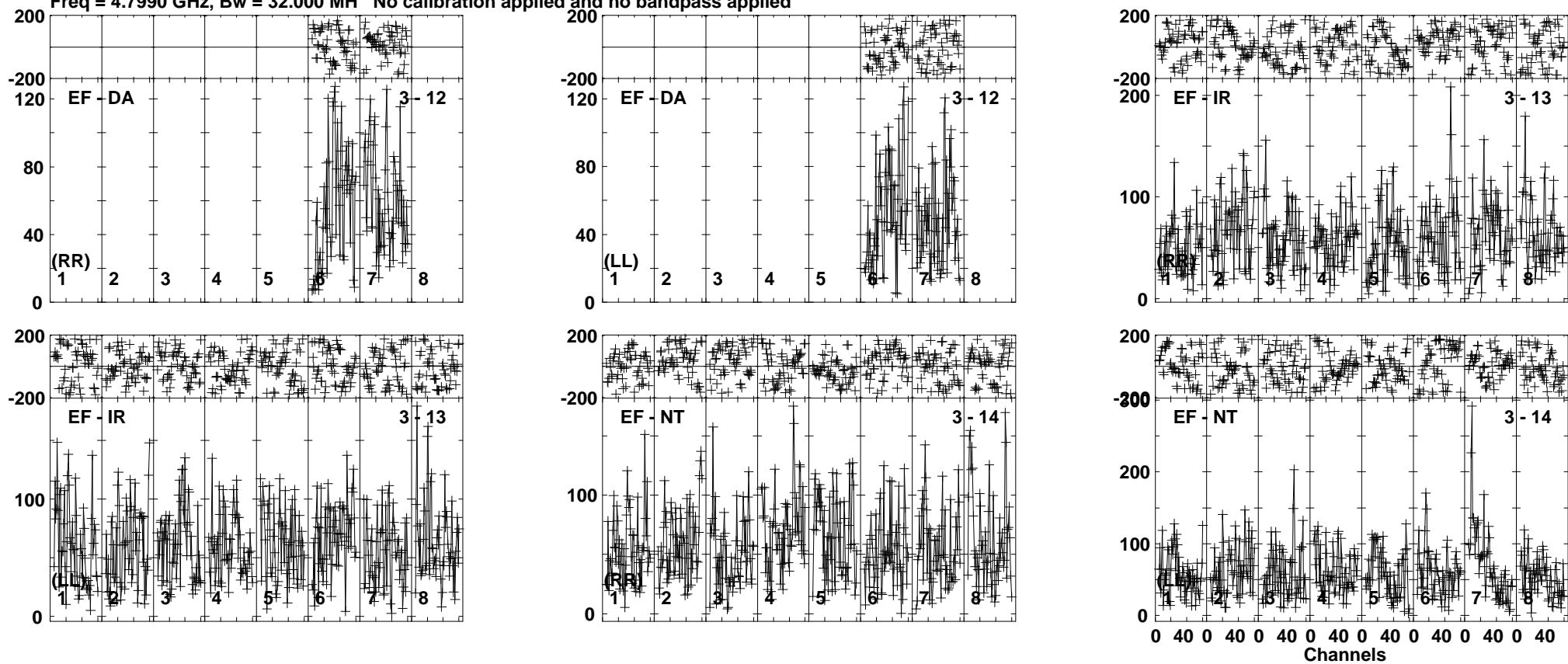

Lower frame: Micro Ampl Jy Top frame: Phas deg  
Vector averaged cross-power spectrum Baseline: EF (03) - DA (12)  
Timerange: 01/01:47:41 to 01/01:51:39

Plot file version 298 created 11-NOV-2019 15:07:50

J1826+0149 EK040B.UVDATA.1

Freq = 4.7990 GHz, Bw = 32.000 MH No calibration applied and no bandpass applied

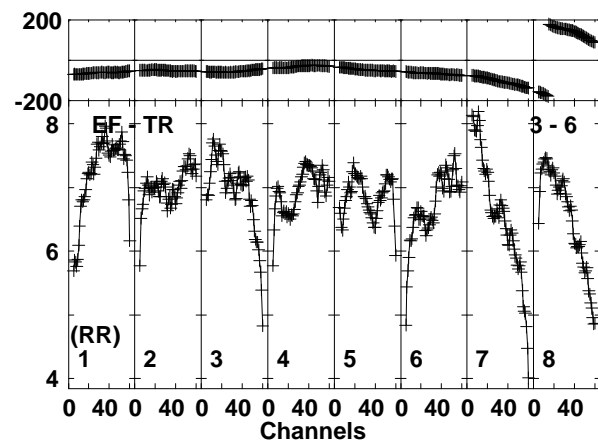
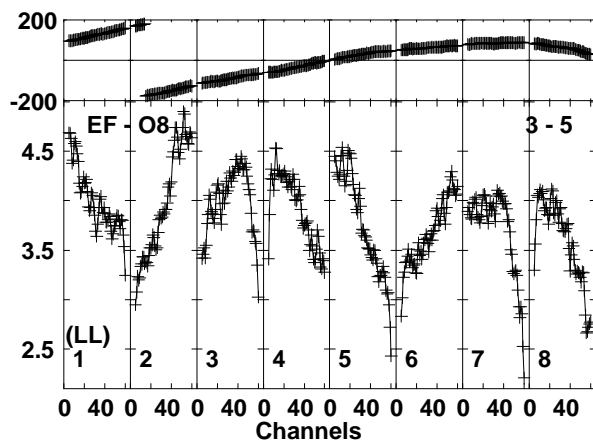
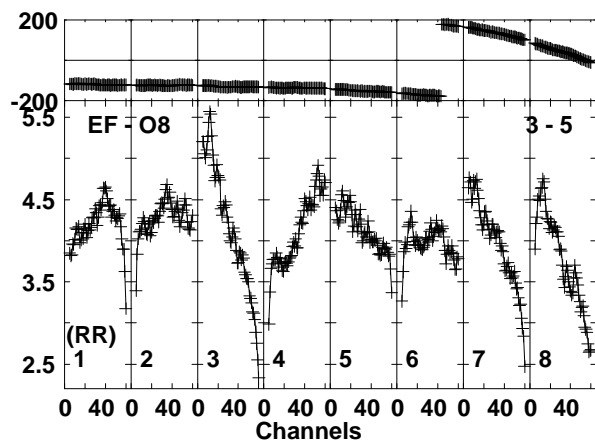
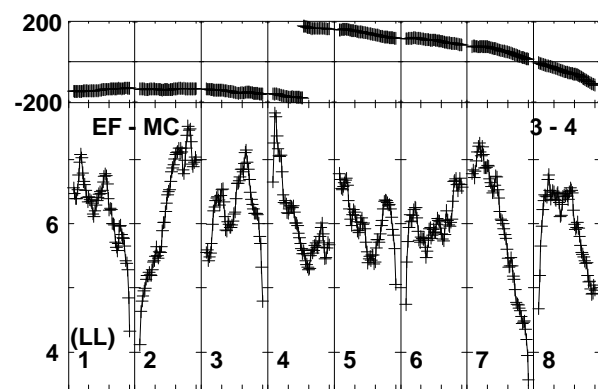
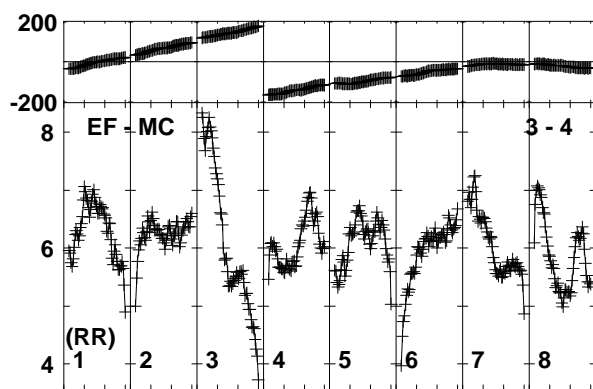
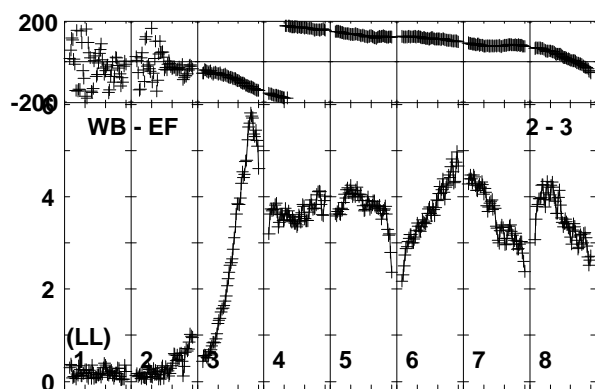
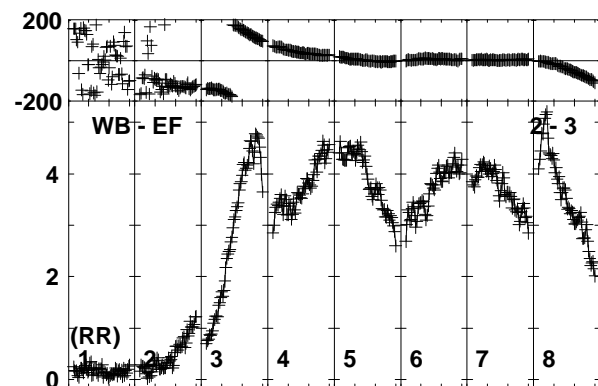
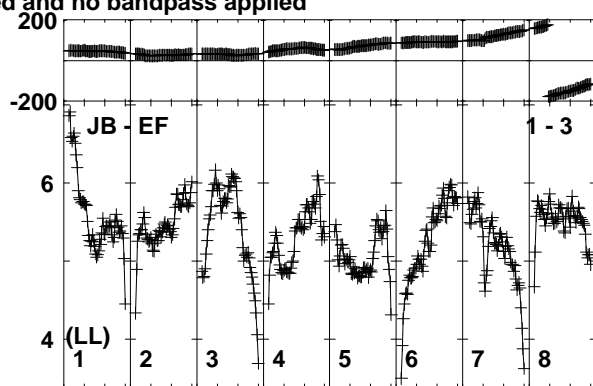
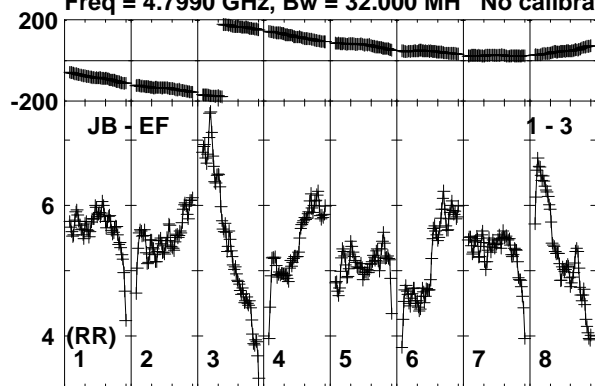

Lower frame: Milli Ampl Jy Top frame: Phas deg  
Vector averaged cross-power spectrum Baseline: JB (01) - EF (03)  
Timerange: 01/01:52:21 to 01/01:53:19



Plot file version 299 created 11-NOV-2019 15:07:50

J1826+0149 EK040B.UVDATA.1

Freq = 4.7990 GHz, Bw = 32.000 MH No calibration applied and no bandpass applied

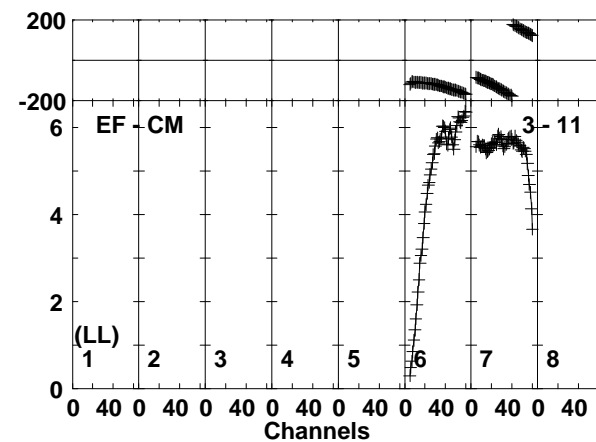
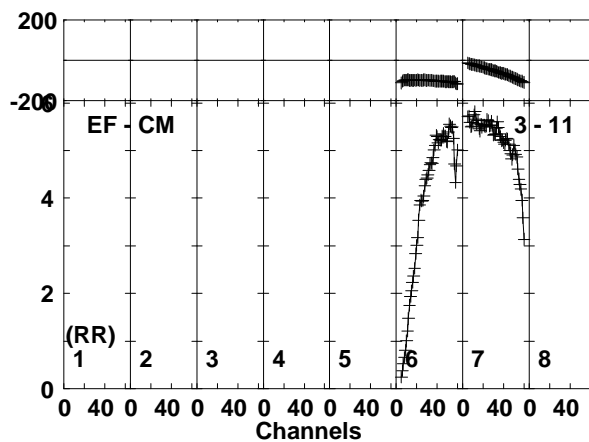
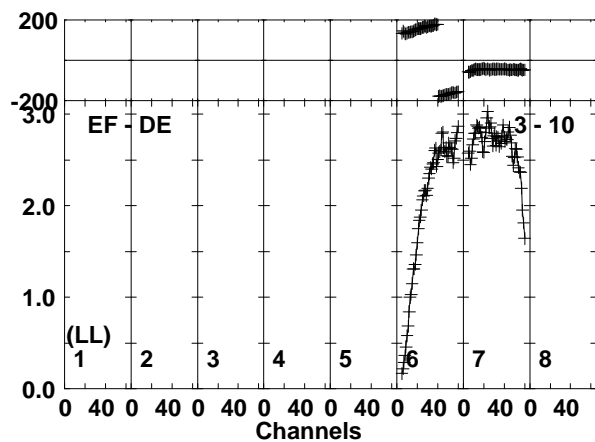
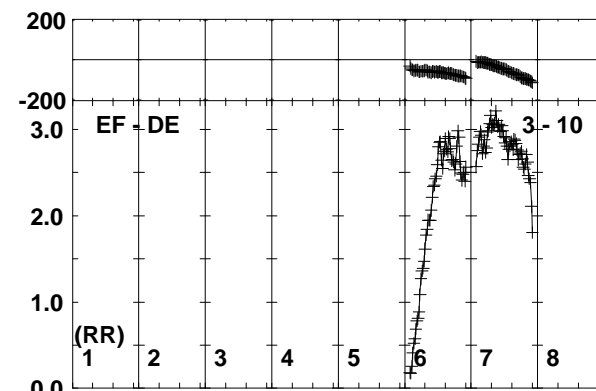
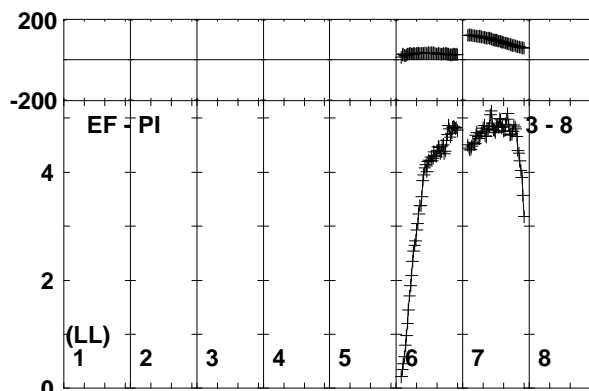
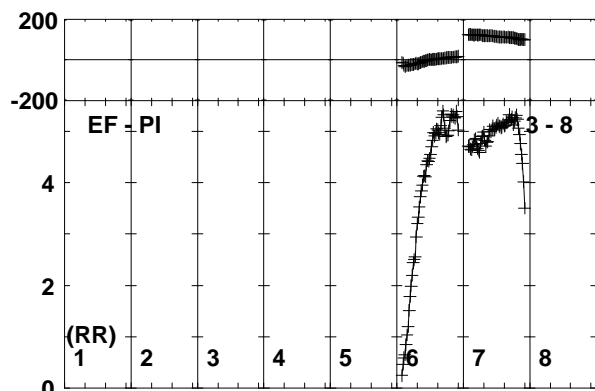
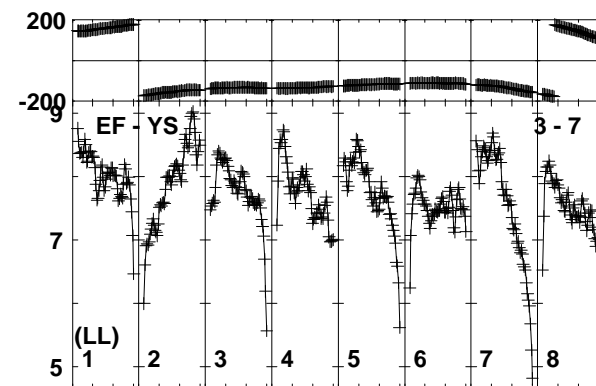
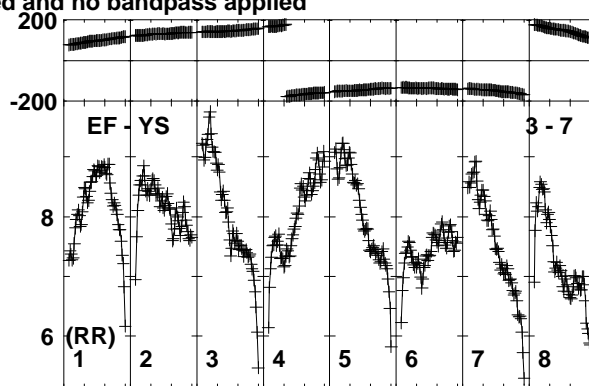
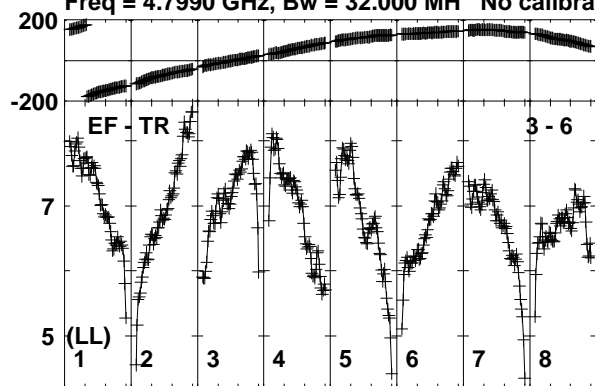

Lower frame: Milli Ampl Jy Top frame: Phas deg  
Vector averaged cross-power spectrum Baseline: EF (03) - TR (06)  
Timerange: 01/01:52:21 to 01/01:53:19

Plot file version 300 created 11-NOV-2019 15:07:50

J1826+0149 EK040B.UVDATA.1

Freq = 4.7990 GHz, Bw = 32.000 MH No calibration applied and no bandpass applied

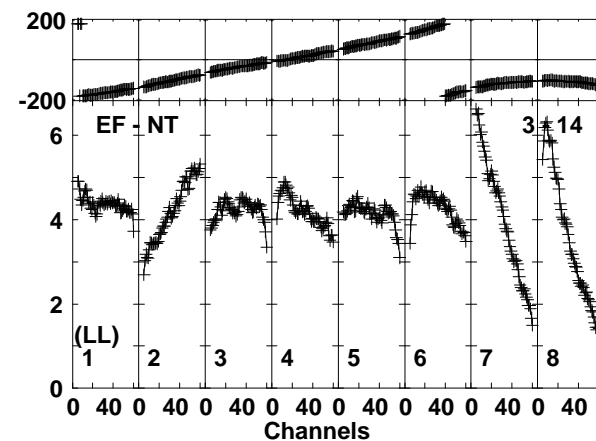
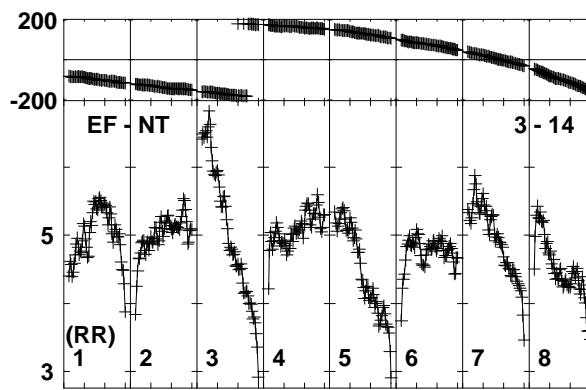
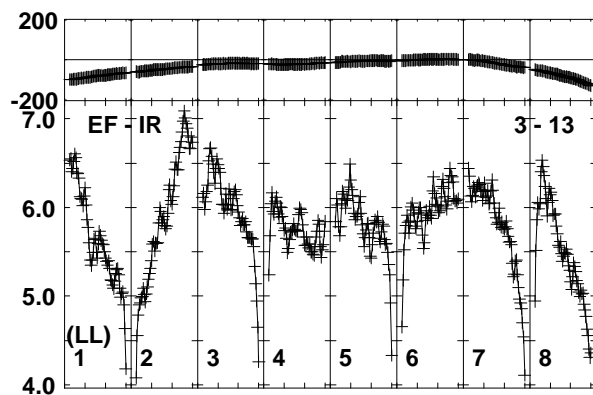
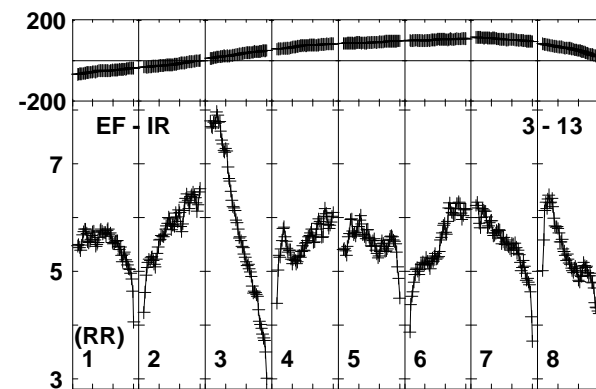
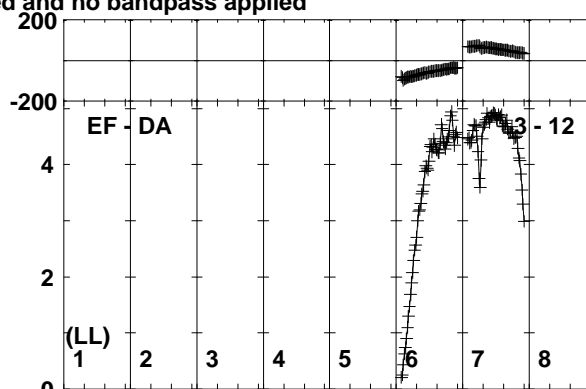
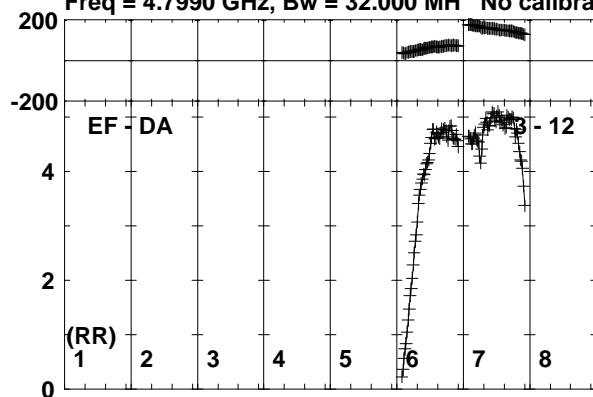

Lower frame: Milli Ampl Jy Top frame: Phas deg  
Vector averaged cross-power spectrum Baseline: EF (03) - DA (12)  
Timerange: 01/01:52:21 to 01/01:53:19

Plot file version 301 created 11-NOV-2019 15:07:50

SER8NJ EK040B.UVDATA.1

Freq = 4.7990 GHz, Bw = 32.000 MH No calibration applied and no bandpass applied

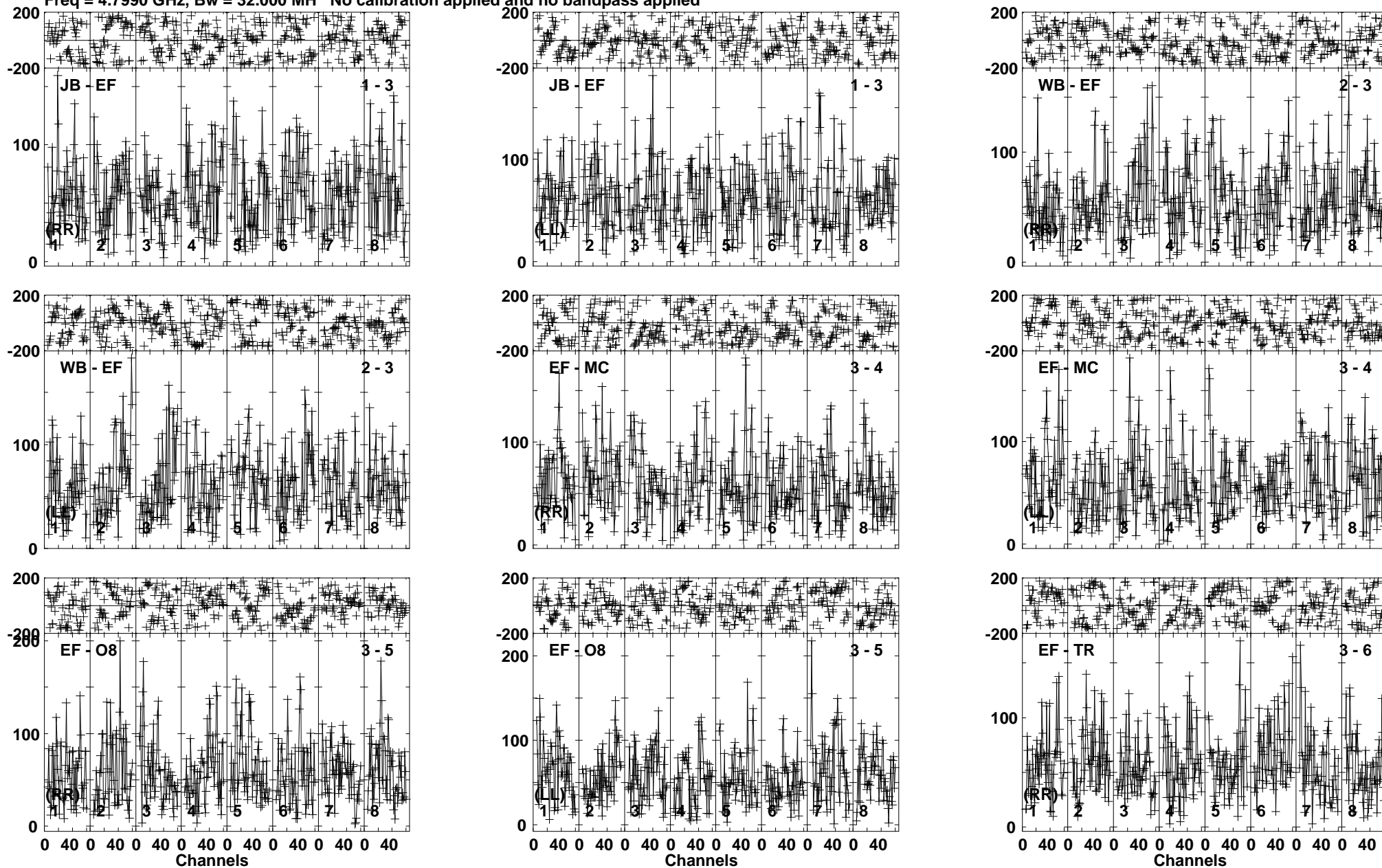

Lower frame: Micro Ampl Jy Top frame: Phas deg  
Vector averaged cross-power spectrum Baseline: JB (01) - EF (03)  
Timerange: 01/01:53:23 to 01/01:57:19

Plot file version 302 created 11-NOV-2019 15:07:51

SER8NJ EK040B.UVDATA.1

Freq = 4.7990 GHz, Bw = 32.000 MH No calibration applied and no bandpass applied

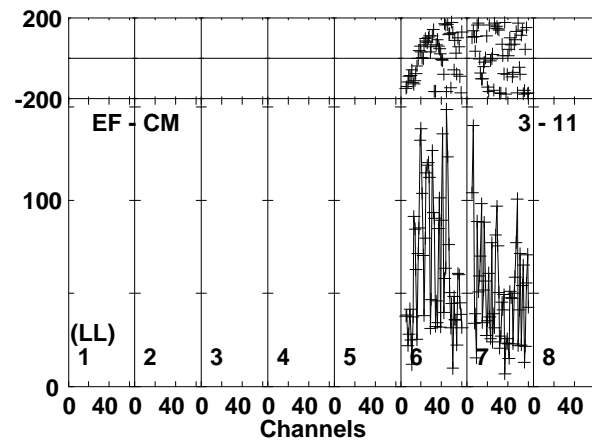
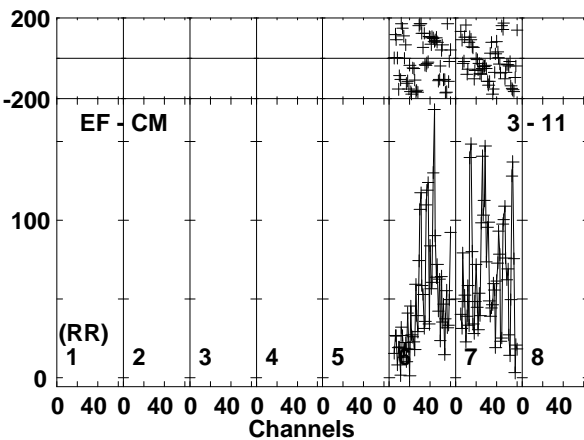
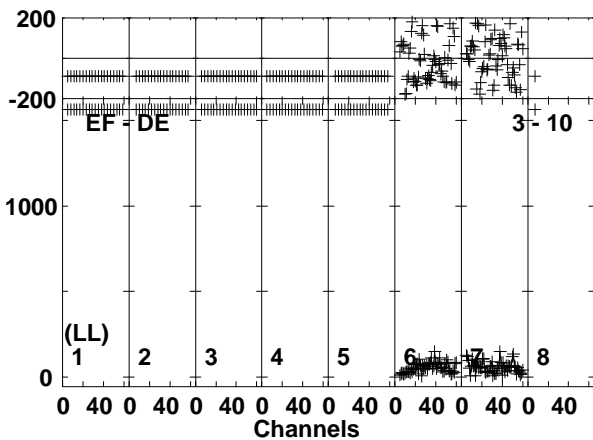
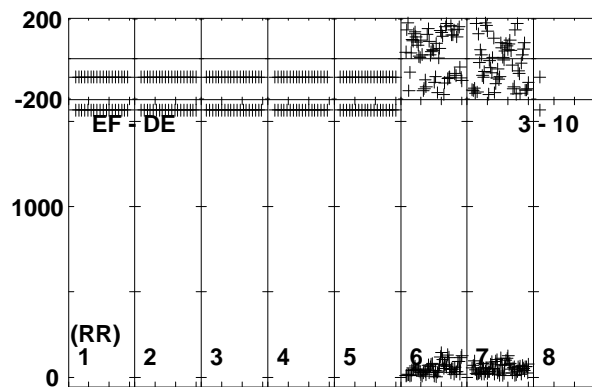
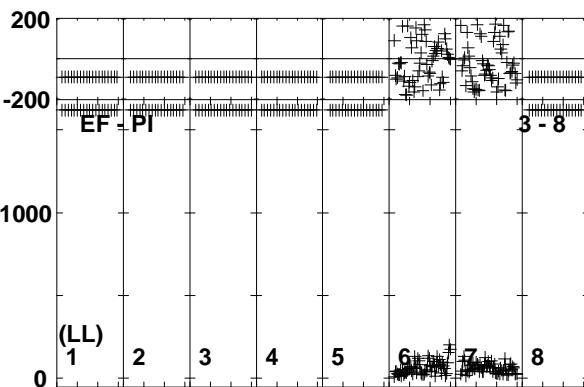
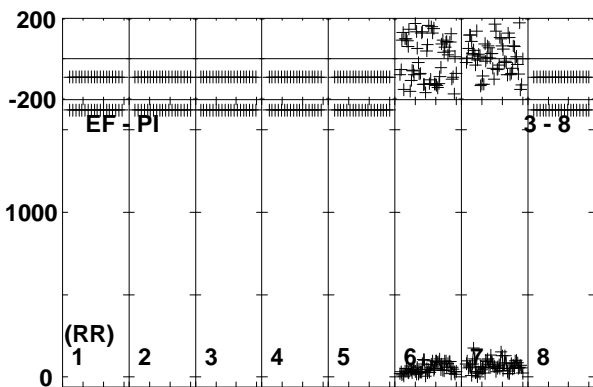
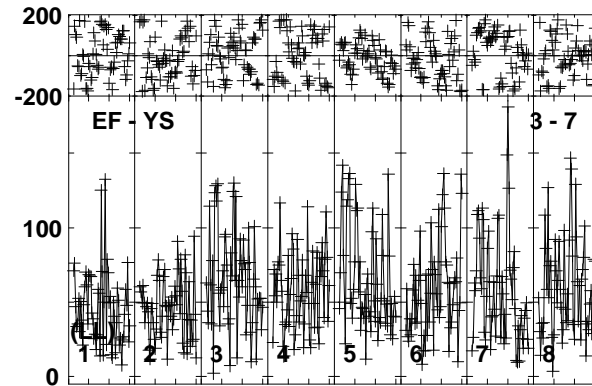
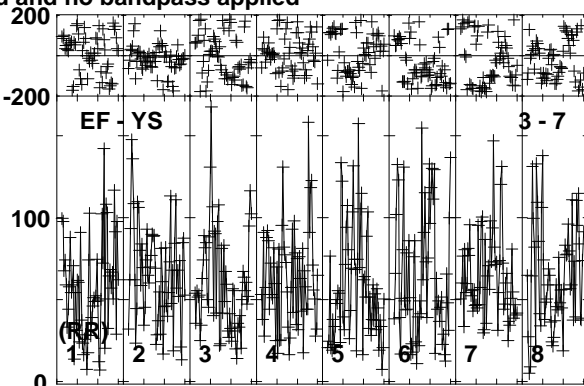
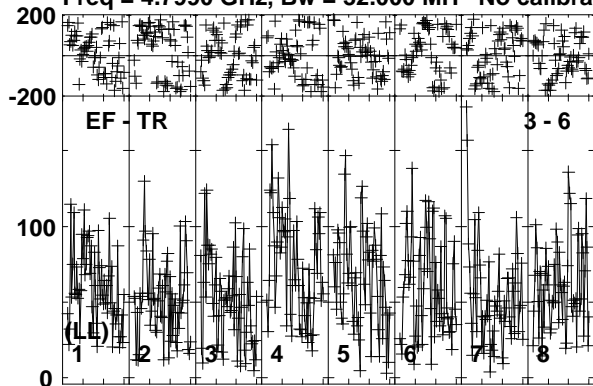

Lower frame: Micro Ampl Jy Top frame: Phas deg  
Vector averaged cross-power spectrum Baseline: EF (03) - TR (06)  
Timerange: 01/01:53:23 to 01/01:57:19

Plot file version 303 created 11-NOV-2019 15:07:51

SER8NJ EK040B.UVDATA.1

Freq = 4.7990 GHz, Bw = 32.000 MH No calibration applied and no bandpass applied

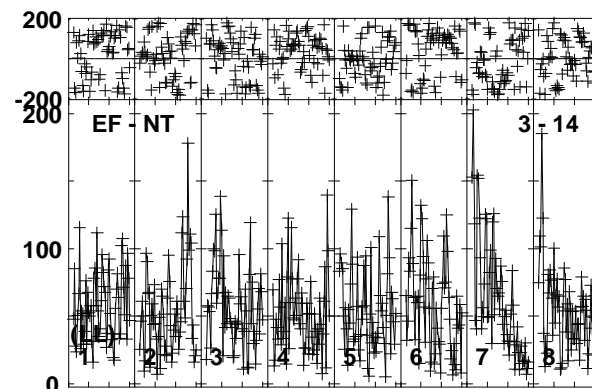
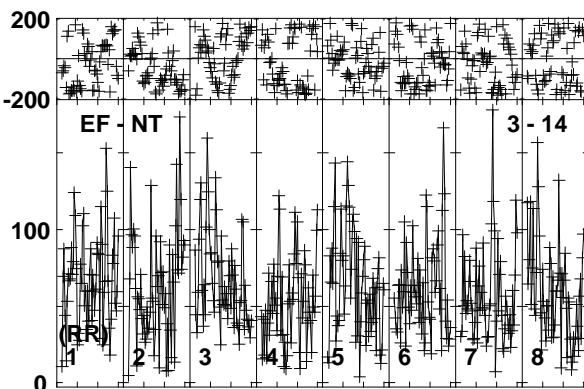
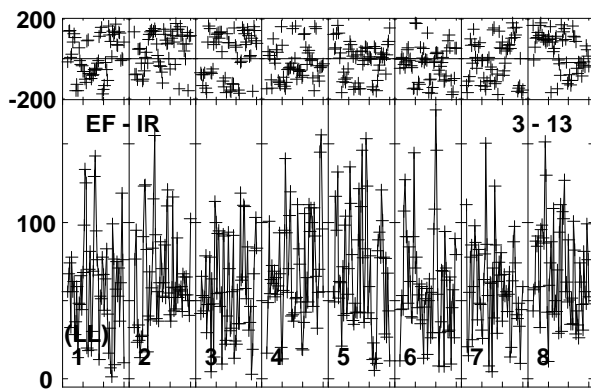
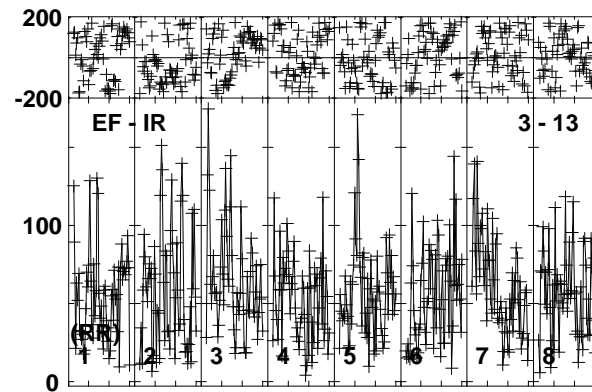
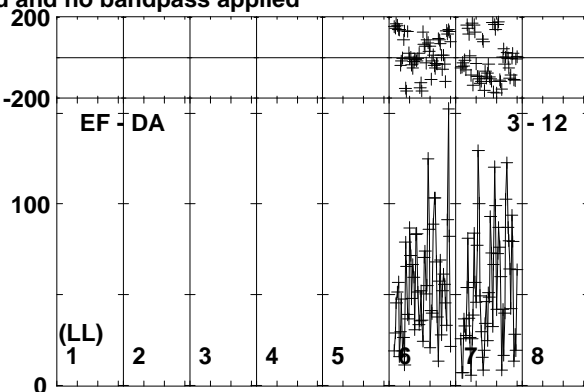
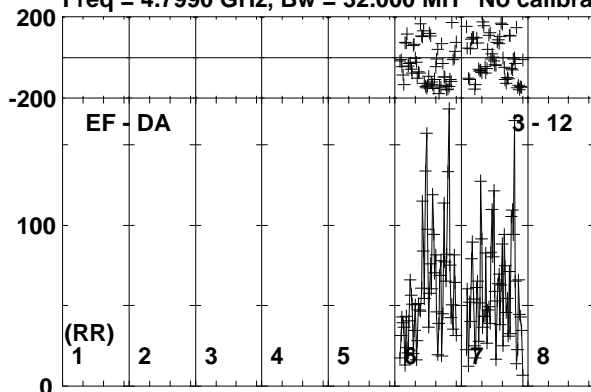

0 40 0 40 0 40 0 40 0 40 0 40 0 40 0 40  
Channels

Lower frame: Micro Ampl Jy Top frame: Phas deg  
Vector averaged cross-power spectrum Baseline: EF (03) - DA (12)  
Timerange: 01/01:53:23 to 01/01:57:19

Plot file version 304 created 11-NOV-2019 15:07:51

J1826+0149 EK040B.UVDATA.1

Freq = 4.7990 GHz, Bw = 32.000 MH No calibration applied and no bandpass applied

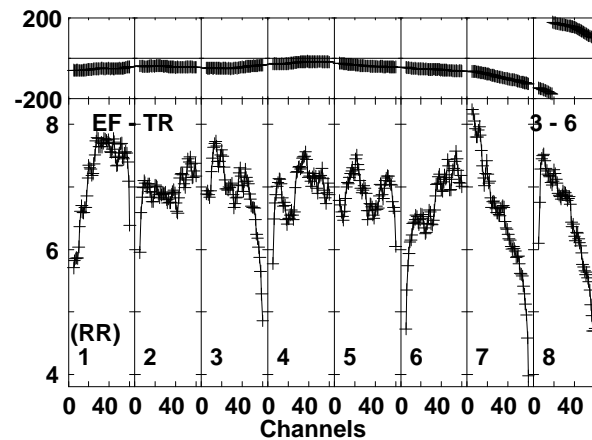
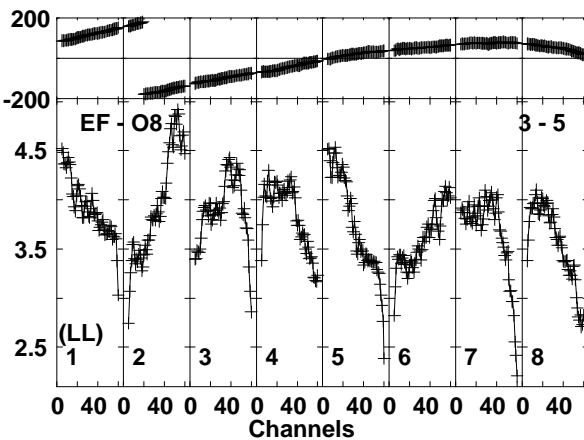
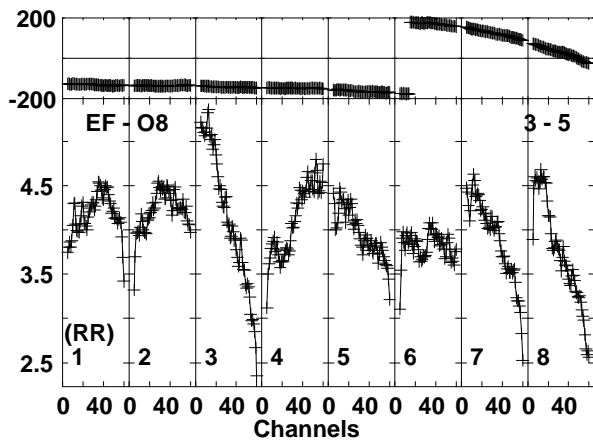
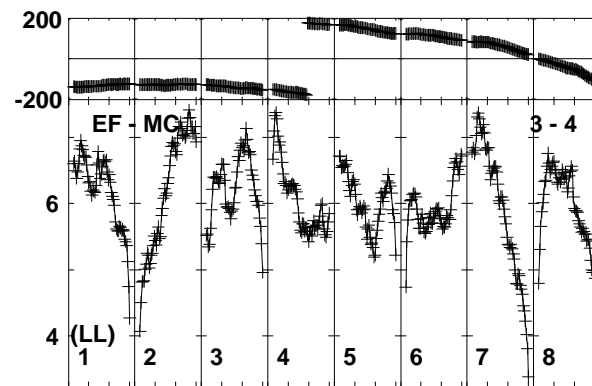
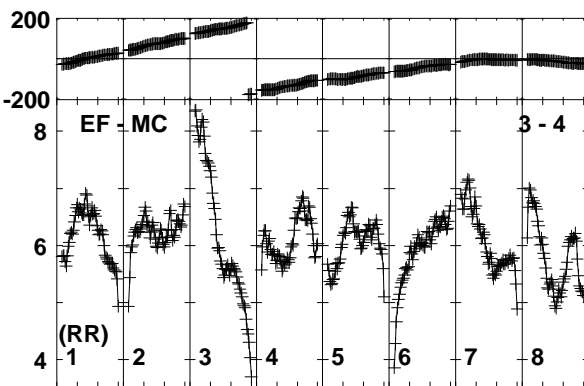
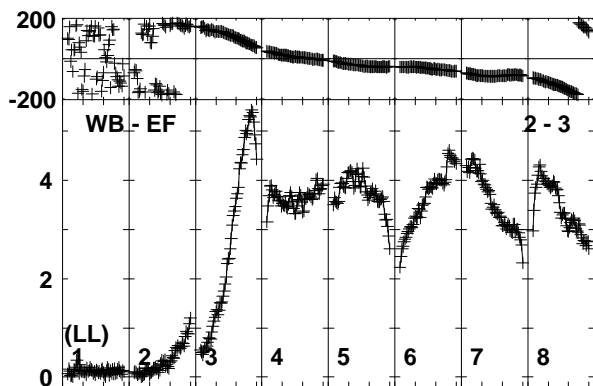
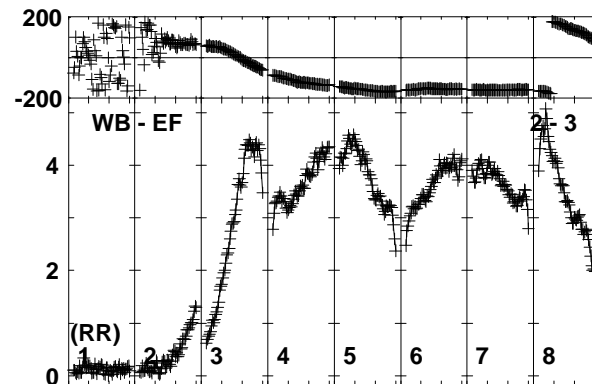
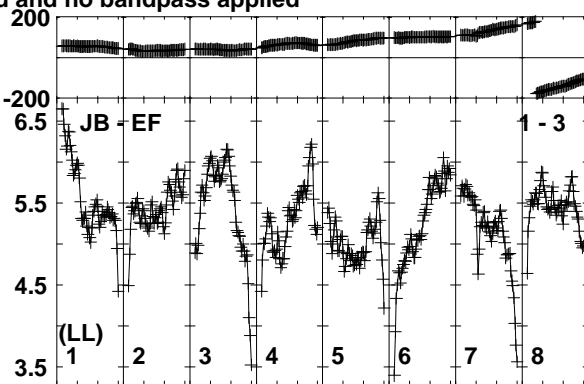
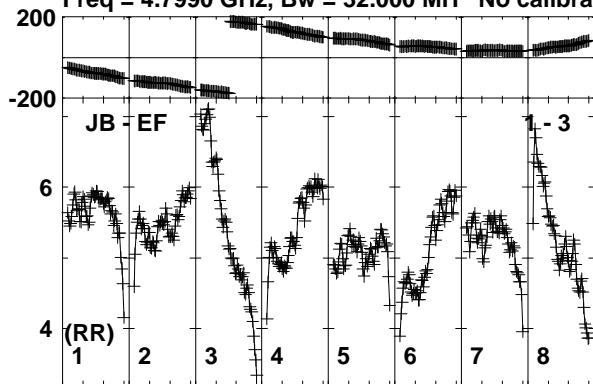

Lower frame: Milli Ampl Jy Top frame: Phas deg  
Vector averaged cross-power spectrum Baseline: JB (01) - EF (03)  
Timerange: 01/01:57:21 to 01/01:58:49

Plot file version 305 created 11-NOV-2019 15:07:51

J1826+0149 EK040B.UVDATA.1

Freq = 4.7990 GHz, Bw = 32.000 MH No calibration applied and no bandpass applied

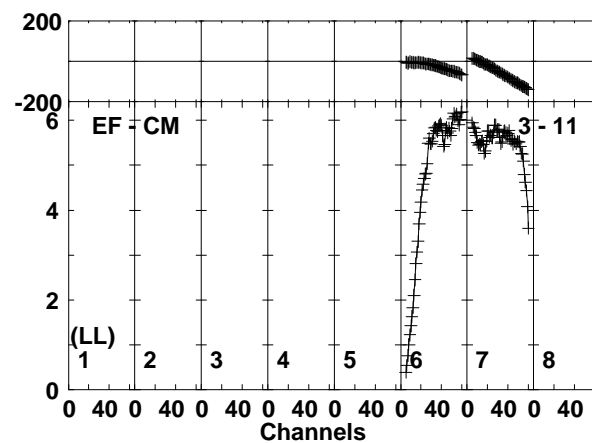
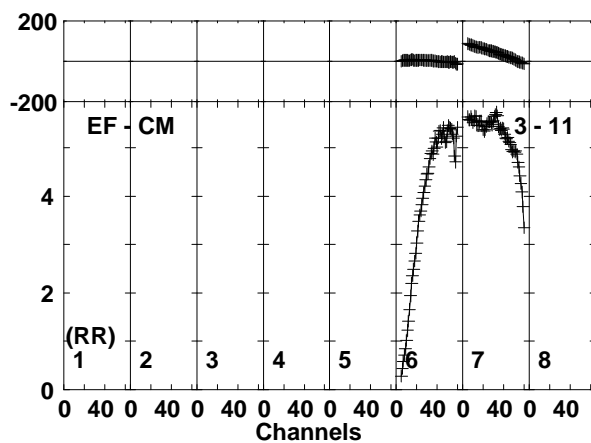
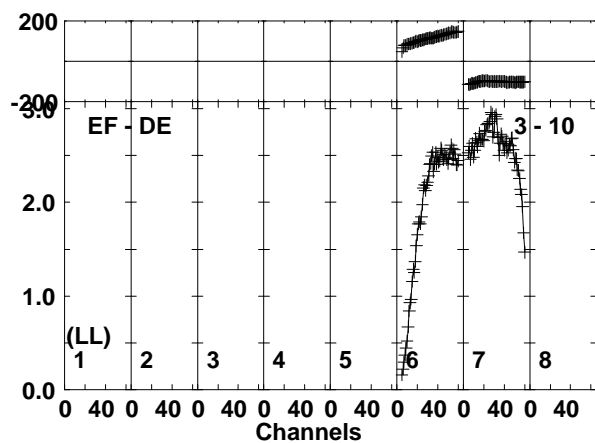
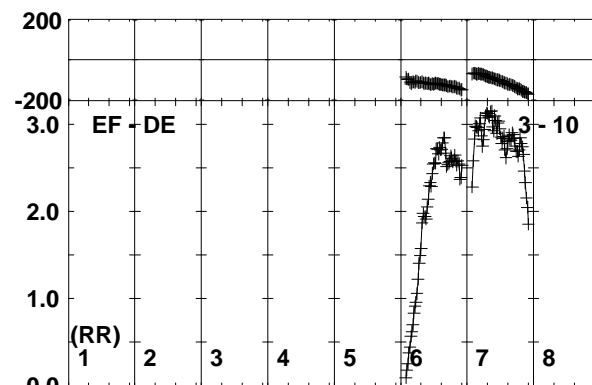
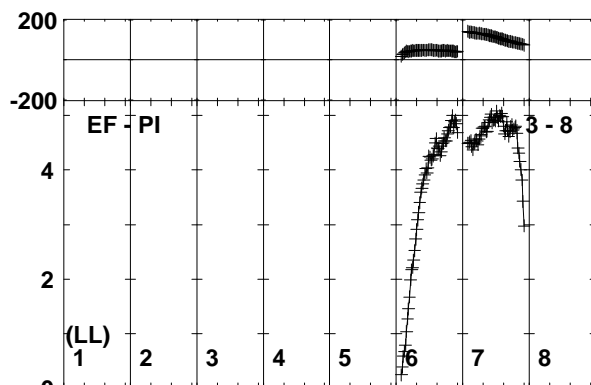
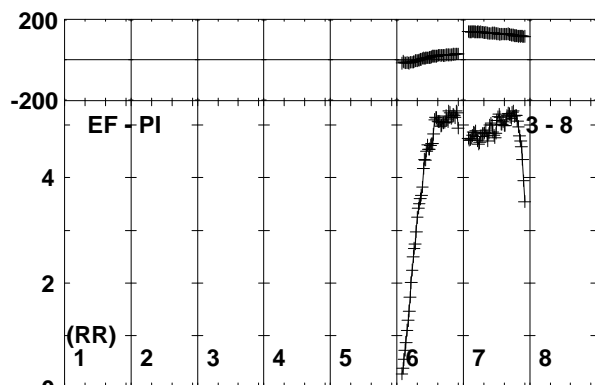
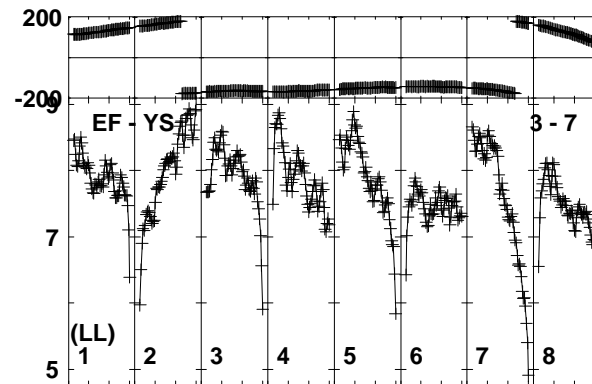
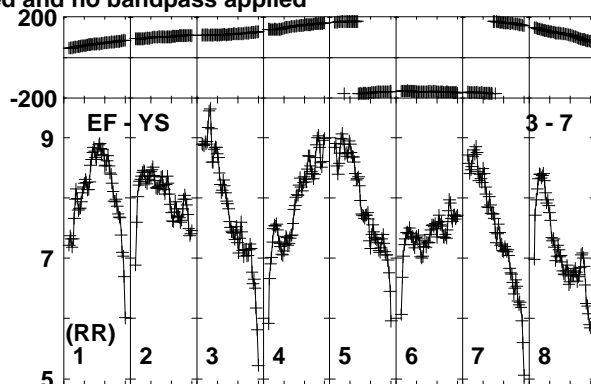
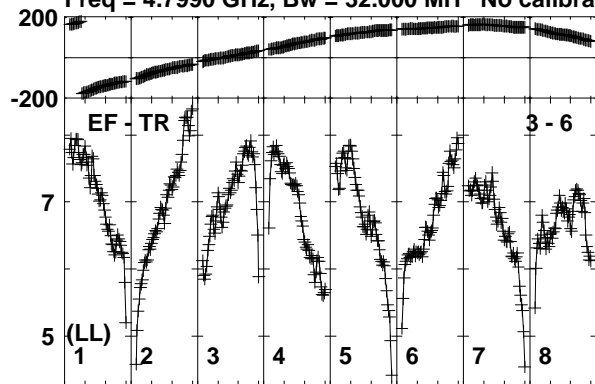

Lower frame: Milli Ampl Jy Top frame: Phas deg  
Vector averaged cross-power spectrum Baseline: EF (03) - TR (06)  
Timerange: 01/01:57:21 to 01/01:58:49

Plot file version 306 created 11-NOV-2019 15:07:51

J1826+0149 EK040B.UVDATA.1

Freq = 4.7990 GHz, Bw = 32.000 MH No calibration applied and no bandpass applied

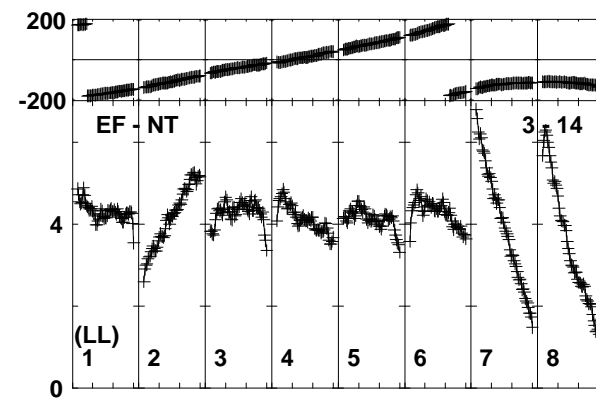
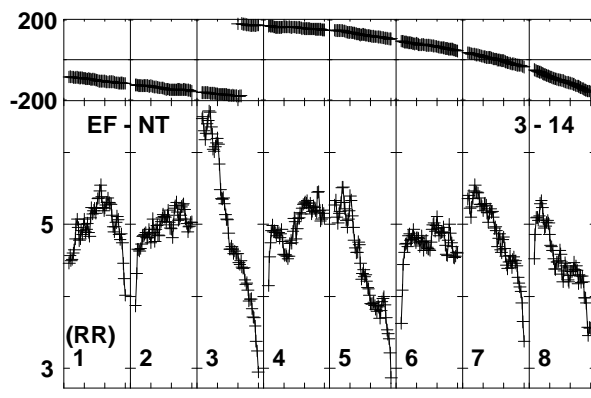
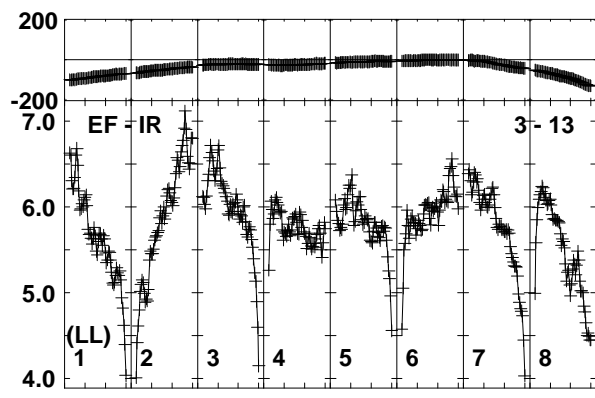
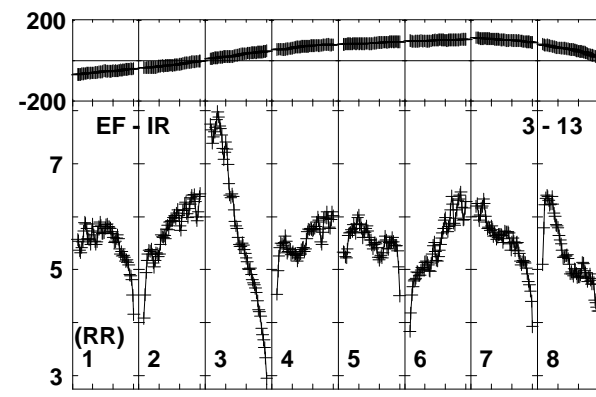
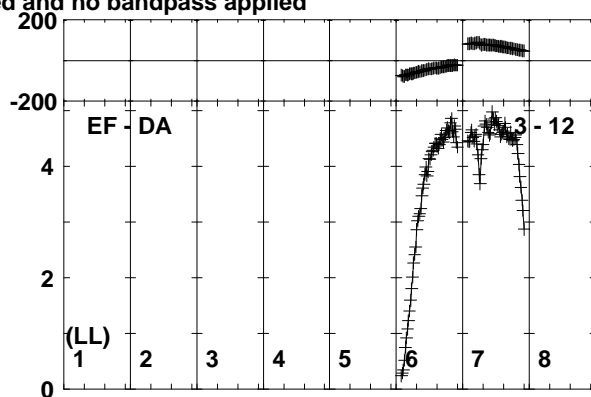
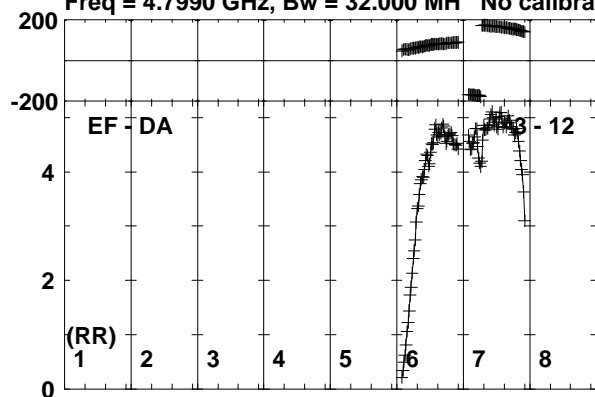

Channels

Lower frame: Milli Ampl Jy Top frame: Phas deg  
Vector averaged cross-power spectrum Baseline: EF (03) - DA (12)  
Timerange: 01/01:57:21 to 01/01:58:49



Plot file version 307 created 11-NOV-2019 15:07:51

SER8NJ EK040B.UVDATA.1

Freq = 4.7990 GHz, Bw = 32.000 MH No calibration applied and no bandpass applied

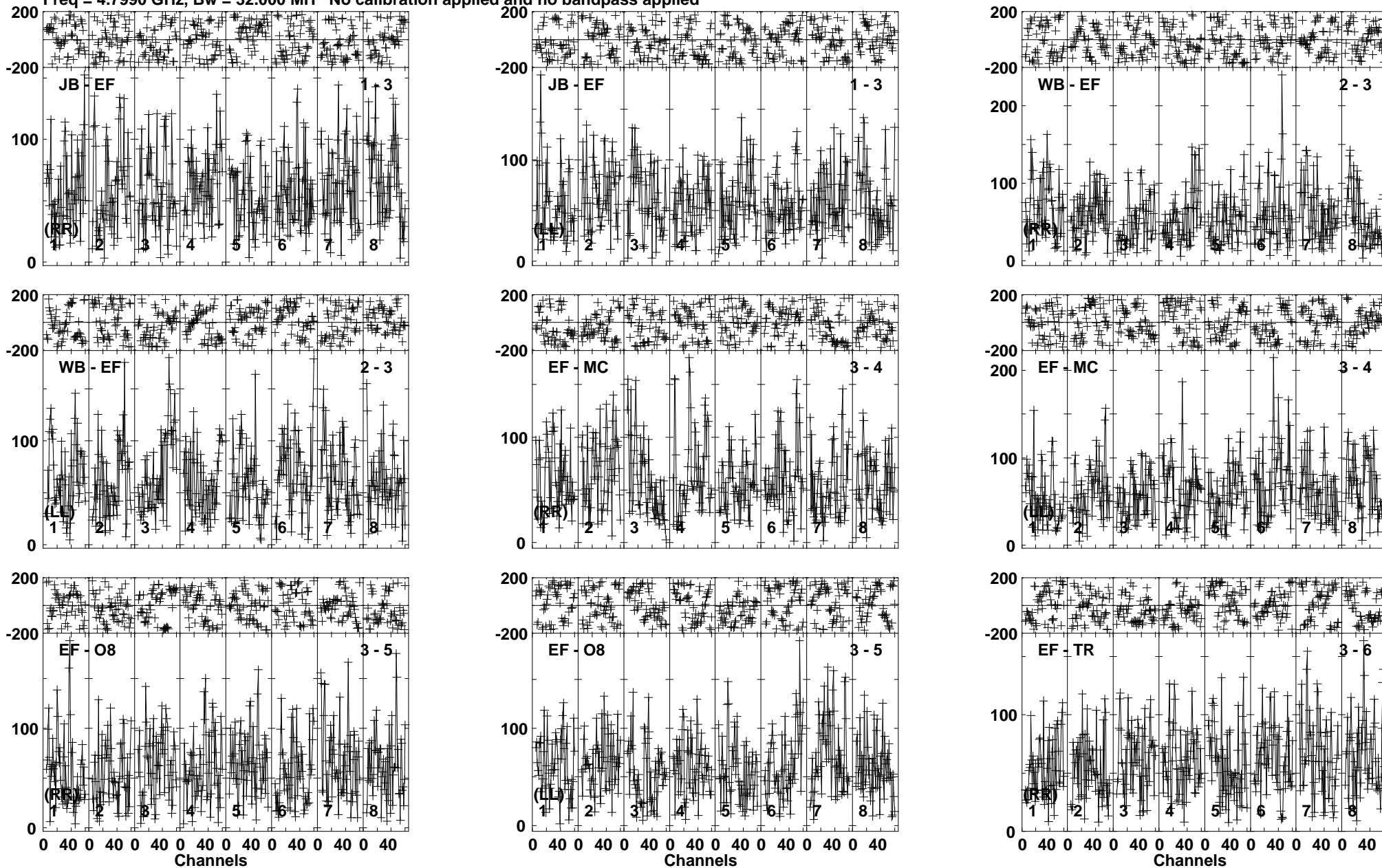

Lower frame: Micro Ampl Jy Top frame: Phas deg  
Vector averaged cross-power spectrum Baseline: JB (01) - EF (03)  
Timerange: 01/01:58:51 to 01/02:02:49

Plot file version 308 created 11-NOV-2019 15:07:51

SER8NJ EK040B.UVDATA.1

Freq = 4.7990 GHz, Bw = 32.000 MH No calibration applied and no bandpass applied

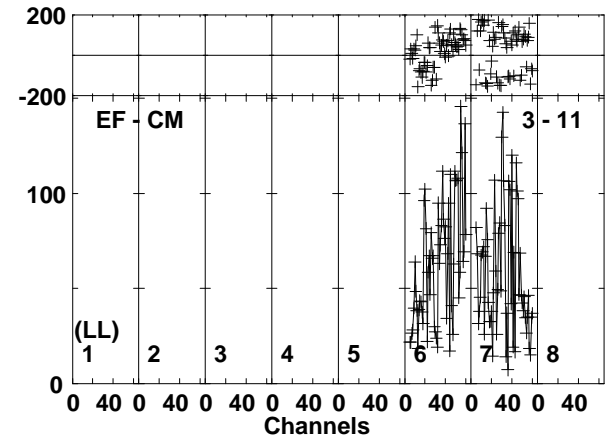
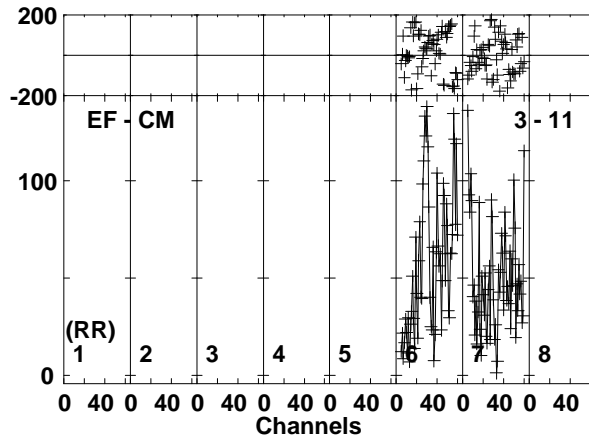
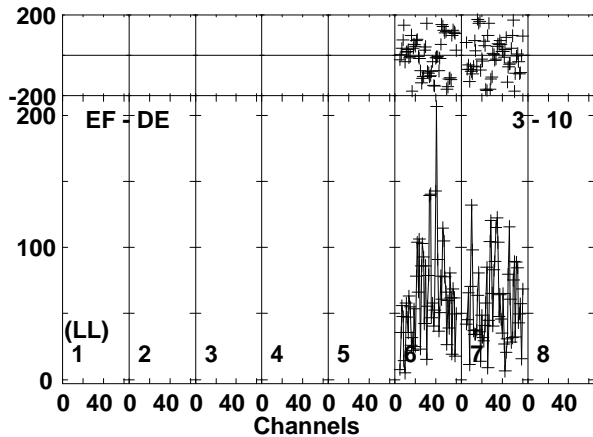
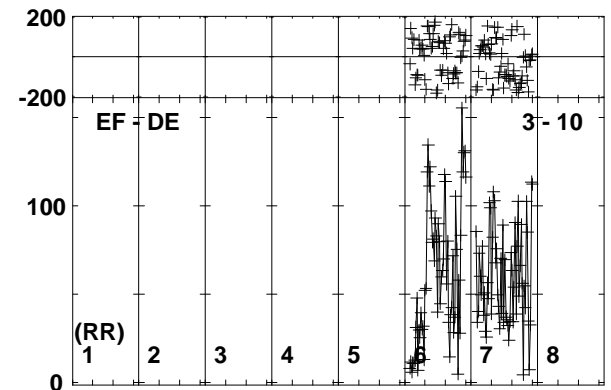
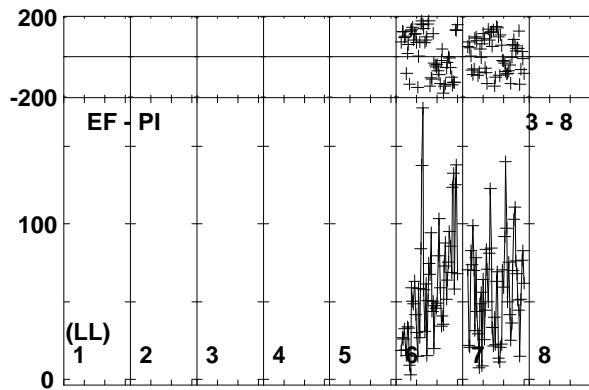
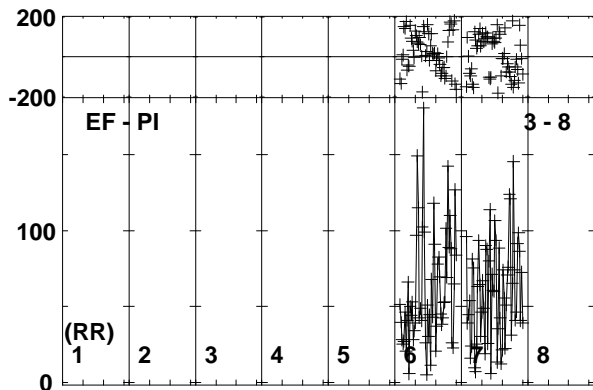
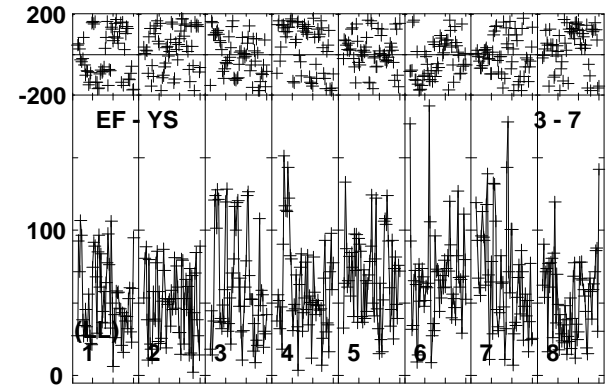
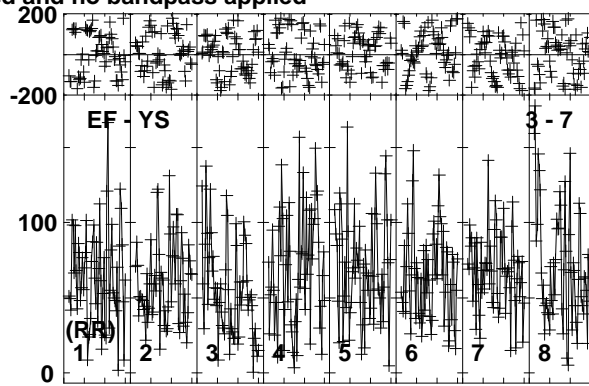
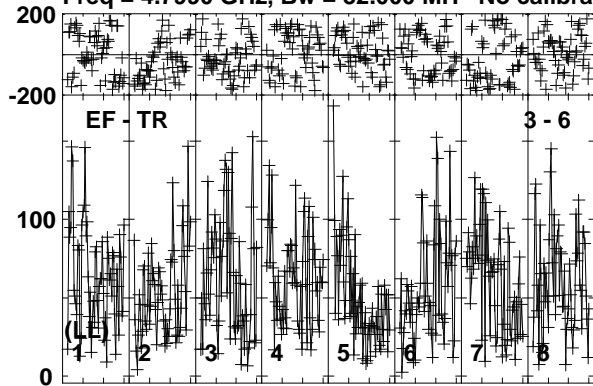

Lower frame: Micro Ampl Jy Top frame: Phas deg  
Vector averaged cross-power spectrum Baseline: EF (03) - TR (06)  
Timerange: 01/01:58:51 to 01/02:02:49

Plot file version 309 created 11-NOV-2019 15:07:51

SER8NJ EK040B.UVDATA.1

Freq = 4.7990 GHz, Bw = 32.000 MH No calibration applied and no bandpass applied

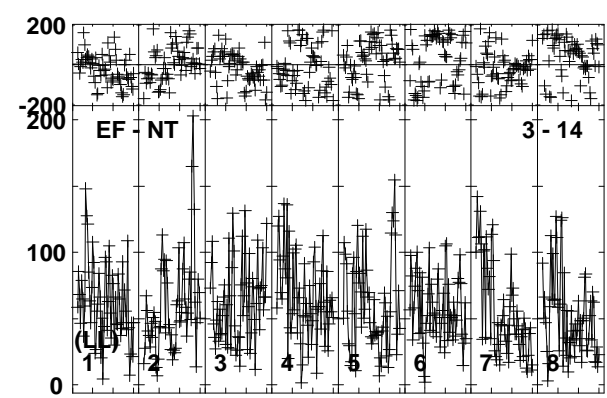
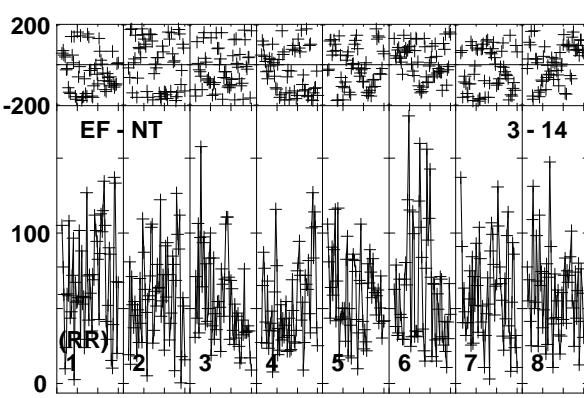
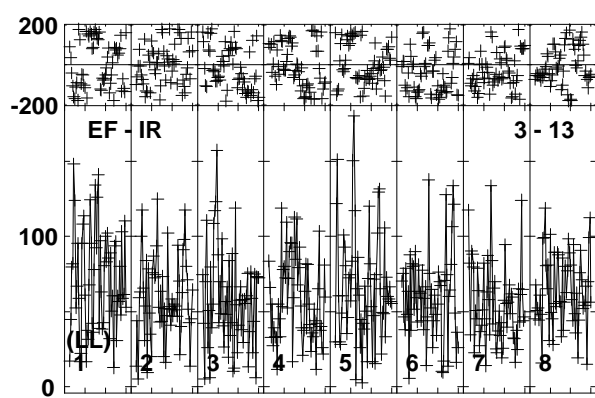
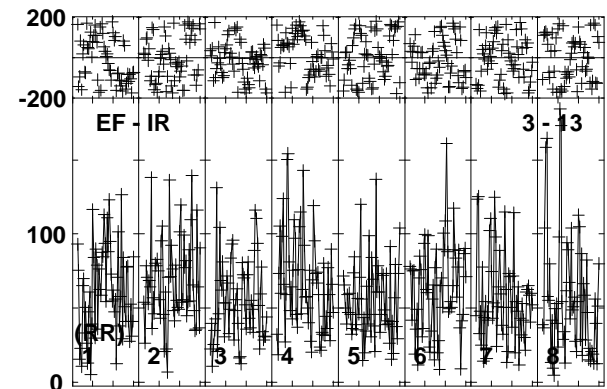
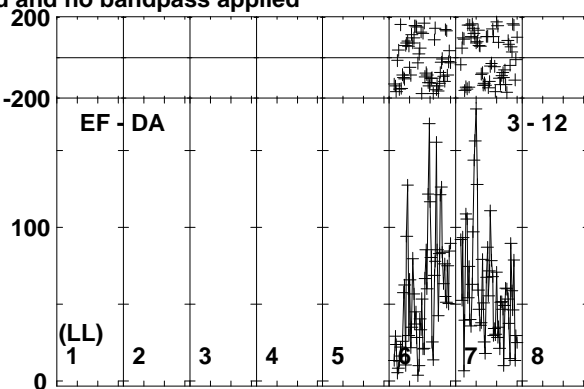
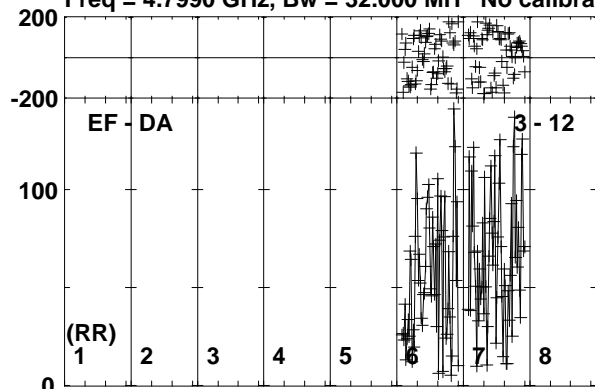

0 40 0 40 0 40 0 40 0 40 0 40 0 40 0 40 0 40 0 40  
Channels

Lower frame: Micro Ampl Jy Top frame: Phas deg  
Vector averaged cross-power spectrum Baseline: EF (03) - DA (12)  
Timerange: 01/01:58:51 to 01/02:02:49

Plot file version 310 created 11-NOV-2019 15:07:51

J1826+0149 EK040B.UVDATA.1

Freq = 4.7990 GHz, Bw = 32.000 MH No calibration applied and no bandpass applied

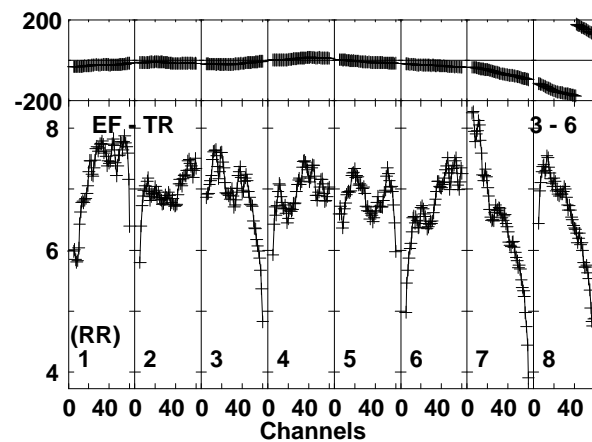
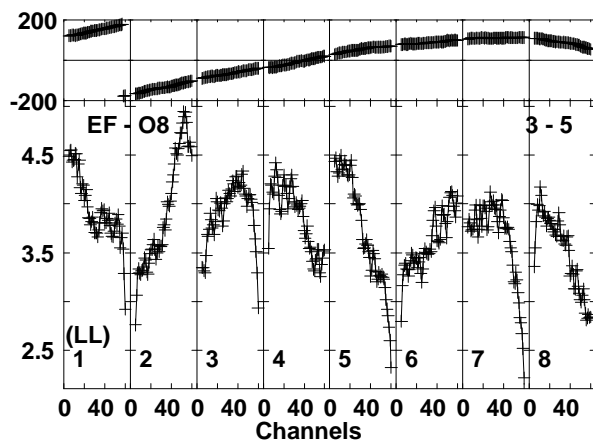
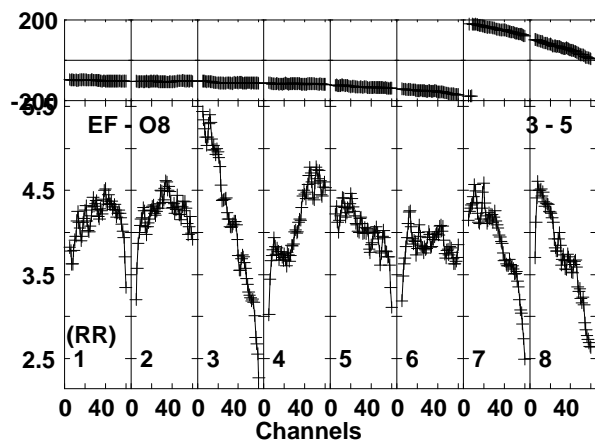
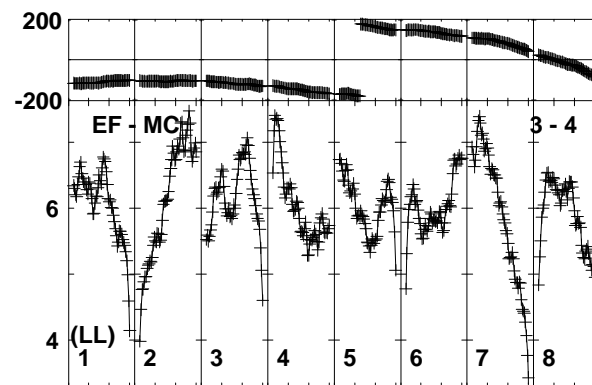
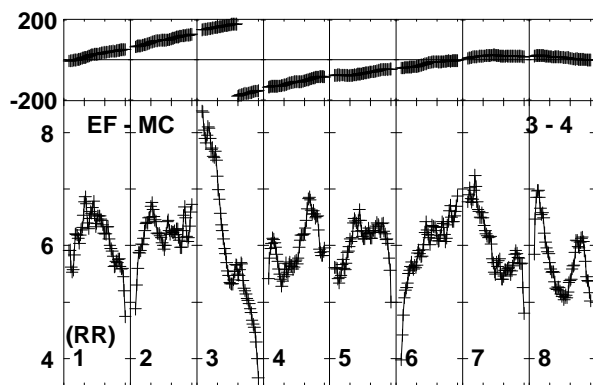
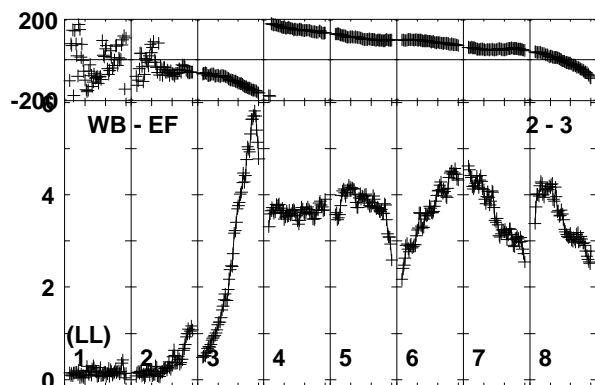
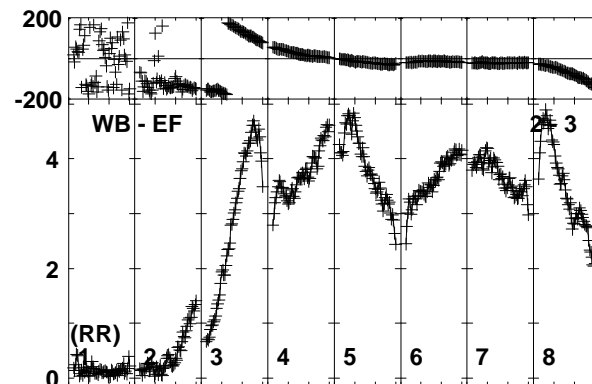
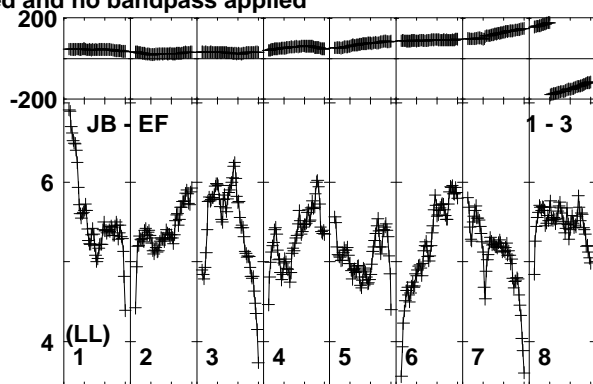
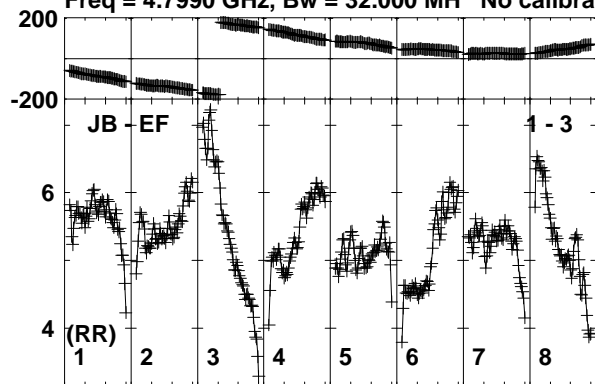

Lower frame: Milli Ampl Jy Top frame: Phas deg  
Vector averaged cross-power spectrum Baseline: JB (01) - EF (03)  
Timerange: 01/02:03:31 to 01/02:04:29

Plot file version 311 created 11-NOV-2019 15:07:52

J1826+0149 EK040B.UVDATA.1

Freq = 4.7990 GHz, Bw = 32.000 MH No calibration applied and no bandpass applied

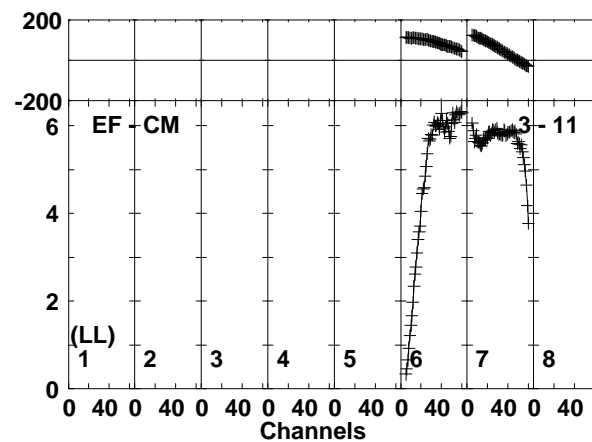
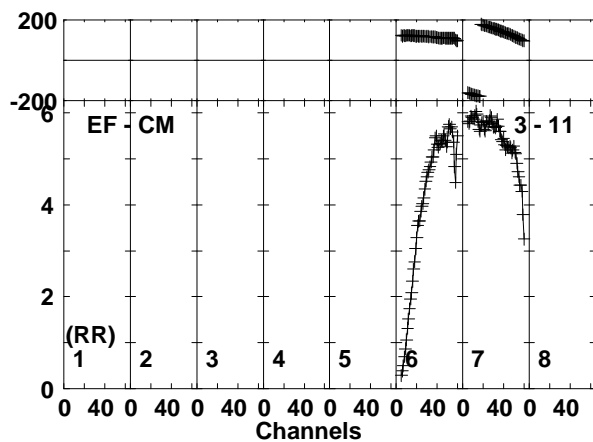
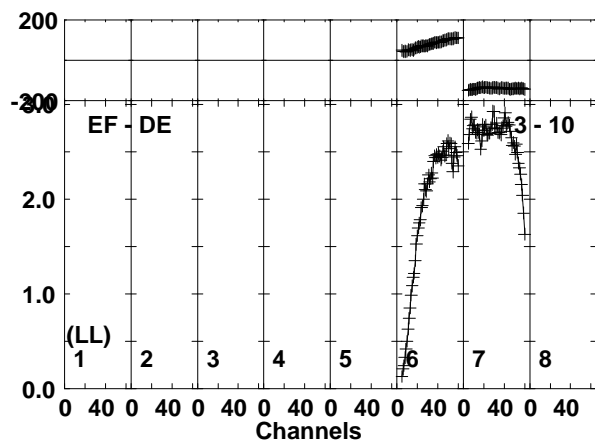
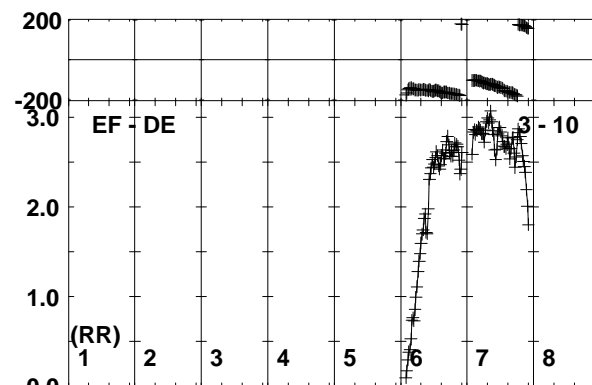
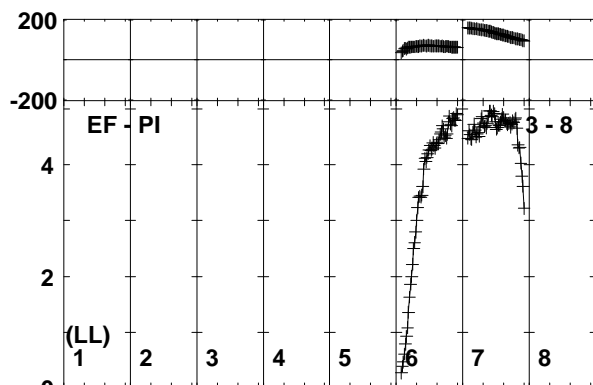
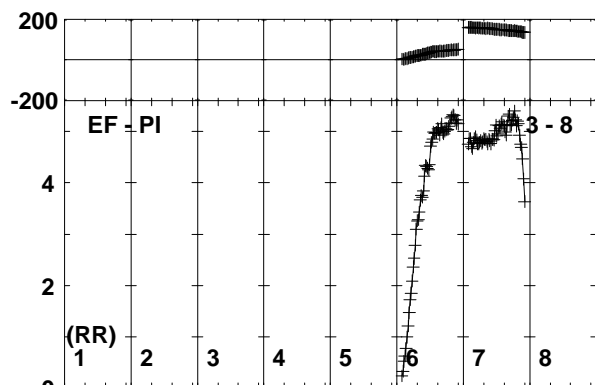
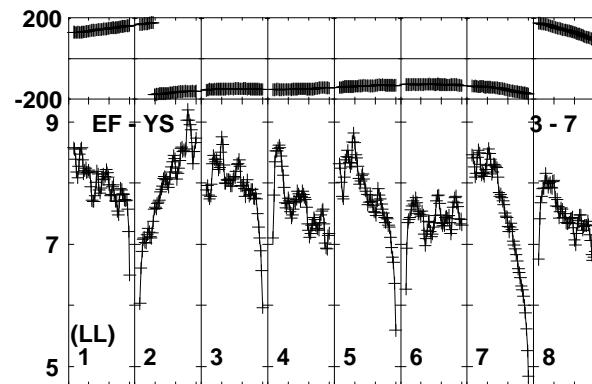
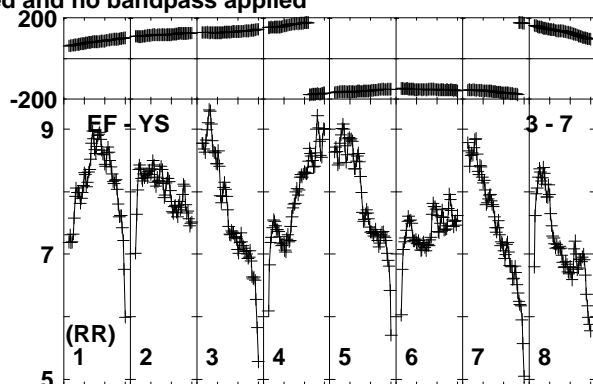
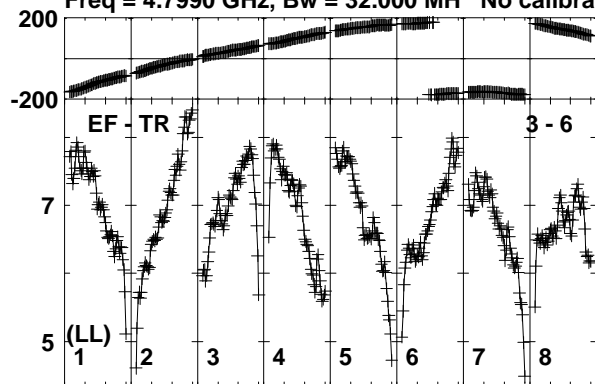

Lower frame: Milli Ampl Jy Top frame: Phas deg  
Vector averaged cross-power spectrum Baseline: EF (03) - TR (06)  
Timerange: 01/02:03:31 to 01/02:04:29

Plot file version 312 created 11-NOV-2019 15:07:52

J1826+0149 EK040B.UVDATA.1

Freq = 4.7990 GHz, Bw = 32.000 MH No calibration applied and no bandpass applied

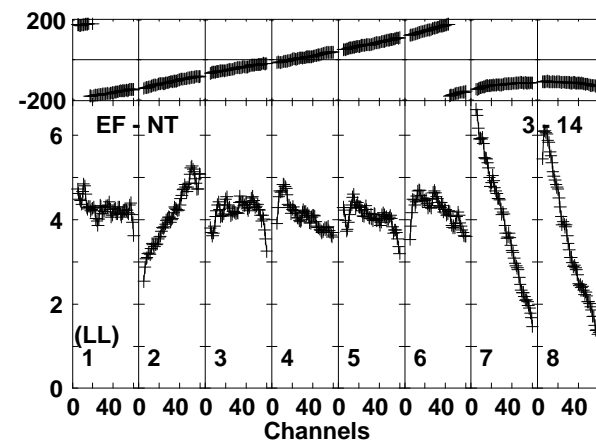
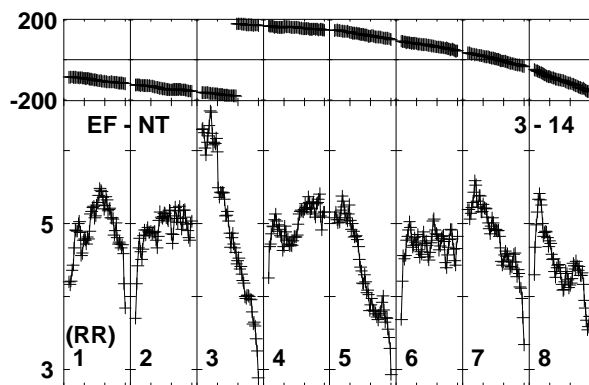
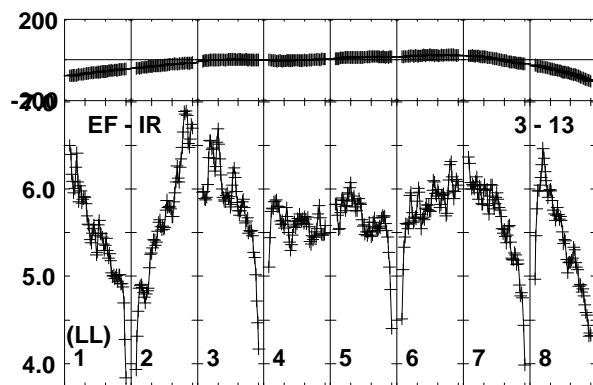
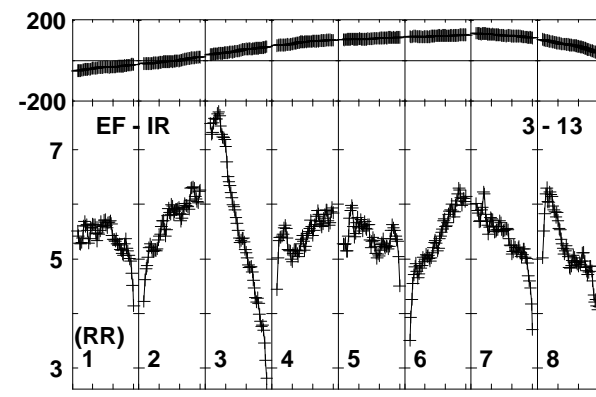
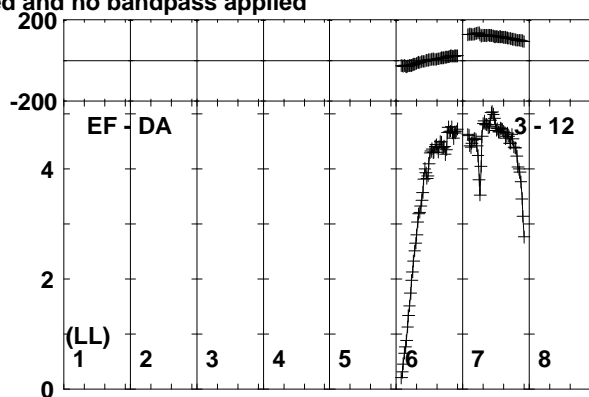
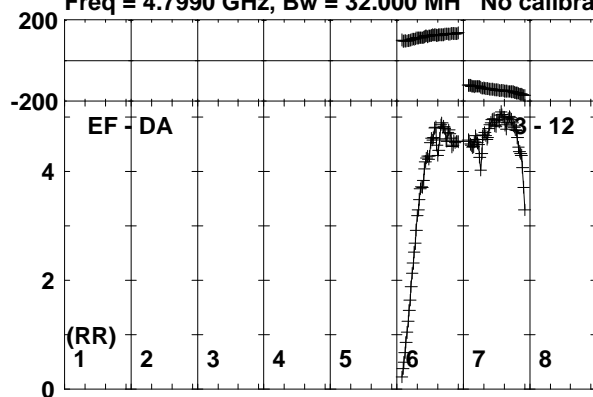

Lower frame: Milli Ampl Jy Top frame: Phas deg  
Vector averaged cross-power spectrum Baseline: EF (03) - DA (12)  
Timerange: 01/02:03:31 to 01/02:04:29

Plot file version 313 created 11-NOV-2019 15:07:52

SER8NJ EK040B.UVDATA.1

Freq = 4.7990 GHz, Bw = 32.000 MH No calibration applied and no bandpass applied

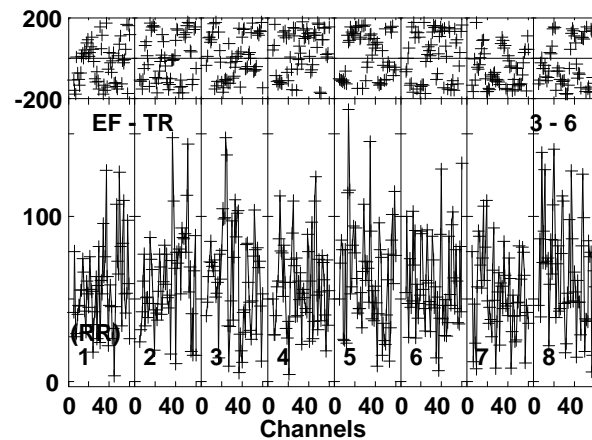
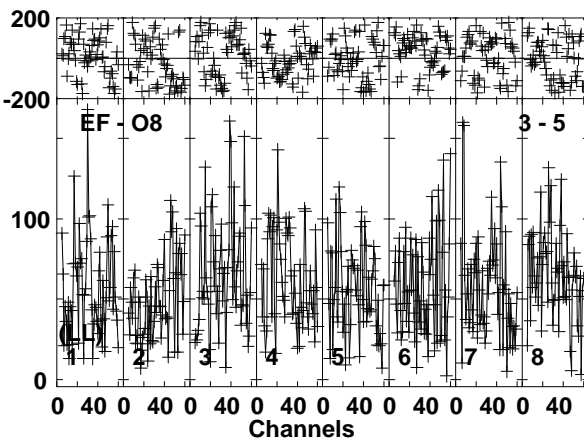
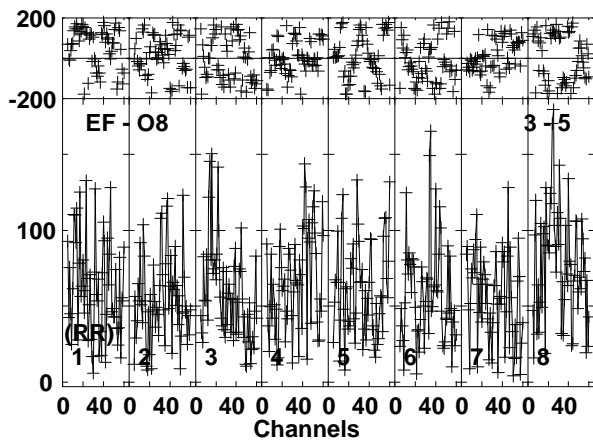
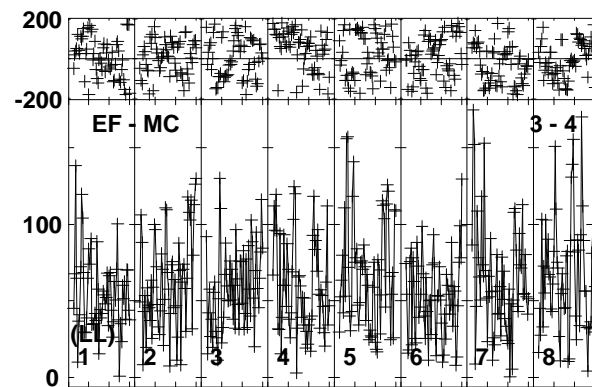
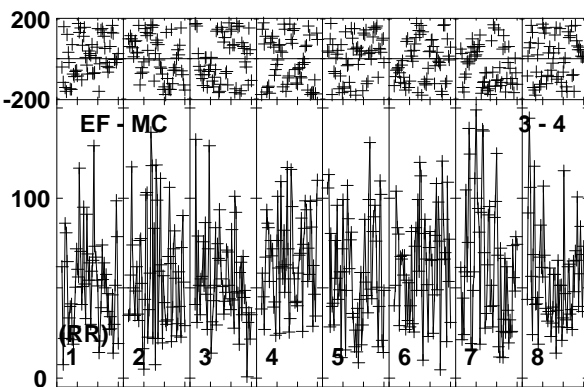
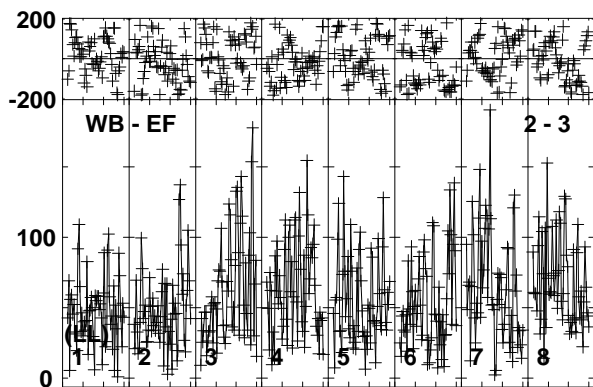
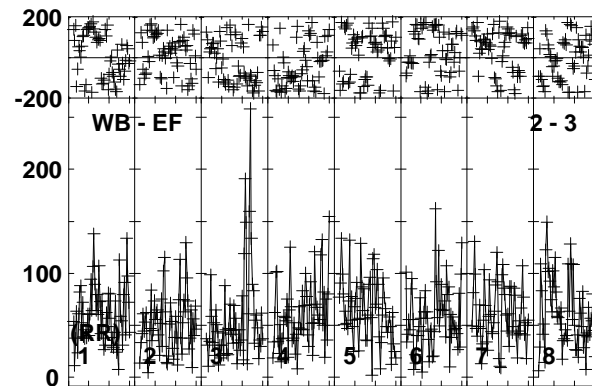
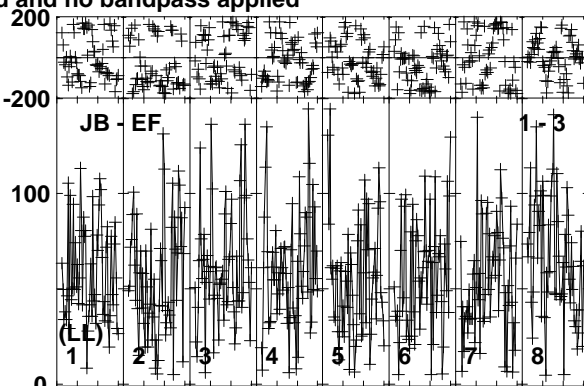
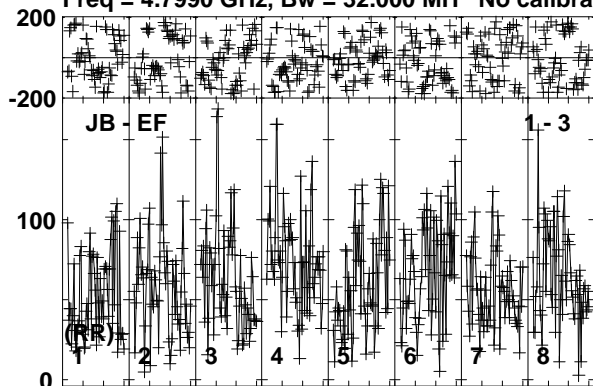

Lower frame: Micro Ampl Jy Top frame: Phas deg  
Vector averaged cross-power spectrum Baseline: JB (01) - EF (03)  
Timerange: 01/02:04:33 to 01/02:08:29

Plot file version 314 created 11-NOV-2019 15:07:52

SER8NJ EK040B.UVDATA.1

Freq = 4.7990 GHz, Bw = 32.000 MH No calibration applied and no bandpass applied

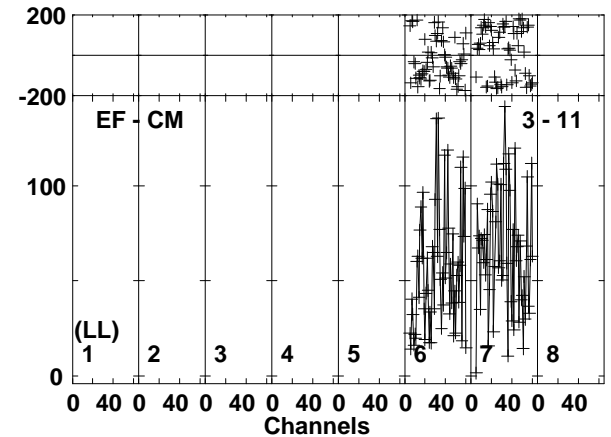
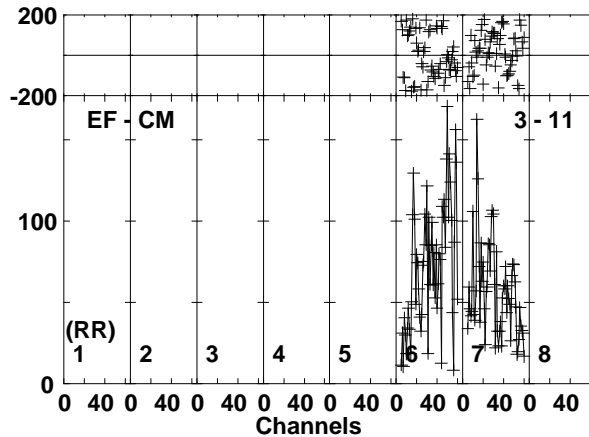
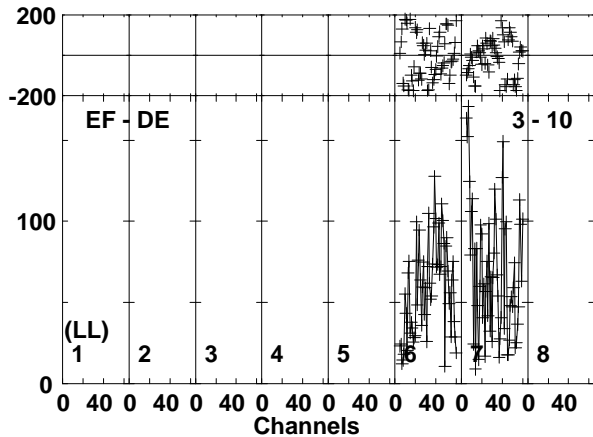
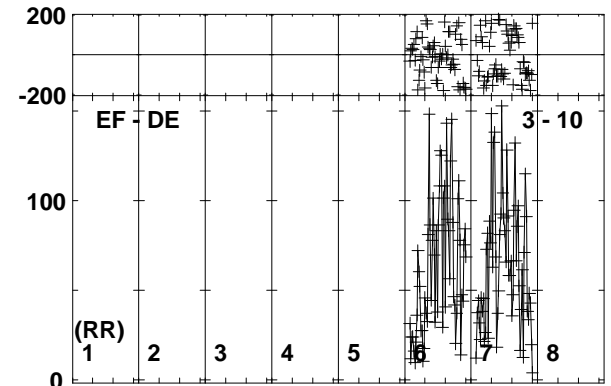
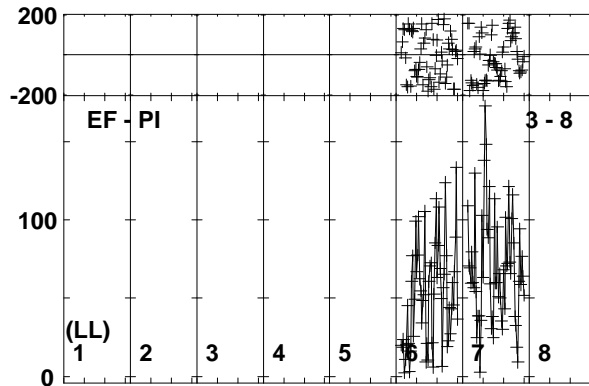
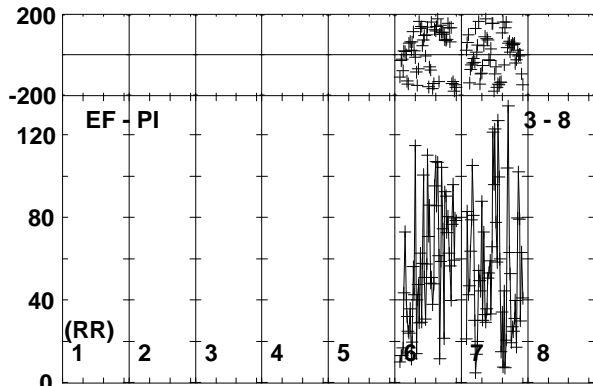
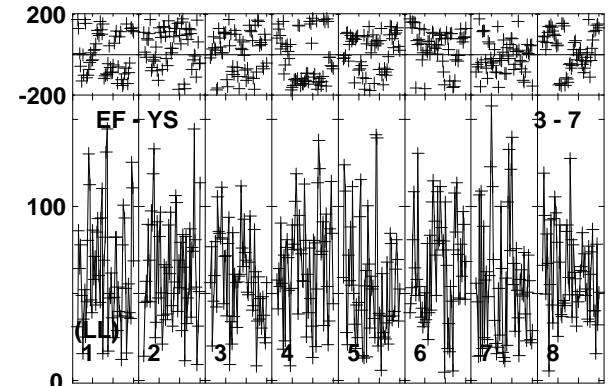
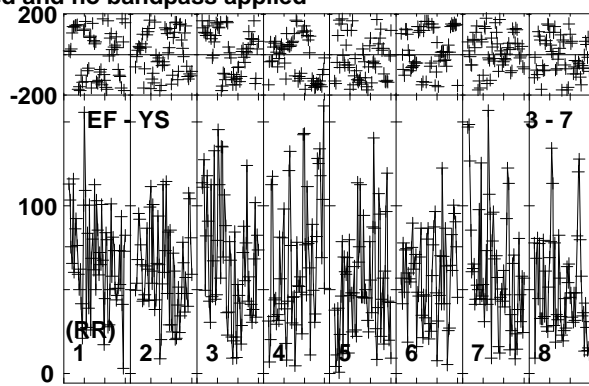
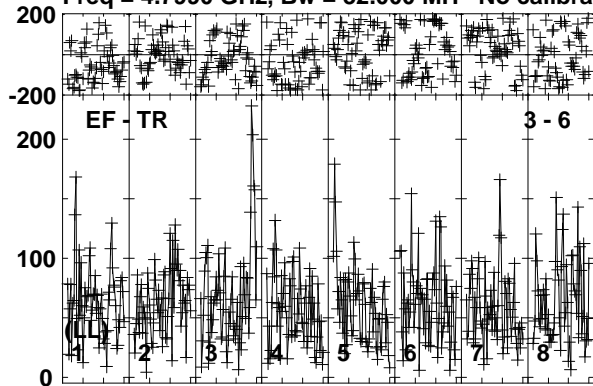

Lower frame: Micro Ampl Jy Top frame: Phas deg  
Vector averaged cross-power spectrum Baseline: EF (03) - TR (06)  
Timerange: 01/02:04:33 to 01/02:08:29



Plot file version 315 created 11-NOV-2019 15:07:52

SER8NJ EK040B.UVDATA.1

Freq = 4.7990 GHz, Bw = 32.000 MH No calibration applied and no bandpass applied

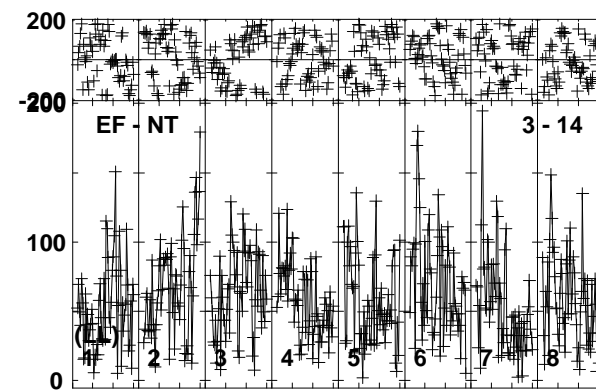
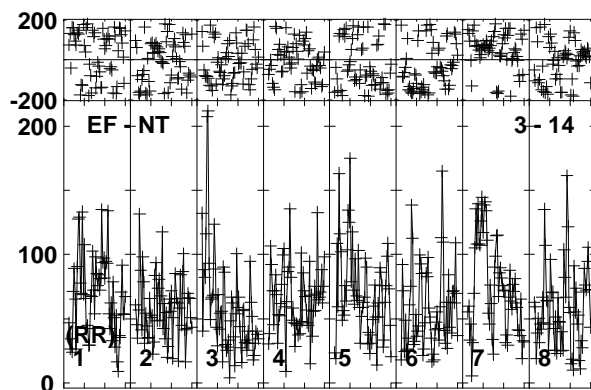
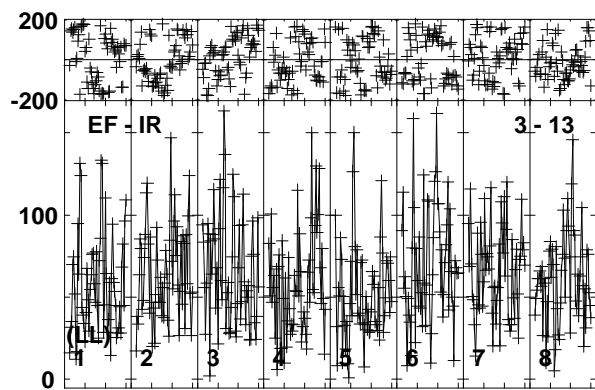
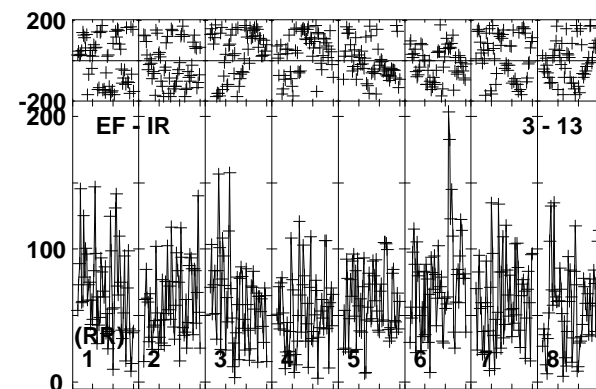
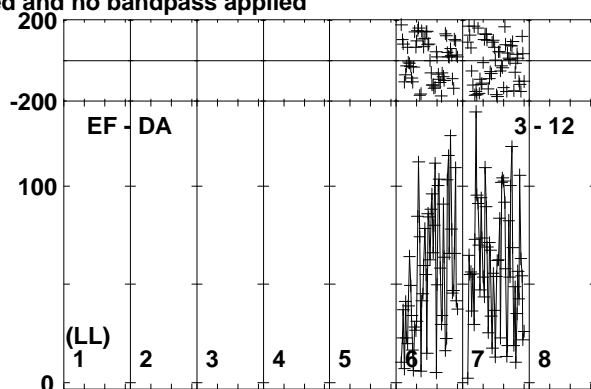
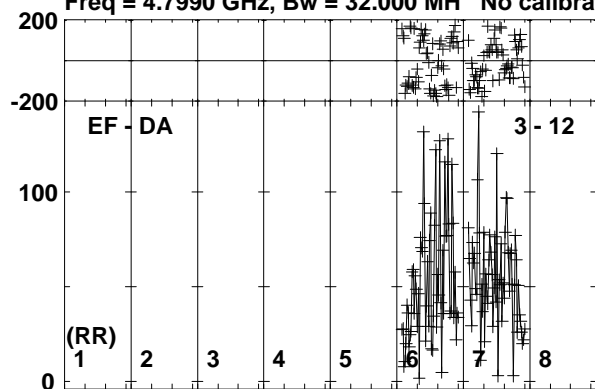

0 40 0 40 0 40 0 40 0 40 0 40 0 40 0 40 0 40 0 40  
Channels

Lower frame: Micro Ampl Jy Top frame: Phas deg  
Vector averaged cross-power spectrum Baseline: EF (03) - DA (12)  
Timerange: 01/02:04:33 to 01/02:08:29

Plot file version 316 created 11-NOV-2019 15:07:52

J1826+0149 EK040B.UVDATA.1

Freq = 4.7990 GHz, Bw = 32.000 MH No calibration applied and no bandpass applied

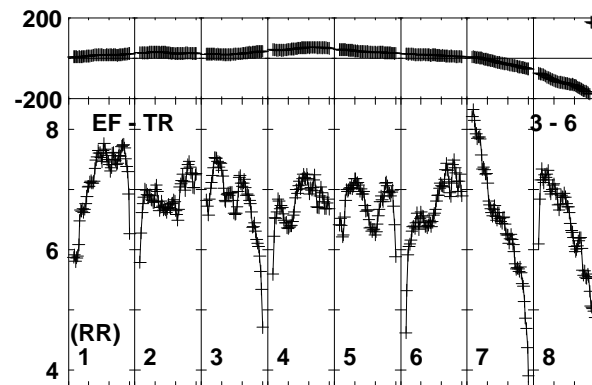
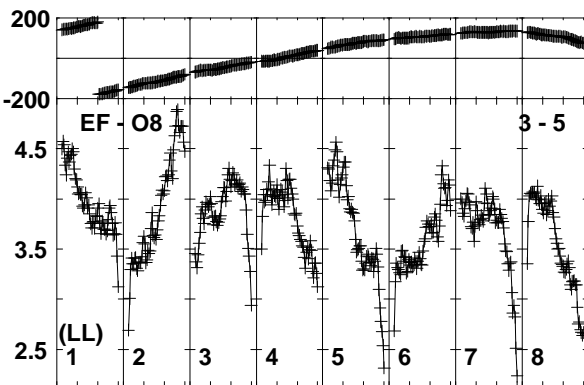
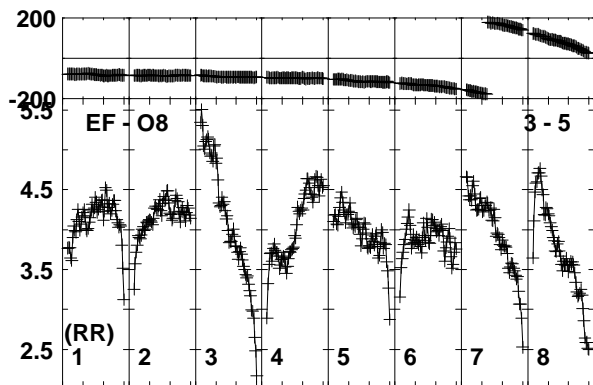
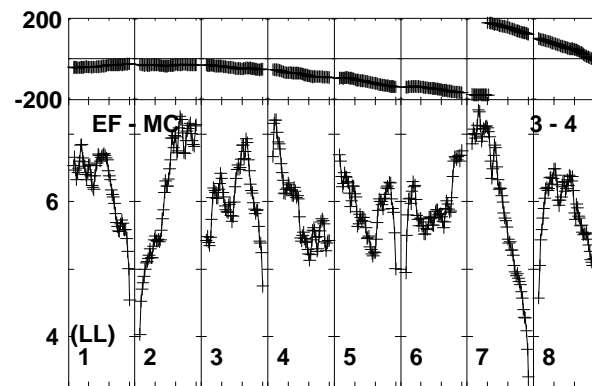
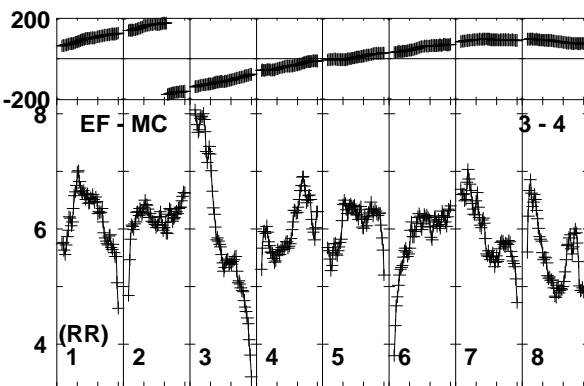
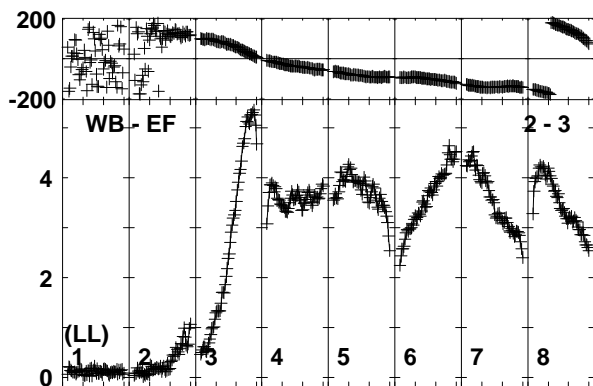
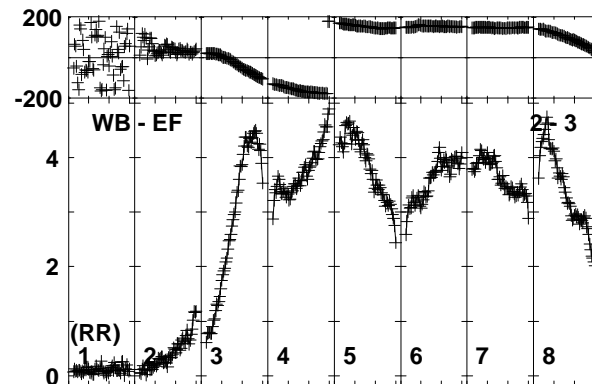
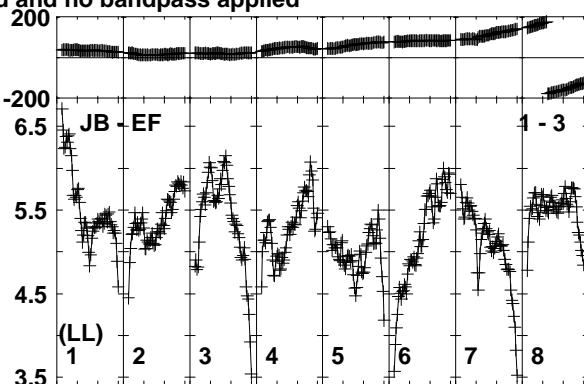
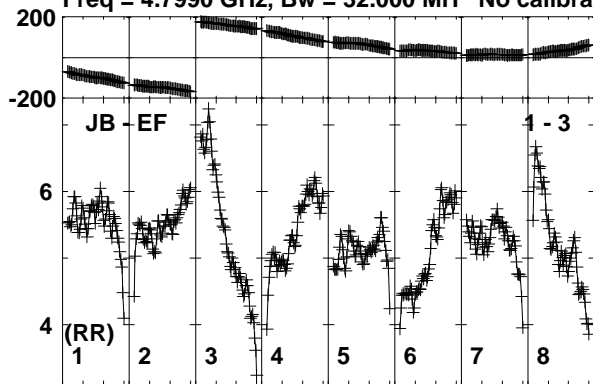

Lower frame: Milli Ampl Jy Top frame: Phas deg  
Vector averaged cross-power spectrum Baseline: JB (01) - EF (03)  
Timerange: 01/02:08:31 to 01/02:09:59

Plot file version 317 created 11-NOV-2019 15:07:52

J1826+0149 EK040B.UVDATA.1

Freq = 4.7990 GHz, Bw = 32.000 MH No calibration applied and no bandpass applied

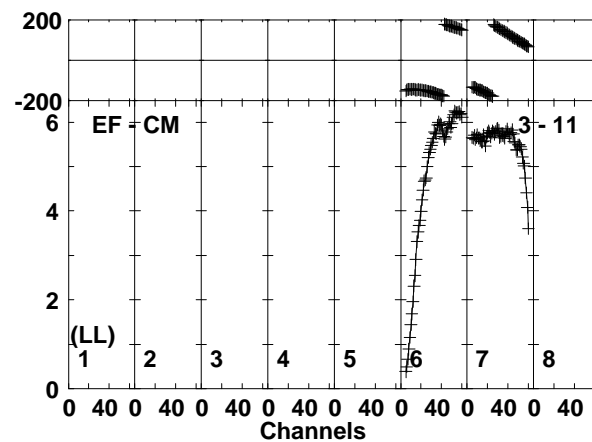
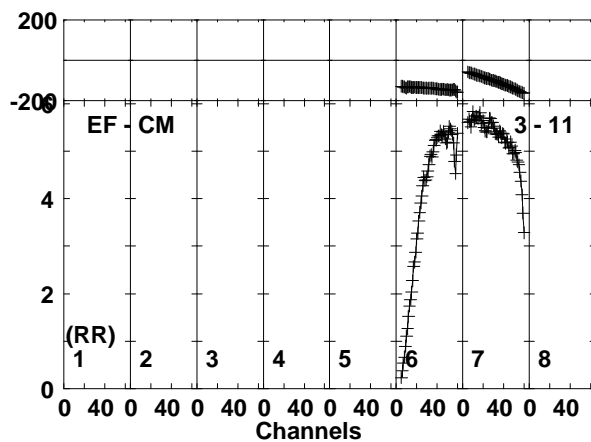
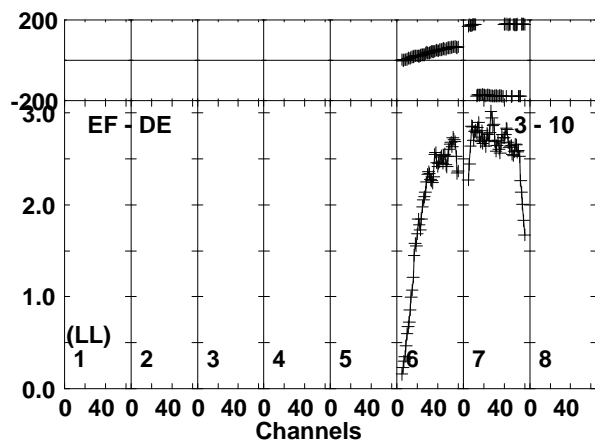
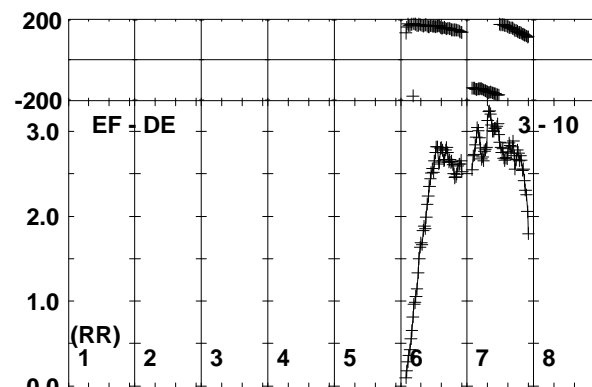
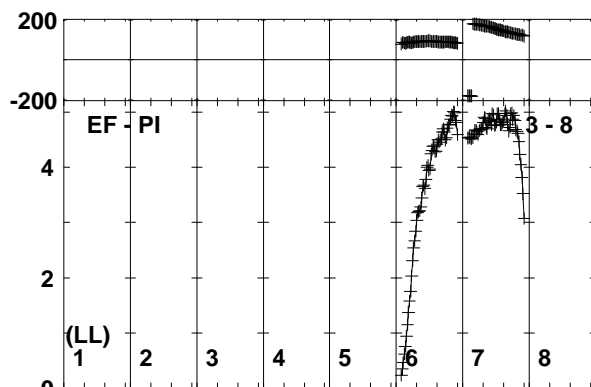
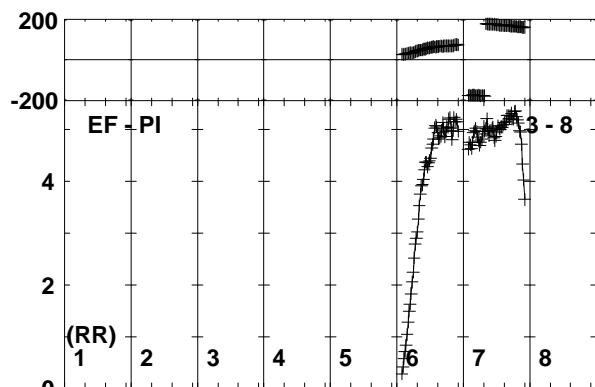
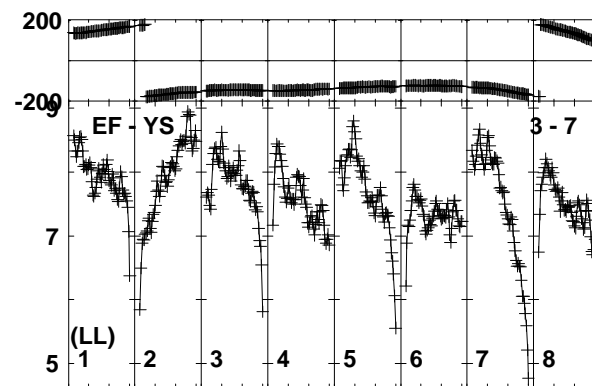
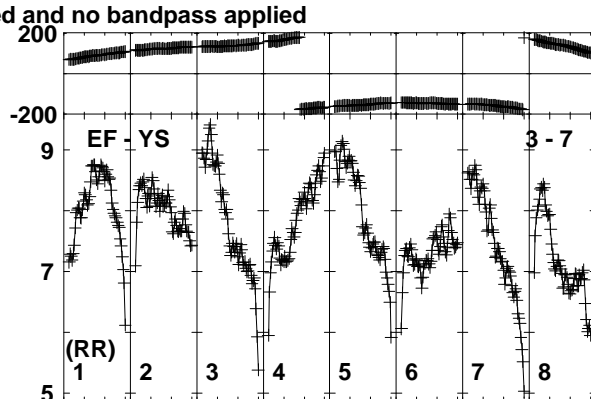
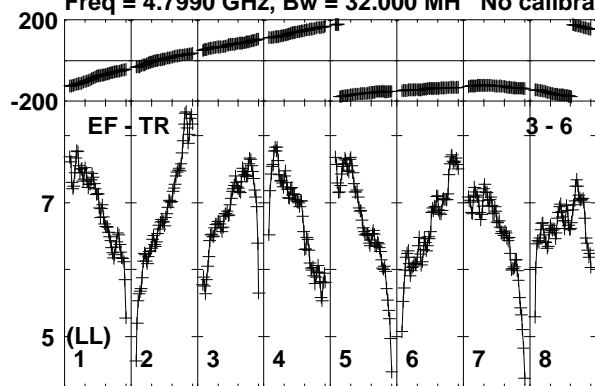

Lower frame: Milli Ampl Jy Top frame: Phas deg  
Vector averaged cross-power spectrum Baseline: EF (03) - TR (06)  
Timerange: 01/02:08:31 to 01/02:09:59

Plot file version 318 created 11-NOV-2019 15:07:52

J1826+0149 EK040B.UVDATA.1

Freq = 4.7990 GHz, Bw = 32.000 MH No calibration applied and no bandpass applied

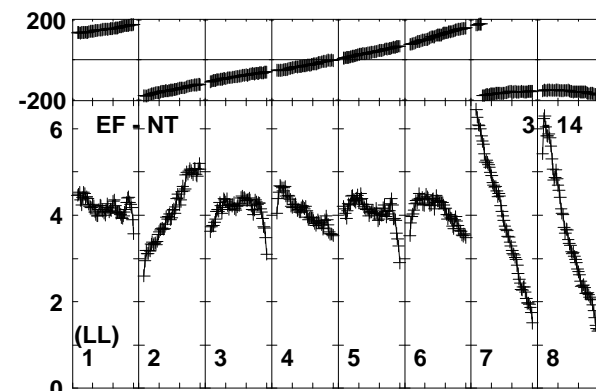
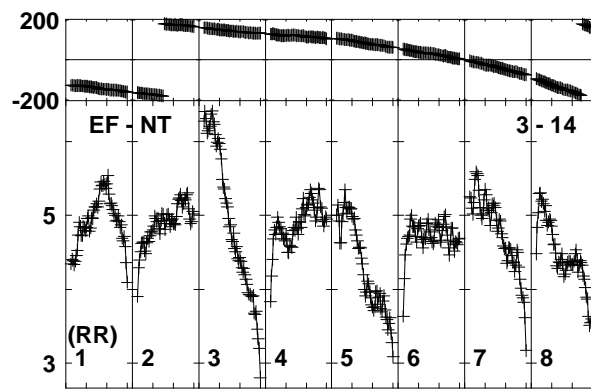
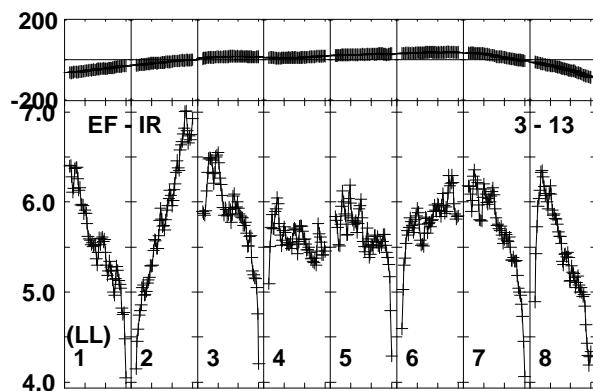
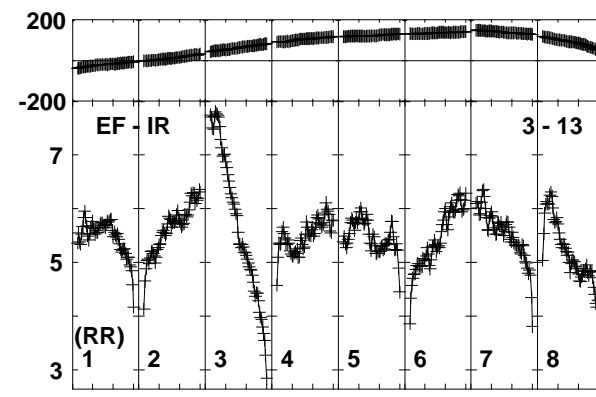
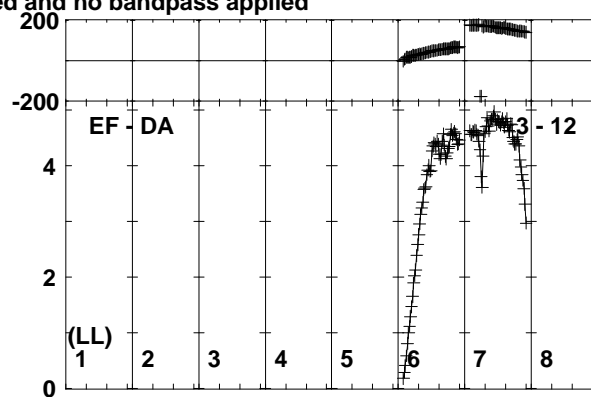
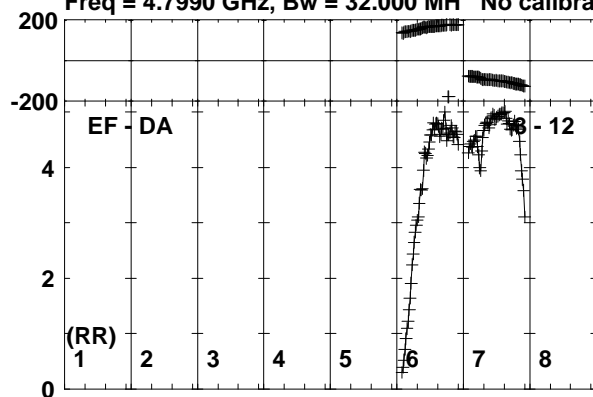

Channels

Lower frame: Milli Ampl Jy Top frame: Phas deg  
Vector averaged cross-power spectrum Baseline: EF (03) - DA (12)  
Timerange: 01/02:08:31 to 01/02:09:59

Plot file version 319 created 11-NOV-2019 15:07:52

SER8NJ EK040B.UVDATA.1

Freq = 4.7990 GHz, Bw = 32.000 MH No calibration applied and no bandpass applied

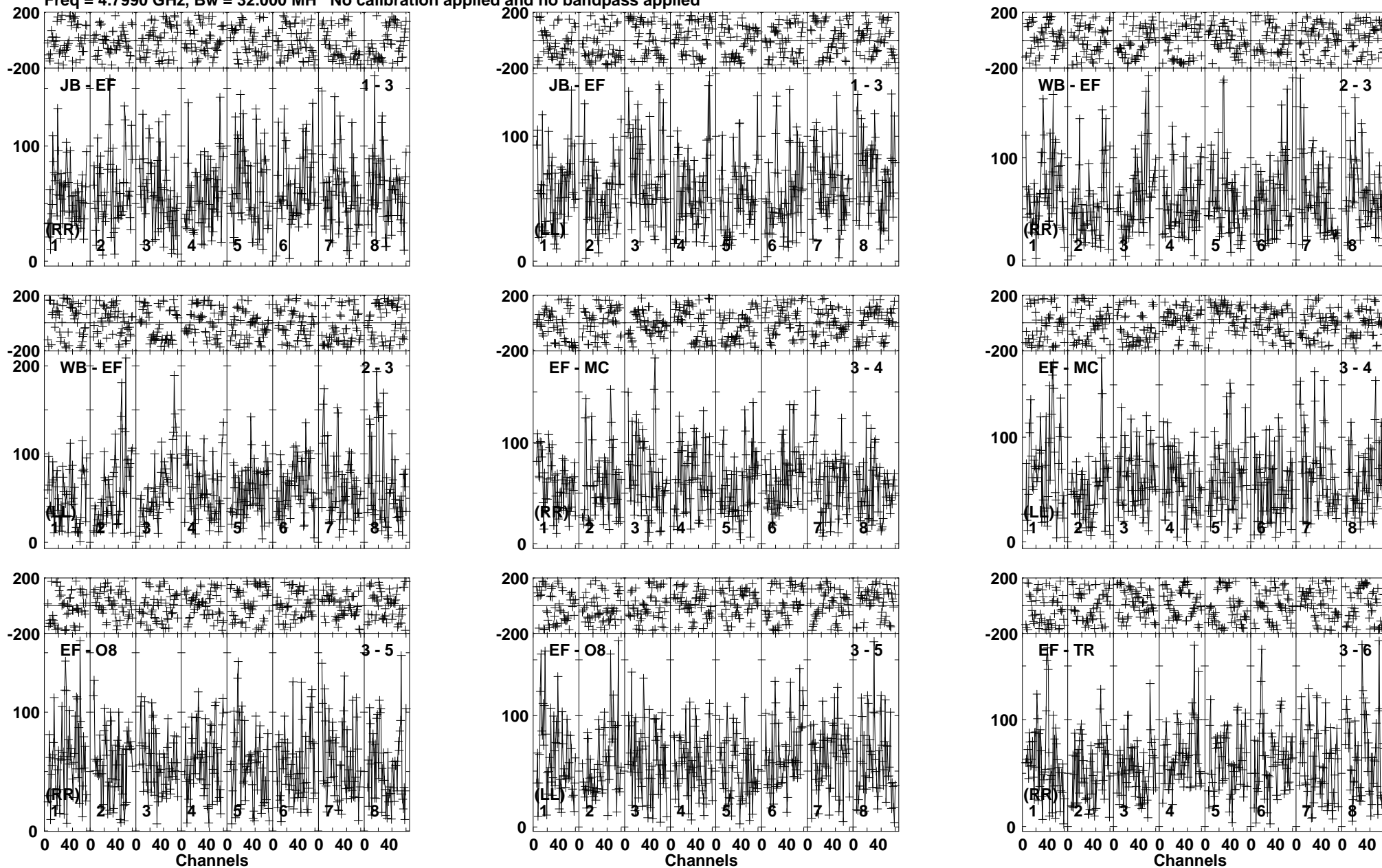

Lower frame: Micro Ampl Jy Top frame: Phas deg  
Vector averaged cross-power spectrum Baseline: JB (01) - EF (03)  
Timerange: 01/02:10:03 to 01/02:13:59

Plot file version 320 created 11-NOV-2019 15:07:53

SER8NJ EK040B.UVDATA.1

Freq = 4.7990 GHz, Bw = 32.000 MH No calibration applied and no bandpass applied

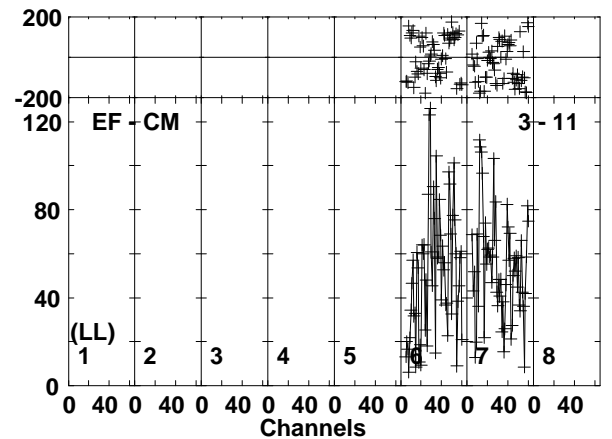
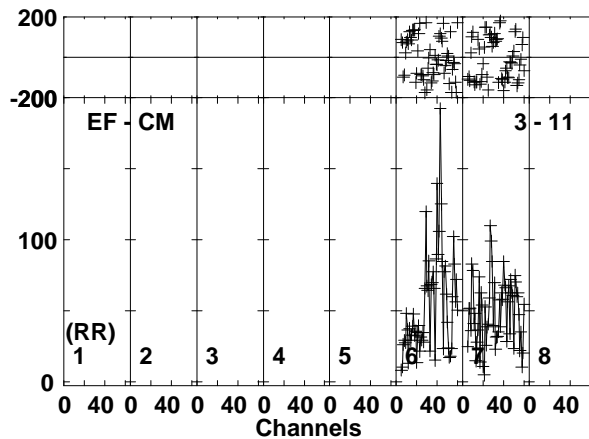
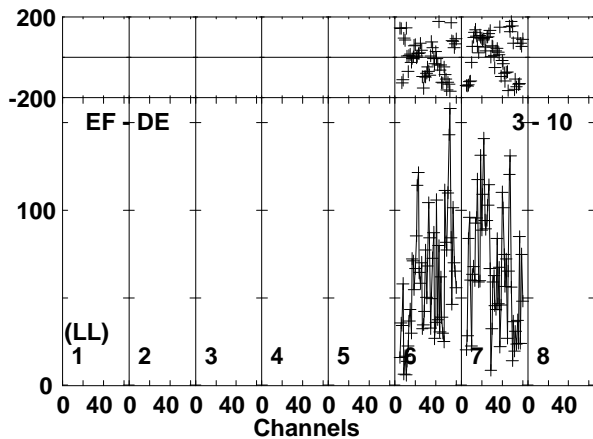
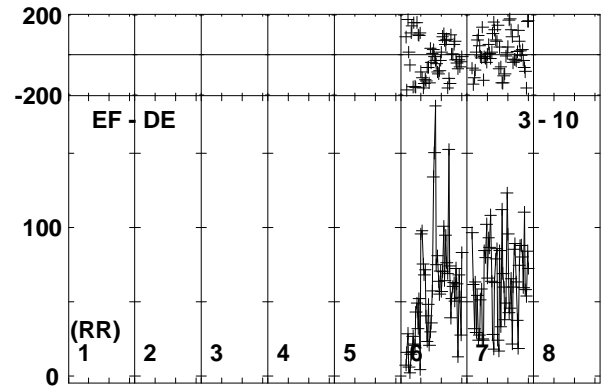
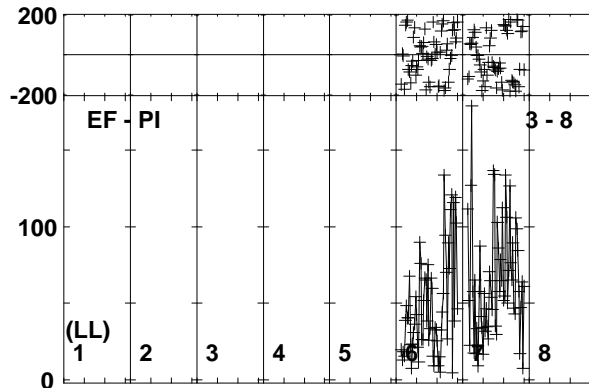
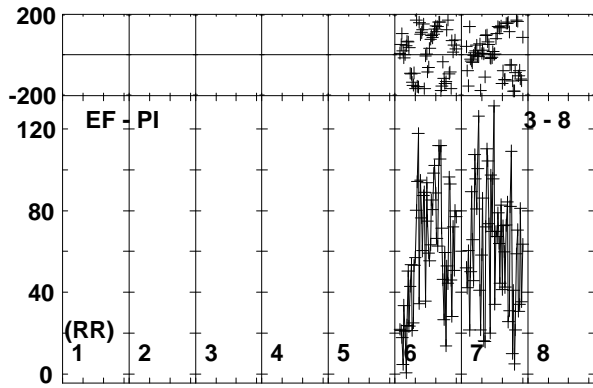
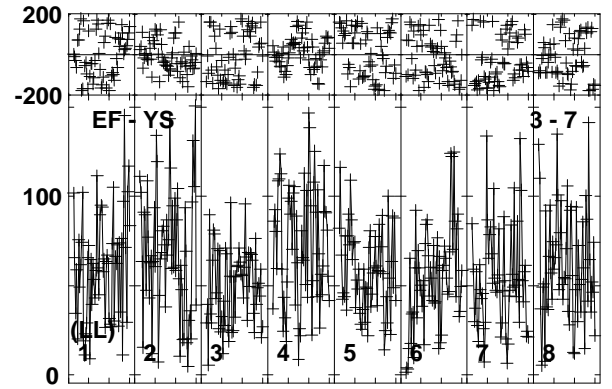
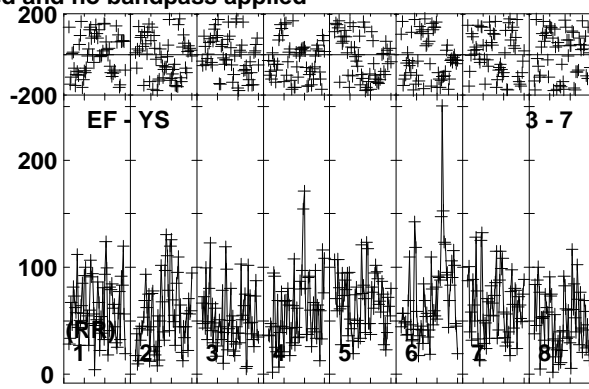
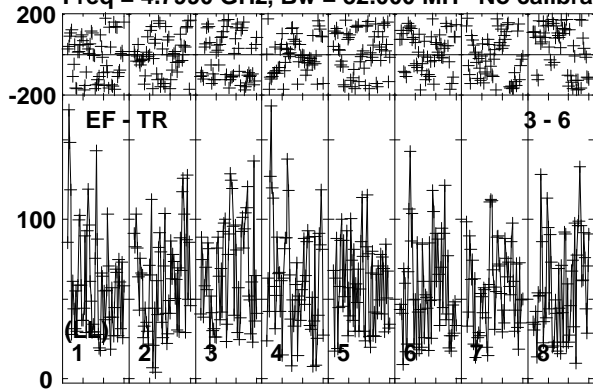

Lower frame: Micro Ampl Jy Top frame: Phas deg  
Vector averaged cross-power spectrum Baseline: EF (03) - TR (06)  
Timerange: 01/02:10:03 to 01/02:13:59

Plot file version 321 created 11-NOV-2019 15:07:53

SER8NJ EK040B.UVDATA.1

Freq = 4.7990 GHz, Bw = 32.000 MH No calibration applied and no bandpass applied

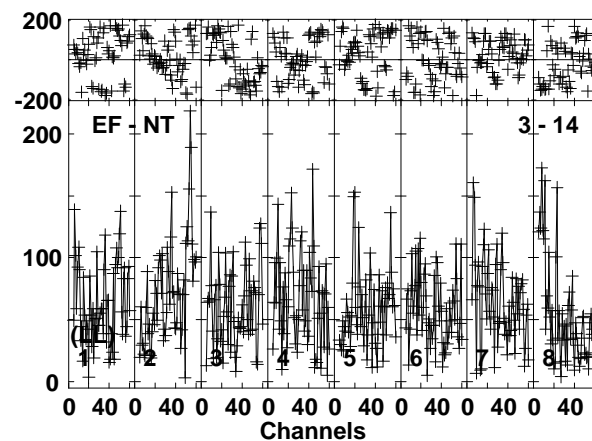
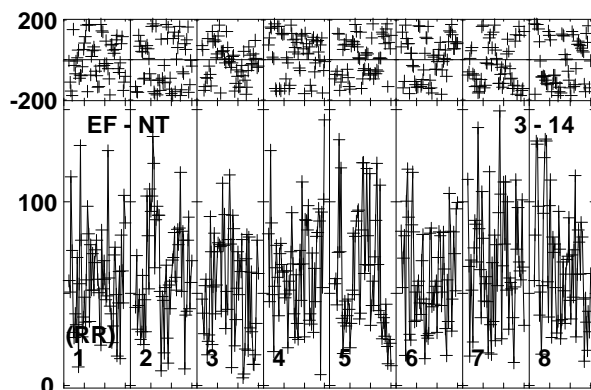
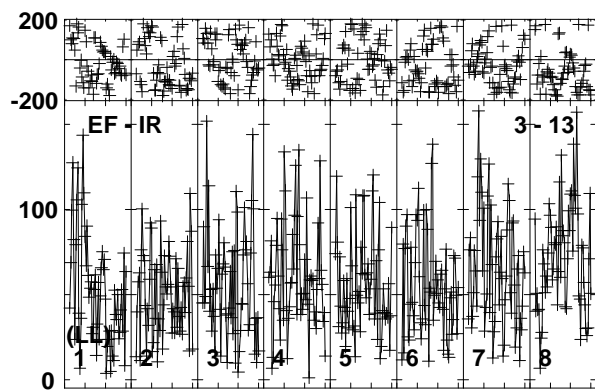
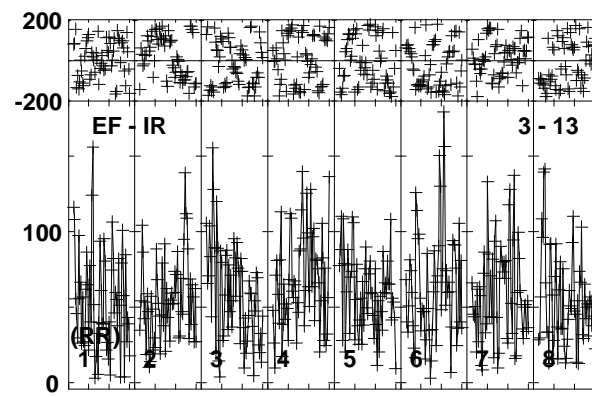
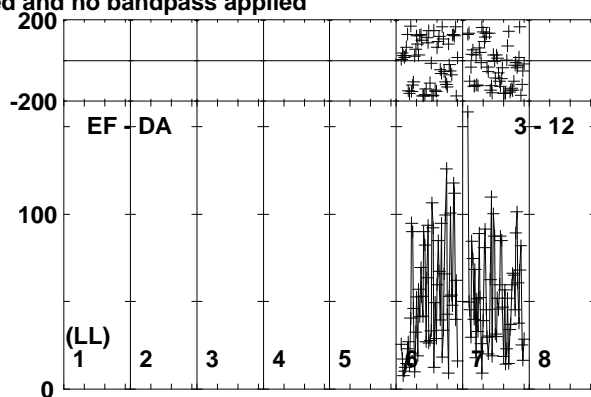
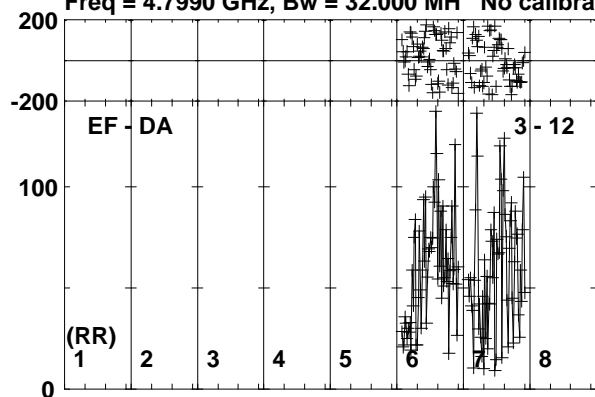

Lower frame: Micro Ampl Jy Top frame: Phas deg  
Vector averaged cross-power spectrum Baseline: EF (03) - DA (12)  
Timerange: 01/02:10:03 to 01/02:13:59

Plot file version 322 created 11-NOV-2019 15:07:53

J1826+0149 EK040B.UVDATA.1

Freq = 4.7990 GHz, Bw = 32.000 MH No calibration applied and no bandpass applied

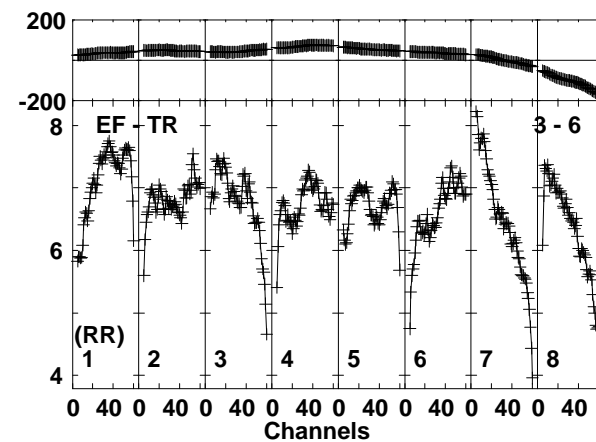
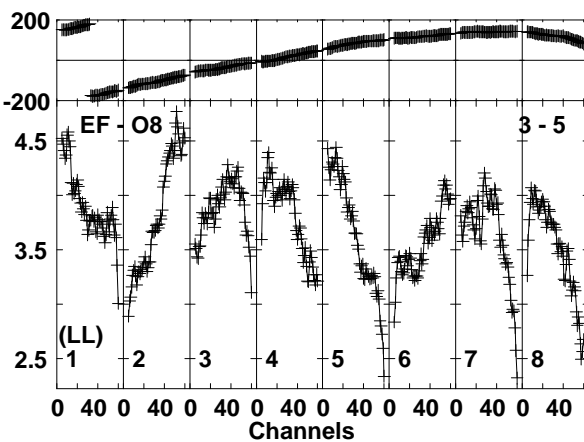
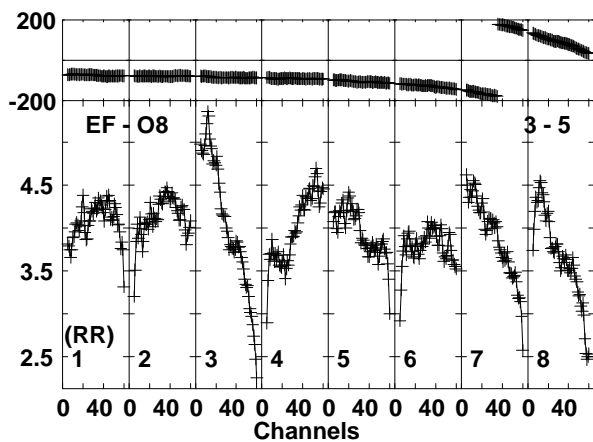
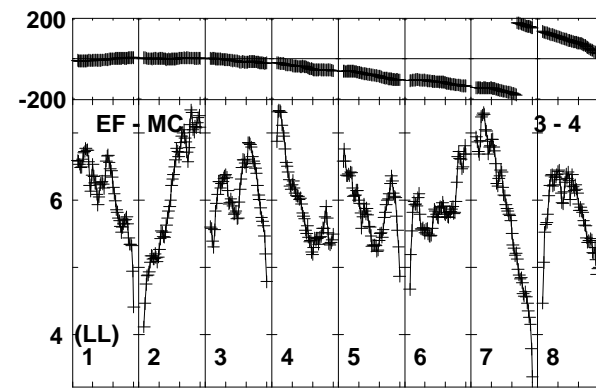
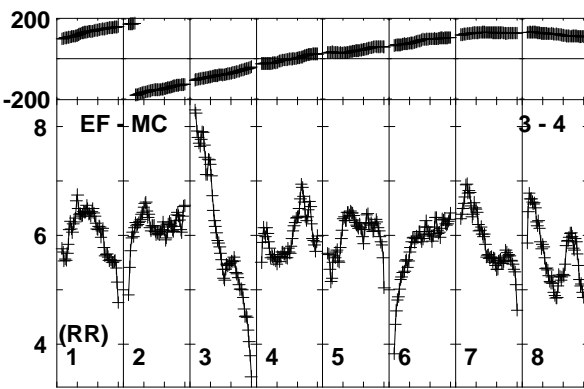
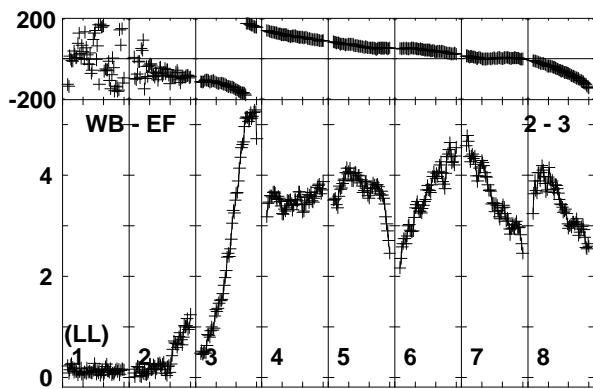
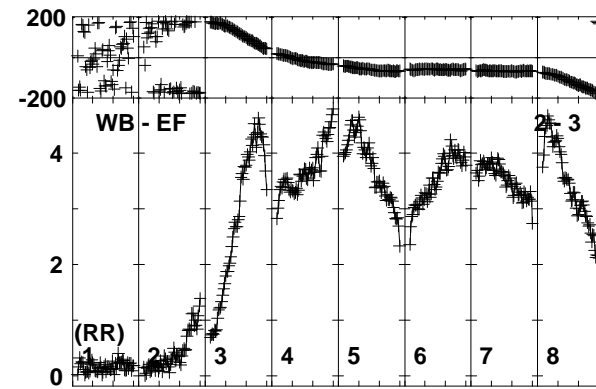
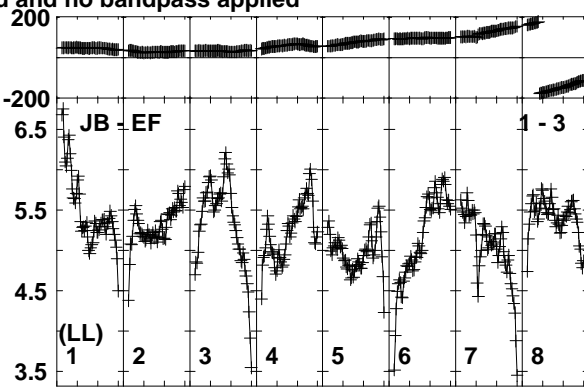
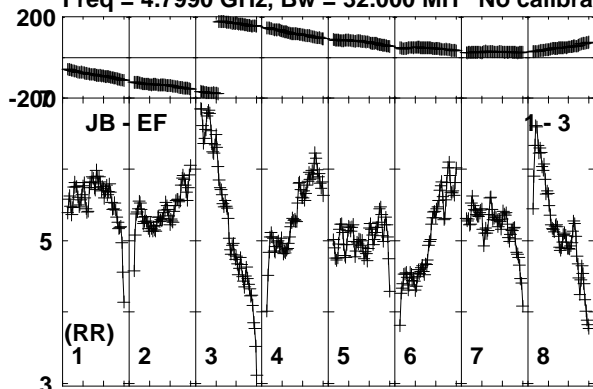

Lower frame: Milli Ampl Jy Top frame: Phas deg  
Vector averaged cross-power spectrum Baseline: JB (01) - EF (03)  
Timerange: 01/02:14:41 to 01/02:15:39



Plot file version 323 created 11-NOV-2019 15:07:53

J1826+0149 EK040B.UVDATA.1

Freq = 4.7990 GHz, Bw = 32.000 MH No calibration applied and no bandpass applied

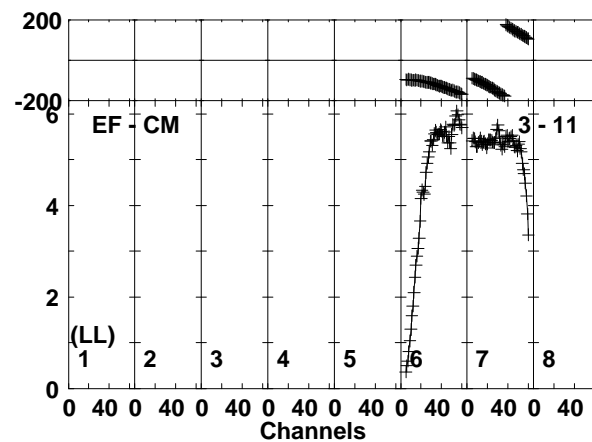
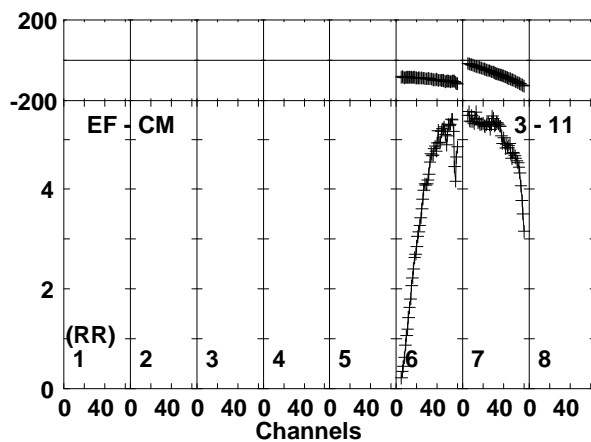
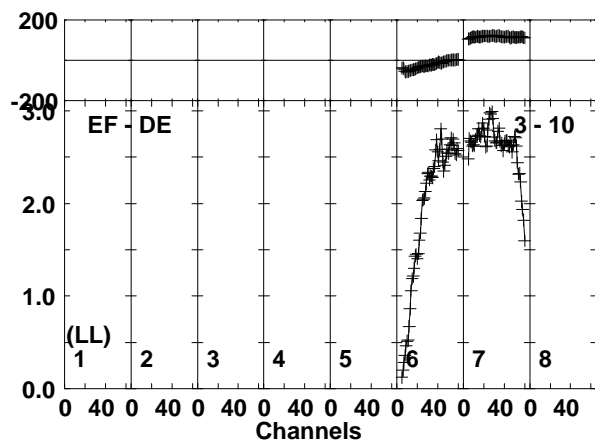
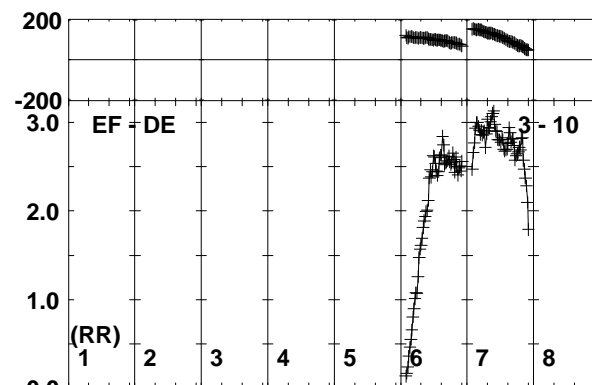
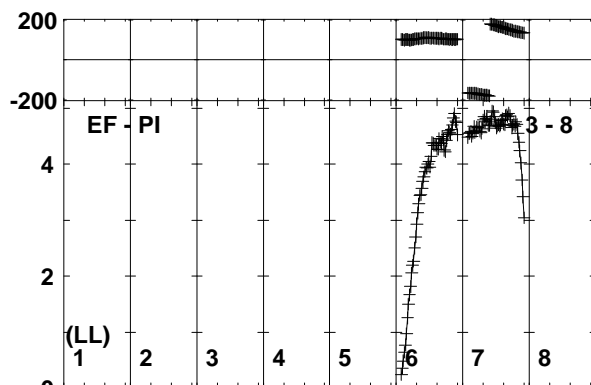
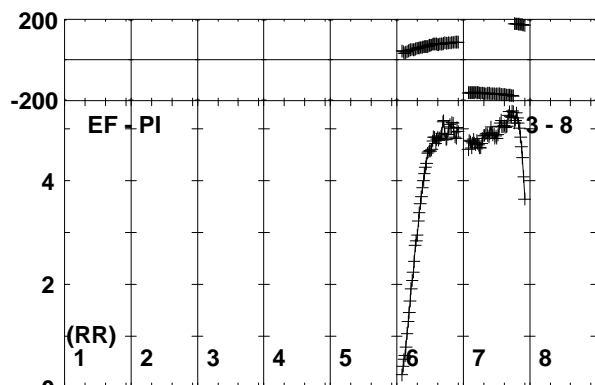
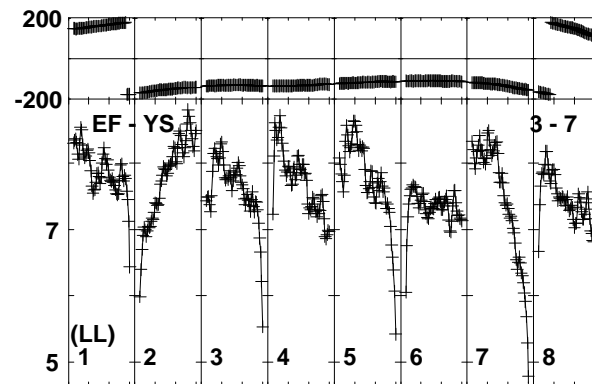
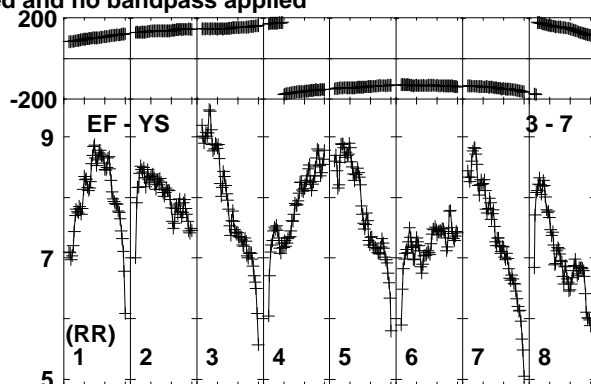
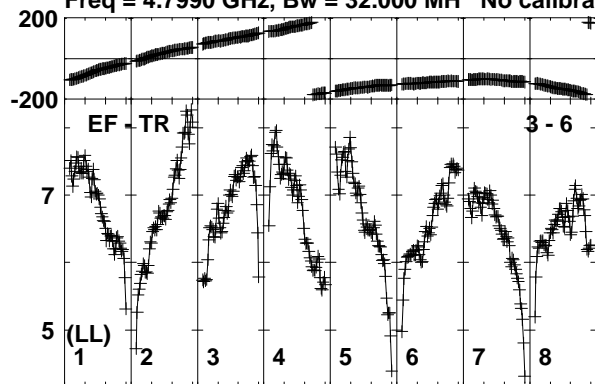

Lower frame: Milli Ampl Jy Top frame: Phas deg  
Vector averaged cross-power spectrum Baseline: EF (03) - TR (06)  
Timerange: 01/02:14:41 to 01/02:15:39

Plot file version 324 created 11-NOV-2019 15:07:53

J1826+0149 EK040B.UVDATA.1

Freq = 4.7990 GHz, Bw = 32.000 MH No calibration applied and no bandpass applied

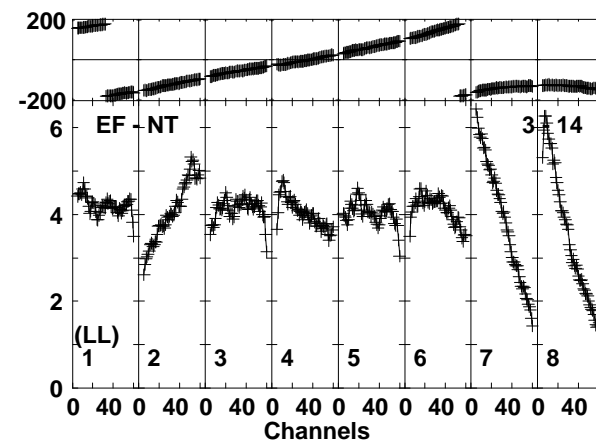
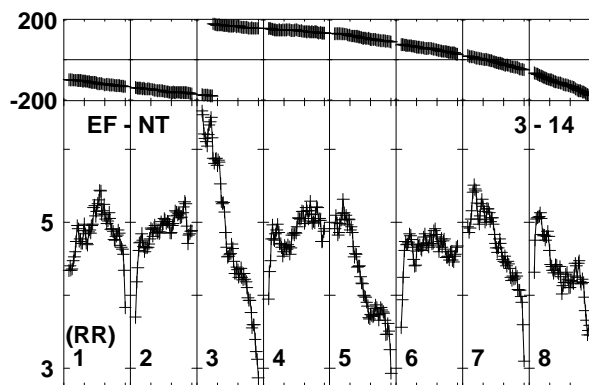
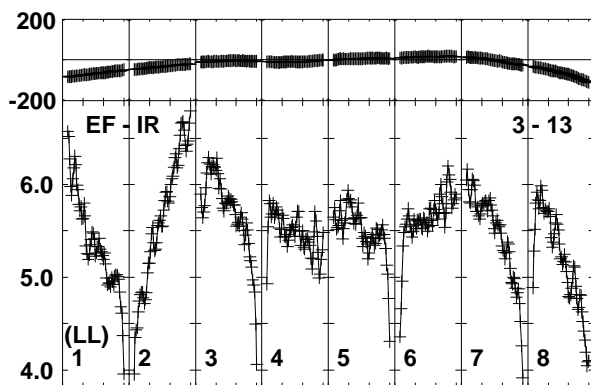
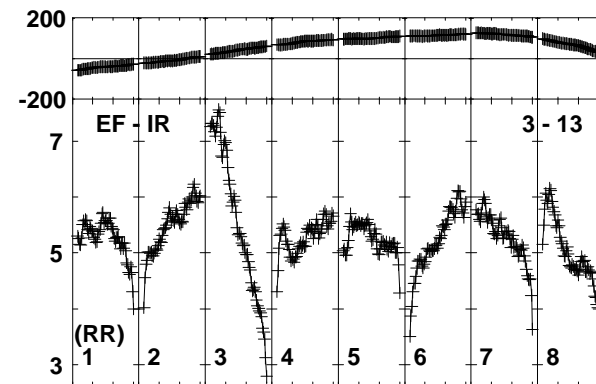
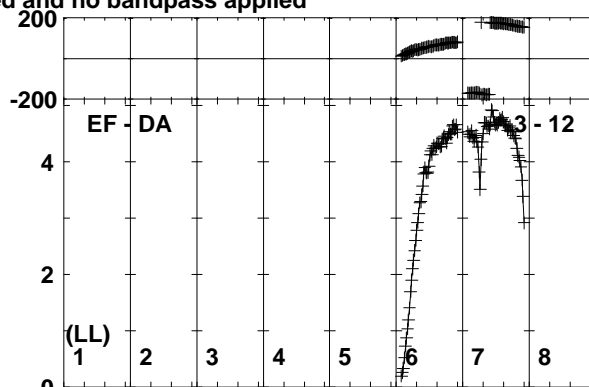
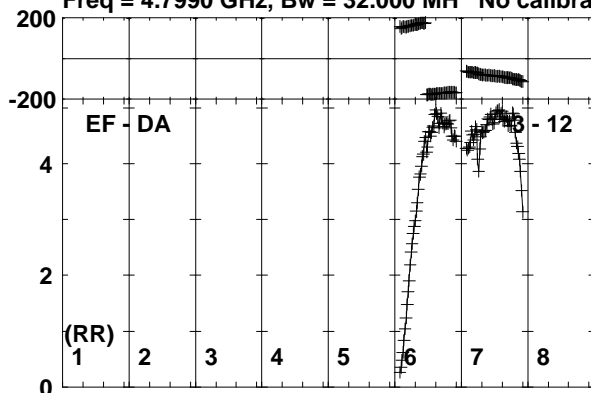

Lower frame: Milli Ampl Jy Top frame: Phas deg  
Vector averaged cross-power spectrum Baseline: EF (03) - DA (12)  
Timerange: 01/02:14:41 to 01/02:15:39

Plot file version 325 created 11-NOV-2019 15:07:53

SER8NJ EK040B.UVDATA.1

Freq = 4.7990 GHz, Bw = 32.000 MH No calibration applied and no bandpass applied

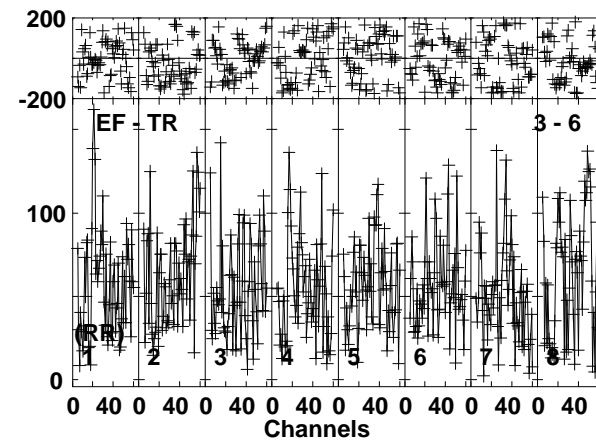
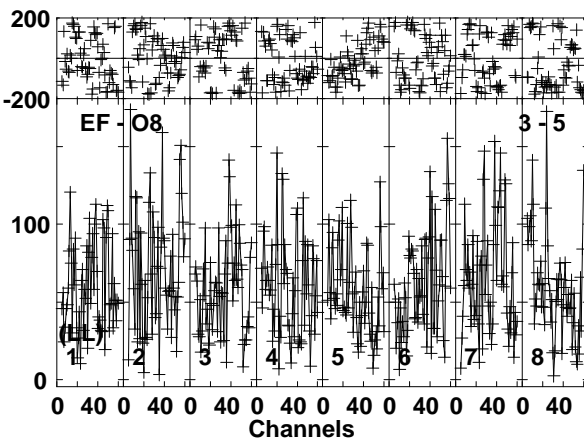
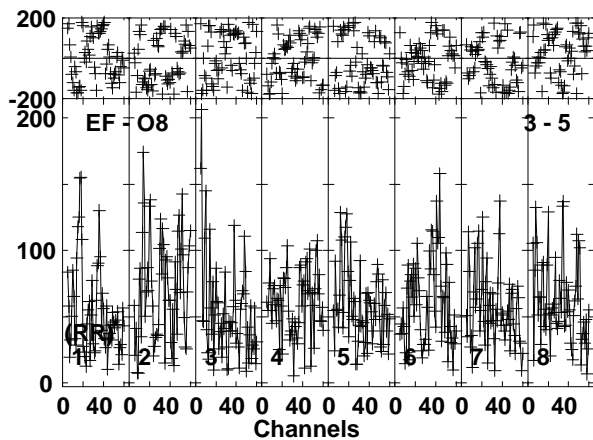
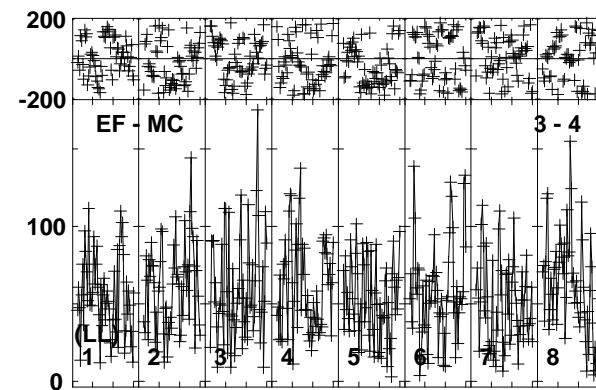
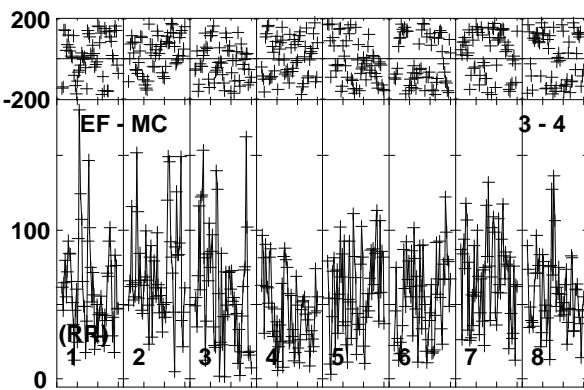
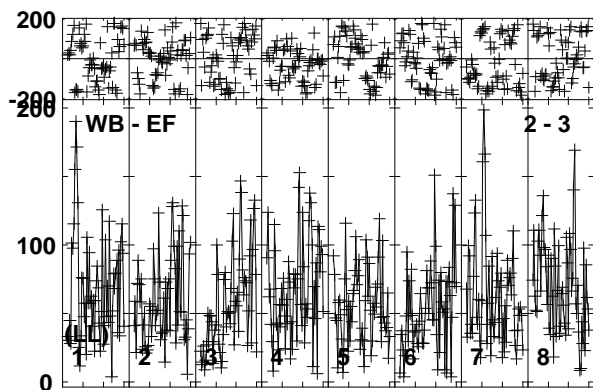
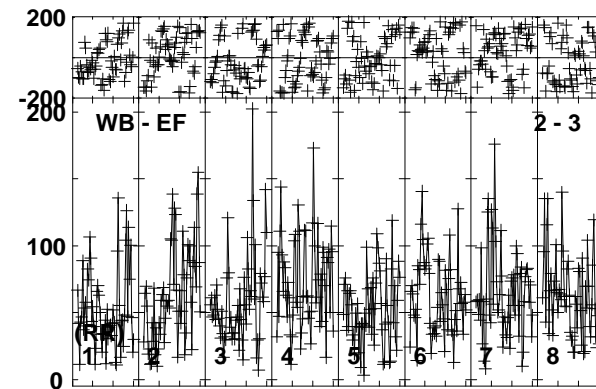
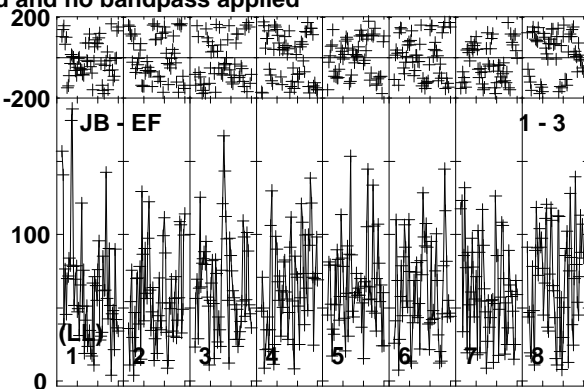
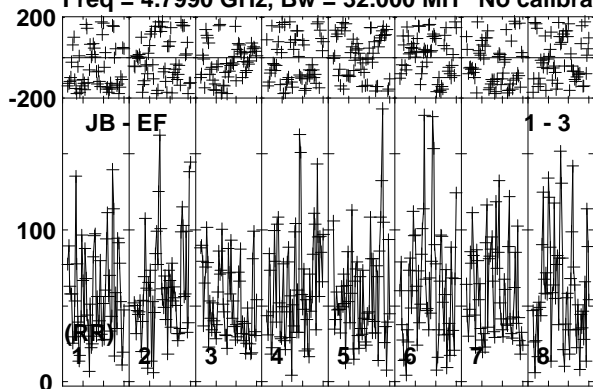

Lower frame: Micro Ampl Jy Top frame: Phas deg  
Vector averaged cross-power spectrum Baseline: JB (01) - EF (03)  
Timerange: 01/02:15:43 to 01/02:19:39

Plot file version 326 created 11-NOV-2019 15:07:53

SER8NJ EK040B.UVDATA.1

Freq = 4.7990 GHz, Bw = 32.000 MH No calibration applied and no bandpass applied

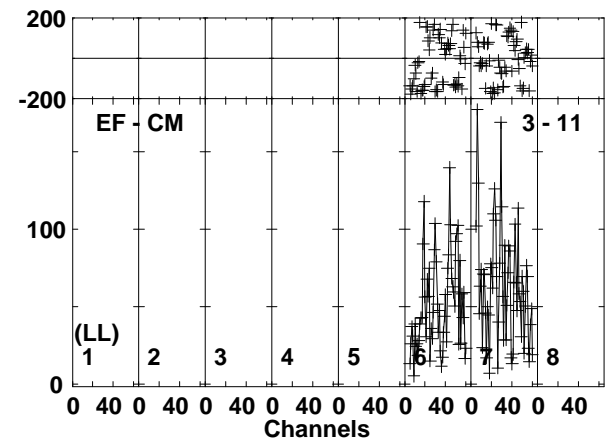
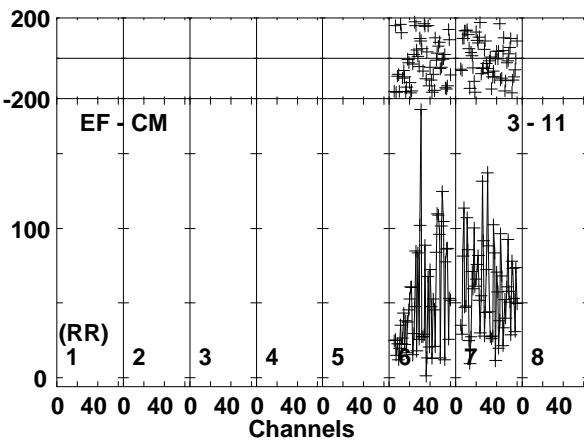
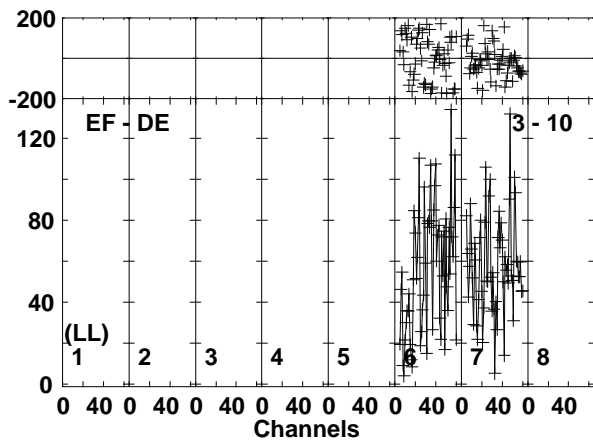
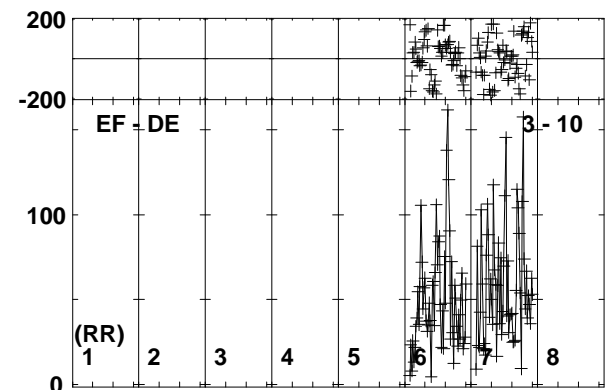
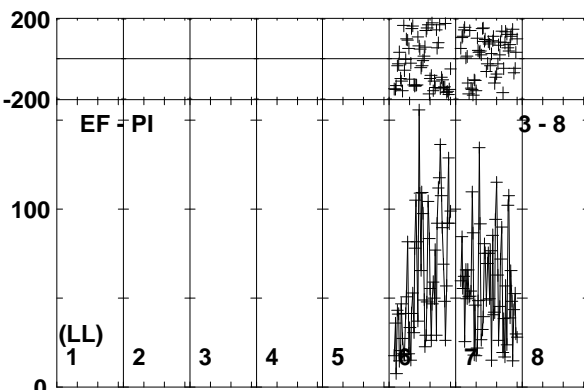
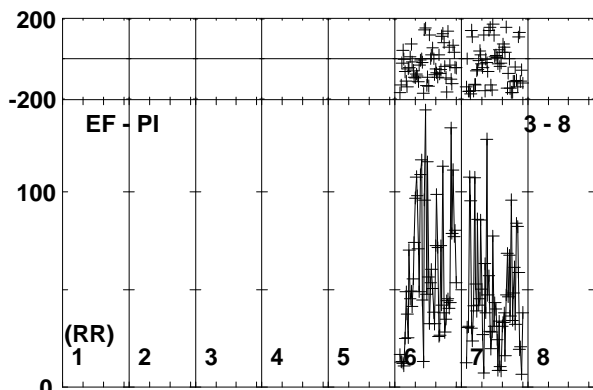
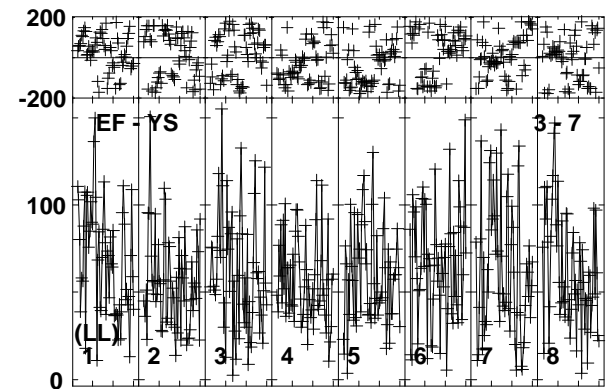
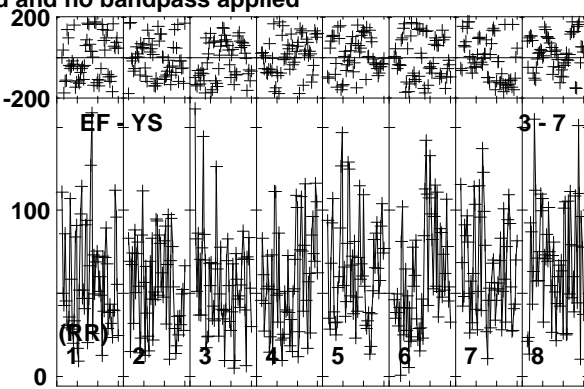
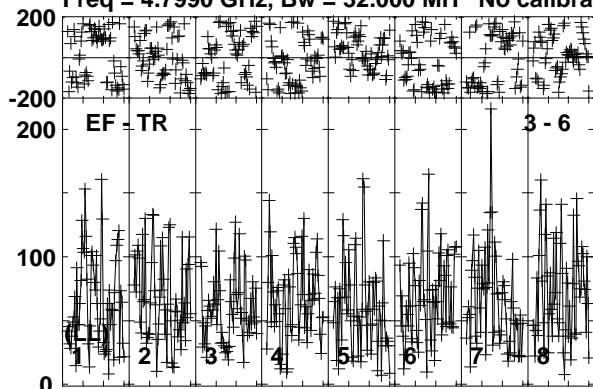

Lower frame: Micro Ampl Jy Top frame: Phas deg  
Vector averaged cross-power spectrum Baseline: EF (03) - TR (06)  
Timerange: 01/02:15:43 to 01/02:19:39

Plot file version 327 created 11-NOV-2019 15:07:53

SER8NJ EK040B.UVDATA.1

Freq = 4.7990 GHz, Bw = 32.000 MH No calibration applied and no bandpass applied

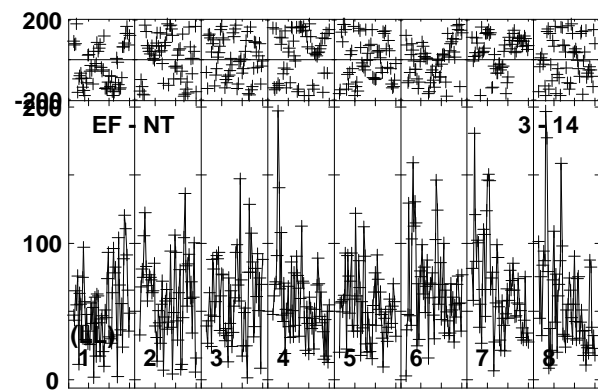
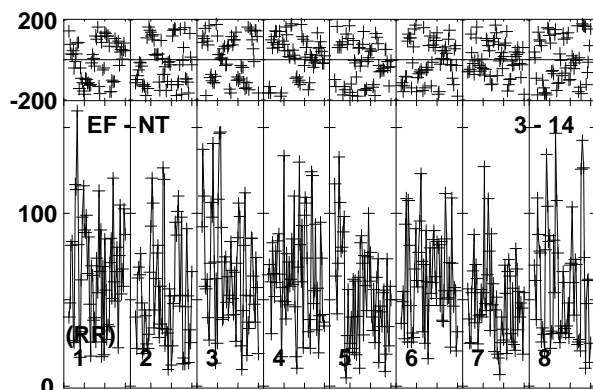
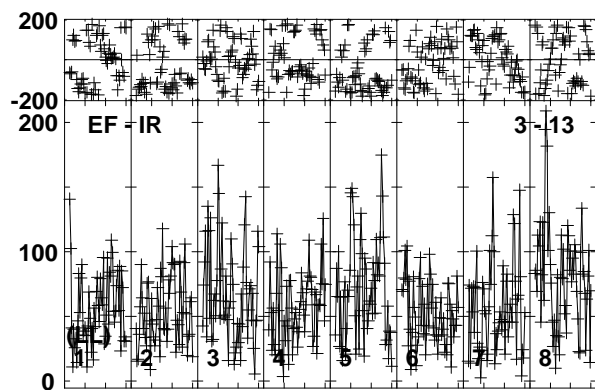
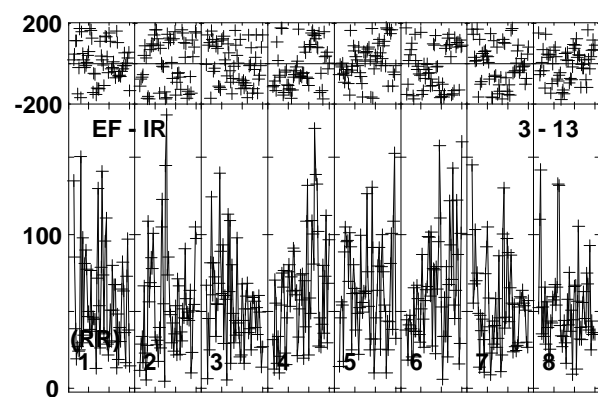
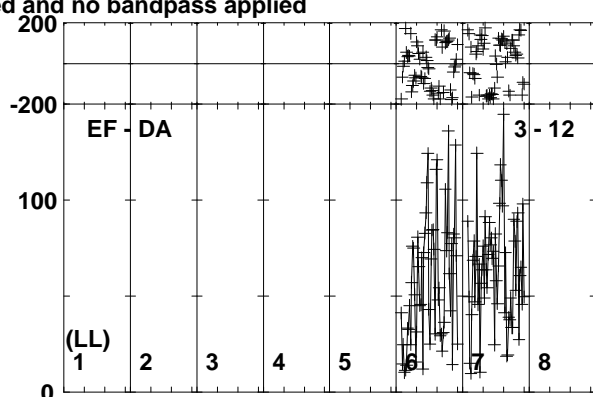
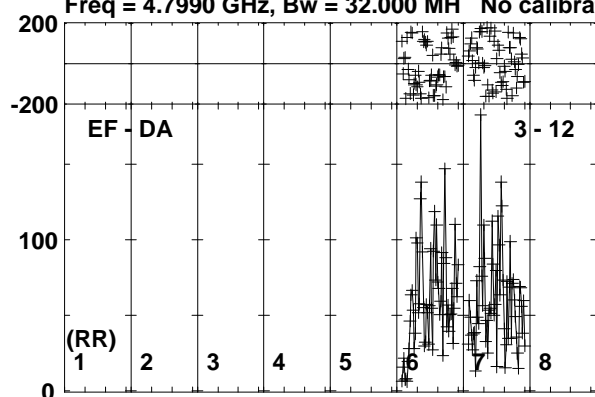

0 40 0 40 0 40 0 40 0 40 0 40 0 40 0 40 0 40  
Channels

Lower frame: Micro Ampl Jy Top frame: Phas deg  
Vector averaged cross-power spectrum Baseline: EF (03) - DA (12)  
Timerange: 01/02:15:43 to 01/02:19:39

Plot file version 328 created 11-NOV-2019 15:07:53

J1826+0149 EK040B.UVDATA.1

Freq = 4.7990 GHz, Bw = 32.000 MH No calibration applied and no bandpass applied

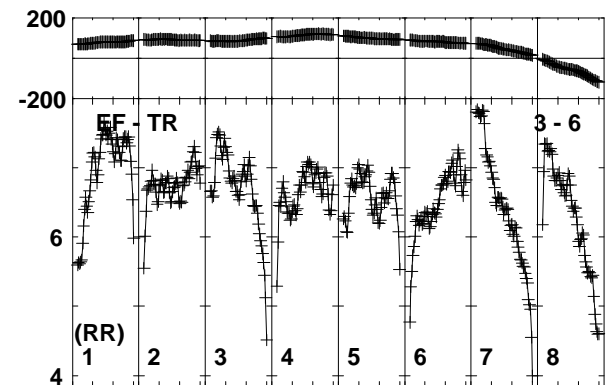
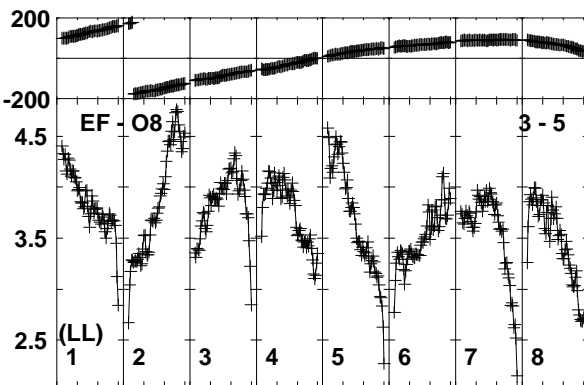
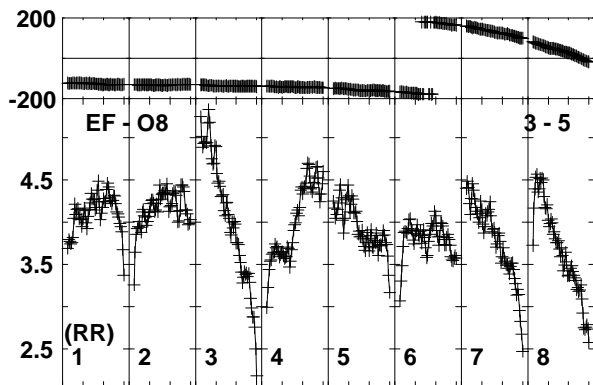
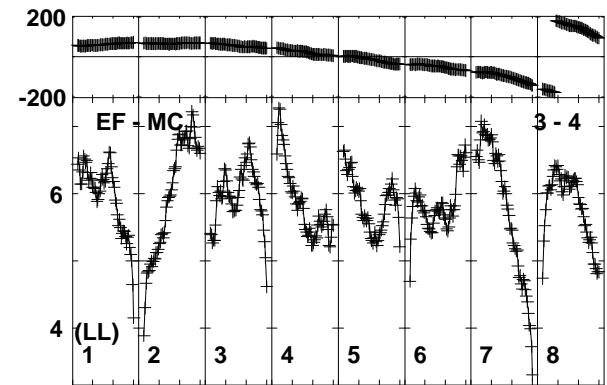
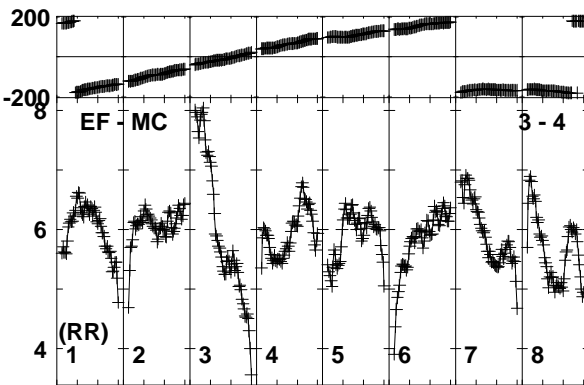
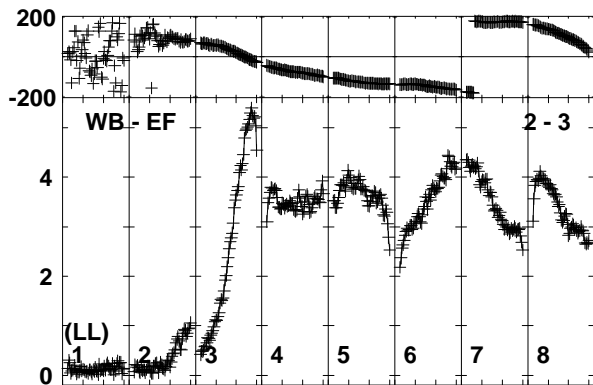
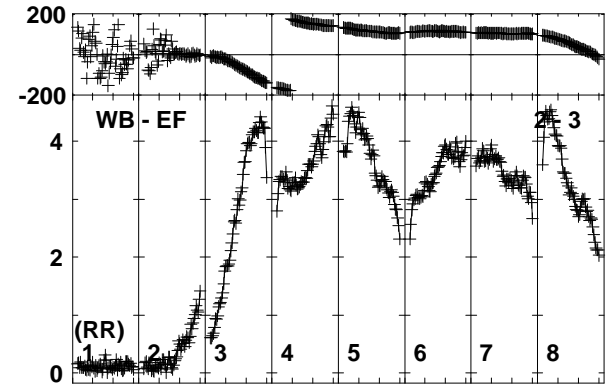
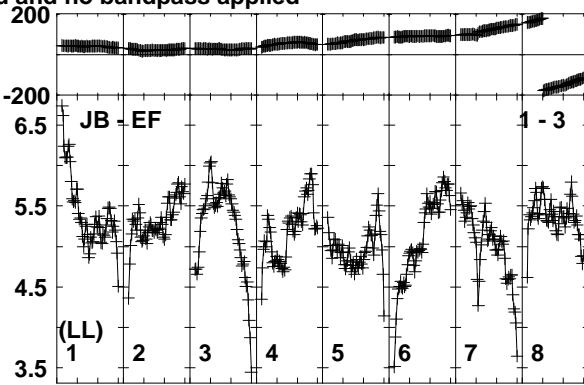
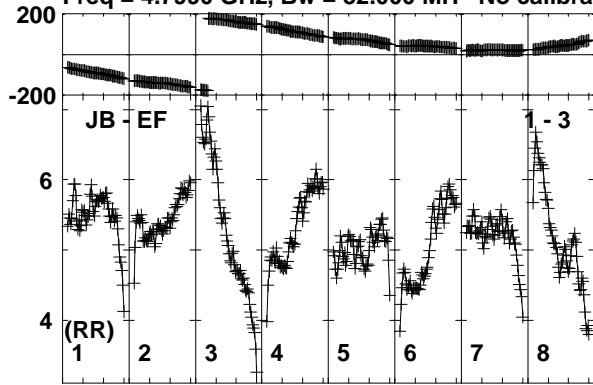

Lower frame: Milli Ampl Jy Top frame: Phas deg  
Vector averaged cross-power spectrum Baseline: JB (01) - EF (03)  
Timerange: 01/02:19:43 to 01/02:21:09

Plot file version 329 created 11-NOV-2019 15:07:54

J1826+0149 EK040B.UVDATA.1

Freq = 4.7990 GHz, Bw = 32.000 MH No calibration applied and no bandpass applied

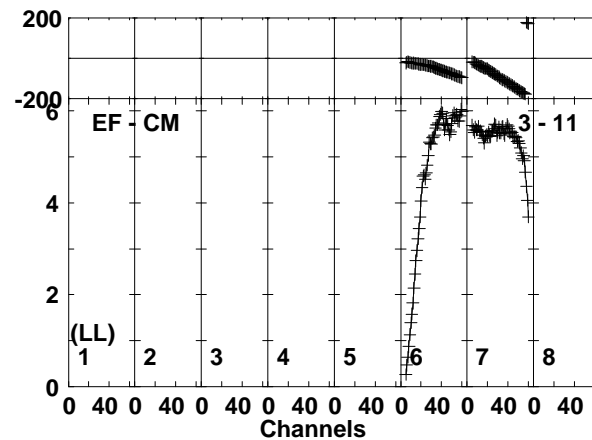
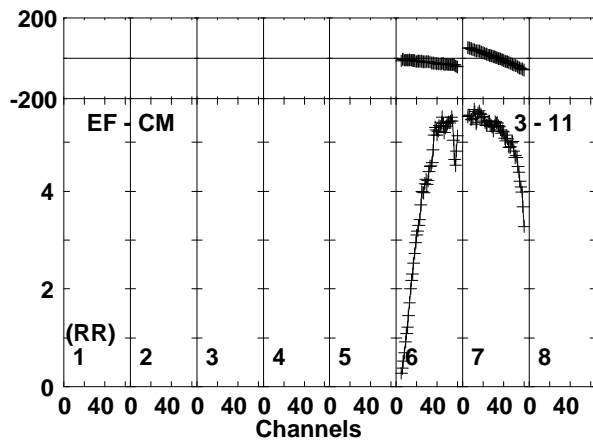
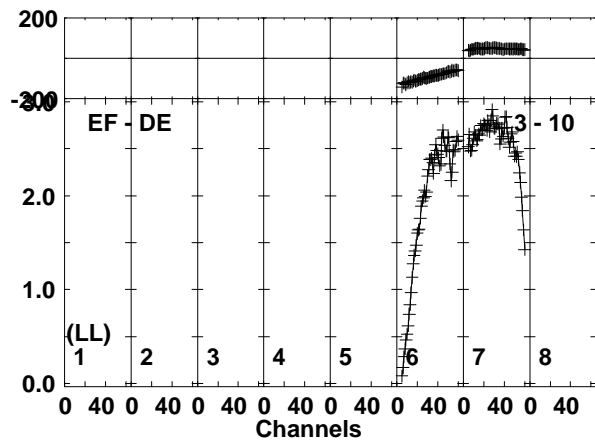
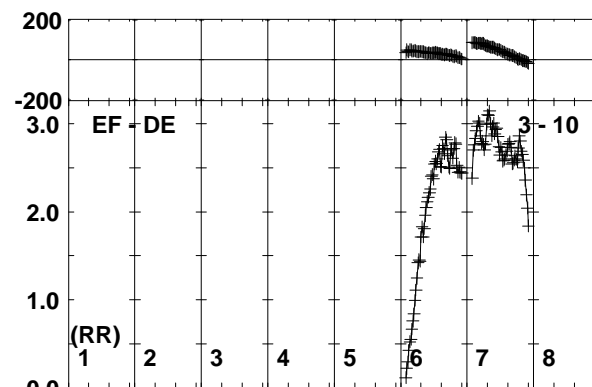
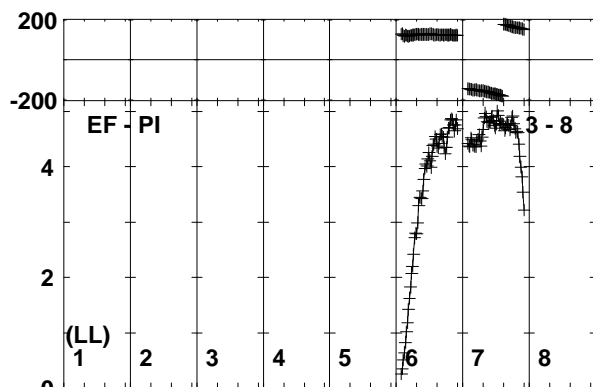
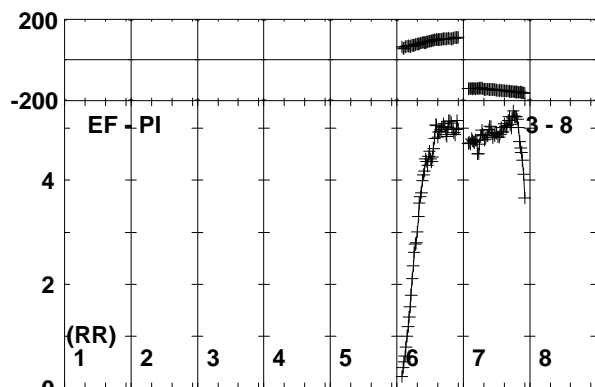
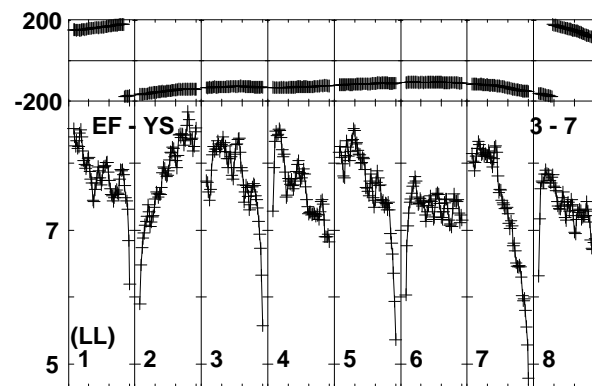
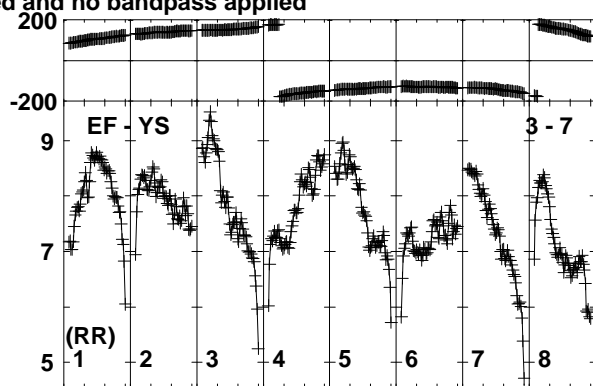
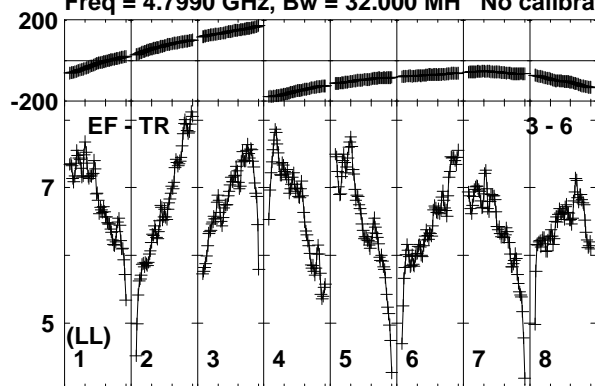

Lower frame: Milli Ampl Jy Top frame: Phas deg  
Vector averaged cross-power spectrum Baseline: EF (03) - TR (06)  
Timerange: 01/02:19:43 to 01/02:21:09

Plot file version 330 created 11-NOV-2019 15:07:54

J1826+0149 EK040B.UVDATA.1

Freq = 4.7990 GHz, Bw = 32.000 MH No calibration applied and no bandpass applied

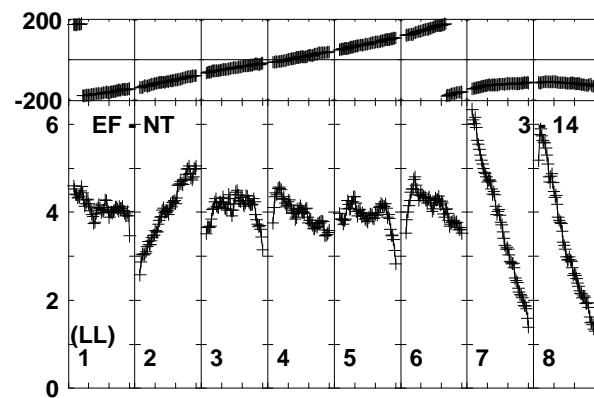
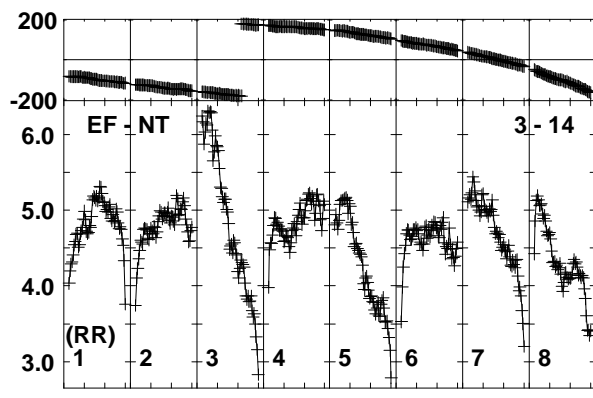
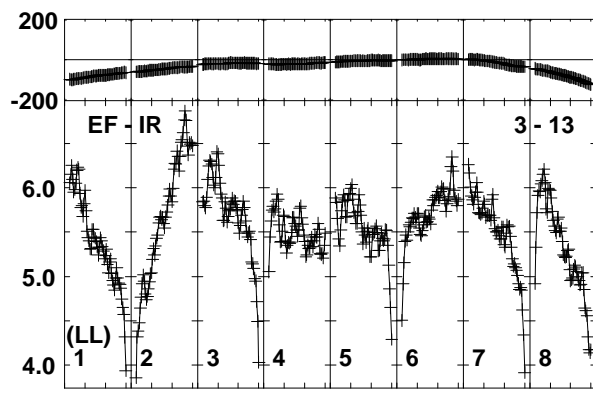
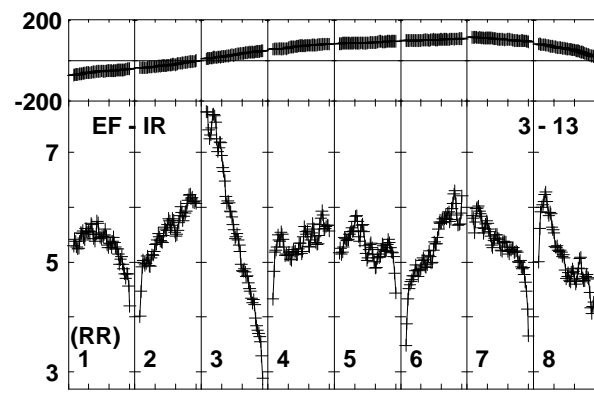
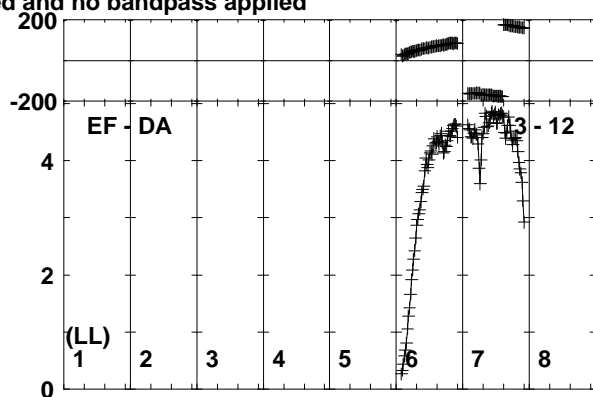
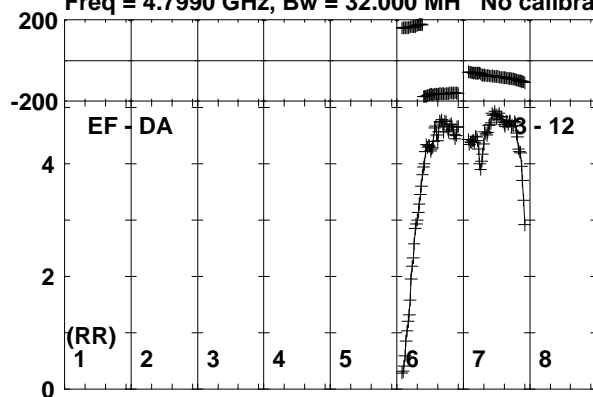

Lower frame: Milli Ampl Jy Top frame: Phas deg  
Vector averaged cross-power spectrum Baseline: EF (03) - DA (12)  
Timerange: 01/02:19:43 to 01/02:21:09



Plot file version 331 created 11-NOV-2019 15:07:54

SER8NJ EK040B.UVDATA.1

Freq = 4.7990 GHz, Bw = 32.000 MH No calibration applied and no bandpass applied

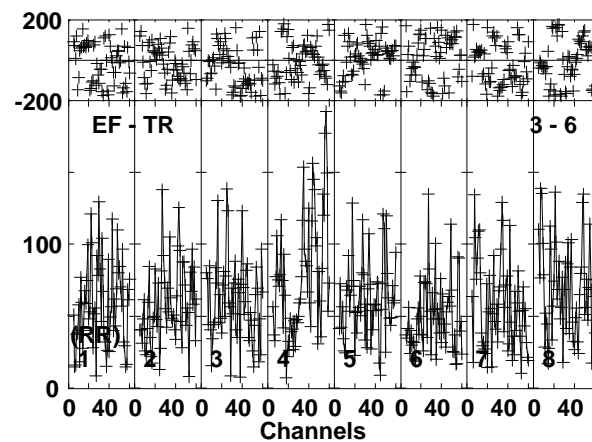
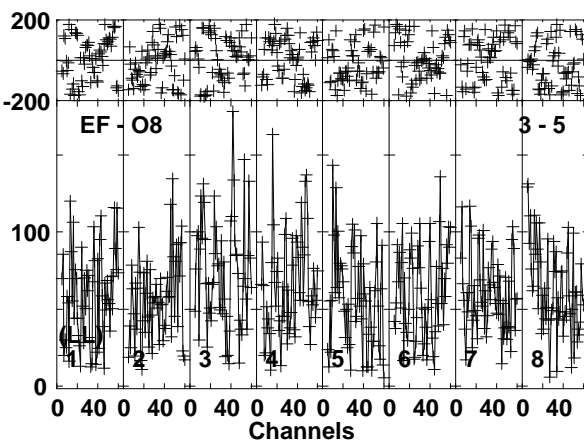
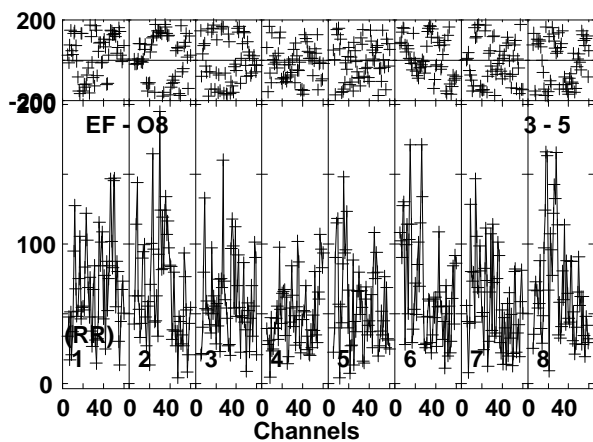
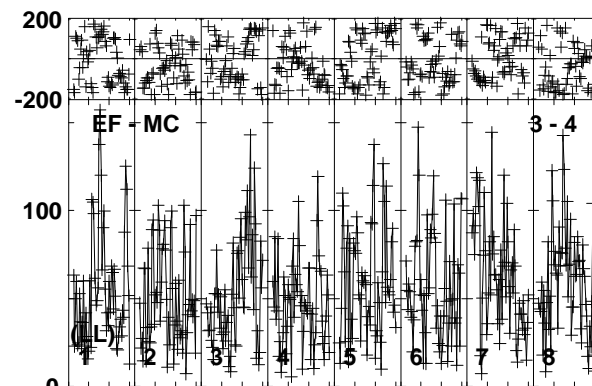
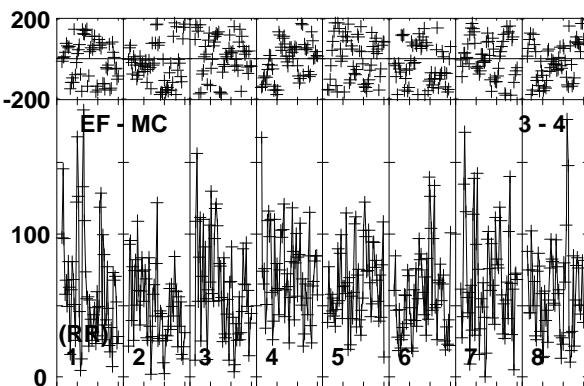
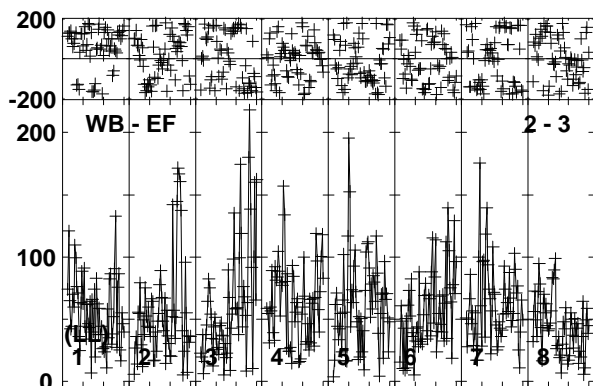
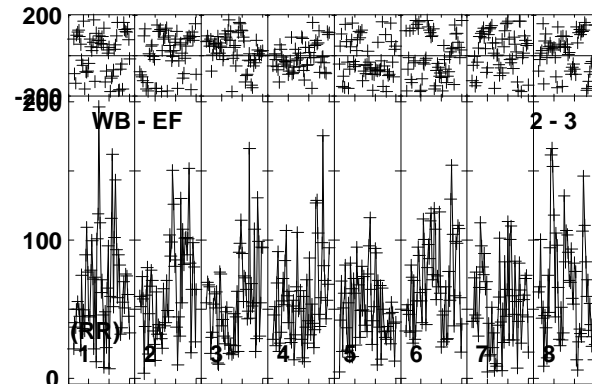
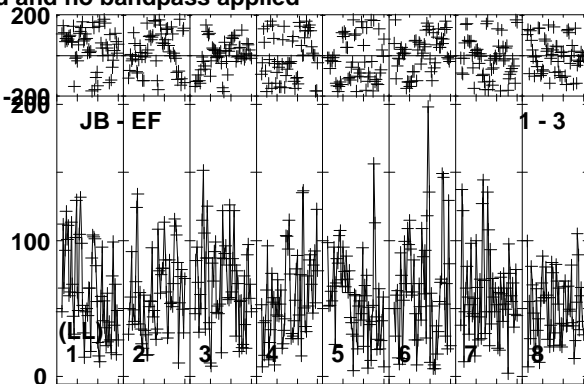
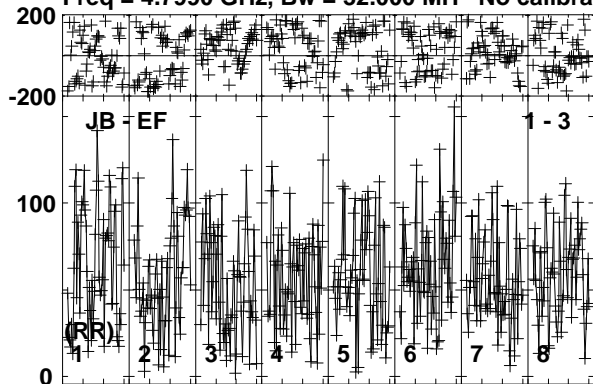

Lower frame: Micro Ampl Jy Top frame: Phas deg  
Vector averaged cross-power spectrum Baseline: JB (01) - EF (03)  
Timerange: 01/02:21:13 to 01/02:25:09

Plot file version 332 created 11-NOV-2019 15:07:54

SER8NJ EK040B.UVDATA.1

Freq = 4.7990 GHz, Bw = 32.000 MH No calibration applied and no bandpass applied

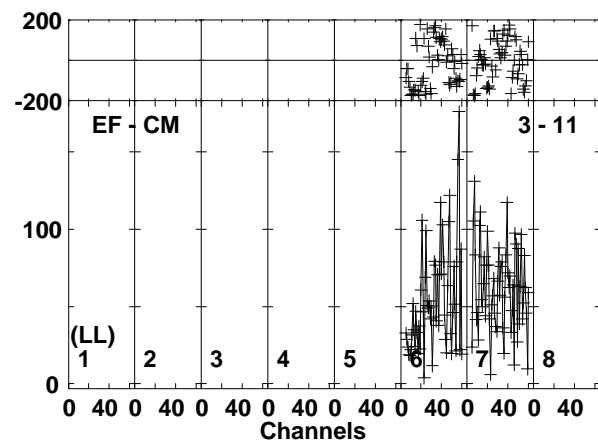
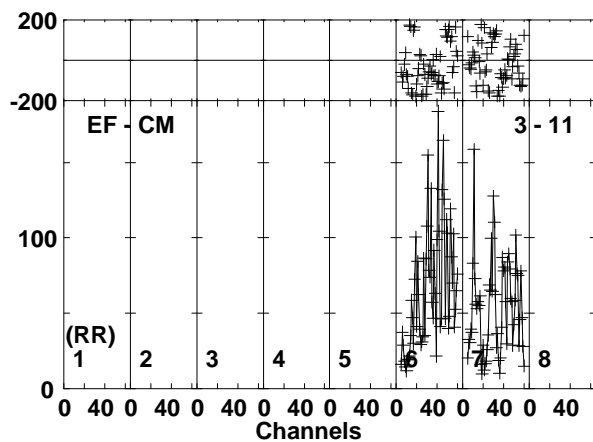
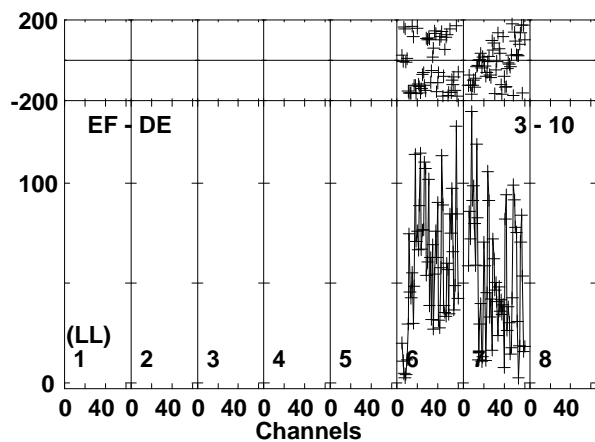
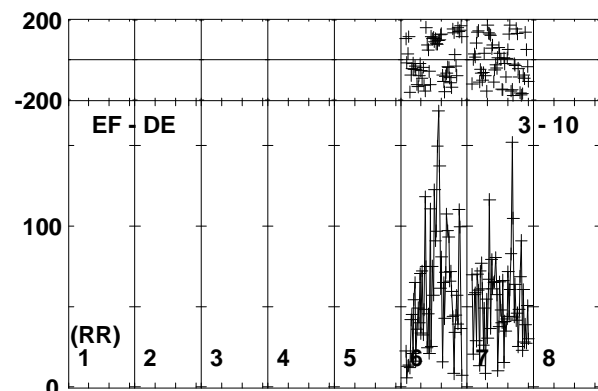
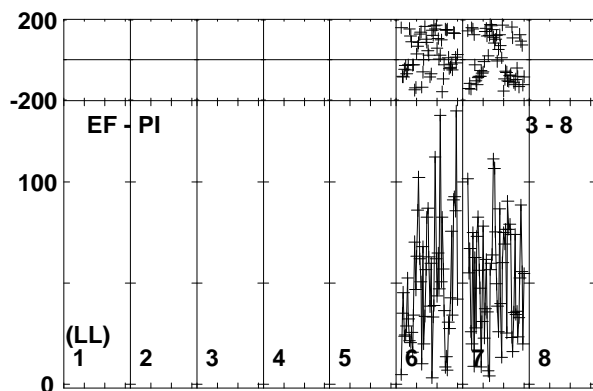
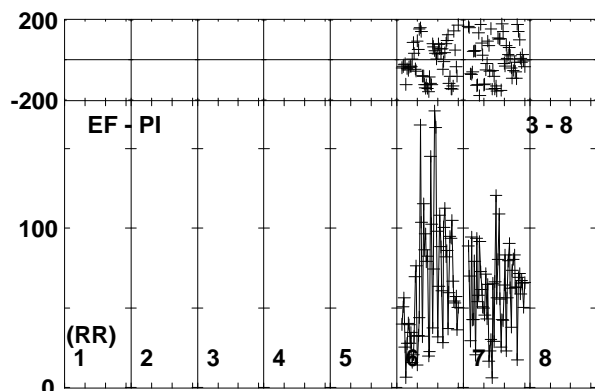
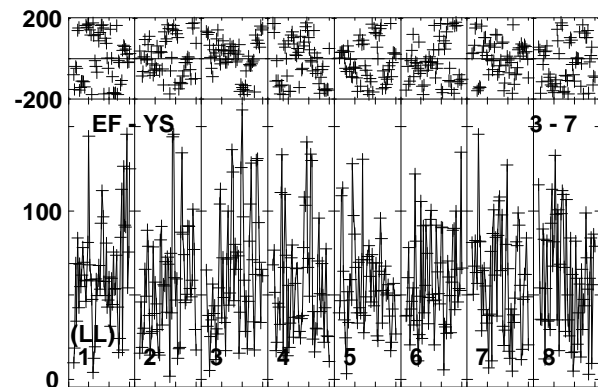
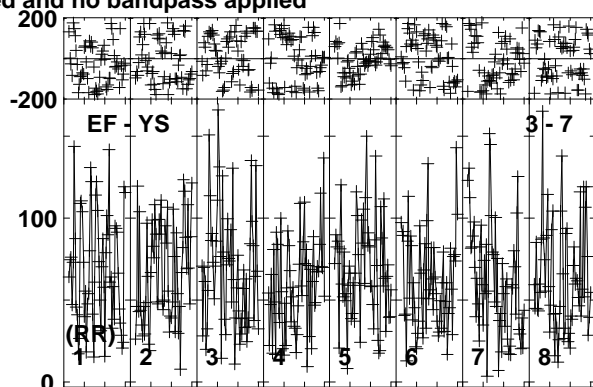
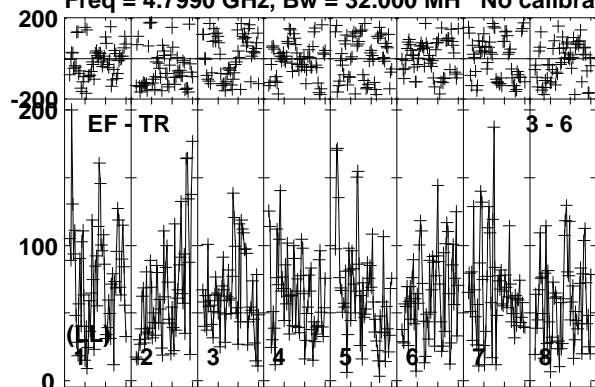

Lower frame: Micro Ampl Jy Top frame: Phas deg  
Vector averaged cross-power spectrum Baseline: EF (03) - TR (06)  
Timerange: 01/02:21:13 to 01/02:25:09

Plot file version 333 created 11-NOV-2019 15:07:54

SER8NJ EK040B.UVDATA.1

Freq = 4.7990 GHz, Bw = 32.000 MH No calibration applied and no bandpass applied

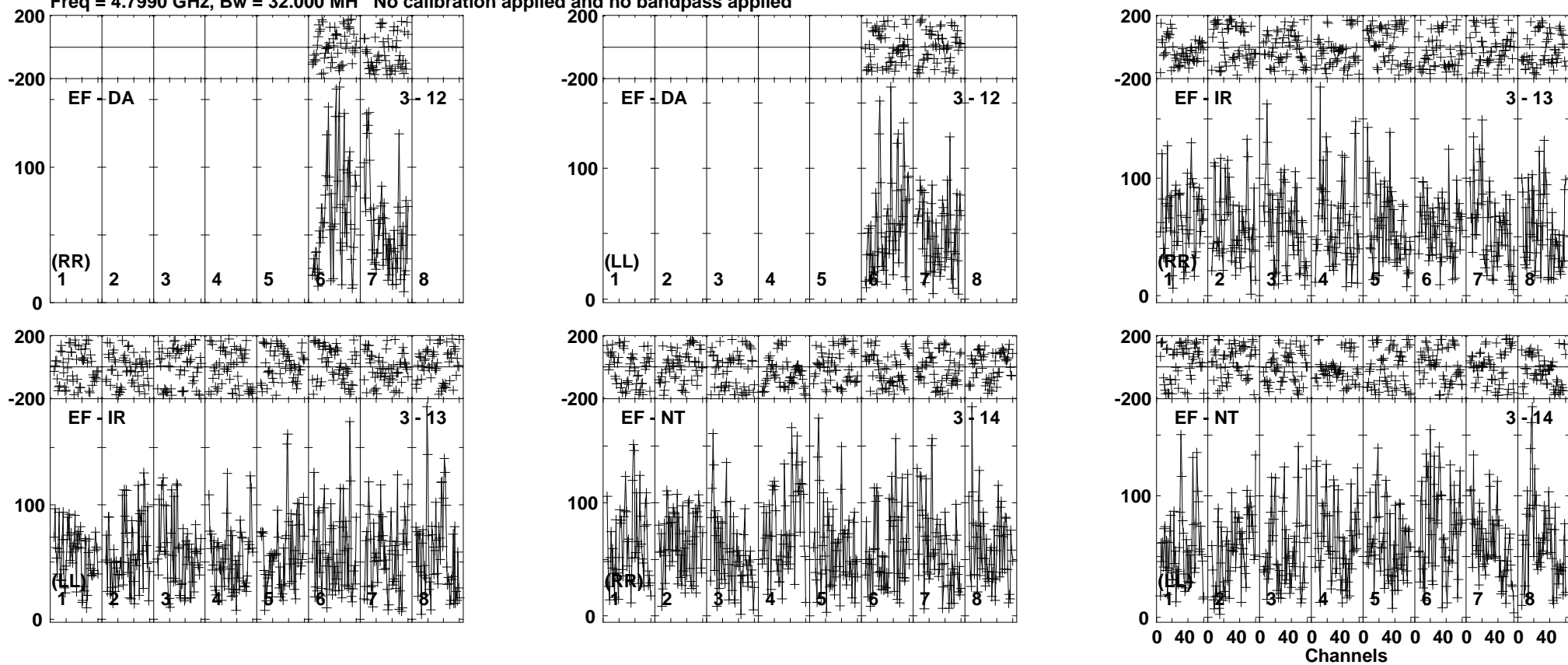

Lower frame: Micro Ampl Jy Top frame: Phas deg  
Vector averaged cross-power spectrum Baseline: EF (03) - DA (12)  
Timerange: 01/02:21:13 to 01/02:25:09

Plot file version 334 created 11-NOV-2019 15:07:54

J1826+0149 EK040B.UVDATA.1

Freq = 4.7990 GHz, Bw = 32.000 MH No calibration applied and no bandpass applied

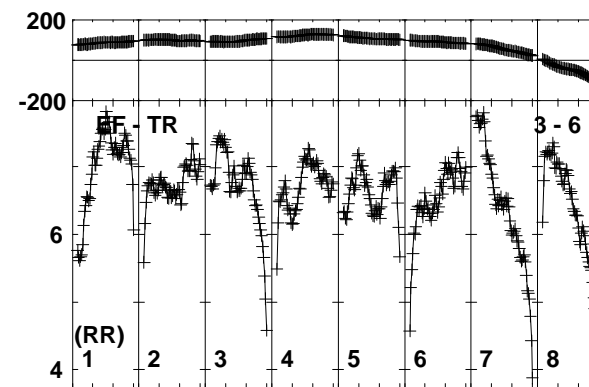
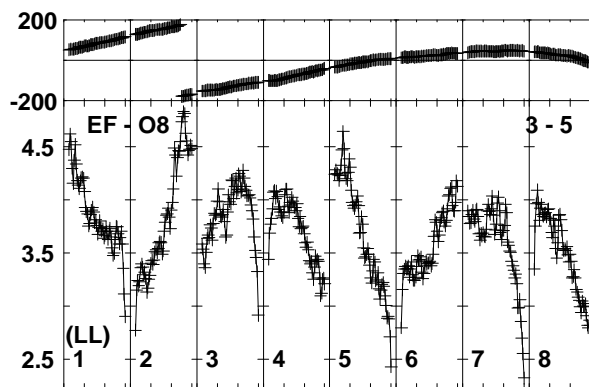
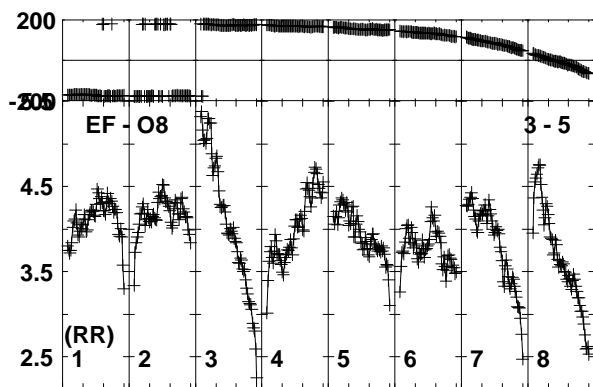
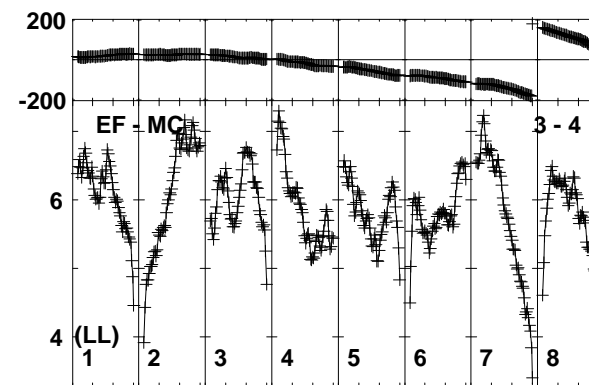
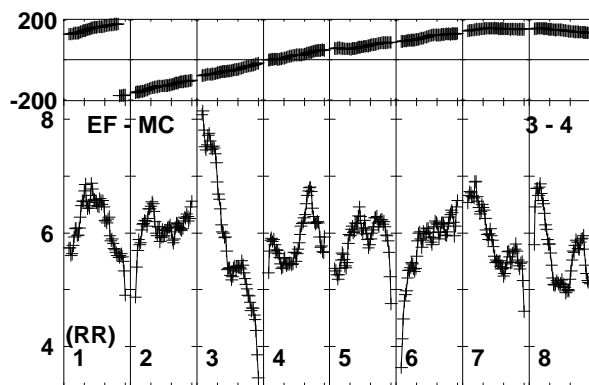
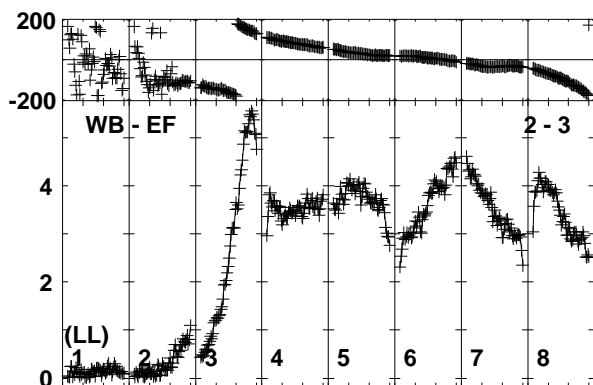
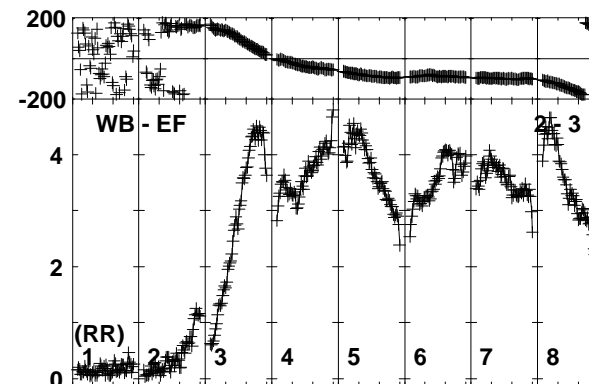
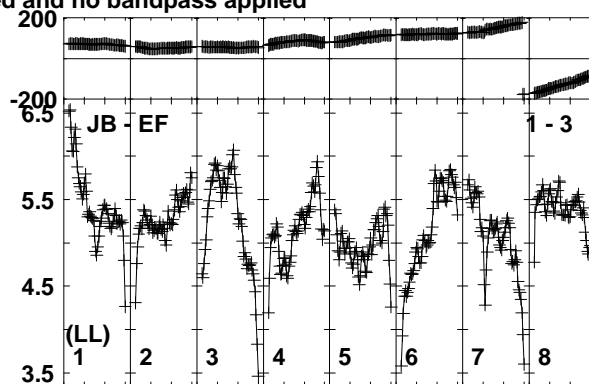
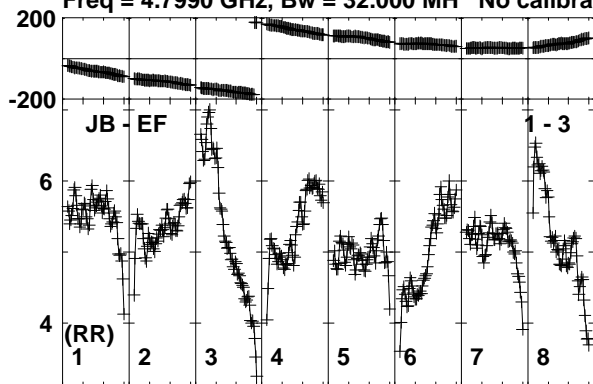

Lower frame: Milli Ampl Jy Top frame: Phas deg  
Vector averaged cross-power spectrum Baseline: JB (01) - EF (03)  
Timerange: 01/02:25:51 to 01/02:26:49

Plot file version 335 created 11-NOV-2019 15:07:54

J1826+0149 EK040B.UVDATA.1

Freq = 4.7990 GHz, Bw = 32.000 MH No calibration applied and no bandpass applied

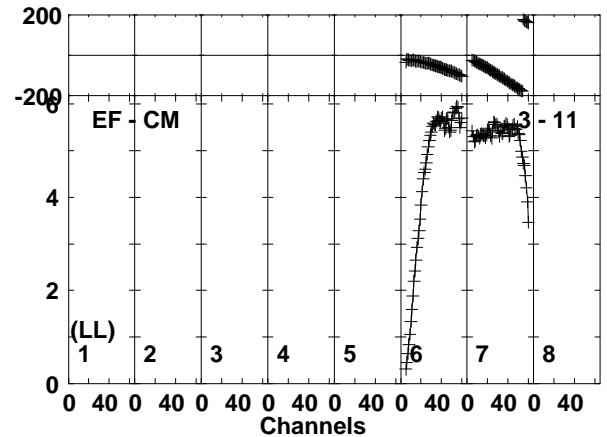
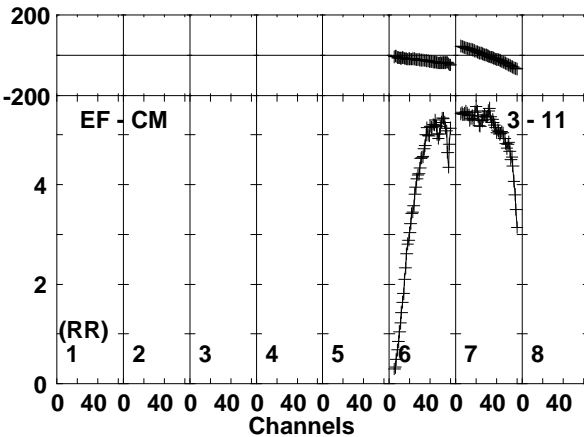
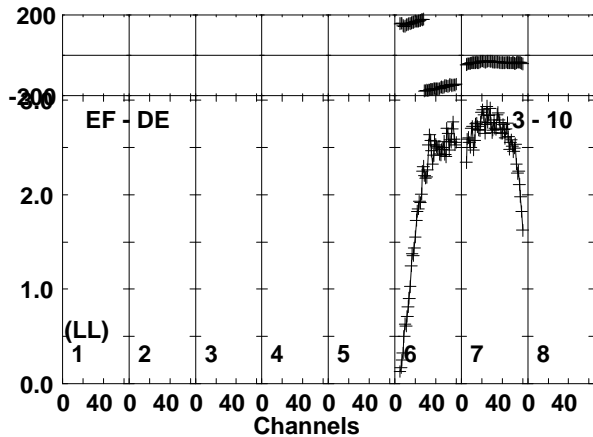
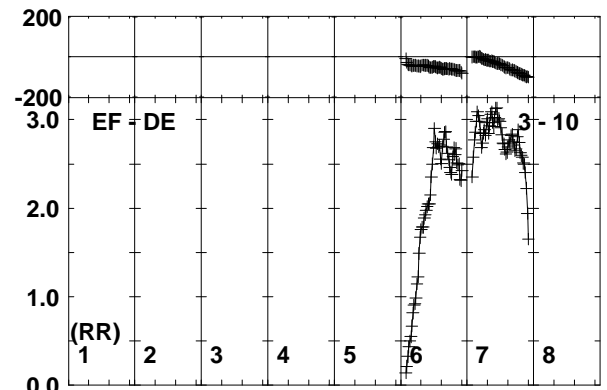
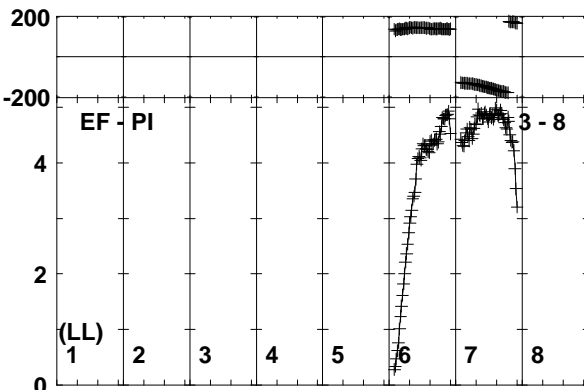
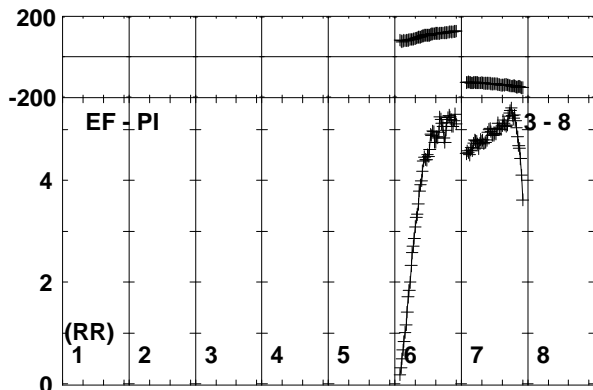
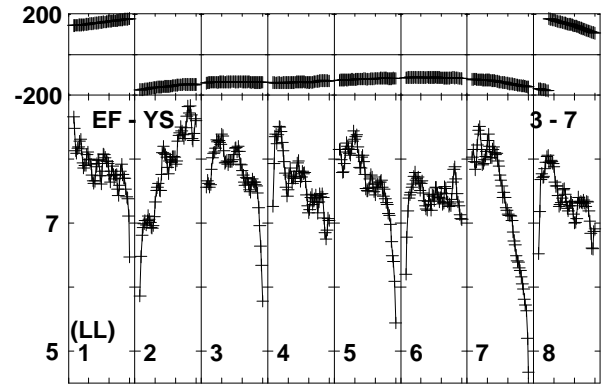
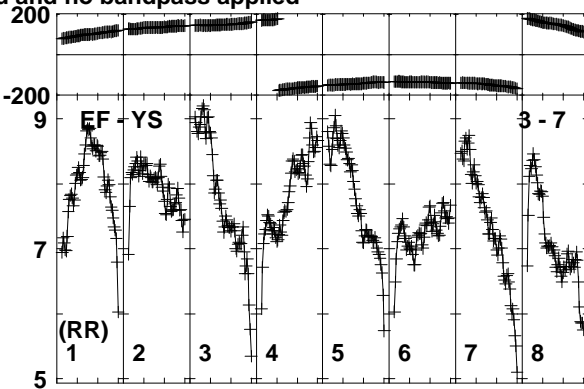
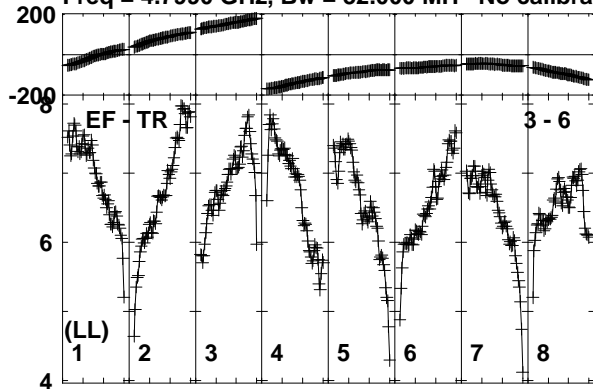

Lower frame: Milli Ampl Jy Top frame: Phas deg  
Vector averaged cross-power spectrum Baseline: EF (03) - TR (06)  
Timerange: 01/02:25:51 to 01/02:26:49

Plot file version 336 created 11-NOV-2019 15:07:54

J1826+0149 EK040B.UVDATA.1

Freq = 4.7990 GHz, Bw = 32.000 MH No calibration applied and no bandpass applied

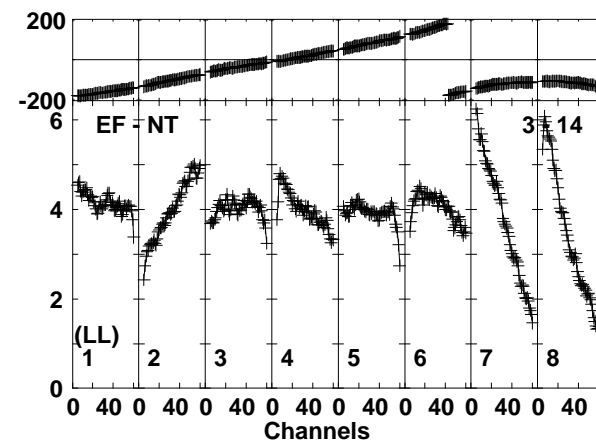
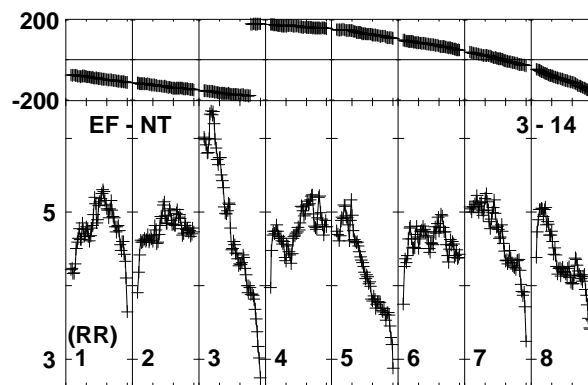
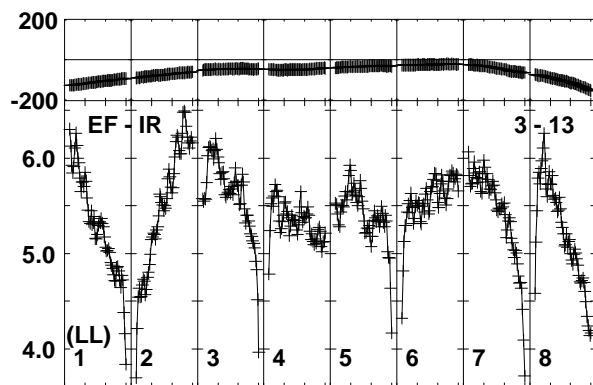
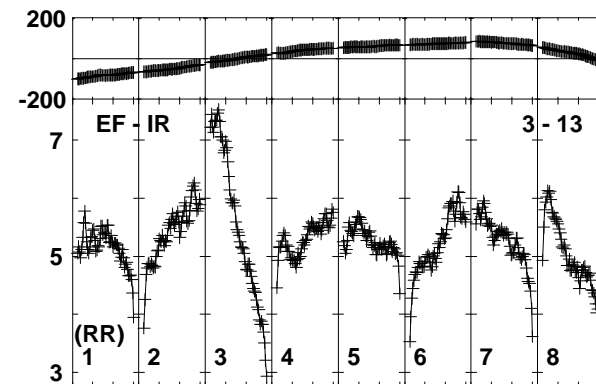
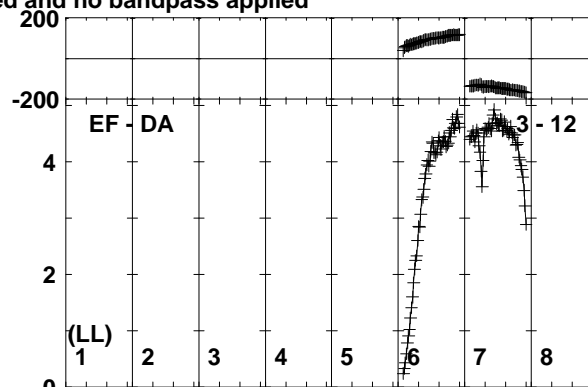
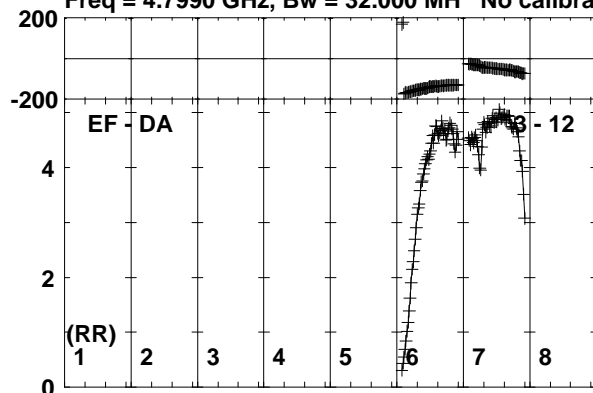

Lower frame: Milli Ampl Jy Top frame: Phas deg  
Vector averaged cross-power spectrum Baseline: EF (03) - DA (12)  
Timerange: 01/02:25:51 to 01/02:26:49

Plot file version 337 created 11-NOV-2019 15:07:54

SER8NJ EK040B.UVDATA.1

Freq = 4.7990 GHz, Bw = 32.000 MH No calibration applied and no bandpass applied

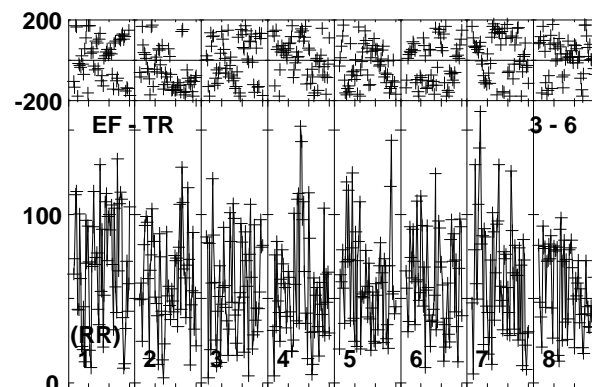
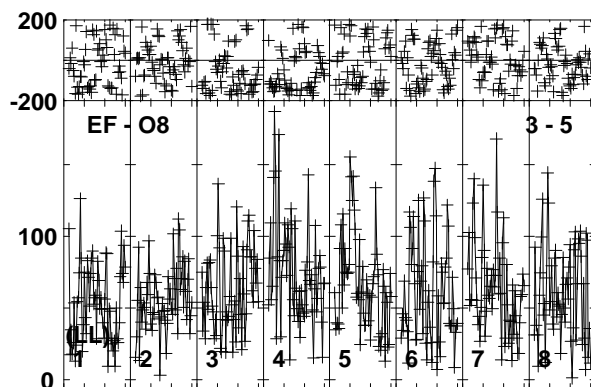
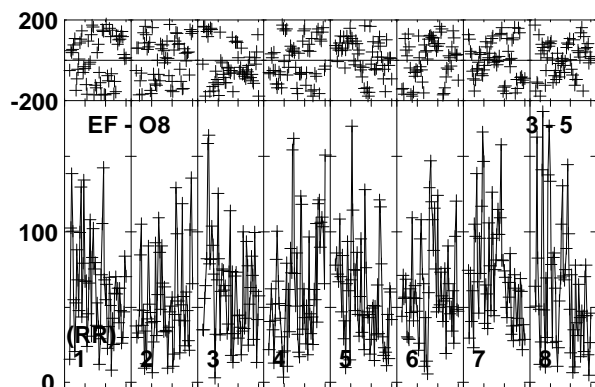
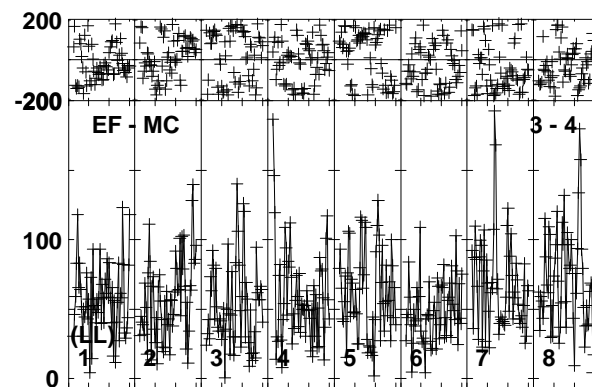
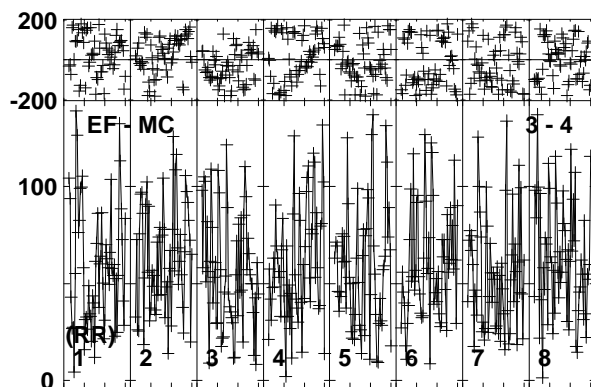
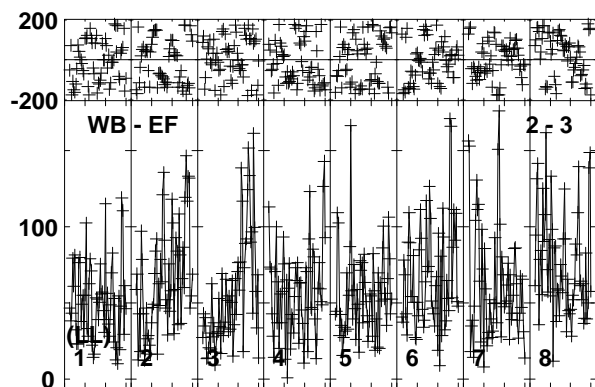
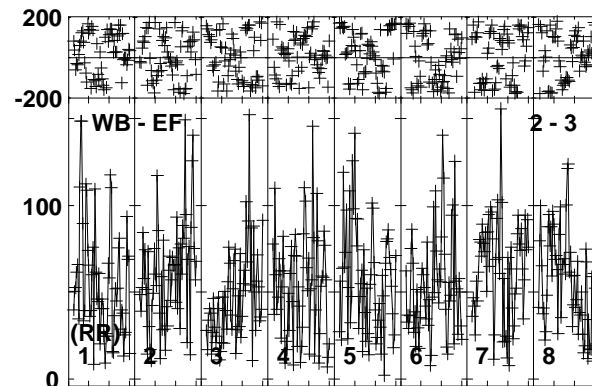
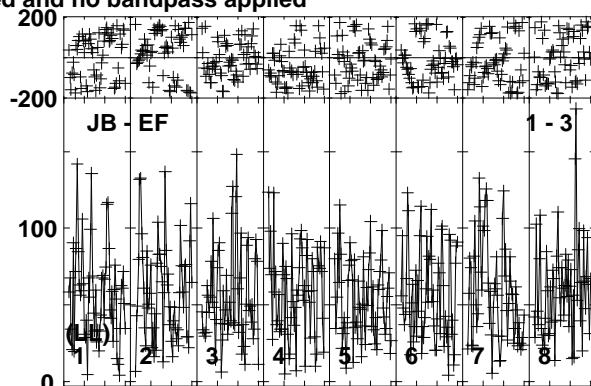
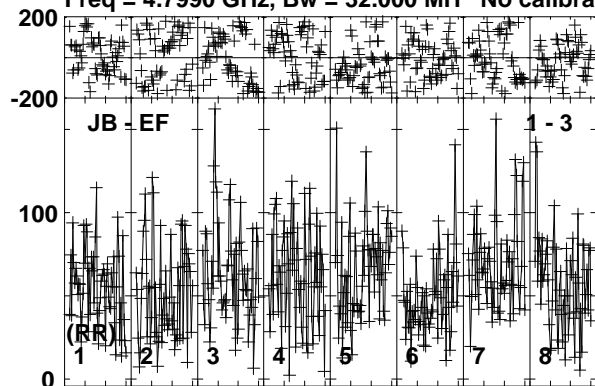

Lower frame: Micro Ampl Jy Top frame: Phas deg  
Vector averaged cross-power spectrum Baseline: JB (01) - EF (03)  
Timerange: 01/02:26:51 to 01/02:30:49

Plot file version 338 created 11-NOV-2019 15:07:55

SER8NJ EK040B.UVDATA.1

Freq = 4.7990 GHz, Bw = 32.000 MH No calibration applied and no bandpass applied

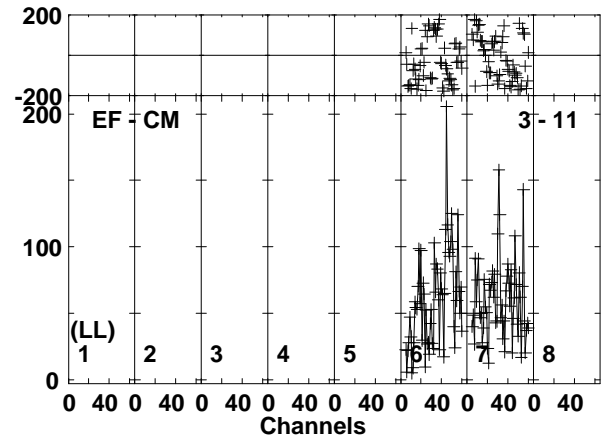
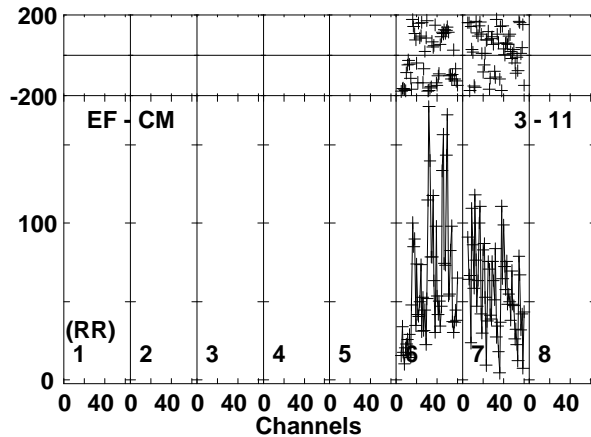
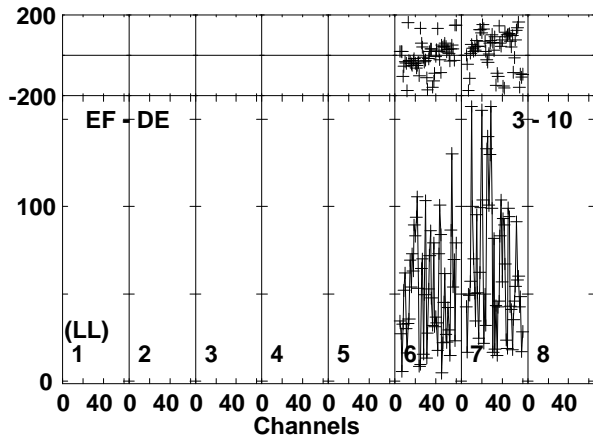
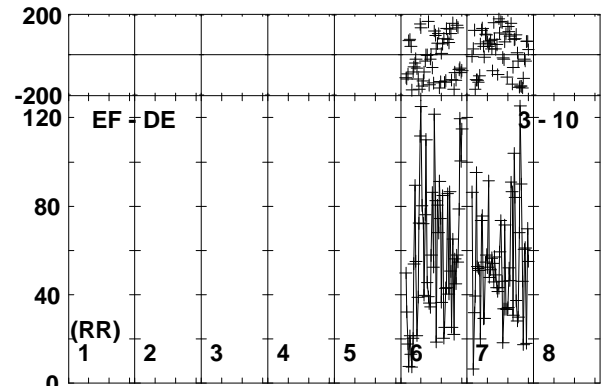
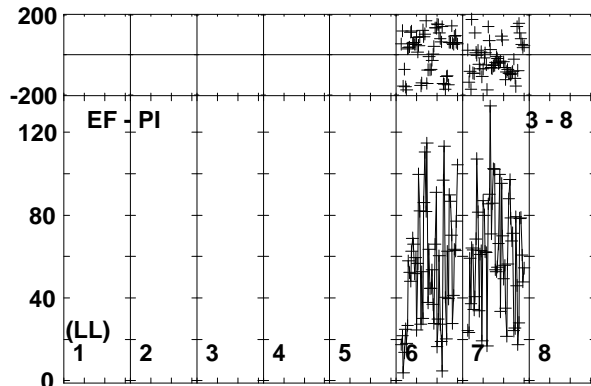
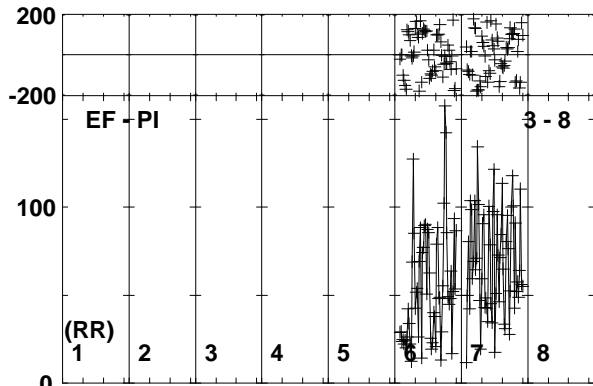
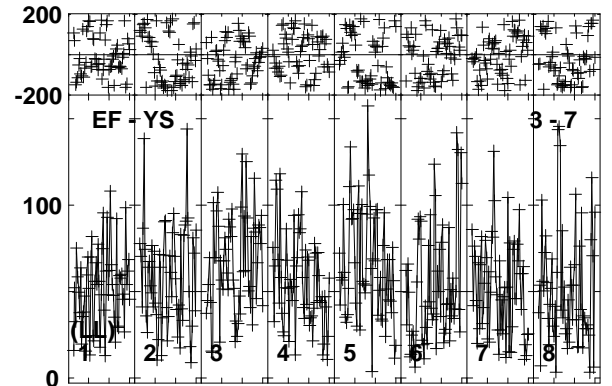
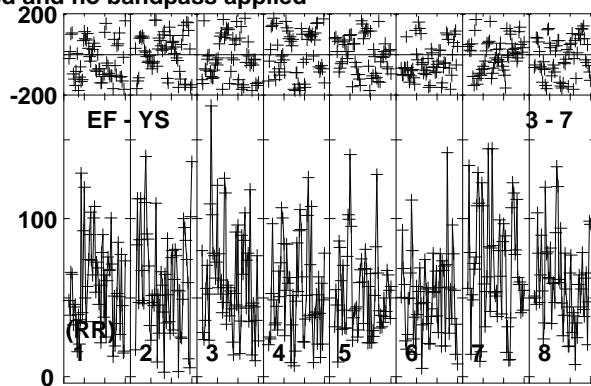
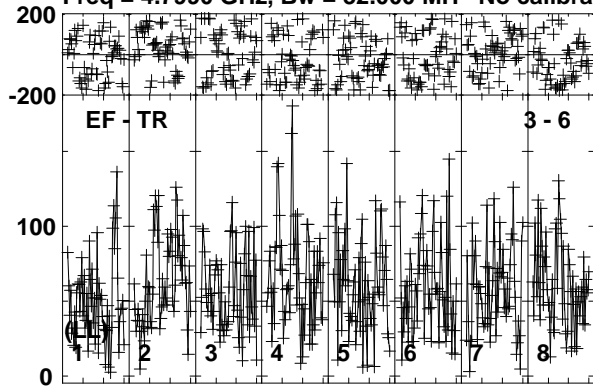

Lower frame: Micro Ampl Jy Top frame: Phas deg  
Vector averaged cross-power spectrum Baseline: EF (03) - TR (06)  
Timerange: 01/02:26:51 to 01/02:30:49



Plot file version 339 created 11-NOV-2019 15:07:55

SER8NJ EK040B.UVDATA.1

Freq = 4.7990 GHz, Bw = 32.000 MH No calibration applied and no bandpass applied

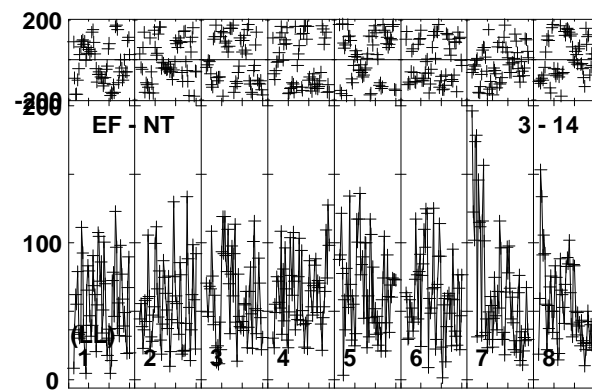
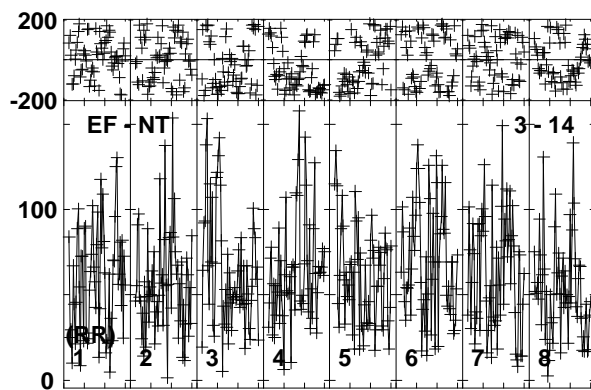
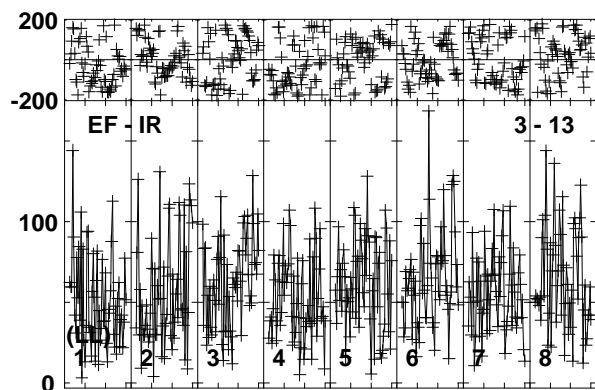
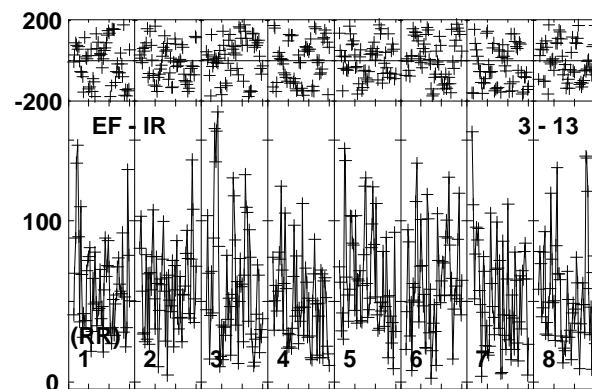
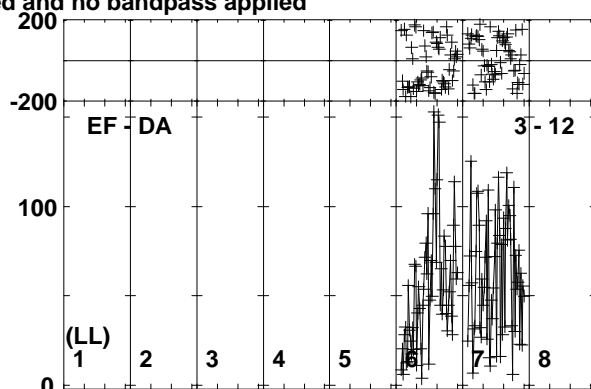
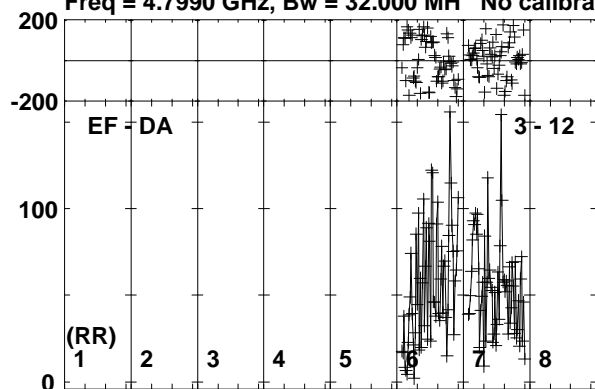

0 40 0 40 0 40 0 40 0 40 0 40 0 40 0 40 0 40 0 40  
Channels

Lower frame: Micro Ampl Jy Top frame: Phas deg  
Vector averaged cross-power spectrum Baseline: EF (03) - DA (12)  
Timerange: 01/02:26:51 to 01/02:30:49

Plot file version 340 created 11-NOV-2019 15:07:55

J1826+0149 EK040B.UVDATA.1

Freq = 4.7990 GHz, Bw = 32.000 MH No calibration applied and no bandpass applied

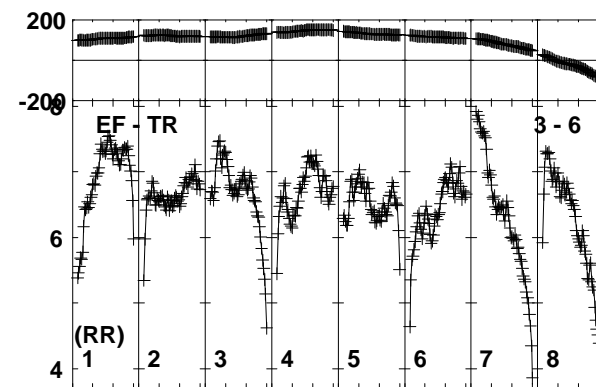
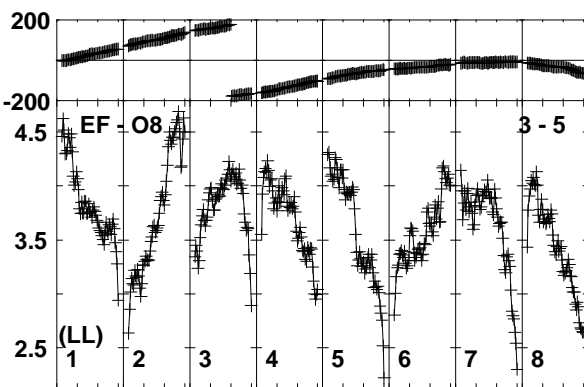
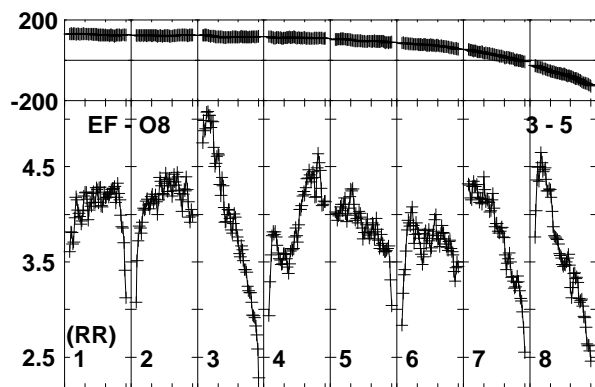
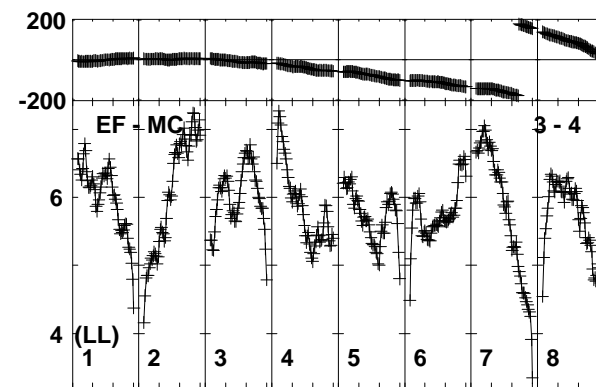
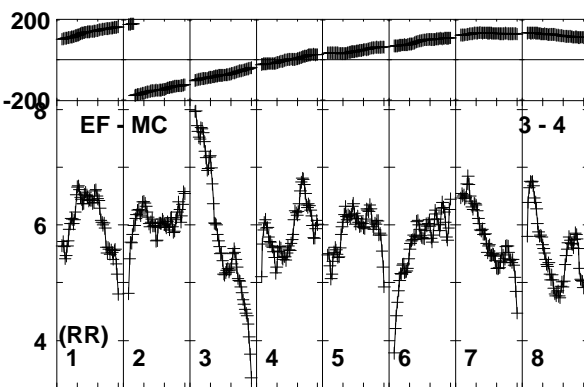
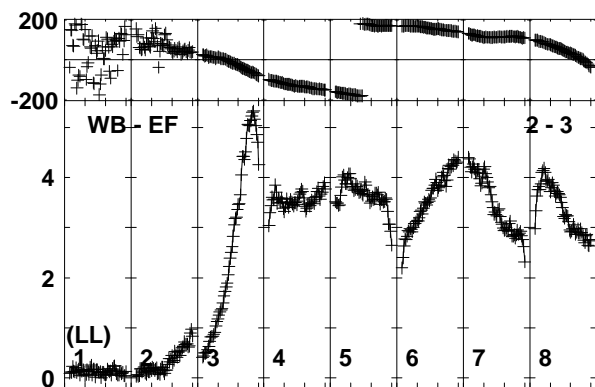
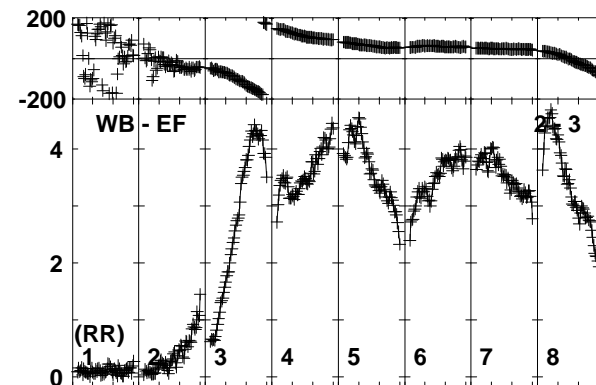
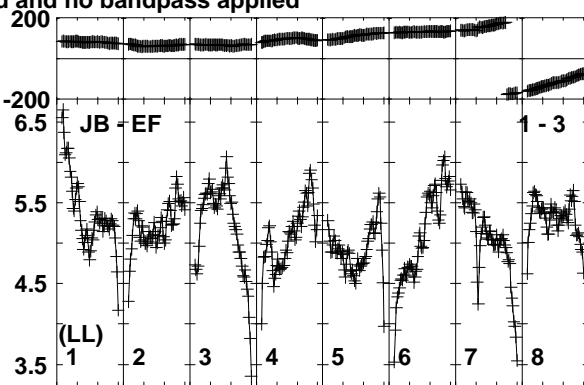
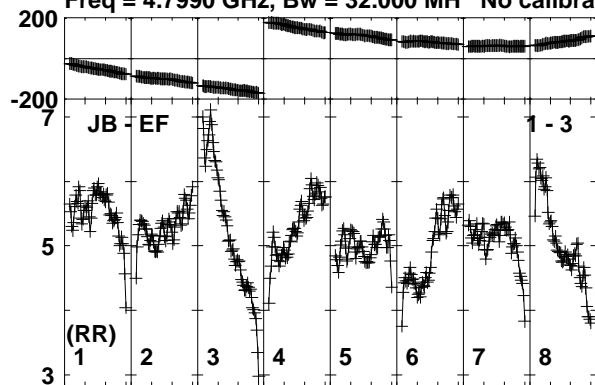

Lower frame: Milli Ampl Jy Top frame: Phas deg

Vector averaged cross-power spectrum Baseline: JB (01) - EF (03)

Timerange: 01/02:30:51 to 01/02:32:19

Plot file version 341 created 11-NOV-2019 15:07:55

J1826+0149 EK040B.UVDATA.1

Freq = 4.7990 GHz, Bw = 32.000 MH No calibration applied and no bandpass applied

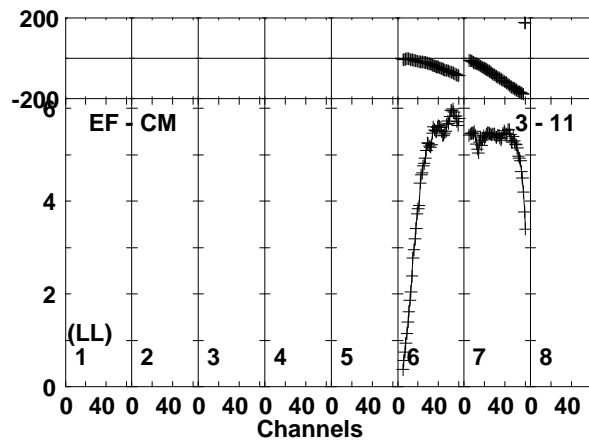
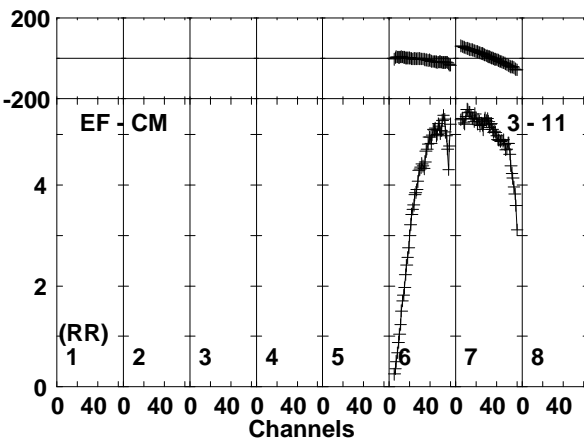
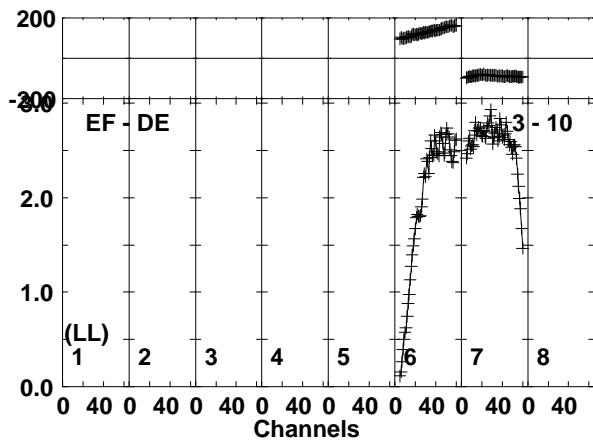
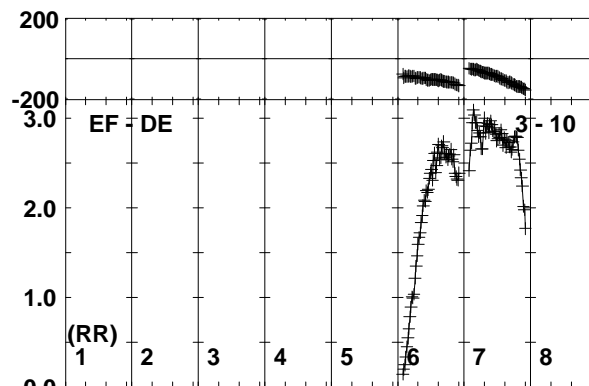
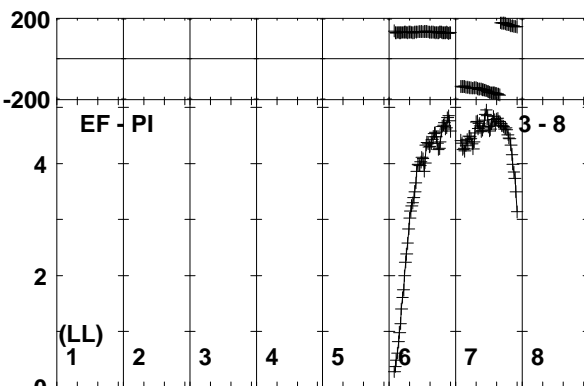
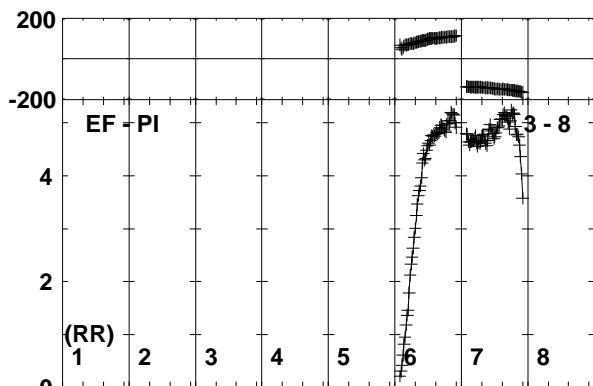
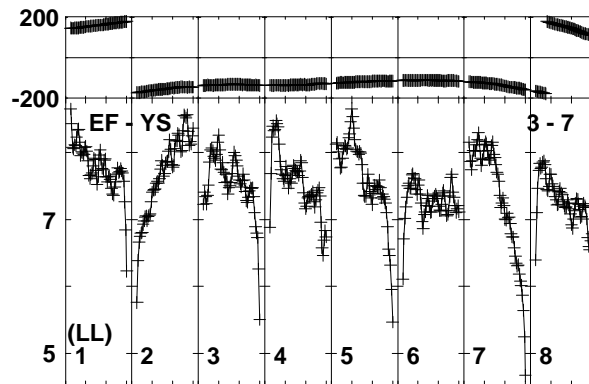
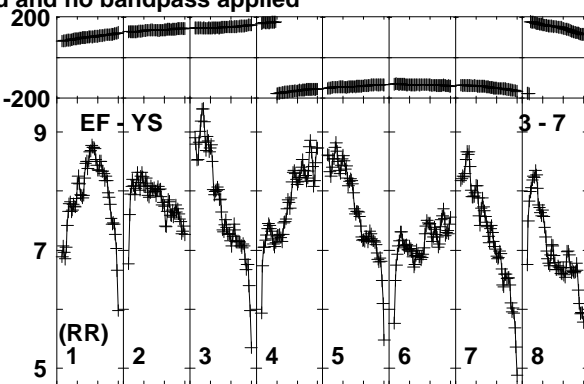
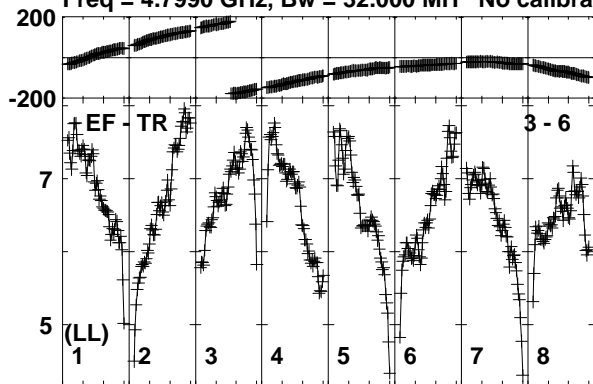

Lower frame: Milli Ampl Jy Top frame: Phas deg  
Vector averaged cross-power spectrum Baseline: EF (03) - TR (06)  
Timerange: 01/02:30:51 to 01/02:32:19

Plot file version 342 created 11-NOV-2019 15:07:55

J1826+0149 EK040B.UVDATA.1

Freq = 4.7990 GHz, Bw = 32.000 MH No calibration applied and no bandpass applied

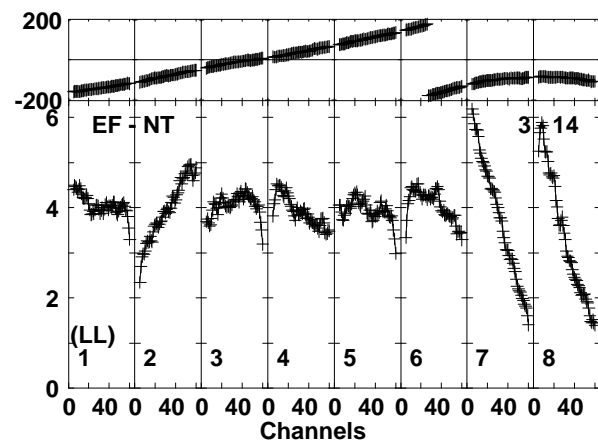
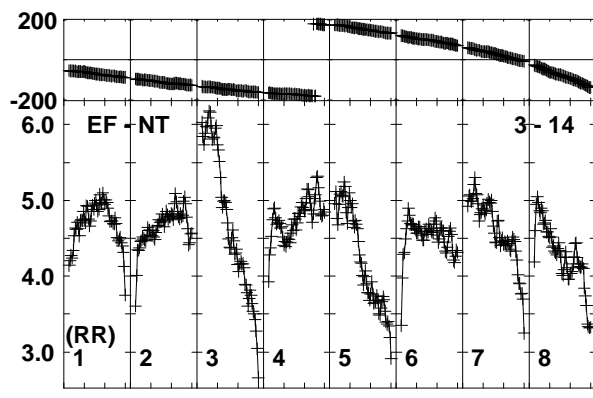
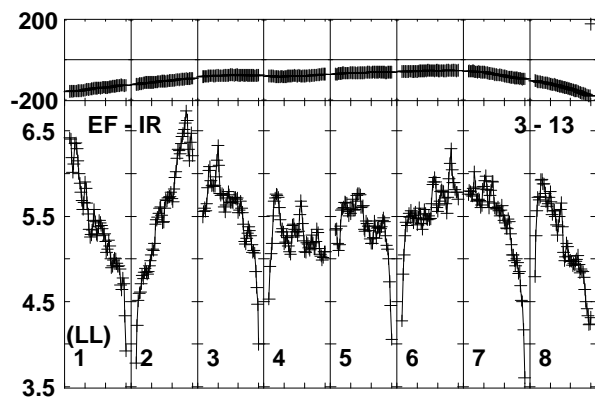
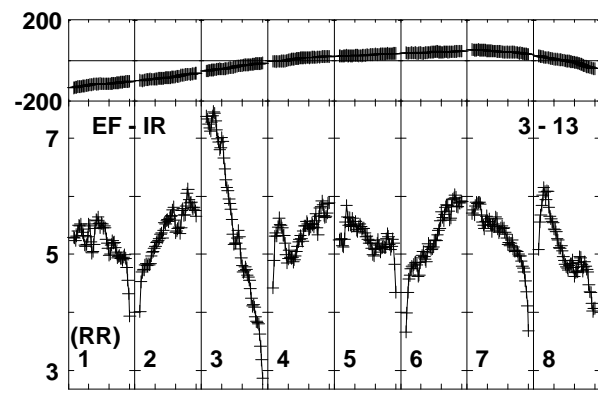
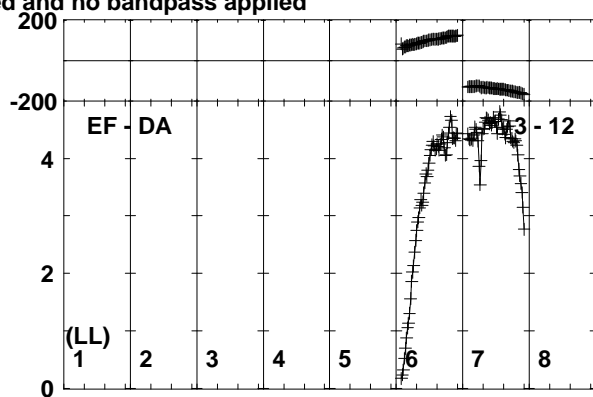
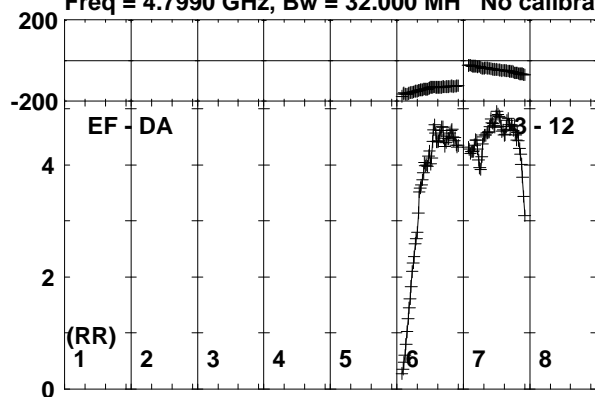

Lower frame: Milli Ampl Jy Top frame: Phas deg  
Vector averaged cross-power spectrum Baseline: EF (03) - DA (12)  
Timerange: 01/02:30:51 to 01/02:32:19

Plot file version 343 created 11-NOV-2019 15:07:55

SER8NJ EK040B.UVDATA.1

Freq = 4.7990 GHz, Bw = 32.000 MH No calibration applied and no bandpass applied

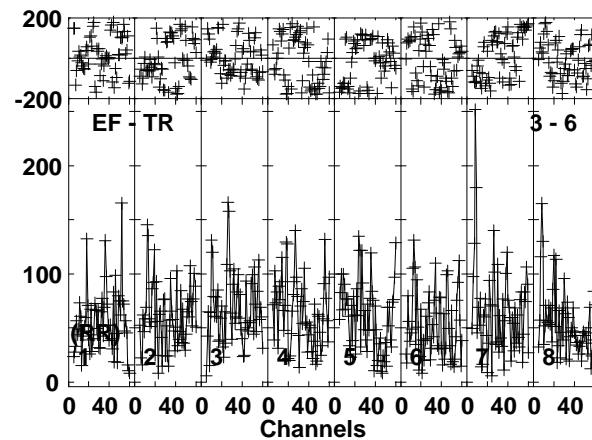
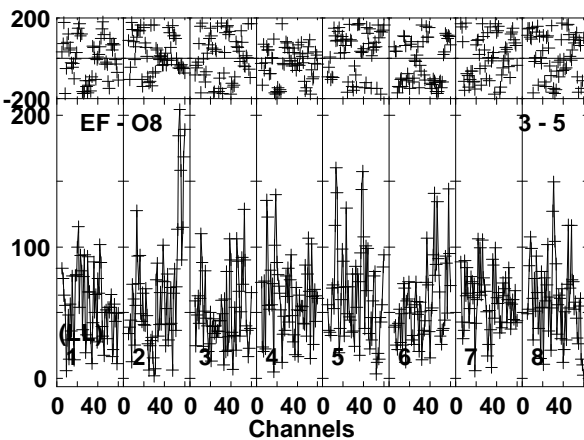
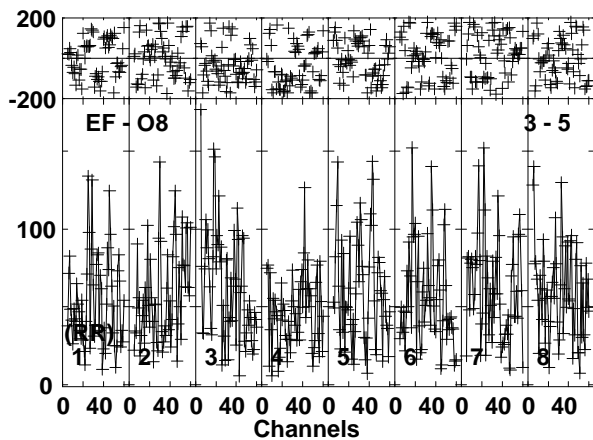
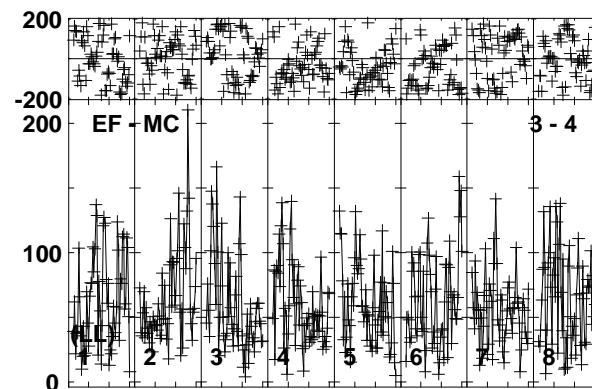
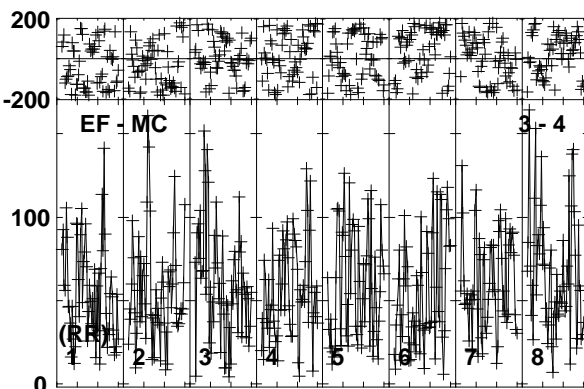
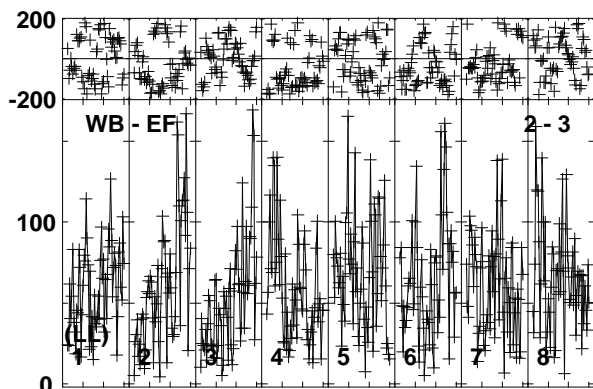
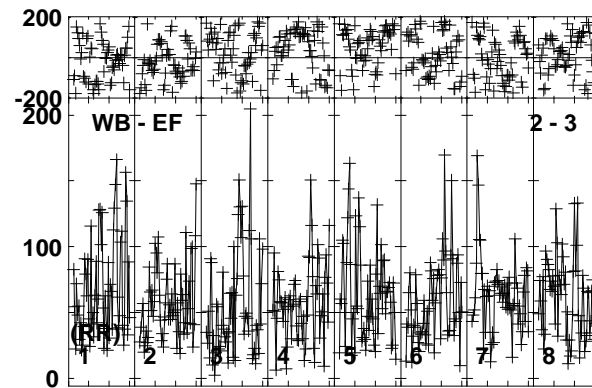
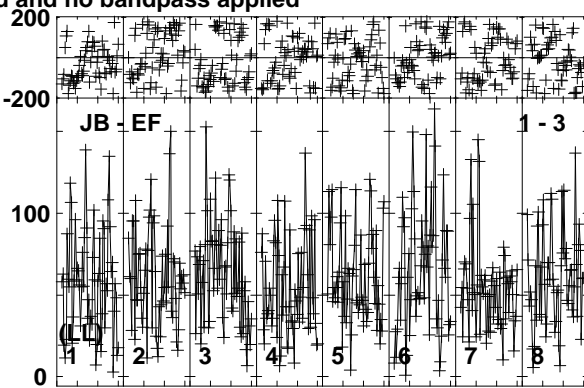
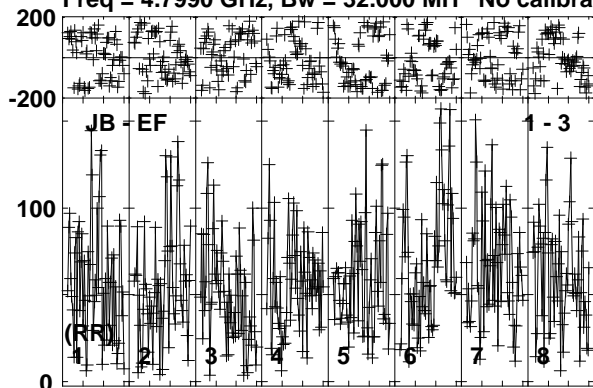

Lower frame: Micro Ampl Jy Top frame: Phas deg  
Vector averaged cross-power spectrum Baseline: JB (01) - EF (03)  
Timerange: 01/02:32:23 to 01/02:36:19

Plot file version 344 created 11-NOV-2019 15:07:55

SER8NJ EK040B.UVDATA.1

Freq = 4.7990 GHz, Bw = 32.000 MH No calibration applied and no bandpass applied

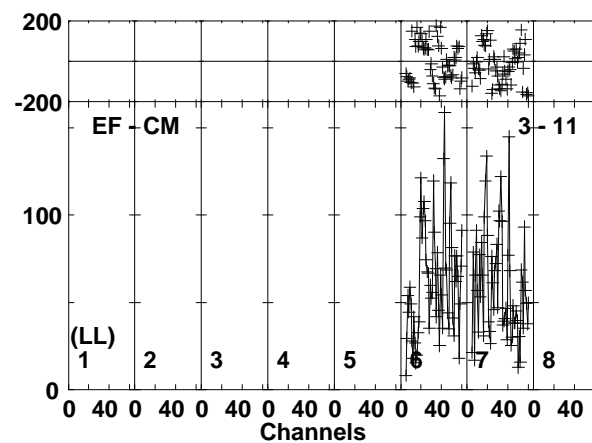
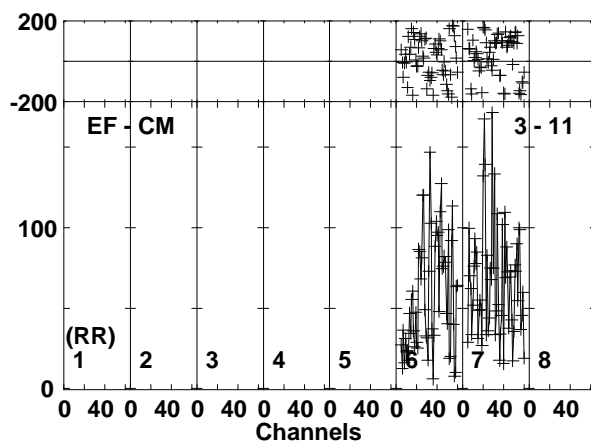
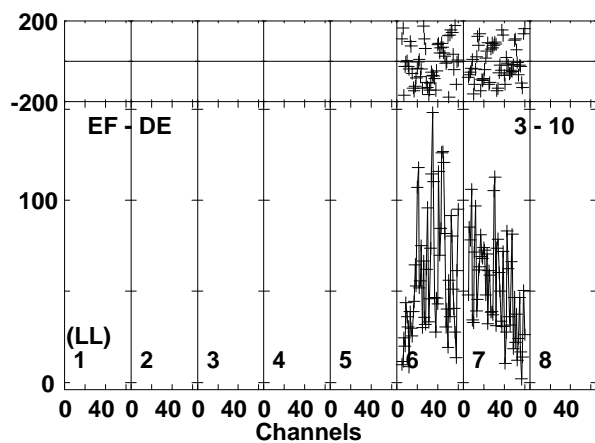
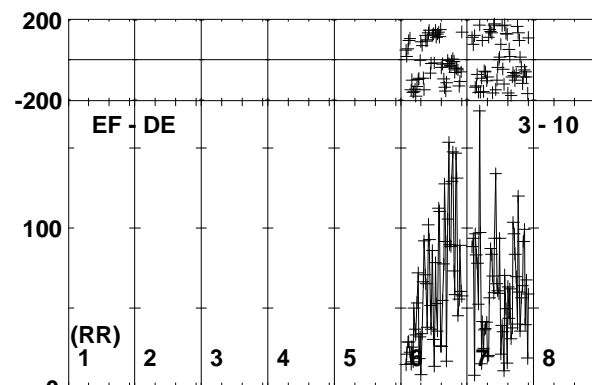
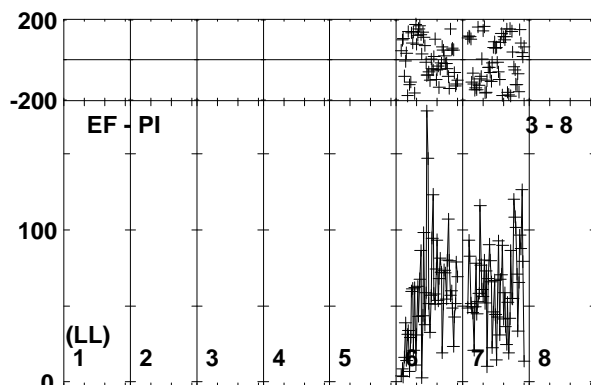
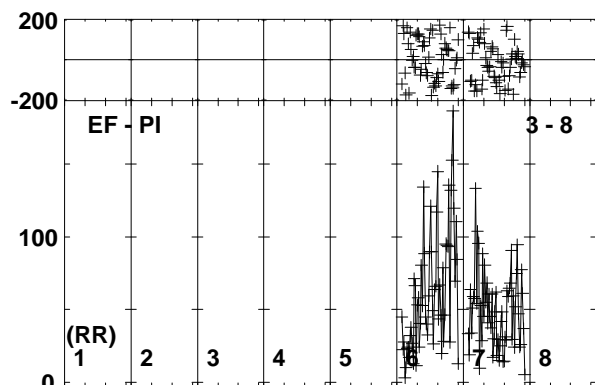
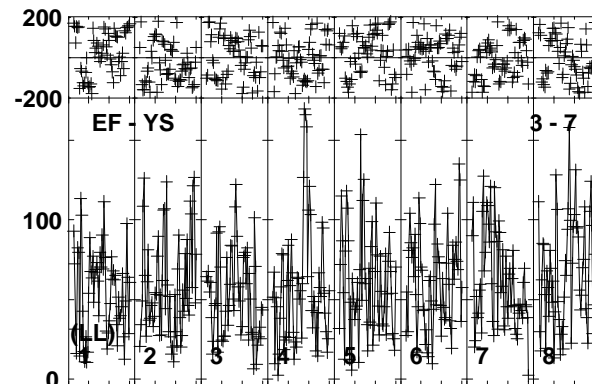
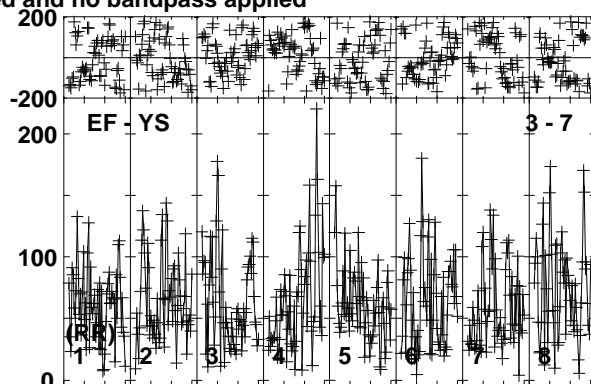
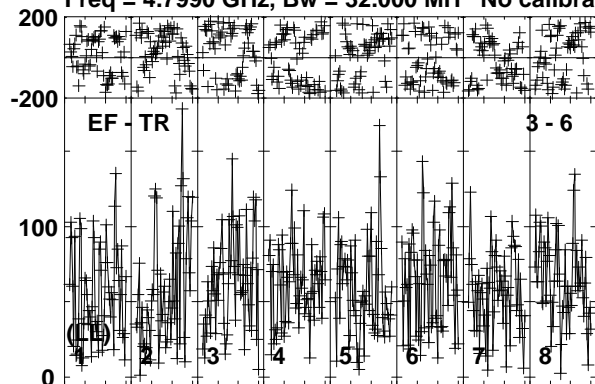

Lower frame: Micro Ampl Jy Top frame: Phas deg  
Vector averaged cross-power spectrum Baseline: EF (03) - TR (06)  
Timerange: 01/02:32:23 to 01/02:36:19

Plot file version 345 created 11-NOV-2019 15:07:55

SER8NJ EK040B.UVDATA.1

Freq = 4.7990 GHz, Bw = 32.000 MH No calibration applied and no bandpass applied

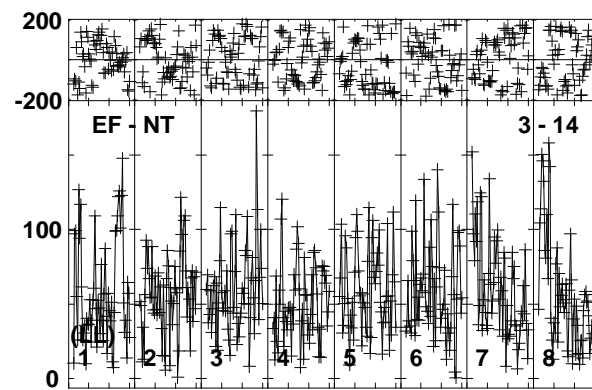
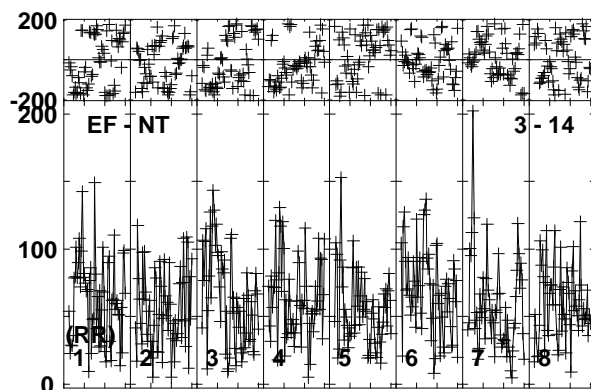
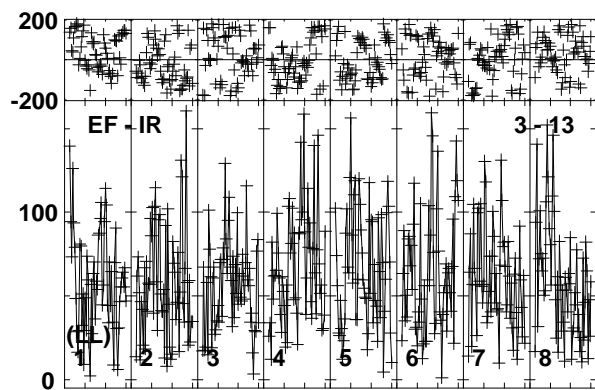
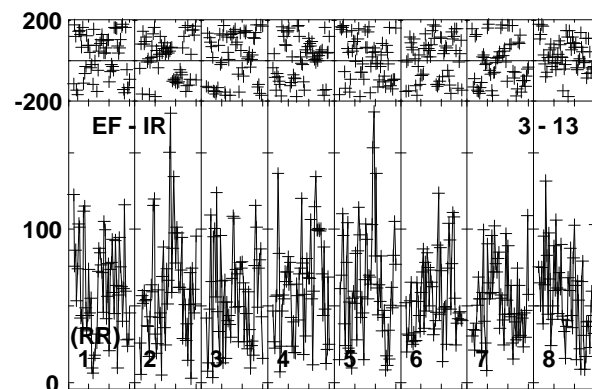
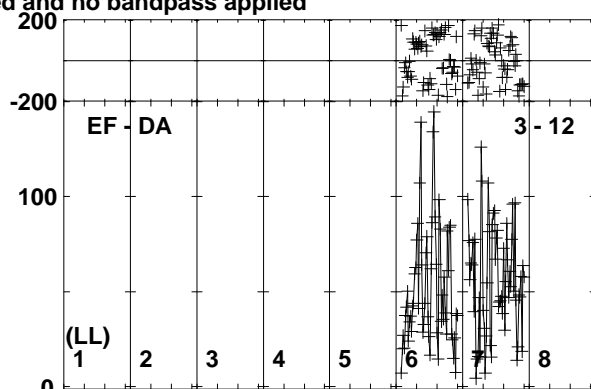
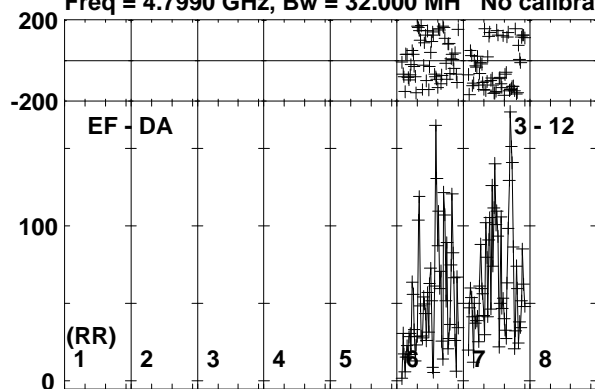

0 40 0 40 0 40 0 40 0 40 0 40 0 40 0 40 0 40 0 40  
Channels

Lower frame: Micro Ampl Jy Top frame: Phas deg  
Vector averaged cross-power spectrum Baseline: EF (03) - DA (12)  
Timerange: 01/02:32:23 to 01/02:36:19

Plot file version 346 created 11-NOV-2019 15:07:55

J1826+0149 EK040B.UVDATA.1

Freq = 4.7990 GHz, Bw = 32.000 MH No calibration applied and no bandpass applied

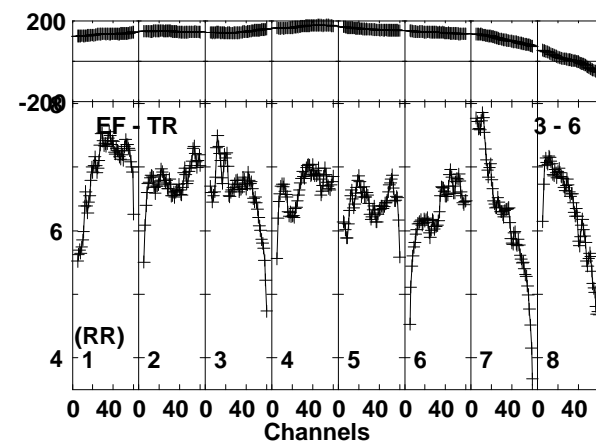
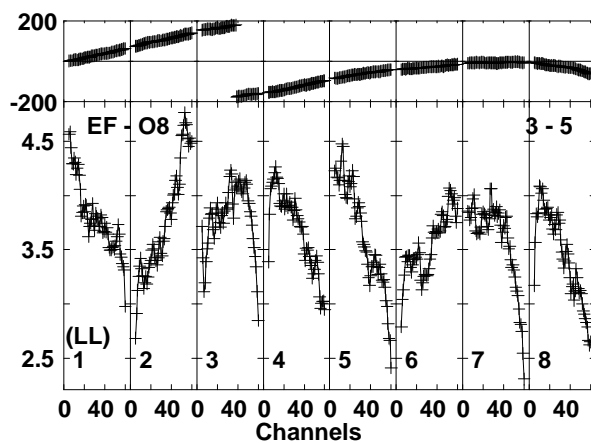
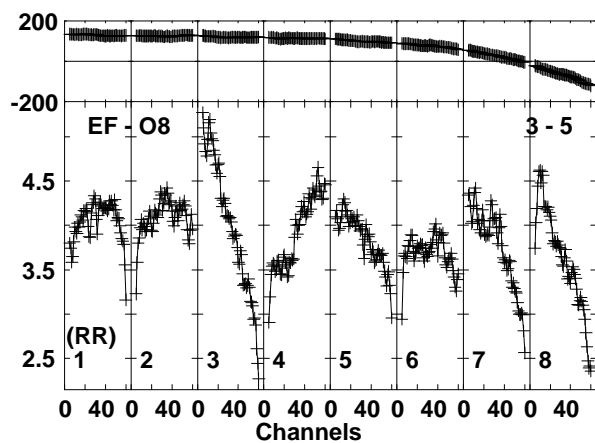
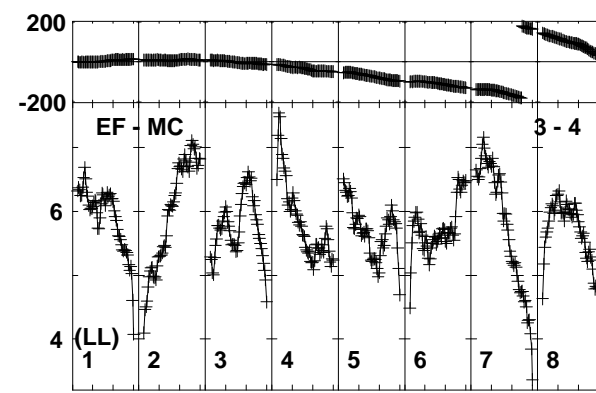
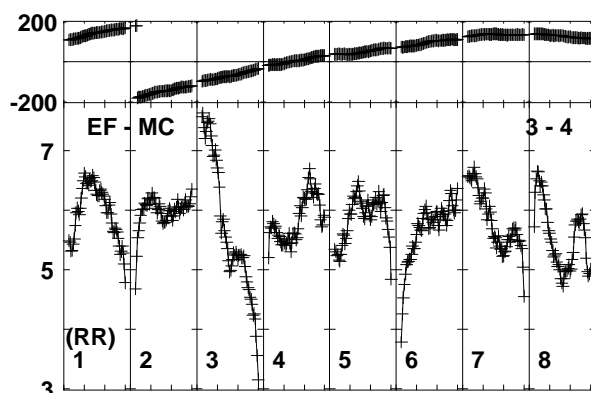
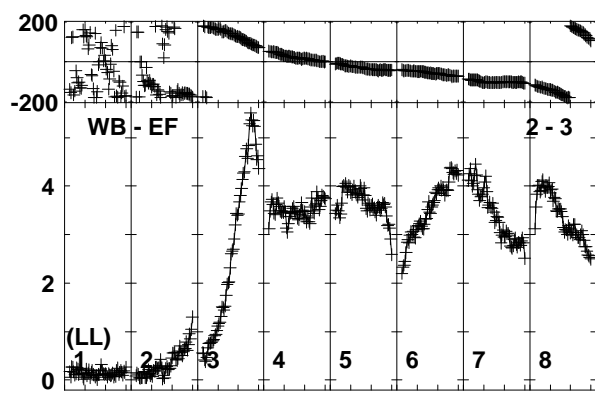
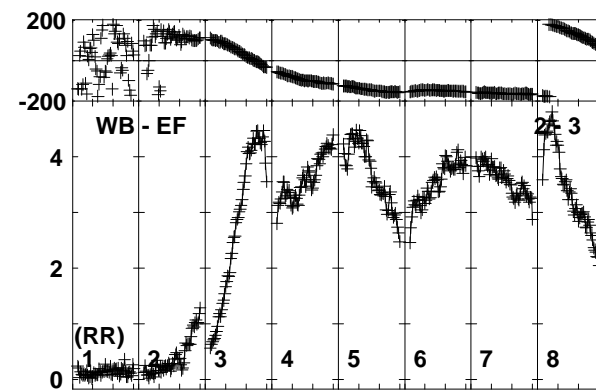
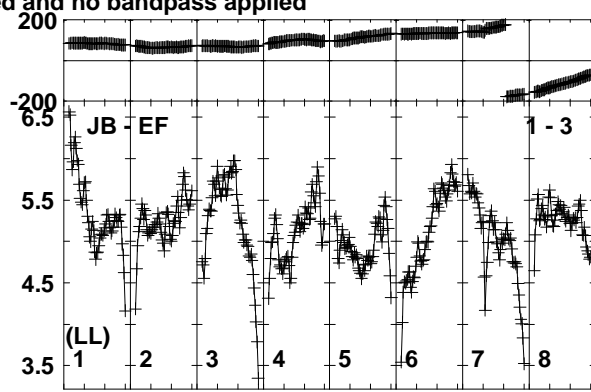
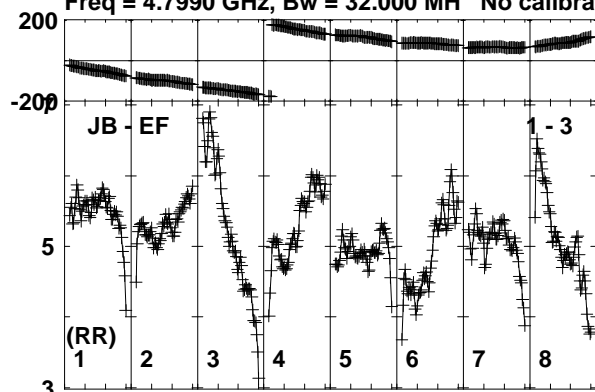

Lower frame: Milli Ampl Jy Top frame: Phas deg  
Vector averaged cross-power spectrum Baseline: JB (01) - EF (03)  
Timerange: 01/02:37:01 to 01/02:37:59



Plot file version 347 created 11-NOV-2019 15:07:56

J1826+0149 EK040B.UVDATA.1

Freq = 4.7990 GHz, Bw = 32.000 MH No calibration applied and no bandpass applied

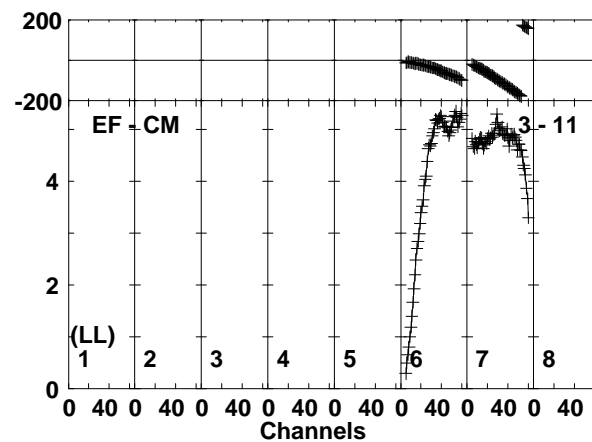
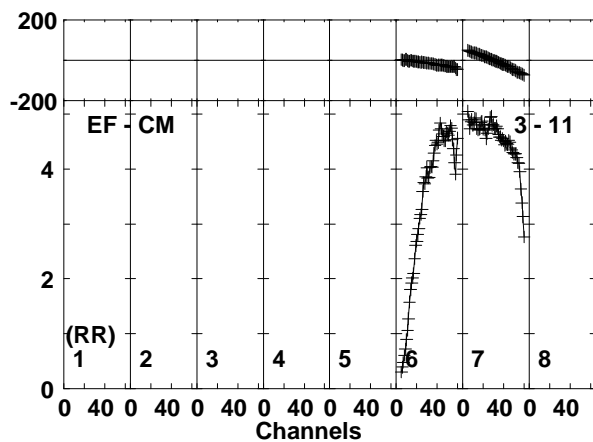
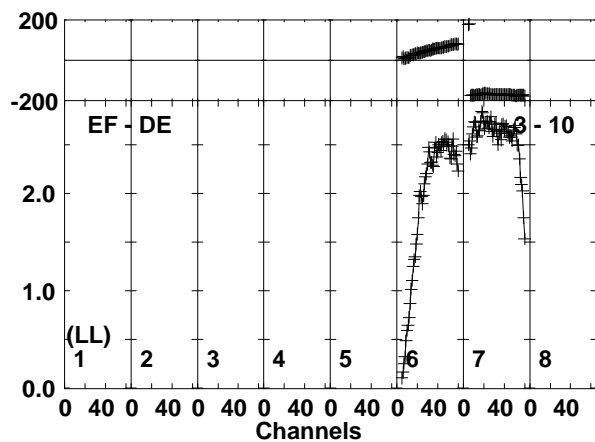
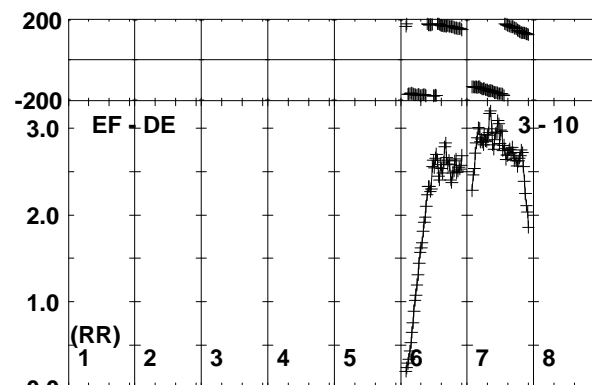
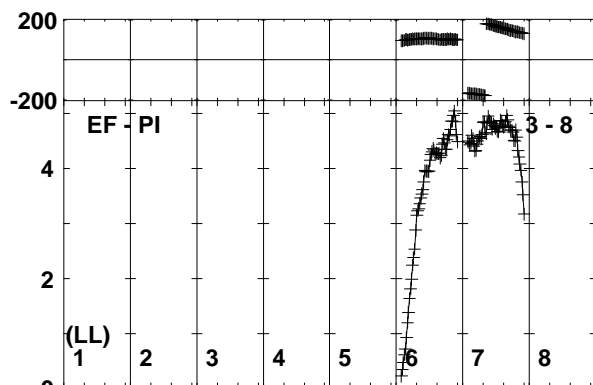
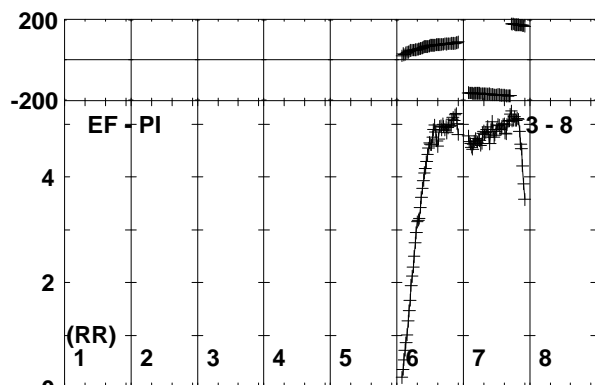
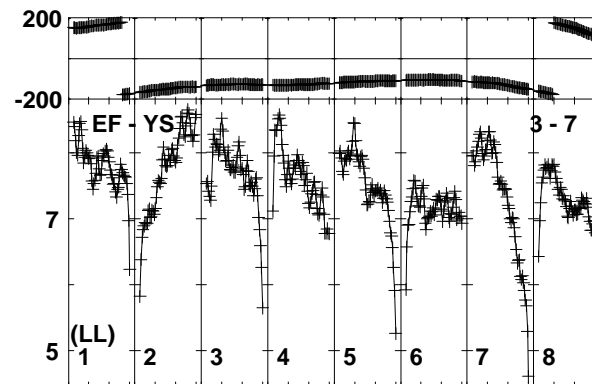
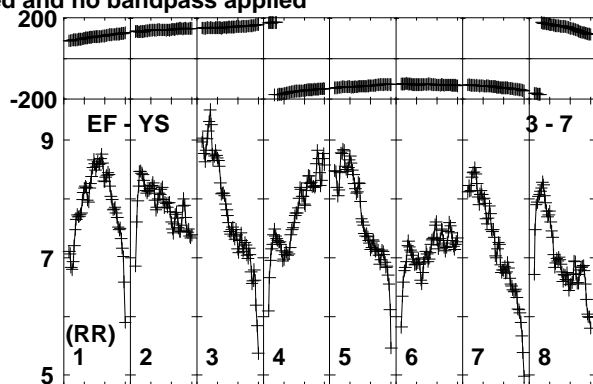
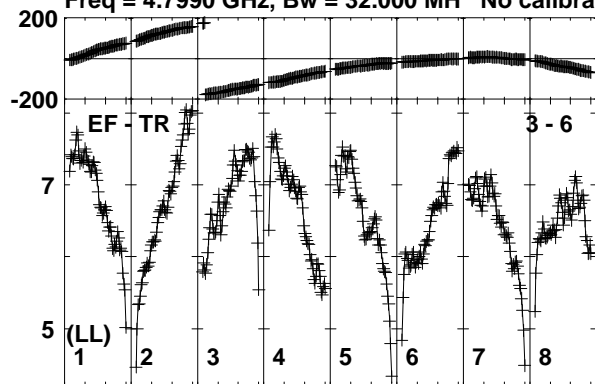

Lower frame: Milli Ampl Jy Top frame: Phas deg  
Vector averaged cross-power spectrum Baseline: EF (03) - TR (06)  
Timerange: 01/02:37:01 to 01/02:37:59

Plot file version 348 created 11-NOV-2019 15:07:56

J1826+0149 EK040B.UVDATA.1

Freq = 4.7990 GHz, Bw = 32.000 MH No calibration applied and no bandpass applied

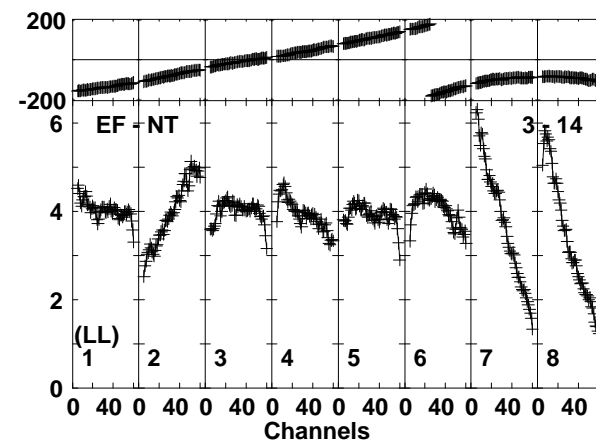
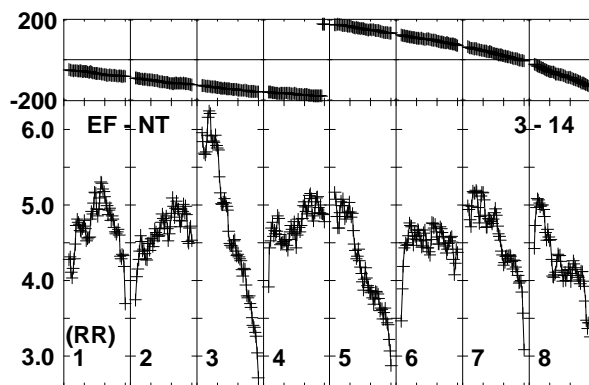
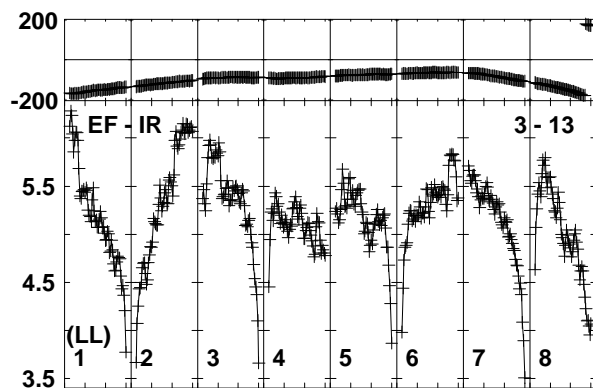
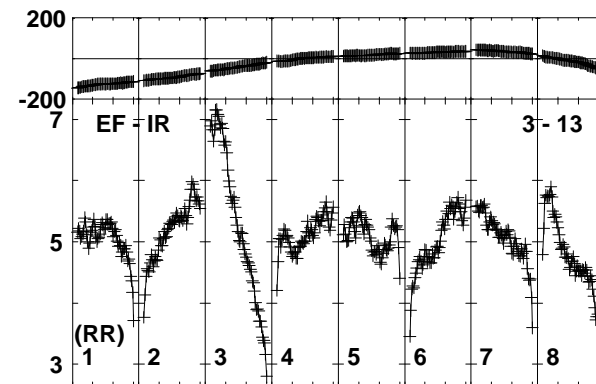
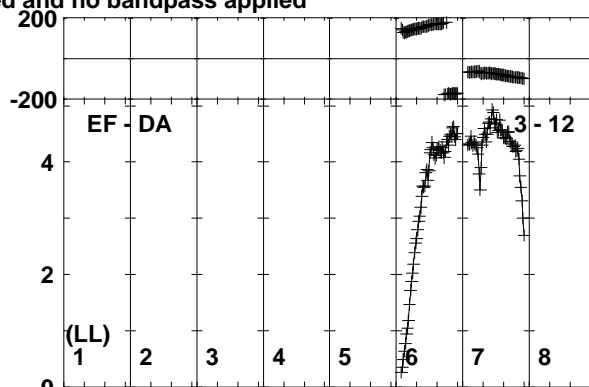
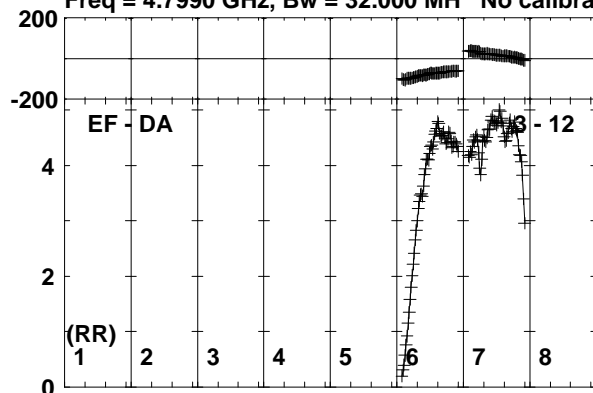

Lower frame: Milli Ampl Jy Top frame: Phas deg  
Vector averaged cross-power spectrum Baseline: EF (03) - DA (12)  
Timerange: 01/02:37:01 to 01/02:37:59

Plot file version 349 created 11-NOV-2019 15:07:56

SER8NJ EK040B.UVDATA.1

Freq = 4.7990 GHz, Bw = 32.000 MH No calibration applied and no bandpass applied

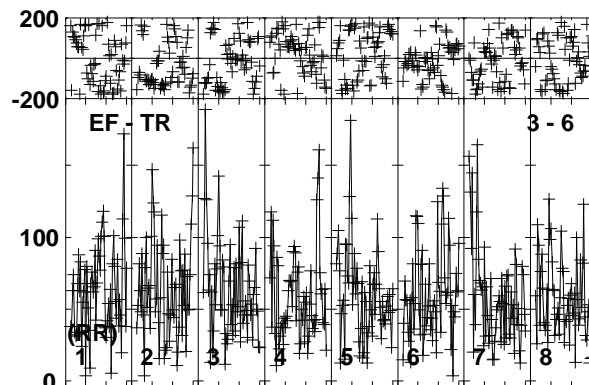
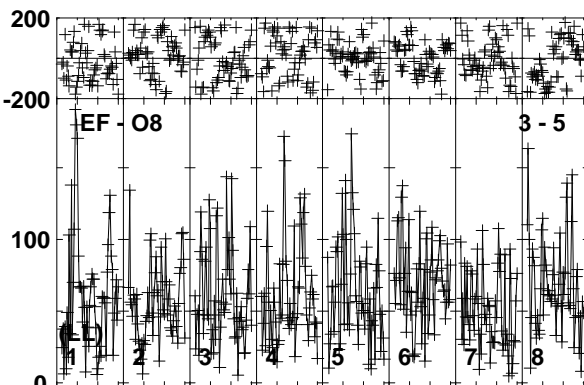
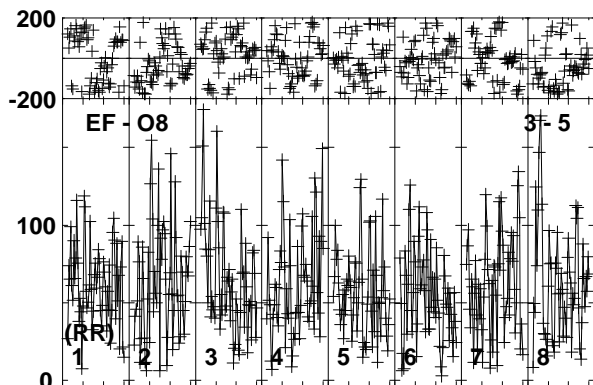
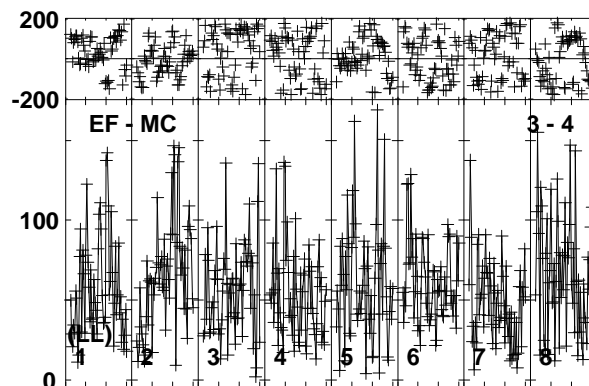
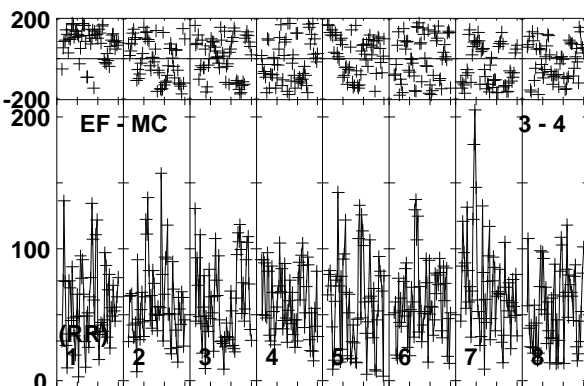
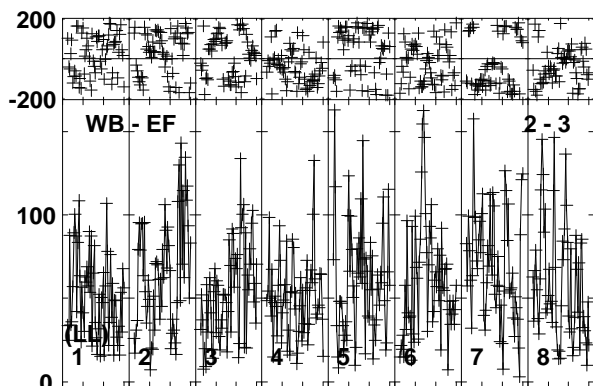
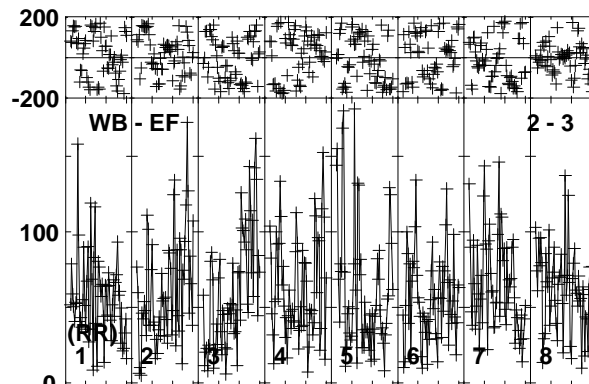
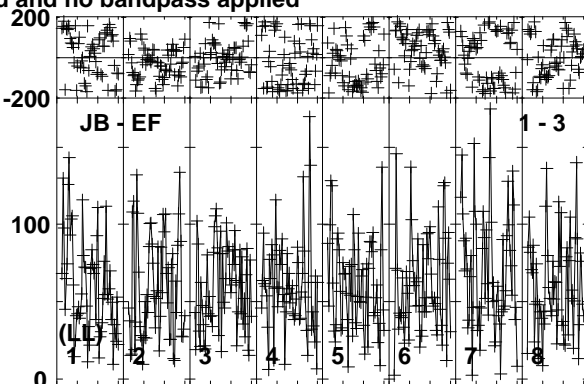
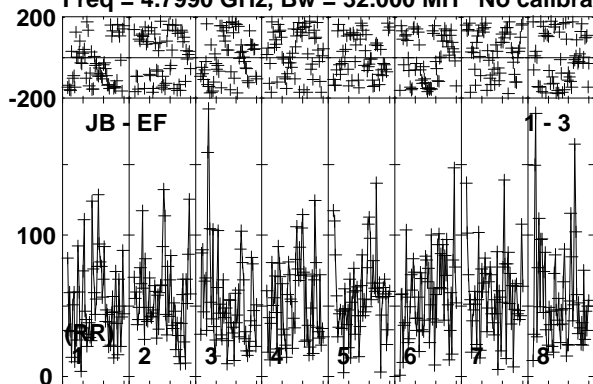

Lower frame: Micro Ampl Jy Top frame: Phas deg  
Vector averaged cross-power spectrum Baseline: JB (01) - EF (03)  
Timerange: 01/02:38:03 to 01/02:41:59

Plot file version 350 created 11-NOV-2019 15:07:56

SER8NJ EK040B.UVDATA.1

Freq = 4.7990 GHz, Bw = 32.000 MH No calibration applied and no bandpass applied

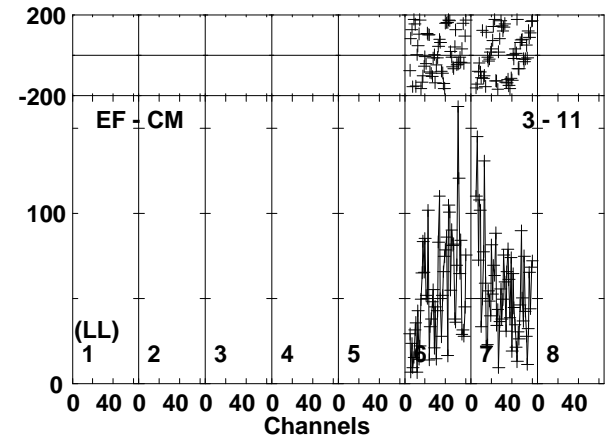
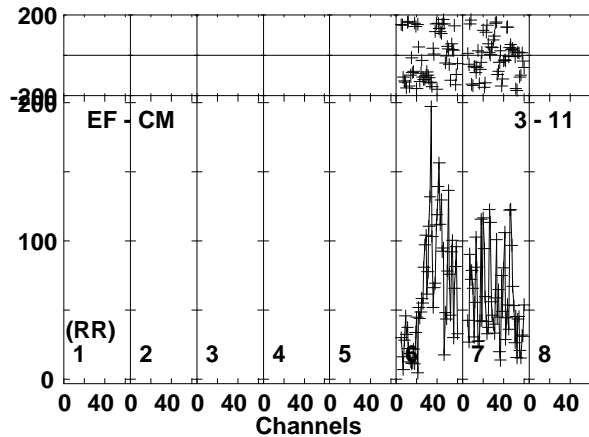
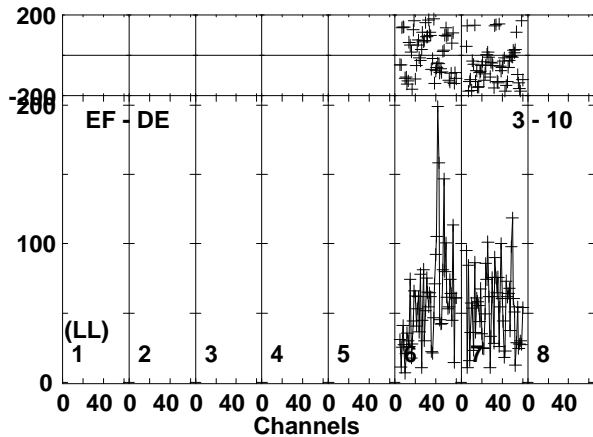
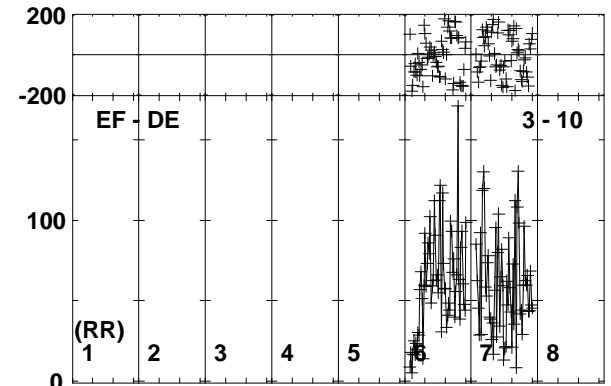
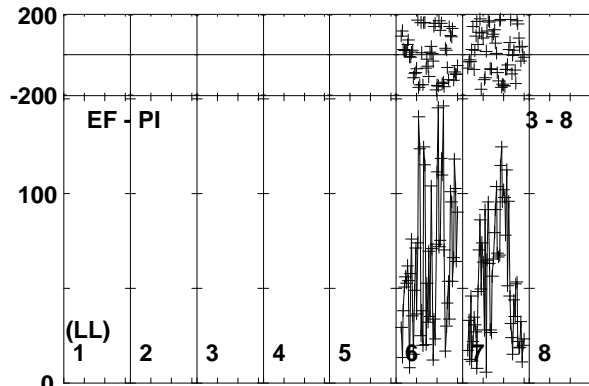
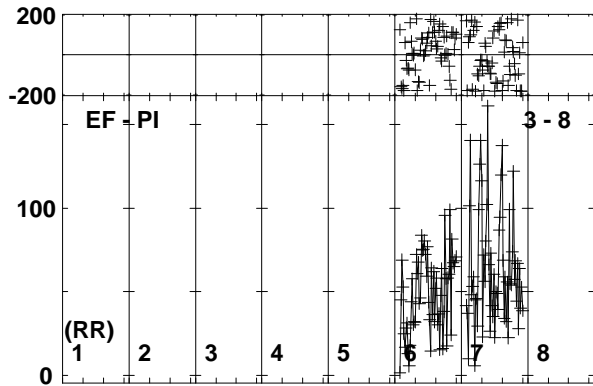
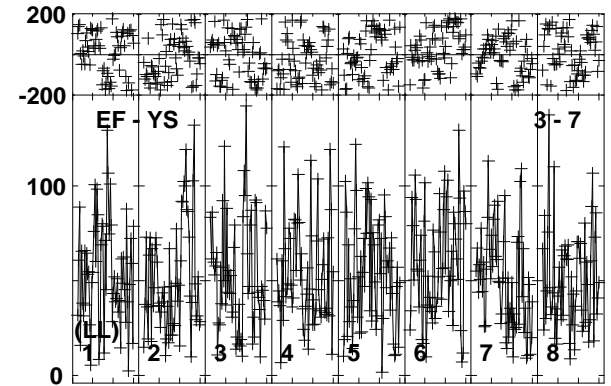
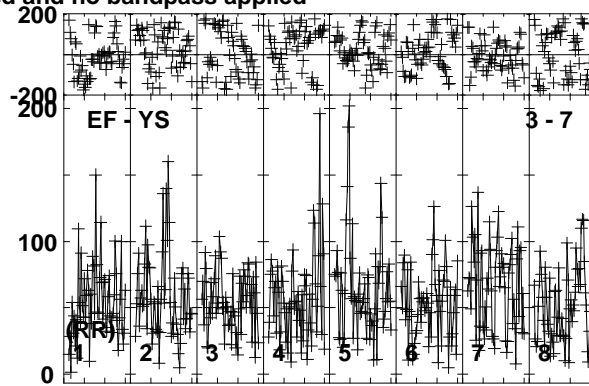
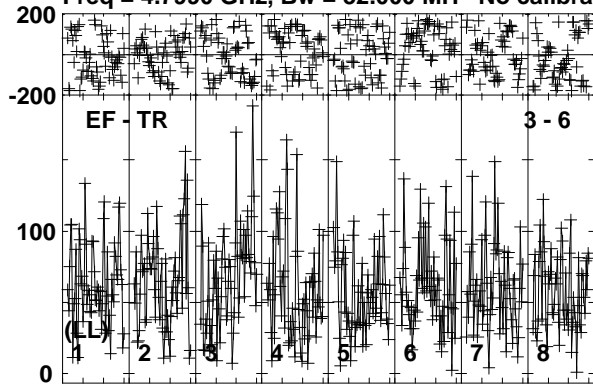

Lower frame: Micro Ampl Jy Top frame: Phas deg  
Vector averaged cross-power spectrum Baseline: EF (03) - TR (06)  
Timerange: 01/02:38:03 to 01/02:41:59

Plot file version 351 created 11-NOV-2019 15:07:56

SER8NJ EK040B.UVDATA.1

Freq = 4.7990 GHz, Bw = 32.000 MH No calibration applied and no bandpass applied

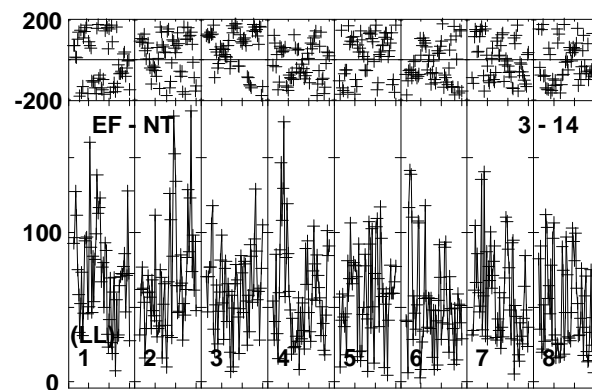
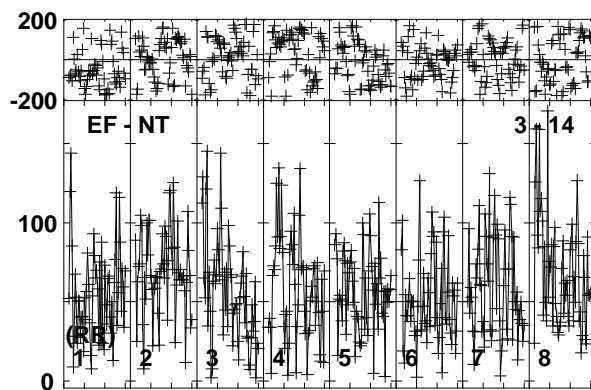
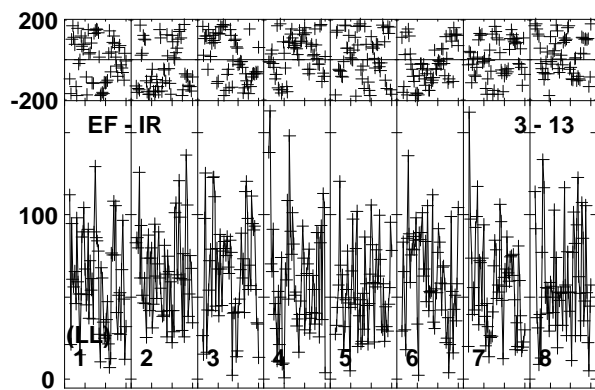
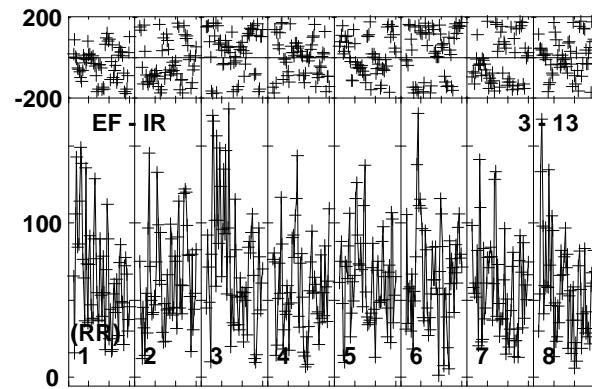
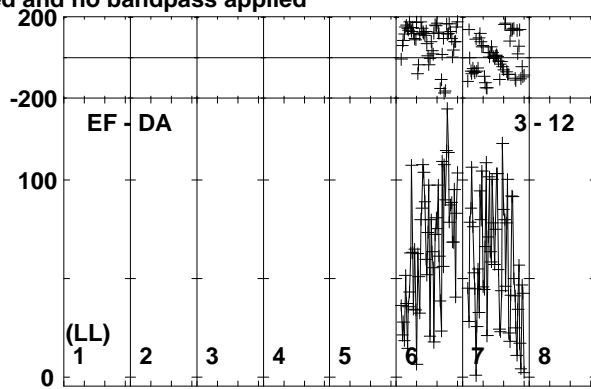
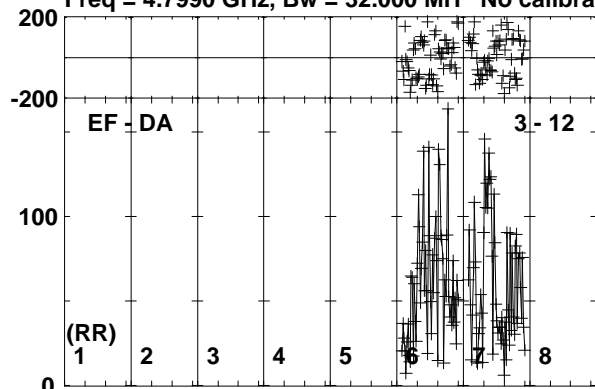

0 40 0 40 0 40 0 40 0 40 0 40 0 40 0 40 0 40 0 40  
Channels

Lower frame: Micro Ampl Jy Top frame: Phas deg  
Vector averaged cross-power spectrum Baseline: EF (03) - DA (12)  
Timerange: 01/02:38:03 to 01/02:41:59

Plot file version 352 created 11-NOV-2019 15:07:56

J1826+0149 EK040B.UVDATA.1

Freq = 4.7990 GHz, Bw = 32.000 MH No calibration applied and no bandpass applied

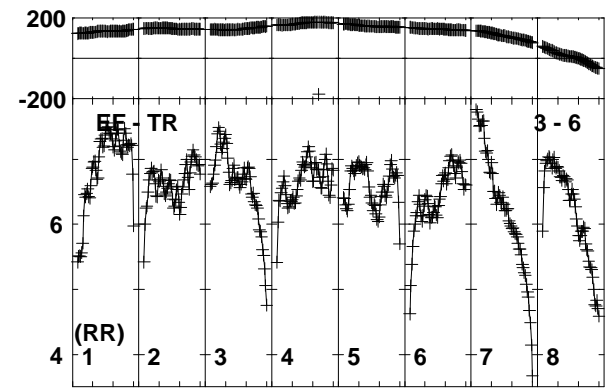
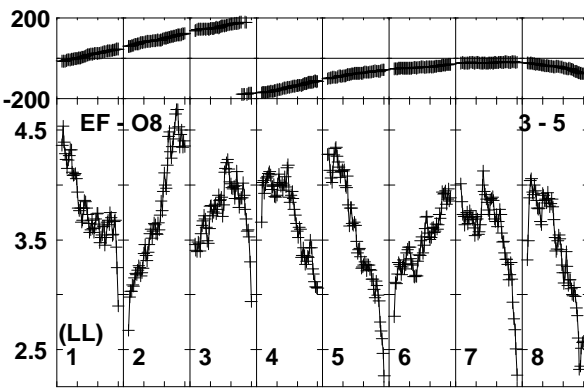
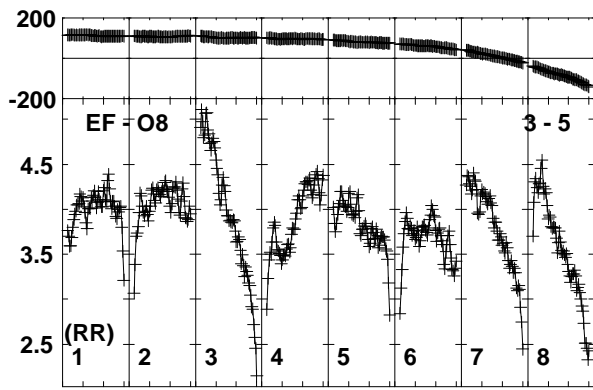
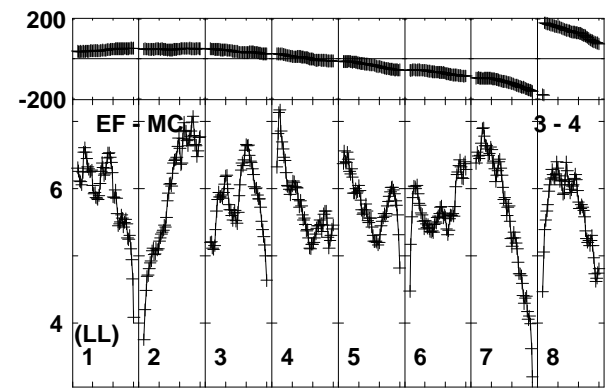
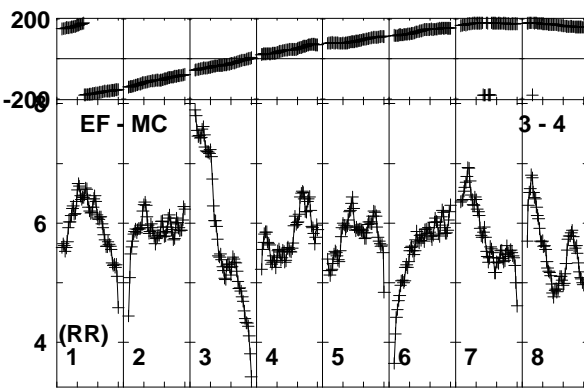
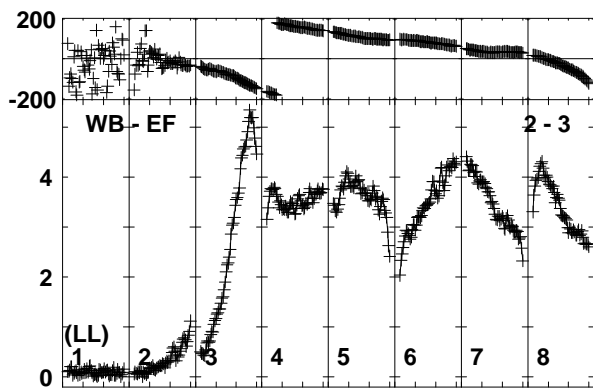
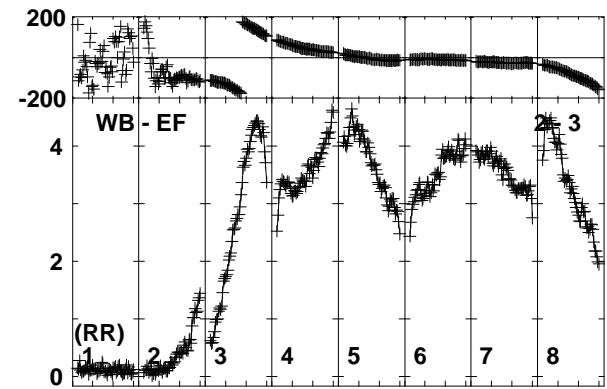
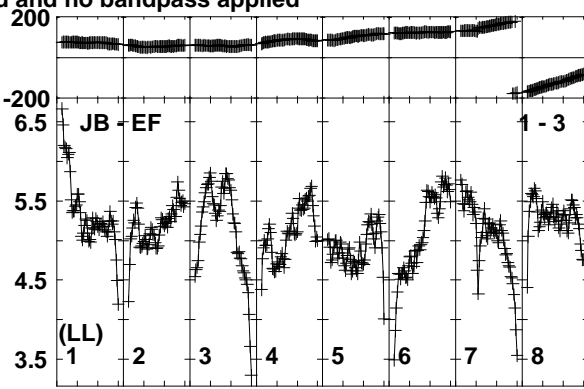
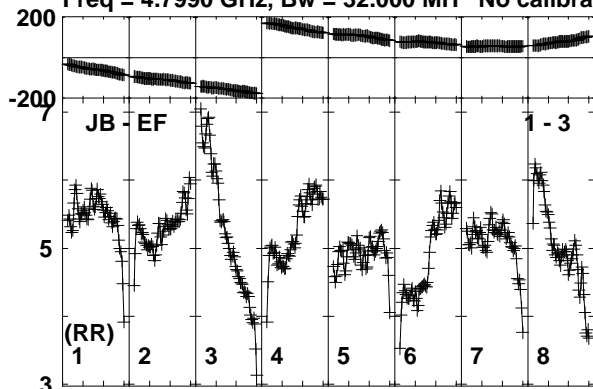

Lower frame: Milli Ampl Jy Top frame: Phas deg  
Vector averaged cross-power spectrum Baseline: JB (01) - EF (03)  
Timerange: 01/02:42:03 to 01/02:43:29

Plot file version 353 created 11-NOV-2019 15:07:56

J1826+0149 EK040B.UVDATA.1

Freq = 4.7990 GHz, Bw = 32.000 MH No calibration applied and no bandpass applied

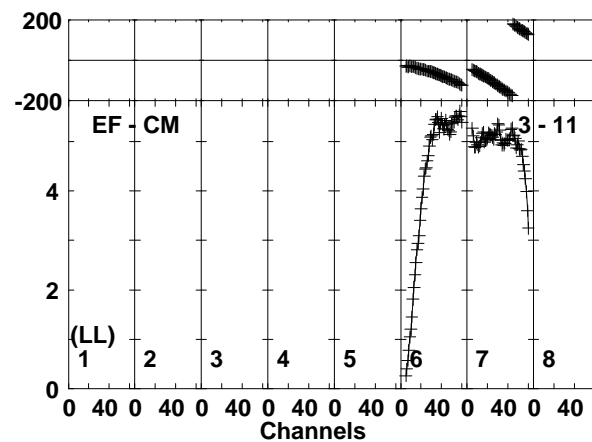
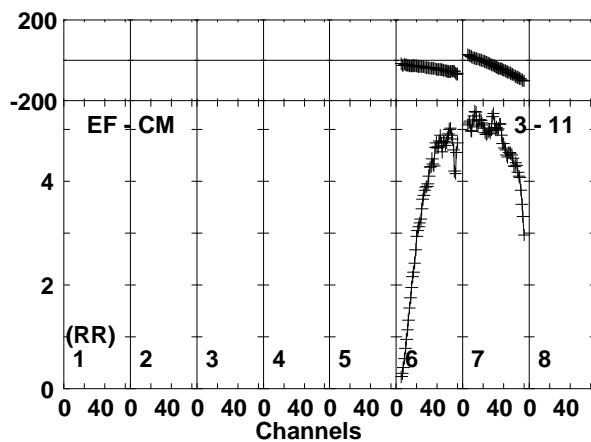
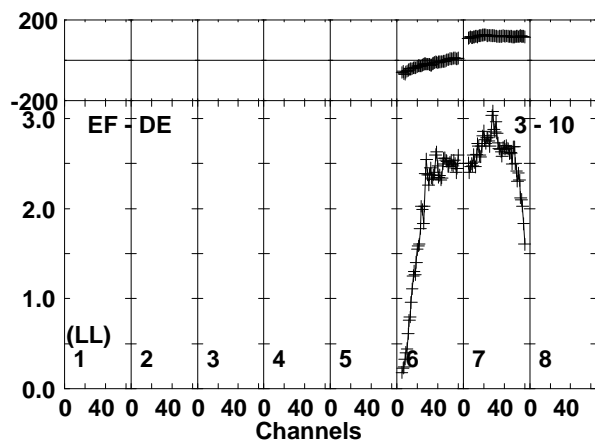
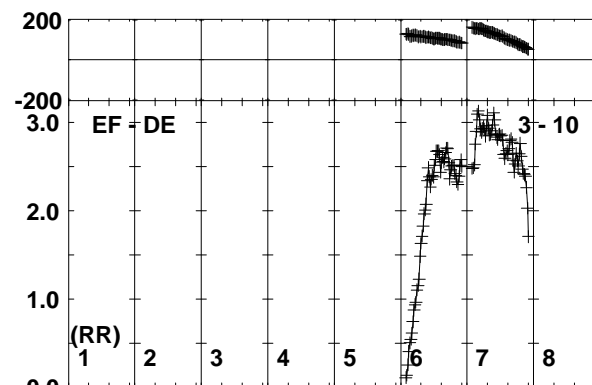
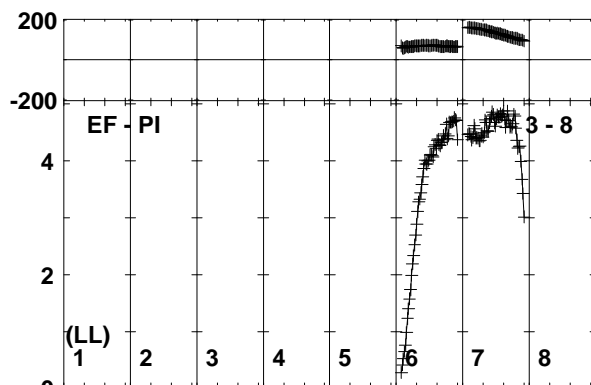
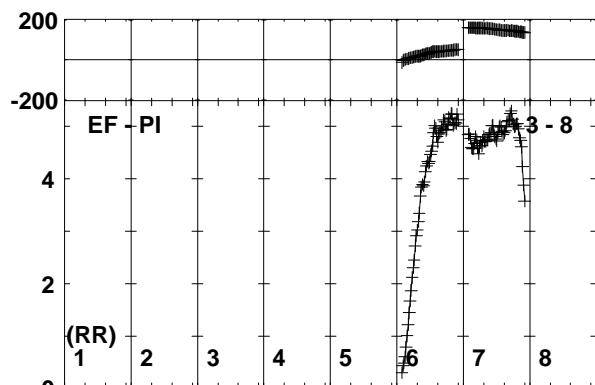
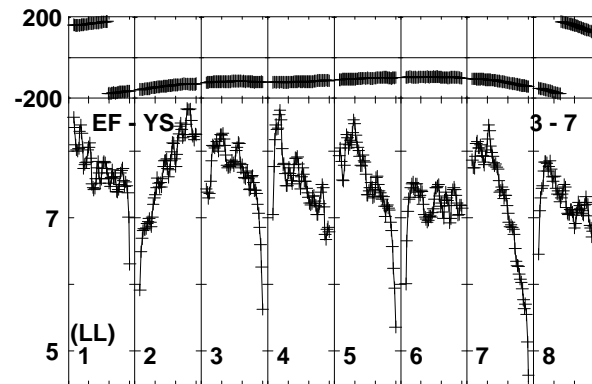
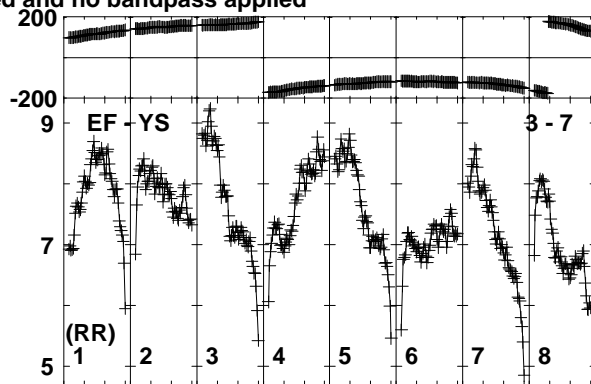
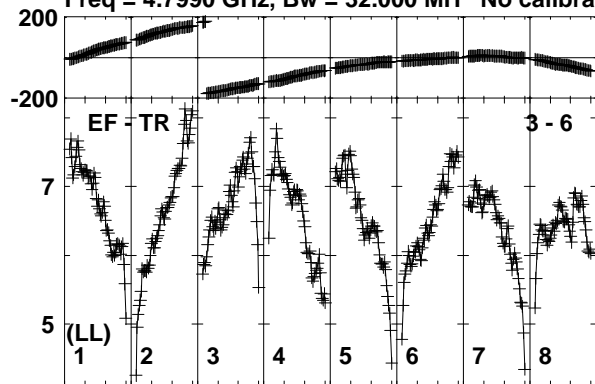

Lower frame: Milli Ampl Jy Top frame: Phas deg  
Vector averaged cross-power spectrum Baseline: EF (03) - TR (06)  
Timerange: 01/02:42:03 to 01/02:43:29

Plot file version 354 created 11-NOV-2019 15:07:56

J1826+0149 EK040B.UVDATA.1

Freq = 4.7990 GHz, Bw = 32.000 MH No calibration applied and no bandpass applied

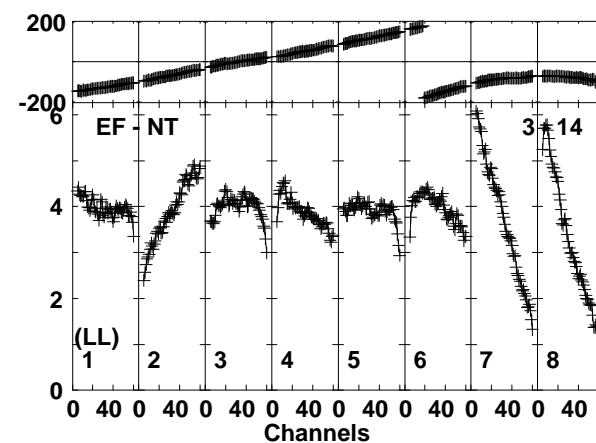
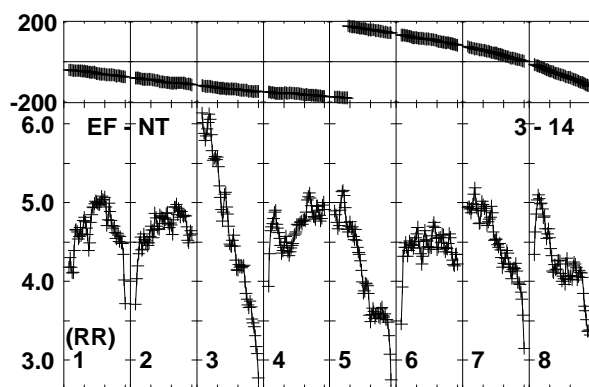
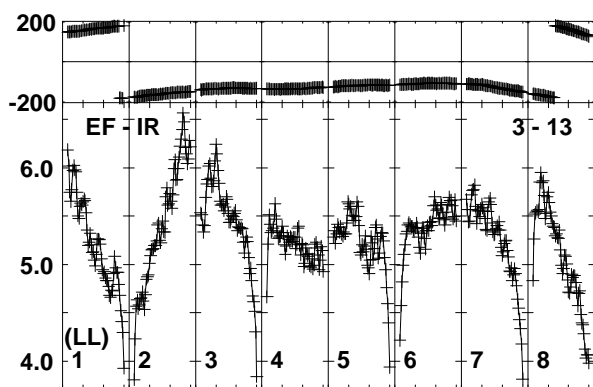
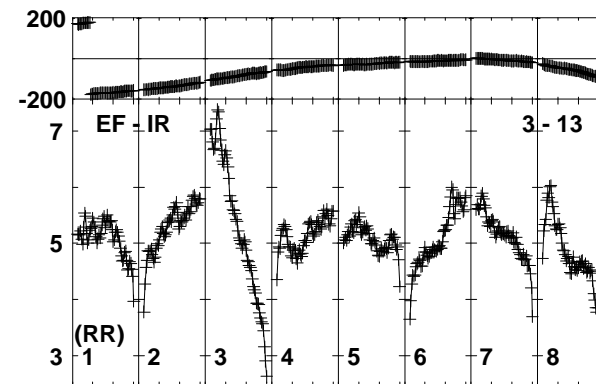
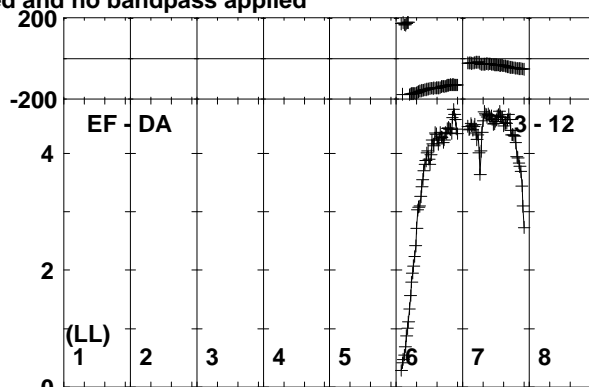
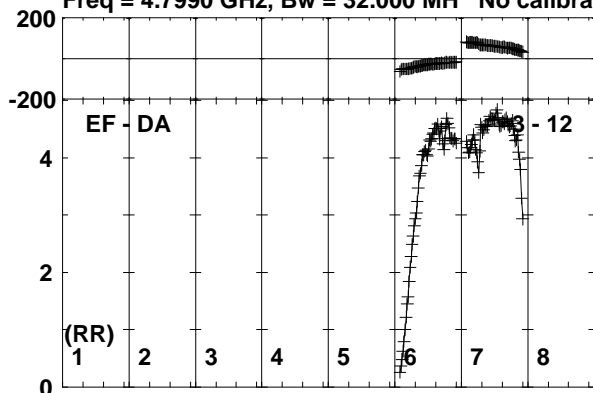

Lower frame: Milli Ampl Jy Top frame: Phas deg  
Vector averaged cross-power spectrum Baseline: EF (03) - DA (12)  
Timerange: 01/02:42:03 to 01/02:43:29



Plot file version 355 created 11-NOV-2019 15:07:56

SER8NJ EK040B.UVDATA.1

Freq = 4.7990 GHz, Bw = 32.000 MH No calibration applied and no bandpass applied

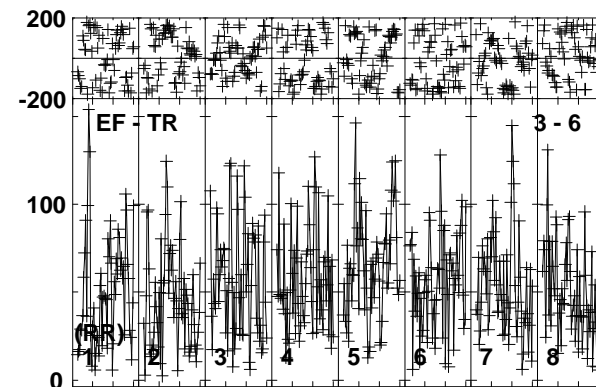
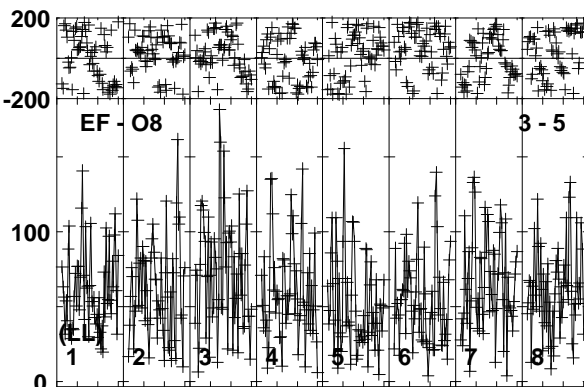
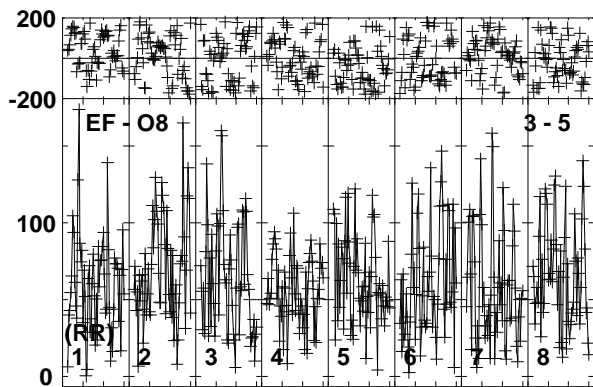
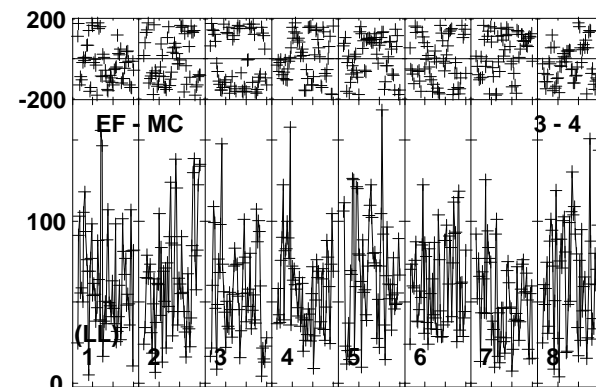
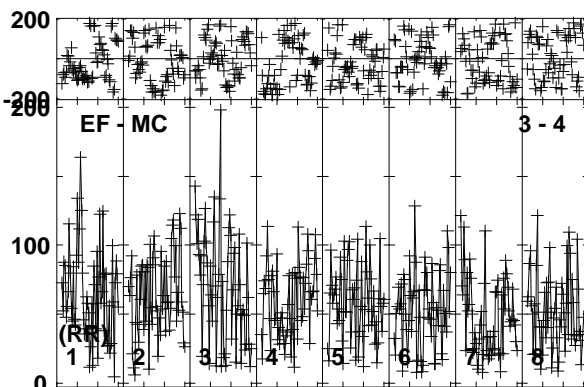
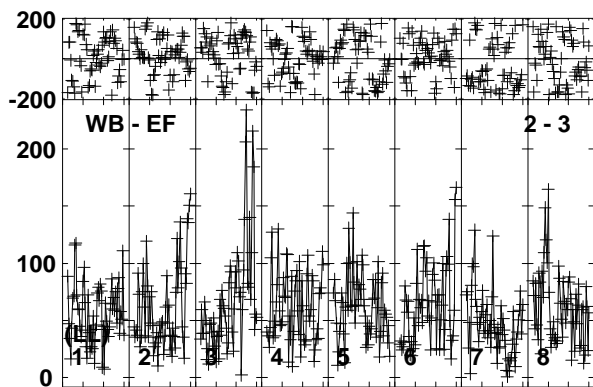
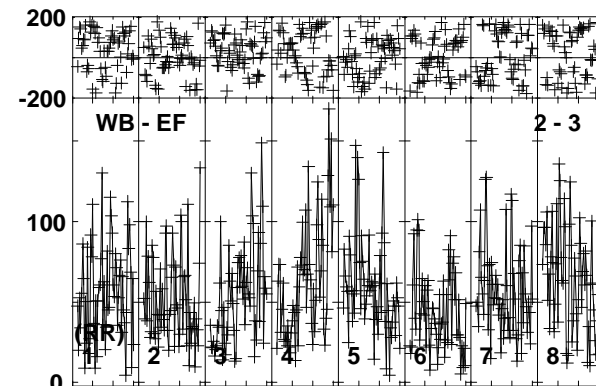
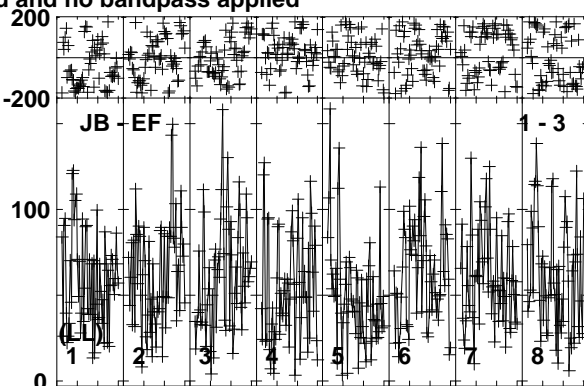
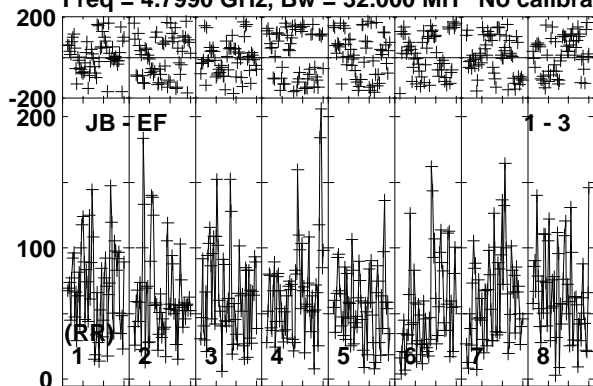

Lower frame: Micro Ampl Jy Top frame: Phas deg  
Vector averaged cross-power spectrum Baseline: JB (01) - EF (03)  
Timerange: 01/02:43:31 to 01/02:47:29

Plot file version 356 created 11-NOV-2019 15:07:57

SER8NJ EK040B.UVDATA.1

Freq = 4.7990 GHz, Bw = 32.000 MH No calibration applied and no bandpass applied

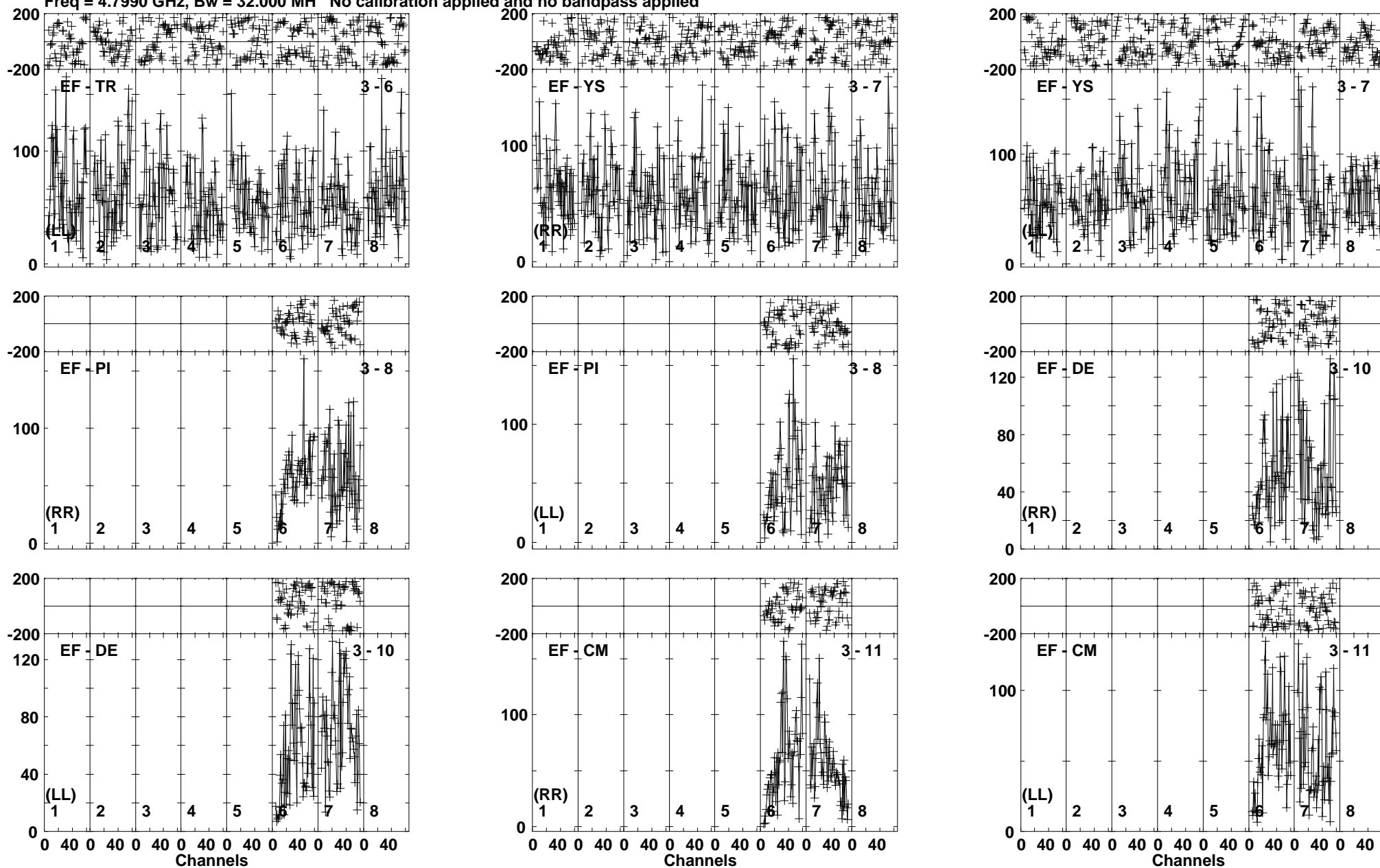

Lower frame: Micro Ampl Jy Top frame: Phas deg  
Vector averaged cross-power spectrum Baseline: EF (03) - TR (06)  
Timerange: 01/02:43:31 to 01/02:47:29

Plot file version 357 created 11-NOV-2019 15:07:57

SER8NJ EK040B.UVDATA.1

Freq = 4.7990 GHz, Bw = 32.000 MH No calibration applied and no bandpass applied

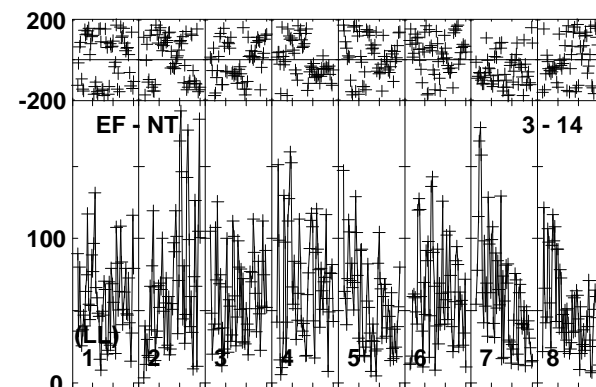
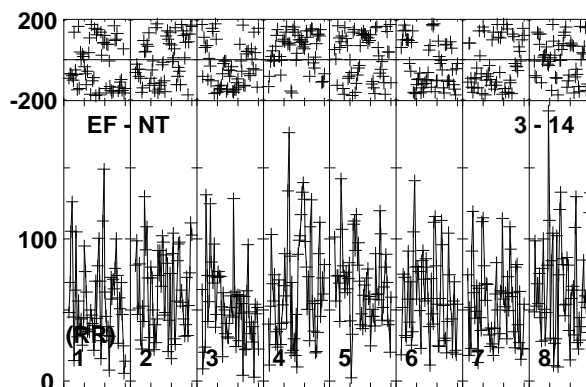
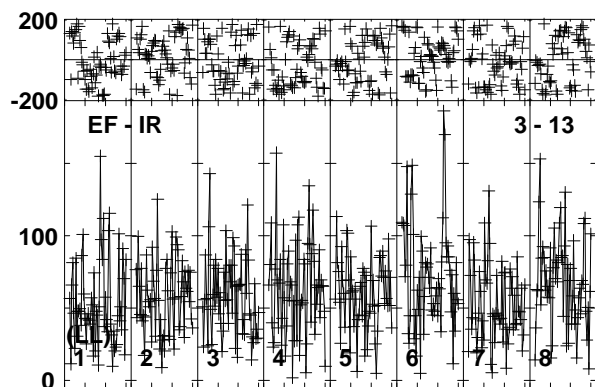
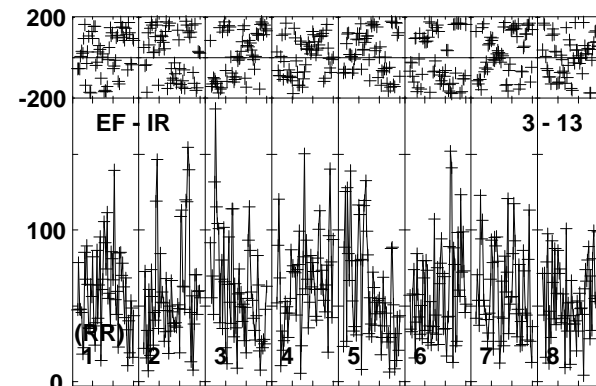
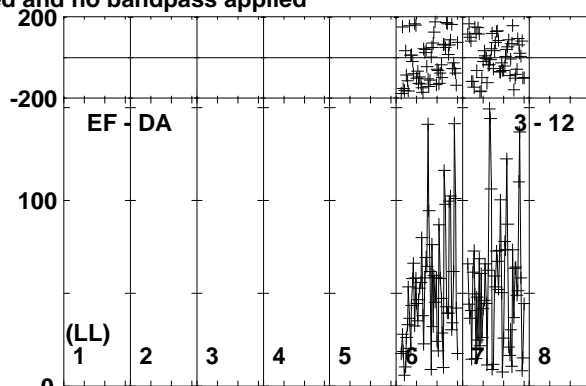
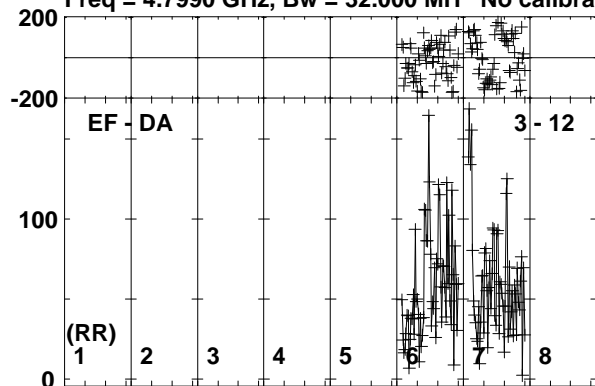

0 40 0 40 0 40 0 40 0 40 0 40 0 40 0 40 0 40  
Channels

Lower frame: Micro Ampl Jy Top frame: Phas deg  
Vector averaged cross-power spectrum Baseline: EF (03) - DA (12)  
Timerange: 01/02:43:31 to 01/02:47:29

Plot file version 358 created 11-NOV-2019 15:07:57

J1826+0149 EK040B.UVDATA.1

Freq = 4.7990 GHz, Bw = 32.000 MH No calibration applied and no bandpass applied

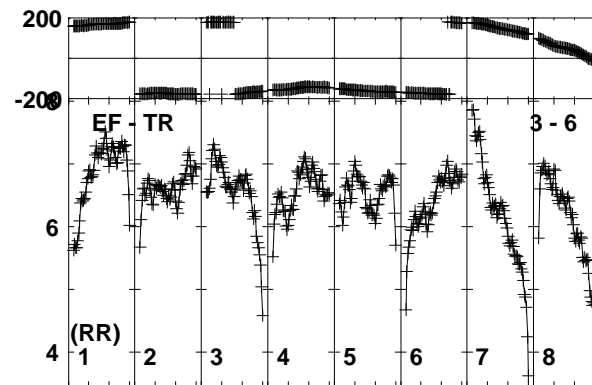
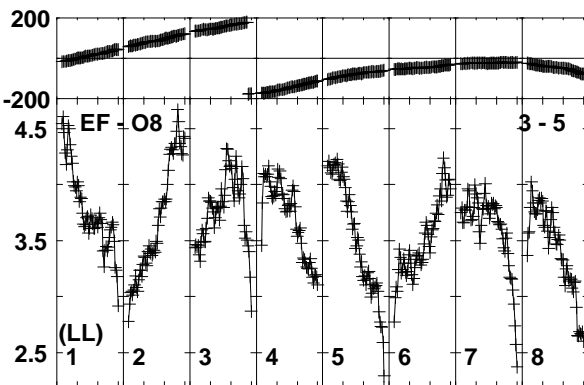
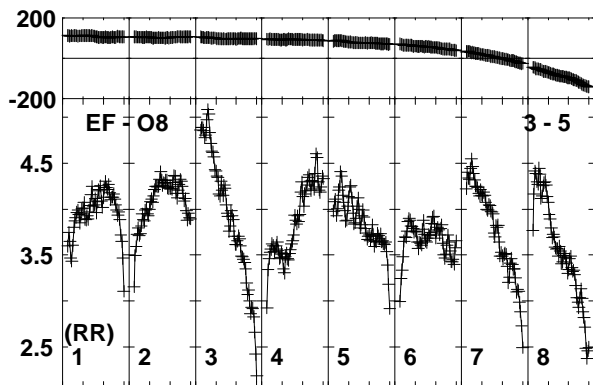
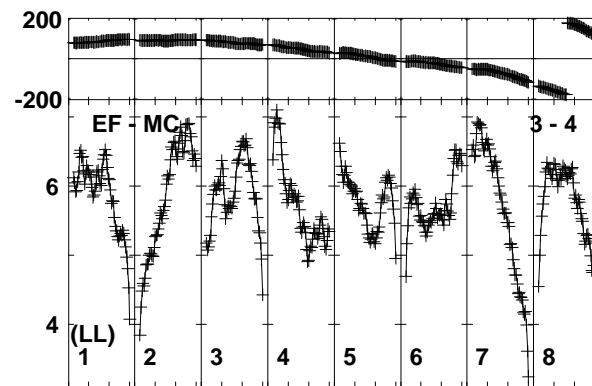
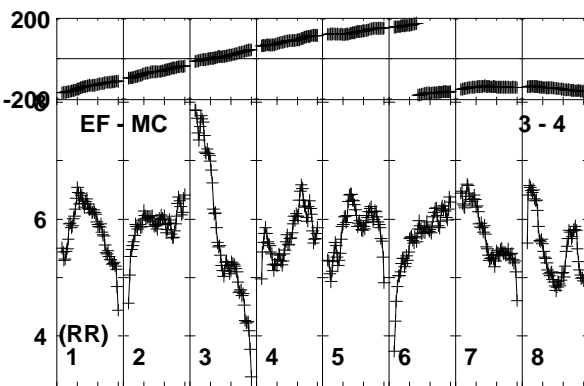
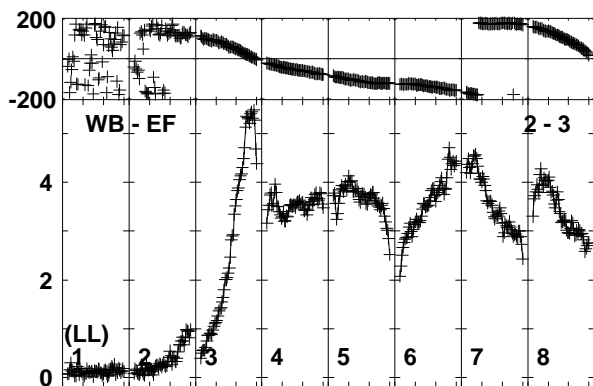
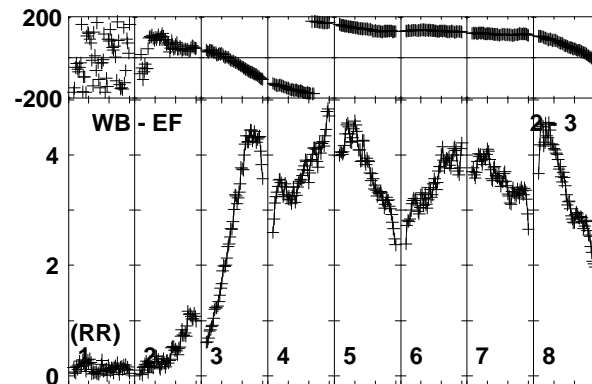
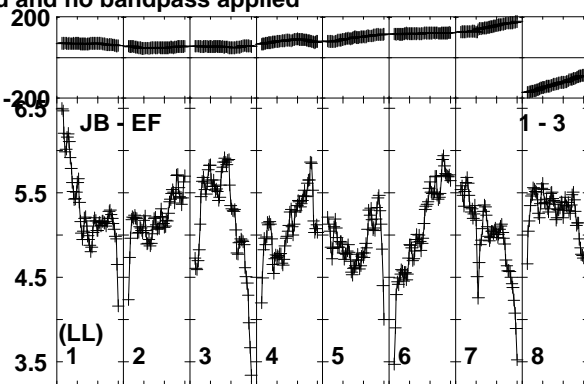
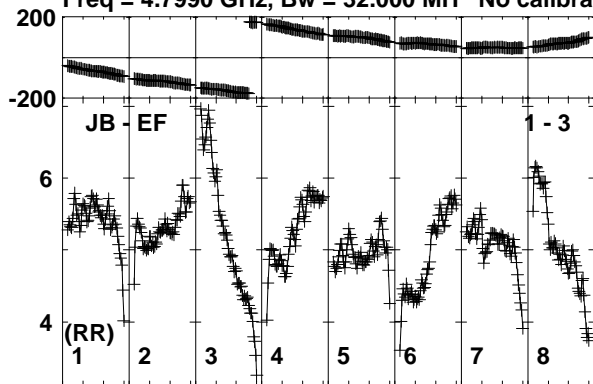

Lower frame: Milli Ampl Jy Top frame: Phas deg  
Vector averaged cross-power spectrum Baseline: JB (01) - EF (03)  
Timerange: 01/02:48:11 to 01/02:49:09

Plot file version 359 created 11-NOV-2019 15:07:57

J1826+0149 EK040B.UVDATA.1

Freq = 4.7990 GHz, Bw = 32.000 MH No calibration applied and no bandpass applied

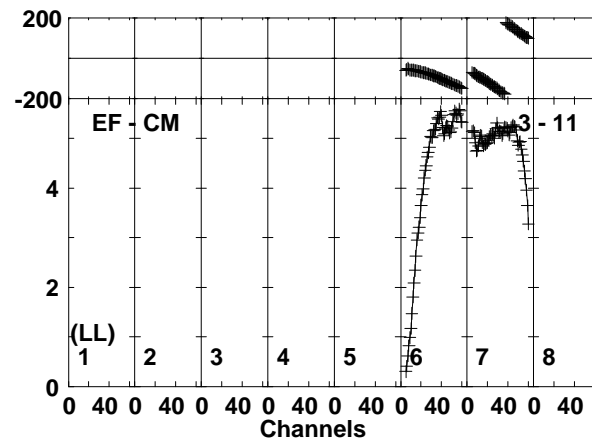
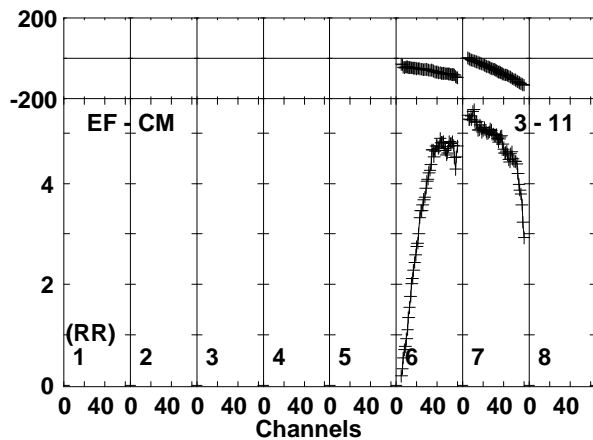
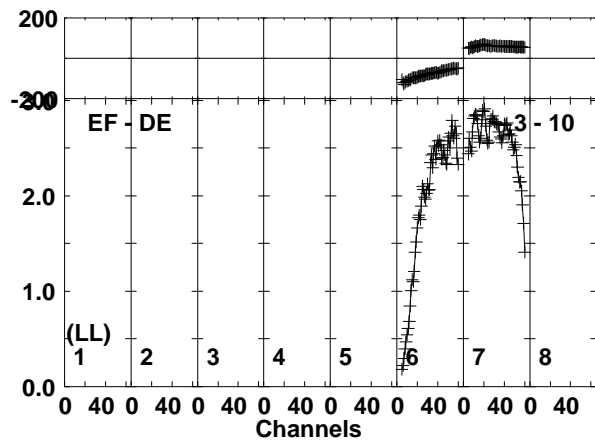
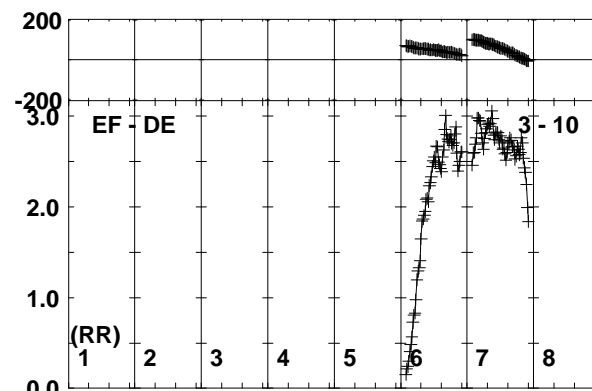
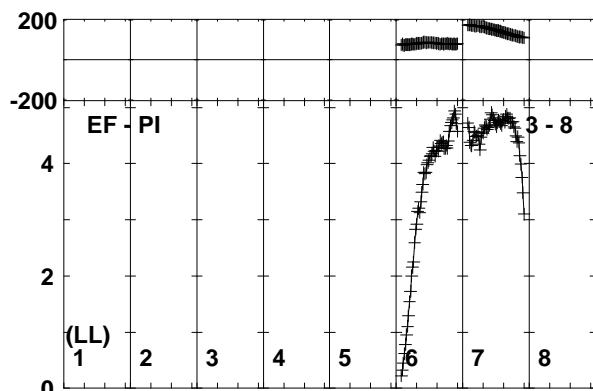
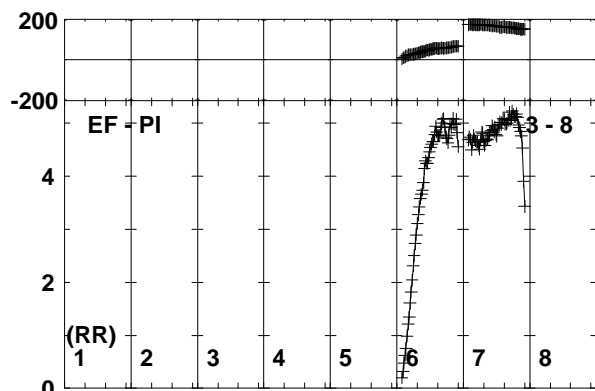
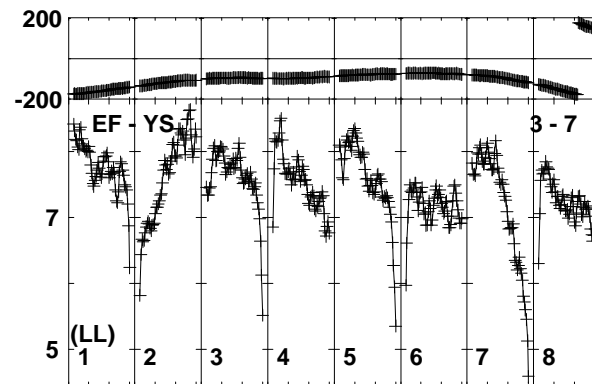
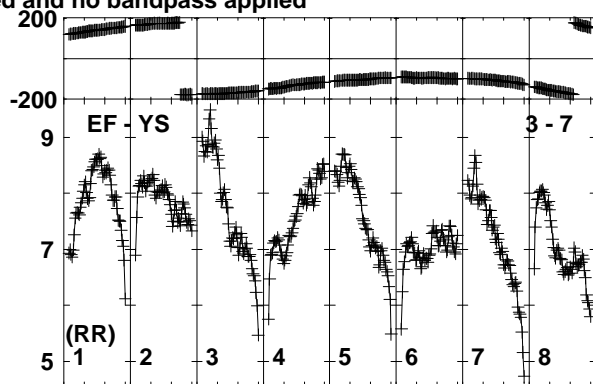
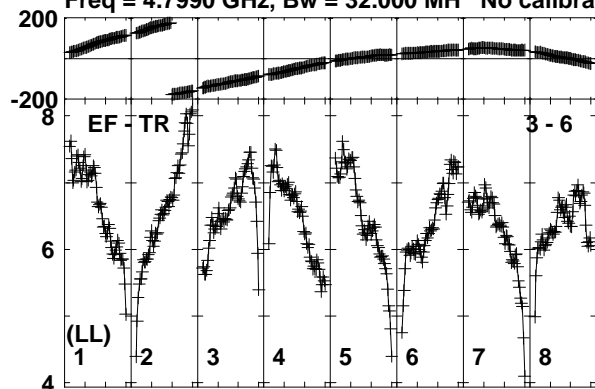

Lower frame: Milli Ampl Jy Top frame: Phas deg  
Vector averaged cross-power spectrum Baseline: EF (03) - TR (06)  
Timerange: 01/02:48:11 to 01/02:49:09

Plot file version 360 created 11-NOV-2019 15:07:57

J1826+0149 EK040B.UVDATA.1

Freq = 4.7990 GHz, Bw = 32.000 MH No calibration applied and no bandpass applied

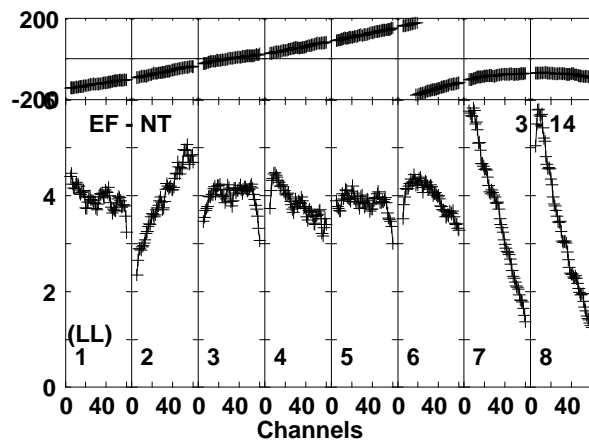
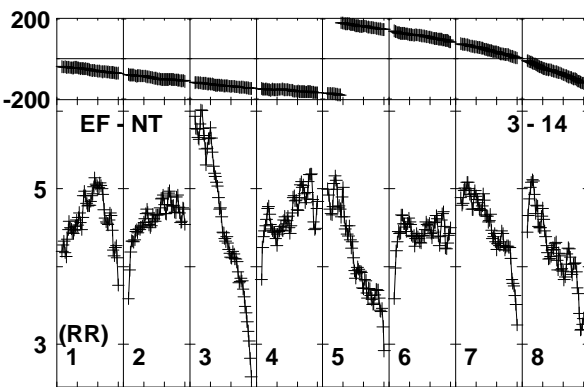
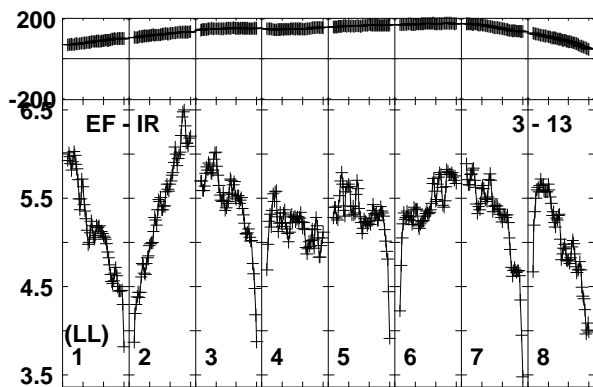
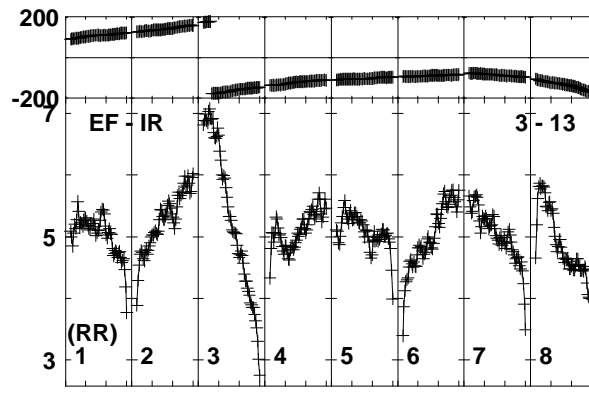
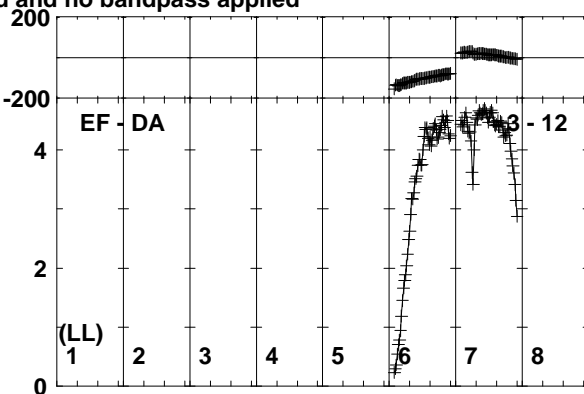
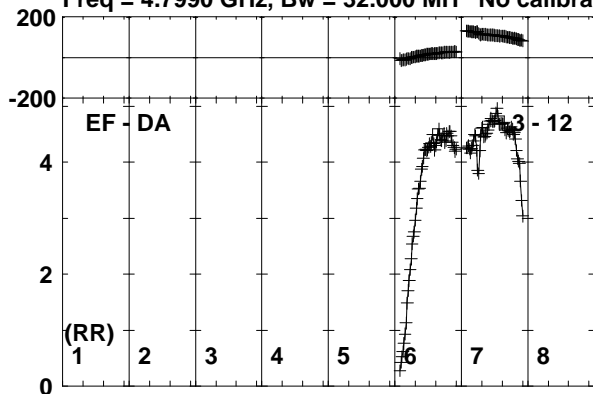

Lower frame: Milli Ampl Jy Top frame: Phas deg  
Vector averaged cross-power spectrum Baseline: EF (03) - DA (12)  
Timerange: 01/02:48:11 to 01/02:49:09

Plot file version 361 created 11-NOV-2019 15:07:57

J1751+0939 EK040B.UVDATA.1

Freq = 4.7990 GHz, Bw = 32.000 MH No calibration applied and no bandpass applied

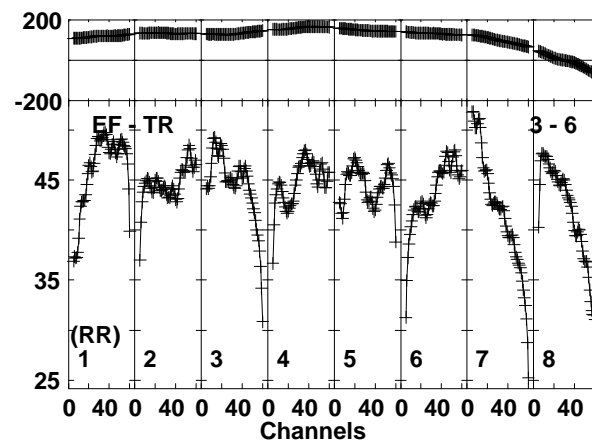
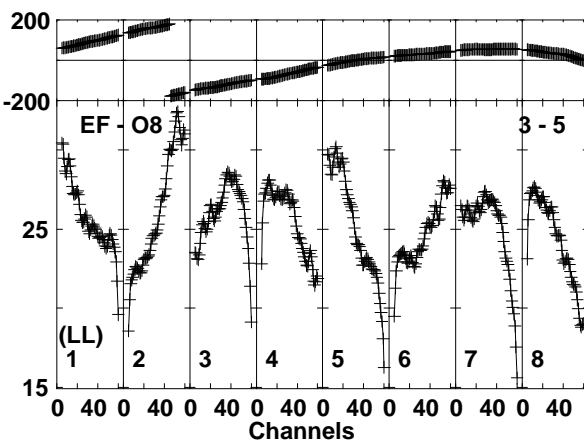
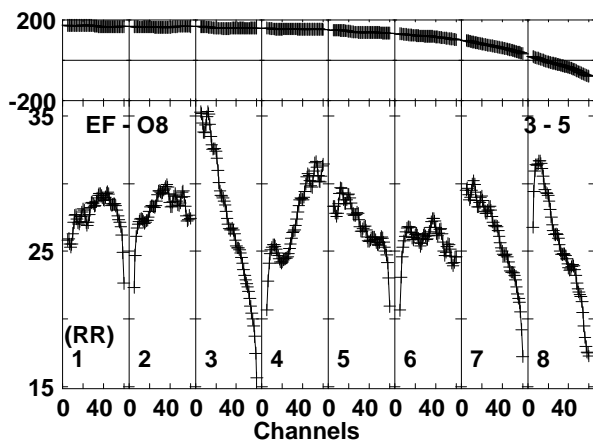
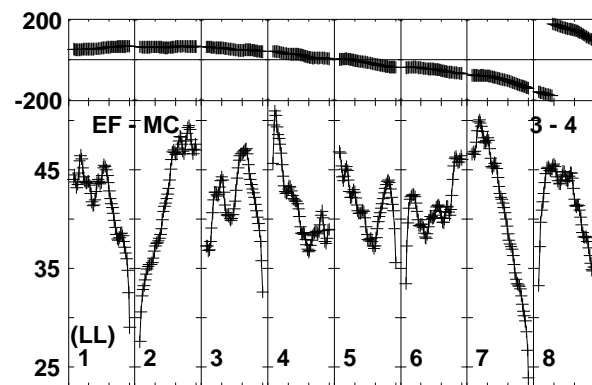
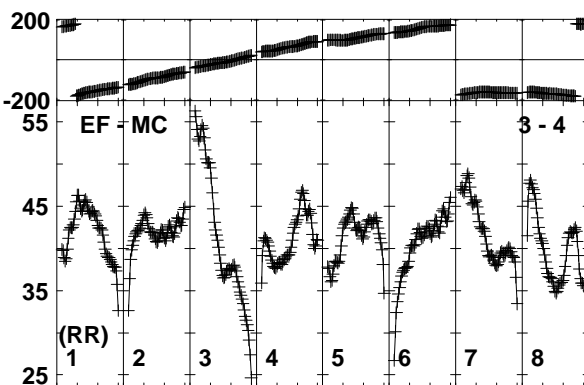
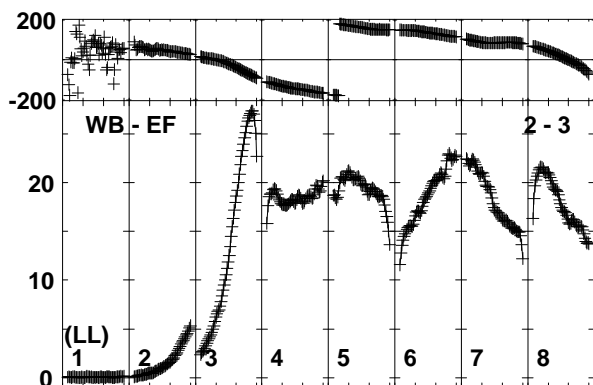
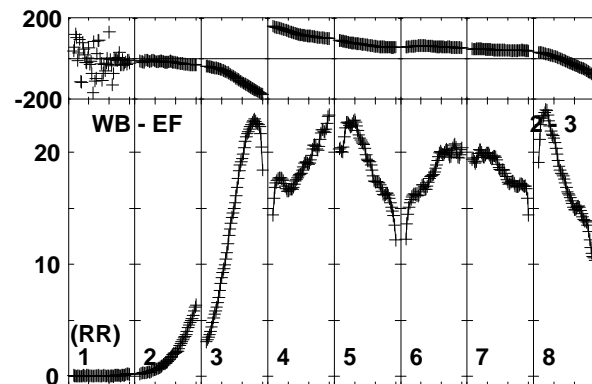
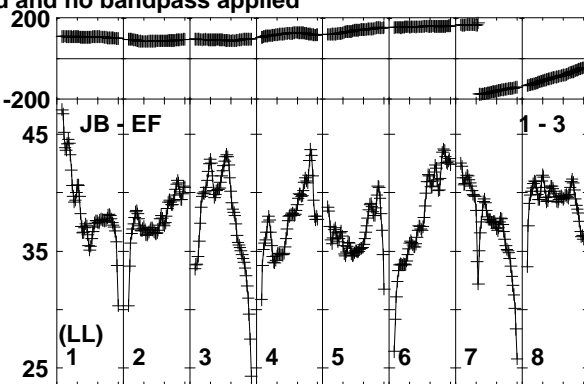
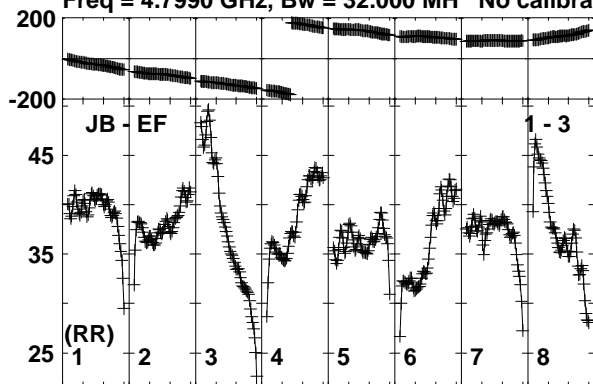

Lower frame: Milli Ampl Jy Top frame: Phas deg  
Vector averaged cross-power spectrum Baseline: JB (01) - EF (03)  
Timerange: 01/02:50:56 to 01/02:55:54

Plot file version 362 created 11-NOV-2019 15:07:57

J1751+0939 EK040B.UVDATA.1

Freq = 4.7990 GHz, Bw = 32.000 MH No calibration applied and no bandpass applied

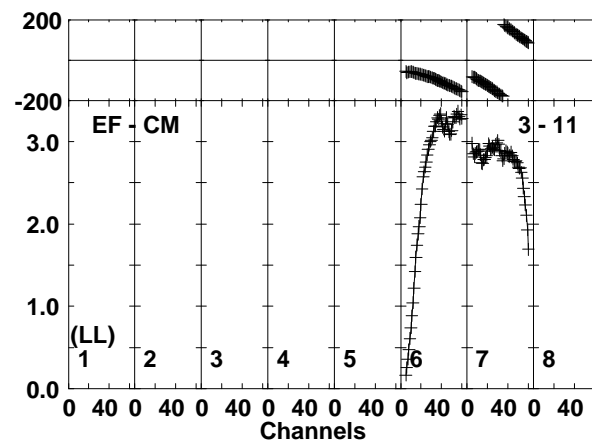
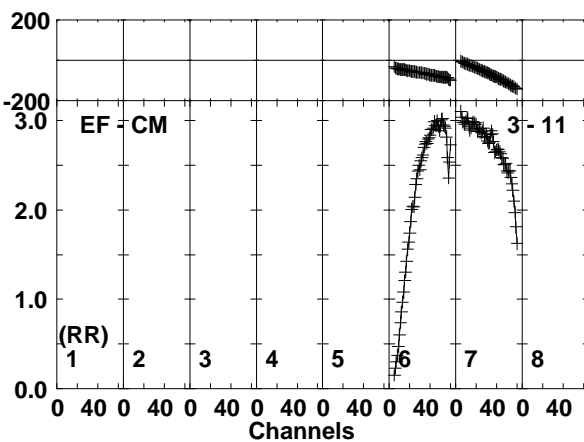
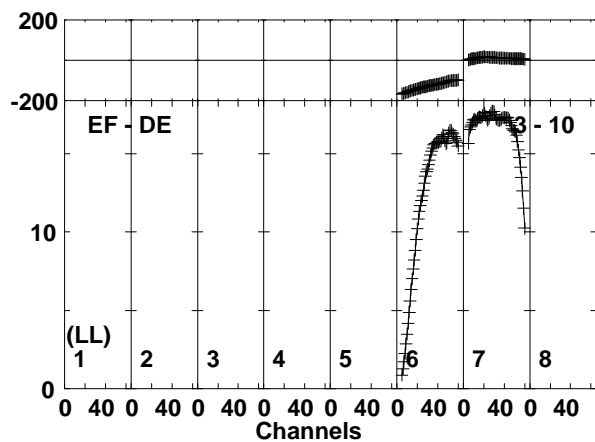
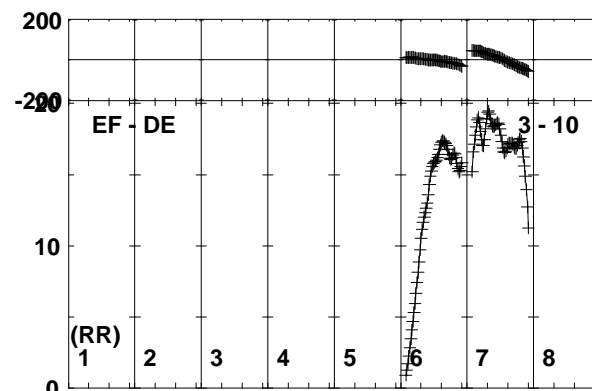
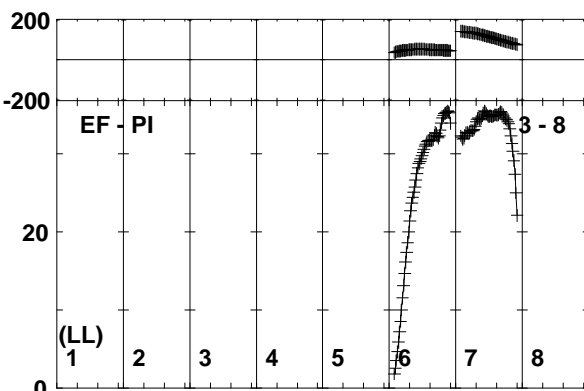
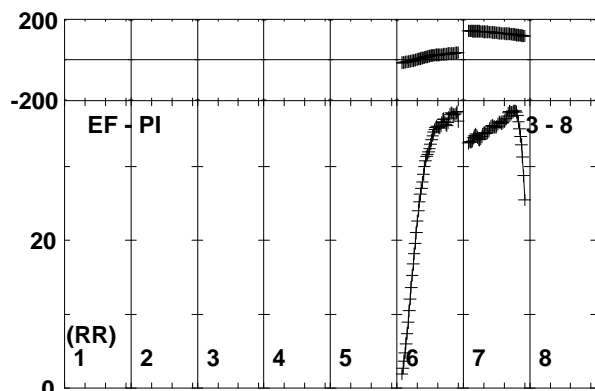
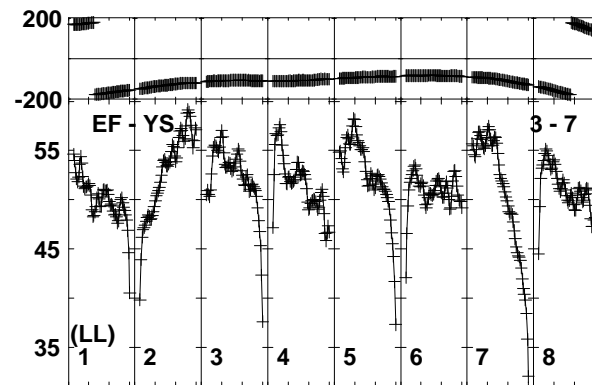
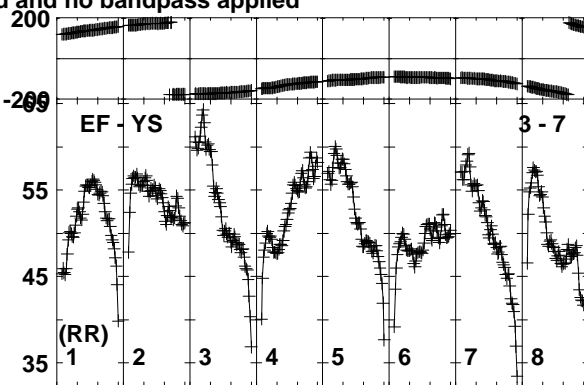
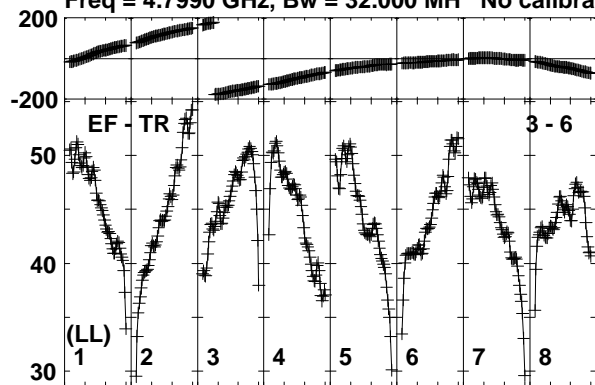

Lower frame: Milli Ampl Jy Top frame: Phas deg  
Vector averaged cross-power spectrum Baseline: EF (03) - TR (06)  
Timerange: 01/02:50:56 to 01/02:55:54



Plot file version 363 created 11-NOV-2019 15:07:57

J1751+0939 EK040B.UVDATA.1

Freq = 4.7990 GHz, Bw = 32.000 MH No calibration applied and no bandpass applied

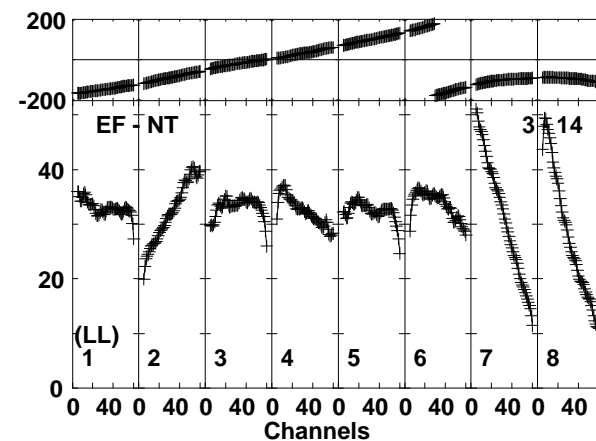
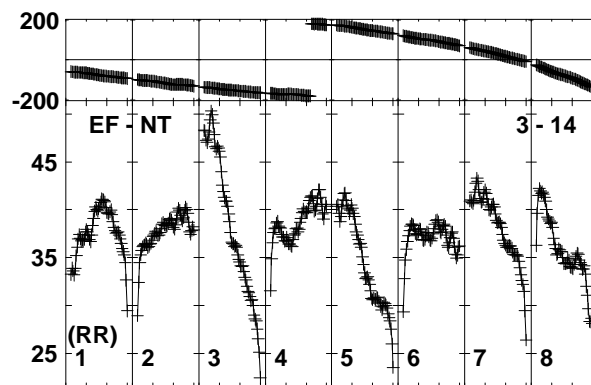
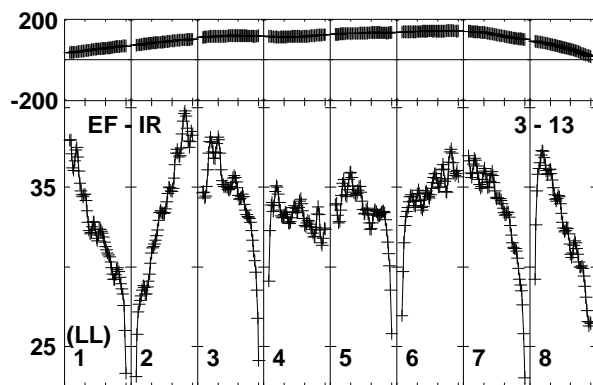
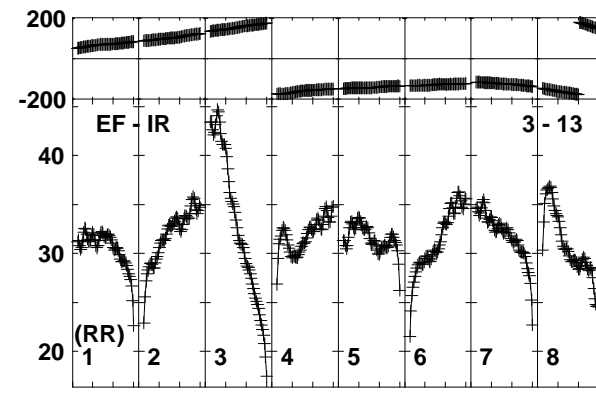
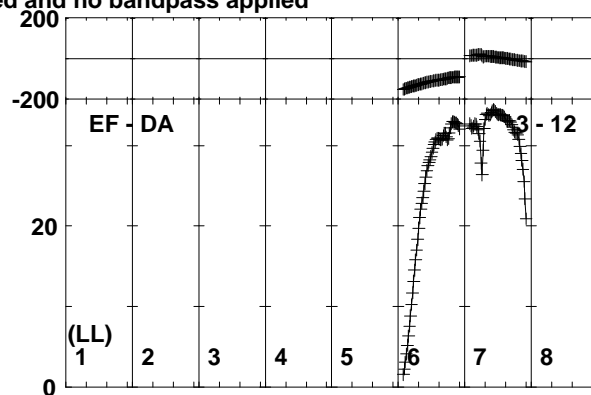
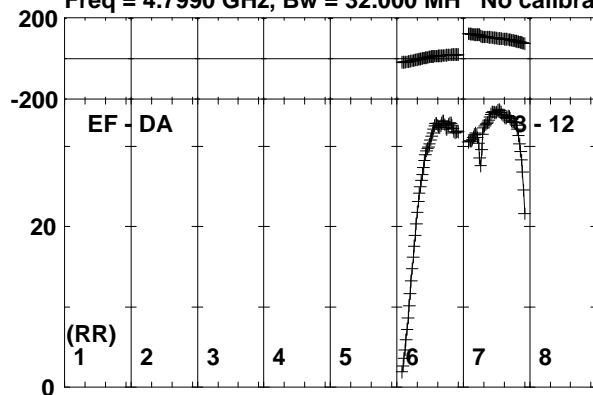

Lower frame: Milli Ampl Jy Top frame: Phas deg  
Vector averaged cross-power spectrum Baseline: EF (03) - DA (12)  
Timerange: 01/02:50:56 to 01/02:55:54

Plot file version 364 created 11-NOV-2019 15:07:58

J1826+0149 EK040B.UVDATA.1

Freq = 4.7990 GHz, Bw = 32.000 MH No calibration applied and no bandpass applied

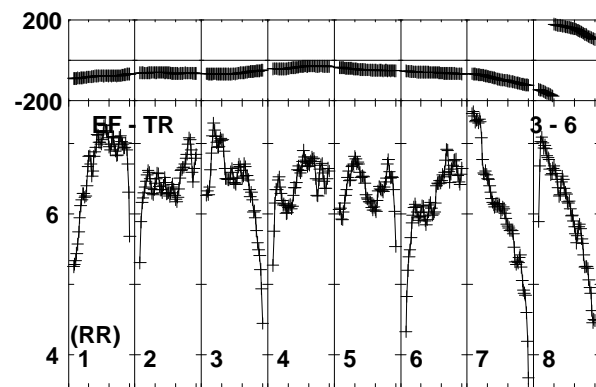
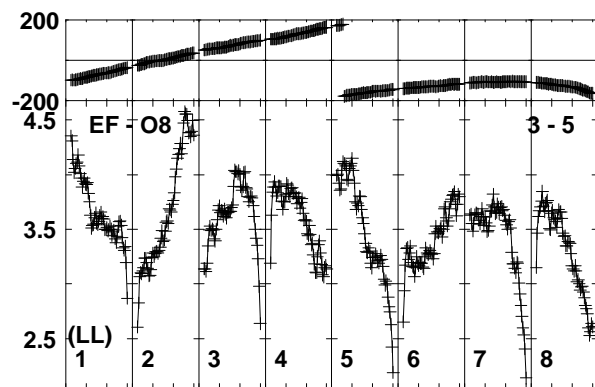
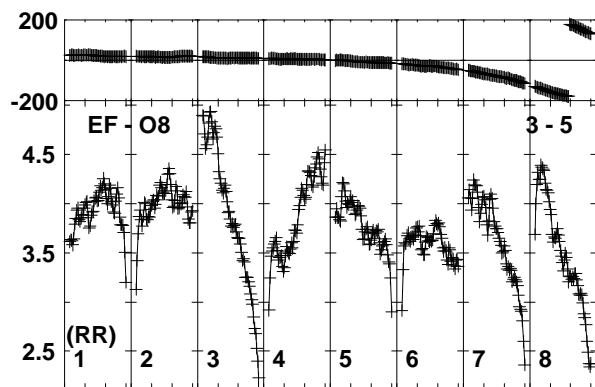
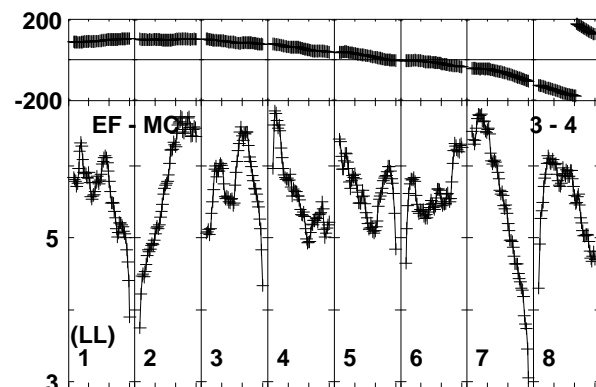
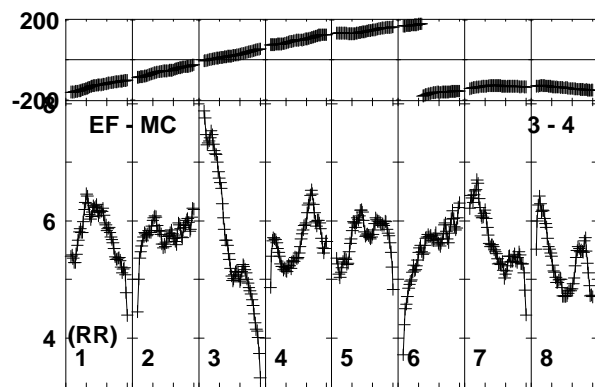
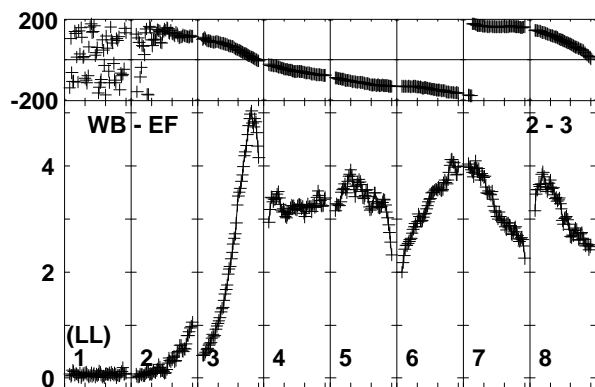
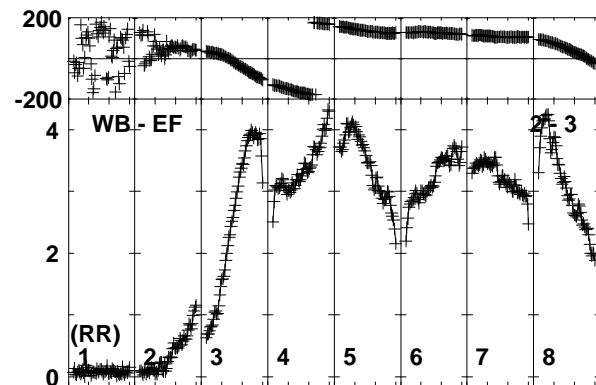
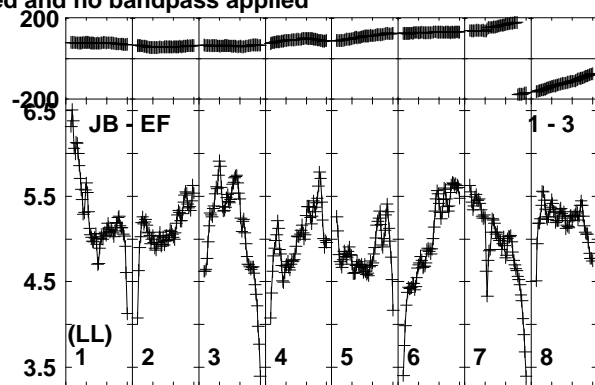
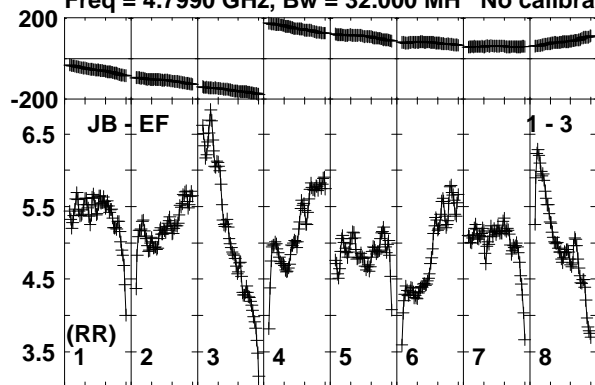

Lower frame: Milli Ampl Jy Top frame: Phas deg  
Vector averaged cross-power spectrum Baseline: JB (01) - EF (03)  
Timerange: 01/02:57:41 to 01/02:59:39

Plot file version 365 created 11-NOV-2019 15:07:58

J1826+0149 EK040B.UVDATA.1

Freq = 4.7990 GHz, Bw = 32.000 MH No calibration applied and no bandpass applied

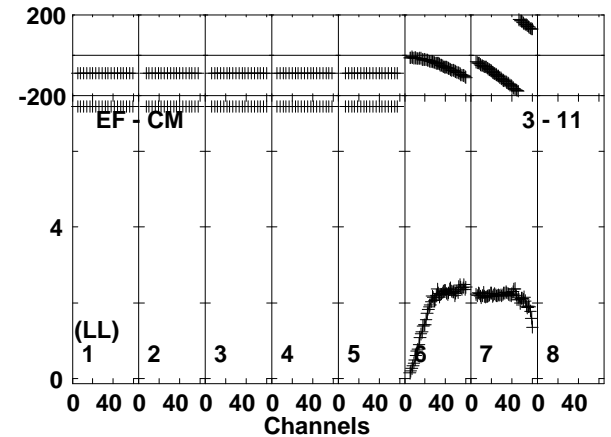
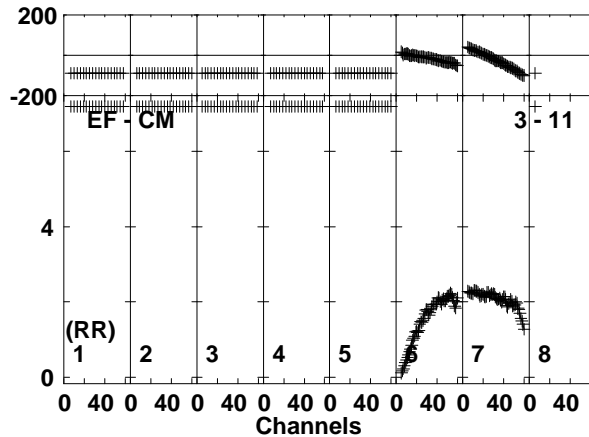
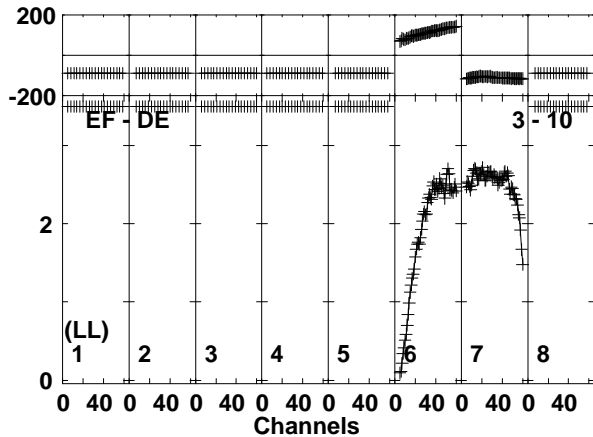
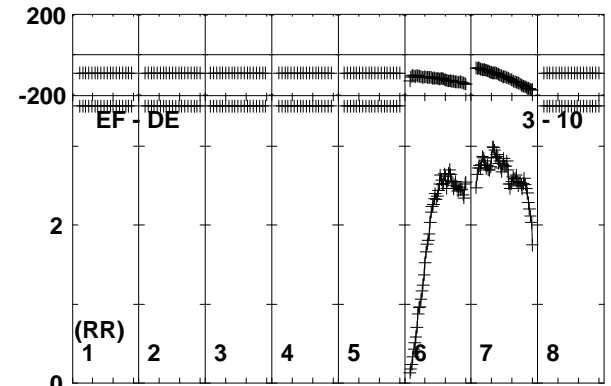
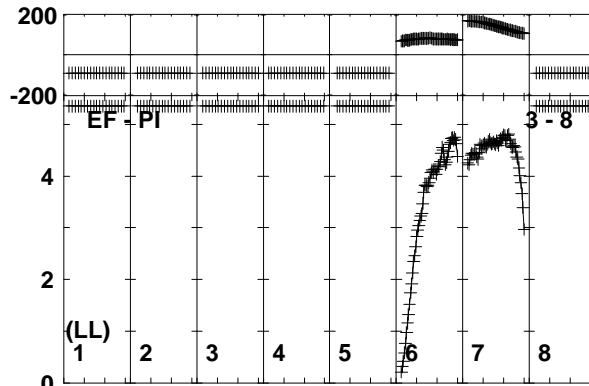
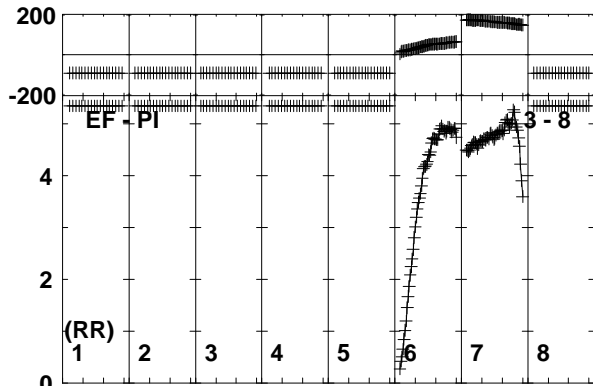
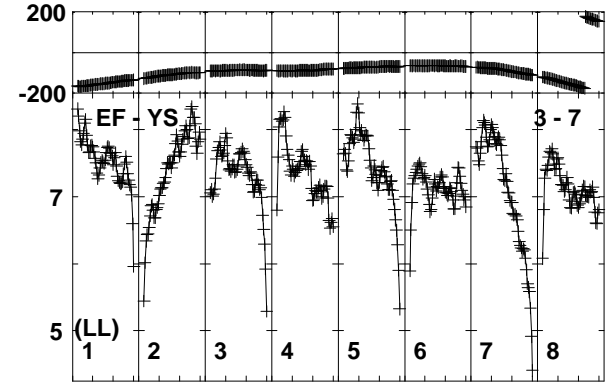
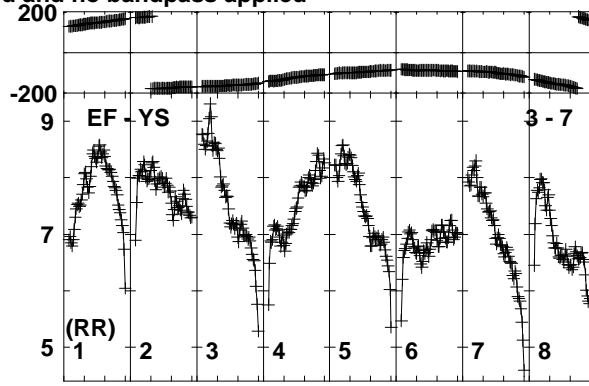
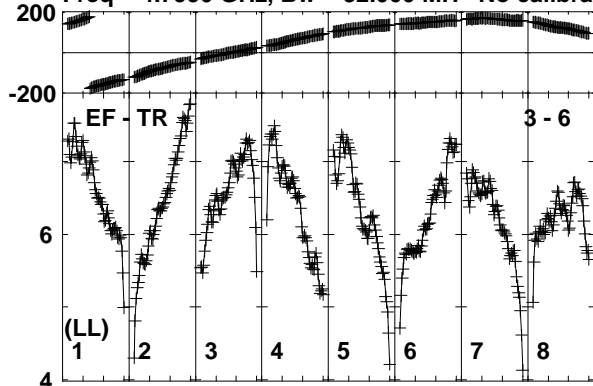

Lower frame: Milli Ampl Jy Top frame: Phas deg  
Vector averaged cross-power spectrum Baseline: EF (03) - TR (06)  
Timerange: 01/02:57:41 to 01/02:59:39

Plot file version 366 created 11-NOV-2019 15:07:58

J1826+0149 EK040B.UVDATA.1

Freq = 4.7990 GHz, Bw = 32.000 MH No calibration applied and no bandpass applied

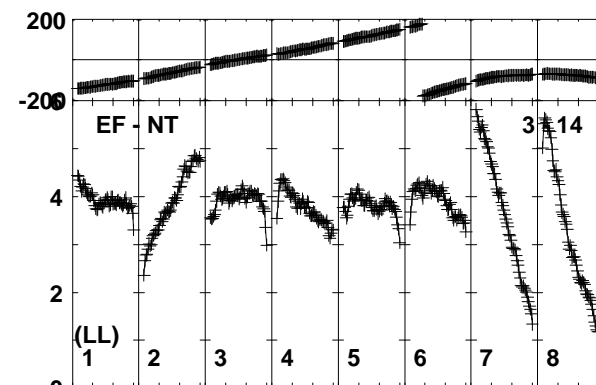
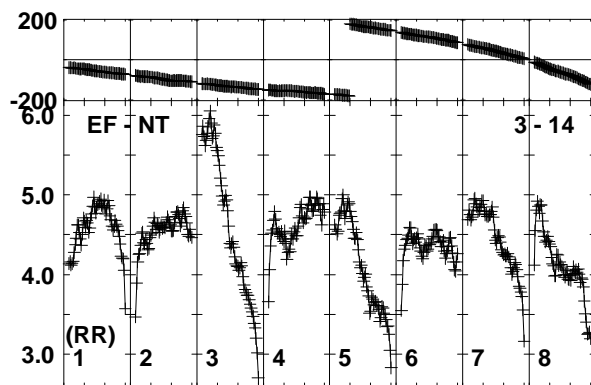
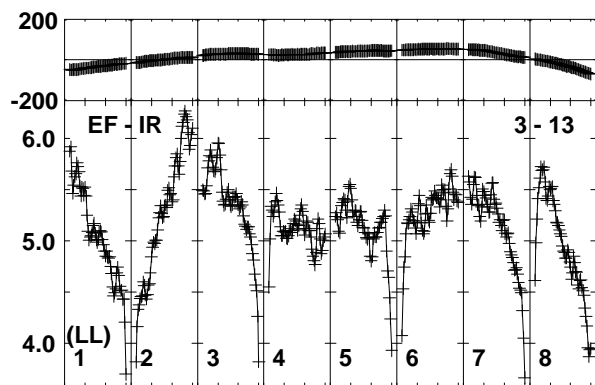
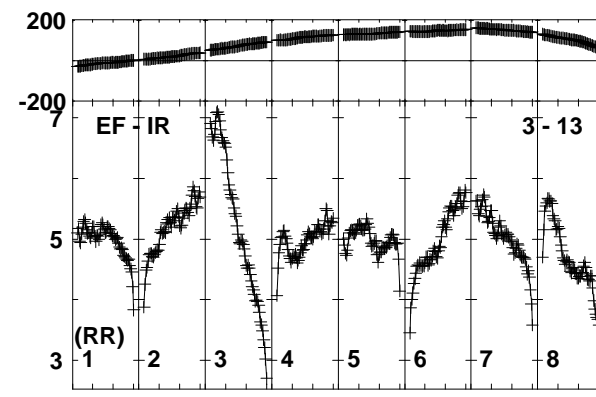
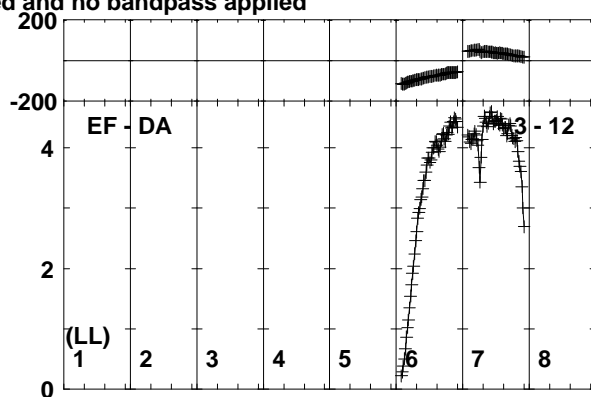
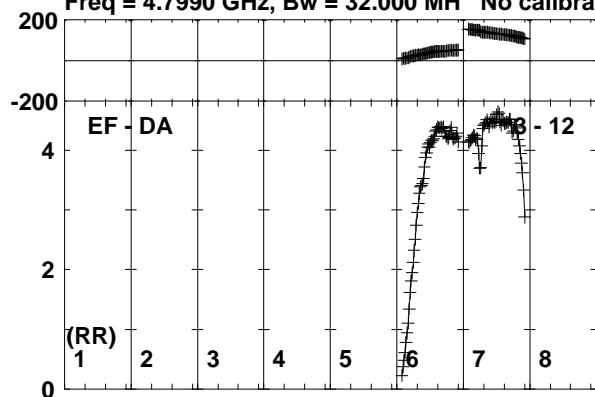

Lower frame: Milli Ampl Jy Top frame: Phas deg  
Vector averaged cross-power spectrum Baseline: EF (03) - DA (12)  
Timerange: 01/02:57:41 to 01/02:59:39

Plot file version 367 created 11-NOV-2019 15:07:58

SER8NJ EK040B.UVDATA.1

Freq = 4.7990 GHz, Bw = 32.000 MH No calibration applied and no bandpass applied

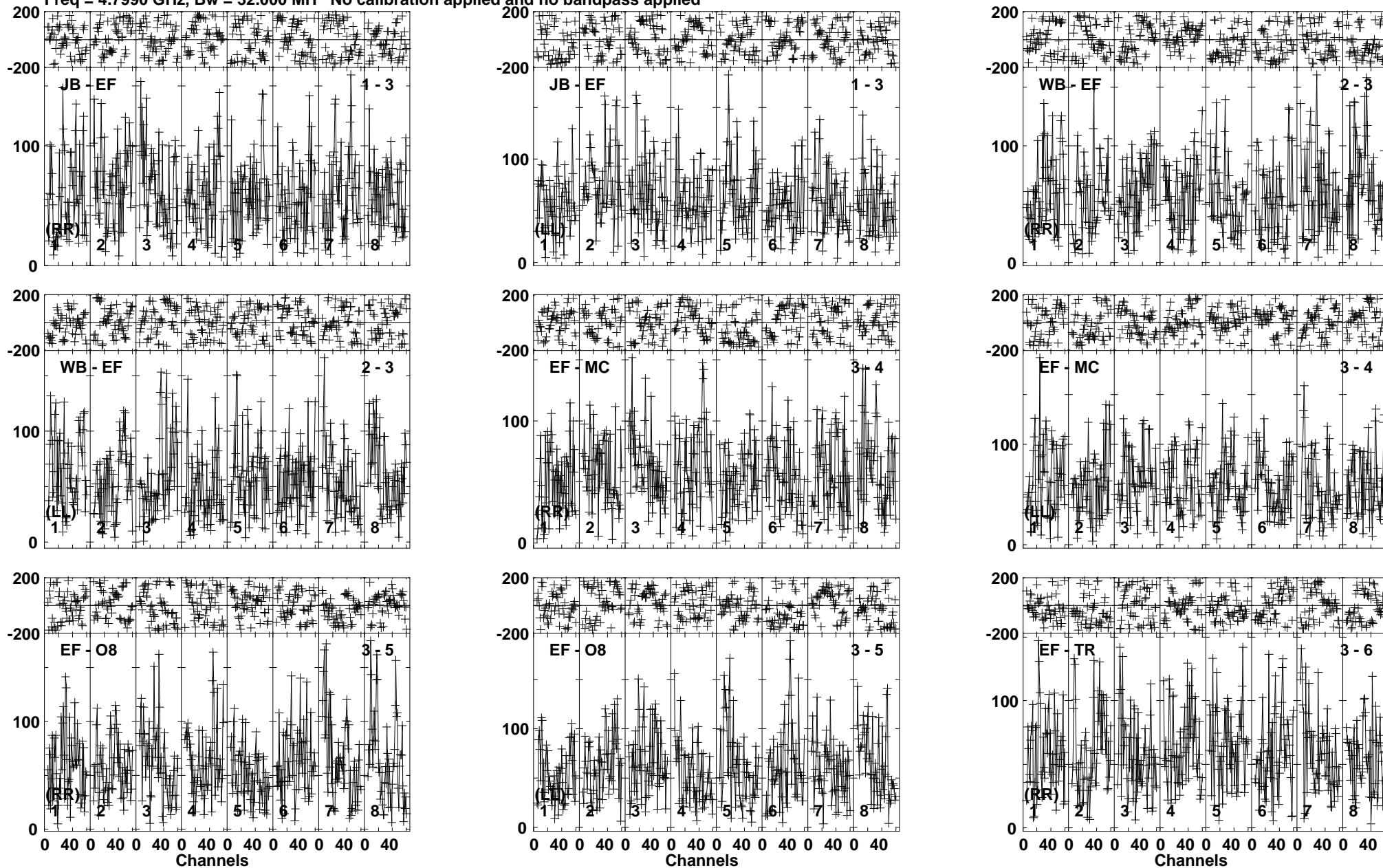

Lower frame: Micro Ampl Jy Top frame: Phas deg  
Vector averaged cross-power spectrum Baseline: JB (01) - EF (03)  
Timerange: 01/02:59:41 to 01/03:03:39

Plot file version 368 created 11-NOV-2019 15:07:58

SER8NJ EK040B.UVDATA.1

Freq = 4.7990 GHz, Bw = 32.000 MH No calibration applied and no bandpass applied

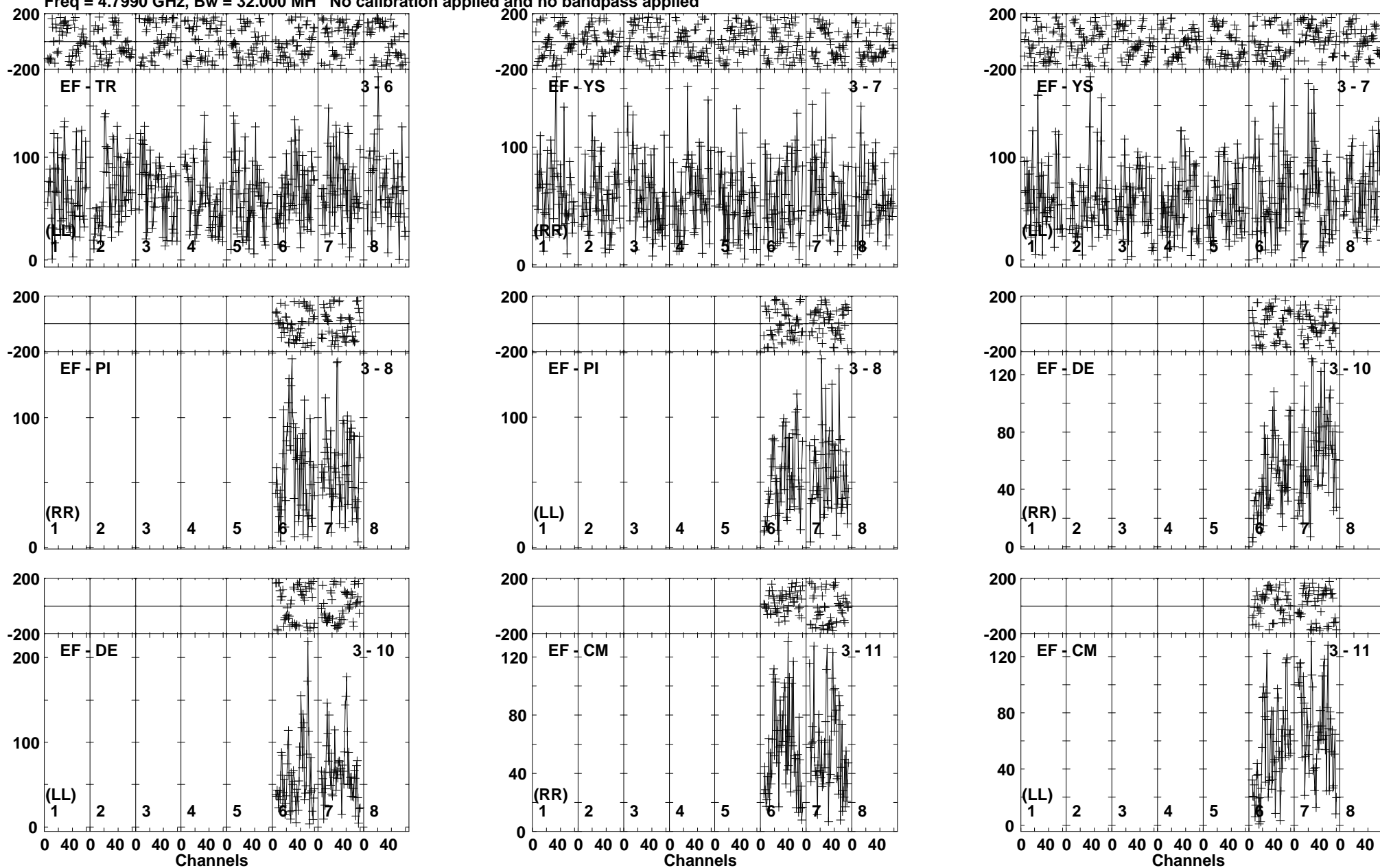

Lower frame: Micro Ampl Jy Top frame: Phas deg  
Vector averaged cross-power spectrum Baseline: EF (03) - TR (06)  
Timerange: 01/02:59:41 to 01/03:03:39

Plot file version 369 created 11-NOV-2019 15:07:58

SER8NJ EK040B.UVDATA.1

Freq = 4.7990 GHz, Bw = 32.000 MH No calibration applied and no bandpass applied

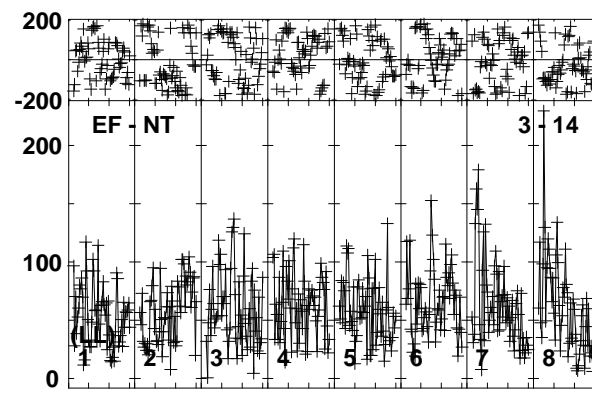
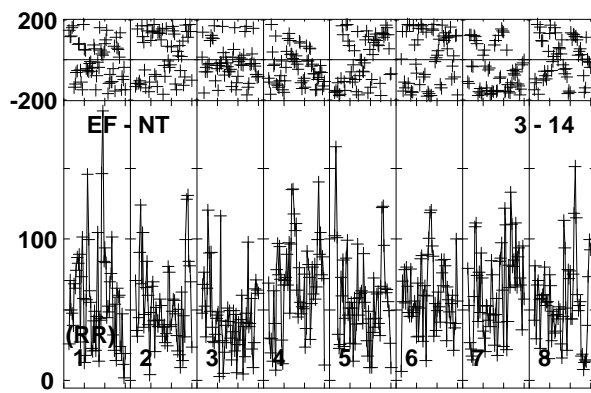
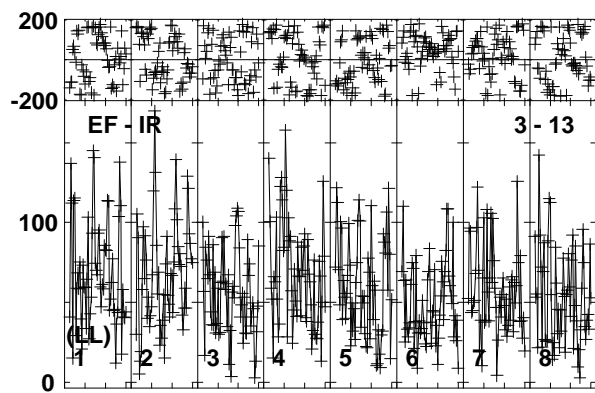
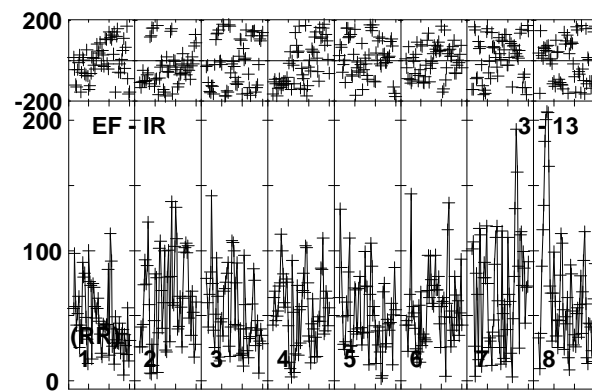
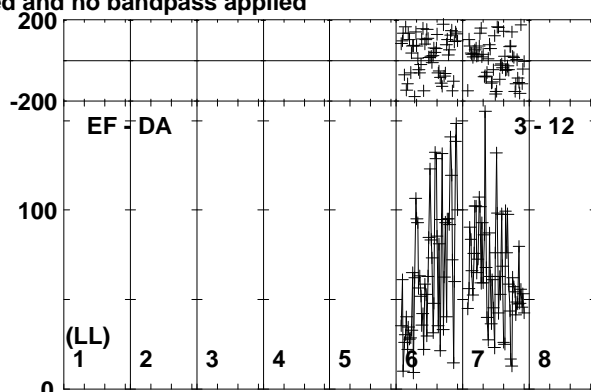
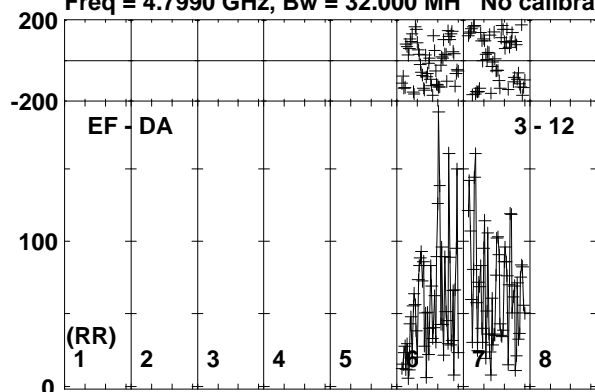

0 40 0 40 0 40 0 40 0 40 0 40 0 40 0 40 0 40  
Channels

Lower frame: Micro Ampl Jy Top frame: Phas deg  
Vector averaged cross-power spectrum Baseline: EF (03) - DA (12)  
Timerange: 01/02:59:41 to 01/03:03:39

Plot file version 370 created 11-NOV-2019 15:07:58

J1826+0149 EK040B.UVDATA.1

Freq = 4.7990 GHz, Bw = 32.000 MH No calibration applied and no bandpass applied

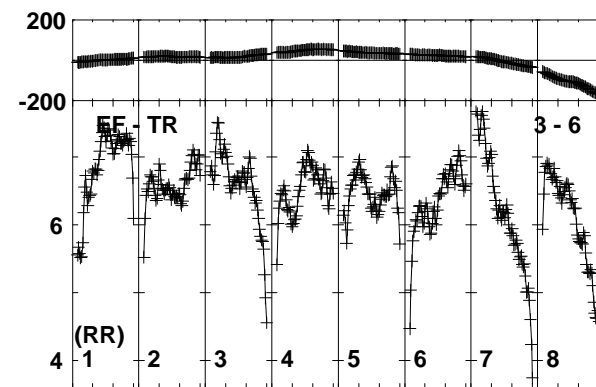
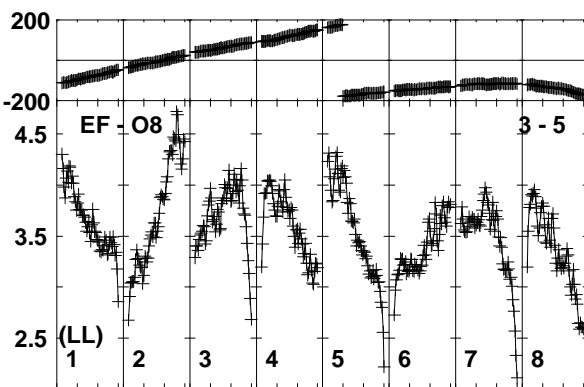
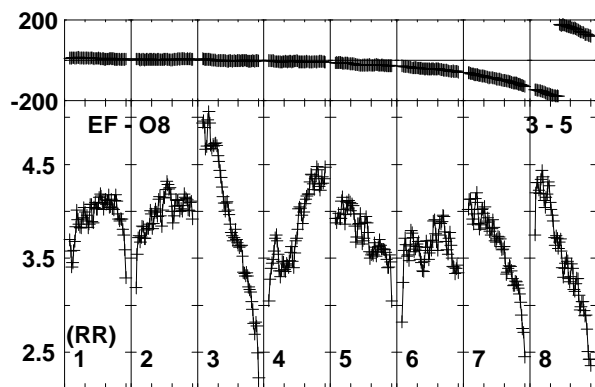
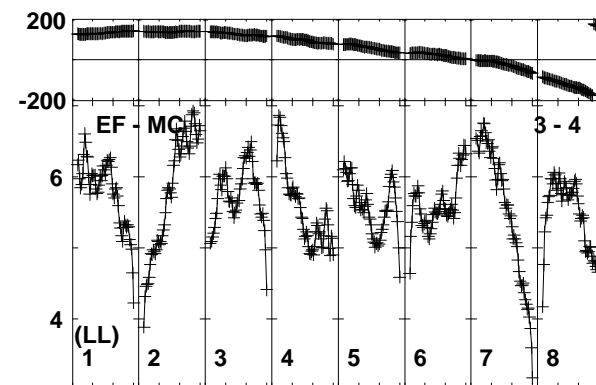
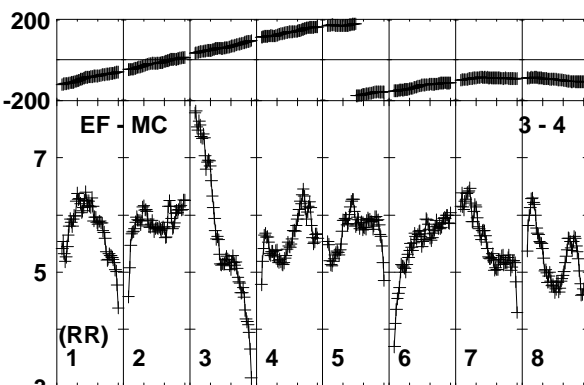
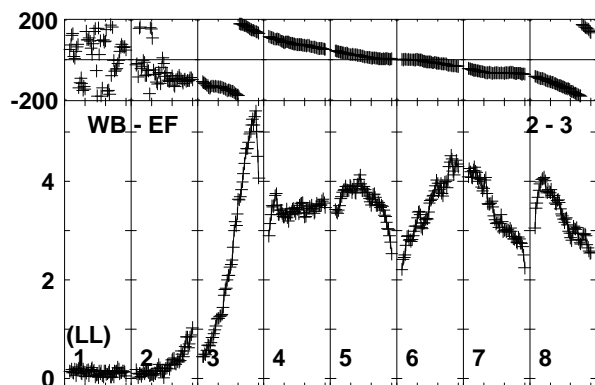
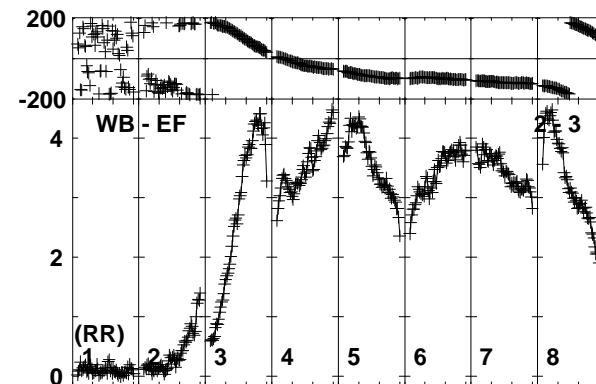
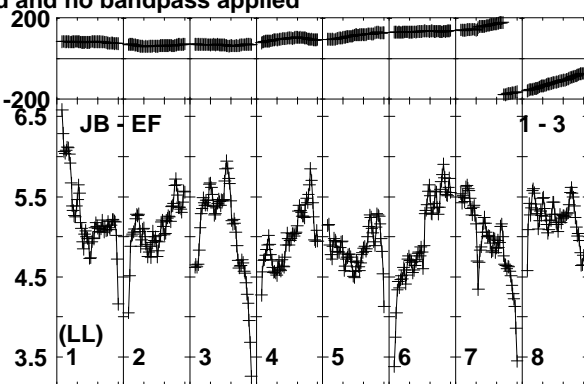
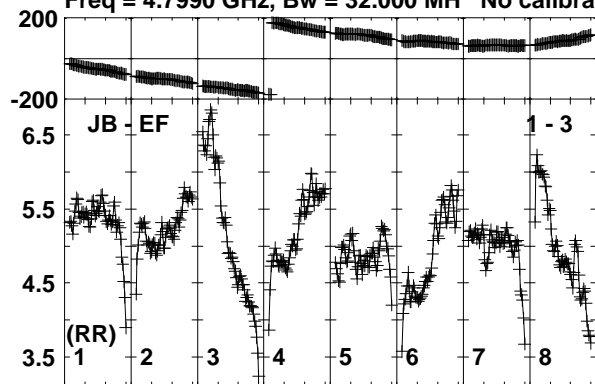

Lower frame: Milli Ampl Jy Top frame: Phas deg  
Vector averaged cross-power spectrum Baseline: JB (01) - EF (03)  
Timerange: 01/03:03:41 to 01/03:05:09



Plot file version 371 created 11-NOV-2019 15:07:58

J1826+0149 EK040B.UVDATA.1

Freq = 4.7990 GHz, Bw = 32.000 MH No calibration applied and no bandpass applied

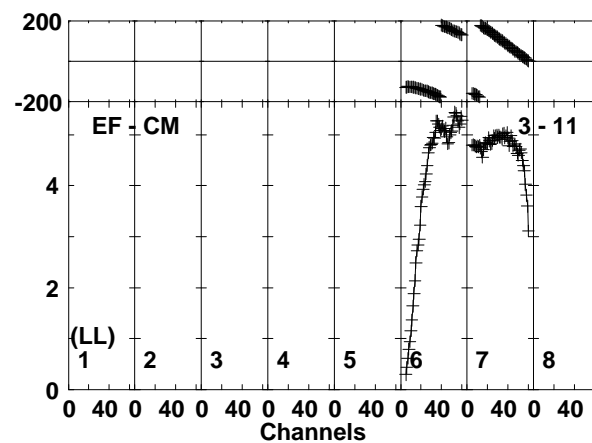
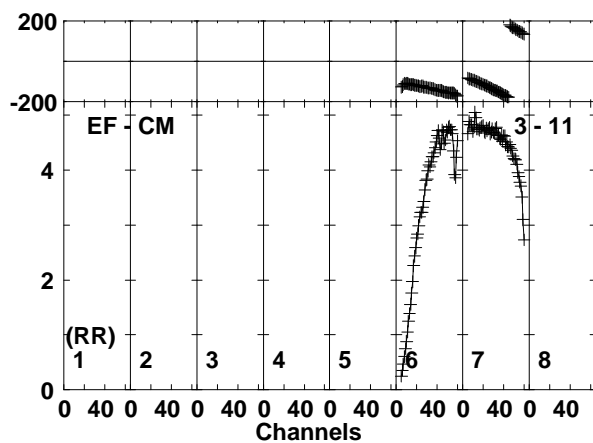
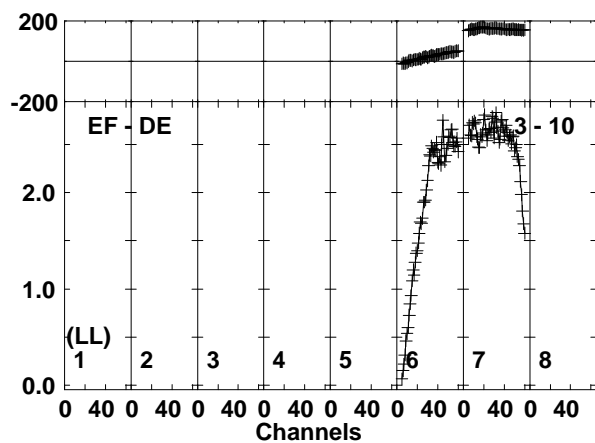
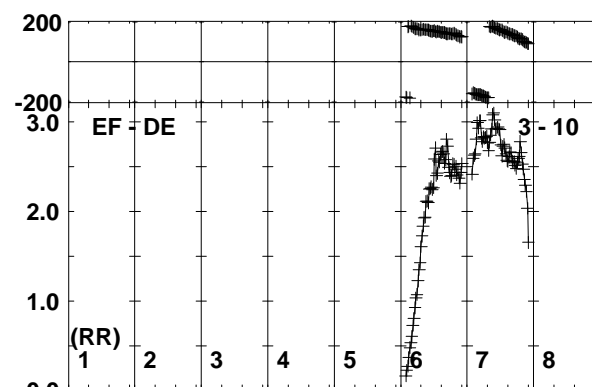
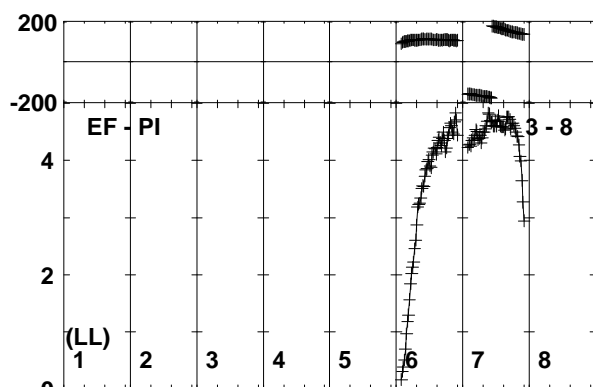
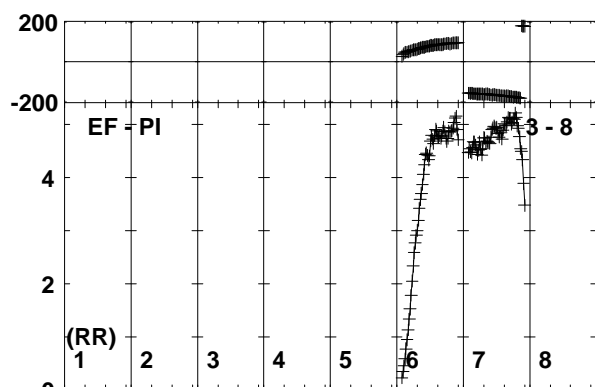
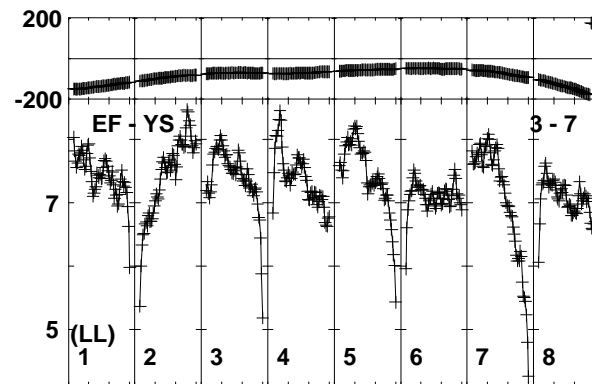
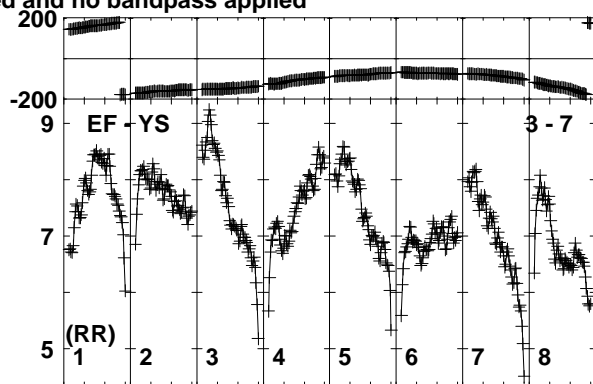
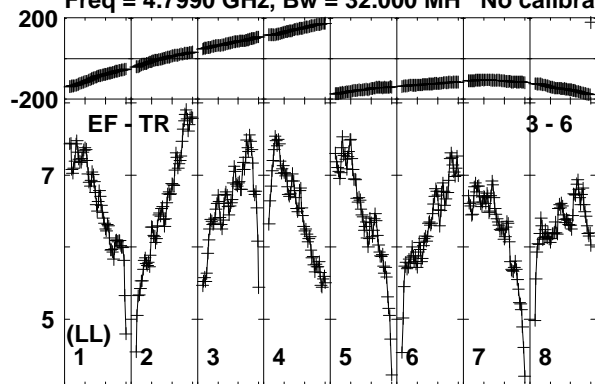

Lower frame: Milli Ampl Jy Top frame: Phas deg  
Vector averaged cross-power spectrum Baseline: EF (03) - TR (06)  
Timerange: 01/03:03:41 to 01/03:05:09

Plot file version 372 created 11-NOV-2019 15:07:59

J1826+0149 EK040B.UVDATA.1

Freq = 4.7990 GHz, Bw = 32.000 MH No calibration applied and no bandpass applied

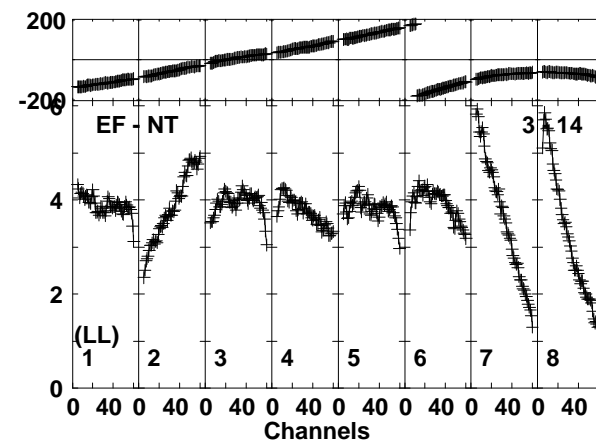
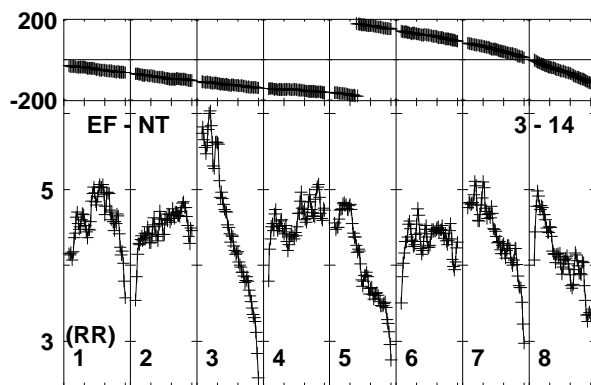
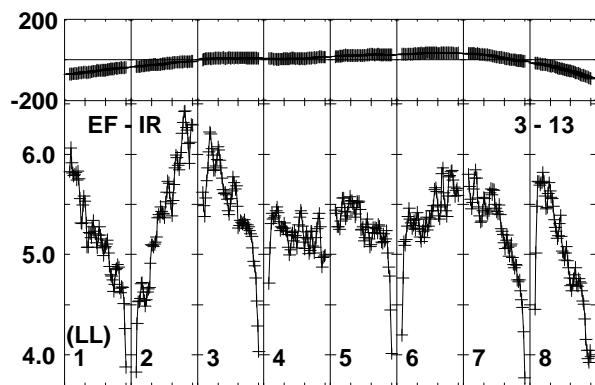
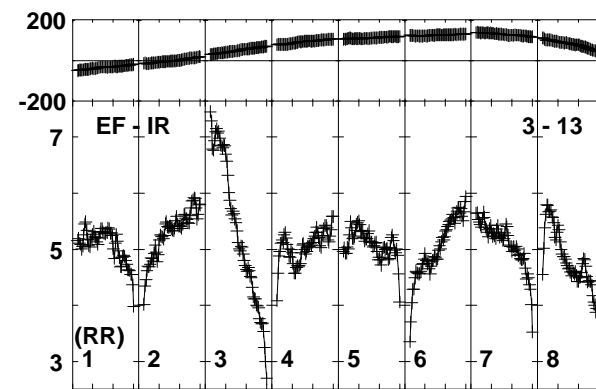
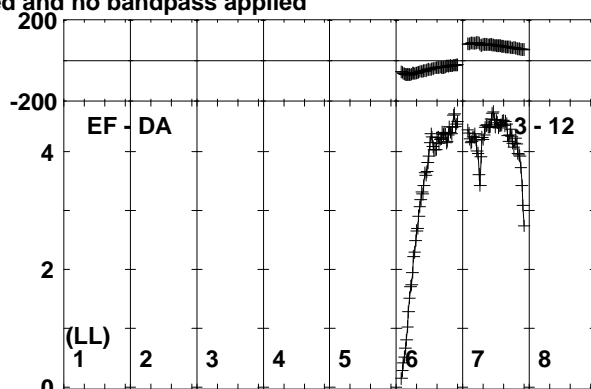
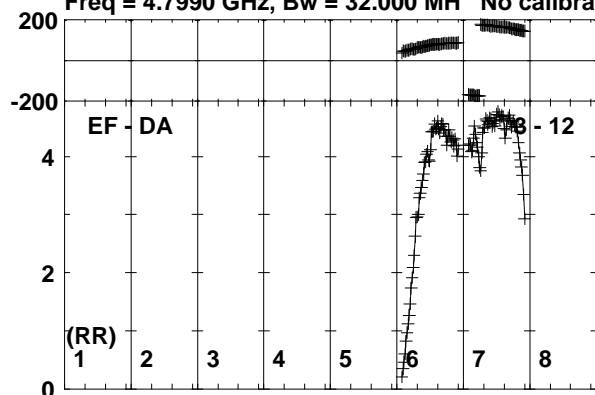

Lower frame: Milli Ampl Jy Top frame: Phas deg  
Vector averaged cross-power spectrum Baseline: EF (03) - DA (12)  
Timerange: 01/03:03:41 to 01/03:05:09

Plot file version 373 created 11-NOV-2019 15:07:59

SER8NJ EK040B.UVDATA.1

Freq = 4.7990 GHz, Bw = 32.000 MH No calibration applied and no bandpass applied

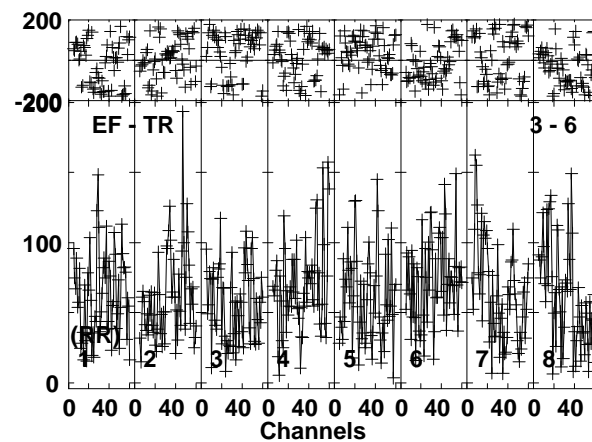
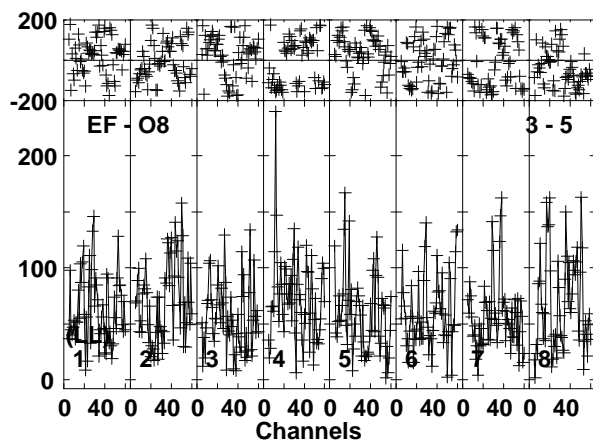
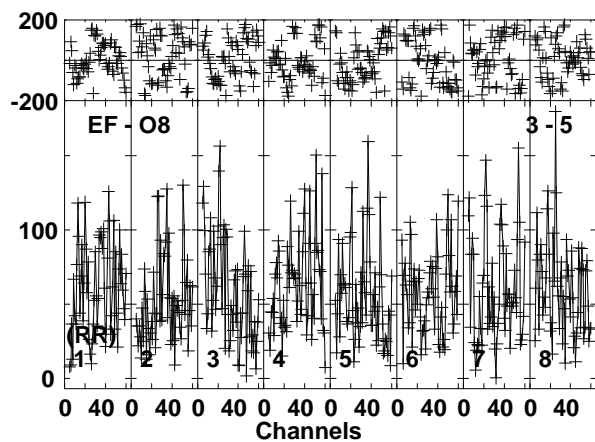
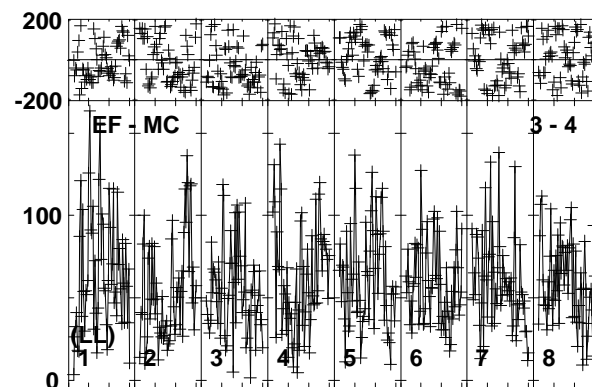
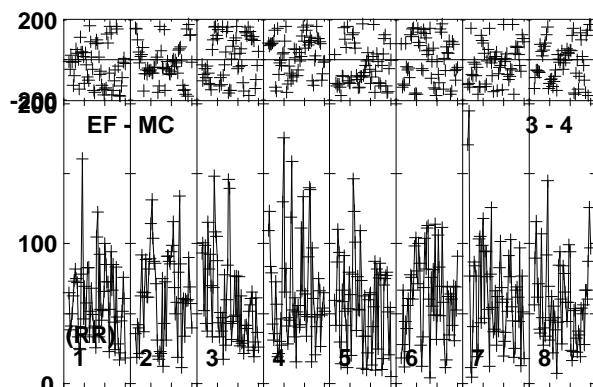
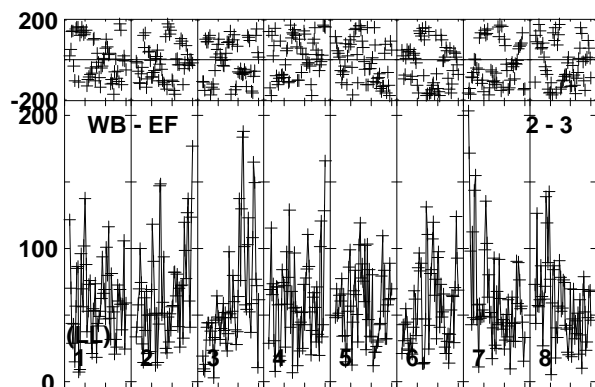
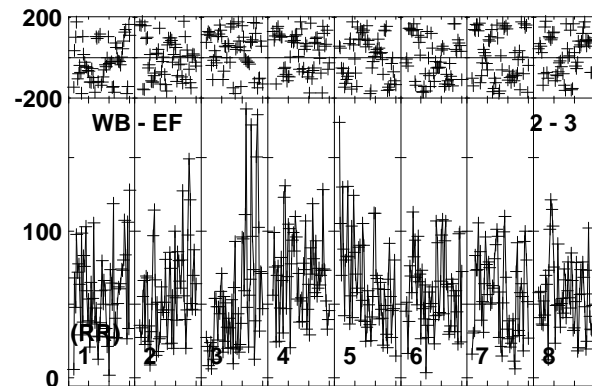
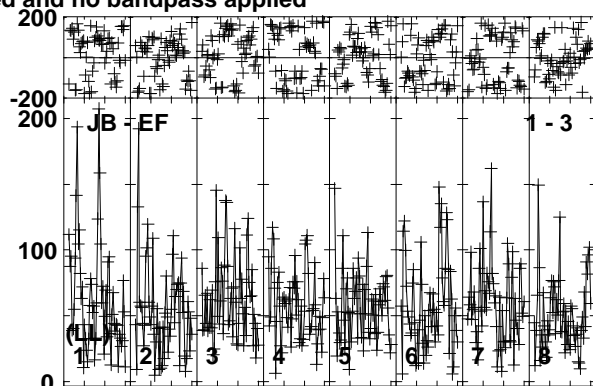
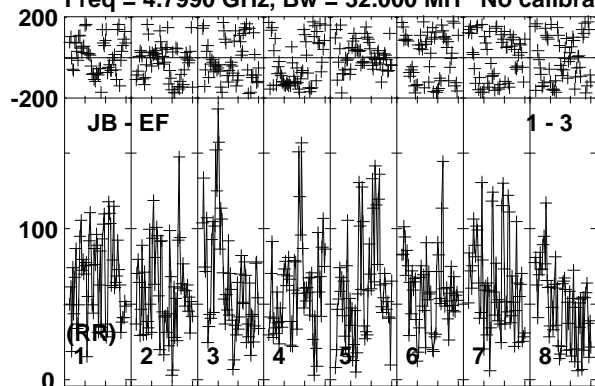

Lower frame: Micro Ampl Jy Top frame: Phas deg  
Vector averaged cross-power spectrum Baseline: JB (01) - EF (03)  
Timerange: 01/03:05:13 to 01/03:09:09

Plot file version 374 created 11-NOV-2019 15:07:59

SER8NJ EK040B.UVDATA.1

Freq = 4.7990 GHz, Bw = 32.000 MH No calibration applied and no bandpass applied

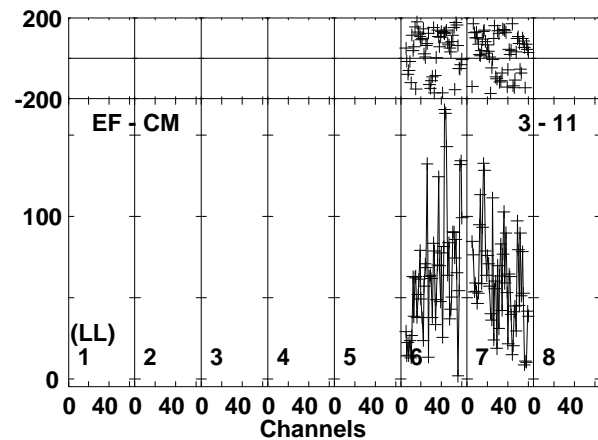
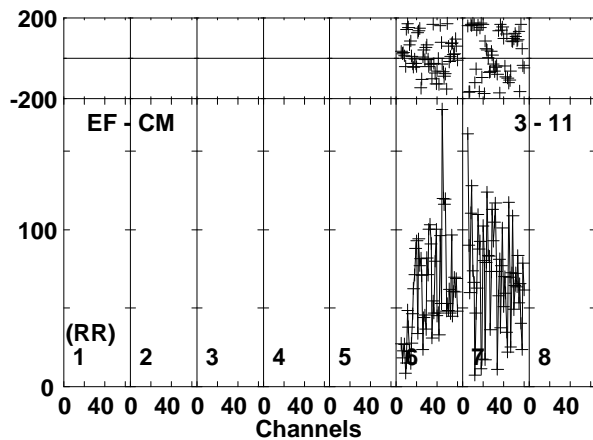
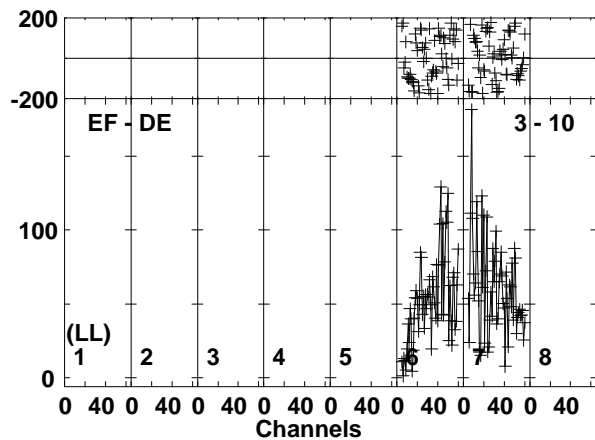
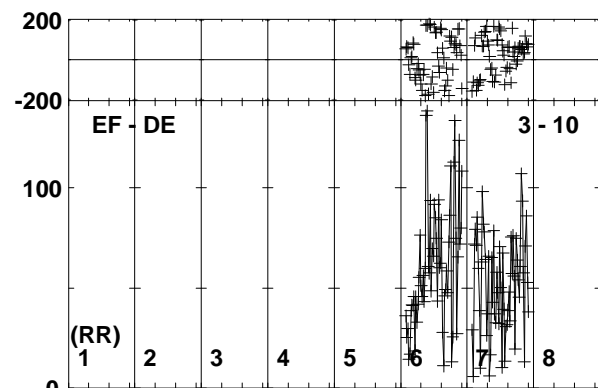
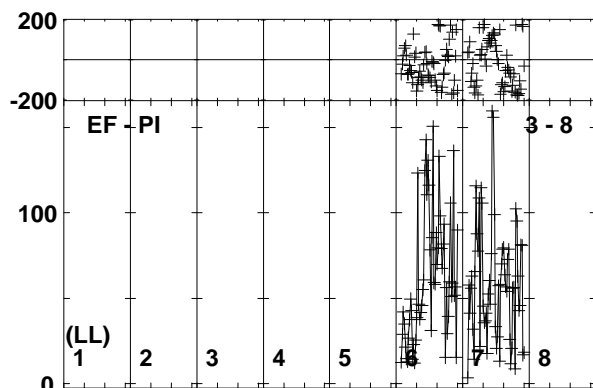
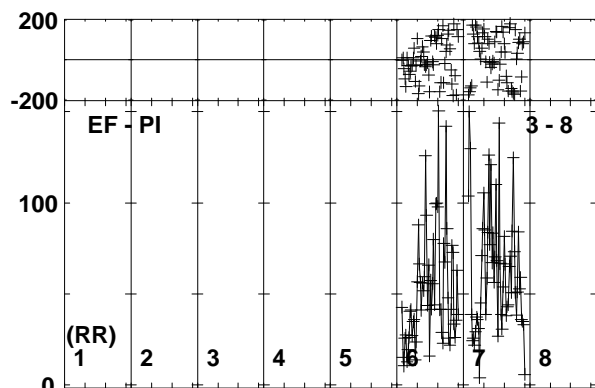
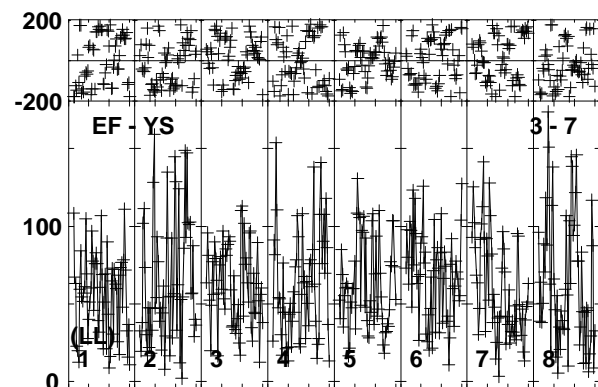
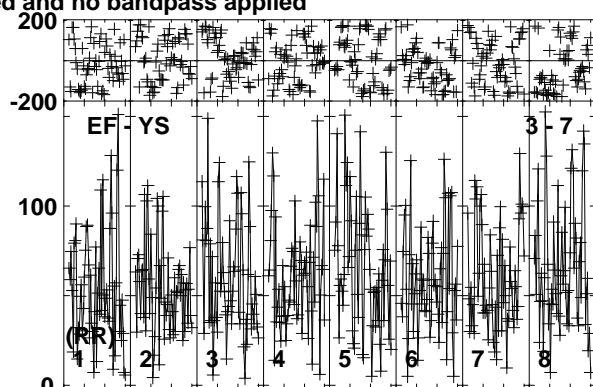
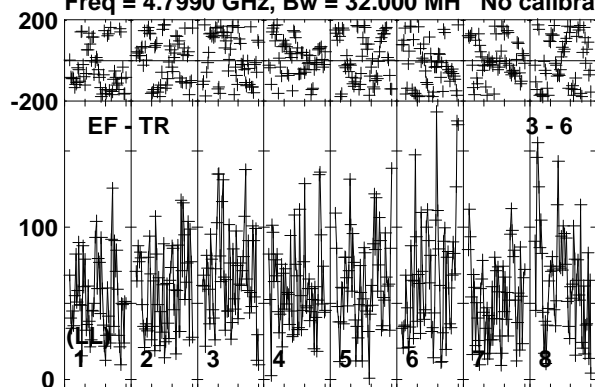

Lower frame: Micro Ampl Jy Top frame: Phas deg  
Vector averaged cross-power spectrum Baseline: EF (03) - TR (06)  
Timerange: 01/03:05:13 to 01/03:09:09

Plot file version 375 created 11-NOV-2019 15:07:59

SER8NJ EK040B.UVDATA.1

Freq = 4.7990 GHz, Bw = 32.000 MH No calibration applied and no bandpass applied

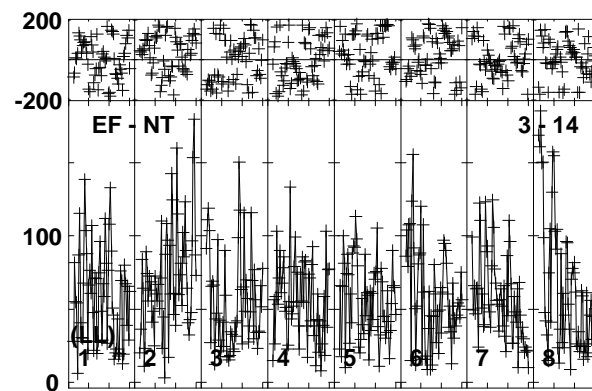
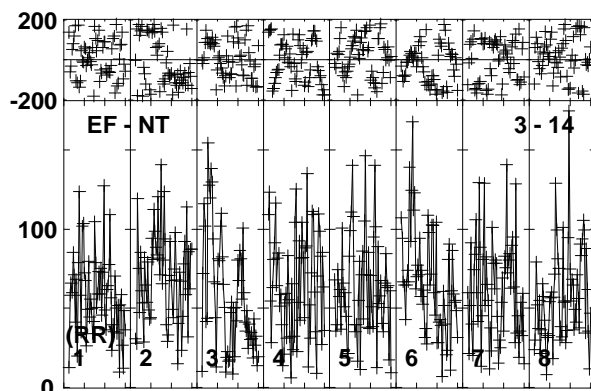
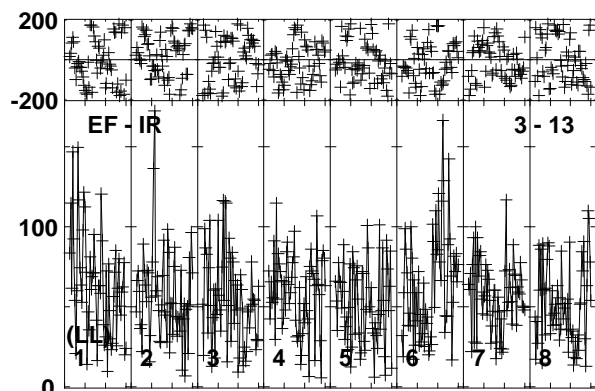
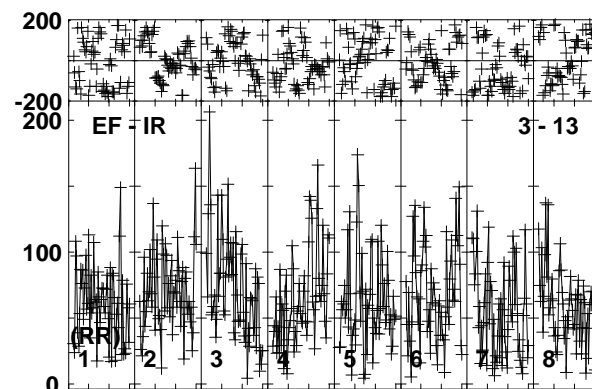
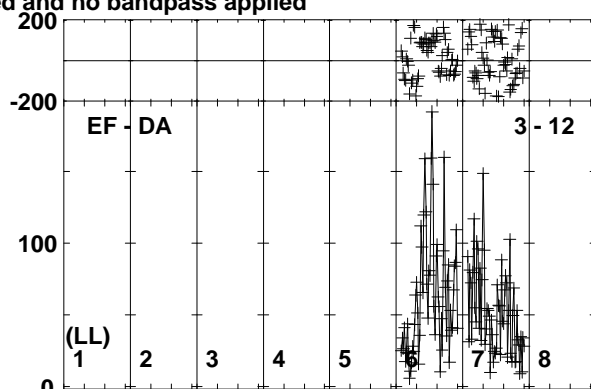
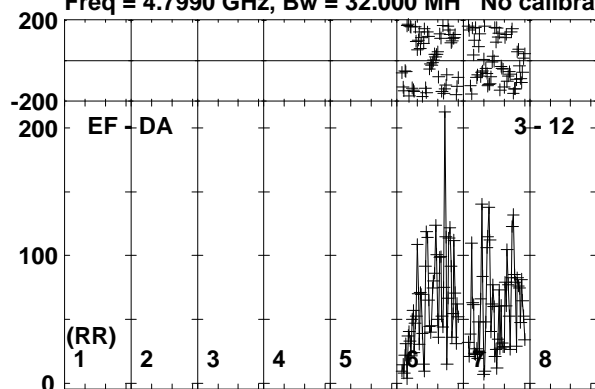

0 40 0 40 0 40 0 40 0 40 0 40 0 40 0 40 0 40 0 40  
Channels

Lower frame: Micro Ampl Jy Top frame: Phas deg  
Vector averaged cross-power spectrum Baseline: EF (03) - DA (12)  
Timerange: 01/03:05:13 to 01/03:09:09

Plot file version 376 created 11-NOV-2019 15:07:59

J1826+0149 EK040B.UVDATA.1

Freq = 4.7990 GHz, Bw = 32.000 MH No calibration applied and no bandpass applied

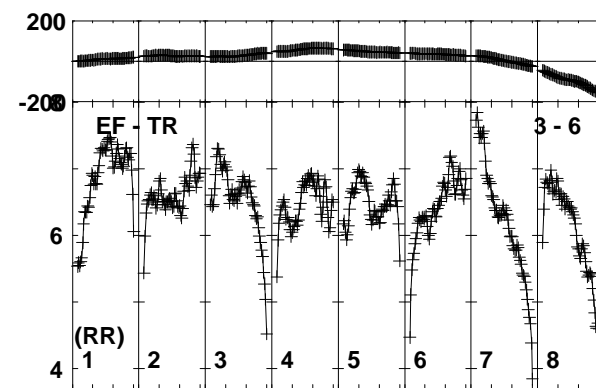
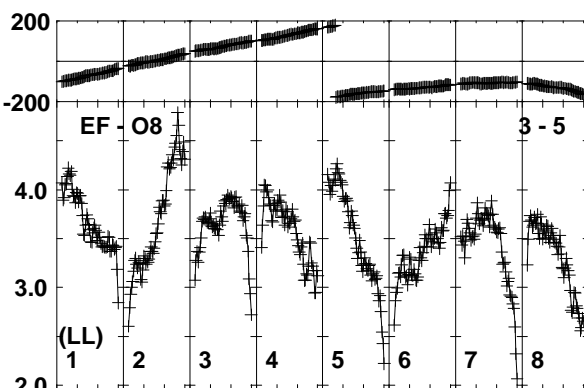
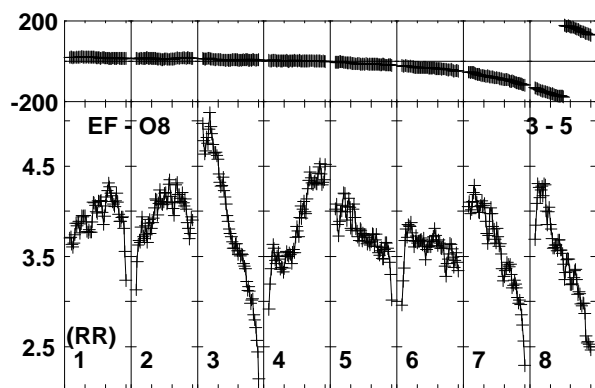
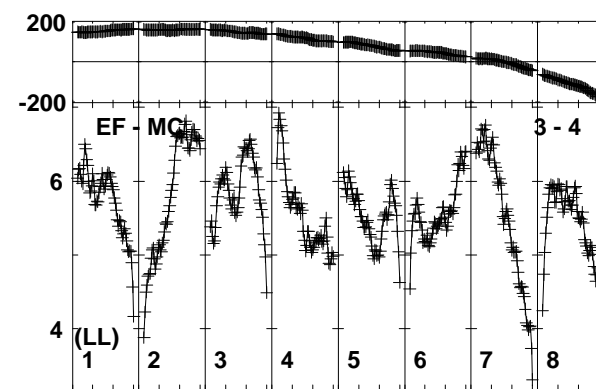
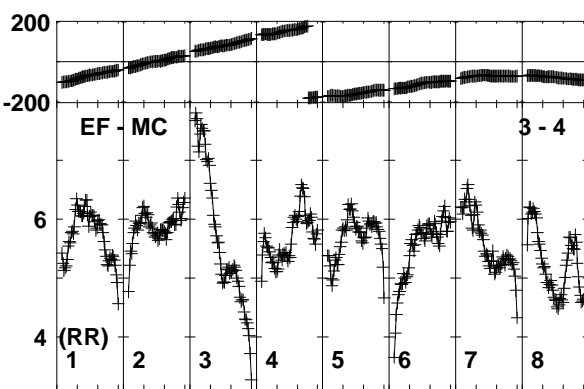
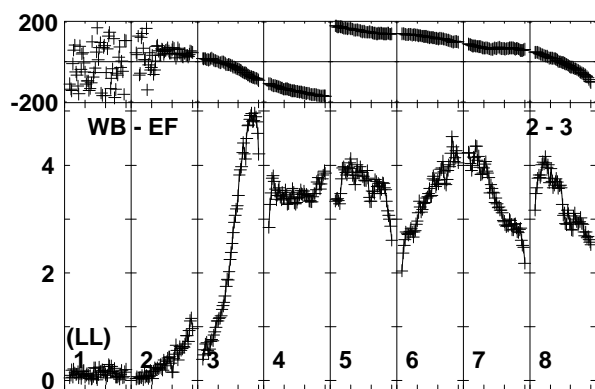
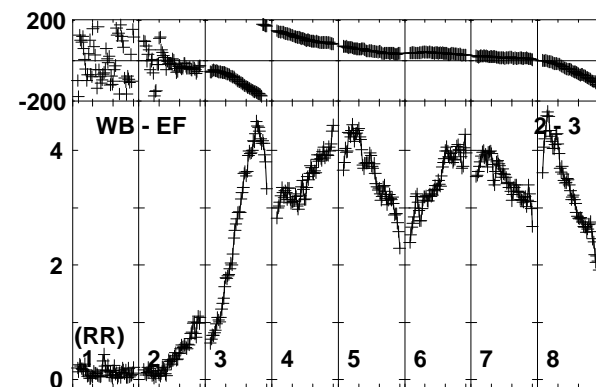
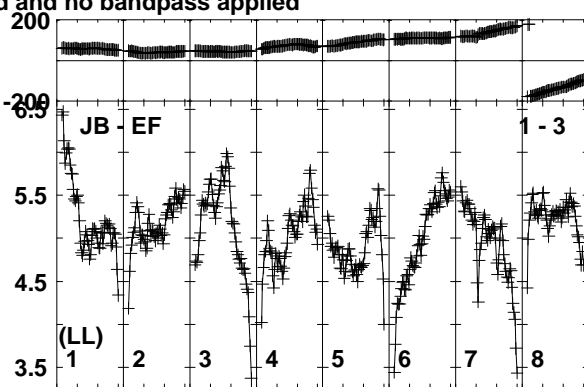
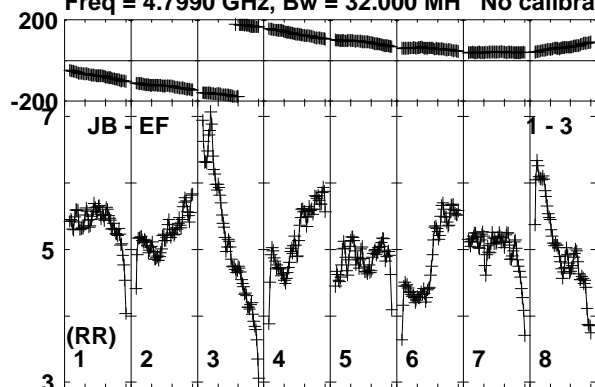

Lower frame: Milli Ampl Jy Top frame: Phas deg

Vector averaged cross-power spectrum Baseline: JB (01) - EF (03)

Timerange: 01/03:09:51 to 01/03:10:49

Plot file version 377 created 11-NOV-2019 15:07:59

J1826+0149 EK040B.UVDATA.1

Freq = 4.7990 GHz, Bw = 32.000 MH No calibration applied and no bandpass applied

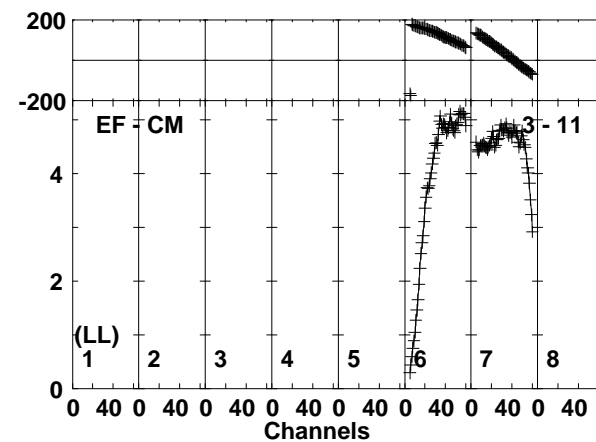
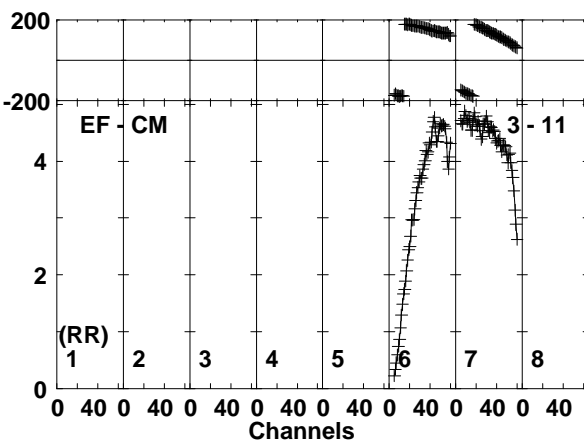
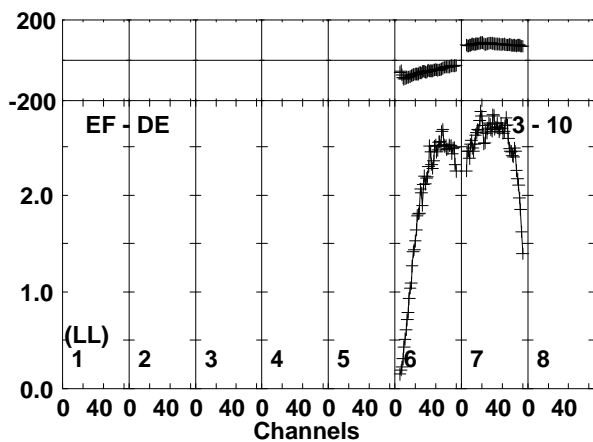
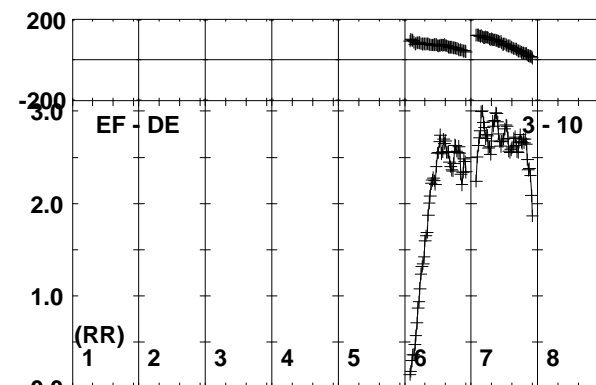
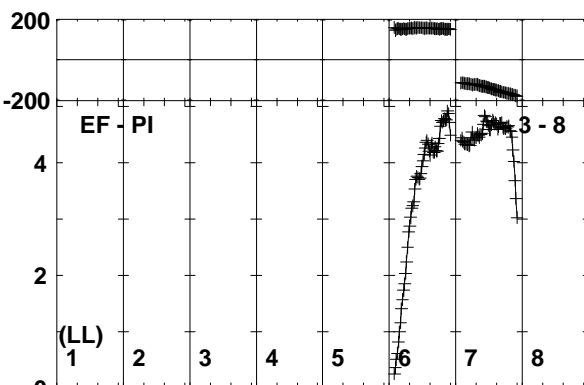
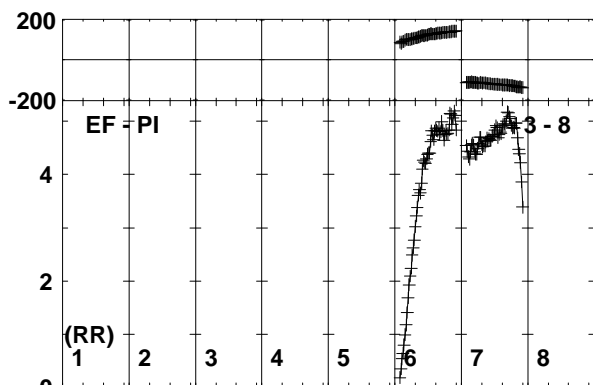
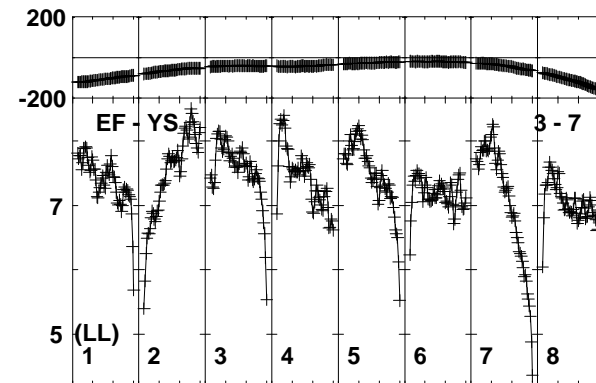
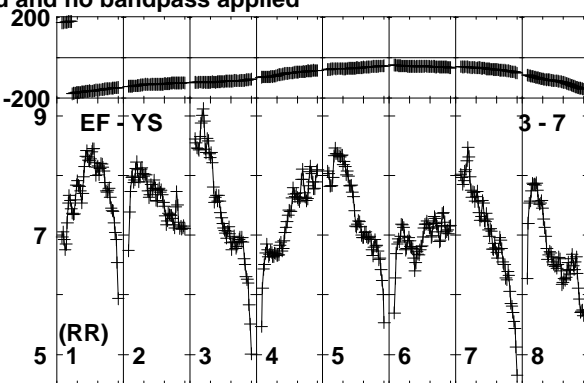
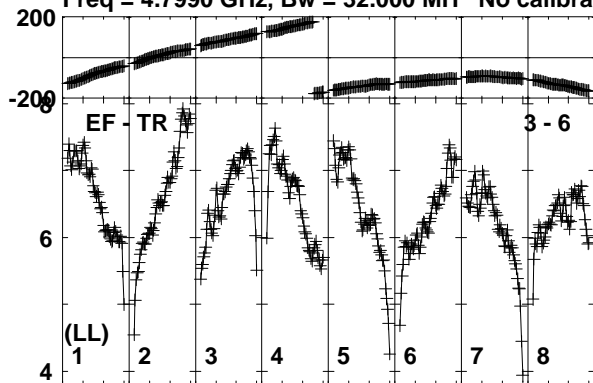

Lower frame: Milli Ampl Jy Top frame: Phas deg  
Vector averaged cross-power spectrum Baseline: EF (03) - TR (06)  
Timerange: 01/03:09:51 to 01/03:10:49

Plot file version 378 created 11-NOV-2019 15:07:59

J1826+0149 EK040B.UVDATA.1

Freq = 4.7990 GHz, Bw = 32.000 MH No calibration applied and no bandpass applied

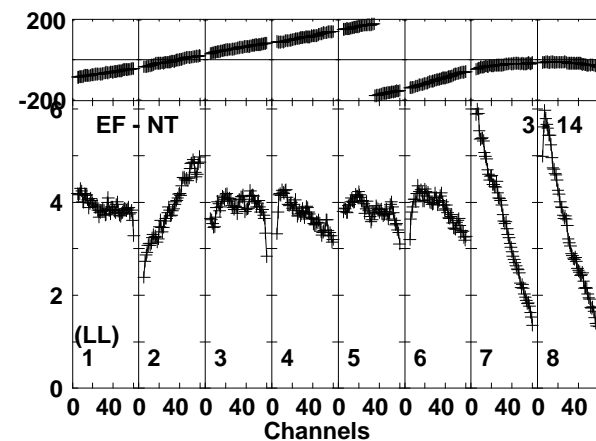
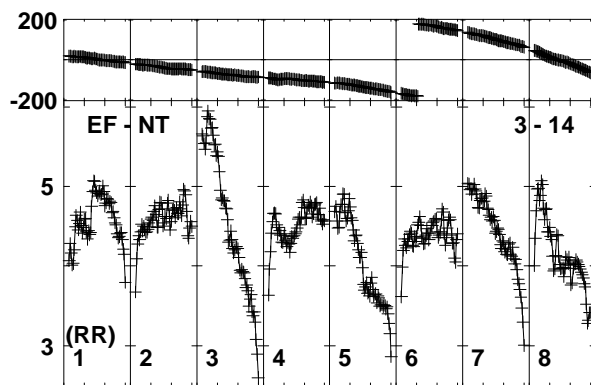
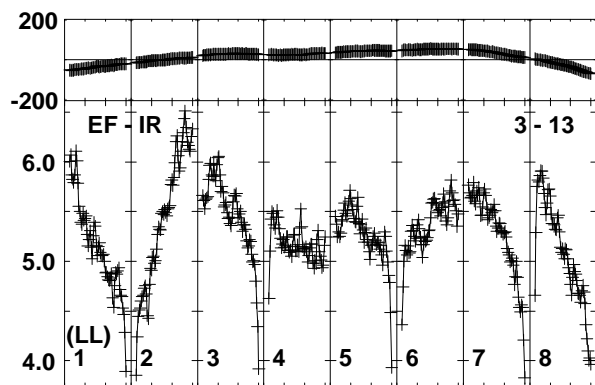
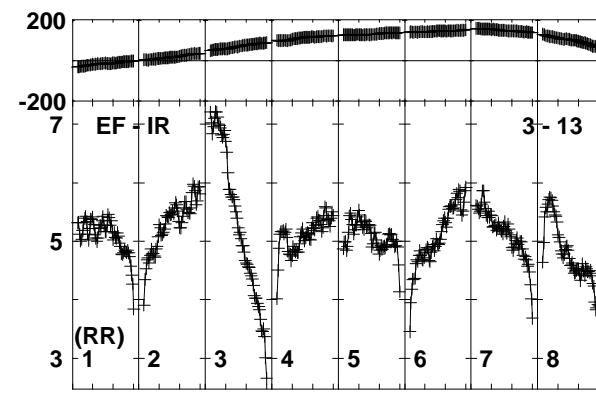
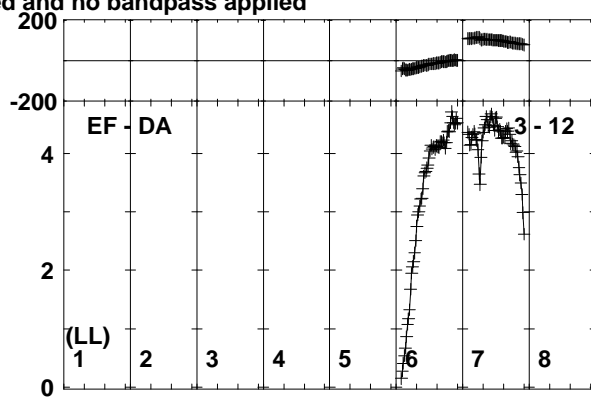
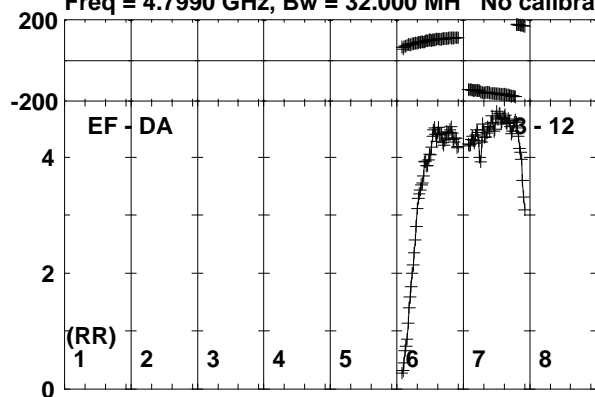

Lower frame: Milli Ampl Jy Top frame: Phas deg  
Vector averaged cross-power spectrum Baseline: EF (03) - DA (12)  
Timerange: 01/03:09:51 to 01/03:10:49



Plot file version 379 created 11-NOV-2019 15:07:59

SER8NJ EK040B.UVDATA.1

Freq = 4.7990 GHz, Bw = 32.000 MH No calibration applied and no bandpass applied

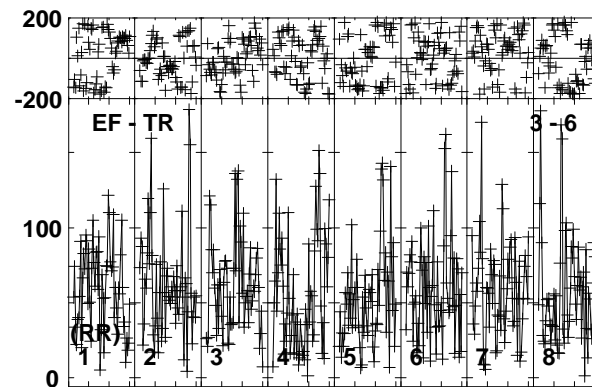
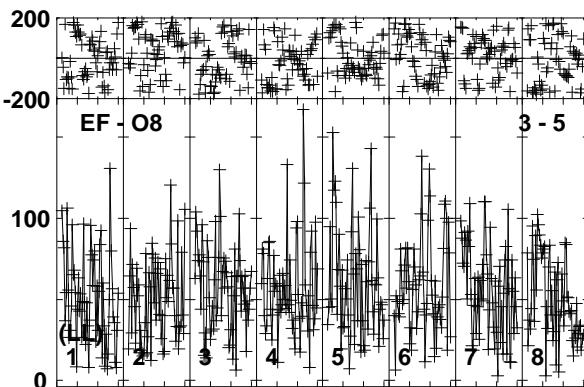
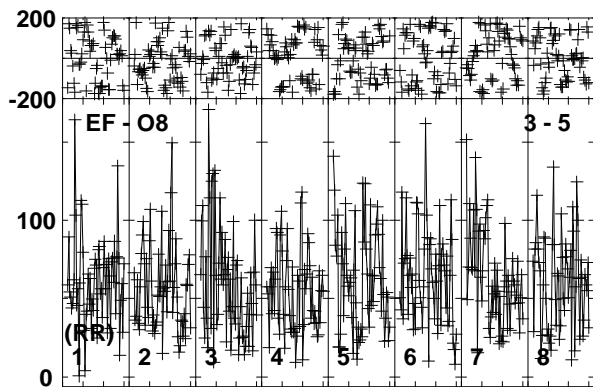
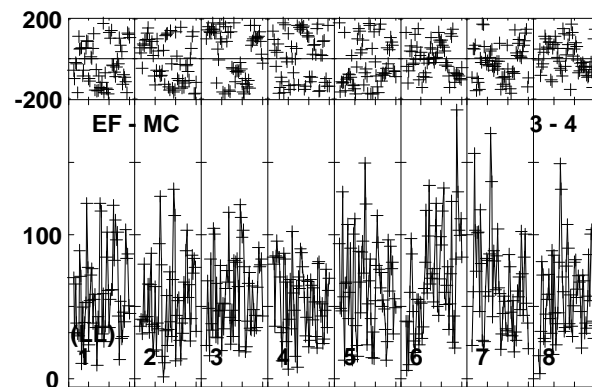
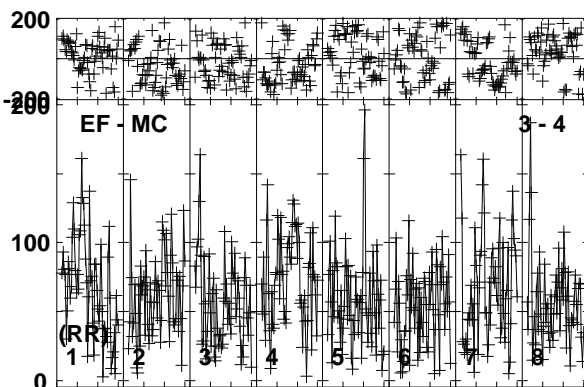
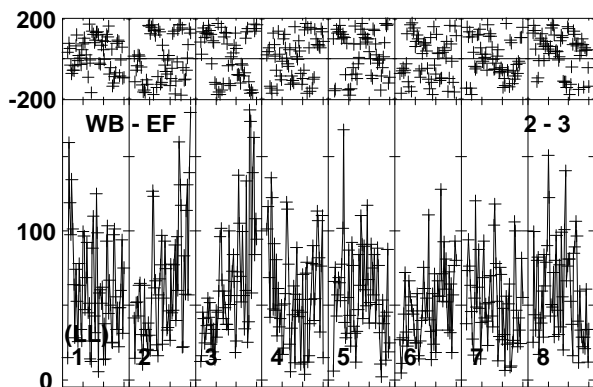
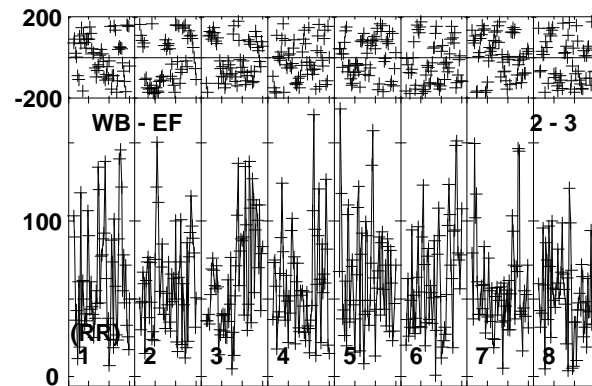
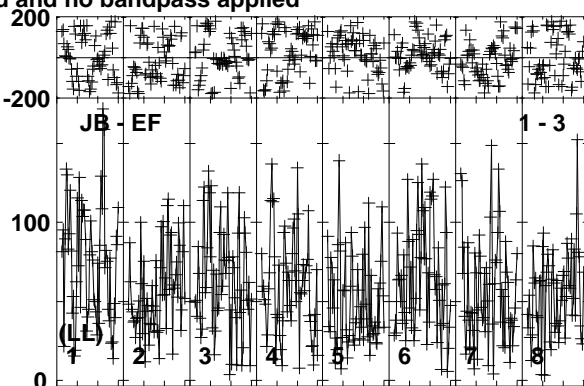
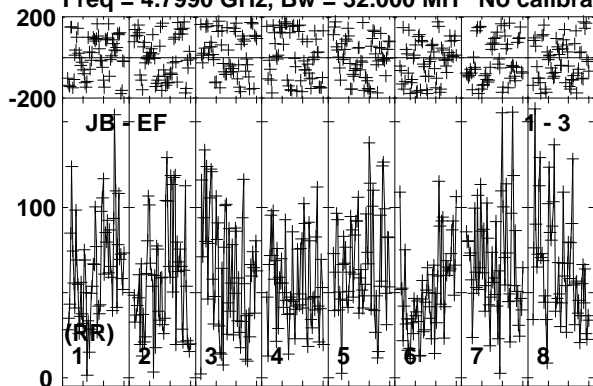

Lower frame: Micro Ampl Jy Top frame: Phas deg  
Vector averaged cross-power spectrum Baseline: JB (01) - EF (03)  
Timerange: 01/03:10:53 to 01/03:14:49

Plot file version 380 created 11-NOV-2019 15:07:59

SER8NJ EK040B.UVDATA.1

Freq = 4.7990 GHz, Bw = 32.000 MH No calibration applied and no bandpass applied

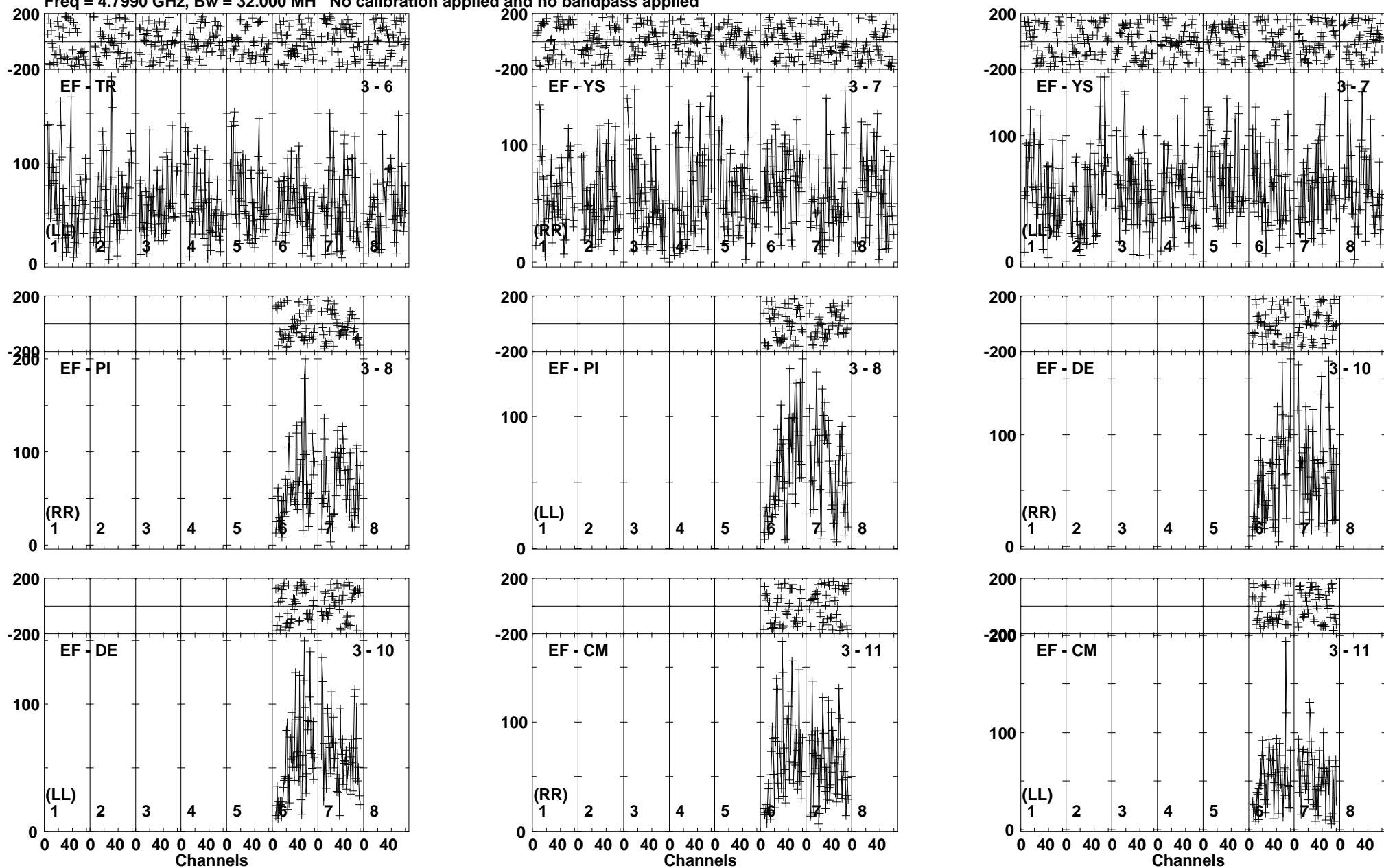

Lower frame: Micro Ampl Jy Top frame: Phas deg  
Vector averaged cross-power spectrum Baseline: EF (03) - TR (06)  
Timerange: 01/03:10:53 to 01/03:14:49

Plot file version 381 created 11-NOV-2019 15:08:00

SER8NJ EK040B.UVDATA.1

Freq = 4.7990 GHz, Bw = 32.000 MH No calibration applied and no bandpass applied

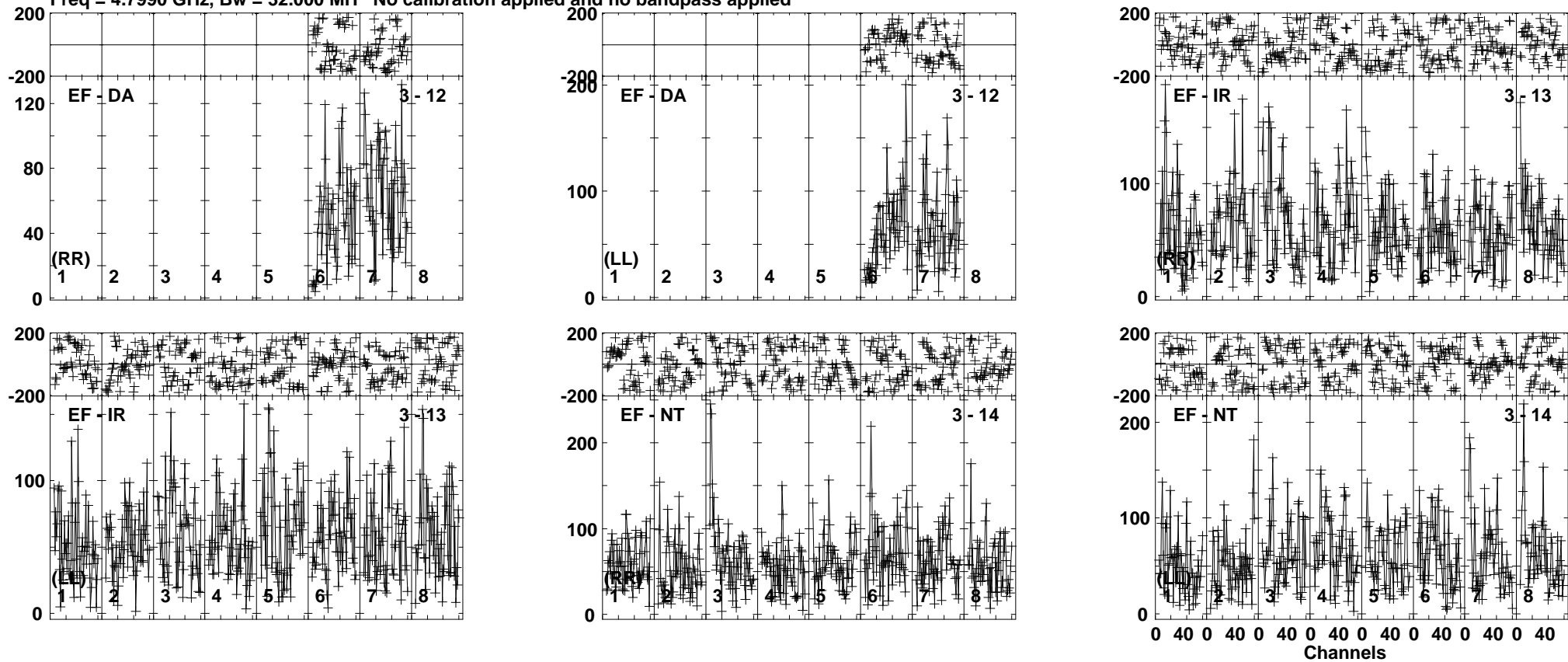

Lower frame: Micro Ampl Jy Top frame: Phas deg  
Vector averaged cross-power spectrum Baseline: EF (03) - DA (12)  
Timerange: 01/03:10:53 to 01/03:14:49

Plot file version 382 created 11-NOV-2019 15:08:00

J1826+0149 EK040B.UVDATA.1

Freq = 4.7990 GHz, Bw = 32.000 MH No calibration applied and no bandpass applied

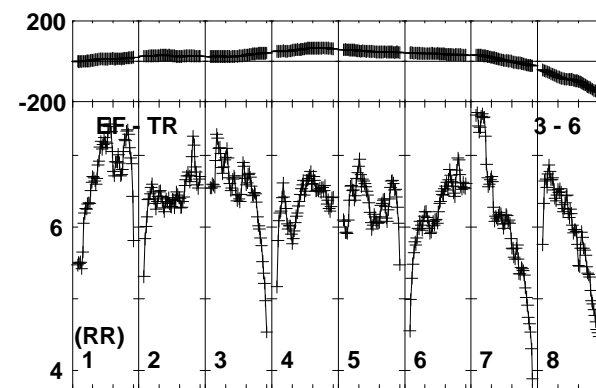
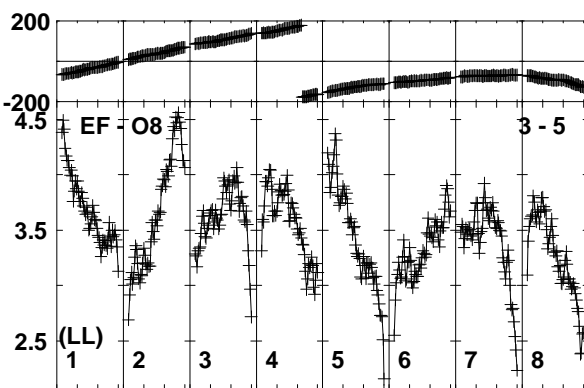
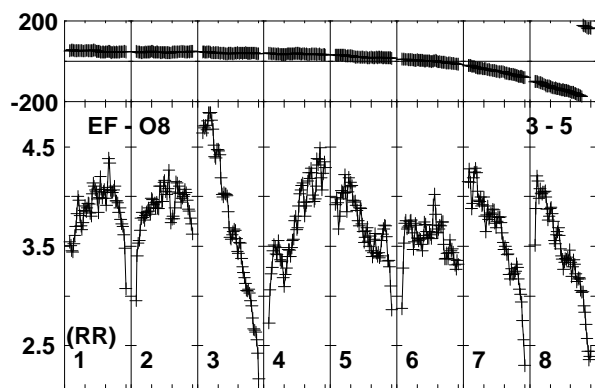
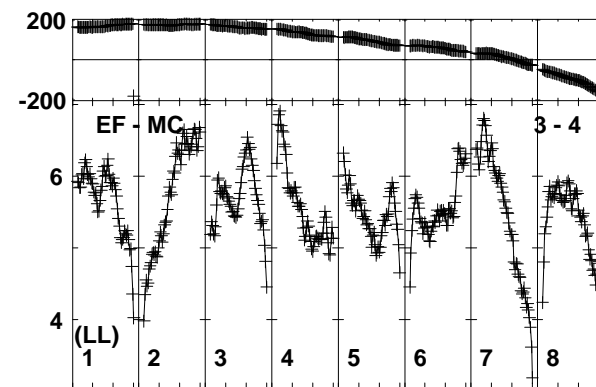
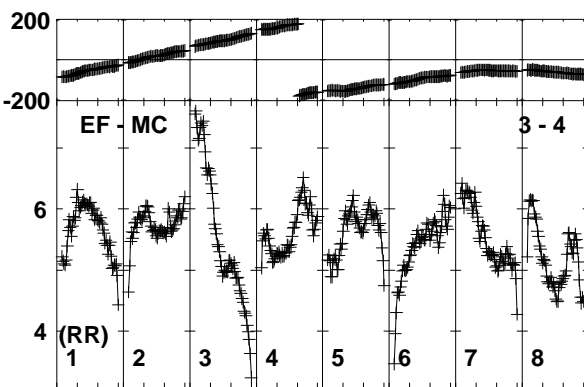
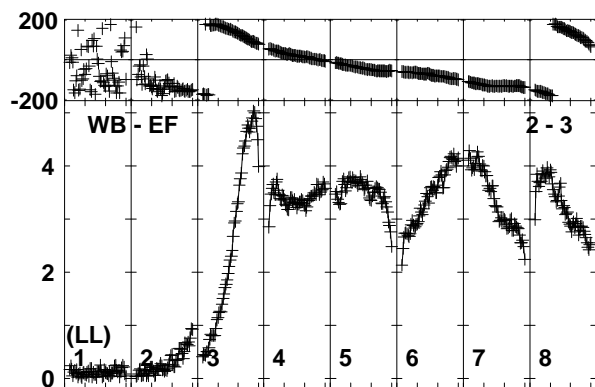
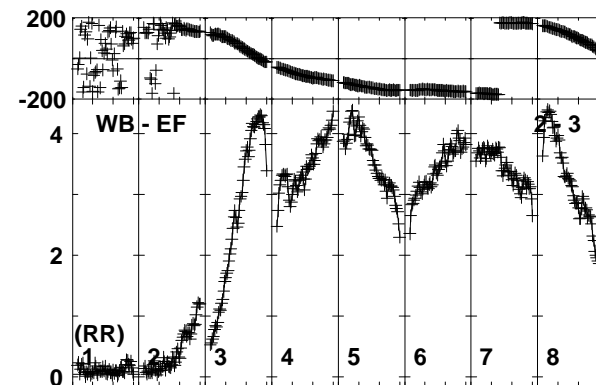
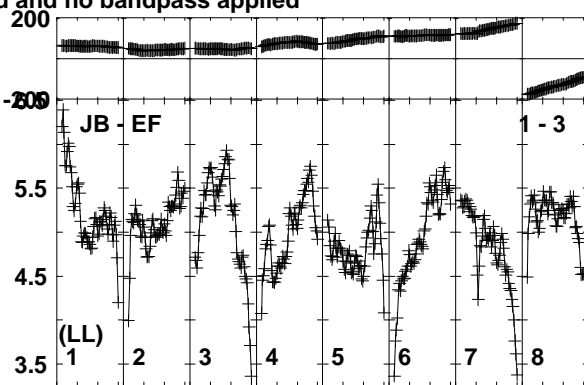
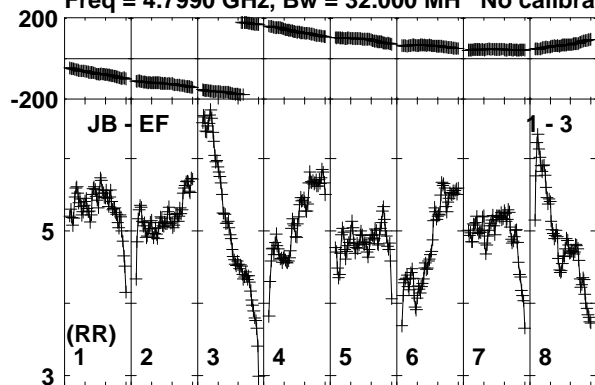

Lower frame: Milli Ampl Jy Top frame: Phas deg  
Vector averaged cross-power spectrum Baseline: JB (01) - EF (03)  
Timerange: 01/03:14:53 to 01/03:16:19

Plot file version 383 created 11-NOV-2019 15:08:00

J1826+0149 EK040B.UVDATA.1

Freq = 4.7990 GHz, Bw = 32.000 MH No calibration applied and no bandpass applied

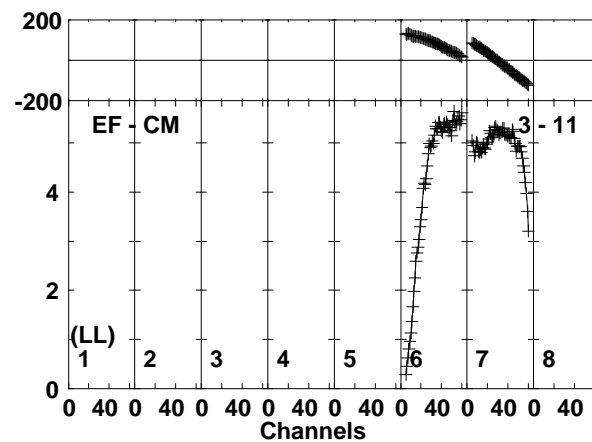
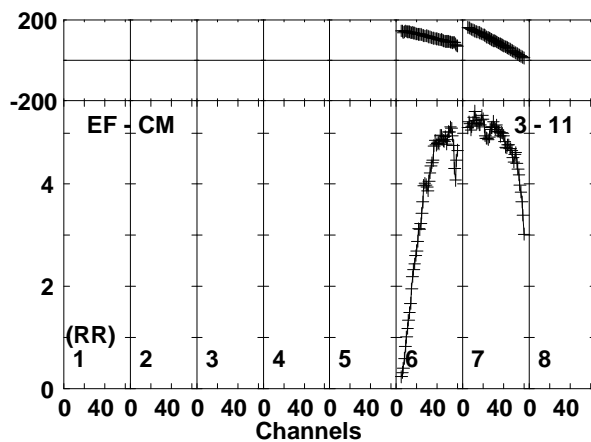
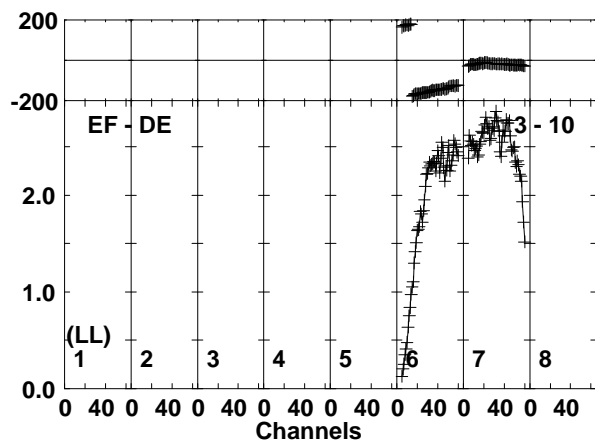
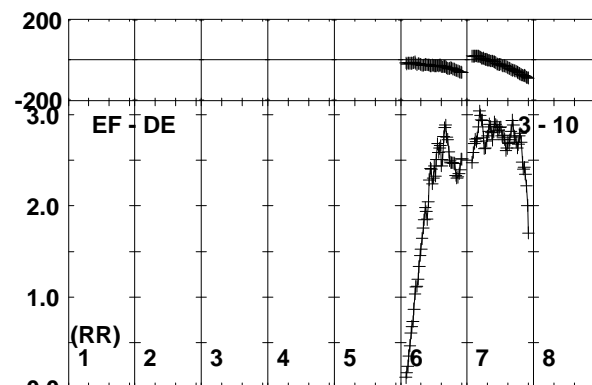
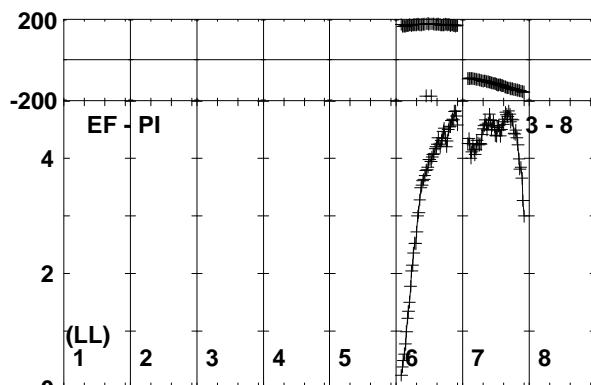
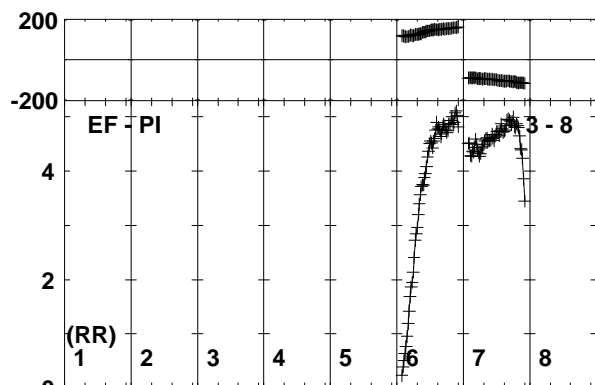
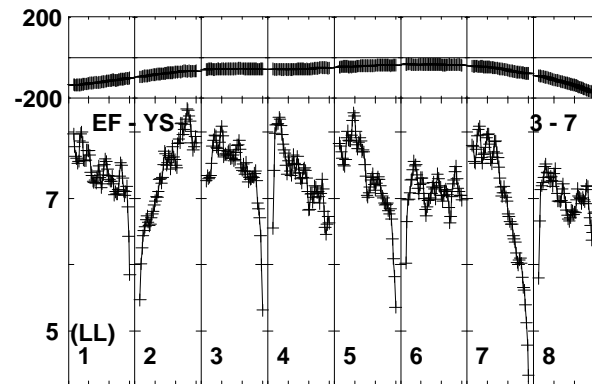
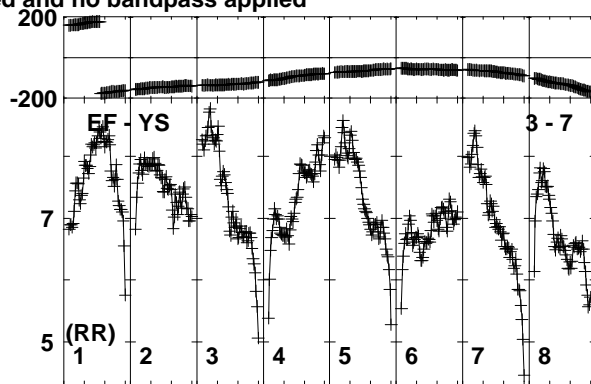
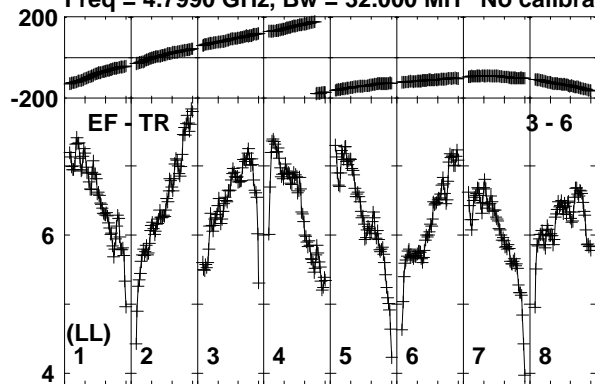

Lower frame: Milli Ampl Jy Top frame: Phas deg  
Vector averaged cross-power spectrum Baseline: EF (03) - TR (06)  
Timerange: 01/03:14:53 to 01/03:16:19

Plot file version 384 created 11-NOV-2019 15:08:00

J1826+0149 EK040B.UVDATA.1

Freq = 4.7990 GHz, Bw = 32.000 MH No calibration applied and no bandpass applied

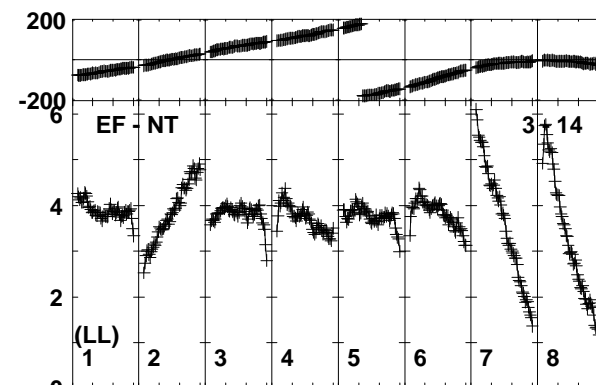
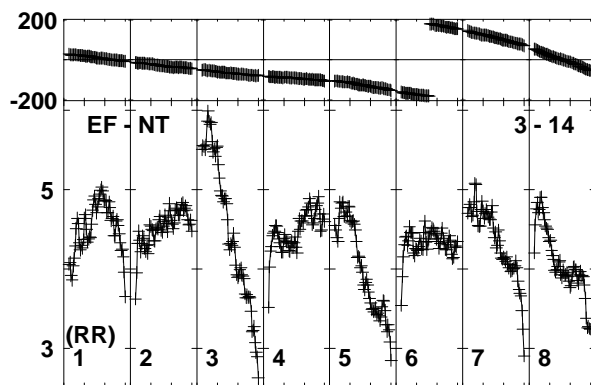
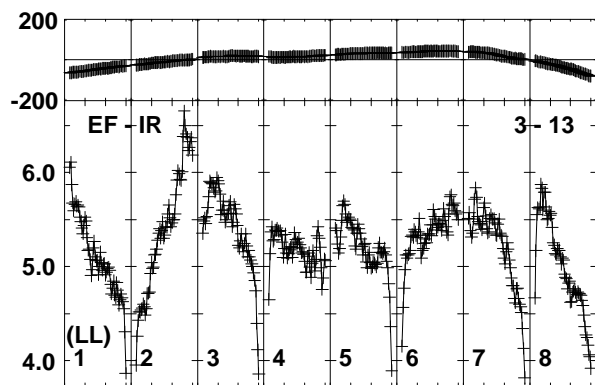
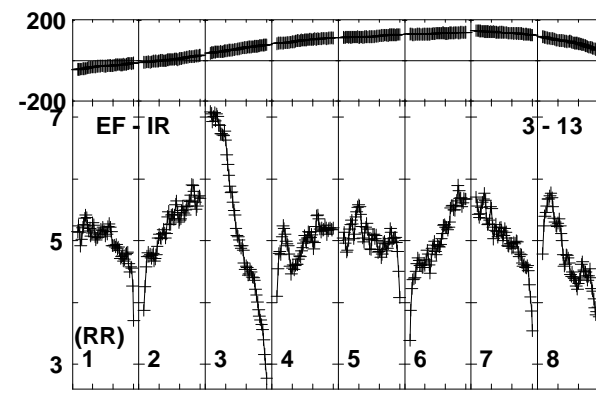
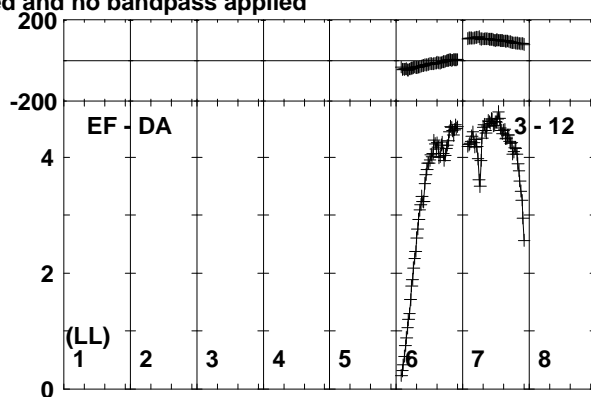
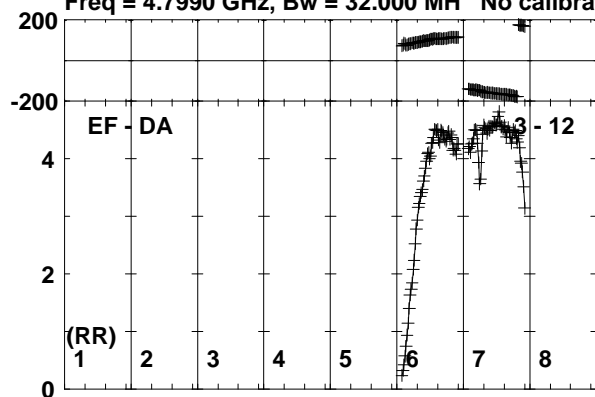

Channels

Lower frame: Milli Ampl Jy Top frame: Phas deg  
Vector averaged cross-power spectrum Baseline: EF (03) - DA (12)  
Timerange: 01/03:14:53 to 01/03:16:19

Plot file version 385 created 11-NOV-2019 15:08:00

SER8NJ EK040B.UVDATA.1

Freq = 4.7990 GHz, Bw = 32.000 MH No calibration applied and no bandpass applied

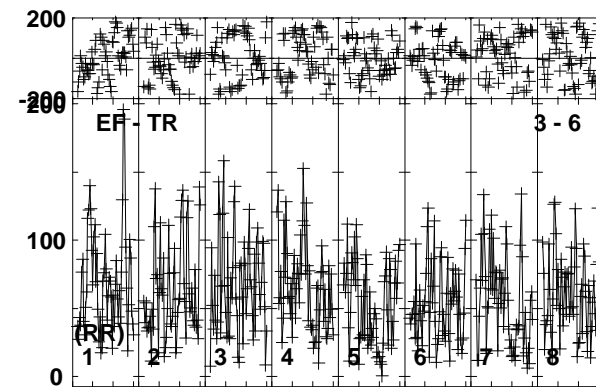
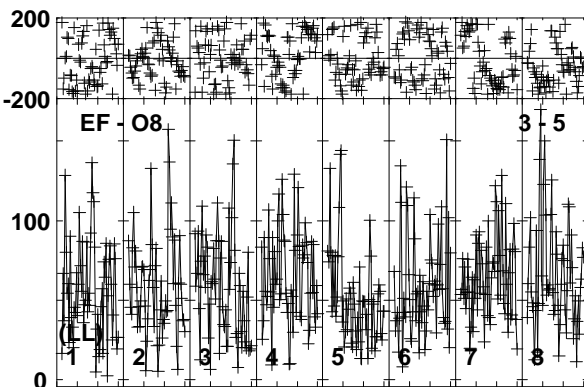
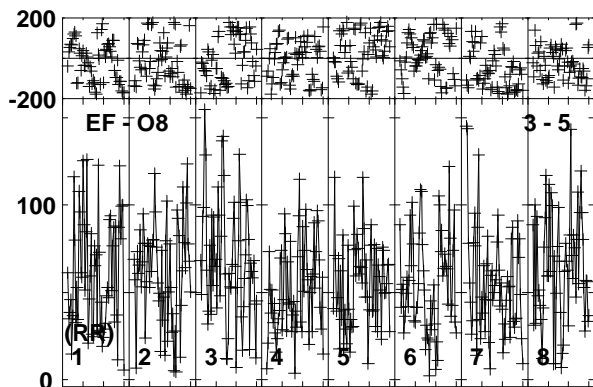
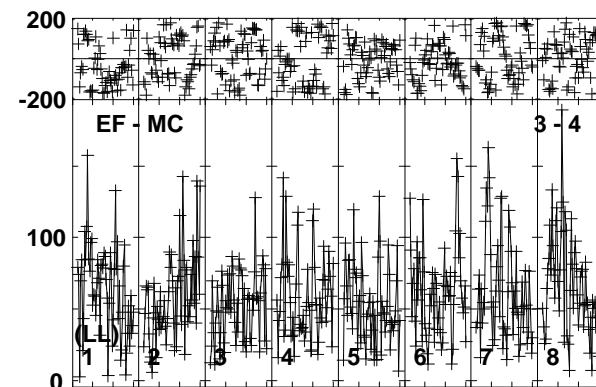
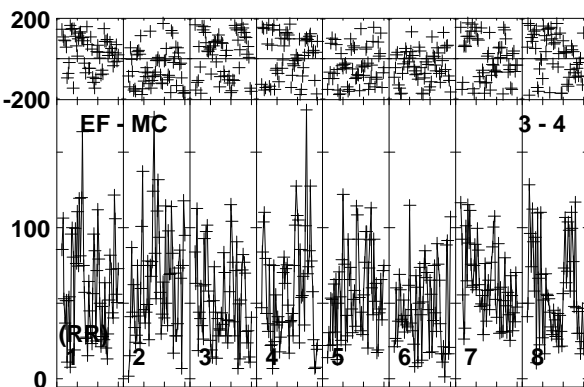
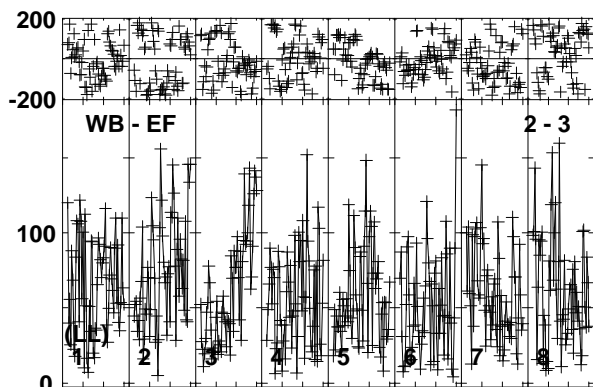
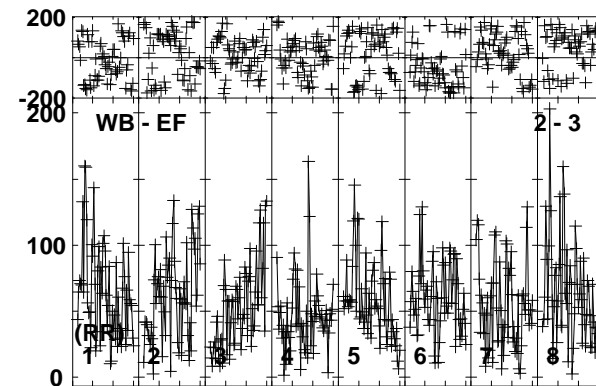
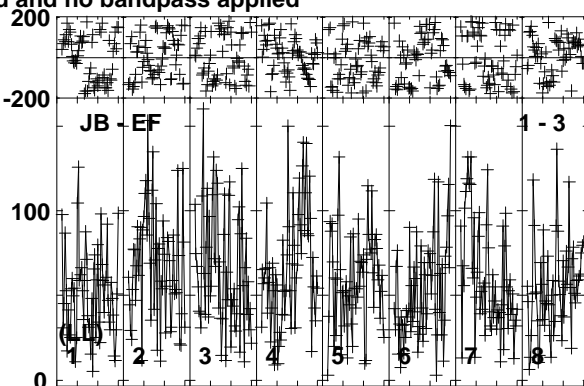
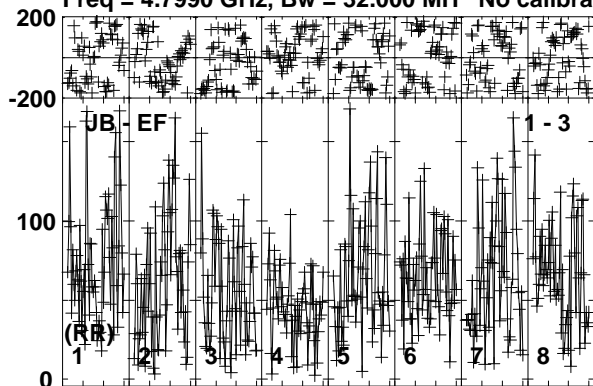

Lower frame: Micro Ampl Jy Top frame: Phas deg  
Vector averaged cross-power spectrum Baseline: JB (01) - EF (03)  
Timerange: 01/03:16:21 to 01/03:20:19

Plot file version 386 created 11-NOV-2019 15:08:00

SER8NJ EK040B.UVDATA.1

Freq = 4.7990 GHz, Bw = 32.000 MH No calibration applied and no bandpass applied

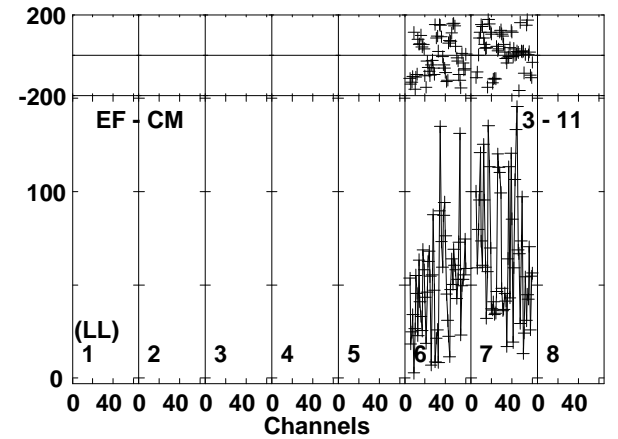
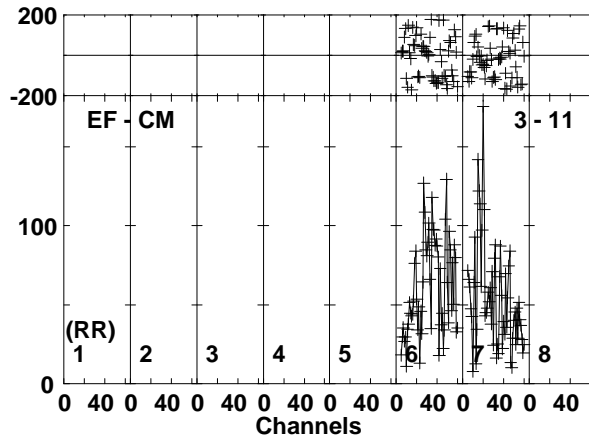
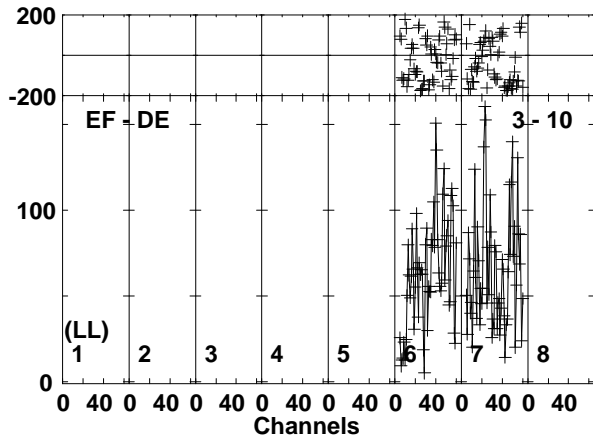
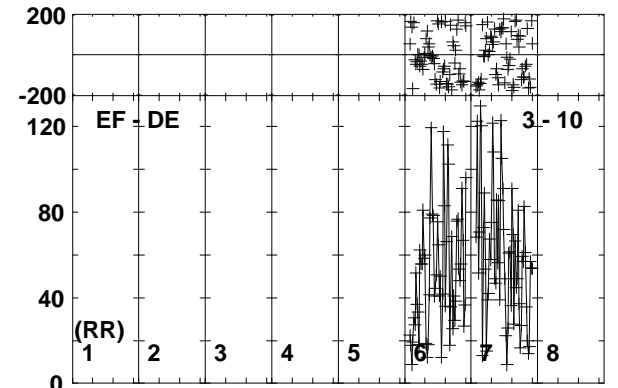
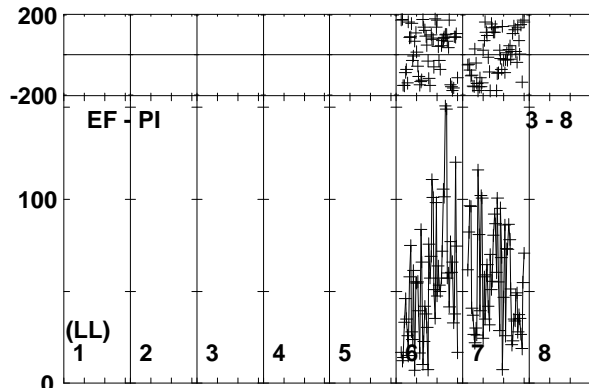
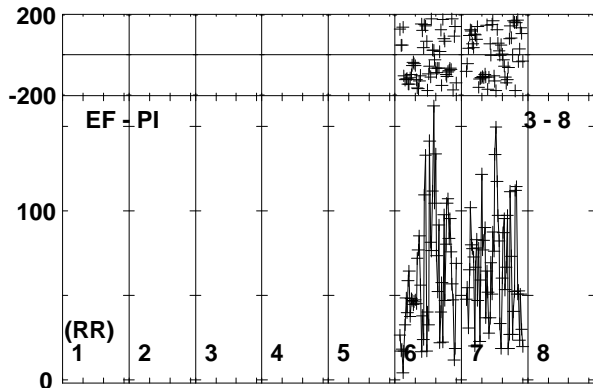
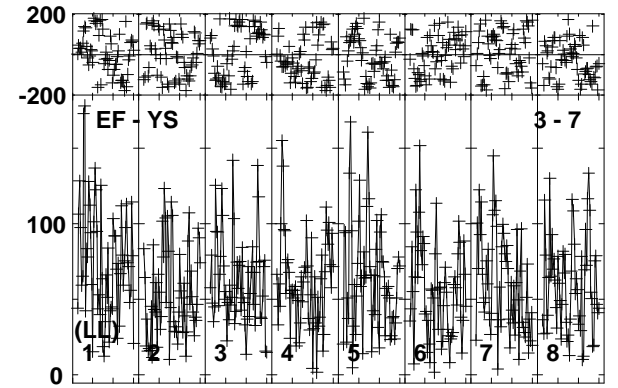
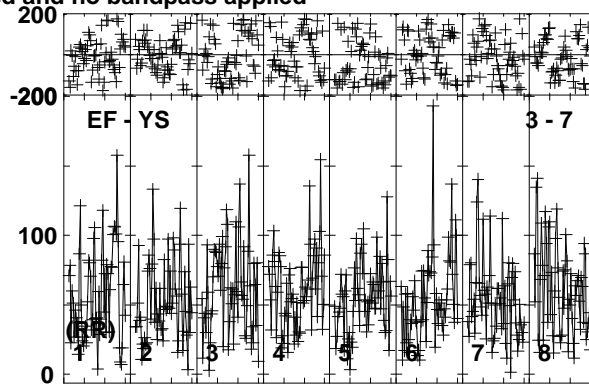
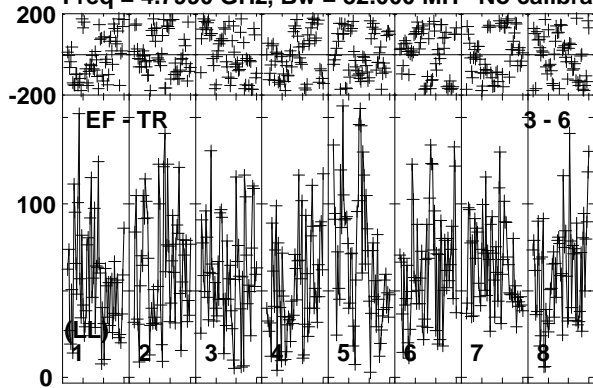

Lower frame: Micro Ampl Jy Top frame: Phas deg  
Vector averaged cross-power spectrum Baseline: EF (03) - TR (06)  
Timerange: 01/03:16:21 to 01/03:20:19



Plot file version 387 created 11-NOV-2019 15:08:00  
 SER8NJ EK040B.UVDATA.1  
 Freq = 4.7990 GHz, Bw = 32.000 MH No calibration applied and no bandpass applied

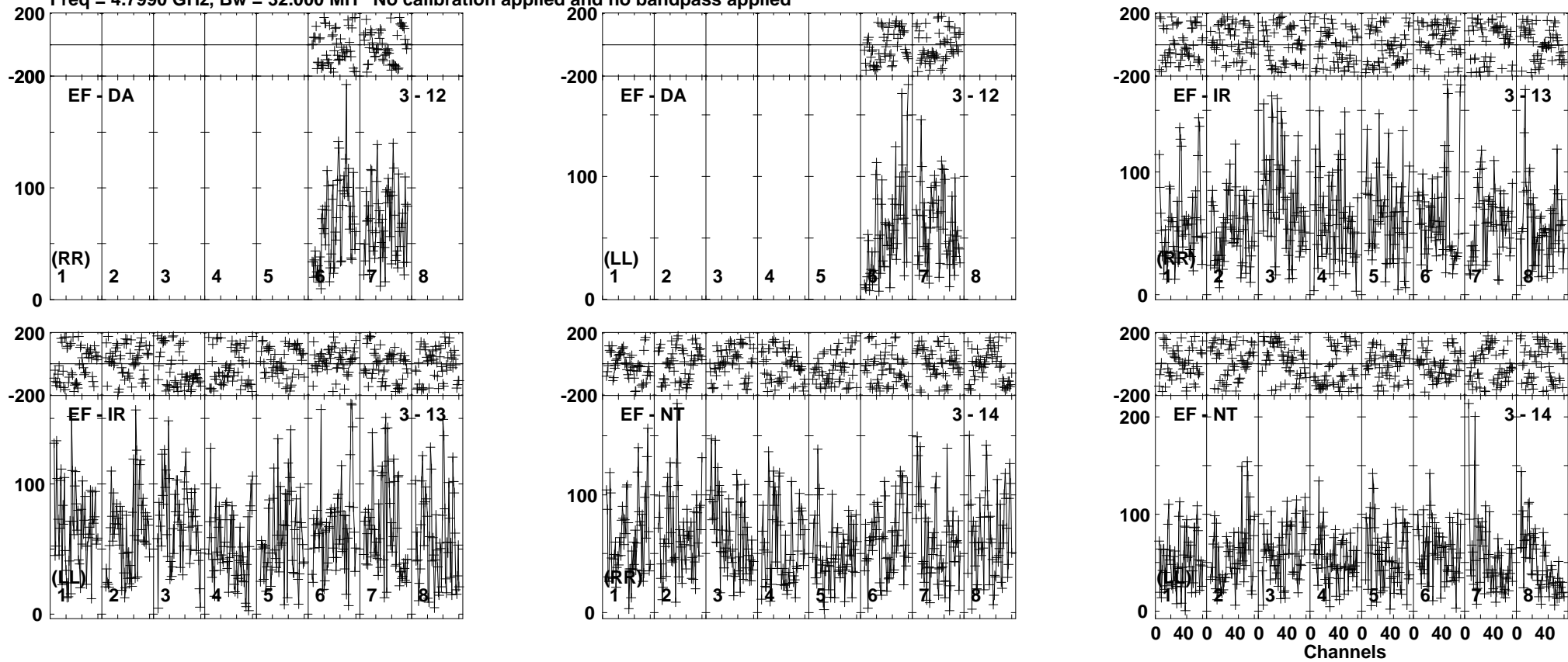

Lower frame: Micro Ampl Jy Top frame: Phas deg  
 Vector averaged cross-power spectrum Baseline: EF (03) - DA (12)  
 Timerange: 01/03:16:21 to 01/03:20:19

Plot file version 388 created 11-NOV-2019 15:08:00

J1826+0149 EK040B.UVDATA.1

Freq = 4.7990 GHz, Bw = 32.000 MH No calibration applied and no bandpass applied

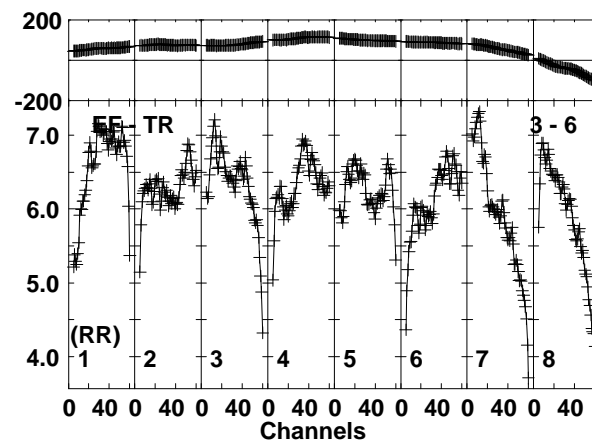
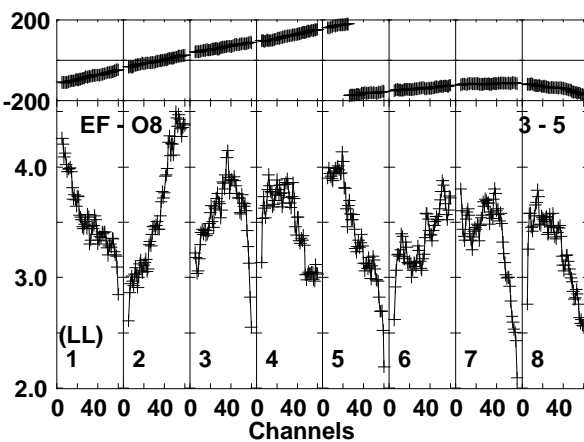
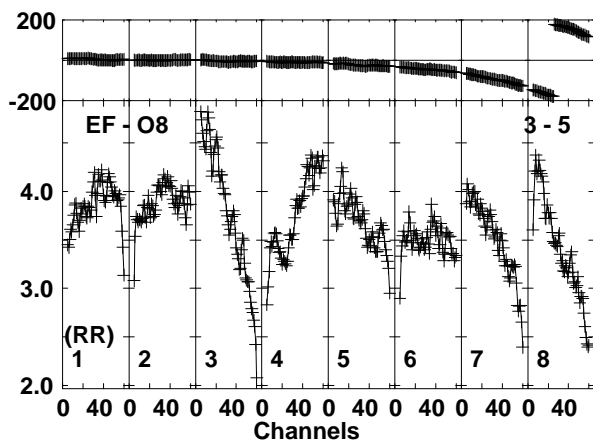
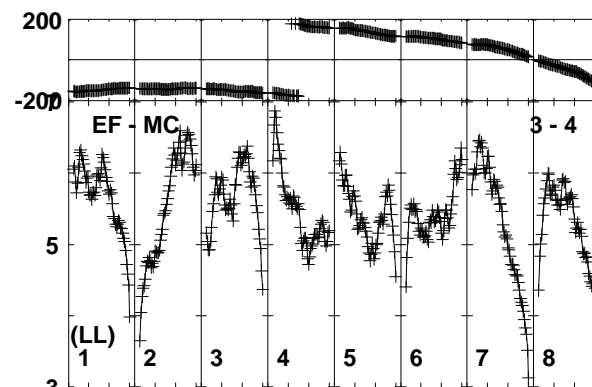
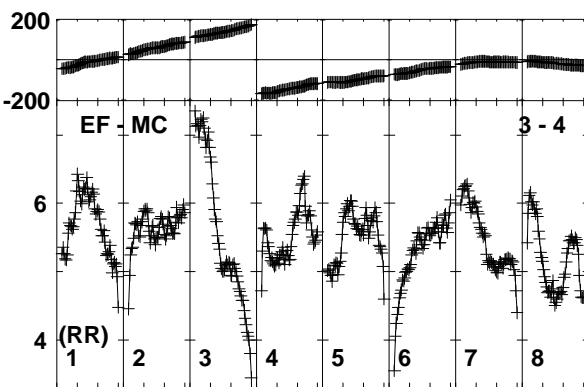
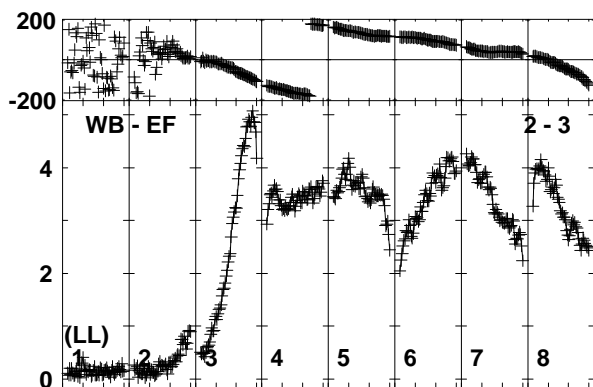
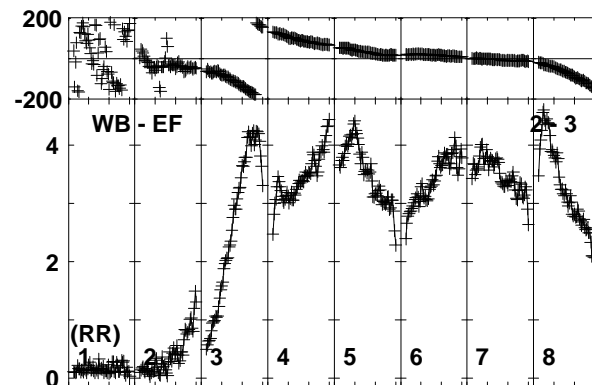
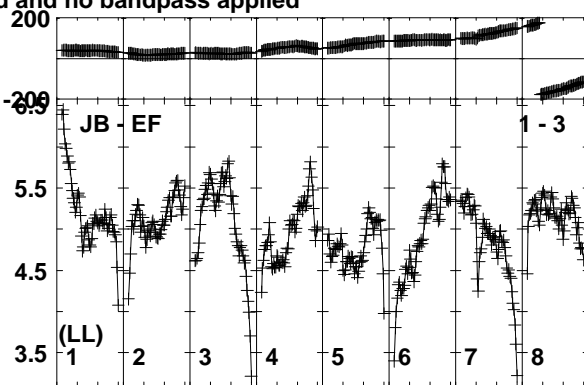
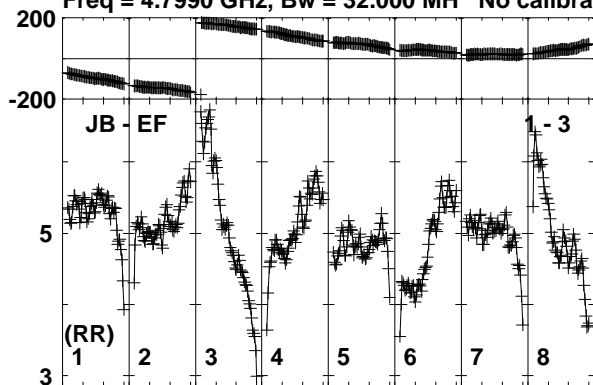

Lower frame: Milli Ampl Jy Top frame: Phas deg  
Vector averaged cross-power spectrum Baseline: JB (01) - EF (03)  
Timerange: 01/03:21:01 to 01/03:21:59

Plot file version 389 created 11-NOV-2019 15:08:00  
 J1826+0149 EK040B.UVDATA.1  
 Freq = 4.7990 GHz, Bw = 32.000 MH No calibration applied and no bandpass applied

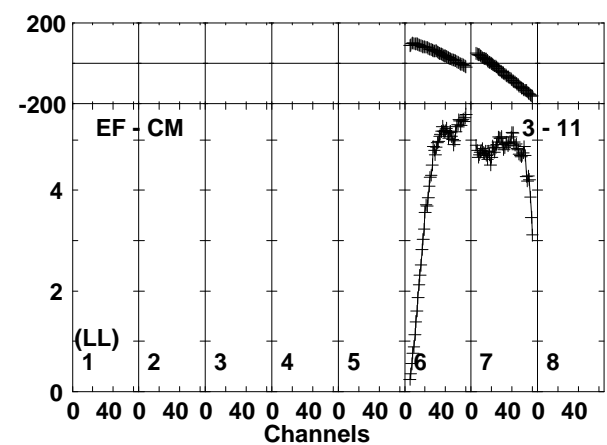
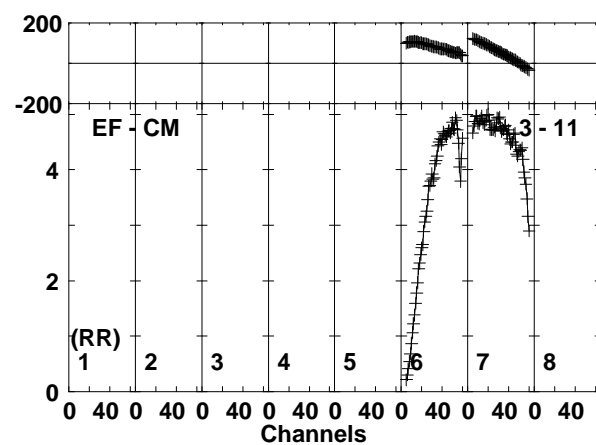
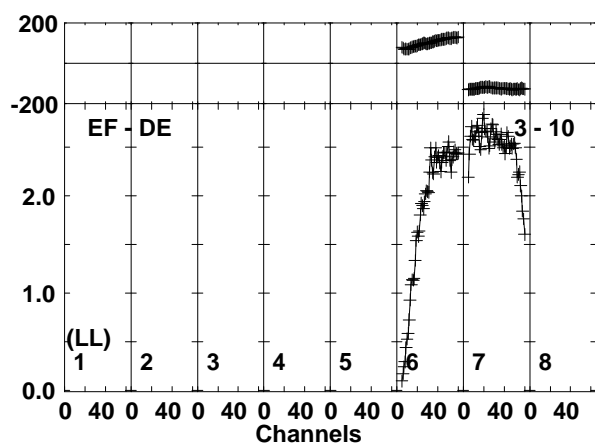
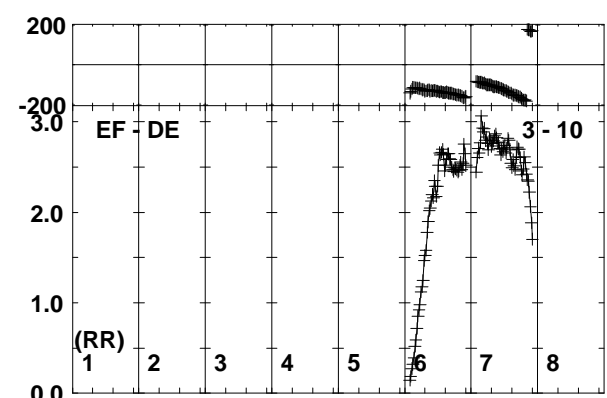
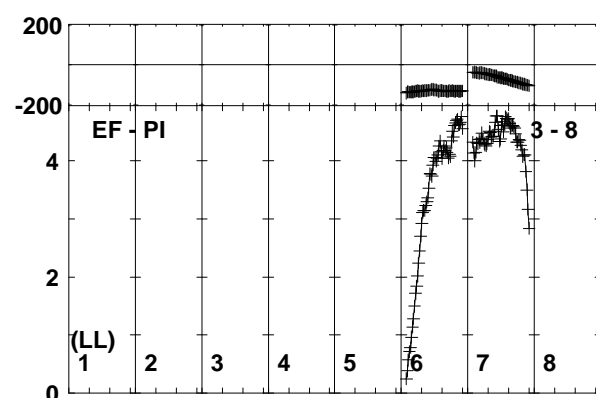
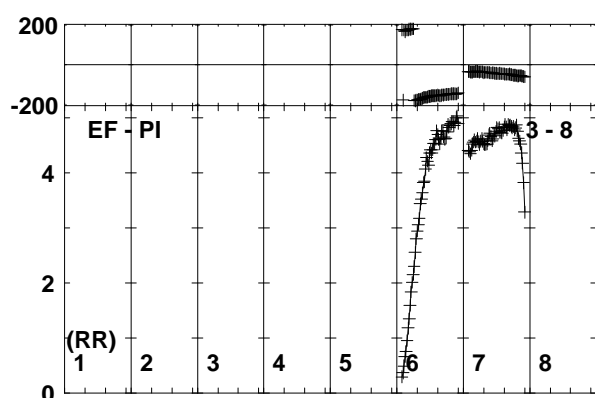
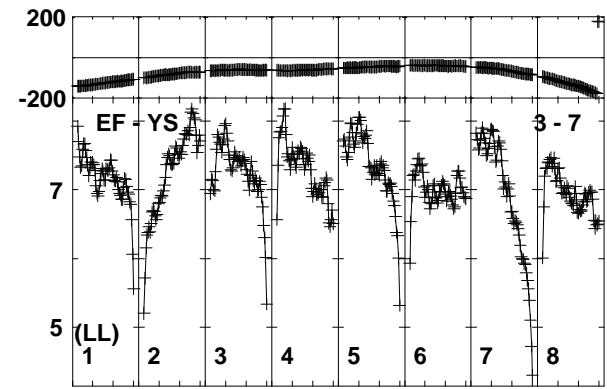
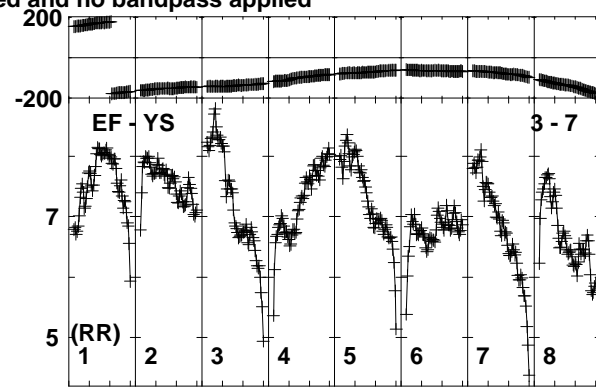
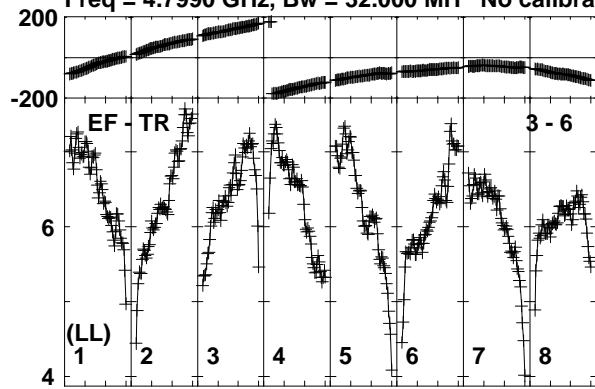

Lower frame: Milli Ampl Jy Top frame: Phas deg  
 Vector averaged cross-power spectrum Baseline: EF (03) - TR (06)  
 Timerange: 01/03:21:01 to 01/03:21:59

Plot file version 390 created 11-NOV-2019 15:08:01

J1826+0149 EK040B.UVDATA.1

Freq = 4.7990 GHz, Bw = 32.000 MH No calibration applied and no bandpass applied

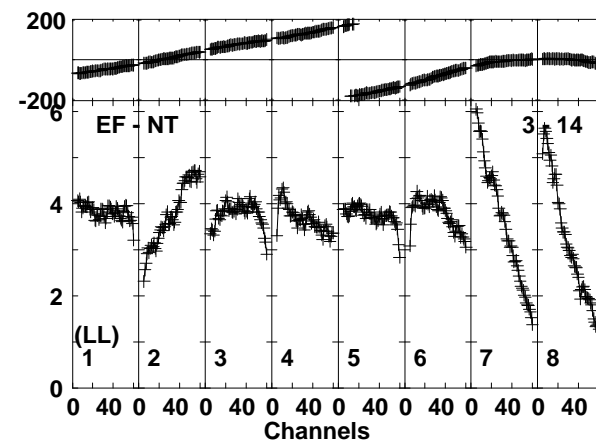
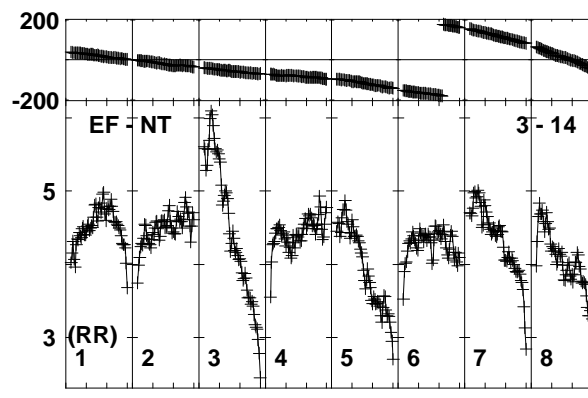
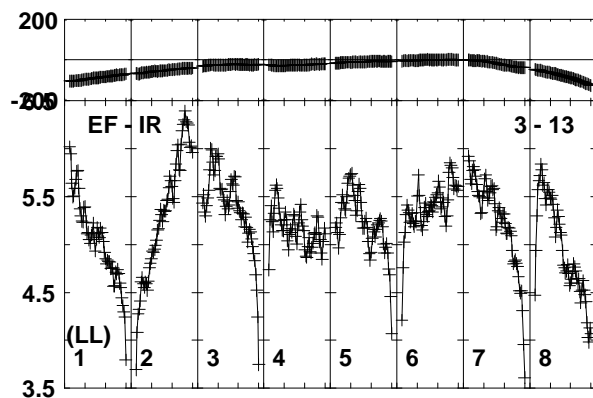
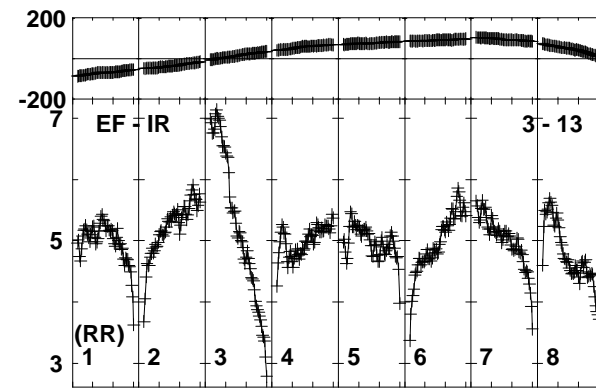
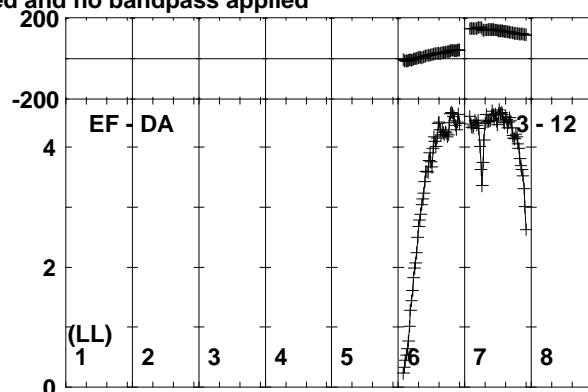
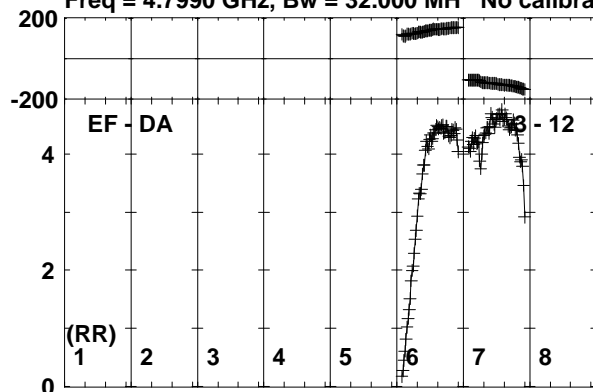

Lower frame: Milli Ampl Jy Top frame: Phas deg  
Vector averaged cross-power spectrum Baseline: EF (03) - DA (12)  
Timerange: 01/03:21:01 to 01/03:21:59

Plot file version 391 created 11-NOV-2019 15:08:01

SER8NJ EK040B.UVDATA.1

Freq = 4.7990 GHz, Bw = 32.000 MH No calibration applied and no bandpass applied

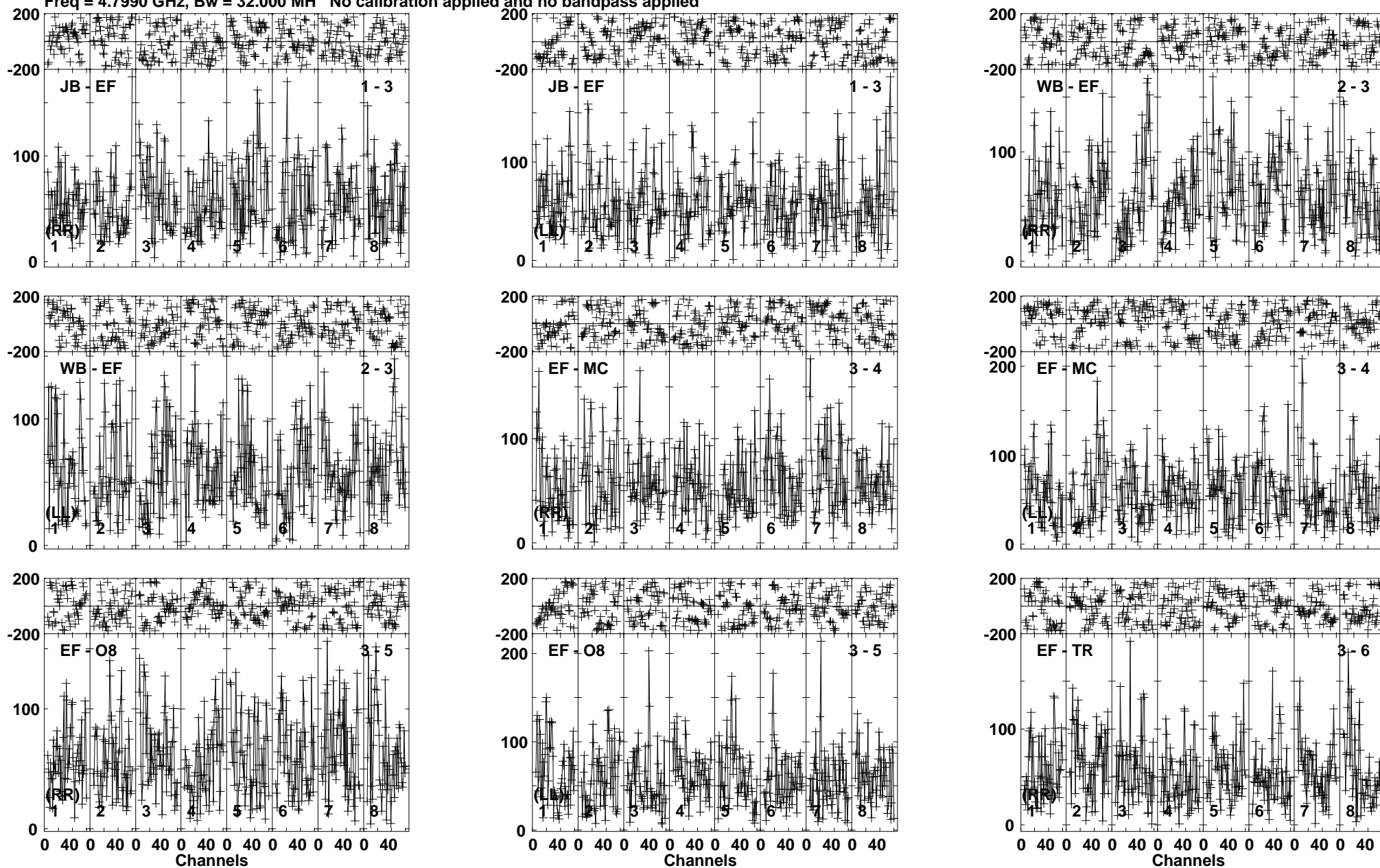

Lower frame: Micro Ampl Jy Top frame: Phas deg  
Vector averaged cross-power spectrum Baseline: JB (01) - EF (03)  
Timerange: 01/03:22:01 to 01/03:25:59

Plot file version 392 created 11-NOV-2019 15:08:01

SER8NJ EK040B.UVDATA.1

Freq = 4.7990 GHz, Bw = 32.000 MH No calibration applied and no bandpass applied

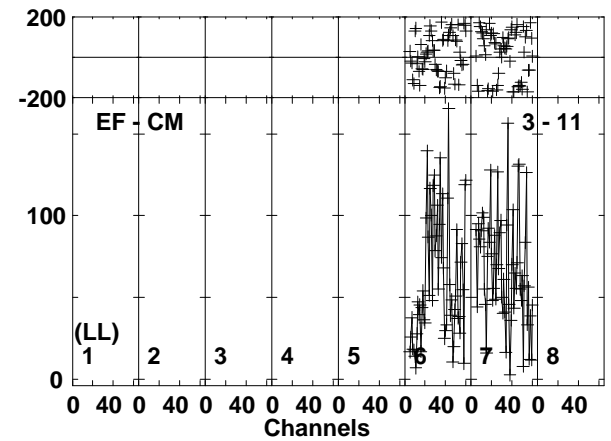
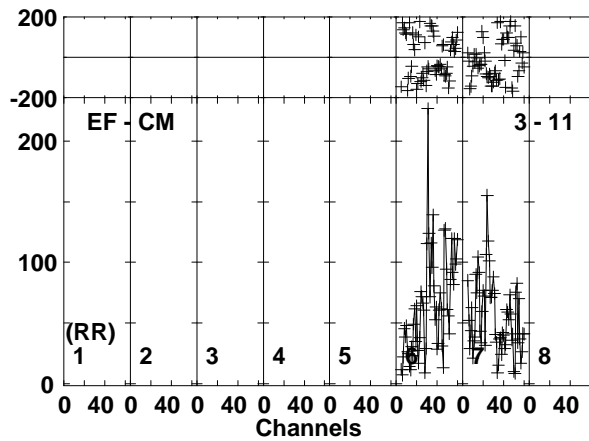
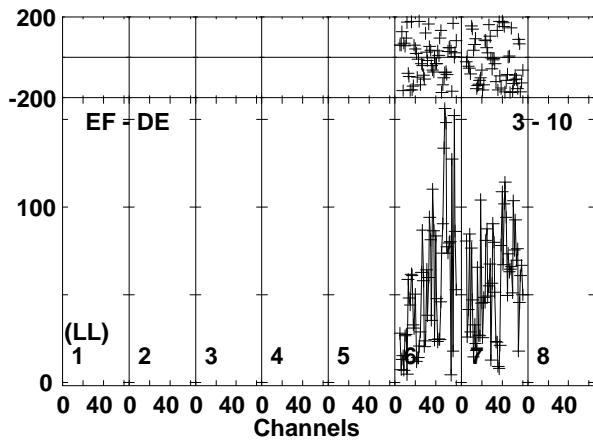
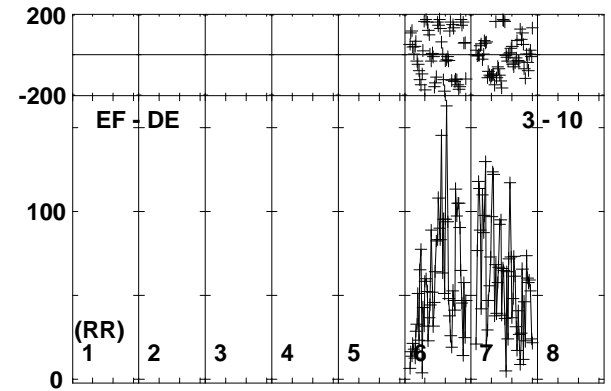
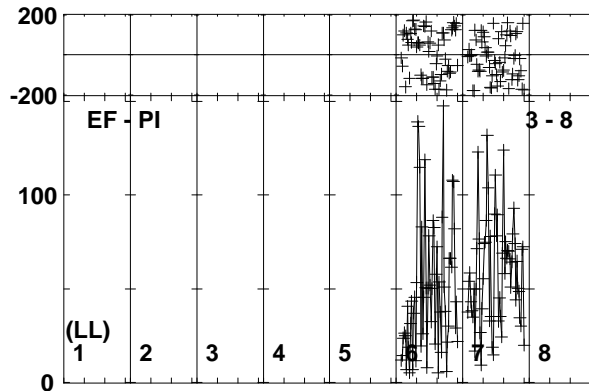
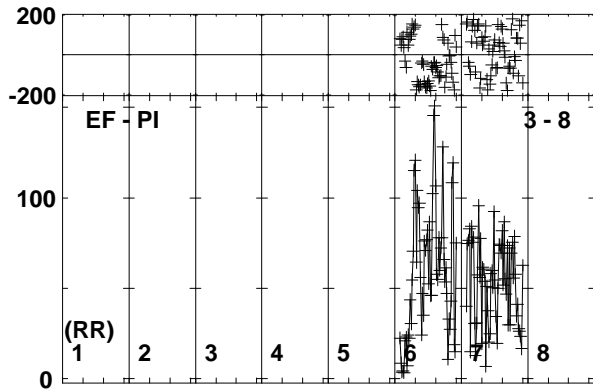
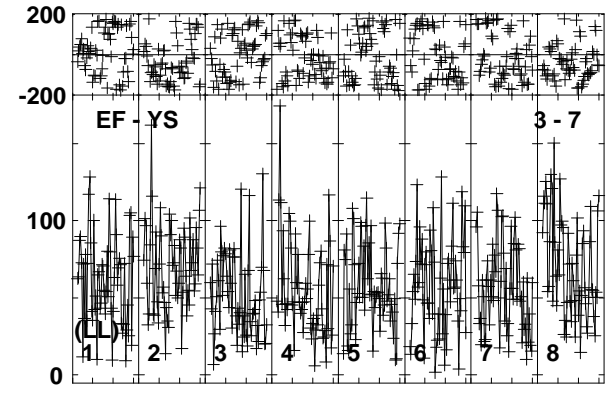
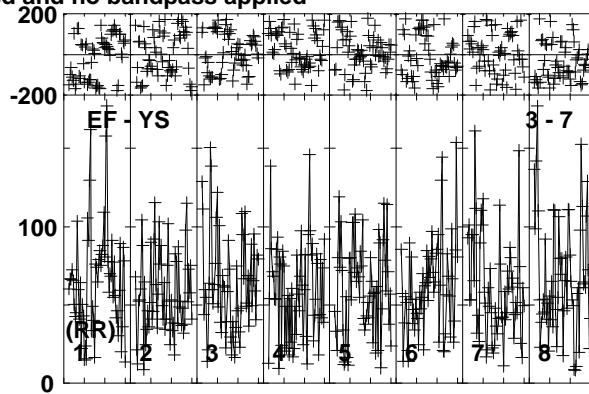
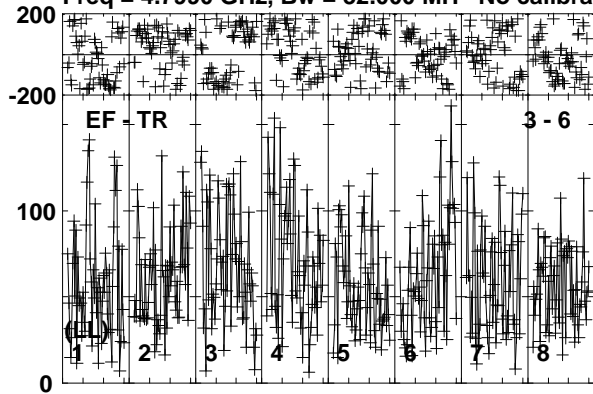

Lower frame: Micro Ampl Jy Top frame: Phas deg  
Vector averaged cross-power spectrum Baseline: EF (03) - TR (06)  
Timerange: 01/03:22:01 to 01/03:25:59

Plot file version 393 created 11-NOV-2019 15:08:01

SER8NJ EK040B.UVDATA.1

Freq = 4.7990 GHz, Bw = 32.000 MH No calibration applied and no bandpass applied

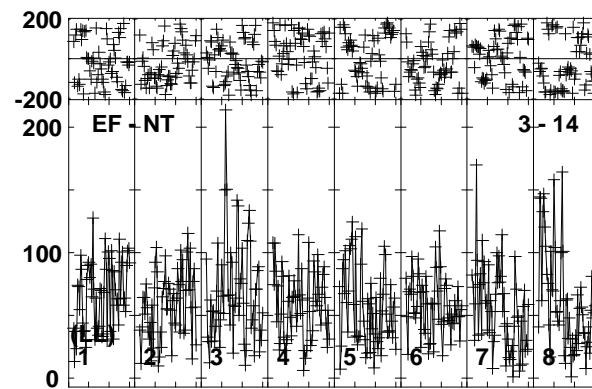
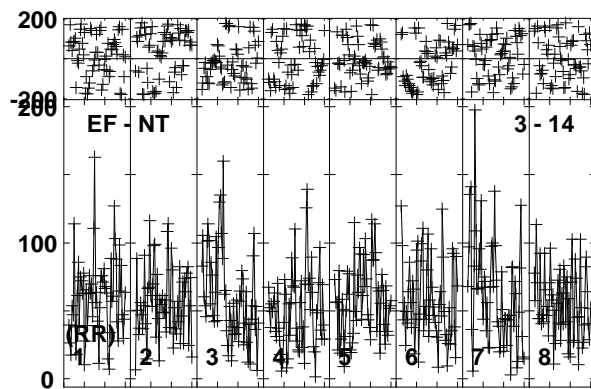
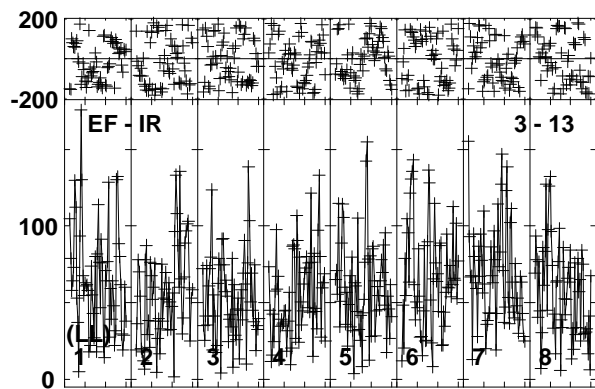
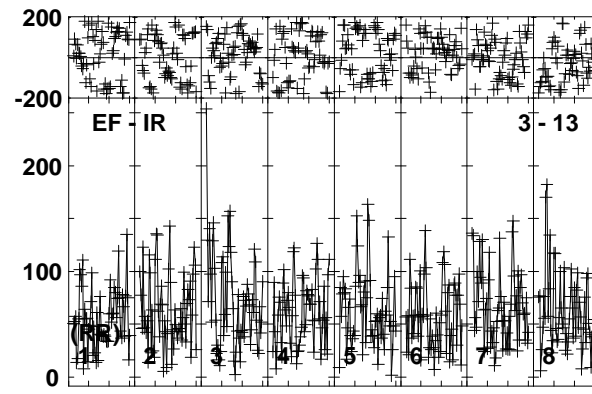
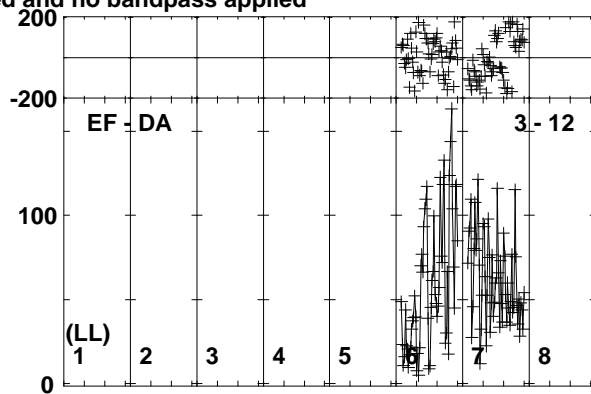
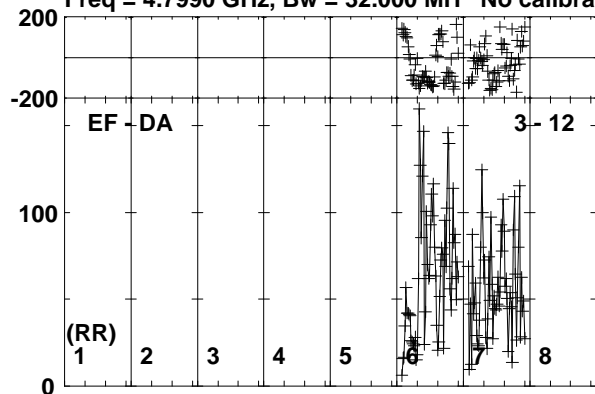

0 40 0 40 0 40 0 40 0 40 0 40 0 40 0 40 0 40 0 40  
Channels

Lower frame: Micro Ampl Jy Top frame: Phas deg  
Vector averaged cross-power spectrum Baseline: EF (03) - DA (12)  
Timerange: 01/03:22:01 to 01/03:25:59

Plot file version 394 created 11-NOV-2019 15:08:01

J1826+0149 EK040B.UVDATA.1

Freq = 4.7990 GHz, Bw = 32.000 MH No calibration applied and no bandpass applied

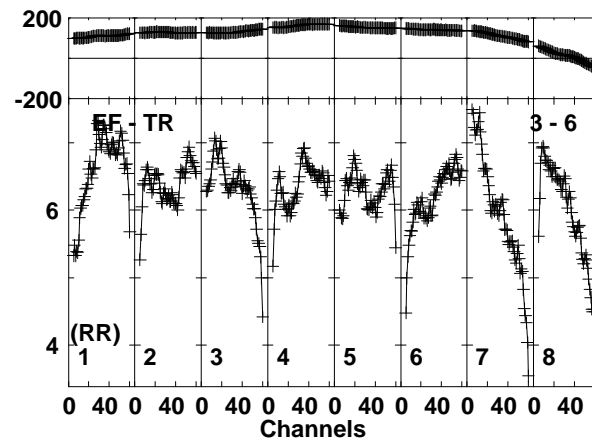
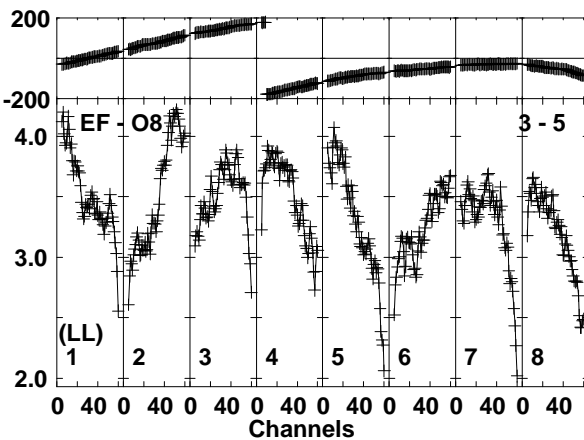
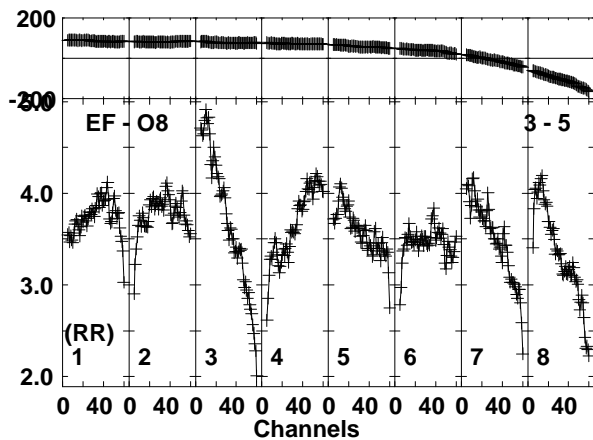
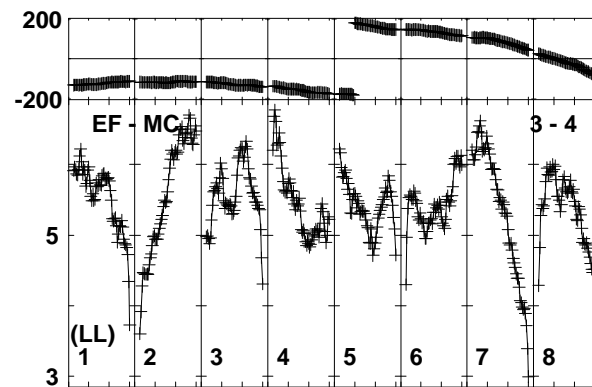
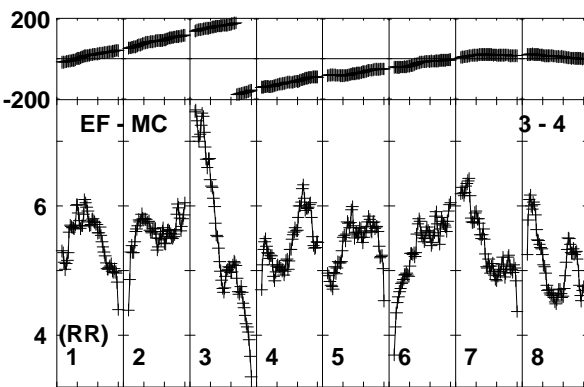
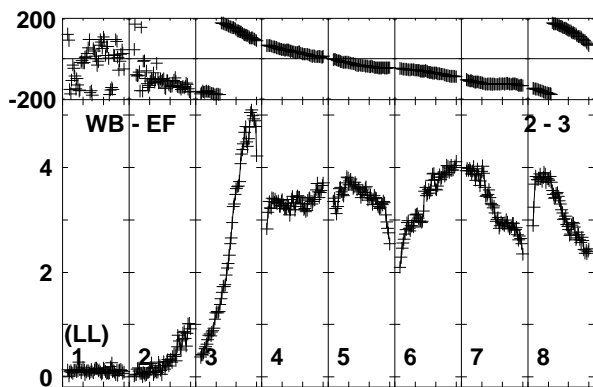
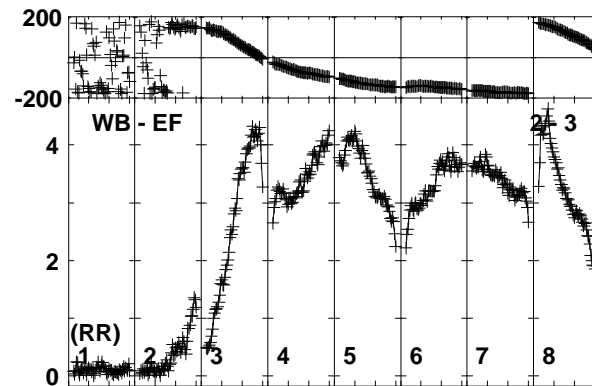
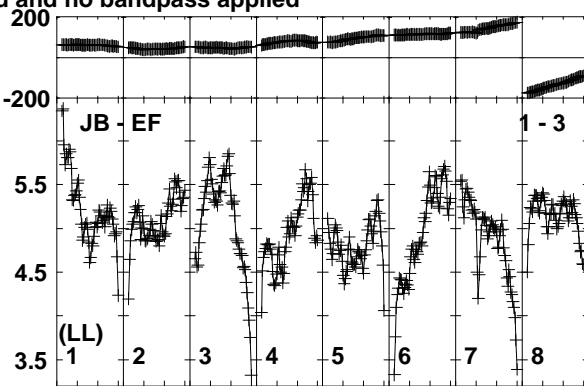
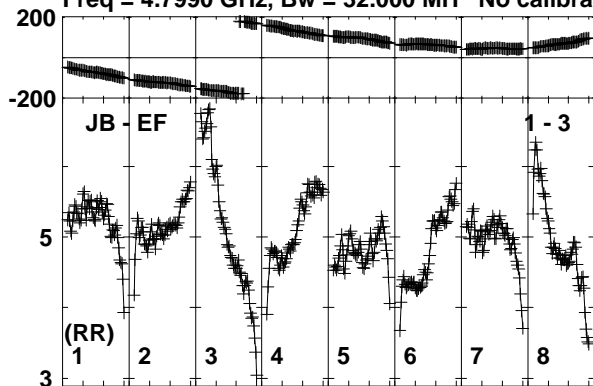

Lower frame: Milli Ampl Jy Top frame: Phas deg  
Vector averaged cross-power spectrum Baseline: JB (01) - EF (03)  
Timerange: 01/03:26:03 to 01/03:27:29



Plot file version 395 created 11-NOV-2019 15:08:01

J1826+0149 EK040B.UVDATA.1

Freq = 4.7990 GHz, Bw = 32.000 MH No calibration applied and no bandpass applied

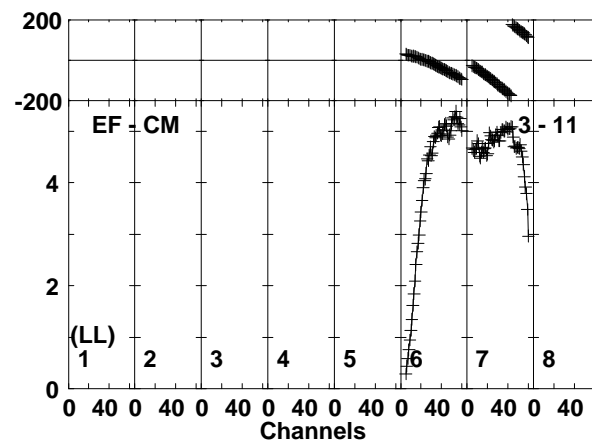
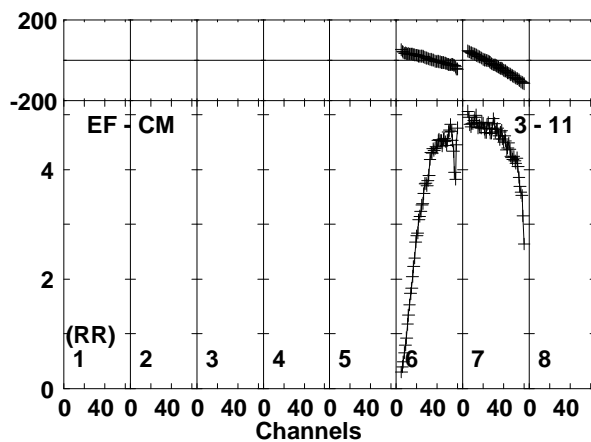
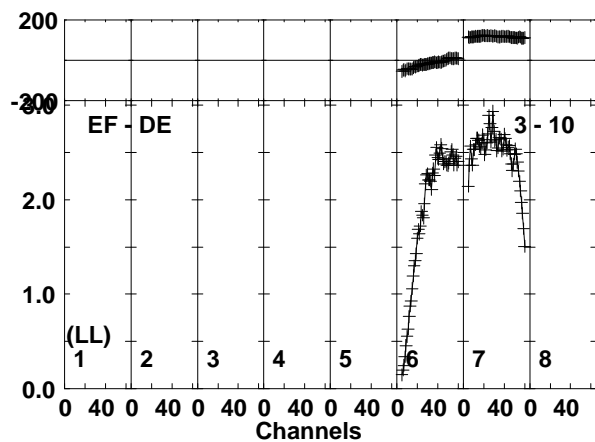
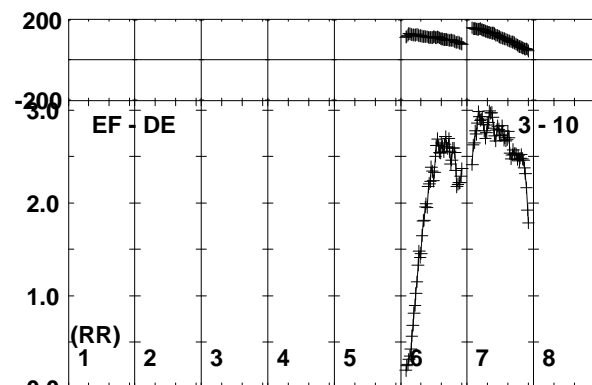
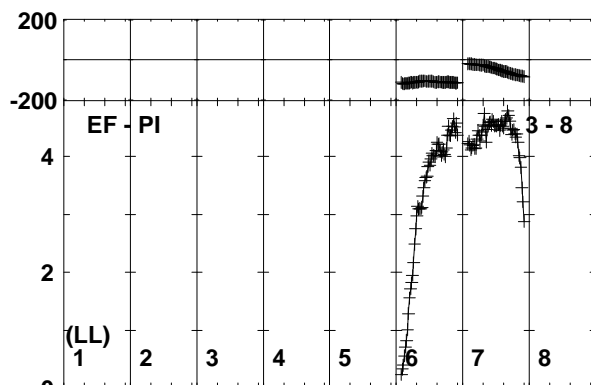
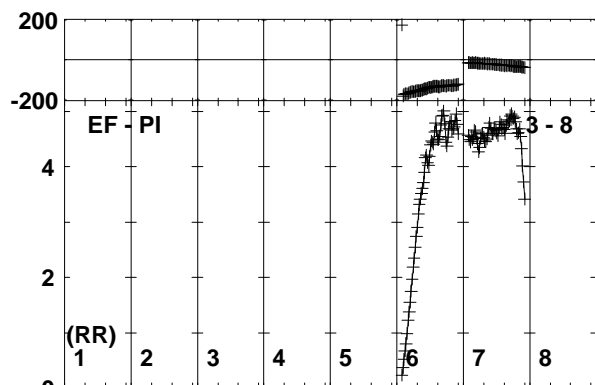
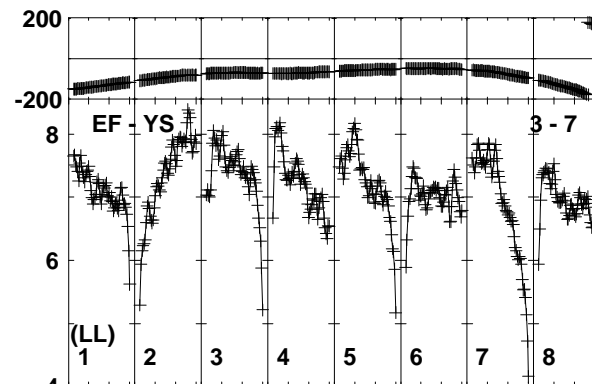
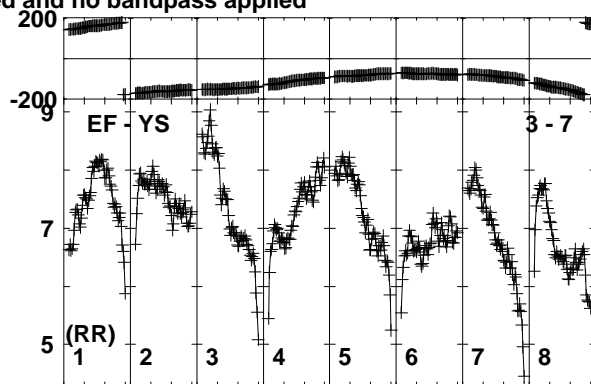
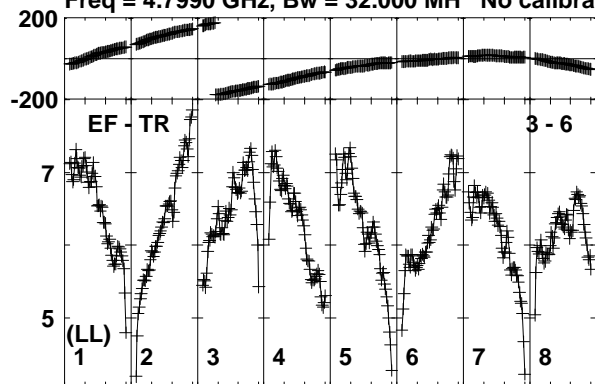

Lower frame: Milli Ampl Jy Top frame: Phas deg  
Vector averaged cross-power spectrum Baseline: EF (03) - TR (06)  
Timerange: 01/03:26:03 to 01/03:27:29

Plot file version 396 created 11-NOV-2019 15:08:01  
 J1826+0149 EK040B.UVDATA.1  
 Freq = 4.7990 GHz, Bw = 32.000 MH No calibration applied and no bandpass applied

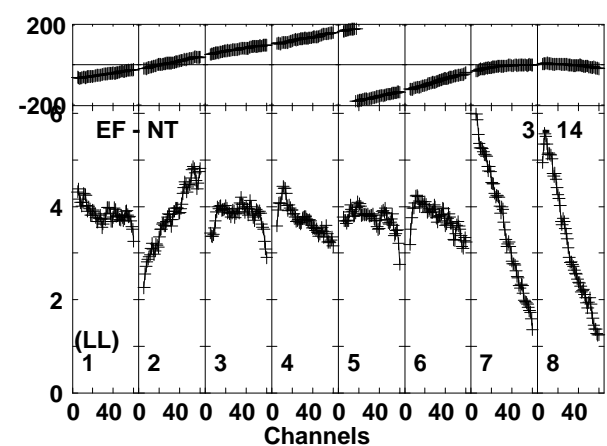
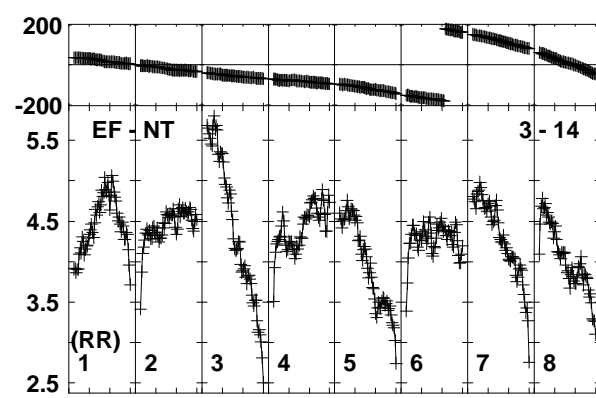
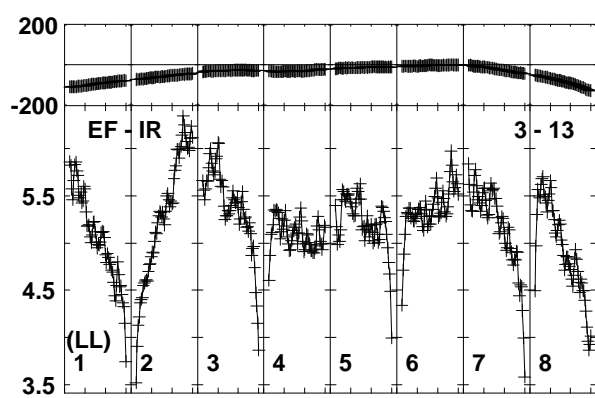
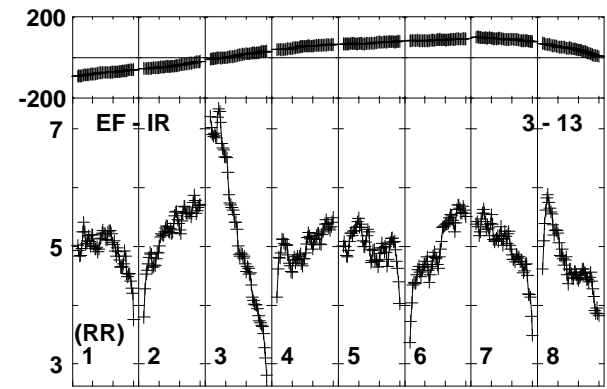
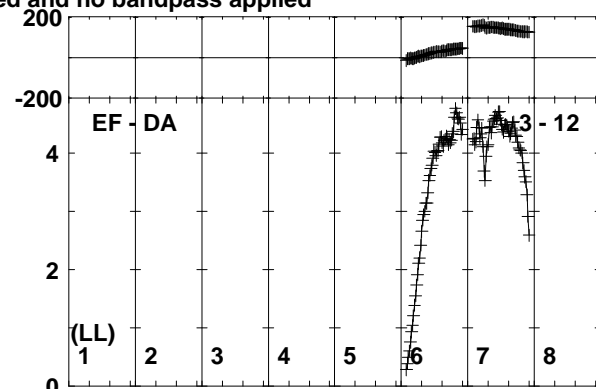
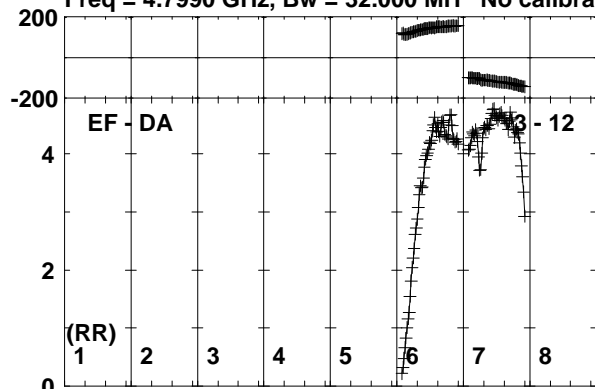

Lower frame: Milli Ampl Jy Top frame: Phas deg  
 Vector averaged cross-power spectrum Baseline: EF (03) - DA (12)  
 Timerange: 01/03:26:03 to 01/03:27:29

Plot file version 397 created 11-NOV-2019 15:08:01

SER8NJ EK040B.UVDATA.1

Freq = 4.7990 GHz, Bw = 32.000 MH No calibration applied and no bandpass applied

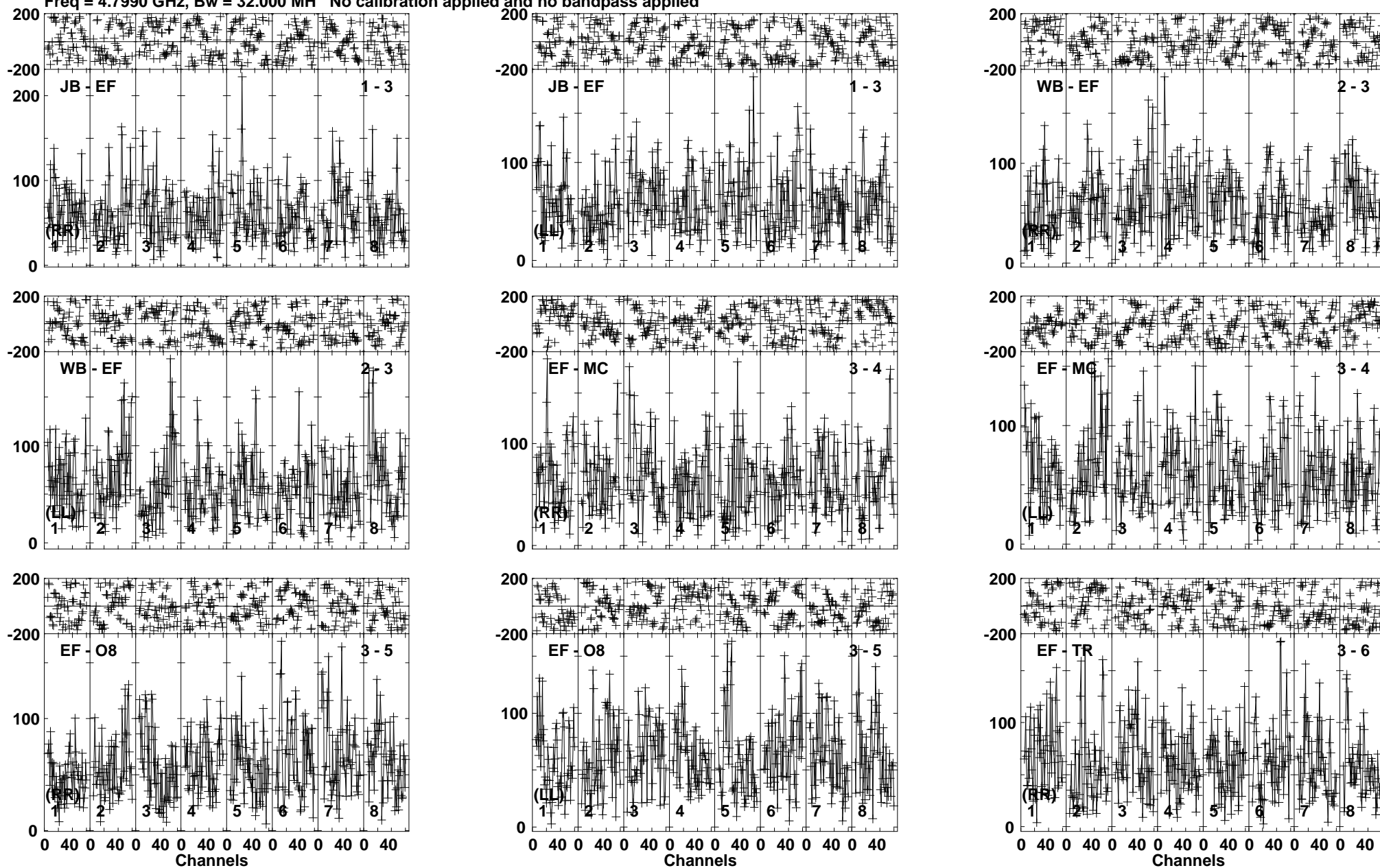

Lower frame: Micro Ampl Jy Top frame: Phas deg  
Vector averaged cross-power spectrum Baseline: JB (01) - EF (03)  
Timerange: 01/03:27:33 to 01/03:31:29

Plot file version 398 created 11-NOV-2019 15:08:01  
 SER8NJ EK040B.UVDATA.1

Freq = 4.7990 GHz, Bw = 32.000 MH No calibration applied and no bandpass applied

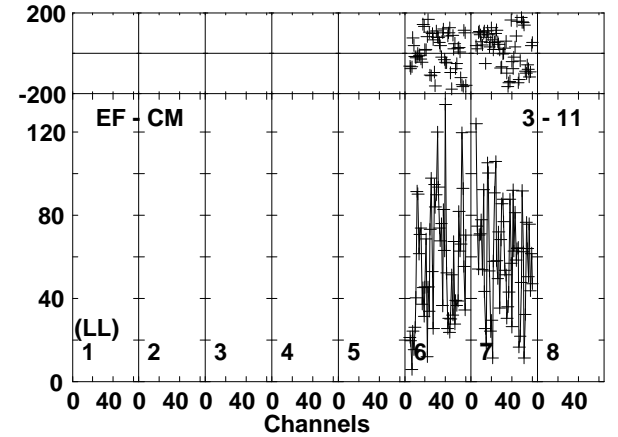
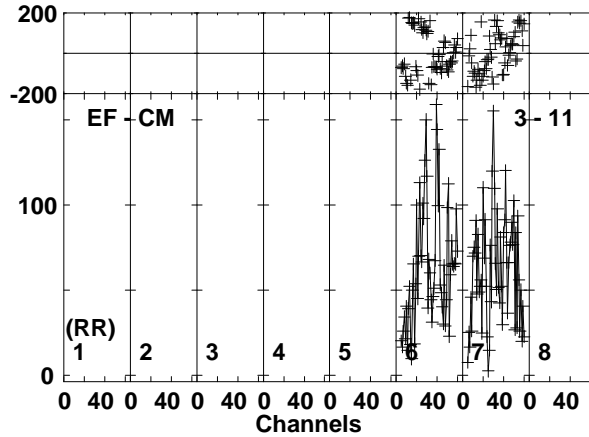
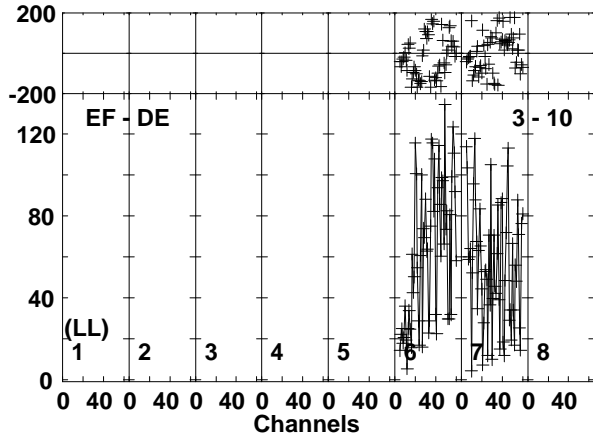
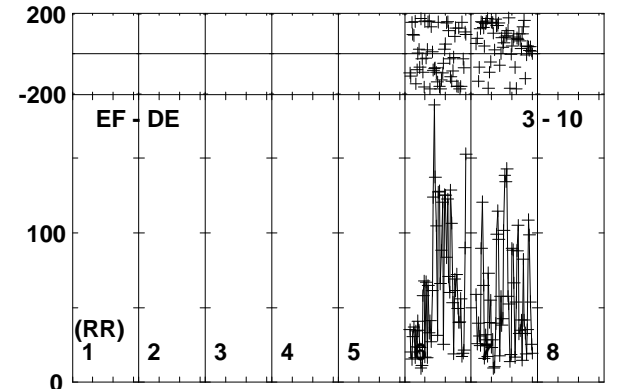
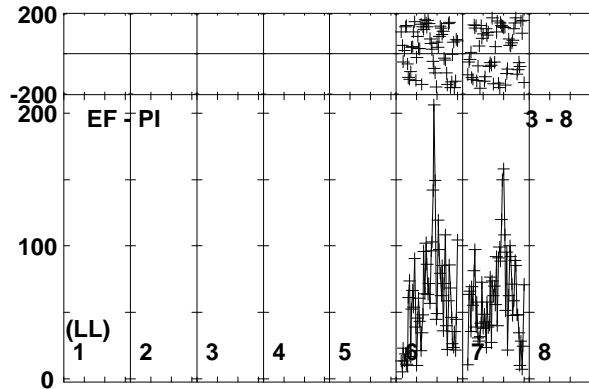
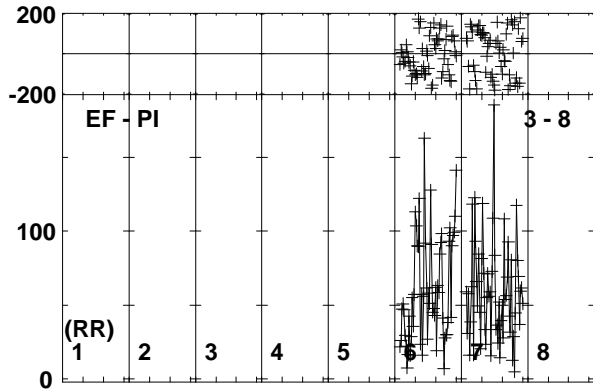
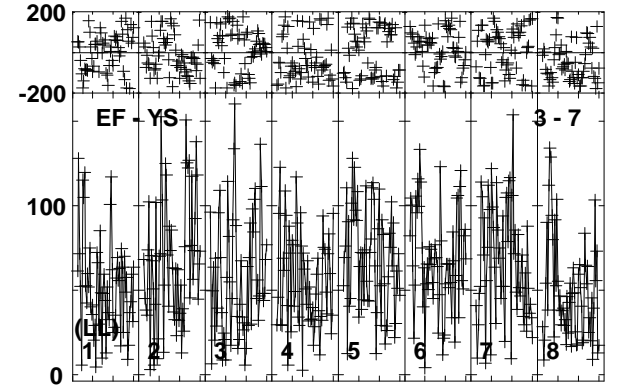
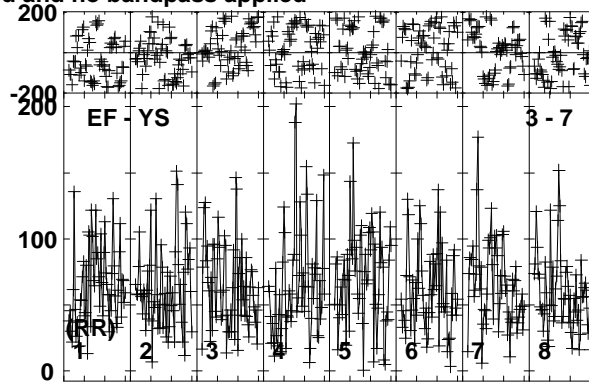
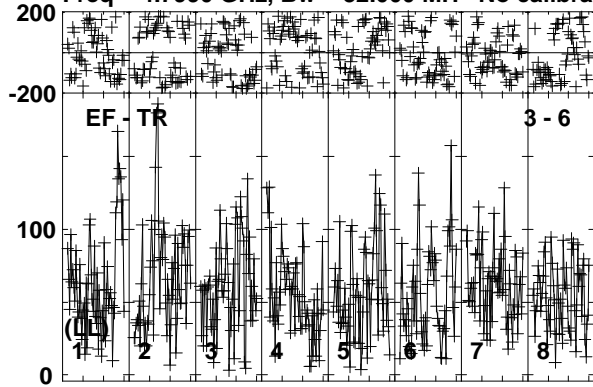

Lower frame: Micro Ampl Jy Top frame: Phas deg  
 Vector averaged cross-power spectrum Baseline: EF (03) - TR (06)  
 Timerange: 01/03:27:33 to 01/03:31:29

Plot file version 399 created 11-NOV-2019 15:08:02  
 SER8NJ EK040B.UVDATA.1  
 Freq = 4.7990 GHz, Bw = 32.000 MH No calibration applied and no bandpass applied

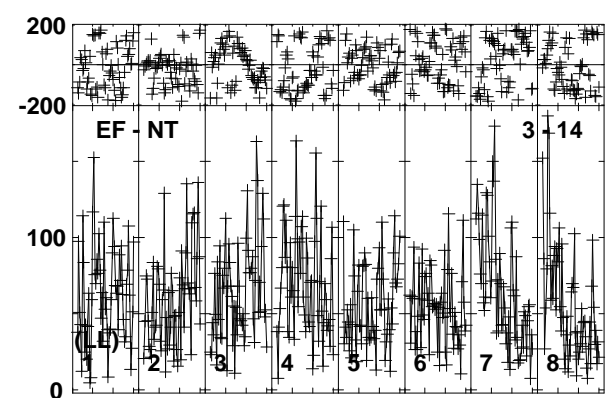
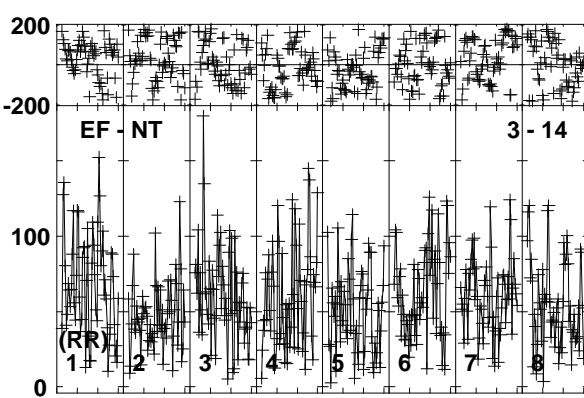
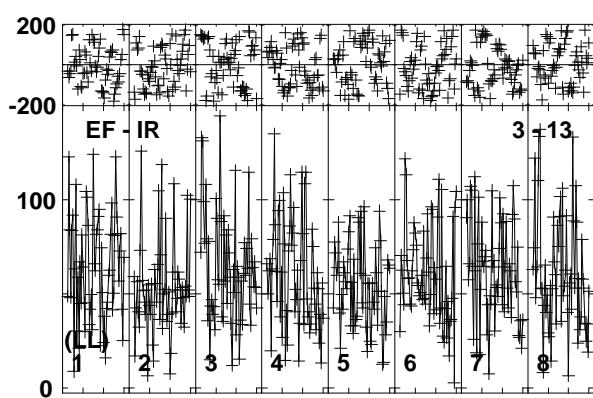
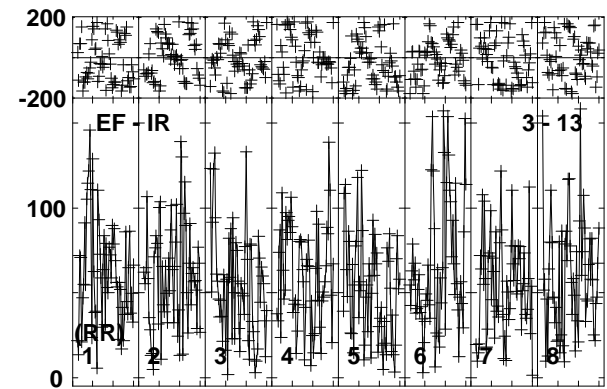
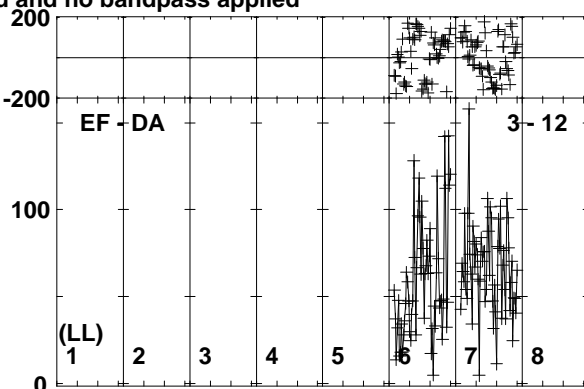
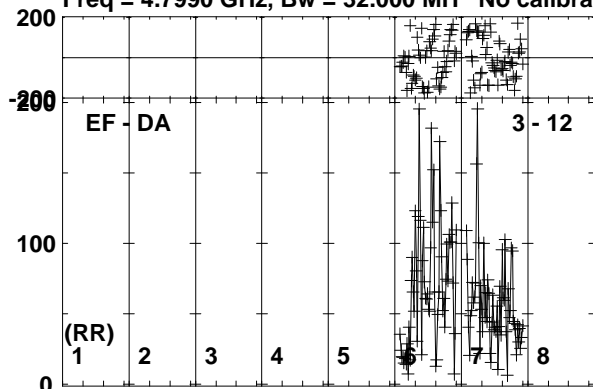

0 40 0 40 0 40 0 40 0 40 0 40 0 40 0 40 0 40  
 Channels

Lower frame: Micro Ampl Jy Top frame: Phas deg  
 Vector averaged cross-power spectrum Baseline: EF (03) - DA (12)  
 Timerange: 01/03:27:33 to 01/03:31:29

Plot file version 400 created 11-NOV-2019 15:08:02

J1826+0149 EK040B.UVDATA.1

Freq = 4.7990 GHz, Bw = 32.000 MH No calibration applied and no bandpass applied

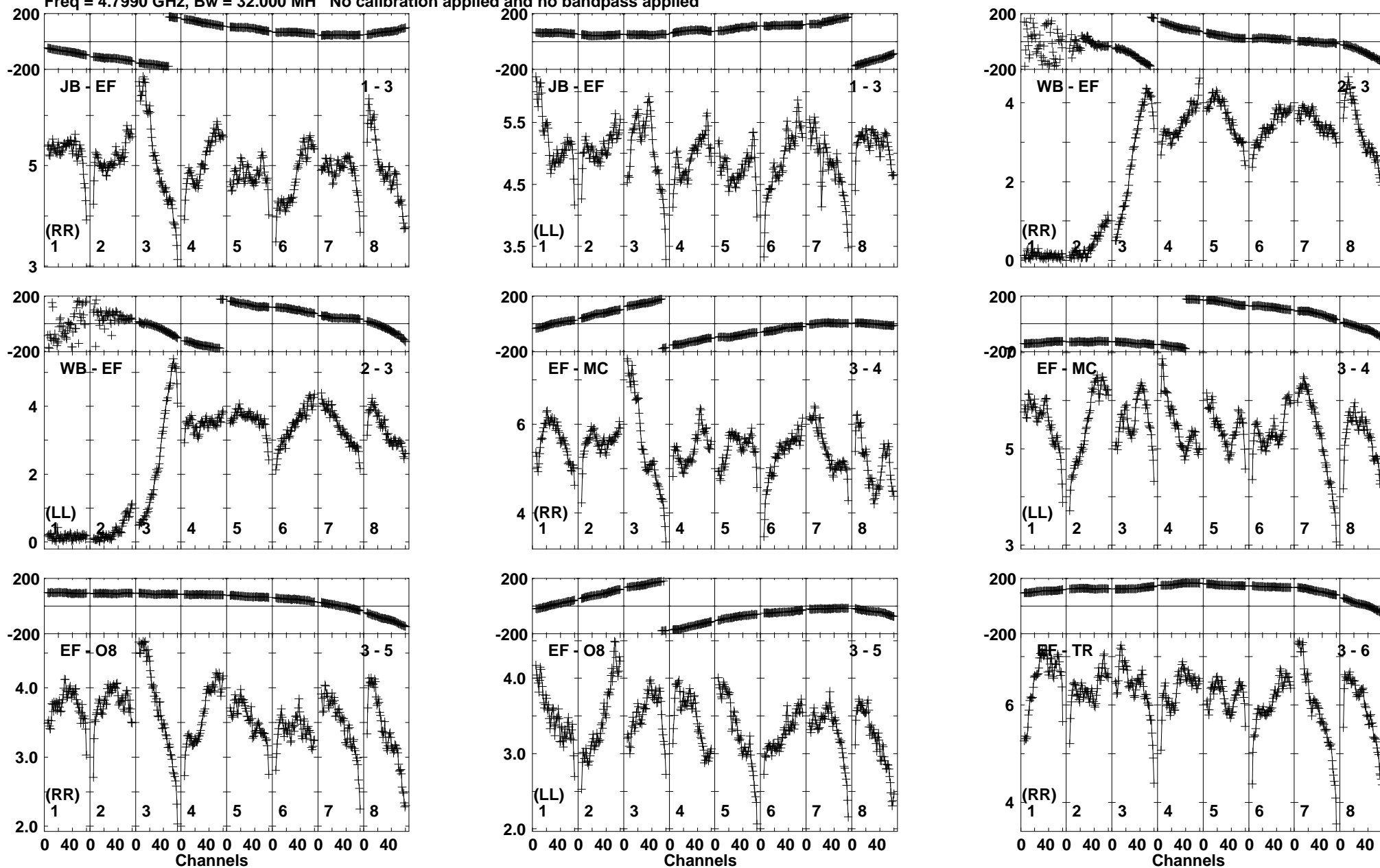

Lower frame: Milli Ampl Jy Top frame: Phas deg  
Vector averaged cross-power spectrum Baseline: JB (01) - EF (03)  
Timerange: 01/03:32:11 to 01/03:33:09

Plot file version 401 created 11-NOV-2019 15:08:02

J1826+0149 EK040B.UVDATA.1

Freq = 4.7990 GHz, Bw = 32.000 MH No calibration applied and no bandpass applied

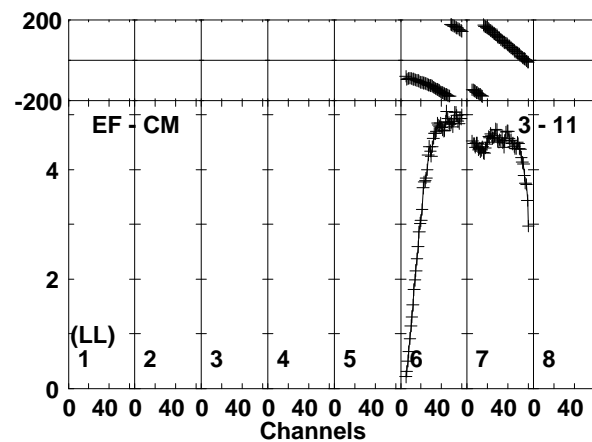
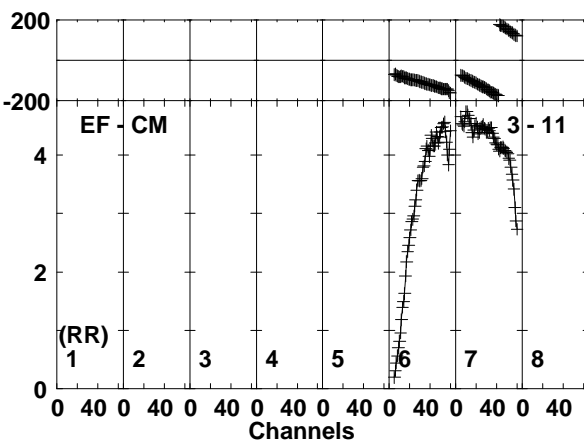
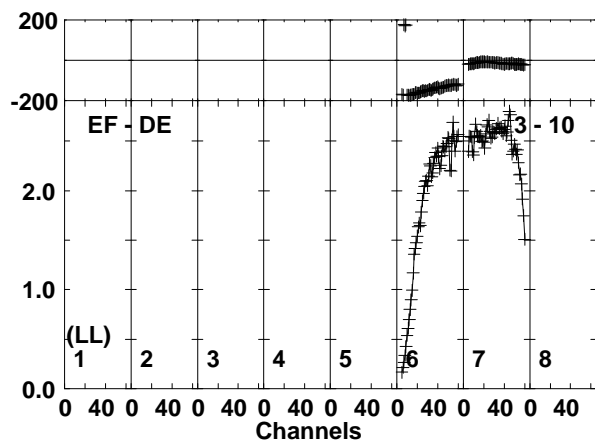
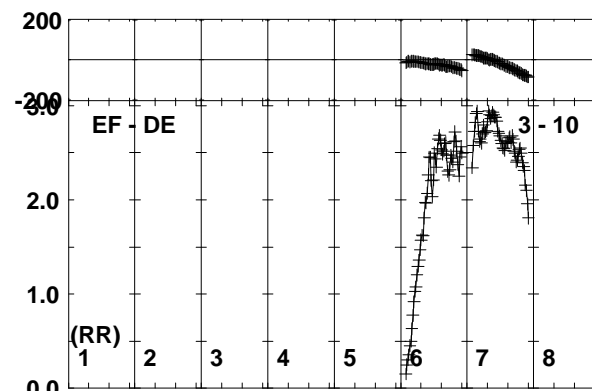
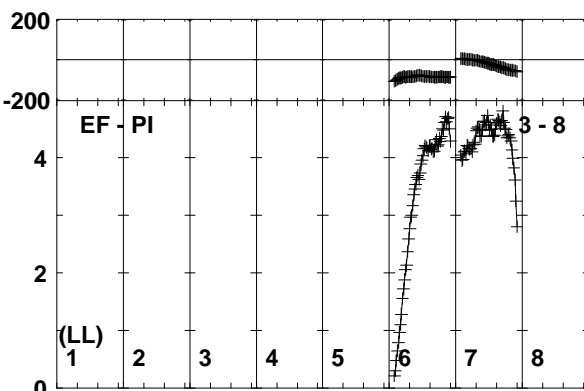
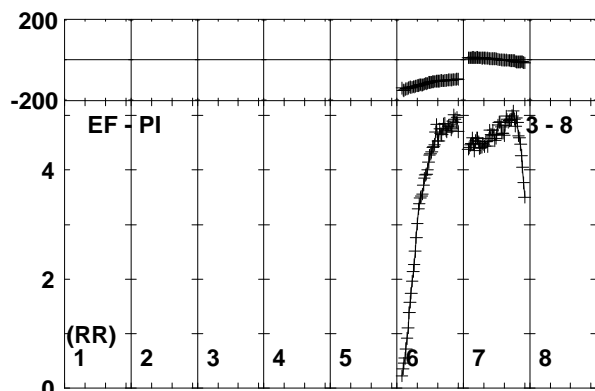
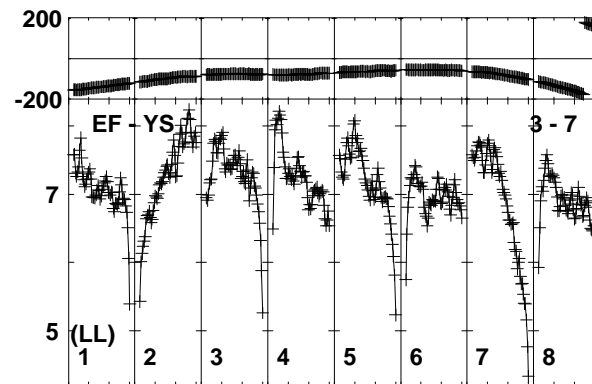
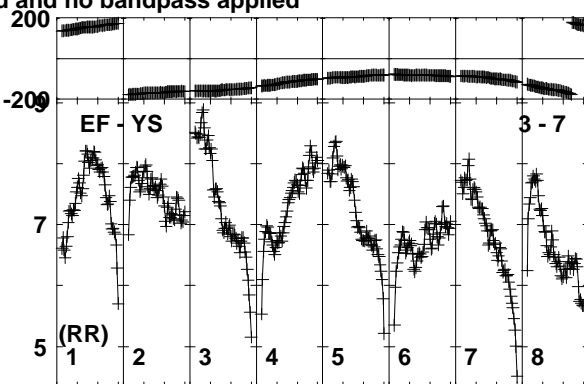
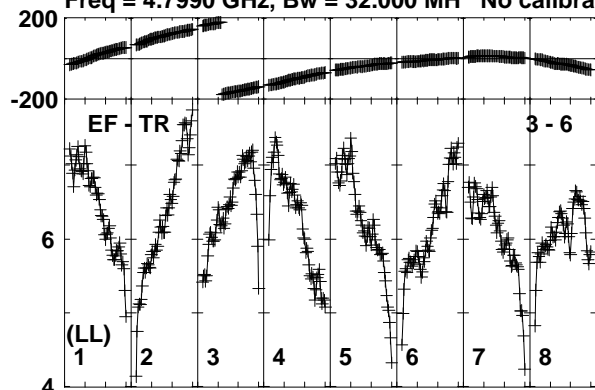

Lower frame: Milli Ampl Jy Top frame: Phas deg  
Vector averaged cross-power spectrum Baseline: EF (03) - TR (06)  
Timerange: 01/03:32:11 to 01/03:33:09

Plot file version 402 created 11-NOV-2019 15:08:02

J1826+0149 EK040B.UVDATA.1

Freq = 4.7990 GHz, Bw = 32.000 MH No calibration applied and no bandpass applied

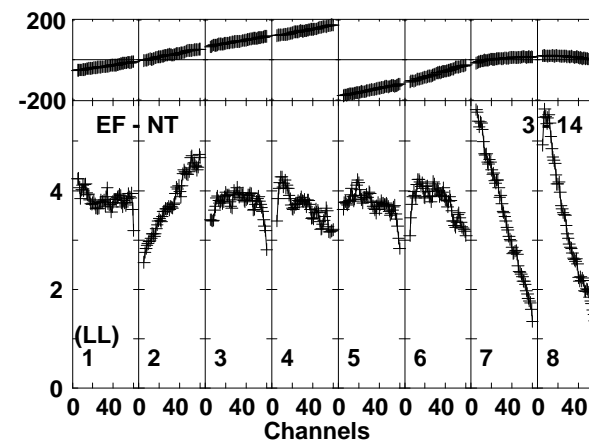
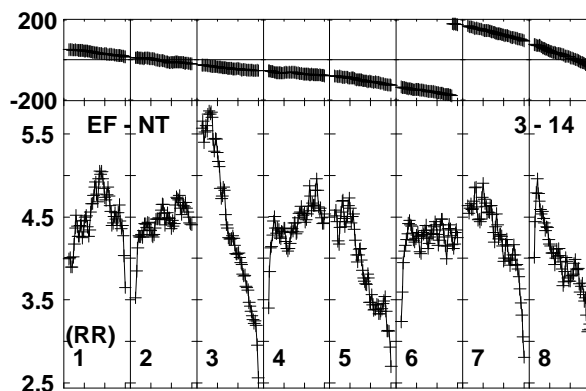
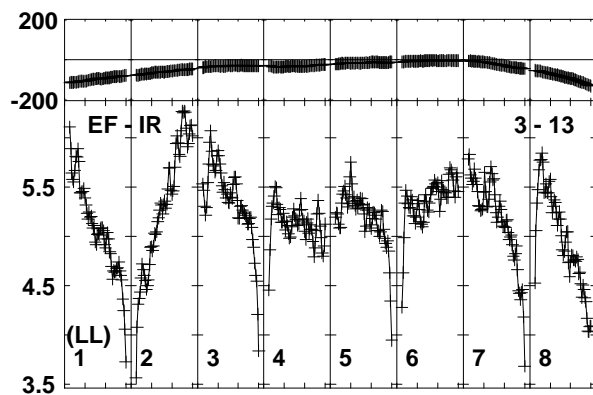
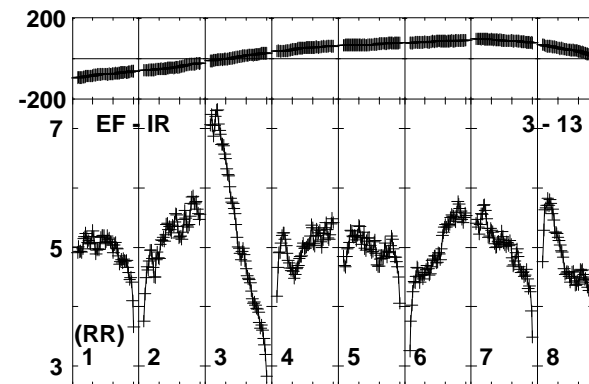
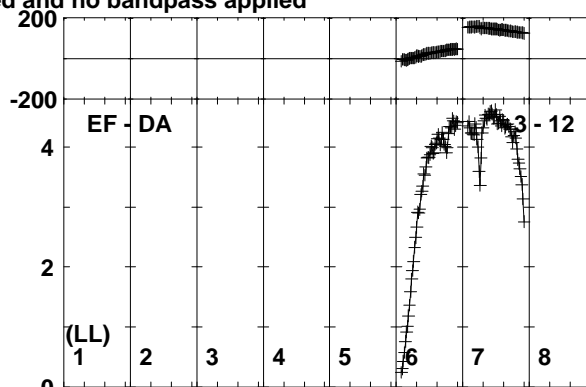
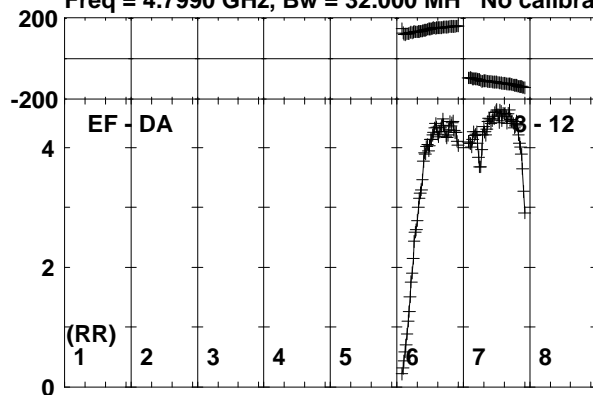

Lower frame: Milli Ampl Jy Top frame: Phas deg  
Vector averaged cross-power spectrum Baseline: EF (03) - DA (12)  
Timerange: 01/03:32:11 to 01/03:33:09



Plot file version 403 created 11-NOV-2019 15:08:02

SER8NJ EK040B.UVDATA.1

Freq = 4.7990 GHz, Bw = 32.000 MH No calibration applied and no bandpass applied

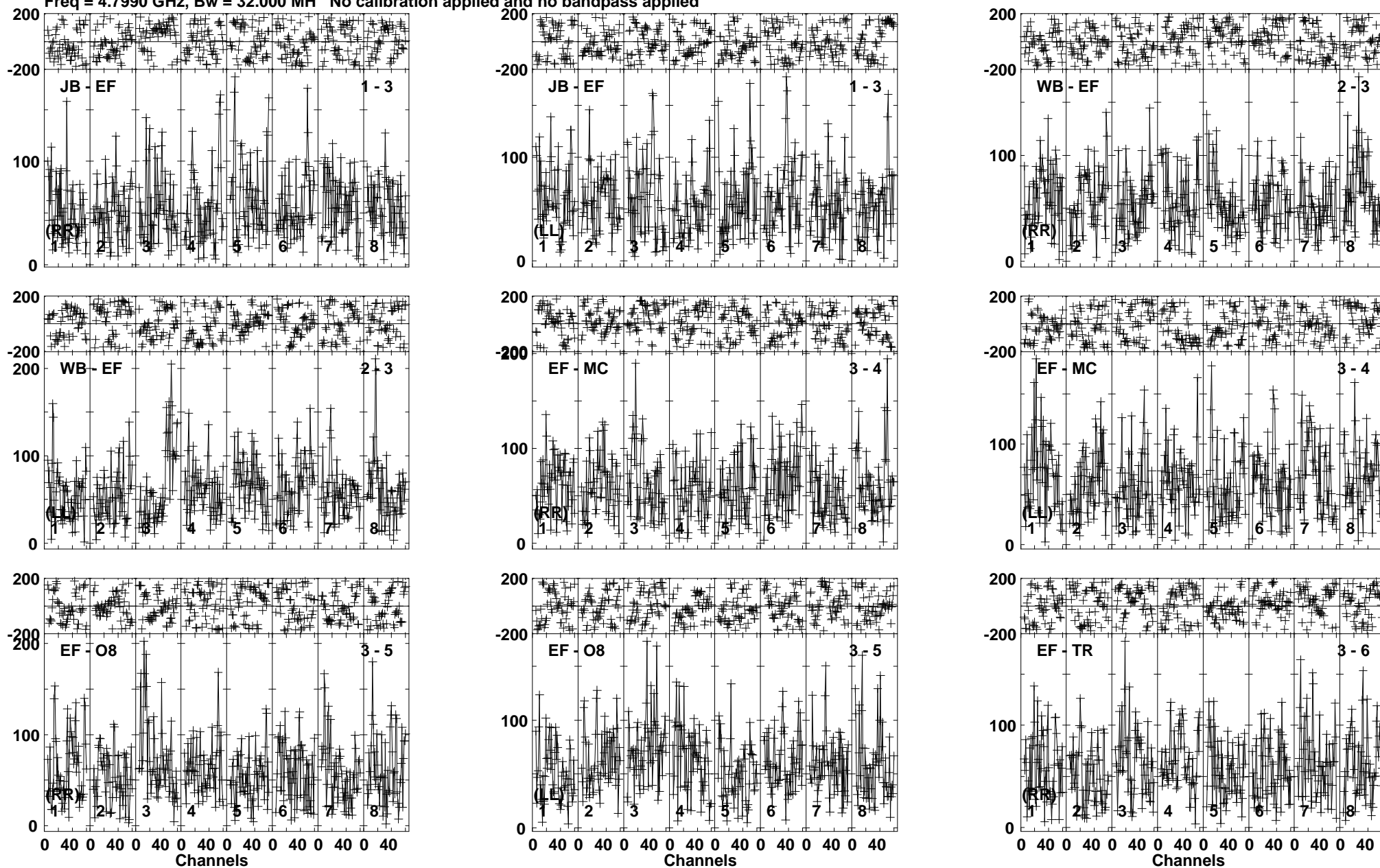

Lower frame: Micro Ampl Jy Top frame: Phas deg  
Vector averaged cross-power spectrum Baseline: JB (01) - EF (03)  
Timerange: 01/03:33:13 to 01/03:37:09

Plot file version 404 created 11-NOV-2019 15:08:02

SER8NJ EK040B.UVDATA.1

Freq = 4.7990 GHz, Bw = 32.000 MH No calibration applied and no bandpass applied

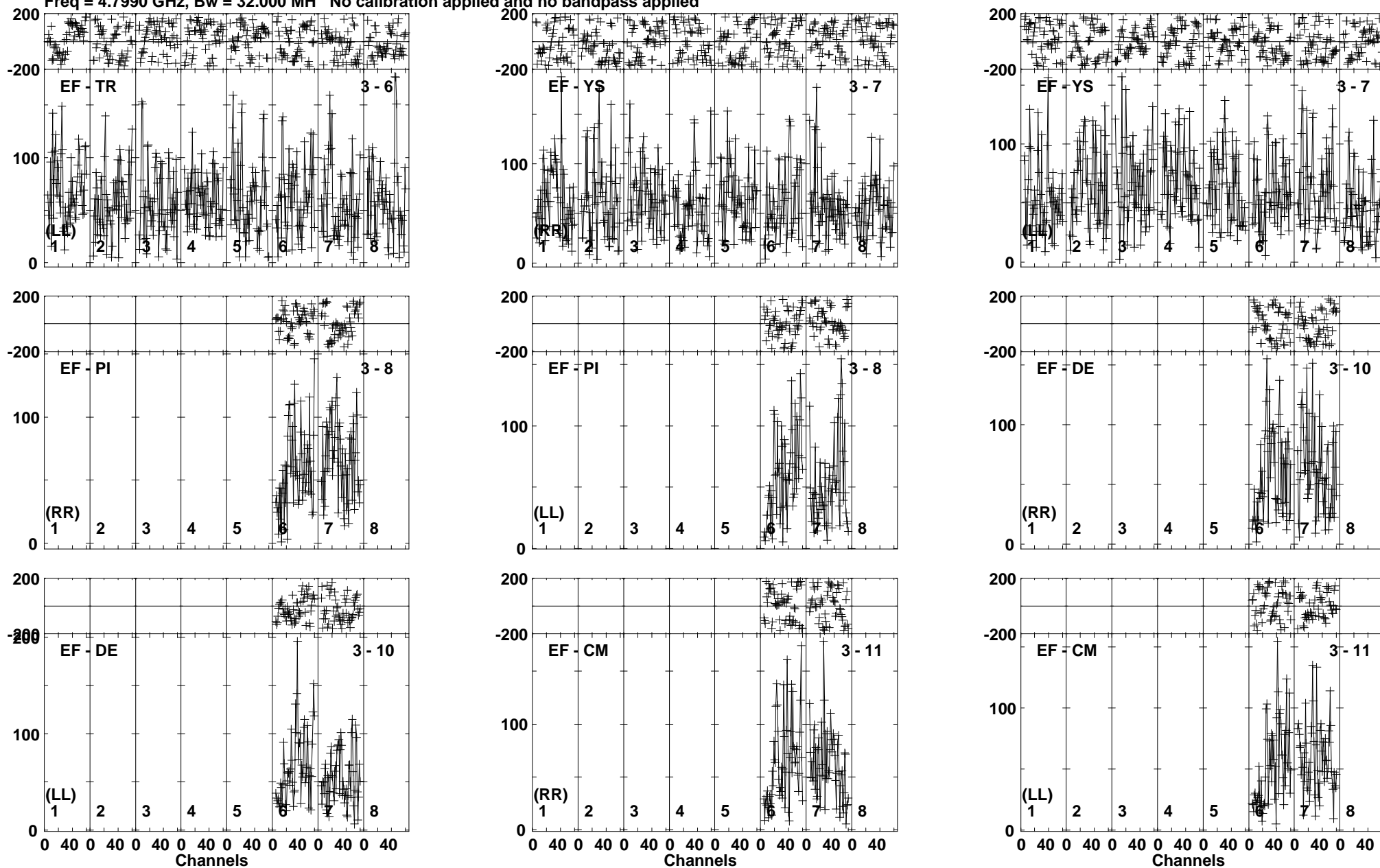

Lower frame: Micro Ampl Jy Top frame: Phas deg  
Vector averaged cross-power spectrum Baseline: EF (03) - TR (06)  
Timerange: 01/03:33:13 to 01/03:37:09

Plot file version 405 created 11-NOV-2019 15:08:02

SER8NJ EK040B.UVDATA.1

Freq = 4.7990 GHz, Bw = 32.000 MH No calibration applied and no bandpass applied

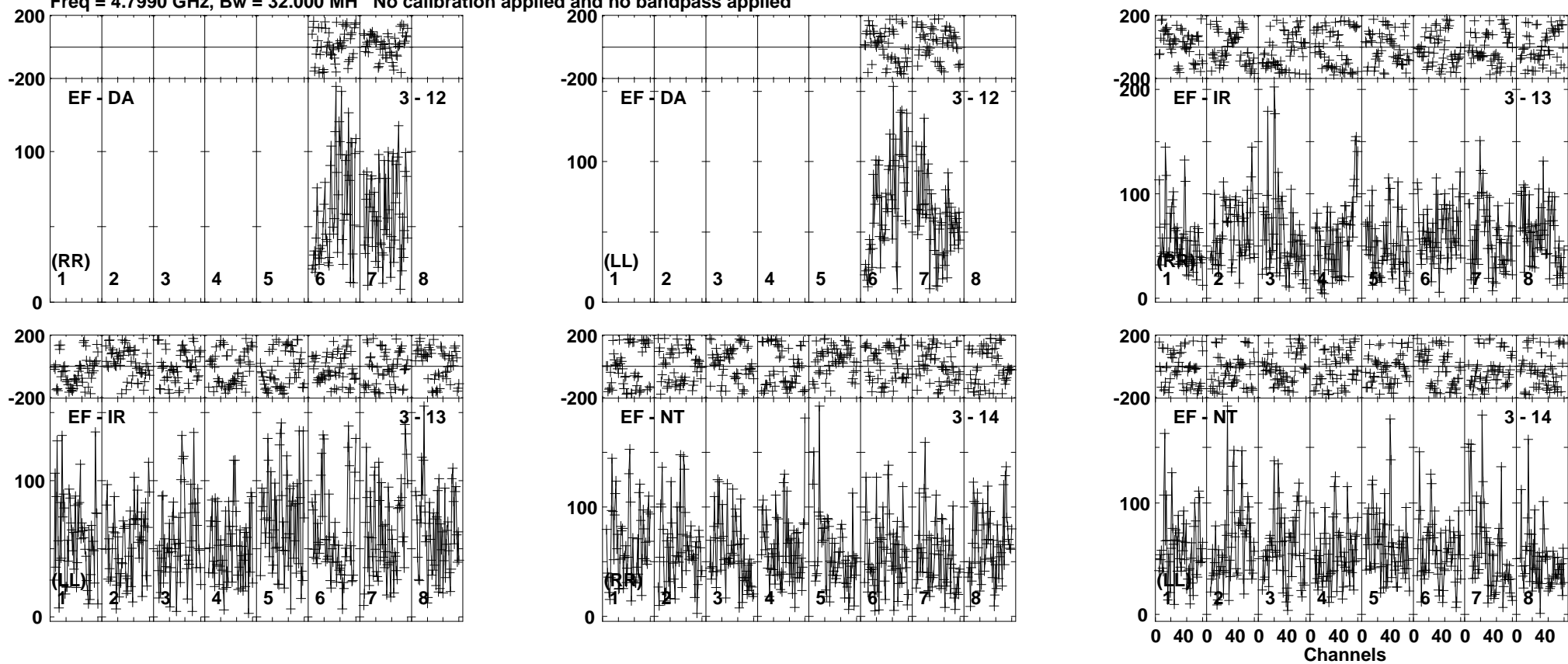

Lower frame: Micro Ampl Jy Top frame: Phas deg  
Vector averaged cross-power spectrum Baseline: EF (03) - DA (12)  
Timerange: 01/03:33:13 to 01/03:37:09

Plot file version 406 created 11-NOV-2019 15:08:02

J1826+0149 EK040B.UVDATA.1

Freq = 4.7990 GHz, Bw = 32.000 MH No calibration applied and no bandpass applied

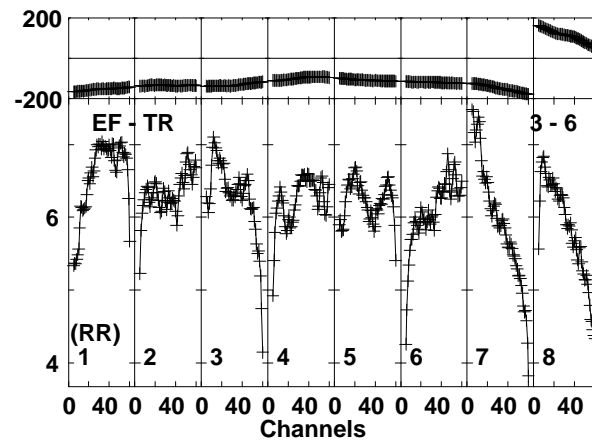
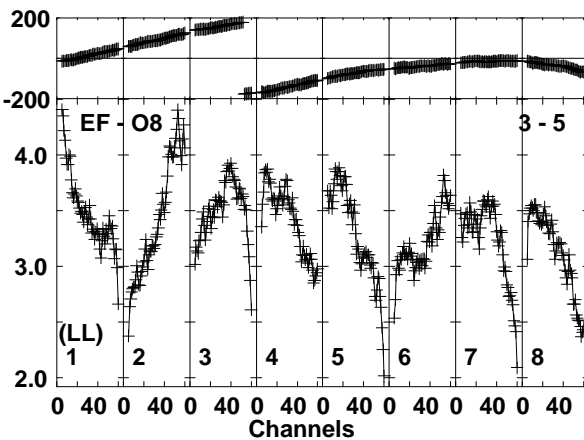
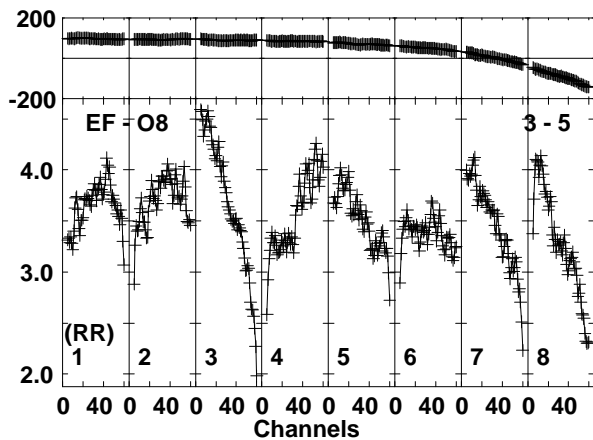
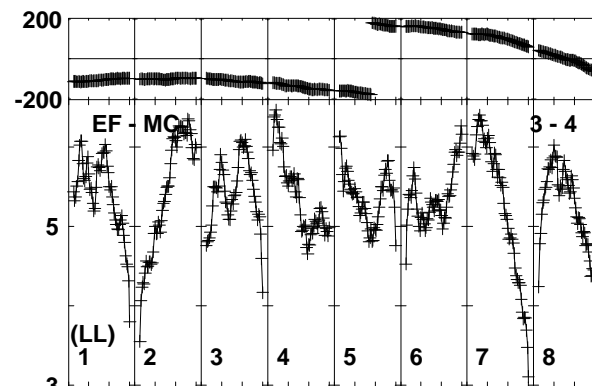
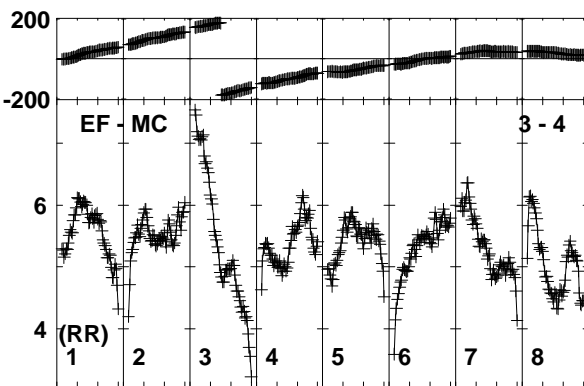
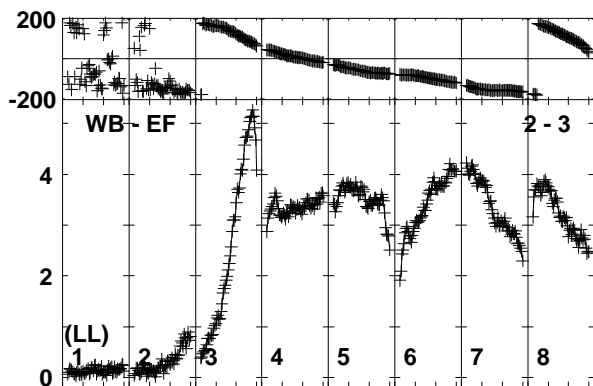
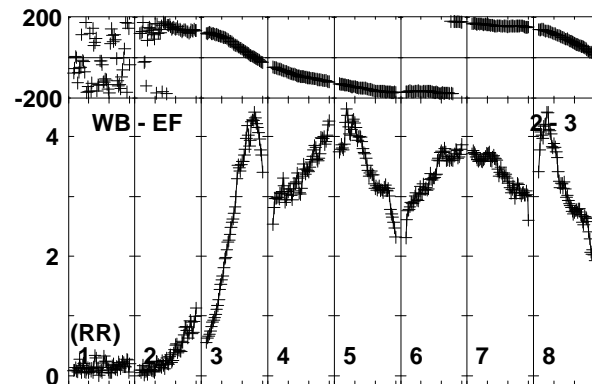
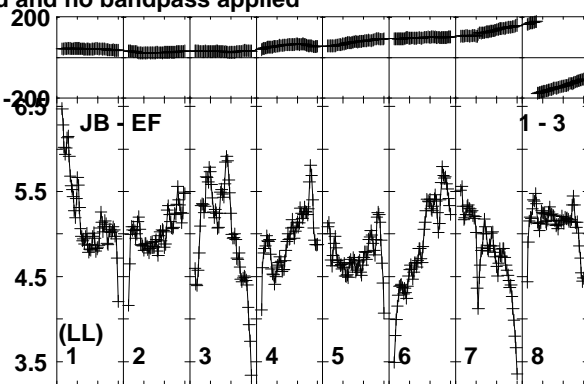
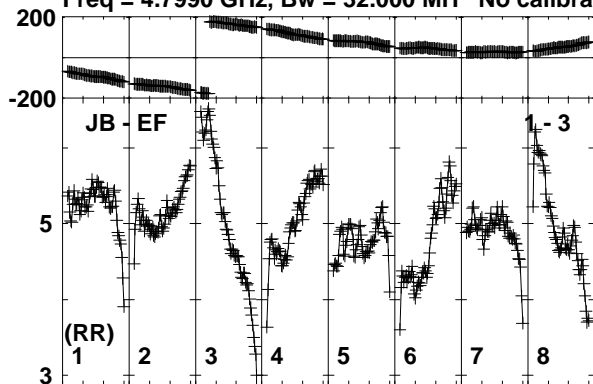

Lower frame: Milli Ampl Jy Top frame: Phas deg  
Vector averaged cross-power spectrum Baseline: JB (01) - EF (03)  
Timerange: 01/03:37:13 to 01/03:38:39

Plot file version 407 created 11-NOV-2019 15:08:02

J1826+0149 EK040B.UVDATA.1

Freq = 4.7990 GHz, Bw = 32.000 MH No calibration applied and no bandpass applied

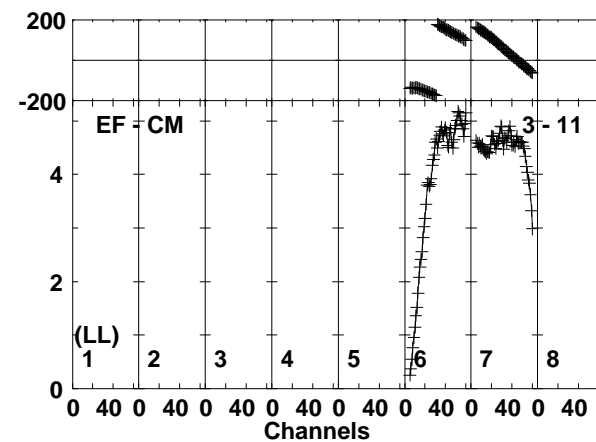
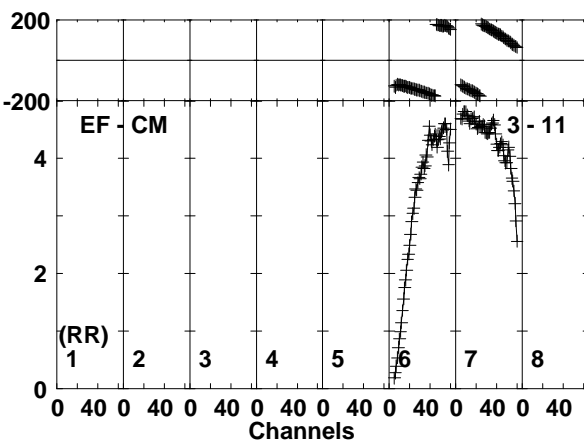
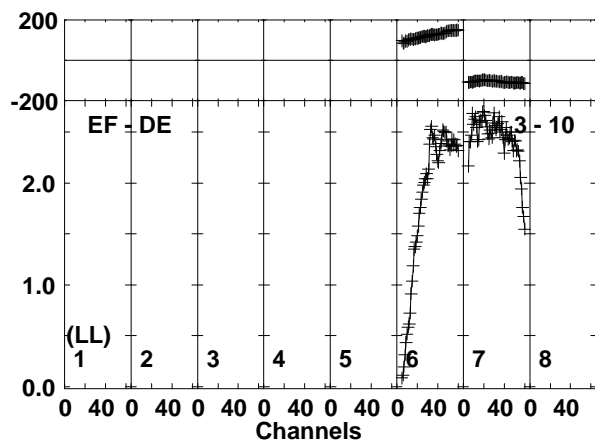
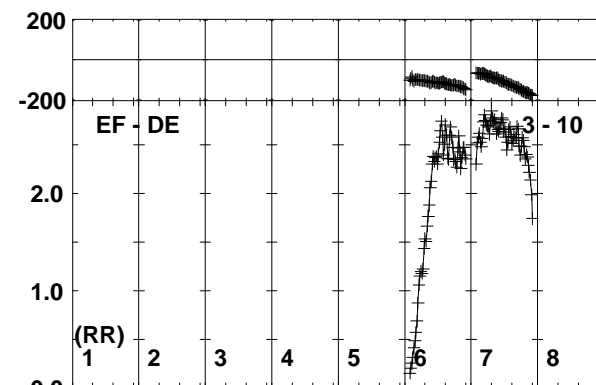
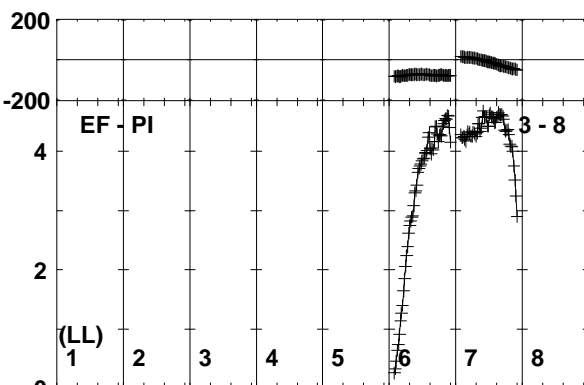
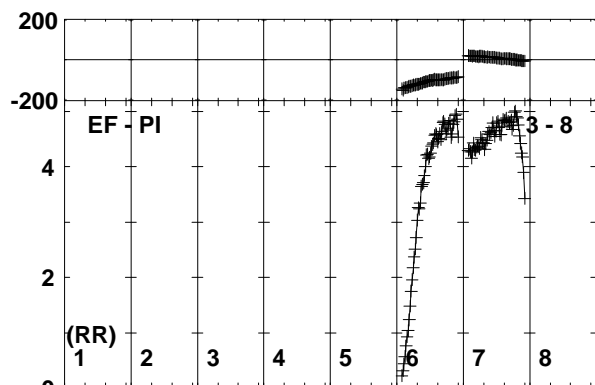
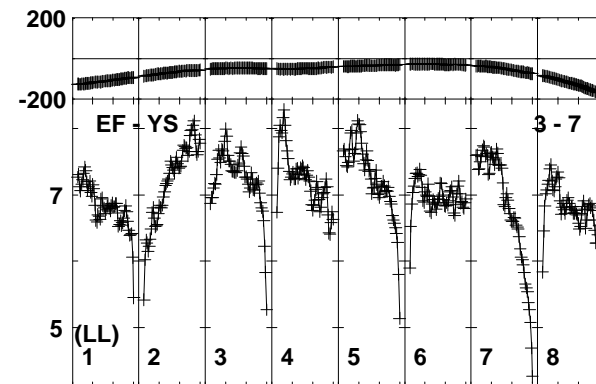
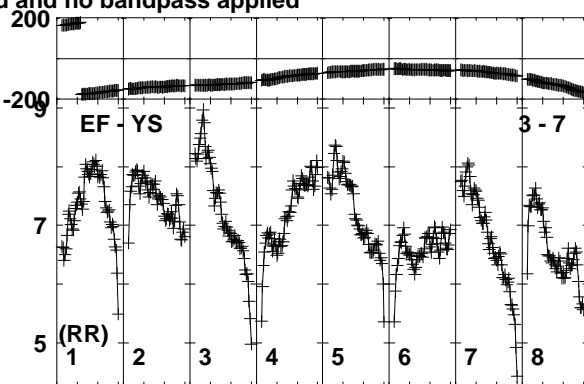
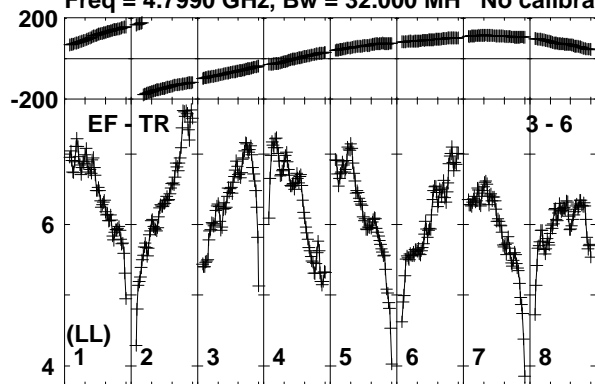

Lower frame: Milli Ampl Jy Top frame: Phas deg  
Vector averaged cross-power spectrum Baseline: EF (03) - TR (06)  
Timerange: 01/03:37:13 to 01/03:38:39

Plot file version 408 created 11-NOV-2019 15:08:03

J1826+0149 EK040B.UVDATA.1

Freq = 4.7990 GHz, Bw = 32.000 MH No calibration applied and no bandpass applied

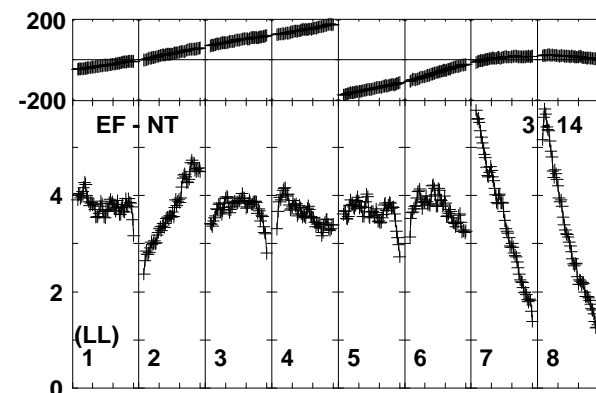
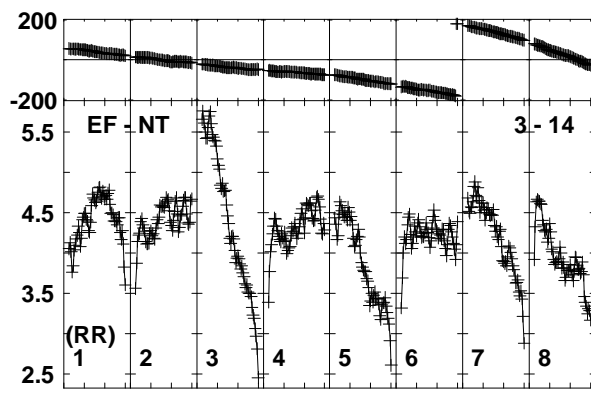
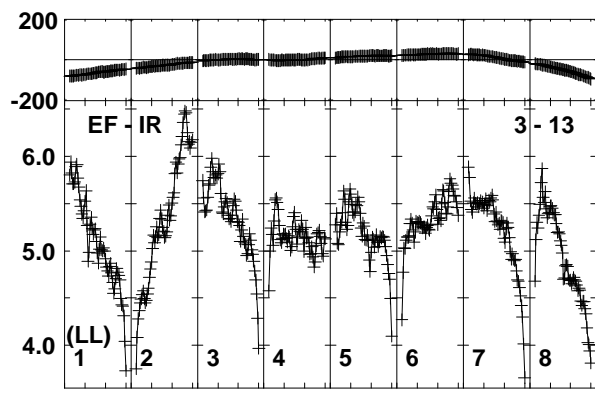
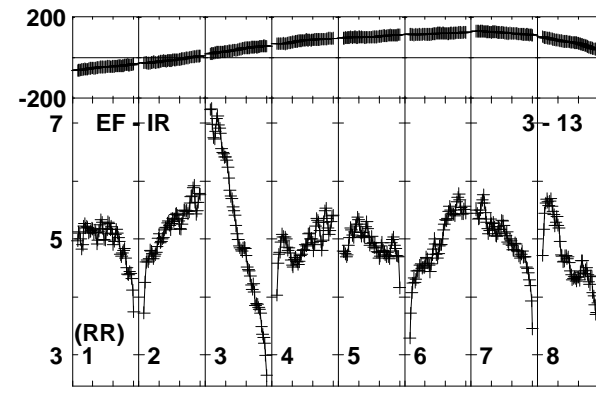
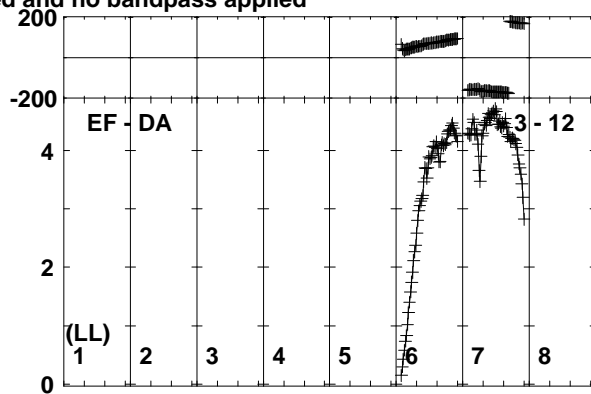
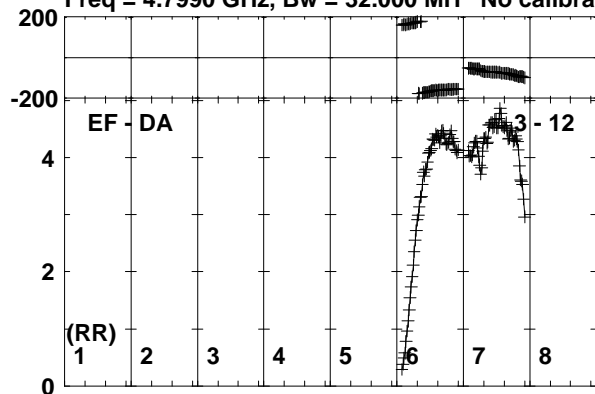

Channels

Lower frame: Milli Ampl Jy Top frame: Phas deg  
Vector averaged cross-power spectrum Baseline: EF (03) - DA (12)  
Timerange: 01/03:37:13 to 01/03:38:39

Plot file version 409 created 11-NOV-2019 15:08:03  
SER8NJ EK040B.UVDATA.1

Freq = 4.7990 GHz, Bw = 32.000 MH No calibration applied and no bandpass applied

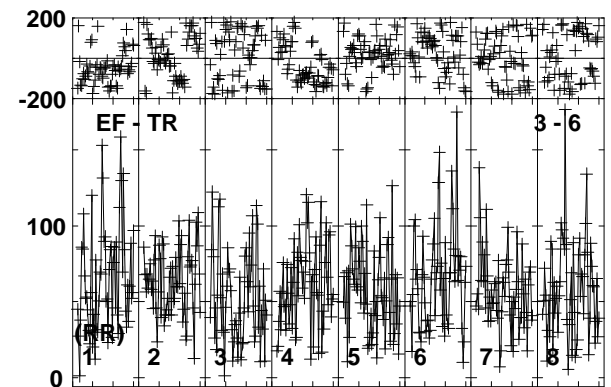
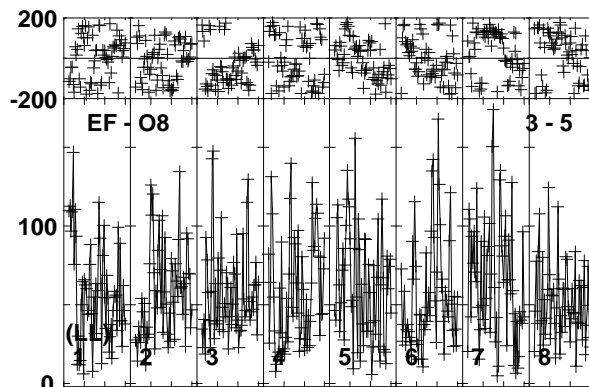
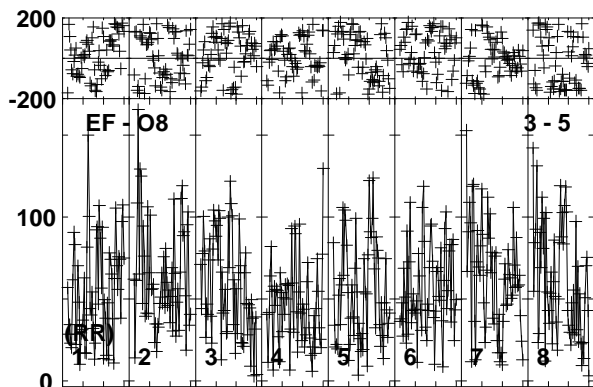
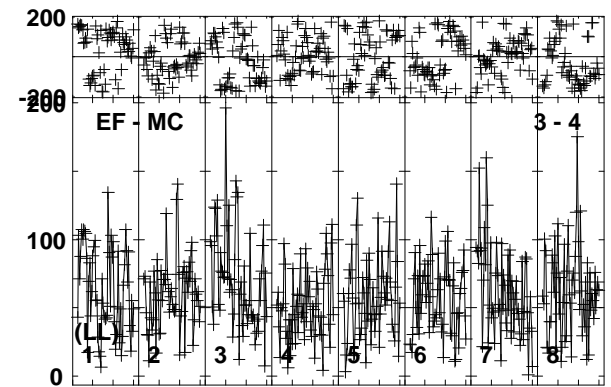
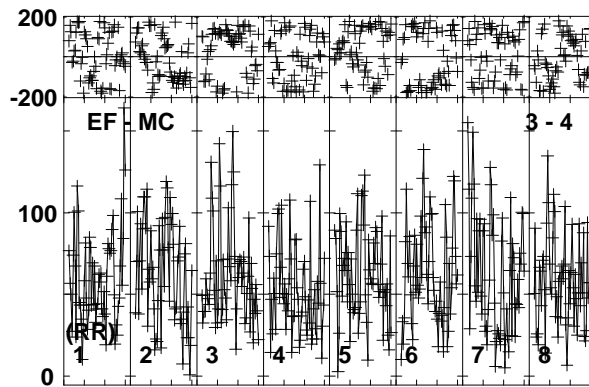
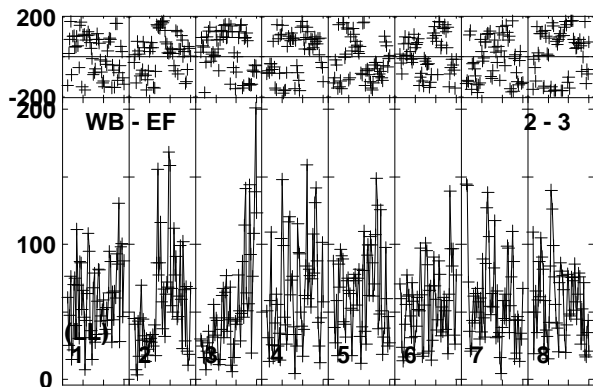
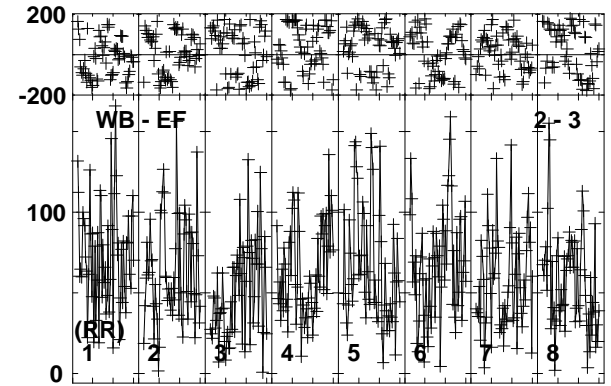
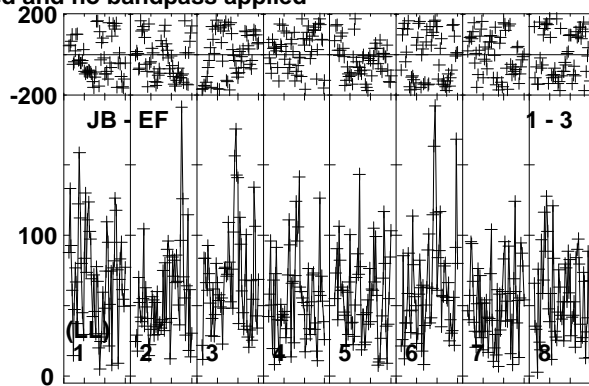
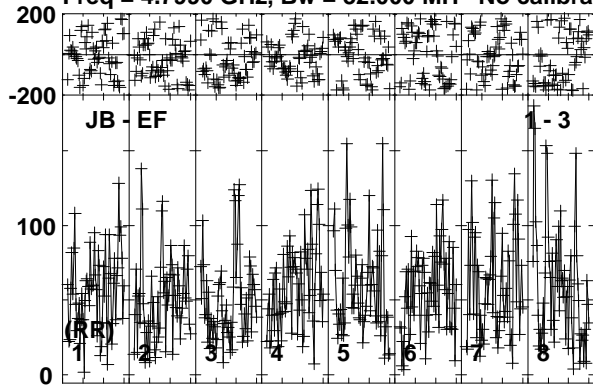

Lower frame: Micro Ampl Jy Top frame: Phas deg  
Vector averaged cross-power spectrum Baseline: JB (01) - EF (03)  
Timerange: 01/03:38:41 to 01/03:42:39

Plot file version 410 created 11-NOV-2019 15:08:03

SER8NJ EK040B.UVDATA.1

Freq = 4.7990 GHz, Bw = 32.000 MH No calibration applied and no bandpass applied

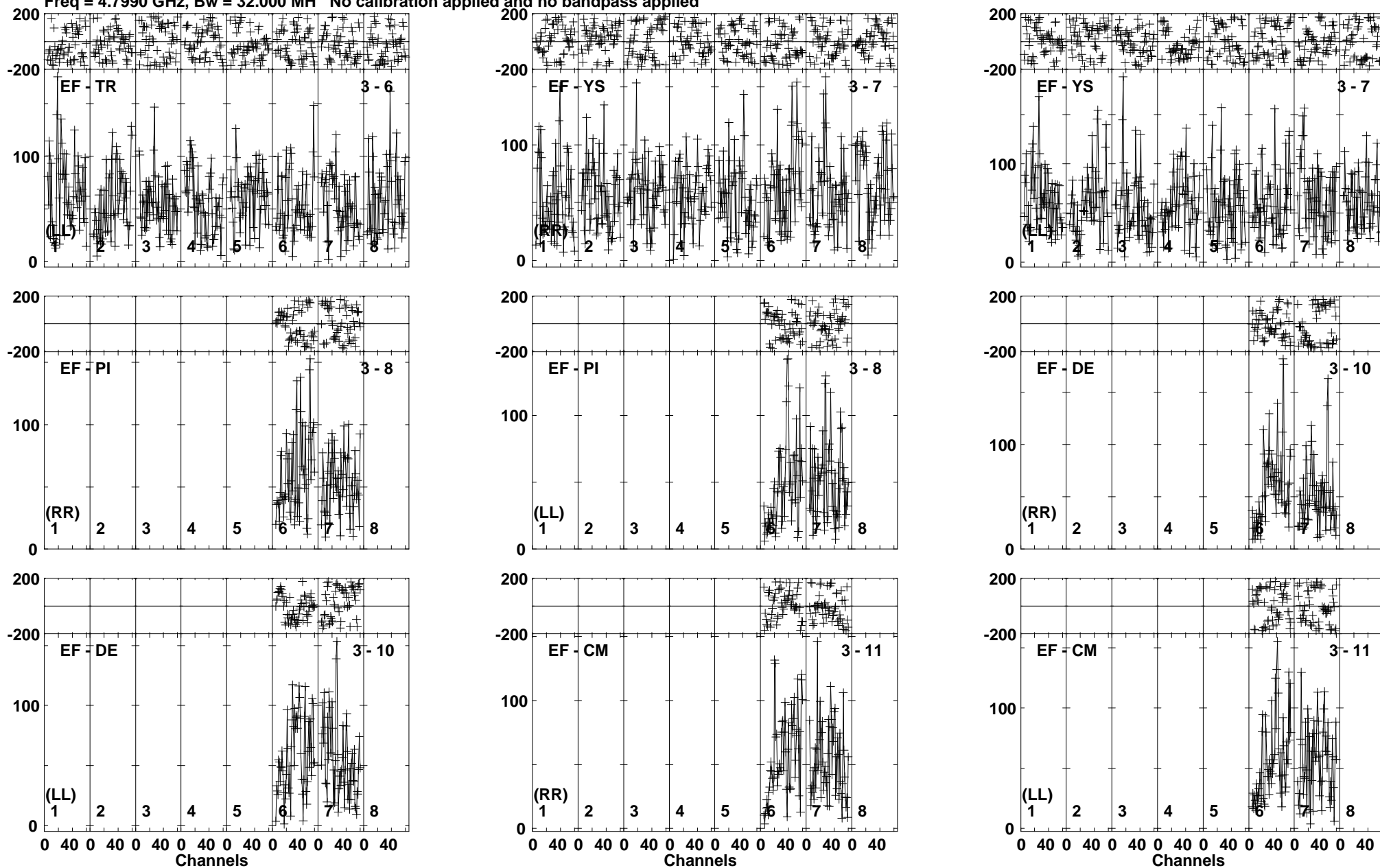

Lower frame: Micro Ampl Jy Top frame: Phas deg  
Vector averaged cross-power spectrum Baseline: EF (03) - TR (06)  
Timerange: 01/03:38:41 to 01/03:42:39



Plot file version 411 created 11-NOV-2019 15:08:03

SER8NJ EK040B.UVDATA.1

Freq = 4.7990 GHz, Bw = 32.000 MH No calibration applied and no bandpass applied

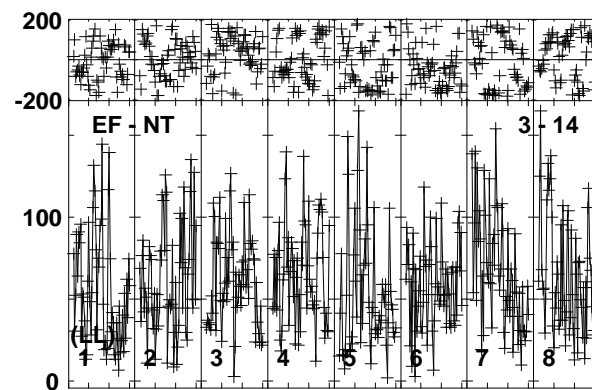
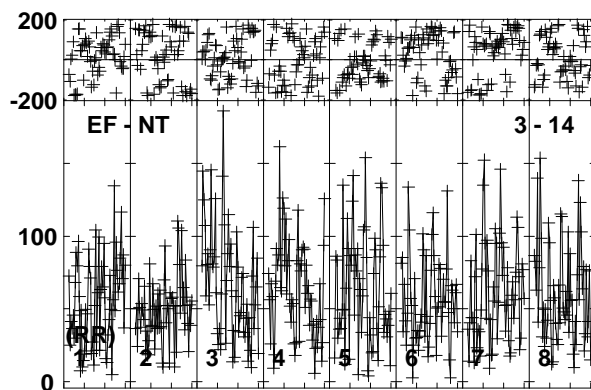
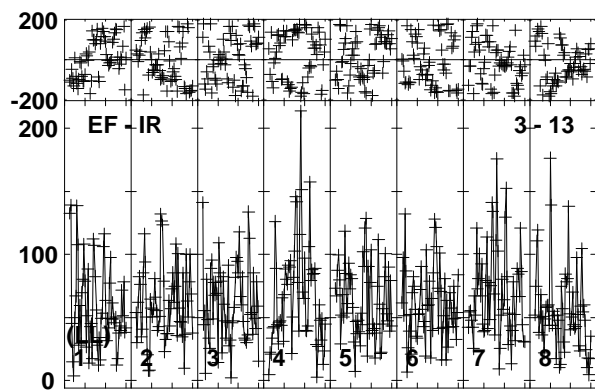
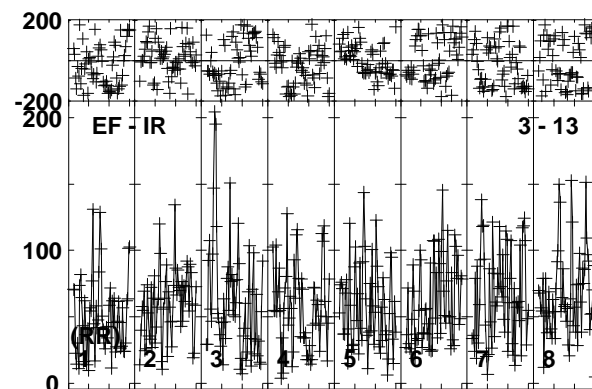
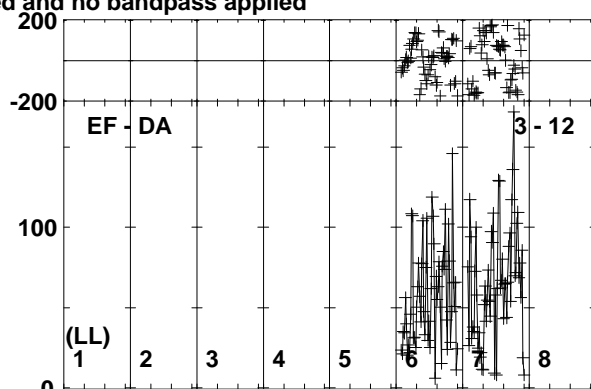
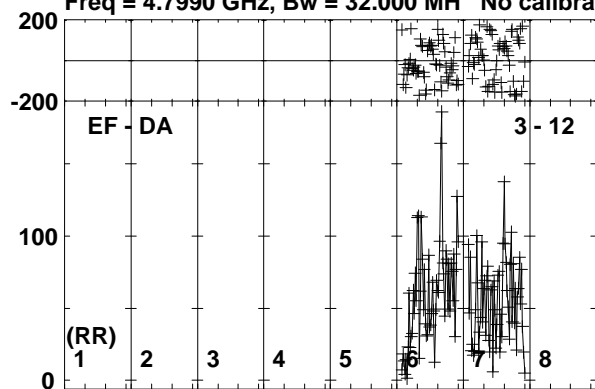

0 40 0 40 0 40 0 40 0 40 0 40 0 40 0 40 0 40  
Channels

Lower frame: Micro Ampl Jy Top frame: Phas deg  
Vector averaged cross-power spectrum Baseline: EF (03) - DA (12)  
Timerange: 01/03:38:41 to 01/03:42:39

Plot file version 412 created 11-NOV-2019 15:08:03

J1826+0149 EK040B.UVDATA.1

Freq = 4.7990 GHz, Bw = 32.000 MH No calibration applied and no bandpass applied

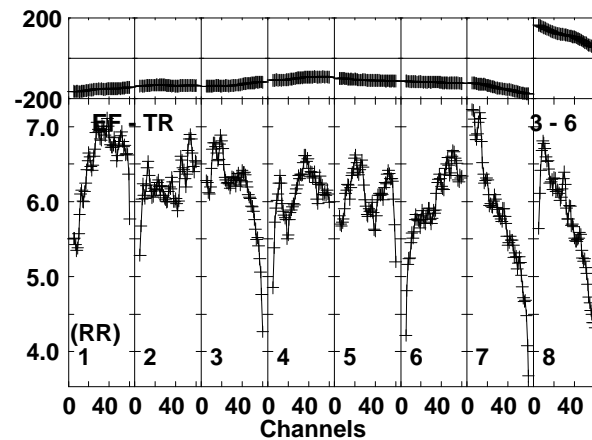
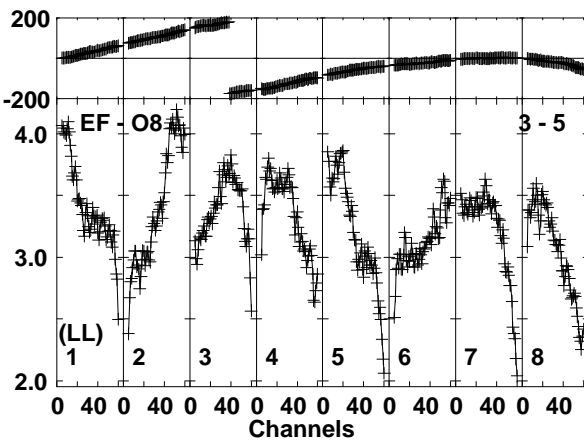
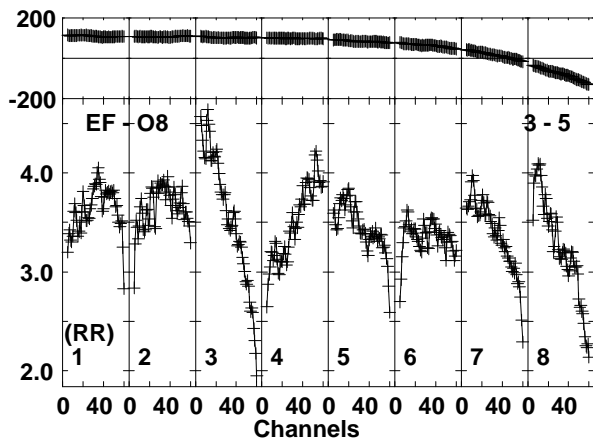
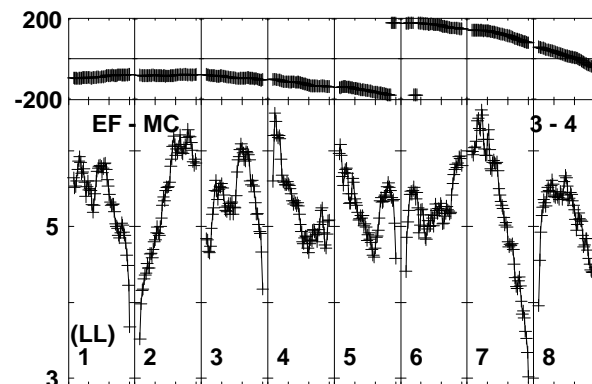
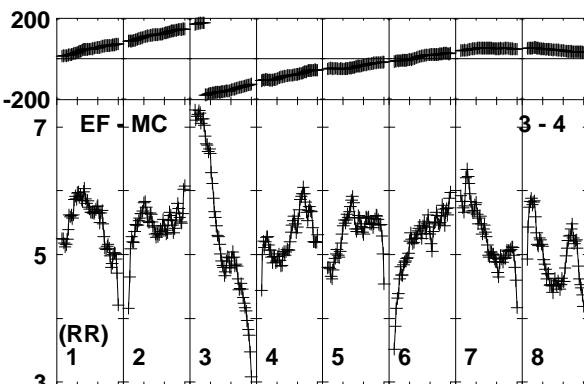
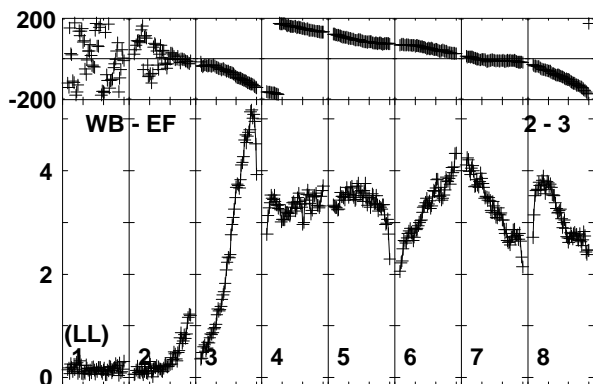
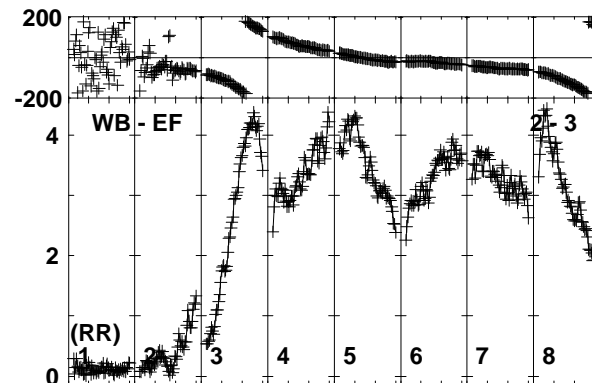
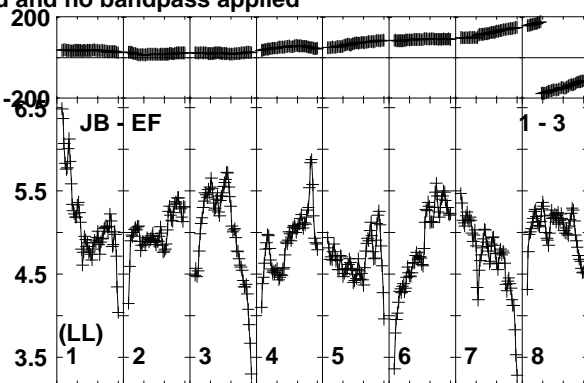
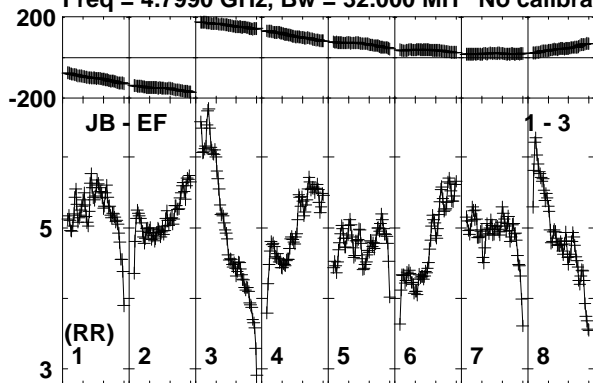

Lower frame: Milli Ampl Jy Top frame: Phas deg  
Vector averaged cross-power spectrum Baseline: JB (01) - EF (03)  
Timerange: 01/03:43:21 to 01/03:44:19

Plot file version 413 created 11-NOV-2019 15:08:03

J1826+0149 EK040B.UVDATA.1

Freq = 4.7990 GHz, Bw = 32.000 MH No calibration applied and no bandpass applied

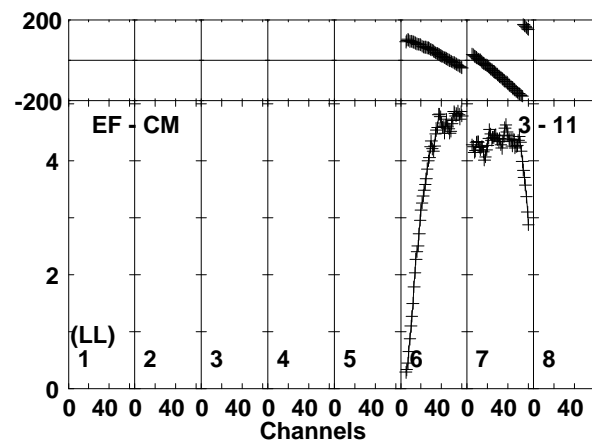
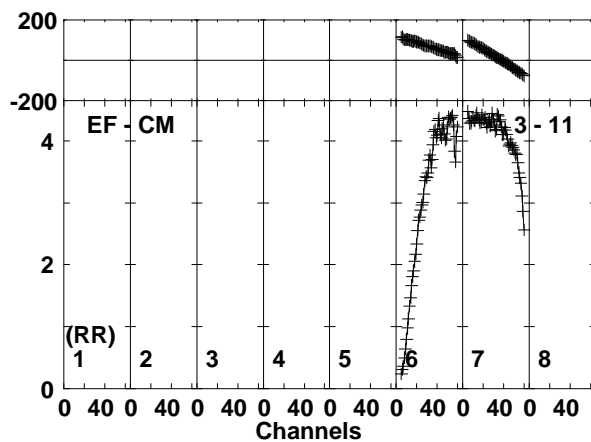
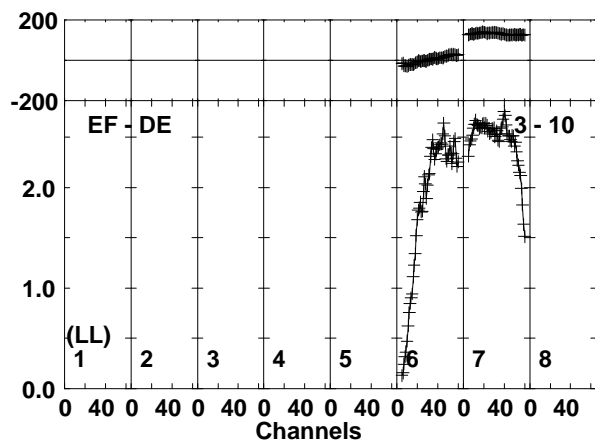
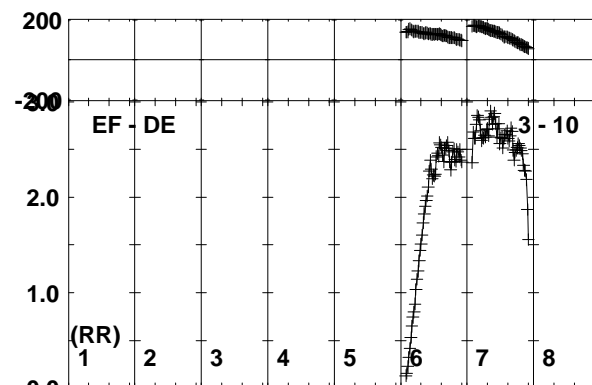
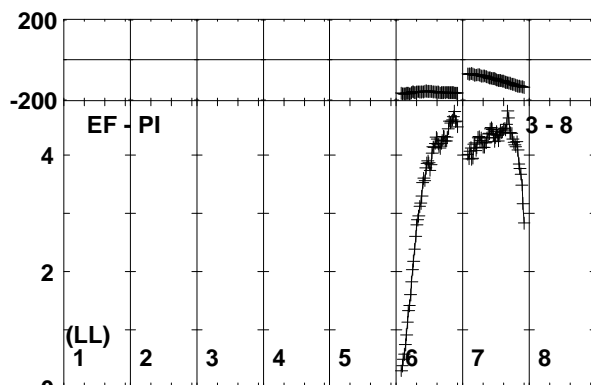
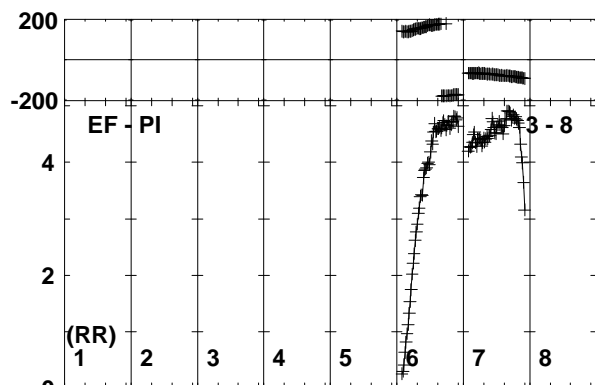
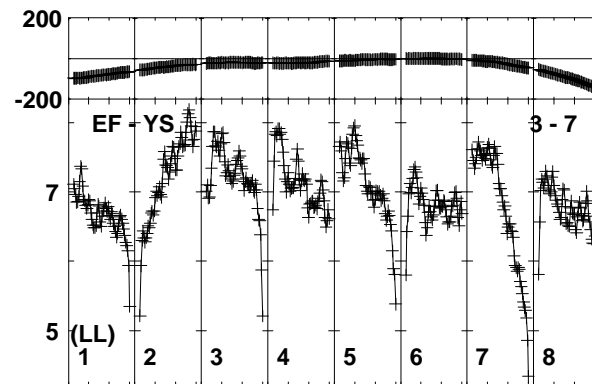
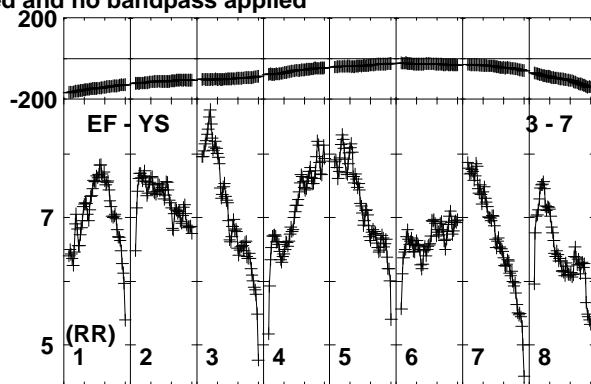
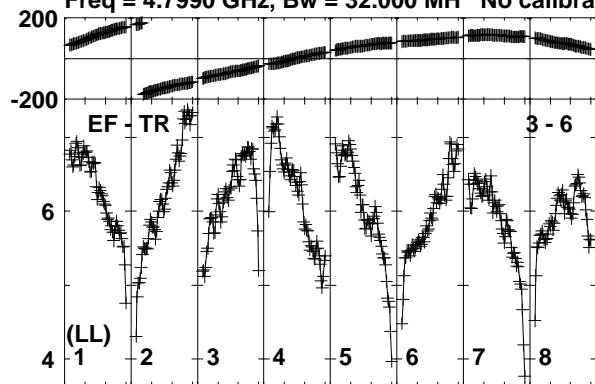

Lower frame: Milli Ampl Jy Top frame: Phas deg  
Vector averaged cross-power spectrum Baseline: EF (03) - TR (06)  
Timerange: 01/03:43:21 to 01/03:44:19

Plot file version 414 created 11-NOV-2019 15:08:03

J1826+0149 EK040B.UVDATA.1

Freq = 4.7990 GHz, Bw = 32.000 MH No calibration applied and no bandpass applied

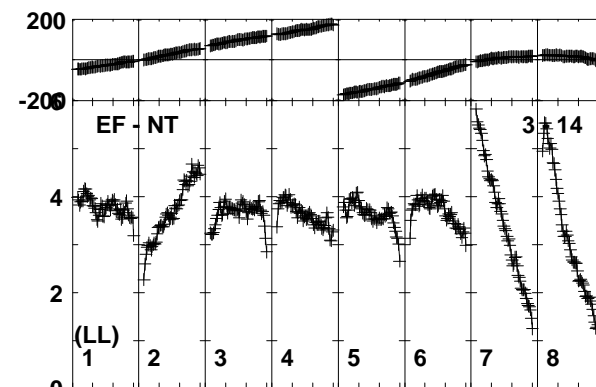
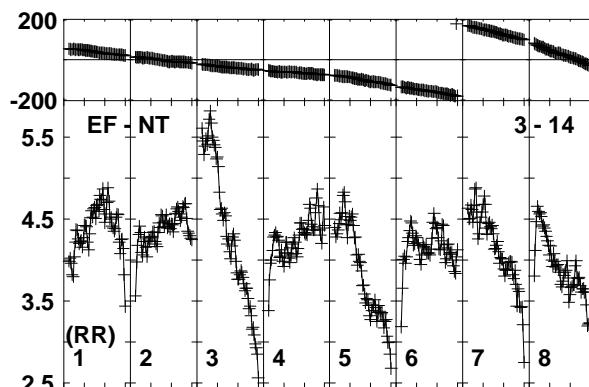
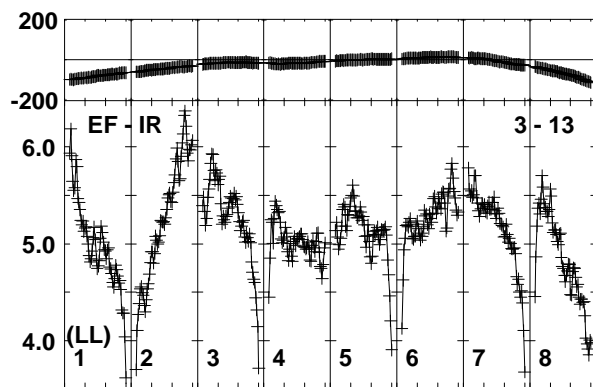
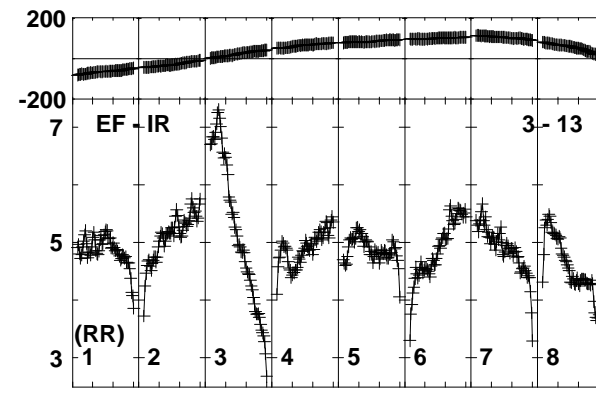
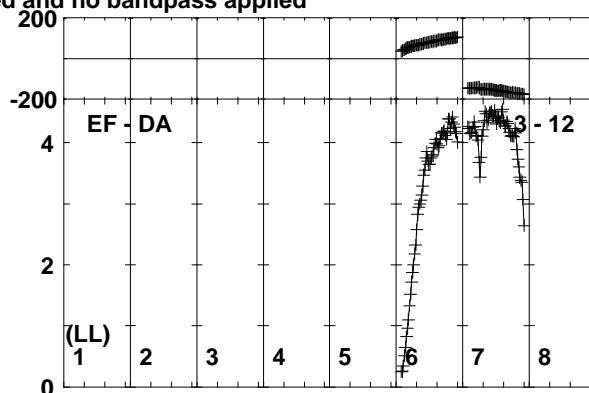
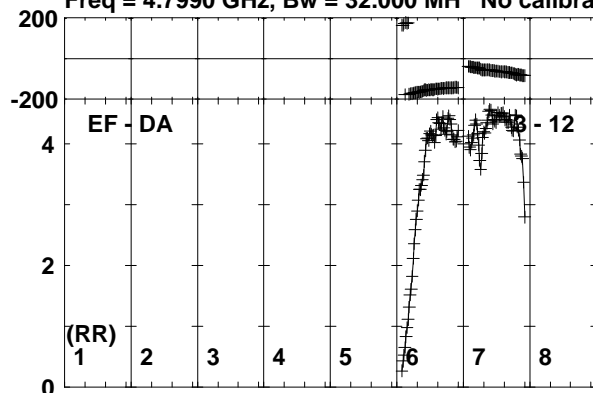

Lower frame: Milli Ampl Jy Top frame: Phas deg  
Vector averaged cross-power spectrum Baseline: EF (03) - DA (12)  
Timerange: 01/03:43:21 to 01/03:44:19

Plot file version 415 created 11-NOV-2019 15:08:03

SER8NJ EK040B.UVDATA.1

Freq = 4.7990 GHz, Bw = 32.000 MH No calibration applied and no bandpass applied

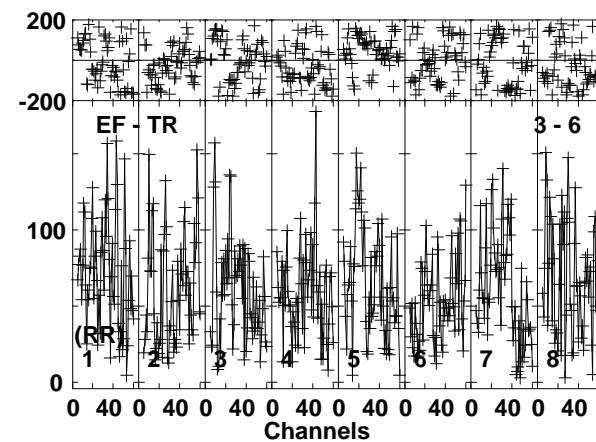
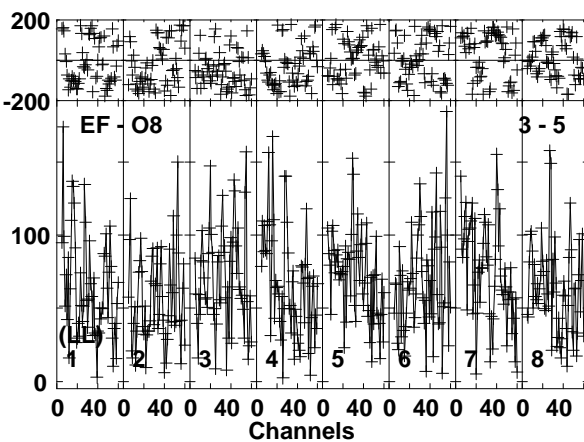
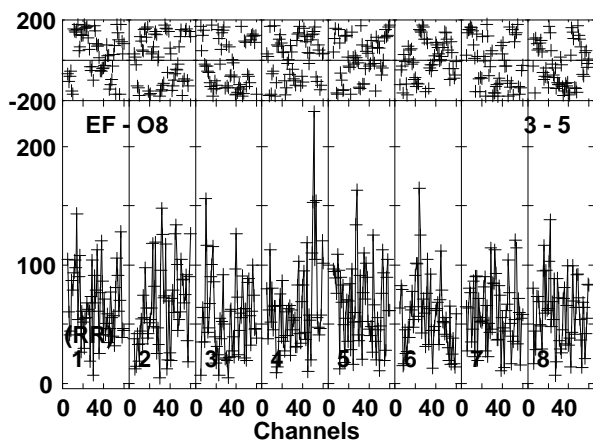
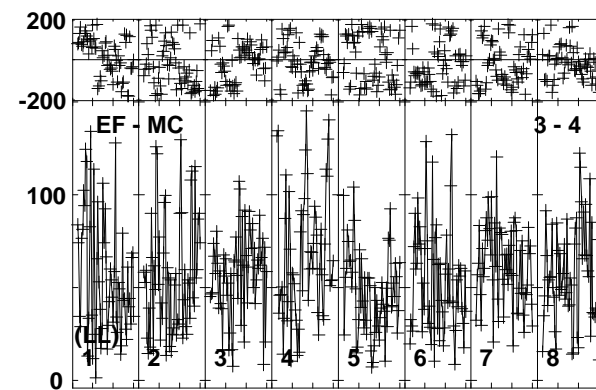
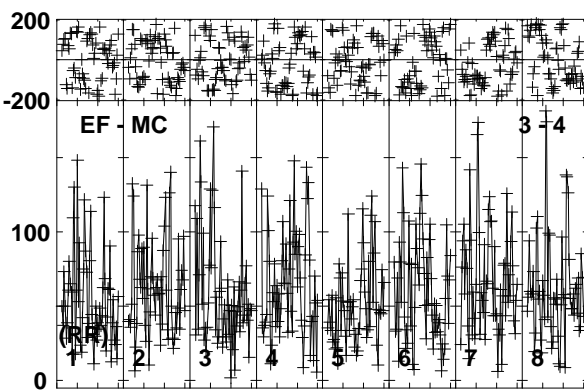
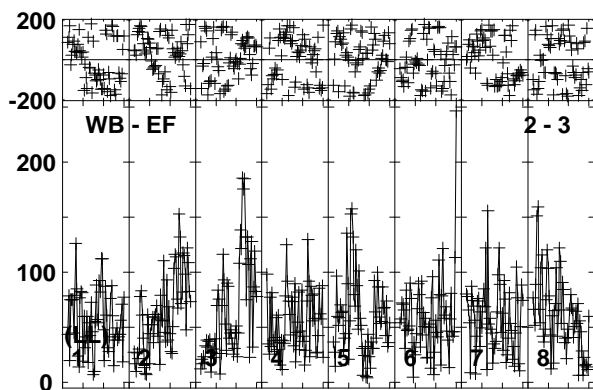
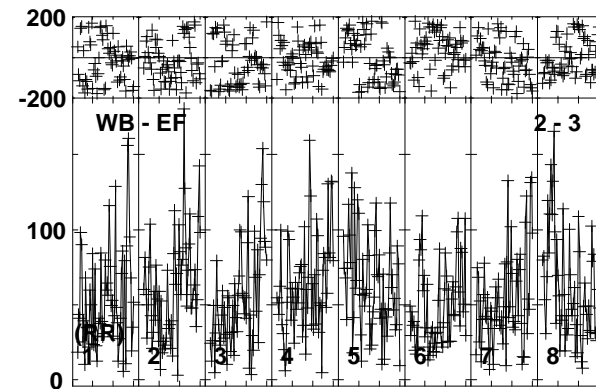
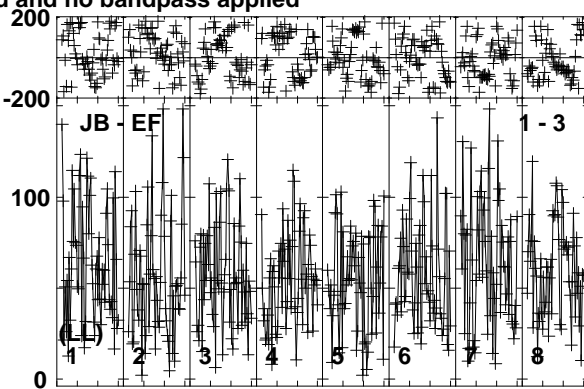
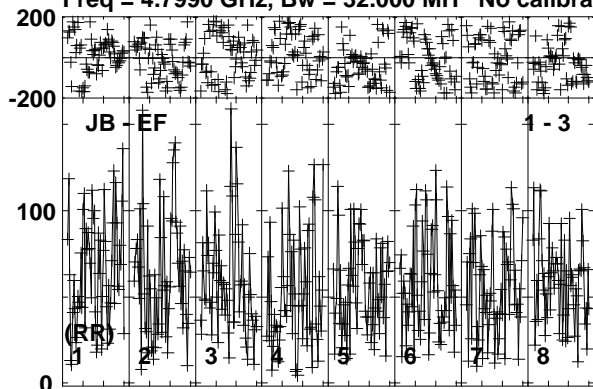

Lower frame: Micro Ampl Jy Top frame: Phas deg  
Vector averaged cross-power spectrum Baseline: JB (01) - EF (03)  
Timerange: 01/03:44:23 to 01/03:48:19

Plot file version 416 created 11-NOV-2019 15:08:03

SER8NJ EK040B.UVDATA.1

Freq = 4.7990 GHz, Bw = 32.000 MH No calibration applied and no bandpass applied

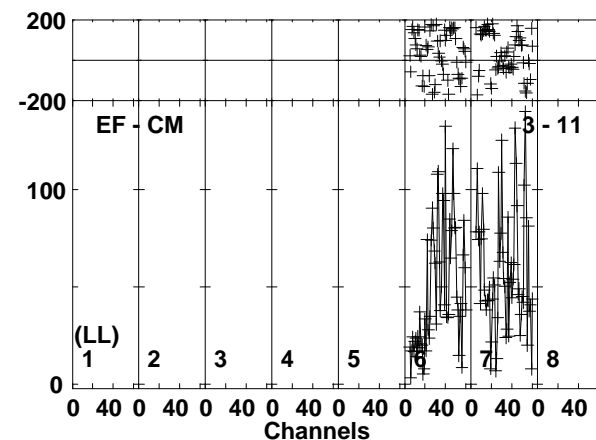
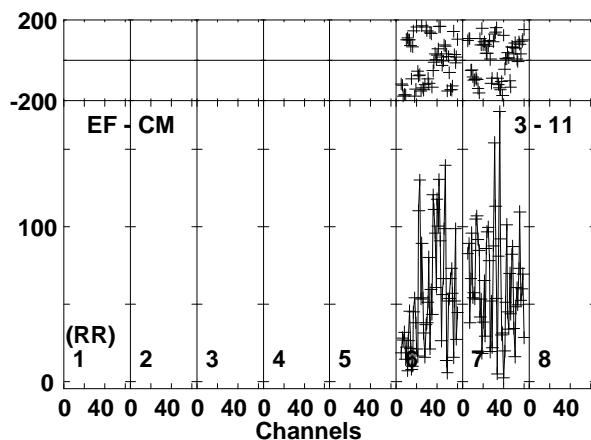
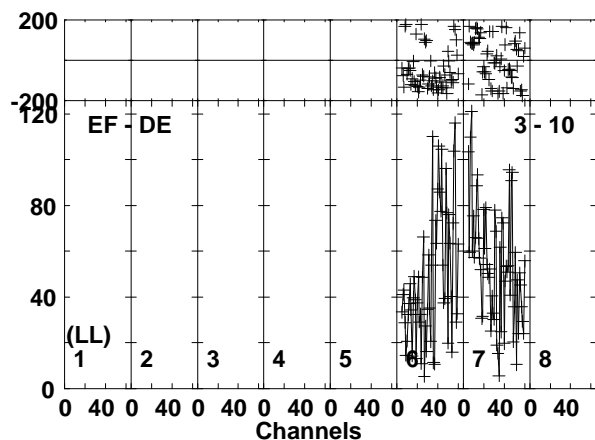
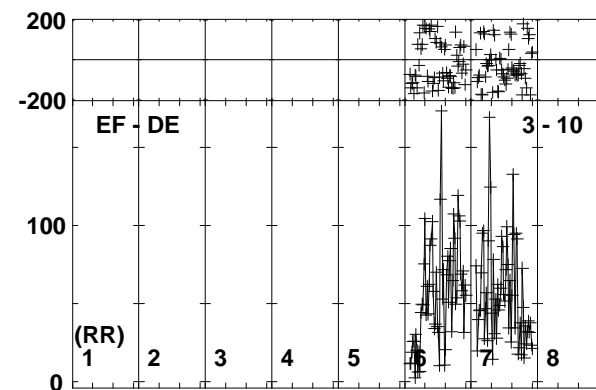
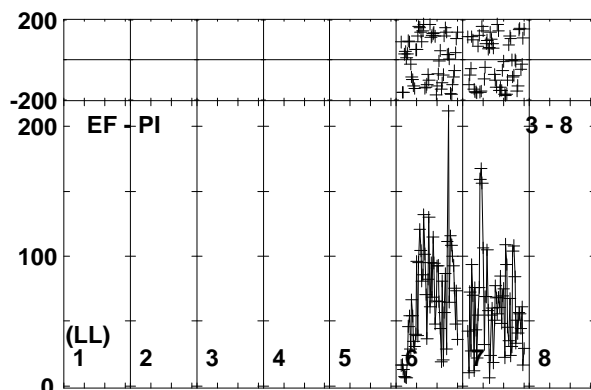
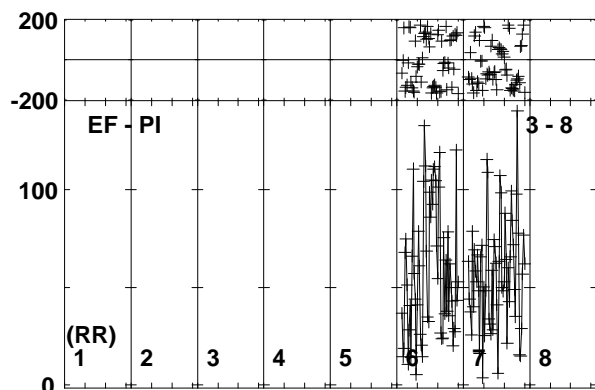
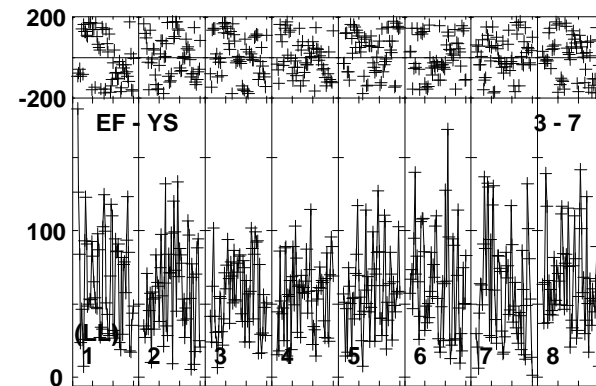
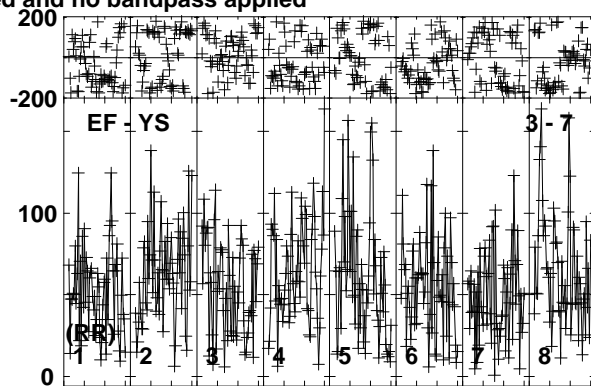
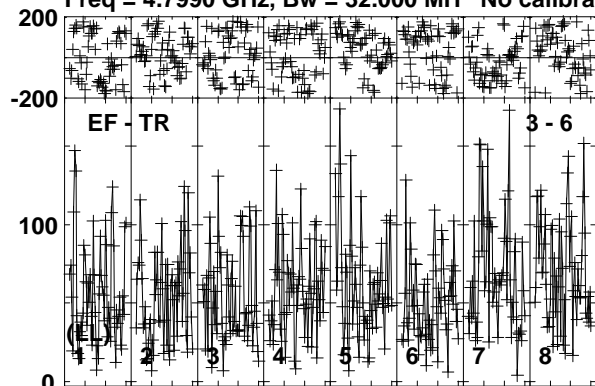

Lower frame: Micro Ampl Jy Top frame: Phas deg  
Vector averaged cross-power spectrum Baseline: EF (03) - TR (06)  
Timerange: 01/03:44:23 to 01/03:48:19

Plot file version 417 created 11-NOV-2019 15:08:04

SER8NJ EK040B.UVDATA.1

Freq = 4.7990 GHz, Bw = 32.000 MH No calibration applied and no bandpass applied

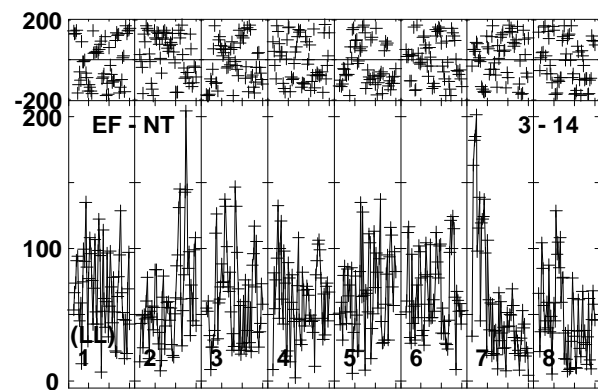
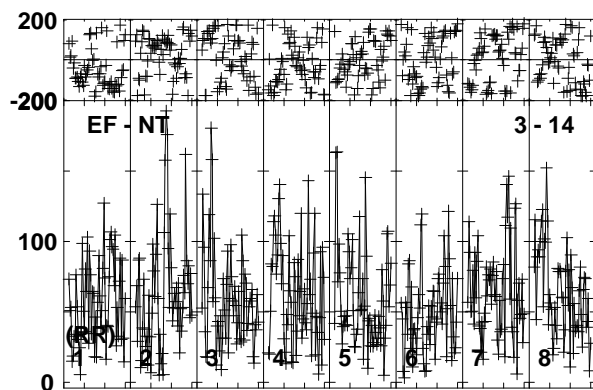
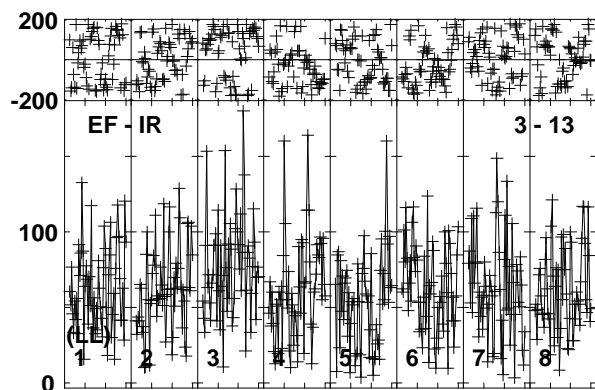
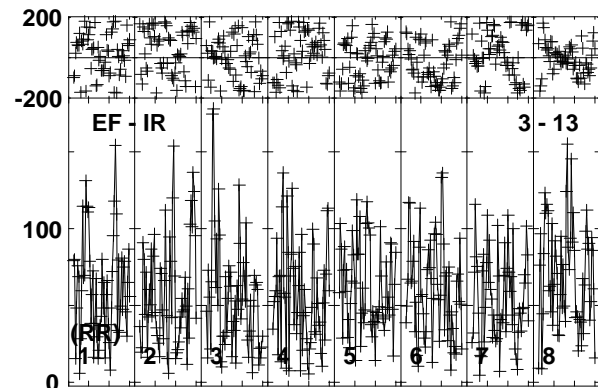
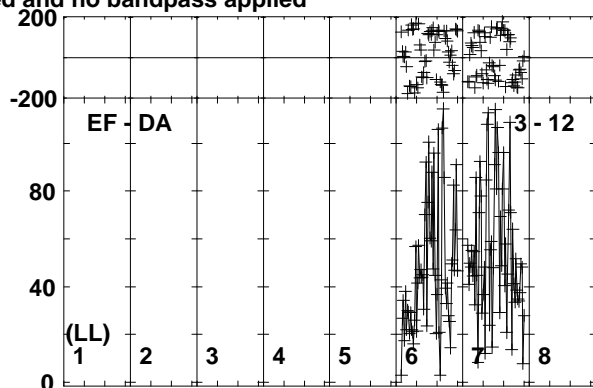
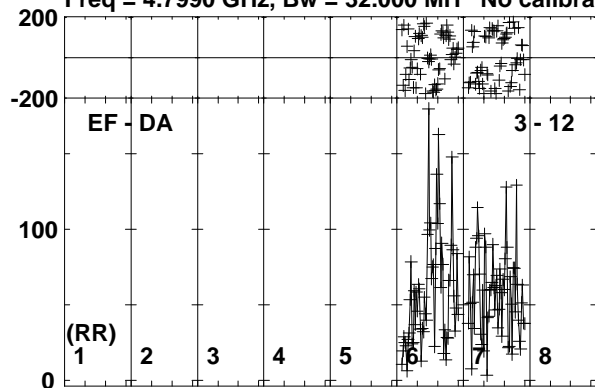

0 40 0 40 0 40 0 40 0 40 0 40 0 40 0 40 0 40 0 40  
Channels

Lower frame: Micro Ampl Jy Top frame: Phas deg  
Vector averaged cross-power spectrum Baseline: EF (03) - DA (12)  
Timerange: 01/03:44:23 to 01/03:48:19

Plot file version 418 created 11-NOV-2019 15:08:04

J1826+0149 EK040B.UVDATA.1

Freq = 4.7990 GHz, Bw = 32.000 MH No calibration applied and no bandpass applied

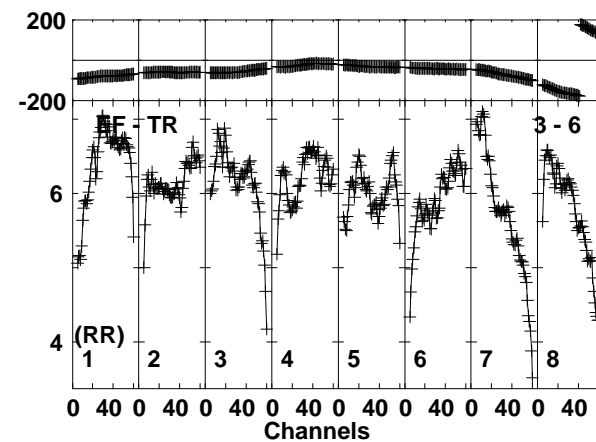
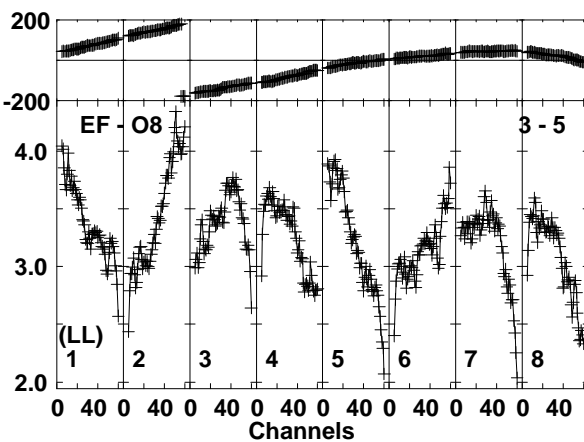
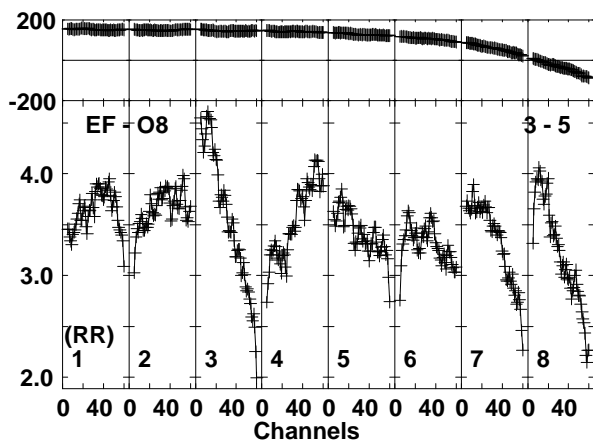
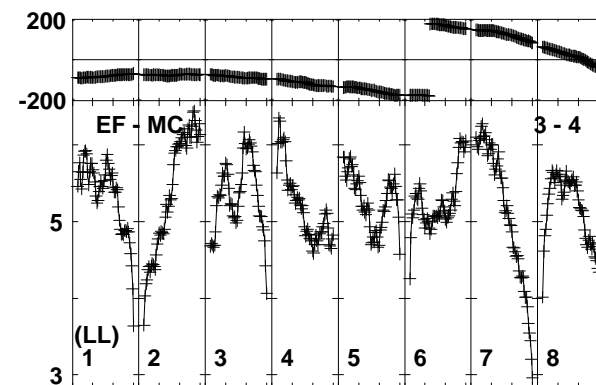
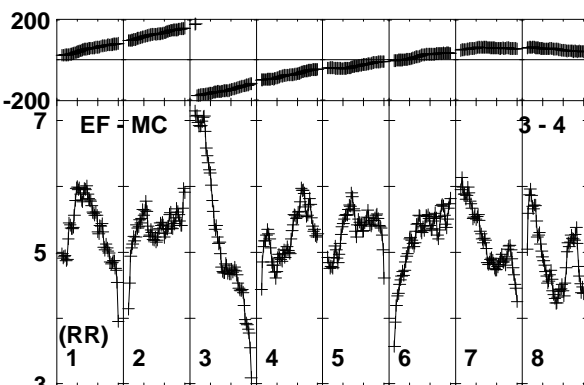
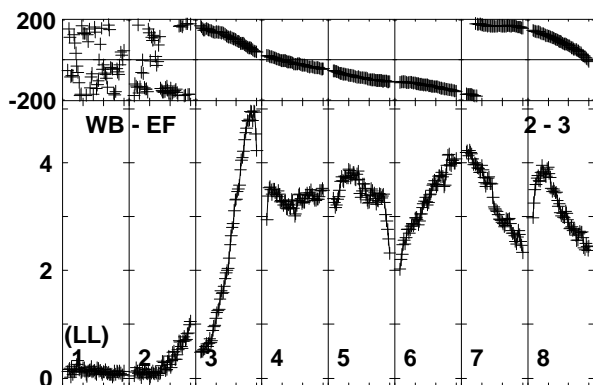
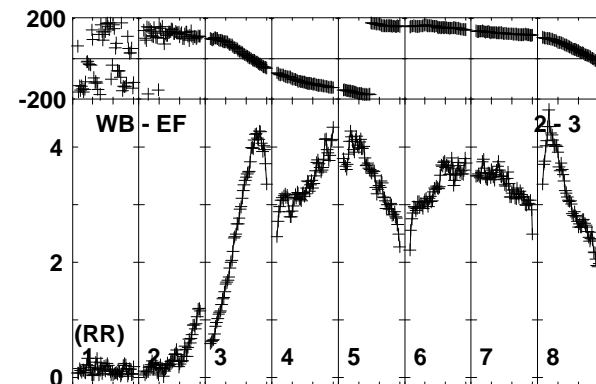
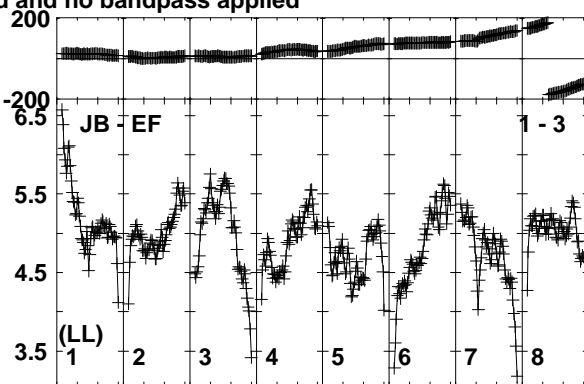
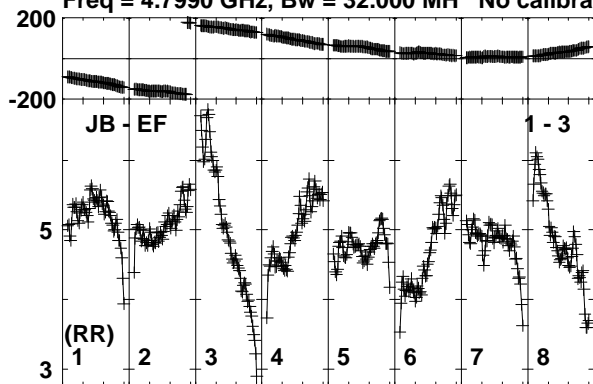

Lower frame: Milli Ampl Jy Top frame: Phas deg  
Vector averaged cross-power spectrum Baseline: JB (01) - EF (03)  
Timerange: 01/03:48:21 to 01/03:49:49



Plot file version 419 created 11-NOV-2019 15:08:04

J1826+0149 EK040B.UVDATA.1

Freq = 4.7990 GHz, Bw = 32.000 MH No calibration applied and no bandpass applied

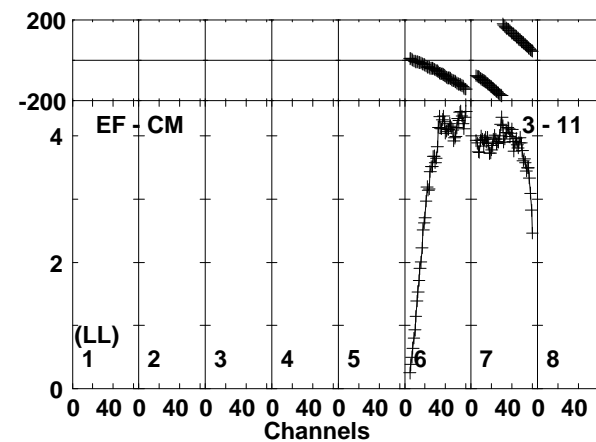
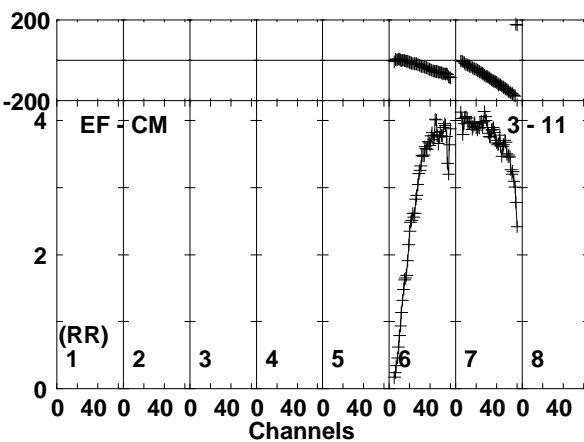
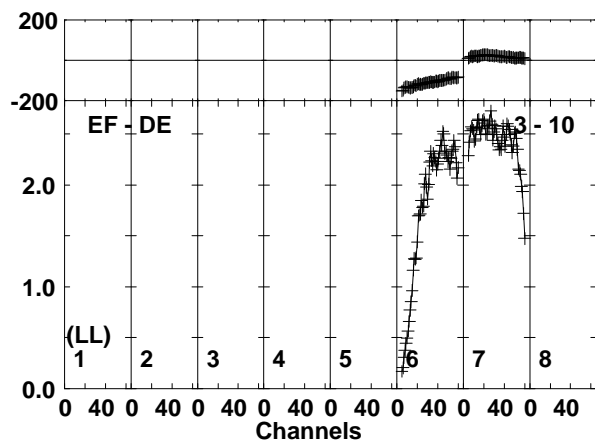
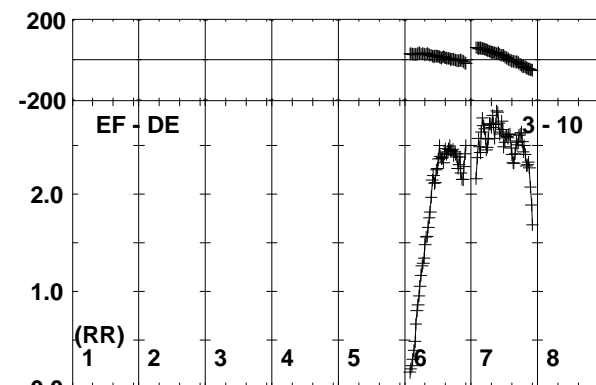
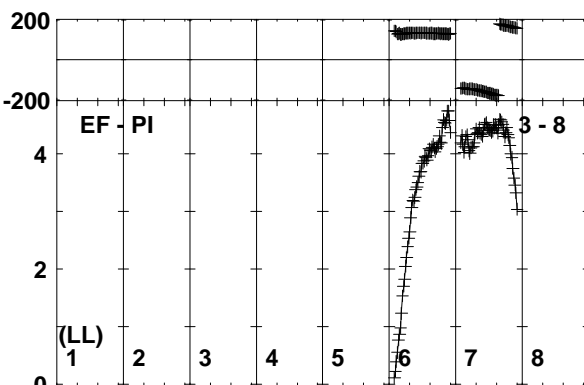
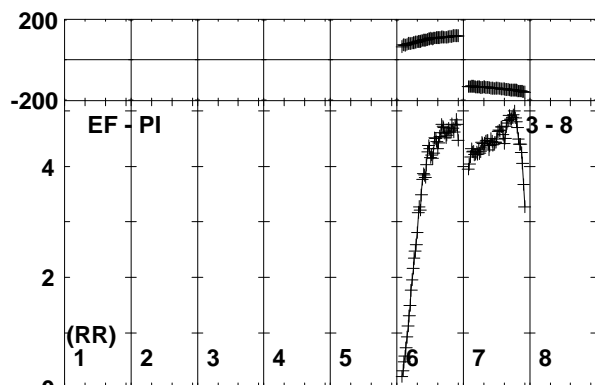
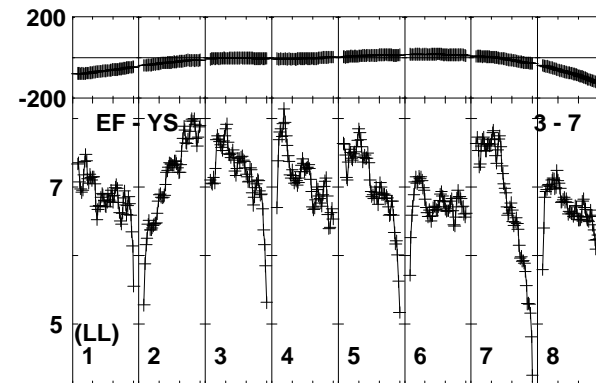
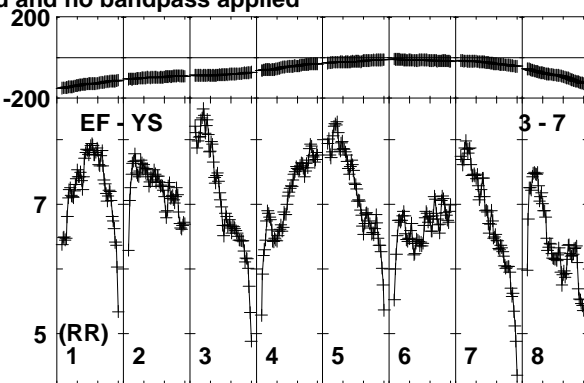
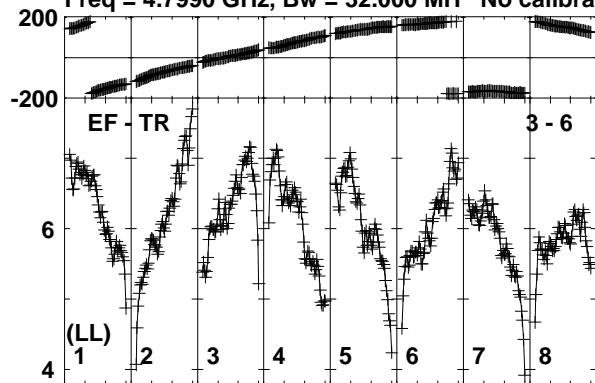

Lower frame: Milli Ampl Jy Top frame: Phas deg  
Vector averaged cross-power spectrum Baseline: EF (03) - TR (06)  
Timerange: 01/03:48:21 to 01/03:49:49

Plot file version 420 created 11-NOV-2019 15:08:04

J1826+0149 EK040B.UVDATA.1

Freq = 4.7990 GHz, Bw = 32.000 MH No calibration applied and no bandpass applied

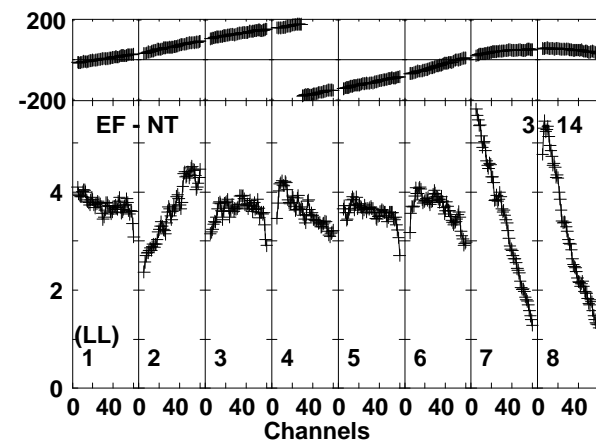
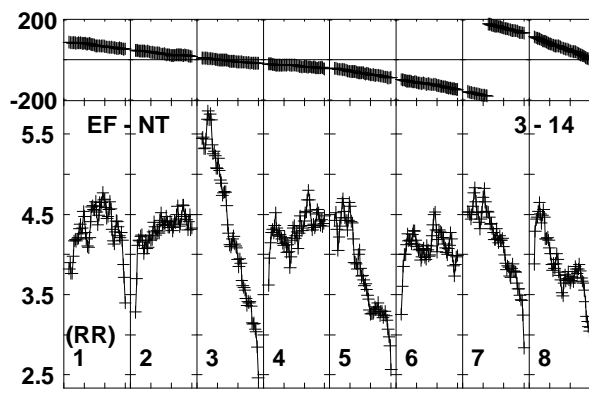
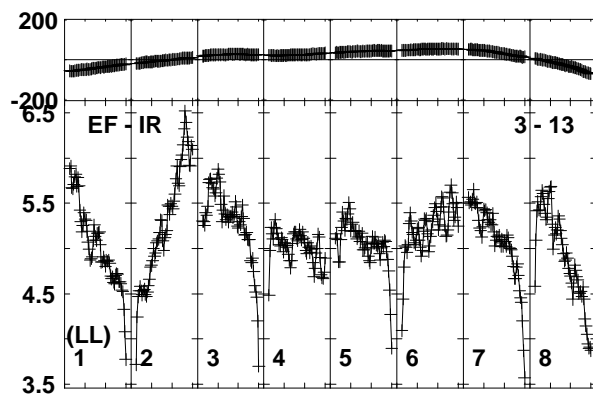
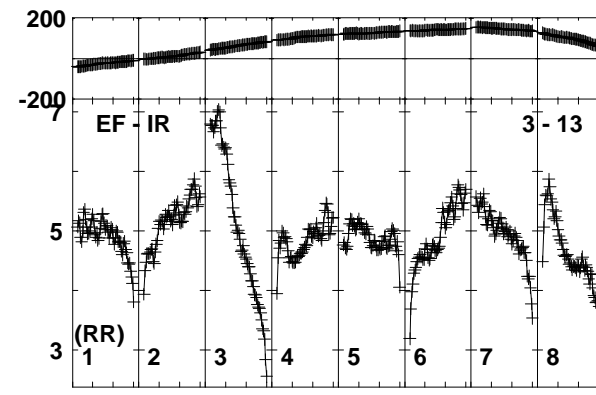
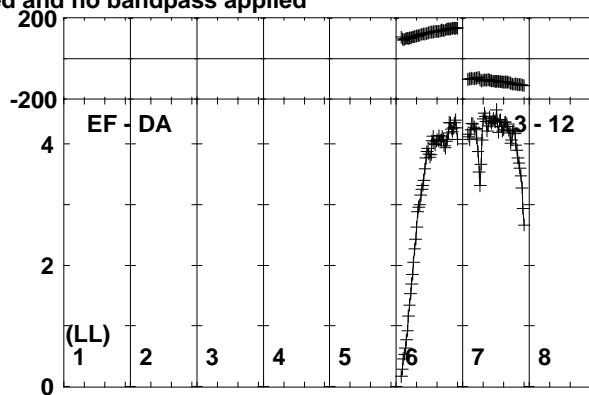
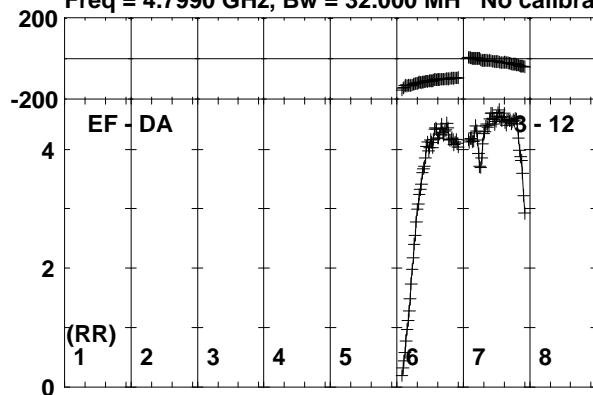

Lower frame: Milli Ampl Jy Top frame: Phas deg  
Vector averaged cross-power spectrum Baseline: EF (03) - DA (12)  
Timerange: 01/03:48:21 to 01/03:49:49

Plot file version 421 created 11-NOV-2019 15:08:04  
 SER8NJ EK040B.UVDATA.1  
 Freq = 4.7990 GHz, Bw = 32.000 MH No calibration applied and no bandpass applied

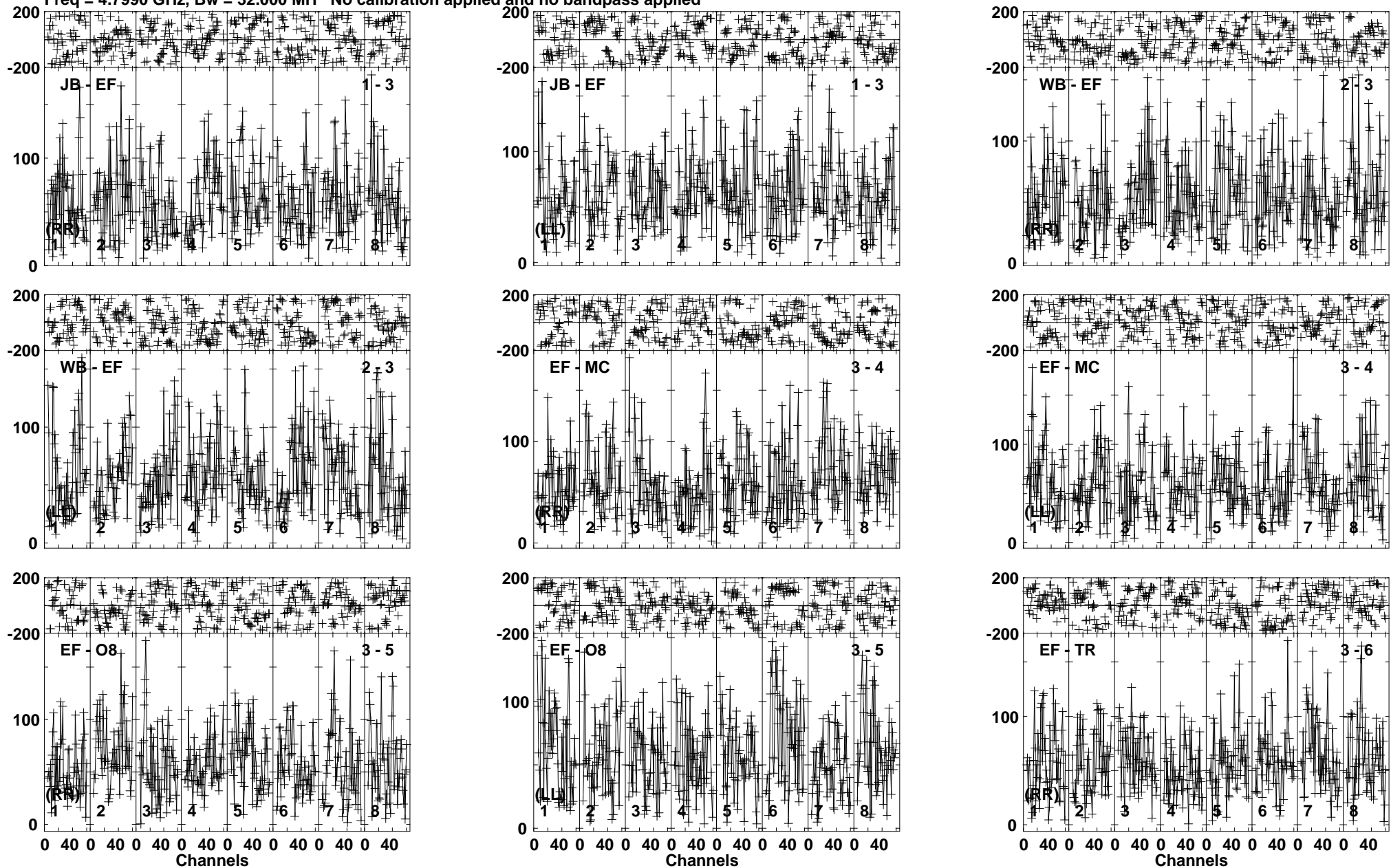

Lower frame: Micro Ampl Jy Top frame: Phas deg  
 Vector averaged cross-power spectrum Baseline: JB (01) - EF (03)  
 Timerange: 01/03:49:53 to 01/03:53:49

Plot file version 422 created 11-NOV-2019 15:08:04

SER8NJ EK040B.UVDATA.1

Freq = 4.7990 GHz, Bw = 32.000 MH No calibration applied and no bandpass applied

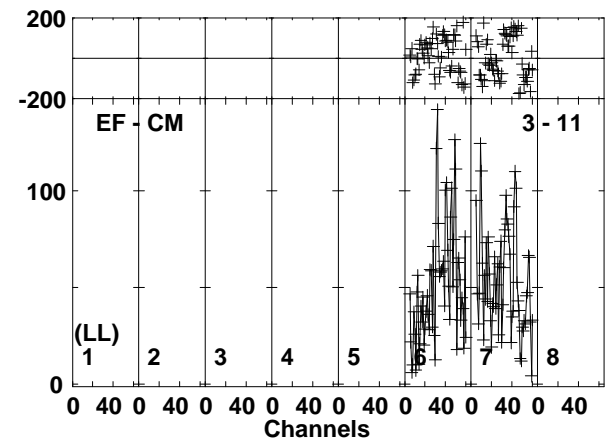
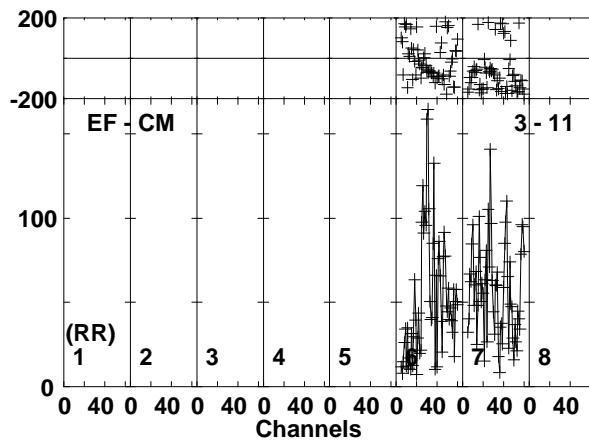
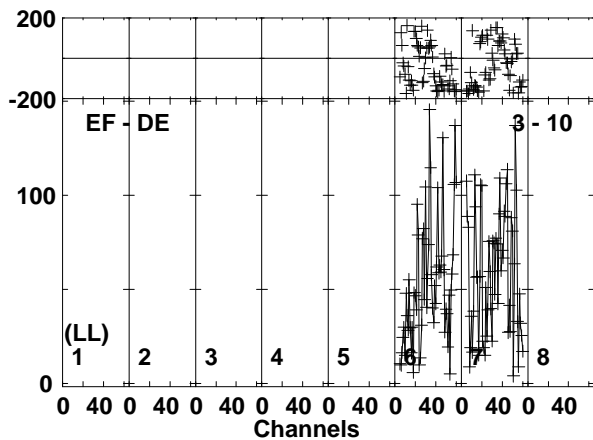
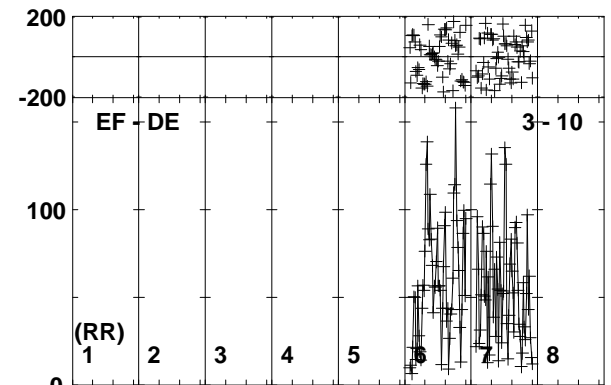
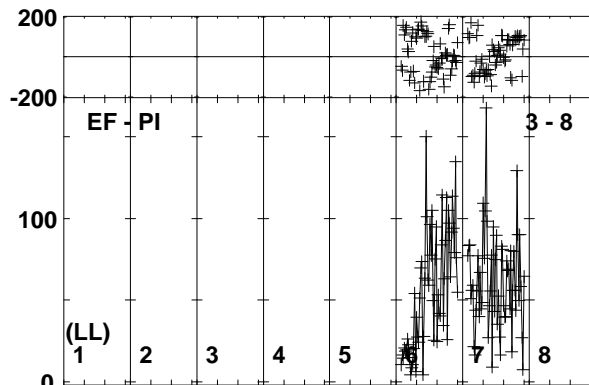
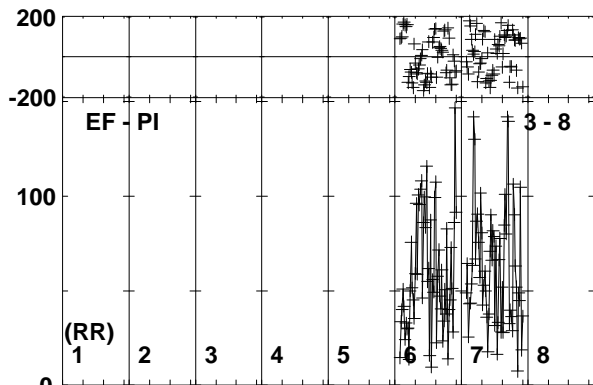
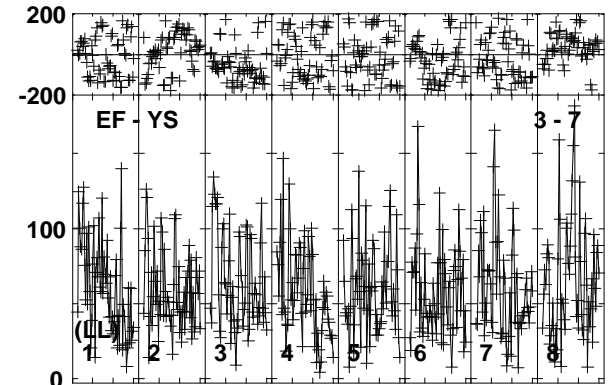
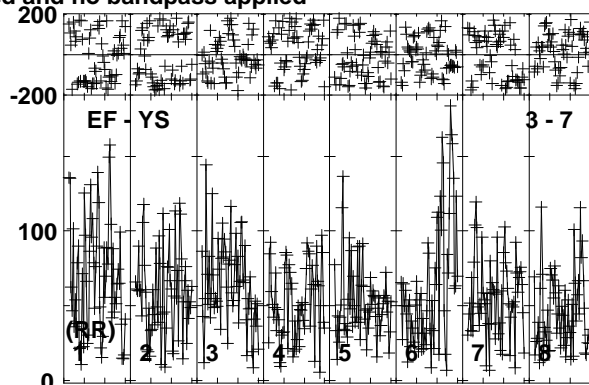
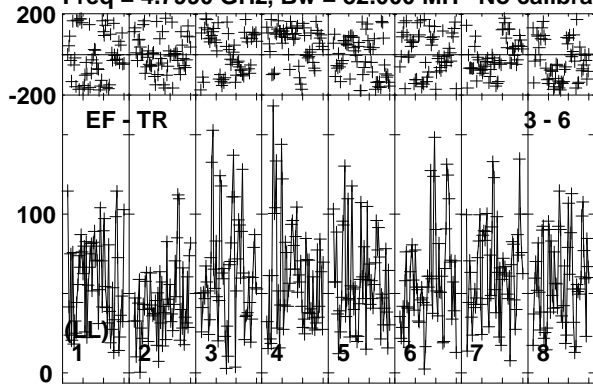

Lower frame: Micro Ampl Jy Top frame: Phas deg  
Vector averaged cross-power spectrum Baseline: EF (03) - TR (06)  
Timerange: 01/03:49:53 to 01/03:53:49

Plot file version 423 created 11-NOV-2019 15:08:04

SER8NJ EK040B.UVDATA.1

Freq = 4.7990 GHz, Bw = 32.000 MH No calibration applied and no bandpass applied

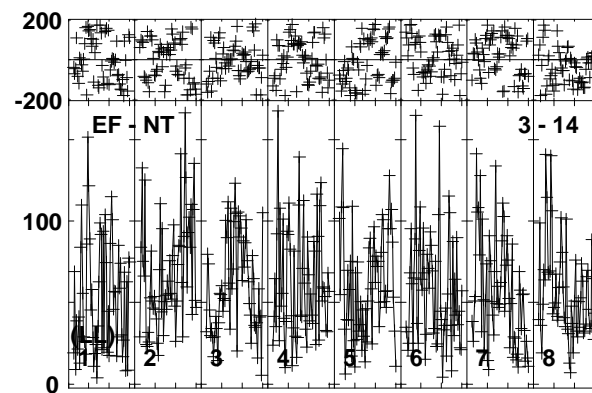
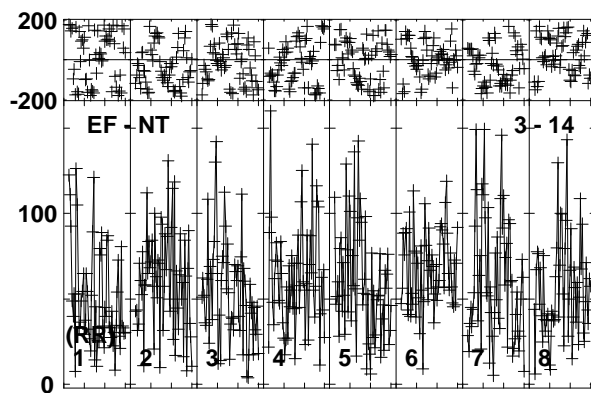
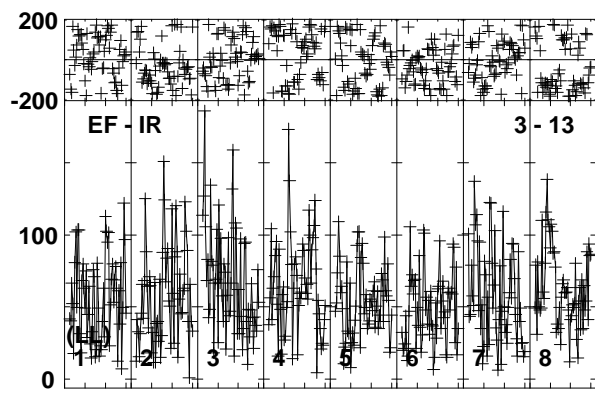
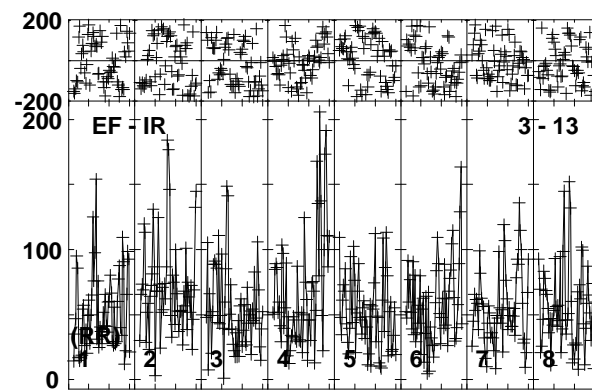
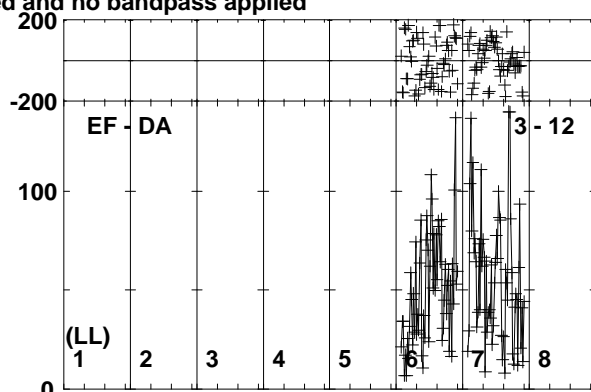
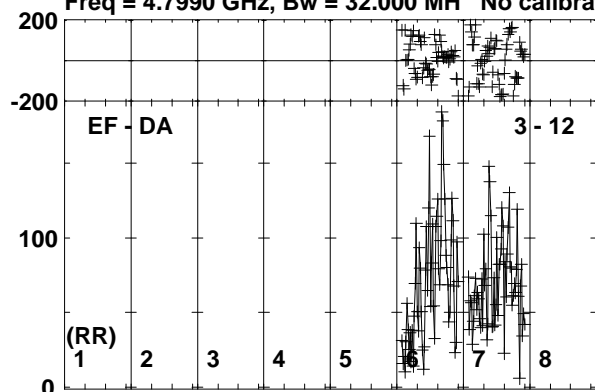

0 40 0 40 0 40 0 40 0 40 0 40 0 40 0 40 0 40 0 40  
Channels

Lower frame: Micro Ampl Jy Top frame: Phas deg  
Vector averaged cross-power spectrum Baseline: EF (03) - DA (12)  
Timerange: 01/03:49:53 to 01/03:53:49

Plot file version 424 created 11-NOV-2019 15:08:04

J1826+0149 EK040B.UVDATA.1

Freq = 4.7990 GHz, Bw = 32.000 MH No calibration applied and no bandpass applied

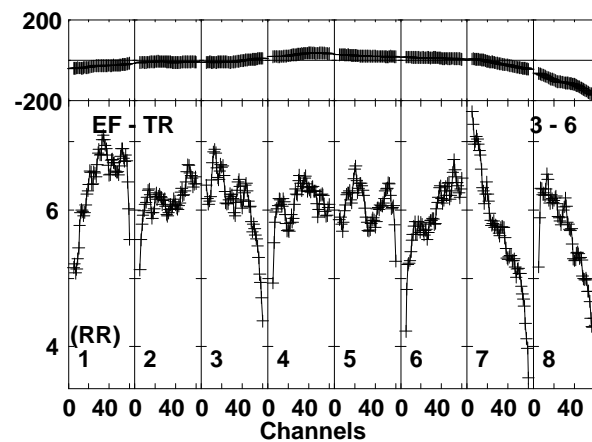
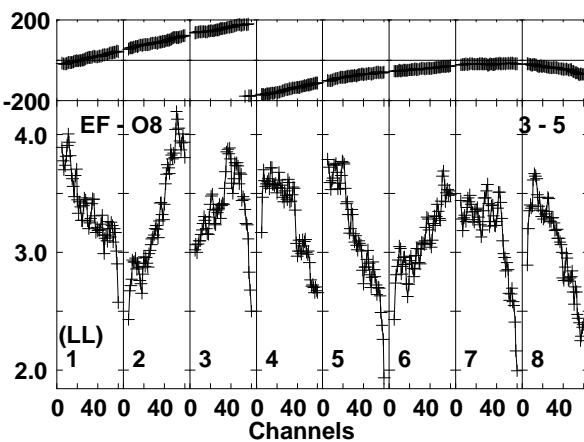
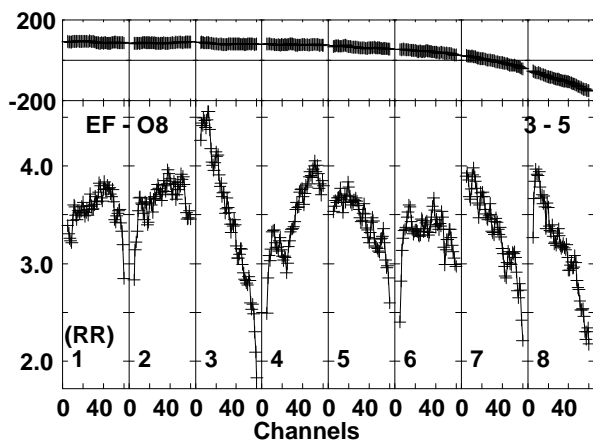
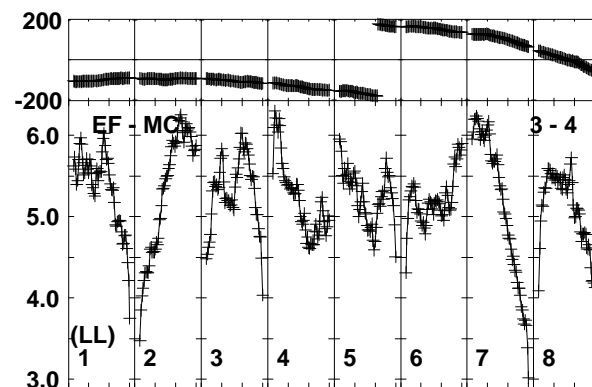
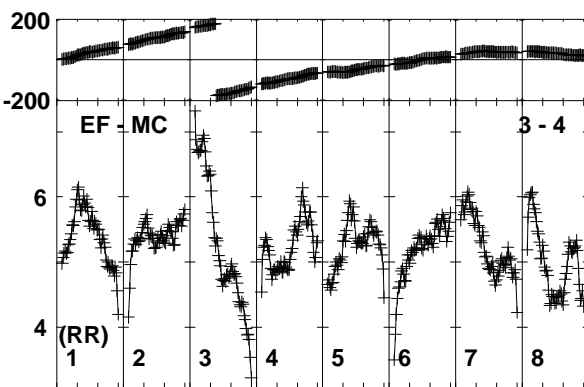
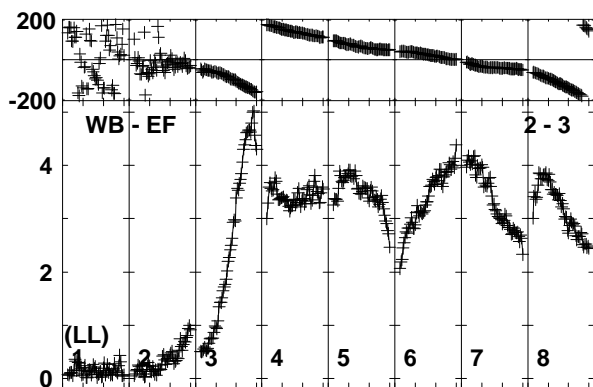
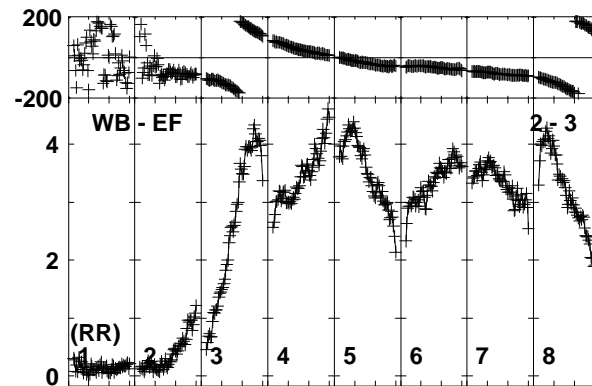
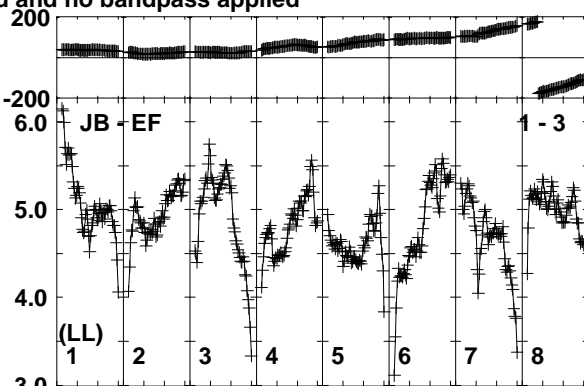
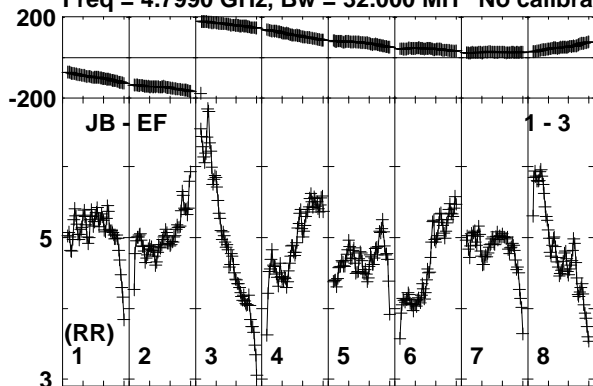

Lower frame: Milli Ampl Jy Top frame: Phas deg  
Vector averaged cross-power spectrum Baseline: JB (01) - EF (03)  
Timerange: 01/03:54:31 to 01/03:55:29

Plot file version 425 created 11-NOV-2019 15:08:04  
 J1826+0149 EK040B.UVDATA.1  
 Freq = 4.7990 GHz, Bw = 32.000 MH No calibration applied and no bandpass applied

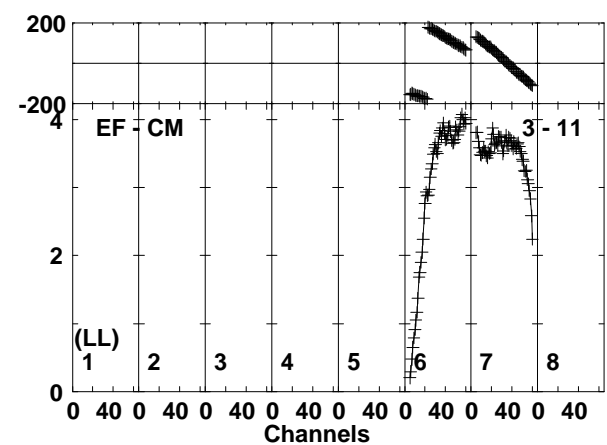
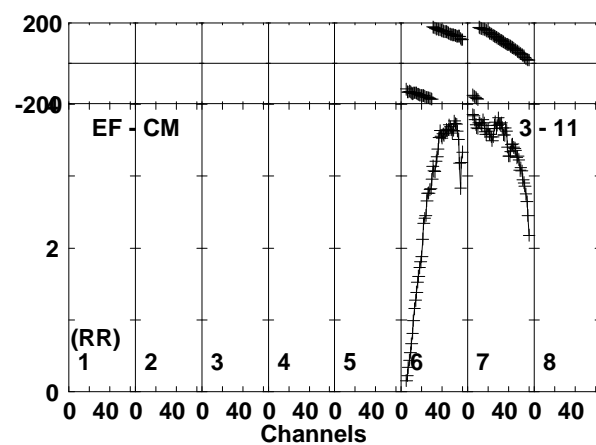
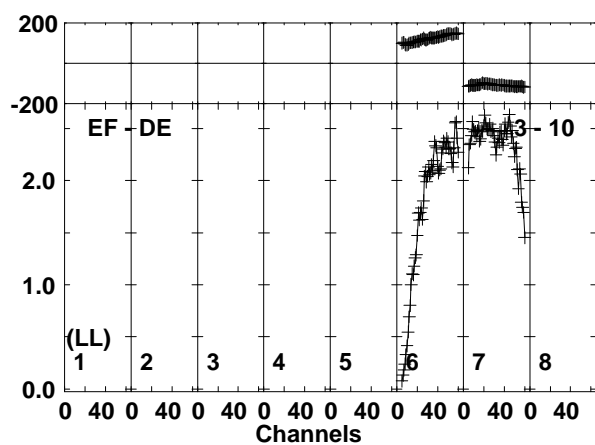
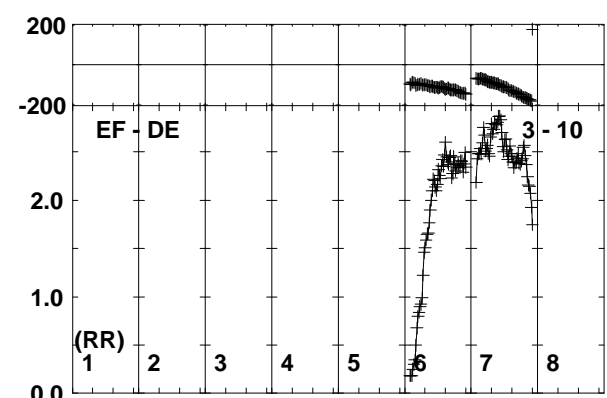
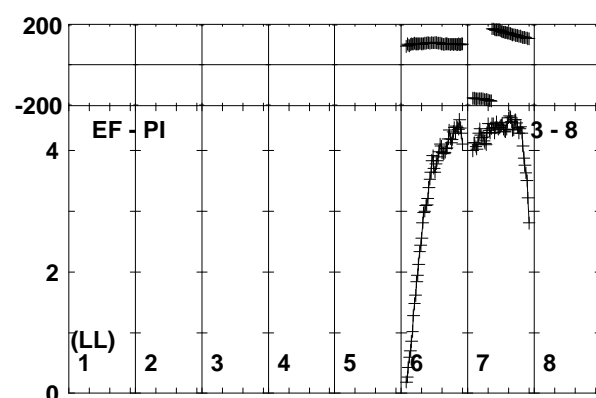
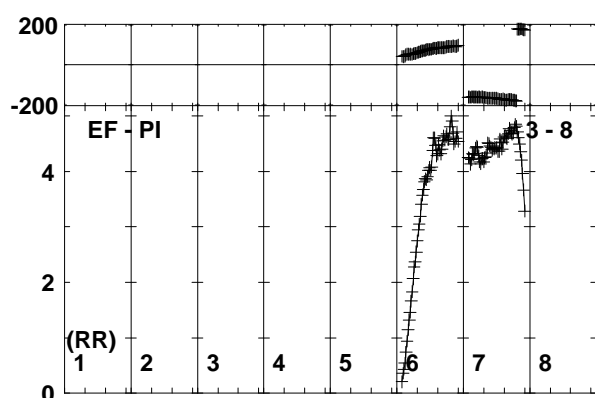
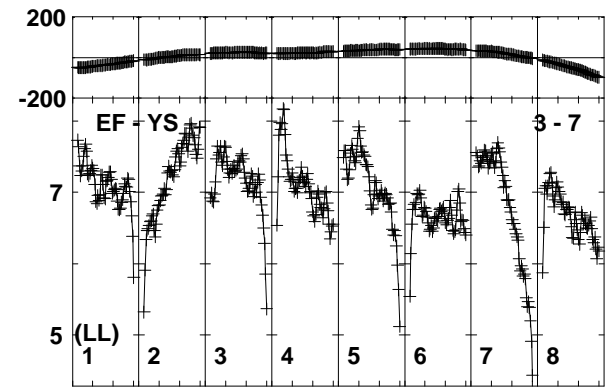
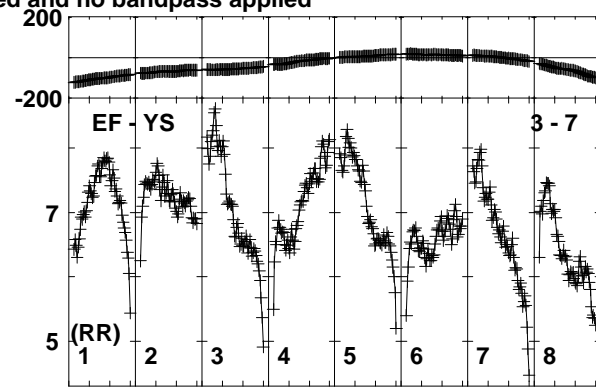
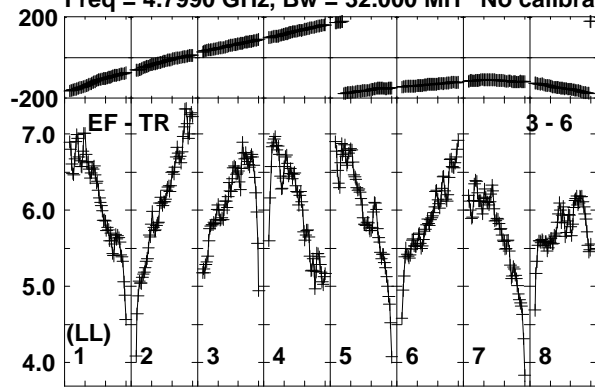

Lower frame: Milli Ampl Jy Top frame: Phas deg  
 Vector averaged cross-power spectrum Baseline: EF (03) - TR (06)  
 Timerange: 01/03:54:31 to 01/03:55:29

Plot file version 426 created 11-NOV-2019 15:08:05

J1826+0149 EK040B.UVDATA.1

Freq = 4.7990 GHz, Bw = 32.000 MH No calibration applied and no bandpass applied

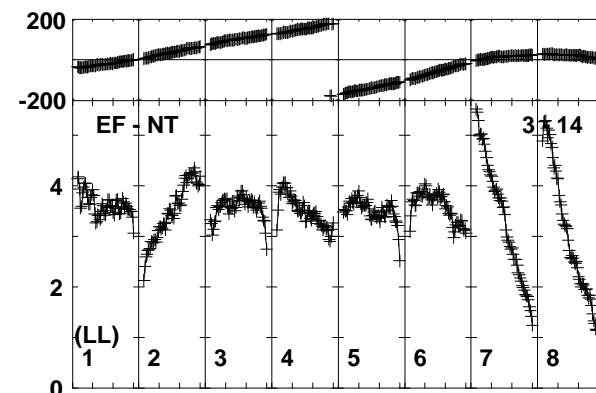
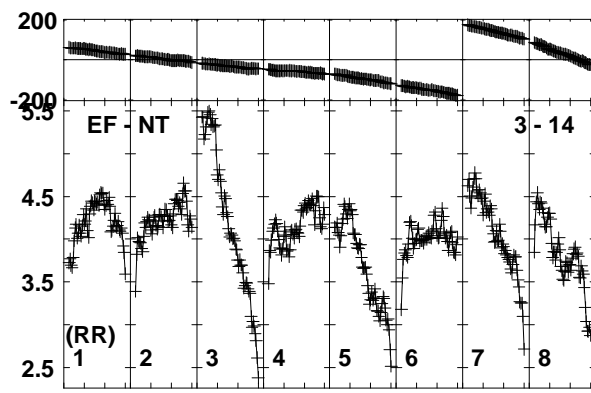
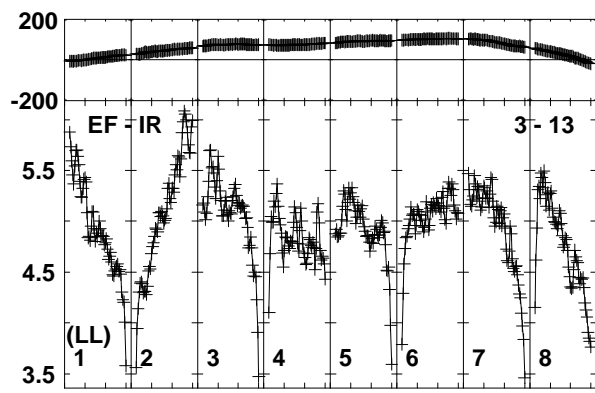
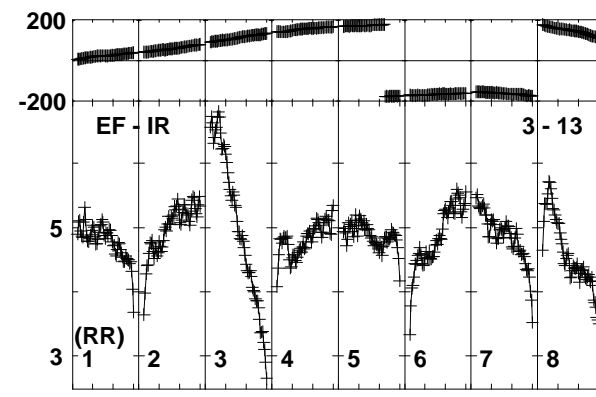
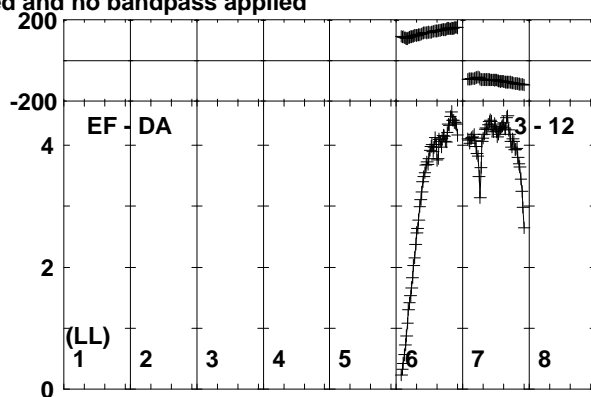
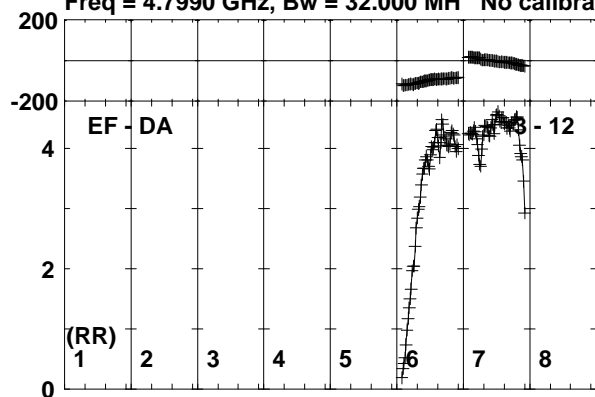

Channels

Lower frame: Milli Ampl Jy Top frame: Phas deg  
Vector averaged cross-power spectrum Baseline: EF (03) - DA (12)  
Timerange: 01/03:54:31 to 01/03:55:29



Plot file version 427 created 11-NOV-2019 15:08:05

SER8NJ EK040B.UVDATA.1

Freq = 4.7990 GHz, Bw = 32.000 MH No calibration applied and no bandpass applied

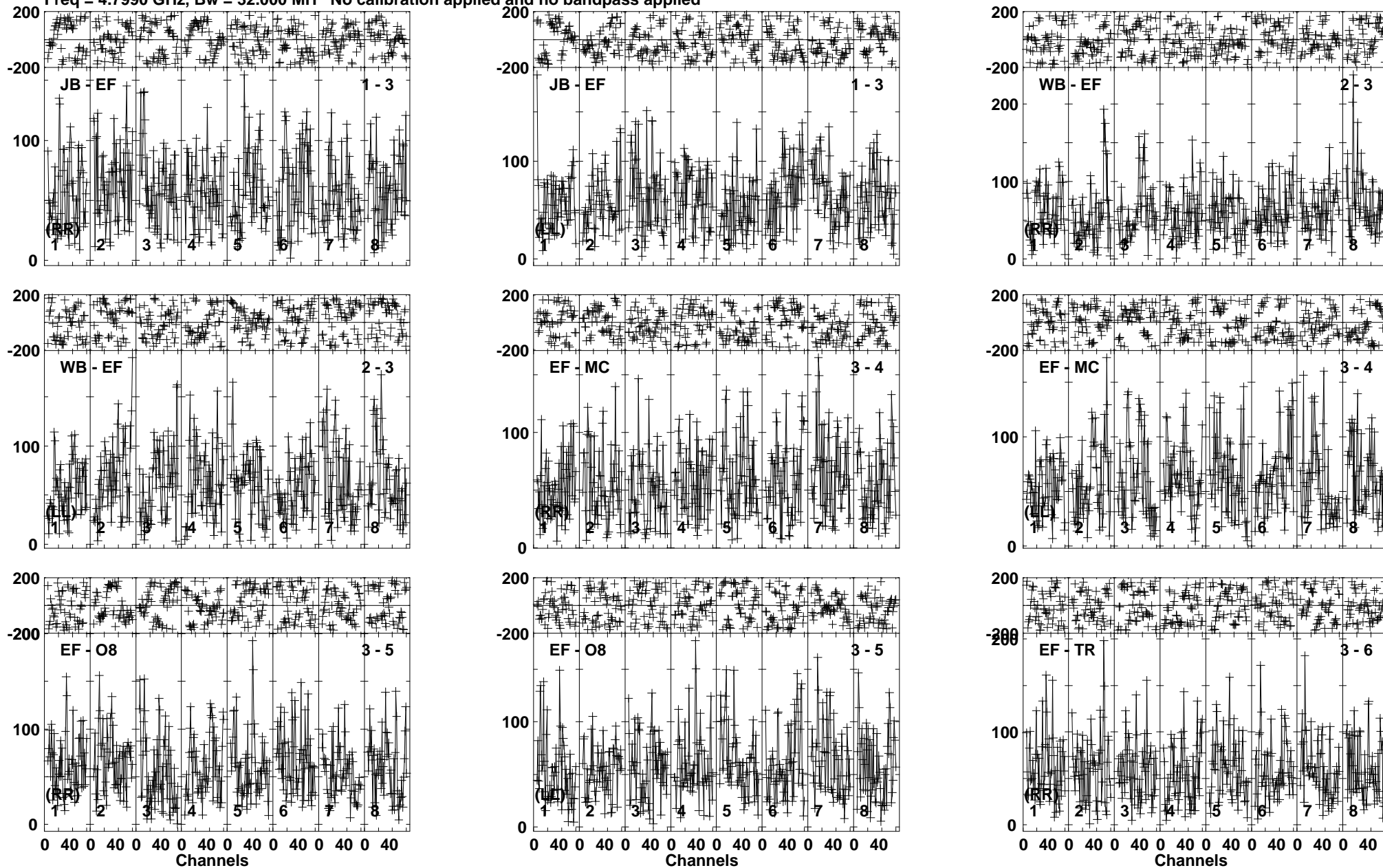

Lower frame: Micro Ampl Jy Top frame: Phas deg  
Vector averaged cross-power spectrum Baseline: JB (01) - EF (03)  
Timerange: 01/03:55:33 to 01/03:59:29

Plot file version 428 created 11-NOV-2019 15:08:05

SER8NJ EK040B.UVDATA.1

Freq = 4.7990 GHz, Bw = 32.000 MH No calibration applied and no bandpass applied

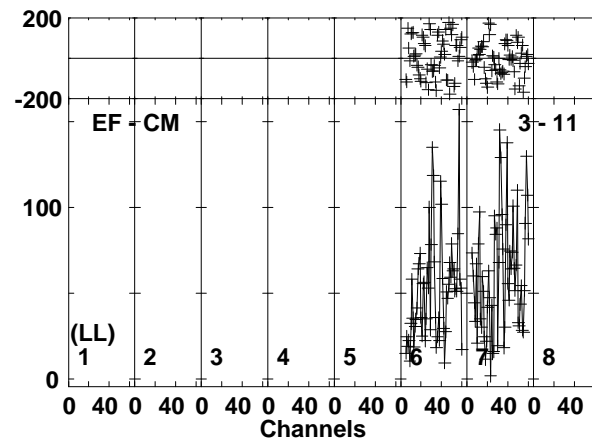
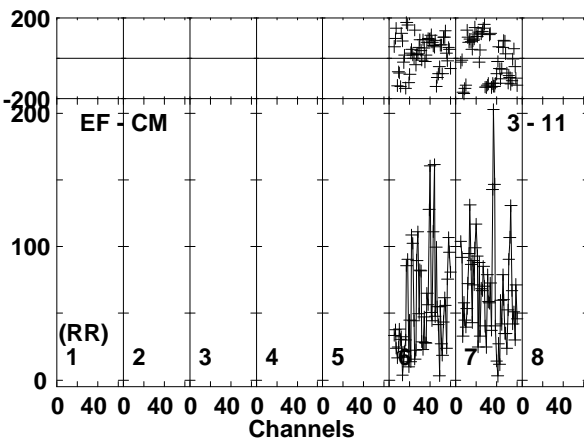
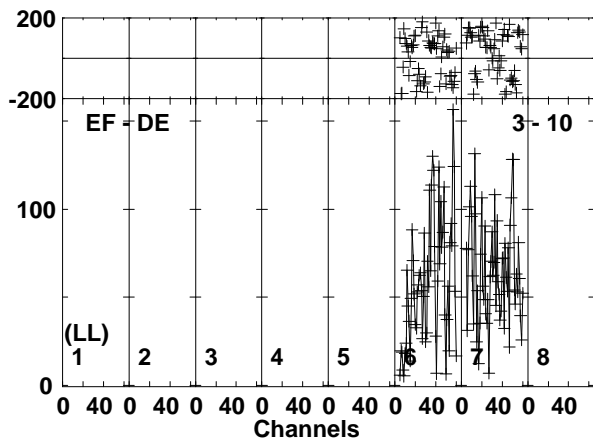
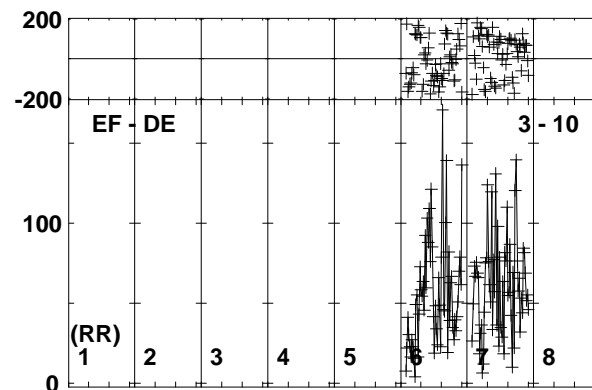
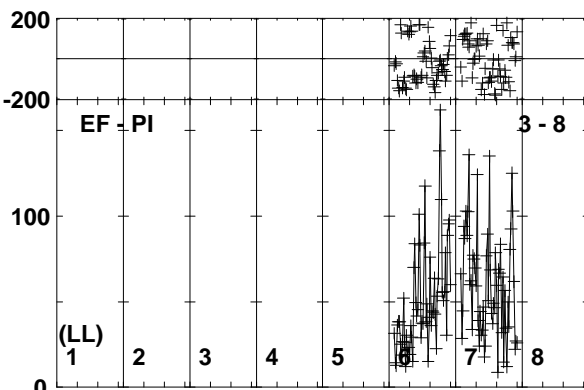
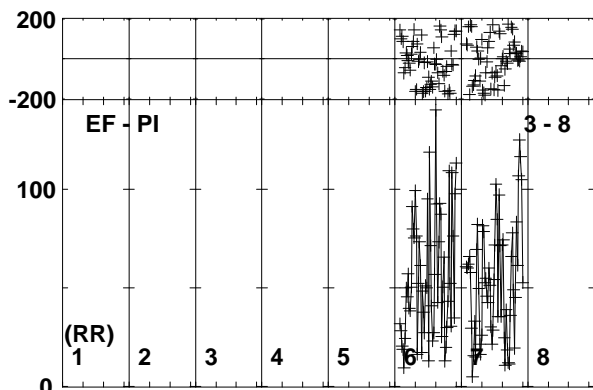
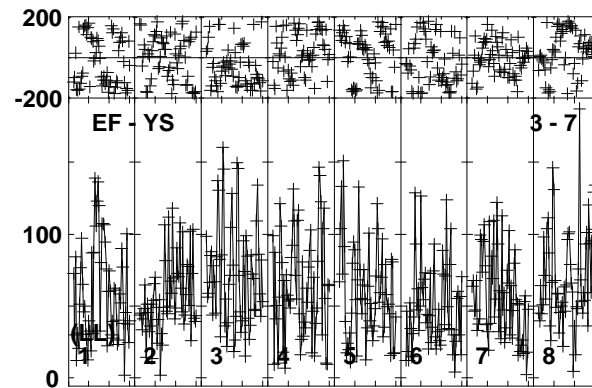
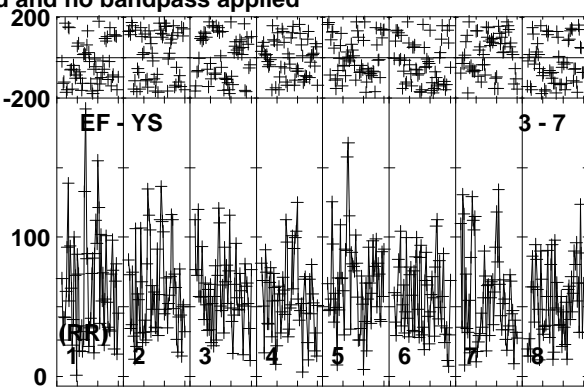
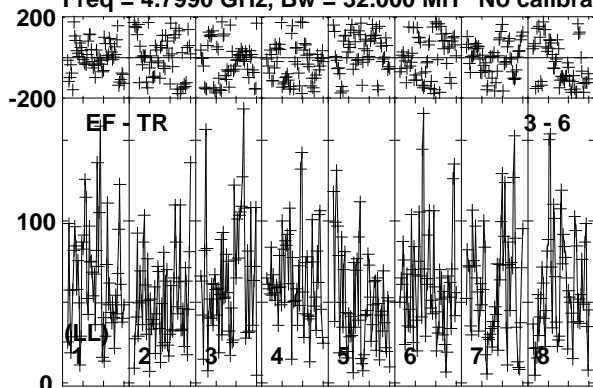

Lower frame: Micro Ampl Jy Top frame: Phas deg  
Vector averaged cross-power spectrum Baseline: EF (03) - TR (06)  
Timerange: 01/03:55:33 to 01/03:59:29

Plot file version 429 created 11-NOV-2019 15:08:05

SER8NJ EK040B.UVDATA.1

Freq = 4.7990 GHz, Bw = 32.000 MH No calibration applied and no bandpass applied

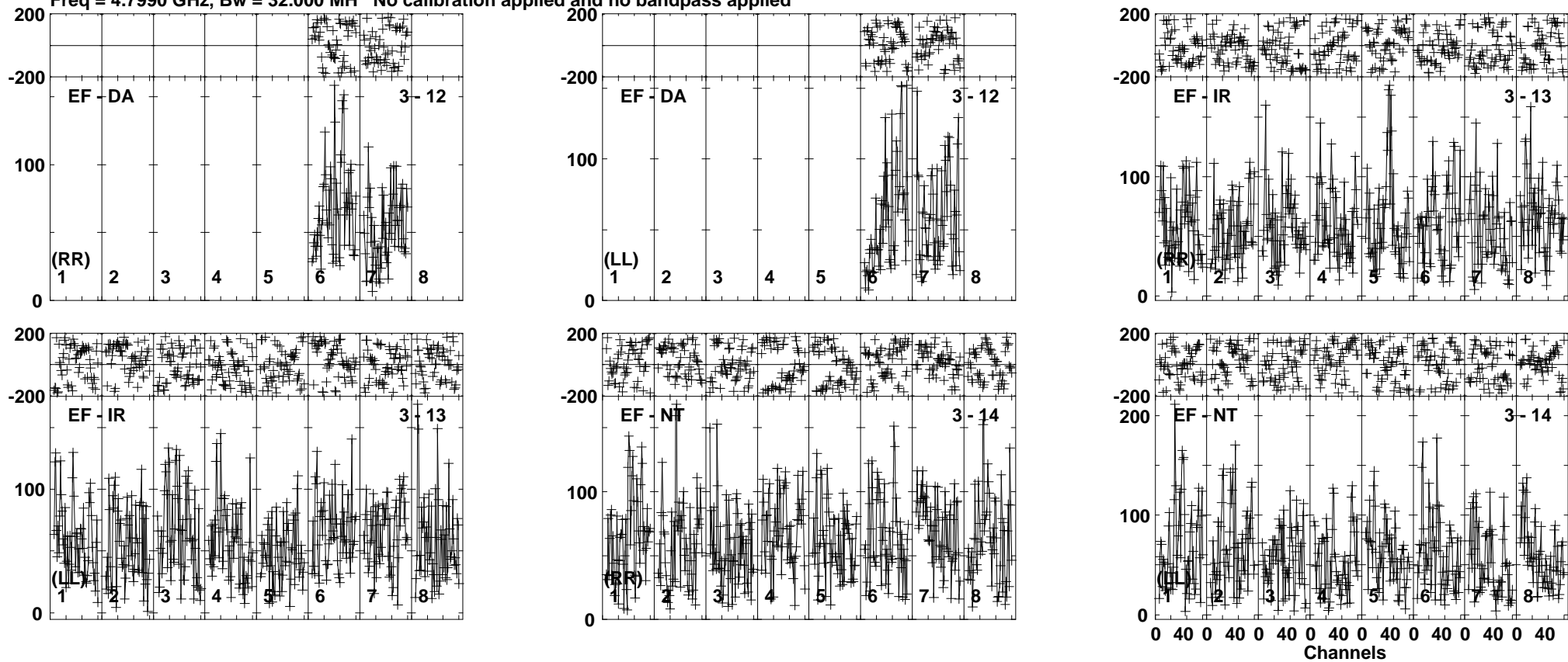

Lower frame: Micro Ampl Jy Top frame: Phas deg  
Vector averaged cross-power spectrum Baseline: EF (03) - DA (12)  
Timerange: 01/03:55:33 to 01/03:59:29

Plot file version 430 created 11-NOV-2019 15:08:05

J1826+0149 EK040B.UVDATA.1

Freq = 4.7990 GHz, Bw = 32.000 MH No calibration applied and no bandpass applied

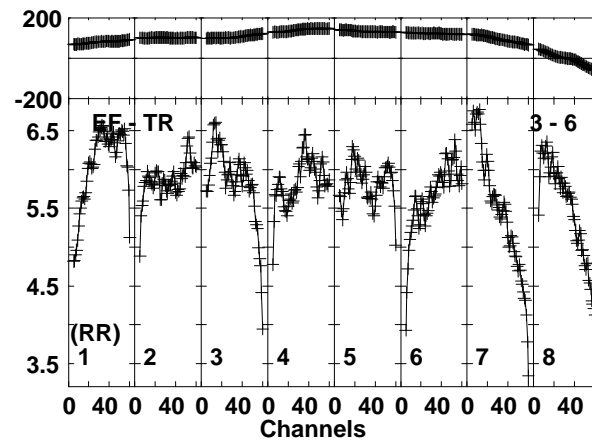
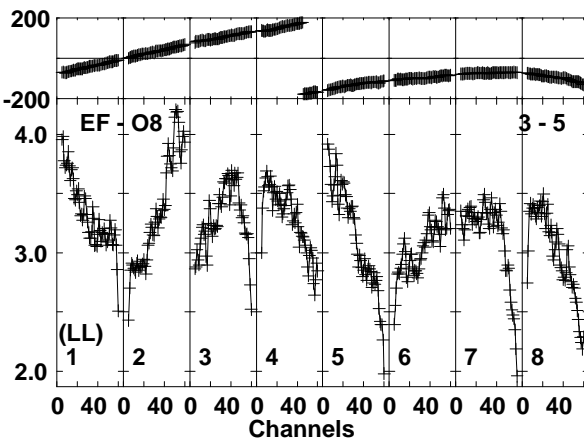
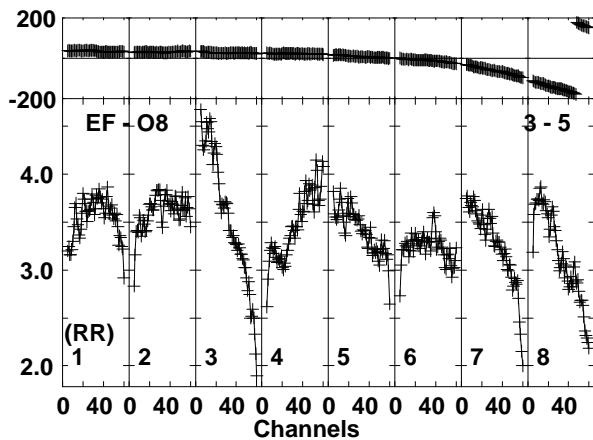
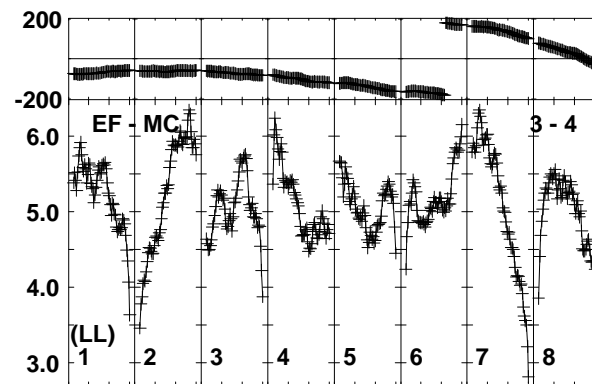
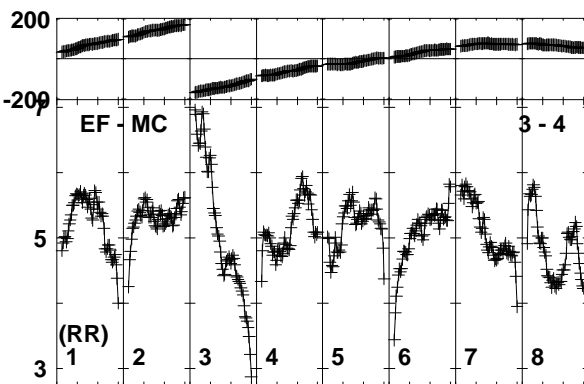
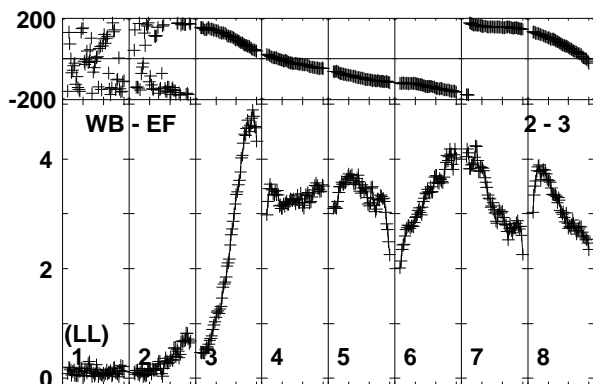
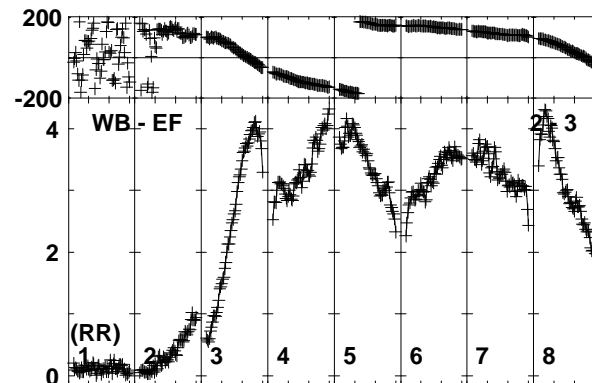
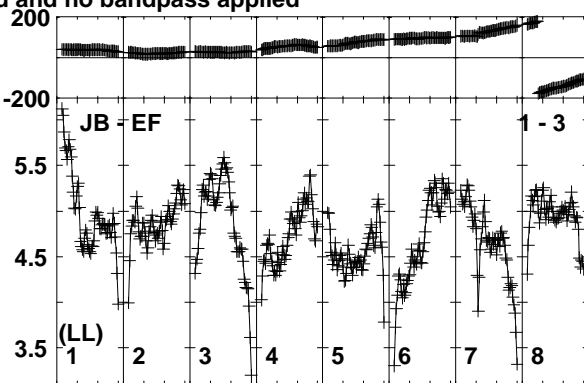
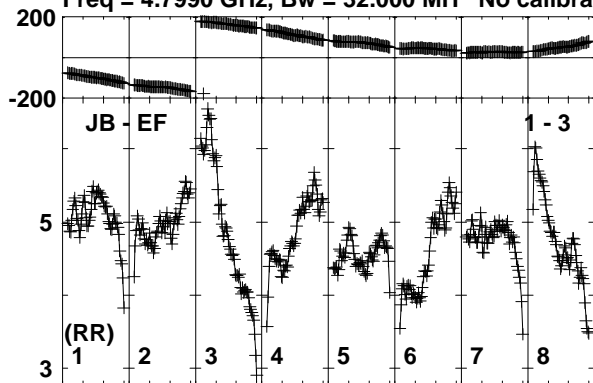

Lower frame: Milli Ampl Jy Top frame: Phas deg  
Vector averaged cross-power spectrum Baseline: JB (01) - EF (03)  
Timerange: 01/03:59:33 to 01/04:00:59

Plot file version 431 created 11-NOV-2019 15:08:05

J1826+0149 EK040B.UVDATA.1

Freq = 4.7990 GHz, Bw = 32.000 MH No calibration applied and no bandpass applied

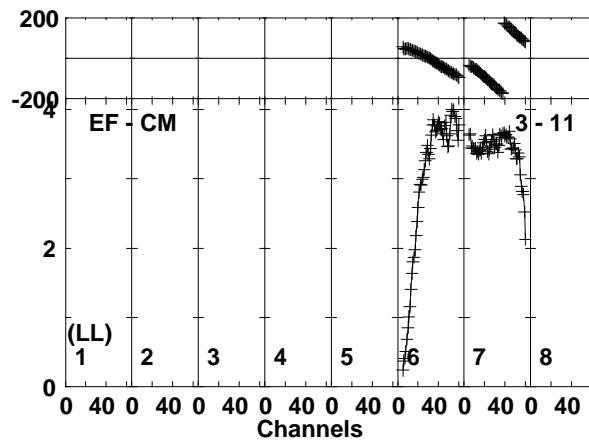
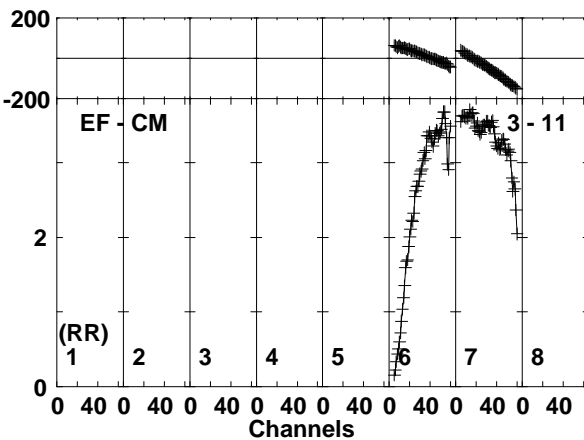
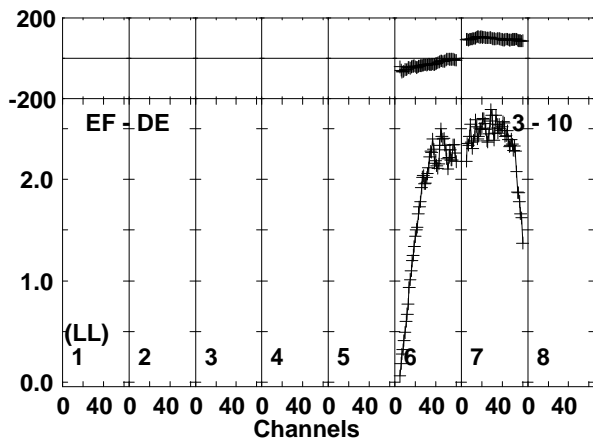
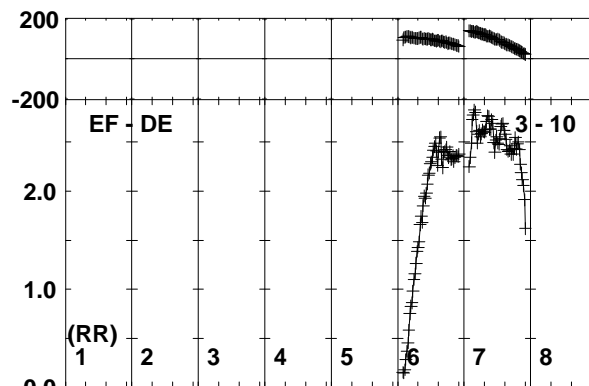
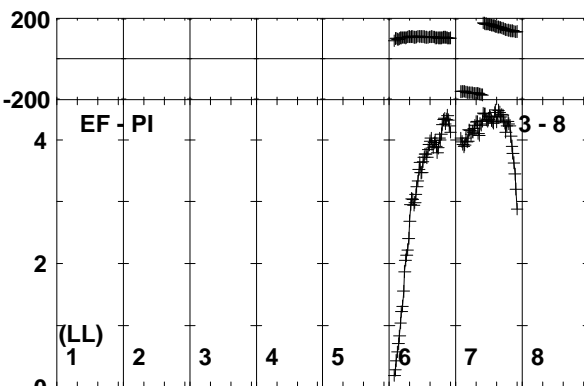
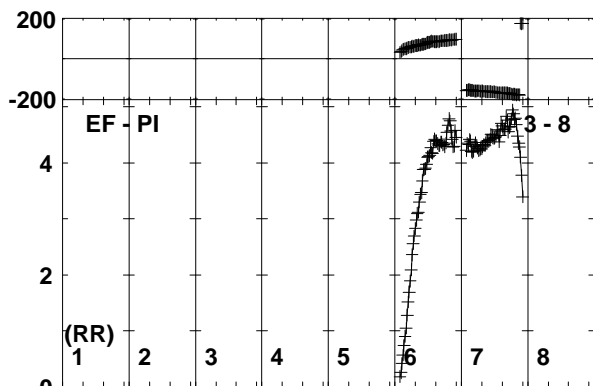
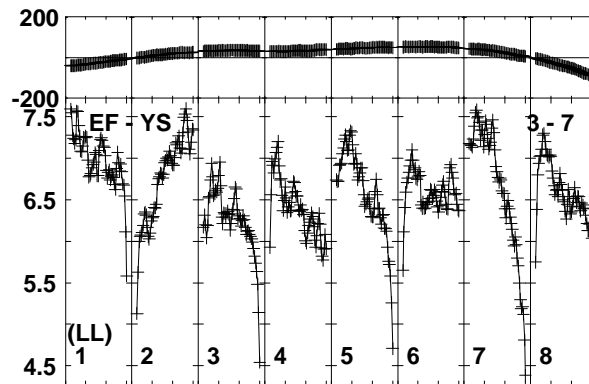
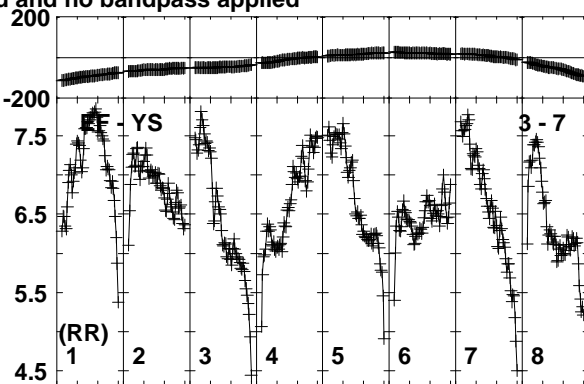
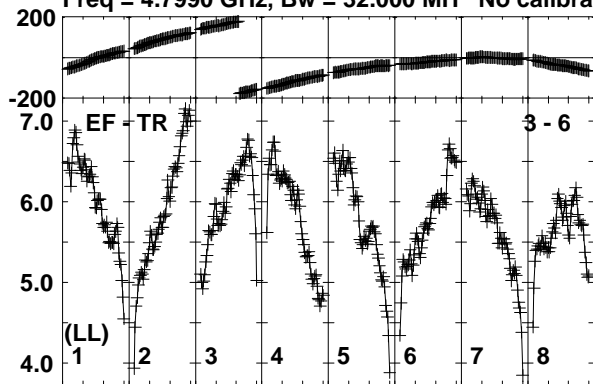

Lower frame: Milli Ampl Jy Top frame: Phas deg  
Vector averaged cross-power spectrum Baseline: EF (03) - TR (06)  
Timerange: 01/03:59:33 to 01/04:00:59

Plot file version 432 created 11-NOV-2019 15:08:05

J1826+0149 EK040B.UVDATA.1

Freq = 4.7990 GHz, Bw = 32.000 MH No calibration applied and no bandpass applied

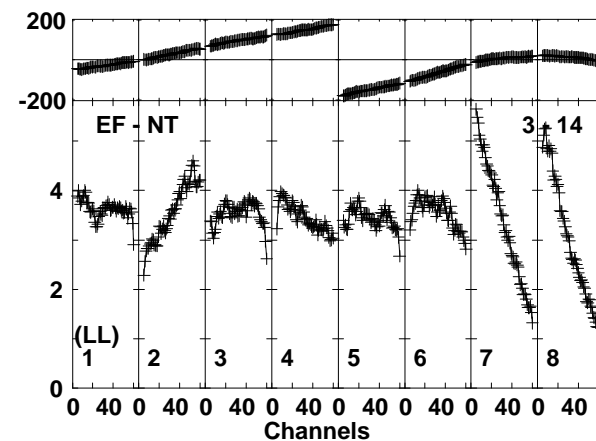
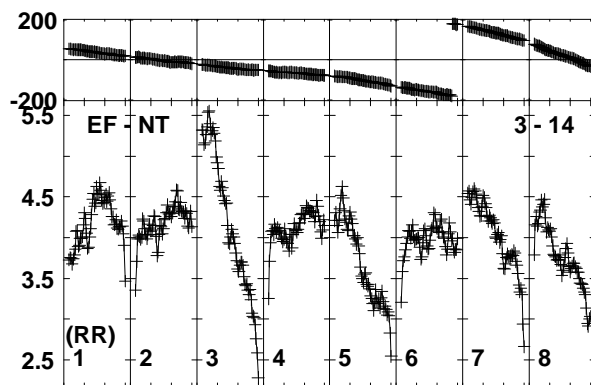
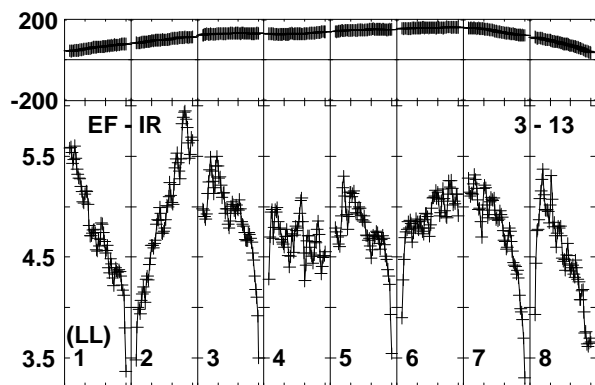
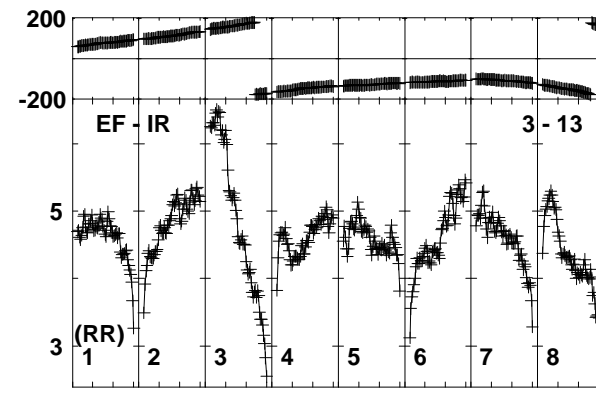
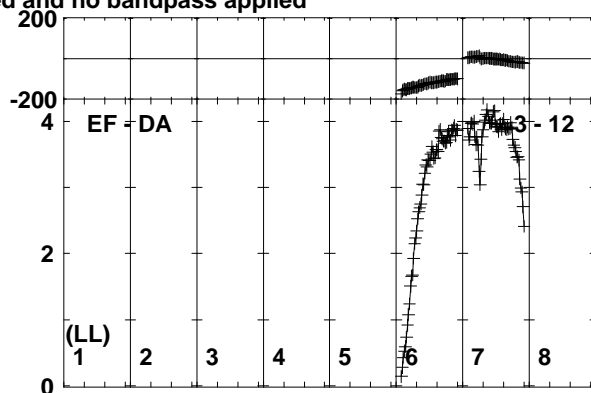
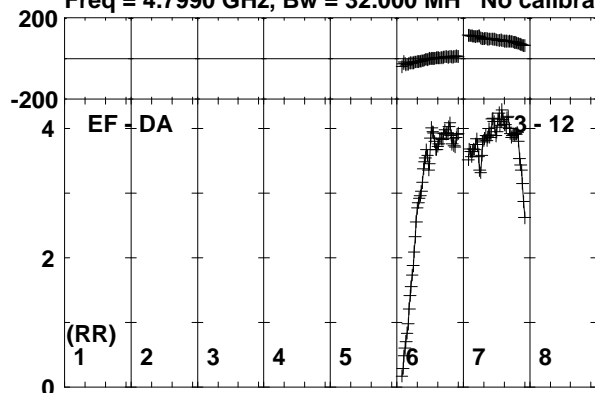

Lower frame: Milli Ampl Jy Top frame: Phas deg  
Vector averaged cross-power spectrum Baseline: EF (03) - DA (12)  
Timerange: 01/03:59:33 to 01/04:00:59

Plot file version 433 created 11-NOV-2019 15:08:05

SER8NJ EK040B.UVDATA.1

Freq = 4.7990 GHz, Bw = 32.000 MH No calibration applied and no bandpass applied

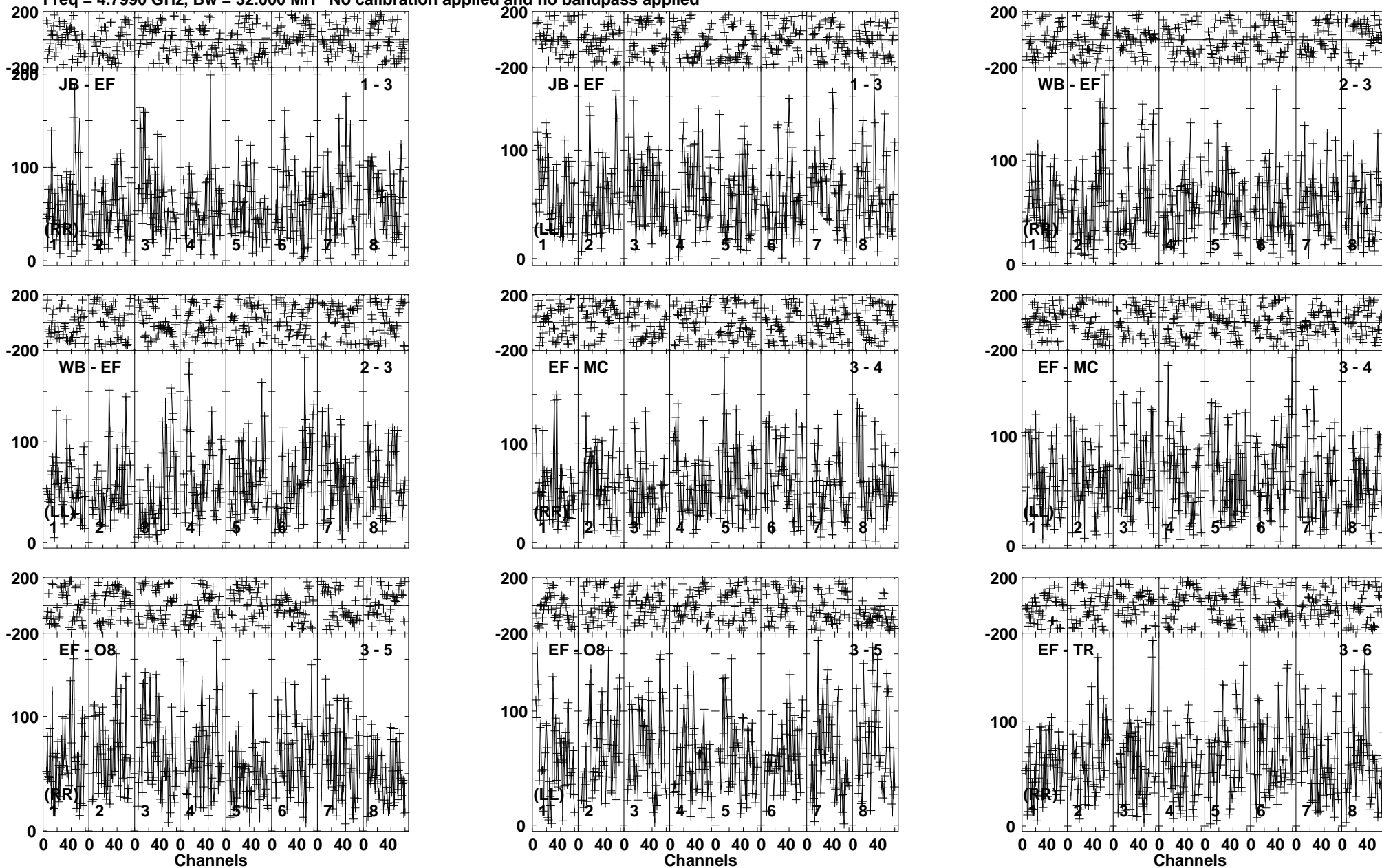

Lower frame: Micro Ampl Jy Top frame: Phas deg  
Vector averaged cross-power spectrum Baseline: JB (01) - EF (03)  
Timerange: 01/04:01:03 to 01/04:04:59

Plot file version 434 created 11-NOV-2019 15:08:05

SER8NJ EK040B.UVDATA.1

Freq = 4.7990 GHz, Bw = 32.000 MH No calibration applied and no bandpass applied

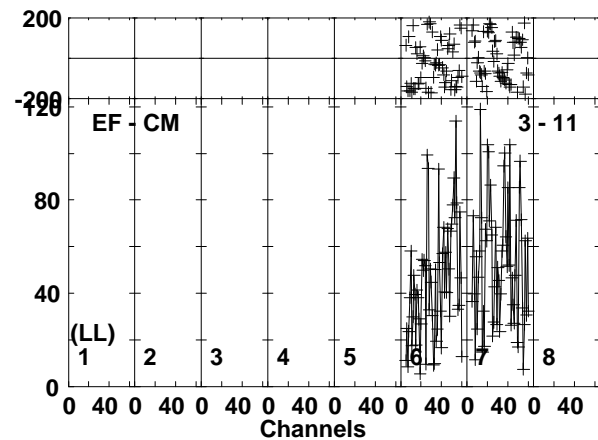
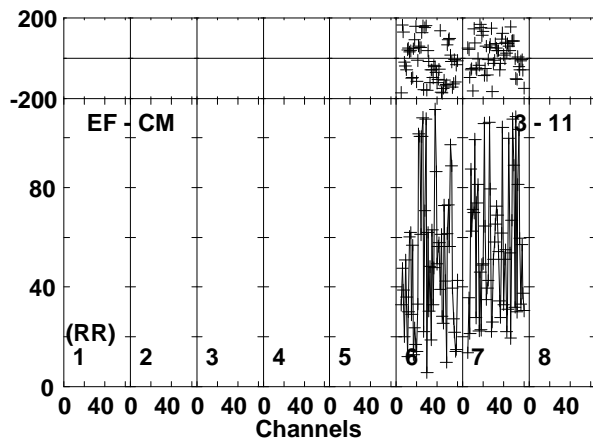
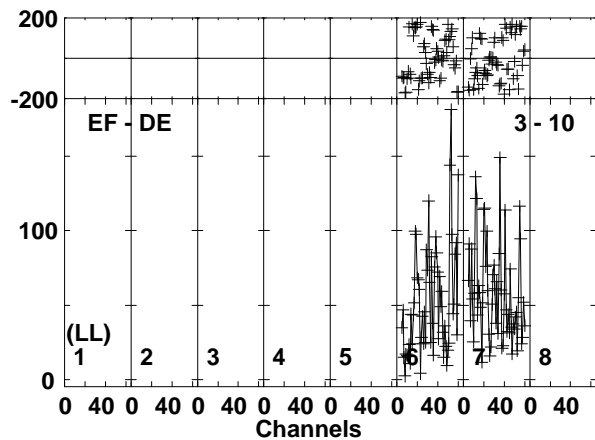
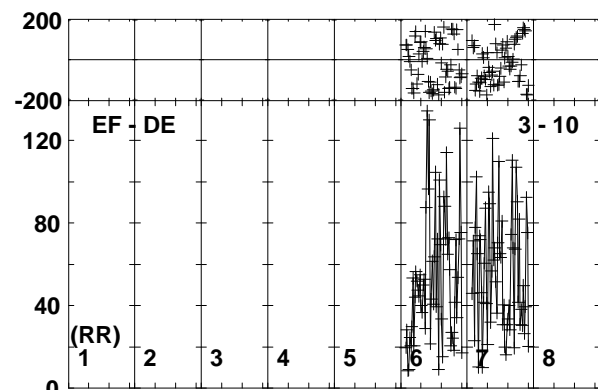
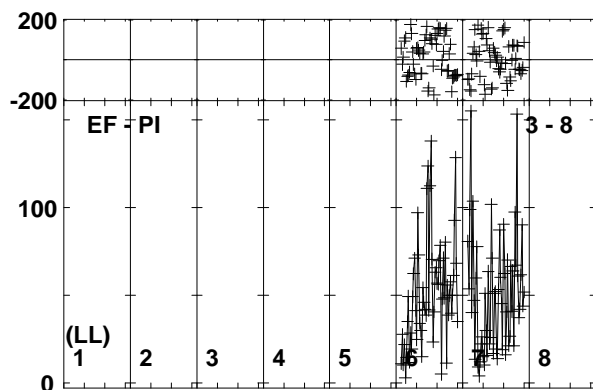
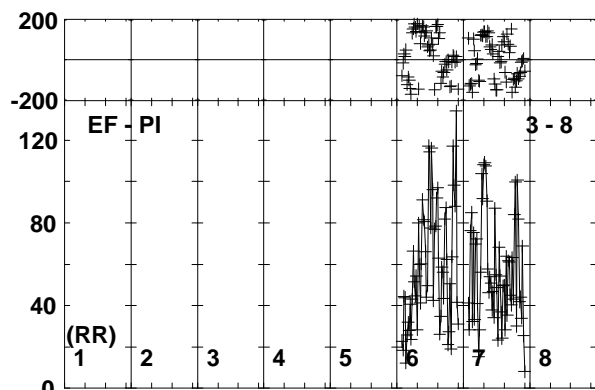
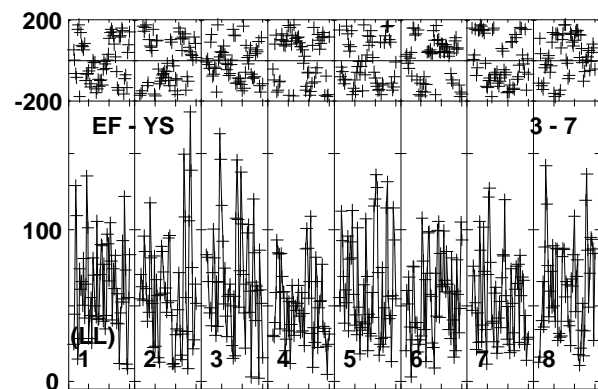
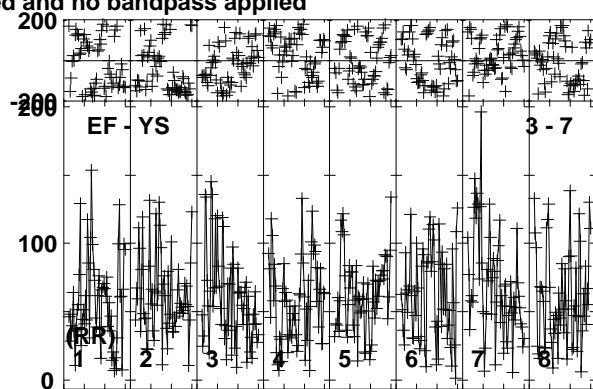
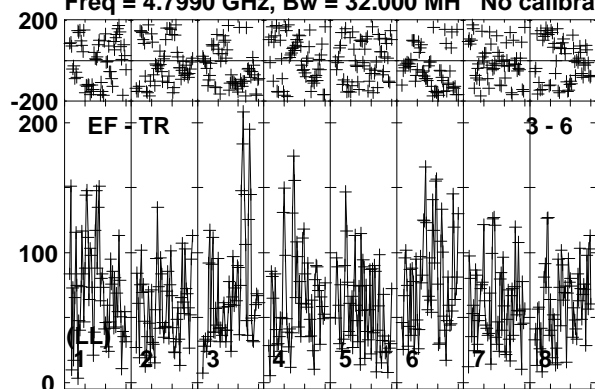

Lower frame: Micro Ampl Jy Top frame: Phas deg  
Vector averaged cross-power spectrum Baseline: EF (03) - TR (06)  
Timerange: 01/04:01:03 to 01/04:04:59



Plot file version 435 created 11-NOV-2019 15:08:06

SER8NJ EK040B.UVDATA.1

Freq = 4.7990 GHz, Bw = 32.000 MH No calibration applied and no bandpass applied

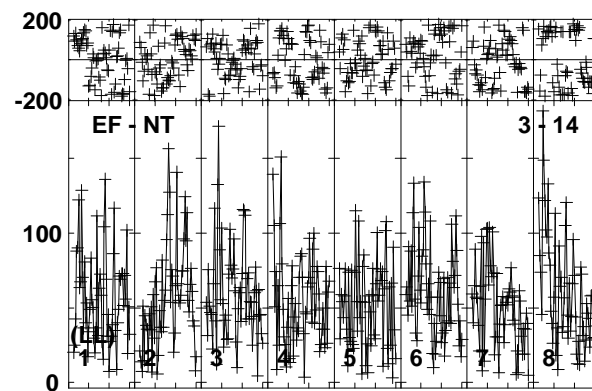
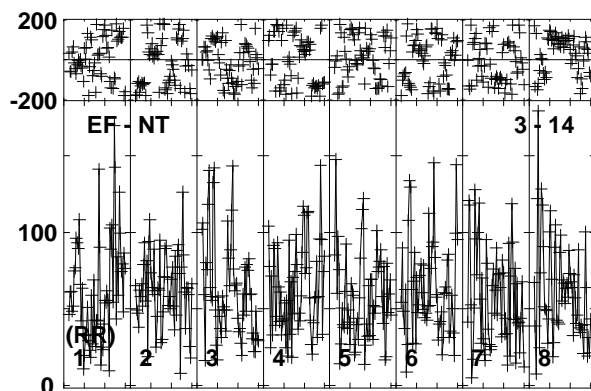
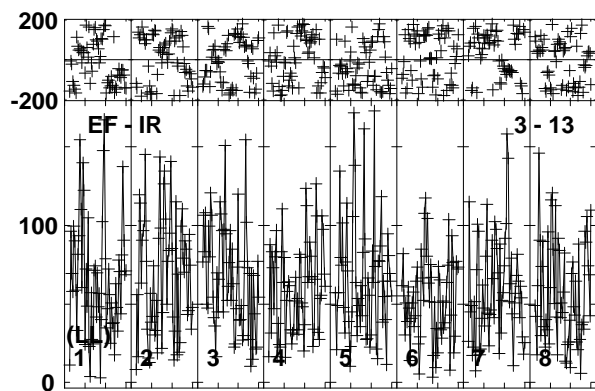
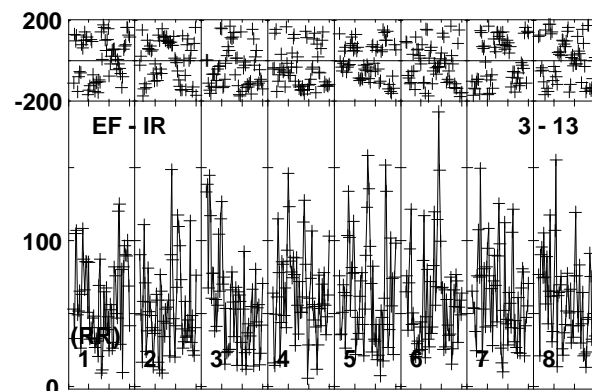
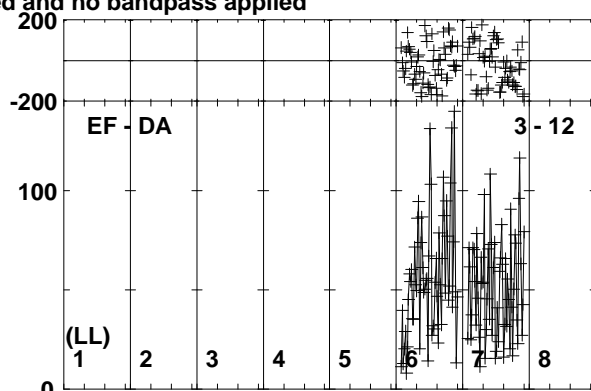
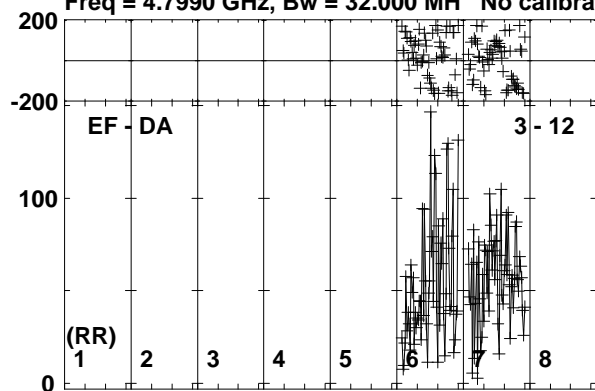

0 40 0 40 0 40 0 40 0 40 0 40 0 40 0 40 0 40 0 40  
Channels

Lower frame: Micro Ampl Jy Top frame: Phas deg  
Vector averaged cross-power spectrum Baseline: EF (03) - DA (12)  
Timerange: 01/04:01:03 to 01/04:04:59

Plot file version 436 created 11-NOV-2019 15:08:06

J1826+0149 EK040B.UVDATA.1

Freq = 4.7990 GHz, Bw = 32.000 MH No calibration applied and no bandpass applied

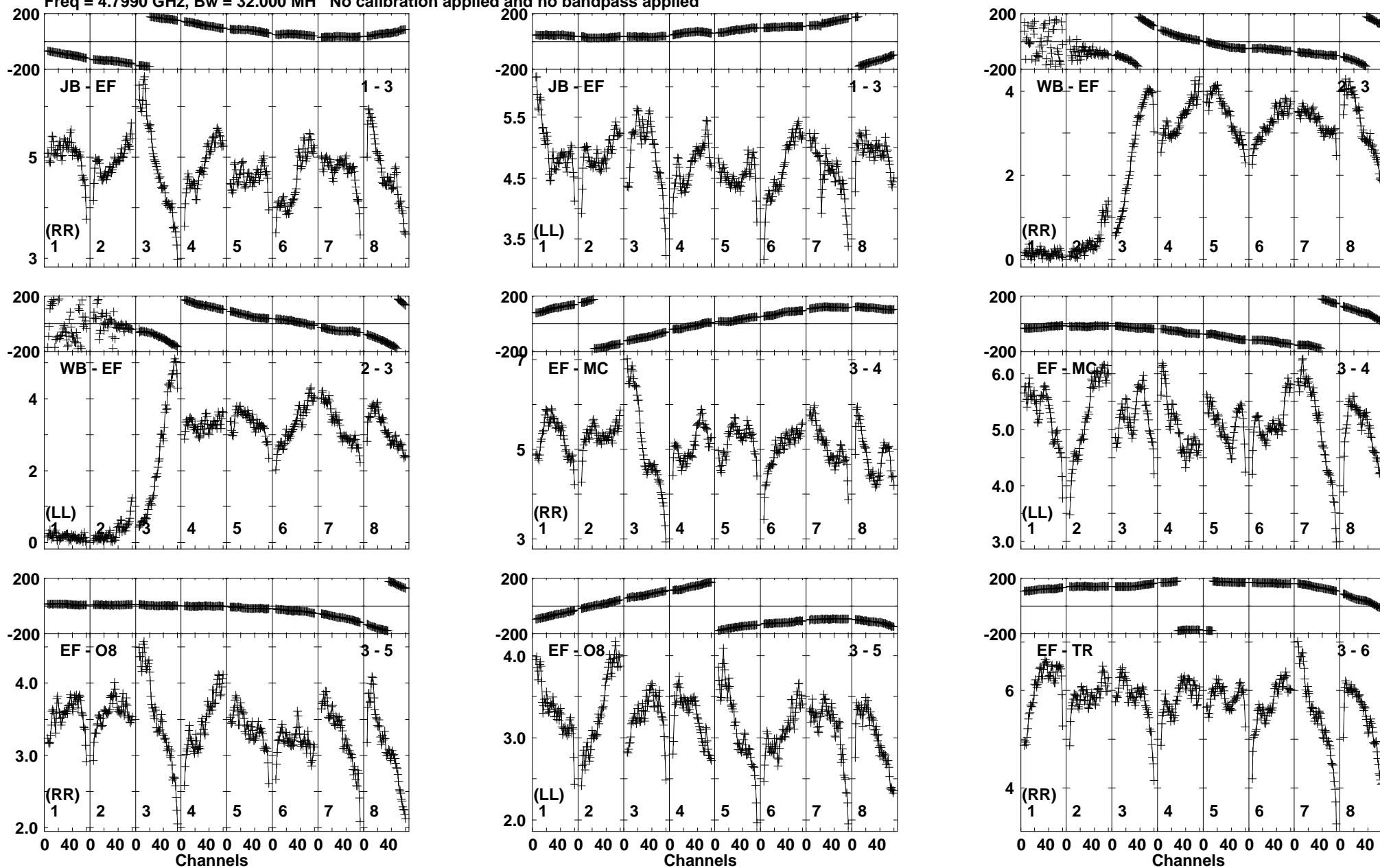

Lower frame: Milli Ampl Jy Top frame: Phas deg  
Vector averaged cross-power spectrum Baseline: JB (01) - EF (03)  
Timerange: 01/04:05:41 to 01/04:06:39

Plot file version 437 created 11-NOV-2019 15:08:06

J1826+0149 EK040B.UVDATA.1

Freq = 4.7990 GHz, Bw = 32.000 MH No calibration applied and no bandpass applied

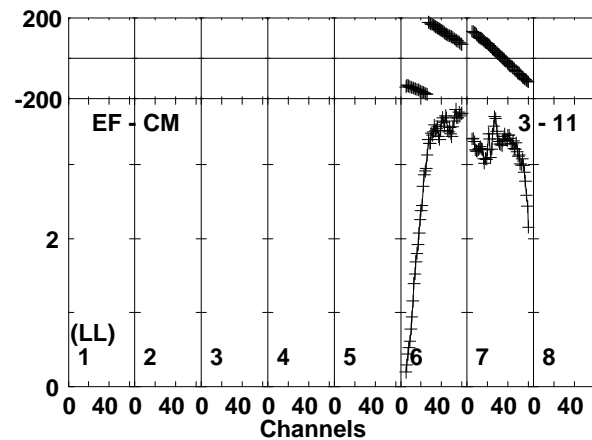
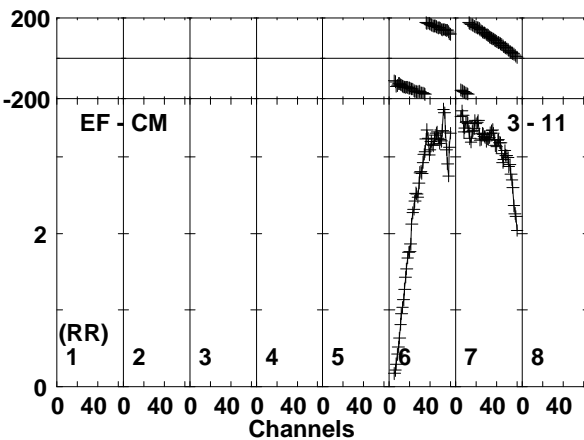
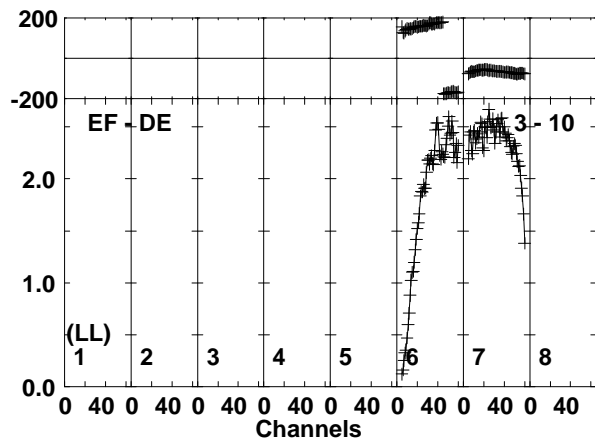
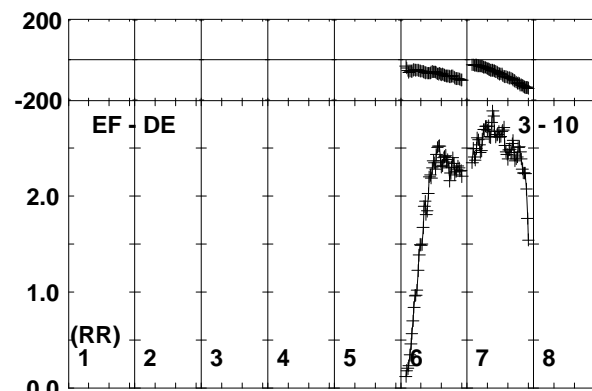
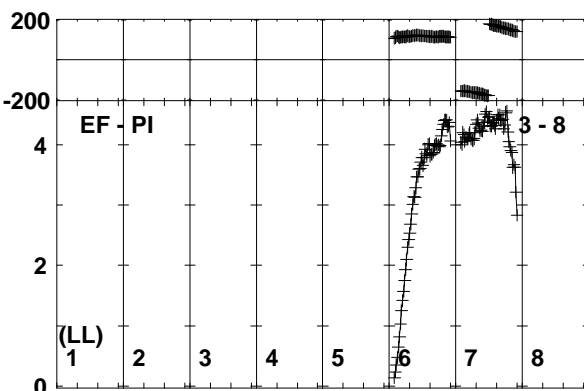
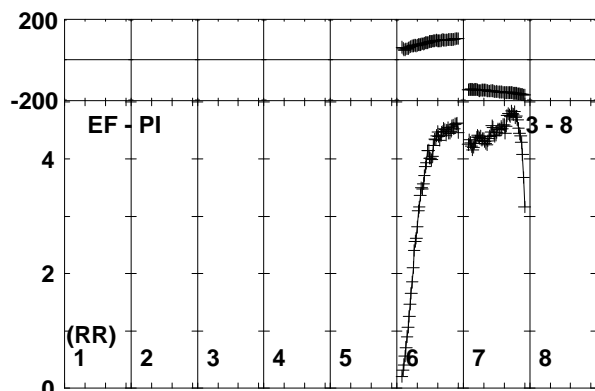
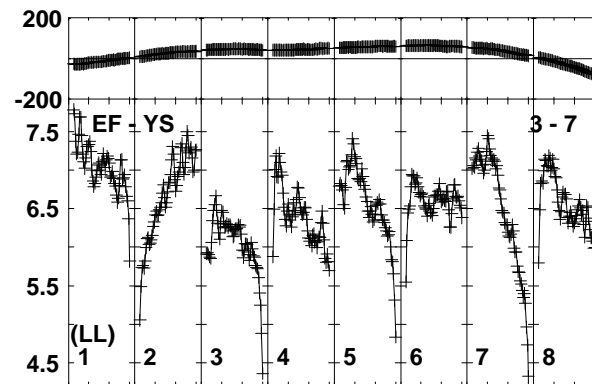
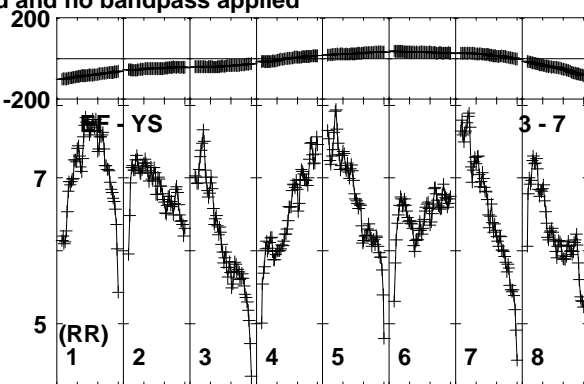
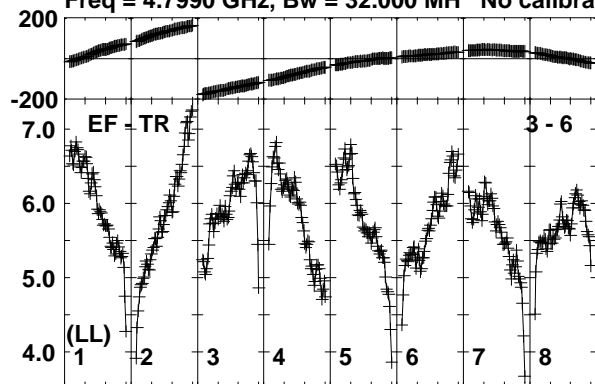

Lower frame: Milli Ampl Jy Top frame: Phas deg  
Vector averaged cross-power spectrum Baseline: EF (03) - TR (06)  
Timerange: 01/04:05:41 to 01/04:06:39

Plot file version 438 created 11-NOV-2019 15:08:06

J1826+0149 EK040B.UVDATA.1

Freq = 4.7990 GHz, Bw = 32.000 MH No calibration applied and no bandpass applied

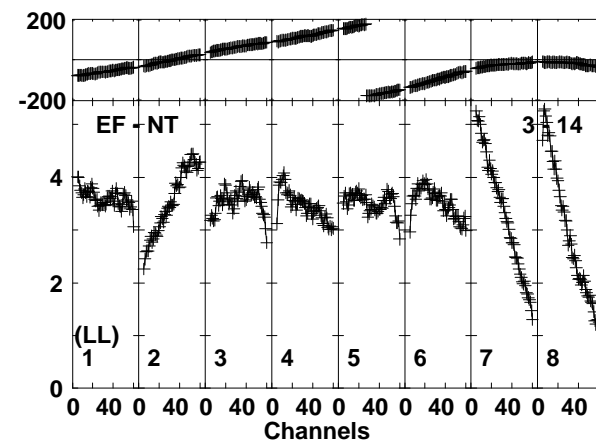
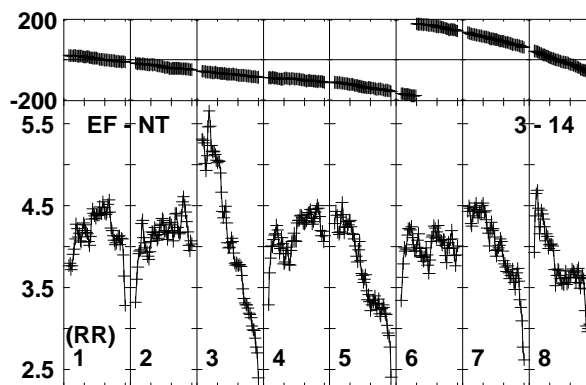
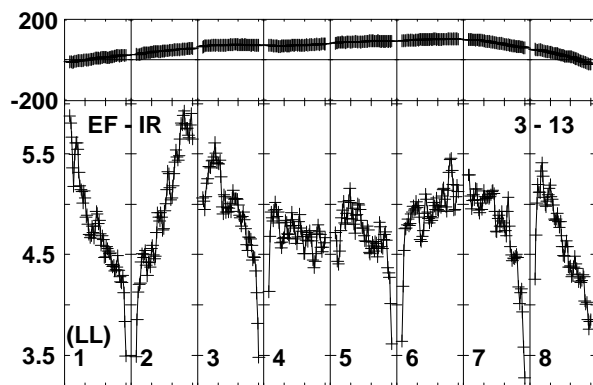
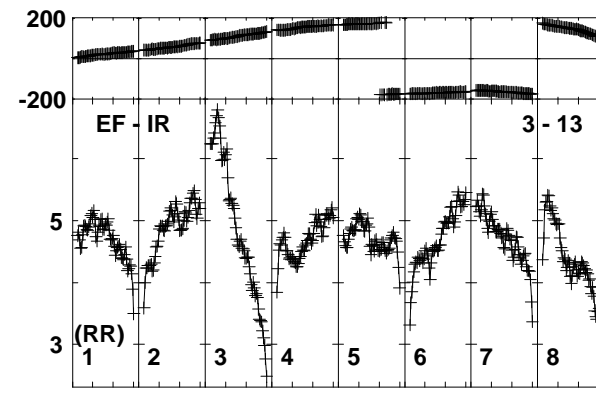
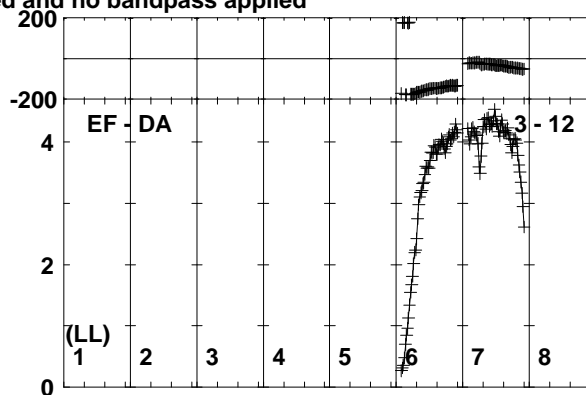
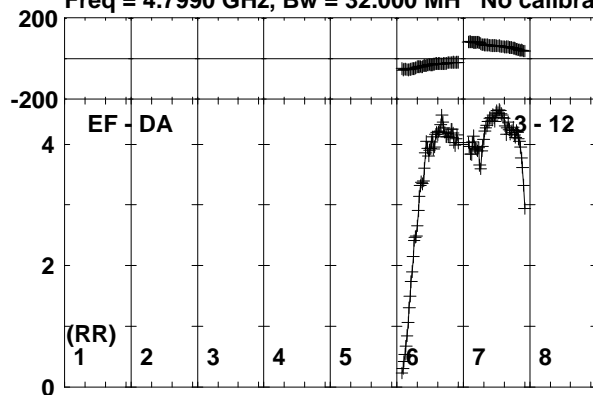

Lower frame: Milli Ampl Jy Top frame: Phas deg  
Vector averaged cross-power spectrum Baseline: EF (03) - DA (12)  
Timerange: 01/04:05:41 to 01/04:06:39

Plot file version 439 created 11-NOV-2019 15:08:06

SER8NJ EK040B.UVDATA.1

Freq = 4.7990 GHz, Bw = 32.000 MH No calibration applied and no bandpass applied

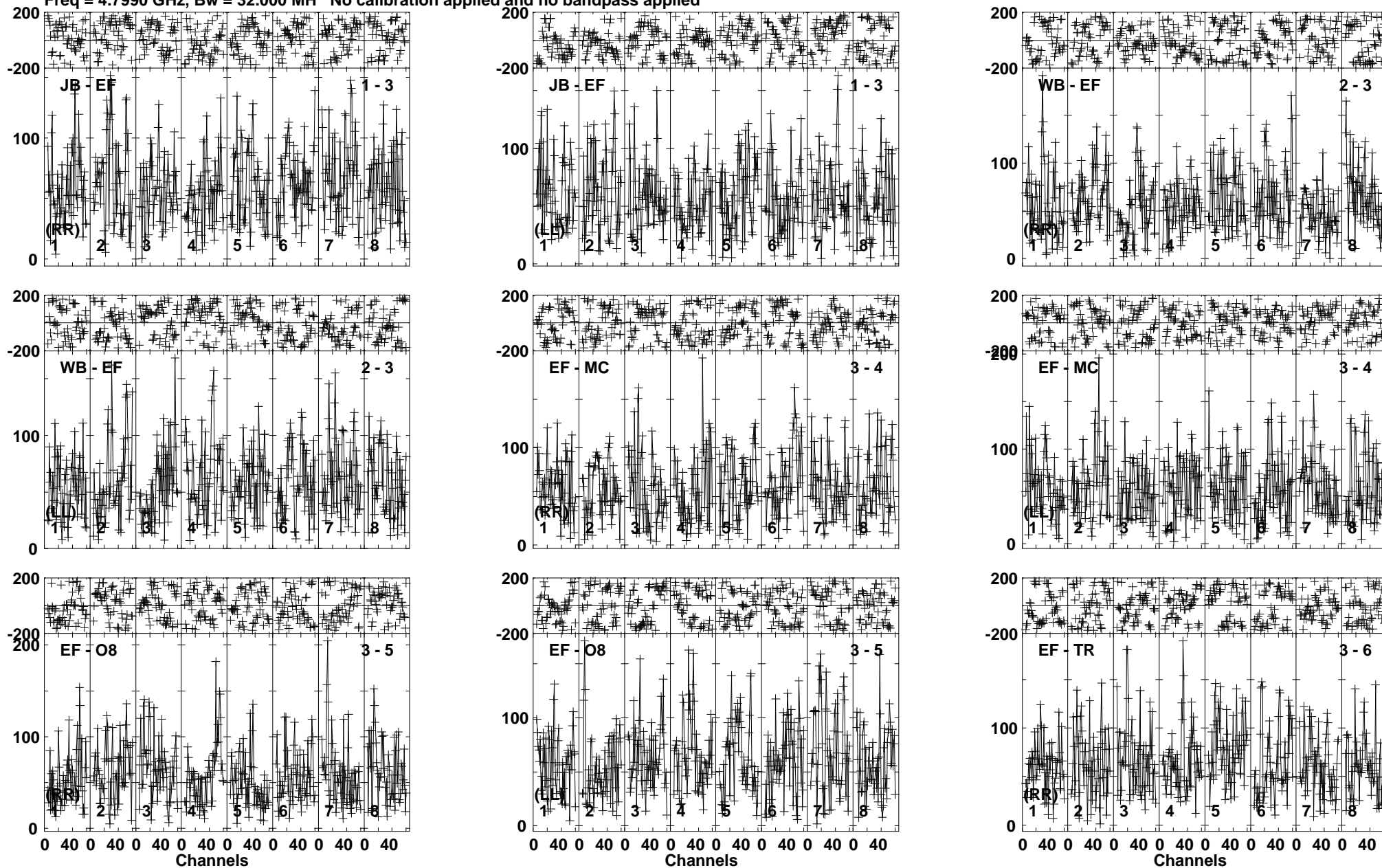

Lower frame: Micro Ampl Jy Top frame: Phas deg  
Vector averaged cross-power spectrum Baseline: JB (01) - EF (03)  
Timerange: 01/04:06:43 to 01/04:10:39

Plot file version 440 created 11-NOV-2019 15:08:06

SER8NJ EK040B.UVDATA.1

Freq = 4.7990 GHz, Bw = 32.000 MH No calibration applied and no bandpass applied

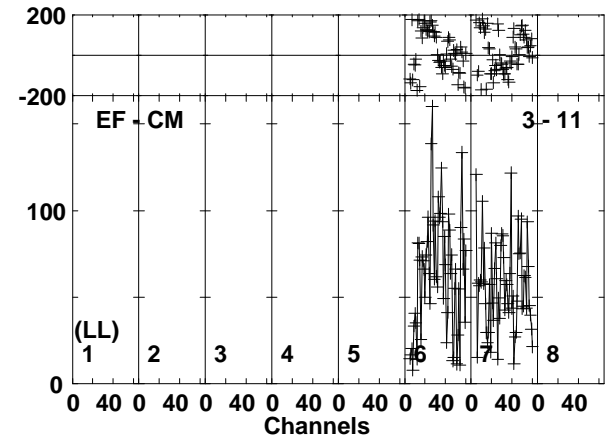
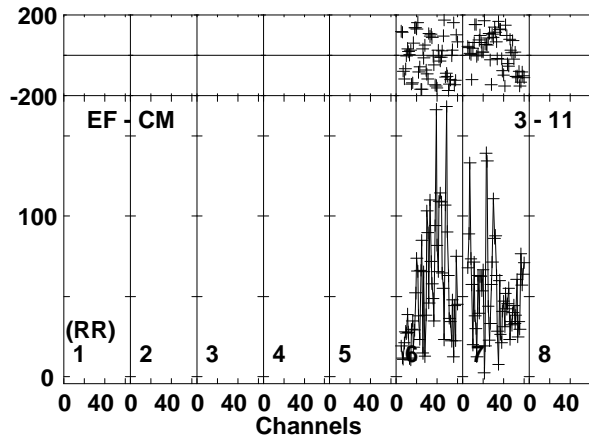
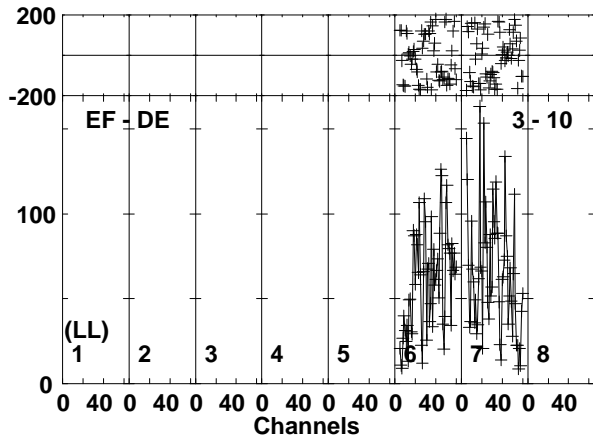
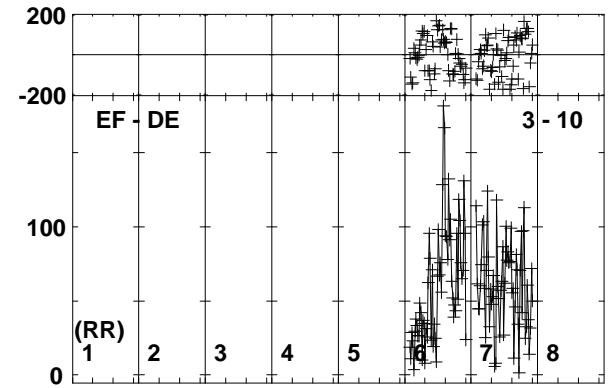
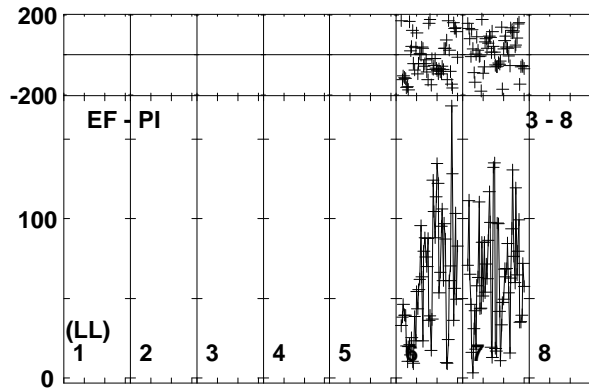
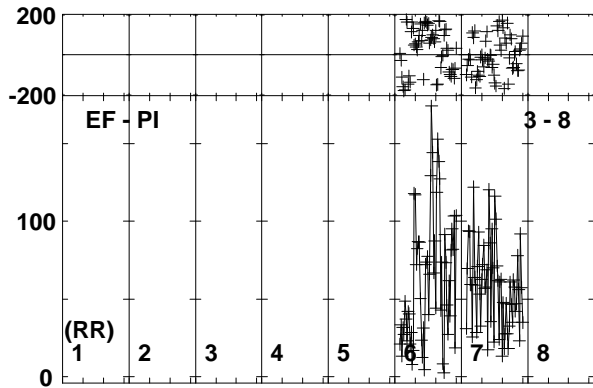
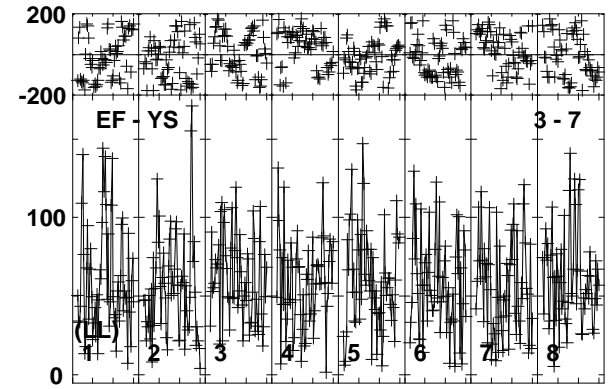
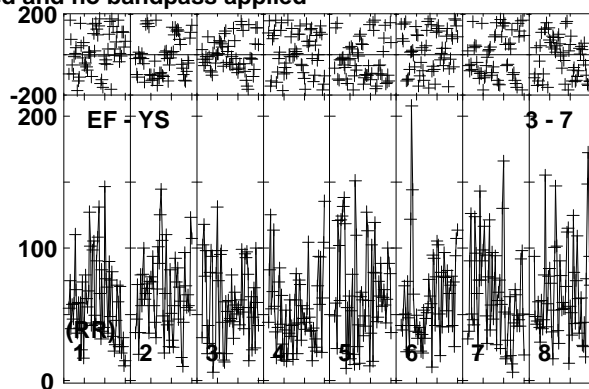
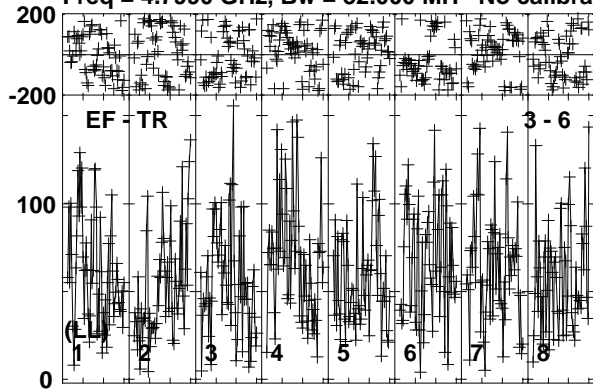

Lower frame: Micro Ampl Jy Top frame: Phas deg  
Vector averaged cross-power spectrum Baseline: EF (03) - TR (06)  
Timerange: 01/04:06:43 to 01/04:10:39

Plot file version 441 created 11-NOV-2019 15:08:06

SER8NJ EK040B.UVDATA.1

Freq = 4.7990 GHz, Bw = 32.000 MH No calibration applied and no bandpass applied

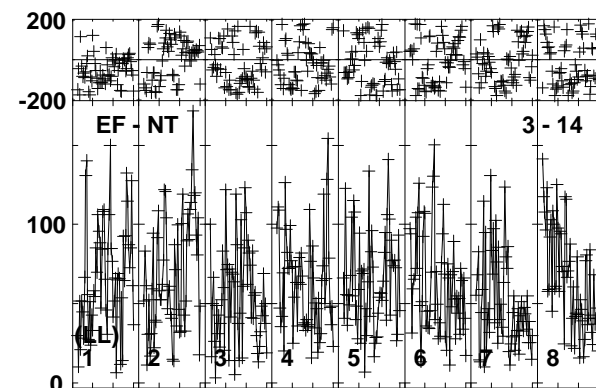
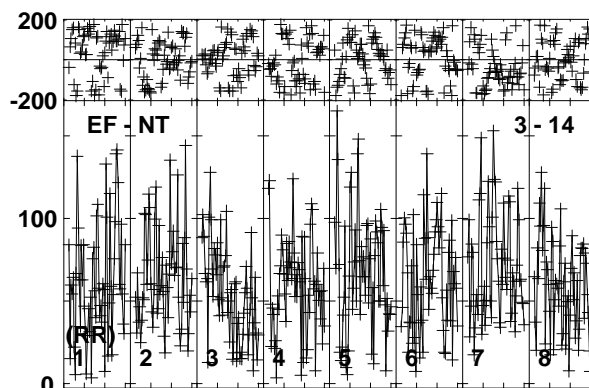
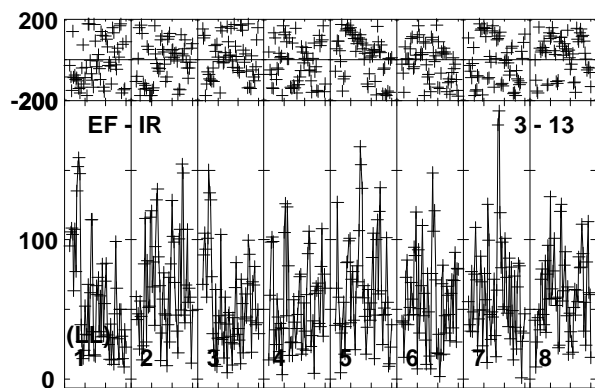
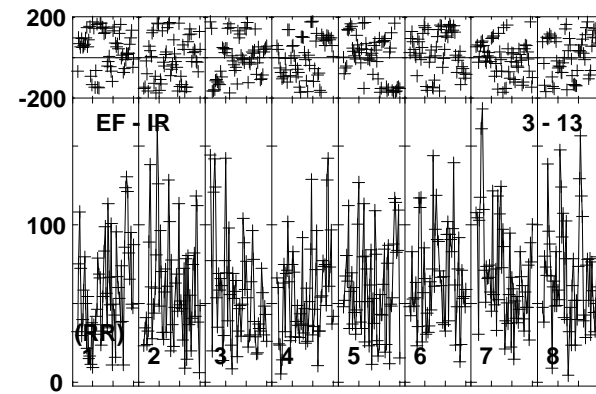
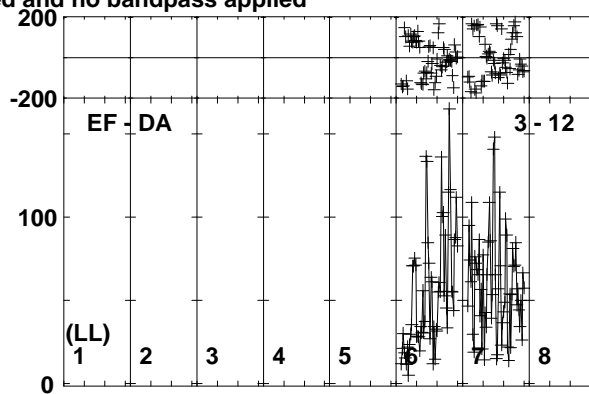
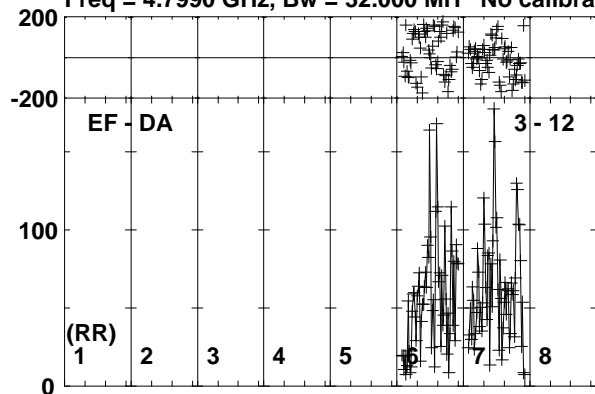

0 40 0 40 0 40 0 40 0 40 0 40 0 40 0 40 0 40  
Channels

Lower frame: Micro Ampl Jy Top frame: Phas deg  
Vector averaged cross-power spectrum Baseline: EF (03) - DA (12)  
Timerange: 01/04:06:43 to 01/04:10:39

Plot file version 442 created 11-NOV-2019 15:08:06

J1826+0149 EK040B.UVDATA.1

Freq = 4.7990 GHz, Bw = 32.000 MH No calibration applied and no bandpass applied

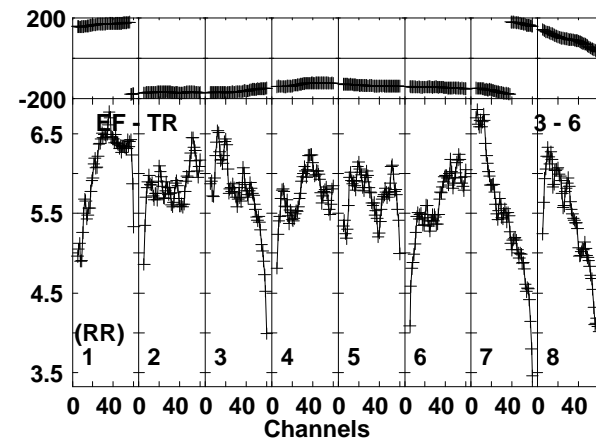
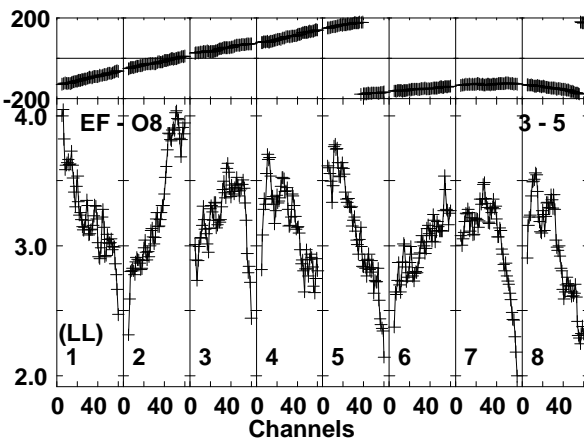
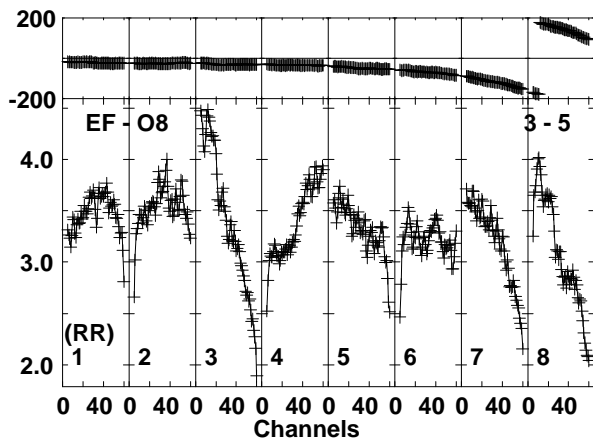
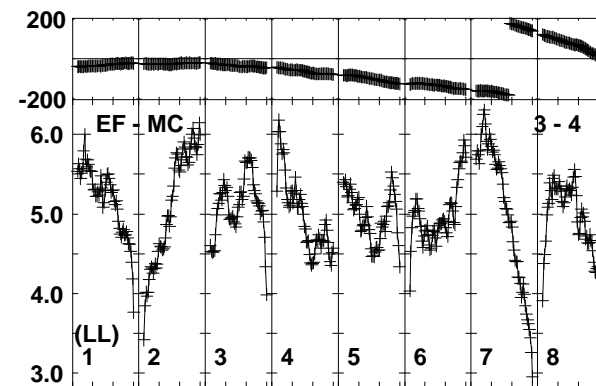
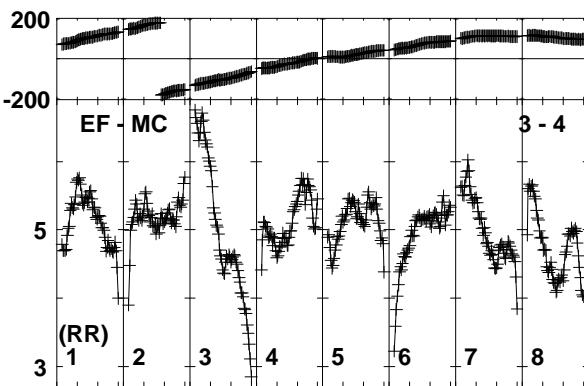
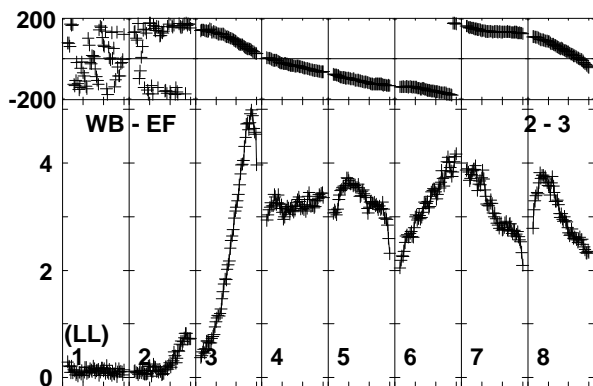
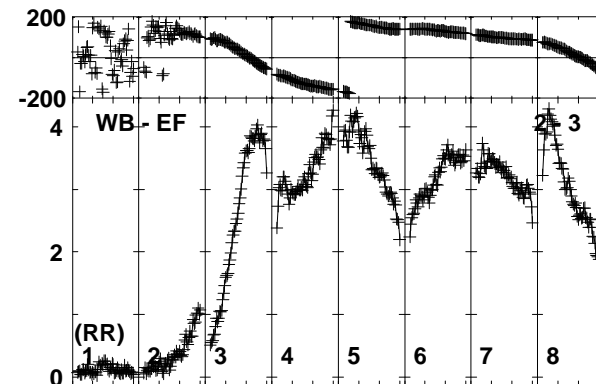
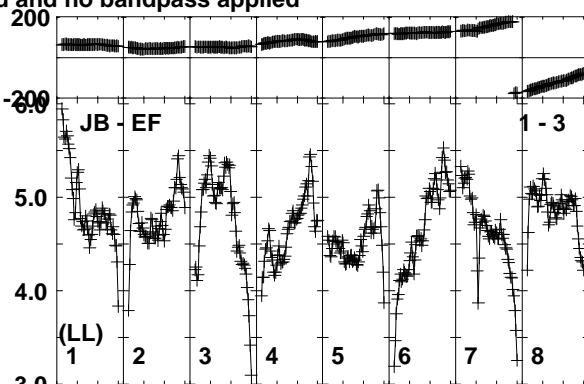
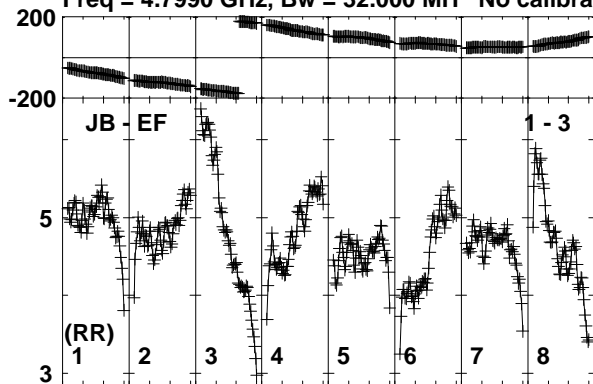

Lower frame: Milli Ampl Jy Top frame: Phas deg  
Vector averaged cross-power spectrum Baseline: JB (01) - EF (03)  
Timerange: 01/04:10:41 to 01/04:12:09



Plot file version 443 created 11-NOV-2019 15:08:06

J1826+0149 EK040B.UVDATA.1

Freq = 4.7990 GHz, Bw = 32.000 MH No calibration applied and no bandpass applied

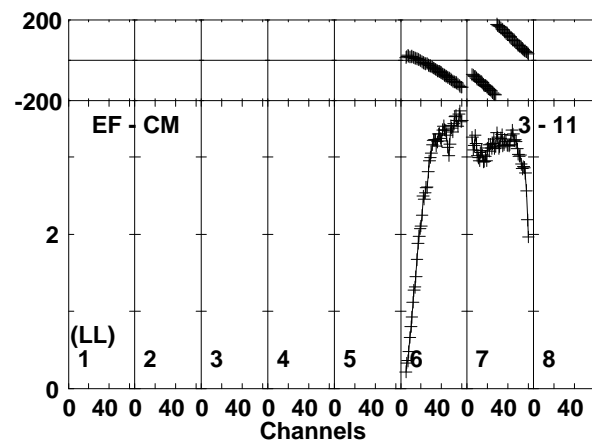
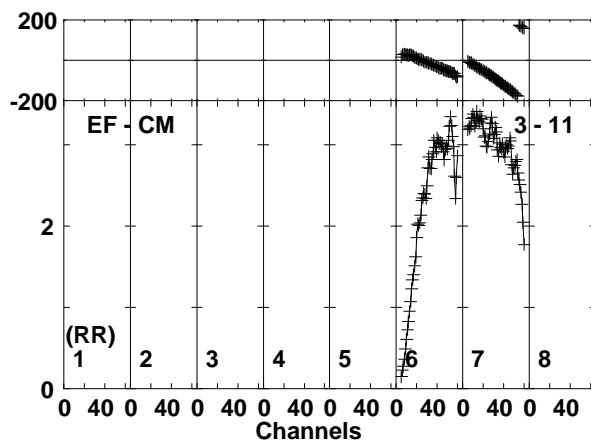
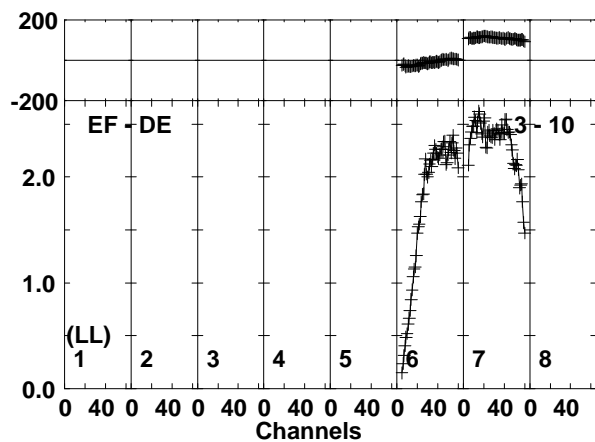
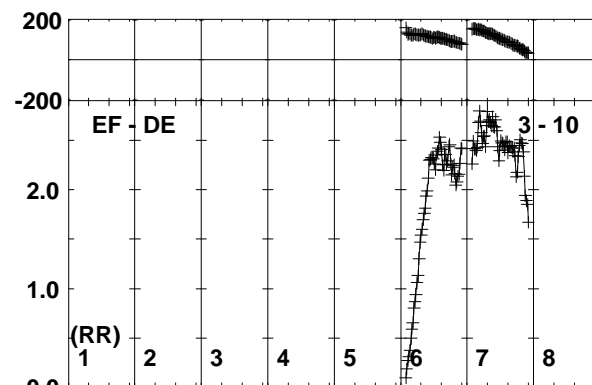
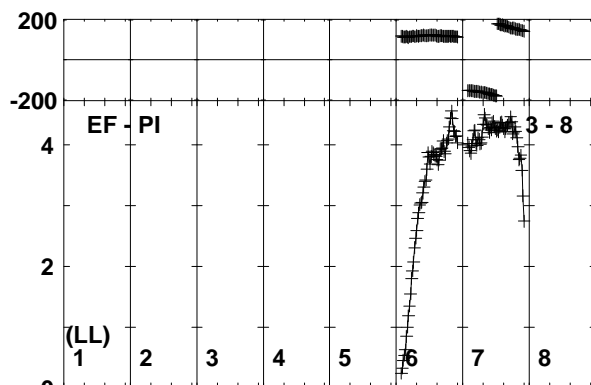
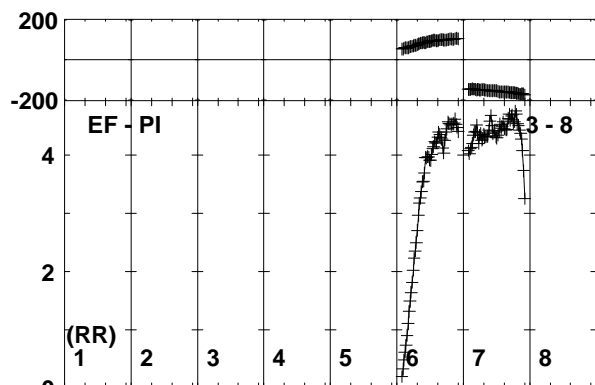
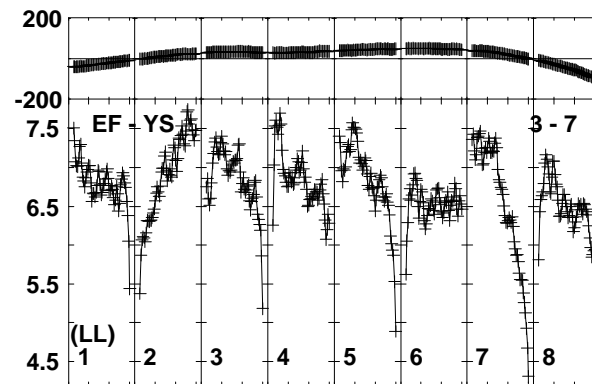
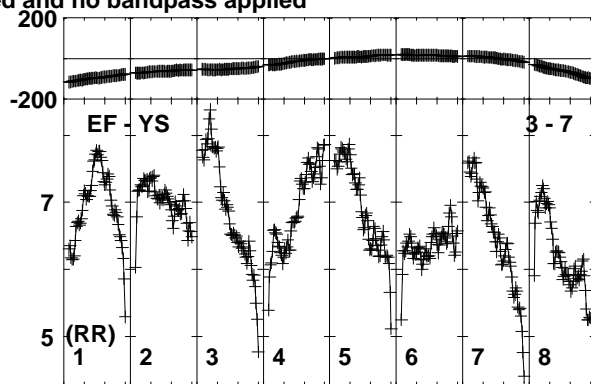
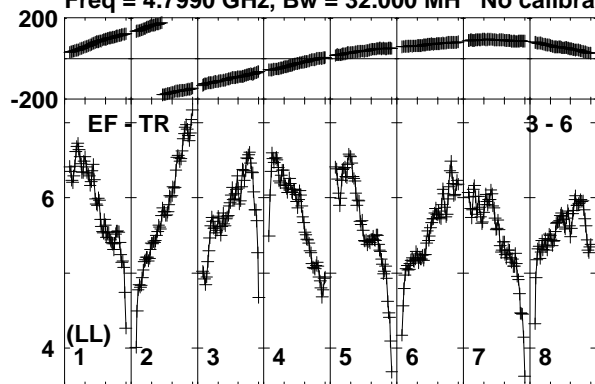

Lower frame: Milli Ampl Jy Top frame: Phas deg  
Vector averaged cross-power spectrum Baseline: EF (03) - TR (06)  
Timerange: 01/04:10:41 to 01/04:12:09

Plot file version 444 created 11-NOV-2019 15:08:07

J1826+0149 EK040B.UVDATA.1

Freq = 4.7990 GHz, Bw = 32.000 MH No calibration applied and no bandpass applied

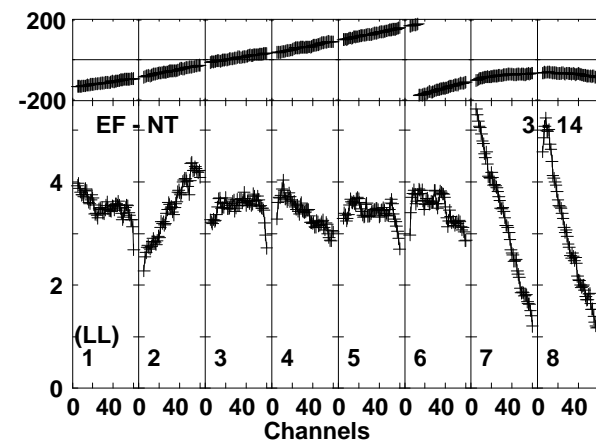
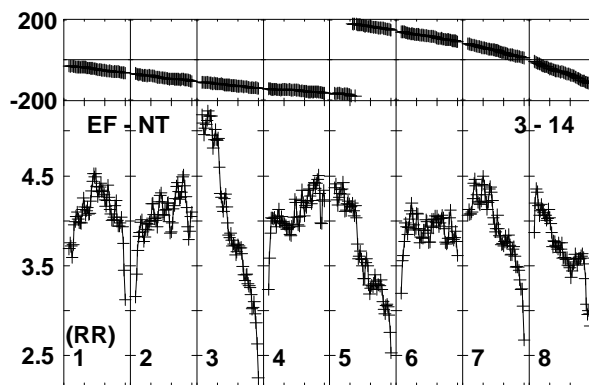
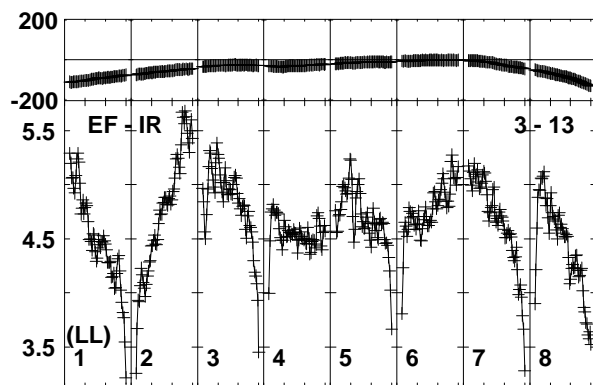
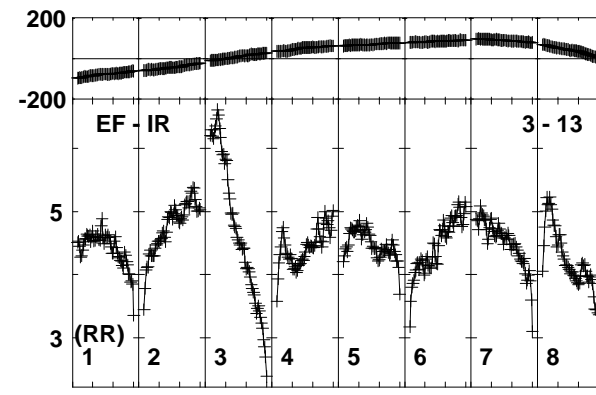
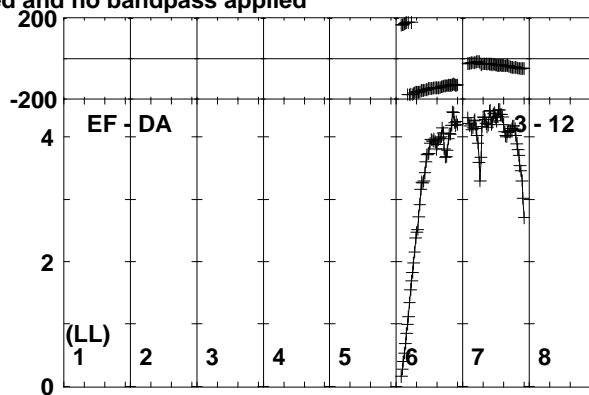
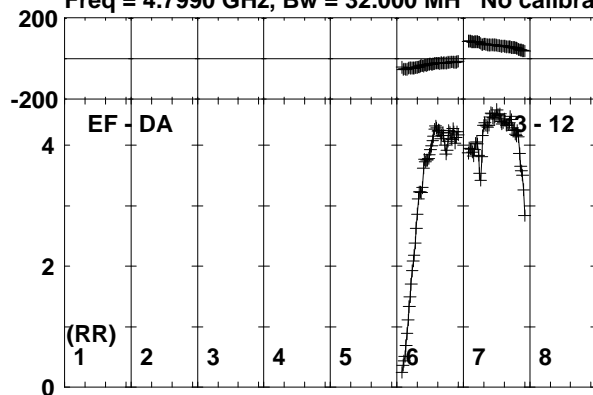

Lower frame: Milli Ampl Jy Top frame: Phas deg  
Vector averaged cross-power spectrum Baseline: EF (03) - DA (12)  
Timerange: 01/04:10:41 to 01/04:12:09

Plot file version 445 created 11-NOV-2019 15:08:07  
 SER8NJ\_EK040B.UVDATA.1  
 Freq = 4.7990 GHz, Bw = 32.000 MH No calibration applied and no bandpass applied

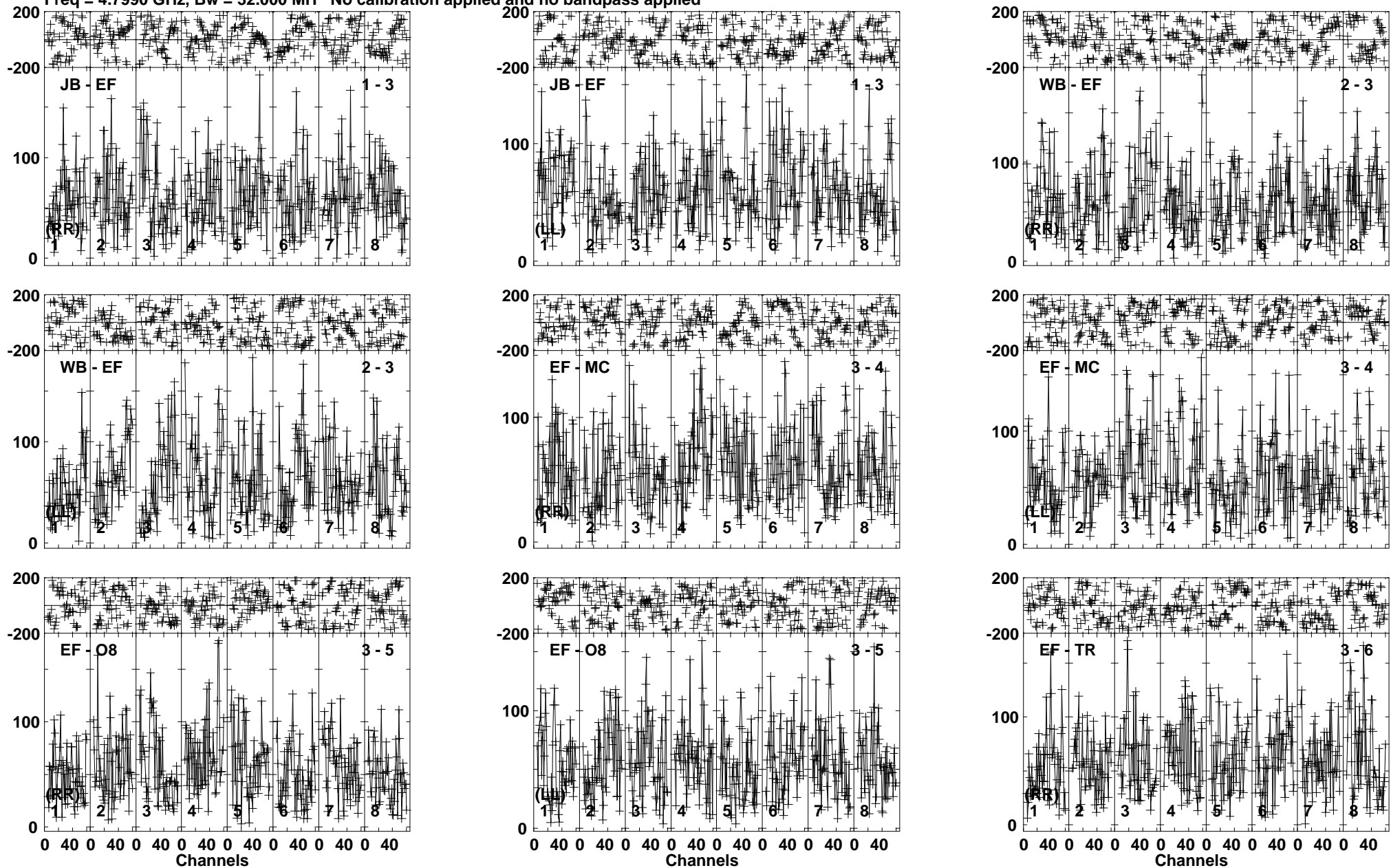

Lower frame: Micro Ampl Jy Top frame: Phas deg  
 Vector averaged cross-power spectrum Baseline: JB (01) - EF (03)  
 Timerange: 01/04:12:11 to 01/04:16:07

Plot file version 446 created 11-NOV-2019 15:08:07

SER8NJ EK040B.UVDATA.1

Freq = 4.7990 GHz, Bw = 32.000 MH No calibration applied and no bandpass applied

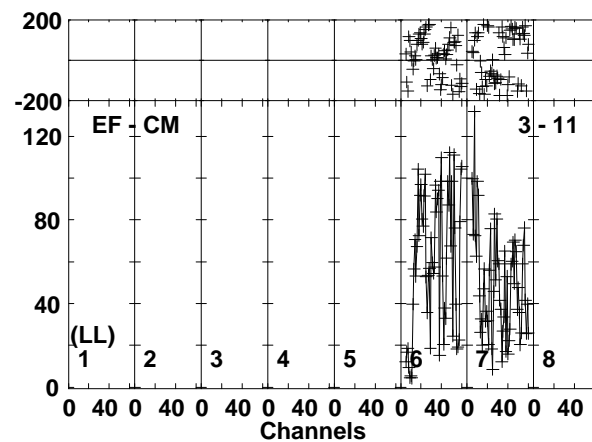
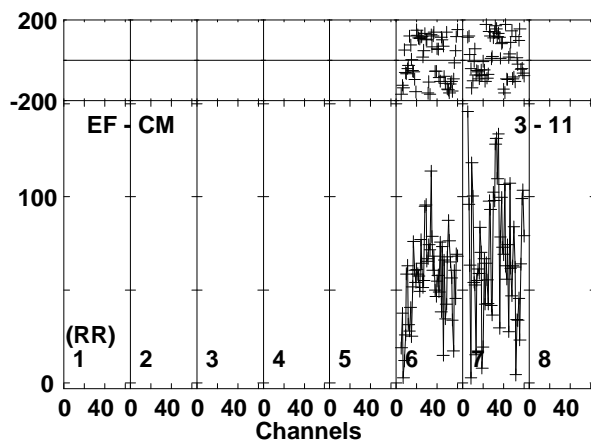
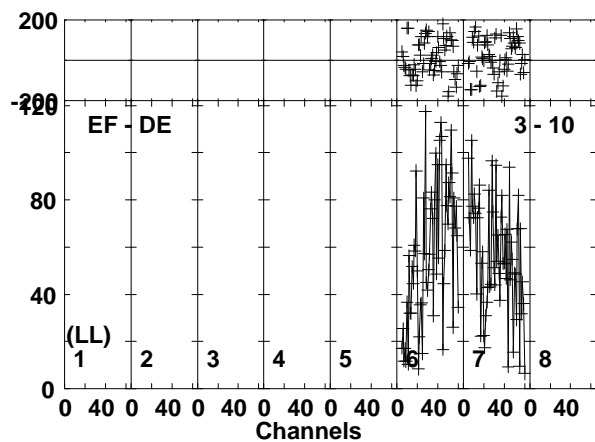
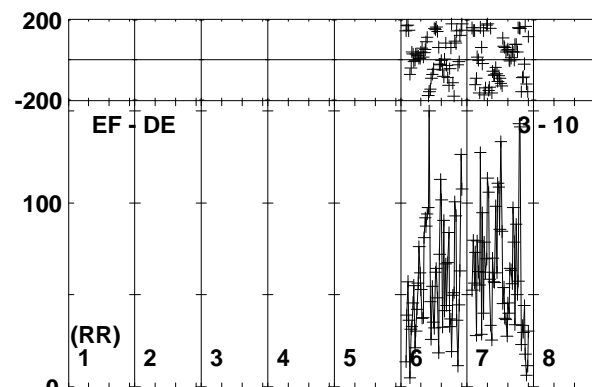
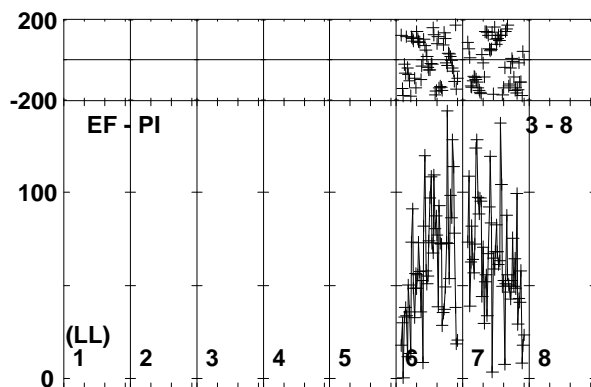
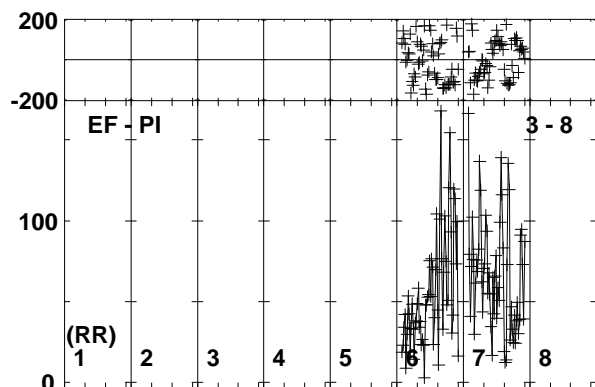
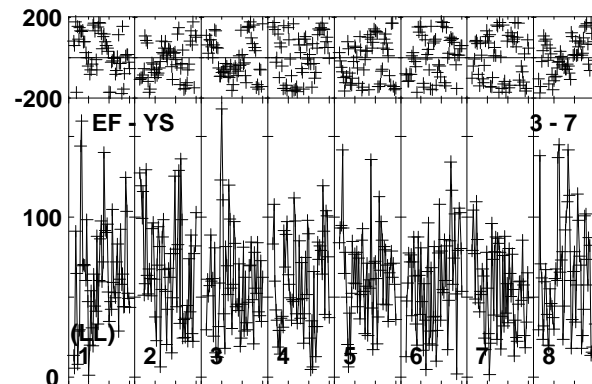
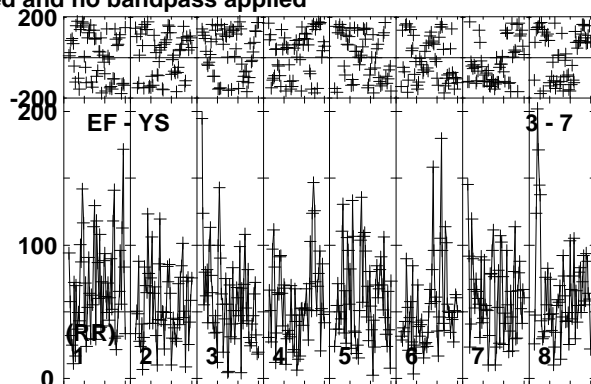
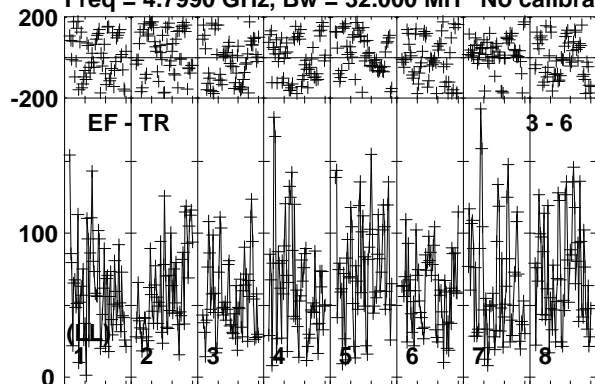

Lower frame: Micro Ampl Jy Top frame: Phas deg  
Vector averaged cross-power spectrum Baseline: EF (03) - TR (06)  
Timerange: 01/04:12:11 to 01/04:16:07

Plot file version 447 created 11-NOV-2019 15:08:07

SER8NJ EK040B.UVDATA.1

Freq = 4.7990 GHz, Bw = 32.000 MH No calibration applied and no bandpass applied

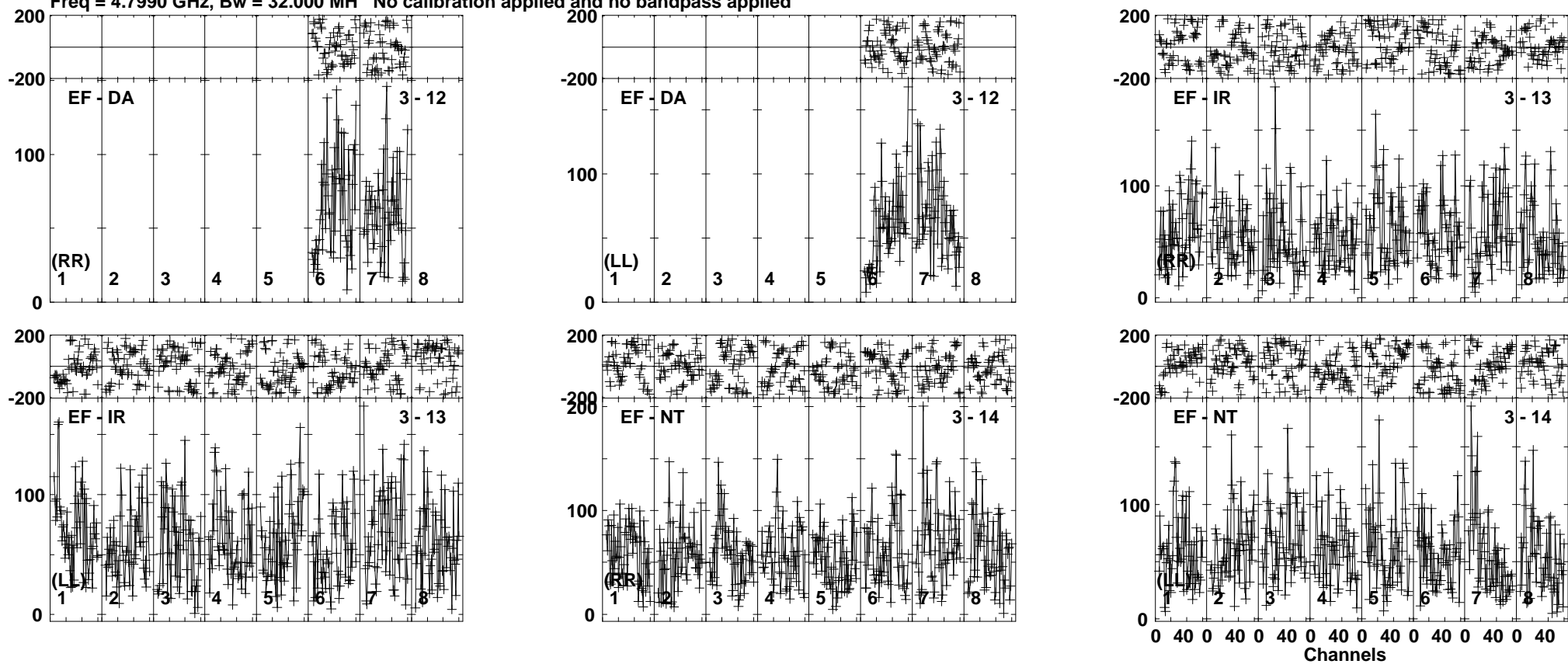

Lower frame: Micro Ampl Jy Top frame: Phas deg  
Vector averaged cross-power spectrum Baseline: EF (03) - DA (12)  
Timerange: 01/04:12:11 to 01/04:16:07

Plot file version 448 created 11-NOV-2019 15:08:07

J1826+0149 EK040B.UVDATA.1

Freq = 4.7990 GHz, Bw = 32.000 MH No calibration applied and no bandpass applied

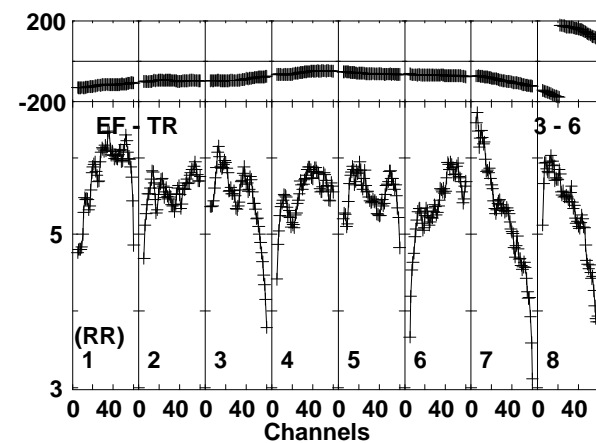
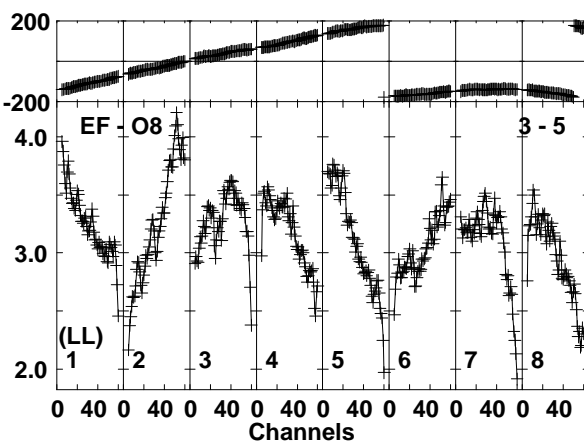
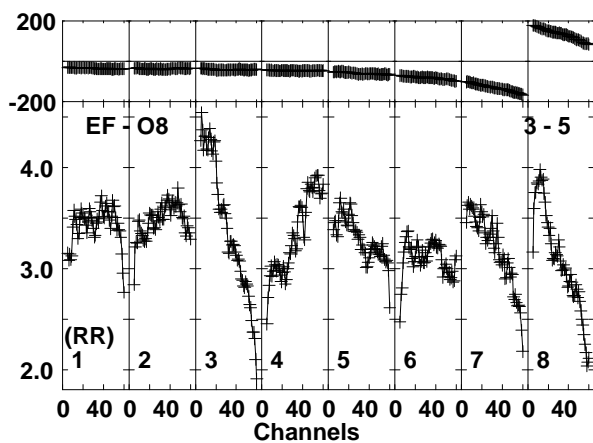
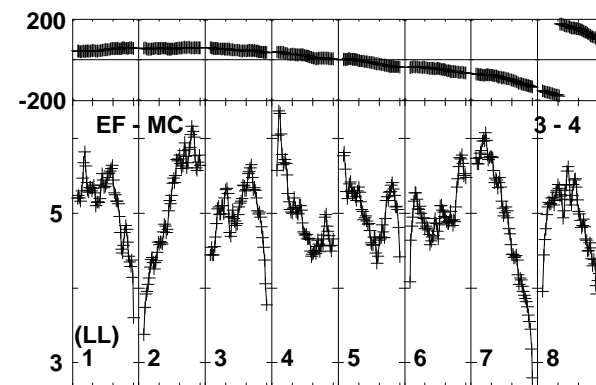
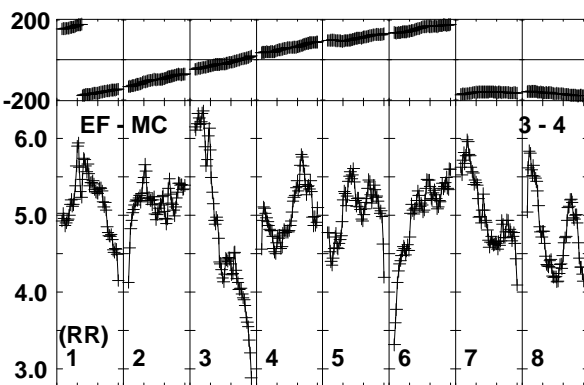
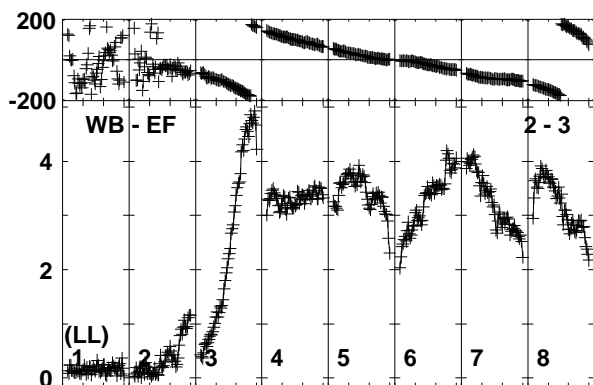
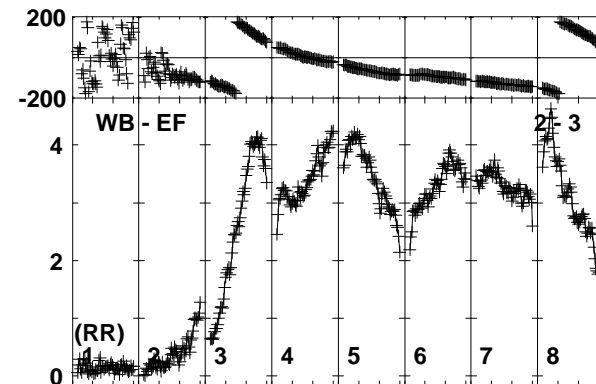
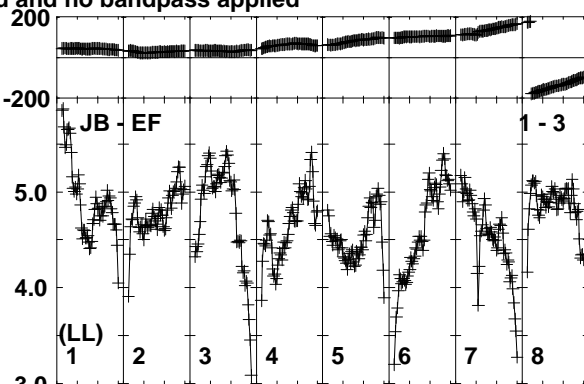
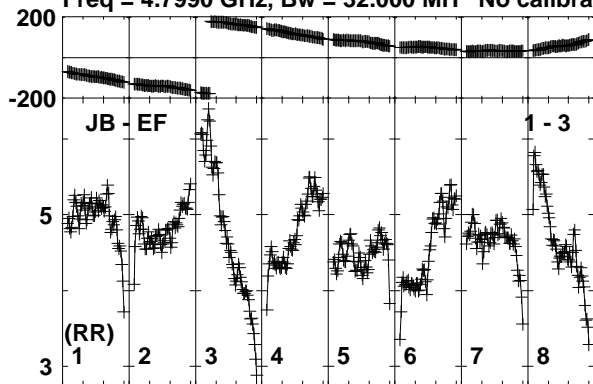

Lower frame: Milli Ampl Jy Top frame: Phas deg  
Vector averaged cross-power spectrum Baseline: JB (01) - EF (03)  
Timerange: 01/04:16:51 to 01/04:17:49

Plot file version 449 created 11-NOV-2019 15:08:07

J1826+0149 EK040B.UVDATA.1

Freq = 4.7990 GHz, Bw = 32.000 MH No calibration applied and no bandpass applied

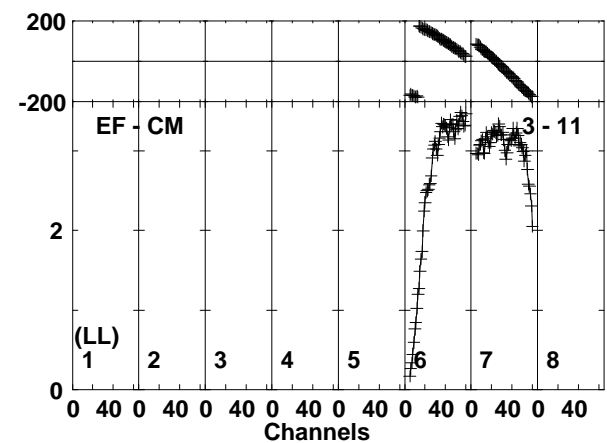
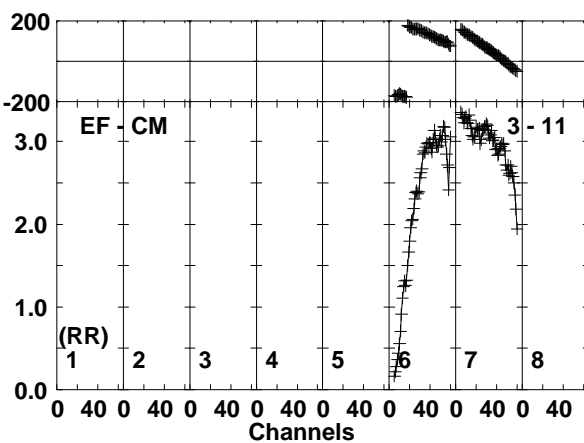
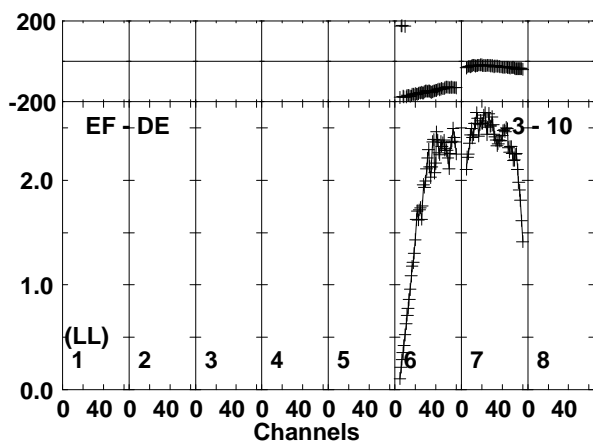
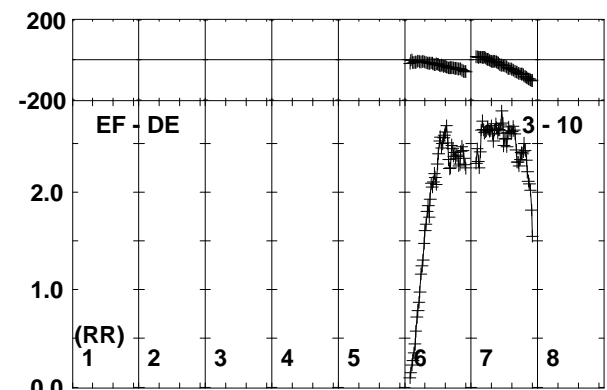
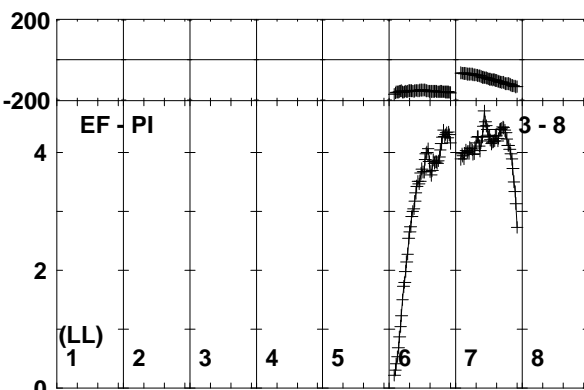
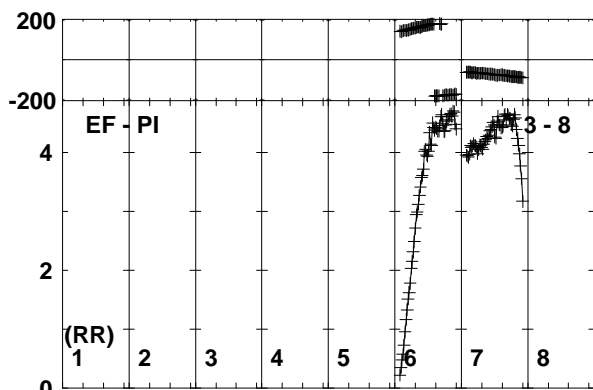
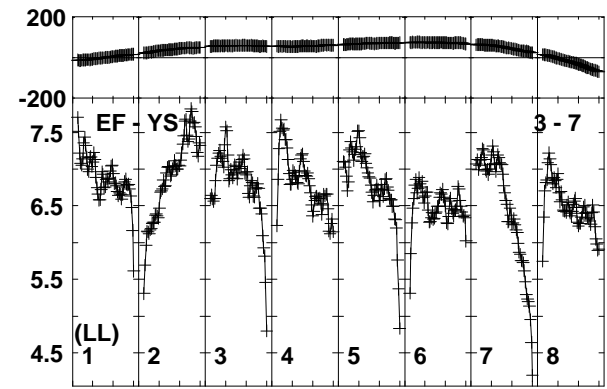
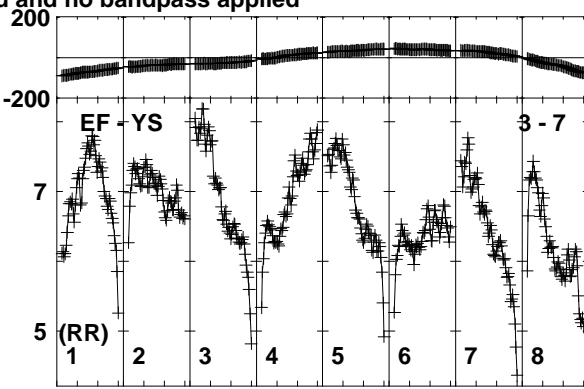
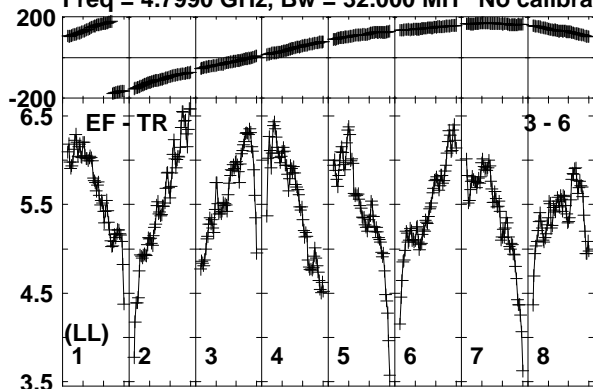

Lower frame: Milli Ampl Jy Top frame: Phas deg  
Vector averaged cross-power spectrum Baseline: EF (03) - TR (06)  
Timerange: 01/04:16:51 to 01/04:17:49

Plot file version 450 created 11-NOV-2019 15:08:07

J1826+0149 EK040B.UVDATA.1

Freq = 4.7990 GHz, Bw = 32.000 MH No calibration applied and no bandpass applied

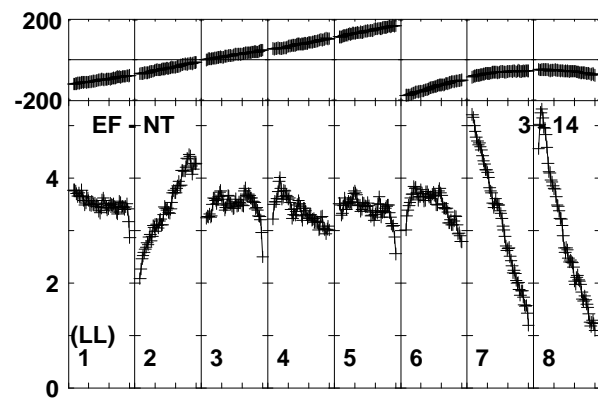
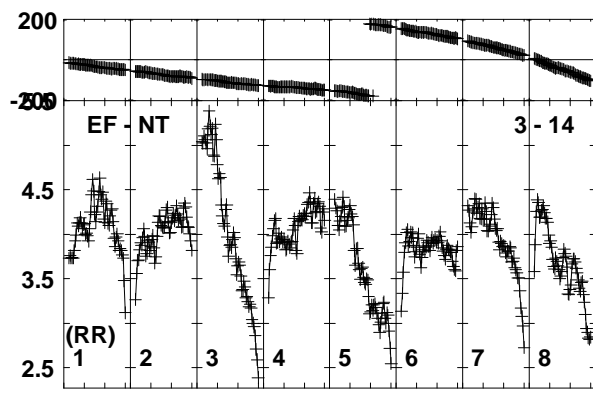
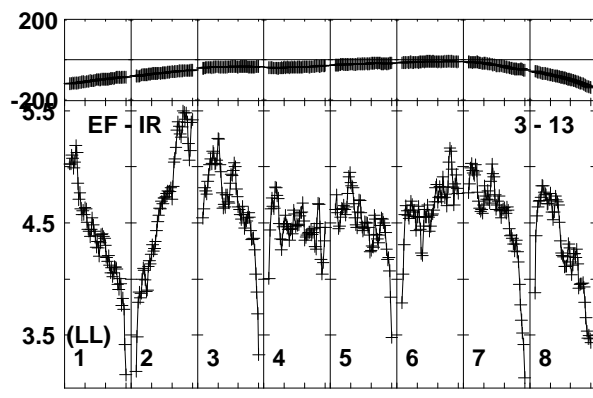
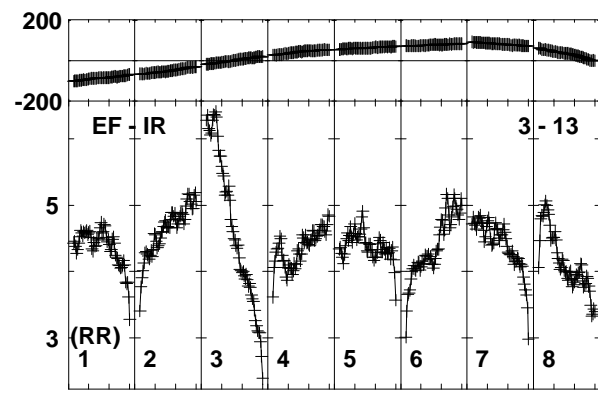
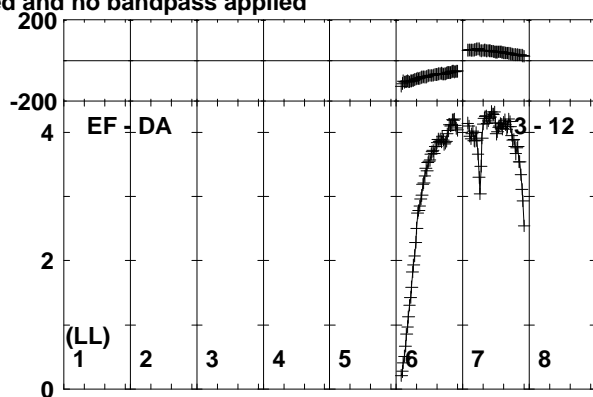
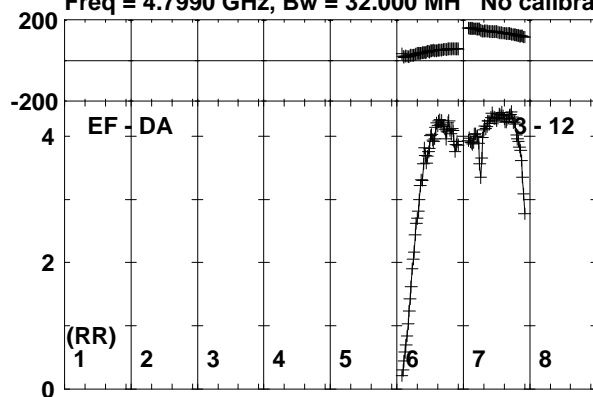

Channels

Lower frame: Milli Ampl Jy Top frame: Phas deg  
Vector averaged cross-power spectrum Baseline: EF (03) - DA (12)  
Timerange: 01/04:16:51 to 01/04:17:49



Plot file version 451 created 11-NOV-2019 15:08:07

SER8NJ EK040B.UVDATA.1

Freq = 4.7990 GHz, Bw = 32.000 MH No calibration applied and no bandpass applied

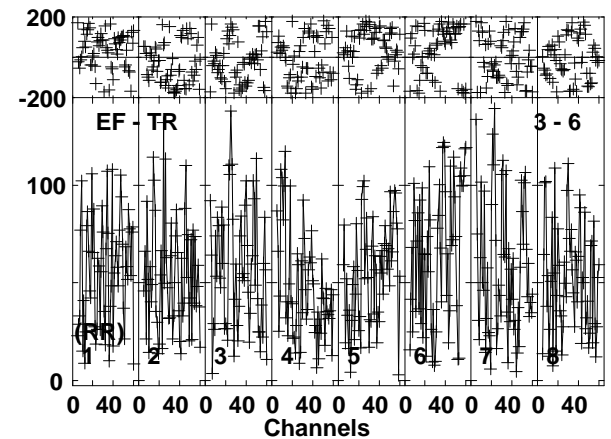
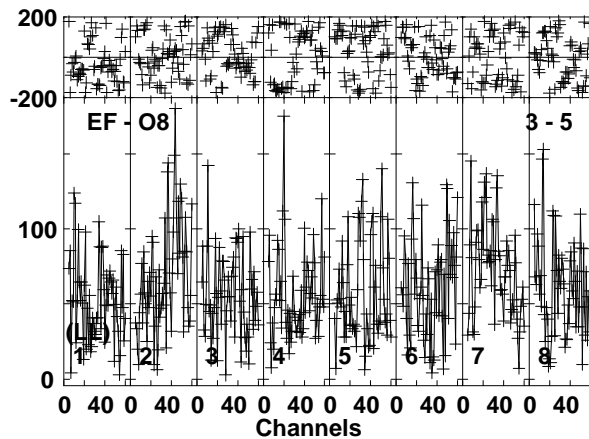
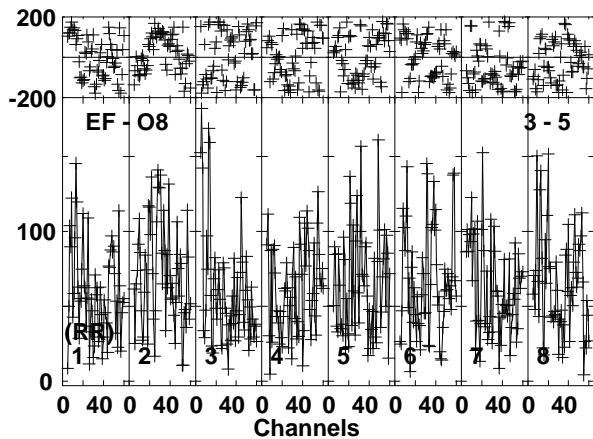
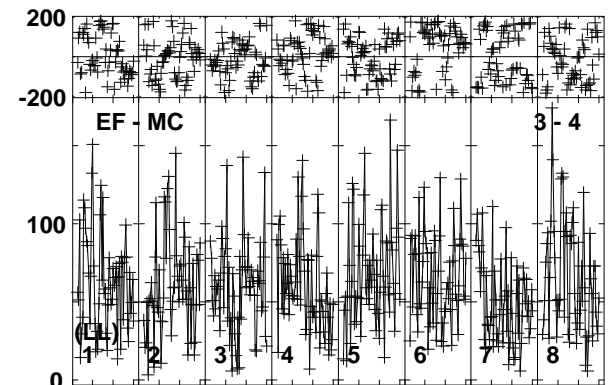
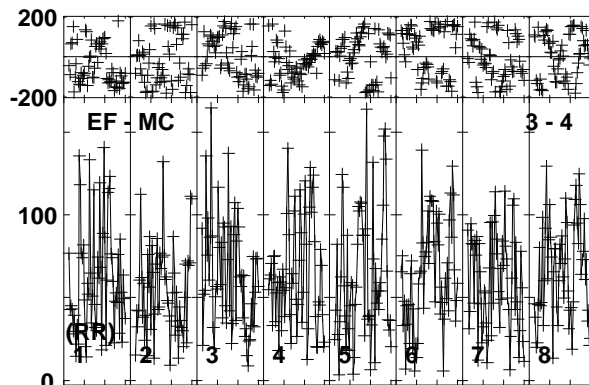
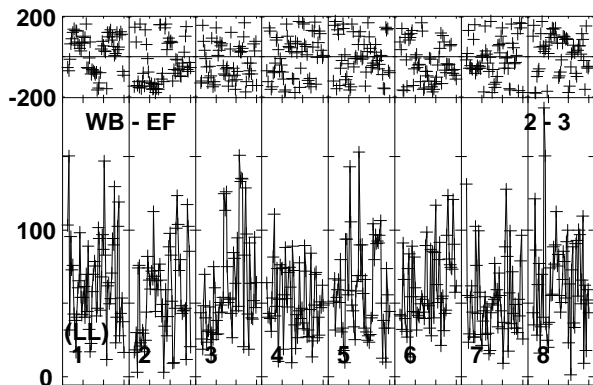
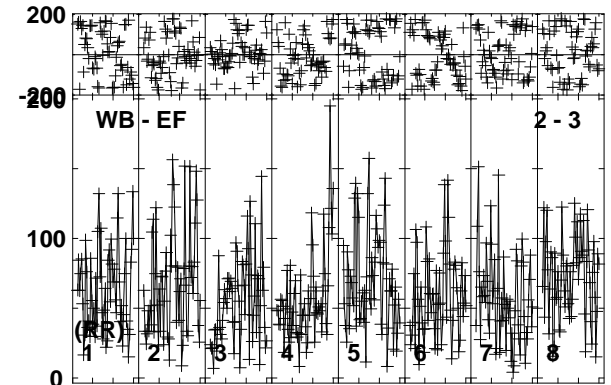
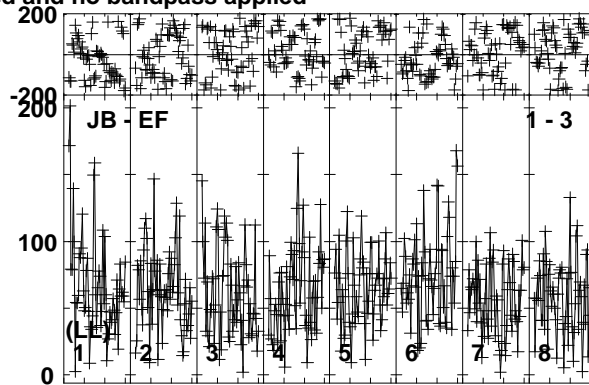
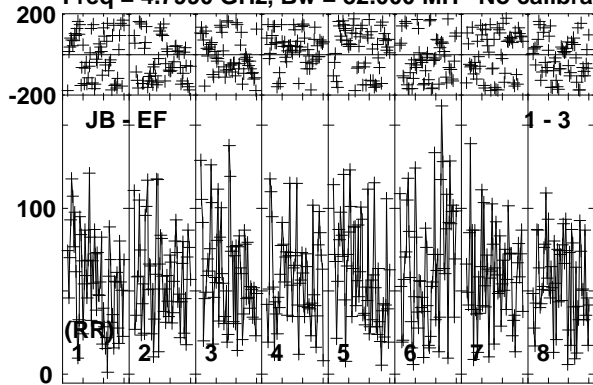

Lower frame: Micro Ampl Jy Top frame: Phas deg  
Vector averaged cross-power spectrum Baseline: JB (01) - EF (03)  
Timerange: 01/04:17:53 to 01/04:21:49

Plot file version 452 created 11-NOV-2019 15:08:07

SER8NJ EK040B.UVDATA.1

Freq = 4.7990 GHz, Bw = 32.000 MH No calibration applied and no bandpass applied

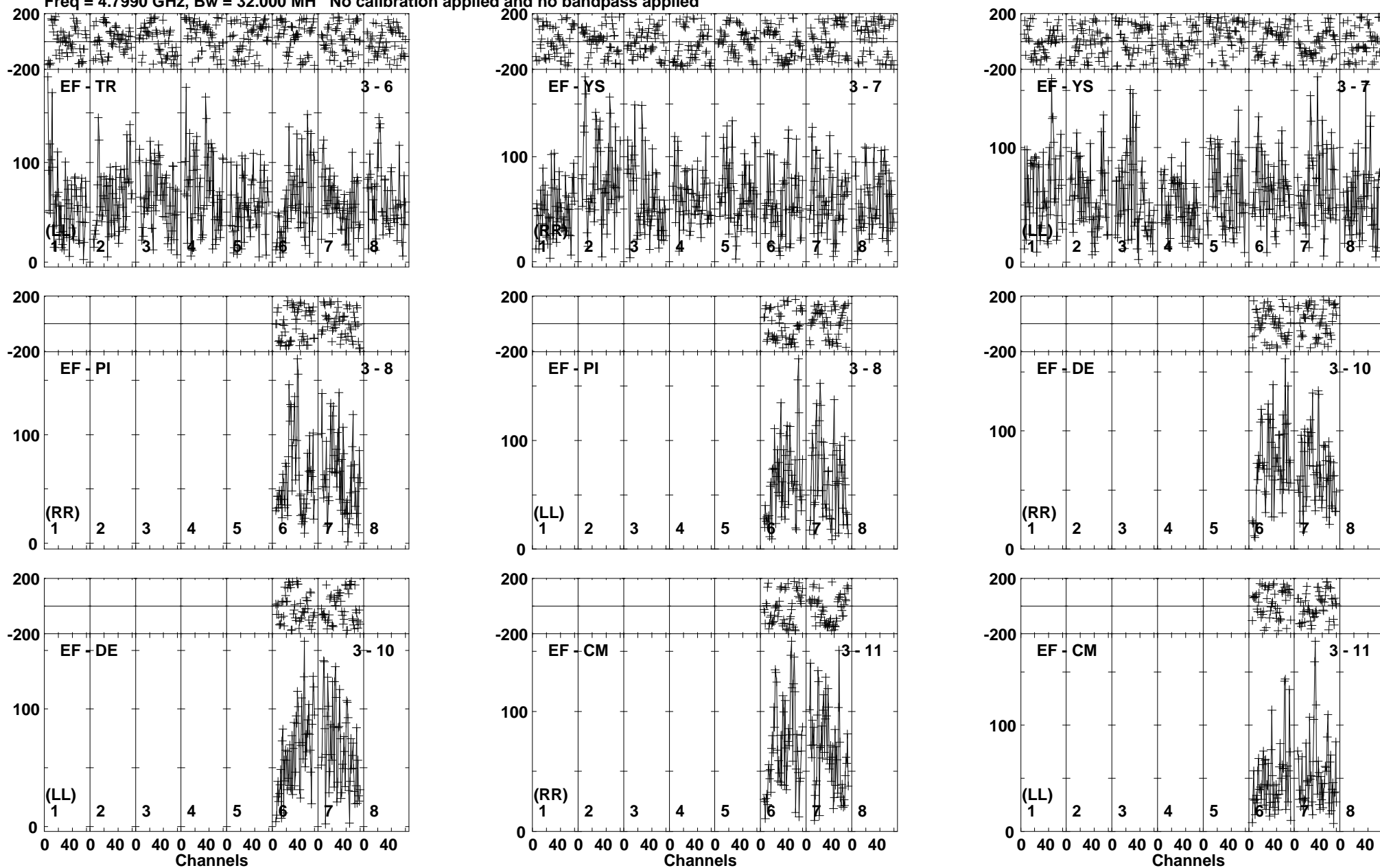

Lower frame: Micro Ampl Jy Top frame: Phas deg  
Vector averaged cross-power spectrum Baseline: EF (03) - TR (06)  
Timerange: 01/04:17:53 to 01/04:21:49

Plot file version 453 created 11-NOV-2019 15:08:08

SER8NJ EK040B.UVDATA.1

Freq = 4.7990 GHz, Bw = 32.000 MH No calibration applied and no bandpass applied

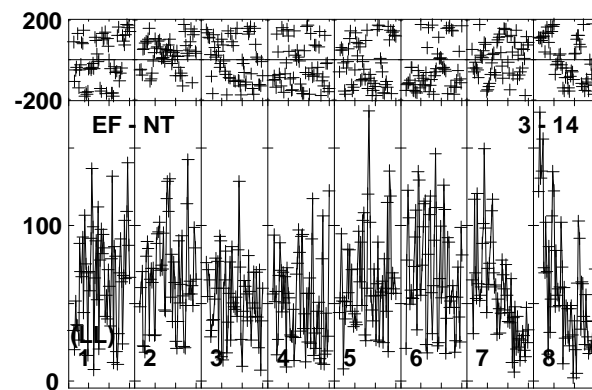
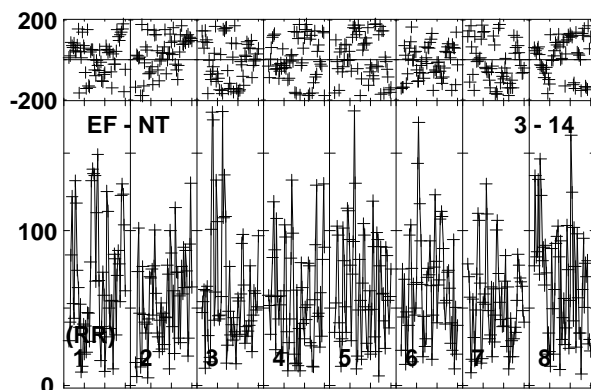
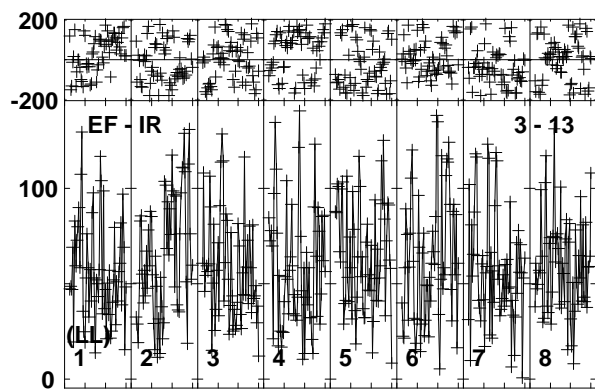
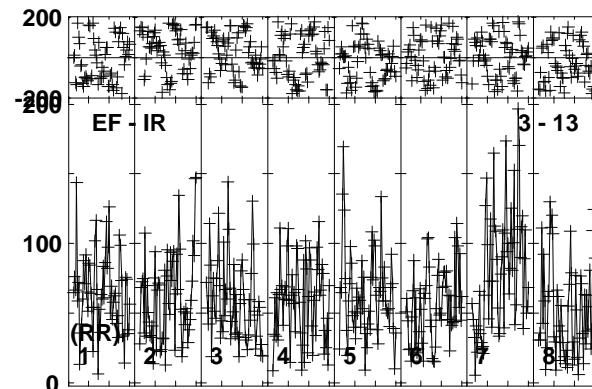
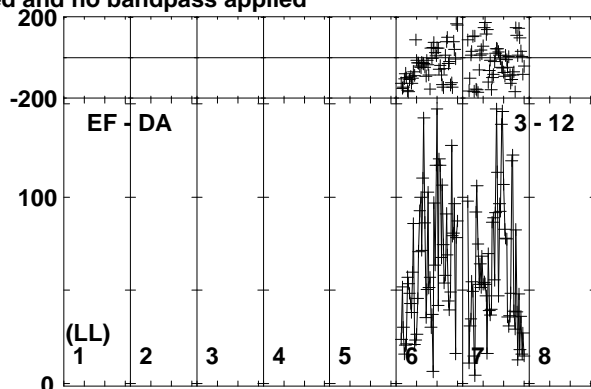
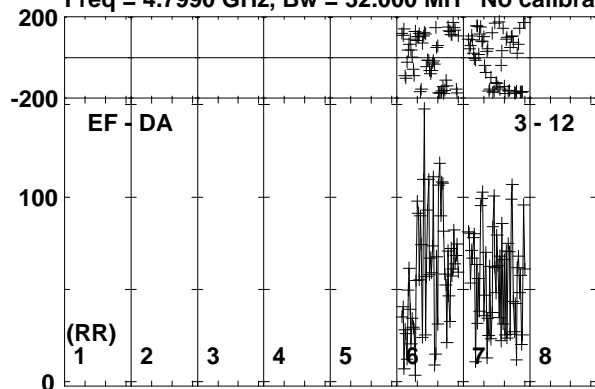

0 40 0 40 0 40 0 40 0 40 0 40 0 40 0 40 0 40 0 40  
Channels

Lower frame: Micro Ampl Jy Top frame: Phas deg  
Vector averaged cross-power spectrum Baseline: EF (03) - DA (12)  
Timerange: 01/04:17:53 to 01/04:21:49

Plot file version 454 created 11-NOV-2019 15:08:08

J1826+0149 EK040B.UVDATA.1

Freq = 4.7990 GHz, Bw = 32.000 MH No calibration applied and no bandpass applied

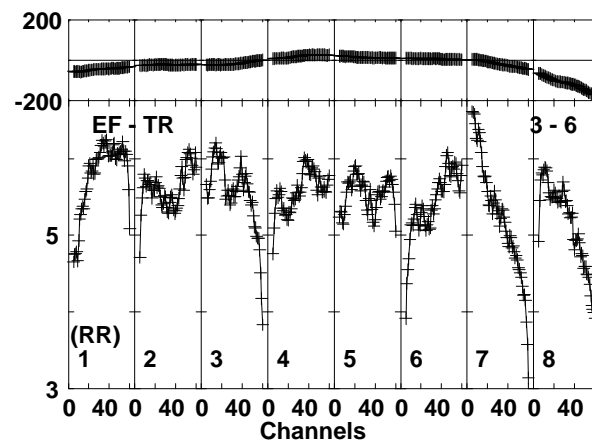
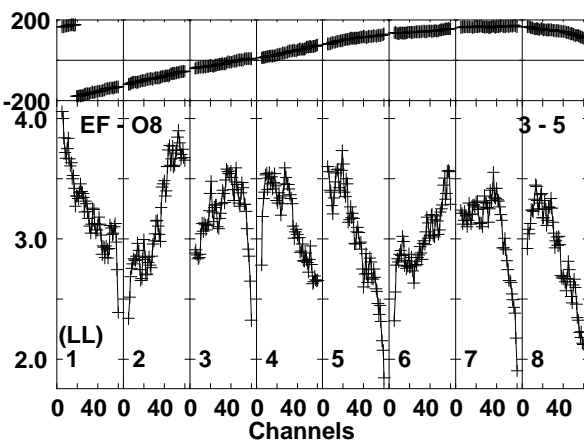
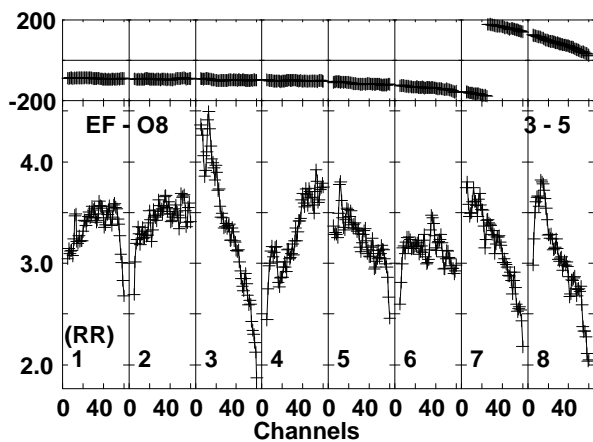
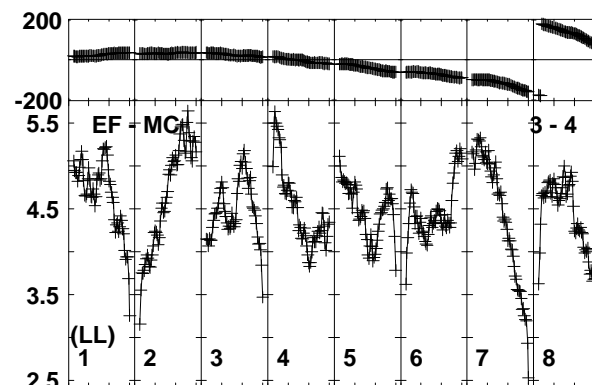
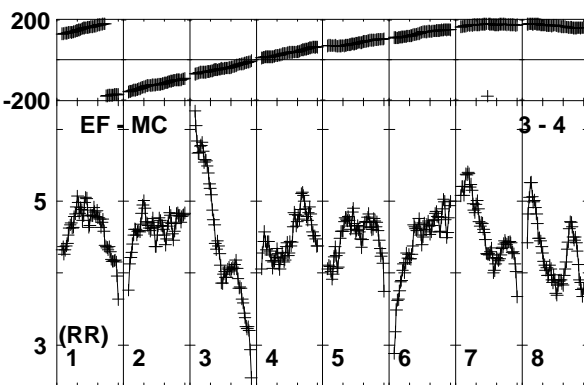
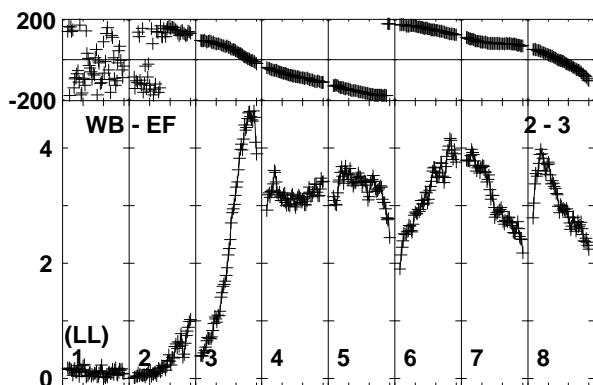
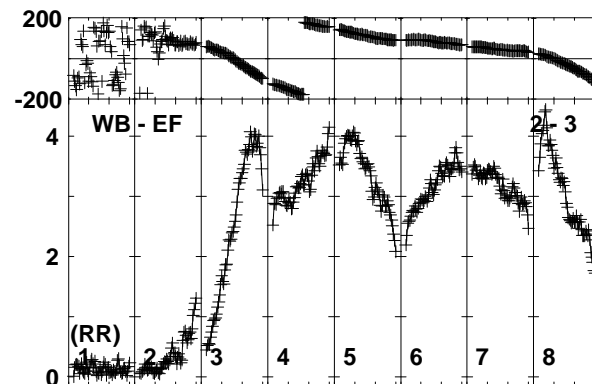
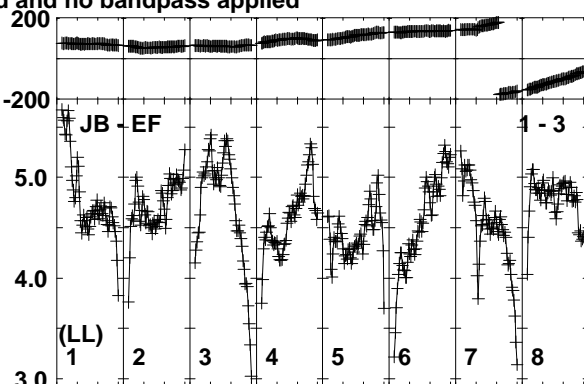
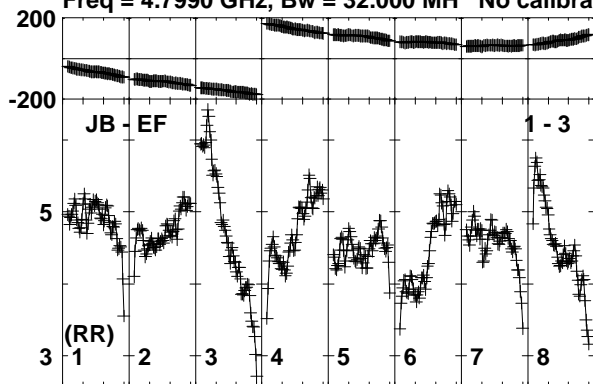

Lower frame: Milli Ampl Jy Top frame: Phas deg  
Vector averaged cross-power spectrum Baseline: JB (01) - EF (03)  
Timerange: 01/04:21:53 to 01/04:23:19

Plot file version 455 created 11-NOV-2019 15:08:08  
 J1826+0149 EK040B.UVDATA.1  
 Freq = 4.7990 GHz, Bw = 32.000 MH No calibration applied and no bandpass applied

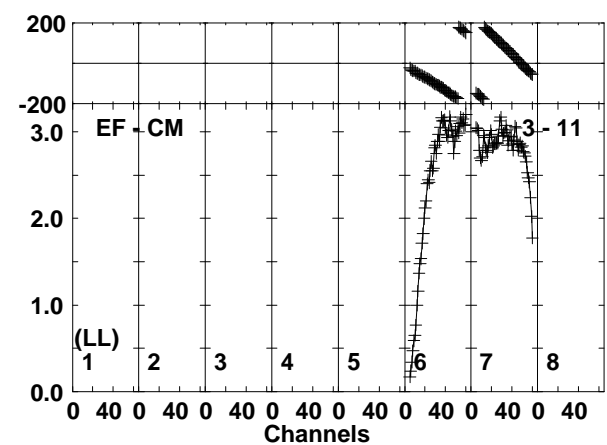
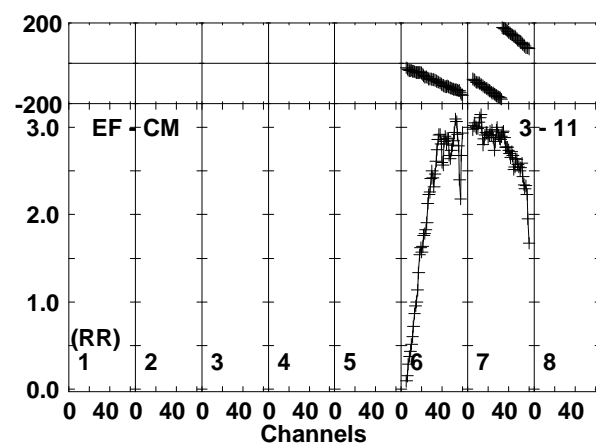
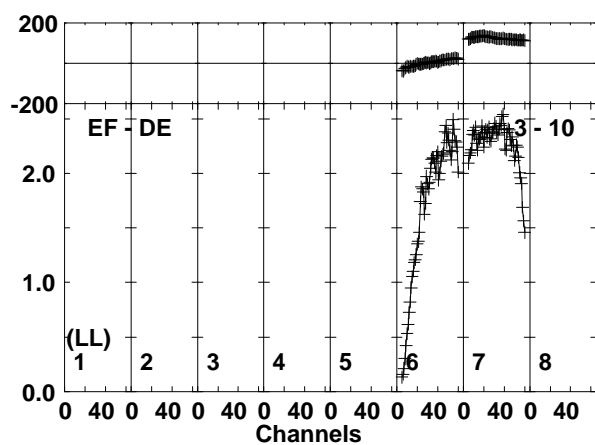
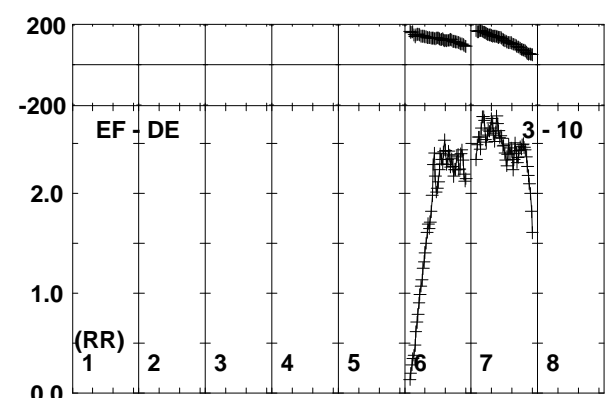
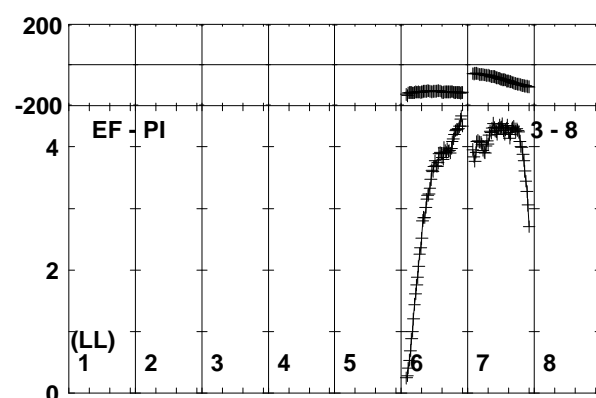
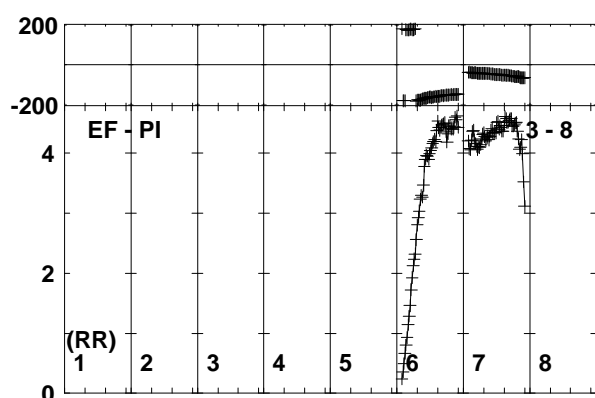
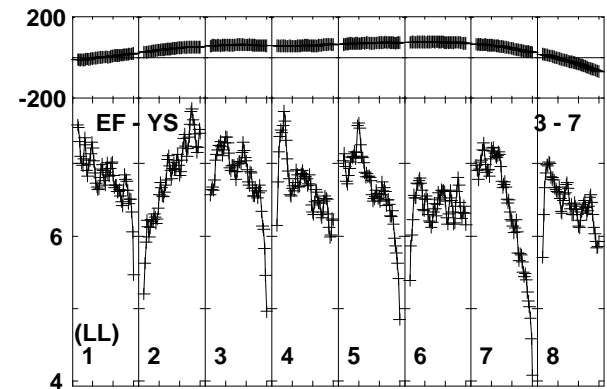
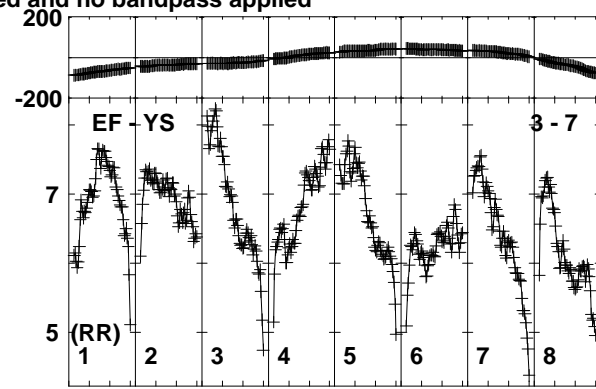
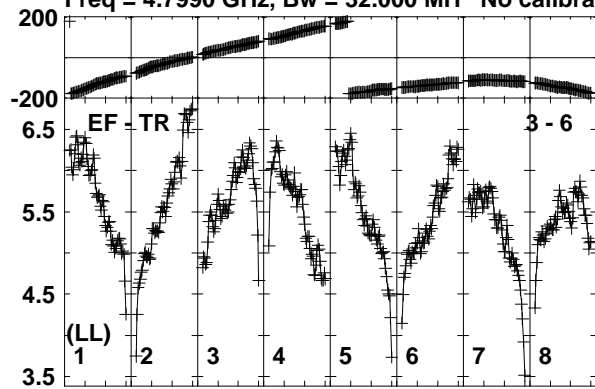

Lower frame: Milli Ampl Jy Top frame: Phas deg  
 Vector averaged cross-power spectrum Baseline: EF (03) - TR (06)  
 Timerange: 01/04:21:53 to 01/04:23:19

Plot file version 456 created 11-NOV-2019 15:08:08

J1826+0149 EK040B.UVDATA.1

Freq = 4.7990 GHz, Bw = 32.000 MH No calibration applied and no bandpass applied

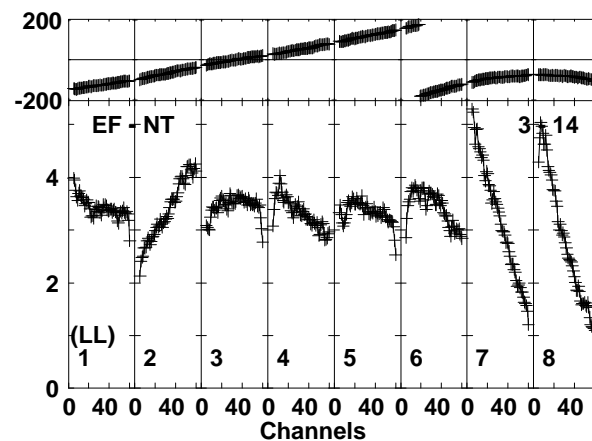
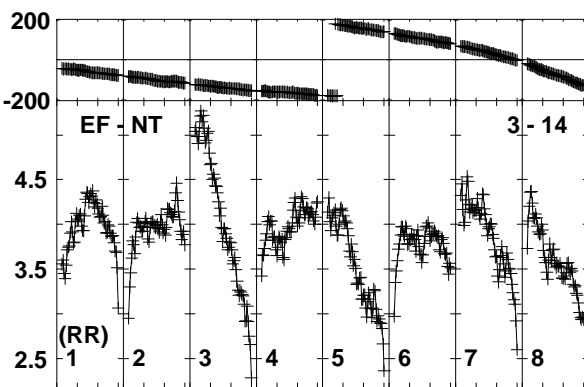
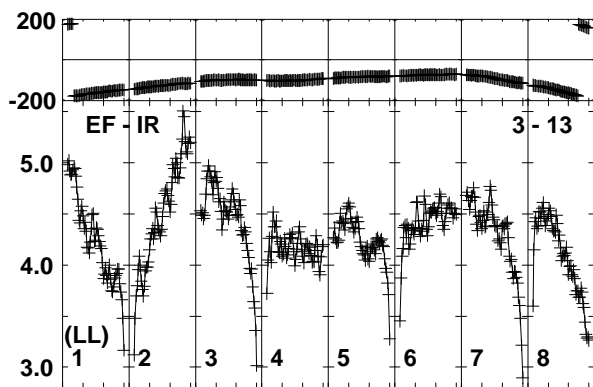
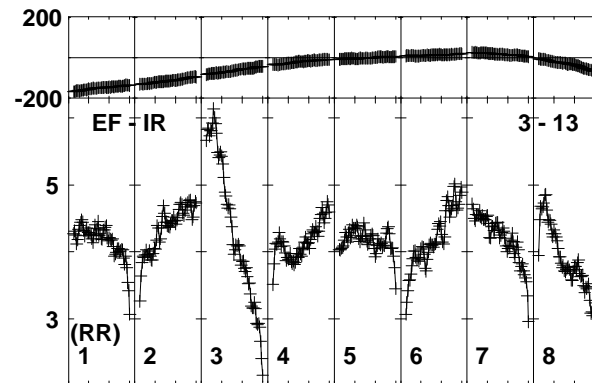
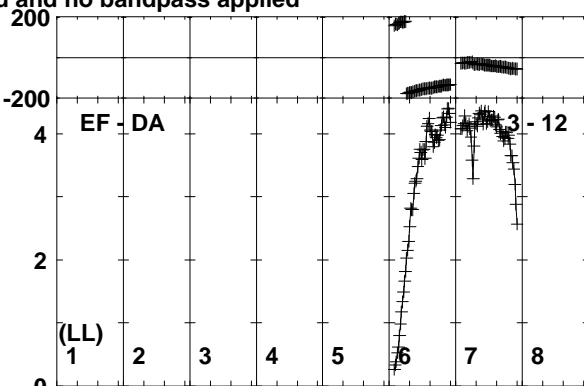
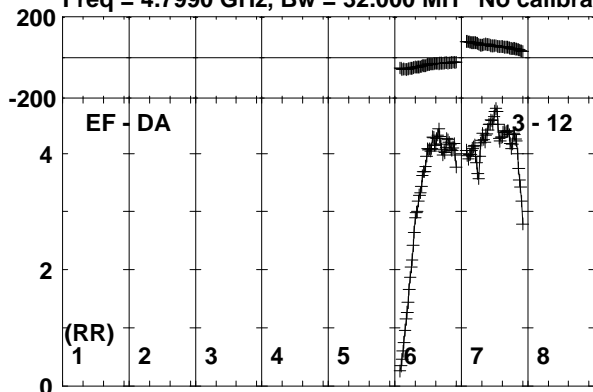

Lower frame: Milli Ampl Jy Top frame: Phas deg  
Vector averaged cross-power spectrum Baseline: EF (03) - DA (12)  
Timerange: 01/04:21:53 to 01/04:23:19

Plot file version 457 created 11-NOV-2019 15:08:08

SER8NJ EK040B.UVDATA.1

Freq = 4.7990 GHz, Bw = 32.000 MH No calibration applied and no bandpass applied

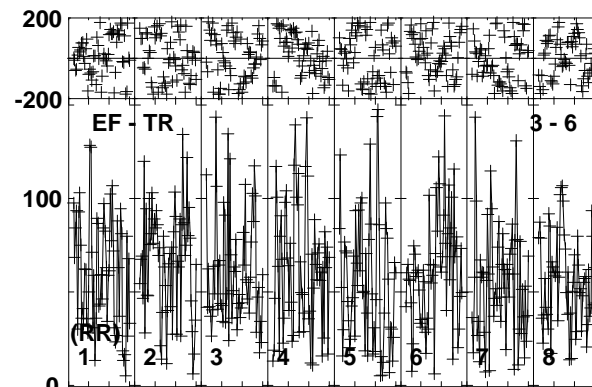
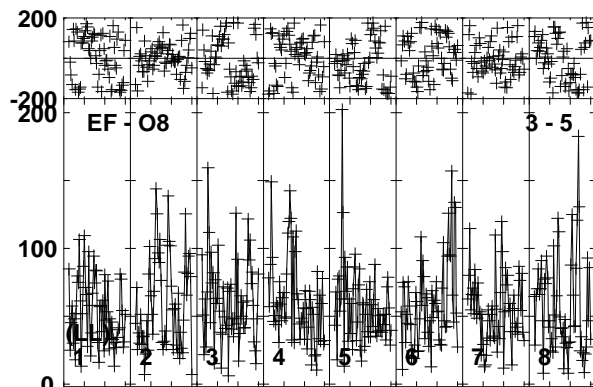
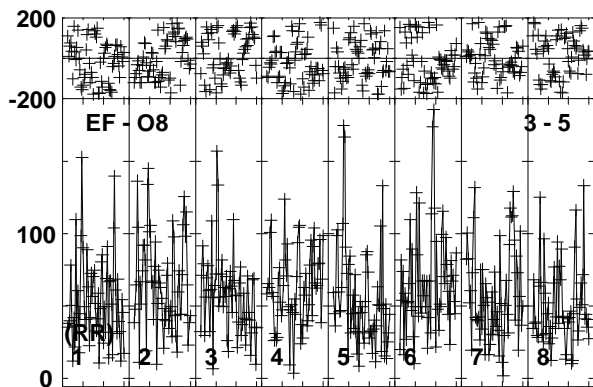
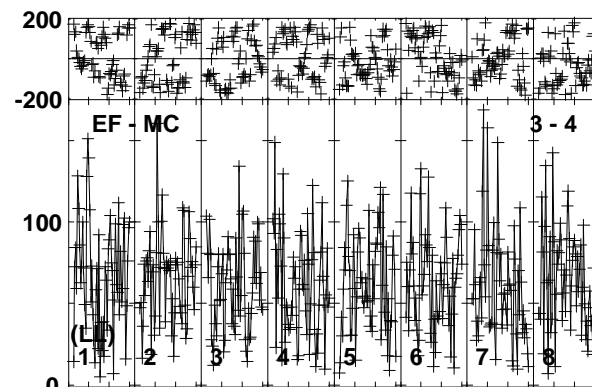
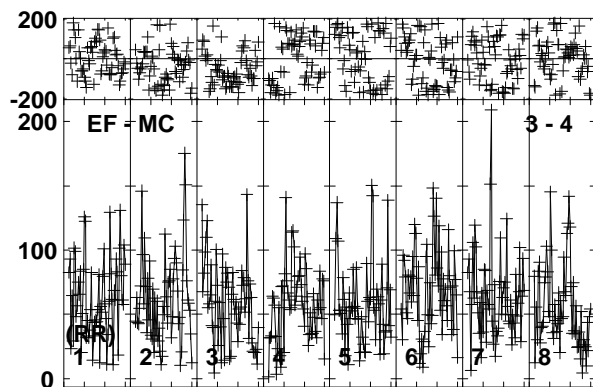
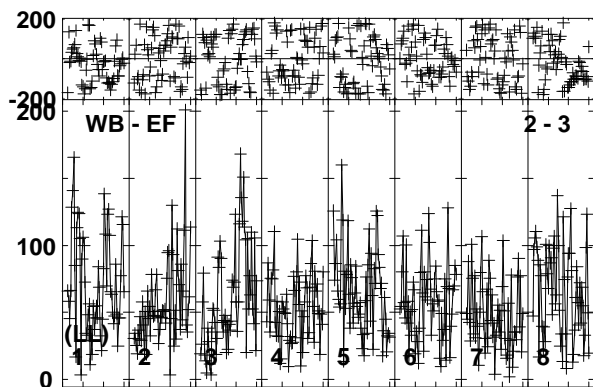
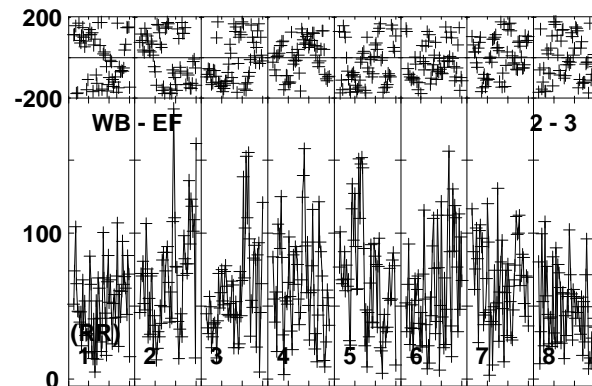
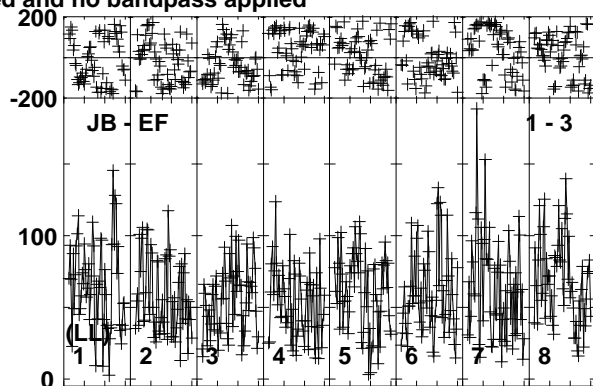
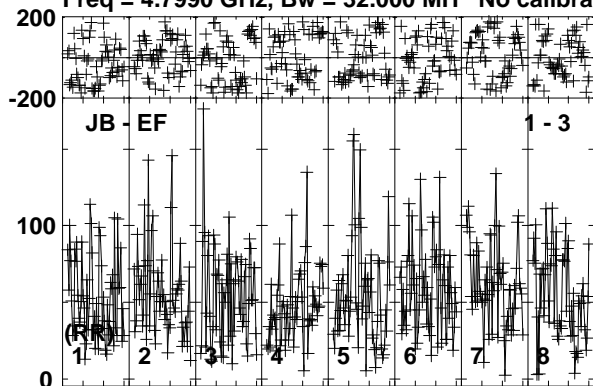

Lower frame: Micro Ampl Jy Top frame: Phas deg  
Vector averaged cross-power spectrum Baseline: JB (01) - EF (03)  
Timerange: 01/04:23:21 to 01/04:27:19

Plot file version 458 created 11-NOV-2019 15:08:08

SER8NJ EK040B.UVDATA.1

Freq = 4.7990 GHz, Bw = 32.000 MH No calibration applied and no bandpass applied

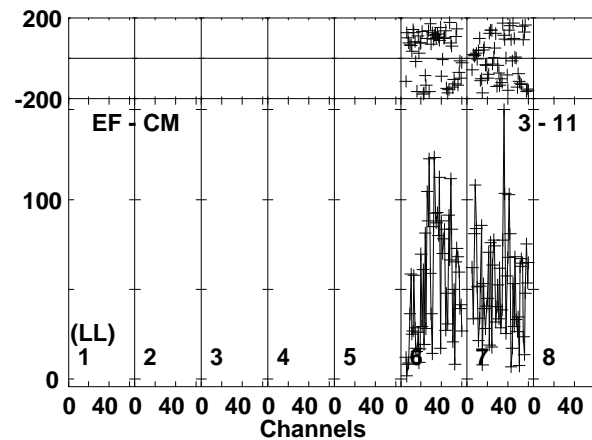
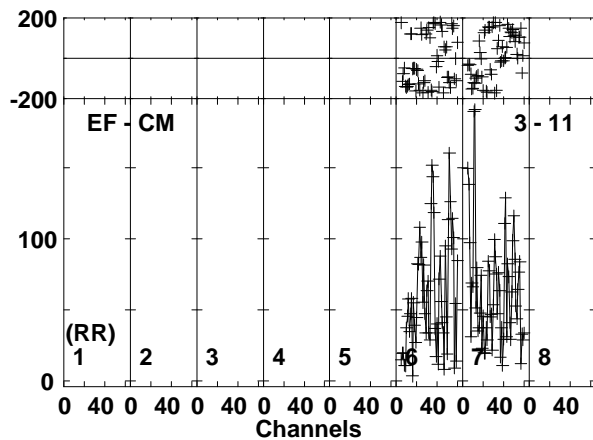
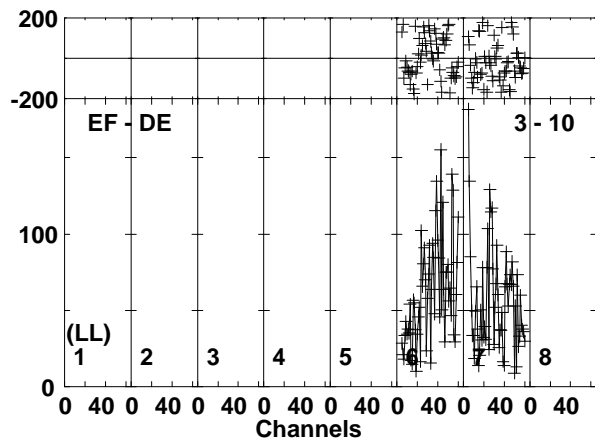
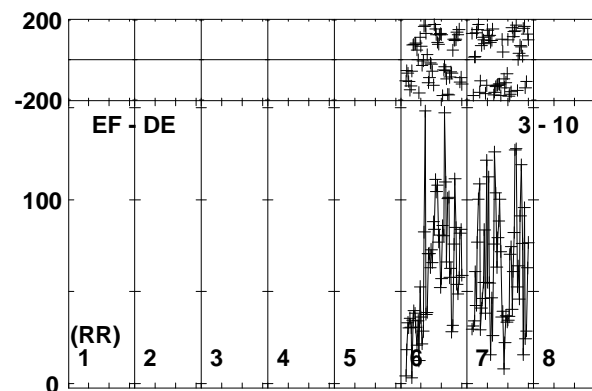
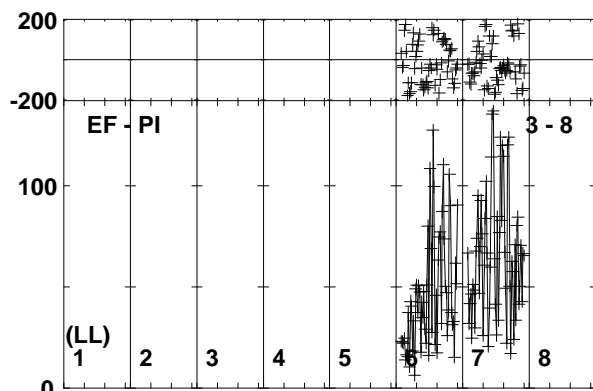
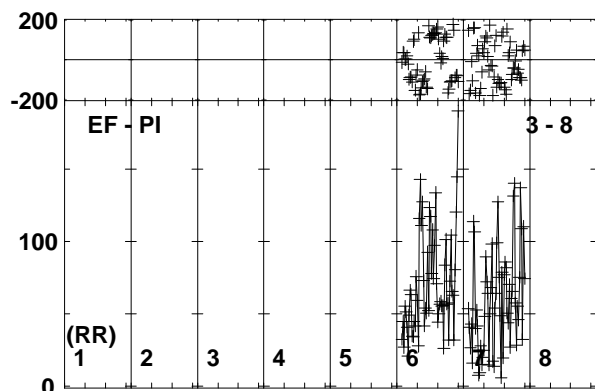
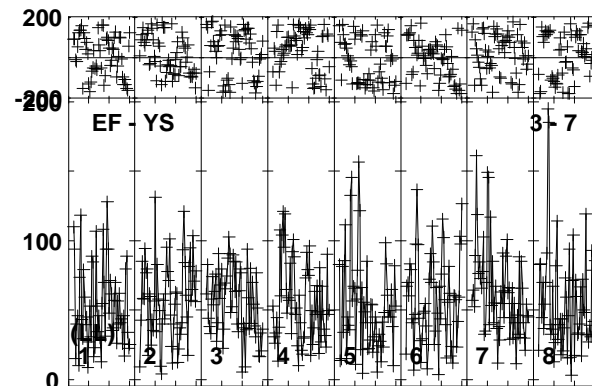
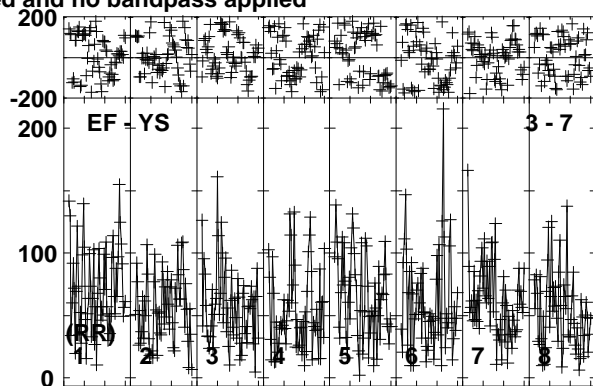
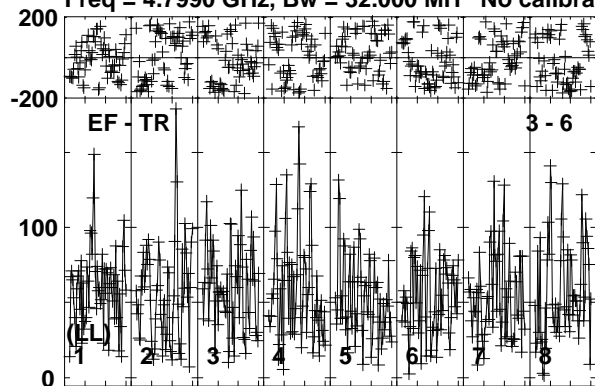

Lower frame: Micro Ampl Jy Top frame: Phas deg  
Vector averaged cross-power spectrum Baseline: EF (03) - TR (06)  
Timerange: 01/04:23:21 to 01/04:27:19



Plot file version 459 created 11-NOV-2019 15:08:08

SER8NJ EK040B.UVDATA.1

Freq = 4.7990 GHz, Bw = 32.000 MH No calibration applied and no bandpass applied

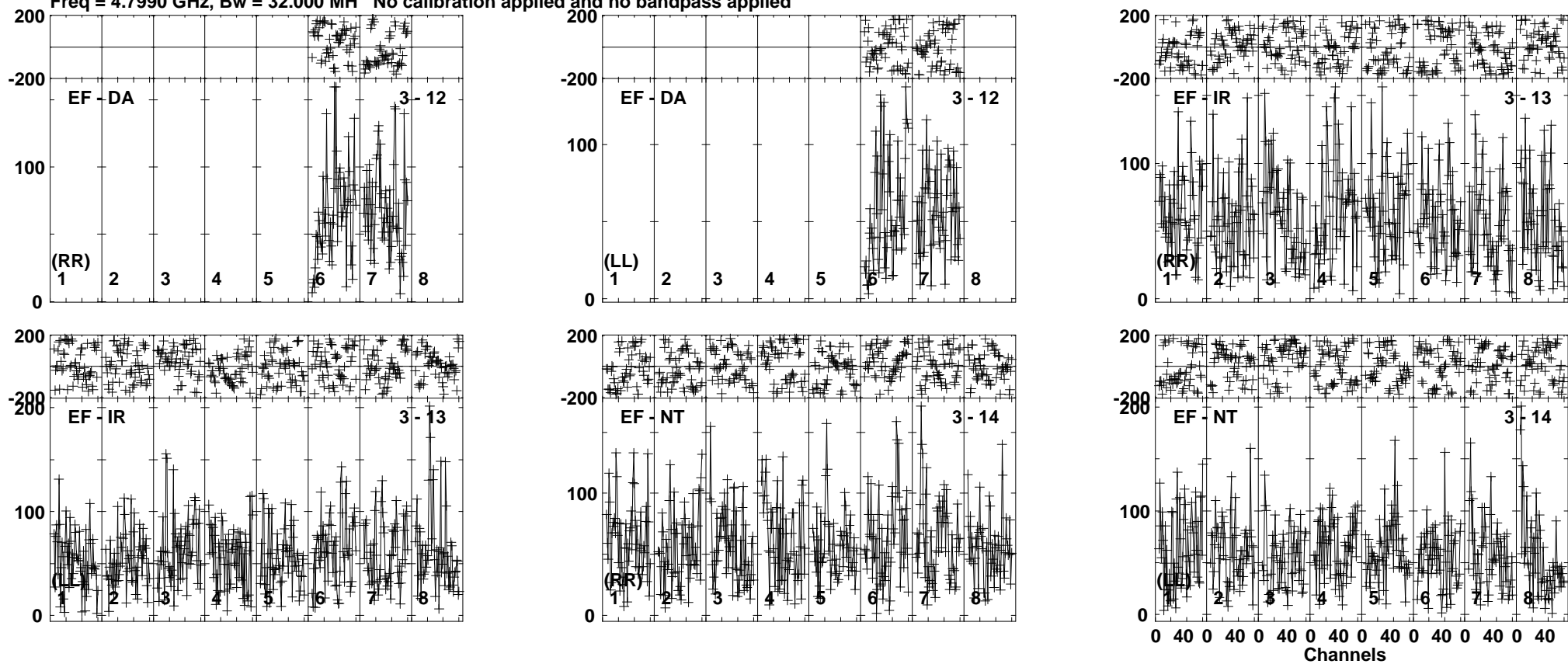

Lower frame: Micro Ampl Jy Top frame: Phas deg  
Vector averaged cross-power spectrum Baseline: EF (03) - DA (12)  
Timerange: 01/04:23:21 to 01/04:27:19

Plot file version 460 created 11-NOV-2019 15:08:08

J1826+0149 EK040B.UVDATA.1

Freq = 4.7990 GHz, Bw = 32.000 MH No calibration applied and no bandpass applied

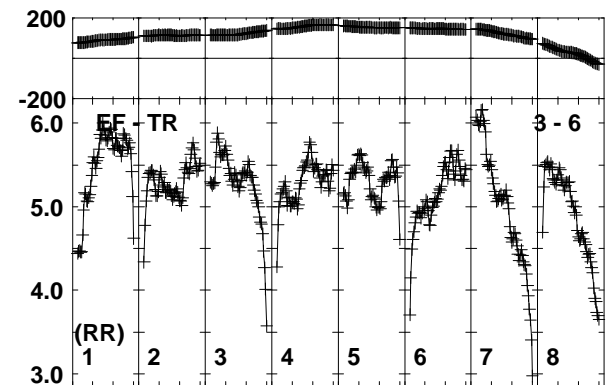
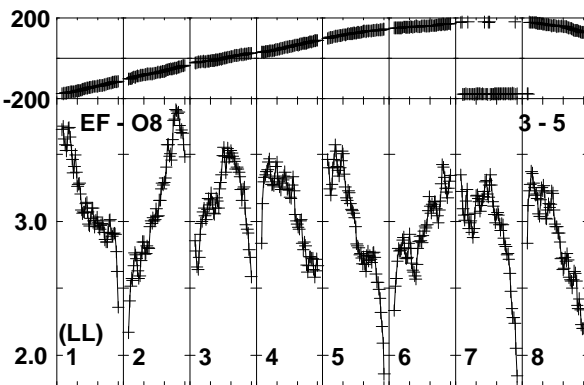
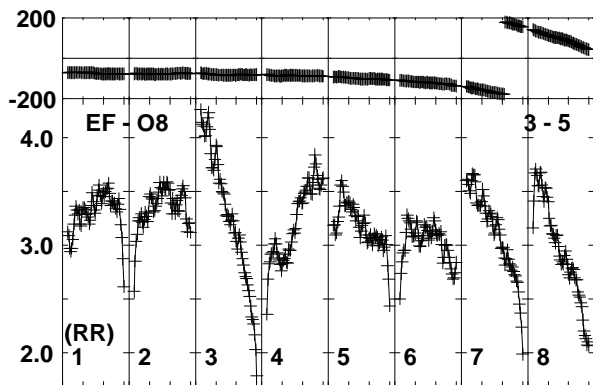
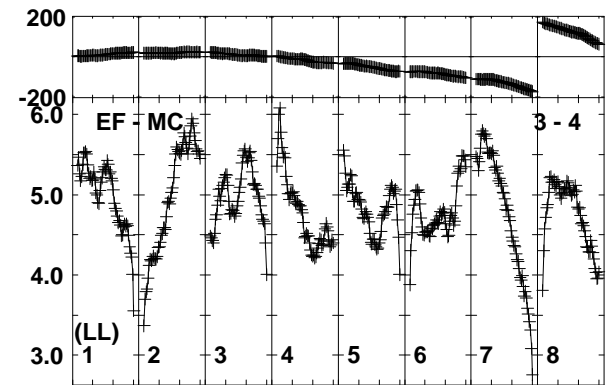
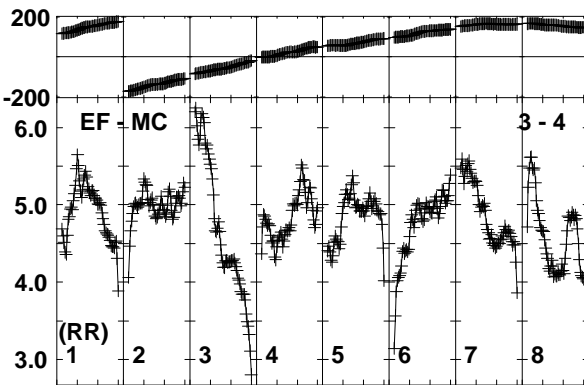
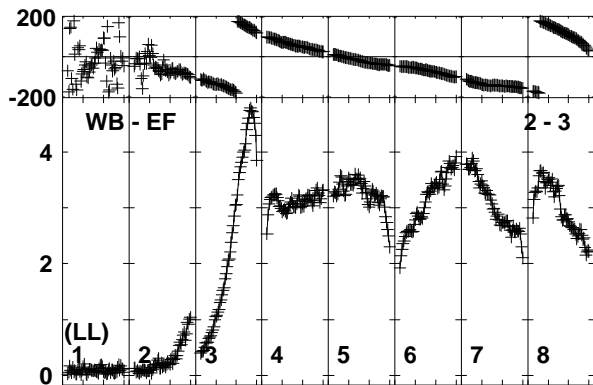
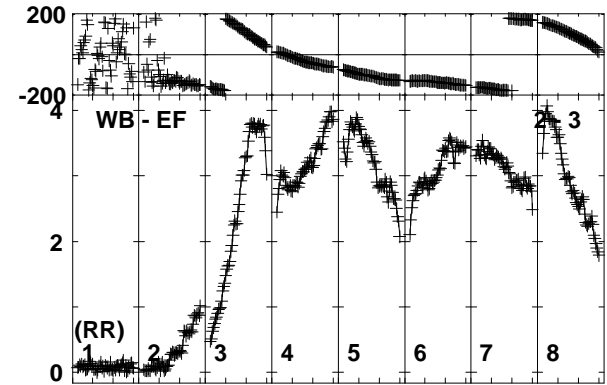
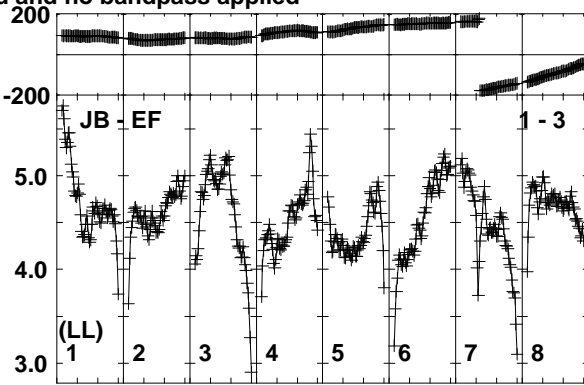
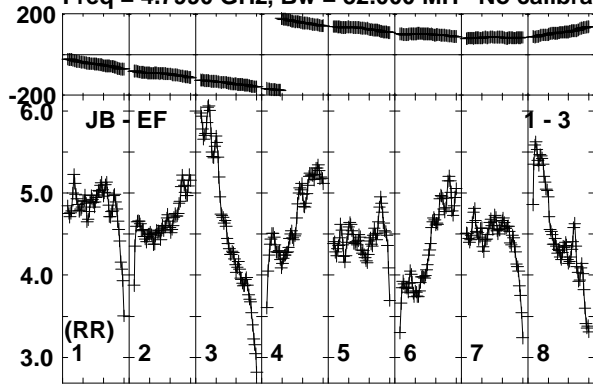

Lower frame: Milli Ampl Jy Top frame: Phas deg

Vector averaged cross-power spectrum Baseline: JB (01) - EF (03)

Timerange: 01/04:28:01 to 01/04:29:59

Plot file version 461 created 11-NOV-2019 15:08:08

J1826+0149 EK040B.UVDATA.1

Freq = 4.7990 GHz, Bw = 32.000 MH No calibration applied and no bandpass applied

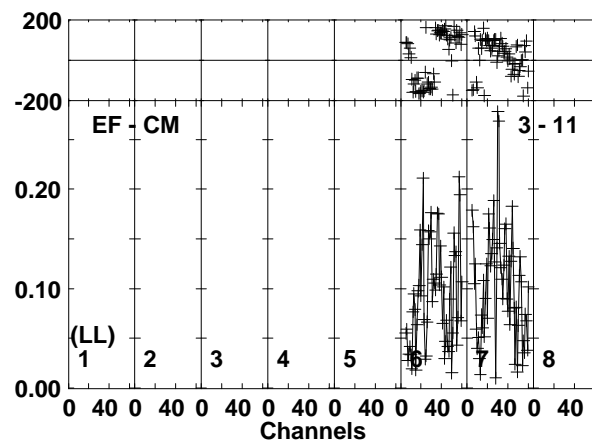
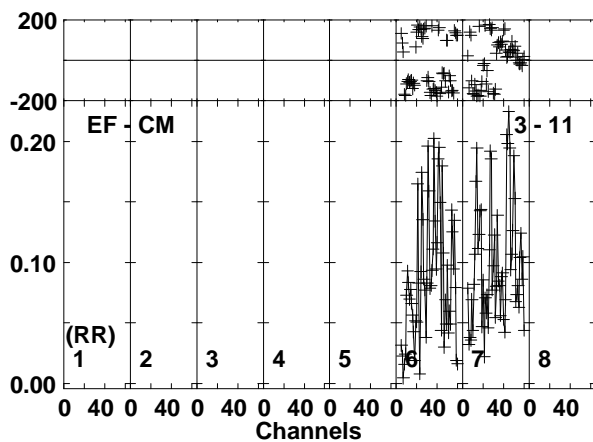
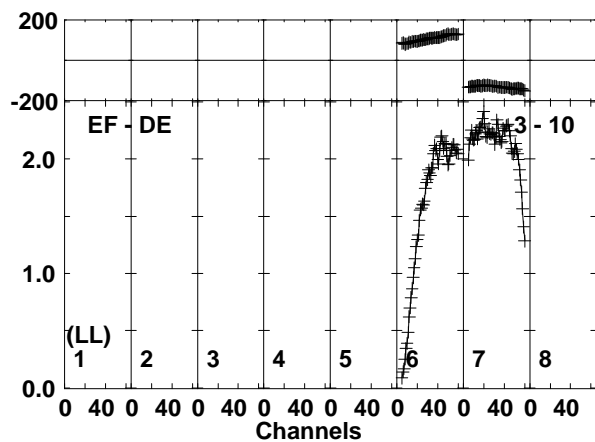
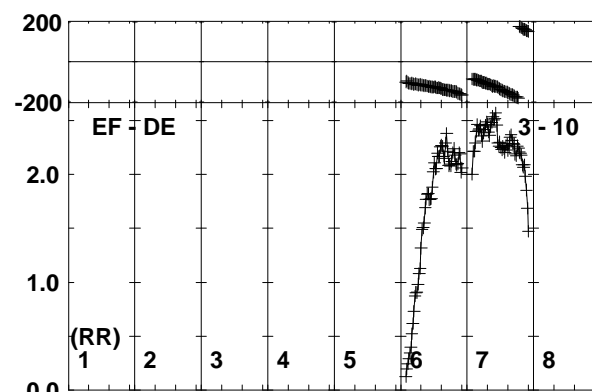
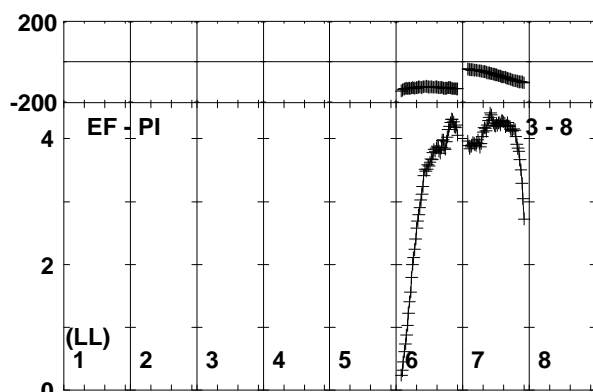
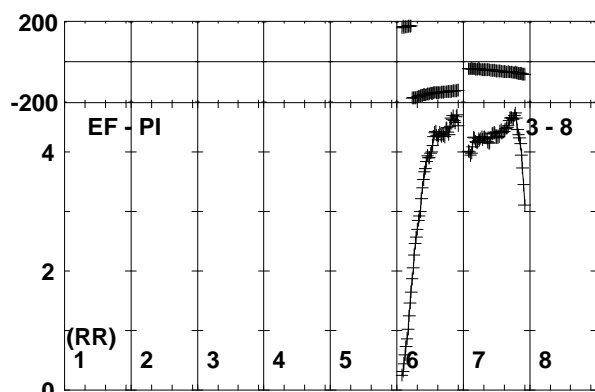
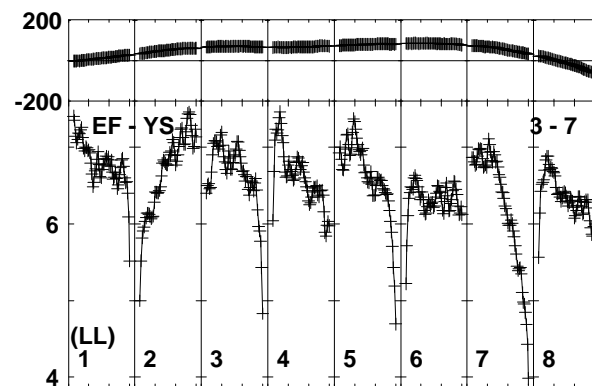
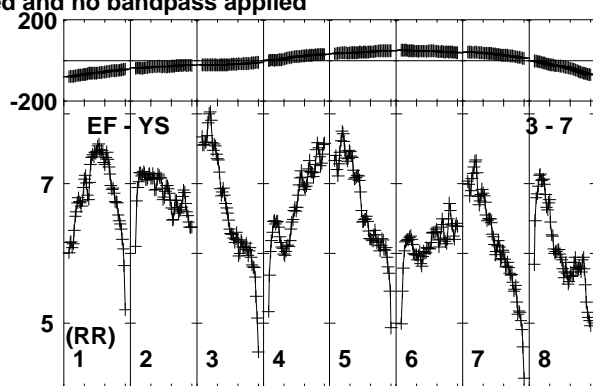
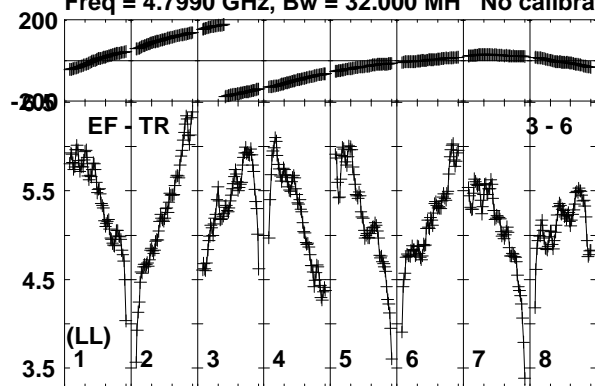

Lower frame: Milli Ampl Jy Top frame: Phas deg  
Vector averaged cross-power spectrum Baseline: EF (03) - TR (06)  
Timerange: 01/04:28:01 to 01/04:29:59

Plot file version 462 created 11-NOV-2019 15:08:08

J1826+0149 EK040B.UVDATA.1

Freq = 4.7990 GHz, Bw = 32.000 MH No calibration applied and no bandpass applied

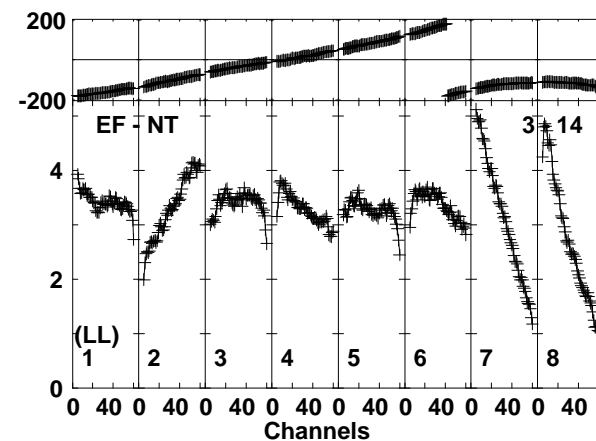
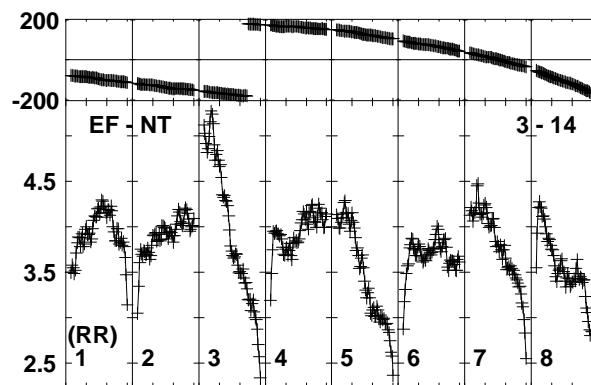
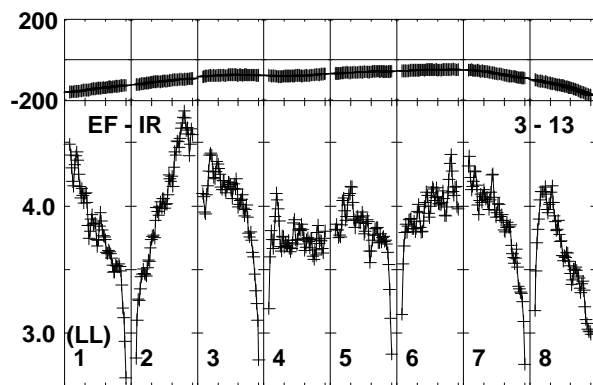
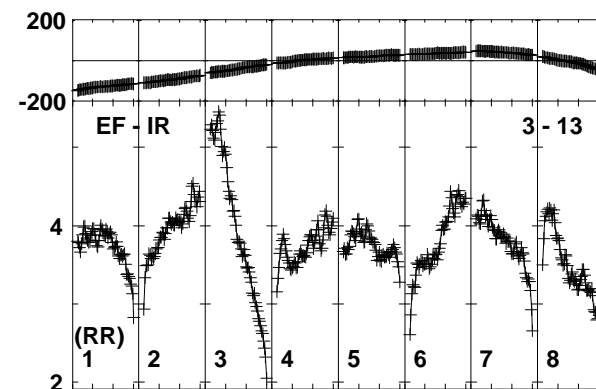
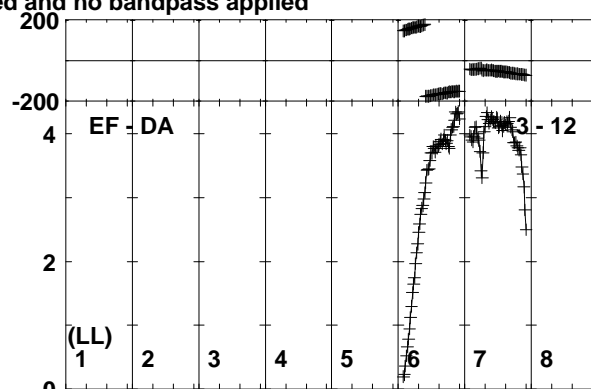
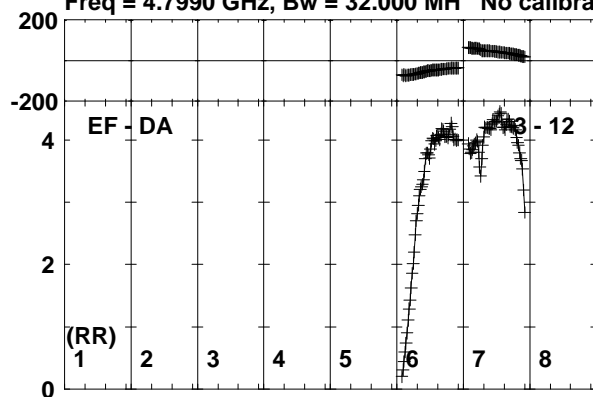

Lower frame: Milli Ampl Jy Top frame: Phas deg  
Vector averaged cross-power spectrum Baseline: EF (03) - DA (12)  
Timerange: 01/04:28:01 to 01/04:29:59