

Plot file version 1 created 17-FEB-2020 15:42:38

J1642+6856 EK047 2.UVDATA.1

Freq = 4.9270 GHz, Bw = 16.000 MH No calibration applied and no bandpass applied

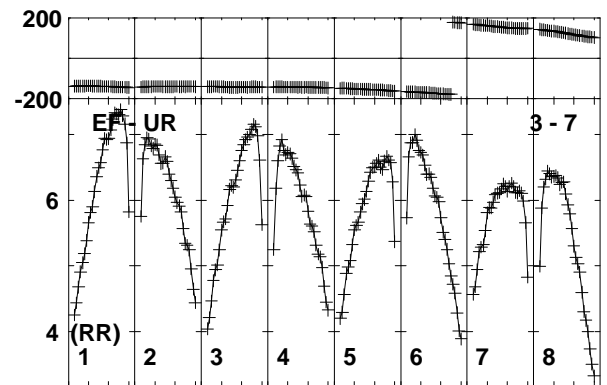
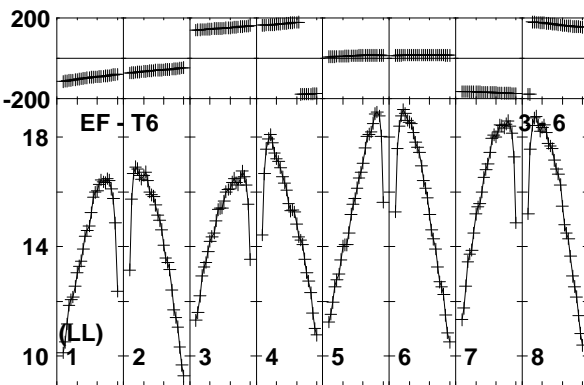
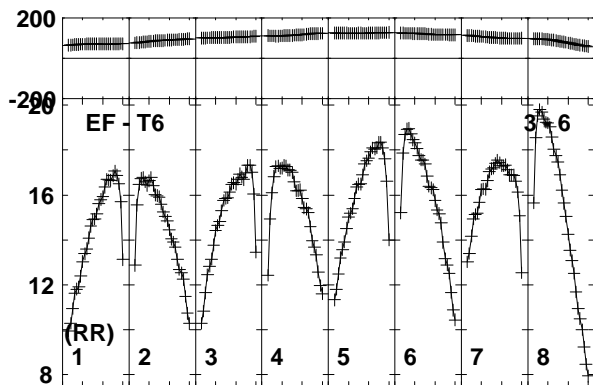
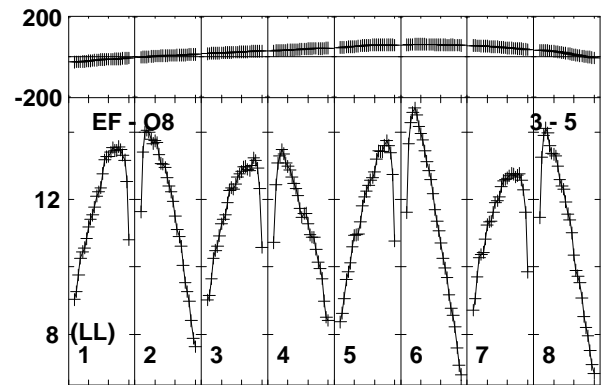
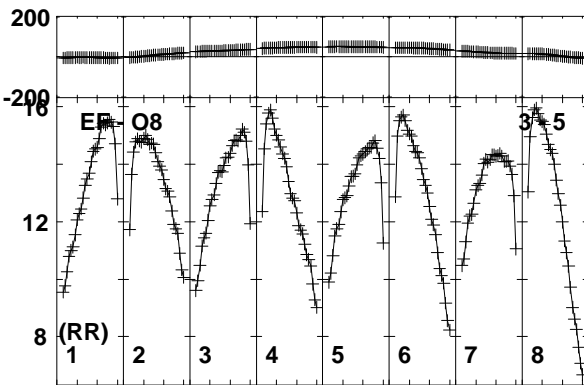
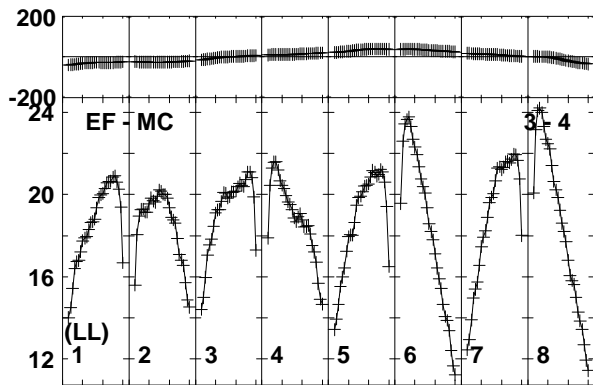
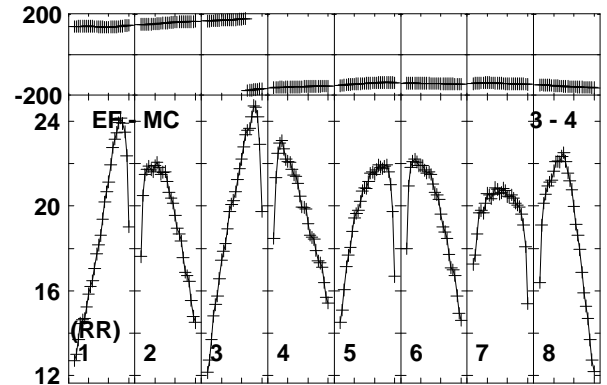
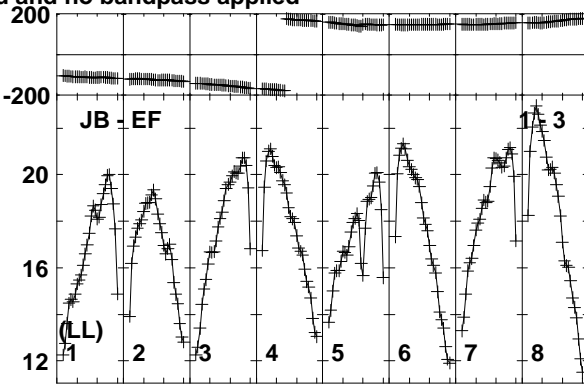
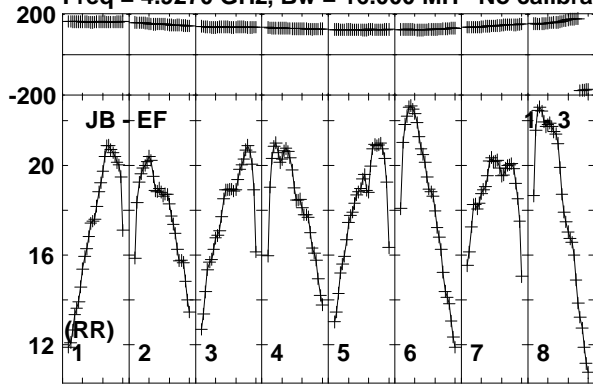

Lower frame: Milli Ampl Jy Top frame: Phas deg

Vector averaged cross-power spectrum Baseline: JB (01) - EF (03)

Timerange: 00/00:30:01 to 00/00:34:59

Plot file version 2 created 17-FEB-2020 15:42:38

J1642+6856 EK047 2.UVDATA.1

Freq = 4.9270 GHz, Bw = 16.000 MH No calibration applied and no bandpass applied

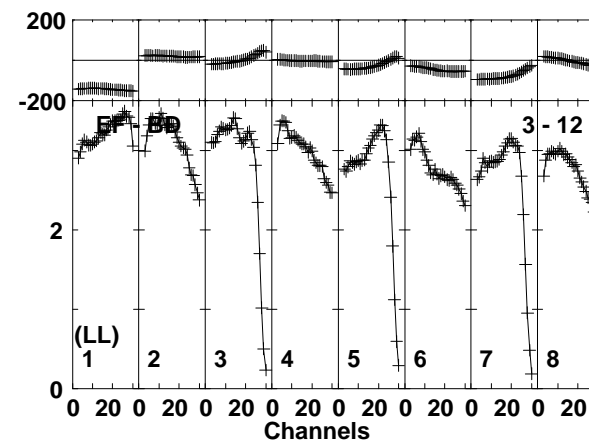
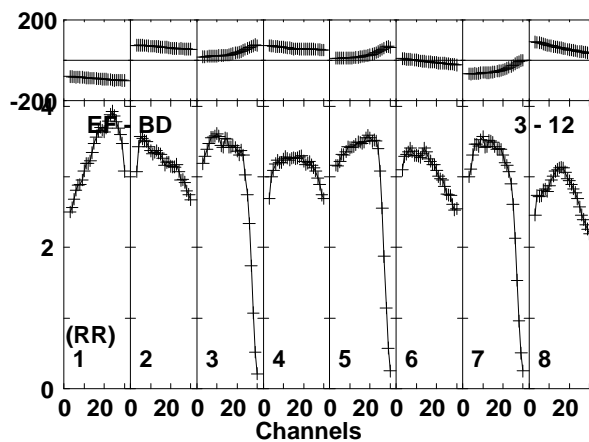
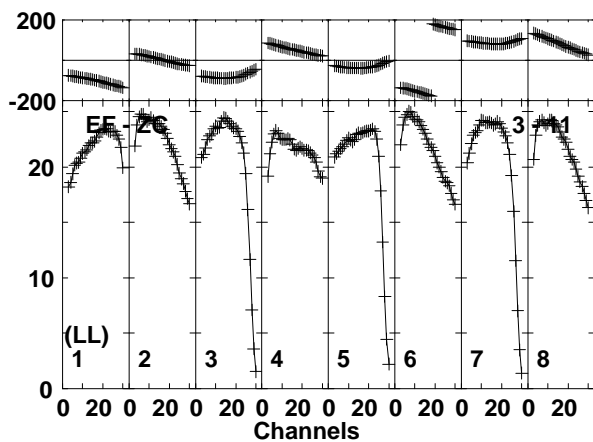
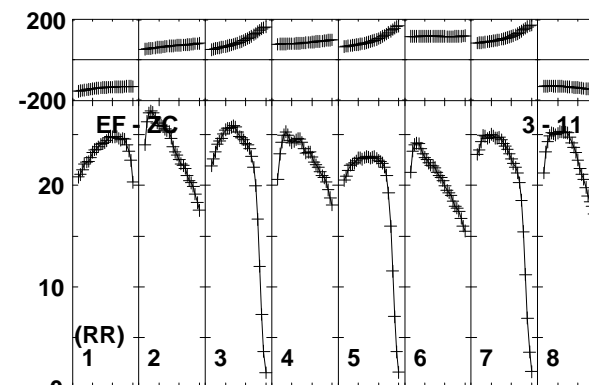
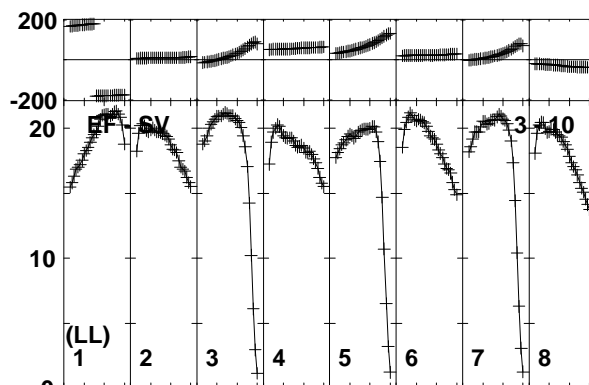
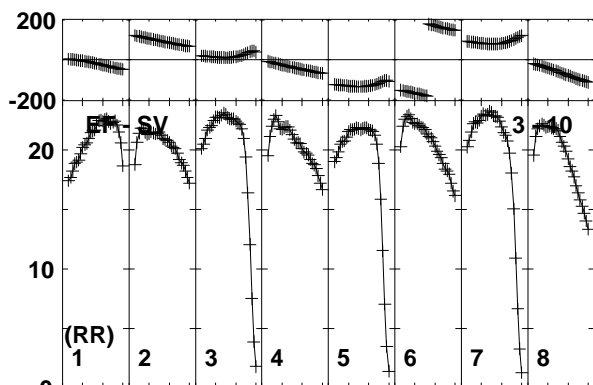
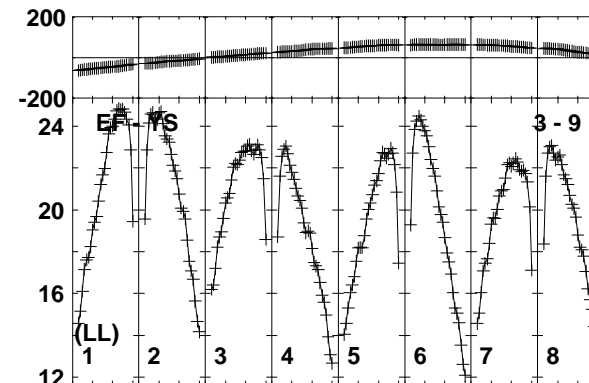
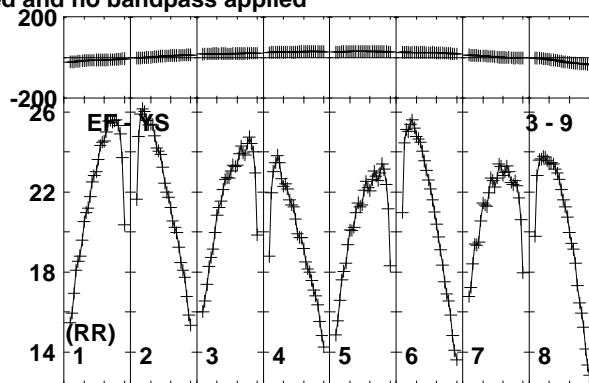
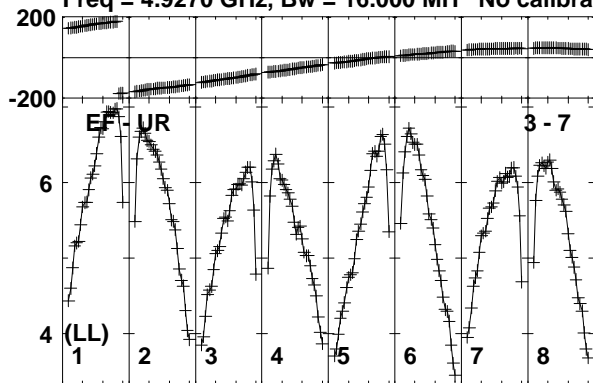

Lower frame: Milli Ampl Jy Top frame: Phas deg
Vector averaged cross-power spectrum Baseline: EF (03) - UR (07)
Timerange: 00/00:30:01 to 00/00:34:59

Plot file version 3 created 17-FEB-2020 15:42:38
J1642+6856 EK047 2.UVDATA.1

Freq = 4.9270 GHz, Bw = 16.000 MH No calibration applied and no bandpass applied

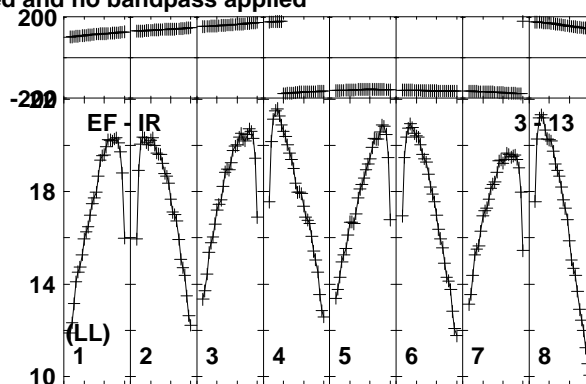
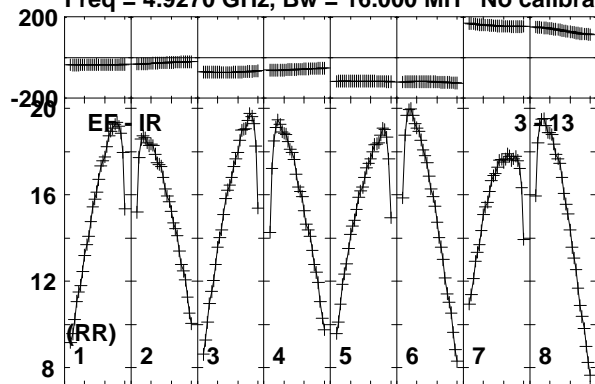

Lower frame: Milli Ampl Jy Top frame: Phas deg
Vector averaged cross-power spectrum Baseline: EF (03) - IR (13)
Timerange: 00/00:30:01 to 00/00:34:59

Plot file version 4 created 17-FEB-2020 15:42:38

J1359+5544 EK047 2.UVDATA.1

Freq = 4.9270 GHz, Bw = 16.000 MH No calibration applied and no bandpass applied

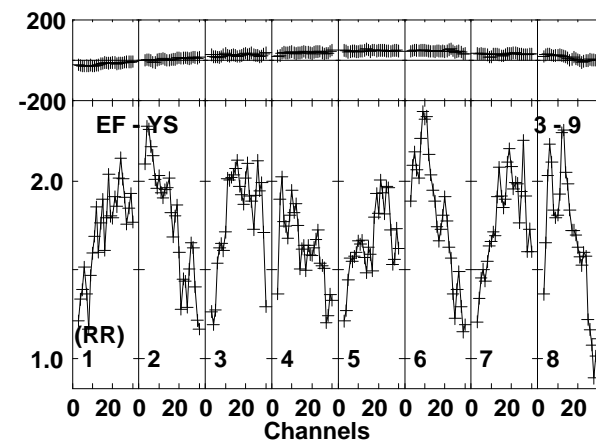
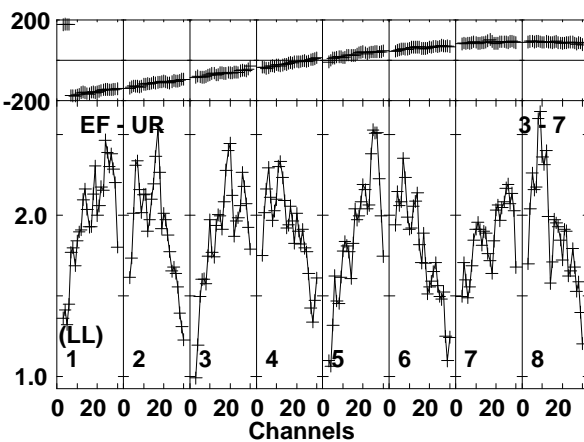
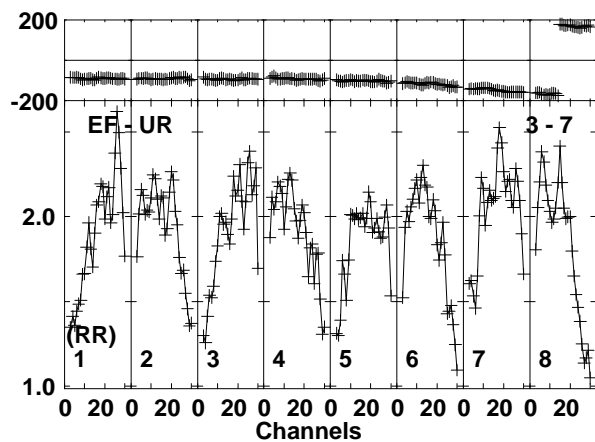
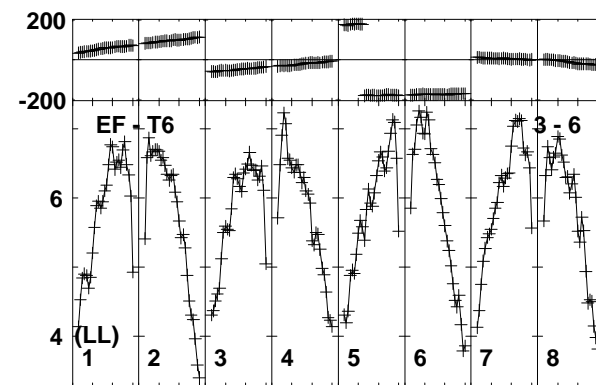
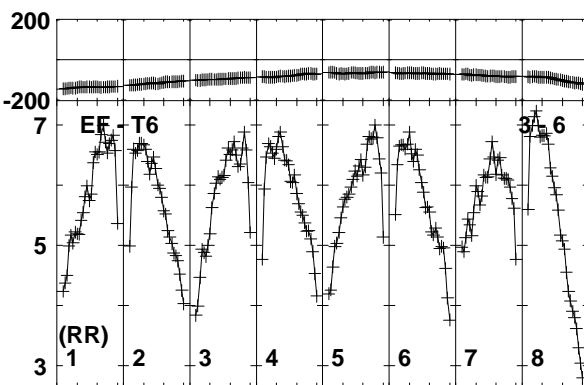
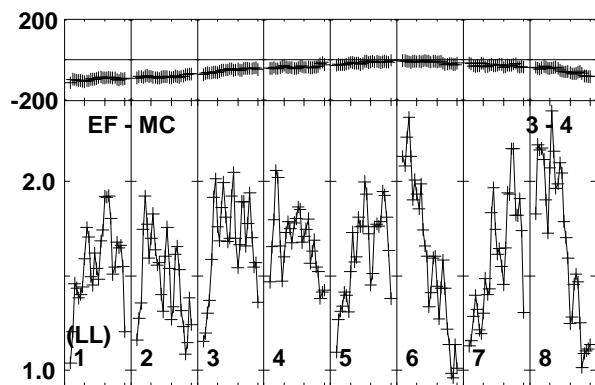
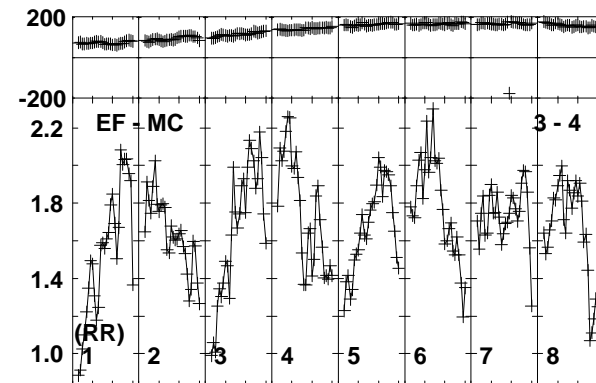
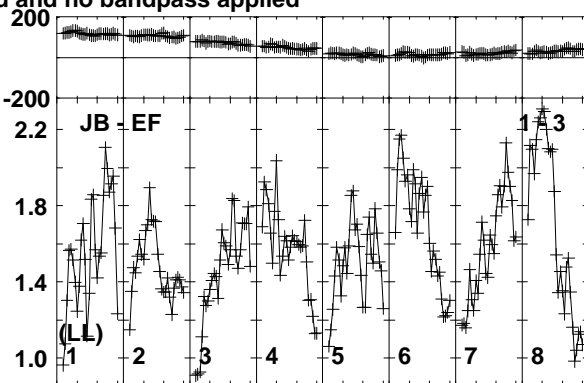
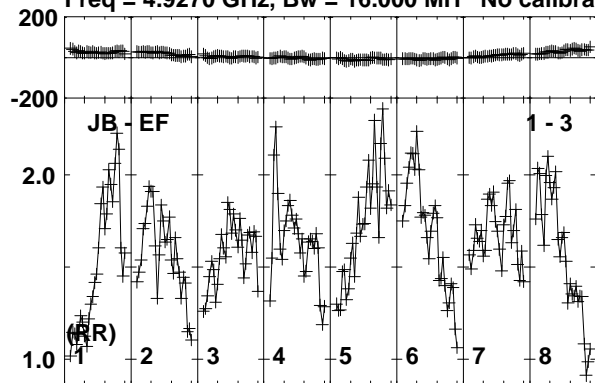

Lower frame: Milli Ampl Jy Top frame: Phas deg
Vector averaged cross-power spectrum Baseline: JB (01) - EF (03)
Timerange: 00/00:35:41 to 00/00:37:19

Plot file version 5 created 17-FEB-2020 15:42:38

J1359+5544 EK047 2.UVDATA.1

Freq = 4.9270 GHz, Bw = 16.000 MH No calibration applied and no bandpass applied

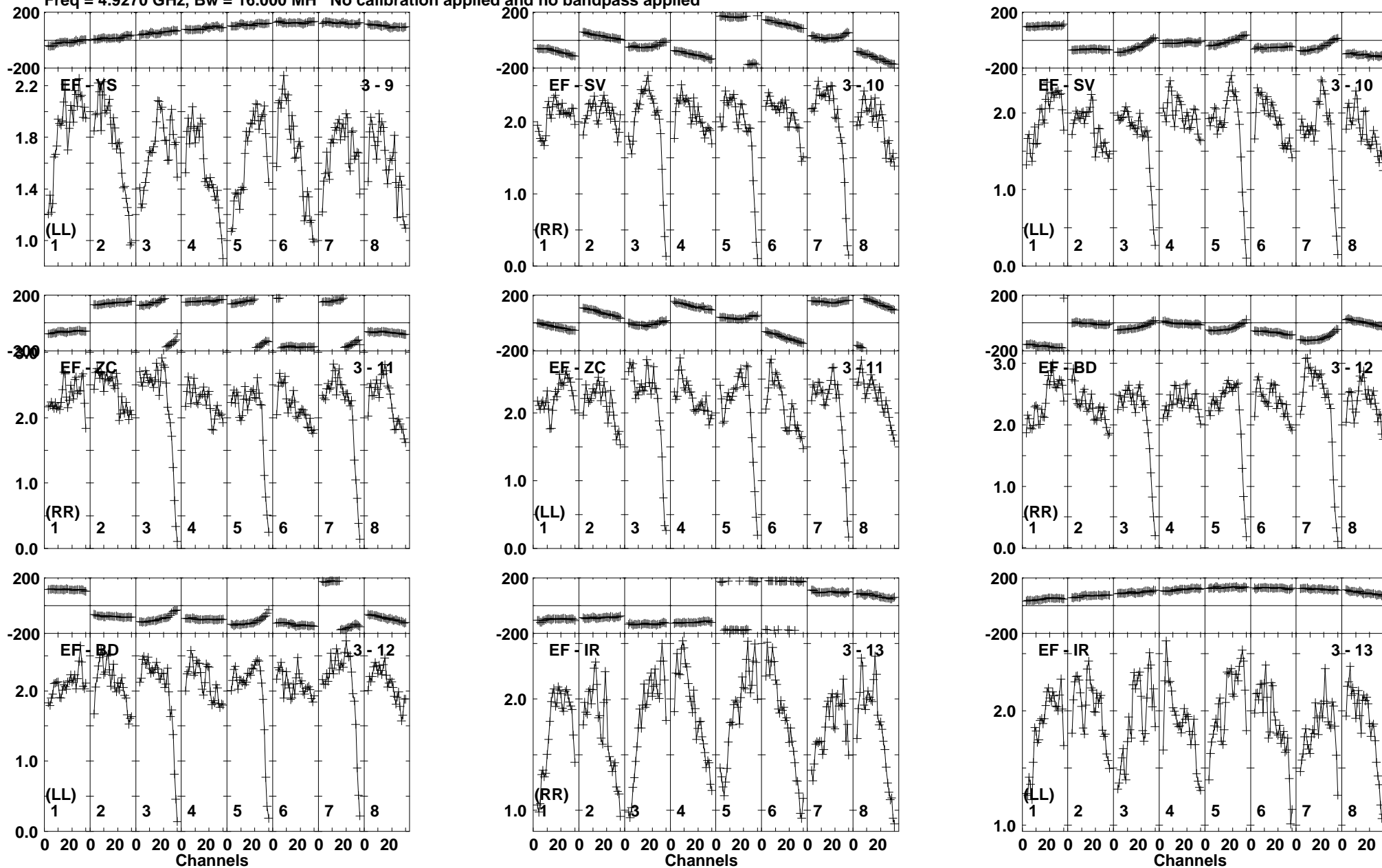

Lower frame: Milli Ampl Jy Top frame: Phas deg
Vector averaged cross-power spectrum Baseline: EF (03) - YS (09)
Timerange: 00/00:35:41 to 00/00:37:19

Plot file version 6 created 17-FEB-2020 15:42:38

J1402+5347 EK047 2.UVDATA.1

Freq = 4.9270 GHz, Bw = 16.000 MH No calibration applied and no bandpass applied

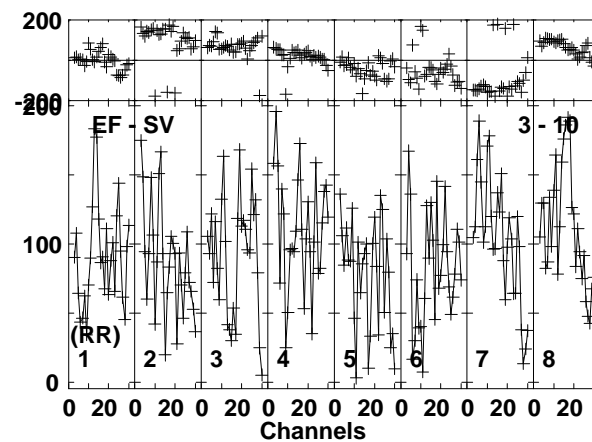
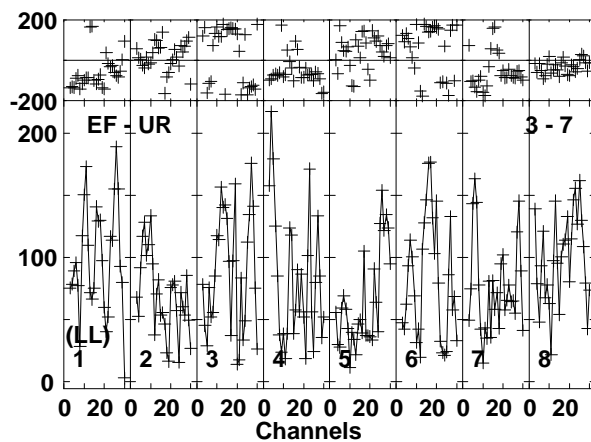
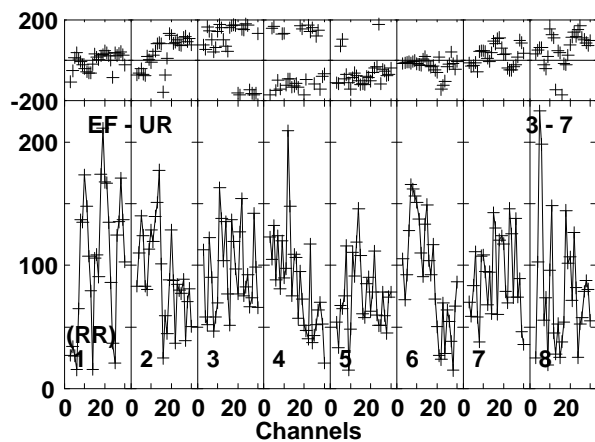
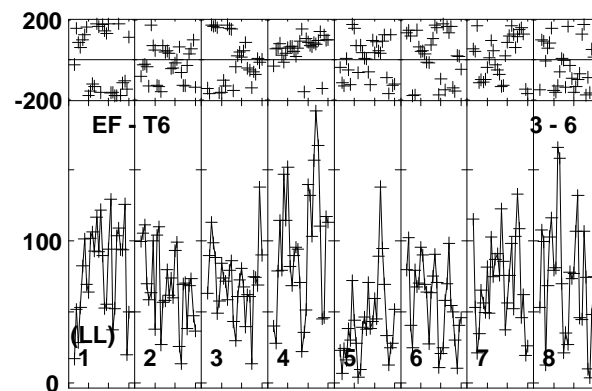
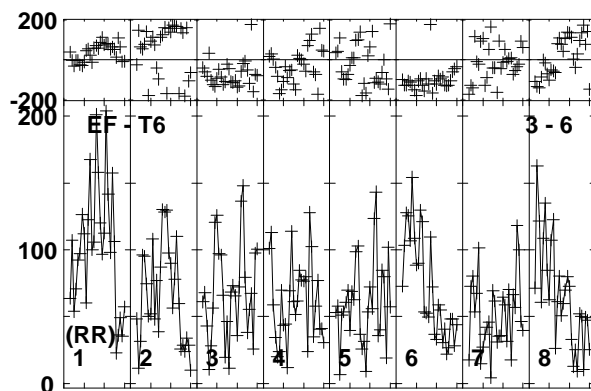
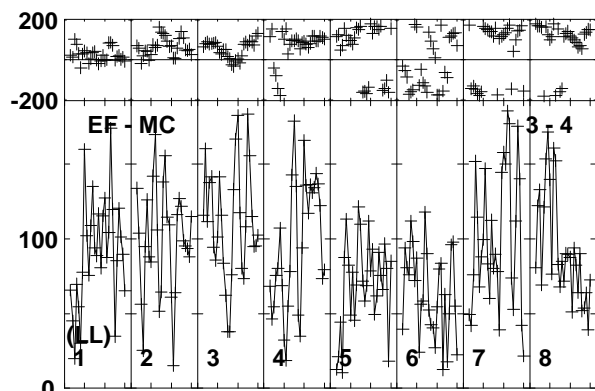
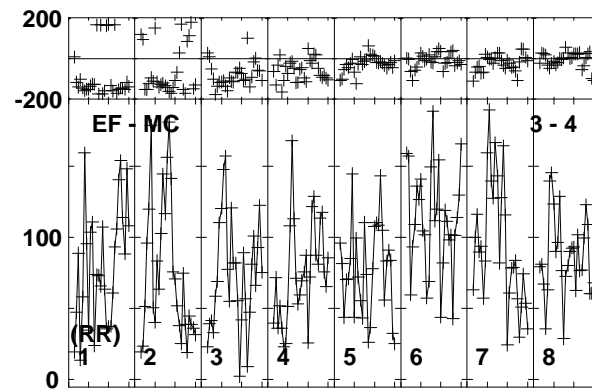
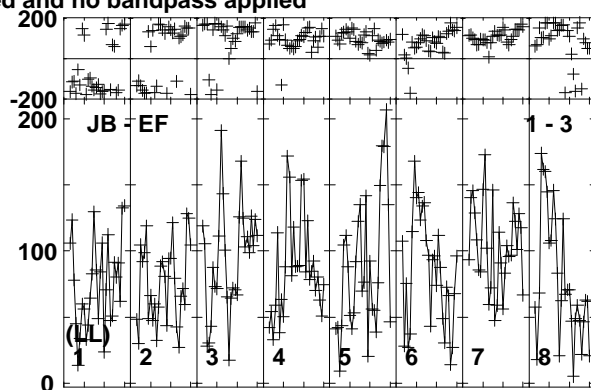
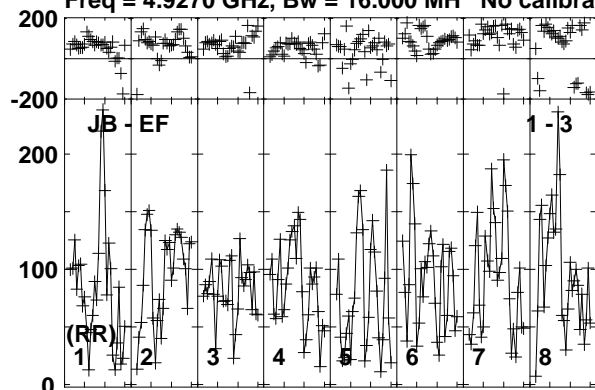

Lower frame: Micro Ampl Jy Top frame: Phas deg
Vector averaged cross-power spectrum Baseline: JB (01) - EF (03)
Timerange: 00/00:37:21 to 00/00:41:19

Plot file version 7 created 17-FEB-2020 15:42:38

J1402+5347 EK047 2.UVDATA.1

Freq = 4.9270 GHz, Bw = 16.000 MH No calibration applied and no bandpass applied

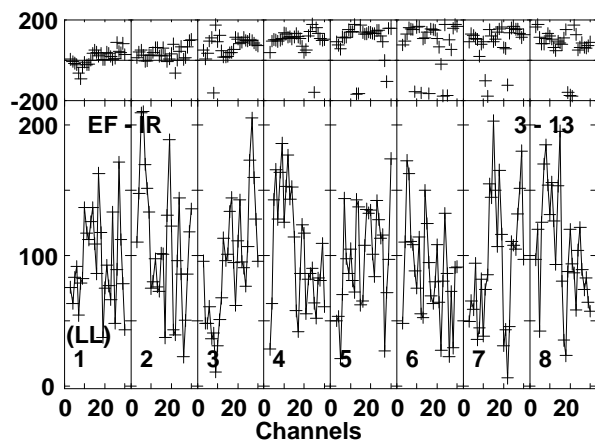
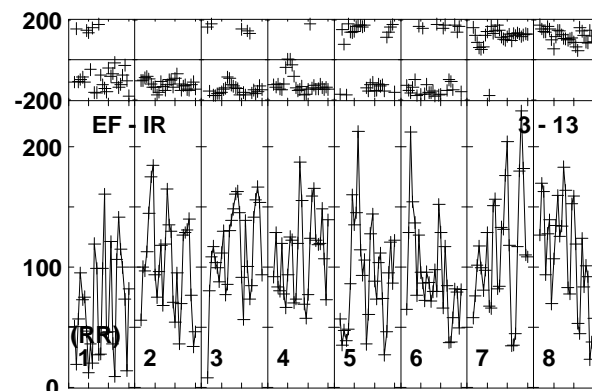
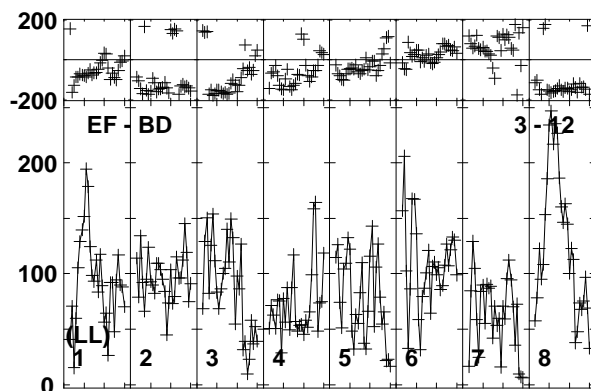
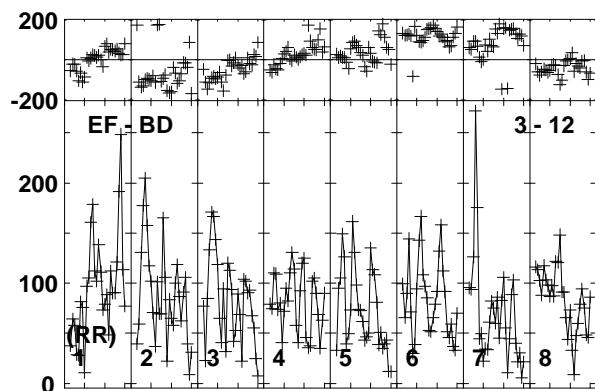
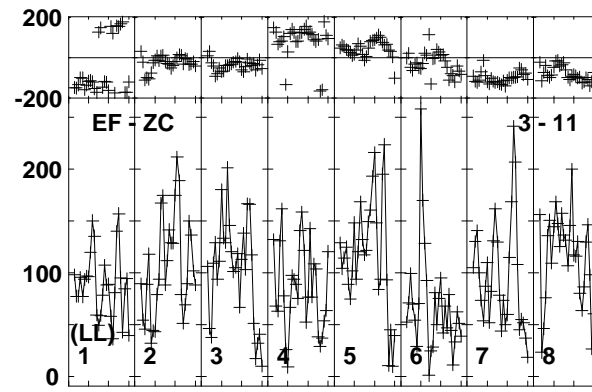
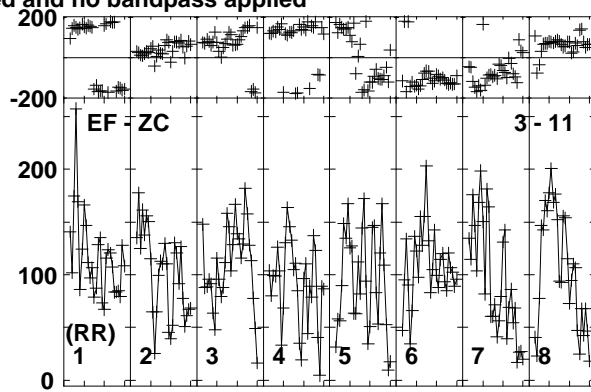
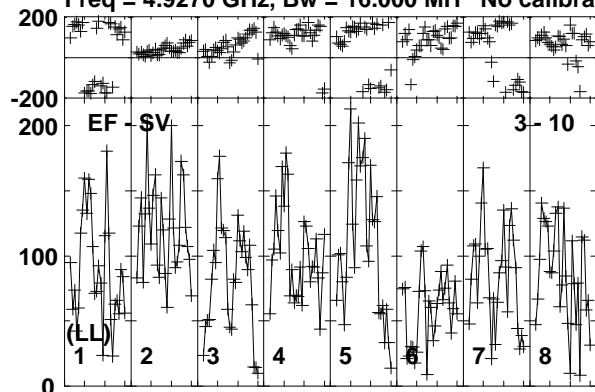

Lower frame: Micro Ampl Jy Top frame: Phas deg
Vector averaged cross-power spectrum Baseline: EF (03) - SV (10)
Timerange: 00/00:37:21 to 00/00:41:19

Plot file version 8 created 17-FEB-2020 15:42:38

J1359+5544 EK047 2.UVDATA.1

Freq = 4.9270 GHz, Bw = 16.000 MH No calibration applied and no bandpass applied

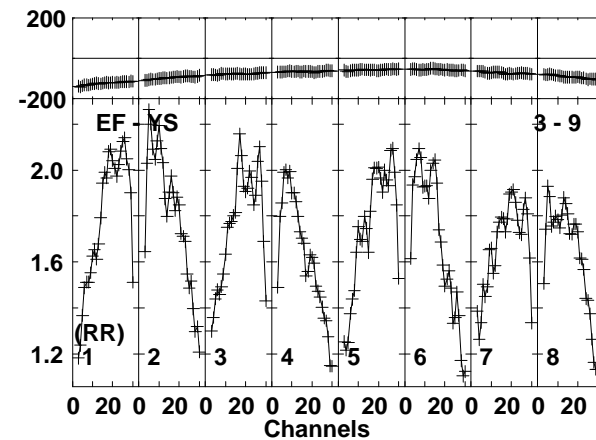
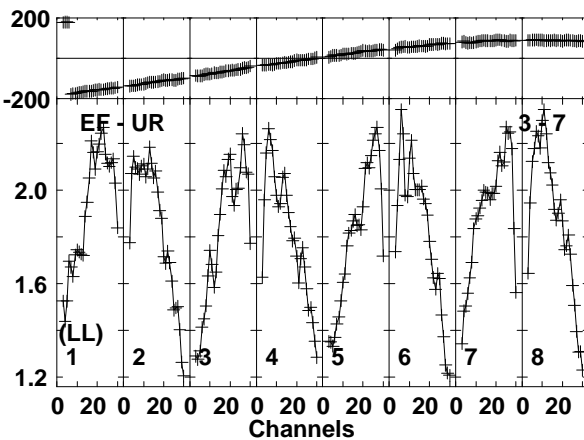
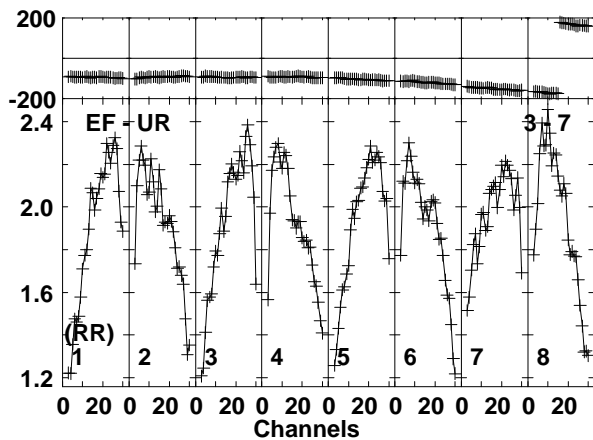
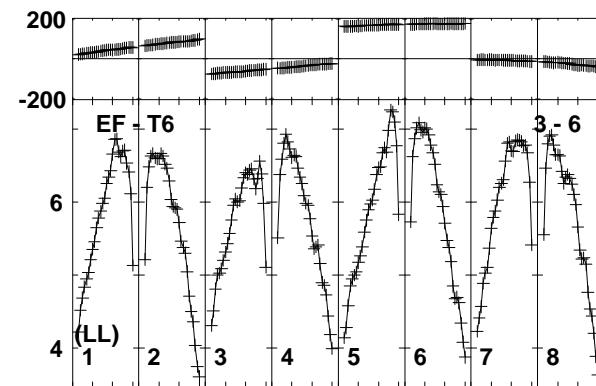
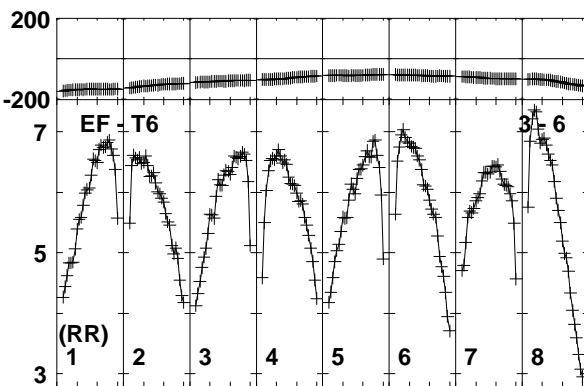
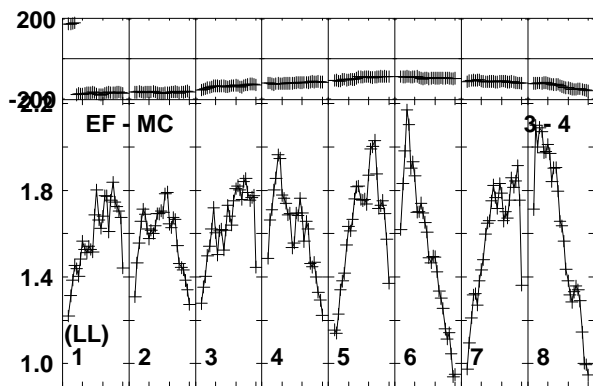
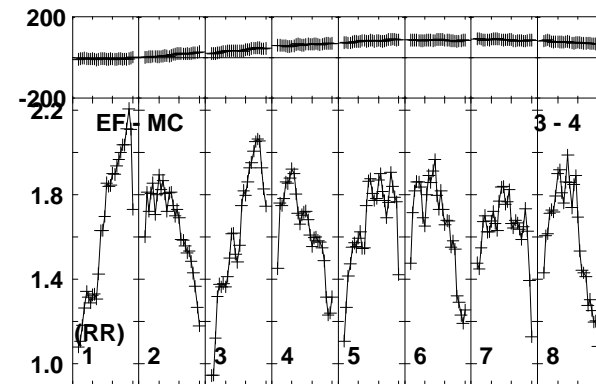
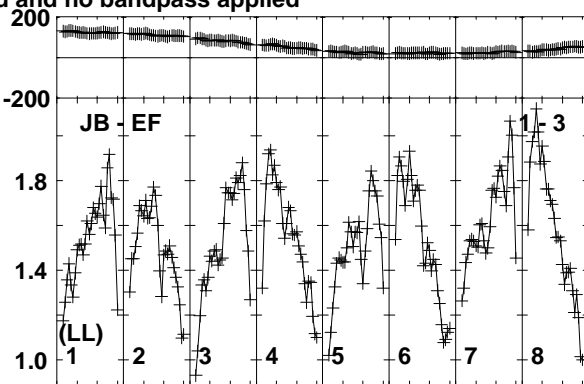
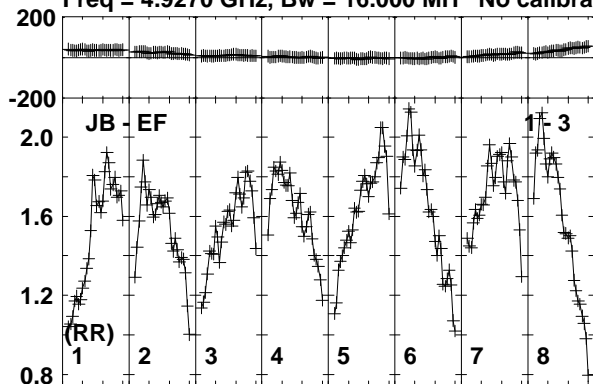

Lower frame: Milli Ampl Jy Top frame: Phas deg
Vector averaged cross-power spectrum Baseline: JB (01) - EF (03)
Timerange: 00/00:41:21 to 00/00:43:19

Plot file version 9 created 17-FEB-2020 15:42:38

J1359+5544 EK047 2.UVDATA.1

Freq = 4.9270 GHz, Bw = 16.000 MH No calibration applied and no bandpass applied

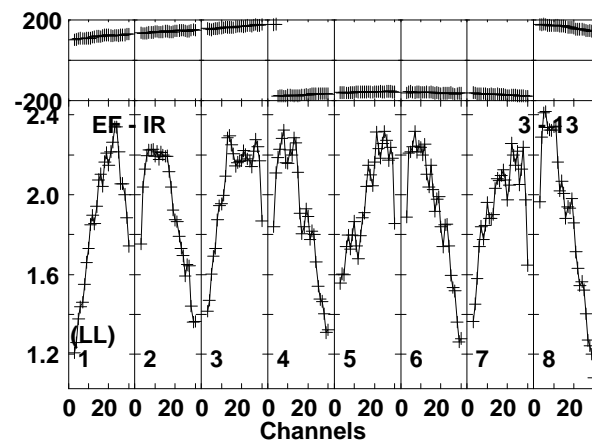
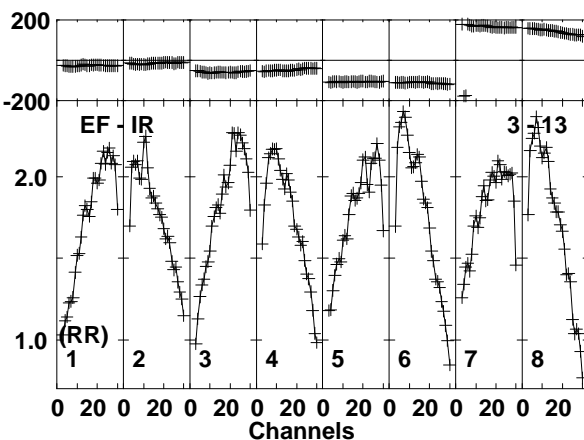
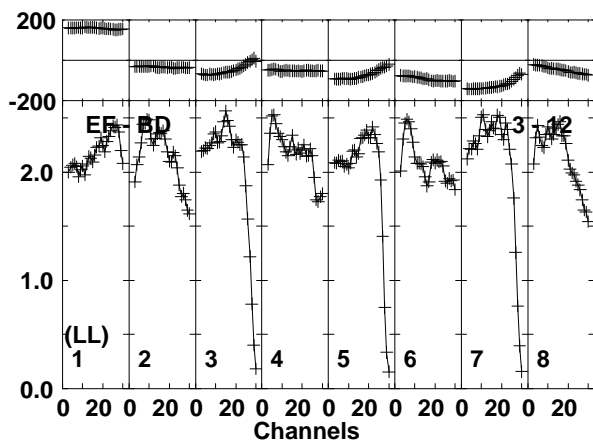
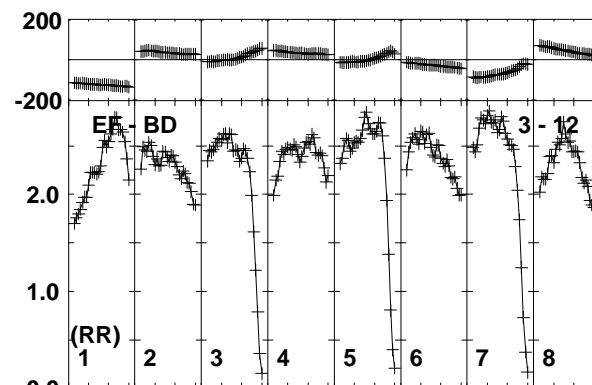
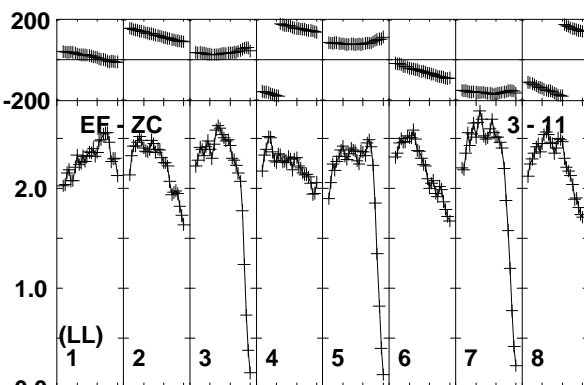
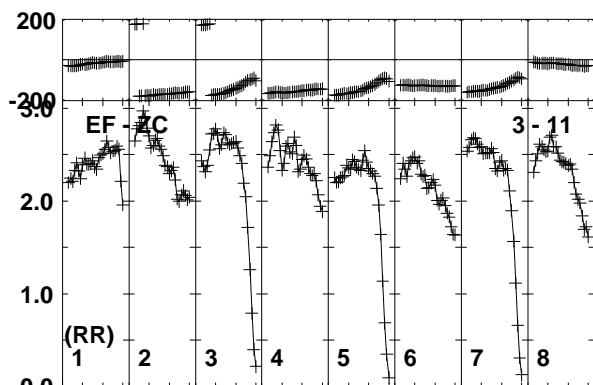
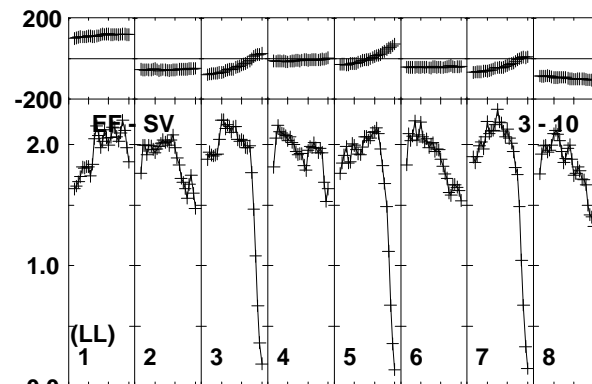
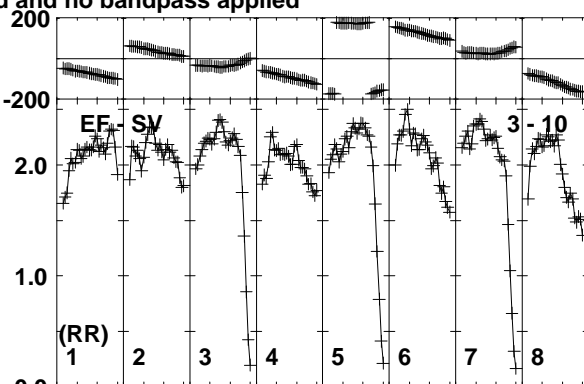
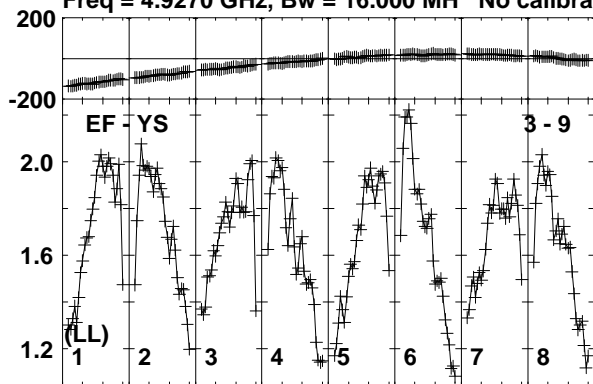

Lower frame: Milli Ampl Jy Top frame: Phas deg
Vector averaged cross-power spectrum Baseline: EF (03) - YS (09)
Timerange: 00/00:41:21 to 00/00:43:19

Plot file version 10 created 17-FEB-2020 15:42:39

J1402+5347 EK047 2.UVDATA.1

Freq = 4.9270 GHz, Bw = 16.000 MH No calibration applied and no bandpass applied

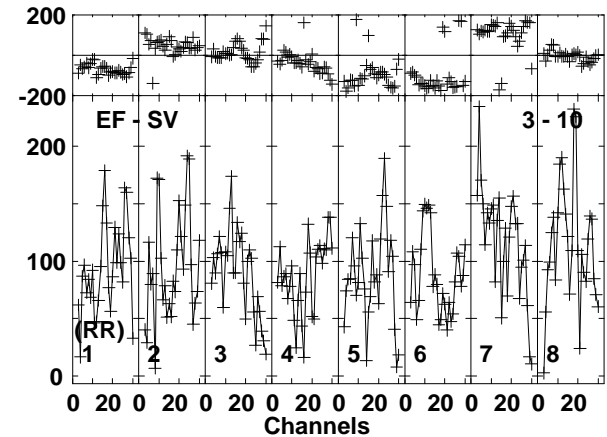
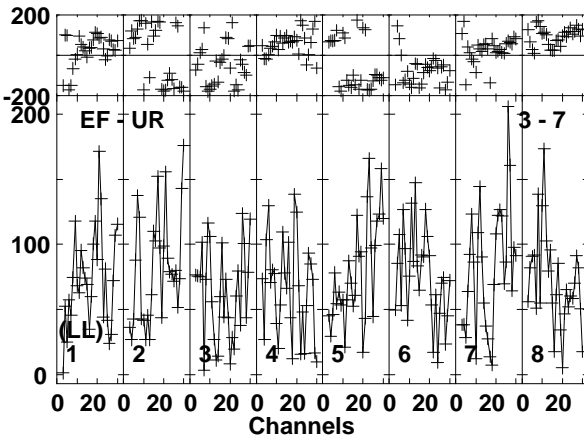
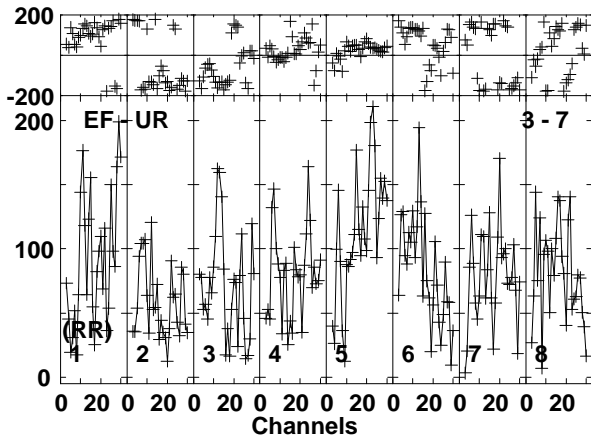
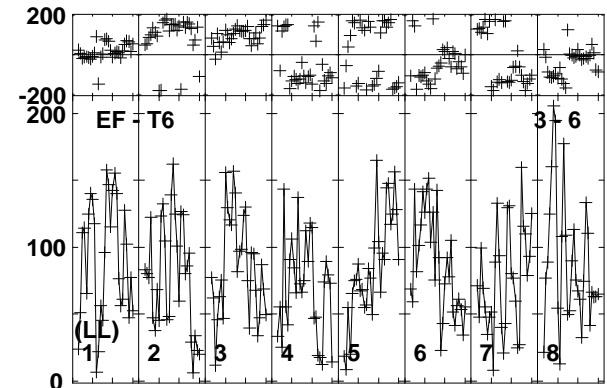
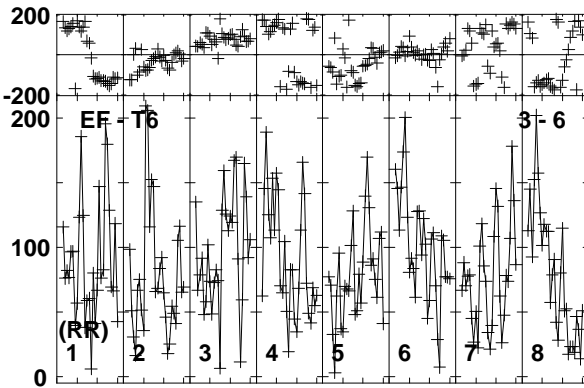
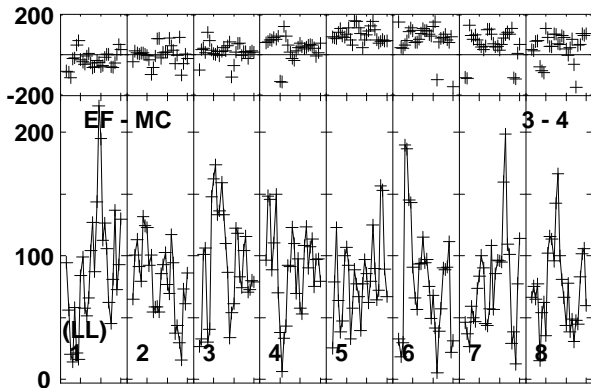
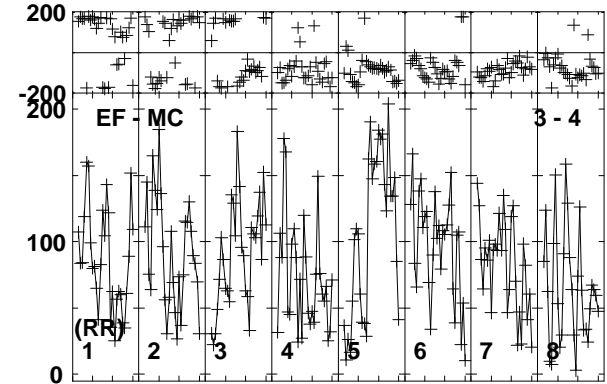
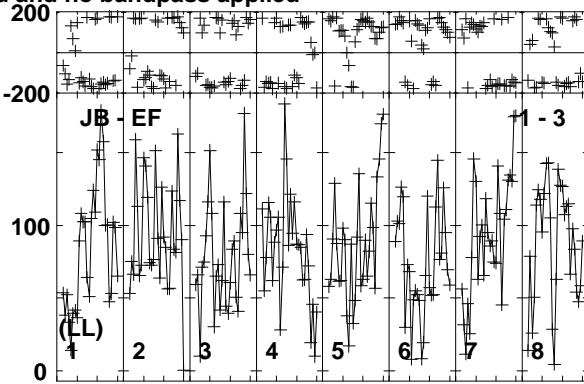
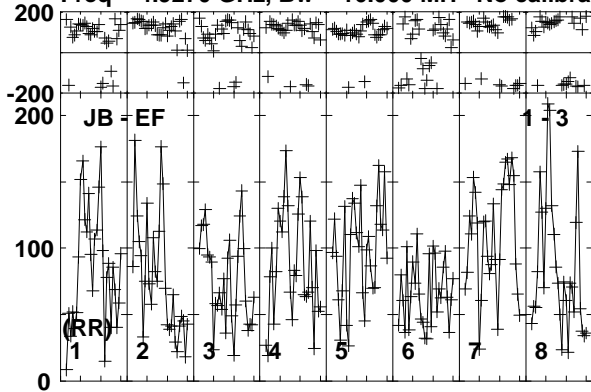

Lower frame: Micro Ampl Jy Top frame: Phas deg
Vector averaged cross-power spectrum Baseline: JB (01) - EF (03)
Timerange: 00/00:43:21 to 00/00:47:19

Plot file version 11 created 17-FEB-2020 15:42:39

J1402+5347 EK047 2.UVDATA.1

Freq = 4.9270 GHz, Bw = 16.000 MH No calibration applied and no bandpass applied

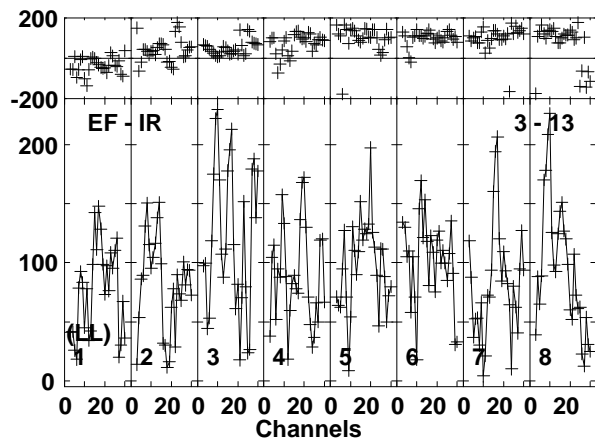
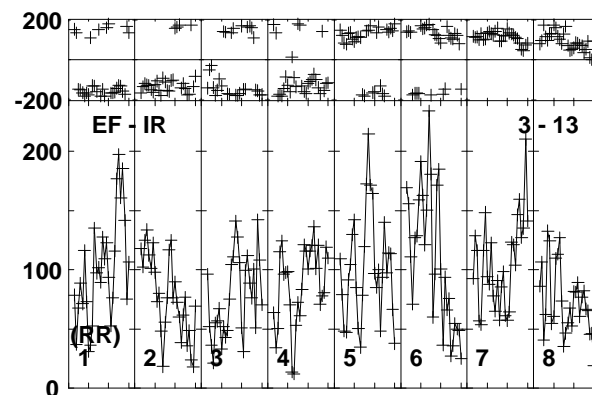
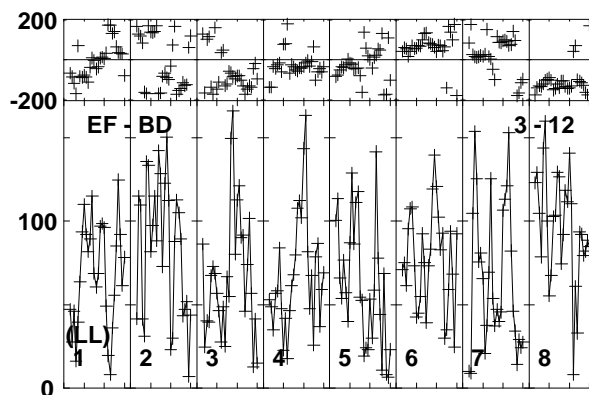
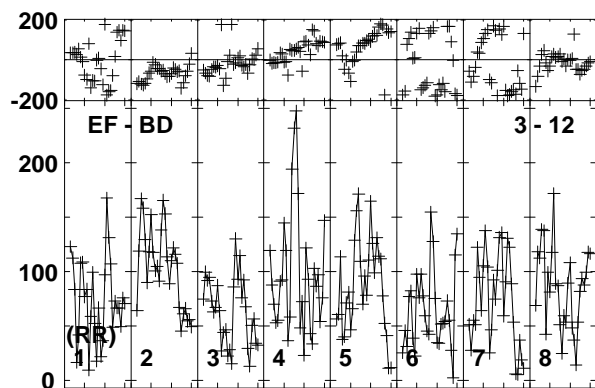
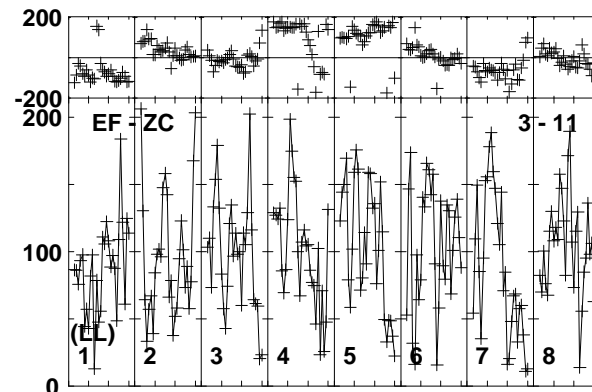
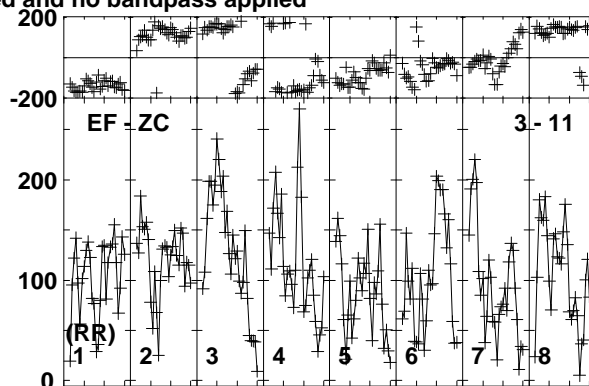
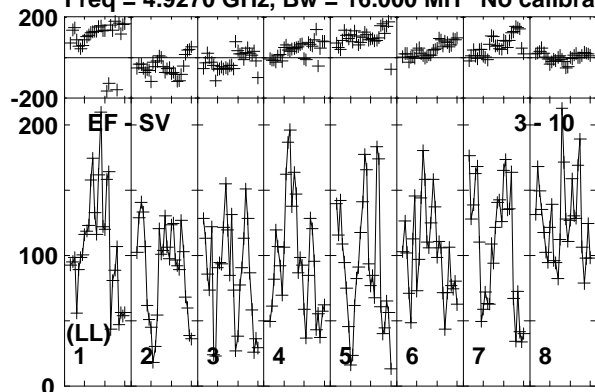

Lower frame: Micro Ampl Jy Top frame: Phas deg
Vector averaged cross-power spectrum Baseline: EF (03) - SV (10)
Timerange: 00/00:43:21 to 00/00:47:19

Plot file version 12 created 17-FEB-2020 15:42:39

J1359+5544 EK047 2.UVDATA.1

Freq = 4.9270 GHz, Bw = 16.000 MH No calibration applied and no bandpass applied

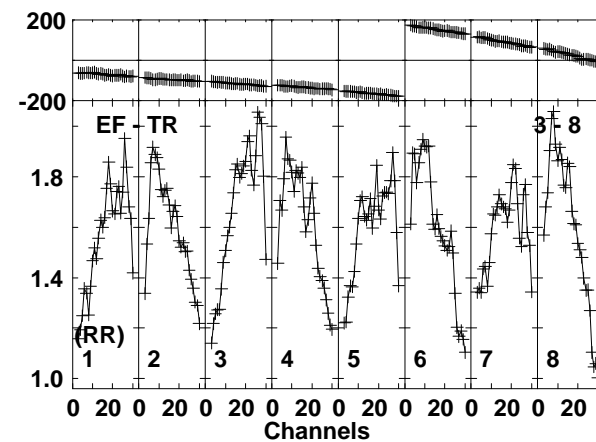
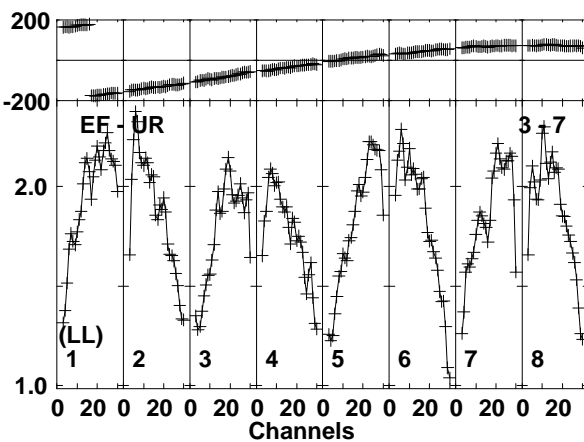
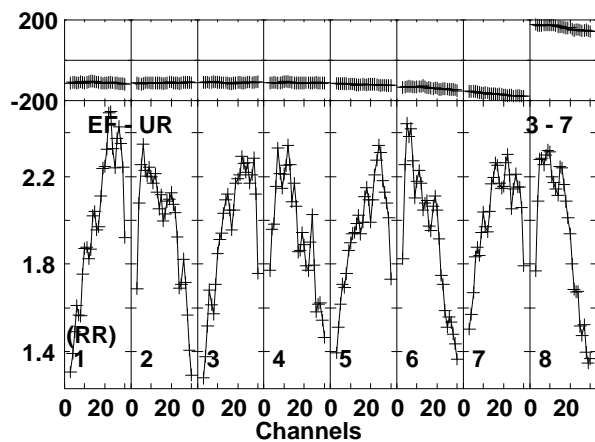
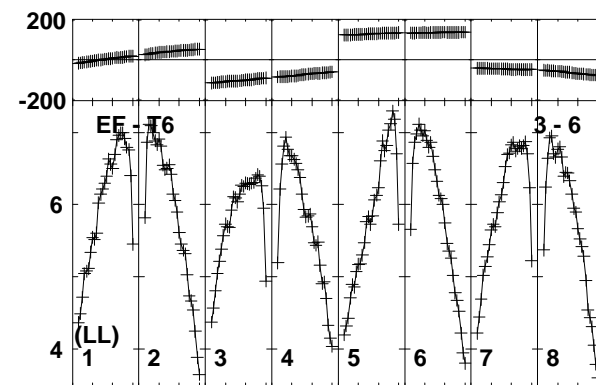
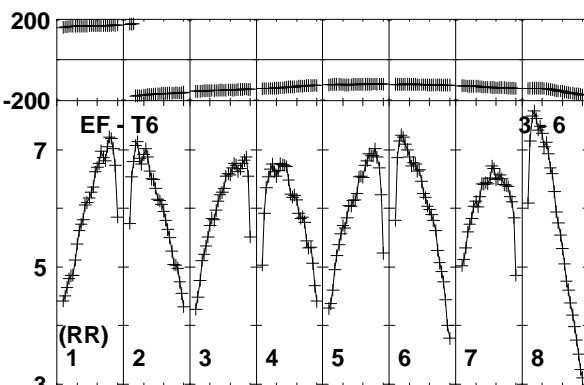
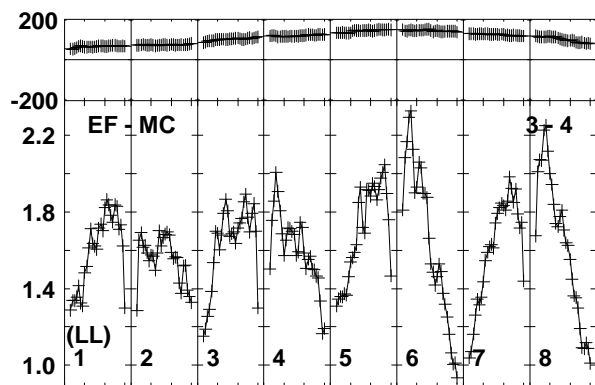
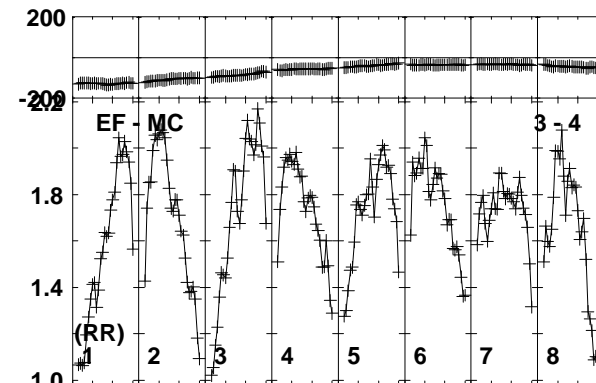
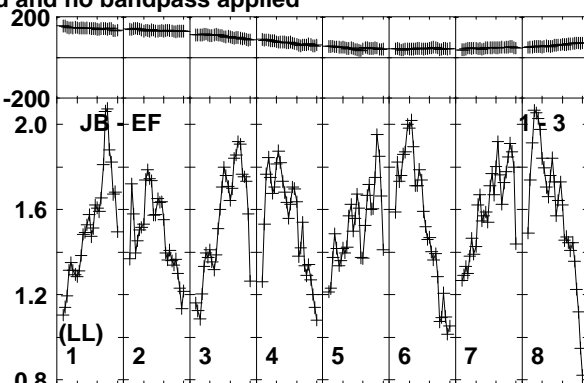
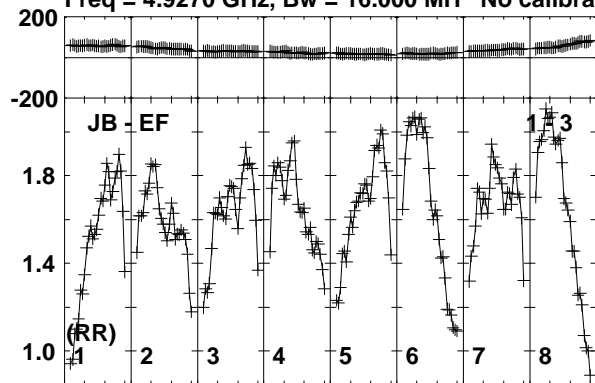

Lower frame: Milli Ampl Jy Top frame: Phas deg
Vector averaged cross-power spectrum Baseline: JB (01) - EF (03)
Timerange: 00/00:48:01 to 00/00:49:19

Plot file version 13 created 17-FEB-2020 15:42:39

J1359+5544 EK047 2.UVDATA.1

Freq = 4.9270 GHz, Bw = 16.000 MH No calibration applied and no bandpass applied

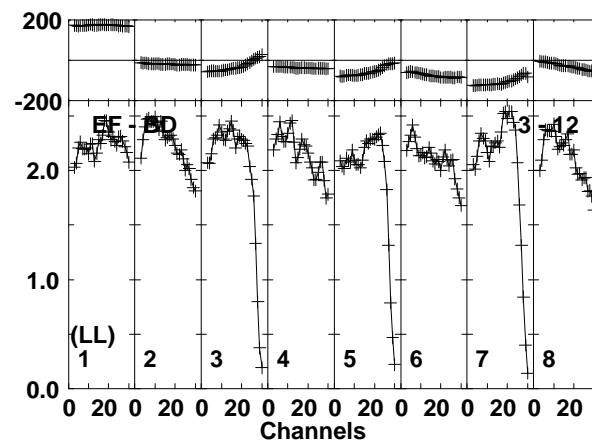
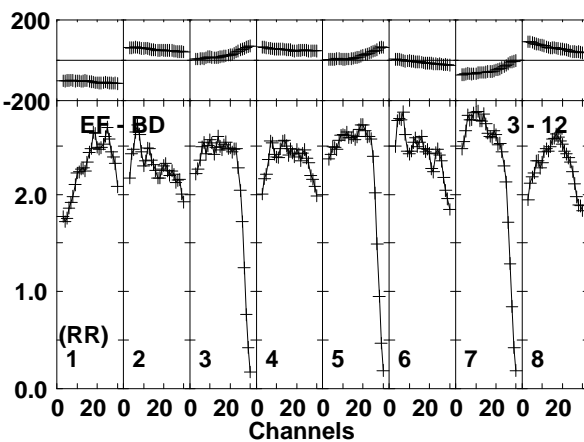
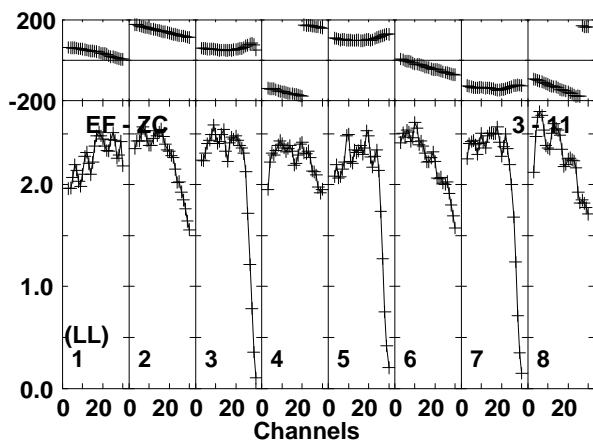
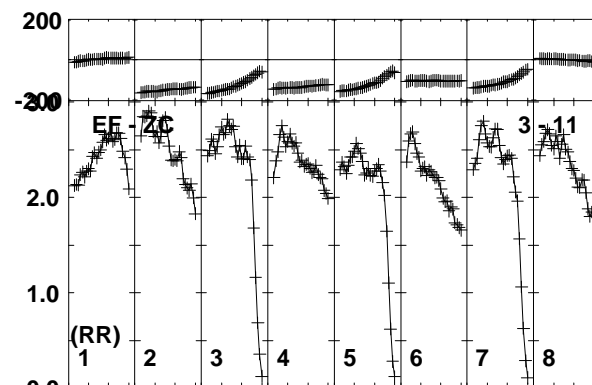
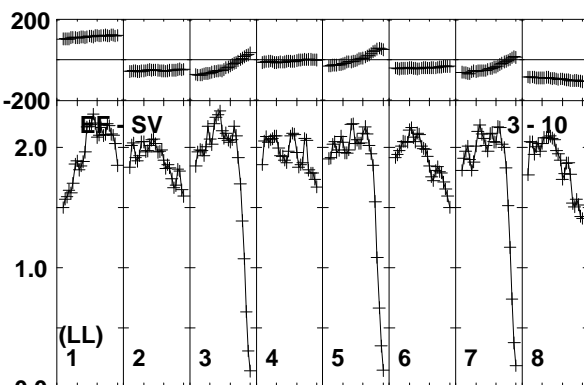
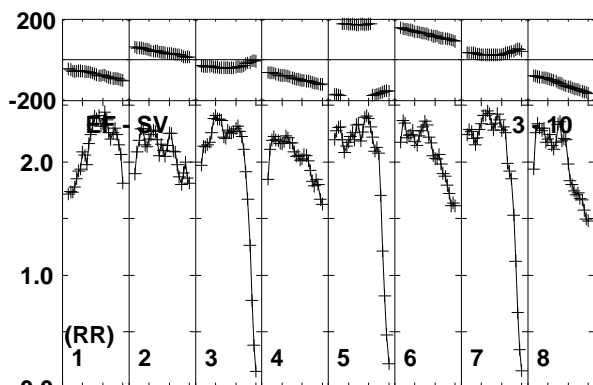
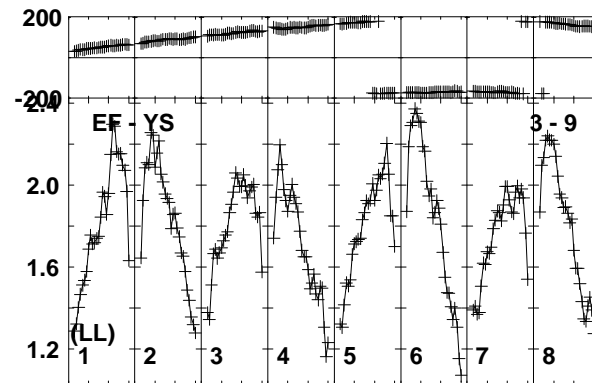
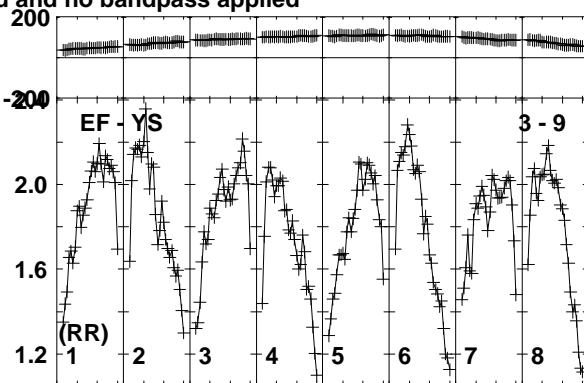
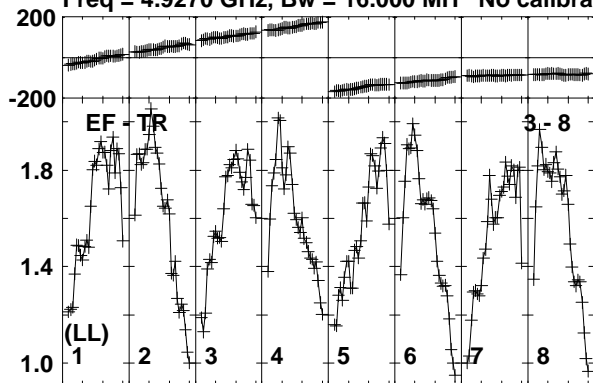

Lower frame: Milli Ampl Jy Top frame: Phas deg
Vector averaged cross-power spectrum Baseline: EF (03) - TR (08)
Timerange: 00/00:48:01 to 00/00:49:19

Plot file version 14 created 17-FEB-2020 15:42:39

J1359+5544 EK047 2.UVDATA.1

Freq = 4.9270 GHz, Bw = 16.000 MH No calibration applied and no bandpass applied

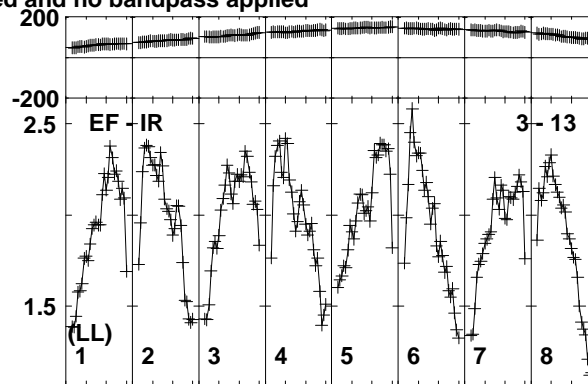
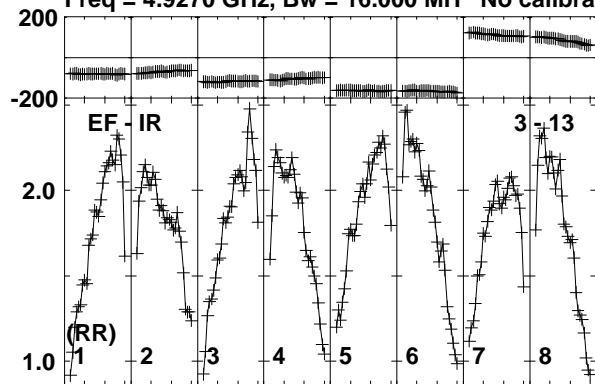

Lower frame: Milli Ampl Jy Top frame: Phas deg
Vector averaged cross-power spectrum Baseline: EF (03) - IR (13)
Timerange: 00/00:48:01 to 00/00:49:19

Plot file version 15 created 17-FEB-2020 15:42:39

J1402+5347 EK047 2.UVDATA.1

Freq = 4.9270 GHz, Bw = 16.000 MH No calibration applied and no bandpass applied

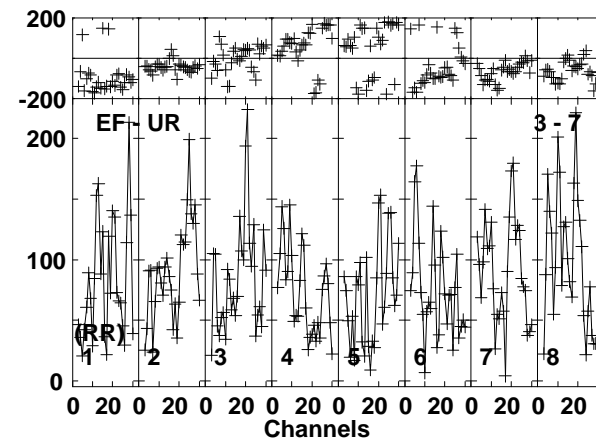
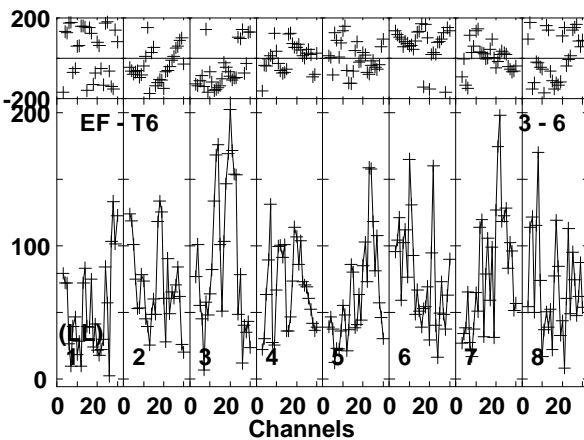
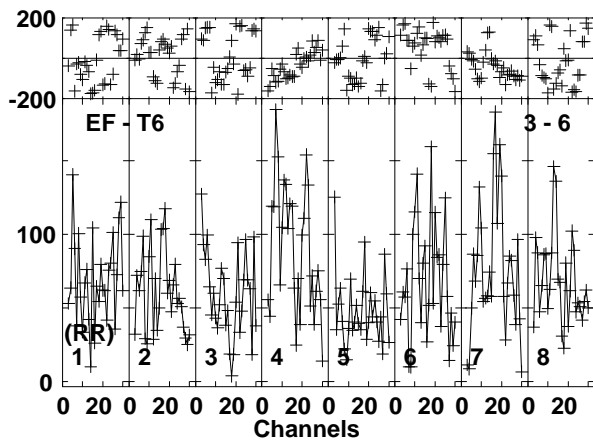
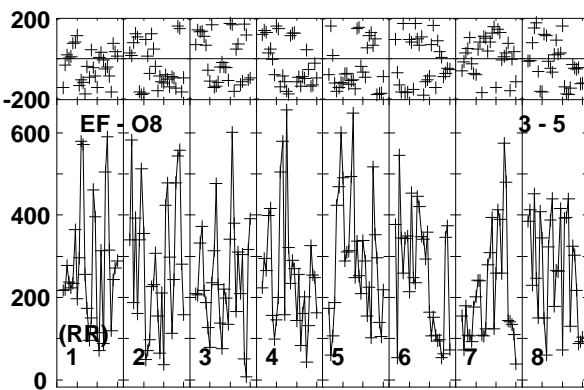
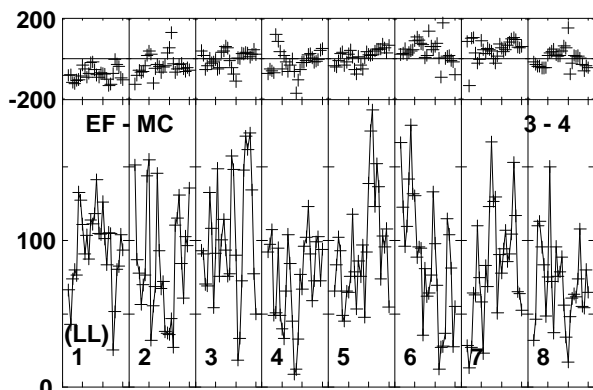
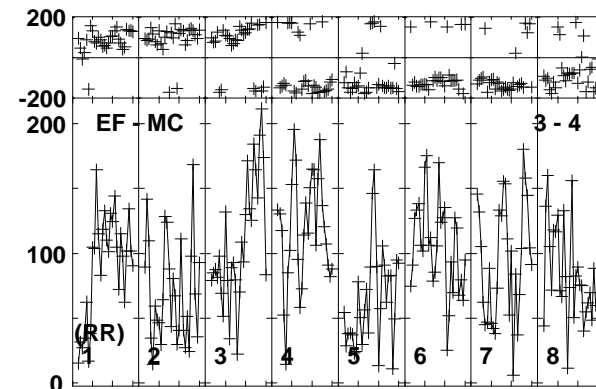
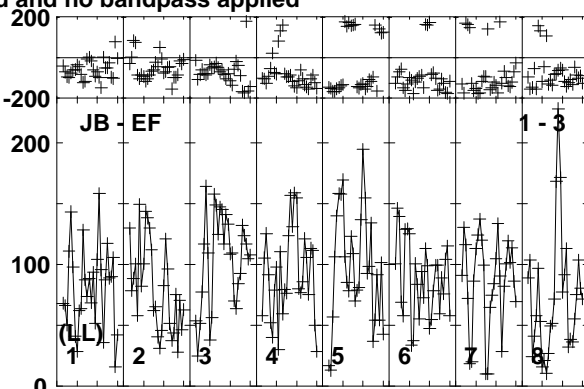
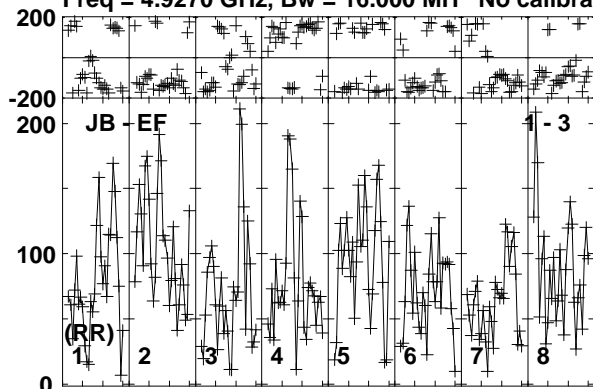

Lower frame: Micro Ampl Jy Top frame: Phas deg
Vector averaged cross-power spectrum Baseline: JB (01) - EF (03)
Timerange: 00/00:49:21 to 00/00:53:19

Plot file version 16 created 17-FEB-2020 15:42:39

J1402+5347 EK047 2.UVDATA.1

Freq = 4.9270 GHz, Bw = 16.000 MH No calibration applied and no bandpass applied

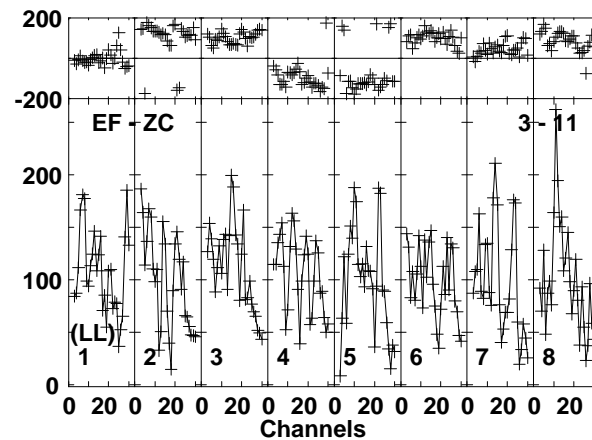
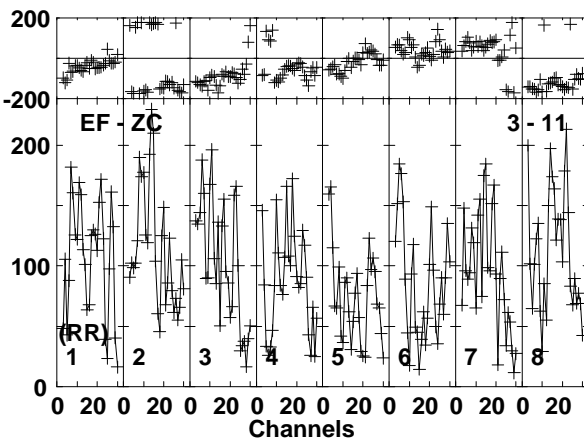
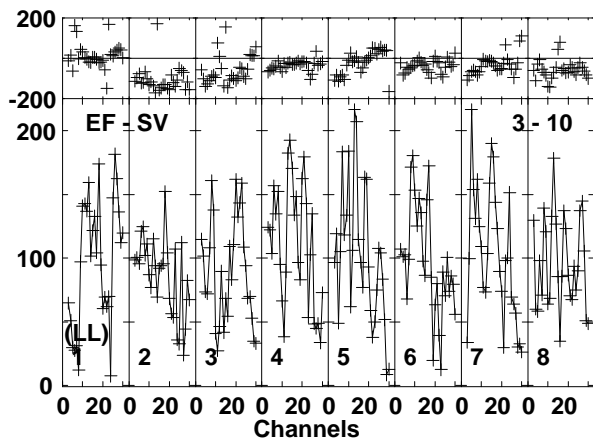
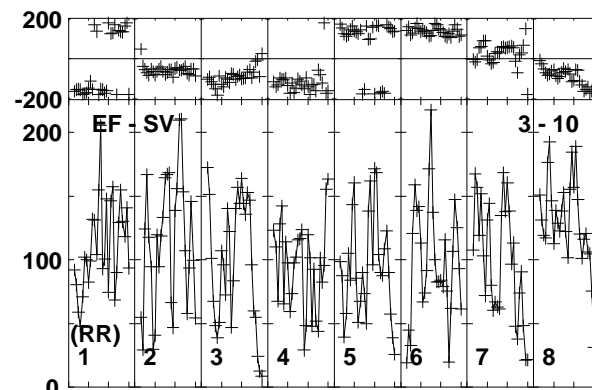
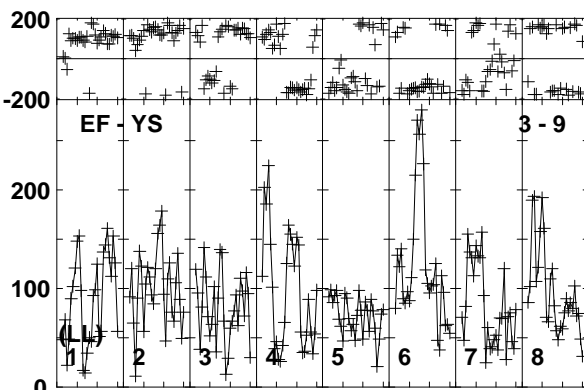
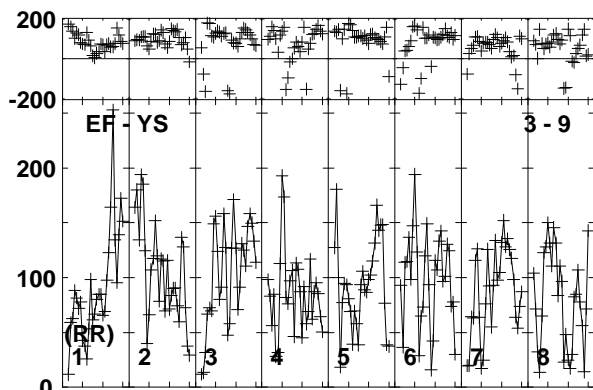
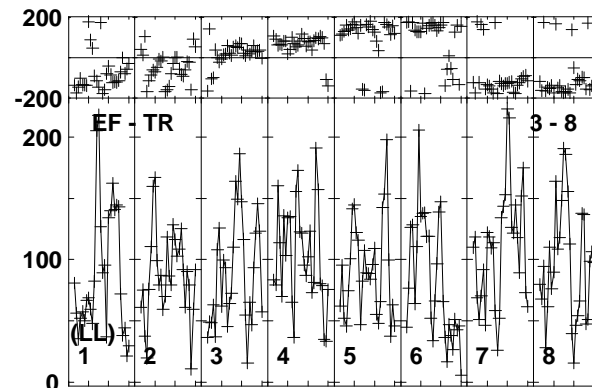
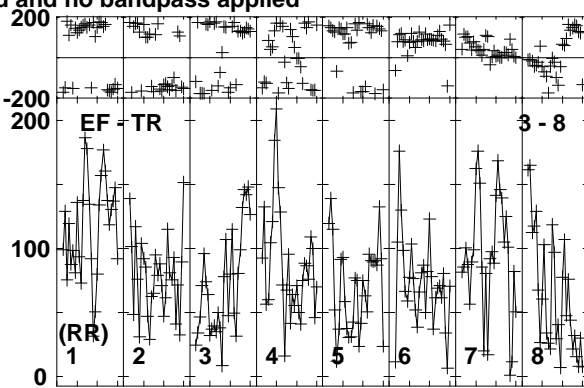
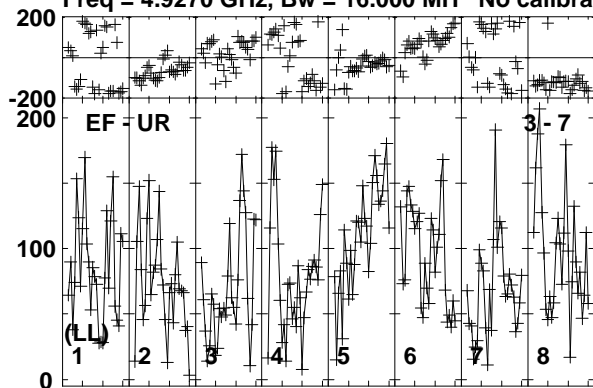

Lower frame: Micro Ampl Jy Top frame: Phas deg
Vector averaged cross-power spectrum Baseline: EF (03) - UR (07)
Timerange: 00/00:49:21 to 00/00:53:19

Plot file version 17 created 17-FEB-2020 15:42:39

J1402+5347 EK047 2.UVDATA.1

Freq = 4.9270 GHz, Bw = 16.000 MH No calibration applied and no bandpass applied

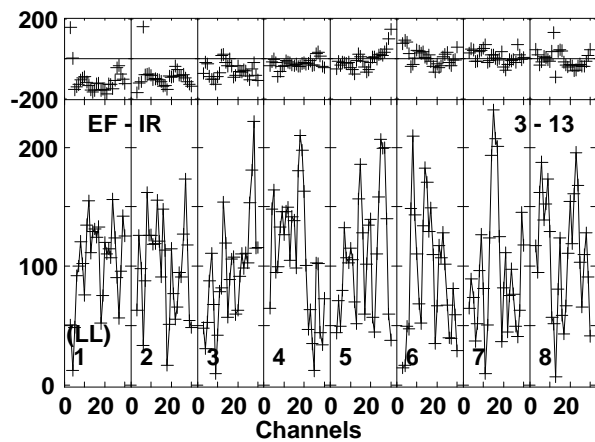
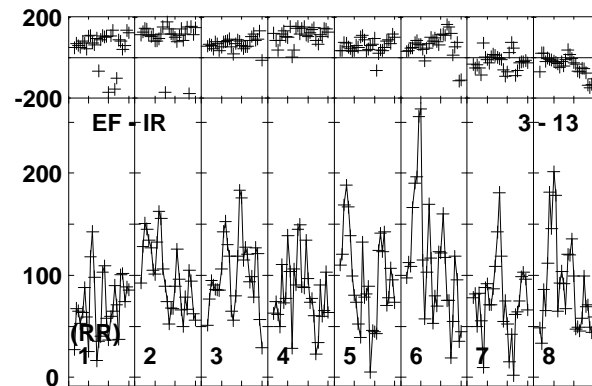
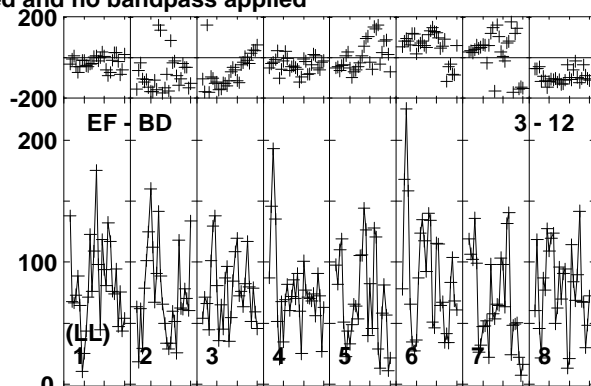
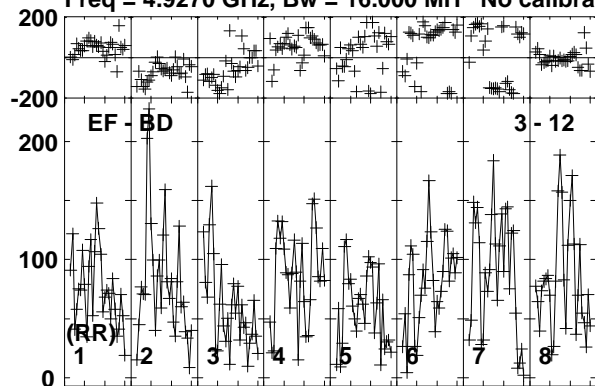

Lower frame: Micro Ampl Jy Top frame: Phas deg
Vector averaged cross-power spectrum Baseline: EF (03) - BD (12)
Timerange: 00/00:49:21 to 00/00:53:19

Plot file version 18 created 17-FEB-2020 15:42:39

J1359+5544 EK047 2.UVDATA.1

Freq = 4.9270 GHz, Bw = 16.000 MH No calibration applied and no bandpass applied

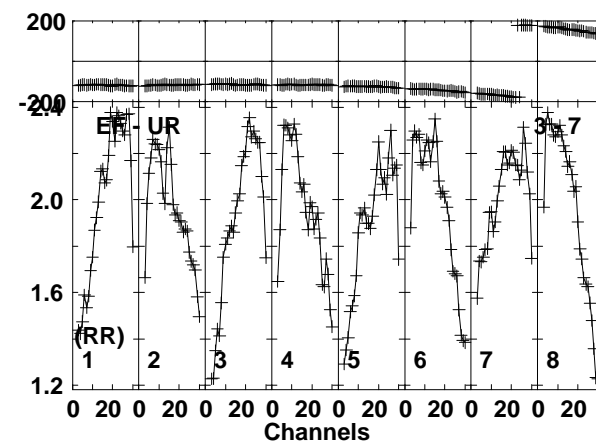
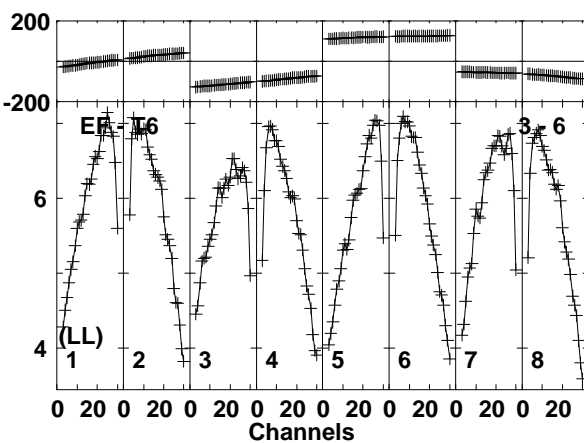
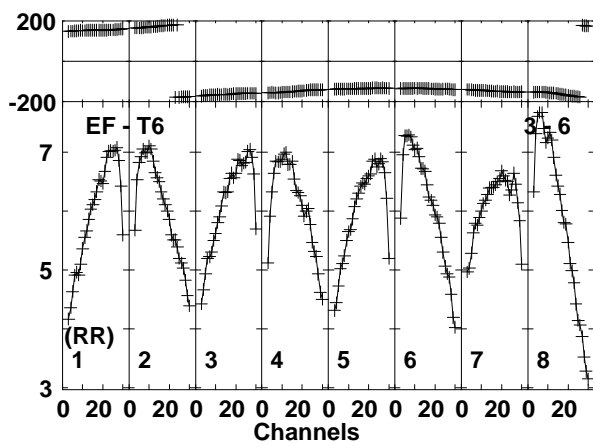
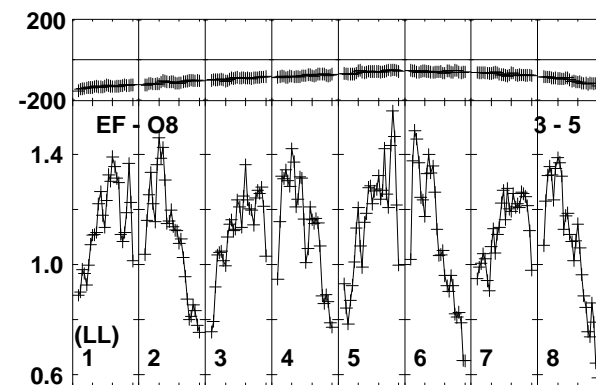
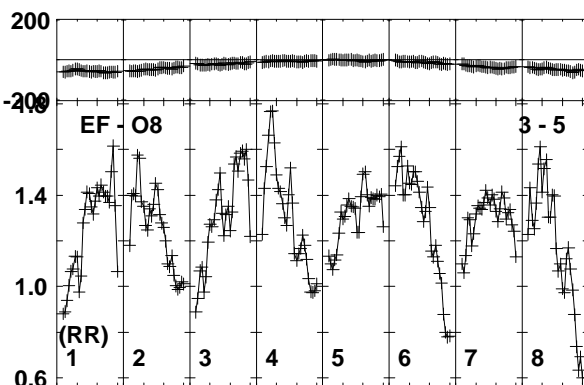
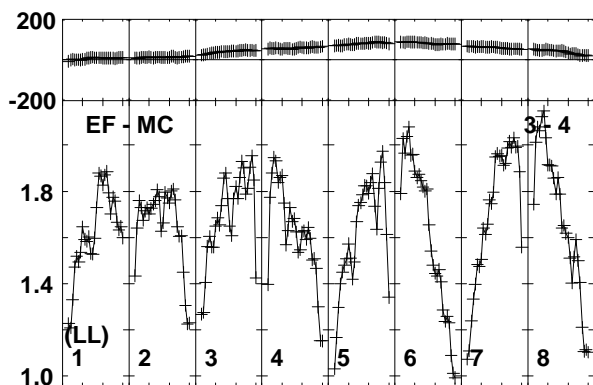
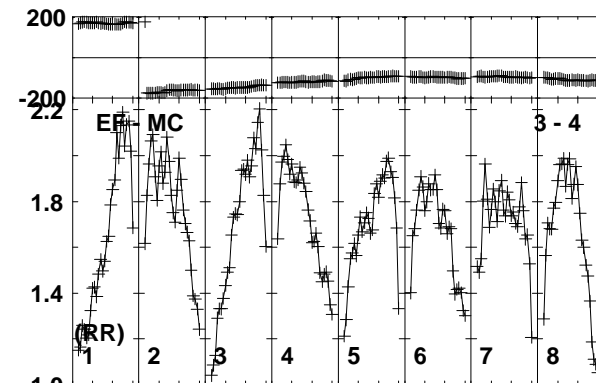
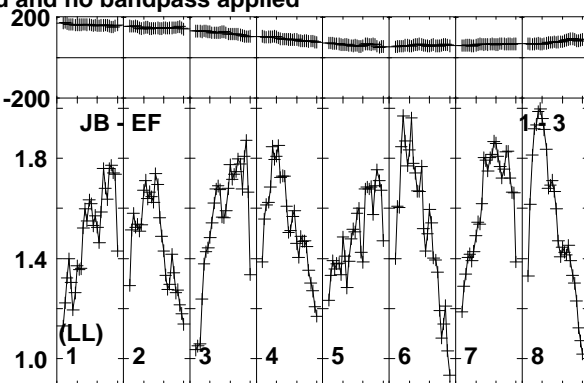
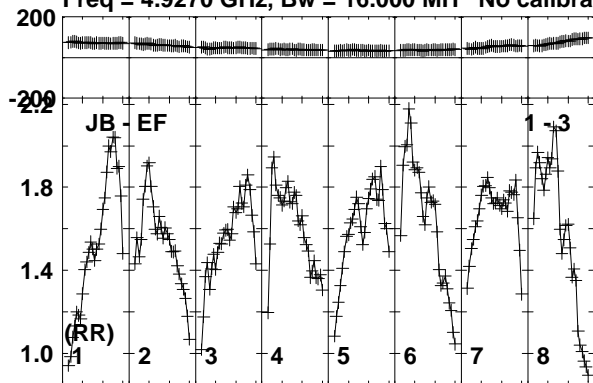

Lower frame: Milli Ampl Jy Top frame: Phas deg
Vector averaged cross-power spectrum Baseline: JB (01) - EF (03)
Timerange: 00/00:53:21 to 00/00:55:19

Plot file version 19 created 17-FEB-2020 15:42:39

J1359+5544 EK047 2.UVDATA.1

Freq = 4.9270 GHz, Bw = 16.000 MH No calibration applied and no bandpass applied

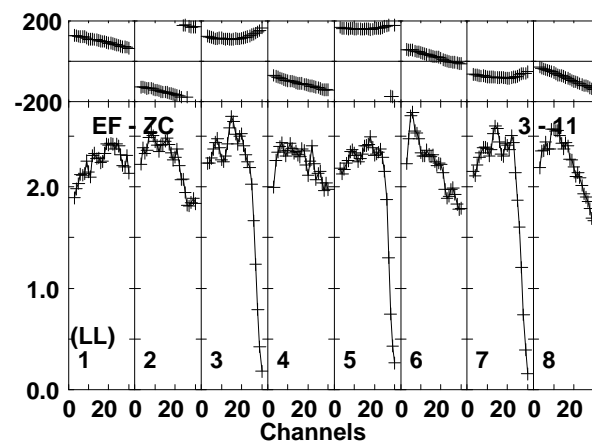
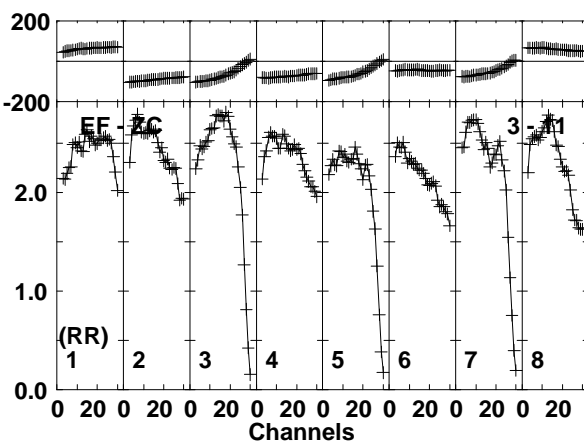
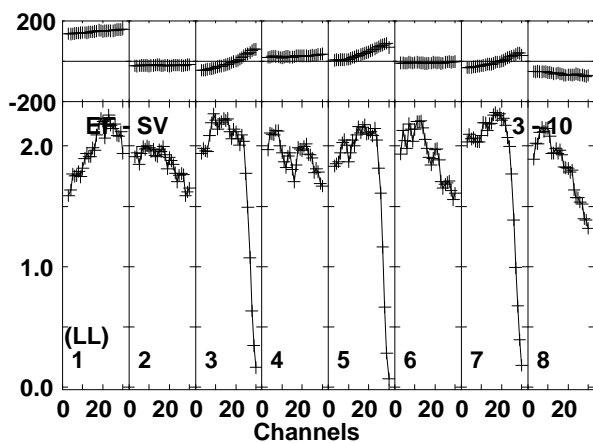
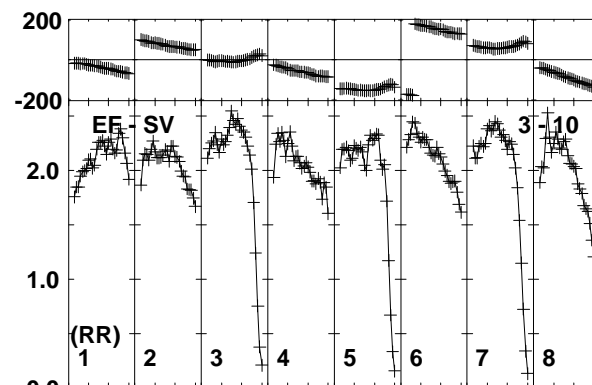
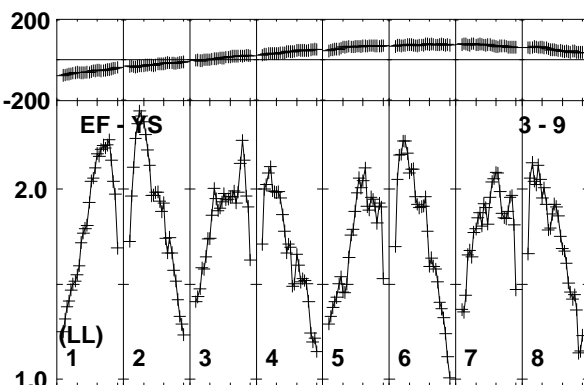
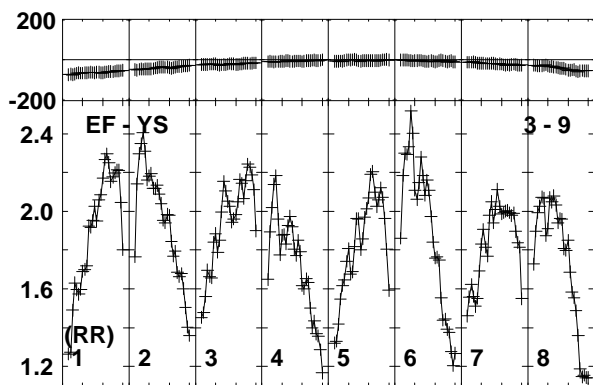
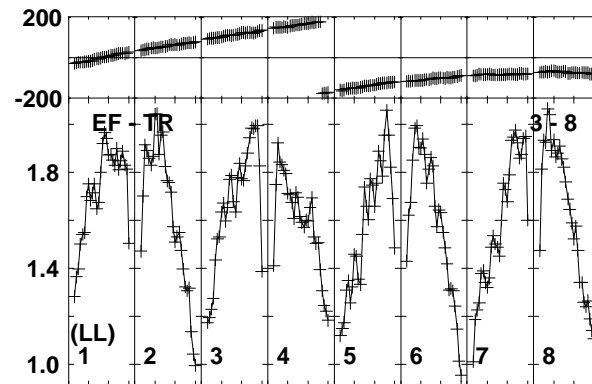
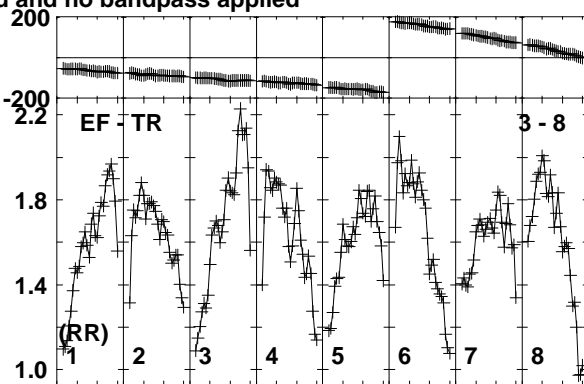
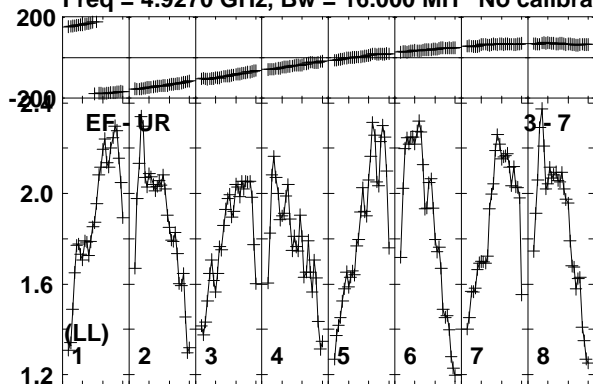

Lower frame: Milli Ampl Jy Top frame: Phas deg
Vector averaged cross-power spectrum Baseline: EF (03) - UR (07)
Timerange: 00/00:53:21 to 00/00:55:19

Plot file version 20 created 17-FEB-2020 15:42:40

J1359+5544 EK047 2.UVDATA.1

Freq = 4.9270 GHz, Bw = 16.000 MH No calibration applied and no bandpass applied

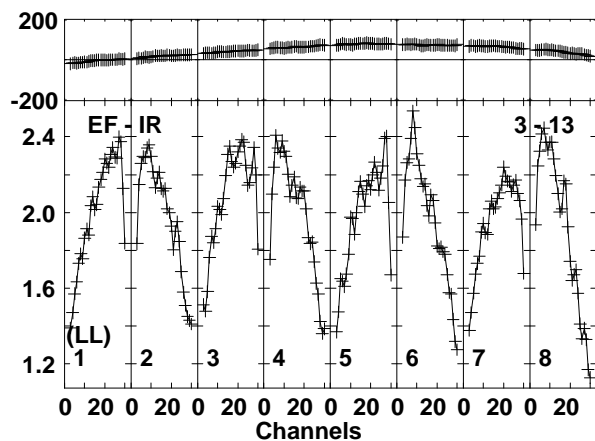
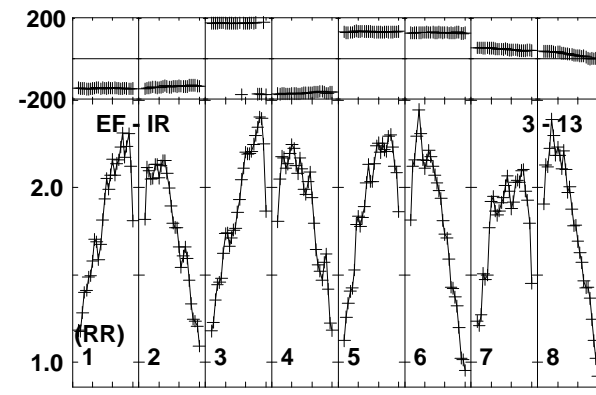
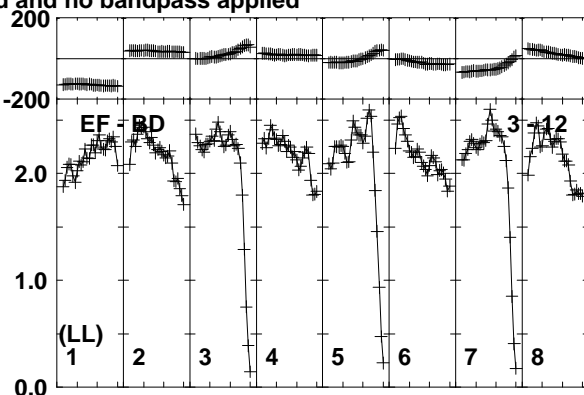
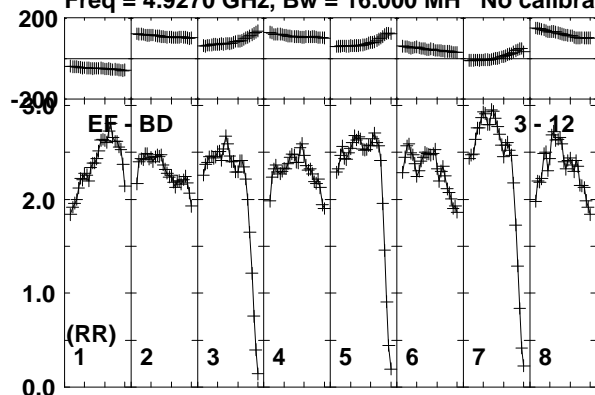

Lower frame: Milli Ampl Jy Top frame: Phas deg
Vector averaged cross-power spectrum Baseline: EF (03) - BD (12)
Timerange: 00/00:53:21 to 00/00:55:19

Plot file version 21 created 17-FEB-2020 15:42:40

J1402+5347 EK047 2.UVDATA.1

Freq = 4.9270 GHz, Bw = 16.000 MH No calibration applied and no bandpass applied

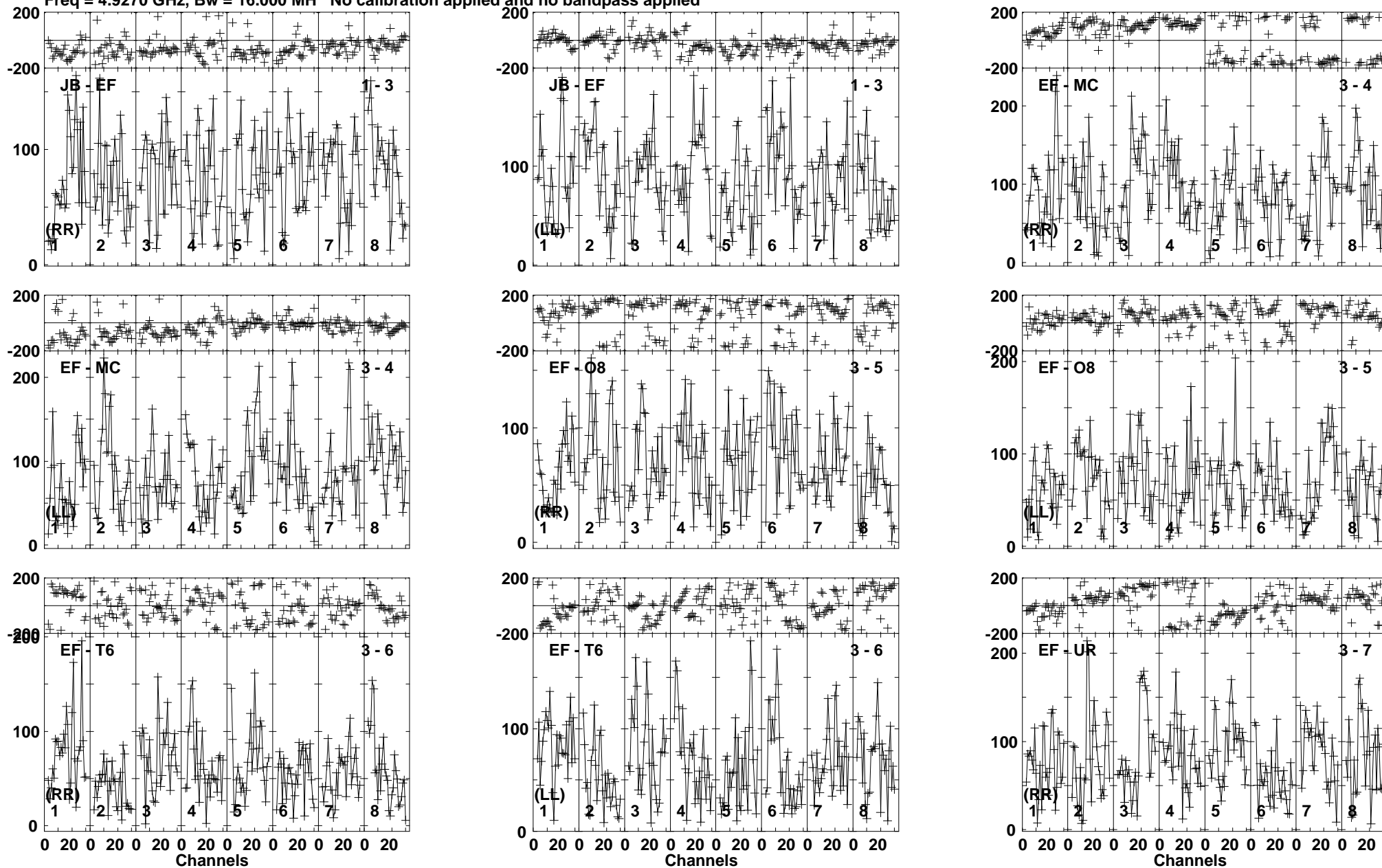

Lower frame: Micro Ampl Jy Top frame: Phas deg
Vector averaged cross-power spectrum Baseline: JB (01) - EF (03)
Timerange: 00/00:55:21 to 00/00:59:19

Plot file version 22 created 17-FEB-2020 15:42:40

J1402+5347 EK047 2.UVDATA.1

Freq = 4.9270 GHz, Bw = 16.000 MH No calibration applied and no bandpass applied

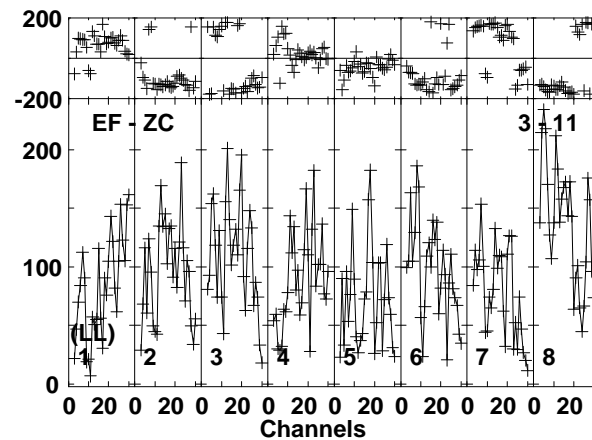
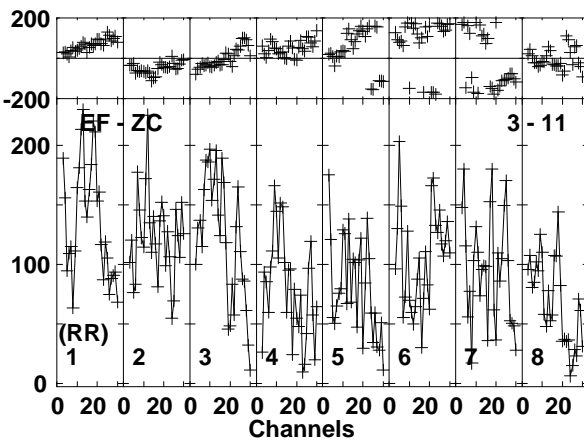
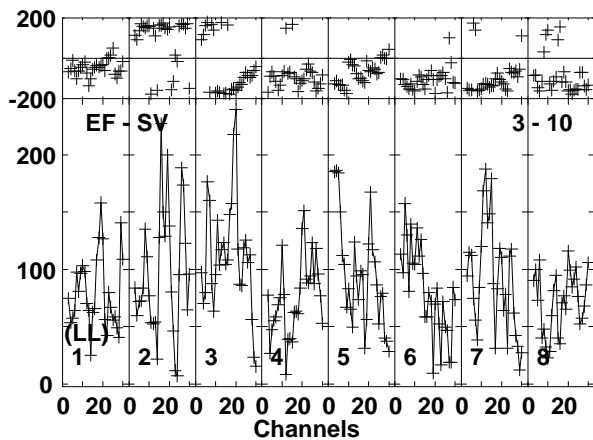
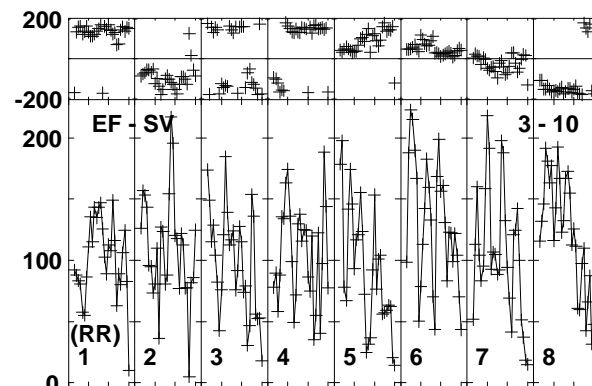
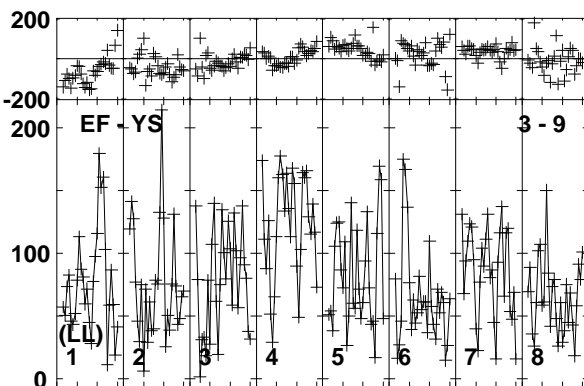
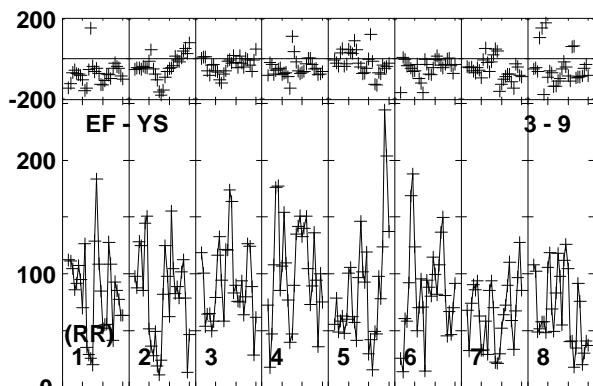
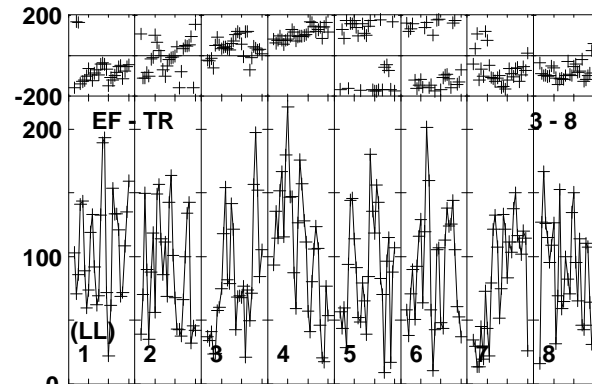
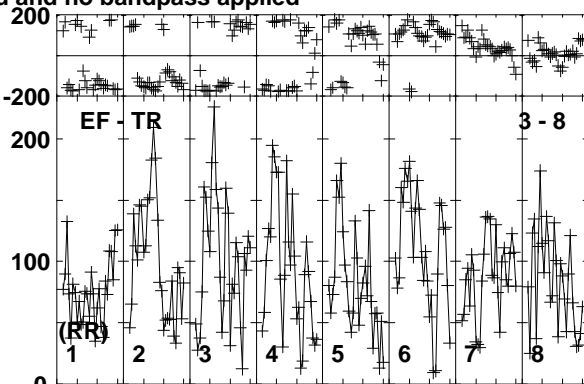
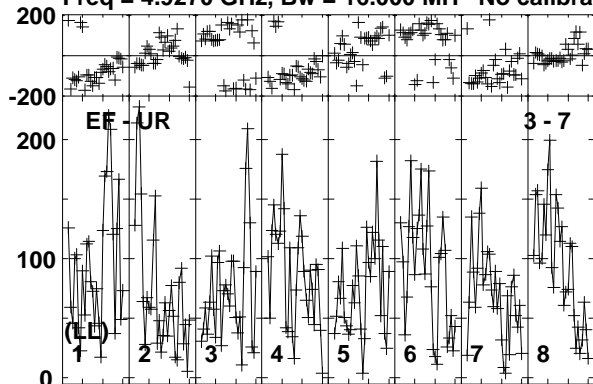

Lower frame: Micro Ampl Jy Top frame: Phas deg
Vector averaged cross-power spectrum Baseline: EF (03) - UR (07)
Timerange: 00/00:55:21 to 00/00:59:19

Plot file version 23 created 17-FEB-2020 15:42:40

J1402+5347 EK047 2.UVDATA.1

Freq = 4.9270 GHz, Bw = 16.000 MH No calibration applied and no bandpass applied

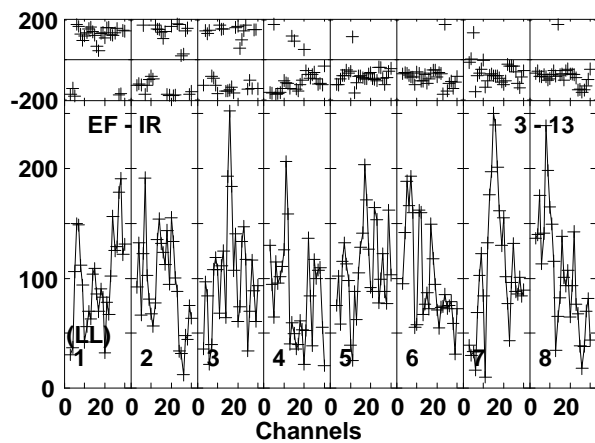
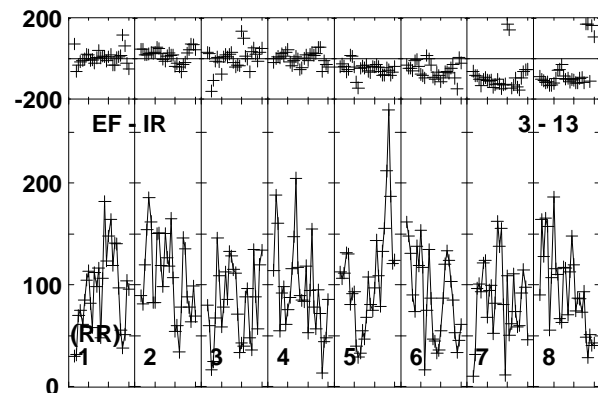
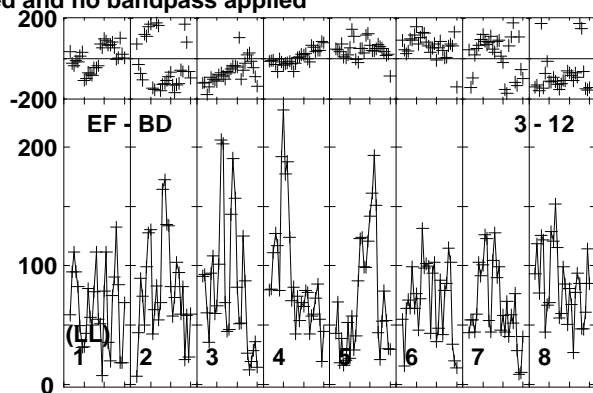
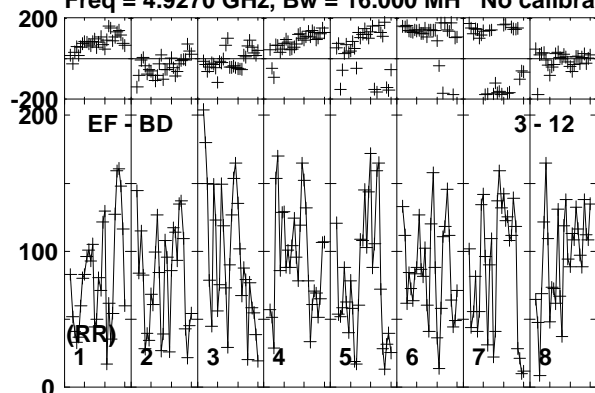

Lower frame: Micro Ampl Jy Top frame: Phas deg
Vector averaged cross-power spectrum Baseline: EF (03) - BD (12)
Timerange: 00/00:55:21 to 00/00:59:19

Plot file version 24 created 17-FEB-2020 15:42:40

J1359+5544 EK047 2.UVDATA.1

Freq = 4.9270 GHz, Bw = 16.000 MH No calibration applied and no bandpass applied

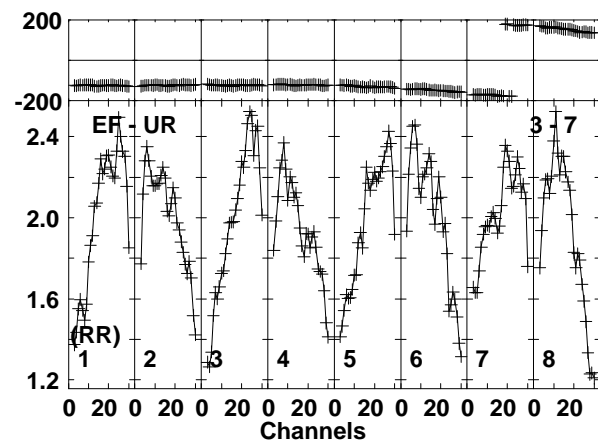
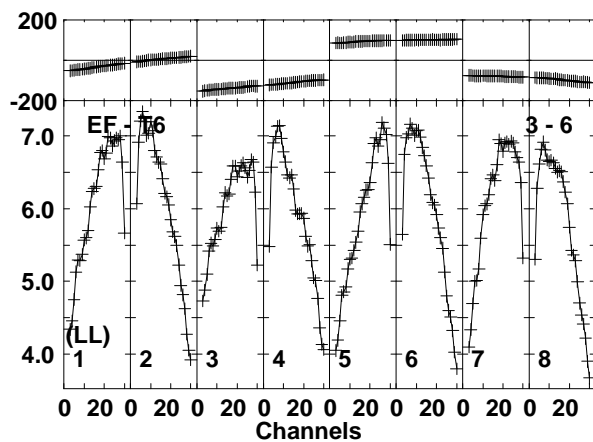
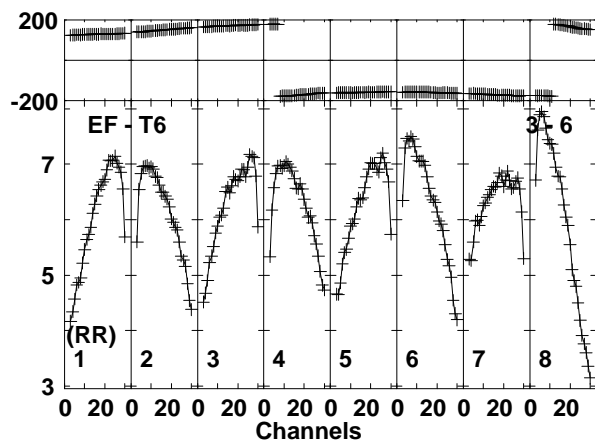
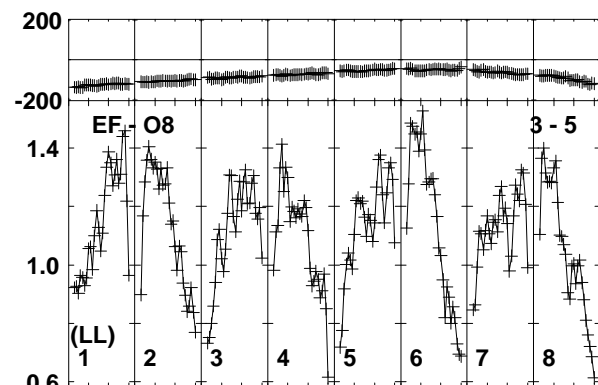
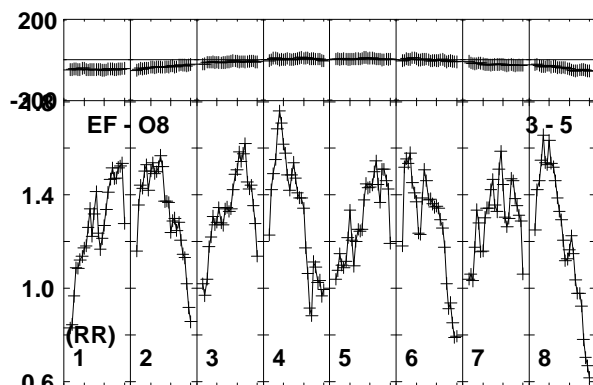
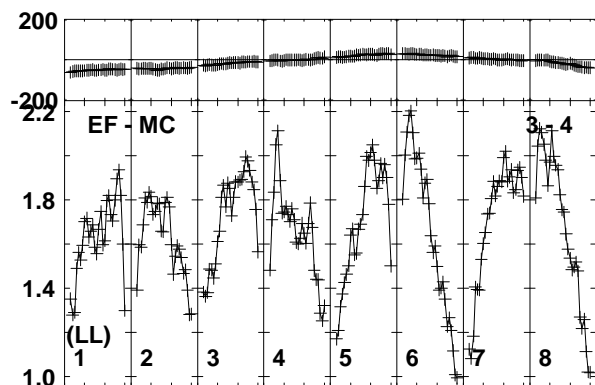
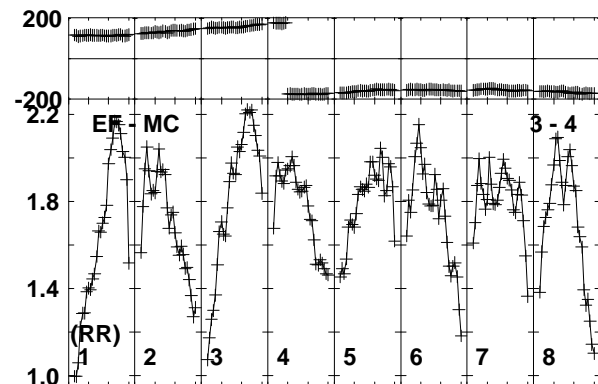
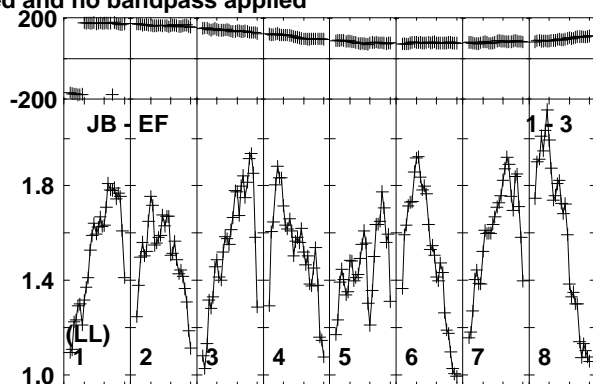
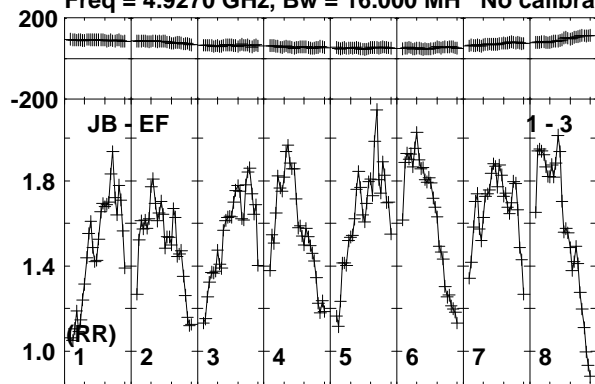

Lower frame: Milli Ampl Jy Top frame: Phas deg
Vector averaged cross-power spectrum Baseline: JB (01) - EF (03)
Timerange: 00/01:00:01 to 00/01:01:19

Plot file version 25 created 17-FEB-2020 15:42:40

J1359+5544 EK047 2.UVDATA.1

Freq = 4.9270 GHz, Bw = 16.000 MH No calibration applied and no bandpass applied

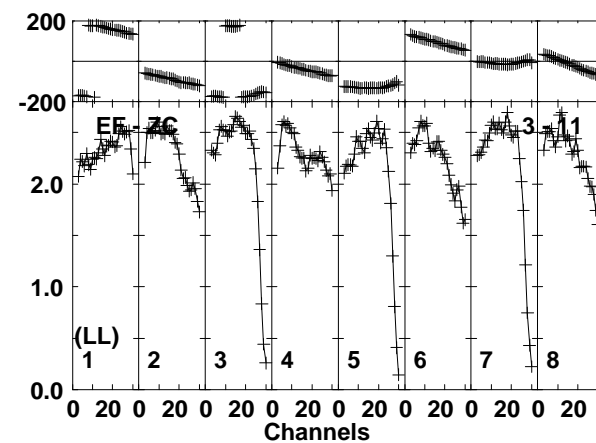
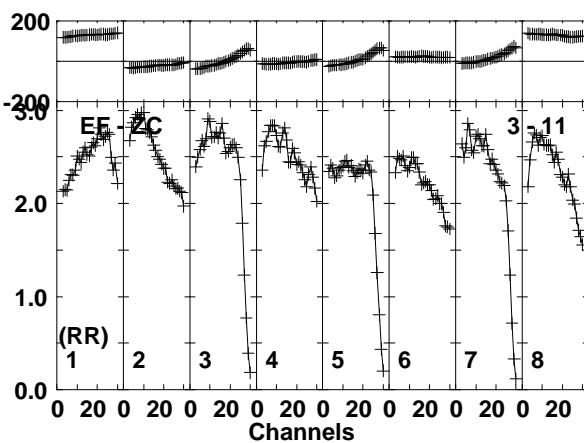
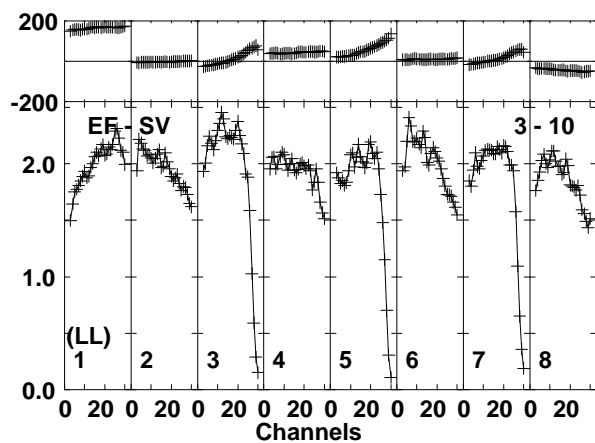
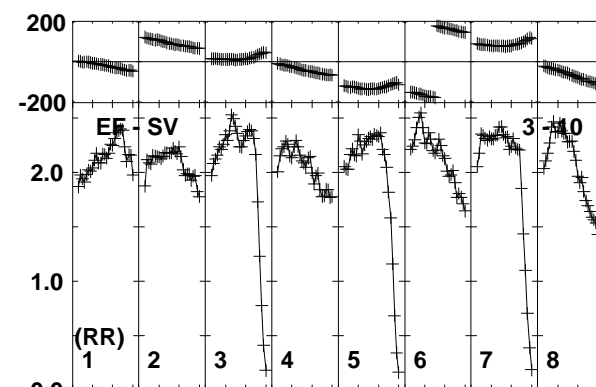
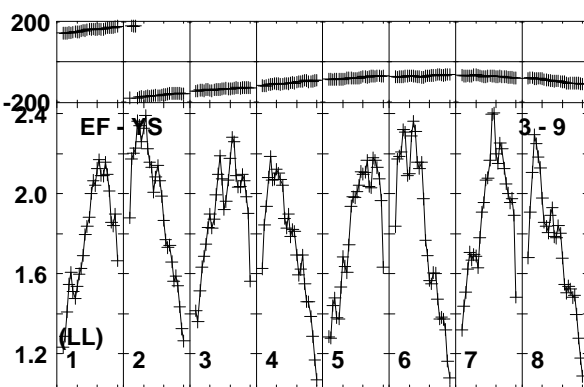
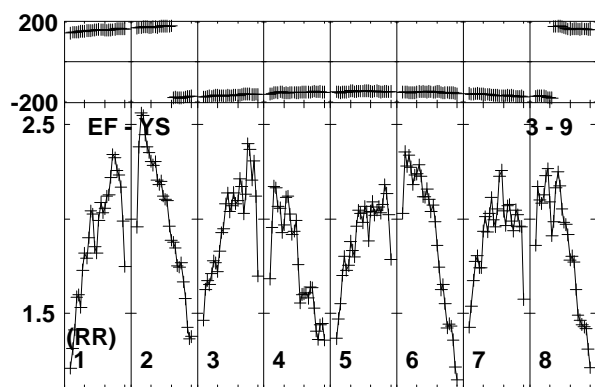
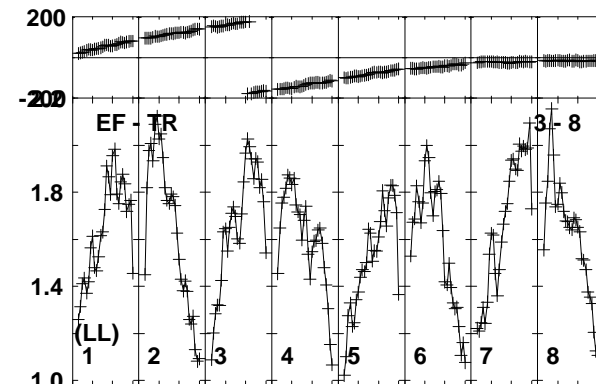
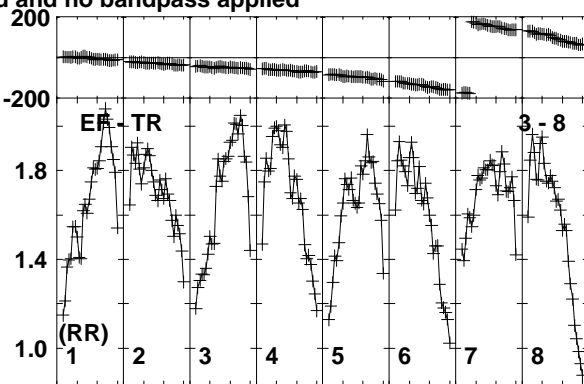
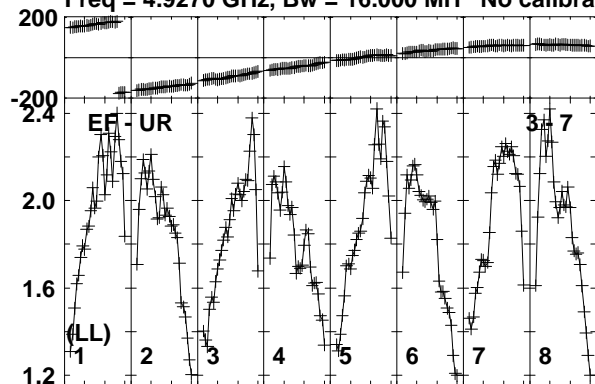

Lower frame: Milli Ampl Jy Top frame: Phas deg
Vector averaged cross-power spectrum Baseline: EF (03) - UR (07)
Timerange: 00/01:00:01 to 00/01:01:19

Plot file version 26 created 17-FEB-2020 15:42:40

J1359+5544 EK047 2.UVDATA.1

Freq = 4.9270 GHz, Bw = 16.000 MH No calibration applied and no bandpass applied

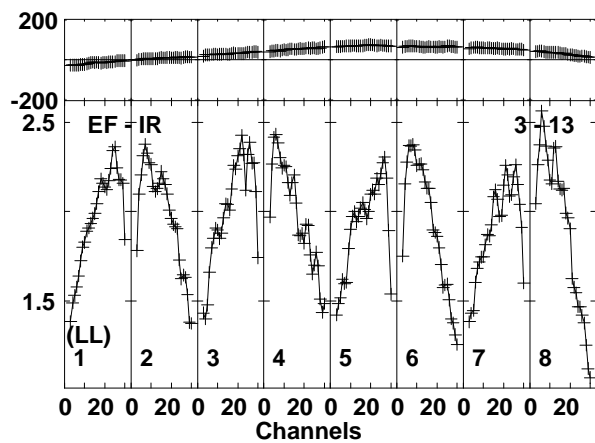
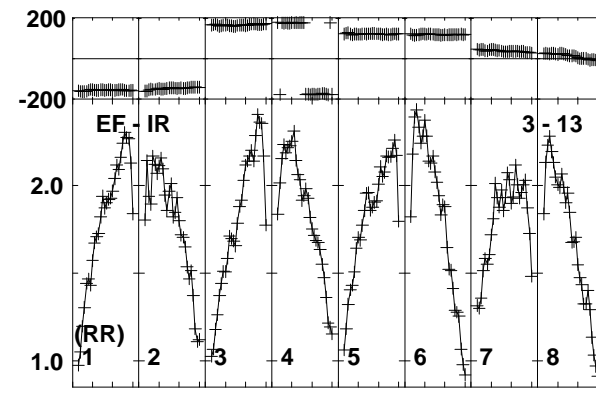
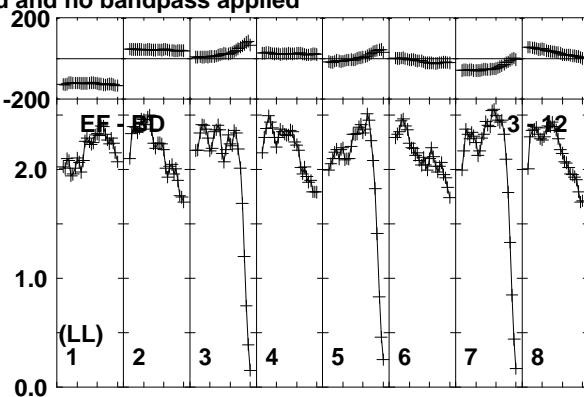
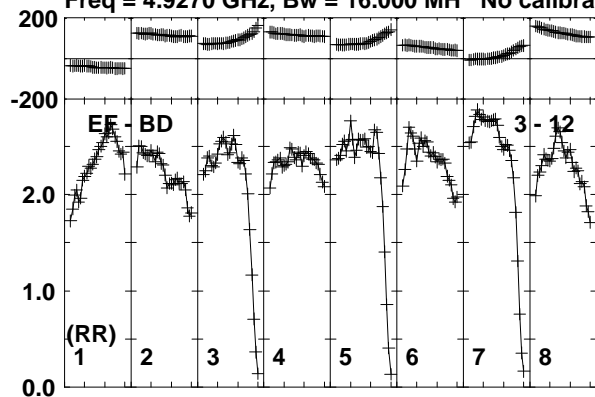

Lower frame: Milli Ampl Jy Top frame: Phas deg
Vector averaged cross-power spectrum Baseline: EF (03) - BD (12)
Timerange: 00/01:00:01 to 00/01:01:19

Plot file version 27 created 17-FEB-2020 15:42:40

J1402+5347 EK047 2.UVDATA.1

Freq = 4.9270 GHz, Bw = 16.000 MH No calibration applied and no bandpass applied

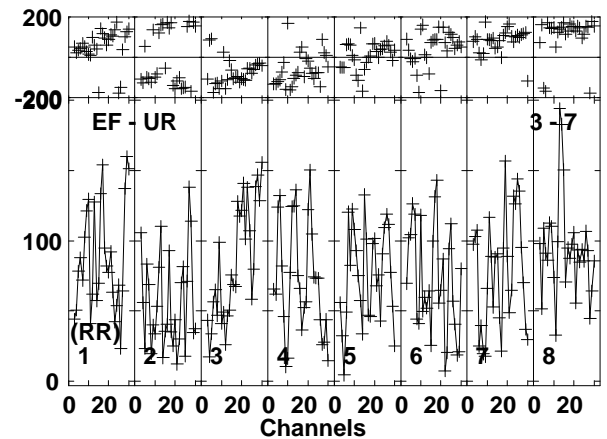
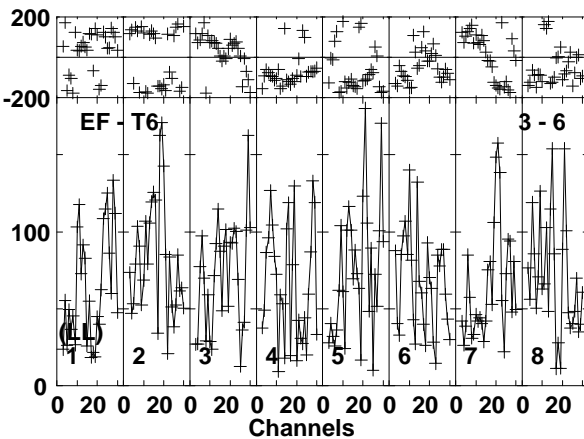
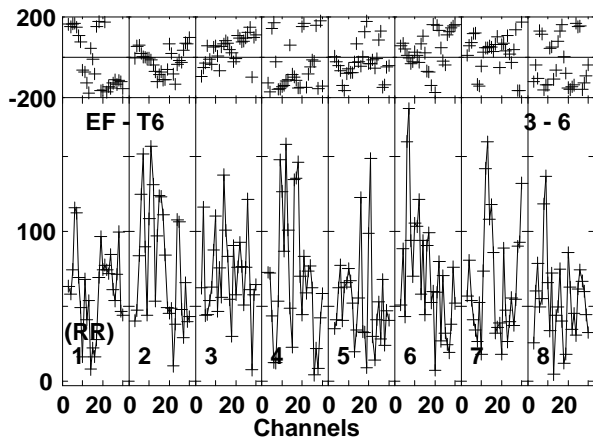
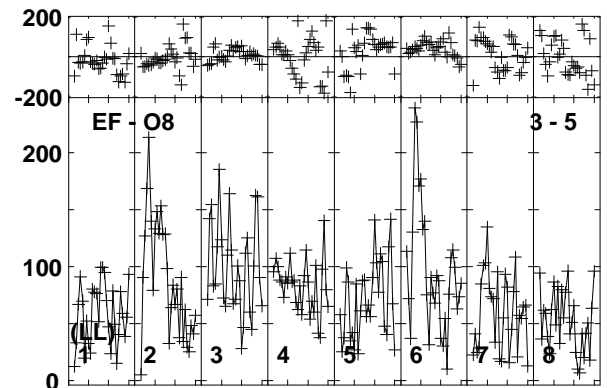
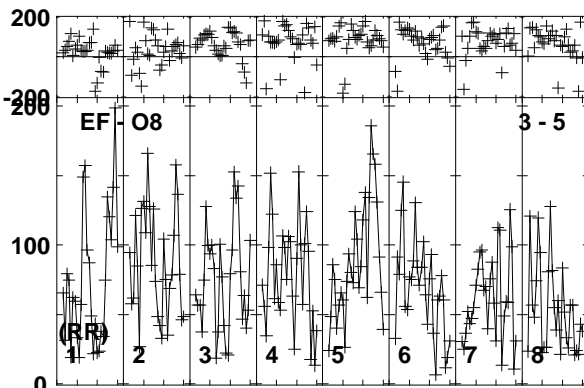
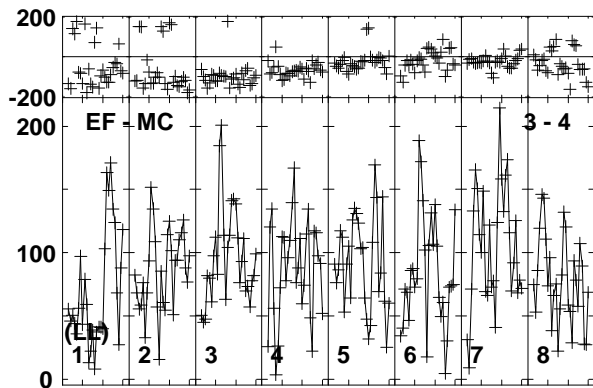
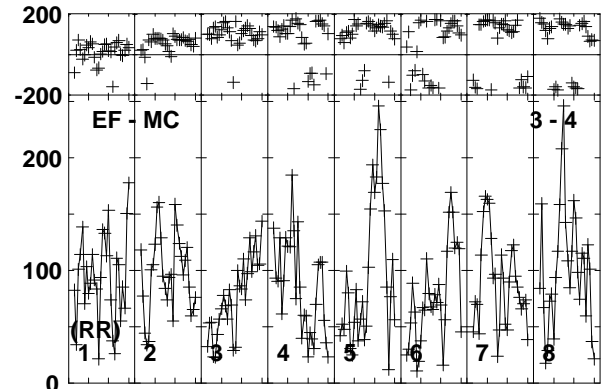
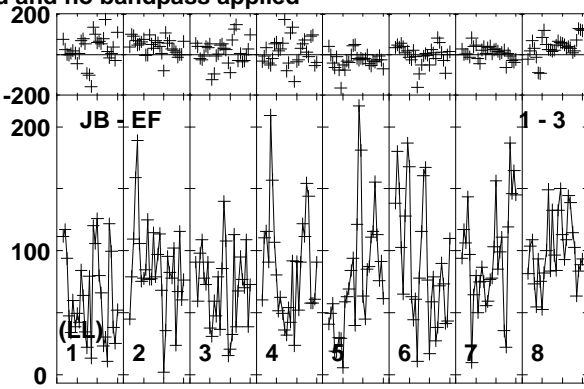
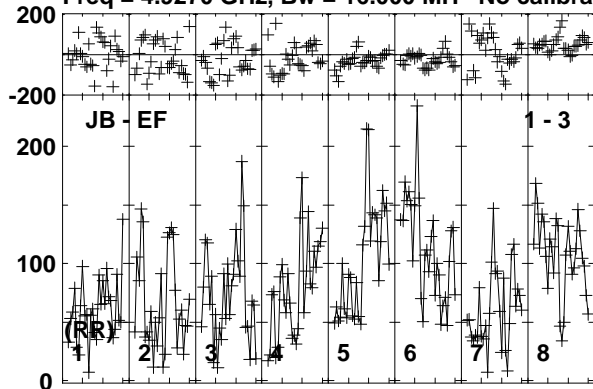

Lower frame: Micro Ampl Jy Top frame: Phas deg
Vector averaged cross-power spectrum Baseline: JB (01) - EF (03)
Timerange: 00/01:01:21 to 00/01:05:19

Plot file version 28 created 17-FEB-2020 15:42:40

J1402+5347 EK047 2.UVDATA.1

Freq = 4.9270 GHz, Bw = 16.000 MH No calibration applied and no bandpass applied

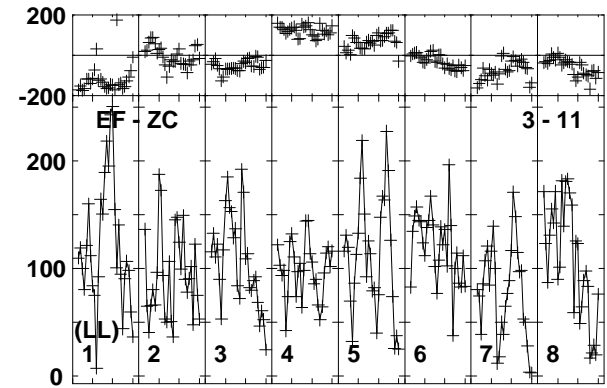
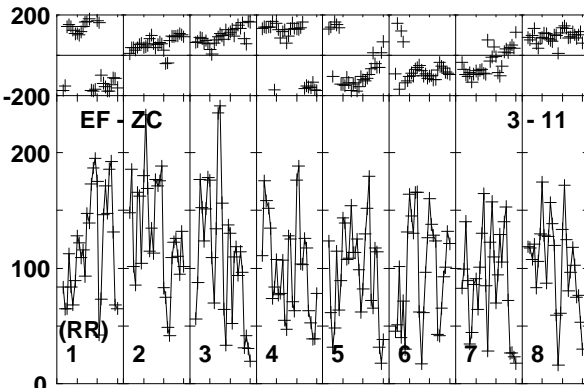
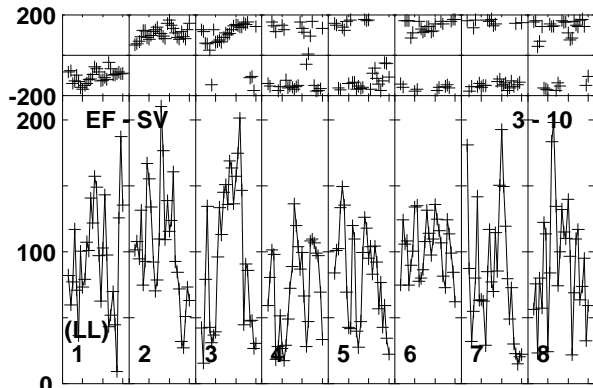
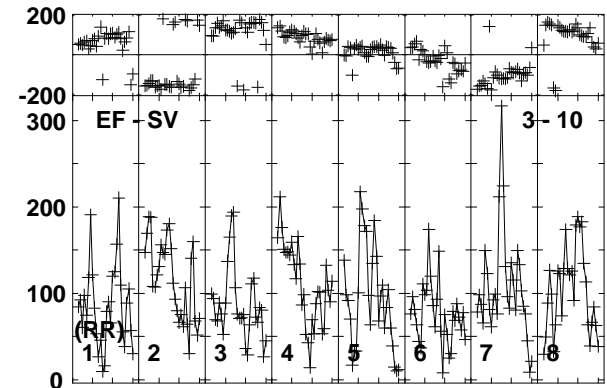
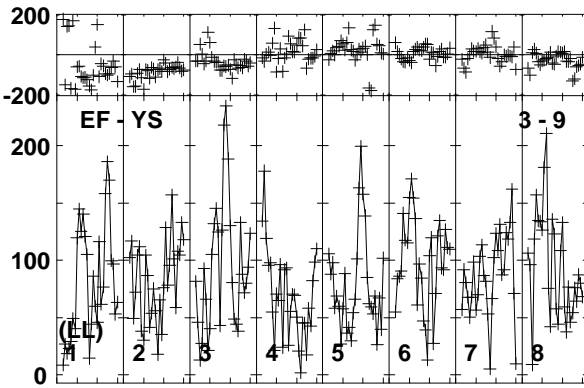
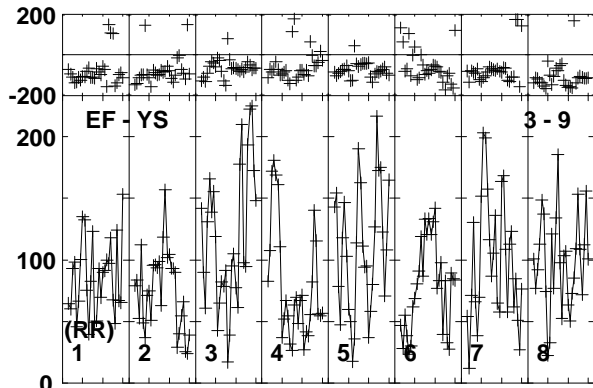
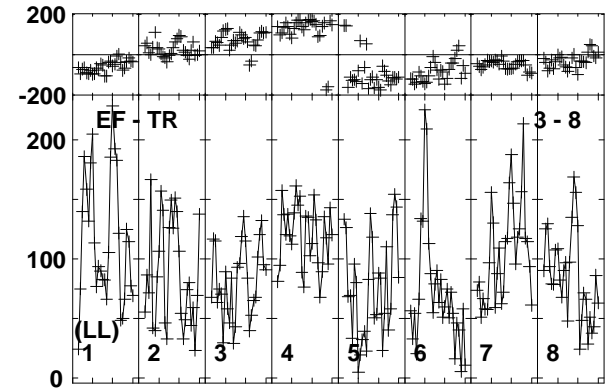
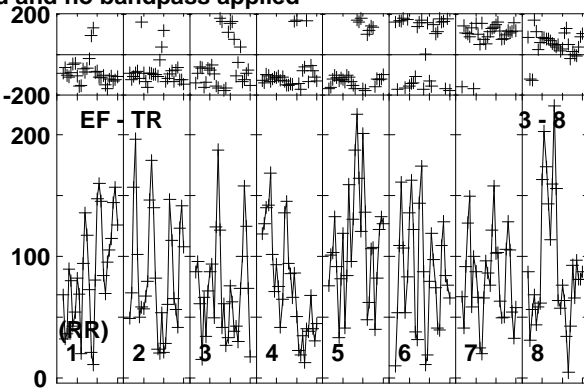
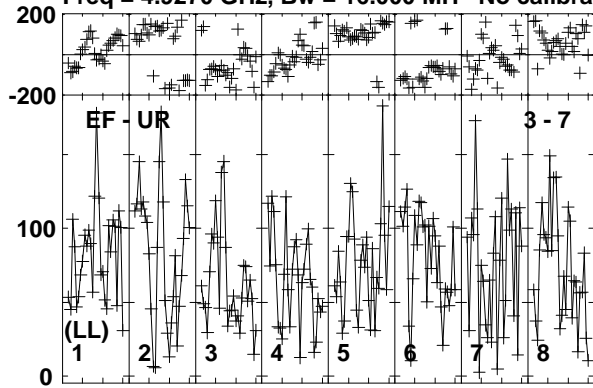

Lower frame: Micro Ampl Jy Top frame: Phas deg
Vector averaged cross-power spectrum Baseline: EF (03) - UR (07)
Timerange: 00/01:01:21 to 00/01:05:19

Plot file version 29 created 17-FEB-2020 15:42:40

J1402+5347 EK047 2.UVDATA.1

Freq = 4.9270 GHz, Bw = 16.000 MH No calibration applied and no bandpass applied

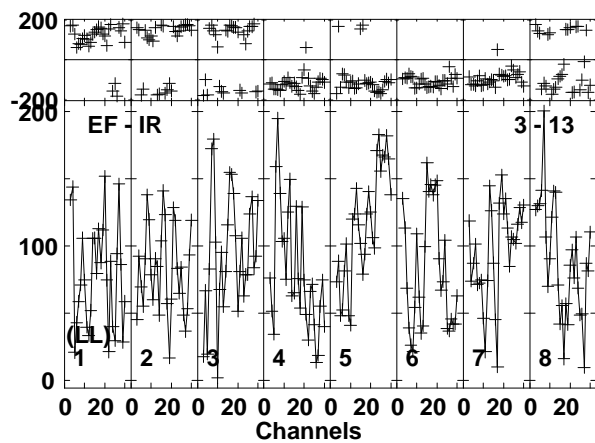
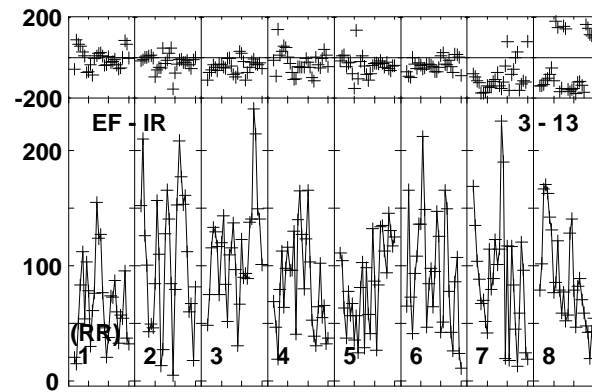
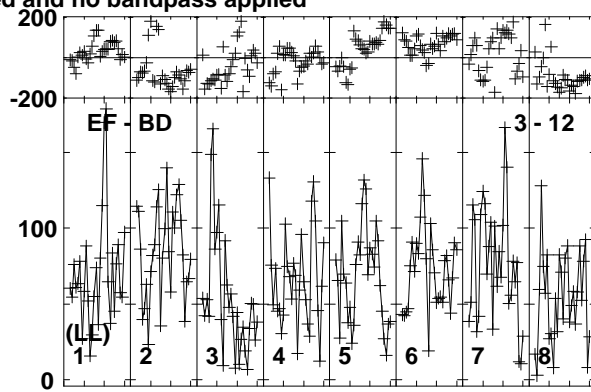
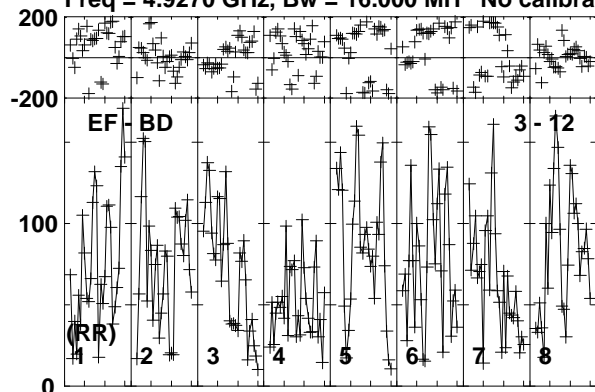

Lower frame: Micro Ampl Jy Top frame: Phas deg
Vector averaged cross-power spectrum Baseline: EF (03) - BD (12)
Timerange: 00/01:01:21 to 00/01:05:19

Plot file version 30 created 17-FEB-2020 15:42:40

J1359+5544 EK047 2.UVDATA.1

Freq = 4.9270 GHz, Bw = 16.000 MH No calibration applied and no bandpass applied

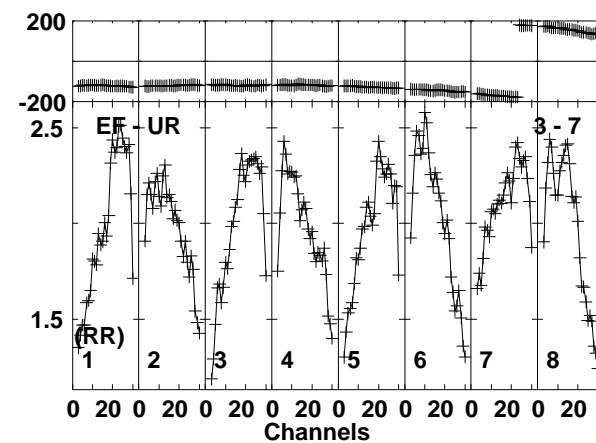
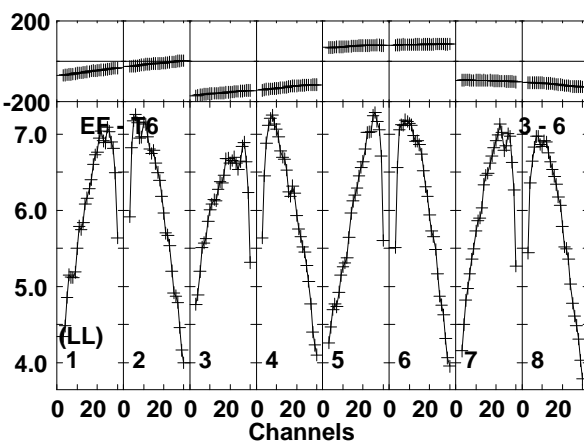
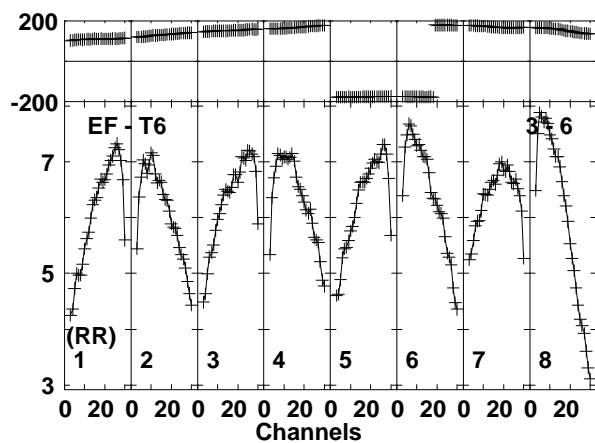
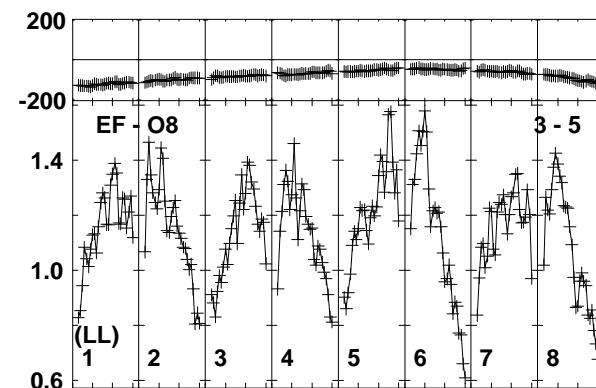
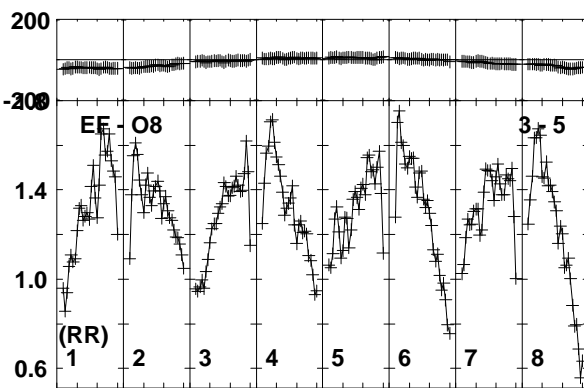
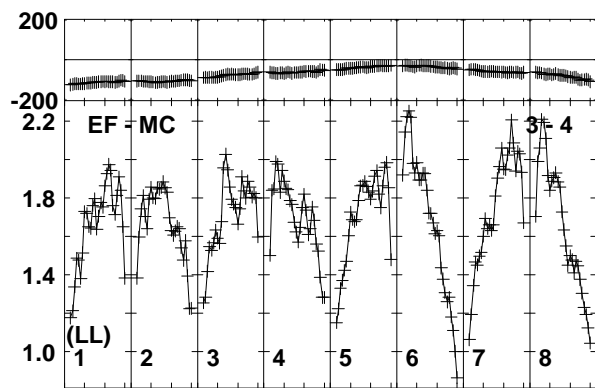
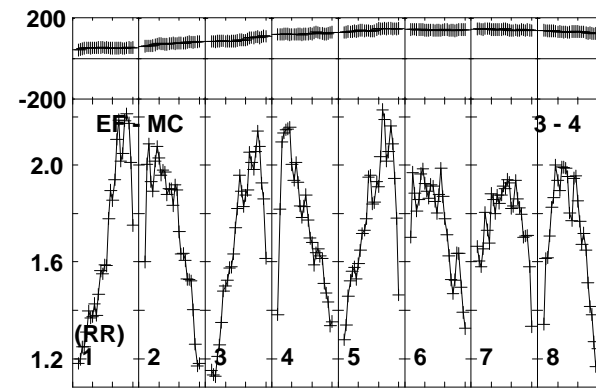
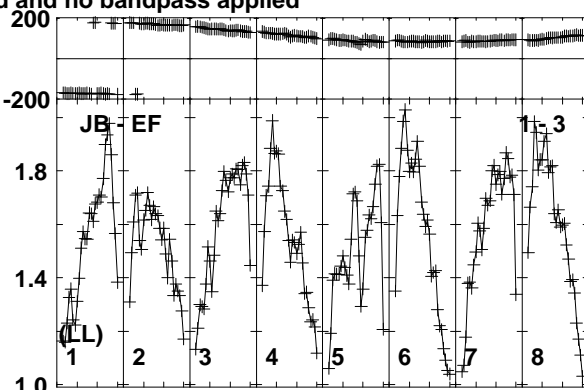
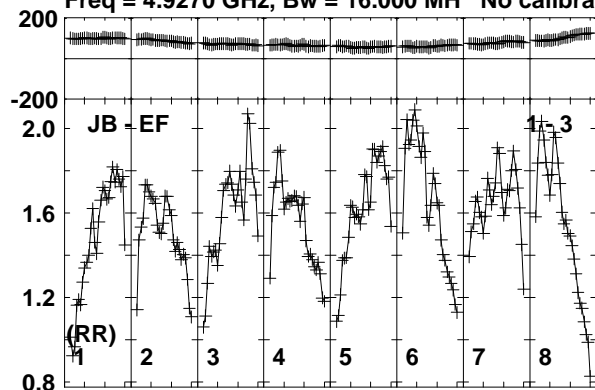

Lower frame: Milli Ampl Jy Top frame: Phas deg
Vector averaged cross-power spectrum Baseline: JB (01) - EF (03)
Timerange: 00/01:05:21 to 00/01:07:19

Plot file version 31 created 17-FEB-2020 15:42:41

J1359+5544 EK047 2.UVDATA.1

Freq = 4.9270 GHz, Bw = 16.000 MH No calibration applied and no bandpass applied

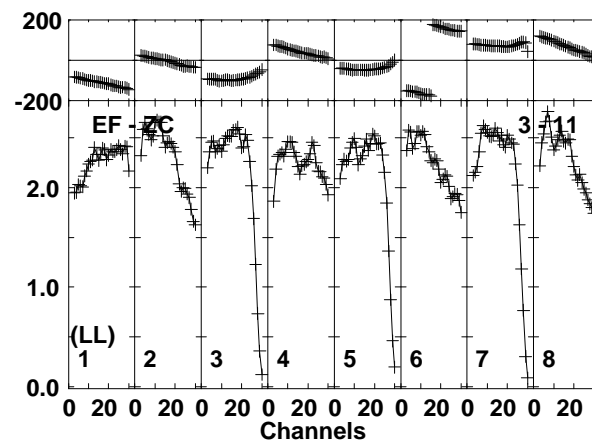
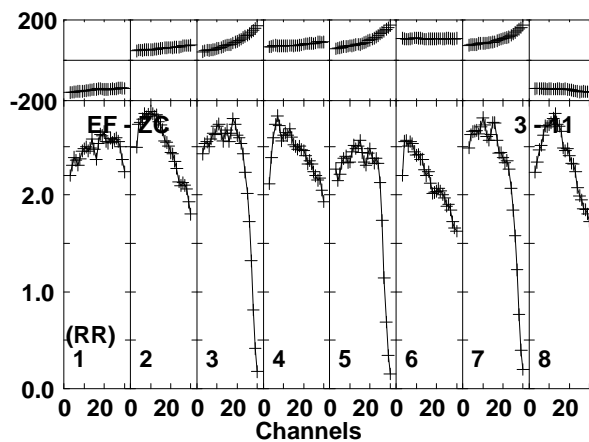
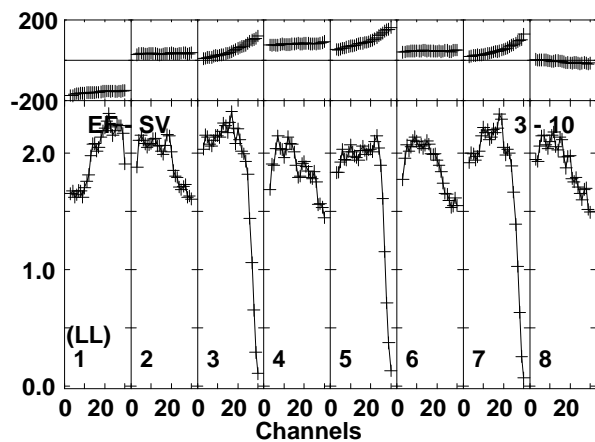
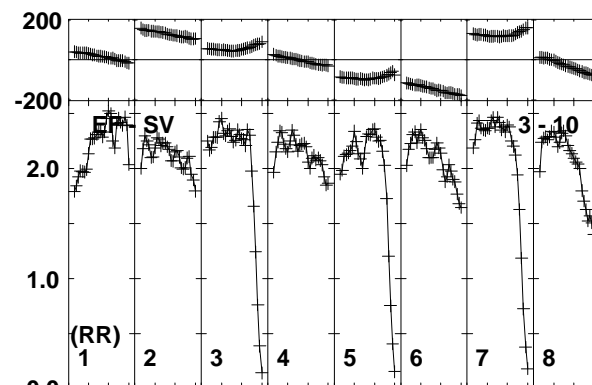
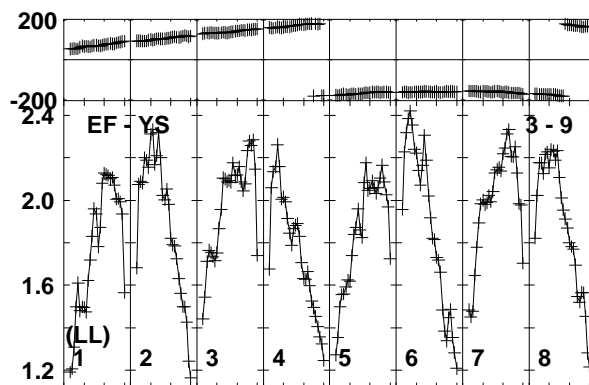
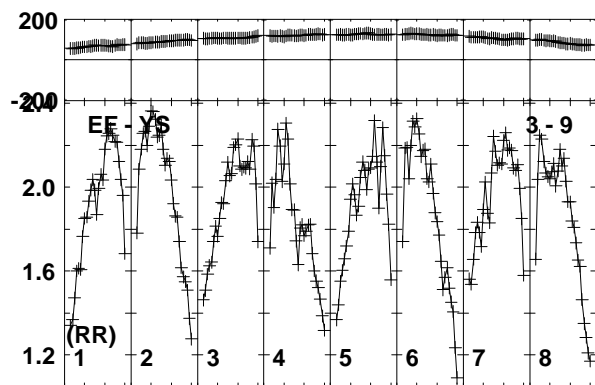
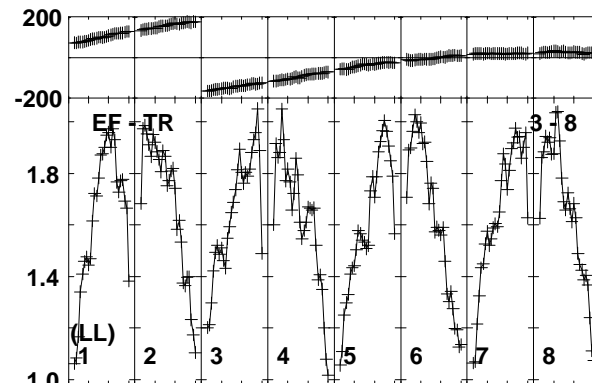
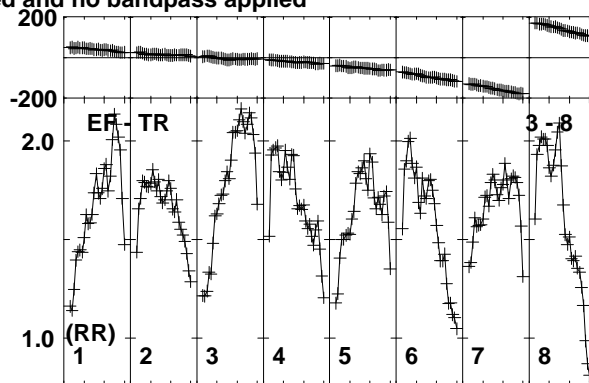
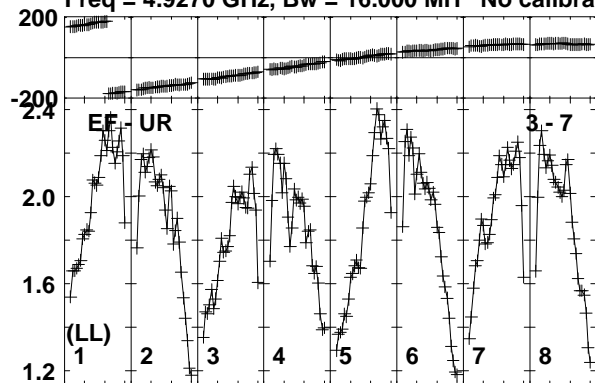

Lower frame: Milli Ampl Jy Top frame: Phas deg
Vector averaged cross-power spectrum Baseline: EF (03) - UR (07)
Timerange: 00/01:05:21 to 00/01:07:19

Plot file version 32 created 17-FEB-2020 15:42:41

J1359+5544 EK047 2.UVDATA.1

Freq = 4.9270 GHz, Bw = 16.000 MH No calibration applied and no bandpass applied

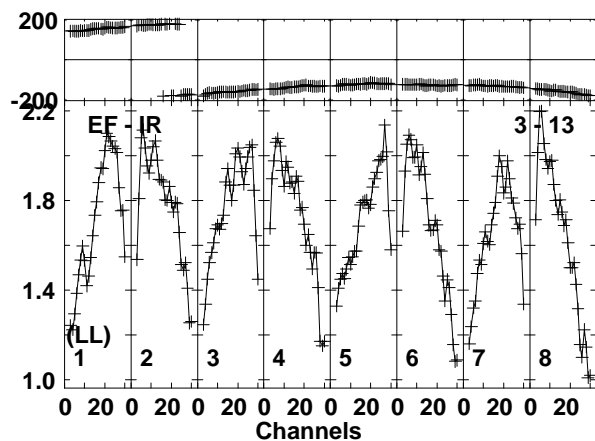
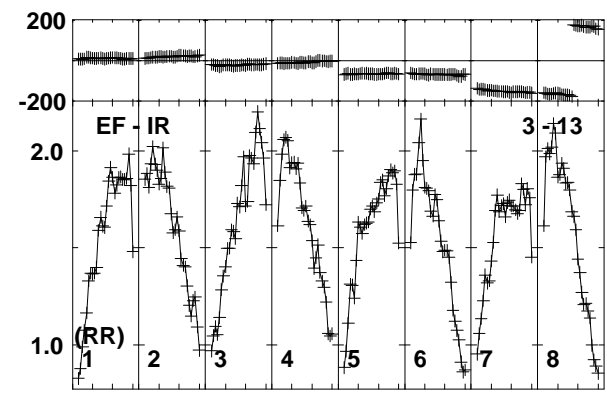
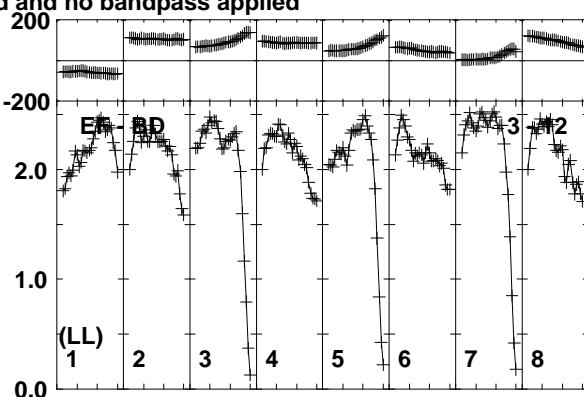
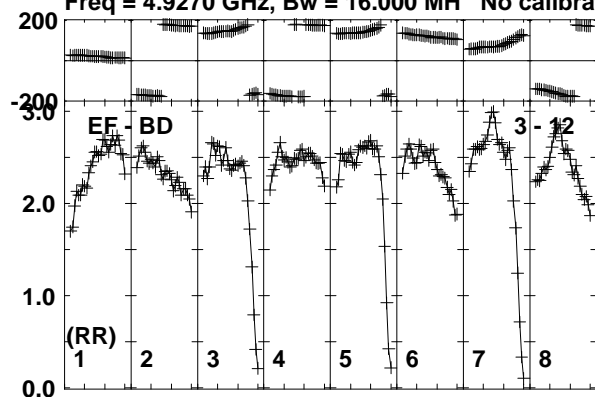

Lower frame: Milli Ampl Jy Top frame: Phas deg
Vector averaged cross-power spectrum Baseline: EF (03) - BD (12)
Timerange: 00/01:05:21 to 00/01:07:19

Plot file version 33 created 17-FEB-2020 15:42:41

J1402+5347 EK047 2.UVDATA.1

Freq = 4.9270 GHz, Bw = 16.000 MH No calibration applied and no bandpass applied

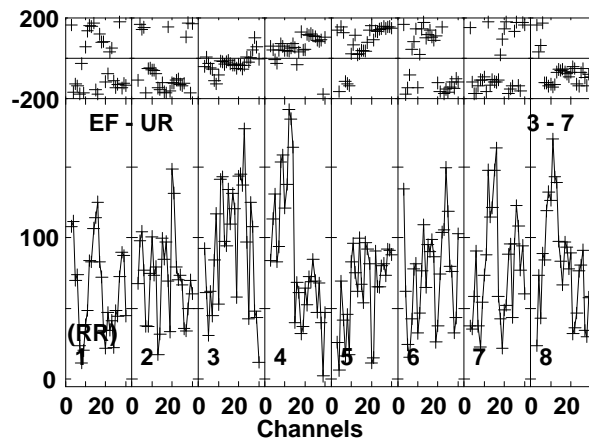
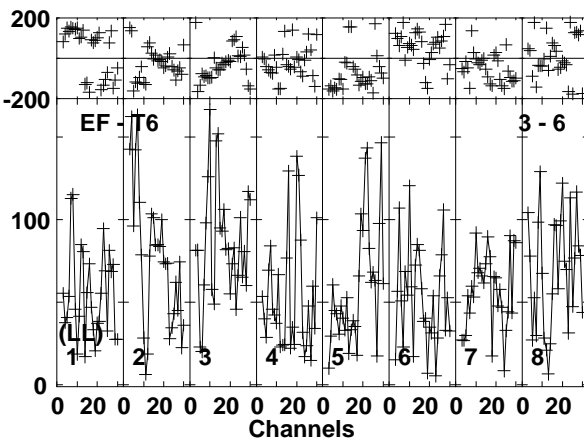
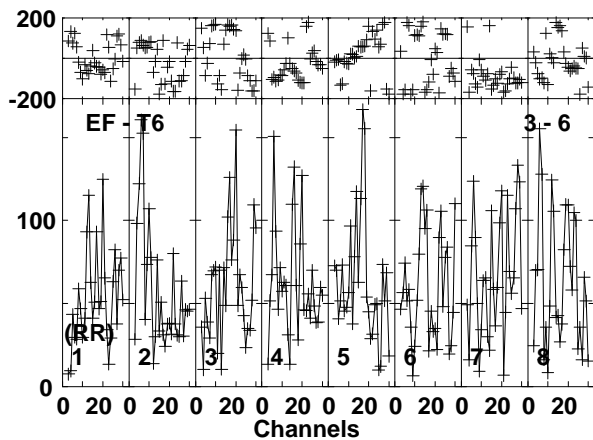
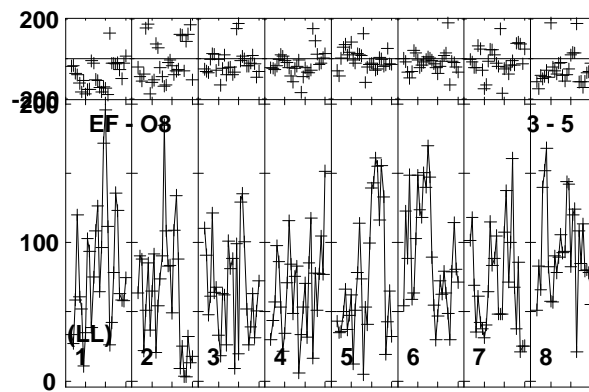
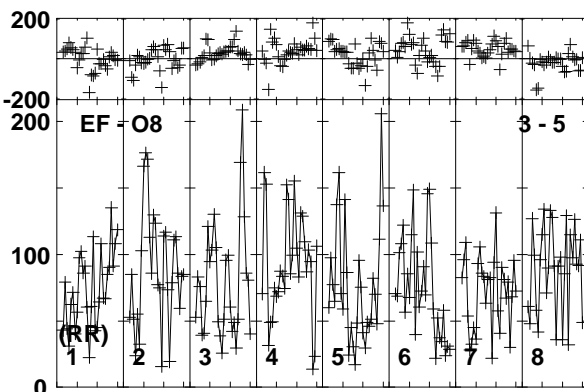
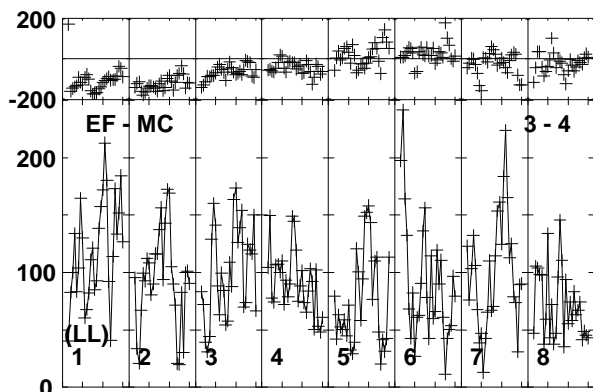
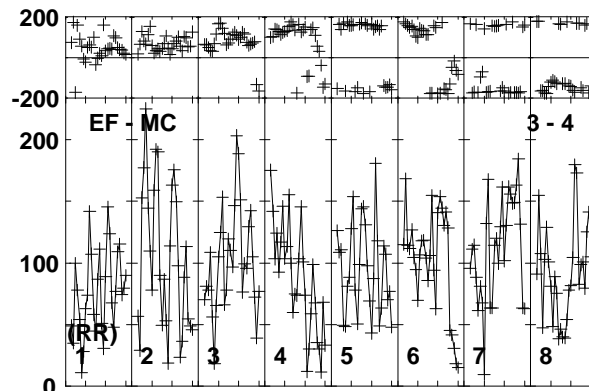
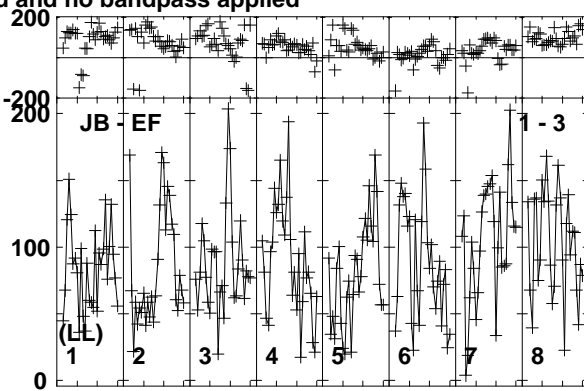
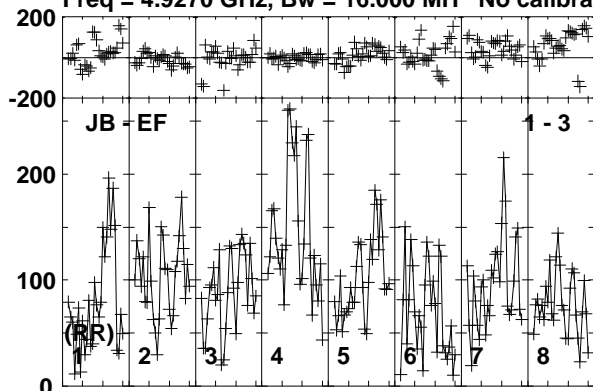

Lower frame: Micro Ampl Jy Top frame: Phas deg
Vector averaged cross-power spectrum Baseline: JB (01) - EF (03)
Timerange: 00/01:07:21 to 00/01:11:19

Plot file version 34 created 17-FEB-2020 15:42:41

J1402+5347 EK047 2.UVDATA.1

Freq = 4.9270 GHz, Bw = 16.000 MH No calibration applied and no bandpass applied

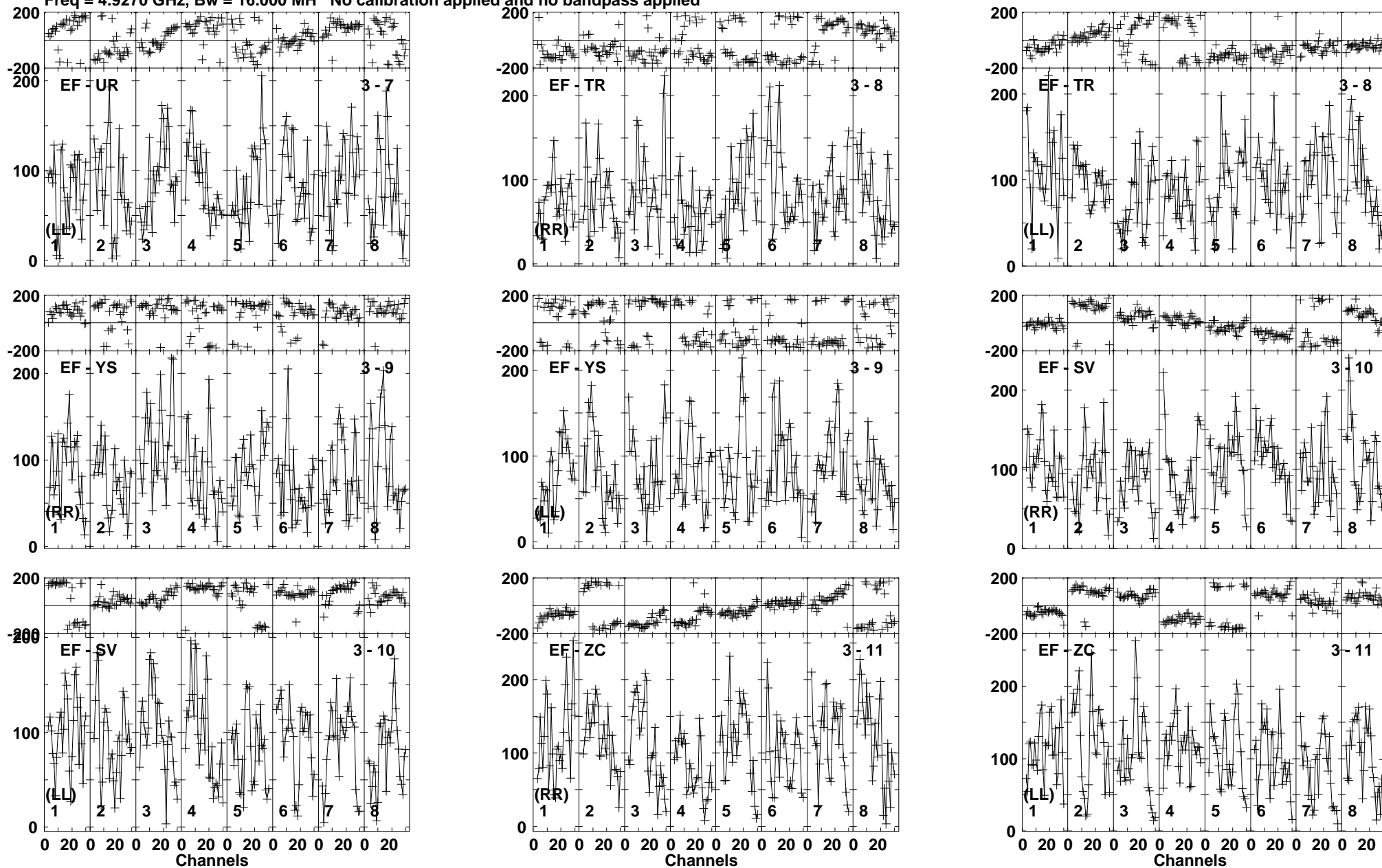

Lower frame: Micro Ampl Jy Top frame: Phas deg
Vector averaged cross-power spectrum Baseline: EF (03) - UR (07)
Timerange: 00/01:07:21 to 00/01:11:19

Plot file version 35 created 17-FEB-2020 15:42:41

J1402+5347 EK047 2.UVDATA.1

Freq = 4.9270 GHz, Bw = 16.000 MH No calibration applied and no bandpass applied

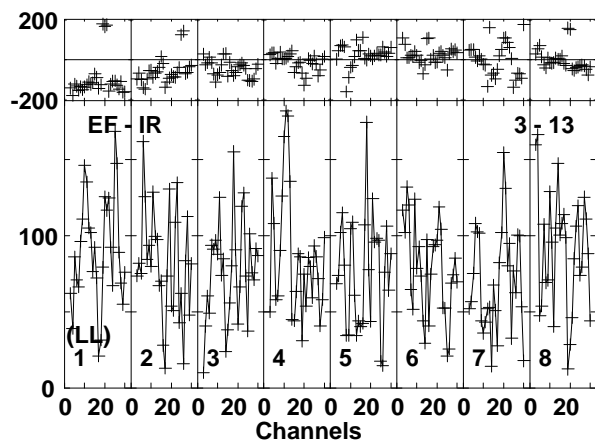
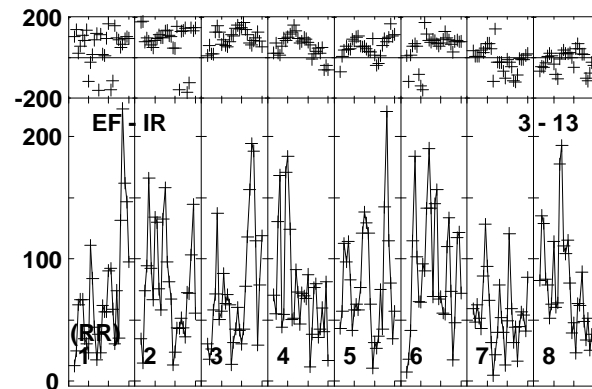
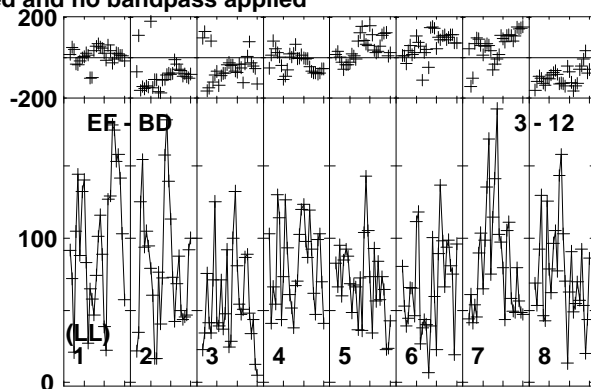
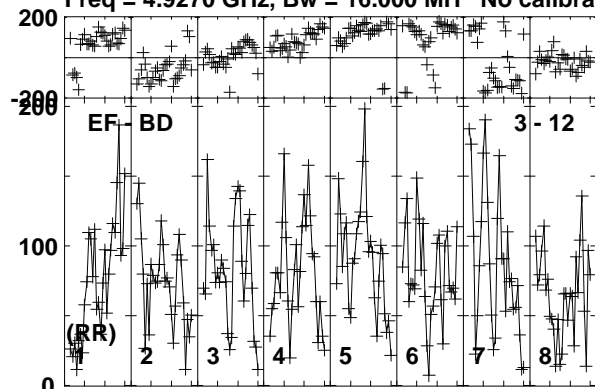

Lower frame: Micro Ampl Jy Top frame: Phas deg
Vector averaged cross-power spectrum Baseline: EF (03) - BD (12)
Timerange: 00/01:07:21 to 00/01:11:19

Plot file version 36 created 17-FEB-2020 15:42:41

J1359+5544 EK047 2.UVDATA.1

Freq = 4.9270 GHz, Bw = 16.000 MH No calibration applied and no bandpass applied

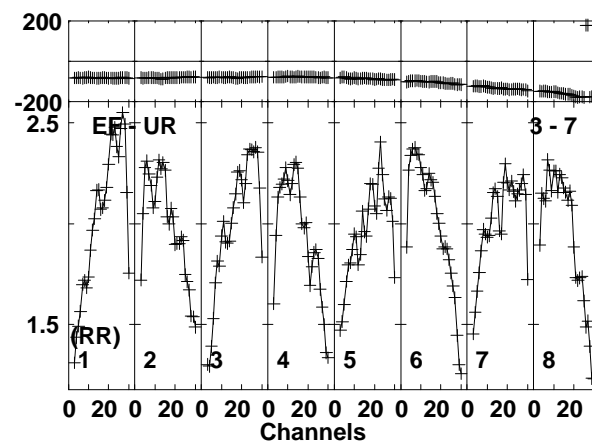
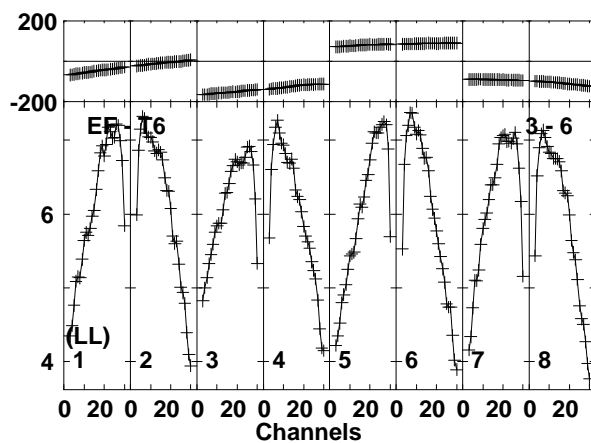
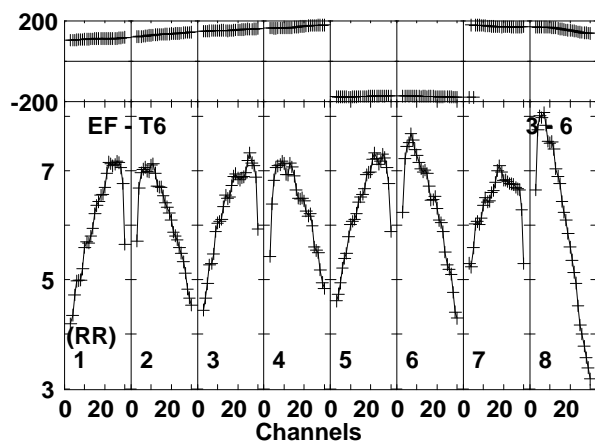
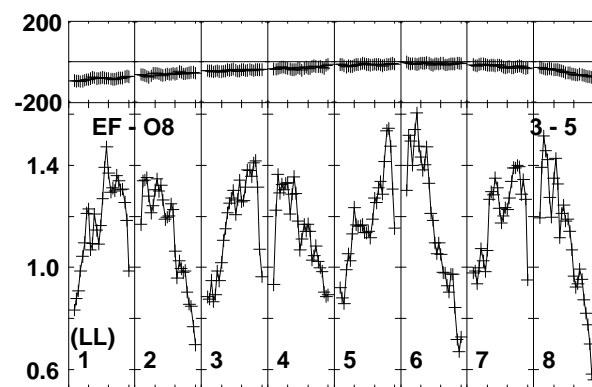
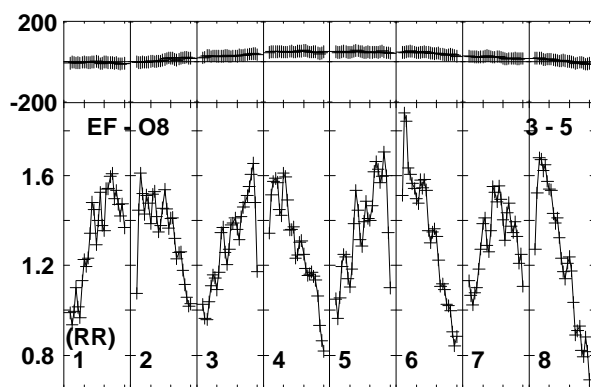
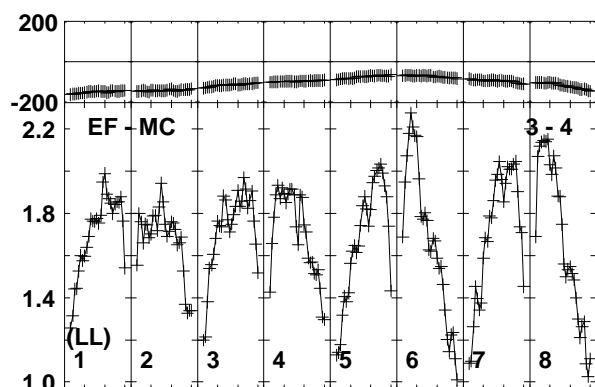
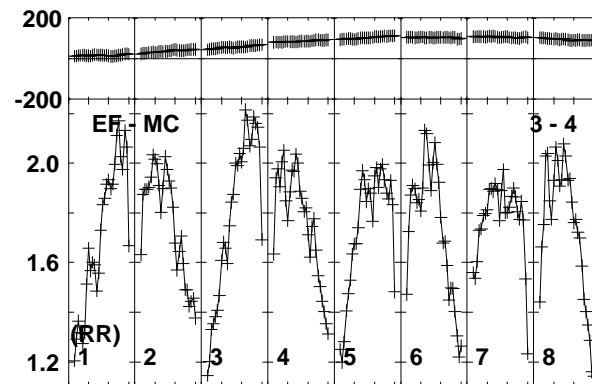
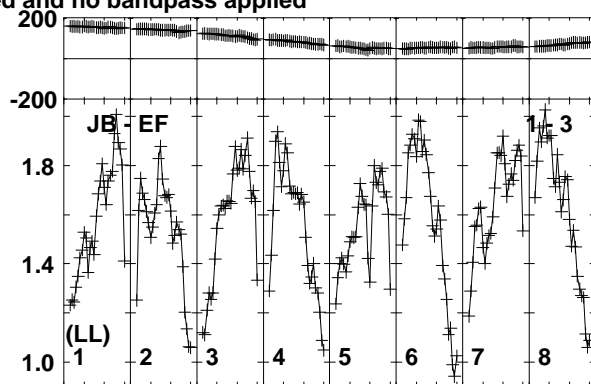
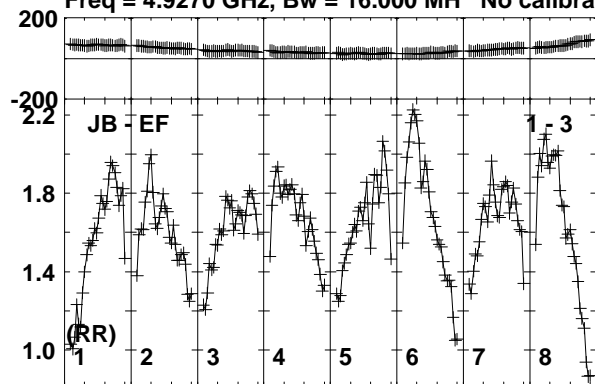

Lower frame: Milli Ampl Jy Top frame: Phas deg
Vector averaged cross-power spectrum Baseline: JB (01) - EF (03)
Timerange: 00/01:12:01 to 00/01:13:19

Plot file version 37 created 17-FEB-2020 15:42:41

J1359+5544 EK047 2.UVDATA.1

Freq = 4.9270 GHz, Bw = 16.000 MH No calibration applied and no bandpass applied

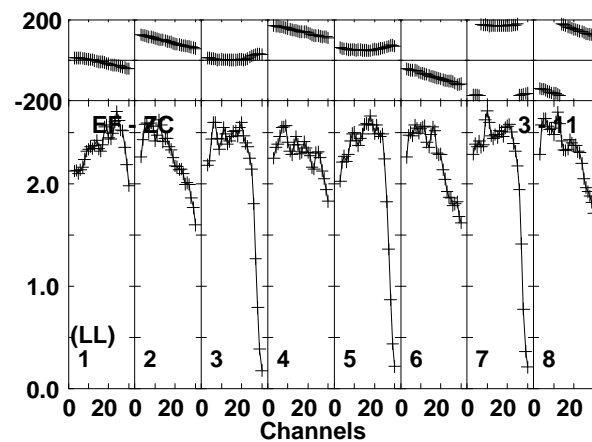
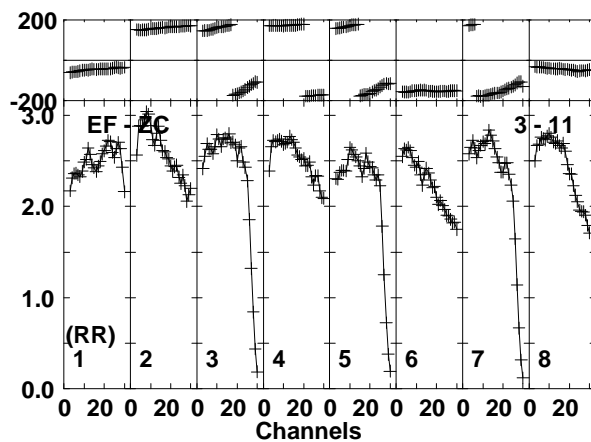
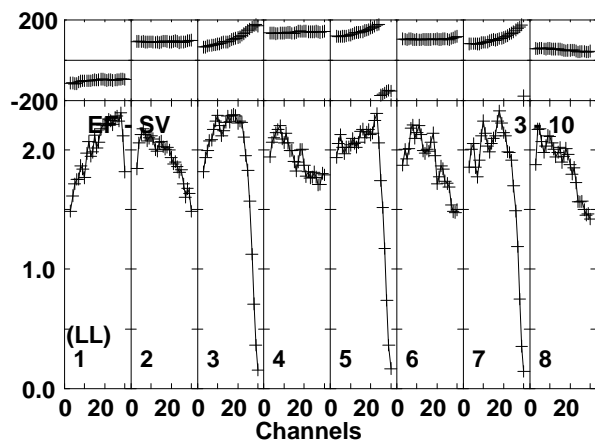
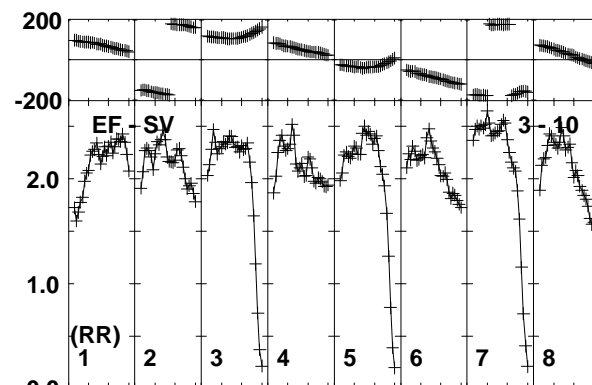
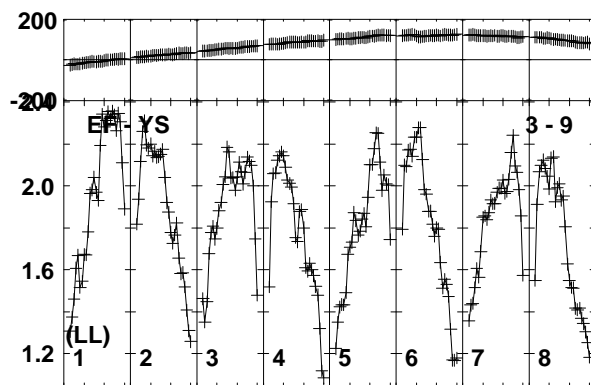
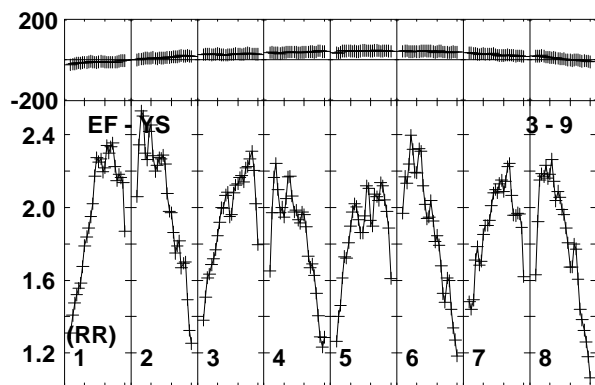
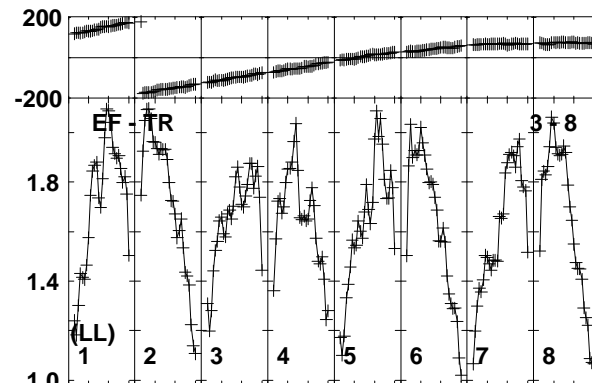
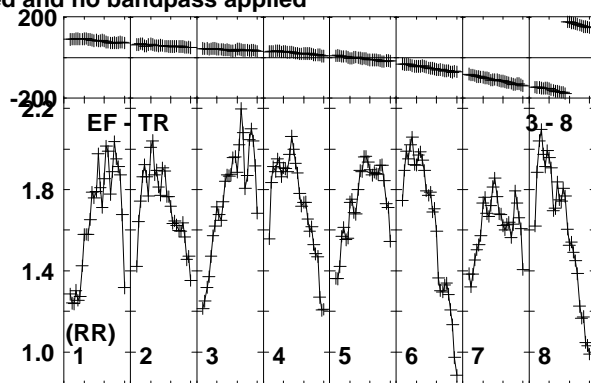
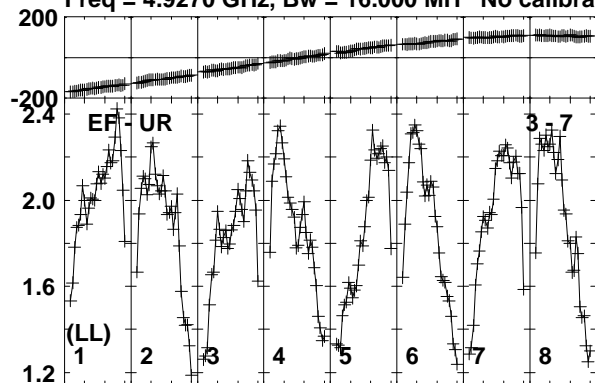

Lower frame: Milli Ampl Jy Top frame: Phas deg
Vector averaged cross-power spectrum Baseline: EF (03) - UR (07)
Timerange: 00/01:12:01 to 00/01:13:19

Plot file version 38 created 17-FEB-2020 15:42:41

J1359+5544 EK047 2.UVDATA.1

Freq = 4.9270 GHz, Bw = 16.000 MH No calibration applied and no bandpass applied

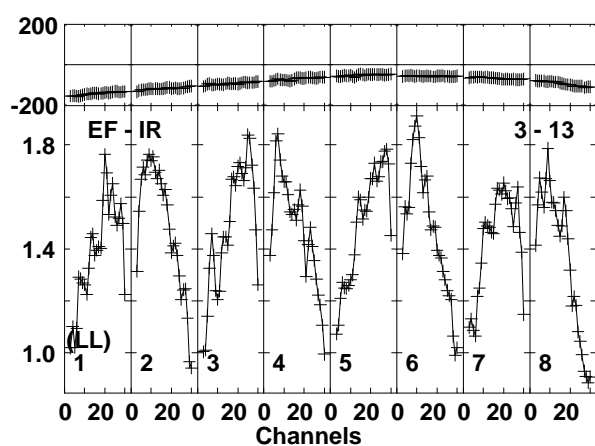
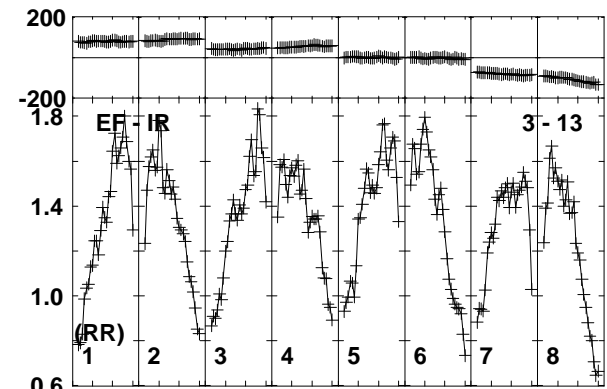
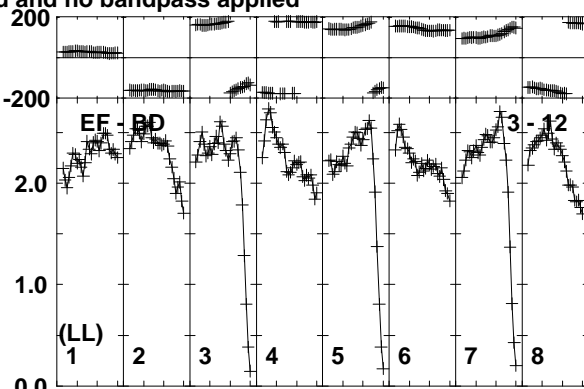
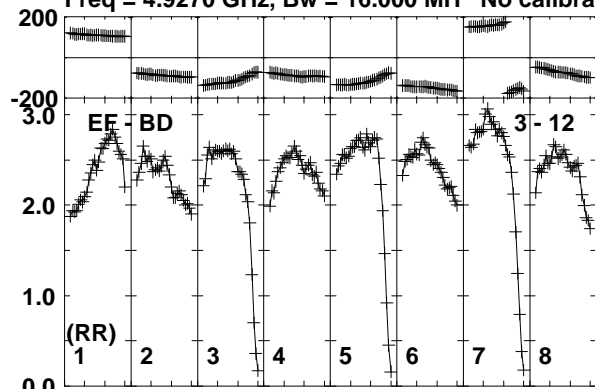

Lower frame: Milli Ampl Jy Top frame: Phas deg
Vector averaged cross-power spectrum Baseline: EF (03) - BD (12)
Timerange: 00/01:12:01 to 00/01:13:19

Plot file version 39 created 17-FEB-2020 15:42:41

J1402+5347 EK047 2.UVDATA.1

Freq = 4.9270 GHz, Bw = 16.000 MH No calibration applied and no bandpass applied

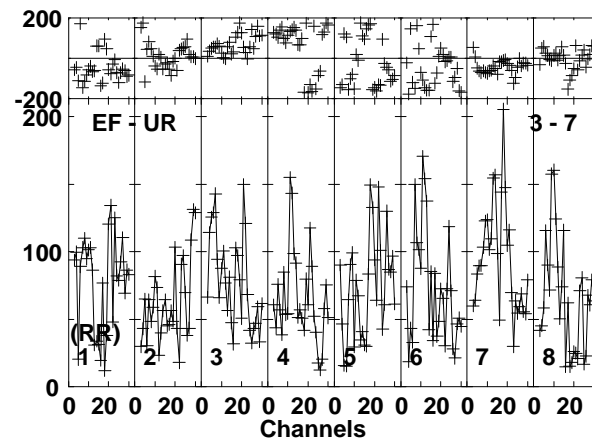
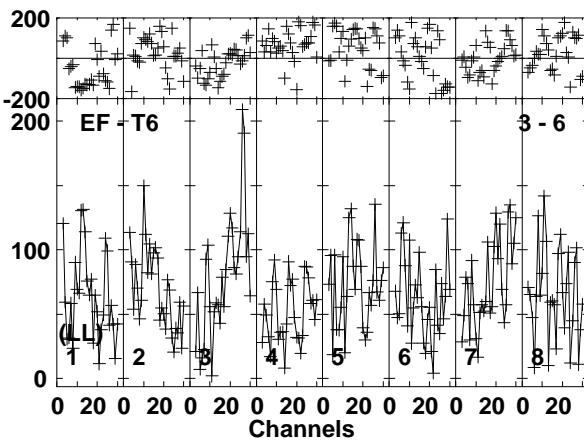
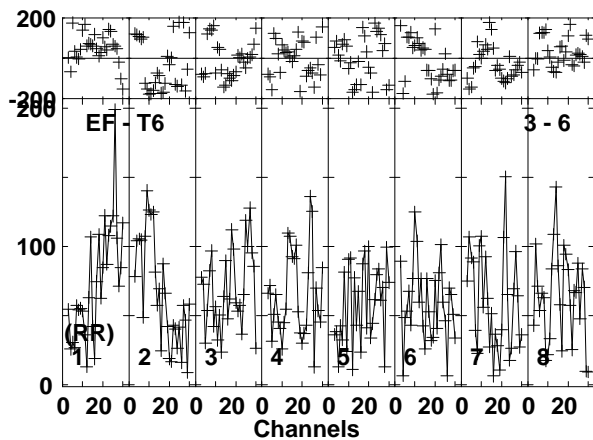
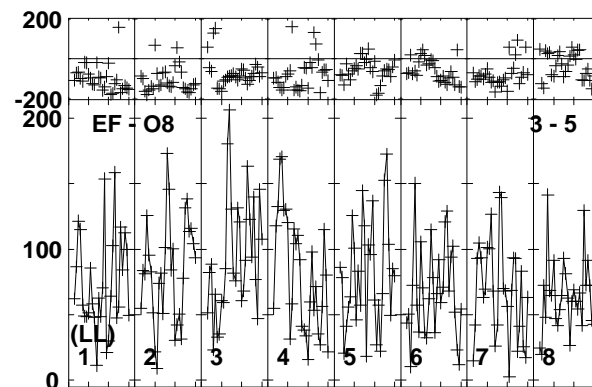
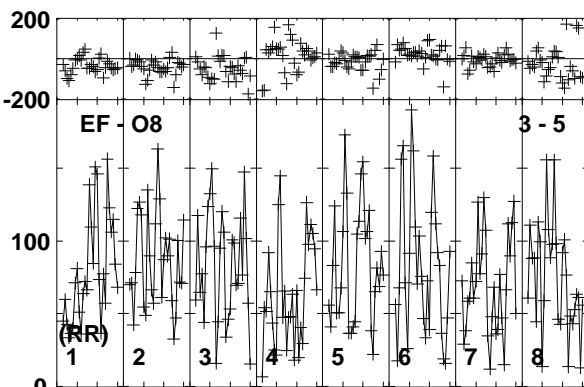
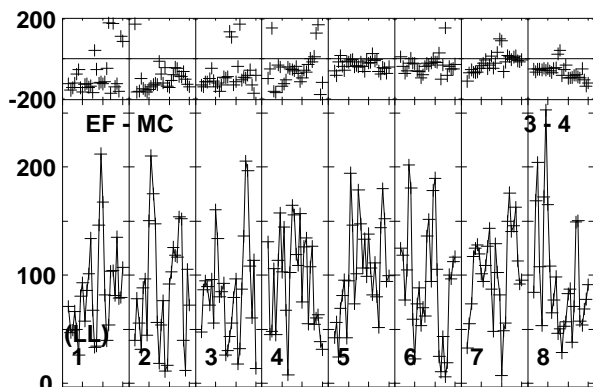
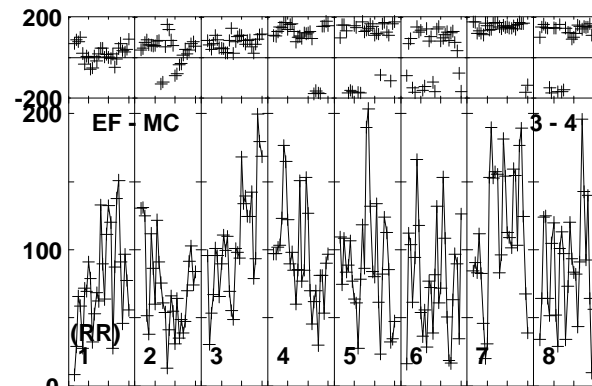
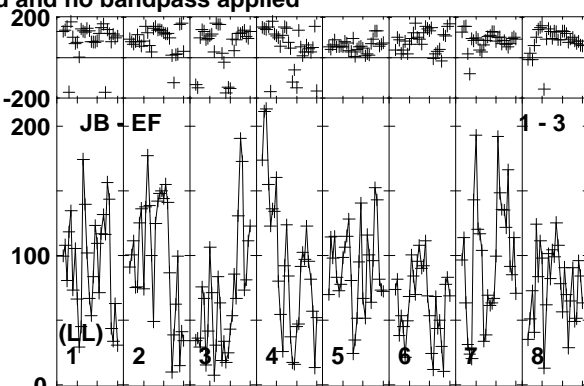
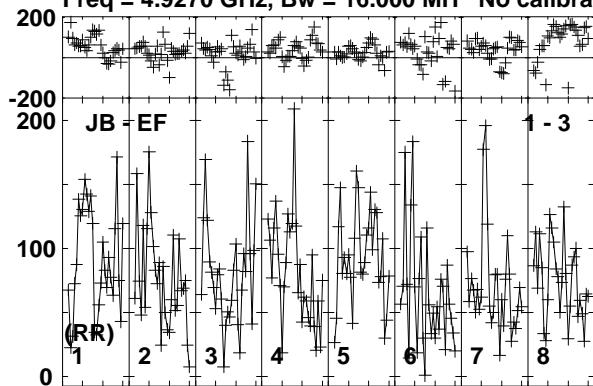

Lower frame: Micro Ampl Jy Top frame: Phas deg
Vector averaged cross-power spectrum Baseline: JB (01) - EF (03)
Timerange: 00/01:13:21 to 00/01:17:19

Plot file version 40 created 17-FEB-2020 15:42:41

J1402+5347 EK047 2.UVDATA.1

Freq = 4.9270 GHz, Bw = 16.000 MH No calibration applied and no bandpass applied

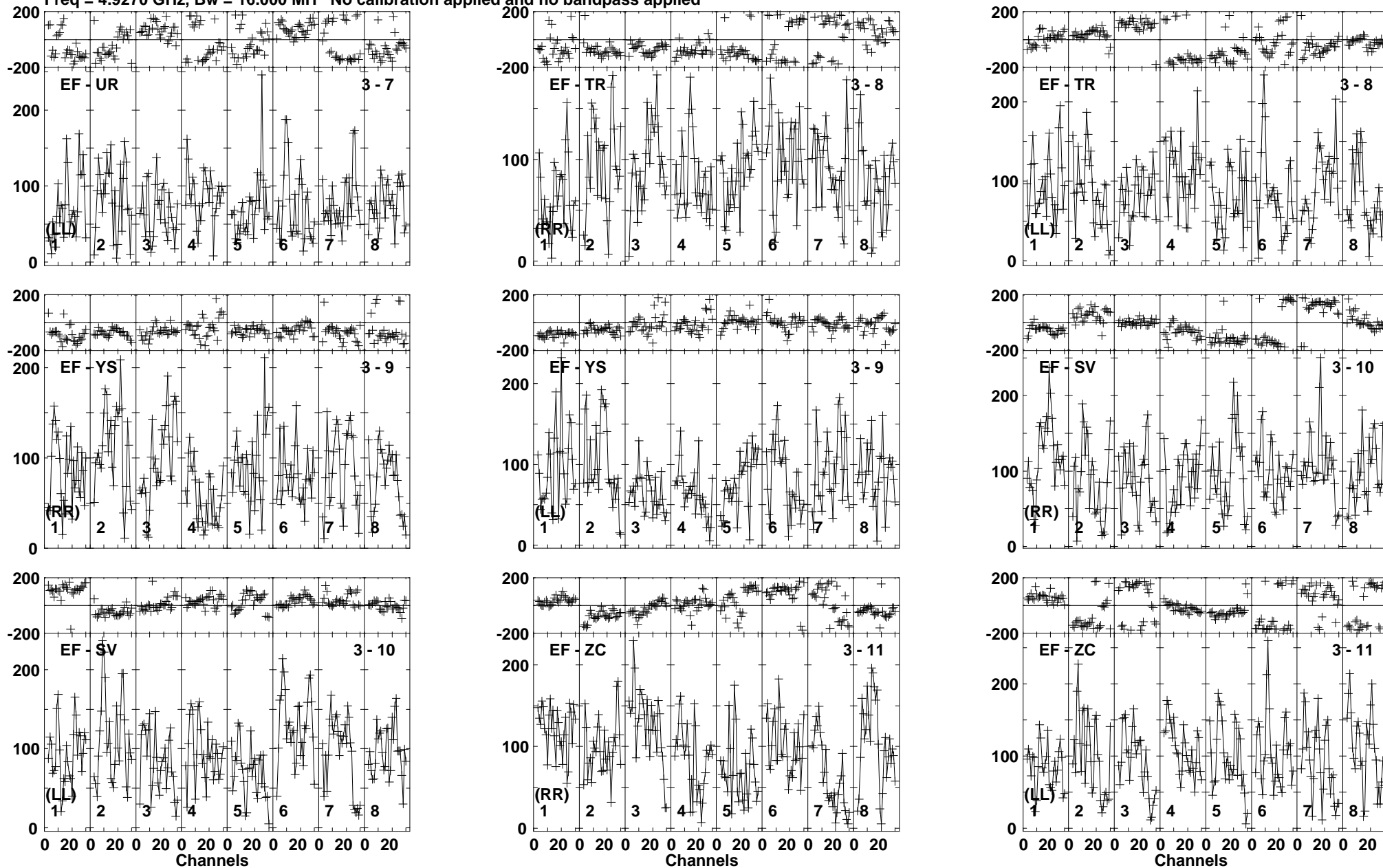

Lower frame: Micro Ampl Jy Top frame: Phas deg
Vector averaged cross-power spectrum Baseline: EF (03) - UR (07)
Timerange: 00/01:13:21 to 00/01:17:19

Plot file version 41 created 17-FEB-2020 15:42:42

J1402+5347 EK047 2.UVDATA.1

Freq = 4.9270 GHz, Bw = 16.000 MH No calibration applied and no bandpass applied

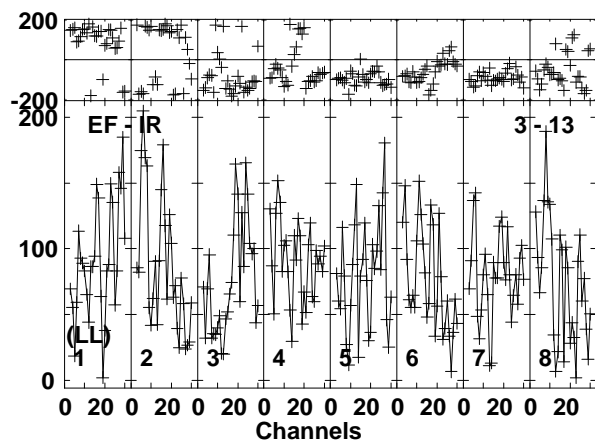
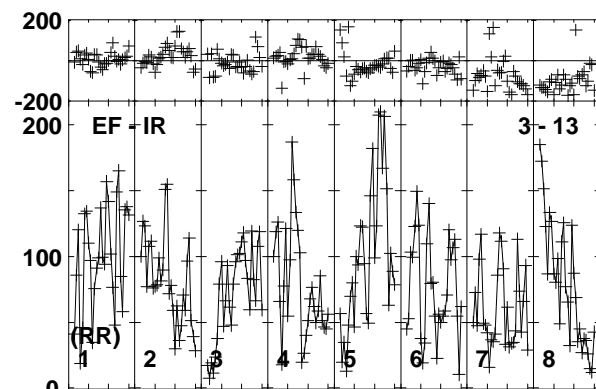
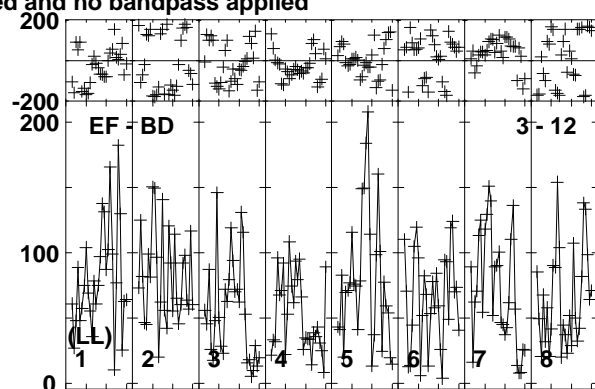
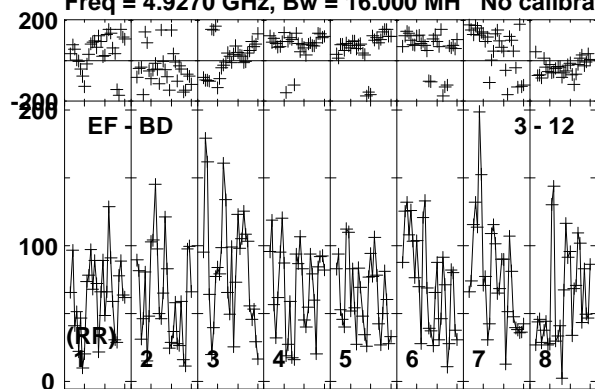

Lower frame: Micro Ampl Jy Top frame: Phas deg
Vector averaged cross-power spectrum Baseline: EF (03) - BD (12)
Timerange: 00/01:13:21 to 00/01:17:19

Plot file version 42 created 17-FEB-2020 15:42:42

J1359+5544 EK047 2.UVDATA.1

Freq = 4.9270 GHz, Bw = 16.000 MH No calibration applied and no bandpass applied

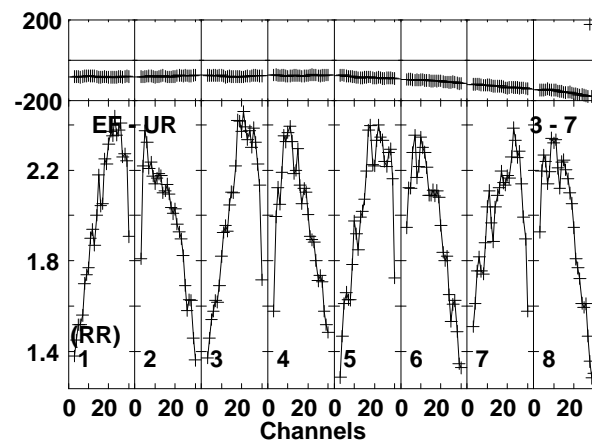
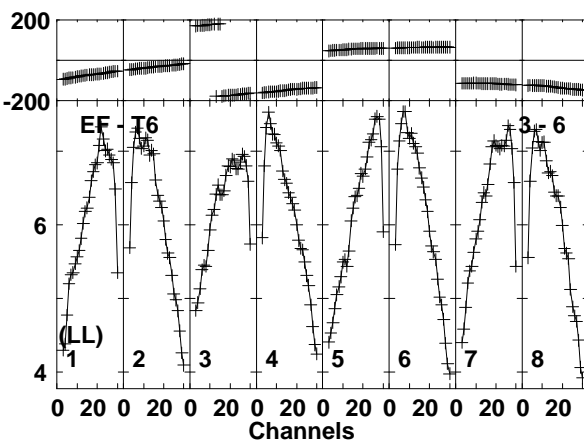
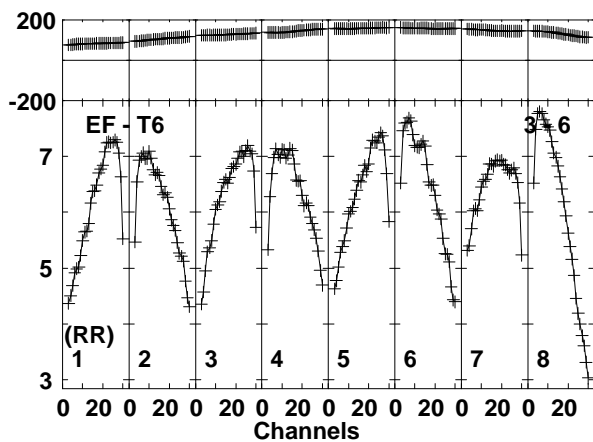
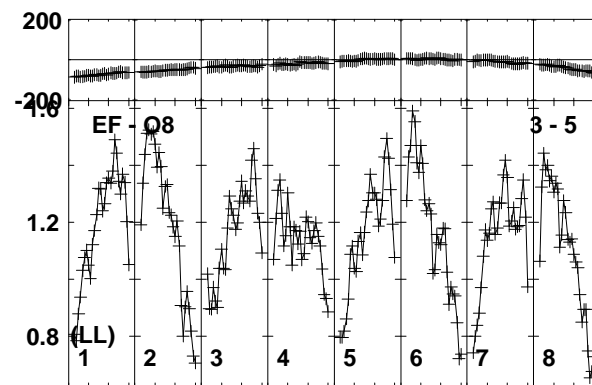
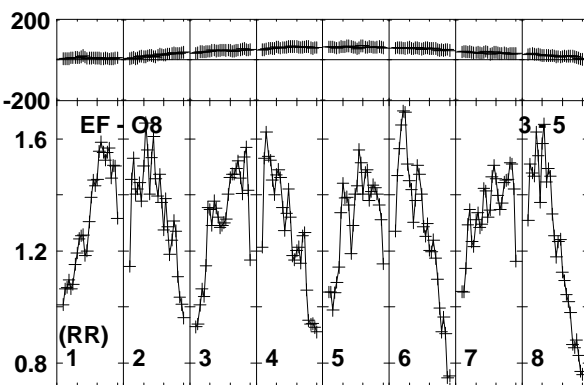
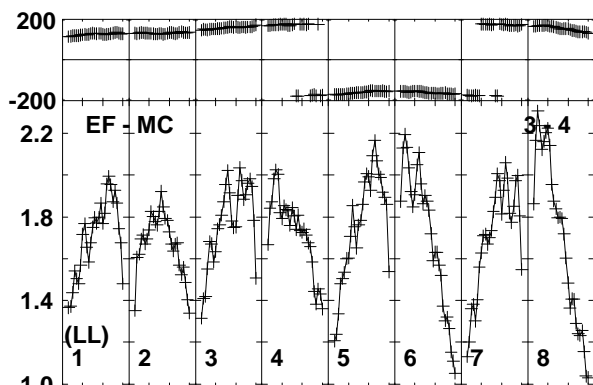
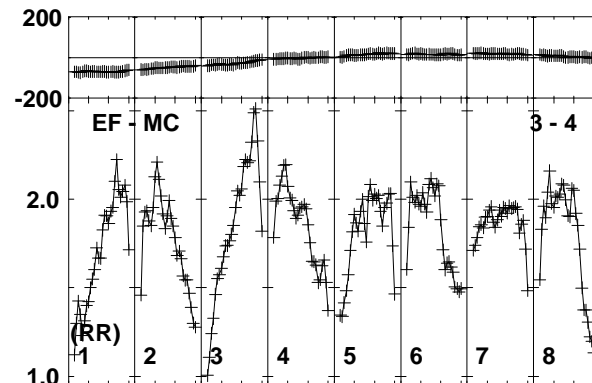
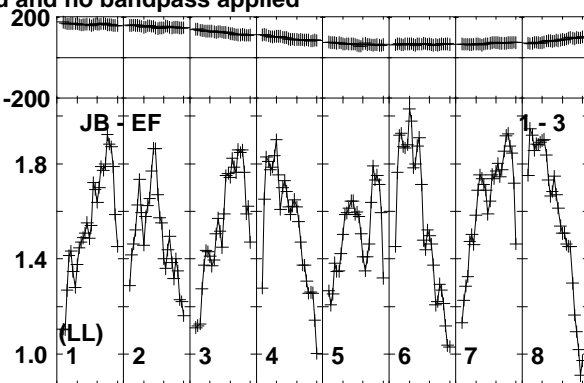
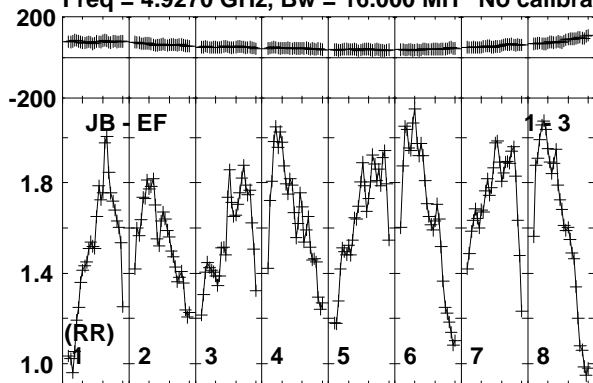

Lower frame: Milli Ampl Jy Top frame: Phas deg
Vector averaged cross-power spectrum Baseline: JB (01) - EF (03)
Timerange: 00/01:17:21 to 00/01:19:19

Plot file version 43 created 17-FEB-2020 15:42:42

J1359+5544 EK047 2.UVDATA.1

Freq = 4.9270 GHz, Bw = 16.000 MH No calibration applied and no bandpass applied

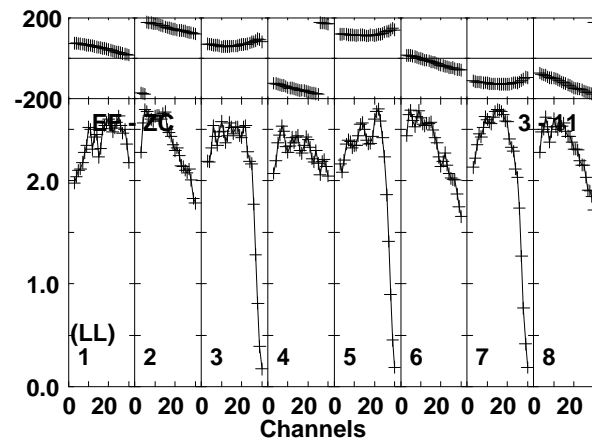
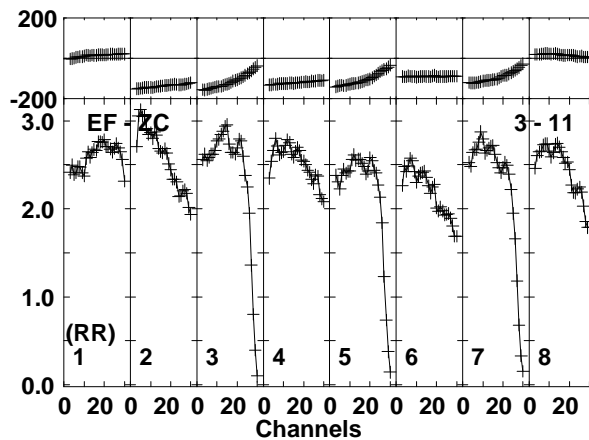
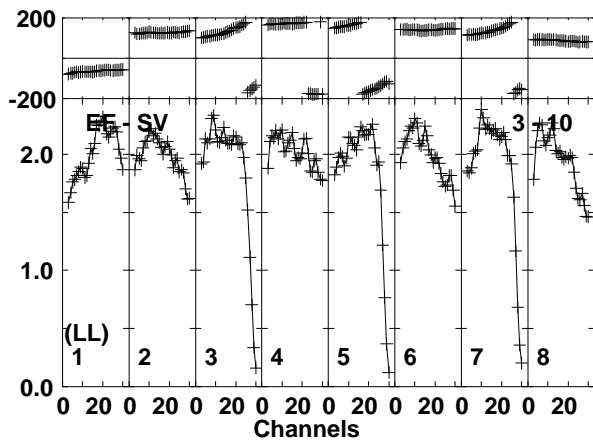
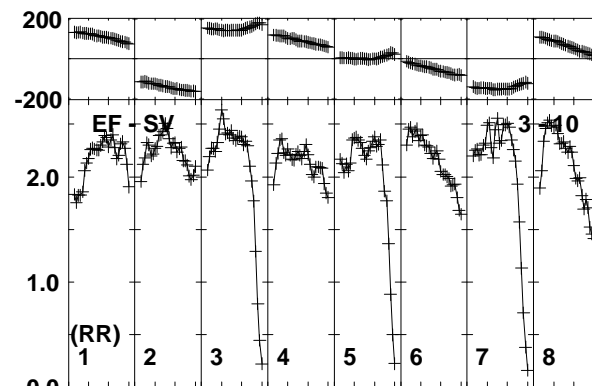
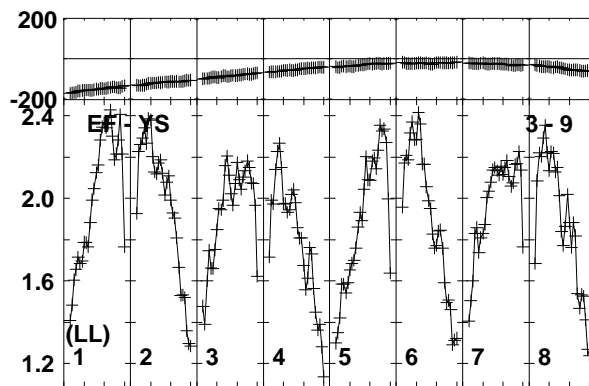
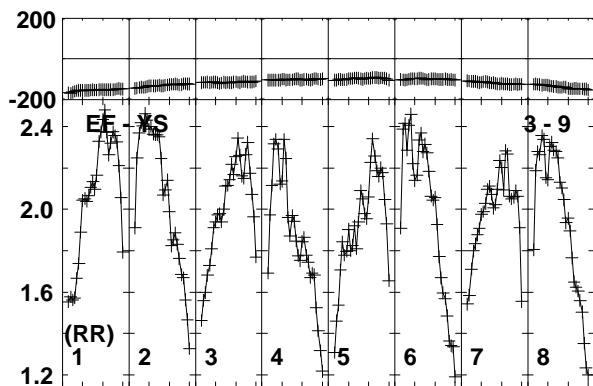
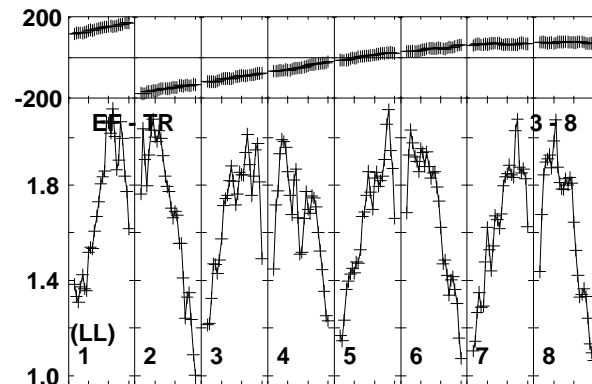
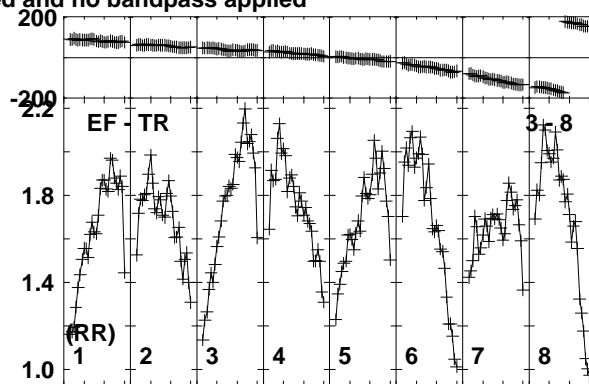
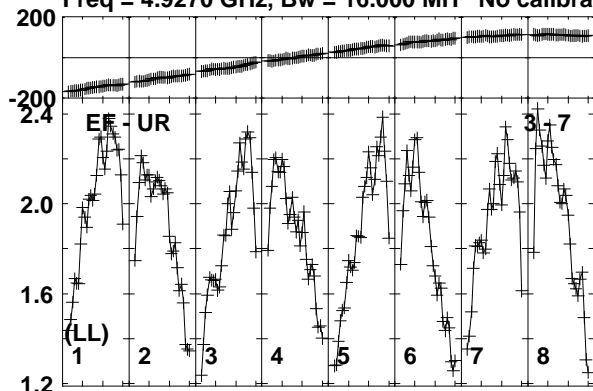

Lower frame: Milli Ampl Jy Top frame: Phas deg
Vector averaged cross-power spectrum Baseline: EF (03) - UR (07)
Timerange: 00/01:17:21 to 00/01:19:19

Plot file version 44 created 17-FEB-2020 15:42:42

J1359+5544 EK047 2.UVDATA.1

Freq = 4.9270 GHz, Bw = 16.000 MH No calibration applied and no bandpass applied

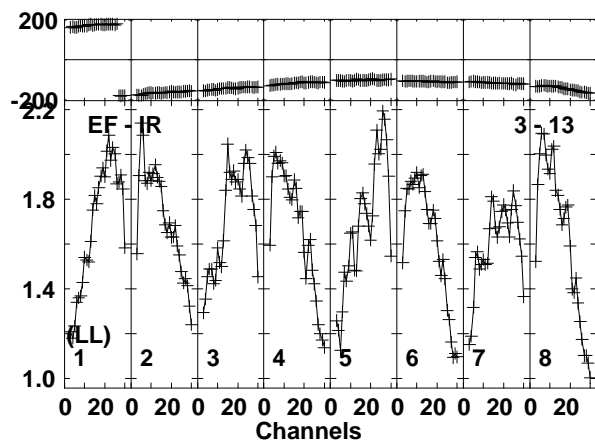
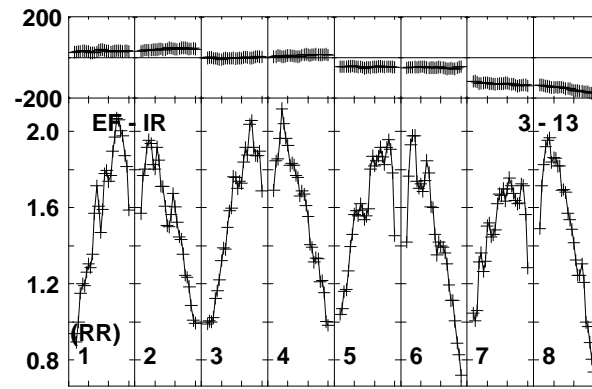
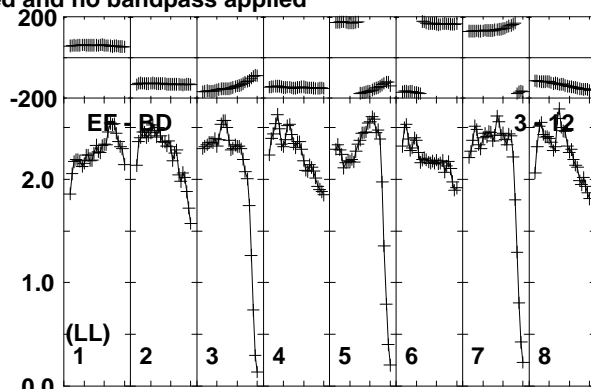
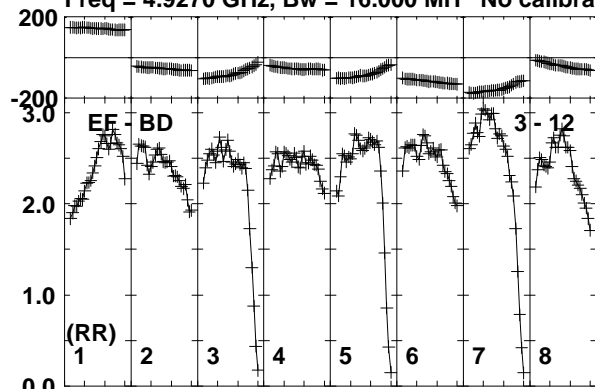

Lower frame: Milli Ampl Jy Top frame: Phas deg
Vector averaged cross-power spectrum Baseline: EF (03) - BD (12)
Timerange: 00/01:17:21 to 00/01:19:19

Plot file version 45 created 17-FEB-2020 15:42:42

J1402+5347 EK047 2.UVDATA.1

Freq = 4.9270 GHz, Bw = 16.000 MH No calibration applied and no bandpass applied

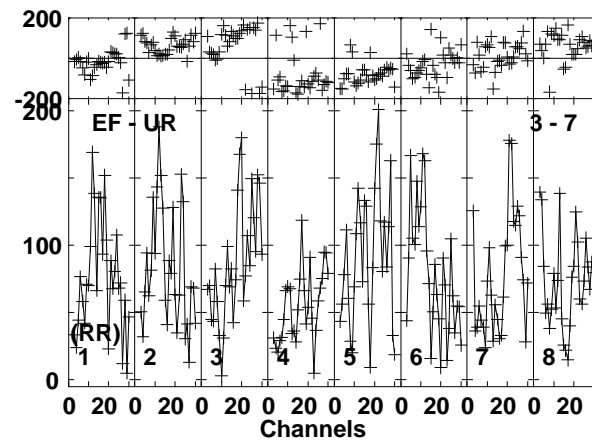
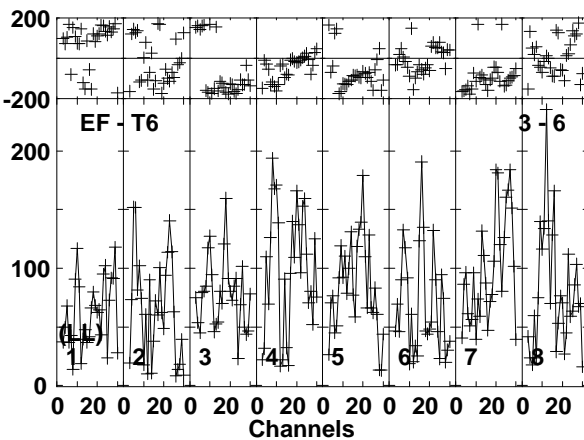
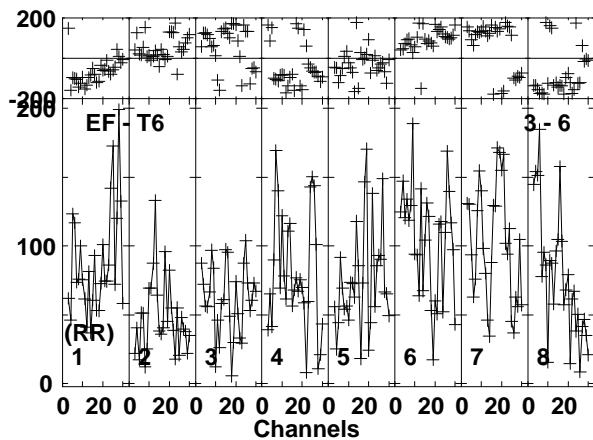
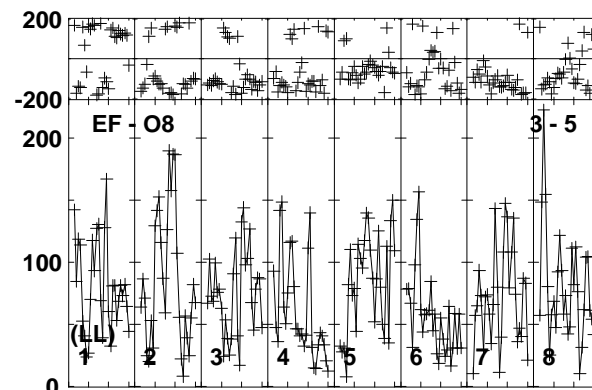
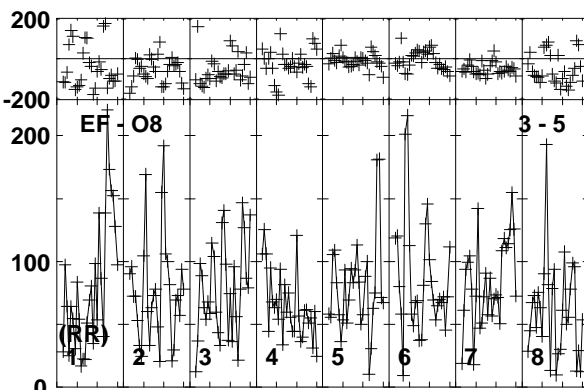
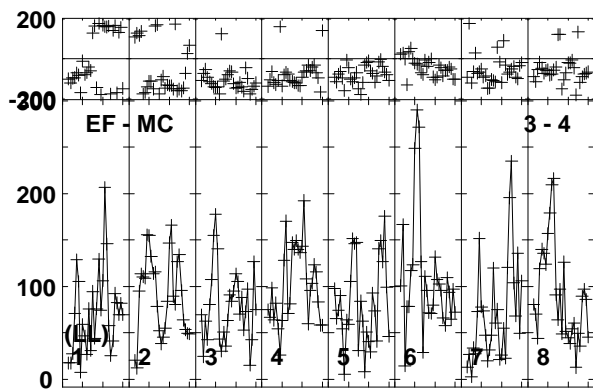
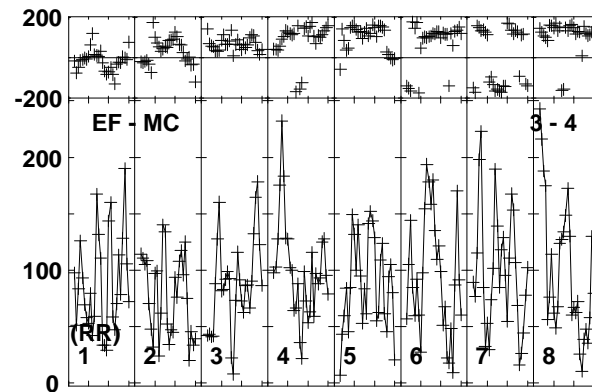
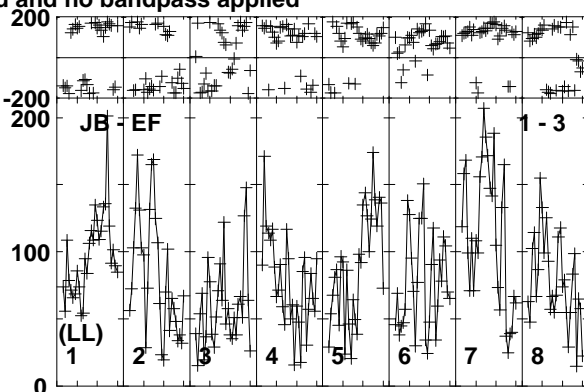
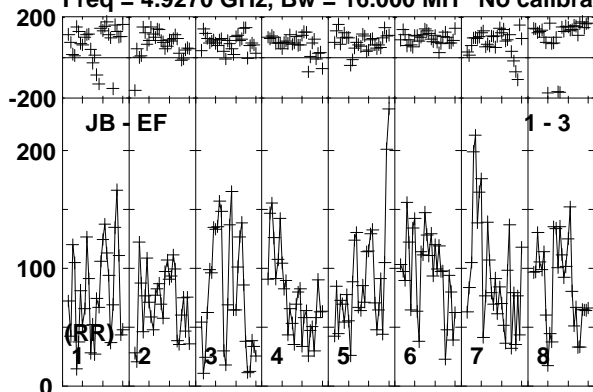

Lower frame: Micro Ampl Jy Top frame: Phas deg
Vector averaged cross-power spectrum Baseline: JB (01) - EF (03)
Timerange: 00/01:19:23 to 00/01:23:19

Plot file version 46 created 17-FEB-2020 15:42:42

J1402+5347 EK047 2.UVDATA.1

Freq = 4.9270 GHz, Bw = 16.000 MH No calibration applied and no bandpass applied

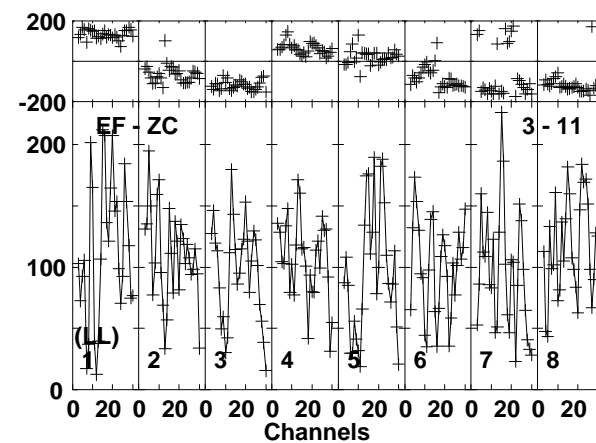
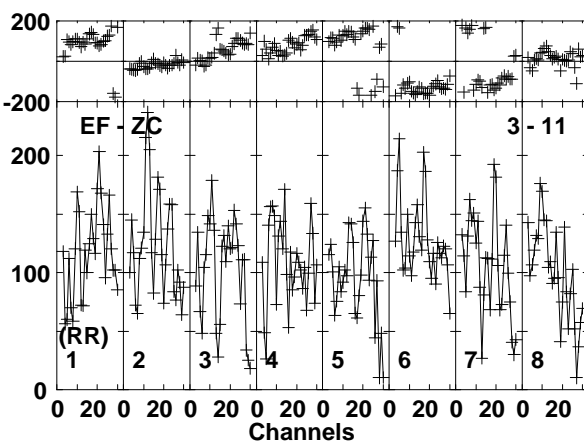
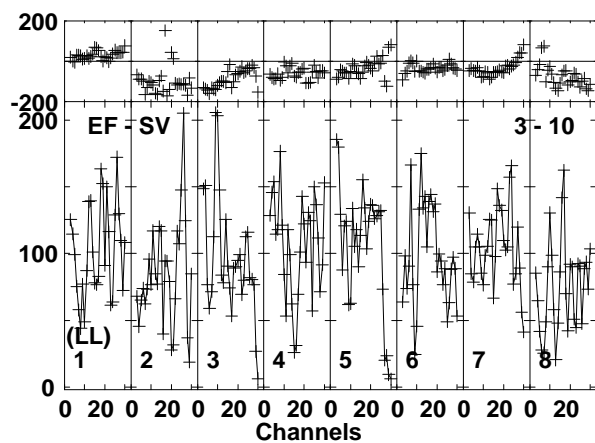
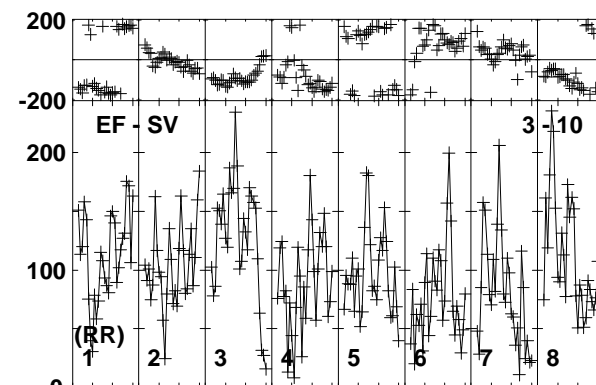
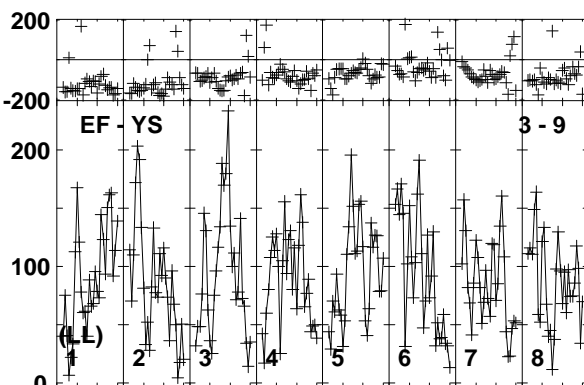
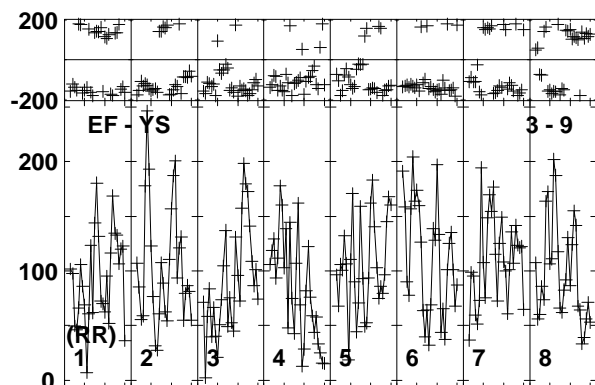
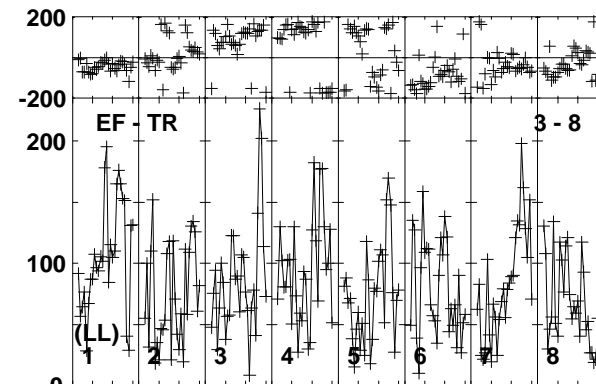
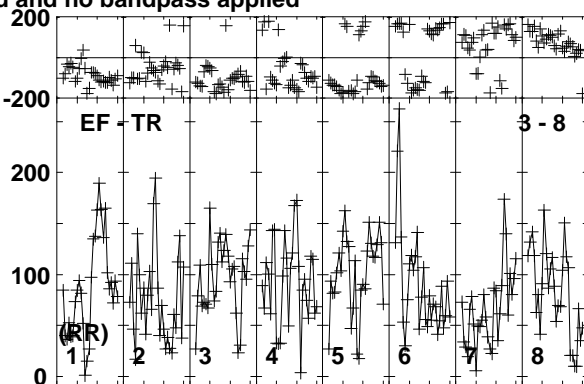
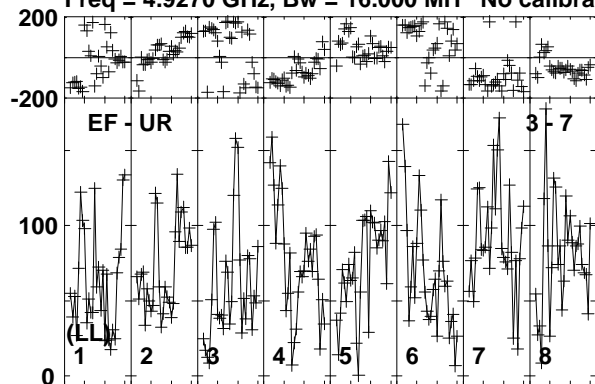

Lower frame: Micro Ampl Jy Top frame: Phas deg
Vector averaged cross-power spectrum Baseline: EF (03) - UR (07)
Timerange: 00/01:19:23 to 00/01:23:19

Plot file version 47 created 17-FEB-2020 15:42:42

J1402+5347 EK047 2.UVDATA.1

Freq = 4.9270 GHz, Bw = 16.000 MH No calibration applied and no bandpass applied

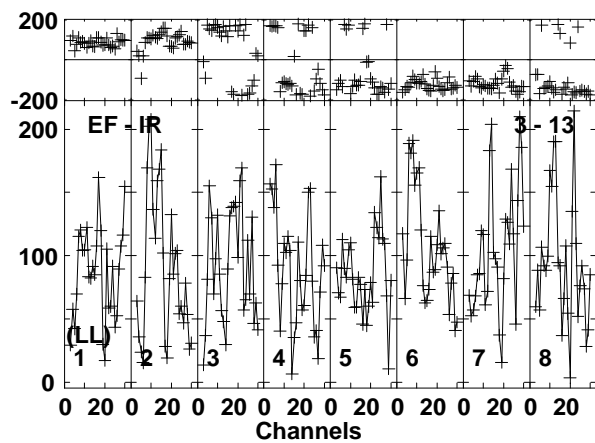
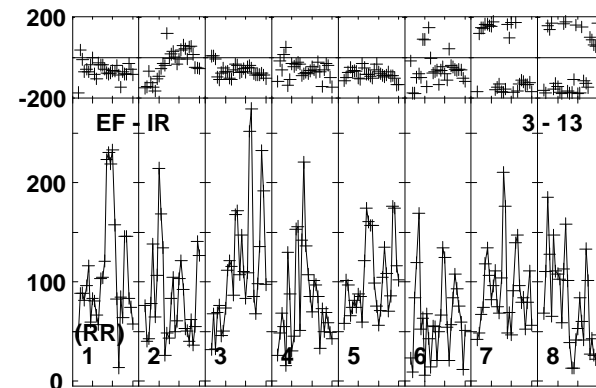
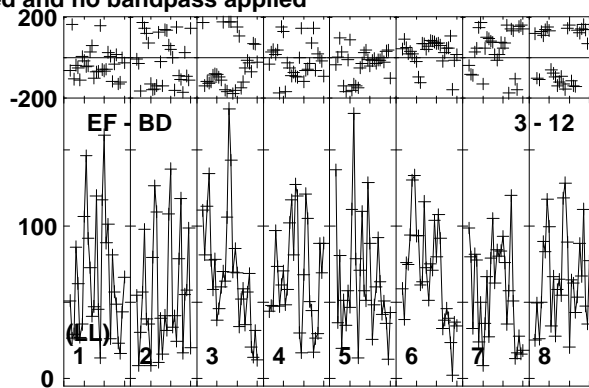
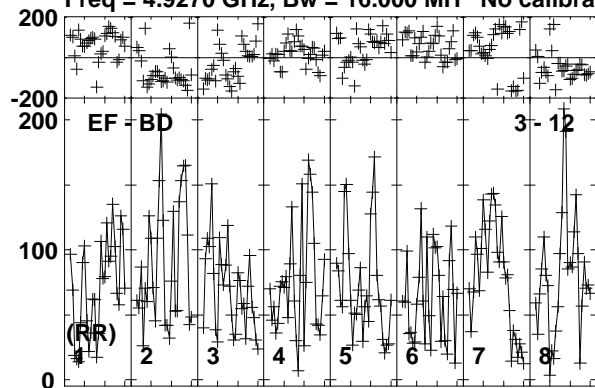

Lower frame: Micro Ampl Jy Top frame: Phas deg
Vector averaged cross-power spectrum Baseline: EF (03) - BD (12)
Timerange: 00/01:19:23 to 00/01:23:19

Plot file version 48 created 17-FEB-2020 15:42:42

J1359+5544 EK047 2.UVDATA.1

Freq = 4.9270 GHz, Bw = 16.000 MH No calibration applied and no bandpass applied

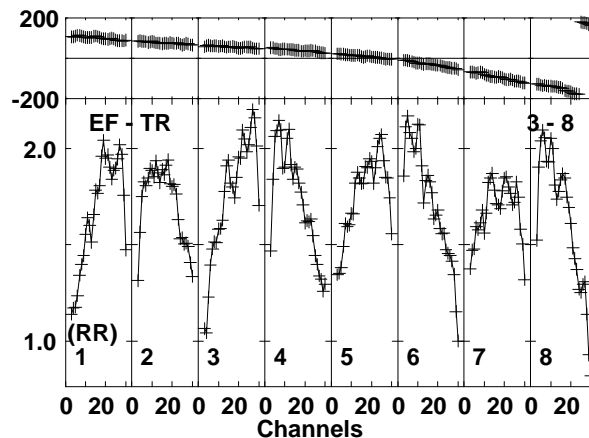
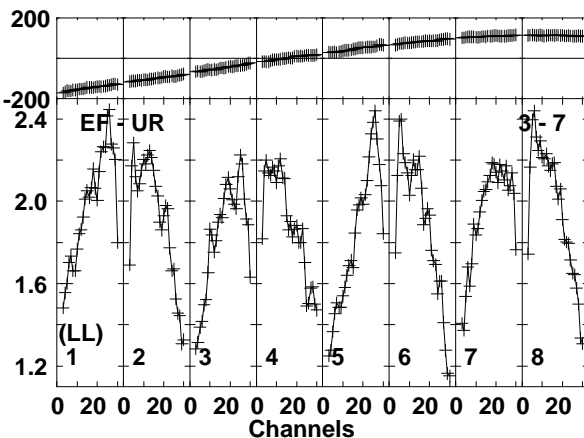
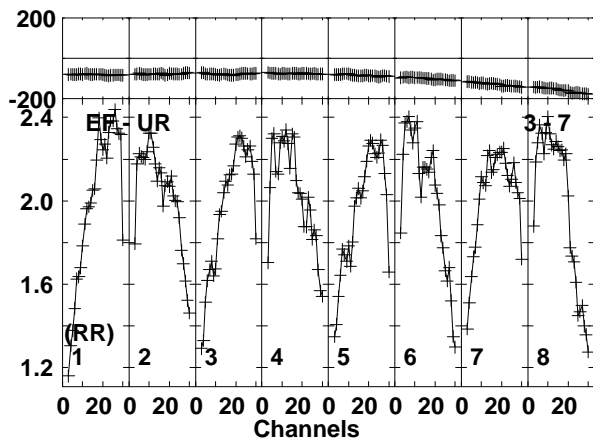
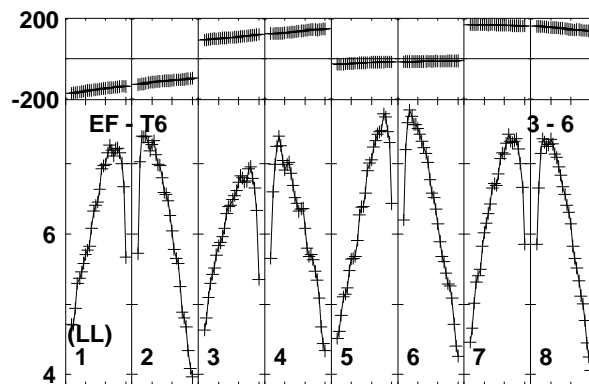
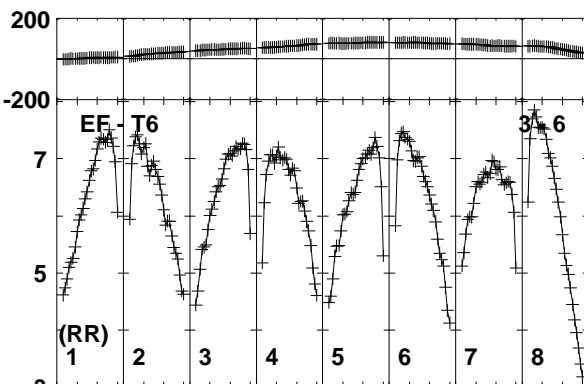
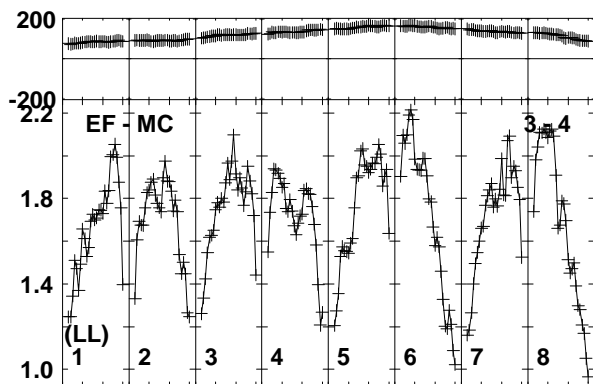
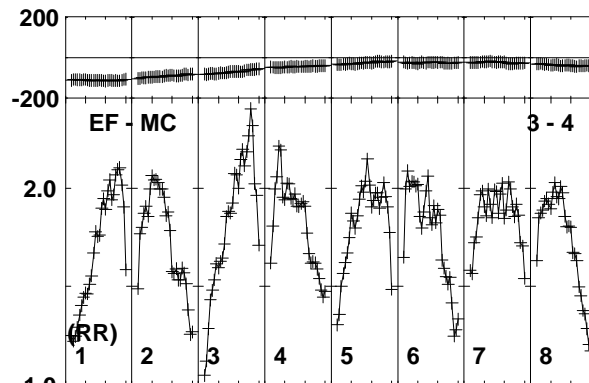
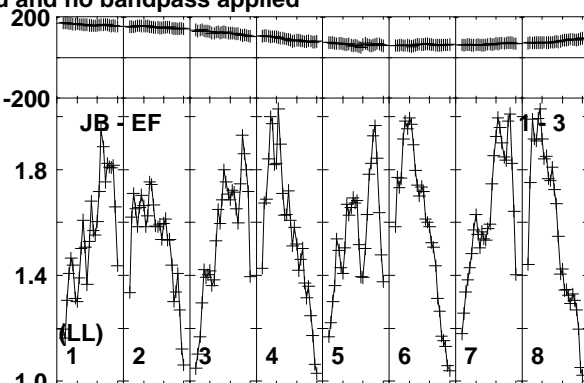
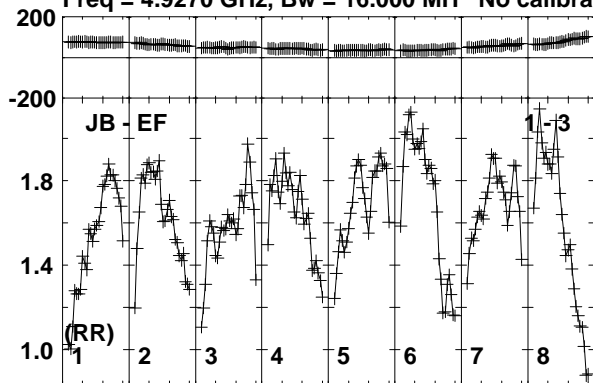

Lower frame: Milli Ampl Jy Top frame: Phas deg
Vector averaged cross-power spectrum Baseline: JB (01) - EF (03)
Timerange: 00/01:24:01 to 00/01:25:19

Plot file version 49 created 17-FEB-2020 15:42:42

J1359+5544 EK047 2.UVDATA.1

Freq = 4.9270 GHz, Bw = 16.000 MH No calibration applied and no bandpass applied

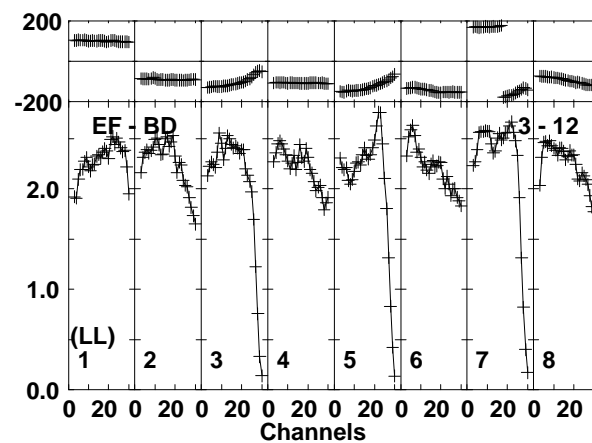
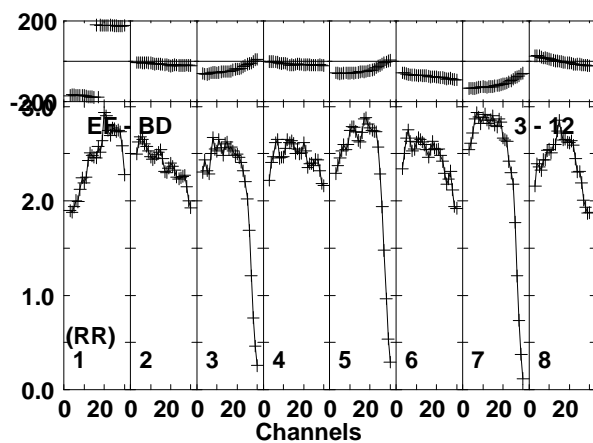
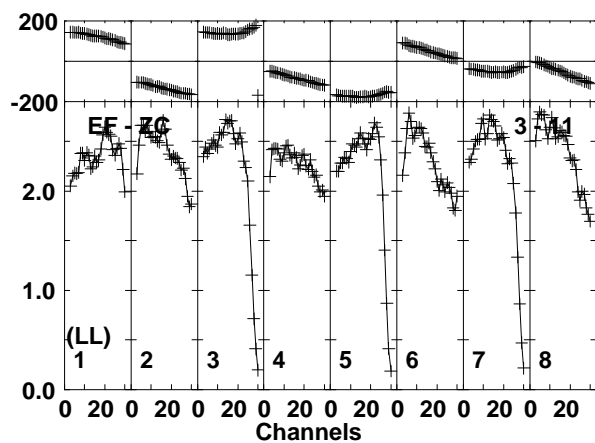
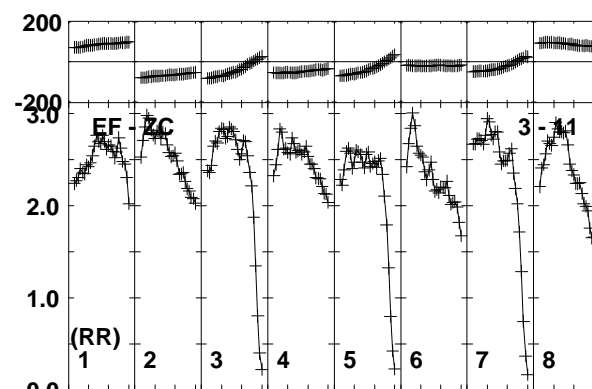
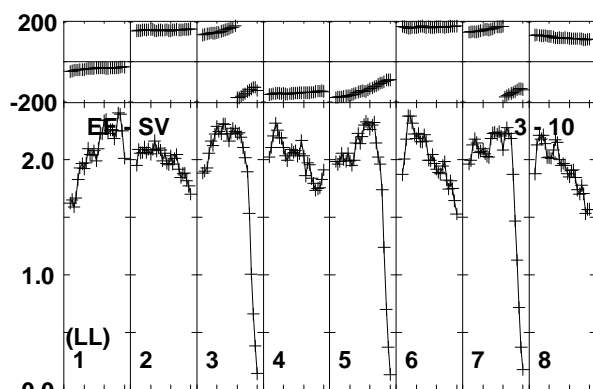
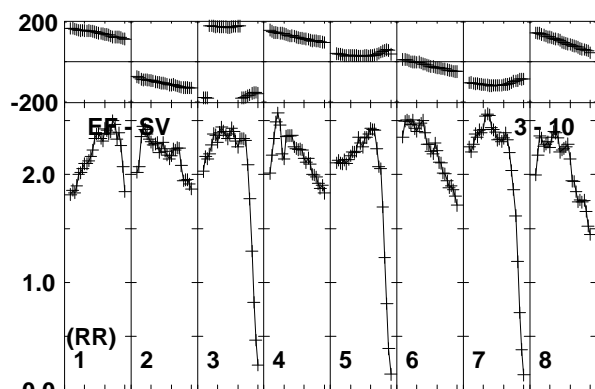
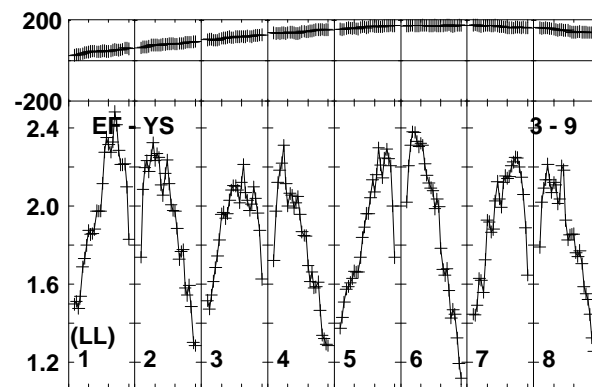
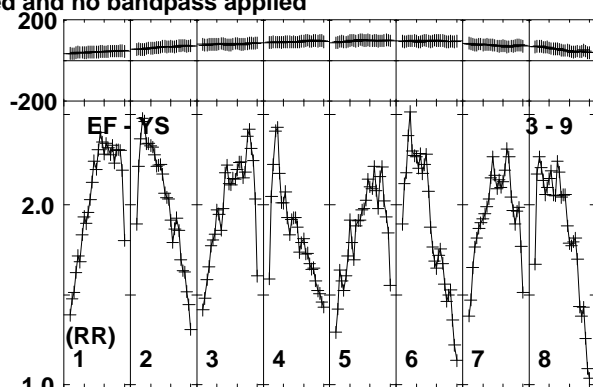
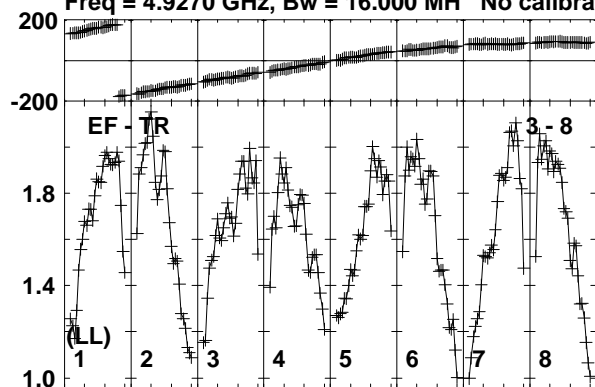

Lower frame: Milli Ampl Jy Top frame: Phas deg
Vector averaged cross-power spectrum Baseline: EF (03) - TR (08)
Timerange: 00/01:24:01 to 00/01:25:19

Plot file version 50 created 17-FEB-2020 15:42:43

J1359+5544 EK047 2.UVDATA.1

Freq = 4.9270 GHz, Bw = 16.000 MH No calibration applied and no bandpass applied

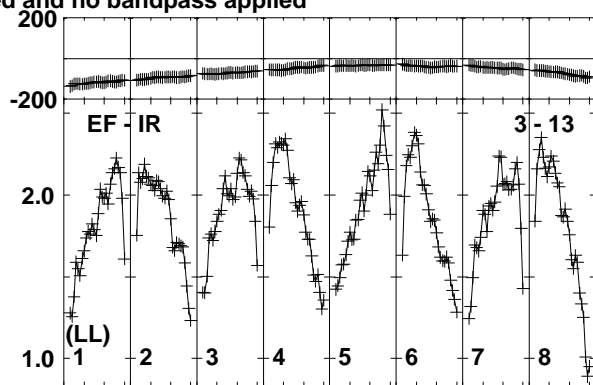
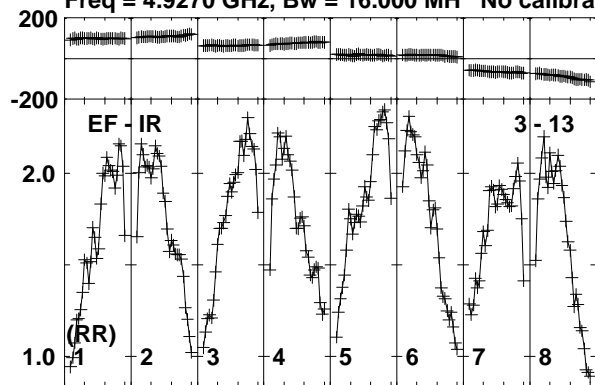

Lower frame: Milli Ampl Jy Top frame: Phas deg
Vector averaged cross-power spectrum Baseline: EF (03) - IR (13)
Timerange: 00/01:24:01 to 00/01:25:19

Plot file version 51 created 17-FEB-2020 15:42:43

J1402+5347 EK047 2.UVDATA.1

Freq = 4.9270 GHz, Bw = 16.000 MH No calibration applied and no bandpass applied

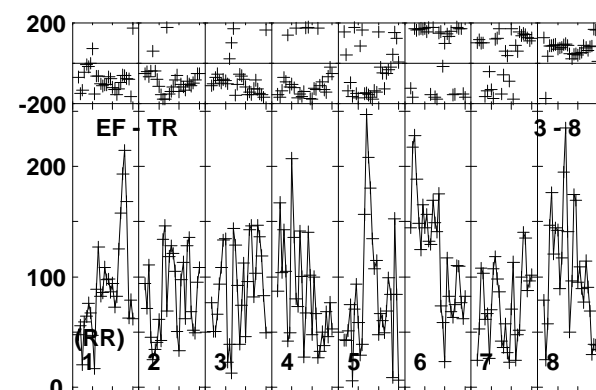
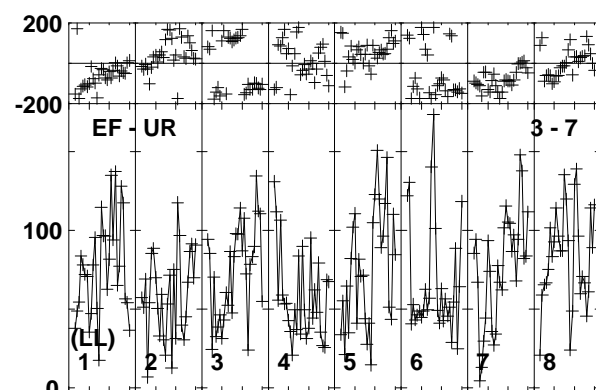
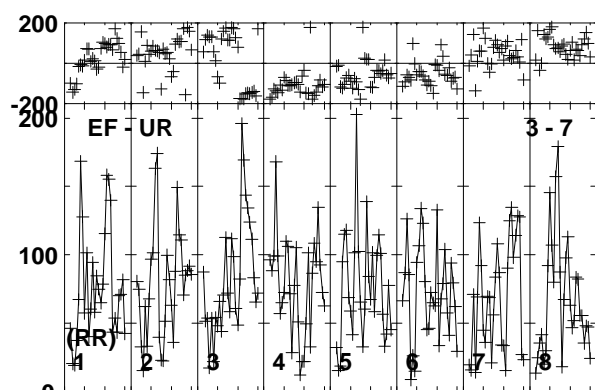
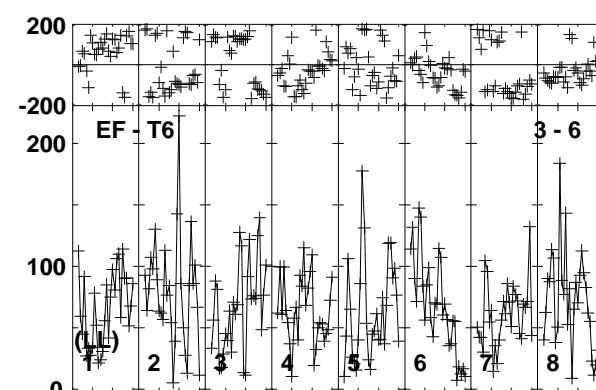
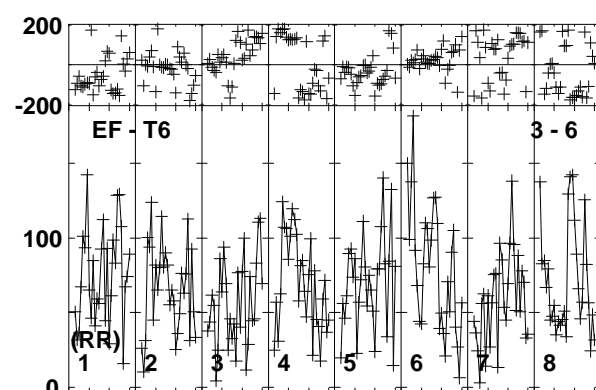
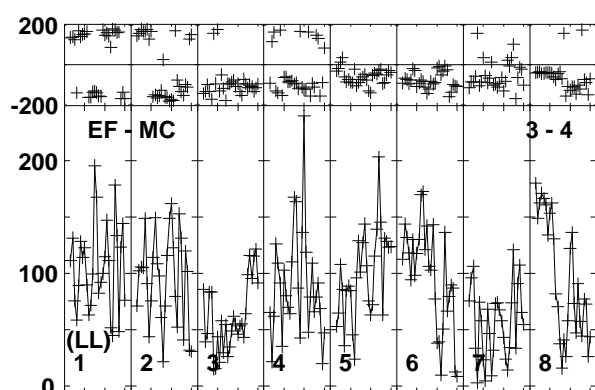
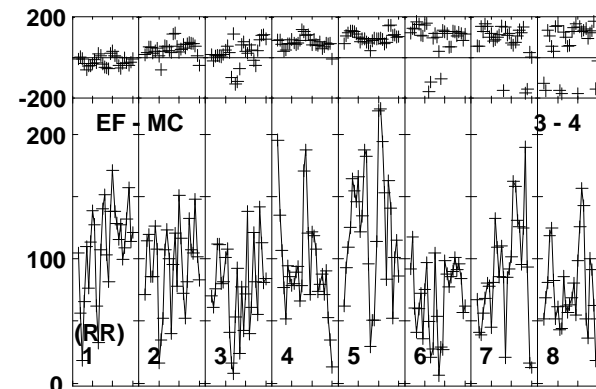
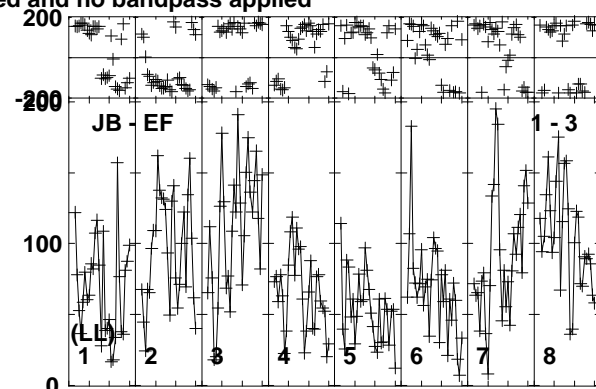
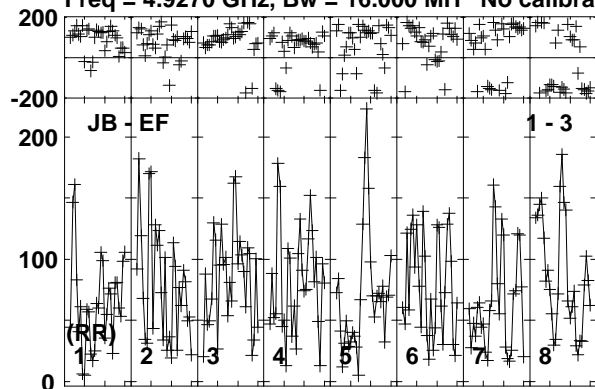

Lower frame: Micro Ampl Jy Top frame: Phas deg
Vector averaged cross-power spectrum Baseline: JB (01) - EF (03)
Timerange: 00/01:25:21 to 00/01:29:19

Plot file version 52 created 17-FEB-2020 15:42:43

J1402+5347 EK047 2.UVDATA.1

Freq = 4.9270 GHz, Bw = 16.000 MH No calibration applied and no bandpass applied

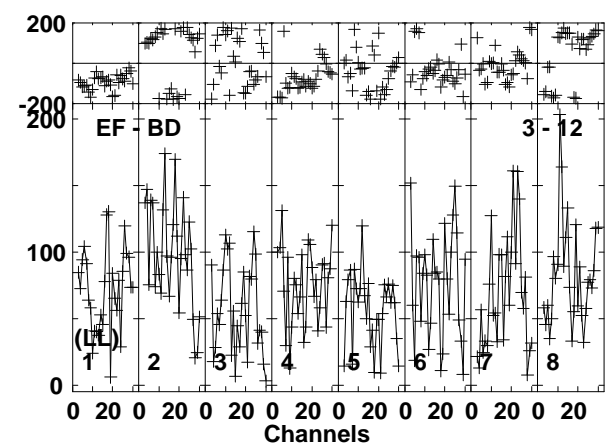
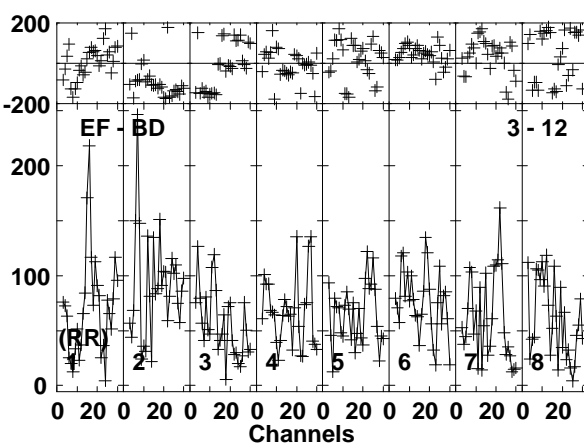
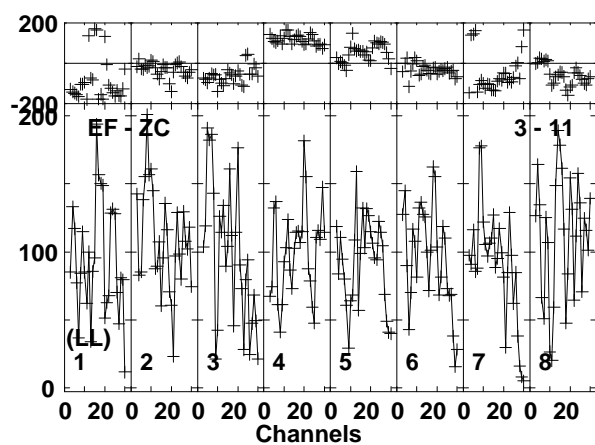
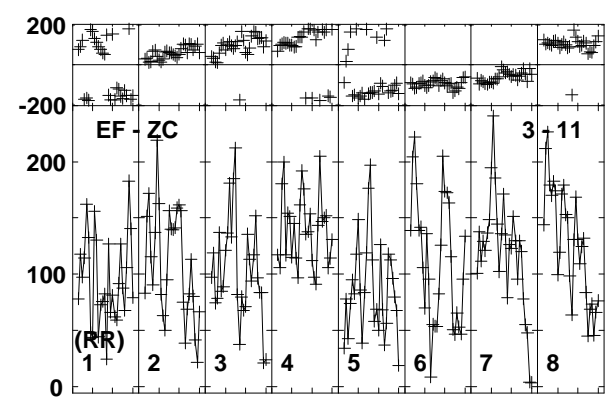
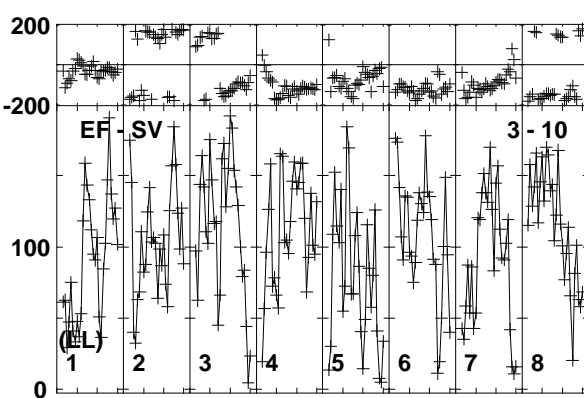
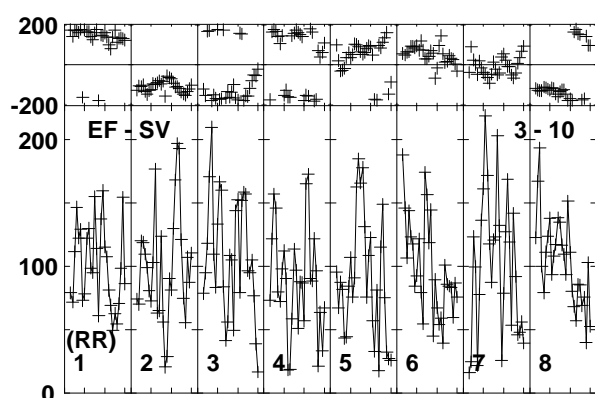
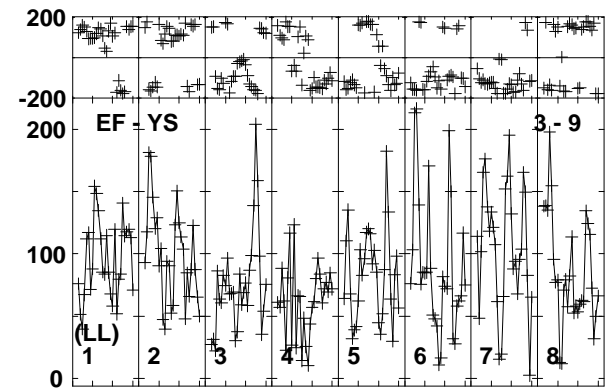
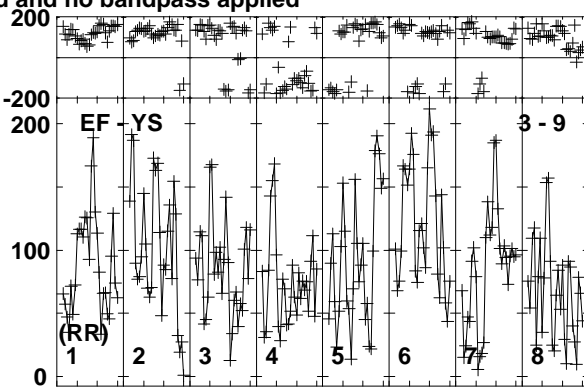
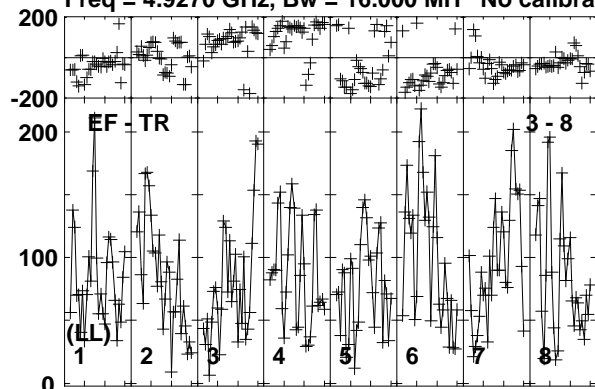

Lower frame: Micro Ampl Jy Top frame: Phas deg
Vector averaged cross-power spectrum Baseline: EF (03) - TR (08)
Timerange: 00/01:25:21 to 00/01:29:19

Plot file version 53 created 17-FEB-2020 15:42:43

J1402+5347 EK047 2.UVDATA.1

Freq = 4.9270 GHz, Bw = 16.000 MH No calibration applied and no bandpass applied

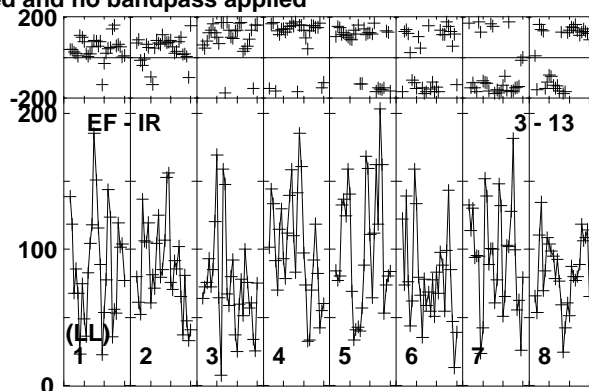
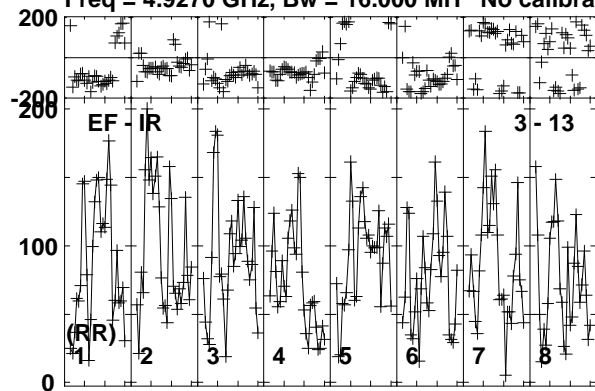

Lower frame: Micro Ampl Jy Top frame: Phas deg
Vector averaged cross-power spectrum Baseline: EF (03) - IR (13)
Timerange: 00/01:25:21 to 00/01:29:19

Plot file version 54 created 17-FEB-2020 15:42:43

J1359+5544 EK047 2.UVDATA.1

Freq = 4.9270 GHz, Bw = 16.000 MH No calibration applied and no bandpass applied

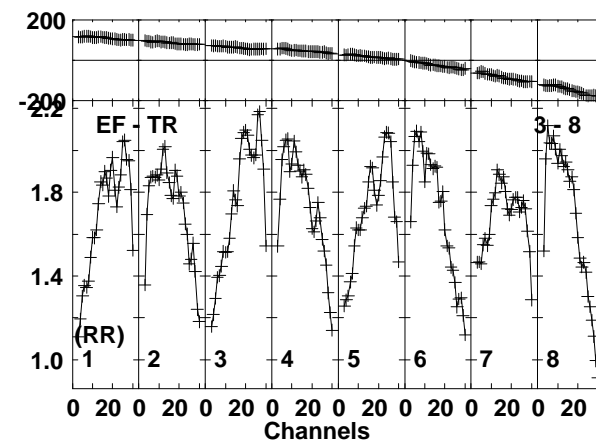
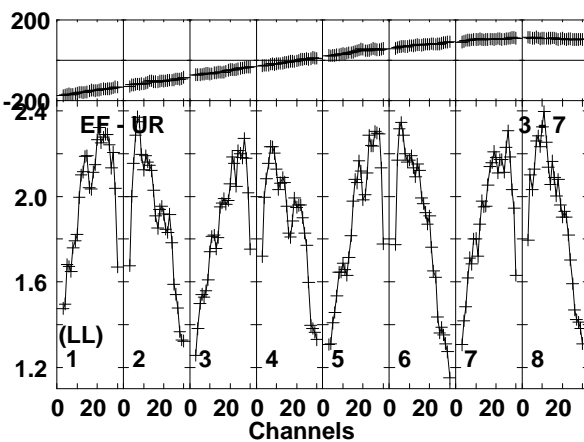
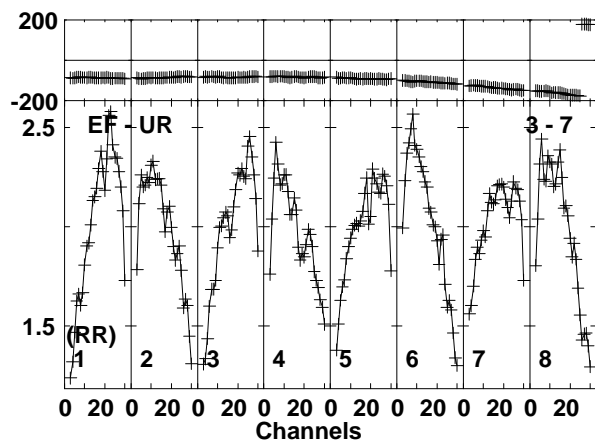
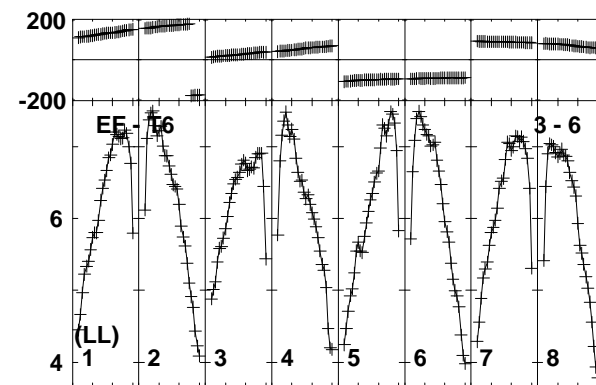
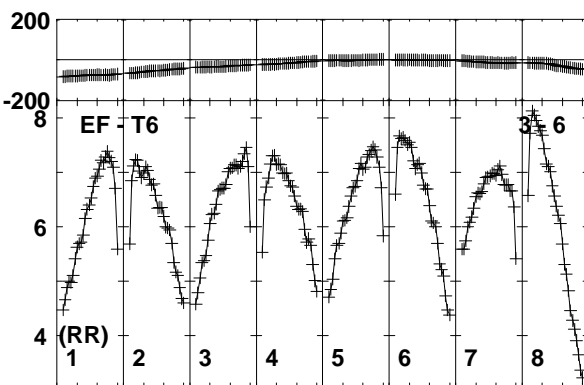
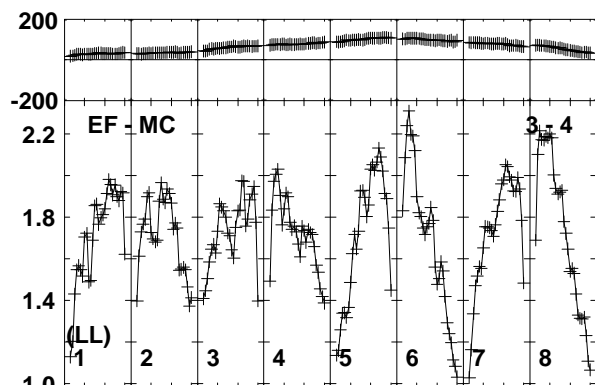
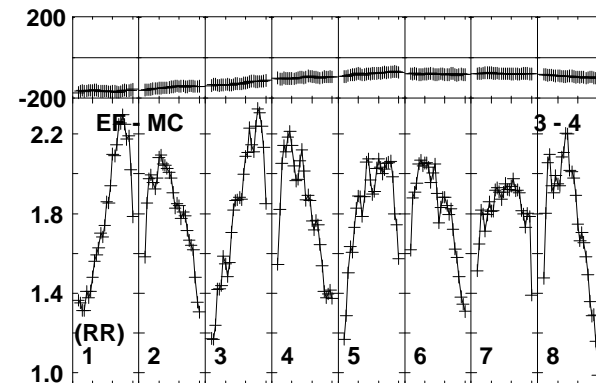
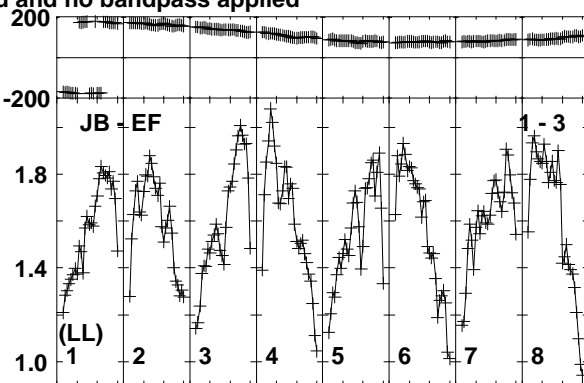
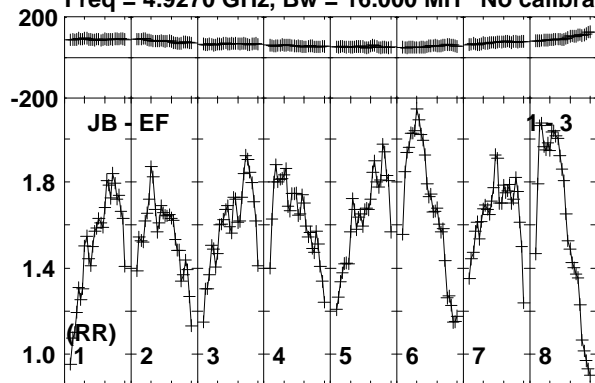

Lower frame: Milli Ampl Jy Top frame: Phas deg
Vector averaged cross-power spectrum Baseline: JB (01) - EF (03)
Timerange: 00/01:29:21 to 00/01:31:19

Plot file version 55 created 17-FEB-2020 15:42:43

J1359+5544 EK047 2.UVDATA.1

Freq = 4.9270 GHz, Bw = 16.000 MH No calibration applied and no bandpass applied

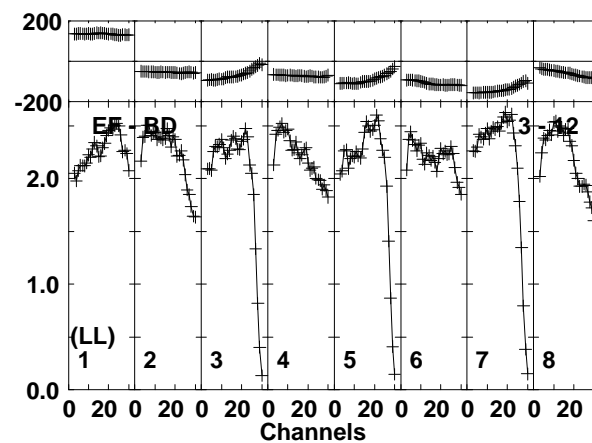
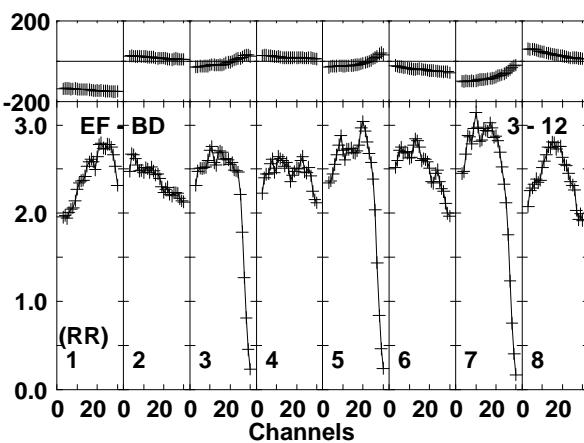
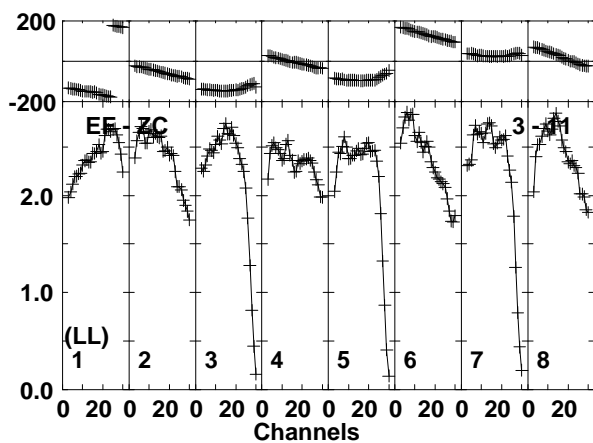
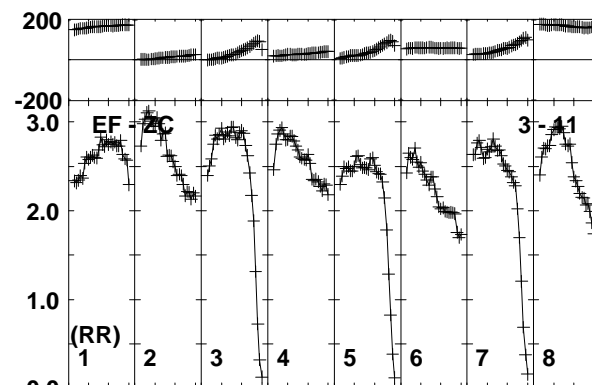
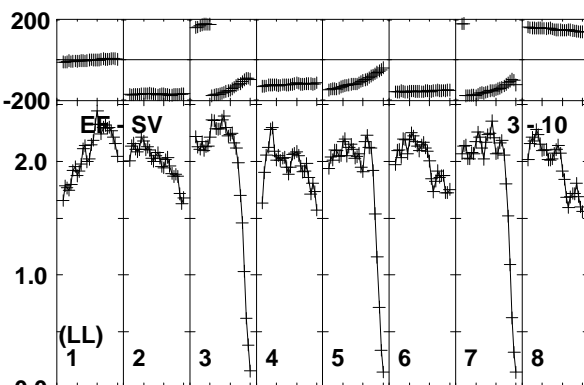
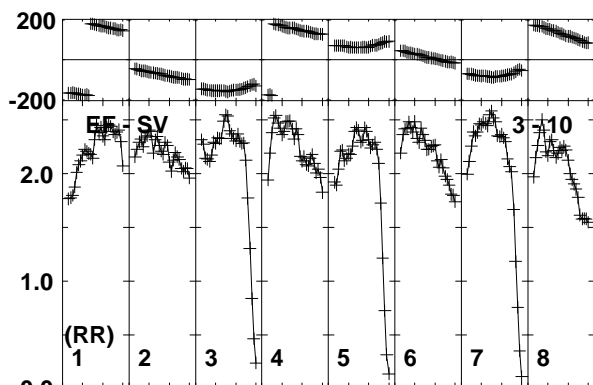
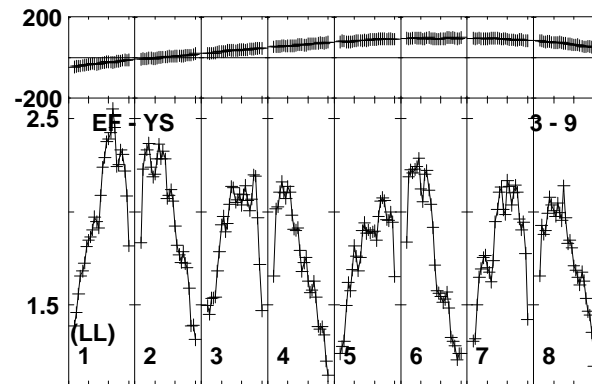
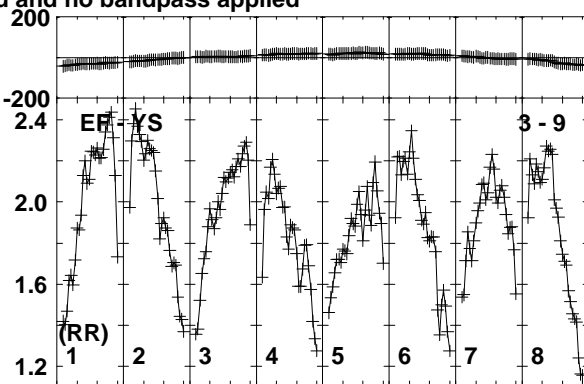
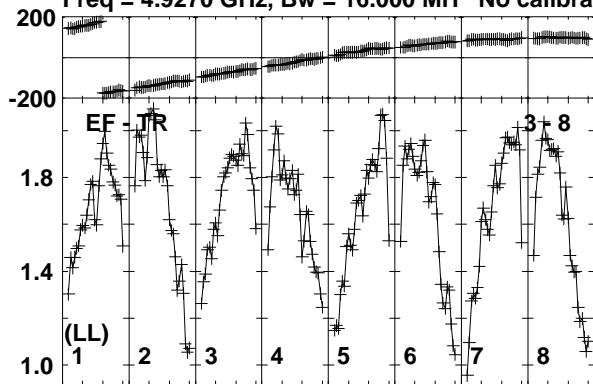

Lower frame: Milli Ampl Jy Top frame: Phas deg
Vector averaged cross-power spectrum Baseline: EF (03) - TR (08)
Timerange: 00/01:29:21 to 00/01:31:19

Plot file version 56 created 17-FEB-2020 15:42:43

J1359+5544 EK047 2.UVDATA.1

Freq = 4.9270 GHz, Bw = 16.000 MH No calibration applied and no bandpass applied

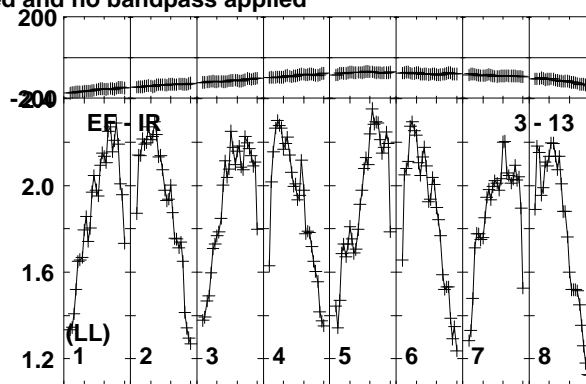
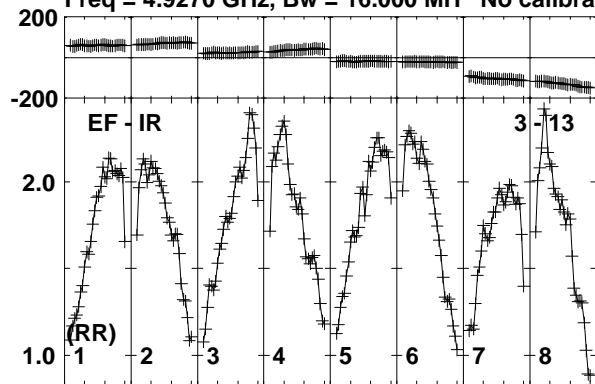

Lower frame: Milli Ampl Jy Top frame: Phas deg
Vector averaged cross-power spectrum Baseline: EF (03) - IR (13)
Timerange: 00/01:29:21 to 00/01:31:19

Plot file version 57 created 17-FEB-2020 15:42:43

J1402+5347 EK047 2.UVDATA.1

Freq = 4.9270 GHz, Bw = 16.000 MH No calibration applied and no bandpass applied

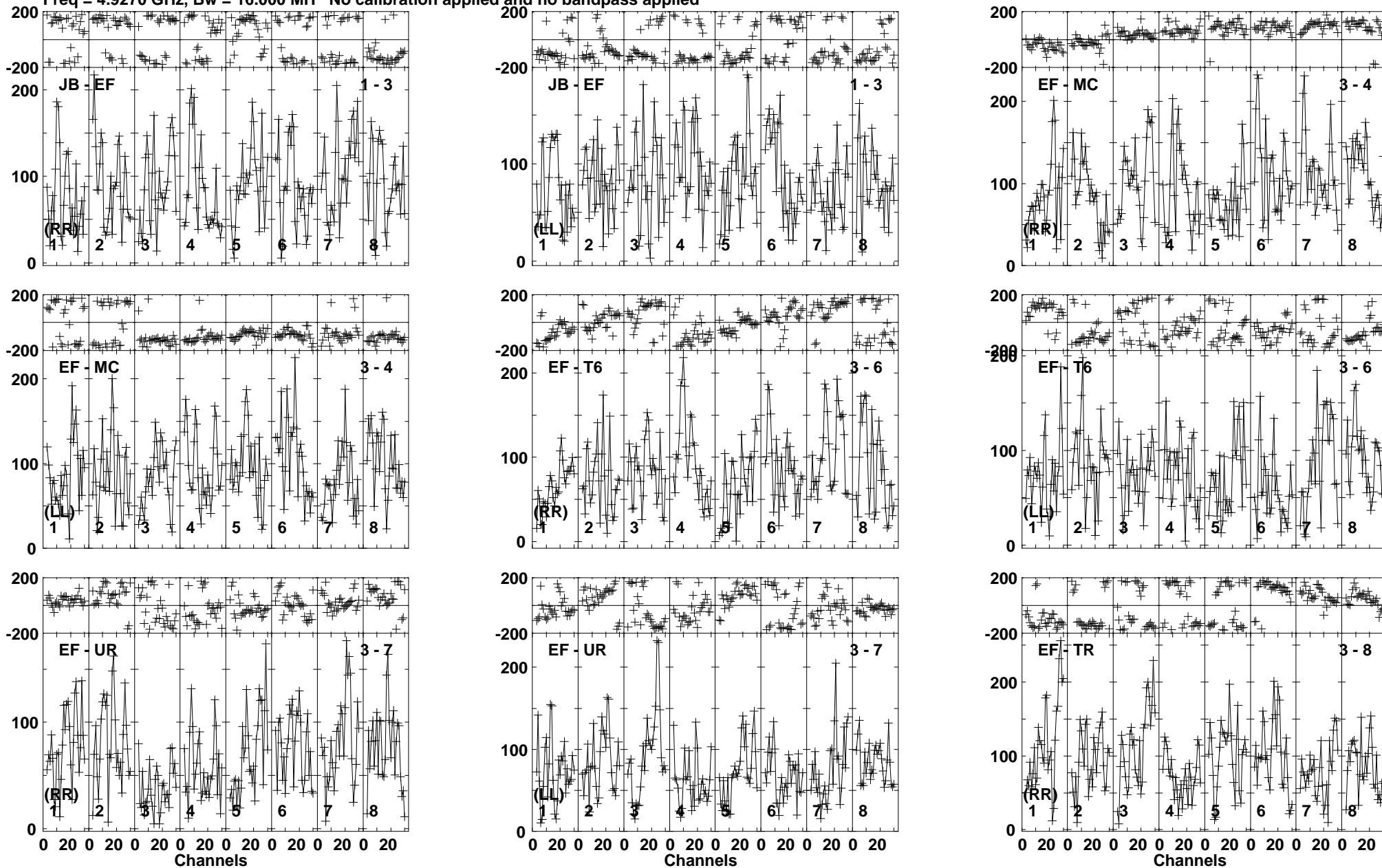

Lower frame: Micro Ampl Jy Top frame: Phas deg
 Vector averaged cross-power spectrum Baseline: JB (01) - EF (03)
 Timerange: 00/01:31:23 to 00/01:35:19

Plot file version 58 created 17-FEB-2020 15:42:43

J1402+5347 EK047 2.UVDATA.1

Freq = 4.9270 GHz, Bw = 16.000 MH No calibration applied and no bandpass applied

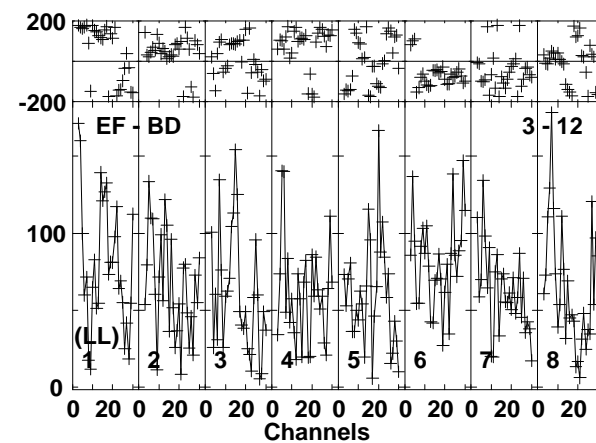
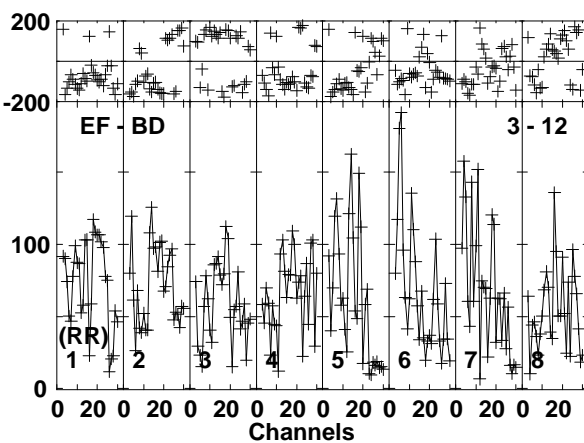
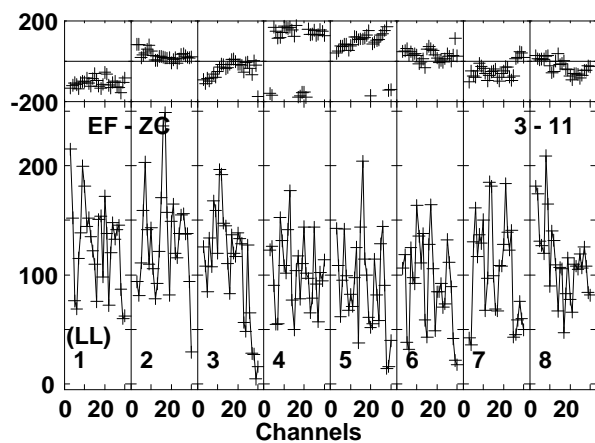
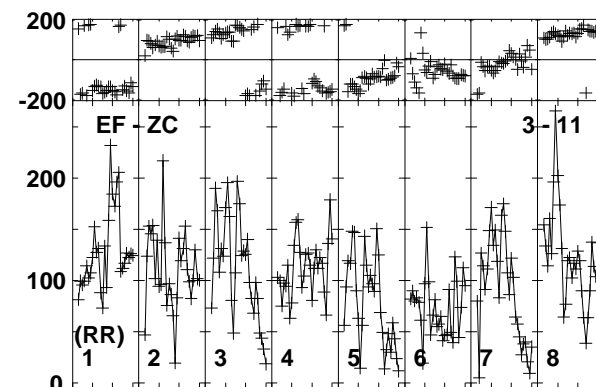
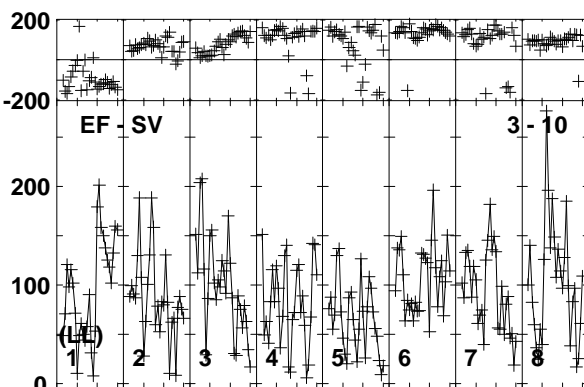
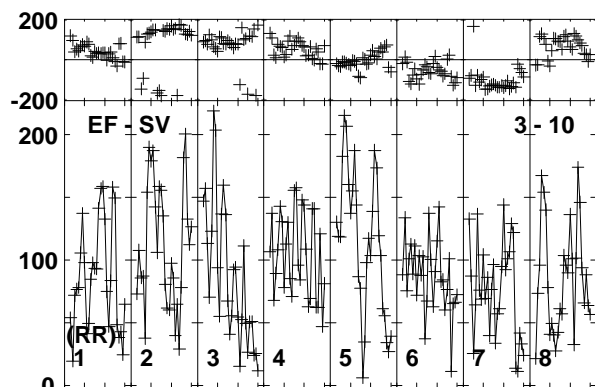
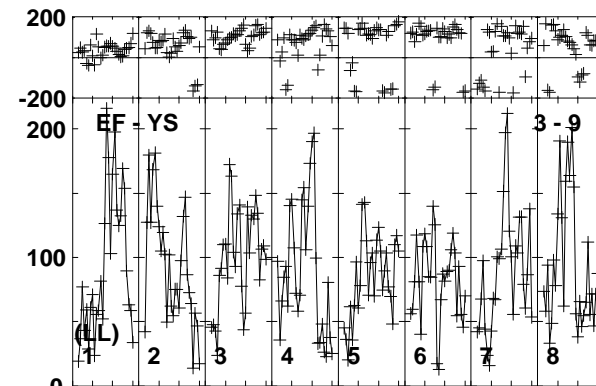
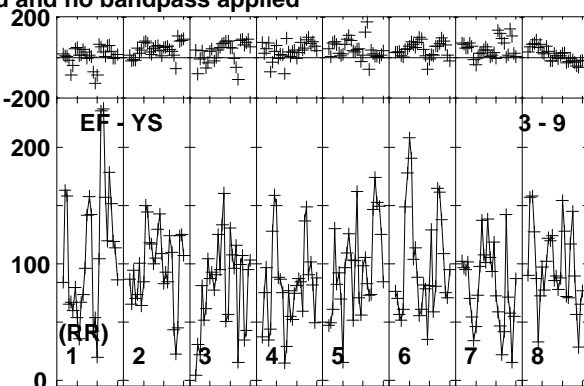
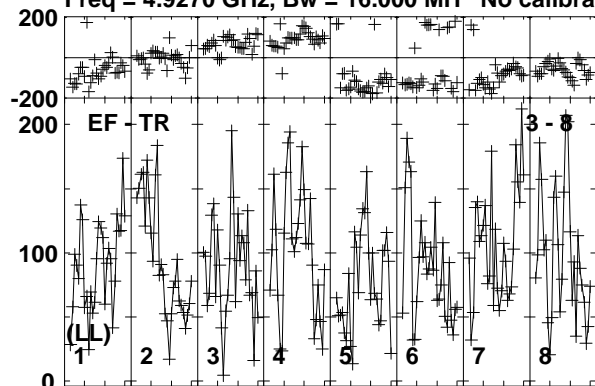

Lower frame: Micro Ampl Jy Top frame: Phas deg
Vector averaged cross-power spectrum Baseline: EF (03) - TR (08)
Timerange: 00/01:31:23 to 00/01:35:19

Plot file version 59 created 17-FEB-2020 15:42:44

J1402+5347 EK047 2.UVDATA.1

Freq = 4.9270 GHz, Bw = 16.000 MH No calibration applied and no bandpass applied

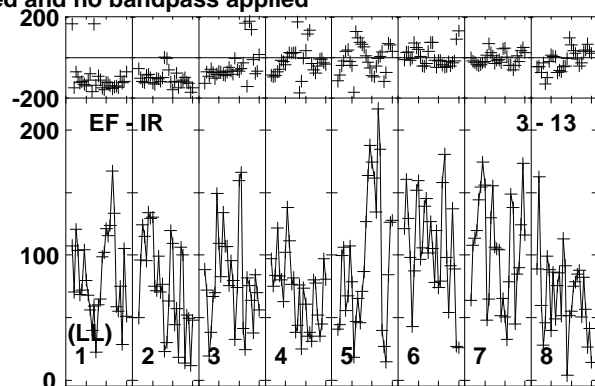
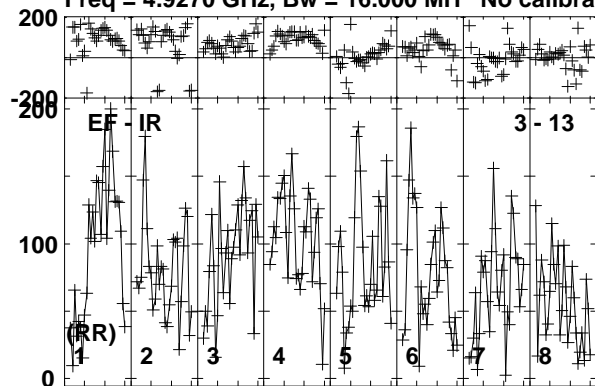

Lower frame: Micro Ampl Jy Top frame: Phas deg
Vector averaged cross-power spectrum Baseline: EF (03) - IR (13)
Timerange: 00/01:31:23 to 00/01:35:19

Plot file version 60 created 17-FEB-2020 15:42:44

J1359+5544 EK047 2.UVDATA.1

Freq = 4.9270 GHz, Bw = 16.000 MH No calibration applied and no bandpass applied

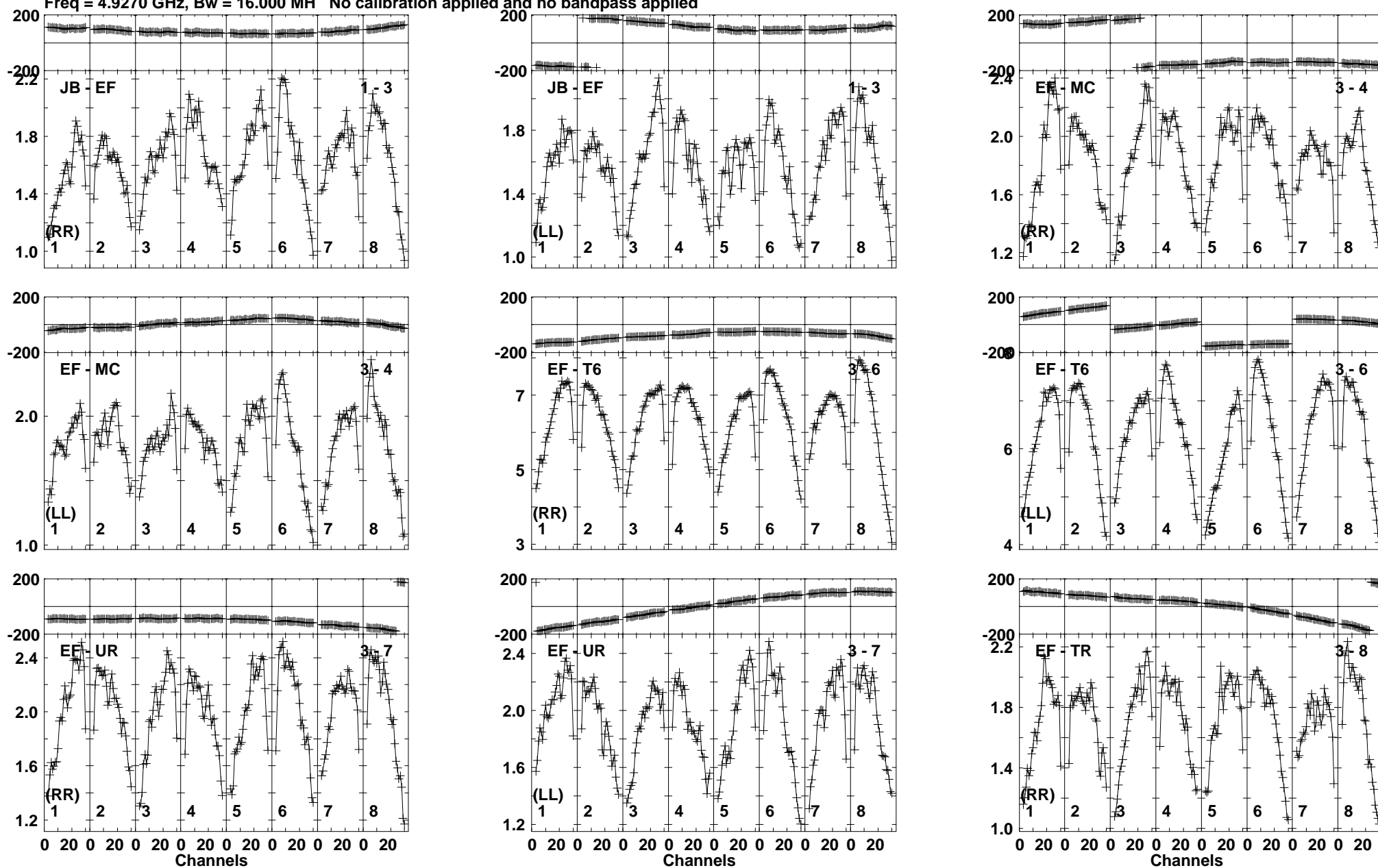

Lower frame: Milli Ampl Jy Top frame: Phas deg
Vector averaged cross-power spectrum Baseline: JB (01) - EF (03)
Timerange: 00/01:36:01 to 00/01:37:19

Plot file version 61 created 17-FEB-2020 15:42:44

J1359+5544 EK047 2.UVDATA.1

Freq = 4.9270 GHz, Bw = 16.000 MH No calibration applied and no bandpass applied

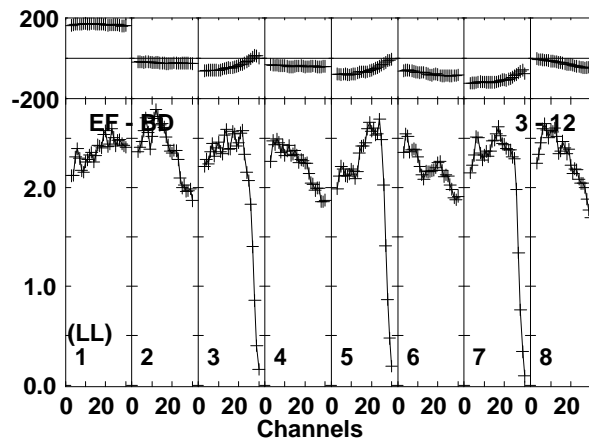
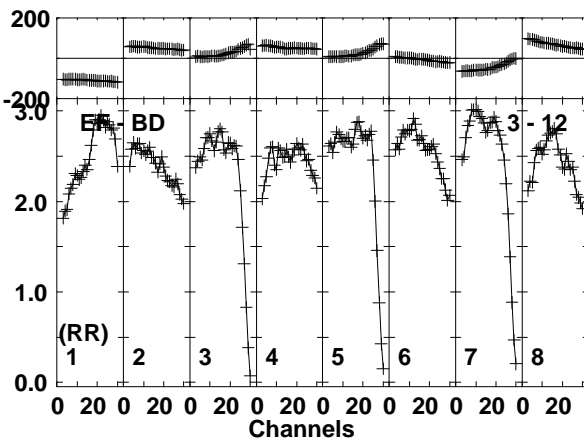
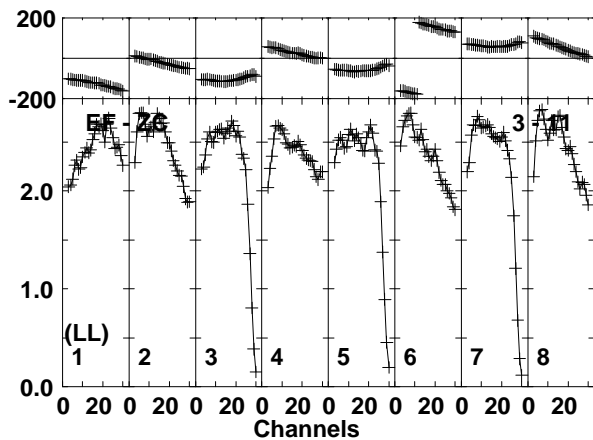
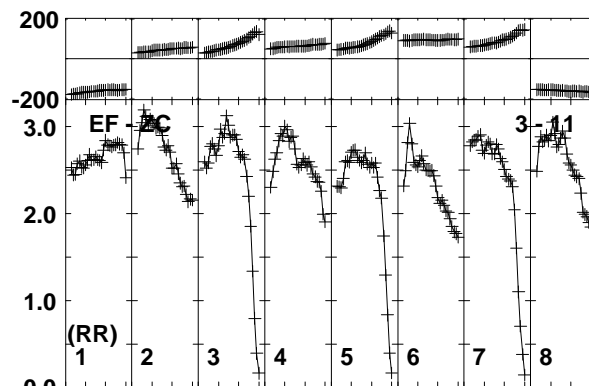
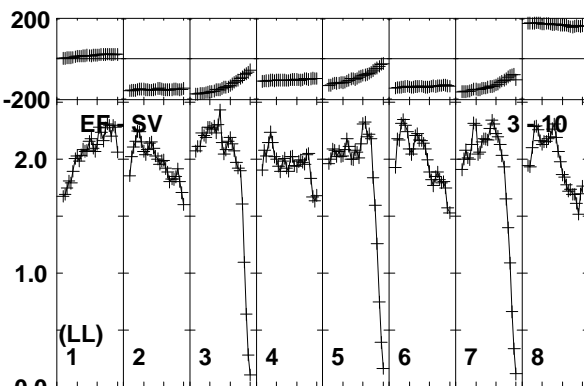
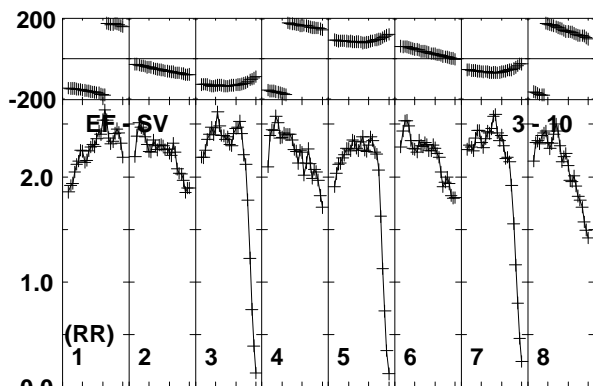
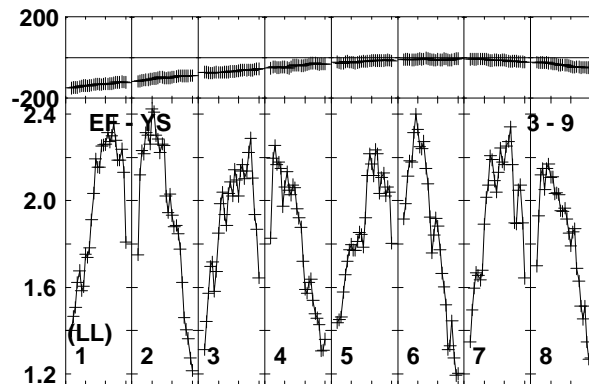
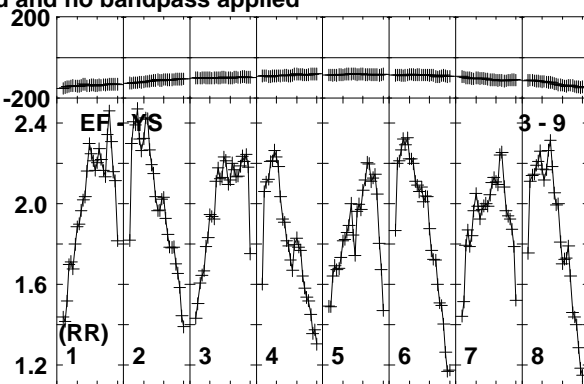
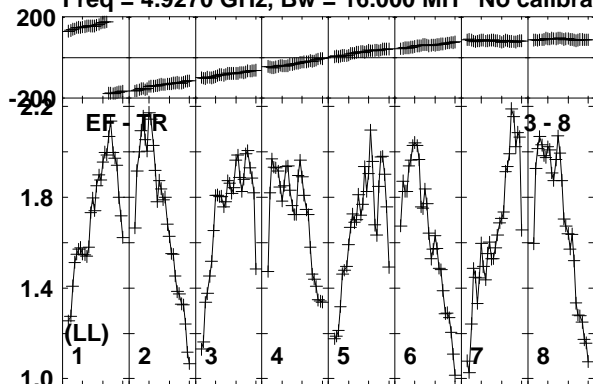

Lower frame: Milli Ampl Jy Top frame: Phas deg
Vector averaged cross-power spectrum Baseline: EF (03) - TR (08)
Timerange: 00/01:36:01 to 00/01:37:19

Plot file version 62 created 17-FEB-2020 15:42:44

J1359+5544 EK047 2.UVDATA.1

Freq = 4.9270 GHz, Bw = 16.000 MH No calibration applied and no bandpass applied

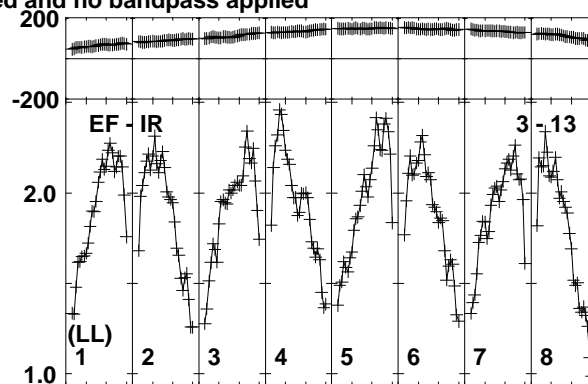
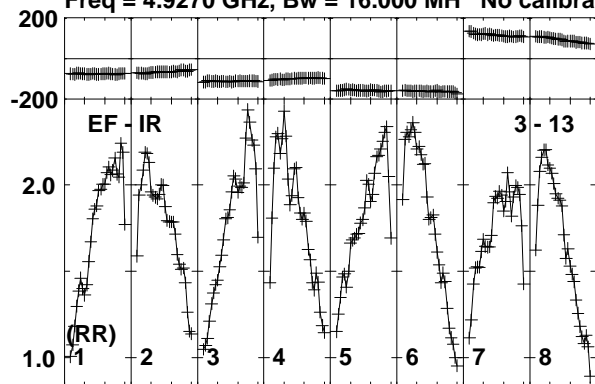

Lower frame: Milli Ampl Jy Top frame: Phas deg
Vector averaged cross-power spectrum Baseline: EF (03) - IR (13)
Timerange: 00/01:36:01 to 00/01:37:19

Plot file version 63 created 17-FEB-2020 15:42:44

J1402+5347 EK047 2.UVDATA.1

Freq = 4.9270 GHz, Bw = 16.000 MH No calibration applied and no bandpass applied

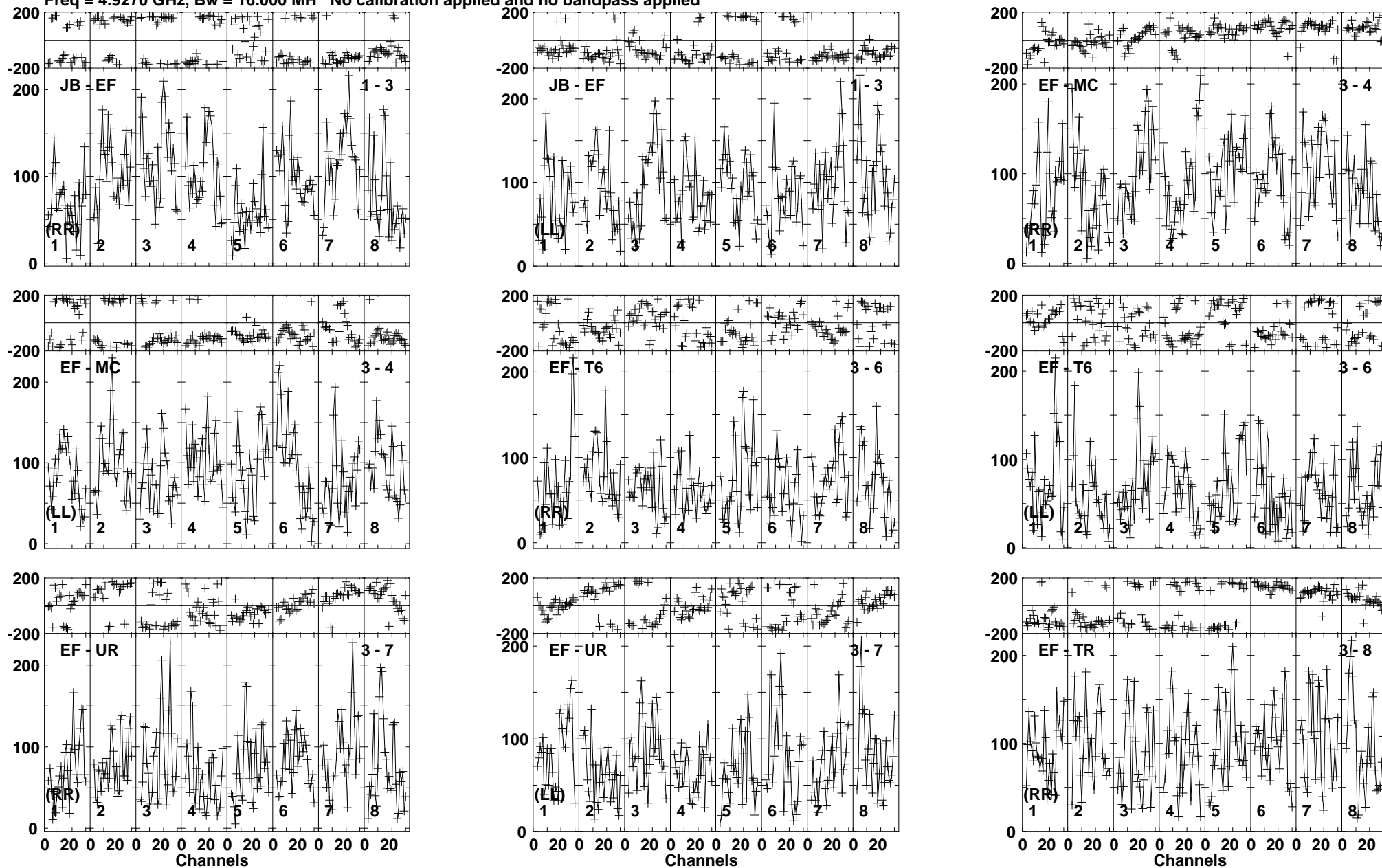

Lower frame: Micro Ampl Jy Top frame: Phas deg
Vector averaged cross-power spectrum Baseline: JB (01) - EF (03)
Timerange: 00/01:37:21 to 00/01:41:19

Plot file version 64 created 17-FEB-2020 15:42:44

J1402+5347 EK047 2.UVDATA.1

Freq = 4.9270 GHz, Bw = 16.000 MH No calibration applied and no bandpass applied

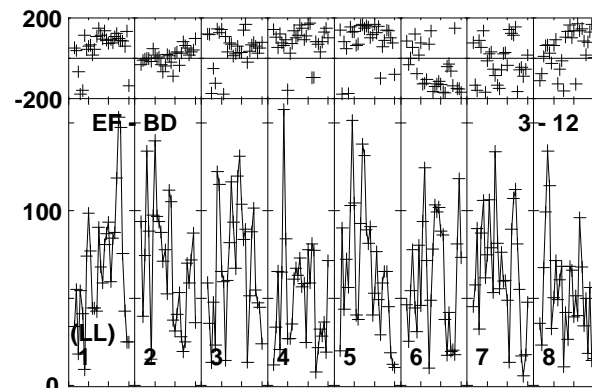
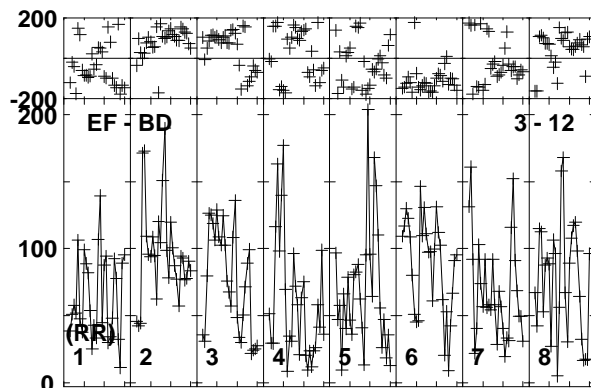
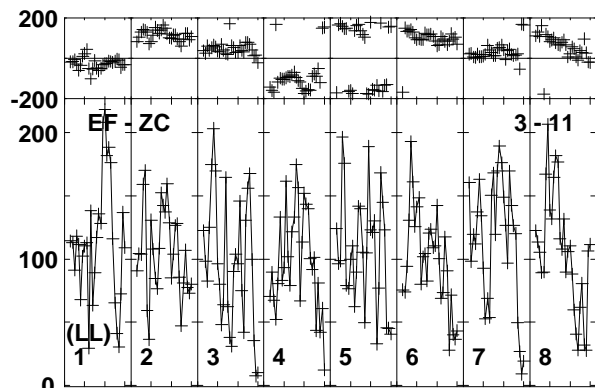
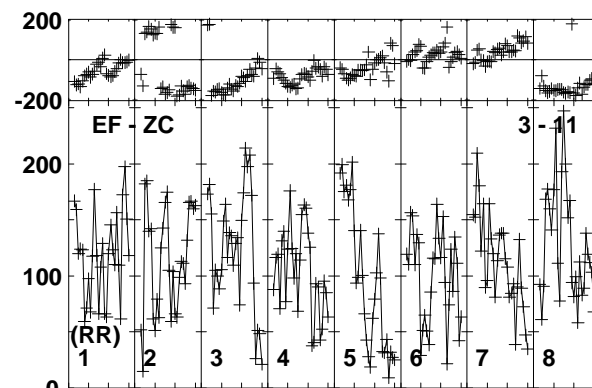
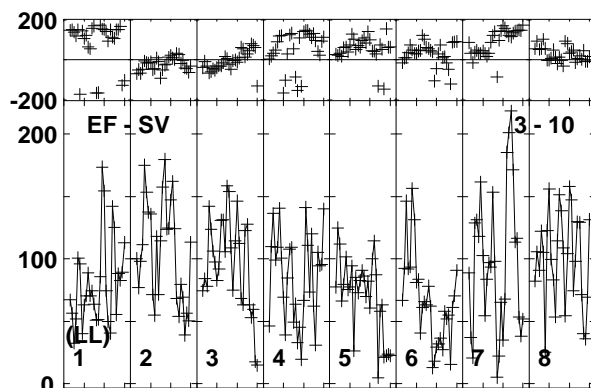
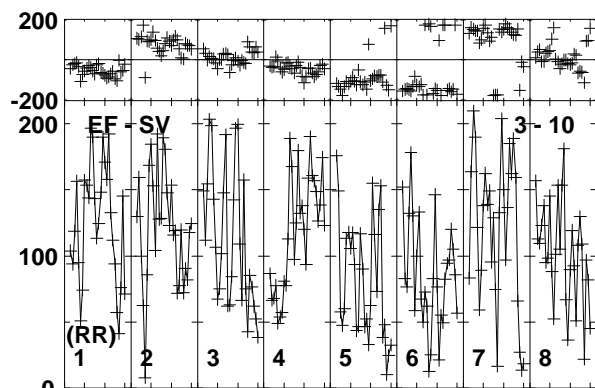
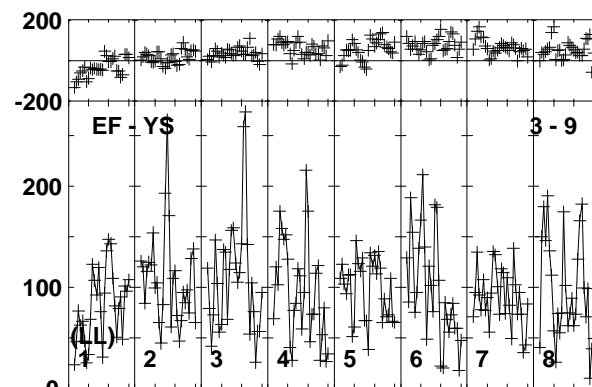
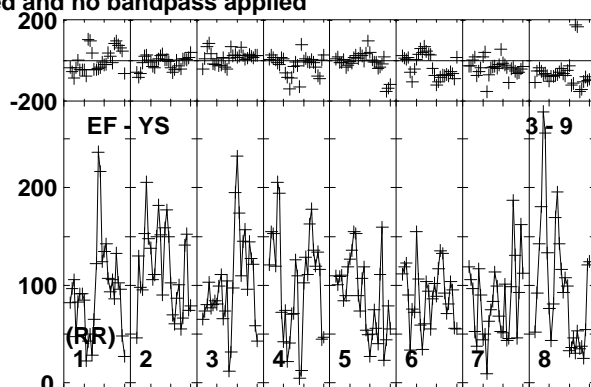
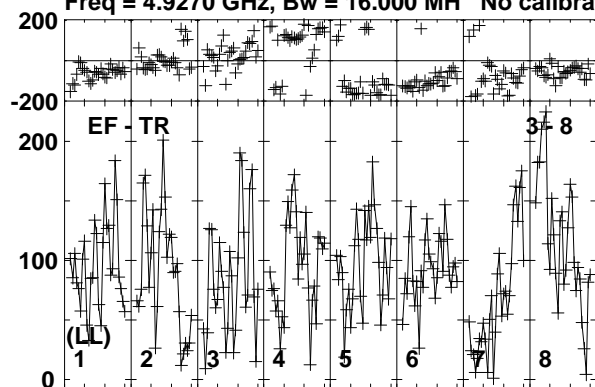

Lower frame: Micro Ampl Jy Top frame: Phas deg
Vector averaged cross-power spectrum Baseline: EF (03) - TR (08)
Timerange: 00/01:37:21 to 00/01:41:19

Plot file version 65 created 17-FEB-2020 15:42:44

J1402+5347 EK047 2.UVDATA.1

Freq = 4.9270 GHz, Bw = 16.000 MH No calibration applied and no bandpass applied

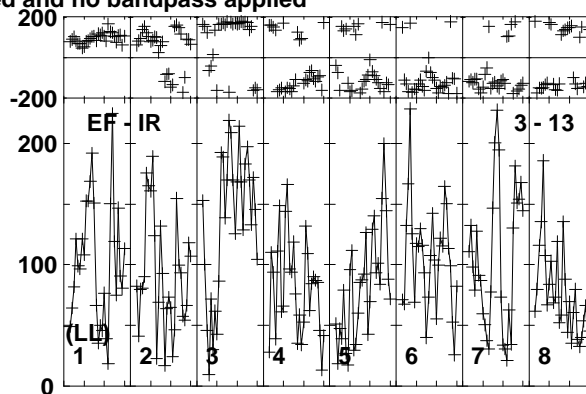
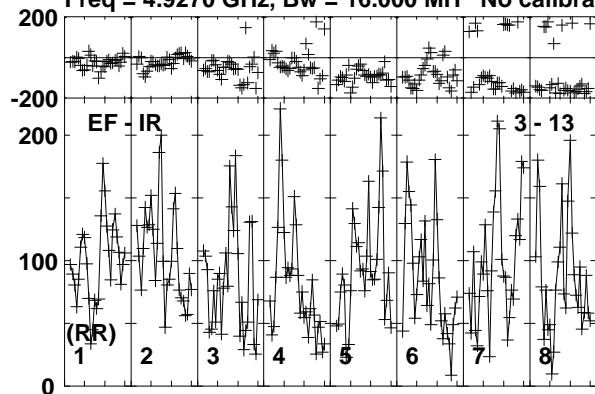

Lower frame: Micro Ampl Jy Top frame: Phas deg
Vector averaged cross-power spectrum Baseline: EF (03) - IR (13)
Timerange: 00/01:37:21 to 00/01:41:19

Plot file version 66 created 17-FEB-2020 15:42:44

J1359+5544 EK047 2.UVDATA.1

Freq = 4.9270 GHz, Bw = 16.000 MH No calibration applied and no bandpass applied

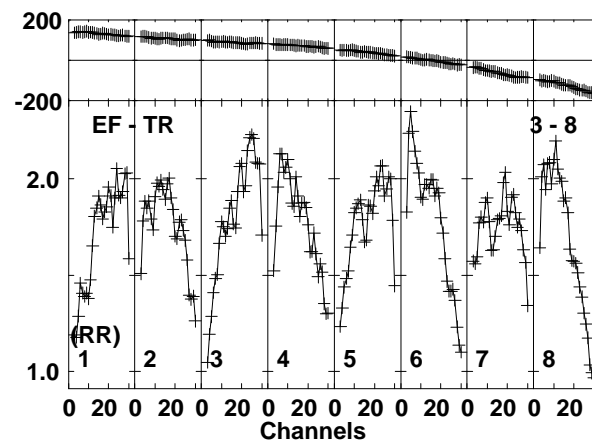
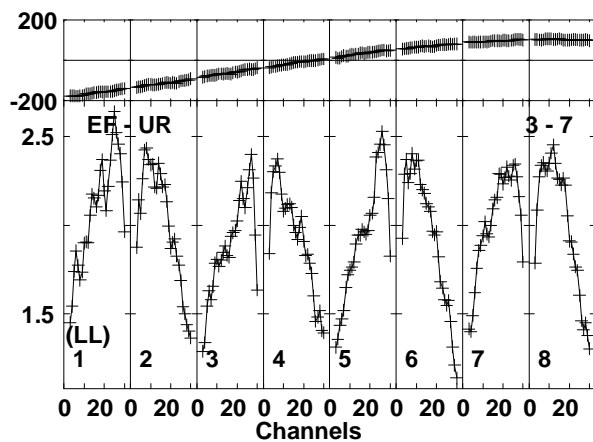
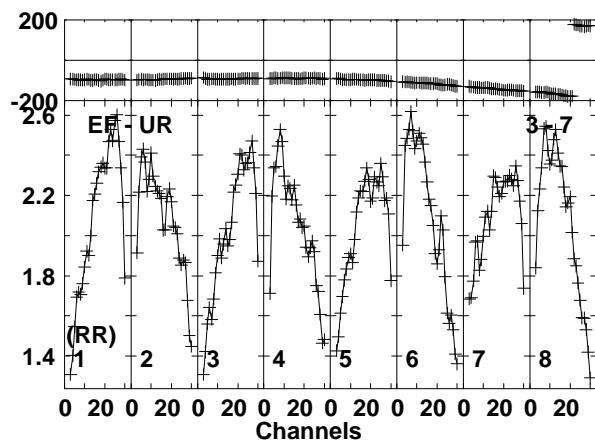
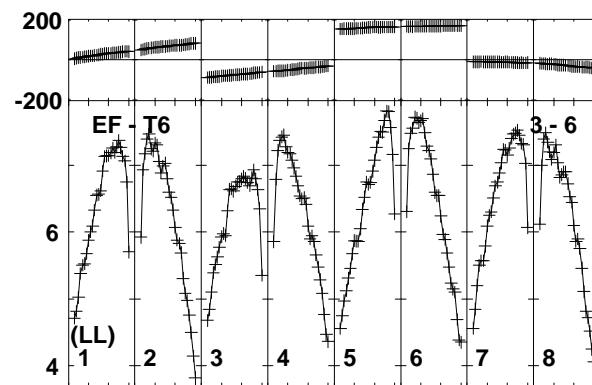
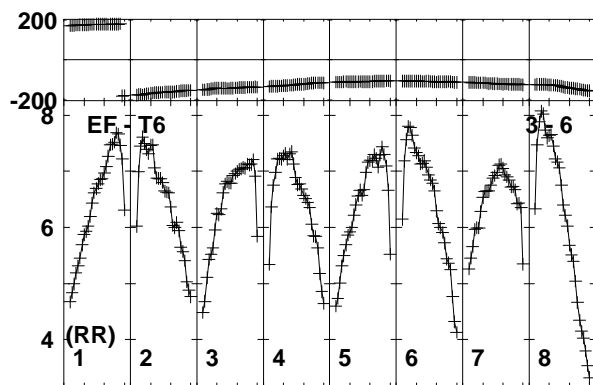
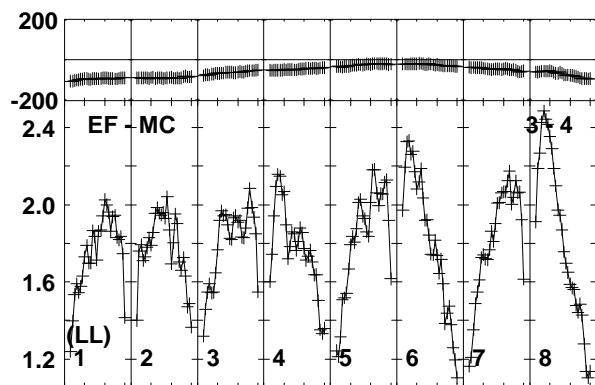
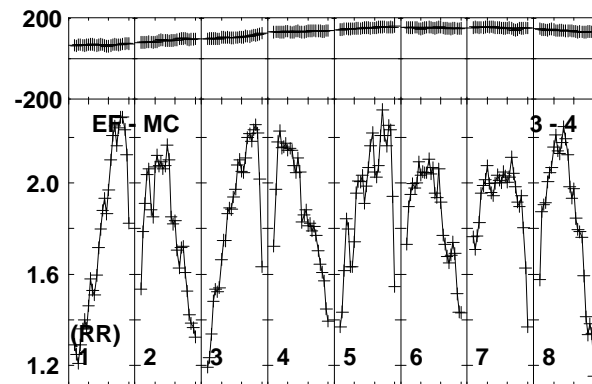
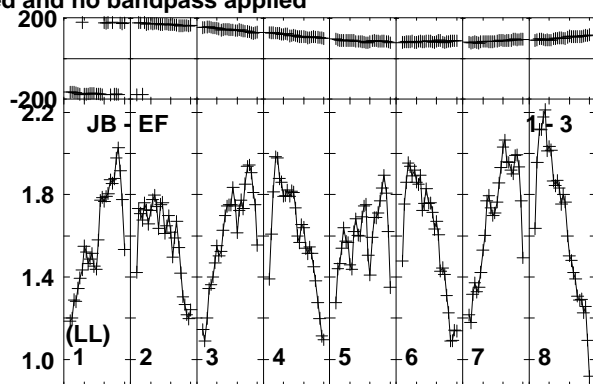
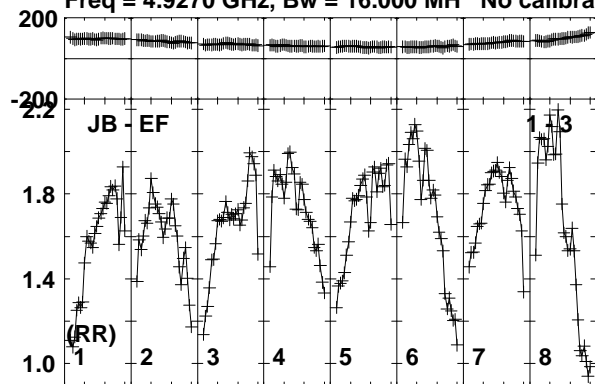

Lower frame: Milli Ampl Jy Top frame: Phas deg
Vector averaged cross-power spectrum Baseline: JB (01) - EF (03)
Timerange: 00/01:41:21 to 00/01:43:19

Plot file version 67 created 17-FEB-2020 15:42:44

J1359+5544 EK047 2.UVDATA.1

Freq = 4.9270 GHz, Bw = 16.000 MH No calibration applied and no bandpass applied

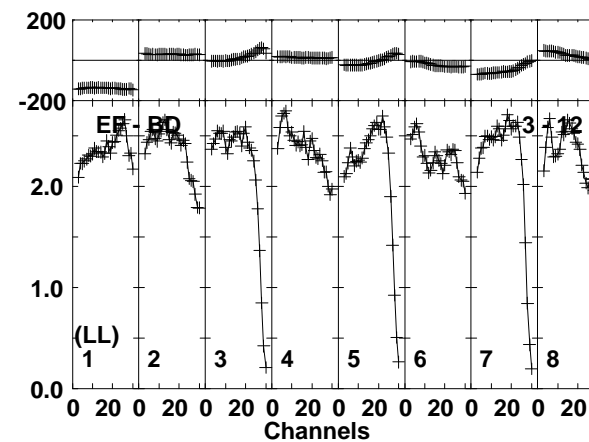
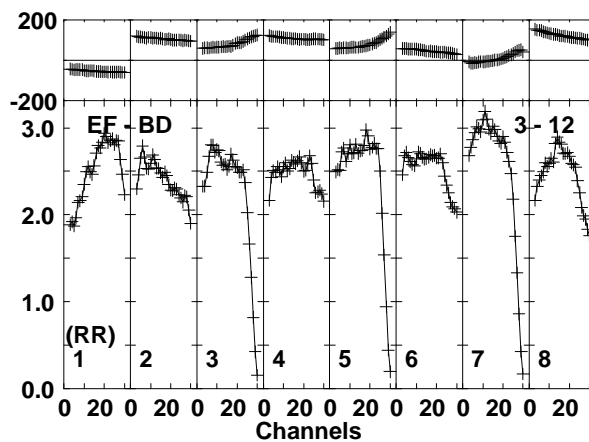
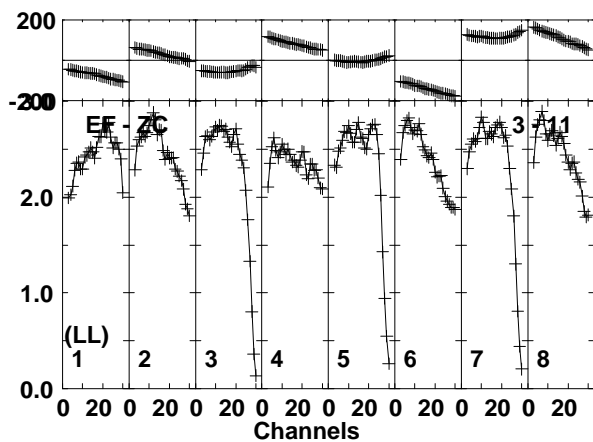
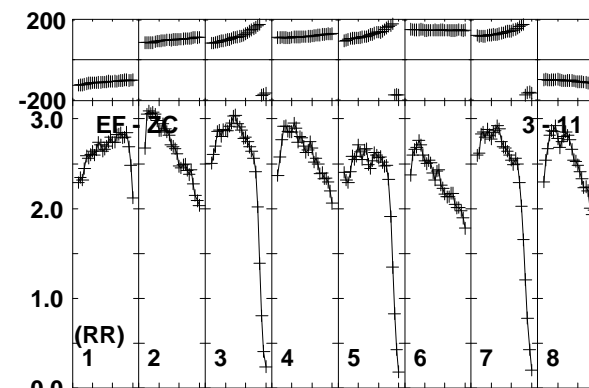
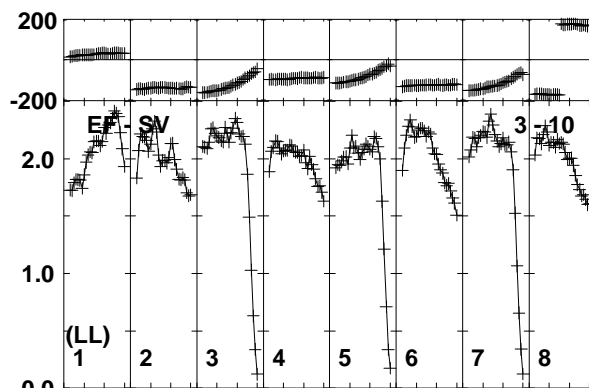
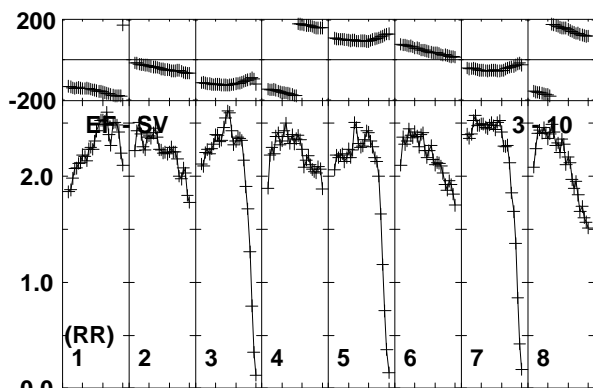
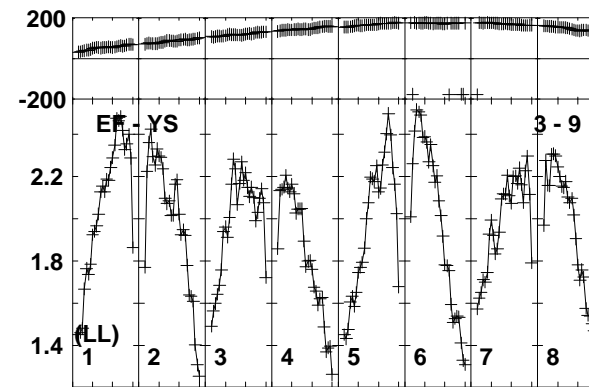
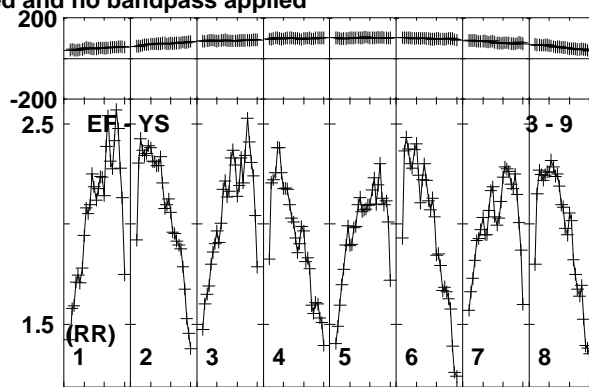
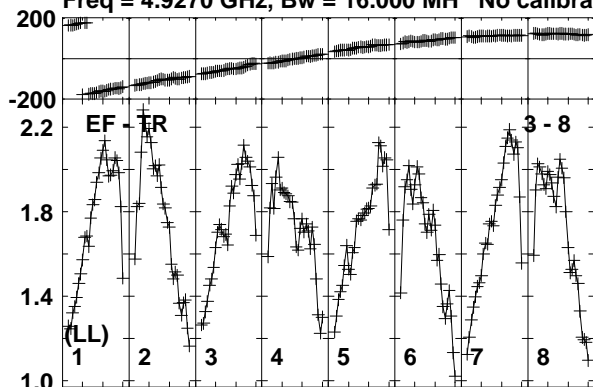

Lower frame: Milli Ampl Jy Top frame: Phas deg
Vector averaged cross-power spectrum Baseline: EF (03) - TR (08)
Timerange: 00/01:41:21 to 00/01:43:19

Plot file version 68 created 17-FEB-2020 15:42:44

J1359+5544 EK047 2.UVDATA.1

Freq = 4.9270 GHz, Bw = 16.000 MH No calibration applied and no bandpass applied

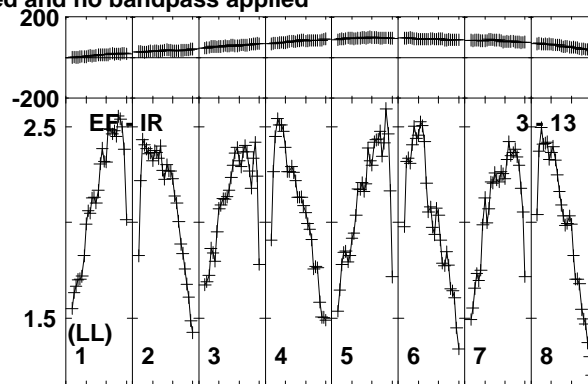
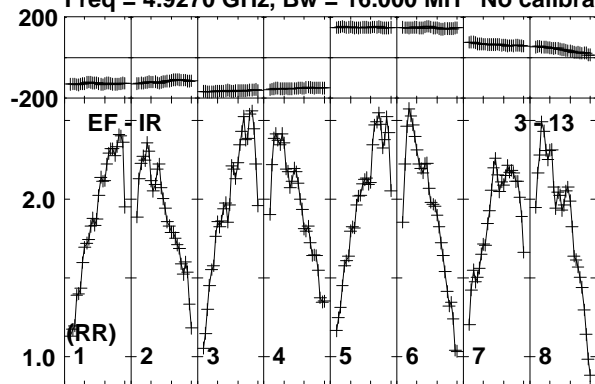

Lower frame: Milli Ampl Jy Top frame: Phas deg
Vector averaged cross-power spectrum Baseline: EF (03) - IR (13)
Timerange: 00/01:41:21 to 00/01:43:19

Plot file version 69 created 17-FEB-2020 15:42:44

J1402+5347 EK047 2.UVDATA.1

Freq = 4.9270 GHz, Bw = 16.000 MH No calibration applied and no bandpass applied

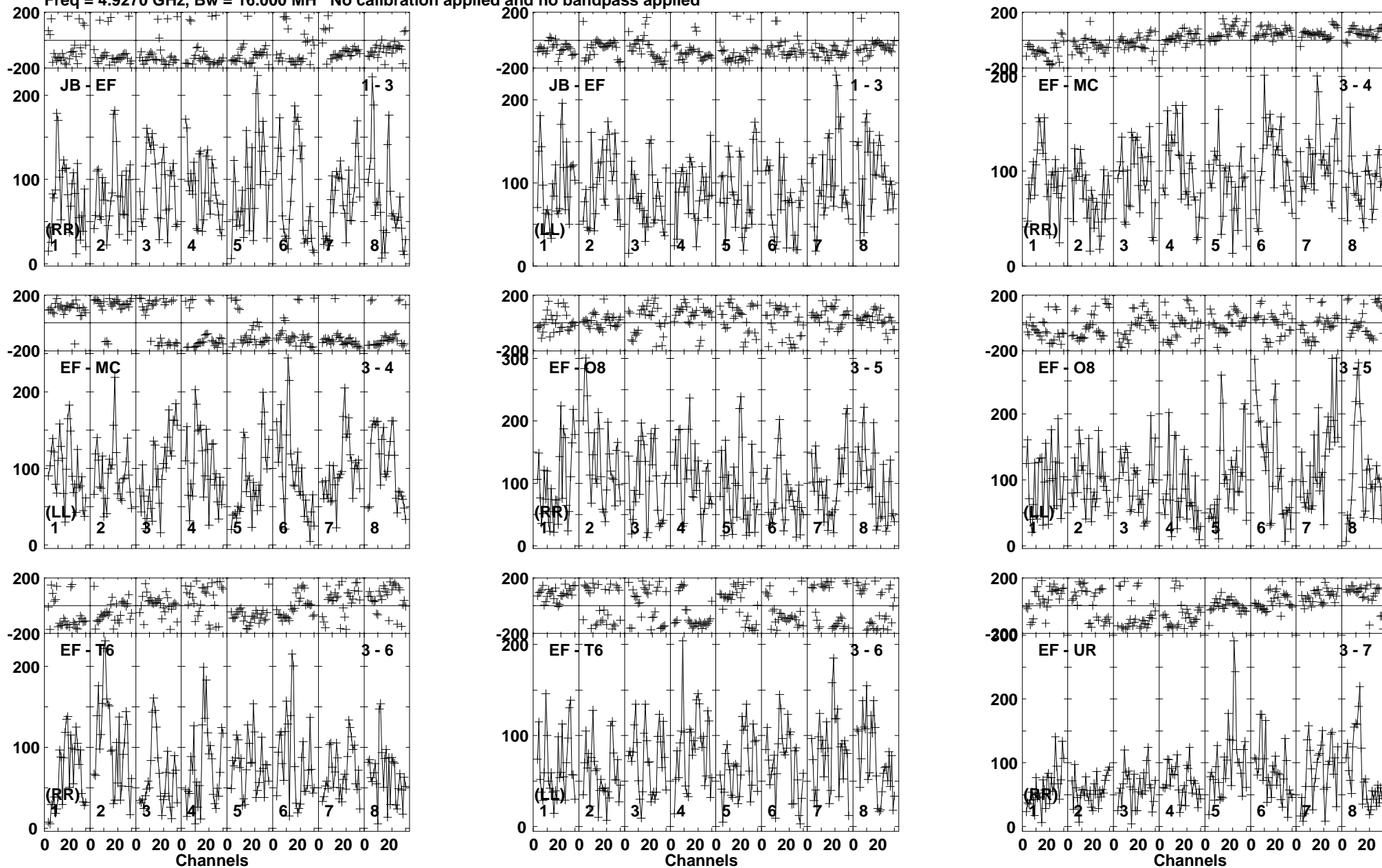

Lower frame: Micro Ampl Jy Top frame: Phas deg
Vector averaged cross-power spectrum Baseline: JB (01) - EF (03)
Timerange: 00/01:43:23 to 00/01:47:19

Plot file version 70 created 17-FEB-2020 15:42:44

J1402+5347 EK047 2.UVDATA.1

Freq = 4.9270 GHz, Bw = 16.000 MH No calibration applied and no bandpass applied

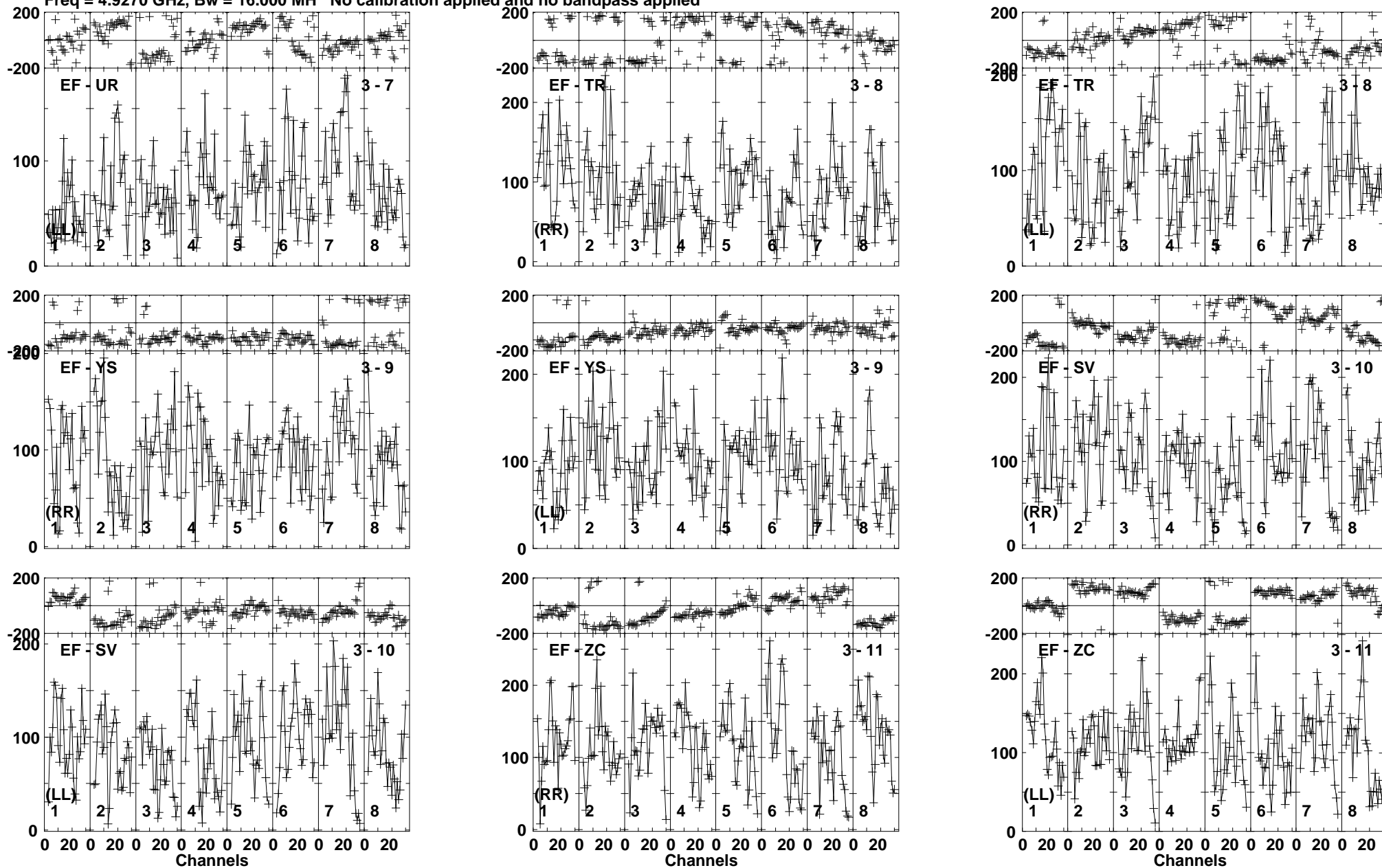

Lower frame: Micro Ampl Jy Top frame: Phas deg
Vector averaged cross-power spectrum Baseline: EF (03) - UR (07)
Timerange: 00/01:43:23 to 00/01:47:19

Plot file version 71 created 17-FEB-2020 15:42:45

J1402+5347 EK047 2.UVDATA.1

Freq = 4.9270 GHz, Bw = 16.000 MH No calibration applied and no bandpass applied

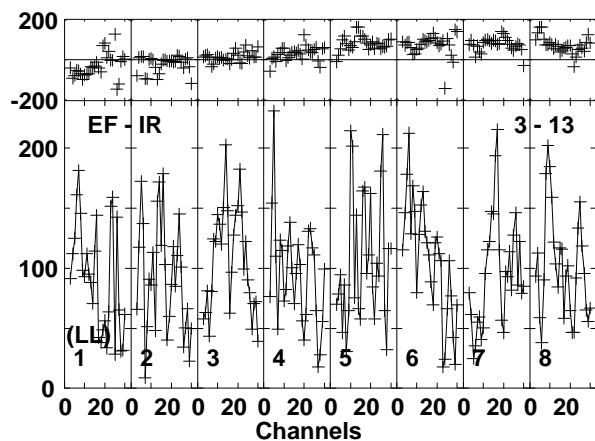
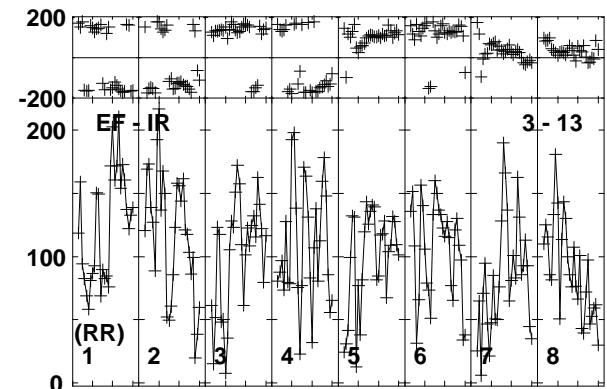
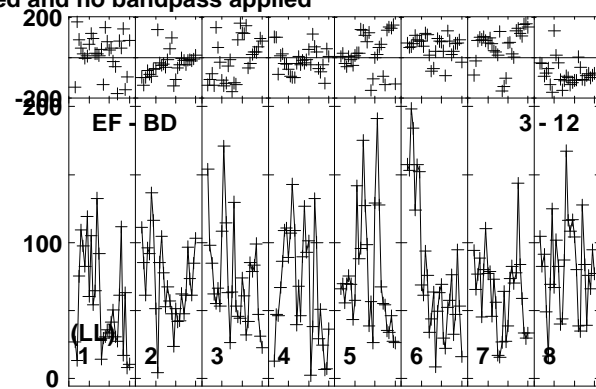
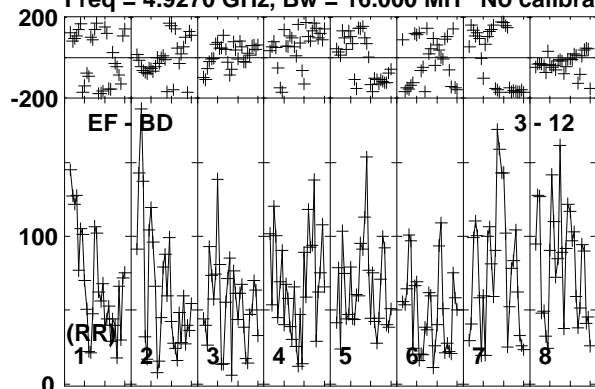

Lower frame: Micro Ampl Jy Top frame: Phas deg
Vector averaged cross-power spectrum Baseline: EF (03) - BD (12)
Timerange: 00/01:43:23 to 00/01:47:19

Plot file version 72 created 17-FEB-2020 15:42:45

J1359+5544 EK047 2.UVDATA.1

Freq = 4.9270 GHz, Bw = 16.000 MH No calibration applied and no bandpass applied

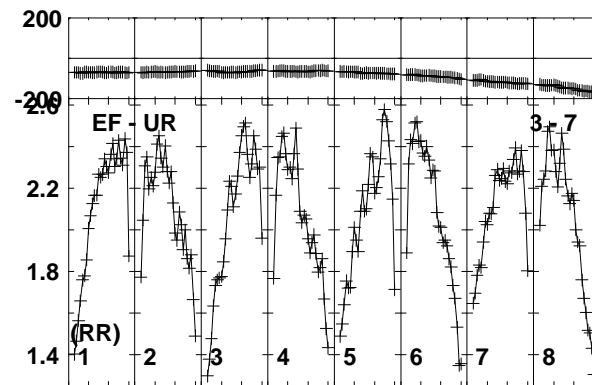
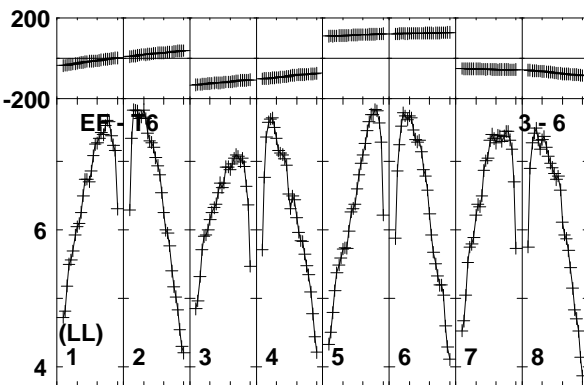
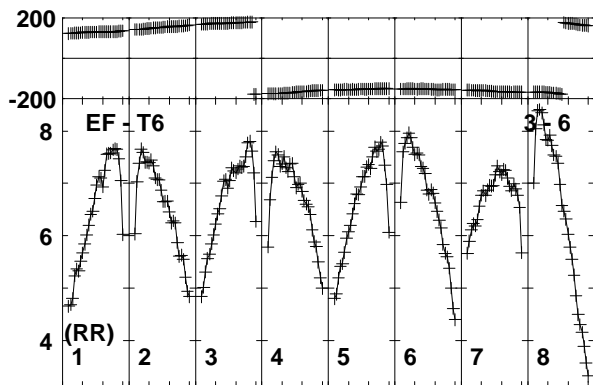
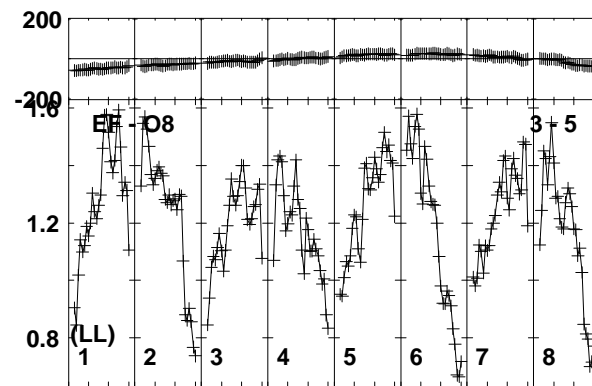
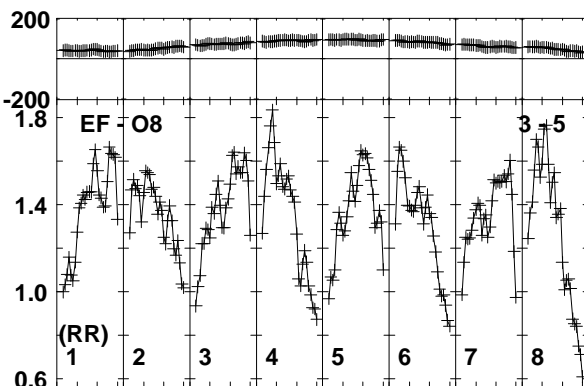
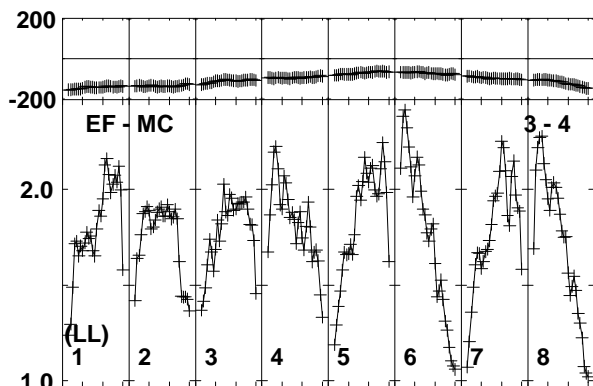
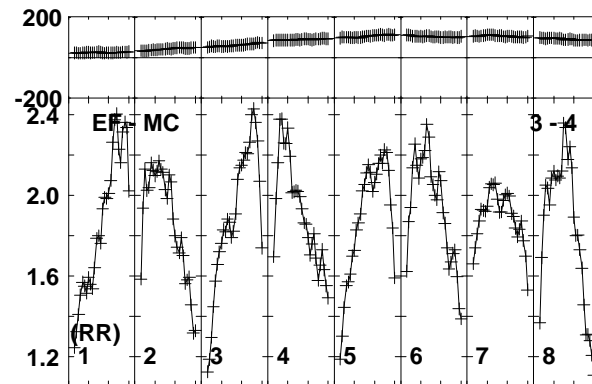
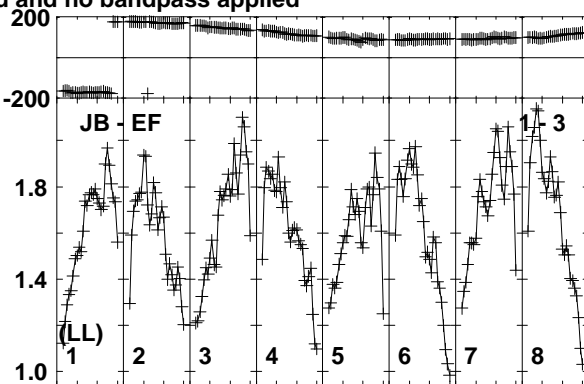
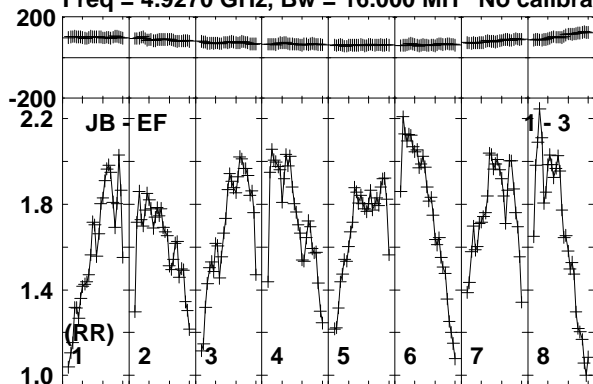

Lower frame: Milli Ampl Jy Top frame: Phas deg
Vector averaged cross-power spectrum Baseline: JB (01) - EF (03)
Timerange: 00/01:48:01 to 00/01:49:19

Plot file version 73 created 17-FEB-2020 15:42:45

J1359+5544 EK047 2.UVDATA.1

Freq = 4.9270 GHz, Bw = 16.000 MH No calibration applied and no bandpass applied

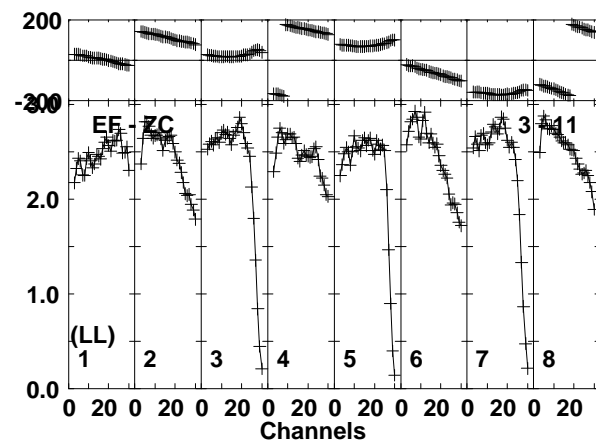
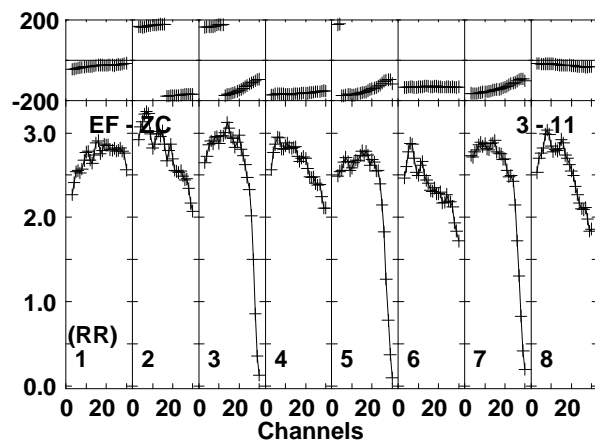
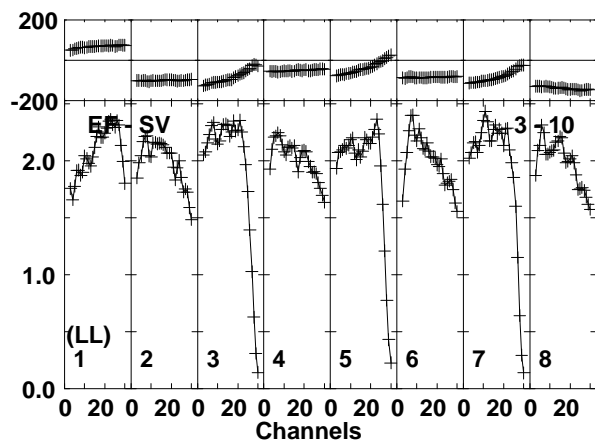
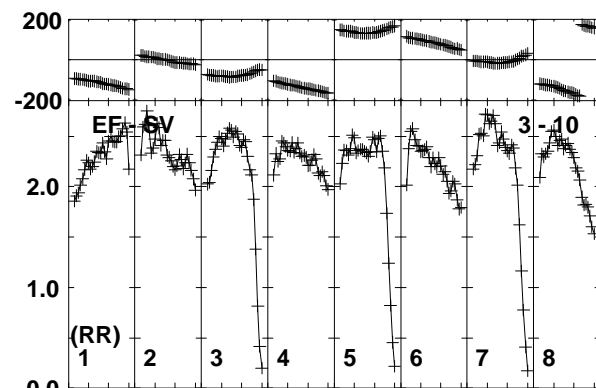
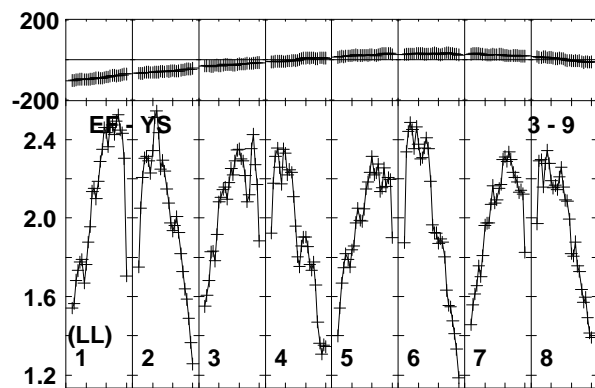
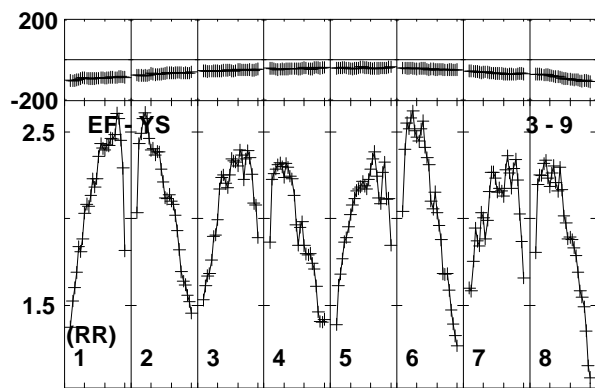
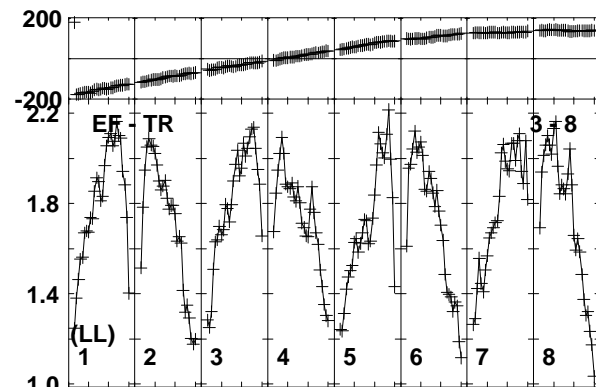
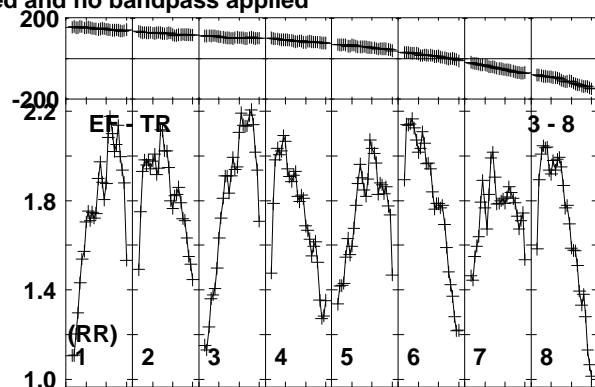
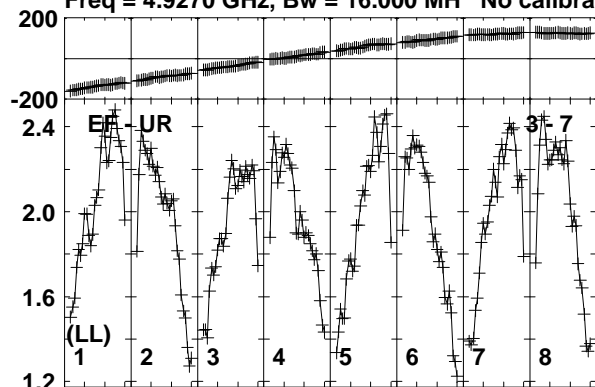

Lower frame: Milli Ampl Jy Top frame: Phas deg
Vector averaged cross-power spectrum Baseline: EF (03) - UR (07)
Timerange: 00/01:48:01 to 00/01:49:19

Plot file version 74 created 17-FEB-2020 15:42:45

J1359+5544 EK047 2.UVDATA.1

Freq = 4.9270 GHz, Bw = 16.000 MH No calibration applied and no bandpass applied

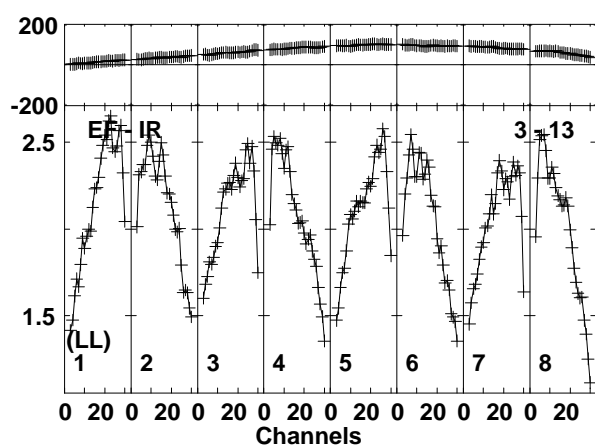
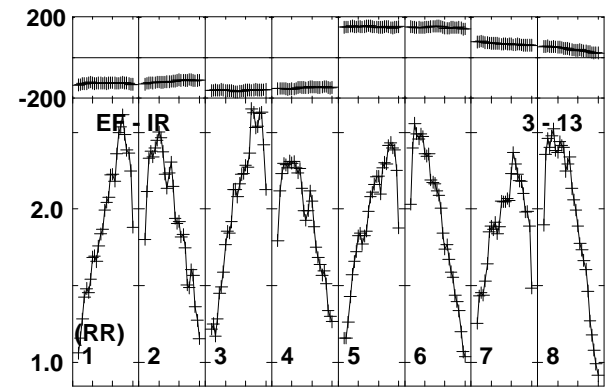
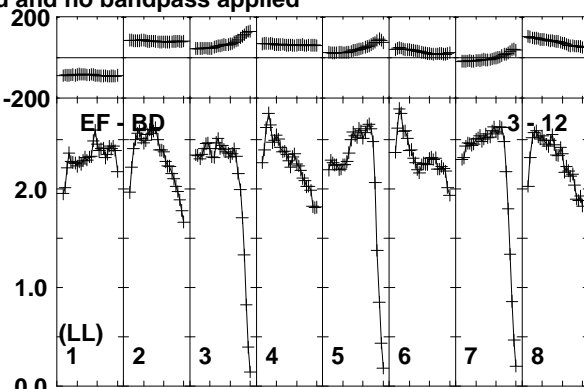
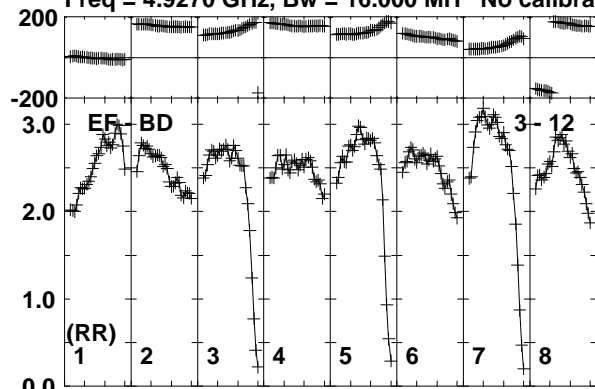

Lower frame: Milli Ampl Jy Top frame: Phas deg
Vector averaged cross-power spectrum Baseline: EF (03) - BD (12)
Timerange: 00/01:48:01 to 00/01:49:19

Plot file version 75 created 17-FEB-2020 15:42:45

J1402+5347 EK047 2.UVDATA.1

Freq = 4.9270 GHz, Bw = 16.000 MH No calibration applied and no bandpass applied

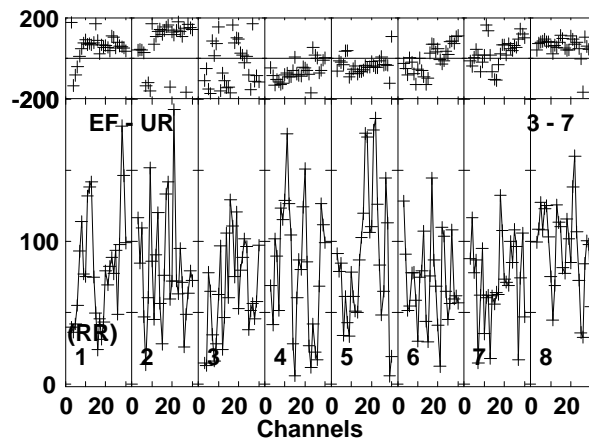
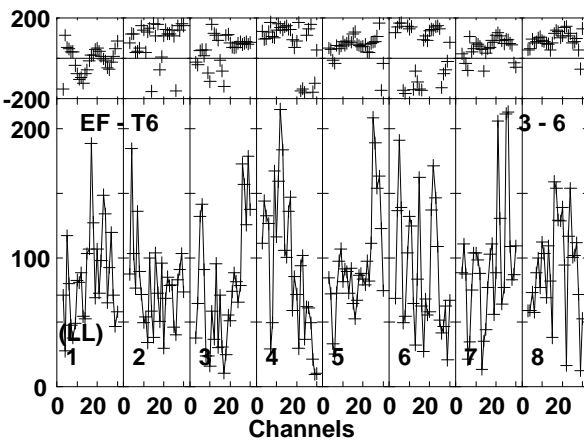
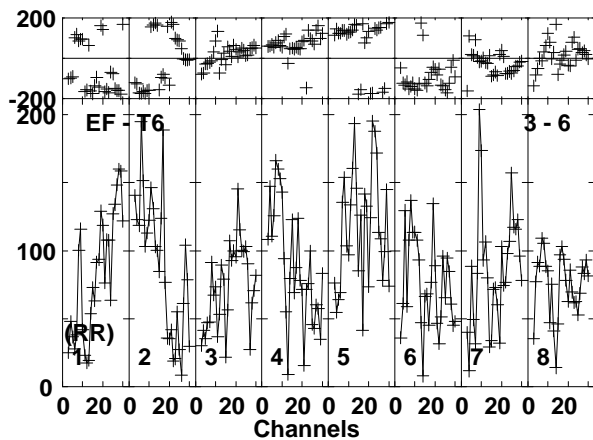
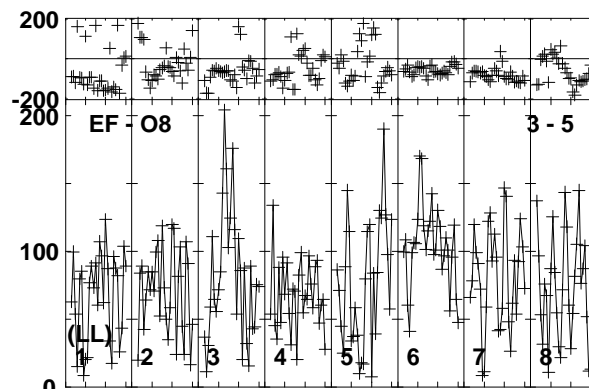
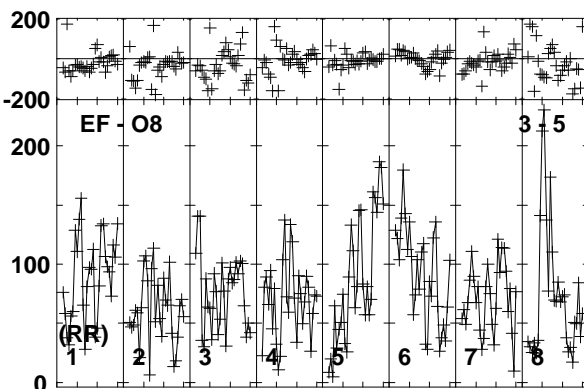
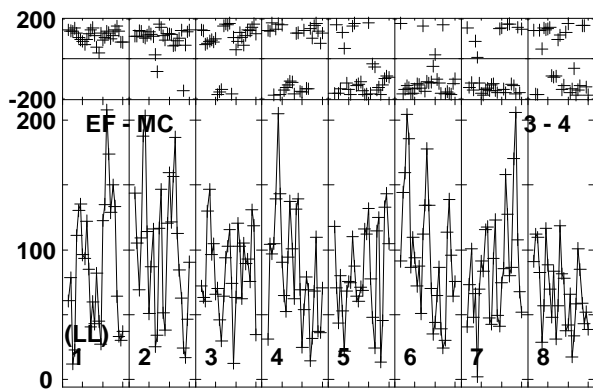
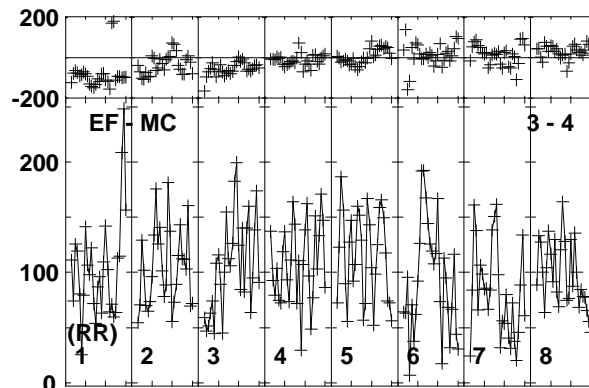
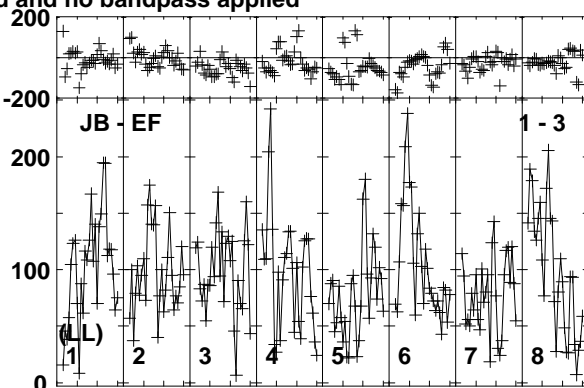
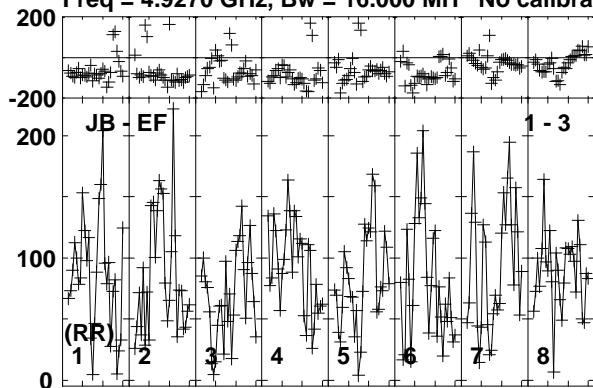

Lower frame: Micro Ampl Jy Top frame: Phas deg
Vector averaged cross-power spectrum Baseline: JB (01) - EF (03)
Timerange: 00/01:49:21 to 00/01:53:19

Plot file version 76 created 17-FEB-2020 15:42:45

J1402+5347 EK047 2.UVDATA.1

Freq = 4.9270 GHz, Bw = 16.000 MH No calibration applied and no bandpass applied

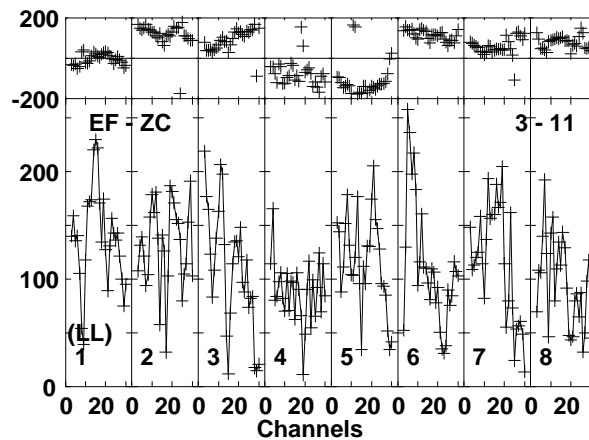
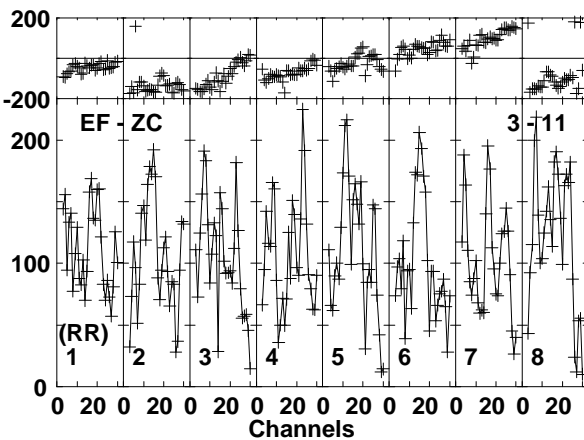
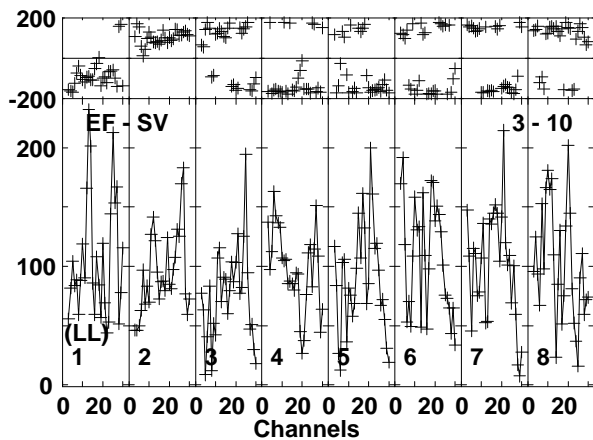
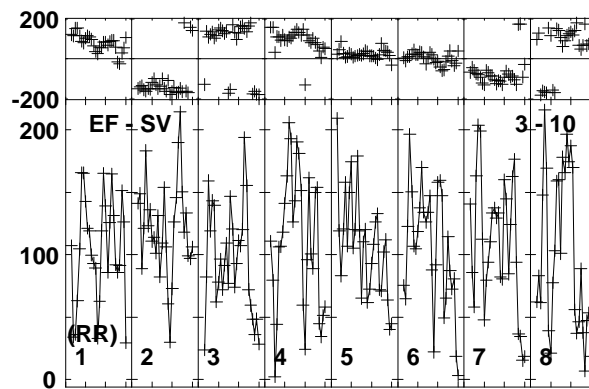
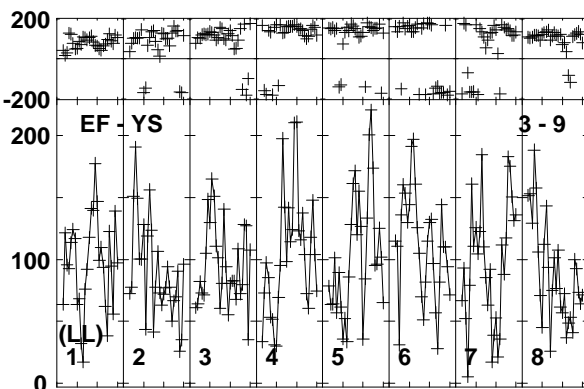
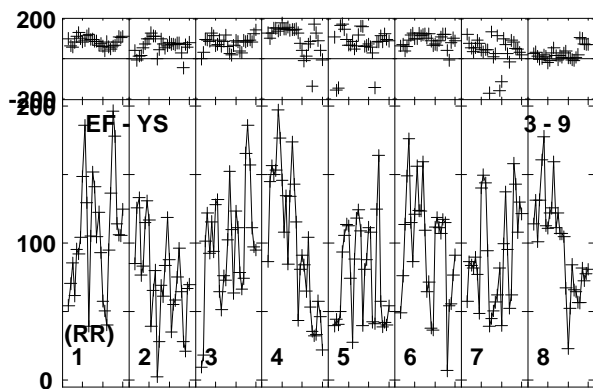
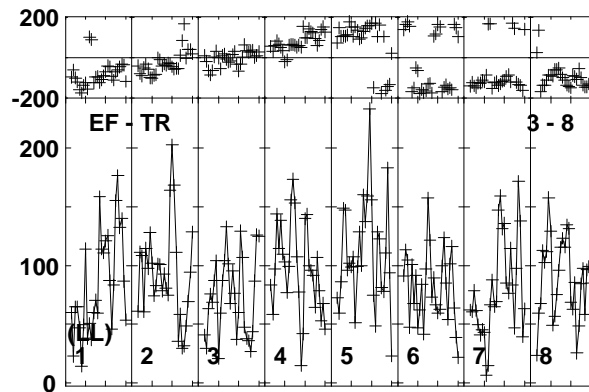
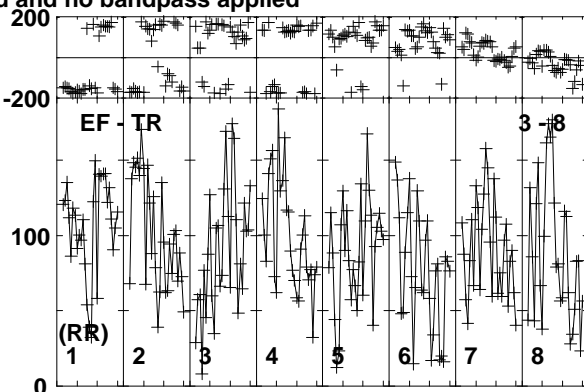
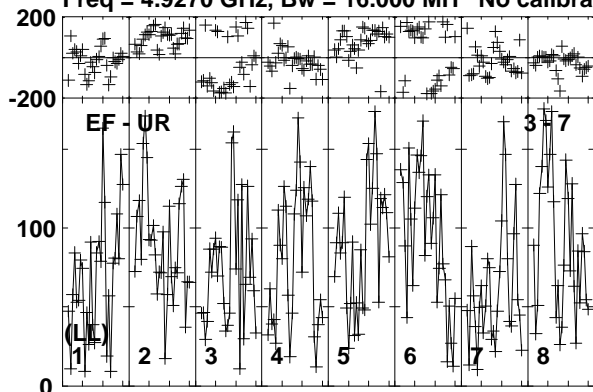

Lower frame: Micro Ampl Jy Top frame: Phas deg
Vector averaged cross-power spectrum Baseline: EF (03) - UR (07)
Timerange: 00/01:49:21 to 00/01:53:19

Plot file version 77 created 17-FEB-2020 15:42:45

J1402+5347 EK047 2.UVDATA.1

Freq = 4.9270 GHz, Bw = 16.000 MH No calibration applied and no bandpass applied

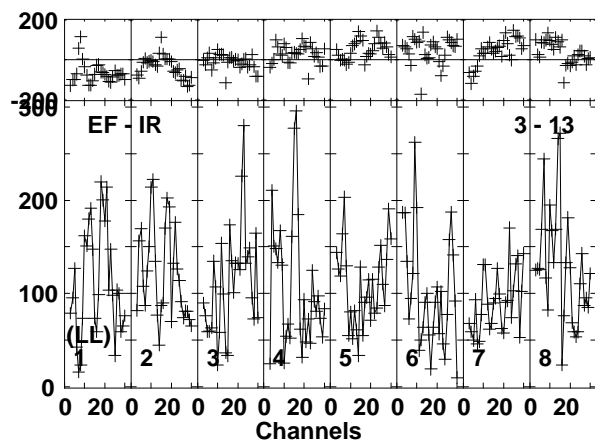
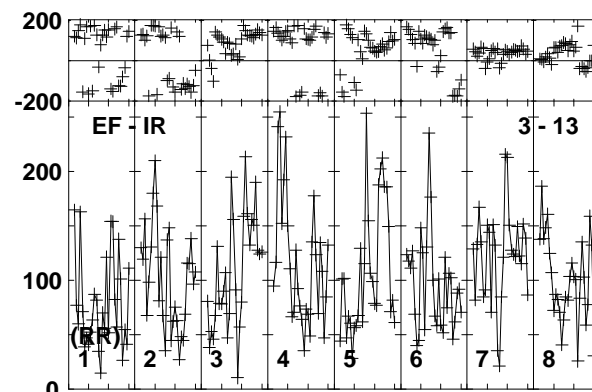
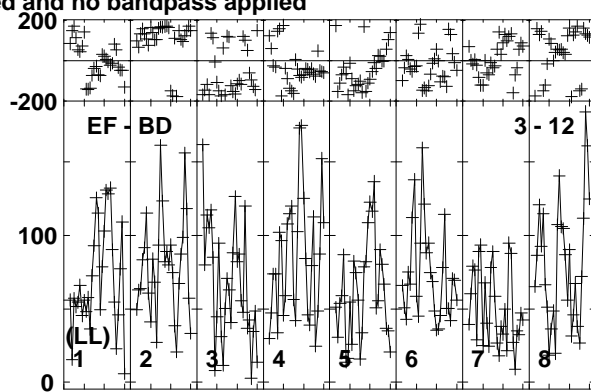
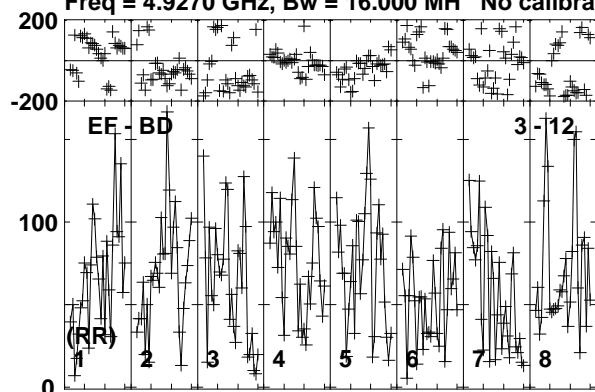

Lower frame: Micro Ampl Jy Top frame: Phas deg
Vector averaged cross-power spectrum Baseline: EF (03) - BD (12)
Timerange: 00/01:49:21 to 00/01:53:19

Plot file version 78 created 17-FEB-2020 15:42:45

J1359+5544 EK047 2.UVDATA.1

Freq = 4.9270 GHz, Bw = 16.000 MH No calibration applied and no bandpass applied

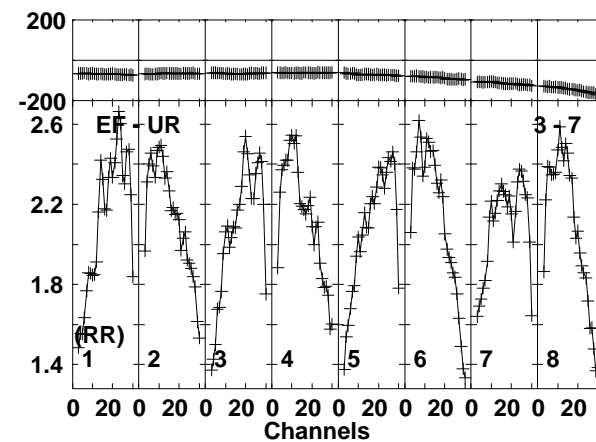
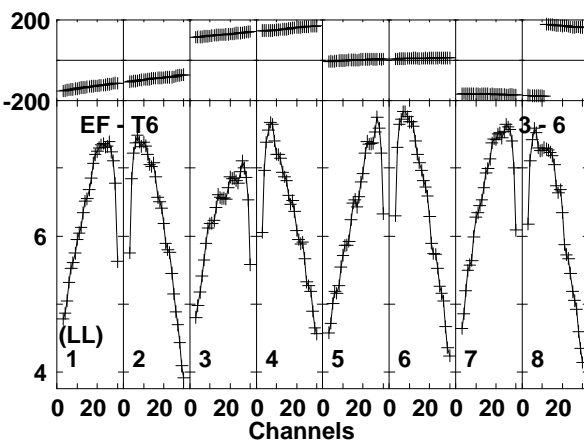
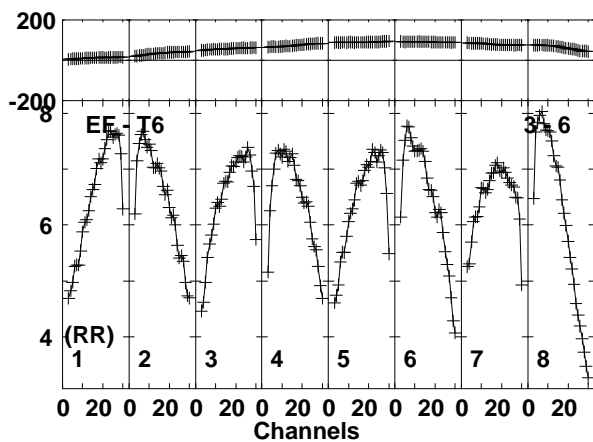
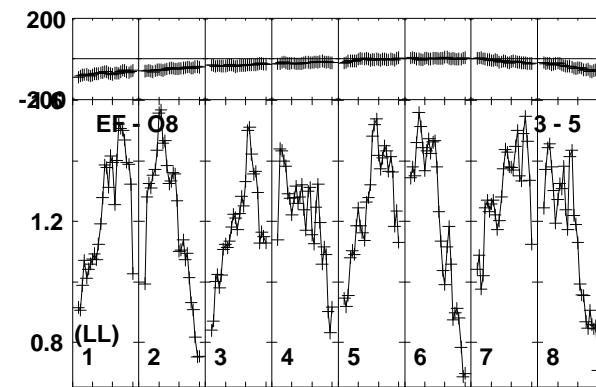
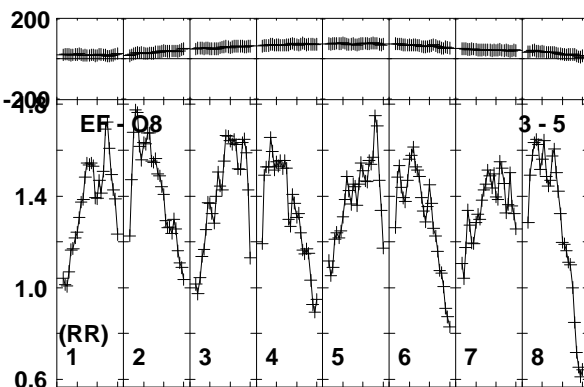
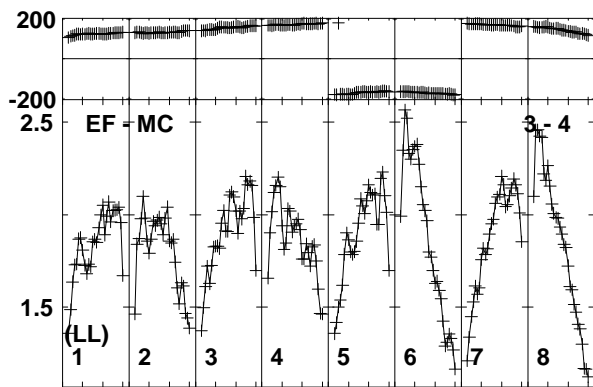
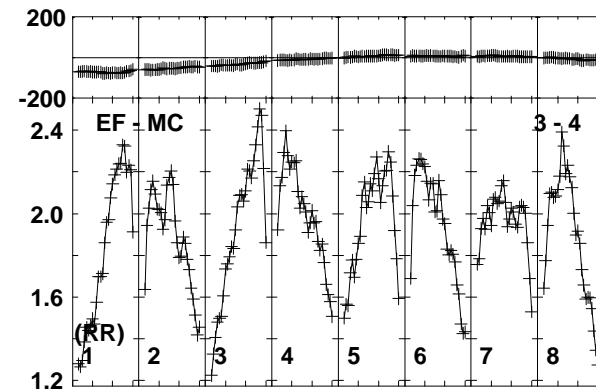
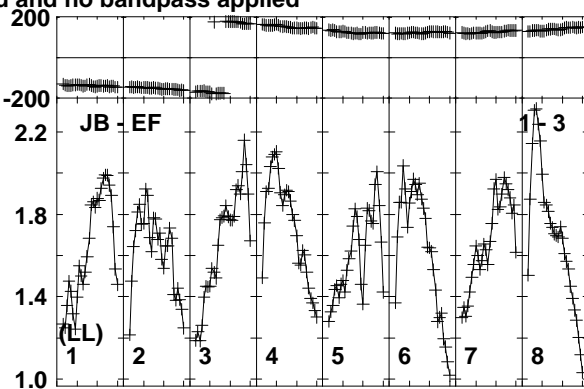
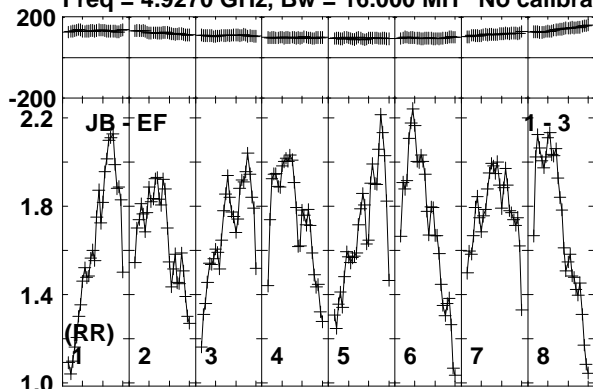

Lower frame: Milli Ampl Jy Top frame: Phas deg
Vector averaged cross-power spectrum Baseline: JB (01) - EF (03)
Timerange: 00/01:53:21 to 00/01:55:19

Plot file version 79 created 17-FEB-2020 15:42:45

J1359+5544 EK047 2.UVDATA.1

Freq = 4.9270 GHz, Bw = 16.000 MH No calibration applied and no bandpass applied

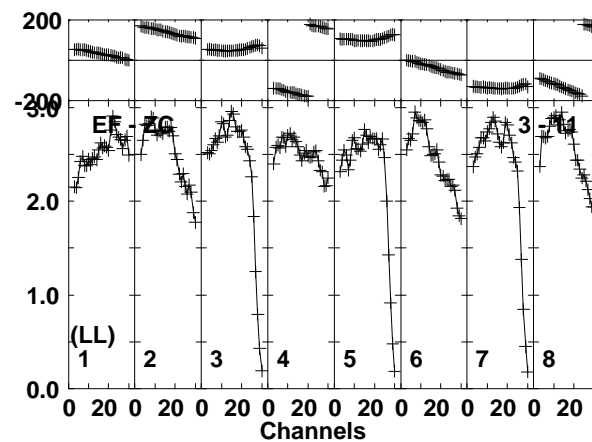
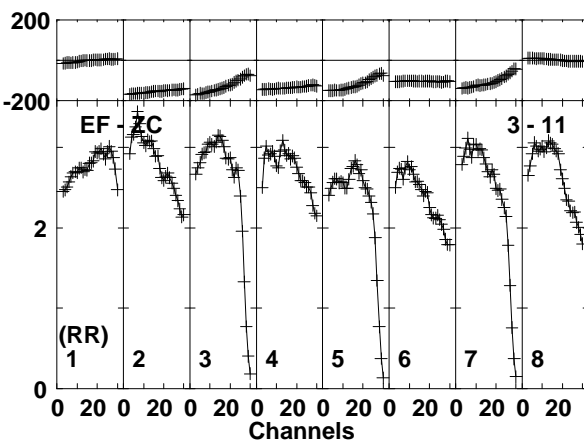
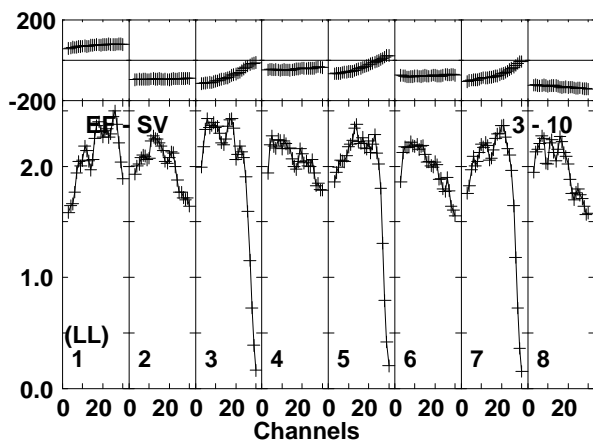
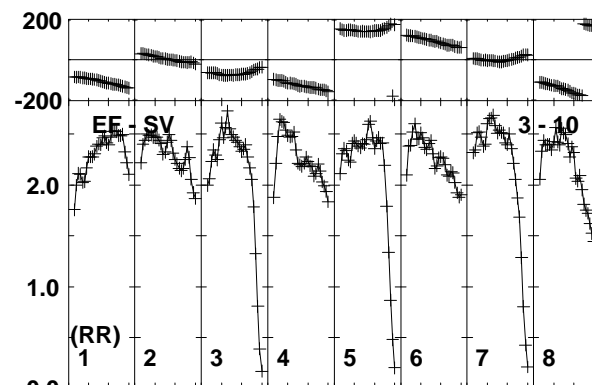
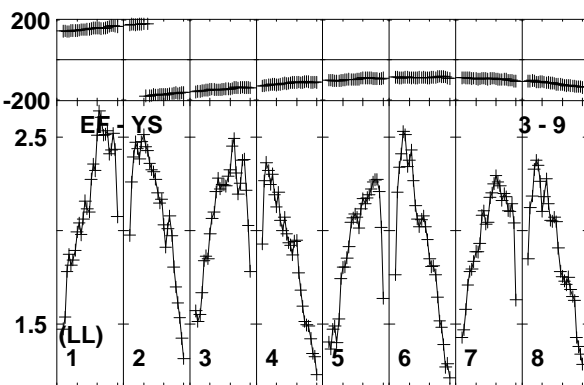
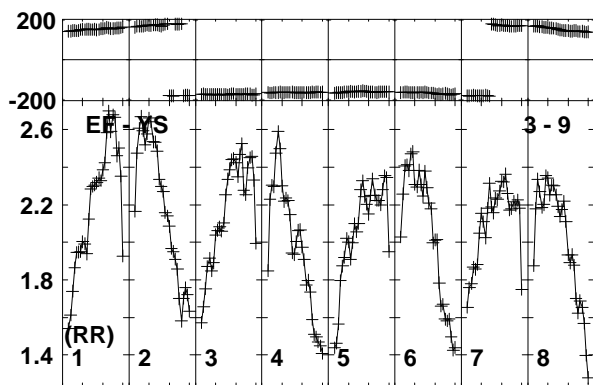
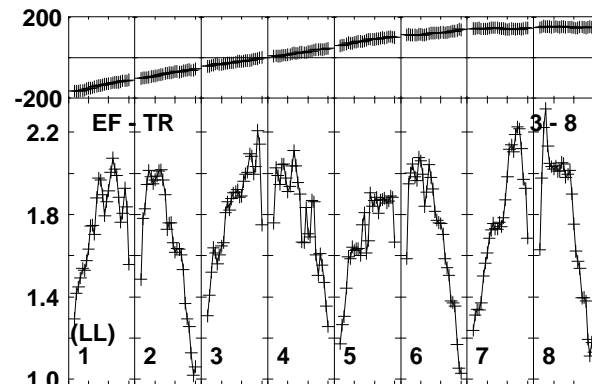
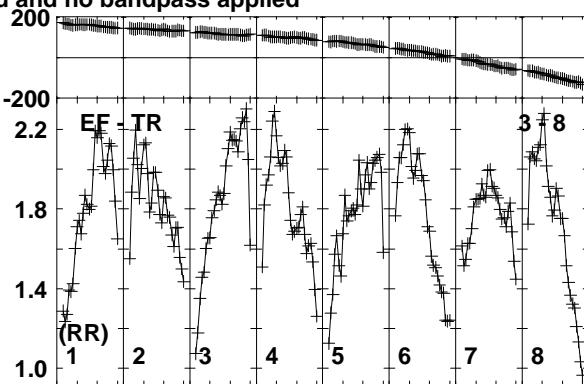
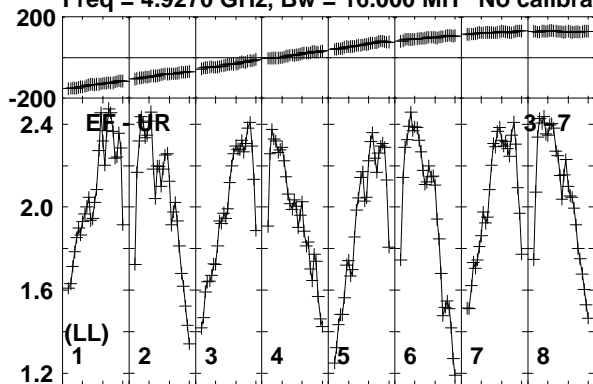

Lower frame: Milli Ampl Jy Top frame: Phas deg
Vector averaged cross-power spectrum Baseline: EF (03) - UR (07)
Timerange: 00/01:53:21 to 00/01:55:19

Plot file version 80 created 17-FEB-2020 15:42:45

J1359+5544 EK047 2.UVDATA.1

Freq = 4.9270 GHz, Bw = 16.000 MH No calibration applied and no bandpass applied

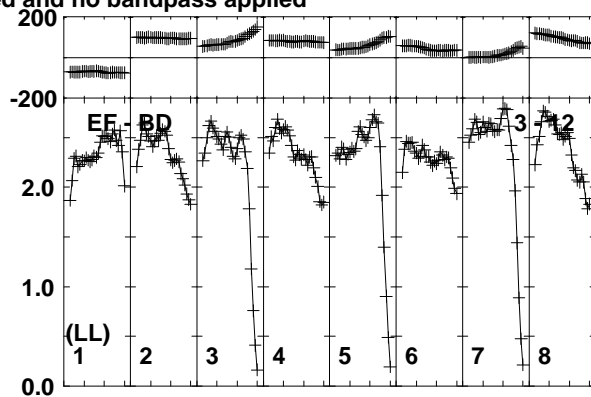
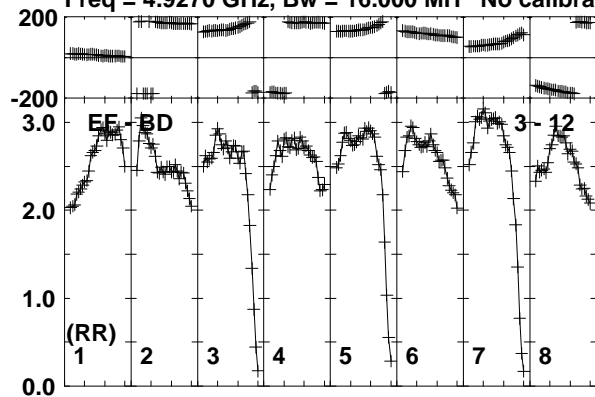

Lower frame: Milli Ampl Jy Top frame: Phas deg
Vector averaged cross-power spectrum Baseline: EF (03) - BD (12)
Timerange: 00/01:53:21 to 00/01:55:19

Plot file version 81 created 17-FEB-2020 15:42:45

J1402+5347 EK047 2.UVDATA.1

Freq = 4.9270 GHz, Bw = 16.000 MH No calibration applied and no bandpass applied

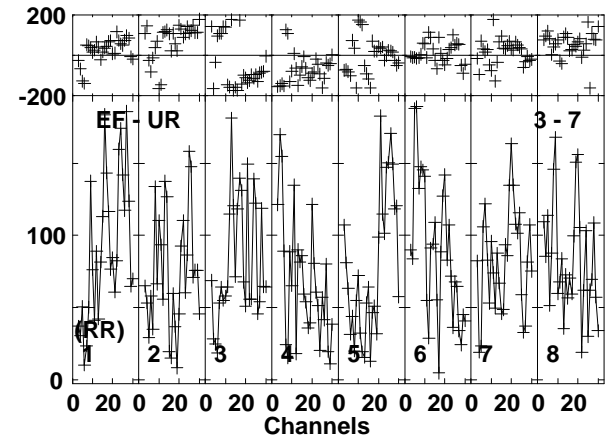
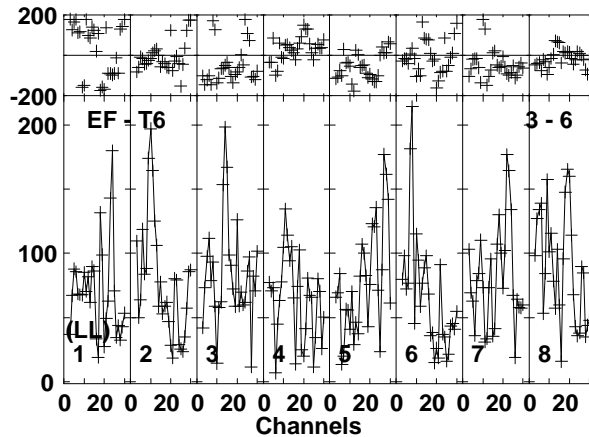
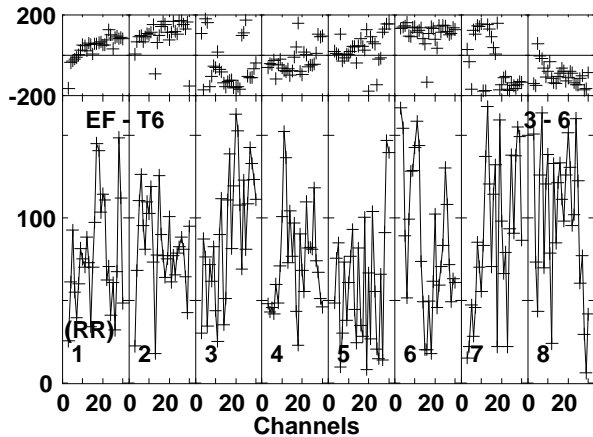
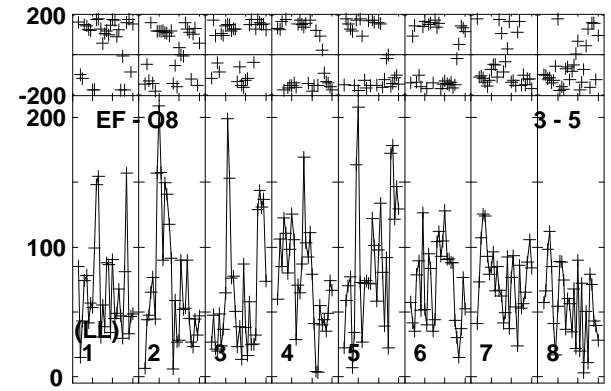
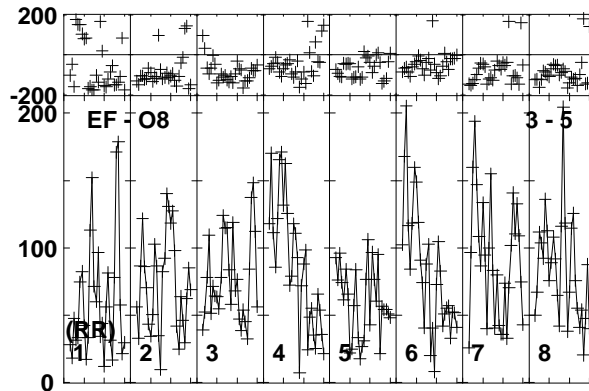
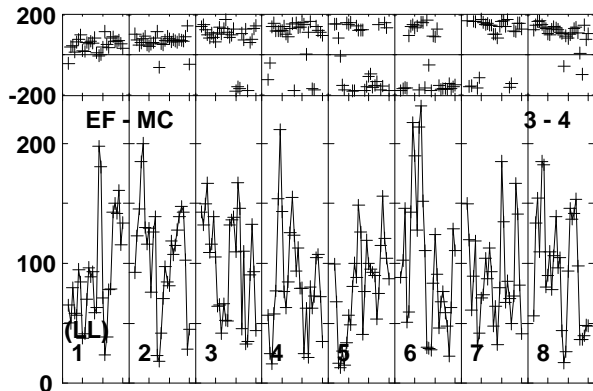
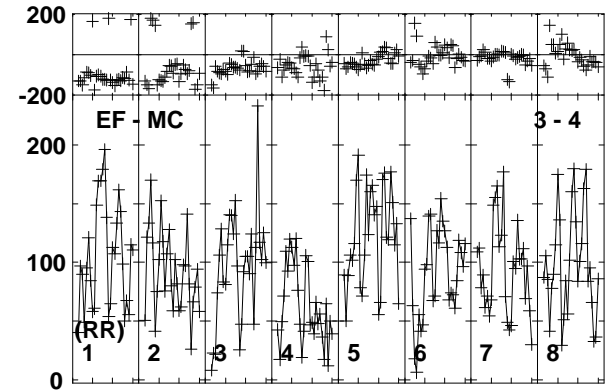
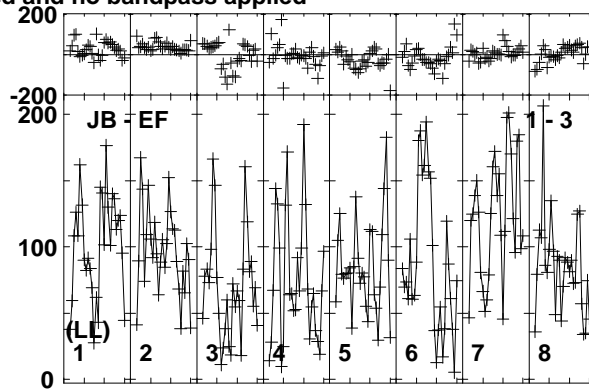
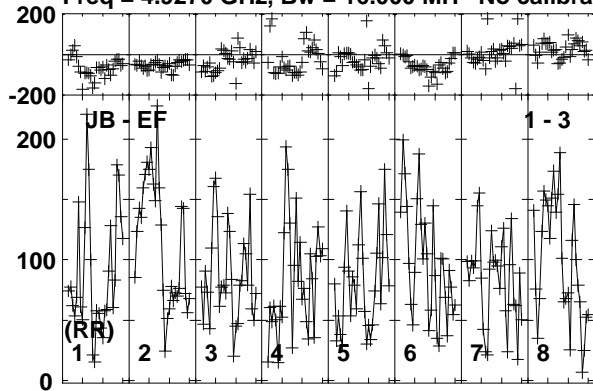

Lower frame: Micro Ampl Jy Top frame: Phas deg
Vector averaged cross-power spectrum Baseline: JB (01) - EF (03)
Timerange: 00/01:55:23 to 00/01:59:19

Plot file version 82 created 17-FEB-2020 15:42:46

J1402+5347 EK047 2.UVDATA.1

Freq = 4.9270 GHz, Bw = 16.000 MH No calibration applied and no bandpass applied

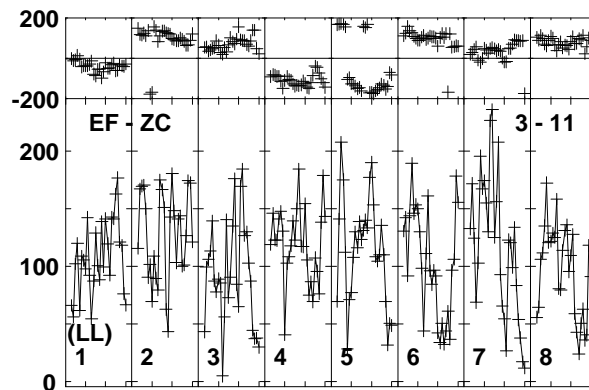
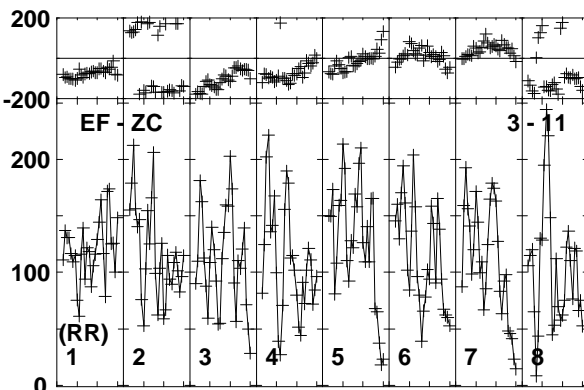
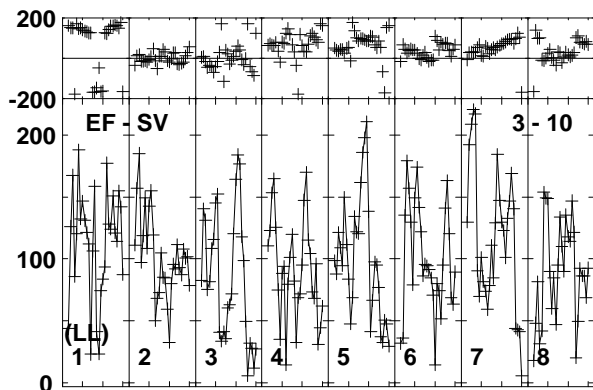
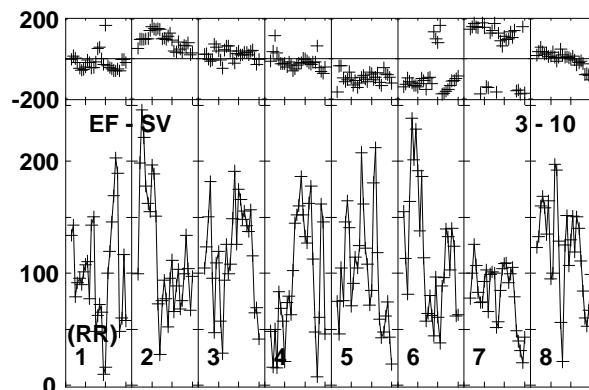
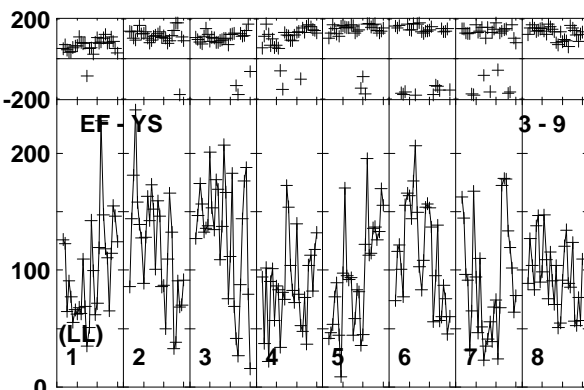
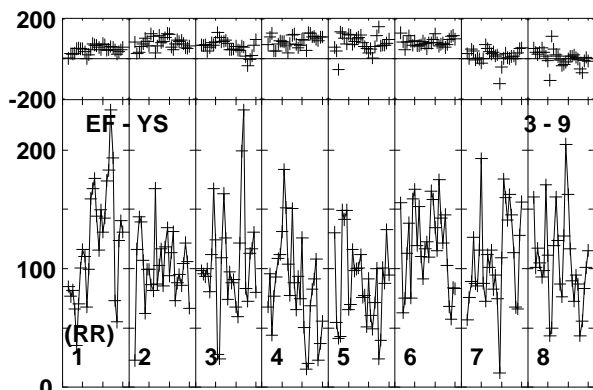
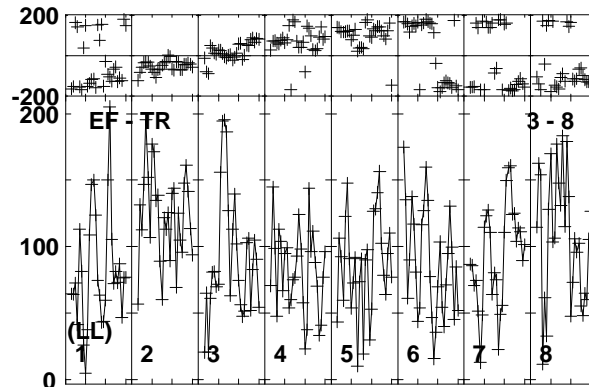
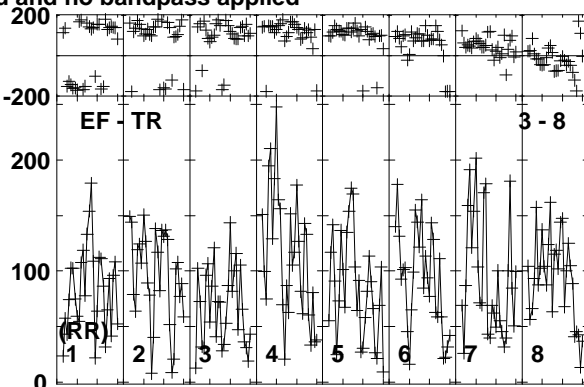
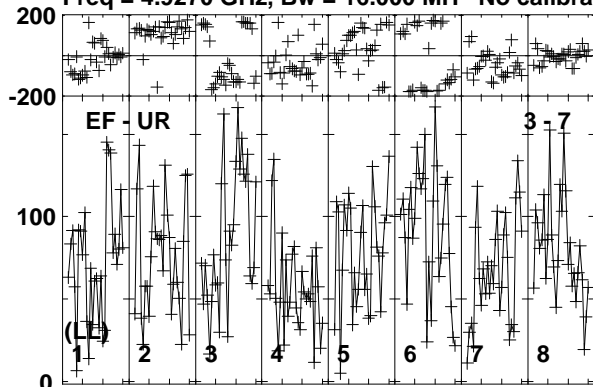

Lower frame: Micro Ampl Jy Top frame: Phas deg
Vector averaged cross-power spectrum Baseline: EF (03) - UR (07)
Timerange: 00/01:55:23 to 00/01:59:19

Plot file version 83 created 17-FEB-2020 15:42:46

J1402+5347 EK047 2.UVDATA.1

Freq = 4.9270 GHz, Bw = 16.000 MH No calibration applied and no bandpass applied

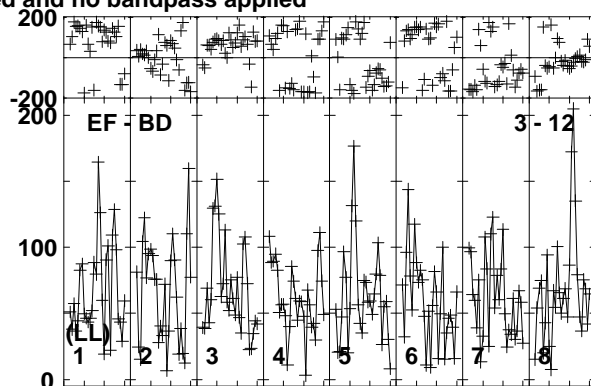
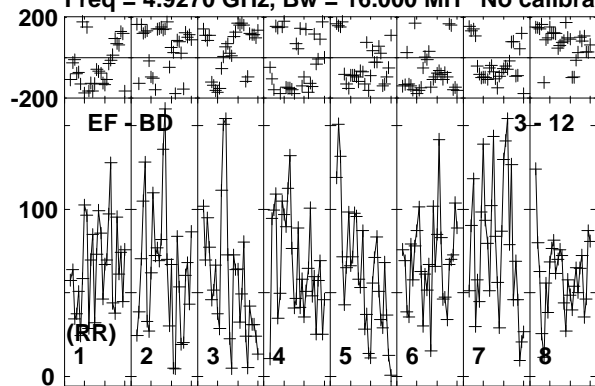

Lower frame: Micro Ampl Jy Top frame: Phas deg
Vector averaged cross-power spectrum Baseline: EF (03) - BD (12)
Timerange: 00/01:55:23 to 00/01:59:19

Plot file version 84 created 17-FEB-2020 15:42:46

J1359+5544 EK047 2.UVDATA.1

Freq = 4.9270 GHz, Bw = 16.000 MH No calibration applied and no bandpass applied

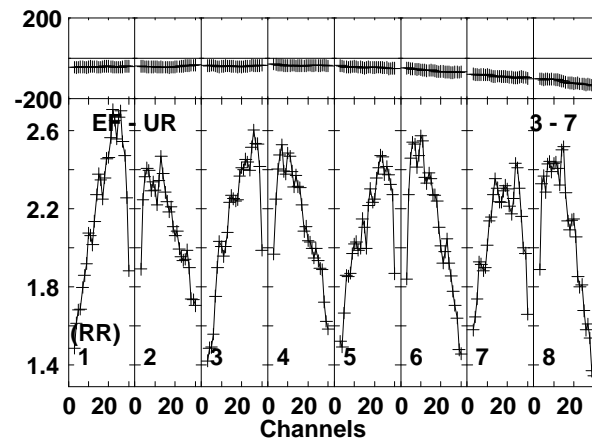
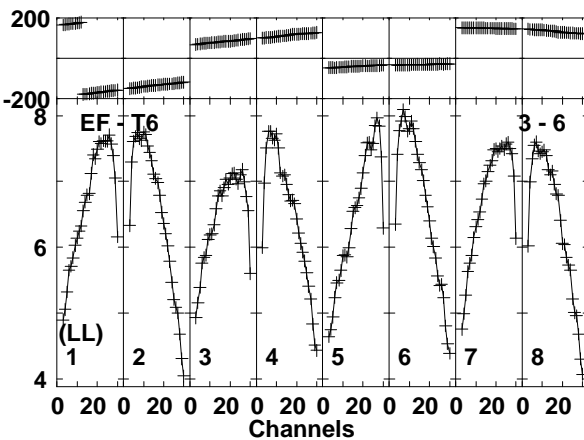
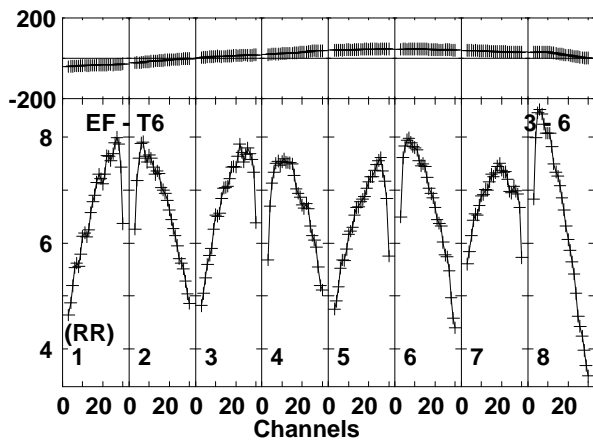
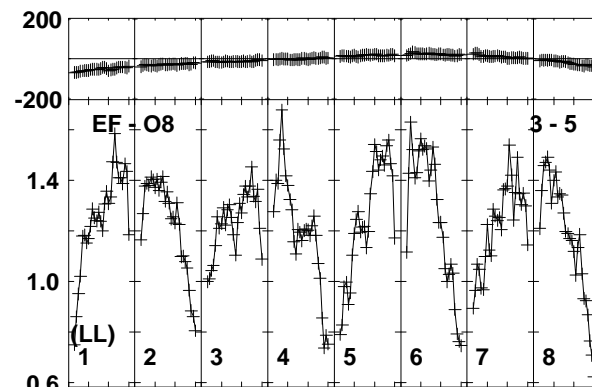
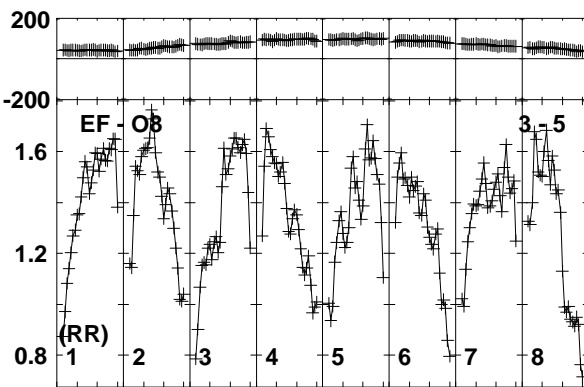
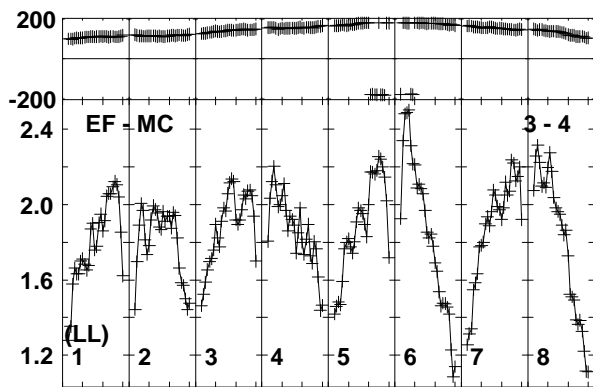
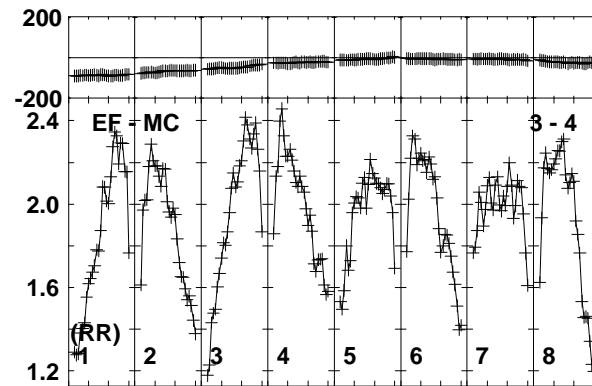
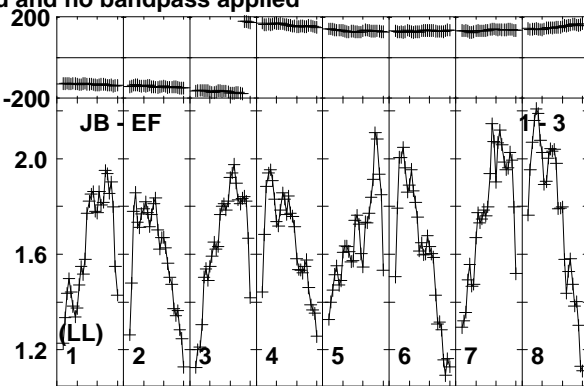
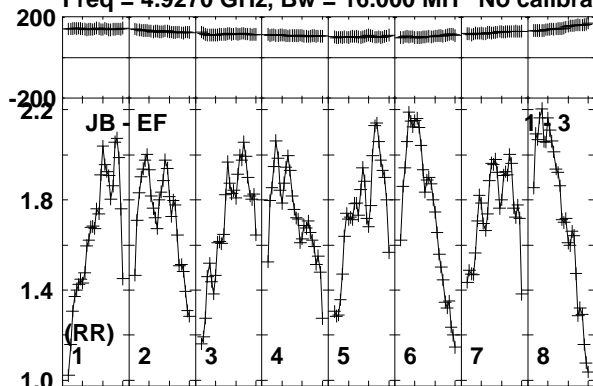

Lower frame: Milli Ampl Jy Top frame: Phas deg
Vector averaged cross-power spectrum Baseline: JB (01) - EF (03)
Timerange: 00/02:00:01 to 00/02:01:19

Plot file version 85 created 17-FEB-2020 15:42:46

J1359+5544 EK047 2.UVDATA.1

Freq = 4.9270 GHz, Bw = 16.000 MH No calibration applied and no bandpass applied

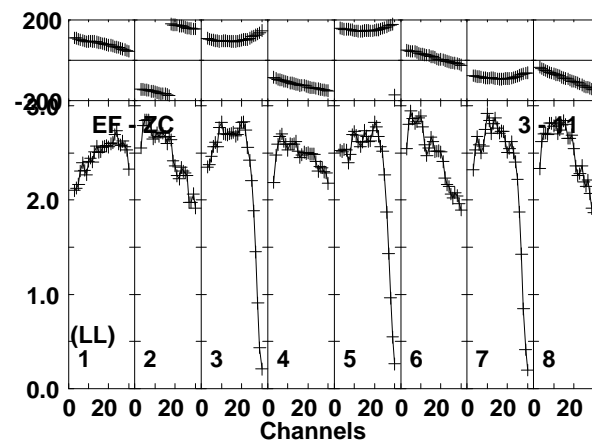
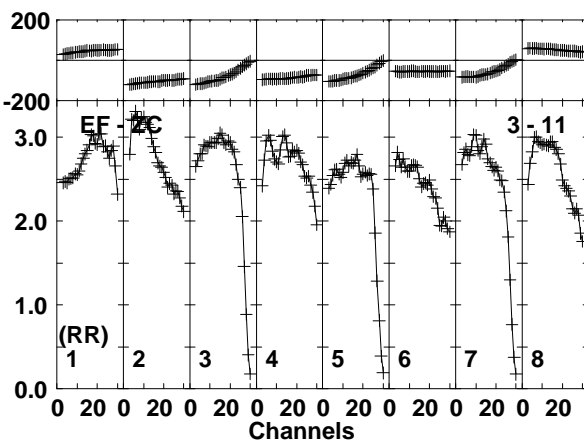
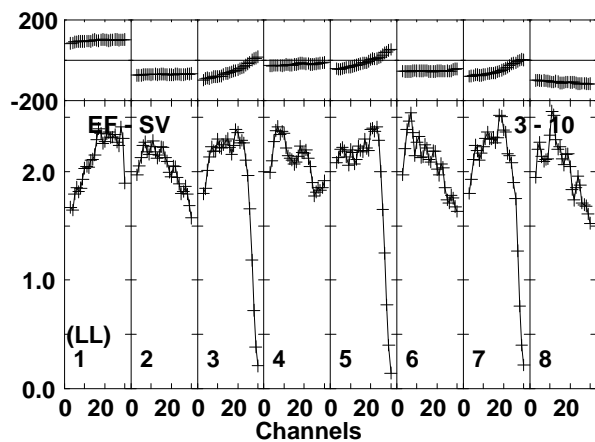
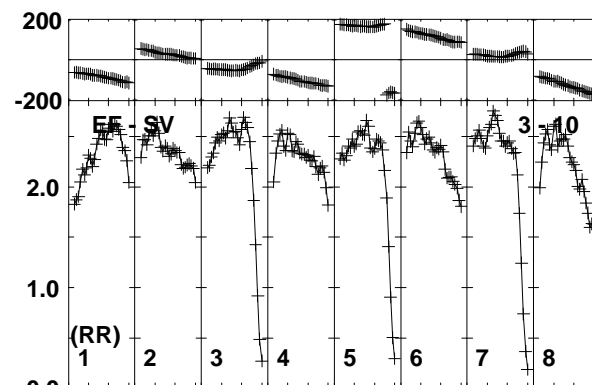
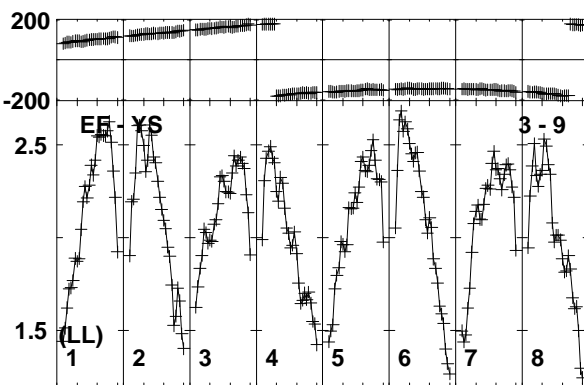
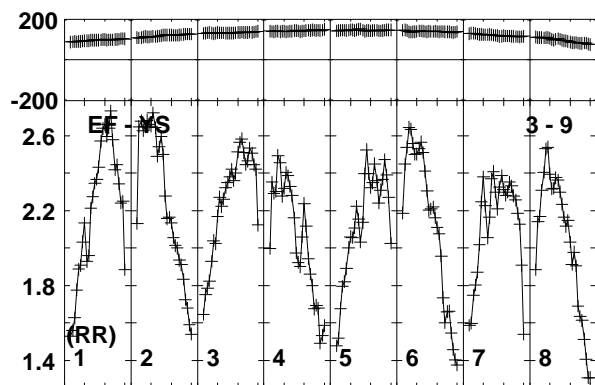
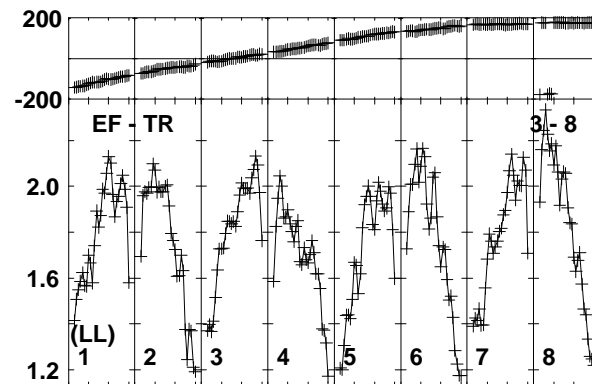
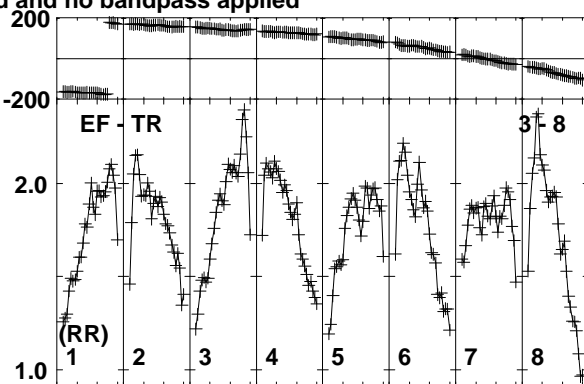
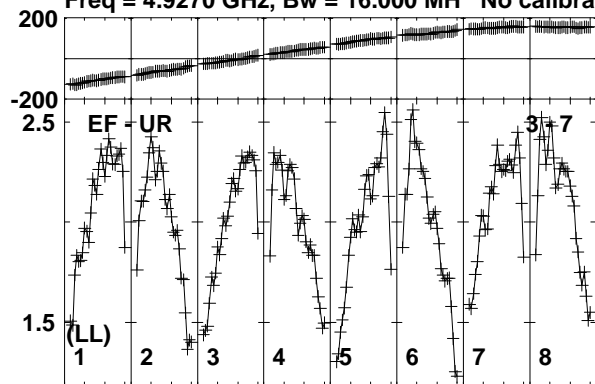

Lower frame: Milli Ampl Jy Top frame: Phas deg
Vector averaged cross-power spectrum Baseline: EF (03) - UR (07)
Timerange: 00/02:00:01 to 00/02:01:19

Plot file version 86 created 17-FEB-2020 15:42:46

J1359+5544 EK047 2.UVDATA.1

Freq = 4.9270 GHz, Bw = 16.000 MH No calibration applied and no bandpass applied

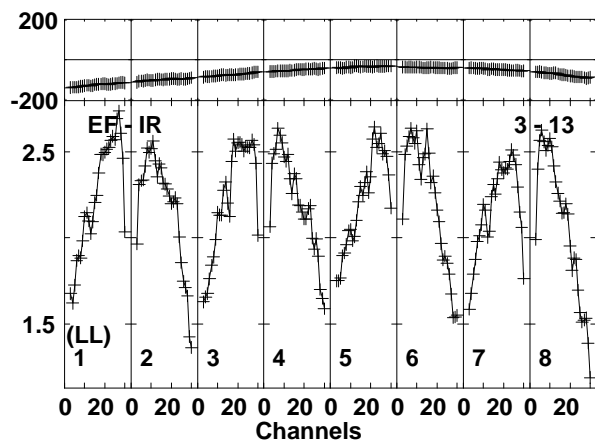
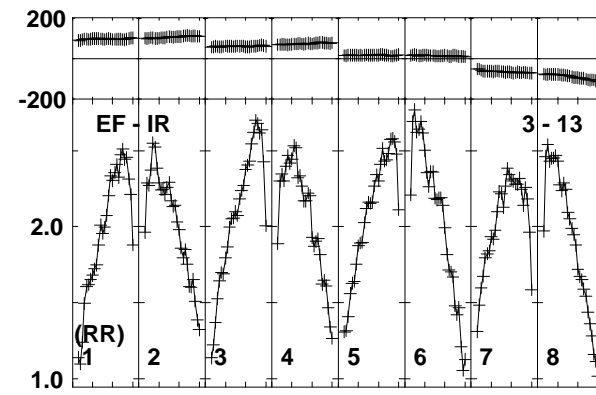
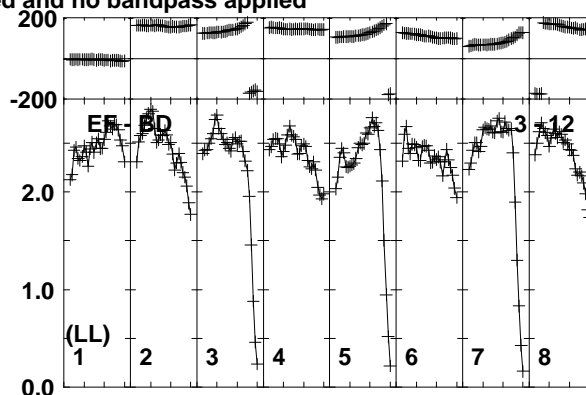
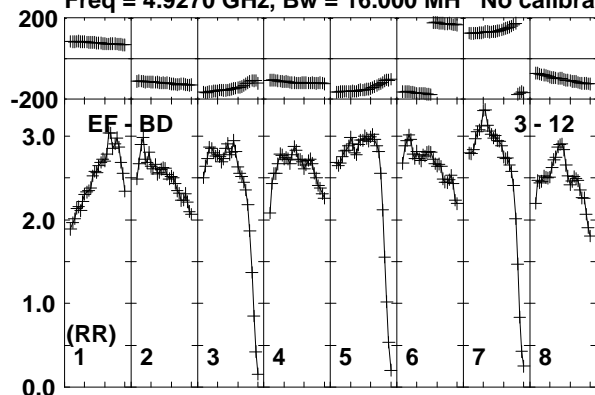

Lower frame: Milli Ampl Jy Top frame: Phas deg
Vector averaged cross-power spectrum Baseline: EF (03) - BD (12)
Timerange: 00/02:00:01 to 00/02:01:19

Plot file version 87 created 17-FEB-2020 15:42:46

J1402+5347 EK047 2.UVDATA.1

Freq = 4.9270 GHz, Bw = 16.000 MH No calibration applied and no bandpass applied

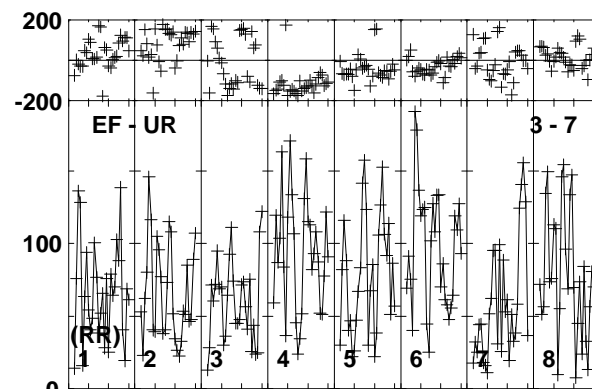
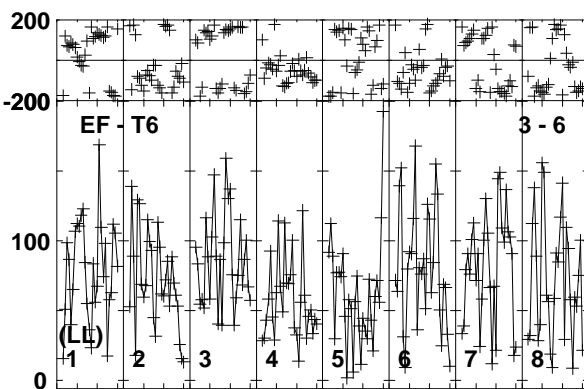
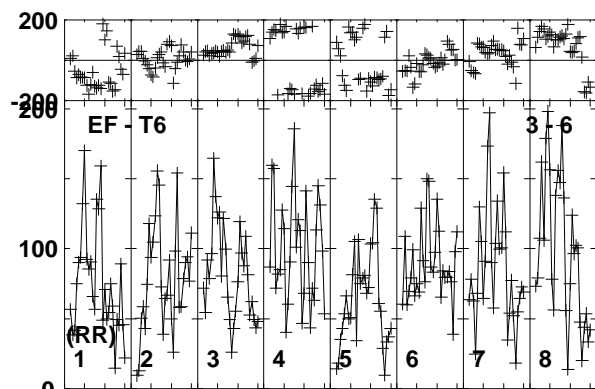
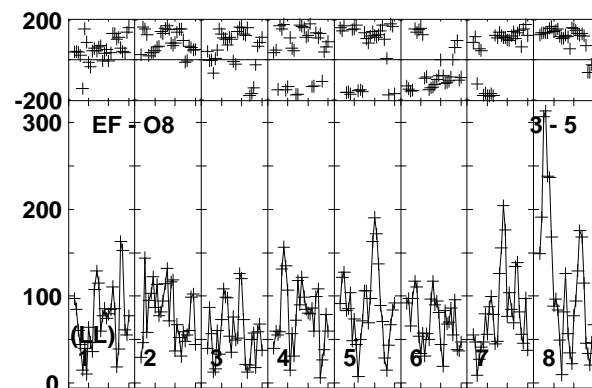
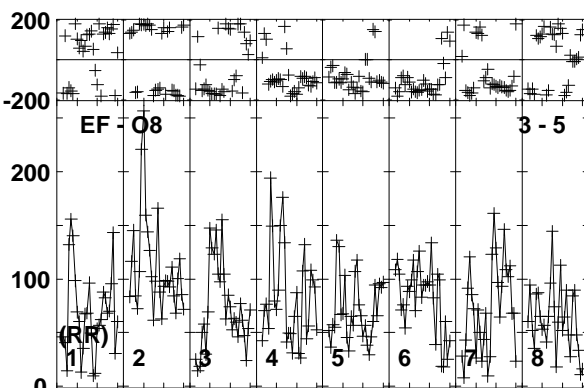
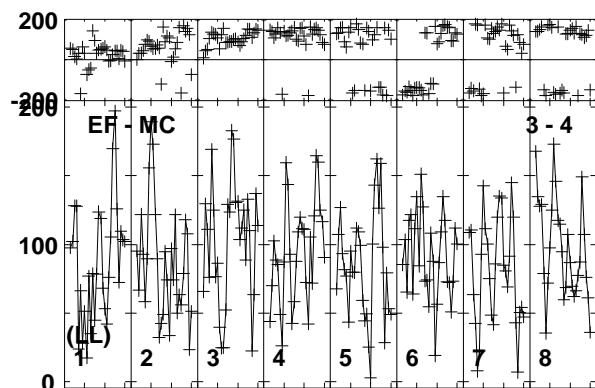
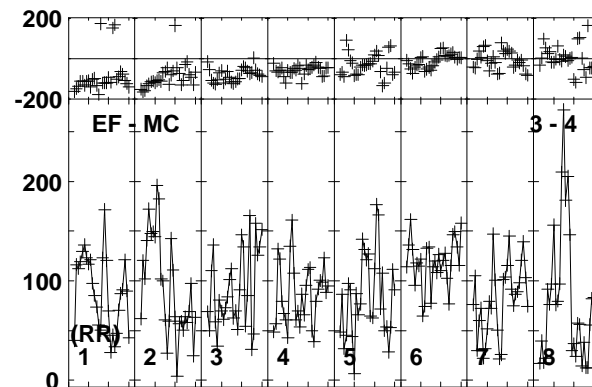
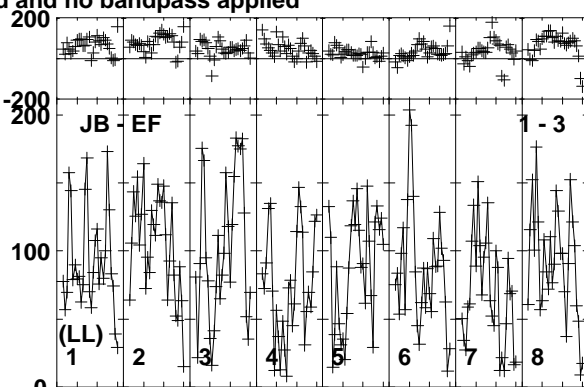
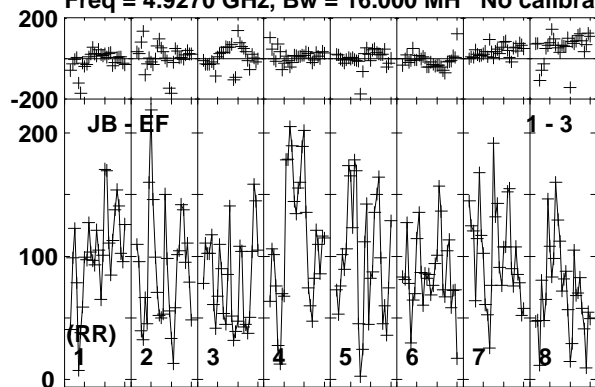

Lower frame: Micro Ampl Jy Top frame: Phas deg
Vector averaged cross-power spectrum Baseline: JB (01) - EF (03)
Timerange: 00/02:01:21 to 00/02:05:19

Plot file version 88 created 17-FEB-2020 15:42:46

J1402+5347 EK047 2.UVDATA.1

Freq = 4.9270 GHz, Bw = 16.000 MH No calibration applied and no bandpass applied

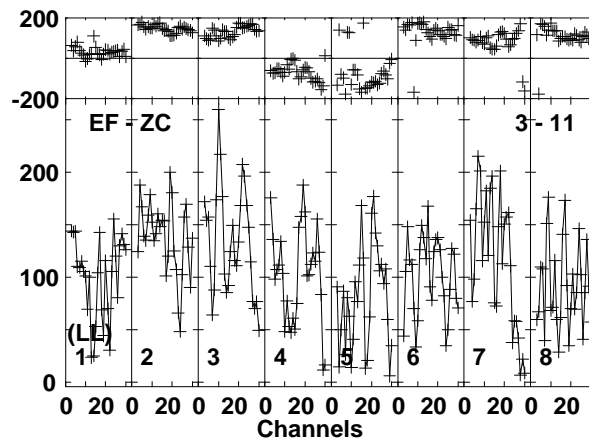
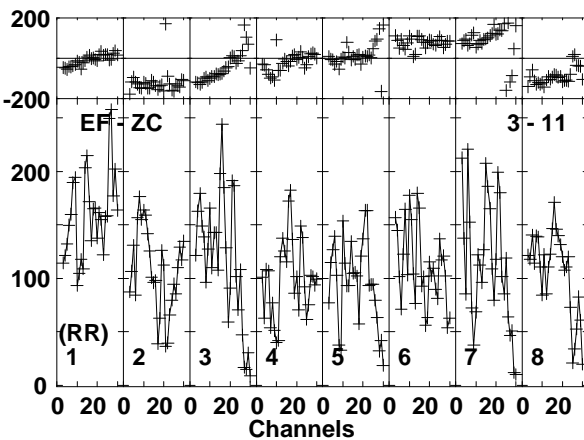
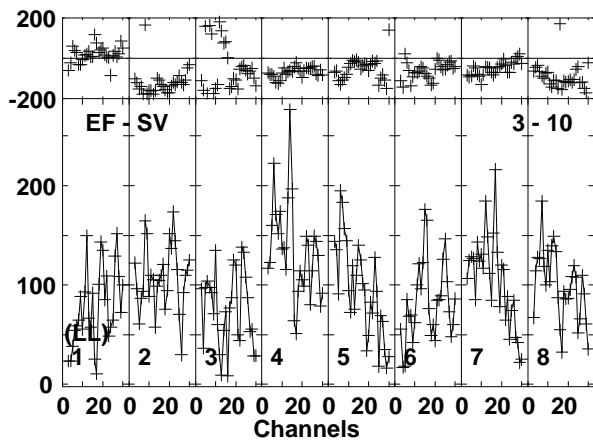
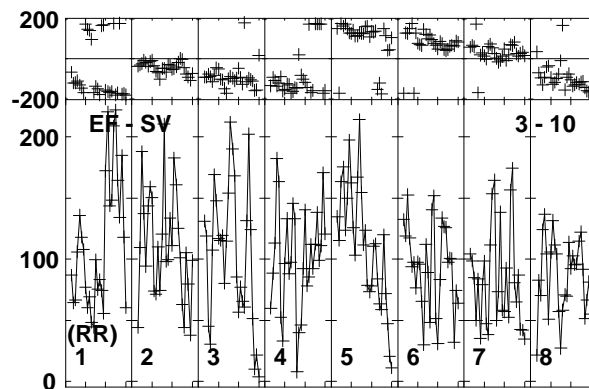
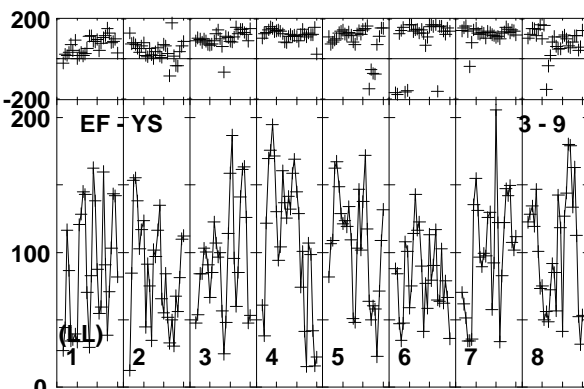
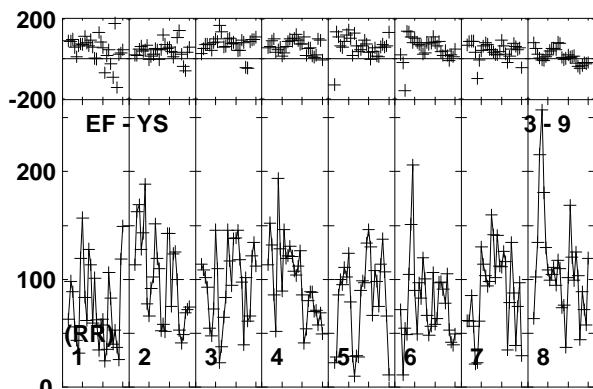
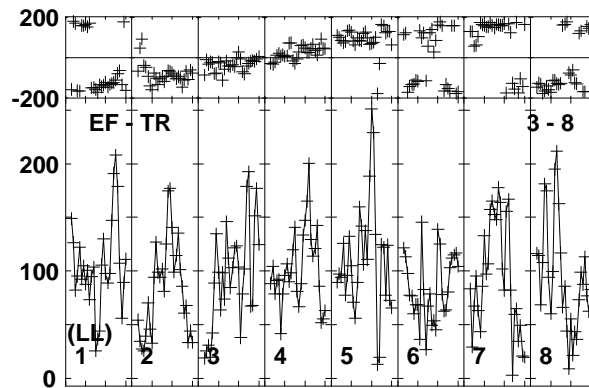
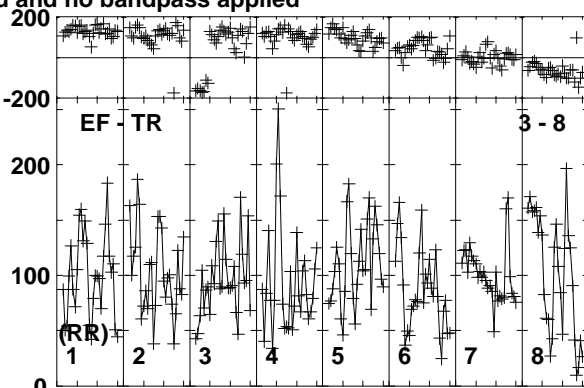
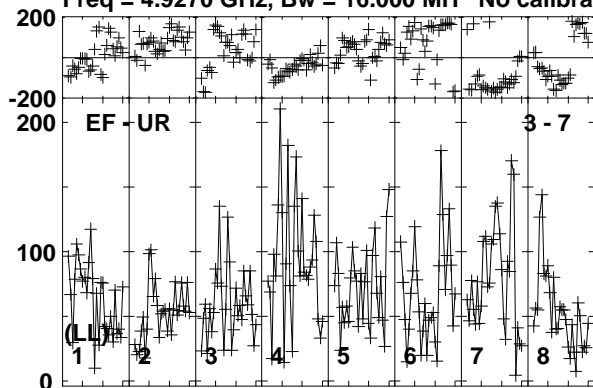

Lower frame: Micro Ampl Jy Top frame: Phas deg
Vector averaged cross-power spectrum Baseline: EF (03) - UR (07)
Timerange: 00/02:01:21 to 00/02:05:19

Plot file version 89 created 17-FEB-2020 15:42:46

J1402+5347 EK047 2.UVDATA.1

Freq = 4.9270 GHz, Bw = 16.000 MH No calibration applied and no bandpass applied

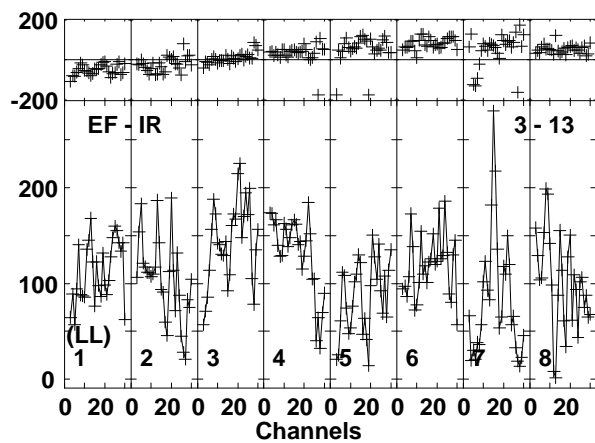
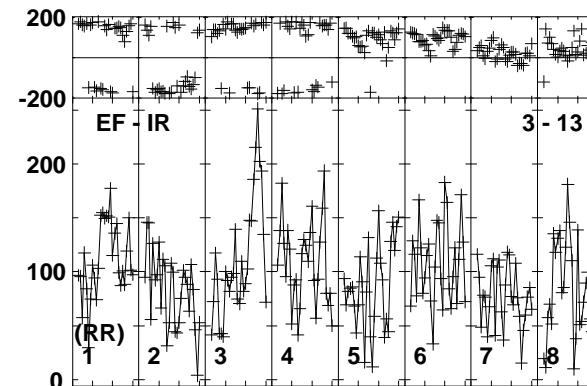
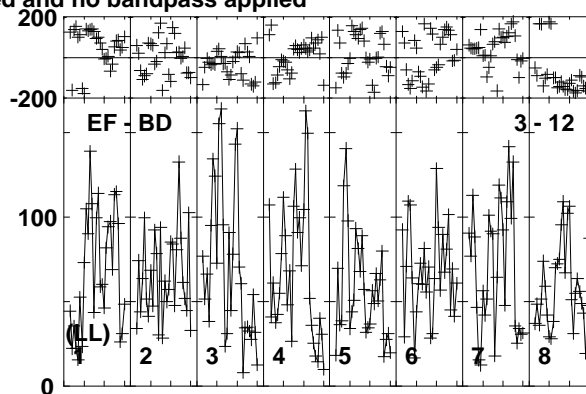
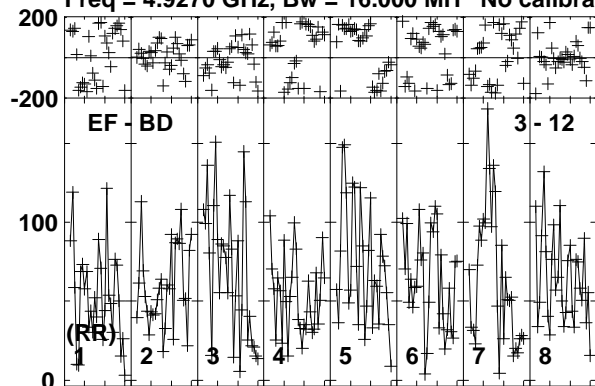

Lower frame: Micro Ampl Jy Top frame: Phas deg
Vector averaged cross-power spectrum Baseline: EF (03) - BD (12)
Timerange: 00/02:01:21 to 00/02:05:19

Plot file version 90 created 17-FEB-2020 15:42:46

J1359+5544 EK047 2.UVDATA.1

Freq = 4.9270 GHz, Bw = 16.000 MH No calibration applied and no bandpass applied

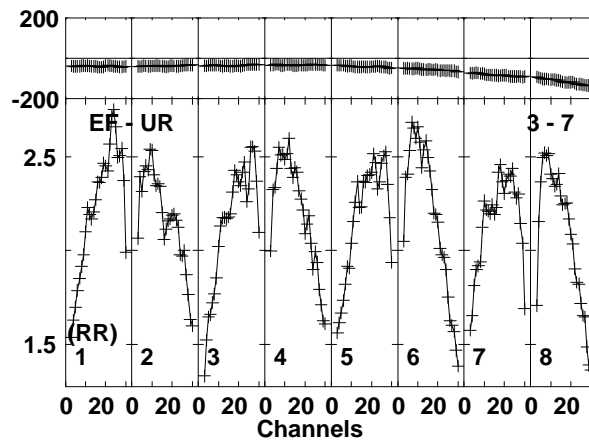
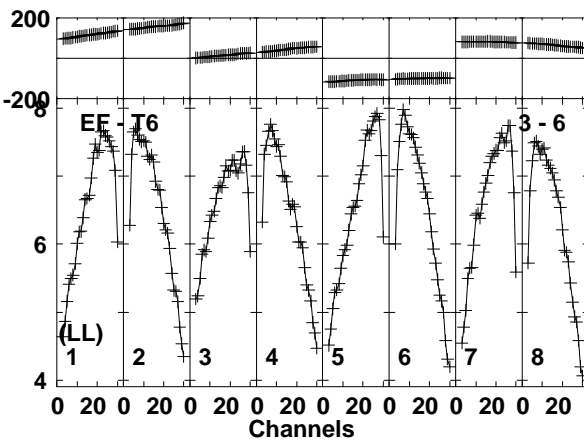
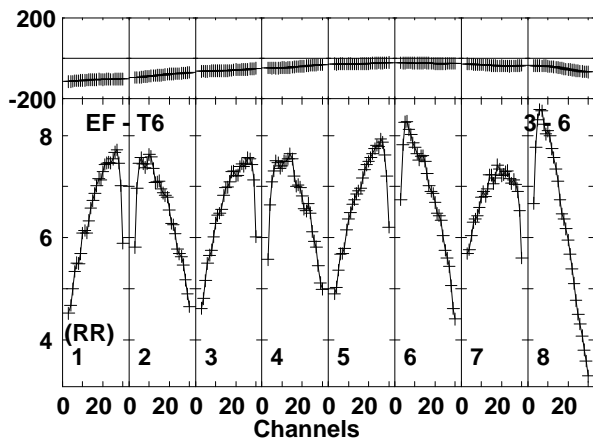
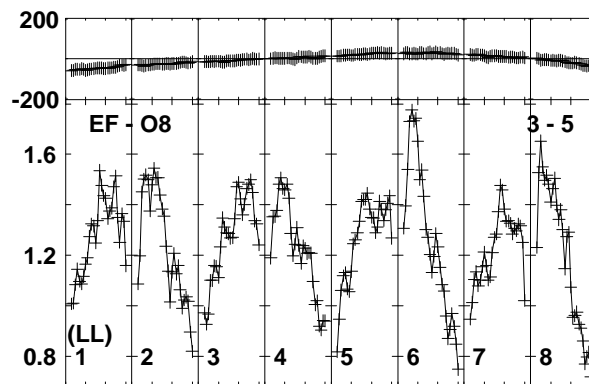
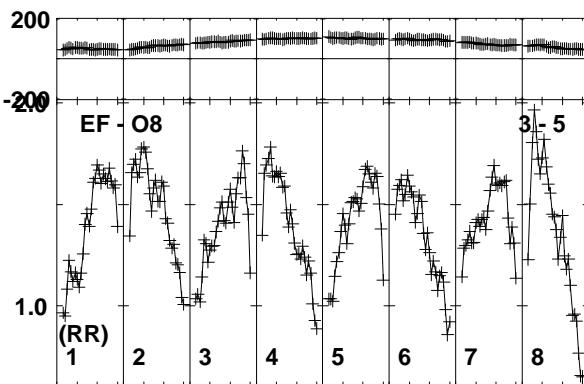
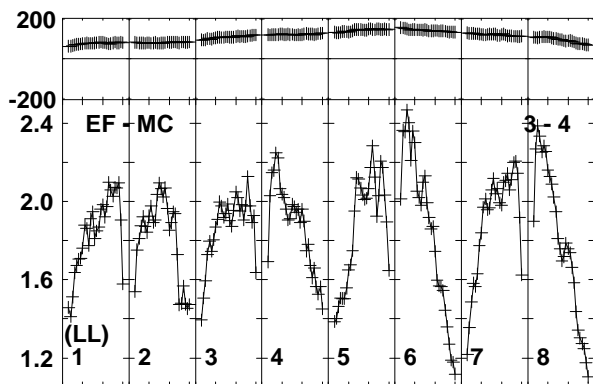
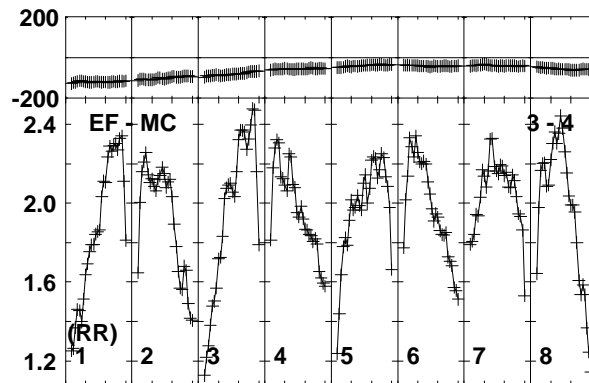
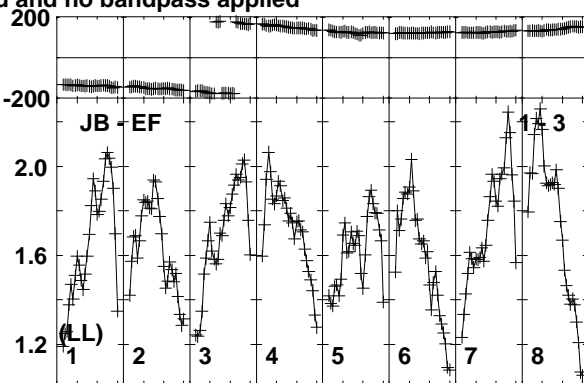
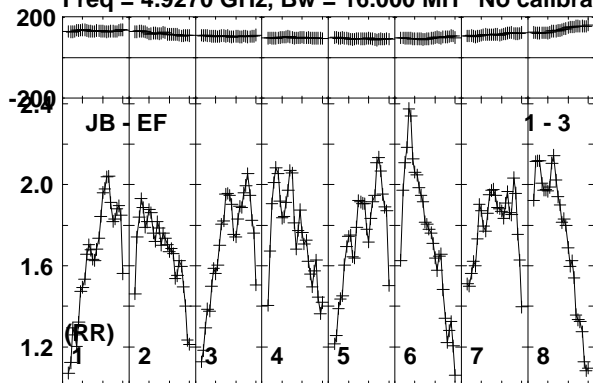

Lower frame: Milli Ampl Jy Top frame: Phas deg
Vector averaged cross-power spectrum Baseline: JB (01) - EF (03)
Timerange: 00/02:05:21 to 00/02:07:19

Plot file version 91 created 17-FEB-2020 15:42:46

J1359+5544 EK047 2.UVDATA.1

Freq = 4.9270 GHz, Bw = 16.000 MH No calibration applied and no bandpass applied

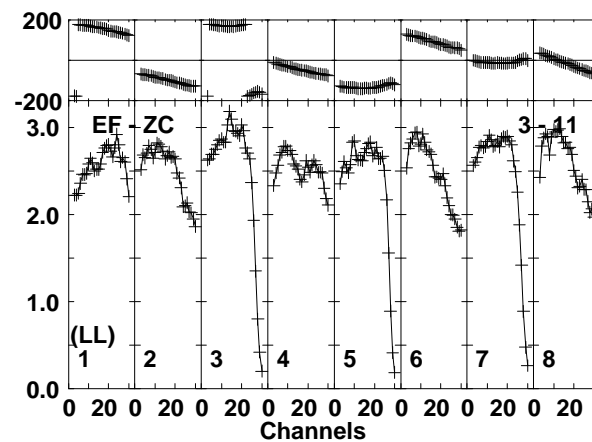
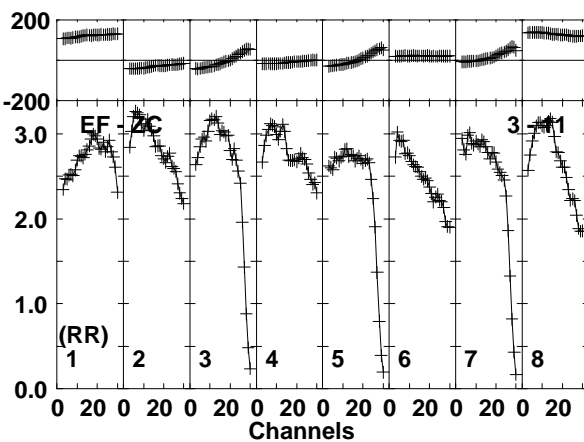
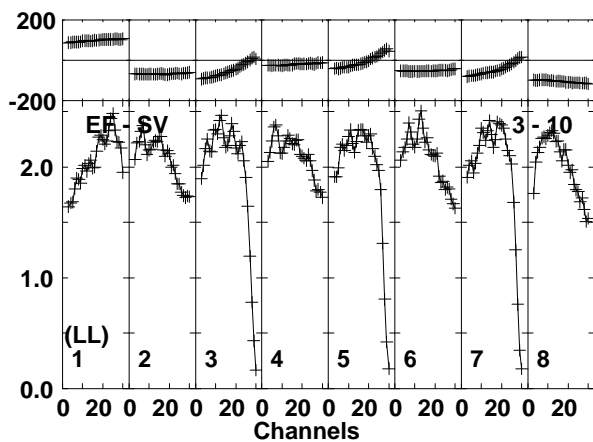
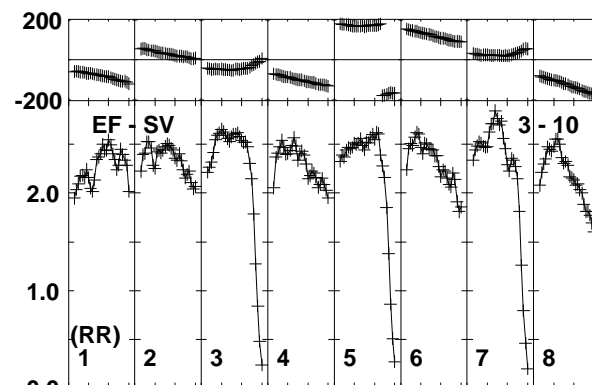
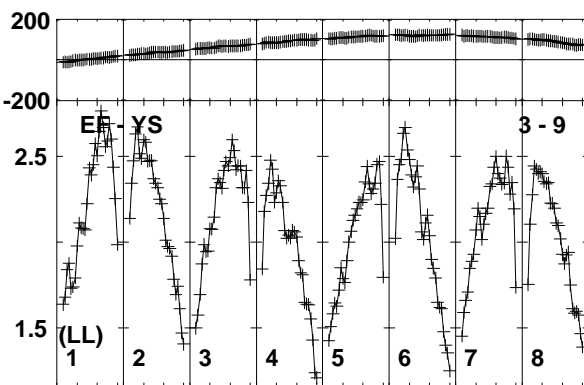
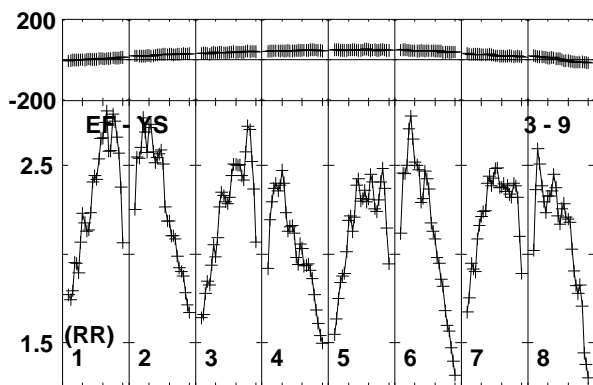
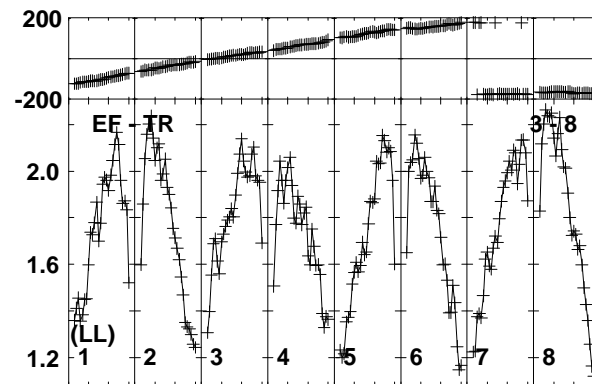
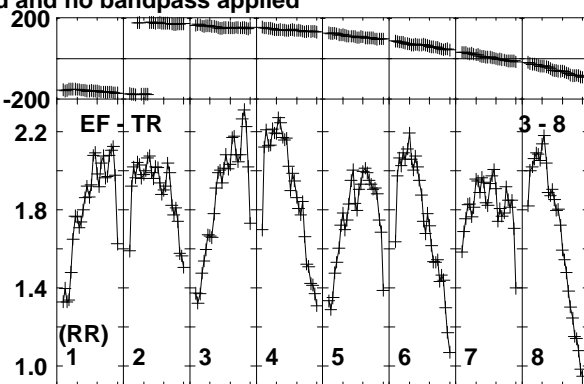
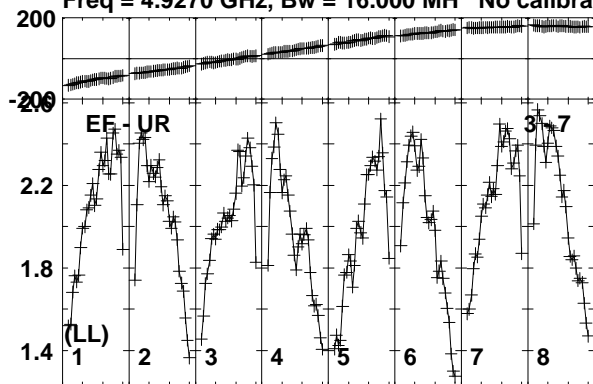

Lower frame: Milli Ampl Jy Top frame: Phas deg
Vector averaged cross-power spectrum Baseline: EF (03) - UR (07)
Timerange: 00/02:05:21 to 00/02:07:19

Plot file version 92 created 17-FEB-2020 15:42:47

J1359+5544 EK047 2.UVDATA.1

Freq = 4.9270 GHz, Bw = 16.000 MH No calibration applied and no bandpass applied

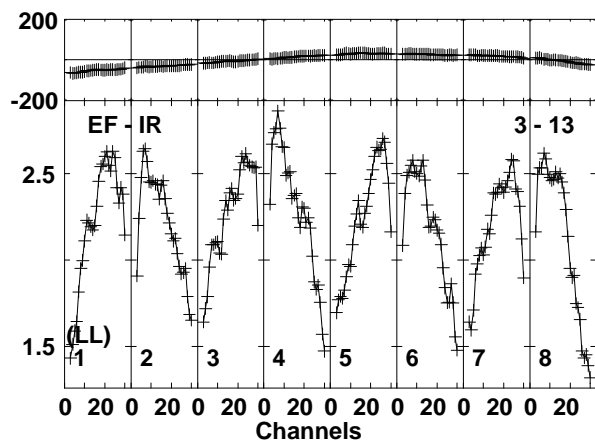
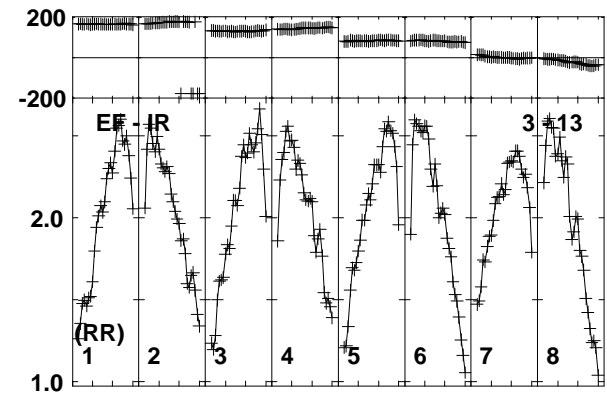
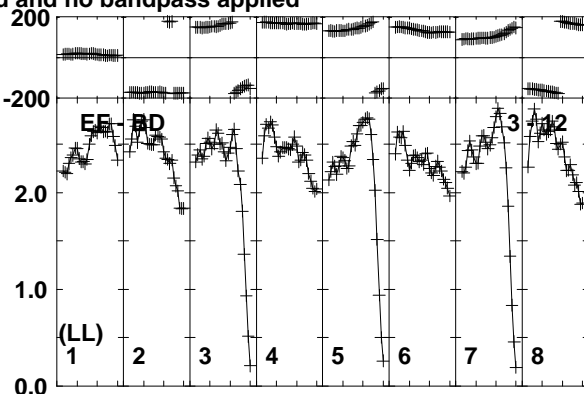
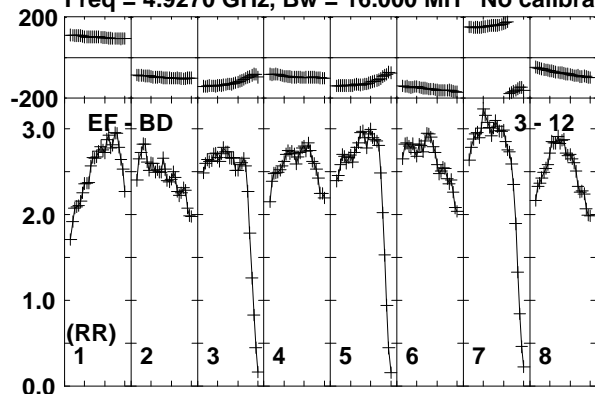

Lower frame: Milli Ampl Jy Top frame: Phas deg
Vector averaged cross-power spectrum Baseline: EF (03) - BD (12)
Timerange: 00/02:05:21 to 00/02:07:19

Plot file version 93 created 17-FEB-2020 15:42:47

J1402+5347 EK047 2.UVDATA.1

Freq = 4.9270 GHz, Bw = 16.000 MH No calibration applied and no bandpass applied

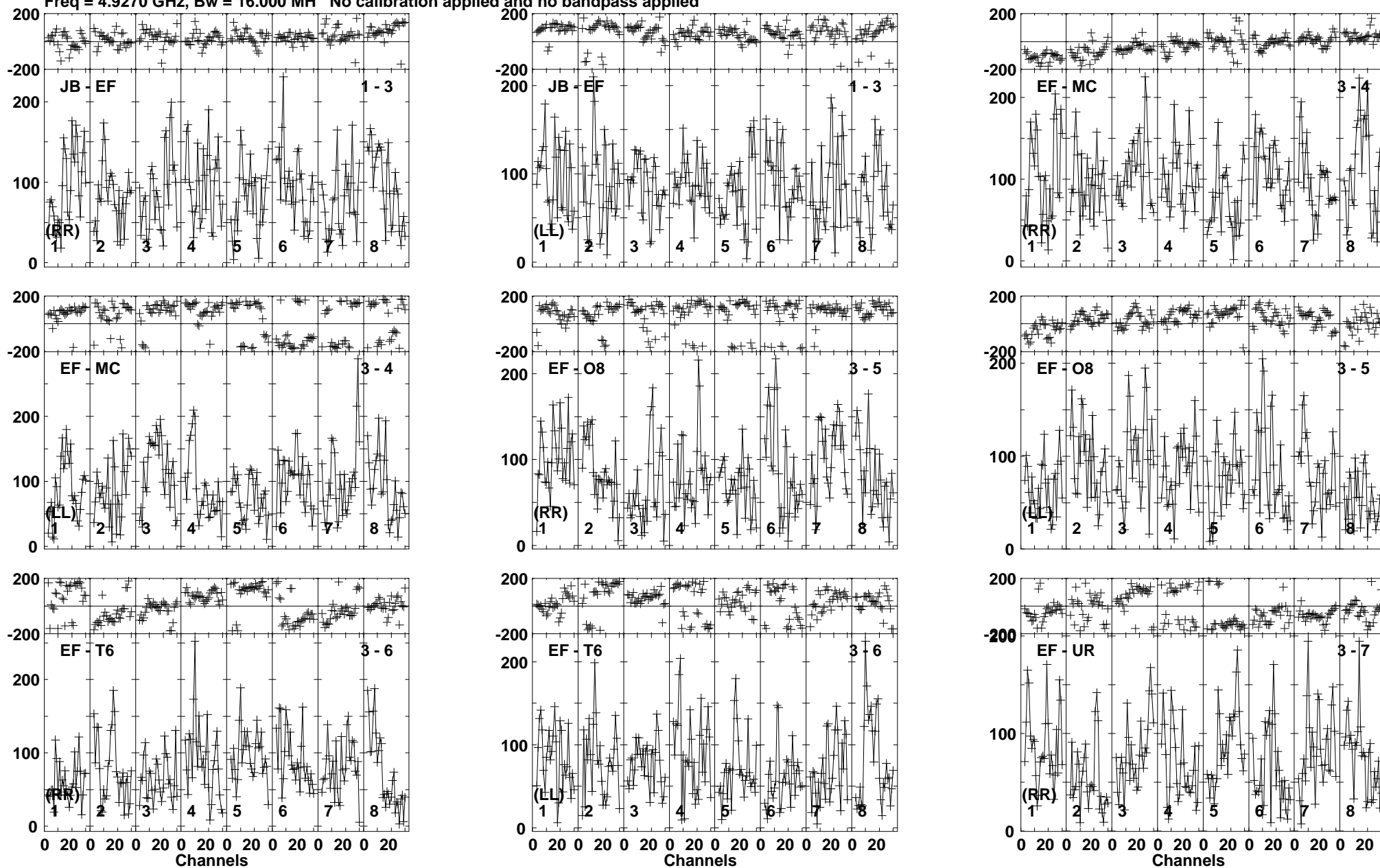

Lower frame: Micro Ampl Jy Top frame: Phas deg
Vector averaged cross-power spectrum Baseline: JB (01) - EF (03)
Timerange: 00/02:07:23 to 00/02:11:19

Plot file version 94 created 17-FEB-2020 15:42:47

J1402+5347 EK047 2.UVDATA.1

Freq = 4.9270 GHz, Bw = 16.000 MH No calibration applied and no bandpass applied

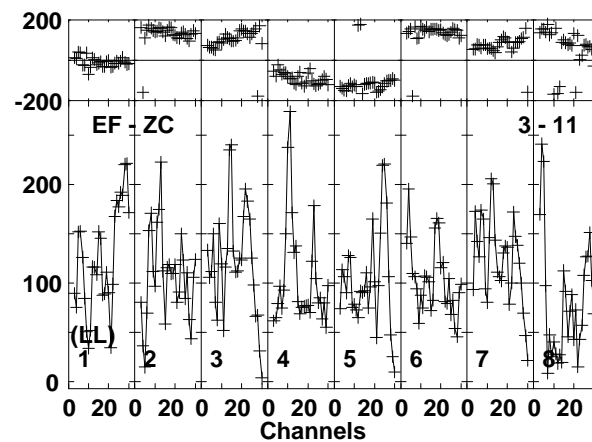
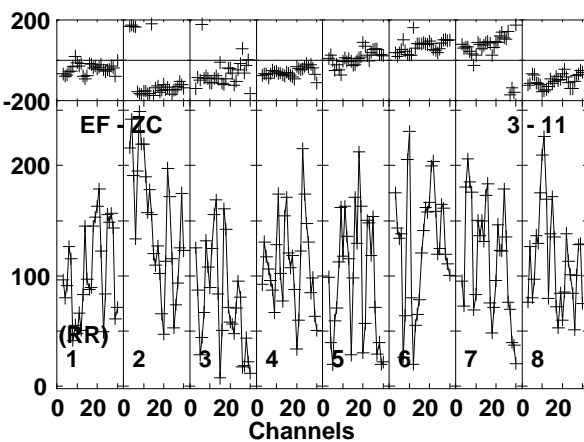
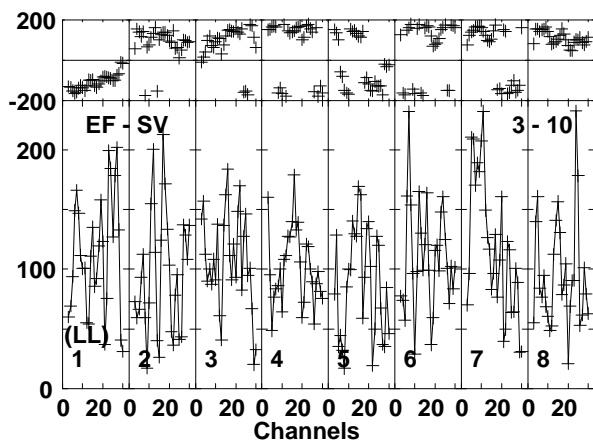
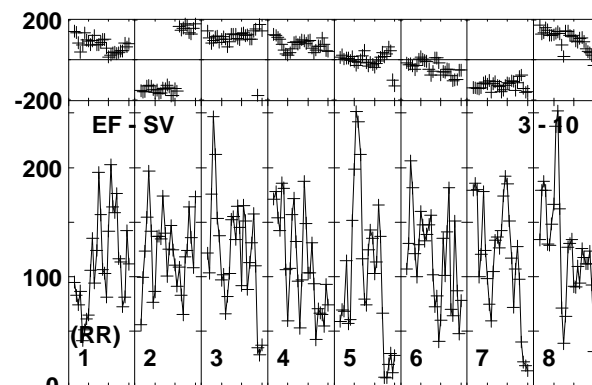
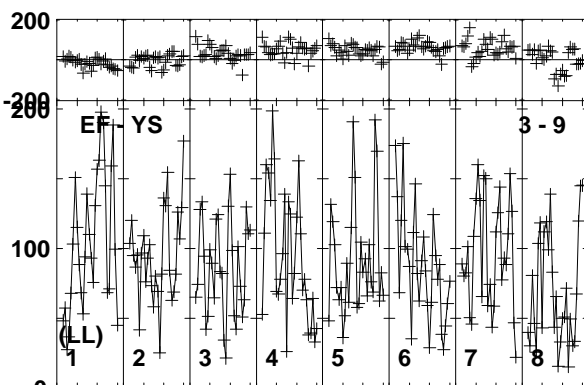
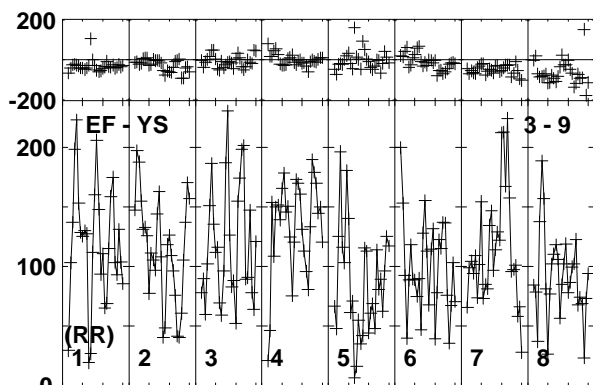
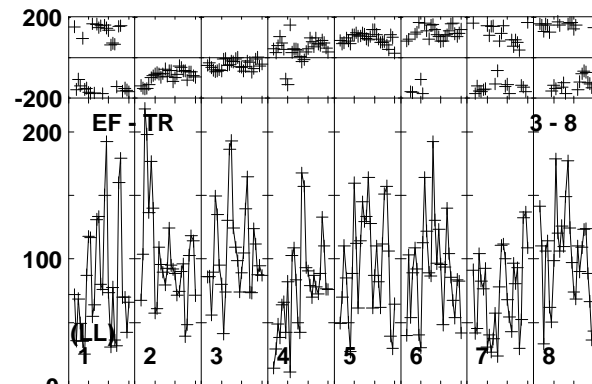
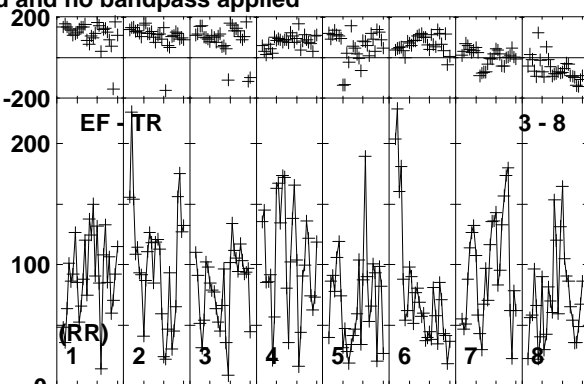
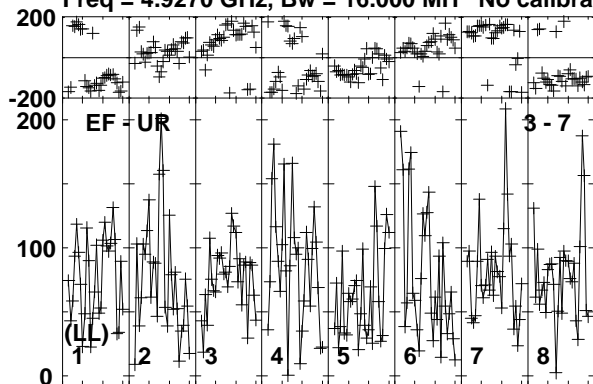

Lower frame: Micro Ampl Jy Top frame: Phas deg
Vector averaged cross-power spectrum Baseline: EF (03) - UR (07)
Timerange: 00/02:07:23 to 00/02:11:19

Plot file version 95 created 17-FEB-2020 15:42:47

J1402+5347 EK047 2.UVDATA.1

Freq = 4.9270 GHz, Bw = 16.000 MH No calibration applied and no bandpass applied

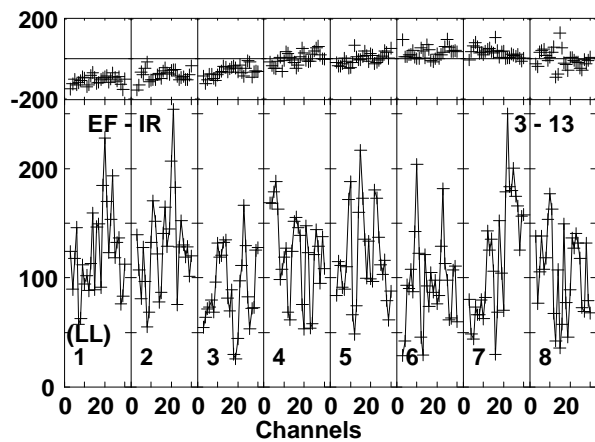
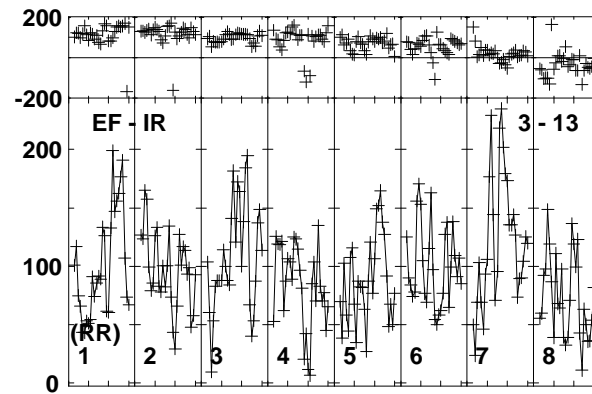
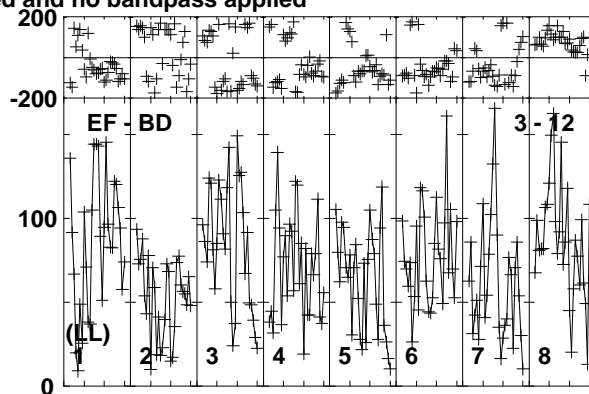
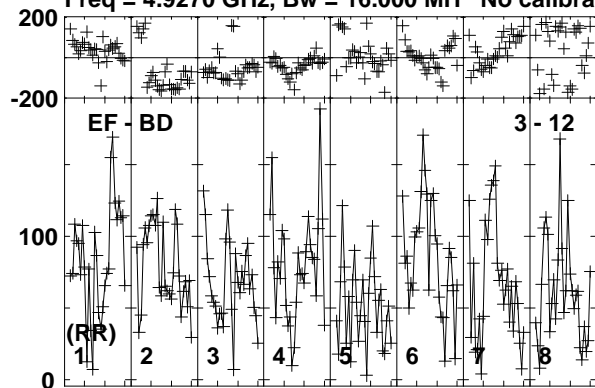

Lower frame: Micro Ampl Jy Top frame: Phas deg
Vector averaged cross-power spectrum Baseline: EF (03) - BD (12)
Timerange: 00/02:07:23 to 00/02:11:19

Plot file version 96 created 17-FEB-2020 15:42:47

J1359+5544 EK047 2.UVDATA.1

Freq = 4.9270 GHz, Bw = 16.000 MH No calibration applied and no bandpass applied

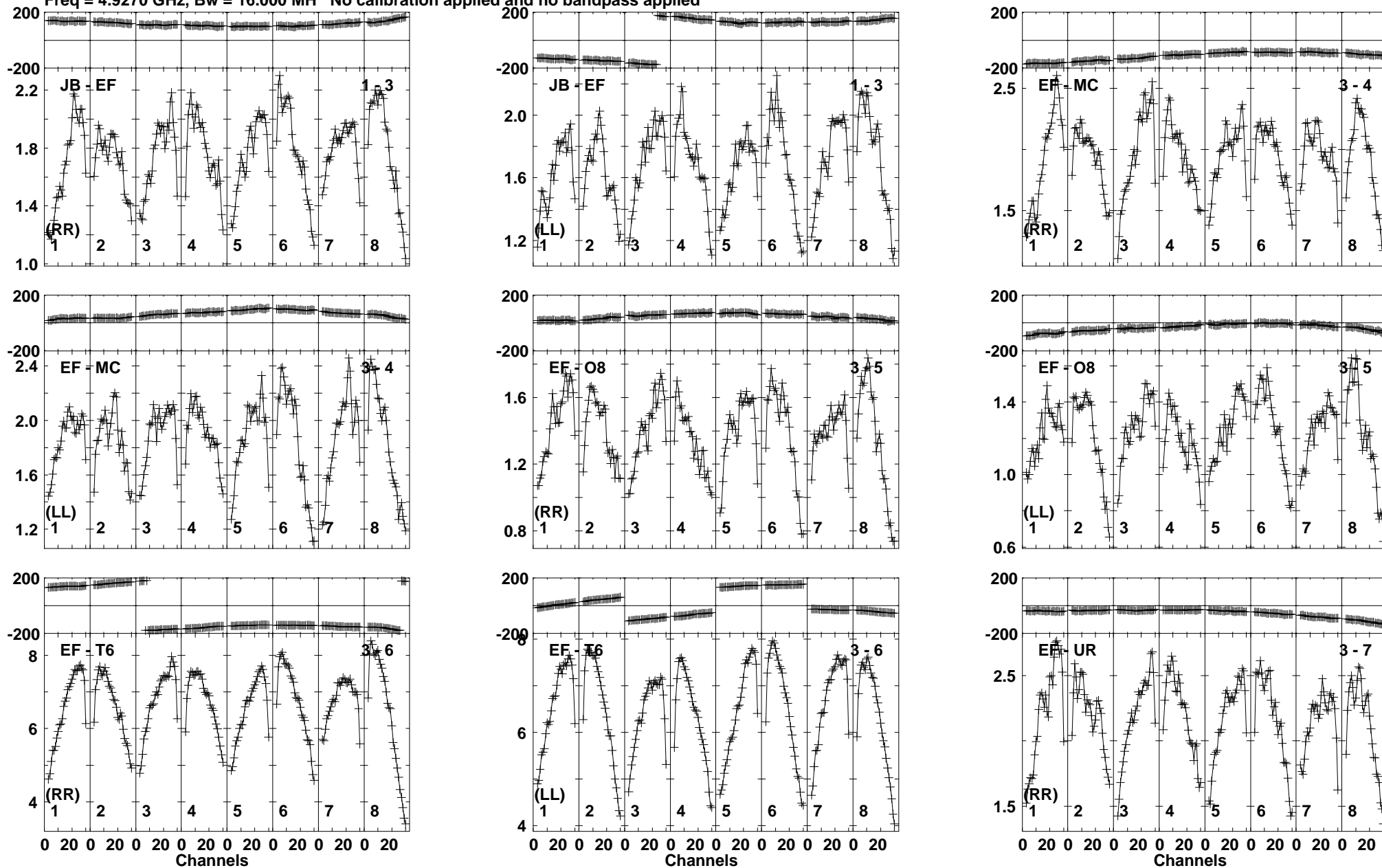

Lower frame: Milli Ampl Jy Top frame: Phas deg
Vector averaged cross-power spectrum Baseline: JB (01) - EF (03)
Timerange: 00/02:12:01 to 00/02:13:19

Plot file version 97 created 17-FEB-2020 15:42:47

J1359+5544 EK047 2.UVDATA.1

Freq = 4.9270 GHz, Bw = 16.000 MH No calibration applied and no bandpass applied

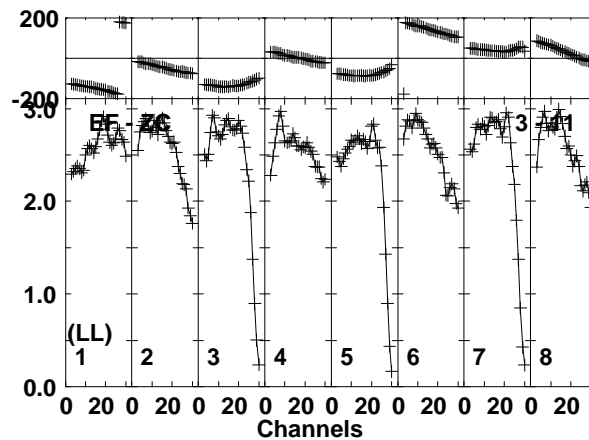
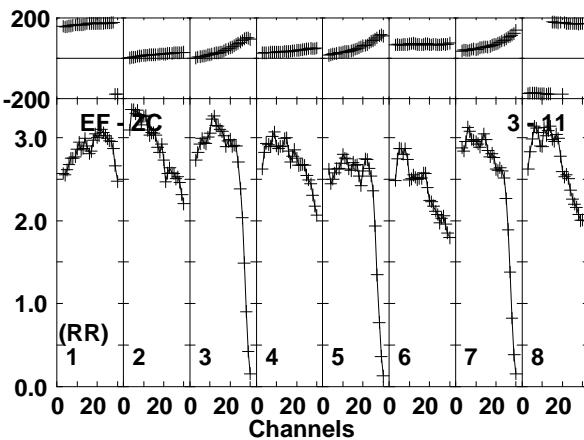
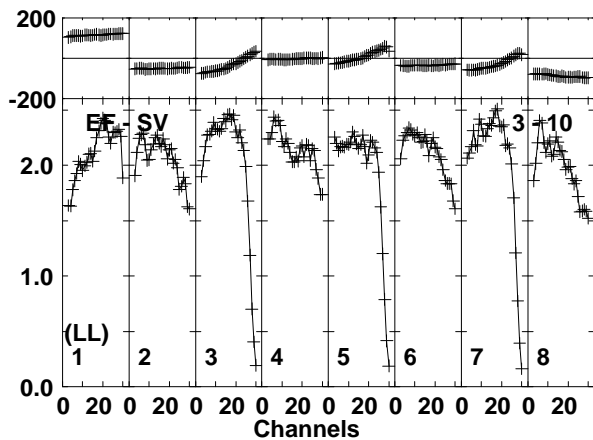
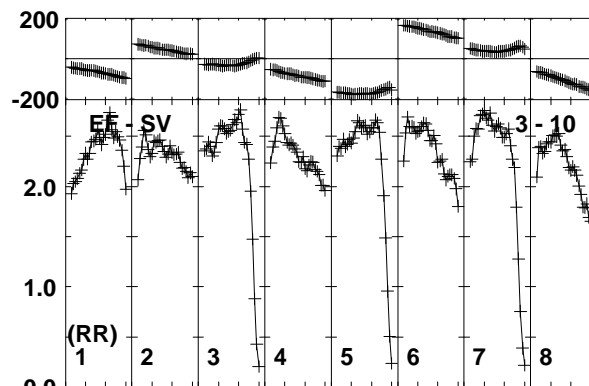
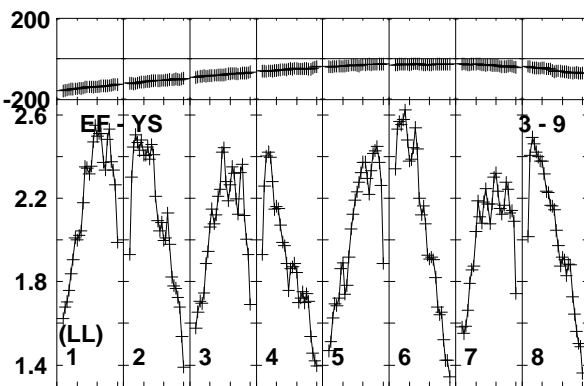
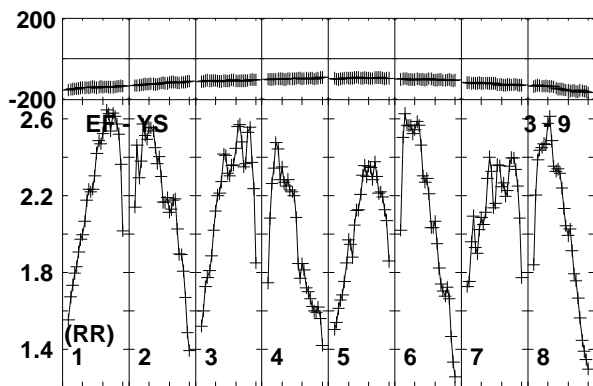
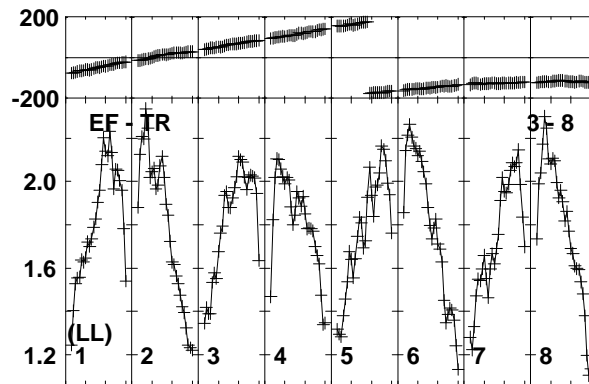
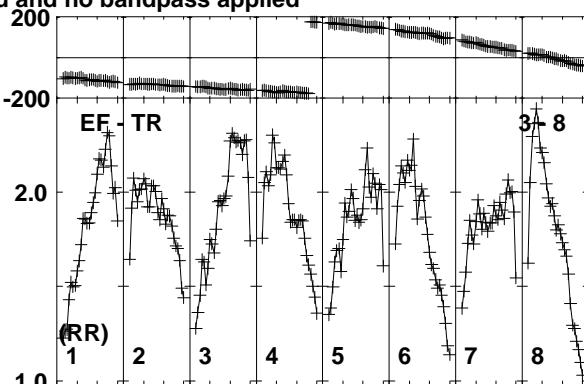
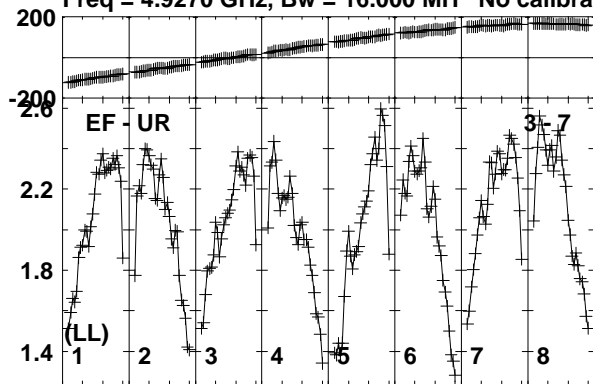

Lower frame: Milli Ampl Jy Top frame: Phas deg
Vector averaged cross-power spectrum Baseline: EF (03) - UR (07)
Timerange: 00/02:12:01 to 00/02:13:19

Plot file version 98 created 17-FEB-2020 15:42:47

J1359+5544 EK047 2.UVDATA.1

Freq = 4.9270 GHz, Bw = 16.000 MH No calibration applied and no bandpass applied

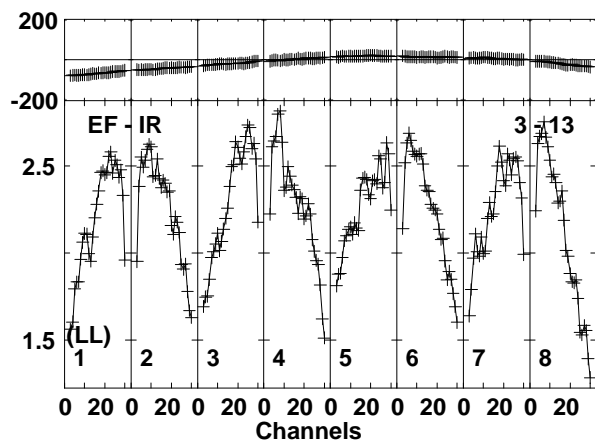
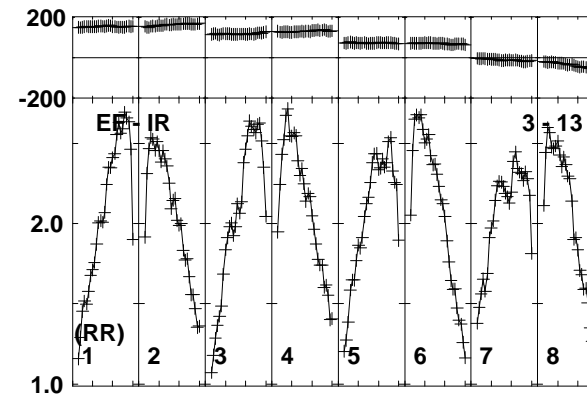
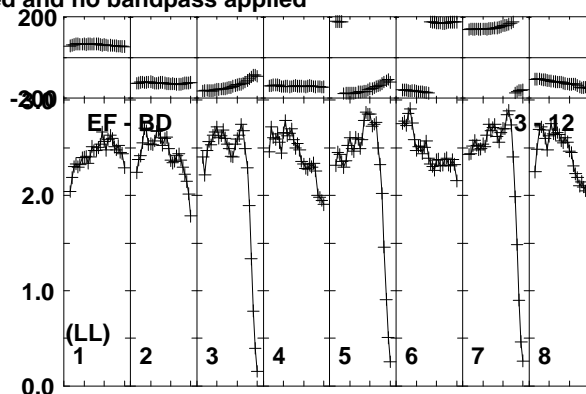
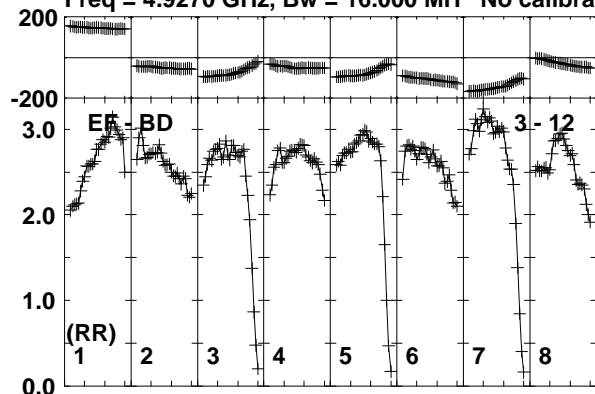

Lower frame: Milli Ampl Jy Top frame: Phas deg
Vector averaged cross-power spectrum Baseline: EF (03) - BD (12)
Timerange: 00/02:12:01 to 00/02:13:19

Plot file version 99 created 17-FEB-2020 15:42:47

J1402+5347 EK047 2.UVDATA.1

Freq = 4.9270 GHz, Bw = 16.000 MH No calibration applied and no bandpass applied

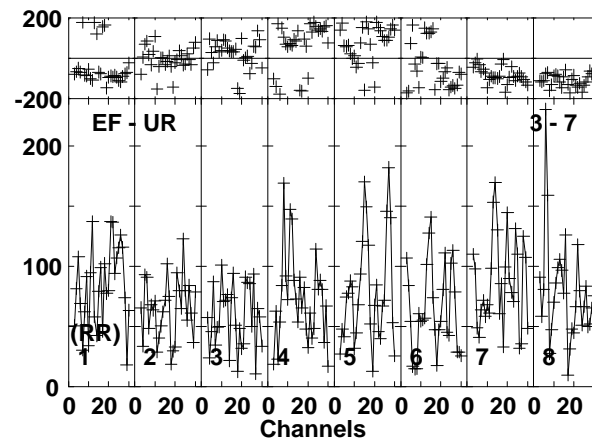
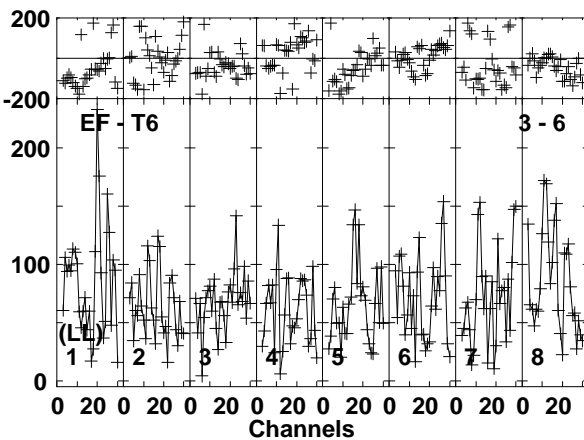
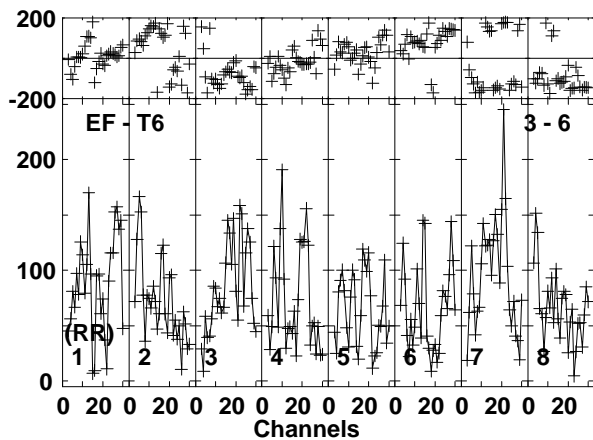
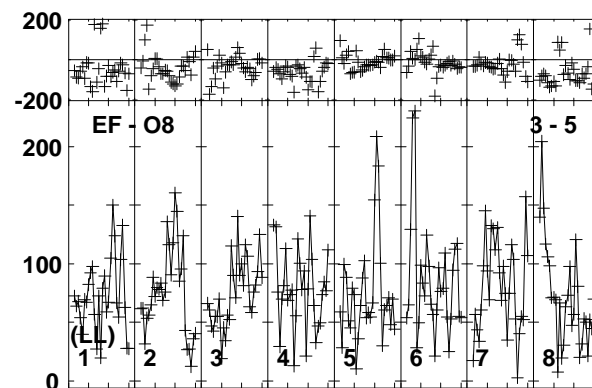
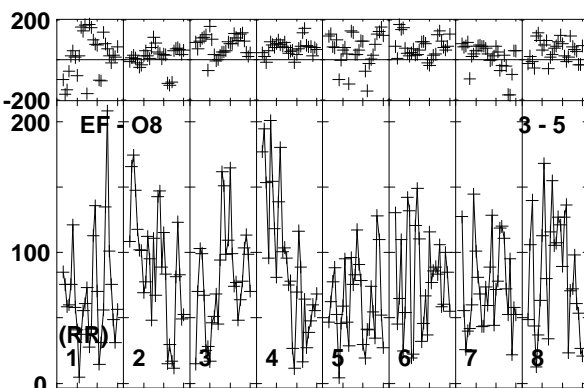
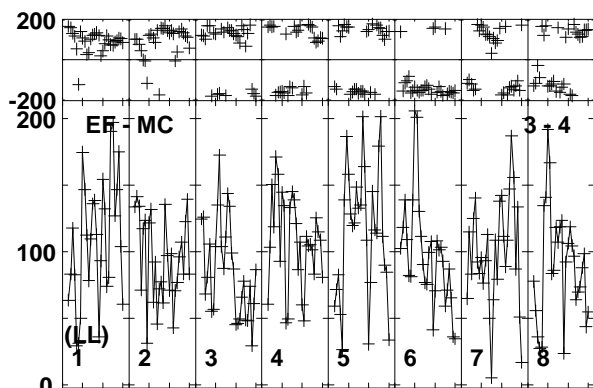
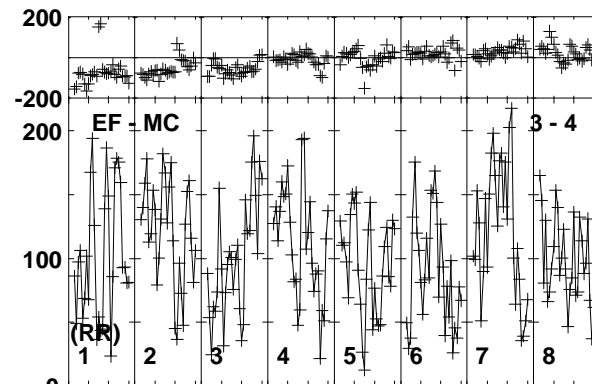
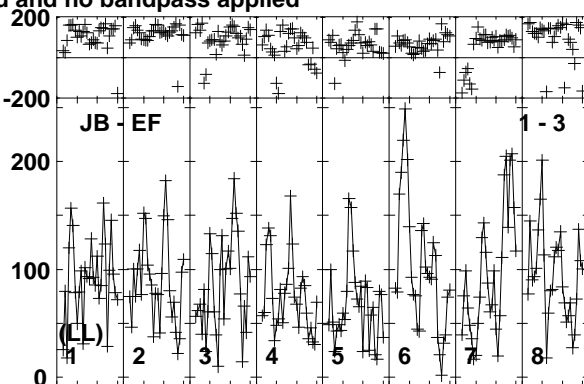
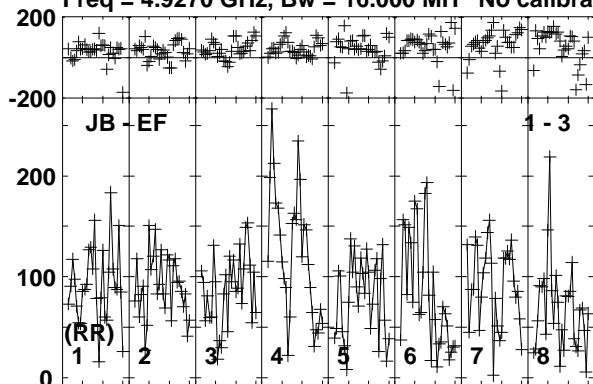

Lower frame: Micro Ampl Jy Top frame: Phas deg
Vector averaged cross-power spectrum Baseline: JB (01) - EF (03)
Timerange: 00/02:13:21 to 00/02:17:19

Plot file version 100 created 17-FEB-2020 15:42:47

J1402+5347 EK047 2.UVDATA.1

Freq = 4.9270 GHz, Bw = 16.000 MH No calibration applied and no bandpass applied

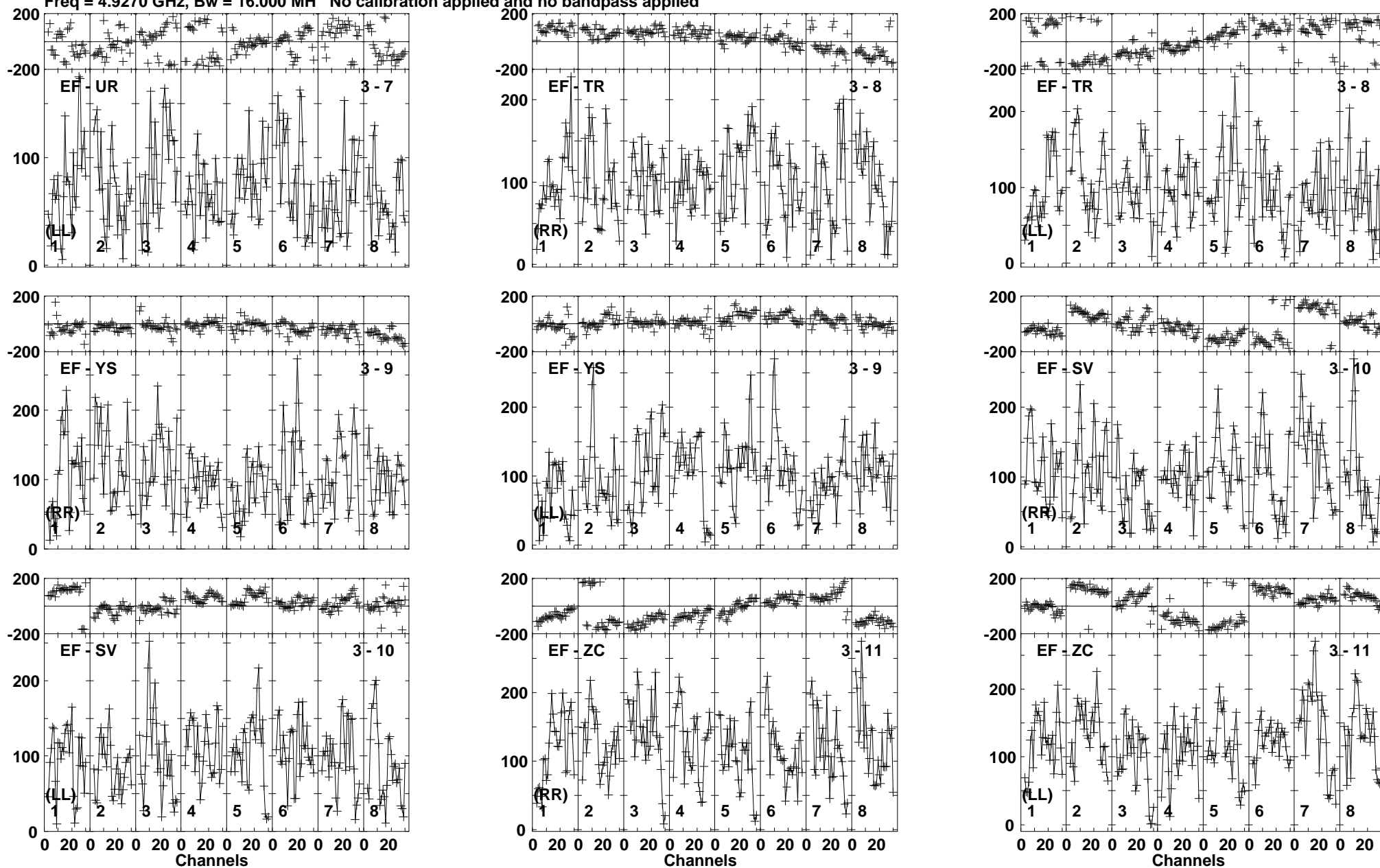

Lower frame: Micro Ampl Jy Top frame: Phas deg
Vector averaged cross-power spectrum Baseline: EF (03) - UR (07)
Timerange: 00/02:13:21 to 00/02:17:19

Plot file version 101 created 17-FEB-2020 15:42:48

J1402+5347 EK047 2.UVDATA.1

Freq = 4.9270 GHz, Bw = 16.000 MH No calibration applied and no bandpass applied

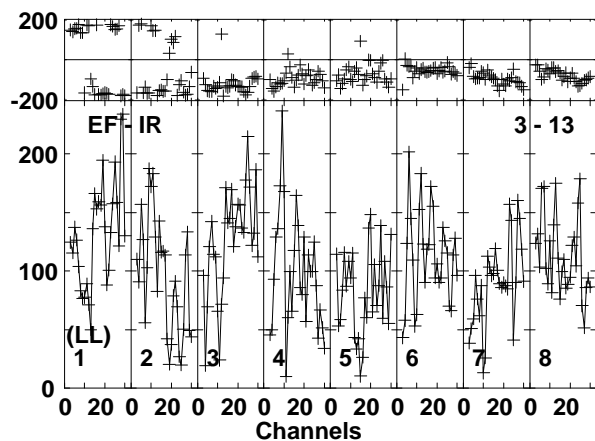
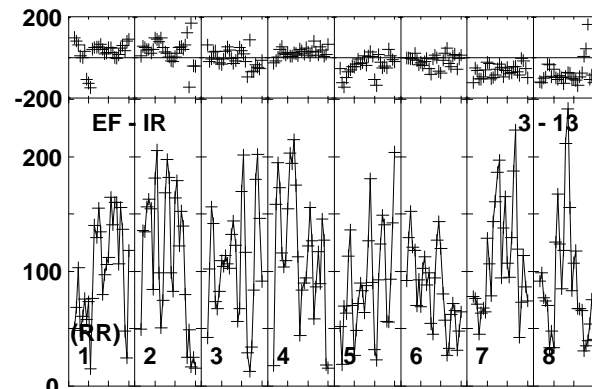
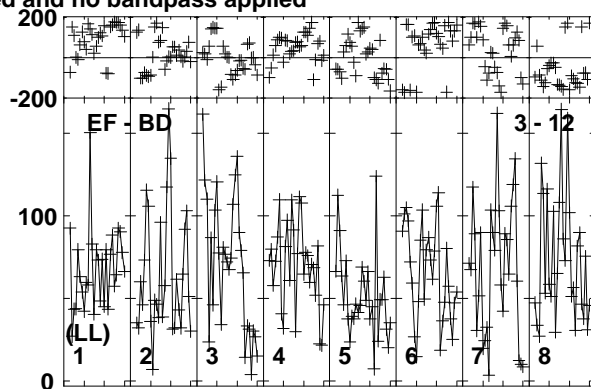
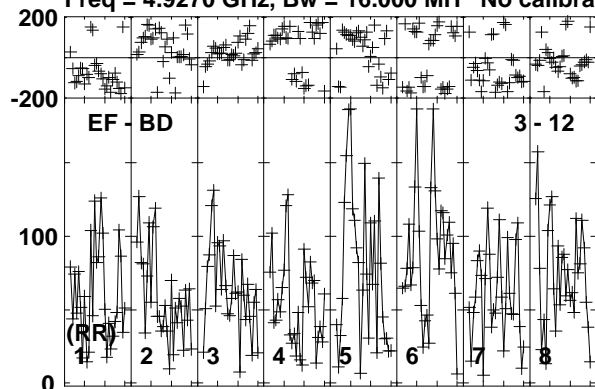

Lower frame: Micro Ampl Jy Top frame: Phas deg
Vector averaged cross-power spectrum Baseline: EF (03) - BD (12)
Timerange: 00/02:13:21 to 00/02:17:19

Plot file version 102 created 17-FEB-2020 15:42:48

J1359+5544 EK047 2.UVDATA.1

Freq = 4.9270 GHz, Bw = 16.000 MH No calibration applied and no bandpass applied

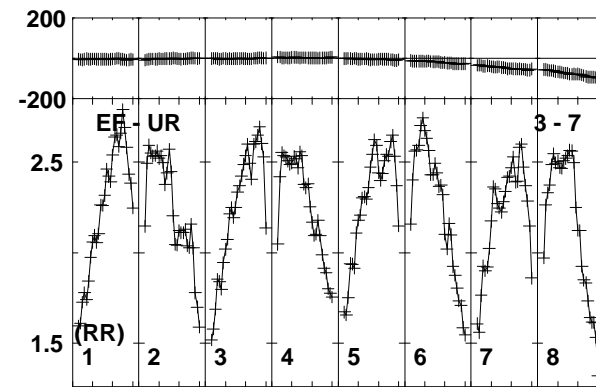
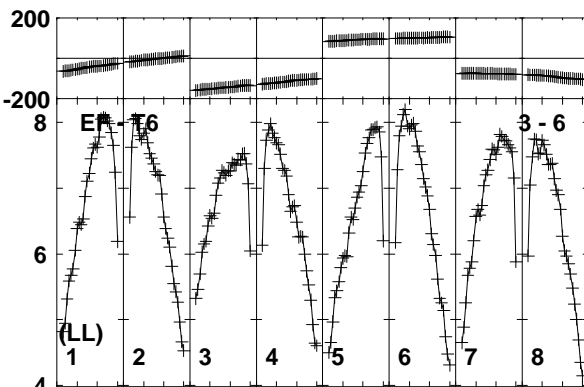
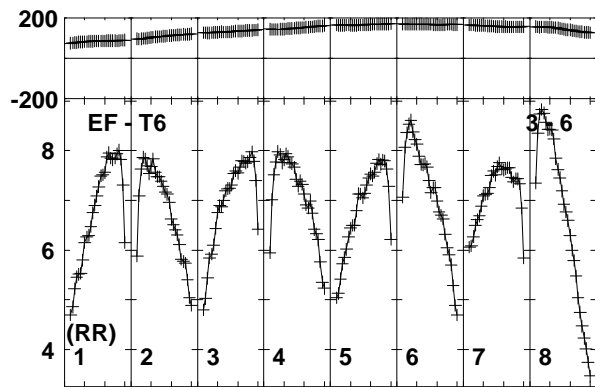
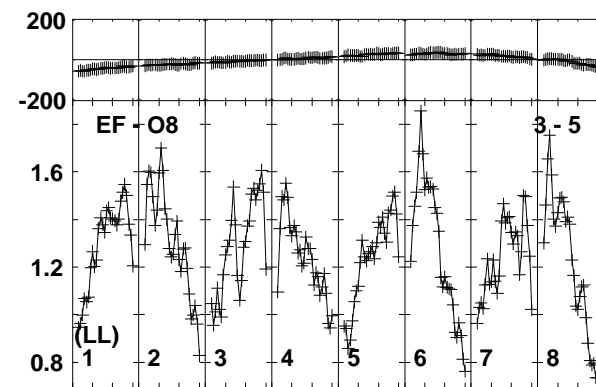
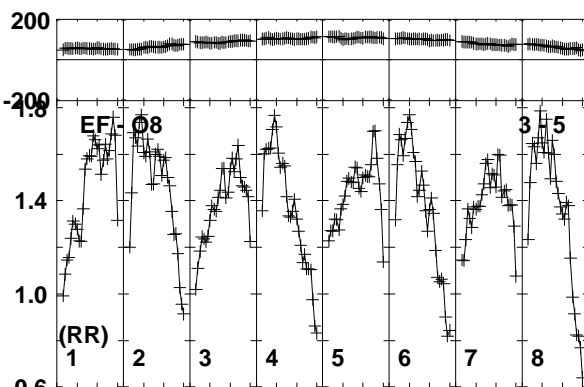
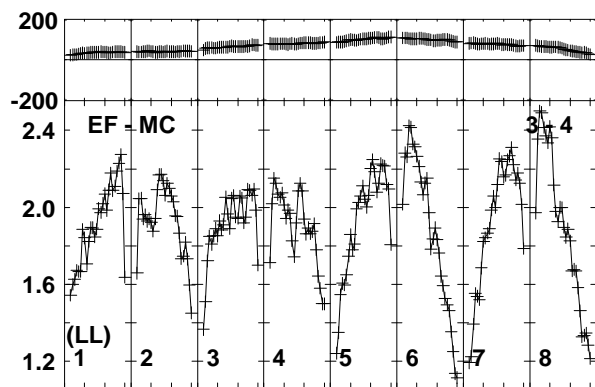
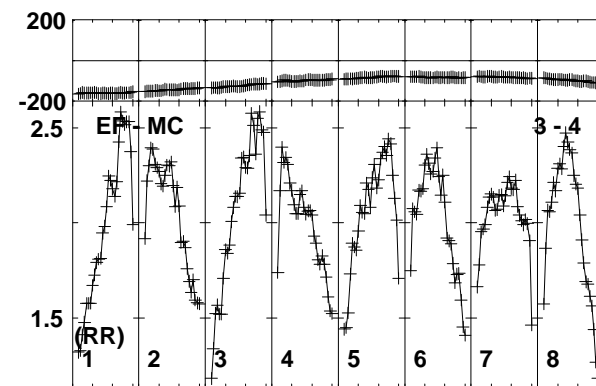
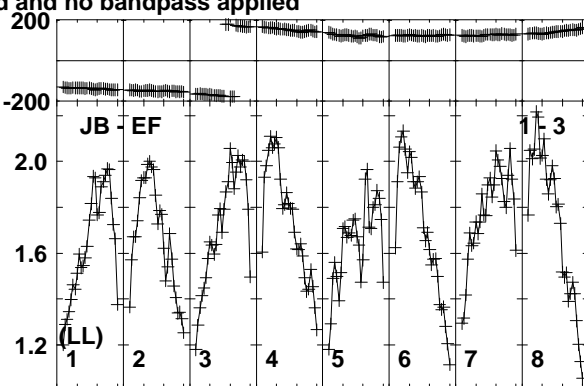
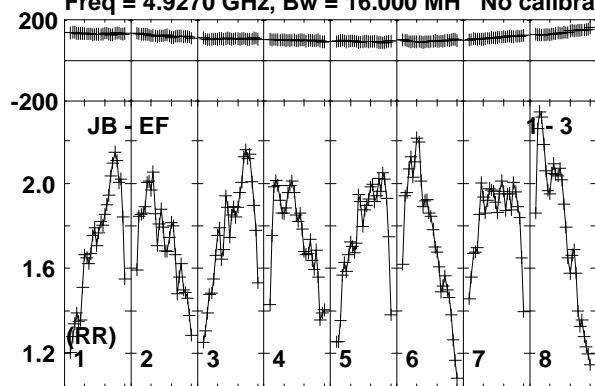

Lower frame: Milli Ampl Jy Top frame: Phas deg
Vector averaged cross-power spectrum Baseline: JB (01) - EF (03)
Timerange: 00/02:17:21 to 00/02:19:19

Plot file version 103 created 17-FEB-2020 15:42:48

J1359+5544 EK047 2.UVDATA.1

Freq = 4.9270 GHz, Bw = 16.000 MH No calibration applied and no bandpass applied

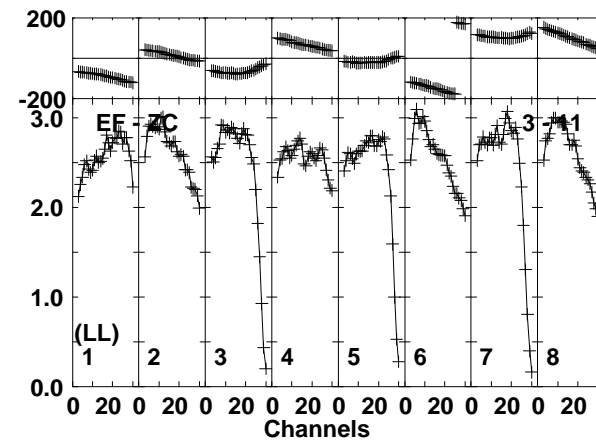
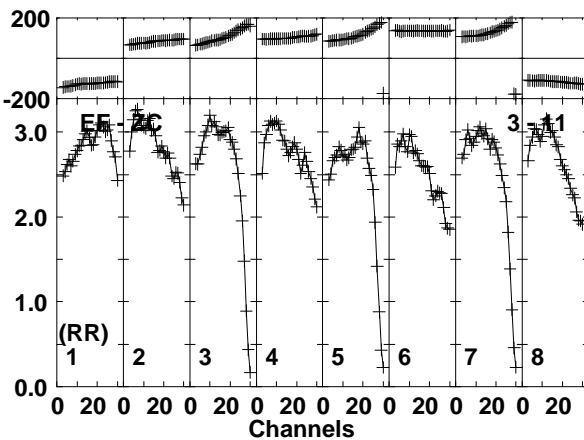
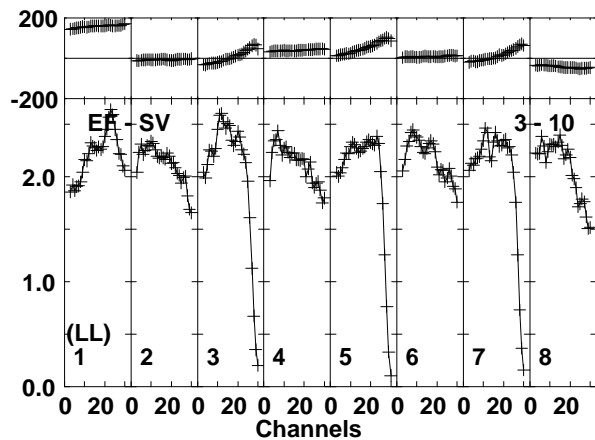
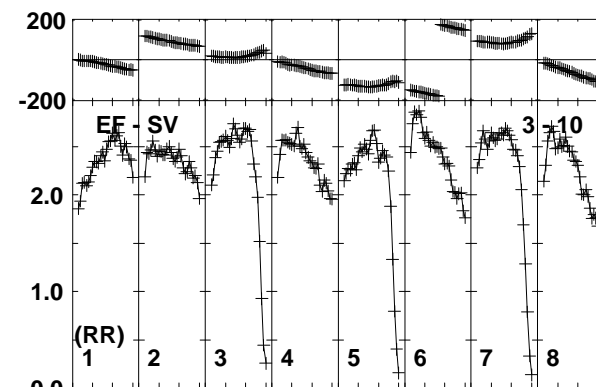
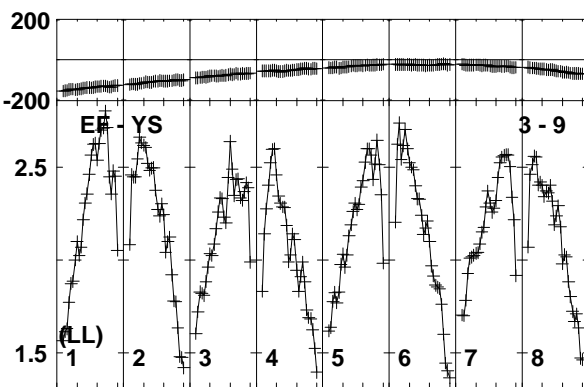
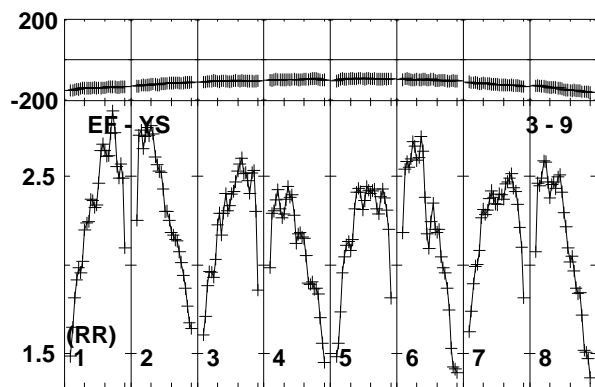
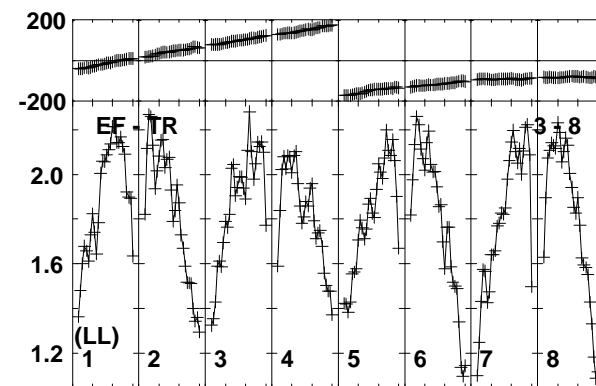
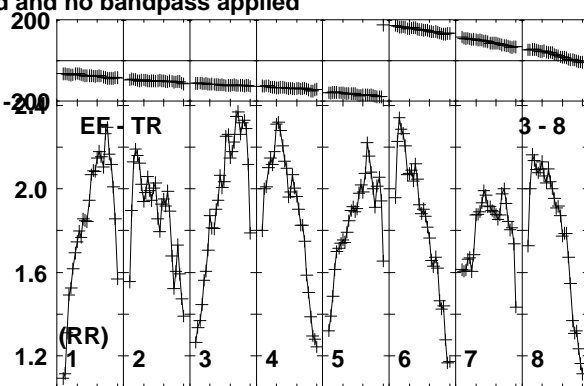
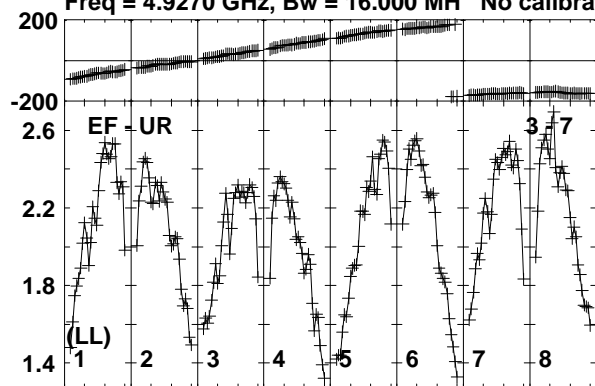

Lower frame: Milli Ampl Jy Top frame: Phas deg
Vector averaged cross-power spectrum Baseline: EF (03) - UR (07)
Timerange: 00/02:17:21 to 00/02:19:19

Plot file version 104 created 17-FEB-2020 15:42:48

J1359+5544 EK047 2.UVDATA.1

Freq = 4.9270 GHz, Bw = 16.000 MH No calibration applied and no bandpass applied

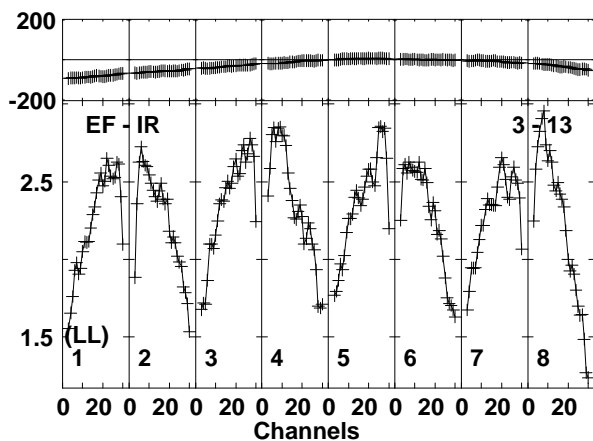
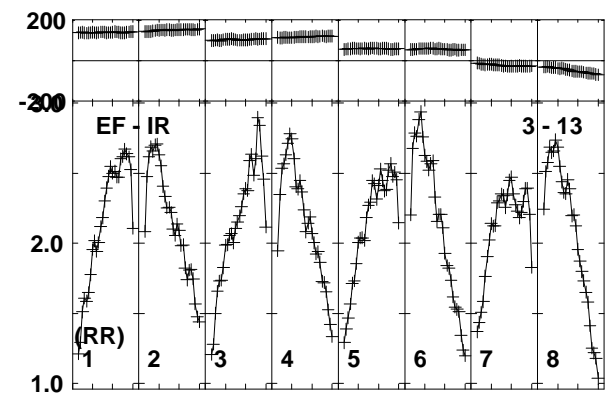
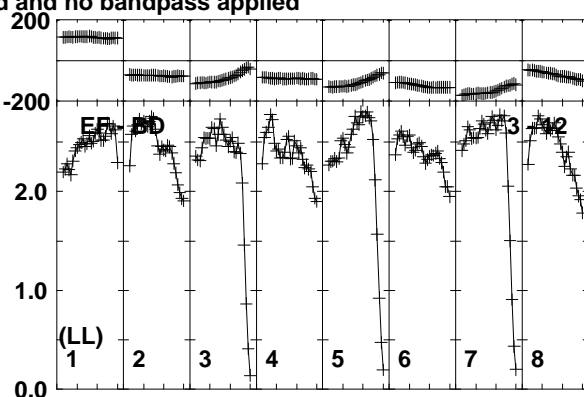
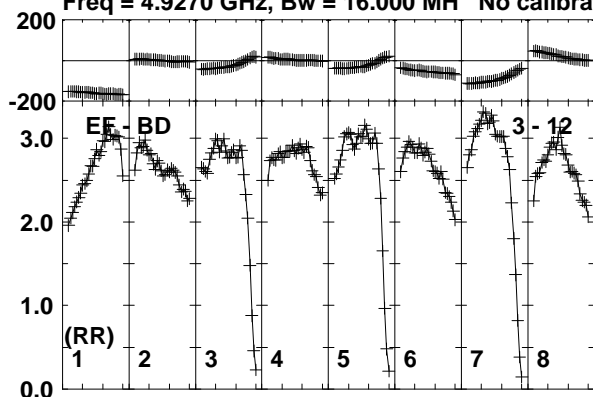

Lower frame: Milli Ampl Jy Top frame: Phas deg
Vector averaged cross-power spectrum Baseline: EF (03) - BD (12)
Timerange: 00/02:17:21 to 00/02:19:19

Plot file version 105 created 17-FEB-2020 15:42:48

J1402+5347 EK047 2.UVDATA.1

Freq = 4.9270 GHz, Bw = 16.000 MH No calibration applied and no bandpass applied

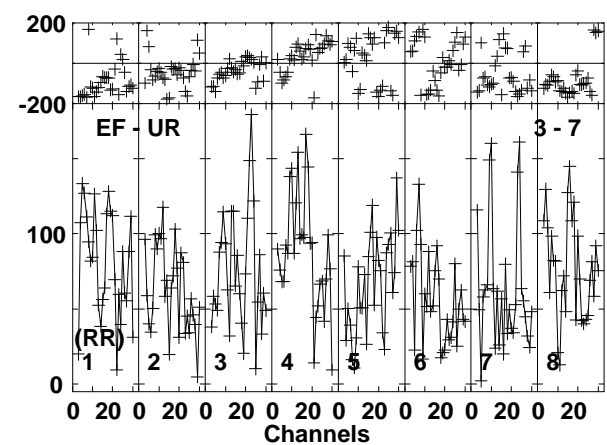
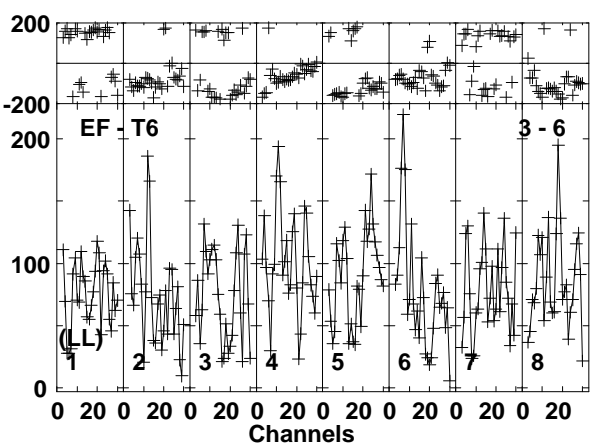
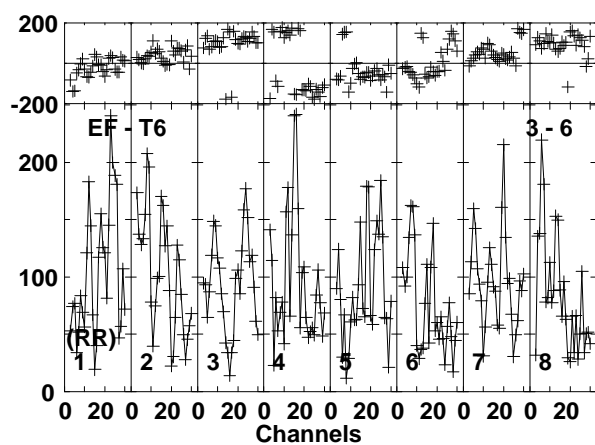
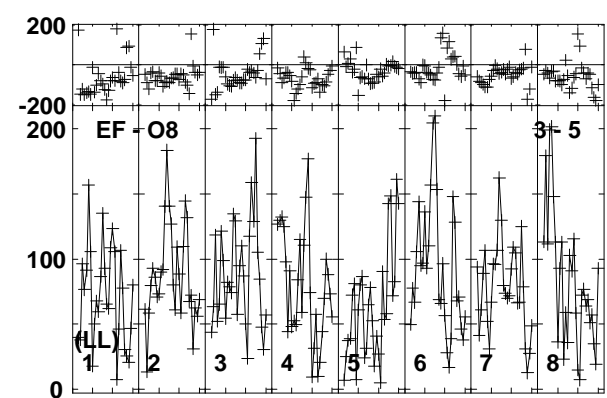
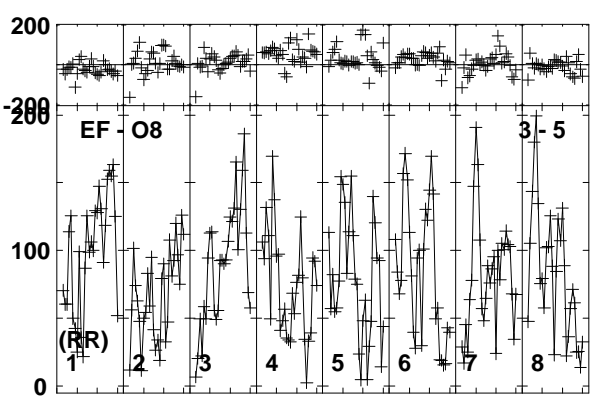
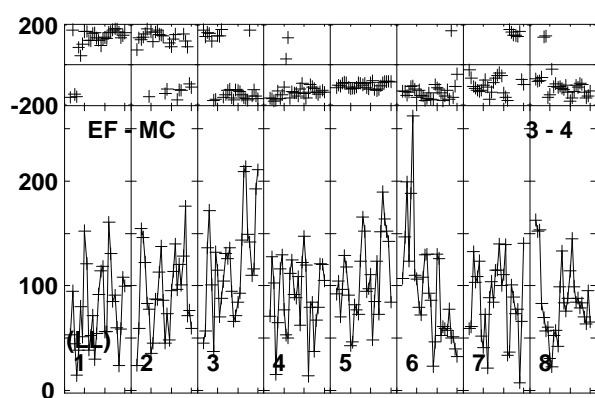
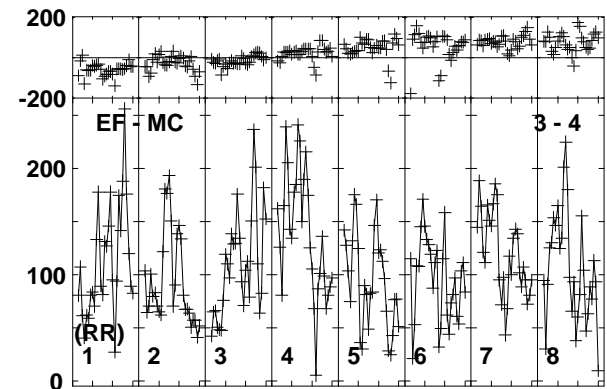
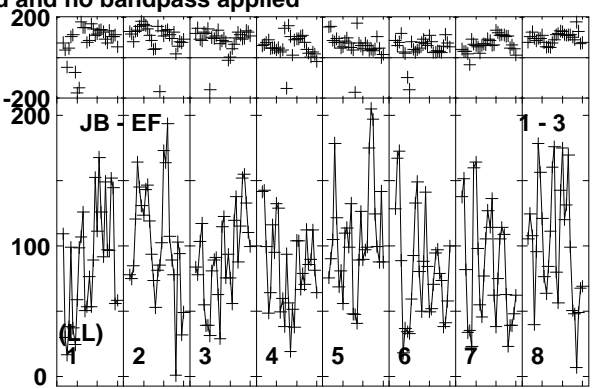
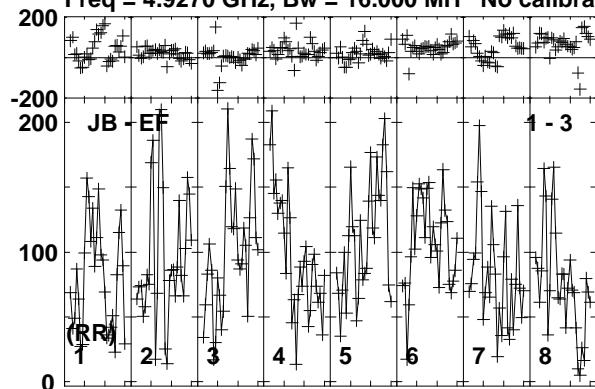

Lower frame: Micro Ampl Jy Top frame: Phas deg
Vector averaged cross-power spectrum Baseline: JB (01) - EF (03)
Timerange: 00/02:19:23 to 00/02:23:19

Plot file version 106 created 17-FEB-2020 15:42:48

J1402+5347 EK047 2.UVDATA.1

Freq = 4.9270 GHz, Bw = 16.000 MH No calibration applied and no bandpass applied

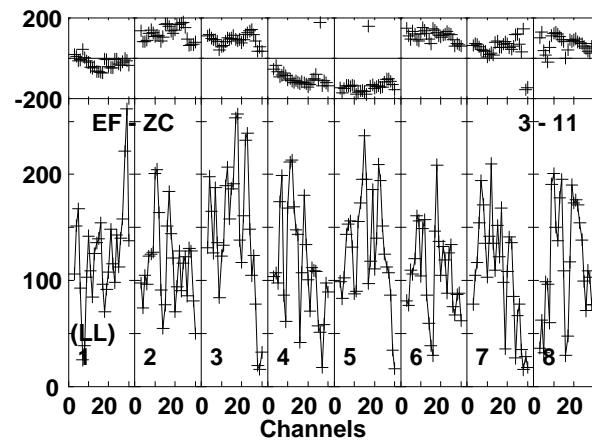
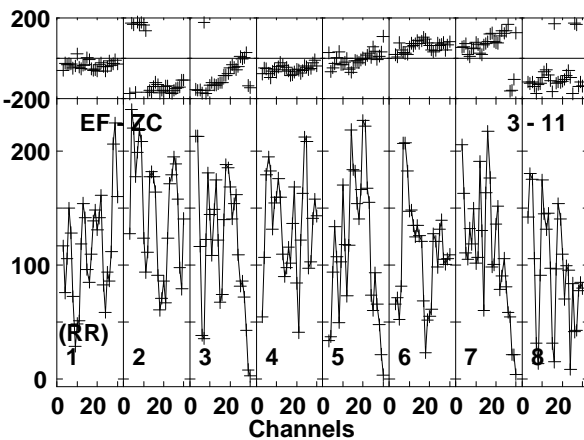
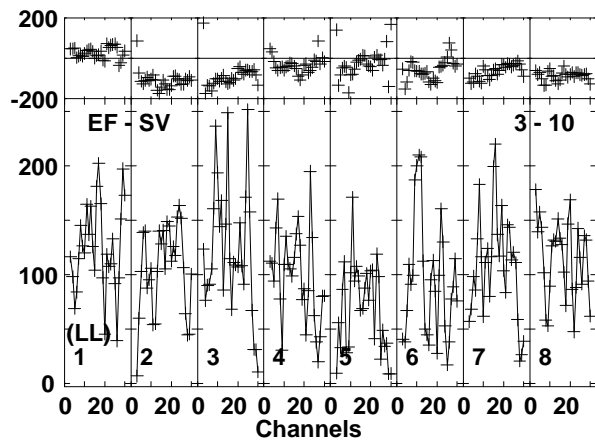
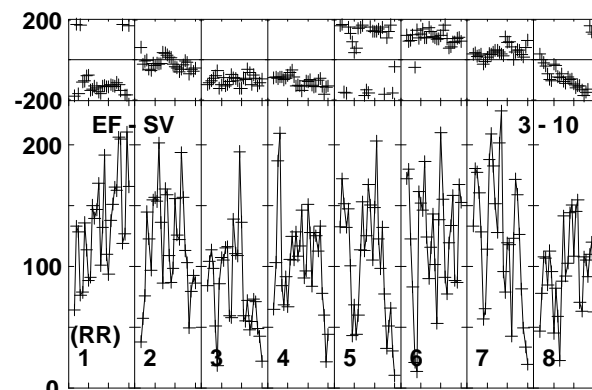
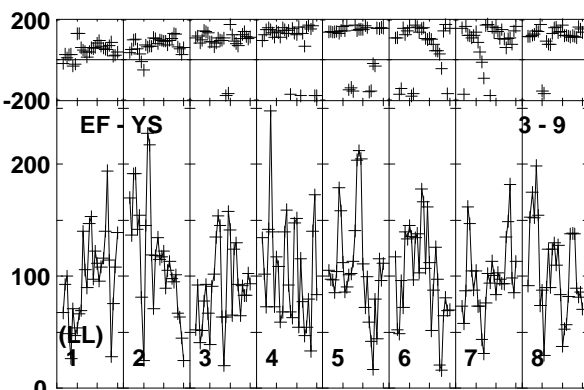
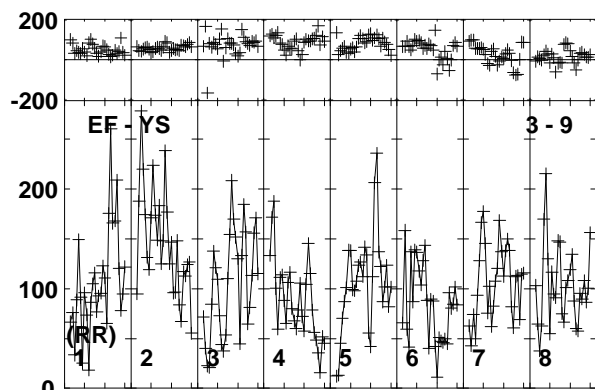
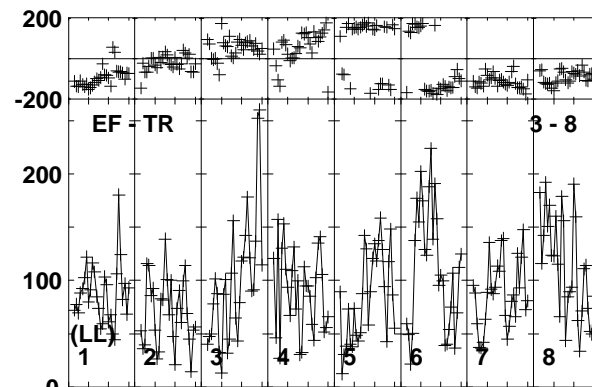
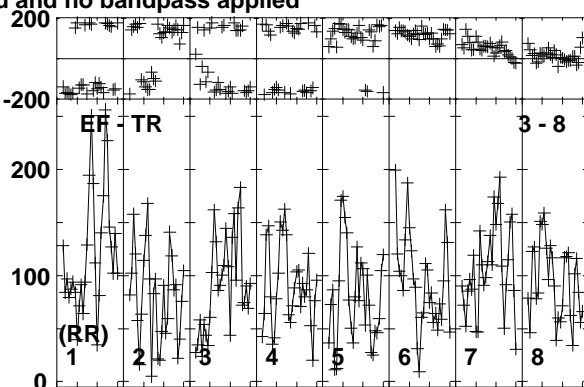
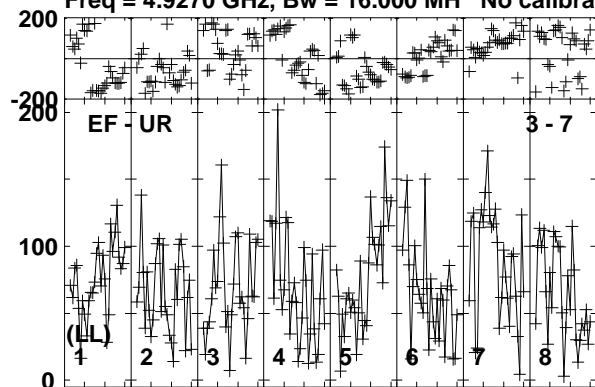

Lower frame: Micro Ampl Jy Top frame: Phas deg
Vector averaged cross-power spectrum Baseline: EF (03) - UR (07)
Timerange: 00/02:19:23 to 00/02:23:19

Plot file version 107 created 17-FEB-2020 15:42:48

J1402+5347 EK047 2.UVDATA.1

Freq = 4.9270 GHz, Bw = 16.000 MH No calibration applied and no bandpass applied

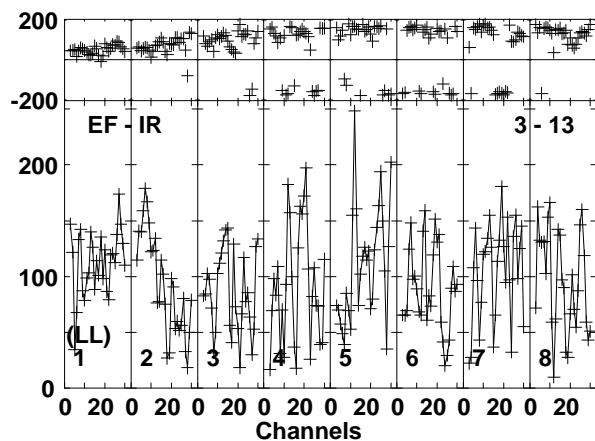
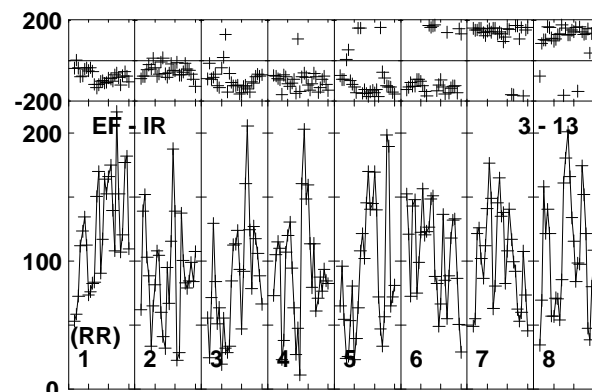
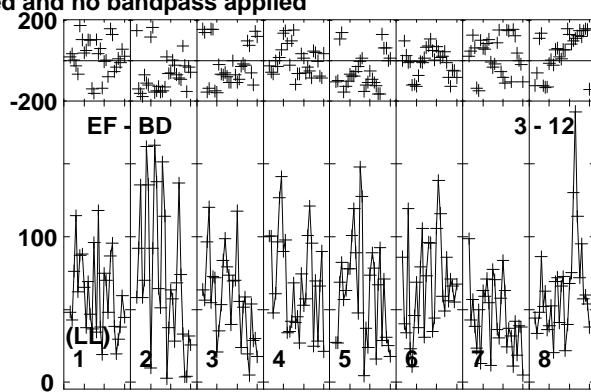
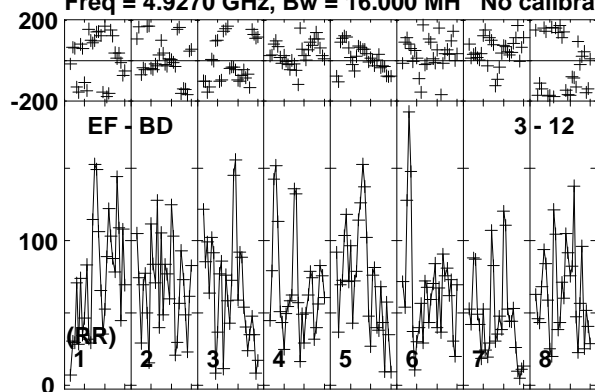

Lower frame: Micro Ampl Jy Top frame: Phas deg
Vector averaged cross-power spectrum Baseline: EF (03) - BD (12)
Timerange: 00/02:19:23 to 00/02:23:19

Plot file version 108 created 17-FEB-2020 15:42:48

J1359+5544 EK047 2.UVDATA.1

Freq = 4.9270 GHz, Bw = 16.000 MH No calibration applied and no bandpass applied

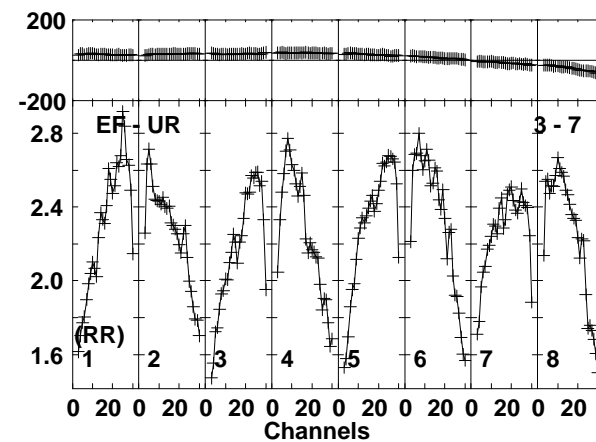
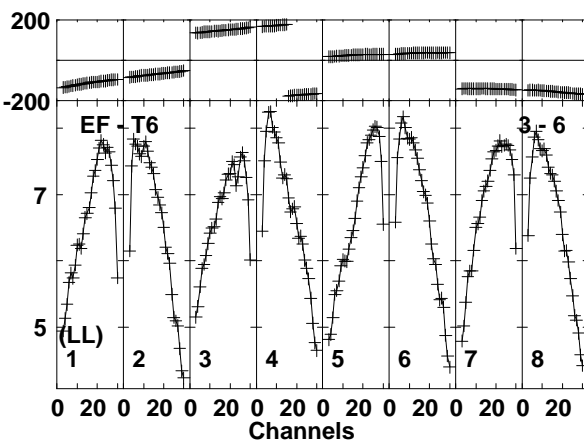
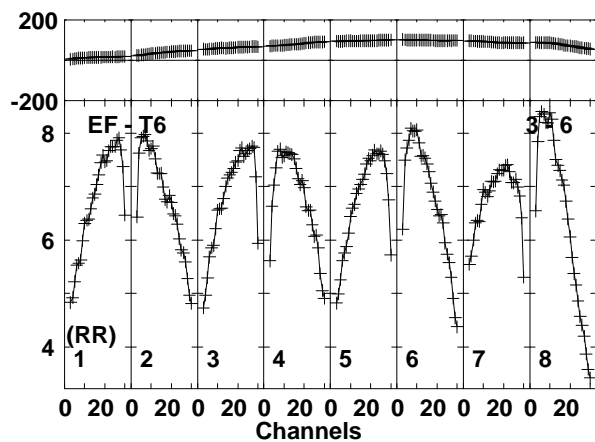
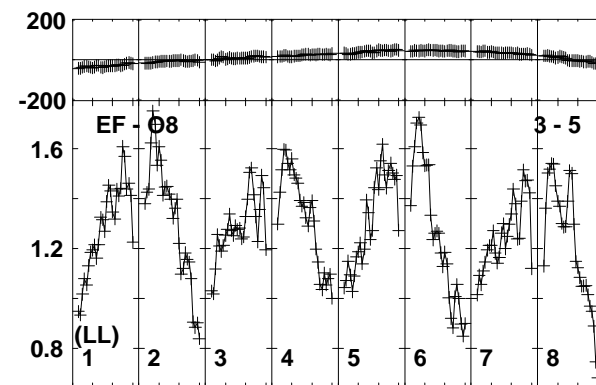
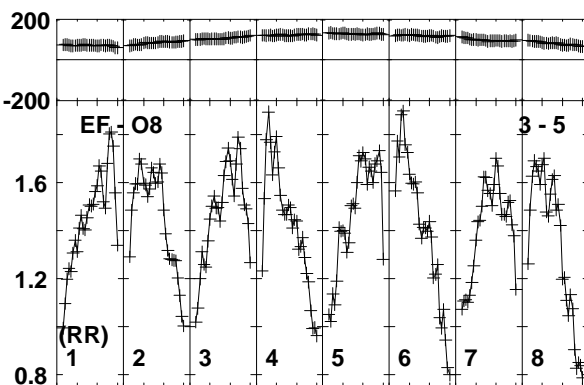
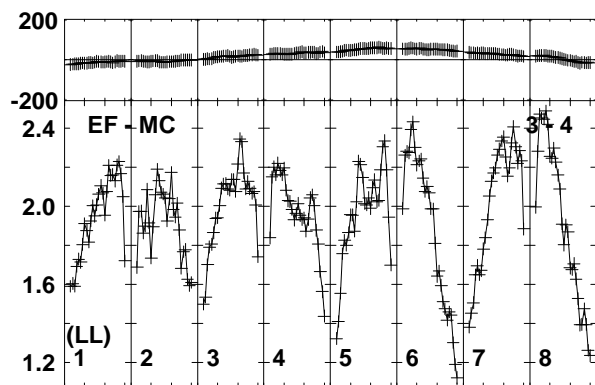
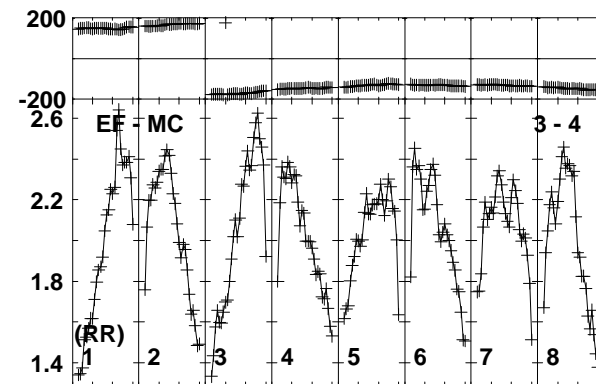
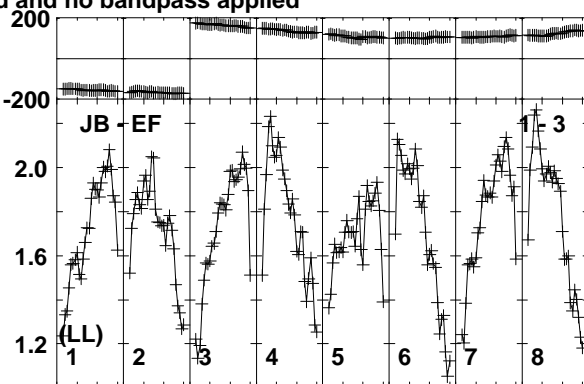
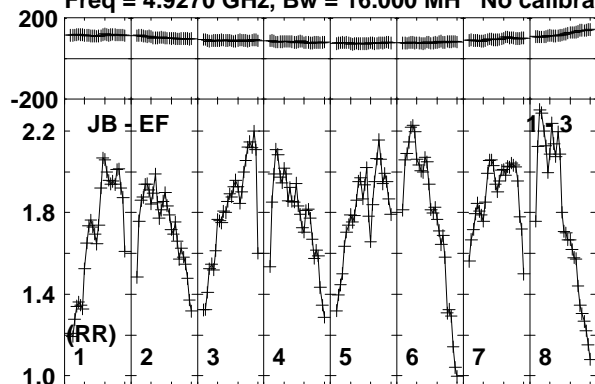

Lower frame: Milli Ampl Jy Top frame: Phas deg
Vector averaged cross-power spectrum Baseline: JB (01) - EF (03)
Timerange: 00/02:24:01 to 00/02:25:19

Plot file version 109 created 17-FEB-2020 15:42:48

J1359+5544 EK047 2.UVDATA.1

Freq = 4.9270 GHz, Bw = 16.000 MH No calibration applied and no bandpass applied

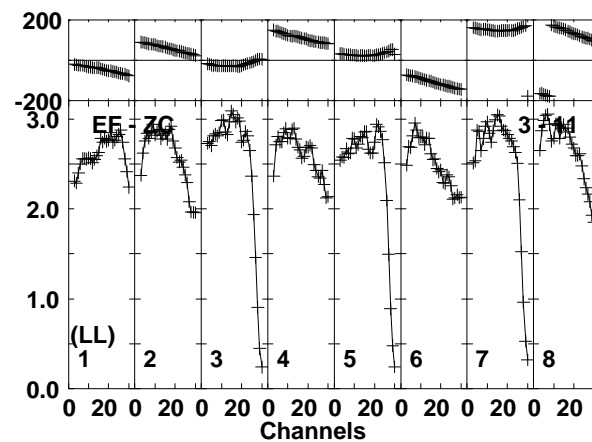
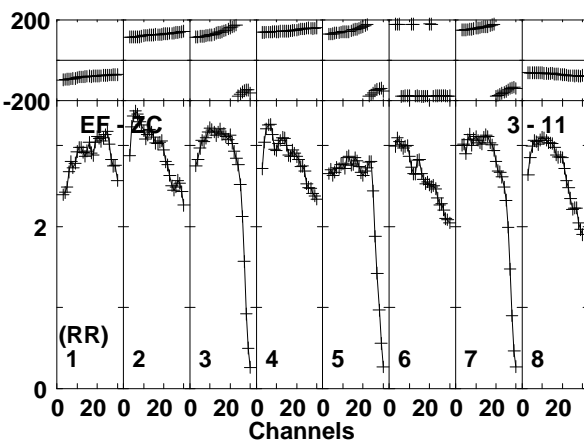
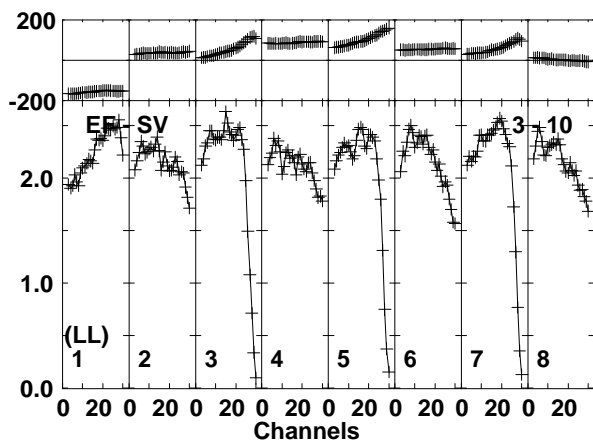
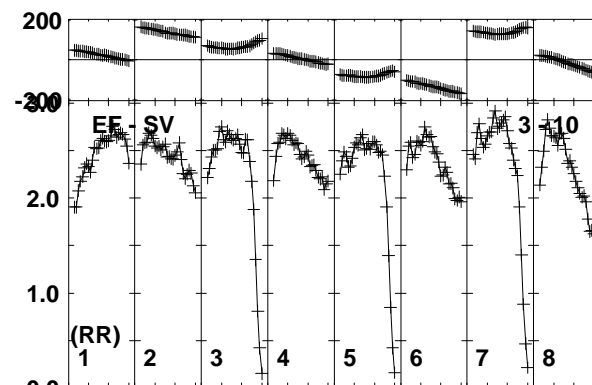
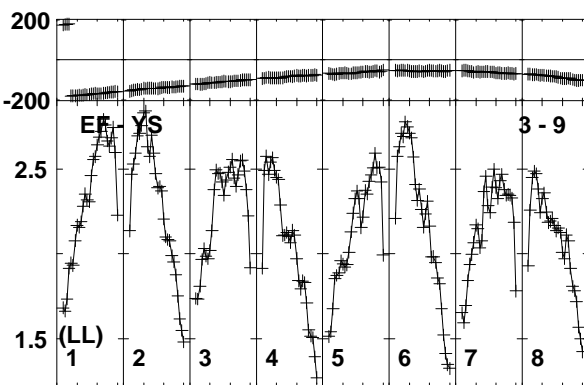
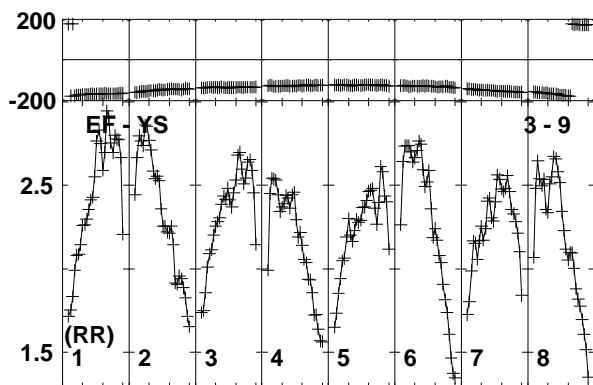
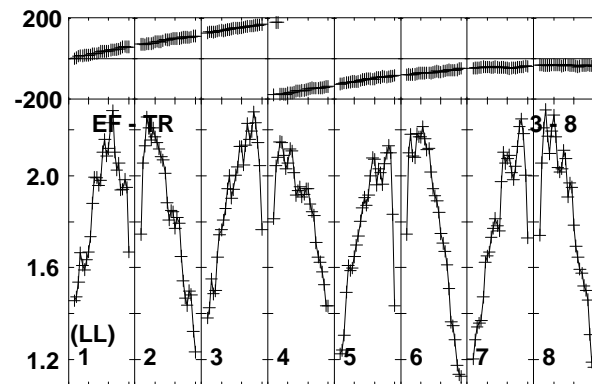
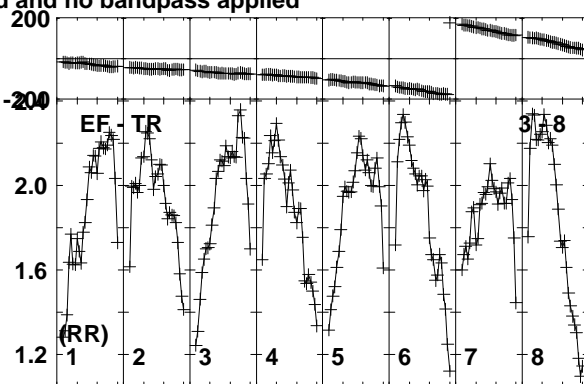
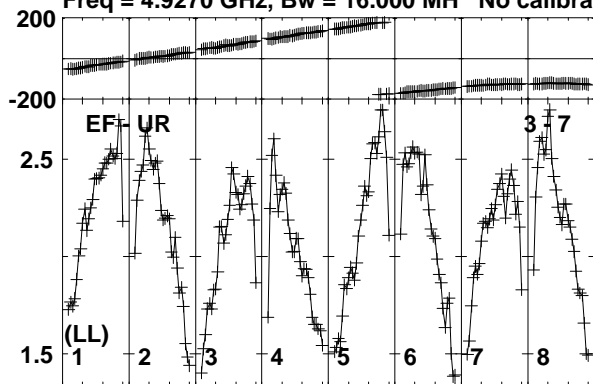

Lower frame: Milli Ampl Jy Top frame: Phas deg
Vector averaged cross-power spectrum Baseline: EF (03) - UR (07)
Timerange: 00/02:24:01 to 00/02:25:19

Plot file version 110 created 17-FEB-2020 15:42:48

J1359+5544 EK047 2.UVDATA.1

Freq = 4.9270 GHz, Bw = 16.000 MH No calibration applied and no bandpass applied

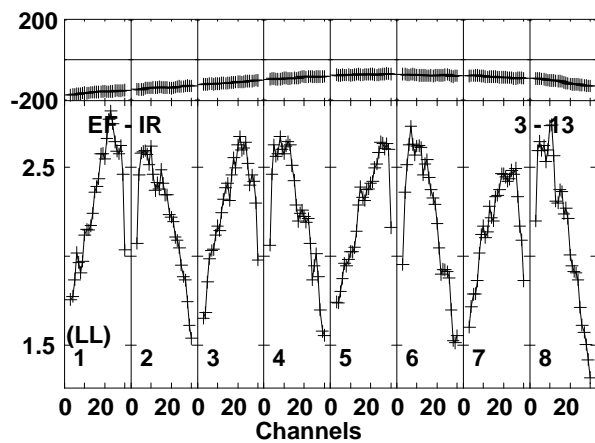
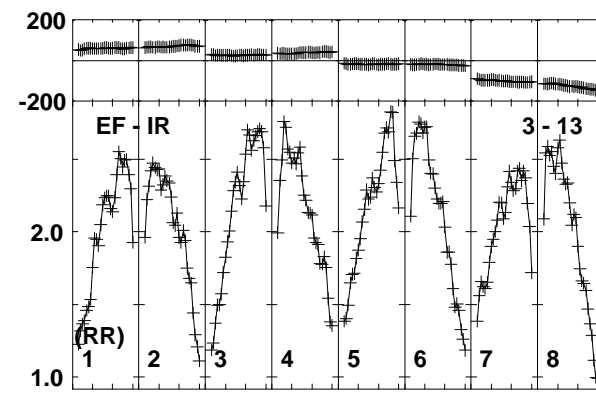
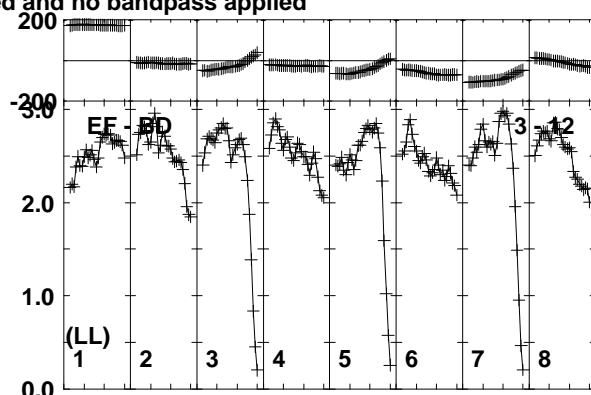
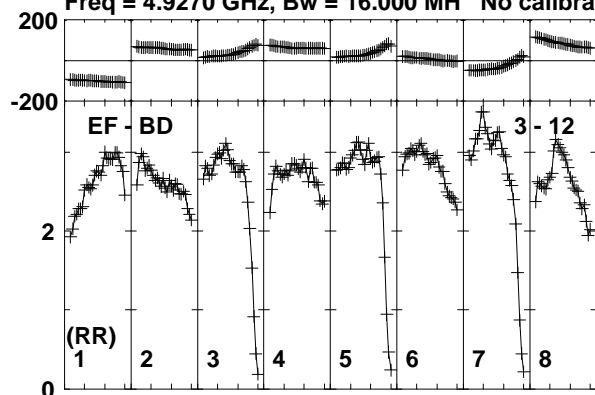

Lower frame: Milli Ampl Jy Top frame: Phas deg
Vector averaged cross-power spectrum Baseline: EF (03) - BD (12)
Timerange: 00/02:24:01 to 00/02:25:19

Plot file version 111 created 17-FEB-2020 15:42:48

J1402+5347 EK047 2.UVDATA.1

Freq = 4.9270 GHz, Bw = 16.000 MH No calibration applied and no bandpass applied

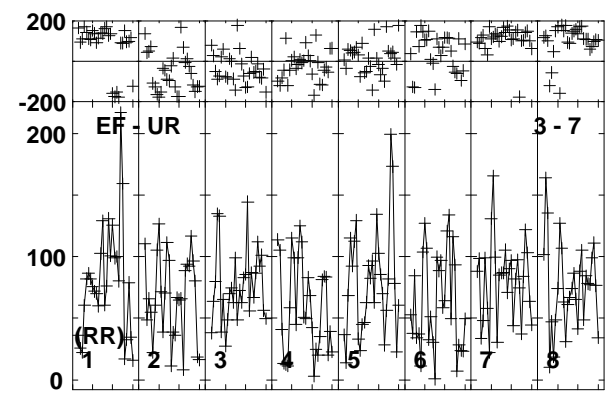
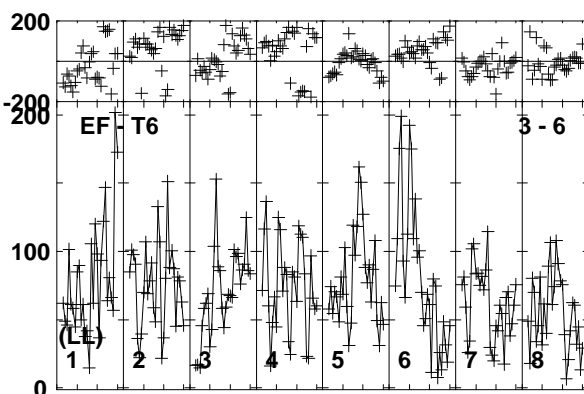
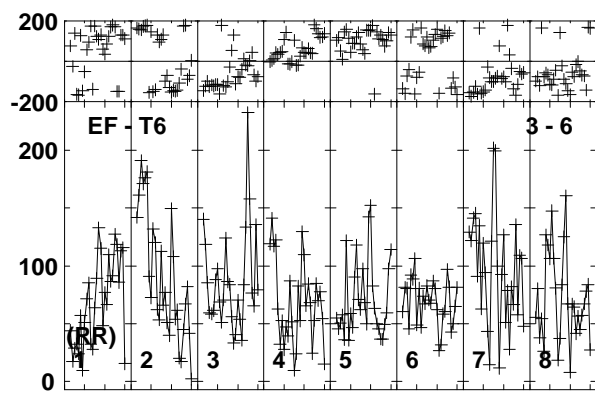
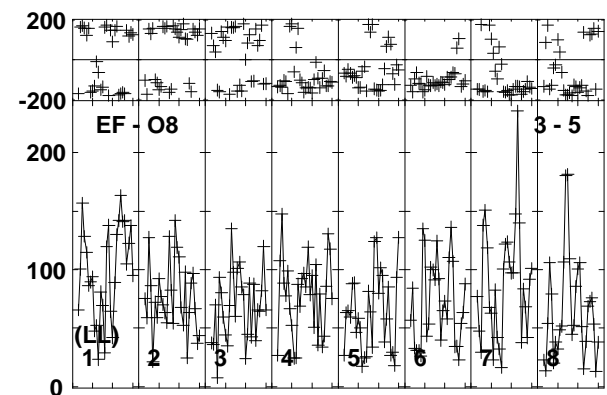
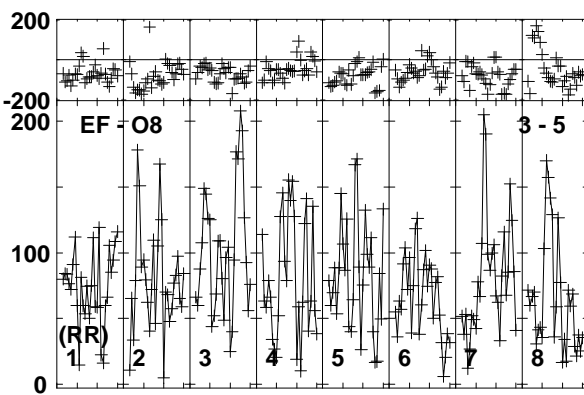
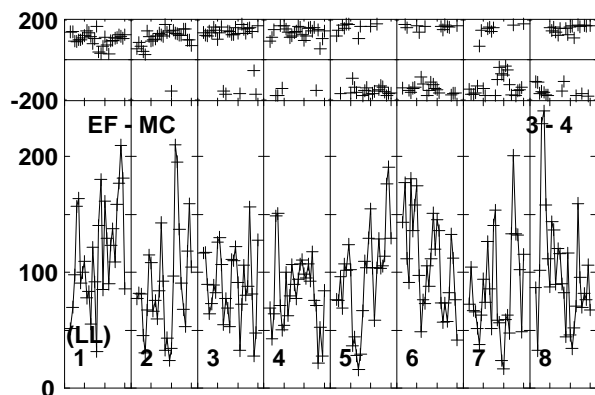
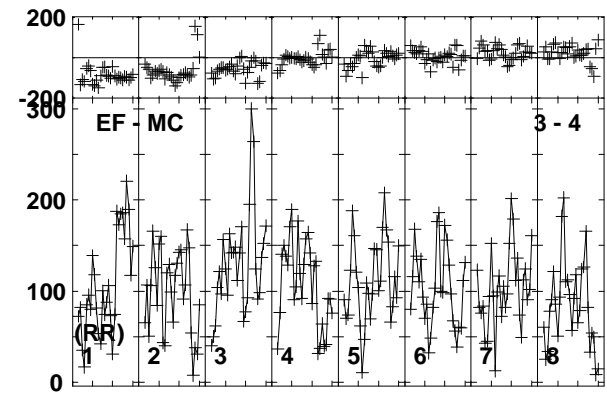
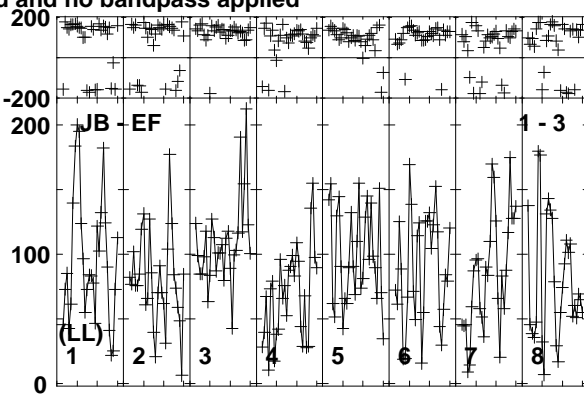
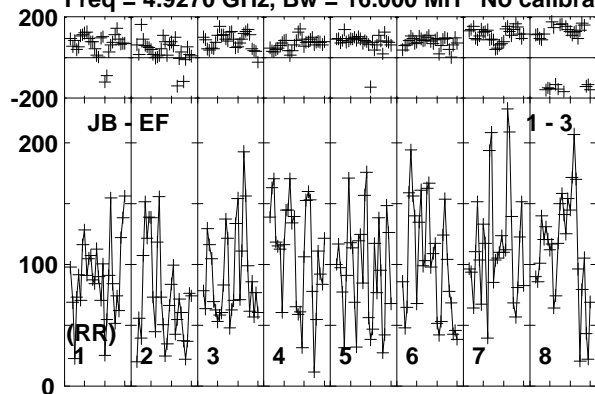

Lower frame: Micro Ampl Jy Top frame: Phas deg
Vector averaged cross-power spectrum Baseline: JB (01) - EF (03)
Timerange: 00/02:25:21 to 00/02:29:19

Plot file version 112 created 17-FEB-2020 15:42:49

J1402+5347 EK047 2.UVDATA.1

Freq = 4.9270 GHz, Bw = 16.000 MH No calibration applied and no bandpass applied

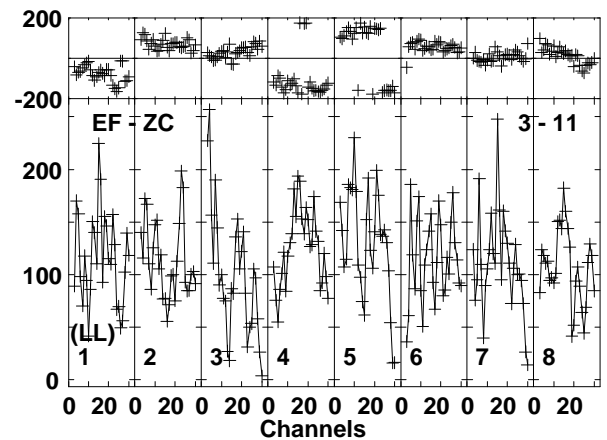
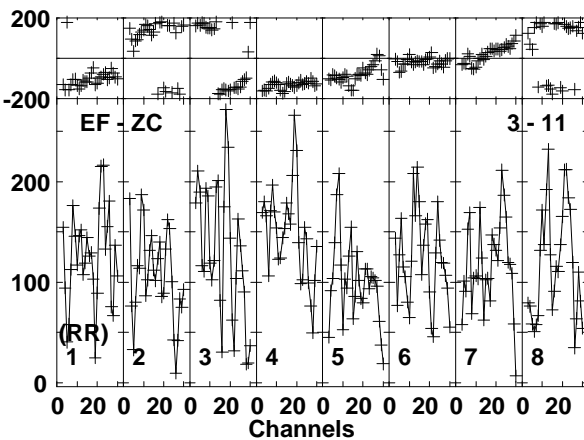
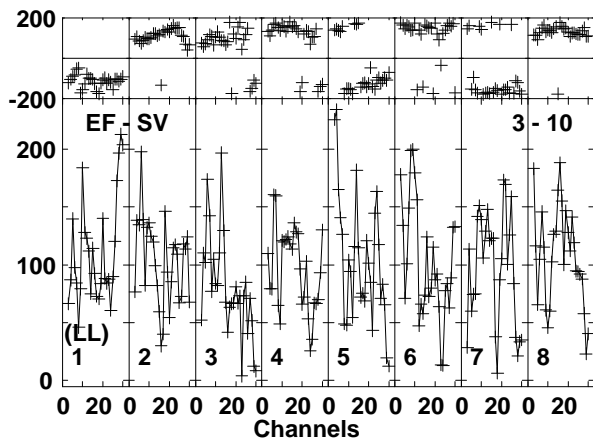
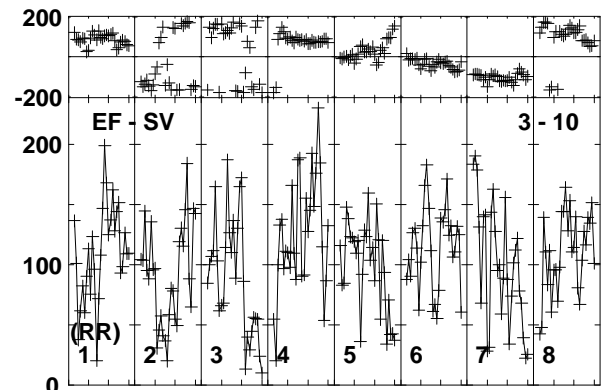
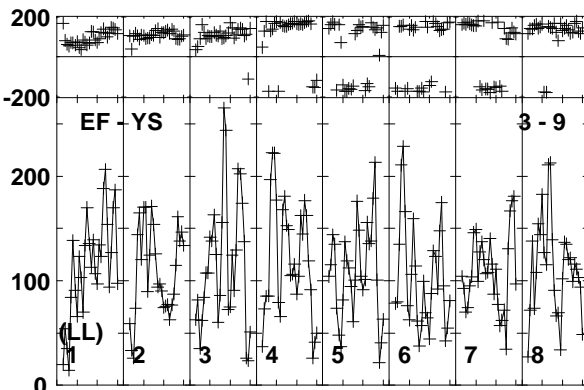
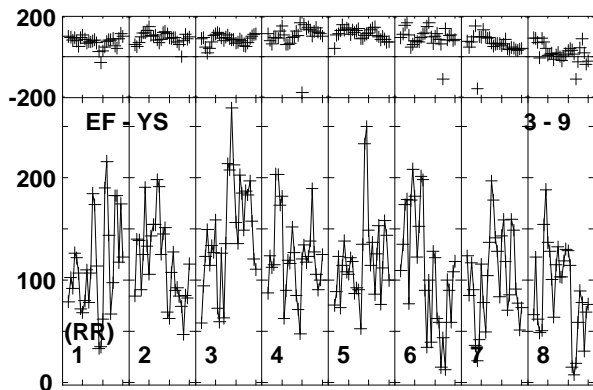
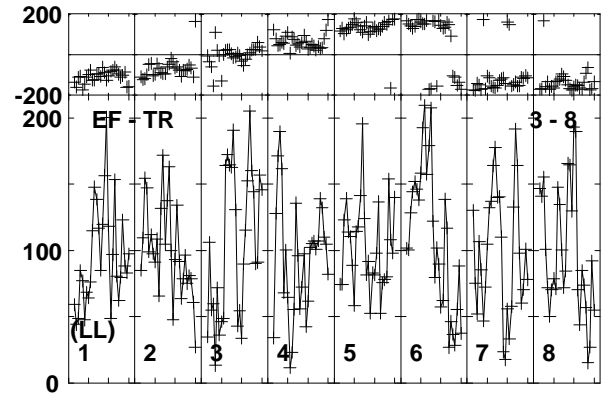
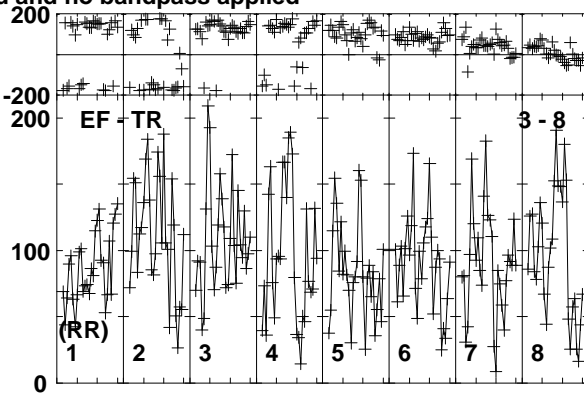
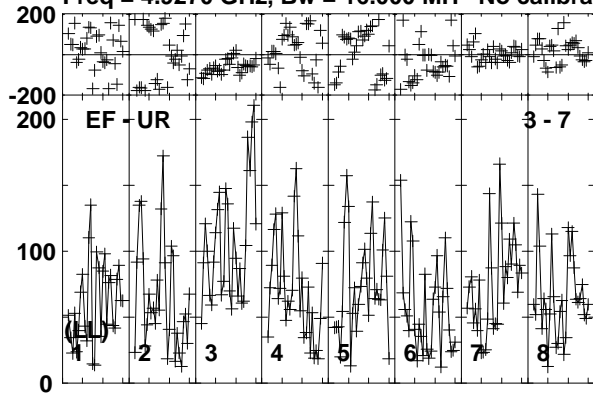

Lower frame: Micro Ampl Jy Top frame: Phas deg
Vector averaged cross-power spectrum Baseline: EF (03) - UR (07)
Timerange: 00/02:25:21 to 00/02:29:19

Plot file version 113 created 17-FEB-2020 15:42:49

J1402+5347 EK047 2.UVDATA.1

Freq = 4.9270 GHz, Bw = 16.000 MH No calibration applied and no bandpass applied

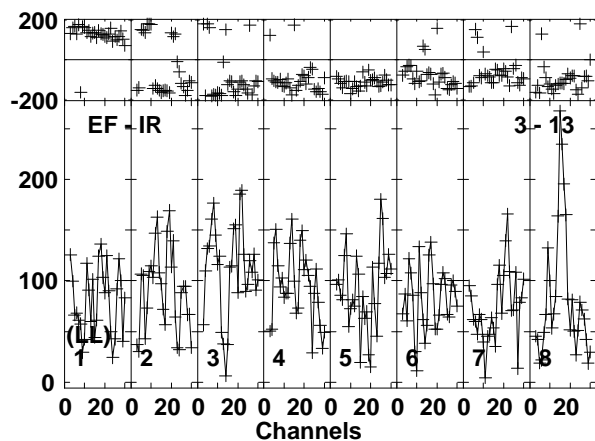
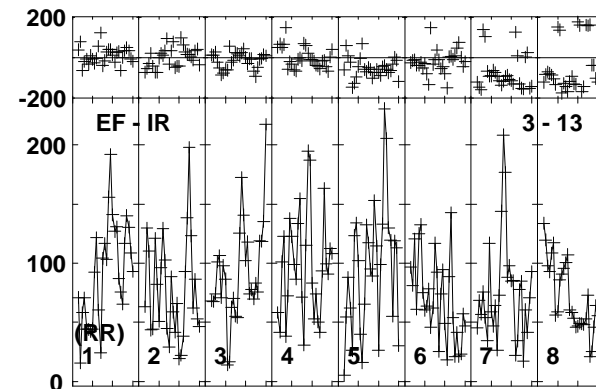
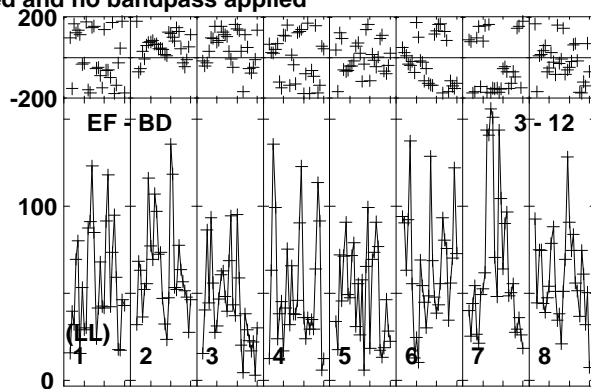
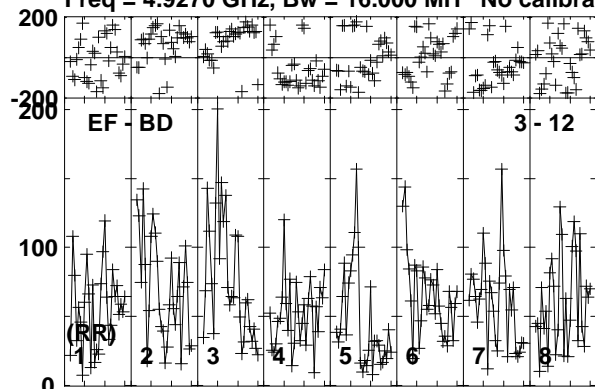

Lower frame: Micro Ampl Jy Top frame: Phas deg
Vector averaged cross-power spectrum Baseline: EF (03) - BD (12)
Timerange: 00/02:25:21 to 00/02:29:19

Plot file version 114 created 17-FEB-2020 15:42:49

J1359+5544 EK047 2.UVDATA.1

Freq = 4.9270 GHz, Bw = 16.000 MH No calibration applied and no bandpass applied

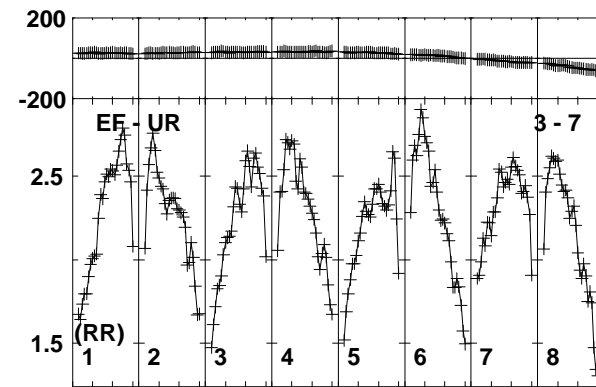
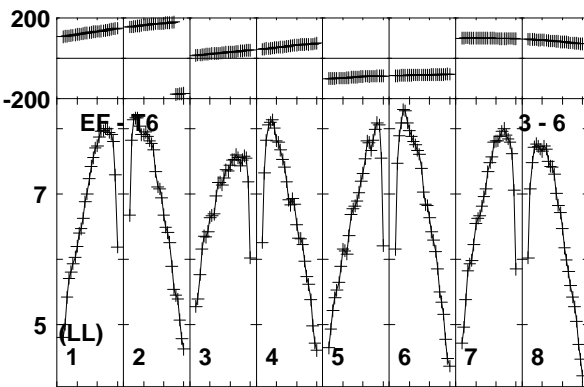
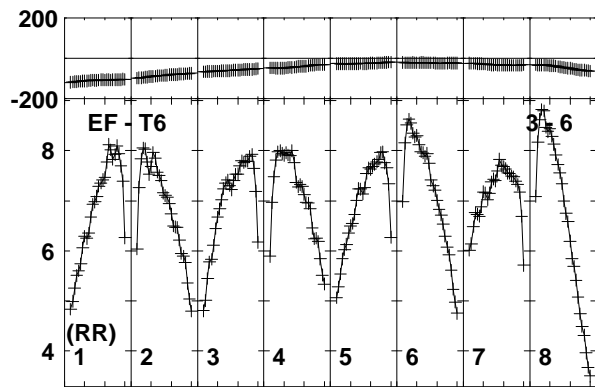
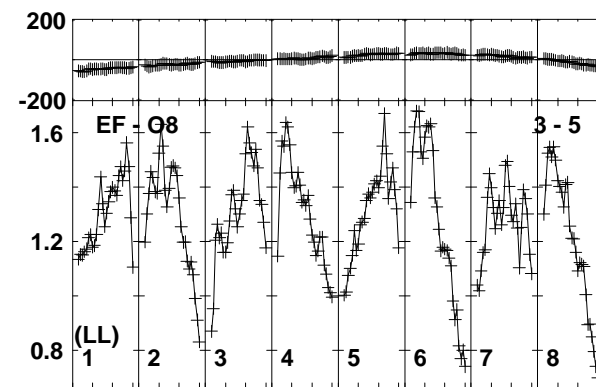
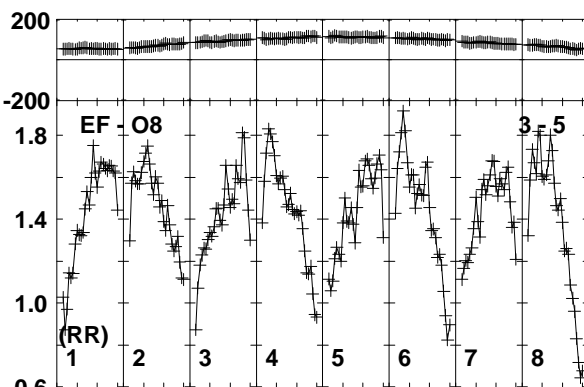
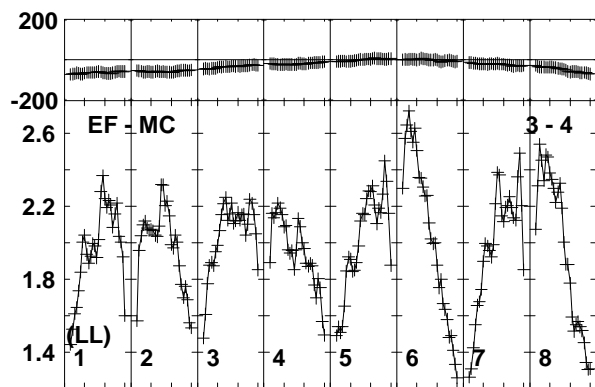
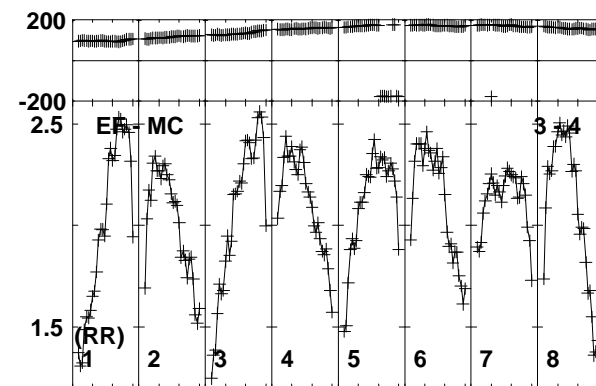
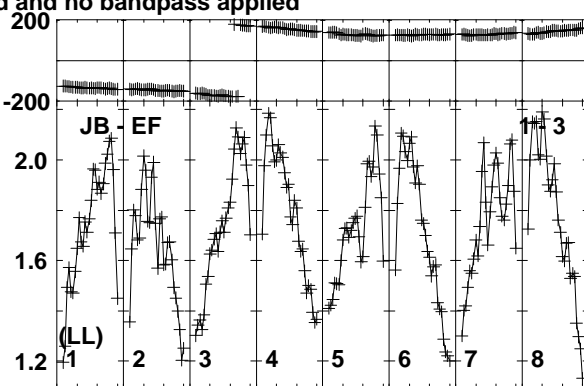
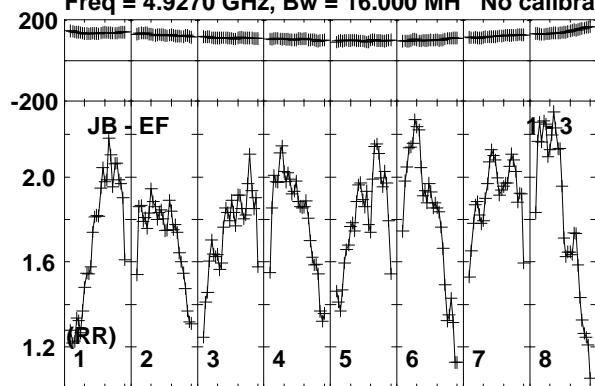

Lower frame: Milli Ampl Jy Top frame: Phas deg
Vector averaged cross-power spectrum Baseline: JB (01) - EF (03)
Timerange: 00/02:29:21 to 00/02:31:19

Plot file version 115 created 17-FEB-2020 15:42:49

J1359+5544 EK047 2.UVDATA.1

Freq = 4.9270 GHz, Bw = 16.000 MH No calibration applied and no bandpass applied

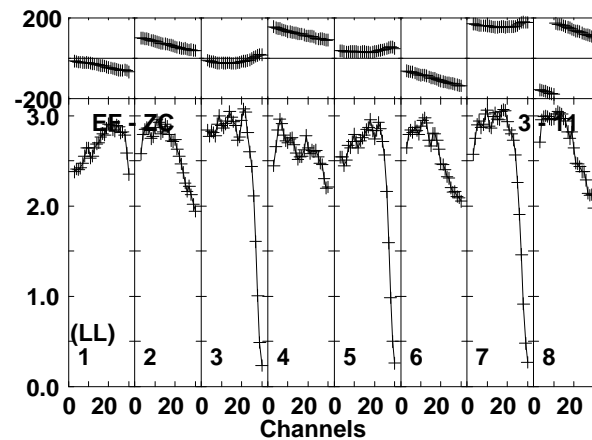
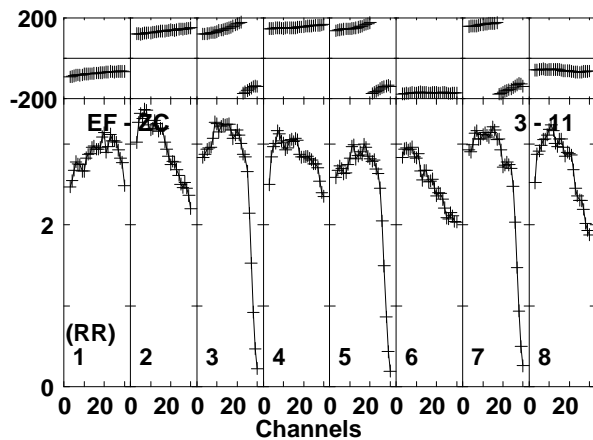
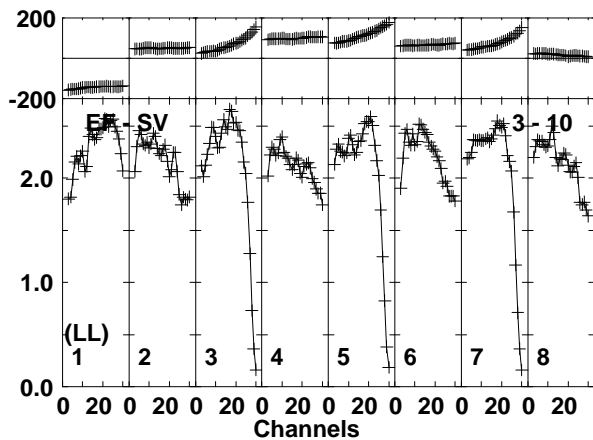
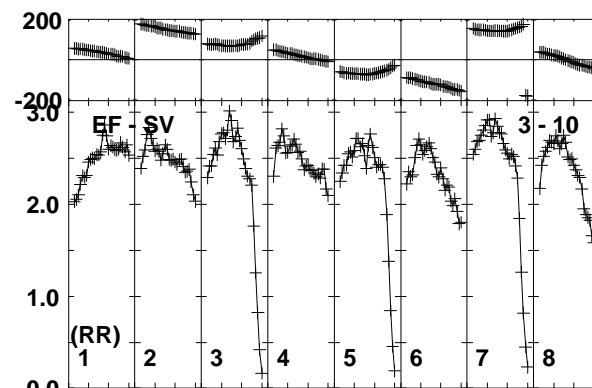
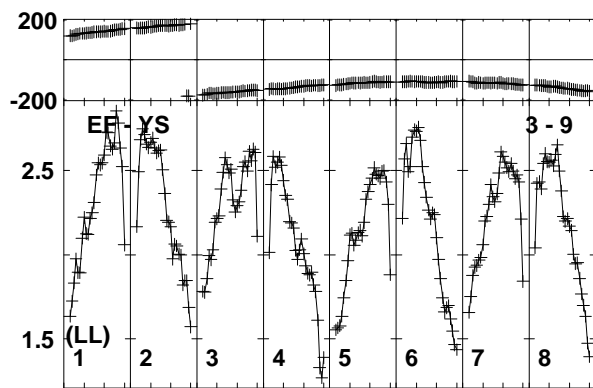
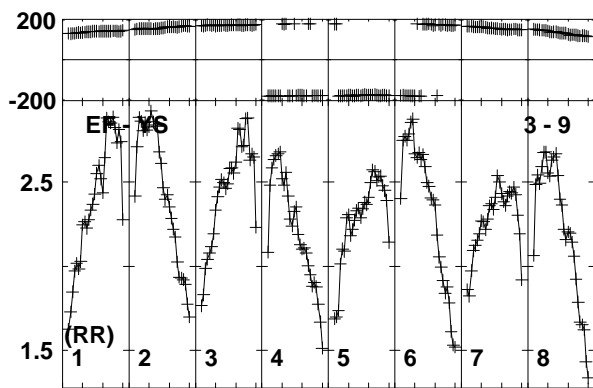
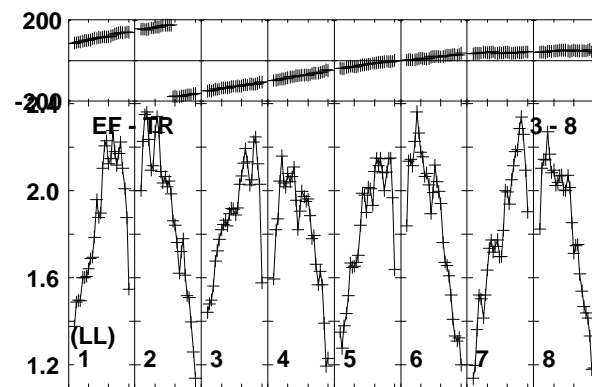
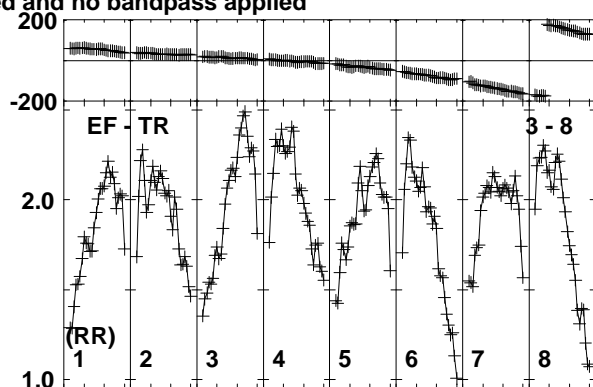
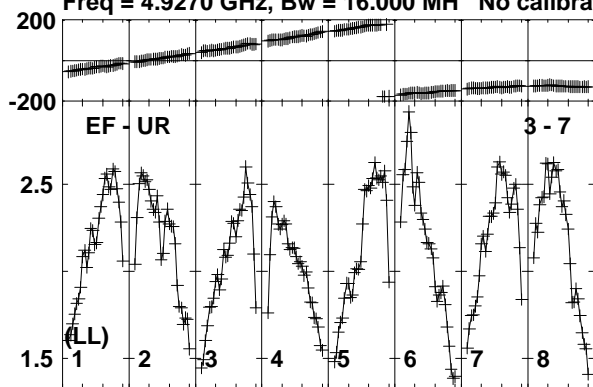

Lower frame: Milli Ampl Jy Top frame: Phas deg
Vector averaged cross-power spectrum Baseline: EF (03) - UR (07)
Timerange: 00/02:29:21 to 00/02:31:19

Plot file version 116 created 17-FEB-2020 15:42:49

J1359+5544 EK047 2.UVDATA.1

Freq = 4.9270 GHz, Bw = 16.000 MH No calibration applied and no bandpass applied

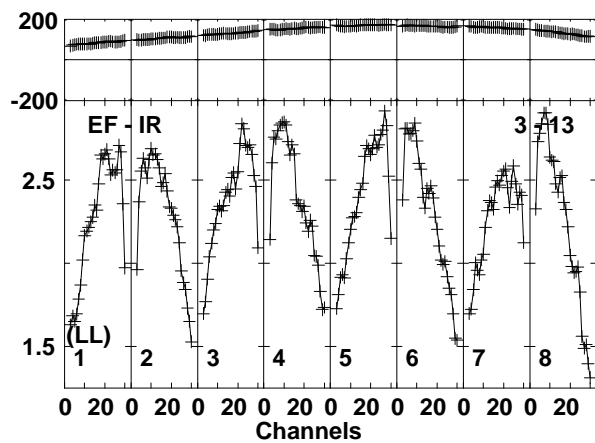
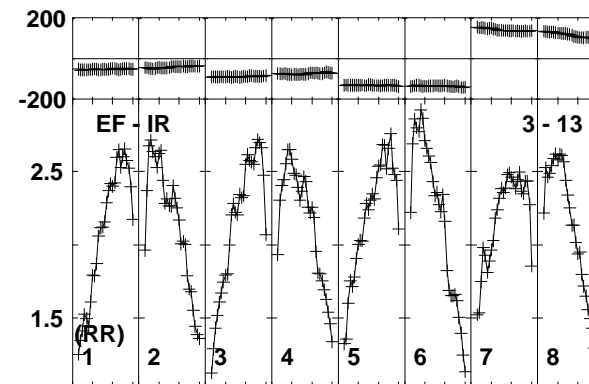
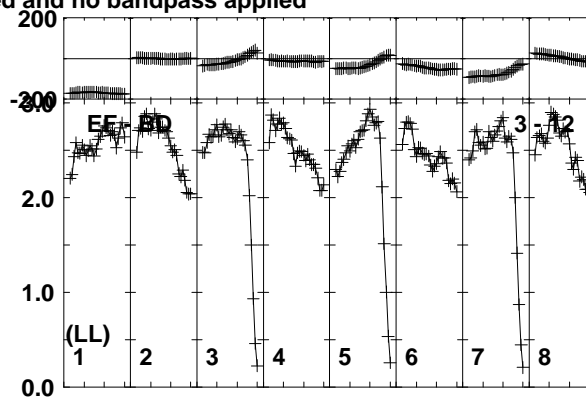
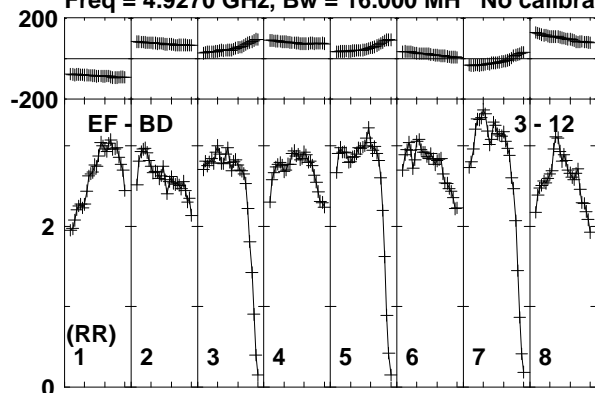

Lower frame: Milli Ampl Jy Top frame: Phas deg
Vector averaged cross-power spectrum Baseline: EF (03) - BD (12)
Timerange: 00/02:29:21 to 00/02:31:19

Plot file version 117 created 17-FEB-2020 15:42:49

J1402+5347 EK047 2.UVDATA.1

Freq = 4.9270 GHz, Bw = 16.000 MH No calibration applied and no bandpass applied

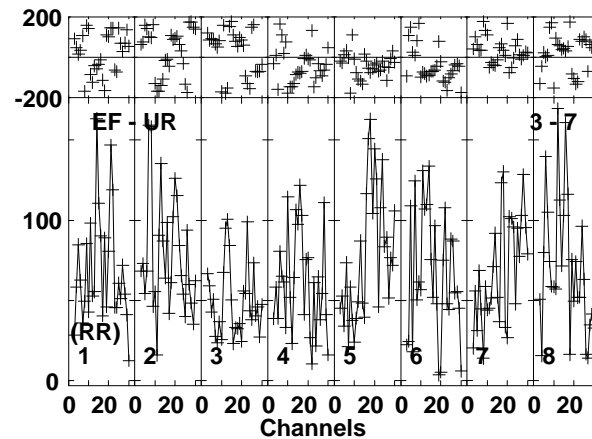
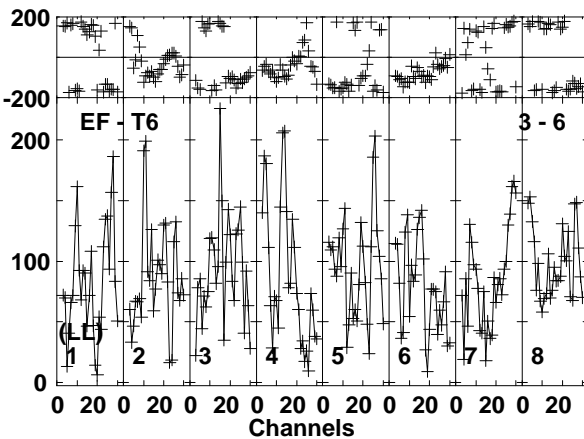
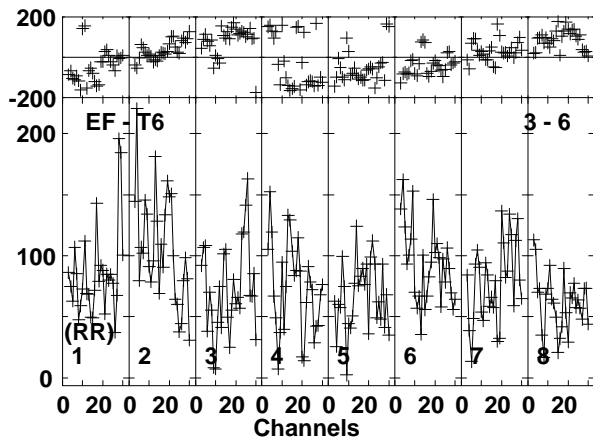
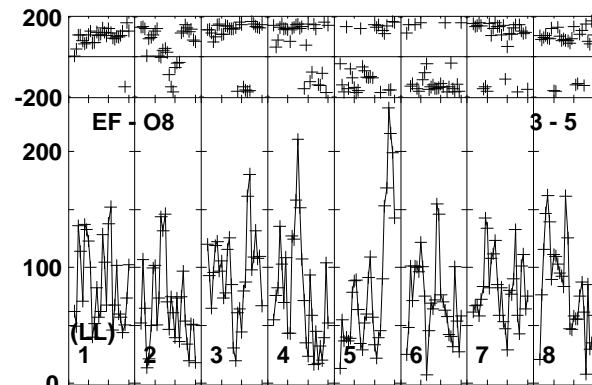
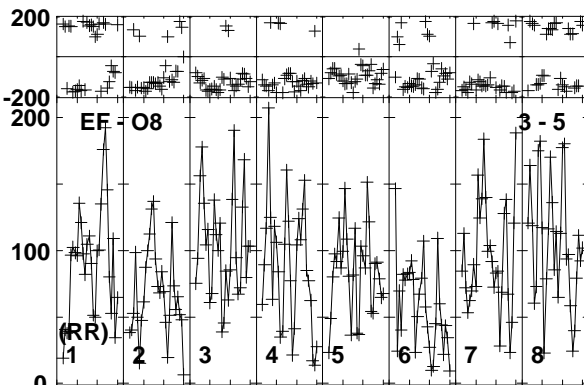
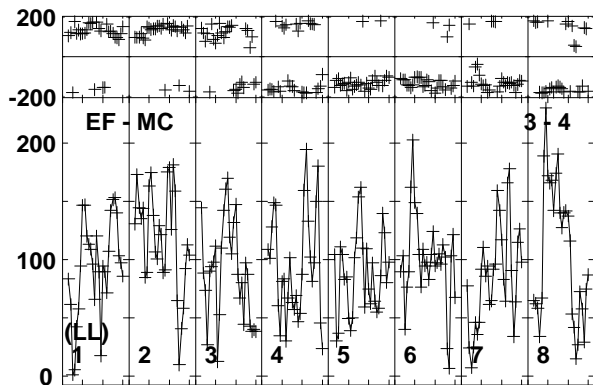
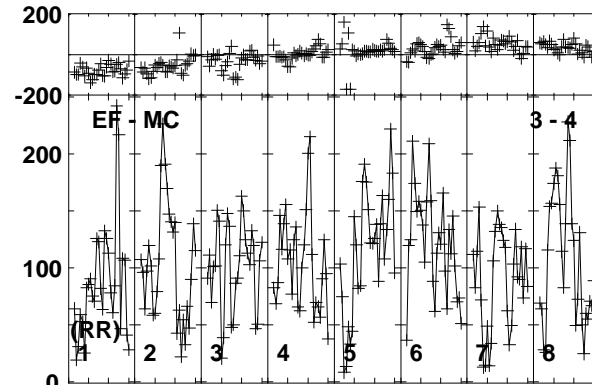
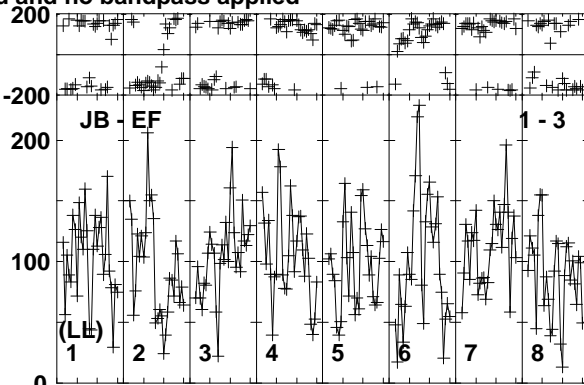
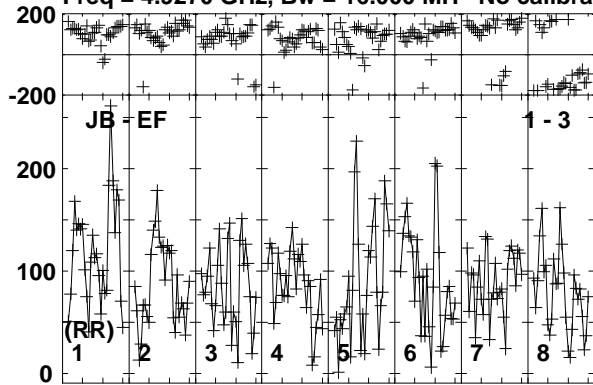

Lower frame: Micro Ampl Jy Top frame: Phas deg
Vector averaged cross-power spectrum Baseline: JB (01) - EF (03)
Timerange: 00/02:31:23 to 00/02:35:19

Plot file version 118 created 17-FEB-2020 15:42:49

J1402+5347 EK047 2.UVDATA.1

Freq = 4.9270 GHz, Bw = 16.000 MH No calibration applied and no bandpass applied

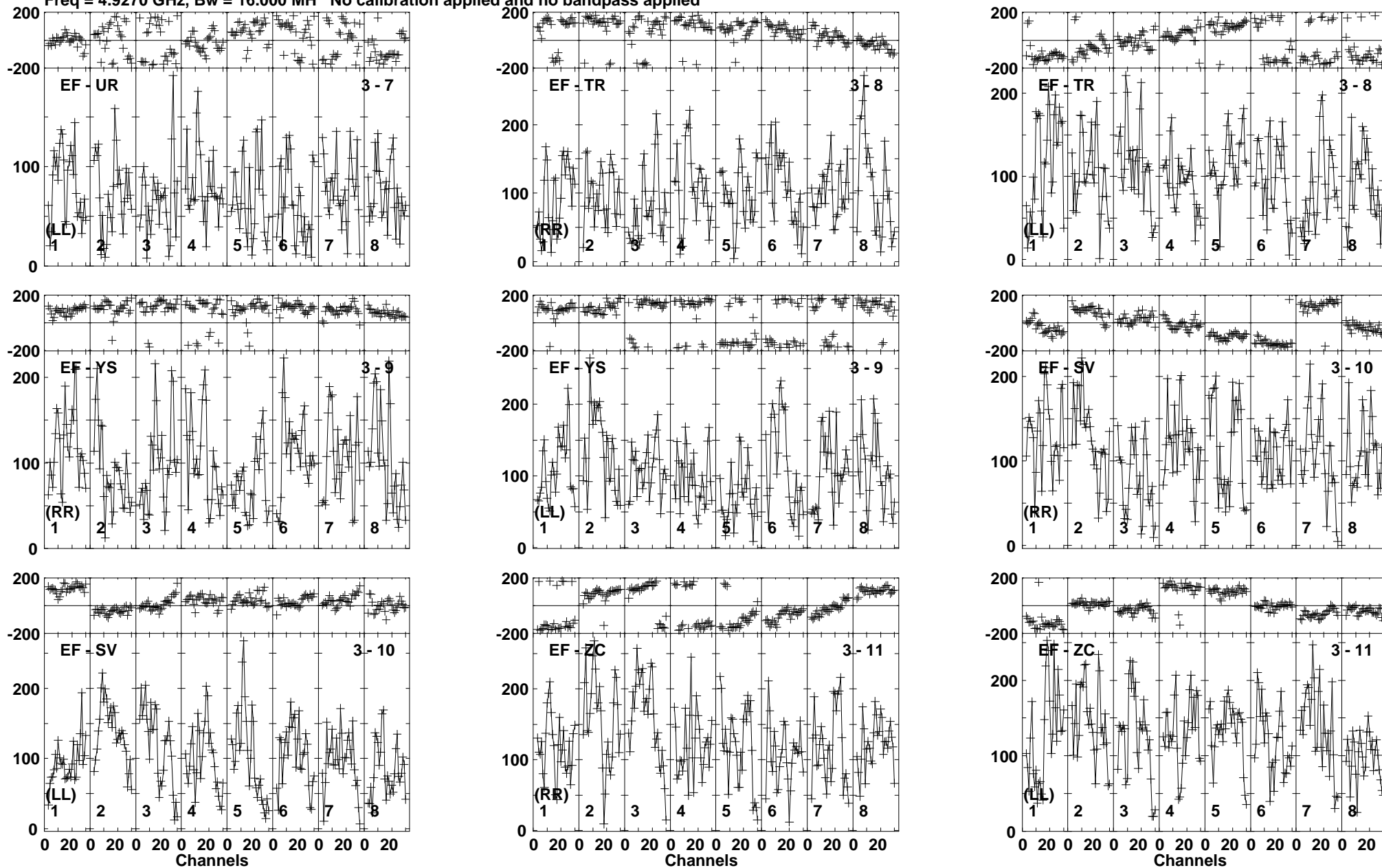

Lower frame: Micro Ampl Jy Top frame: Phas deg
Vector averaged cross-power spectrum Baseline: EF (03) - UR (07)
Timerange: 00/02:31:23 to 00/02:35:19

Plot file version 119 created 17-FEB-2020 15:42:49

J1402+5347 EK047 2.UVDATA.1

Freq = 4.9270 GHz, Bw = 16.000 MH No calibration applied and no bandpass applied

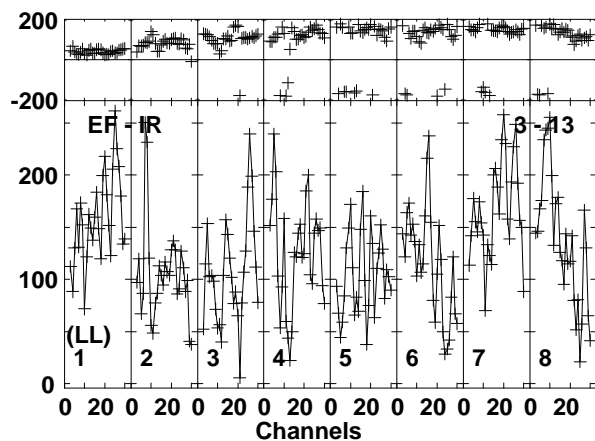
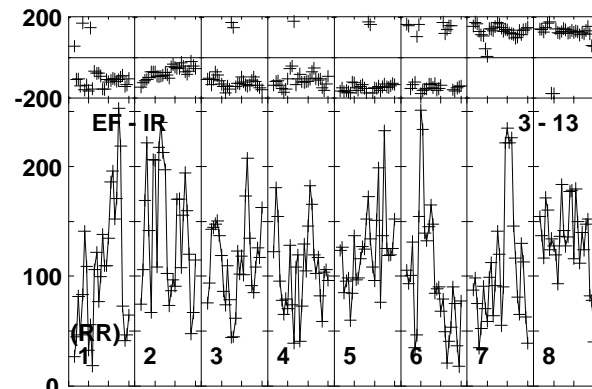
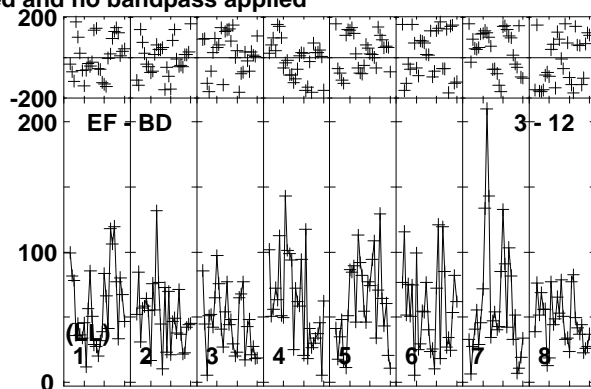
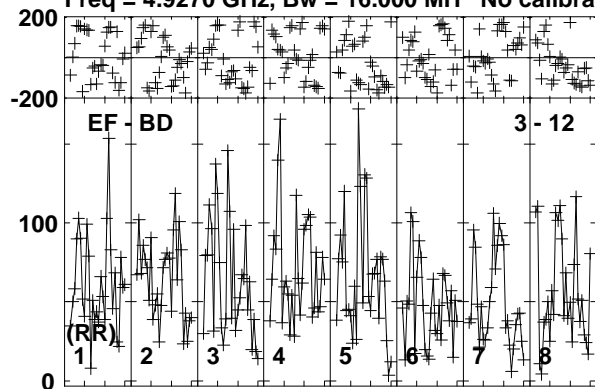

Lower frame: Micro Ampl Jy Top frame: Phas deg
Vector averaged cross-power spectrum Baseline: EF (03) - BD (12)
Timerange: 00/02:31:23 to 00/02:35:19

Plot file version 120 created 17-FEB-2020 15:42:49

J1359+5544 EK047 2.UVDATA.1

Freq = 4.9270 GHz, Bw = 16.000 MH No calibration applied and no bandpass applied

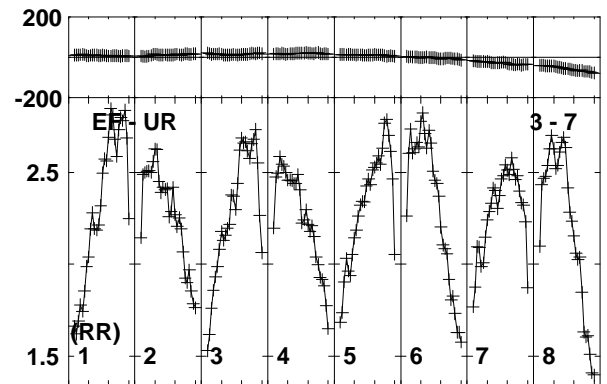
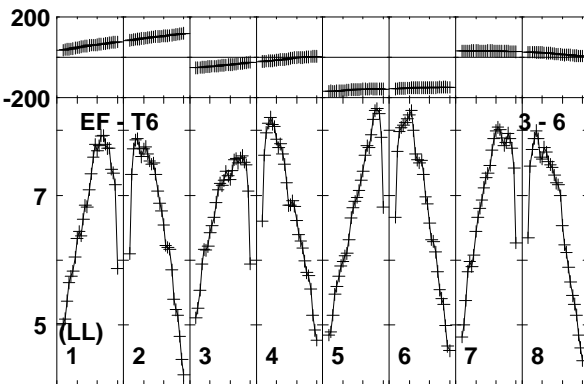
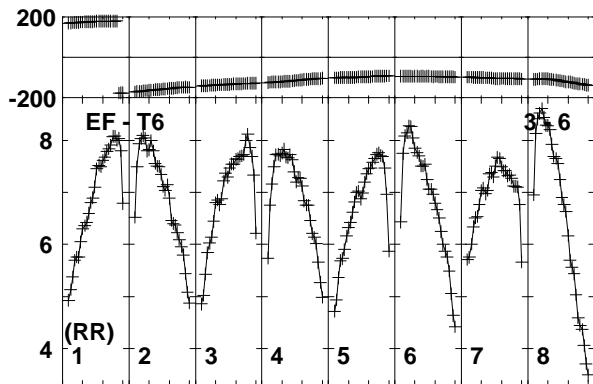
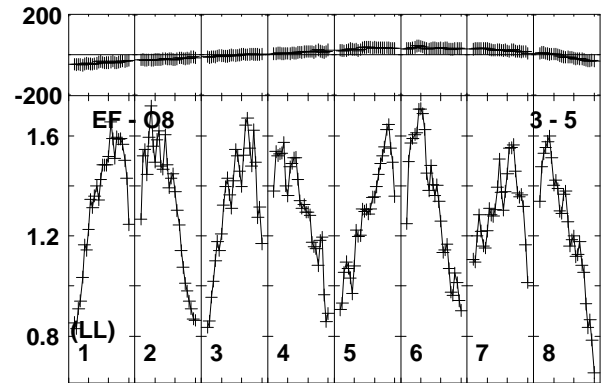
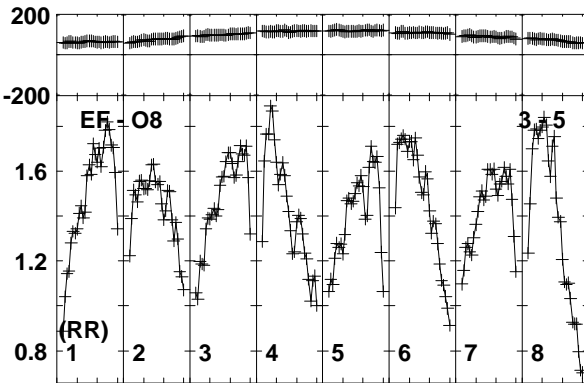
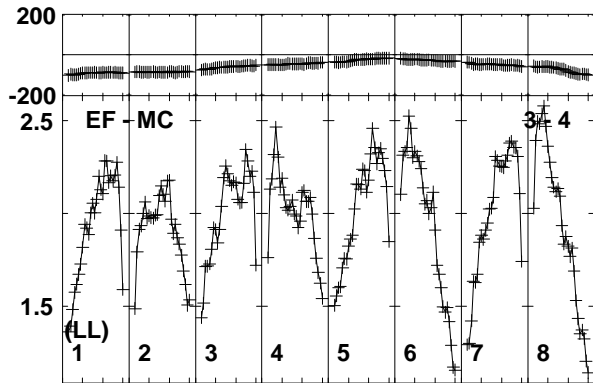
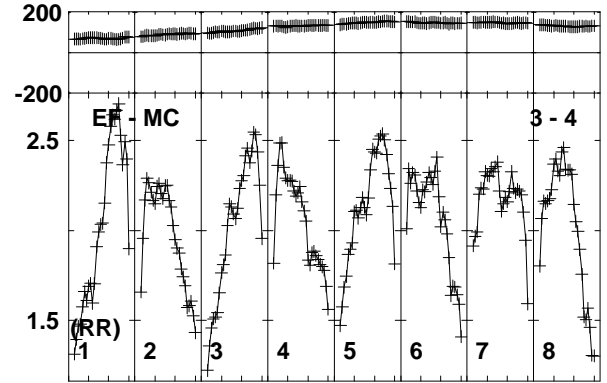
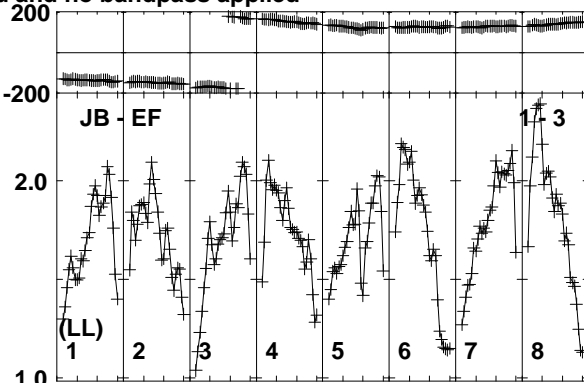
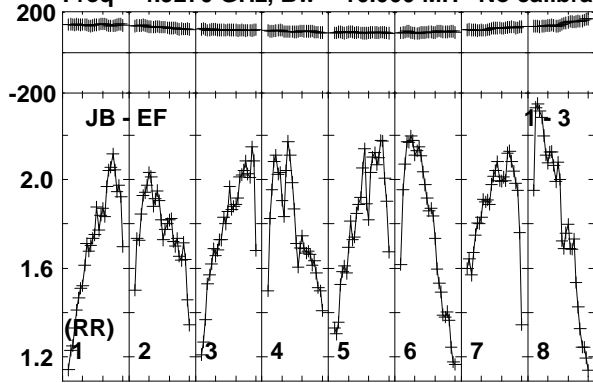

Lower frame: Milli Ampl Jy Top frame: Phas deg

Vector averaged cross-power spectrum Baseline: JB (01) - EF (03)

Timerange: 00/02:36:01 to 00/02:37:19

Plot file version 121 created 17-FEB-2020 15:42:49

J1359+5544 EK047 2.UVDATA.1

Freq = 4.9270 GHz, Bw = 16.000 MH No calibration applied and no bandpass applied

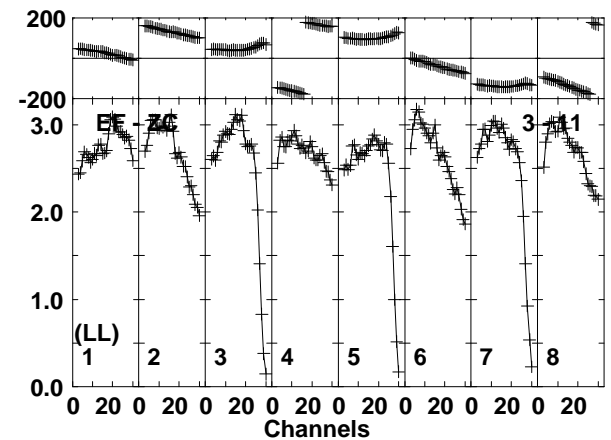
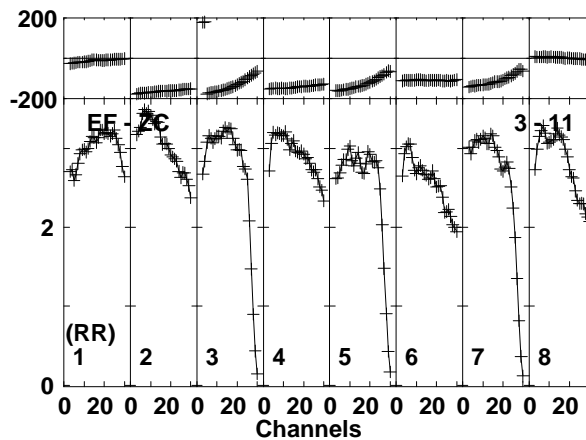
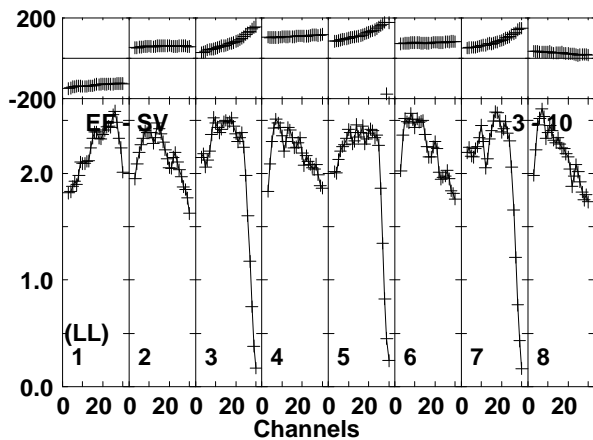
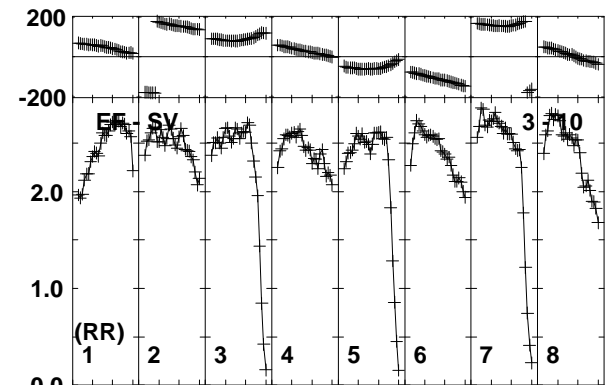
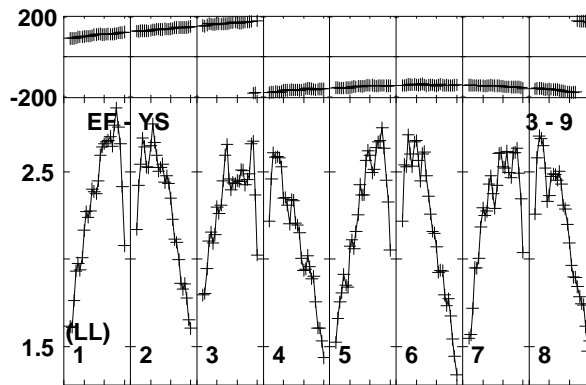
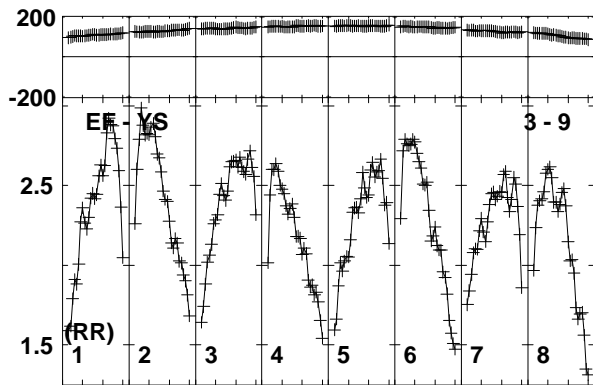
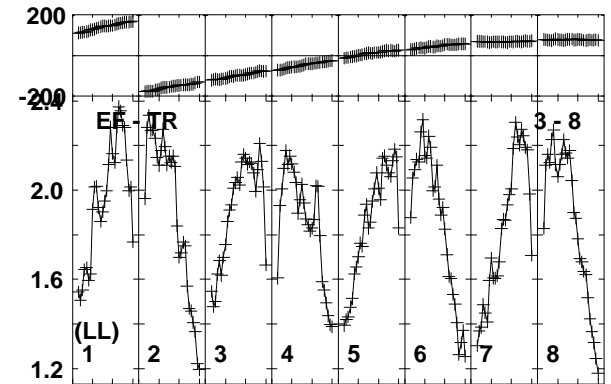
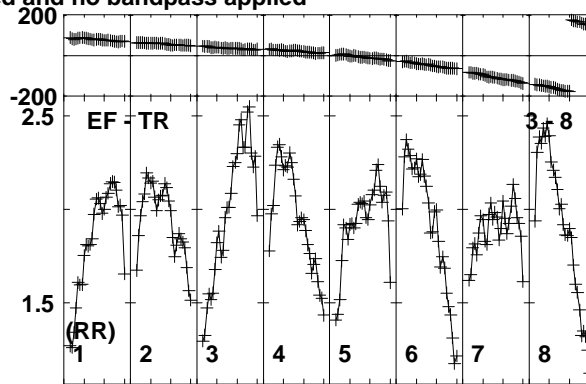
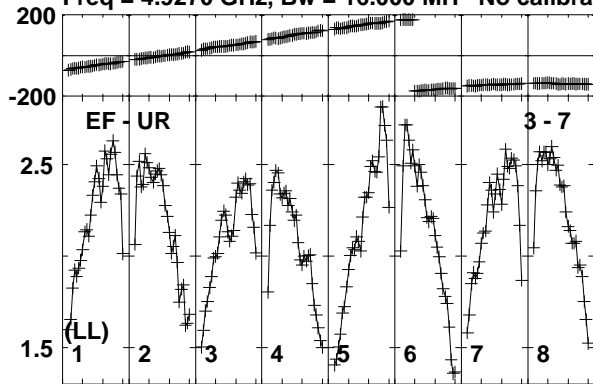

Lower frame: Milli Ampl Jy Top frame: Phas deg
Vector averaged cross-power spectrum Baseline: EF (03) - UR (07)
Timerange: 00/02:36:01 to 00/02:37:19

Plot file version 122 created 17-FEB-2020 15:42:50

J1359+5544 EK047 2.UVDATA.1

Freq = 4.9270 GHz, Bw = 16.000 MH No calibration applied and no bandpass applied

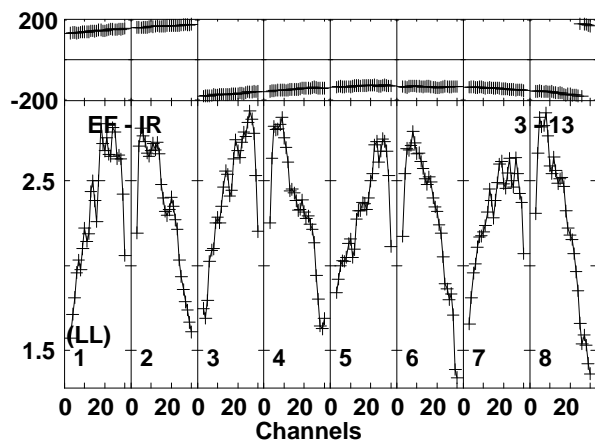
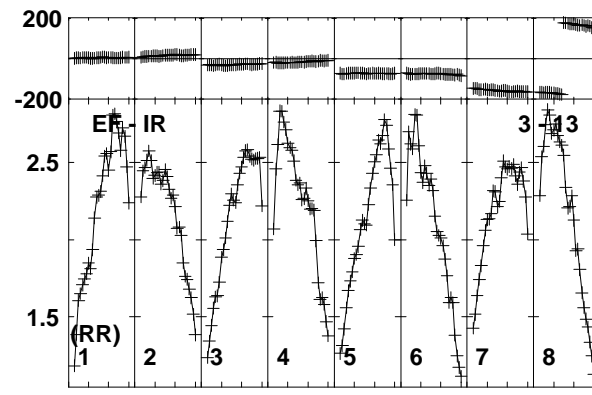
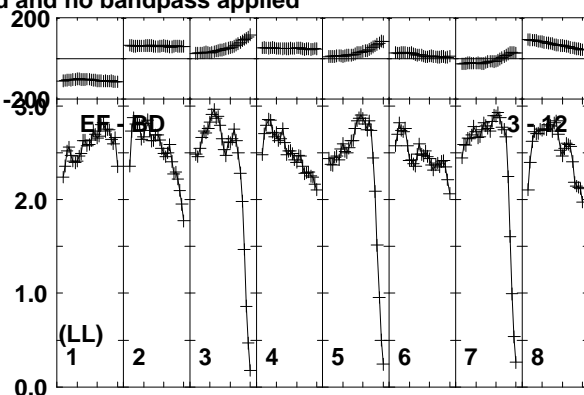
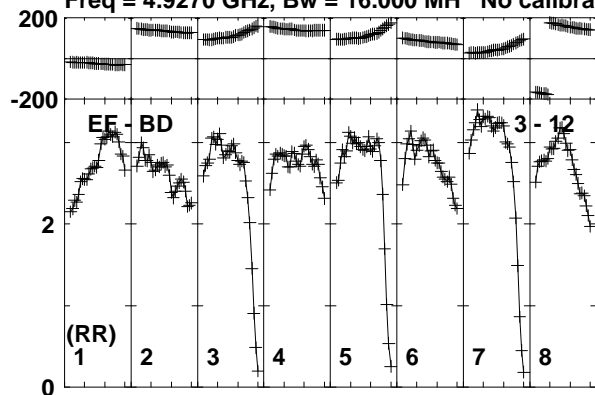

Lower frame: Milli Ampl Jy Top frame: Phas deg
Vector averaged cross-power spectrum Baseline: EF (03) - BD (12)
Timerange: 00/02:36:01 to 00/02:37:19

Plot file version 123 created 17-FEB-2020 15:42:50

J1402+5347 EK047 2.UVDATA.1

Freq = 4.9270 GHz, Bw = 16.000 MH No calibration applied and no bandpass applied

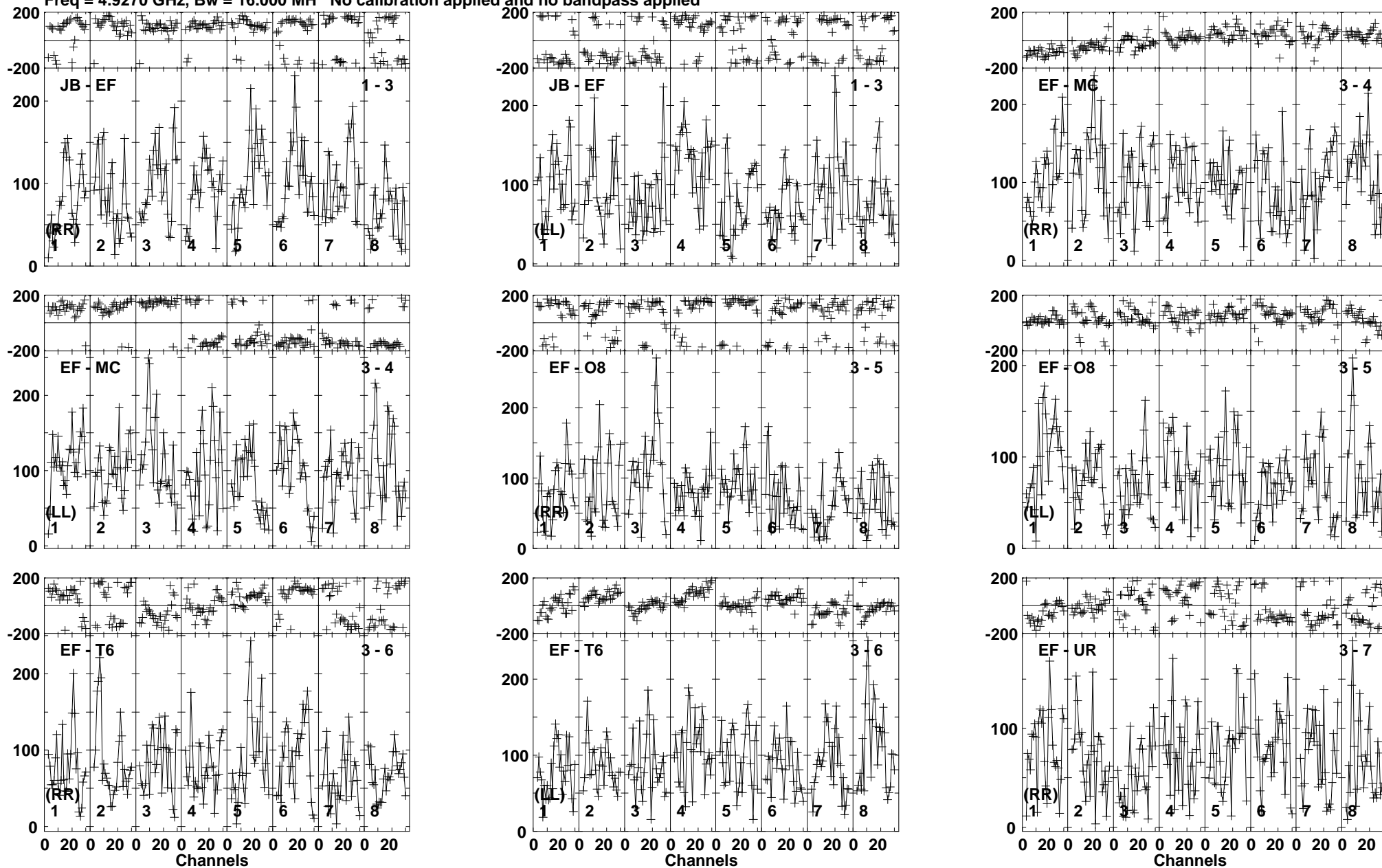

Lower frame: Micro Ampl Jy Top frame: Phas deg
Vector averaged cross-power spectrum Baseline: JB (01) - EF (03)
Timerange: 00/02:37:21 to 00/02:41:19

Plot file version 124 created 17-FEB-2020 15:42:50

J1402+5347 EK047 2.UVDATA.1

Freq = 4.9270 GHz, Bw = 16.000 MH No calibration applied and no bandpass applied

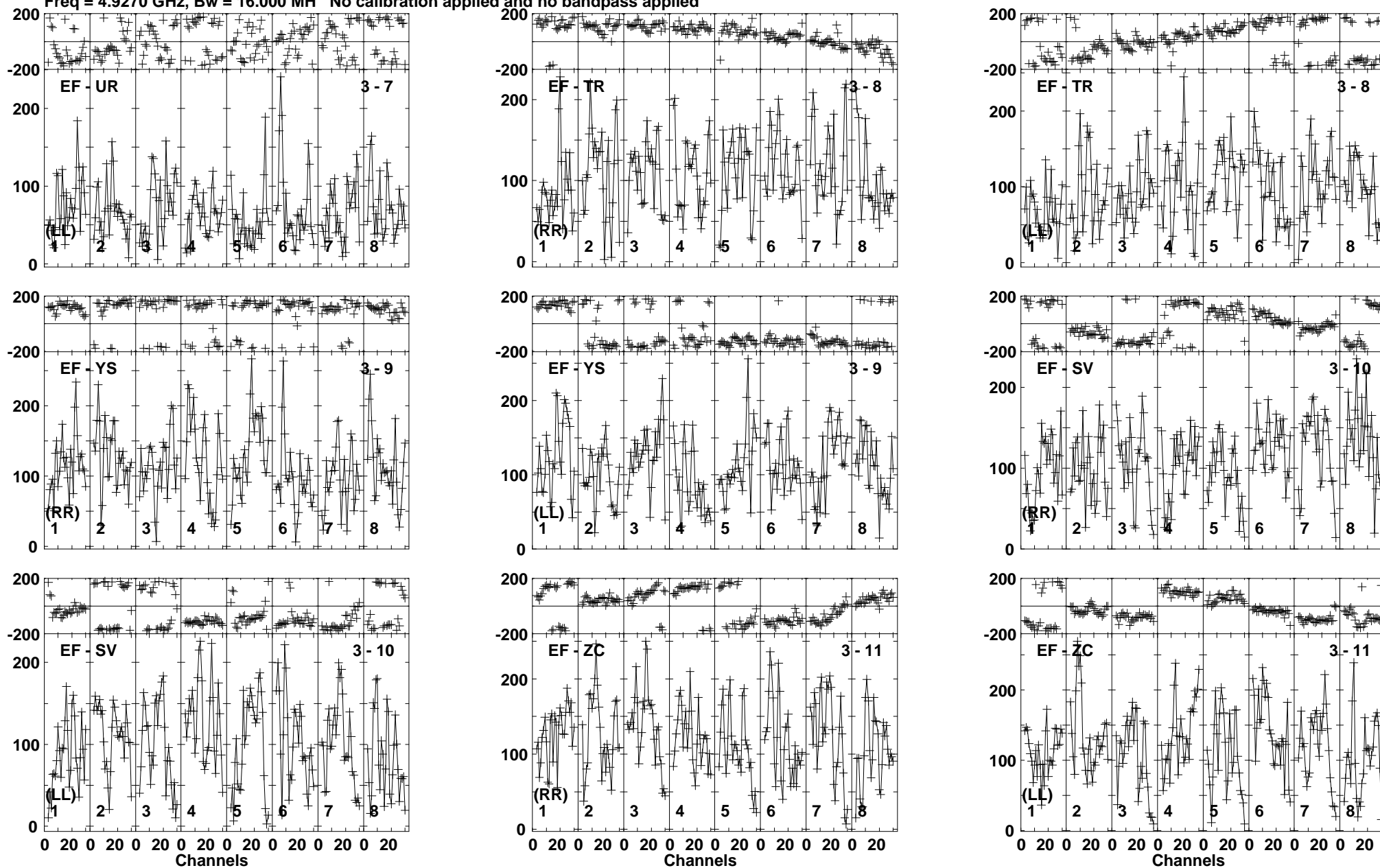

Lower frame: Micro Ampl Jy Top frame: Phas deg
Vector averaged cross-power spectrum Baseline: EF (03) - UR (07)
Timerange: 00/02:37:21 to 00/02:41:19

Plot file version 125 created 17-FEB-2020 15:42:50

J1402+5347 EK047 2.UVDATA.1

Freq = 4.9270 GHz, Bw = 16.000 MH No calibration applied and no bandpass applied

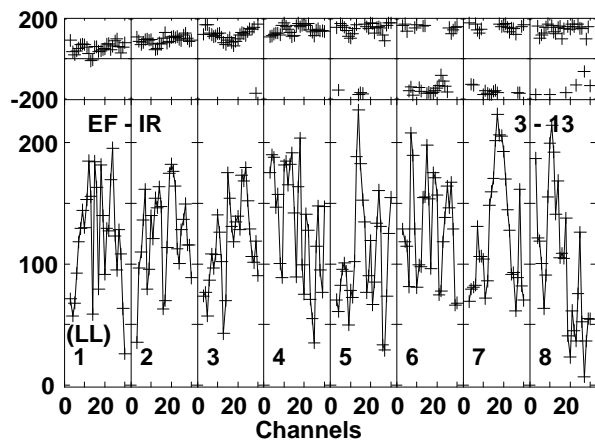
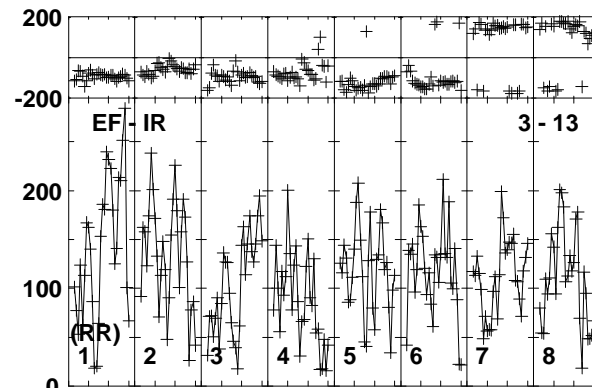
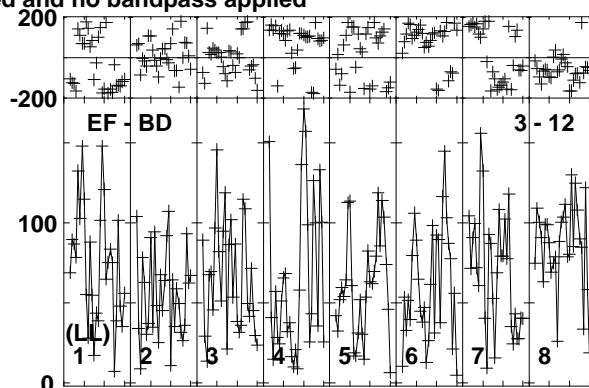
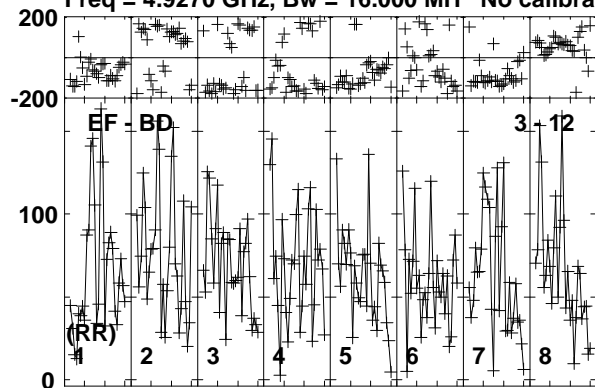

Lower frame: Micro Ampl Jy Top frame: Phas deg
Vector averaged cross-power spectrum Baseline: EF (03) - BD (12)
Timerange: 00/02:37:21 to 00/02:41:19

Plot file version 126 created 17-FEB-2020 15:42:50

J1359+5544 EK047 2.UVDATA.1

Freq = 4.9270 GHz, Bw = 16.000 MH No calibration applied and no bandpass applied

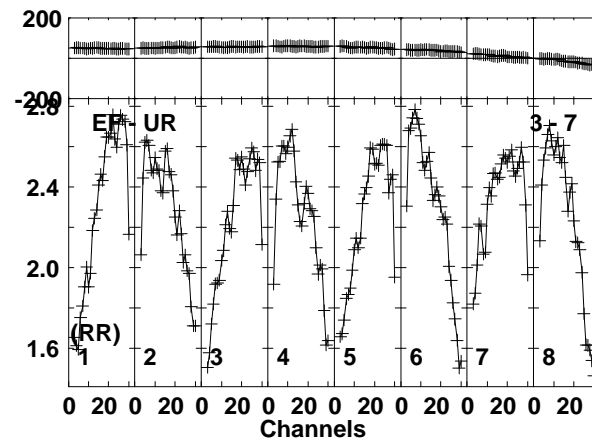
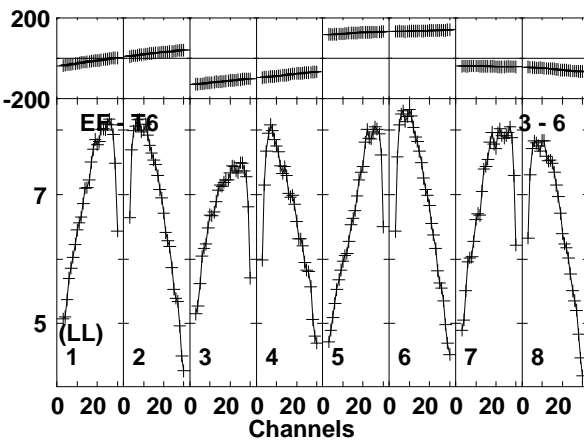
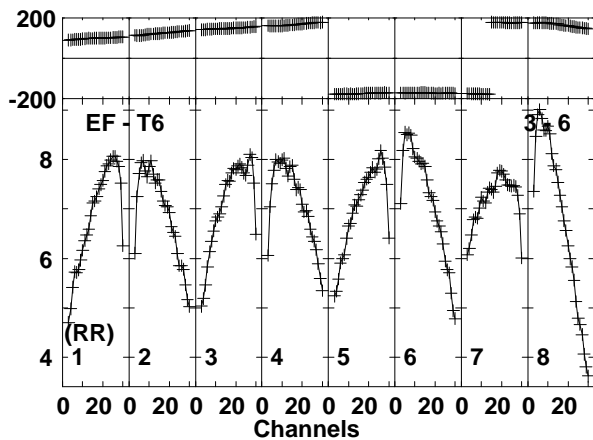
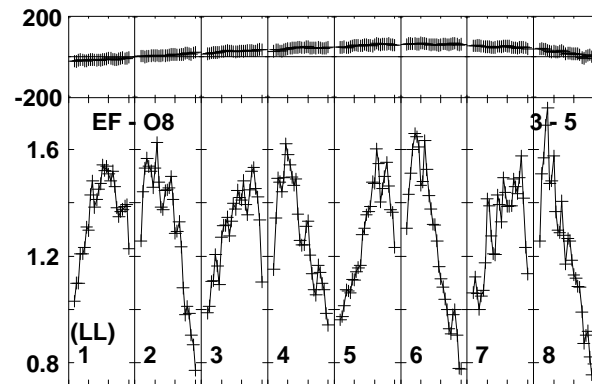
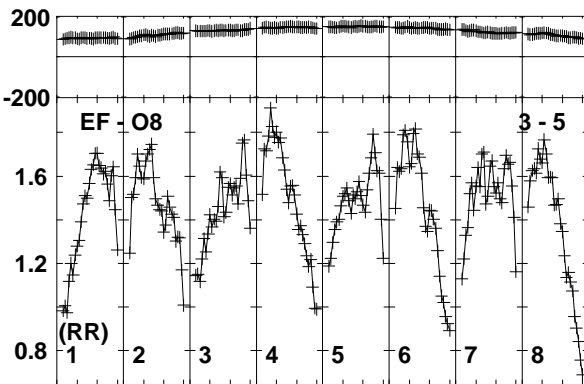
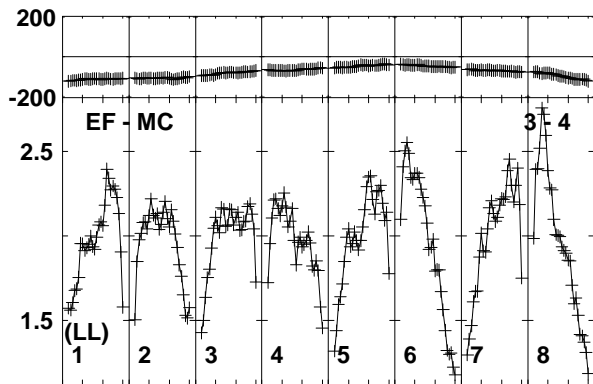
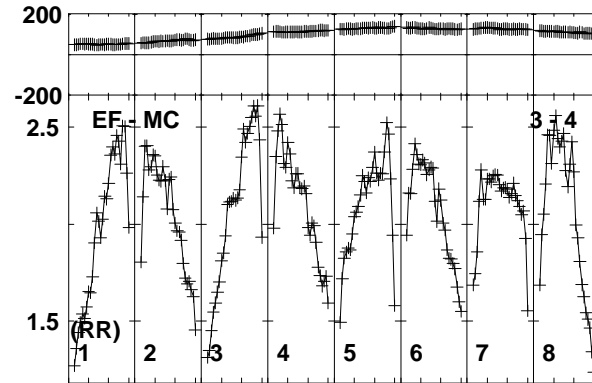
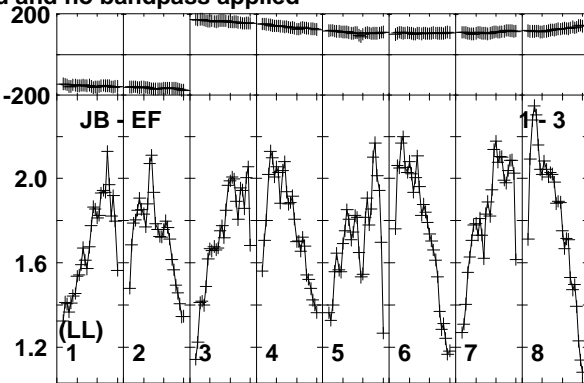
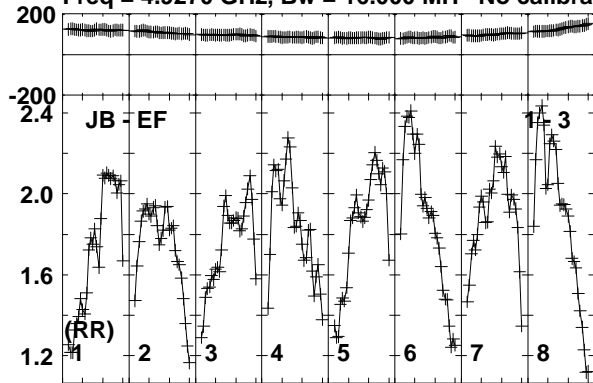

Lower frame: Milli Ampl Jy Top frame: Phas deg
Vector averaged cross-power spectrum Baseline: JB (01) - EF (03)
Timerange: 00/02:41:21 to 00/02:43:19

Plot file version 127 created 17-FEB-2020 15:42:50

J1359+5544 EK047 2.UVDATA.1

Freq = 4.9270 GHz, Bw = 16.000 MH No calibration applied and no bandpass applied

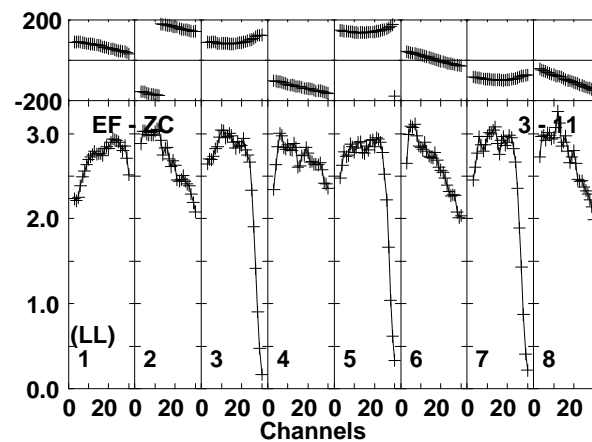
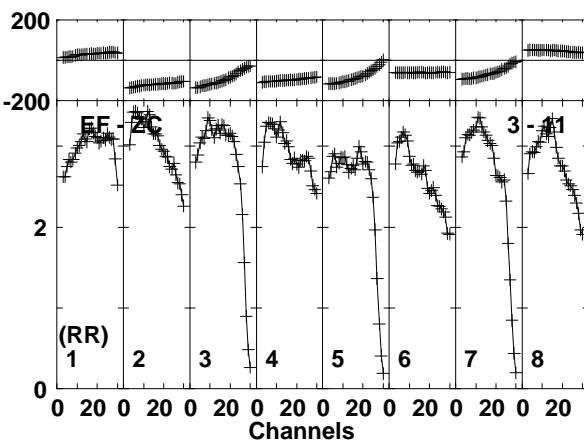
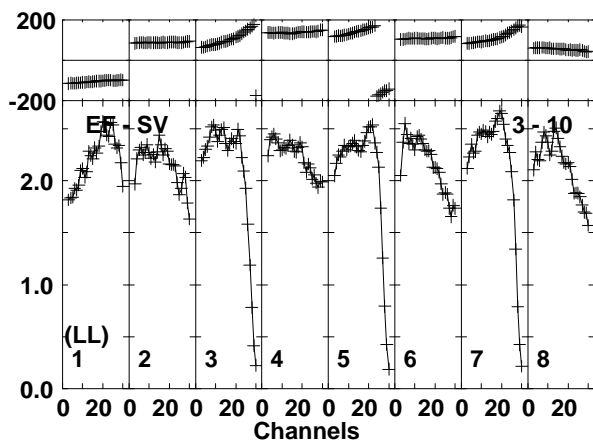
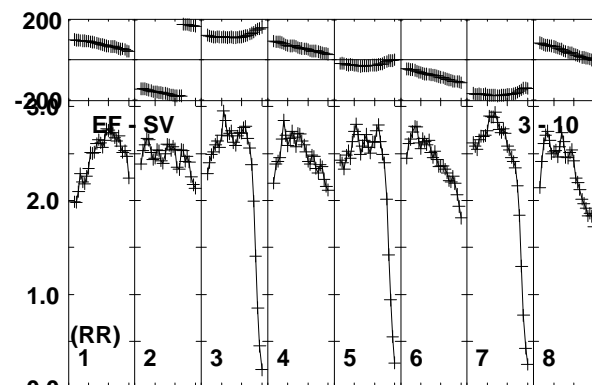
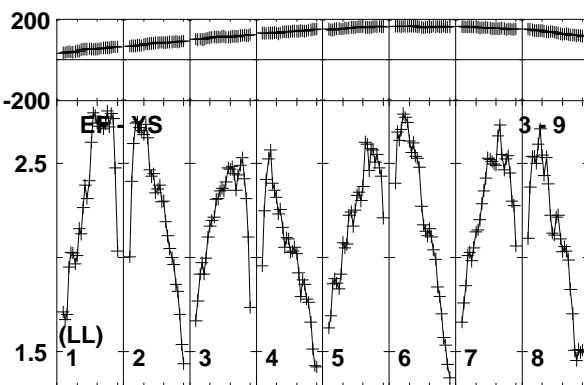
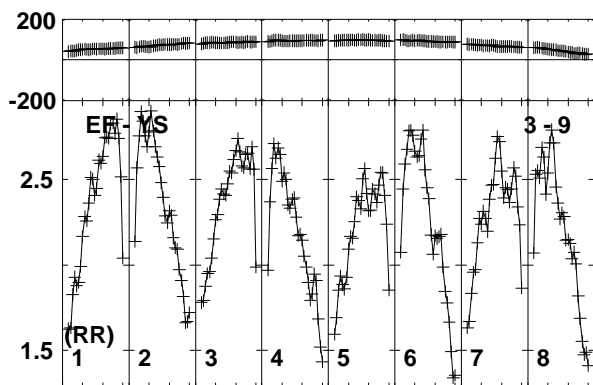
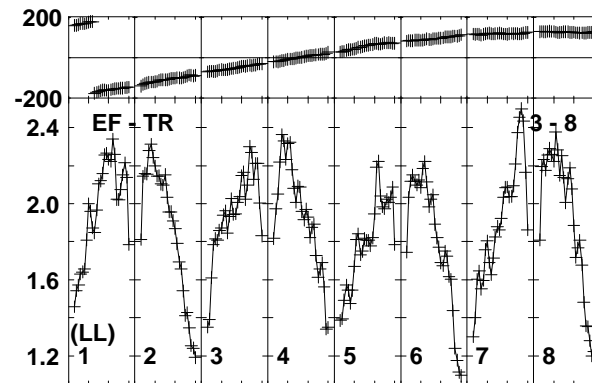
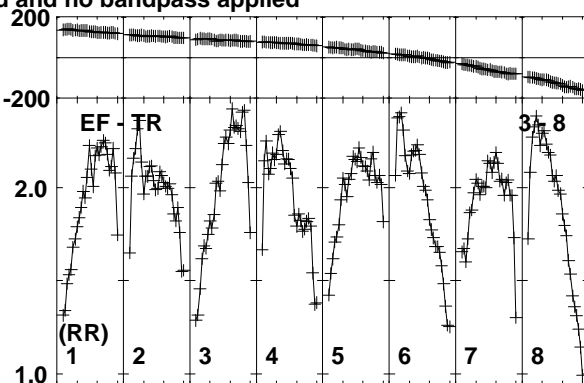
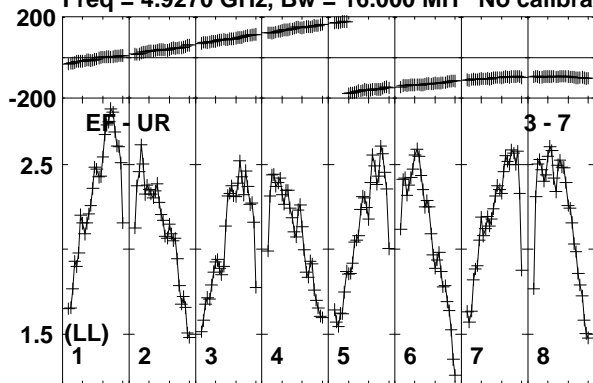

Lower frame: Milli Ampl Jy Top frame: Phas deg
Vector averaged cross-power spectrum Baseline: EF (03) - UR (07)
Timerange: 00/02:41:21 to 00/02:43:19

Plot file version 128 created 17-FEB-2020 15:42:50

J1359+5544 EK047 2.UVDATA.1

Freq = 4.9270 GHz, Bw = 16.000 MH No calibration applied and no bandpass applied

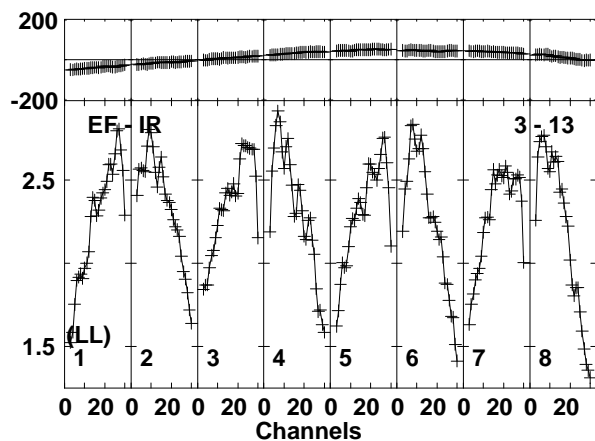
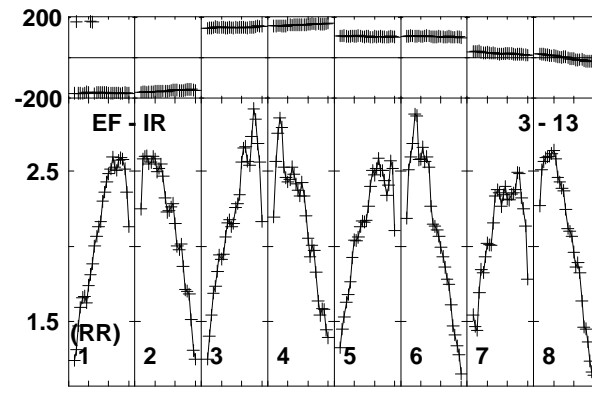
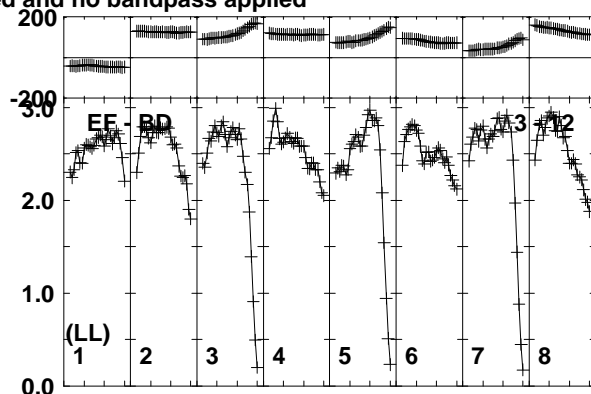
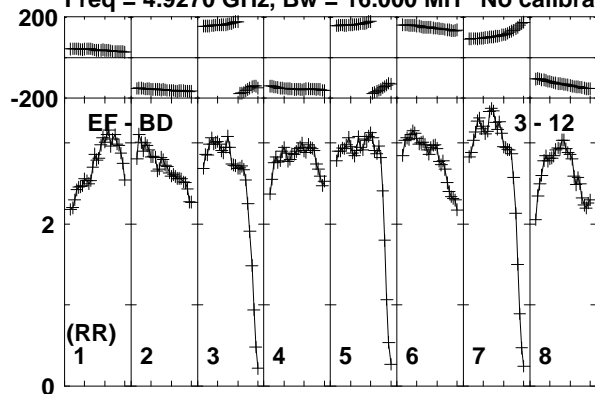

Lower frame: Milli Ampl Jy Top frame: Phas deg
Vector averaged cross-power spectrum Baseline: EF (03) - BD (12)
Timerange: 00/02:41:21 to 00/02:43:19

Plot file version 129 created 17-FEB-2020 15:42:50

J1402+5347 EK047 2.UVDATA.1

Freq = 4.9270 GHz, Bw = 16.000 MH No calibration applied and no bandpass applied

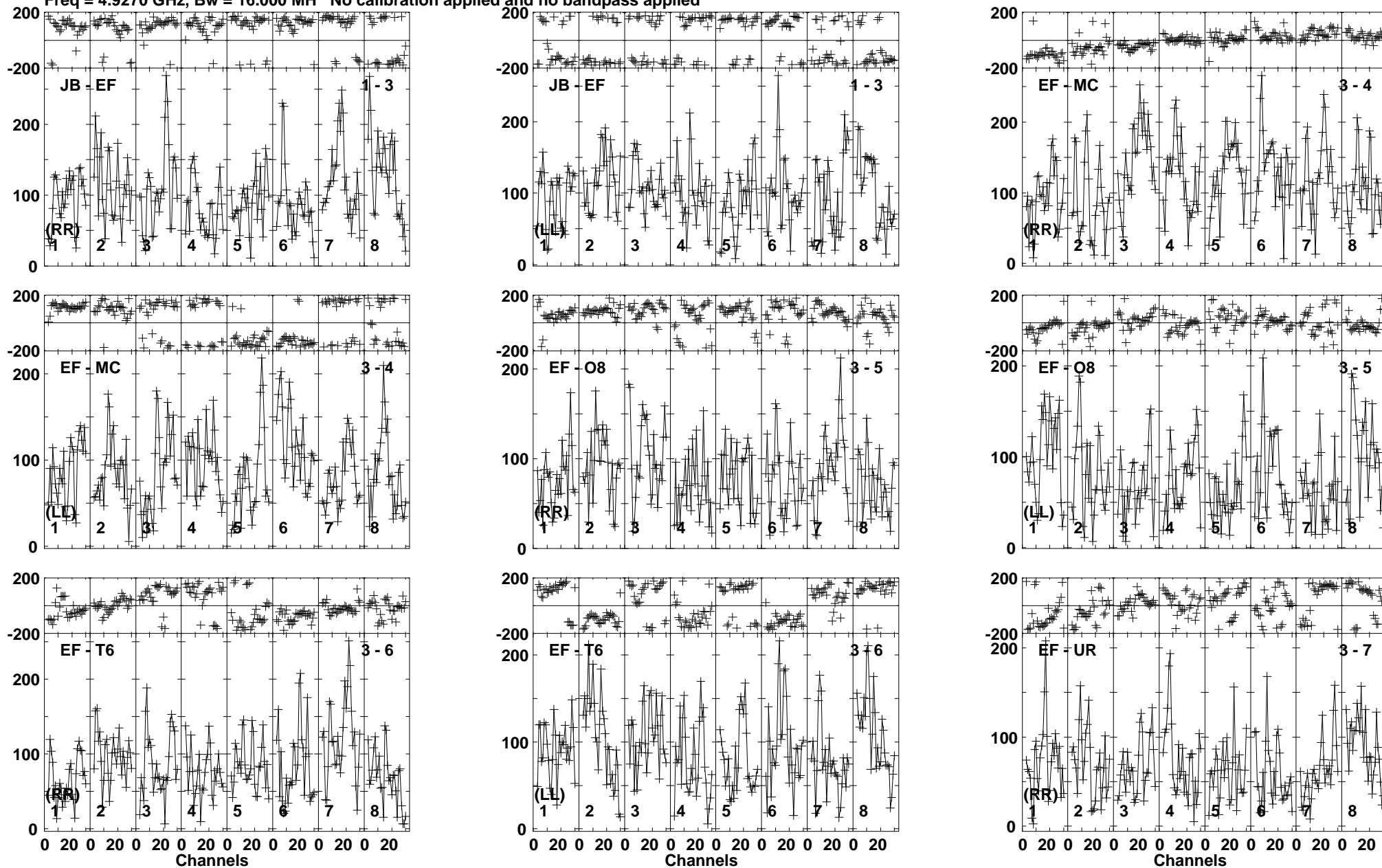

Lower frame: Micro Ampl Jy Top frame: Phas deg
Vector averaged cross-power spectrum Baseline: JB (01) - EF (03)
Timerange: 00/02:43:23 to 00/02:47:19

Plot file version 130 created 17-FEB-2020 15:42:50

J1402+5347 EK047 2.UVDATA.1

Freq = 4.9270 GHz, Bw = 16.000 MH No calibration applied and no bandpass applied

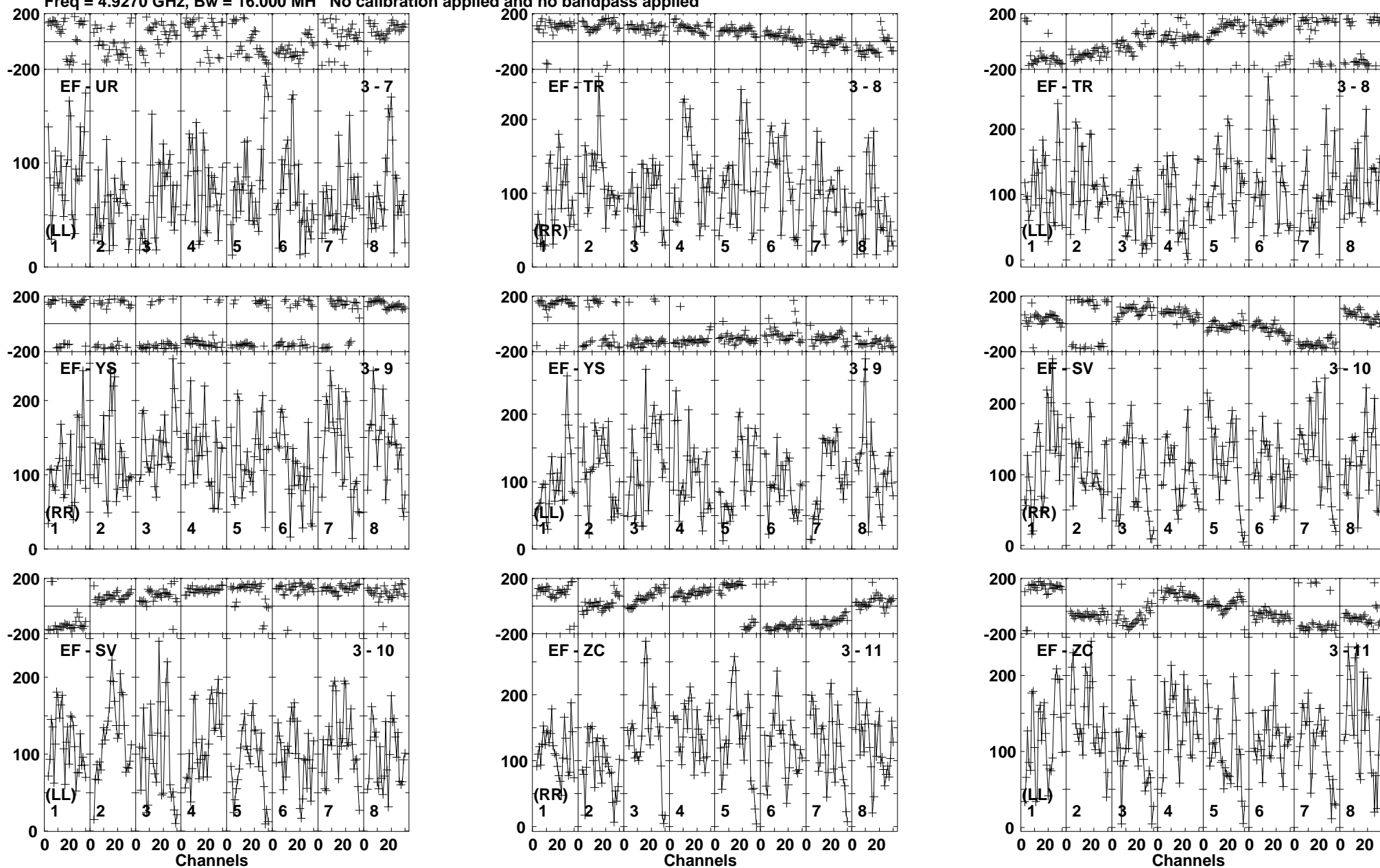

Lower frame: Micro Ampl Jy Top frame: Phas deg
Vector averaged cross-power spectrum Baseline: EF (03) - UR (07)
Timerange: 00/02:43:23 to 00/02:47:19

Plot file version 131 created 17-FEB-2020 15:42:50

J1402+5347 EK047 2.UVDATA.1

Freq = 4.9270 GHz, Bw = 16.000 MH No calibration applied and no bandpass applied

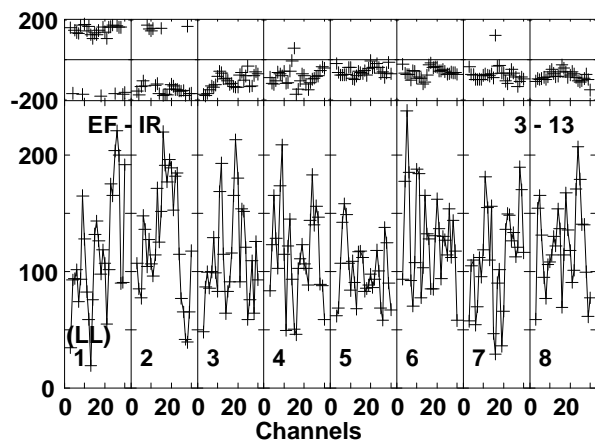
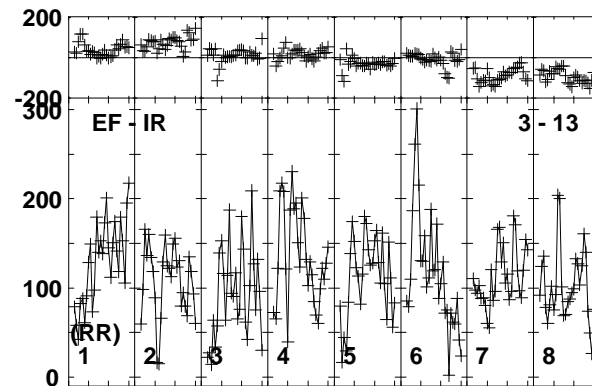
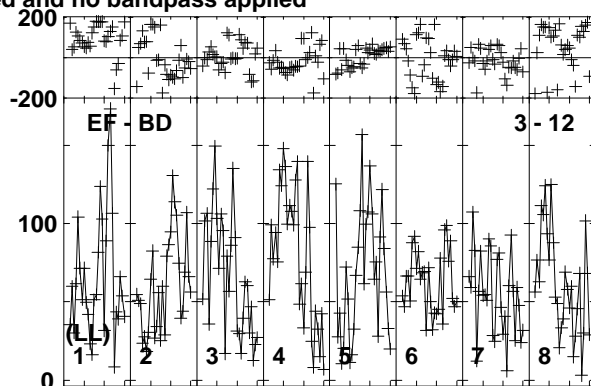
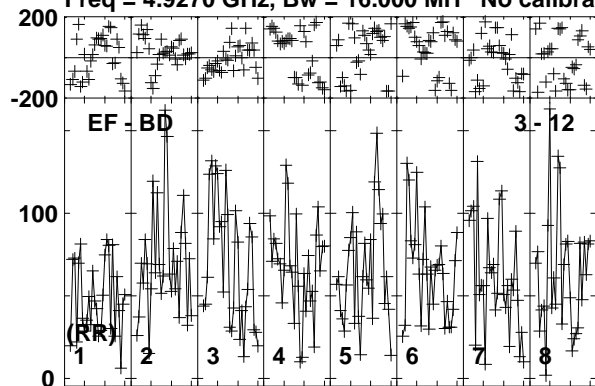

Lower frame: Micro Ampl Jy Top frame: Phas deg
Vector averaged cross-power spectrum Baseline: EF (03) - BD (12)
Timerange: 00/02:43:23 to 00/02:47:19

Plot file version 132 created 17-FEB-2020 15:42:50

J1359+5544 EK047 2.UVDATA.1

Freq = 4.9270 GHz, Bw = 16.000 MH No calibration applied and no bandpass applied

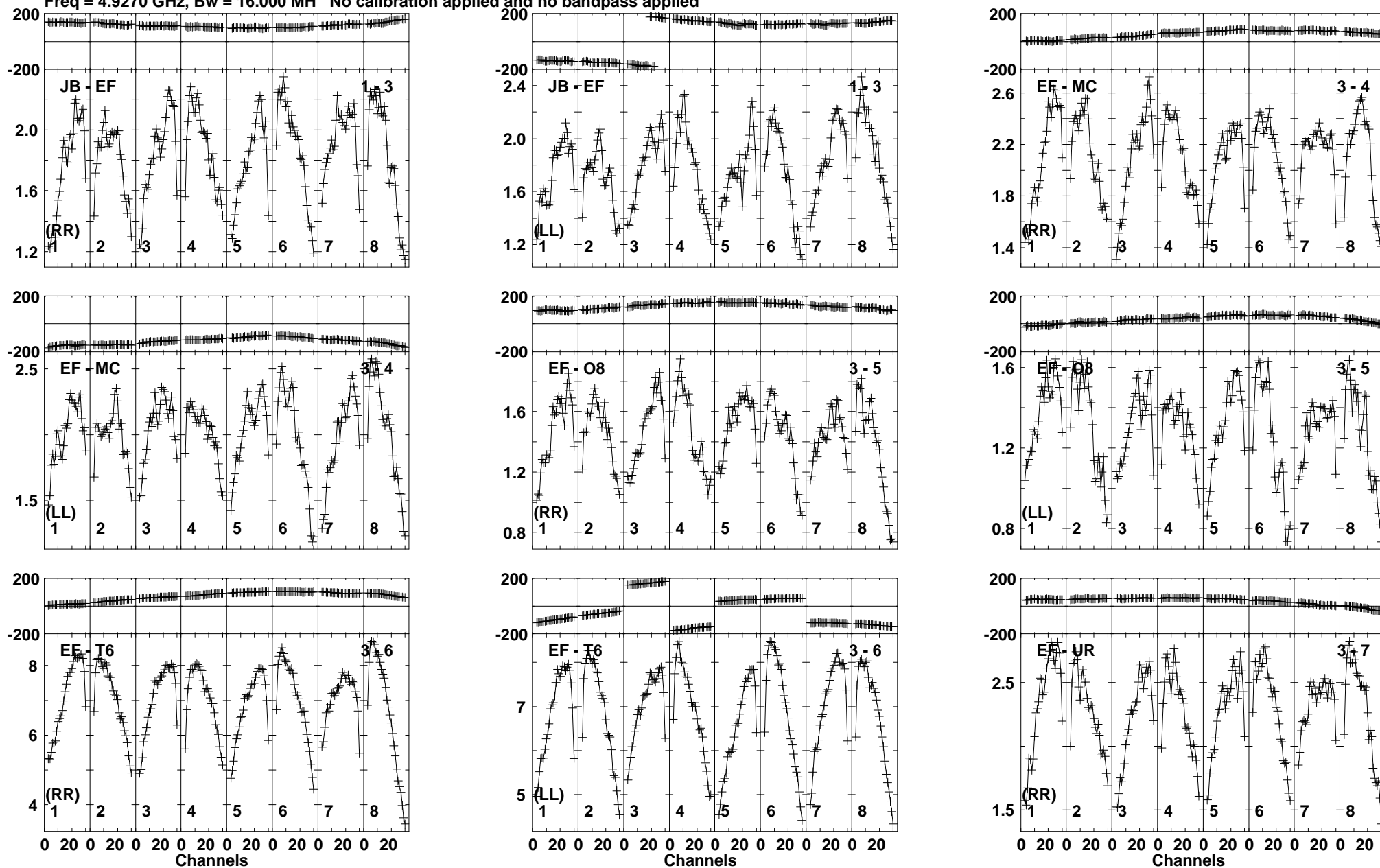

Lower frame: Milli Ampl Jy Top frame: Phas deg
Vector averaged cross-power spectrum Baseline: JB (01) - EF (03)
Timerange: 00/02:48:01 to 00/02:49:19

Plot file version 133 created 17-FEB-2020 15:42:51

J1359+5544 EK047 2.UVDATA.1

Freq = 4.9270 GHz, Bw = 16.000 MH No calibration applied and no bandpass applied

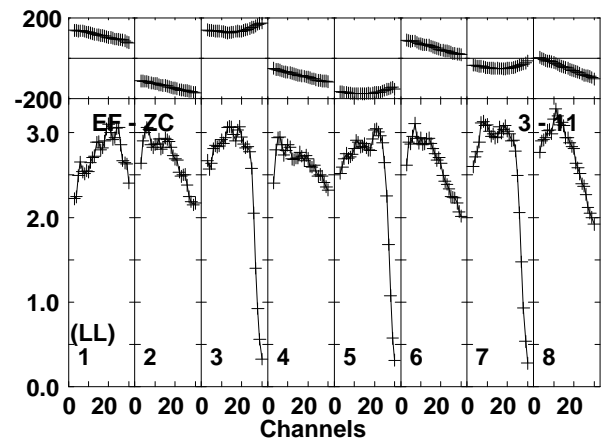
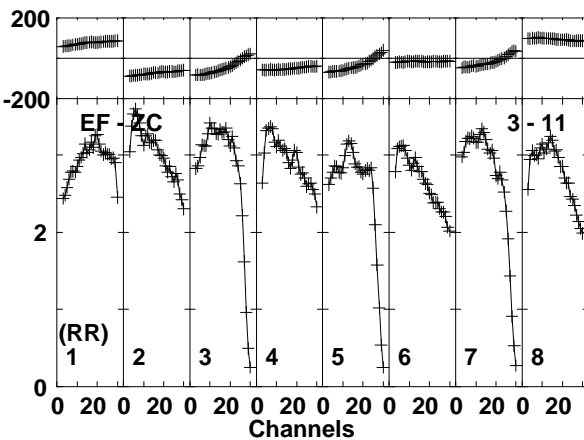
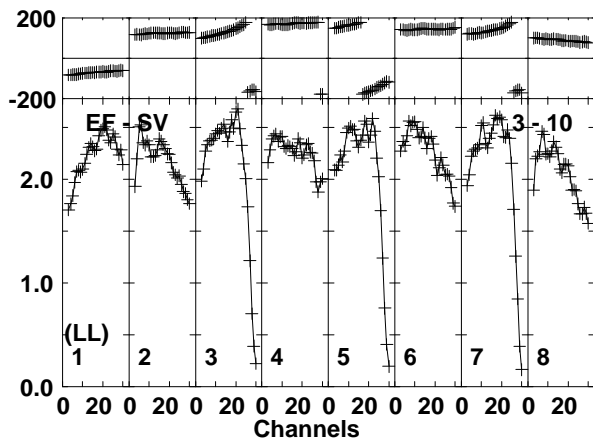
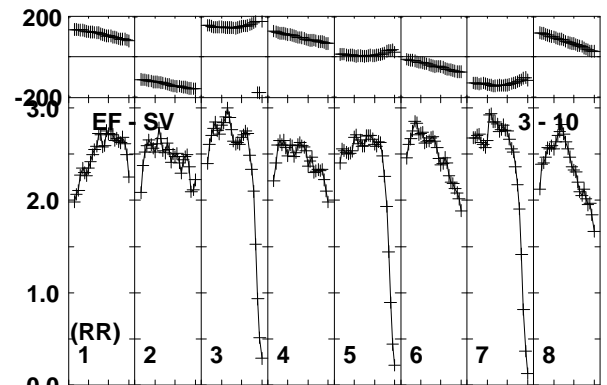
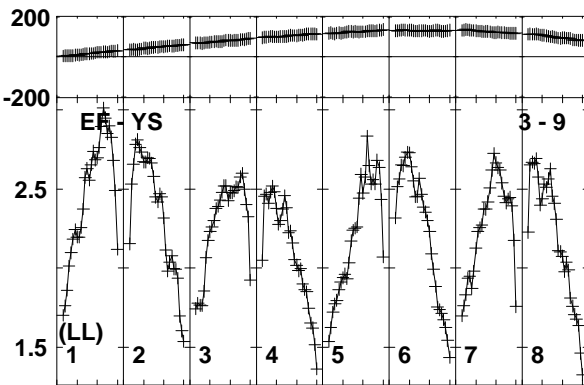
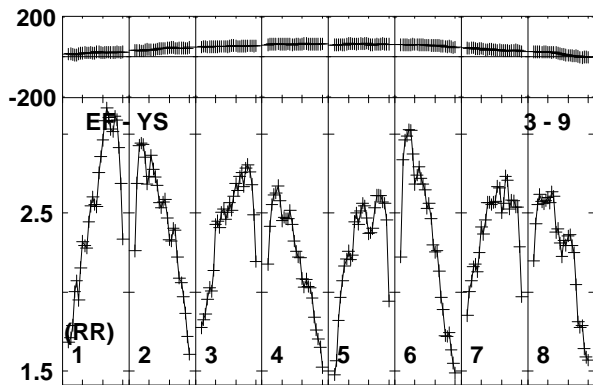
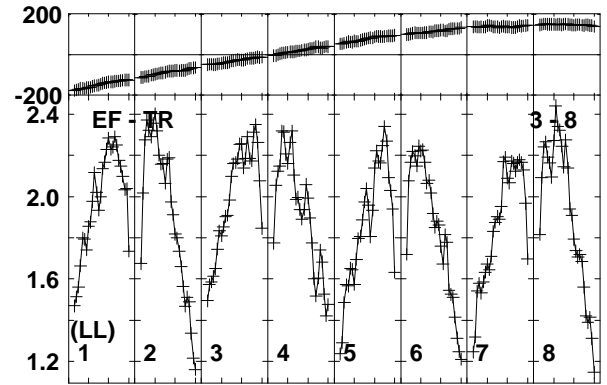
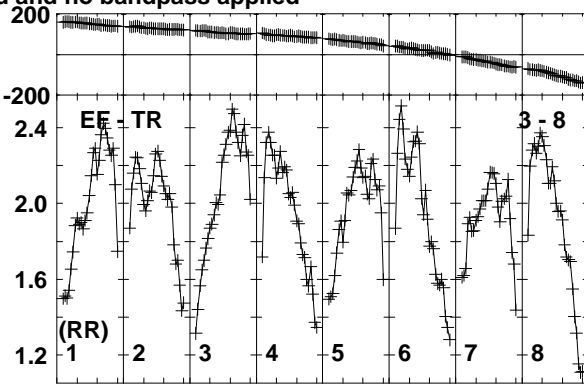
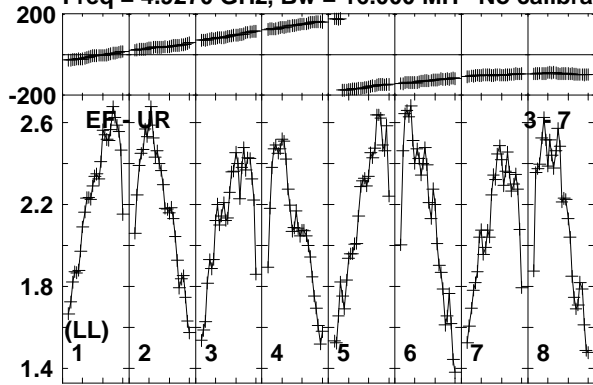

Lower frame: Milli Ampl Jy Top frame: Phas deg
Vector averaged cross-power spectrum Baseline: EF (03) - UR (07)
Timerange: 00/02:48:01 to 00/02:49:19

Plot file version 134 created 17-FEB-2020 15:42:51

J1359+5544 EK047 2.UVDATA.1

Freq = 4.9270 GHz, Bw = 16.000 MH No calibration applied and no bandpass applied

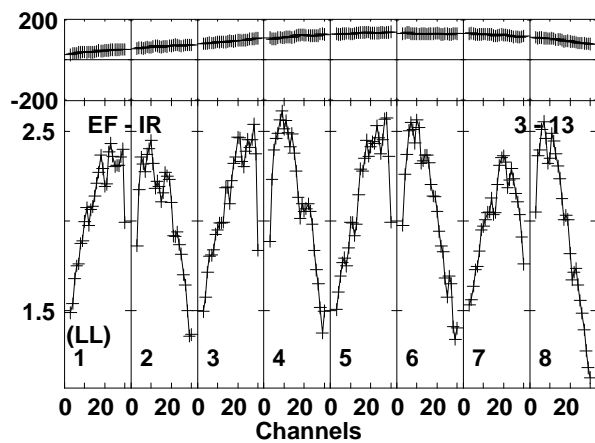
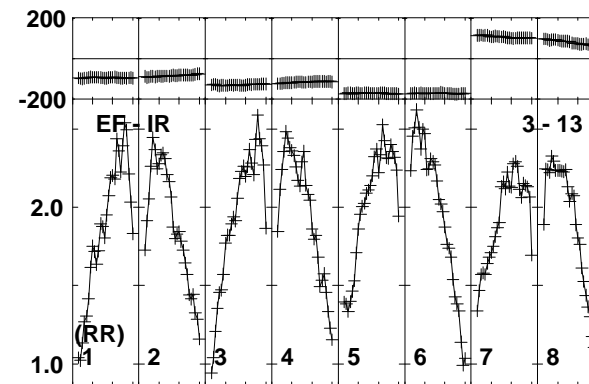
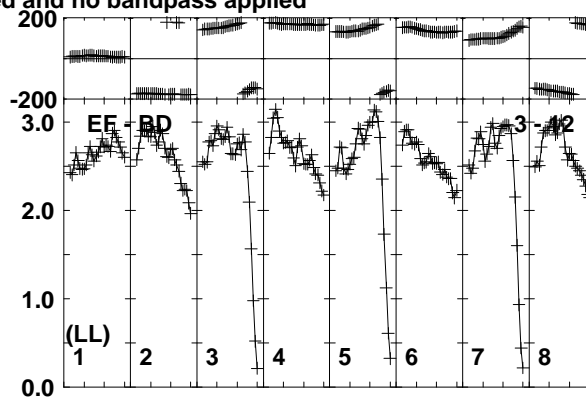
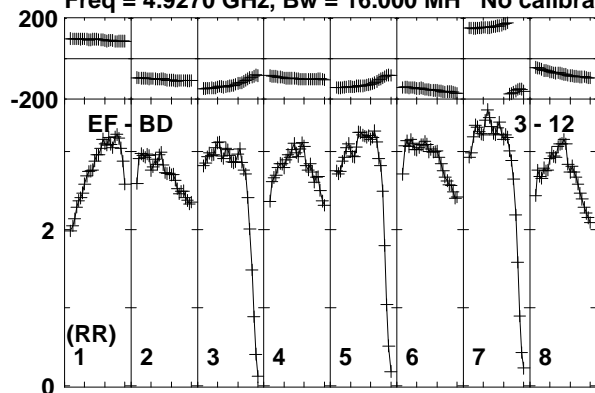

Lower frame: Milli Ampl Jy Top frame: Phas deg
Vector averaged cross-power spectrum Baseline: EF (03) - BD (12)
Timerange: 00/02:48:01 to 00/02:49:19

Plot file version 135 created 17-FEB-2020 15:42:51

J1402+5347 EK047 2.UVDATA.1

Freq = 4.9270 GHz, Bw = 16.000 MH No calibration applied and no bandpass applied

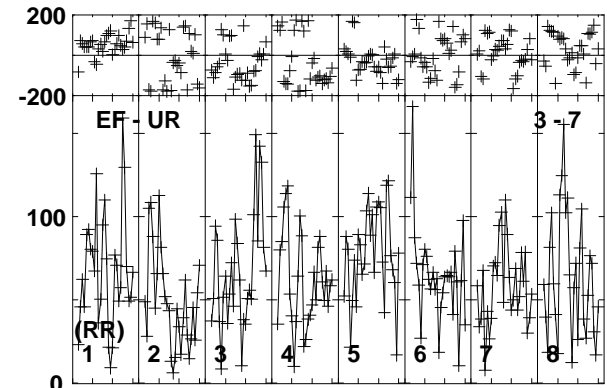
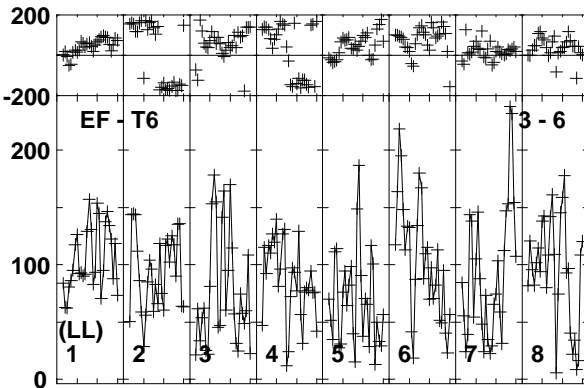
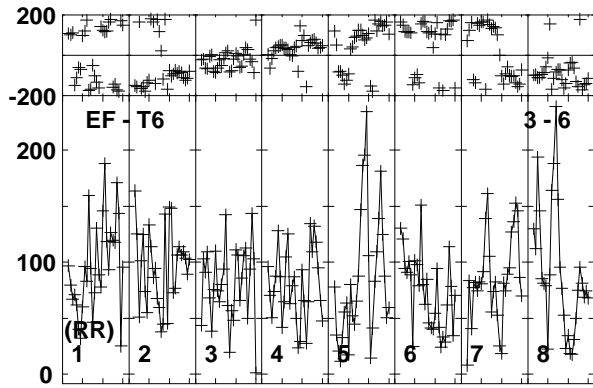
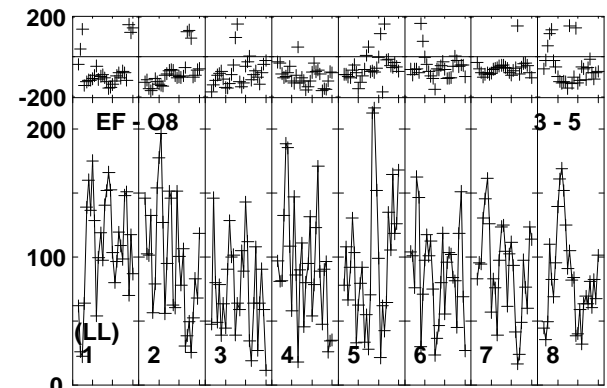
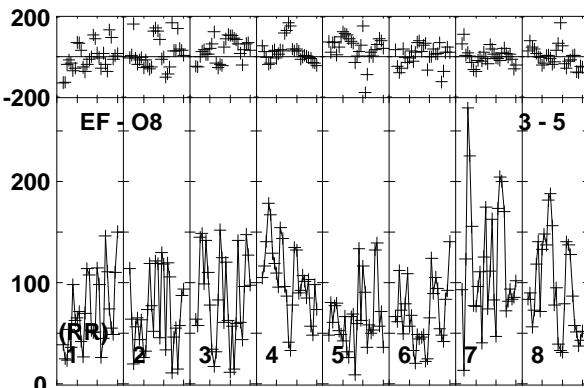
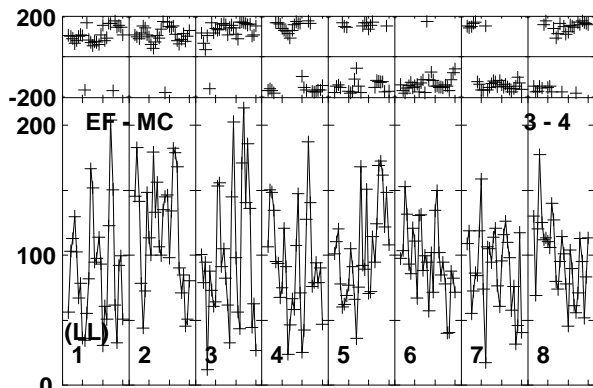
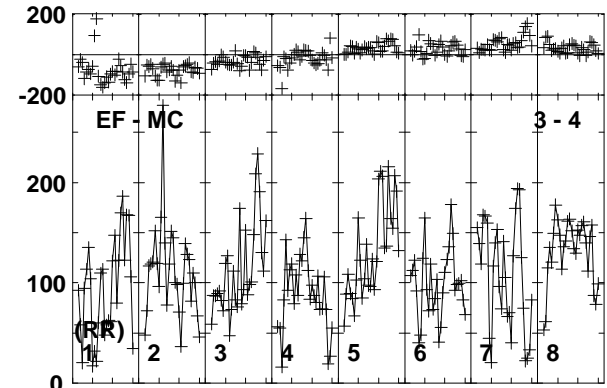
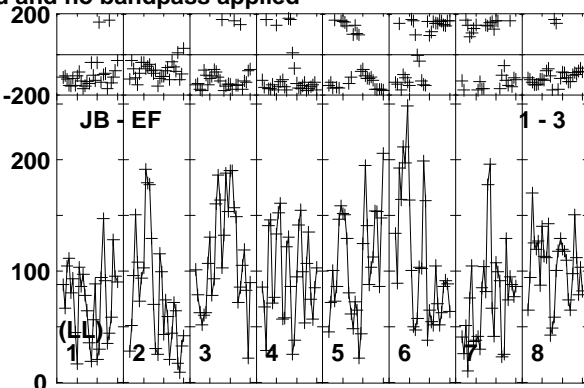
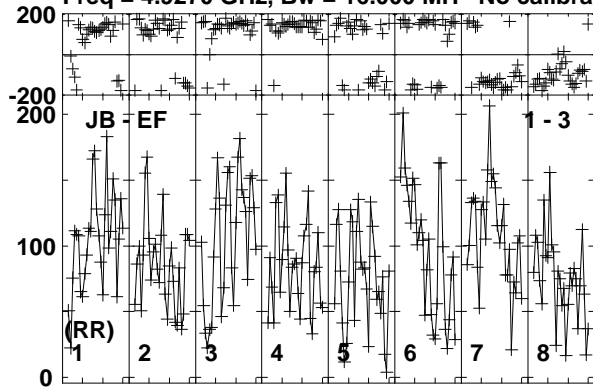

Lower frame: Micro Ampl Jy Top frame: Phas deg
Vector averaged cross-power spectrum Baseline: JB (01) - EF (03)
Timerange: 00/02:49:21 to 00/02:53:19

Plot file version 136 created 17-FEB-2020 15:42:51

J1402+5347 EK047 2.UVDATA.1

Freq = 4.9270 GHz, Bw = 16.000 MH No calibration applied and no bandpass applied

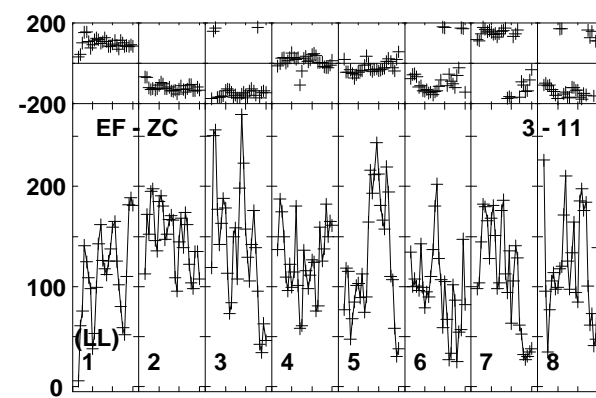
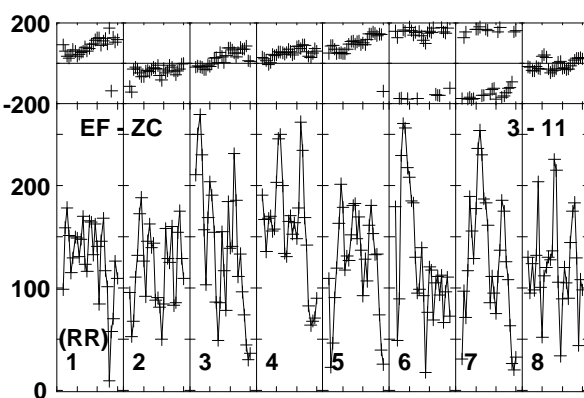
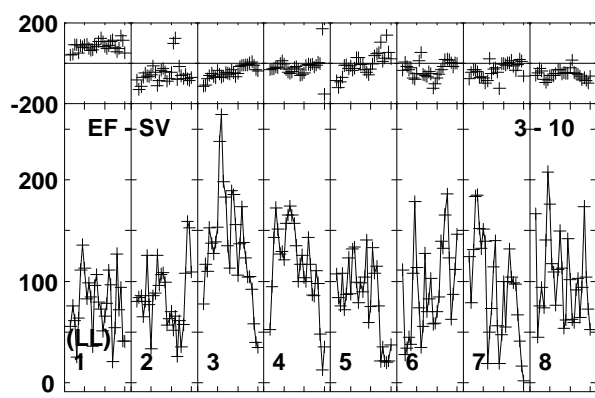
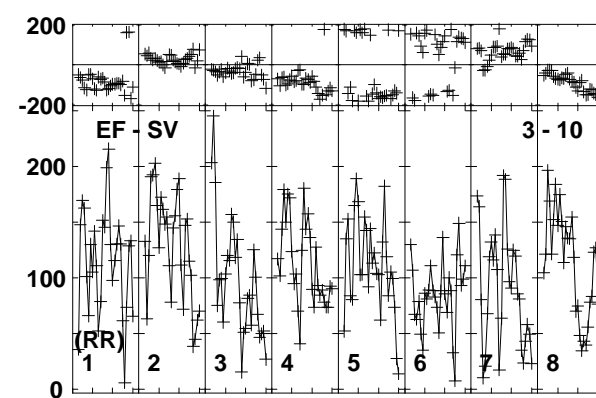
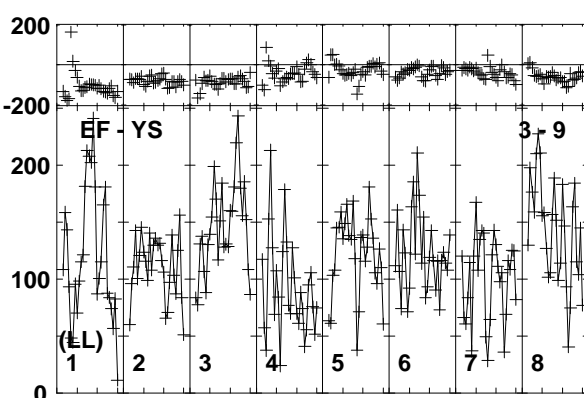
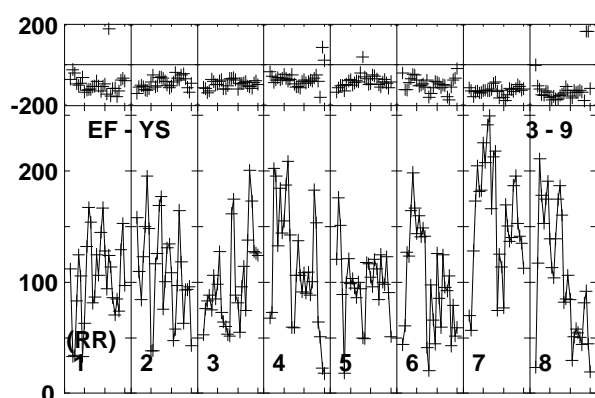
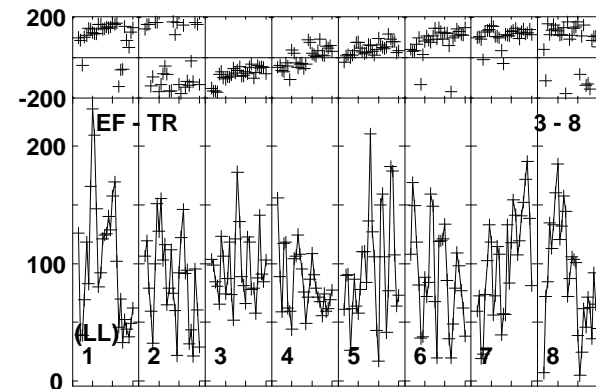
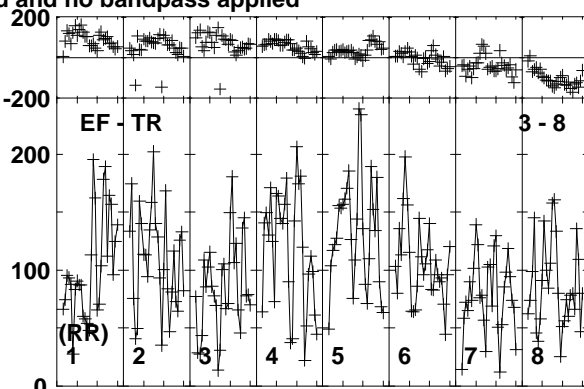
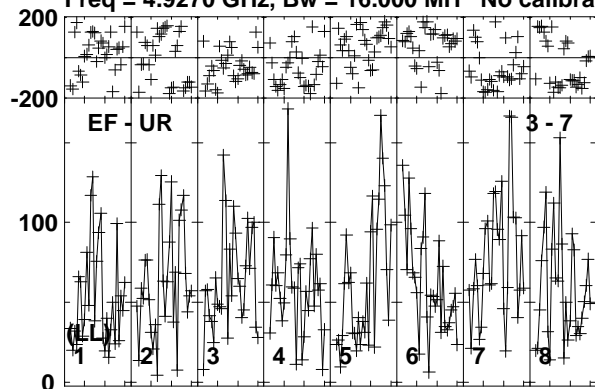

Lower frame: Micro Ampl Jy Top frame: Phas deg
Vector averaged cross-power spectrum Baseline: EF (03) - UR (07)
Timerange: 00/02:49:21 to 00/02:53:19

Plot file version 137 created 17-FEB-2020 15:42:51

J1402+5347 EK047 2.UVDATA.1

Freq = 4.9270 GHz, Bw = 16.000 MH No calibration applied and no bandpass applied

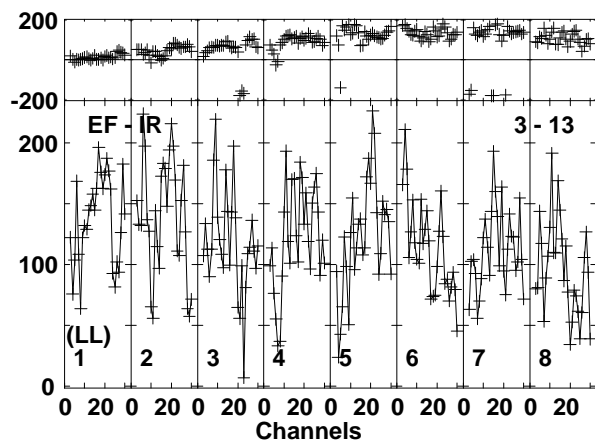
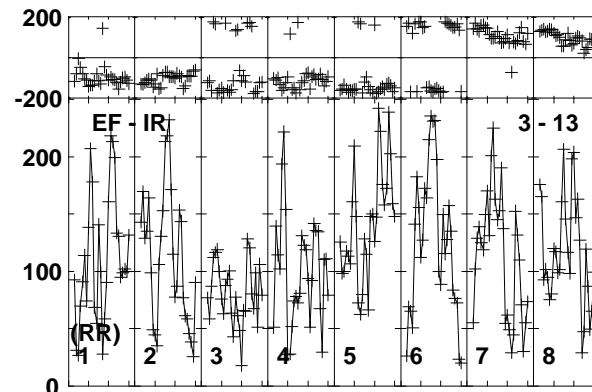
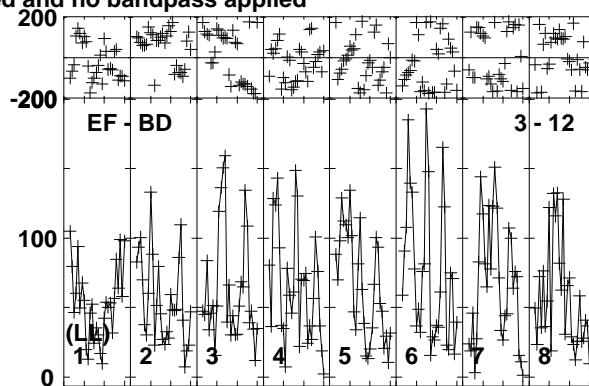
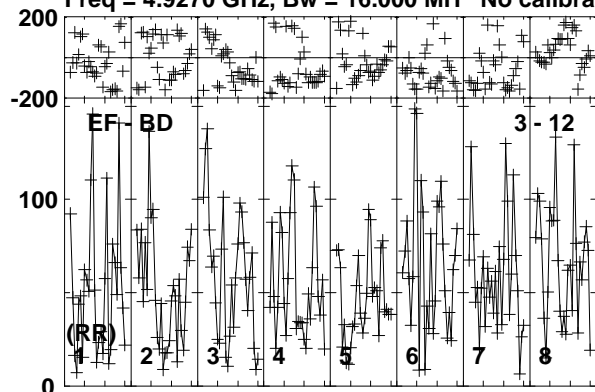

Lower frame: Micro Ampl Jy Top frame: Phas deg
Vector averaged cross-power spectrum Baseline: EF (03) - BD (12)
Timerange: 00/02:49:21 to 00/02:53:19

Plot file version 138 created 17-FEB-2020 15:42:51

J1359+5544 EK047 2.UVDATA.1

Freq = 4.9270 GHz, Bw = 16.000 MH No calibration applied and no bandpass applied

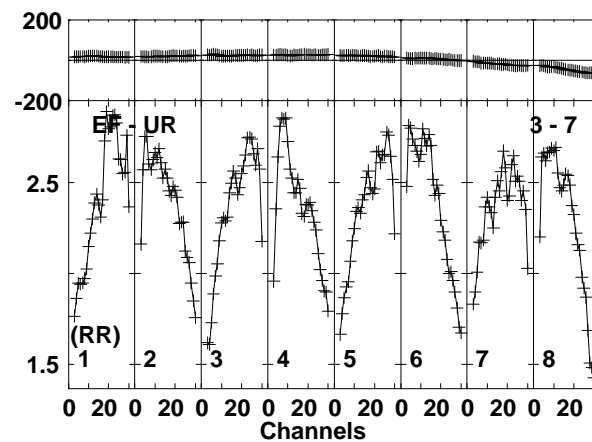
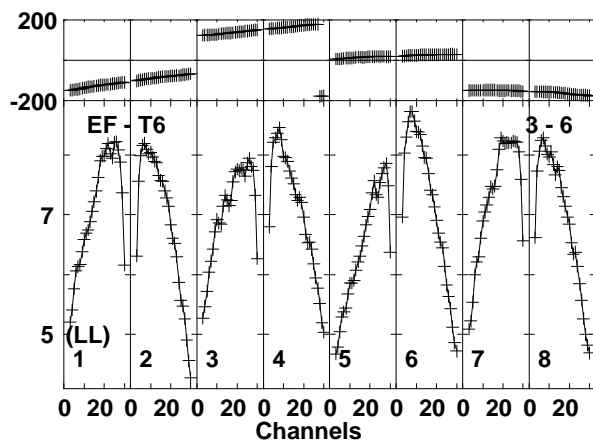
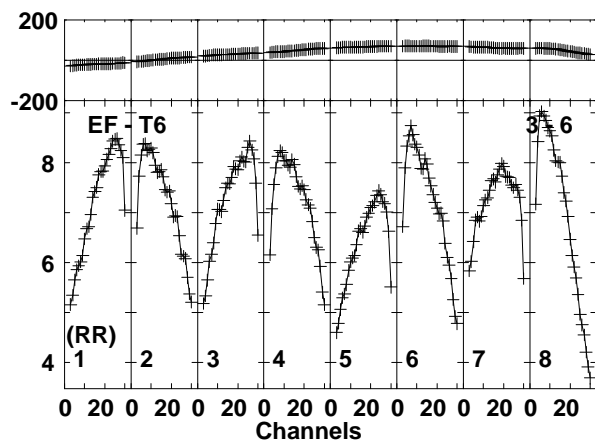
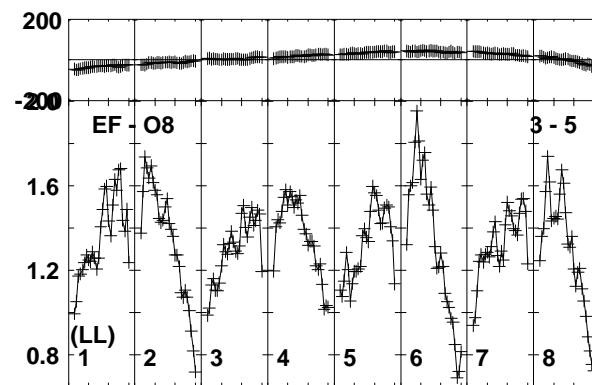
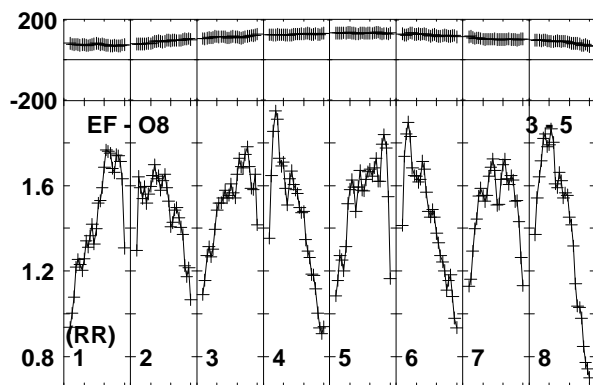
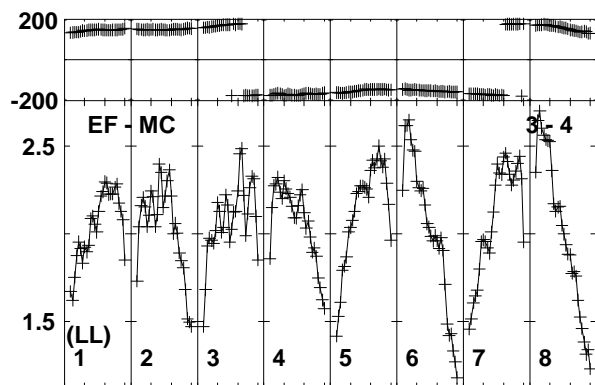
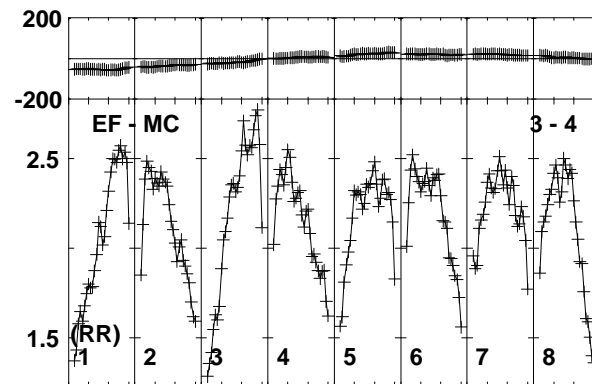
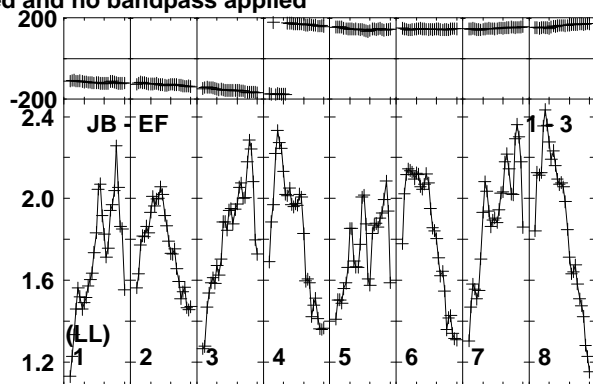
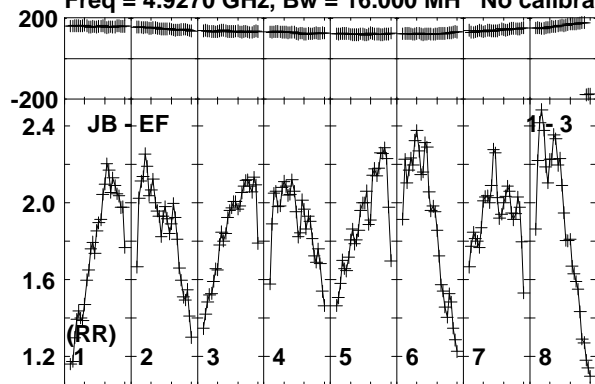

Lower frame: Milli Ampl Jy Top frame: Phas deg
Vector averaged cross-power spectrum Baseline: JB (01) - EF (03)
Timerange: 00/02:53:21 to 00/02:55:19

Plot file version 139 created 17-FEB-2020 15:42:51

J1359+5544 EK047 2.UVDATA.1

Freq = 4.9270 GHz, Bw = 16.000 MH No calibration applied and no bandpass applied

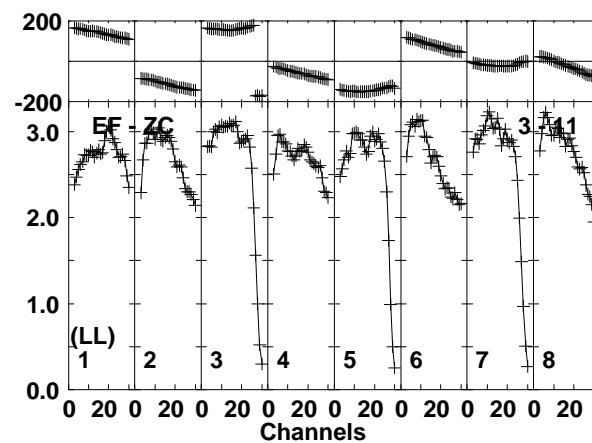
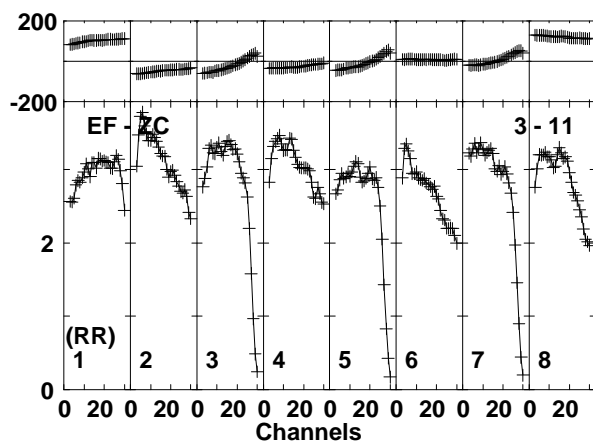
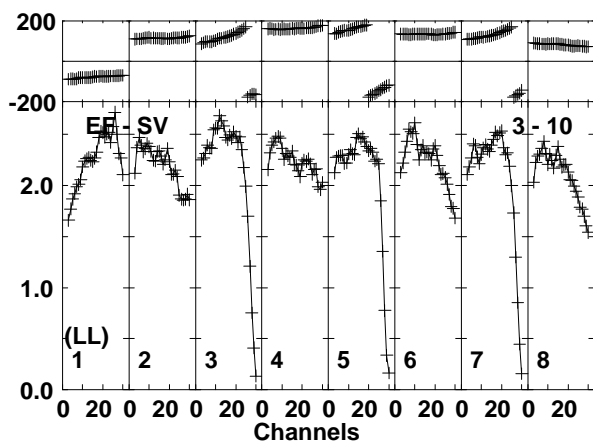
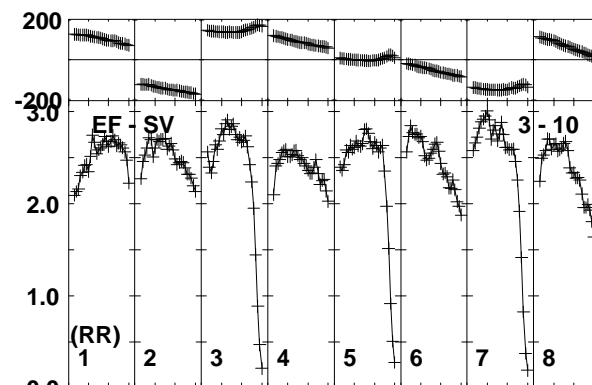
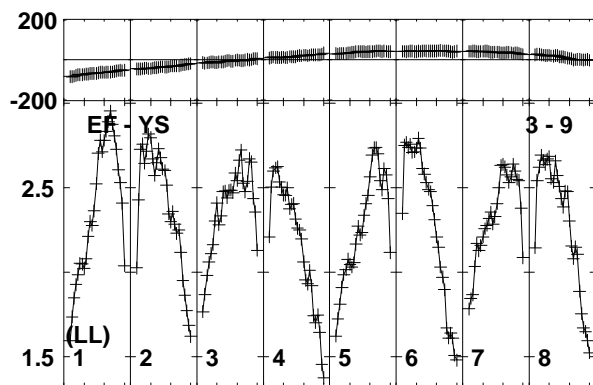
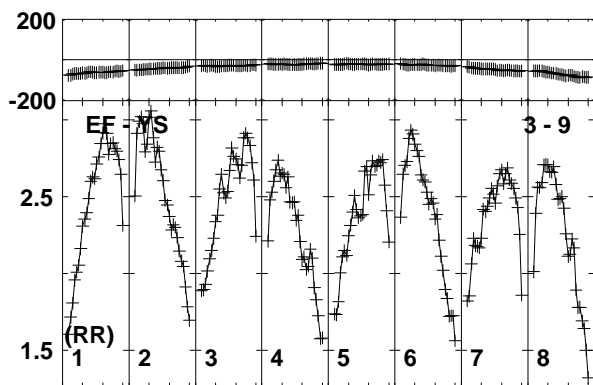
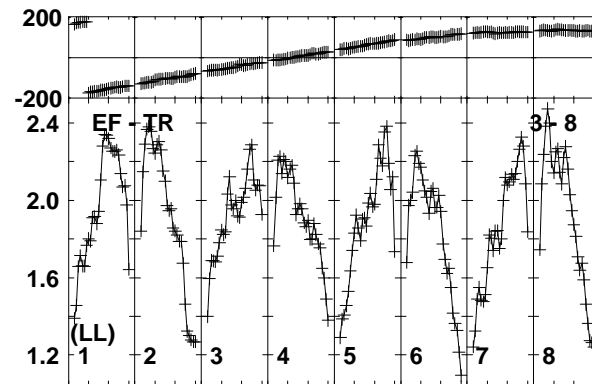
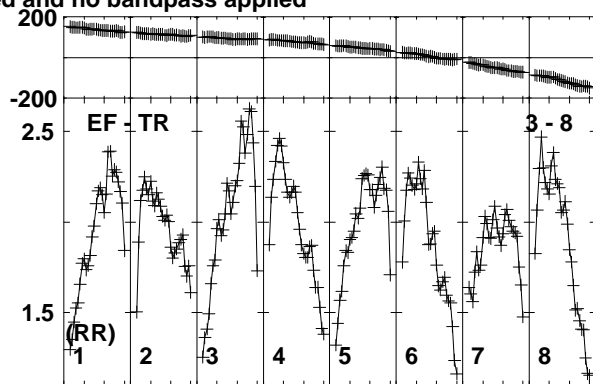
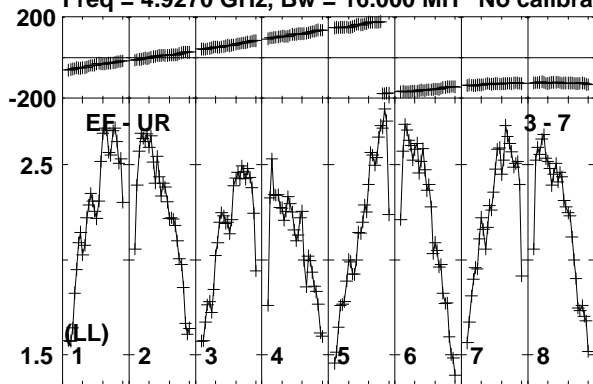

Lower frame: Milli Ampl Jy Top frame: Phas deg
Vector averaged cross-power spectrum Baseline: EF (03) - UR (07)
Timerange: 00/02:53:21 to 00/02:55:19

Plot file version 140 created 17-FEB-2020 15:42:51

J1359+5544 EK047 2.UVDATA.1

Freq = 4.9270 GHz, Bw = 16.000 MH No calibration applied and no bandpass applied

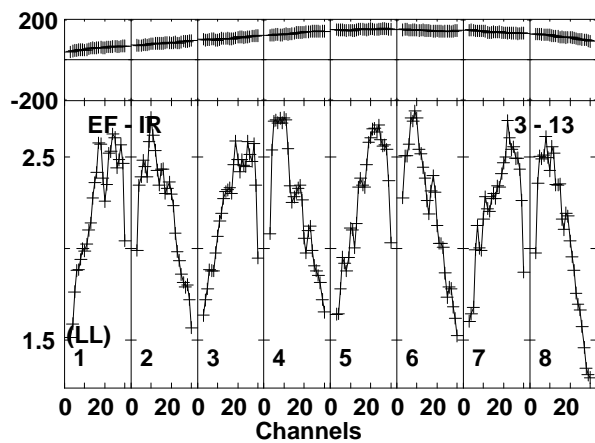
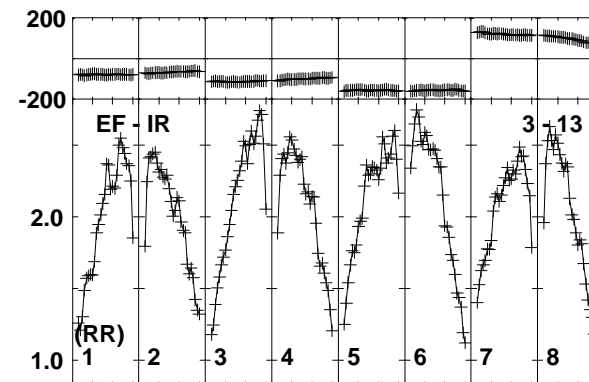
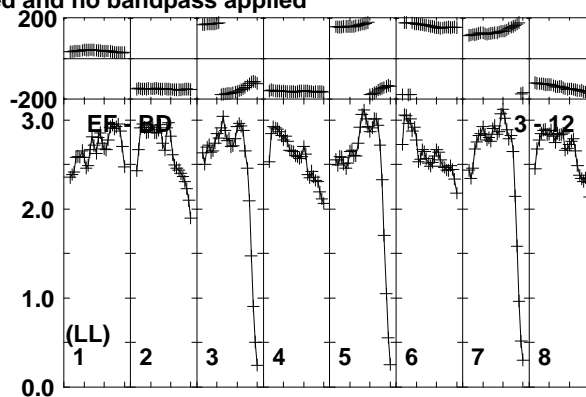
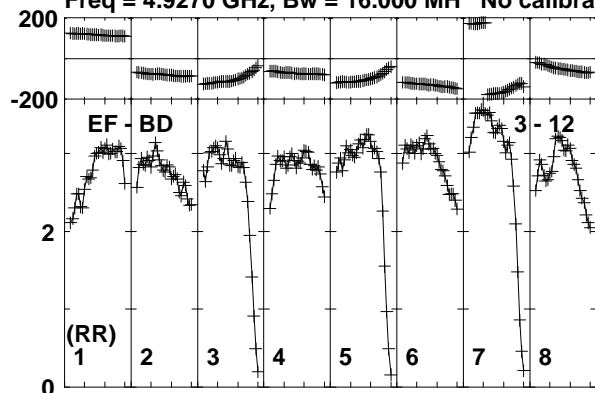

Lower frame: Milli Ampl Jy Top frame: Phas deg
Vector averaged cross-power spectrum Baseline: EF (03) - BD (12)
Timerange: 00/02:53:21 to 00/02:55:19

Plot file version 141 created 17-FEB-2020 15:42:51

J1402+5347 EK047 2.UVDATA.1

Freq = 4.9270 GHz, Bw = 16.000 MH No calibration applied and no bandpass applied

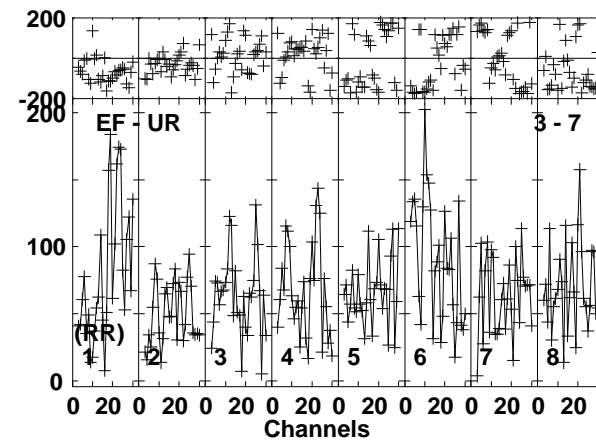
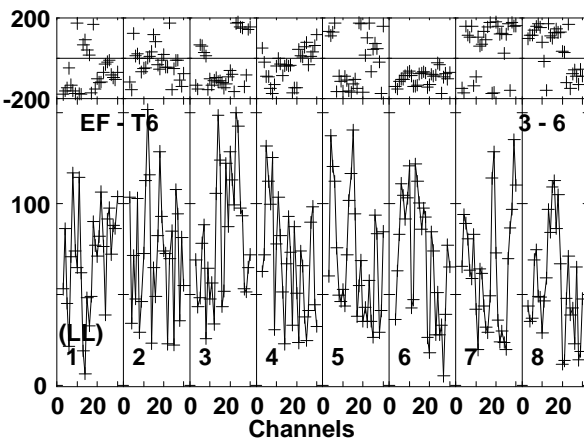
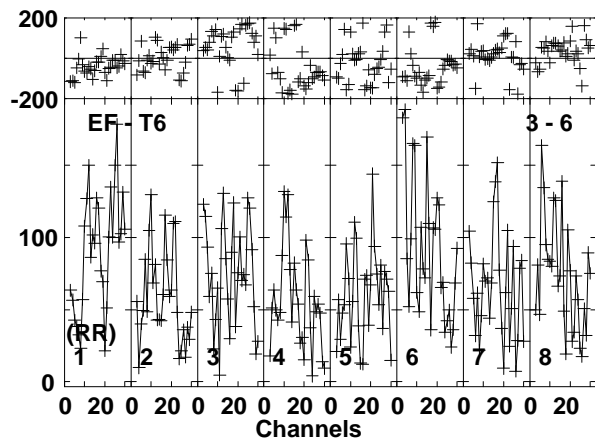
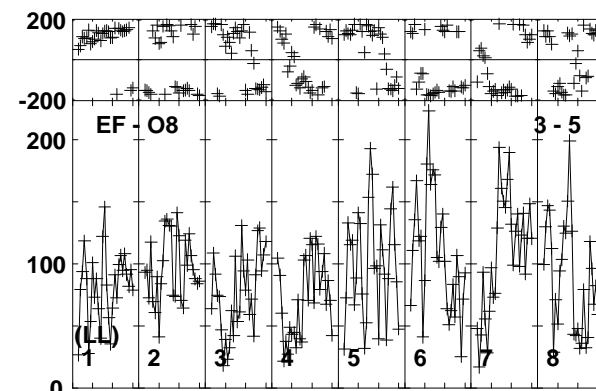
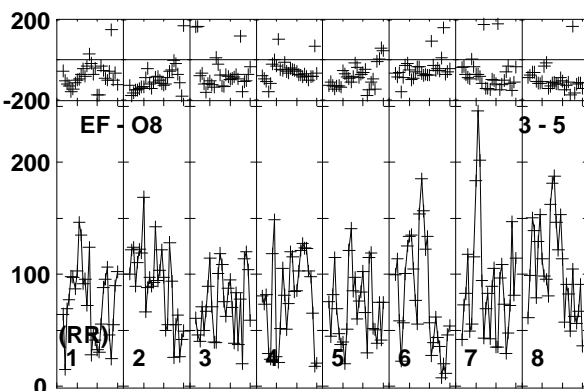
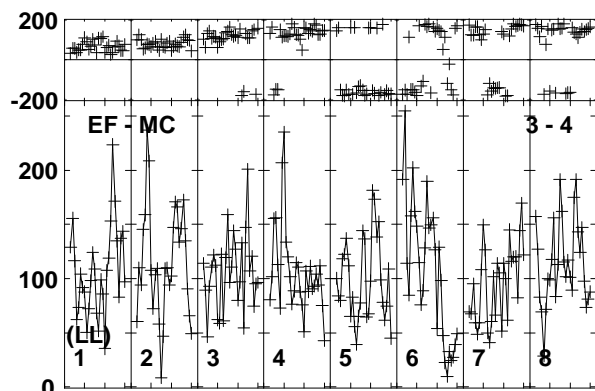
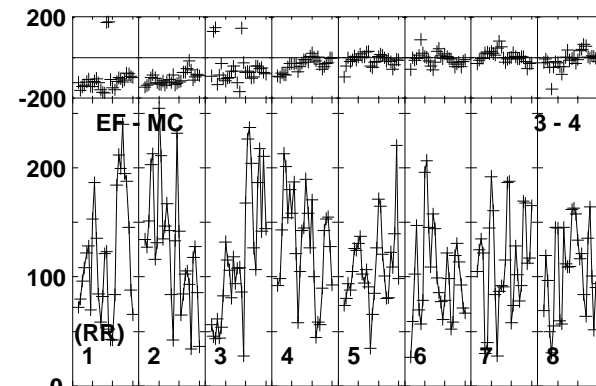
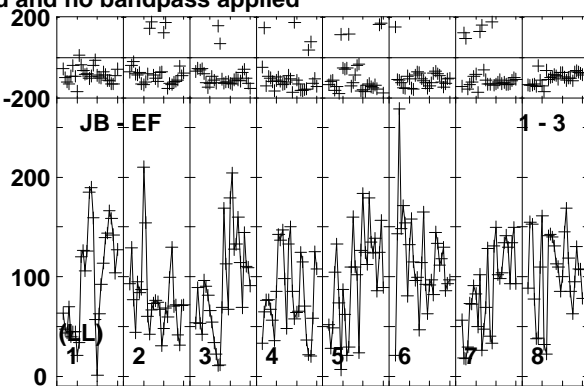
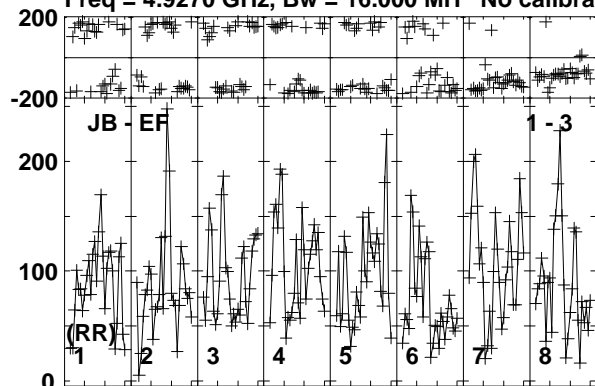

Lower frame: Micro Ampl Jy Top frame: Phas deg
Vector averaged cross-power spectrum Baseline: JB (01) - EF (03)
Timerange: 00/02:55:23 to 00/02:59:19

Plot file version 142 created 17-FEB-2020 15:42:51

J1402+5347 EK047 2.UVDATA.1

Freq = 4.9270 GHz, Bw = 16.000 MH No calibration applied and no bandpass applied

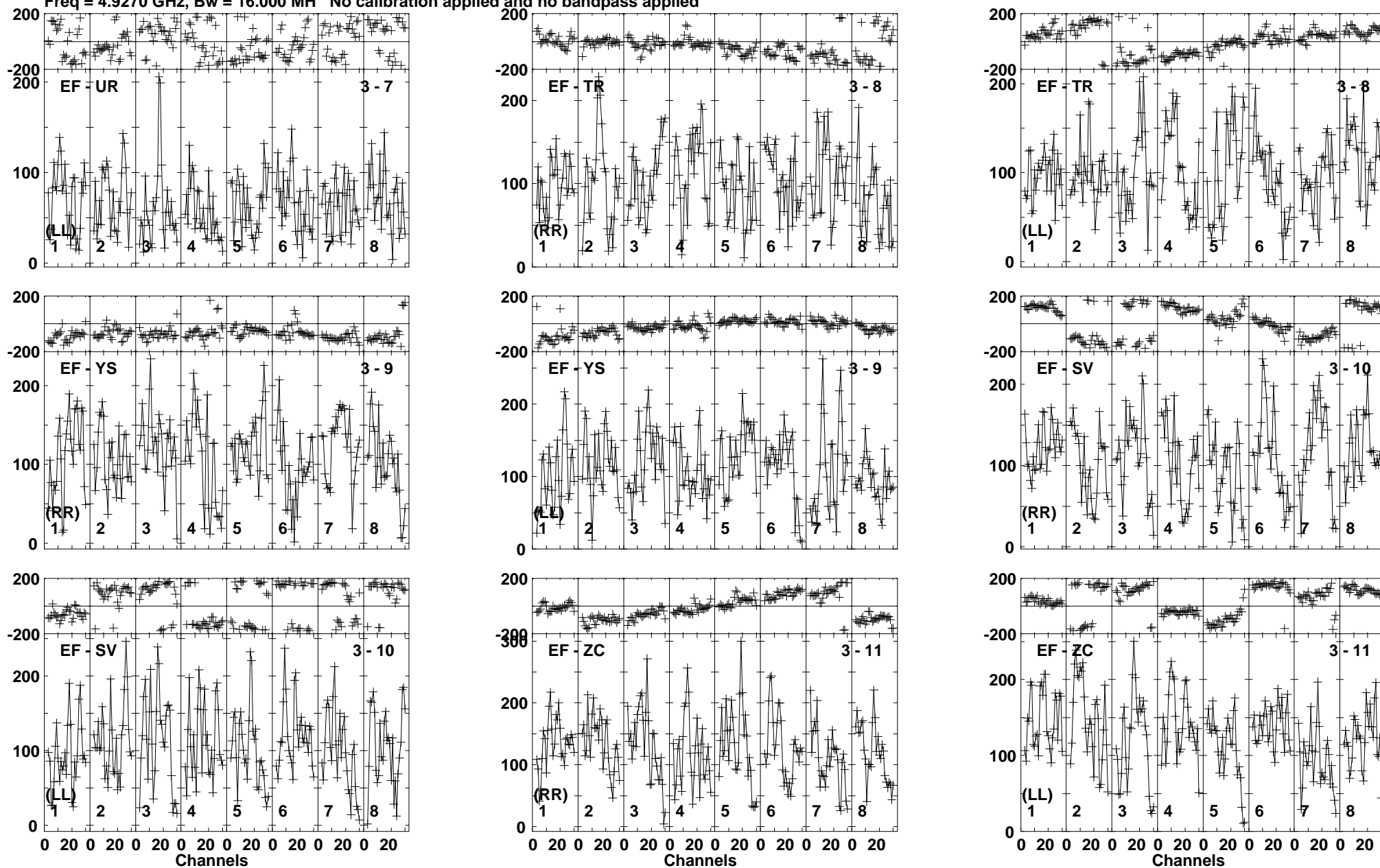

Lower frame: Micro Ampl Jy Top frame: Phas deg
Vector averaged cross-power spectrum Baseline: EF (03) - UR (07)
Timerange: 00/02:55:23 to 00/02:59:19

Plot file version 143 created 17-FEB-2020 15:42:52

J1402+5347 EK047 2.UVDATA.1

Freq = 4.9270 GHz, Bw = 16.000 MH No calibration applied and no bandpass applied

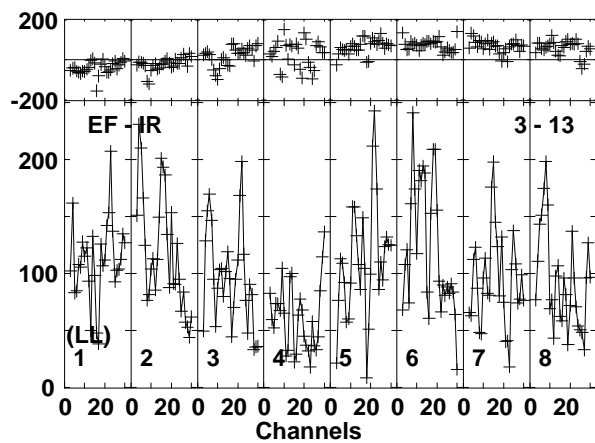
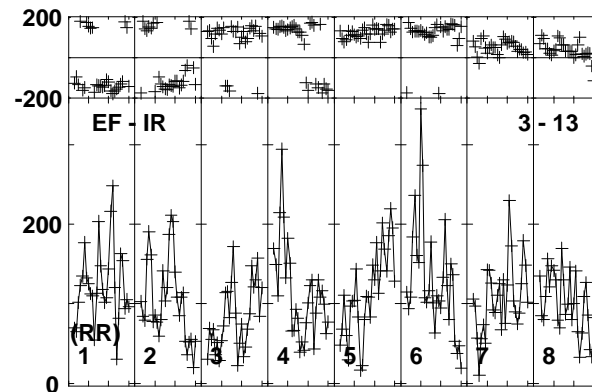
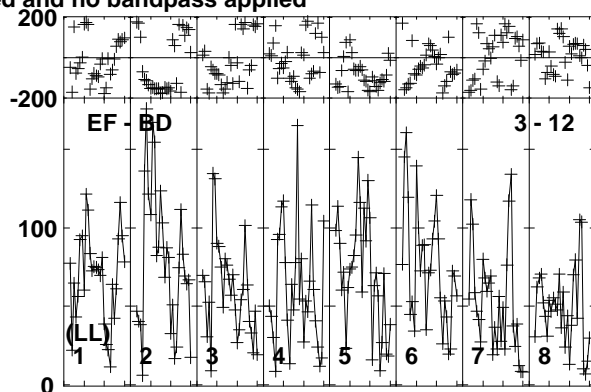
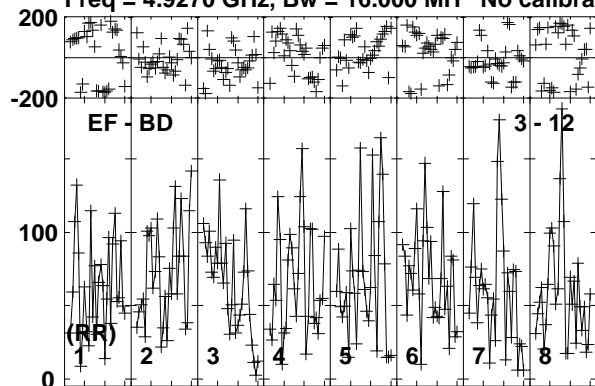

Lower frame: Micro Ampl Jy Top frame: Phas deg
Vector averaged cross-power spectrum Baseline: EF (03) - BD (12)
Timerange: 00/02:55:23 to 00/02:59:19

Plot file version 144 created 17-FEB-2020 15:42:52

J1359+5544 EK047 2.UVDATA.1

Freq = 4.9270 GHz, Bw = 16.000 MH No calibration applied and no bandpass applied

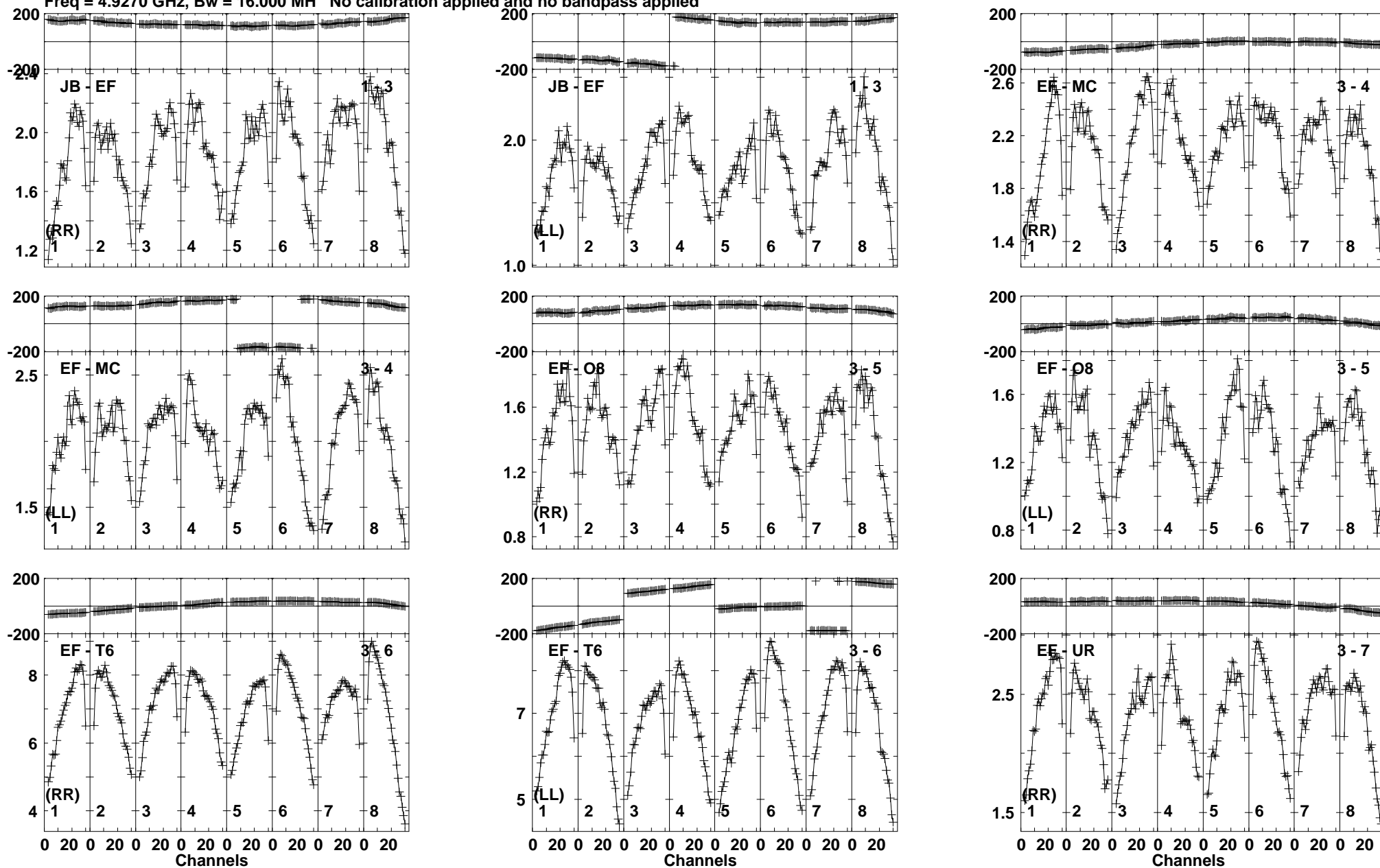

Lower frame: Milli Ampl Jy Top frame: Phas deg
Vector averaged cross-power spectrum Baseline: JB (01) - EF (03)
Timerange: 00/03:00:01 to 00/03:01:19

Plot file version 145 created 17-FEB-2020 15:42:52

J1359+5544 EK047 2.UVDATA.1

Freq = 4.9270 GHz, Bw = 16.000 MH No calibration applied and no bandpass applied

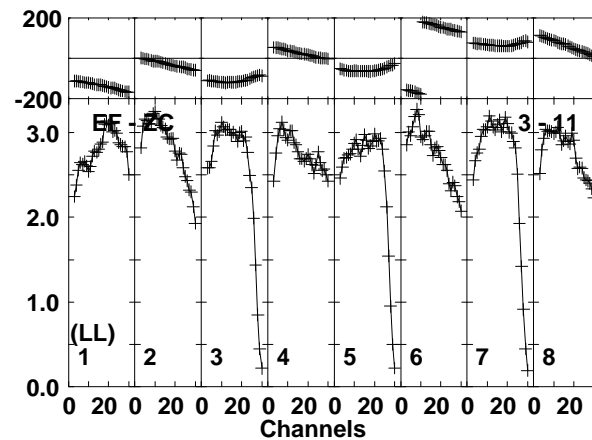
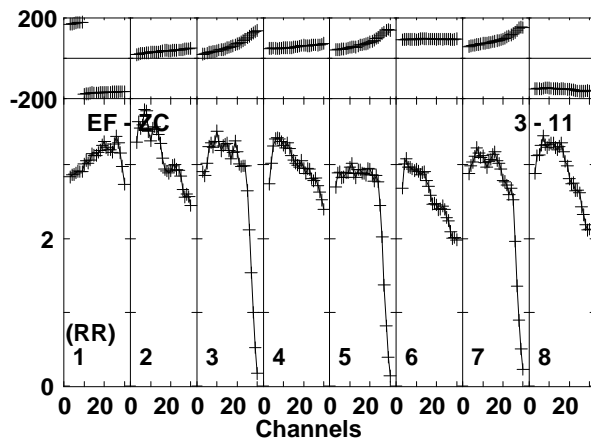
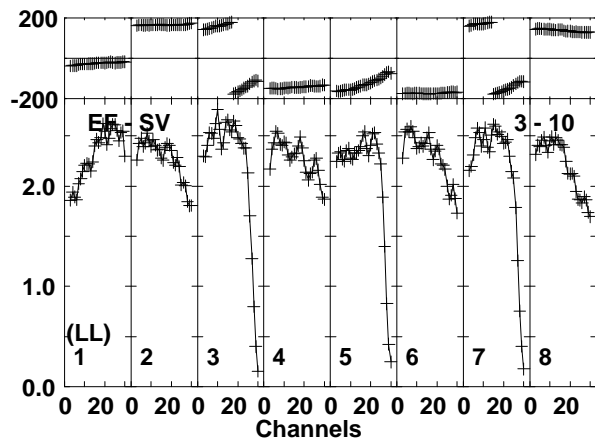
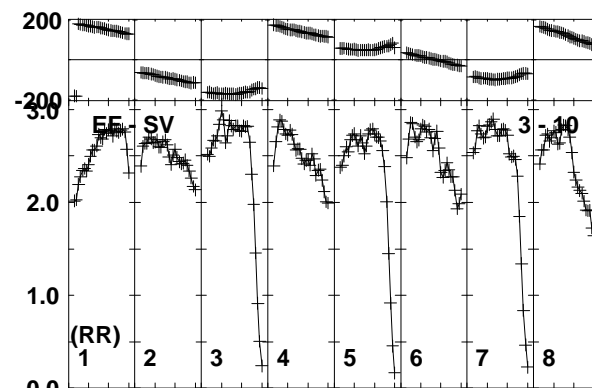
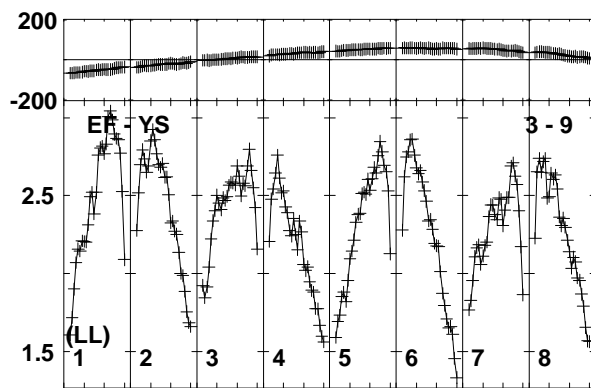
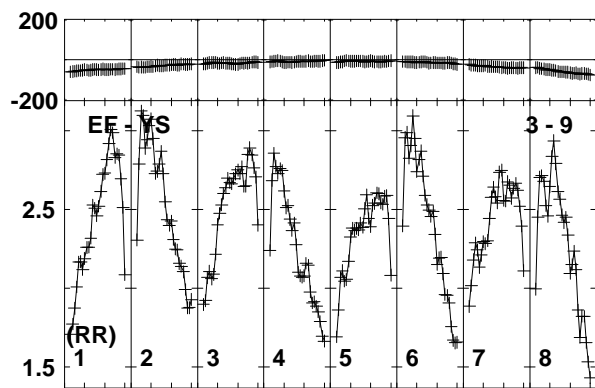
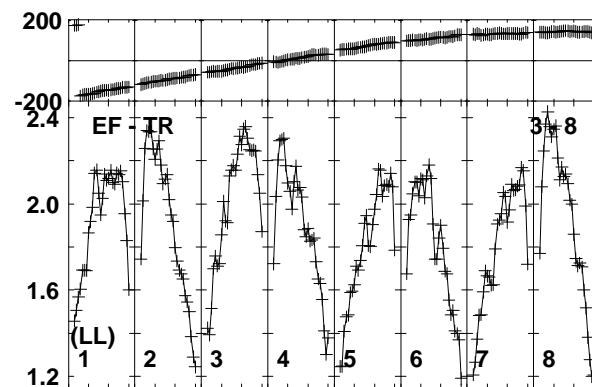
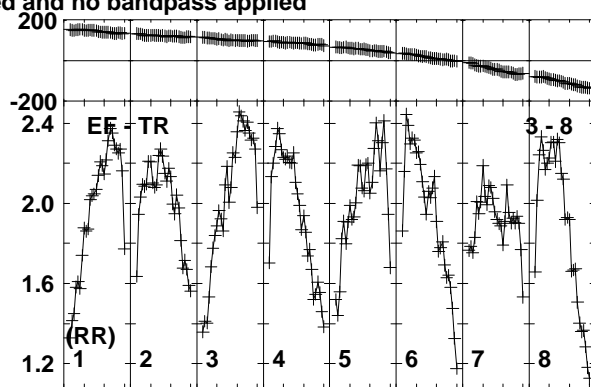
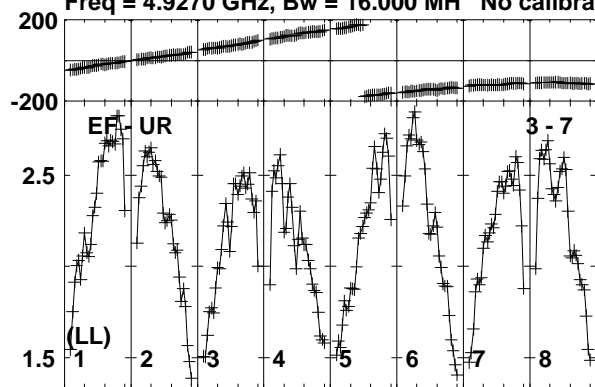

Lower frame: Milli Ampl Jy Top frame: Phas deg
Vector averaged cross-power spectrum Baseline: EF (03) - UR (07)
Timerange: 00/03:00:01 to 00/03:01:19

Plot file version 146 created 17-FEB-2020 15:42:52

J1359+5544 EK047 2.UVDATA.1

Freq = 4.9270 GHz, Bw = 16.000 MH No calibration applied and no bandpass applied

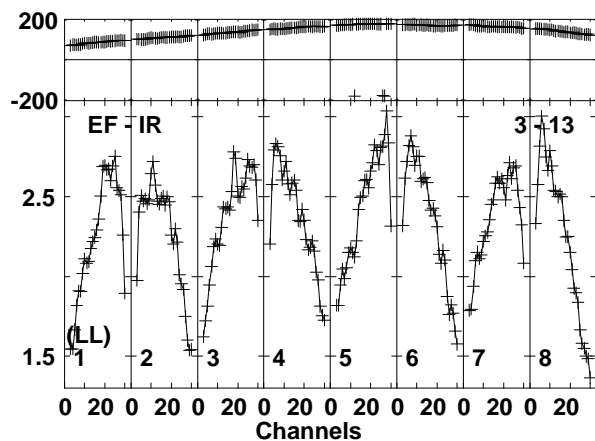
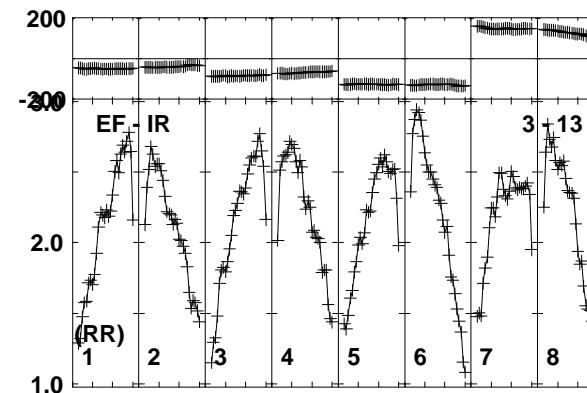
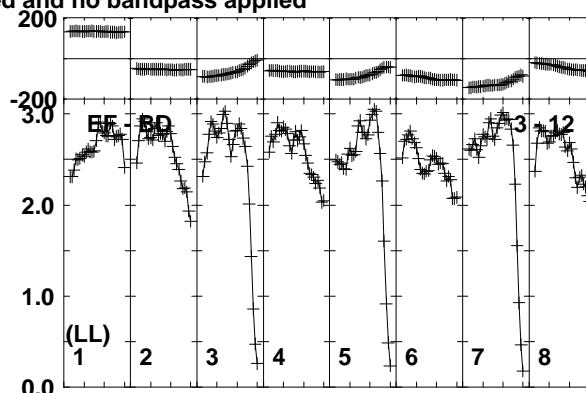
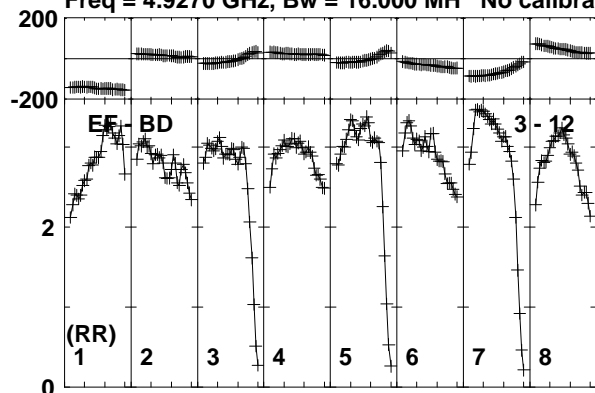

Lower frame: Milli Ampl Jy Top frame: Phas deg
Vector averaged cross-power spectrum Baseline: EF (03) - BD (12)
Timerange: 00/03:00:01 to 00/03:01:19

Plot file version 147 created 17-FEB-2020 15:42:52

J1402+5347 EK047 2.UVDATA.1

Freq = 4.9270 GHz, Bw = 16.000 MH No calibration applied and no bandpass applied

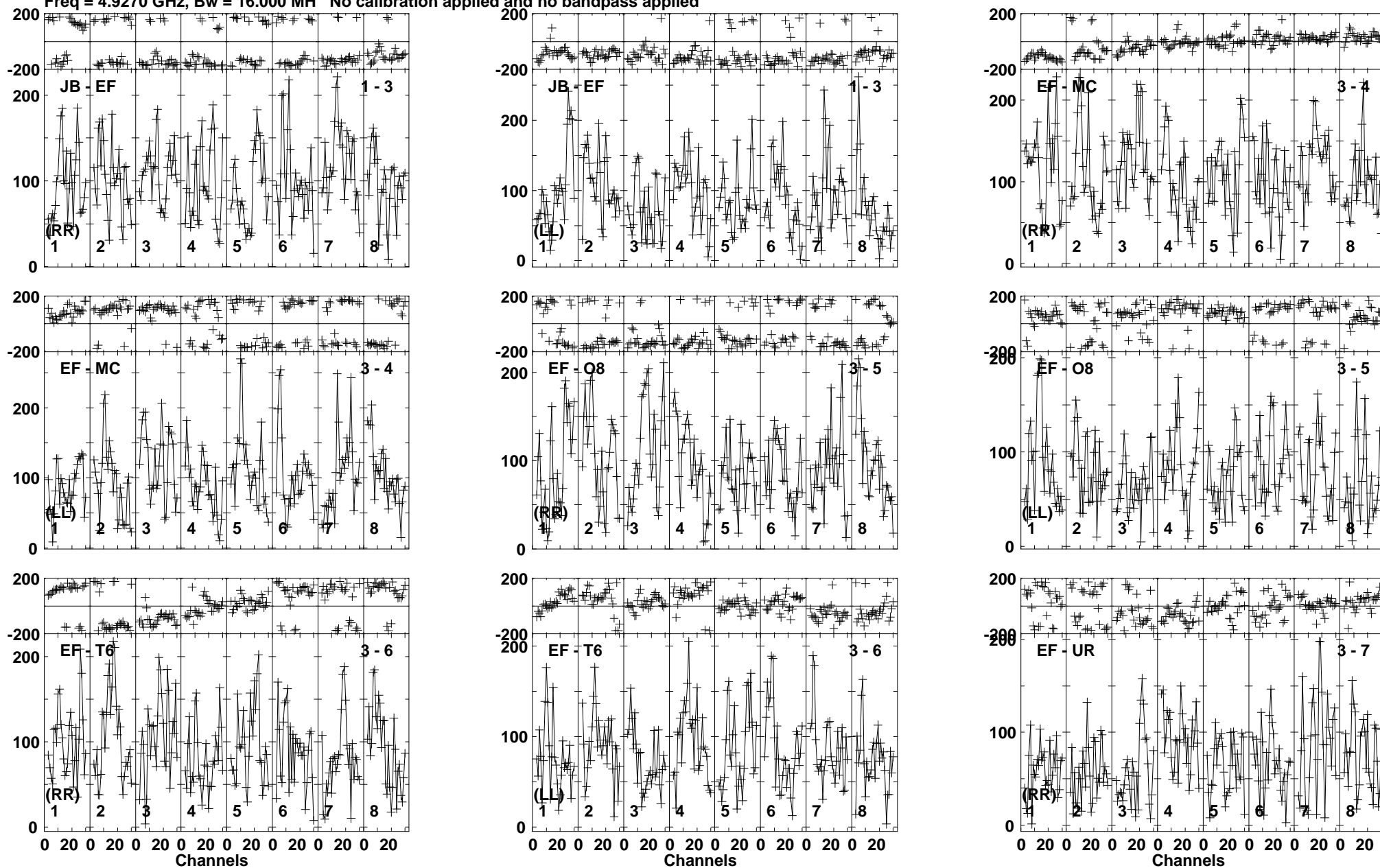

Lower frame: Micro Ampl Jy Top frame: Phas deg
Vector averaged cross-power spectrum Baseline: JB (01) - EF (03)
Timerange: 00/03:01:21 to 00/03:05:19

Plot file version 148 created 17-FEB-2020 15:42:52

J1402+5347 EK047 2.UVDATA.1

Freq = 4.9270 GHz, Bw = 16.000 MH No calibration applied and no bandpass applied

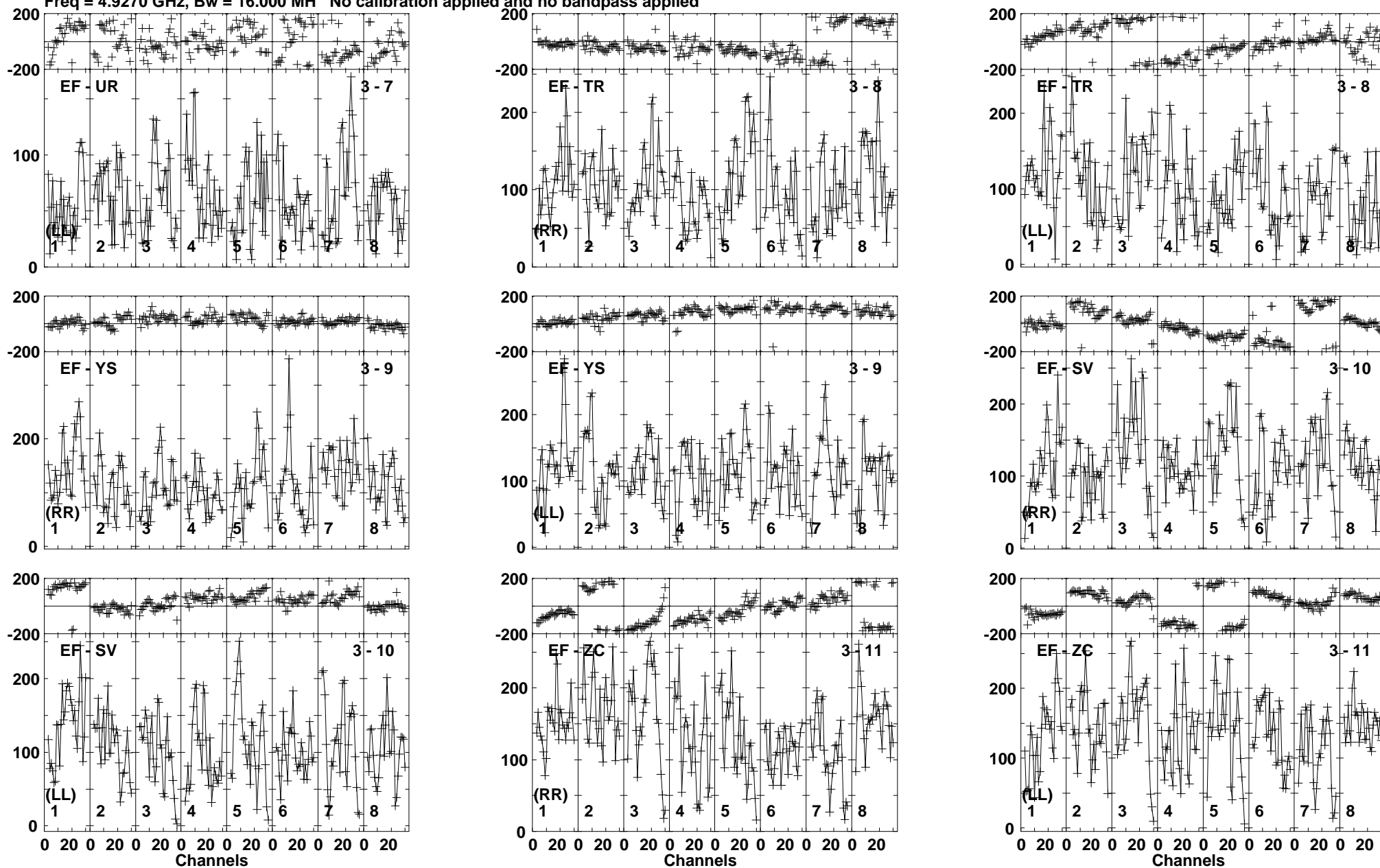

Lower frame: Micro Ampl Jy Top frame: Phas deg
Vector averaged cross-power spectrum Baseline: EF (03) - UR (07)
Timerange: 00/03:01:21 to 00/03:05:19

Plot file version 149 created 17-FEB-2020 15:42:52

J1402+5347 EK047 2.UVDATA.1

Freq = 4.9270 GHz, Bw = 16.000 MH No calibration applied and no bandpass applied

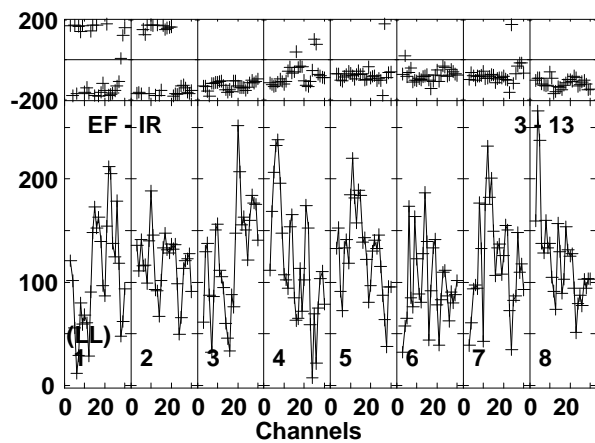
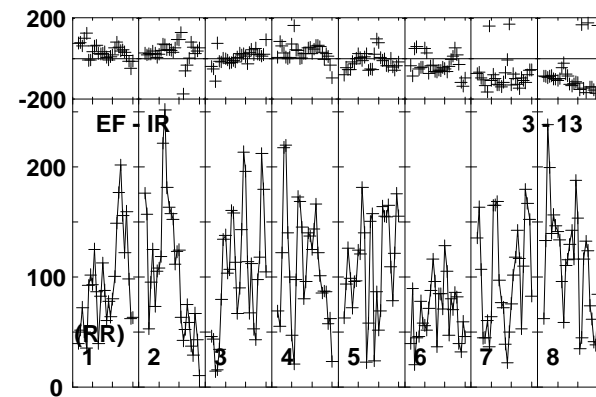
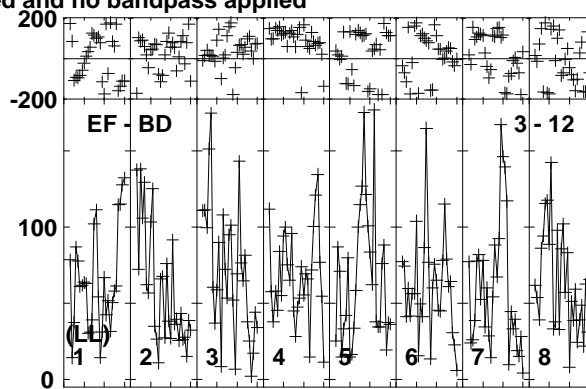
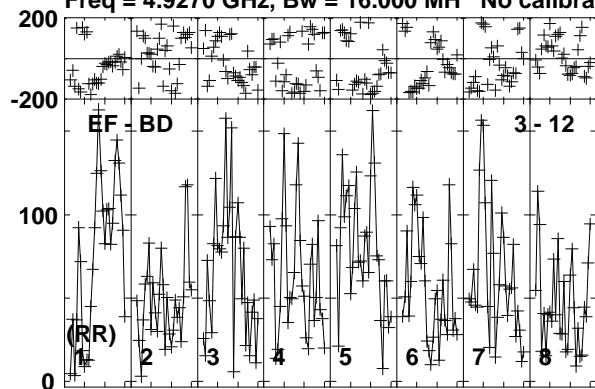

Lower frame: Micro Ampl Jy Top frame: Phas deg
Vector averaged cross-power spectrum Baseline: EF (03) - BD (12)
Timerange: 00/03:01:21 to 00/03:05:19

Plot file version 150 created 17-FEB-2020 15:42:52

J1359+5544 EK047 2.UVDATA.1

Freq = 4.9270 GHz, Bw = 16.000 MH No calibration applied and no bandpass applied

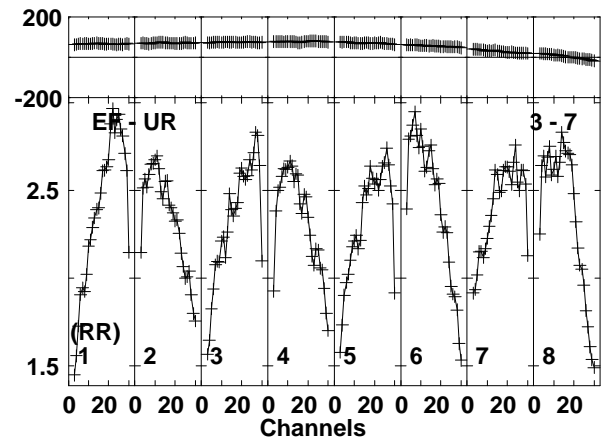
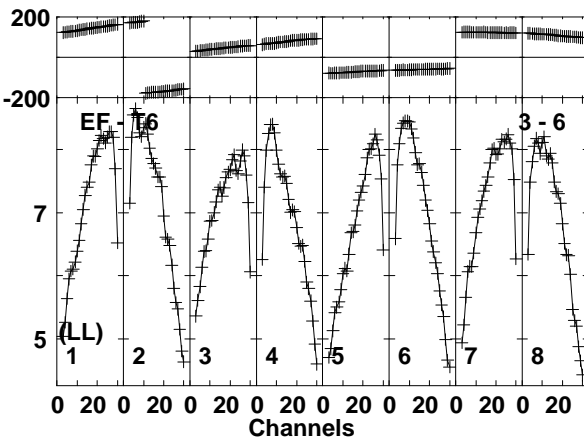
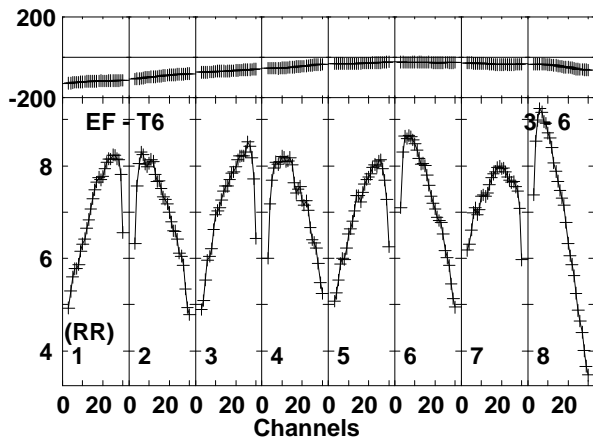
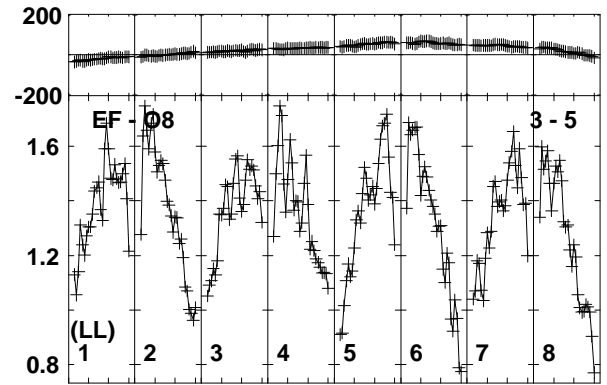
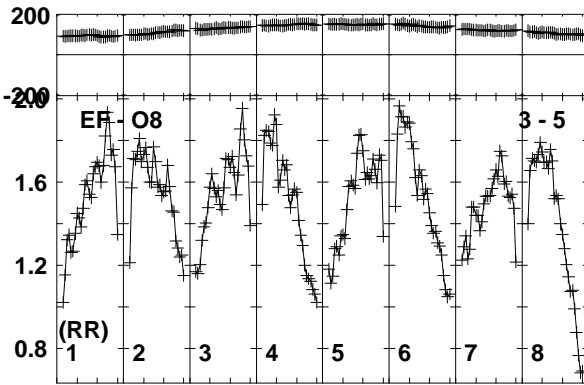
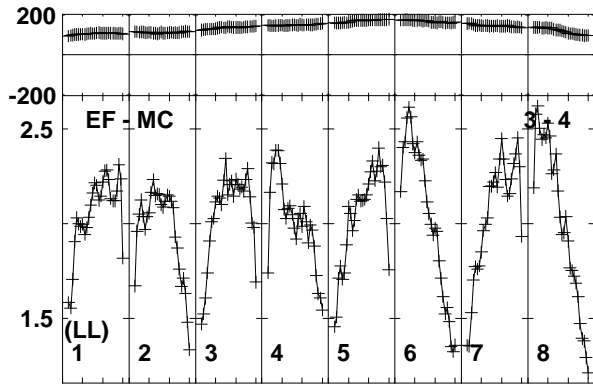
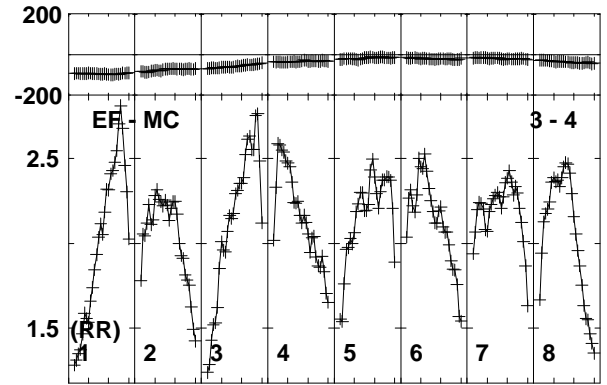
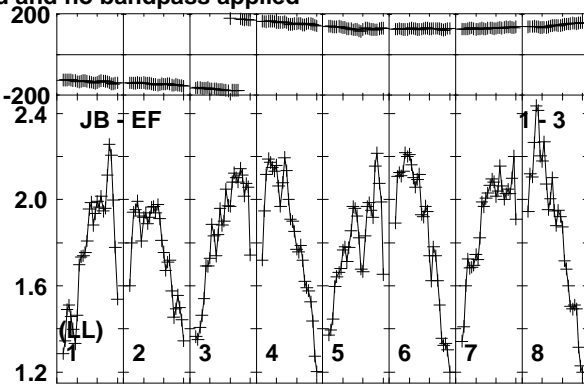
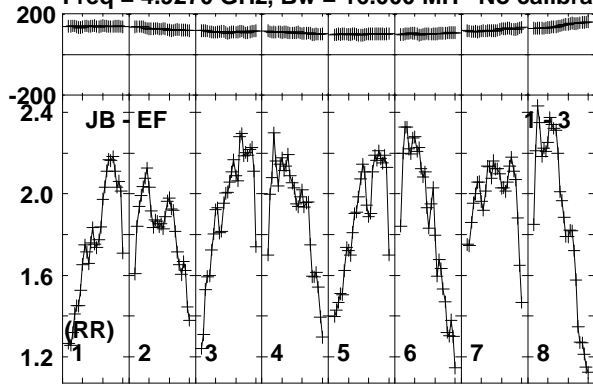

Lower frame: Milli Ampl Jy Top frame: Phas deg
Vector averaged cross-power spectrum Baseline: JB (01) - EF (03)
Timerange: 00/03:05:21 to 00/03:07:19

Plot file version 151 created 17-FEB-2020 15:42:52

J1359+5544 EK047 2.UVDATA.1

Freq = 4.9270 GHz, Bw = 16.000 MH No calibration applied and no bandpass applied

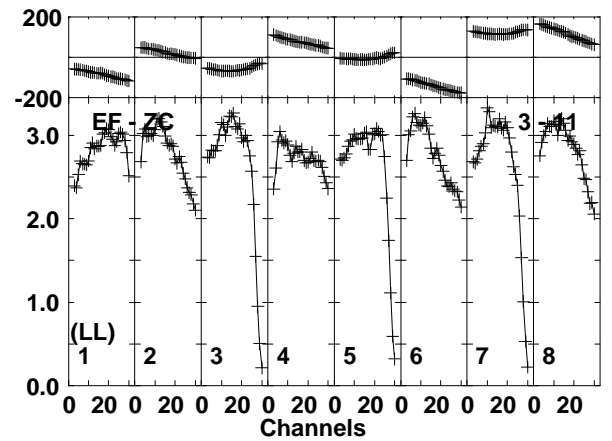
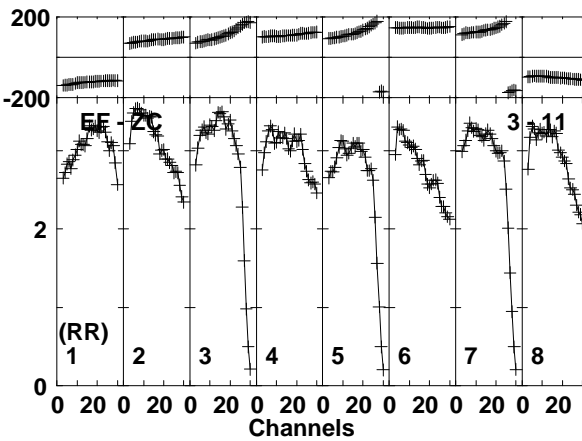
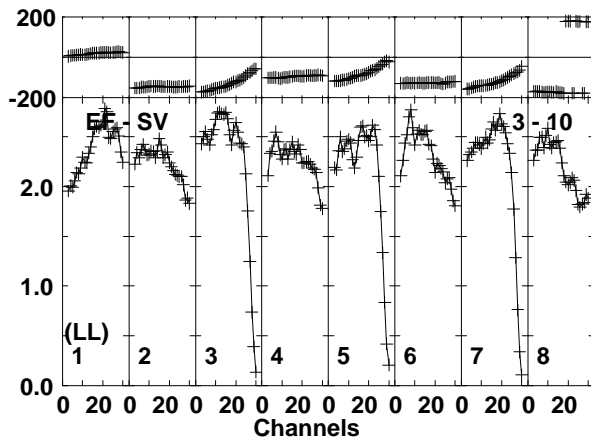
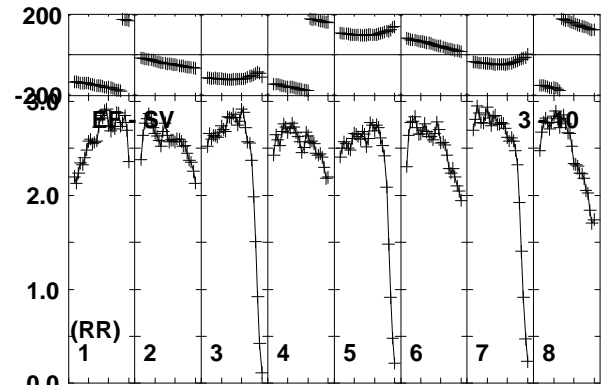
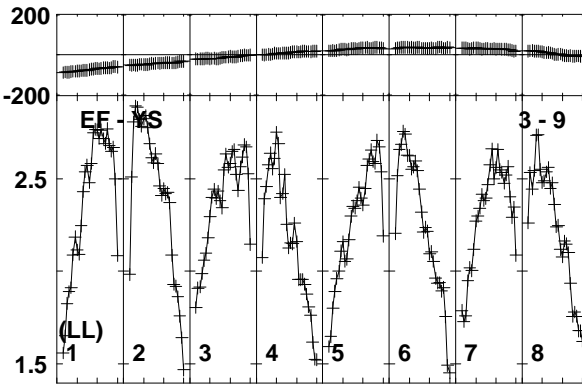
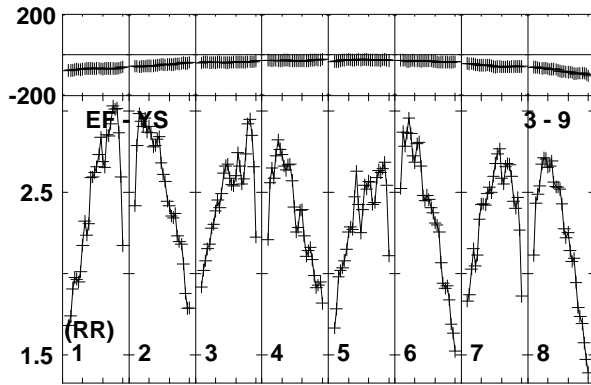
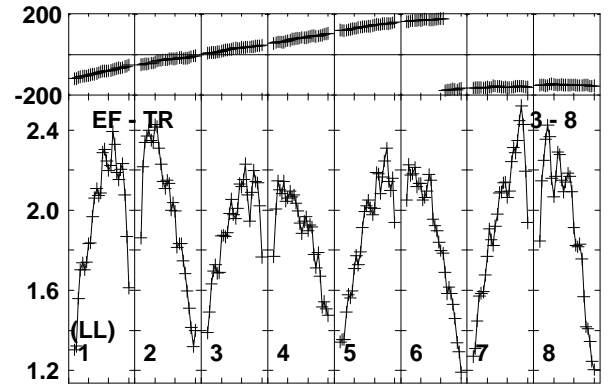
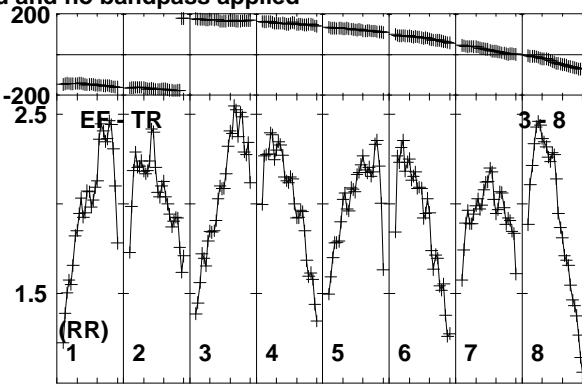
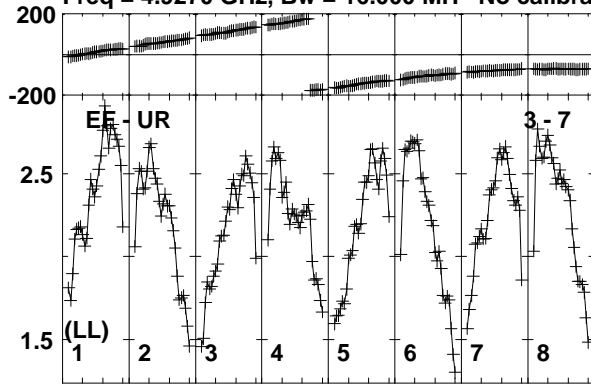

Lower frame: Milli Ampl Jy Top frame: Phas deg
Vector averaged cross-power spectrum Baseline: EF (03) - UR (07)
Timerange: 00/03:05:21 to 00/03:07:19

Plot file version 152 created 17-FEB-2020 15:42:52

J1359+5544 EK047 2.UVDATA.1

Freq = 4.9270 GHz, Bw = 16.000 MH No calibration applied and no bandpass applied

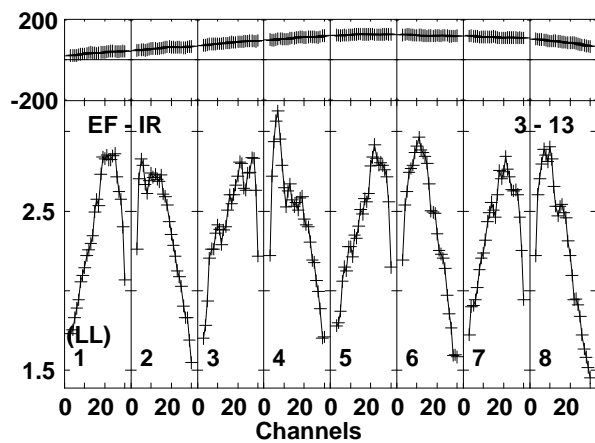
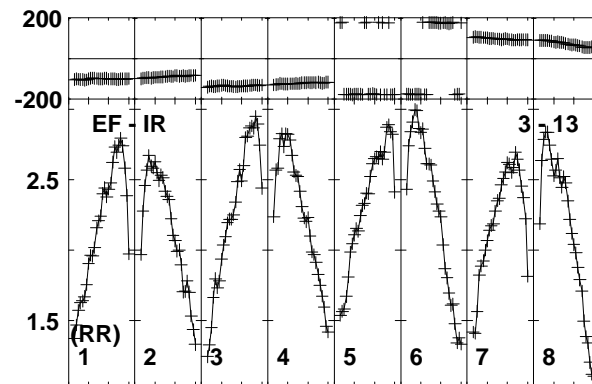
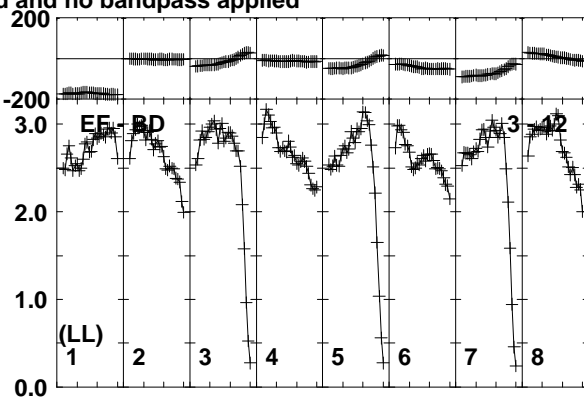
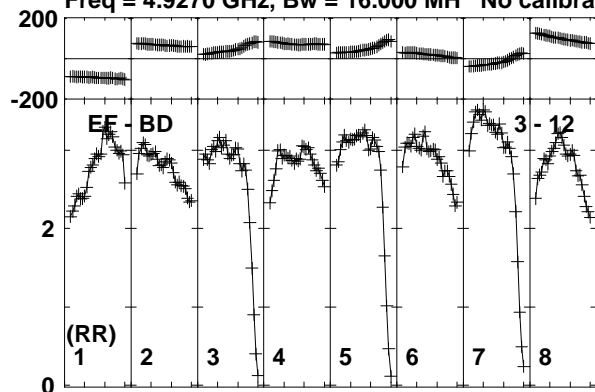

Lower frame: Milli Ampl Jy Top frame: Phas deg
Vector averaged cross-power spectrum Baseline: EF (03) - BD (12)
Timerange: 00/03:05:21 to 00/03:07:19

Plot file version 153 created 17-FEB-2020 15:42:52

J1402+5347 EK047 2.UVDATA.1

Freq = 4.9270 GHz, Bw = 16.000 MH No calibration applied and no bandpass applied

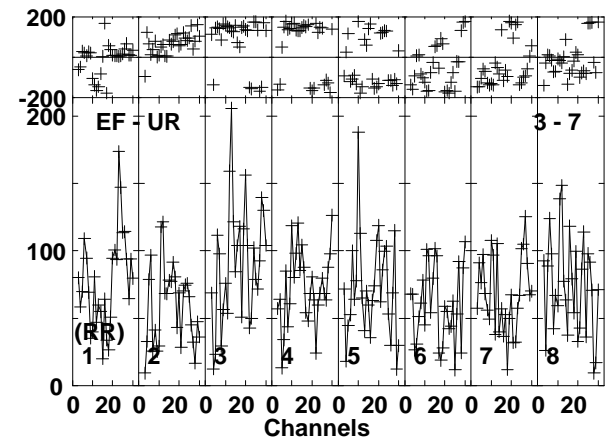
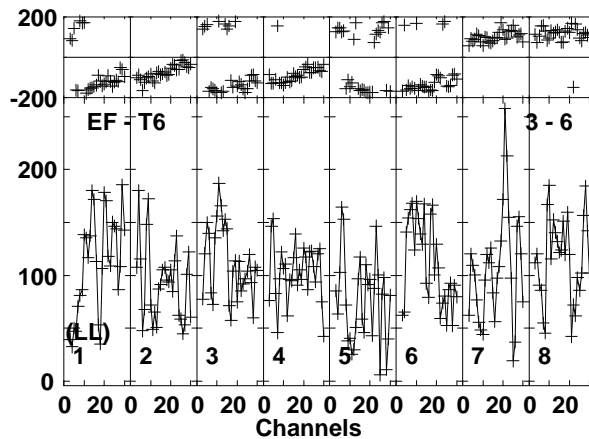
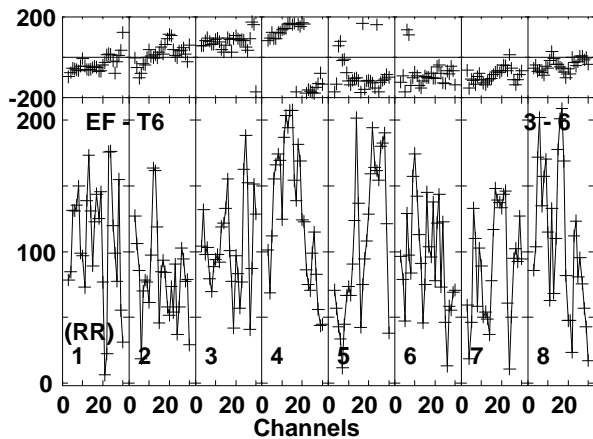
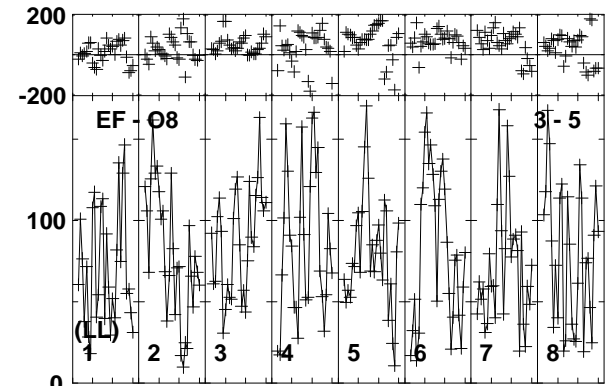
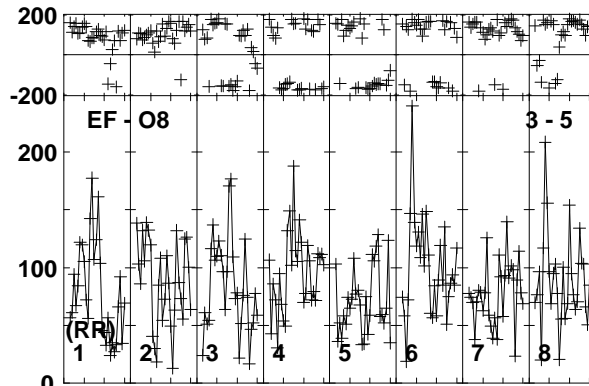
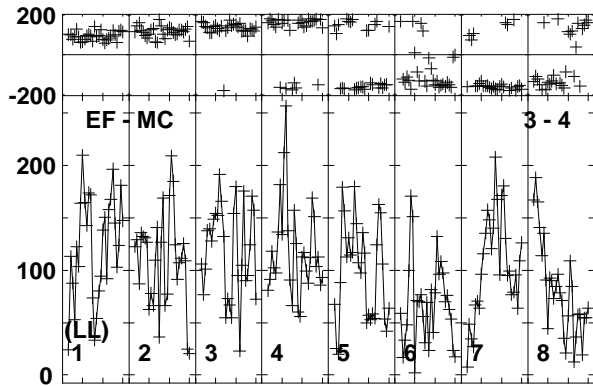
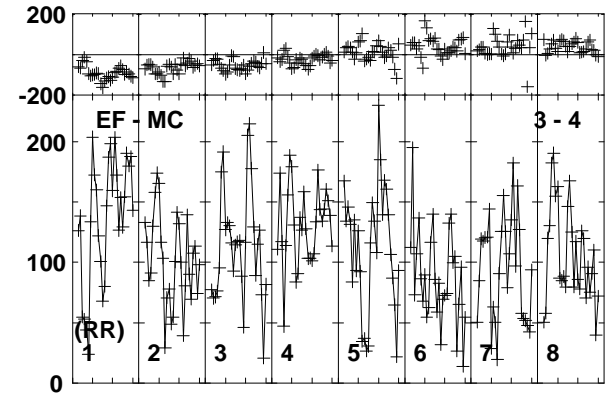
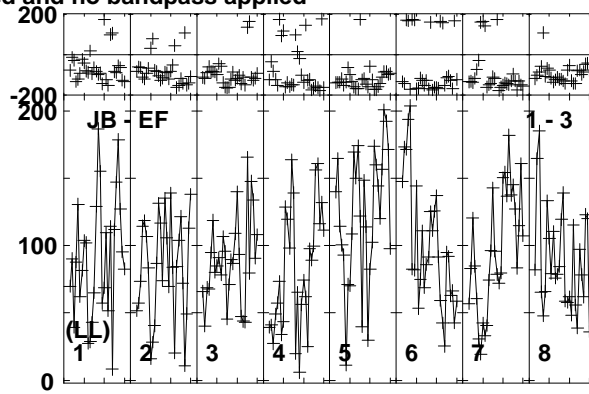
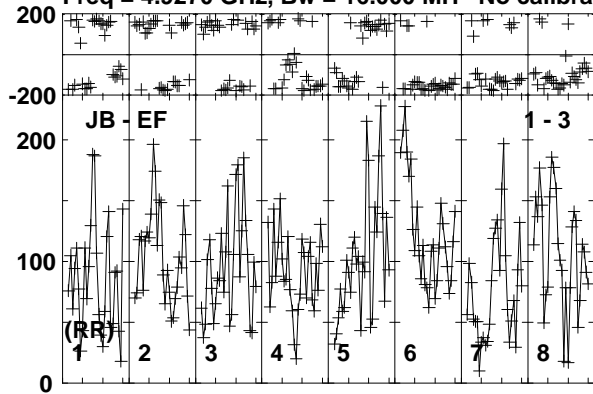

Lower frame: Micro Ampl Jy Top frame: Phas deg
Vector averaged cross-power spectrum Baseline: JB (01) - EF (03)
Timerange: 00/03:07:23 to 00/03:11:19

Plot file version 154 created 17-FEB-2020 15:42:53

J1402+5347 EK047 2.UVDATA.1

Freq = 4.9270 GHz, Bw = 16.000 MH No calibration applied and no bandpass applied

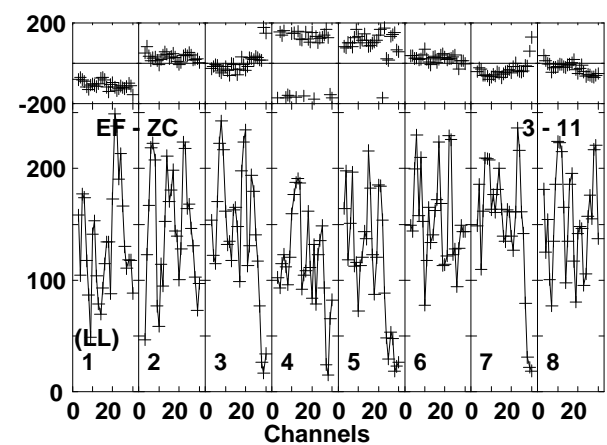
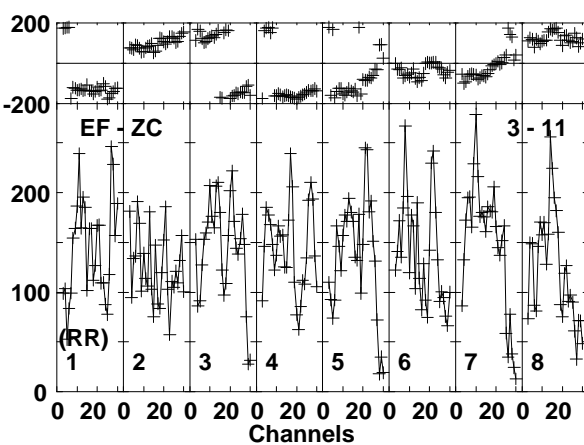
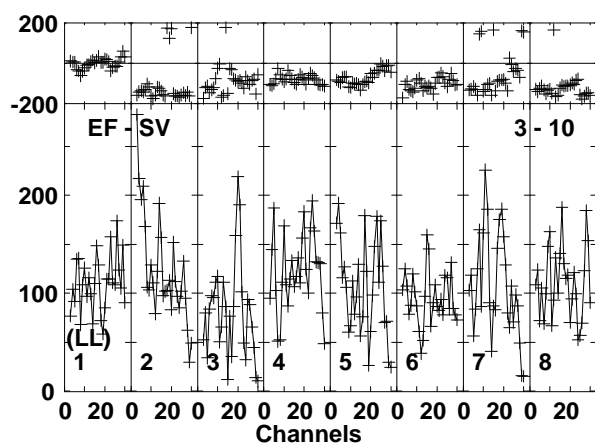
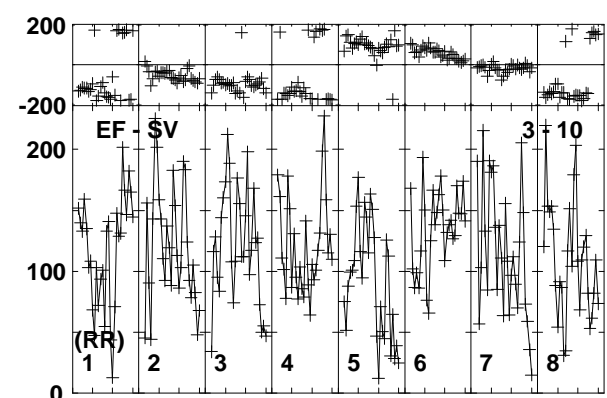
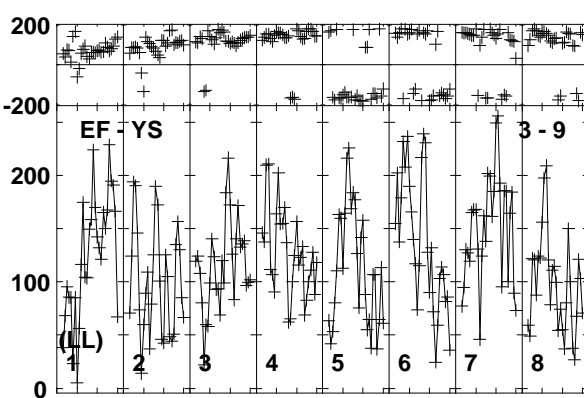
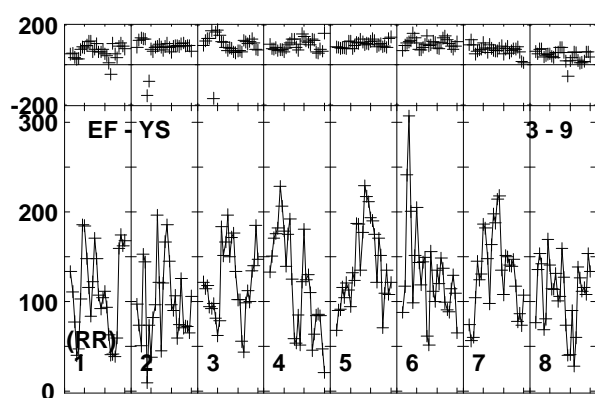
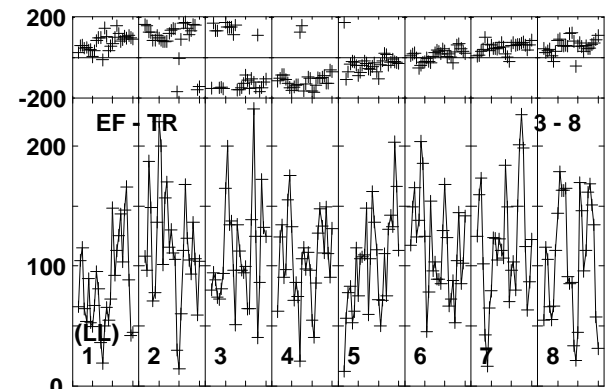
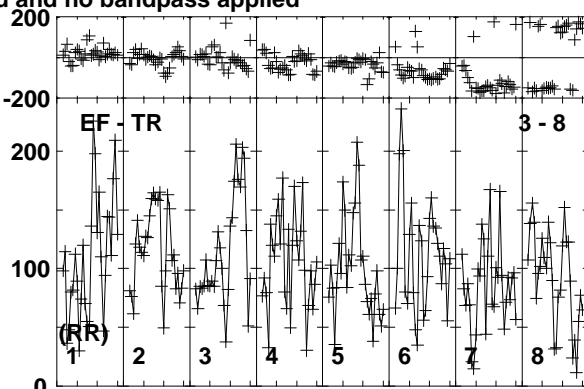
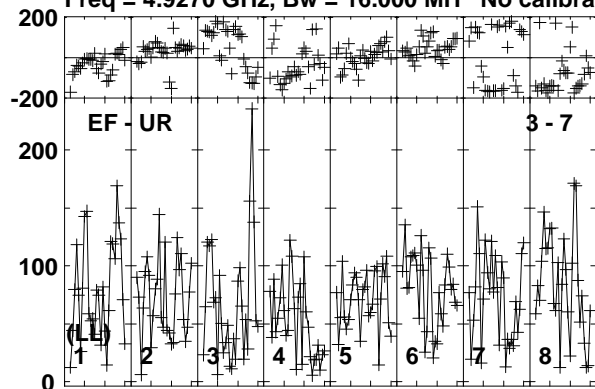

Lower frame: Micro Ampl Jy Top frame: Phas deg
 Vector averaged cross-power spectrum Baseline: EF (03) - UR (07)
 Timerange: 00/03:07:23 to 00/03:11:19

Plot file version 155 created 17-FEB-2020 15:42:53

J1402+5347 EK047 2.UVDATA.1

Freq = 4.9270 GHz, Bw = 16.000 MH No calibration applied and no bandpass applied

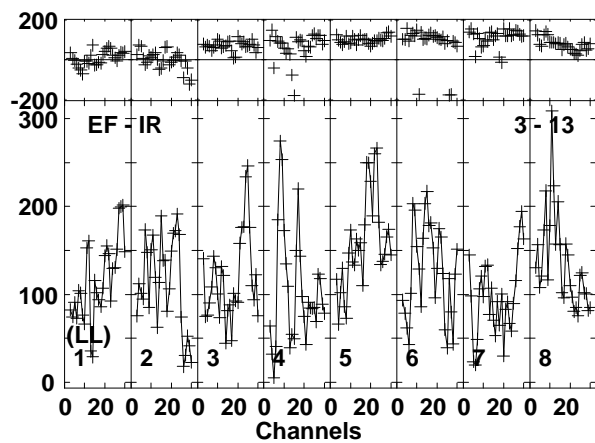
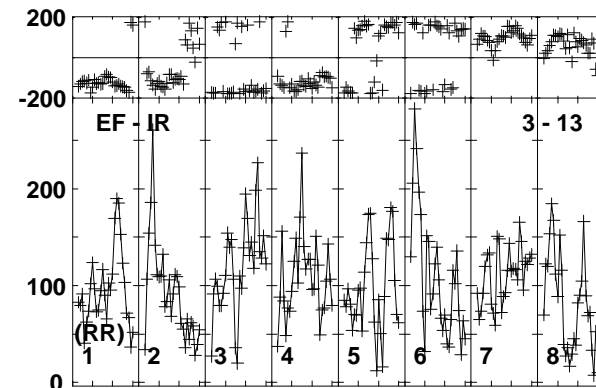
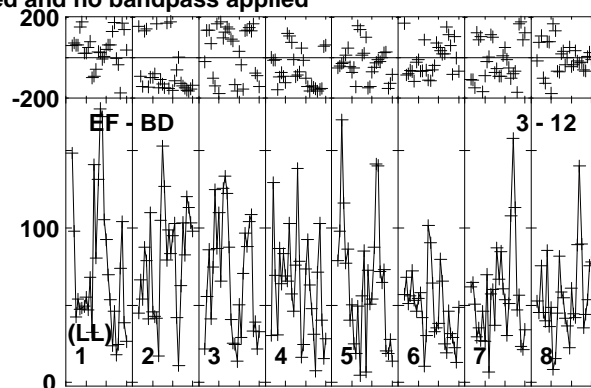
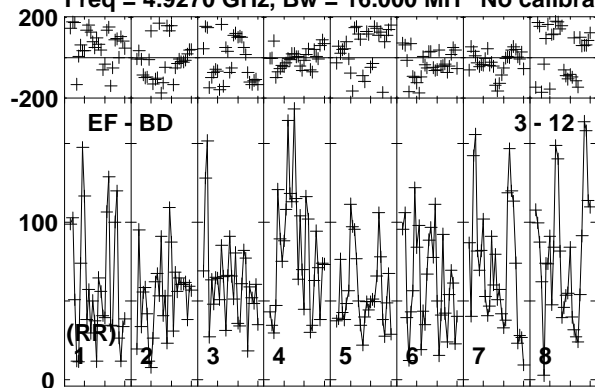

Lower frame: Micro Ampl Jy Top frame: Phas deg
Vector averaged cross-power spectrum Baseline: EF (03) - BD (12)
Timerange: 00/03:07:23 to 00/03:11:19

Plot file version 156 created 17-FEB-2020 15:42:53

J1359+5544 EK047 2.UVDATA.1

Freq = 4.9270 GHz, Bw = 16.000 MH No calibration applied and no bandpass applied

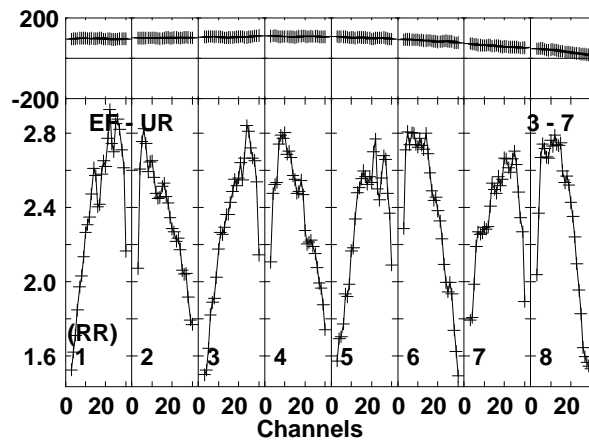
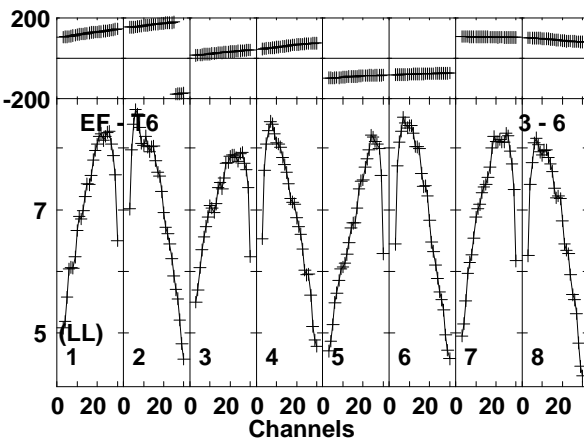
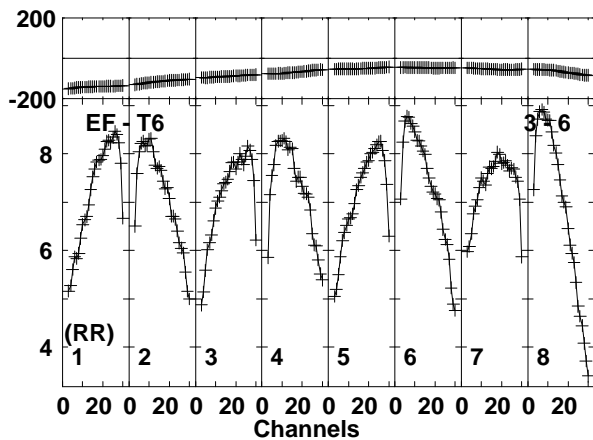
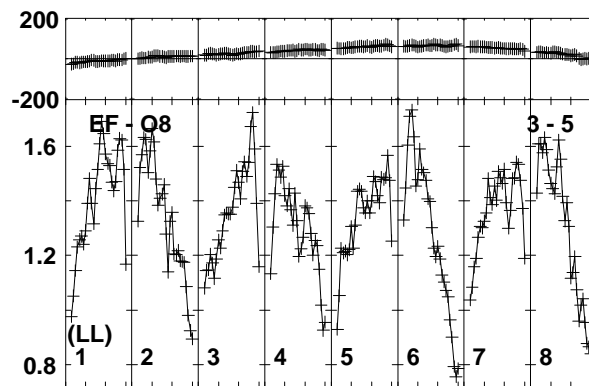
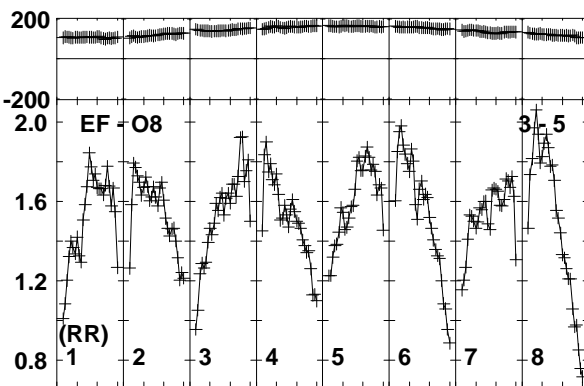
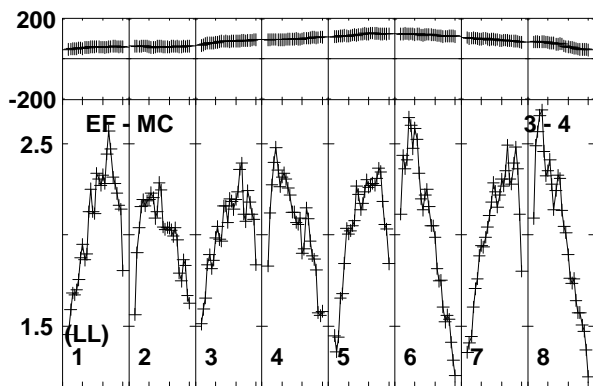
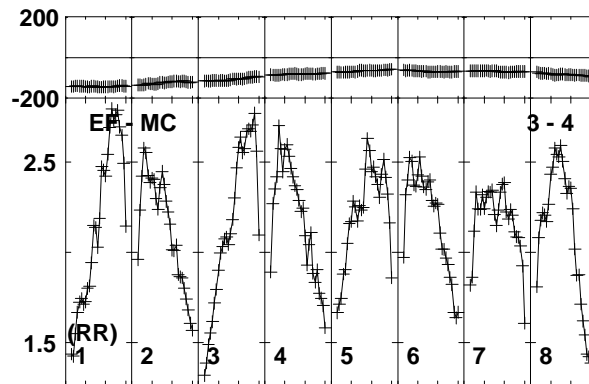
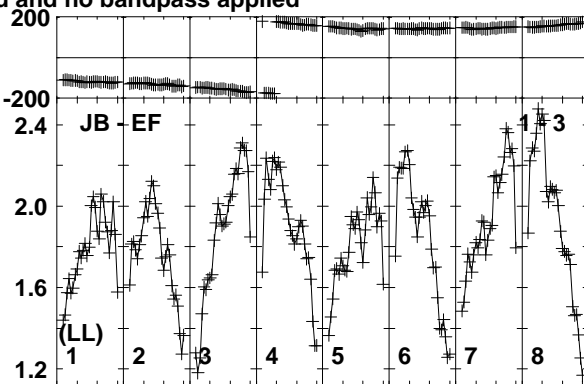
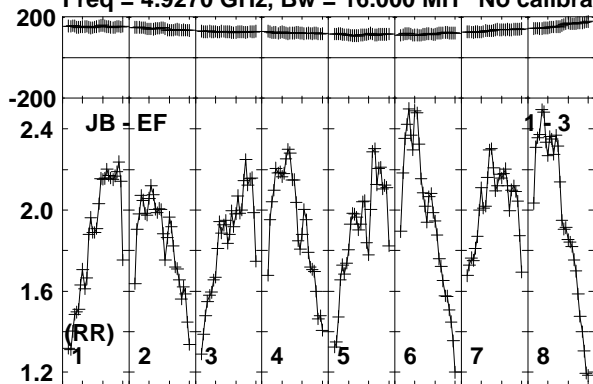

Lower frame: Milli Ampl Jy Top frame: Phas deg
Vector averaged cross-power spectrum Baseline: JB (01) - EF (03)
Timerange: 00/03:12:01 to 00/03:13:19

Plot file version 157 created 17-FEB-2020 15:42:53

J1359+5544 EK047 2.UVDATA.1

Freq = 4.9270 GHz, Bw = 16.000 MH No calibration applied and no bandpass applied

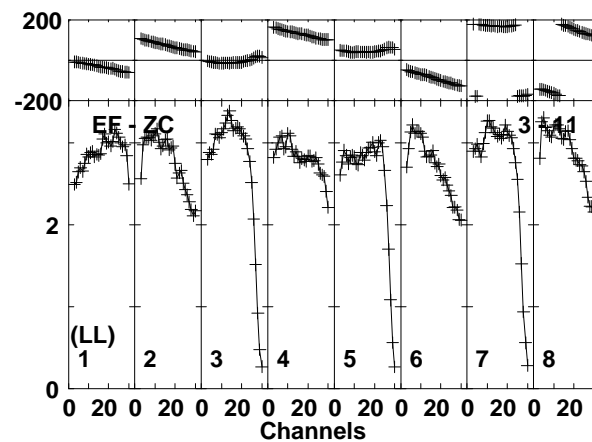
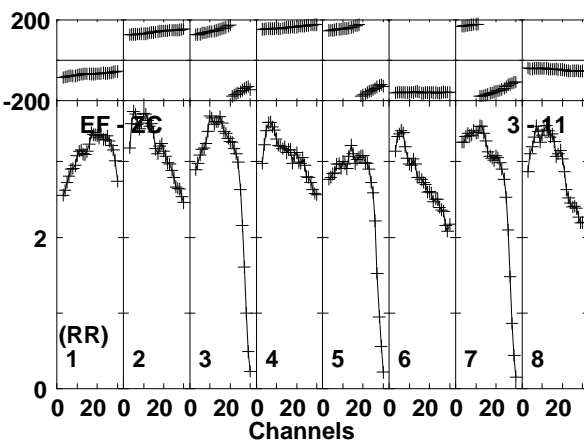
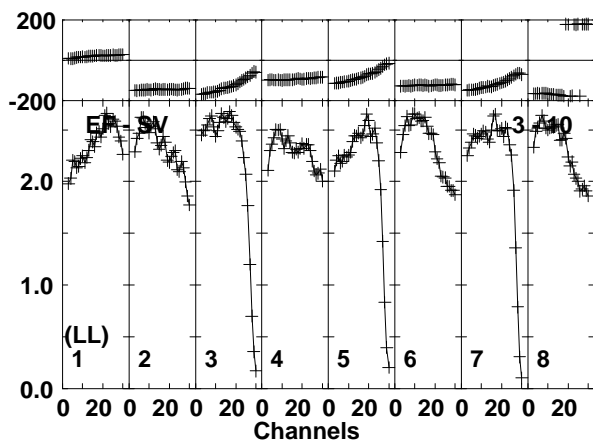
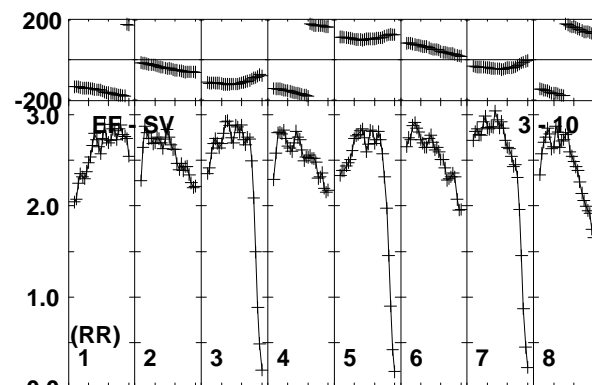
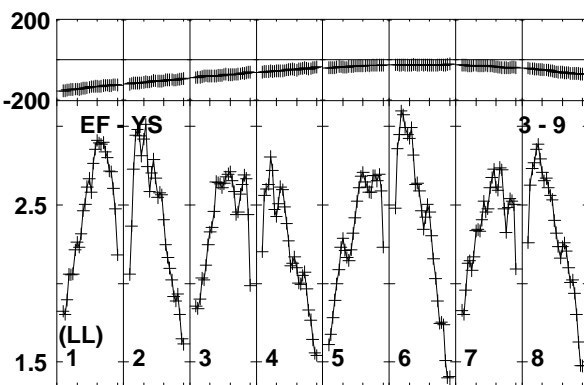
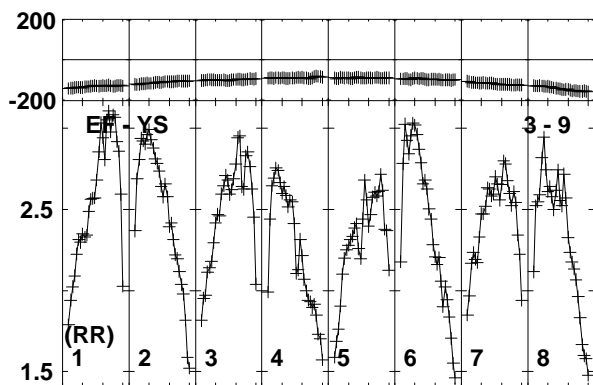
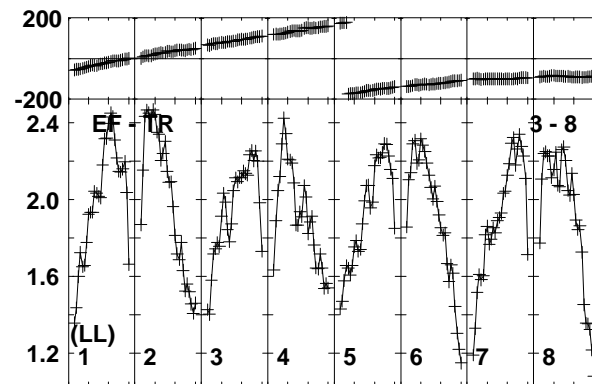
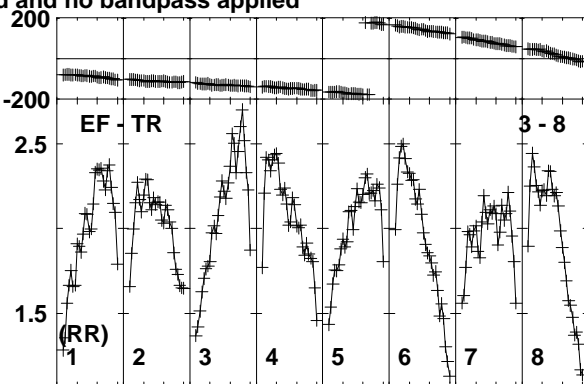
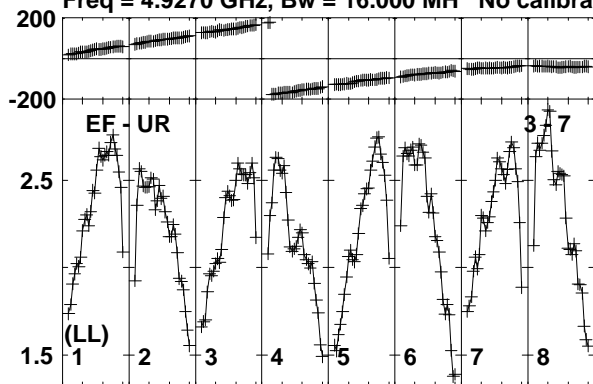

Lower frame: Milli Ampl Jy Top frame: Phas deg
Vector averaged cross-power spectrum Baseline: EF (03) - UR (07)
Timerange: 00/03:12:01 to 00/03:13:19

Plot file version 158 created 17-FEB-2020 15:42:53

J1359+5544 EK047 2.UVDATA.1

Freq = 4.9270 GHz, Bw = 16.000 MH No calibration applied and no bandpass applied

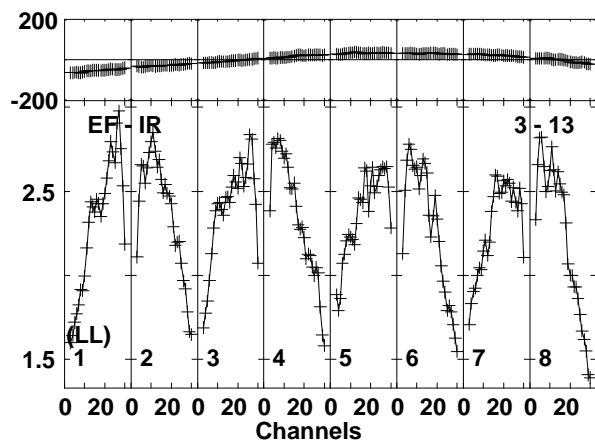
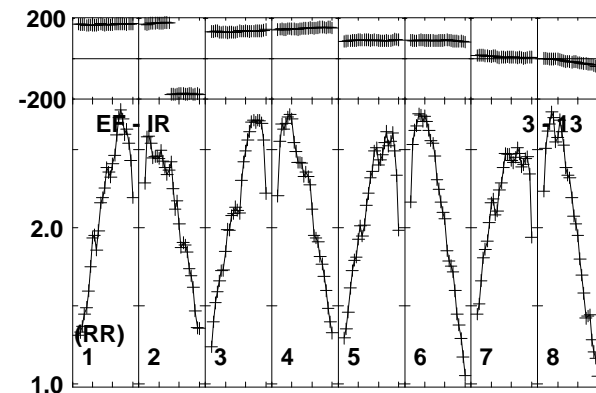
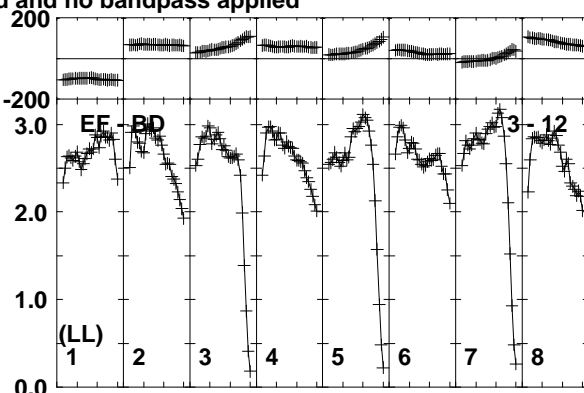
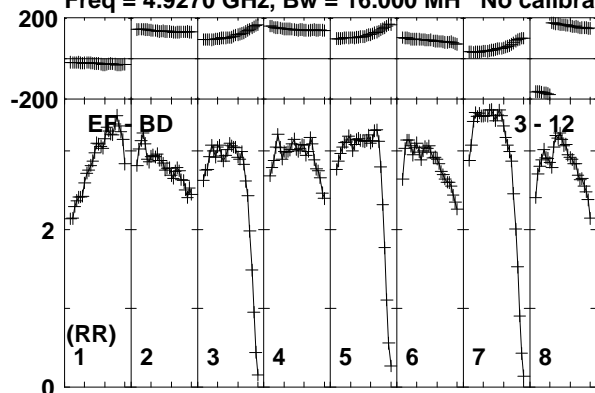

Lower frame: Milli Ampl Jy Top frame: Phas deg
Vector averaged cross-power spectrum Baseline: EF (03) - BD (12)
Timerange: 00/03:12:01 to 00/03:13:19

Plot file version 159 created 17-FEB-2020 15:42:53

J1402+5347 EK047 2.UVDATA.1

Freq = 4.9270 GHz, Bw = 16.000 MH No calibration applied and no bandpass applied

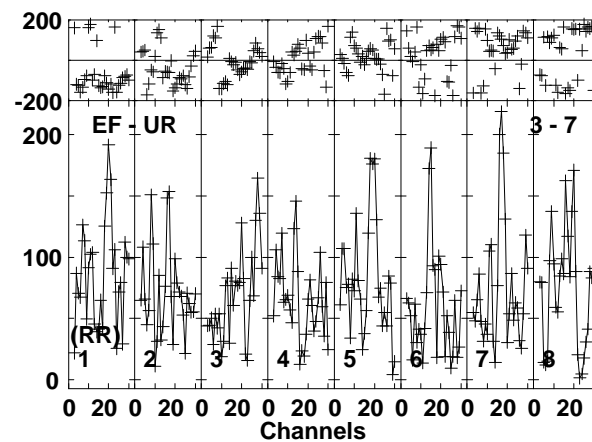
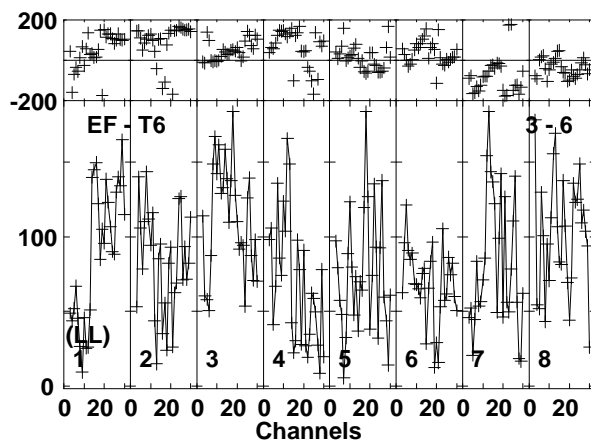
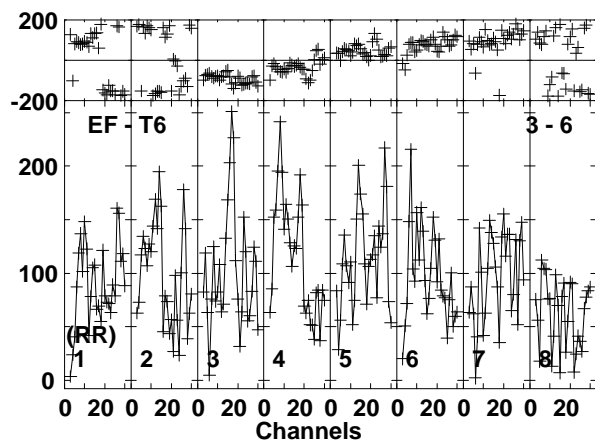
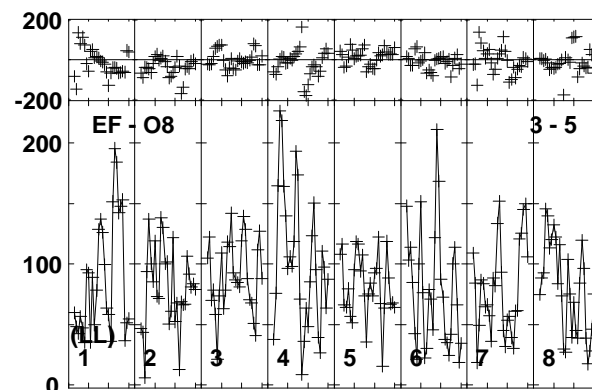
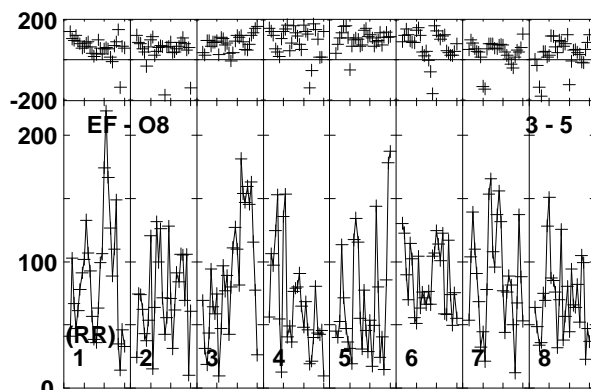
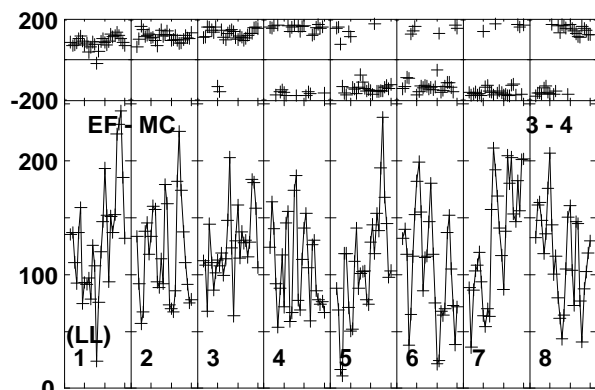
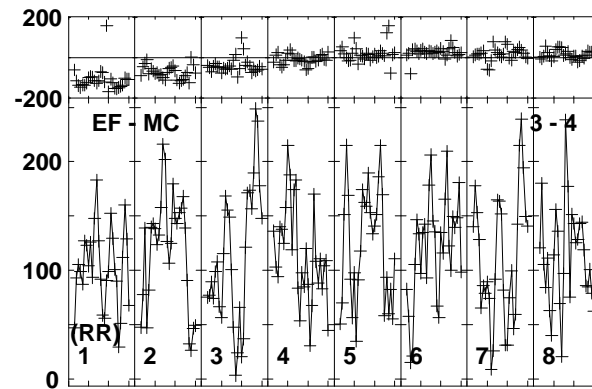
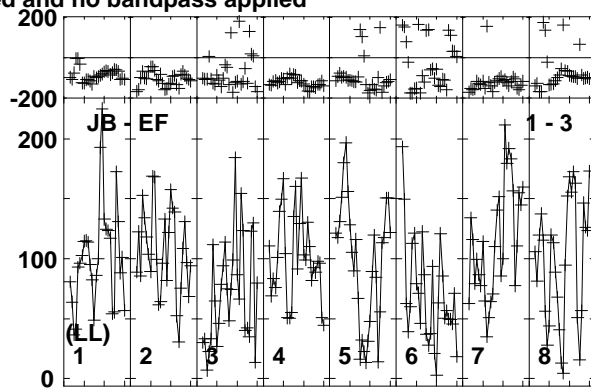
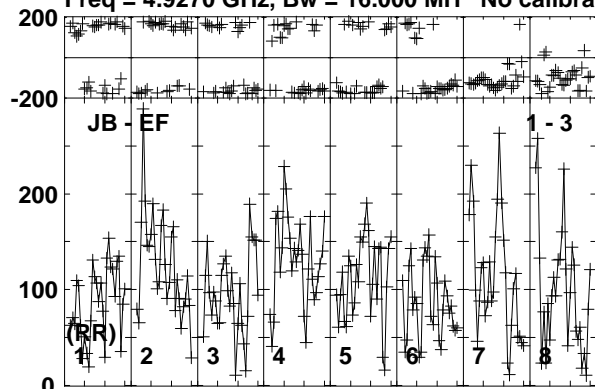

Lower frame: Micro Ampl Jy Top frame: Phas deg
Vector averaged cross-power spectrum Baseline: JB (01) - EF (03)
Timerange: 00/03:13:21 to 00/03:17:19

Plot file version 160 created 17-FEB-2020 15:42:53

J1402+5347 EK047 2.UVDATA.1

Freq = 4.9270 GHz, Bw = 16.000 MH No calibration applied and no bandpass applied

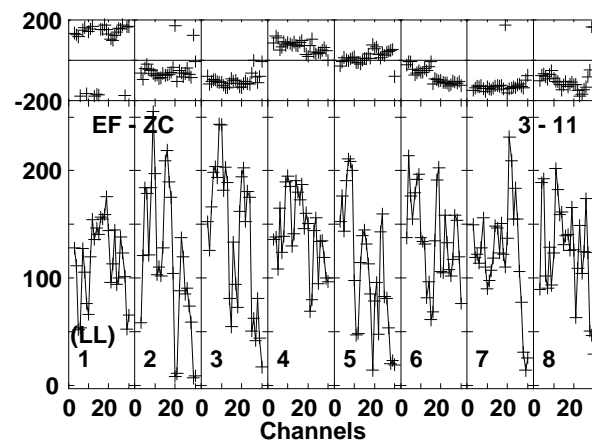
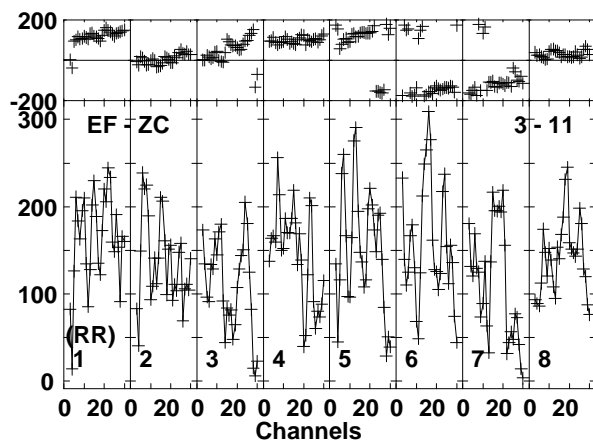
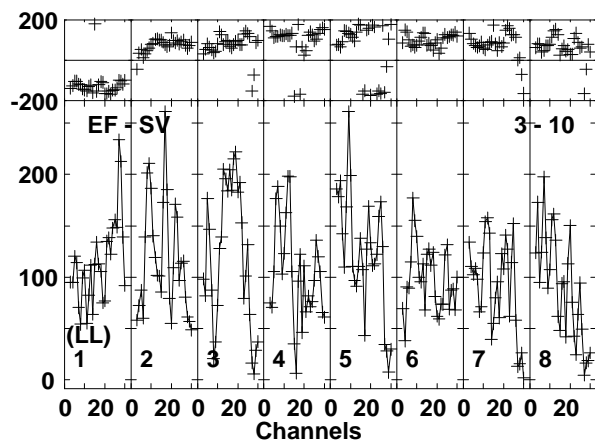
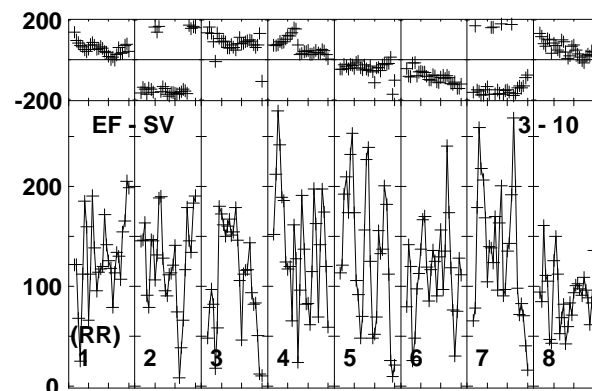
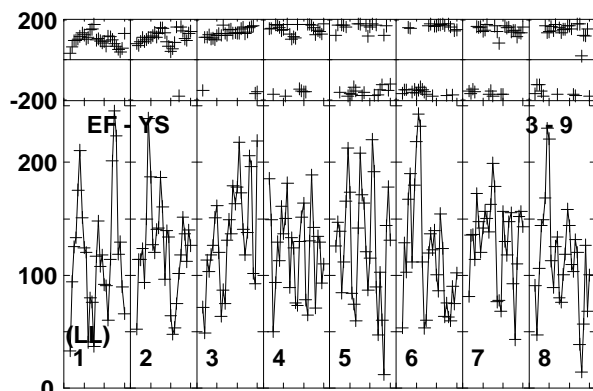
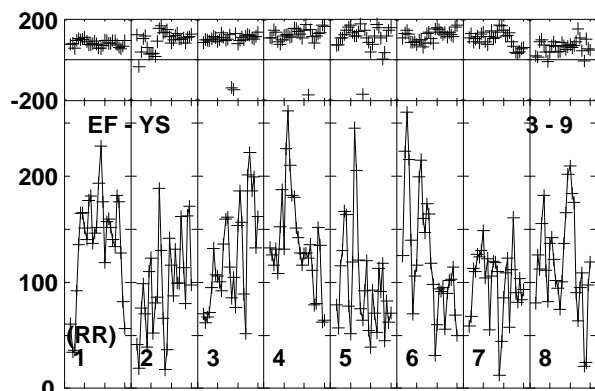
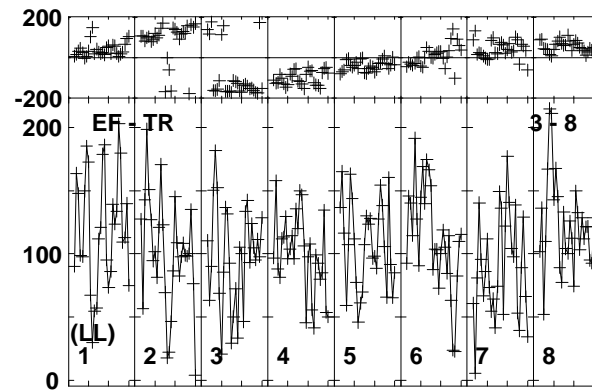
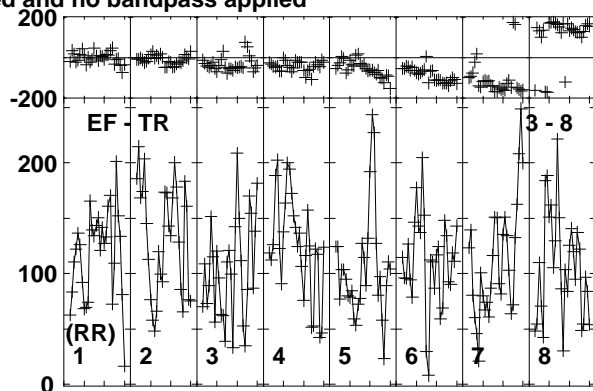
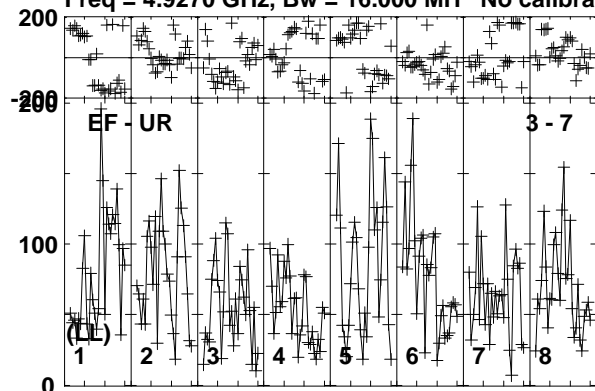

Lower frame: Micro Ampl Jy Top frame: Phas deg
Vector averaged cross-power spectrum Baseline: EF (03) - UR (07)
Timerange: 00/03:13:21 to 00/03:17:19

Plot file version 161 created 17-FEB-2020 15:42:53

J1402+5347 EK047 2.UVDATA.1

Freq = 4.9270 GHz, Bw = 16.000 MH No calibration applied and no bandpass applied

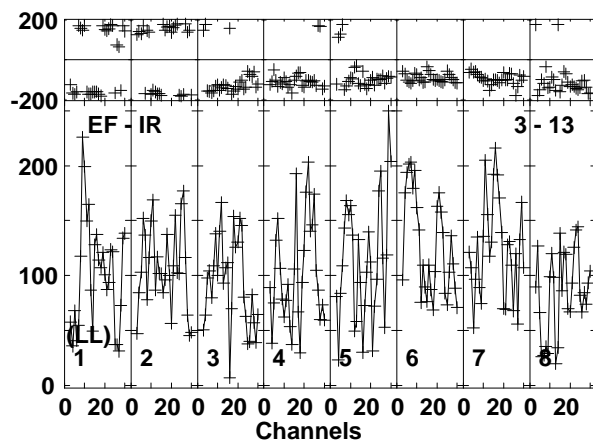
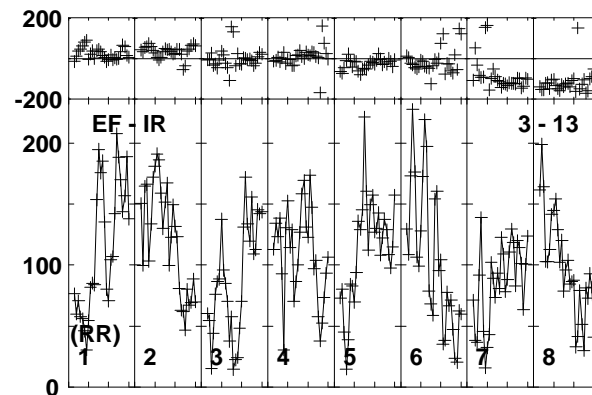
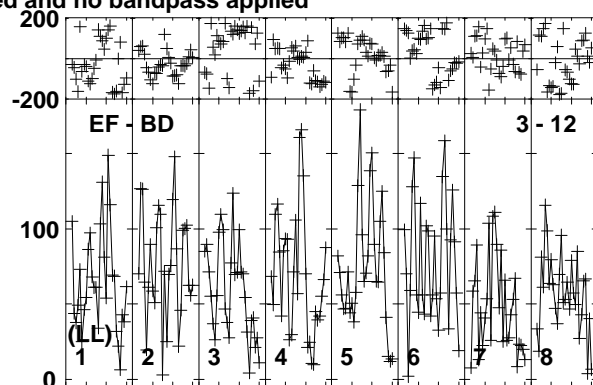
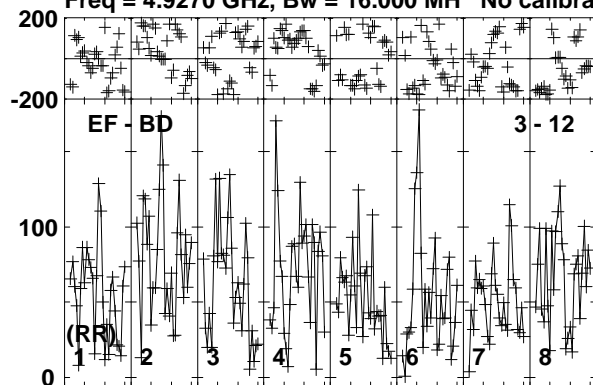

Lower frame: Micro Ampl Jy Top frame: Phas deg
Vector averaged cross-power spectrum Baseline: EF (03) - BD (12)
Timerange: 00/03:13:21 to 00/03:17:19

Plot file version 162 created 17-FEB-2020 15:42:53

J1359+5544 EK047 2.UVDATA.1

Freq = 4.9270 GHz, Bw = 16.000 MH No calibration applied and no bandpass applied

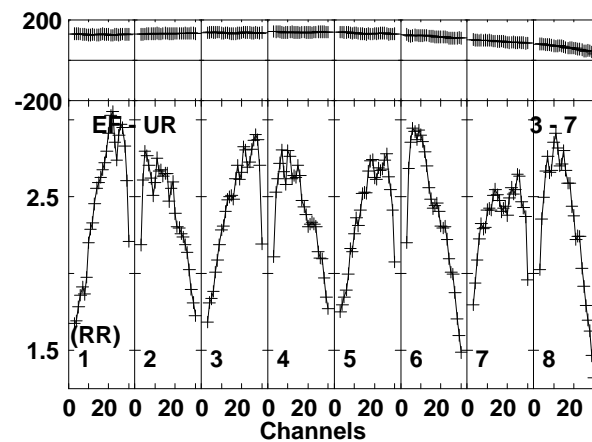
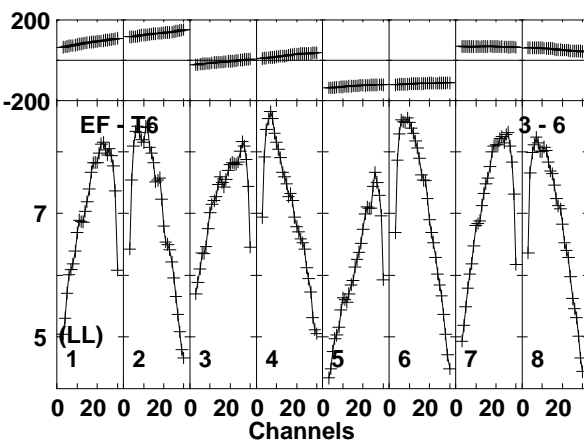
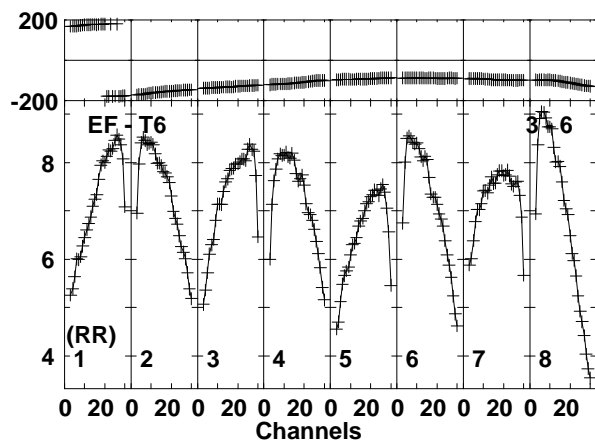
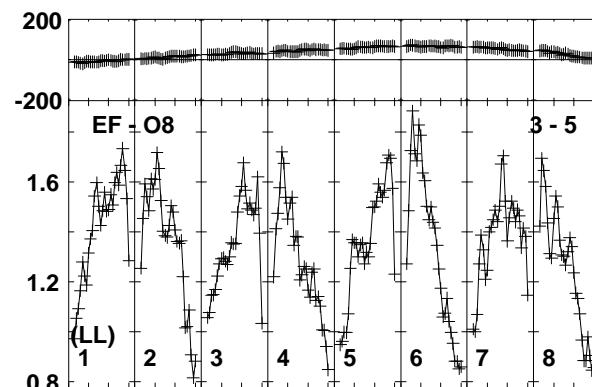
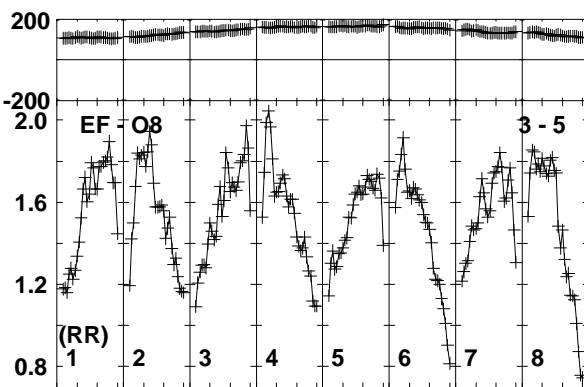
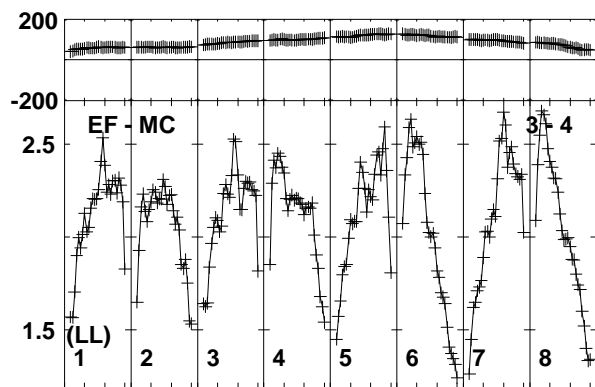
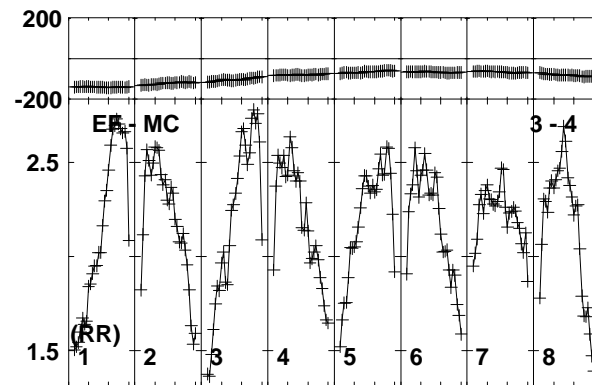
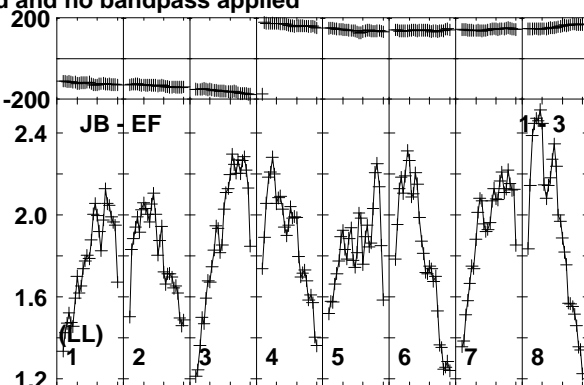
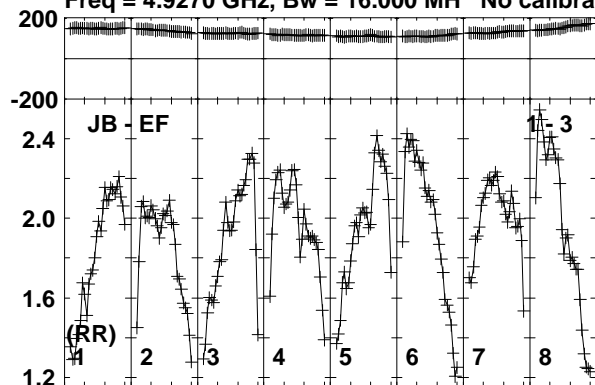

Lower frame: Milli Ampl Jy Top frame: Phas deg
Vector averaged cross-power spectrum Baseline: JB (01) - EF (03)
Timerange: 00/03:17:21 to 00/03:19:19

Plot file version 163 created 17-FEB-2020 15:42:53

J1359+5544 EK047 2.UVDATA.1

Freq = 4.9270 GHz, Bw = 16.000 MH No calibration applied and no bandpass applied

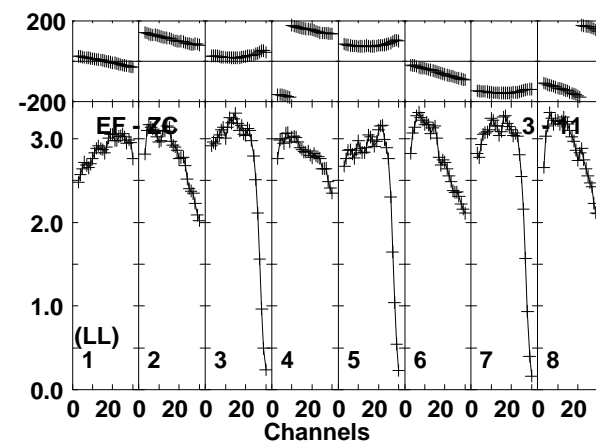
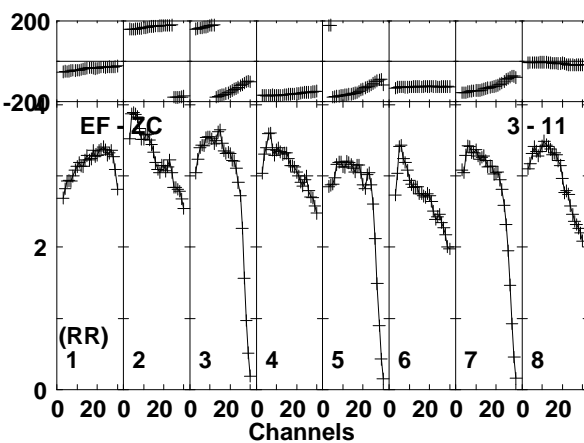
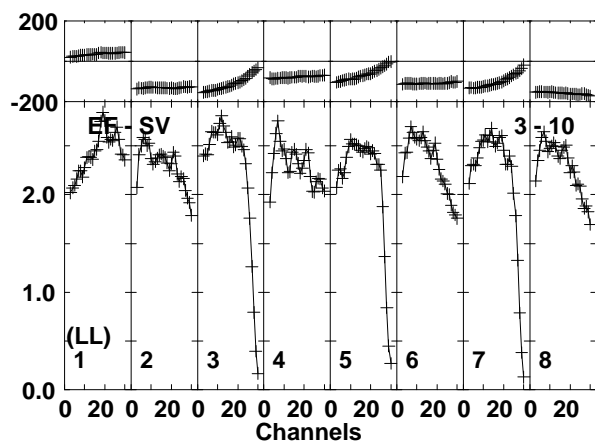
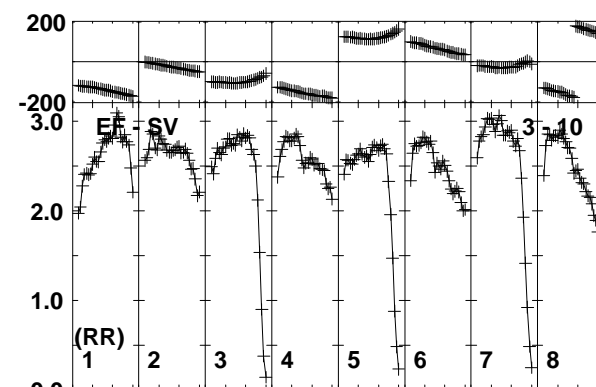
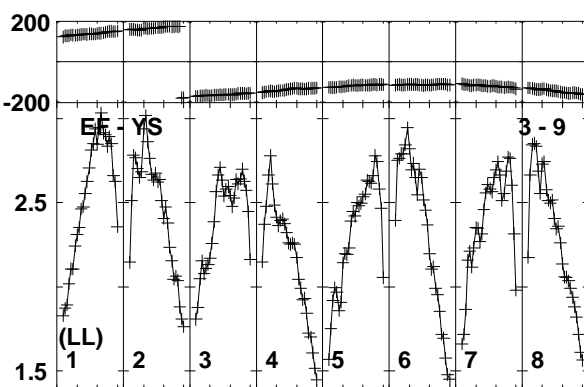
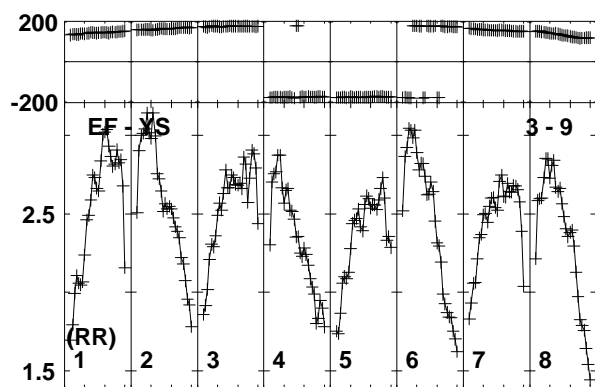
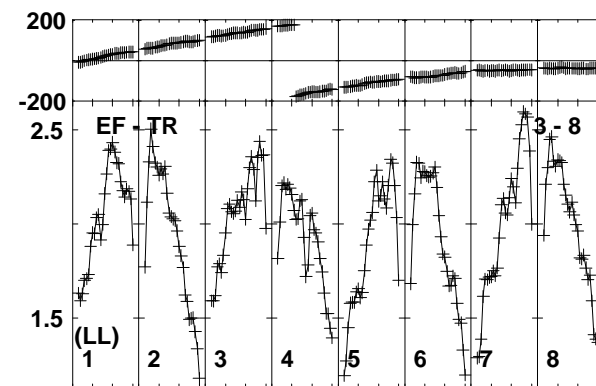
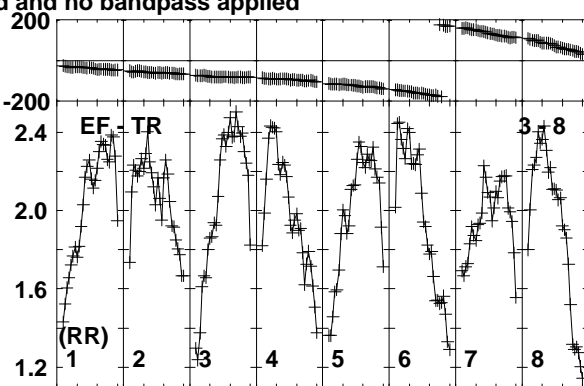
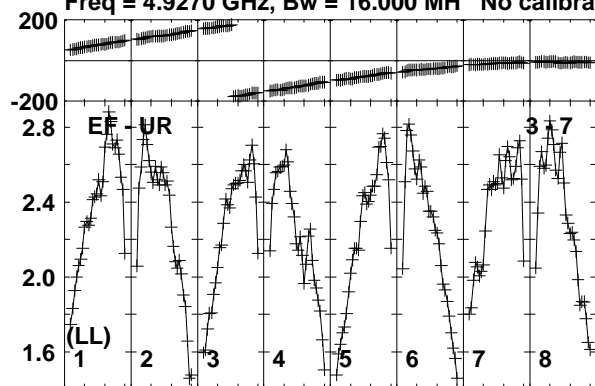

Lower frame: Milli Ampl Jy Top frame: Phas deg
Vector averaged cross-power spectrum Baseline: EF (03) - UR (07)
Timerange: 00/03:17:21 to 00/03:19:19

Plot file version 164 created 17-FEB-2020 15:42:54

J1359+5544 EK047 2.UVDATA.1

Freq = 4.9270 GHz, Bw = 16.000 MH No calibration applied and no bandpass applied

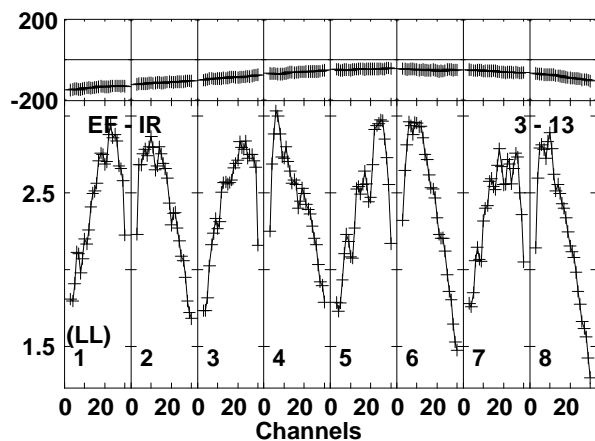
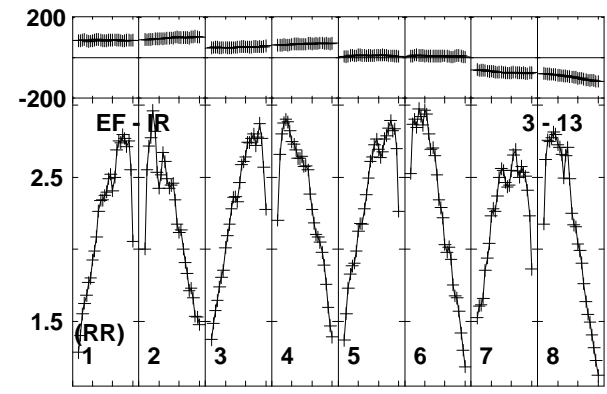
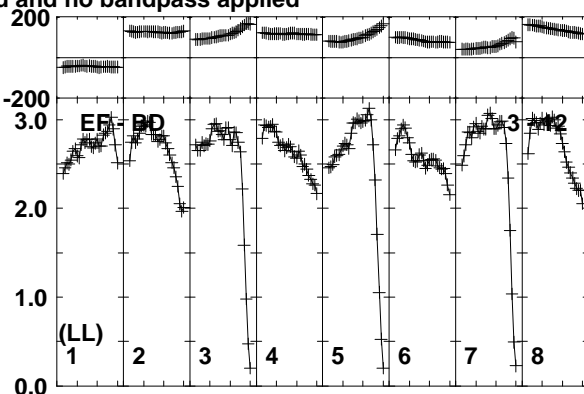
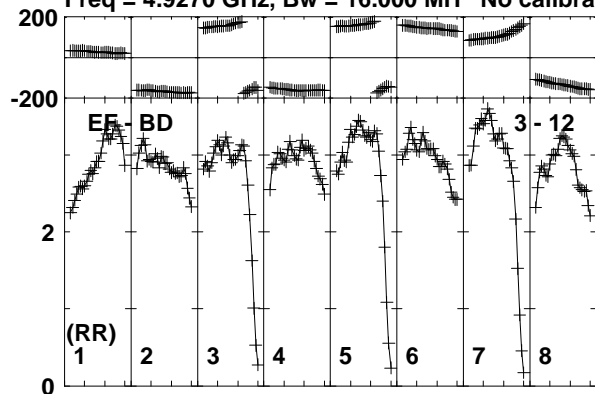

Lower frame: Milli Ampl Jy Top frame: Phas deg
Vector averaged cross-power spectrum Baseline: EF (03) - BD (12)
Timerange: 00/03:17:21 to 00/03:19:19

Plot file version 165 created 17-FEB-2020 15:42:54

J1402+5347 EK047 2.UVDATA.1

Freq = 4.9270 GHz, Bw = 16.000 MH No calibration applied and no bandpass applied

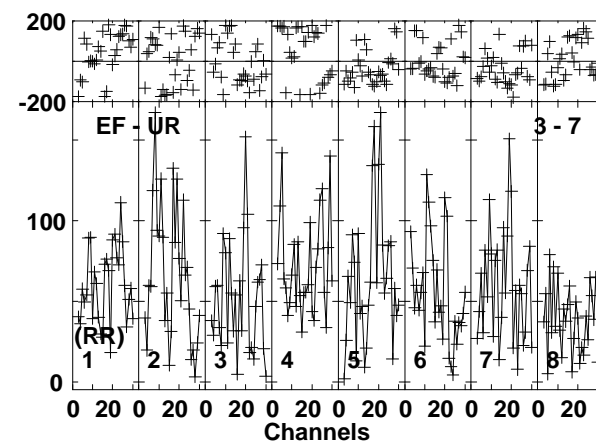
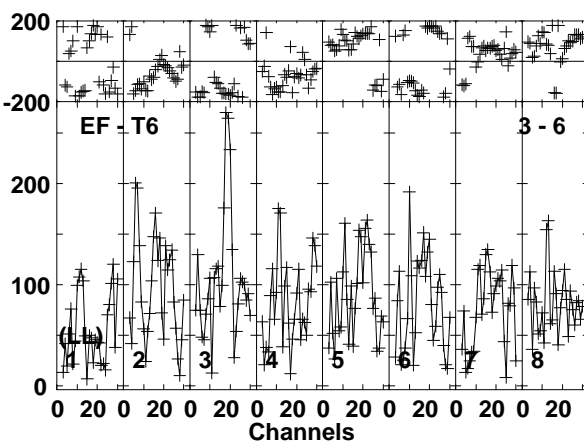
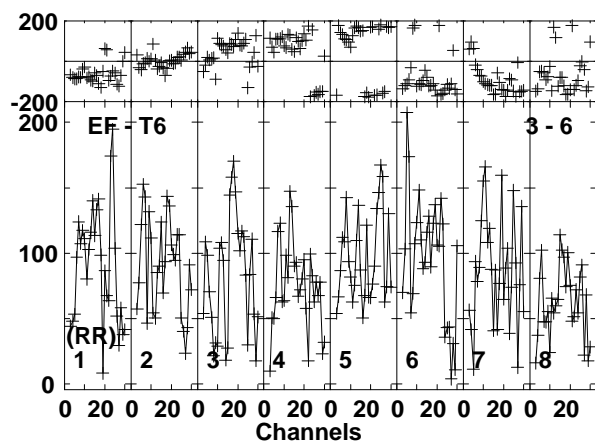
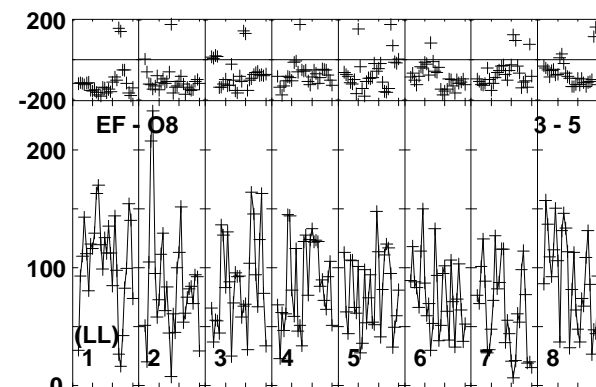
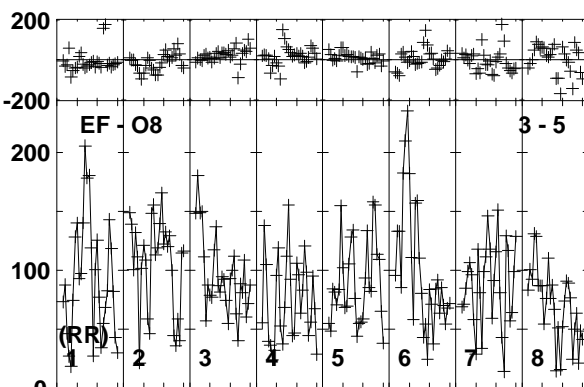
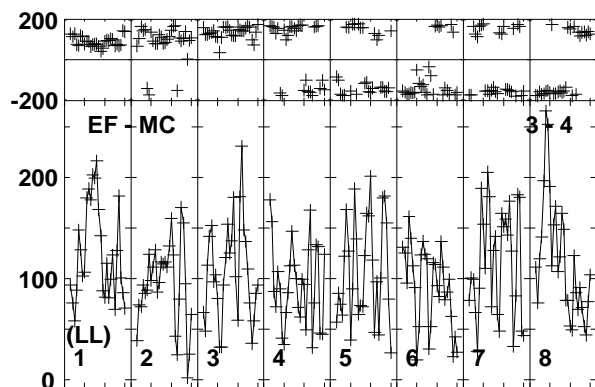
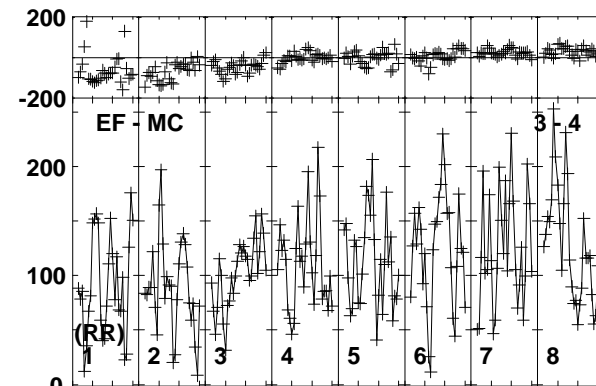
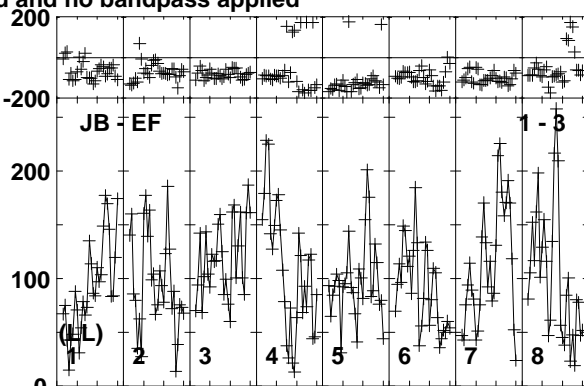
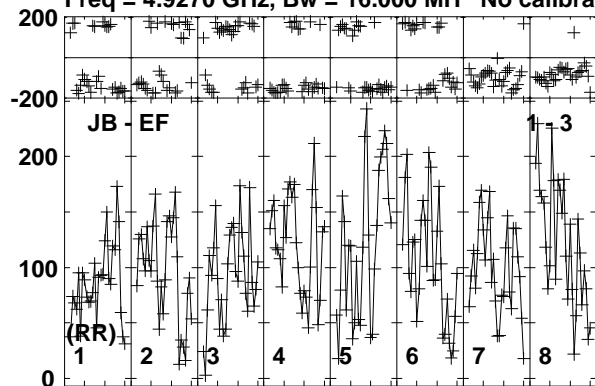

Lower frame: Micro Ampl Jy Top frame: Phas deg
Vector averaged cross-power spectrum Baseline: JB (01) - EF (03)
Timerange: 00/03:19:23 to 00/03:23:19

Plot file version 166 created 17-FEB-2020 15:42:54

J1402+5347 EK047 2.UVDATA.1

Freq = 4.9270 GHz, Bw = 16.000 MH No calibration applied and no bandpass applied

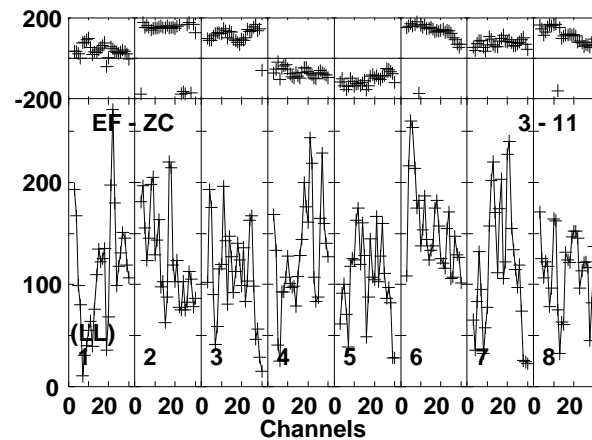
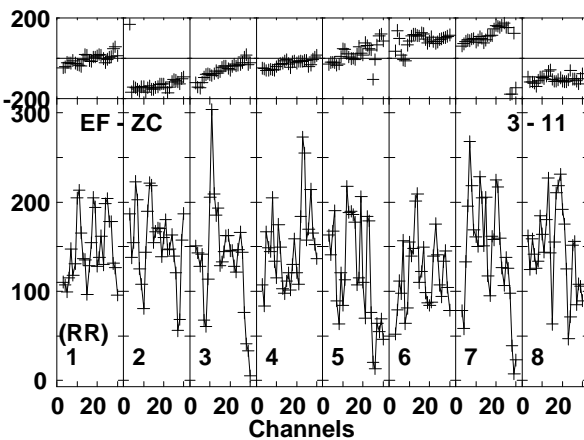
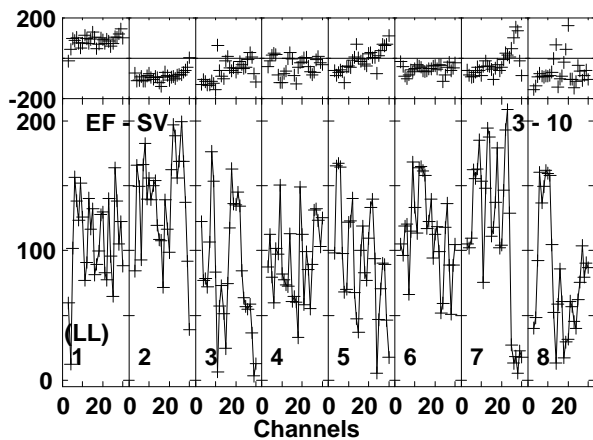
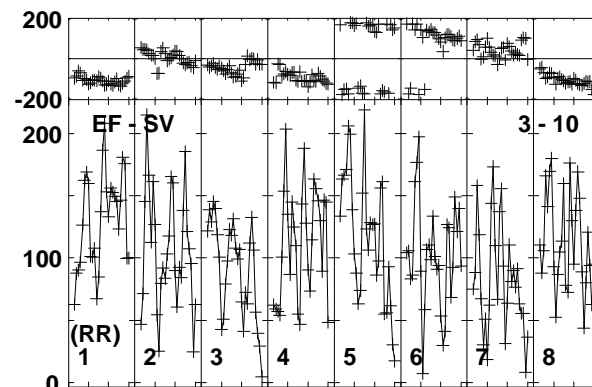
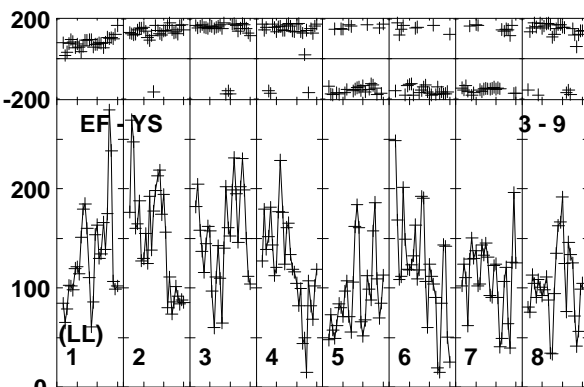
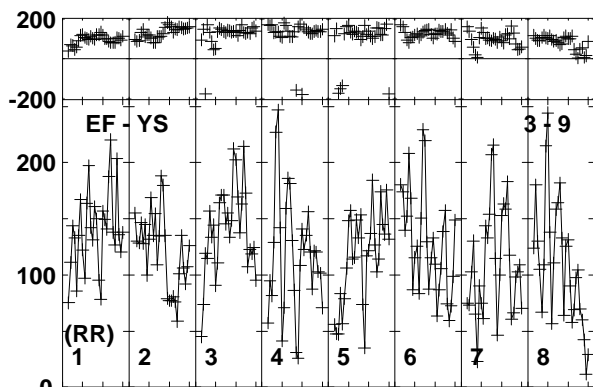
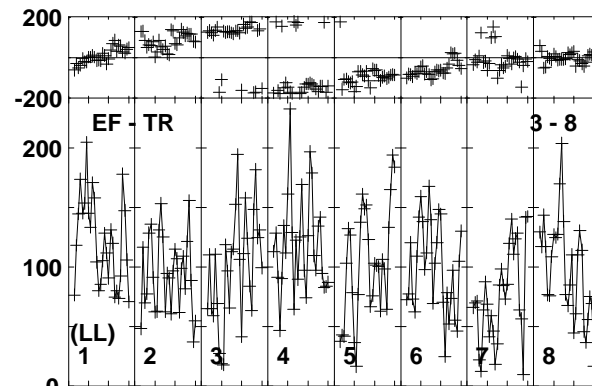
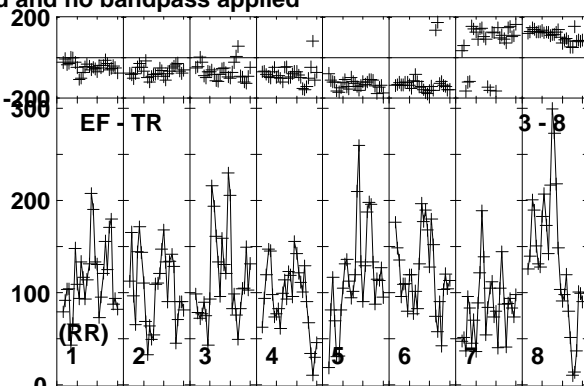
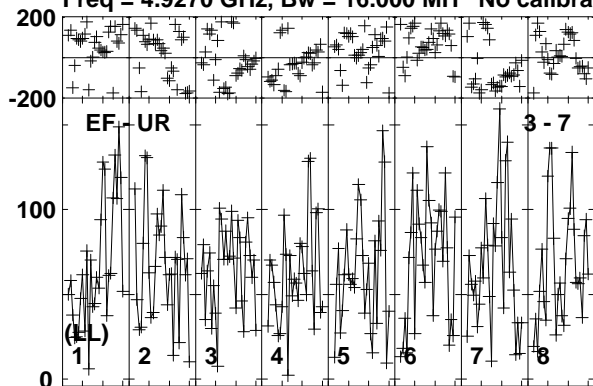

Lower frame: Micro Ampl Jy Top frame: Phas deg
Vector averaged cross-power spectrum Baseline: EF (03) - UR (07)
Timerange: 00/03:19:23 to 00/03:23:19

Plot file version 167 created 17-FEB-2020 15:42:54

J1402+5347 EK047 2.UVDATA.1

Freq = 4.9270 GHz, Bw = 16.000 MH No calibration applied and no bandpass applied

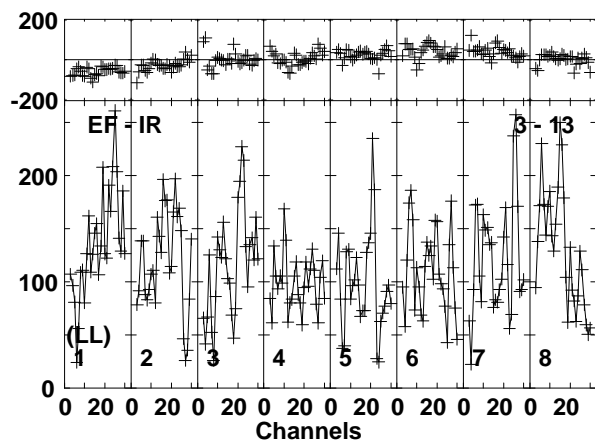
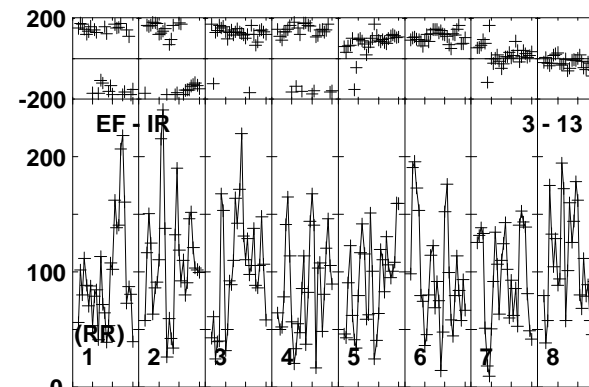
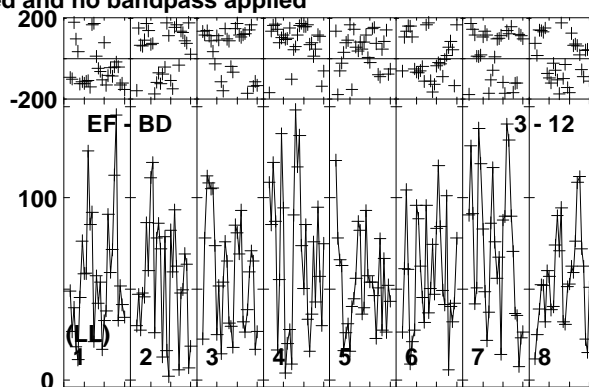
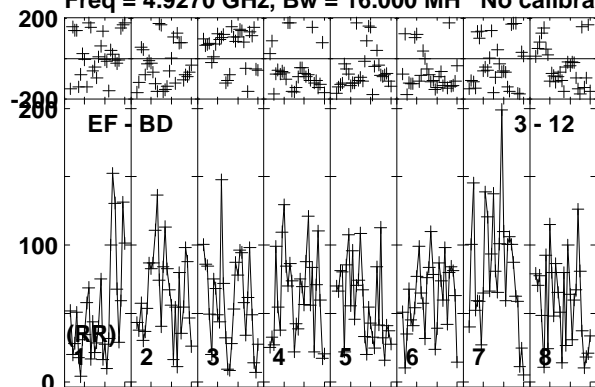

Lower frame: Micro Ampl Jy Top frame: Phas deg
Vector averaged cross-power spectrum Baseline: EF (03) - BD (12)
Timerange: 00/03:19:23 to 00/03:23:19

Plot file version 168 created 17-FEB-2020 15:42:54

J1359+5544 EK047 2.UVDATA.1

Freq = 4.9270 GHz, Bw = 16.000 MH No calibration applied and no bandpass applied

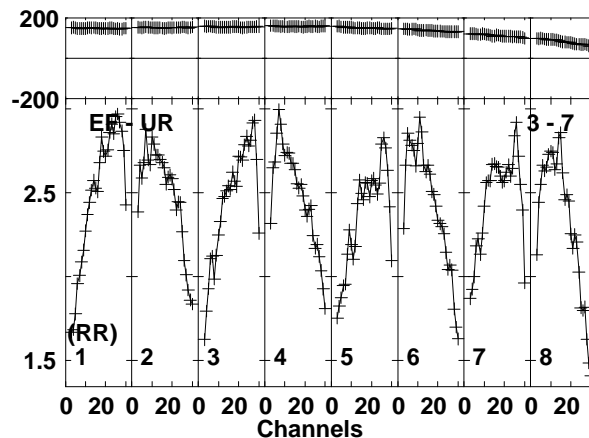
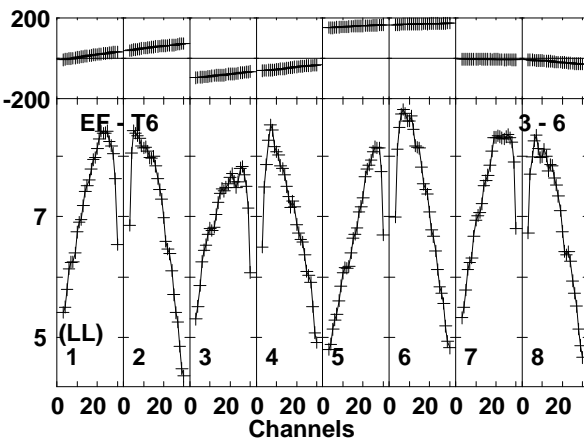
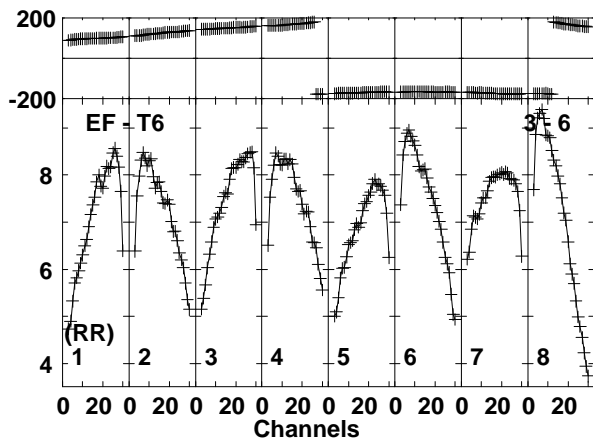
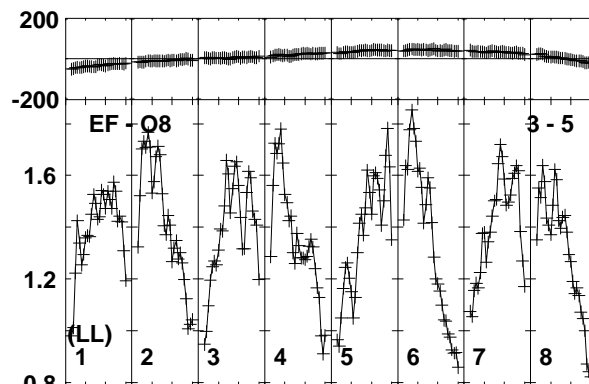
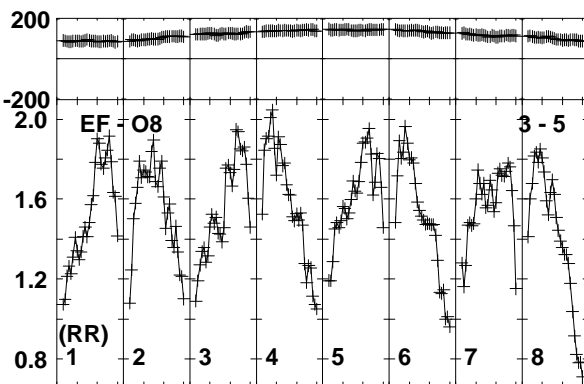
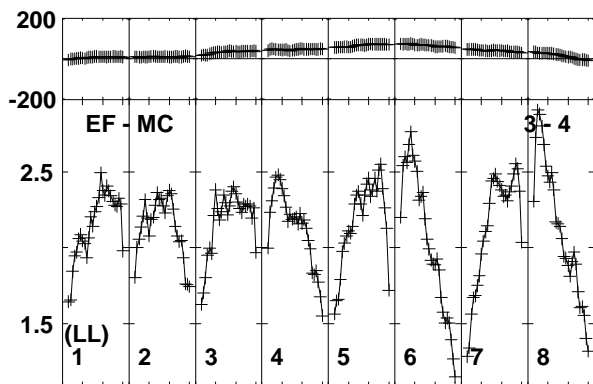
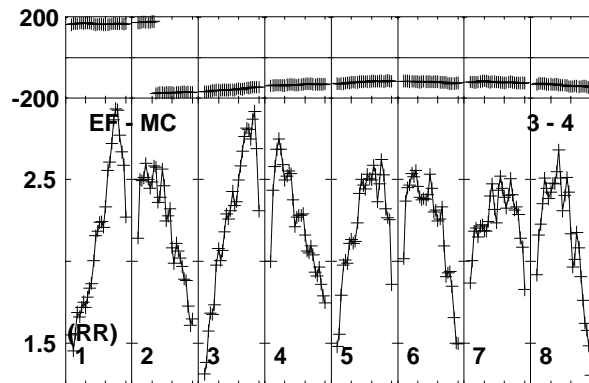
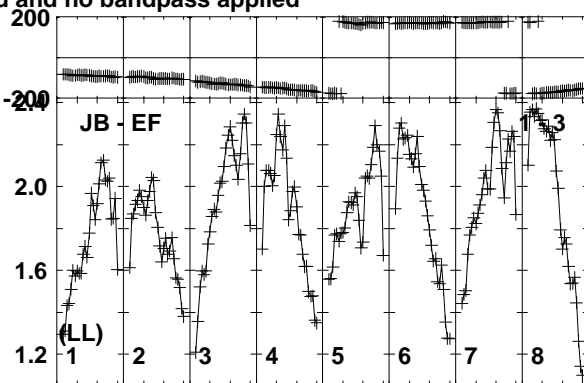
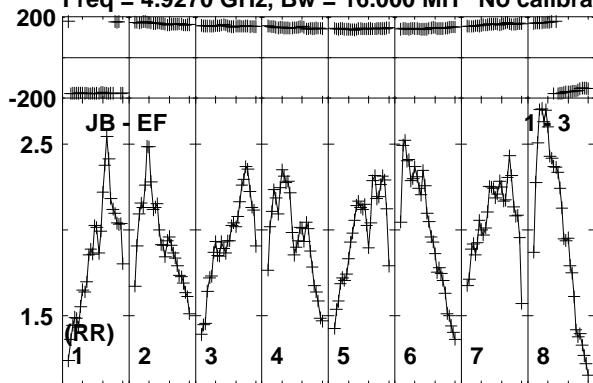

Lower frame: Milli Ampl Jy Top frame: Phas deg
Vector averaged cross-power spectrum Baseline: JB (01) - EF (03)
Timerange: 00/03:24:01 to 00/03:25:19

Plot file version 169 created 17-FEB-2020 15:42:54

J1359+5544 EK047 2.UVDATA.1

Freq = 4.9270 GHz, Bw = 16.000 MH No calibration applied and no bandpass applied

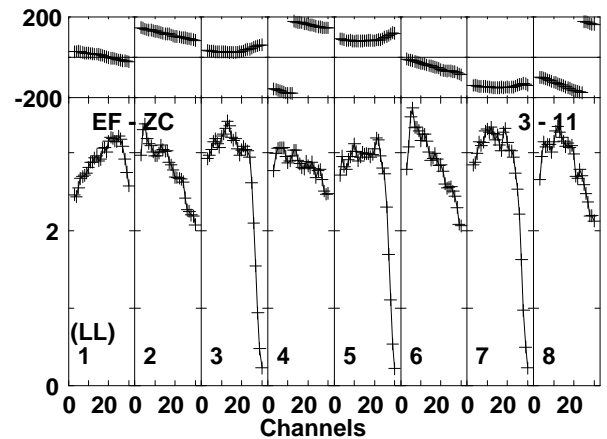
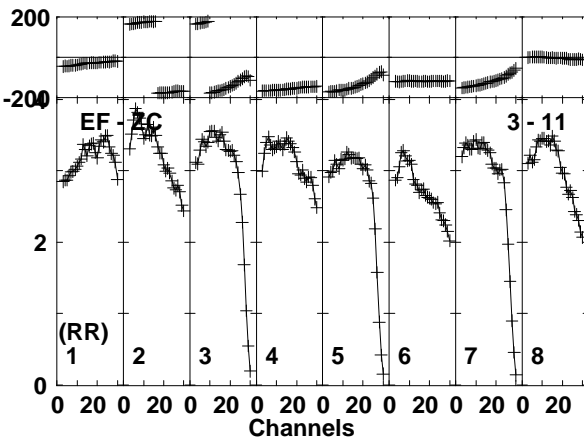
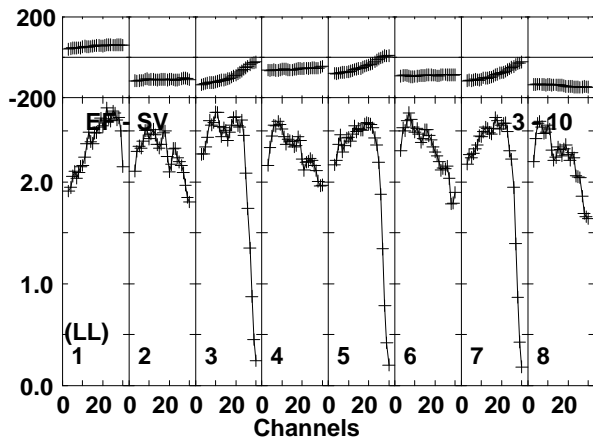
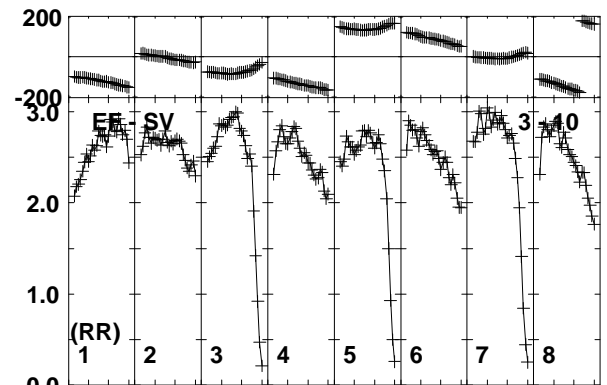
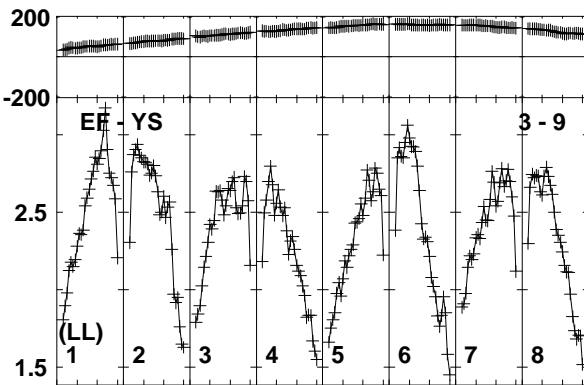
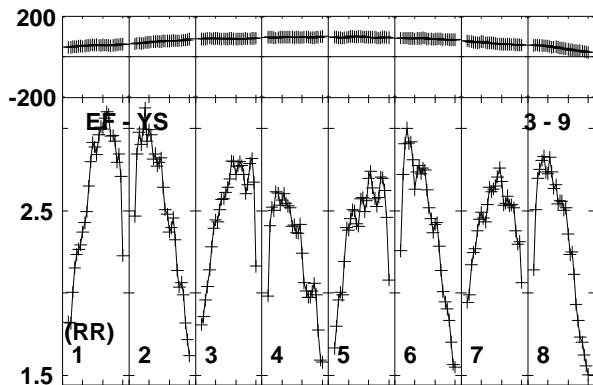
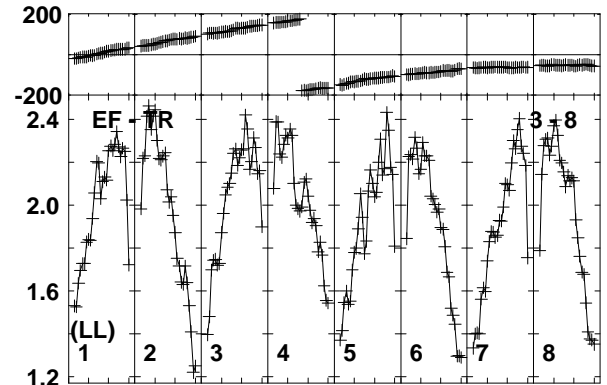
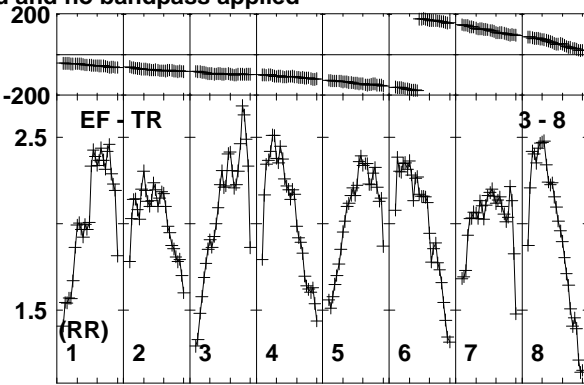
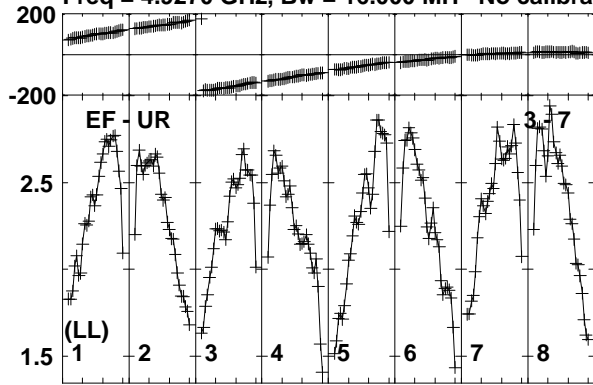

Lower frame: Milli Ampl Jy Top frame: Phas deg
Vector averaged cross-power spectrum Baseline: EF (03) - UR (07)
Timerange: 00/03:24:01 to 00/03:25:19

Plot file version 170 created 17-FEB-2020 15:42:54

J1359+5544 EK047 2.UVDATA.1

Freq = 4.9270 GHz, Bw = 16.000 MH No calibration applied and no bandpass applied

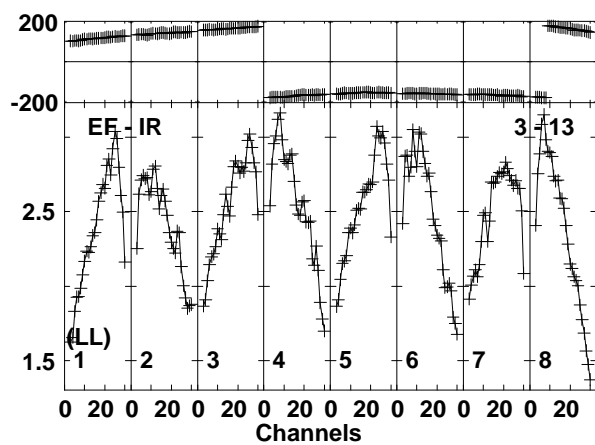
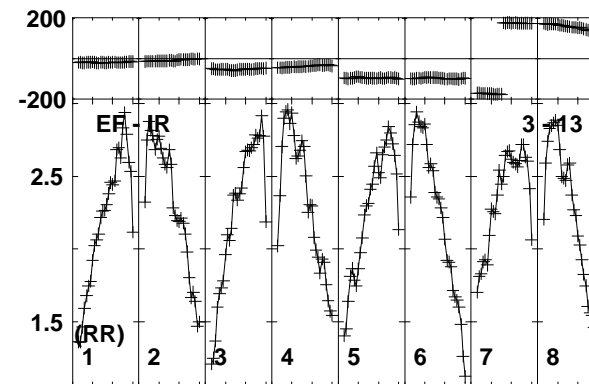
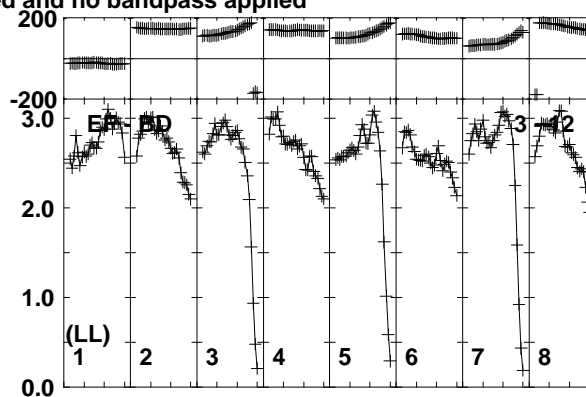
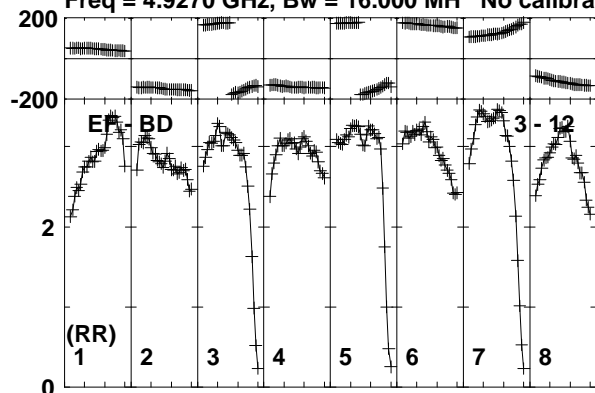

Lower frame: Milli Ampl Jy Top frame: Phas deg
Vector averaged cross-power spectrum Baseline: EF (03) - BD (12)
Timerange: 00/03:24:01 to 00/03:25:19

Plot file version 171 created 17-FEB-2020 15:42:54

J1402+5347 EK047 2.UVDATA.1

Freq = 4.9270 GHz, Bw = 16.000 MH No calibration applied and no bandpass applied

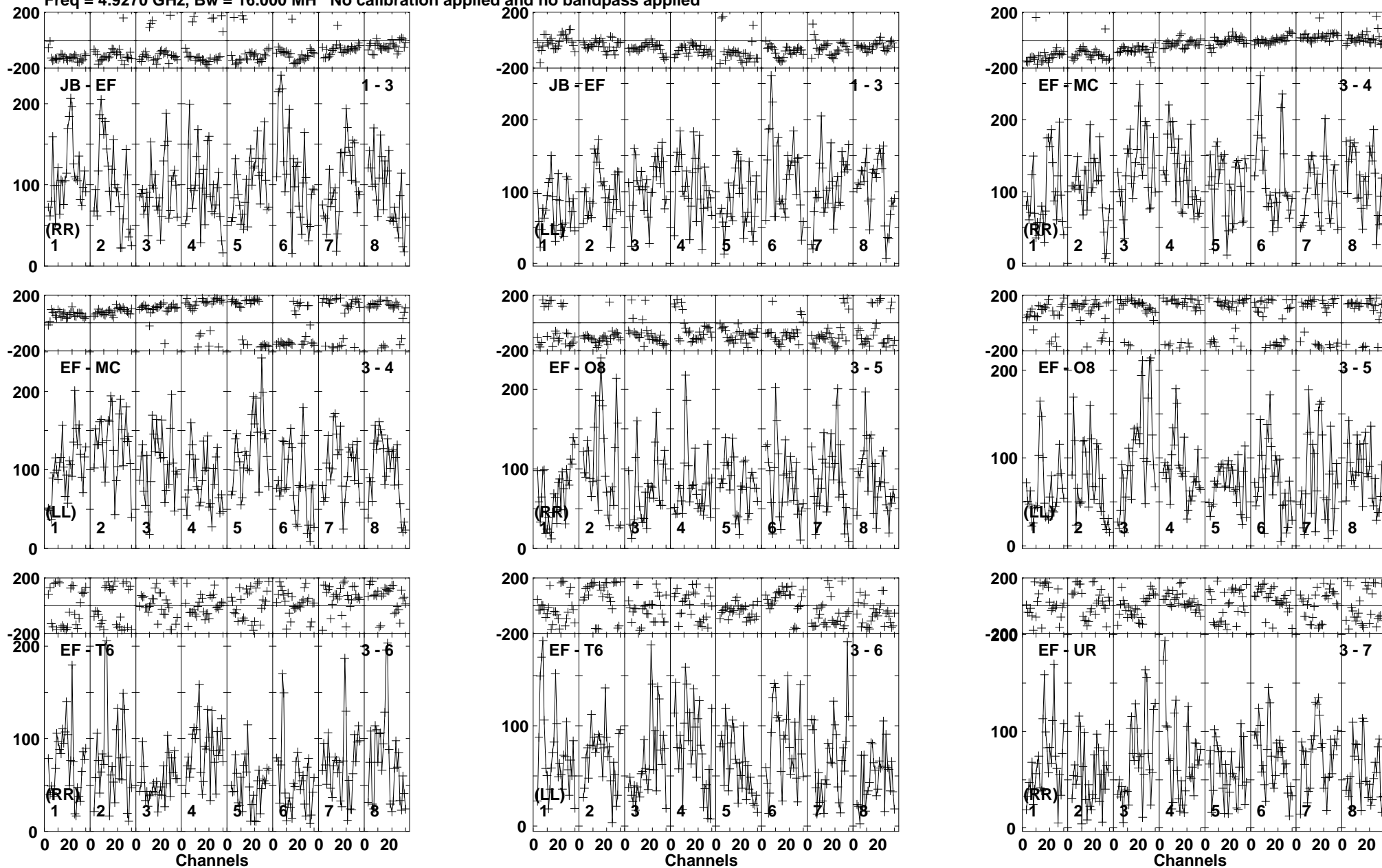

Lower frame: Micro Ampl Jy Top frame: Phas deg
Vector averaged cross-power spectrum Baseline: JB (01) - EF (03)
Timerange: 00/03:25:21 to 00/03:29:19

Plot file version 172 created 17-FEB-2020 15:42:54

J1402+5347 EK047 2.UVDATA.1

Freq = 4.9270 GHz, Bw = 16.000 MH No calibration applied and no bandpass applied

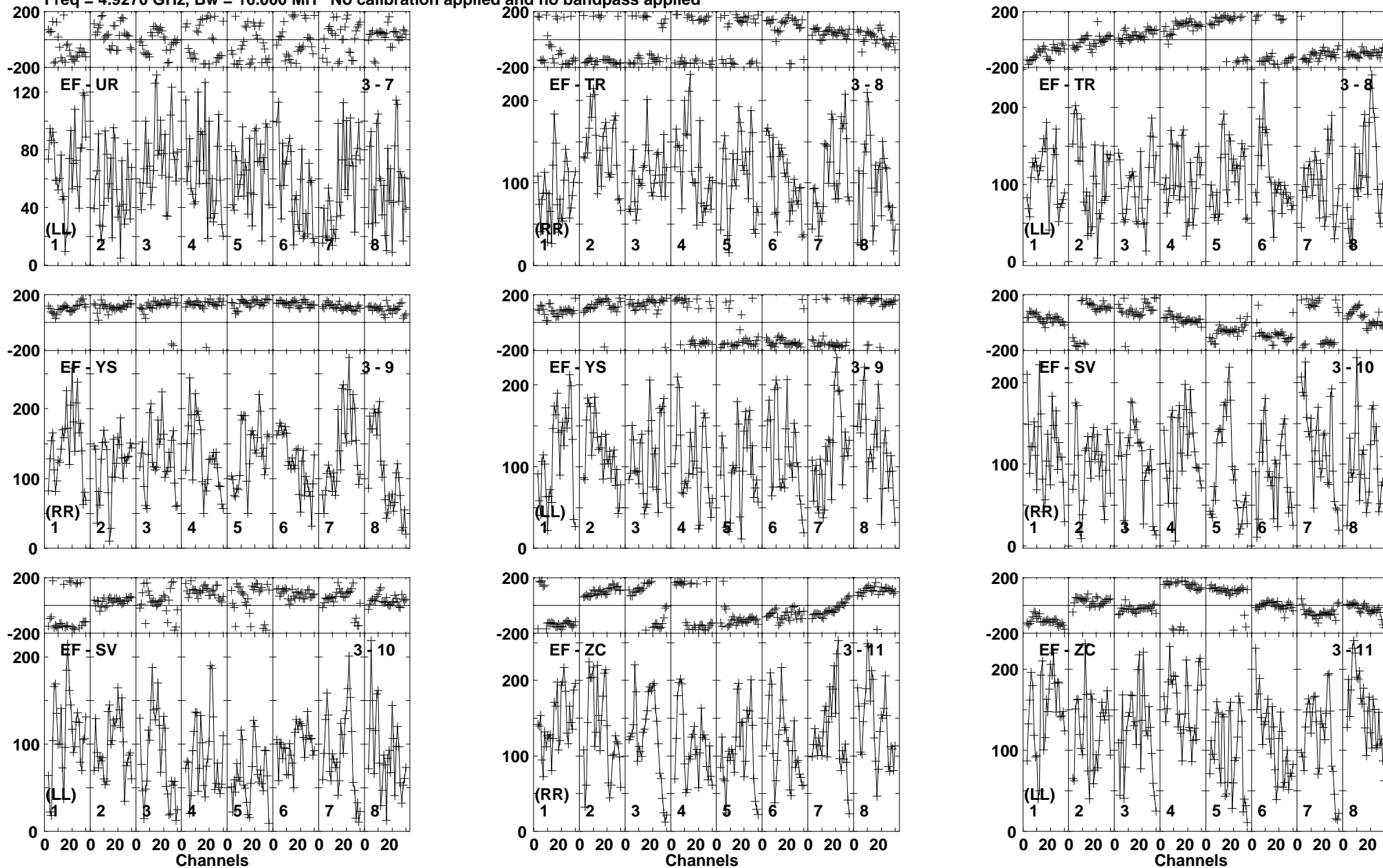

Lower frame: Micro Ampl Jy Top frame: Phas deg
Vector averaged cross-power spectrum Baseline: EF (03) - UR (07)
Timerange: 00/03:25:21 to 00/03:29:19

Plot file version 173 created 17-FEB-2020 15:42:54

J1402+5347 EK047 2.UVDATA.1

Freq = 4.9270 GHz, Bw = 16.000 MH No calibration applied and no bandpass applied

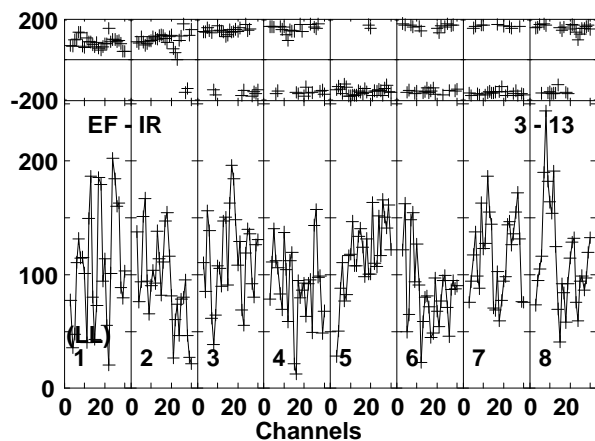
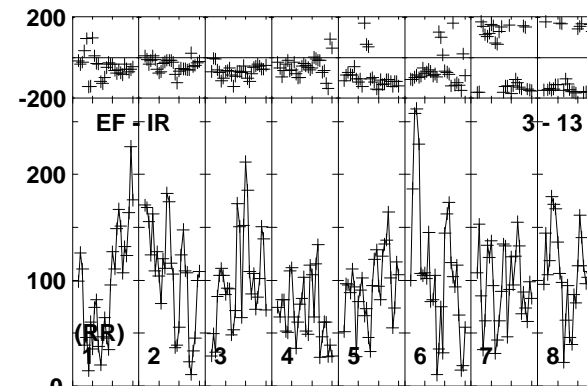
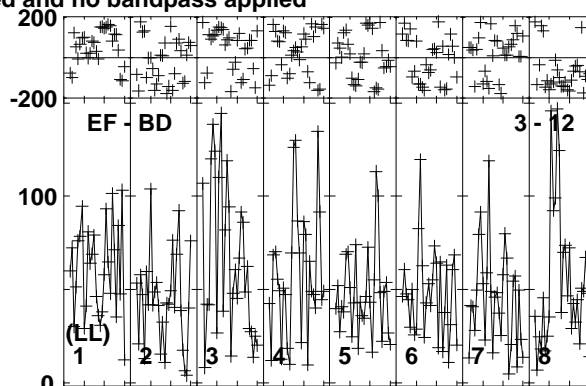
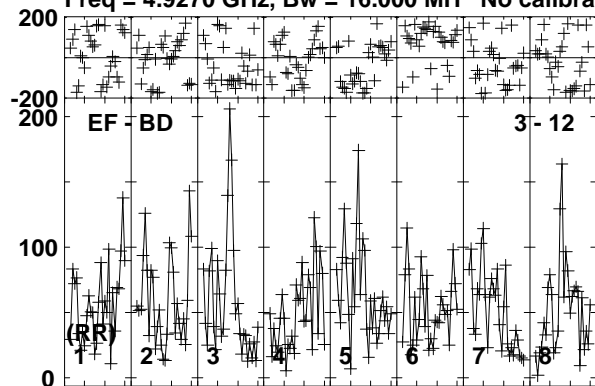

Lower frame: Micro Ampl Jy Top frame: Phas deg
Vector averaged cross-power spectrum Baseline: EF (03) - BD (12)
Timerange: 00/03:25:21 to 00/03:29:19

Plot file version 174 created 17-FEB-2020 15:42:55

J1359+5544 EK047 2.UVDATA.1

Freq = 4.9270 GHz, Bw = 16.000 MH No calibration applied and no bandpass applied

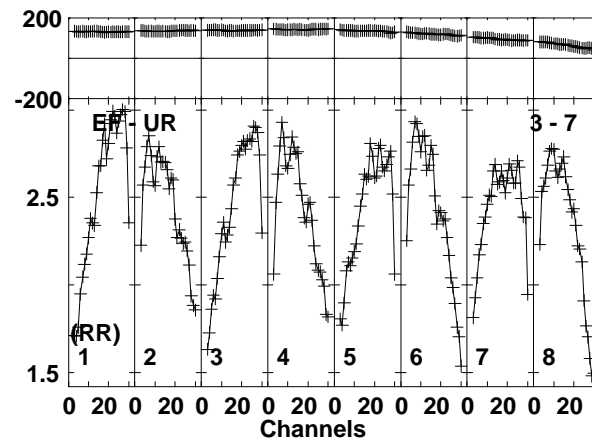
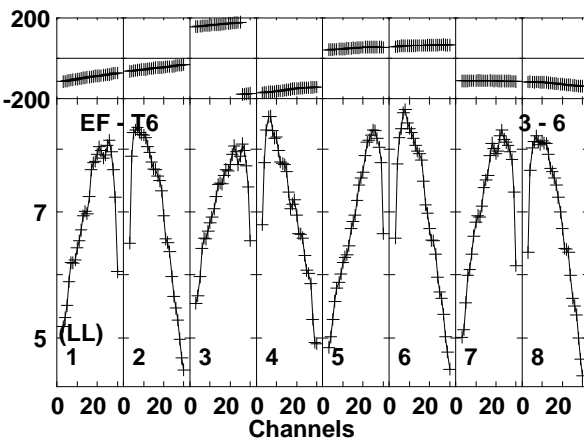
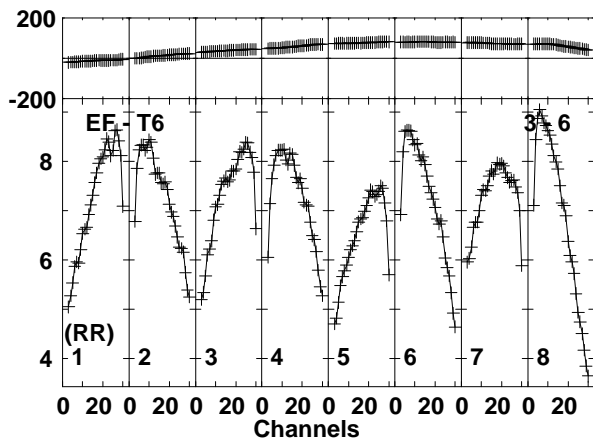
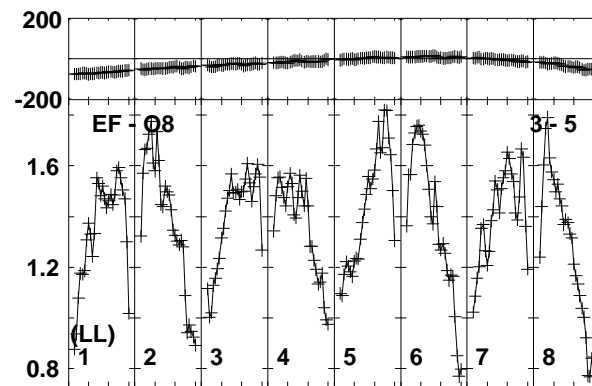
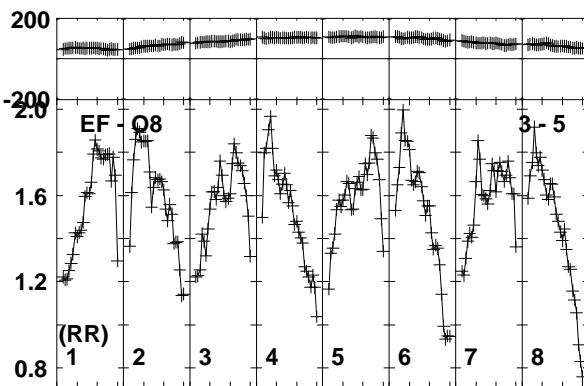
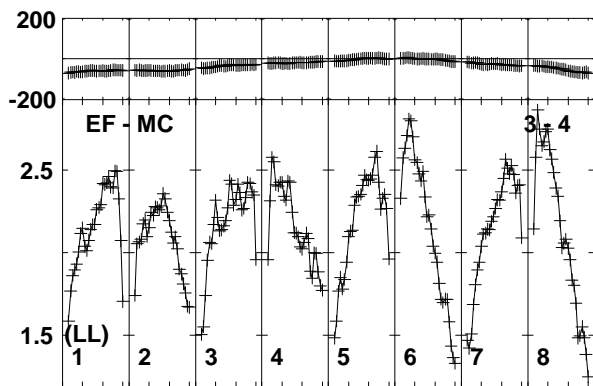
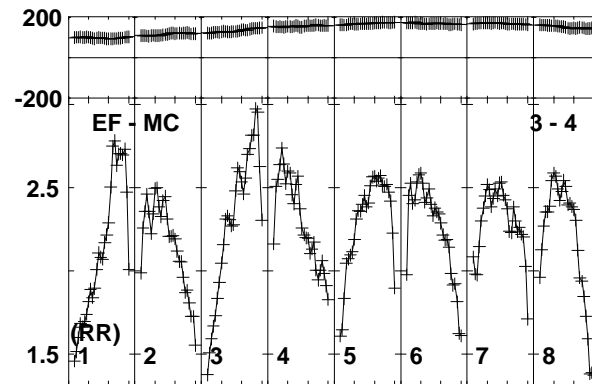
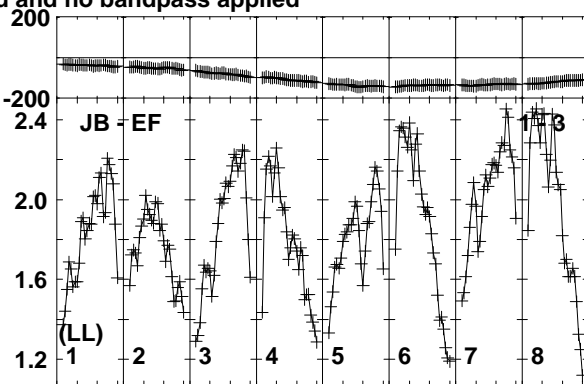
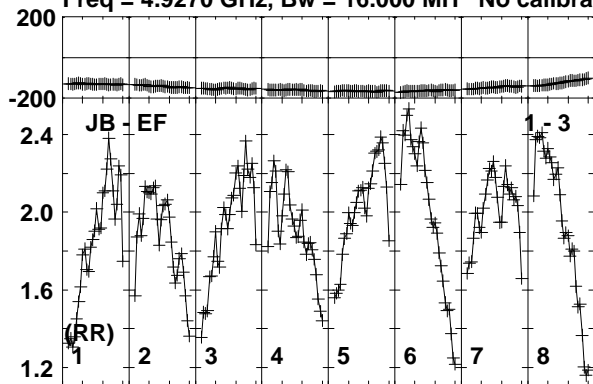

Lower frame: Milli Ampl Jy Top frame: Phas deg
Vector averaged cross-power spectrum Baseline: JB (01) - EF (03)
Timerange: 00/03:29:21 to 00/03:31:19

Plot file version 175 created 17-FEB-2020 15:42:55

J1359+5544 EK047 2.UVDATA.1

Freq = 4.9270 GHz, Bw = 16.000 MH No calibration applied and no bandpass applied

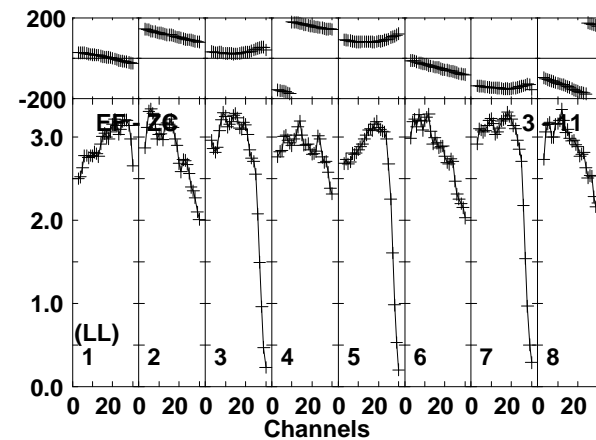
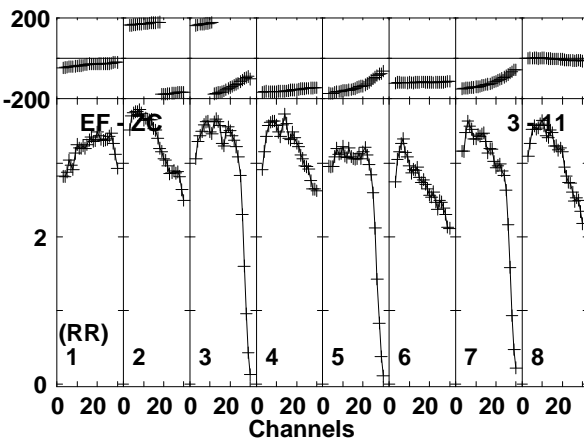
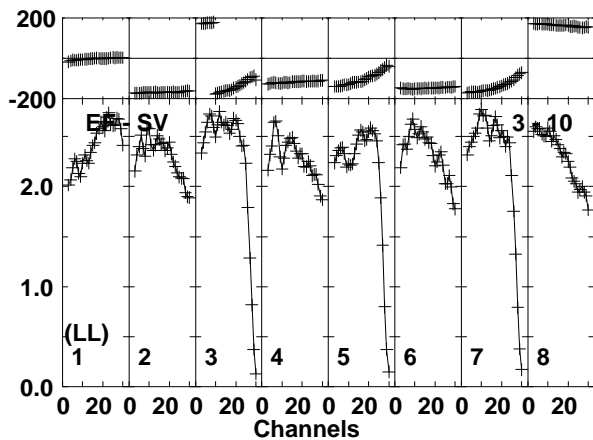
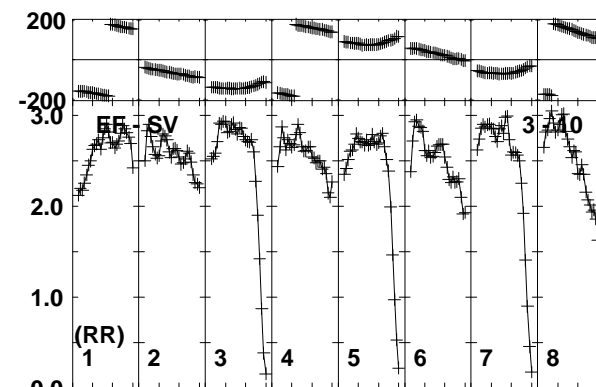
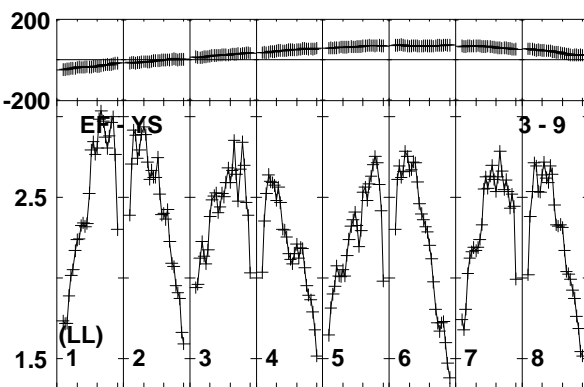
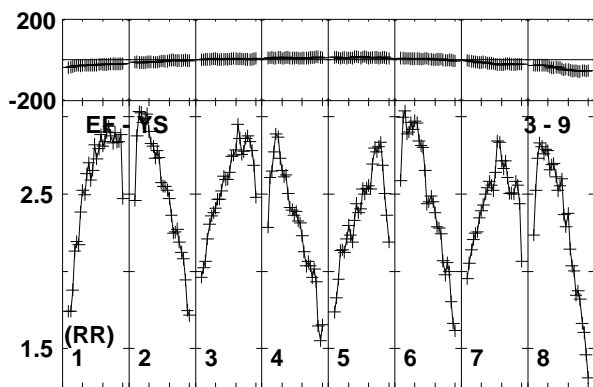
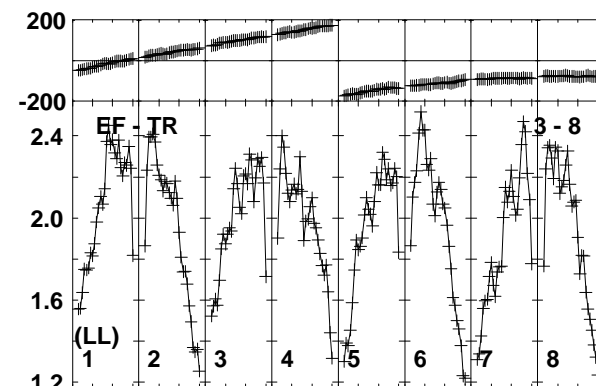
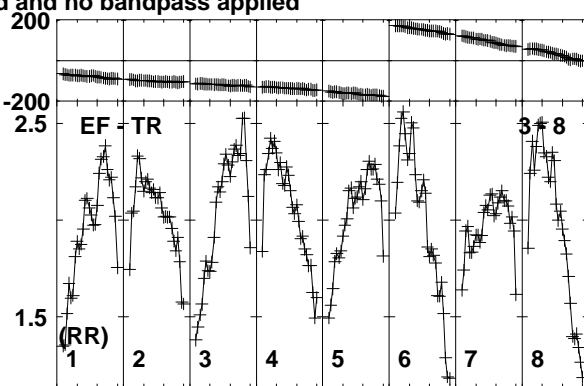
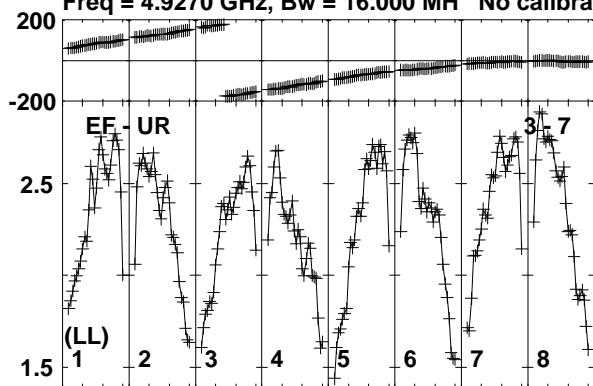

Lower frame: Milli Ampl Jy Top frame: Phas deg
Vector averaged cross-power spectrum Baseline: EF (03) - UR (07)
Timerange: 00/03:29:21 to 00/03:31:19

Plot file version 176 created 17-FEB-2020 15:42:55

J1359+5544 EK047 2.UVDATA.1

Freq = 4.9270 GHz, Bw = 16.000 MH No calibration applied and no bandpass applied

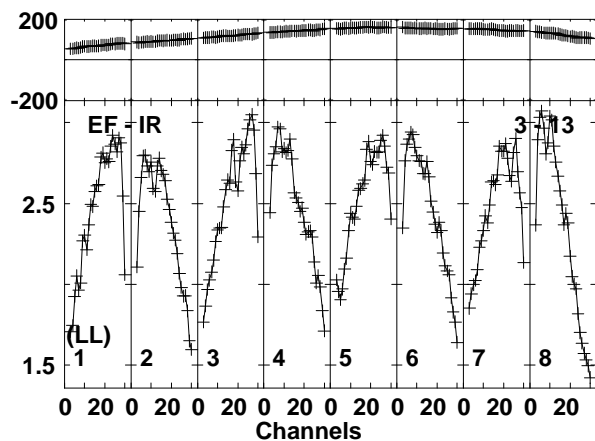
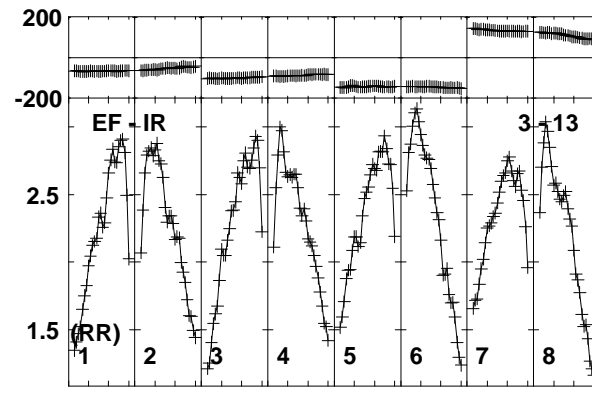
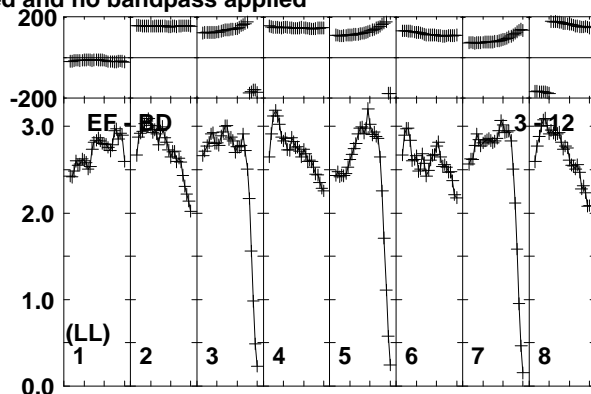
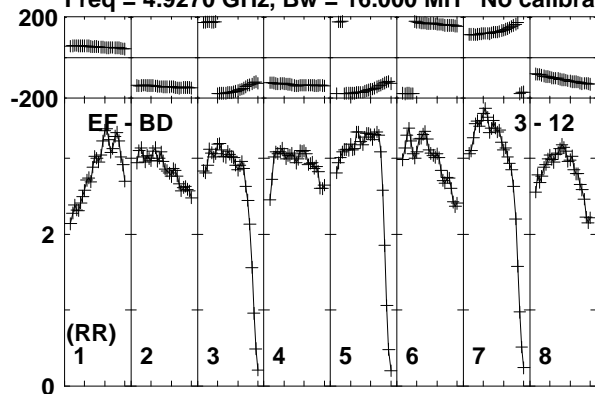

Lower frame: Milli Ampl Jy Top frame: Phas deg
Vector averaged cross-power spectrum Baseline: EF (03) - BD (12)
Timerange: 00/03:29:21 to 00/03:31:19

Plot file version 177 created 17-FEB-2020 15:42:55

J1402+5347 EK047 2.UVDATA.1

Freq = 4.9270 GHz, Bw = 16.000 MH No calibration applied and no bandpass applied

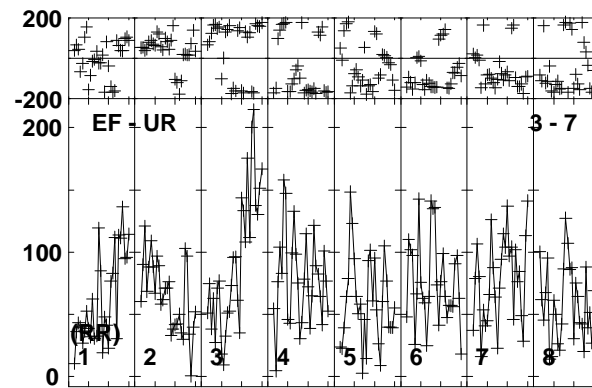
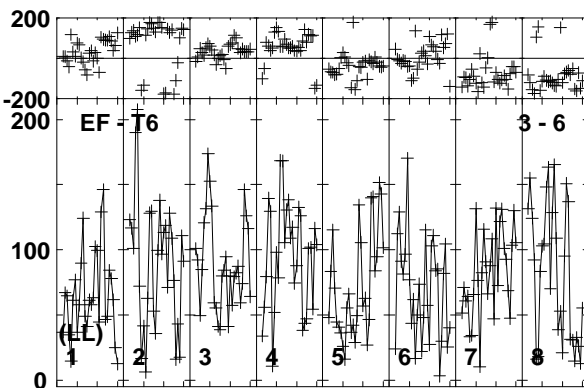
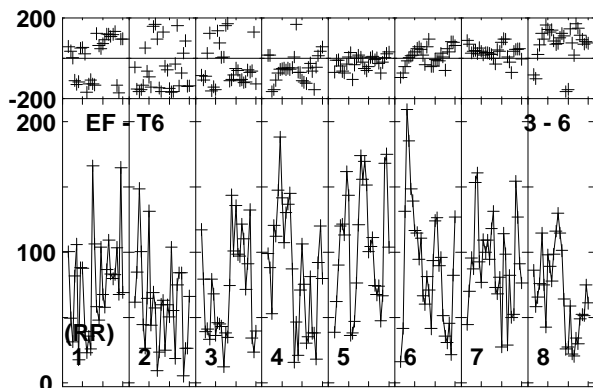
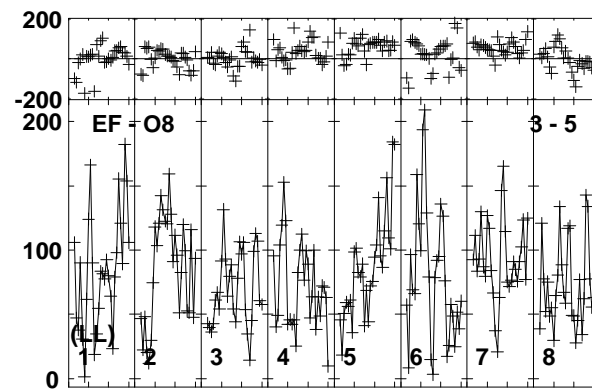
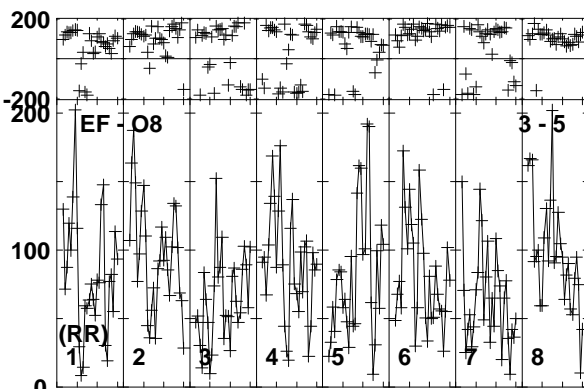
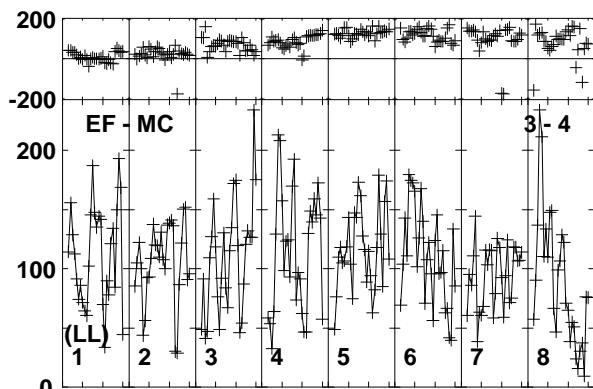
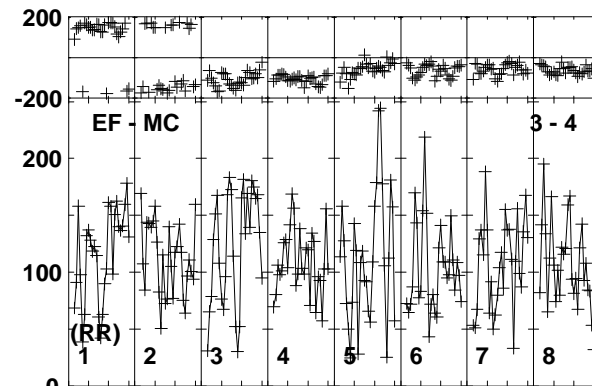
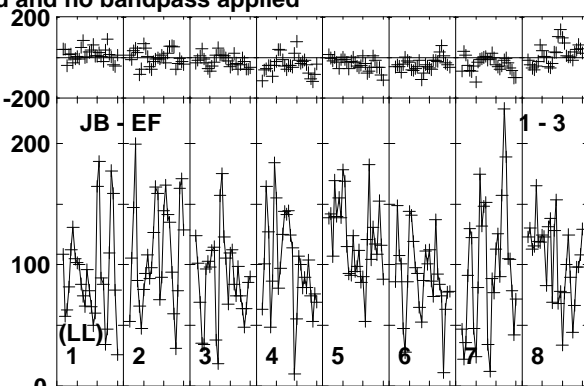
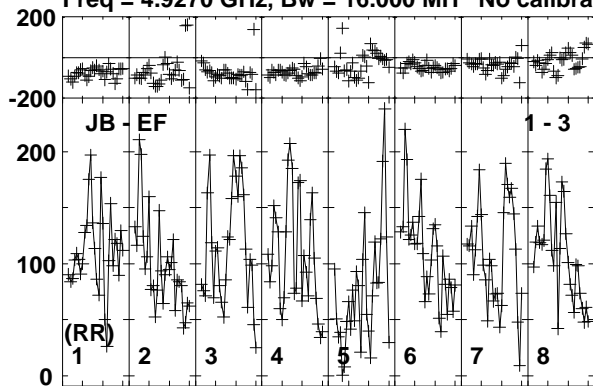

Lower frame: Micro Ampl Jy Top frame: Phas deg
Vector averaged cross-power spectrum Baseline: JB (01) - EF (03)
Timerange: 00/03:31:23 to 00/03:35:19

Plot file version 178 created 17-FEB-2020 15:42:55

J1402+5347 EK047 2.UVDATA.1

Freq = 4.9270 GHz, Bw = 16.000 MH No calibration applied and no bandpass applied

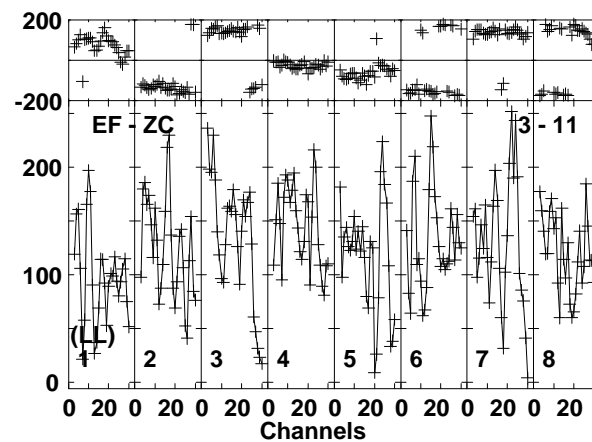
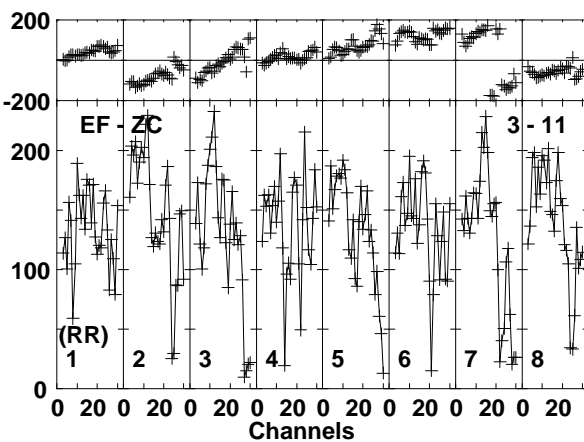
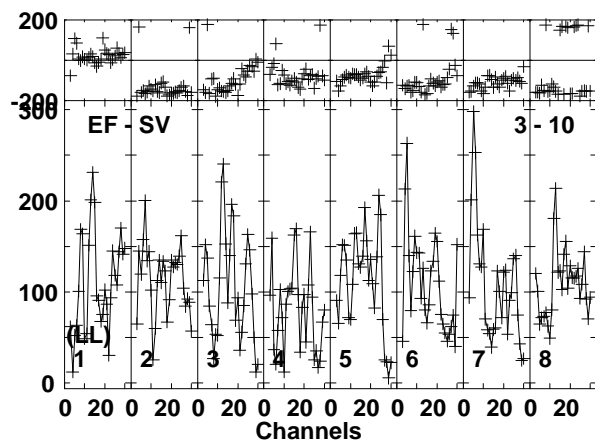
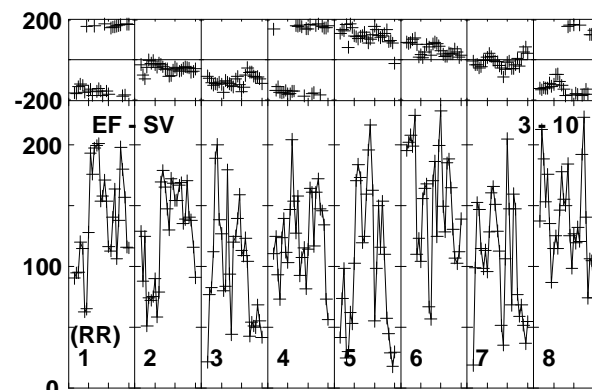
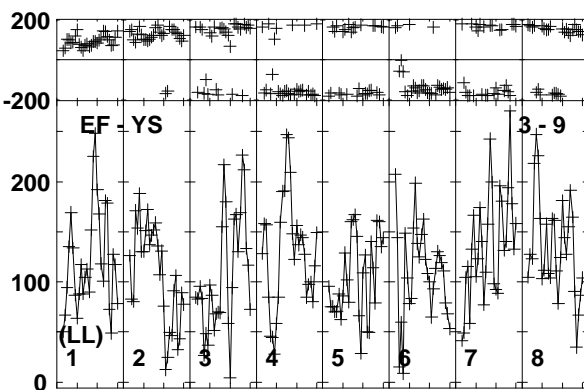
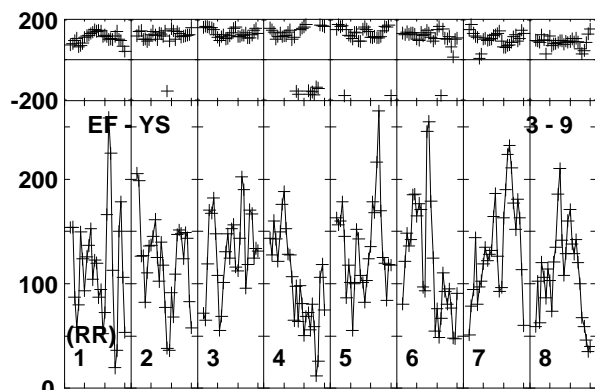
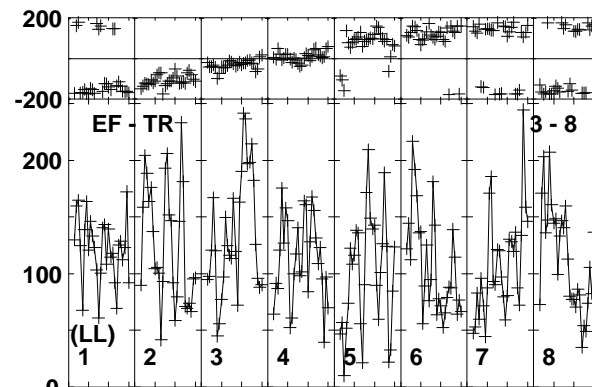
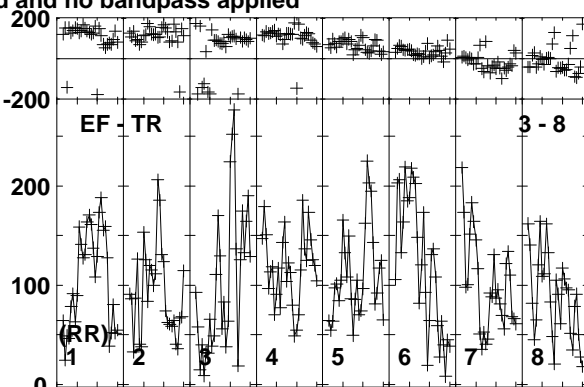
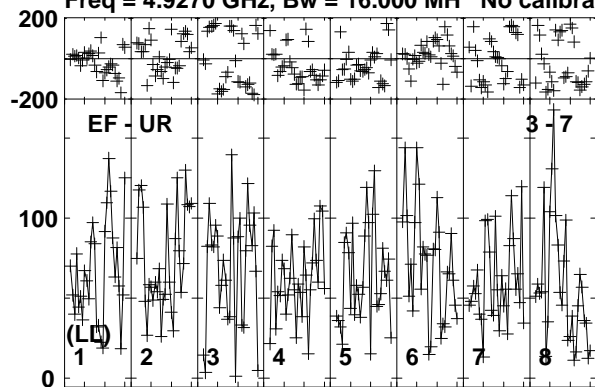

Lower frame: Micro Ampl Jy Top frame: Phas deg
Vector averaged cross-power spectrum Baseline: EF (03) - UR (07)
Timerange: 00/03:31:23 to 00/03:35:19

Plot file version 179 created 17-FEB-2020 15:42:55

J1402+5347 EK047 2.UVDATA.1

Freq = 4.9270 GHz, Bw = 16.000 MH No calibration applied and no bandpass applied

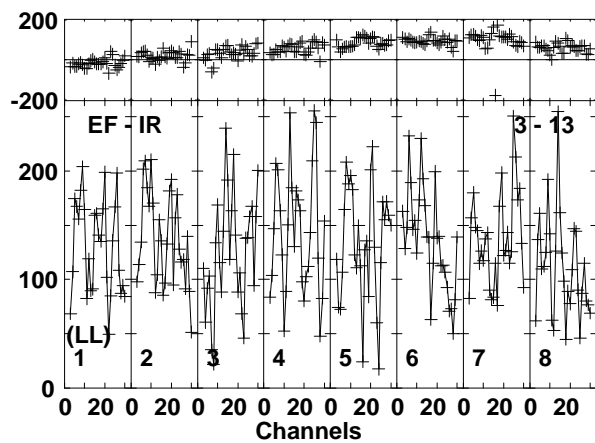
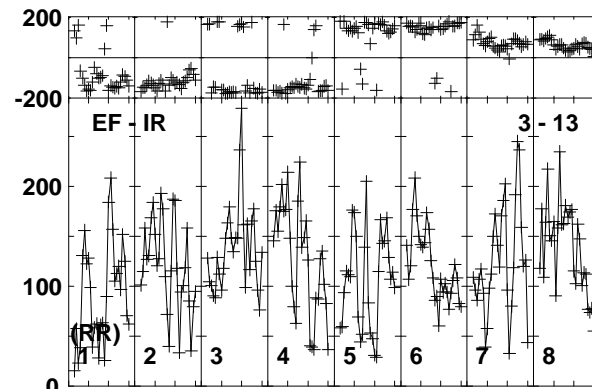
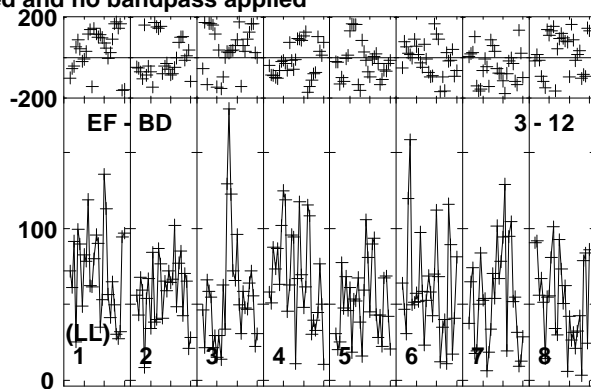
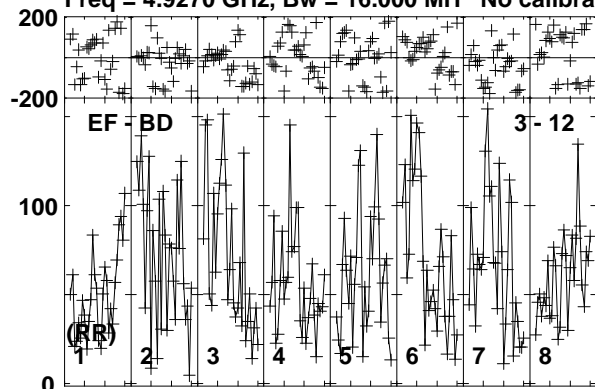

Lower frame: Micro Ampl Jy Top frame: Phas deg
Vector averaged cross-power spectrum Baseline: EF (03) - BD (12)
Timerange: 00/03:31:23 to 00/03:35:19

Plot file version 180 created 17-FEB-2020 15:42:55

J1359+5544 EK047 2.UVDATA.1

Freq = 4.9270 GHz, Bw = 16.000 MH No calibration applied and no bandpass applied

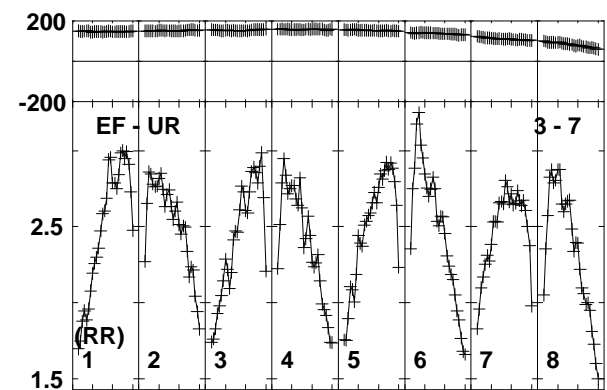
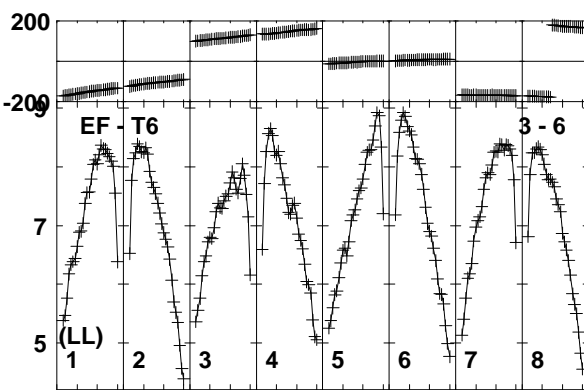
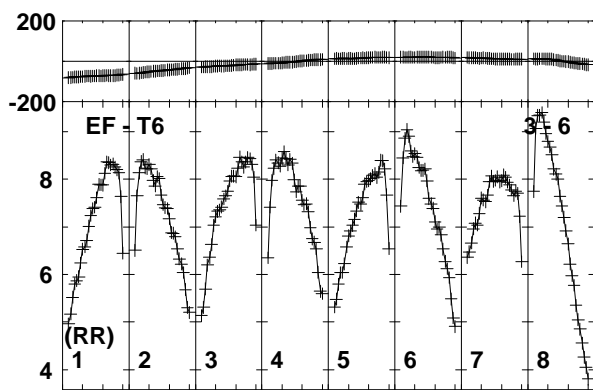
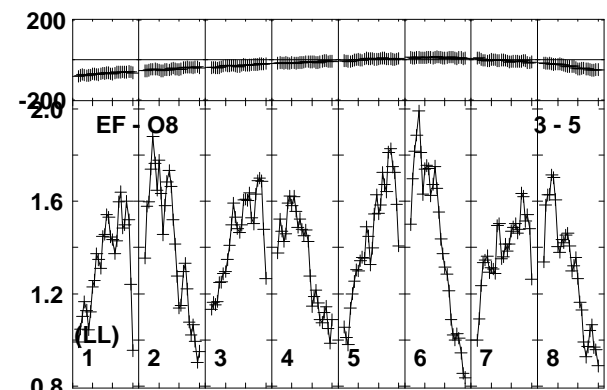
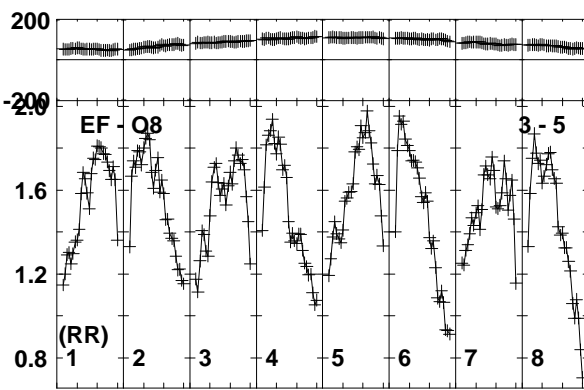
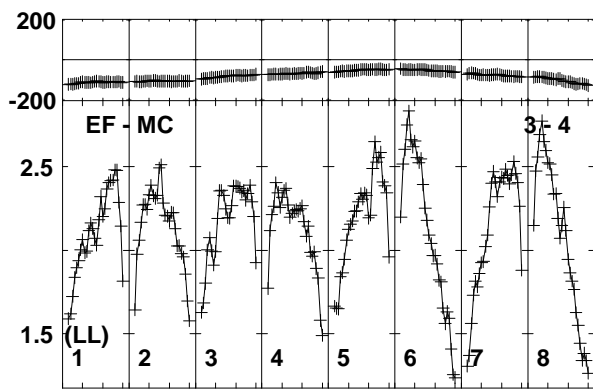
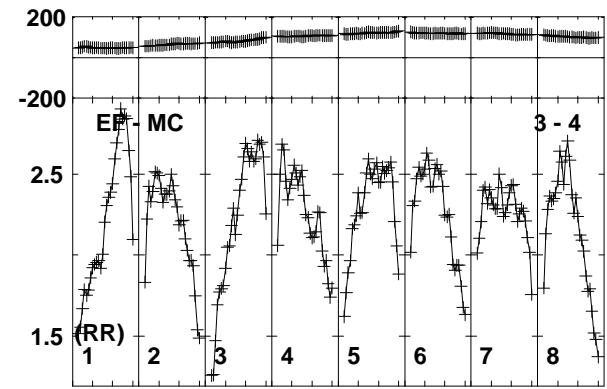
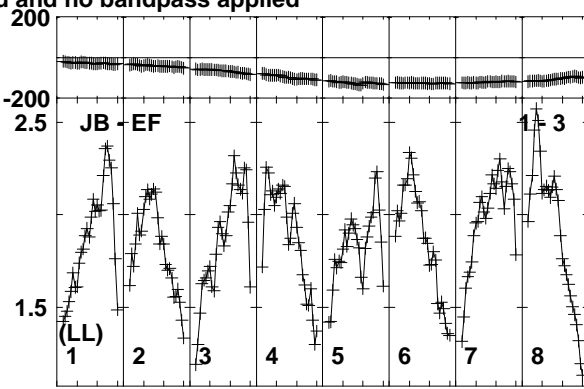
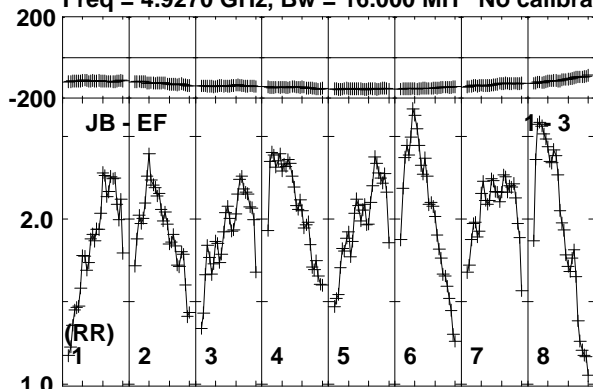

Lower frame: Milli Ampl Jy Top frame: Phas deg

Vector averaged cross-power spectrum Baseline: JB (01) - EF (03)

Timerange: 00/03:36:01 to 00/03:37:19

Plot file version 181 created 17-FEB-2020 15:42:55

J1359+5544 EK047 2.UVDATA.1

Freq = 4.9270 GHz, Bw = 16.000 MH No calibration applied and no bandpass applied

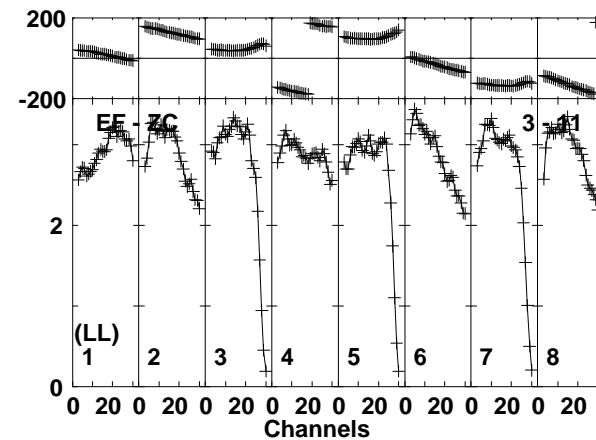
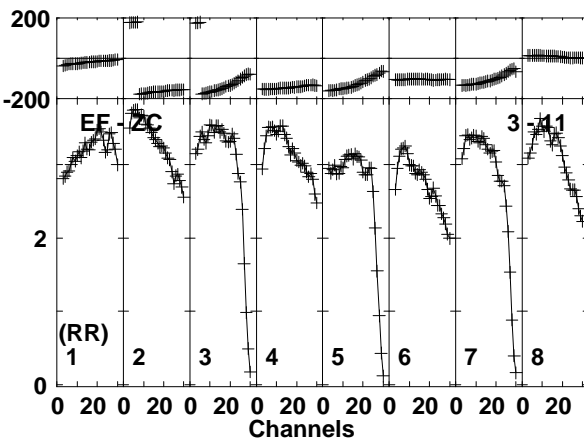
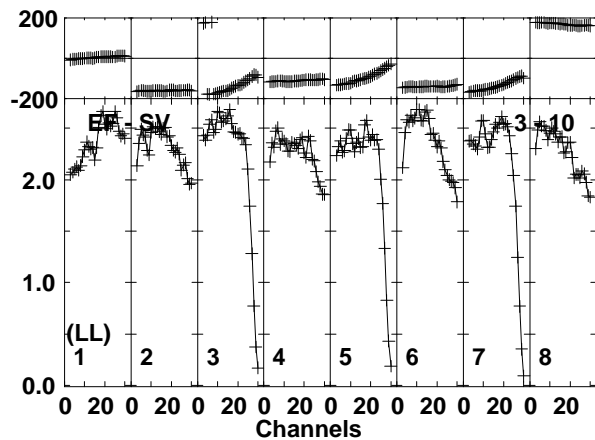
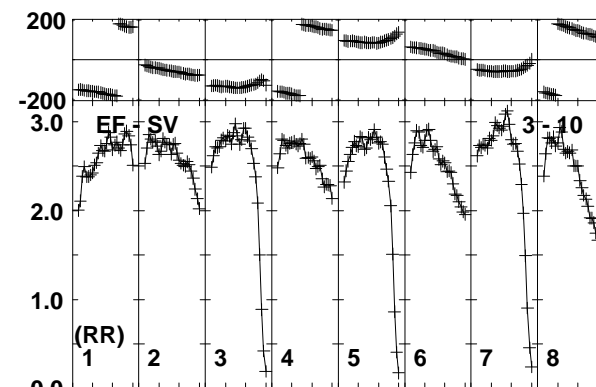
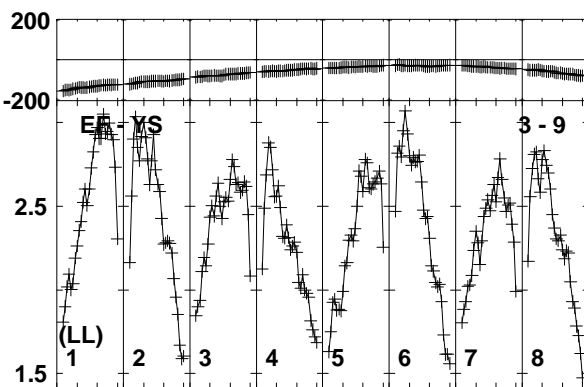
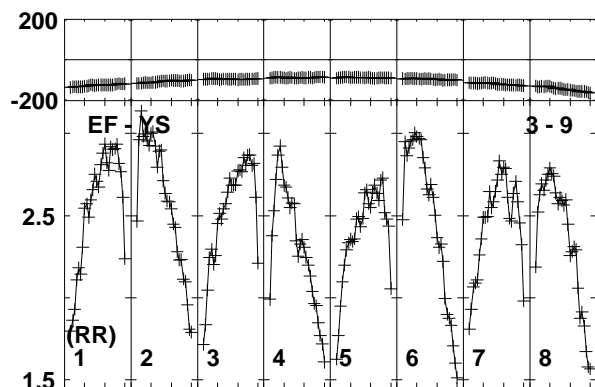
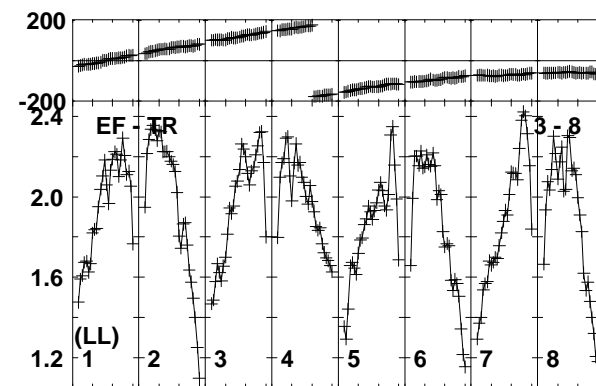
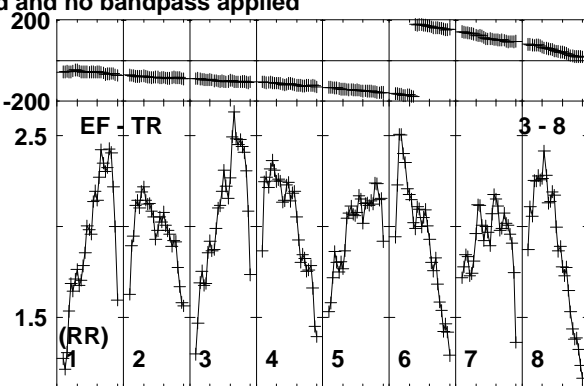
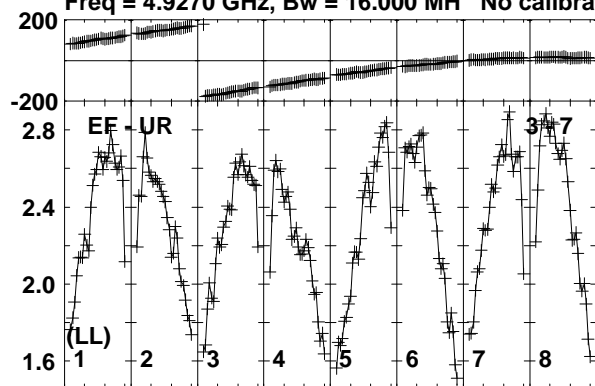

Lower frame: Milli Ampl Jy Top frame: Phas deg
Vector averaged cross-power spectrum Baseline: EF (03) - UR (07)
Timerange: 00/03:36:01 to 00/03:37:19

Plot file version 182 created 17-FEB-2020 15:42:55

J1359+5544 EK047 2.UVDATA.1

Freq = 4.9270 GHz, Bw = 16.000 MH No calibration applied and no bandpass applied

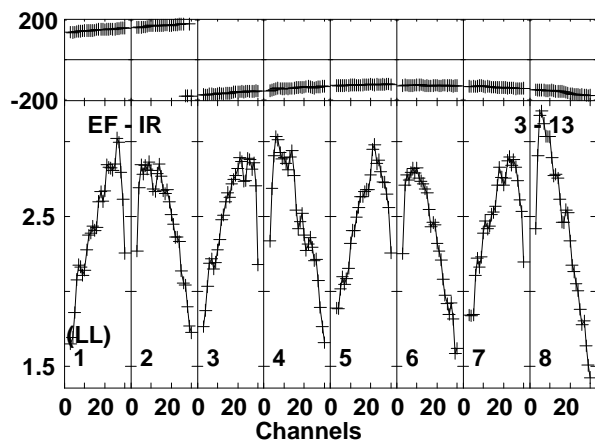
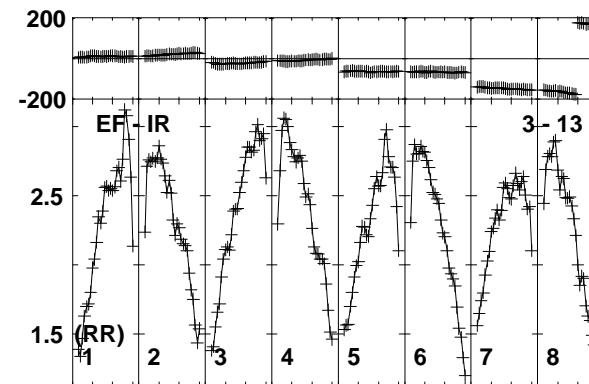
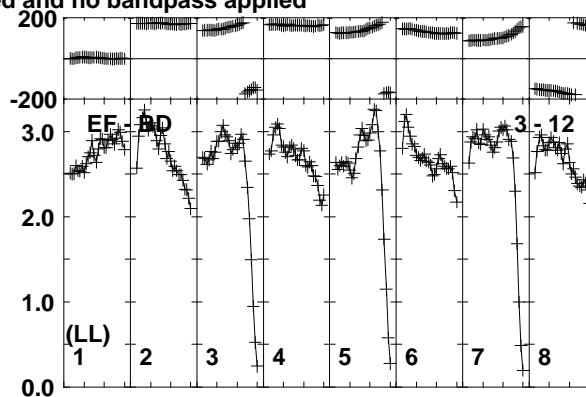
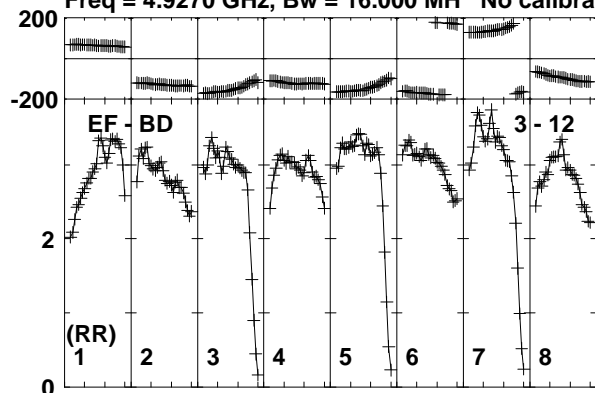

Lower frame: Milli Ampl Jy Top frame: Phas deg
Vector averaged cross-power spectrum Baseline: EF (03) - BD (12)
Timerange: 00/03:36:01 to 00/03:37:19

Plot file version 183 created 17-FEB-2020 15:42:55

J1402+5347 EK047 2.UVDATA.1

Freq = 4.9270 GHz, Bw = 16.000 MH No calibration applied and no bandpass applied

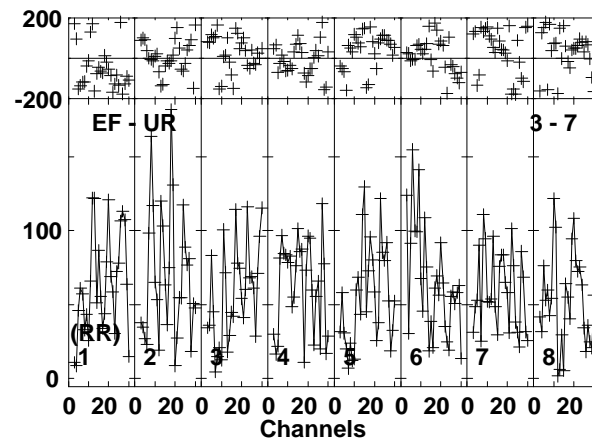
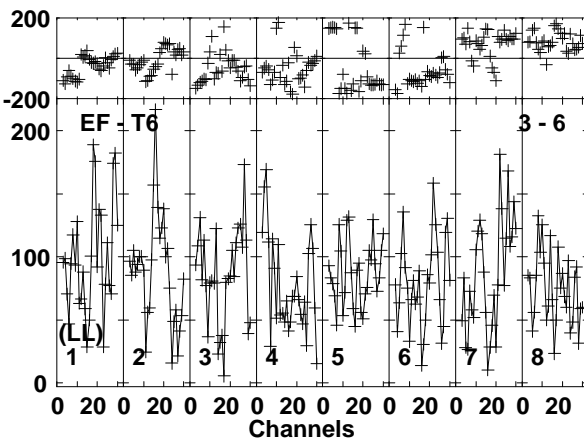
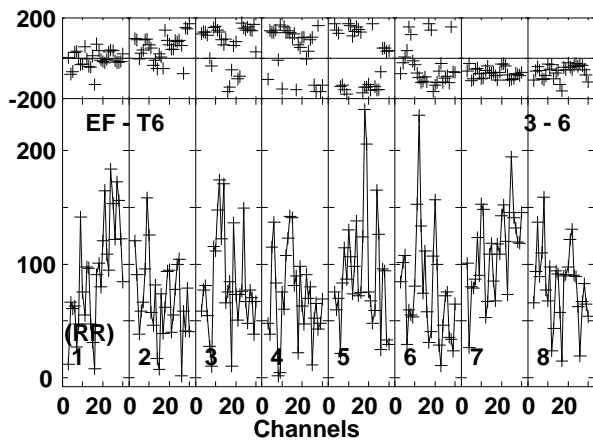
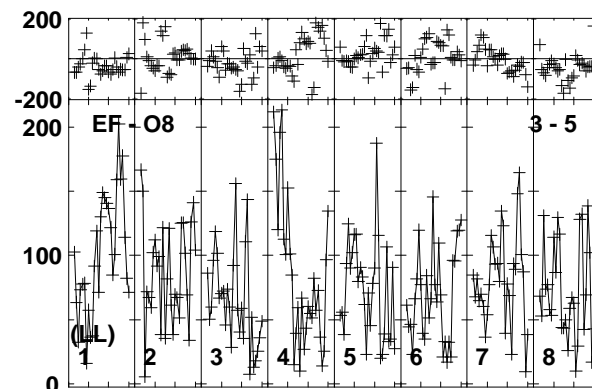
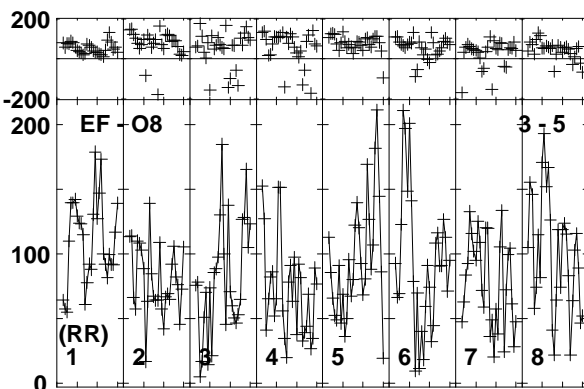
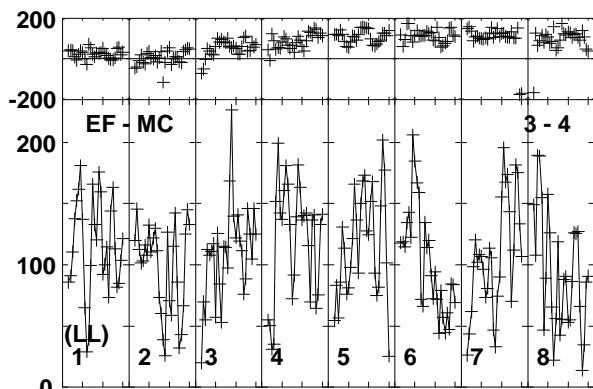
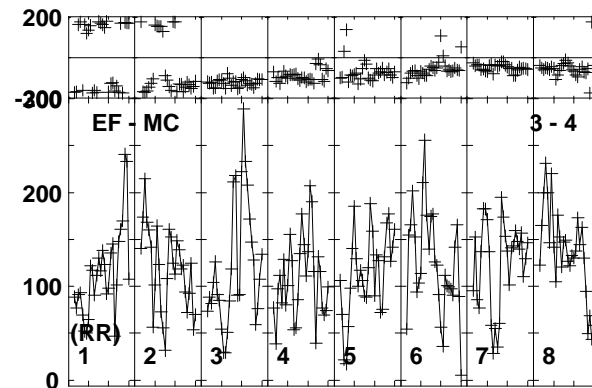
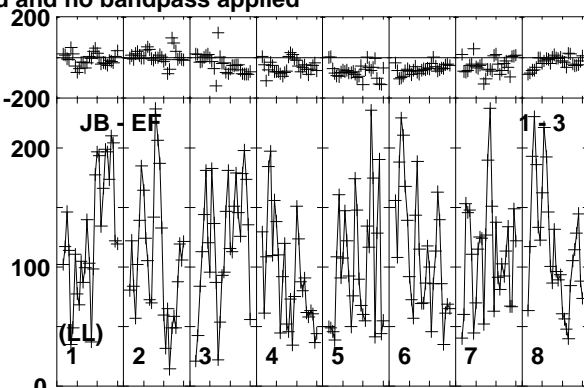
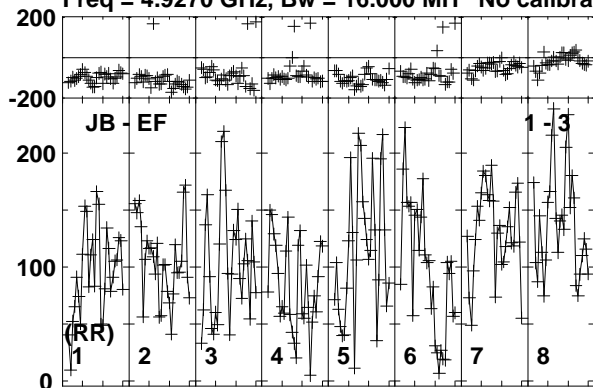

Lower frame: Micro Ampl Jy Top frame: Phas deg
Vector averaged cross-power spectrum Baseline: JB (01) - EF (03)
Timerange: 00/03:37:21 to 00/03:41:19

Plot file version 184 created 17-FEB-2020 15:42:55

J1402+5347 EK047 2.UVDATA.1

Freq = 4.9270 GHz, Bw = 16.000 MH No calibration applied and no bandpass applied

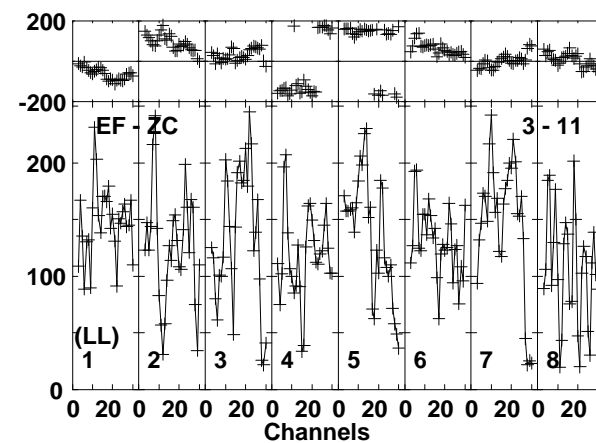
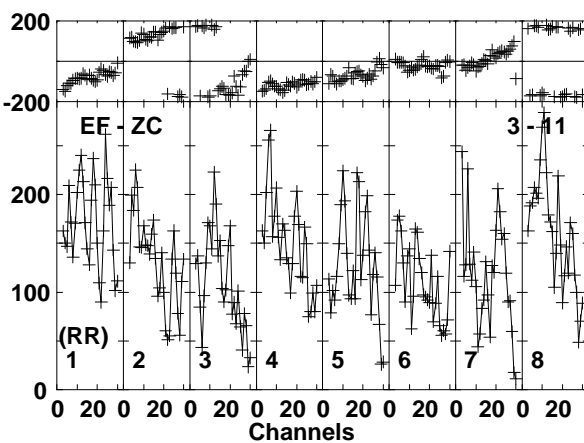
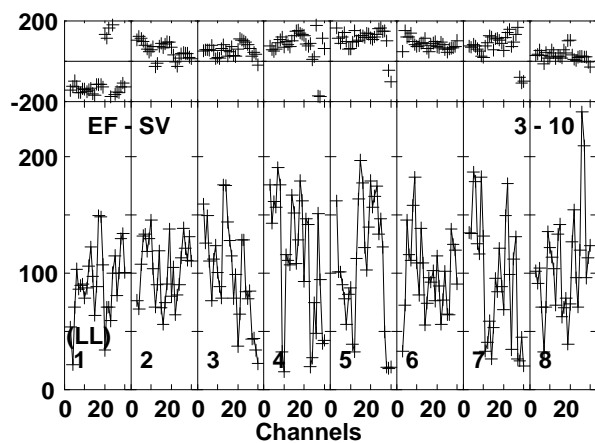
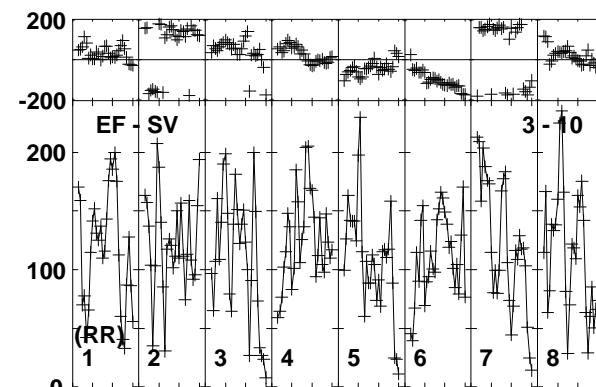
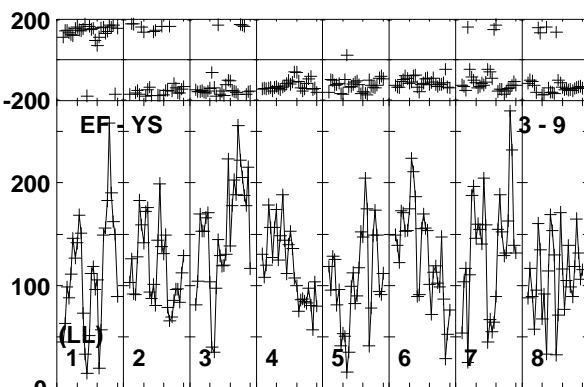
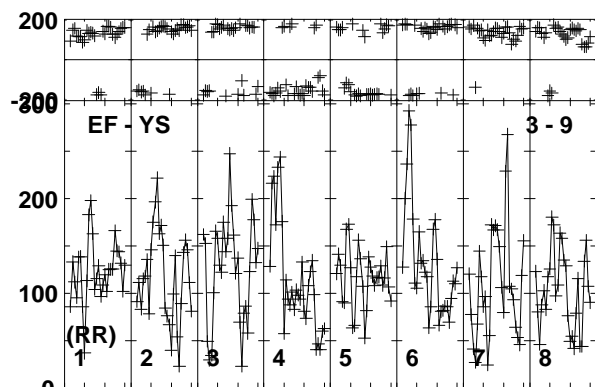
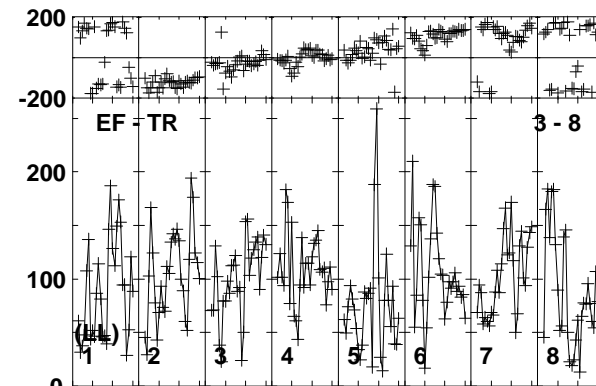
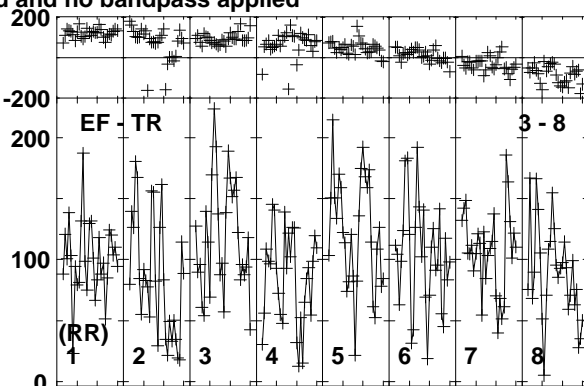
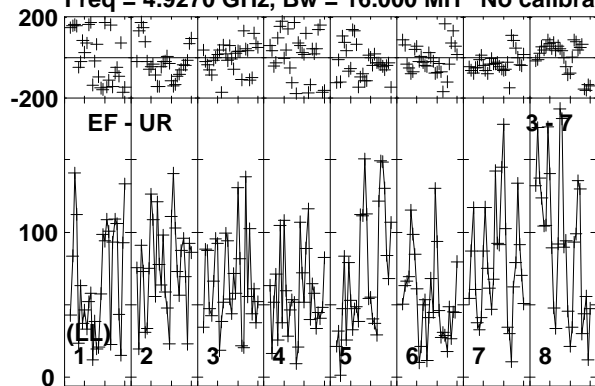

Lower frame: Micro Ampl Jy Top frame: Phas deg
Vector averaged cross-power spectrum Baseline: EF (03) - UR (07)
Timerange: 00/03:37:21 to 00/03:41:19

Plot file version 185 created 17-FEB-2020 15:42:56

J1402+5347 EK047 2.UVDATA.1

Freq = 4.9270 GHz, Bw = 16.000 MH No calibration applied and no bandpass applied

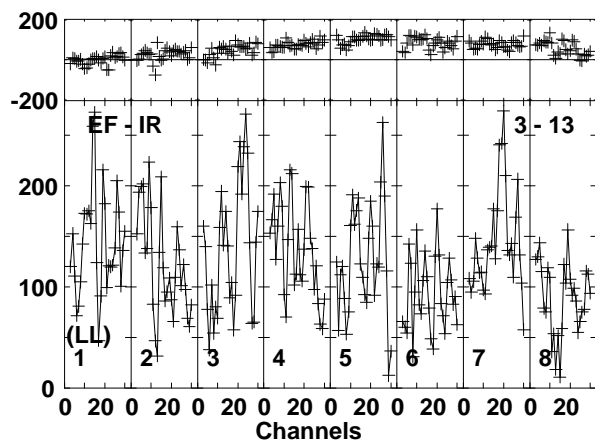
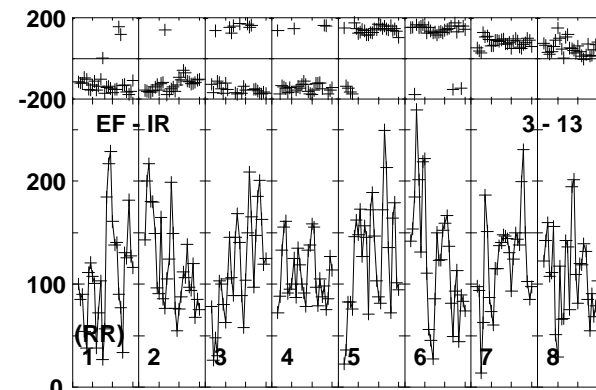
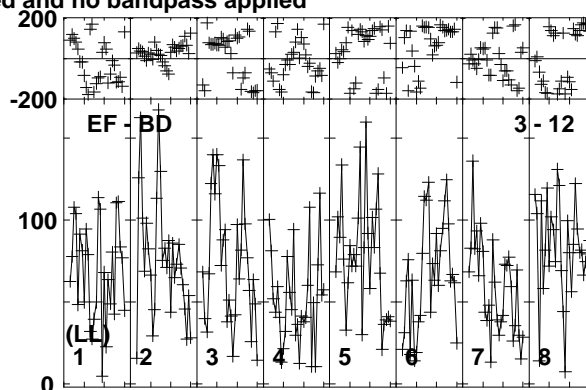
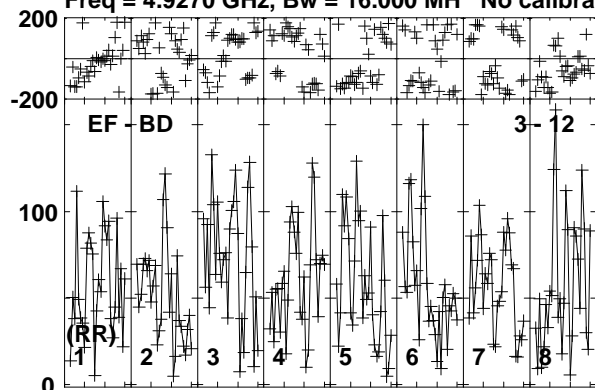

Lower frame: Micro Ampl Jy Top frame: Phas deg
Vector averaged cross-power spectrum Baseline: EF (03) - BD (12)
Timerange: 00/03:37:21 to 00/03:41:19

Plot file version 186 created 17-FEB-2020 15:42:56

J1359+5544 EK047 2.UVDATA.1

Freq = 4.9270 GHz, Bw = 16.000 MH No calibration applied and no bandpass applied

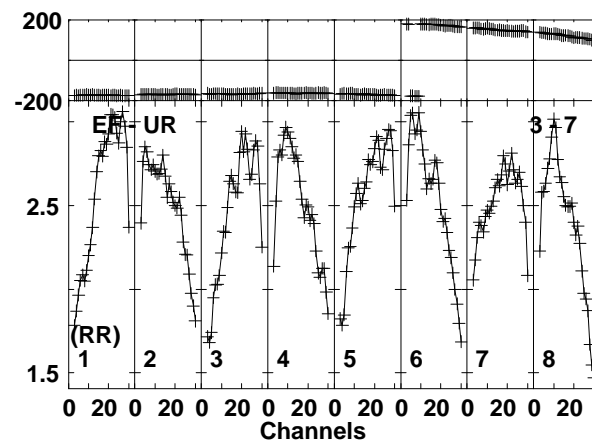
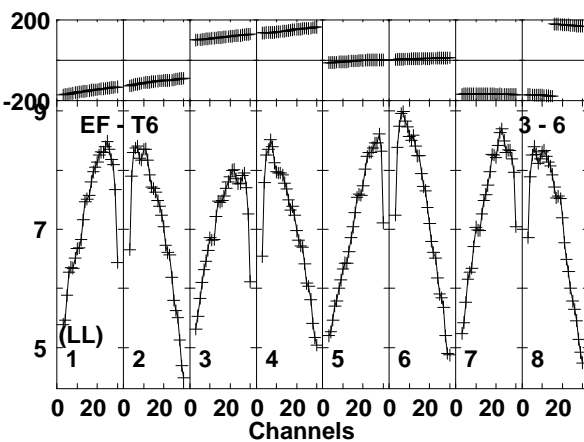
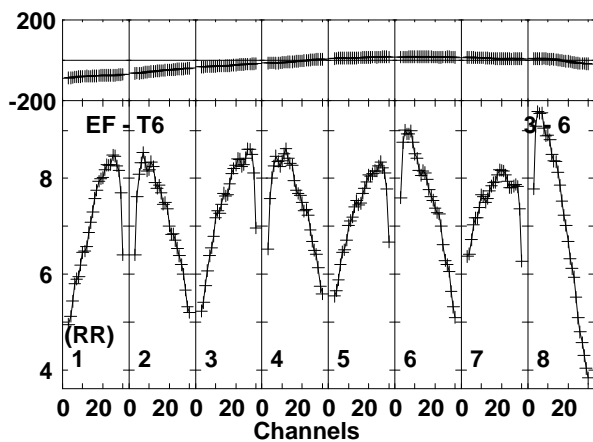
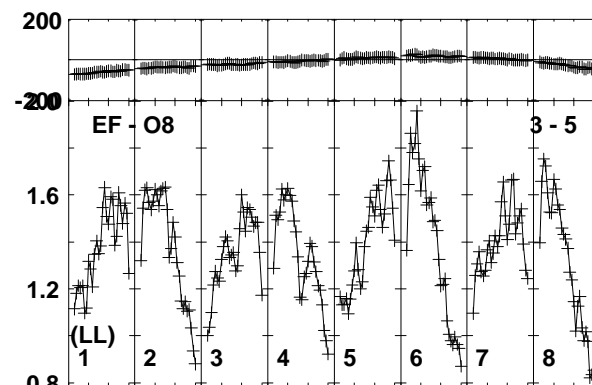
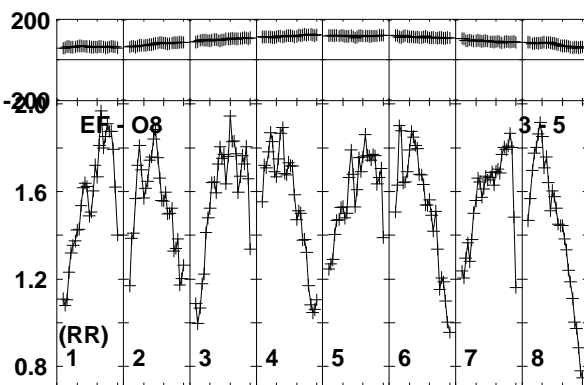
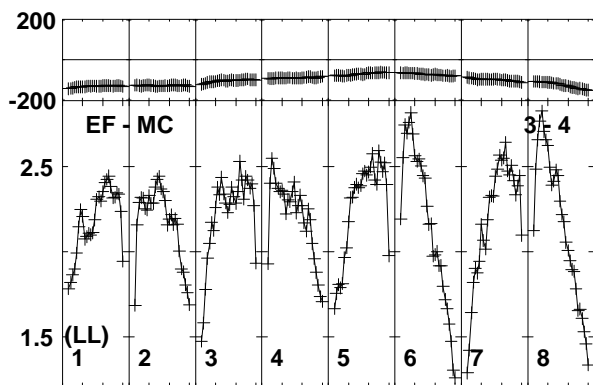
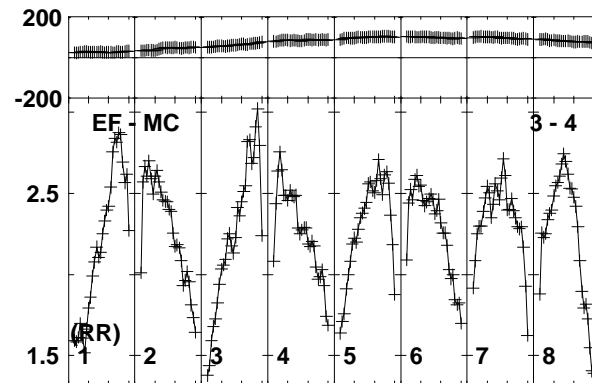
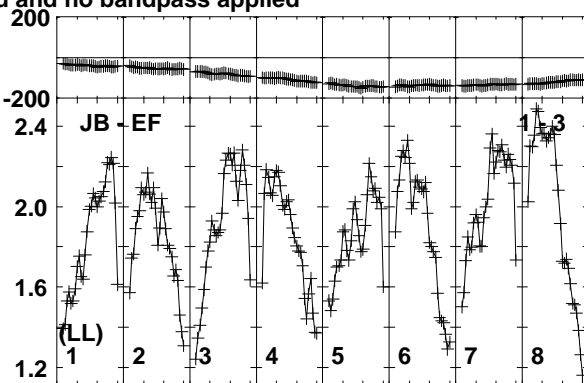
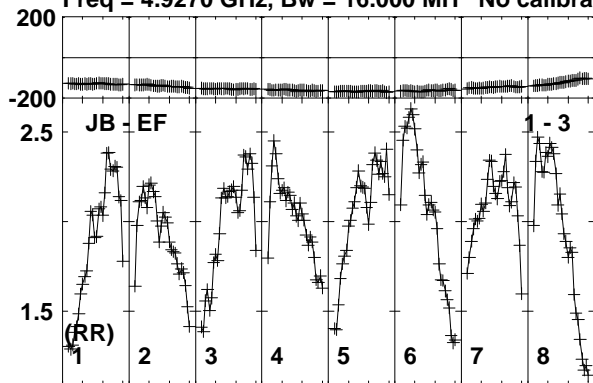

Lower frame: Milli Ampl Jy Top frame: Phas deg
Vector averaged cross-power spectrum Baseline: JB (01) - EF (03)
Timerange: 00/03:41:21 to 00/03:43:19

Plot file version 187 created 17-FEB-2020 15:42:56

J1359+5544 EK047 2.UVDATA.1

Freq = 4.9270 GHz, Bw = 16.000 MH No calibration applied and no bandpass applied

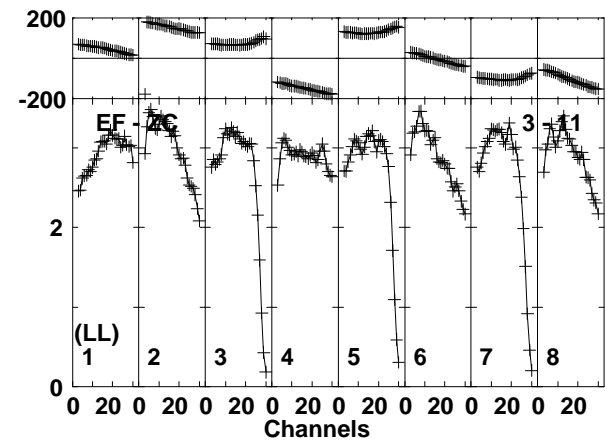
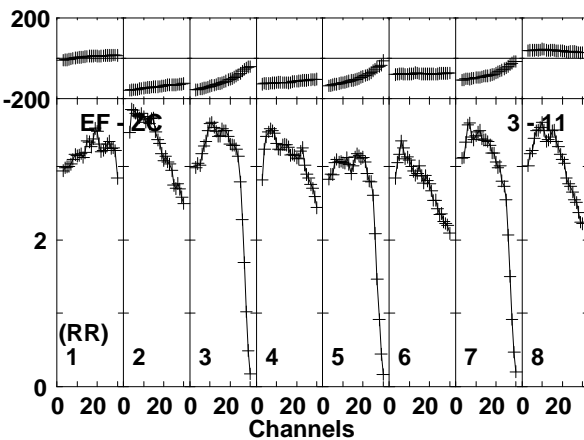
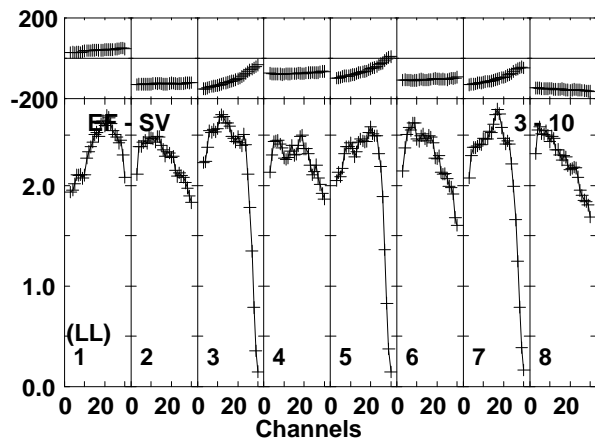
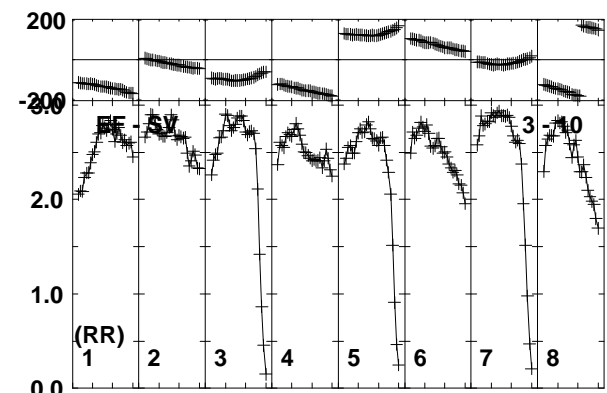
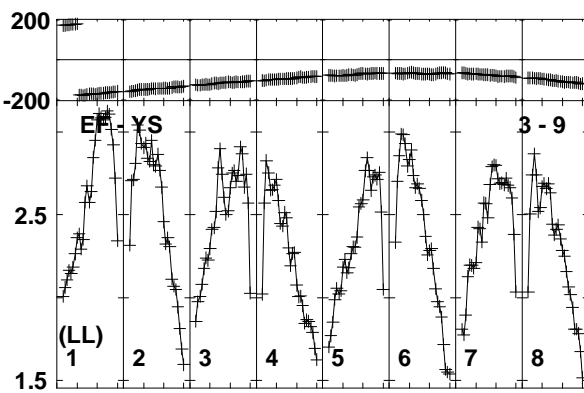
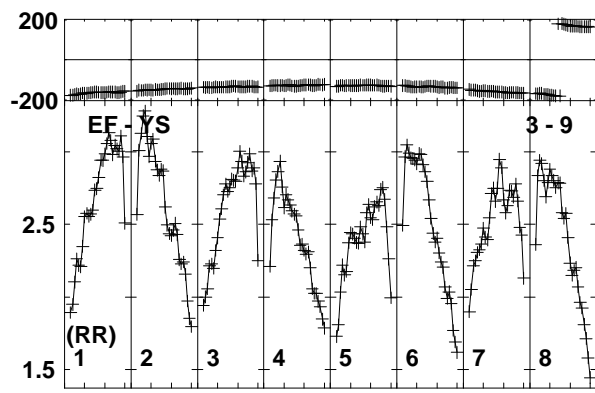
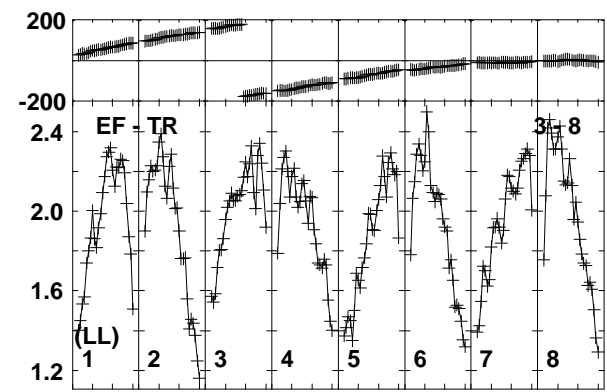
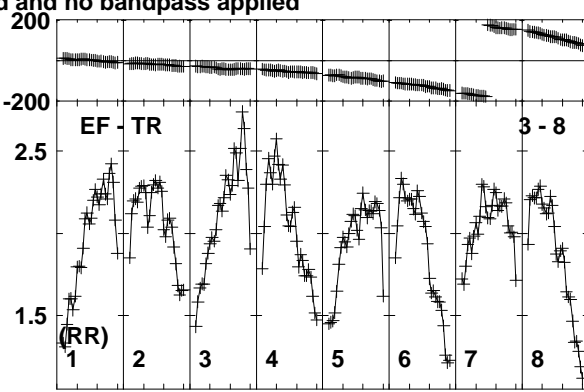
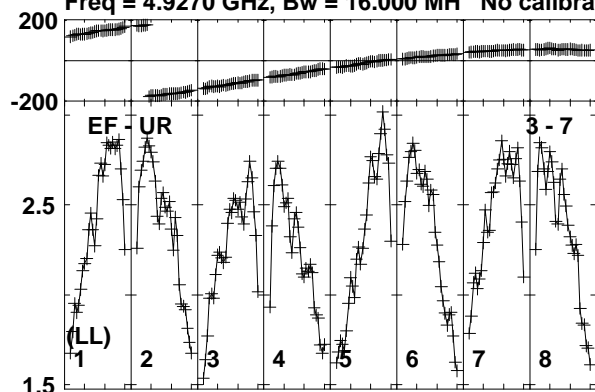

Lower frame: Milli Ampl Jy Top frame: Phas deg
Vector averaged cross-power spectrum Baseline: EF (03) - UR (07)
Timerange: 00/03:41:21 to 00/03:43:19

Plot file version 188 created 17-FEB-2020 15:42:56

J1359+5544 EK047 2.UVDATA.1

Freq = 4.9270 GHz, Bw = 16.000 MH No calibration applied and no bandpass applied

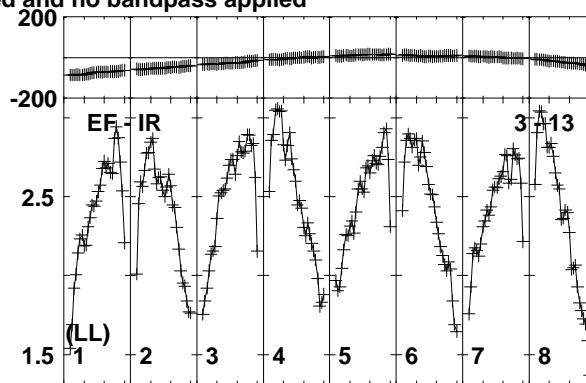
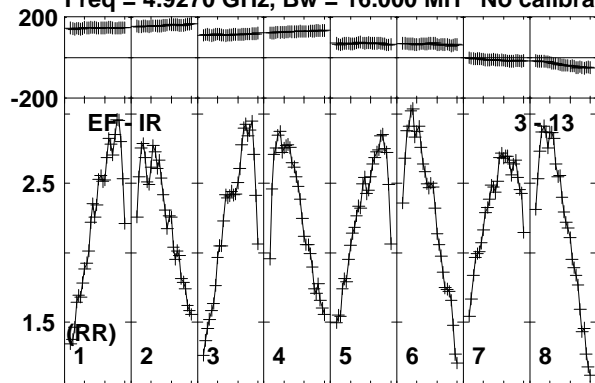

Lower frame: Milli Ampl Jy Top frame: Phas deg
Vector averaged cross-power spectrum Baseline: EF (03) - IR (13)
Timerange: 00/03:41:21 to 00/03:43:19

Plot file version 189 created 17-FEB-2020 15:42:56

J1402+5347 EK047 2.UVDATA.1

Freq = 4.9270 GHz, Bw = 16.000 MH No calibration applied and no bandpass applied

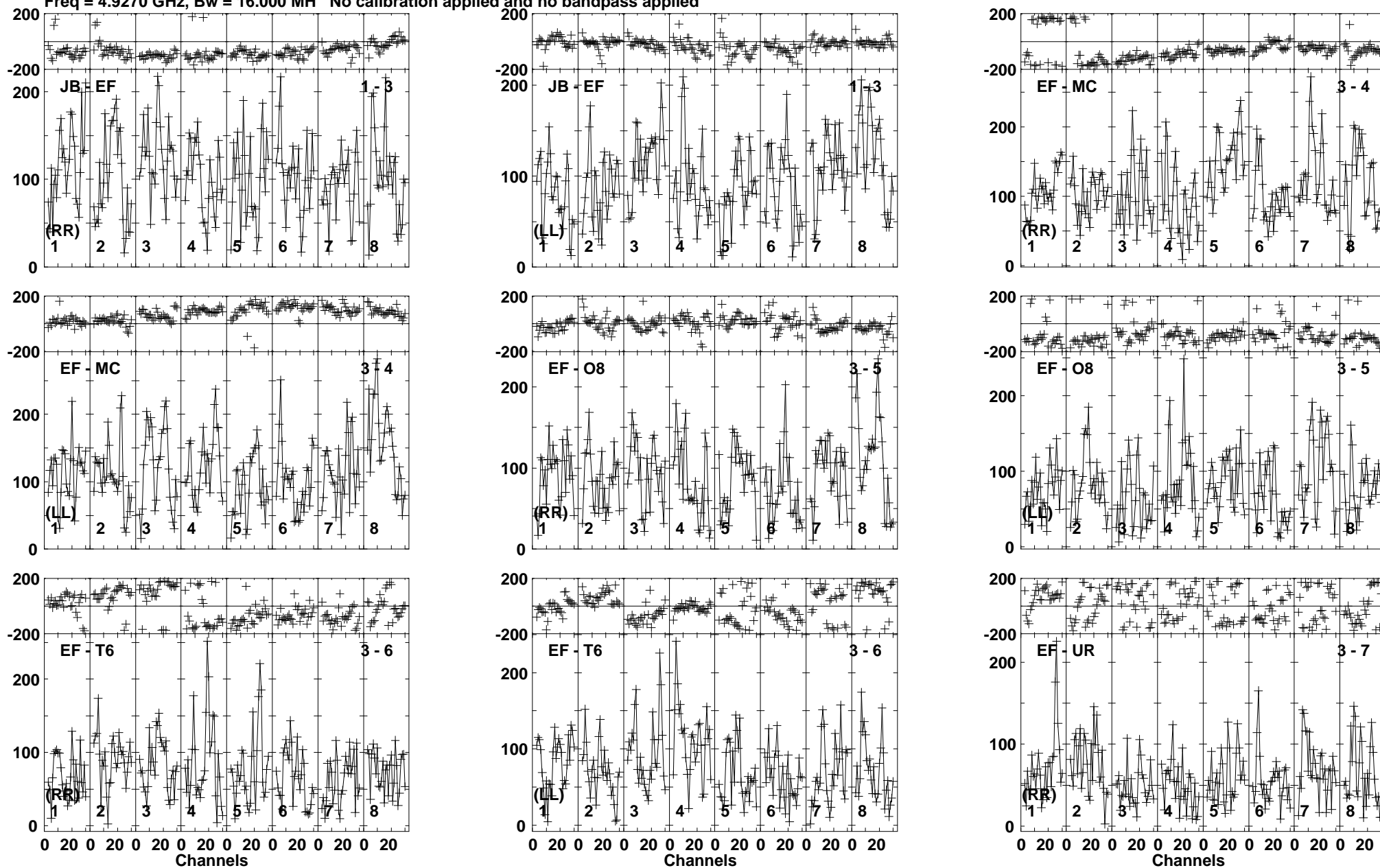

Lower frame: Micro Ampl Jy Top frame: Phas deg
Vector averaged cross-power spectrum Baseline: JB (01) - EF (03)
Timerange: 00/03:43:23 to 00/03:47:19

Plot file version 190 created 17-FEB-2020 15:42:56

J1402+5347 EK047 2.UVDATA.1

Freq = 4.9270 GHz, Bw = 16.000 MH No calibration applied and no bandpass applied

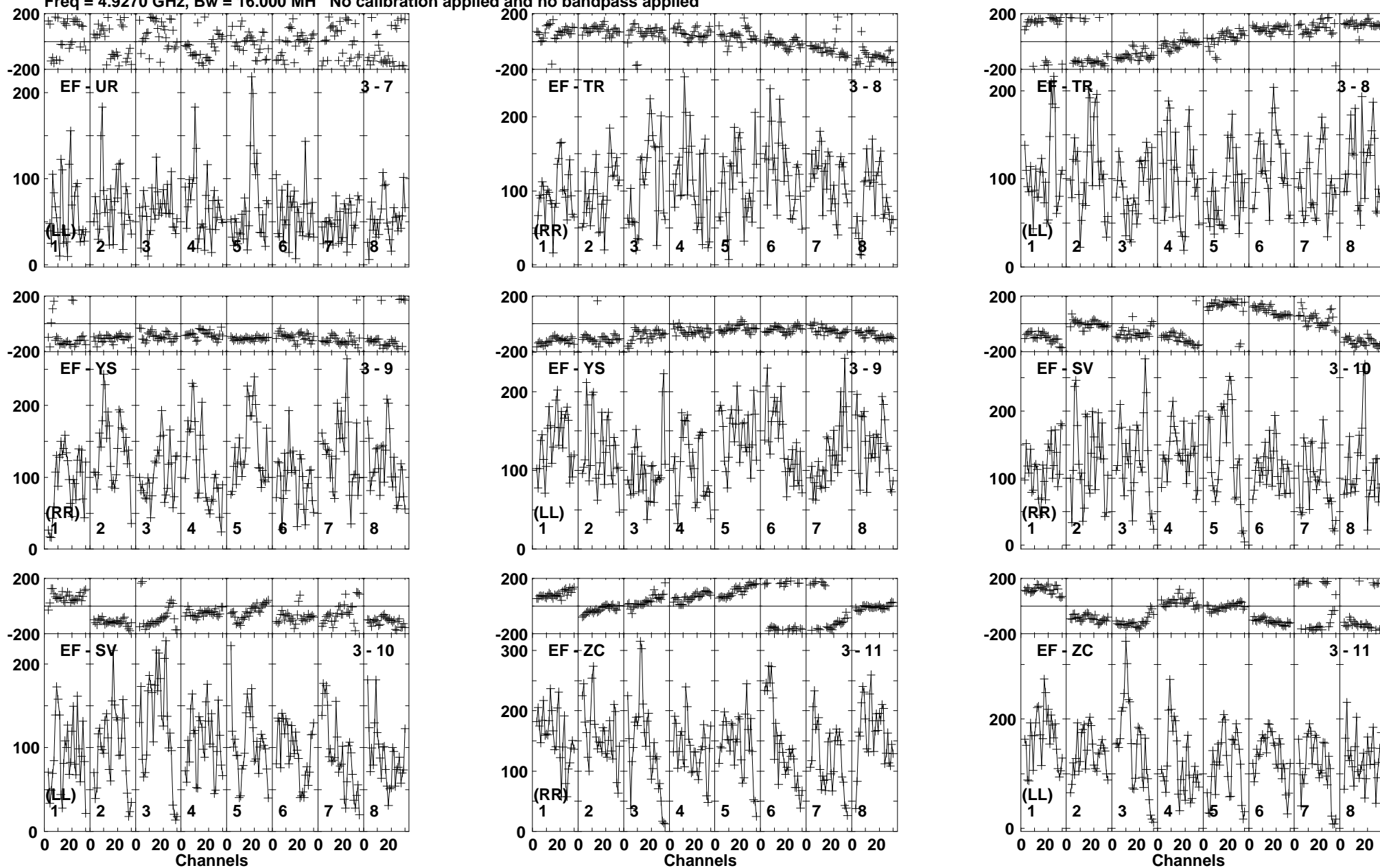

Lower frame: Micro Ampl Jy Top frame: Phas deg
Vector averaged cross-power spectrum Baseline: EF (03) - UR (07)
Timerange: 00/03:43:23 to 00/03:47:19

Plot file version 191 created 17-FEB-2020 15:42:56

J1402+5347 EK047 2.UVDATA.1

Freq = 4.9270 GHz, Bw = 16.000 MH No calibration applied and no bandpass applied

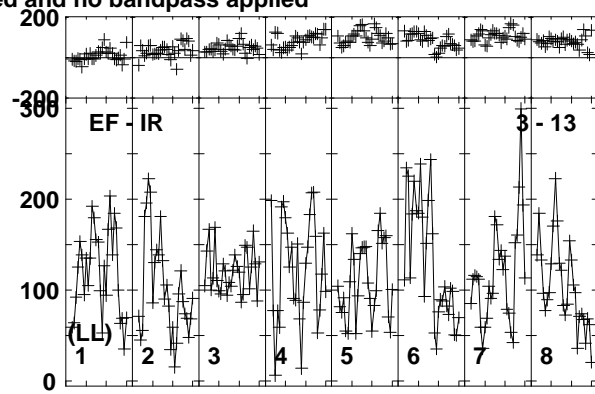
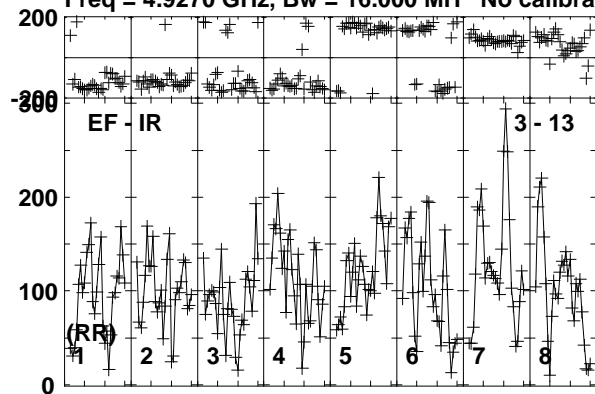

Lower frame: Micro Ampl Jy Top frame: Phas deg
Vector averaged cross-power spectrum Baseline: EF (03) - IR (13)
Timerange: 00/03:43:23 to 00/03:47:19

Plot file version 192 created 17-FEB-2020 15:42:56

J1359+5544 EK047 2.UVDATA.1

Freq = 4.9270 GHz, Bw = 16.000 MH No calibration applied and no bandpass applied

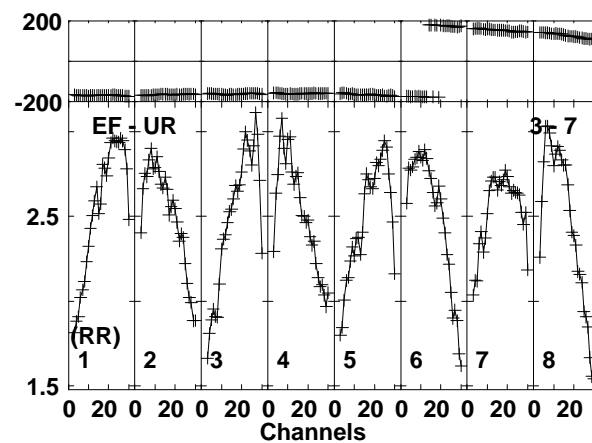
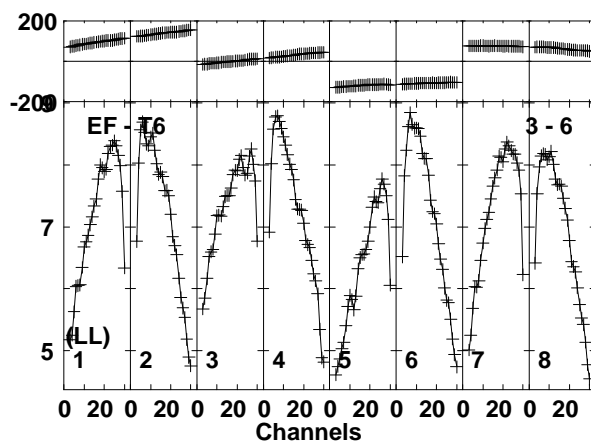
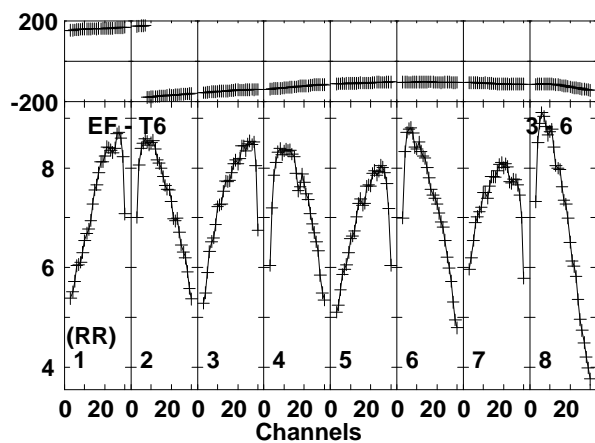
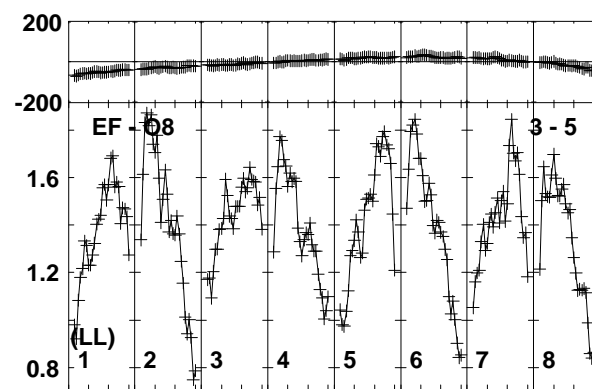
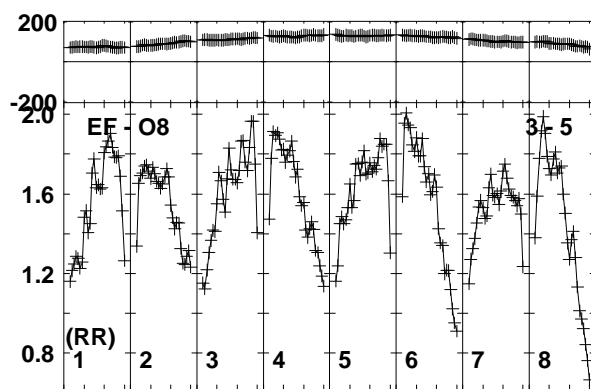
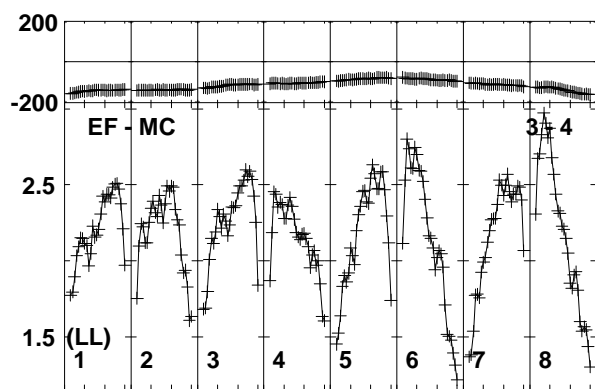
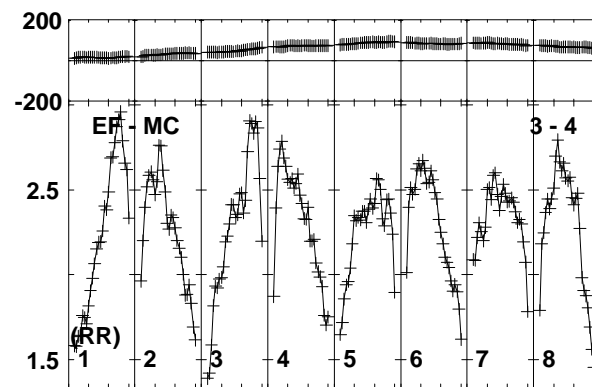
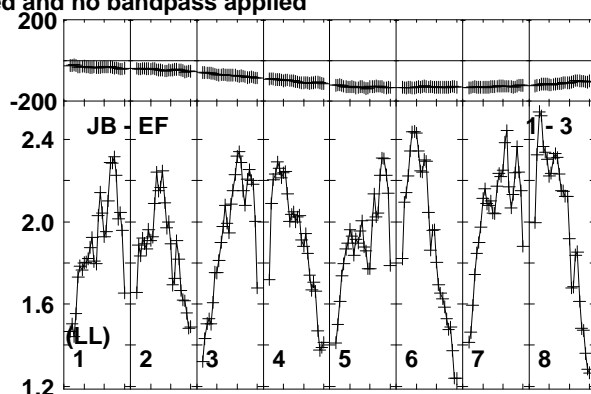
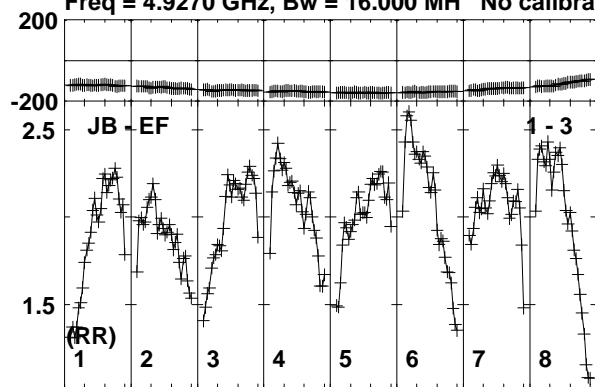

Lower frame: Milli Ampl Jy Top frame: Phas deg
Vector averaged cross-power spectrum Baseline: JB (01) - EF (03)
Timerange: 00/03:48:01 to 00/03:49:19

Plot file version 193 created 17-FEB-2020 15:42:56

J1359+5544 EK047 2.UVDATA.1

Freq = 4.9270 GHz, Bw = 16.000 MH No calibration applied and no bandpass applied

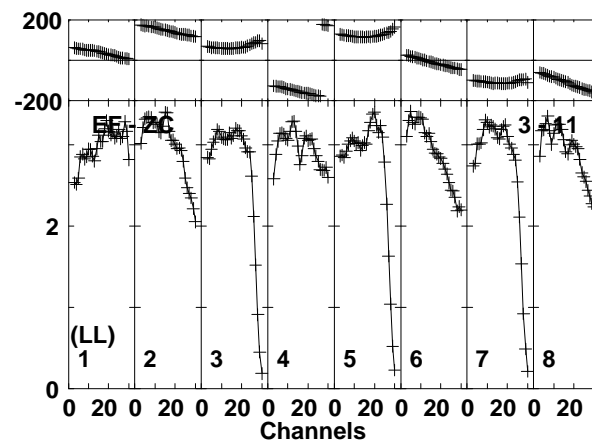
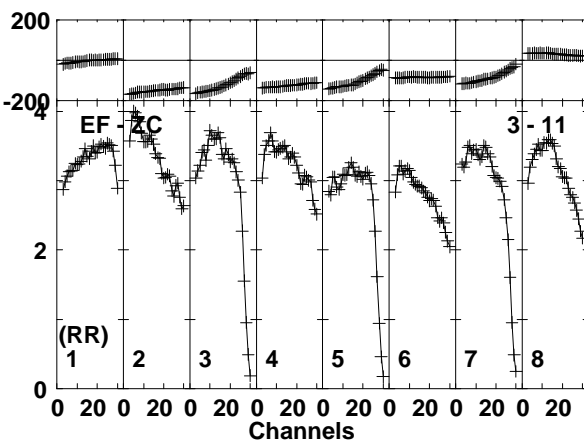
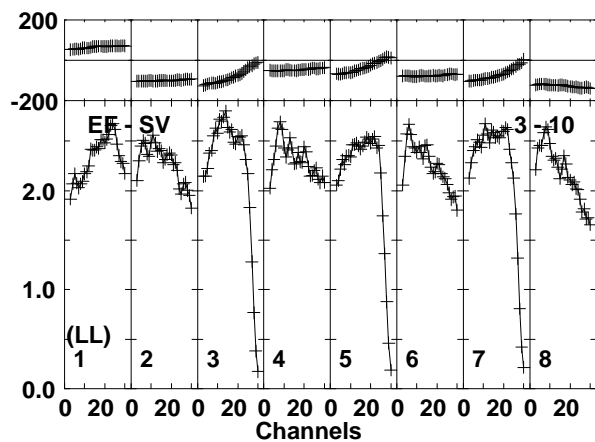
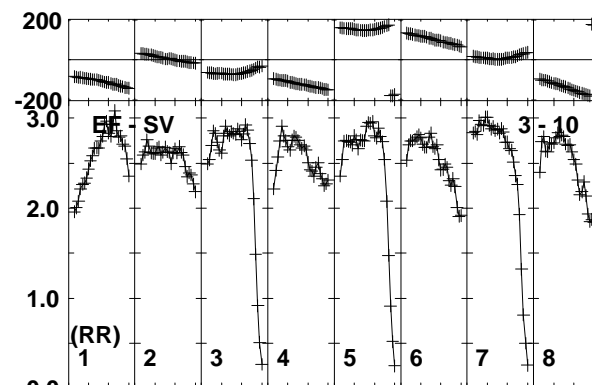
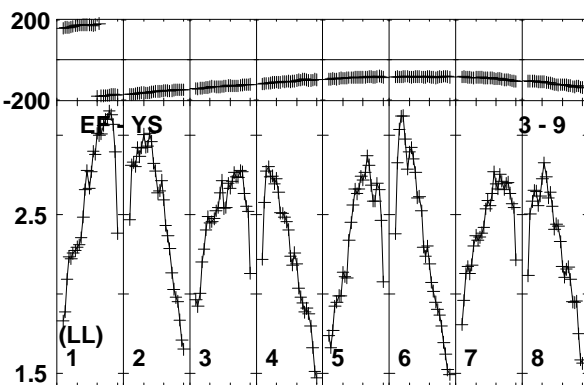
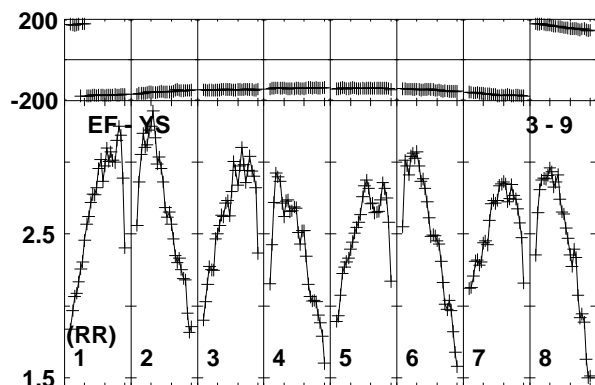
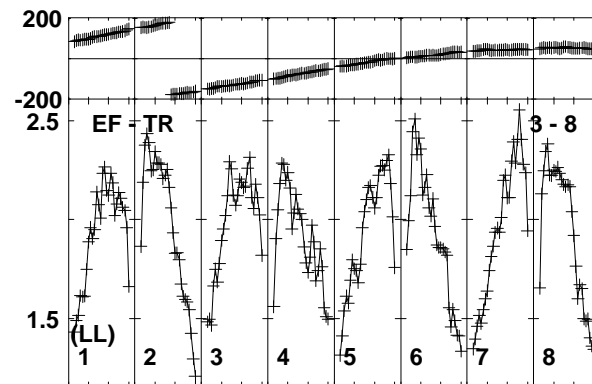
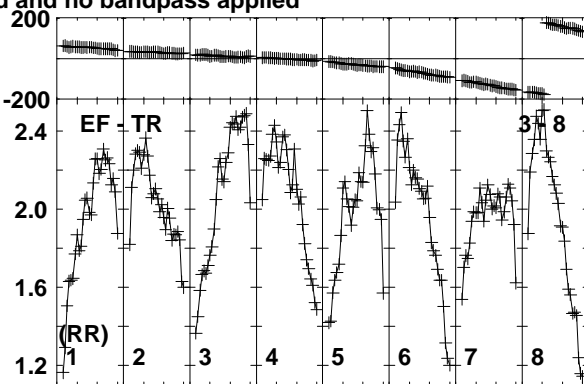
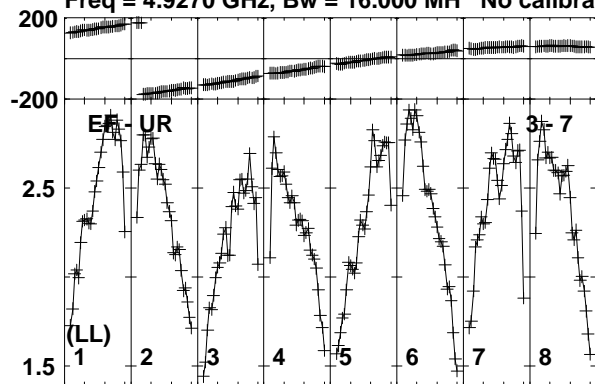

Lower frame: Milli Ampl Jy Top frame: Phas deg
Vector averaged cross-power spectrum Baseline: EF (03) - UR (07)
Timerange: 00/03:48:01 to 00/03:49:19

Plot file version 194 created 17-FEB-2020 15:42:56

J1359+5544 EK047 2.UVDATA.1

Freq = 4.9270 GHz, Bw = 16.000 MH No calibration applied and no bandpass applied

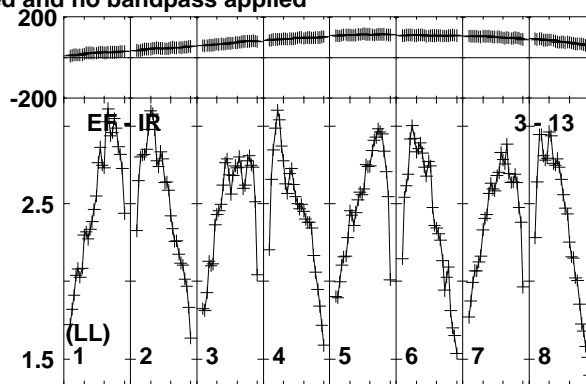
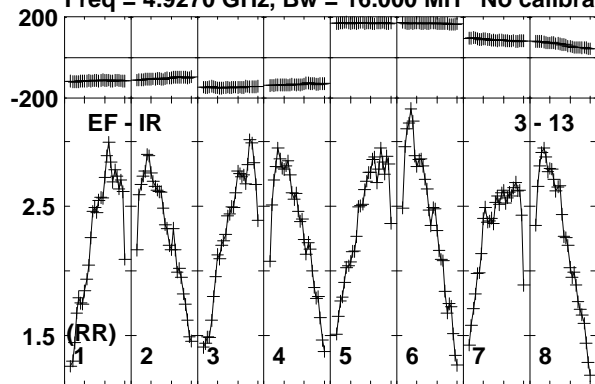

Lower frame: Milli Ampl Jy Top frame: Phas deg
Vector averaged cross-power spectrum Baseline: EF (03) - IR (13)
Timerange: 00/03:48:01 to 00/03:49:19

Plot file version 195 created 17-FEB-2020 15:42:56

J1402+5347 EK047 2.UVDATA.1

Freq = 4.9270 GHz, Bw = 16.000 MH No calibration applied and no bandpass applied

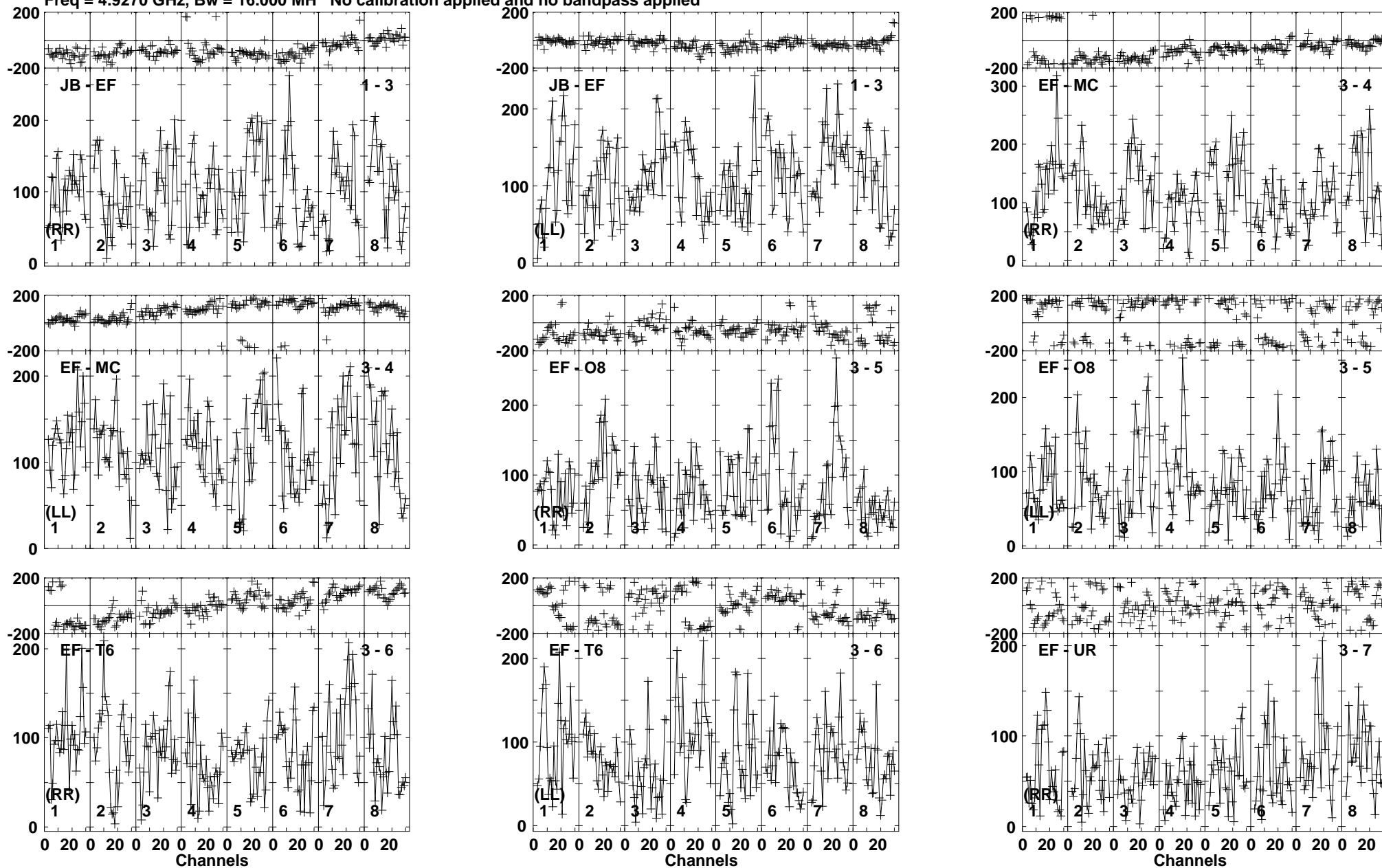

Lower frame: Micro Ampl Jy Top frame: Phas deg
Vector averaged cross-power spectrum Baseline: JB (01) - EF (03)
Timerange: 00/03:49:21 to 00/03:53:19

Plot file version 196 created 17-FEB-2020 15:42:56

J1402+5347 EK047 2.UVDATA.1

Freq = 4.9270 GHz, Bw = 16.000 MH No calibration applied and no bandpass applied

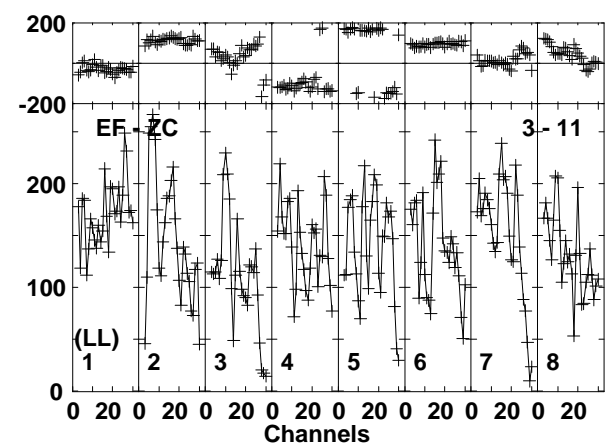
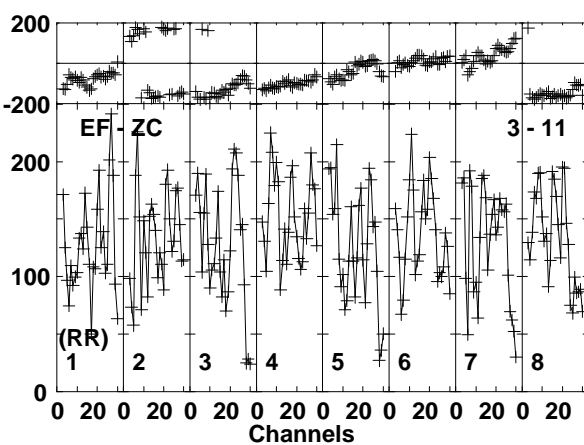
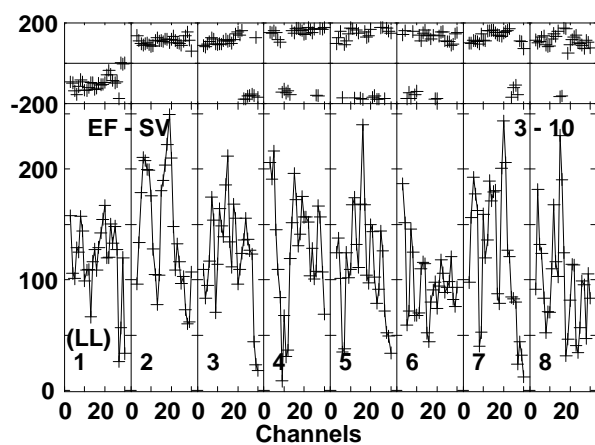
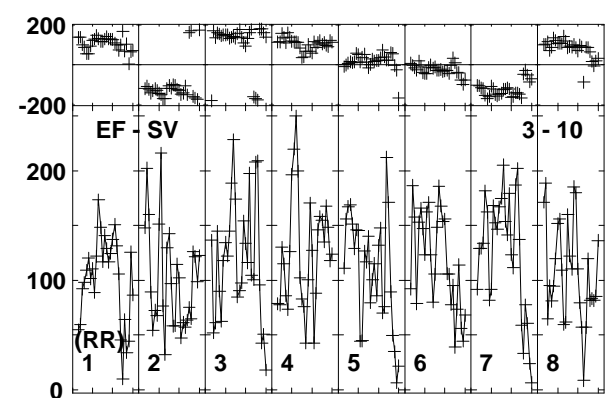
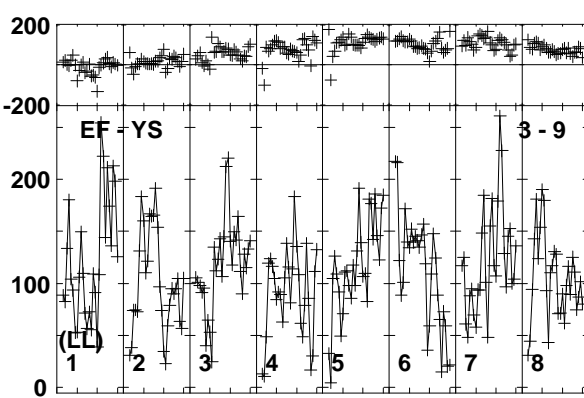
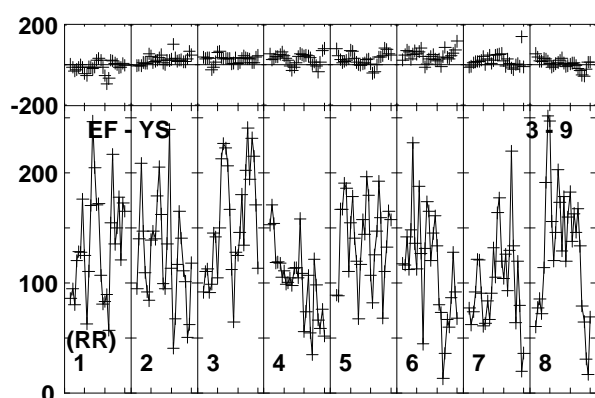
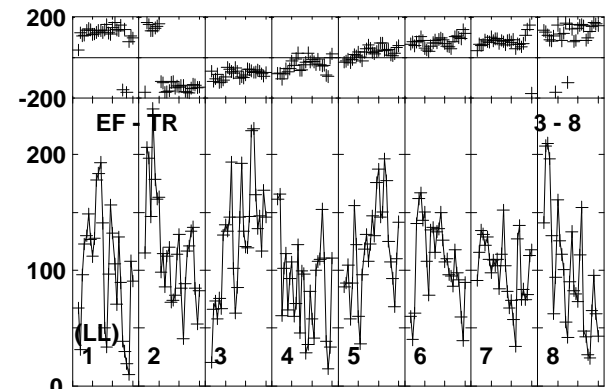
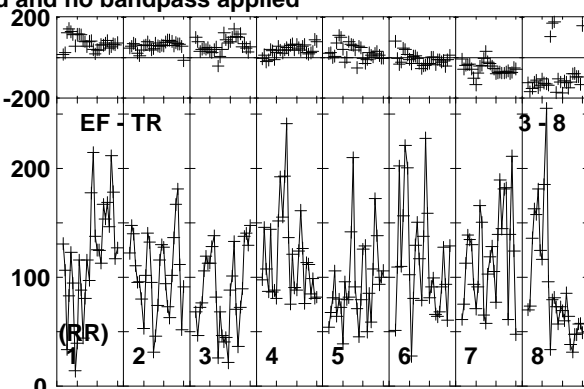
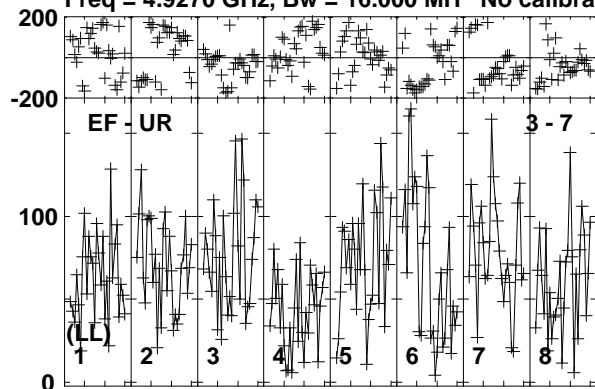

Lower frame: Micro Ampl Jy Top frame: Phas deg
Vector averaged cross-power spectrum Baseline: EF (03) - UR (07)
Timerange: 00/03:49:21 to 00/03:53:19

Plot file version 197 created 17-FEB-2020 15:42:57

J1402+5347 EK047 2.UVDATA.1

Freq = 4.9270 GHz, Bw = 16.000 MH No calibration applied and no bandpass applied

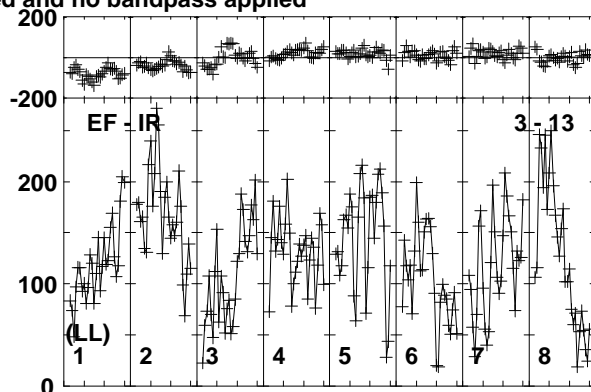
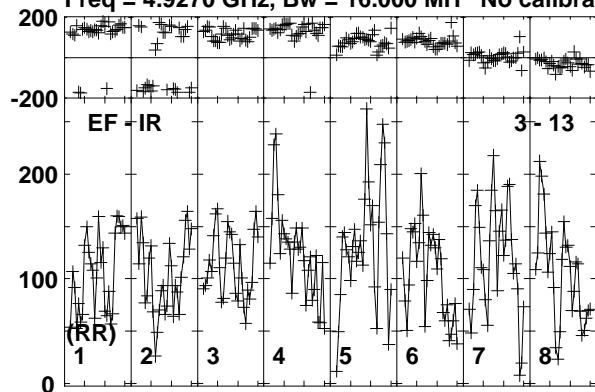

Lower frame: Micro Ampl Jy Top frame: Phas deg
Vector averaged cross-power spectrum Baseline: EF (03) - IR (13)
Timerange: 00/03:49:21 to 00/03:53:19

Plot file version 198 created 17-FEB-2020 15:42:57

J1359+5544 EK047 2.UVDATA.1

Freq = 4.9270 GHz, Bw = 16.000 MH No calibration applied and no bandpass applied

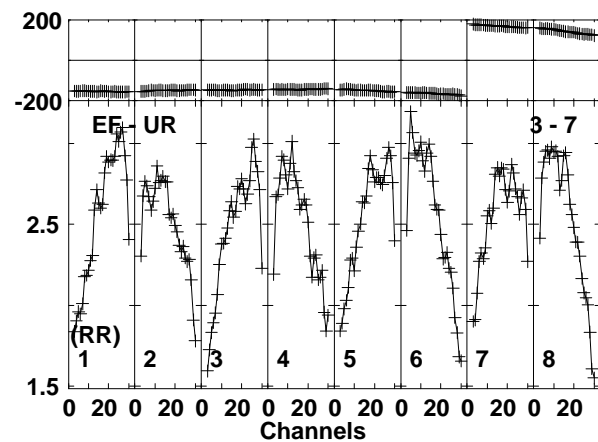
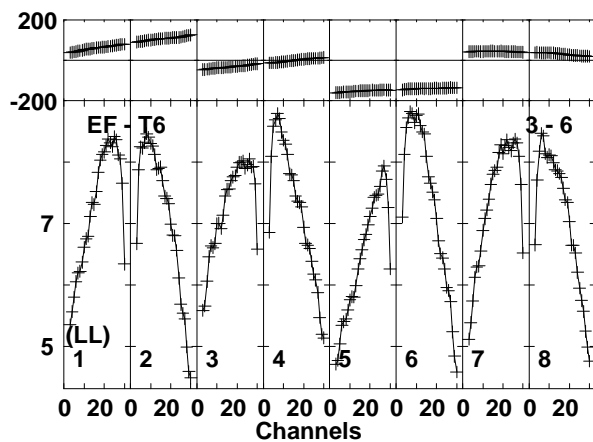
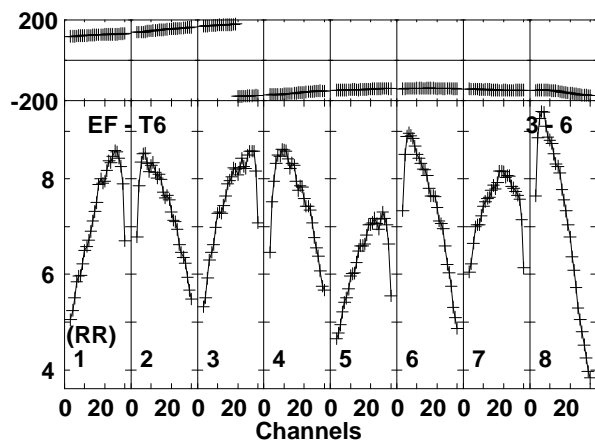
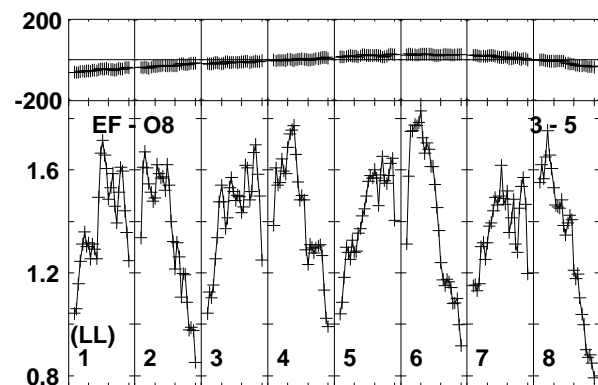
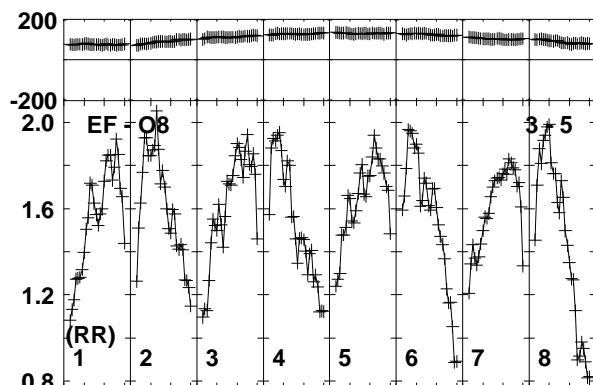
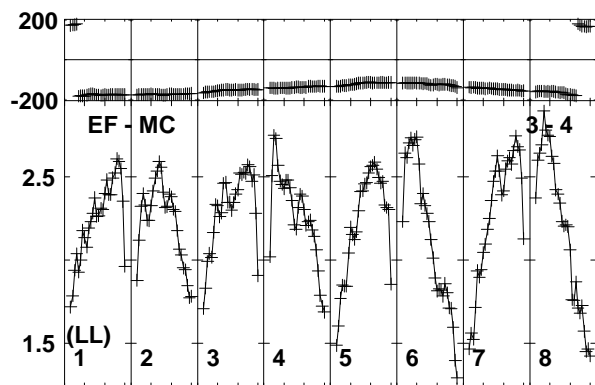
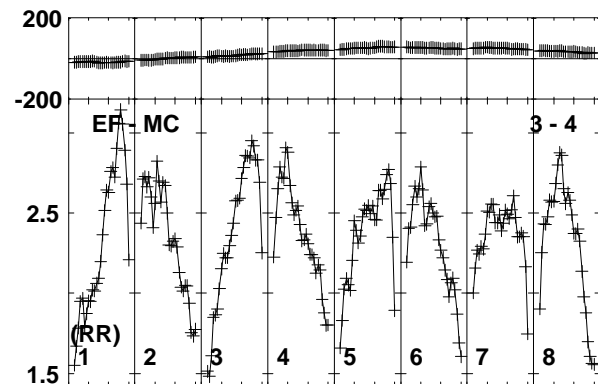
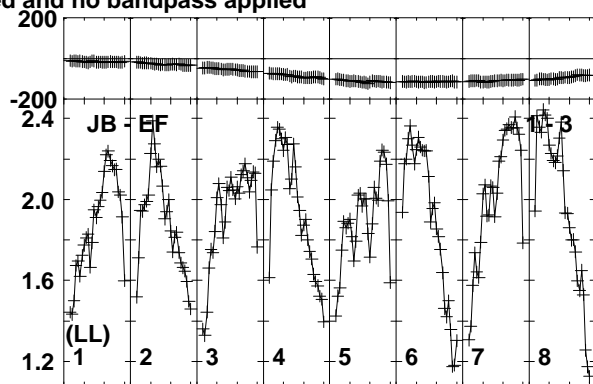
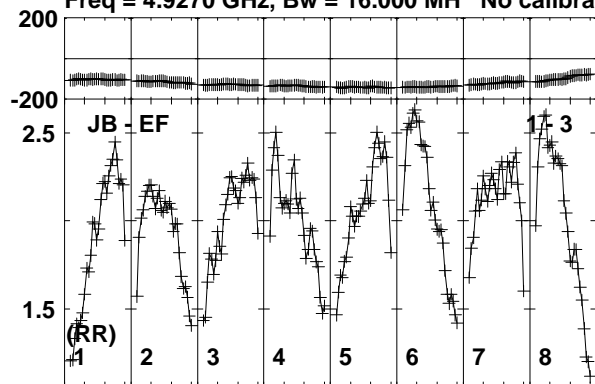

Lower frame: Milli Ampl Jy Top frame: Phas deg
Vector averaged cross-power spectrum Baseline: JB (01) - EF (03)
Timerange: 00/03:53:21 to 00/03:55:19

Plot file version 199 created 17-FEB-2020 15:42:57

J1359+5544 EK047 2.UVDATA.1

Freq = 4.9270 GHz, Bw = 16.000 MH No calibration applied and no bandpass applied

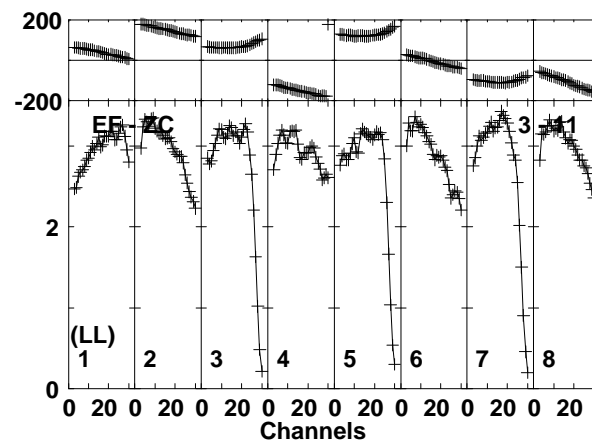
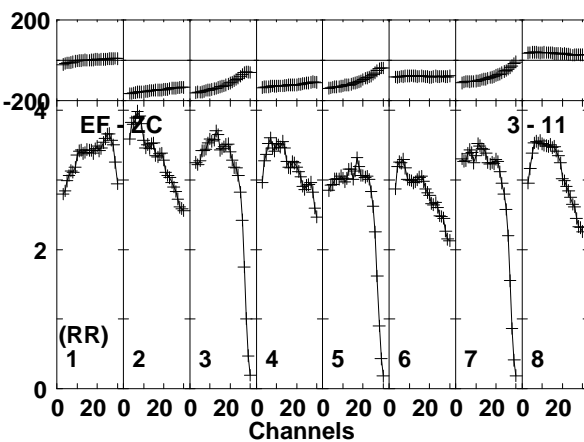
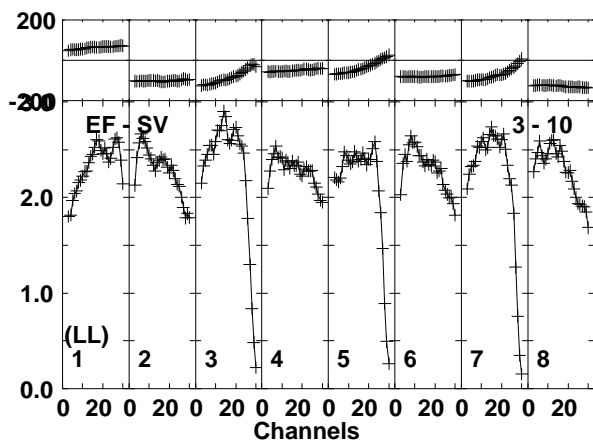
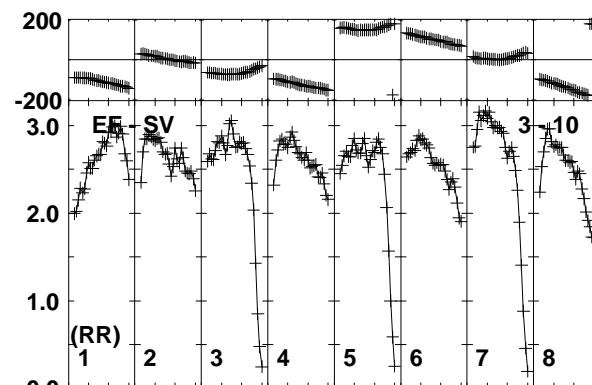
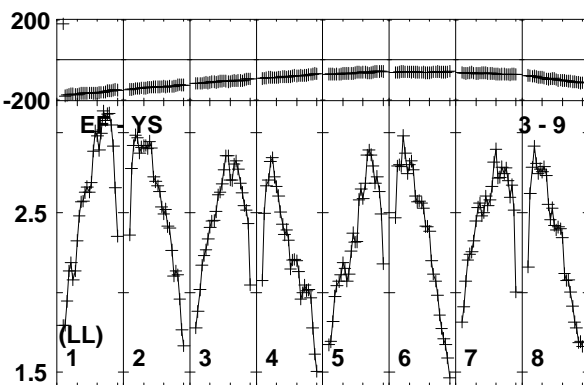
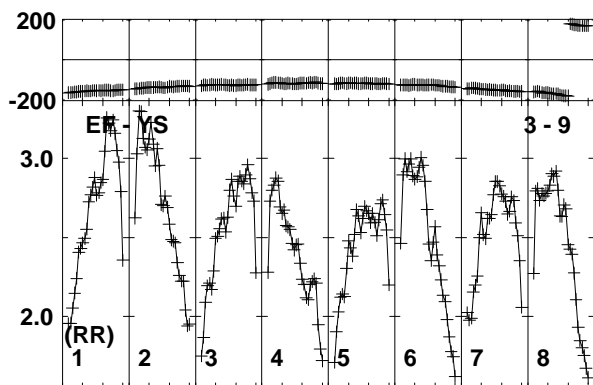
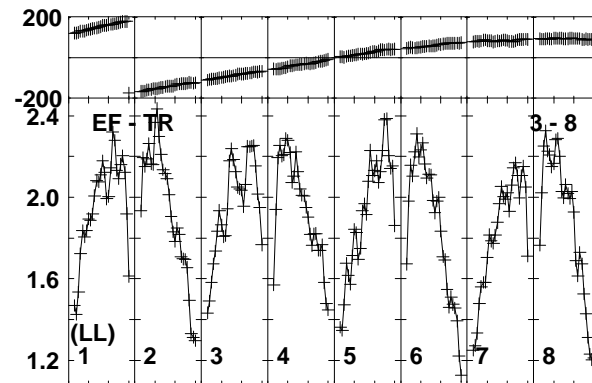
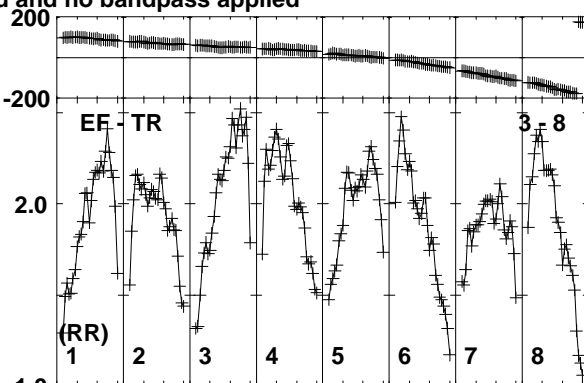
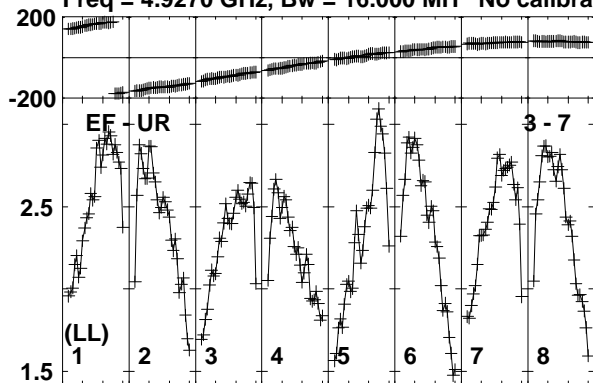

Lower frame: Milli Ampl Jy Top frame: Phas deg
Vector averaged cross-power spectrum Baseline: EF (03) - UR (07)
Timerange: 00/03:53:21 to 00/03:55:19

Plot file version 200 created 17-FEB-2020 15:42:57

J1359+5544 EK047 2.UVDATA.1

Freq = 4.9270 GHz, Bw = 16.000 MH No calibration applied and no bandpass applied

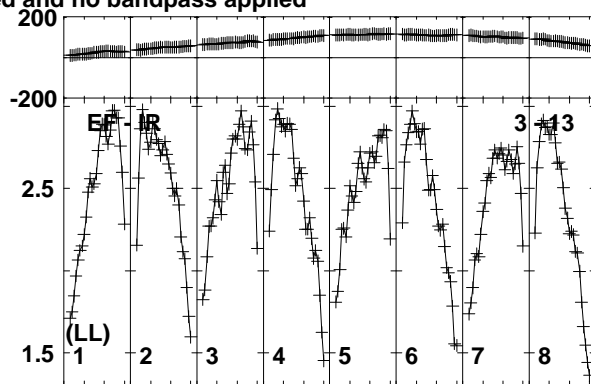
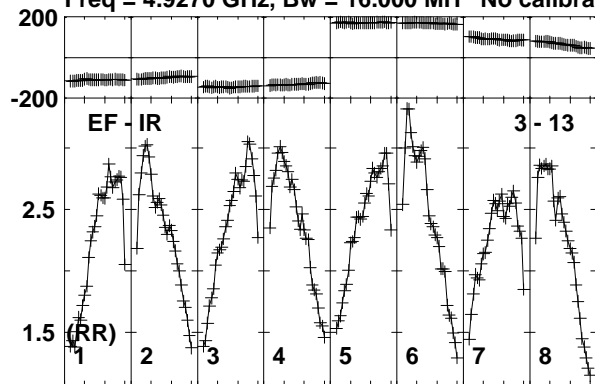

Lower frame: Milli Ampl Jy Top frame: Phas deg
Vector averaged cross-power spectrum Baseline: EF (03) - IR (13)
Timerange: 00/03:53:21 to 00/03:55:19

Plot file version 201 created 17-FEB-2020 15:42:57

J1402+5347 EK047 2.UVDATA.1

Freq = 4.9270 GHz, Bw = 16.000 MH No calibration applied and no bandpass applied

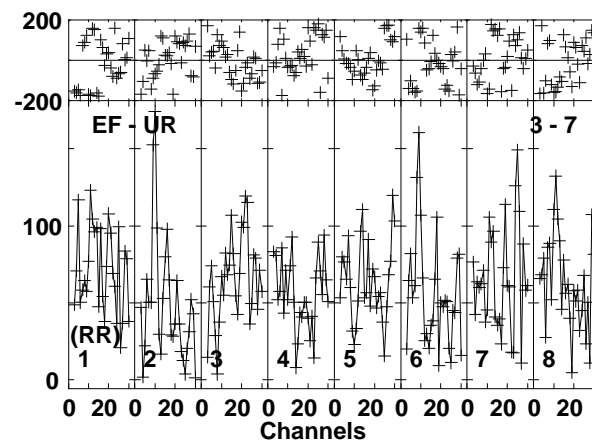
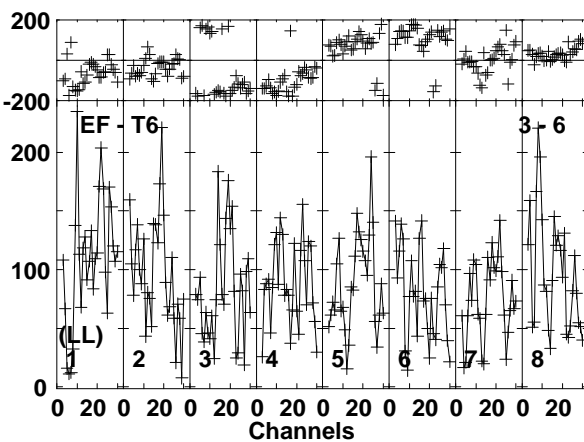
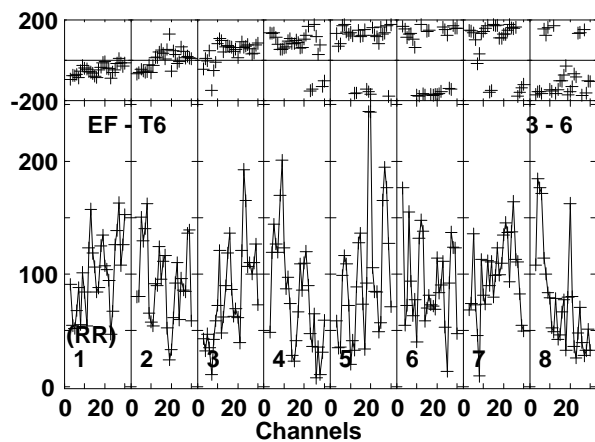
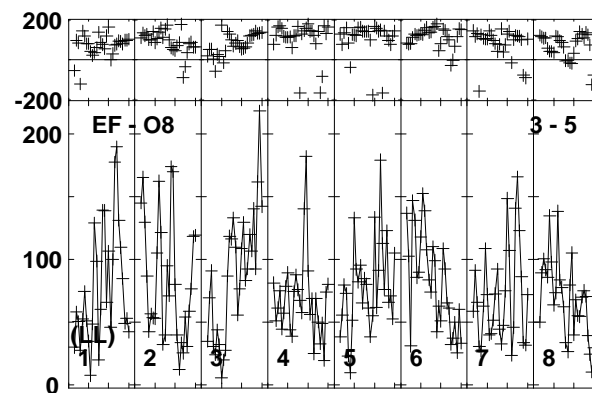
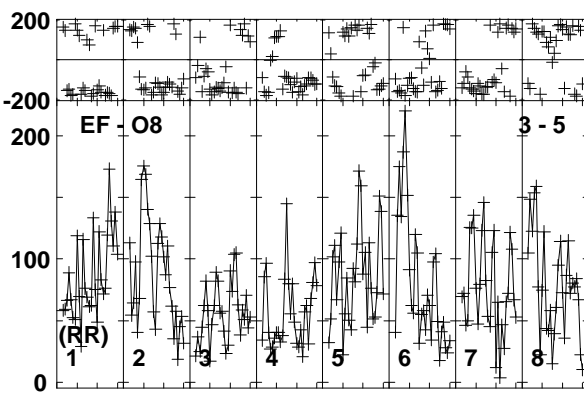
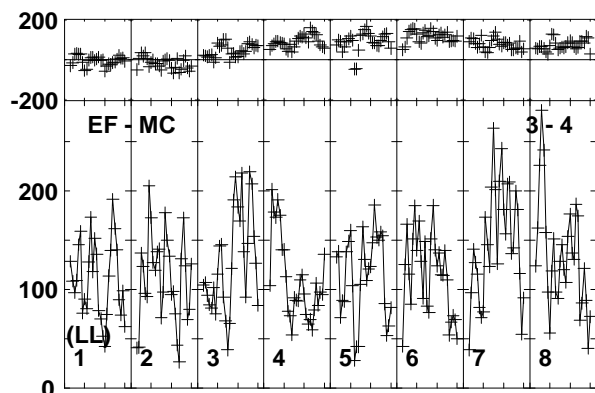
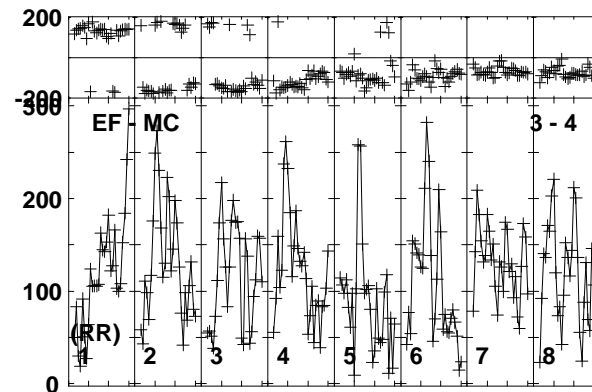
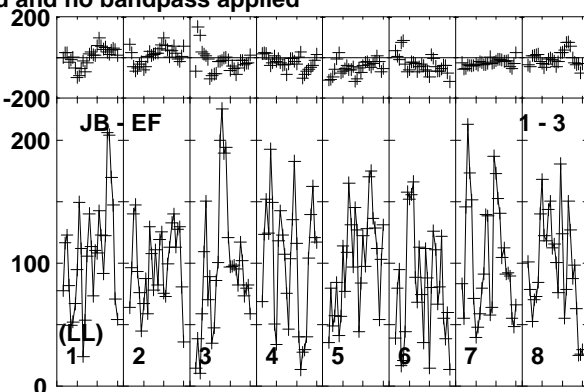
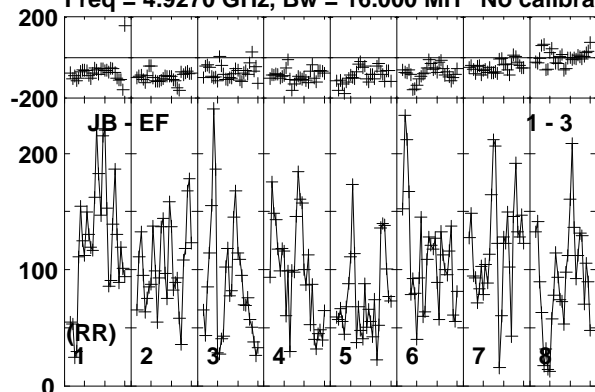

Lower frame: Micro Ampl Jy Top frame: Phas deg
Vector averaged cross-power spectrum Baseline: JB (01) - EF (03)
Timerange: 00/03:55:23 to 00/03:59:19

Plot file version 202 created 17-FEB-2020 15:42:57

J1402+5347 EK047 2.UVDATA.1

Freq = 4.9270 GHz, Bw = 16.000 MH No calibration applied and no bandpass applied

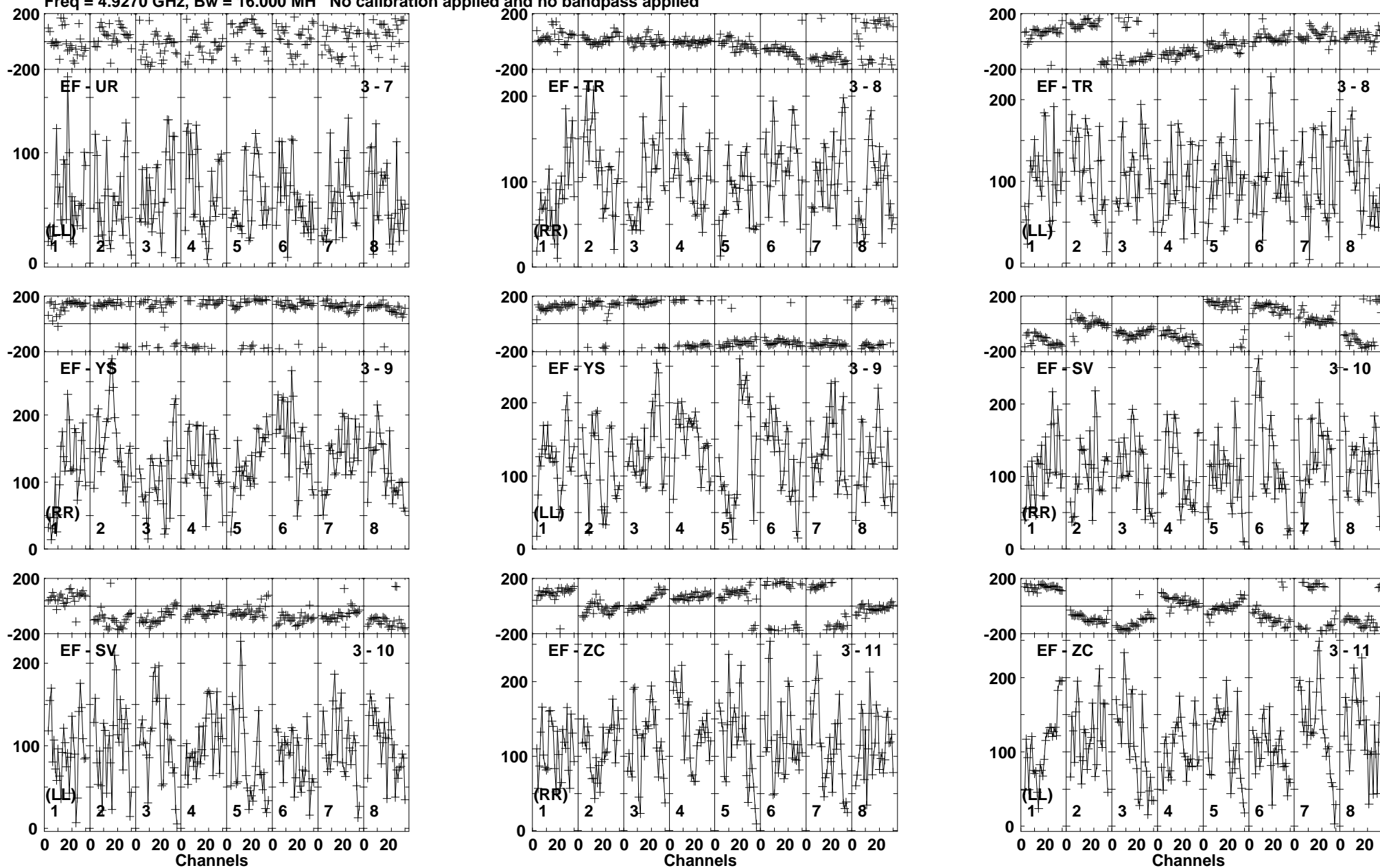

Lower frame: Micro Ampl Jy Top frame: Phas deg
Vector averaged cross-power spectrum Baseline: EF (03) - UR (07)
Timerange: 00/03:55:23 to 00/03:59:19

Plot file version 203 created 17-FEB-2020 15:42:57

J1402+5347 EK047 2.UVDATA.1

Freq = 4.9270 GHz, Bw = 16.000 MH No calibration applied and no bandpass applied

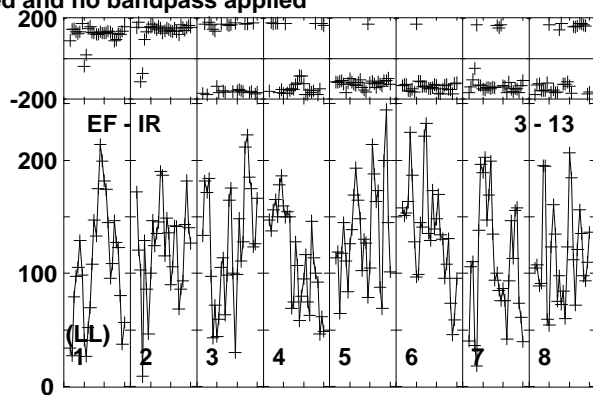
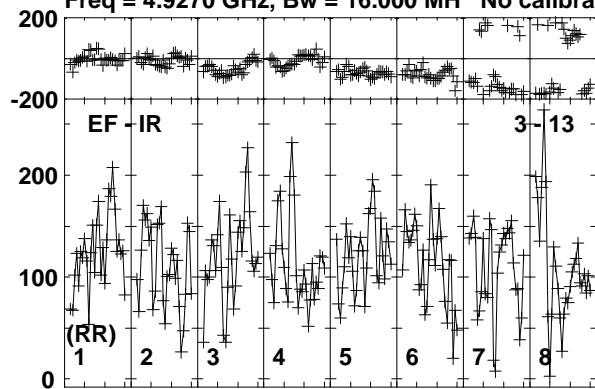

Lower frame: Micro Ampl Jy Top frame: Phas deg
Vector averaged cross-power spectrum Baseline: EF (03) - IR (13)
Timerange: 00/03:55:23 to 00/03:59:19

Plot file version 204 created 17-FEB-2020 15:42:57

J1359+5544 EK047 2.UVDATA.1

Freq = 4.9270 GHz, Bw = 16.000 MH No calibration applied and no bandpass applied

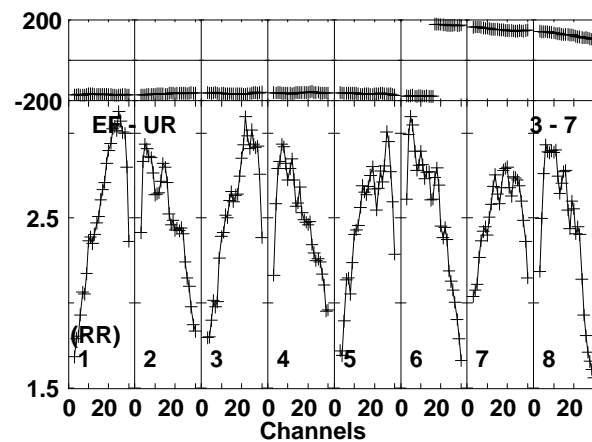
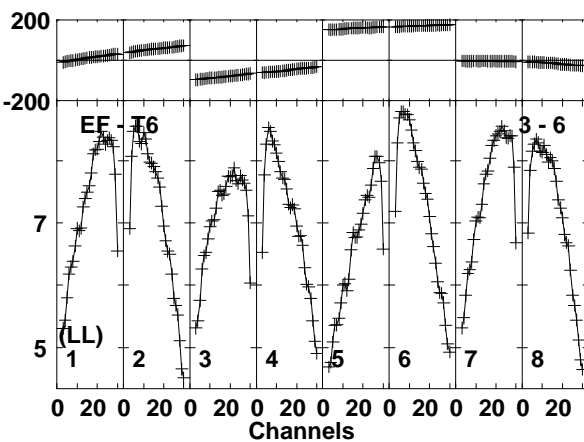
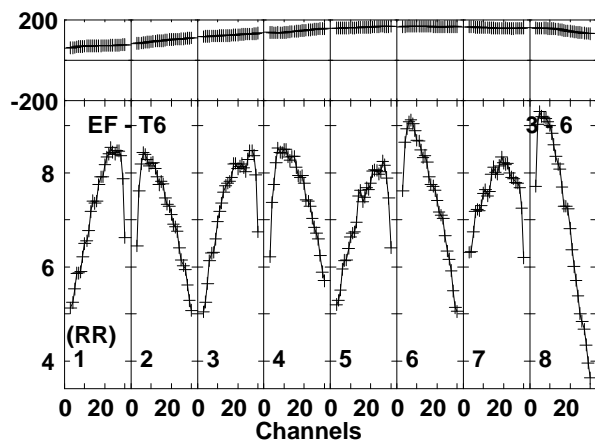
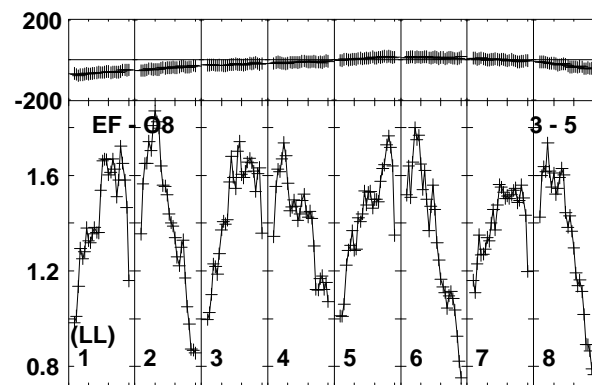
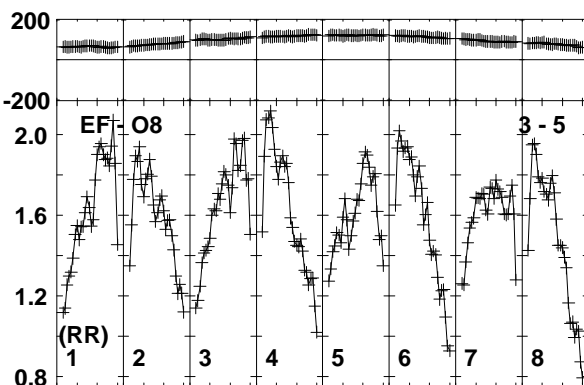
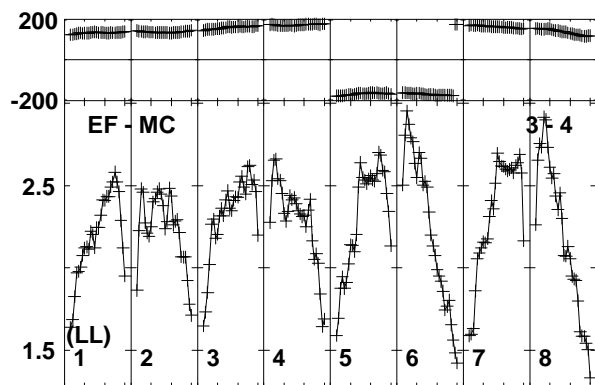
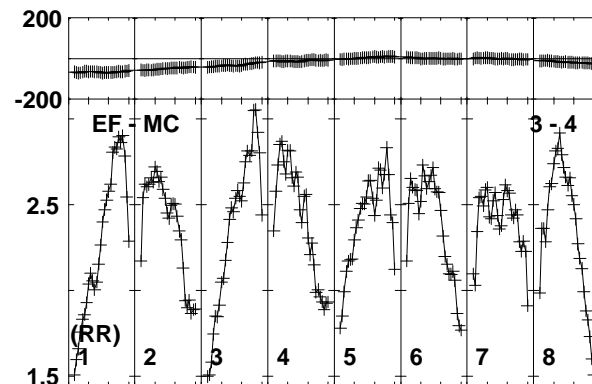
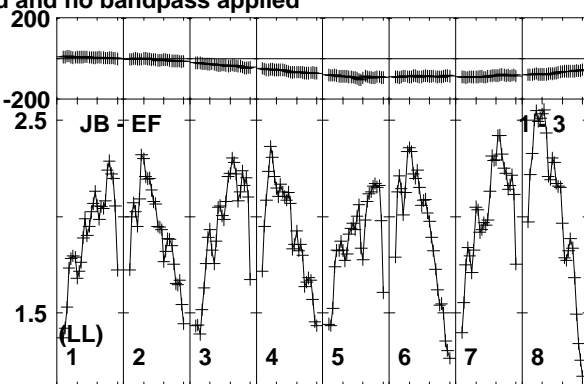
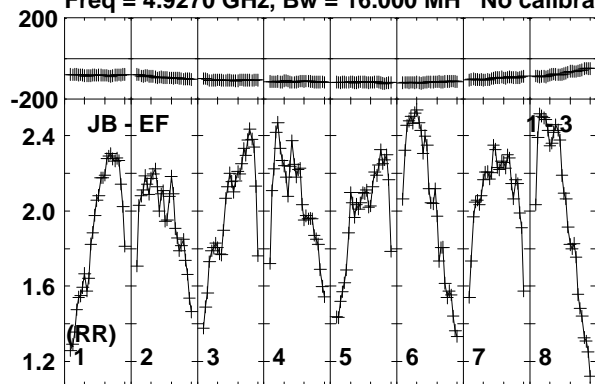

Lower frame: Milli Ampl Jy Top frame: Phas deg
Vector averaged cross-power spectrum Baseline: JB (01) - EF (03)
Timerange: 00/04:00:01 to 00/04:01:19

Plot file version 205 created 17-FEB-2020 15:42:57

J1359+5544 EK047 2.UVDATA.1

Freq = 4.9270 GHz, Bw = 16.000 MH No calibration applied and no bandpass applied

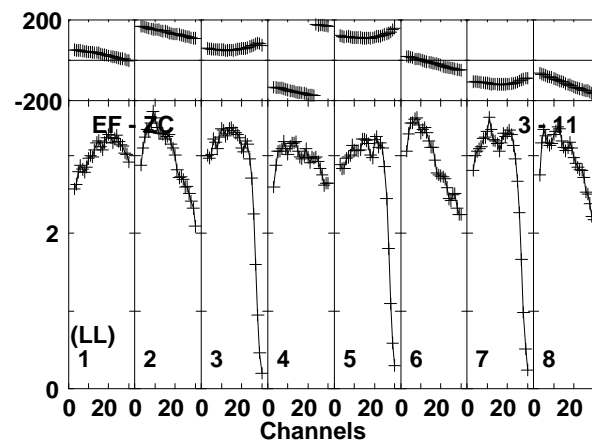
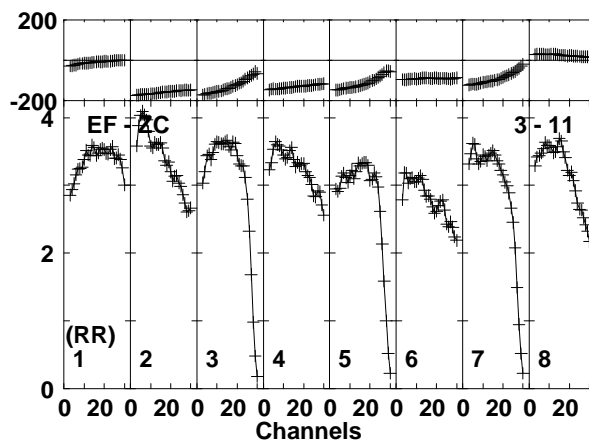
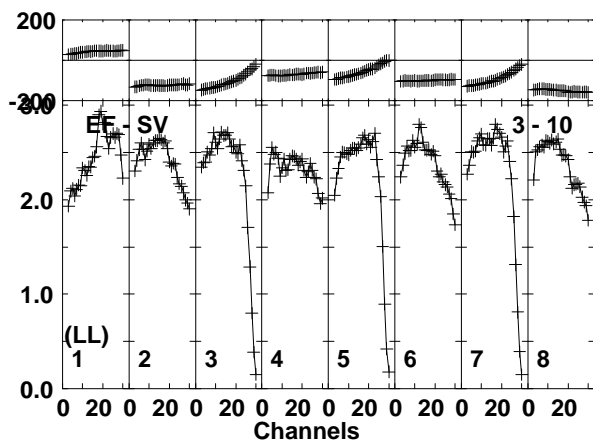
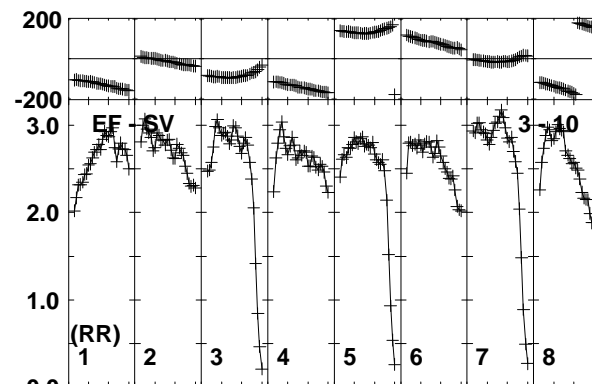
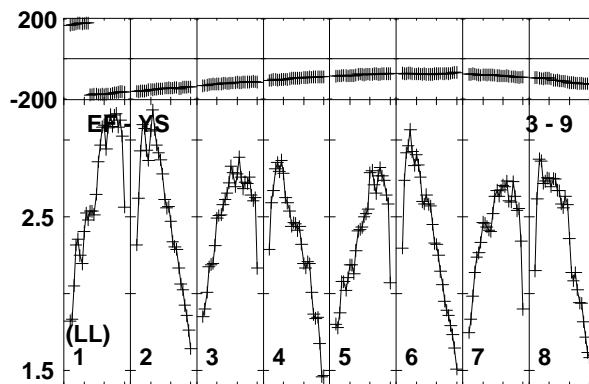
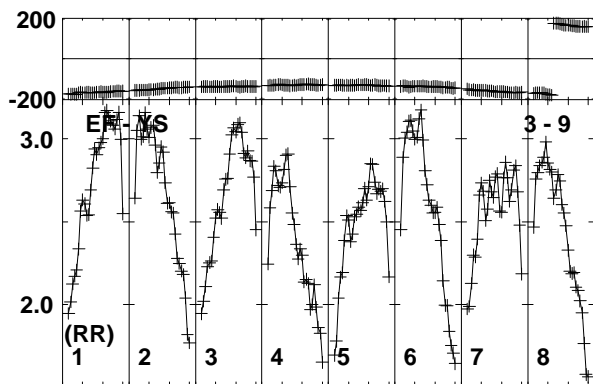
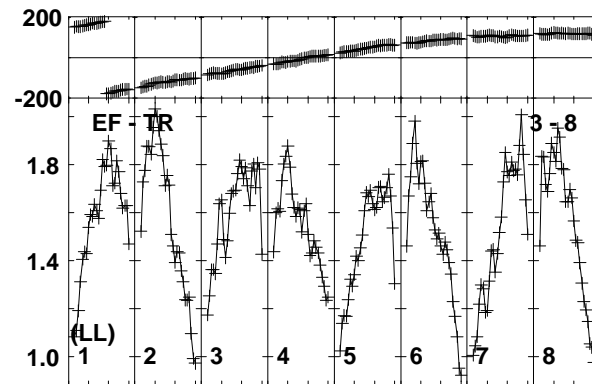
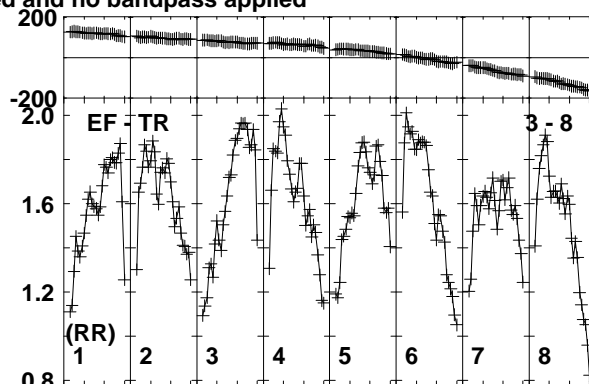
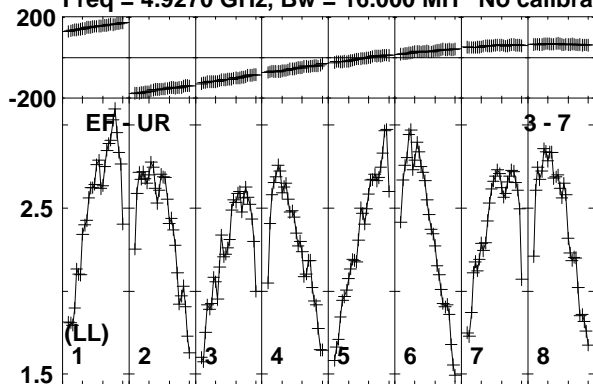

Lower frame: Milli Ampl Jy Top frame: Phas deg
Vector averaged cross-power spectrum Baseline: EF (03) - UR (07)
Timerange: 00/04:00:01 to 00/04:01:19

Plot file version 206 created 17-FEB-2020 15:42:57

J1359+5544 EK047 2.UVDATA.1

Freq = 4.9270 GHz, Bw = 16.000 MH No calibration applied and no bandpass applied

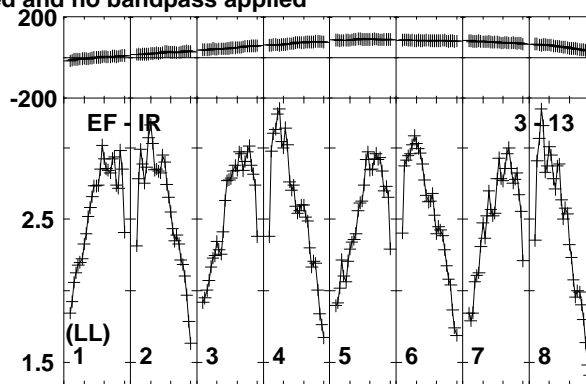
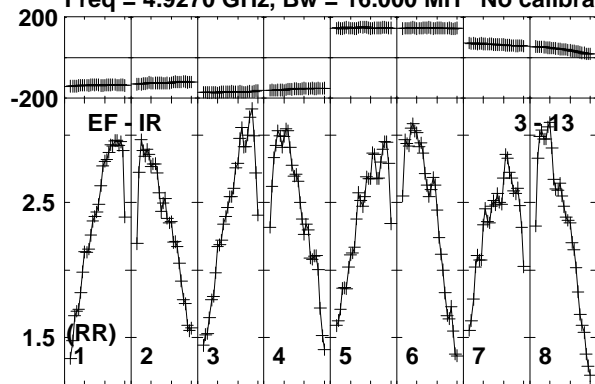

Lower frame: Milli Ampl Jy Top frame: Phas deg
Vector averaged cross-power spectrum Baseline: EF (03) - IR (13)
Timerange: 00/04:00:01 to 00/04:01:19

Plot file version 207 created 17-FEB-2020 15:42:57

J1402+5347 EK047 2.UVDATA.1

Freq = 4.9270 GHz, Bw = 16.000 MH No calibration applied and no bandpass applied

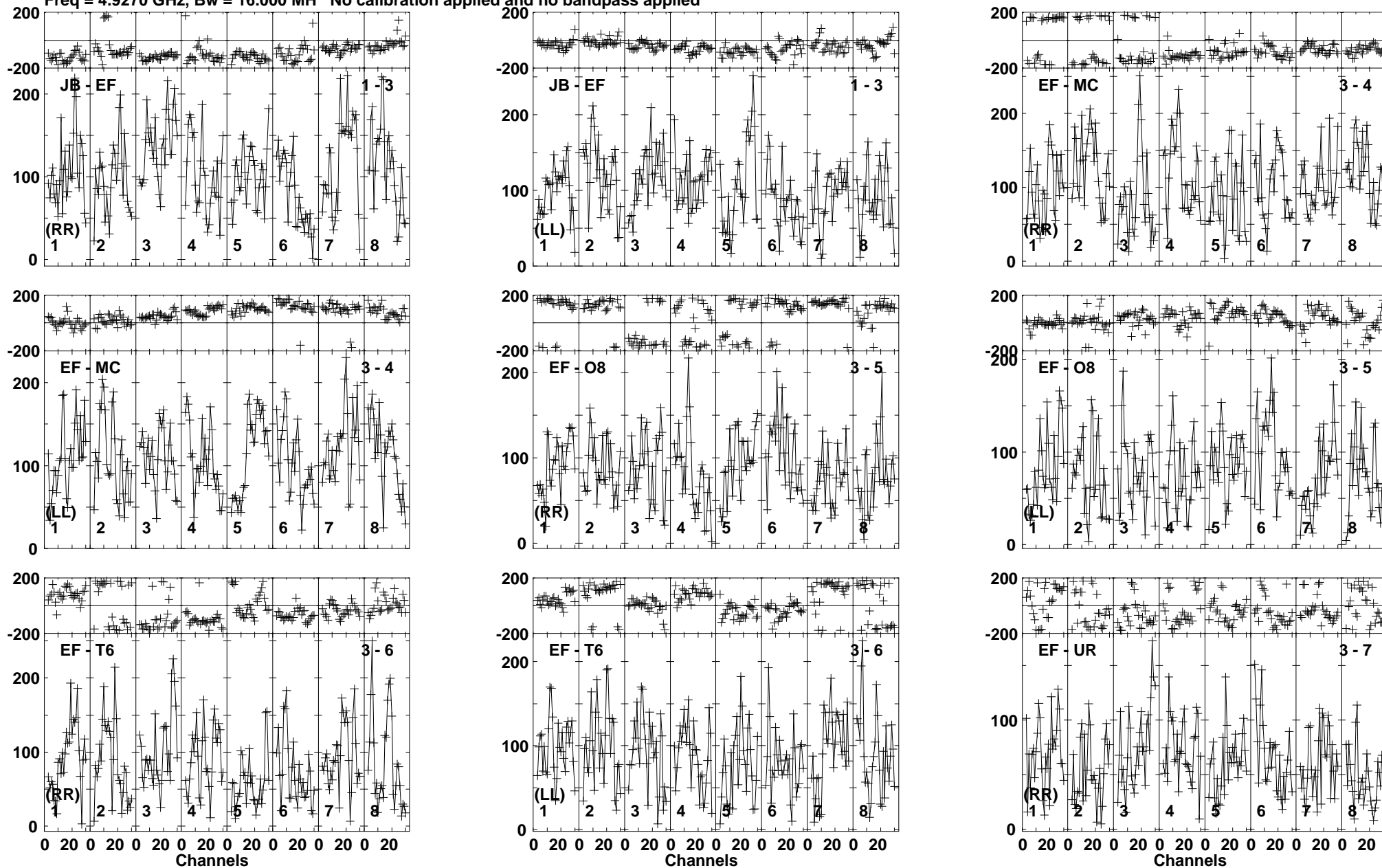

Lower frame: Micro Ampl Jy Top frame: Phas deg
Vector averaged cross-power spectrum Baseline: JB (01) - EF (03)
Timerange: 00/04:01:21 to 00/04:05:19

Plot file version 208 created 17-FEB-2020 15:42:58

J1402+5347 EK047 2.UVDATA.1

Freq = 4.9270 GHz, Bw = 16.000 MH No calibration applied and no bandpass applied

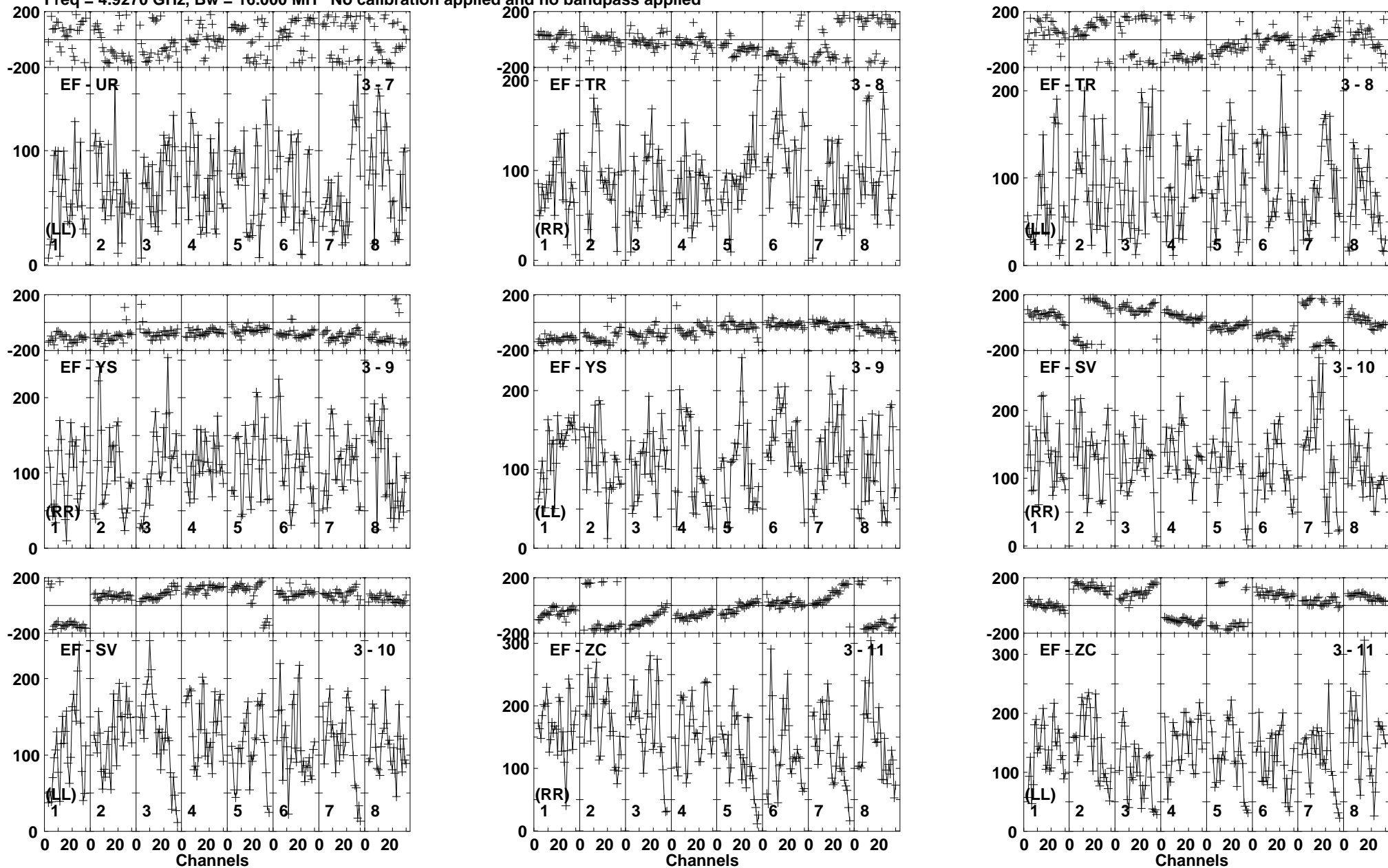

Lower frame: Micro Ampl Jy Top frame: Phas deg
Vector averaged cross-power spectrum Baseline: EF (03) - UR (07)
Timerange: 00/04:01:21 to 00/04:05:19

Plot file version 209 created 17-FEB-2020 15:42:58

J1402+5347 EK047 2.UVDATA.1

Freq = 4.9270 GHz, Bw = 16.000 MH No calibration applied and no bandpass applied

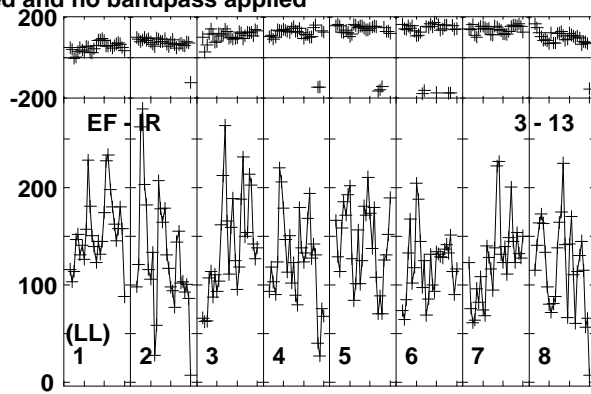
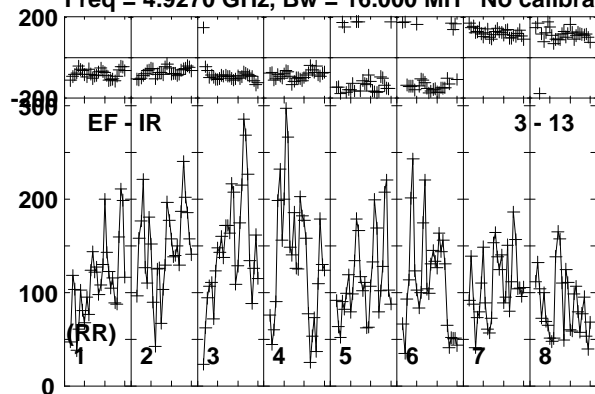

Lower frame: Micro Ampl Jy Top frame: Phas deg
Vector averaged cross-power spectrum Baseline: EF (03) - IR (13)
Timerange: 00/04:01:21 to 00/04:05:19

Plot file version 210 created 17-FEB-2020 15:42:58

J1359+5544 EK047 2.UVDATA.1

Freq = 4.9270 GHz, Bw = 16.000 MH No calibration applied and no bandpass applied

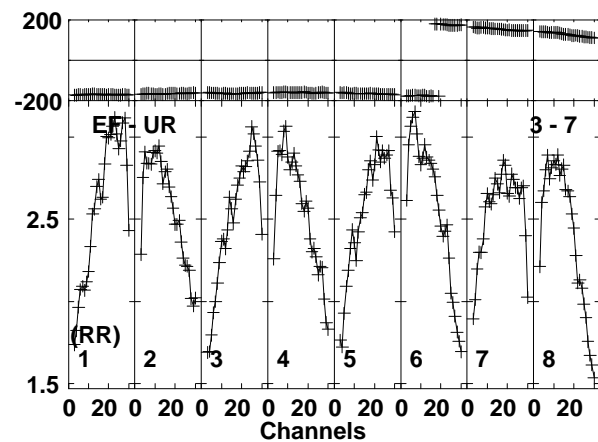
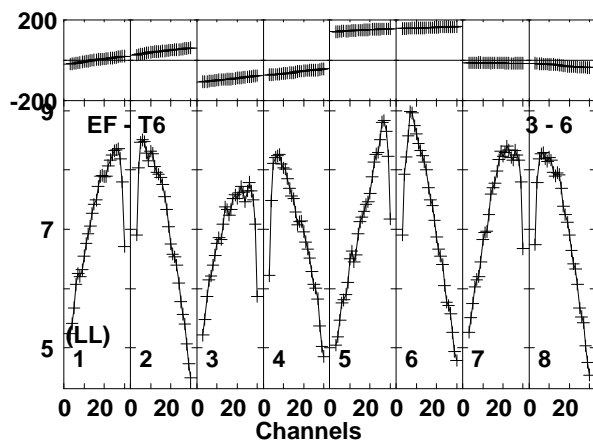
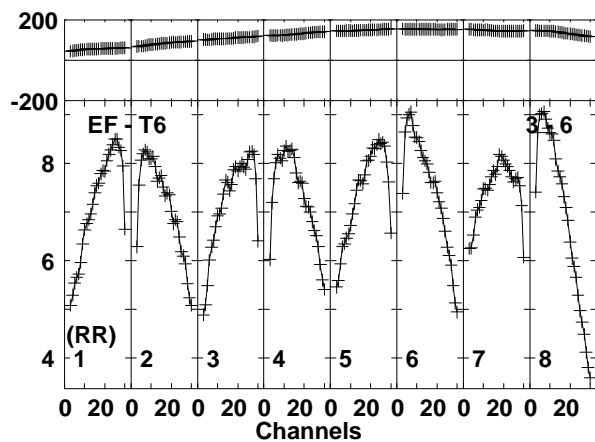
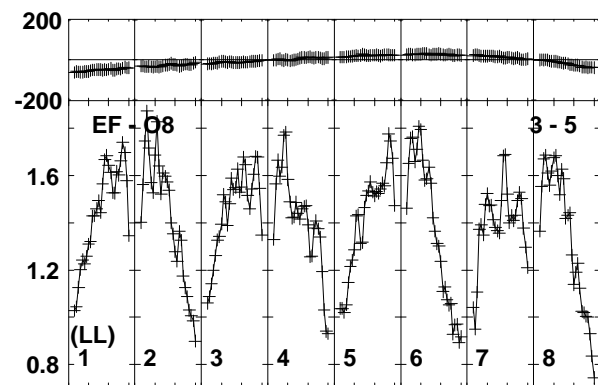
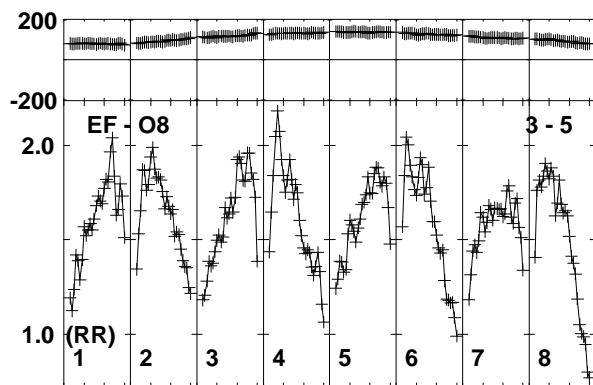
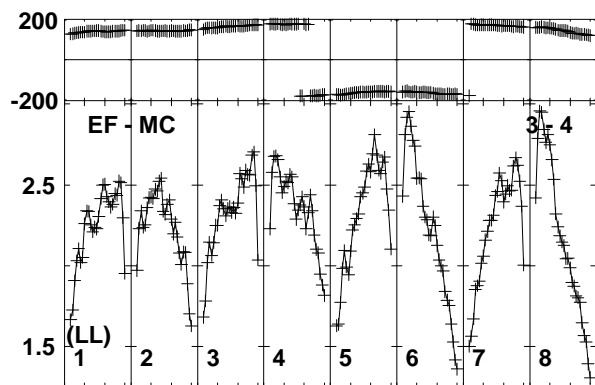
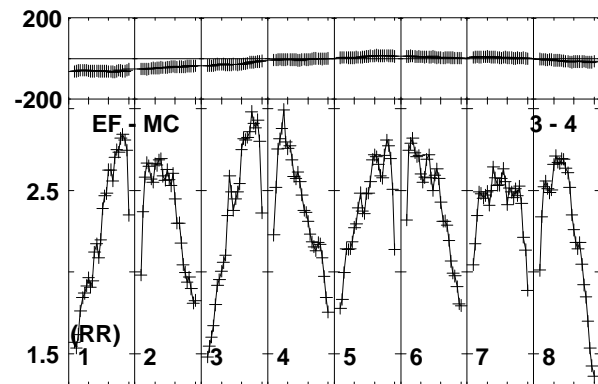
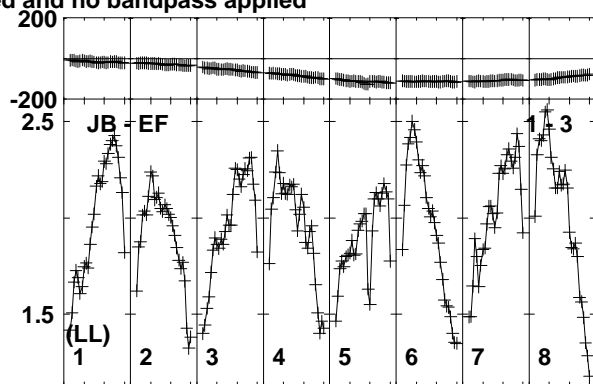
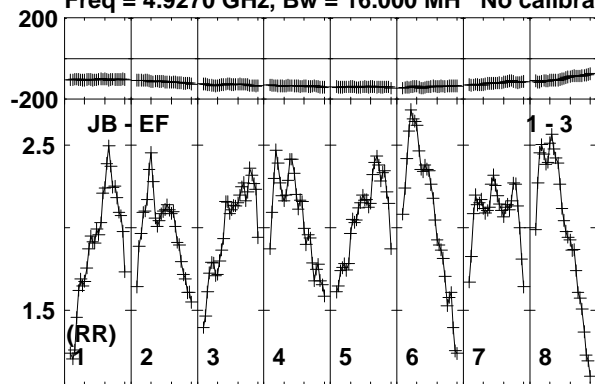

Lower frame: Milli Ampl Jy Top frame: Phas deg
Vector averaged cross-power spectrum Baseline: JB (01) - EF (03)
Timerange: 00/04:05:21 to 00/04:07:19

Plot file version 211 created 17-FEB-2020 15:42:58

J1359+5544 EK047 2.UVDATA.1

Freq = 4.9270 GHz, Bw = 16.000 MH No calibration applied and no bandpass applied

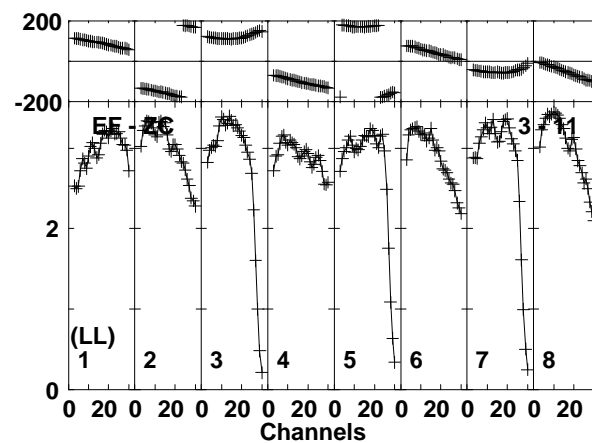
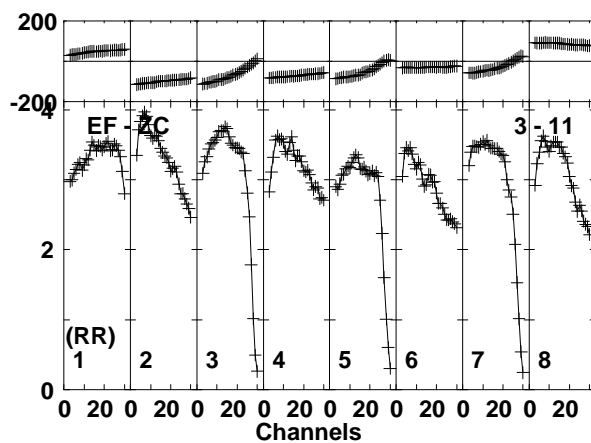
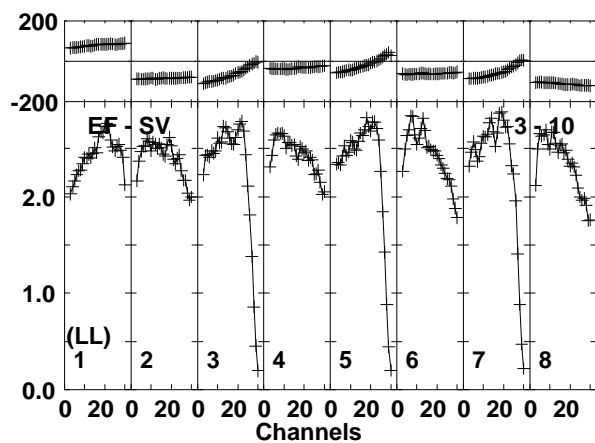
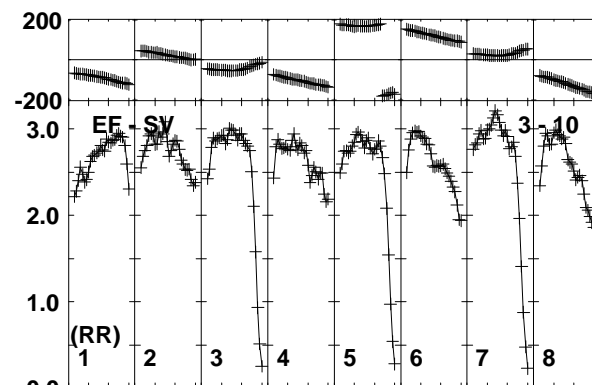
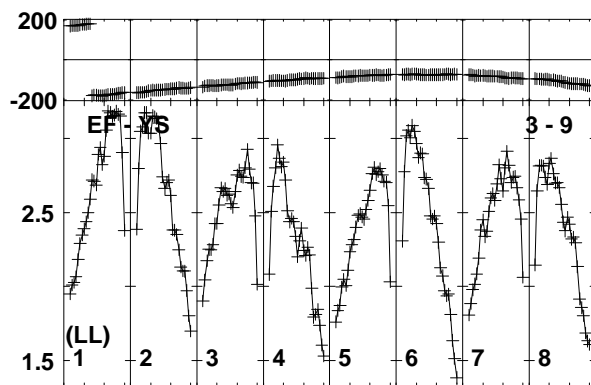
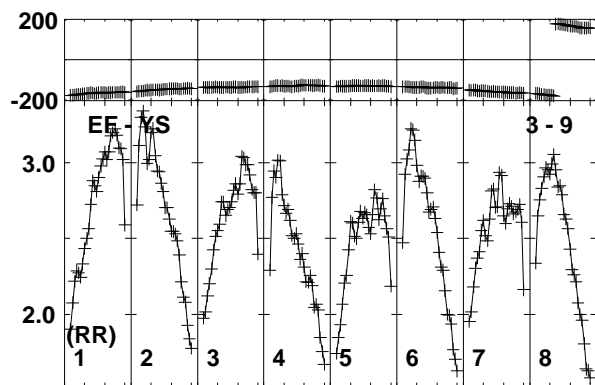
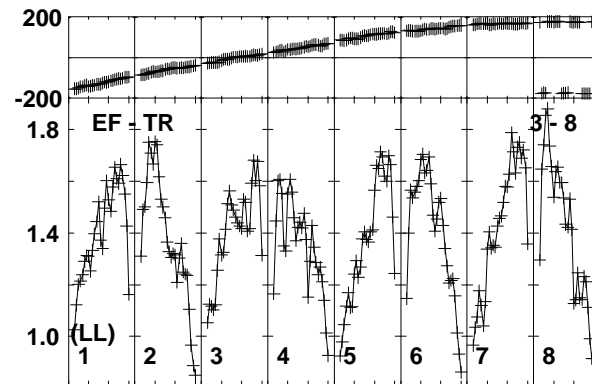
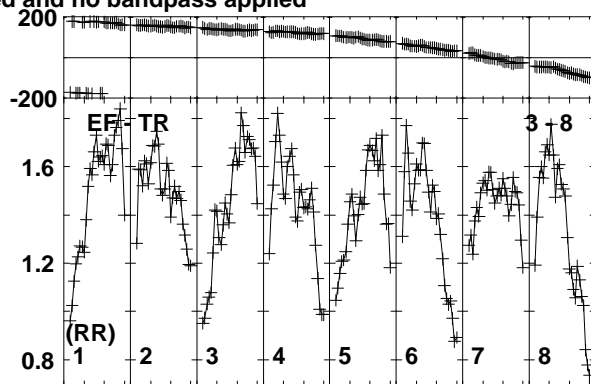
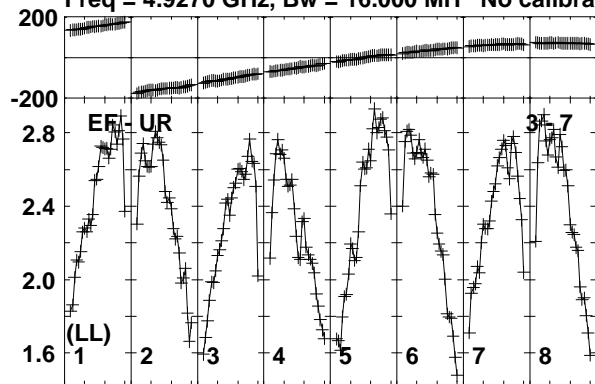

Lower frame: Milli Ampl Jy Top frame: Phas deg
Vector averaged cross-power spectrum Baseline: EF (03) - UR (07)
Timerange: 00/04:05:21 to 00/04:07:19

Plot file version 212 created 17-FEB-2020 15:42:58

J1359+5544 EK047 2.UVDATA.1

Freq = 4.9270 GHz, Bw = 16.000 MH No calibration applied and no bandpass applied

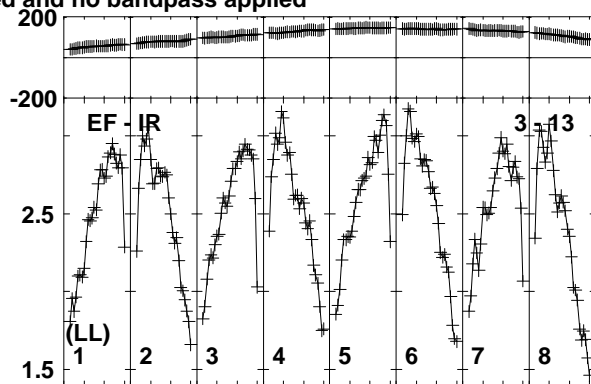
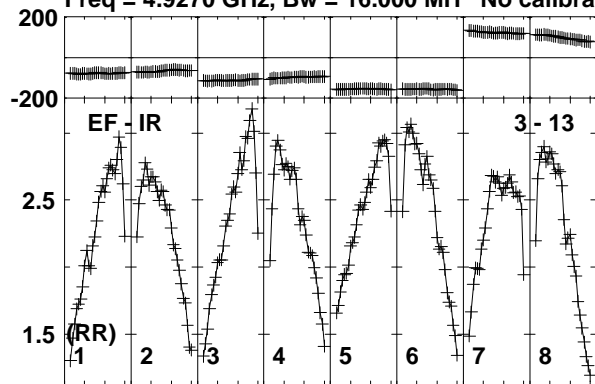

Lower frame: Milli Ampl Jy Top frame: Phas deg
Vector averaged cross-power spectrum Baseline: EF (03) - IR (13)
Timerange: 00/04:05:21 to 00/04:07:19

Plot file version 213 created 17-FEB-2020 15:42:58

J1402+5347 EK047 2.UVDATA.1

Freq = 4.9270 GHz, Bw = 16.000 MH No calibration applied and no bandpass applied

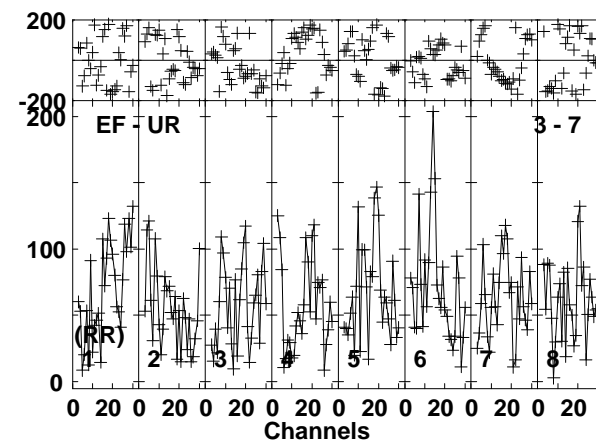
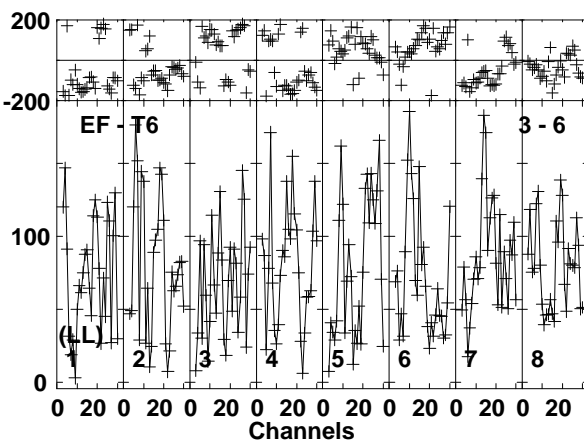
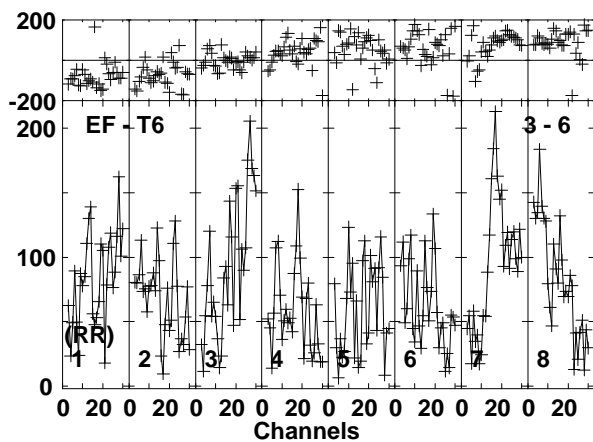
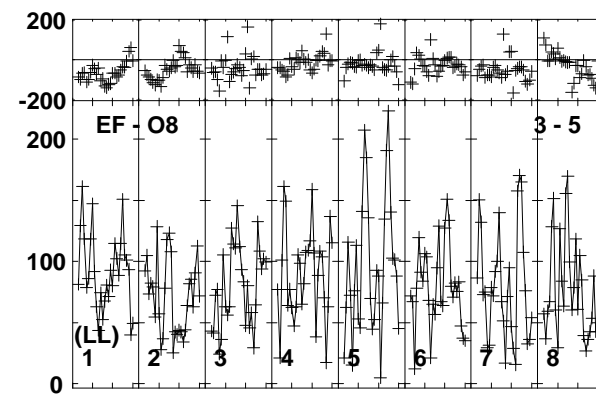
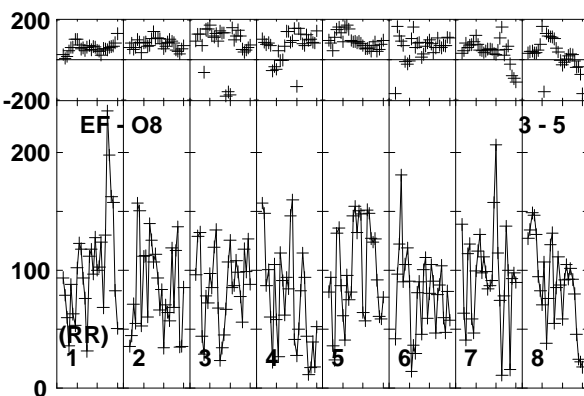
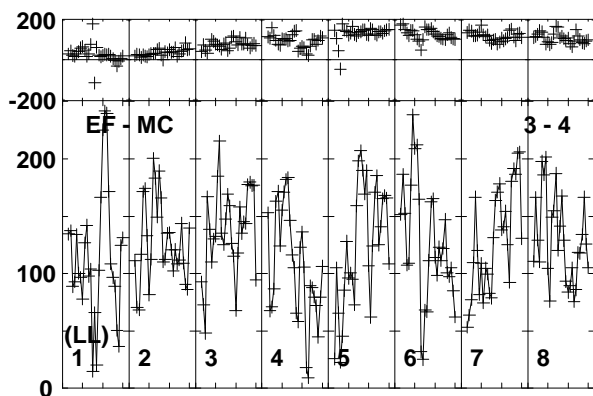
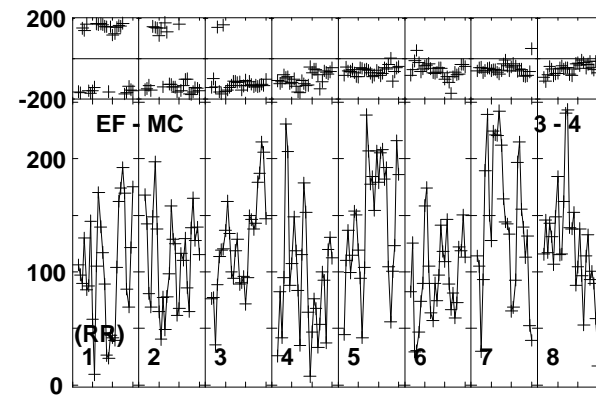
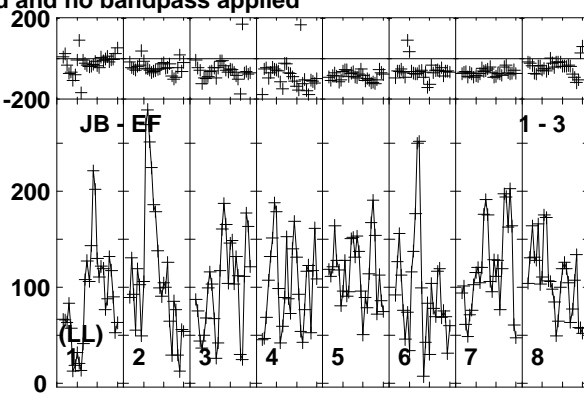
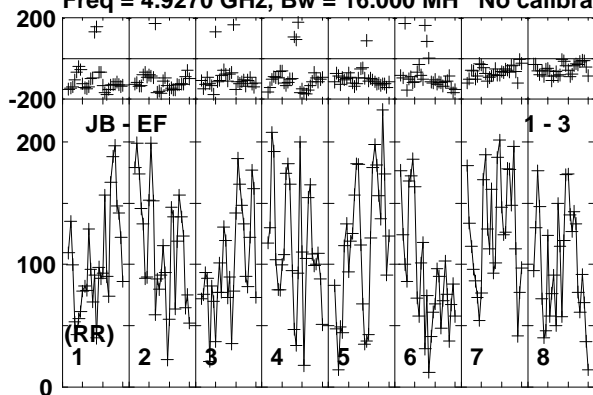

Lower frame: Micro Ampl Jy Top frame: Phas deg
Vector averaged cross-power spectrum Baseline: JB (01) - EF (03)
Timerange: 00/04:07:23 to 00/04:11:19

Plot file version 214 created 17-FEB-2020 15:42:58

J1402+5347 EK047 2.UVDATA.1

Freq = 4.9270 GHz, Bw = 16.000 MH No calibration applied and no bandpass applied

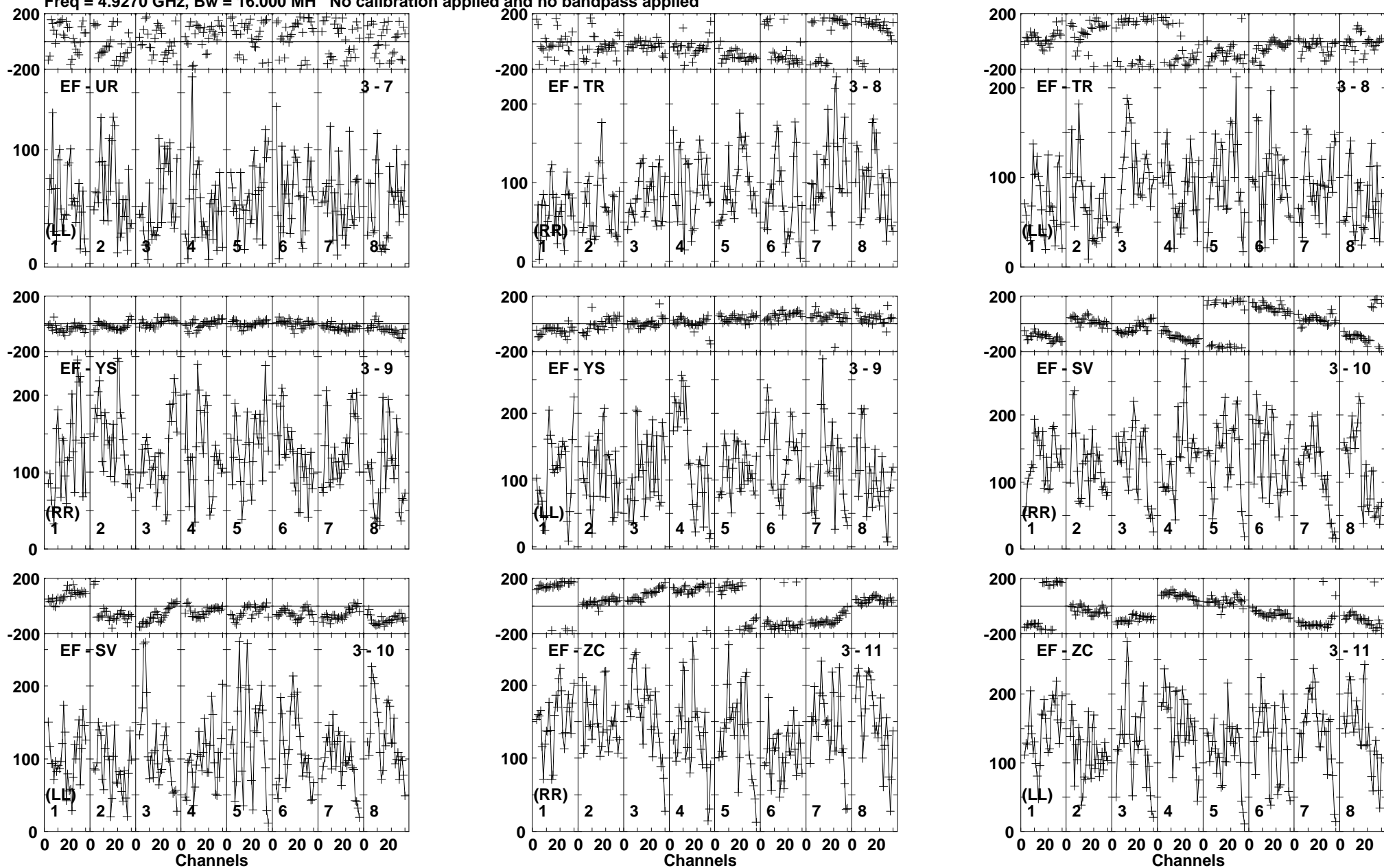

Lower frame: Micro Ampl Jy Top frame: Phas deg
Vector averaged cross-power spectrum Baseline: EF (03) - UR (07)
Timerange: 00/04:07:23 to 00/04:11:19

Plot file version 215 created 17-FEB-2020 15:42:58

J1402+5347 EK047 2.UVDATA.1

Freq = 4.9270 GHz, Bw = 16.000 MH No calibration applied and no bandpass applied

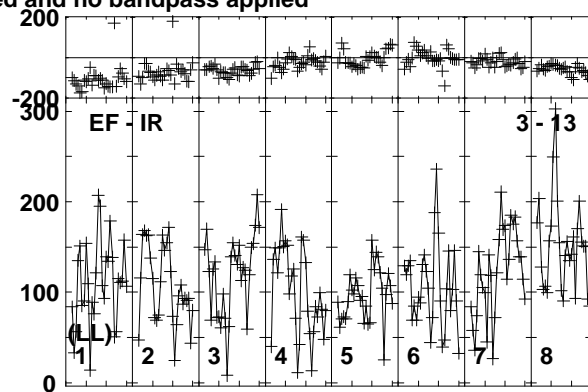
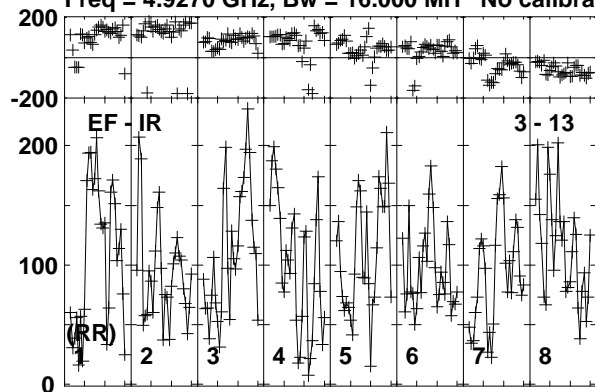

Lower frame: Micro Ampl Jy Top frame: Phas deg
Vector averaged cross-power spectrum Baseline: EF (03) - IR (13)
Timerange: 00/04:07:23 to 00/04:11:19

Plot file version 216 created 17-FEB-2020 15:42:58

J1359+5544 EK047 2.UVDATA.1

Freq = 4.9270 GHz, Bw = 16.000 MH No calibration applied and no bandpass applied

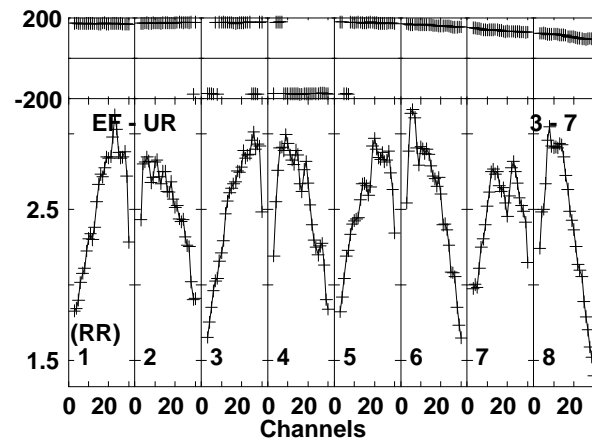
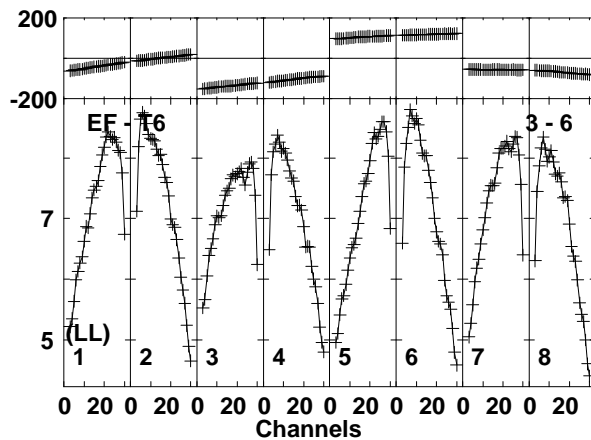
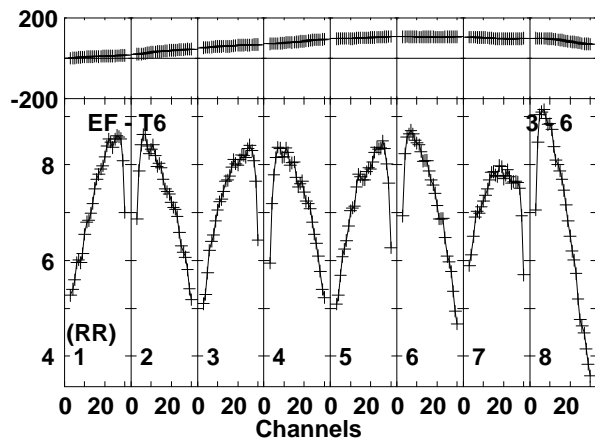
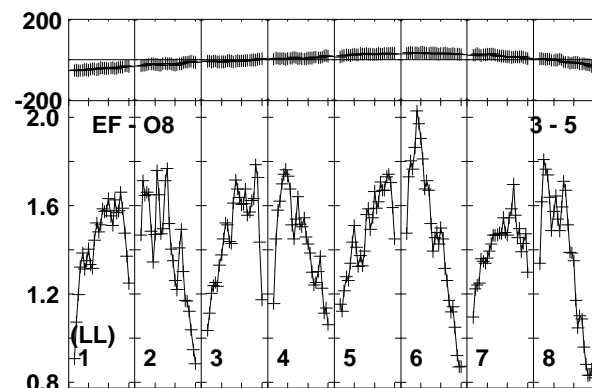
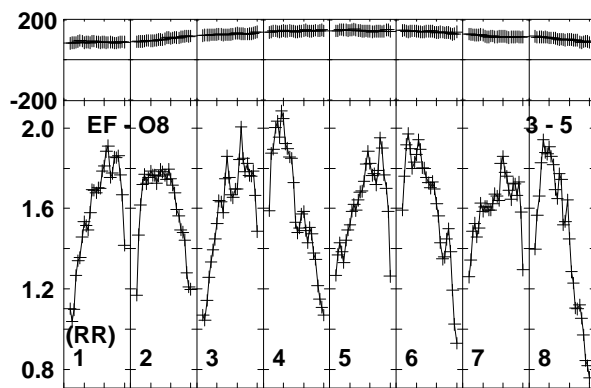
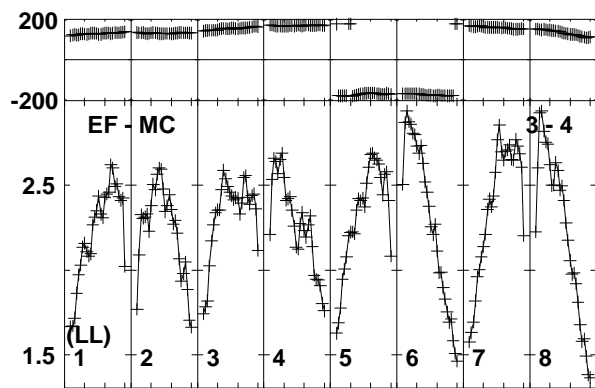
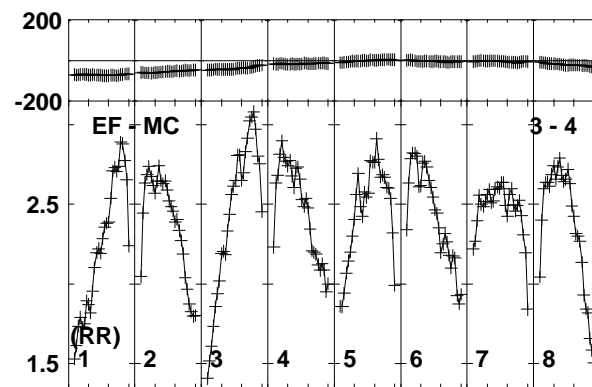
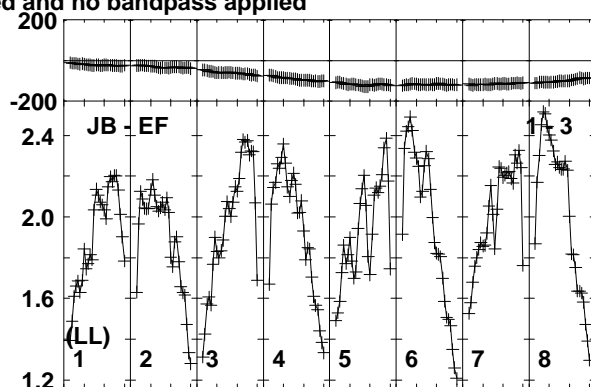
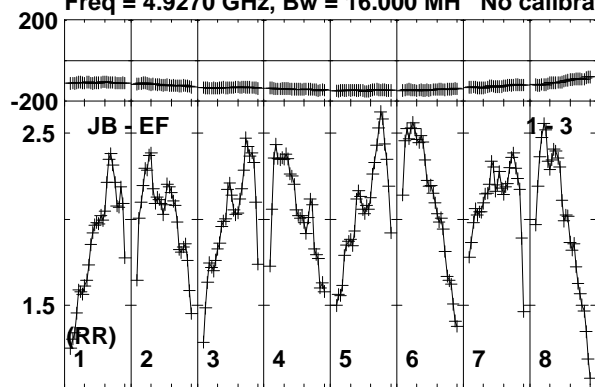

Lower frame: Milli Ampl Jy Top frame: Phas deg
Vector averaged cross-power spectrum Baseline: JB (01) - EF (03)
Timerange: 00/04:12:01 to 00/04:13:19

Plot file version 217 created 17-FEB-2020 15:42:58

J1359+5544 EK047 2.UVDATA.1

Freq = 4.9270 GHz, Bw = 16.000 MH No calibration applied and no bandpass applied

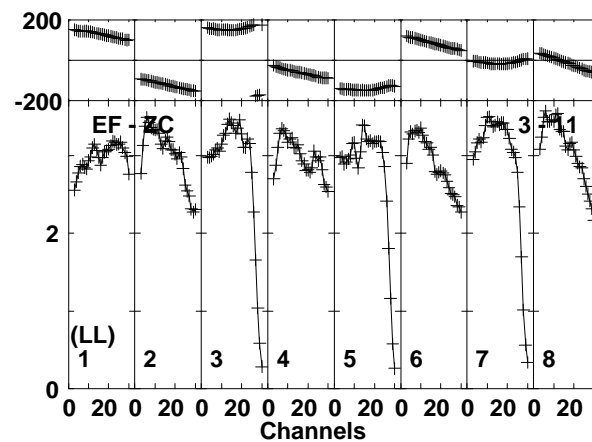
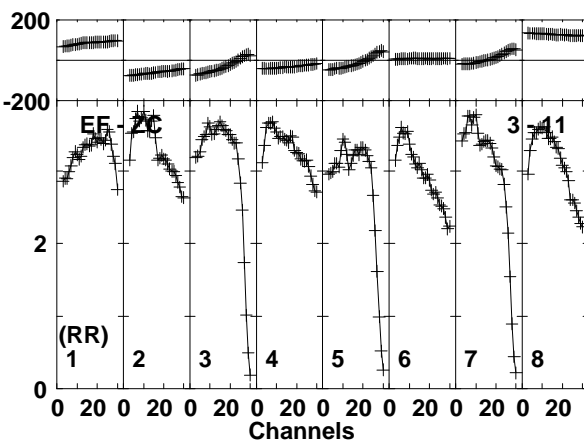
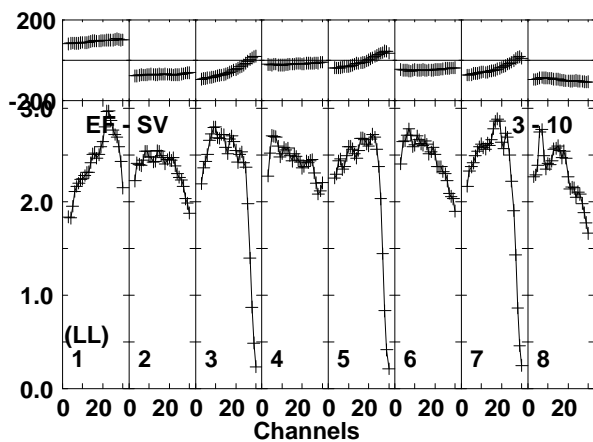
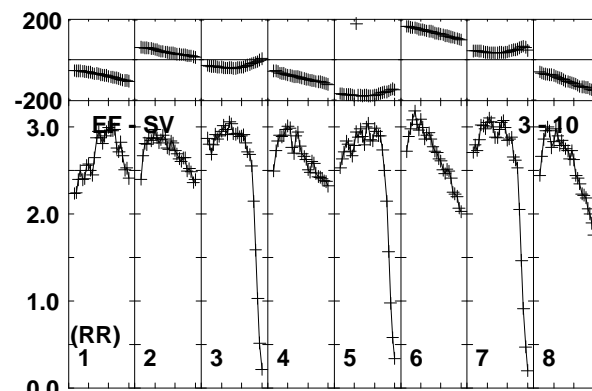
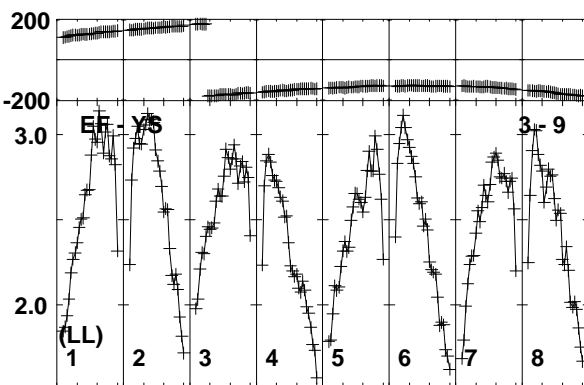
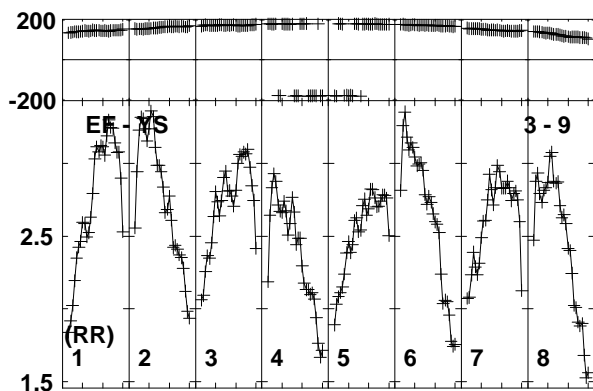
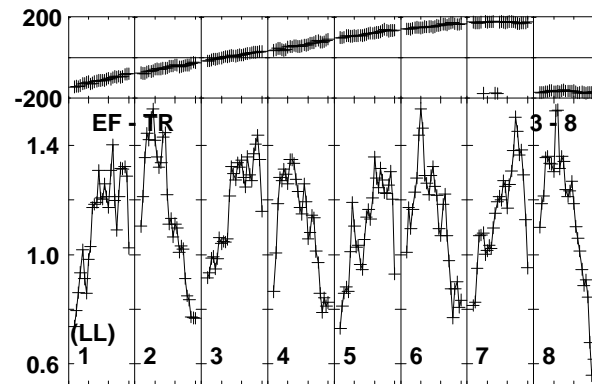
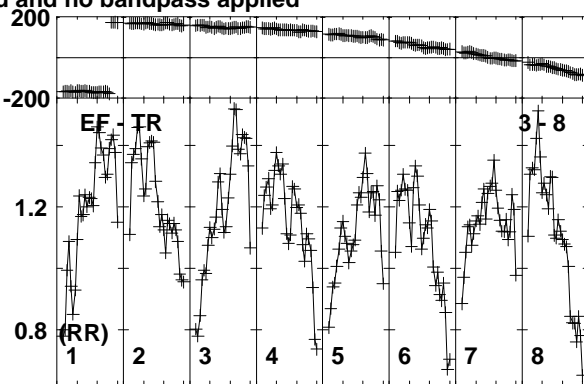
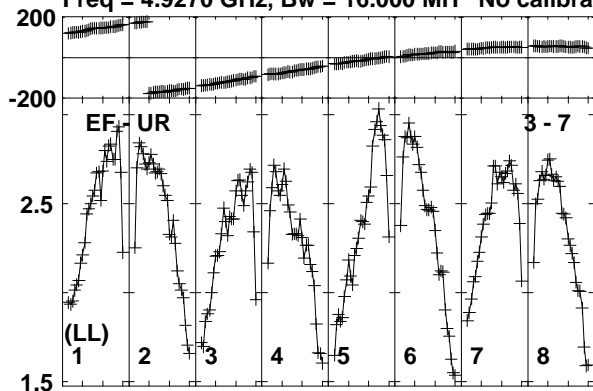

Lower frame: Milli Ampl Jy Top frame: Phas deg
Vector averaged cross-power spectrum Baseline: EF (03) - UR (07)
Timerange: 00/04:12:01 to 00/04:13:19

Plot file version 218 created 17-FEB-2020 15:42:58

J1359+5544 EK047 2.UVDATA.1

Freq = 4.9270 GHz, Bw = 16.000 MH No calibration applied and no bandpass applied

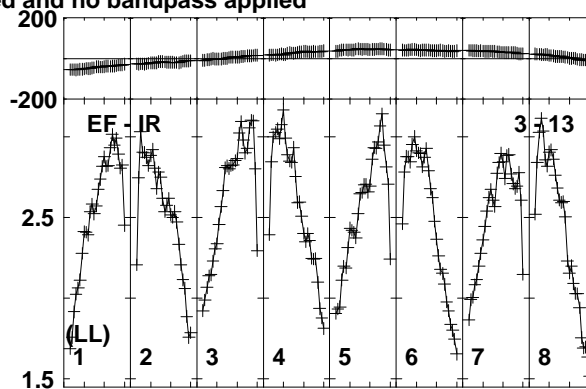
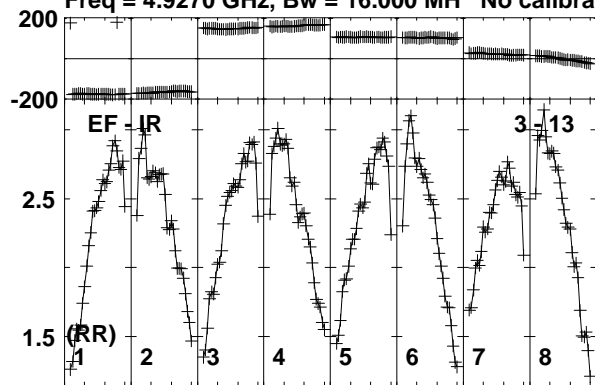

Lower frame: Milli Ampl Jy Top frame: Phas deg
Vector averaged cross-power spectrum Baseline: EF (03) - IR (13)
Timerange: 00/04:12:01 to 00/04:13:19

Plot file version 219 created 17-FEB-2020 15:42:58

J1402+5347 EK047 2.UVDATA.1

Freq = 4.9270 GHz, Bw = 16.000 MH No calibration applied and no bandpass applied

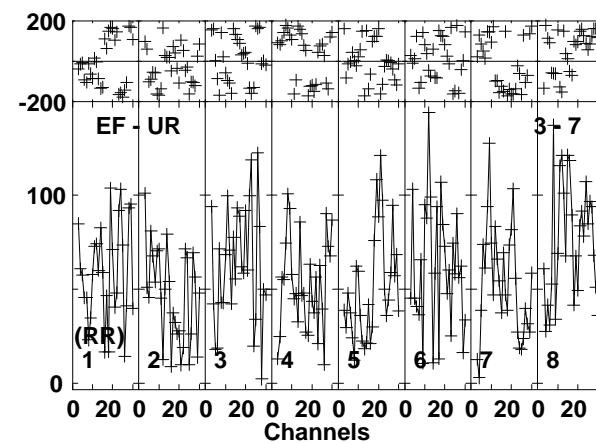
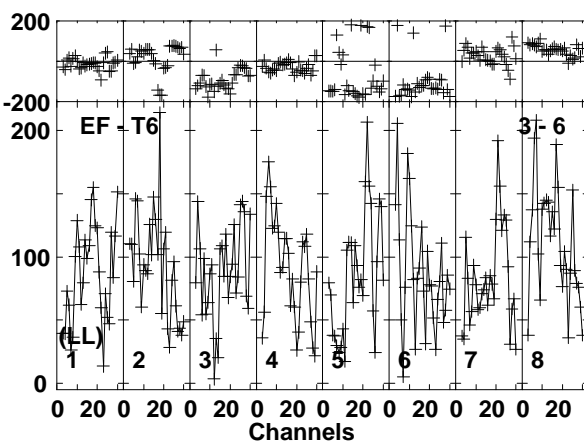
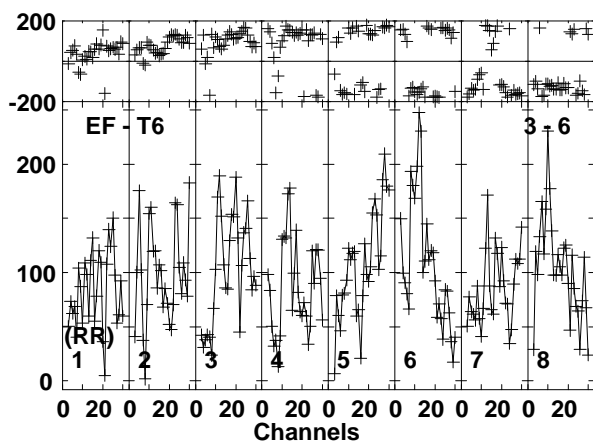
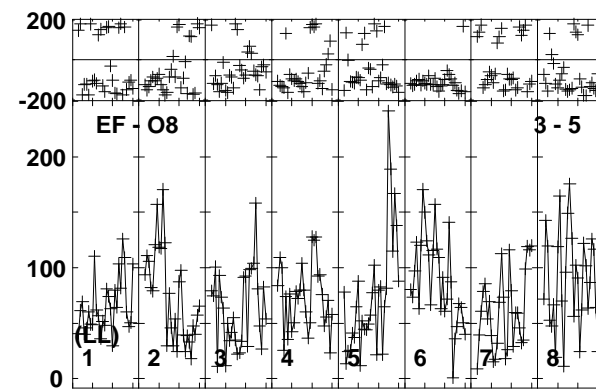
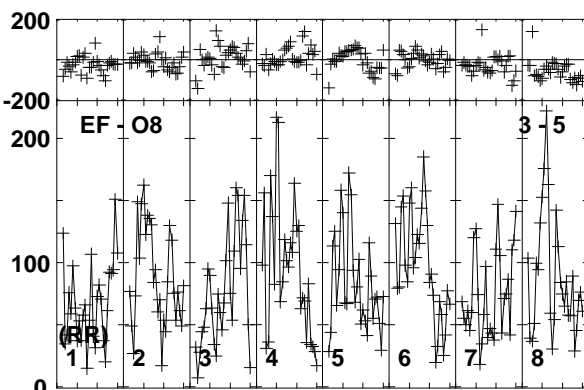
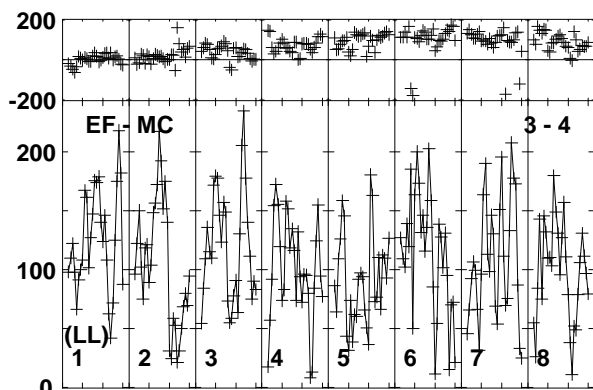
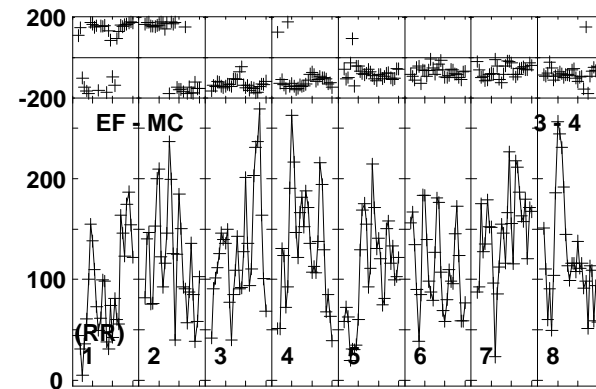
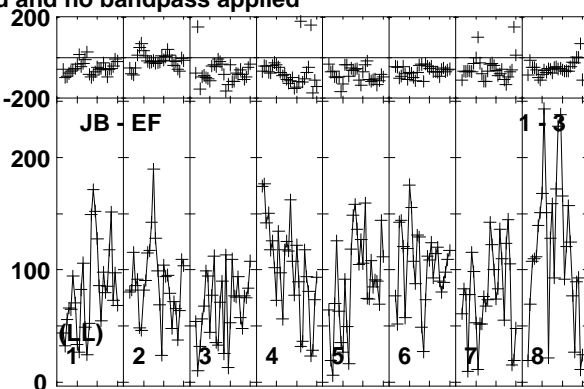
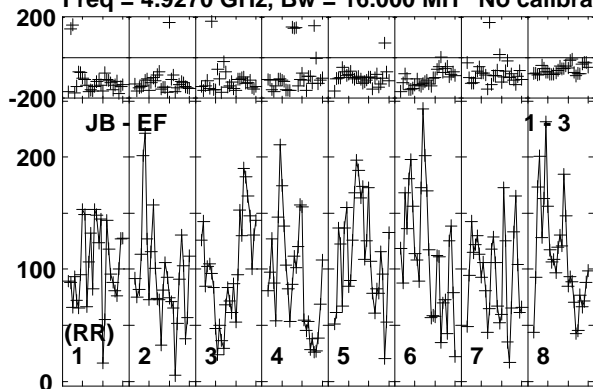

Lower frame: Micro Ampl Jy Top frame: Phas deg
Vector averaged cross-power spectrum Baseline: JB (01) - EF (03)
Timerange: 00/04:13:21 to 00/04:17:19

Plot file version 220 created 17-FEB-2020 15:42:59

J1402+5347 EK047 2.UVDATA.1

Freq = 4.9270 GHz, Bw = 16.000 MH No calibration applied and no bandpass applied

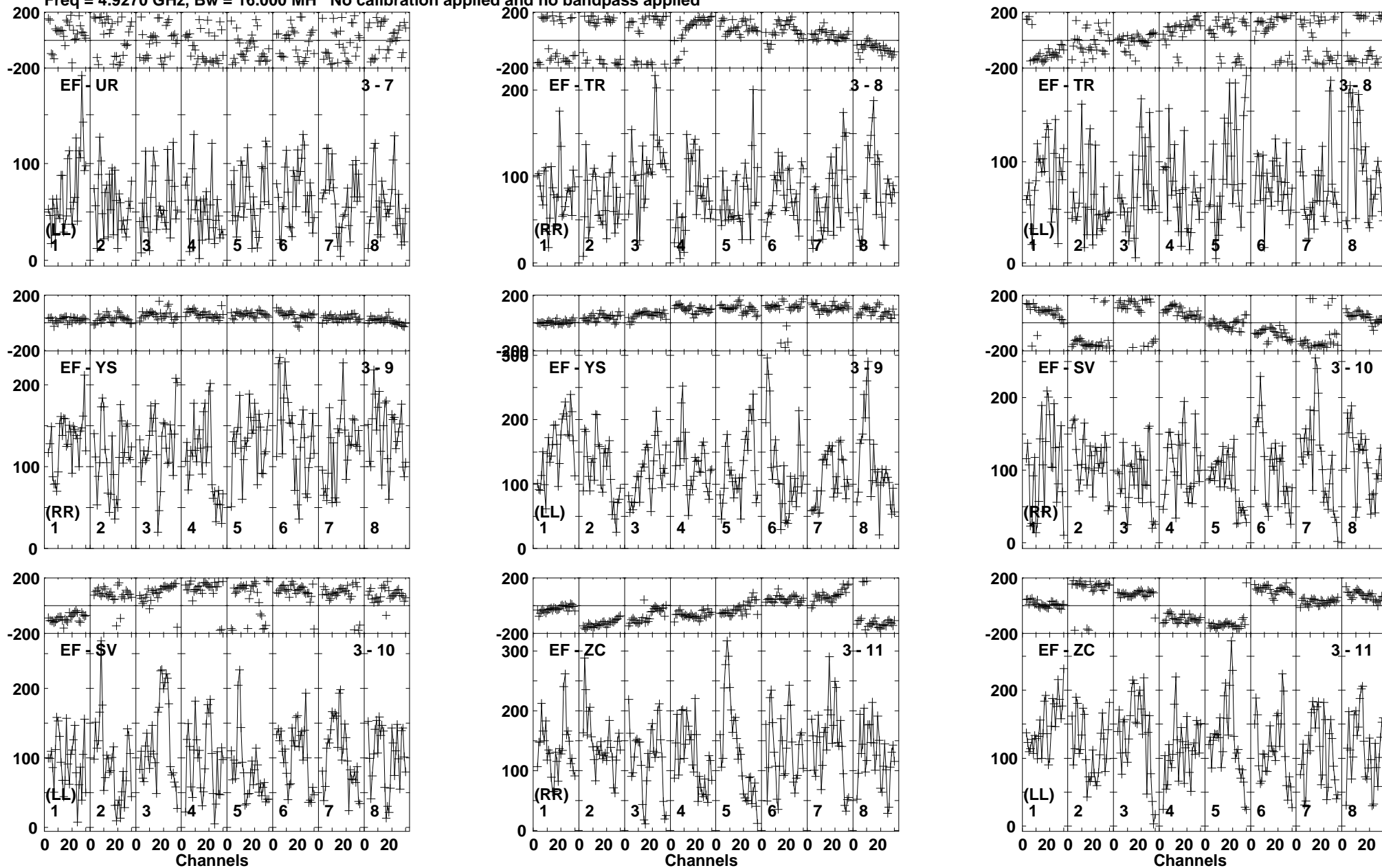

Lower frame: Micro Ampl Jy Top frame: Phas deg
Vector averaged cross-power spectrum Baseline: EF (03) - UR (07)
Timerange: 00/04:13:21 to 00/04:17:19

Plot file version 221 created 17-FEB-2020 15:42:59

J1402+5347 EK047 2.UVDATA.1

Freq = 4.9270 GHz, Bw = 16.000 MH No calibration applied and no bandpass applied

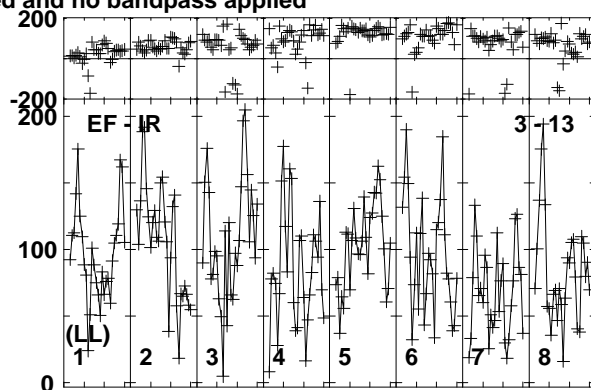
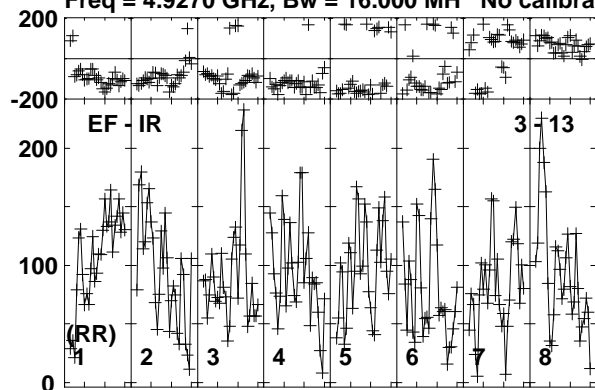

Lower frame: Micro Ampl Jy Top frame: Phas deg
Vector averaged cross-power spectrum Baseline: EF (03) - IR (13)
Timerange: 00/04:13:21 to 00/04:17:19

Plot file version 222 created 17-FEB-2020 15:42:59

J1359+5544 EK047 2.UVDATA.1

Freq = 4.9270 GHz, Bw = 16.000 MH No calibration applied and no bandpass applied

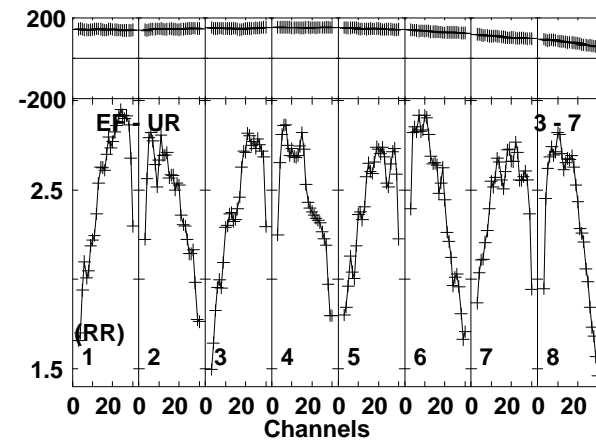
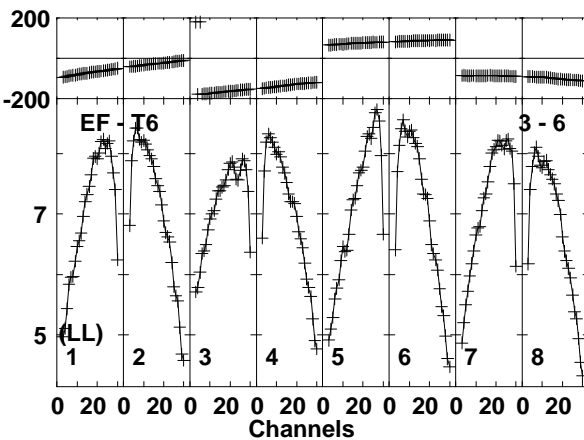
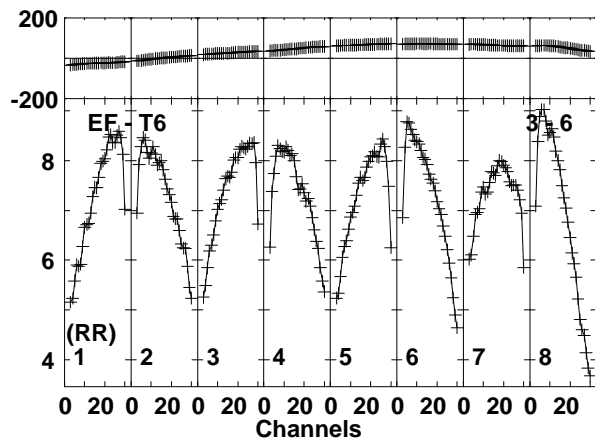
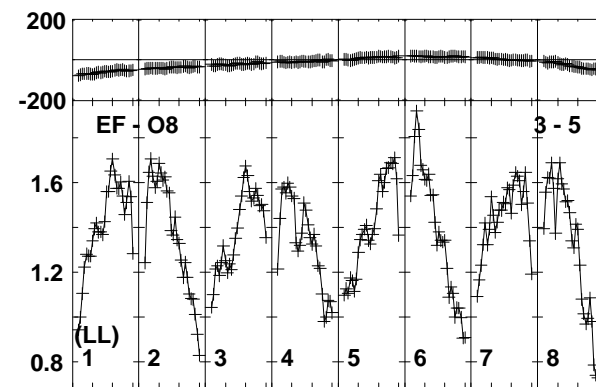
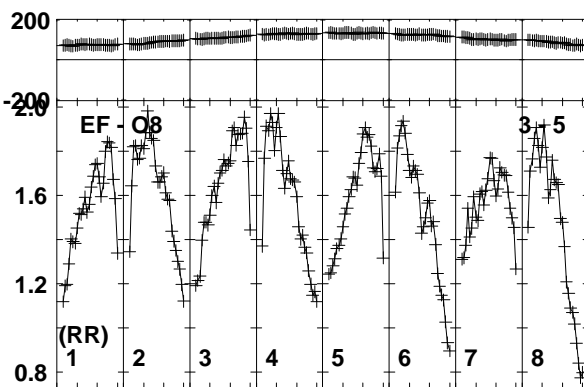
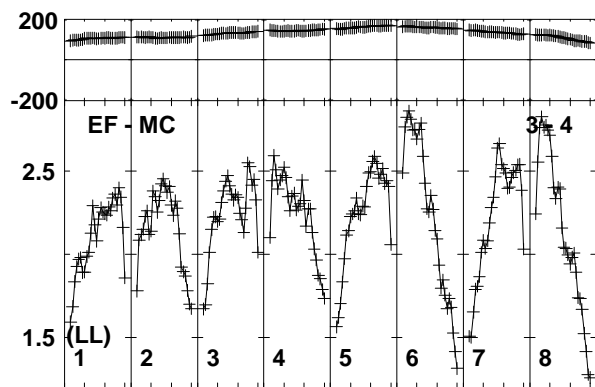
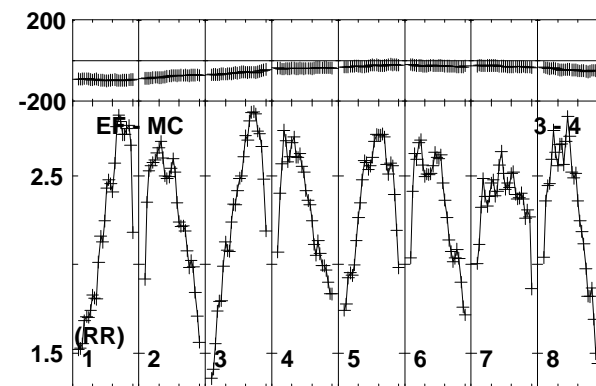
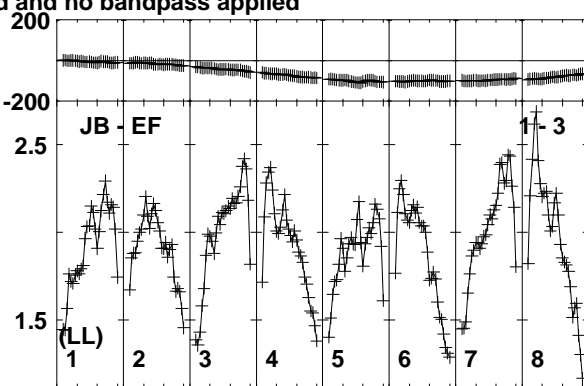
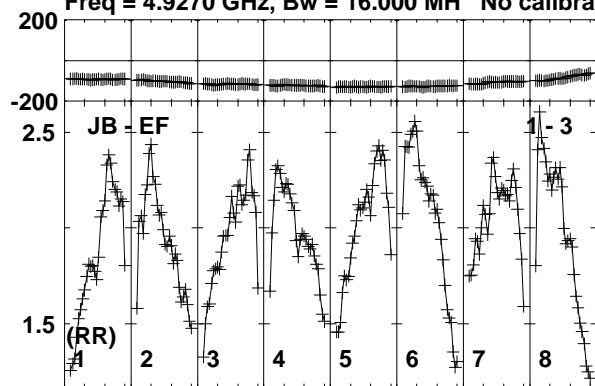

Lower frame: Milli Ampl Jy Top frame: Phas deg
Vector averaged cross-power spectrum Baseline: JB (01) - EF (03)
Timerange: 00/04:17:21 to 00/04:19:19

Plot file version 223 created 17-FEB-2020 15:42:59

J1359+5544 EK047 2.UVDATA.1

Freq = 4.9270 GHz, Bw = 16.000 MH No calibration applied and no bandpass applied

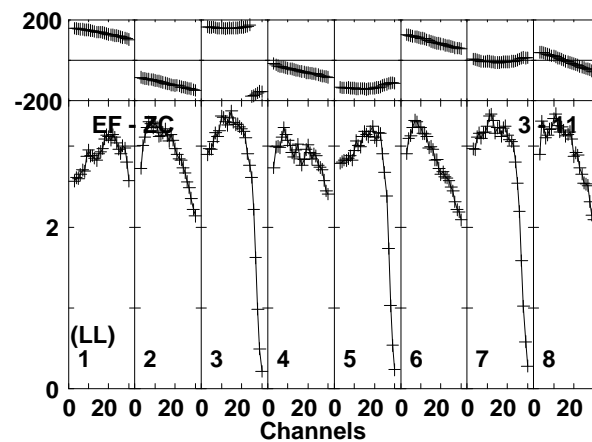
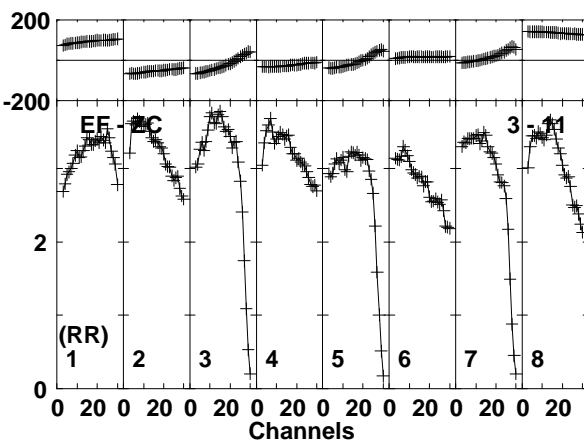
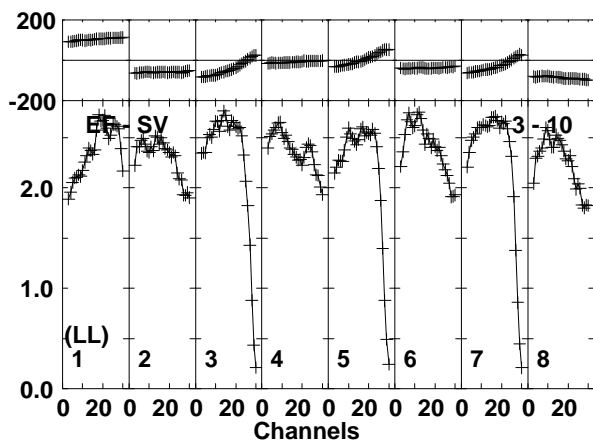
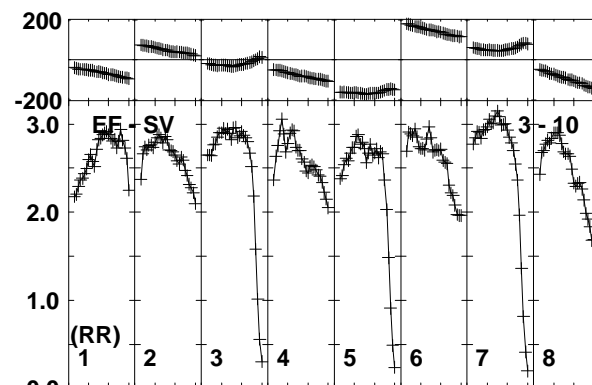
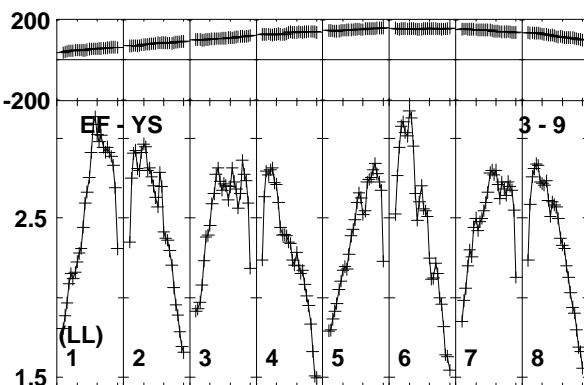
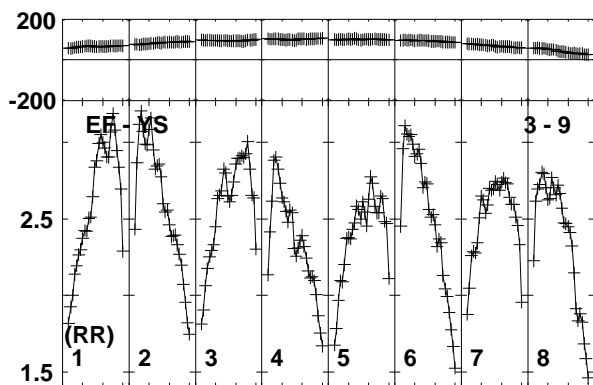
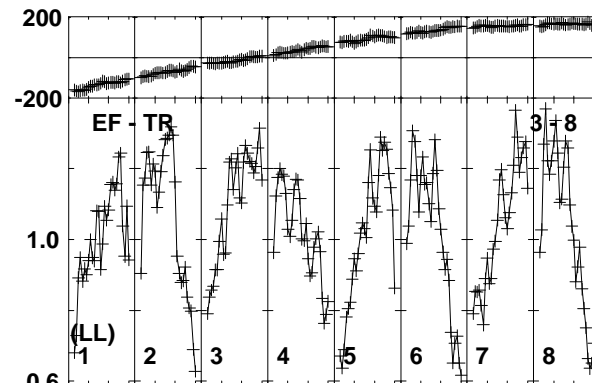
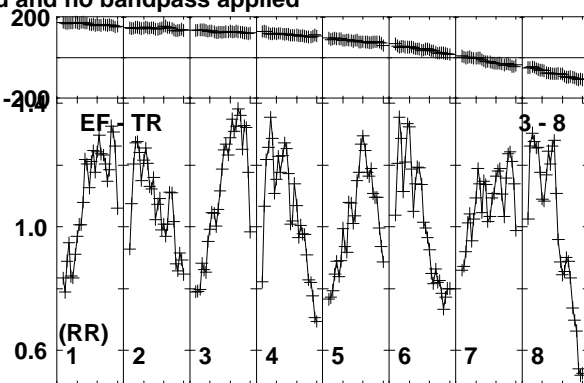
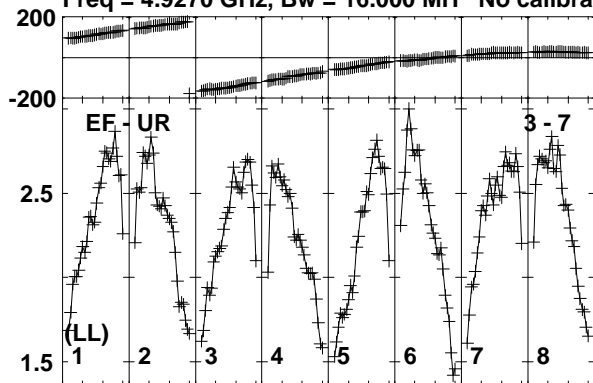

Lower frame: Milli Ampl Jy Top frame: Phas deg
Vector averaged cross-power spectrum Baseline: EF (03) - UR (07)
Timerange: 00/04:17:21 to 00/04:19:19

Plot file version 224 created 17-FEB-2020 15:42:59

J1359+5544 EK047 2.UVDATA.1

Freq = 4.9270 GHz, Bw = 16.000 MH No calibration applied and no bandpass applied

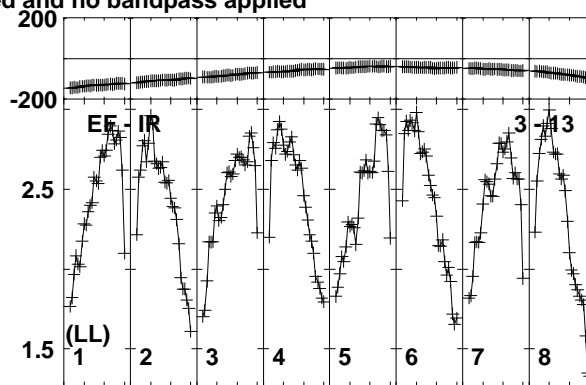
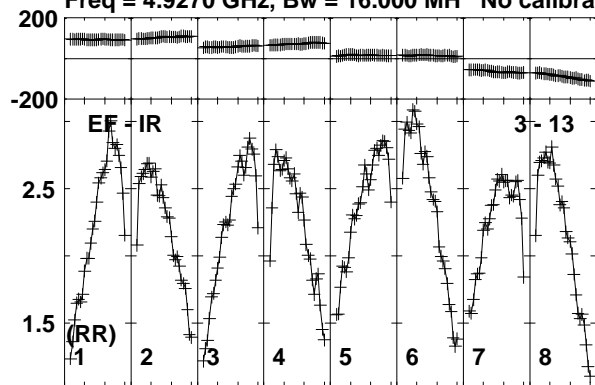

Lower frame: Milli Ampl Jy Top frame: Phas deg
Vector averaged cross-power spectrum Baseline: EF (03) - IR (13)
Timerange: 00/04:17:21 to 00/04:19:19

Plot file version 225 created 17-FEB-2020 15:42:59

J1402+5347 EK047 2.UVDATA.1

Freq = 4.9270 GHz, Bw = 16.000 MH No calibration applied and no bandpass applied

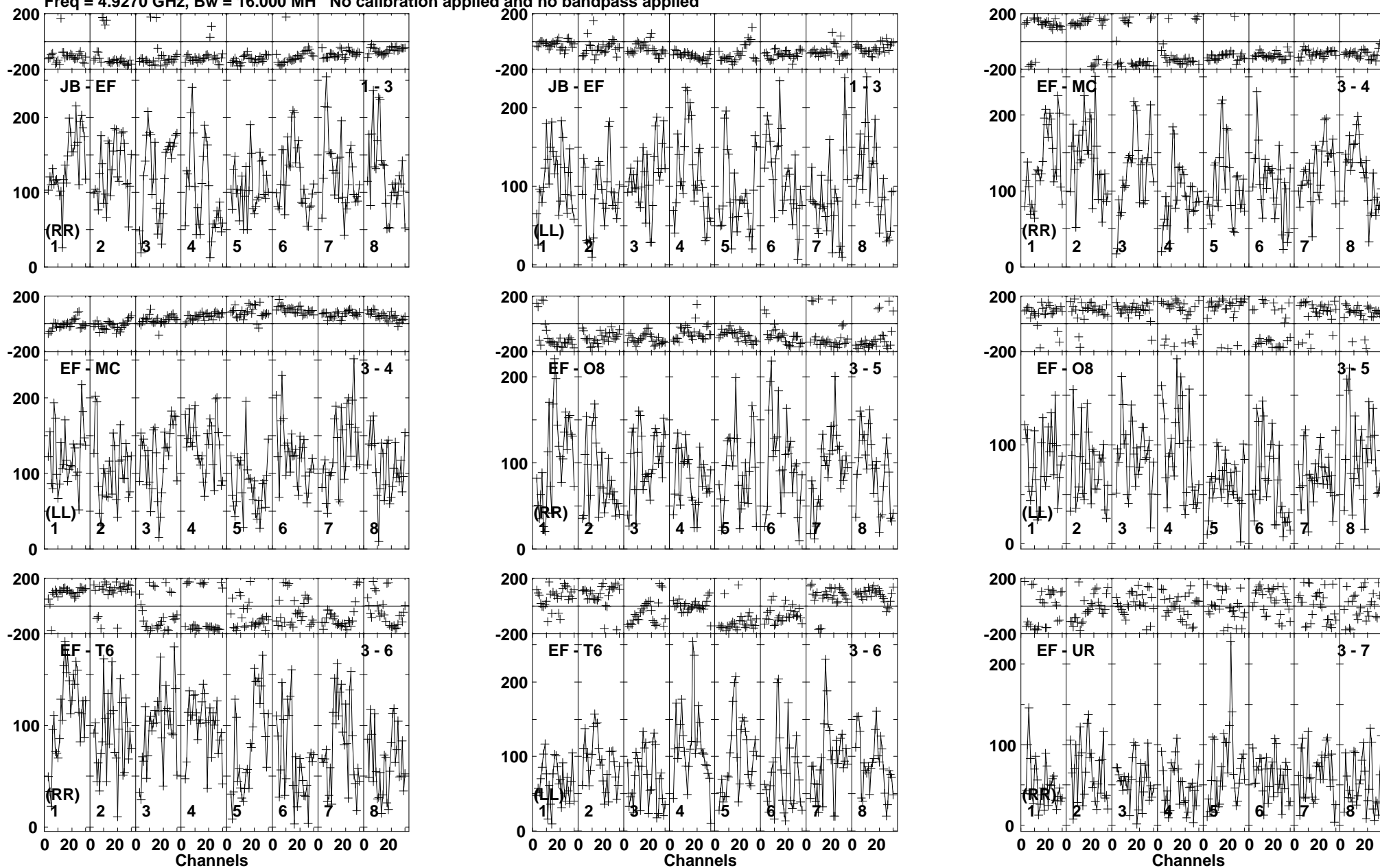

Lower frame: Micro Ampl Jy Top frame: Phas deg
Vector averaged cross-power spectrum Baseline: JB (01) - EF (03)
Timerange: 00/04:19:23 to 00/04:23:19

Plot file version 226 created 17-FEB-2020 15:42:59

J1402+5347 EK047 2.UVDATA.1

Freq = 4.9270 GHz, Bw = 16.000 MH No calibration applied and no bandpass applied

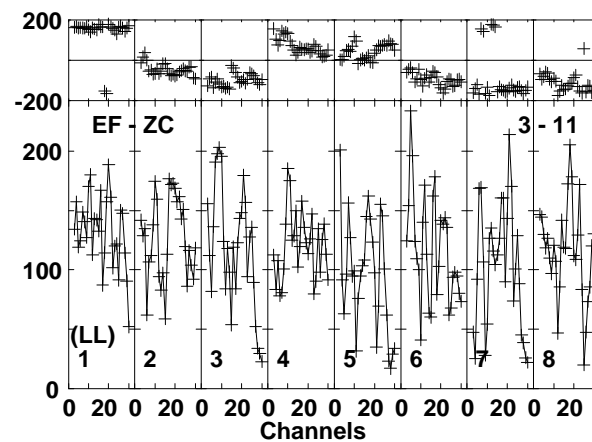
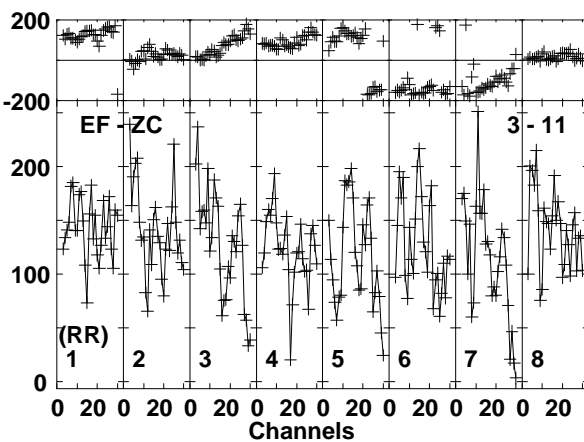
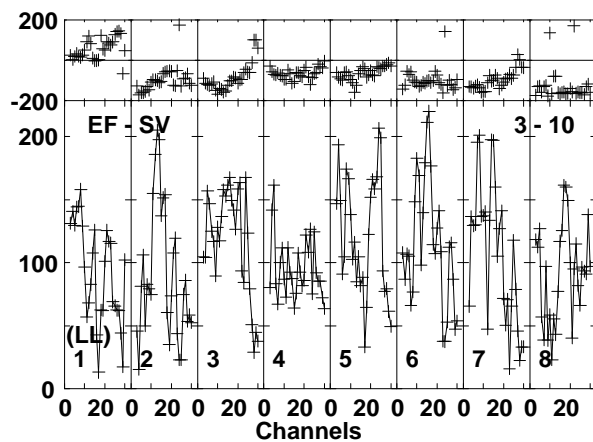
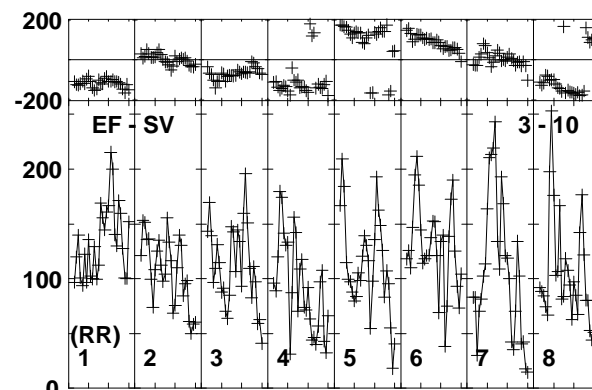
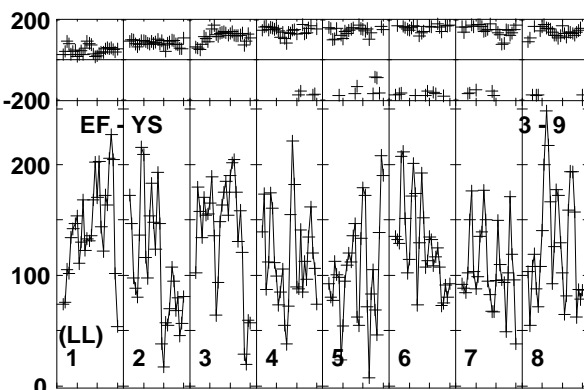
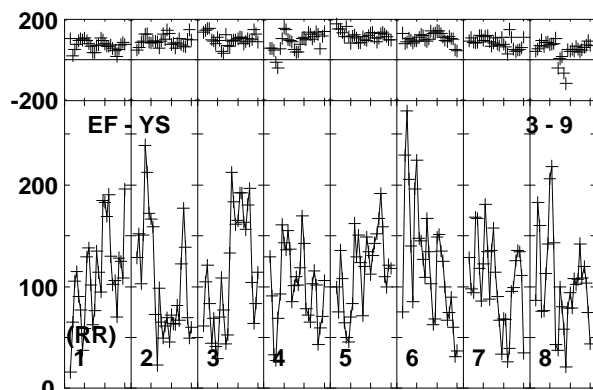
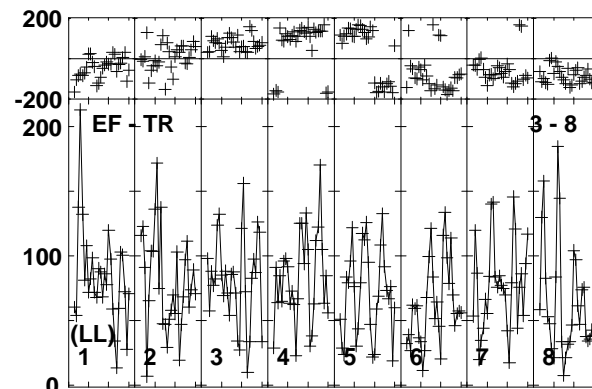
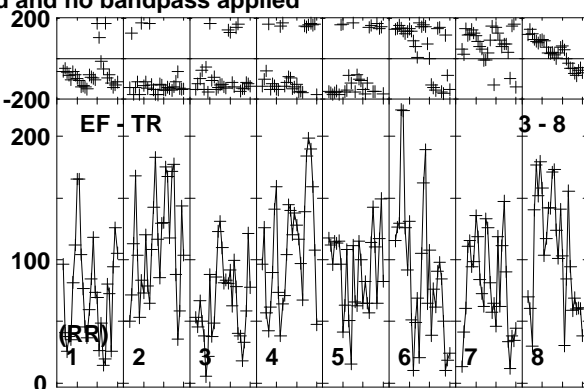
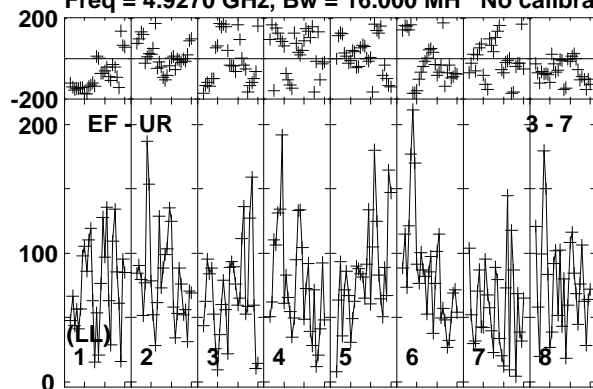

Lower frame: Micro Ampl Jy Top frame: Phas deg
Vector averaged cross-power spectrum Baseline: EF (03) - UR (07)
Timerange: 00/04:19:23 to 00/04:23:19

Plot file version 227 created 17-FEB-2020 15:42:59

J1402+5347 EK047 2.UVDATA.1

Freq = 4.9270 GHz, Bw = 16.000 MH No calibration applied and no bandpass applied

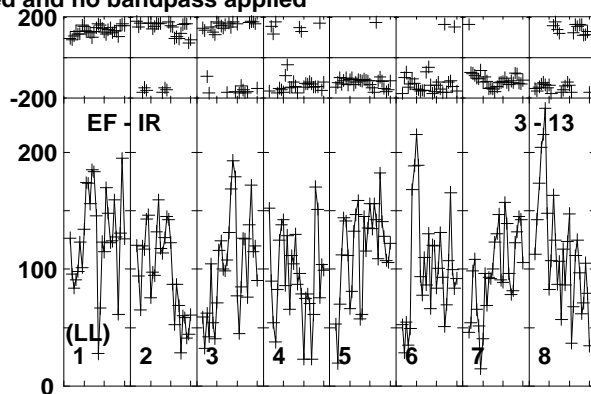
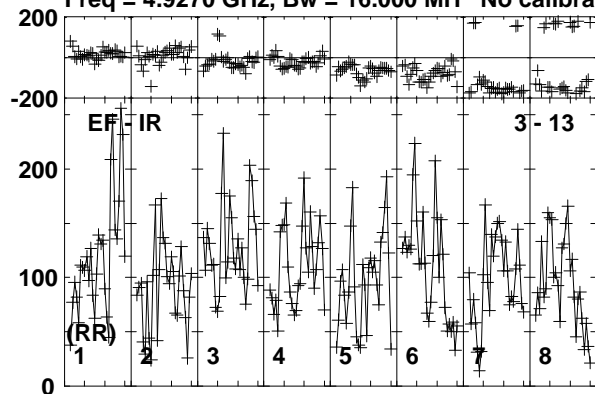

Lower frame: Micro Ampl Jy Top frame: Phas deg
Vector averaged cross-power spectrum Baseline: EF (03) - IR (13)
Timerange: 00/04:19:23 to 00/04:23:19

Plot file version 228 created 17-FEB-2020 15:42:59

J1359+5544 EK047 2.UVDATA.1

Freq = 4.9270 GHz, Bw = 16.000 MH No calibration applied and no bandpass applied

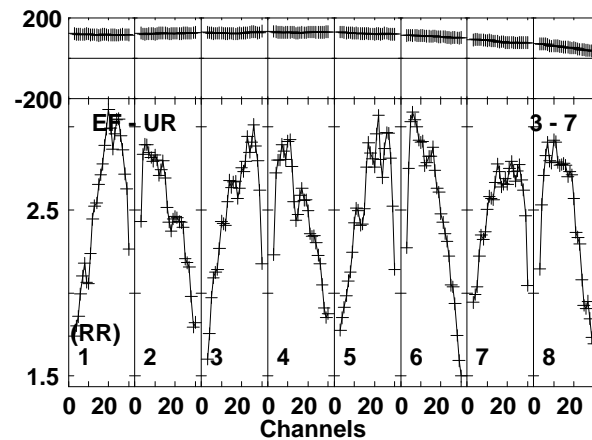
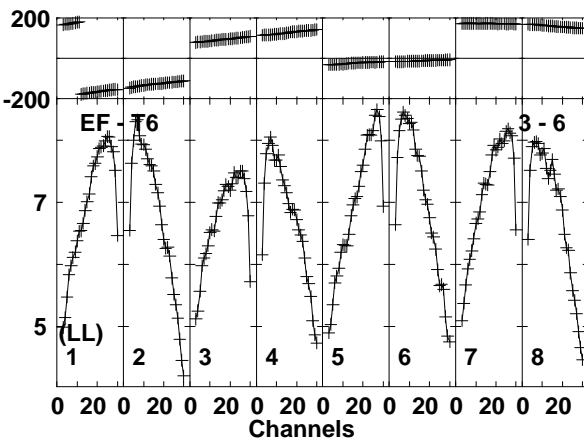
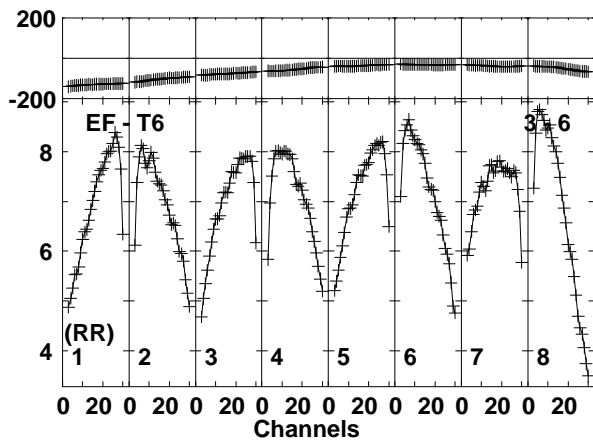
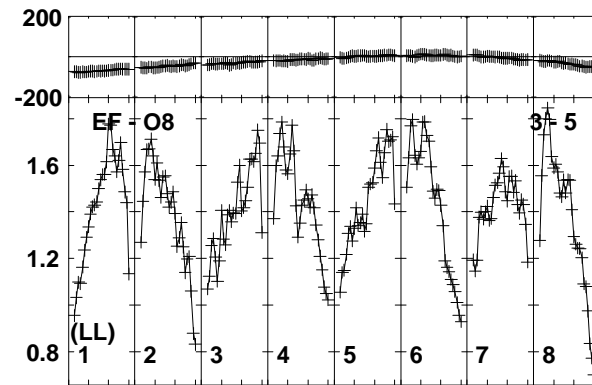
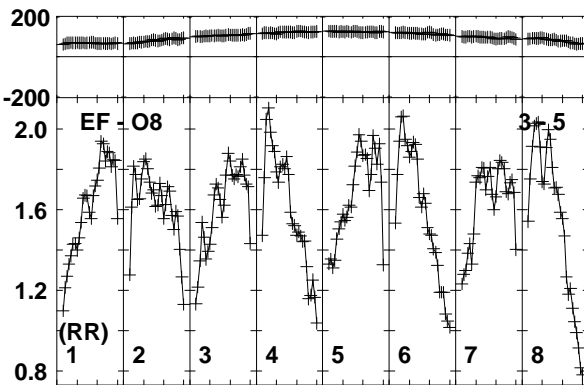
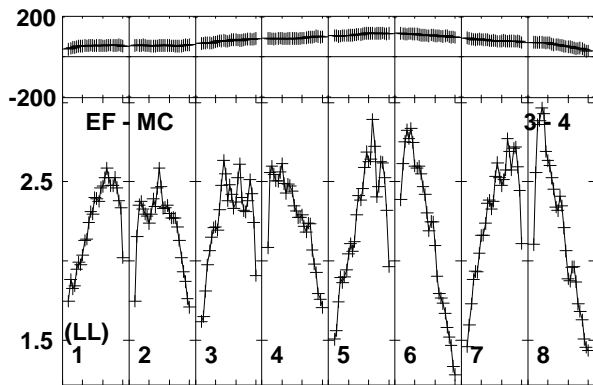
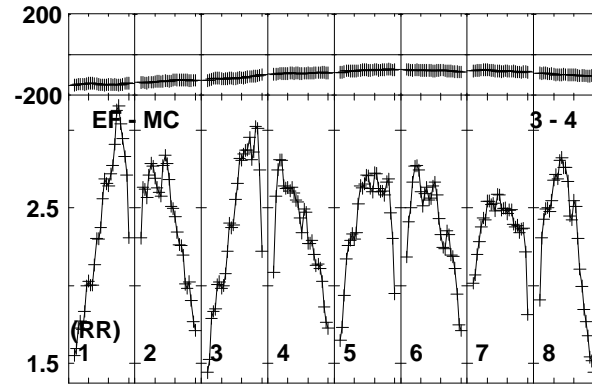
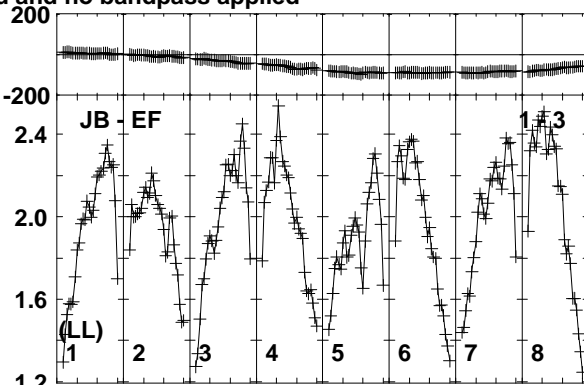
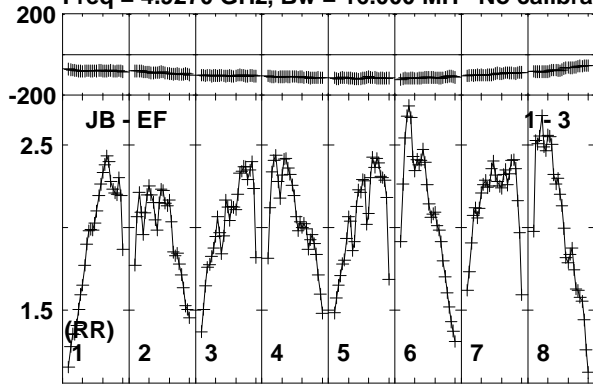

Lower frame: Milli Ampl Jy Top frame: Phas deg
Vector averaged cross-power spectrum Baseline: JB (01) - EF (03)
Timerange: 00/04:24:01 to 00/04:25:19

Plot file version 229 created 17-FEB-2020 15:42:59

J1359+5544 EK047 2.UVDATA.1

Freq = 4.9270 GHz, Bw = 16.000 MH No calibration applied and no bandpass applied

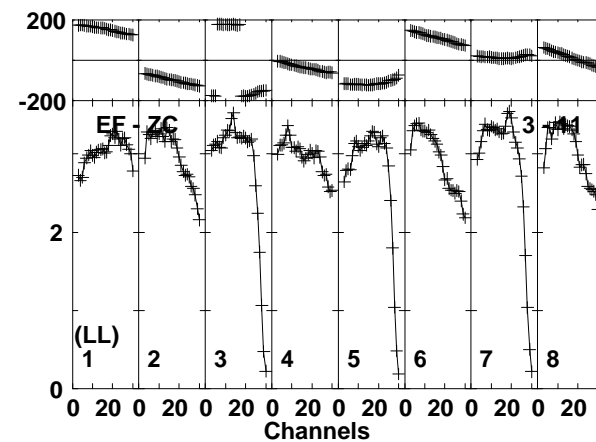
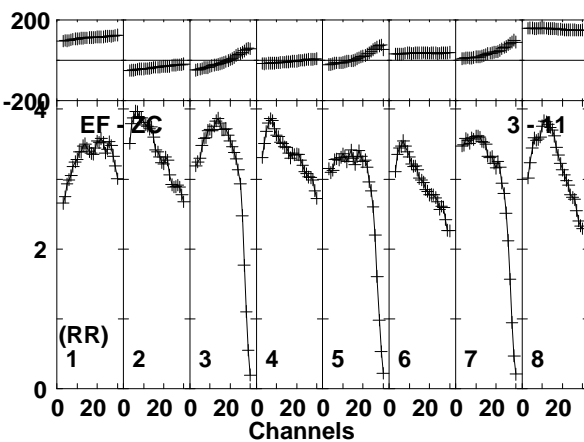
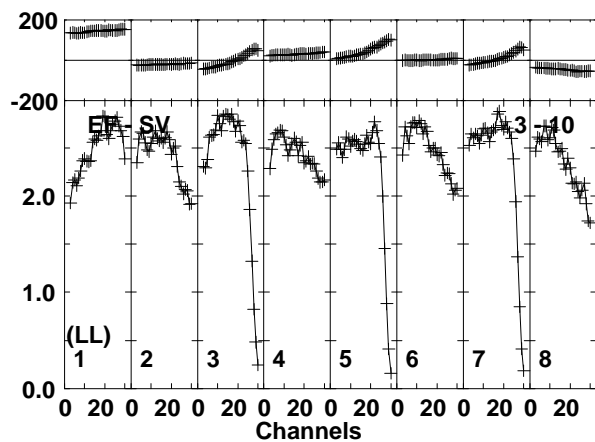
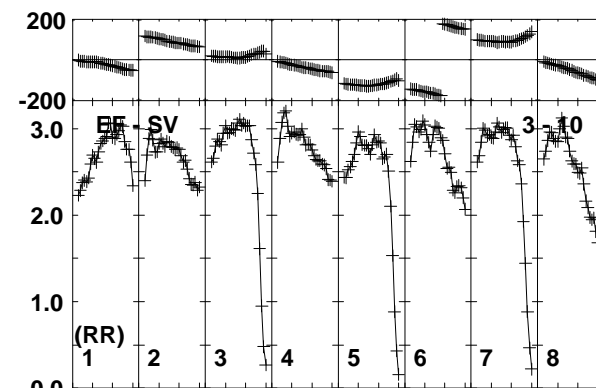
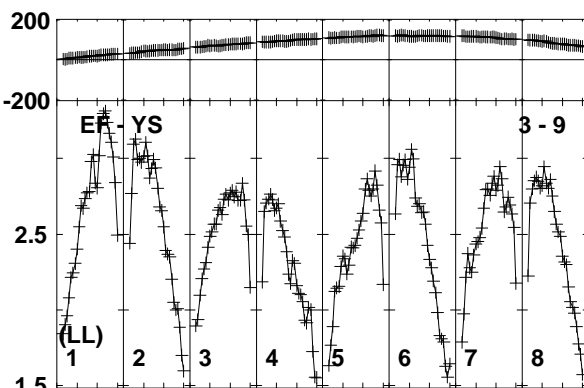
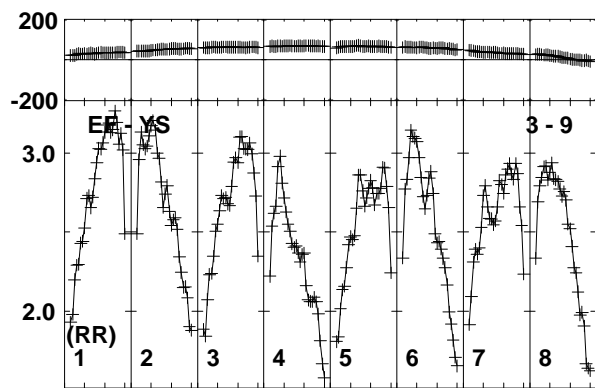
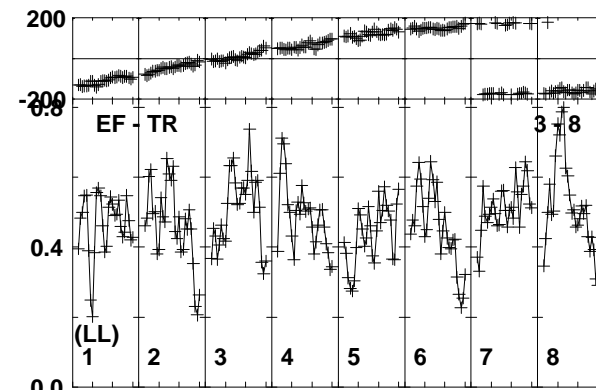
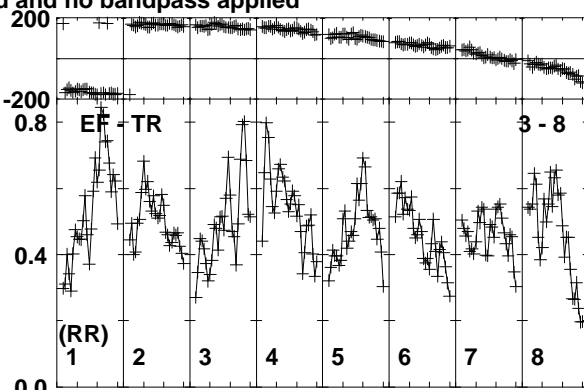
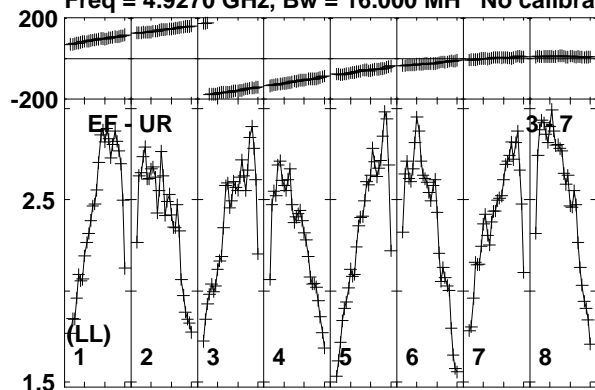

Lower frame: Milli Ampl Jy Top frame: Phas deg
Vector averaged cross-power spectrum Baseline: EF (03) - UR (07)
Timerange: 00/04:24:01 to 00/04:25:19

Plot file version 230 created 17-FEB-2020 15:42:59

J1359+5544 EK047 2.UVDATA.1

Freq = 4.9270 GHz, Bw = 16.000 MH No calibration applied and no bandpass applied

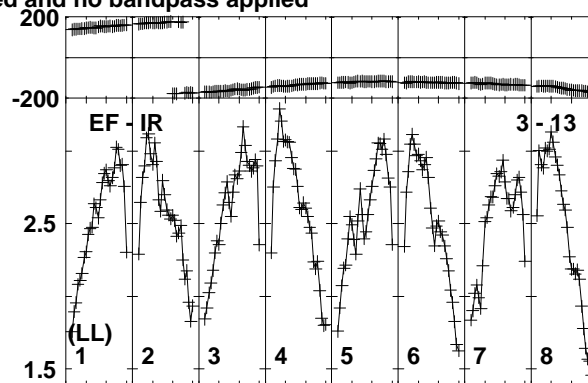
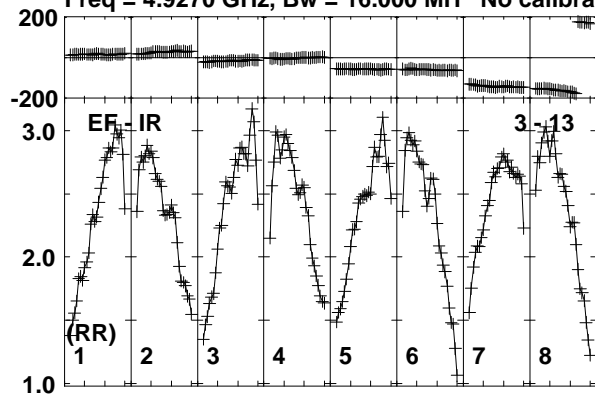

Lower frame: Milli Ampl Jy Top frame: Phas deg
Vector averaged cross-power spectrum Baseline: EF (03) - IR (13)
Timerange: 00/04:24:01 to 00/04:25:19

Plot file version 231 created 17-FEB-2020 15:42:59

J1402+5347 EK047 2.UVDATA.1

Freq = 4.9270 GHz, Bw = 16.000 MH No calibration applied and no bandpass applied

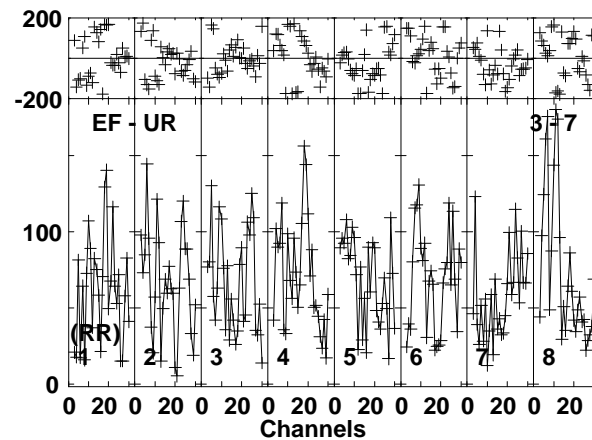
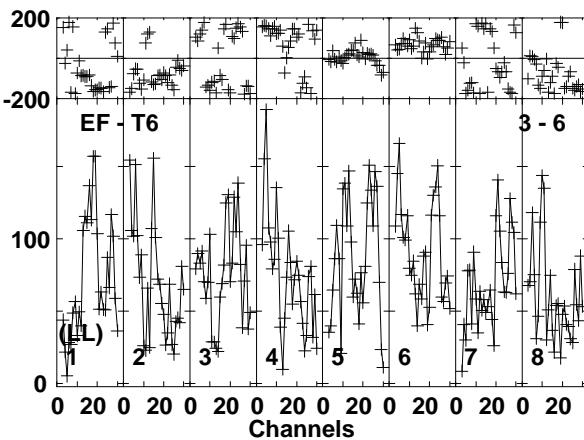
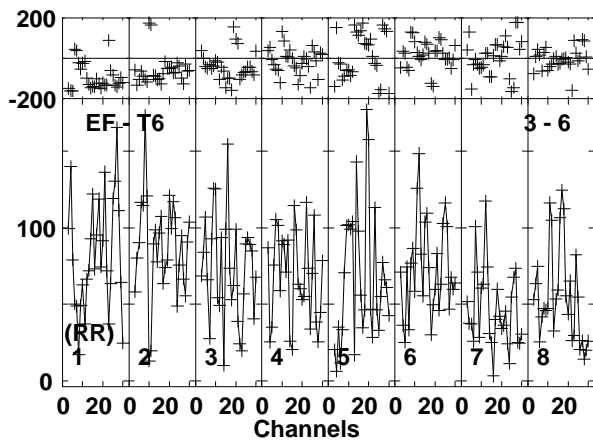
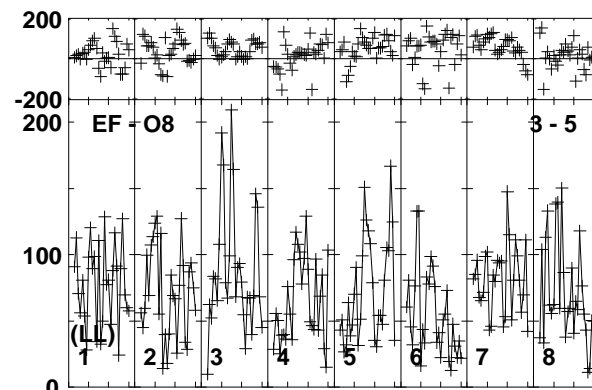
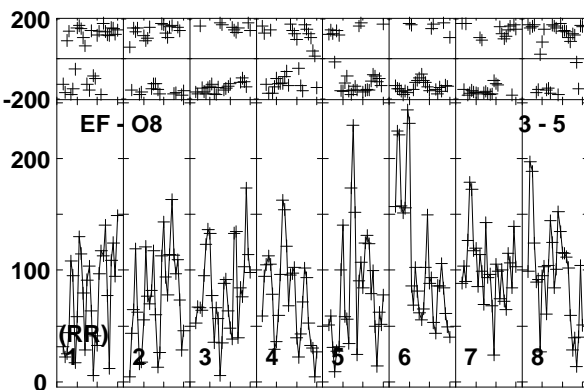
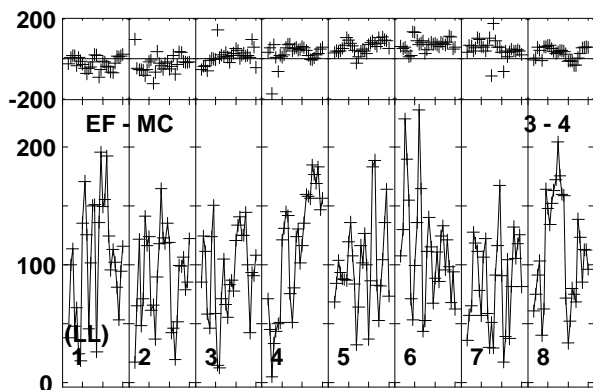
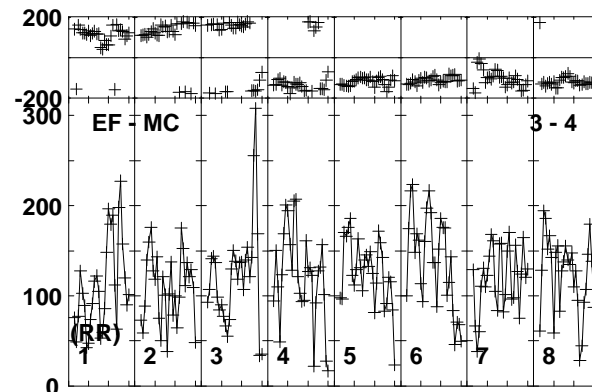
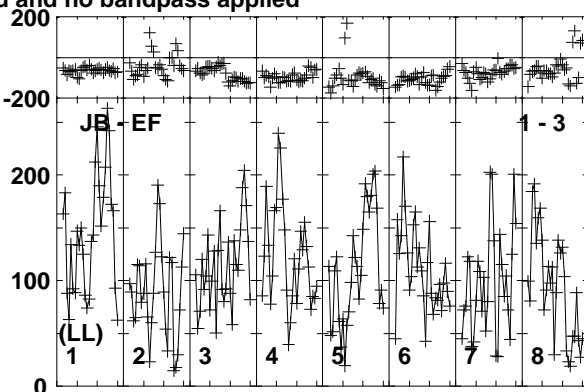
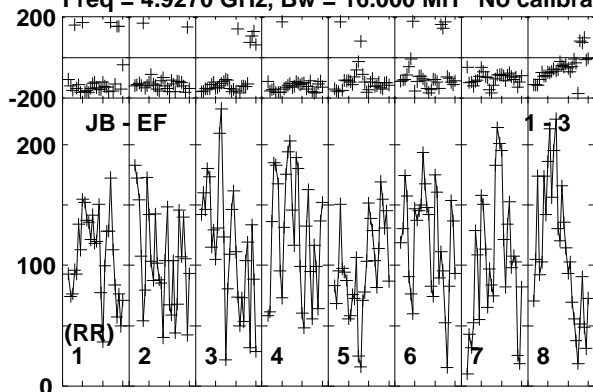

Lower frame: Micro Ampl Jy Top frame: Phas deg
Vector averaged cross-power spectrum Baseline: JB (01) - EF (03)
Timerange: 00/04:25:21 to 00/04:29:19

Plot file version 232 created 17-FEB-2020 15:43:00

J1402+5347 EK047 2.UVDATA.1

Freq = 4.9270 GHz, Bw = 16.000 MH No calibration applied and no bandpass applied

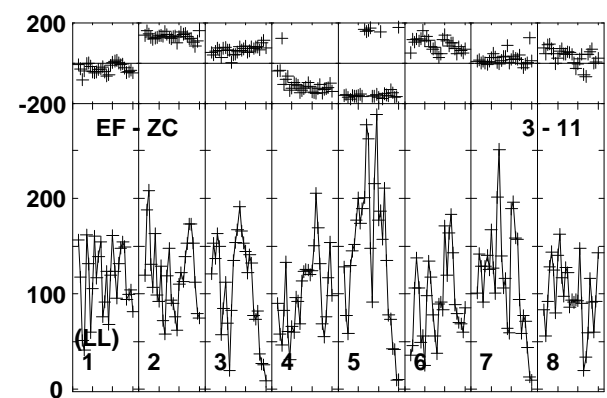
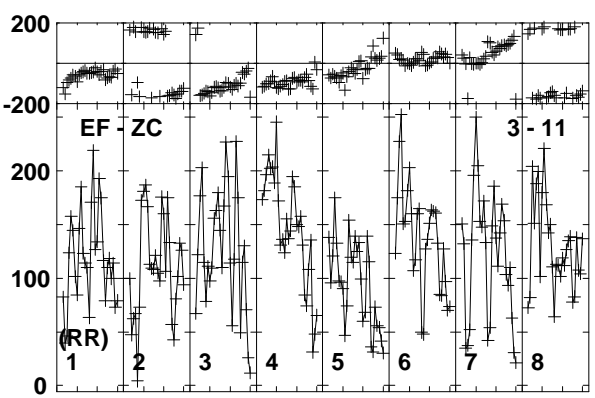
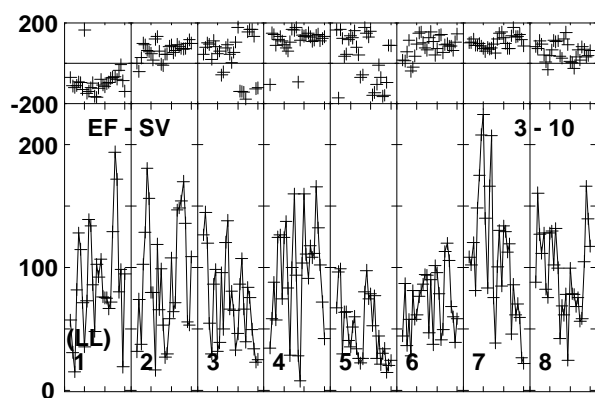
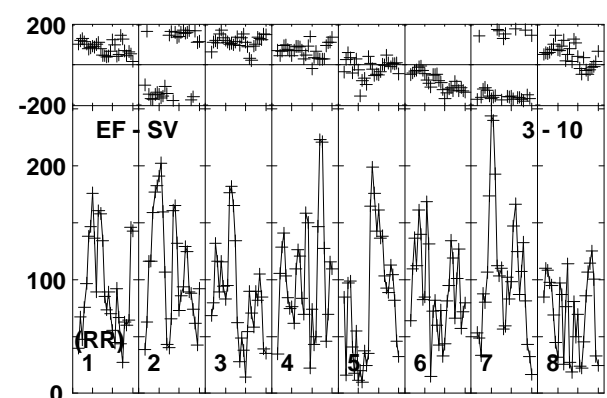
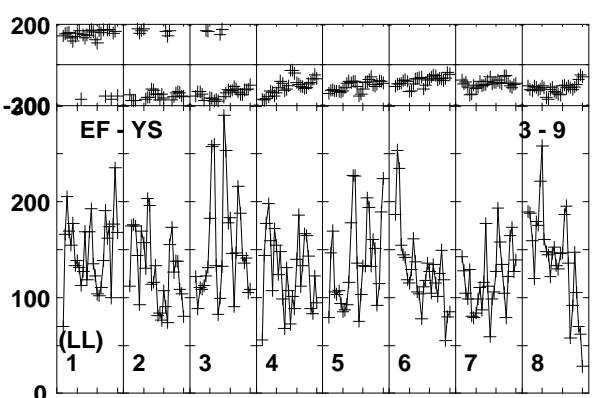
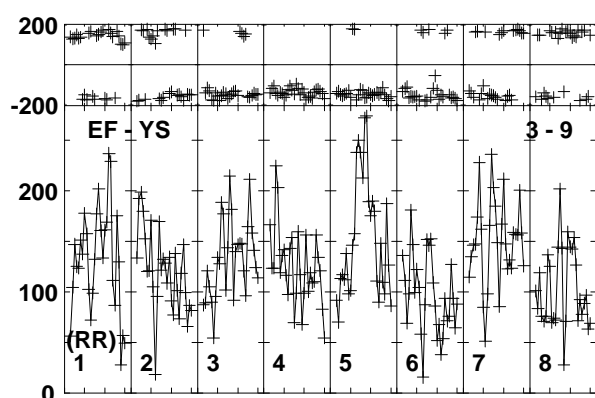
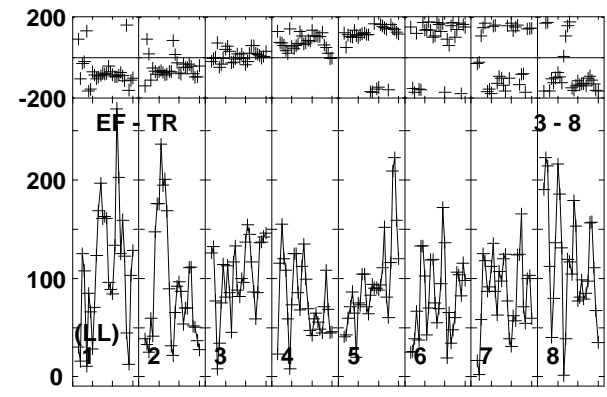
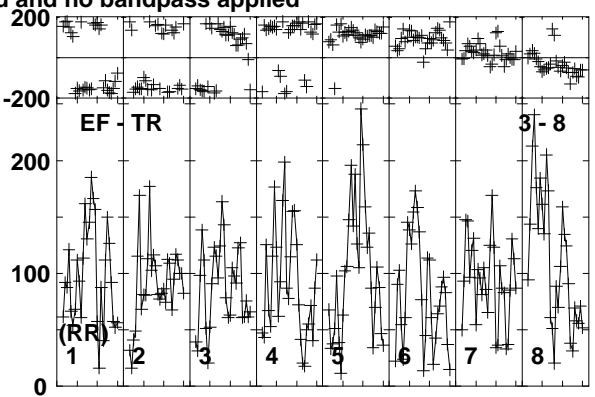
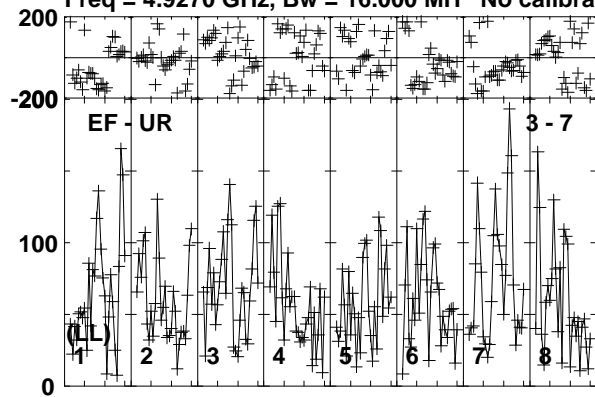

Lower frame: Micro Ampl Jy Top frame: Phas deg
Vector averaged cross-power spectrum Baseline: EF (03) - UR (07)
Timerange: 00/04:25:21 to 00/04:29:19

Plot file version 233 created 17-FEB-2020 15:43:00

J1402+5347 EK047 2.UVDATA.1

Freq = 4.9270 GHz, Bw = 16.000 MH No calibration applied and no bandpass applied

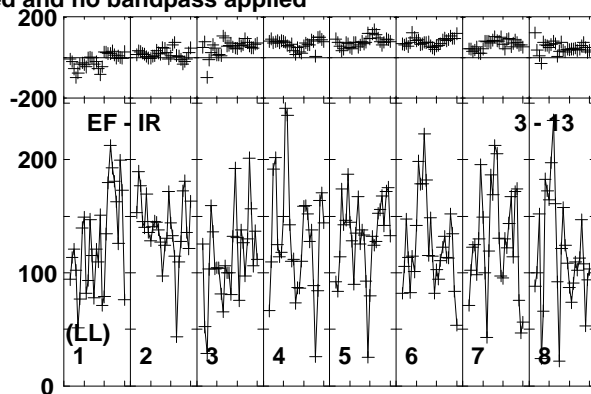
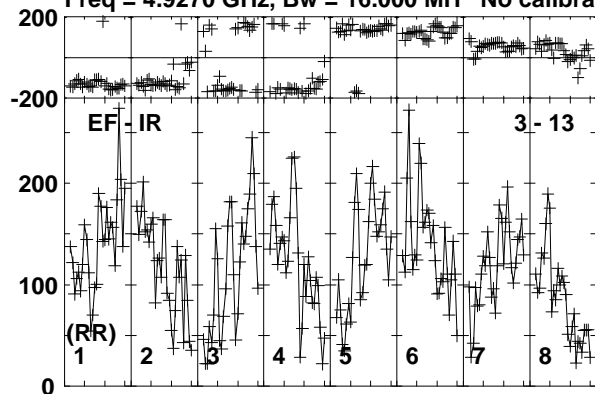

Lower frame: Micro Ampl Jy Top frame: Phas deg
Vector averaged cross-power spectrum Baseline: EF (03) - IR (13)
Timerange: 00/04:25:21 to 00/04:29:19

Plot file version 234 created 17-FEB-2020 15:43:00

J1359+5544 EK047 2.UVDATA.1

Freq = 4.9270 GHz, Bw = 16.000 MH No calibration applied and no bandpass applied

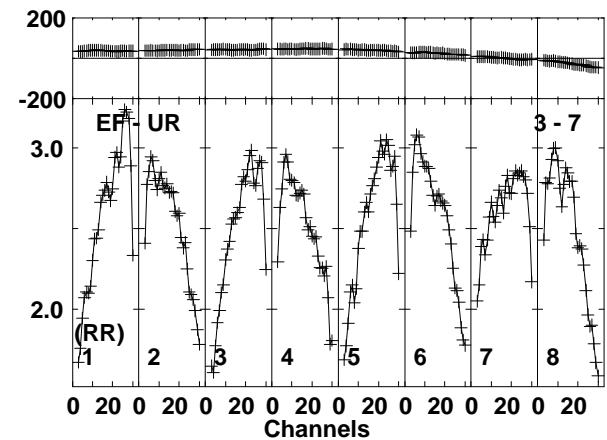
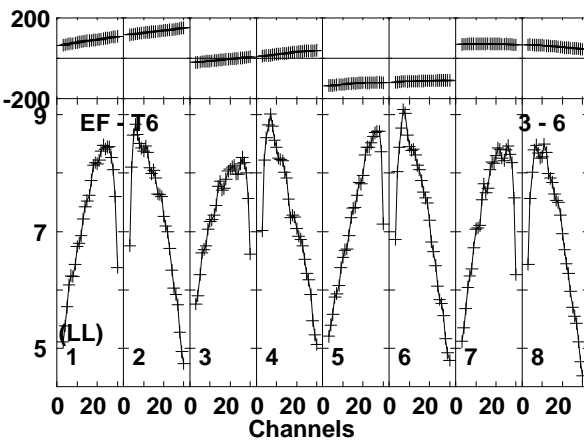
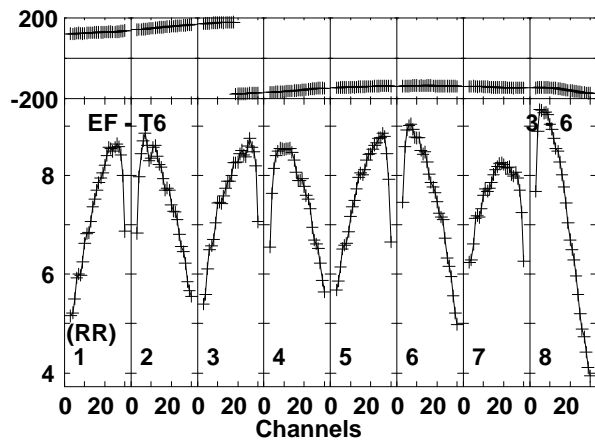
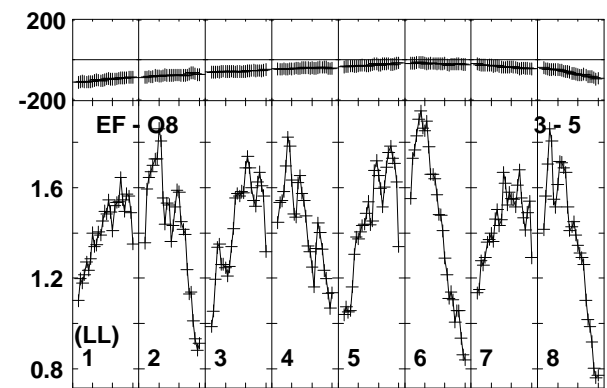
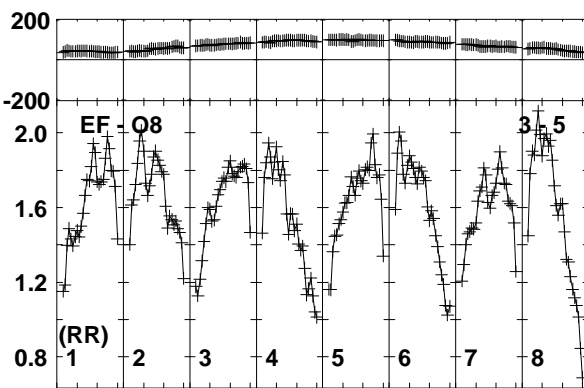
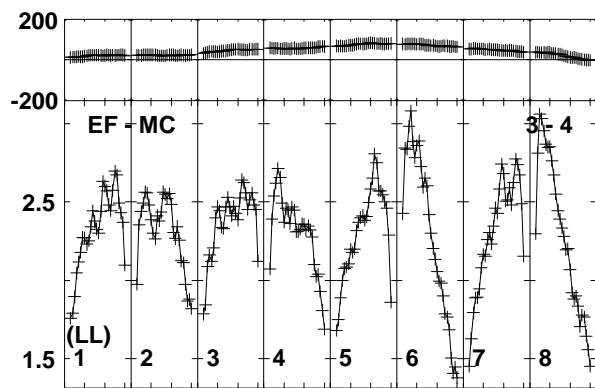
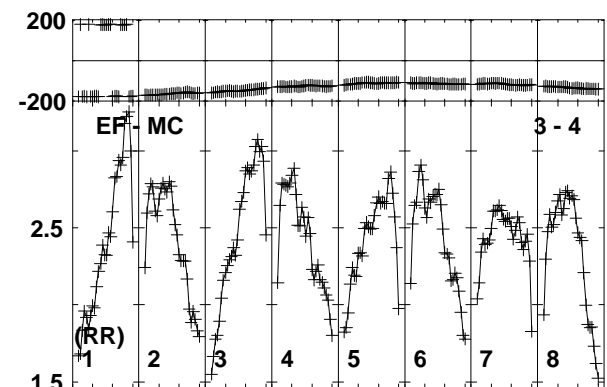
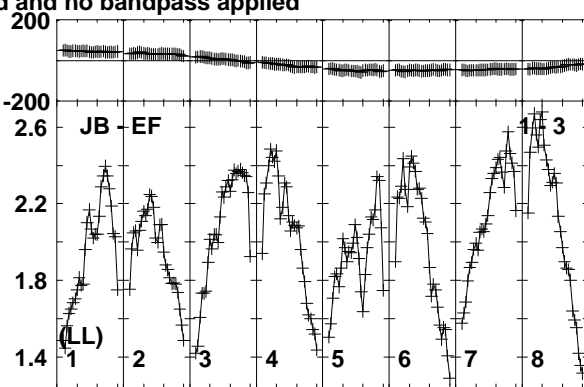
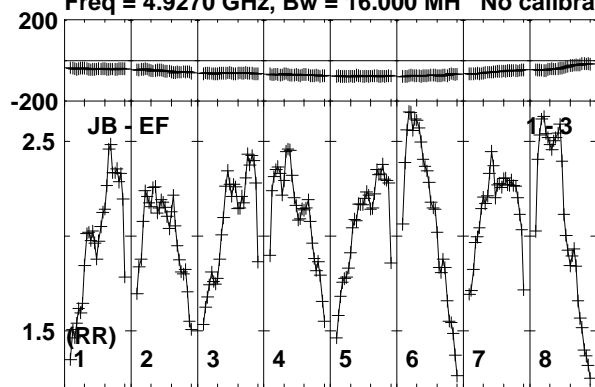

Lower frame: Milli Ampl Jy Top frame: Phas deg
Vector averaged cross-power spectrum Baseline: JB (01) - EF (03)
Timerange: 00/04:29:21 to 00/04:31:19

Plot file version 235 created 17-FEB-2020 15:43:00

J1359+5544 EK047 2.UVDATA.1

Freq = 4.9270 GHz, Bw = 16.000 MH No calibration applied and no bandpass applied

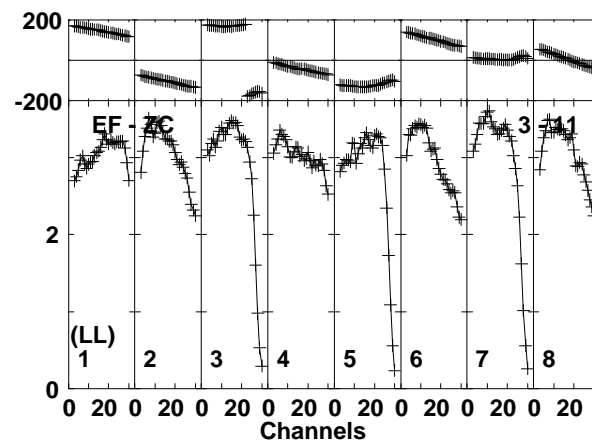
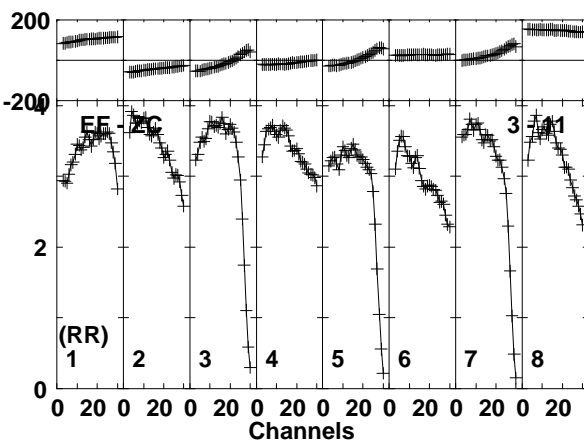
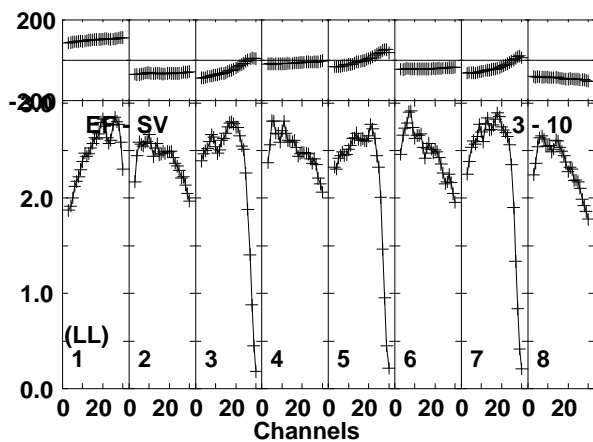
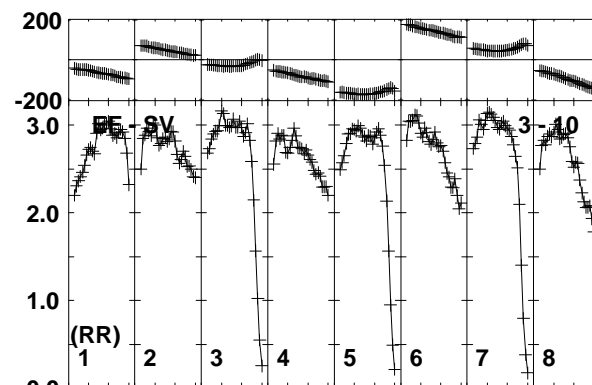
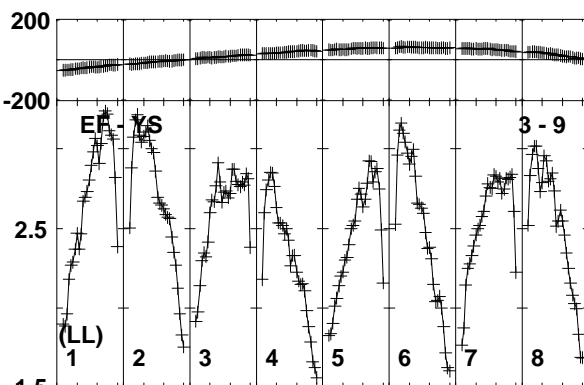
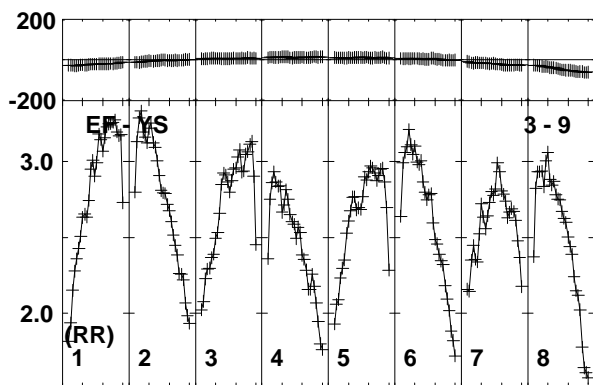
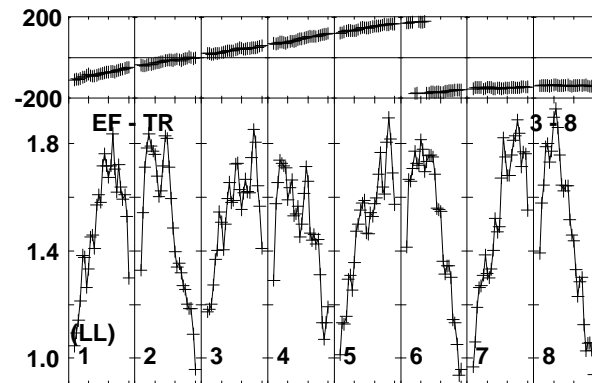
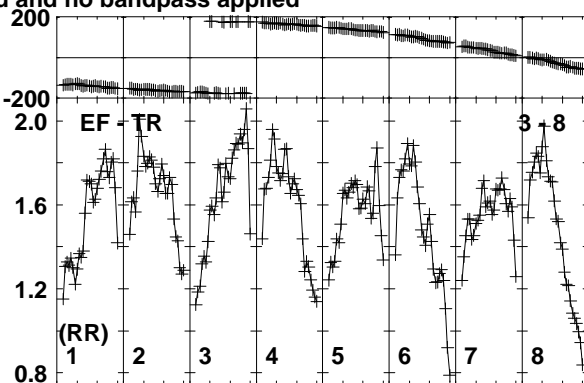
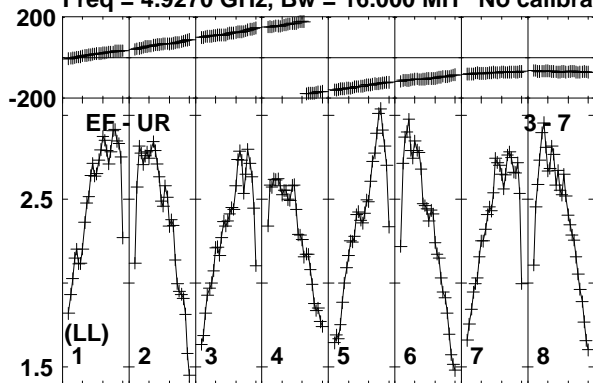

Lower frame: Milli Ampl Jy Top frame: Phas deg
Vector averaged cross-power spectrum Baseline: EF (03) - UR (07)
Timerange: 00/04:29:21 to 00/04:31:19

Plot file version 236 created 17-FEB-2020 15:43:00

J1359+5544 EK047 2.UVDATA.1

Freq = 4.9270 GHz, Bw = 16.000 MH No calibration applied and no bandpass applied

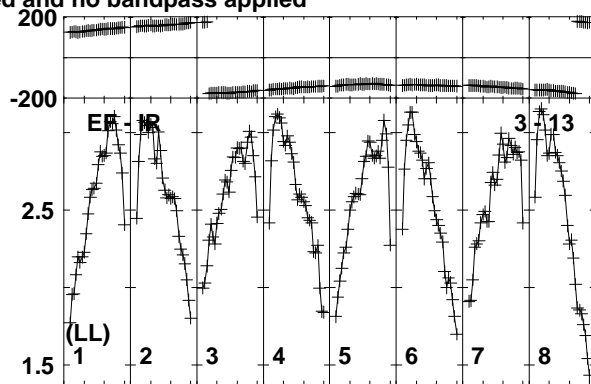
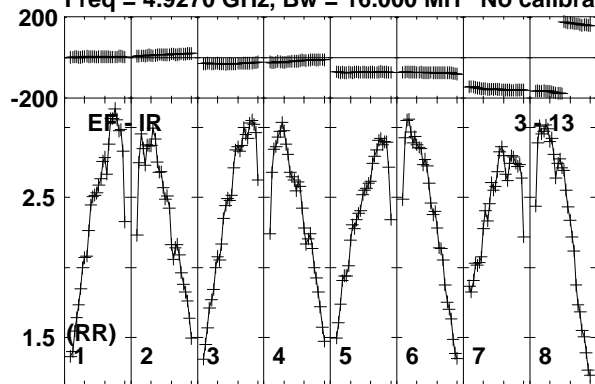

Lower frame: Milli Ampl Jy Top frame: Phas deg
Vector averaged cross-power spectrum Baseline: EF (03) - IR (13)
Timerange: 00/04:29:21 to 00/04:31:19

Plot file version 237 created 17-FEB-2020 15:43:00

J1402+5347 EK047 2.UVDATA.1

Freq = 4.9270 GHz, Bw = 16.000 MH No calibration applied and no bandpass applied

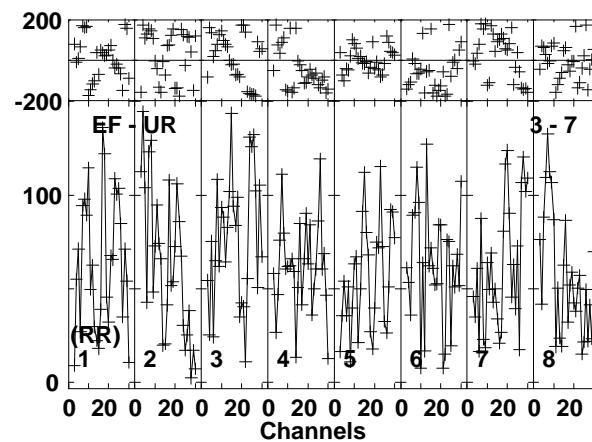
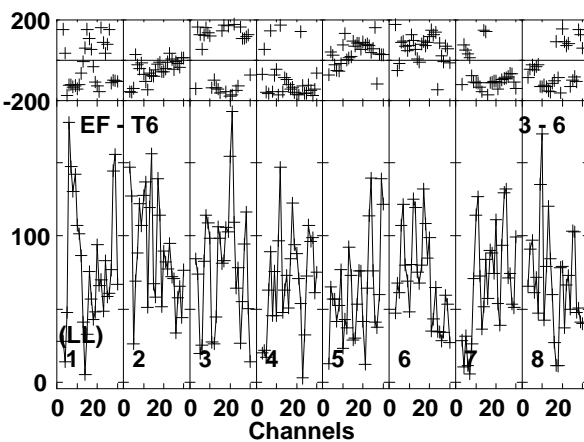
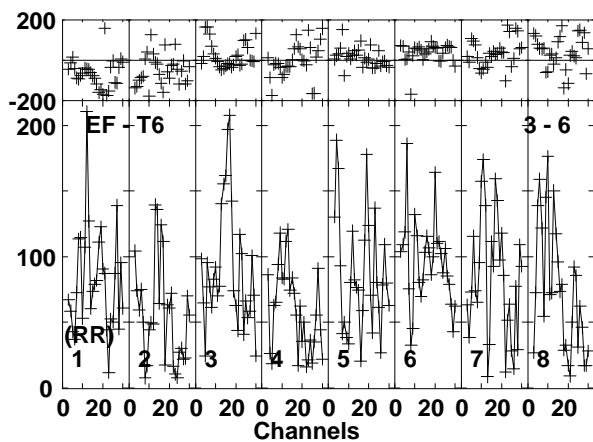
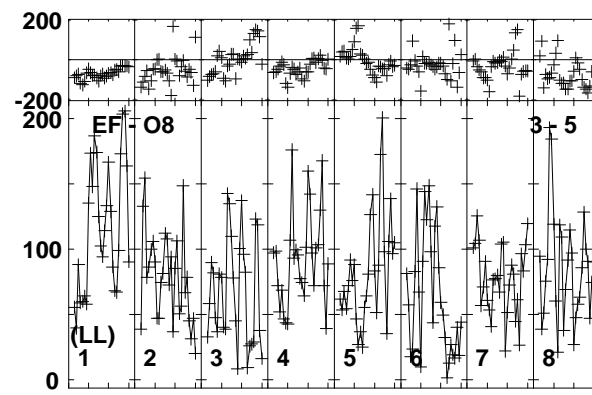
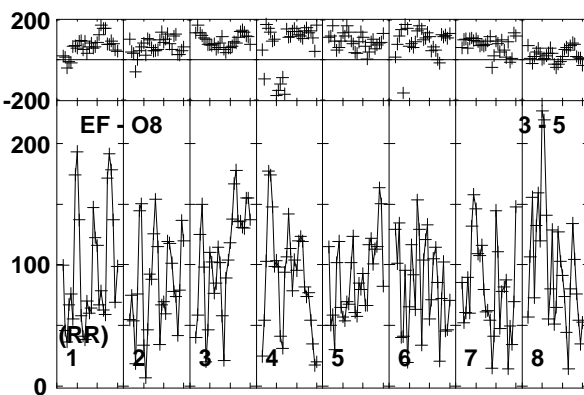
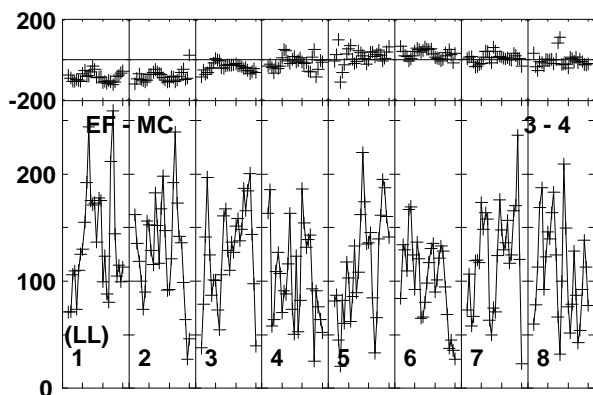
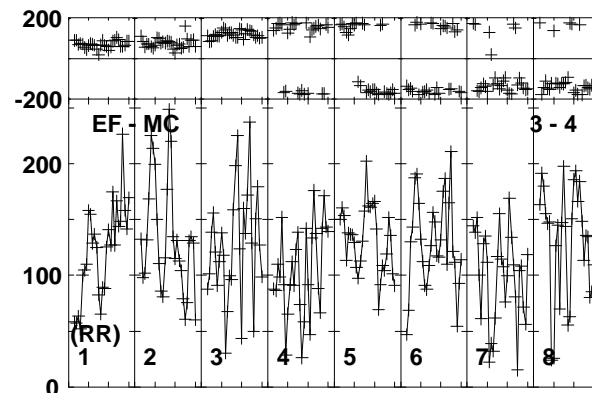
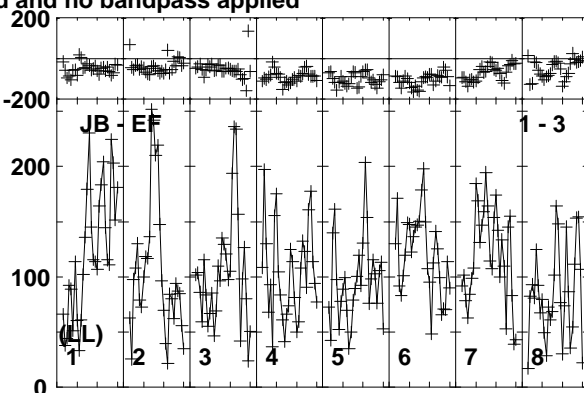
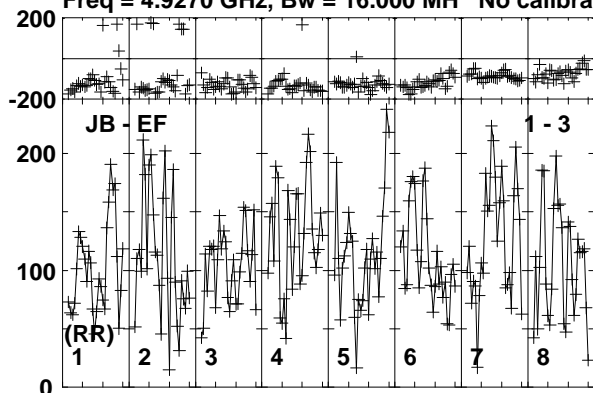

Lower frame: Micro Ampl Jy Top frame: Phas deg
Vector averaged cross-power spectrum Baseline: JB (01) - EF (03)
Timerange: 00/04:31:21 to 00/04:35:19

Plot file version 238 created 17-FEB-2020 15:43:00

J1402+5347 EK047 2.UVDATA.1

Freq = 4.9270 GHz, Bw = 16.000 MH No calibration applied and no bandpass applied

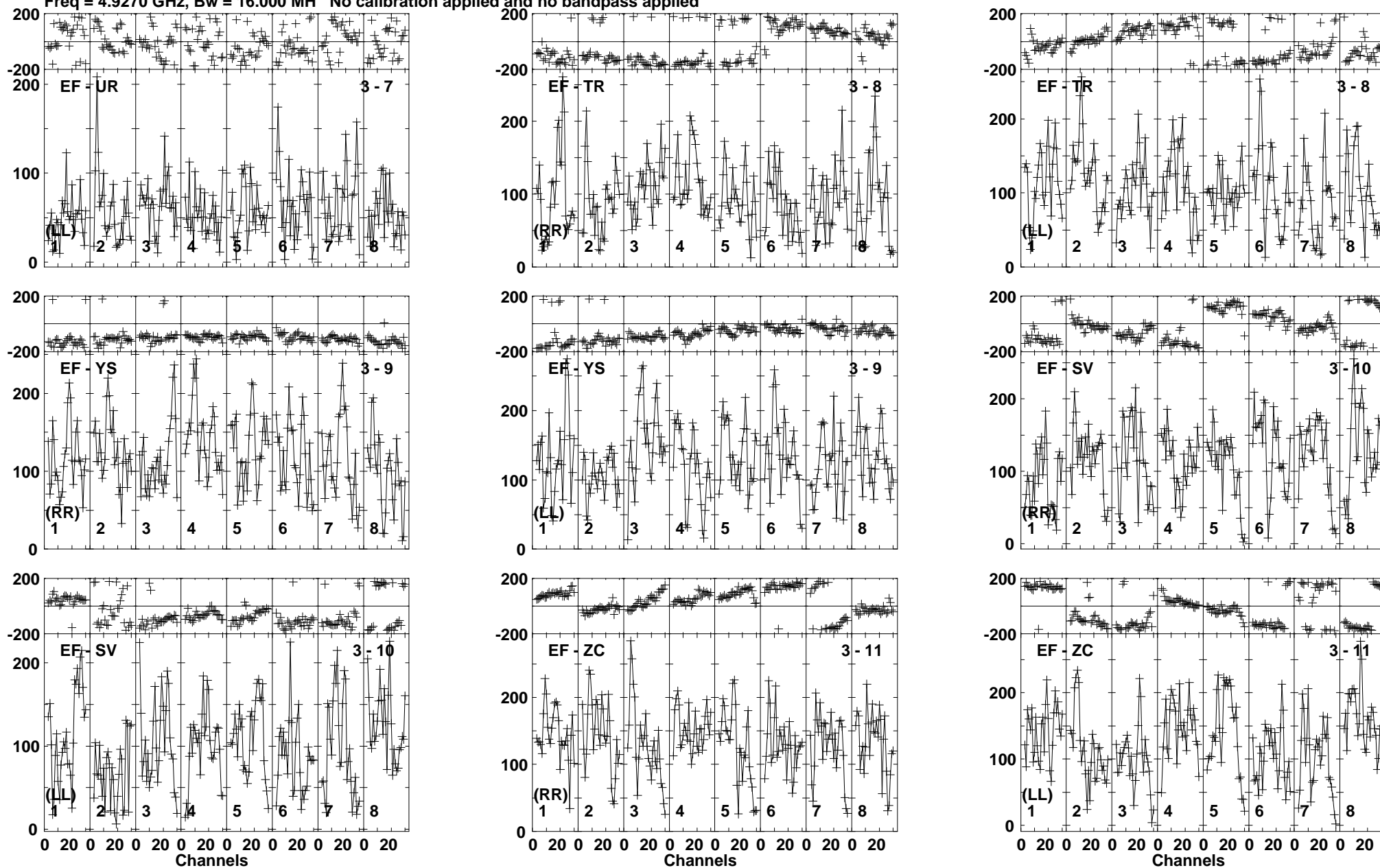

Lower frame: Micro Ampl Jy Top frame: Phas deg
Vector averaged cross-power spectrum Baseline: EF (03) - UR (07)
Timerange: 00/04:31:21 to 00/04:35:19

Plot file version 239 created 17-FEB-2020 15:43:00

J1402+5347 EK047 2.UVDATA.1

Freq = 4.9270 GHz, Bw = 16.000 MH No calibration applied and no bandpass applied

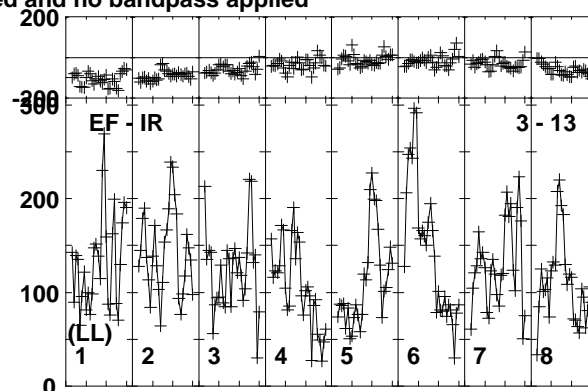
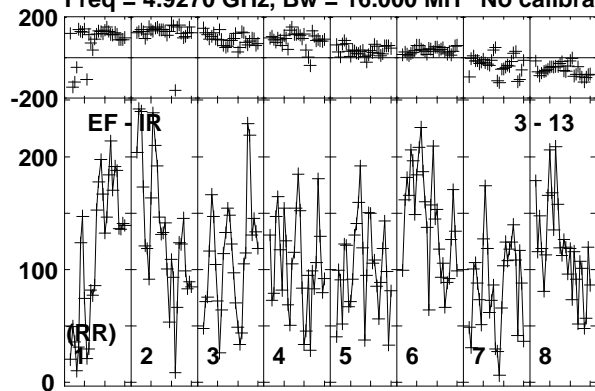

Lower frame: Micro Ampl Jy Top frame: Phas deg
Vector averaged cross-power spectrum Baseline: EF (03) - IR (13)
Timerange: 00/04:31:21 to 00/04:35:19

Plot file version 240 created 17-FEB-2020 15:43:00

J1359+5544 EK047 2.UVDATA.1

Freq = 4.9270 GHz, Bw = 16.000 MH No calibration applied and no bandpass applied

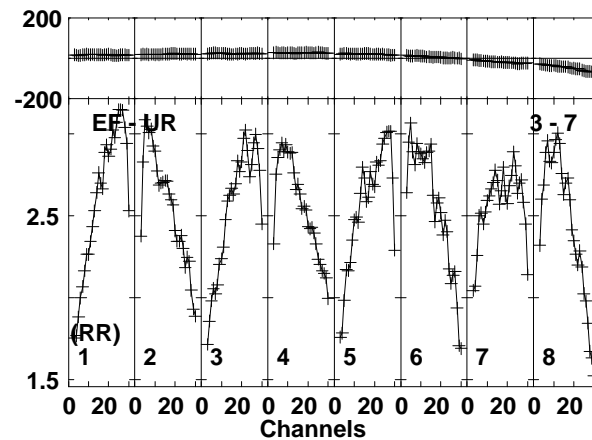
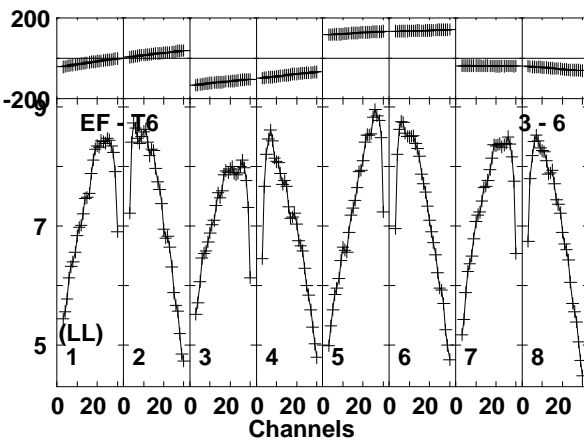
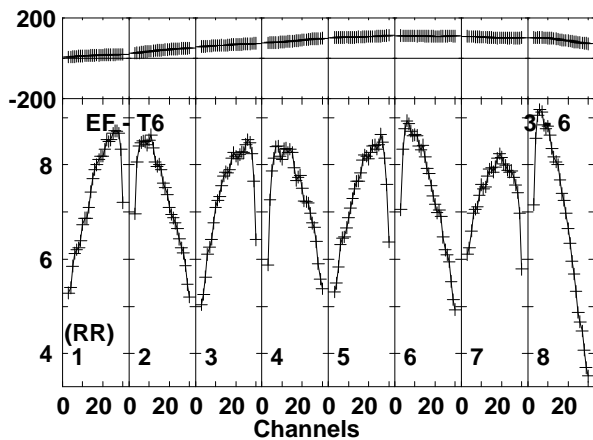
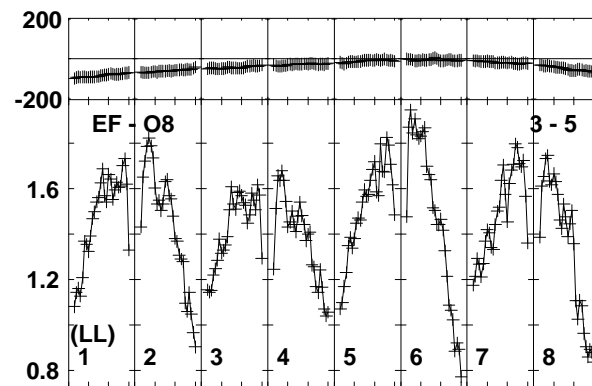
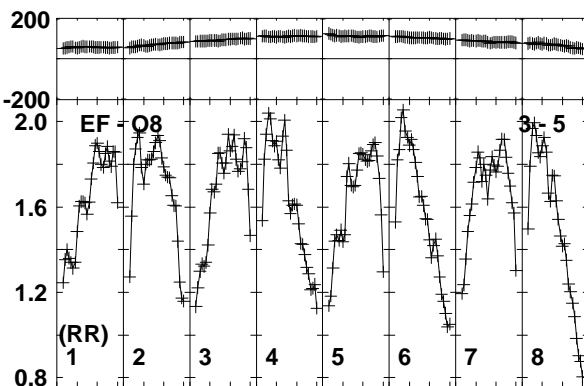
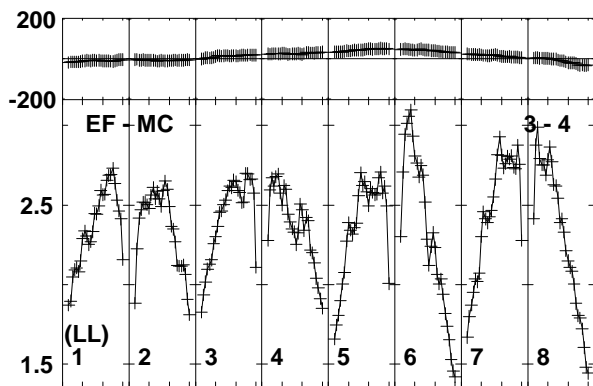
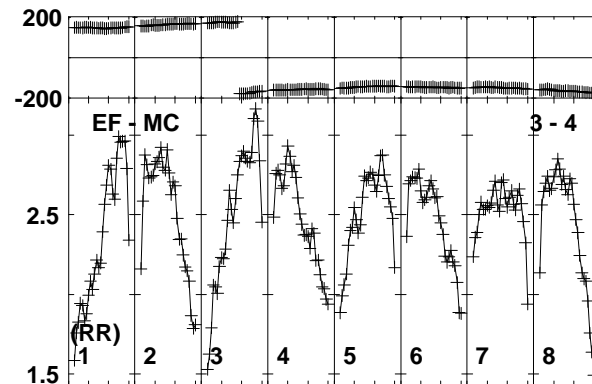
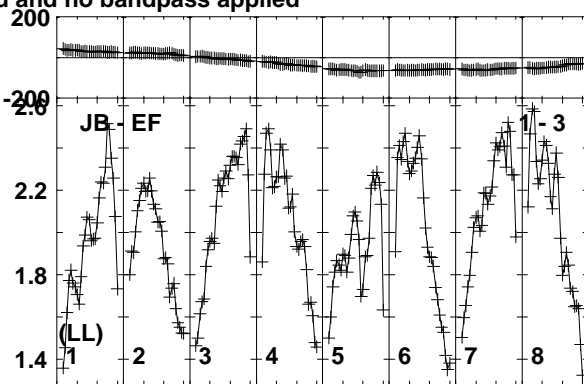
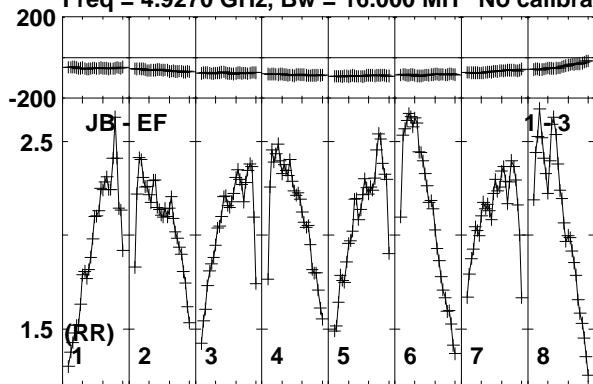

Lower frame: Milli Ampl Jy Top frame: Phas deg
Vector averaged cross-power spectrum Baseline: JB (01) - EF (03)
Timerange: 00/04:36:01 to 00/04:37:19

Plot file version 241 created 17-FEB-2020 15:43:00

J1359+5544 EK047 2.UVDATA.1

Freq = 4.9270 GHz, Bw = 16.000 MH No calibration applied and no bandpass applied

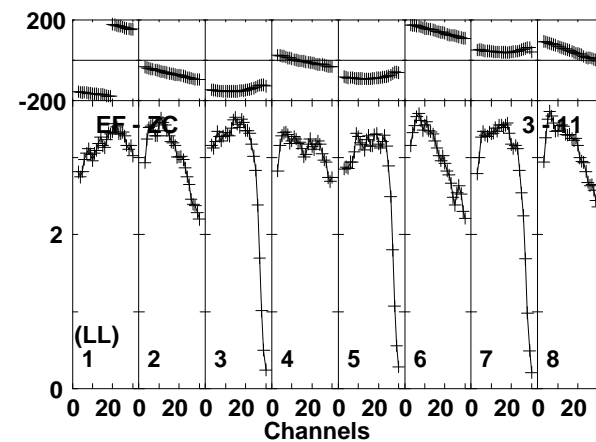
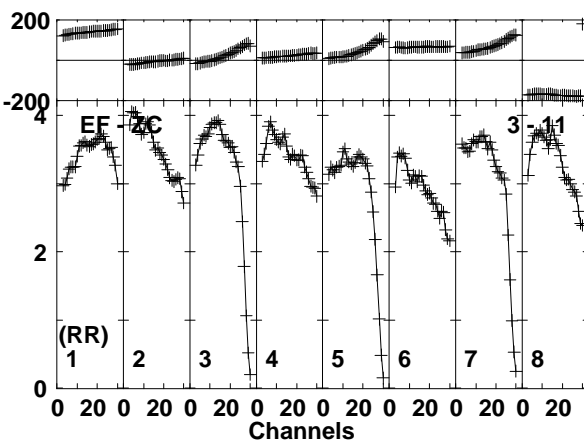
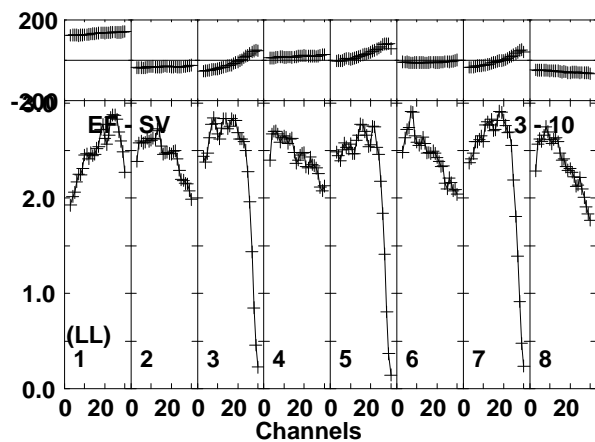
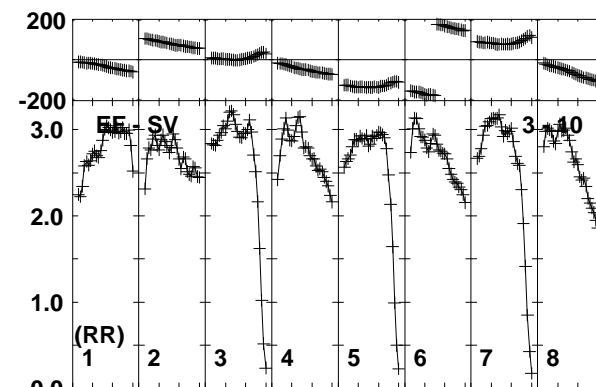
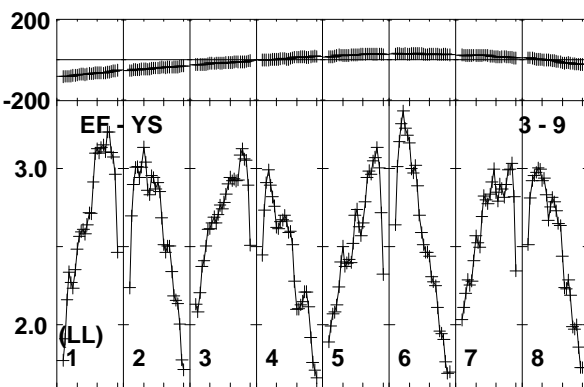
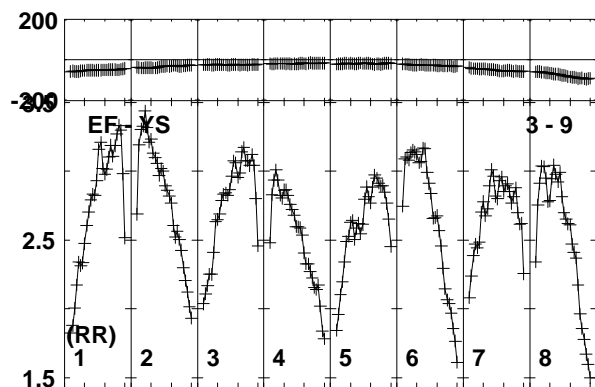
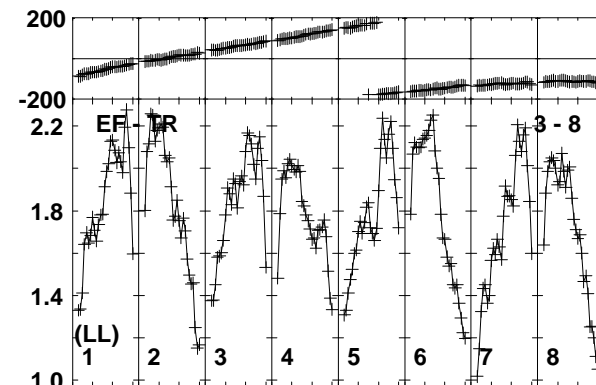
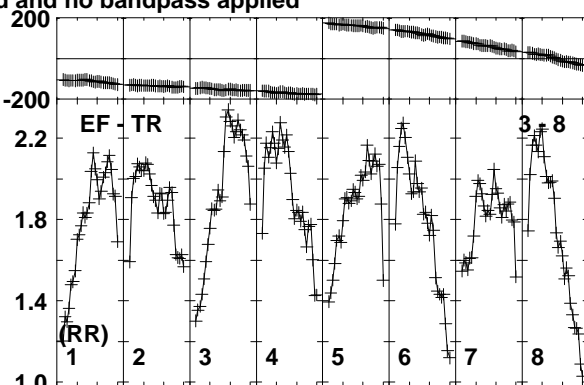
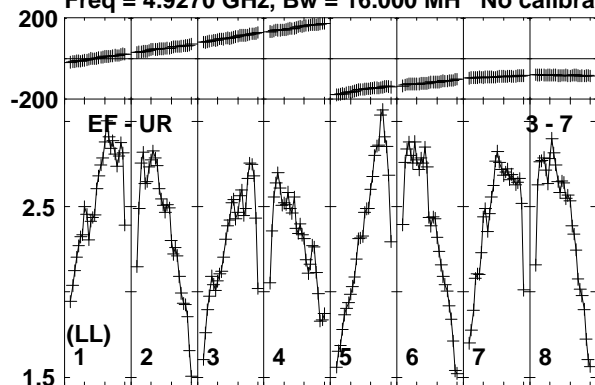

Lower frame: Milli Ampl Jy Top frame: Phas deg
Vector averaged cross-power spectrum Baseline: EF (03) - UR (07)
Timerange: 00/04:36:01 to 00/04:37:19

Plot file version 242 created 17-FEB-2020 15:43:00

J1402+5347 EK047 2.UVDATA.1

Freq = 4.9270 GHz, Bw = 16.000 MH No calibration applied and no bandpass applied

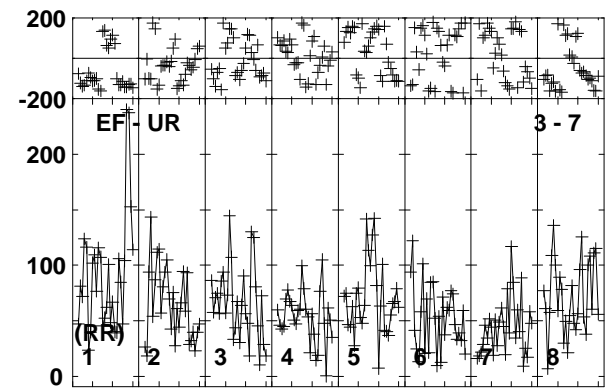
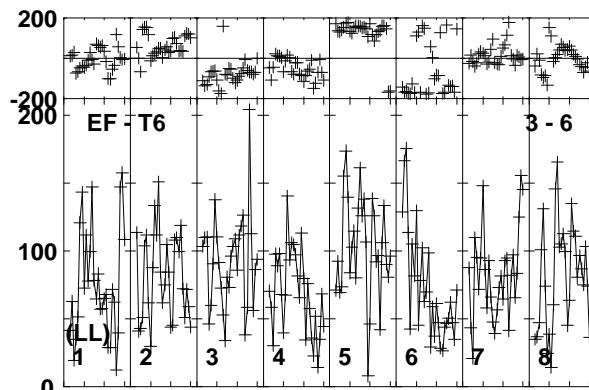
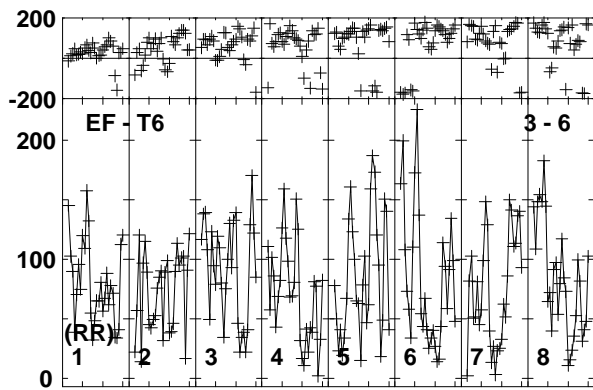
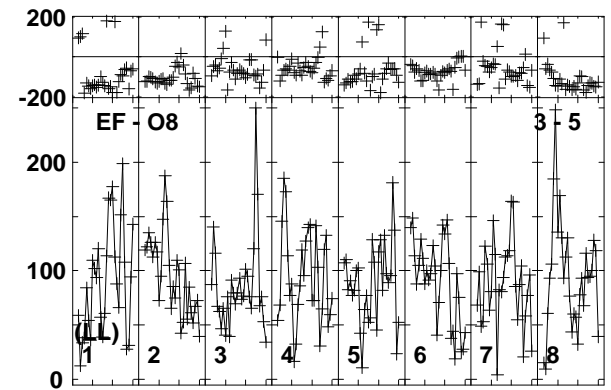
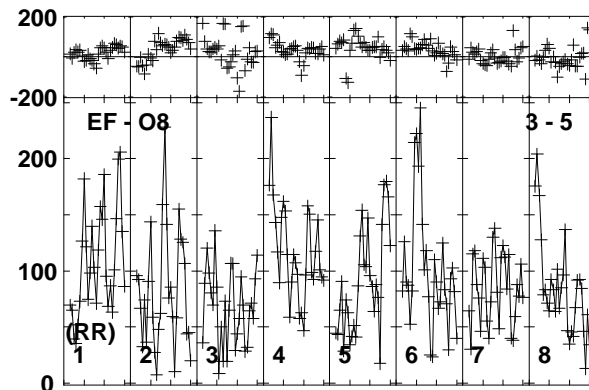
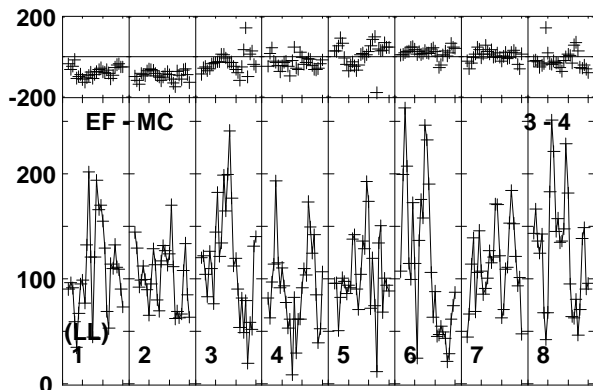
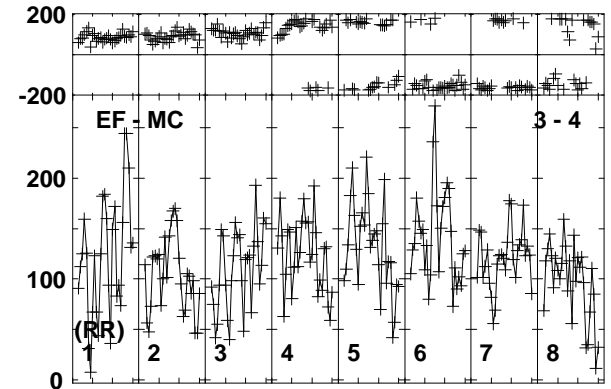
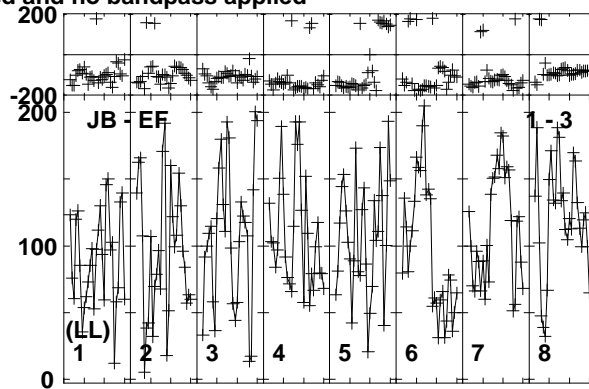
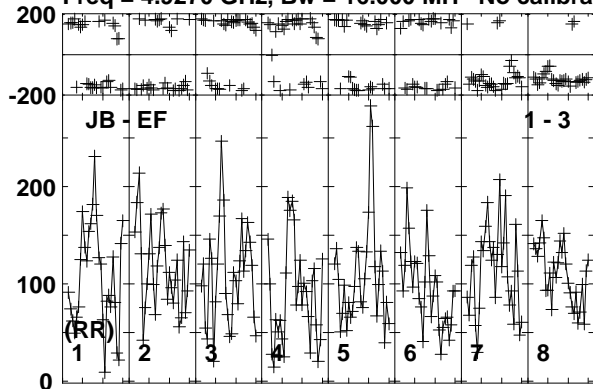

Lower frame: Micro Ampl Jy Top frame: Phas deg
Vector averaged cross-power spectrum Baseline: JB (01) - EF (03)
Timerange: 00/04:37:21 to 00/04:41:19

Plot file version 243 created 17-FEB-2020 15:43:00

J1402+5347 EK047 2.UVDATA.1

Freq = 4.9270 GHz, Bw = 16.000 MH No calibration applied and no bandpass applied

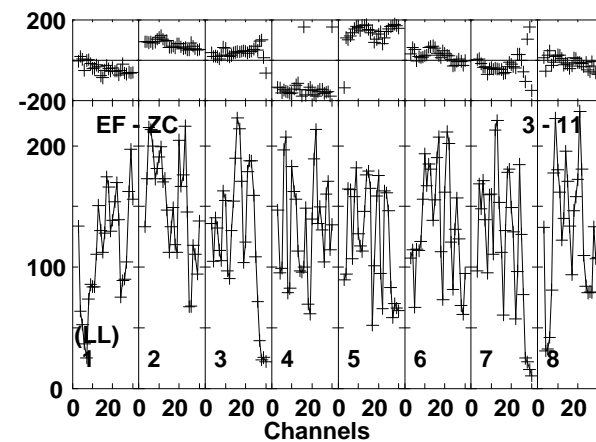
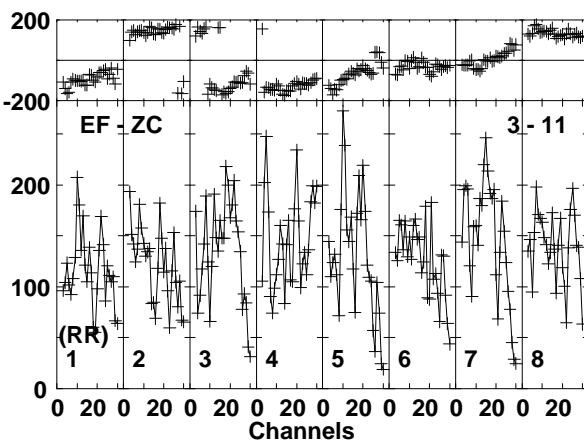
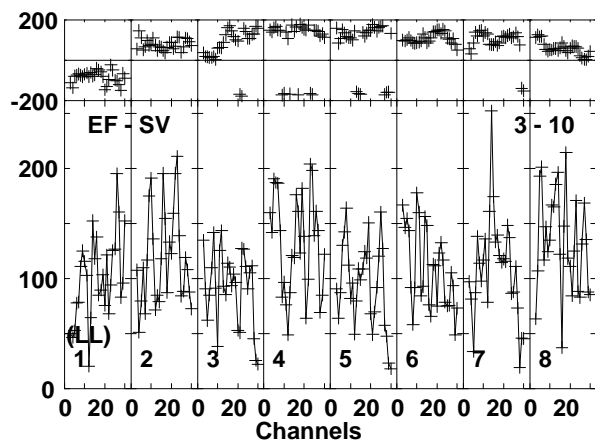
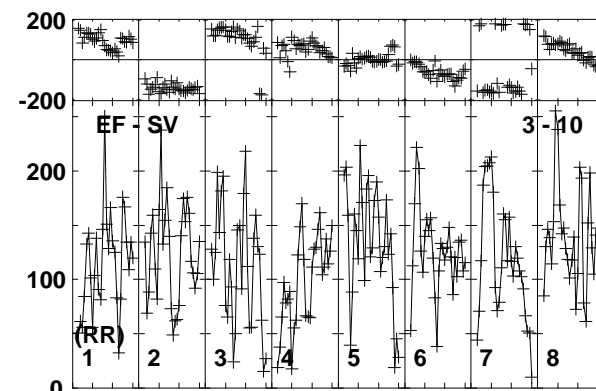
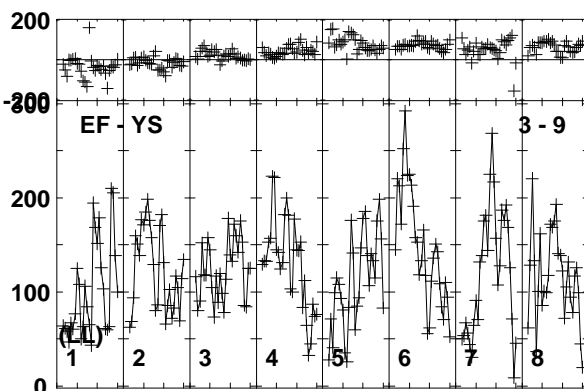
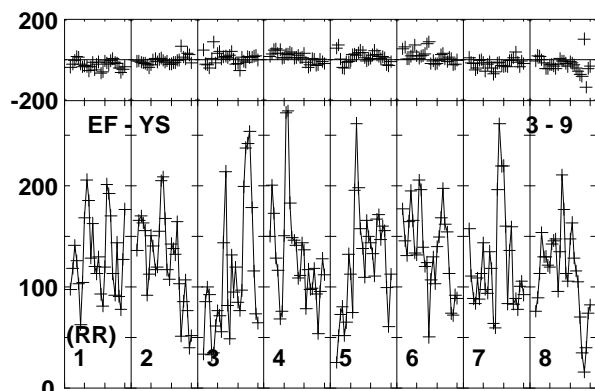
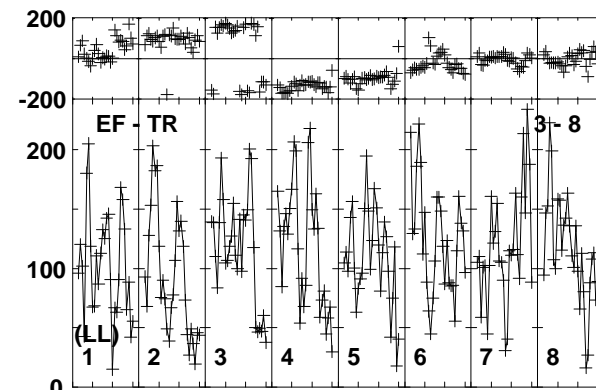
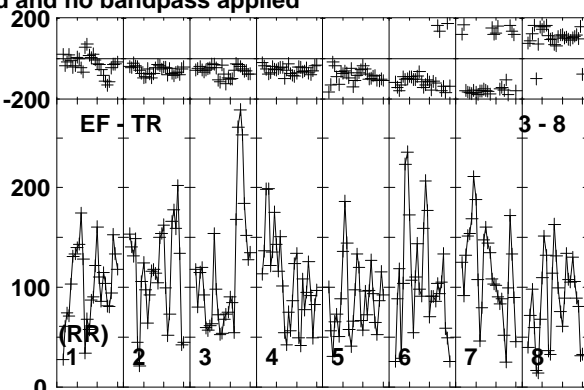
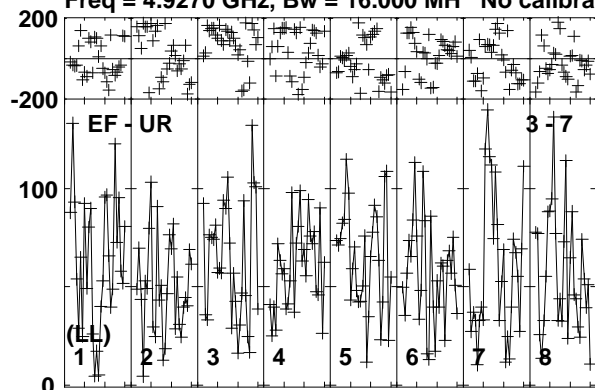

Lower frame: Micro Ampl Jy Top frame: Phas deg
Vector averaged cross-power spectrum Baseline: EF (03) - UR (07)
Timerange: 00/04:37:21 to 00/04:41:19

Plot file version 244 created 17-FEB-2020 15:43:01

J1359+5544 EK047 2.UVDATA.1

Freq = 4.9270 GHz, Bw = 16.000 MH No calibration applied and no bandpass applied

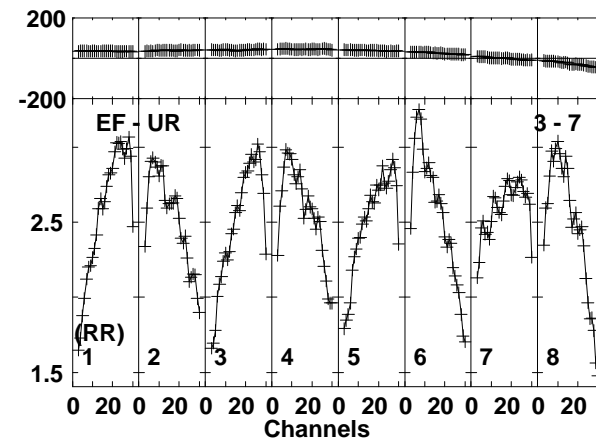
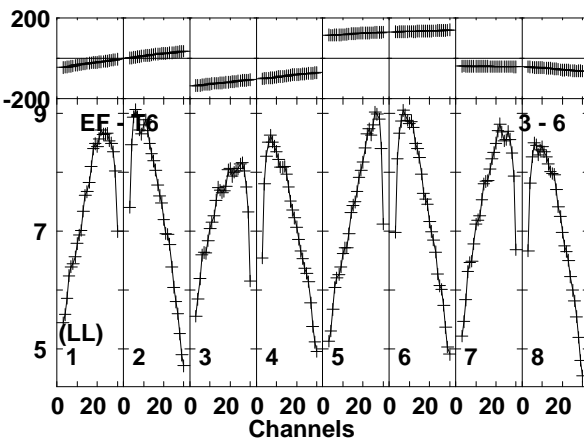
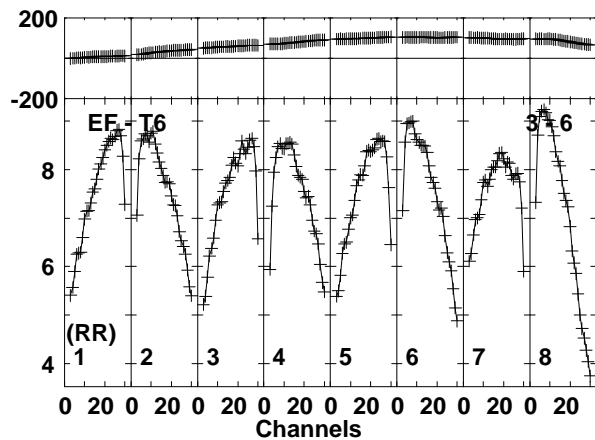
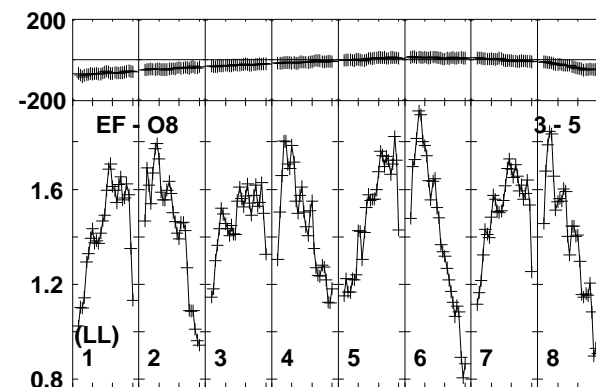
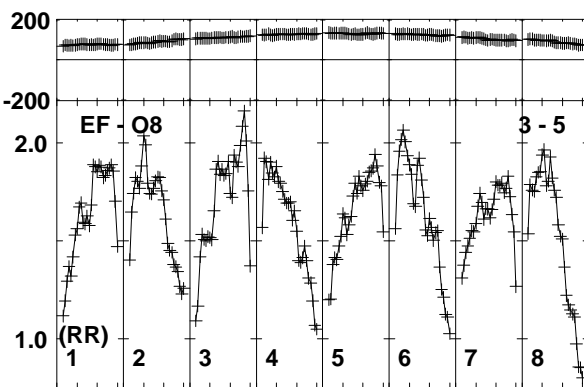
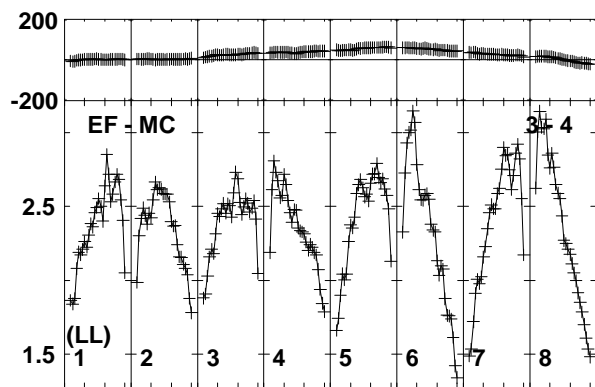
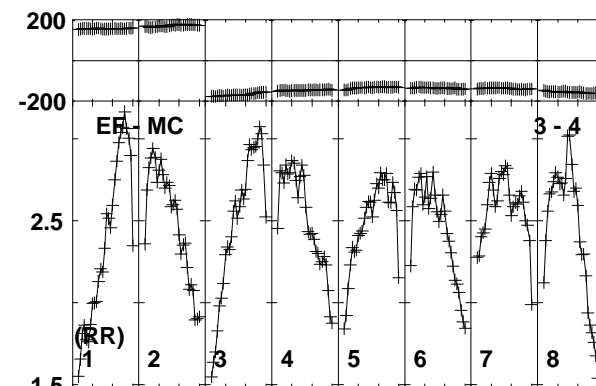
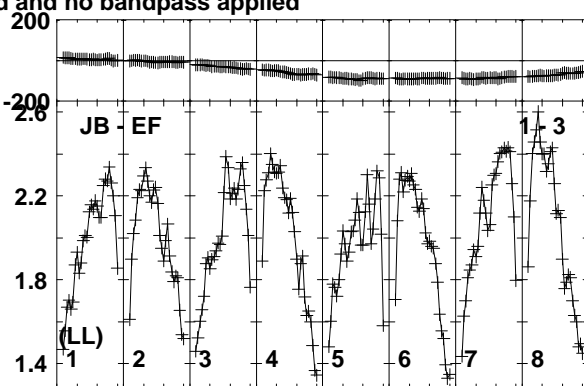
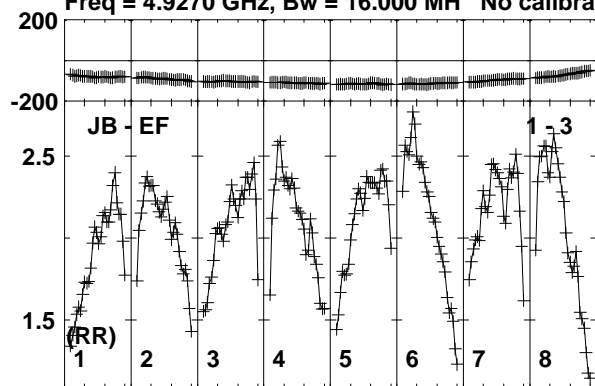

Lower frame: Milli Ampl Jy Top frame: Phas deg
Vector averaged cross-power spectrum Baseline: JB (01) - EF (03)
Timerange: 00/04:41:21 to 00/04:43:19

Plot file version 245 created 17-FEB-2020 15:43:01

J1359+5544 EK047 2.UVDATA.1

Freq = 4.9270 GHz, Bw = 16.000 MH No calibration applied and no bandpass applied

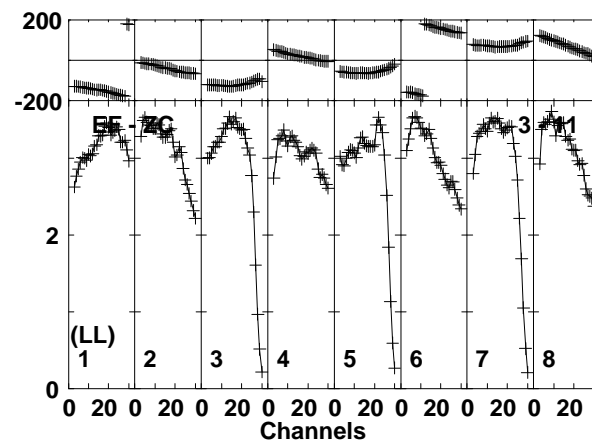
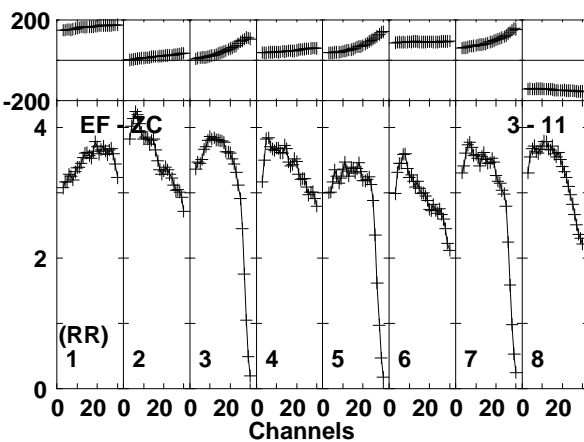
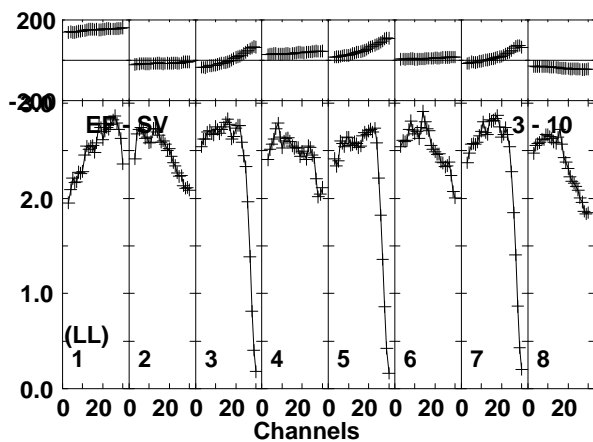
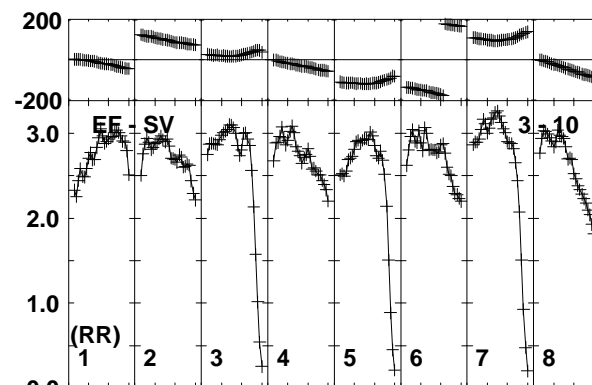
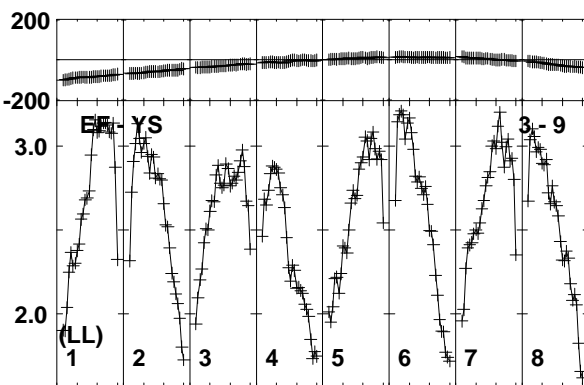
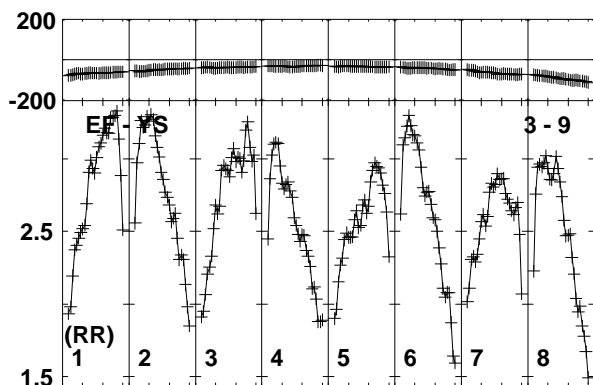
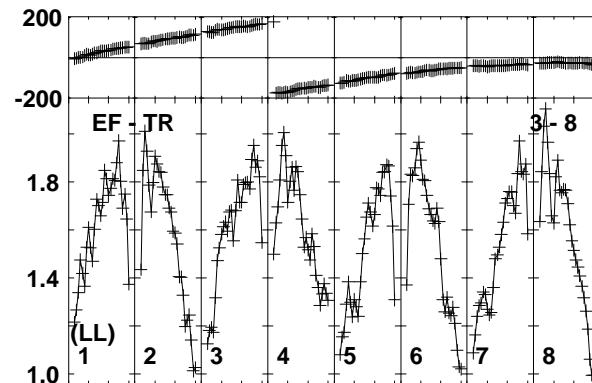
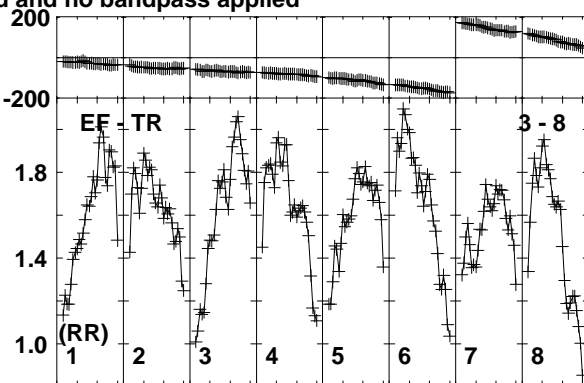
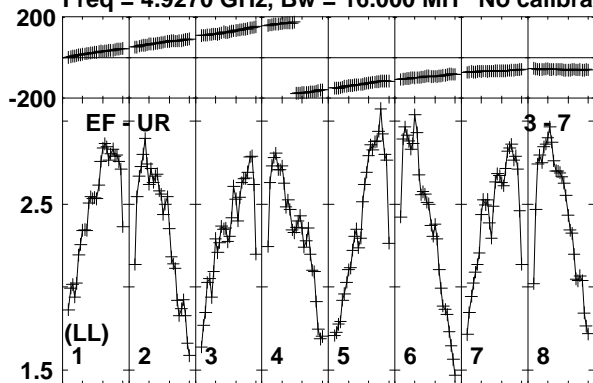

Lower frame: Milli Ampl Jy Top frame: Phas deg
Vector averaged cross-power spectrum Baseline: EF (03) - UR (07)
Timerange: 00/04:41:21 to 00/04:43:19

Plot file version 246 created 17-FEB-2020 15:43:01

J1402+5347 EK047 2.UVDATA.1

Freq = 4.9270 GHz, Bw = 16.000 MH No calibration applied and no bandpass applied

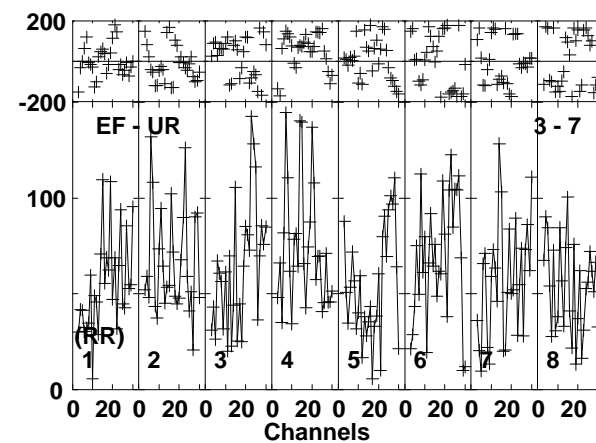
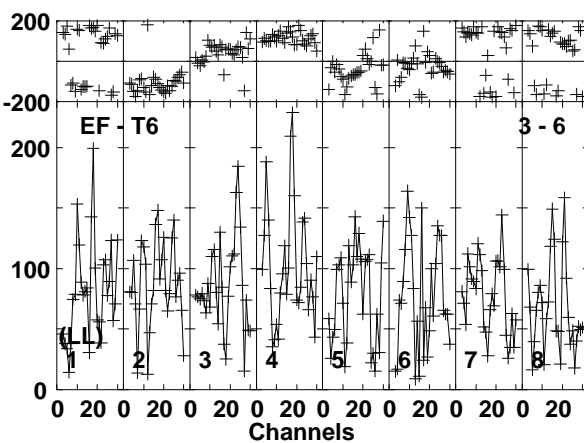
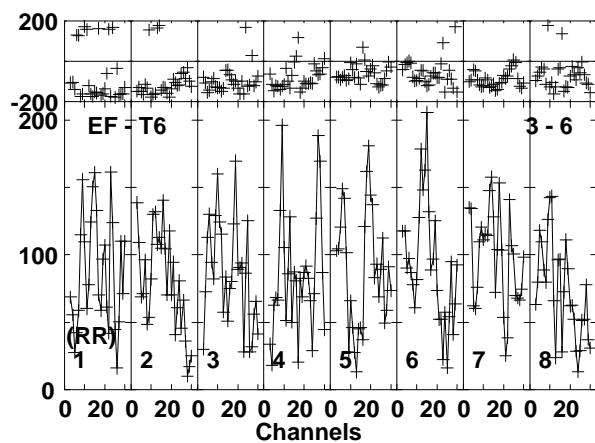
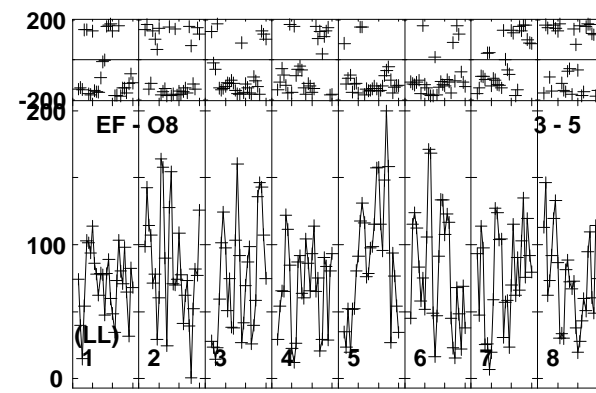
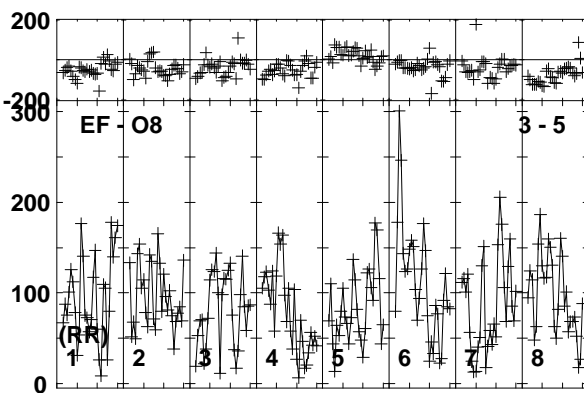
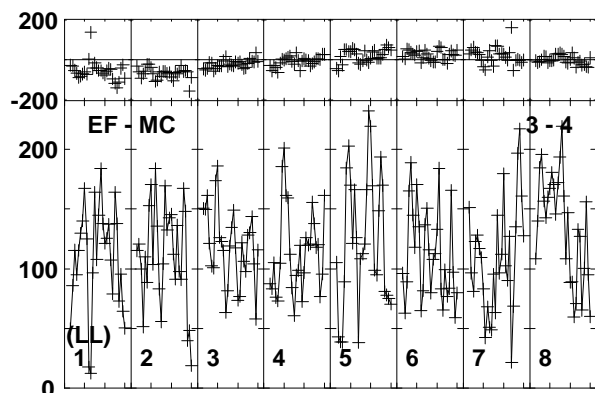
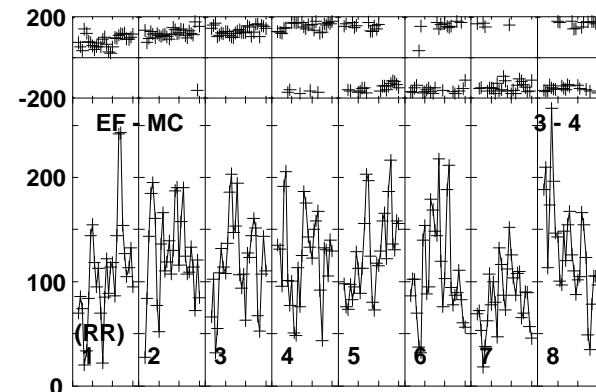
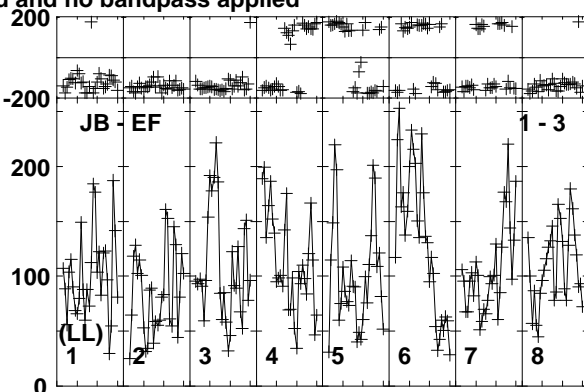
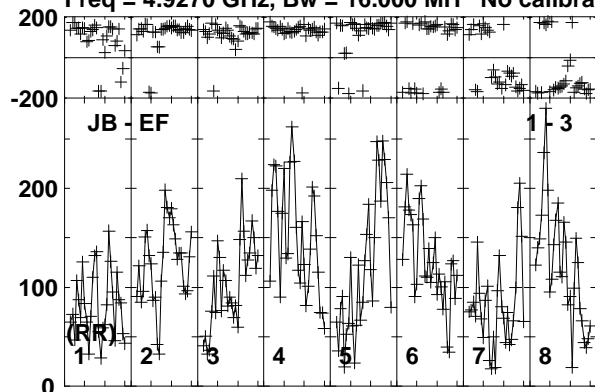

Lower frame: Micro Ampl Jy Top frame: Phas deg
Vector averaged cross-power spectrum Baseline: JB (01) - EF (03)
Timerange: 00/04:43:23 to 00/04:47:19

Plot file version 247 created 17-FEB-2020 15:43:01
 J1402+5347 EK047 2.UVDATA.1
 Freq = 4.9270 GHz, Bw = 16.000 MH No calibration applied and no bandpass applied

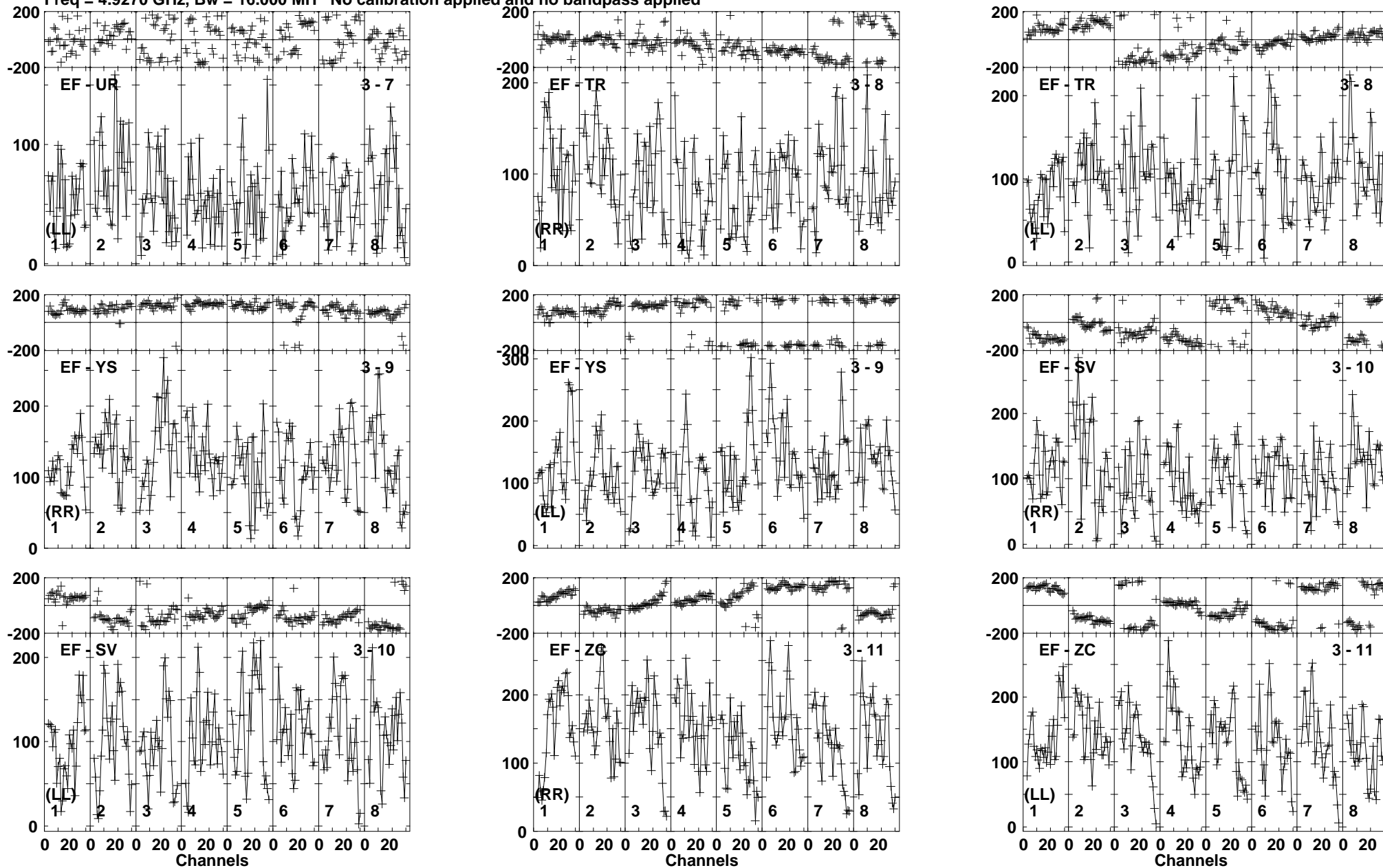

Lower frame: Micro Ampl Jy Top frame: Phas deg
 Vector averaged cross-power spectrum Baseline: EF (03) - UR (07)
 Timerange: 00/04:43:23 to 00/04:47:19

Plot file version 248 created 17-FEB-2020 15:43:01

J1359+5544 EK047 2.UVDATA.1

Freq = 4.9270 GHz, Bw = 16.000 MH No calibration applied and no bandpass applied

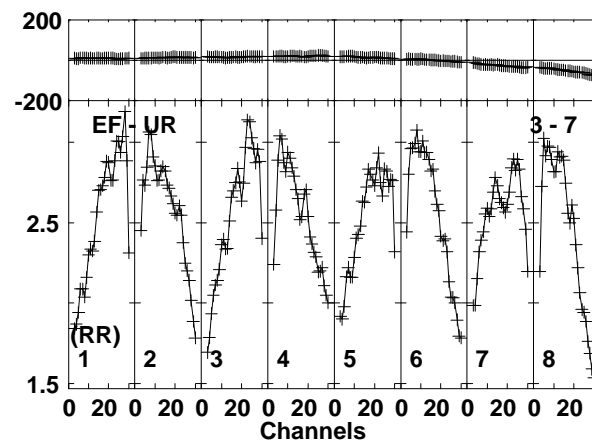
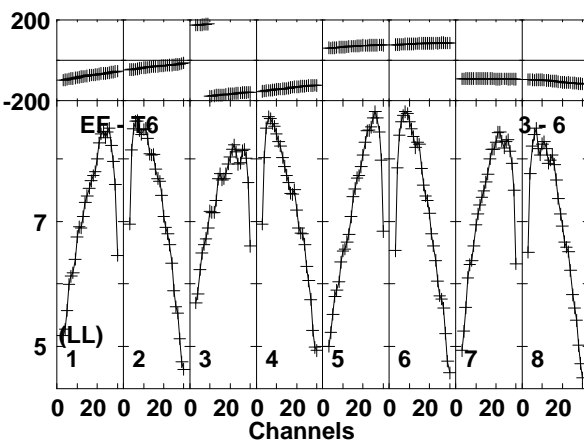
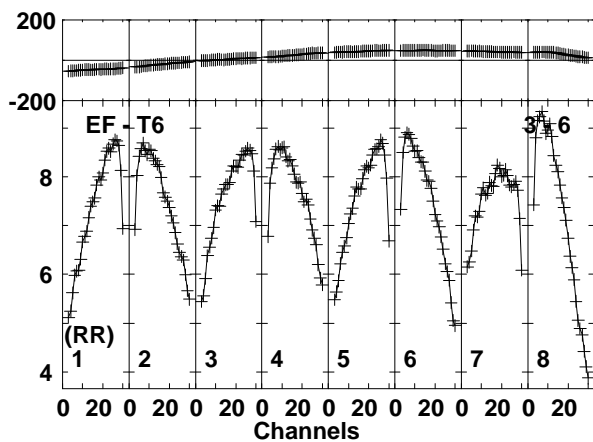
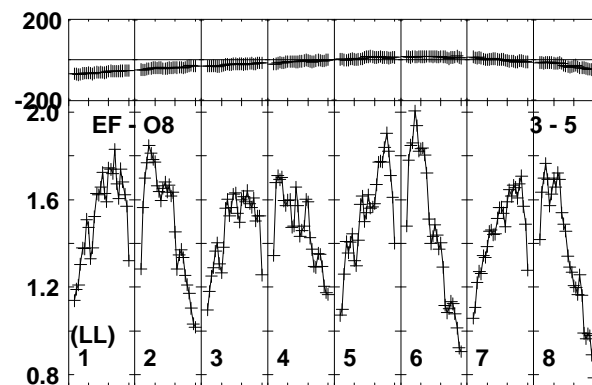
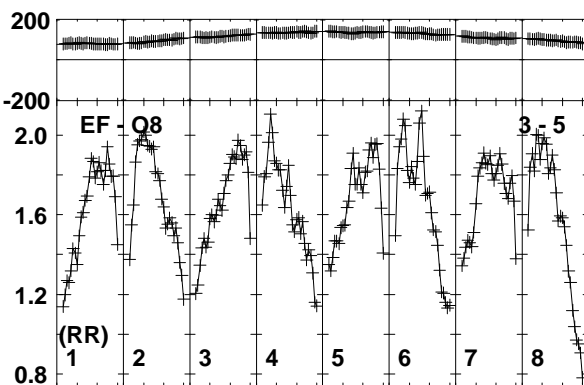
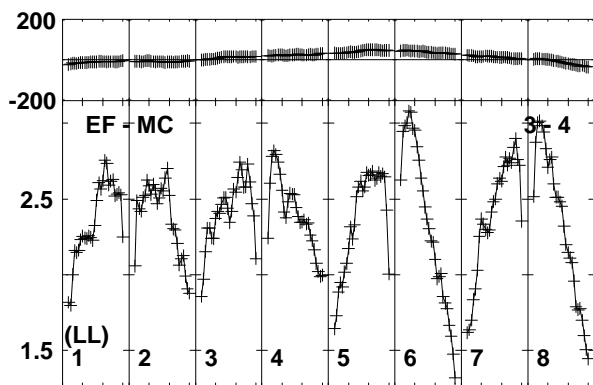
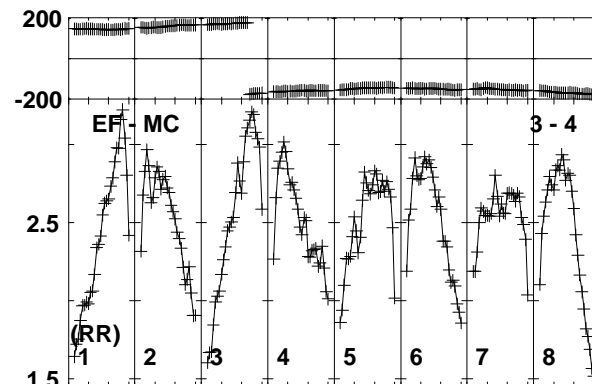
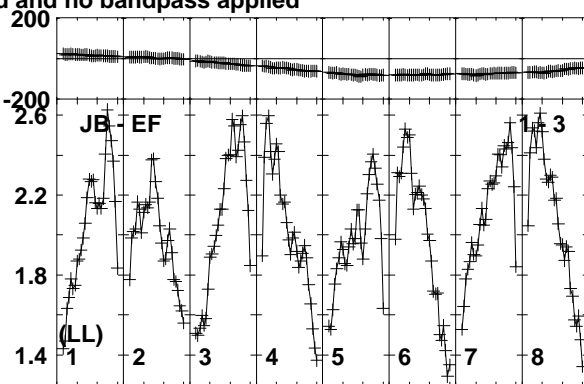
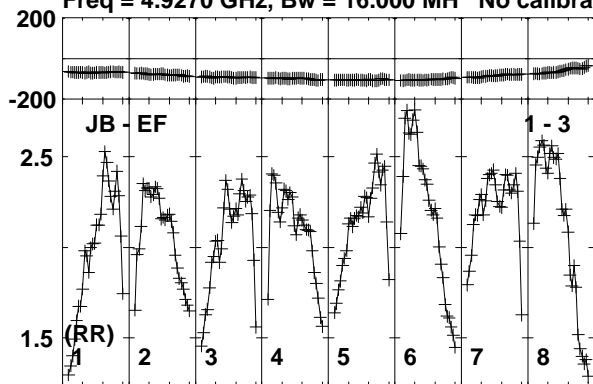

Lower frame: Milli Ampl Jy Top frame: Phas deg
Vector averaged cross-power spectrum Baseline: JB (01) - EF (03)
Timerange: 00/04:48:01 to 00/04:49:19

Plot file version 249 created 17-FEB-2020 15:43:01

J1359+5544 EK047 2.UVDATA.1

Freq = 4.9270 GHz, Bw = 16.000 MH No calibration applied and no bandpass applied

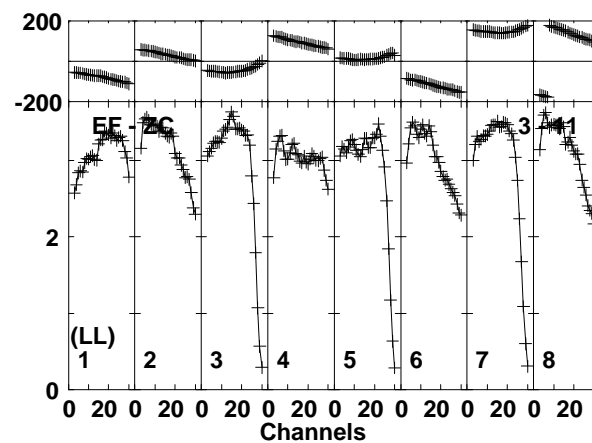
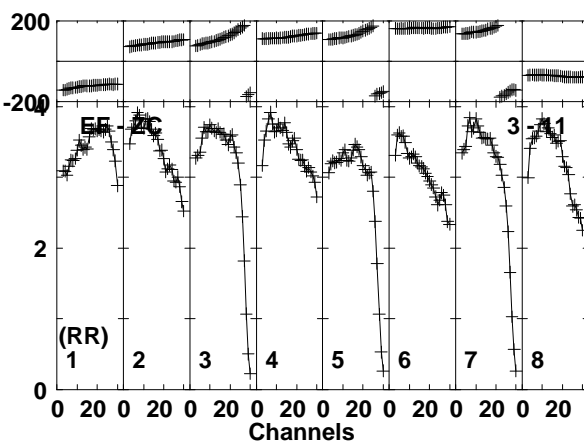
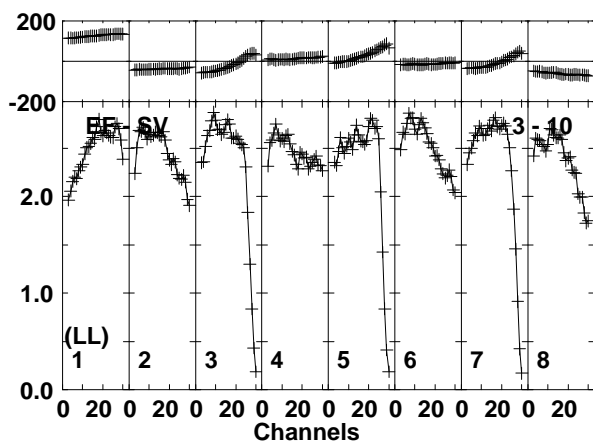
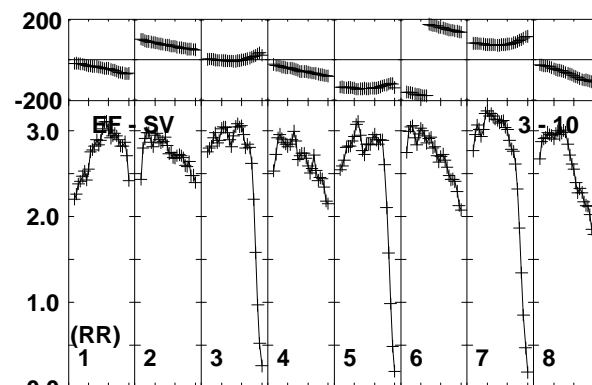
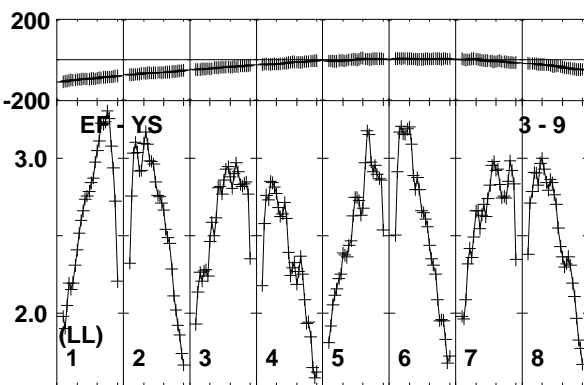
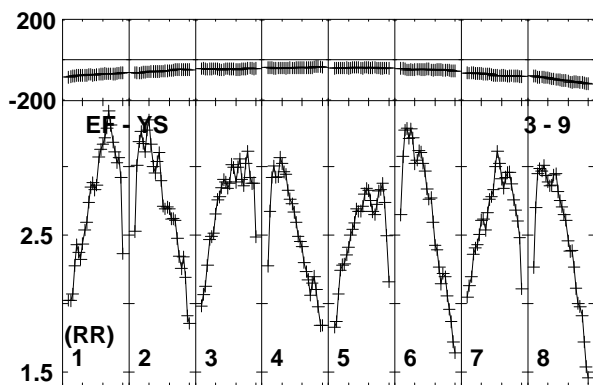
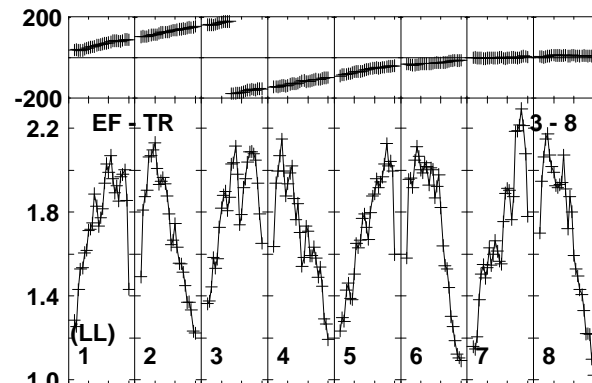
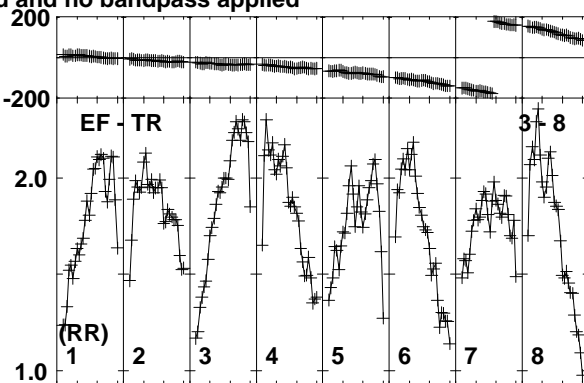
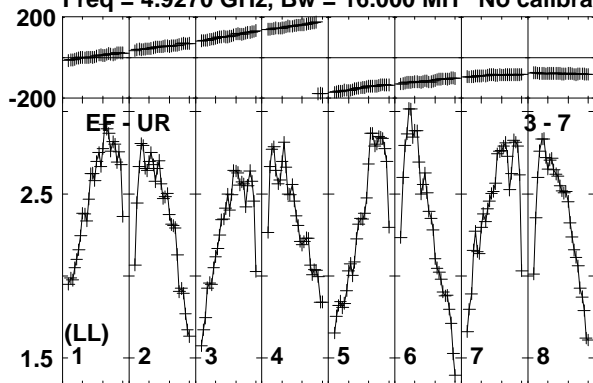

Lower frame: Milli Ampl Jy Top frame: Phas deg
Vector averaged cross-power spectrum Baseline: EF (03) - UR (07)
Timerange: 00/04:48:01 to 00/04:49:19

Plot file version 250 created 17-FEB-2020 15:43:01

J1402+5347 EK047 2.UVDATA.1

Freq = 4.9270 GHz, Bw = 16.000 MH No calibration applied and no bandpass applied

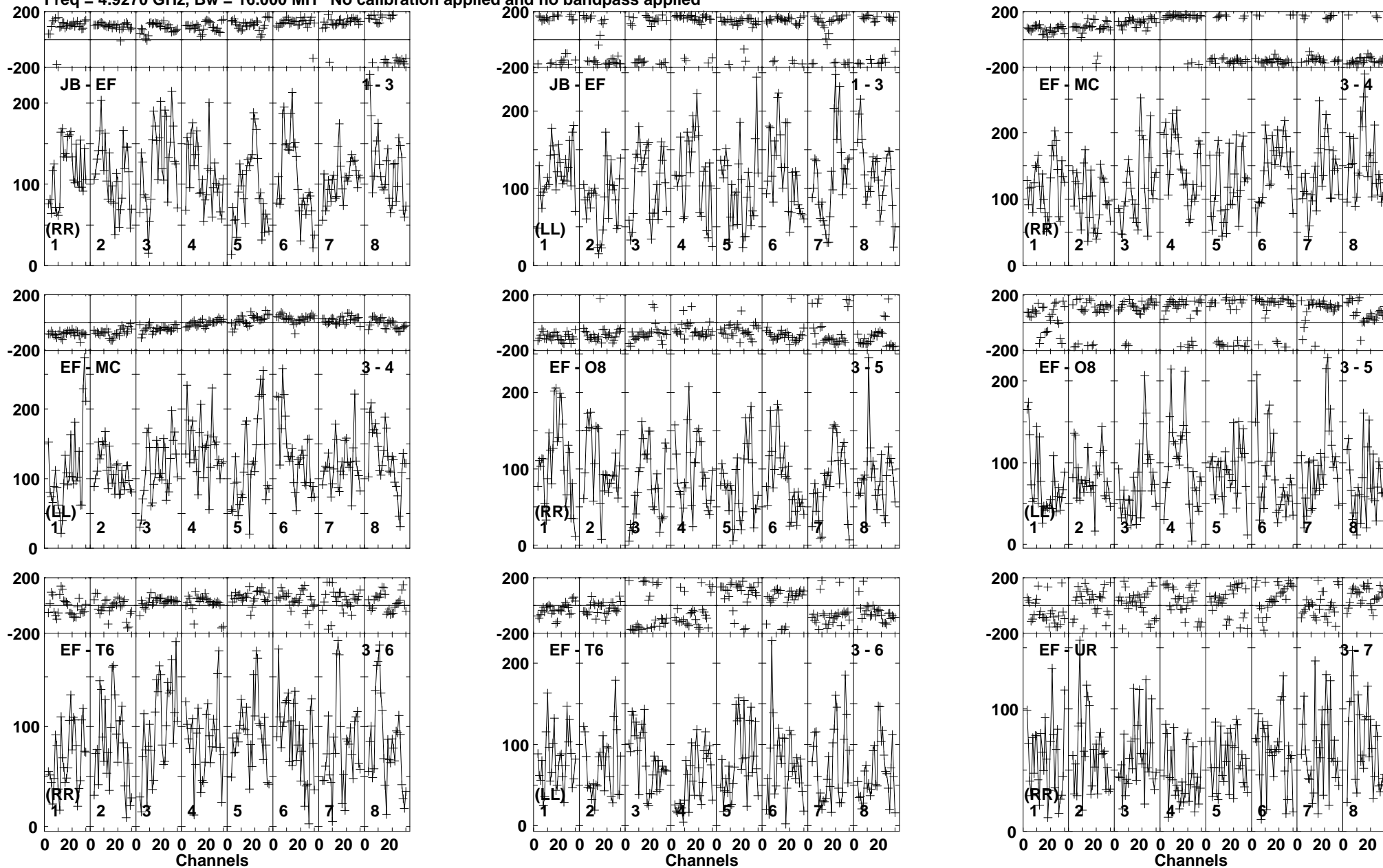

Lower frame: Micro Ampl Jy Top frame: Phas deg
Vector averaged cross-power spectrum Baseline: JB (01) - EF (03)
Timerange: 00/04:49:21 to 00/04:53:19

Plot file version 251 created 17-FEB-2020 15:43:01

J1402+5347 EK047 2.UVDATA.1

Freq = 4.9270 GHz, Bw = 16.000 MH No calibration applied and no bandpass applied

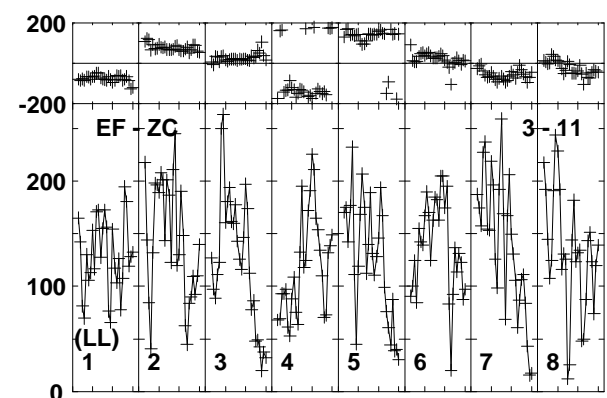
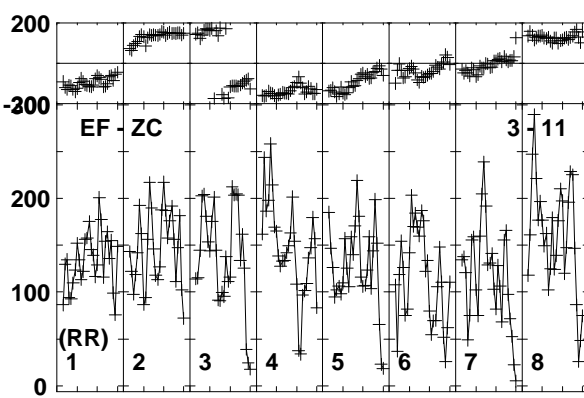
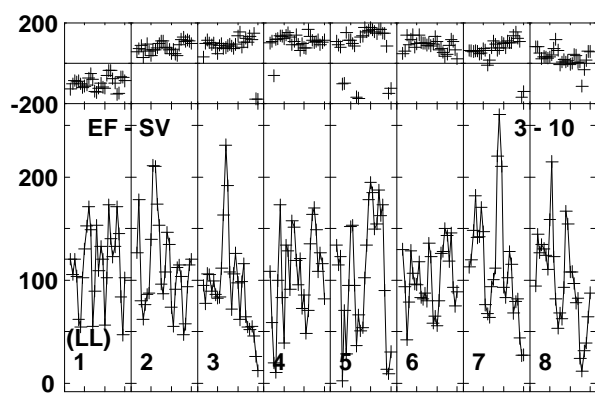
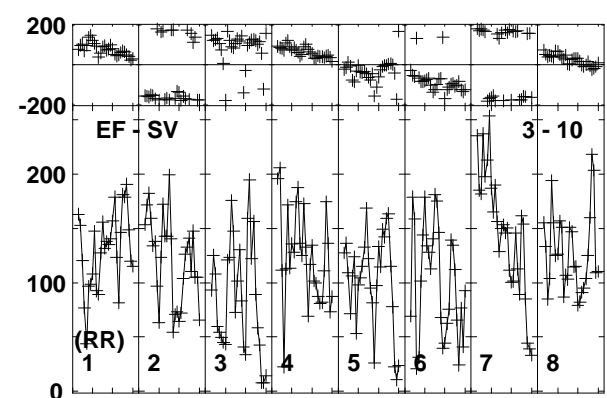
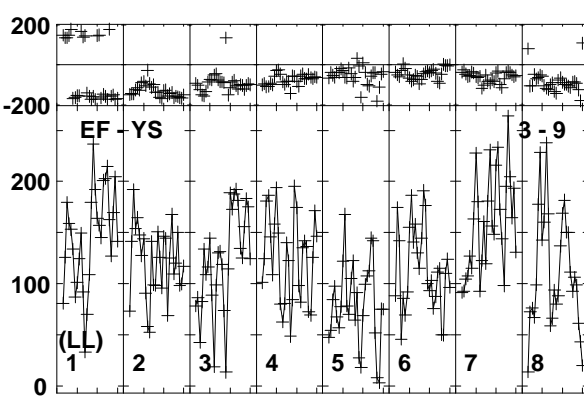
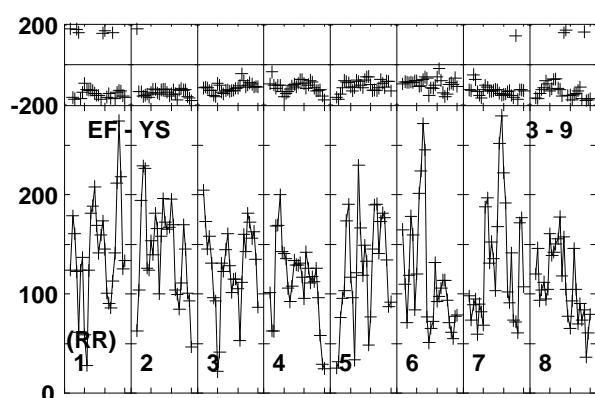
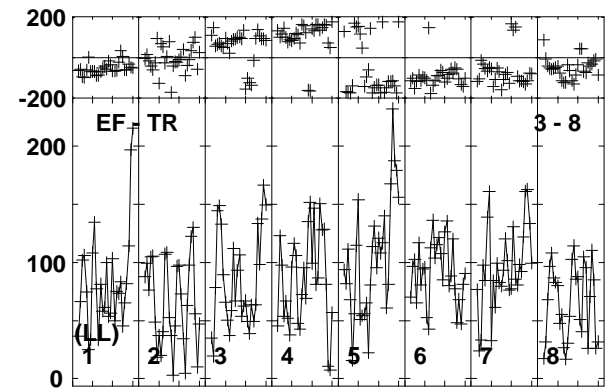
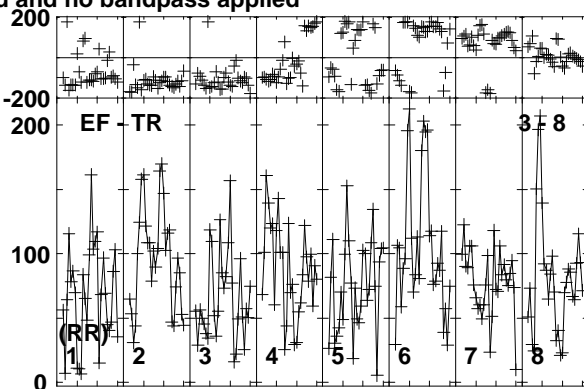
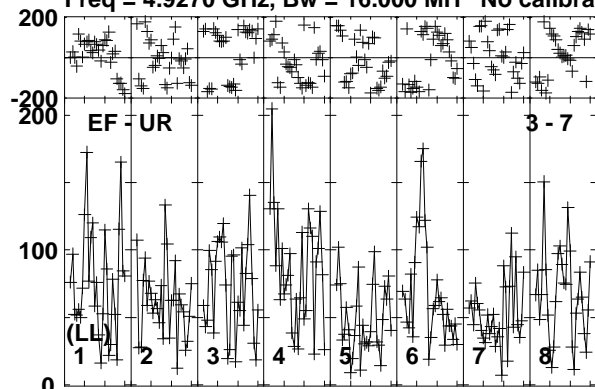

Lower frame: Micro Ampl Jy Top frame: Phas deg
Vector averaged cross-power spectrum Baseline: EF (03) - UR (07)
Timerange: 00/04:49:21 to 00/04:53:19

Plot file version 252 created 17-FEB-2020 15:43:01

J1359+5544 EK047 2.UVDATA.1

Freq = 4.9270 GHz, Bw = 16.000 MH No calibration applied and no bandpass applied

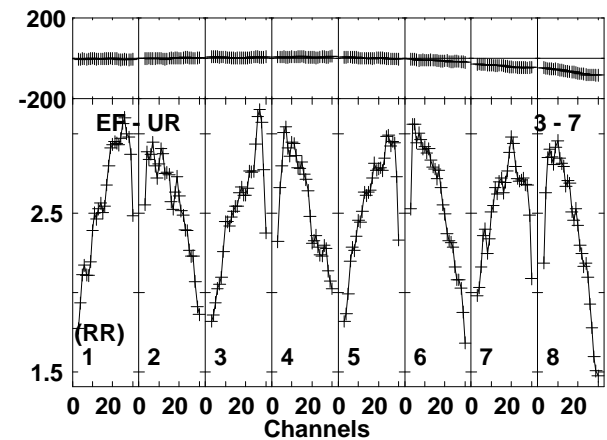
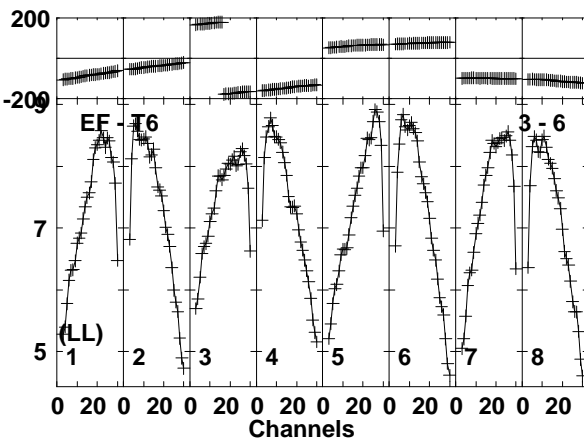
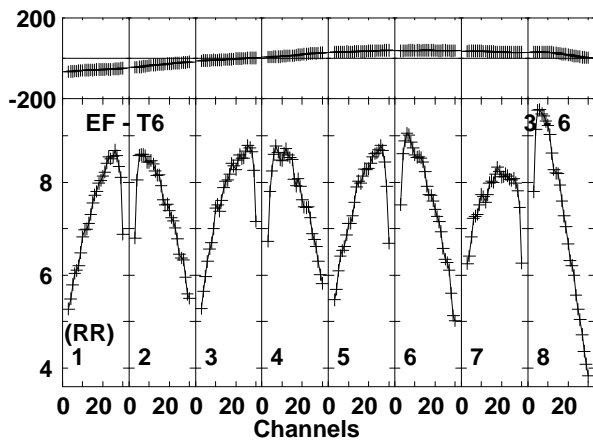
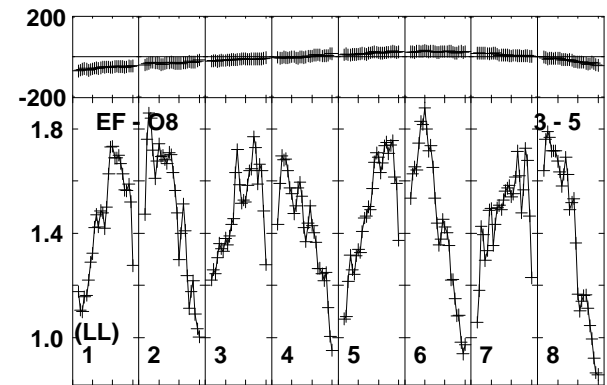
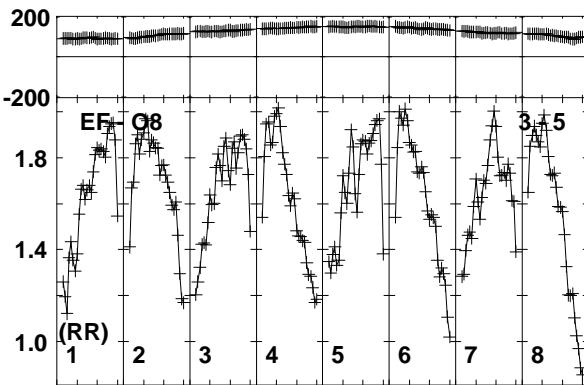
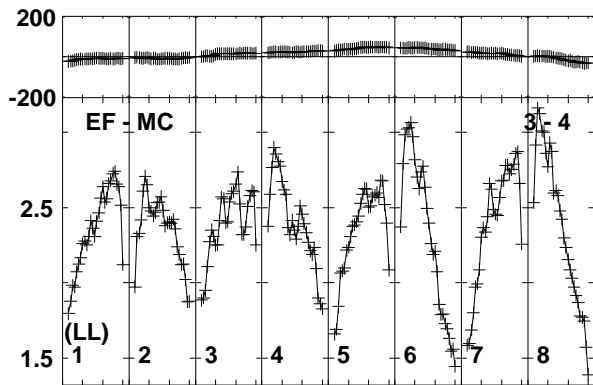
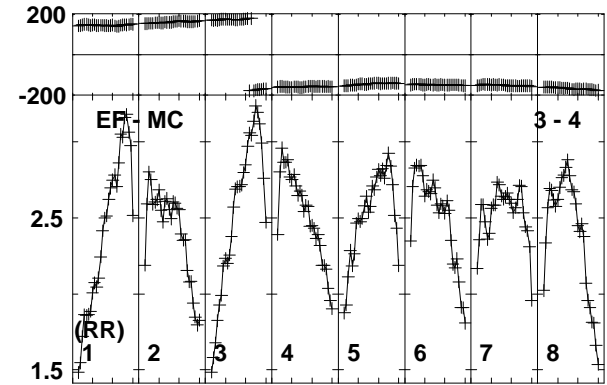
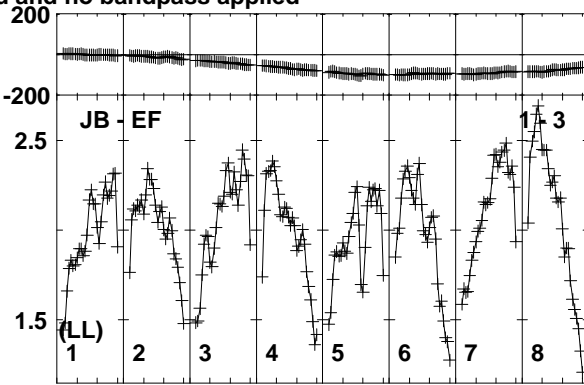
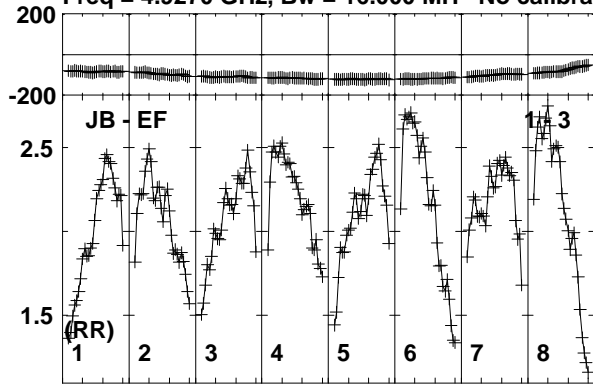

Lower frame: Milli Ampl Jy Top frame: Phas deg
Vector averaged cross-power spectrum Baseline: JB (01) - EF (03)
Timerange: 00/04:53:21 to 00/04:55:19

Plot file version 253 created 17-FEB-2020 15:43:02

J1359+5544 EK047 2.UVDATA.1

Freq = 4.9270 GHz, Bw = 16.000 MH No calibration applied and no bandpass applied

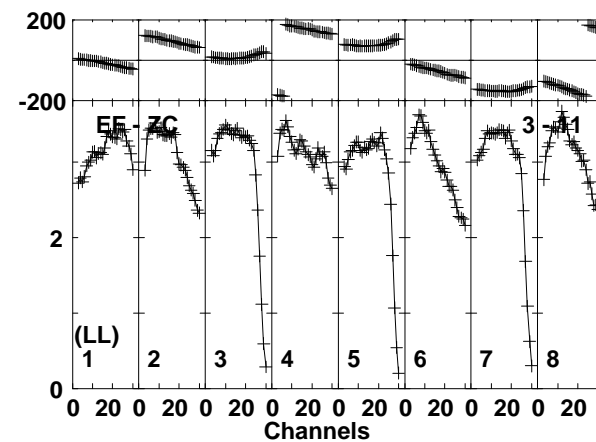
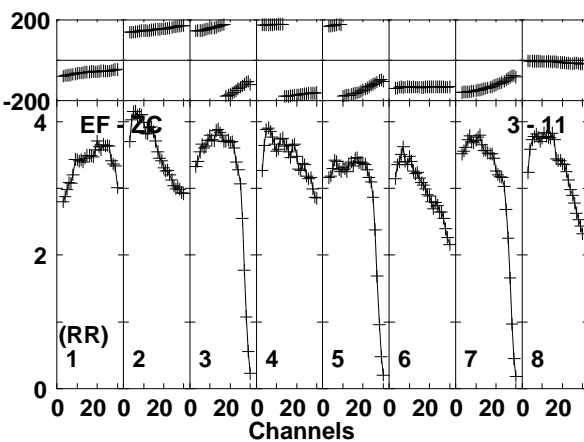
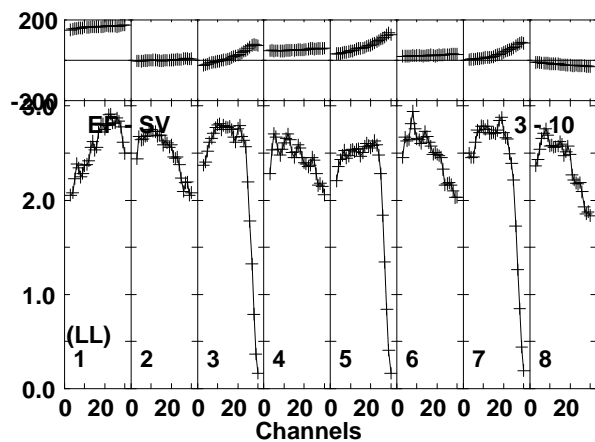
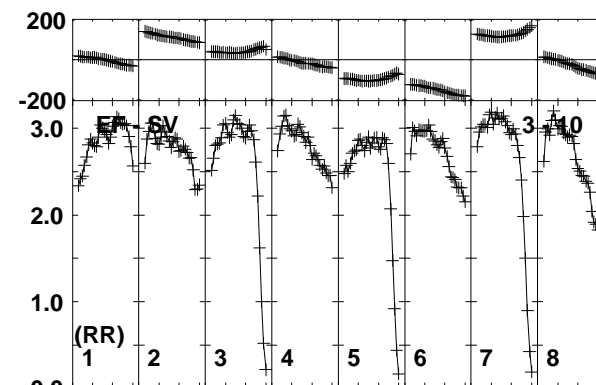
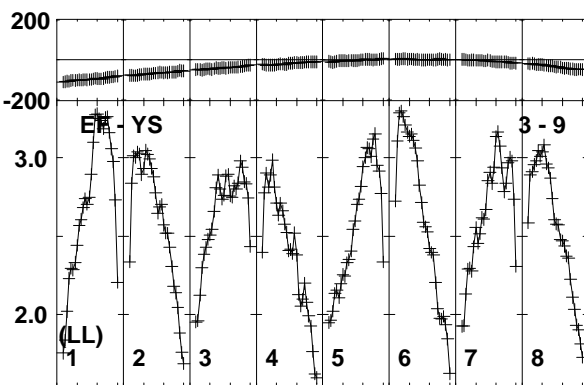
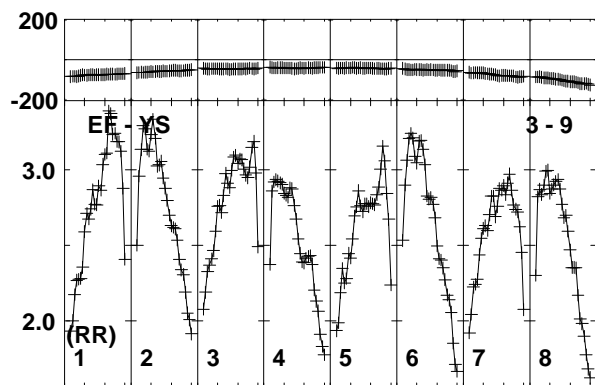
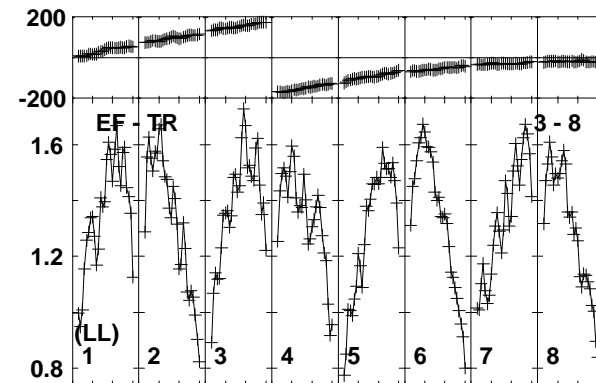
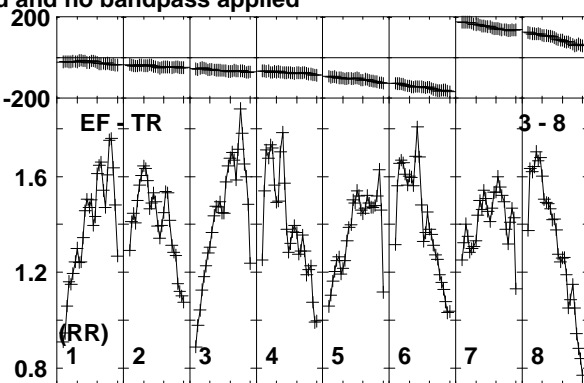
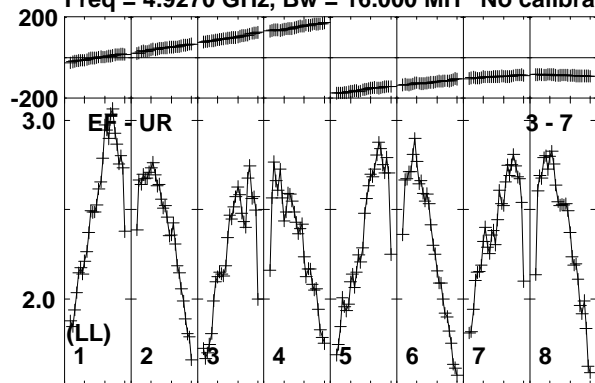

Lower frame: Milli Ampl Jy Top frame: Phas deg
Vector averaged cross-power spectrum Baseline: EF (03) - UR (07)
Timerange: 00/04:53:21 to 00/04:55:19

Plot file version 254 created 17-FEB-2020 15:43:02

J1402+5347 EK047 2.UVDATA.1

Freq = 4.9270 GHz, Bw = 16.000 MH No calibration applied and no bandpass applied

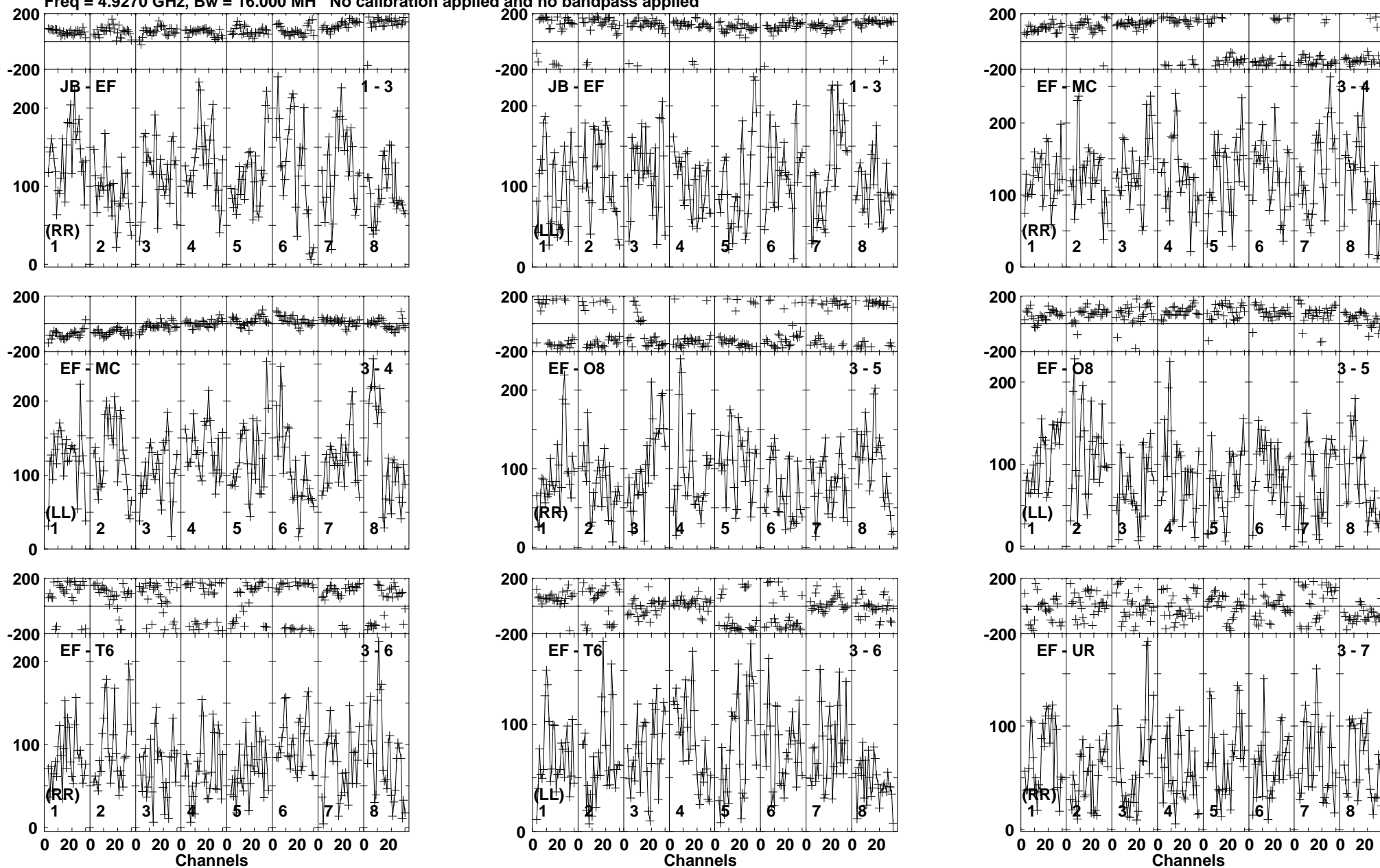

Lower frame: Micro Ampl Jy Top frame: Phas deg
Vector averaged cross-power spectrum Baseline: JB (01) - EF (03)
Timerange: 00/04:55:23 to 00/04:59:19

Plot file version 255 created 17-FEB-2020 15:43:02

J1402+5347 EK047 2.UVDATA.1

Freq = 4.9270 GHz, Bw = 16.000 MH No calibration applied and no bandpass applied

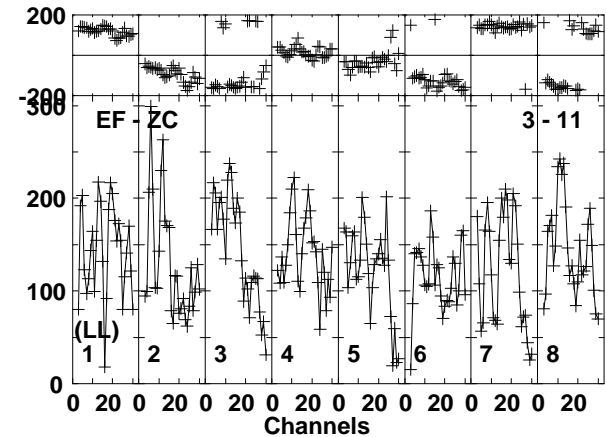
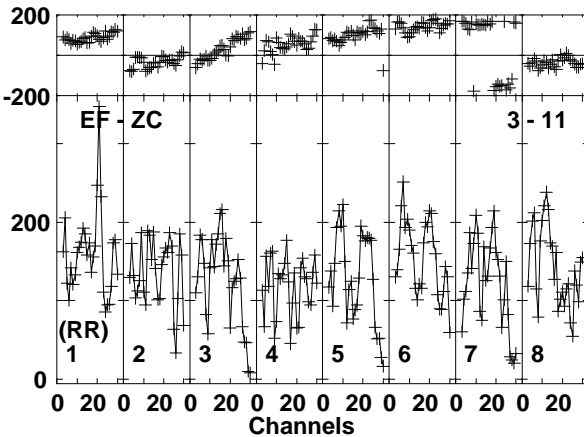
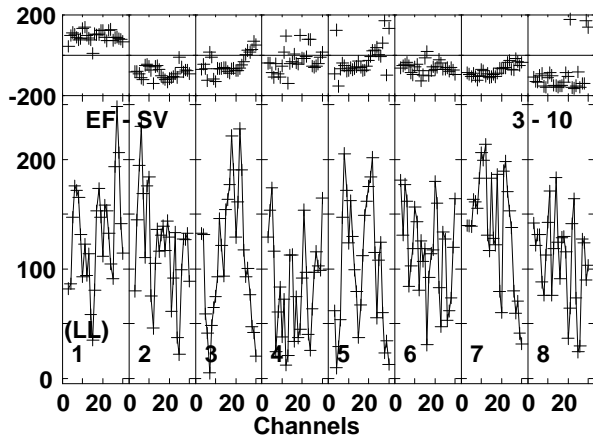
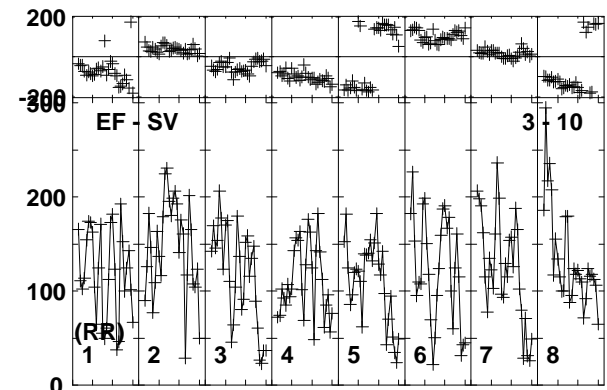
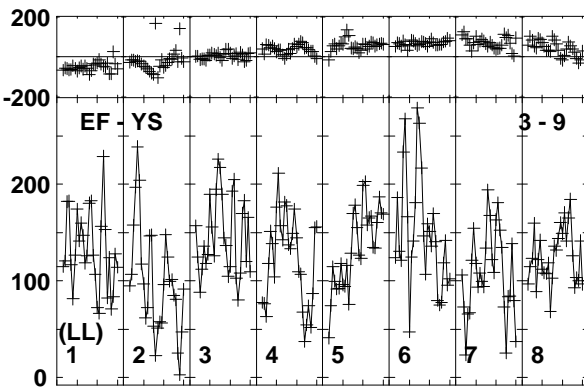
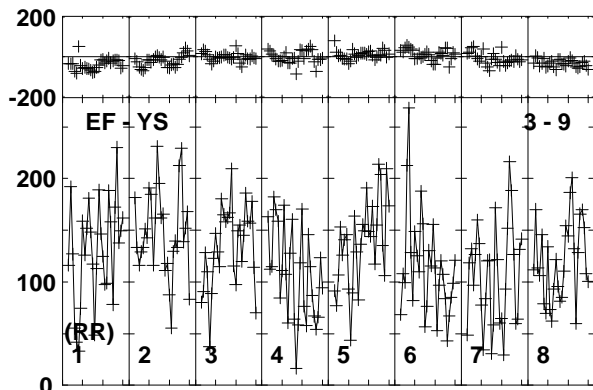
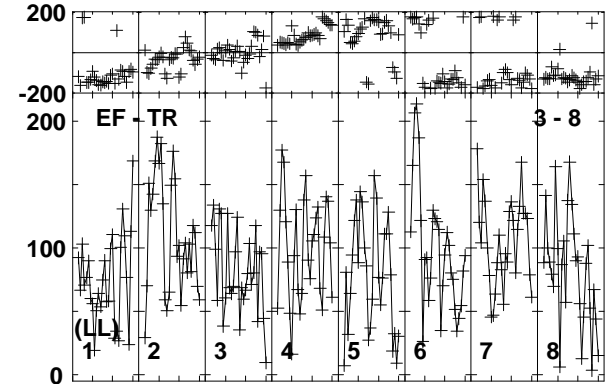
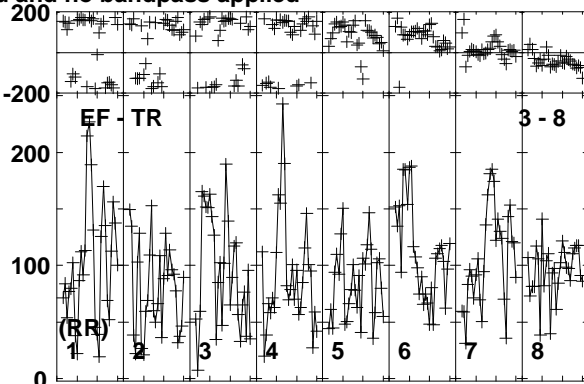
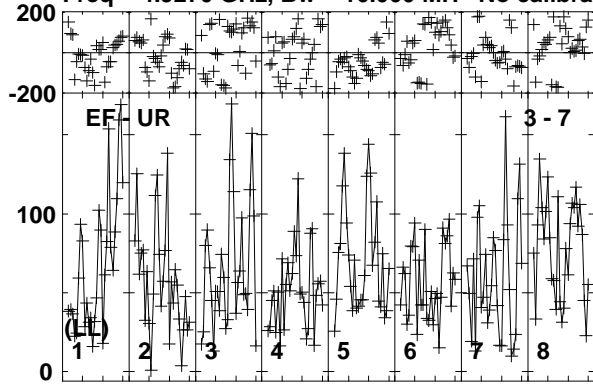

Lower frame: Micro Ampl Jy Top frame: Phas deg
Vector averaged cross-power spectrum Baseline: EF (03) - UR (07)
Timerange: 00/04:55:23 to 00/04:59:19

Plot file version 256 created 17-FEB-2020 15:43:02

J1359+5544 EK047 2.UVDATA.1

Freq = 4.9270 GHz, Bw = 16.000 MH No calibration applied and no bandpass applied

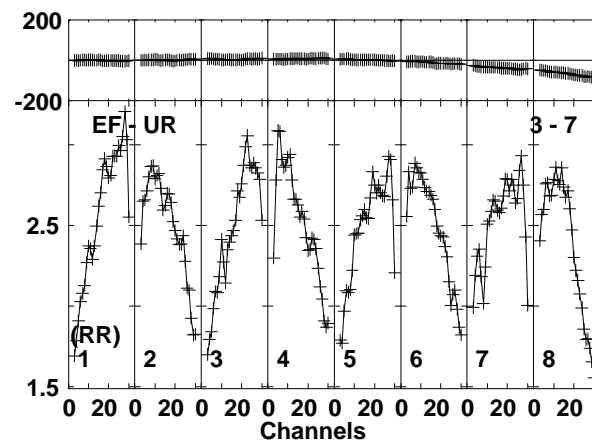
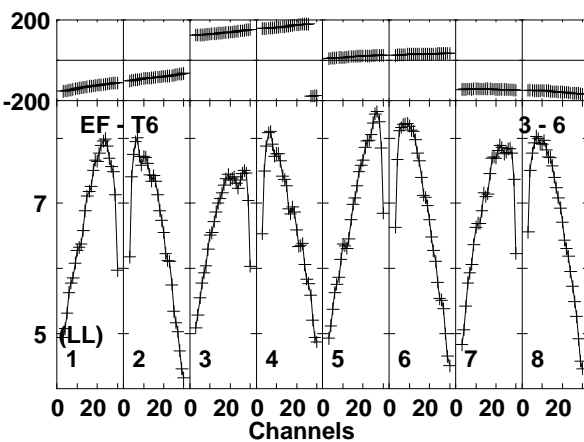
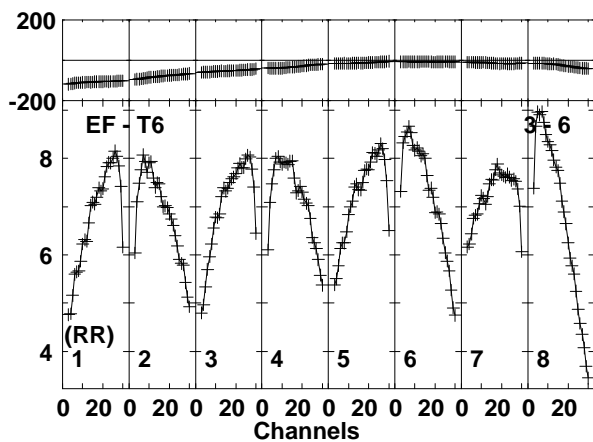
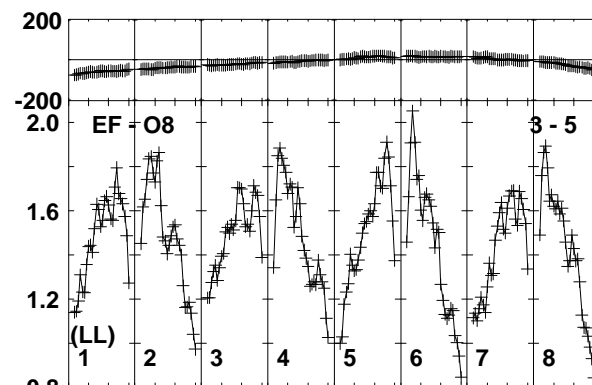
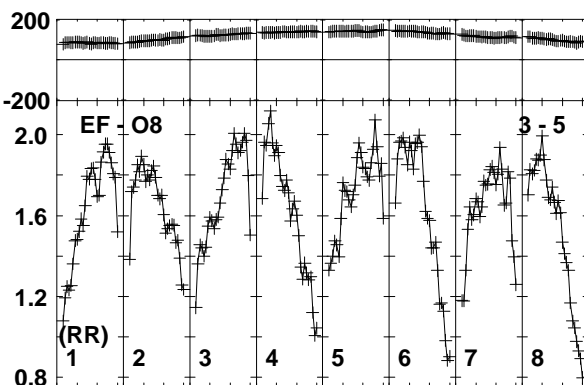
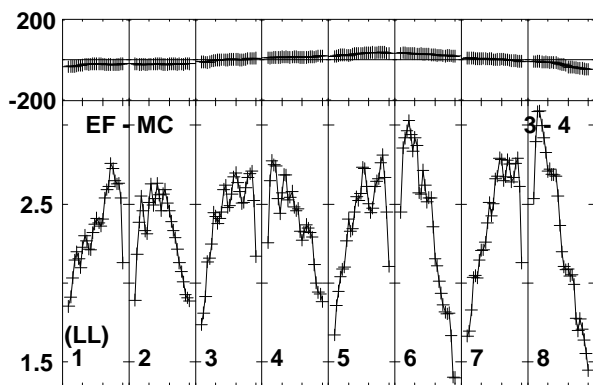
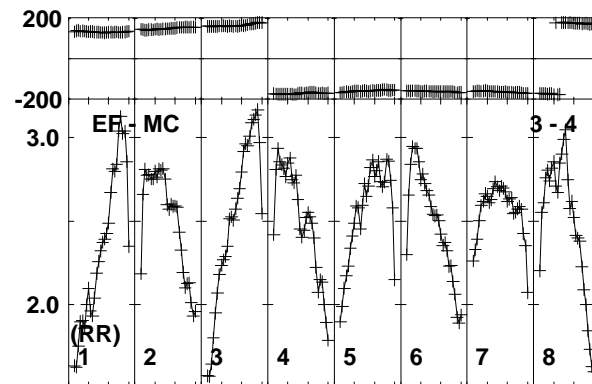
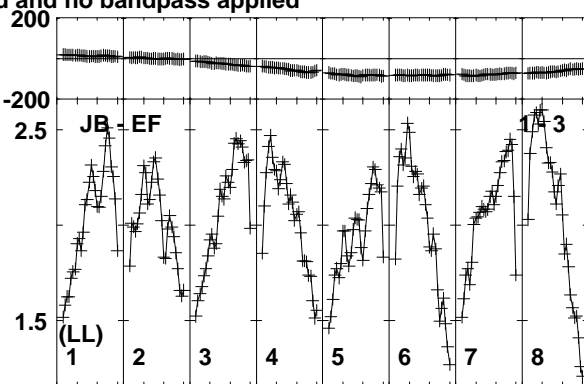
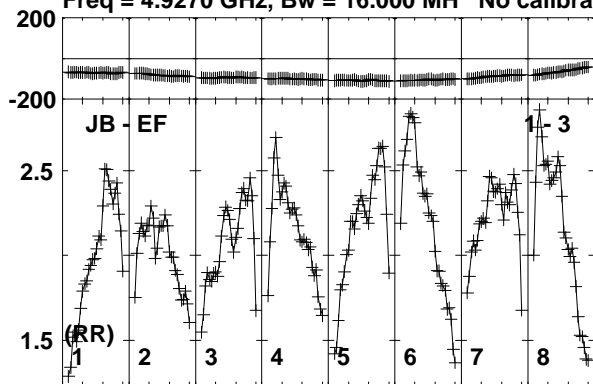

Lower frame: Milli Ampl Jy Top frame: Phas deg
Vector averaged cross-power spectrum Baseline: JB (01) - EF (03)
Timerange: 00/05:00:01 to 00/05:01:19

Plot file version 257 created 17-FEB-2020 15:43:02

J1359+5544 EK047 2.UVDATA.1

Freq = 4.9270 GHz, Bw = 16.000 MH No calibration applied and no bandpass applied

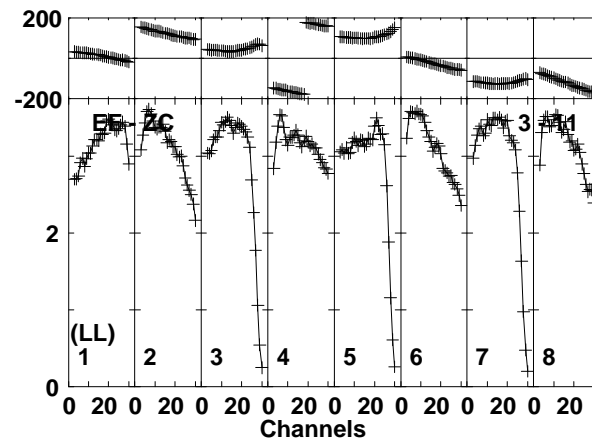
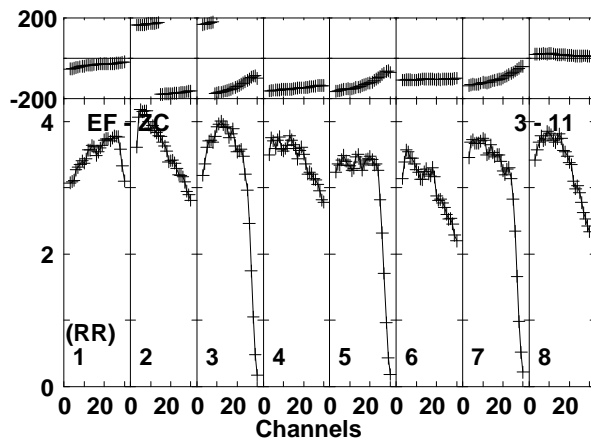
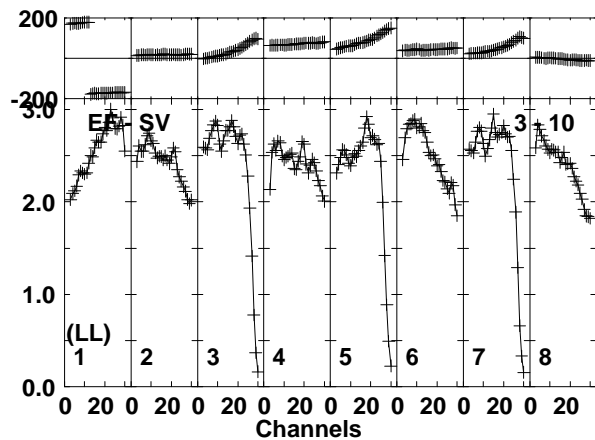
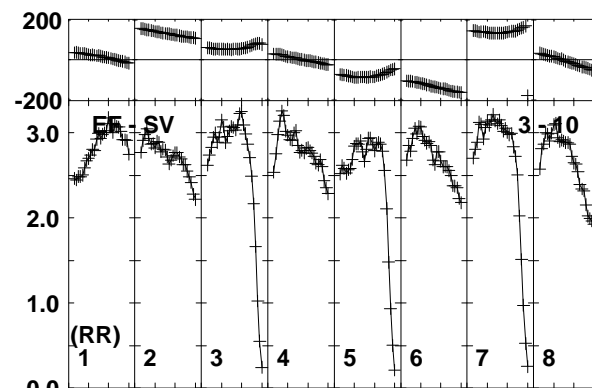
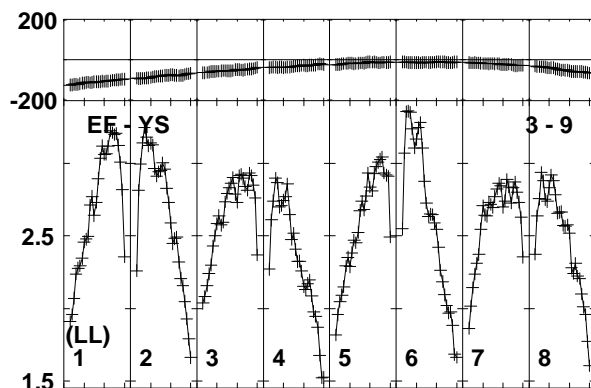
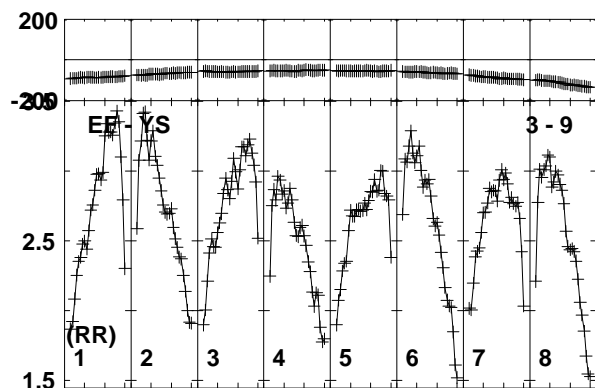
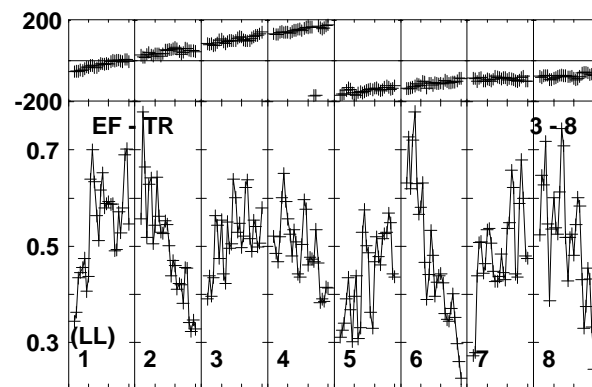
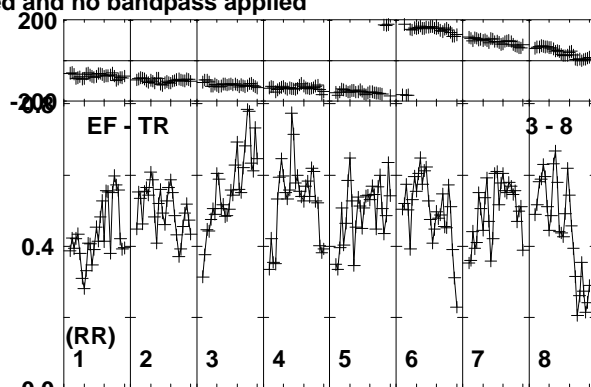
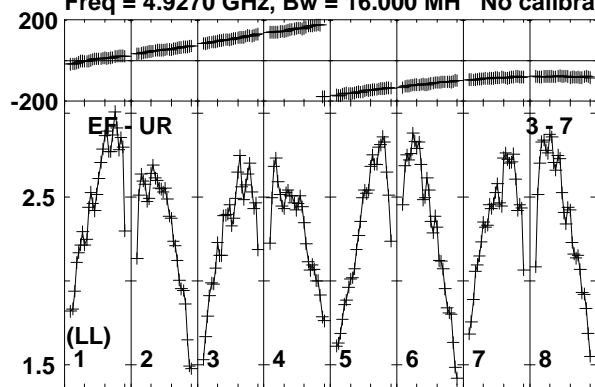

Lower frame: Milli Ampl Jy Top frame: Phas deg
Vector averaged cross-power spectrum Baseline: EF (03) - UR (07)
Timerange: 00/05:00:01 to 00/05:01:19

Plot file version 258 created 17-FEB-2020 15:43:02

J1359+5544 EK047 2.UVDATA.1

Freq = 4.9270 GHz, Bw = 16.000 MH No calibration applied and no bandpass applied

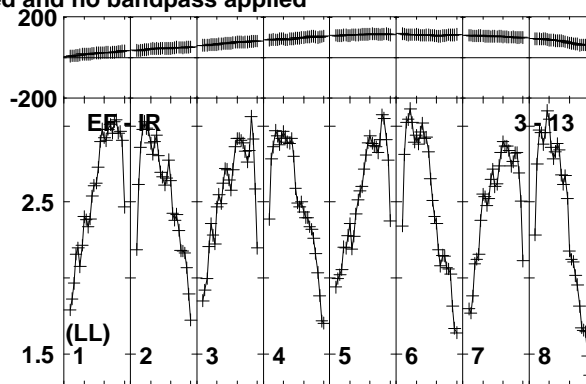
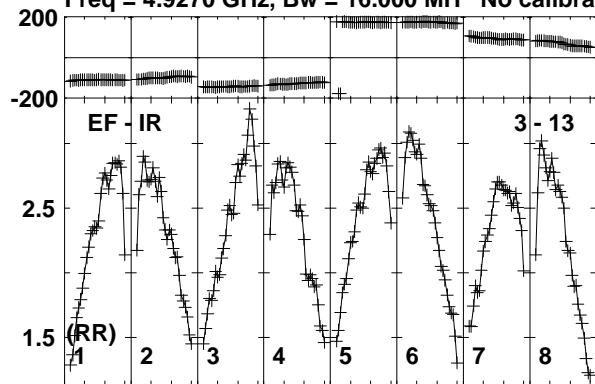

Lower frame: Milli Ampl Jy Top frame: Phas deg
Vector averaged cross-power spectrum Baseline: EF (03) - IR (13)
Timerange: 00/05:00:01 to 00/05:01:19

Plot file version 259 created 17-FEB-2020 15:43:02

J1402+5347 EK047 2.UVDATA.1

Freq = 4.9270 GHz, Bw = 16.000 MH No calibration applied and no bandpass applied

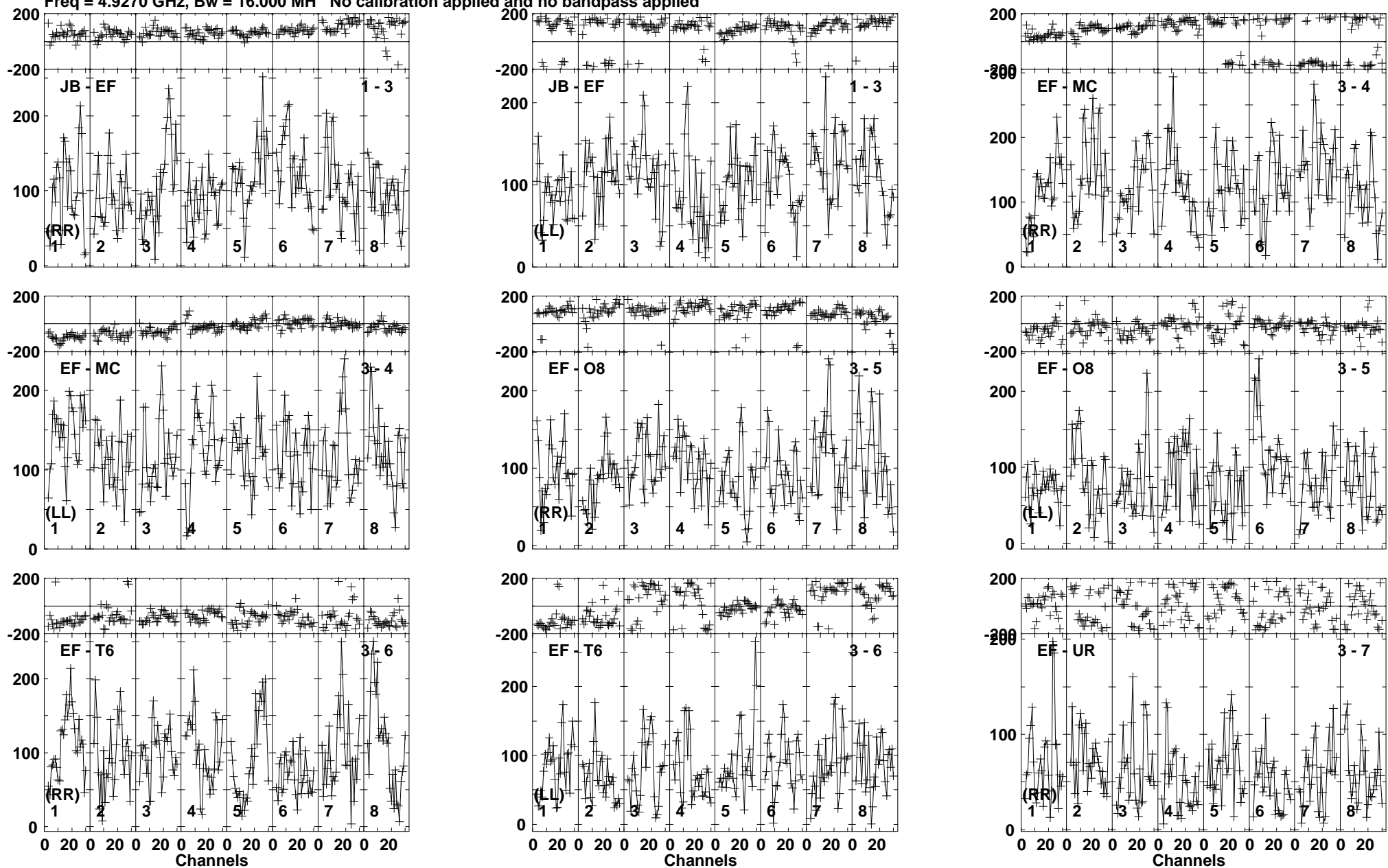

Lower frame: Micro Ampl Jy Top frame: Phas deg
Vector averaged cross-power spectrum Baseline: JB (01) - EF (03)
Timerange: 00/05:01:21 to 00/05:05:19

Plot file version 260 created 17-FEB-2020 15:43:02

J1402+5347 EK047 2.UVDATA.1

Freq = 4.9270 GHz, Bw = 16.000 MH No calibration applied and no bandpass applied

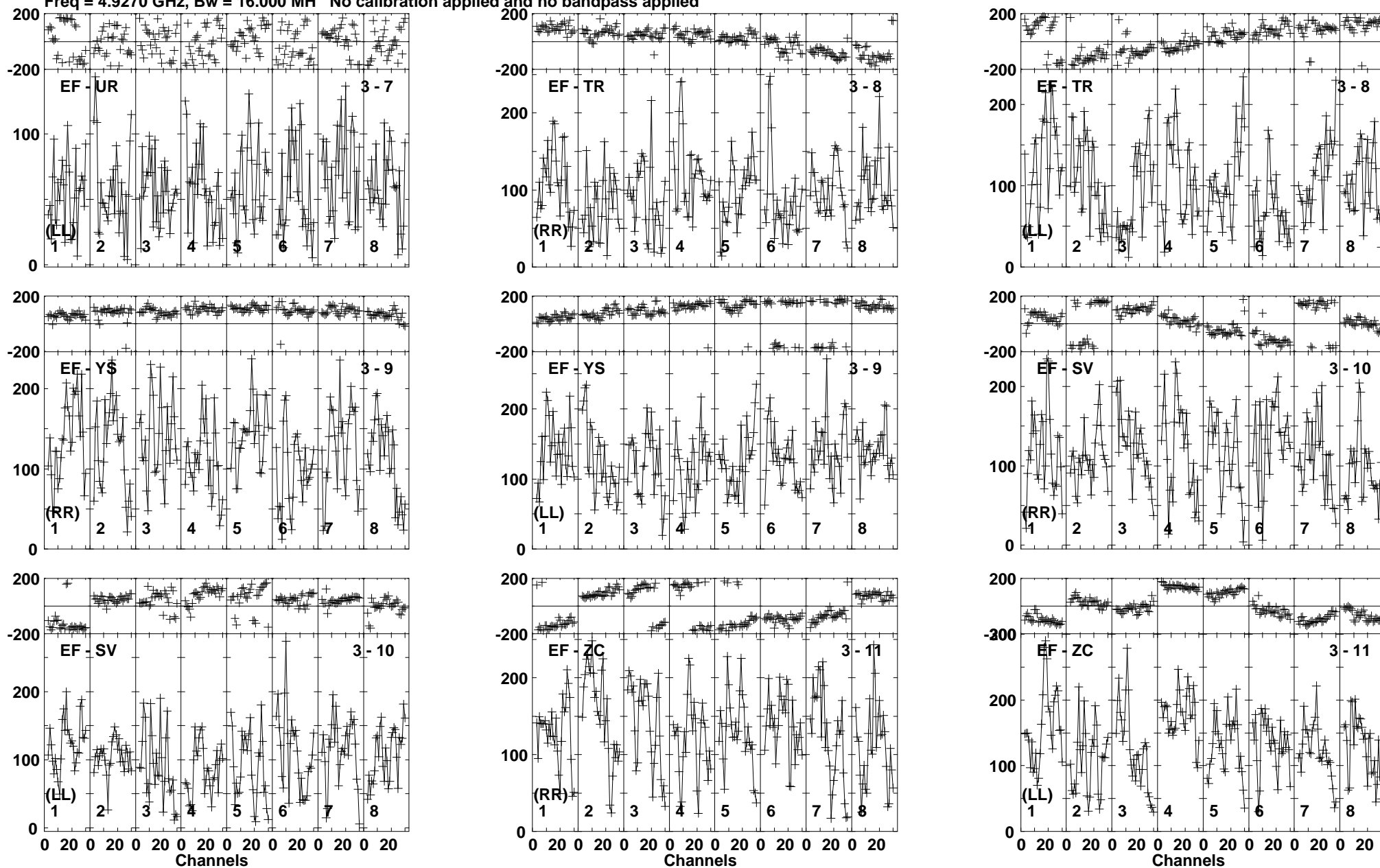

Lower frame: Micro Ampl Jy Top frame: Phas deg
Vector averaged cross-power spectrum Baseline: EF (03) - UR (07)
Timerange: 00/05:01:21 to 00/05:05:19

Plot file version 261 created 17-FEB-2020 15:43:02

J1402+5347 EK047 2.UVDATA.1

Freq = 4.9270 GHz, Bw = 16.000 MH No calibration applied and no bandpass applied

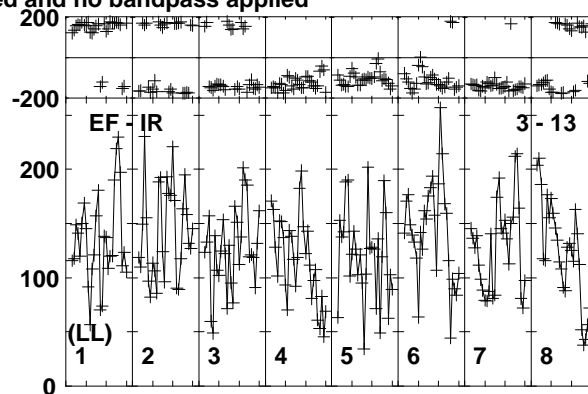
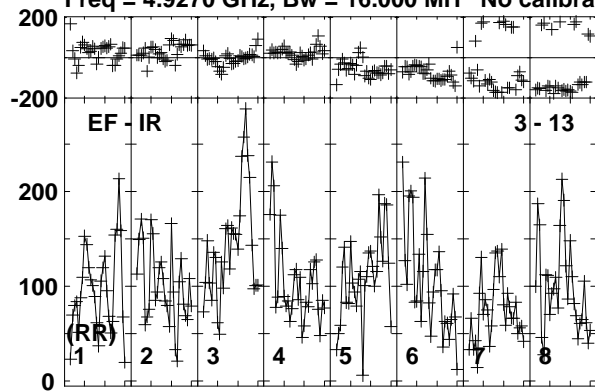

Lower frame: Micro Ampl Jy Top frame: Phas deg
Vector averaged cross-power spectrum Baseline: EF (03) - IR (13)
Timerange: 00/05:01:21 to 00/05:05:19

Plot file version 262 created 17-FEB-2020 15:43:02

J1359+5544 EK047 2.UVDATA.1

Freq = 4.9270 GHz, Bw = 16.000 MH No calibration applied and no bandpass applied

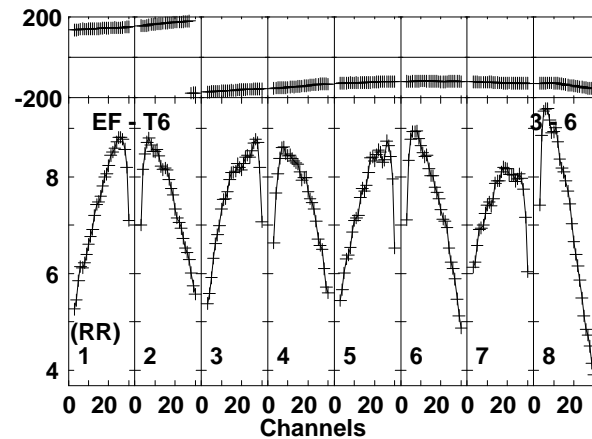
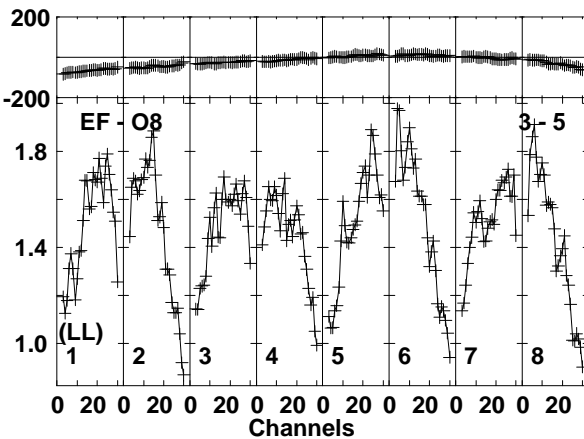
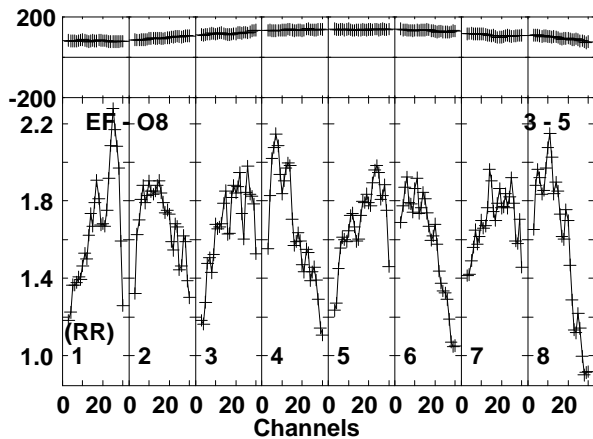
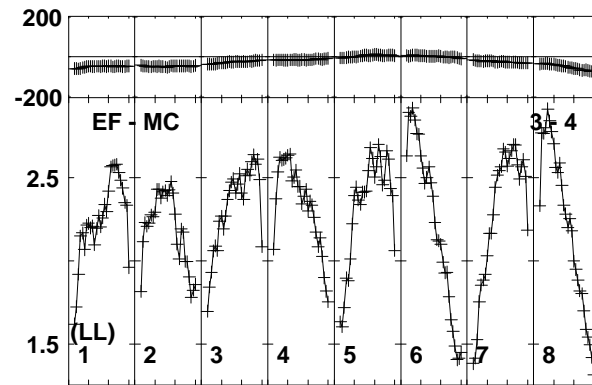
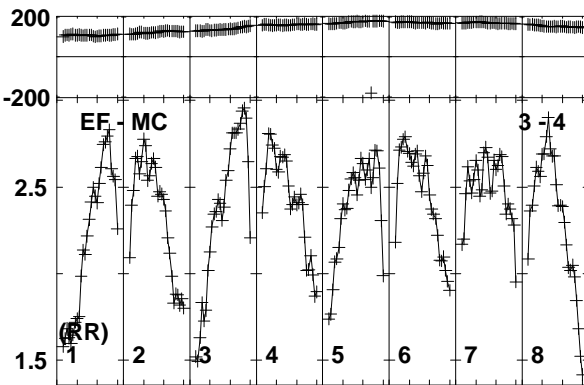
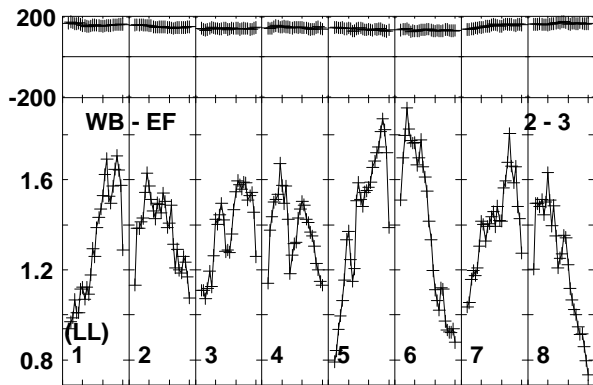
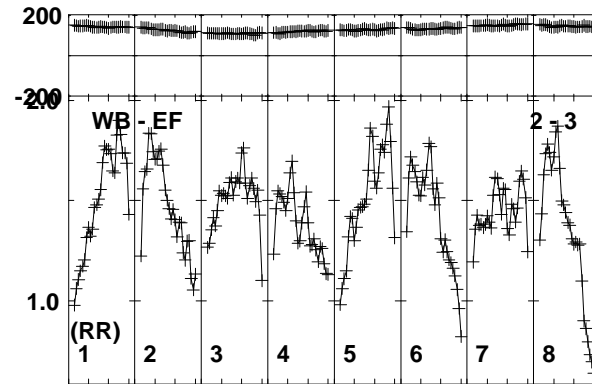
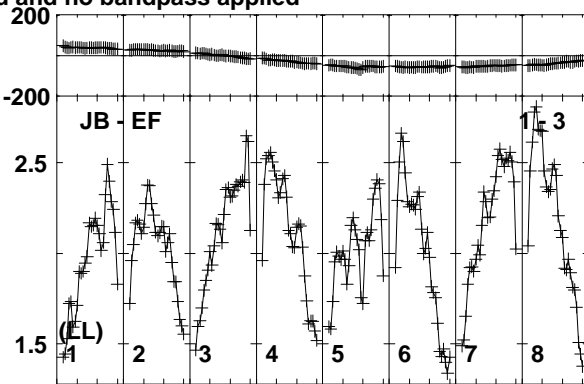
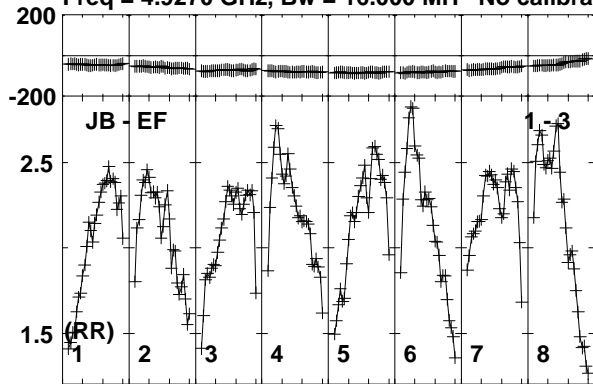

Lower frame: Milli Ampl Jy Top frame: Phas deg
Vector averaged cross-power spectrum Baseline: JB (01) - EF (03)
Timerange: 00/05:05:21 to 00/05:07:19

Plot file version 263 created 17-FEB-2020 15:43:03

J1359+5544 EK047 2.UVDATA.1

Freq = 4.9270 GHz, Bw = 16.000 MH No calibration applied and no bandpass applied

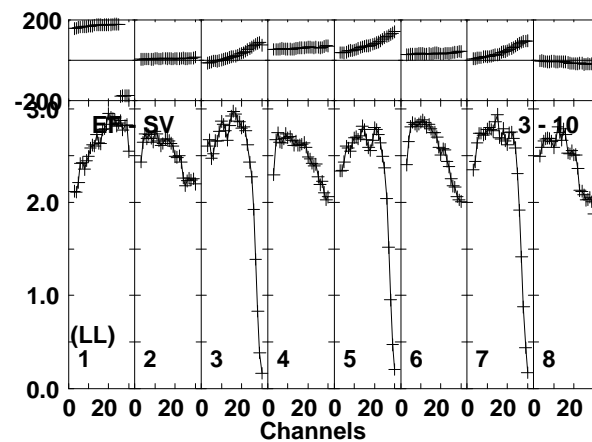
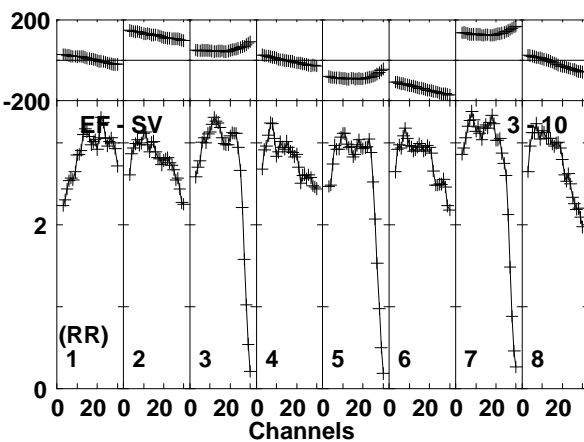
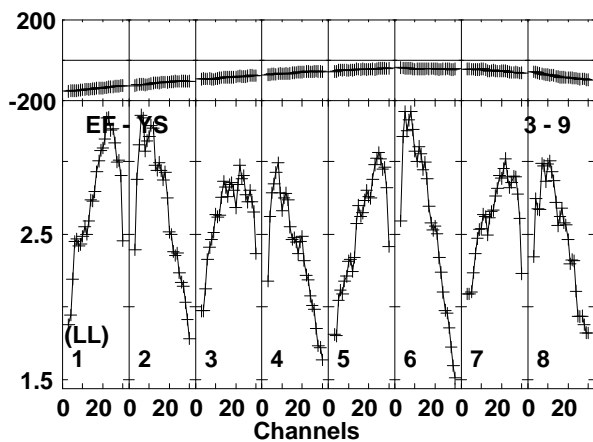
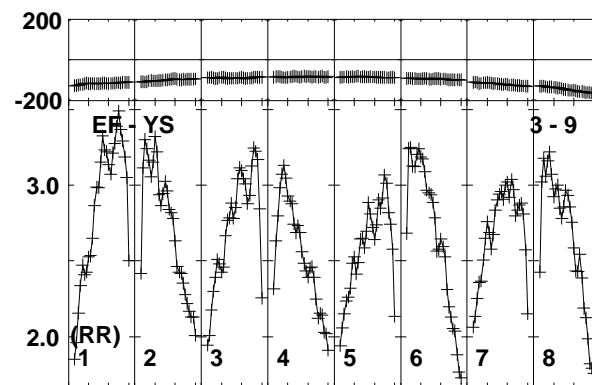
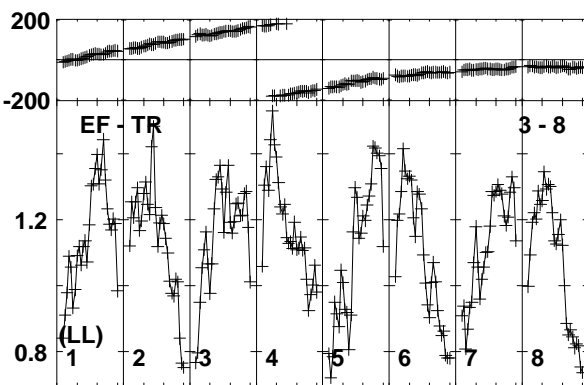
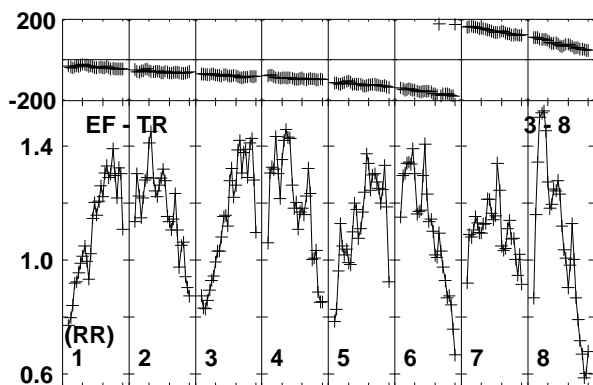
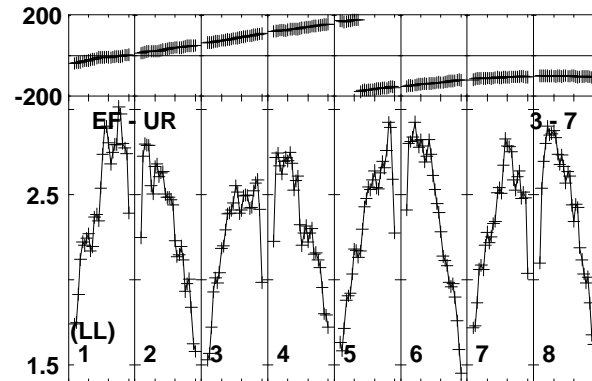
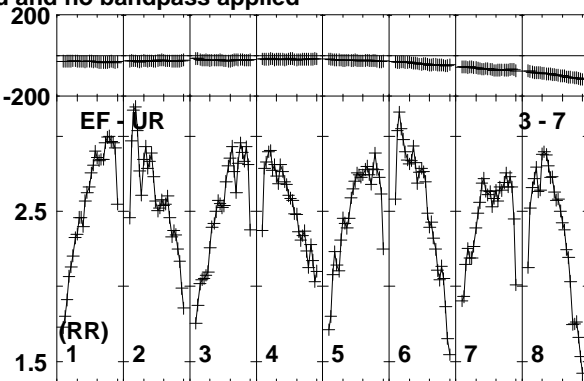
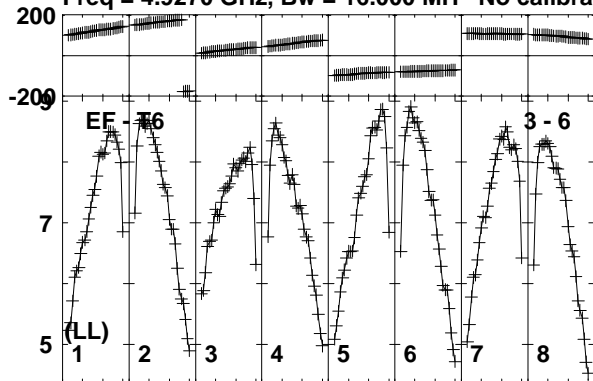

Lower frame: Milli Ampl Jy Top frame: Phas deg
Vector averaged cross-power spectrum Baseline: EF (03) - T6 (06)
Timerange: 00/05:05:21 to 00/05:07:19

Plot file version 264 created 17-FEB-2020 15:43:03

J1359+5544 EK047 2.UVDATA.1

Freq = 4.9270 GHz, Bw = 16.000 MH No calibration applied and no bandpass applied

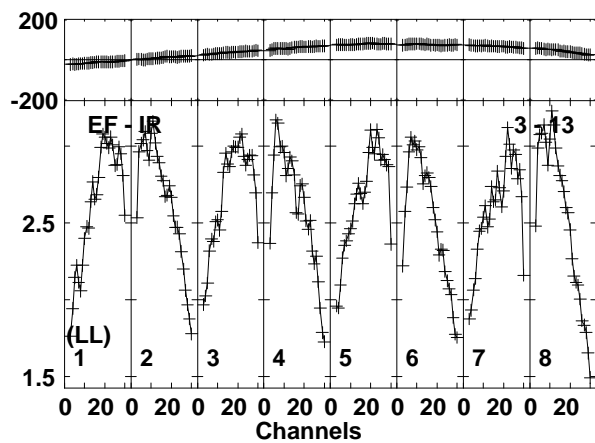
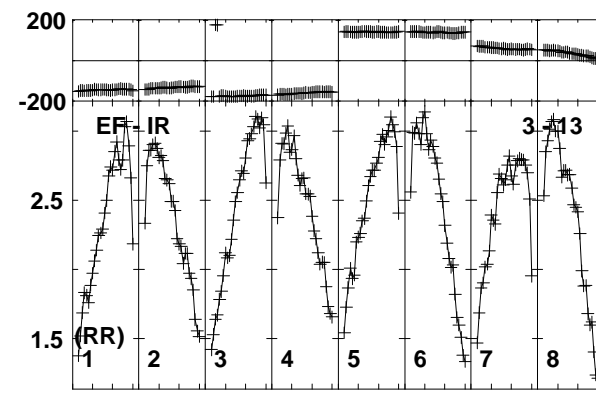
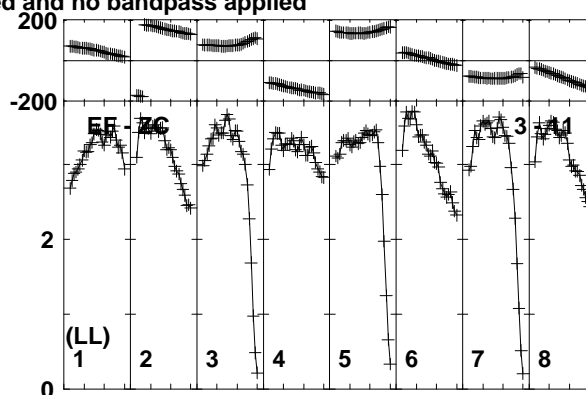
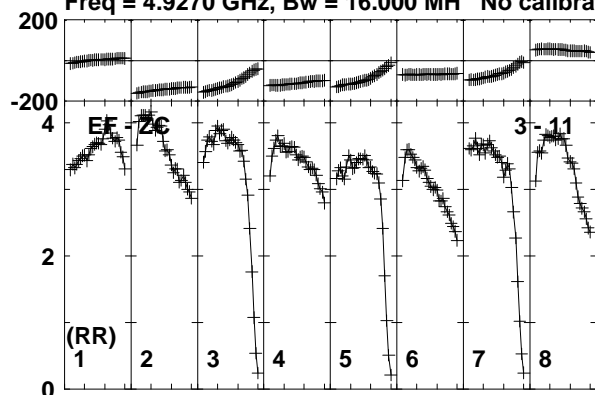

Lower frame: Milli Ampl Jy Top frame: Phas deg
Vector averaged cross-power spectrum Baseline: EF (03) - ZC (11)
Timerange: 00/05:05:21 to 00/05:07:19

Plot file version 265 created 17-FEB-2020 15:43:03

J1402+5347 EK047 2.UVDATA.1

Freq = 4.9270 GHz, Bw = 16.000 MH No calibration applied and no bandpass applied

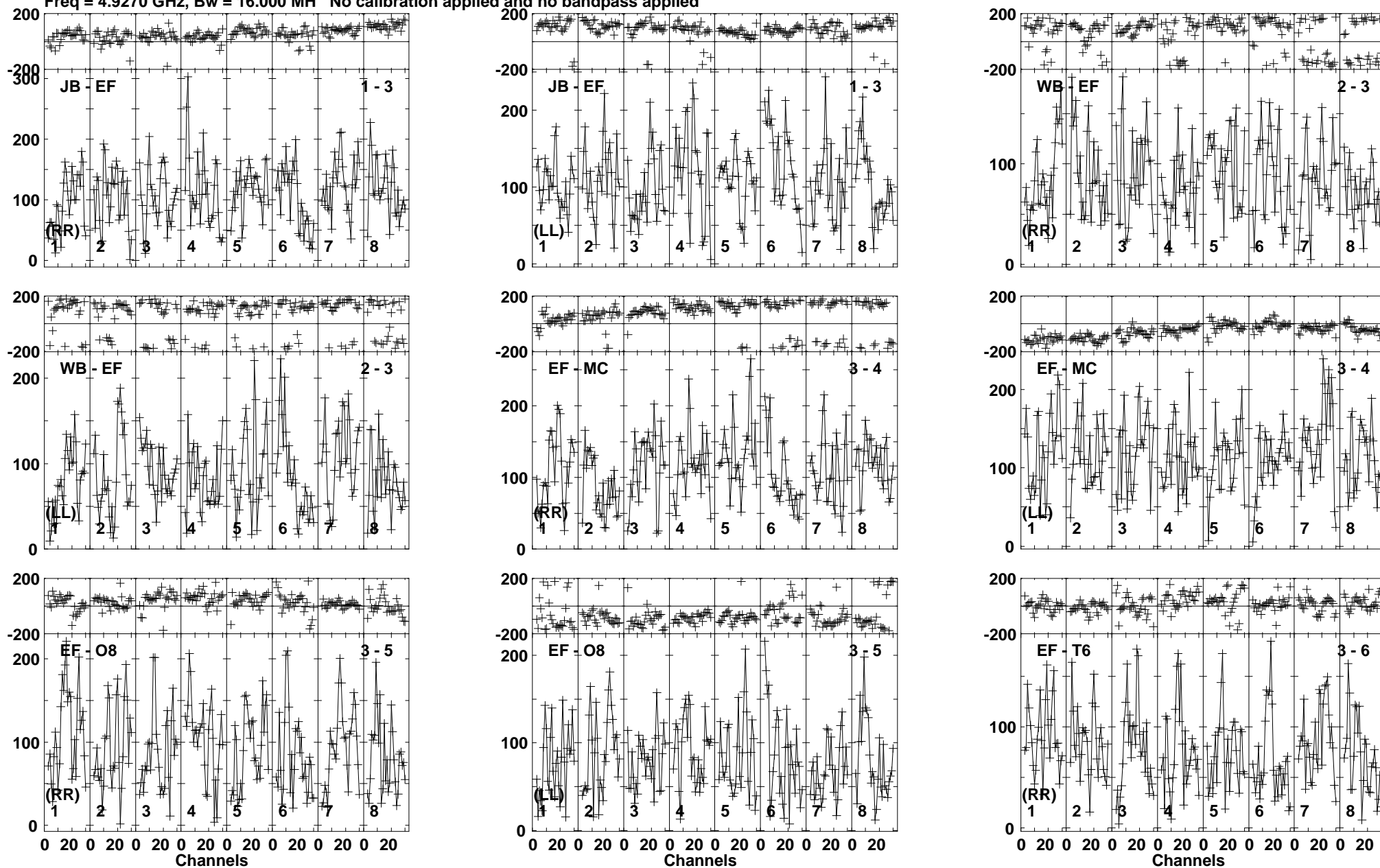

Lower frame: Micro Ampl Jy Top frame: Phas deg
Vector averaged cross-power spectrum Baseline: JB (01) - EF (03)
Timerange: 00/05:07:23 to 00/05:11:19

Plot file version 266 created 17-FEB-2020 15:43:03

J1402+5347 EK047 2.UVDATA.1

Freq = 4.9270 GHz, Bw = 16.000 MH No calibration applied and no bandpass applied

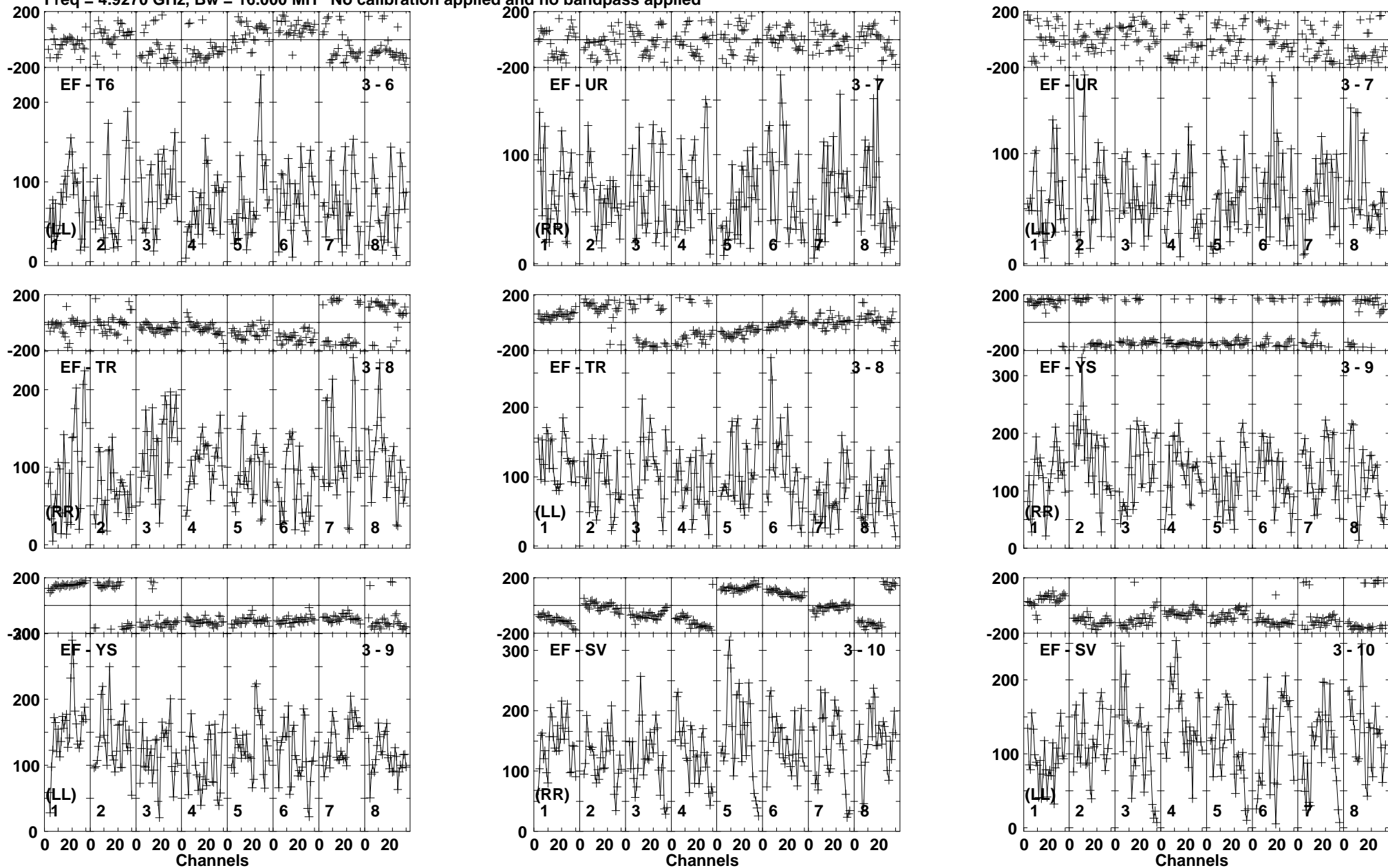

Lower frame: Micro Ampl Jy Top frame: Phas deg
Vector averaged cross-power spectrum Baseline: EF (03) - T6 (06)
Timerange: 00/05:07:23 to 00/05:11:19

Plot file version 267 created 17-FEB-2020 15:43:03

J1402+5347 EK047 2.UVDATA.1

Freq = 4.9270 GHz, Bw = 16.000 MH No calibration applied and no bandpass applied

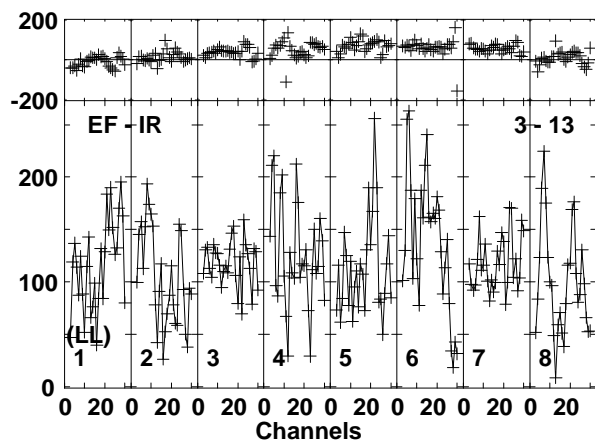
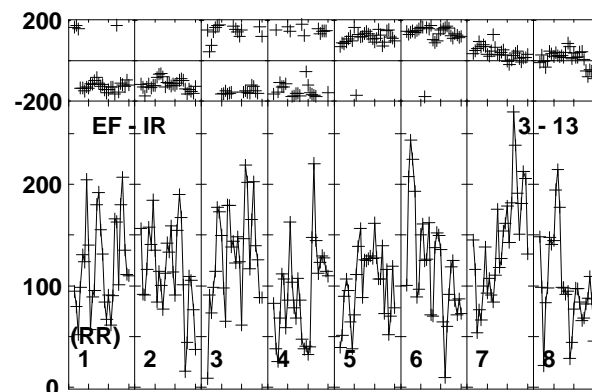
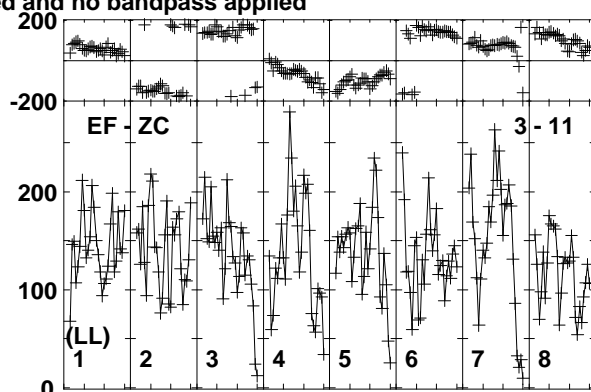
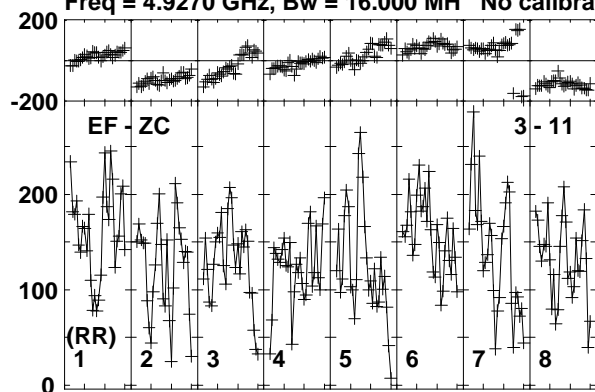

Lower frame: Micro Ampl Jy Top frame: Phas deg
Vector averaged cross-power spectrum Baseline: EF (03) - ZC (11)
Timerange: 00/05:07:23 to 00/05:11:19

Plot file version 268 created 17-FEB-2020 15:43:03

J1359+5544 EK047 2.UVDATA.1

Freq = 4.9270 GHz, Bw = 16.000 MH No calibration applied and no bandpass applied

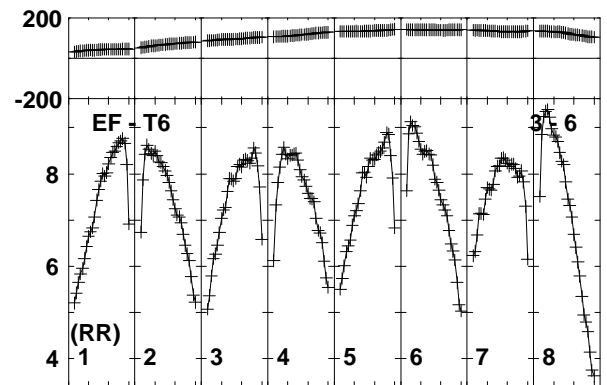
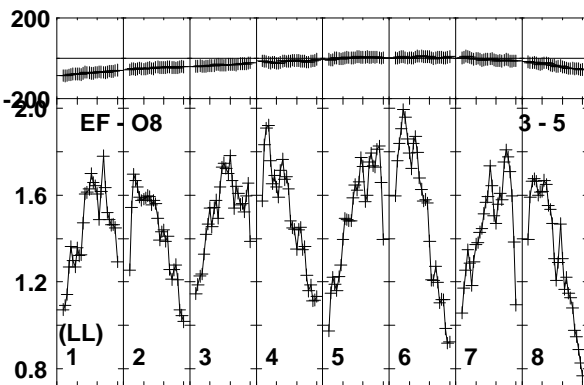
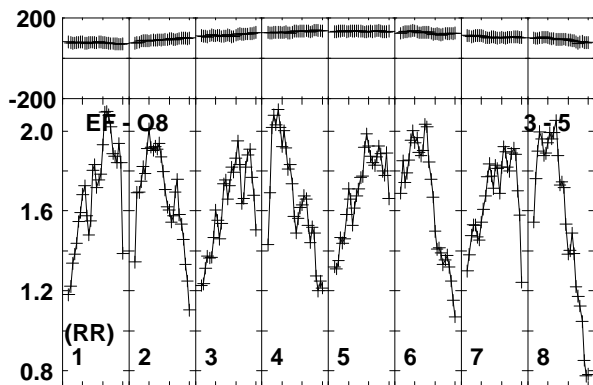
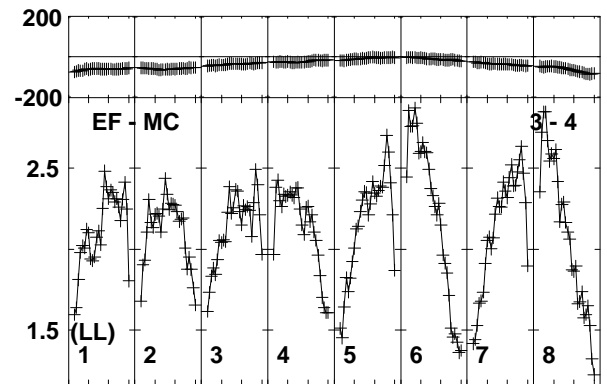
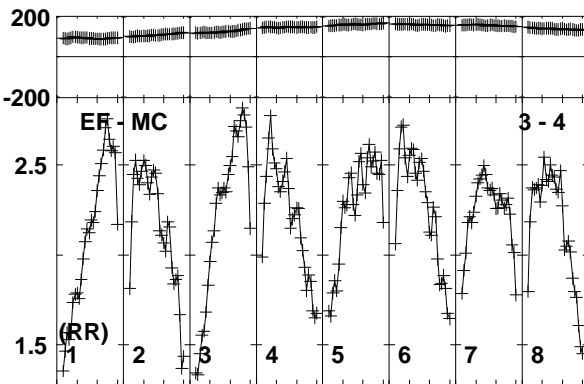
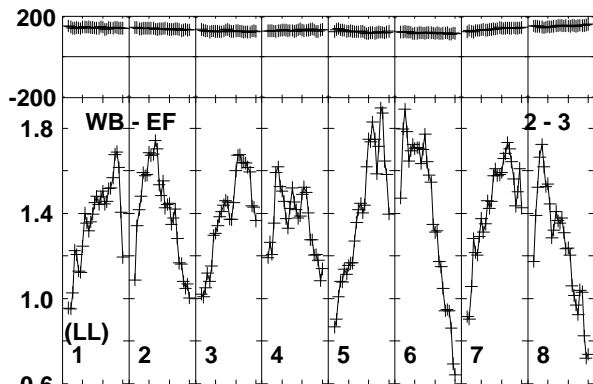
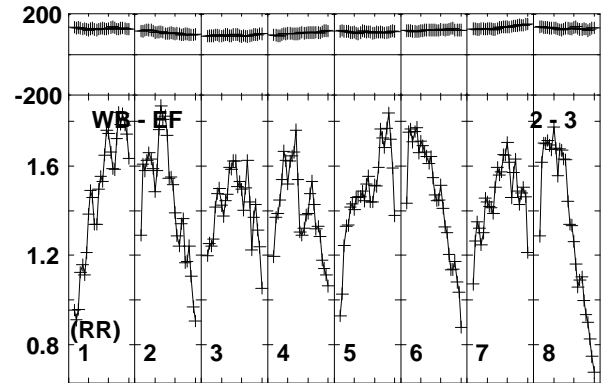
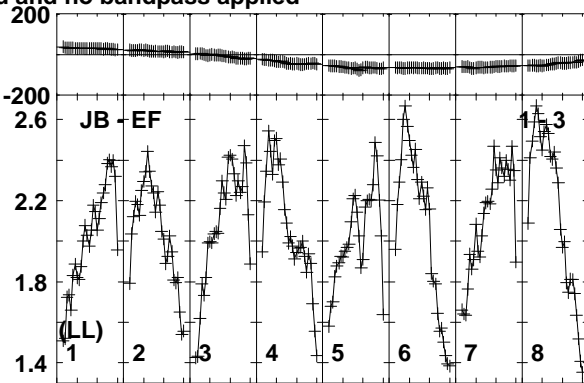
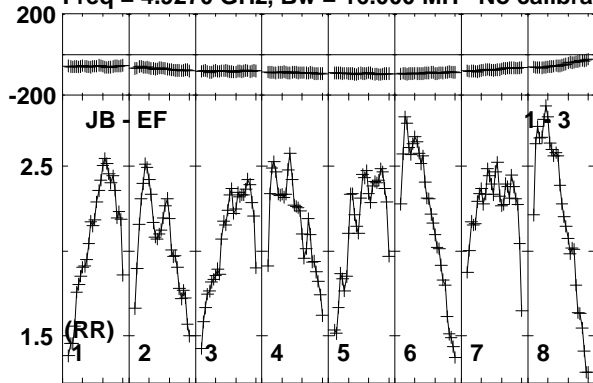

Lower frame: Milli Ampl Jy Top frame: Phas deg
Vector averaged cross-power spectrum Baseline: JB (01) - EF (03)
Timerange: 00/05:12:01 to 00/05:13:19

Plot file version 269 created 17-FEB-2020 15:43:03

J1359+5544 EK047 2.UVDATA.1

Freq = 4.9270 GHz, Bw = 16.000 MH No calibration applied and no bandpass applied

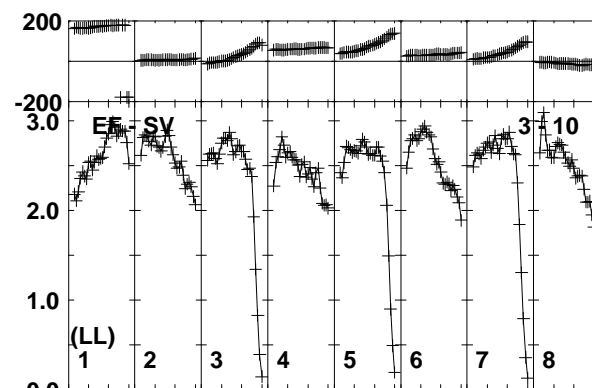
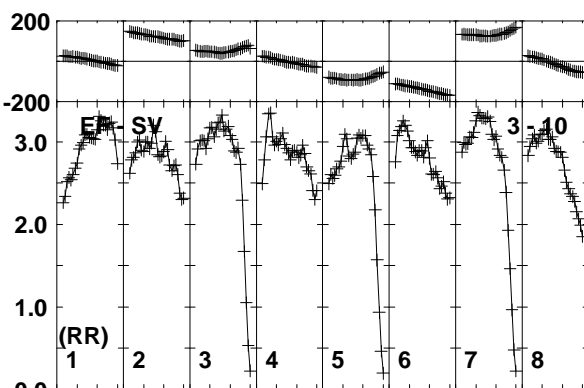
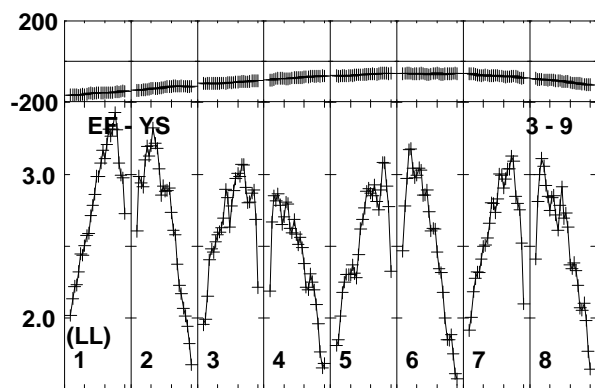
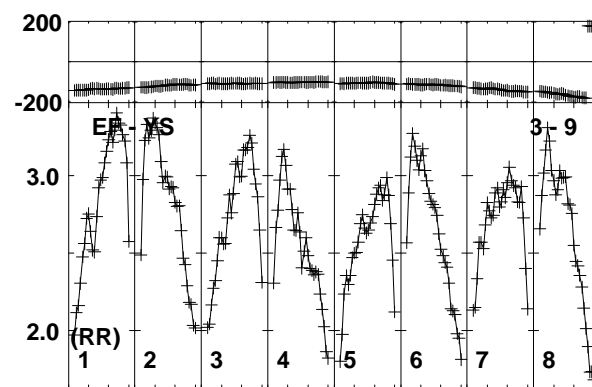
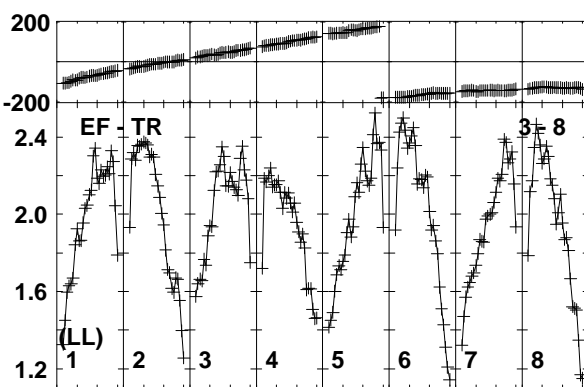
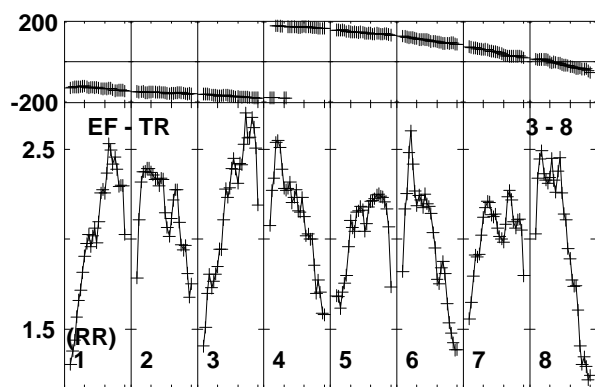
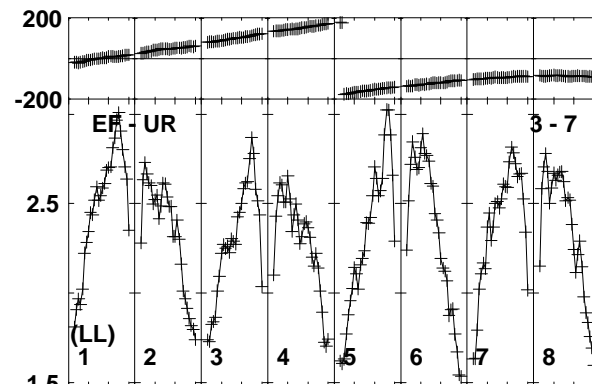
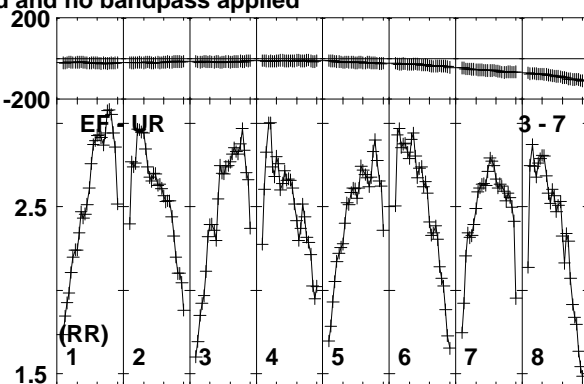
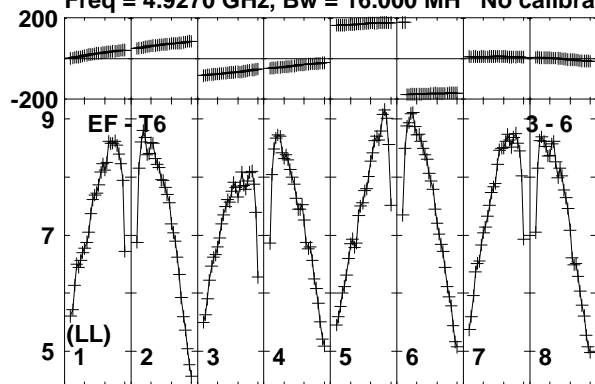

Lower frame: Milli Ampl Jy Top frame: Phas deg
Vector averaged cross-power spectrum Baseline: EF (03) - T6 (06)
Timerange: 00/05:12:01 to 00/05:13:19

Plot file version 270 created 17-FEB-2020 15:43:03

J1359+5544 EK047 2.UVDATA.1

Freq = 4.9270 GHz, Bw = 16.000 MH No calibration applied and no bandpass applied

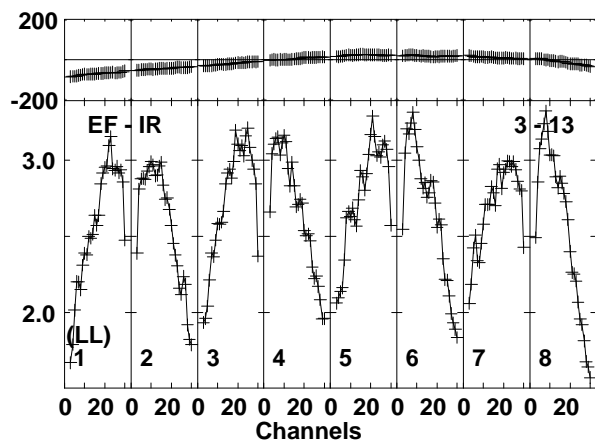
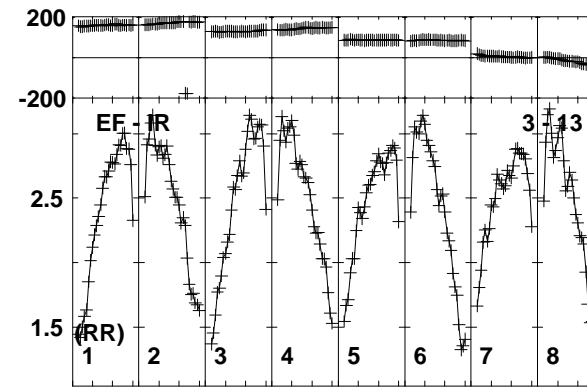
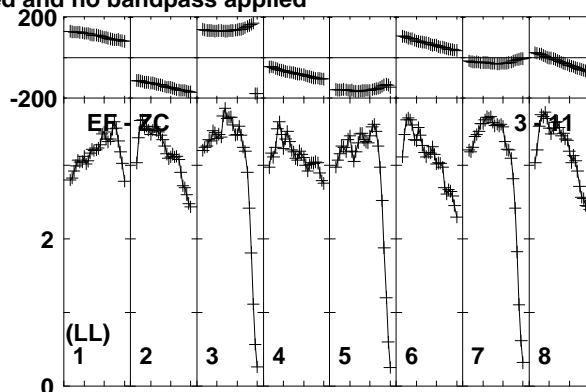
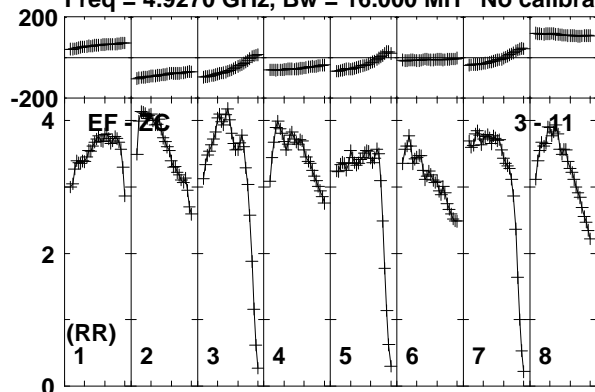

Lower frame: Milli Ampl Jy Top frame: Phas deg
Vector averaged cross-power spectrum Baseline: EF (03) - ZC (11)
Timerange: 00/05:12:01 to 00/05:13:19

Plot file version 271 created 17-FEB-2020 15:43:03

J1402+5347 EK047 2.UVDATA.1

Freq = 4.9270 GHz, Bw = 16.000 MH No calibration applied and no bandpass applied

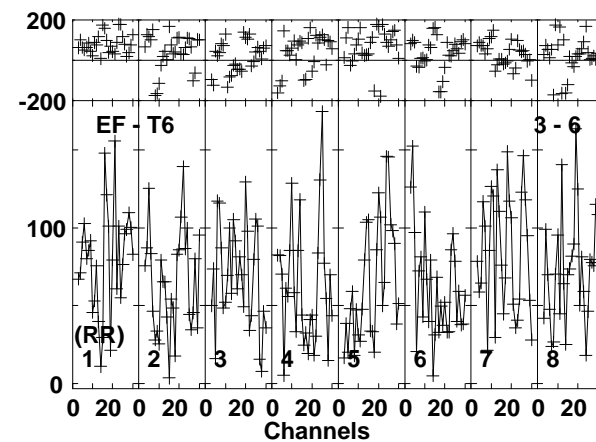
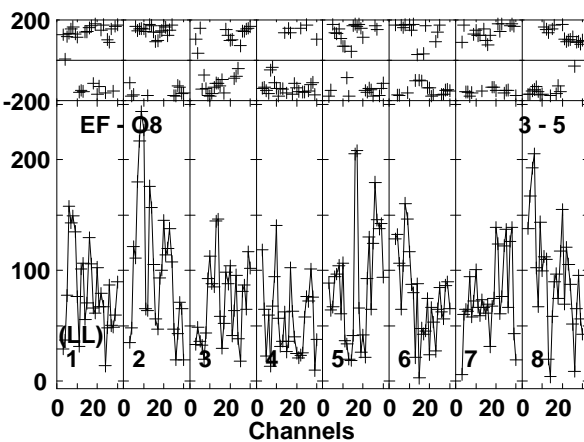
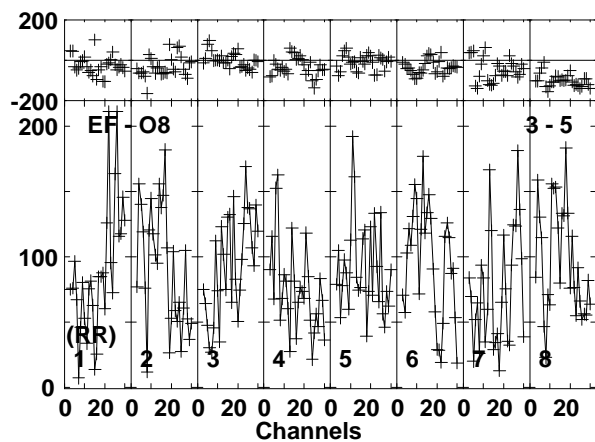
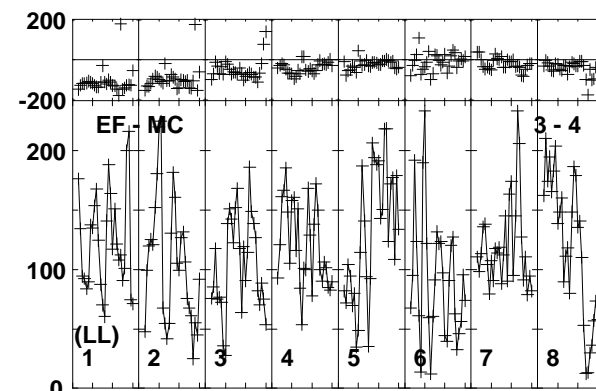
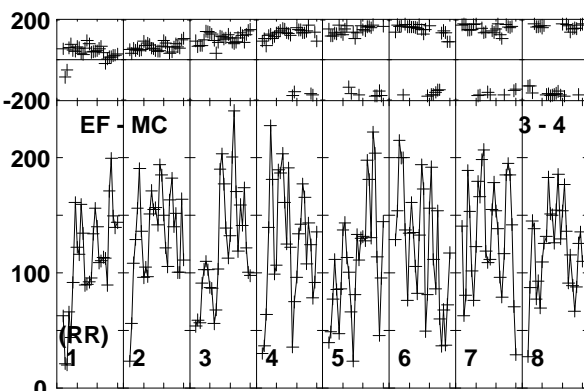
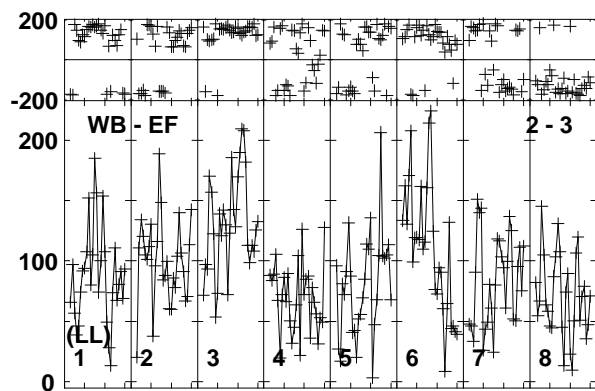
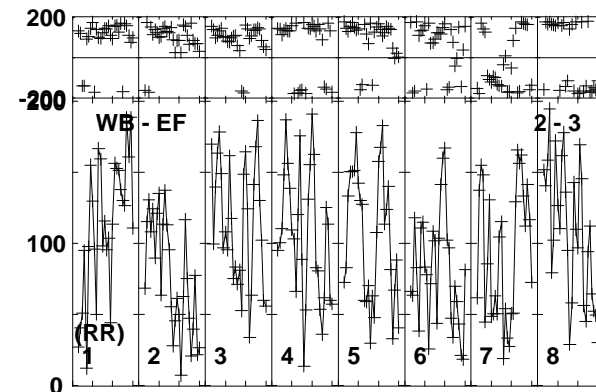
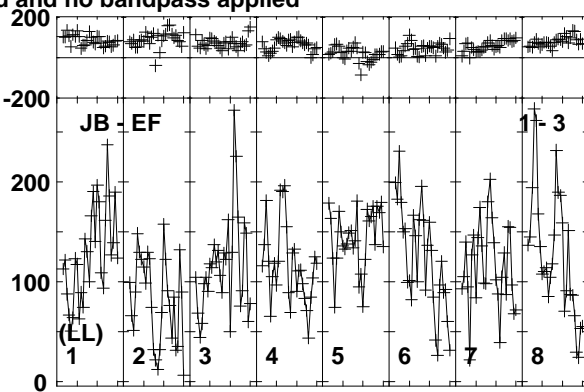
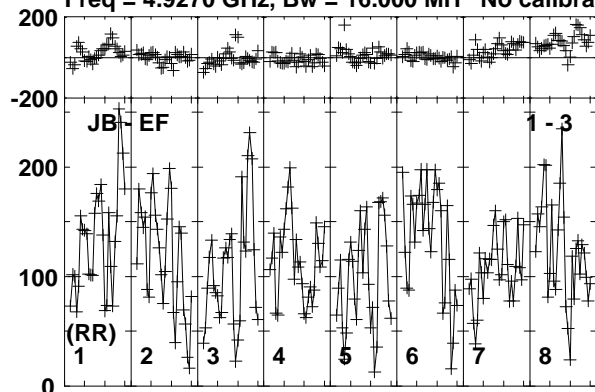

Lower frame: Micro Ampl Jy Top frame: Phas deg
Vector averaged cross-power spectrum Baseline: JB (01) - EF (03)
Timerange: 00/05:13:21 to 00/05:17:19

Plot file version 272 created 17-FEB-2020 15:43:03

J1402+5347 EK047 2.UVDATA.1

Freq = 4.9270 GHz, Bw = 16.000 MH No calibration applied and no bandpass applied

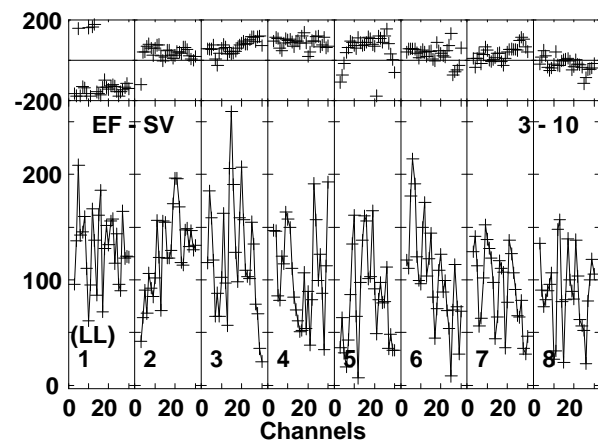
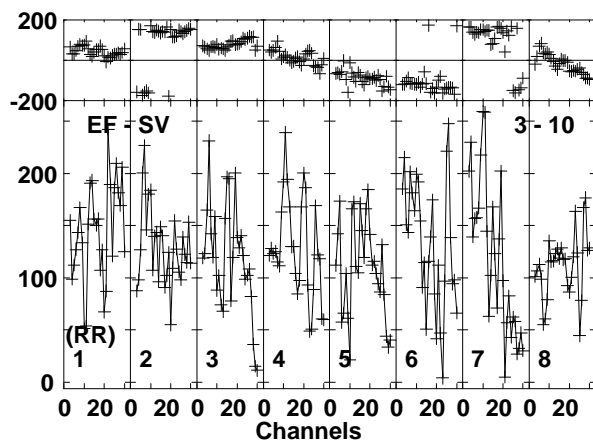
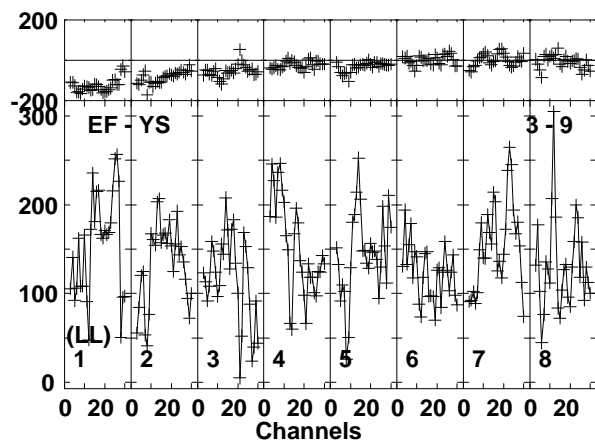
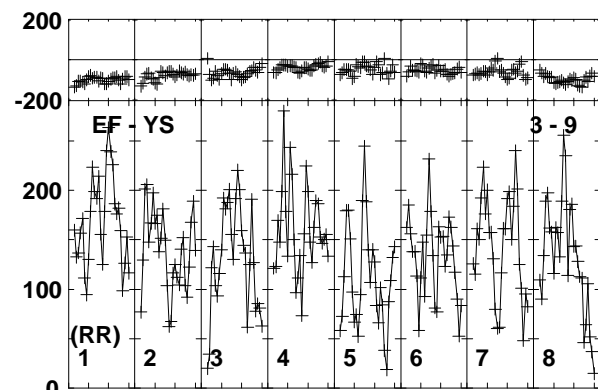
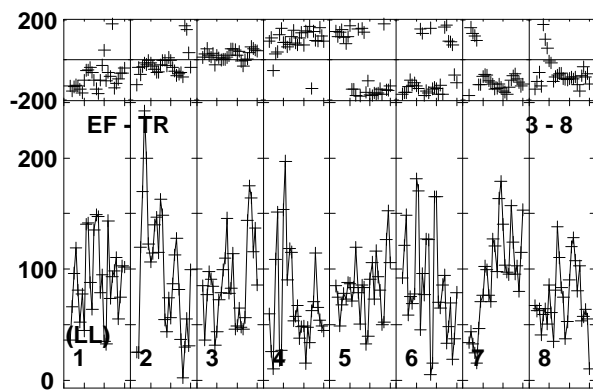
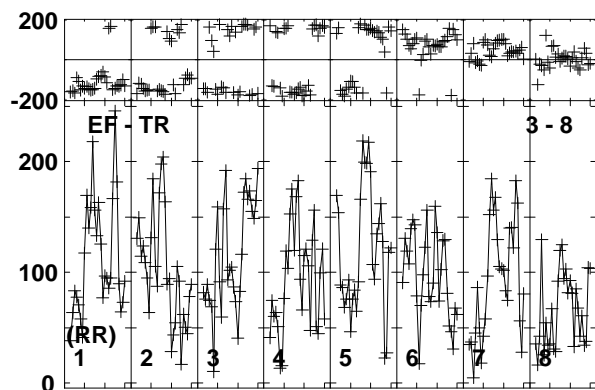
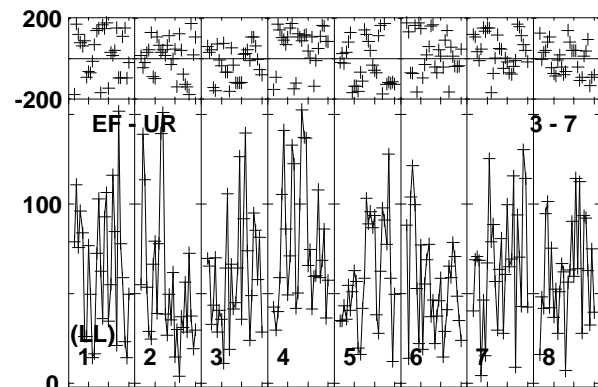
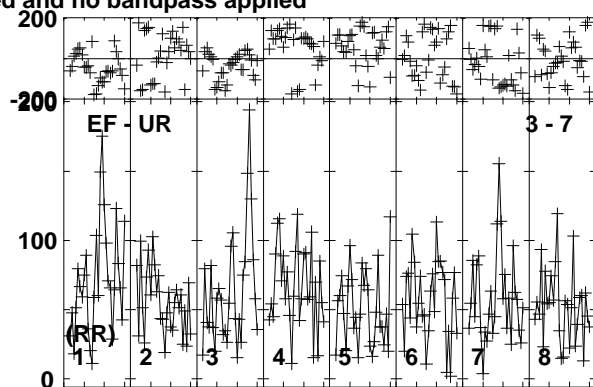
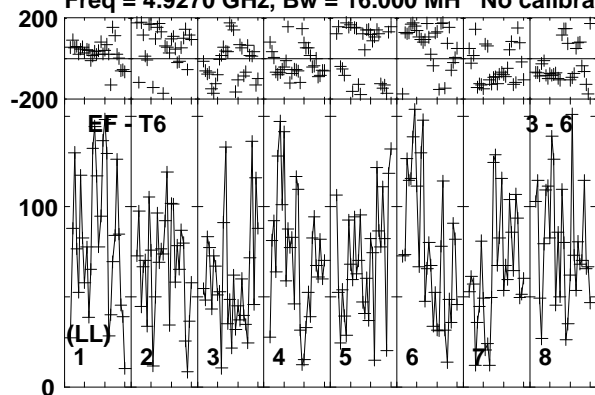

Lower frame: Micro Ampl Jy Top frame: Phas deg
Vector averaged cross-power spectrum Baseline: EF (03) - T6 (06)
Timerange: 00/05:13:21 to 00/05:17:19

Plot file version 273 created 17-FEB-2020 15:43:04

J1402+5347 EK047 2.UVDATA.1

Freq = 4.9270 GHz, Bw = 16.000 MH No calibration applied and no bandpass applied

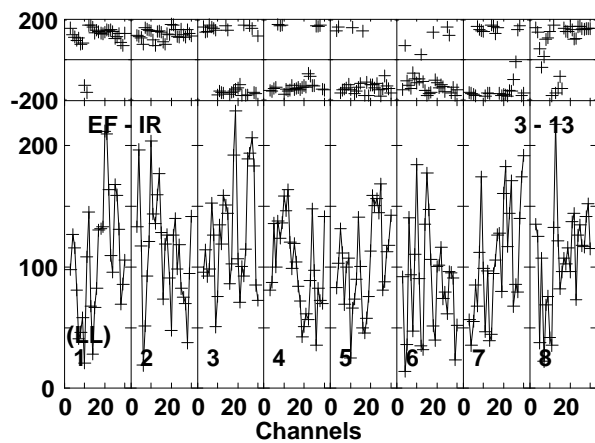
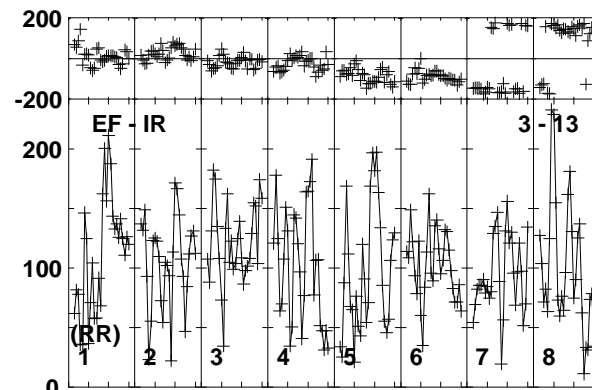
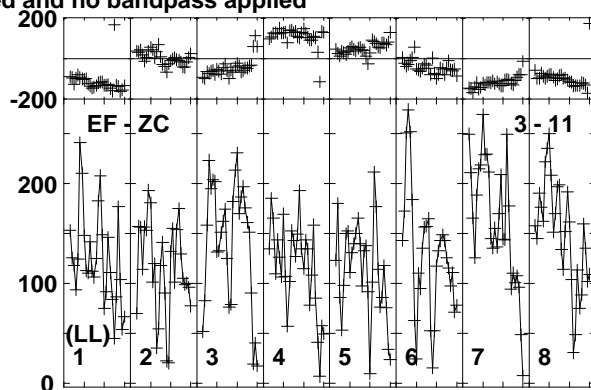
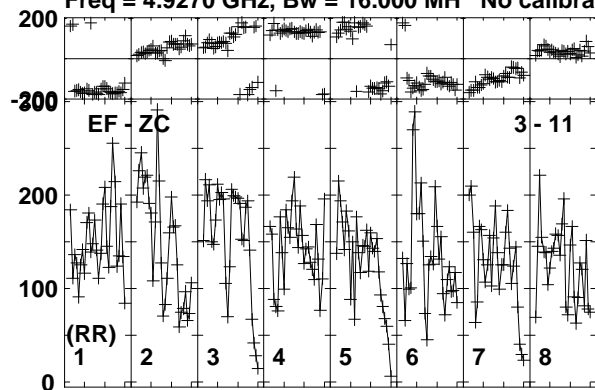

Lower frame: Micro Ampl Jy Top frame: Phas deg
Vector averaged cross-power spectrum Baseline: EF (03) - ZC (11)
Timerange: 00/05:13:21 to 00/05:17:19

Plot file version 274 created 17-FEB-2020 15:43:04

J1359+5544 EK047 2.UVDATA.1

Freq = 4.9270 GHz, Bw = 16.000 MH No calibration applied and no bandpass applied

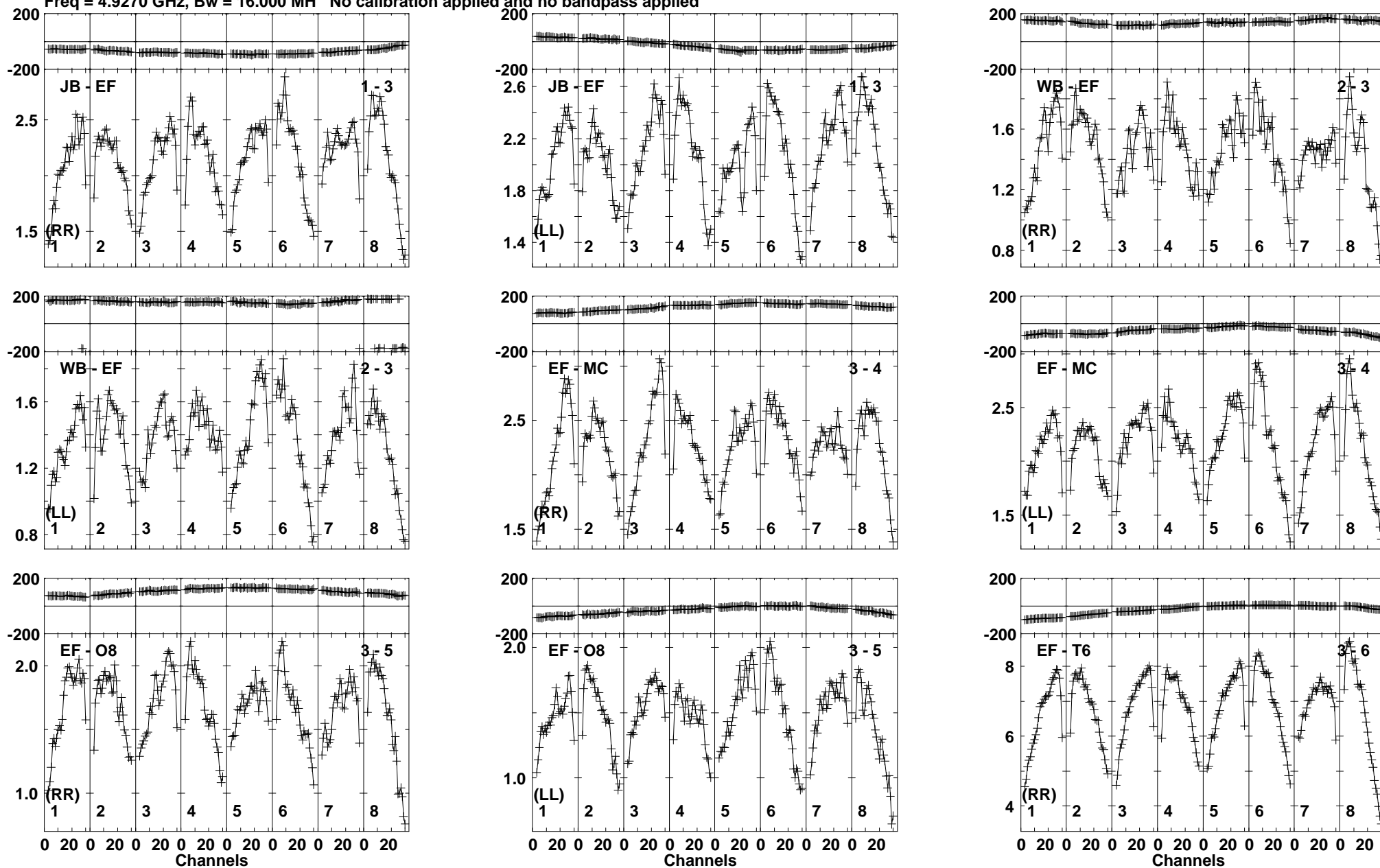

Lower frame: Milli Ampl Jy Top frame: Phas deg
Vector averaged cross-power spectrum Baseline: JB (01) - EF (03)
Timerange: 00/05:17:21 to 00/05:19:19

Plot file version 275 created 17-FEB-2020 15:43:04

J1359+5544 EK047 2.UVDATA.1

Freq = 4.9270 GHz, Bw = 16.000 MH No calibration applied and no bandpass applied

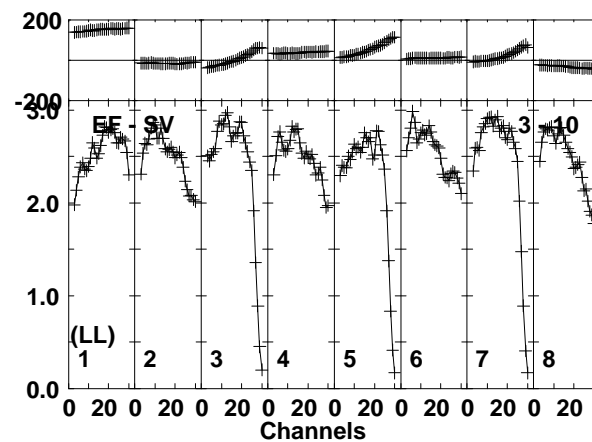
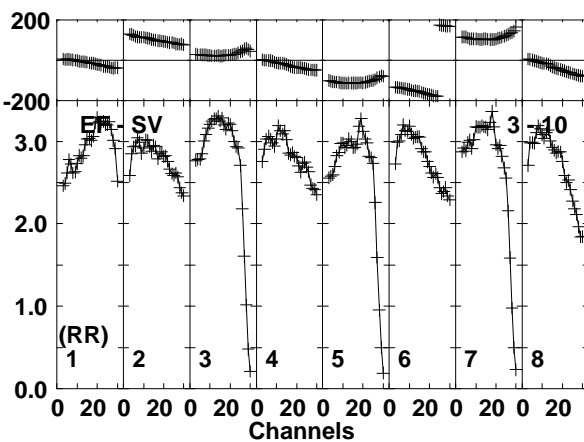
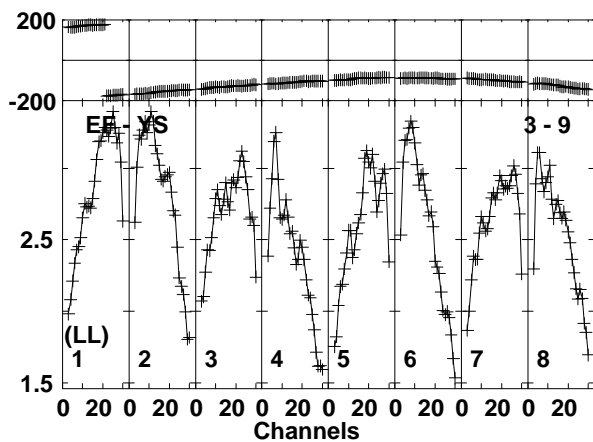
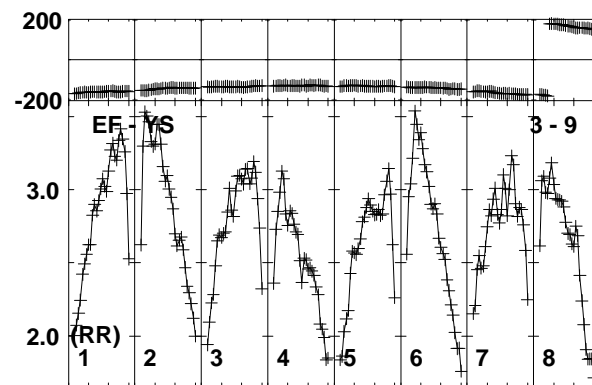
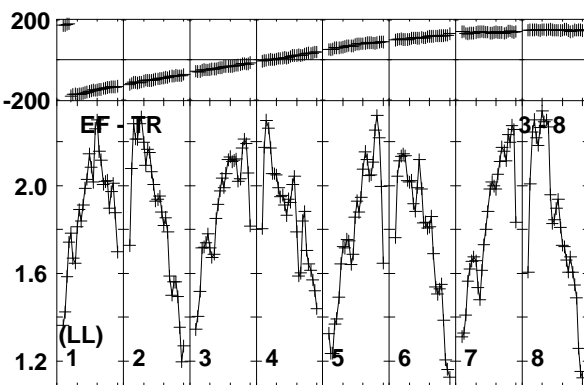
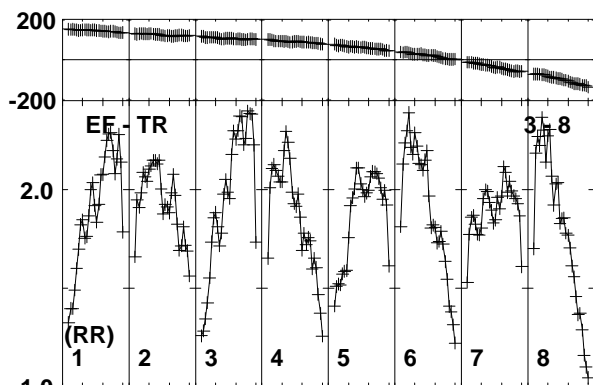
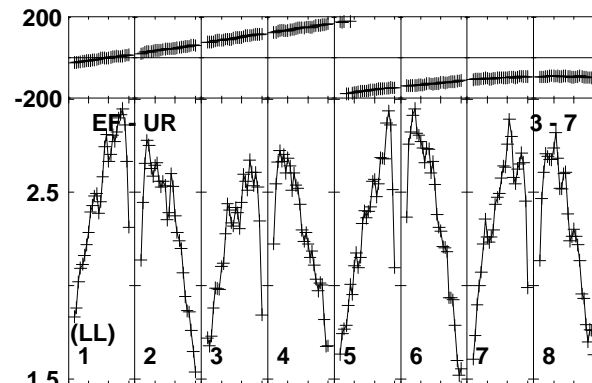
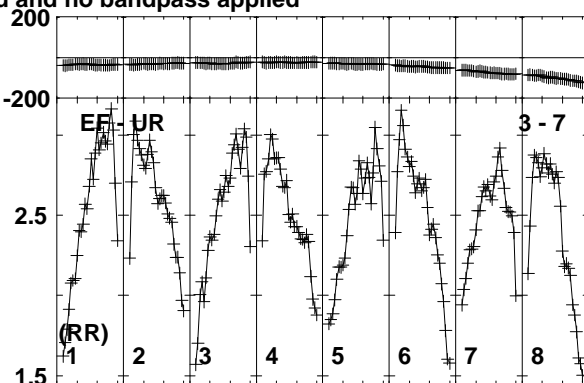
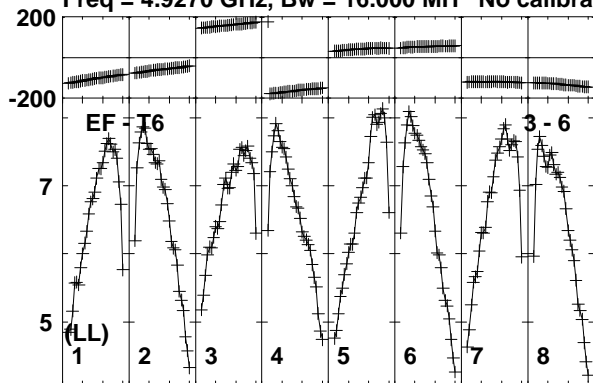

Lower frame: Milli Ampl Jy Top frame: Phas deg
Vector averaged cross-power spectrum Baseline: EF (03) - T6 (06)
Timerange: 00/05:17:21 to 00/05:19:19

Plot file version 276 created 17-FEB-2020 15:43:04

J1359+5544 EK047 2.UVDATA.1

Freq = 4.9270 GHz, Bw = 16.000 MH No calibration applied and no bandpass applied

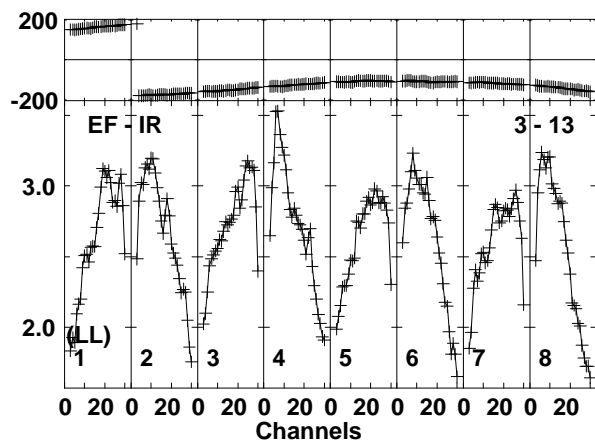
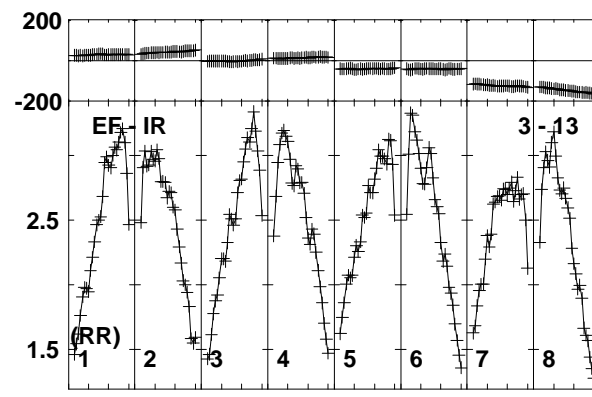
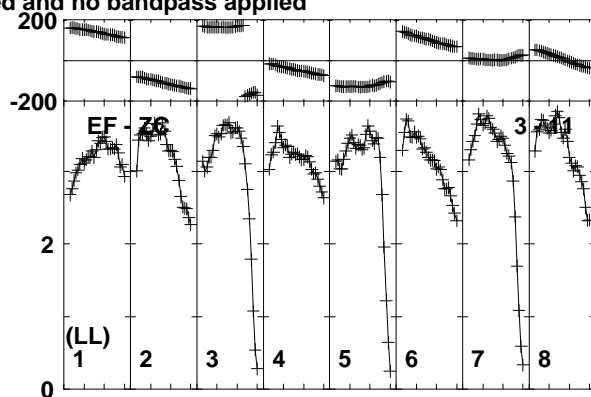
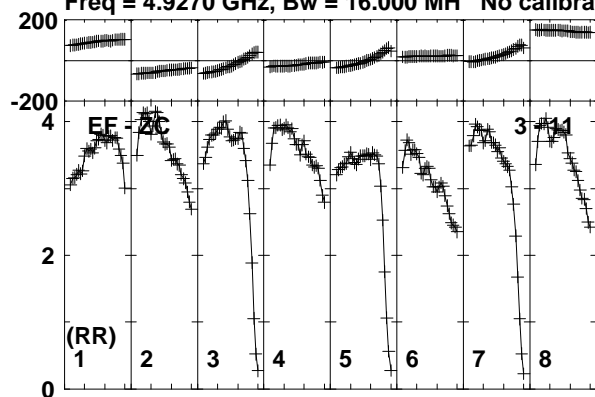

Lower frame: Milli Ampl Jy Top frame: Phas deg
Vector averaged cross-power spectrum Baseline: EF (03) - ZC (11)
Timerange: 00/05:17:21 to 00/05:19:19

Plot file version 277 created 17-FEB-2020 15:43:04

J1402+5347 EK047 2.UVDATA.1

Freq = 4.9270 GHz, Bw = 16.000 MH No calibration applied and no bandpass applied

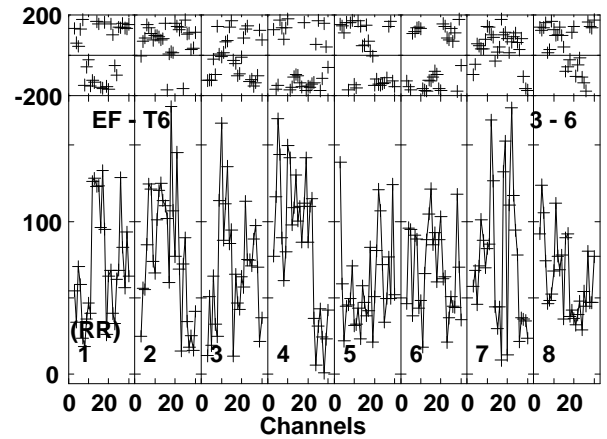
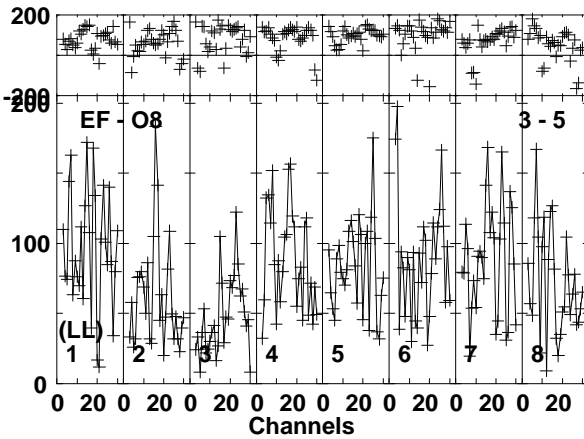
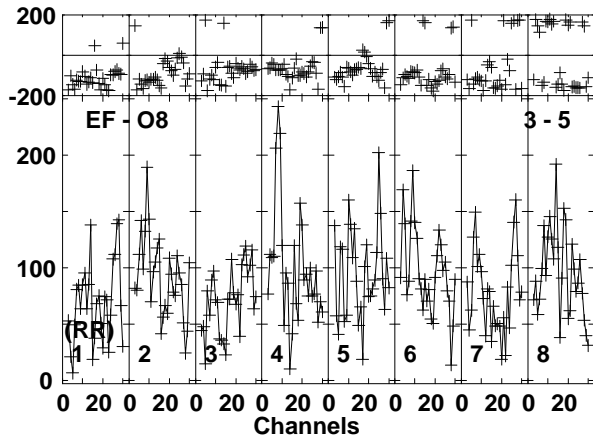
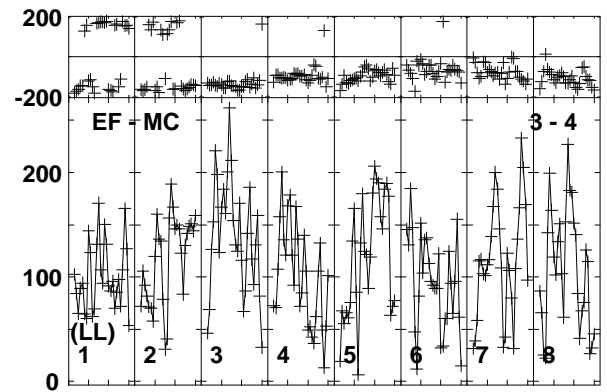
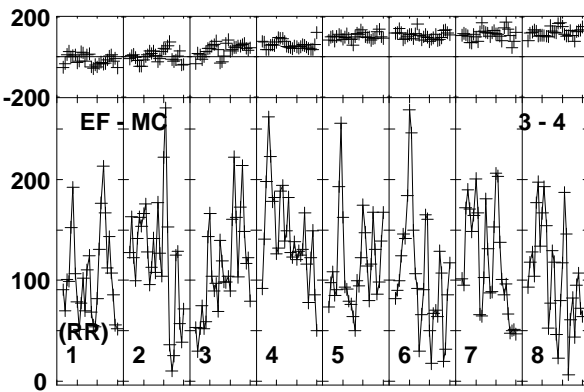
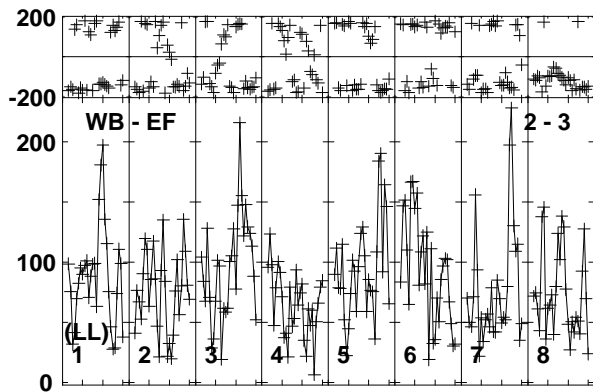
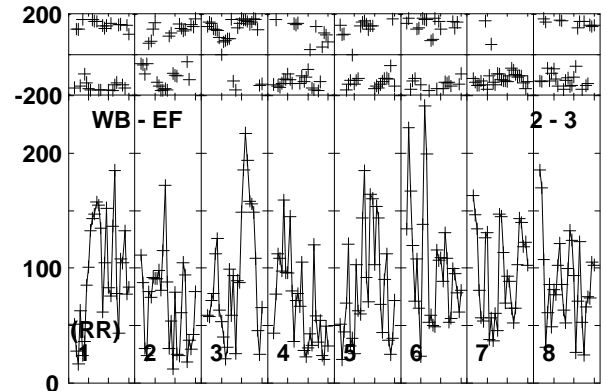
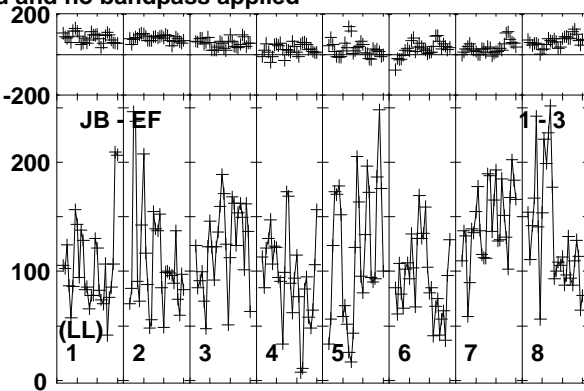
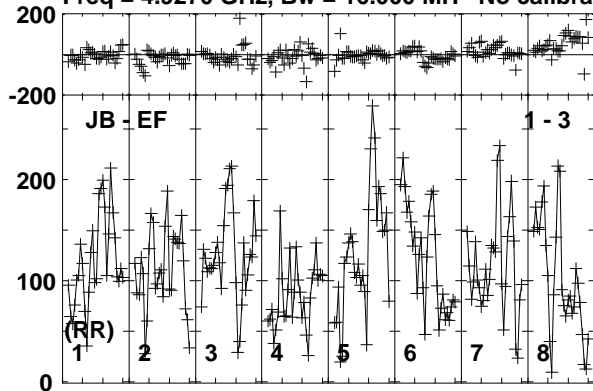

Lower frame: Micro Ampl Jy Top frame: Phas deg
Vector averaged cross-power spectrum Baseline: JB (01) - EF (03)
Timerange: 00/05:19:21 to 00/05:23:19

Plot file version 278 created 17-FEB-2020 15:43:04

J1402+5347 EK047 2.UVDATA.1

Freq = 4.9270 GHz, Bw = 16.000 MH No calibration applied and no bandpass applied

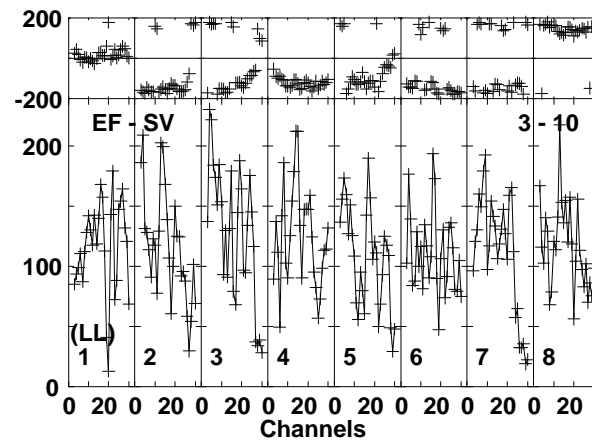
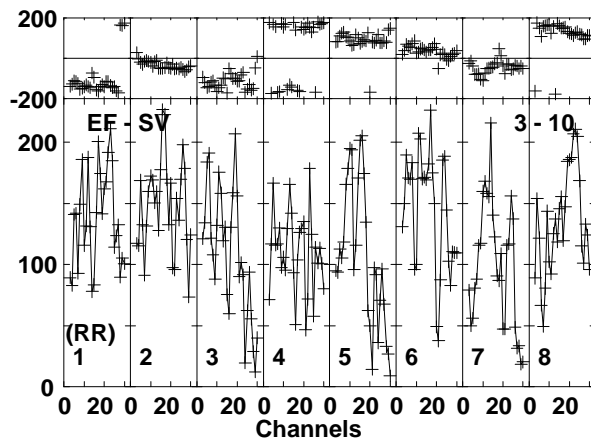
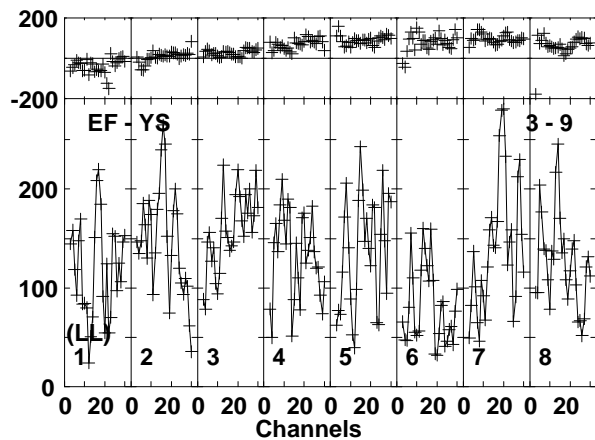
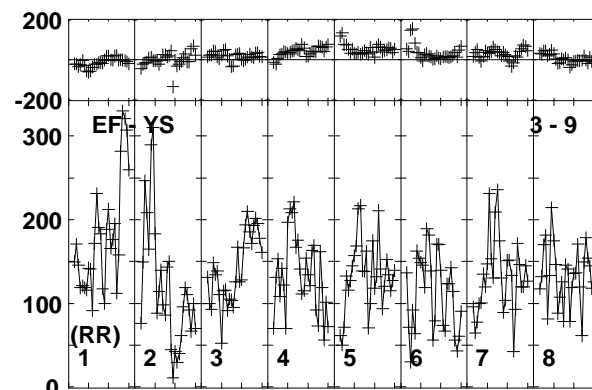
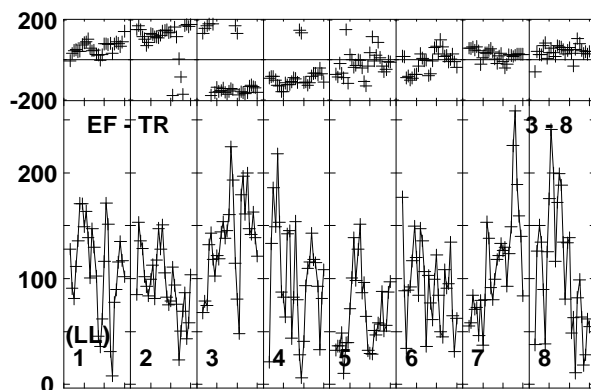
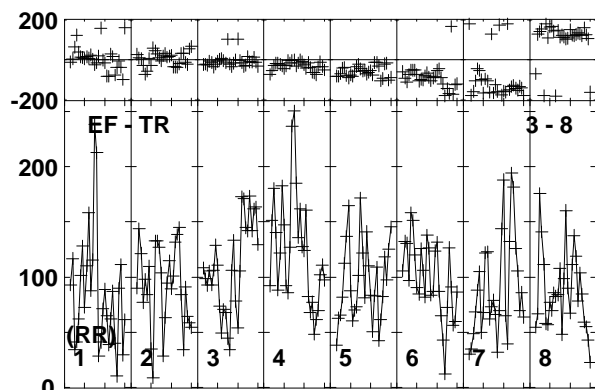
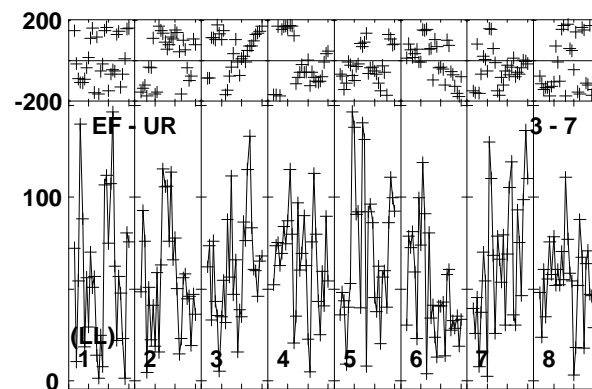
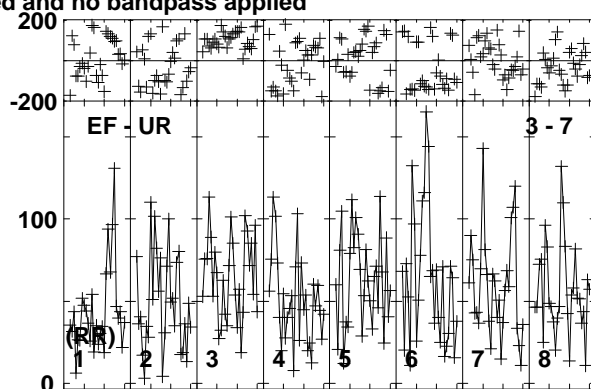
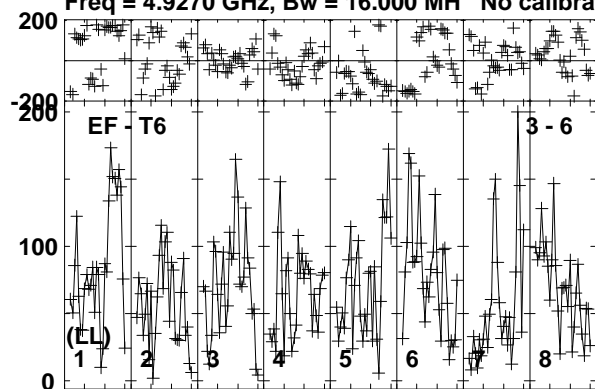

Lower frame: Micro Ampl Jy Top frame: Phas deg
Vector averaged cross-power spectrum Baseline: EF (03) - T6 (06)
Timerange: 00/05:19:21 to 00/05:23:19

Plot file version 279 created 17-FEB-2020 15:43:04

J1402+5347 EK047 2.UVDATA.1

Freq = 4.9270 GHz, Bw = 16.000 MH No calibration applied and no bandpass applied

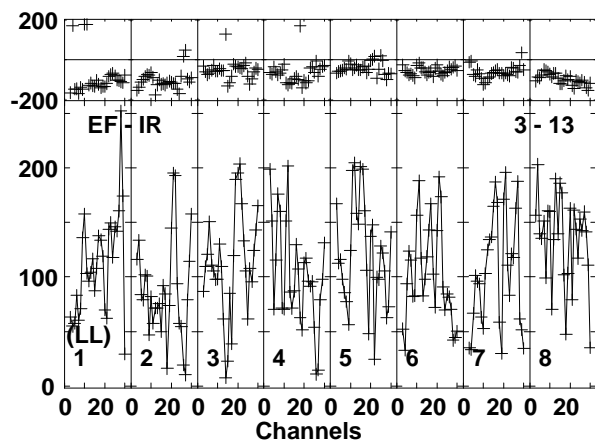
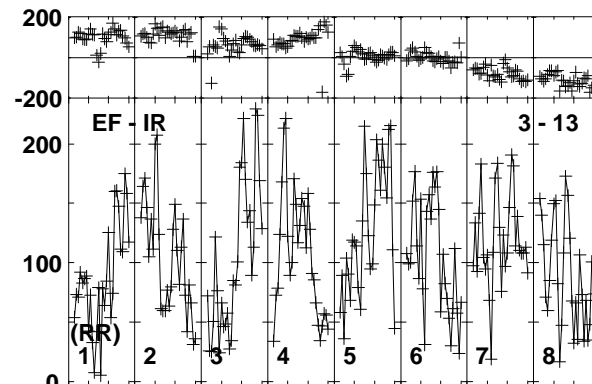
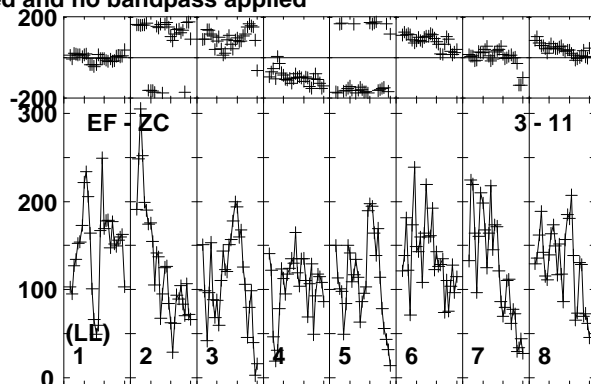
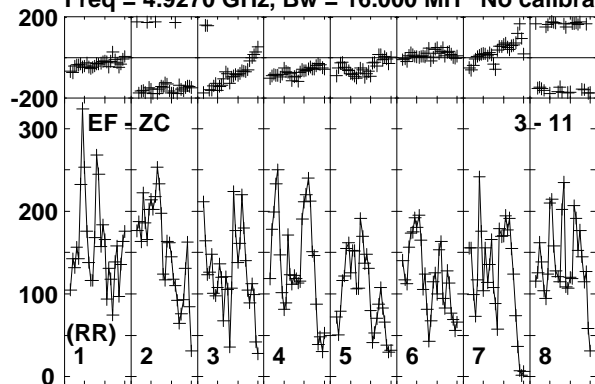

Lower frame: Micro Ampl Jy Top frame: Phas deg
Vector averaged cross-power spectrum Baseline: EF (03) - ZC (11)
Timerange: 00/05:19:21 to 00/05:23:19

Plot file version 280 created 17-FEB-2020 15:43:04

J1359+5544 EK047 2.UVDATA.1

Freq = 4.9270 GHz, Bw = 16.000 MH No calibration applied and no bandpass applied

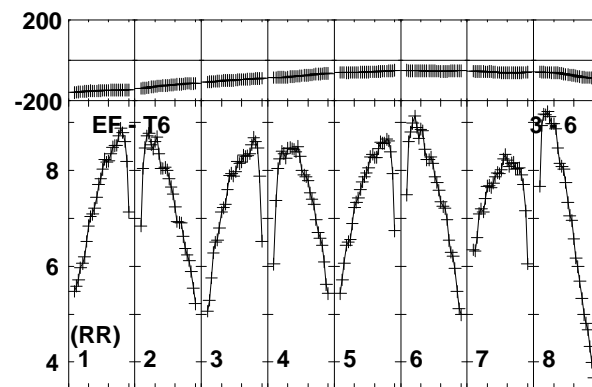
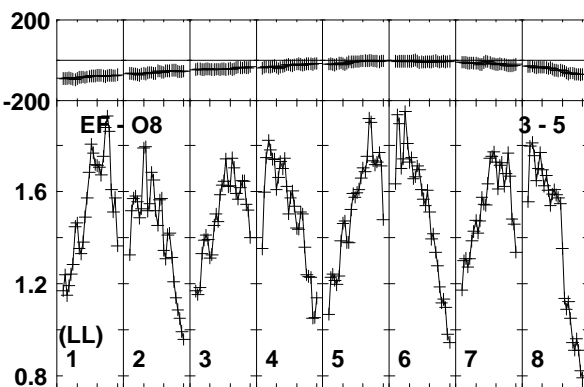
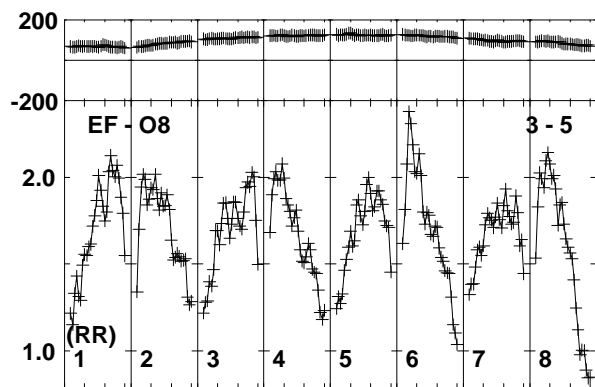
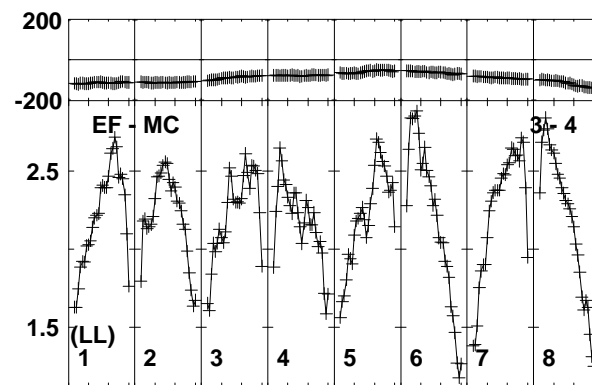
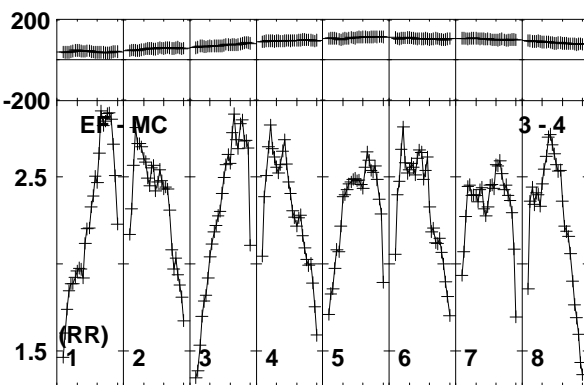
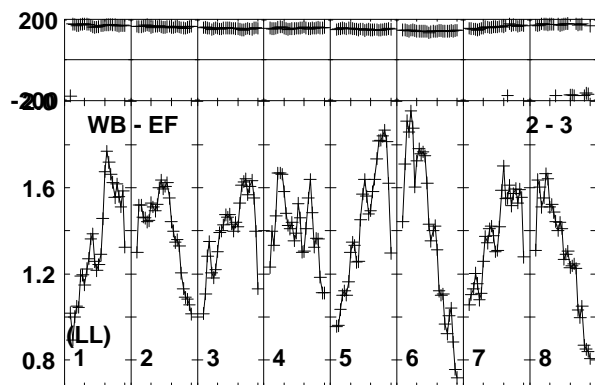
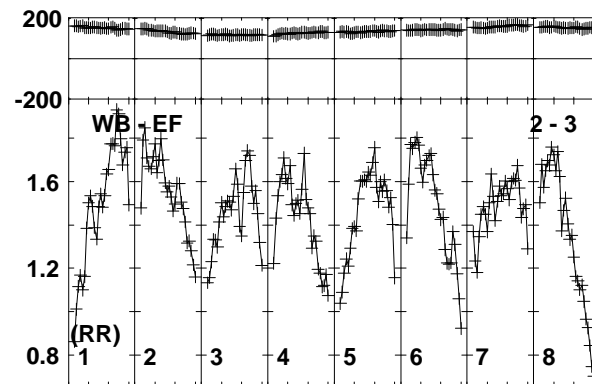
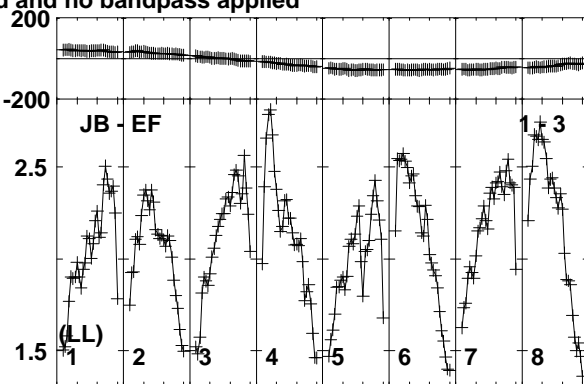
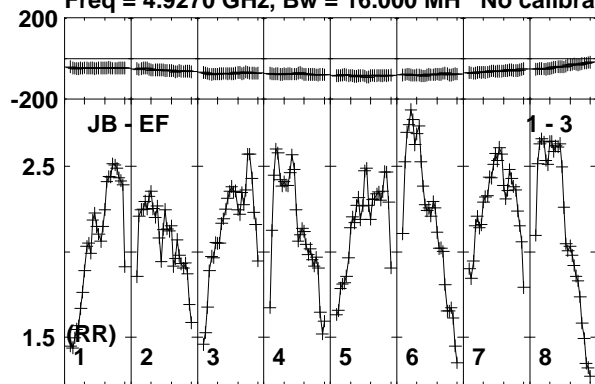

Lower frame: Milli Ampl Jy Top frame: Phas deg

Vector averaged cross-power spectrum Baseline: JB (01) - EF (03)

Timerange: 00/05:24:01 to 00/05:25:19

Plot file version 281 created 17-FEB-2020 15:43:04

J1359+5544 EK047 2.UVDATA.1

Freq = 4.9270 GHz, Bw = 16.000 MH No calibration applied and no bandpass applied

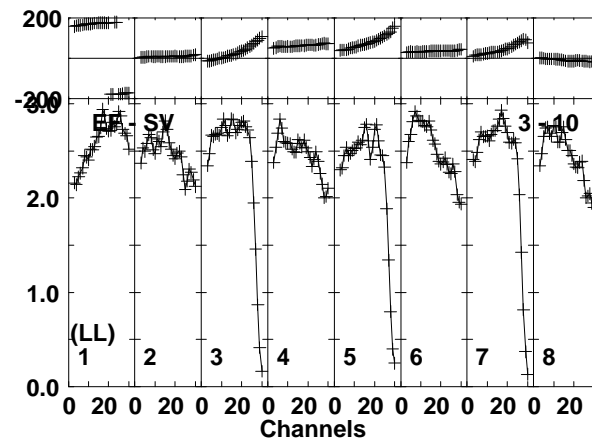
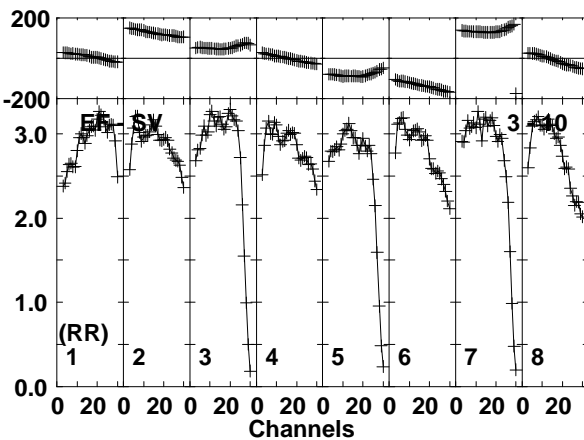
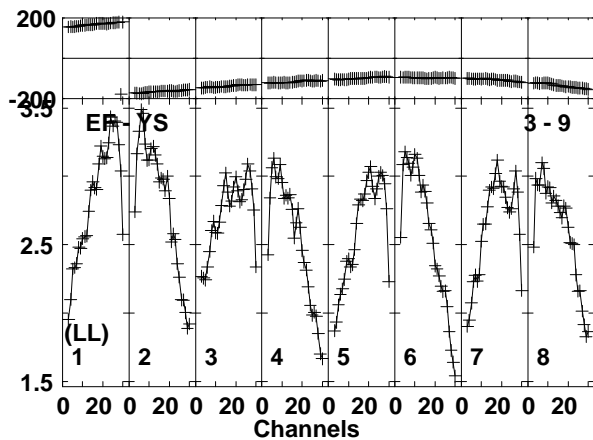
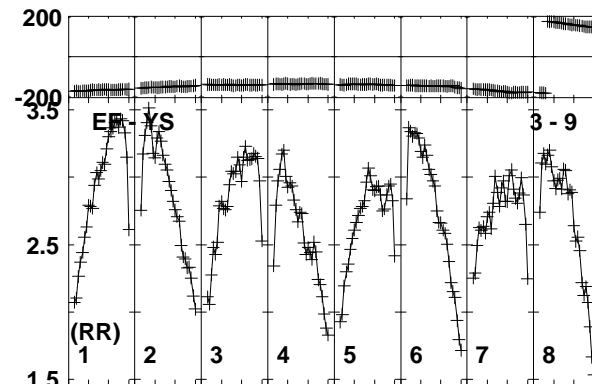
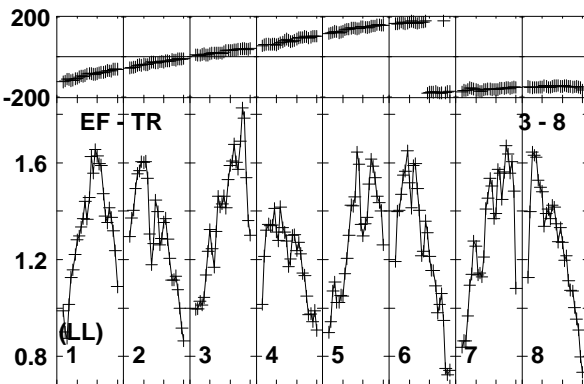
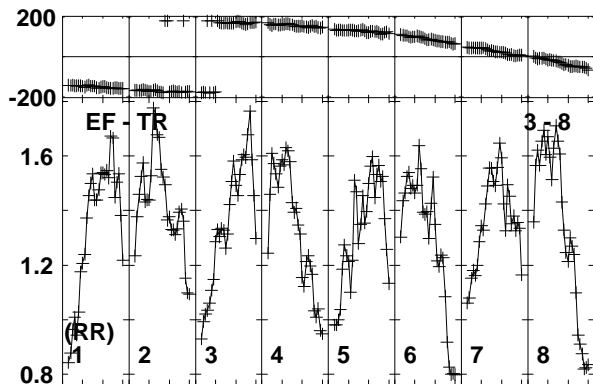
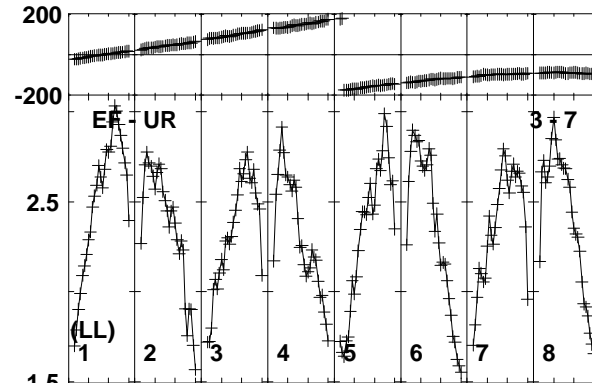
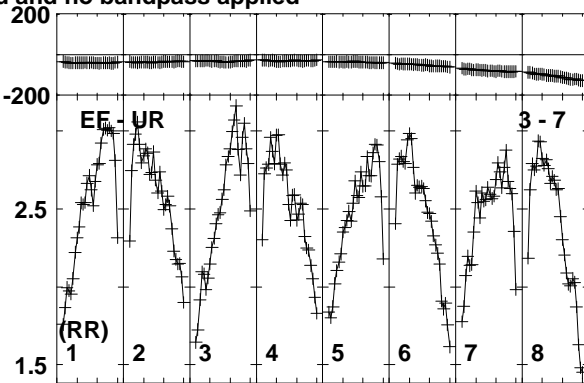
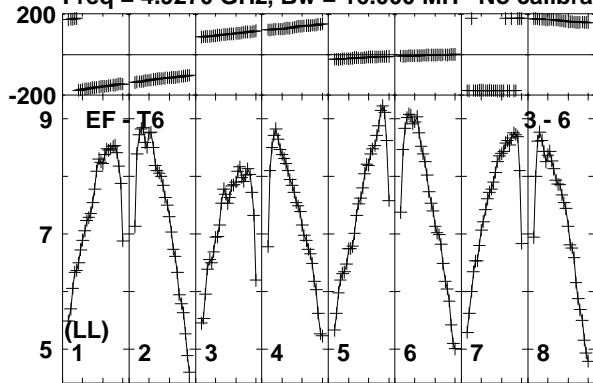

Lower frame: Milli Ampl Jy Top frame: Phas deg
Vector averaged cross-power spectrum Baseline: EF (03) - T6 (06)
Timerange: 00/05:24:01 to 00/05:25:19

Plot file version 282 created 17-FEB-2020 15:43:04

J1359+5544 EK047 2.UVDATA.1

Freq = 4.9270 GHz, Bw = 16.000 MH No calibration applied and no bandpass applied

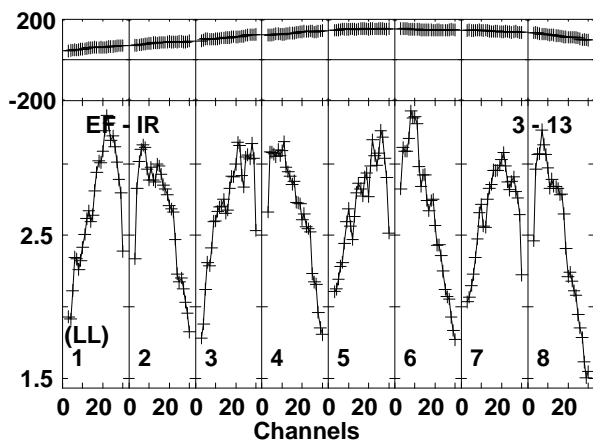
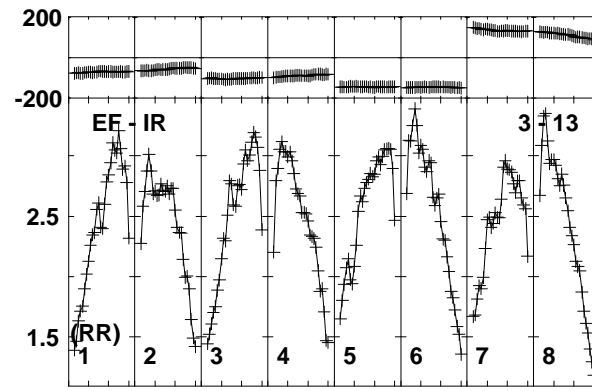
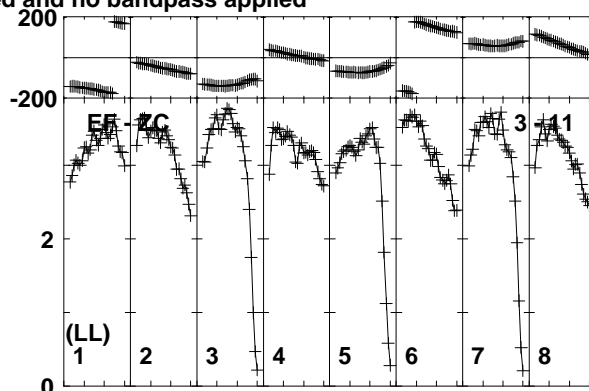
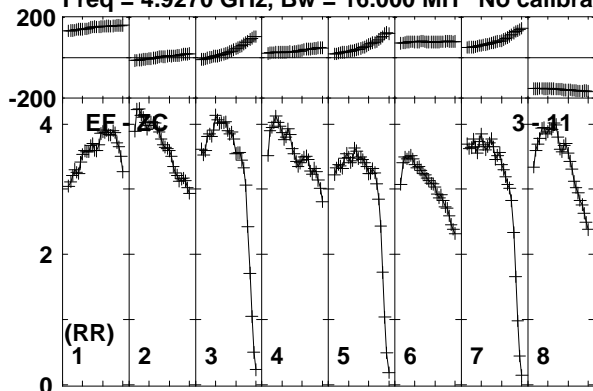

Lower frame: Milli Ampl Jy Top frame: Phas deg
Vector averaged cross-power spectrum Baseline: EF (03) - ZC (11)
Timerange: 00/05:24:01 to 00/05:25:19

Plot file version 283 created 17-FEB-2020 15:43:04

J1402+5347 EK047 2.UVDATA.1

Freq = 4.9270 GHz, Bw = 16.000 MH No calibration applied and no bandpass applied

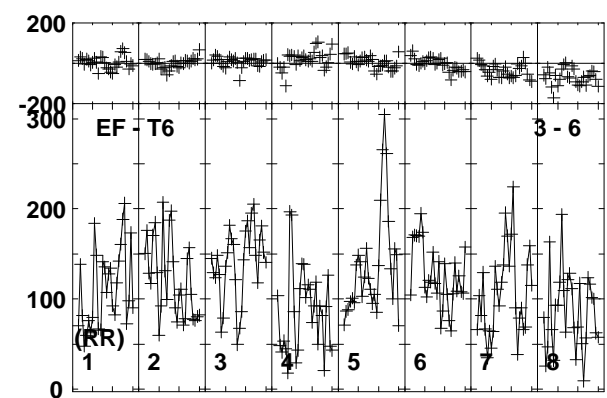
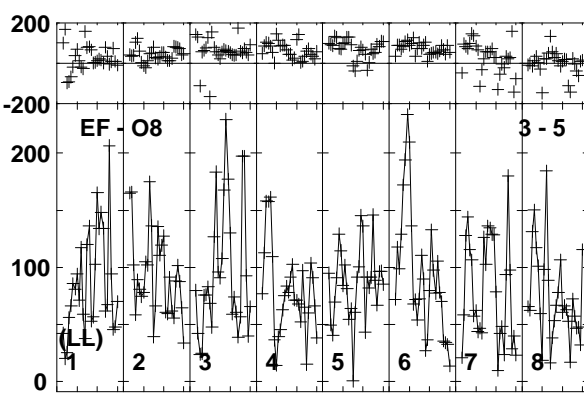
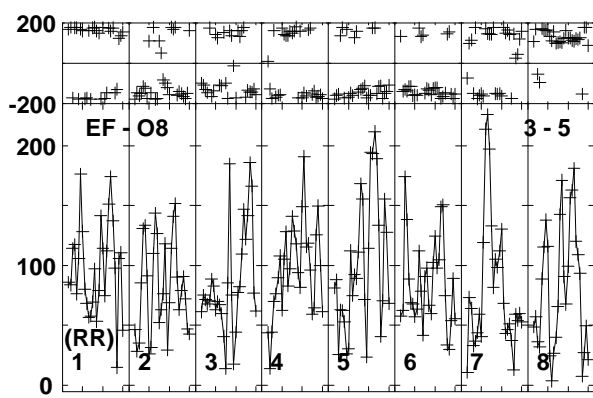
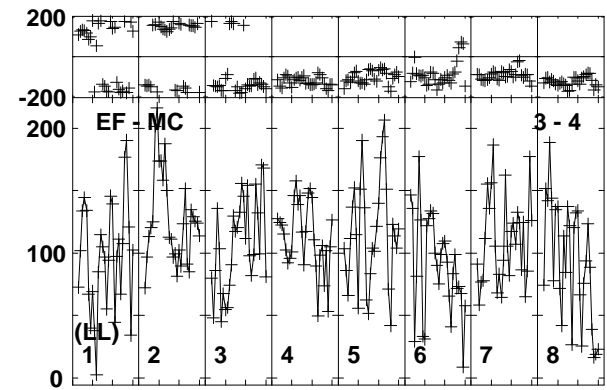
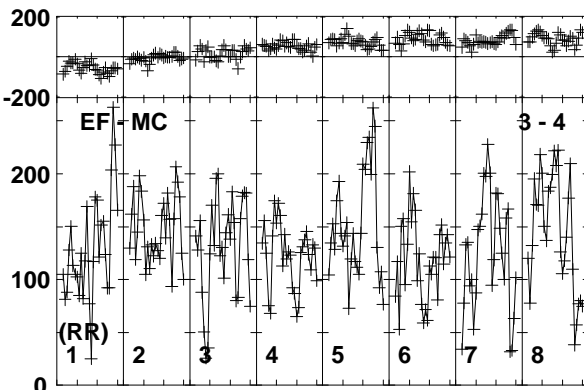
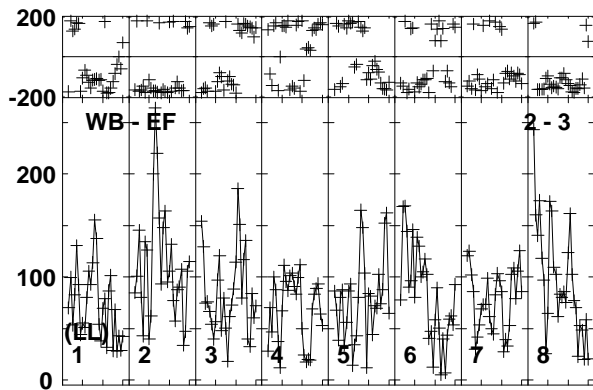
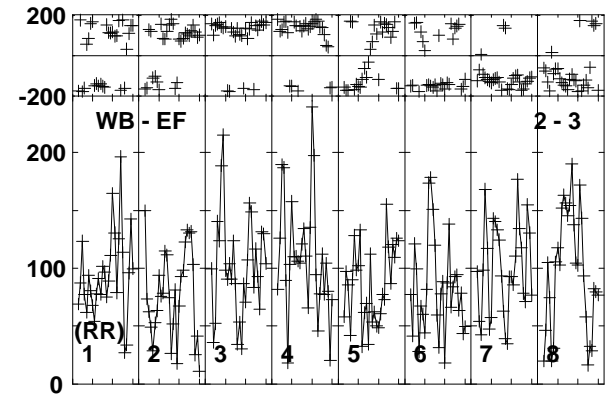
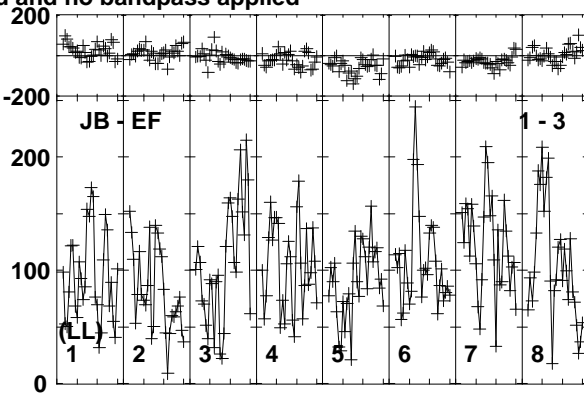
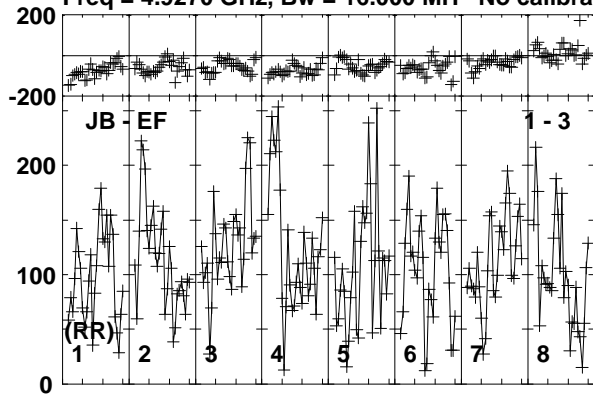

Lower frame: Micro Ampl Jy Top frame: Phas deg
Vector averaged cross-power spectrum Baseline: JB (01) - EF (03)
Timerange: 00/05:25:21 to 00/05:29:19

Plot file version 284 created 17-FEB-2020 15:43:05

J1402+5347 EK047 2.UVDATA.1

Freq = 4.9270 GHz, Bw = 16.000 MH No calibration applied and no bandpass applied

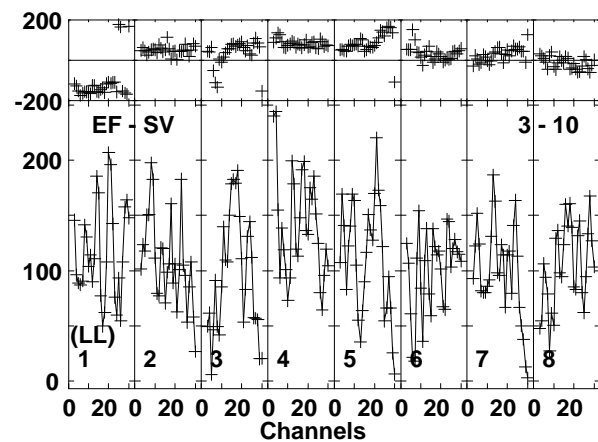
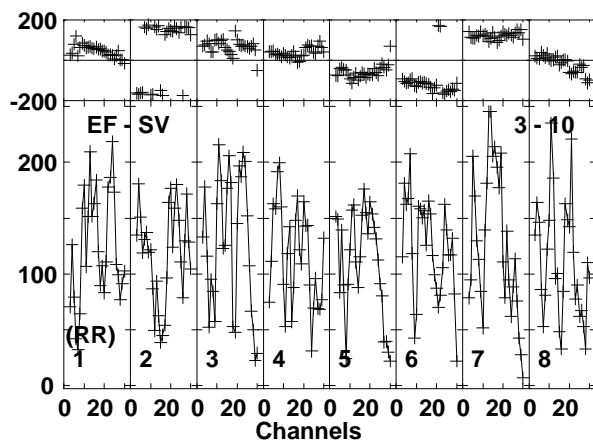
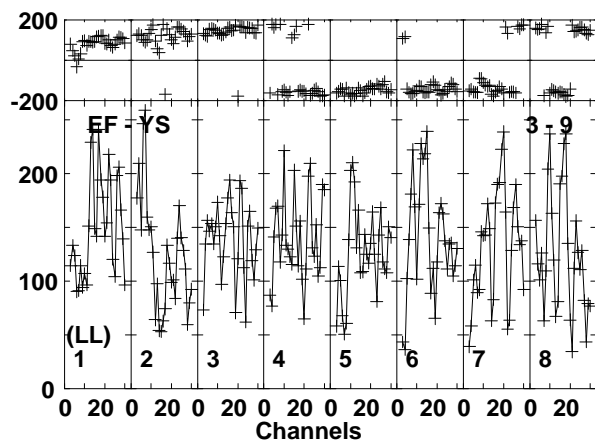
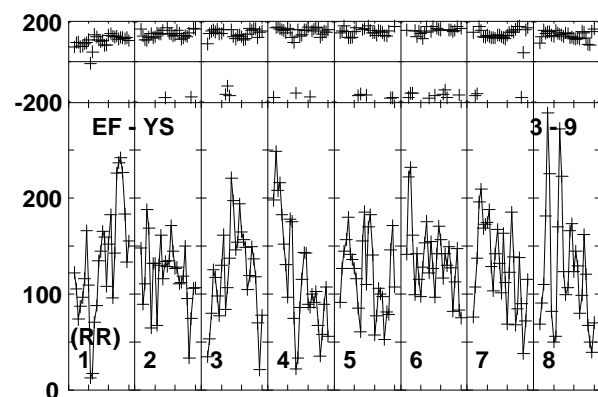
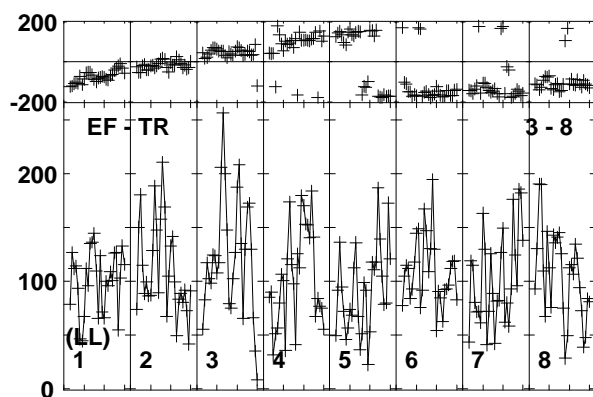
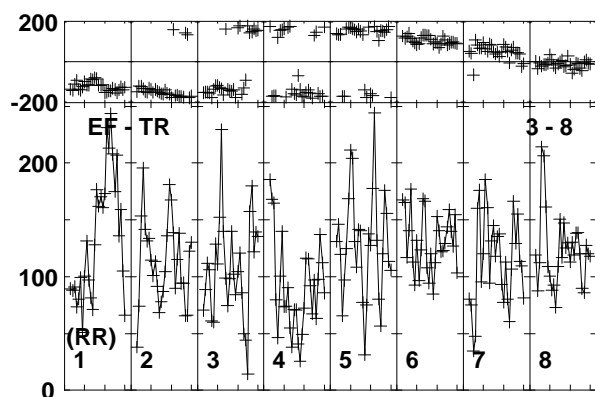
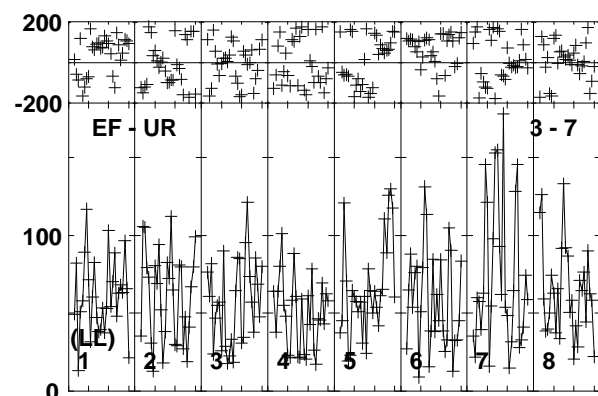
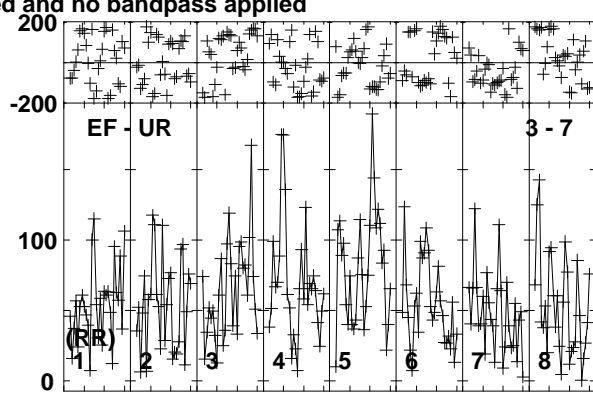
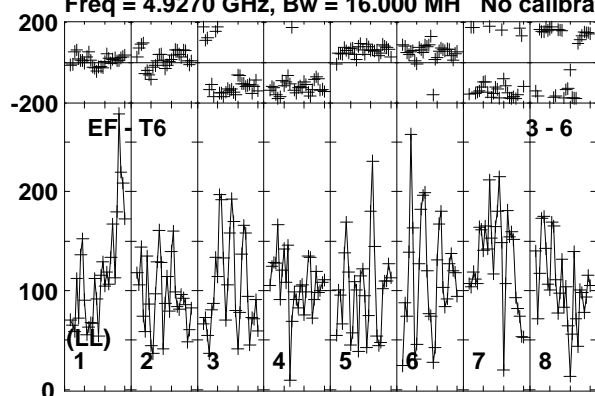

Lower frame: Micro Ampl Jy Top frame: Phas deg
Vector averaged cross-power spectrum Baseline: EF (03) - T6 (06)
Timerange: 00/05:25:21 to 00/05:29:19

Plot file version 285 created 17-FEB-2020 15:43:05

J1402+5347 EK047 2.UVDATA.1

Freq = 4.9270 GHz, Bw = 16.000 MH No calibration applied and no bandpass applied

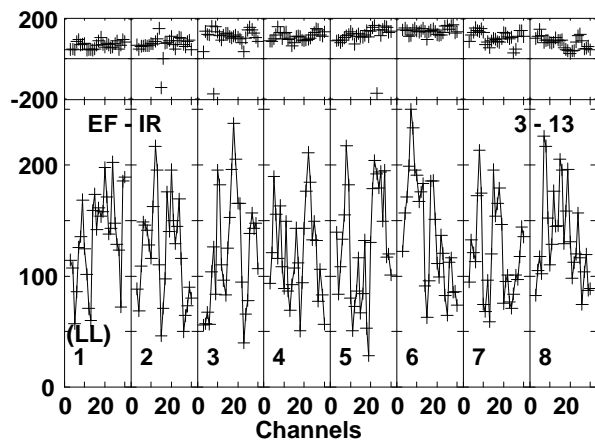
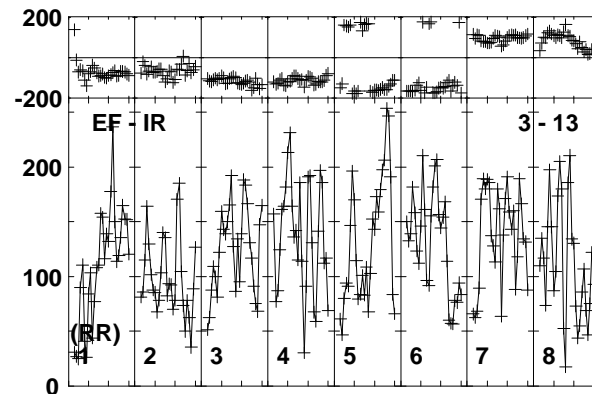
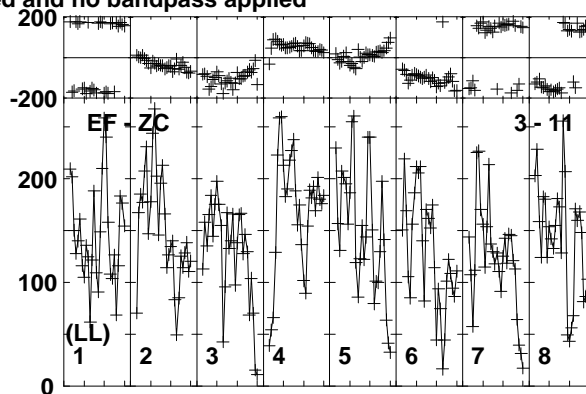
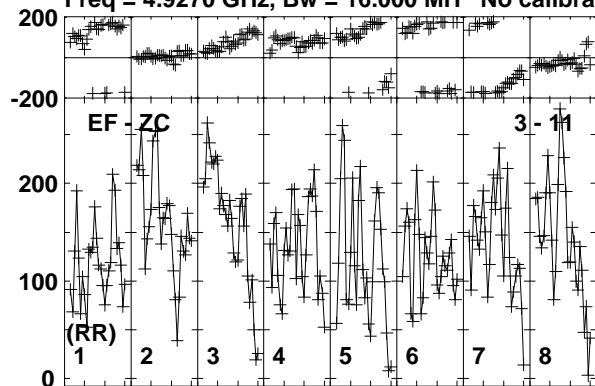

Lower frame: Micro Ampl Jy Top frame: Phas deg
Vector averaged cross-power spectrum Baseline: EF (03) - ZC (11)
Timerange: 00/05:25:21 to 00/05:29:19

Plot file version 286 created 17-FEB-2020 15:43:05

J1359+5544 EK047 2.UVDATA.1

Freq = 4.9270 GHz, Bw = 16.000 MH No calibration applied and no bandpass applied

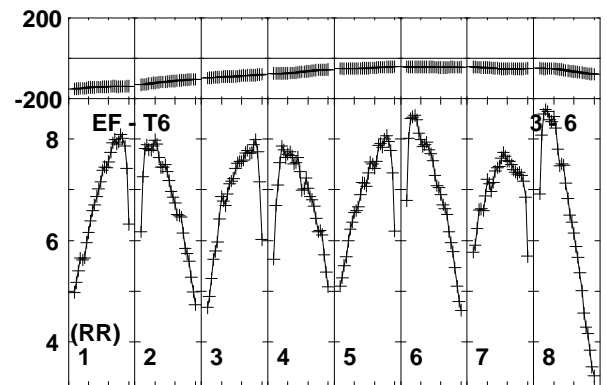
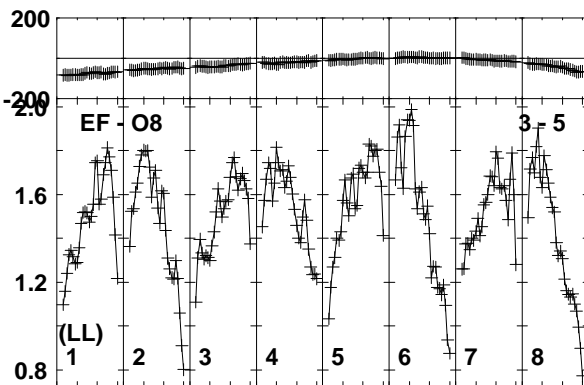
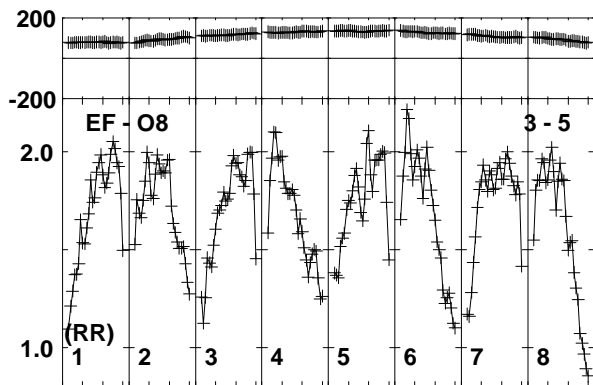
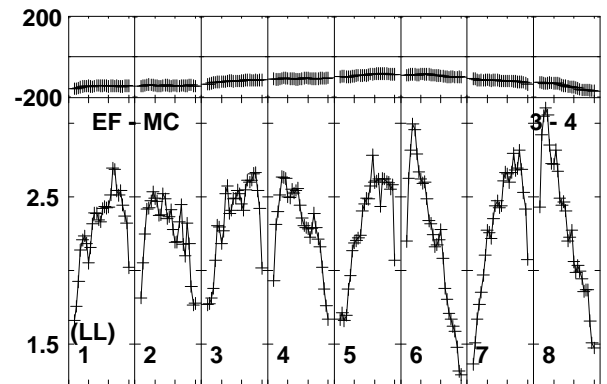
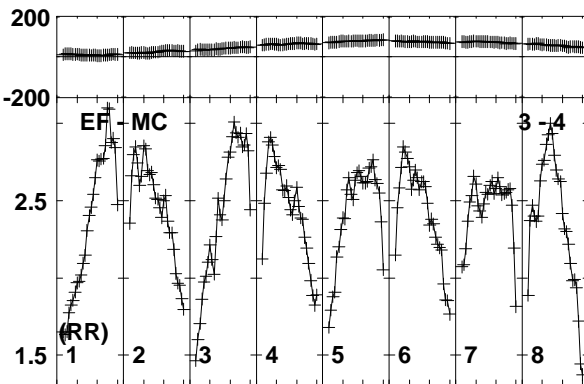
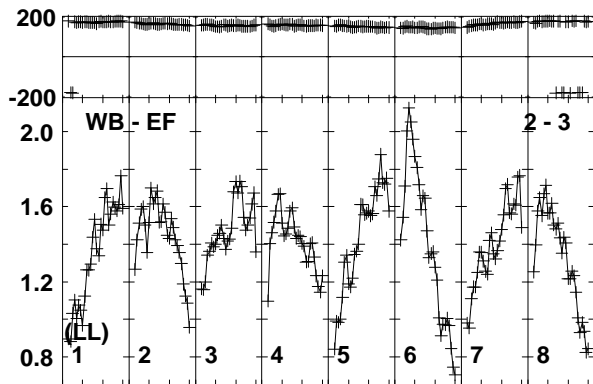
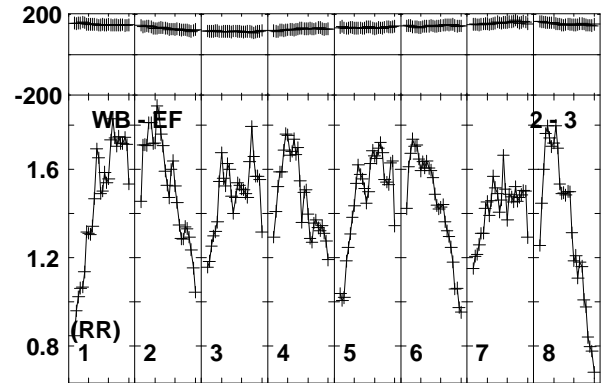
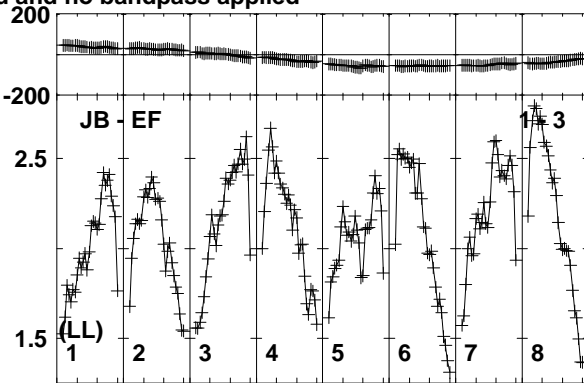
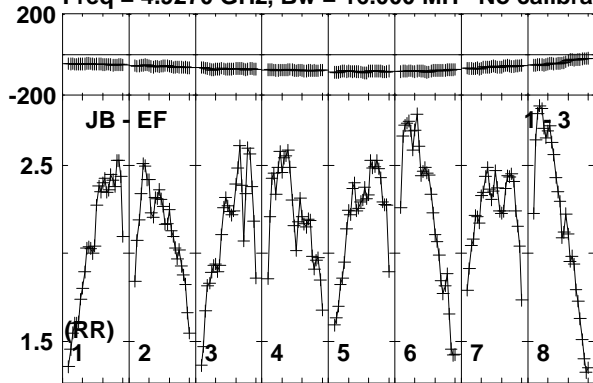

Lower frame: Milli Ampl Jy Top frame: Phas deg

Vector averaged cross-power spectrum Baseline: JB (01) - EF (03)

Timerange: 00/05:29:21 to 00/05:31:19

Plot file version 287 created 17-FEB-2020 15:43:05

J1359+5544 EK047 2.UVDATA.1

Freq = 4.9270 GHz, Bw = 16.000 MH No calibration applied and no bandpass applied

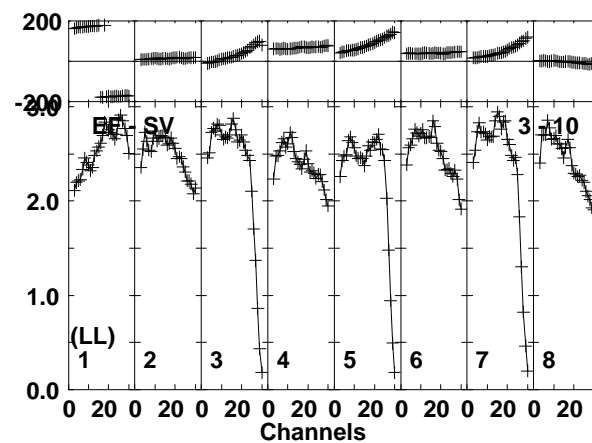
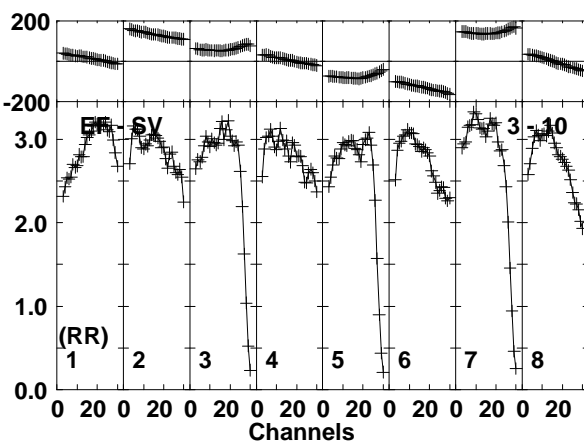
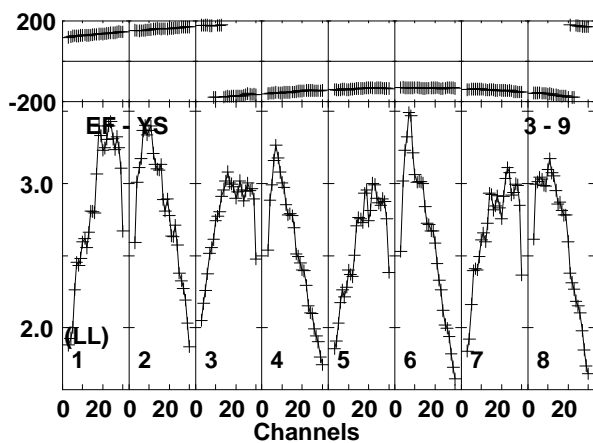
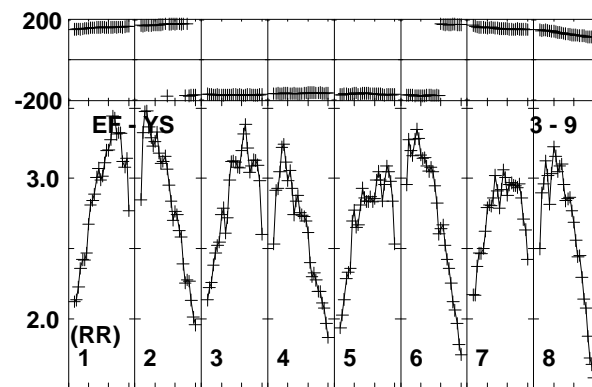
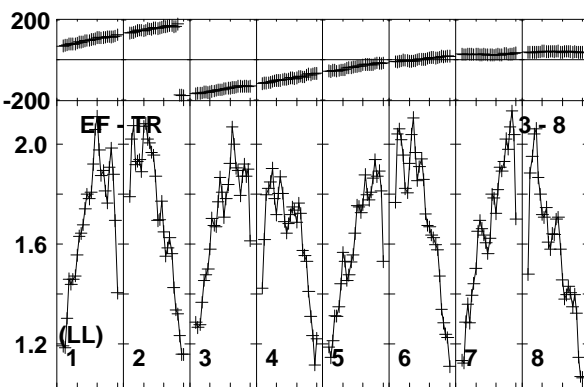
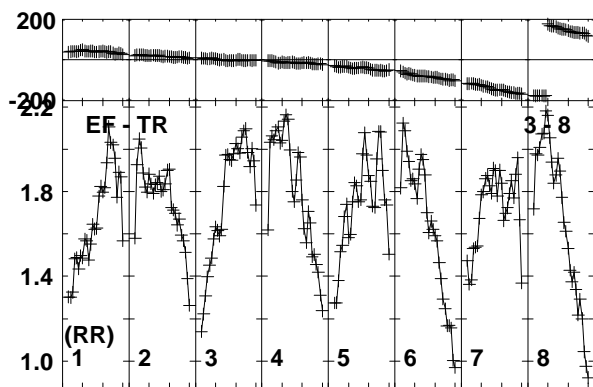
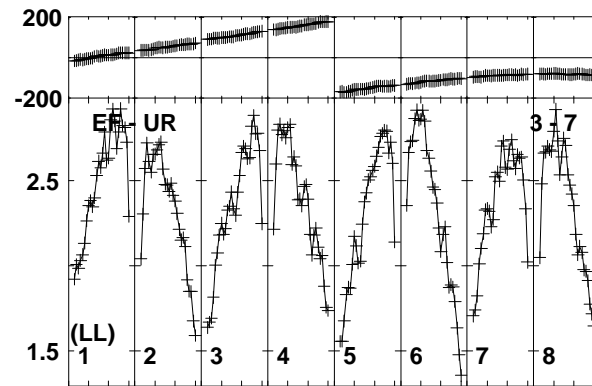
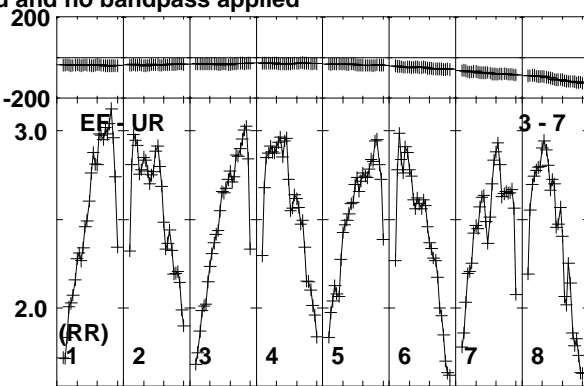
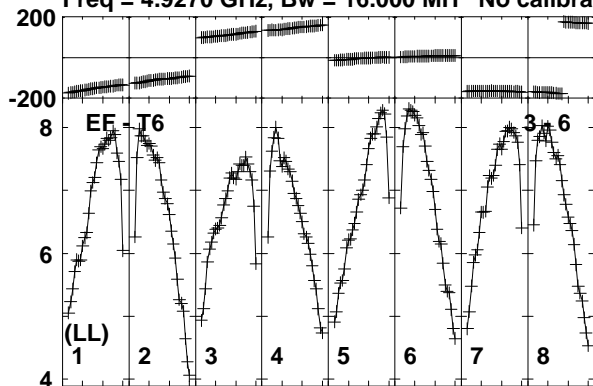

Lower frame: Milli Ampl Jy Top frame: Phas deg
Vector averaged cross-power spectrum Baseline: EF (03) - T6 (06)
Timerange: 00/05:29:21 to 00/05:31:19

Plot file version 288 created 17-FEB-2020 15:43:05

J1359+5544 EK047 2.UVDATA.1

Freq = 4.9270 GHz, Bw = 16.000 MH No calibration applied and no bandpass applied

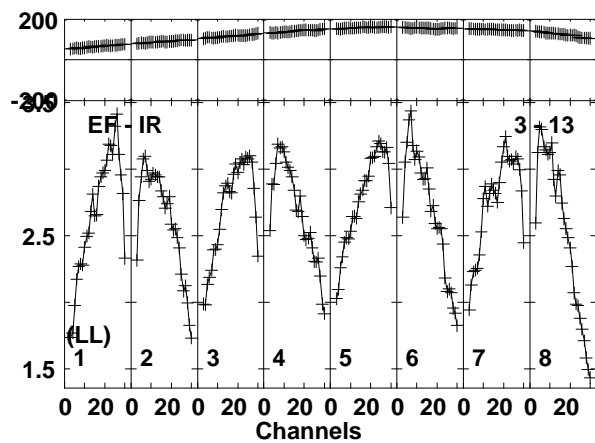
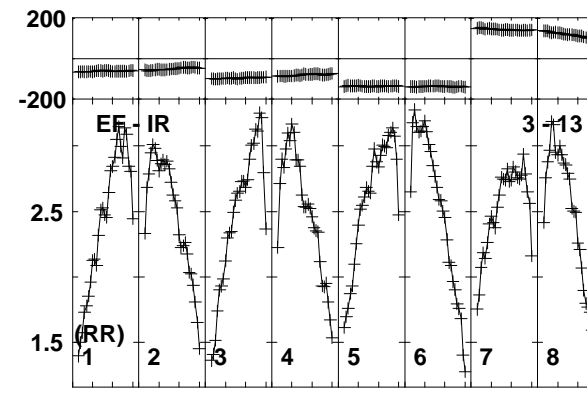
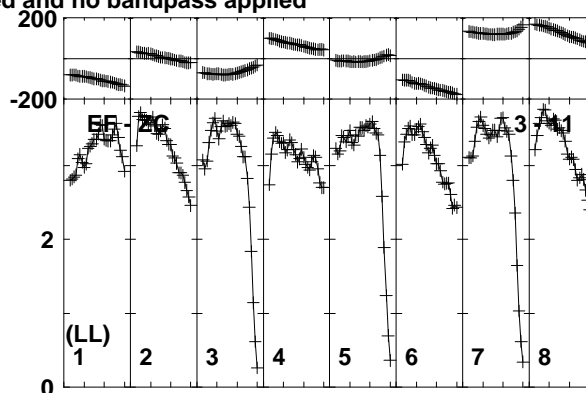
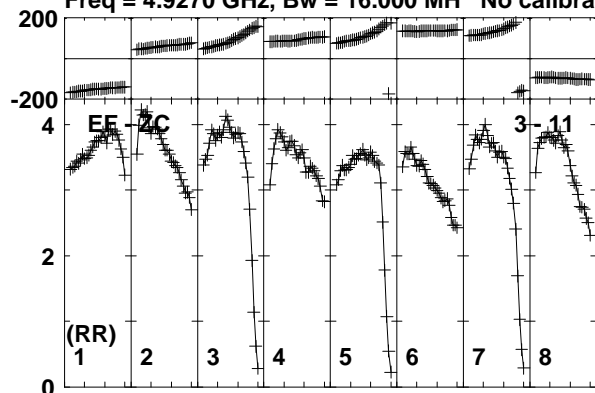

Lower frame: Milli Ampl Jy Top frame: Phas deg
Vector averaged cross-power spectrum Baseline: EF (03) - ZC (11)
Timerange: 00/05:29:21 to 00/05:31:19

Plot file version 289 created 17-FEB-2020 15:43:05

J1402+5347 EK047 2.UVDATA.1

Freq = 4.9270 GHz, Bw = 16.000 MH No calibration applied and no bandpass applied

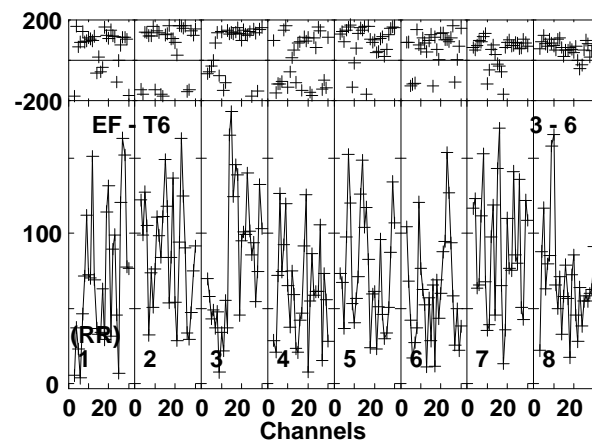
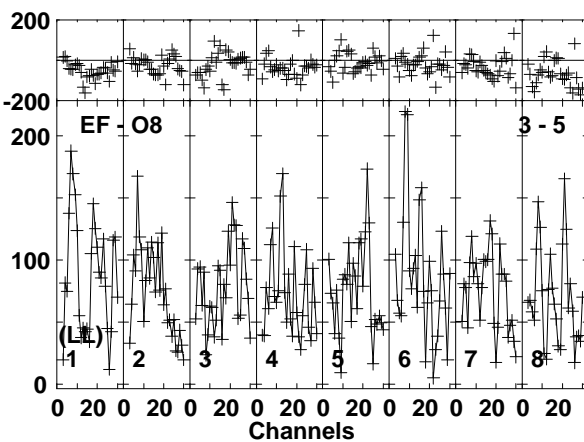
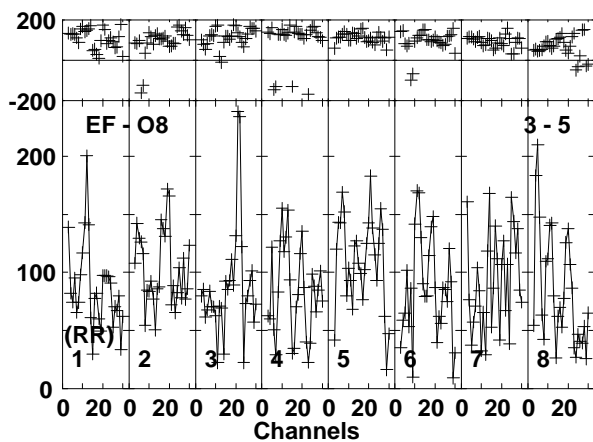
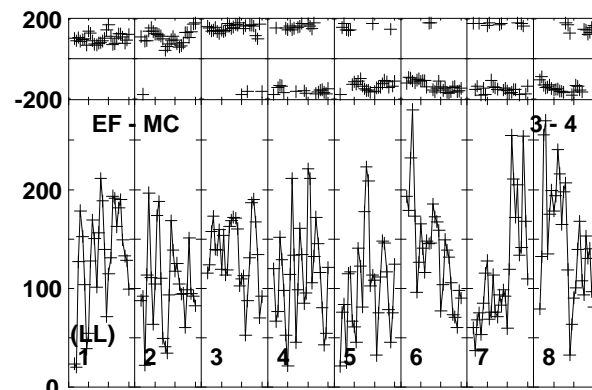
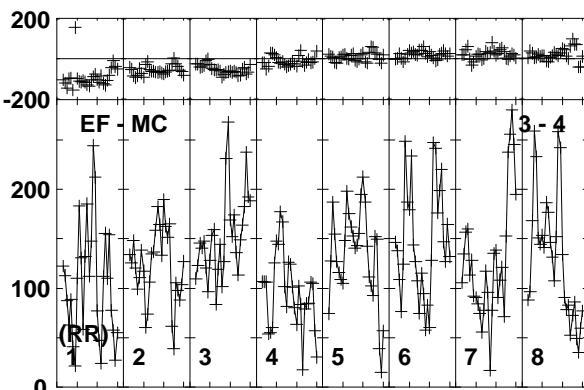
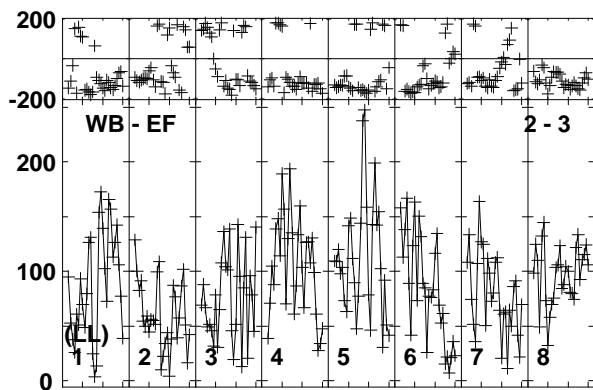
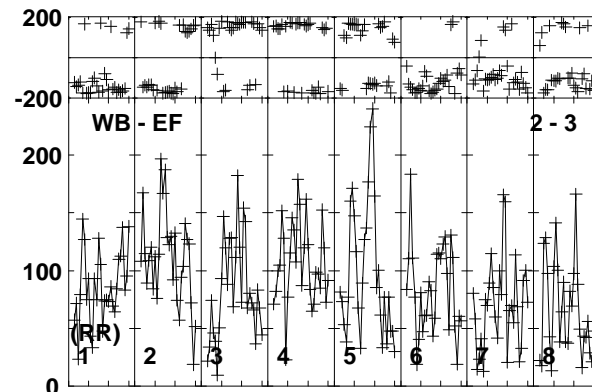
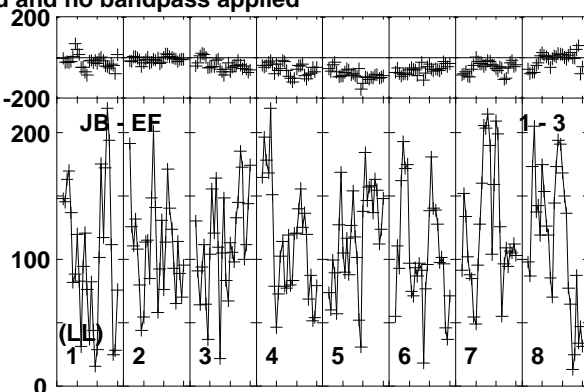
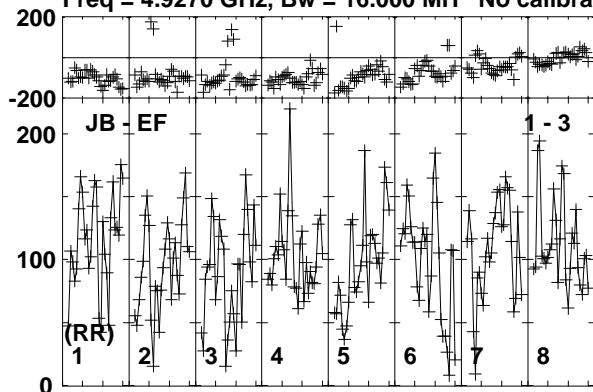

Lower frame: Micro Ampl Jy Top frame: Phas deg
Vector averaged cross-power spectrum Baseline: JB (01) - EF (03)
Timerange: 00/05:31:21 to 00/05:35:19

Plot file version 290 created 17-FEB-2020 15:43:05

J1402+5347 EK047 2.UVDATA.1

Freq = 4.9270 GHz, Bw = 16.000 MH No calibration applied and no bandpass applied

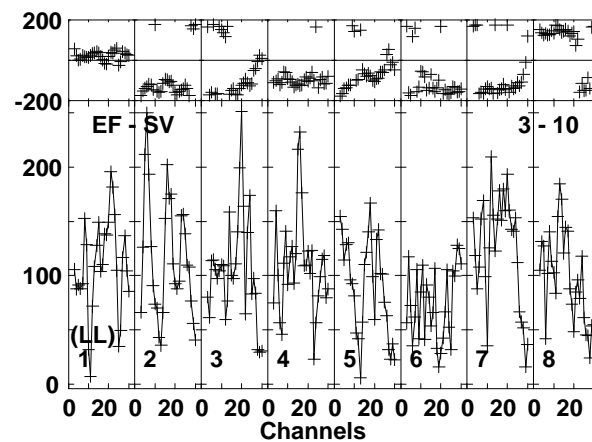
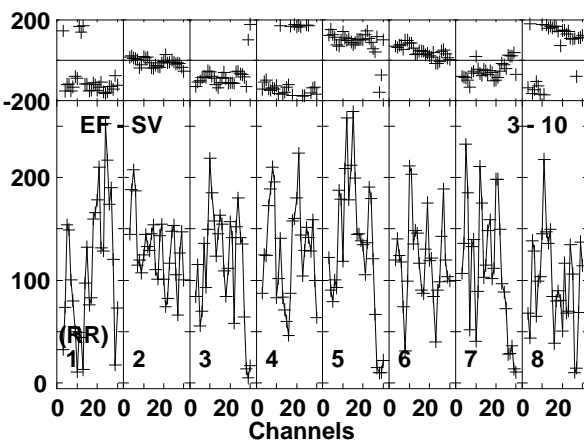
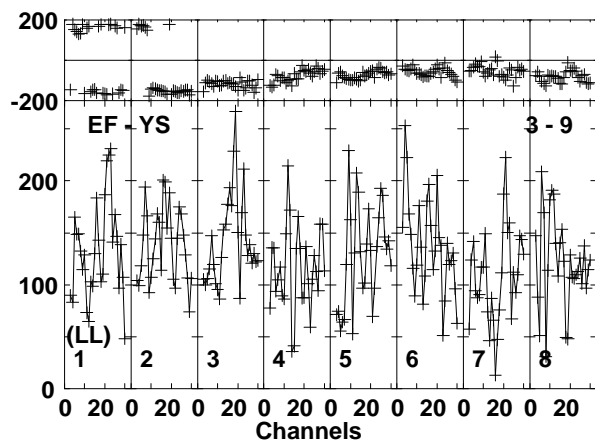
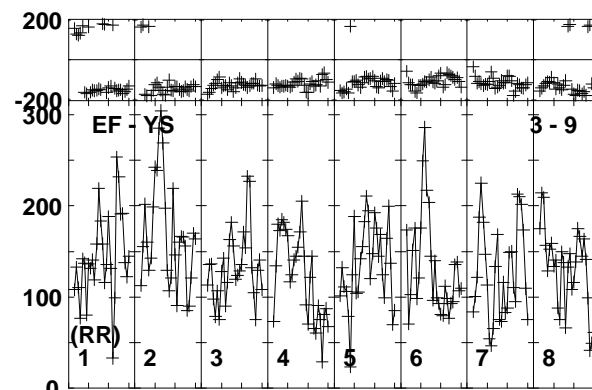
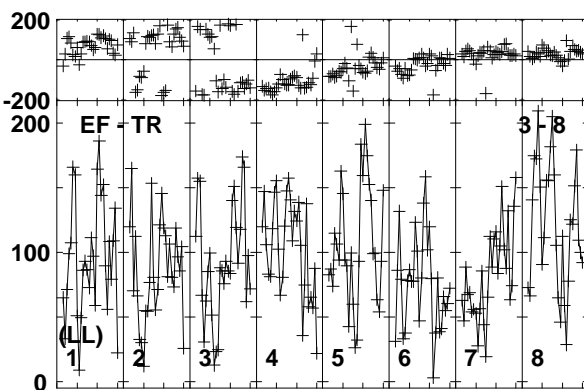
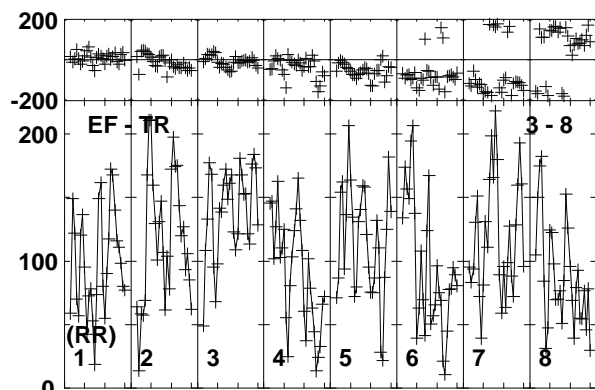
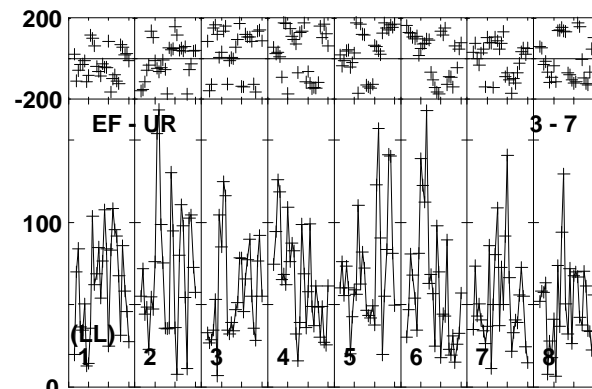
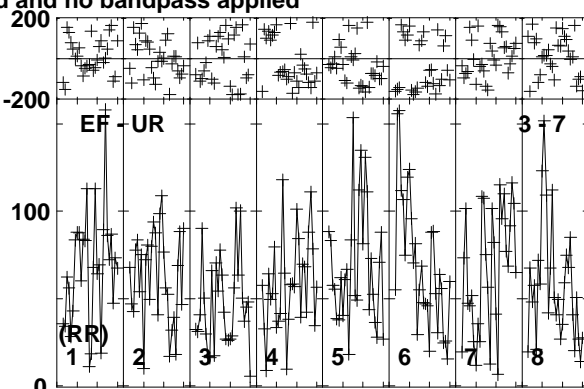
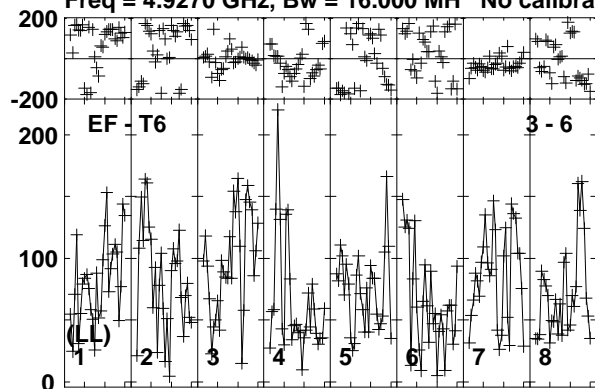

Lower frame: Micro Ampl Jy Top frame: Phas deg
Vector averaged cross-power spectrum Baseline: EF (03) - T6 (06)
Timerange: 00/05:31:21 to 00/05:35:19

Plot file version 291 created 17-FEB-2020 15:43:05

J1402+5347 EK047 2.UVDATA.1

Freq = 4.9270 GHz, Bw = 16.000 MH No calibration applied and no bandpass applied

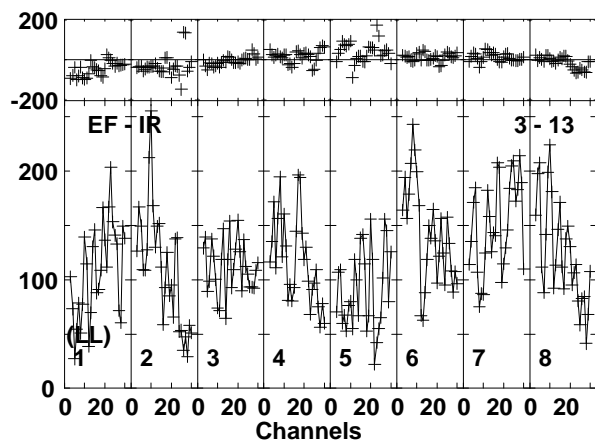
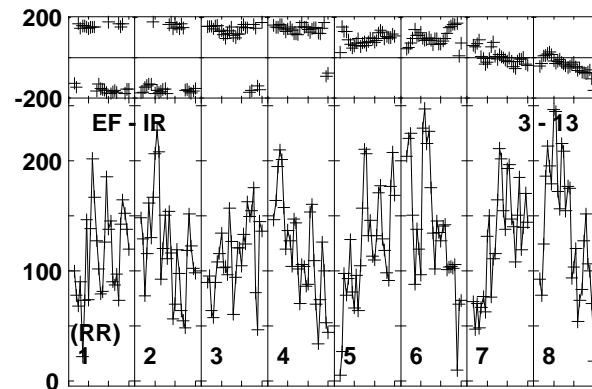
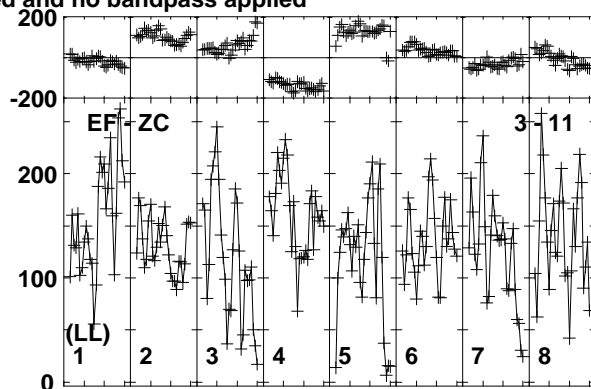
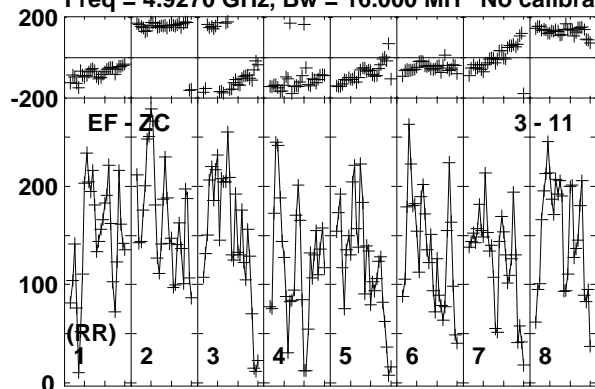

Lower frame: Micro Ampl Jy Top frame: Phas deg
Vector averaged cross-power spectrum Baseline: EF (03) - ZC (11)
Timerange: 00/05:31:21 to 00/05:35:19

Plot file version 292 created 17-FEB-2020 15:43:05

J1359+5544 EK047 2.UVDATA.1

Freq = 4.9270 GHz, Bw = 16.000 MH No calibration applied and no bandpass applied

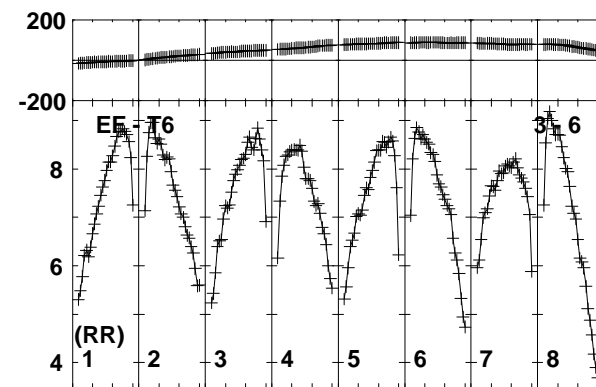
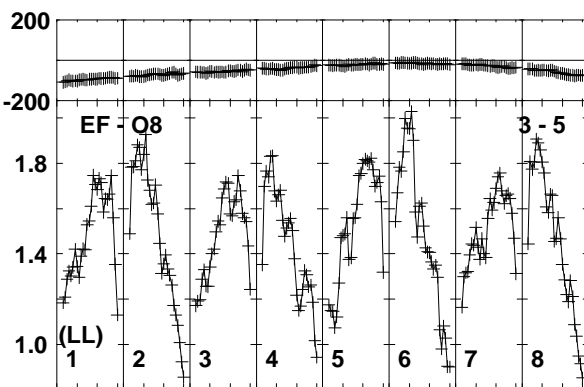
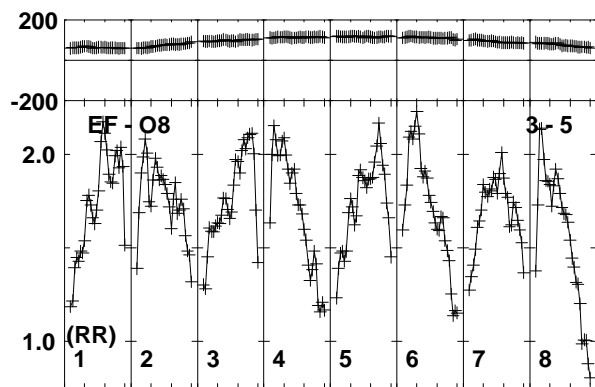
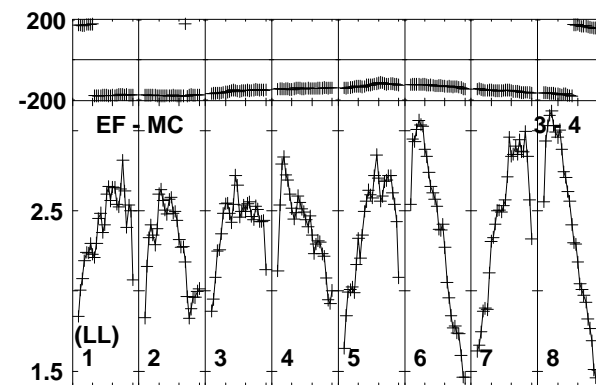
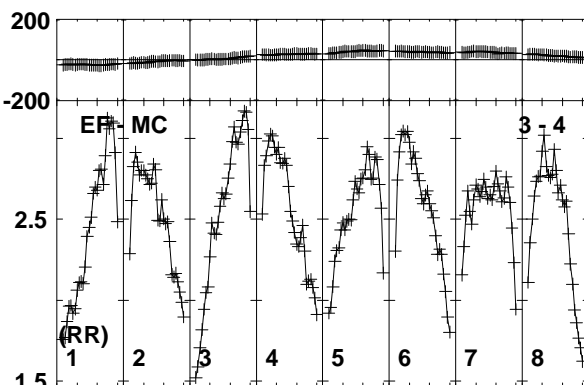
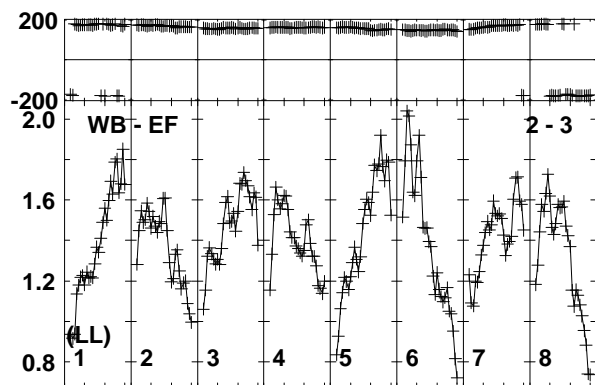
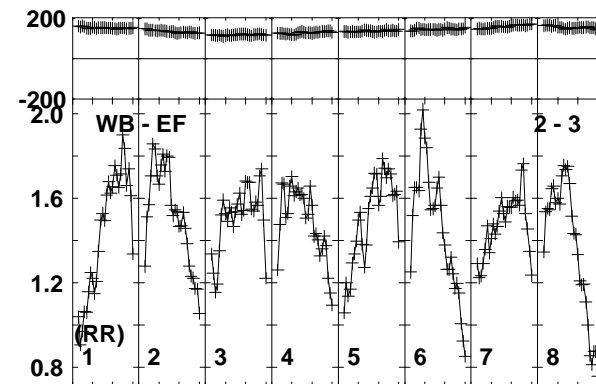
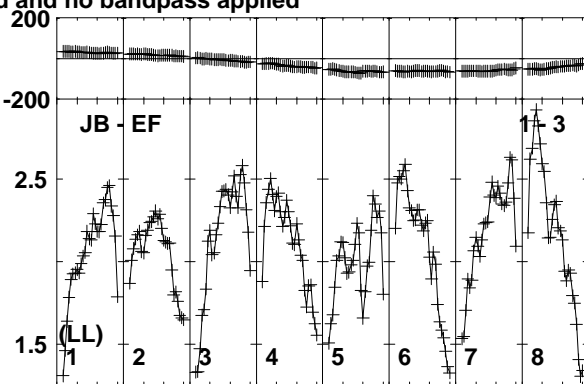
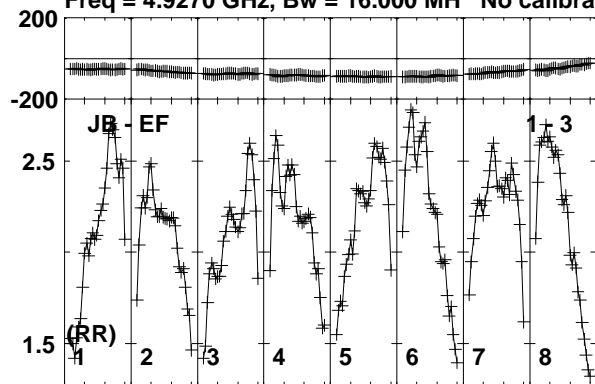

Lower frame: Milli Ampl Jy Top frame: Phas deg

Vector averaged cross-power spectrum Baseline: JB (01) - EF (03)

Timerange: 00/05:36:01 to 00/05:37:19

Plot file version 293 created 17-FEB-2020 15:43:06

J1359+5544 EK047 2.UVDATA.1

Freq = 4.9270 GHz, Bw = 16.000 MH No calibration applied and no bandpass applied

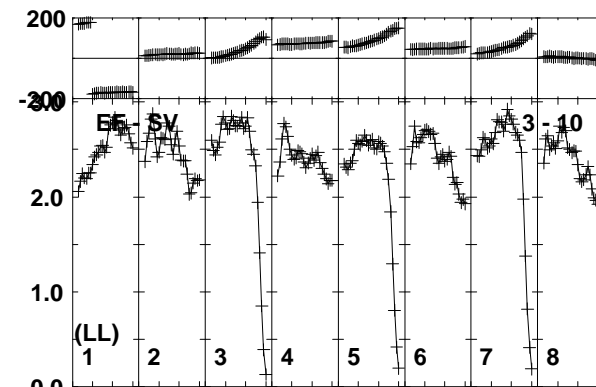
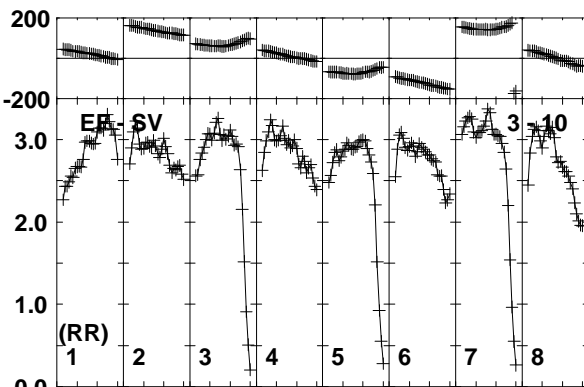
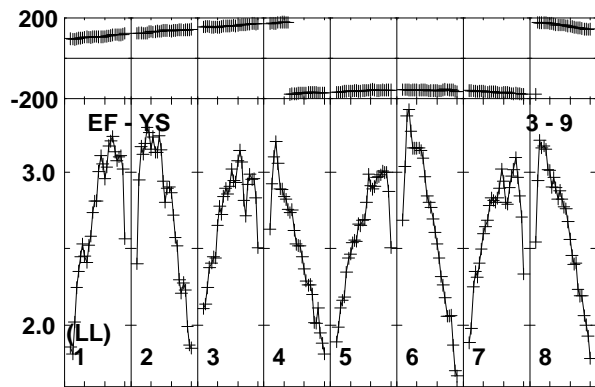
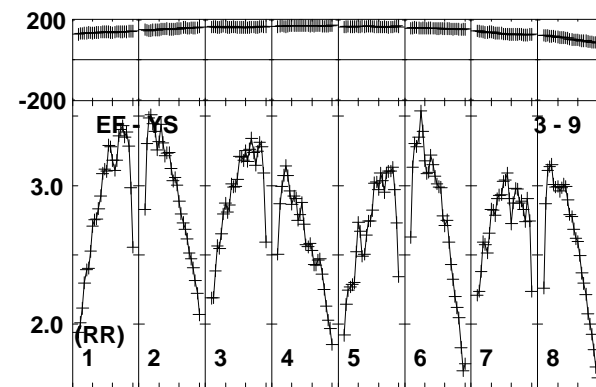
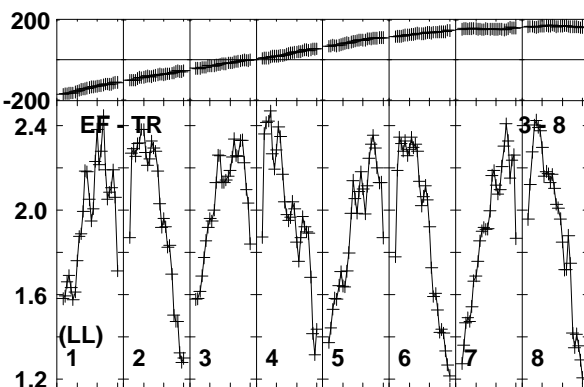
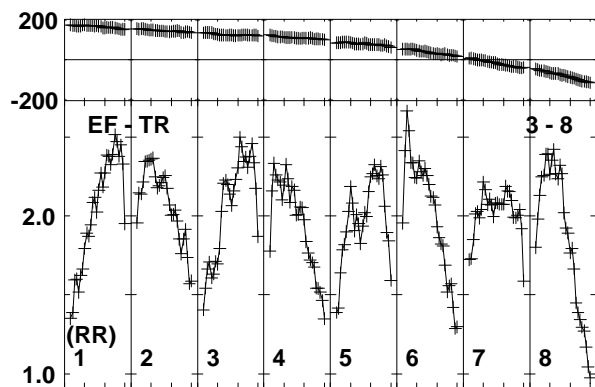
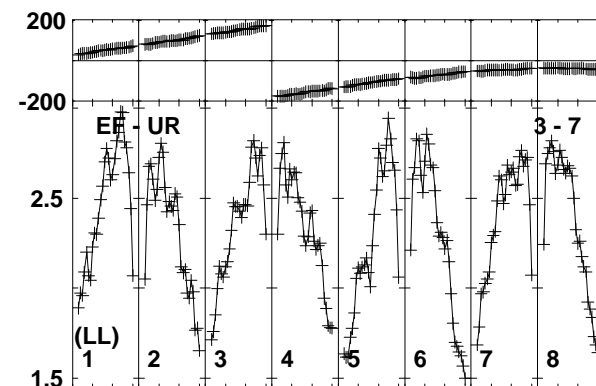
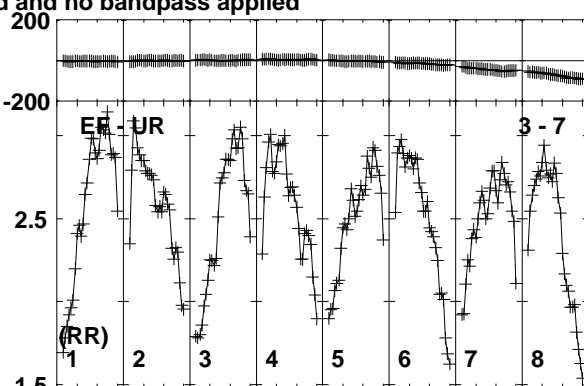
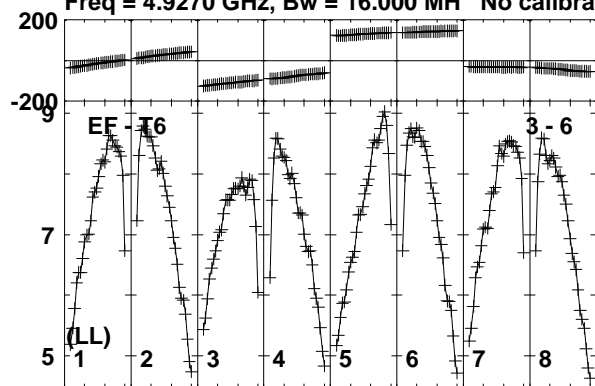

Lower frame: Milli Ampl Jy Top frame: Phas deg
Vector averaged cross-power spectrum Baseline: EF (03) - T6 (06)
Timerange: 00/05:36:01 to 00/05:37:19

Plot file version 294 created 17-FEB-2020 15:43:06

J1359+5544 EK047 2.UVDATA.1

Freq = 4.9270 GHz, Bw = 16.000 MH No calibration applied and no bandpass applied

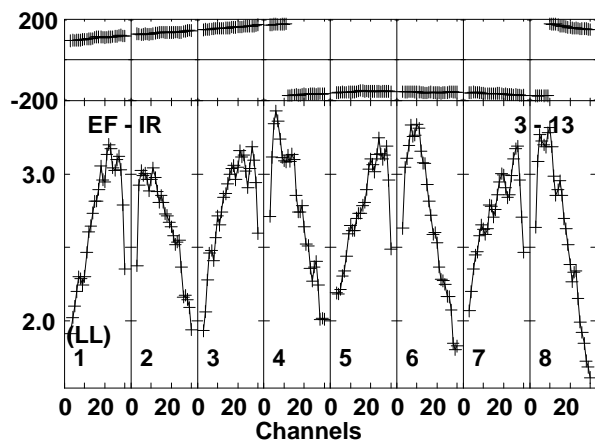
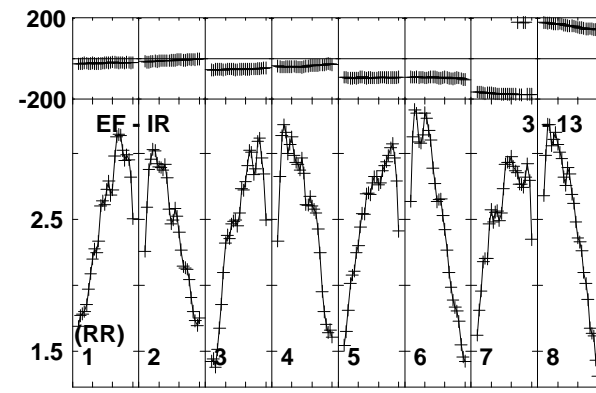
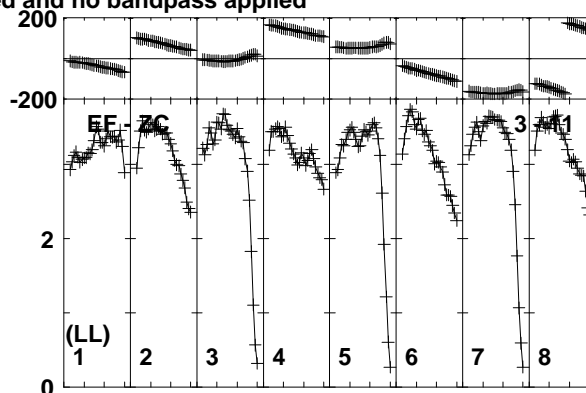
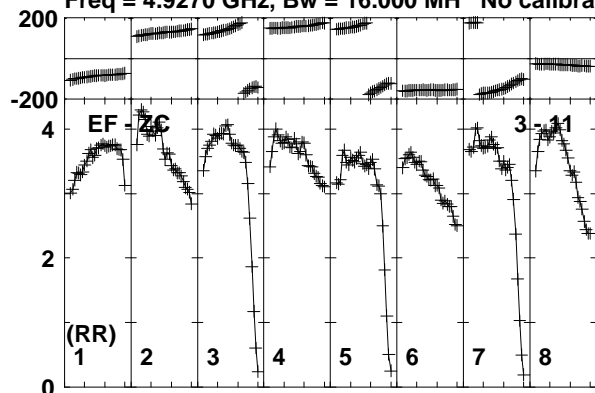

Lower frame: Milli Ampl Jy Top frame: Phas deg
Vector averaged cross-power spectrum Baseline: EF (03) - ZC (11)
Timerange: 00/05:36:01 to 00/05:37:19

Plot file version 295 created 17-FEB-2020 15:43:06

J1402+5347 EK047 2.UVDATA.1

Freq = 4.9270 GHz, Bw = 16.000 MH No calibration applied and no bandpass applied

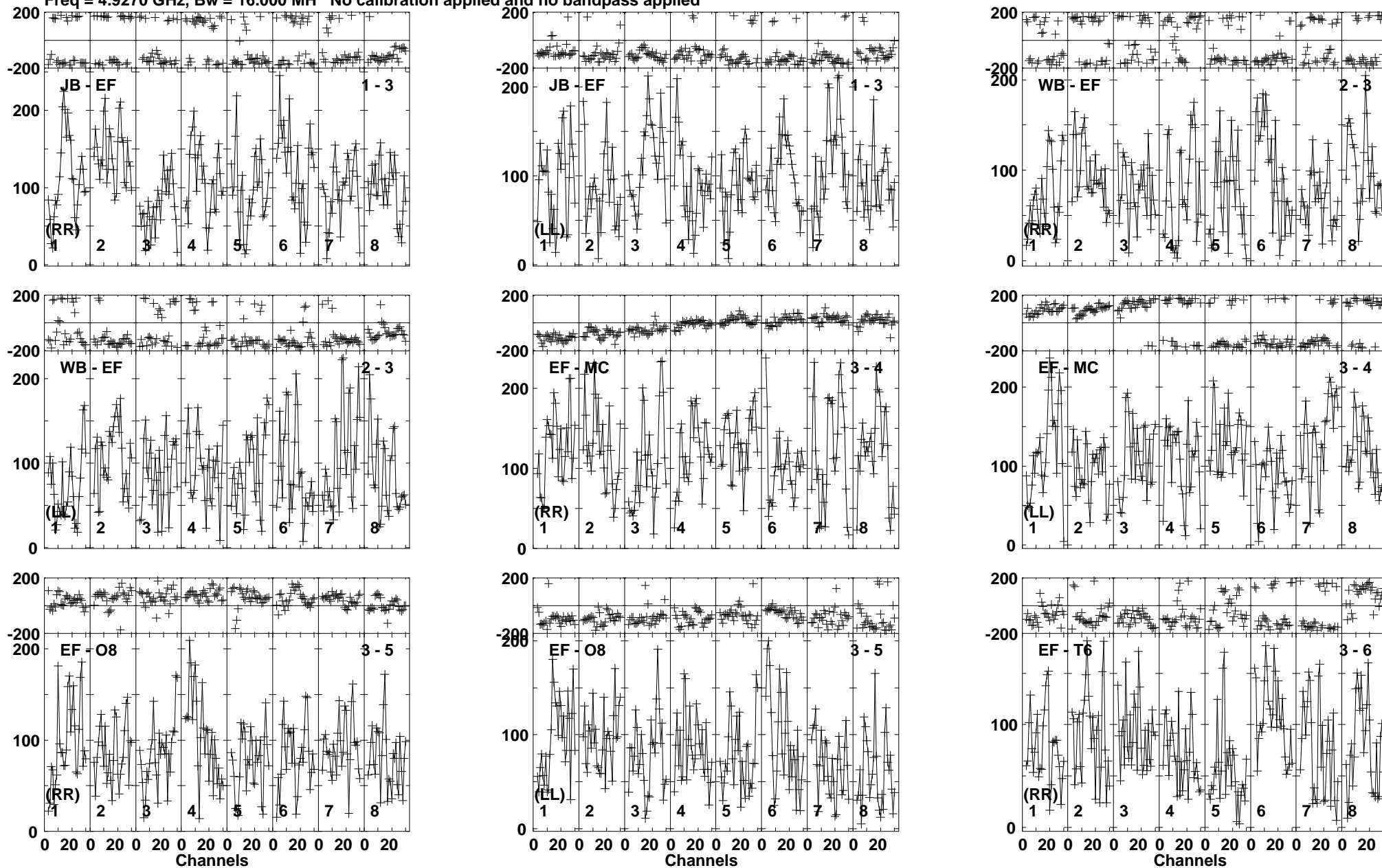

Lower frame: Micro Ampl Jy Top frame: Phas deg
Vector averaged cross-power spectrum Baseline: JB (01) - EF (03)
Timerange: 00/05:37:21 to 00/05:41:19

Plot file version 296 created 17-FEB-2020 15:43:06

J1402+5347 EK047 2.UVDATA.1

Freq = 4.9270 GHz, Bw = 16.000 MH No calibration applied and no bandpass applied

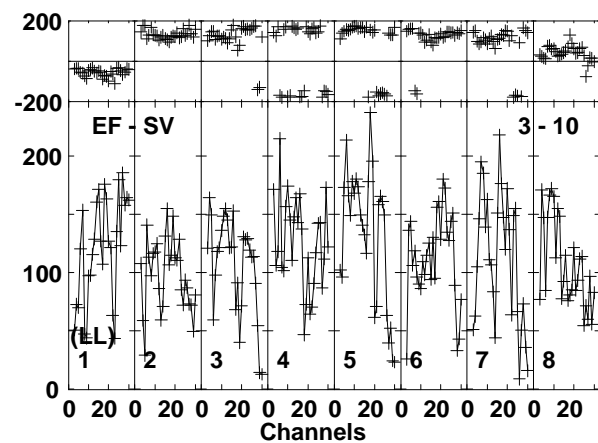
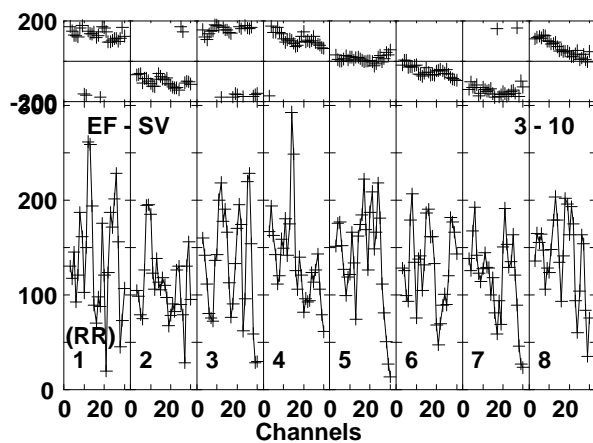
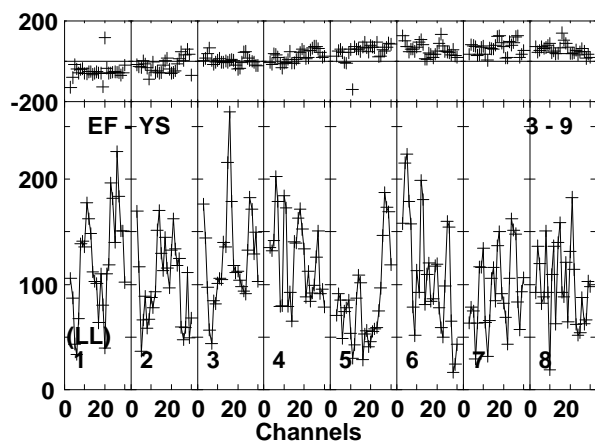
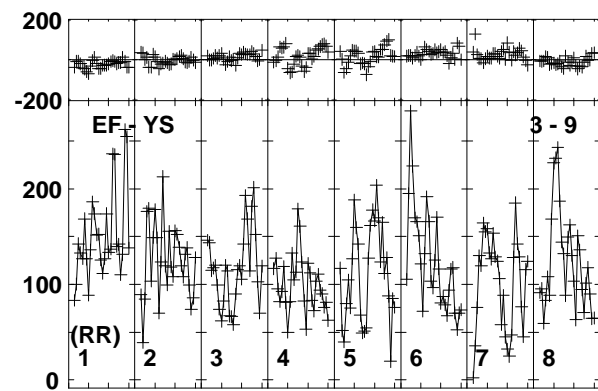
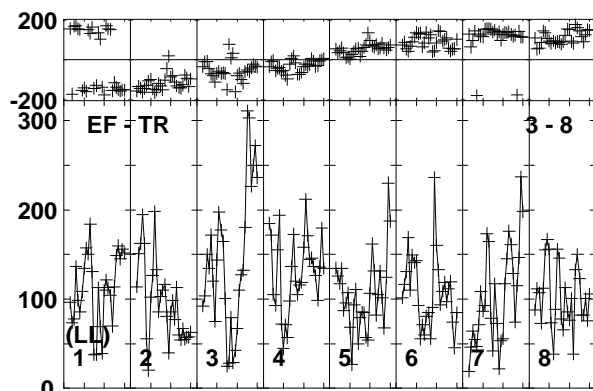
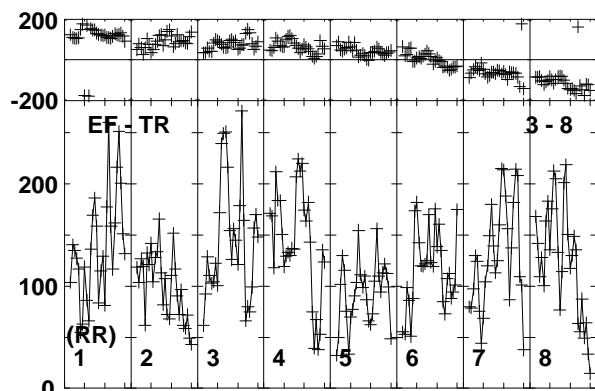
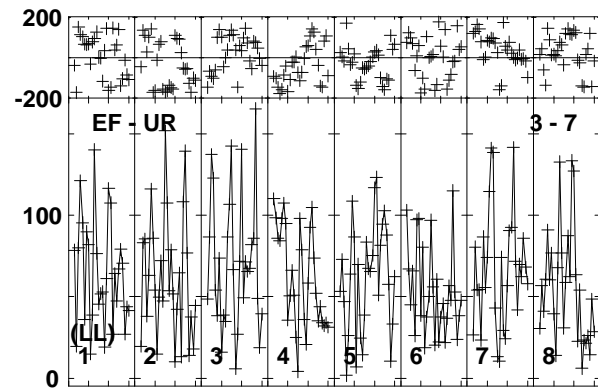
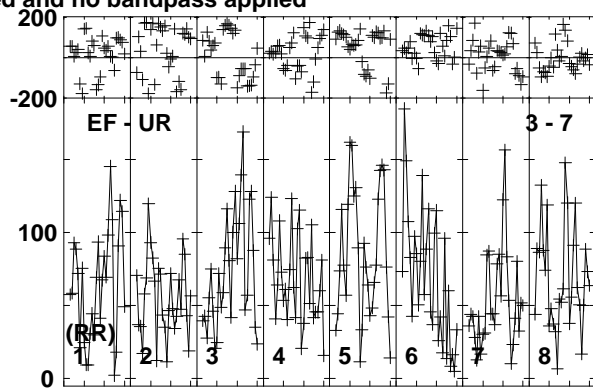
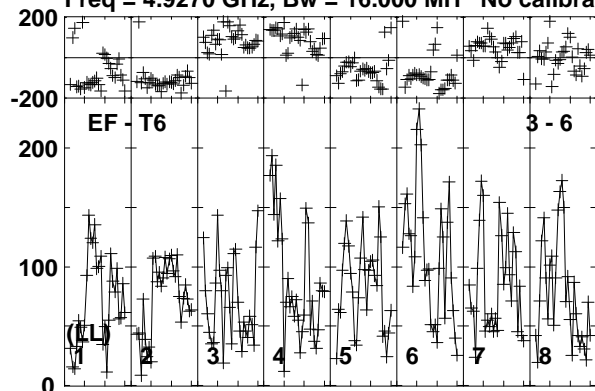

Lower frame: Micro Ampl Jy Top frame: Phas deg
Vector averaged cross-power spectrum Baseline: EF (03) - T6 (06)
Timerange: 00/05:37:21 to 00/05:41:19

Plot file version 298 created 17-FEB-2020 15:43:06

J1359+5544 EK047 2.UVDATA.1

Freq = 4.9270 GHz, Bw = 16.000 MH No calibration applied and no bandpass applied

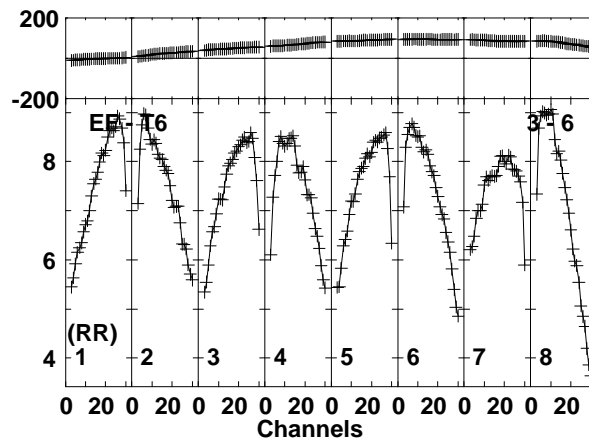
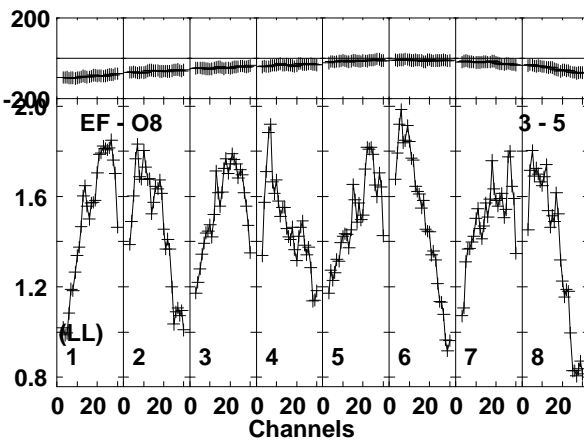
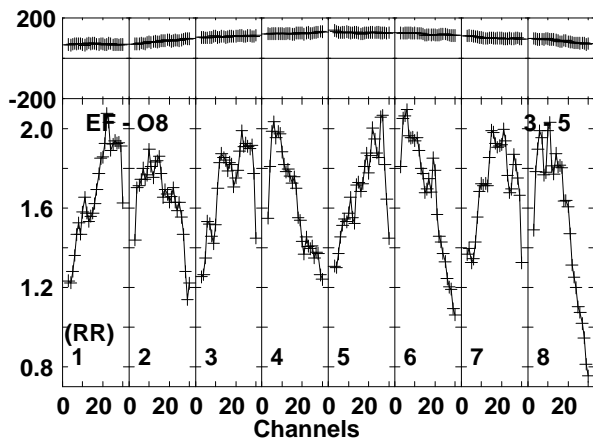
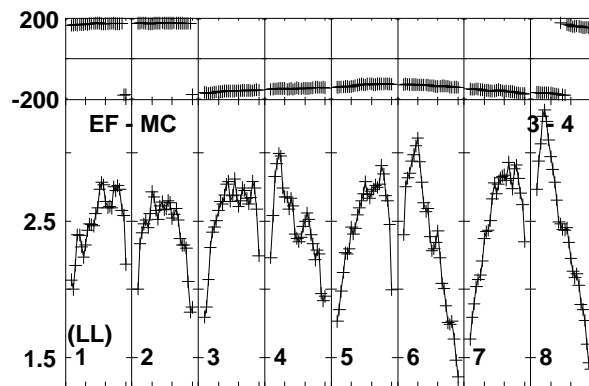
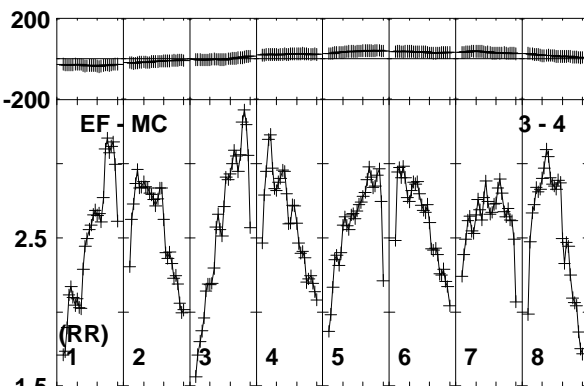
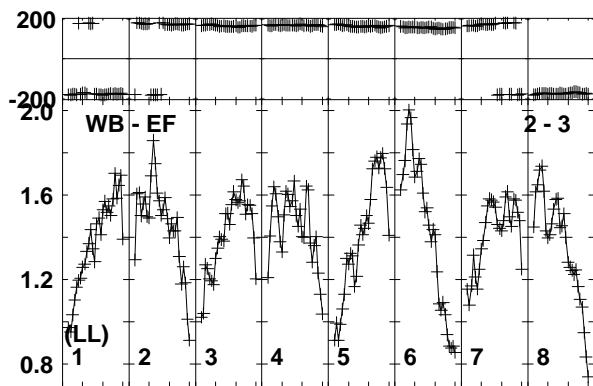
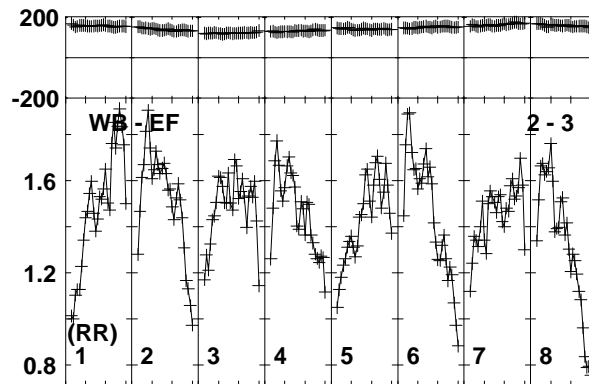
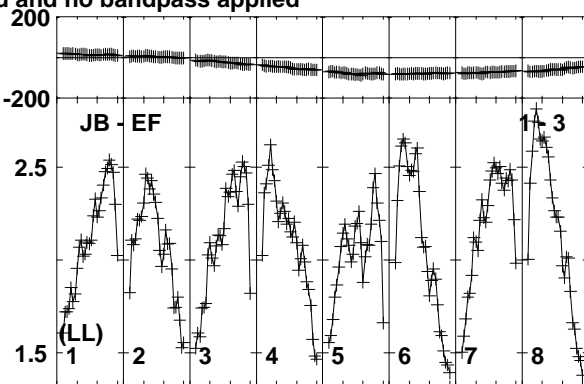
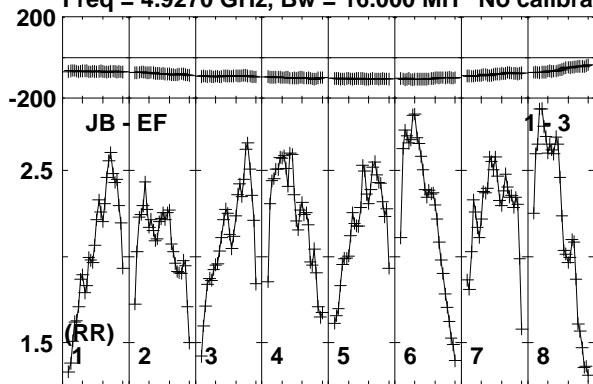

Lower frame: Milli Ampl Jy Top frame: Phas deg
Vector averaged cross-power spectrum Baseline: JB (01) - EF (03)
Timerange: 00/05:41:21 to 00/05:43:19

Plot file version 299 created 17-FEB-2020 15:43:06

J1359+5544 EK047 2.UVDATA.1

Freq = 4.9270 GHz, Bw = 16.000 MH No calibration applied and no bandpass applied

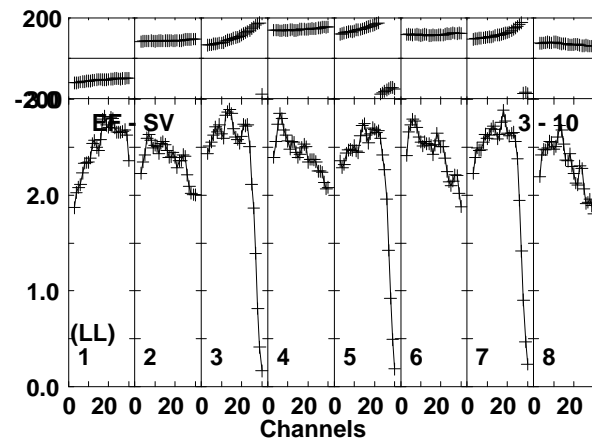
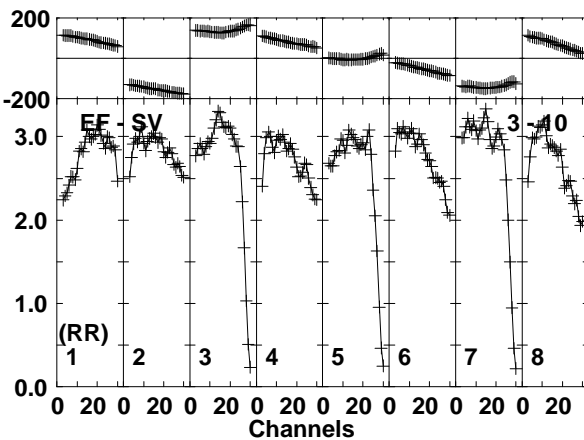
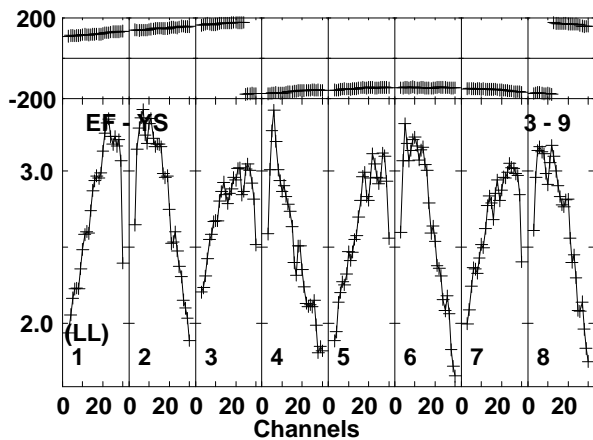
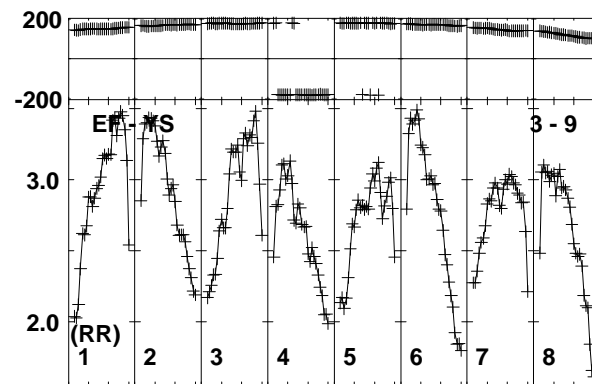
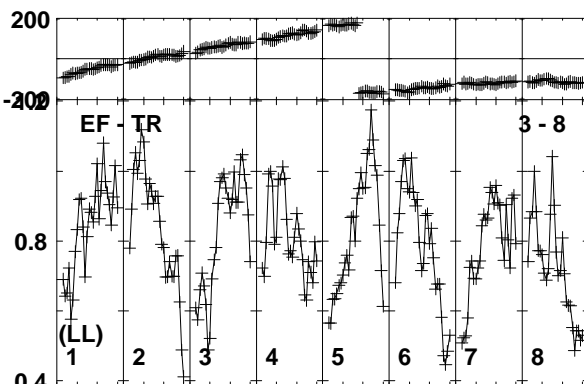
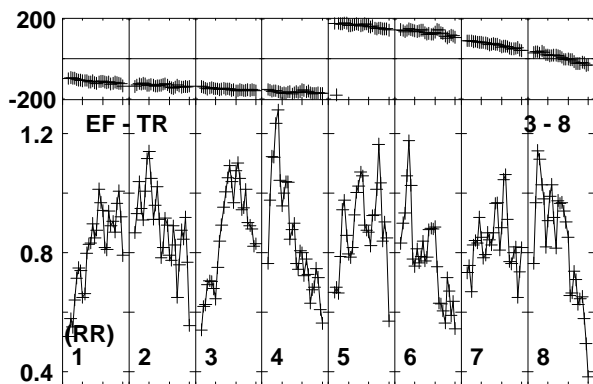
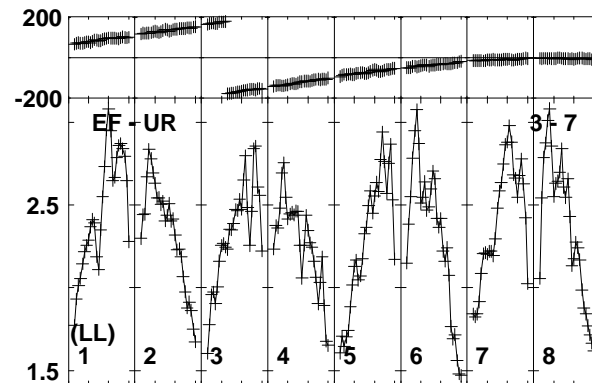
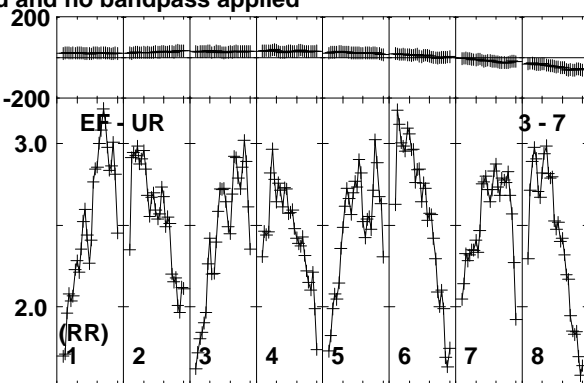
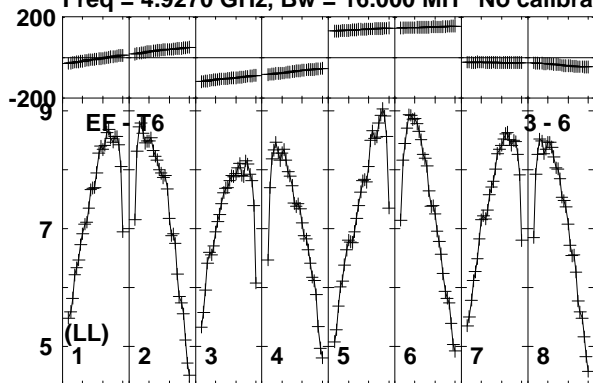

Lower frame: Milli Ampl Jy Top frame: Phas deg
Vector averaged cross-power spectrum Baseline: EF (03) - T6 (06)
Timerange: 00/05:41:21 to 00/05:43:19

Plot file version 300 created 17-FEB-2020 15:43:06

J1359+5544 EK047 2.UVDATA.1

Freq = 4.9270 GHz, Bw = 16.000 MH No calibration applied and no bandpass applied

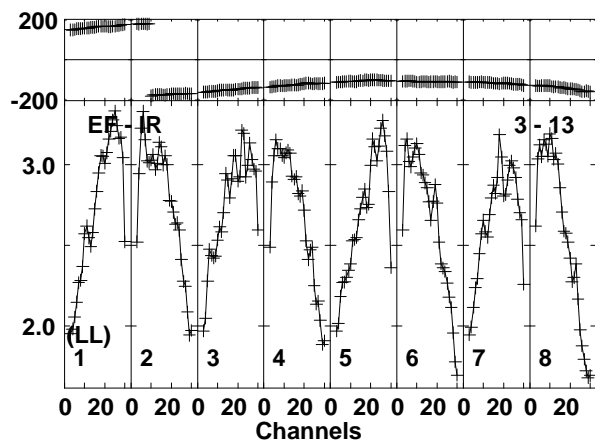
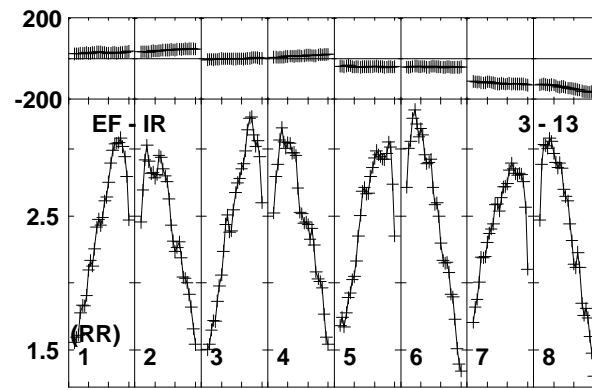
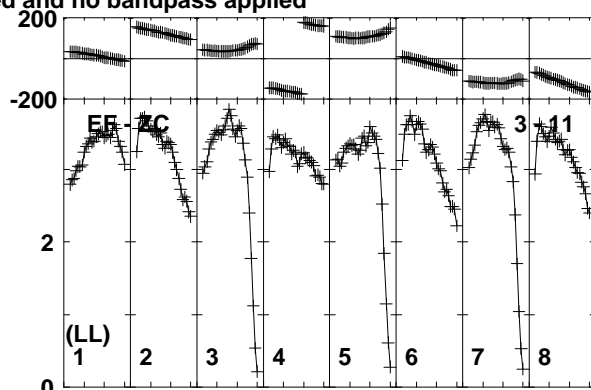
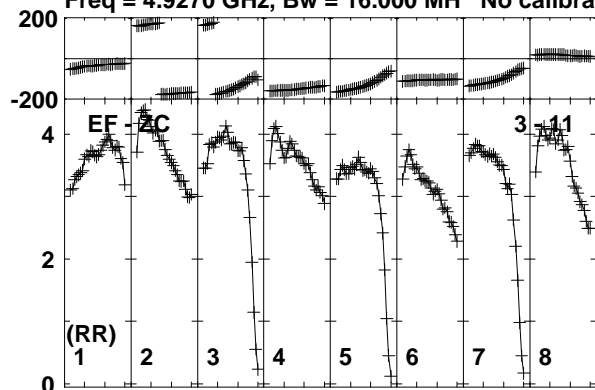

Lower frame: Milli Ampl Jy Top frame: Phas deg
Vector averaged cross-power spectrum Baseline: EF (03) - ZC (11)
Timerange: 00/05:41:21 to 00/05:43:19

Plot file version 301 created 17-FEB-2020 15:43:06

J1402+5347 EK047 2.UVDATA.1

Freq = 4.9270 GHz, Bw = 16.000 MH No calibration applied and no bandpass applied

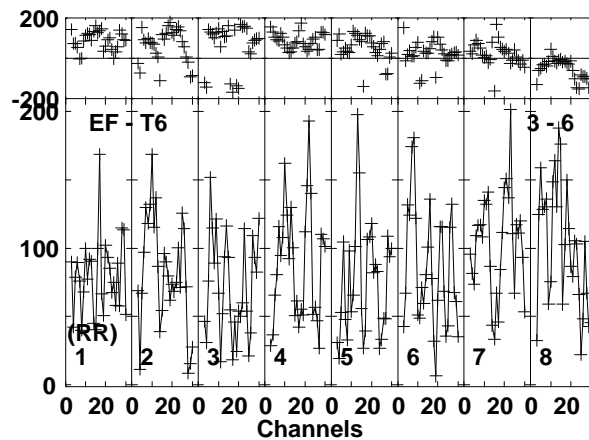
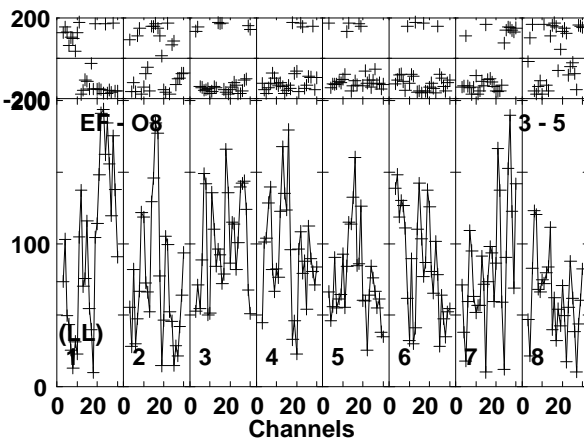
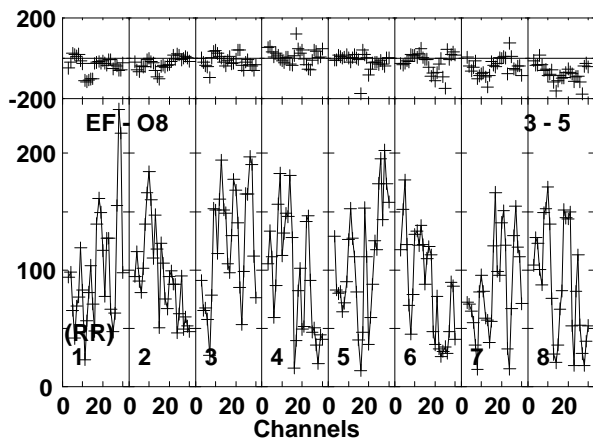
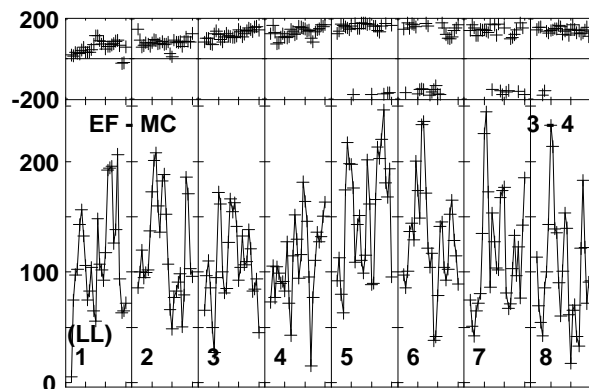
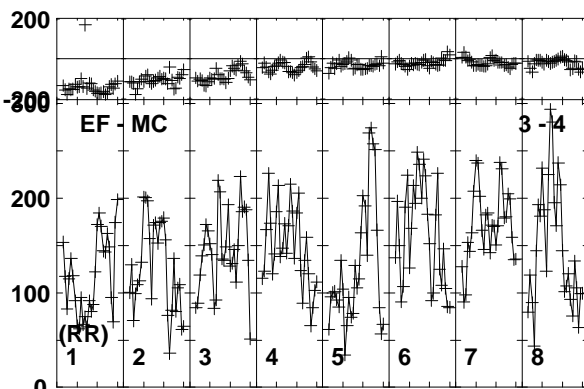
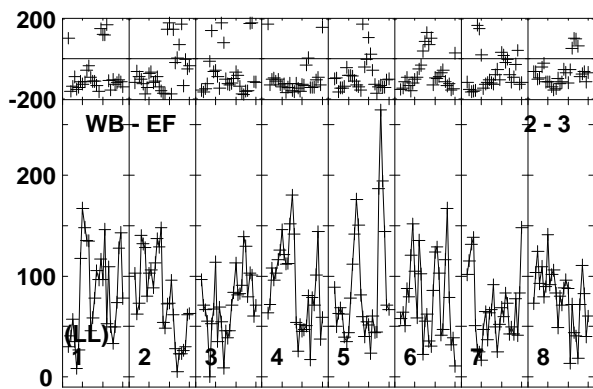
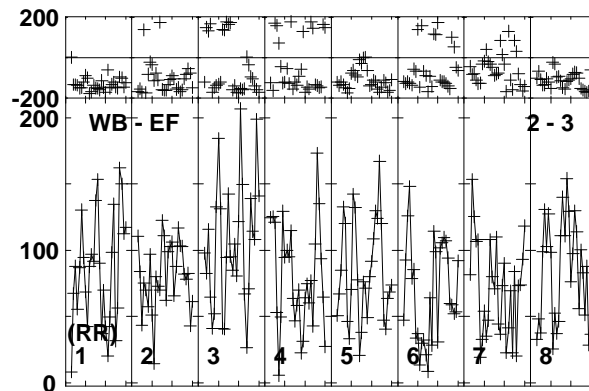
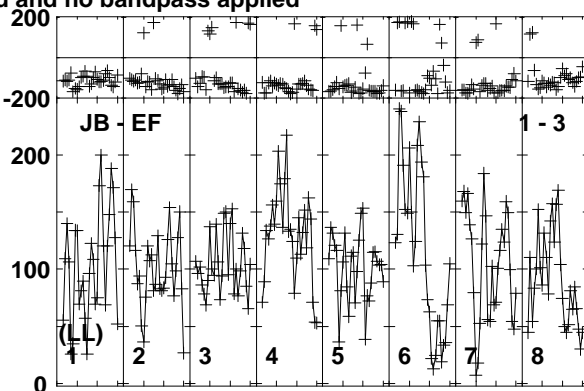
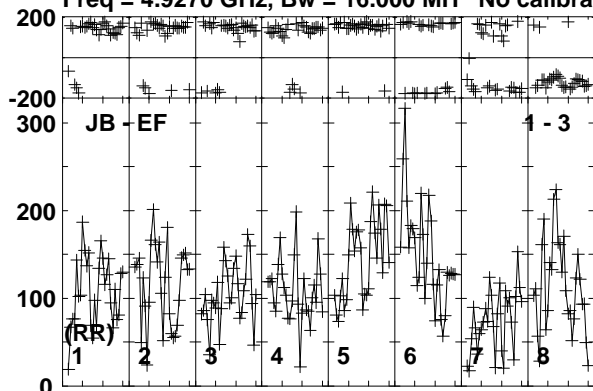

Lower frame: Micro Ampl Jy Top frame: Phas deg
Vector averaged cross-power spectrum Baseline: JB (01) - EF (03)
Timerange: 00/05:43:23 to 00/05:47:19

Plot file version 302 created 17-FEB-2020 15:43:06

J1402+5347 EK047 2.UVDATA.1

Freq = 4.9270 GHz, Bw = 16.000 MH No calibration applied and no bandpass applied

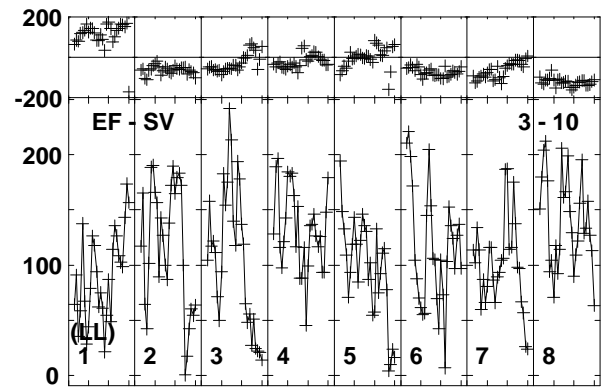
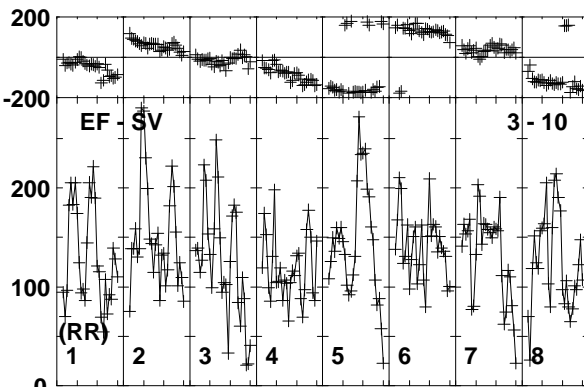
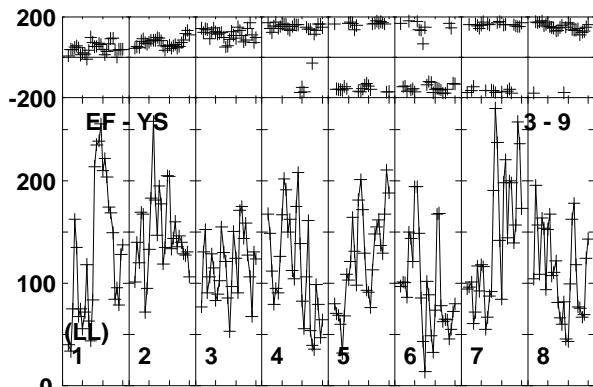
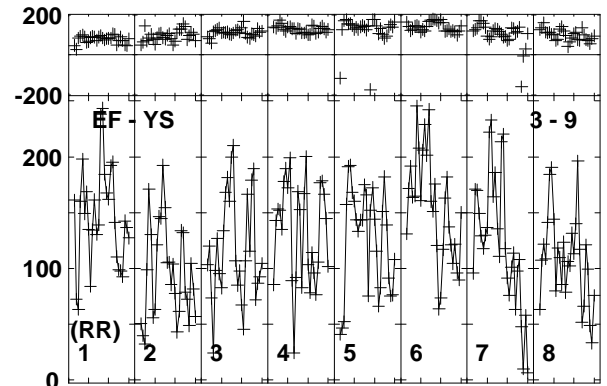
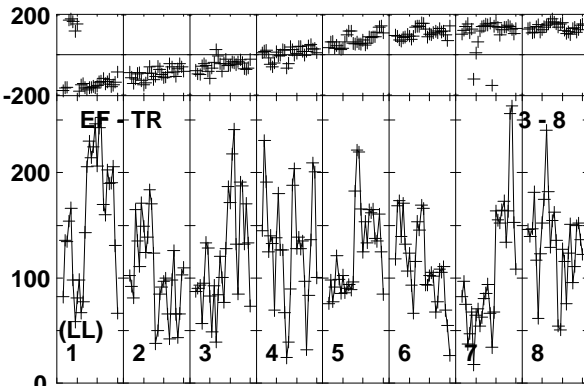
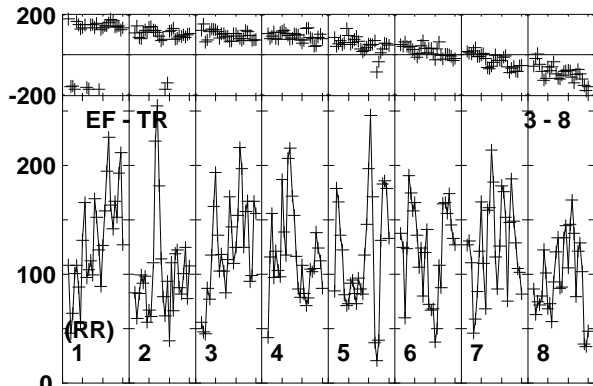
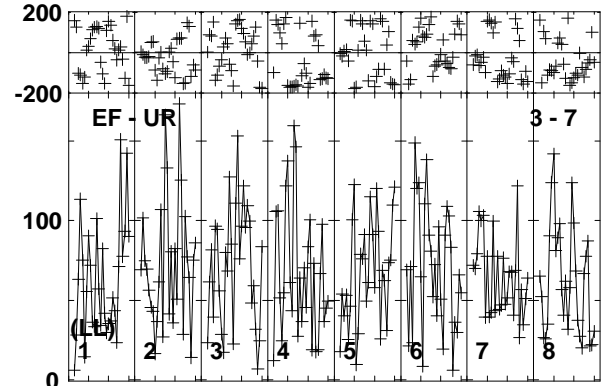
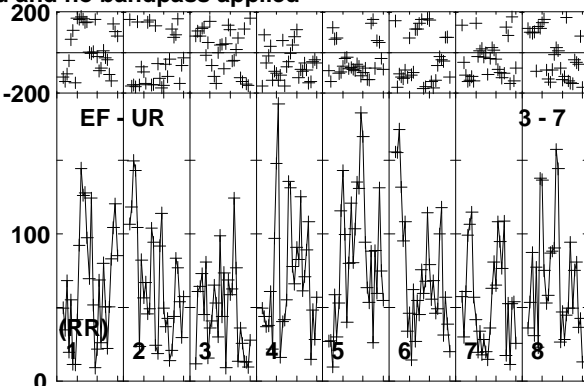
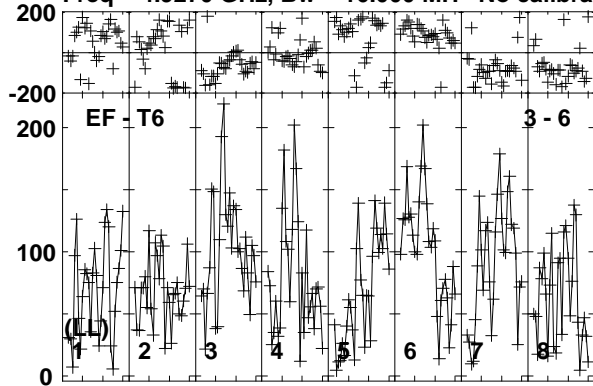

Lower frame: Micro Ampl Jy Top frame: Phas deg
Vector averaged cross-power spectrum Baseline: EF (03) - T6 (06)
Timerange: 00/05:43:23 to 00/05:47:19

Plot file version 303 created 17-FEB-2020 15:43:07

J1402+5347 EK047 2.UVDATA.1

Freq = 4.9270 GHz, Bw = 16.000 MH No calibration applied and no bandpass applied

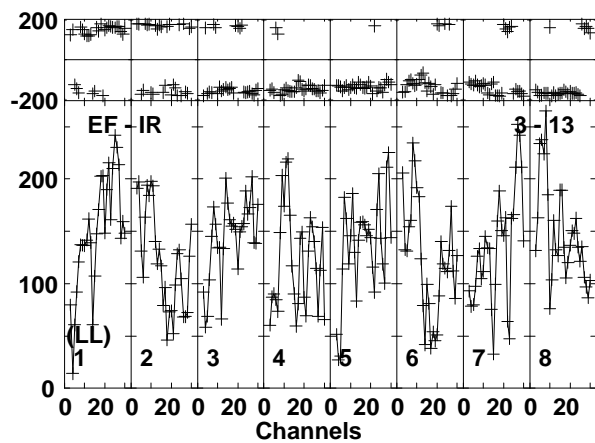
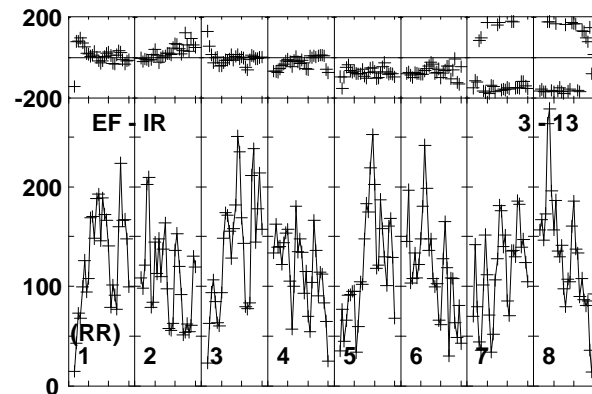
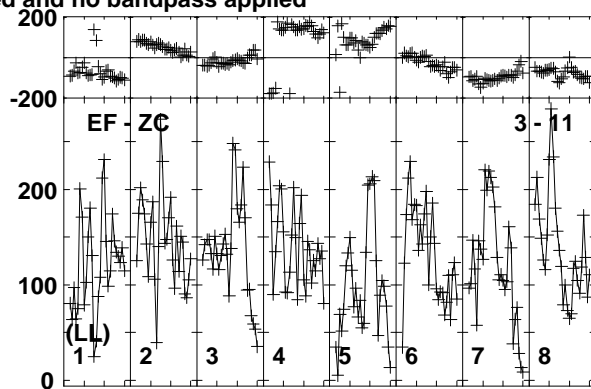
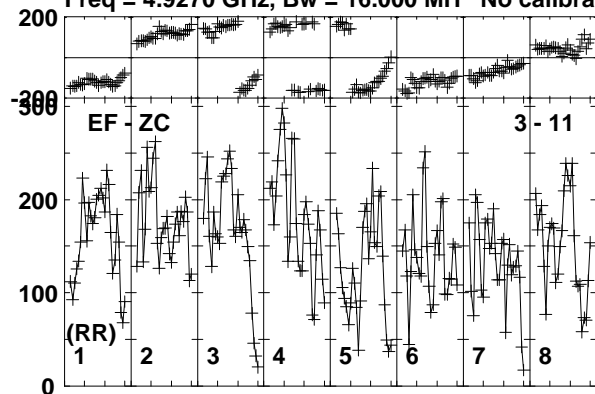

Lower frame: Micro Ampl Jy Top frame: Phas deg
Vector averaged cross-power spectrum Baseline: EF (03) - ZC (11)
Timerange: 00/05:43:23 to 00/05:47:19

Plot file version 304 created 17-FEB-2020 15:43:07

J1359+5544 EK047 2.UVDATA.1

Freq = 4.9270 GHz, Bw = 16.000 MH No calibration applied and no bandpass applied

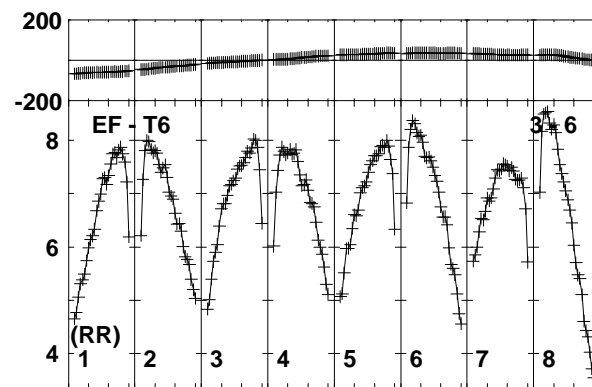
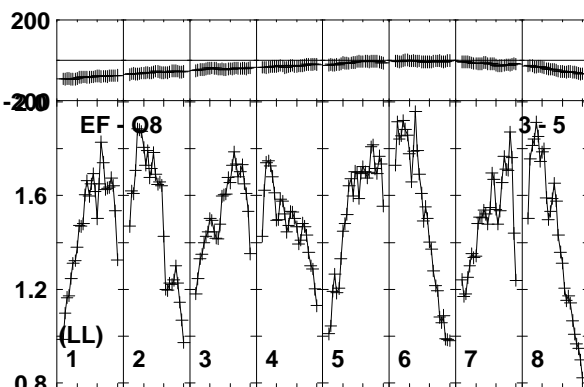
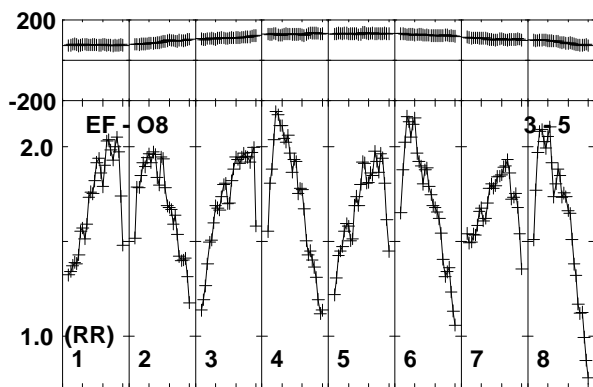
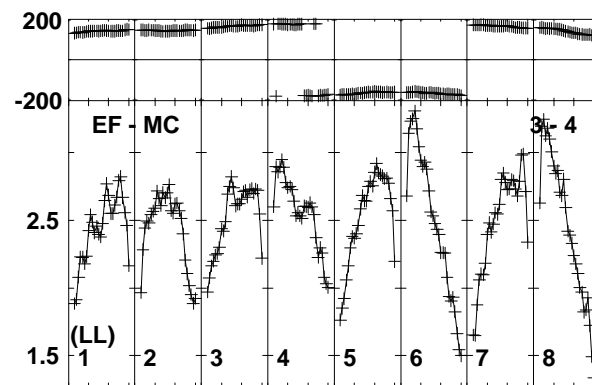
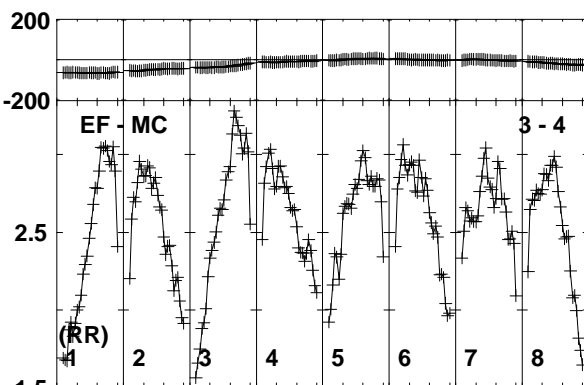
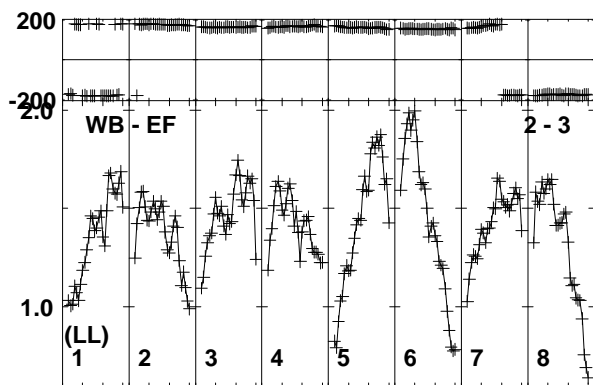
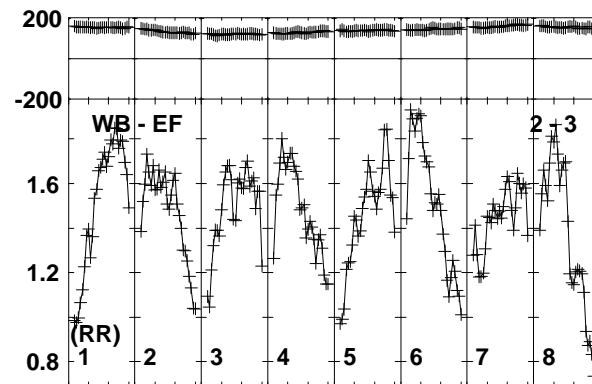
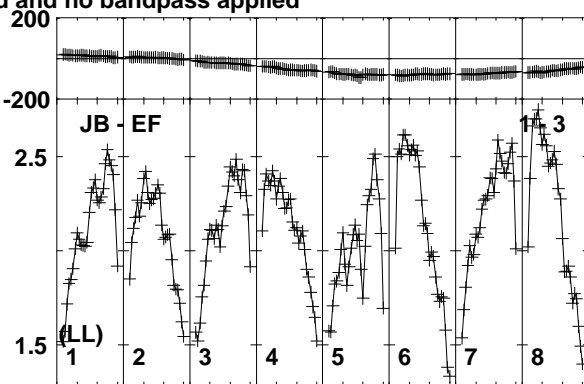
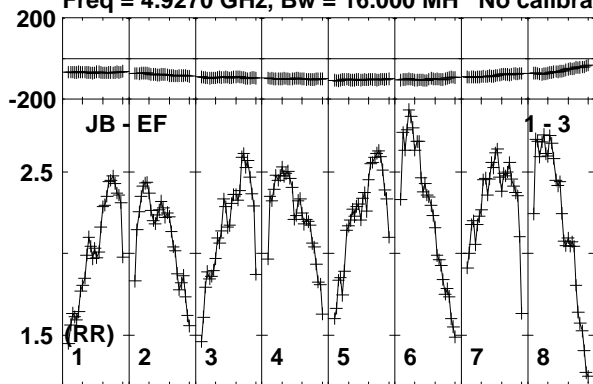

Lower frame: Milli Ampl Jy Top frame: Phas deg

Vector averaged cross-power spectrum Baseline: JB (01) - EF (03)

Timerange: 00/05:48:01 to 00/05:49:19

Plot file version 305 created 17-FEB-2020 15:43:07

J1359+5544 EK047 2.UVDATA.1

Freq = 4.9270 GHz, Bw = 16.000 MH No calibration applied and no bandpass applied

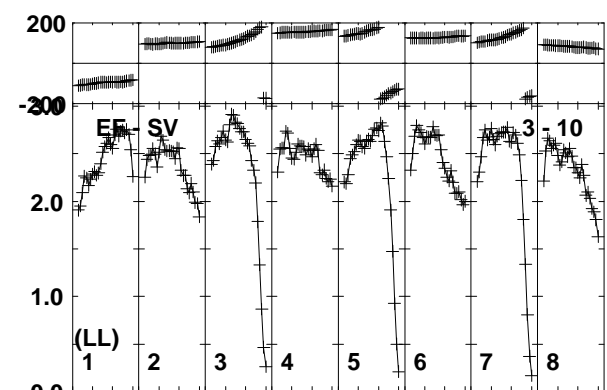
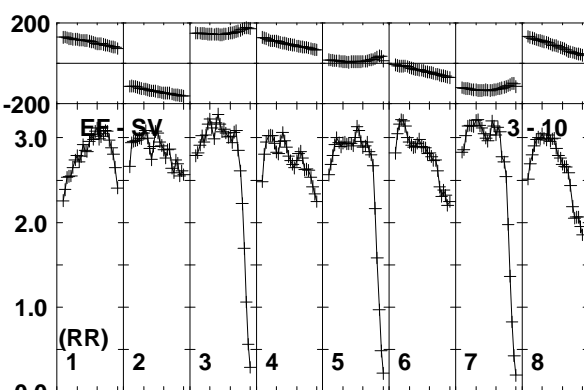
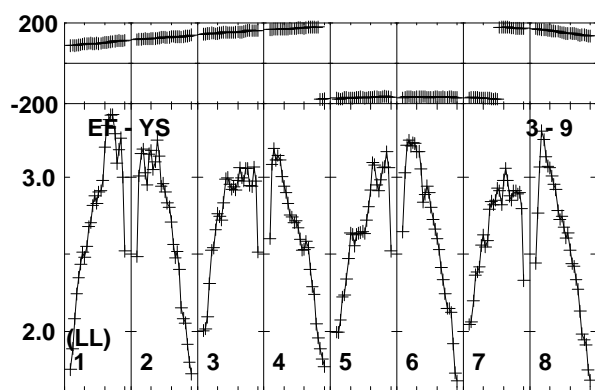
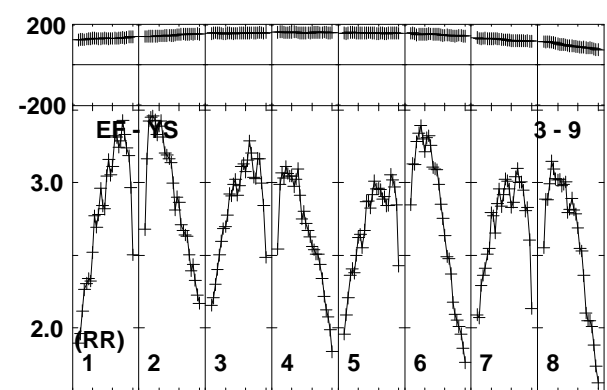
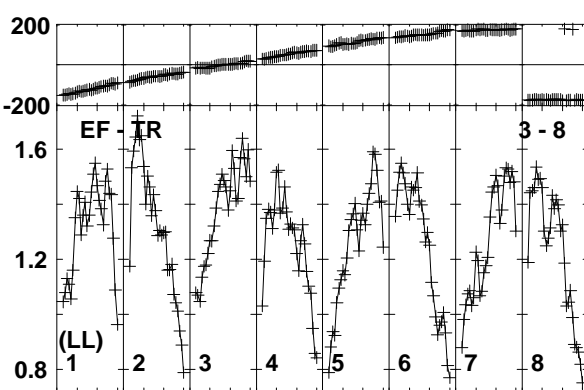
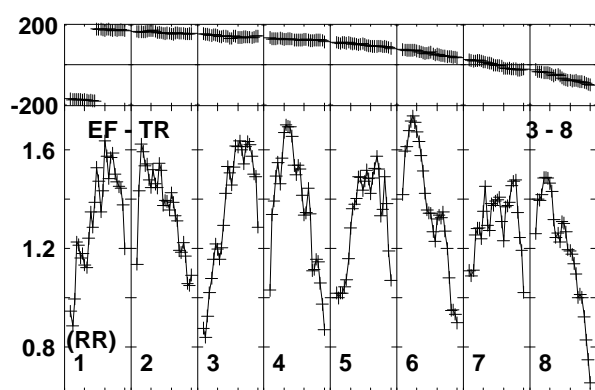
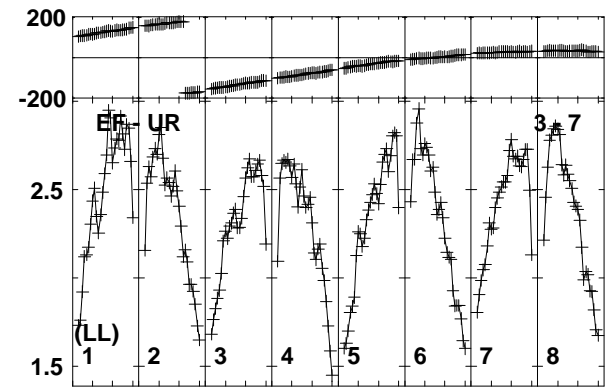
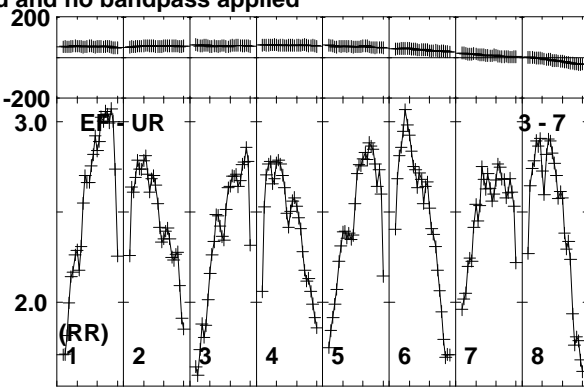
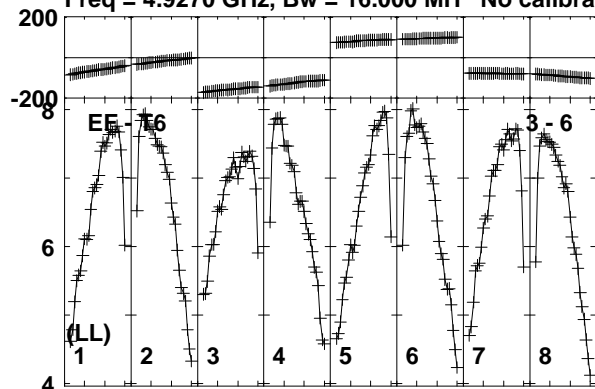

Lower frame: Milli Ampl Jy Top frame: Phas deg
Vector averaged cross-power spectrum Baseline: EF (03) - T6 (06)
Timerange: 00/05:48:01 to 00/05:49:19

Plot file version 306 created 17-FEB-2020 15:43:07

J1359+5544 EK047 2.UVDATA.1

Freq = 4.9270 GHz, Bw = 16.000 MH No calibration applied and no bandpass applied

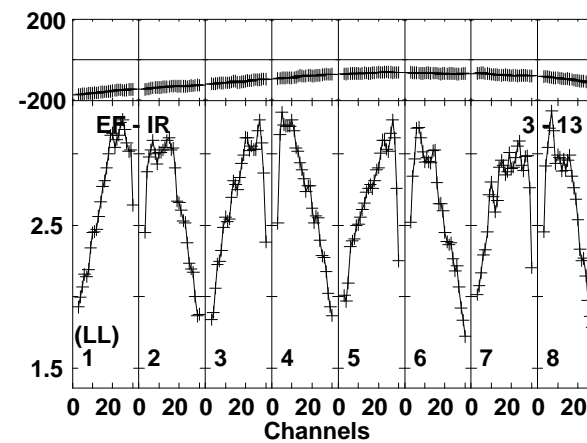
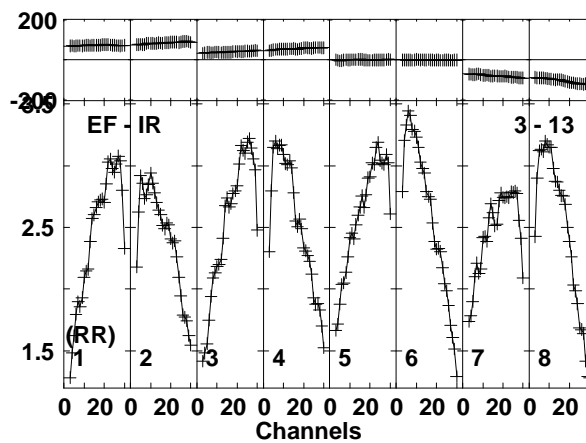
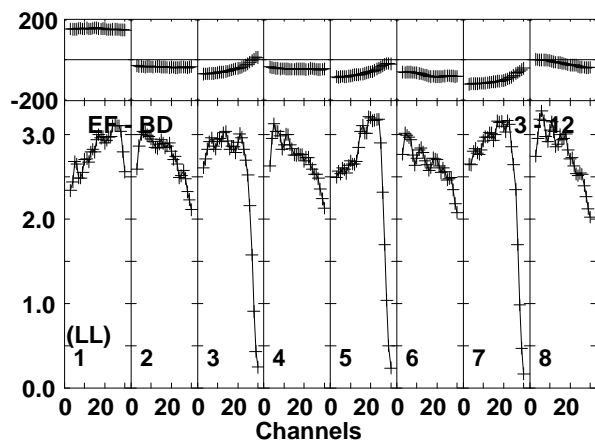
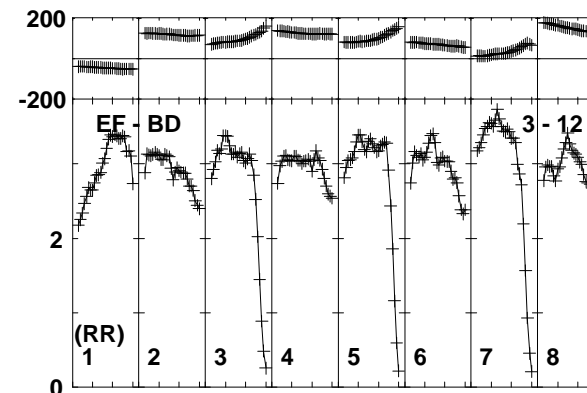
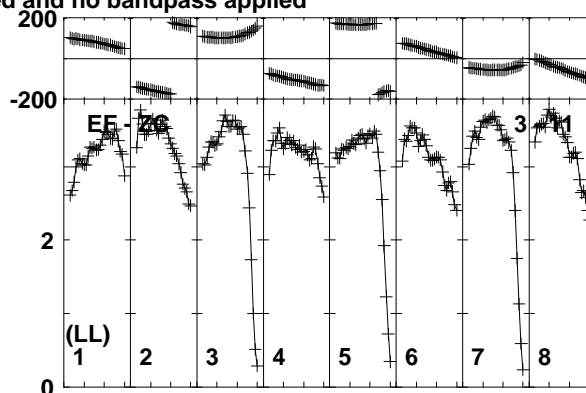
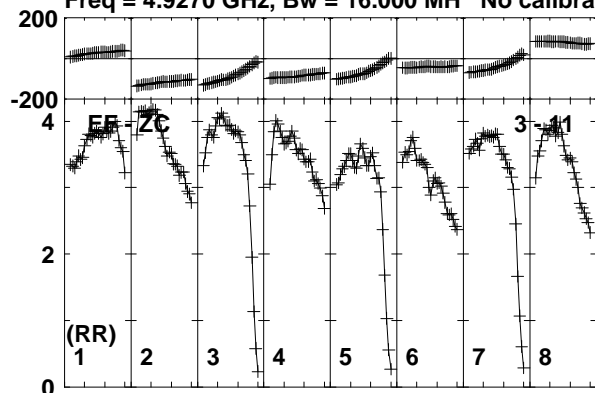

Lower frame: Milli Ampl Jy Top frame: Phas deg
Vector averaged cross-power spectrum Baseline: EF (03) - ZC (11)
Timerange: 00/05:48:01 to 00/05:49:19

Plot file version 307 created 17-FEB-2020 15:43:07

J1402+5347 EK047 2.UVDATA.1

Freq = 4.9270 GHz, Bw = 16.000 MH No calibration applied and no bandpass applied

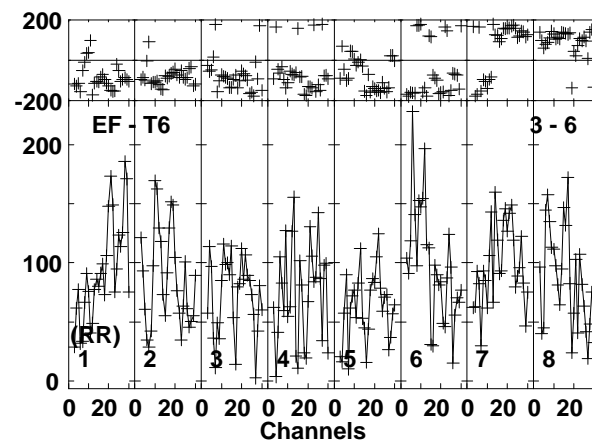
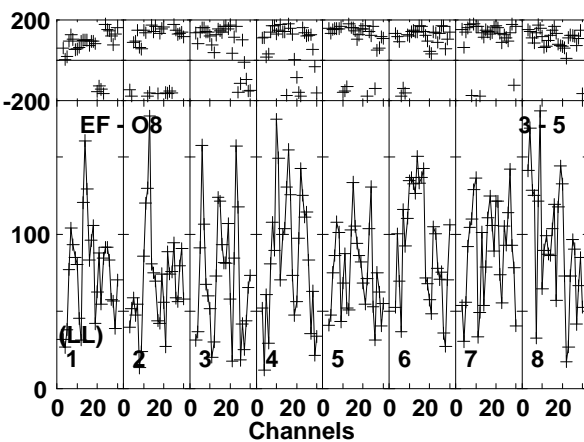
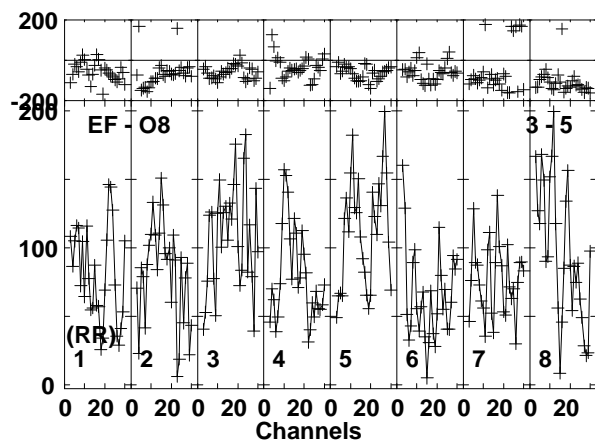
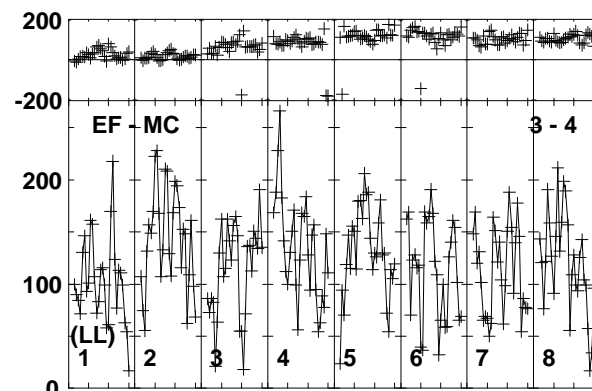
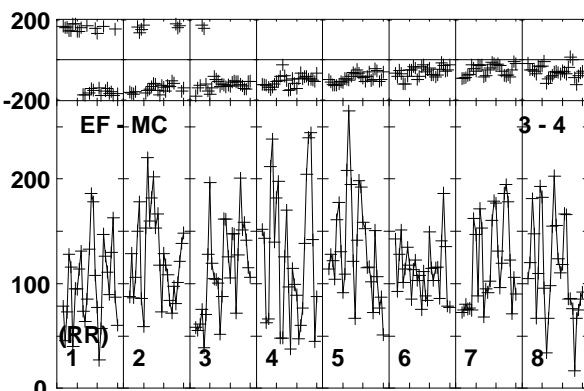
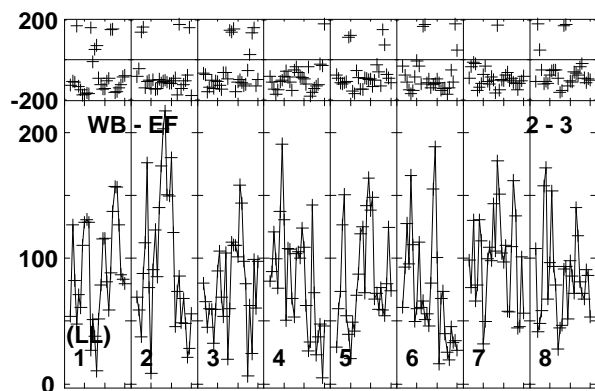
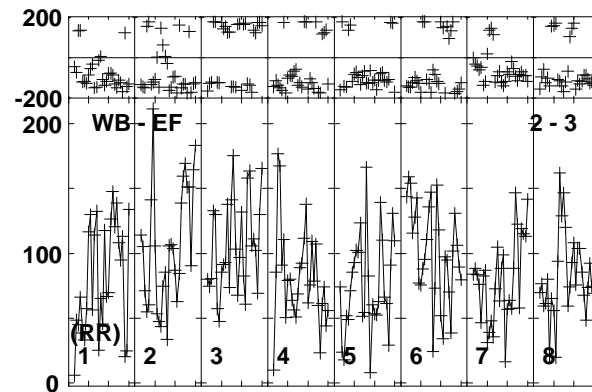
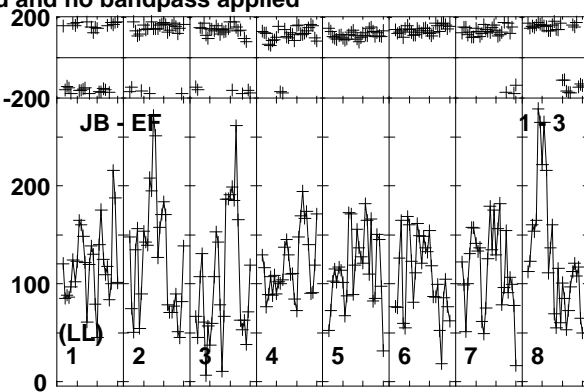
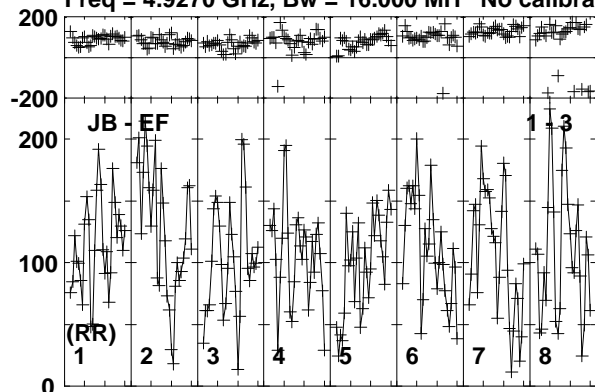

Lower frame: Micro Ampl Jy Top frame: Phas deg
Vector averaged cross-power spectrum Baseline: JB (01) - EF (03)
Timerange: 00/05:49:21 to 00/05:53:19

Plot file version 308 created 17-FEB-2020 15:43:07

J1402+5347 EK047 2.UVDATA.1

Freq = 4.9270 GHz, Bw = 16.000 MH No calibration applied and no bandpass applied

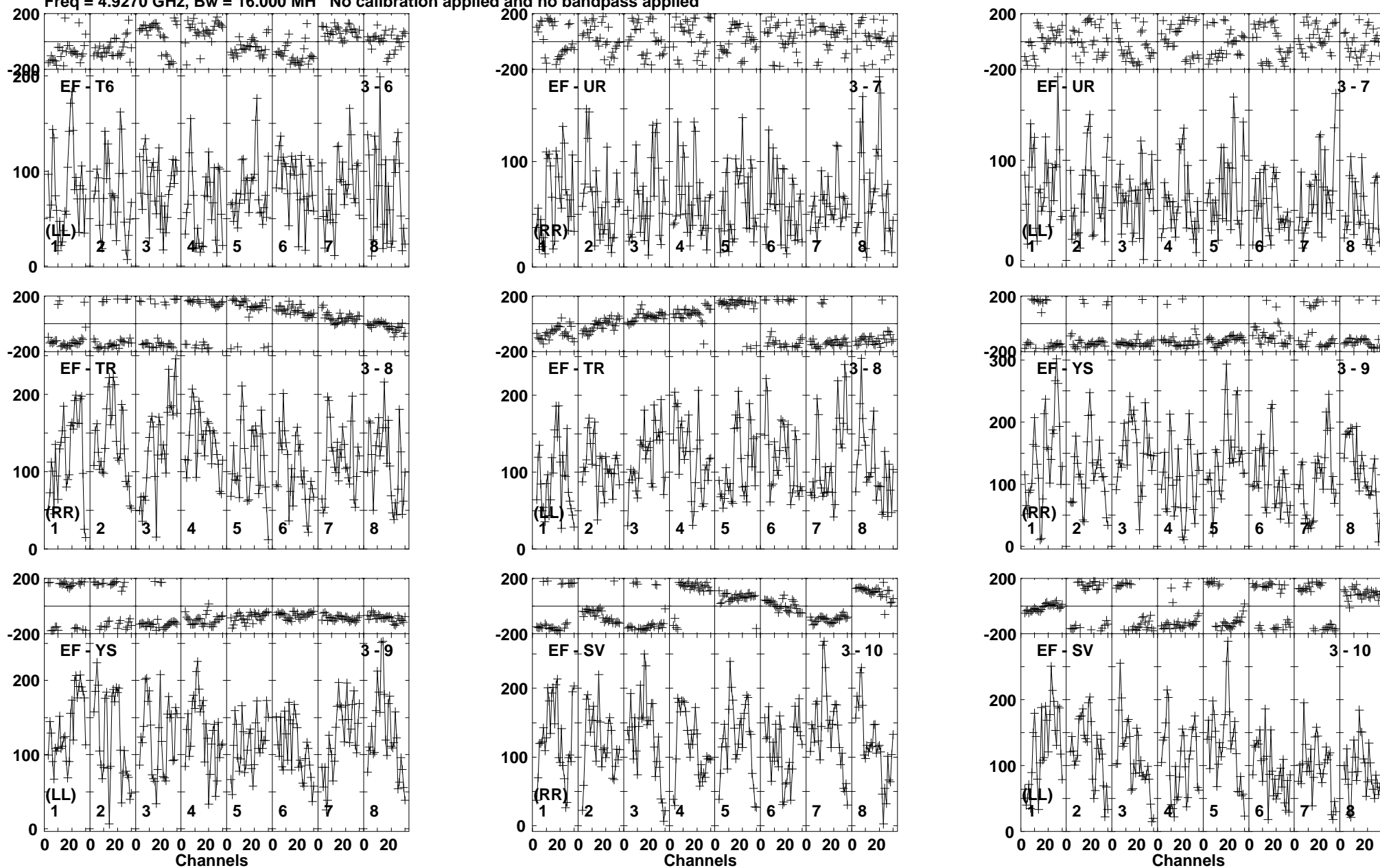

Lower frame: Micro Ampl Jy Top frame: Phas deg
Vector averaged cross-power spectrum Baseline: EF (03) - T6 (06)
Timerange: 00/05:49:21 to 00/05:53:19

Plot file version 309 created 17-FEB-2020 15:43:07

J1402+5347 EK047 2.UVDATA.1

Freq = 4.9270 GHz, Bw = 16.000 MH No calibration applied and no bandpass applied

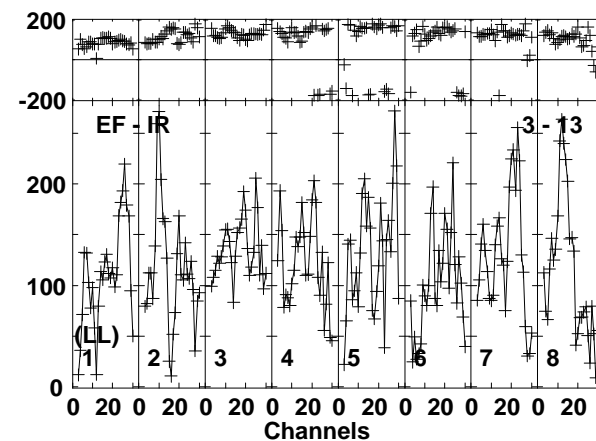
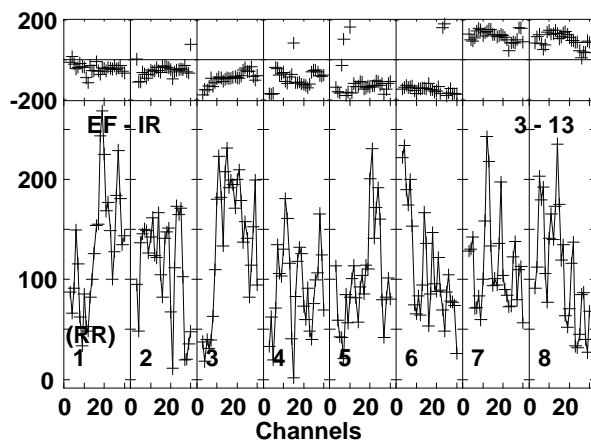
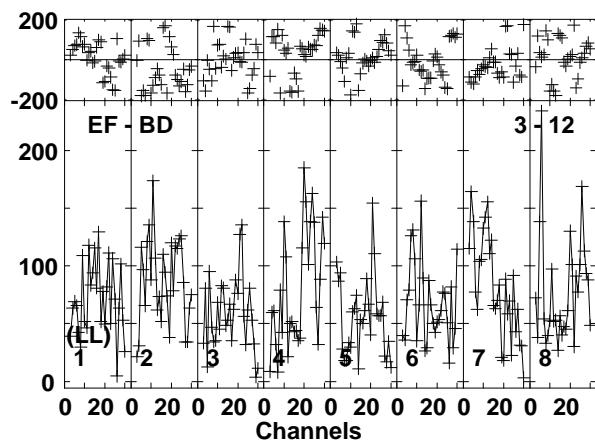
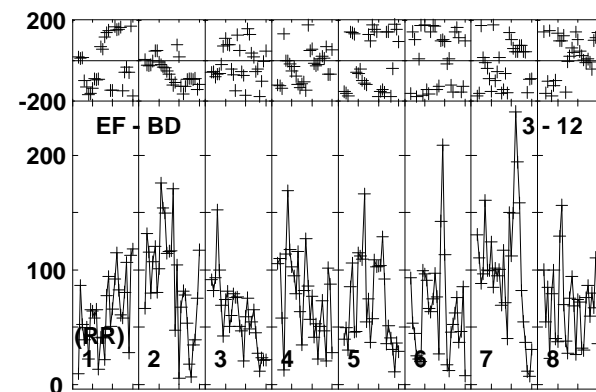
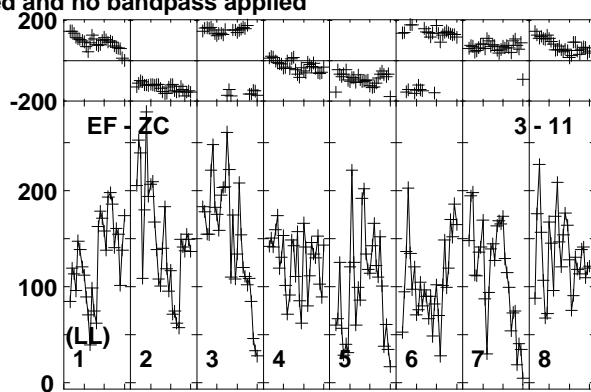
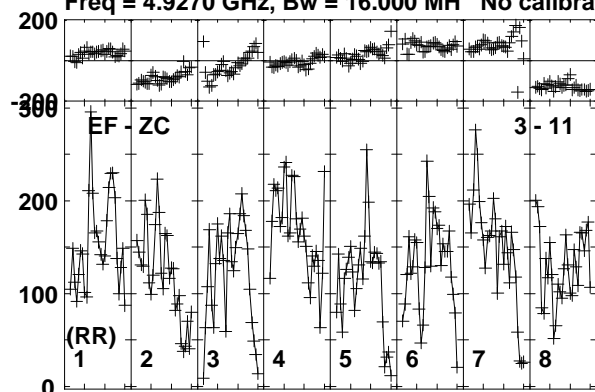

Lower frame: Micro Ampl Jy Top frame: Phas deg
Vector averaged cross-power spectrum Baseline: EF (03) - ZC (11)
Timerange: 00/05:49:21 to 00/05:53:19

Plot file version 310 created 17-FEB-2020 15:43:07

J1359+5544 EK047 2.UVDATA.1

Freq = 4.9270 GHz, Bw = 16.000 MH No calibration applied and no bandpass applied

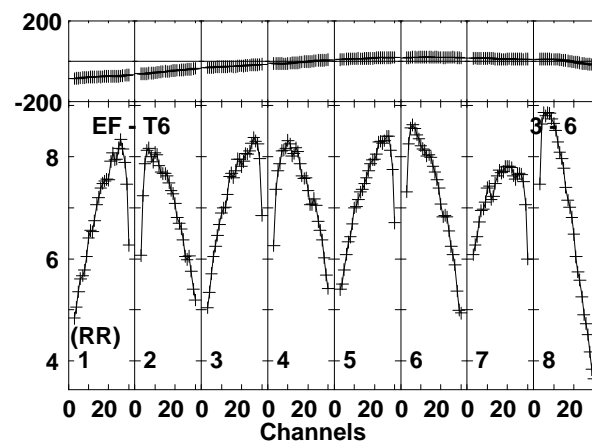
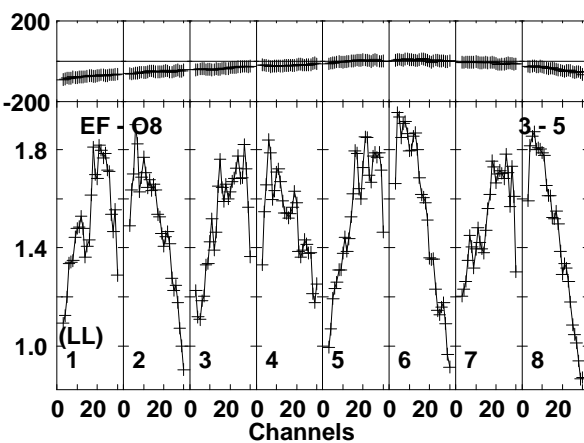
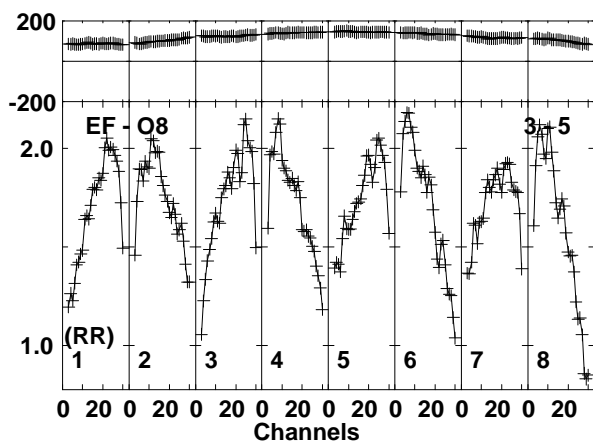
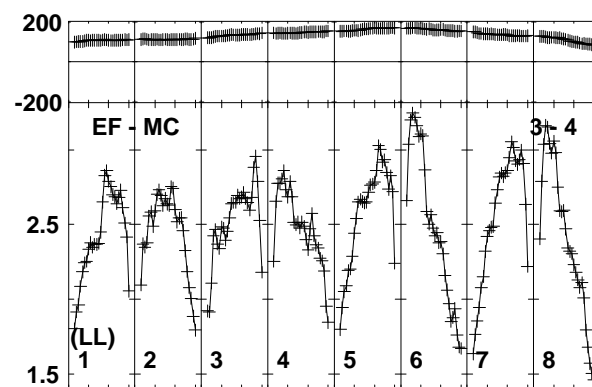
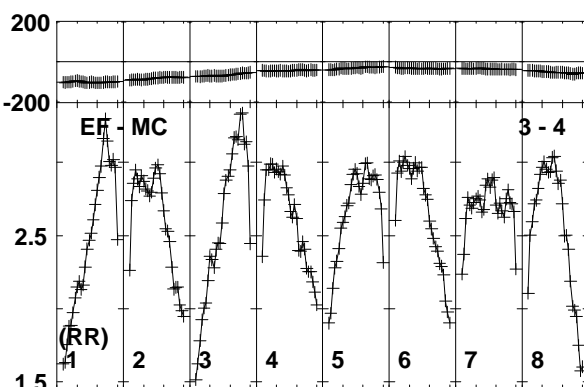
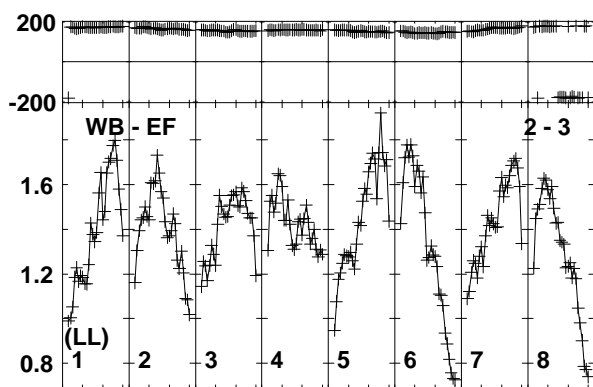
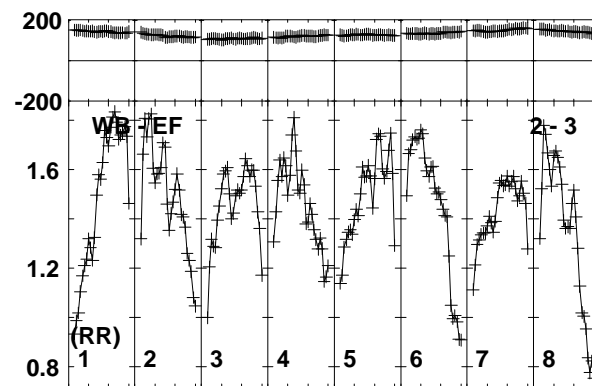
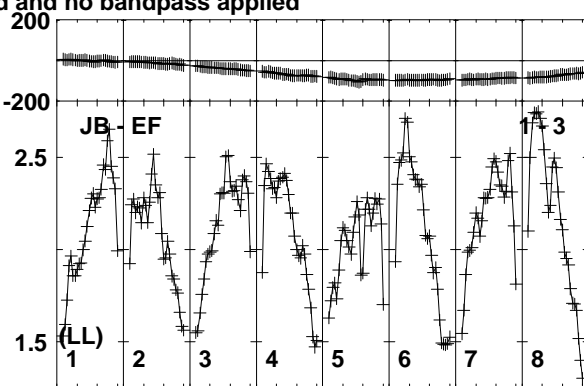
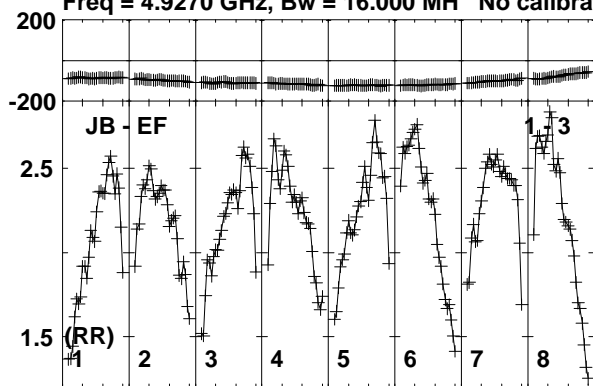

Lower frame: Milli Ampl Jy Top frame: Phas deg
Vector averaged cross-power spectrum Baseline: JB (01) - EF (03)
Timerange: 00/05:53:23 to 00/05:55:19

Plot file version 311 created 17-FEB-2020 15:43:08

J1359+5544 EK047 2.UVDATA.1

Freq = 4.9270 GHz, Bw = 16.000 MH No calibration applied and no bandpass applied

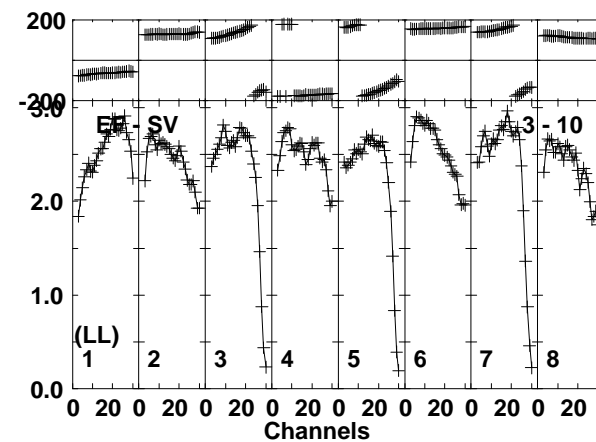
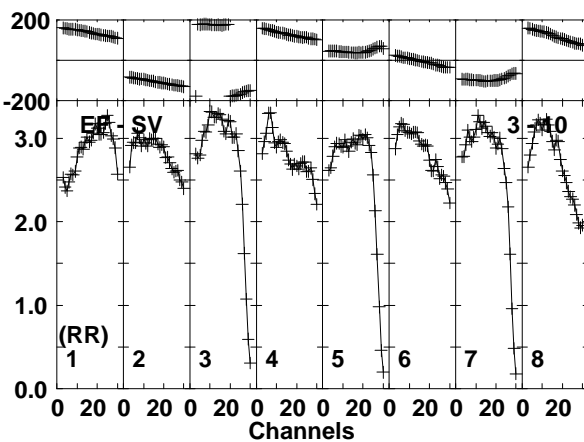
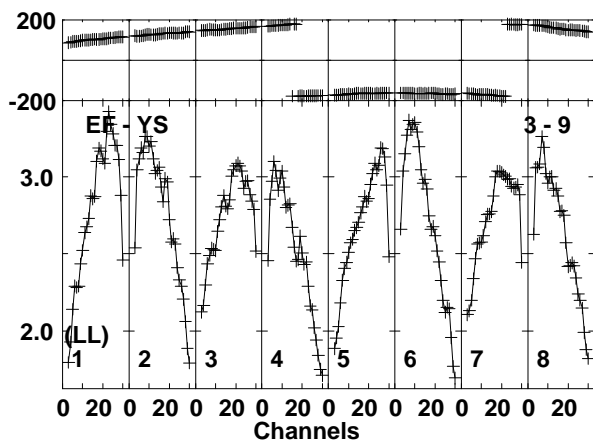
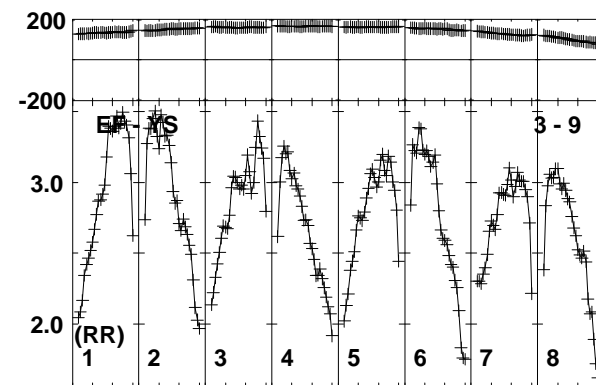
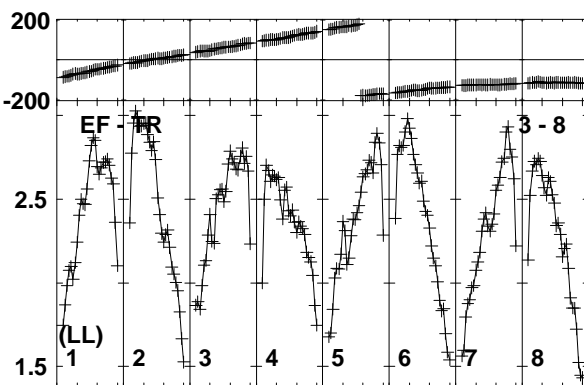
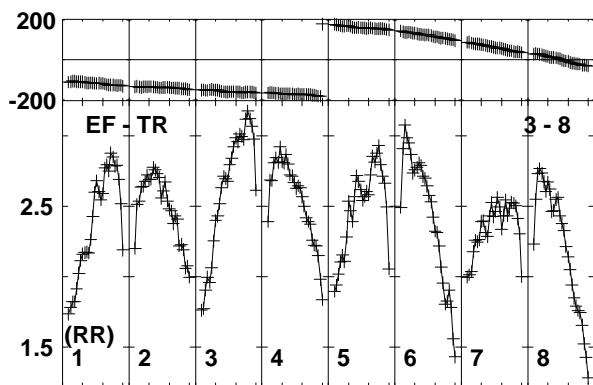
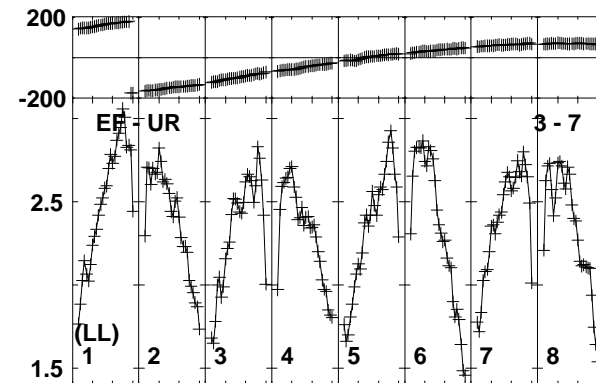
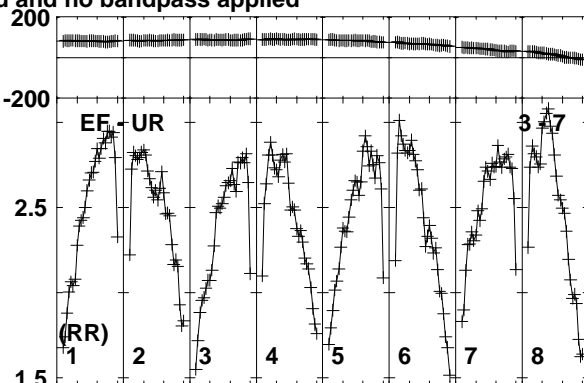
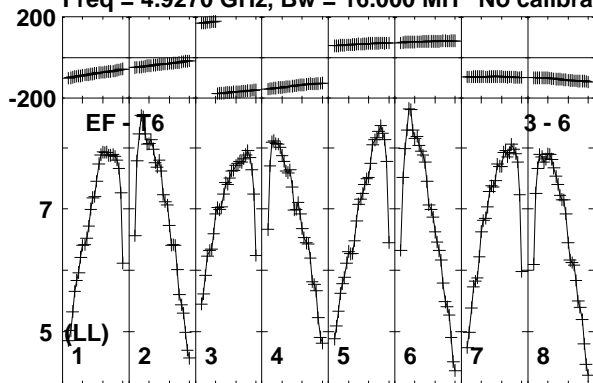

Lower frame: Milli Ampl Jy Top frame: Phas deg
Vector averaged cross-power spectrum Baseline: EF (03) - T6 (06)
Timerange: 00/05:53:23 to 00/05:55:19

Plot file version 312 created 17-FEB-2020 15:43:08

J1359+5544 EK047 2.UVDATA.1

Freq = 4.9270 GHz, Bw = 16.000 MH No calibration applied and no bandpass applied

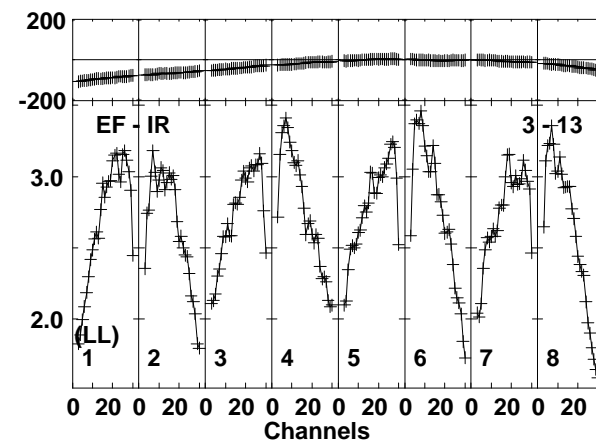
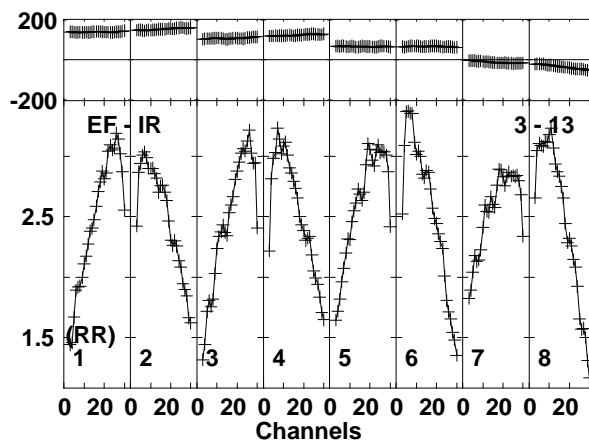
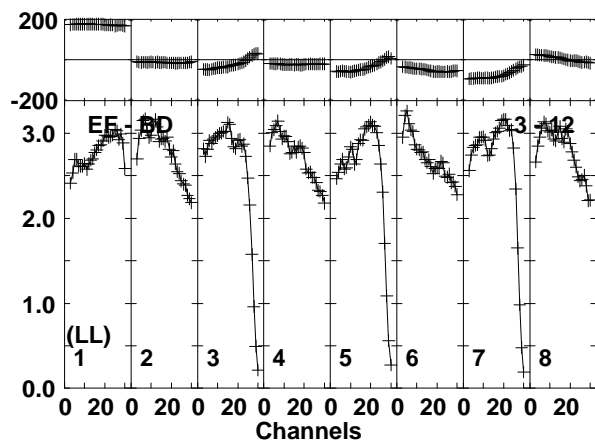
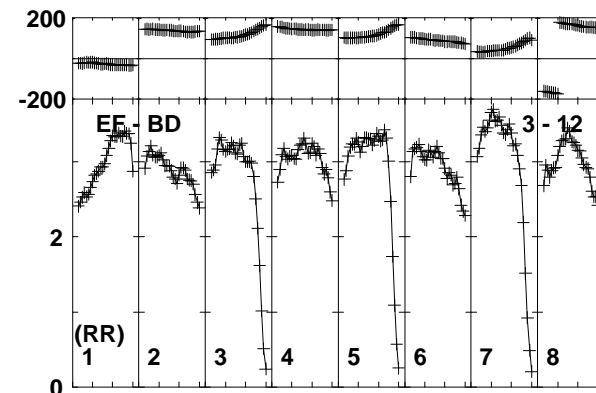
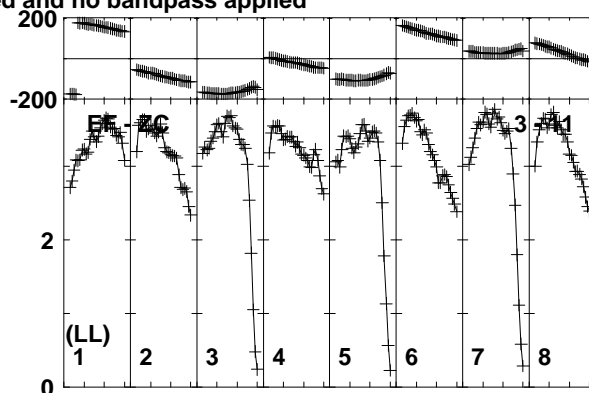
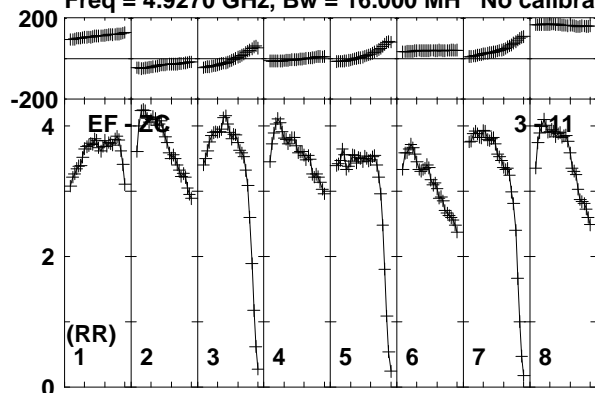

Lower frame: Milli Ampl Jy Top frame: Phas deg
Vector averaged cross-power spectrum Baseline: EF (03) - ZC (11)
Timerange: 00/05:53:23 to 00/05:55:19

Plot file version 313 created 17-FEB-2020 15:43:08

J1402+5347 EK047 2.UVDATA.1

Freq = 4.9270 GHz, Bw = 16.000 MH No calibration applied and no bandpass applied

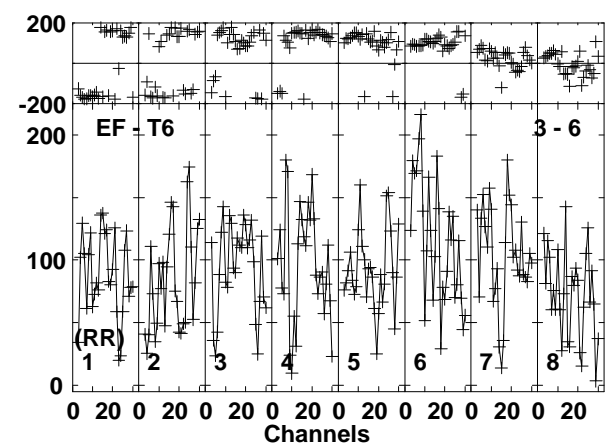
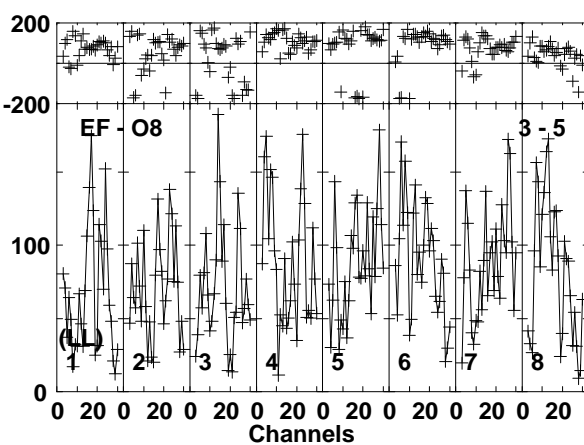
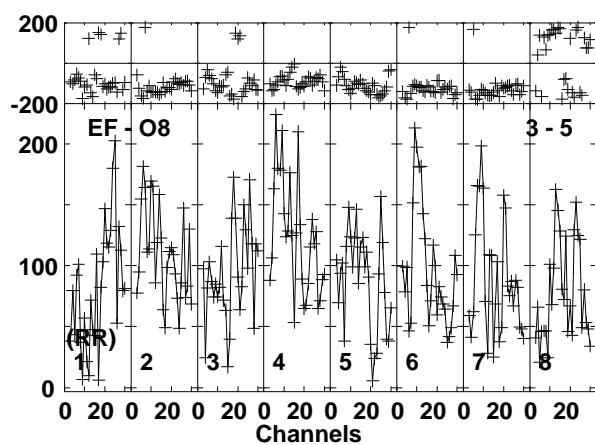
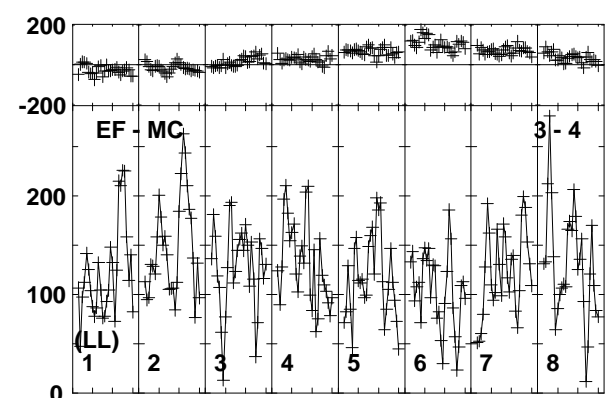
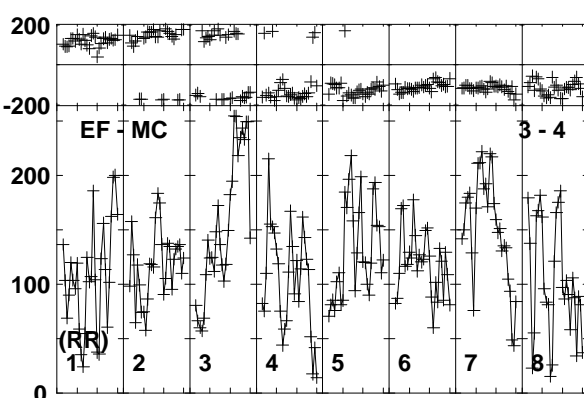
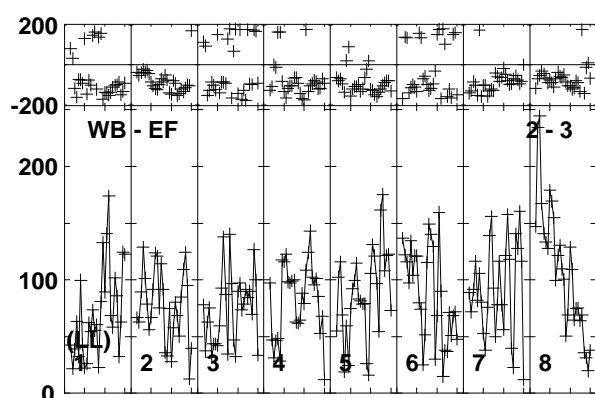
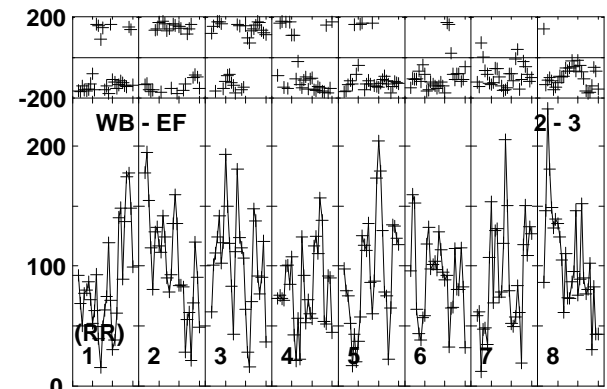
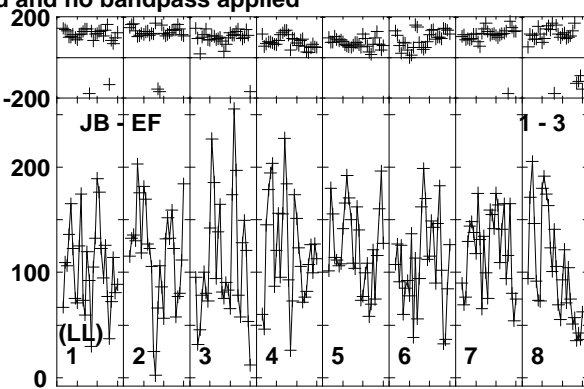
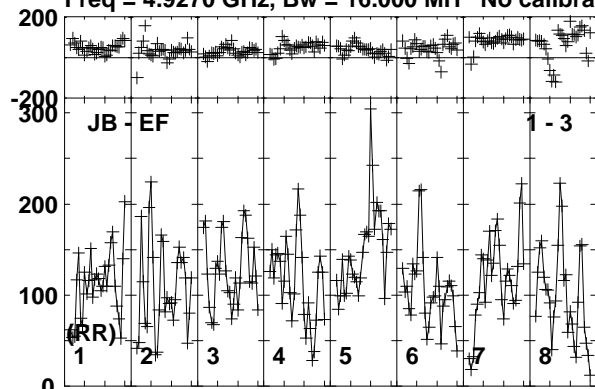

Lower frame: Micro Ampl Jy Top frame: Phas deg
Vector averaged cross-power spectrum Baseline: JB (01) - EF (03)
Timerange: 00/05:55:23 to 00/05:59:19

Plot file version 314 created 17-FEB-2020 15:43:08

J1402+5347 EK047 2.UVDATA.1

Freq = 4.9270 GHz, Bw = 16.000 MH No calibration applied and no bandpass applied

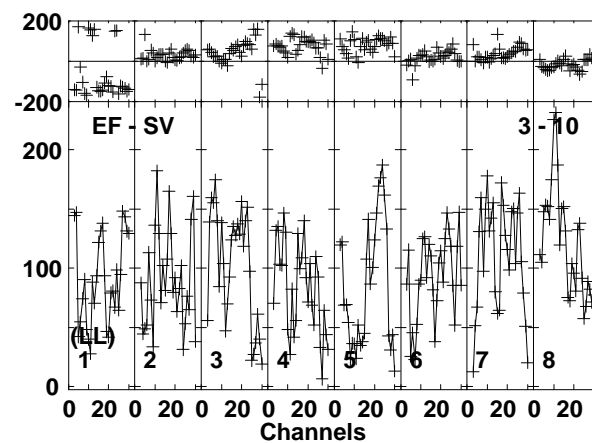
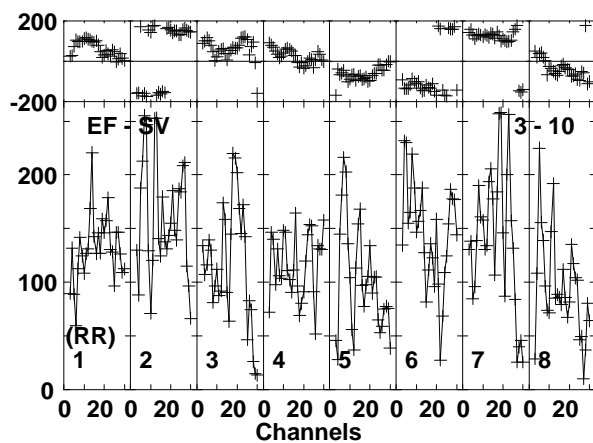
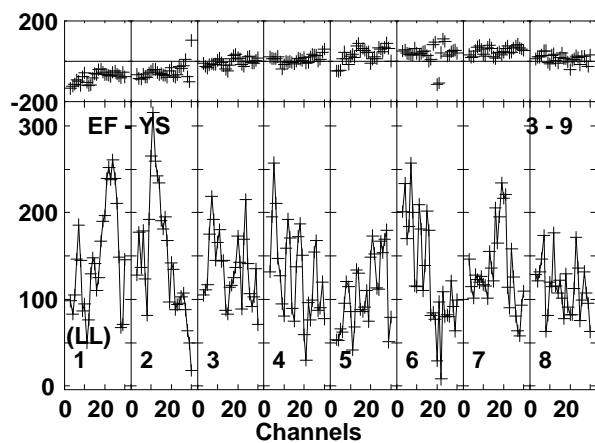
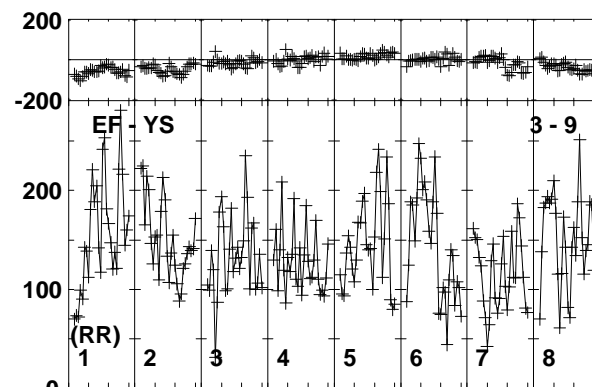
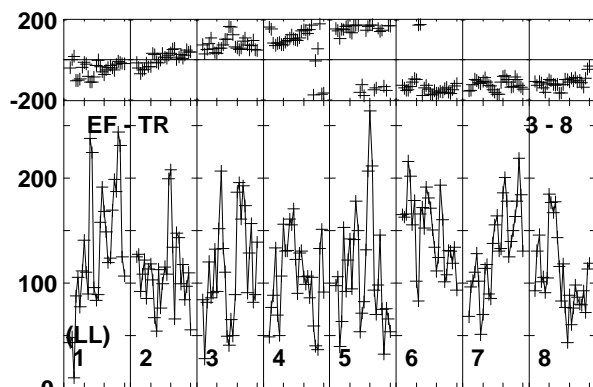
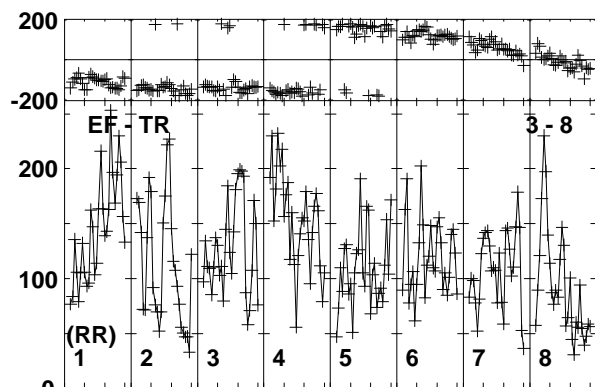
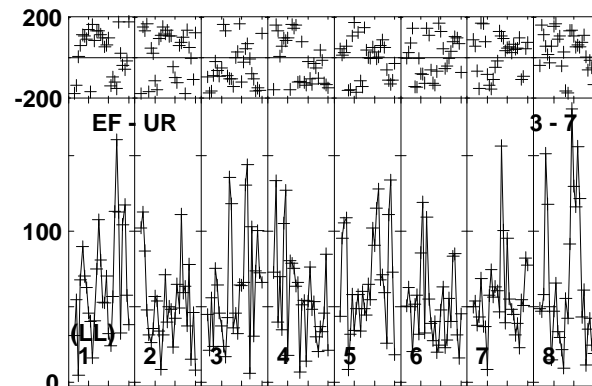
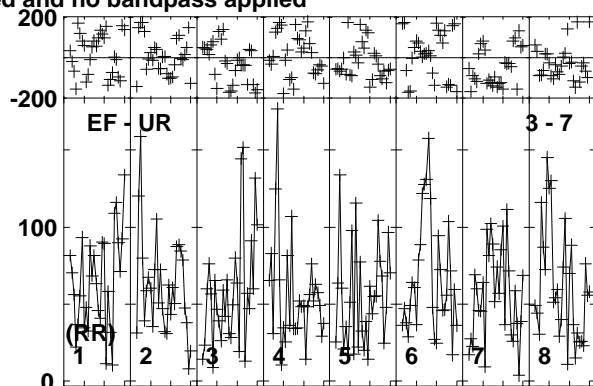
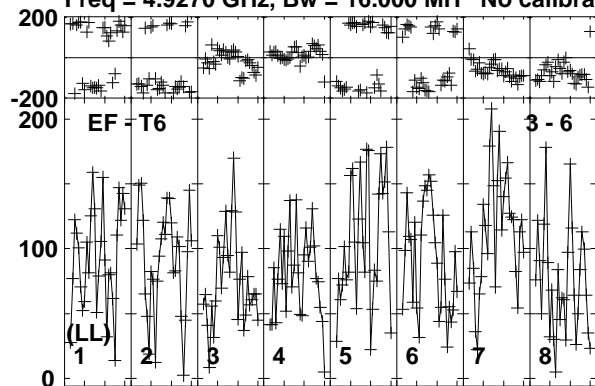

Lower frame: Micro Ampl Jy Top frame: Phas deg
Vector averaged cross-power spectrum Baseline: EF (03) - T6 (06)
Timerange: 00/05:55:23 to 00/05:59:19

Plot file version 315 created 17-FEB-2020 15:43:08

J1402+5347 EK047 2.UVDATA.1

Freq = 4.9270 GHz, Bw = 16.000 MH No calibration applied and no bandpass applied

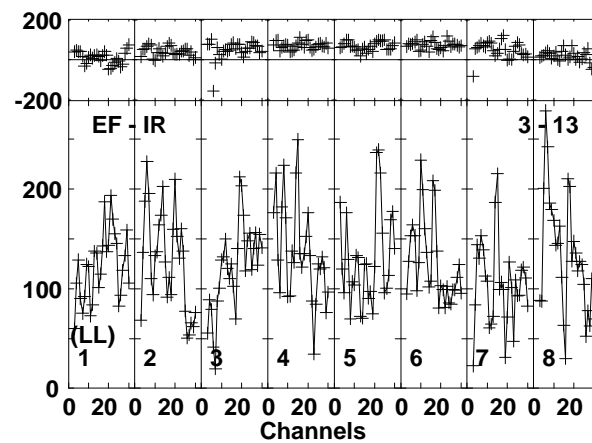
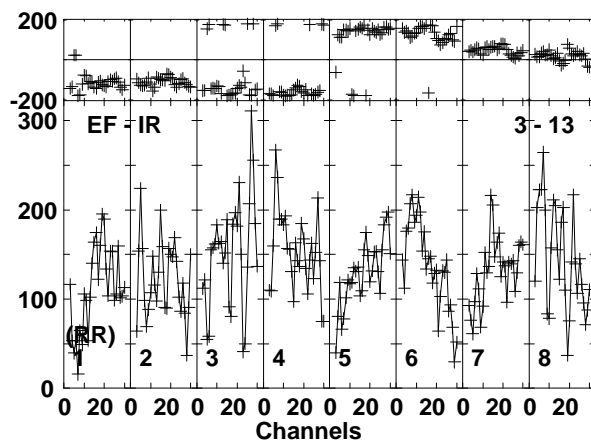
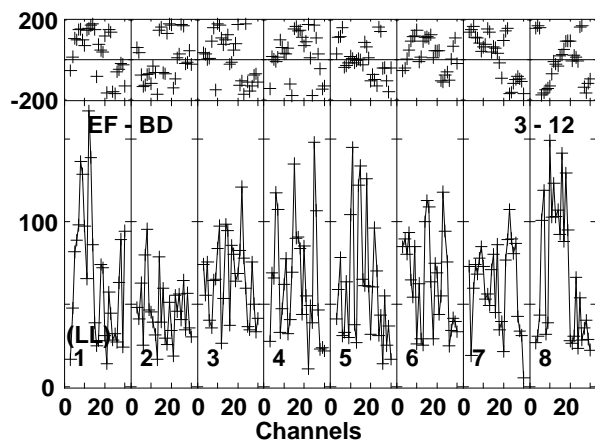
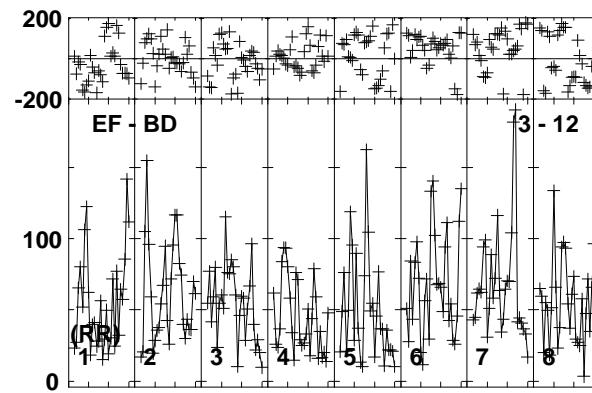
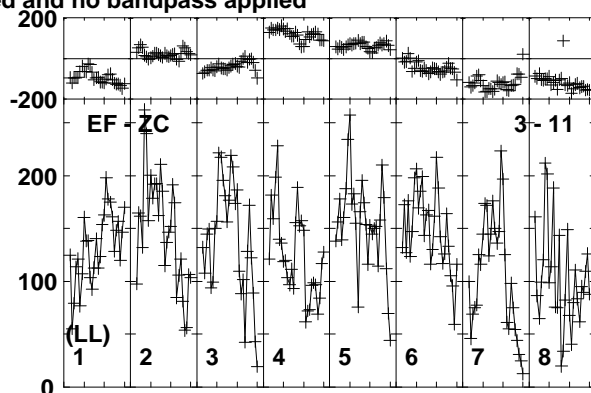
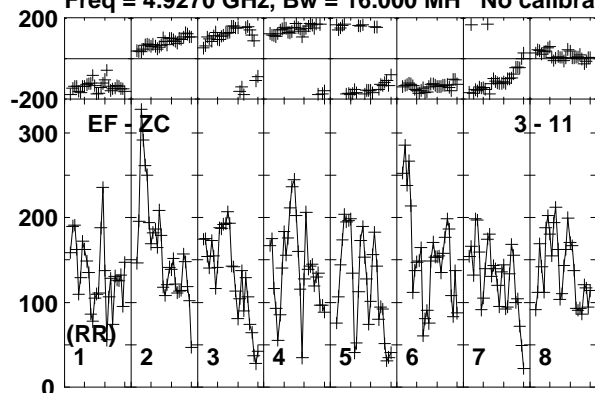

Lower frame: Micro Ampl Jy Top frame: Phas deg
Vector averaged cross-power spectrum Baseline: EF (03) - ZC (11)
Timerange: 00/05:55:23 to 00/05:59:19

Plot file version 316 created 17-FEB-2020 15:43:08

J1359+5544 EK047 2.UVDATA.1

Freq = 4.9270 GHz, Bw = 16.000 MH No calibration applied and no bandpass applied

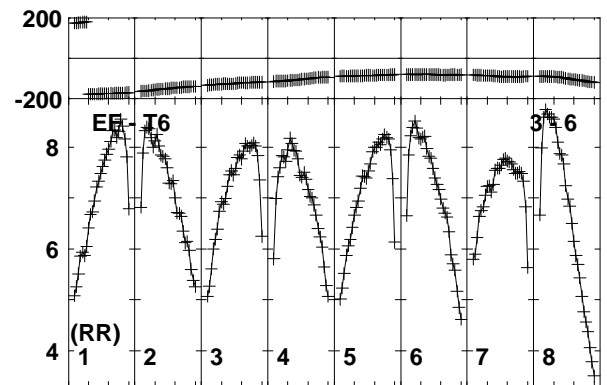
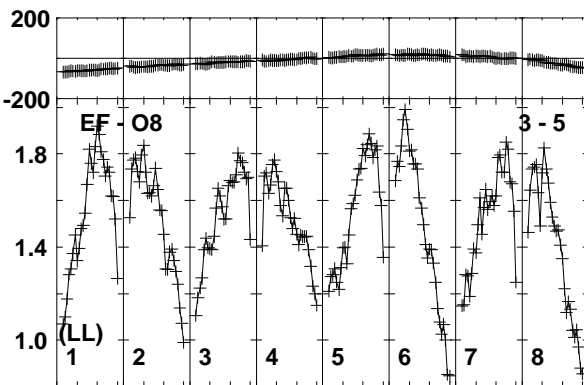
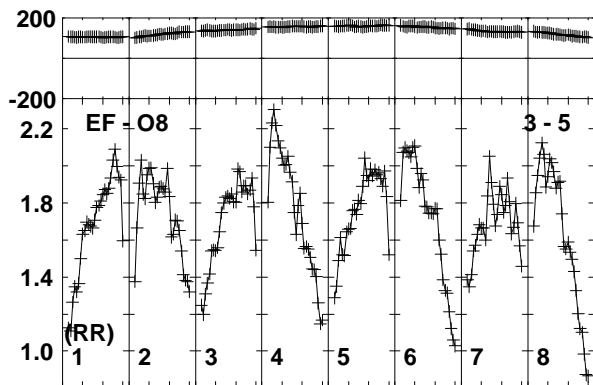
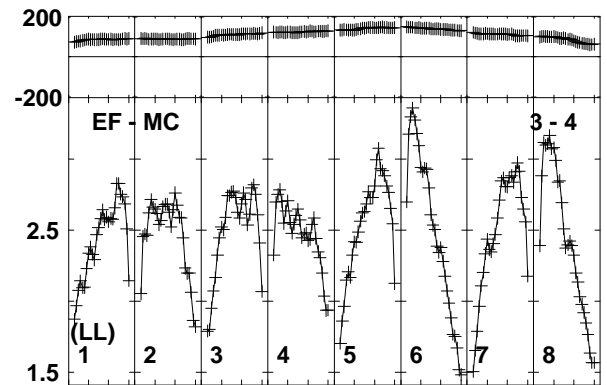
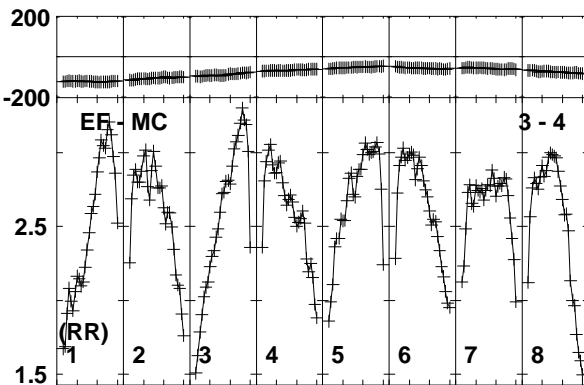
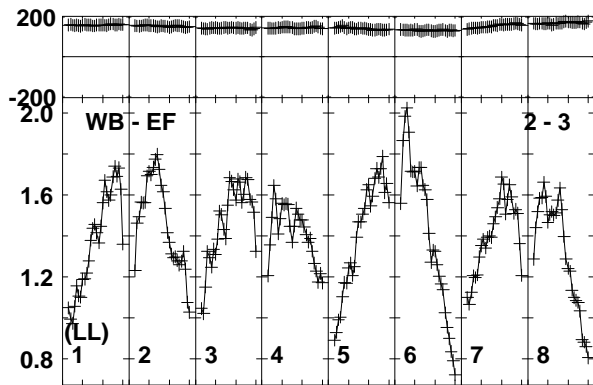
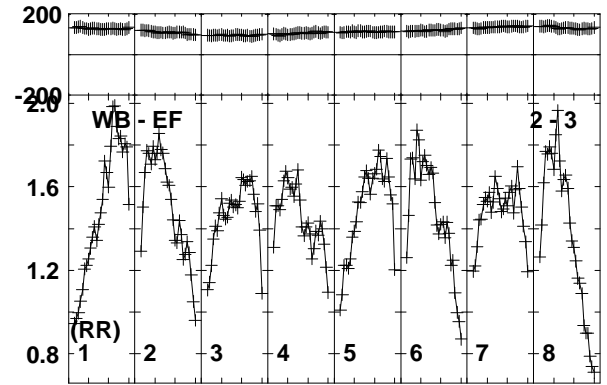
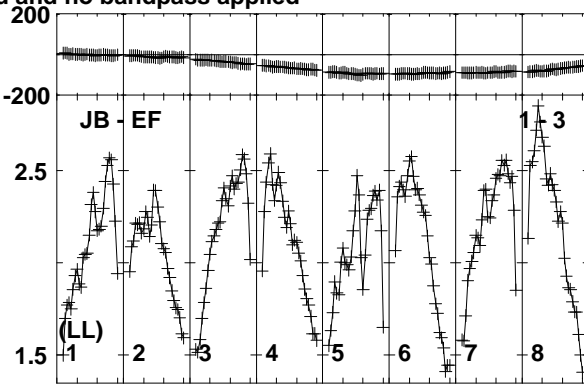
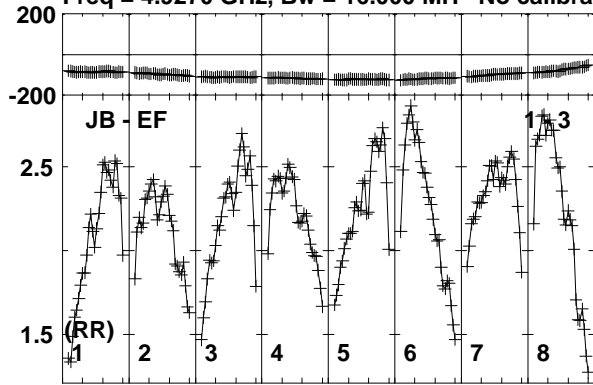

Lower frame: Milli Ampl Jy Top frame: Phas deg

Vector averaged cross-power spectrum Baseline: JB (01) - EF (03)

Timerange: 00/06:00:01 to 00/06:01:19

Plot file version 317 created 17-FEB-2020 15:43:08

J1359+5544 EK047 2.UVDATA.1

Freq = 4.9270 GHz, Bw = 16.000 MH No calibration applied and no bandpass applied

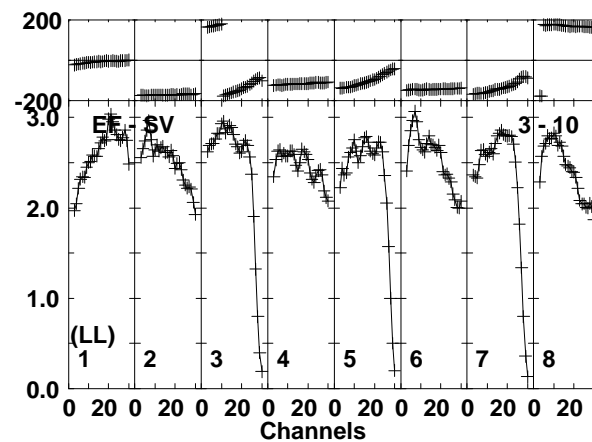
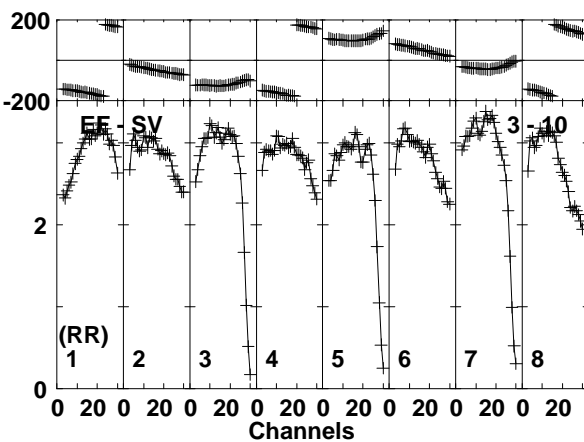
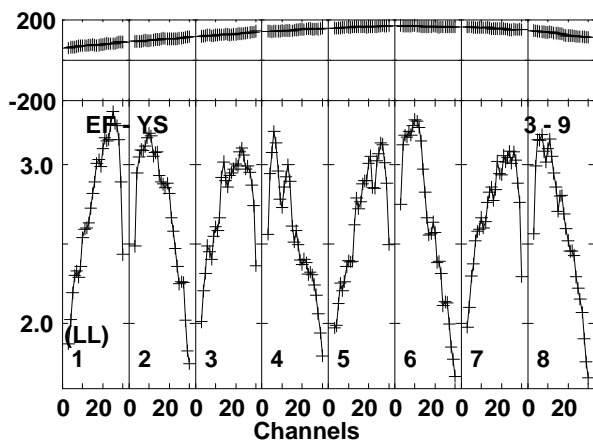
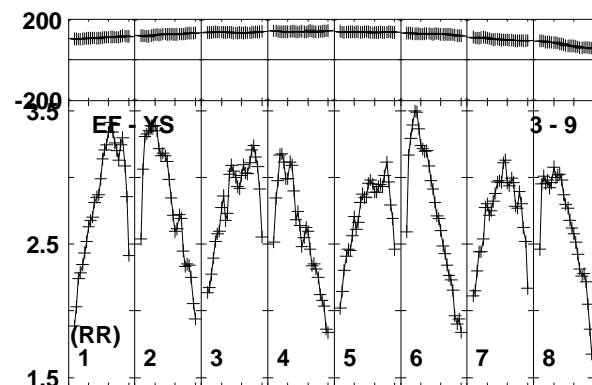
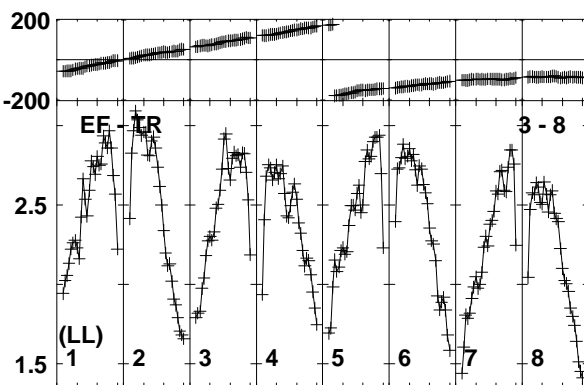
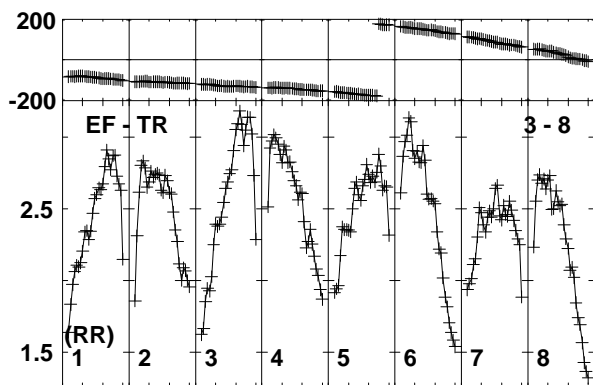
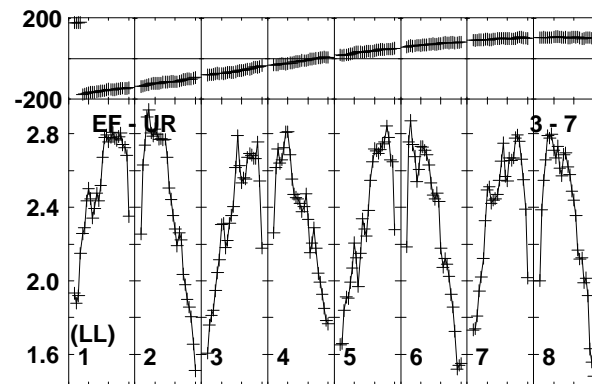
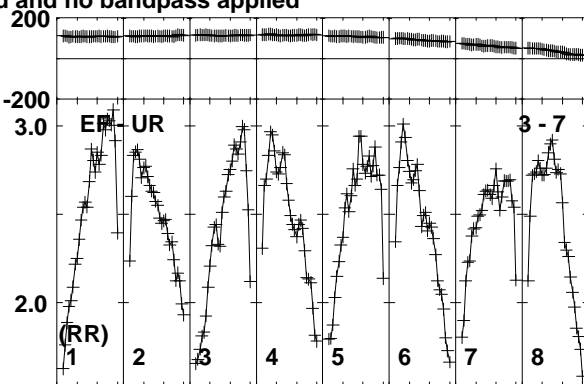
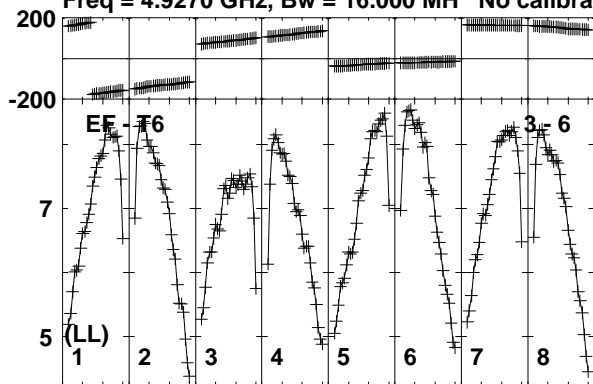

Lower frame: Milli Ampl Jy Top frame: Phas deg
Vector averaged cross-power spectrum Baseline: EF (03) - T6 (06)
Timerange: 00/06:00:01 to 00/06:01:19

Plot file version 318 created 17-FEB-2020 15:43:08

J1359+5544 EK047 2.UVDATA.1

Freq = 4.9270 GHz, Bw = 16.000 MH No calibration applied and no bandpass applied

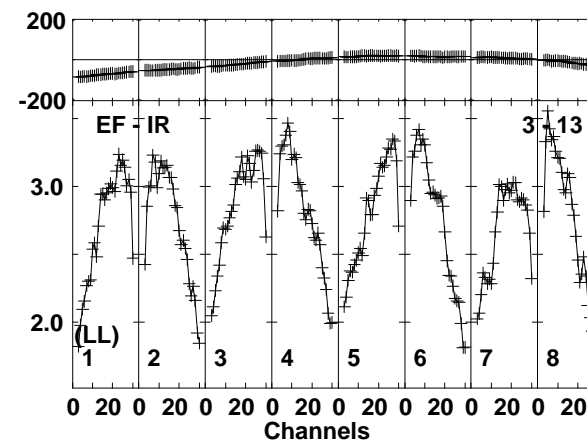
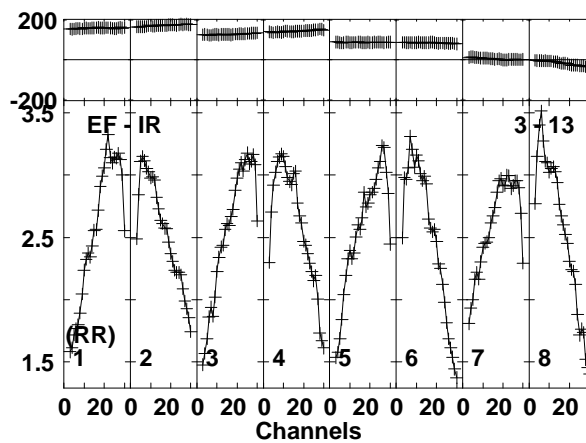
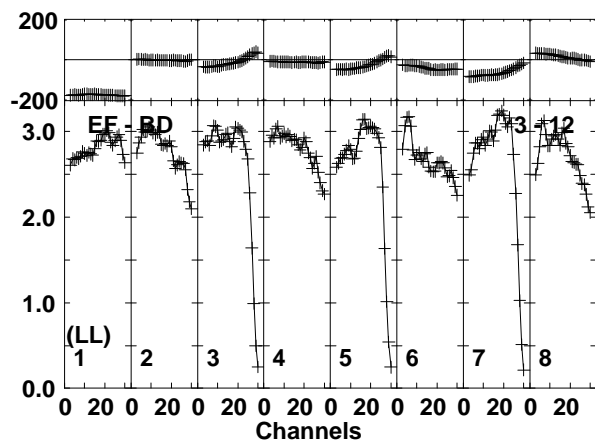
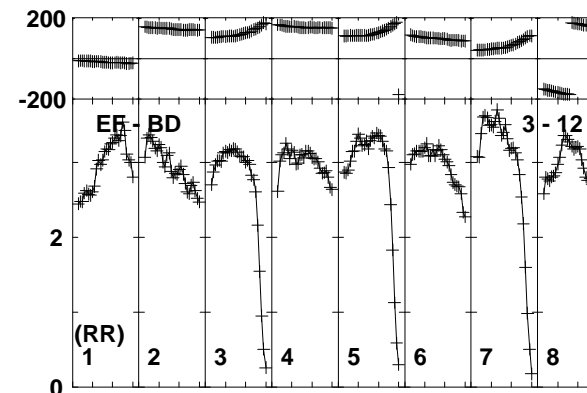
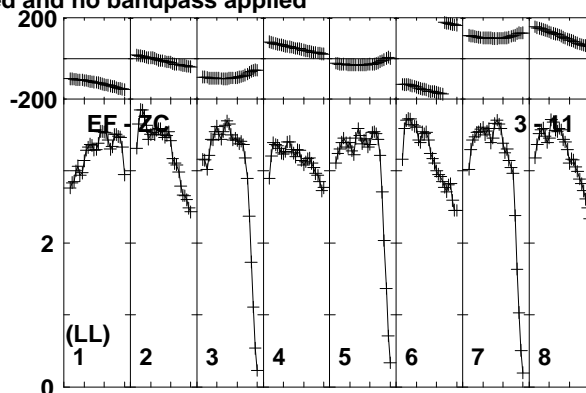
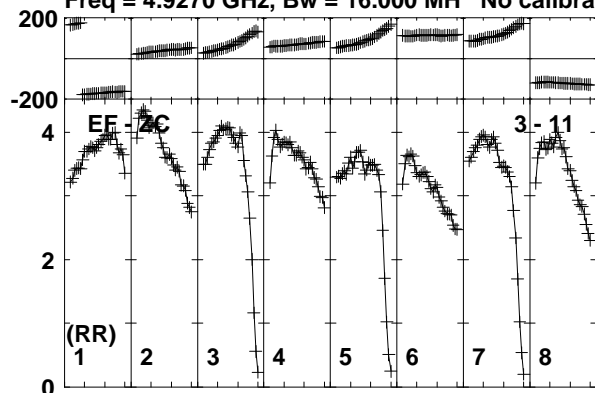

Lower frame: Milli Ampl Jy Top frame: Phas deg
Vector averaged cross-power spectrum Baseline: EF (03) - ZC (11)
Timerange: 00/06:00:01 to 00/06:01:19

Plot file version 319 created 17-FEB-2020 15:43:08

J1402+5347 EK047 2.UVDATA.1

Freq = 4.9270 GHz, Bw = 16.000 MH No calibration applied and no bandpass applied

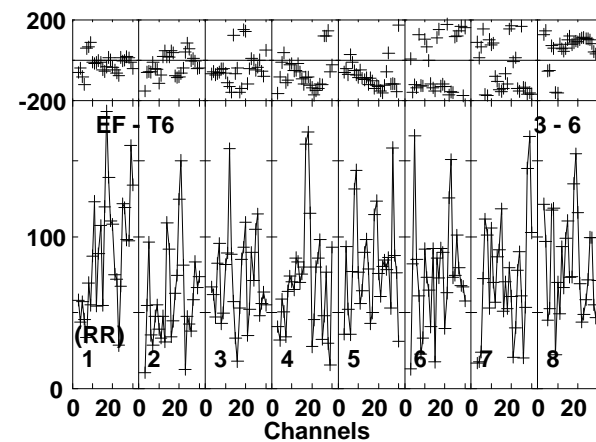
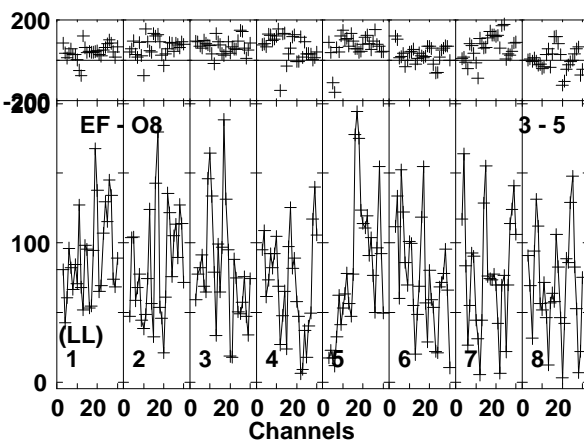
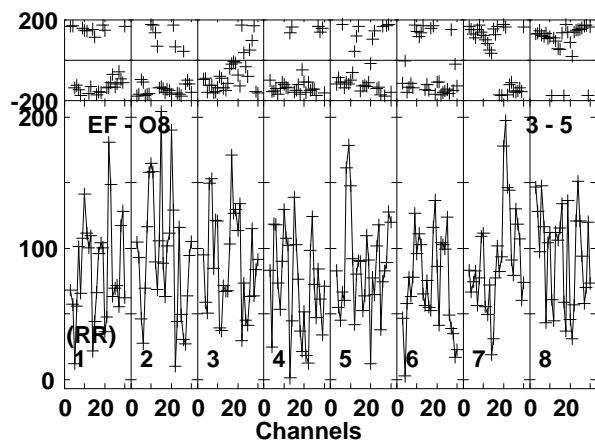
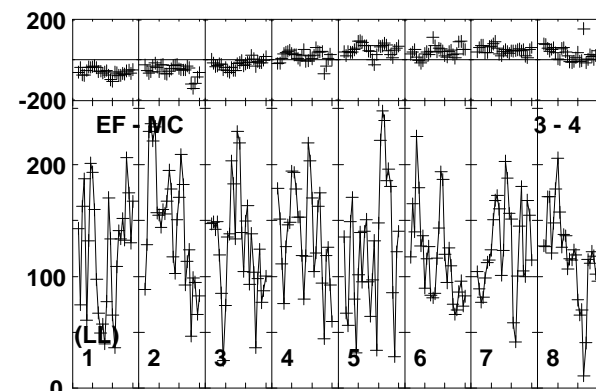
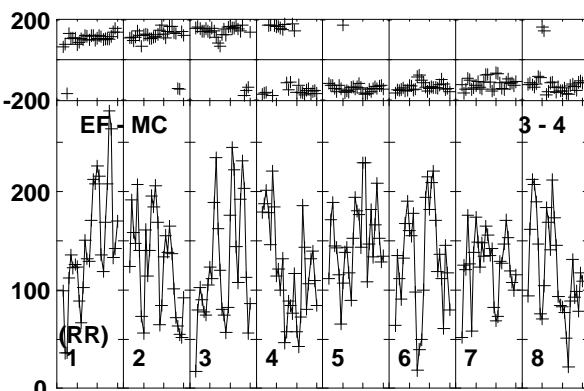
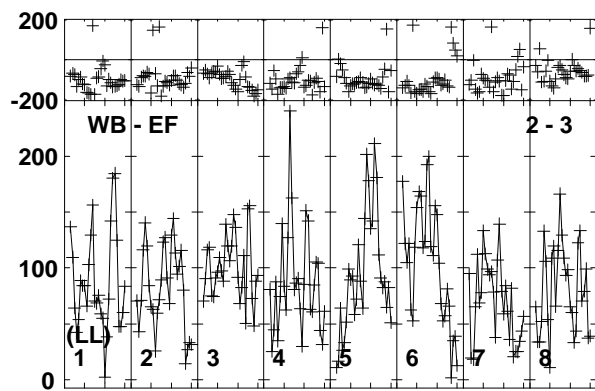
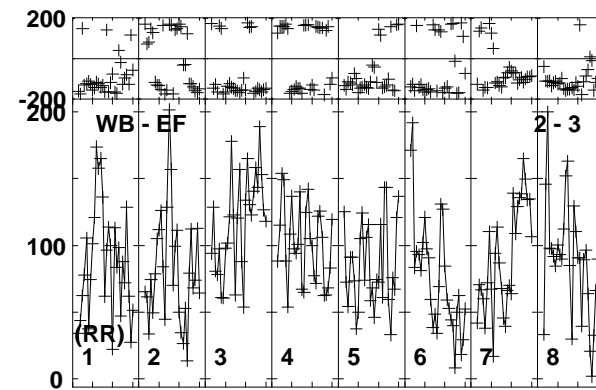
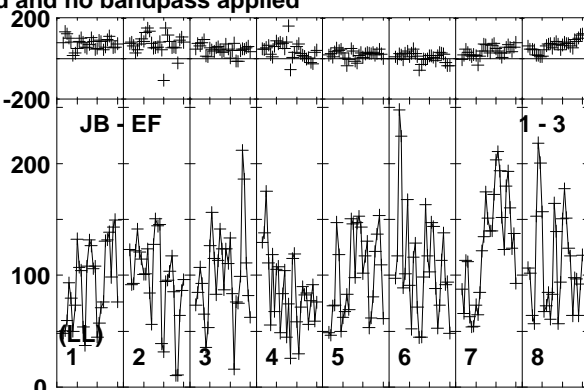
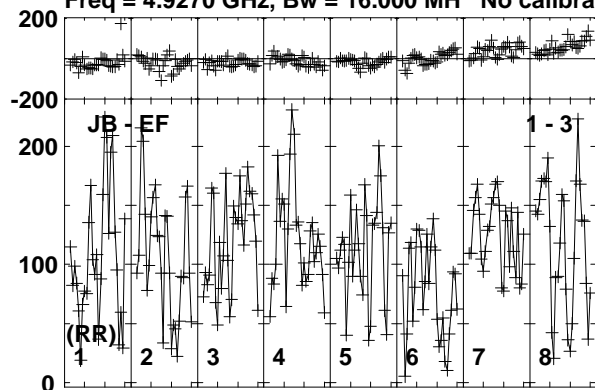

Lower frame: Micro Ampl Jy Top frame: Phas deg
Vector averaged cross-power spectrum Baseline: JB (01) - EF (03)
Timerange: 00/06:01:21 to 00/06:05:19

Plot file version 320 created 17-FEB-2020 15:43:08

J1402+5347 EK047 2.UVDATA.1

Freq = 4.9270 GHz, Bw = 16.000 MH No calibration applied and no bandpass applied

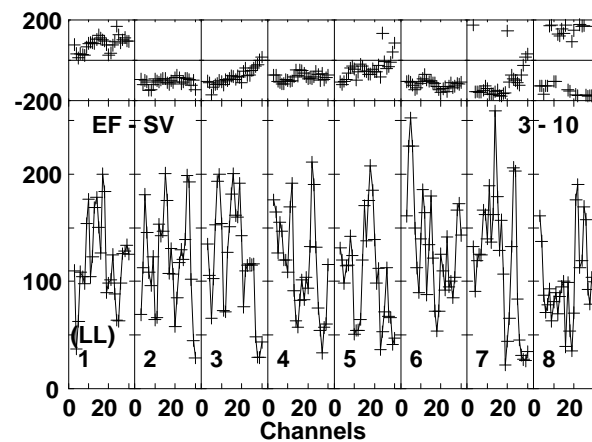
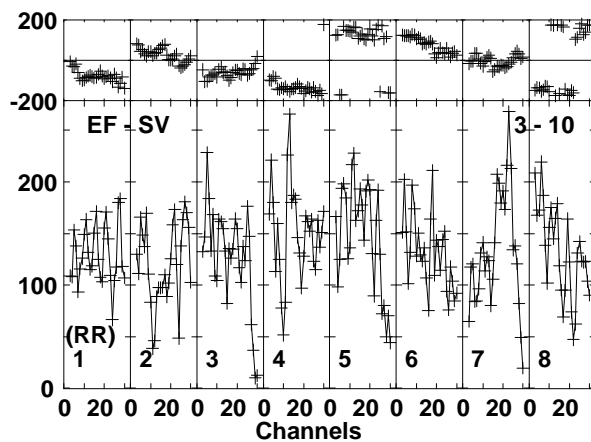
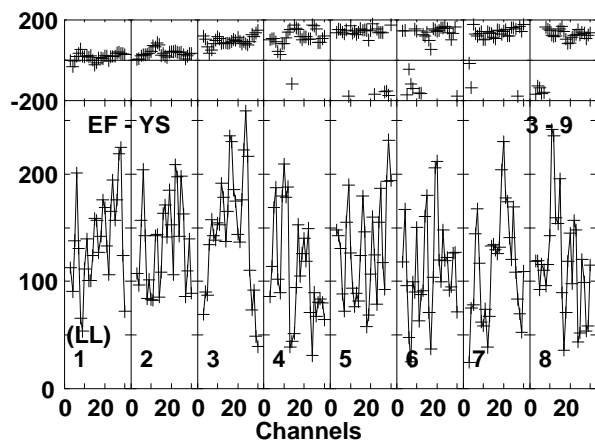
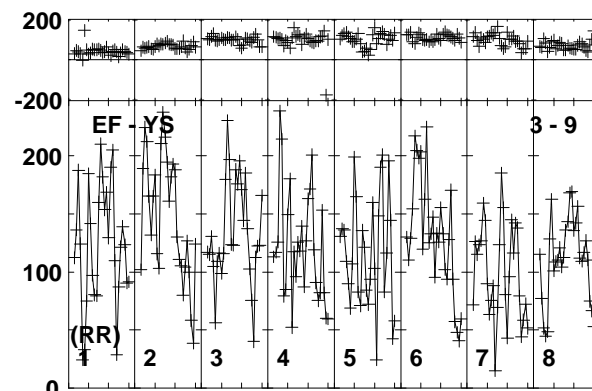
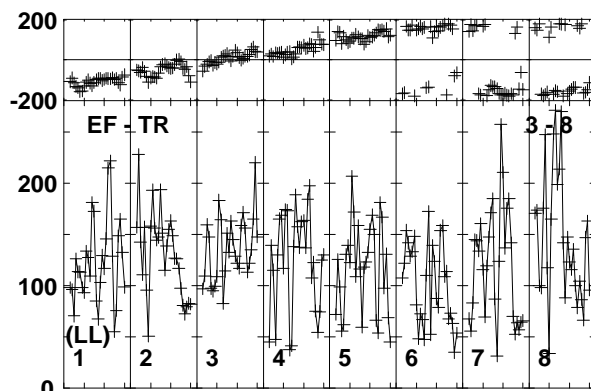
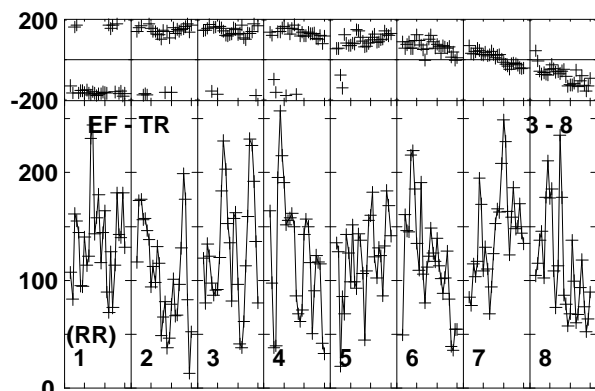
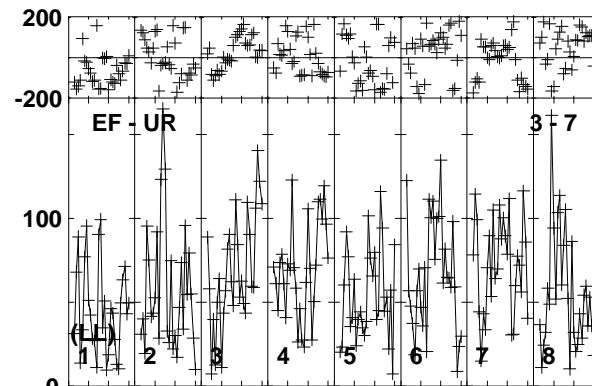
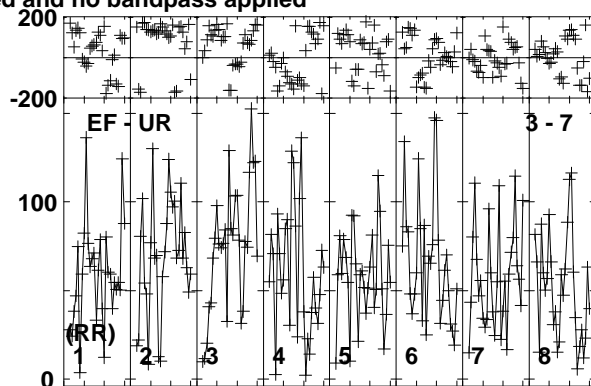
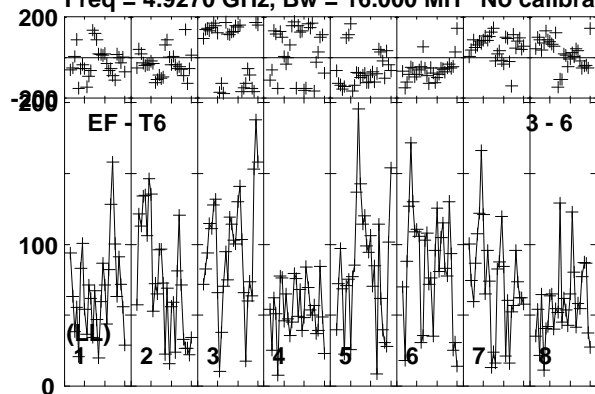

Lower frame: Micro Ampl Jy Top frame: Phas deg
Vector averaged cross-power spectrum Baseline: EF (03) - T6 (06)
Timerange: 00/06:01:21 to 00/06:05:19

Plot file version 321 created 17-FEB-2020 15:43:09

J1402+5347 EK047 2.UVDATA.1

Freq = 4.9270 GHz, Bw = 16.000 MH No calibration applied and no bandpass applied

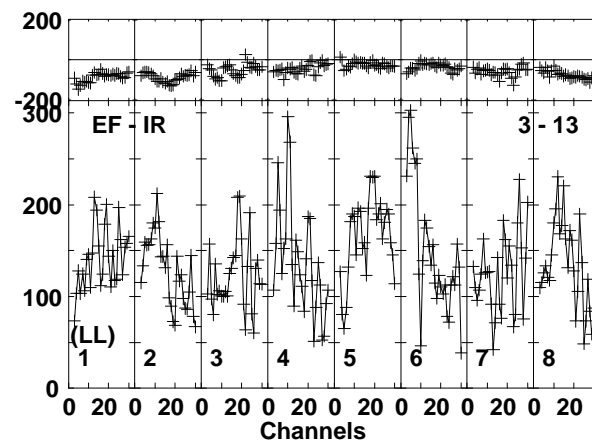
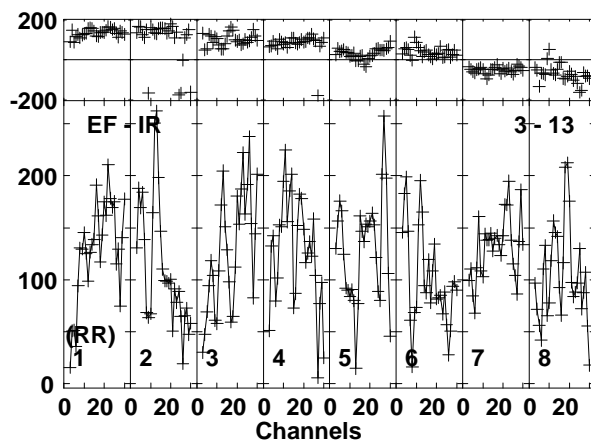
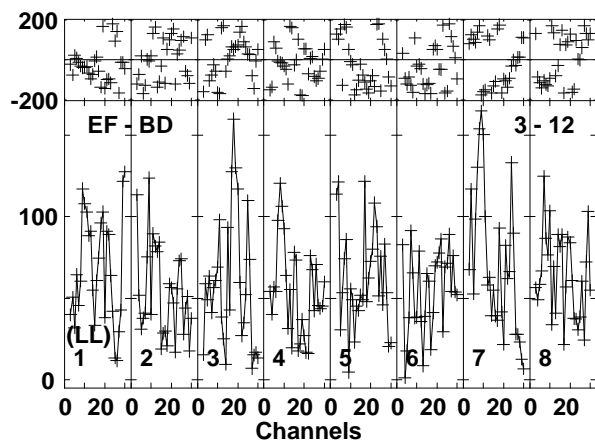
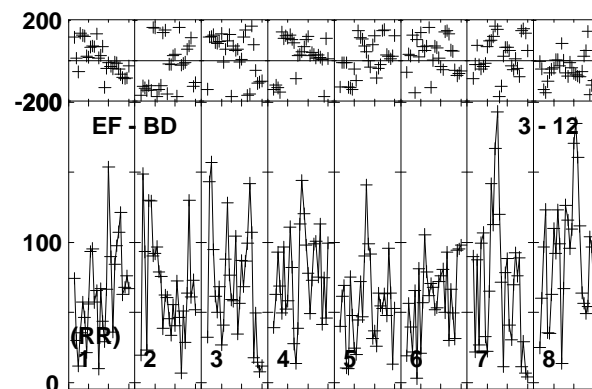
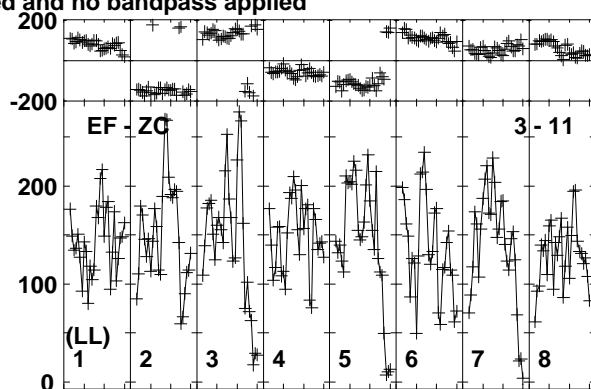
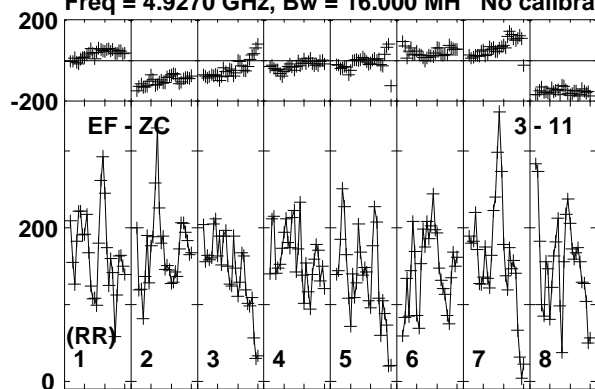

Lower frame: Micro Ampl Jy Top frame: Phas deg
Vector averaged cross-power spectrum Baseline: EF (03) - ZC (11)
Timerange: 00/06:01:21 to 00/06:05:19

Plot file version 322 created 17-FEB-2020 15:43:09

J1359+5544 EK047 2.UVDATA.1

Freq = 4.9270 GHz, Bw = 16.000 MH No calibration applied and no bandpass applied

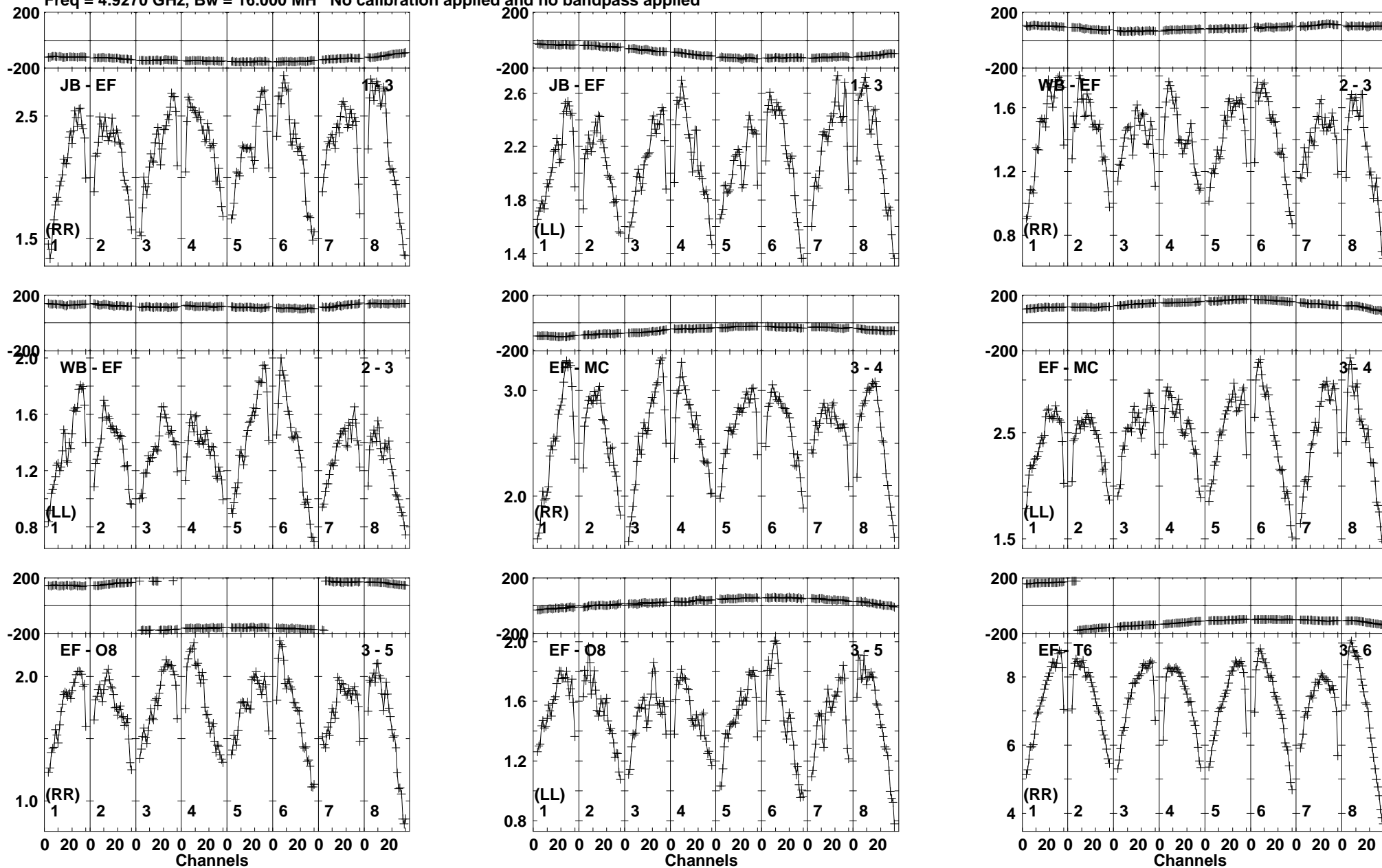

Lower frame: Milli Ampl Jy Top frame: Phas deg
Vector averaged cross-power spectrum Baseline: JB (01) - EF (03)
Timerange: 00/06:05:21 to 00/06:07:19

Plot file version 323 created 17-FEB-2020 15:43:09

J1359+5544 EK047 2.UVDATA.1

Freq = 4.9270 GHz, Bw = 16.000 MH No calibration applied and no bandpass applied

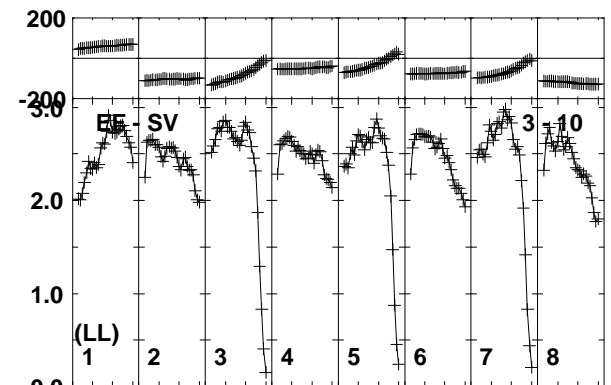
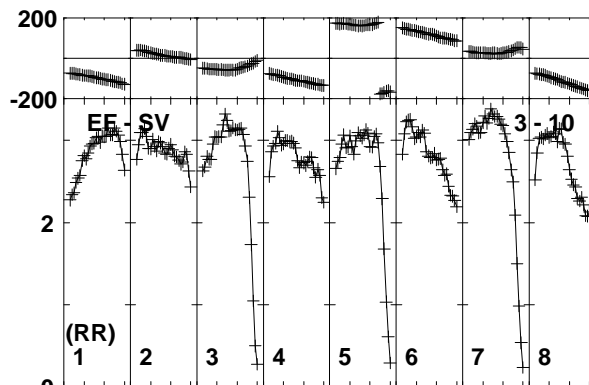
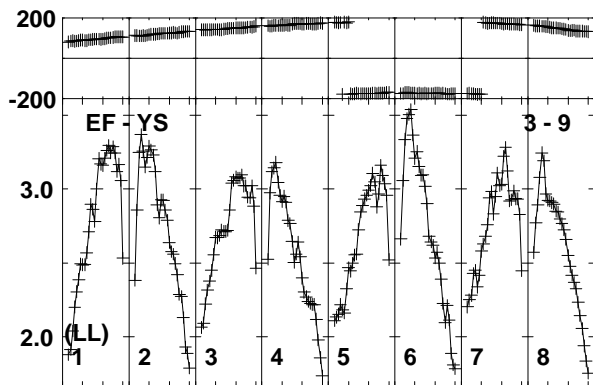
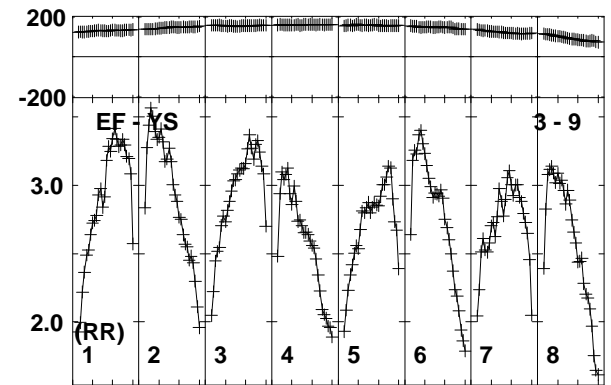
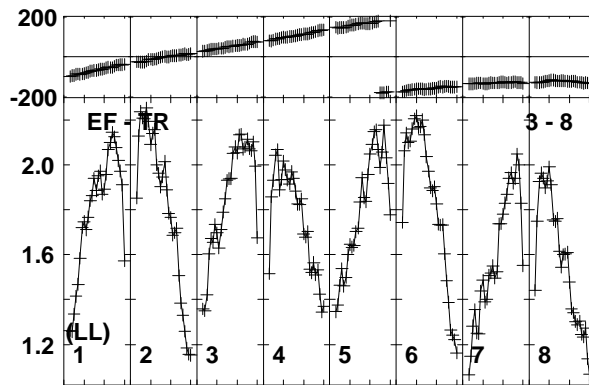
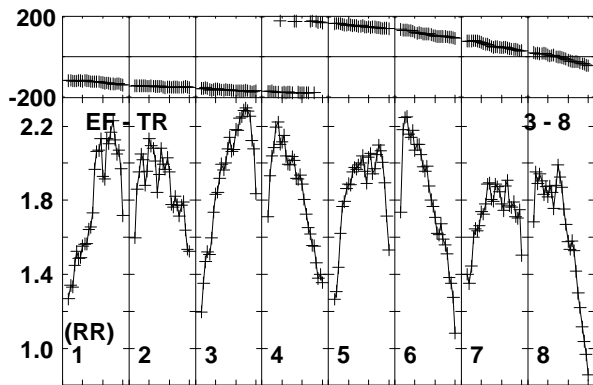
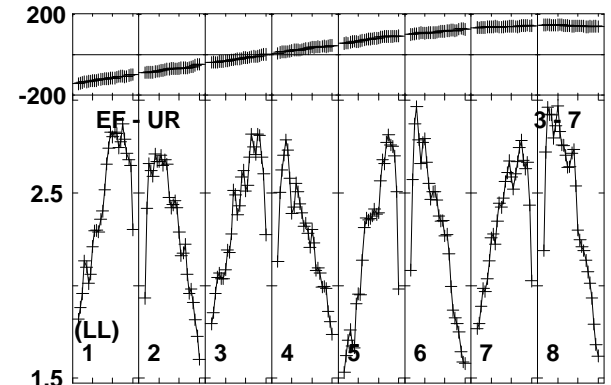
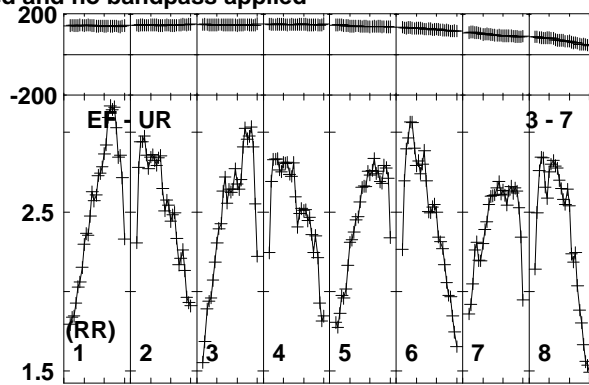
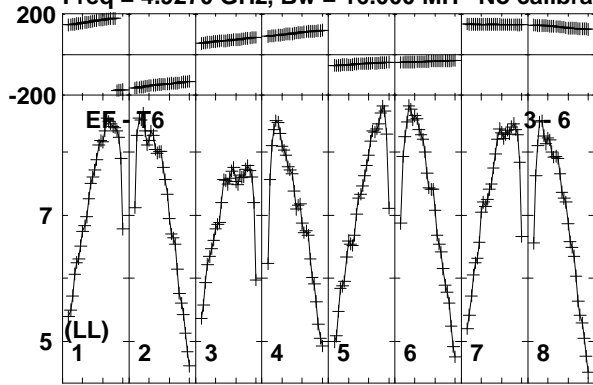

Lower frame: Milli Ampl Jy Top frame: Phas deg
Vector averaged cross-power spectrum Baseline: EF (03) - T6 (06)
Timerange: 00/06:05:21 to 00/06:07:19

Plot file version 324 created 17-FEB-2020 15:43:09

J1359+5544 EK047 2.UVDATA.1

Freq = 4.9270 GHz, Bw = 16.000 MH No calibration applied and no bandpass applied

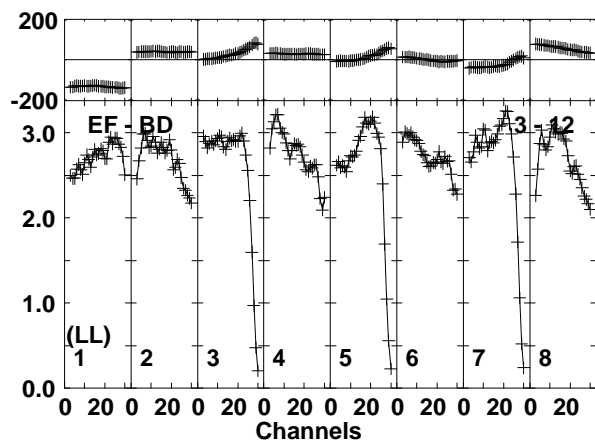
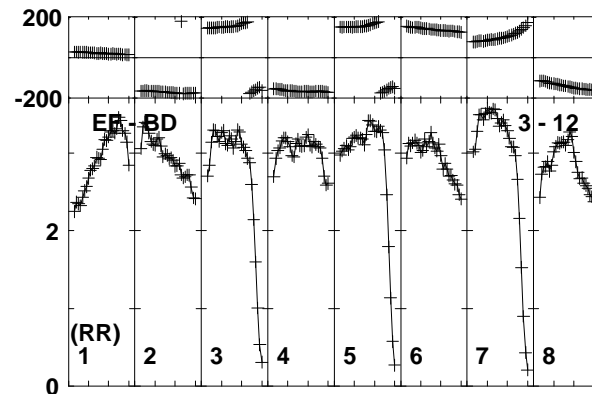
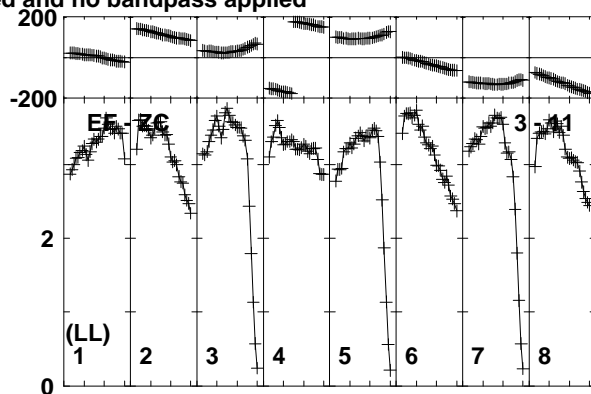
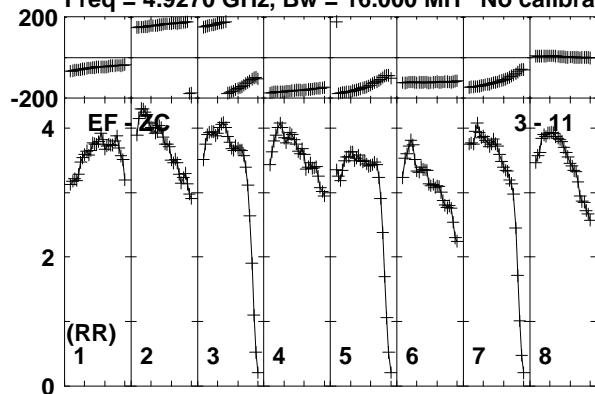

Lower frame: Milli Ampl Jy Top frame: Phas deg
Vector averaged cross-power spectrum Baseline: EF (03) - ZC (11)
Timerange: 00/06:05:21 to 00/06:07:19

Plot file version 325 created 17-FEB-2020 15:43:09

J1402+5347 EK047 2.UVDATA.1

Freq = 4.9270 GHz, Bw = 16.000 MH No calibration applied and no bandpass applied

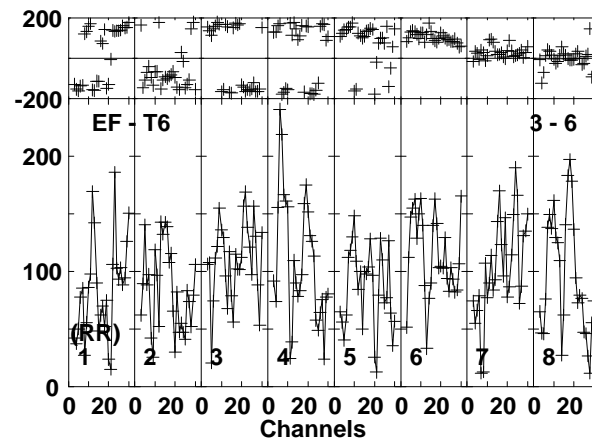
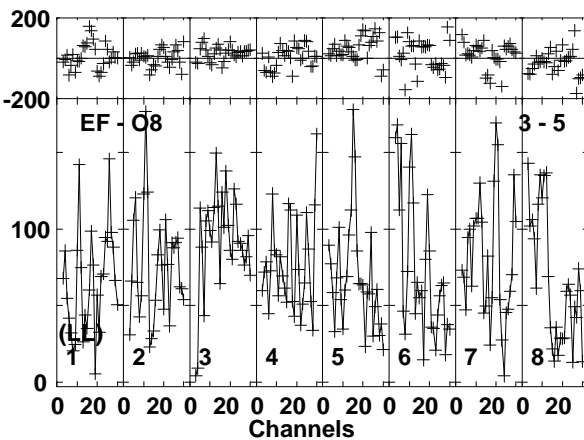
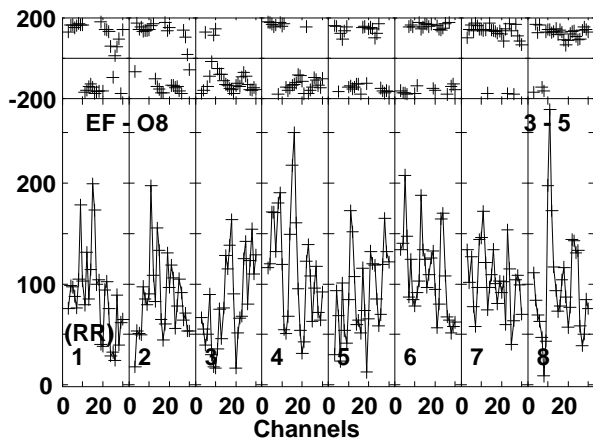
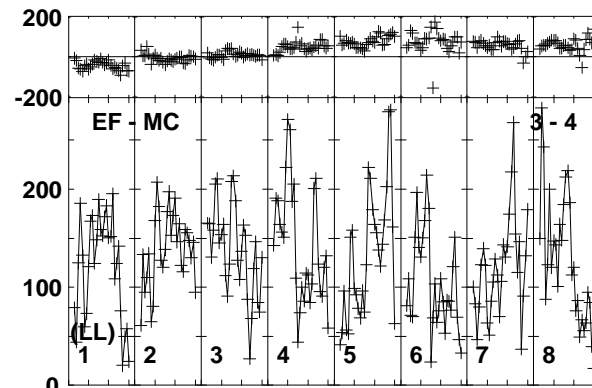
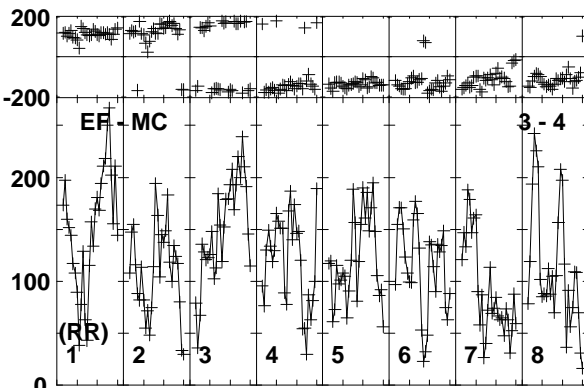
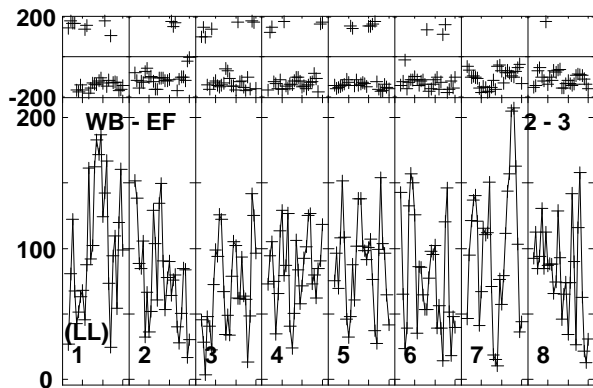
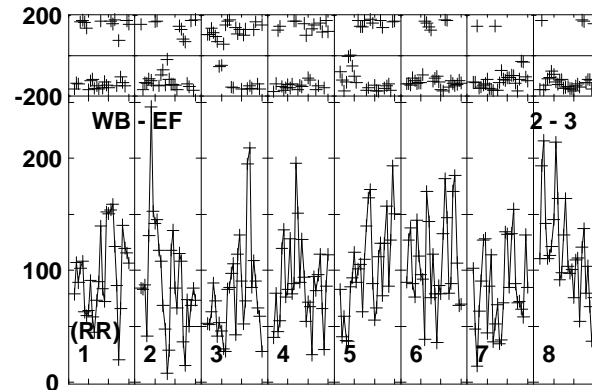
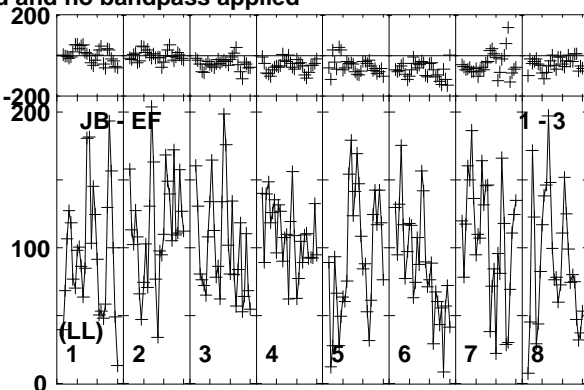
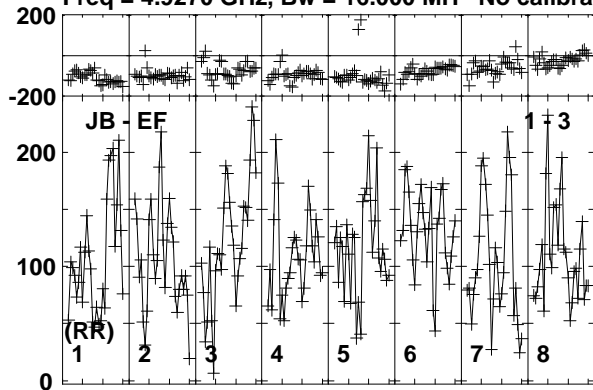

Lower frame: Micro Ampl Jy Top frame: Phas deg
Vector averaged cross-power spectrum Baseline: JB (01) - EF (03)
Timerange: 00/06:07:23 to 00/06:11:19

Plot file version 326 created 17-FEB-2020 15:43:09

J1402+5347 EK047 2.UVDATA.1

Freq = 4.9270 GHz, Bw = 16.000 MH No calibration applied and no bandpass applied

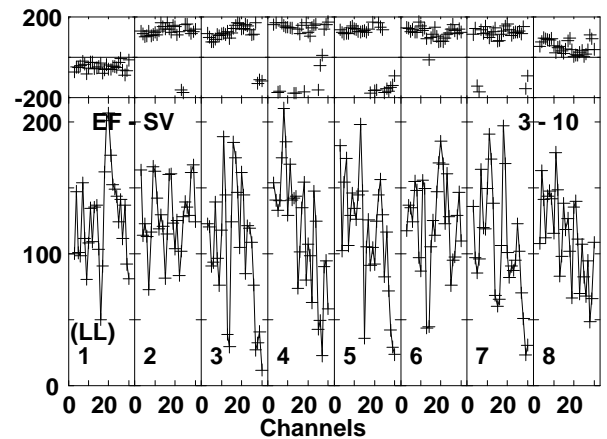
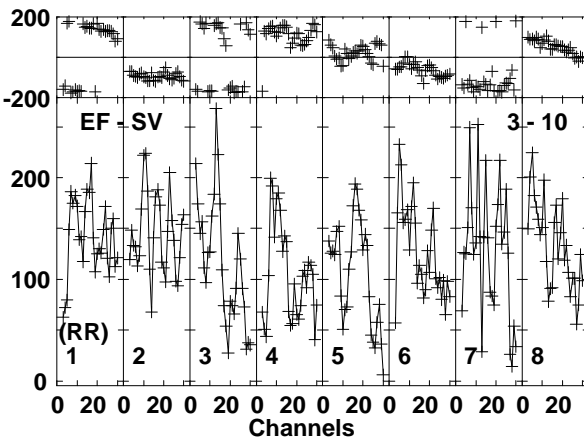
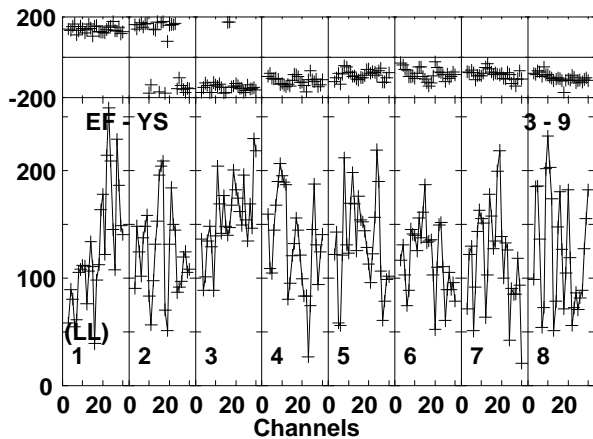
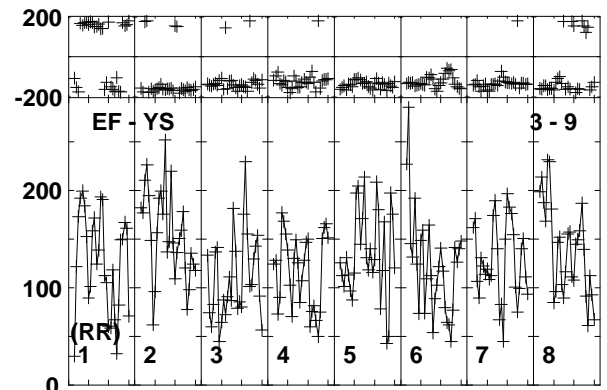
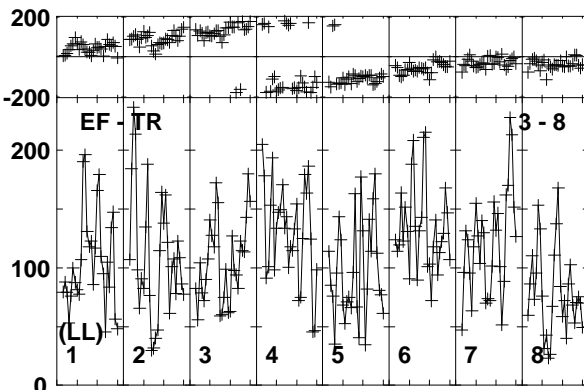
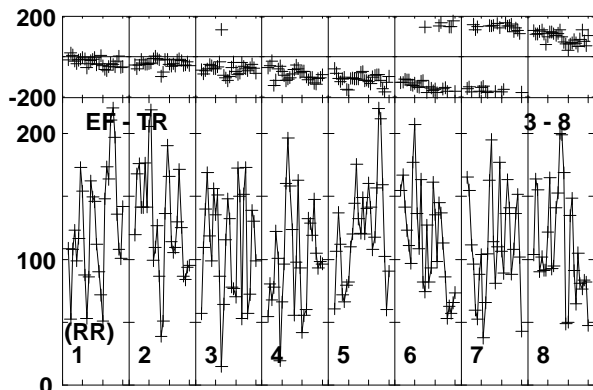
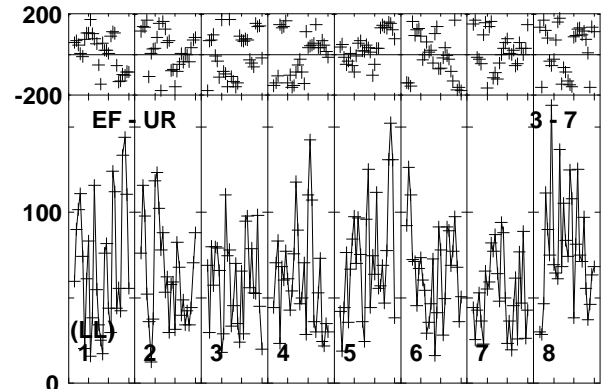
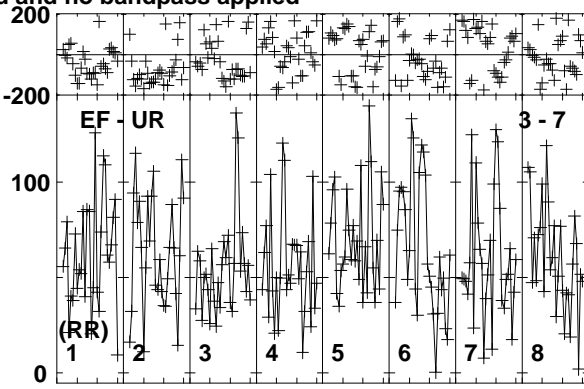
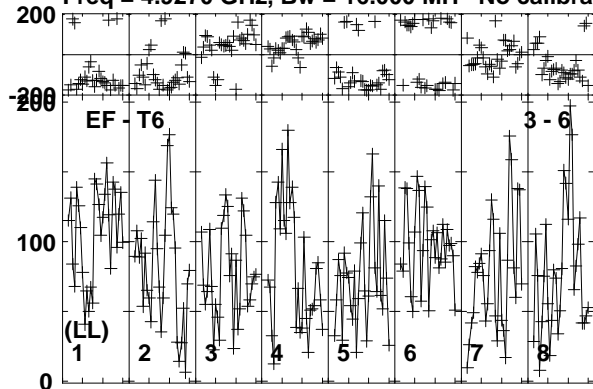

Lower frame: Micro Ampl Jy Top frame: Phas deg
Vector averaged cross-power spectrum Baseline: EF (03) - T6 (06)
Timerange: 00/06:07:23 to 00/06:11:19

Plot file version 327 created 17-FEB-2020 15:43:09

J1402+5347 EK047 2.UVDATA.1

Freq = 4.9270 GHz, Bw = 16.000 MH No calibration applied and no bandpass applied

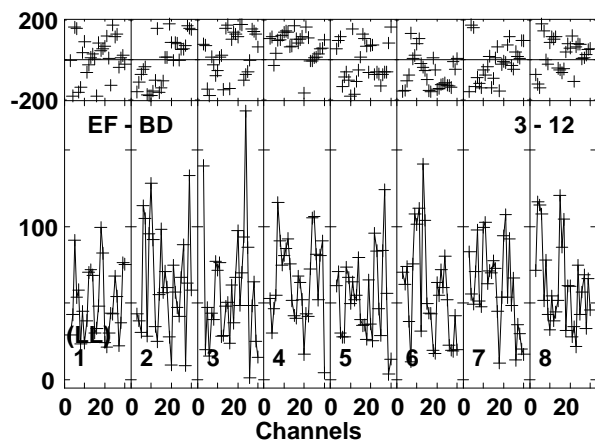
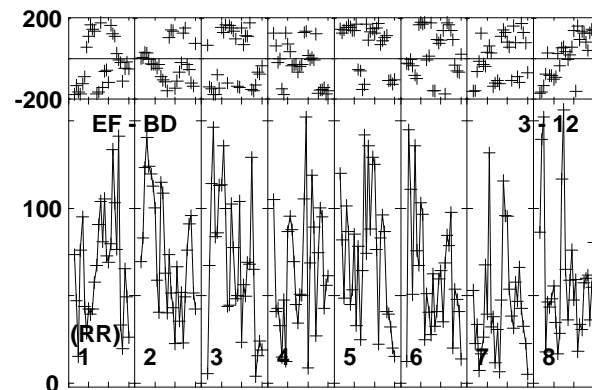
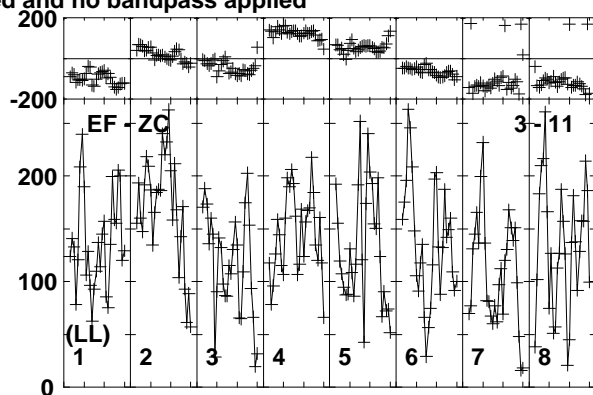
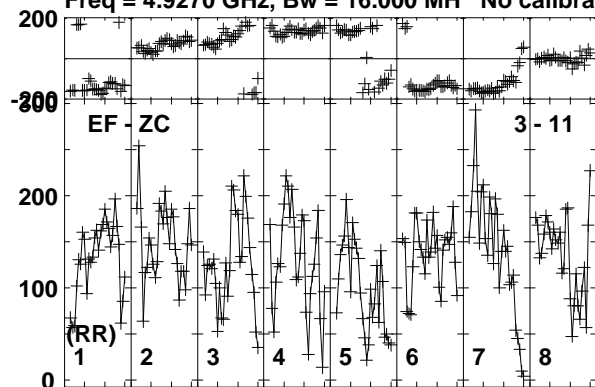

Lower frame: Micro Ampl Jy Top frame: Phas deg
Vector averaged cross-power spectrum Baseline: EF (03) - ZC (11)
Timerange: 00/06:07:23 to 00/06:11:19

Plot file version 328 created 17-FEB-2020 15:43:09

J1359+5544 EK047 2.UVDATA.1

Freq = 4.9270 GHz, Bw = 16.000 MH No calibration applied and no bandpass applied

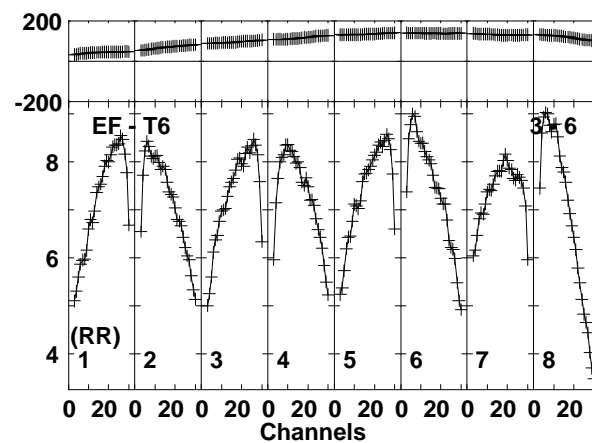
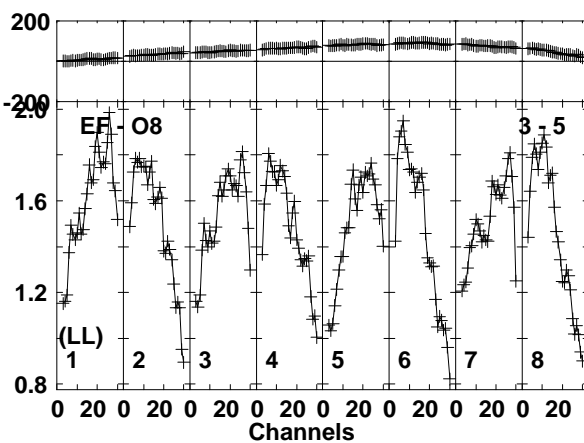
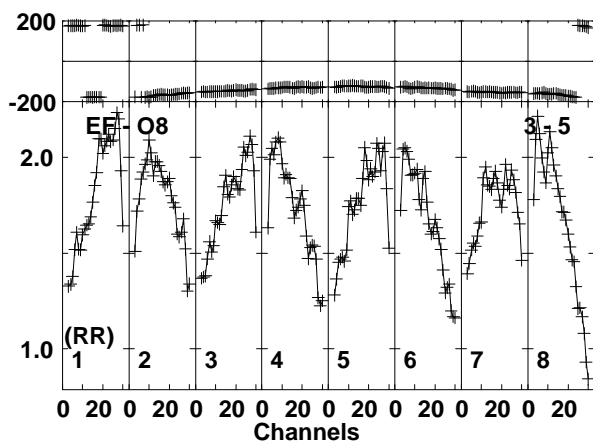
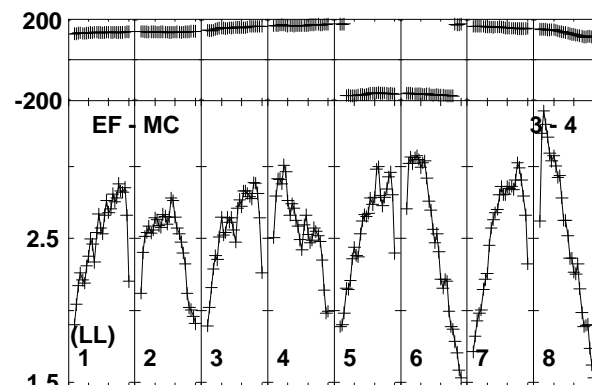
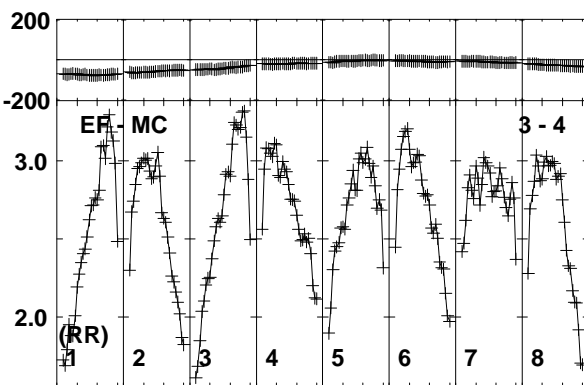
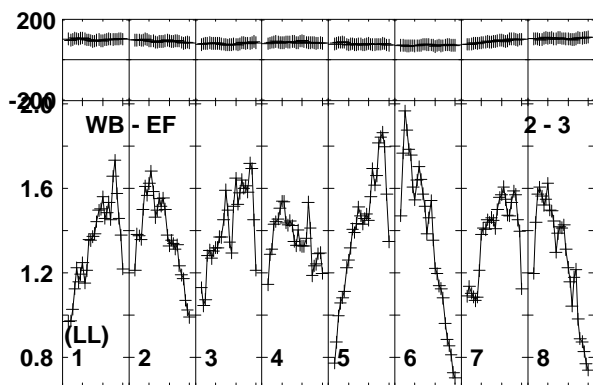
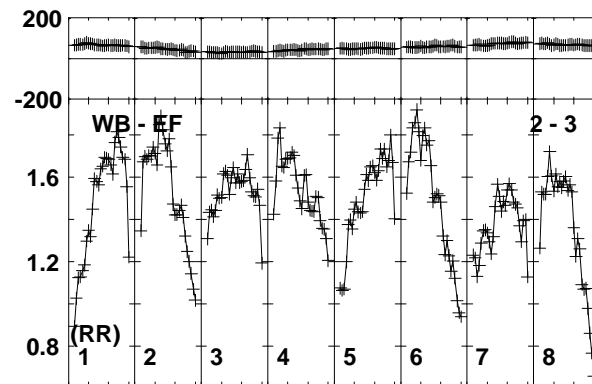
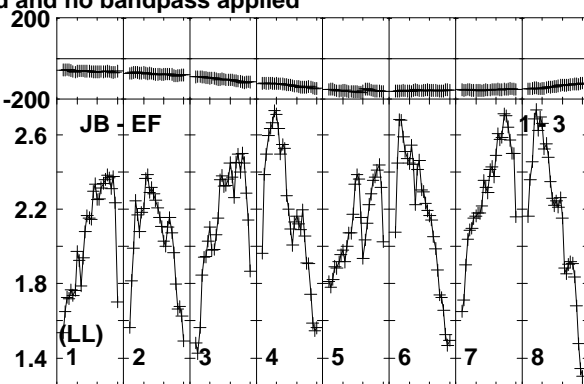
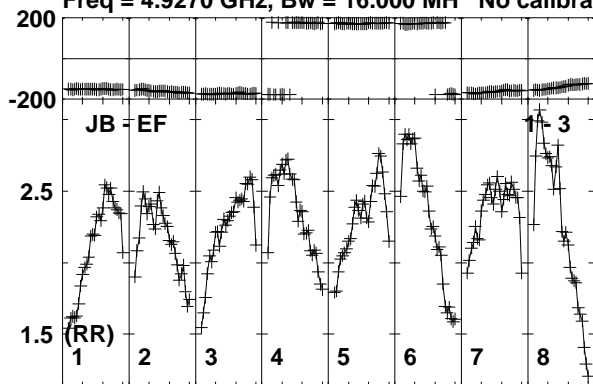

Lower frame: Milli Ampl Jy Top frame: Phas deg
Vector averaged cross-power spectrum Baseline: JB (01) - EF (03)
Timerange: 00/06:12:01 to 00/06:13:19

Plot file version 329 created 17-FEB-2020 15:43:09

J1359+5544 EK047 2.UVDATA.1

Freq = 4.9270 GHz, Bw = 16.000 MH No calibration applied and no bandpass applied

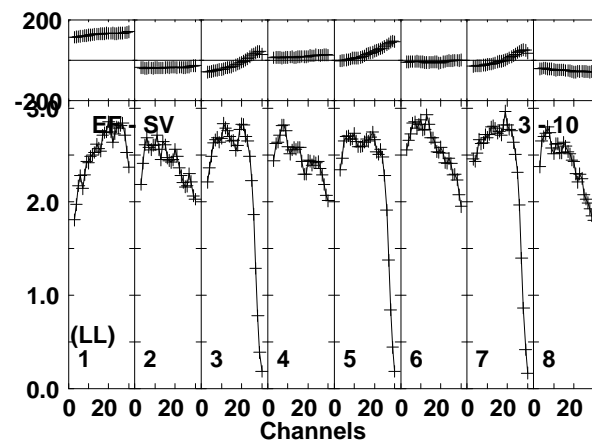
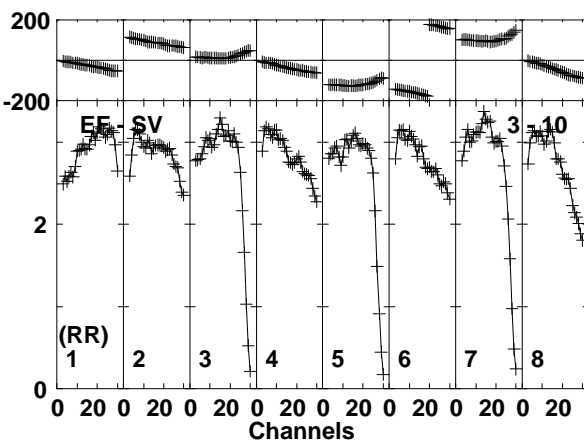
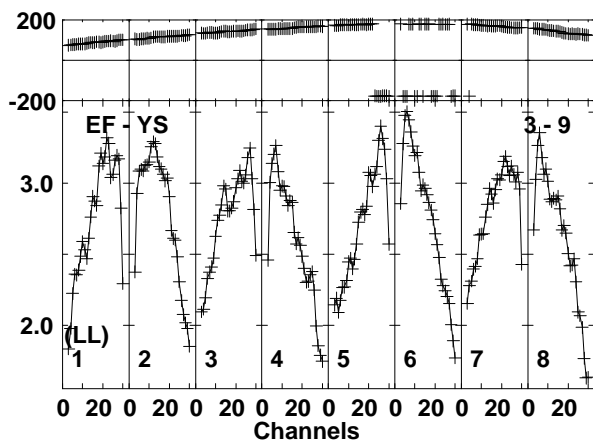
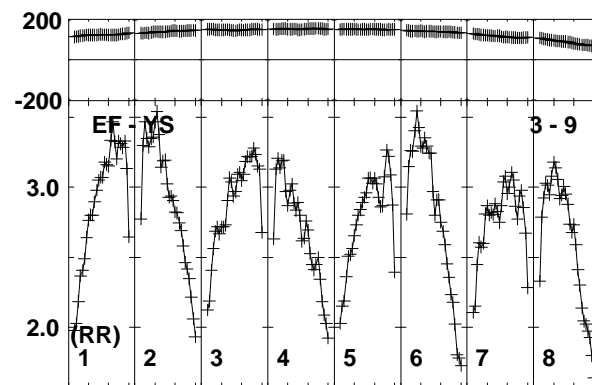
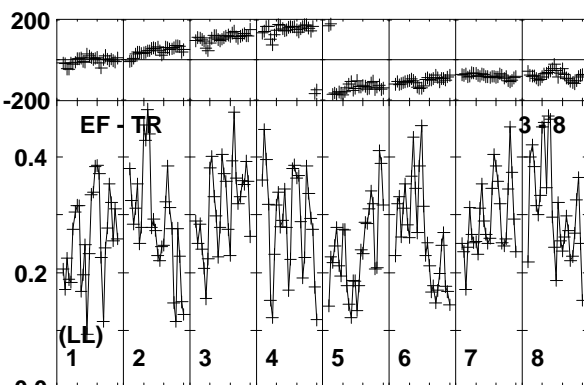
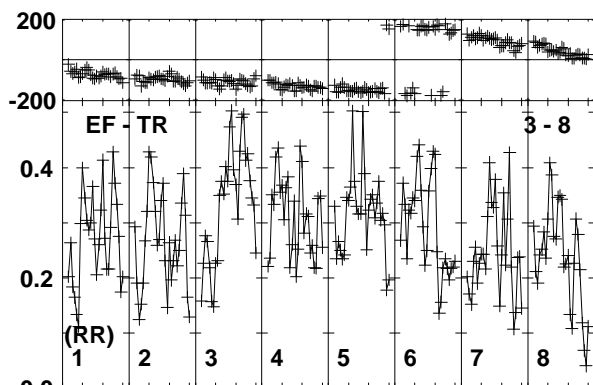
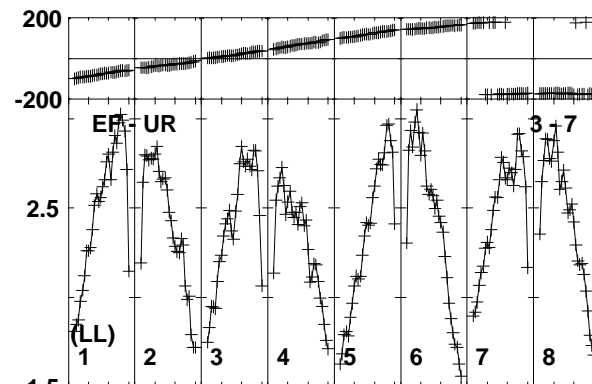
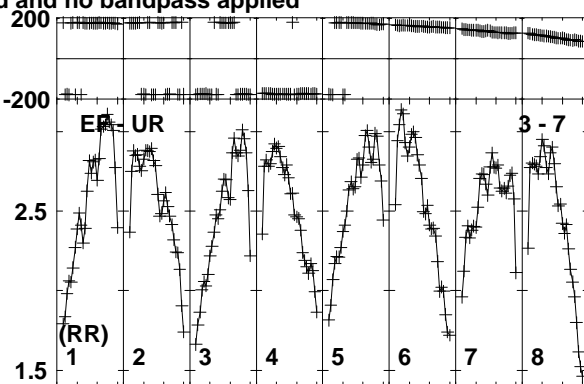
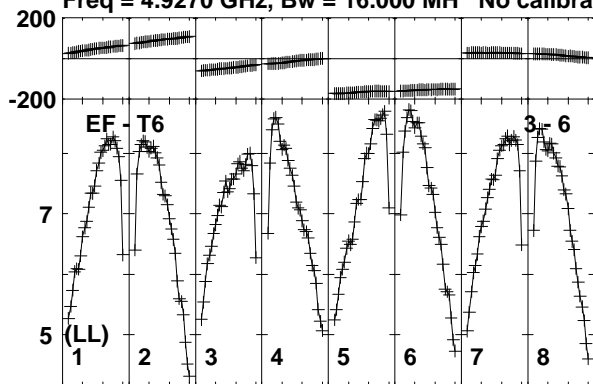

Lower frame: Milli Ampl Jy Top frame: Phas deg
Vector averaged cross-power spectrum Baseline: EF (03) - T6 (06)
Timerange: 00/06:12:01 to 00/06:13:19

Plot file version 330 created 17-FEB-2020 15:43:09

J1359+5544 EK047 2.UVDATA.1

Freq = 4.9270 GHz, Bw = 16.000 MH No calibration applied and no bandpass applied

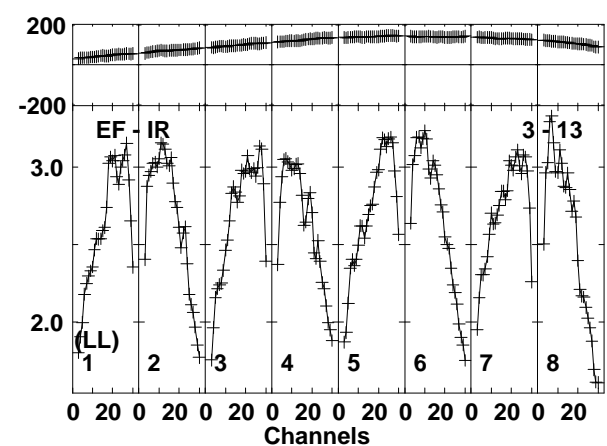
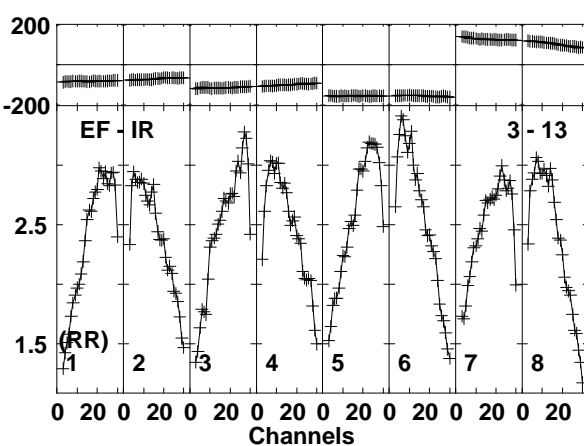
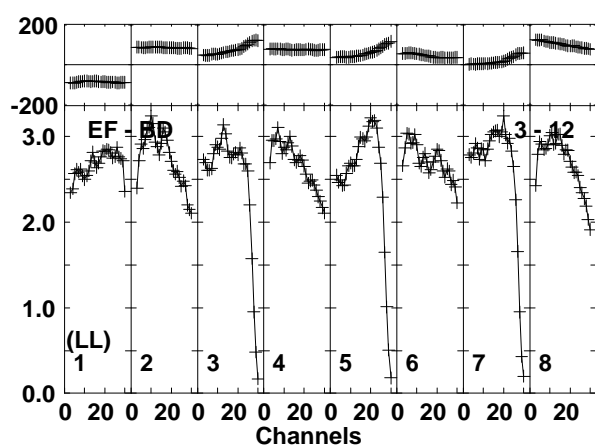
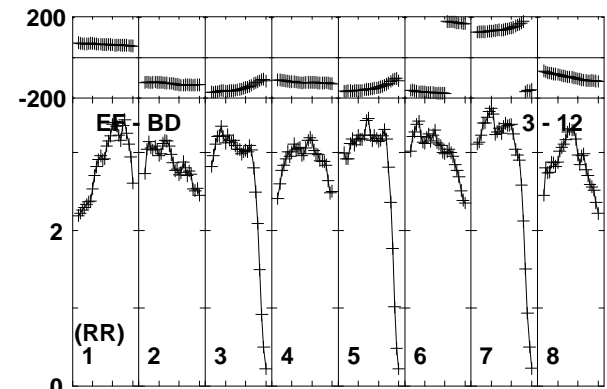
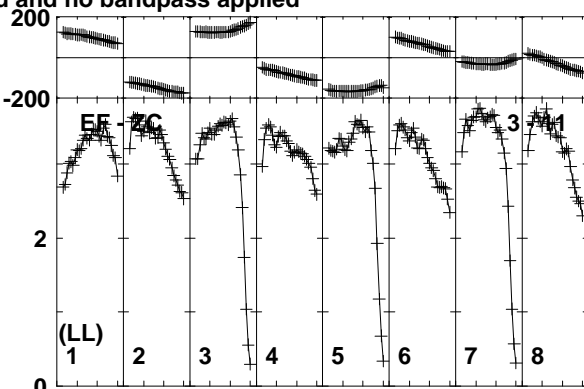
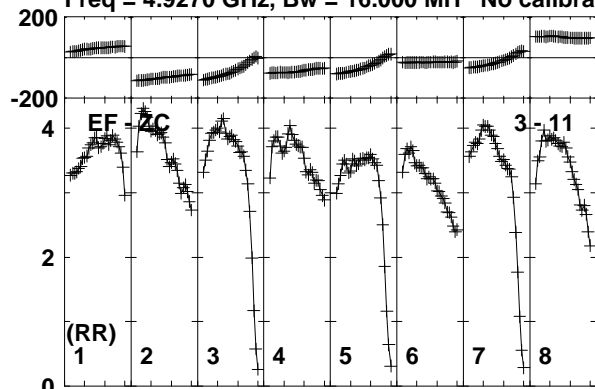

Lower frame: Milli Ampl Jy Top frame: Phas deg
Vector averaged cross-power spectrum Baseline: EF (03) - ZC (11)
Timerange: 00/06:12:01 to 00/06:13:19

Plot file version 331 created 17-FEB-2020 15:43:10

J1402+5347 EK047 2.UVDATA.1

Freq = 4.9270 GHz, Bw = 16.000 MH No calibration applied and no bandpass applied

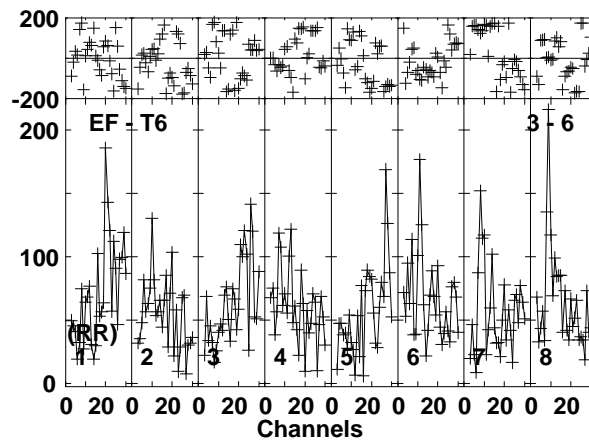
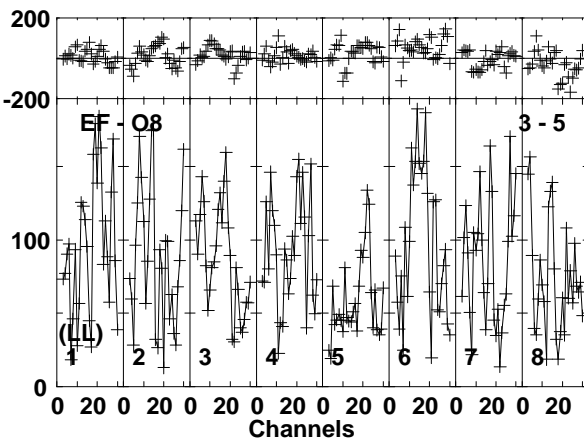
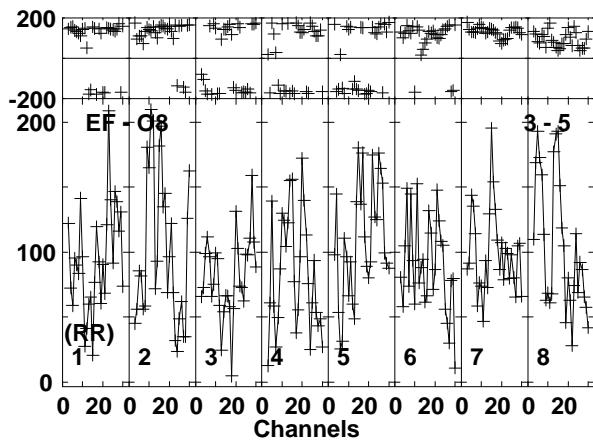
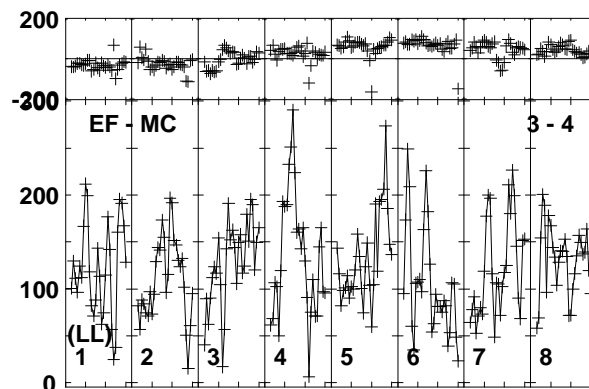
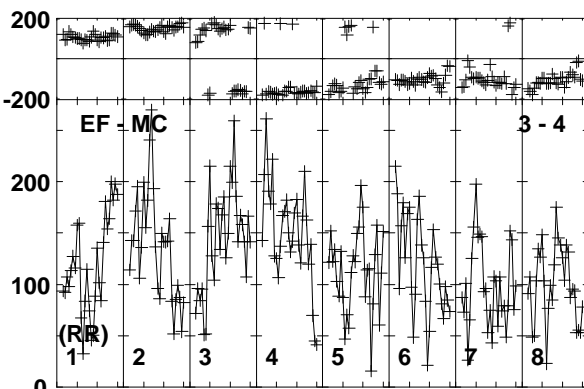
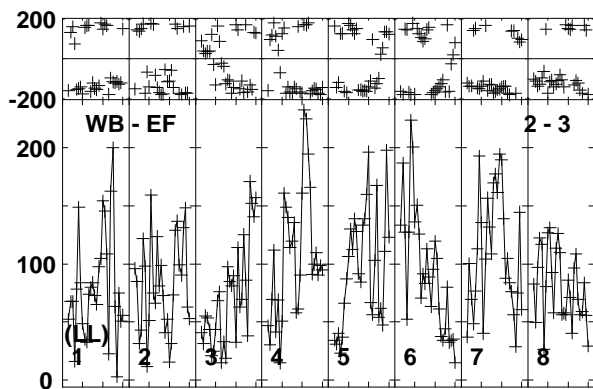
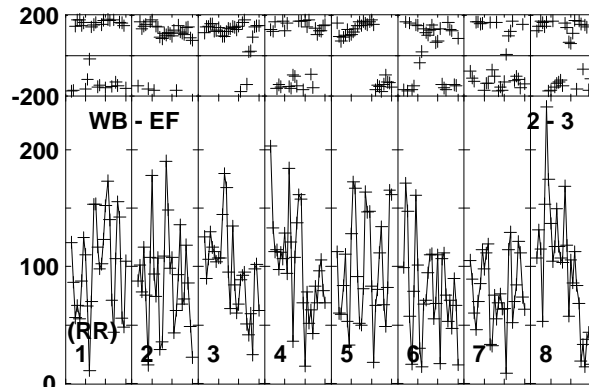
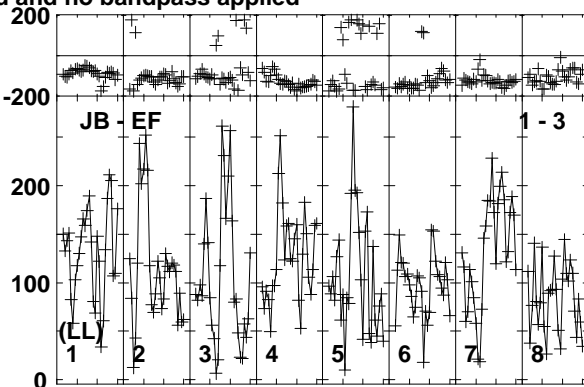
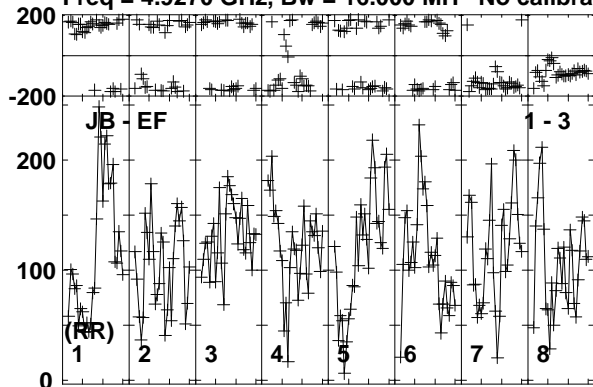

Lower frame: Micro Ampl Jy Top frame: Phas deg
Vector averaged cross-power spectrum Baseline: JB (01) - EF (03)
Timerange: 00/06:13:21 to 00/06:17:19

Plot file version 332 created 17-FEB-2020 15:43:10

J1402+5347 EK047 2.UVDATA.1

Freq = 4.9270 GHz, Bw = 16.000 MH No calibration applied and no bandpass applied

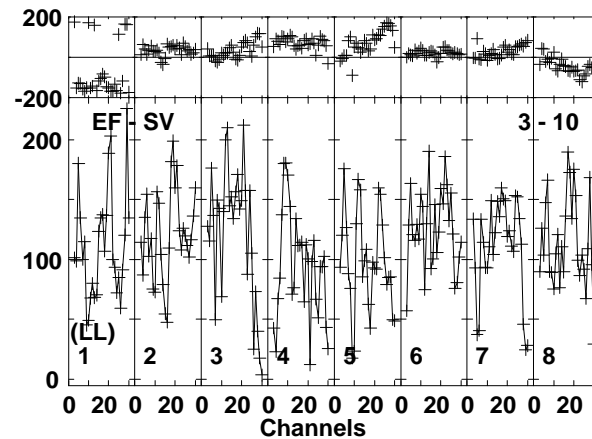
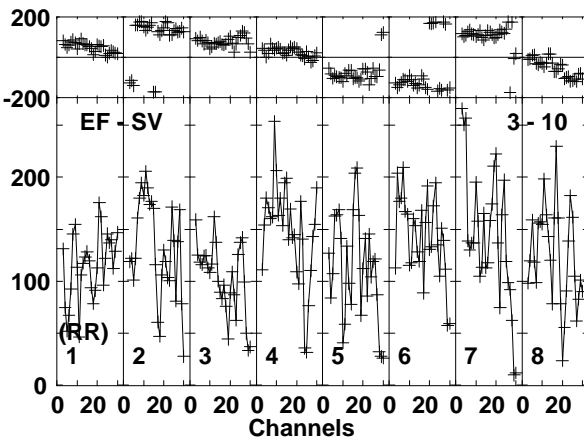
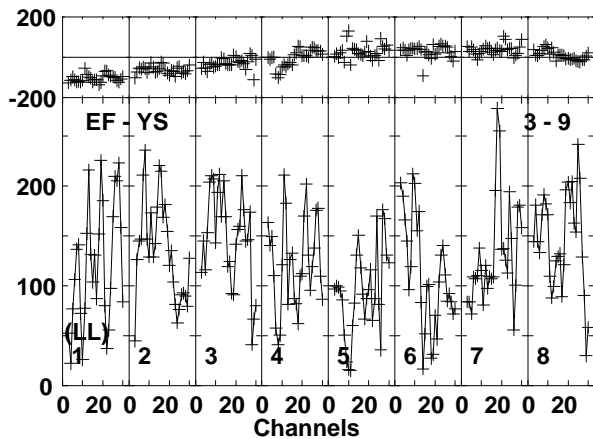
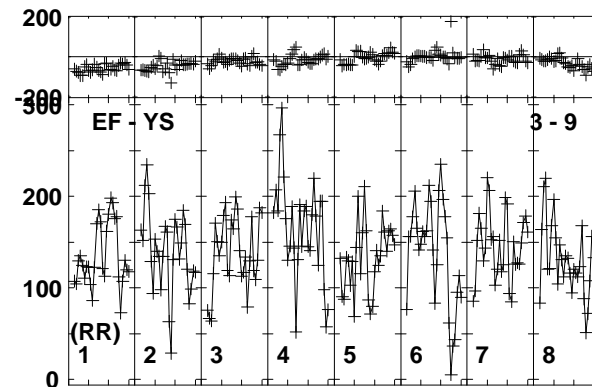
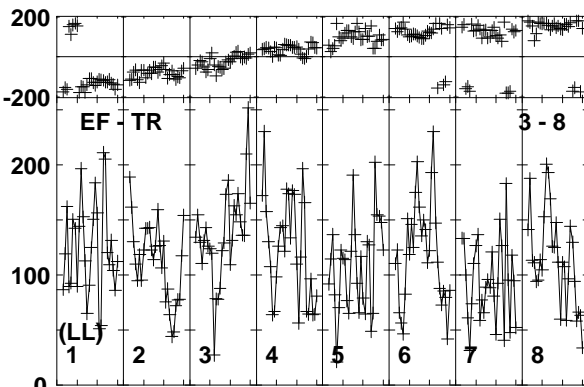
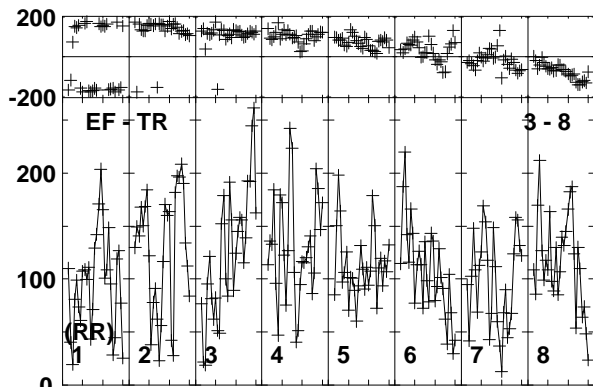
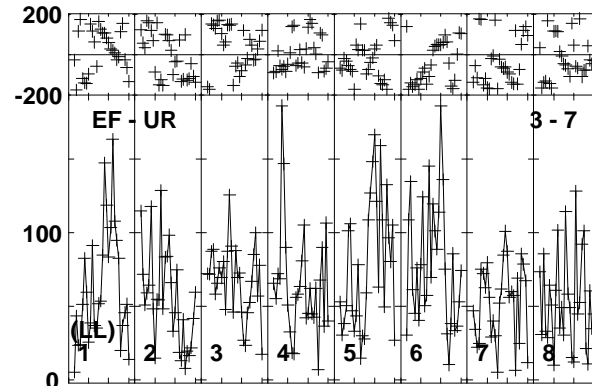
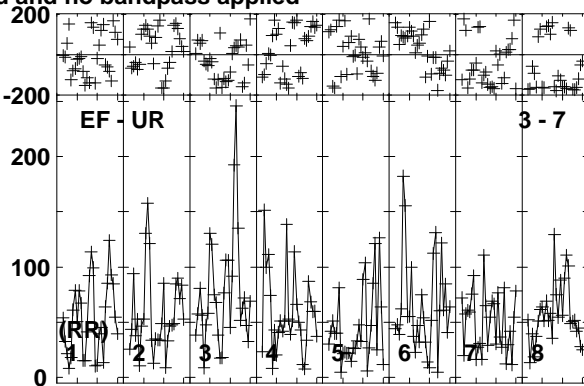
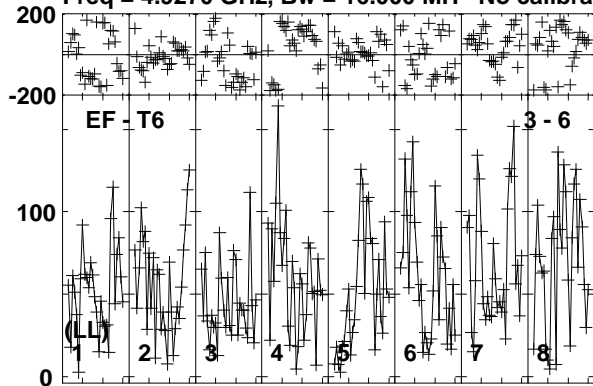

Lower frame: Micro Ampl Jy Top frame: Phas deg
Vector averaged cross-power spectrum Baseline: EF (03) - T6 (06)
Timerange: 00/06:13:21 to 00/06:17:19

Plot file version 333 created 17-FEB-2020 15:43:10

J1402+5347 EK047 2.UVDATA.1

Freq = 4.9270 GHz, Bw = 16.000 MH No calibration applied and no bandpass applied

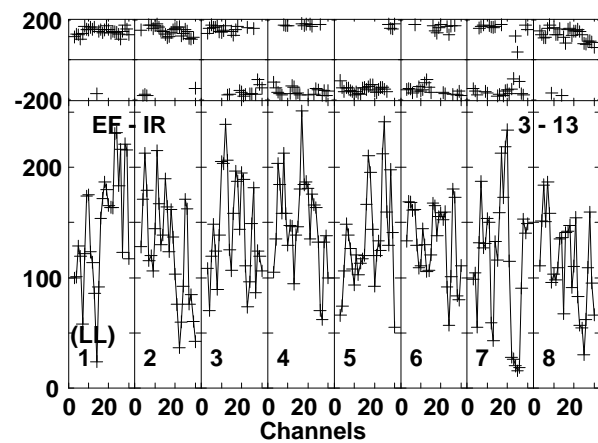
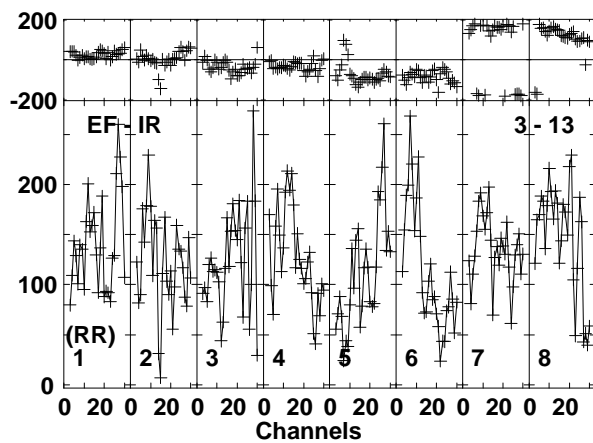
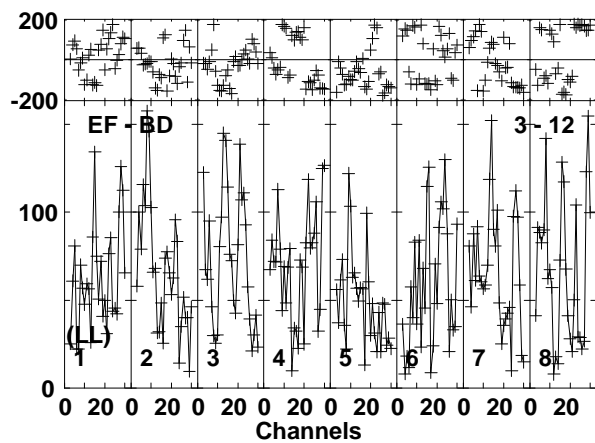
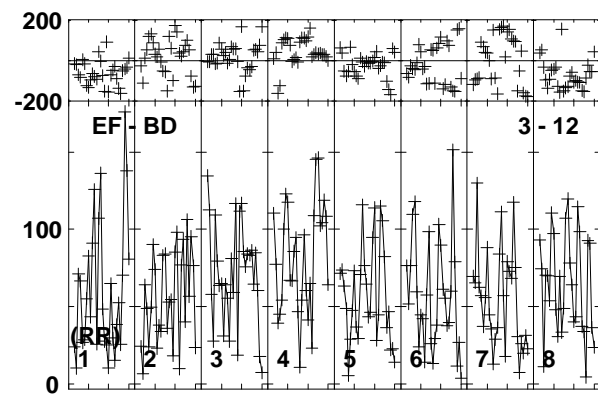
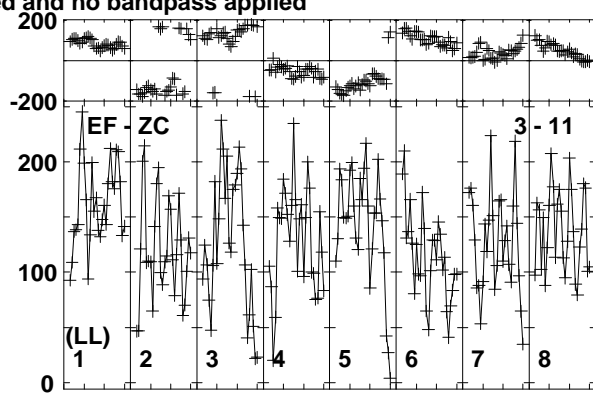
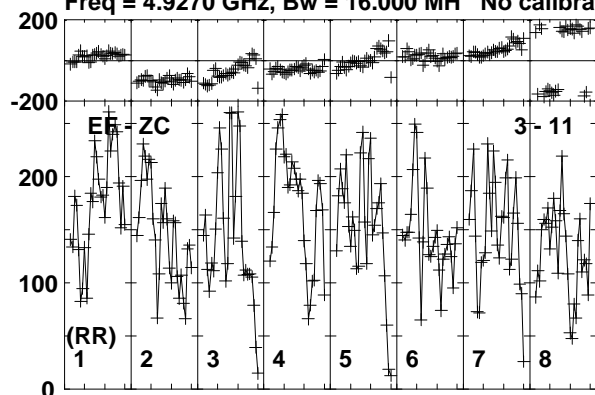

Lower frame: Micro Ampl Jy Top frame: Phas deg
Vector averaged cross-power spectrum Baseline: EF (03) - ZC (11)
Timerange: 00/06:13:21 to 00/06:17:19

Plot file version 334 created 17-FEB-2020 15:43:10

J1359+5544 EK047 2.UVDATA.1

Freq = 4.9270 GHz, Bw = 16.000 MH No calibration applied and no bandpass applied

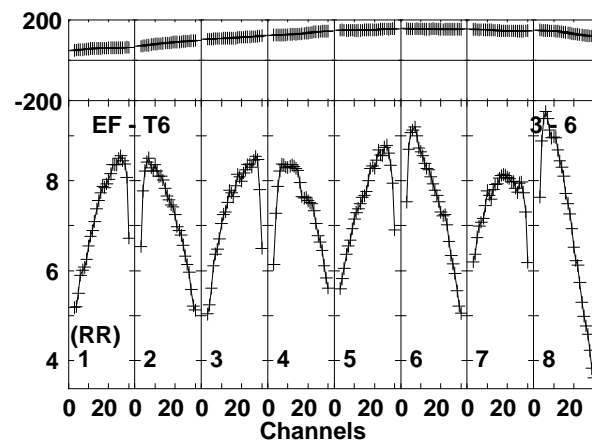
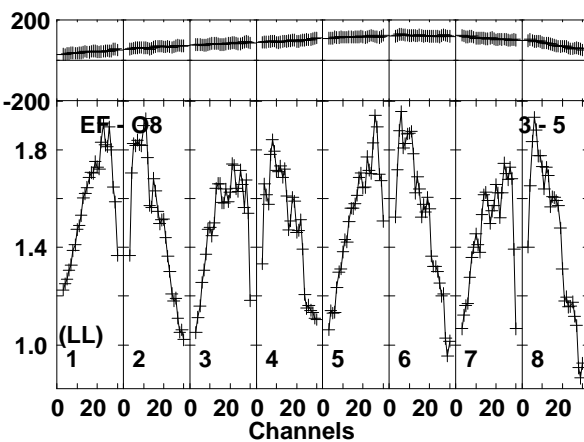
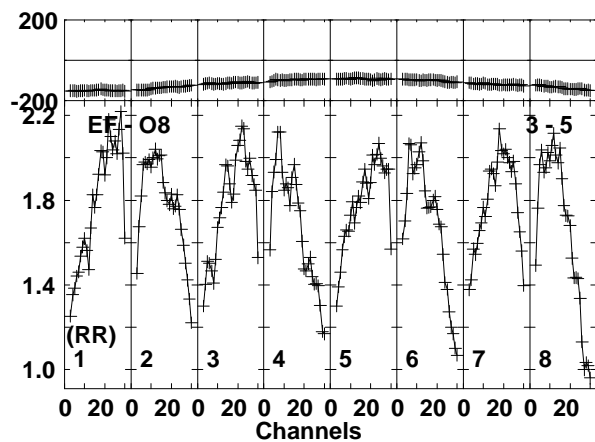
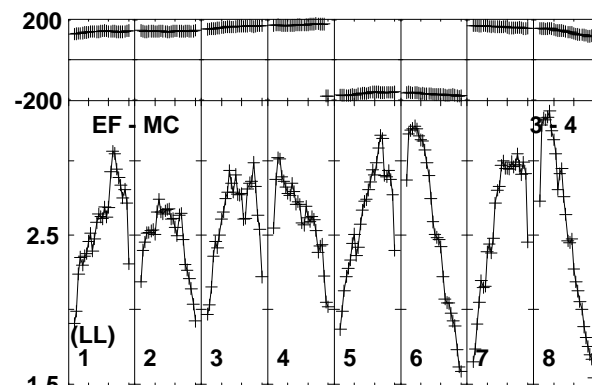
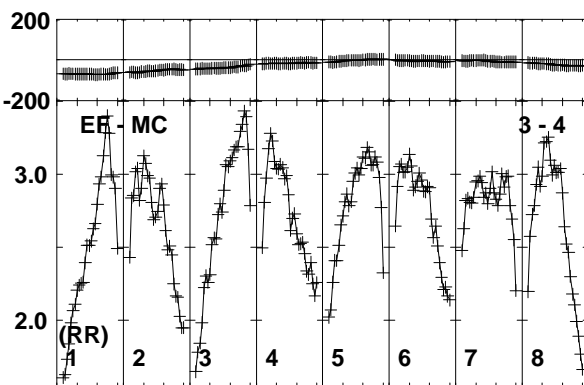
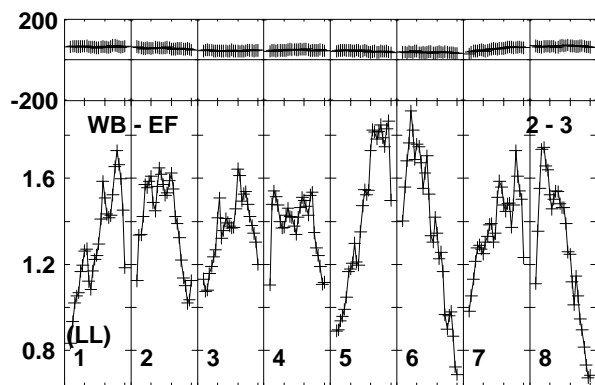
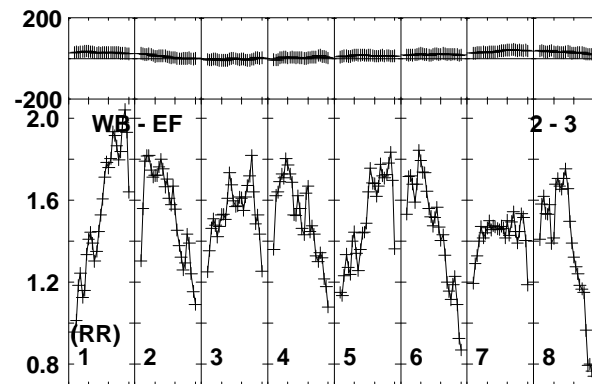
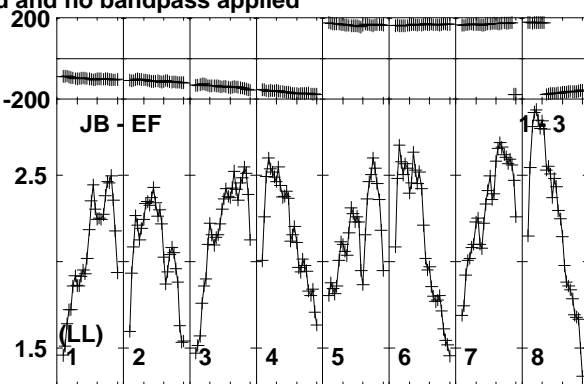
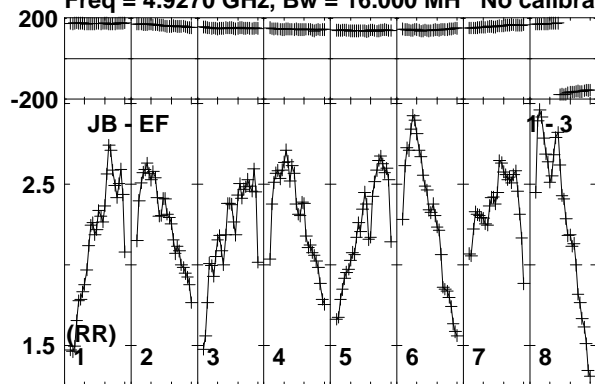

Lower frame: Milli Ampl Jy Top frame: Phas deg
Vector averaged cross-power spectrum Baseline: JB (01) - EF (03)
Timerange: 00/06:17:21 to 00/06:19:19

Plot file version 335 created 17-FEB-2020 15:43:10

J1359+5544 EK047 2.UVDATA.1

Freq = 4.9270 GHz, Bw = 16.000 MH No calibration applied and no bandpass applied

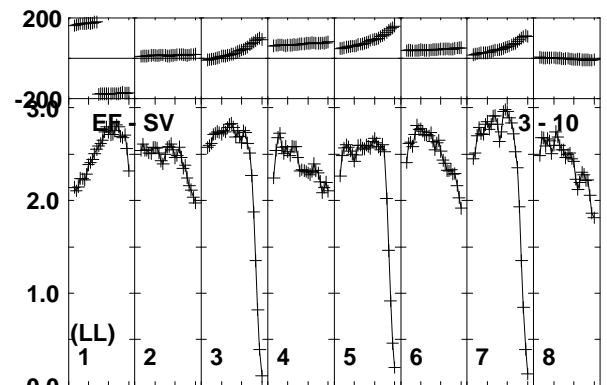
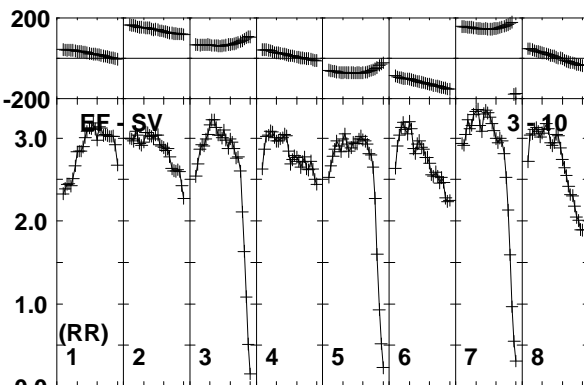
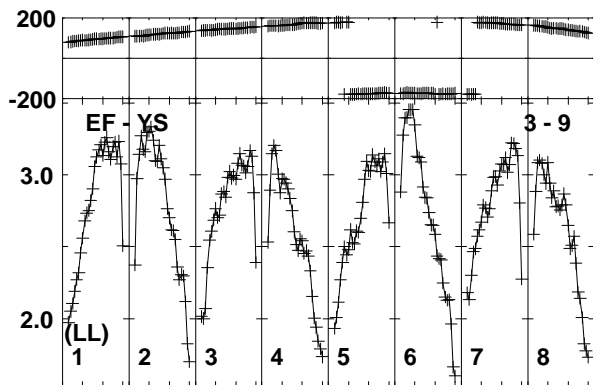
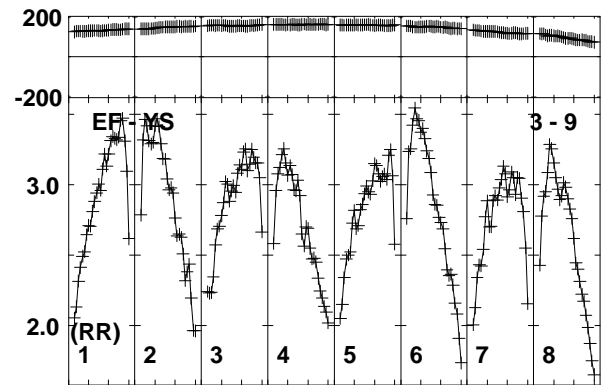
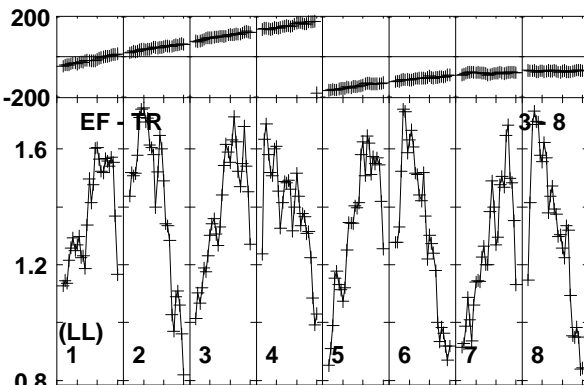
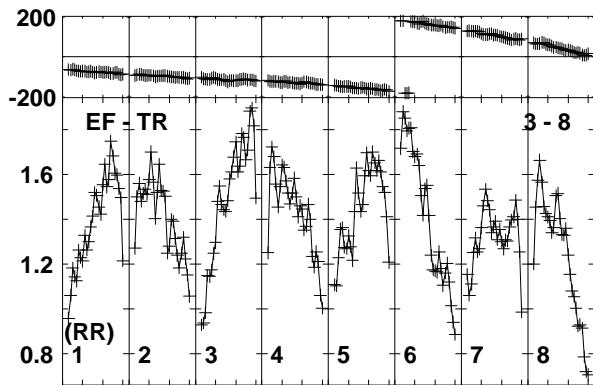
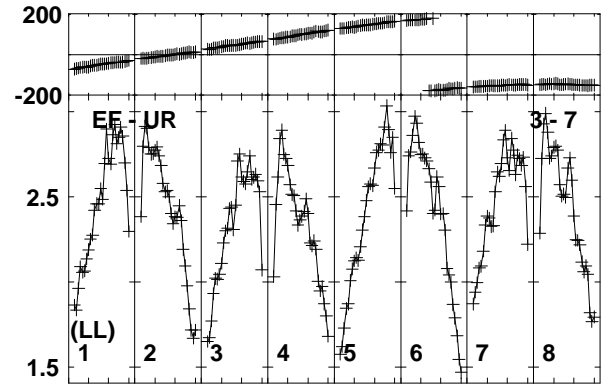
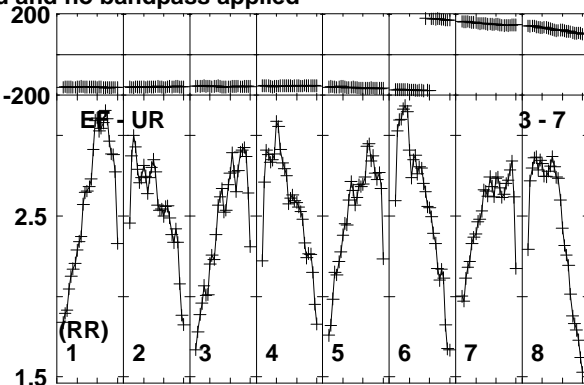
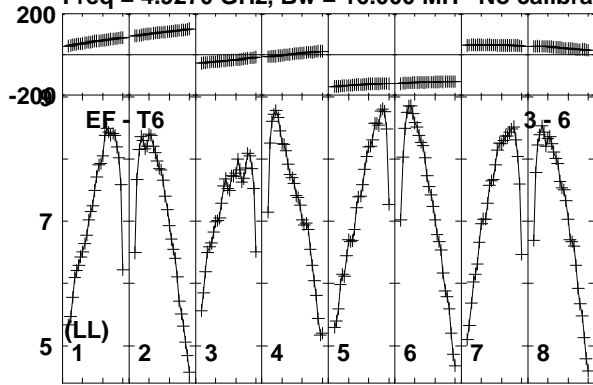

Lower frame: Milli Ampl Jy Top frame: Phas deg
Vector averaged cross-power spectrum Baseline: EF (03) - T6 (06)
Timerange: 00/06:17:21 to 00/06:19:19

Plot file version 336 created 17-FEB-2020 15:43:10

J1359+5544 EK047 2.UVDATA.1

Freq = 4.9270 GHz, Bw = 16.000 MH No calibration applied and no bandpass applied

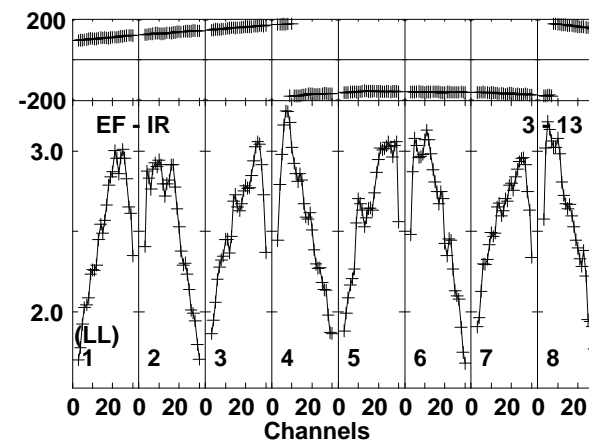
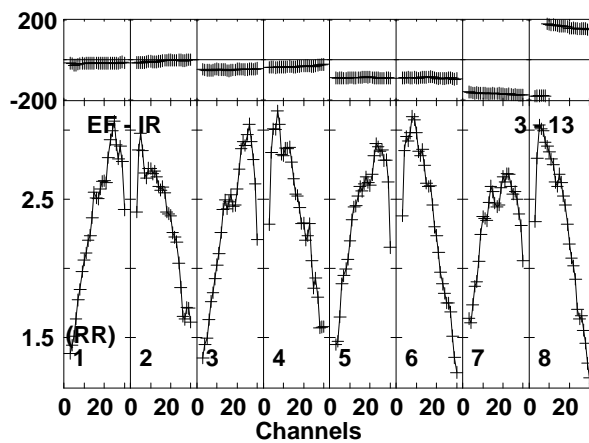
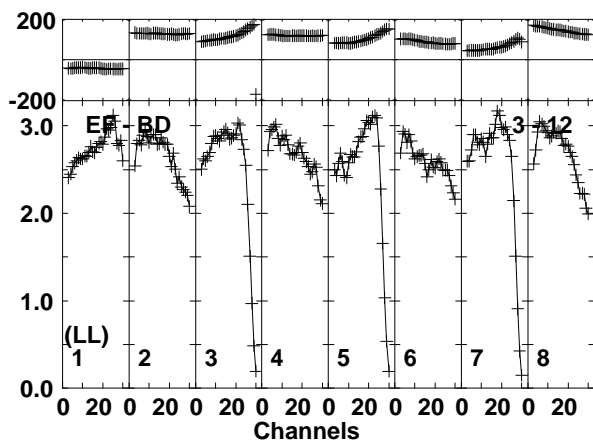
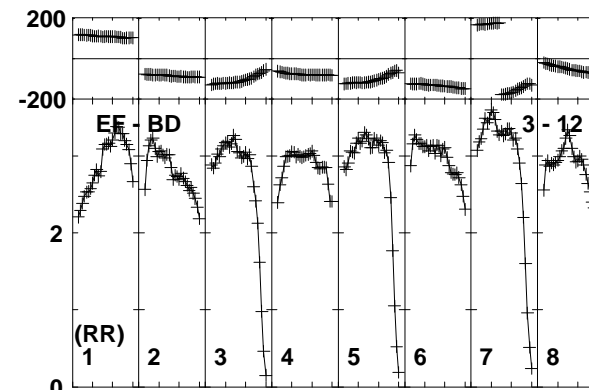
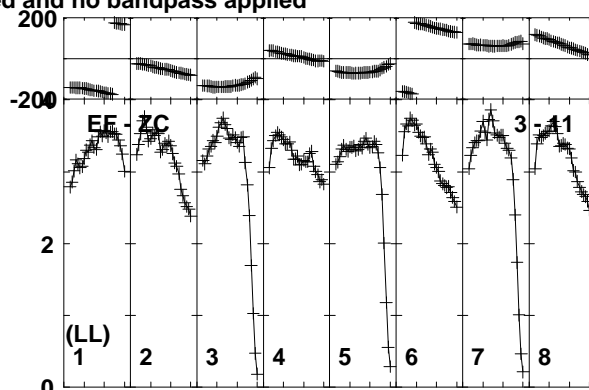
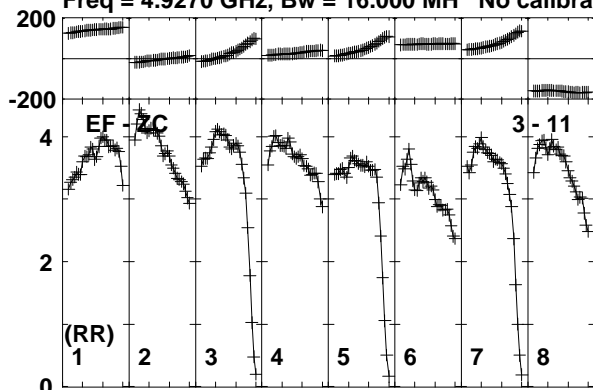

Lower frame: Milli Ampl Jy Top frame: Phas deg
Vector averaged cross-power spectrum Baseline: EF (03) - ZC (11)
Timerange: 00/06:17:21 to 00/06:19:19

Plot file version 337 created 17-FEB-2020 15:43:10

J1402+5347 EK047 2.UVDATA.1

Freq = 4.9270 GHz, Bw = 16.000 MH No calibration applied and no bandpass applied

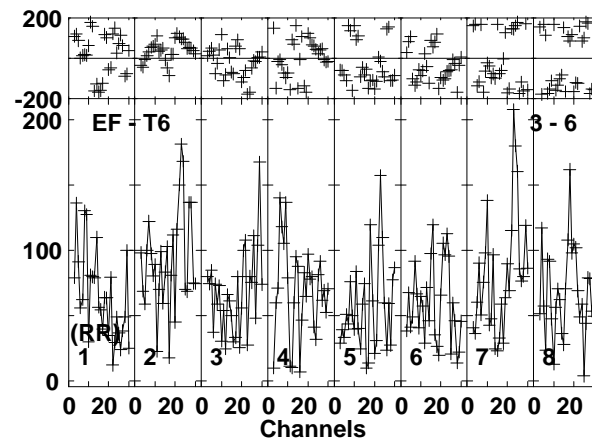
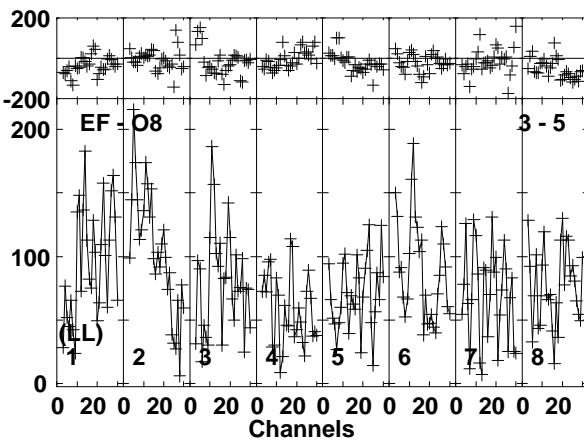
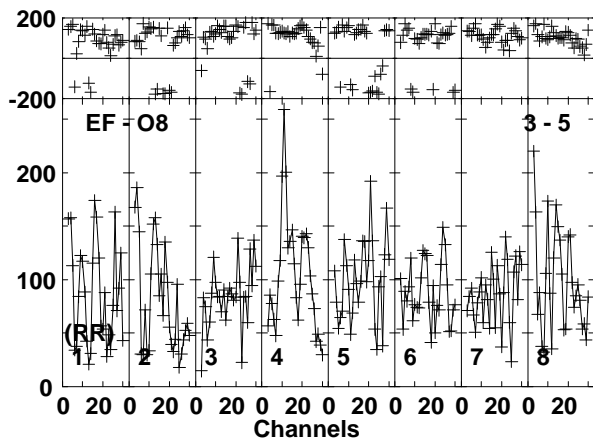
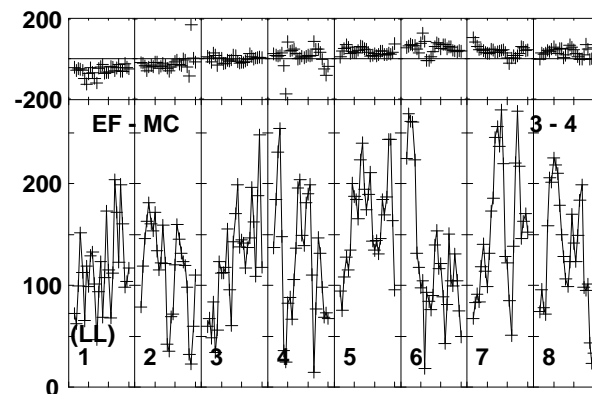
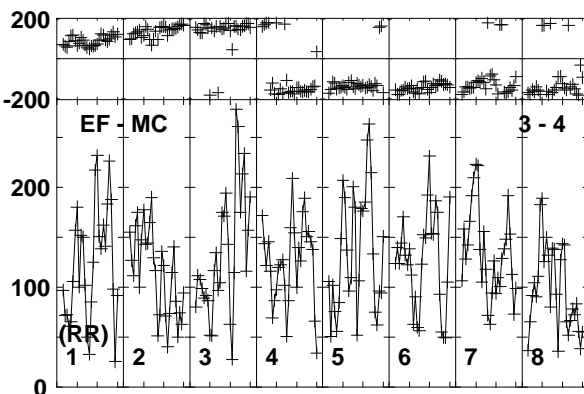
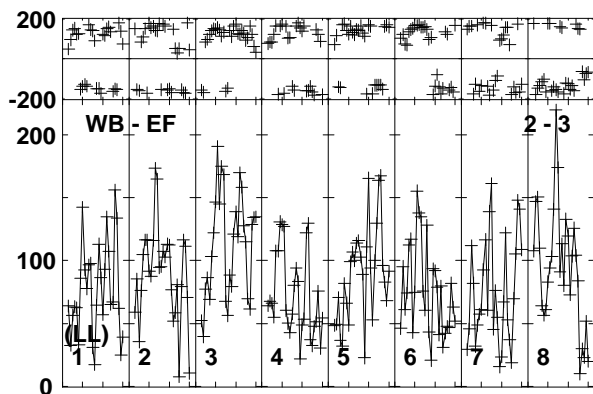
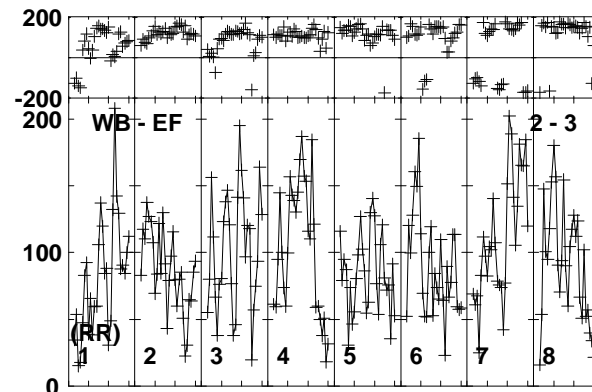
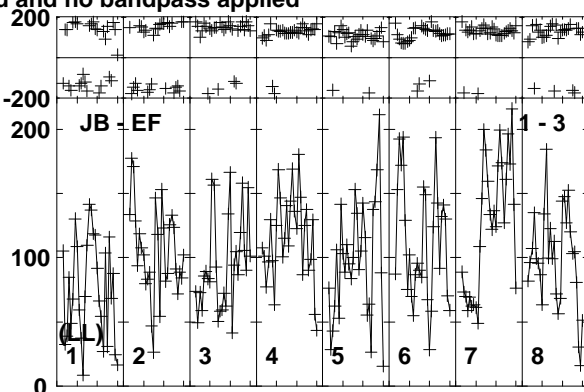
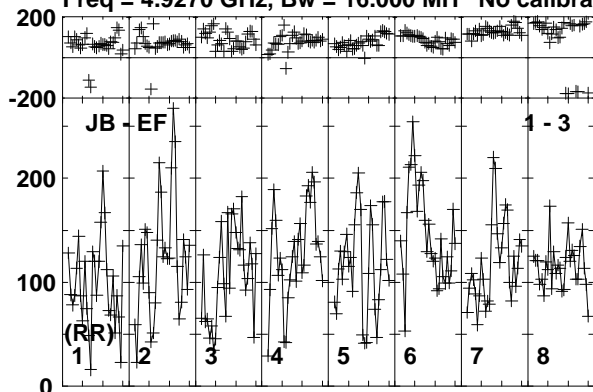

Lower frame: Micro Ampl Jy Top frame: Phas deg
Vector averaged cross-power spectrum Baseline: JB (01) - EF (03)
Timerange: 00/06:19:23 to 00/06:23:19

Plot file version 338 created 17-FEB-2020 15:43:10
J1402+5347 EK047 2.UVDATA.1

Freq = 4.9270 GHz, Bw = 16.000 MH No calibration applied and no bandpass applied

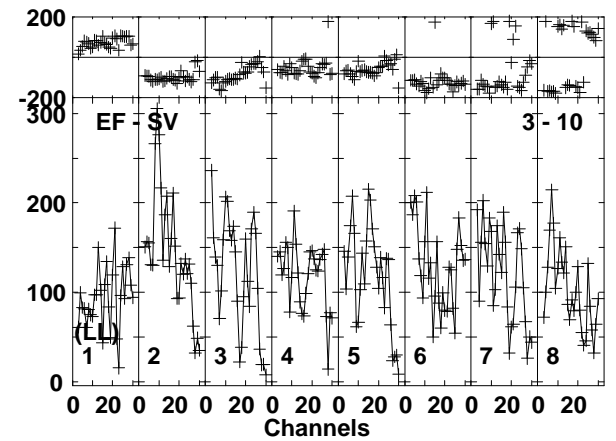
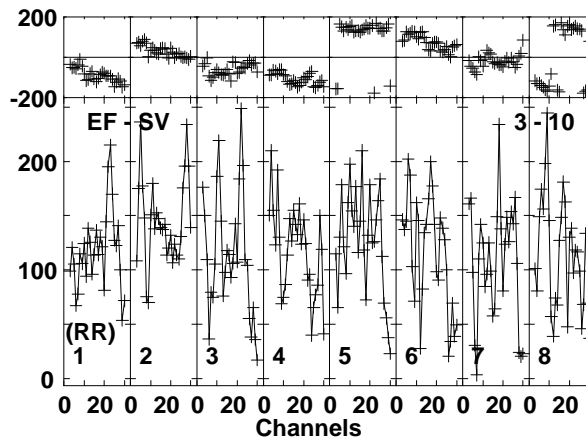
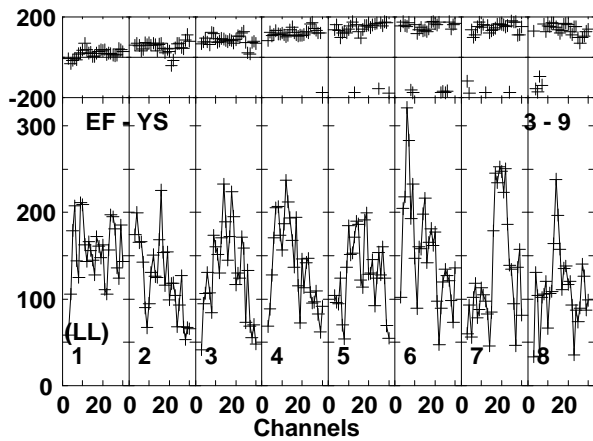
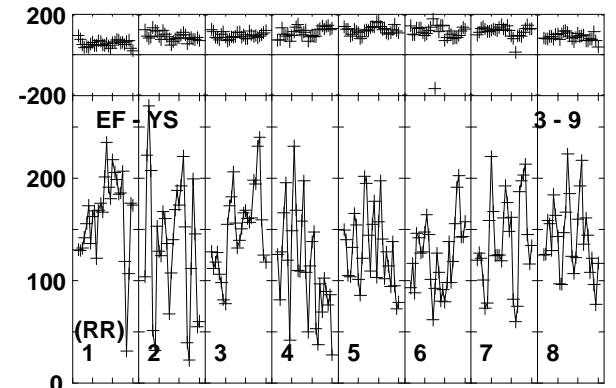
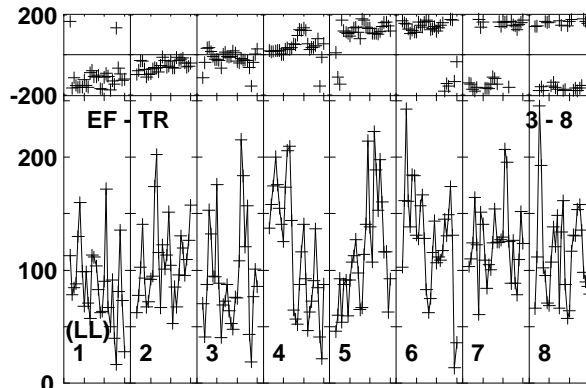
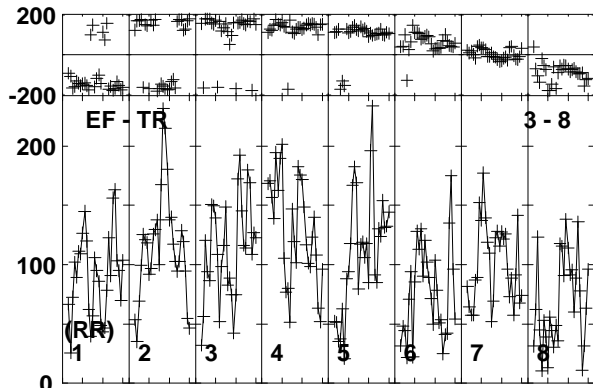
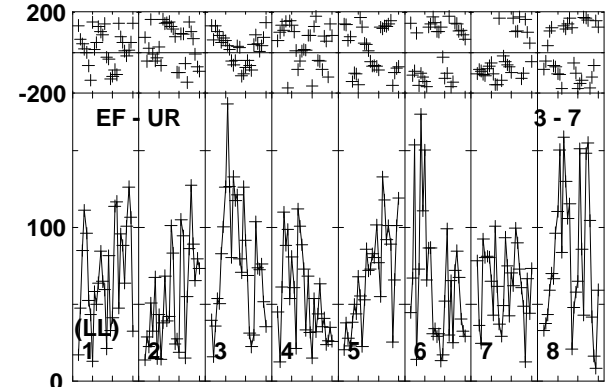
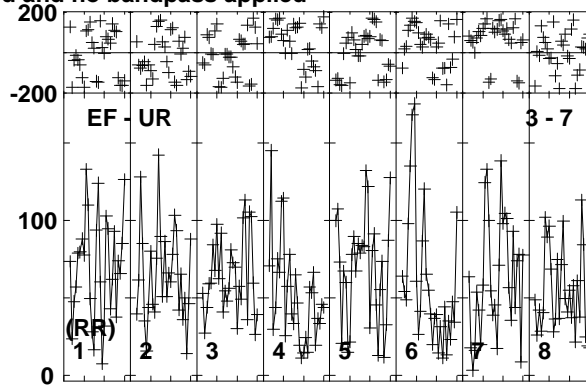
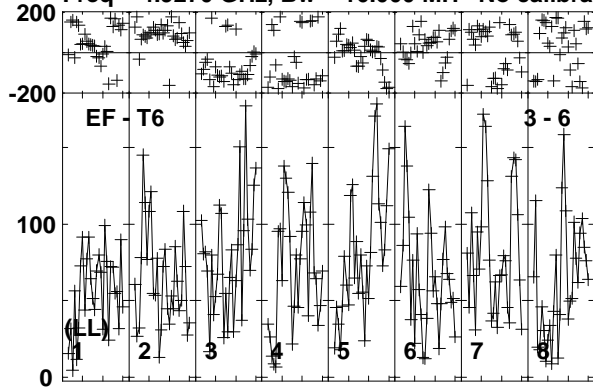

Lower frame: Micro Ampl Jy Top frame: Phas deg
Vector averaged cross-power spectrum Baseline: EF (03) - T6 (06)
Timerange: 00/06:19:23 to 00/06:23:19

Plot file version 339 created 17-FEB-2020 15:43:10

J1402+5347 EK047 2.UVDATA.1

Freq = 4.9270 GHz, Bw = 16.000 MH No calibration applied and no bandpass applied

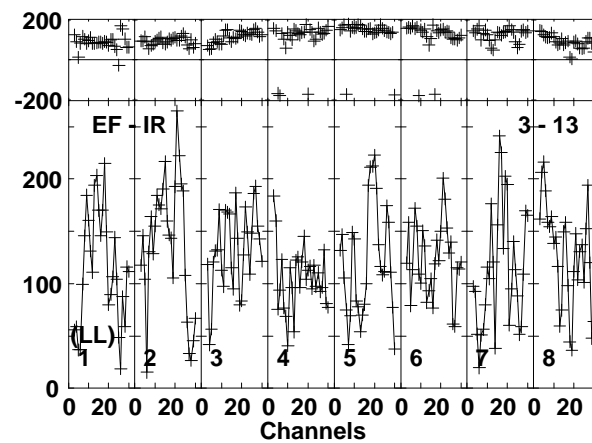
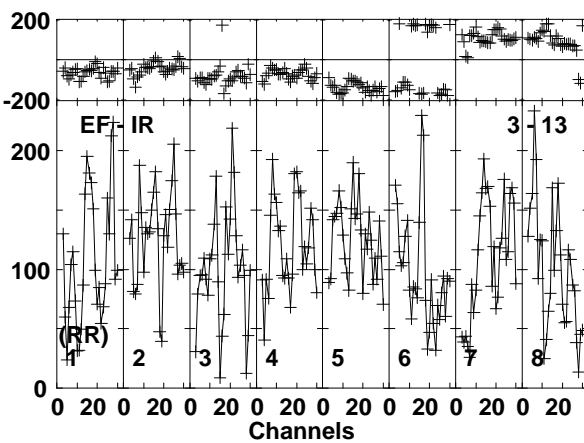
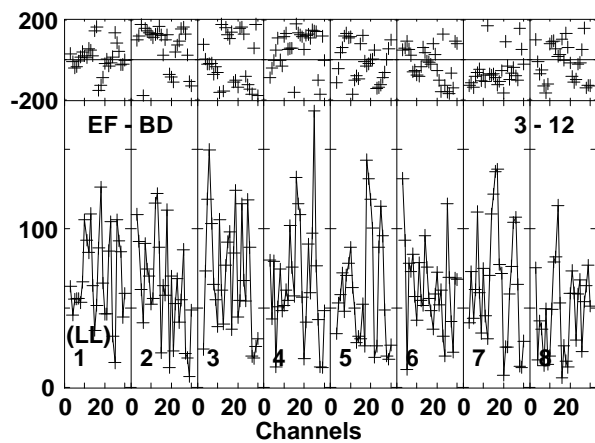
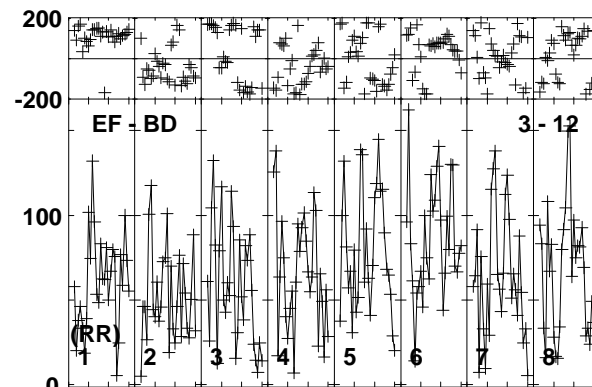
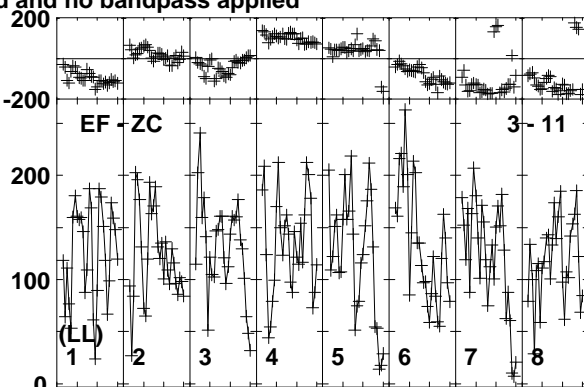
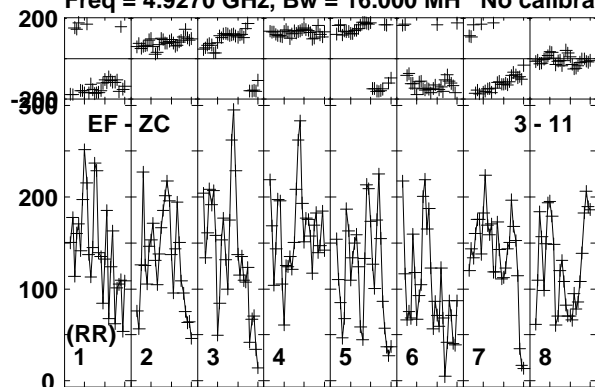

Lower frame: Micro Ampl Jy Top frame: Phas deg
Vector averaged cross-power spectrum Baseline: EF (03) - ZC (11)
Timerange: 00/06:19:23 to 00/06:23:19

Plot file version 340 created 17-FEB-2020 15:43:11

J1359+5544 EK047 2.UVDATA.1

Freq = 4.9270 GHz, Bw = 16.000 MH No calibration applied and no bandpass applied

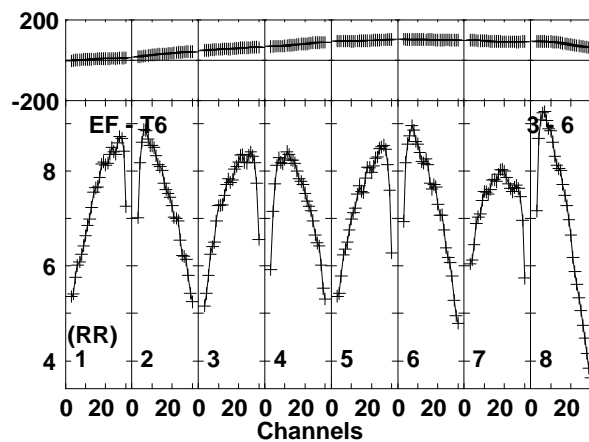
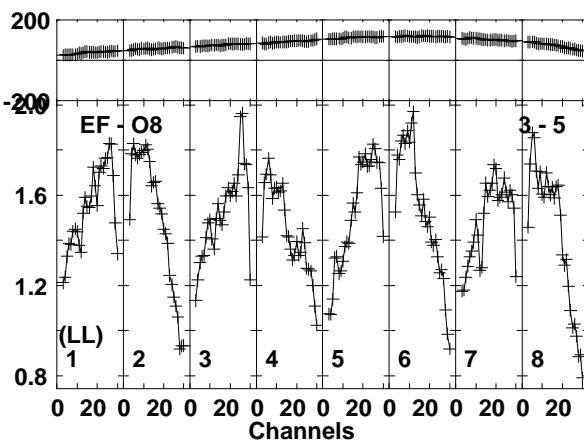
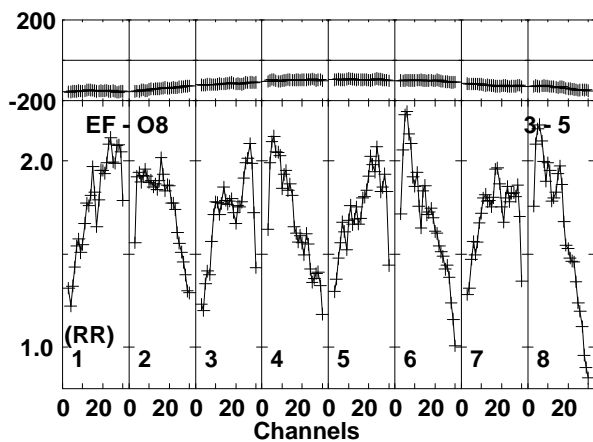
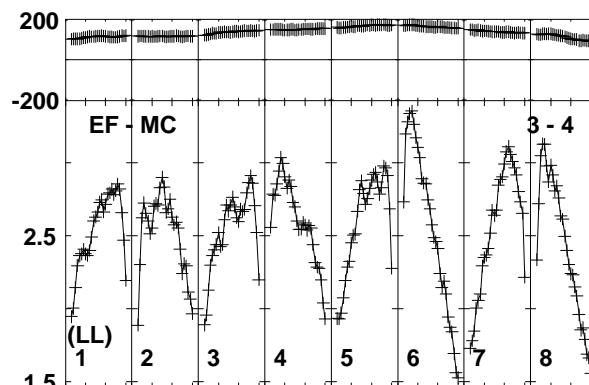
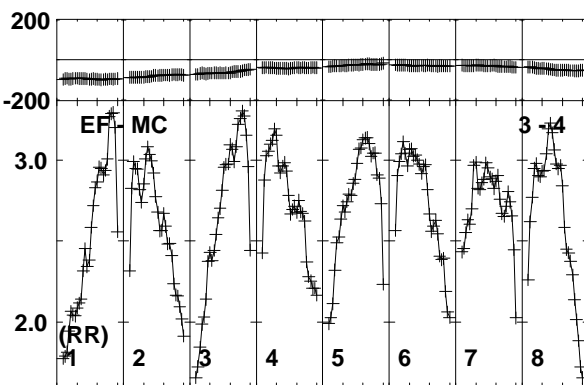
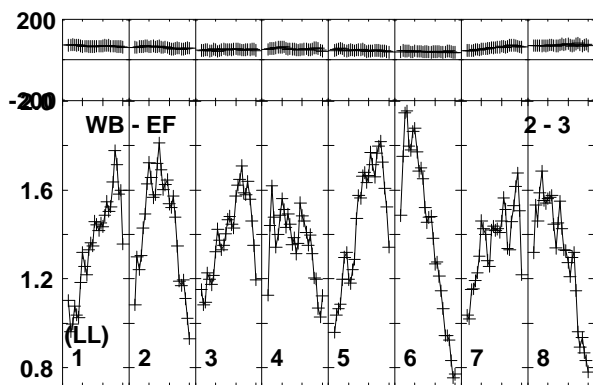
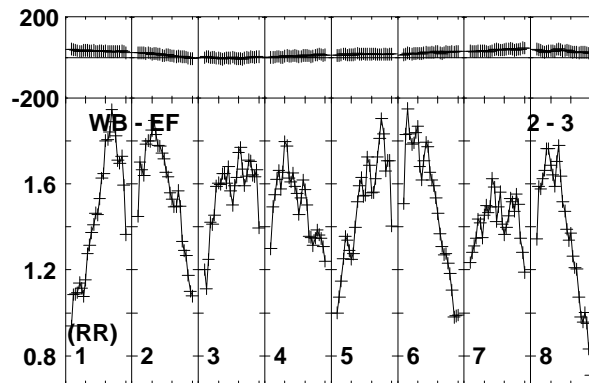
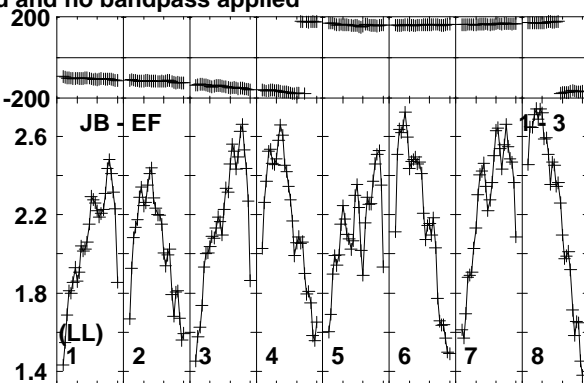
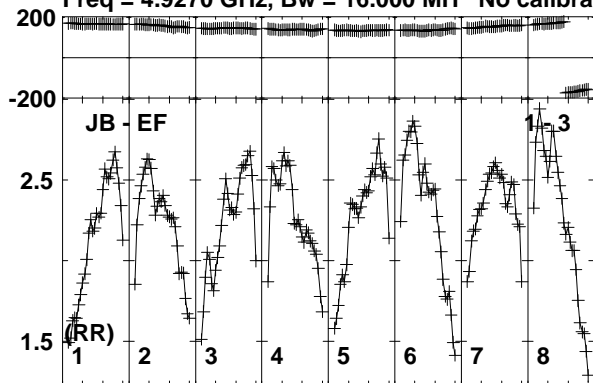

Lower frame: Milli Ampl Jy Top frame: Phas deg
Vector averaged cross-power spectrum Baseline: JB (01) - EF (03)
Timerange: 00/06:24:01 to 00/06:25:19

Plot file version 341 created 17-FEB-2020 15:43:11

J1359+5544 EK047 2.UVDATA.1

Freq = 4.9270 GHz, Bw = 16.000 MH No calibration applied and no bandpass applied

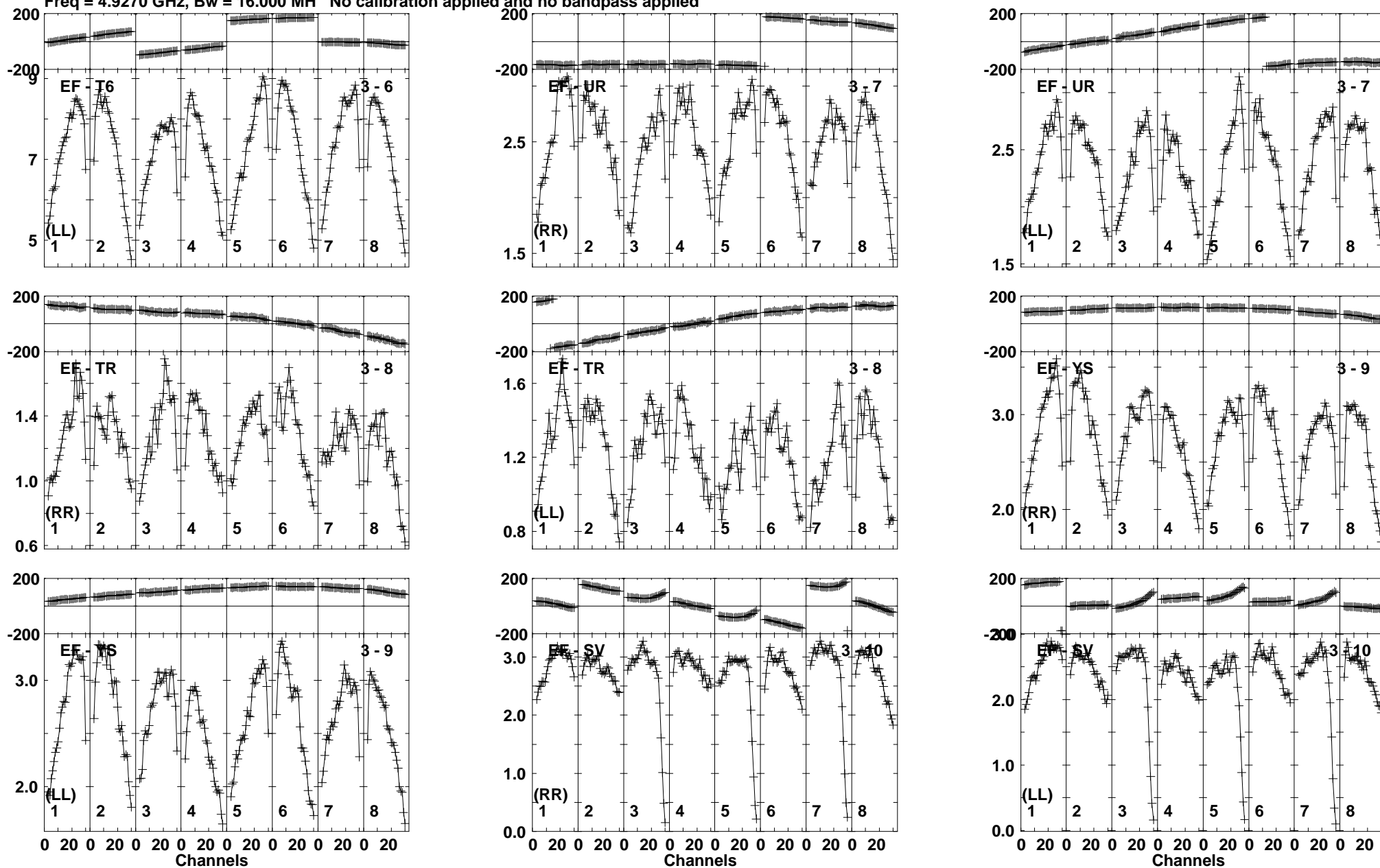

Lower frame: Milli Ampl Jy Top frame: Phas deg
Vector averaged cross-power spectrum Baseline: EF (03) - T6 (06)
Timerange: 00/06:24:01 to 00/06:25:19

Plot file version 342 created 17-FEB-2020 15:43:11

J1359+5544 EK047 2.UVDATA.1

Freq = 4.9270 GHz, Bw = 16.000 MH No calibration applied and no bandpass applied

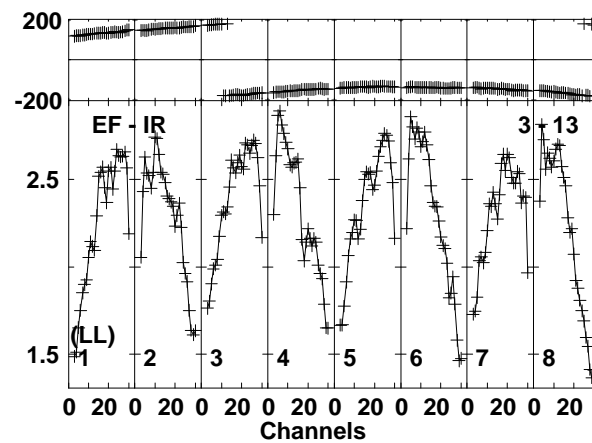
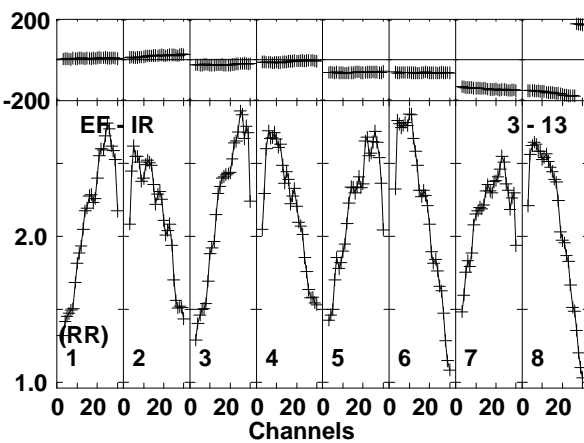
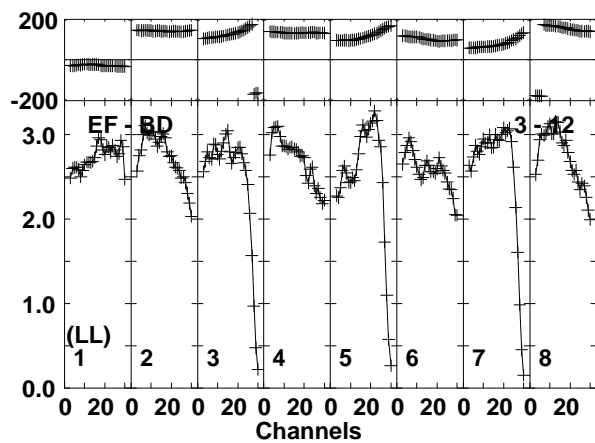
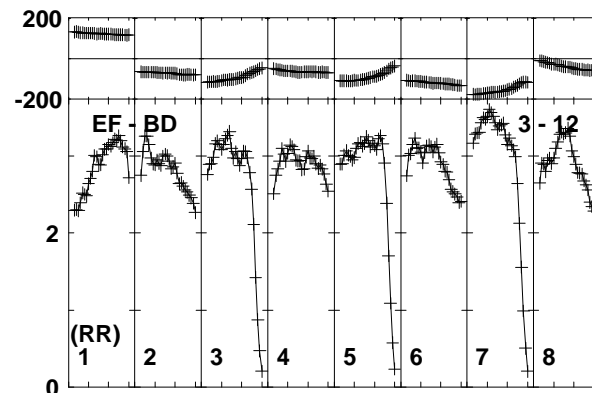
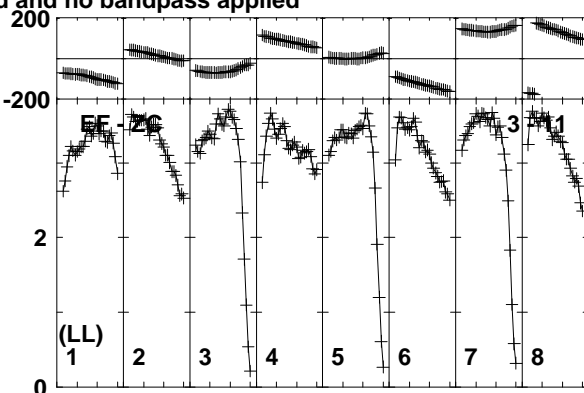
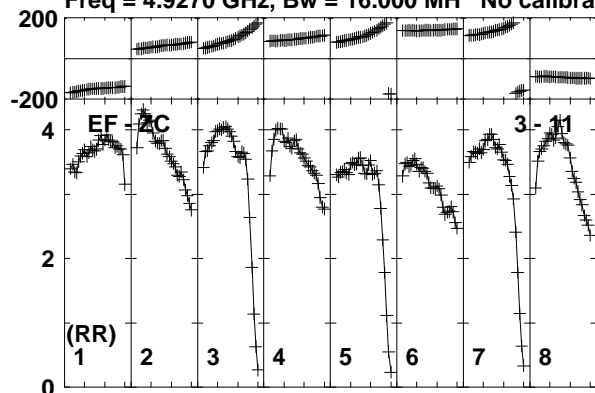

Lower frame: Milli Ampl Jy Top frame: Phas deg
Vector averaged cross-power spectrum Baseline: EF (03) - ZC (11)
Timerange: 00/06:24:01 to 00/06:25:19

Plot file version 343 created 17-FEB-2020 15:43:11

J1402+5347 EK047 2.UVDATA.1

Freq = 4.9270 GHz, Bw = 16.000 MH No calibration applied and no bandpass applied

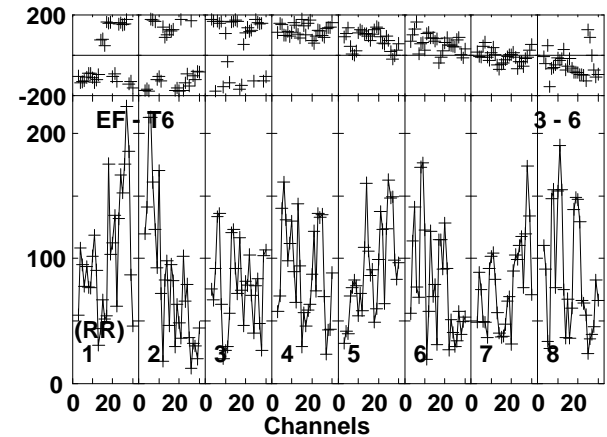
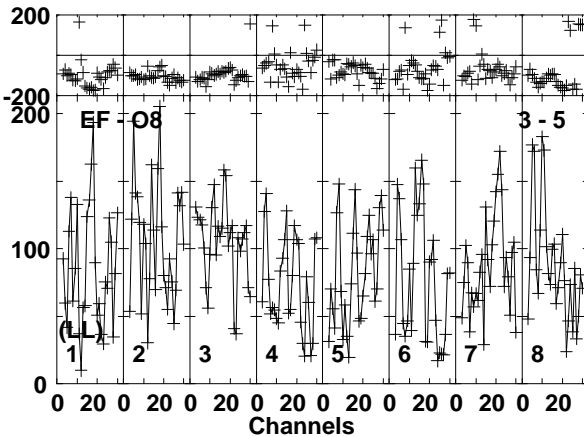
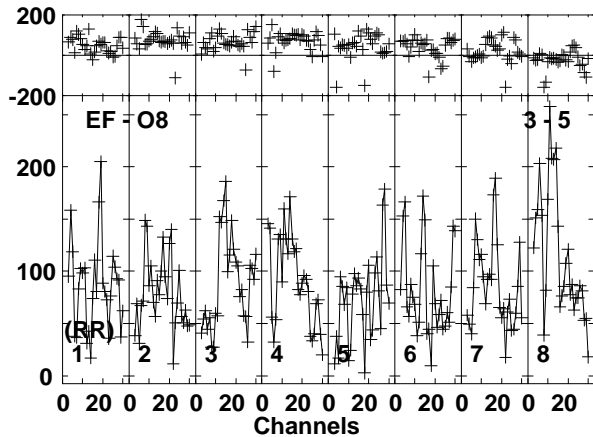
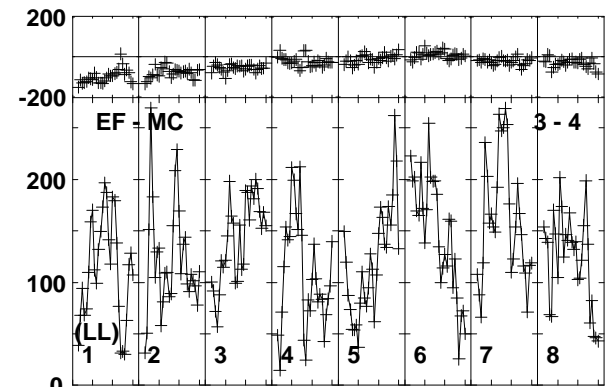
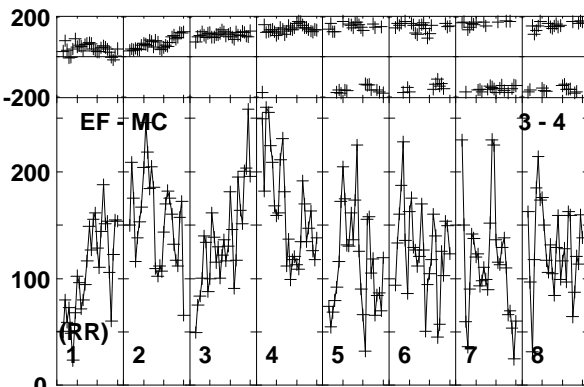
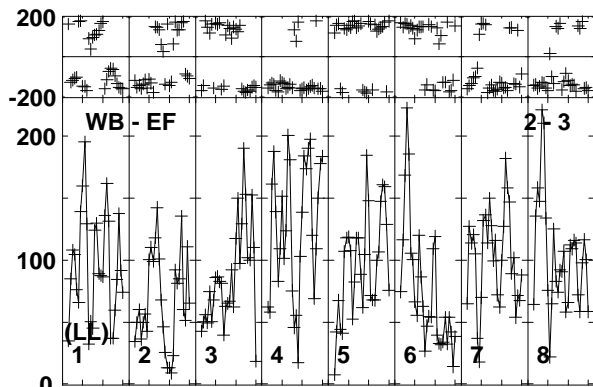
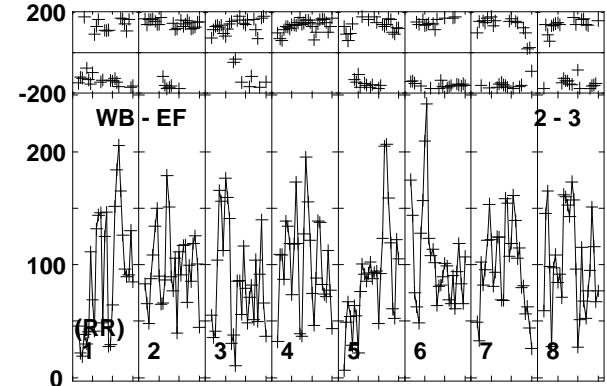
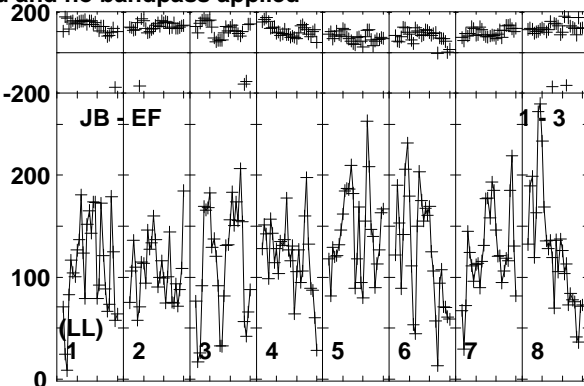
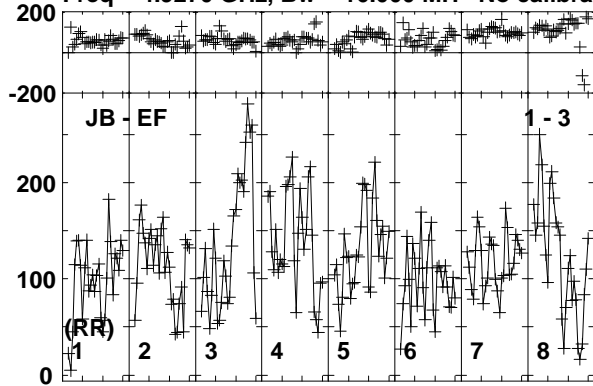

Lower frame: Micro Ampl Jy Top frame: Phas deg
Vector averaged cross-power spectrum Baseline: JB (01) - EF (03)
Timerange: 00/06:25:21 to 00/06:29:19

Plot file version 344 created 17-FEB-2020 15:43:11

J1402+5347 EK047 2.UVDATA.1

Freq = 4.9270 GHz, Bw = 16.000 MH No calibration applied and no bandpass applied

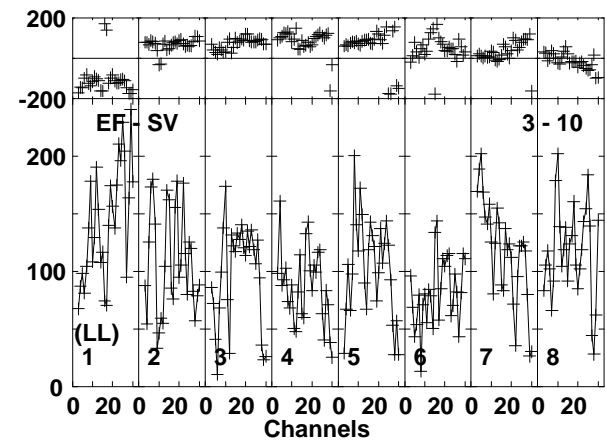
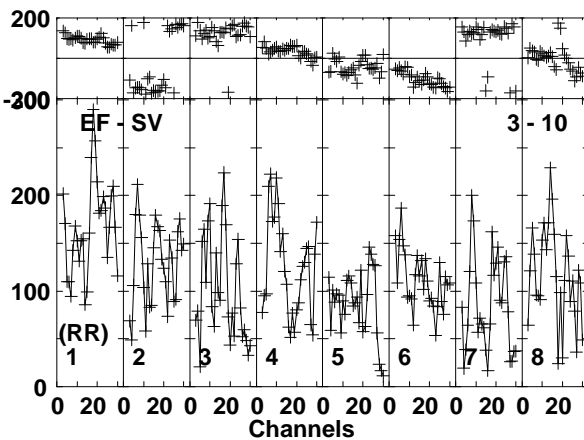
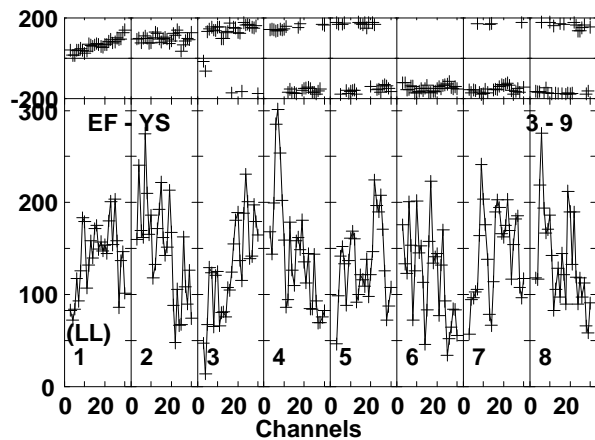
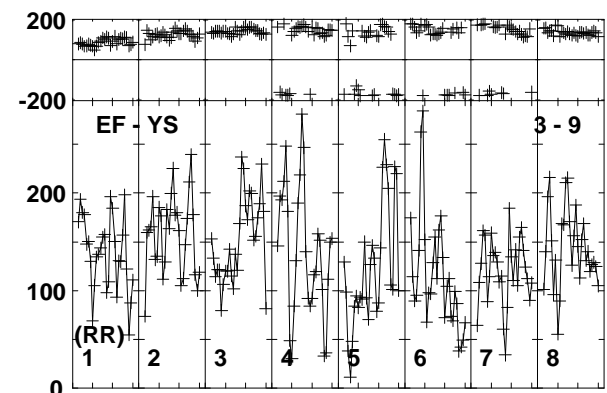
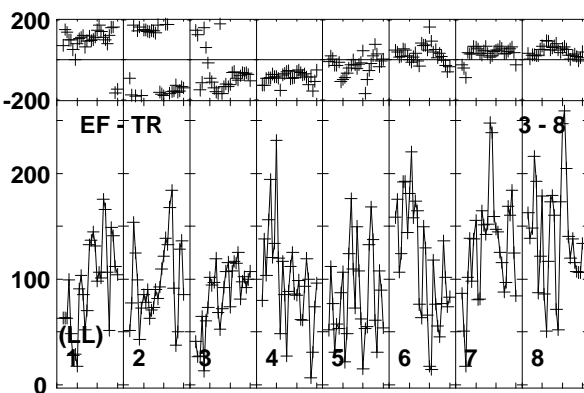
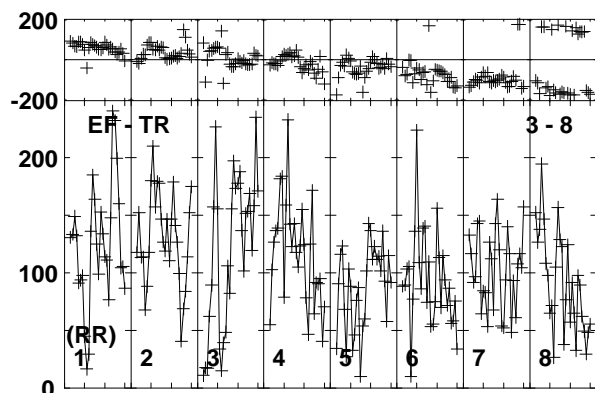
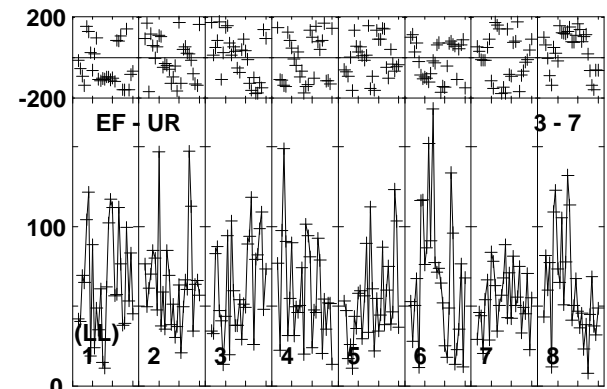
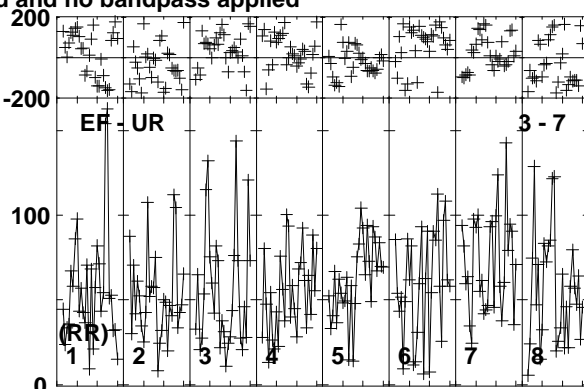
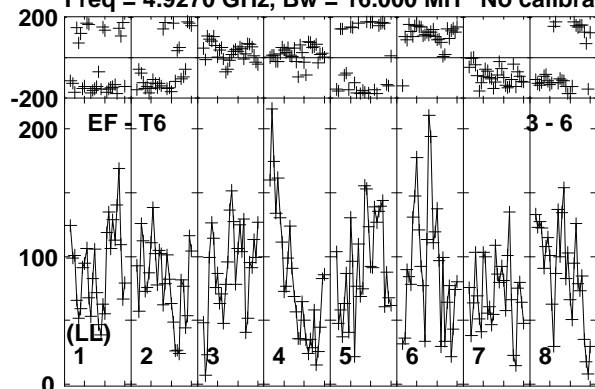

Lower frame: Micro Ampl Jy Top frame: Phas deg
Vector averaged cross-power spectrum Baseline: EF (03) - T6 (06)
Timerange: 00/06:25:21 to 00/06:29:19

Plot file version 345 created 17-FEB-2020 15:43:11

J1402+5347 EK047 2.UVDATA.1

Freq = 4.9270 GHz, Bw = 16.000 MH No calibration applied and no bandpass applied

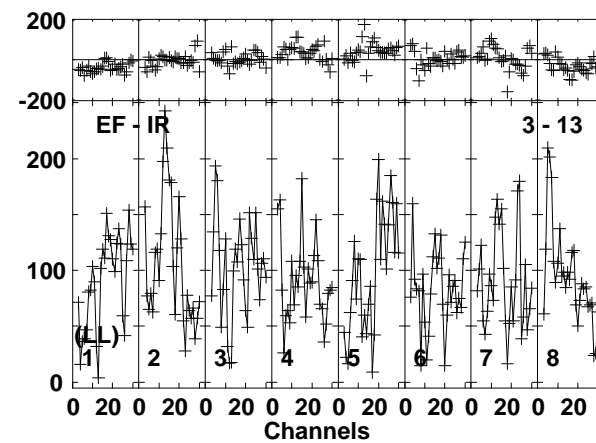
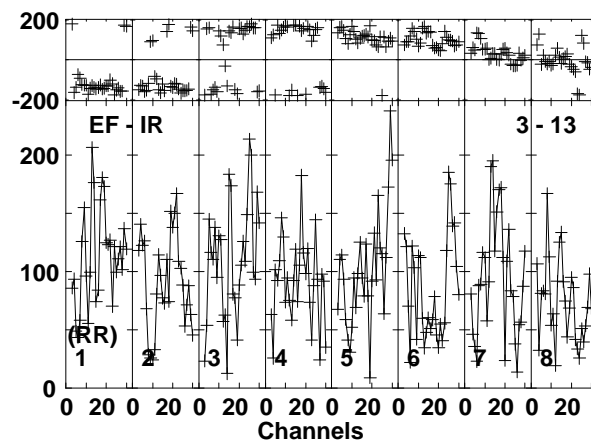
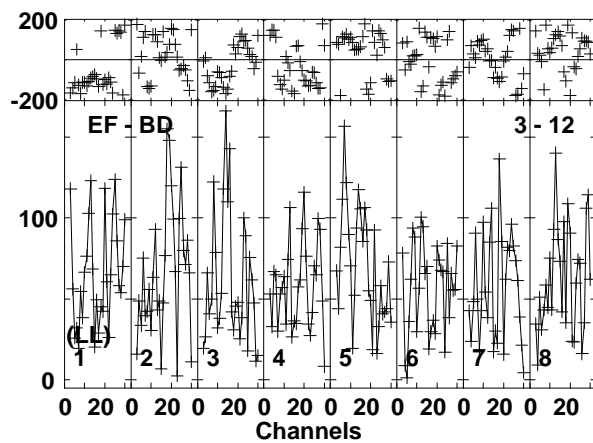
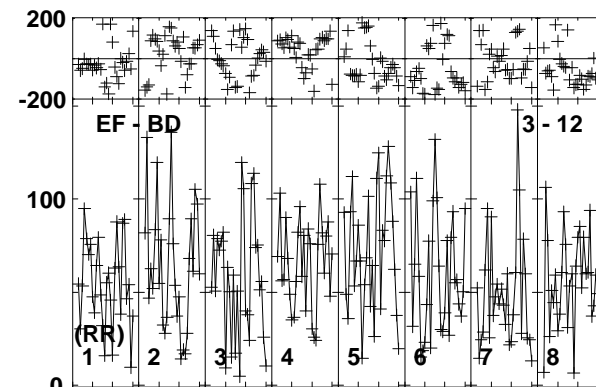
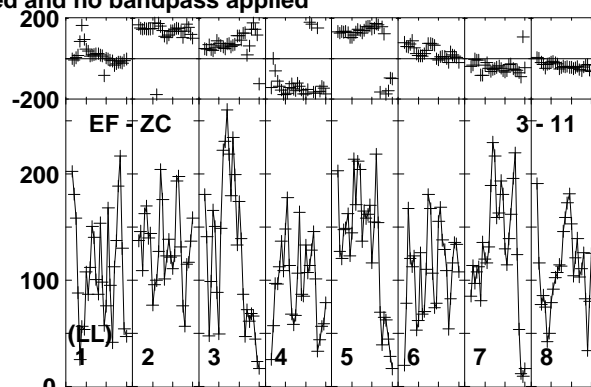
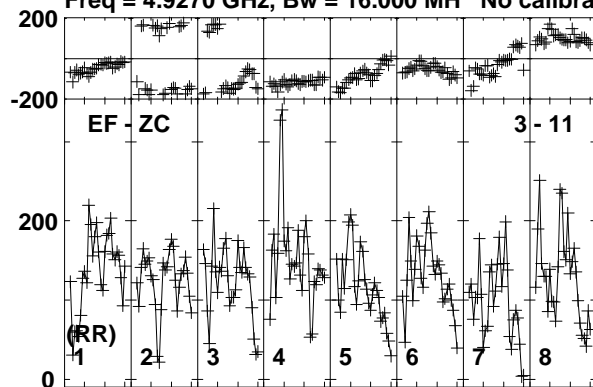

Lower frame: Micro Ampl Jy Top frame: Phas deg
Vector averaged cross-power spectrum Baseline: EF (03) - ZC (11)
Timerange: 00/06:25:21 to 00/06:29:19

Plot file version 346 created 17-FEB-2020 15:43:11

J1359+5544 EK047 2.UVDATA.1

Freq = 4.9270 GHz, Bw = 16.000 MH No calibration applied and no bandpass applied

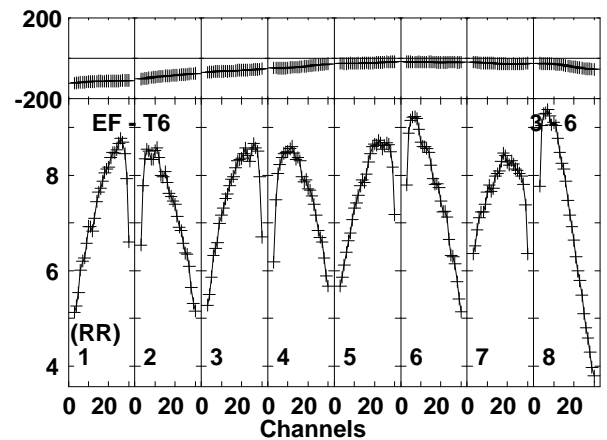
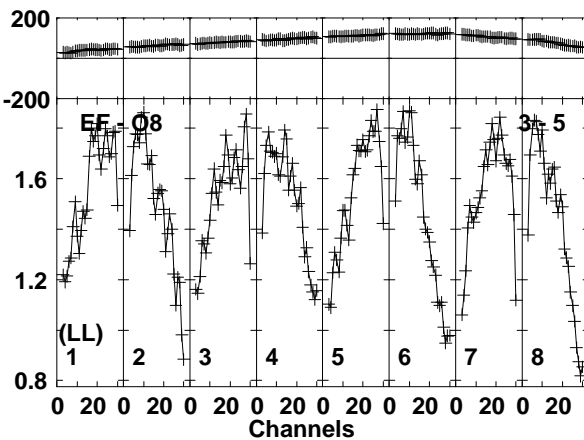
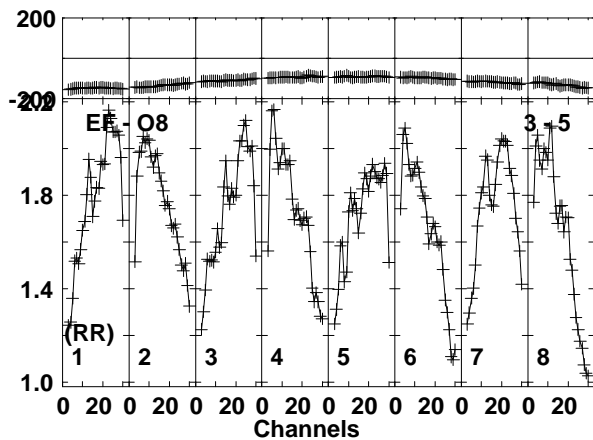
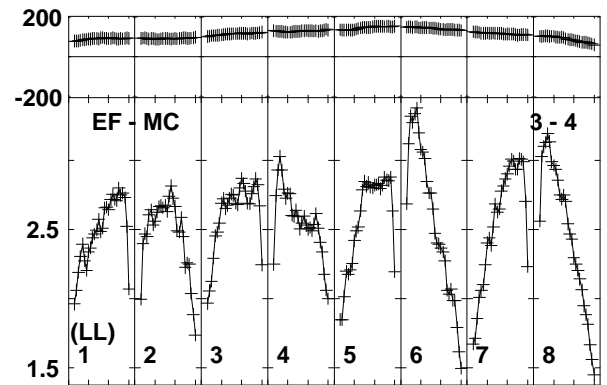
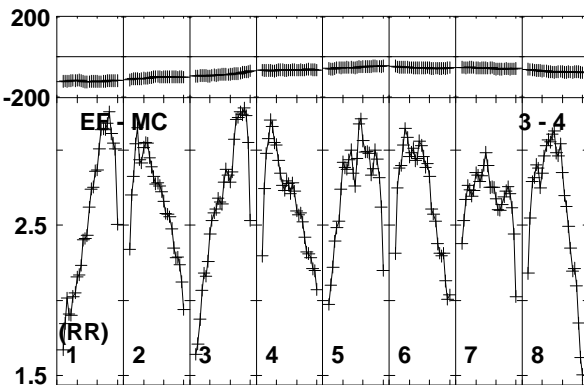
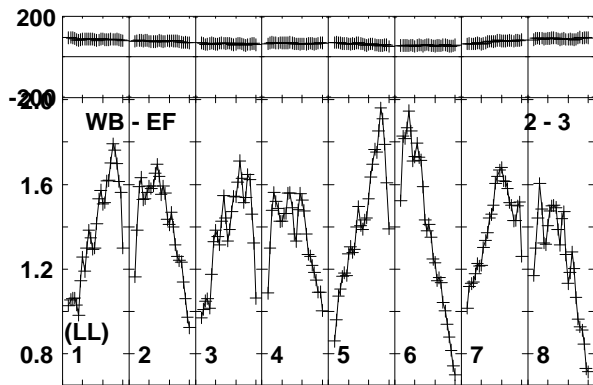
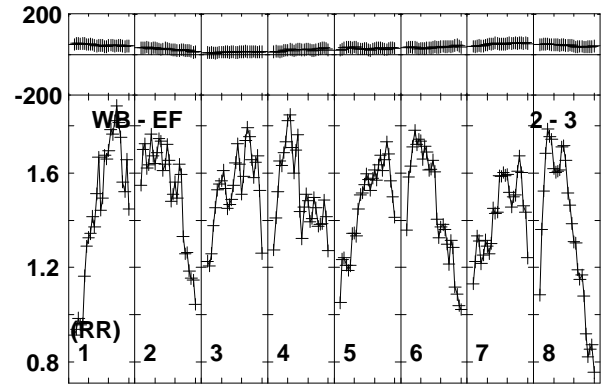
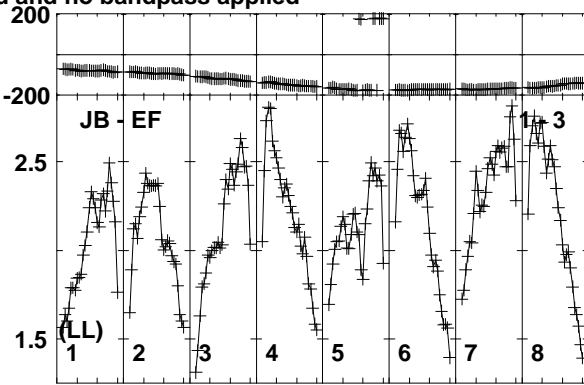
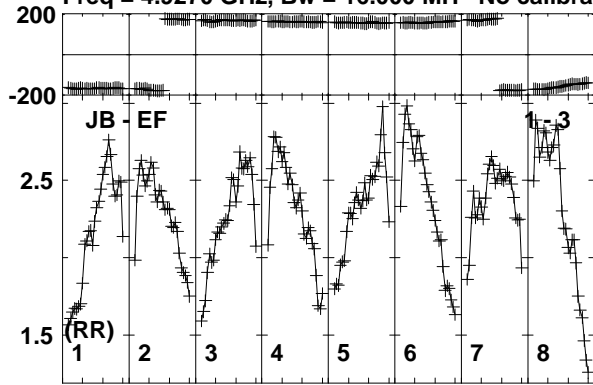

Lower frame: Milli Ampl Jy Top frame: Phas deg
Vector averaged cross-power spectrum Baseline: JB (01) - EF (03)
Timerange: 00/06:29:21 to 00/06:31:19

Plot file version 347 created 17-FEB-2020 15:43:11

J1359+5544 EK047 2.UVDATA.1

Freq = 4.9270 GHz, Bw = 16.000 MH No calibration applied and no bandpass applied

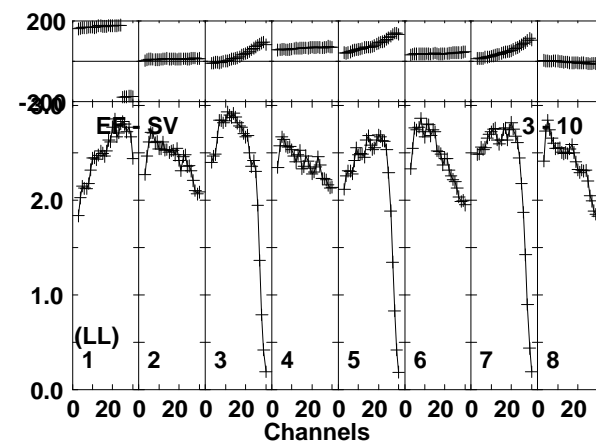
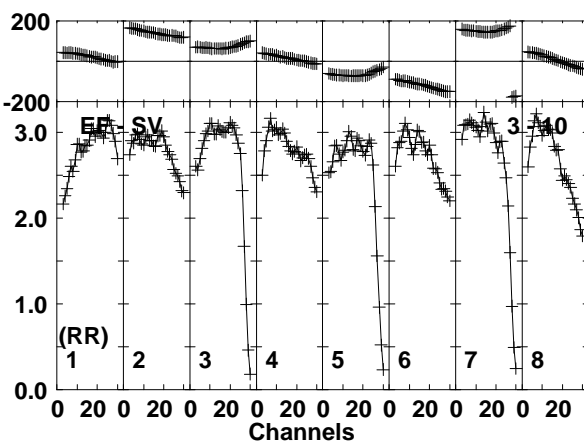
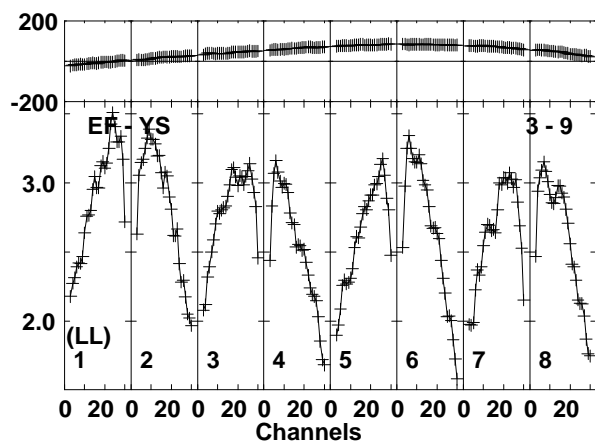
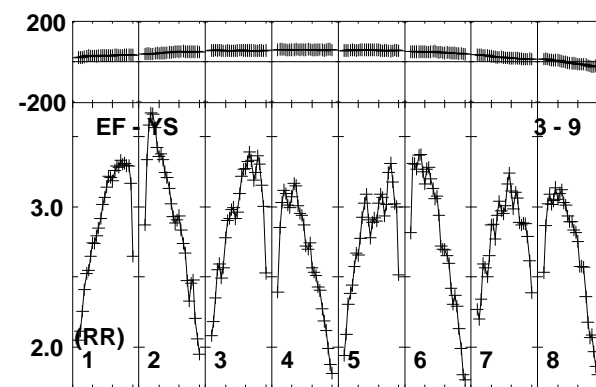
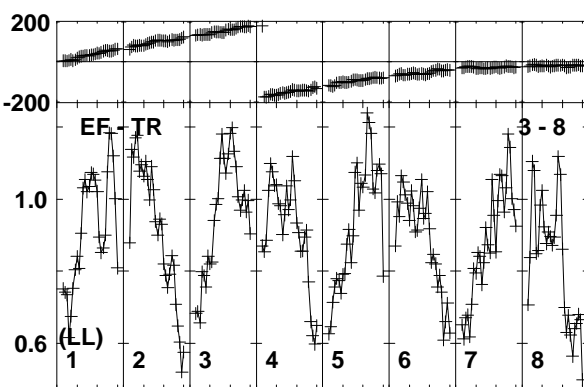
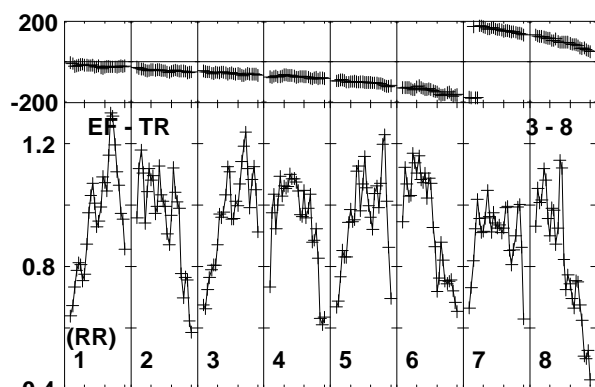
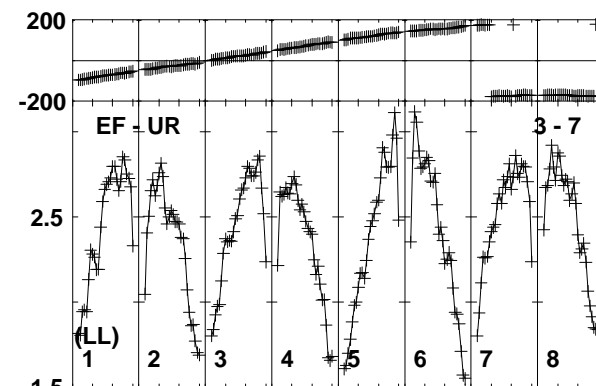
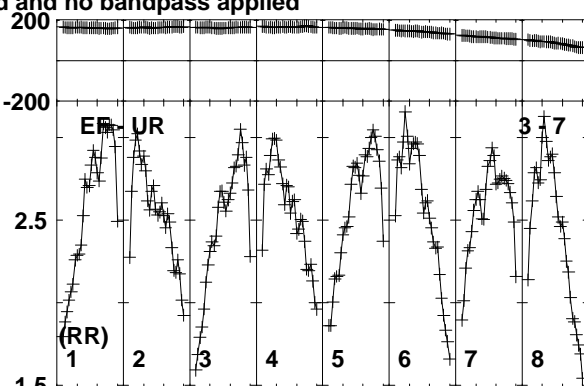
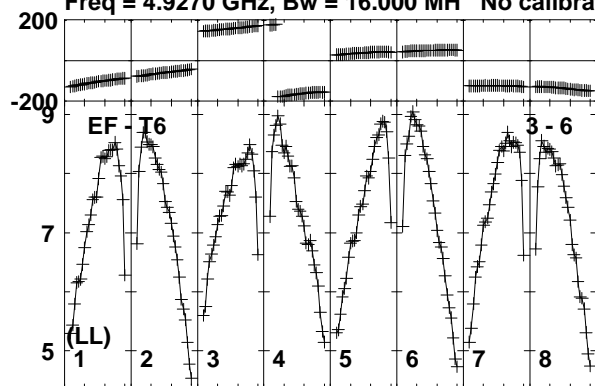

Lower frame: Milli Ampl Jy Top frame: Phas deg
Vector averaged cross-power spectrum Baseline: EF (03) - T6 (06)
Timerange: 00/06:29:21 to 00/06:31:19

Plot file version 348 created 17-FEB-2020 15:43:11

J1359+5544 EK047 2.UVDATA.1

Freq = 4.9270 GHz, Bw = 16.000 MH No calibration applied and no bandpass applied

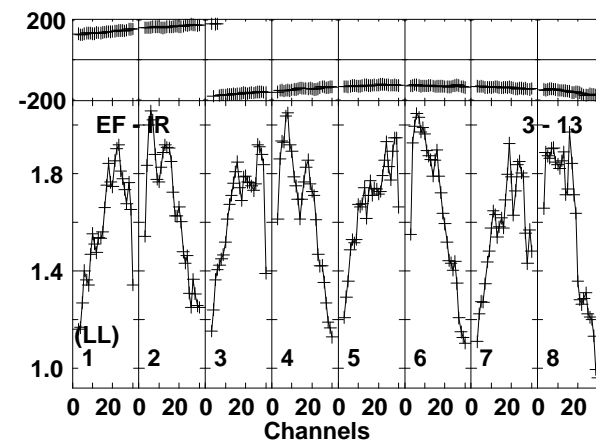
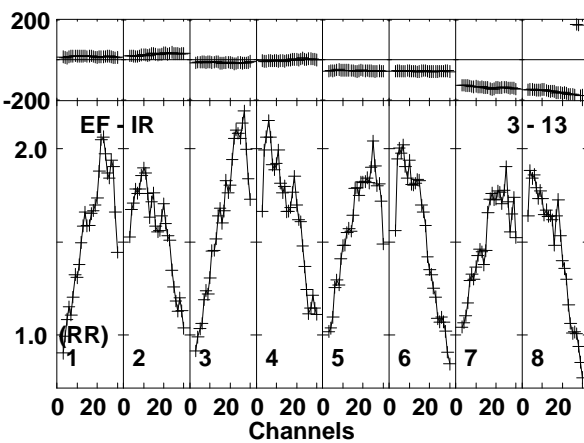
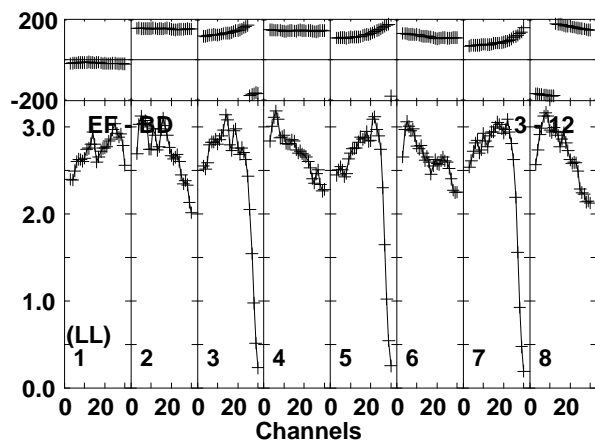
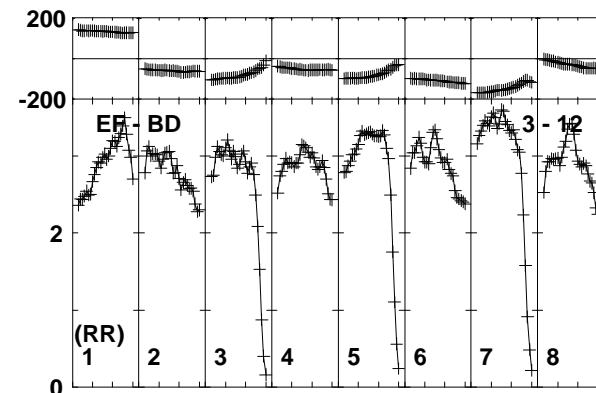
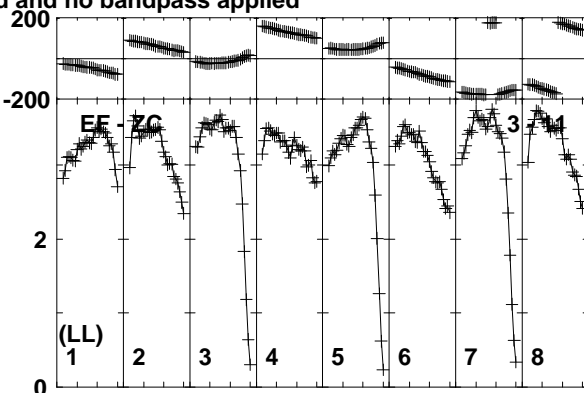
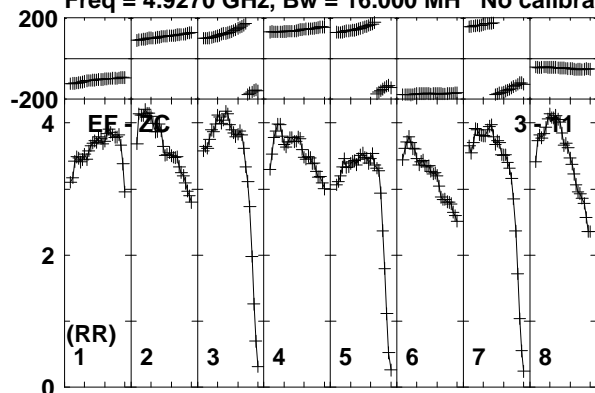

Lower frame: Milli Ampl Jy Top frame: Phas deg
Vector averaged cross-power spectrum Baseline: EF (03) - ZC (11)
Timerange: 00/06:29:21 to 00/06:31:19

Plot file version 349 created 17-FEB-2020 15:43:11

J1402+5347 EK047 2.UVDATA.1

Freq = 4.9270 GHz, Bw = 16.000 MH No calibration applied and no bandpass applied

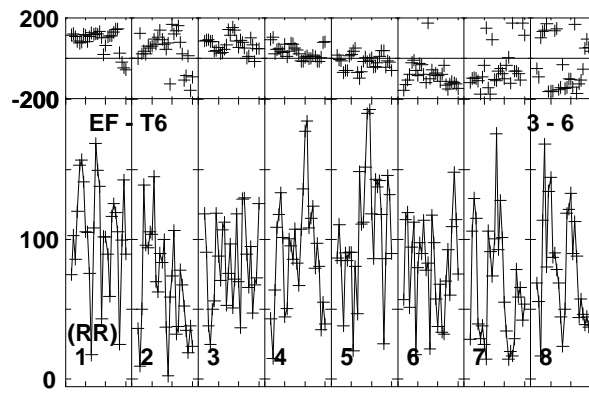
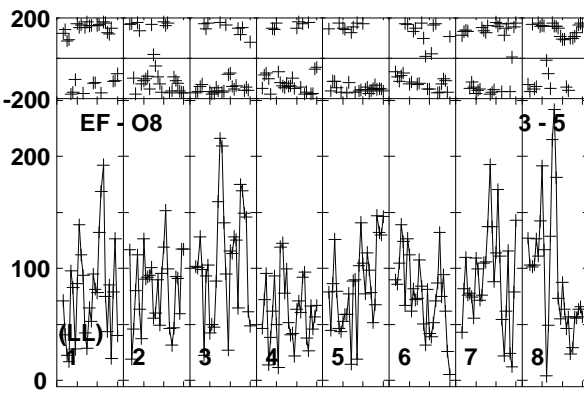
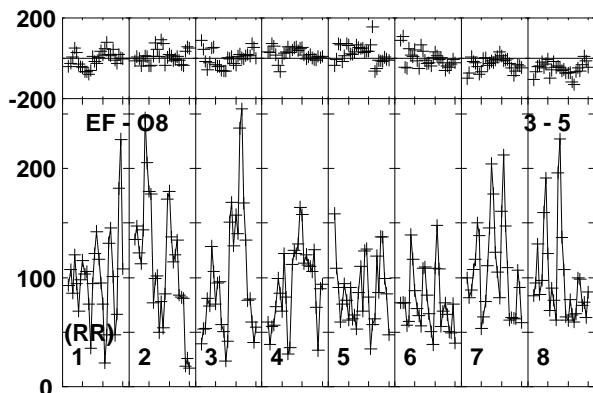
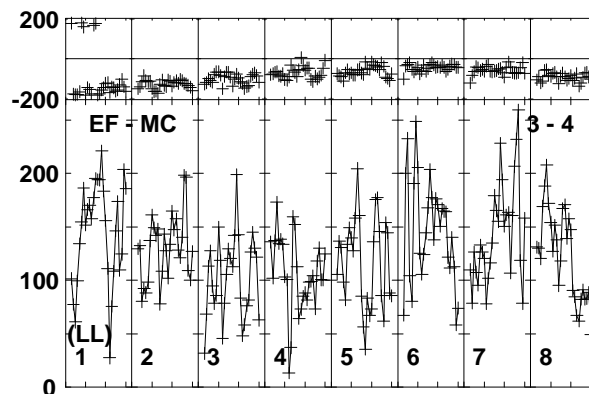
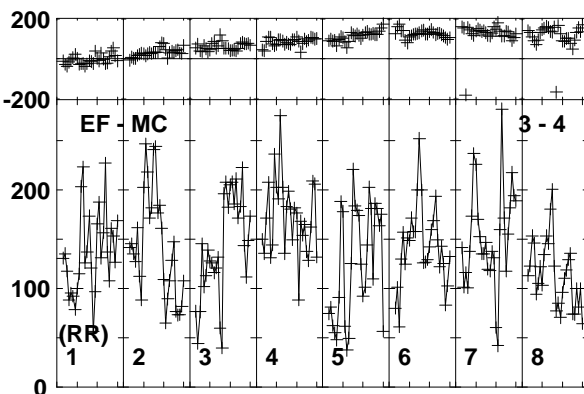
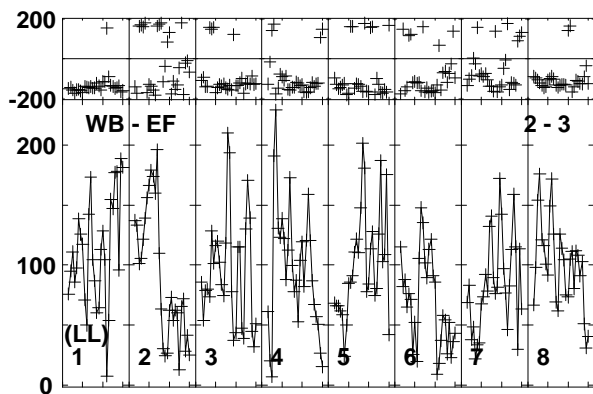
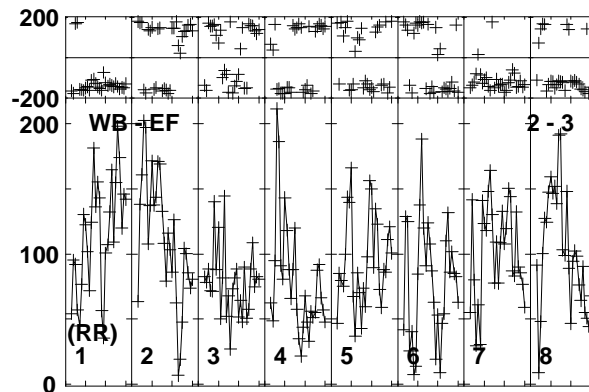
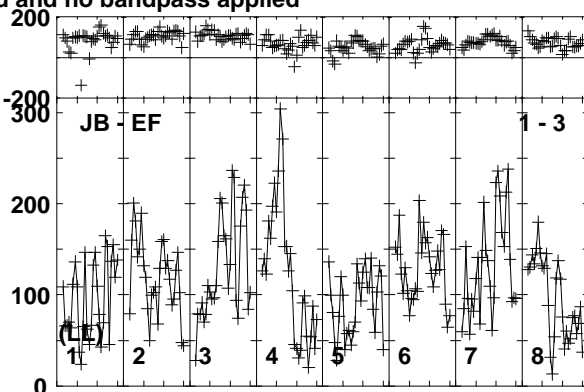
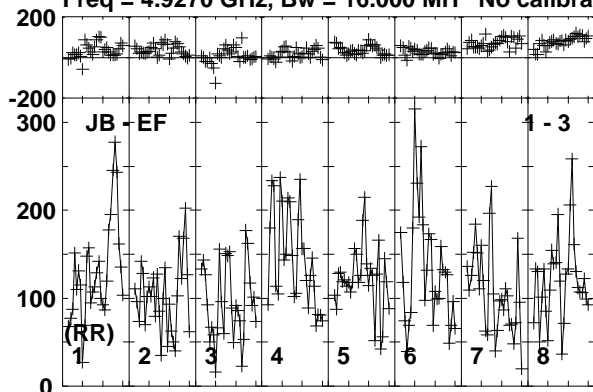

Lower frame: Micro Ampl Jy Top frame: Phas deg
Vector averaged cross-power spectrum Baseline: JB (01) - EF (03)
Timerange: 00/06:31:23 to 00/06:35:19

Plot file version 350 created 17-FEB-2020 15:43:12

J1402+5347 EK047 2.UVDATA.1

Freq = 4.9270 GHz, Bw = 16.000 MH No calibration applied and no bandpass applied

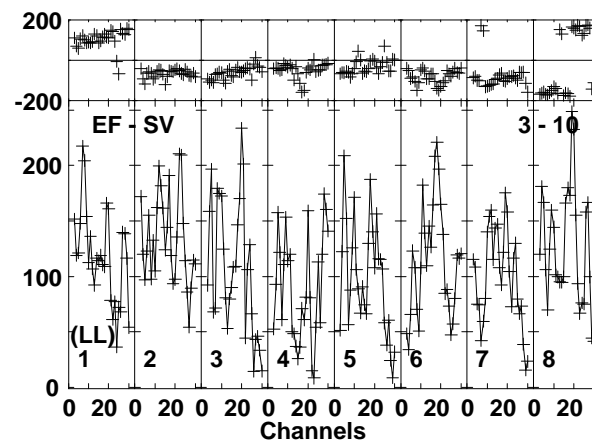
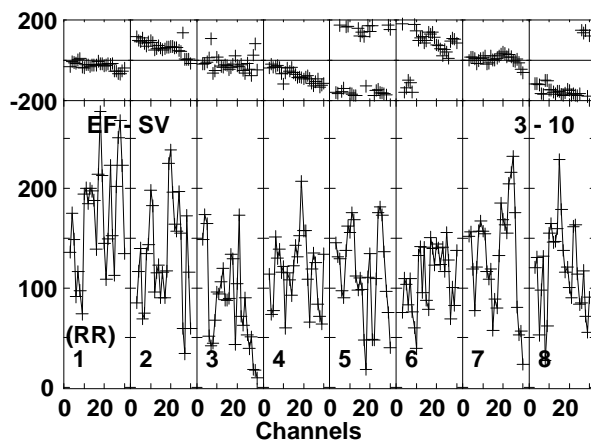
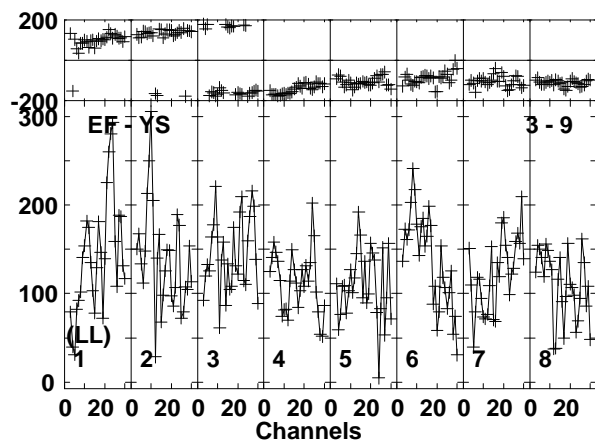
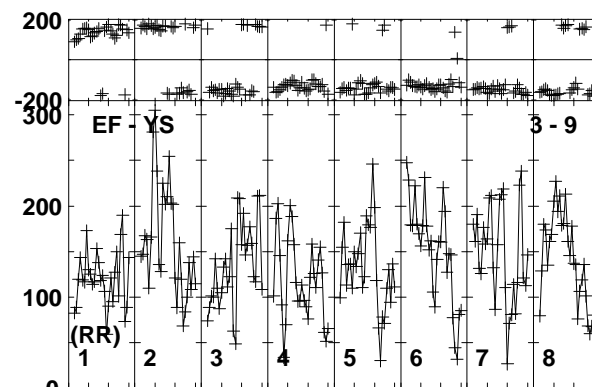
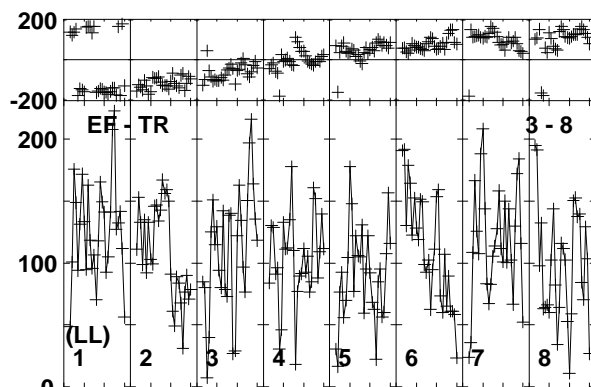
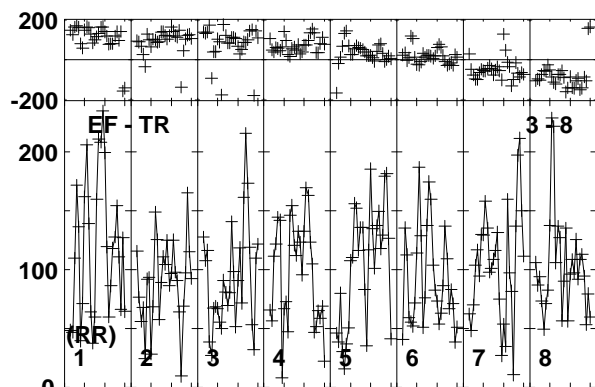
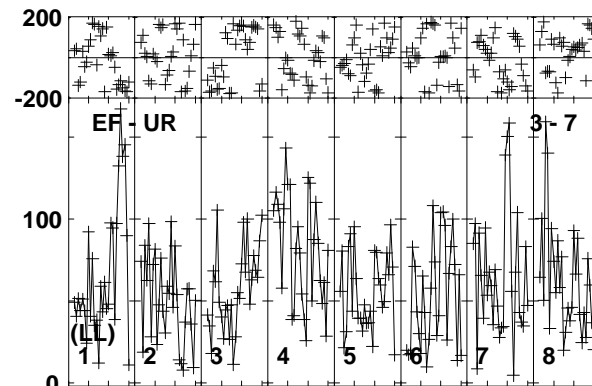
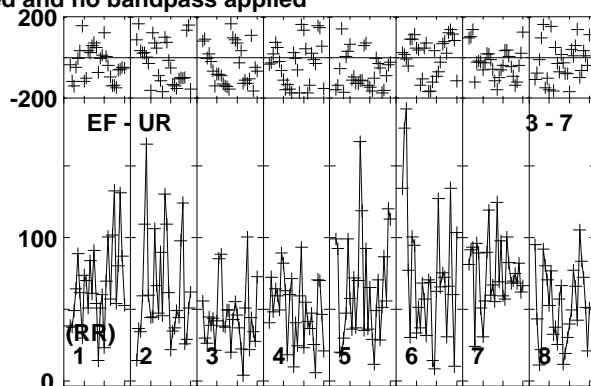
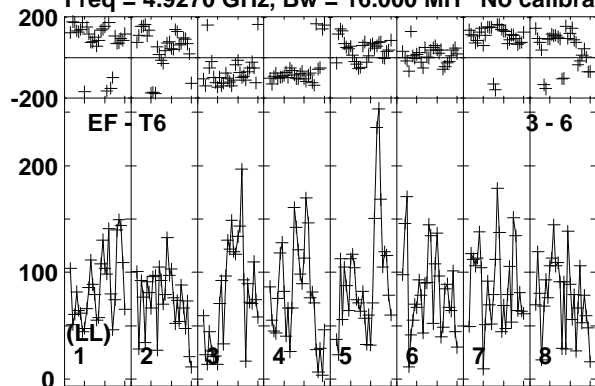

Lower frame: Micro Ampl Jy Top frame: Phas deg
Vector averaged cross-power spectrum Baseline: EF (03) - T6 (06)
Timerange: 00/06:31:23 to 00/06:35:19

Plot file version 351 created 17-FEB-2020 15:43:12

J1402+5347 EK047 2.UVDATA.1

Freq = 4.9270 GHz, Bw = 16.000 MH No calibration applied and no bandpass applied

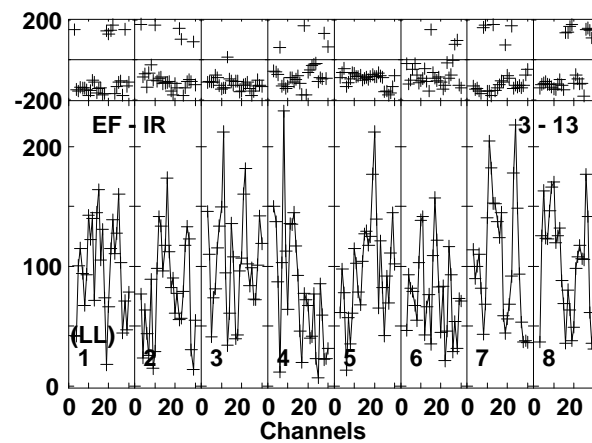
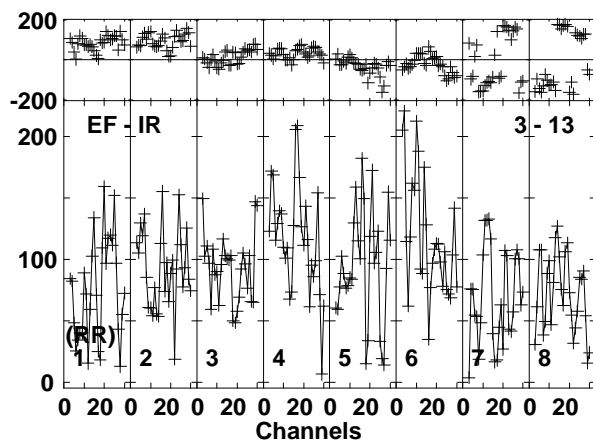
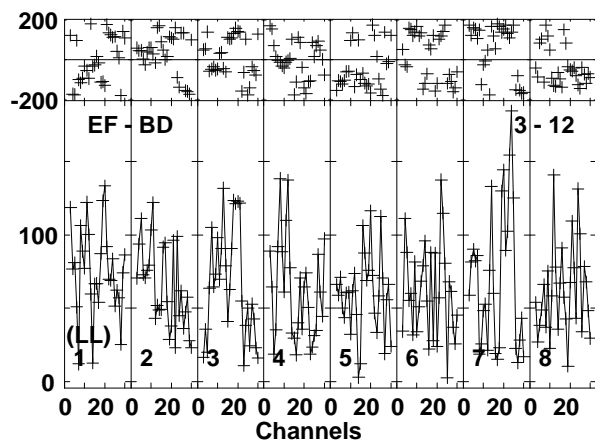
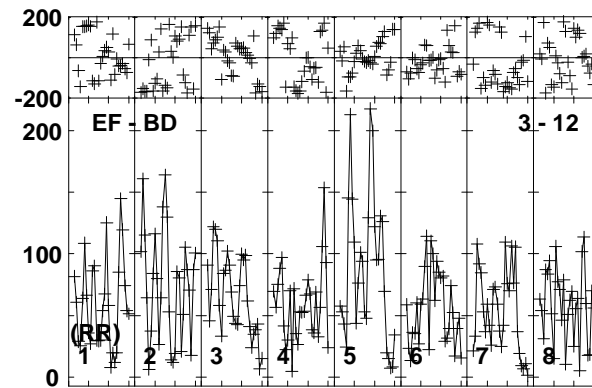
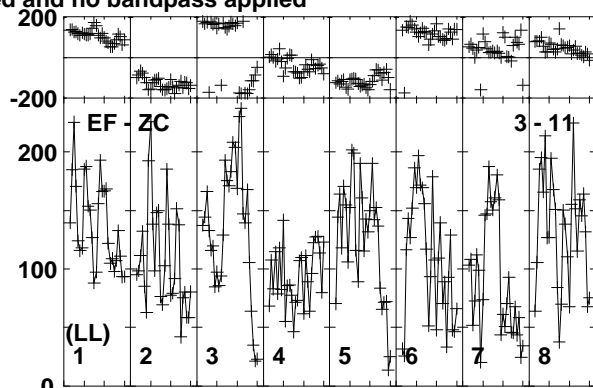
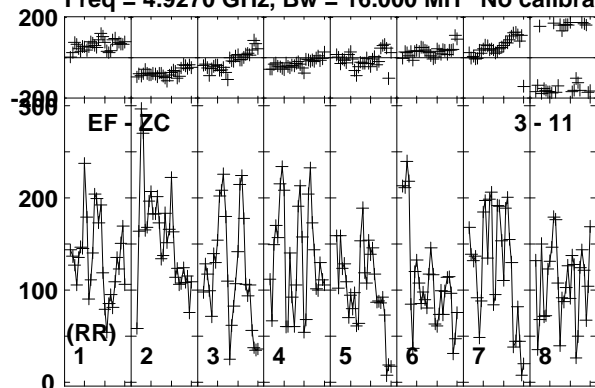

Lower frame: Micro Ampl Jy Top frame: Phas deg
Vector averaged cross-power spectrum Baseline: EF (03) - ZC (11)
Timerange: 00/06:31:23 to 00/06:35:19

Plot file version 352 created 17-FEB-2020 15:43:12

J1359+5544 EK047 2.UVDATA.1

Freq = 4.9270 GHz, Bw = 16.000 MH No calibration applied and no bandpass applied

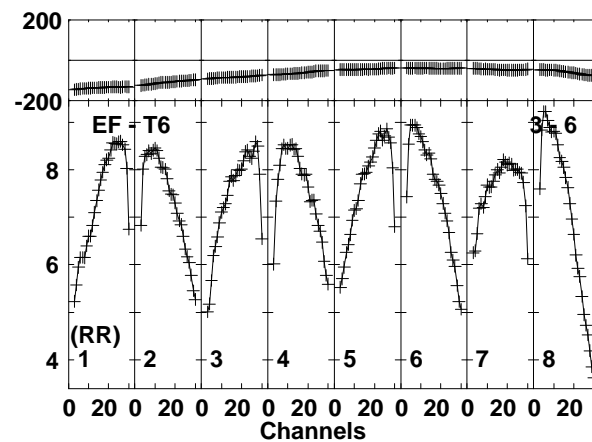
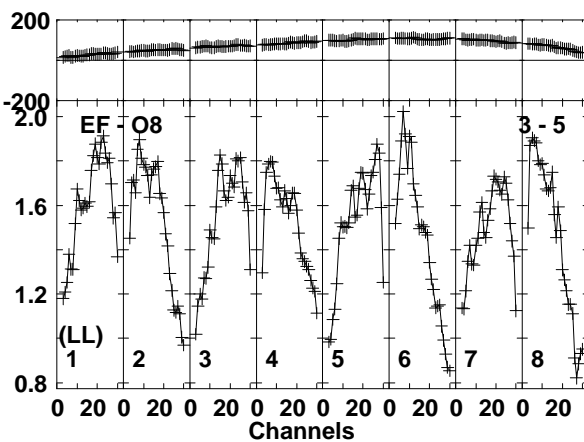
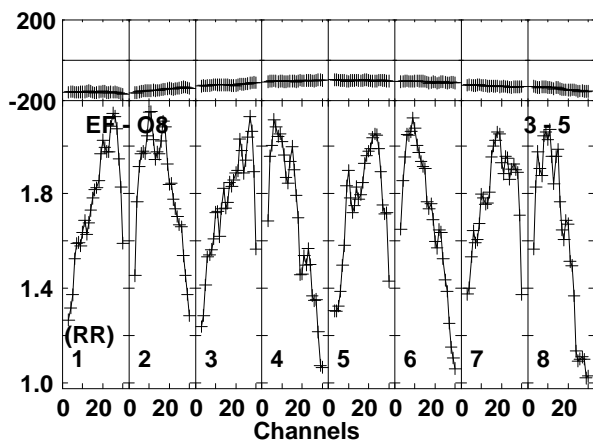
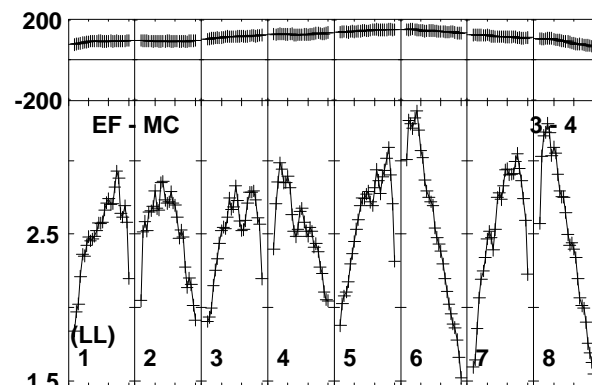
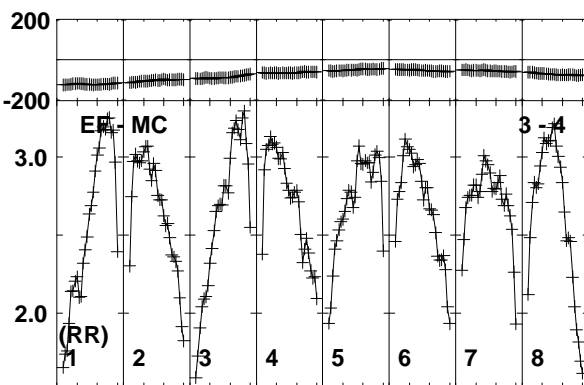
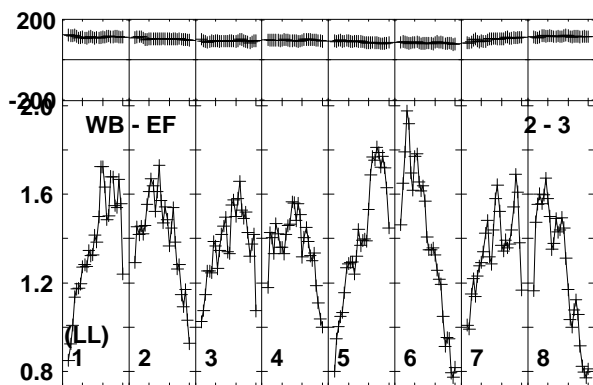
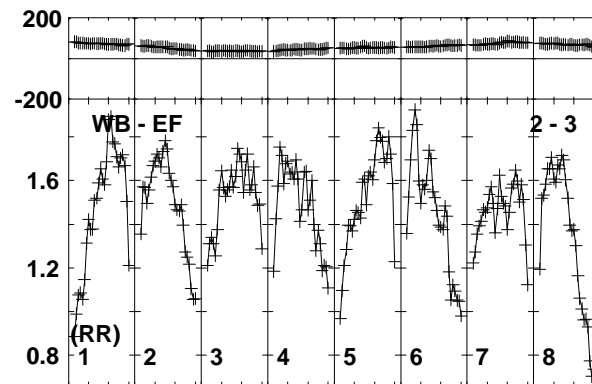
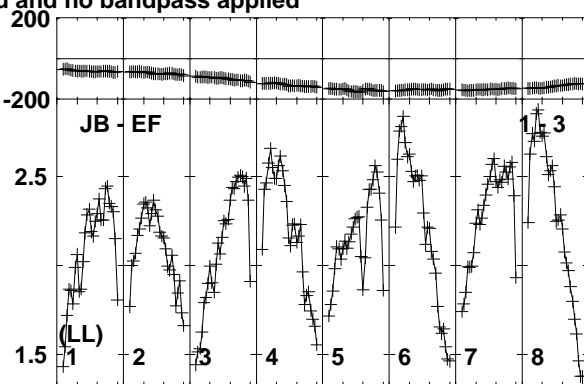
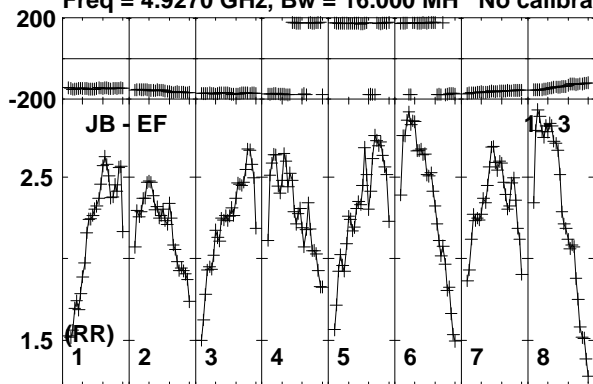

Lower frame: Milli Ampl Jy Top frame: Phas deg
Vector averaged cross-power spectrum Baseline: JB (01) - EF (03)
Timerange: 00/06:36:01 to 00/06:37:19

Plot file version 353 created 17-FEB-2020 15:43:12

J1359+5544 EK047 2.UVDATA.1

Freq = 4.9270 GHz, Bw = 16.000 MH No calibration applied and no bandpass applied

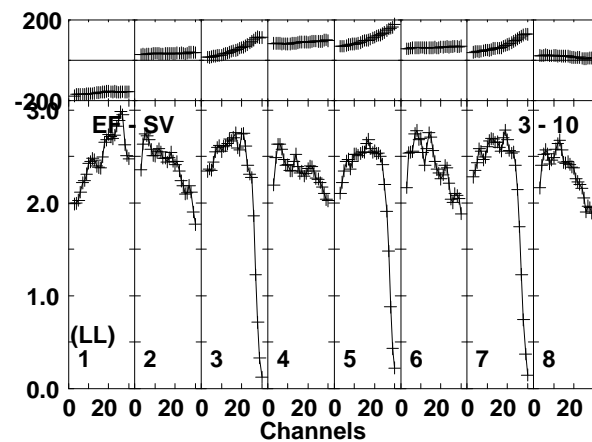
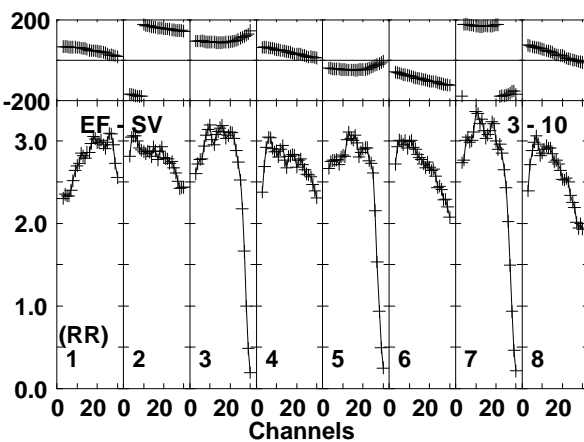
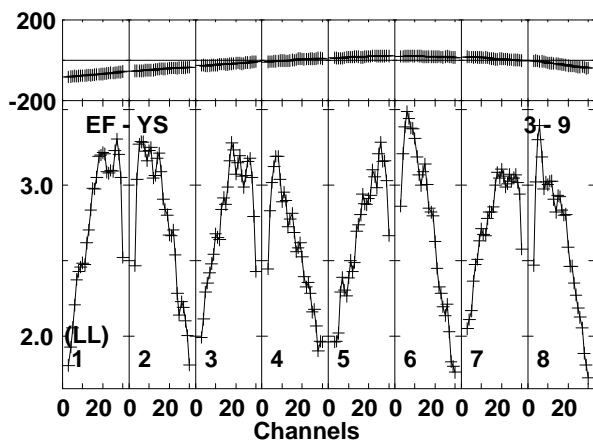
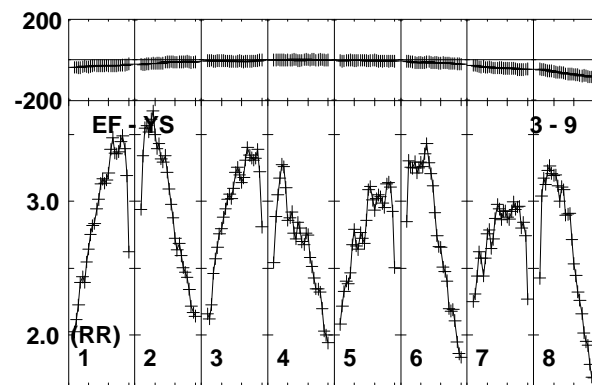
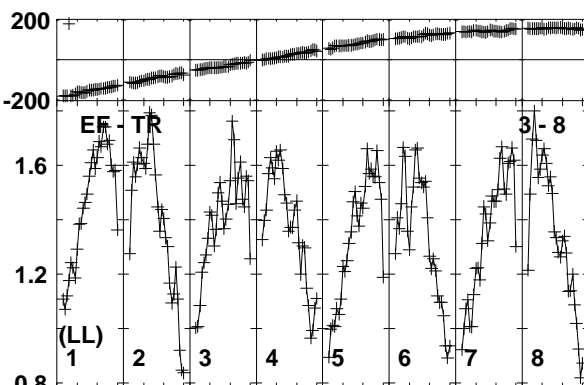
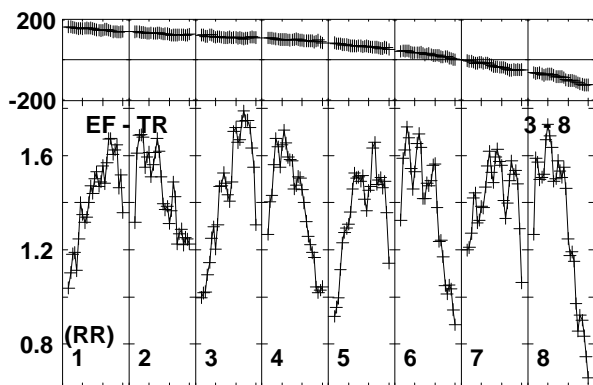
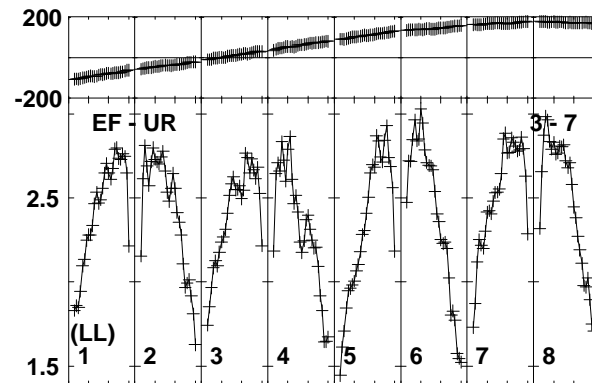
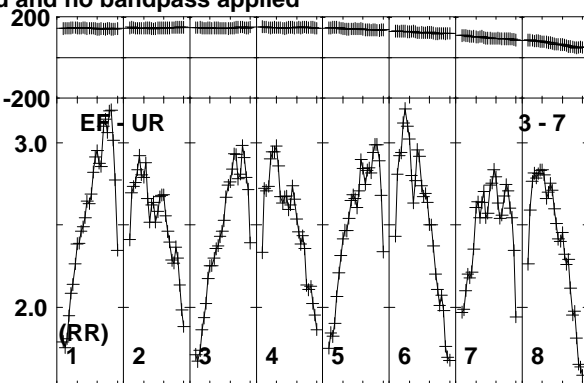
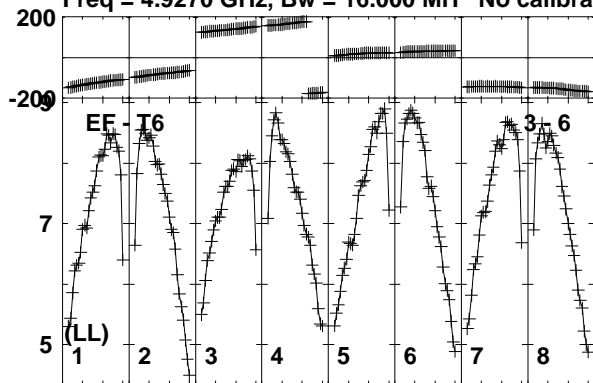

Lower frame: Milli Ampl Jy Top frame: Phas deg
Vector averaged cross-power spectrum Baseline: EF (03) - T6 (06)
Timerange: 00/06:36:01 to 00/06:37:19

Plot file version 354 created 17-FEB-2020 15:43:12

J1359+5544 EK047 2.UVDATA.1

Freq = 4.9270 GHz, Bw = 16.000 MH No calibration applied and no bandpass applied

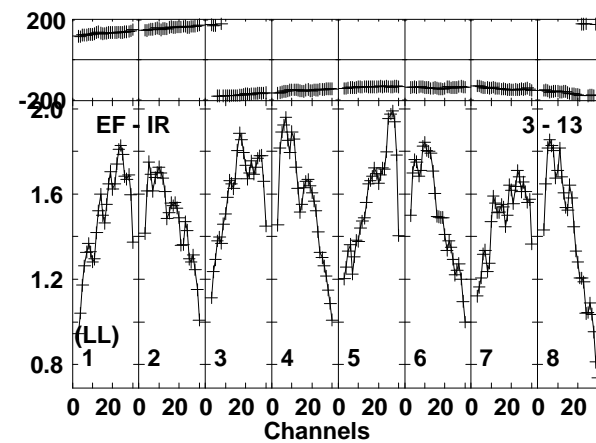
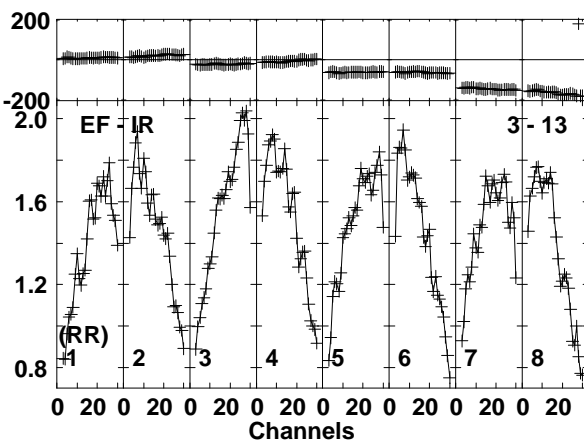
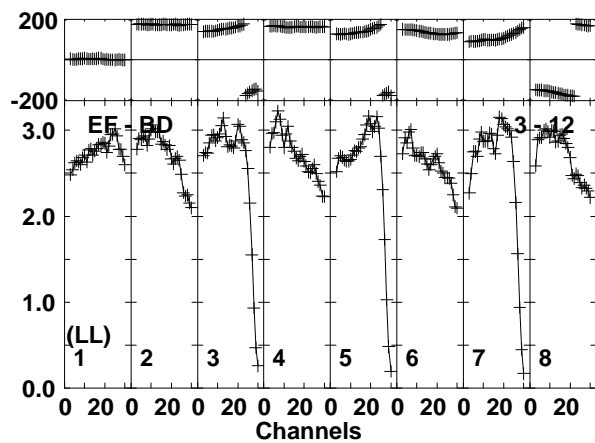
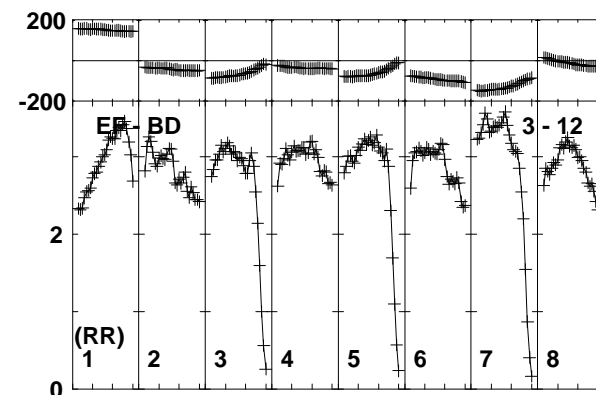
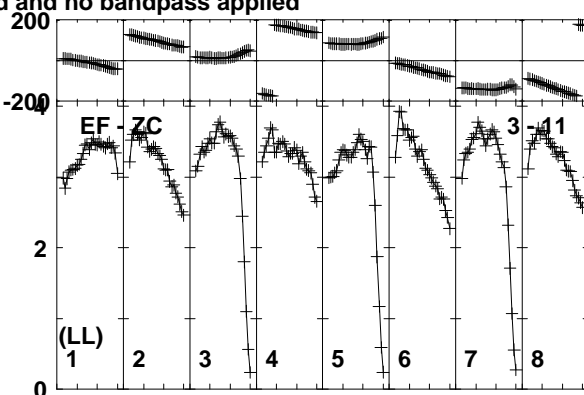
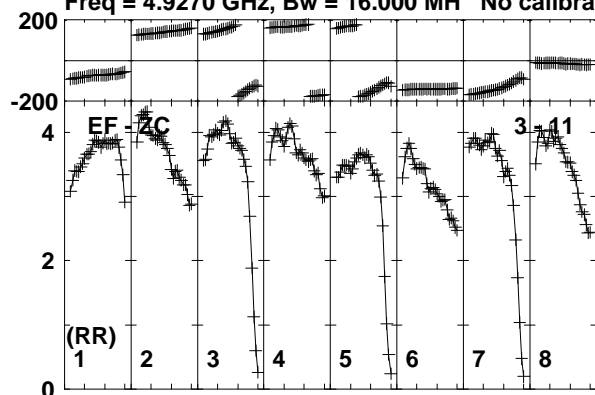

Lower frame: Milli Ampl Jy Top frame: Phas deg
Vector averaged cross-power spectrum Baseline: EF (03) - ZC (11)
Timerange: 00/06:36:01 to 00/06:37:19

Plot file version 355 created 17-FEB-2020 15:43:12

J1402+5347 EK047 2.UVDATA.1

Freq = 4.9270 GHz, Bw = 16.000 MH No calibration applied and no bandpass applied

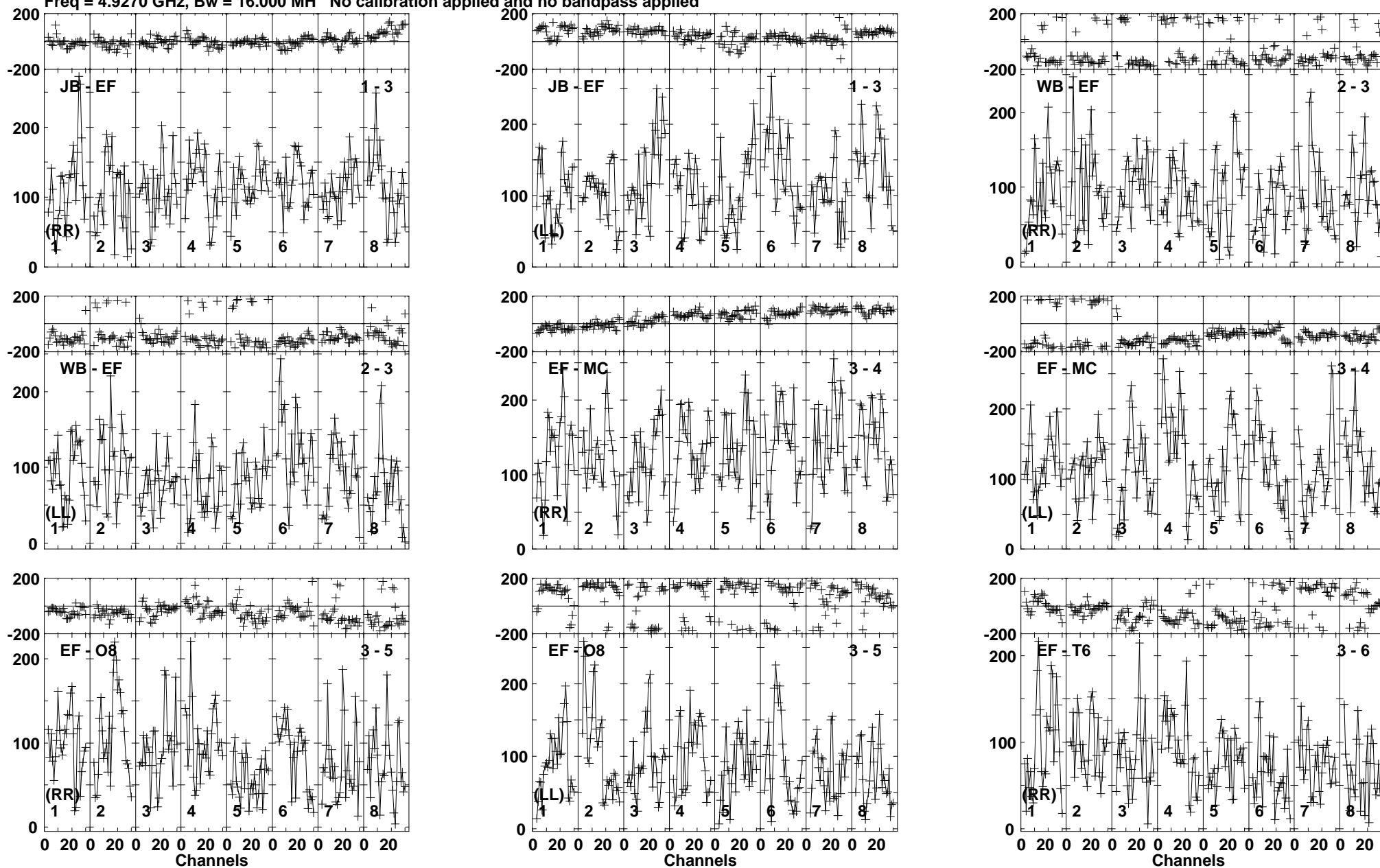

Lower frame: Micro Ampl Jy Top frame: Phas deg
Vector averaged cross-power spectrum Baseline: JB (01) - EF (03)
Timerange: 00/06:37:21 to 00/06:41:19

Plot file version 356 created 17-FEB-2020 15:43:12

J1402+5347 EK047 2.UVDATA.1

Freq = 4.9270 GHz, Bw = 16.000 MH No calibration applied and no bandpass applied

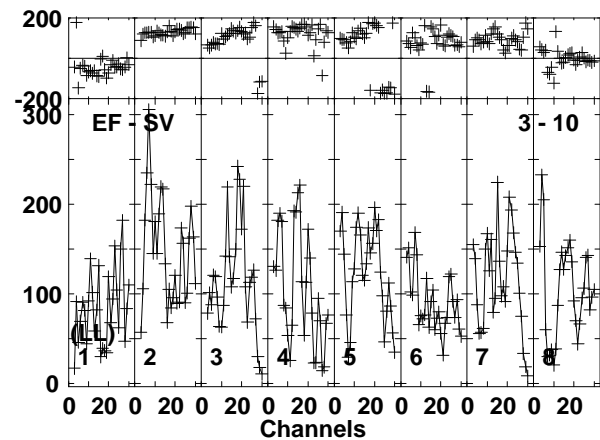
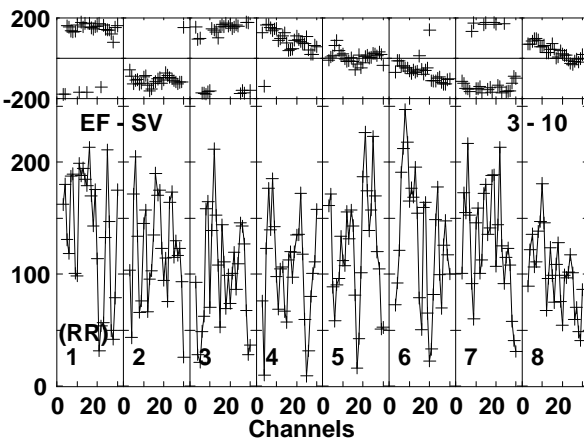
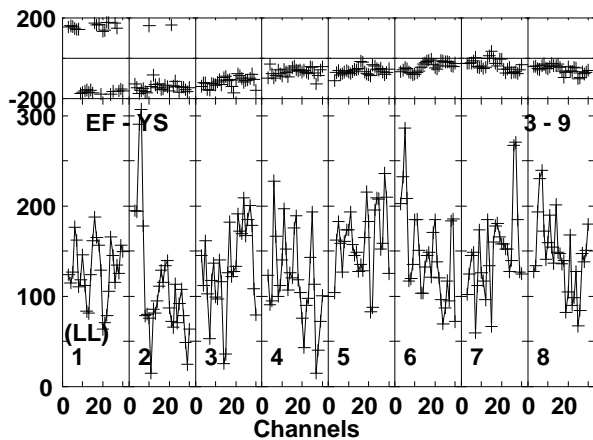
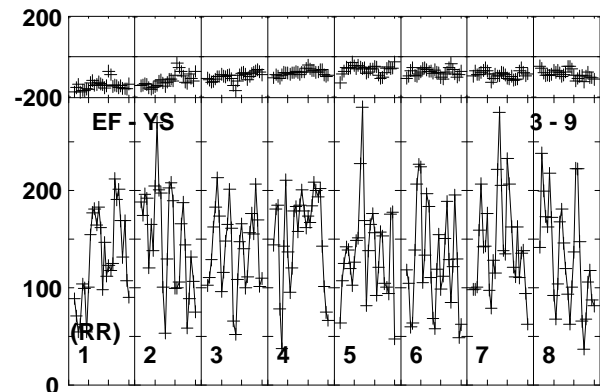
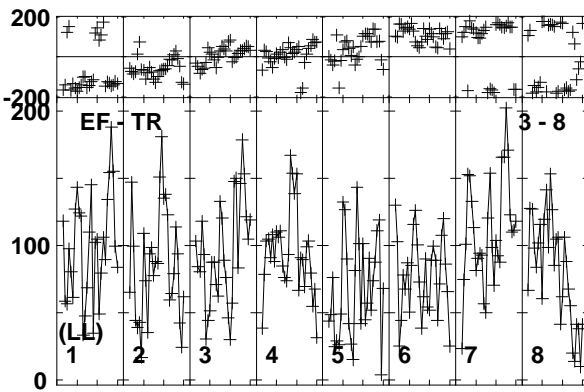
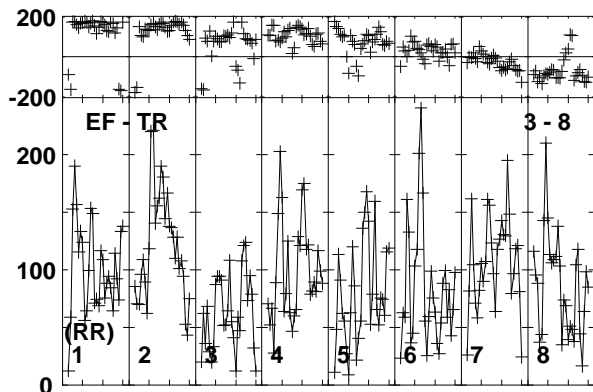
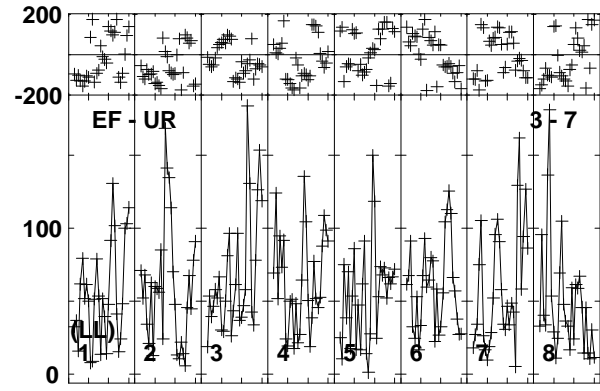
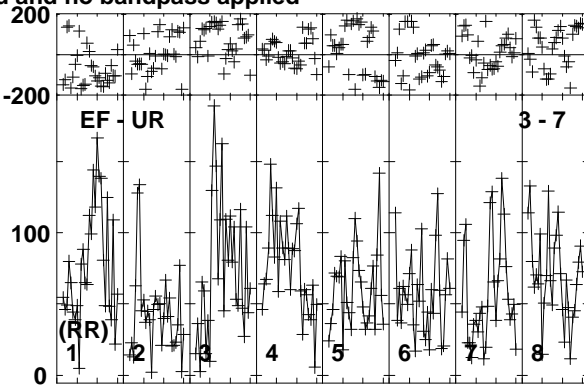
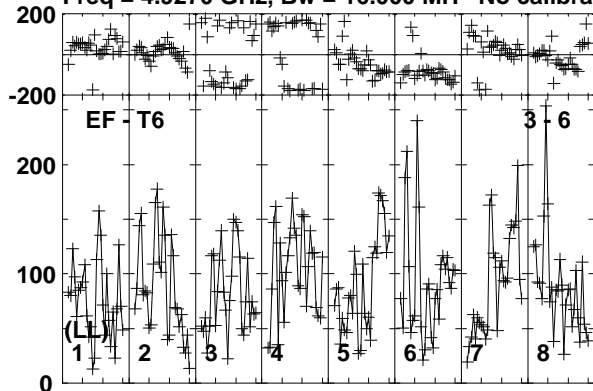

Lower frame: Micro Ampl Jy Top frame: Phas deg
Vector averaged cross-power spectrum Baseline: EF (03) - T6 (06)
Timerange: 00/06:37:21 to 00/06:41:19

Plot file version 357 created 17-FEB-2020 15:43:12

J1402+5347 EK047 2.UVDATA.1

Freq = 4.9270 GHz, Bw = 16.000 MH No calibration applied and no bandpass applied

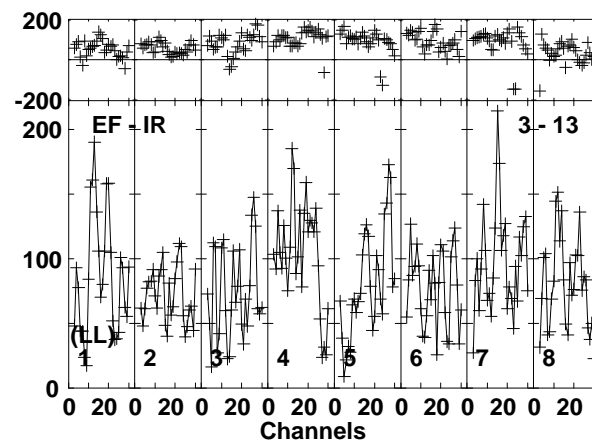
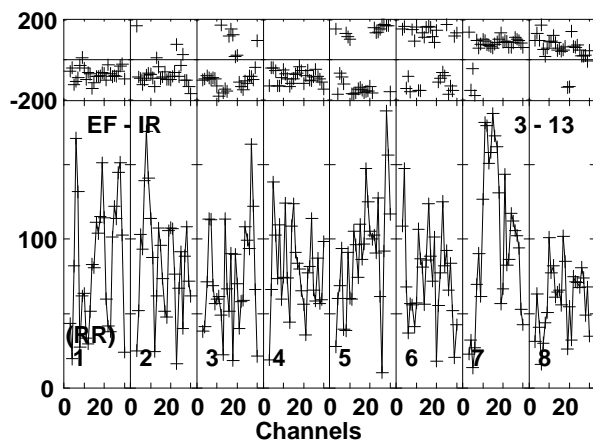
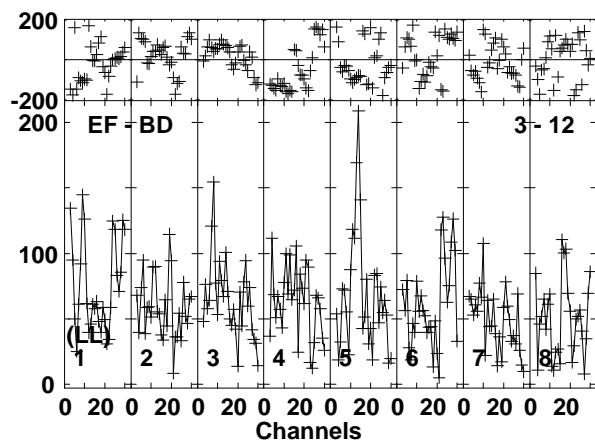
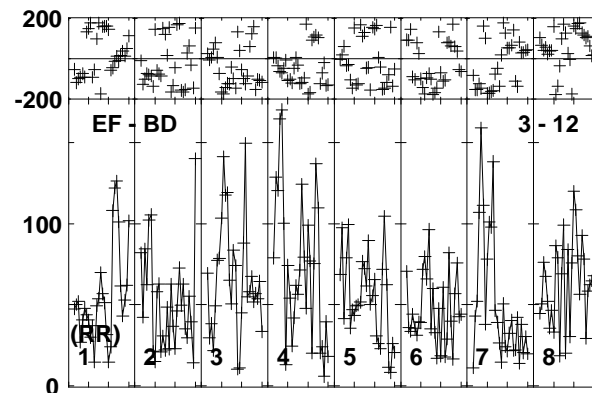
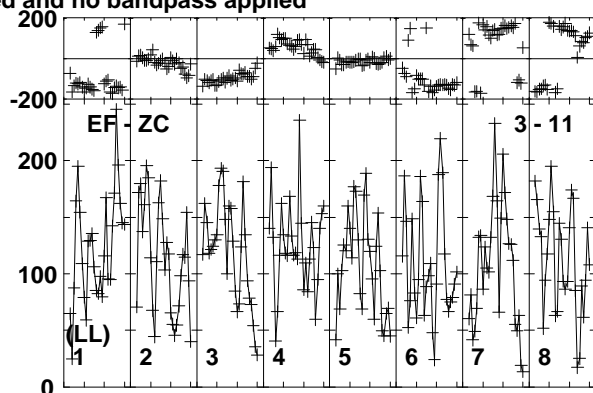
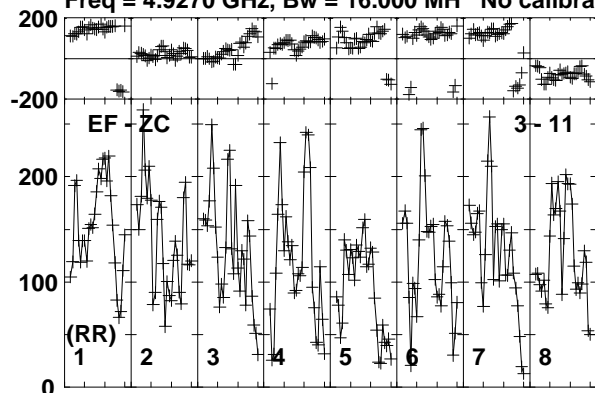

Lower frame: Micro Ampl Jy Top frame: Phas deg
Vector averaged cross-power spectrum Baseline: EF (03) - ZC (11)
Timerange: 00/06:37:21 to 00/06:41:19

Plot file version 358 created 17-FEB-2020 15:43:13

J1359+5544 EK047 2.UVDATA.1

Freq = 4.9270 GHz, Bw = 16.000 MH No calibration applied and no bandpass applied

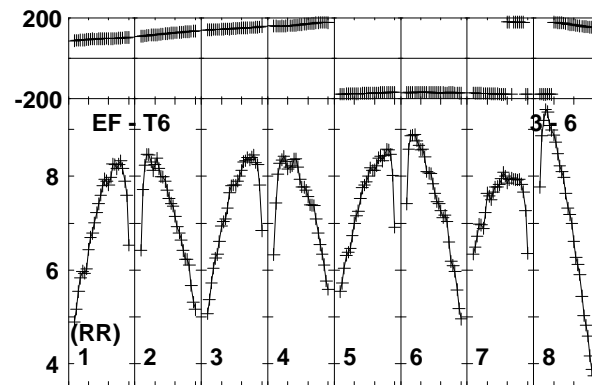
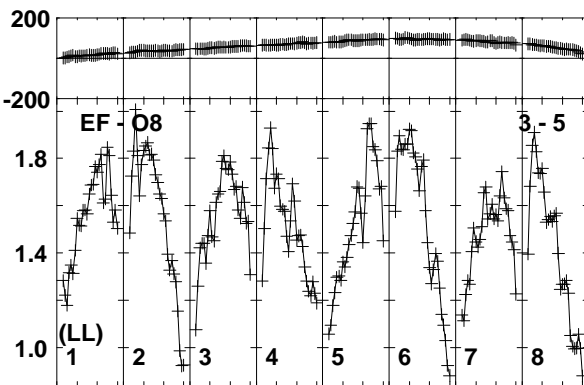
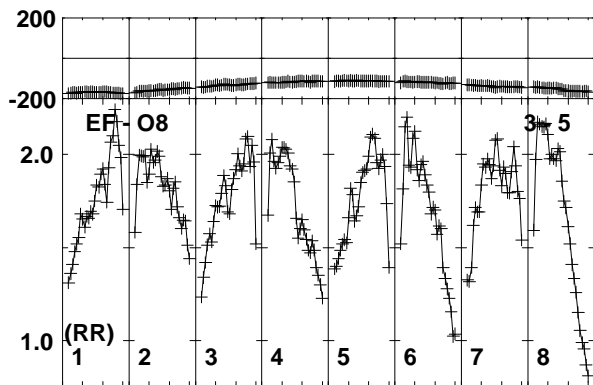
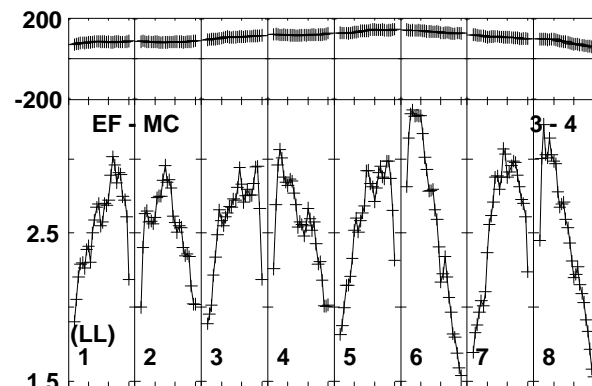
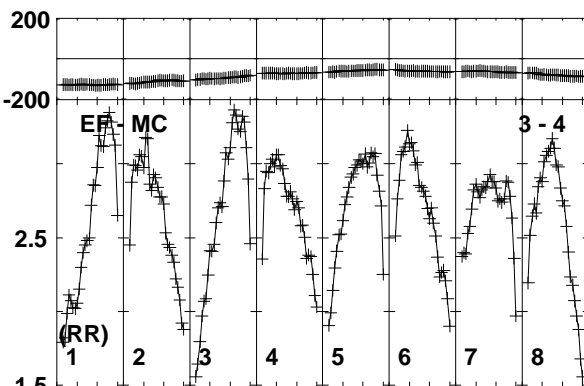
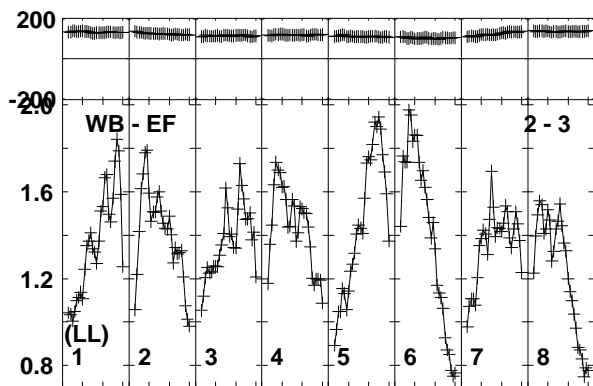
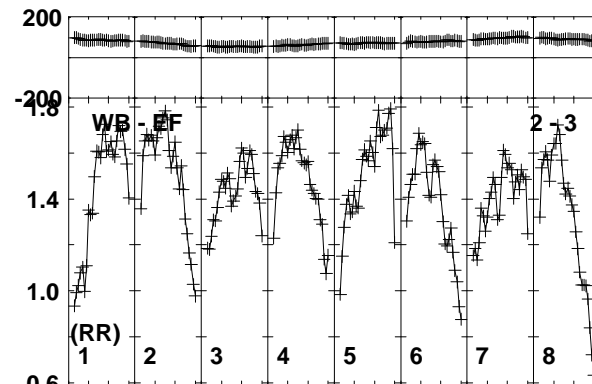
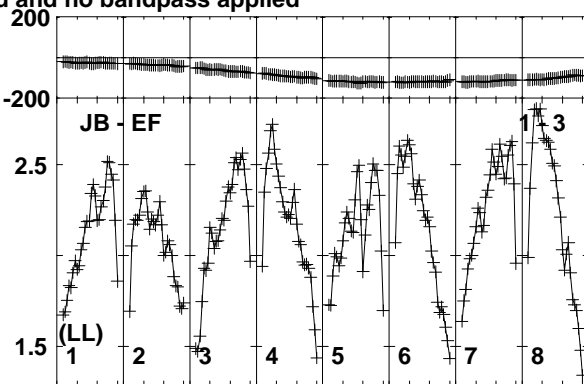
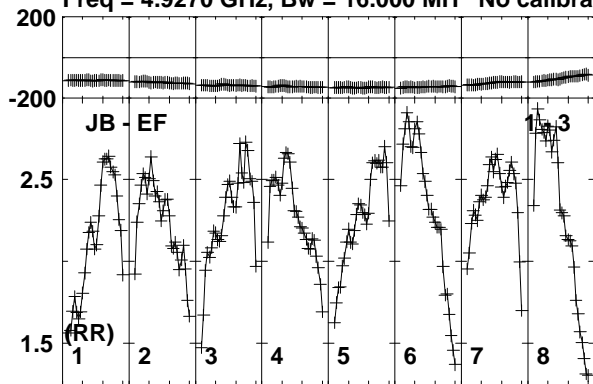

Lower frame: Milli Ampl Jy Top frame: Phas deg

Vector averaged cross-power spectrum Baseline: JB (01) - EF (03)

Timerange: 00/06:41:21 to 00/06:43:19

Plot file version 359 created 17-FEB-2020 15:43:13

J1359+5544 EK047 2.UVDATA.1

Freq = 4.9270 GHz, Bw = 16.000 MH No calibration applied and no bandpass applied

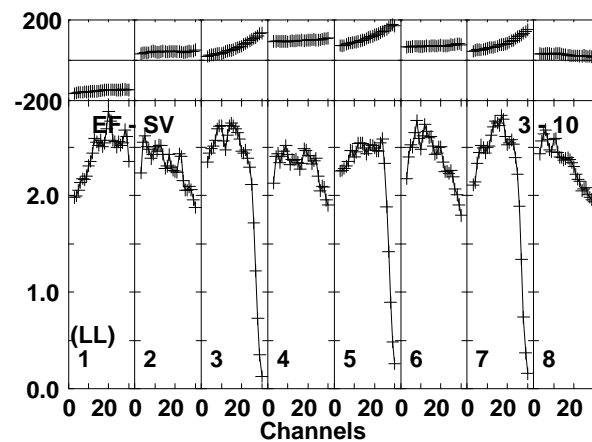
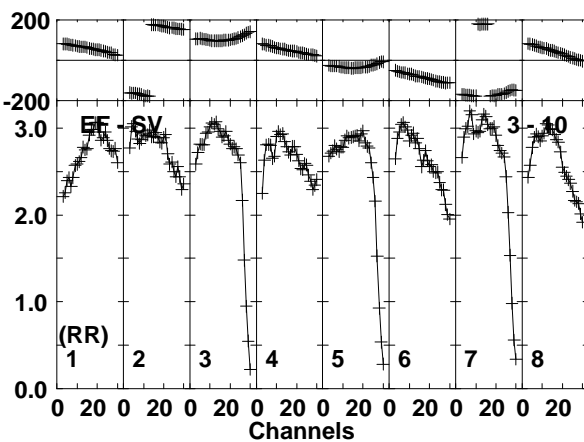
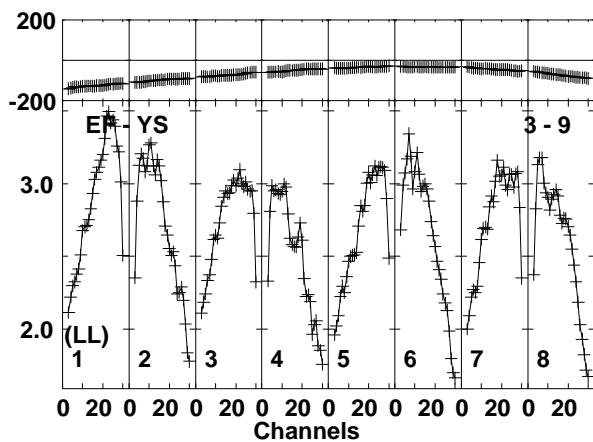
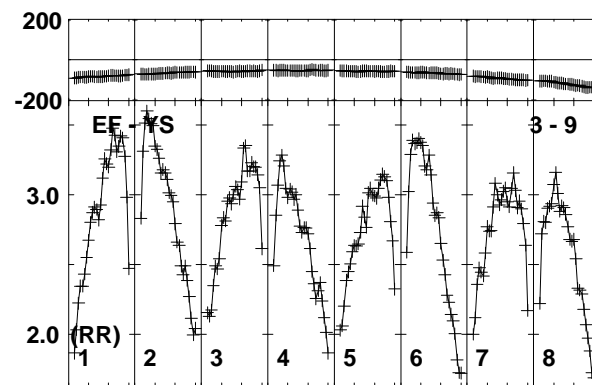
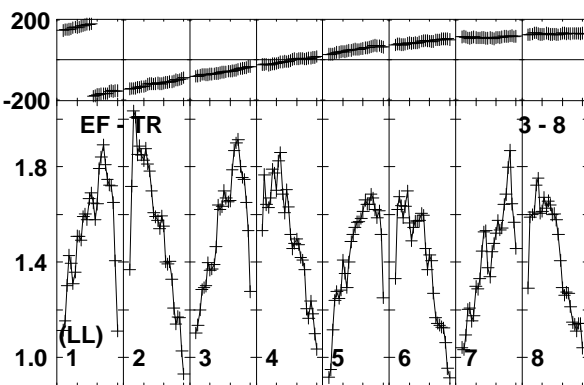
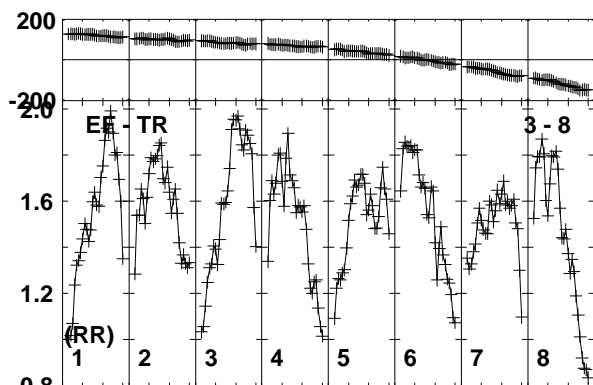
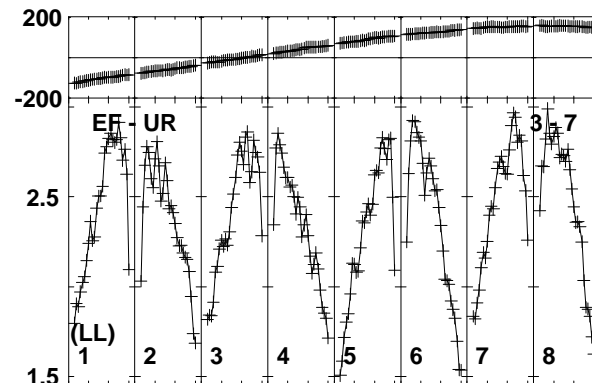
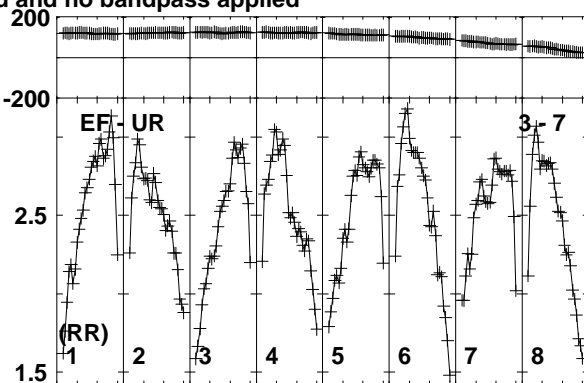
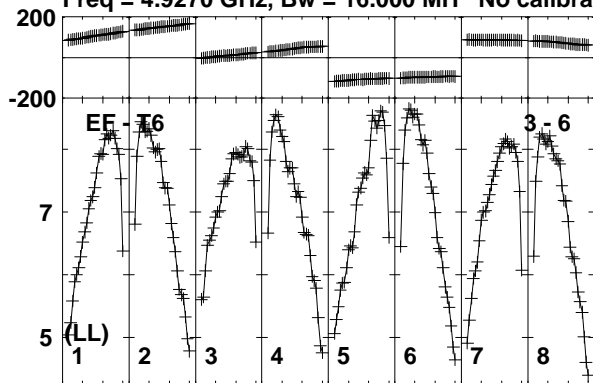

Lower frame: Milli Ampl Jy Top frame: Phas deg
Vector averaged cross-power spectrum Baseline: EF (03) - T6 (06)
Timerange: 00/06:41:21 to 00/06:43:19

Plot file version 360 created 17-FEB-2020 15:43:13

J1359+5544 EK047 2.UVDATA.1

Freq = 4.9270 GHz, Bw = 16.000 MH No calibration applied and no bandpass applied

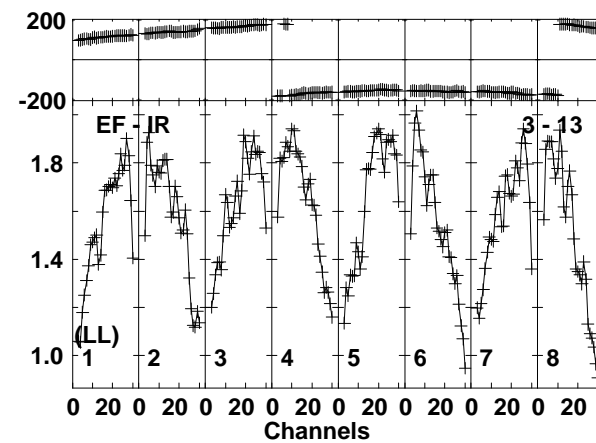
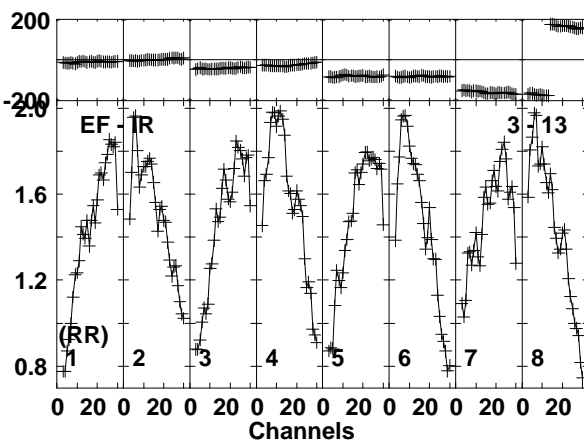
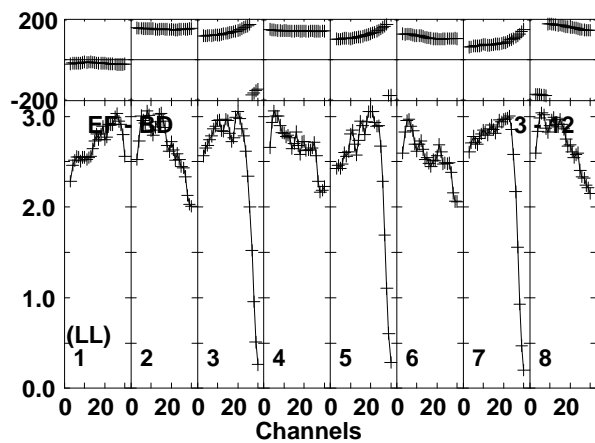
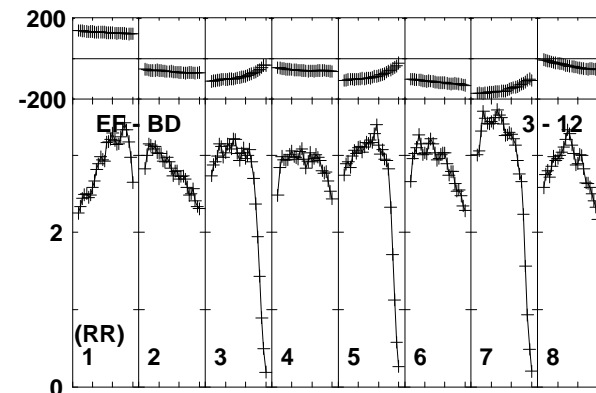
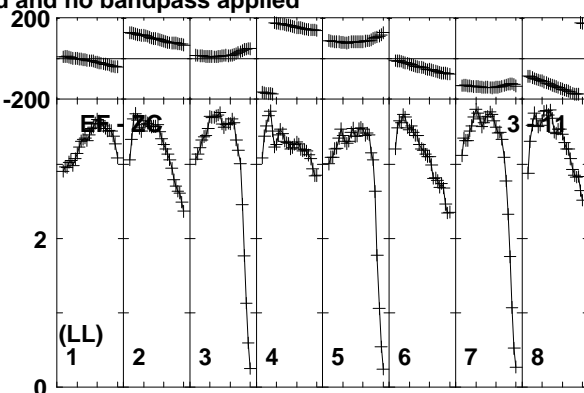
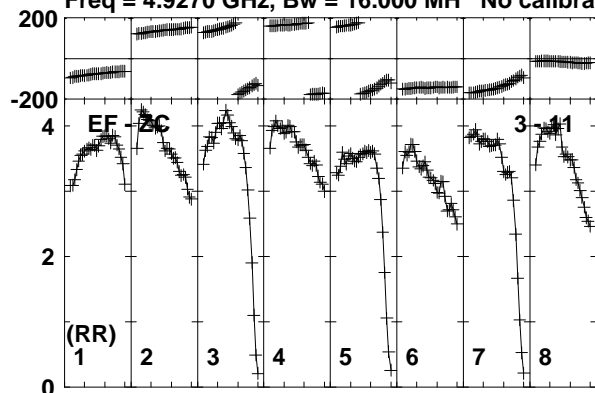

Lower frame: Milli Ampl Jy Top frame: Phas deg
Vector averaged cross-power spectrum Baseline: EF (03) - ZC (11)
Timerange: 00/06:41:21 to 00/06:43:19

Plot file version 361 created 17-FEB-2020 15:43:13

J1402+5347 EK047 2.UVDATA.1

Freq = 4.9270 GHz, Bw = 16.000 MH No calibration applied and no bandpass applied

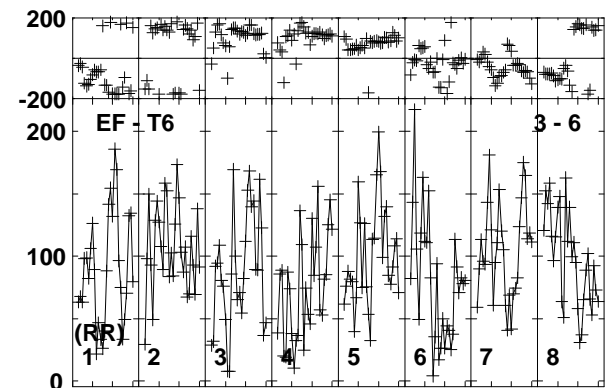
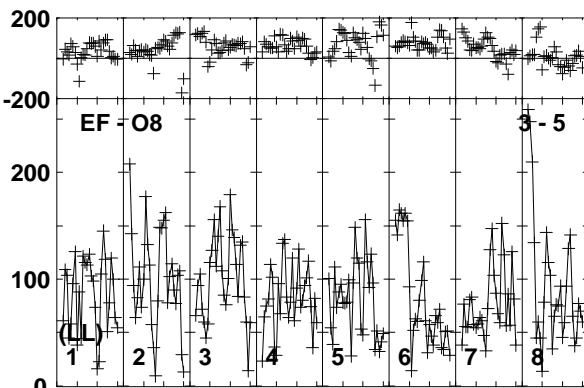
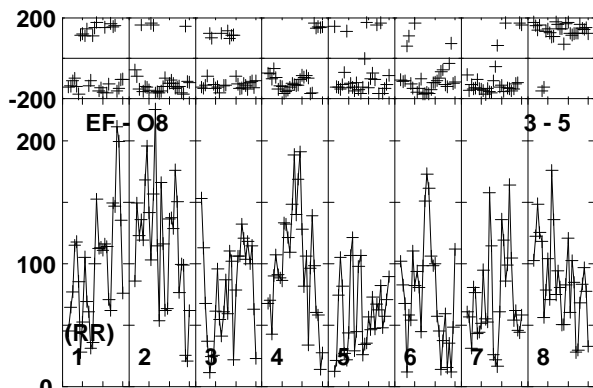
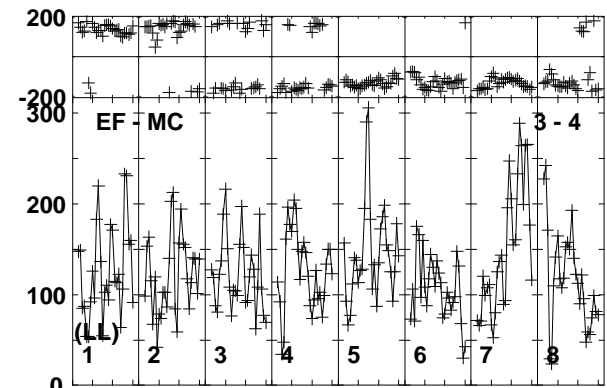
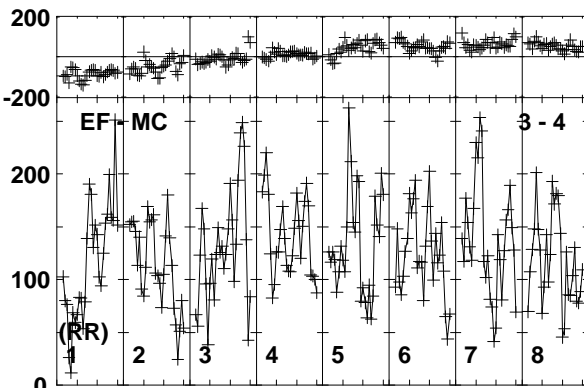
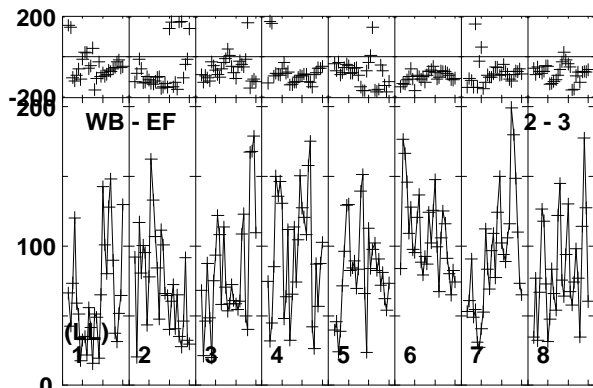
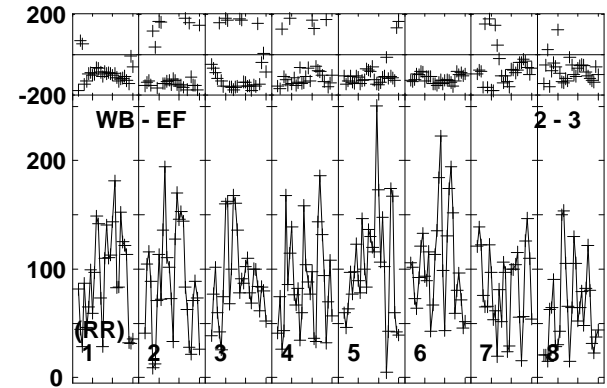
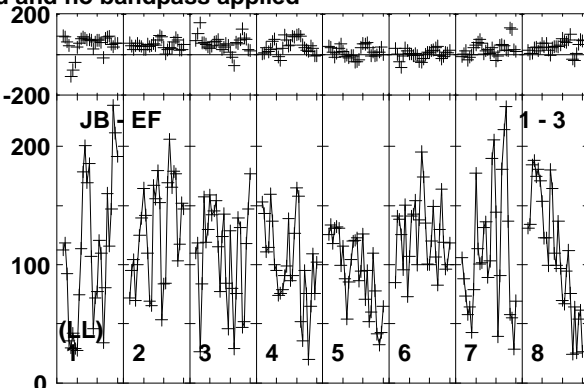
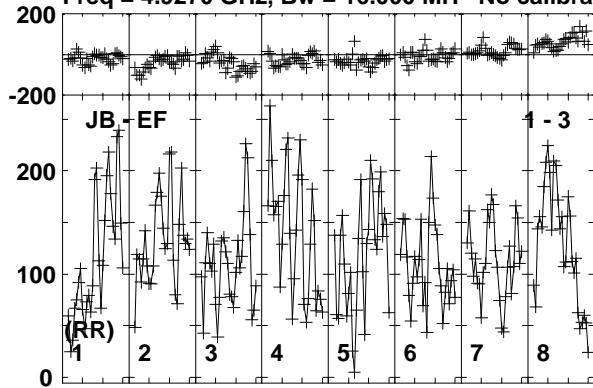

Lower frame: Micro Ampl Jy Top frame: Phas deg
Vector averaged cross-power spectrum Baseline: JB (01) - EF (03)
Timerange: 00/06:43:23 to 00/06:47:19

Plot file version 362 created 17-FEB-2020 15:43:13

J1402+5347 EK047 2.UVDATA.1

Freq = 4.9270 GHz, Bw = 16.000 MH No calibration applied and no bandpass applied

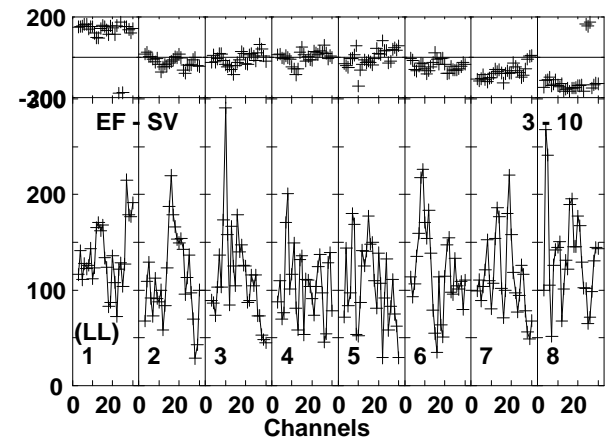
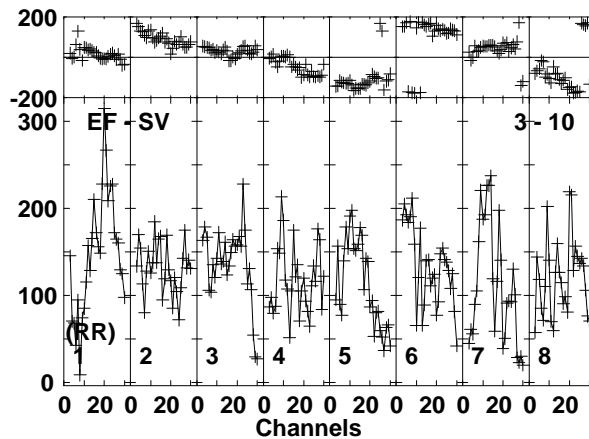
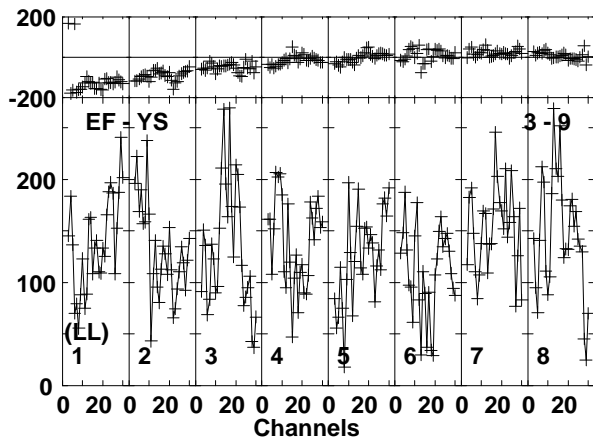
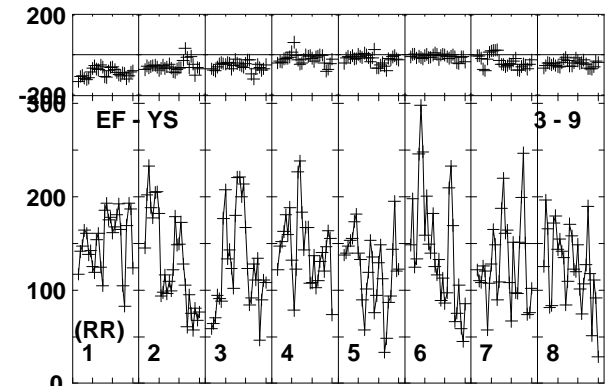
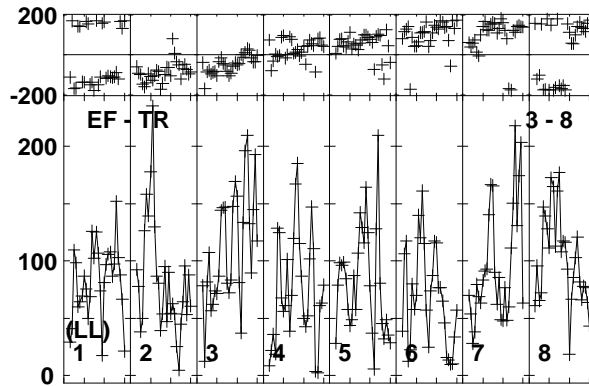
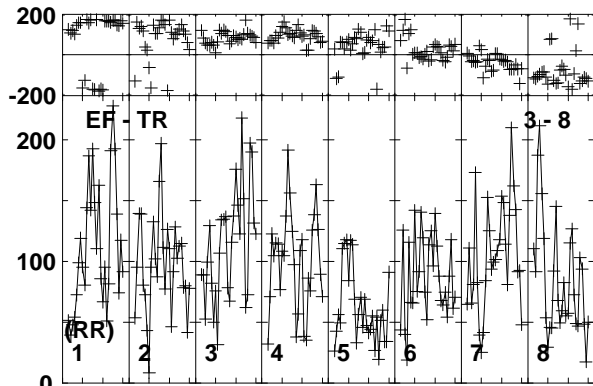
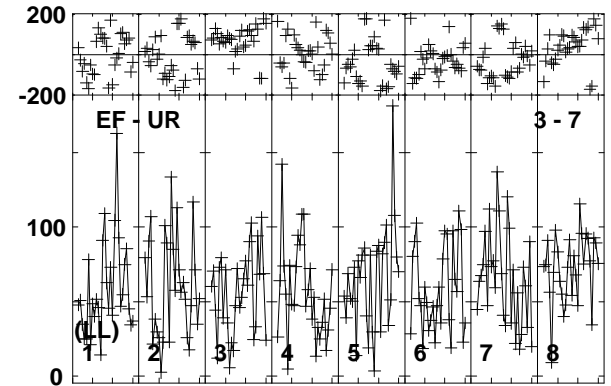
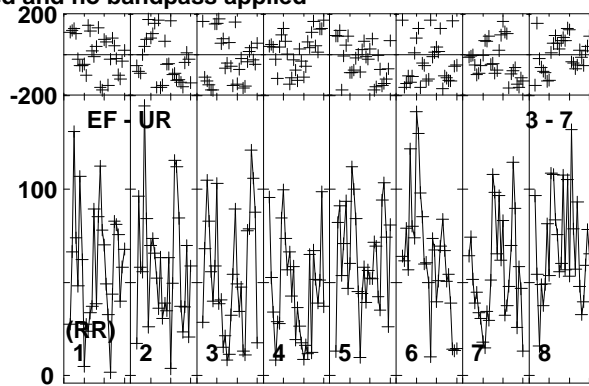
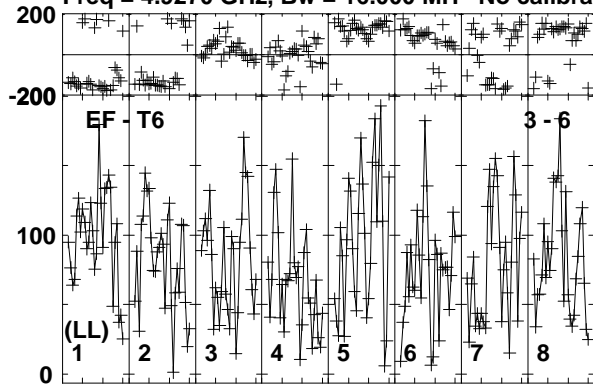

Lower frame: Micro Ampl Jy Top frame: Phas deg
Vector averaged cross-power spectrum Baseline: EF (03) - T6 (06)
Timerange: 00/06:43:23 to 00/06:47:19

Plot file version 363 created 17-FEB-2020 15:43:13

J1402+5347 EK047 2.UVDATA.1

Freq = 4.9270 GHz, Bw = 16.000 MH No calibration applied and no bandpass applied

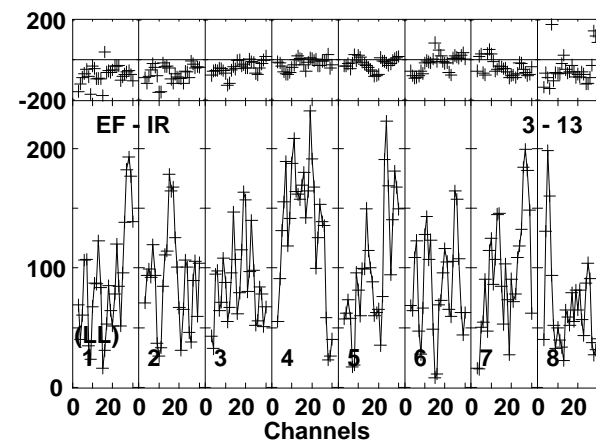
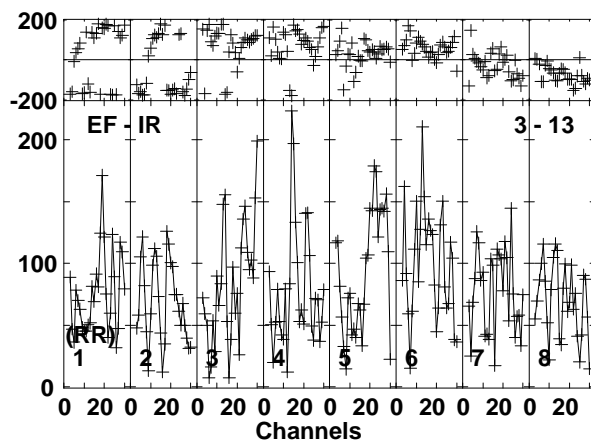
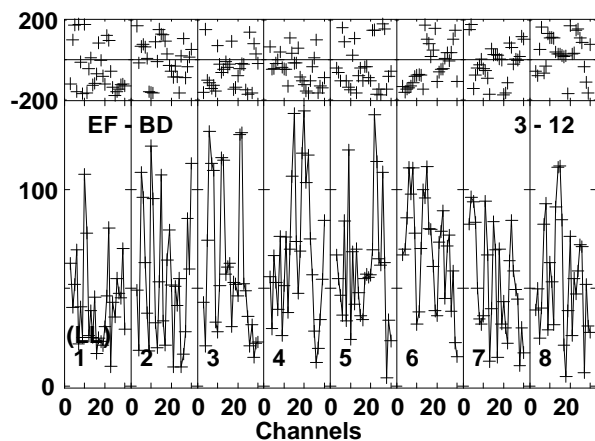
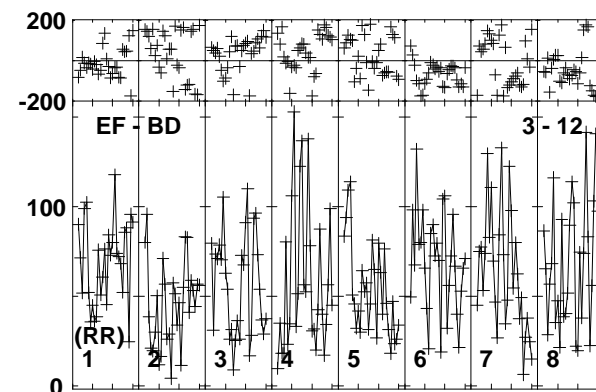
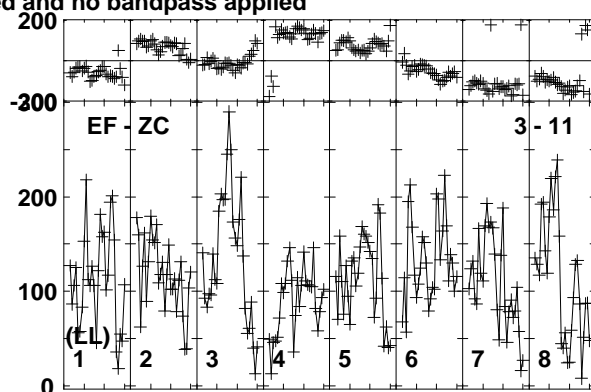
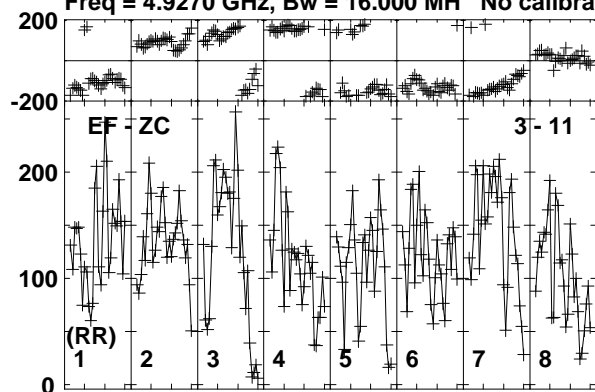

Lower frame: Micro Ampl Jy Top frame: Phas deg
Vector averaged cross-power spectrum Baseline: EF (03) - ZC (11)
Timerange: 00/06:43:23 to 00/06:47:19

Plot file version 364 created 17-FEB-2020 15:43:13

J1359+5544 EK047 2.UVDATA.1

Freq = 4.9270 GHz, Bw = 16.000 MH No calibration applied and no bandpass applied

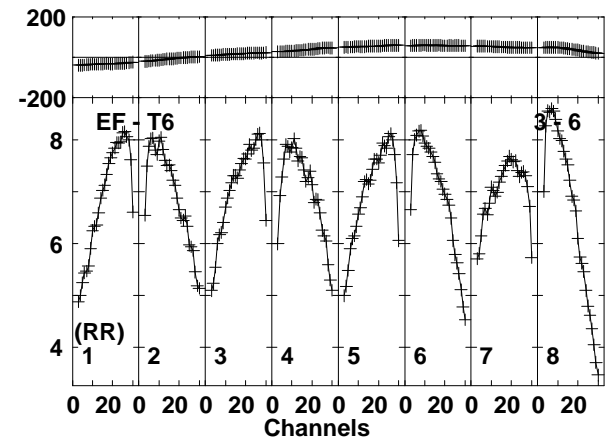
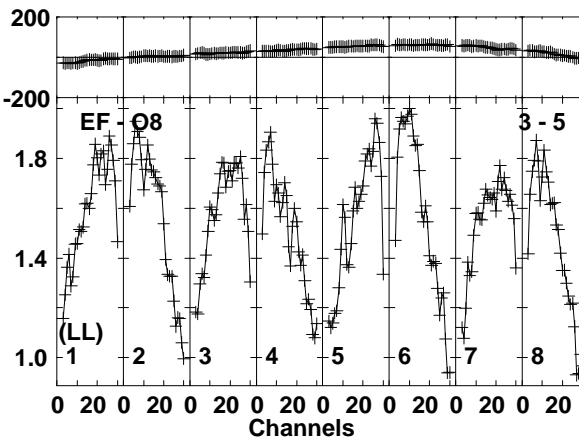
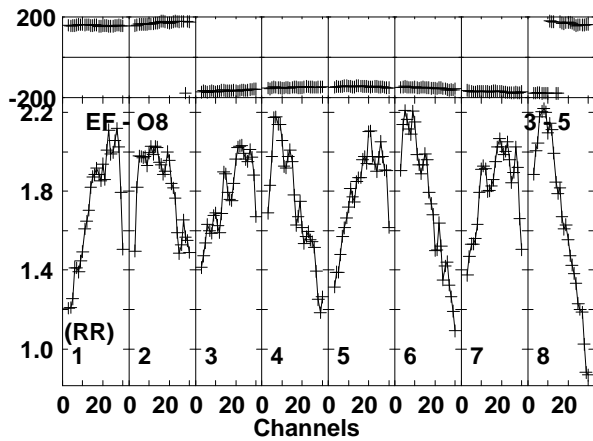
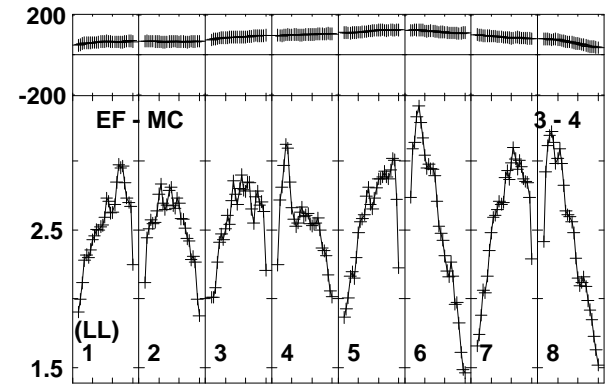
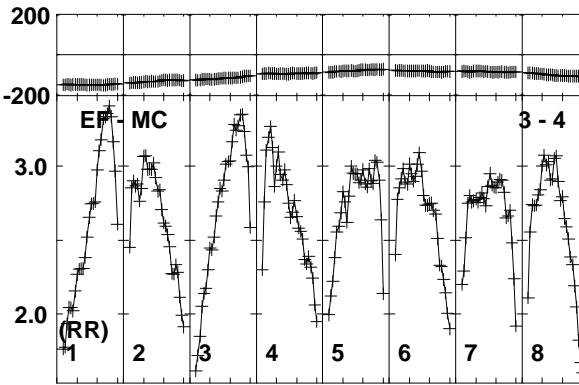
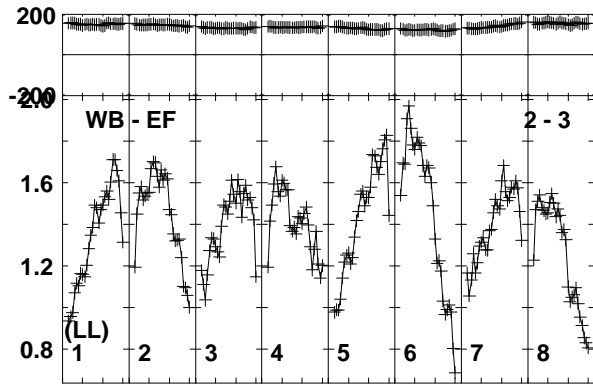
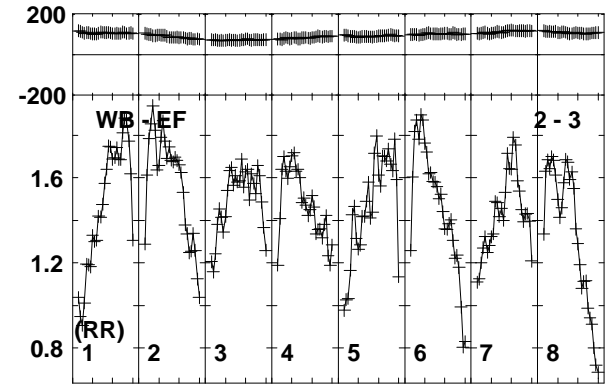
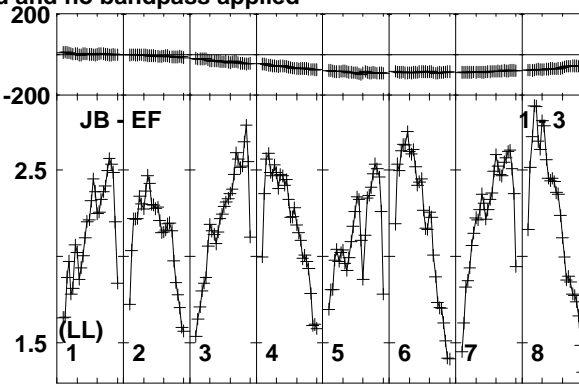
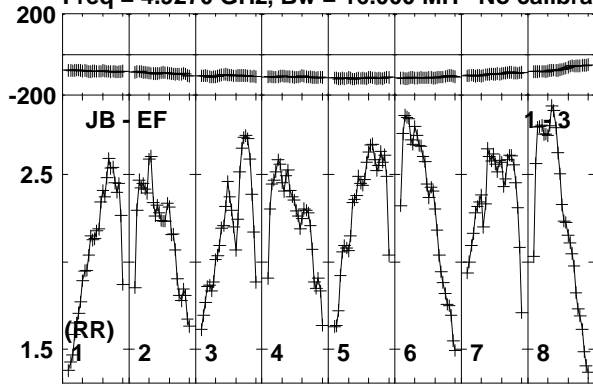

Lower frame: Milli Ampl Jy Top frame: Phas deg
Vector averaged cross-power spectrum Baseline: JB (01) - EF (03)
Timerange: 00/06:48:01 to 00/06:49:19

Plot file version 365 created 17-FEB-2020 15:43:13

J1359+5544 EK047 2.UVDATA.1

Freq = 4.9270 GHz, Bw = 16.000 MH No calibration applied and no bandpass applied

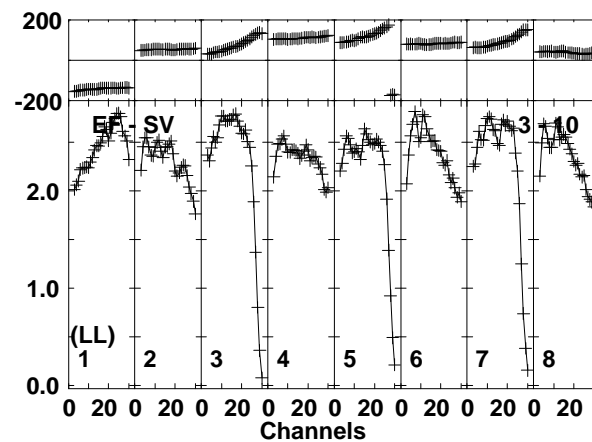
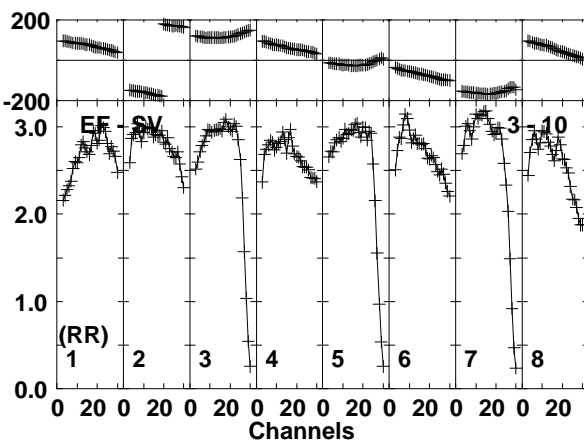
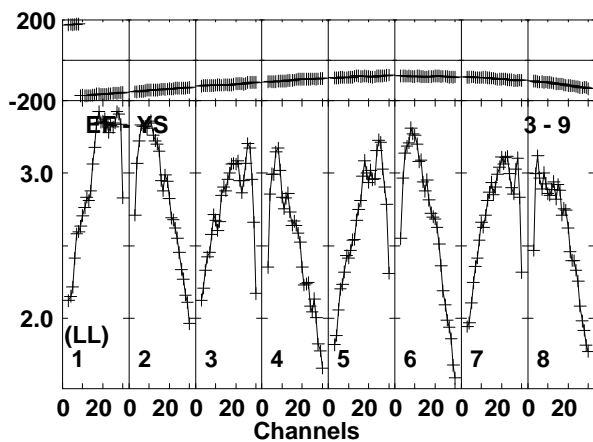
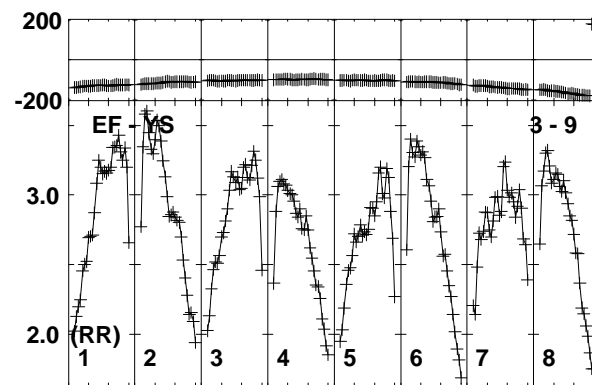
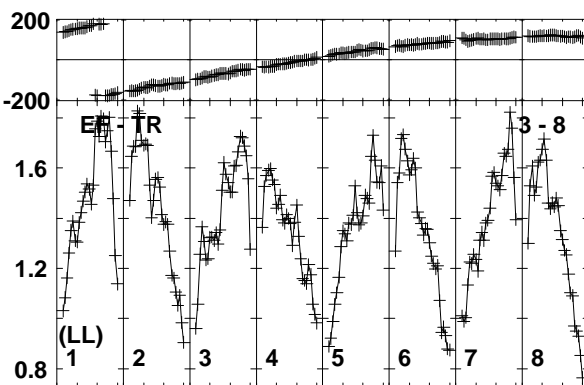
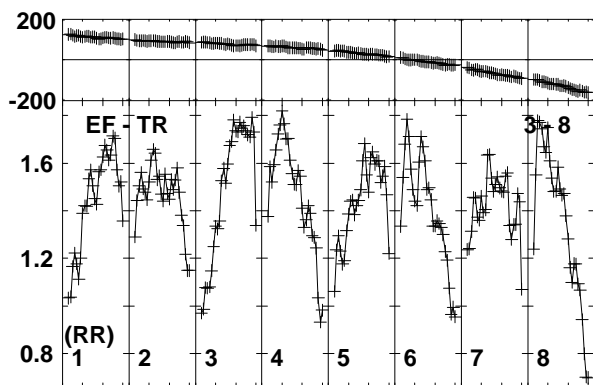
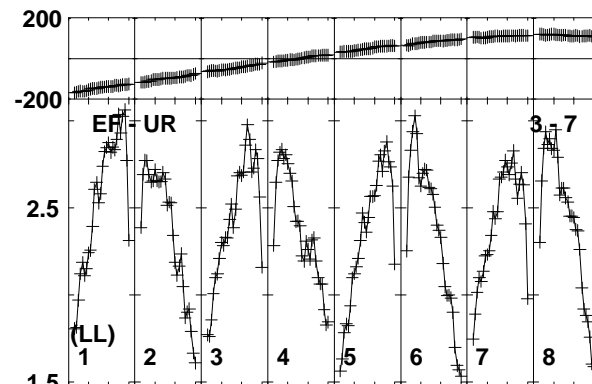
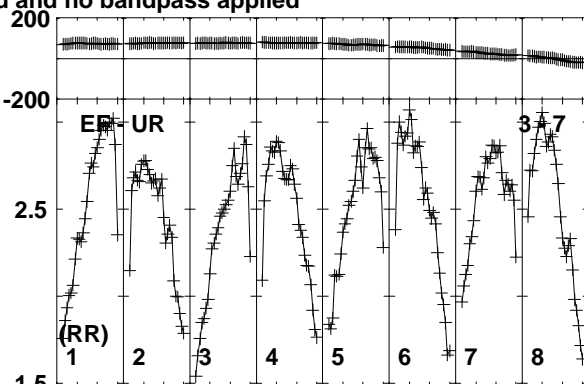
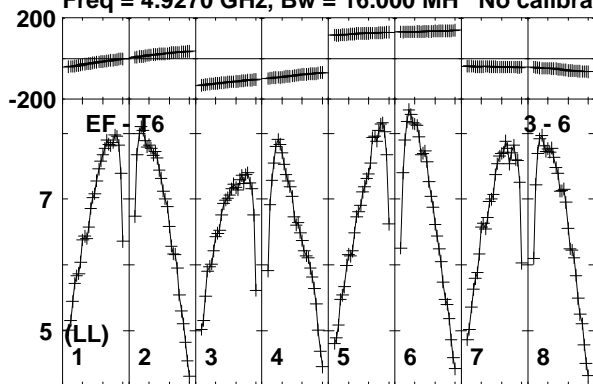

Lower frame: Milli Ampl Jy Top frame: Phas deg
Vector averaged cross-power spectrum Baseline: EF (03) - T6 (06)
Timerange: 00/06:48:01 to 00/06:49:19

Plot file version 366 created 17-FEB-2020 15:43:13

J1359+5544 EK047 2.UVDATA.1

Freq = 4.9270 GHz, Bw = 16.000 MH No calibration applied and no bandpass applied

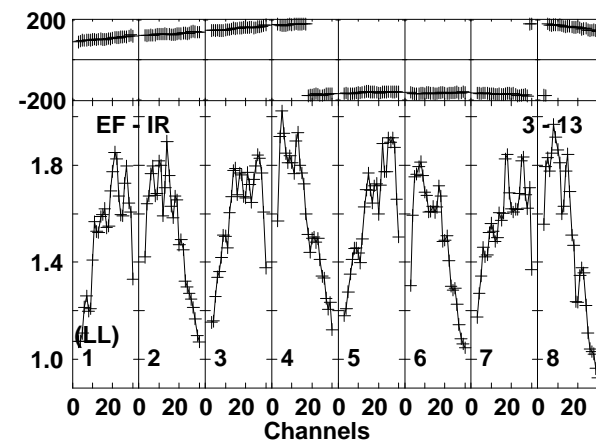
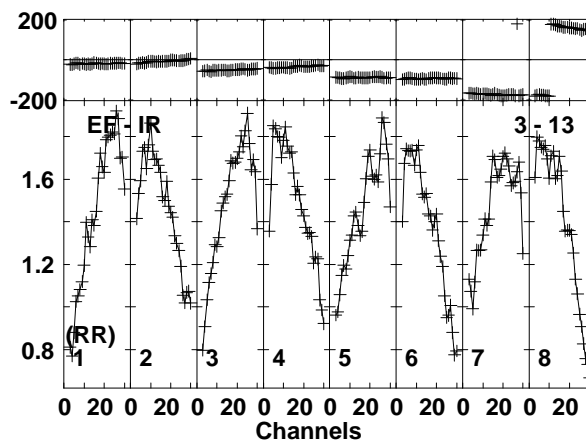
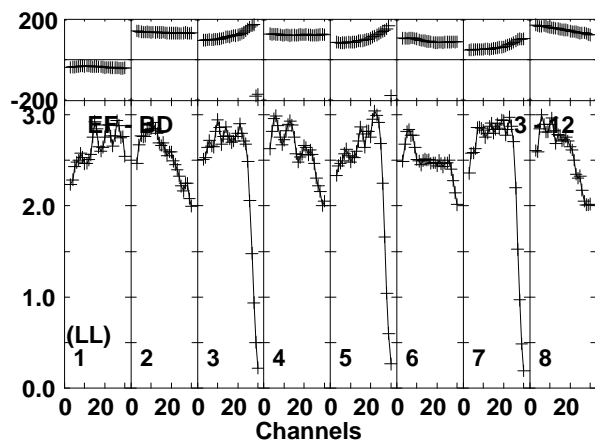
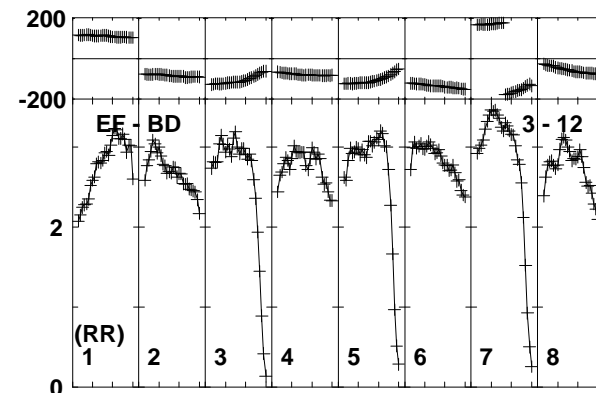
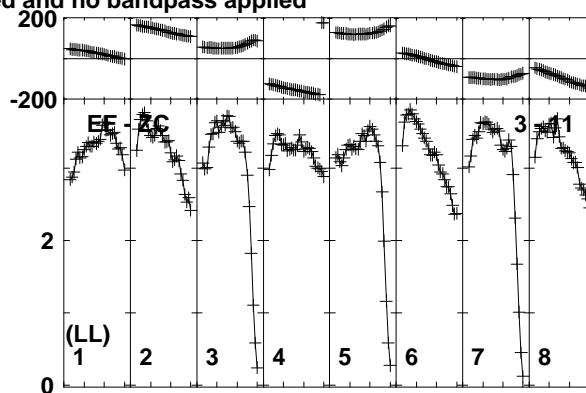
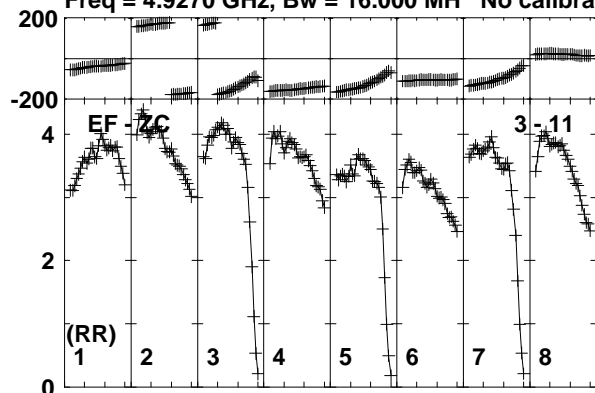

Lower frame: Milli Ampl Jy Top frame: Phas deg
Vector averaged cross-power spectrum Baseline: EF (03) - ZC (11)
Timerange: 00/06:48:01 to 00/06:49:19

Plot file version 367 created 17-FEB-2020 15:43:14

J1402+5347 EK047 2.UVDATA.1

Freq = 4.9270 GHz, Bw = 16.000 MH No calibration applied and no bandpass applied

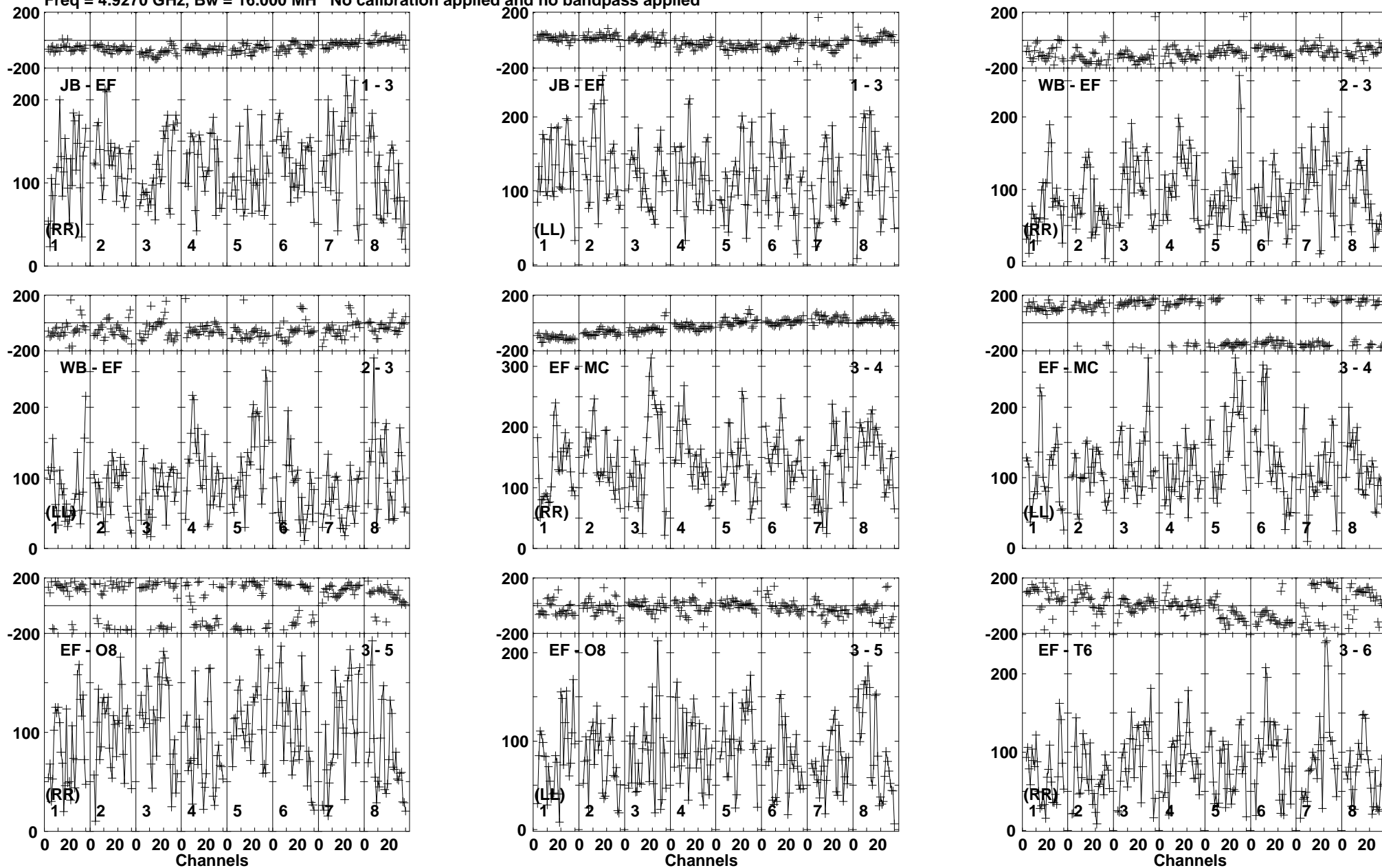

Lower frame: Micro Ampl Jy Top frame: Phas deg
Vector averaged cross-power spectrum Baseline: JB (01) - EF (03)
Timerange: 00/06:49:21 to 00/06:53:19

Plot file version 368 created 17-FEB-2020 15:43:14

J1402+5347 EK047 2.UVDATA.1

Freq = 4.9270 GHz, Bw = 16.000 MH No calibration applied and no bandpass applied

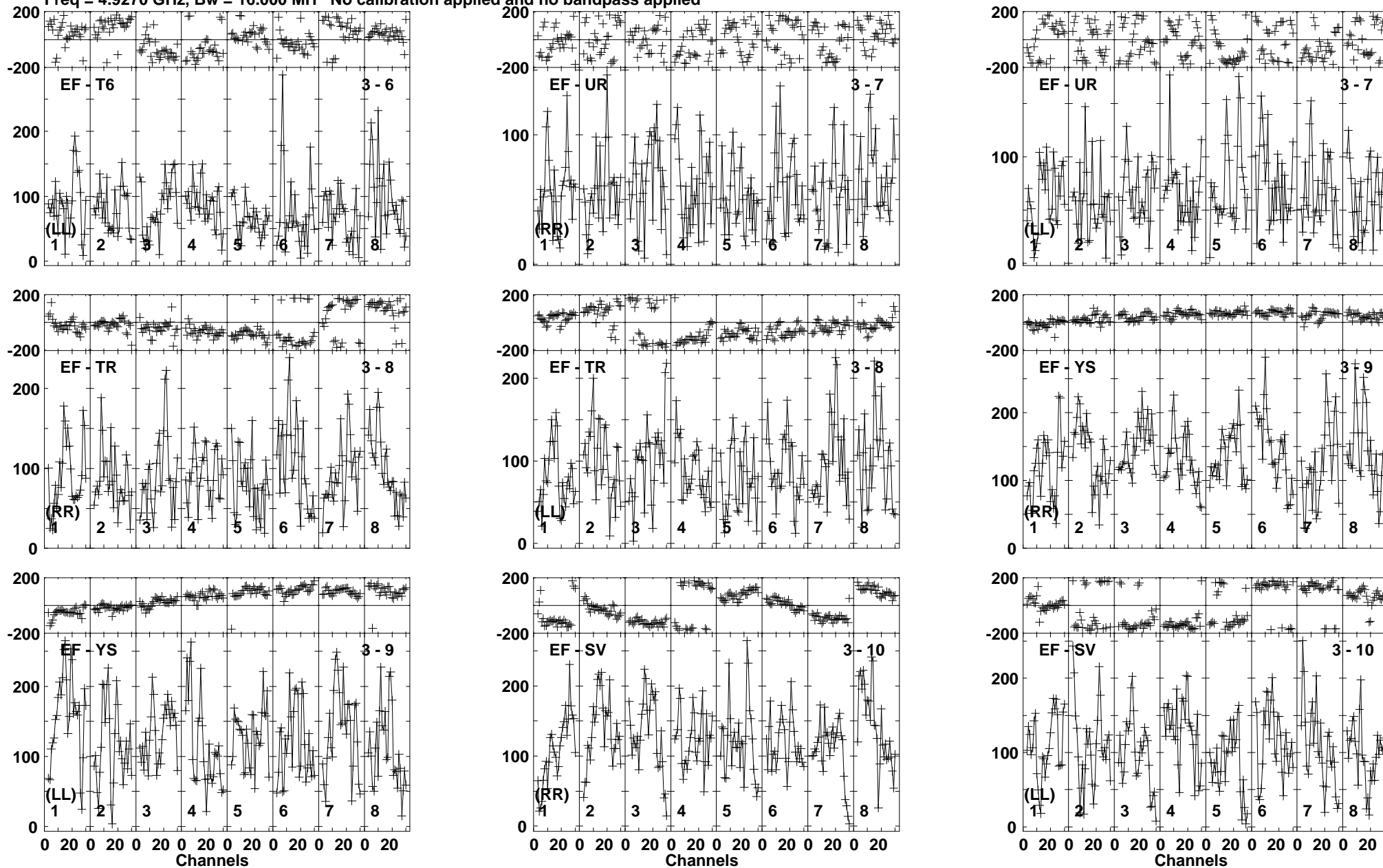

Lower frame: Micro Ampl Jy Top frame: Phas deg
Vector averaged cross-power spectrum Baseline: EF (03) - T6 (06)
Timerange: 00:06:49:21 to 00:06:53:19

Plot file version 369 created 17-FEB-2020 15:43:14

J1402+5347 EK047 2.UVDATA.1

Freq = 4.9270 GHz, Bw = 16.000 MH No calibration applied and no bandpass applied

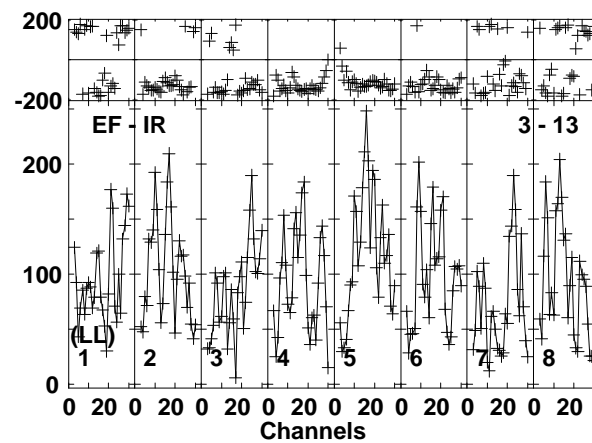
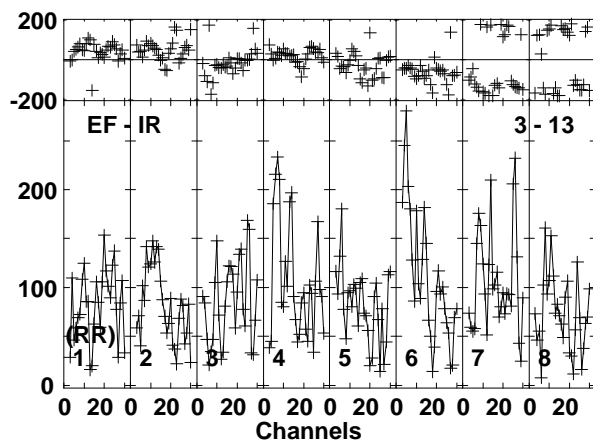
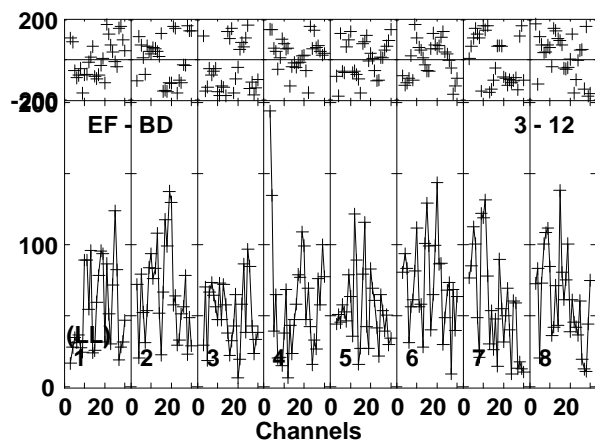
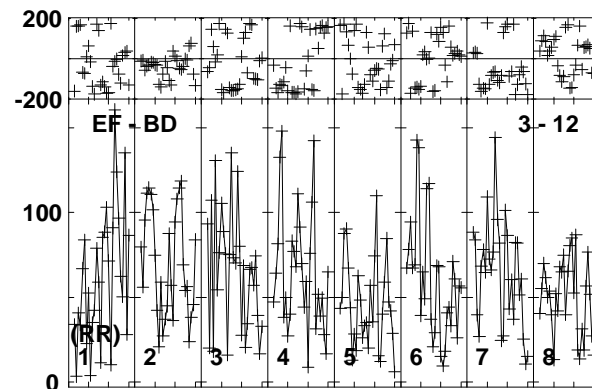
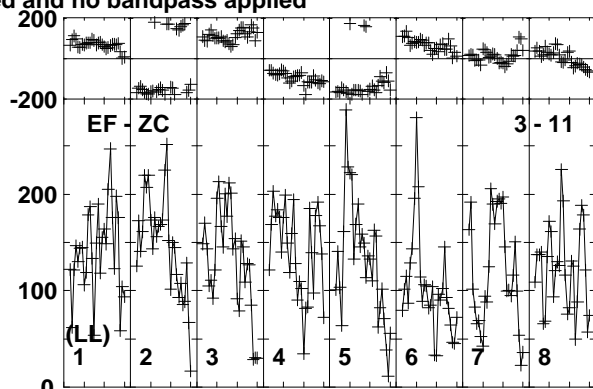
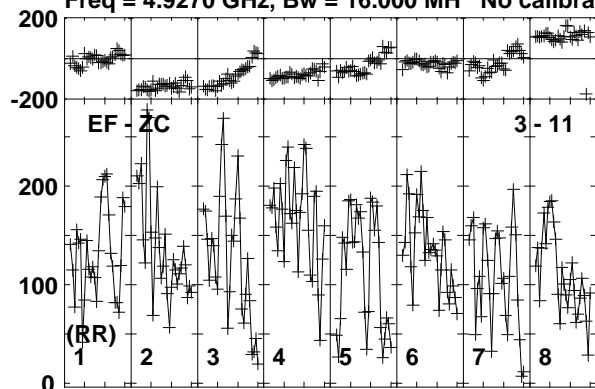

Lower frame: Micro Ampl Jy Top frame: Phas deg
Vector averaged cross-power spectrum Baseline: EF (03) - ZC (11)
Timerange: 00/06:49:21 to 00/06:53:19

Plot file version 370 created 17-FEB-2020 15:43:14

J1359+5544 EK047 2.UVDATA.1

Freq = 4.9270 GHz, Bw = 16.000 MH No calibration applied and no bandpass applied

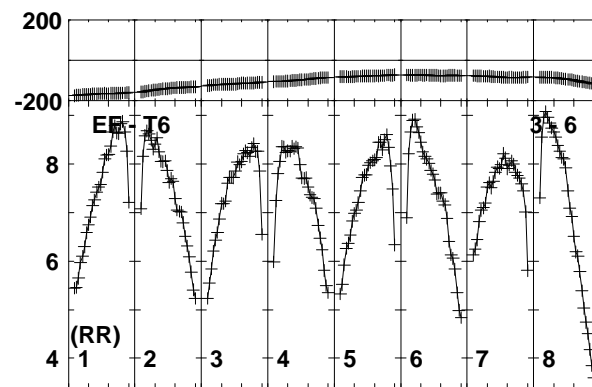
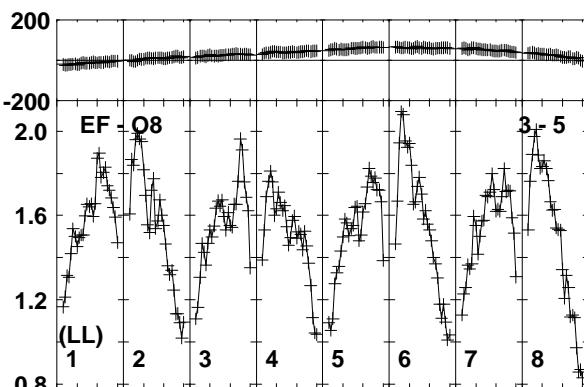
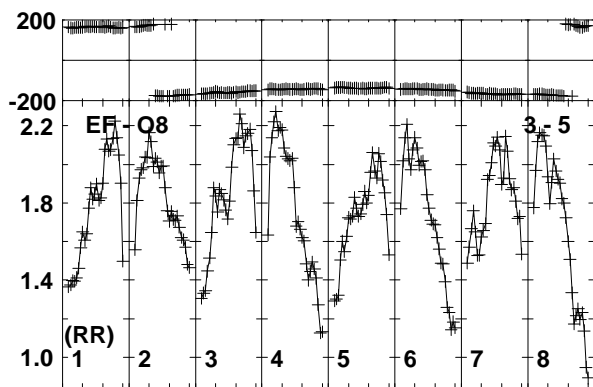
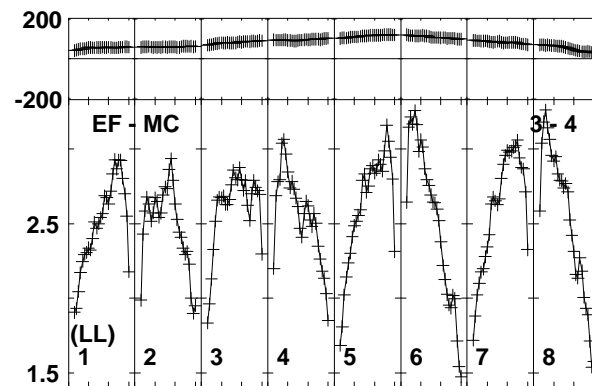
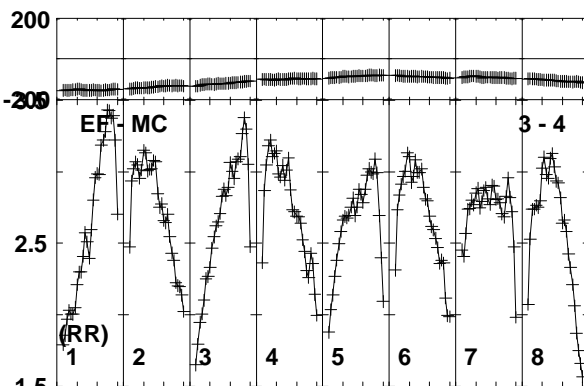
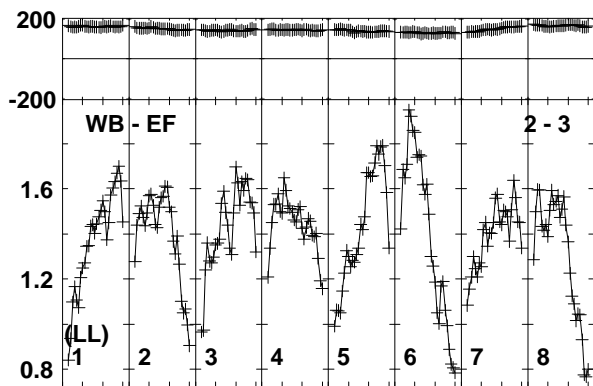
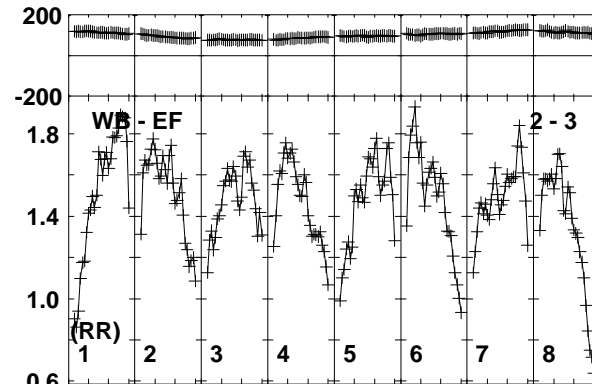
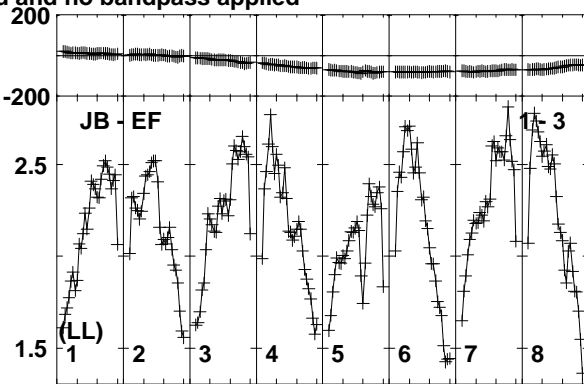
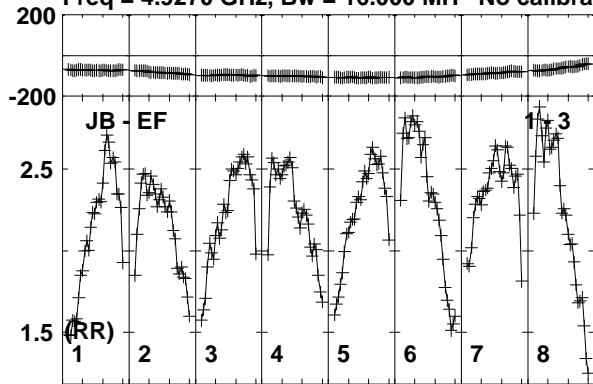

Lower frame: Milli Ampl Jy Top frame: Phas deg
Vector averaged cross-power spectrum Baseline: JB (01) - EF (03)
Timerange: 00/06:53:21 to 00/06:55:19

Plot file version 371 created 17-FEB-2020 15:43:14

J1359+5544 EK047 2.UVDATA.1

Freq = 4.9270 GHz, Bw = 16.000 MH No calibration applied and no bandpass applied

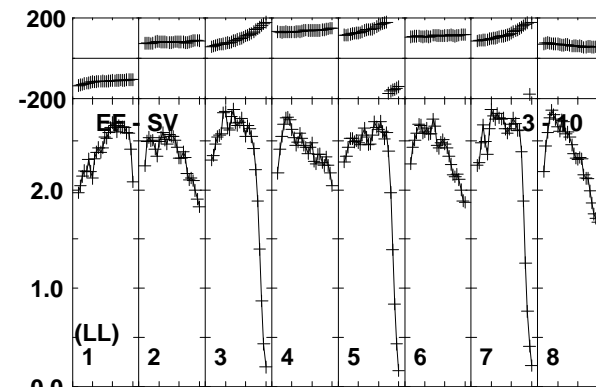
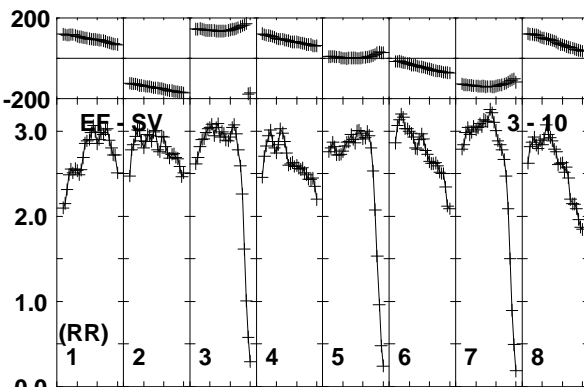
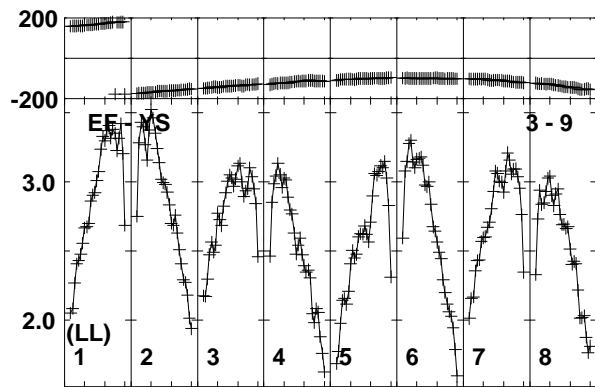
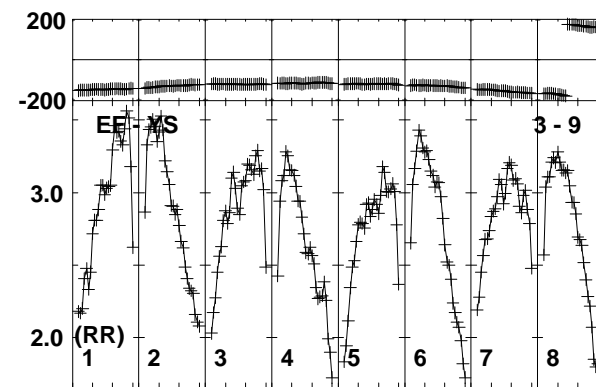
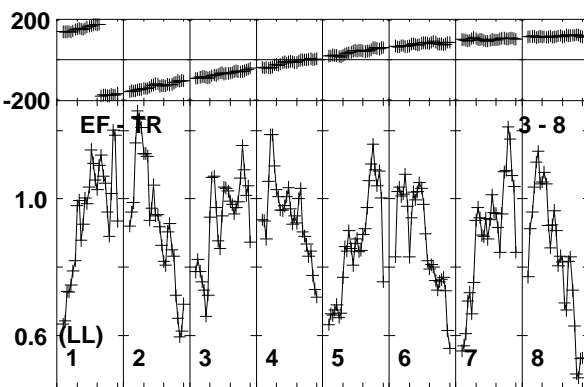
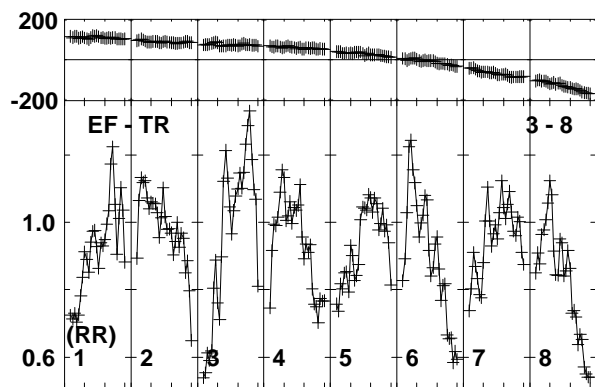
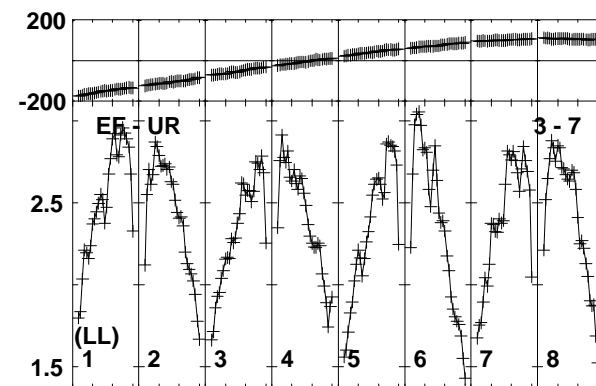
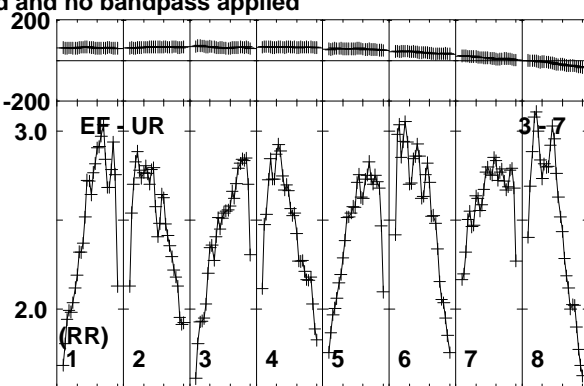
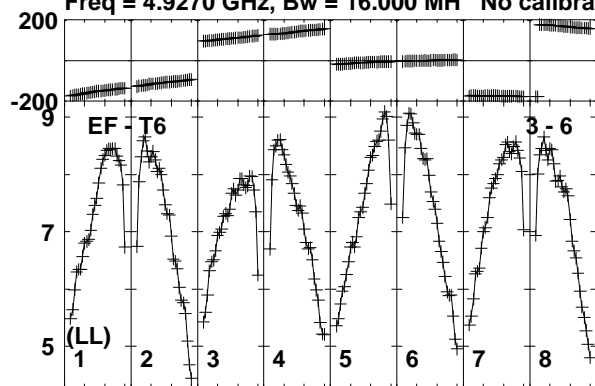

Lower frame: Milli Ampl Jy Top frame: Phas deg
Vector averaged cross-power spectrum Baseline: EF (03) - T6 (06)
Timerange: 00/06:53:21 to 00/06:55:19

Plot file version 372 created 17-FEB-2020 15:43:14

J1359+5544 EK047 2.UVDATA.1

Freq = 4.9270 GHz, Bw = 16.000 MH No calibration applied and no bandpass applied

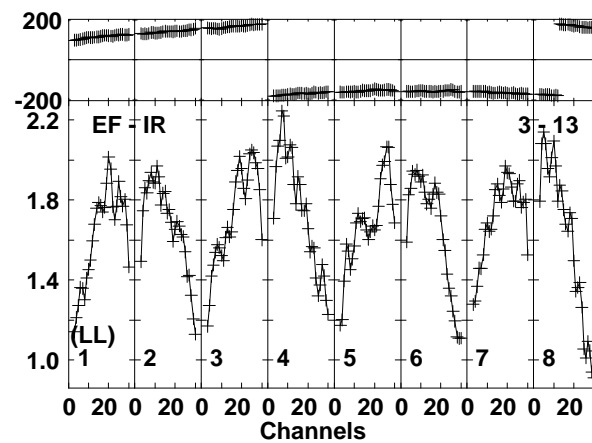
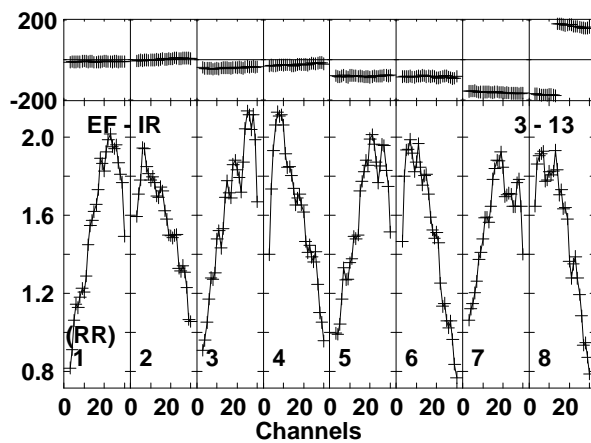
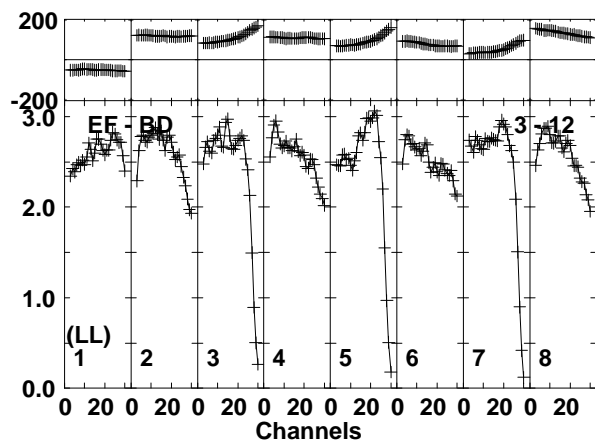
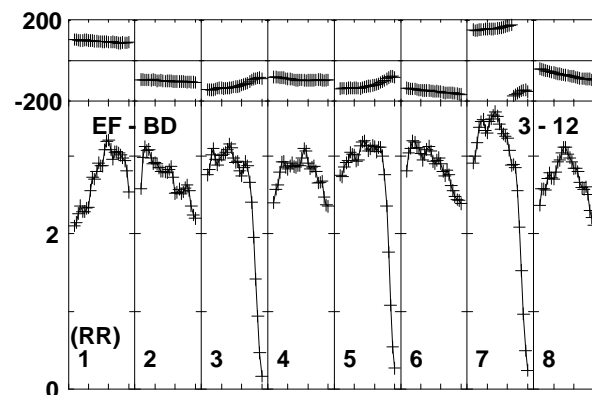
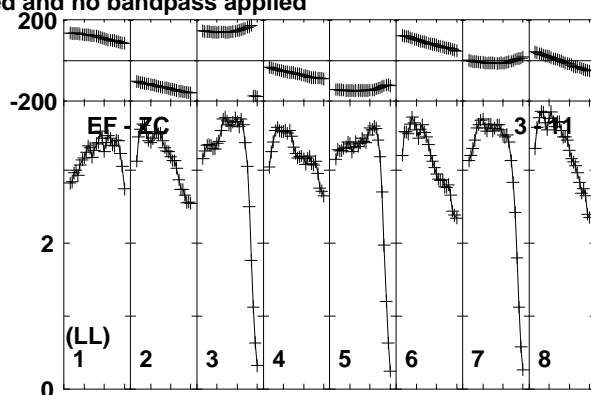
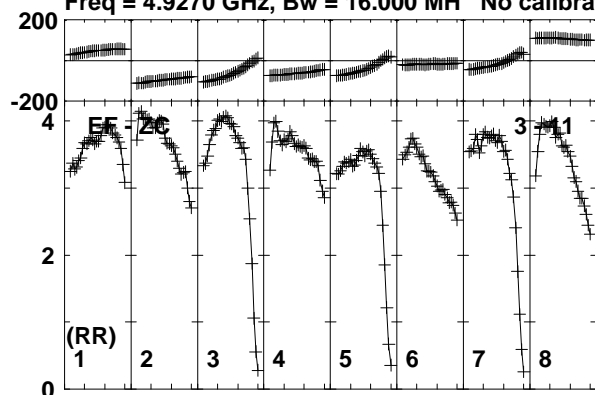

Lower frame: Milli Ampl Jy Top frame: Phas deg
Vector averaged cross-power spectrum Baseline: EF (03) - ZC (11)
Timerange: 00/06:53:21 to 00/06:55:19

Plot file version 373 created 17-FEB-2020 15:43:14

J1402+5347 EK047 2.UVDATA.1

Freq = 4.9270 GHz, Bw = 16.000 MH No calibration applied and no bandpass applied

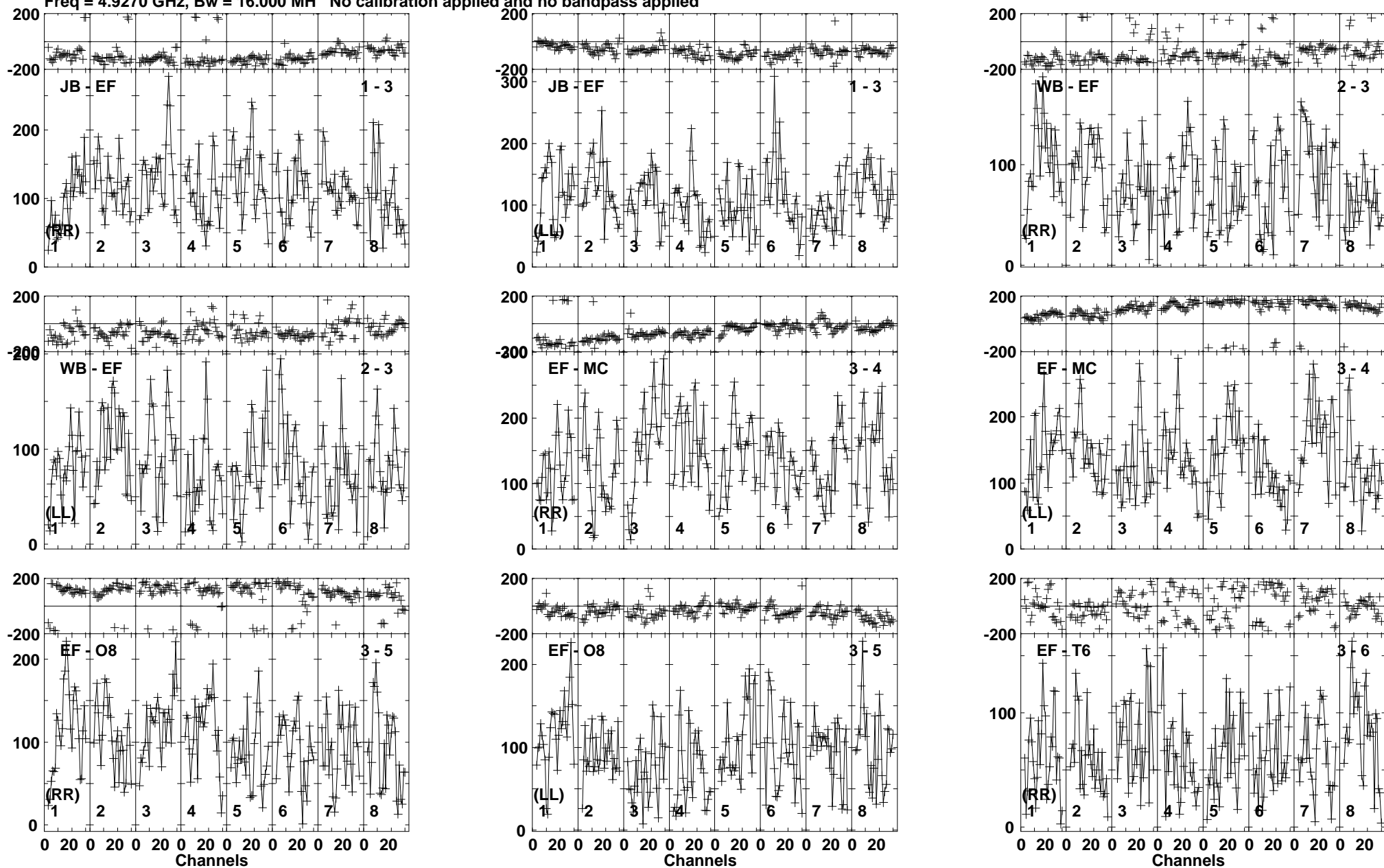

Lower frame: Micro Ampl Jy Top frame: Phas deg
Vector averaged cross-power spectrum Baseline: JB (01) - EF (03)
Timerange: 00/06:55:23 to 00/06:59:19

Plot file version 374 created 17-FEB-2020 15:43:14

J1402+5347 EK047 2.UVDATA.1

Freq = 4.9270 GHz, Bw = 16.000 MH No calibration applied and no bandpass applied

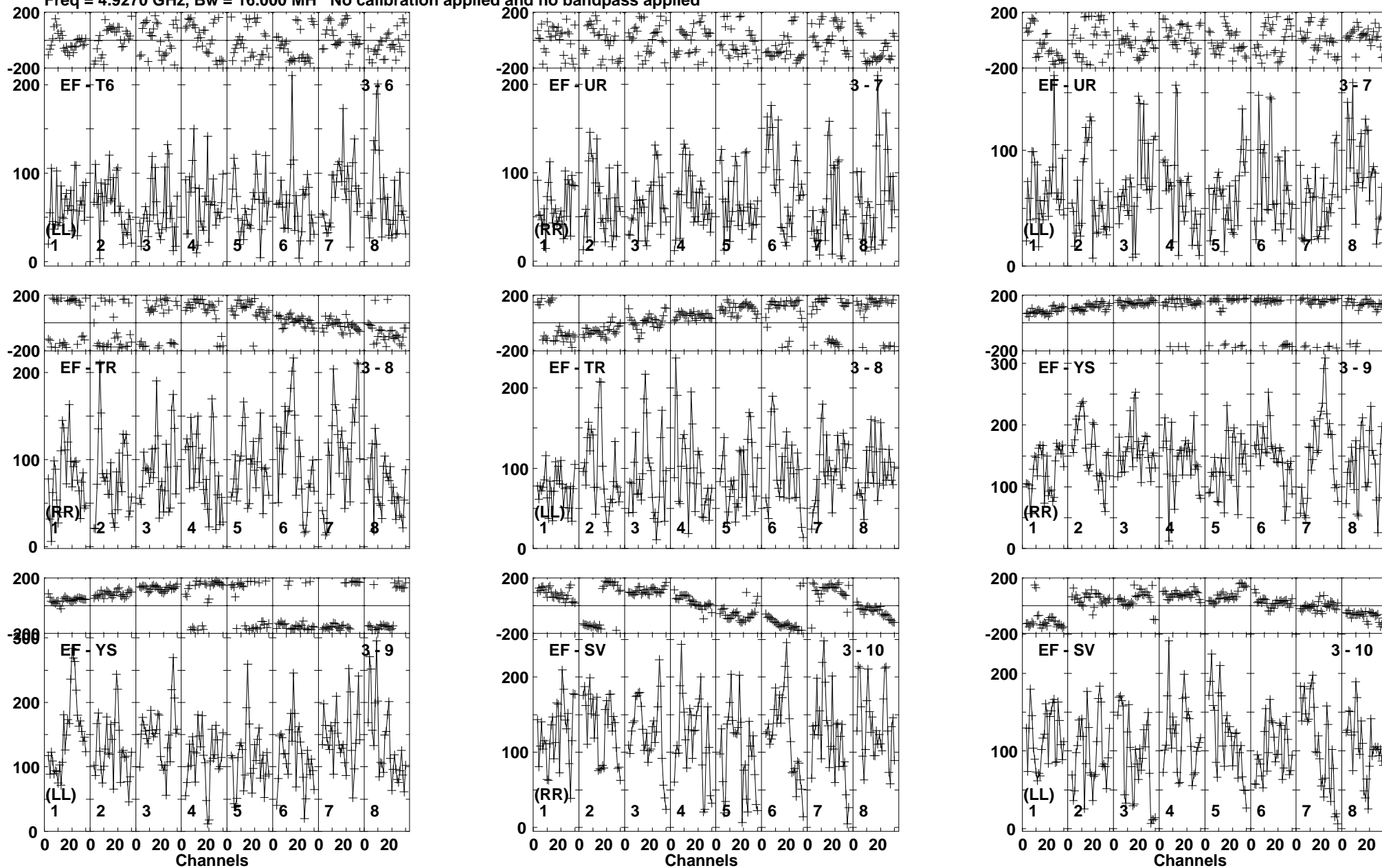

Lower frame: Micro Ampl Jy Top frame: Phas deg
Vector averaged cross-power spectrum Baseline: EF (03) - T6 (06)
Timerange: 00/06:55:23 to 00/06:59:19

Plot file version 375 created 17-FEB-2020 15:43:14

J1402+5347 EK047 2.UVDATA.1

Freq = 4.9270 GHz, Bw = 16.000 MH No calibration applied and no bandpass applied

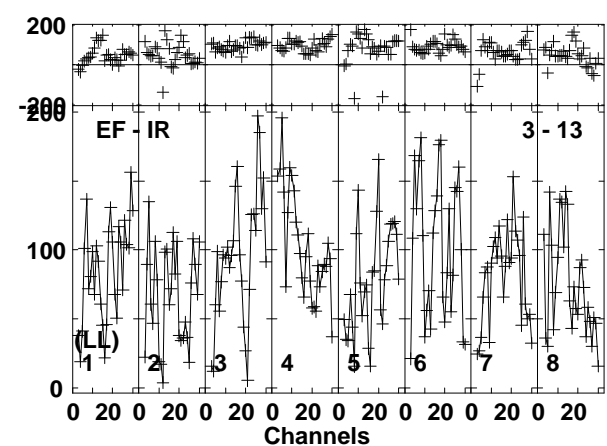
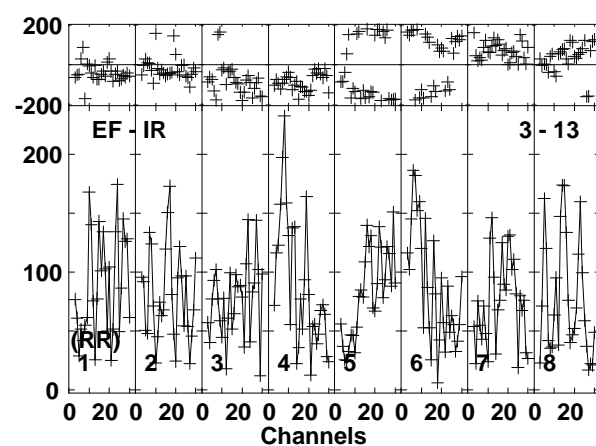
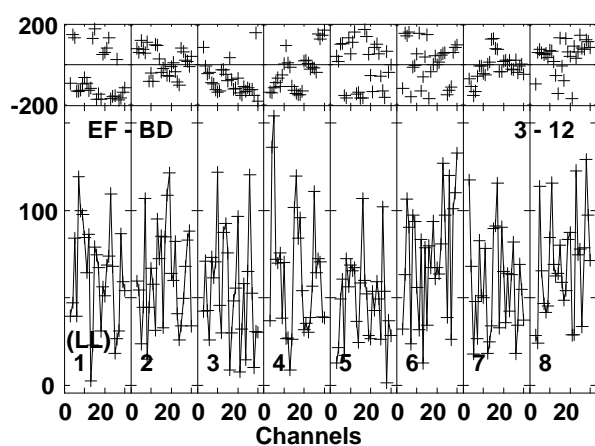
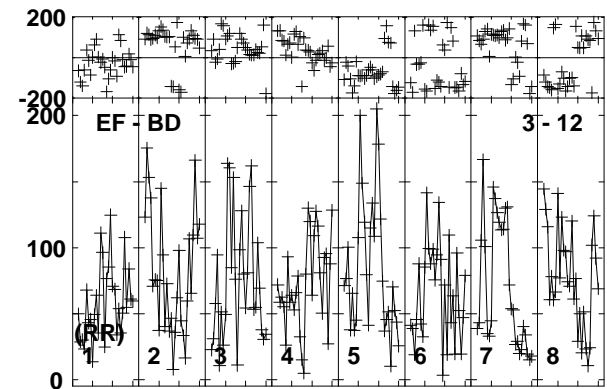
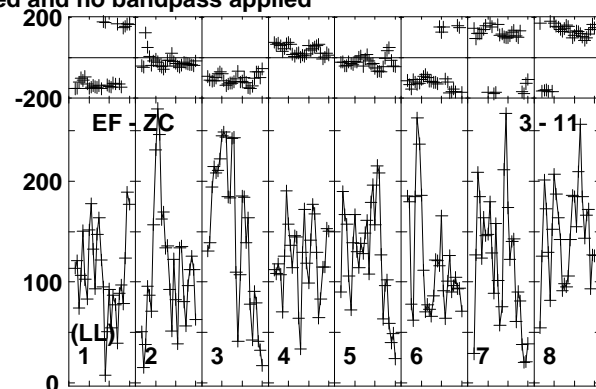
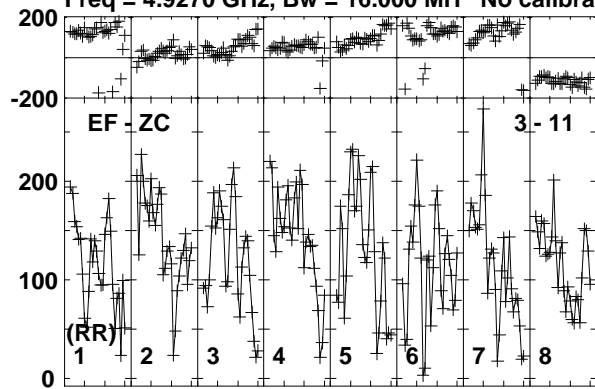

Lower frame: Micro Ampl Jy Top frame: Phas deg
Vector averaged cross-power spectrum Baseline: EF (03) - ZC (11)
Timerange: 00/06:55:23 to 00/06:59:19

Plot file version 376 created 17-FEB-2020 15:43:15

J1359+5544 EK047 2.UVDATA.1

Freq = 4.9270 GHz, Bw = 16.000 MH No calibration applied and no bandpass applied

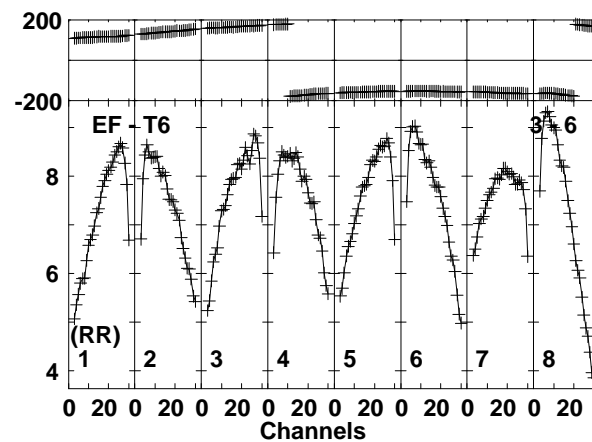
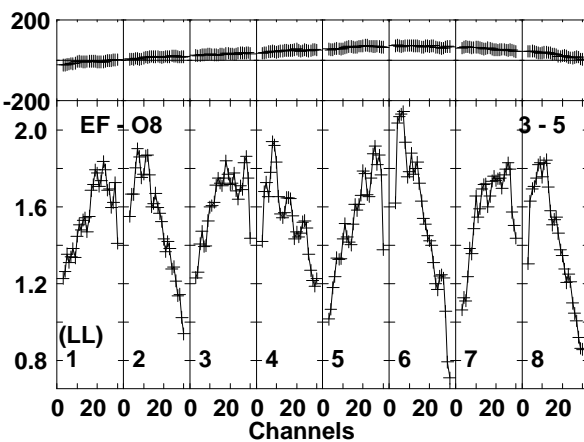
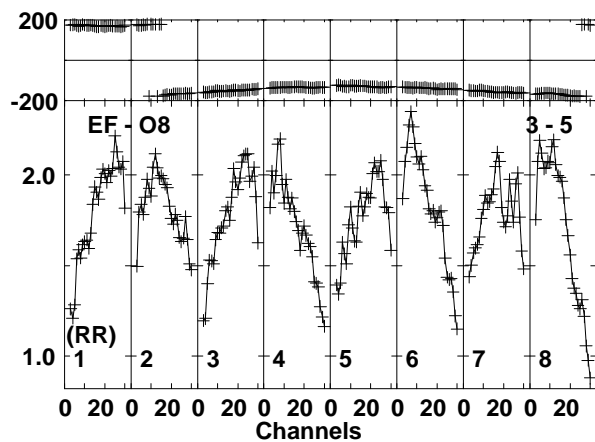
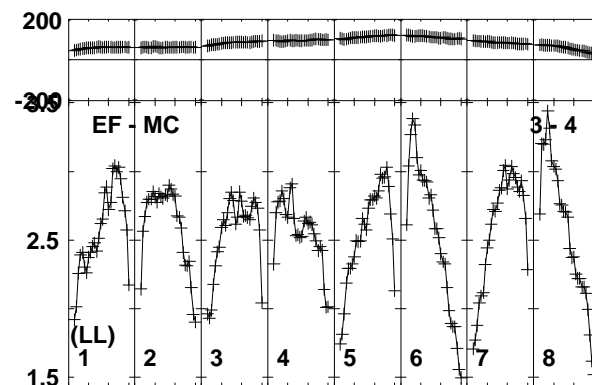
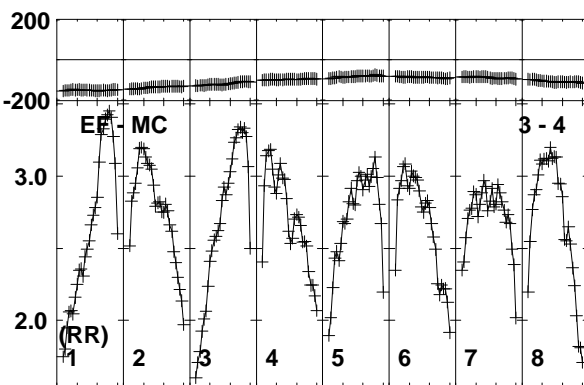
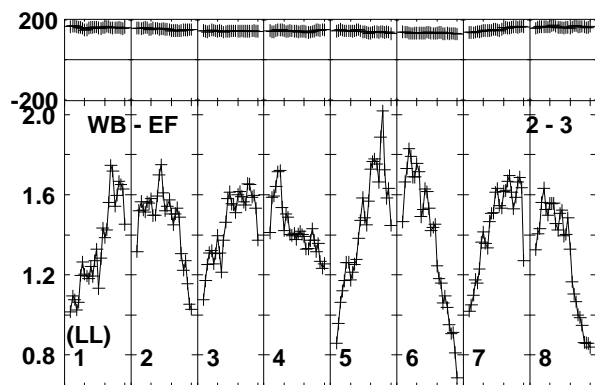
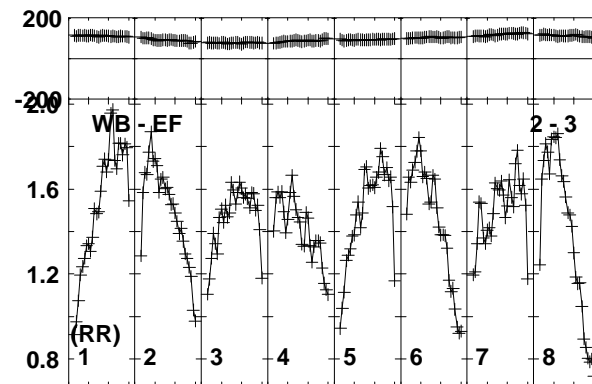
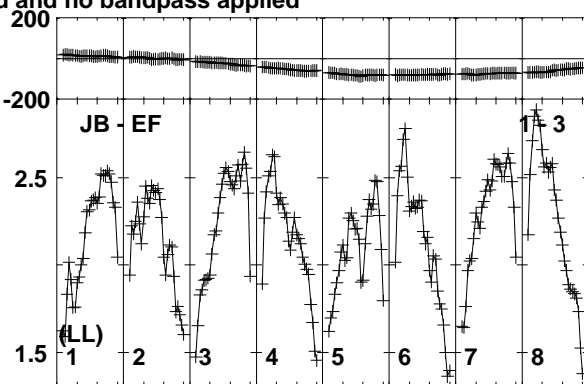
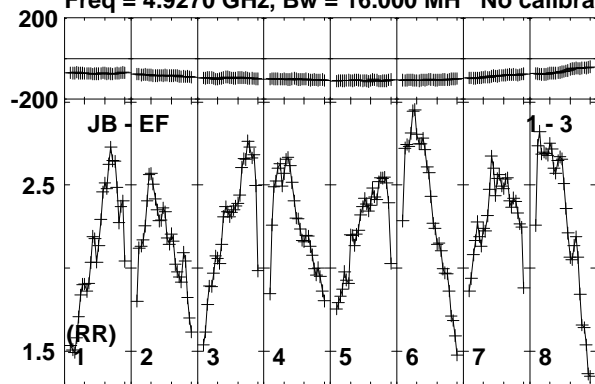

Lower frame: Milli Ampl Jy Top frame: Phas deg
Vector averaged cross-power spectrum Baseline: JB (01) - EF (03)
Timerange: 00/07:00:01 to 00/07:01:19

Plot file version 377 created 17-FEB-2020 15:43:15

J1359+5544 EK047 2.UVDATA.1

Freq = 4.9270 GHz, Bw = 16.000 MH No calibration applied and no bandpass applied

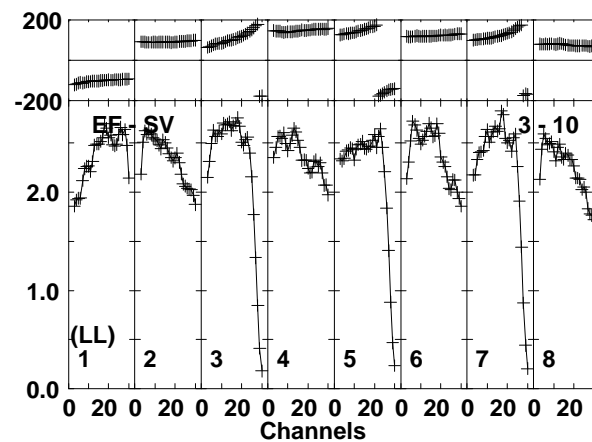
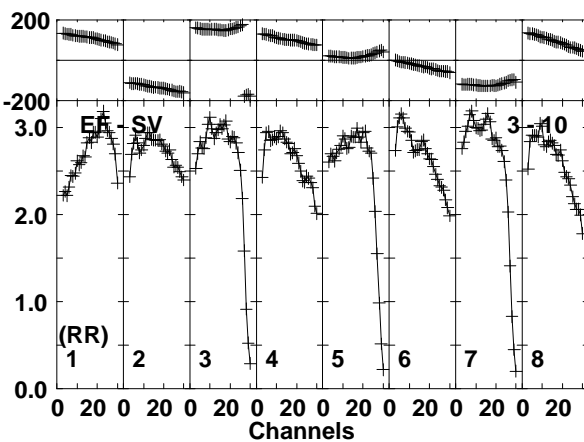
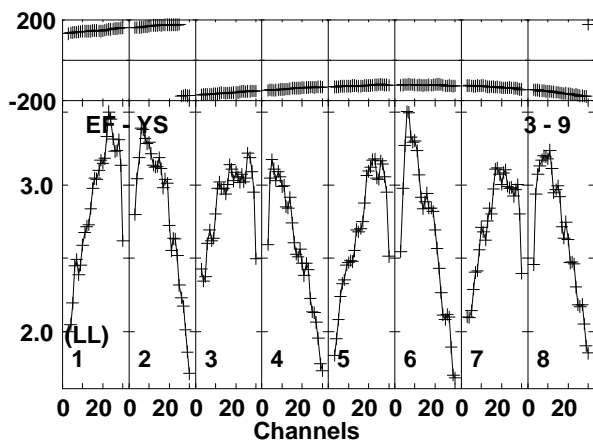
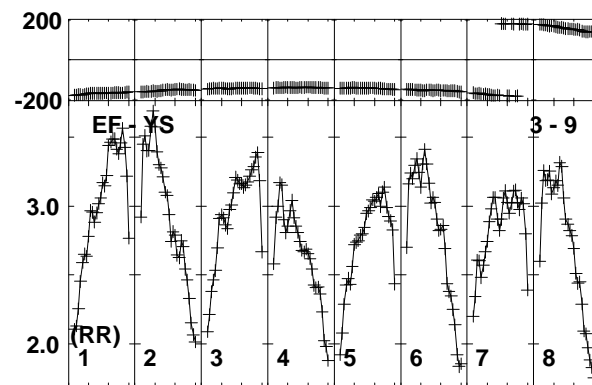
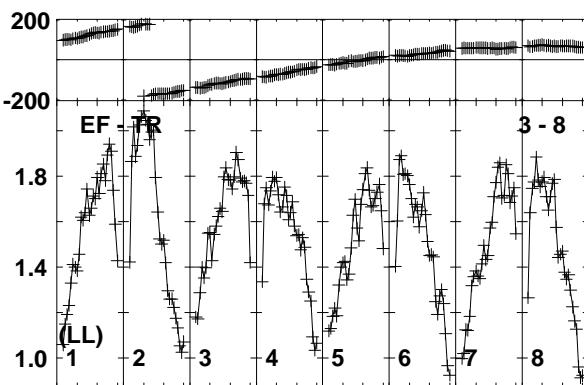
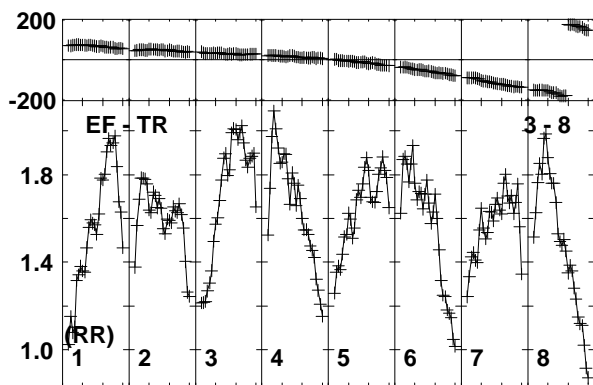
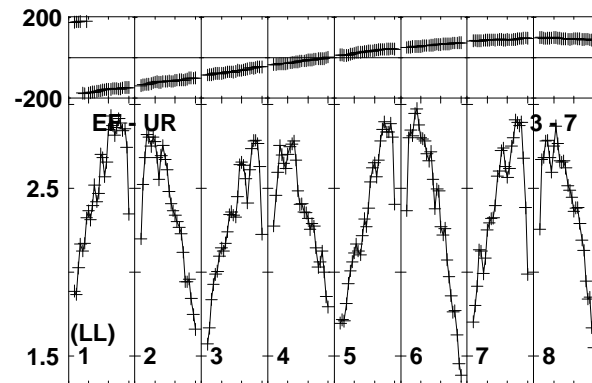
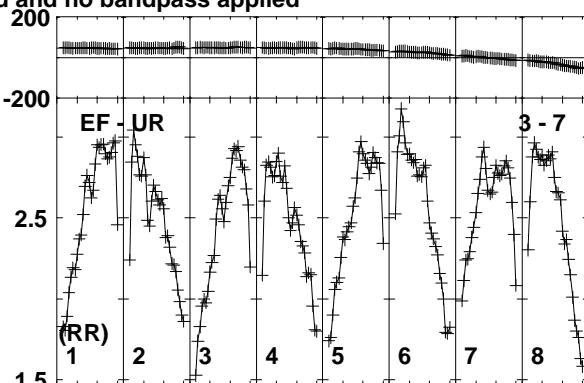
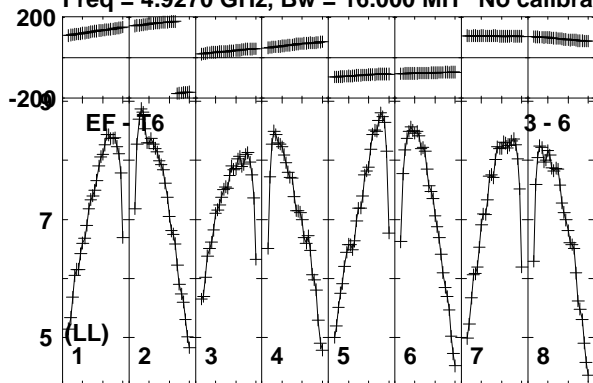

Lower frame: Milli Ampl Jy Top frame: Phas deg
Vector averaged cross-power spectrum Baseline: EF (03) - T6 (06)
Timerange: 00/07:00:01 to 00/07:01:19

Plot file version 378 created 17-FEB-2020 15:43:15

J1359+5544 EK047 2.UVDATA.1

Freq = 4.9270 GHz, Bw = 16.000 MH No calibration applied and no bandpass applied

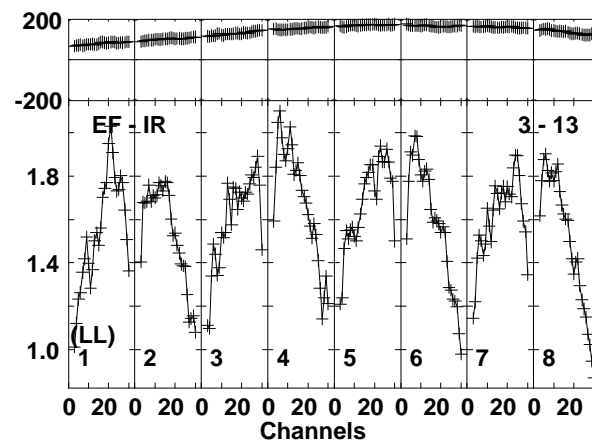
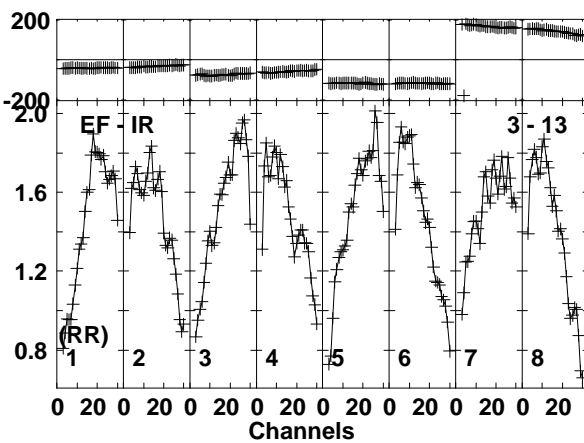
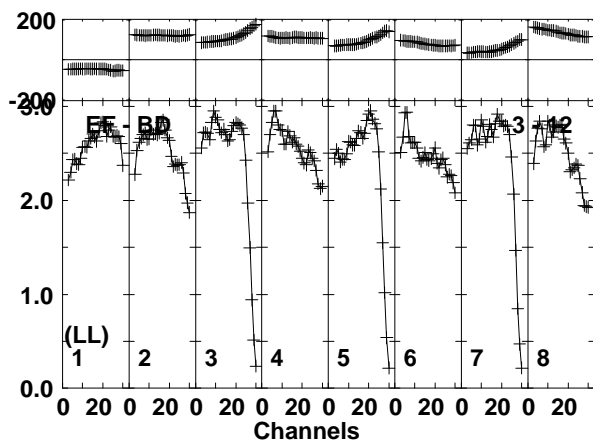
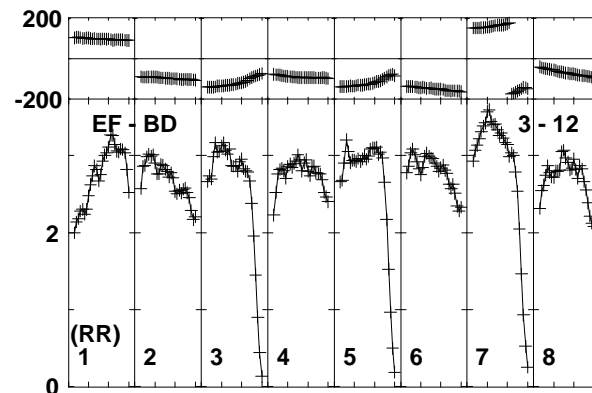
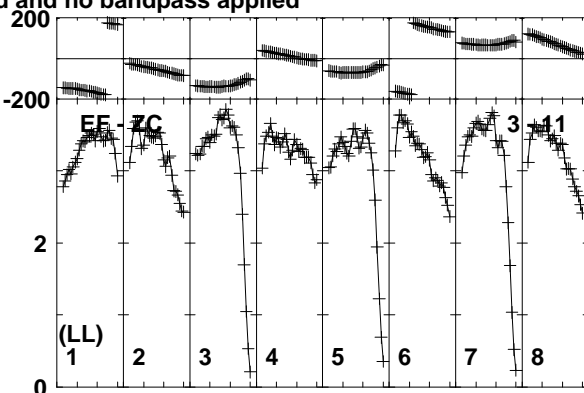
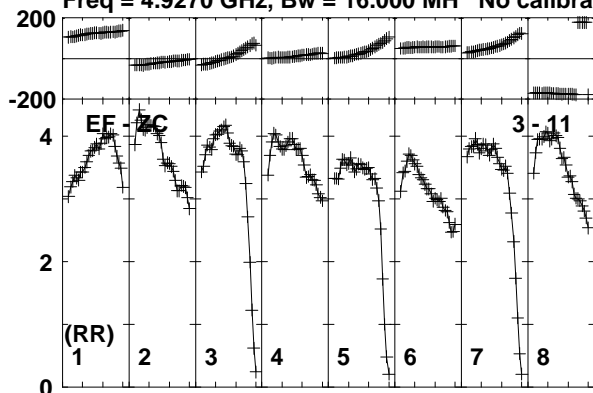

Lower frame: Milli Ampl Jy Top frame: Phas deg
Vector averaged cross-power spectrum Baseline: EF (03) - ZC (11)
Timerange: 00/07:00:01 to 00/07:01:19

Plot file version 379 created 17-FEB-2020 15:43:15

J1402+5347 EK047 2.UVDATA.1

Freq = 4.9270 GHz, Bw = 16.000 MH No calibration applied and no bandpass applied

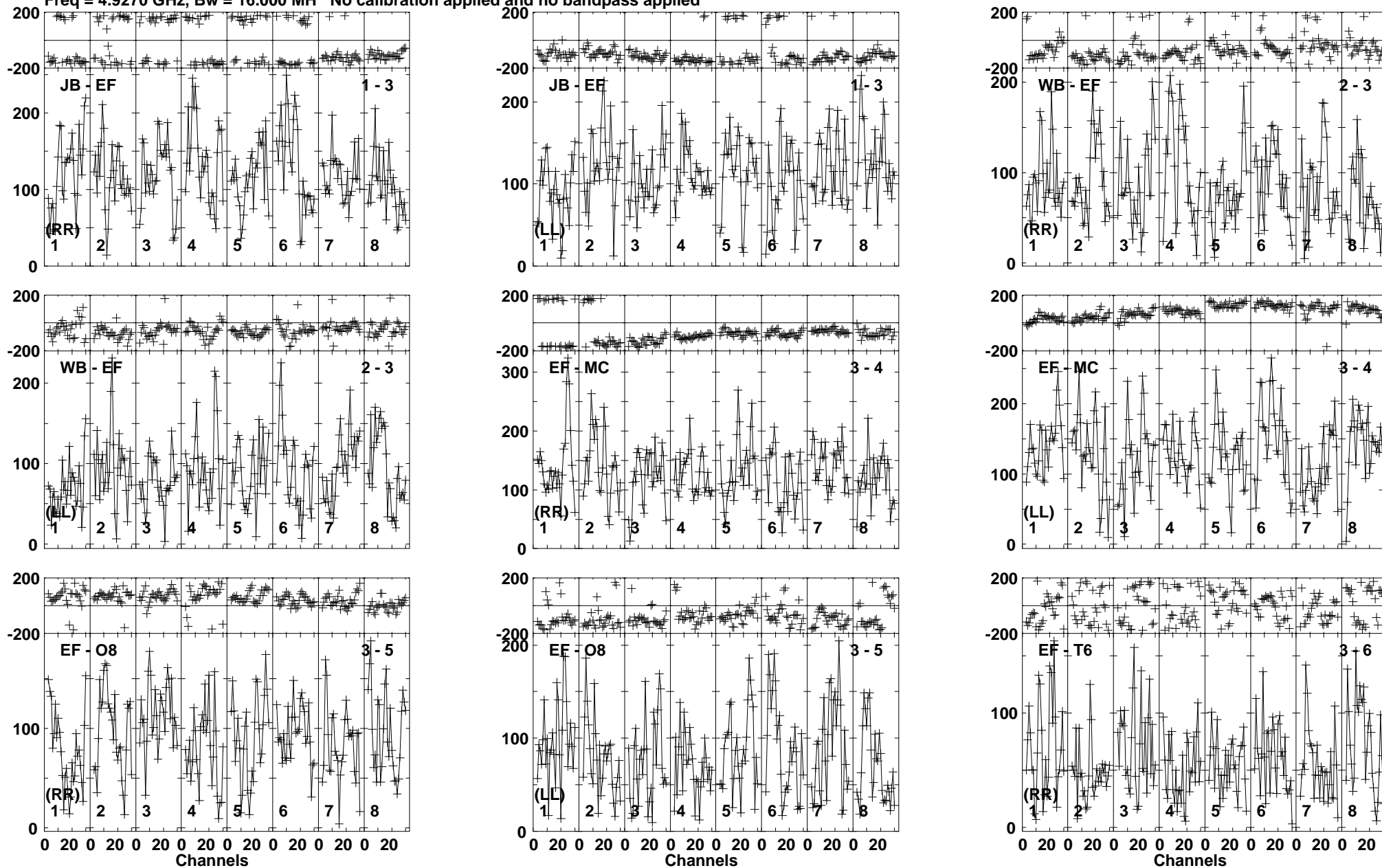

Lower frame: Micro Ampl Jy Top frame: Phas deg
Vector averaged cross-power spectrum Baseline: JB (01) - EF (03)
Timerange: 00/07:01:21 to 00/07:05:19

Plot file version 380 created 17-FEB-2020 15:43:15

J1402+5347 EK047 2.UVDATA.1

Freq = 4.9270 GHz, Bw = 16.000 MH No calibration applied and no bandpass applied

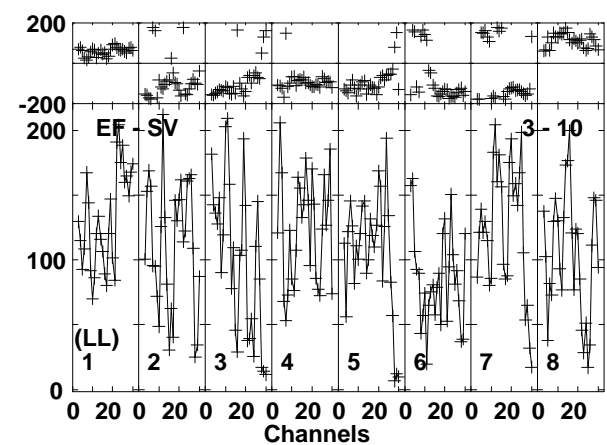
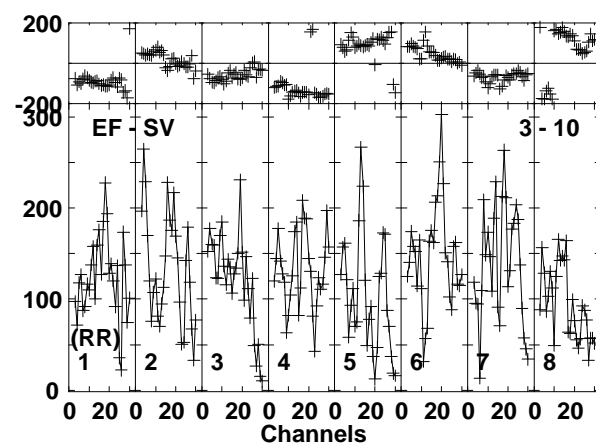
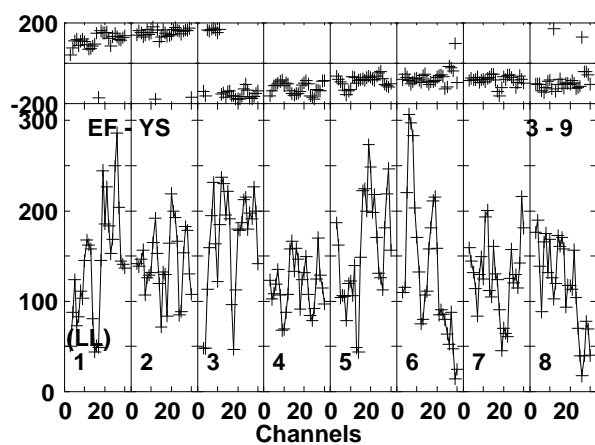
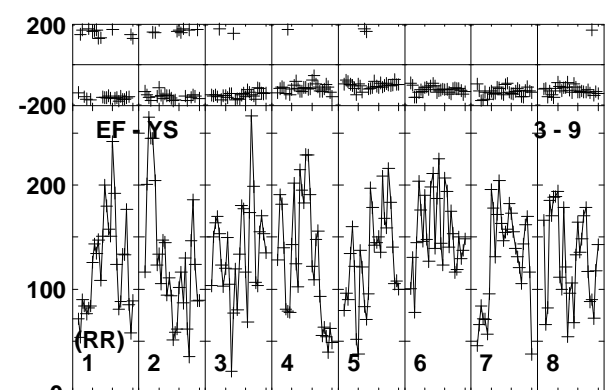
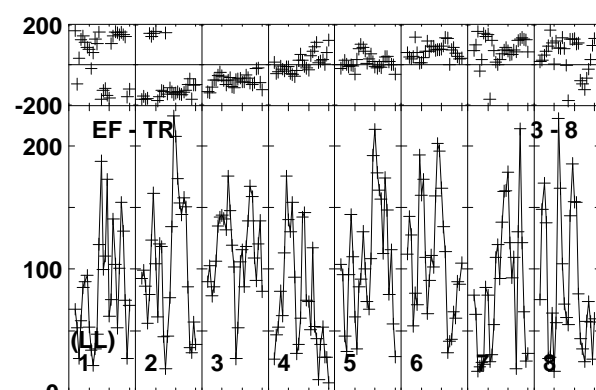
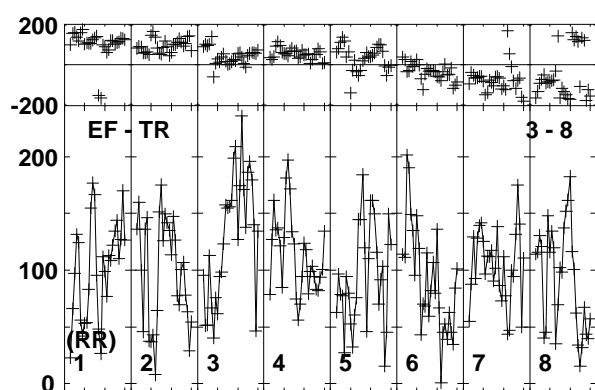
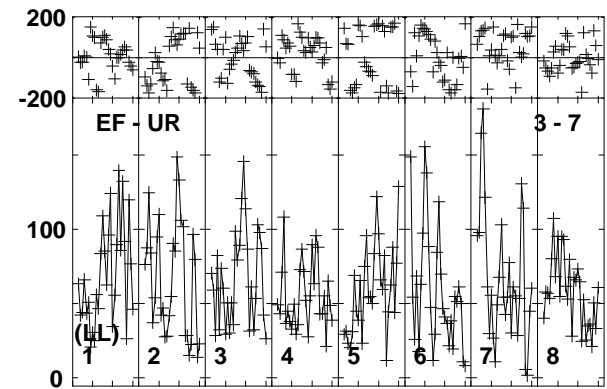
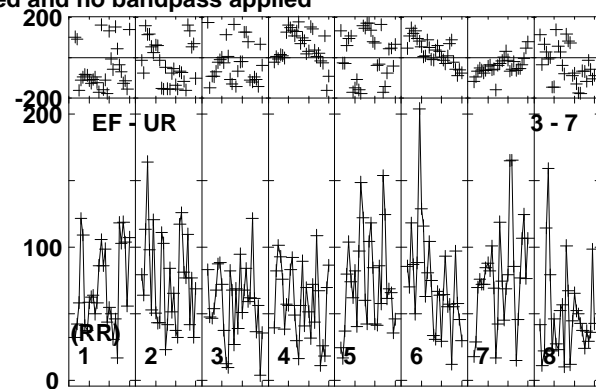
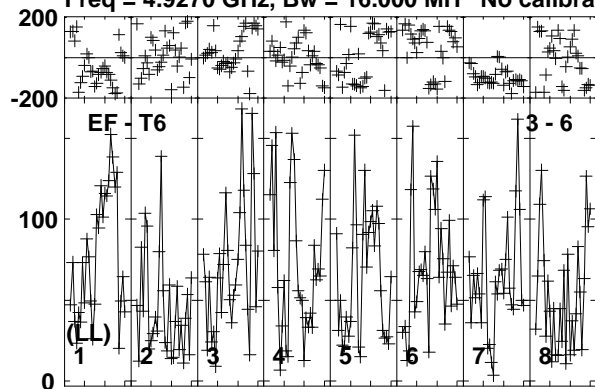

Lower frame: Micro Ampl Jy Top frame: Phas deg
Vector averaged cross-power spectrum Baseline: EF (03) - T6 (06)
Timerange: 00/07:01:21 to 00/07:05:19

Plot file version 381 created 17-FEB-2020 15:43:15

J1402+5347 EK047 2.UVDATA.1

Freq = 4.9270 GHz, Bw = 16.000 MH No calibration applied and no bandpass applied

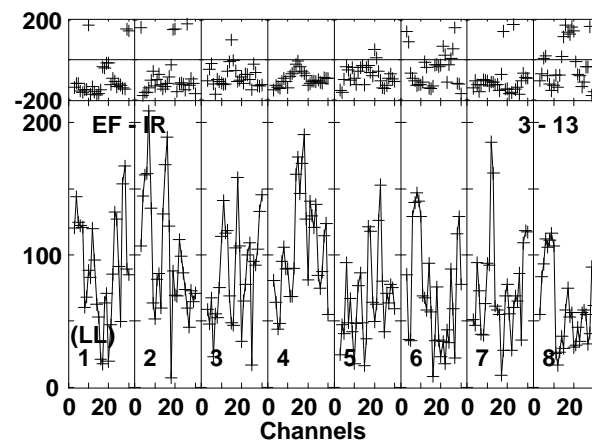
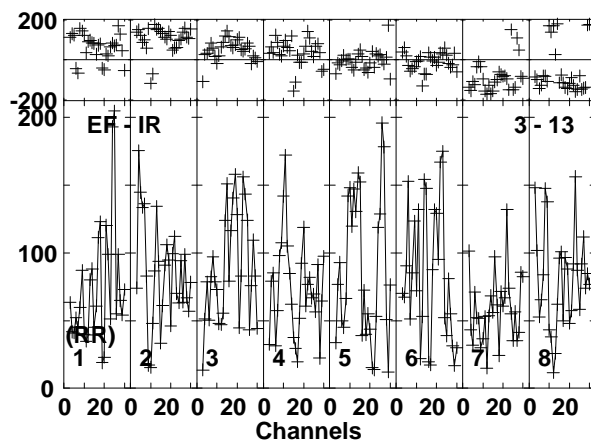
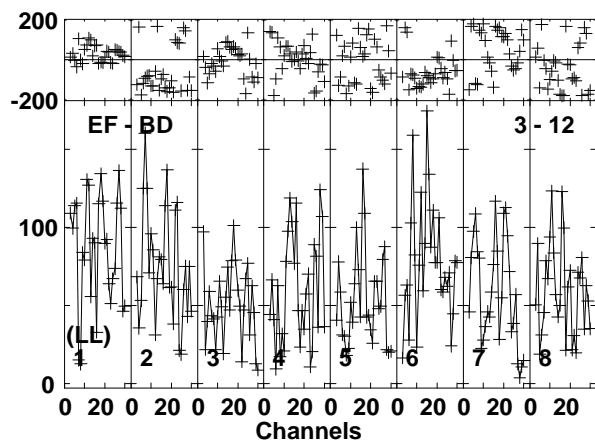
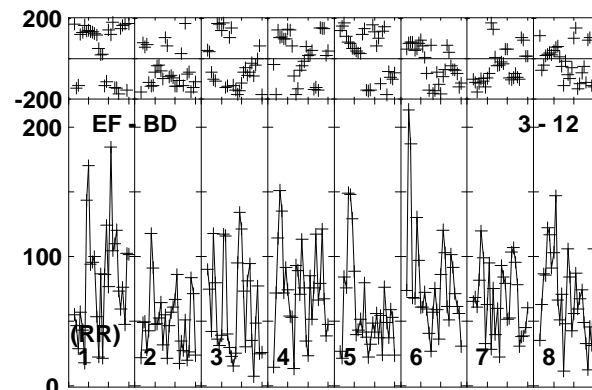
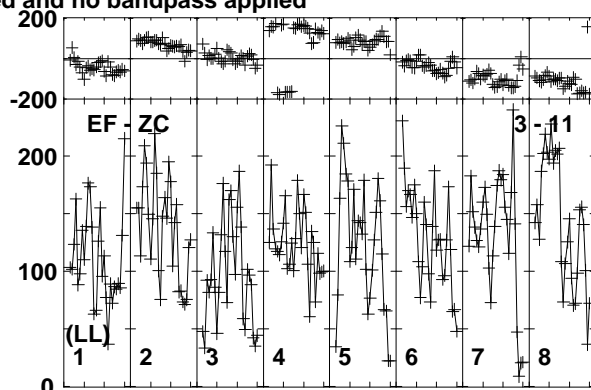
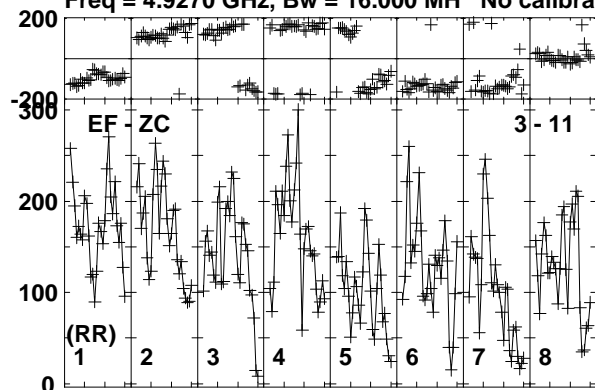

Lower frame: Micro Ampl Jy Top frame: Phas deg
Vector averaged cross-power spectrum Baseline: EF (03) - ZC (11)
Timerange: 00/07:01:21 to 00/07:05:19

Plot file version 382 created 17-FEB-2020 15:43:15

J1359+5544 EK047 2.UVDATA.1

Freq = 4.9270 GHz, Bw = 16.000 MH No calibration applied and no bandpass applied

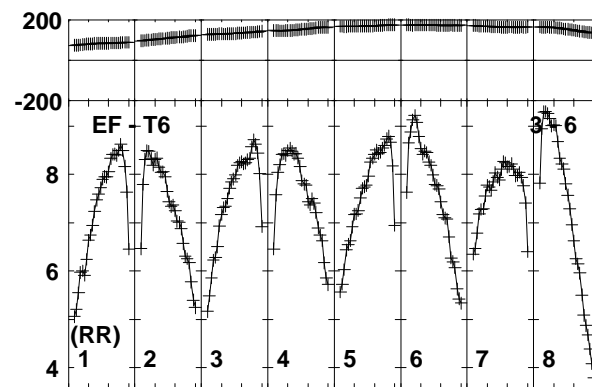
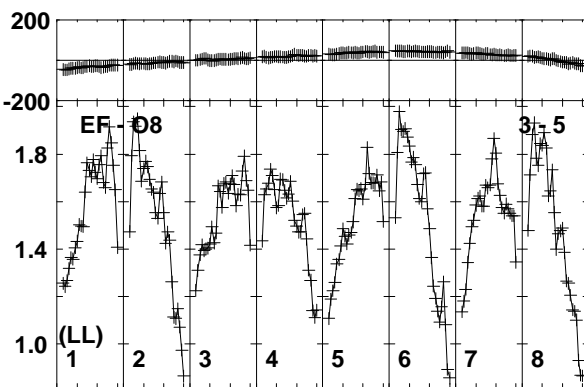
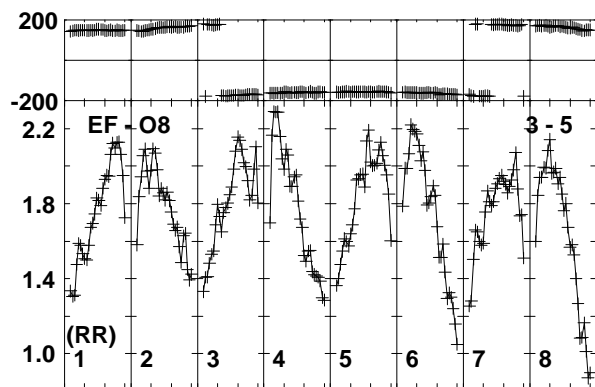
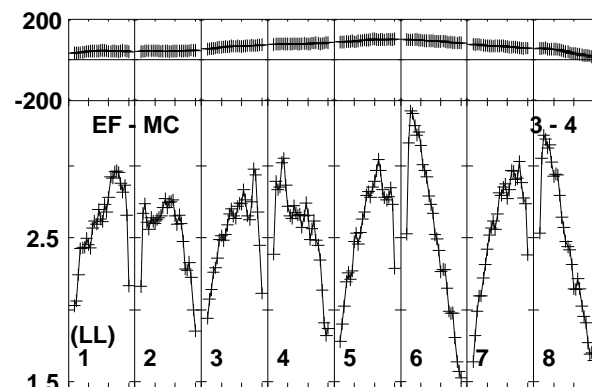
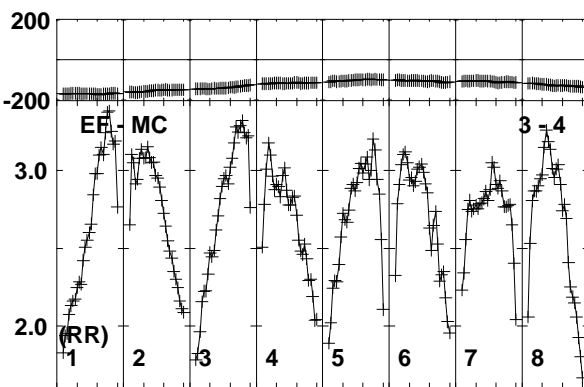
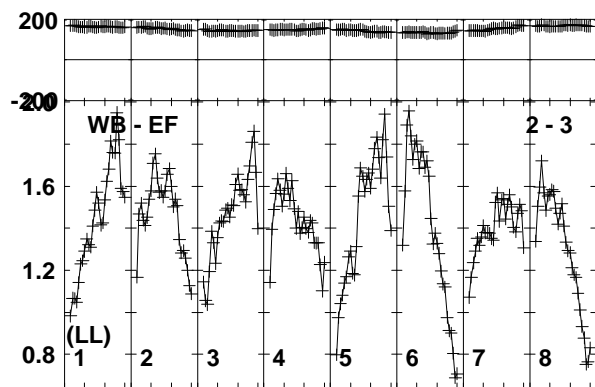
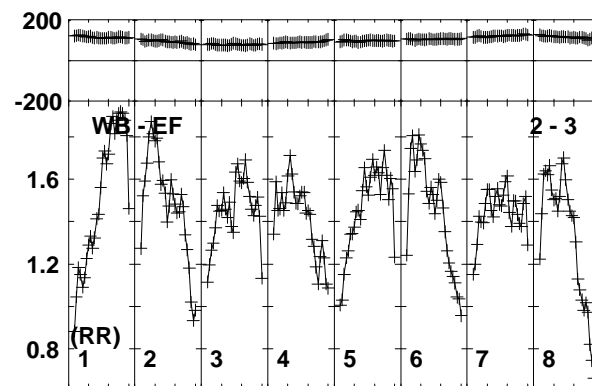
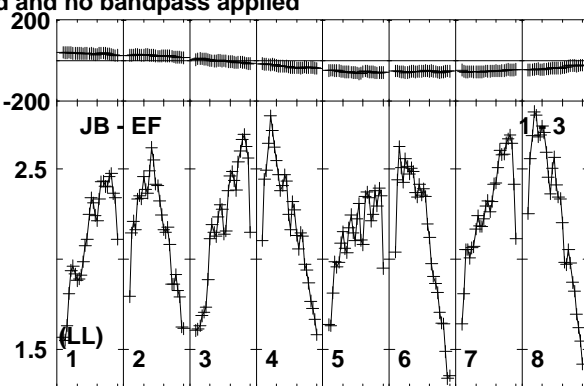
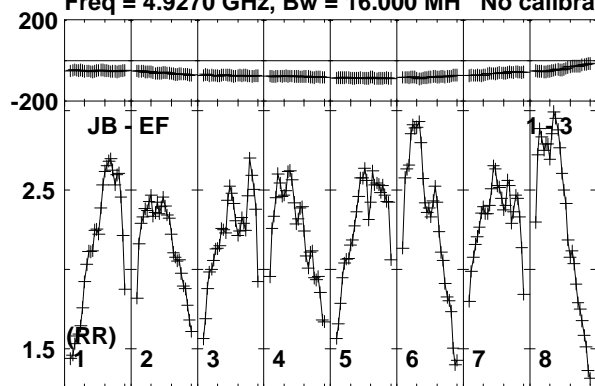

Lower frame: Milli Ampl Jy Top frame: Phas deg
Vector averaged cross-power spectrum Baseline: JB (01) - EF (03)
Timerange: 00/07:05:21 to 00/07:07:19

Plot file version 383 created 17-FEB-2020 15:43:15

J1359+5544 EK047 2.UVDATA.1

Freq = 4.9270 GHz, Bw = 16.000 MH No calibration applied and no bandpass applied

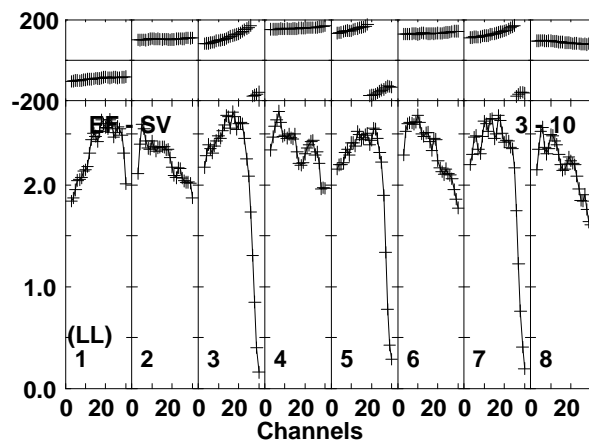
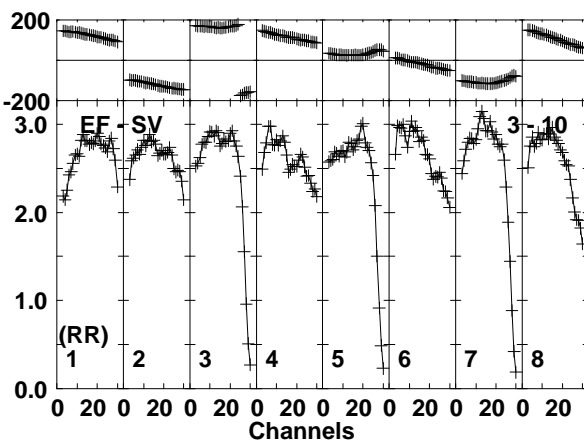
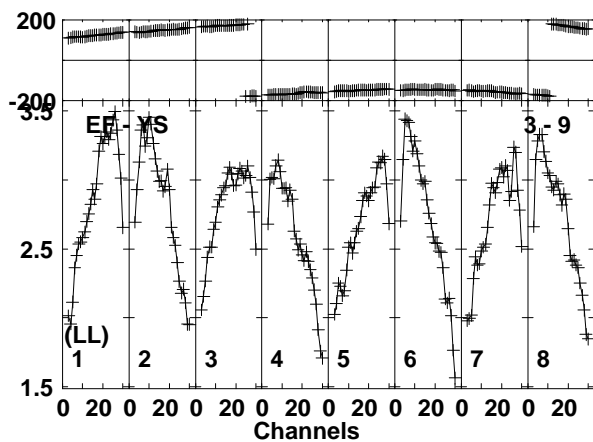
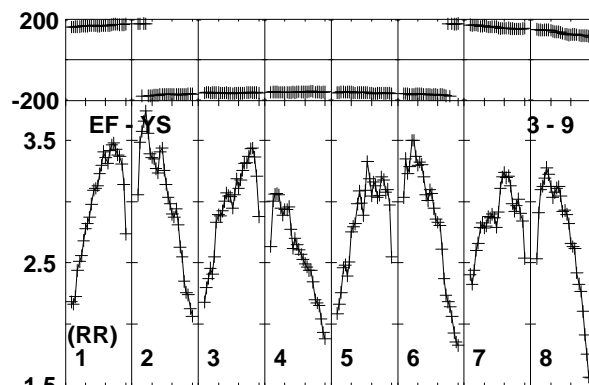
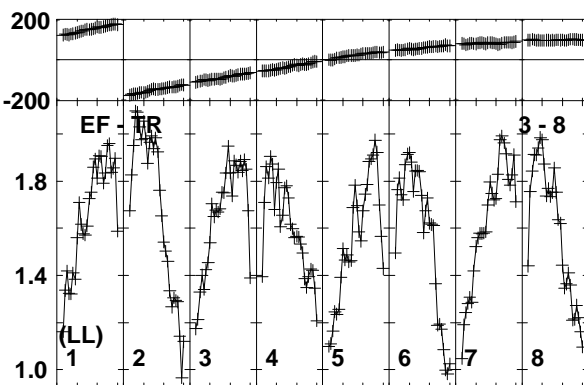
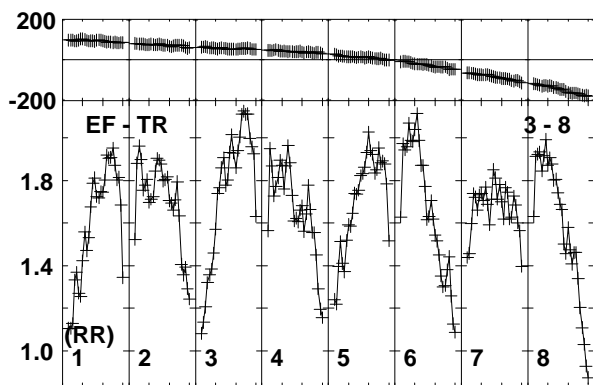
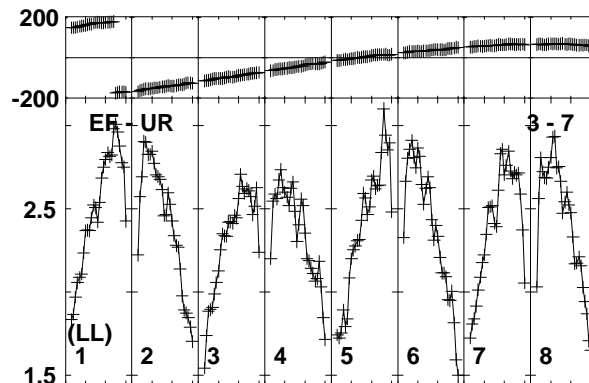
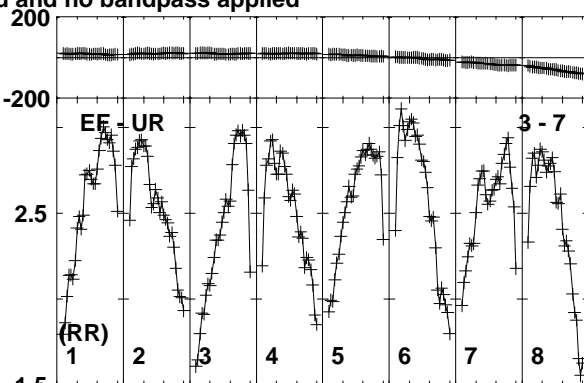
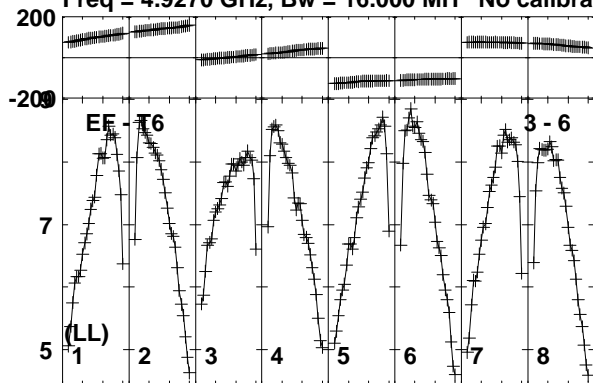

Lower frame: Milli Ampl Jy Top frame: Phas deg
Vector averaged cross-power spectrum Baseline: EF (03) - T6 (06)
Timerange: 00/07:05:21 to 00/07:07:19

Plot file version 384 created 17-FEB-2020 15:43:15

J1359+5544 EK047 2.UVDATA.1

Freq = 4.9270 GHz, Bw = 16.000 MH No calibration applied and no bandpass applied

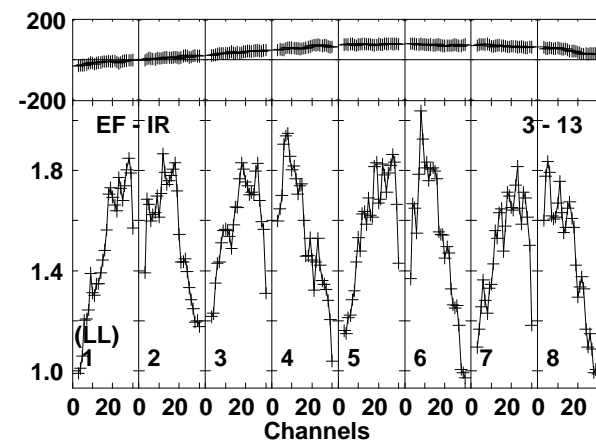
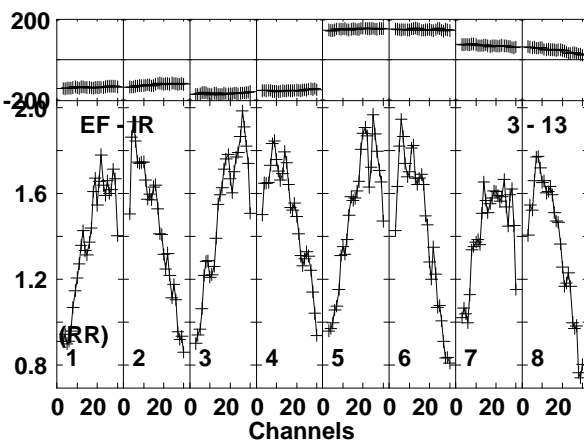
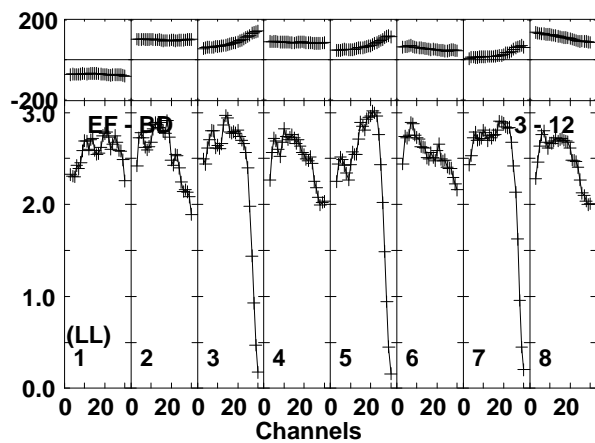
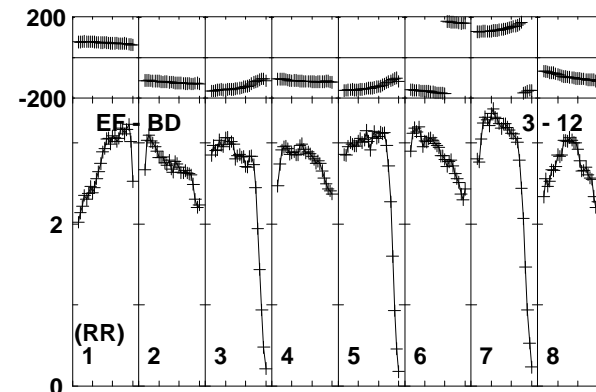
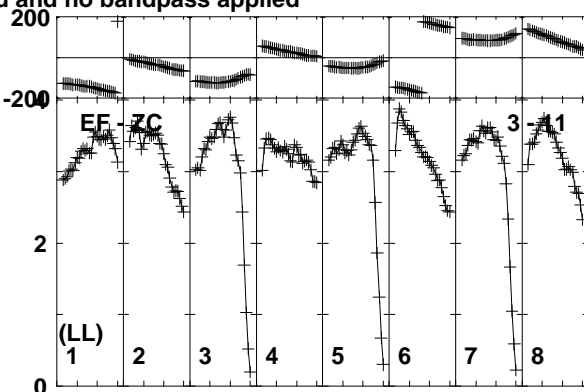
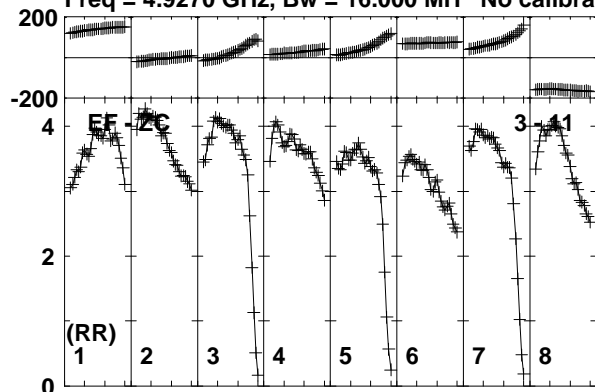

Lower frame: Milli Ampl Jy Top frame: Phas deg
Vector averaged cross-power spectrum Baseline: EF (03) - ZC (11)
Timerange: 00/07:05:21 to 00/07:07:19

Plot file version 385 created 17-FEB-2020 15:43:15

J1402+5347 EK047 2.UVDATA.1

Freq = 4.9270 GHz, Bw = 16.000 MH No calibration applied and no bandpass applied

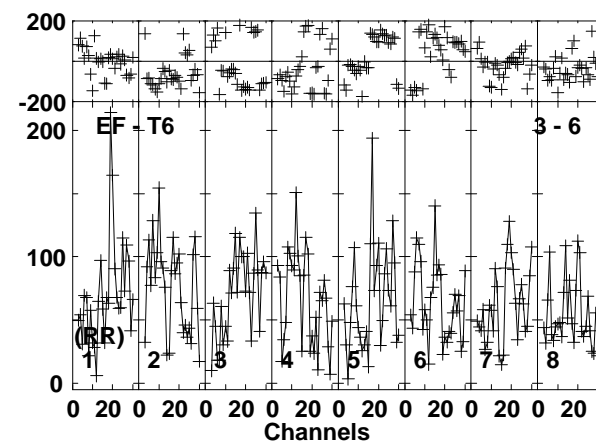
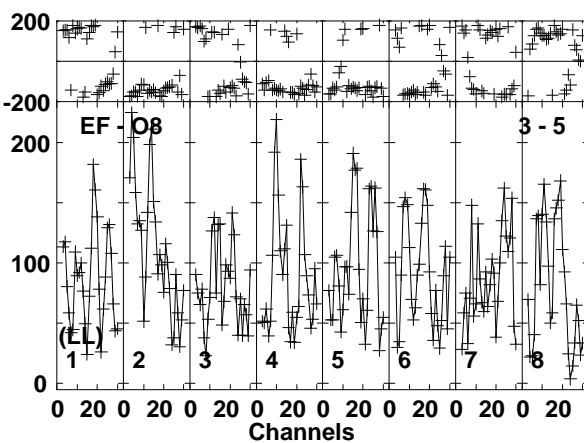
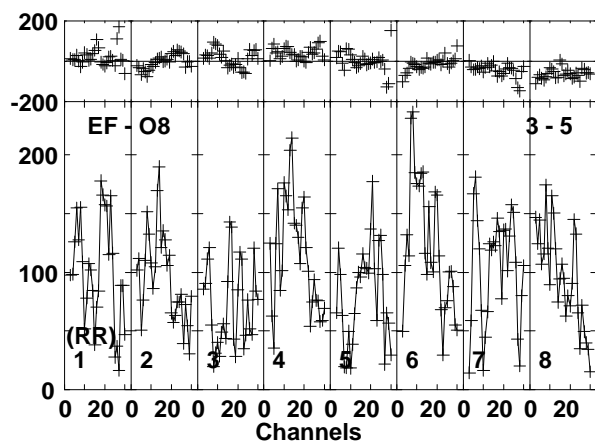
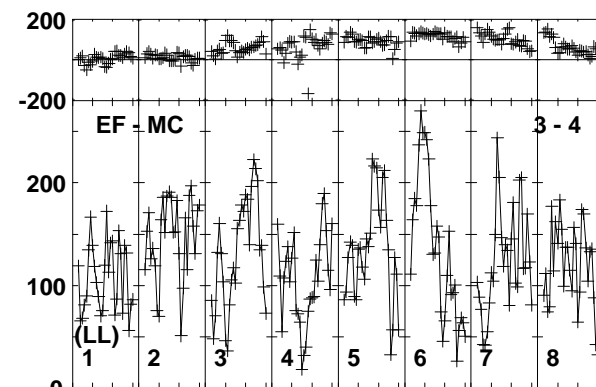
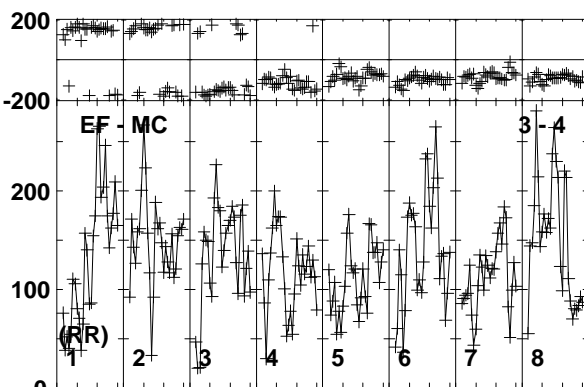
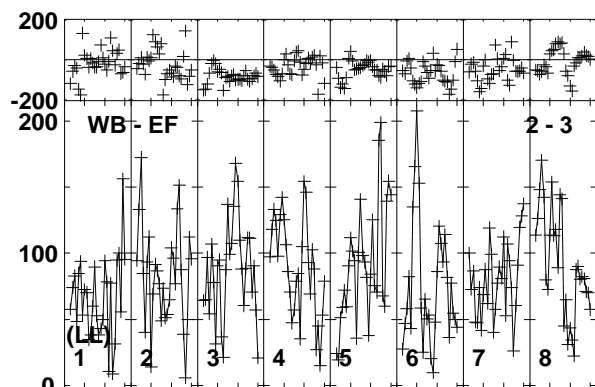
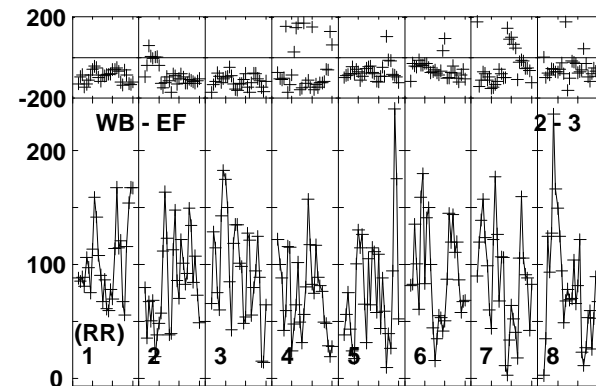
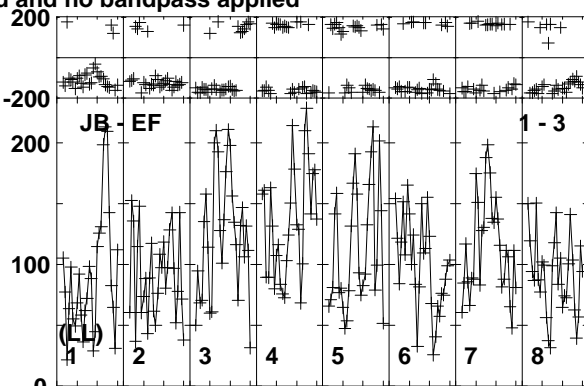
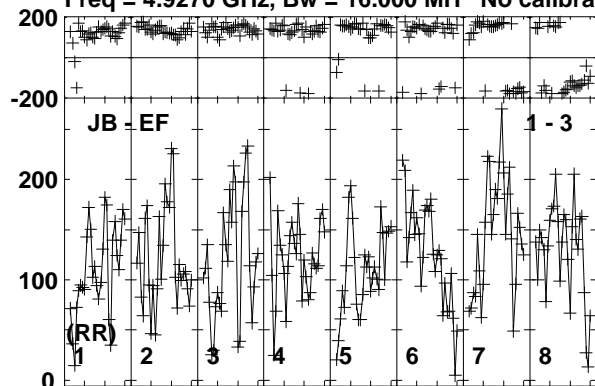

Lower frame: Micro Ampl Jy Top frame: Phas deg
Vector averaged cross-power spectrum Baseline: JB (01) - EF (03)
Timerange: 00/07:07:21 to 00/07:11:19

Plot file version 386 created 17-FEB-2020 15:43:16

J1402+5347 EK047 2.UVDATA.1

Freq = 4.9270 GHz, Bw = 16.000 MH No calibration applied and no bandpass applied

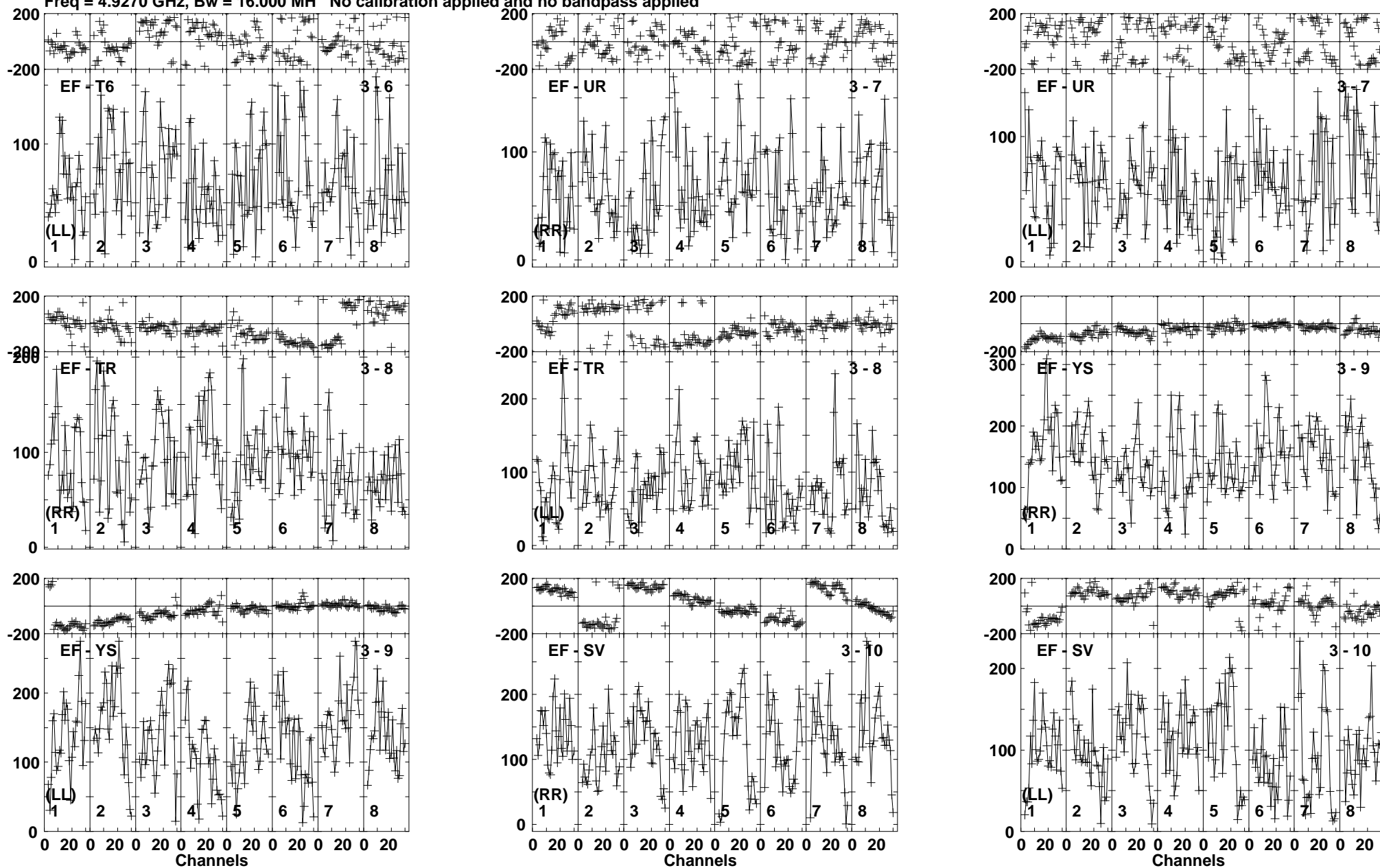

Lower frame: Micro Ampl Jy Top frame: Phas deg
Vector averaged cross-power spectrum Baseline: EF (03) - T6 (06)
Timerange: 00/07:07:21 to 00/07:11:19

Plot file version 387 created 17-FEB-2020 15:43:16

J1402+5347 EK047 2.UVDATA.1

Freq = 4.9270 GHz, Bw = 16.000 MH No calibration applied and no bandpass applied

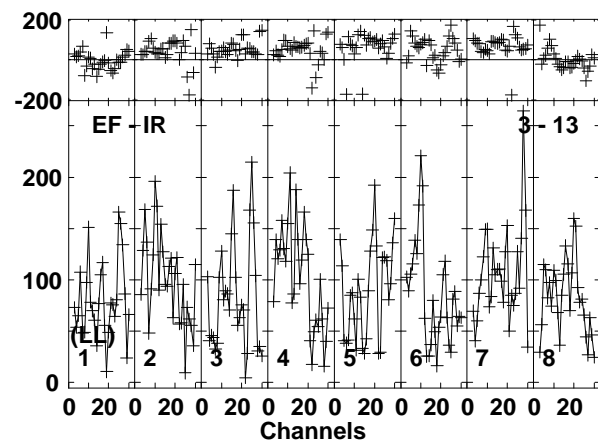
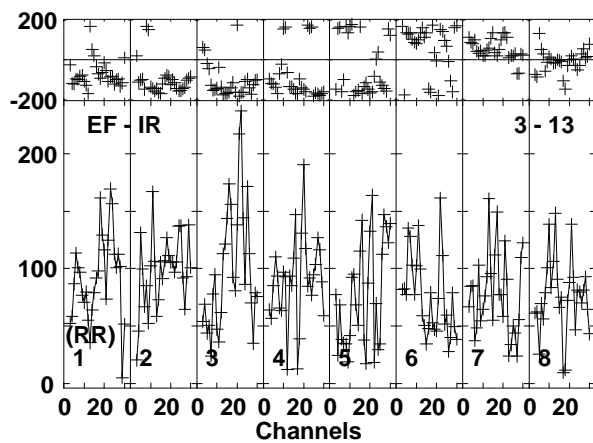
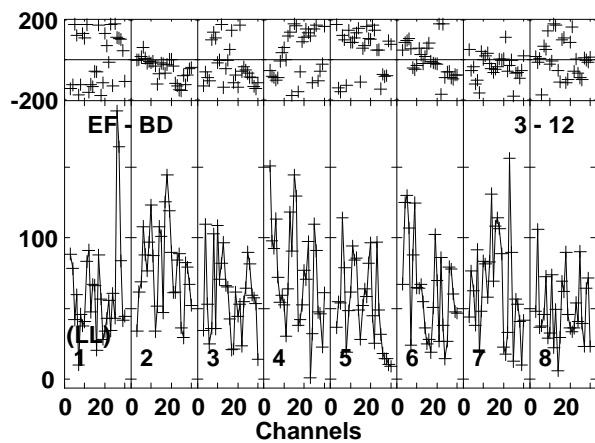
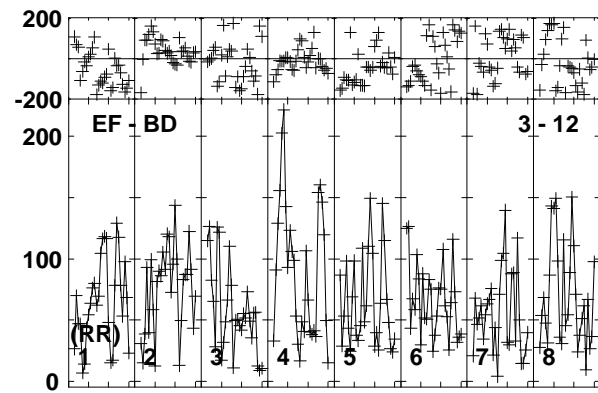
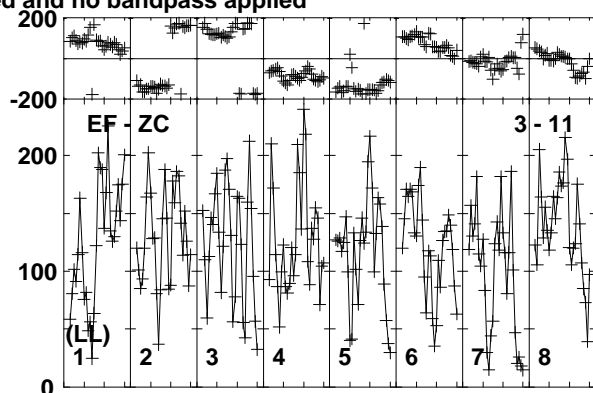
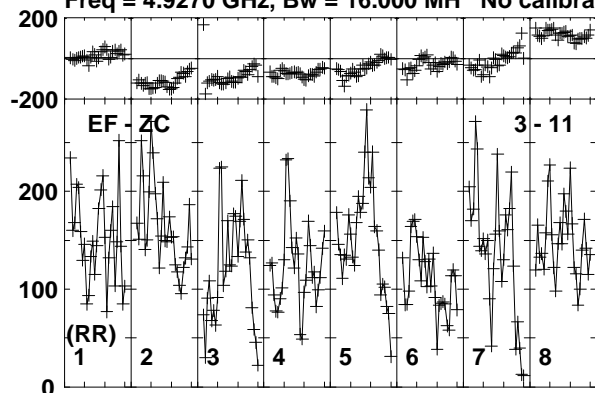

Lower frame: Micro Ampl Jy Top frame: Phas deg
Vector averaged cross-power spectrum Baseline: EF (03) - ZC (11)
Timerange: 00/07:07:21 to 00/07:11:19

Plot file version 388 created 17-FEB-2020 15:43:16

J1359+5544 EK047 2.UVDATA.1

Freq = 4.9270 GHz, Bw = 16.000 MH No calibration applied and no bandpass applied

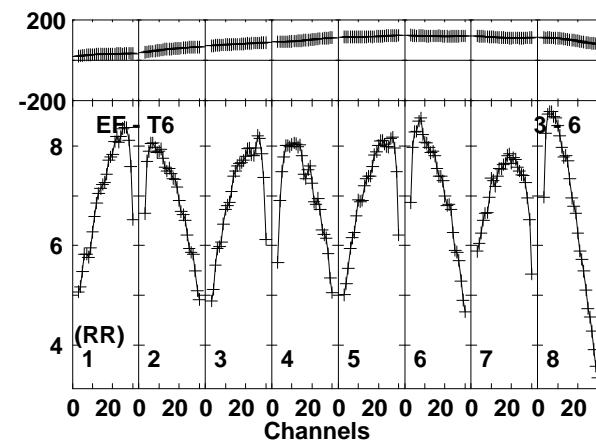
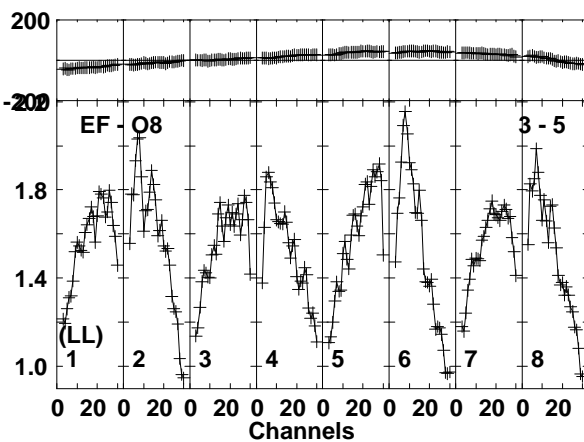
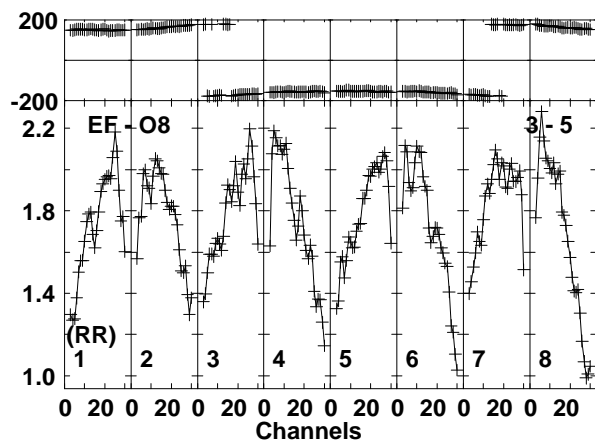
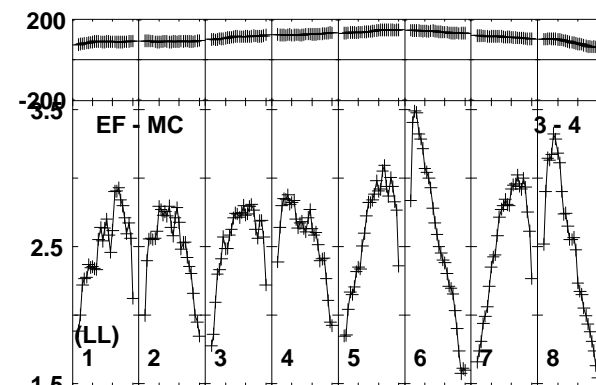
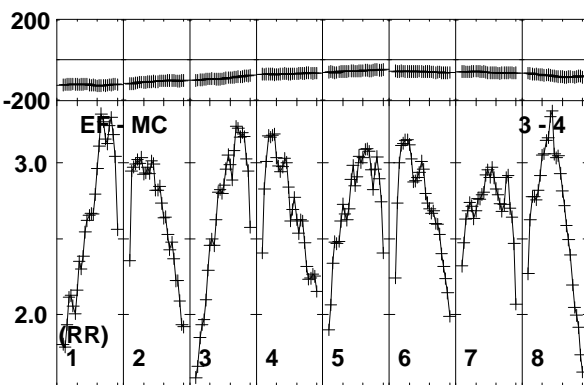
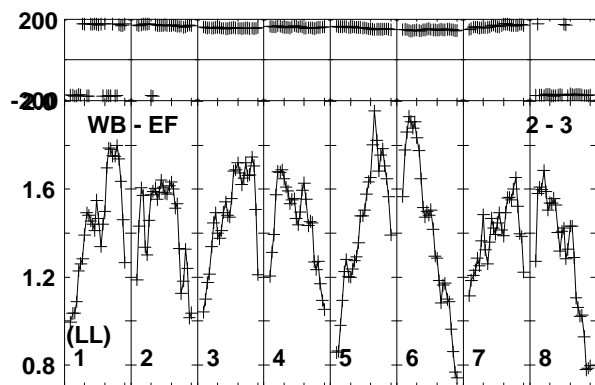
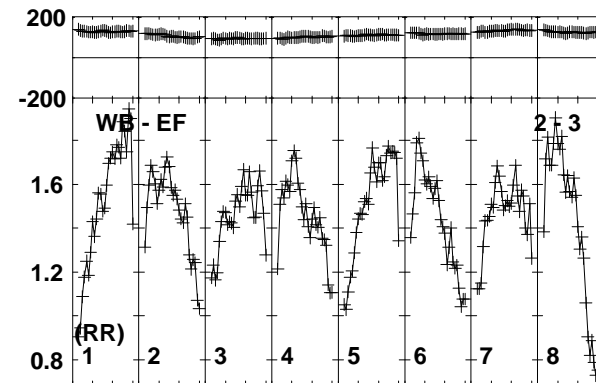
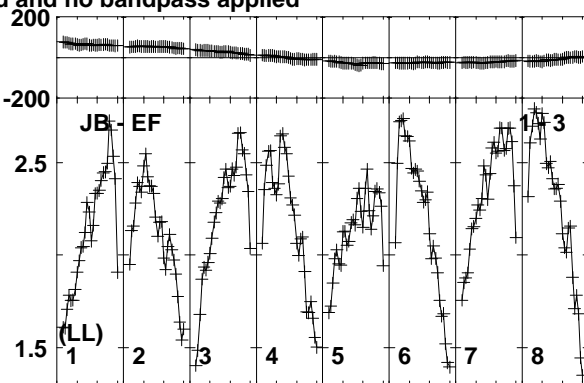
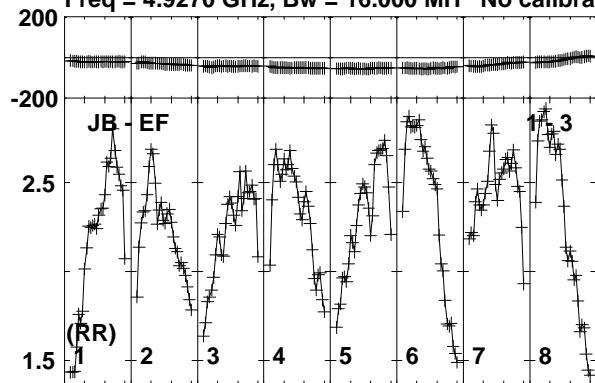

Lower frame: Milli Ampl Jy Top frame: Phas deg
Vector averaged cross-power spectrum Baseline: JB (01) - EF (03)
Timerange: 00/07:12:01 to 00/07:13:19

Plot file version 389 created 17-FEB-2020 15:43:16

J1359+5544 EK047 2.UVDATA.1

Freq = 4.9270 GHz, Bw = 16.000 MH No calibration applied and no bandpass applied

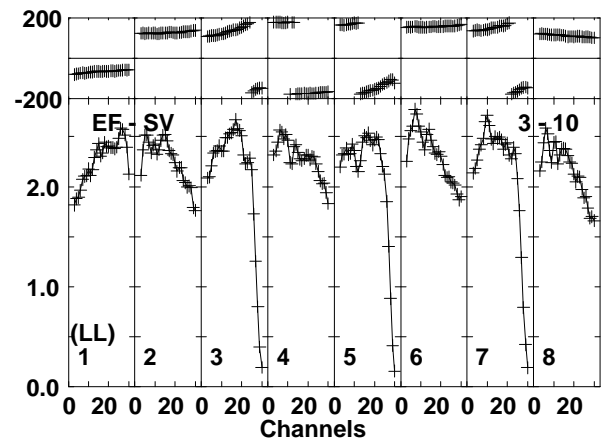
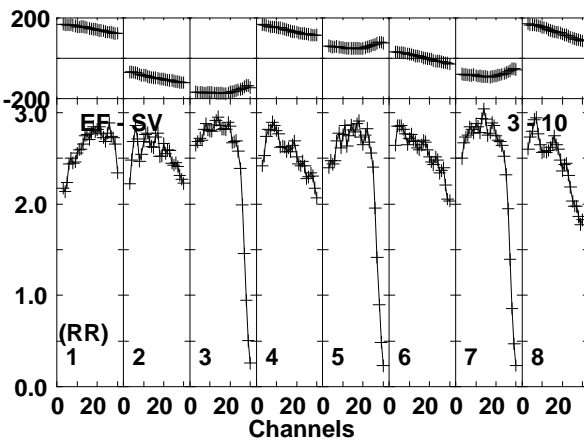
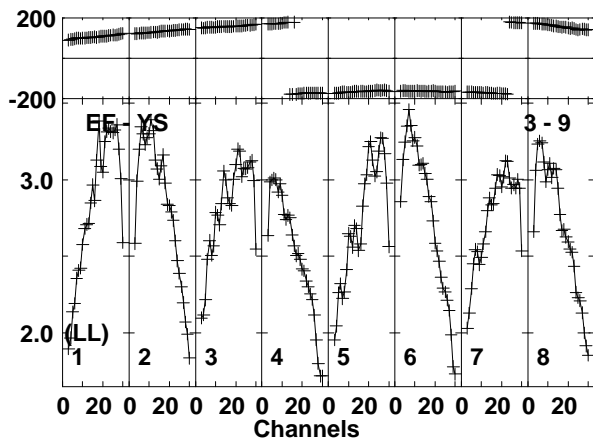
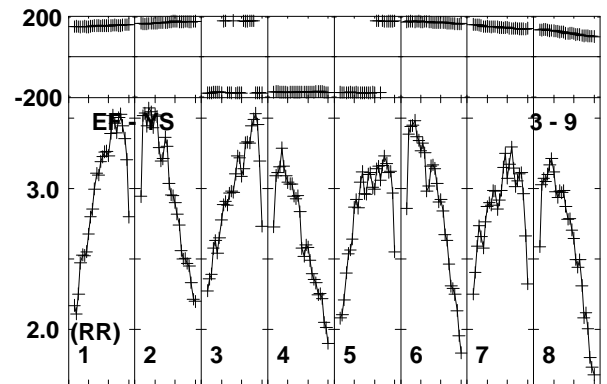
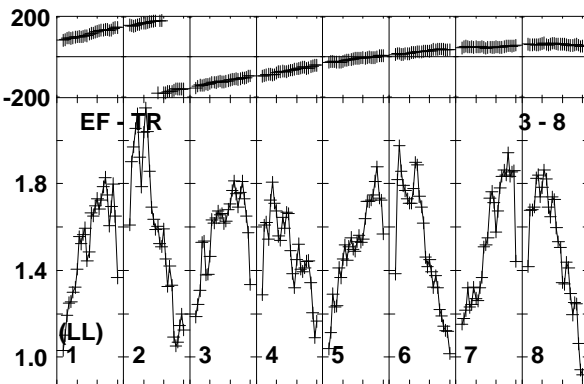
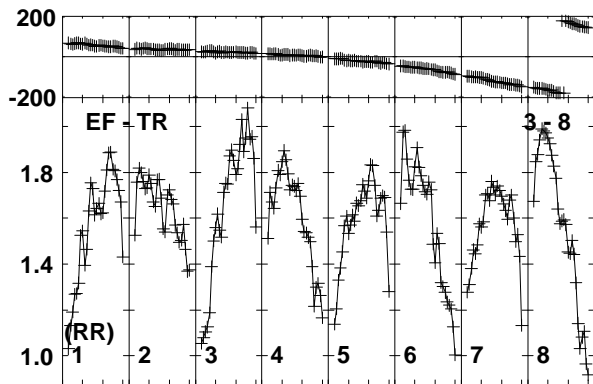
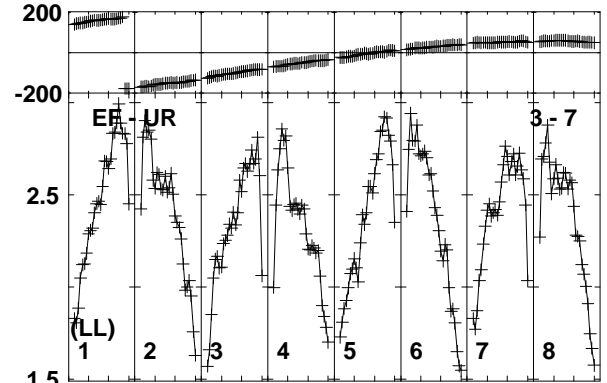
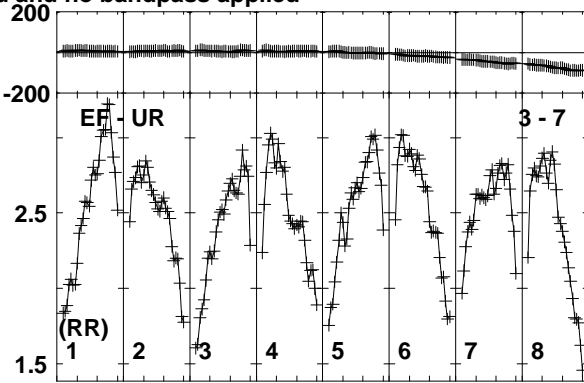
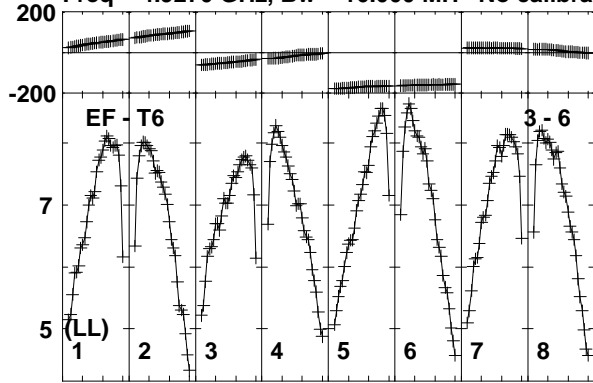

Lower frame: Milli Ampl Jy Top frame: Phas deg
Vector averaged cross-power spectrum Baseline: EF (03) - T6 (06)
Timerange: 00/07:12:01 to 00/07:13:19

Plot file version 390 created 17-FEB-2020 15:43:16

J1359+5544 EK047 2.UVDATA.1

Freq = 4.9270 GHz, Bw = 16.000 MH No calibration applied and no bandpass applied

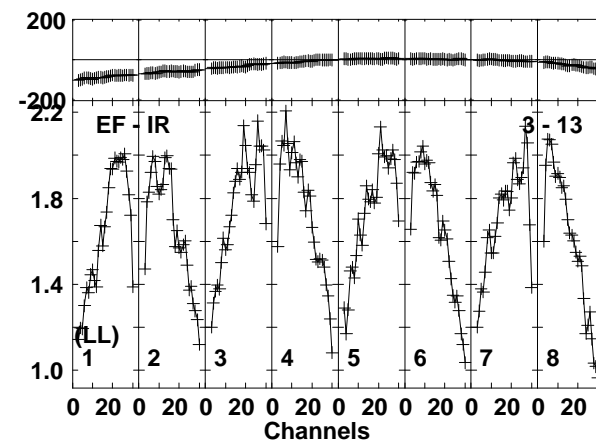
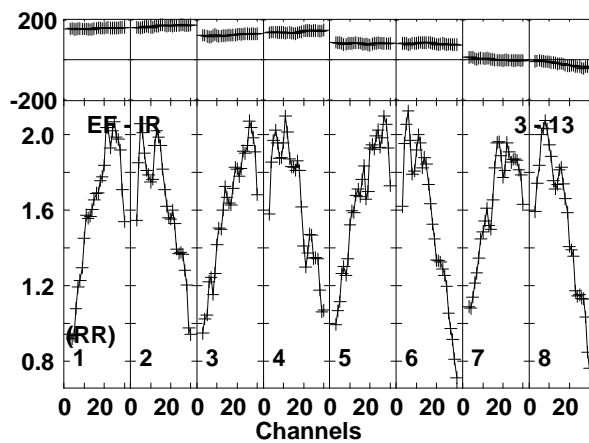
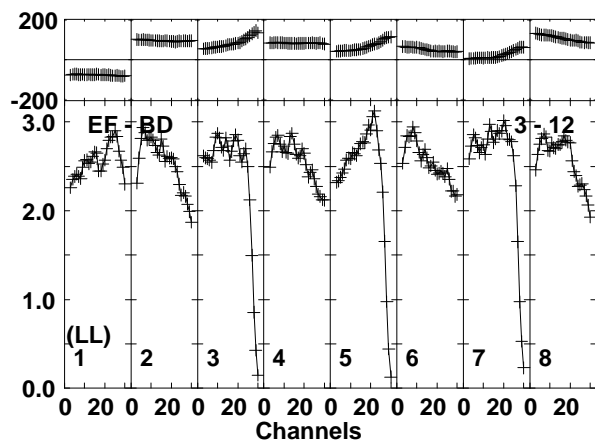
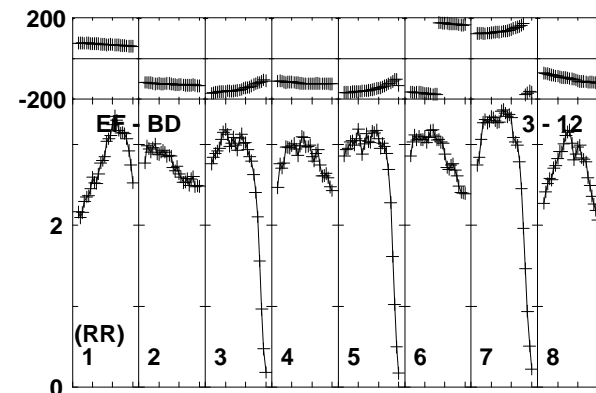
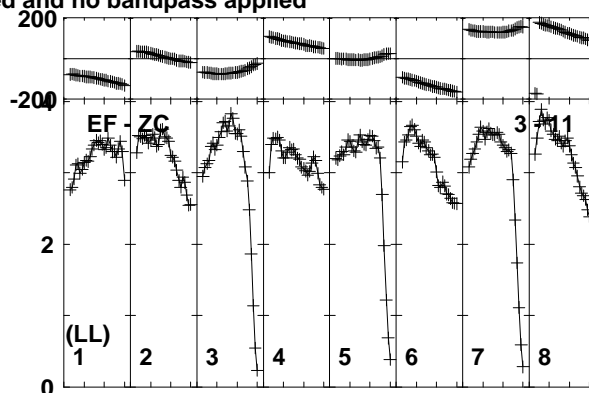
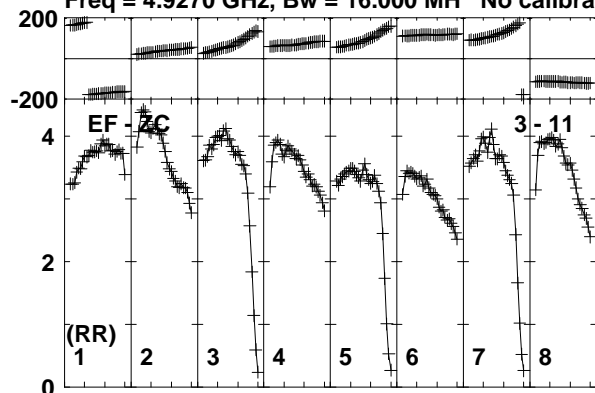

Lower frame: Milli Ampl Jy Top frame: Phas deg
Vector averaged cross-power spectrum Baseline: EF (03) - ZC (11)
Timerange: 00/07:12:01 to 00/07:13:19

Plot file version 391 created 17-FEB-2020 15:43:16

J1402+5347 EK047 2.UVDATA.1

Freq = 4.9270 GHz, Bw = 16.000 MH No calibration applied and no bandpass applied

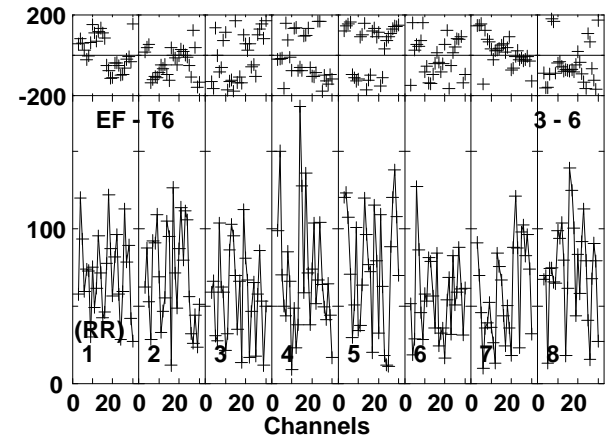
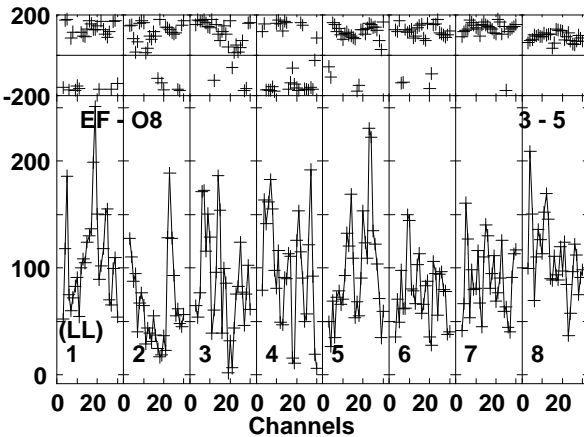
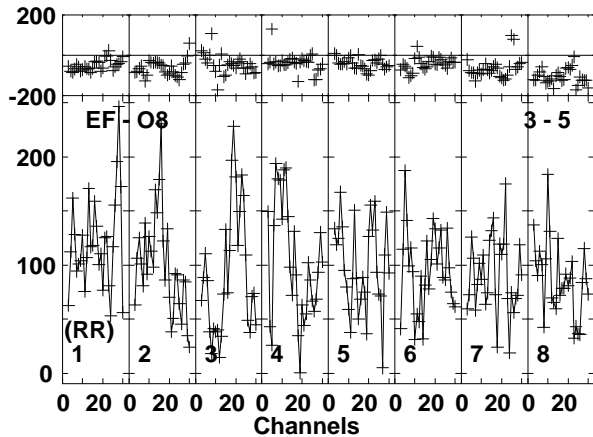
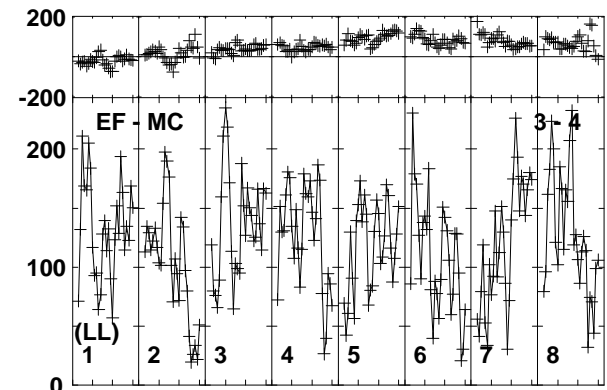
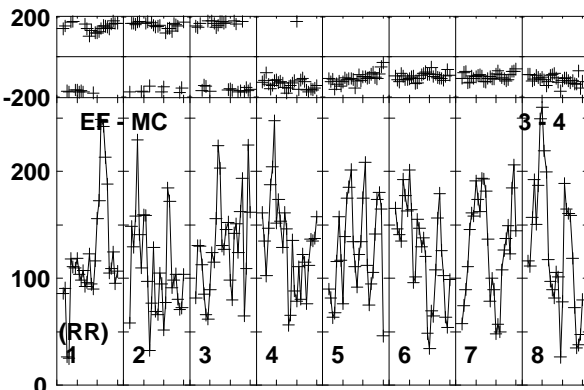
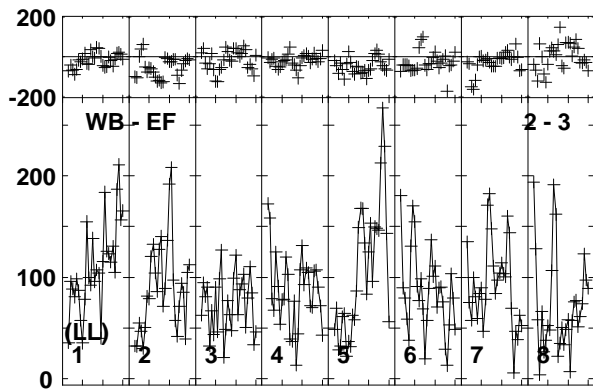
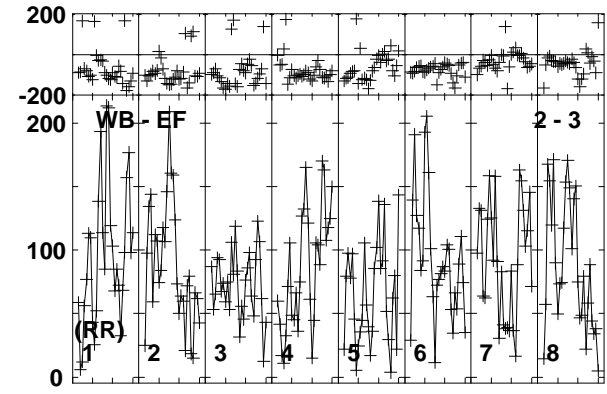
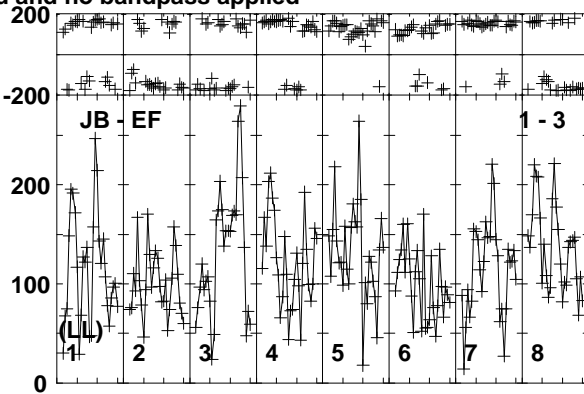
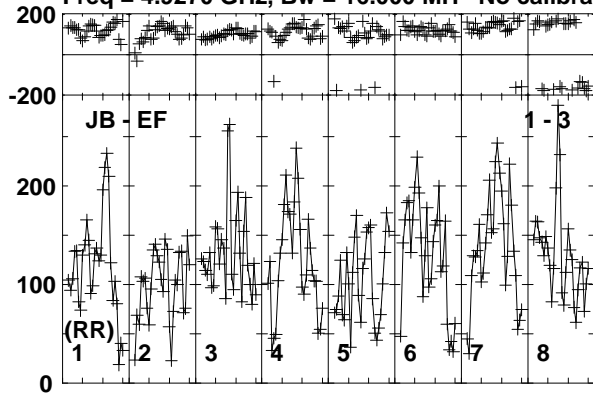

Lower frame: Micro Ampl Jy Top frame: Phas deg
Vector averaged cross-power spectrum Baseline: JB (01) - EF (03)
Timerange: 00/07:13:21 to 00/07:17:19

Plot file version 392 created 17-FEB-2020 15:43:16

J1402+5347 EK047 2.UVDATA.1

Freq = 4.9270 GHz, Bw = 16.000 MH No calibration applied and no bandpass applied

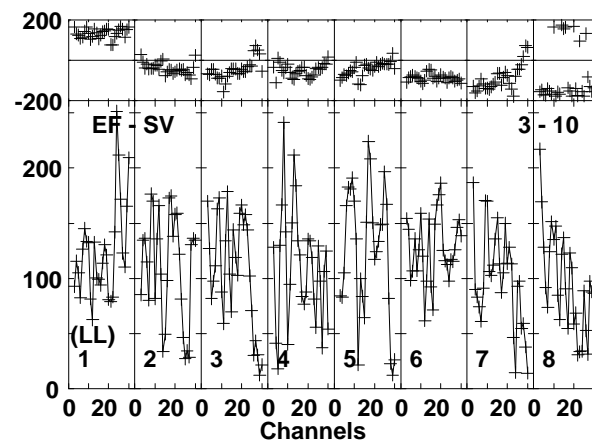
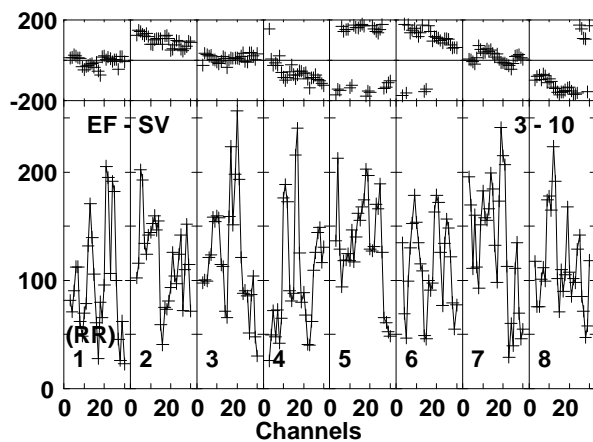
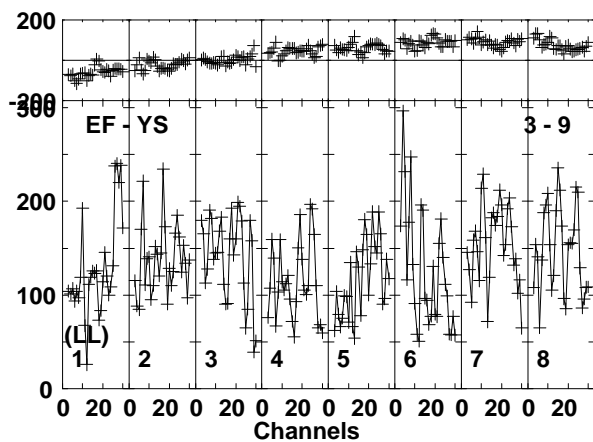
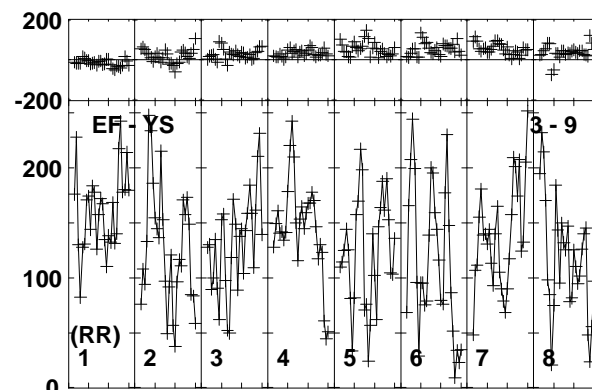
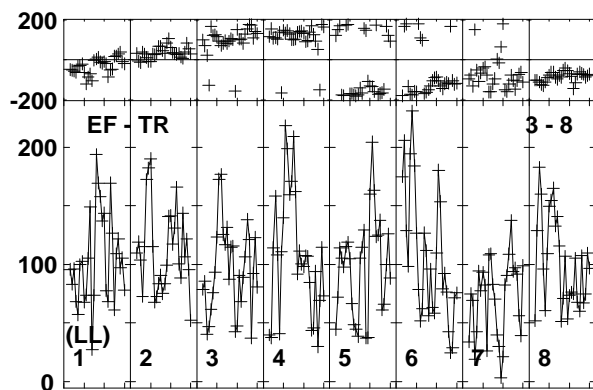
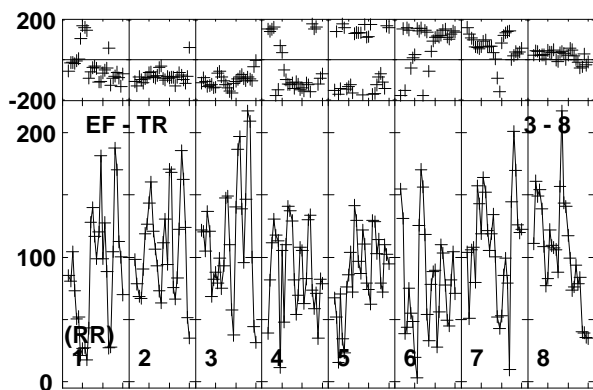
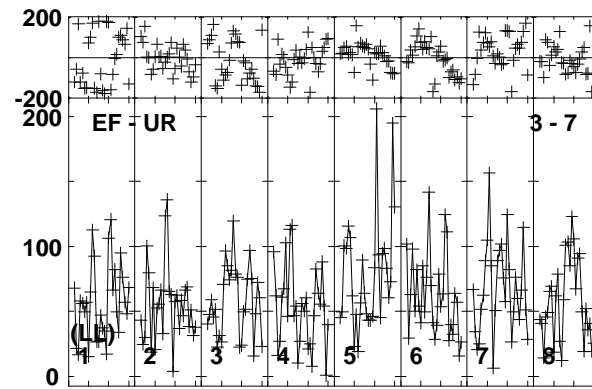
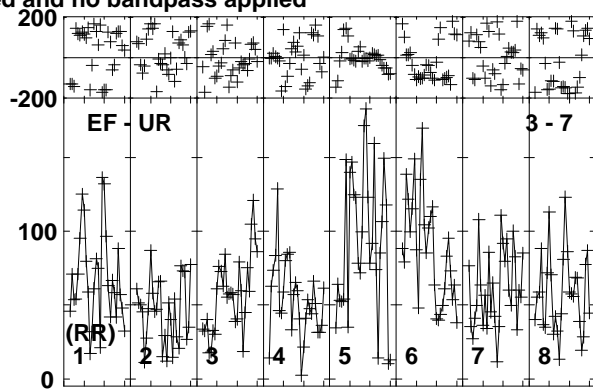
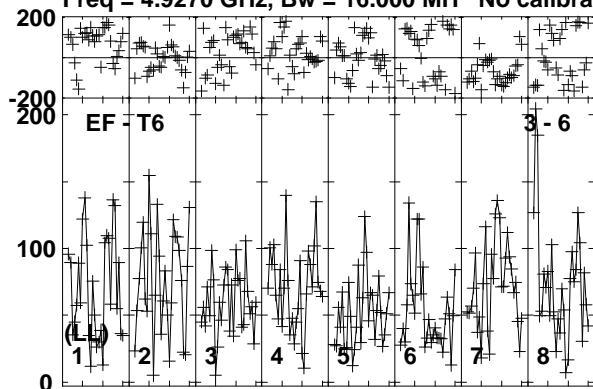

Lower frame: Micro Ampl Jy Top frame: Phas deg
Vector averaged cross-power spectrum Baseline: EF (03) - T6 (06)
Timerange: 00/07:13:21 to 00/07:17:19

Plot file version 393 created 17-FEB-2020 15:43:16

J1402+5347 EK047 2.UVDATA.1

Freq = 4.9270 GHz, Bw = 16.000 MH No calibration applied and no bandpass applied

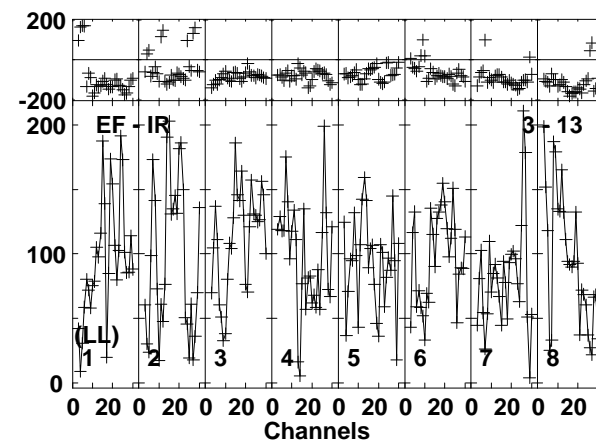
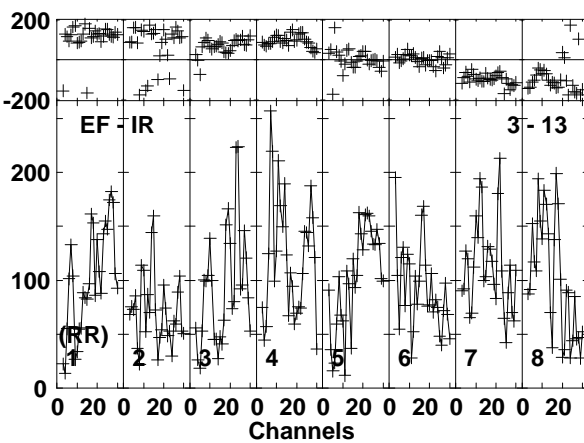
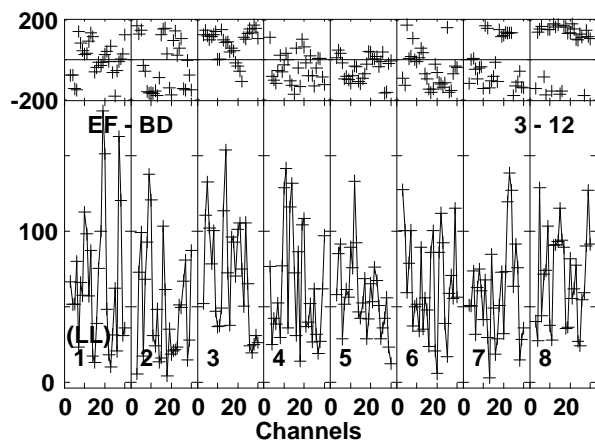
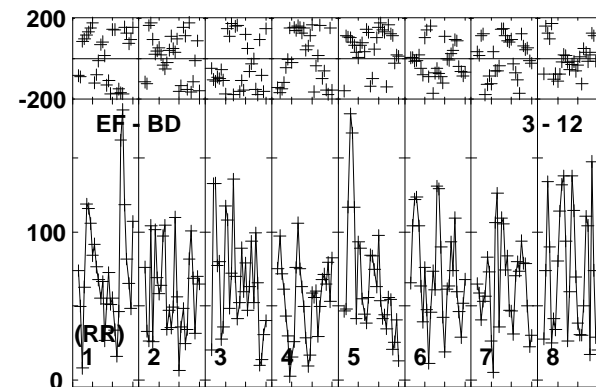
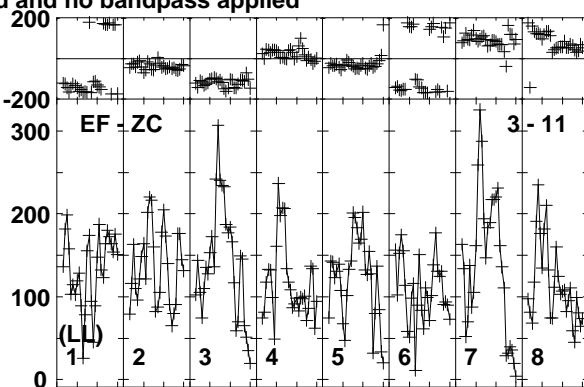
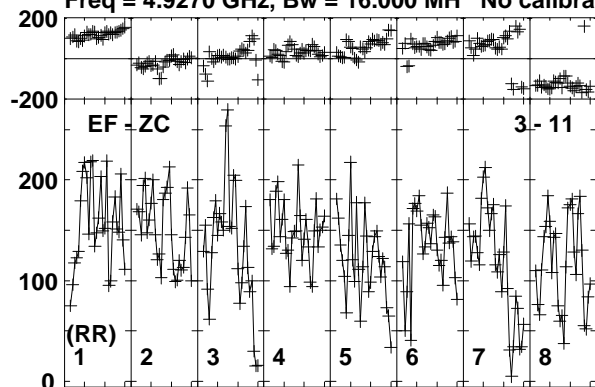

Lower frame: Micro Ampl Jy Top frame: Phas deg
Vector averaged cross-power spectrum Baseline: EF (03) - ZC (11)
Timerange: 00/07:13:21 to 00/07:17:19

Plot file version 394 created 17-FEB-2020 15:43:16

J1359+5544 EK047 2.UVDATA.1

Freq = 4.9270 GHz, Bw = 16.000 MH No calibration applied and no bandpass applied

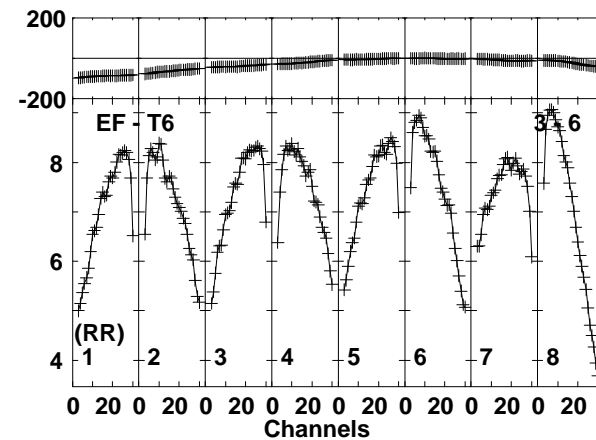
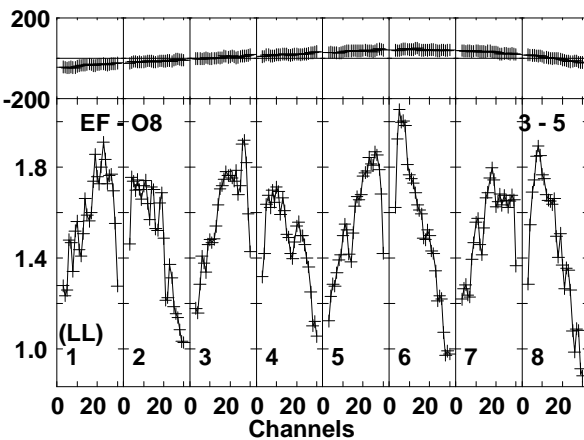
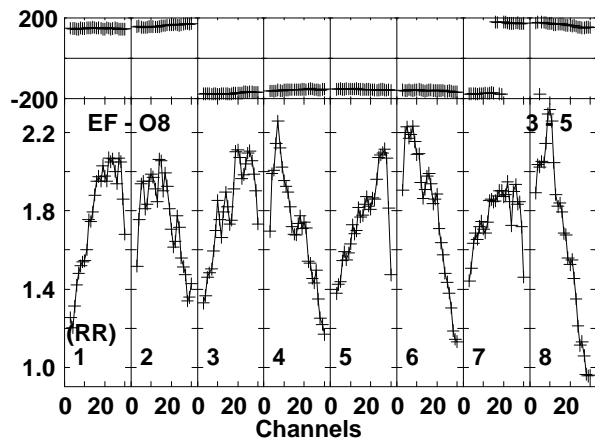
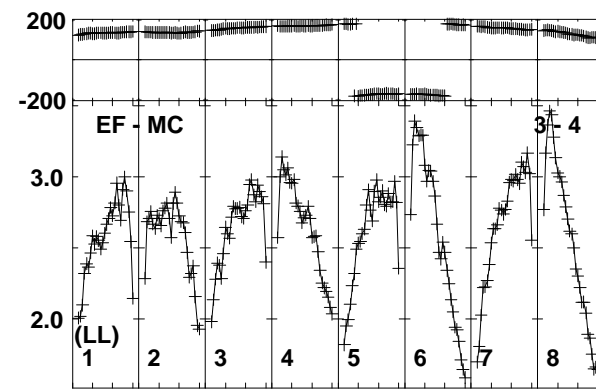
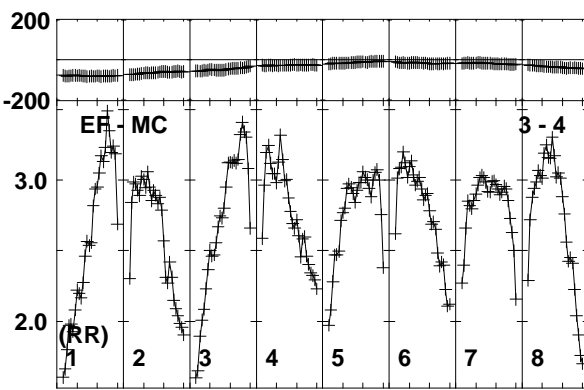
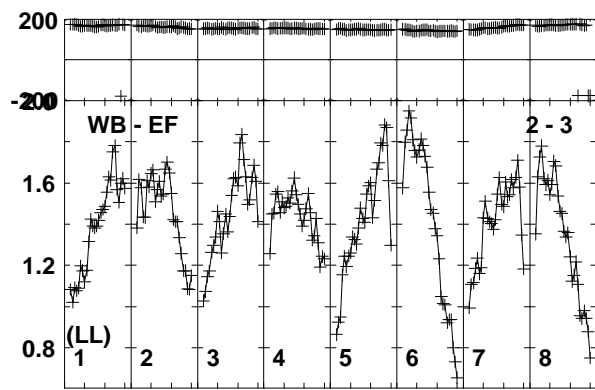
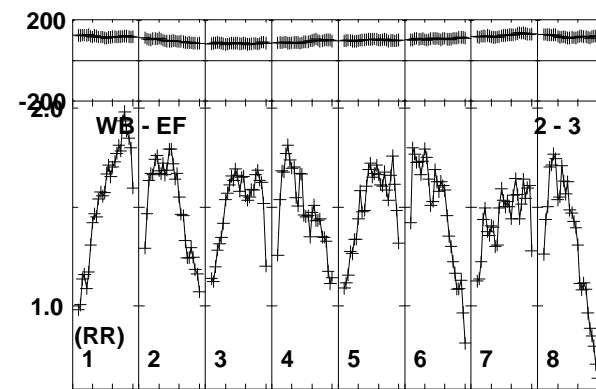
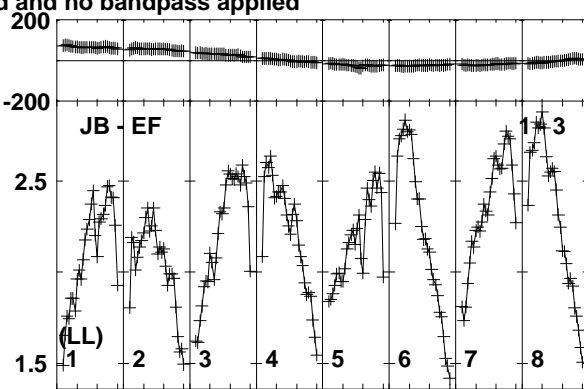
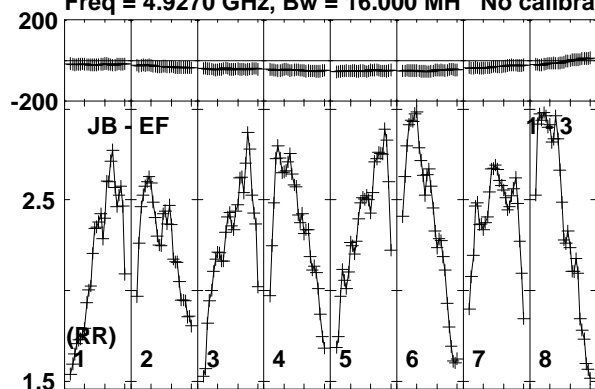

Lower frame: Milli Ampl Jy Top frame: Phas deg
Vector averaged cross-power spectrum Baseline: JB (01) - EF (03)
Timerange: 00/07:17:21 to 00/07:19:19

Plot file version 395 created 17-FEB-2020 15:43:17

J1359+5544 EK047 2.UVDATA.1

Freq = 4.9270 GHz, Bw = 16.000 MH No calibration applied and no bandpass applied

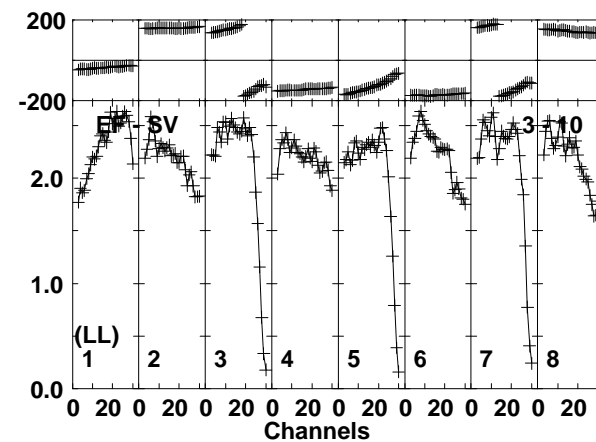
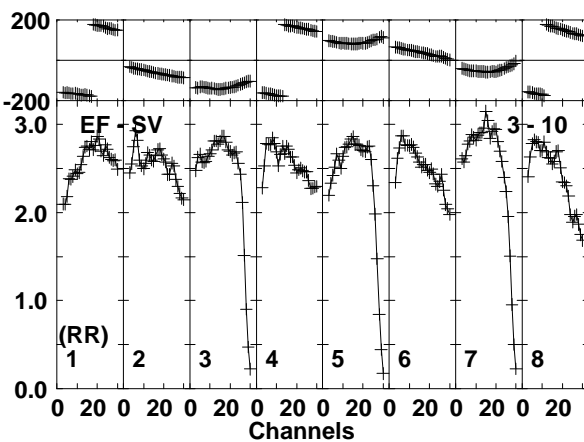
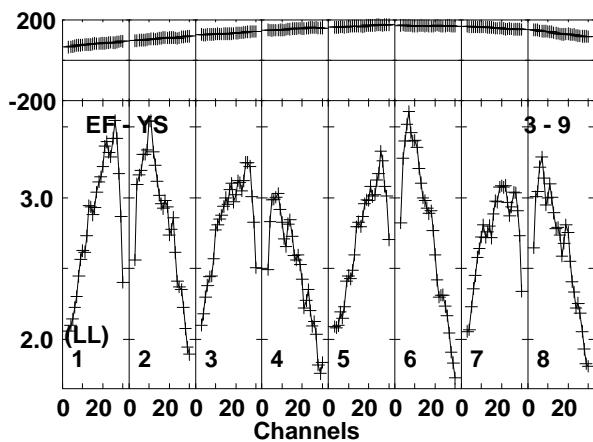
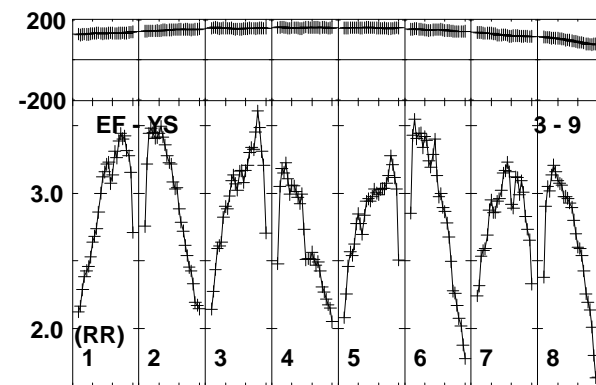
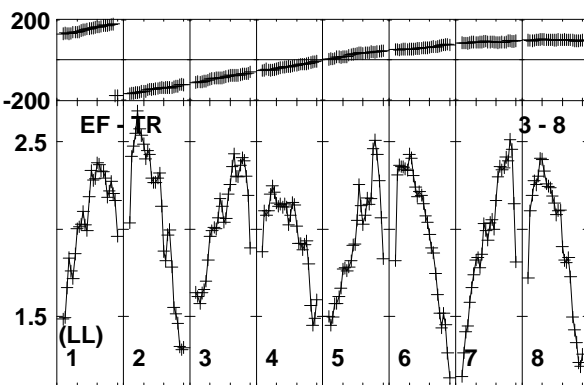
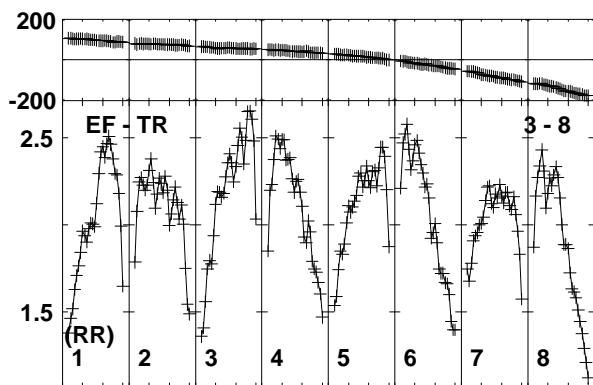
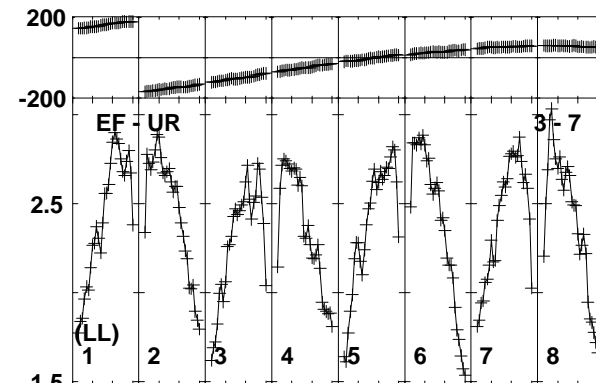
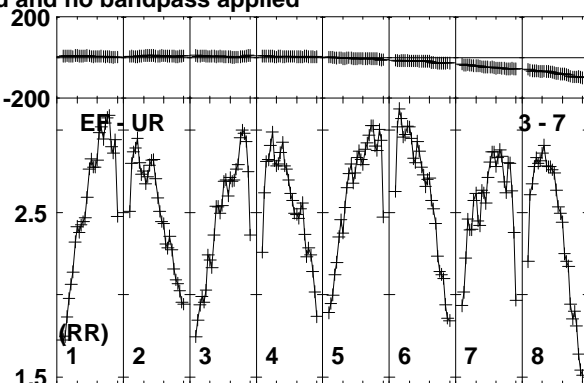
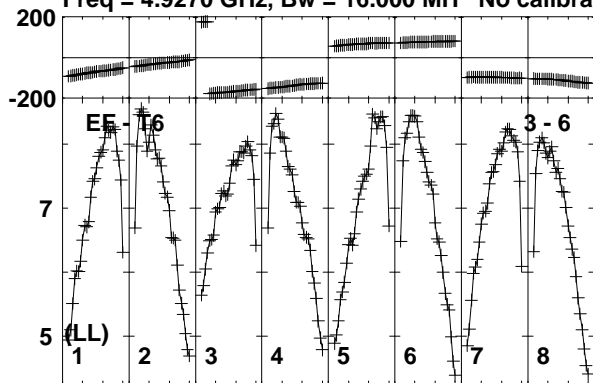

Lower frame: Milli Ampl Jy Top frame: Phas deg
Vector averaged cross-power spectrum Baseline: EF (03) - T6 (06)
Timerange: 00/07:17:21 to 00/07:19:19

Plot file version 396 created 17-FEB-2020 15:43:17

J1359+5544 EK047 2.UVDATA.1

Freq = 4.9270 GHz, Bw = 16.000 MH No calibration applied and no bandpass applied

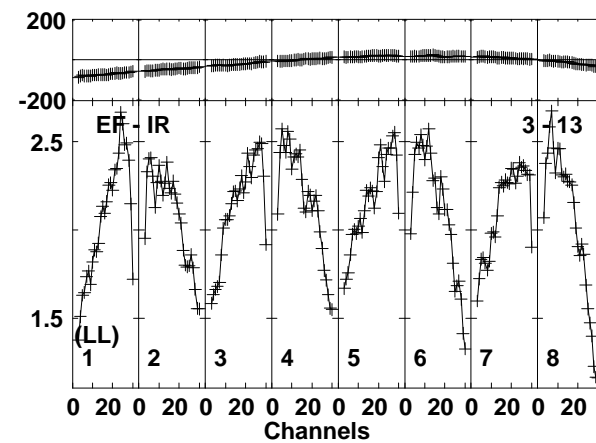
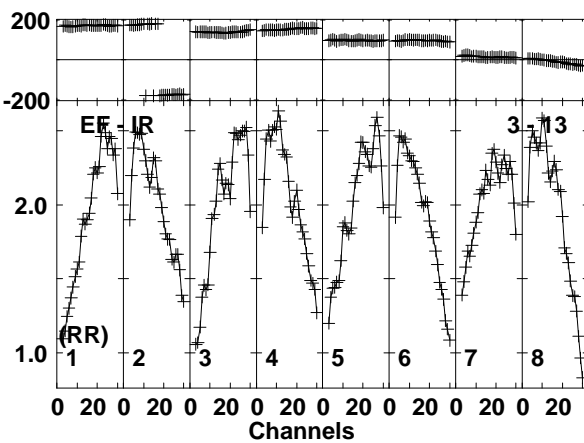
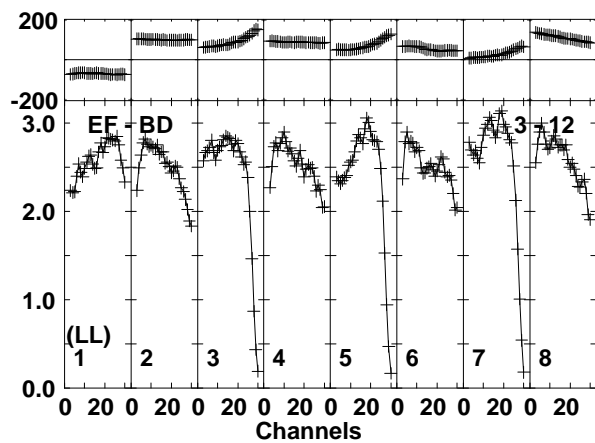
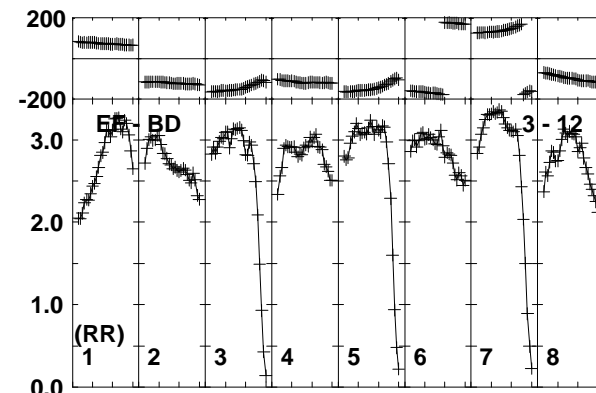
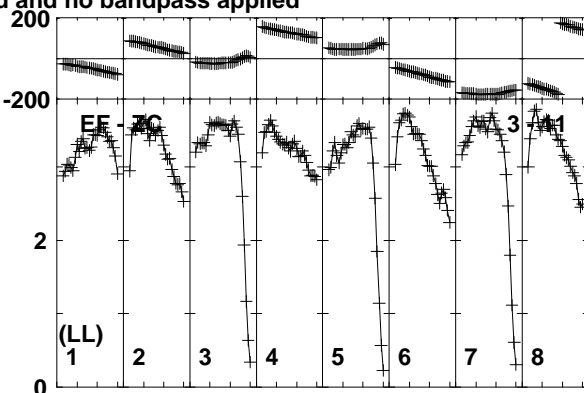
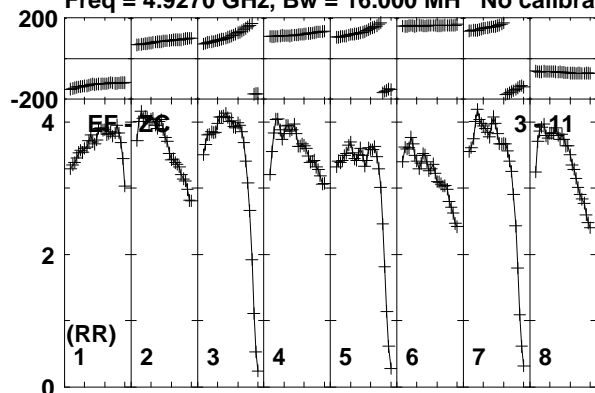

Lower frame: Milli Ampl Jy Top frame: Phas deg
Vector averaged cross-power spectrum Baseline: EF (03) - ZC (11)
Timerange: 00/07:17:21 to 00/07:19:19

Plot file version 397 created 17-FEB-2020 15:43:17

J1402+5347 EK047 2.UVDATA.1

Freq = 4.9270 GHz, Bw = 16.000 MH No calibration applied and no bandpass applied

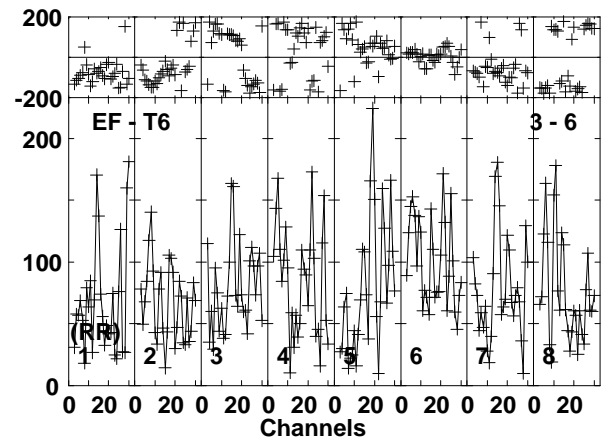
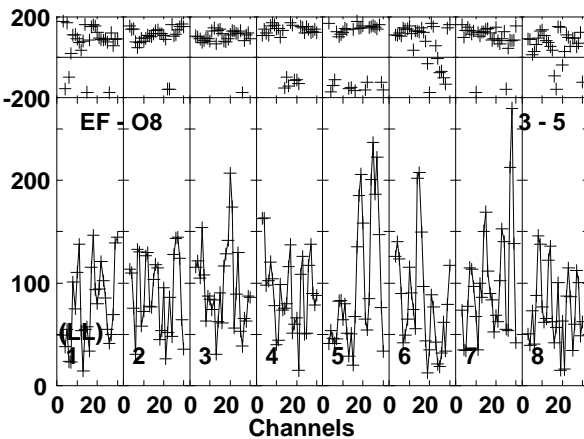
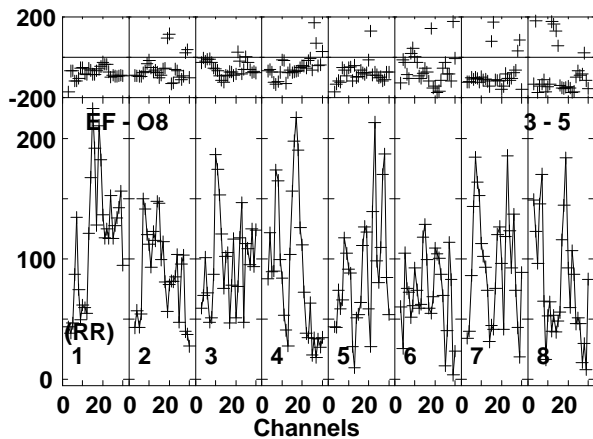
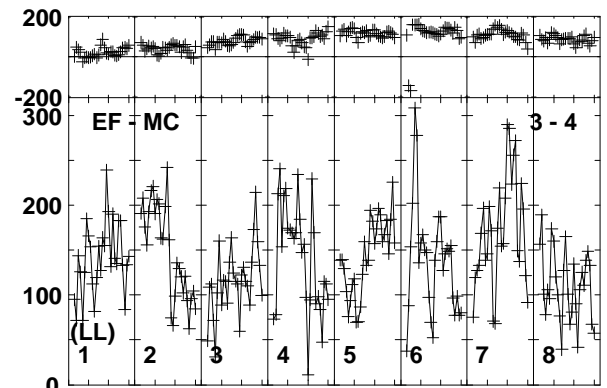
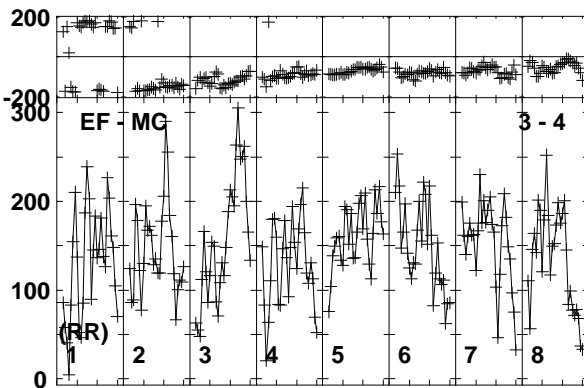
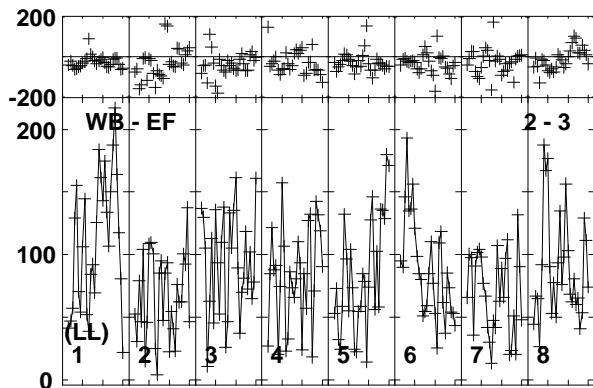
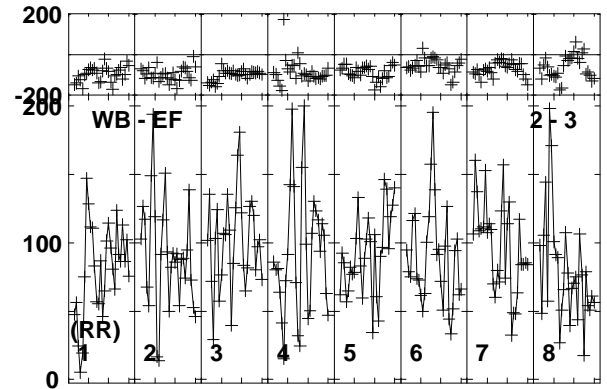
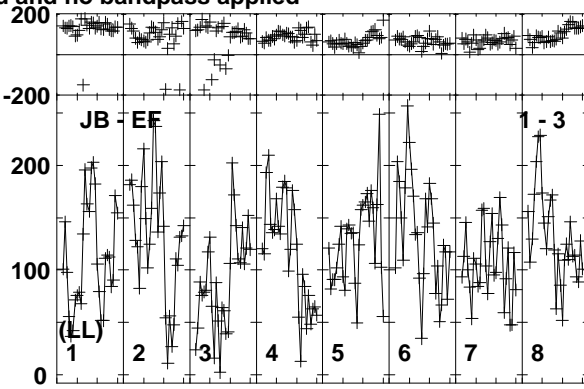
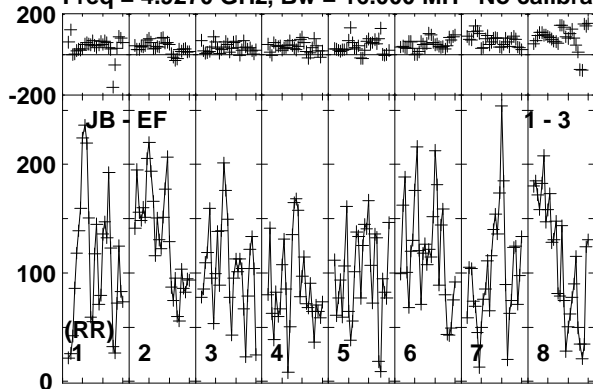

Lower frame: Micro Ampl Jy Top frame: Phas deg
Vector averaged cross-power spectrum Baseline: JB (01) - EF (03)
Timerange: 00/07:19:23 to 00/07:23:19

Plot file version 398 created 17-FEB-2020 15:43:17

J1402+5347 EK047 2.UVDATA.1

Freq = 4.9270 GHz, Bw = 16.000 MH No calibration applied and no bandpass applied

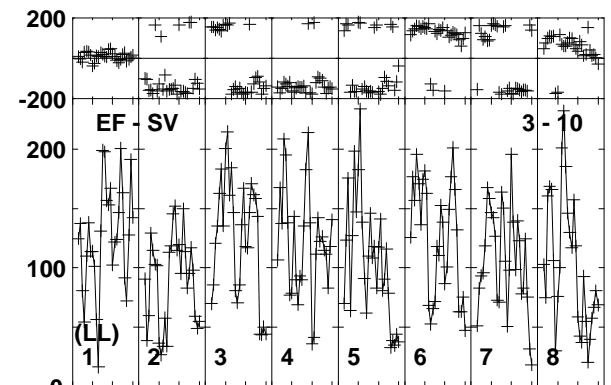
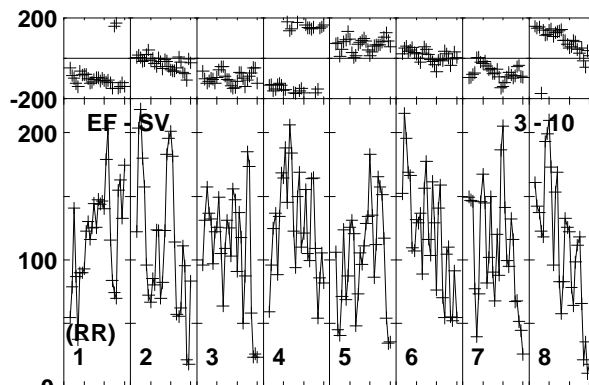
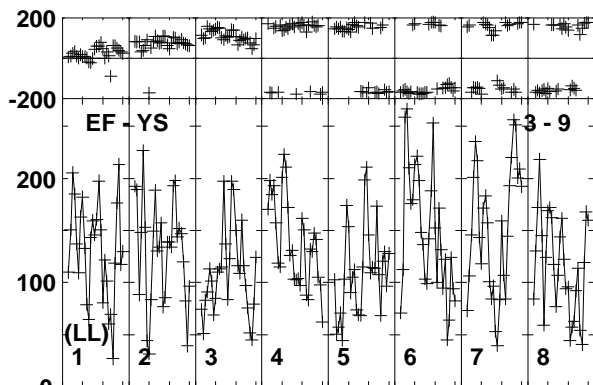
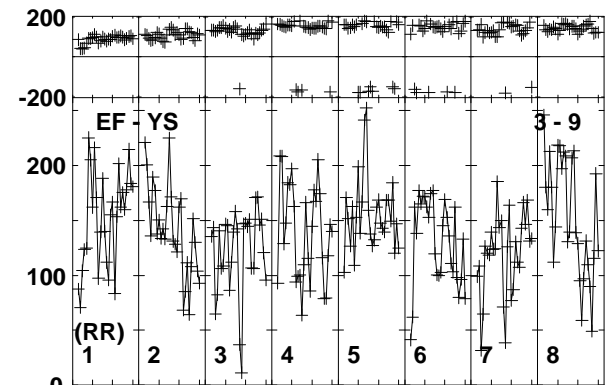
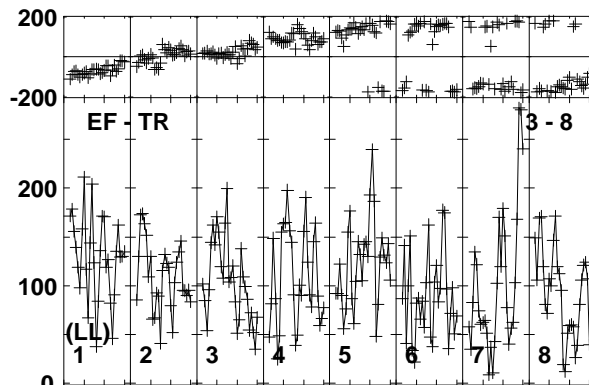
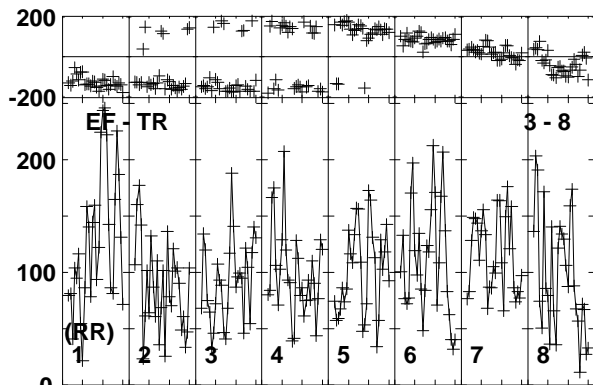
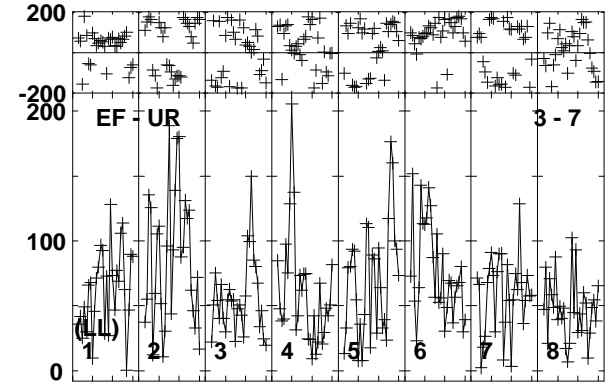
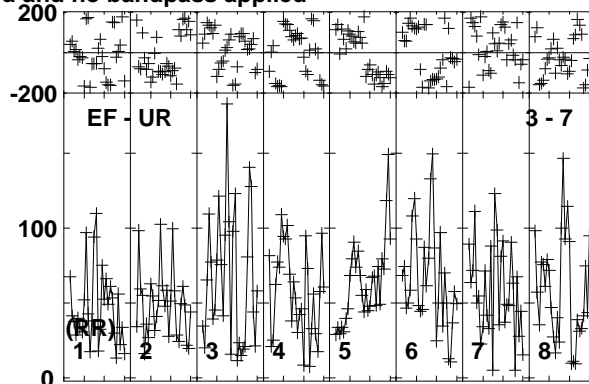
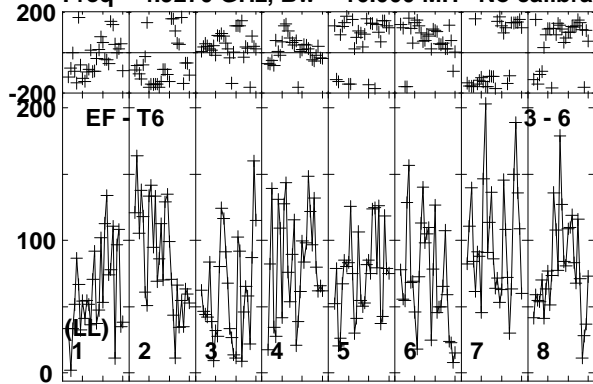

Lower frame: Micro Ampl Jy Top frame: Phas deg
Vector averaged cross-power spectrum Baseline: EF (03) - T6 (06)
Timerange: 00/07:19:23 to 00/07:23:19

Plot file version 399 created 17-FEB-2020 15:43:17

J1402+5347 EK047 2.UVDATA.1

Freq = 4.9270 GHz, Bw = 16.000 MH No calibration applied and no bandpass applied

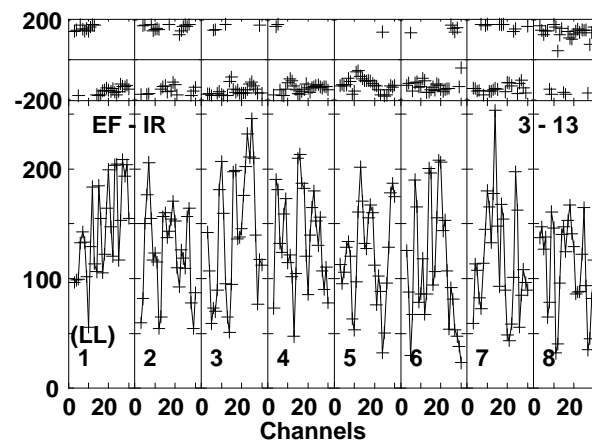
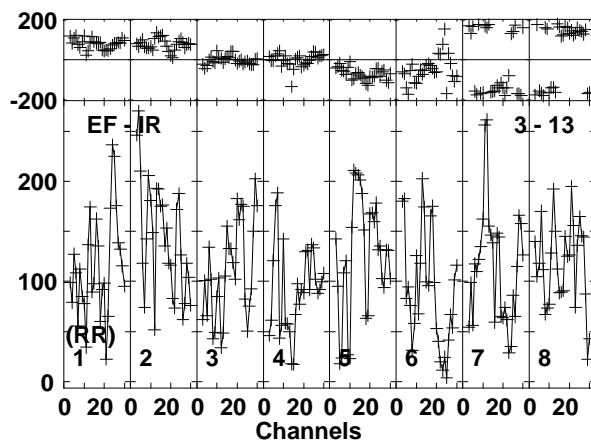
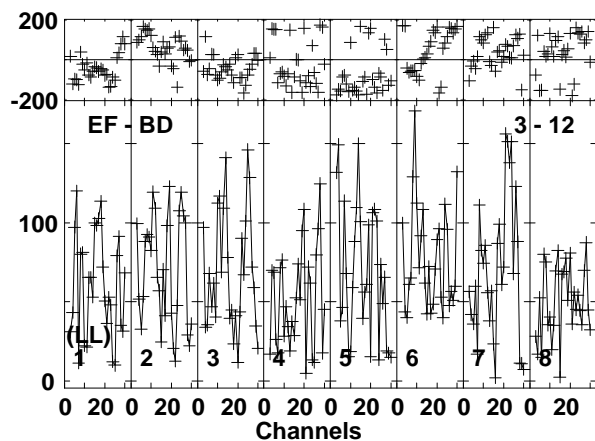
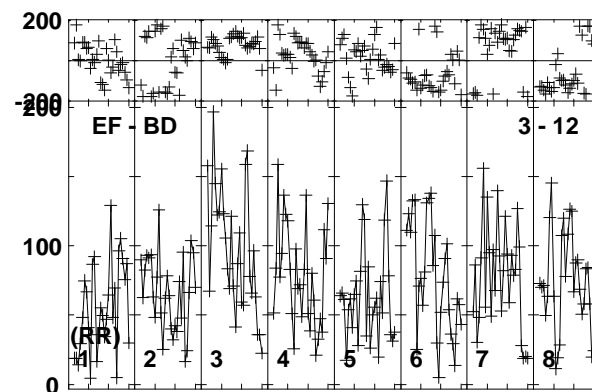
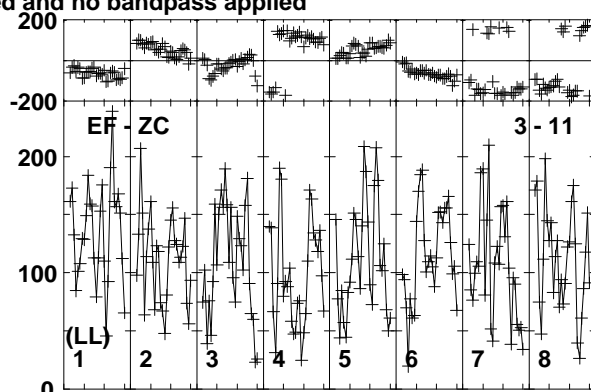
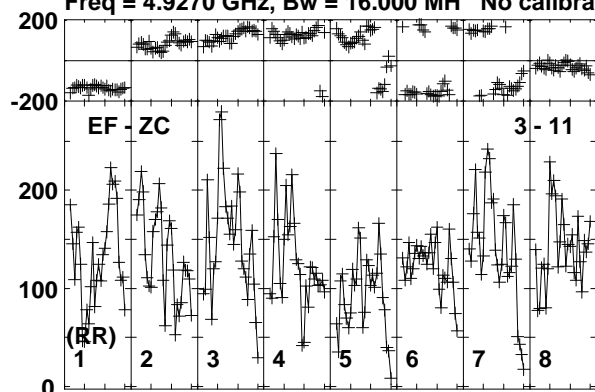

Lower frame: Micro Ampl Jy Top frame: Phas deg
Vector averaged cross-power spectrum Baseline: EF (03) - ZC (11)
Timerange: 00/07:19:23 to 00/07:23:19

Plot file version 400 created 17-FEB-2020 15:43:17

J1359+5544 EK047 2.UVDATA.1

Freq = 4.9270 GHz, Bw = 16.000 MH No calibration applied and no bandpass applied

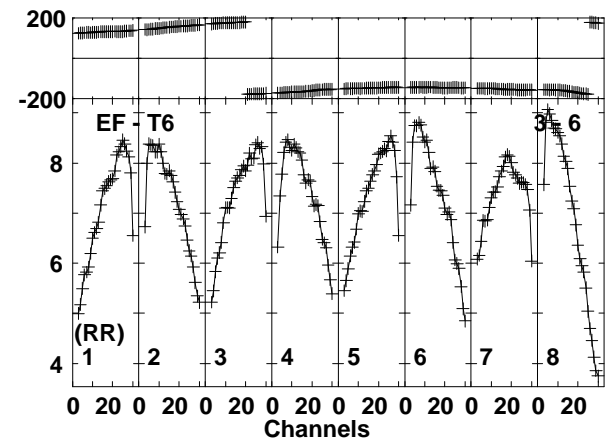
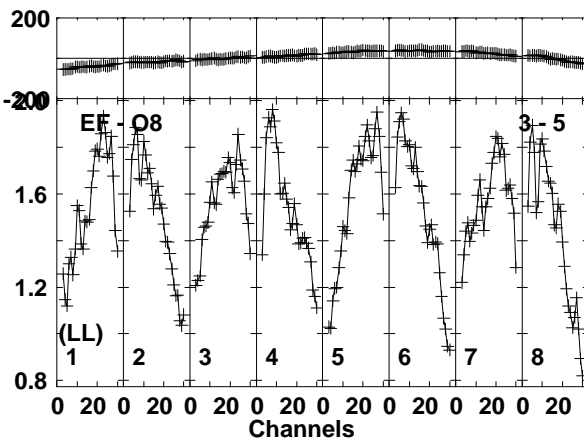
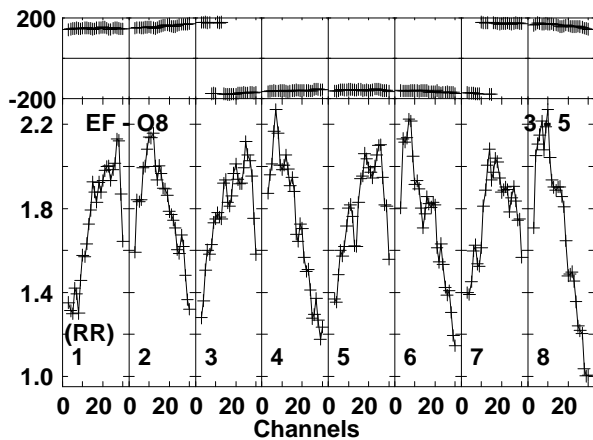
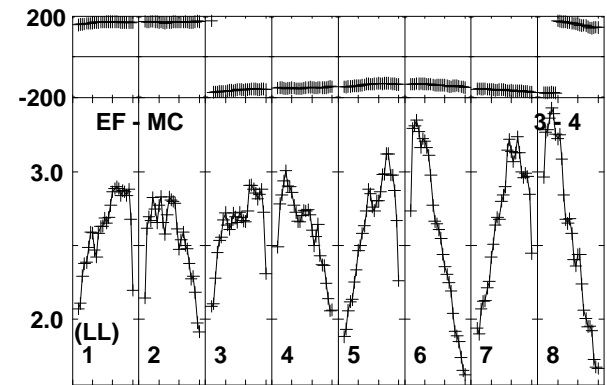
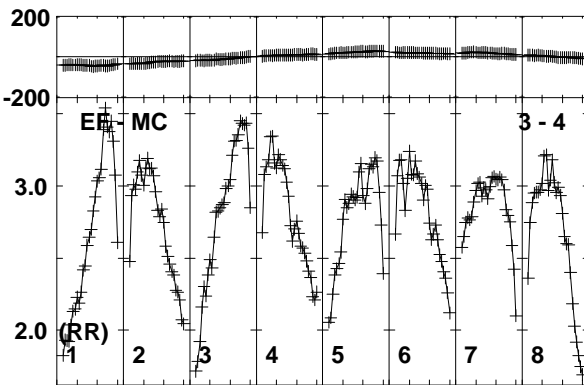
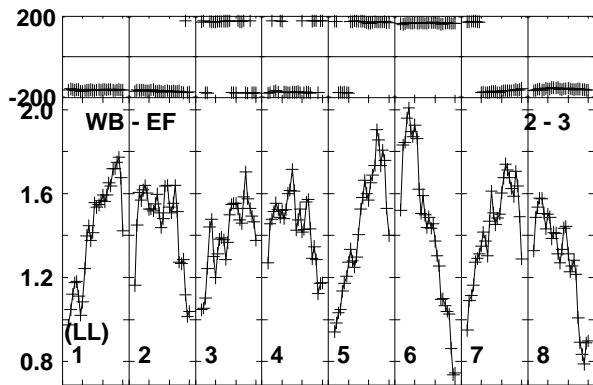
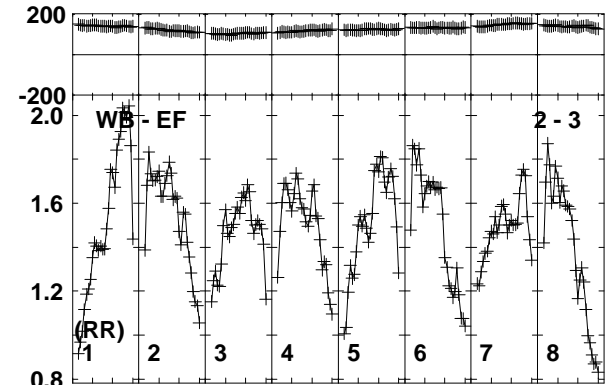
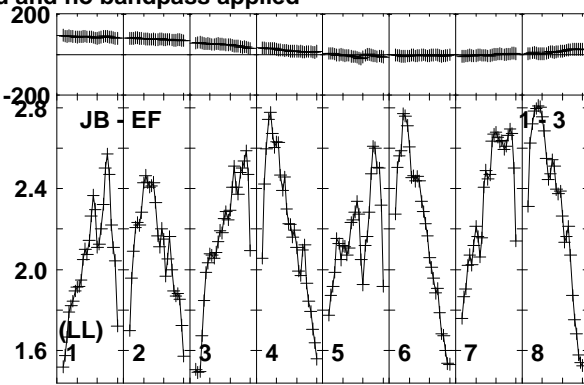
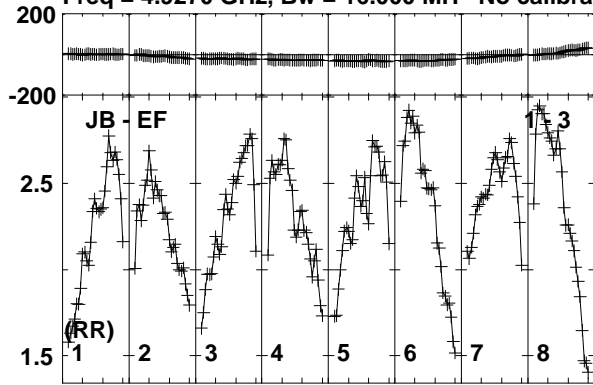

Lower frame: Milli Ampl Jy Top frame: Phas deg
Vector averaged cross-power spectrum Baseline: JB (01) - EF (03)
Timerange: 00/07:24:01 to 00/07:25:19

Plot file version 401 created 17-FEB-2020 15:43:17

J1359+5544 EK047 2.UVDATA.1

Freq = 4.9270 GHz, Bw = 16.000 MH No calibration applied and no bandpass applied

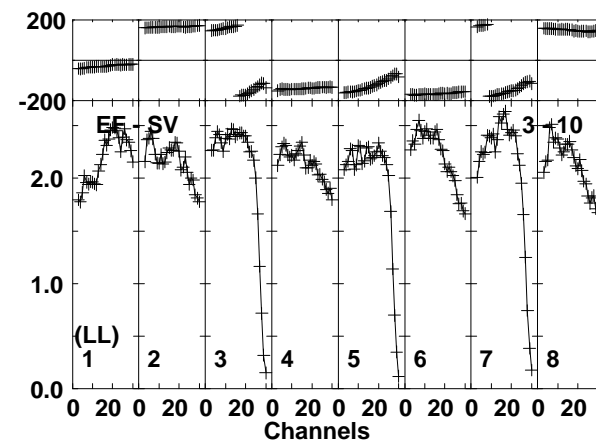
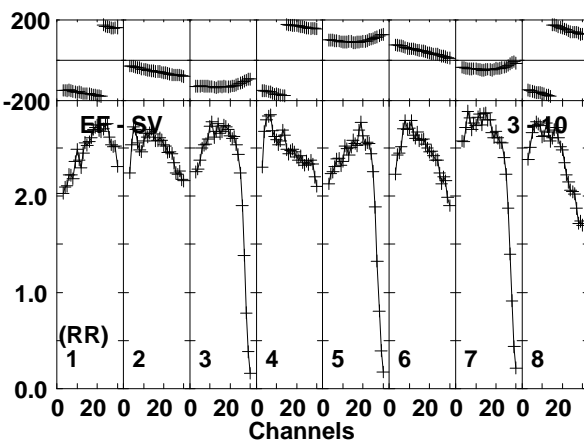
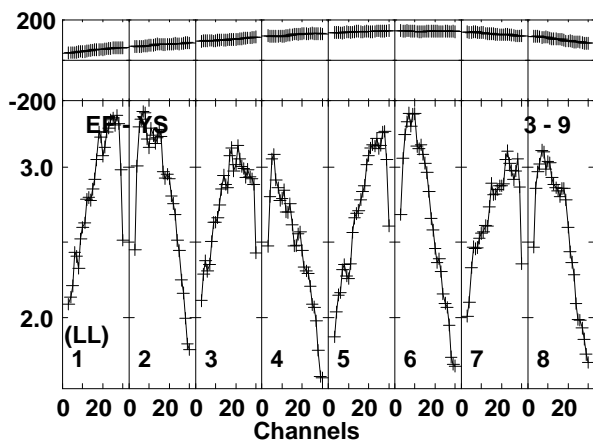
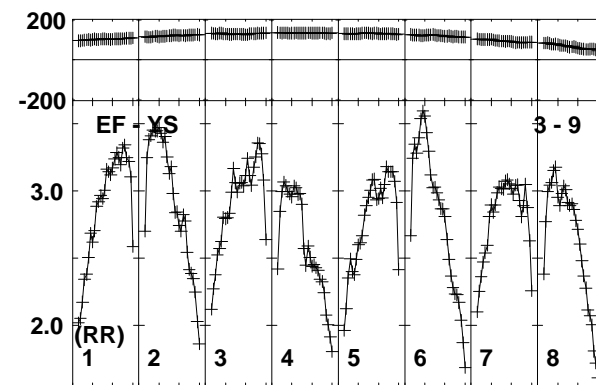
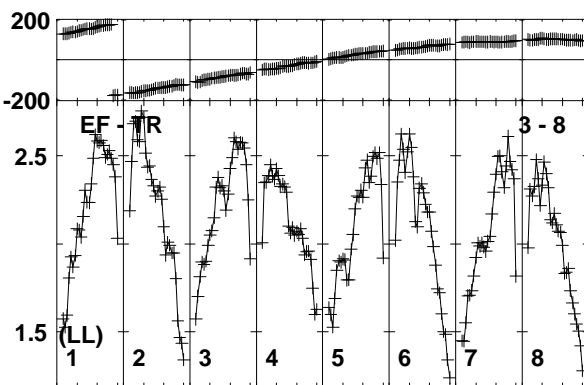
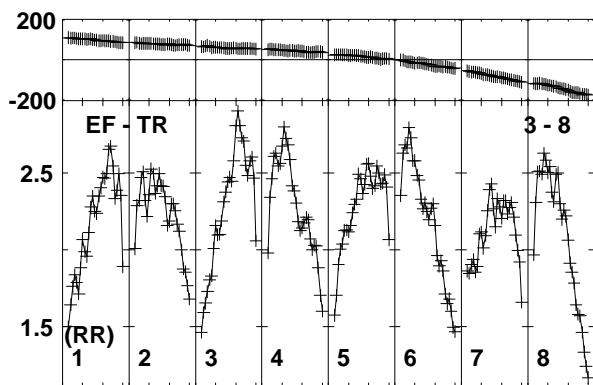
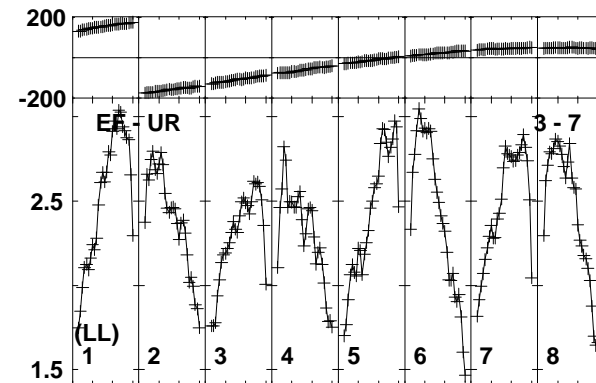
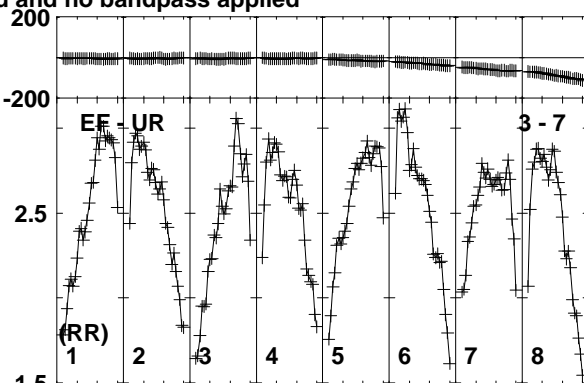
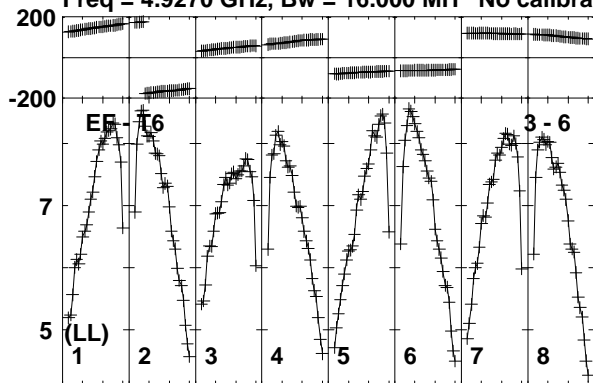

Lower frame: Milli Ampl Jy Top frame: Phas deg
Vector averaged cross-power spectrum Baseline: EF (03) - T6 (06)
Timerange: 00/07:24:01 to 00/07:25:19

Plot file version 402 created 17-FEB-2020 15:43:17

J1359+5544 EK047 2.UVDATA.1

Freq = 4.9270 GHz, Bw = 16.000 MH No calibration applied and no bandpass applied

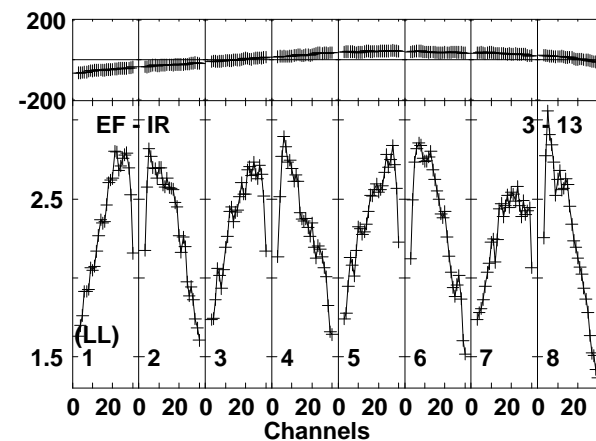
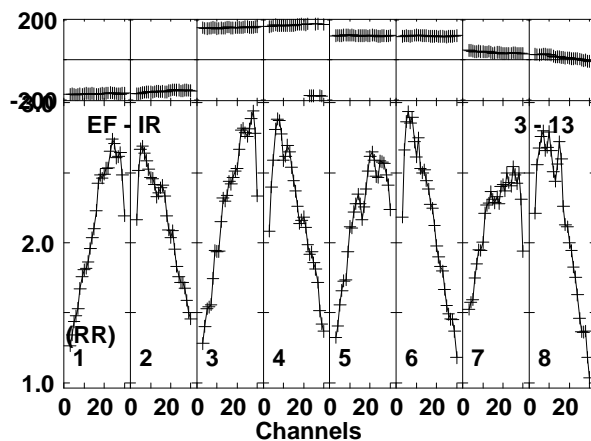
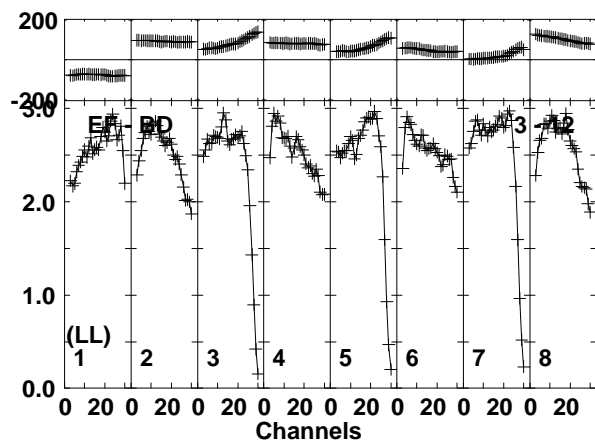
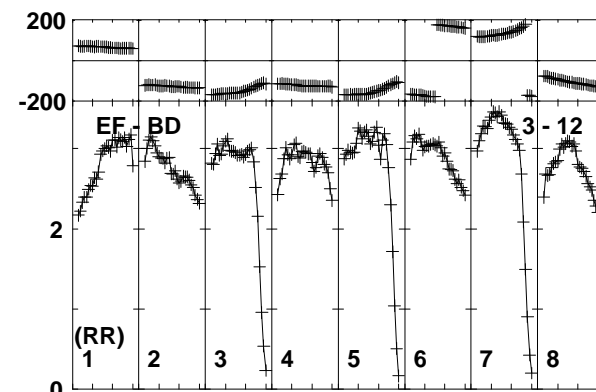
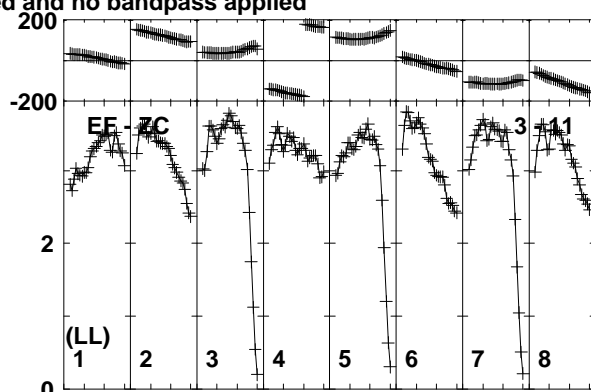
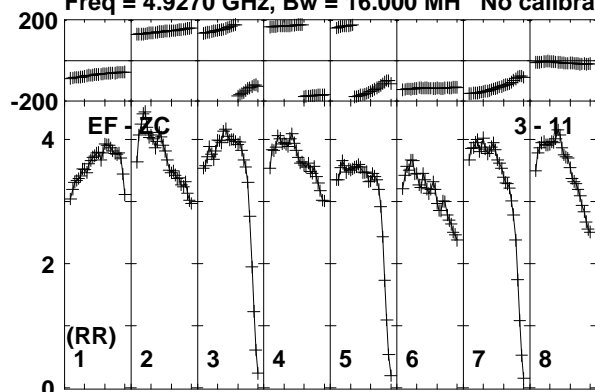

Lower frame: Milli Ampl Jy Top frame: Phas deg
Vector averaged cross-power spectrum Baseline: EF (03) - ZC (11)
Timerange: 00/07:24:01 to 00/07:25:19

Plot file version 403 created 17-FEB-2020 15:43:17

J1402+5347 EK047 2.UVDATA.1

Freq = 4.9270 GHz, Bw = 16.000 MH No calibration applied and no bandpass applied

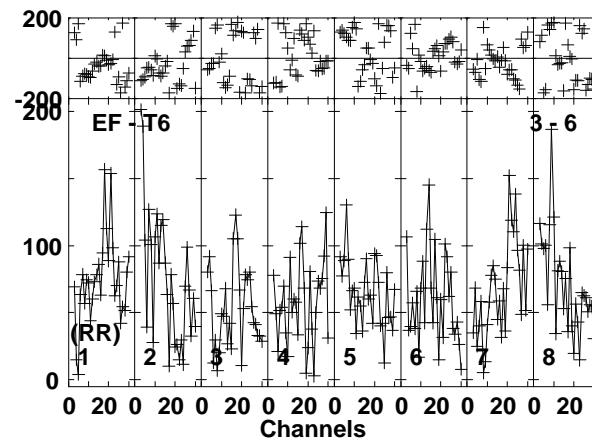
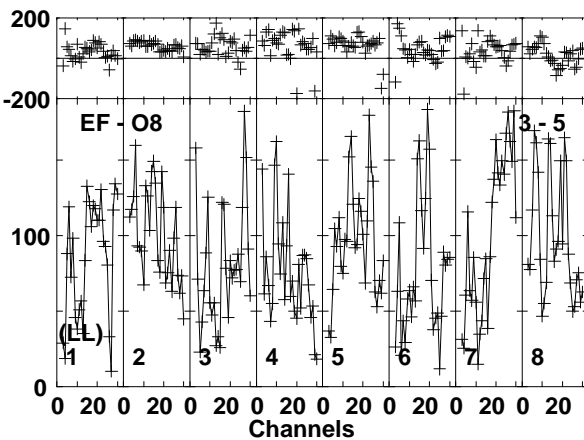
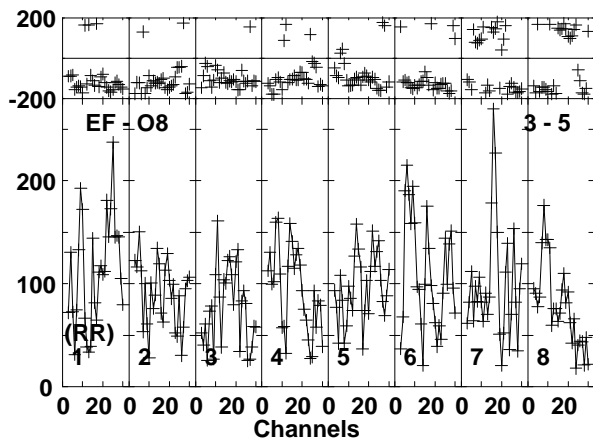
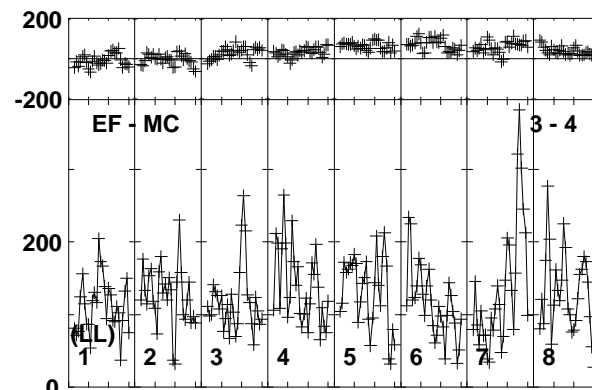
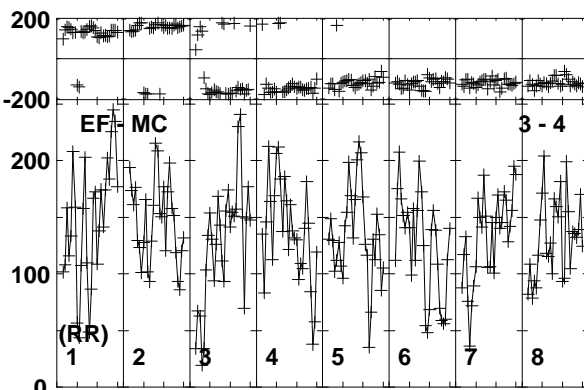
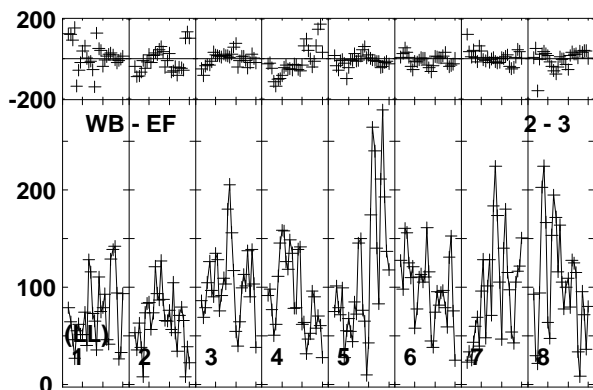
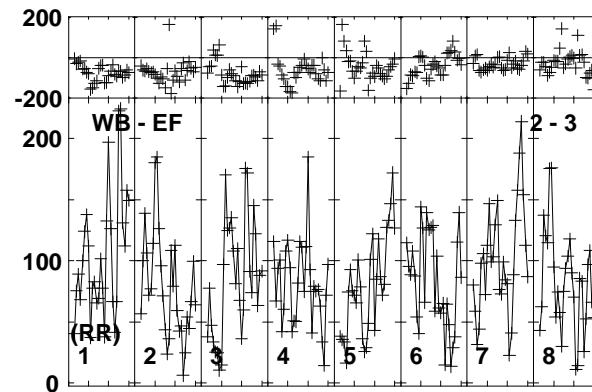
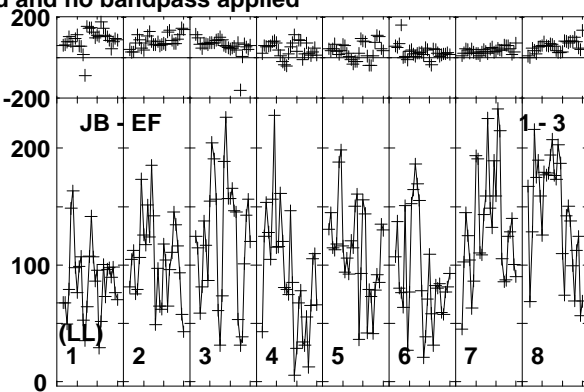
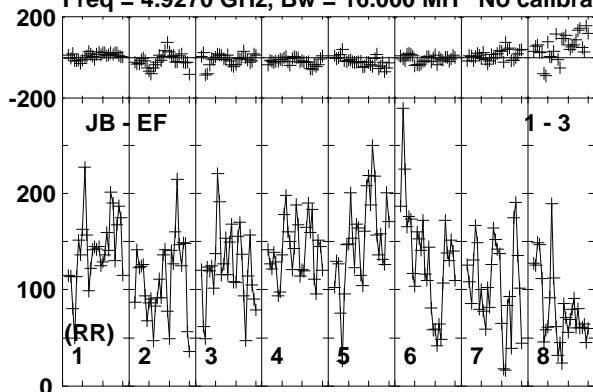

Lower frame: Micro Ampl Jy Top frame: Phas deg
Vector averaged cross-power spectrum Baseline: JB (01) - EF (03)
Timerange: 00/07:25:21 to 00/07:29:19

Plot file version 404 created 17-FEB-2020 15:43:18

J1402+5347 EK047 2.UVDATA.1

Freq = 4.9270 GHz, Bw = 16.000 MH No calibration applied and no bandpass applied

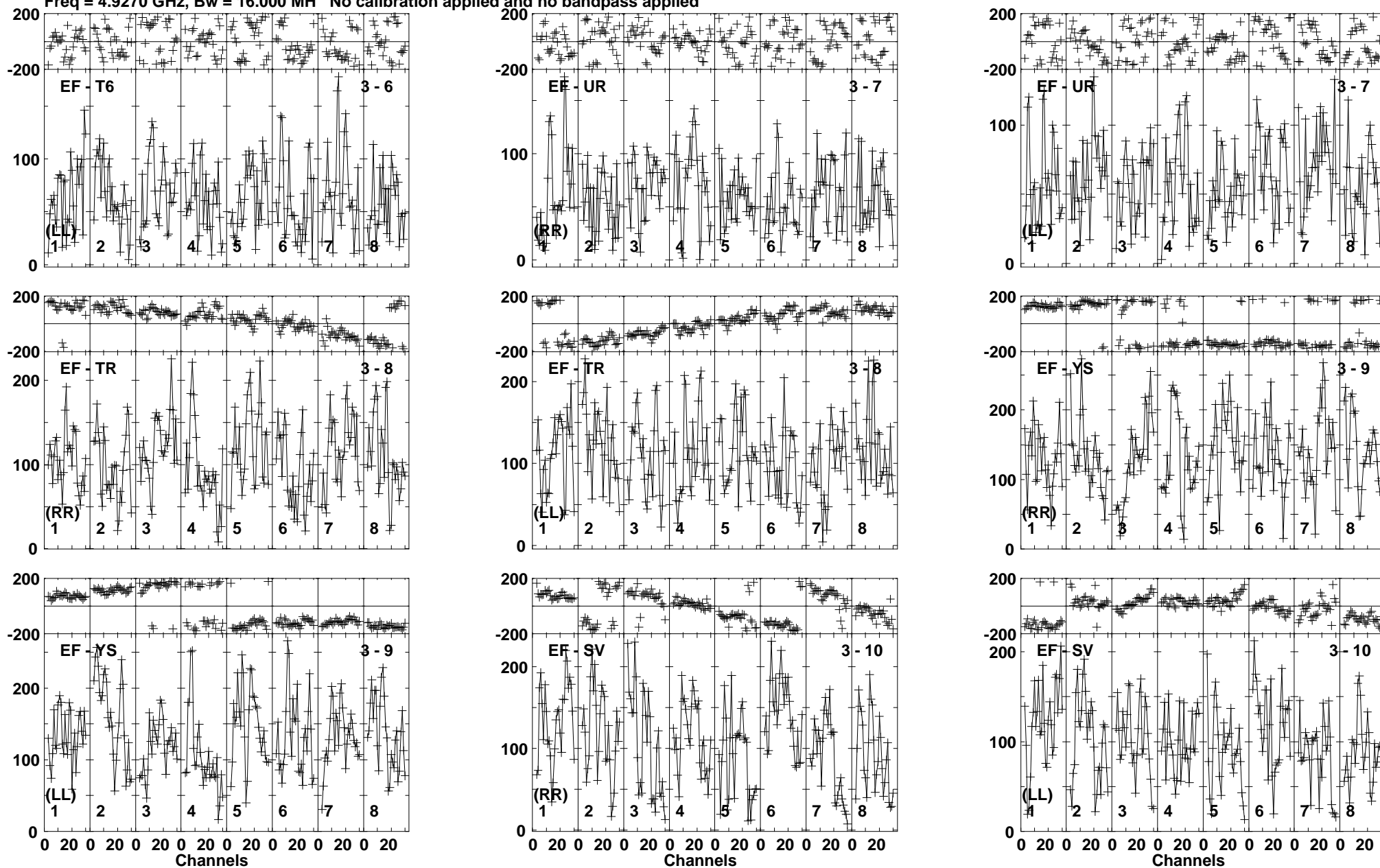

Lower frame: Micro Ampl Jy Top frame: Phas deg
Vector averaged cross-power spectrum Baseline: EF (03) - T6 (06)
Timerange: 00/07:25:21 to 00/07:29:19

Plot file version 405 created 17-FEB-2020 15:43:18

J1402+5347 EK047 2.UVDATA.1

Freq = 4.9270 GHz, Bw = 16.000 MH No calibration applied and no bandpass applied

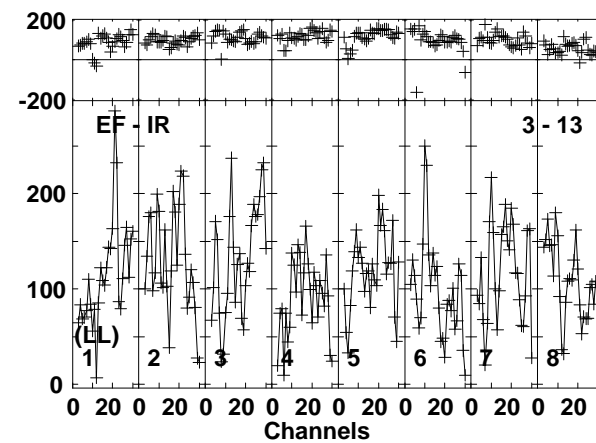
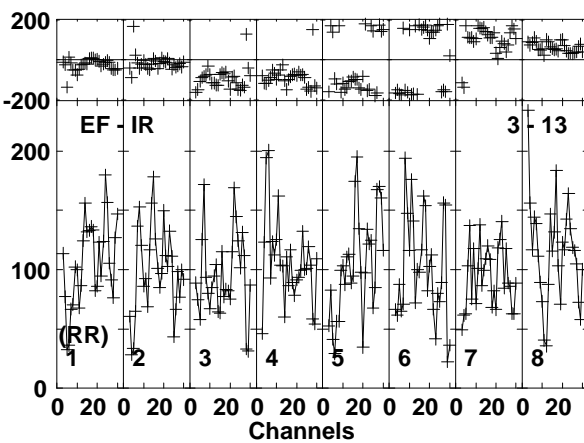
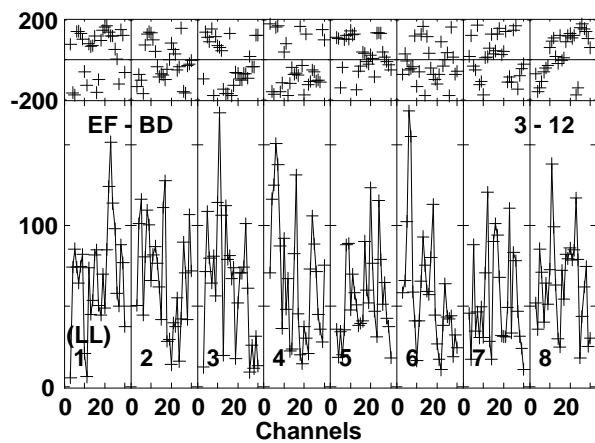
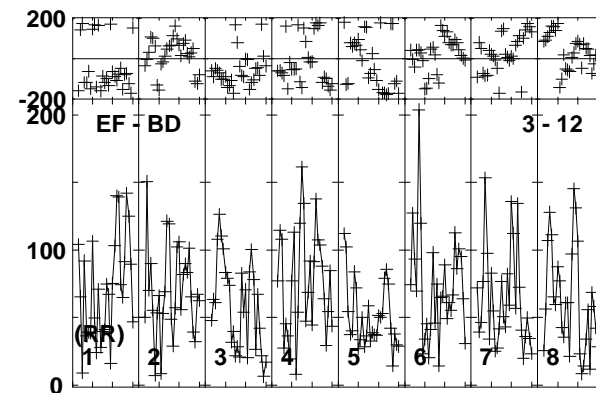
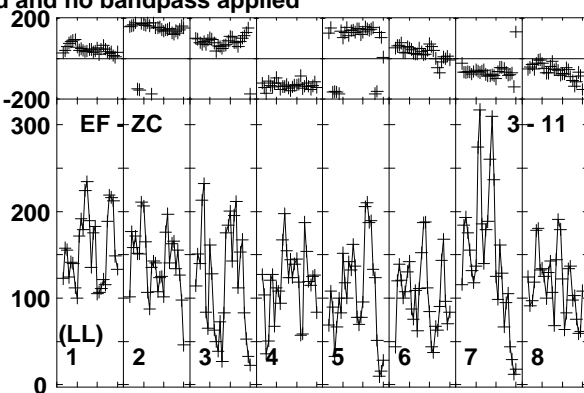
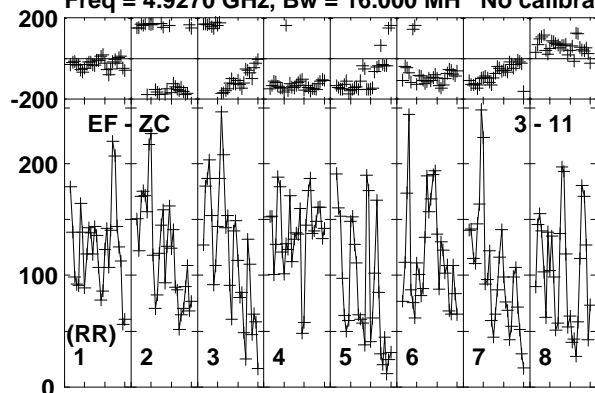

Lower frame: Micro Ampl Jy Top frame: Phas deg
Vector averaged cross-power spectrum Baseline: EF (03) - ZC (11)
Timerange: 00/07:25:21 to 00/07:29:19

Plot file version 406 created 17-FEB-2020 15:43:18

J1359+5544 EK047 2.UVDATA.1

Freq = 4.9270 GHz, Bw = 16.000 MH No calibration applied and no bandpass applied

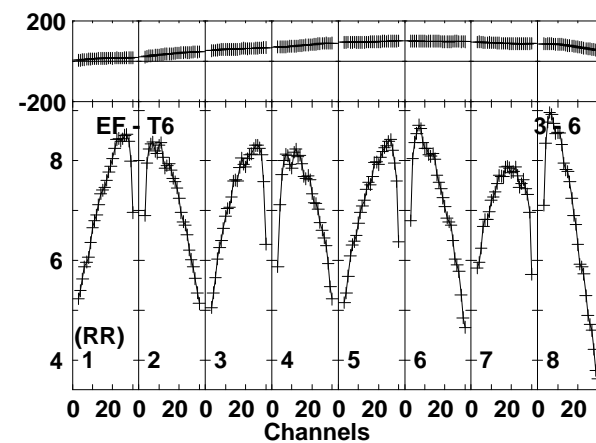
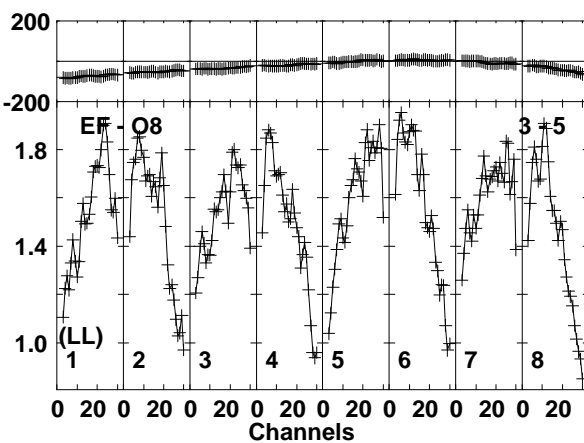
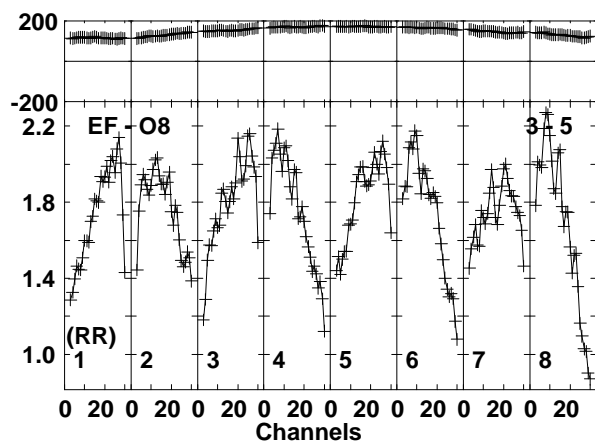
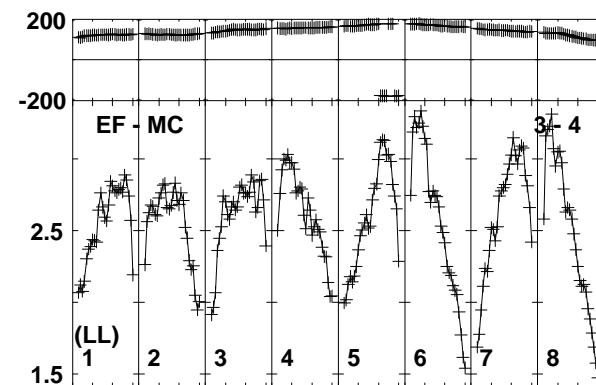
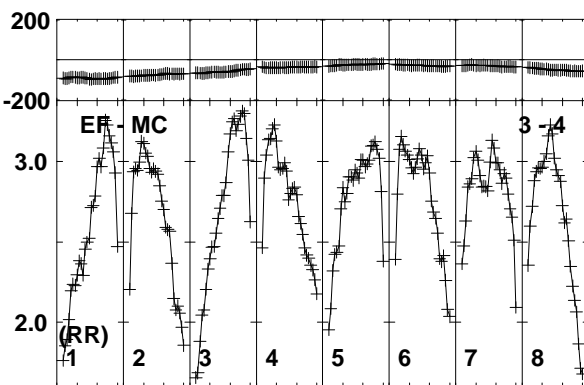
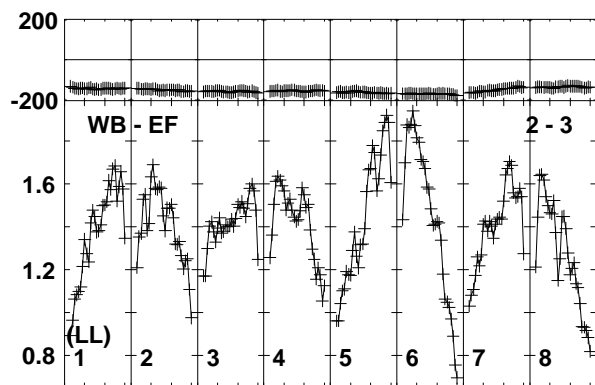
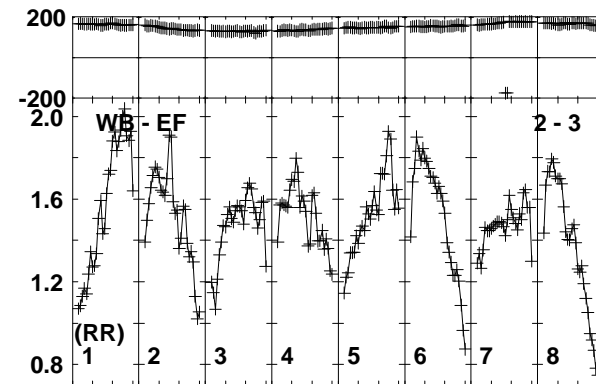
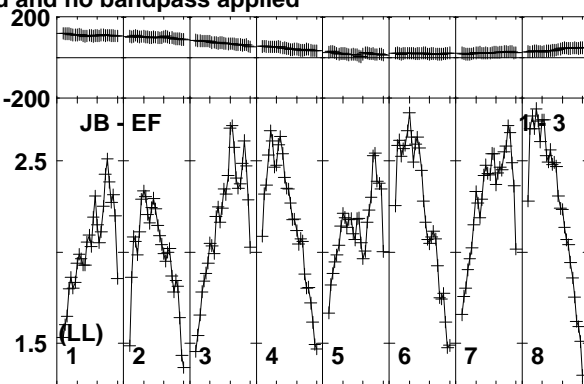
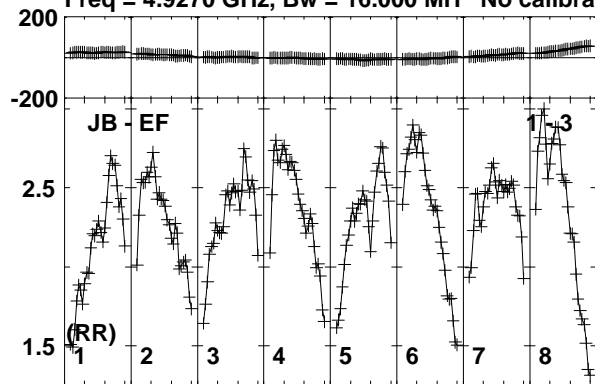

Lower frame: Milli Ampl Jy Top frame: Phas deg
Vector averaged cross-power spectrum Baseline: JB (01) - EF (03)
Timerange: 00/07:29:21 to 00/07:31:19

Plot file version 407 created 17-FEB-2020 15:43:18

J1359+5544 EK047 2.UVDATA.1

Freq = 4.9270 GHz, Bw = 16.000 MH No calibration applied and no bandpass applied

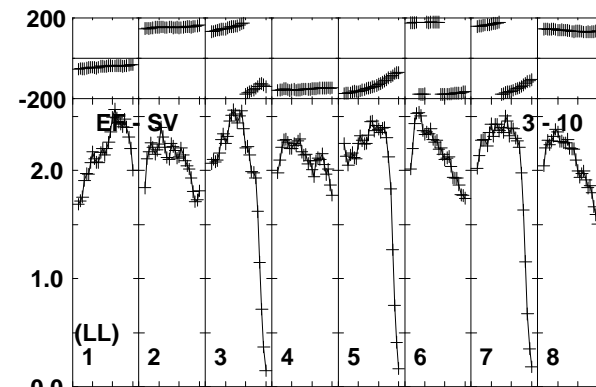
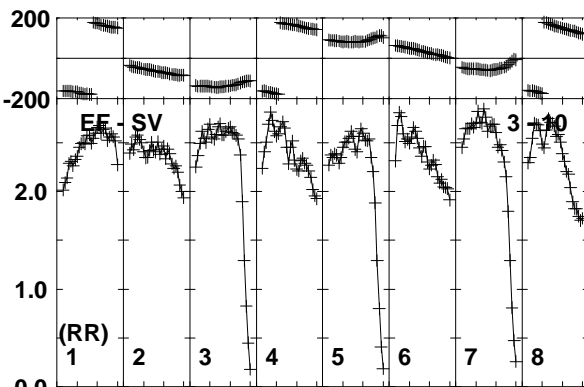
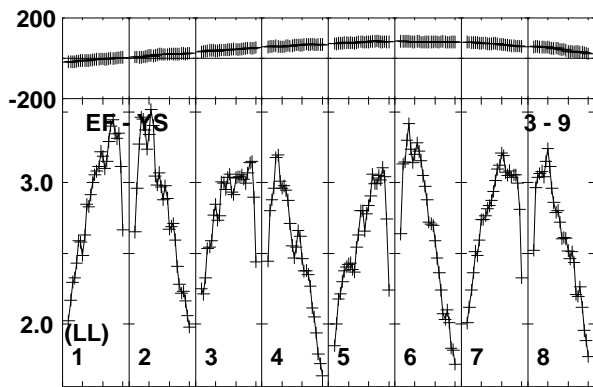
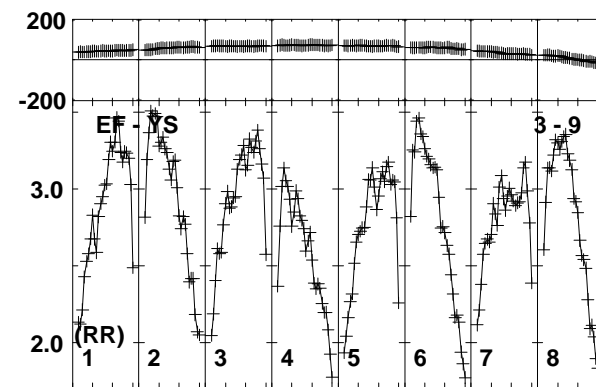
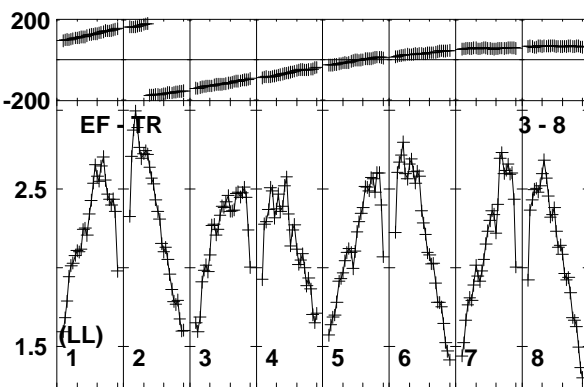
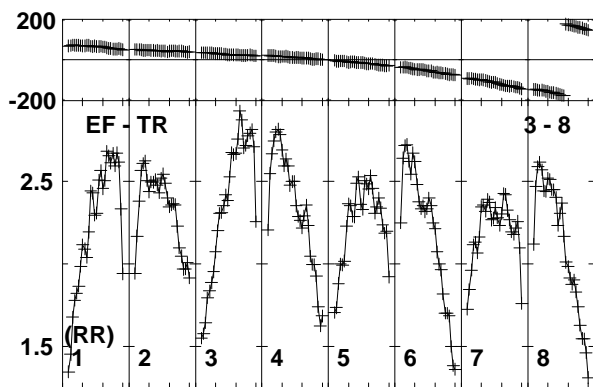
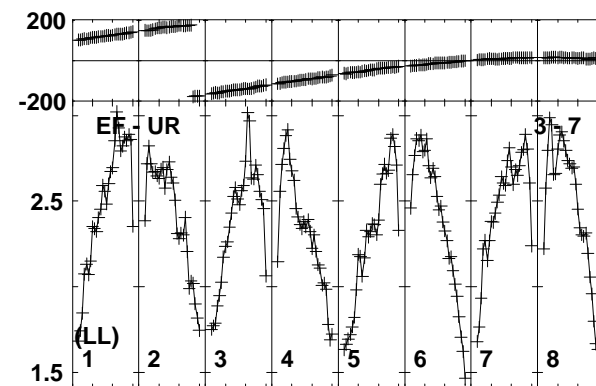
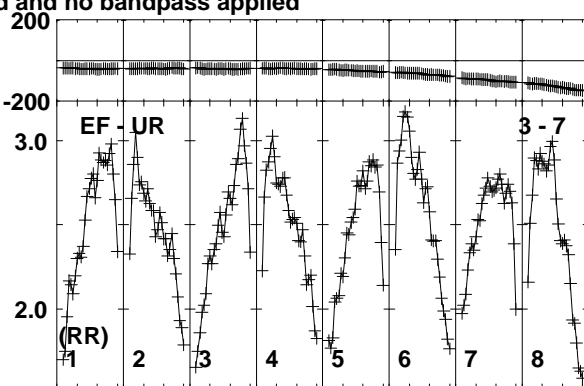
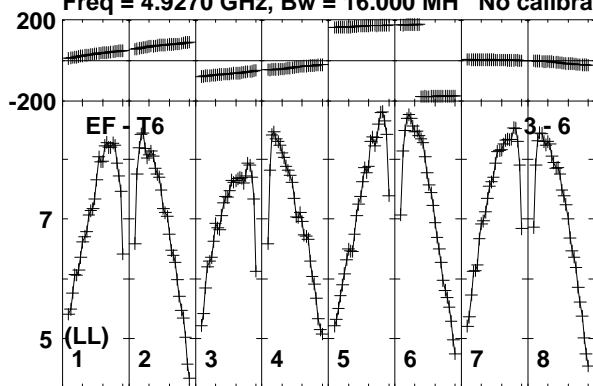

Lower frame: Milli Ampl Jy Top frame: Phas deg
Vector averaged cross-power spectrum Baseline: EF (03) - T6 (06)
Timerange: 00/07:29:21 to 00/07:31:19

Plot file version 408 created 17-FEB-2020 15:43:18

J1359+5544 EK047 2.UVDATA.1

Freq = 4.9270 GHz, Bw = 16.000 MH No calibration applied and no bandpass applied

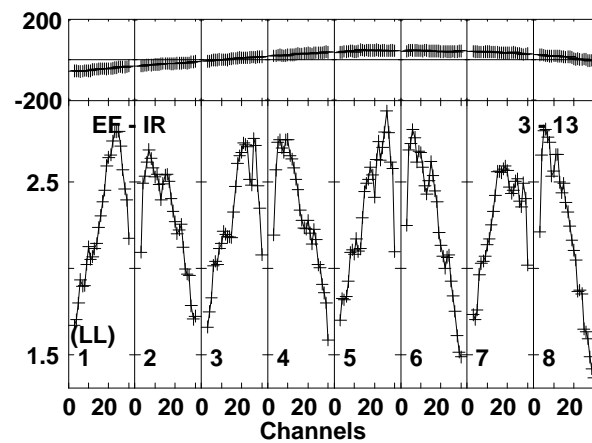
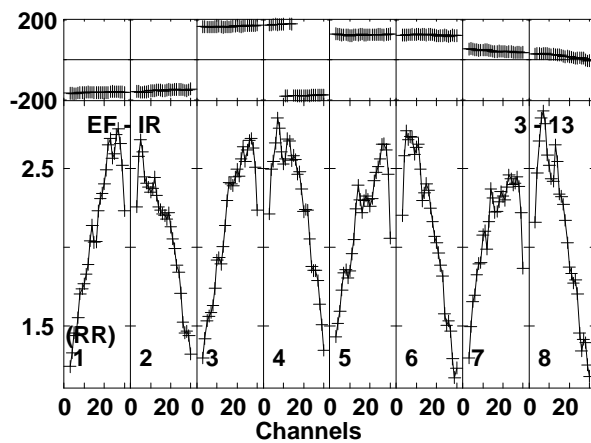
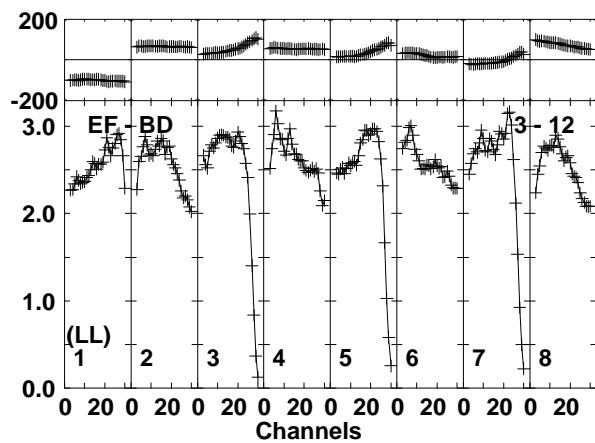
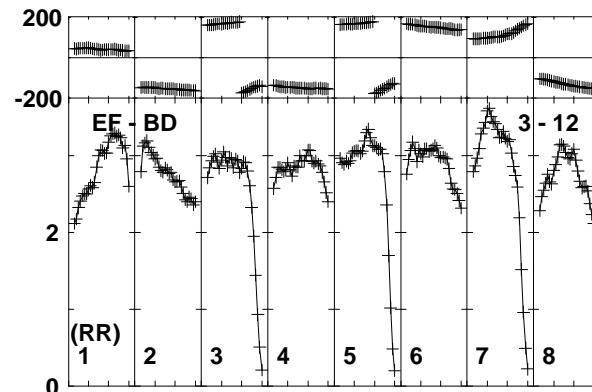
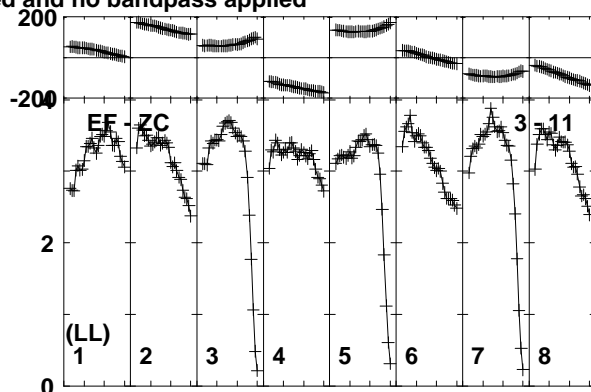
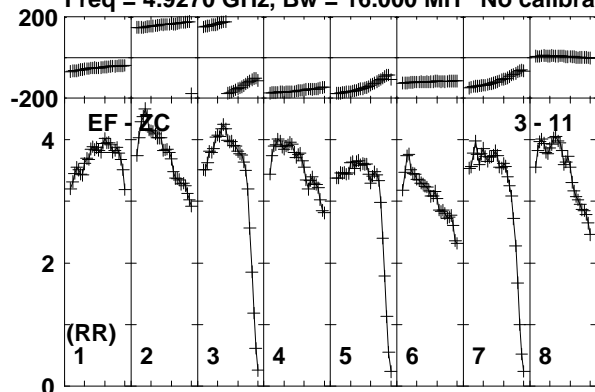

Lower frame: Milli Ampl Jy Top frame: Phas deg
Vector averaged cross-power spectrum Baseline: EF (03) - ZC (11)
Timerange: 00/07:29:21 to 00/07:31:19

Plot file version 409 created 17-FEB-2020 15:43:18

J1402+5347 EK047 2.UVDATA.1

Freq = 4.9270 GHz, Bw = 16.000 MH No calibration applied and no bandpass applied

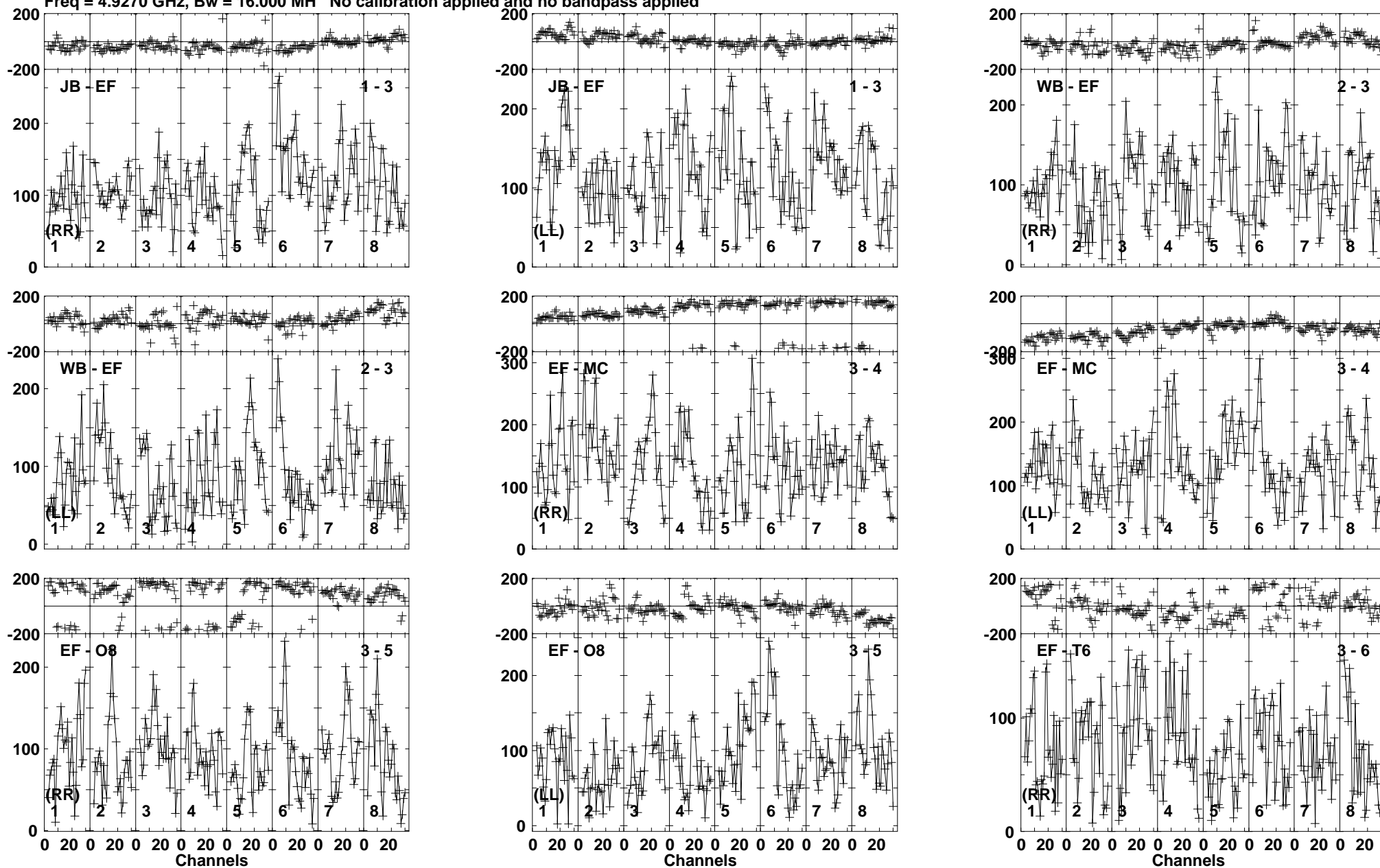

Lower frame: Micro Ampl Jy Top frame: Phas deg
Vector averaged cross-power spectrum Baseline: JB (01) - EF (03)
Timerange: 00/07:31:23 to 00/07:35:19

Plot file version 410 created 17-FEB-2020 15:43:18

J1402+5347 EK047 2.UVDATA.1

Freq = 4.9270 GHz, Bw = 16.000 MH No calibration applied and no bandpass applied

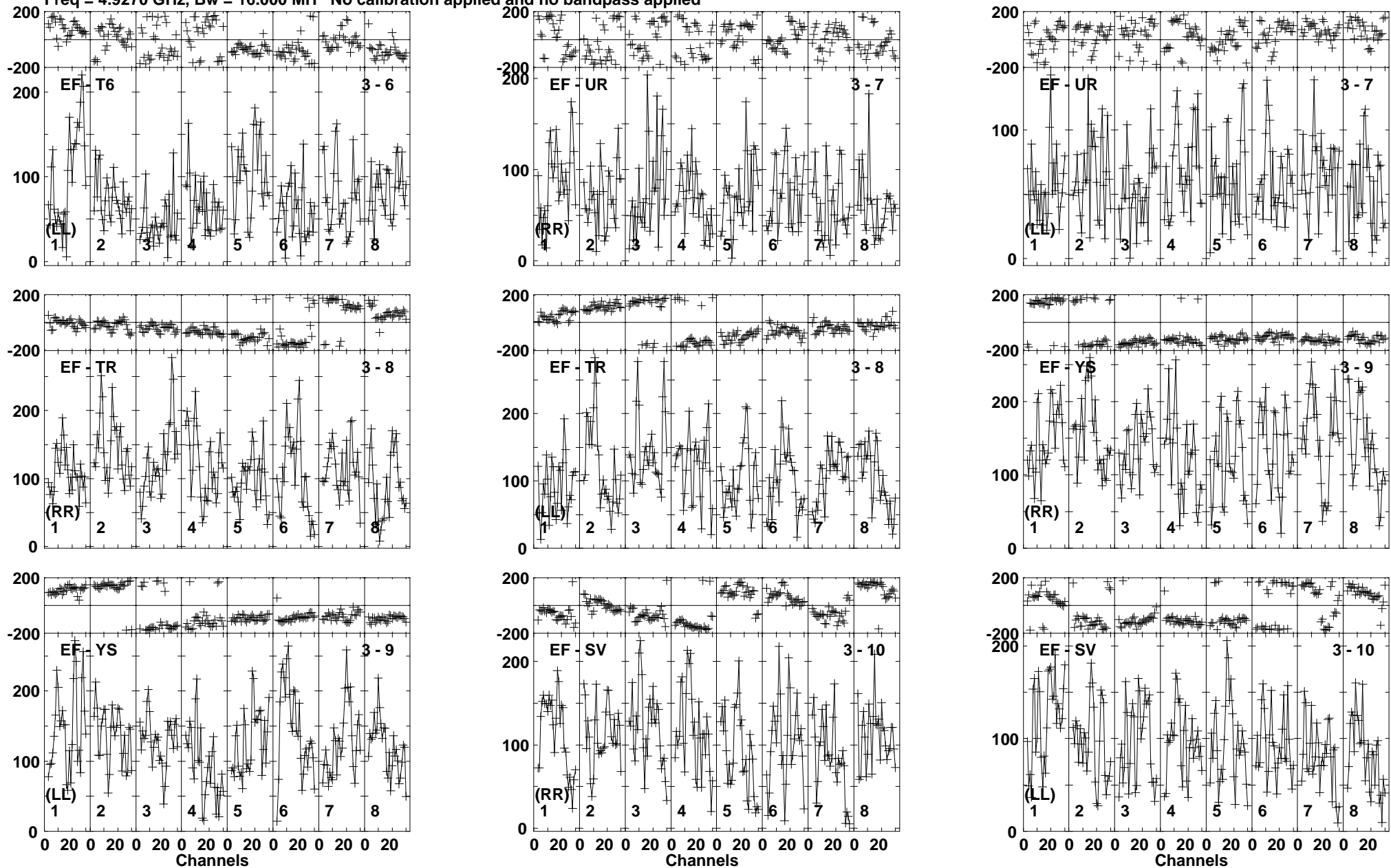

Lower frame: Micro Ampl Jy Top frame: Phas deg
Vector averaged cross-power spectrum Baseline: EF (03) - T6 (06)
Timerange: 00/07:31:23 to 00/07:35:19

Plot file version 411 created 17-FEB-2020 15:43:18

J1402+5347 EK047 2.UVDATA.1

Freq = 4.9270 GHz, Bw = 16.000 MH No calibration applied and no bandpass applied

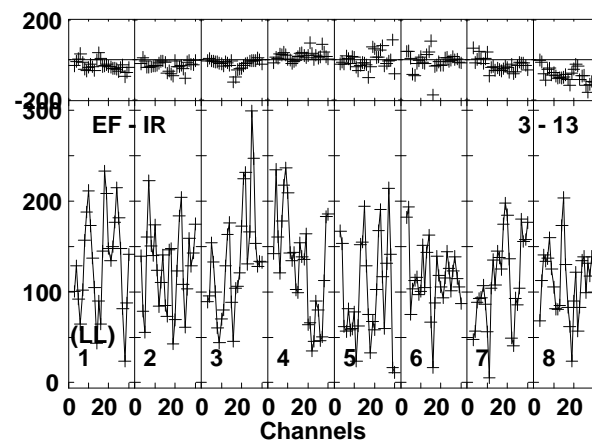
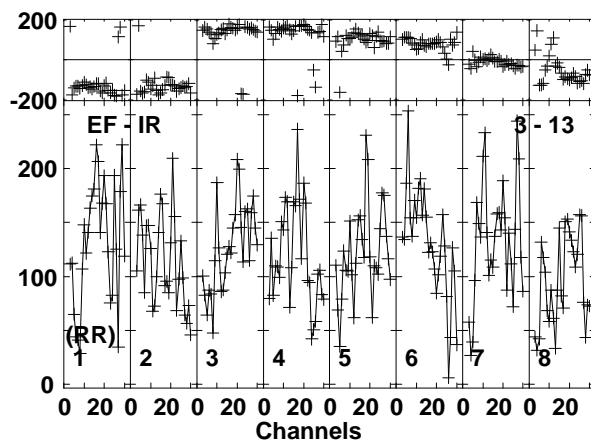
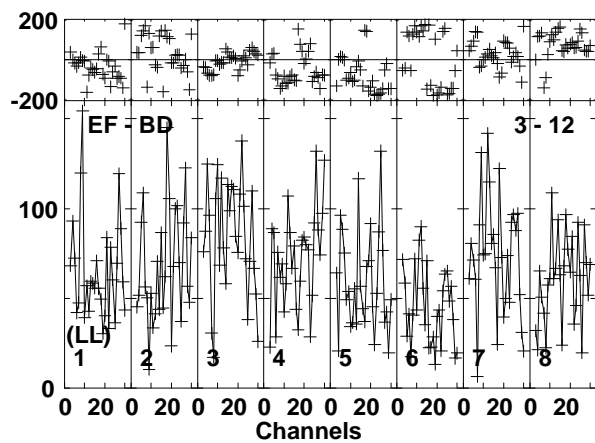
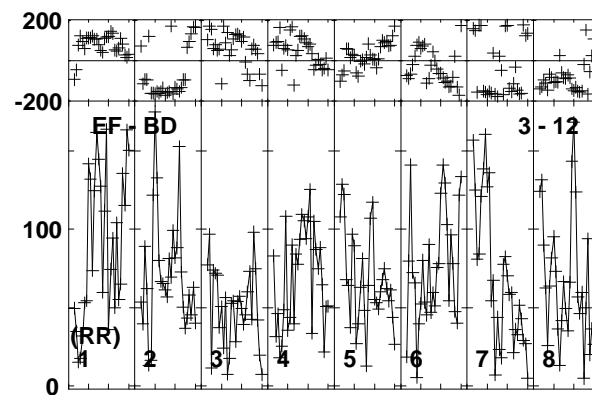
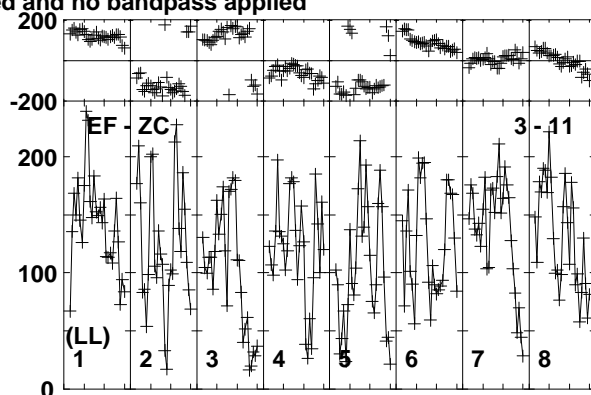
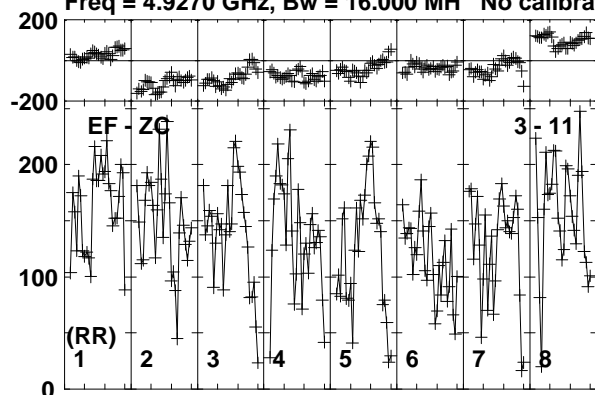

Lower frame: Micro Ampl Jy Top frame: Phas deg
Vector averaged cross-power spectrum Baseline: EF (03) - ZC (11)
Timerange: 00/07:31:23 to 00/07:35:19

Plot file version 412 created 17-FEB-2020 15:43:19

J1359+5544 EK047 2.UVDATA.1

Freq = 4.9270 GHz, Bw = 16.000 MH No calibration applied and no bandpass applied

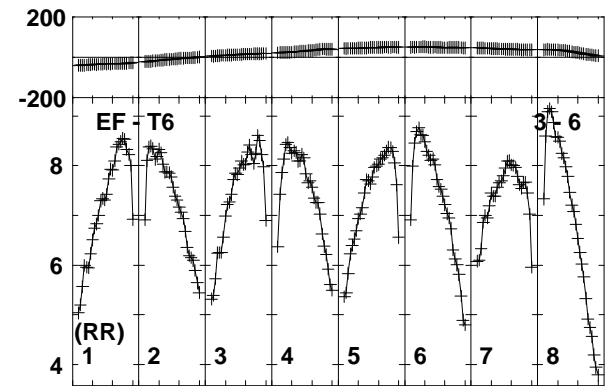
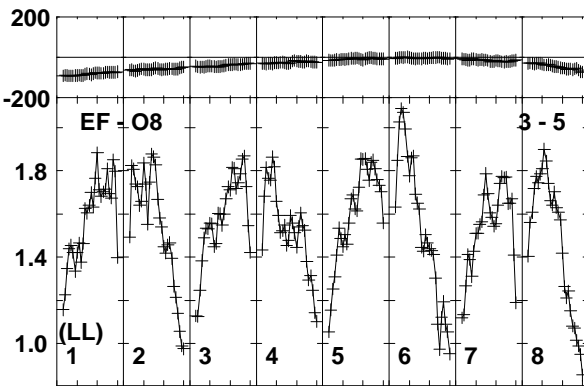
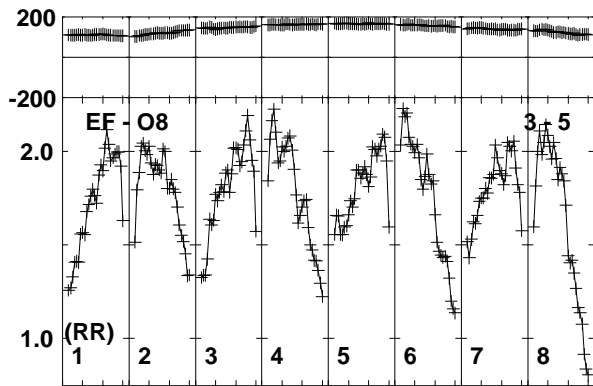
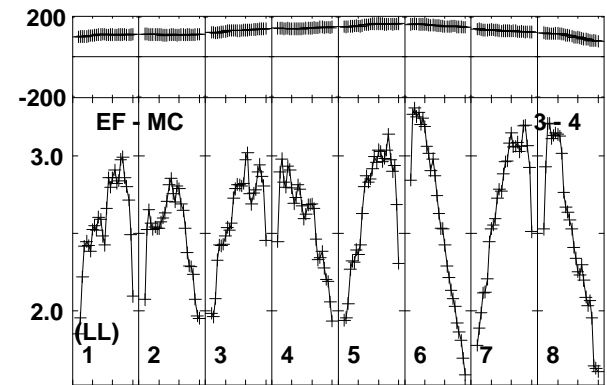
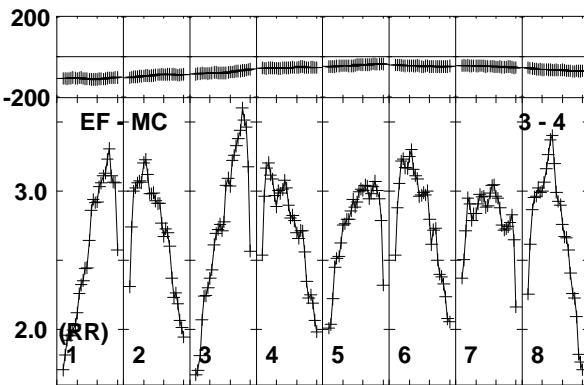
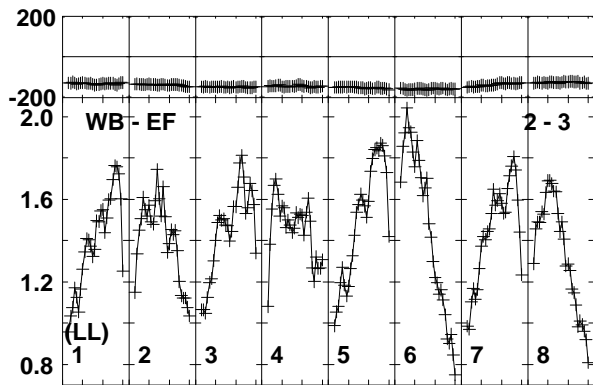
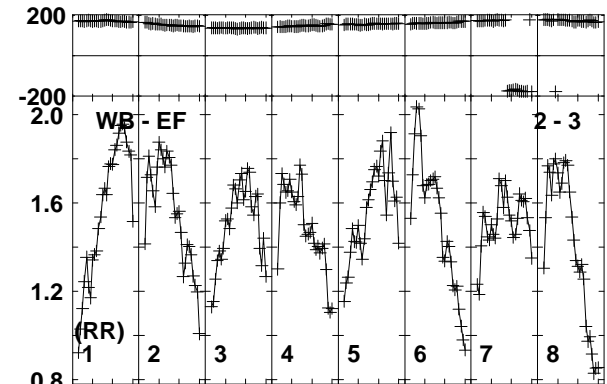
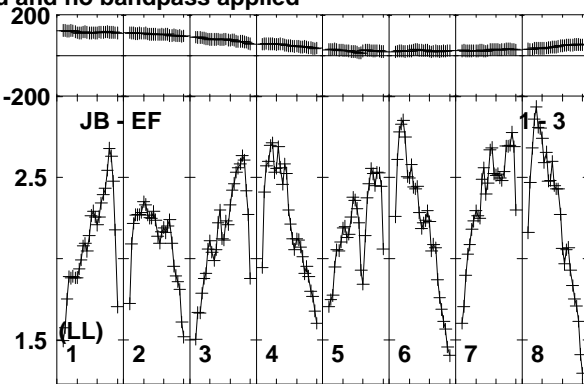
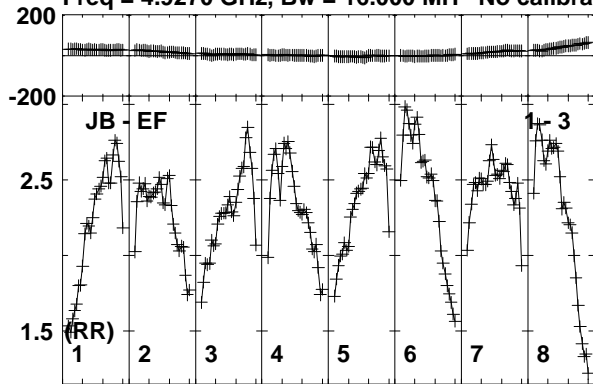

Lower frame: Milli Ampl Jy Top frame: Phas deg
Vector averaged cross-power spectrum Baseline: JB (01) - EF (03)
Timerange: 00/07:36:01 to 00/07:37:19

Plot file version 413 created 17-FEB-2020 15:43:19

J1359+5544 EK047 2.UVDATA.1

Freq = 4.9270 GHz, Bw = 16.000 MH No calibration applied and no bandpass applied

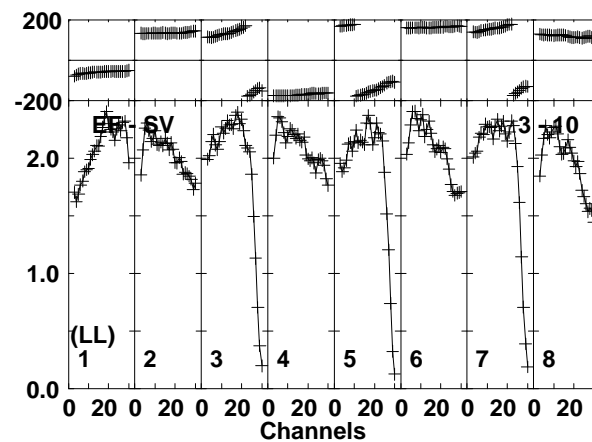
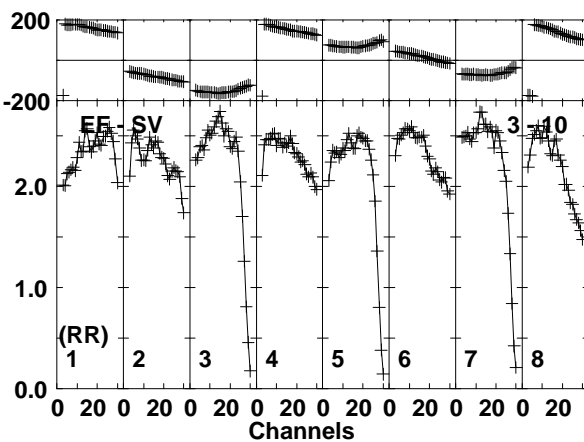
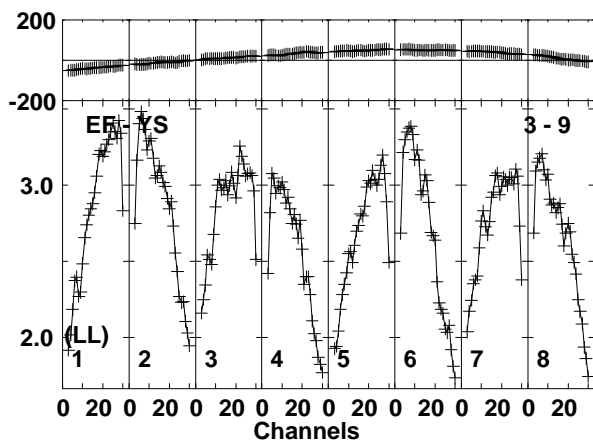
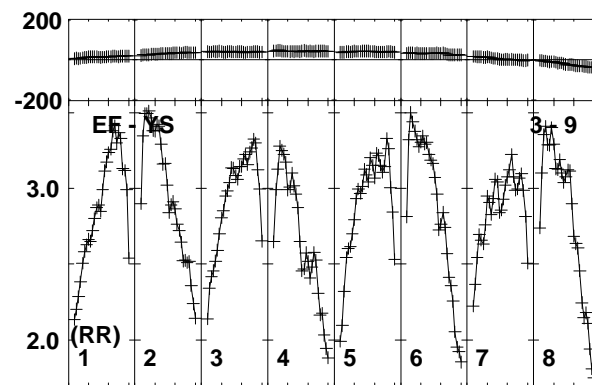
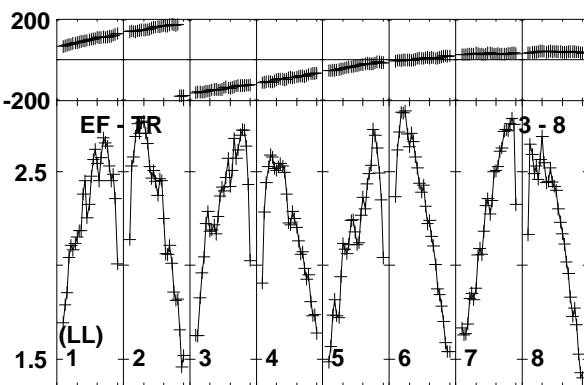
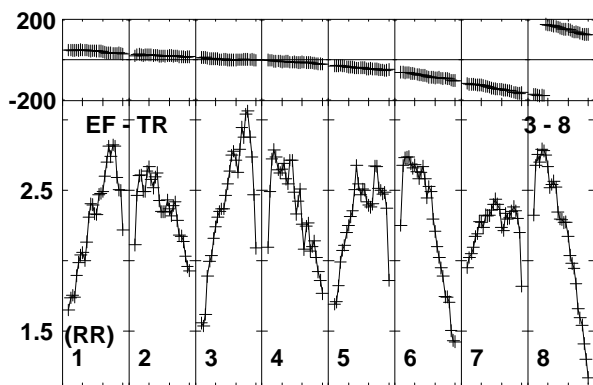
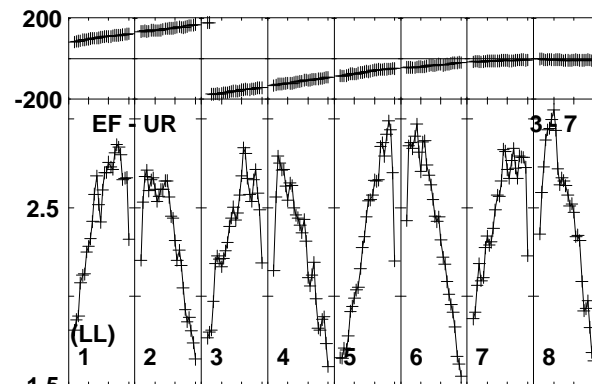
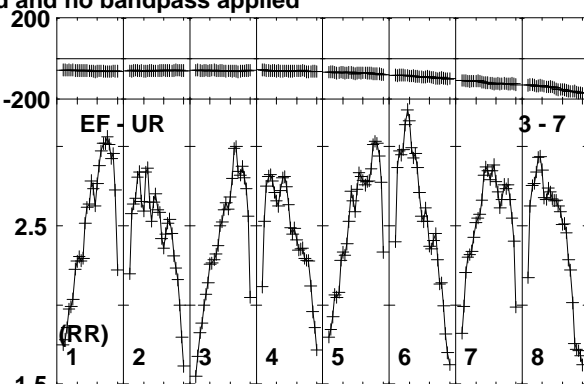
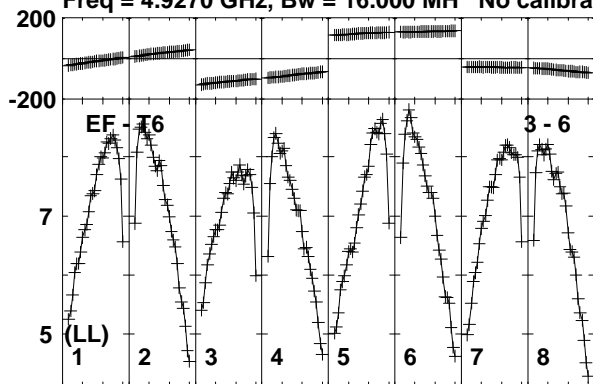

Lower frame: Milli Ampl Jy Top frame: Phas deg
Vector averaged cross-power spectrum Baseline: EF (03) - T6 (06)
Timerange: 00/07:36:01 to 00/07:37:19

Plot file version 414 created 17-FEB-2020 15:43:19

J1359+5544 EK047 2.UVDATA.1

Freq = 4.9270 GHz, Bw = 16.000 MH No calibration applied and no bandpass applied

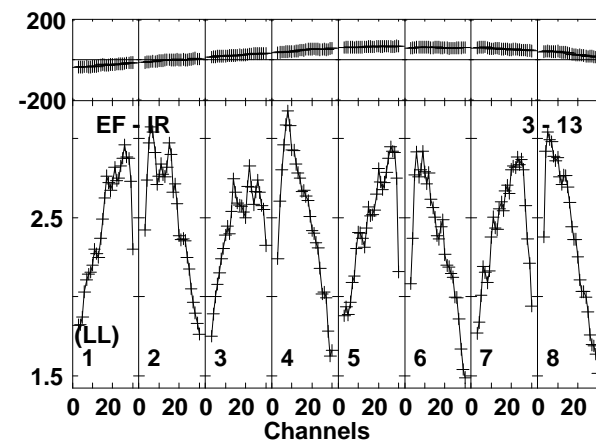
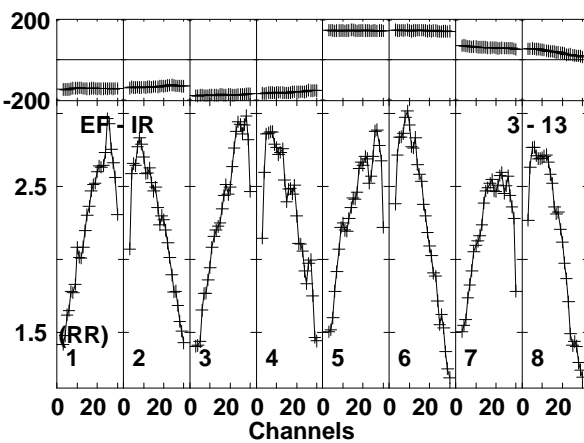
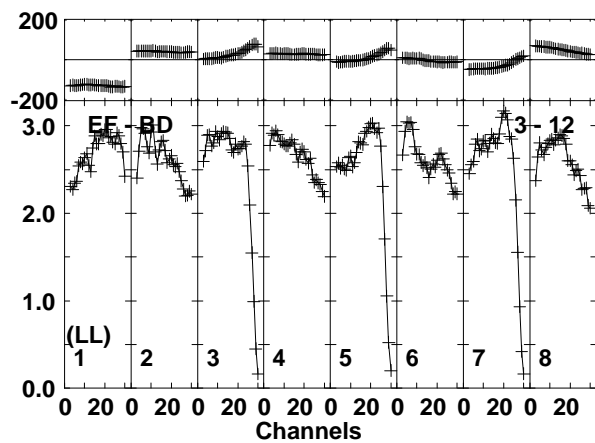
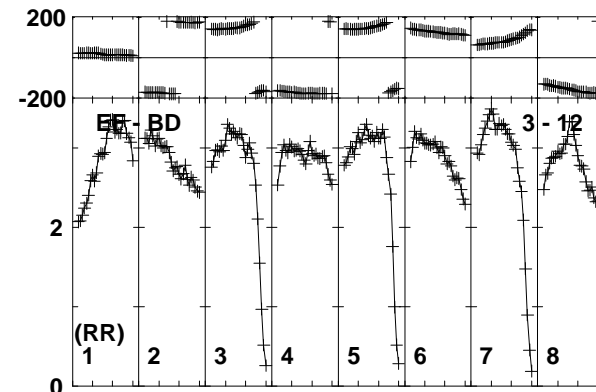
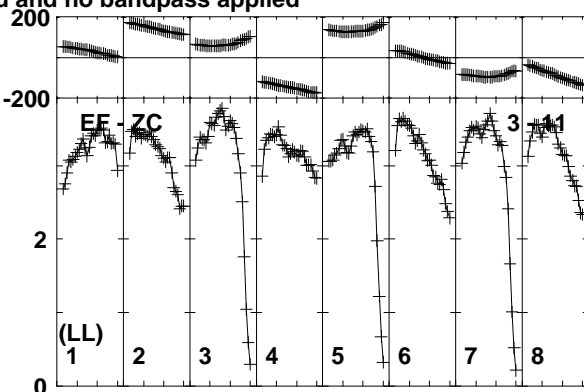
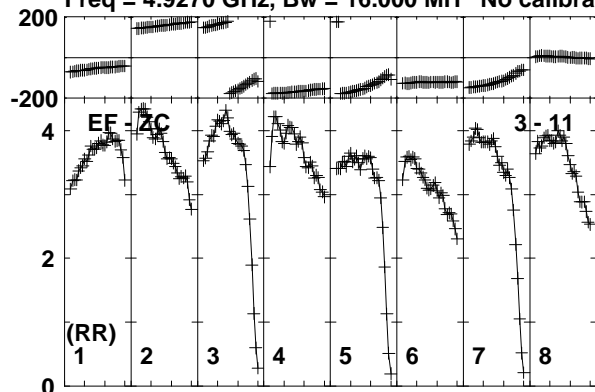

Lower frame: Milli Ampl Jy Top frame: Phas deg
Vector averaged cross-power spectrum Baseline: EF (03) - ZC (11)
Timerange: 00/07:36:01 to 00/07:37:19

Plot file version 415 created 17-FEB-2020 15:43:19

J1402+5347 EK047 2.UVDATA.1

Freq = 4.9270 GHz, Bw = 16.000 MH No calibration applied and no bandpass applied

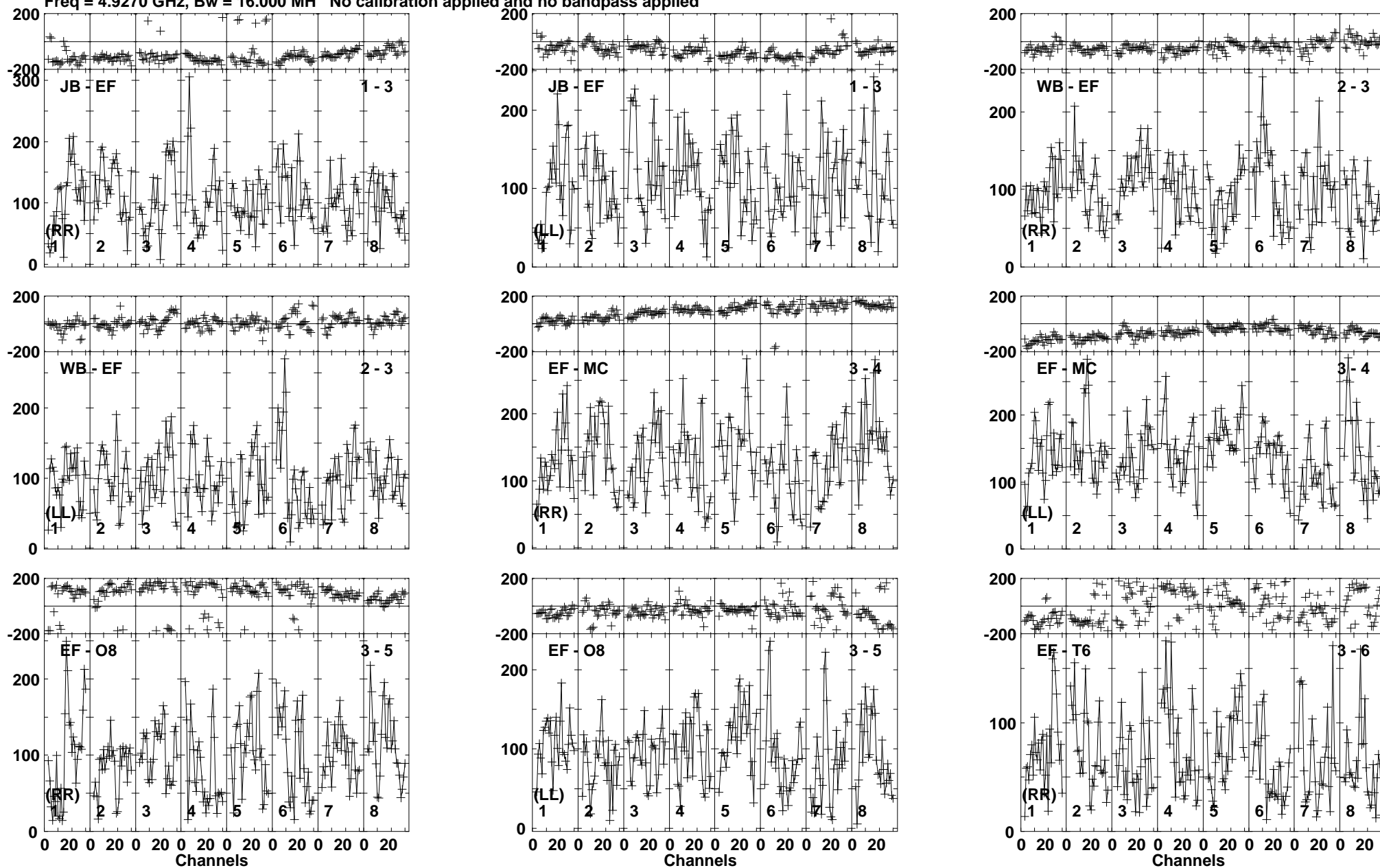

Lower frame: Micro Ampl Jy Top frame: Phas deg
Vector averaged cross-power spectrum Baseline: JB (01) - EF (03)
Timerange: 00/07:37:21 to 00/07:41:19

Plot file version 416 created 17-FEB-2020 15:43:19

J1402+5347 EK047 2.UVDATA.1

Freq = 4.9270 GHz, Bw = 16.000 MH No calibration applied and no bandpass applied

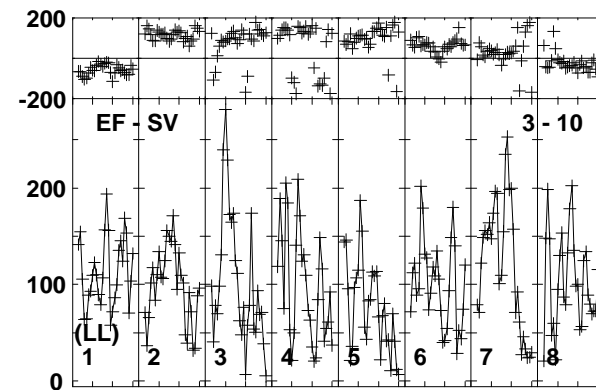
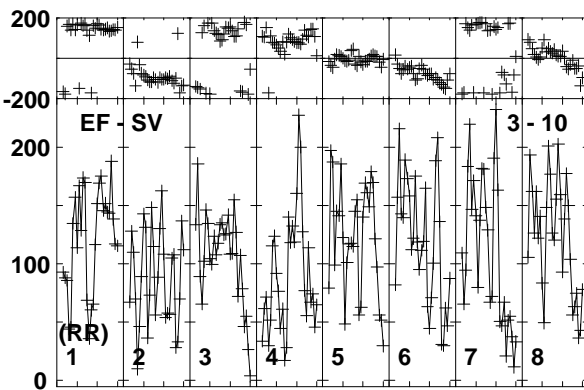
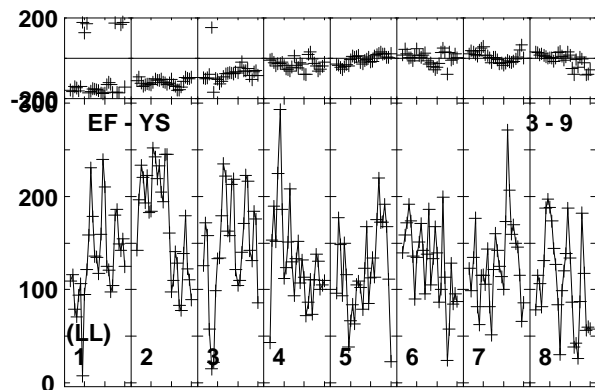
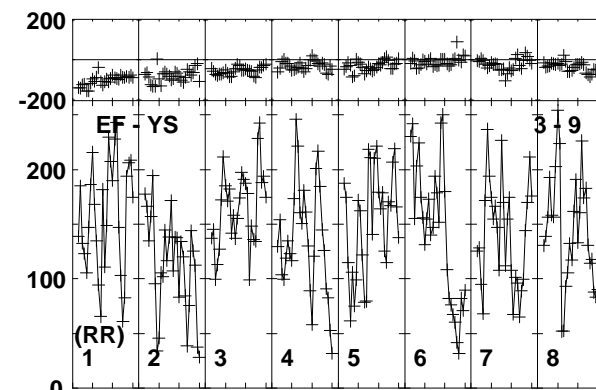
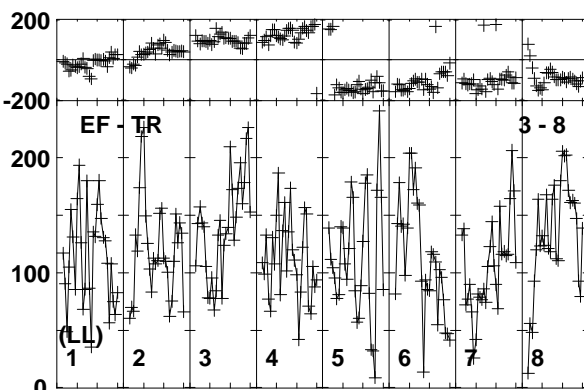
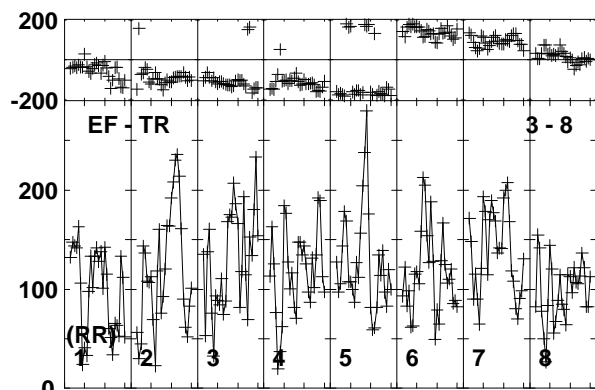
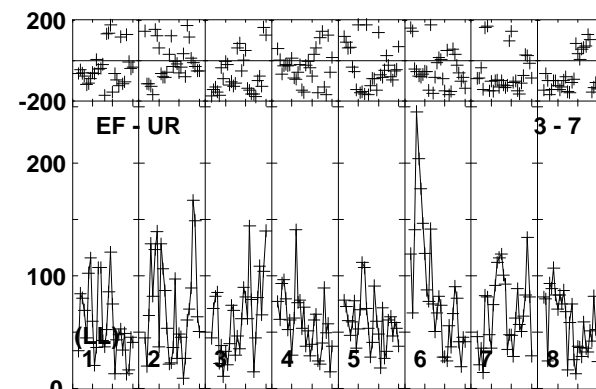
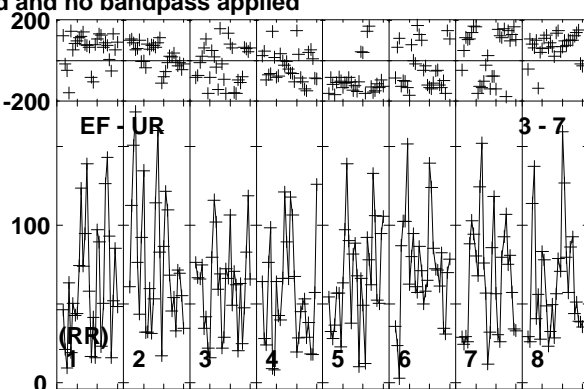
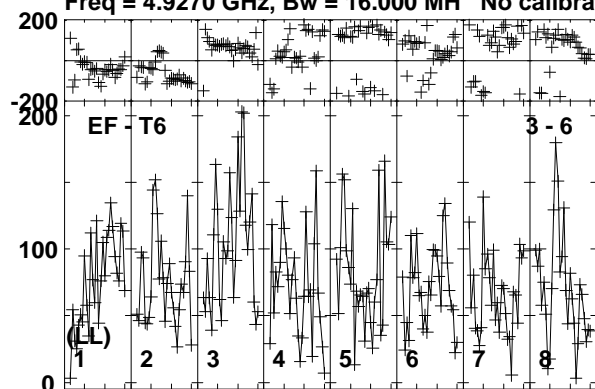

Lower frame: Micro Ampl Jy Top frame: Phas deg
Vector averaged cross-power spectrum Baseline: EF (03) - T6 (06)
Timerange: 00/07:37:21 to 00/07:41:19

Plot file version 417 created 17-FEB-2020 15:43:19

J1402+5347 EK047 2.UVDATA.1

Freq = 4.9270 GHz, Bw = 16.000 MH No calibration applied and no bandpass applied

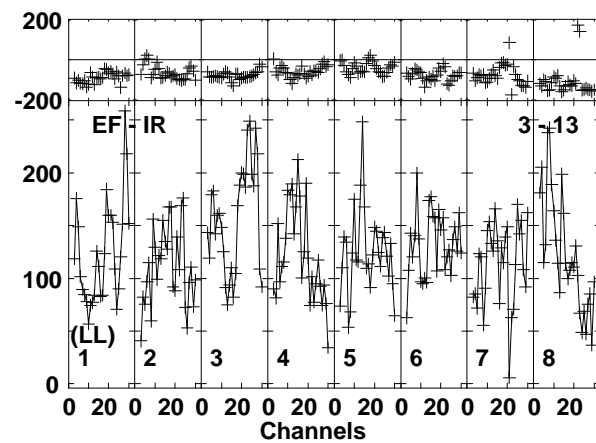
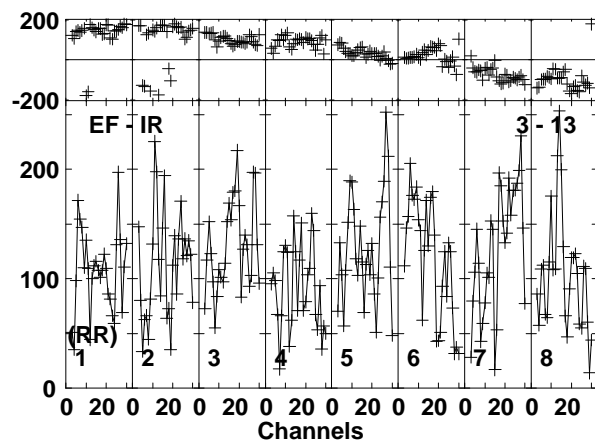
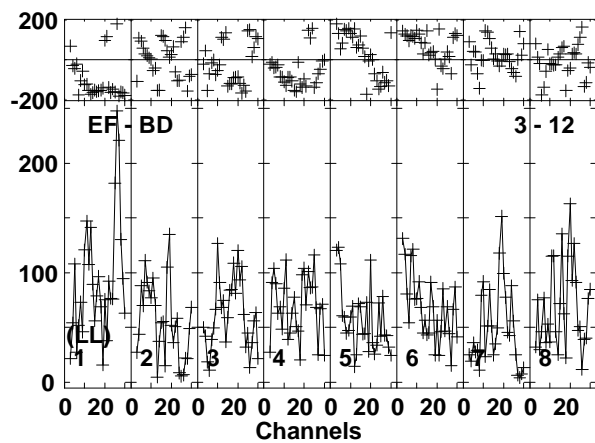
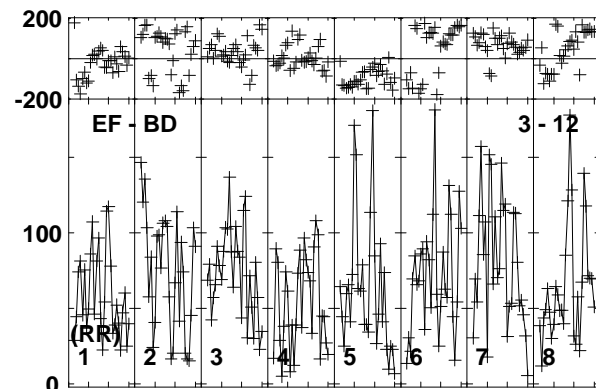
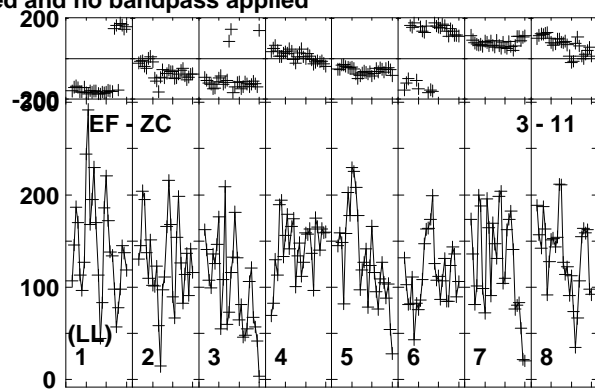
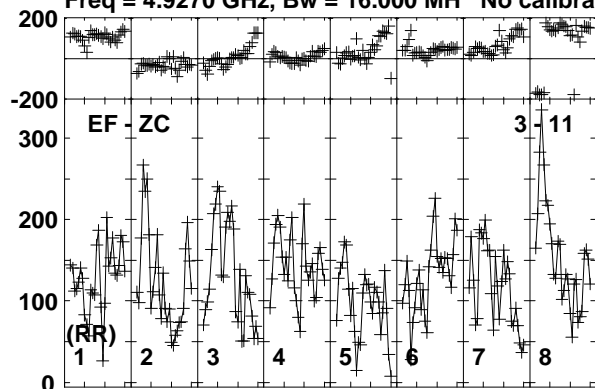

Lower frame: Micro Ampl Jy Top frame: Phas deg
Vector averaged cross-power spectrum Baseline: EF (03) - ZC (11)
Timerange: 00/07:37:21 to 00/07:41:19

Plot file version 418 created 17-FEB-2020 15:43:19

J1359+5544 EK047 2.UVDATA.1

Freq = 4.9270 GHz, Bw = 16.000 MH No calibration applied and no bandpass applied

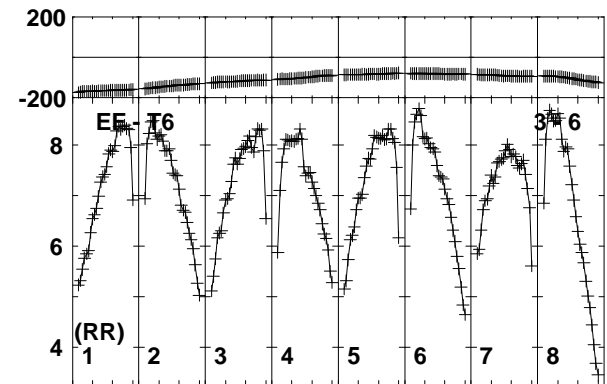
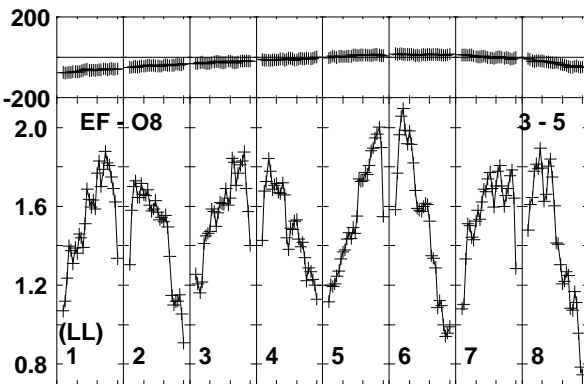
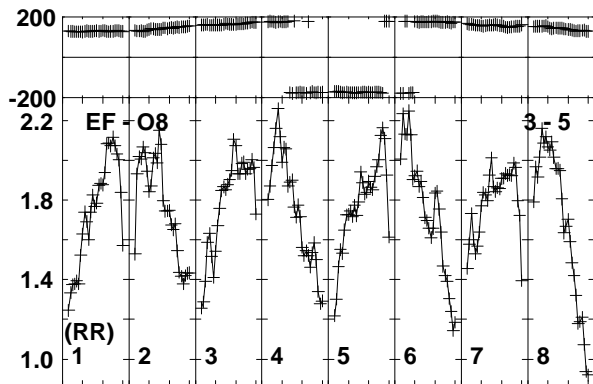
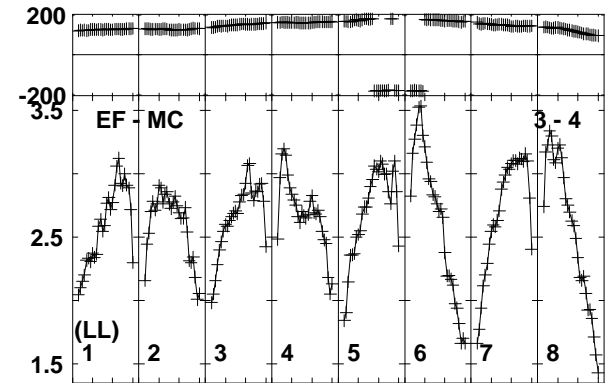
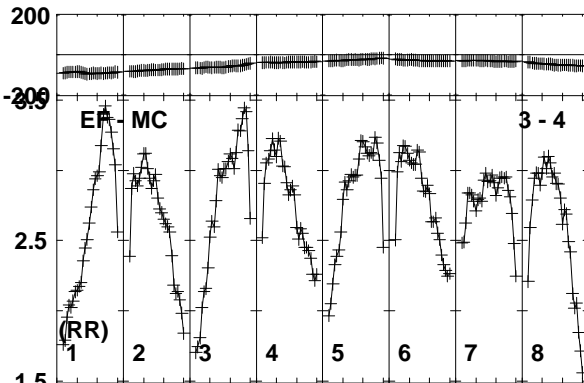
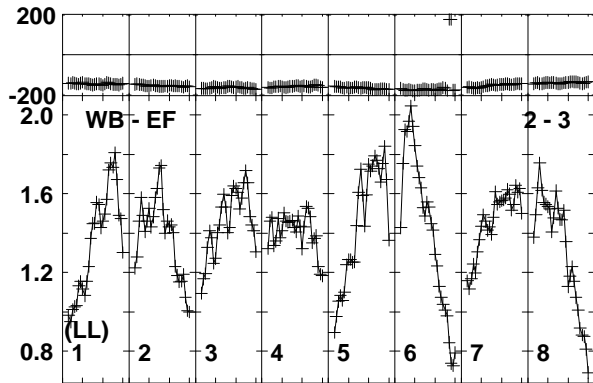
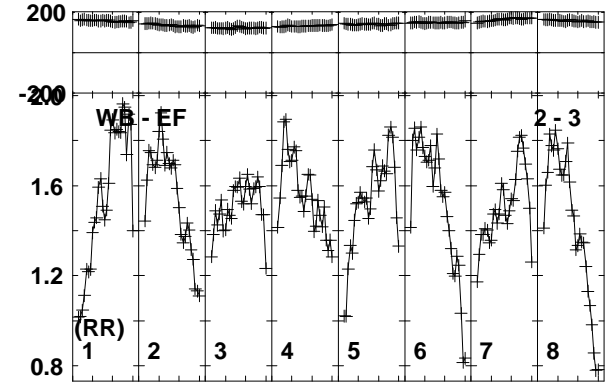
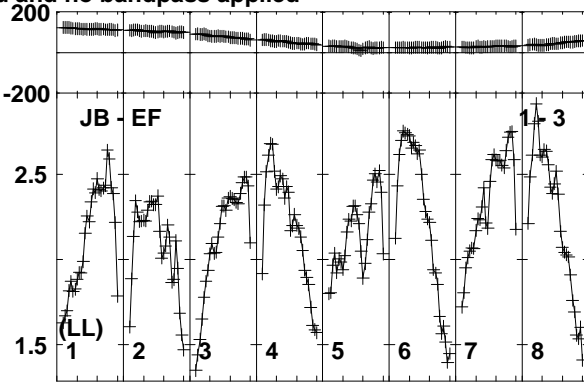
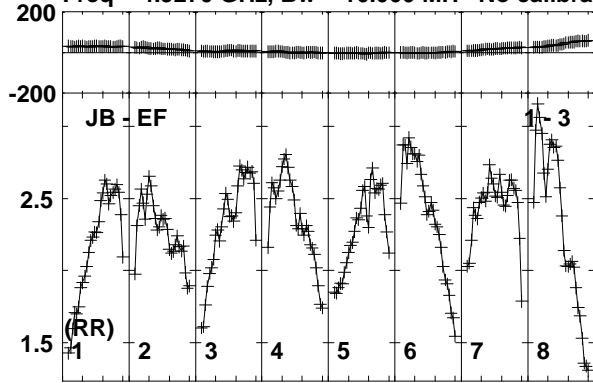

Lower frame: Milli Ampl Jy Top frame: Phas deg
Vector averaged cross-power spectrum Baseline: JB (01) - EF (03)
Timerange: 00/07:41:21 to 00/07:43:19

Plot file version 419 created 17-FEB-2020 15:43:19

J1359+5544 EK047 2.UVDATA.1

Freq = 4.9270 GHz, Bw = 16.000 MH No calibration applied and no bandpass applied

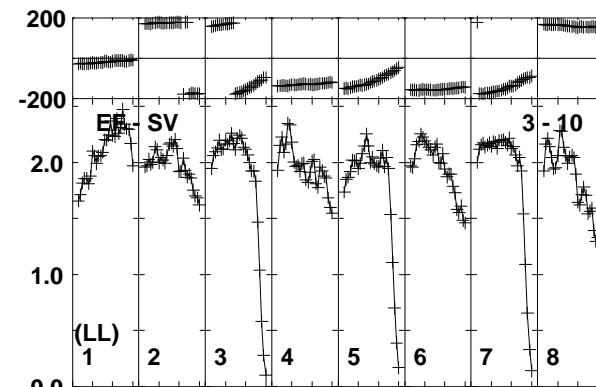
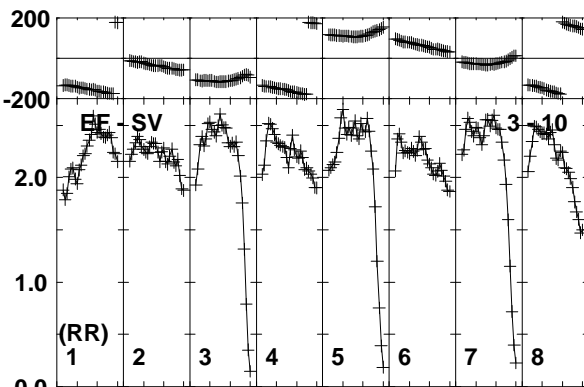
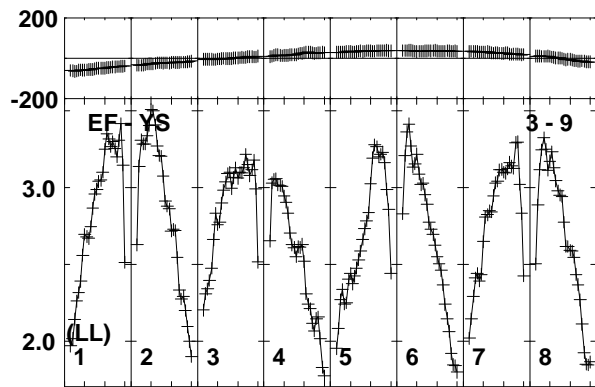
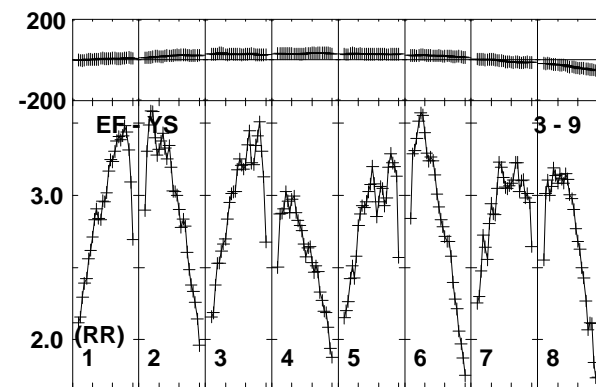
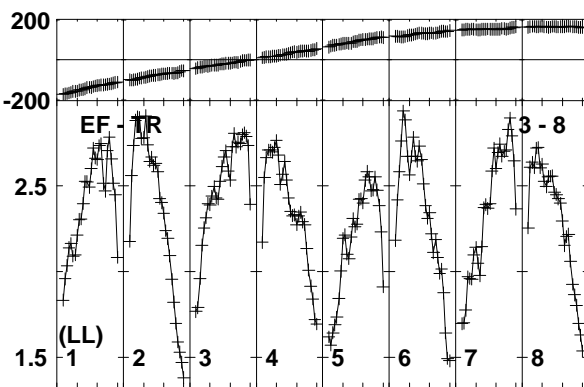
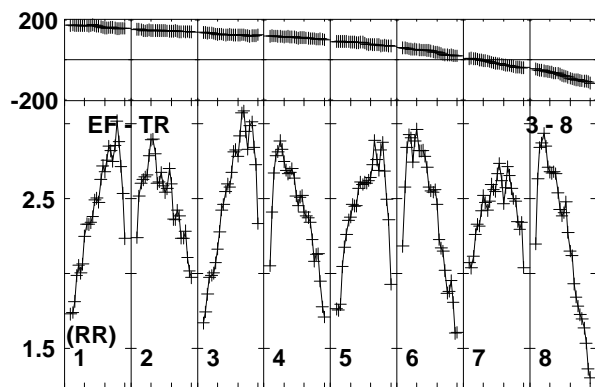
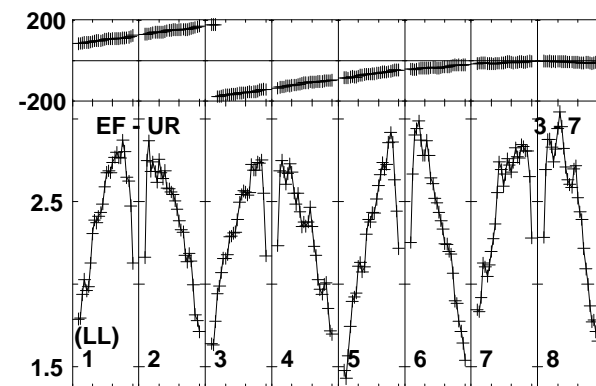
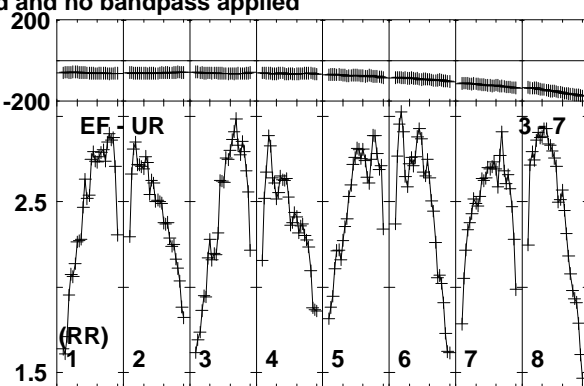
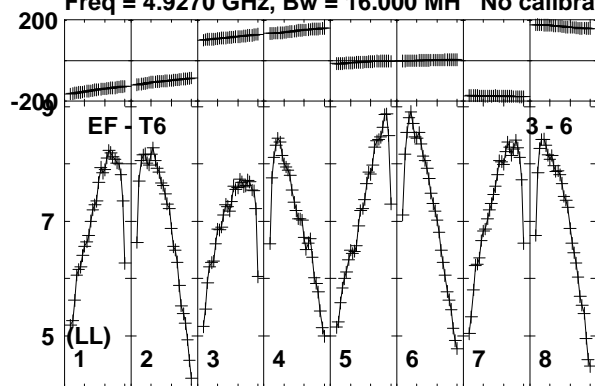

Lower frame: Milli Ampl Jy Top frame: Phas deg
Vector averaged cross-power spectrum Baseline: EF (03) - T6 (06)
Timerange: 00/07:41:21 to 00/07:43:19

Plot file version 420 created 17-FEB-2020 15:43:19

J1359+5544 EK047 2.UVDATA.1

Freq = 4.9270 GHz, Bw = 16.000 MH No calibration applied and no bandpass applied

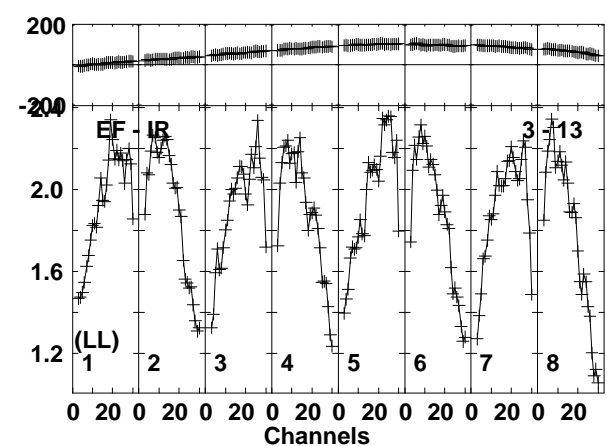
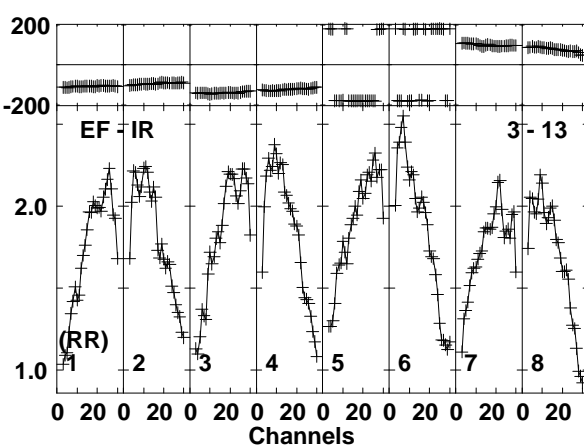
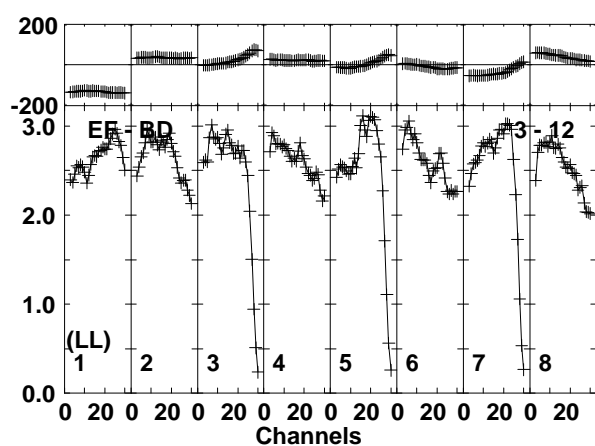
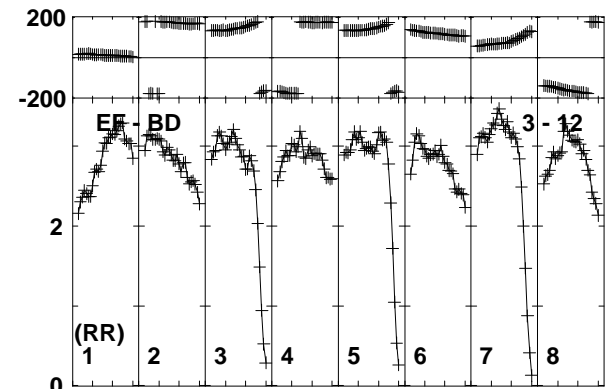
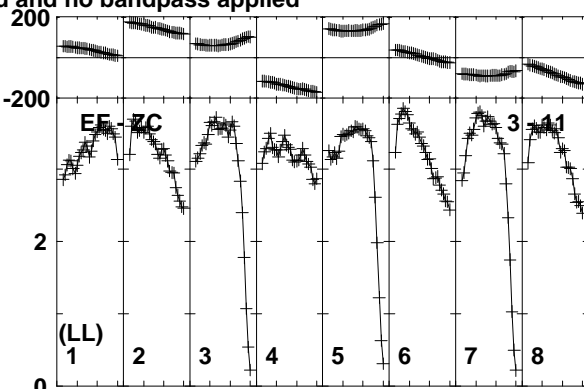
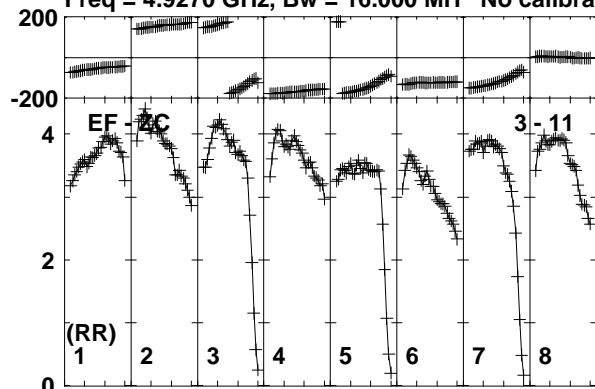

Lower frame: Milli Ampl Jy Top frame: Phas deg
Vector averaged cross-power spectrum Baseline: EF (03) - ZC (11)
Timerange: 00/07:41:21 to 00/07:43:19

Plot file version 421 created 17-FEB-2020 15:43:19

J1402+5347 EK047 2.UVDATA.1

Freq = 4.9270 GHz, Bw = 16.000 MH No calibration applied and no bandpass applied

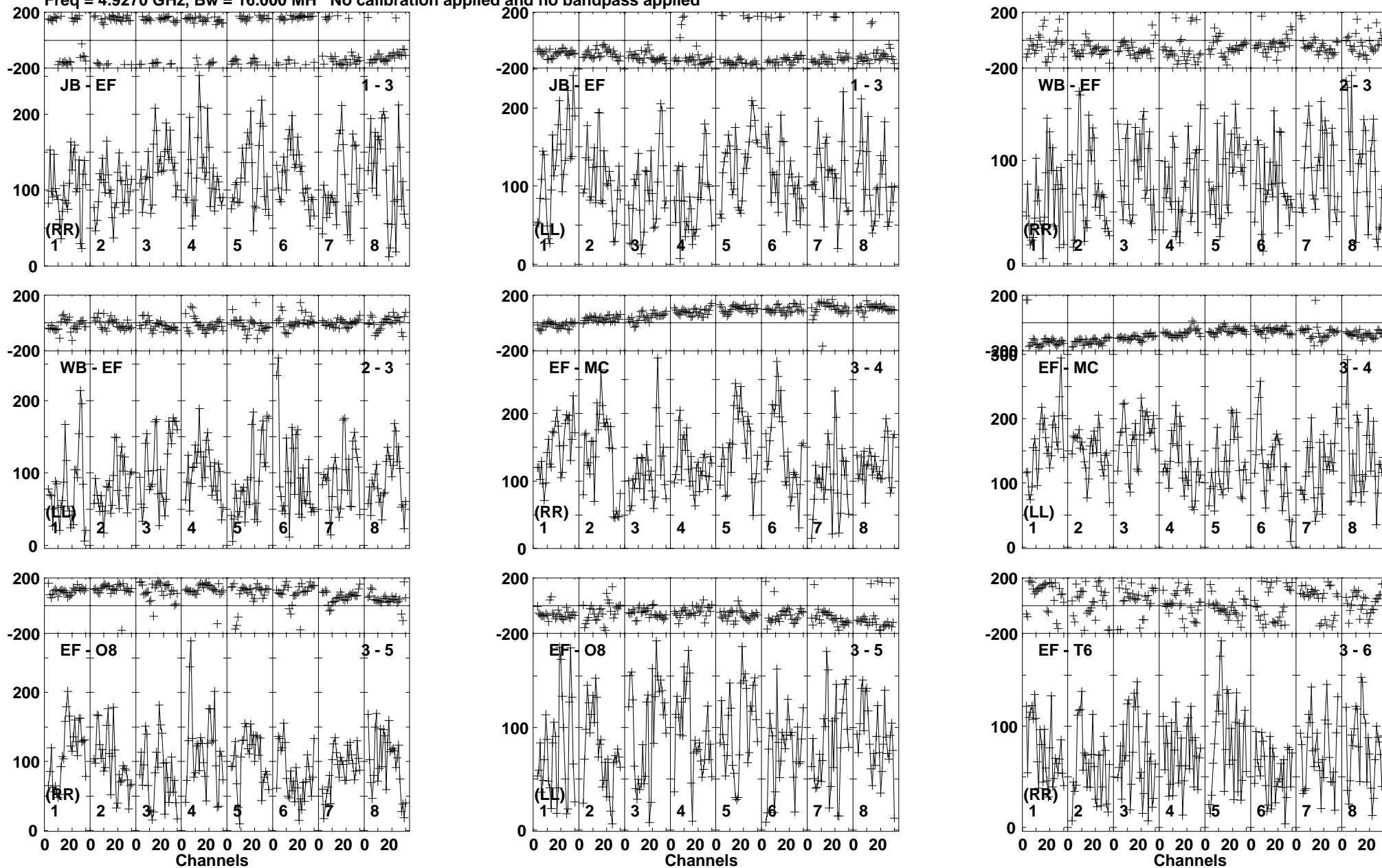

Lower frame: Micro Ampl Jy Top frame: Phas deg
Vector averaged cross-power spectrum Baseline: JB (01) - EF (03)
Timerange: 00/07:43:21 to 00/07:47:19

Plot file version 422 created 17-FEB-2020 15:43:20

J1402+5347 EK047 2.UVDATA.1

Freq = 4.9270 GHz, Bw = 16.000 MH No calibration applied and no bandpass applied

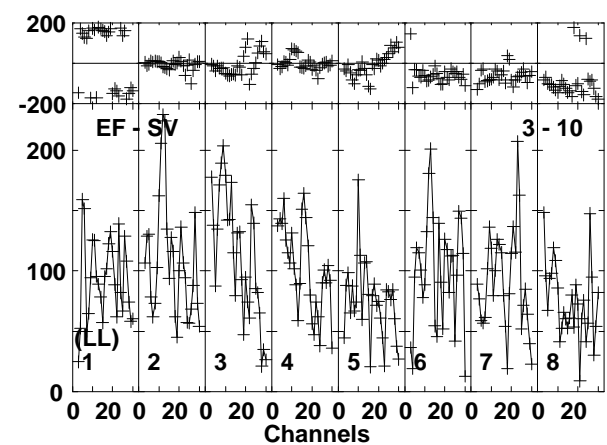
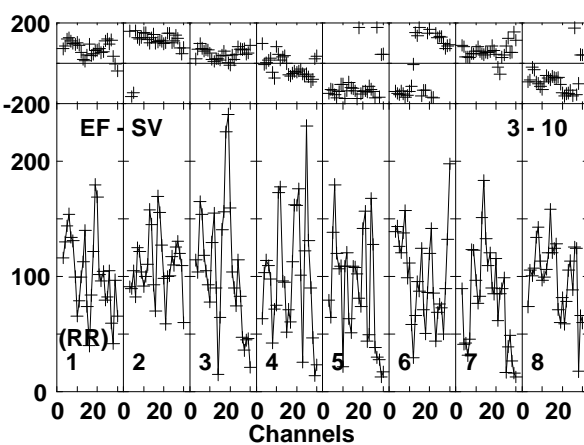
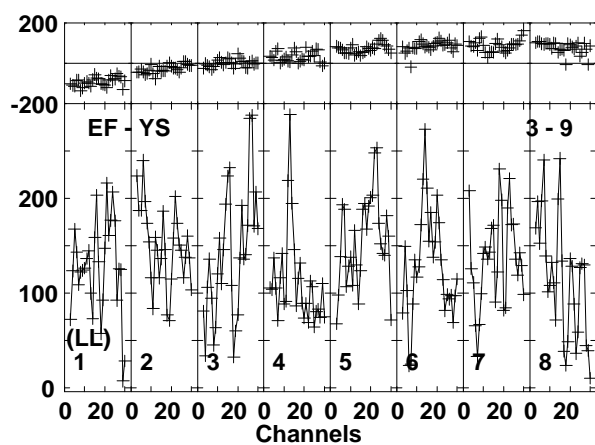
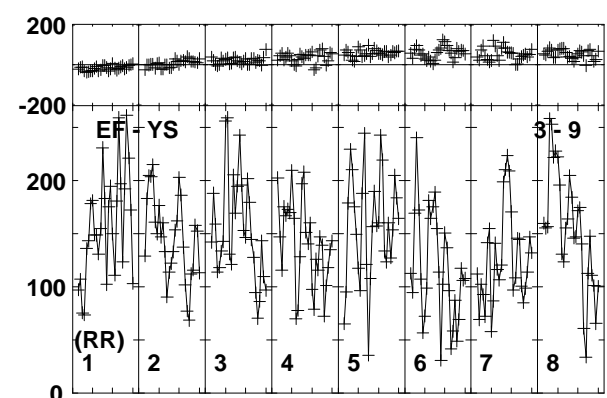
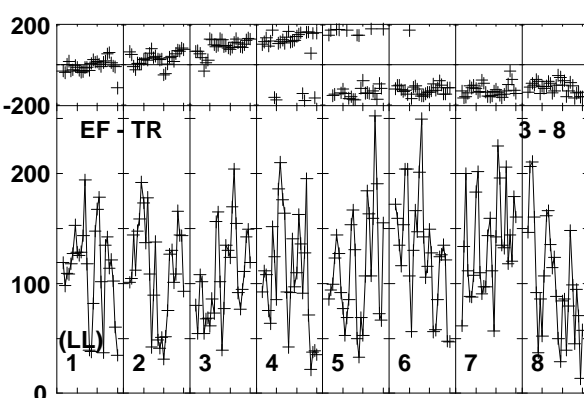
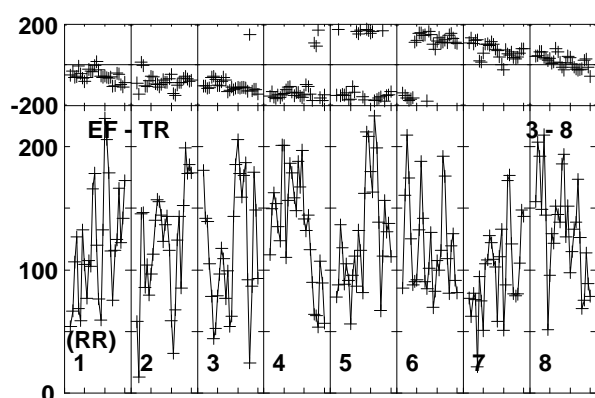
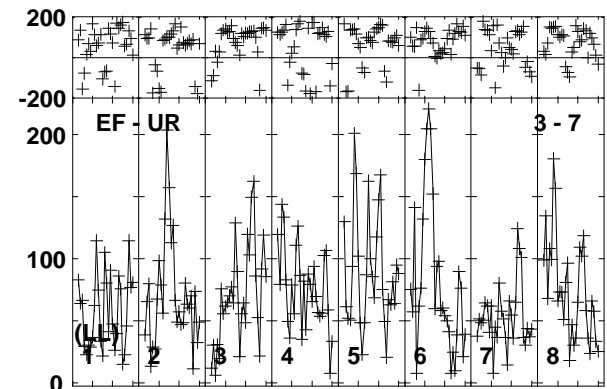
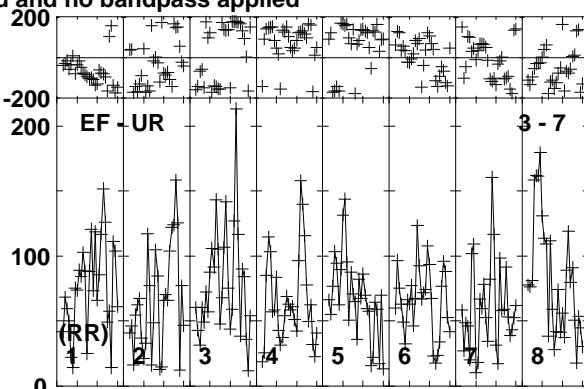
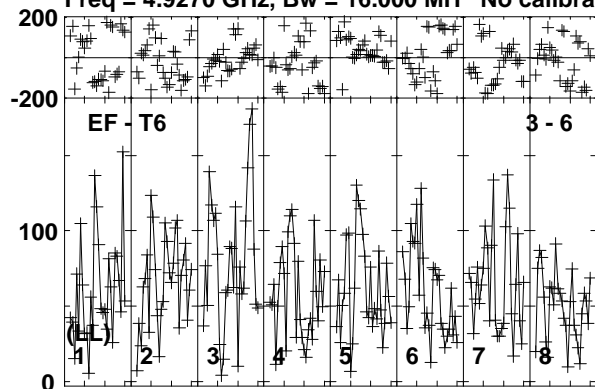

Lower frame: Micro Ampl Jy Top frame: Phas deg
Vector averaged cross-power spectrum Baseline: EF (03) - T6 (06)
Timerange: 00/07:43:21 to 00/07:47:19

Plot file version 423 created 17-FEB-2020 15:43:20

J1402+5347 EK047 2.UVDATA.1

Freq = 4.9270 GHz, Bw = 16.000 MH No calibration applied and no bandpass applied

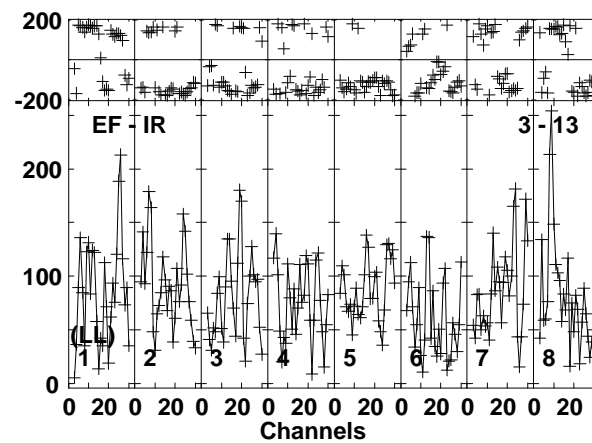
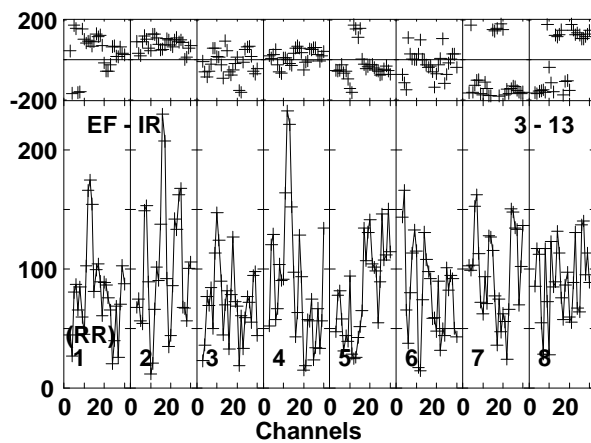
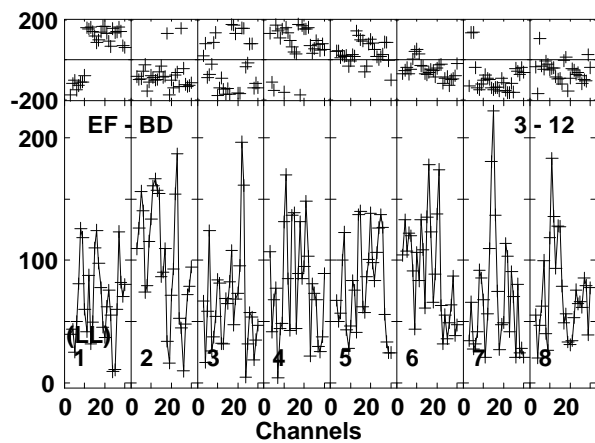
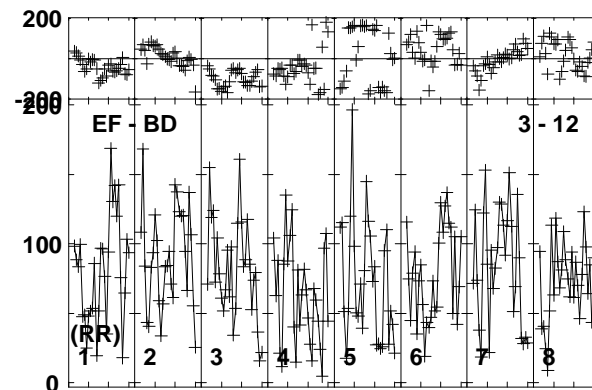
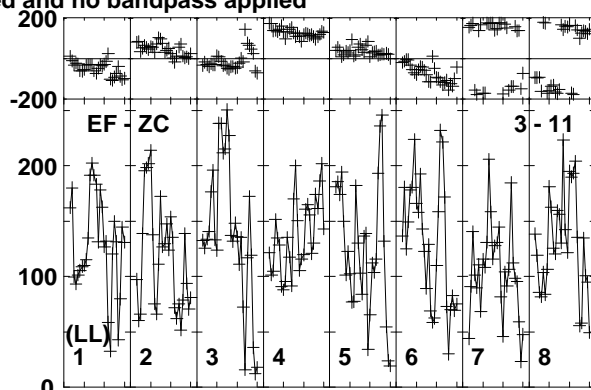
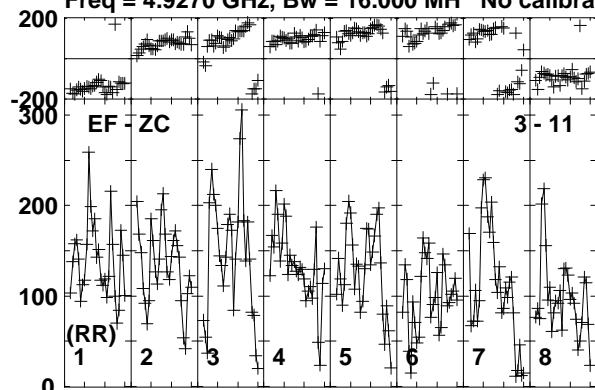

Lower frame: Micro Ampl Jy Top frame: Phas deg
Vector averaged cross-power spectrum Baseline: EF (03) - ZC (11)
Timerange: 00/07:43:21 to 00/07:47:19

Plot file version 424 created 17-FEB-2020 15:43:20

J1359+5544 EK047 2.UVDATA.1

Freq = 4.9270 GHz, Bw = 16.000 MH No calibration applied and no bandpass applied

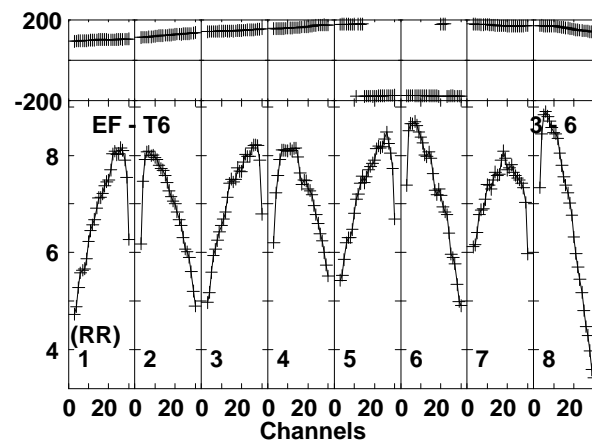
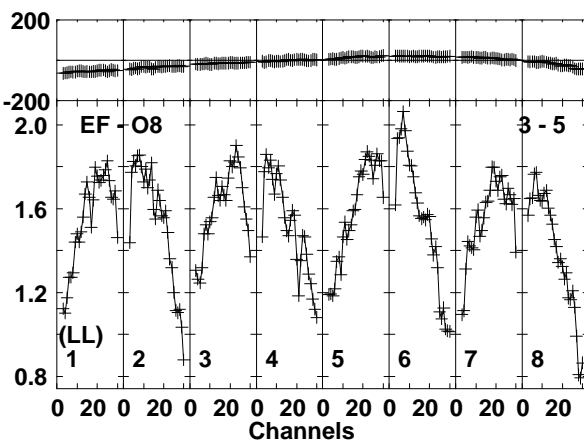
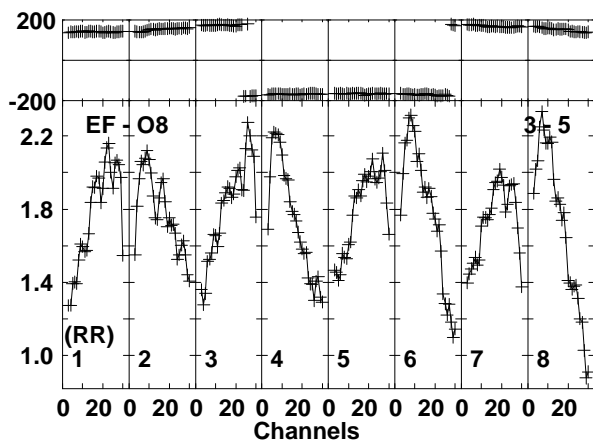
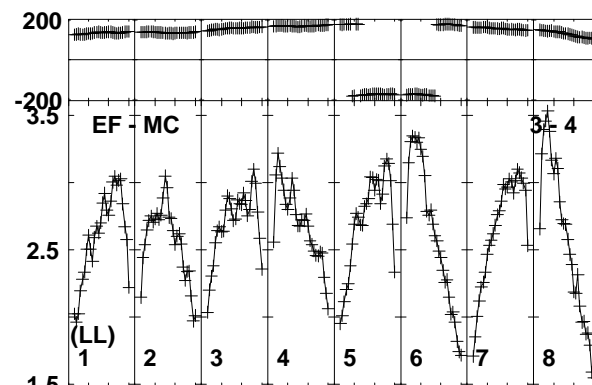
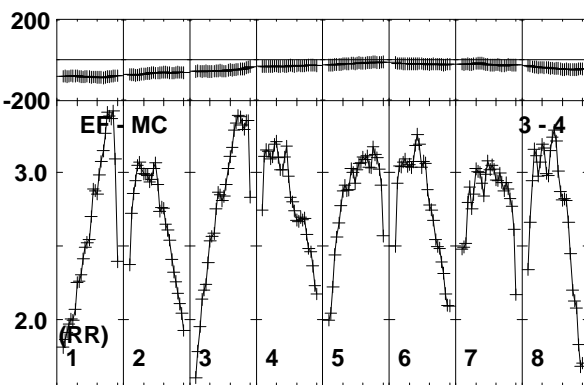
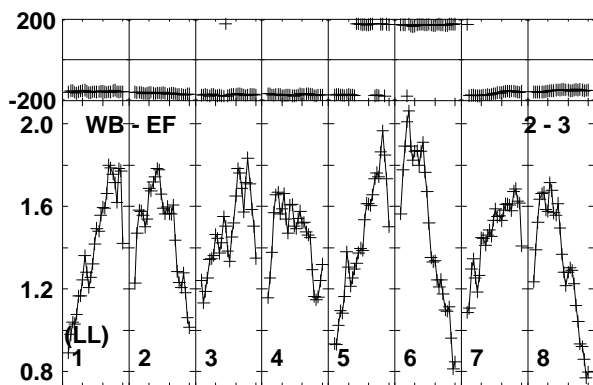
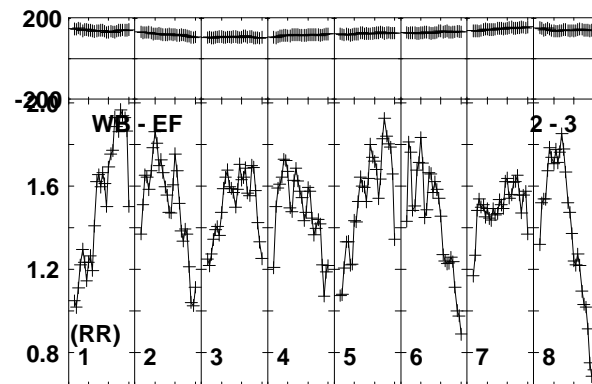
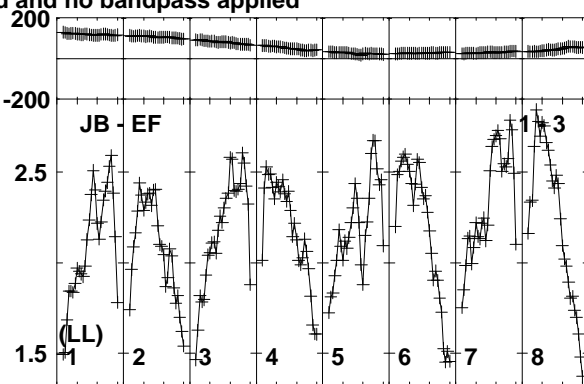
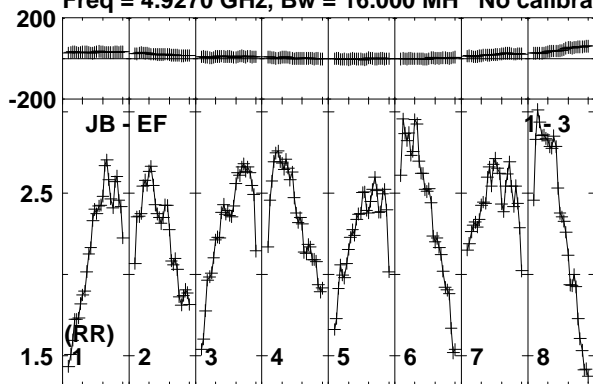

Lower frame: Milli Ampl Jy Top frame: Phas deg
Vector averaged cross-power spectrum Baseline: JB (01) - EF (03)
Timerange: 00/07:48:01 to 00/07:49:19

Plot file version 425 created 17-FEB-2020 15:43:20

J1359+5544 EK047 2.UVDATA.1

Freq = 4.9270 GHz, Bw = 16.000 MH No calibration applied and no bandpass applied

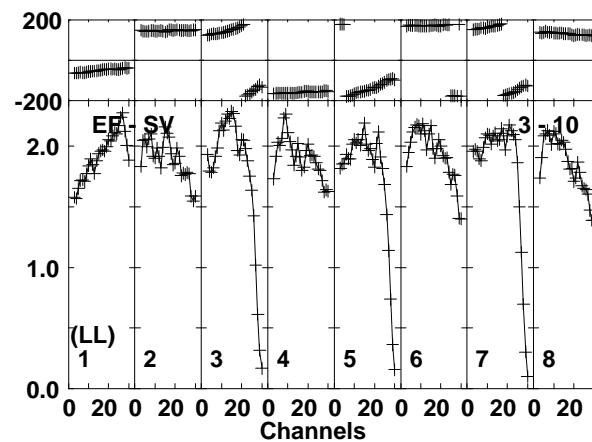
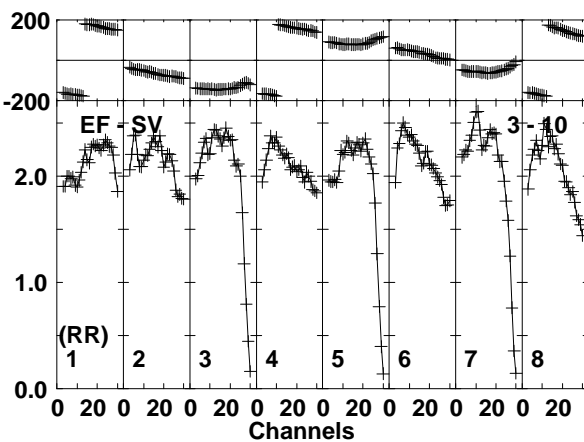
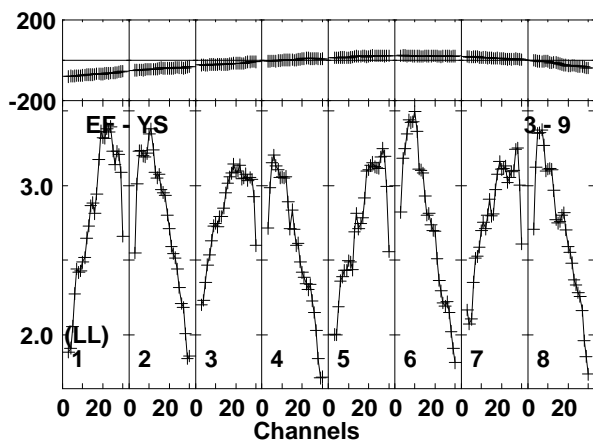
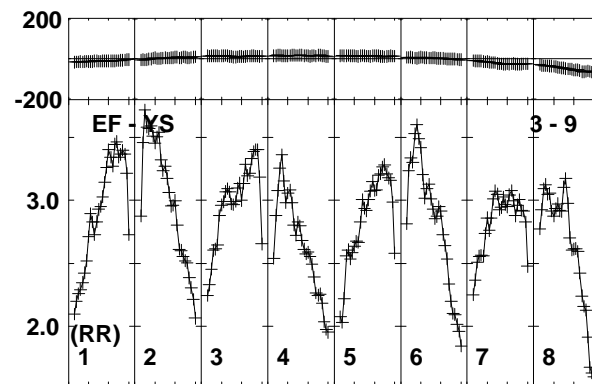
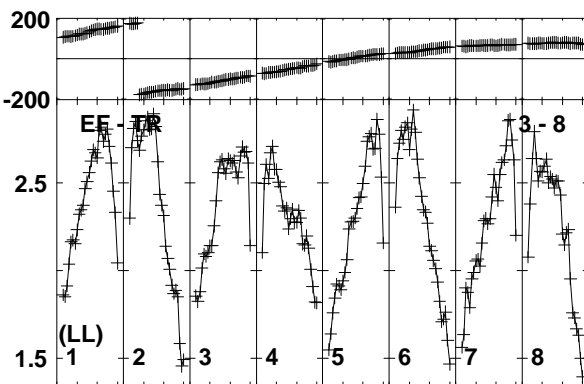
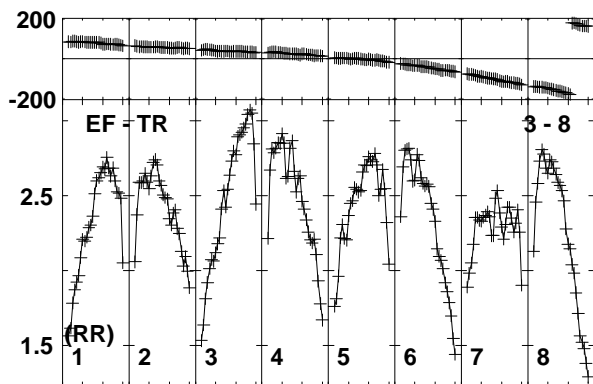
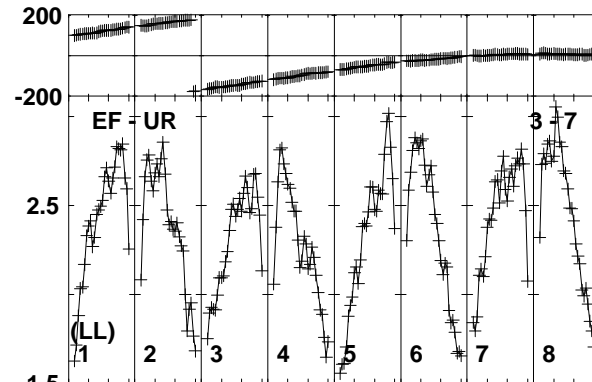
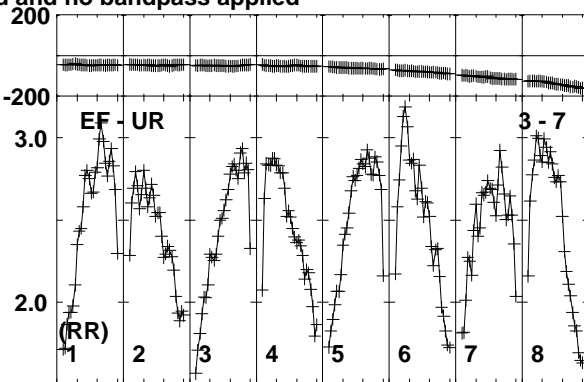
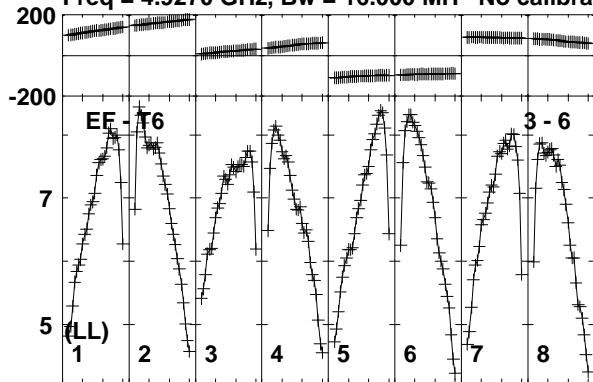

Lower frame: Milli Ampl Jy Top frame: Phas deg
Vector averaged cross-power spectrum Baseline: EF (03) - T6 (06)
Timerange: 00/07:48:01 to 00/07:49:19

Plot file version 426 created 17-FEB-2020 15:43:20

J1359+5544 EK047 2.UVDATA.1

Freq = 4.9270 GHz, Bw = 16.000 MH No calibration applied and no bandpass applied

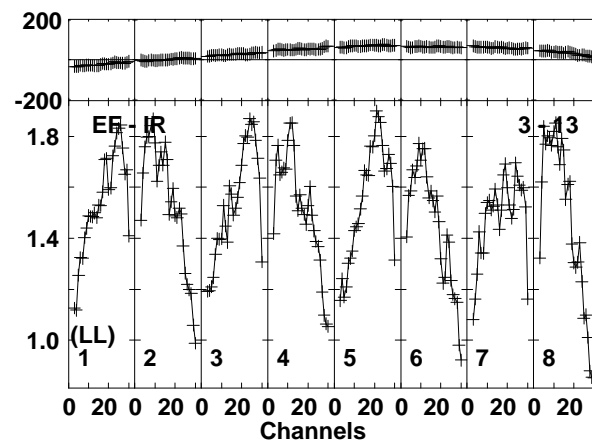
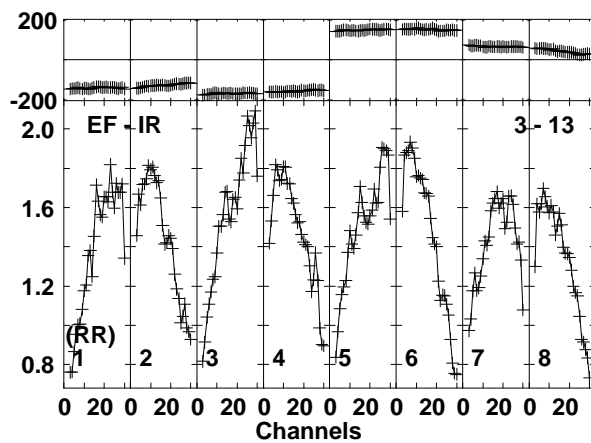
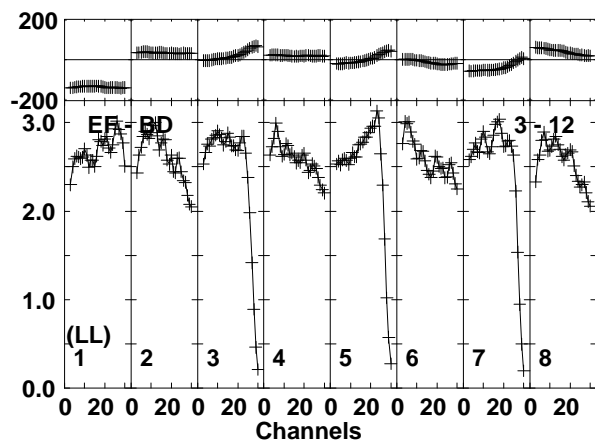
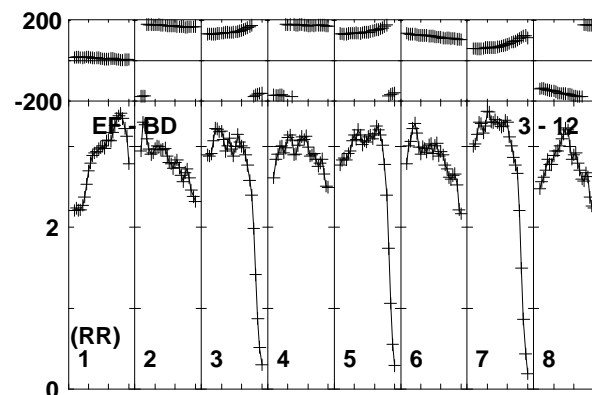
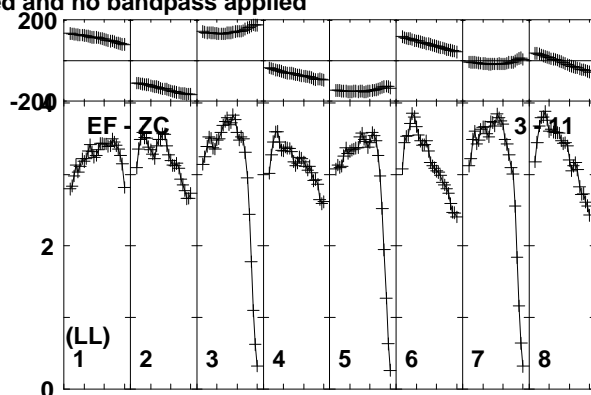
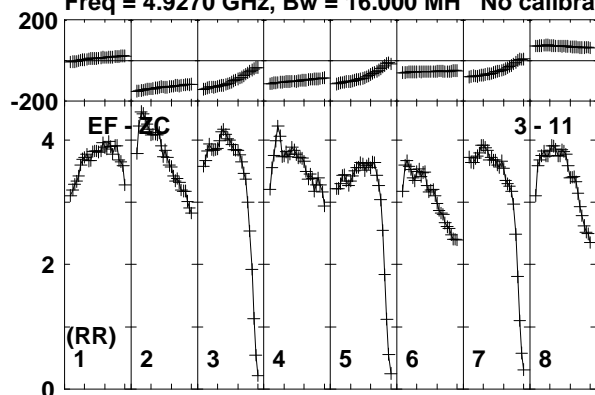

Lower frame: Milli Ampl Jy Top frame: Phas deg
Vector averaged cross-power spectrum Baseline: EF (03) - ZC (11)
Timerange: 00/07:48:01 to 00/07:49:19

Plot file version 427 created 17-FEB-2020 15:43:20

J1402+5347 EK047 2.UVDATA.1

Freq = 4.9270 GHz, Bw = 16.000 MH No calibration applied and no bandpass applied

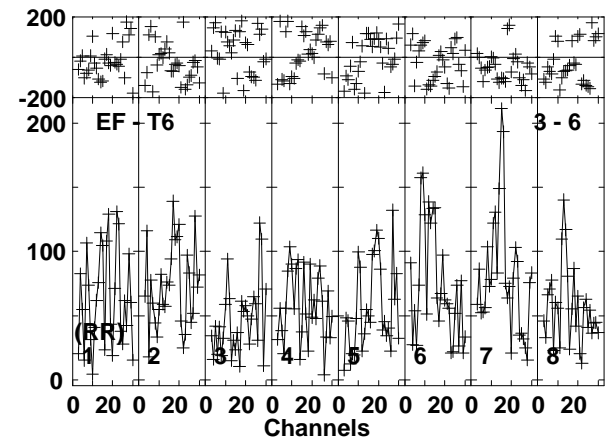
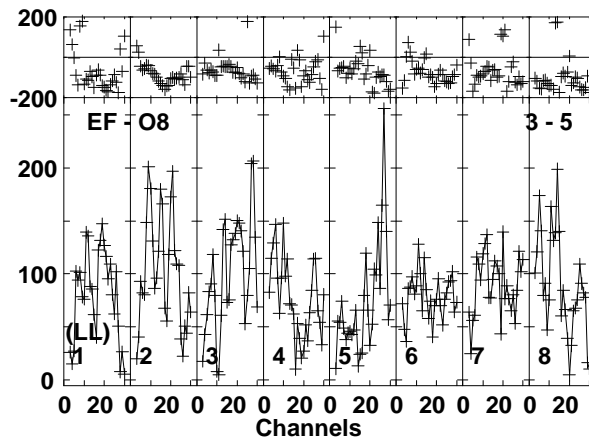
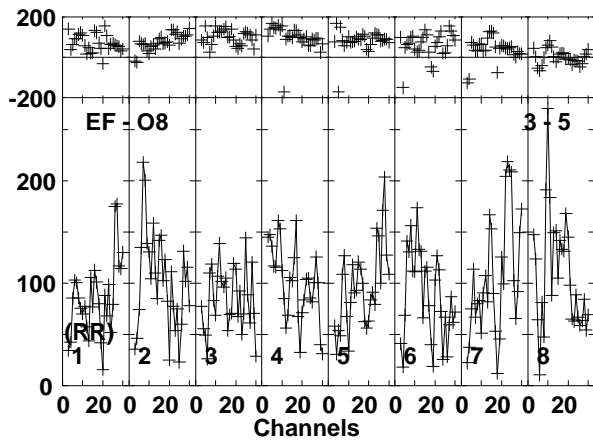
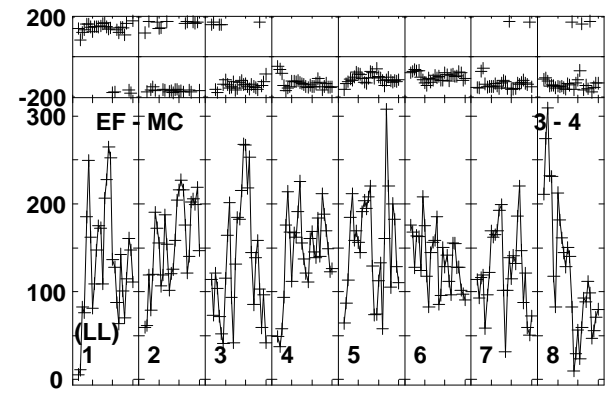
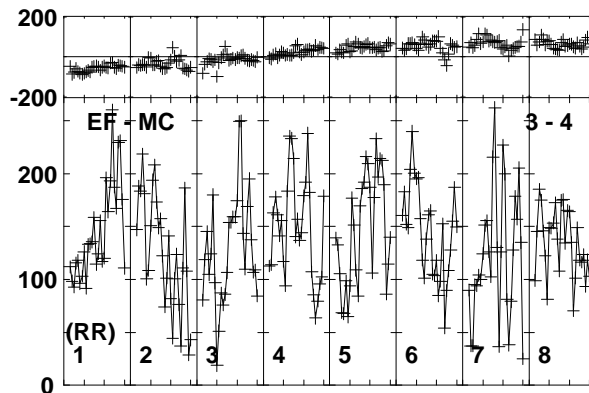
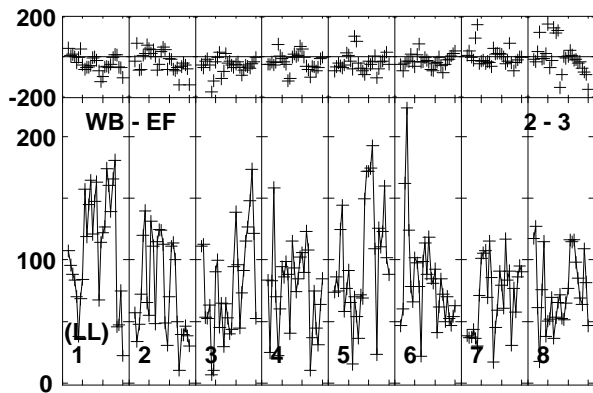
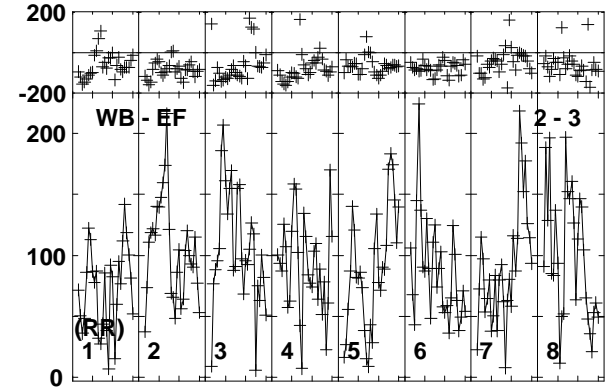
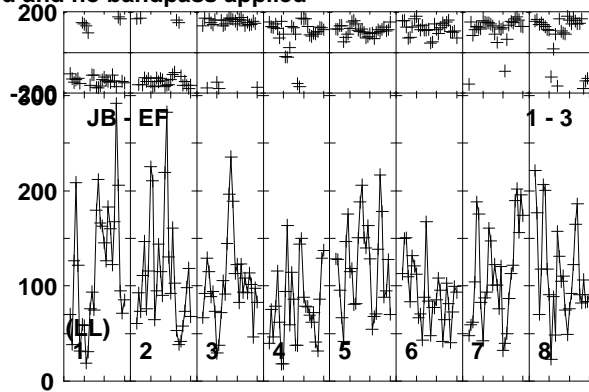
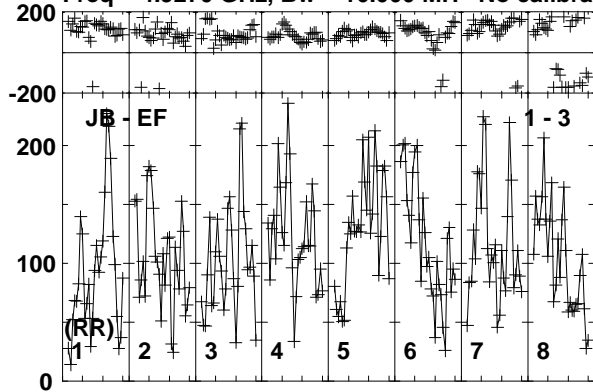

Lower frame: Micro Ampl Jy Top frame: Phas deg
Vector averaged cross-power spectrum Baseline: JB (01) - EF (03)
Timerange: 00/07:49:21 to 00/07:53:19

Plot file version 428 created 17-FEB-2020 15:43:20

J1402+5347 EK047 2.UVDATA.1

Freq = 4.9270 GHz, Bw = 16.000 MH No calibration applied and no bandpass applied

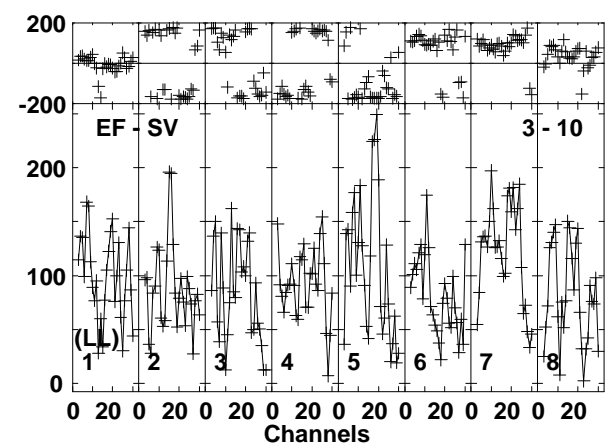
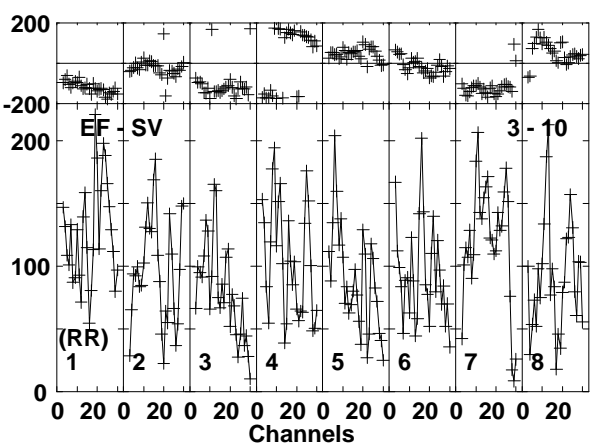
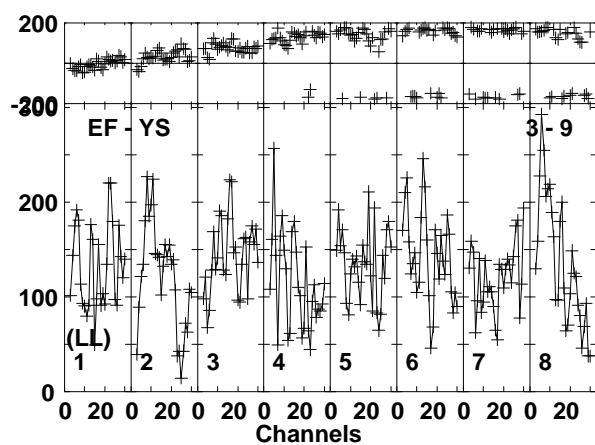
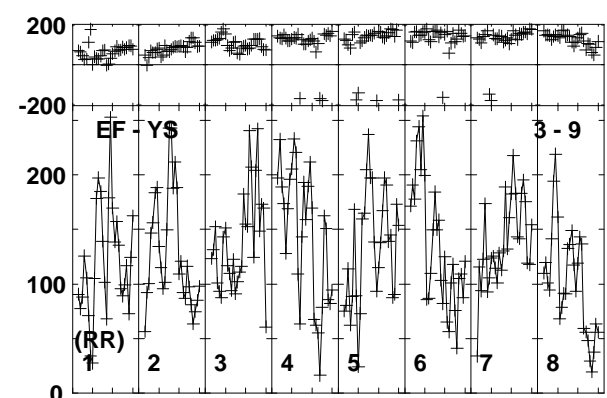
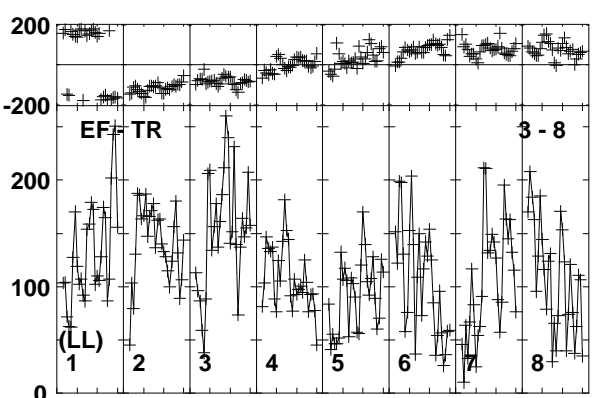
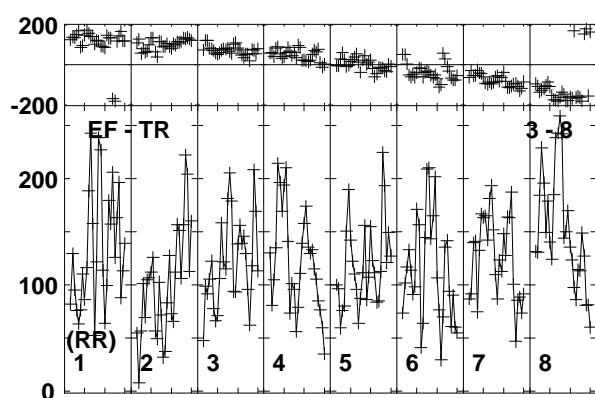
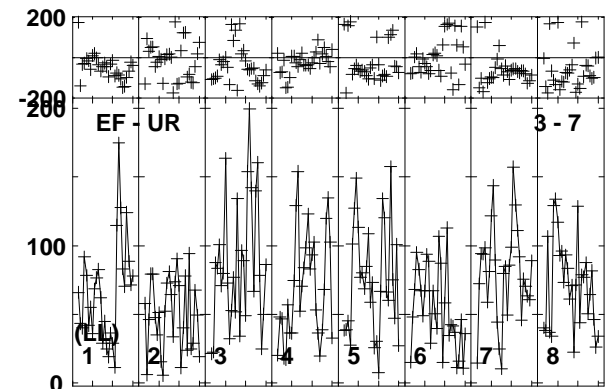
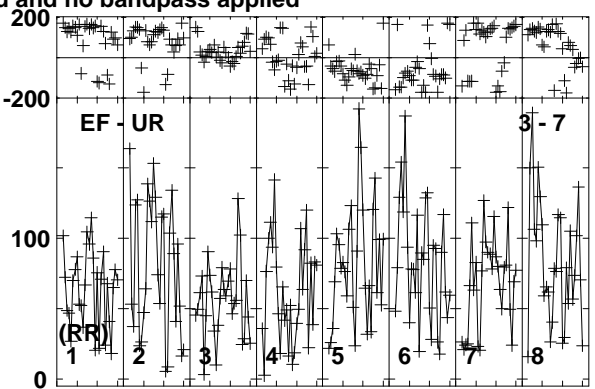
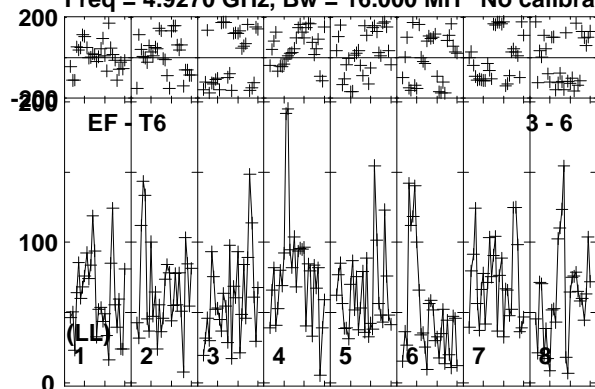

Lower frame: Micro Ampl Jy Top frame: Phas deg
Vector averaged cross-power spectrum Baseline: EF (03) - T6 (06)
Timerange: 00/07:49:21 to 00/07:53:19

Plot file version 429 created 17-FEB-2020 15:43:20

J1402+5347 EK047 2.UVDATA.1

Freq = 4.9270 GHz, Bw = 16.000 MH No calibration applied and no bandpass applied

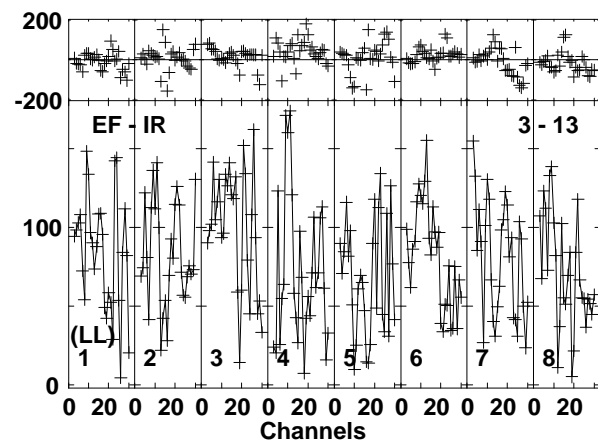
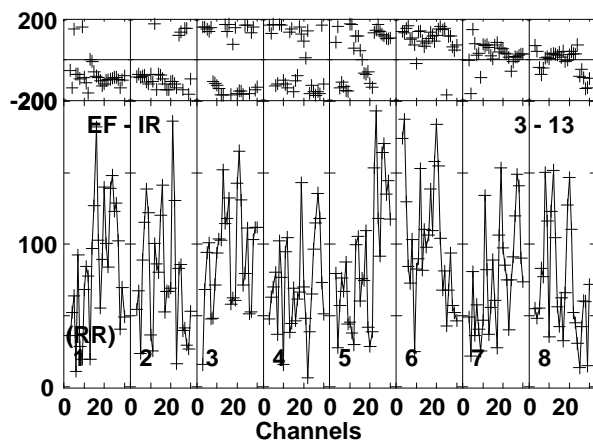
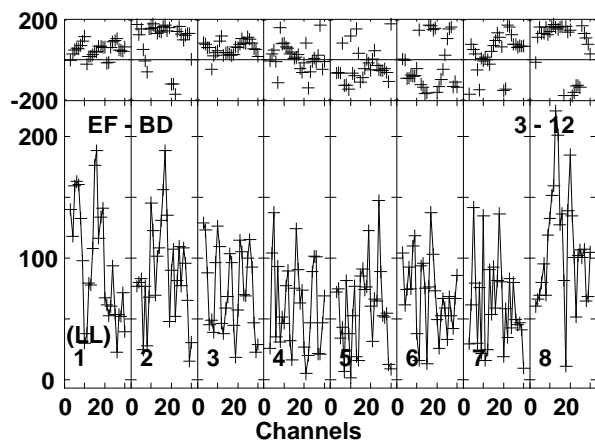
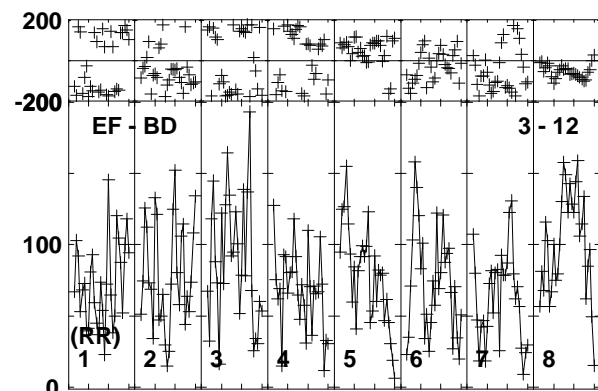
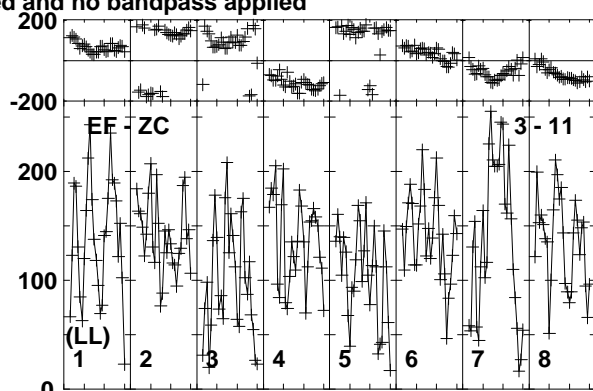
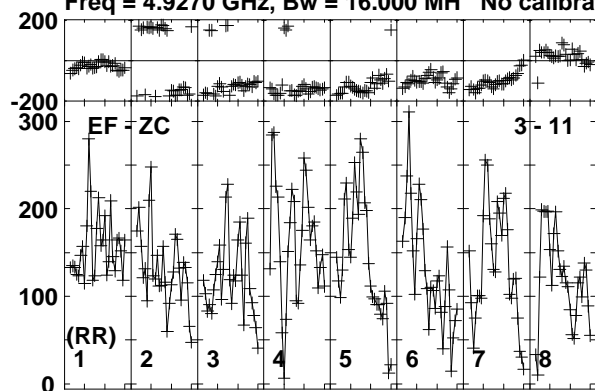

Lower frame: Micro Ampl Jy Top frame: Phas deg
Vector averaged cross-power spectrum Baseline: EF (03) - ZC (11)
Timerange: 00/07:49:21 to 00/07:53:19

Plot file version 430 created 17-FEB-2020 15:43:20

J1359+5544 EK047 2.UVDATA.1

Freq = 4.9270 GHz, Bw = 16.000 MH No calibration applied and no bandpass applied

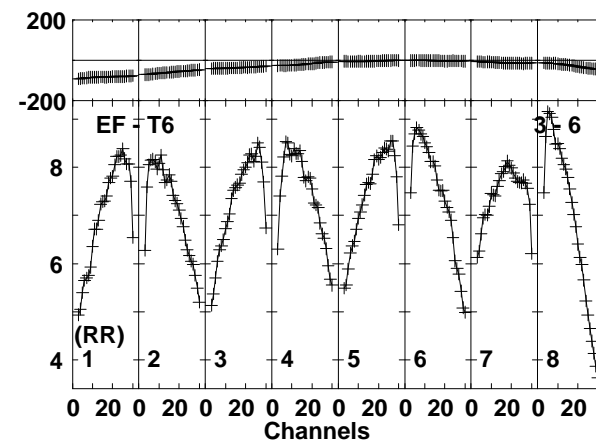
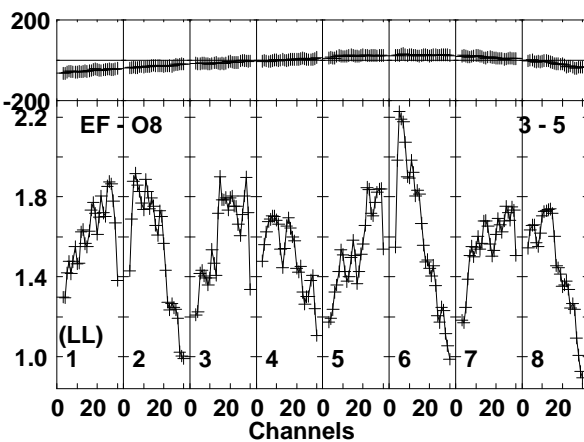
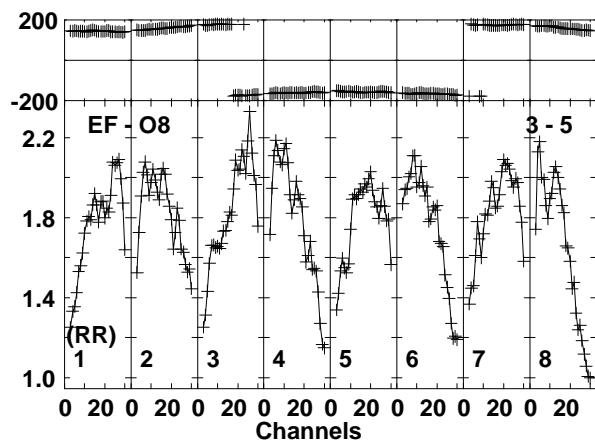
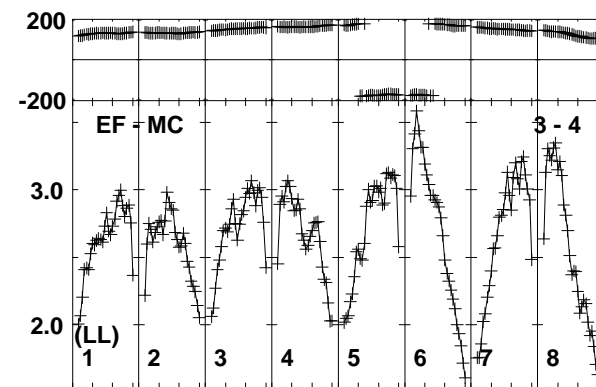
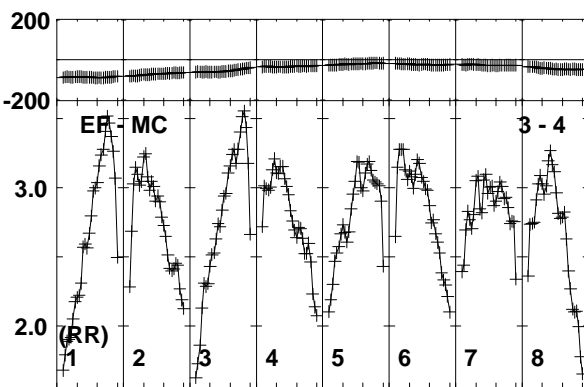
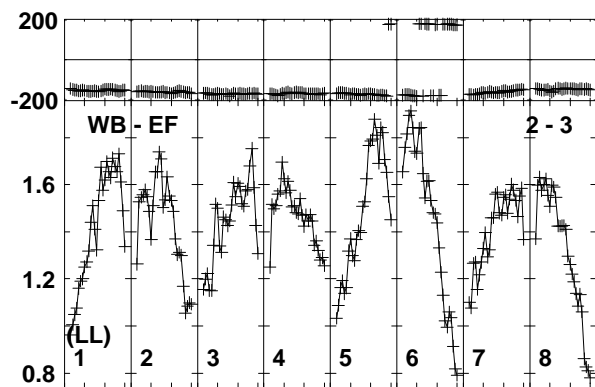
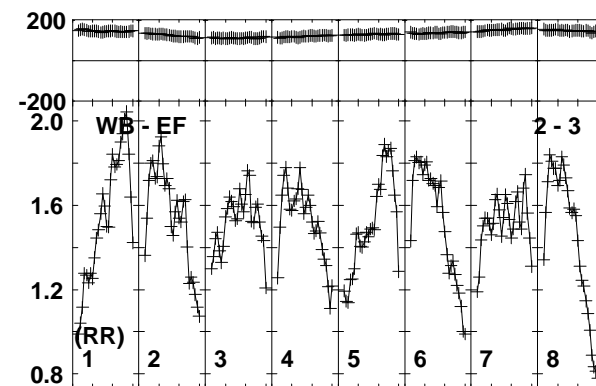
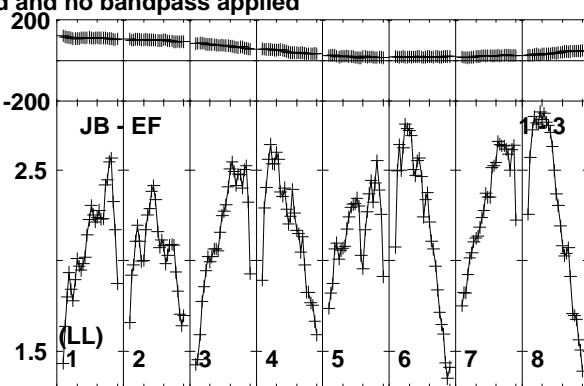
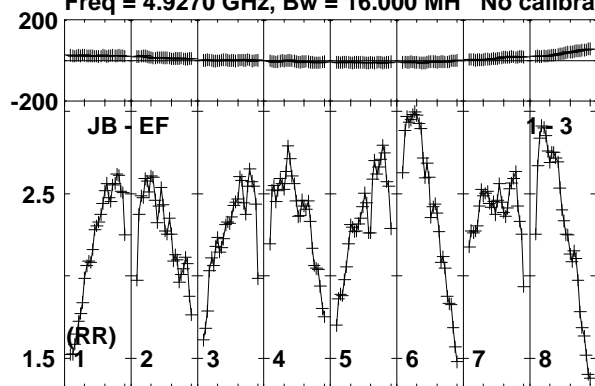

Lower frame: Milli Ampl Jy Top frame: Phas deg
Vector averaged cross-power spectrum Baseline: JB (01) - EF (03)
Timerange: 00/07:53:21 to 00/07:55:19

Plot file version 431 created 17-FEB-2020 15:43:21

J1359+5544 EK047 2.UVDATA.1

Freq = 4.9270 GHz, Bw = 16.000 MH No calibration applied and no bandpass applied

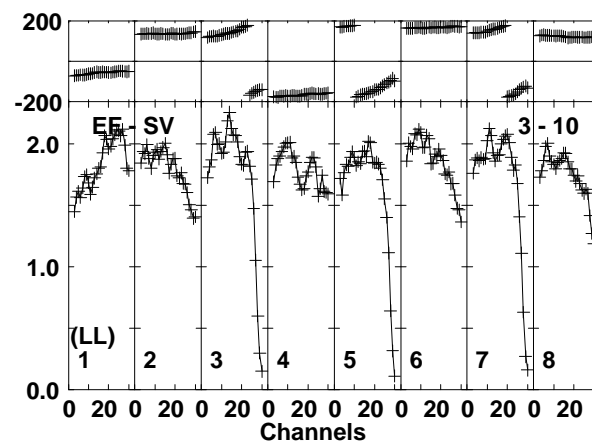
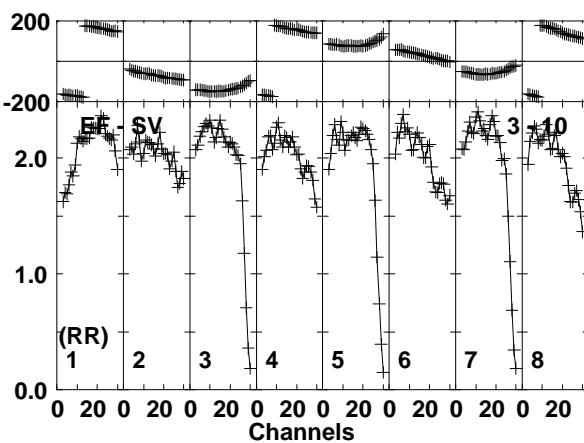
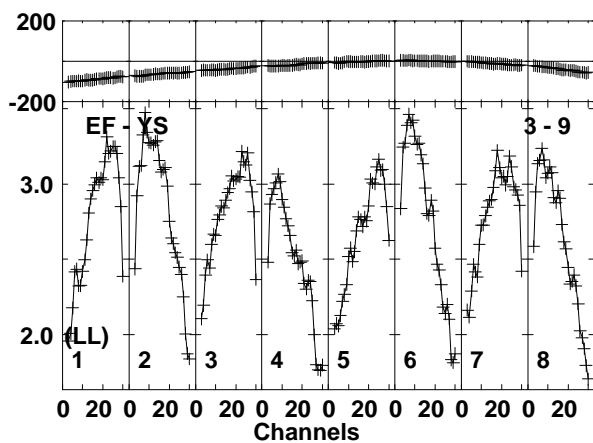
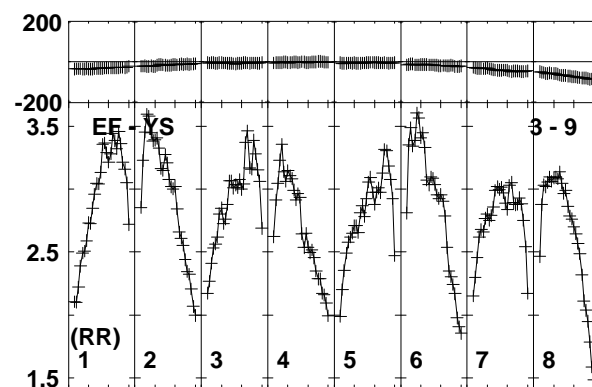
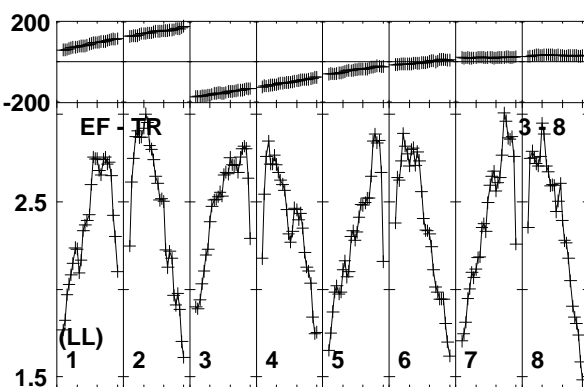
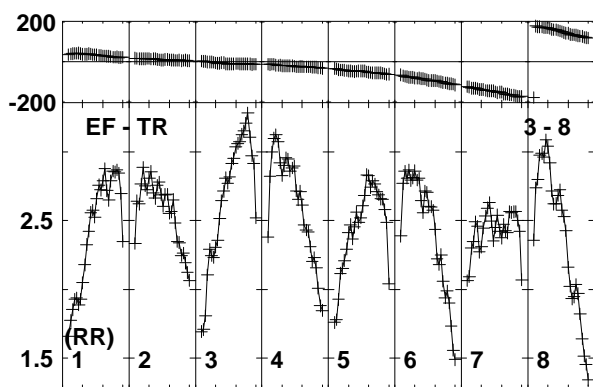
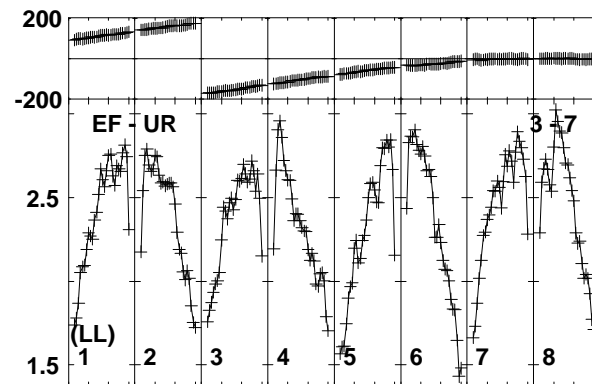
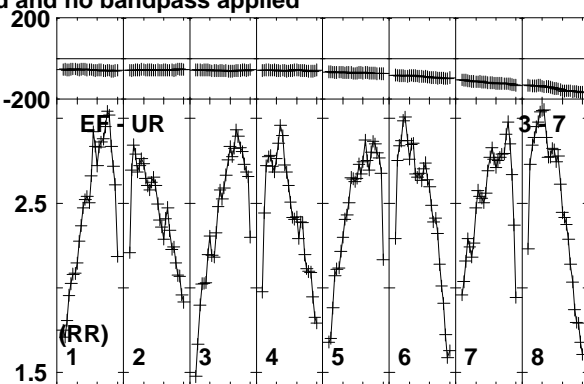
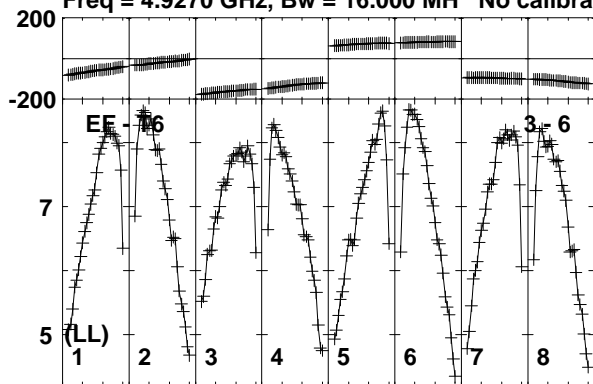

Lower frame: Milli Ampl Jy Top frame: Phas deg
Vector averaged cross-power spectrum Baseline: EF (03) - T6 (06)
Timerange: 00/07:53:21 to 00/07:55:19

Plot file version 432 created 17-FEB-2020 15:43:21

J1359+5544 EK047 2.UVDATA.1

Freq = 4.9270 GHz, Bw = 16.000 MH No calibration applied and no bandpass applied

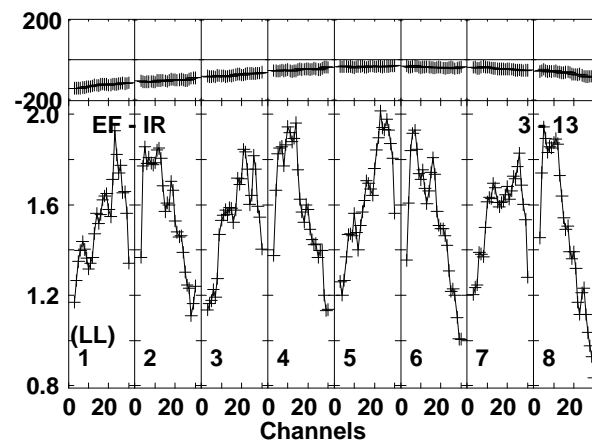
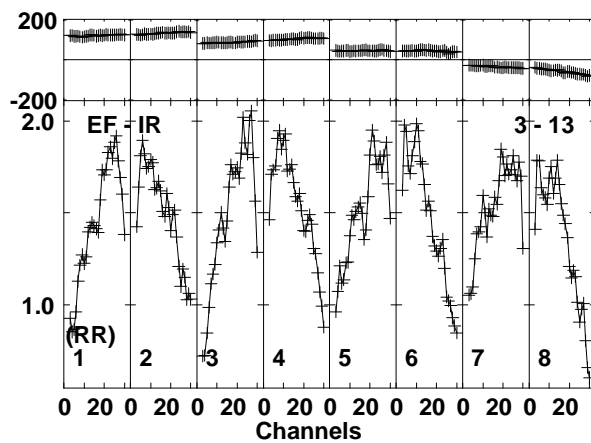
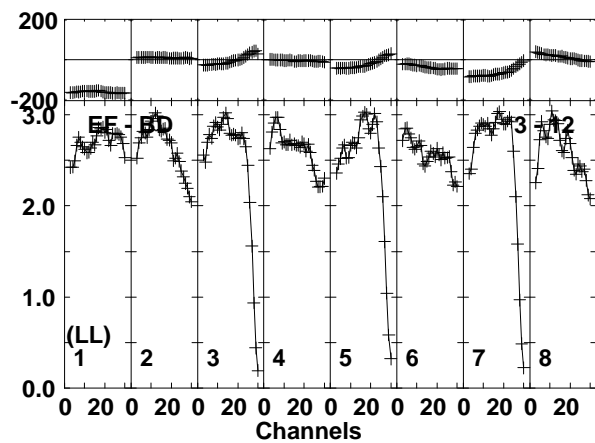
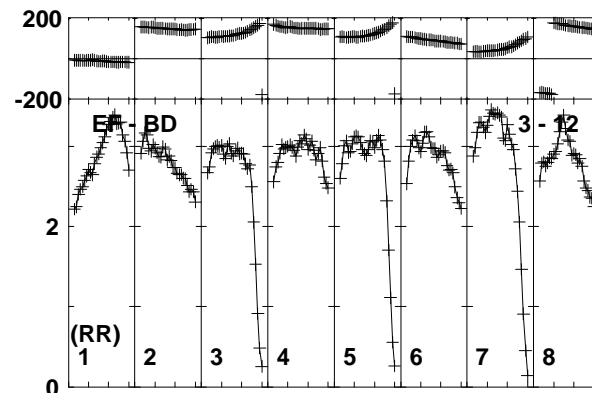
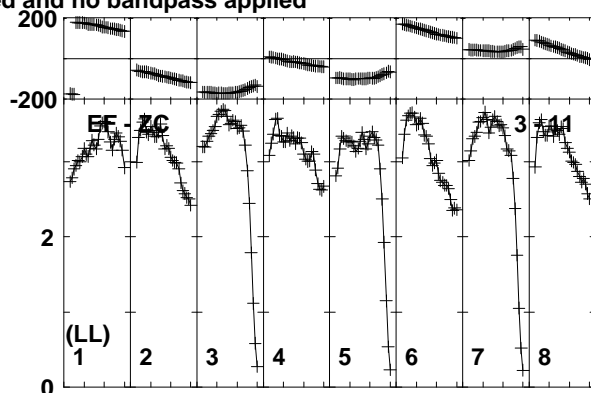
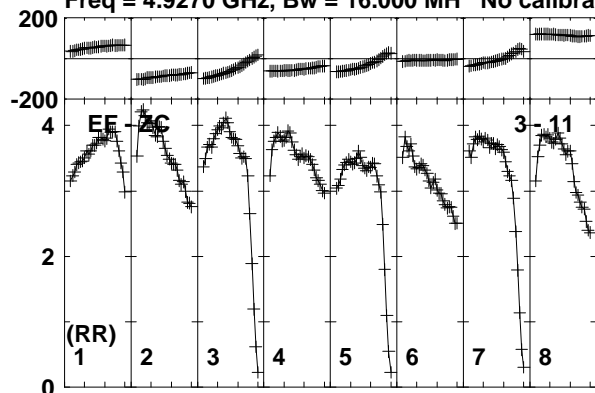

Lower frame: Milli Ampl Jy Top frame: Phas deg
Vector averaged cross-power spectrum Baseline: EF (03) - ZC (11)
Timerange: 00/07:53:21 to 00/07:55:19

Plot file version 433 created 17-FEB-2020 15:43:21

J1402+5347 EK047 2.UVDATA.1

Freq = 4.9270 GHz, Bw = 16.000 MH No calibration applied and no bandpass applied

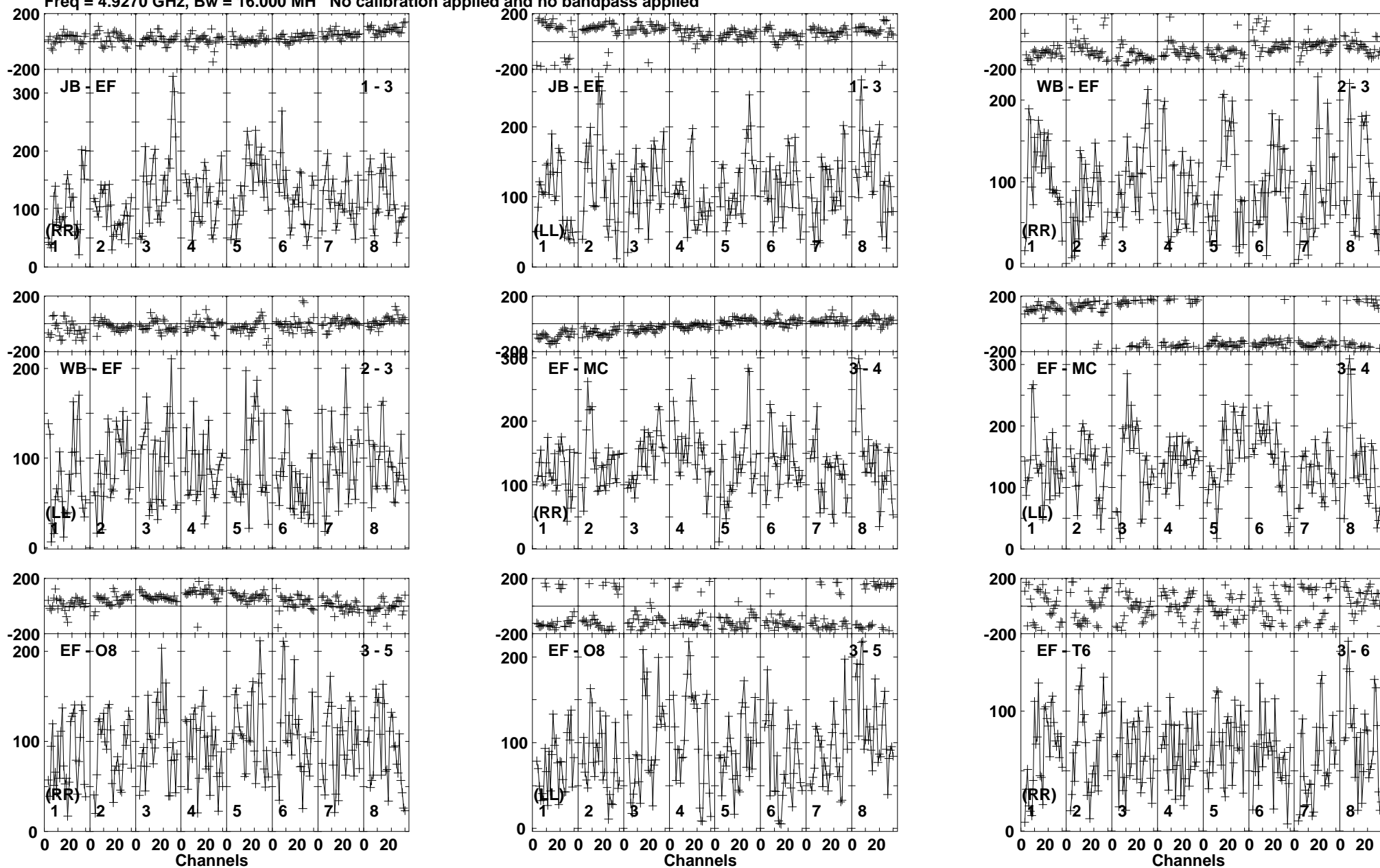

Lower frame: Micro Ampl Jy Top frame: Phas deg
Vector averaged cross-power spectrum Baseline: JB (01) - EF (03)
Timerange: 00/07:55:23 to 00/07:59:19

Plot file version 434 created 17-FEB-2020 15:43:21

J1402+5347 EK047 2.UVDATA.1

Freq = 4.9270 GHz, Bw = 16.000 MH No calibration applied and no bandpass applied

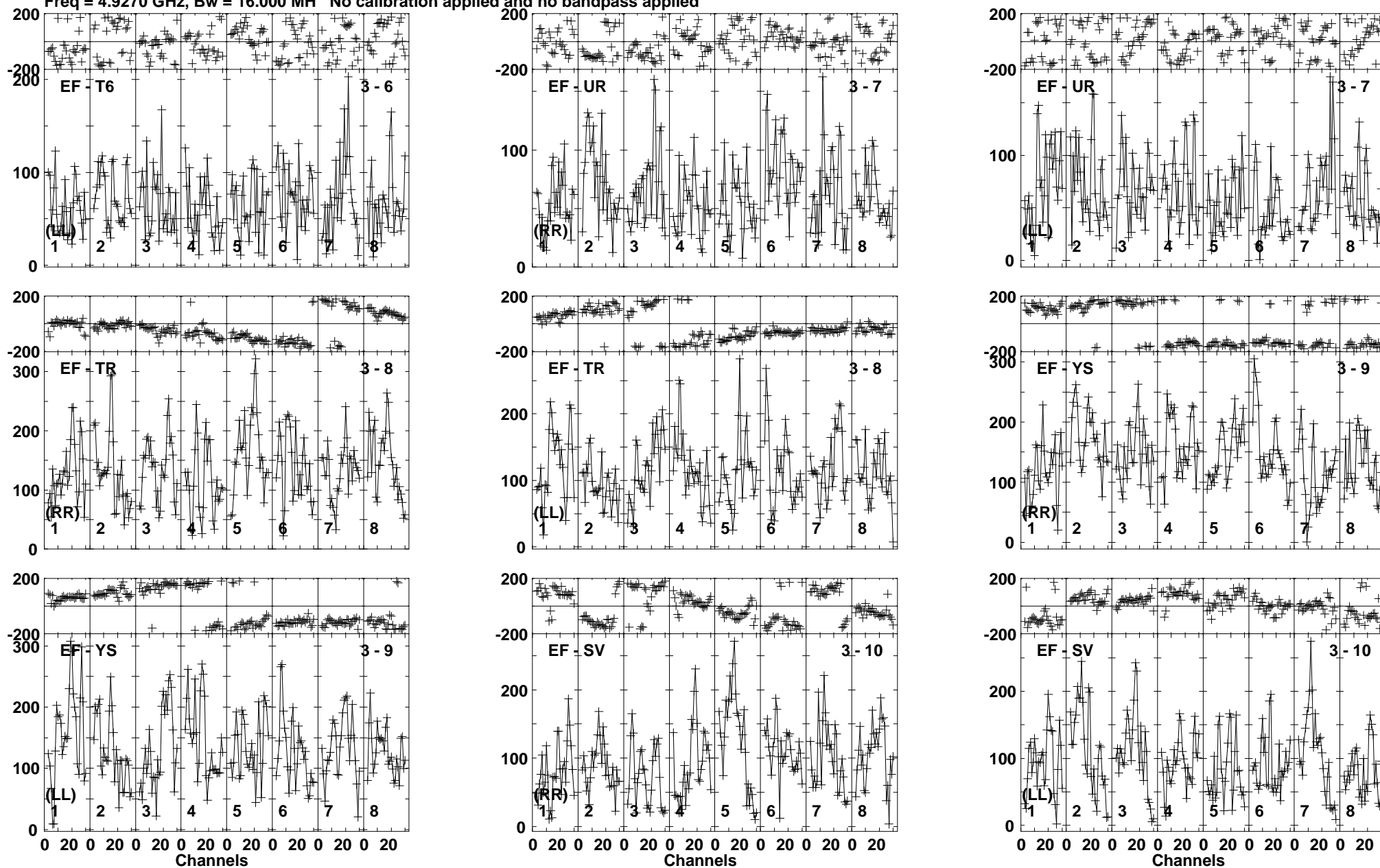

Lower frame: Micro Ampl Jy Top frame: Phas deg
Vector averaged cross-power spectrum Baseline: EF (03) - T6 (06)
Timerange: 00/07:55:23 to 00/07:59:19

Plot file version 435 created 17-FEB-2020 15:43:21

J1402+5347 EK047 2.UVDATA.1

Freq = 4.9270 GHz, Bw = 16.000 MH No calibration applied and no bandpass applied

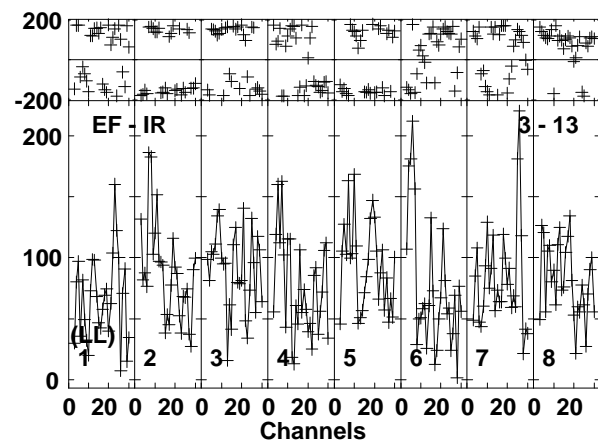
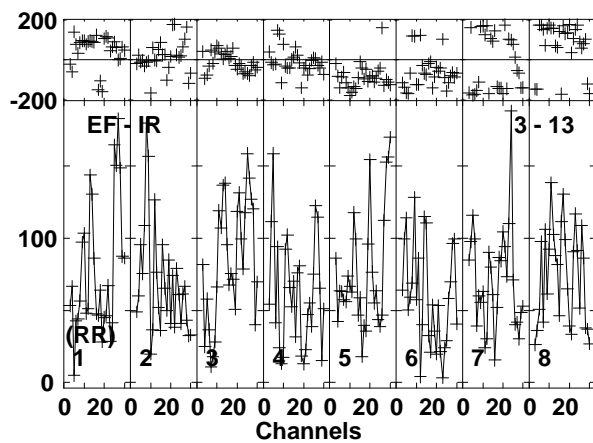
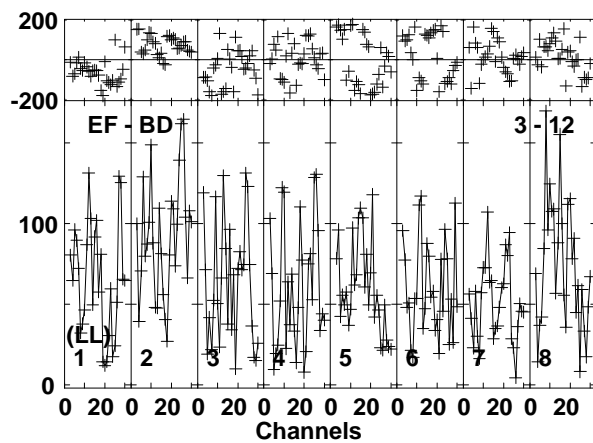
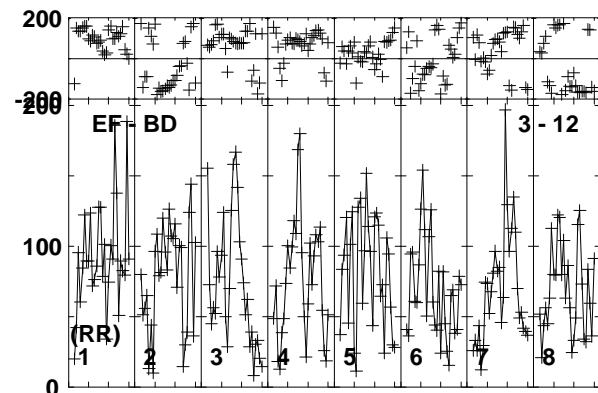
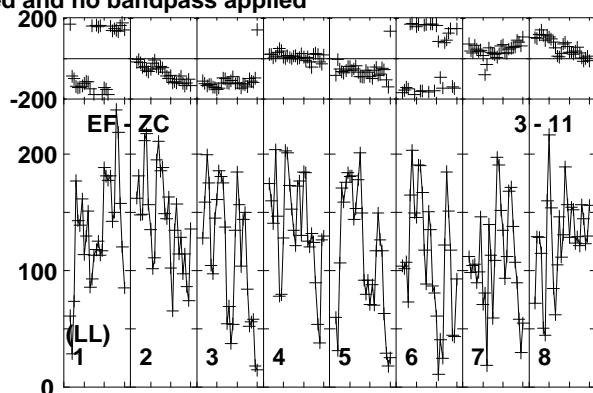
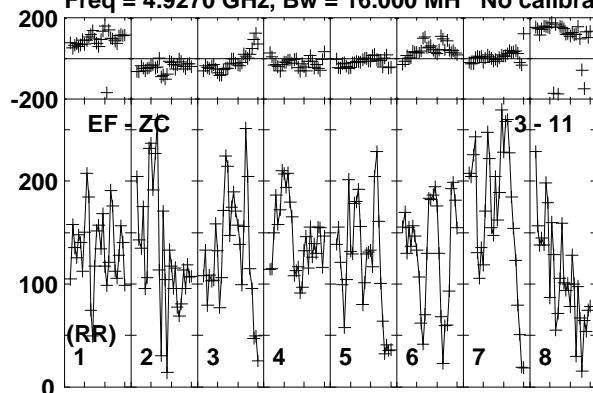

Lower frame: Micro Ampl Jy Top frame: Phas deg
Vector averaged cross-power spectrum Baseline: EF (03) - ZC (11)
Timerange: 00/07:55:23 to 00/07:59:19

Plot file version 436 created 17-FEB-2020 15:43:21

J1359+5544 EK047 2.UVDATA.1

Freq = 4.9270 GHz, Bw = 16.000 MH No calibration applied and no bandpass applied

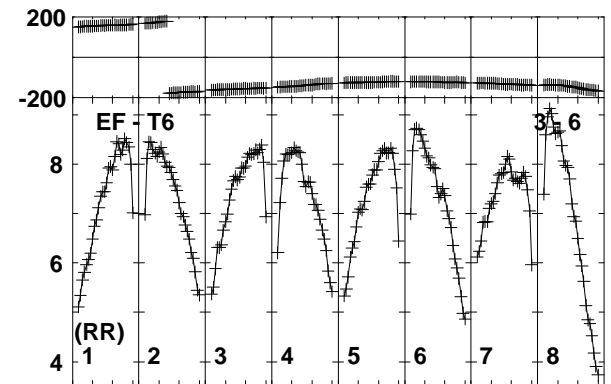
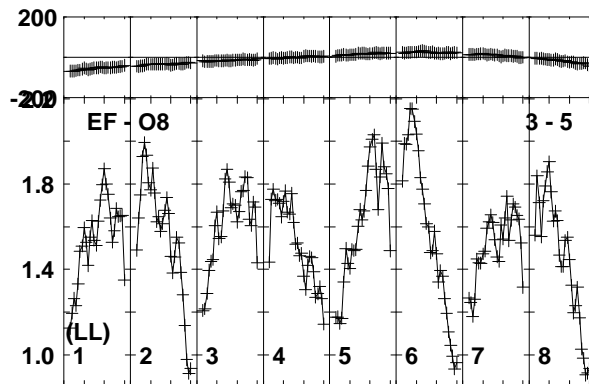
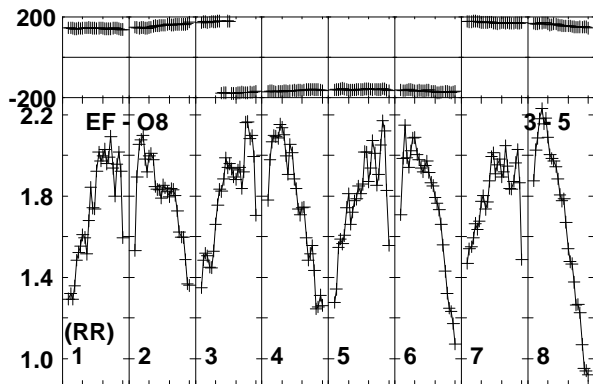
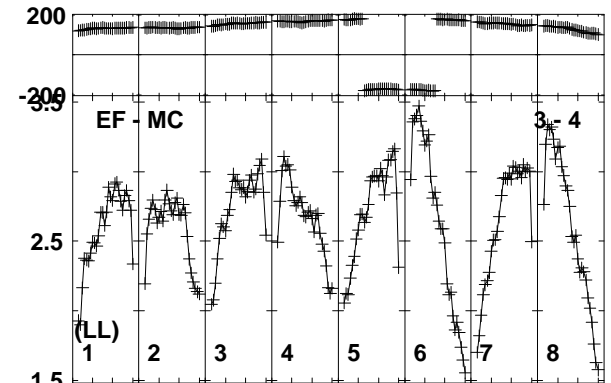
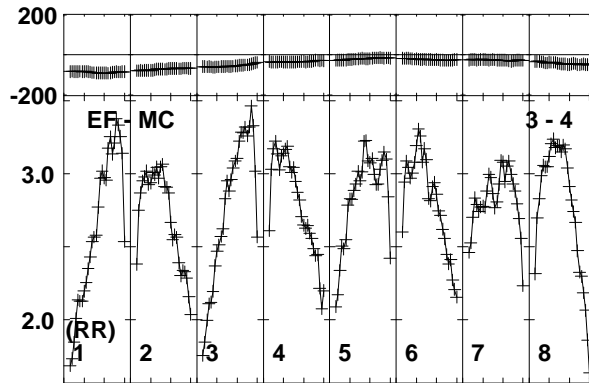
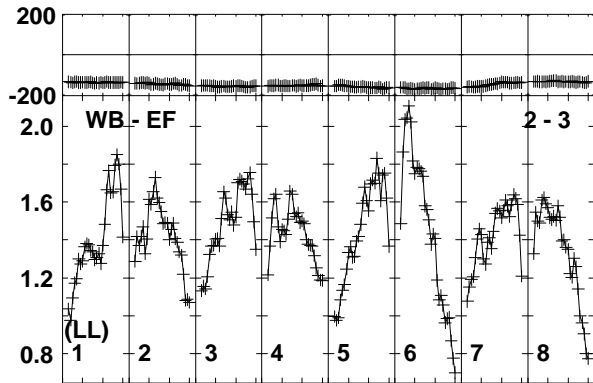
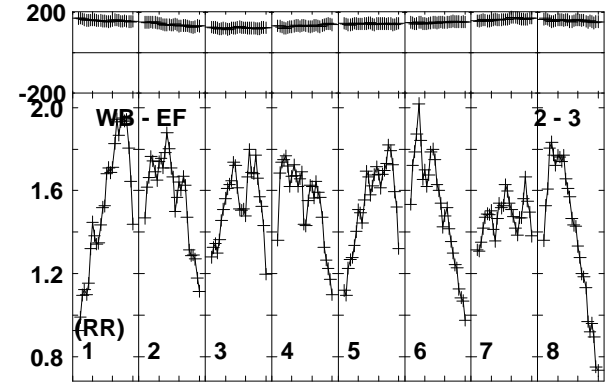
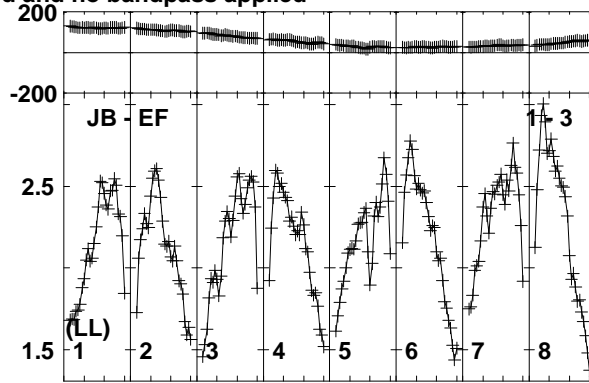
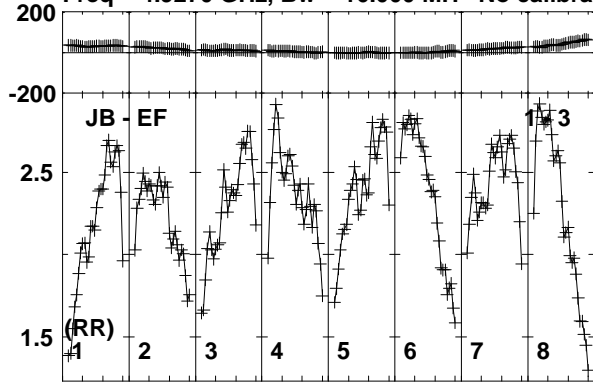

Lower frame: Milli Ampl Jy Top frame: Phas deg

Vector averaged cross-power spectrum Baseline: JB (01) - EF (03)

Timerange: 00/08:00:01 to 00/08:01:19

Plot file version 437 created 17-FEB-2020 15:43:21

J1359+5544 EK047 2.UVDATA.1

Freq = 4.9270 GHz, Bw = 16.000 MH No calibration applied and no bandpass applied

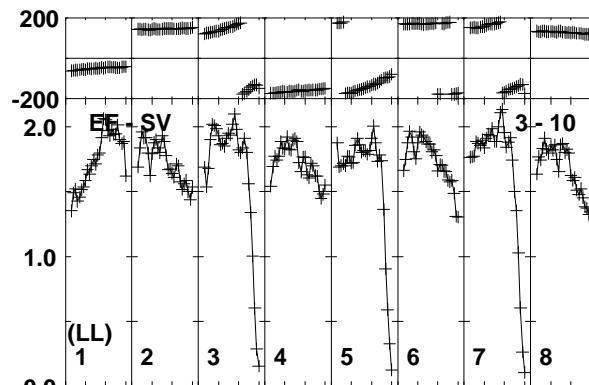
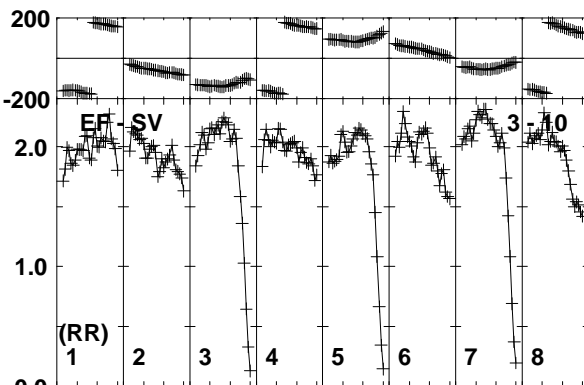
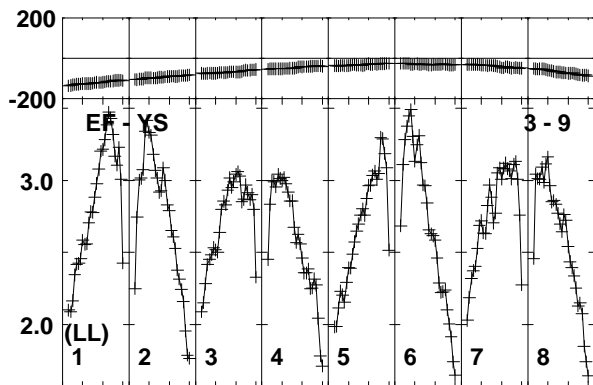
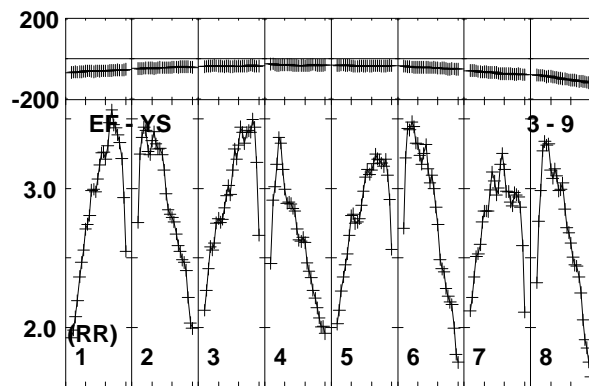
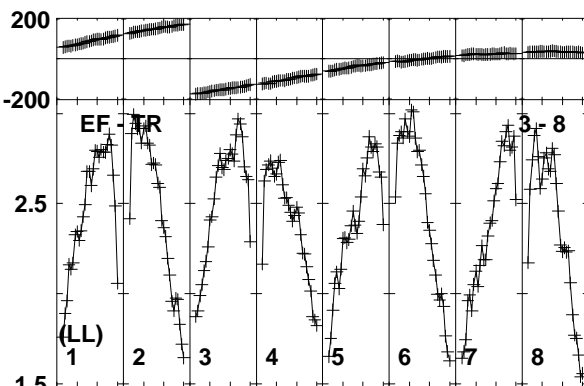
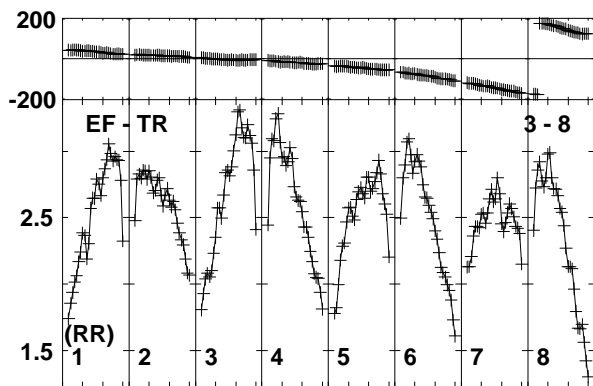
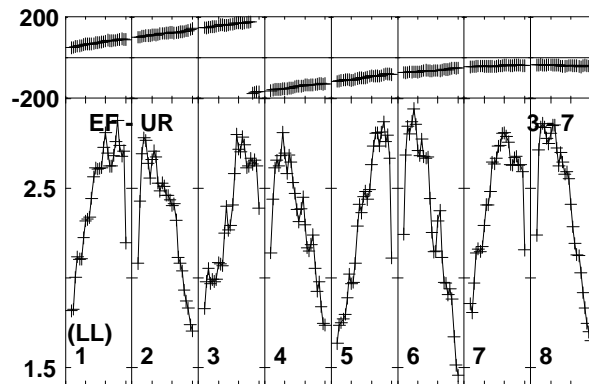
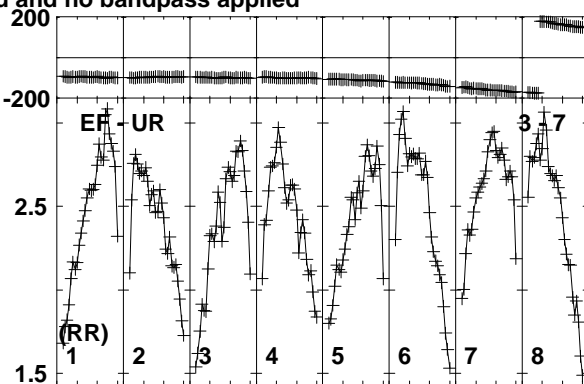
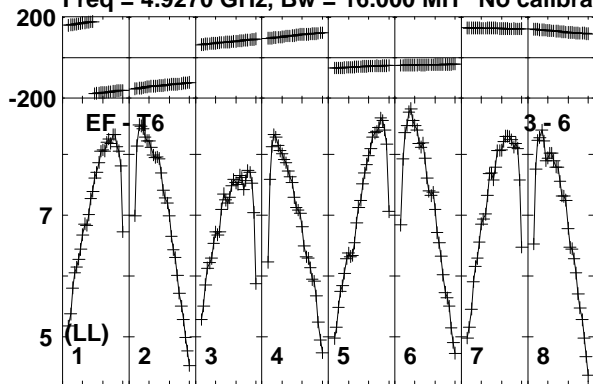

Lower frame: Milli Ampl Jy Top frame: Phas deg
Vector averaged cross-power spectrum Baseline: EF (03) - T6 (06)
Timerange: 00/08:00:01 to 00/08:01:19

Plot file version 438 created 17-FEB-2020 15:43:21

J1359+5544 EK047 2.UVDATA.1

Freq = 4.9270 GHz, Bw = 16.000 MH No calibration applied and no bandpass applied

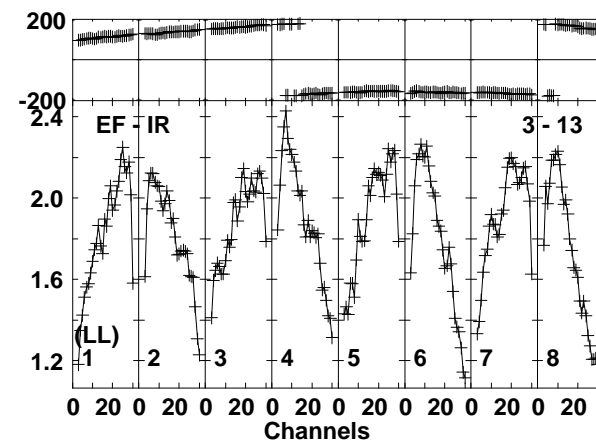
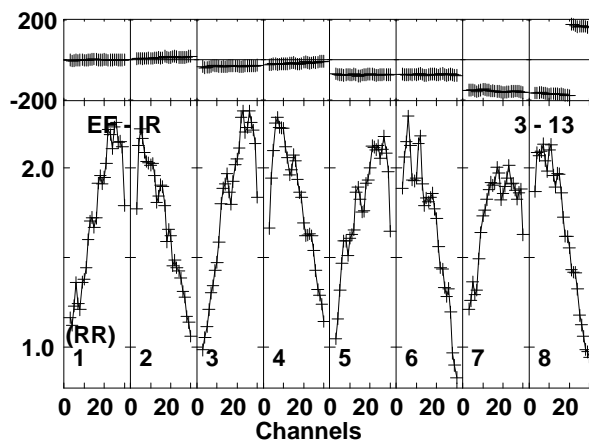
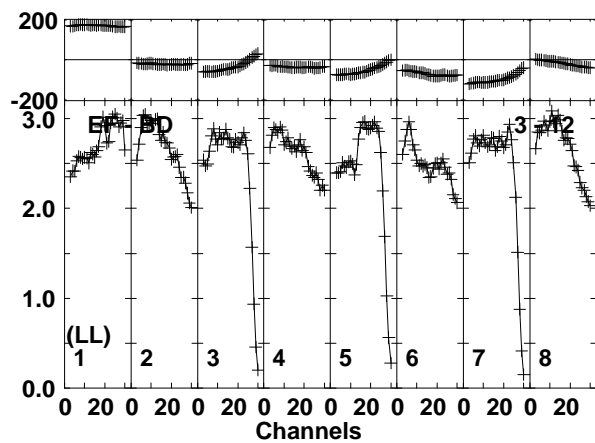
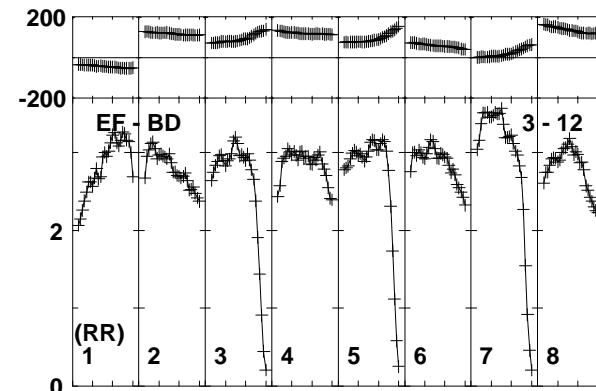
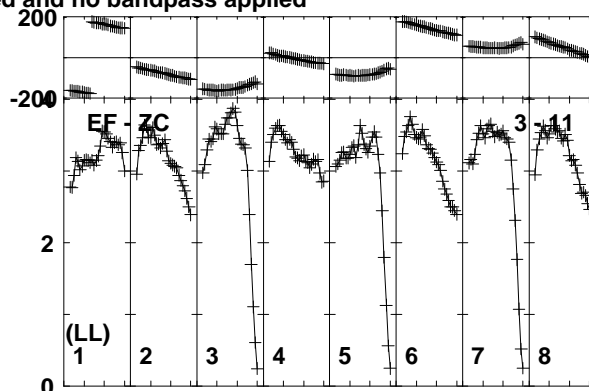
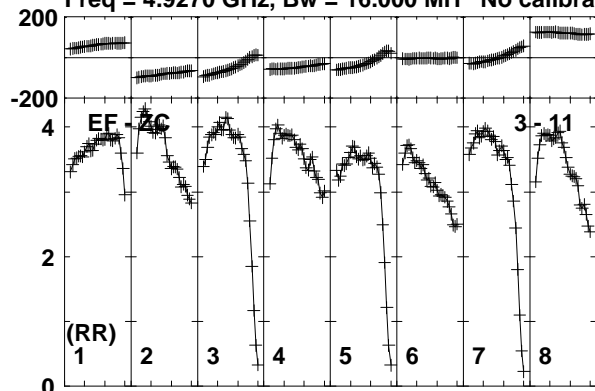

Lower frame: Milli Ampl Jy Top frame: Phas deg
Vector averaged cross-power spectrum Baseline: EF (03) - ZC (11)
Timerange: 00/08:00:01 to 00/08:01:19

Plot file version 439 created 17-FEB-2020 15:43:21

J1402+5347 EK047 2.UVDATA.1

Freq = 4.9270 GHz, Bw = 16.000 MH No calibration applied and no bandpass applied

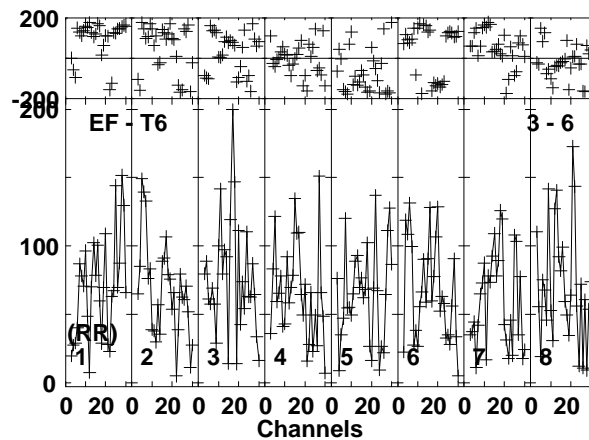
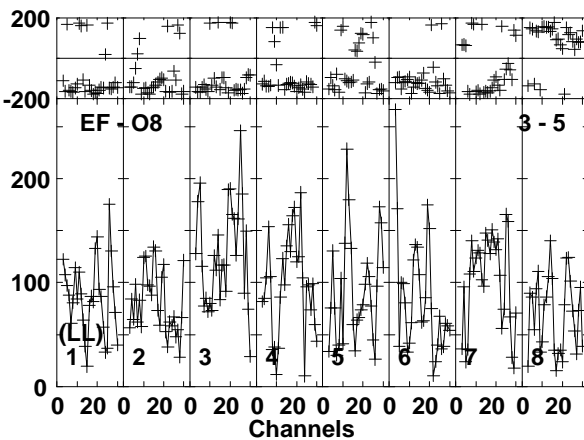
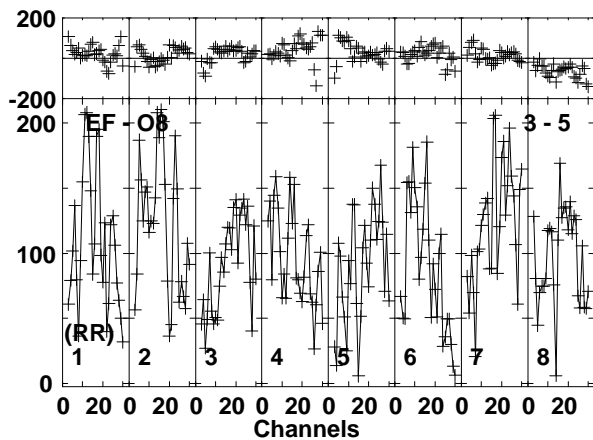
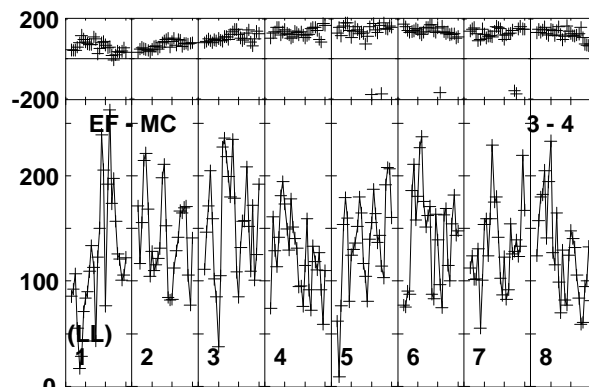
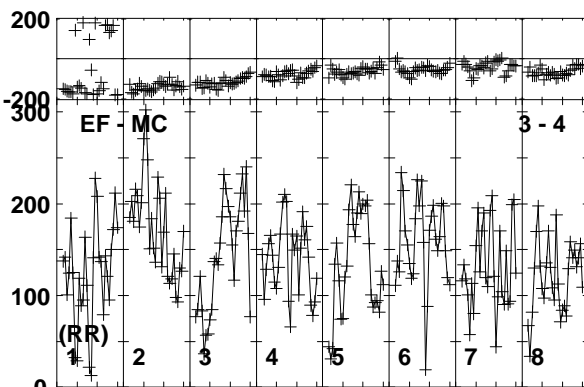
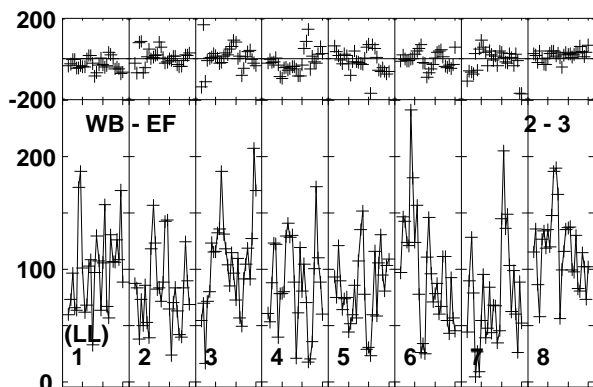
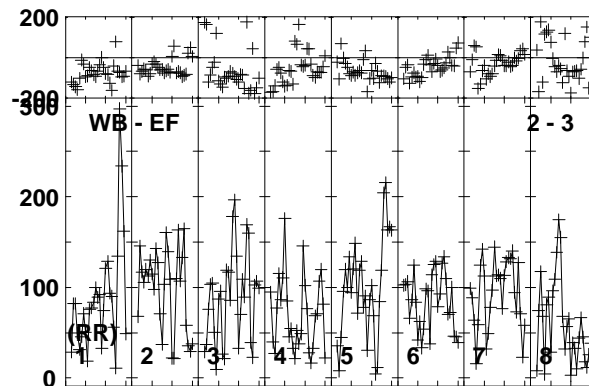
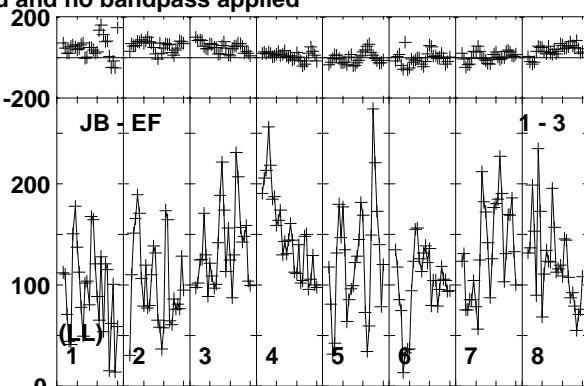
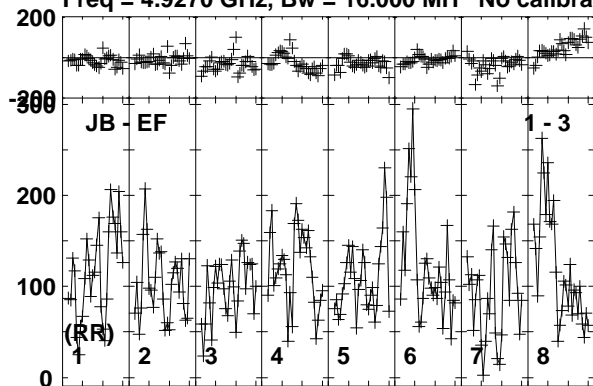

Lower frame: Micro Ampl Jy Top frame: Phas deg
Vector averaged cross-power spectrum Baseline: JB (01) - EF (03)
Timerange: 00/08:01:21 to 00/08:05:19

Plot file version 440 created 17-FEB-2020 15:43:21

J1402+5347 EK047 2.UVDATA.1

Freq = 4.9270 GHz, Bw = 16.000 MH No calibration applied and no bandpass applied

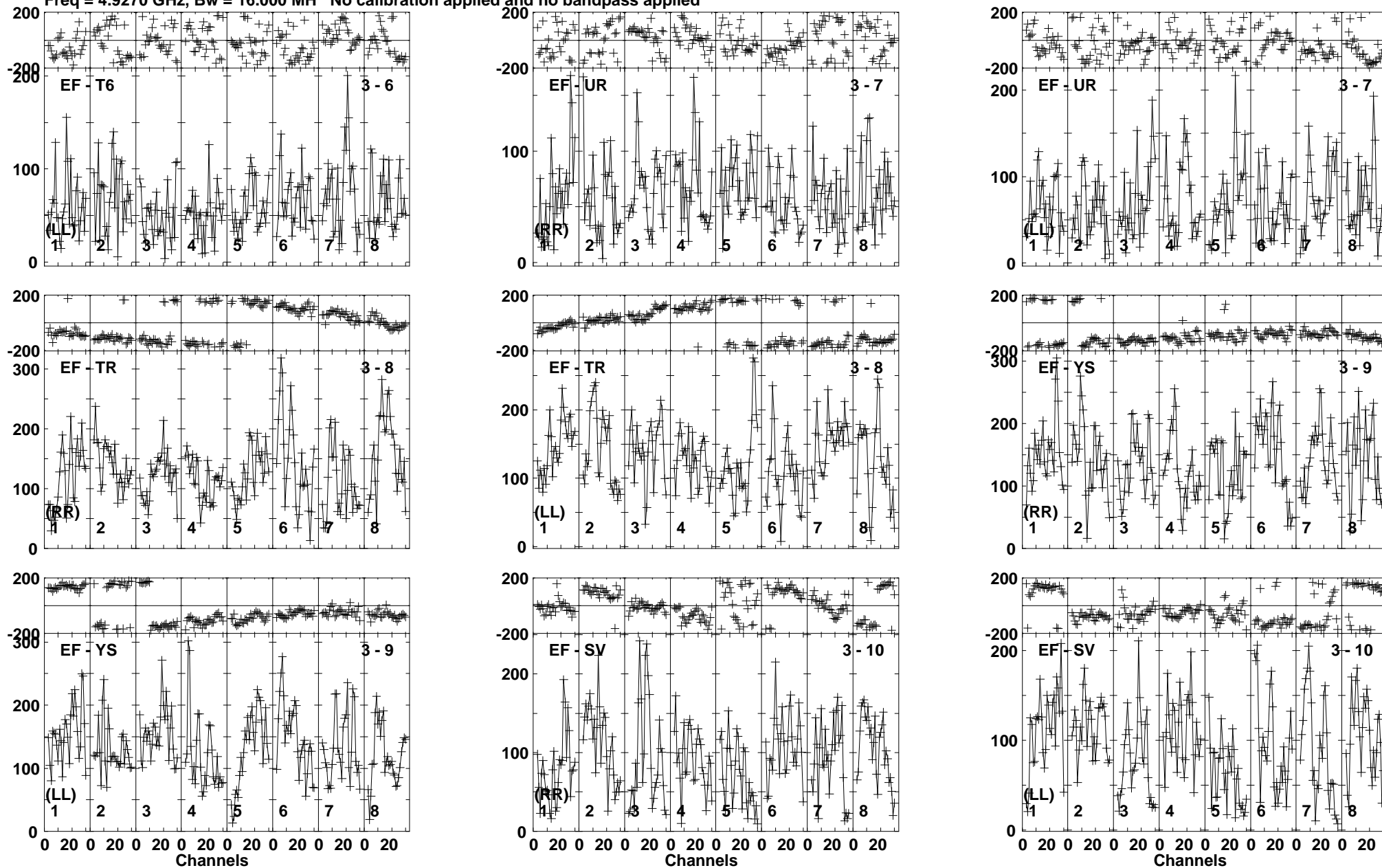

Lower frame: Micro Ampl Jy Top frame: Phas deg
Vector averaged cross-power spectrum Baseline: EF (03) - T6 (06)
Timerange: 00/08:01:21 to 00/08:05:19

Plot file version 441 created 17-FEB-2020 15:43:22

J1402+5347 EK047 2.UVDATA.1

Freq = 4.9270 GHz, Bw = 16.000 MH No calibration applied and no bandpass applied

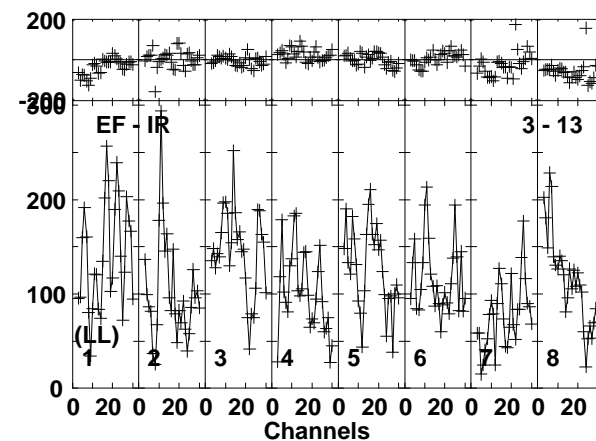
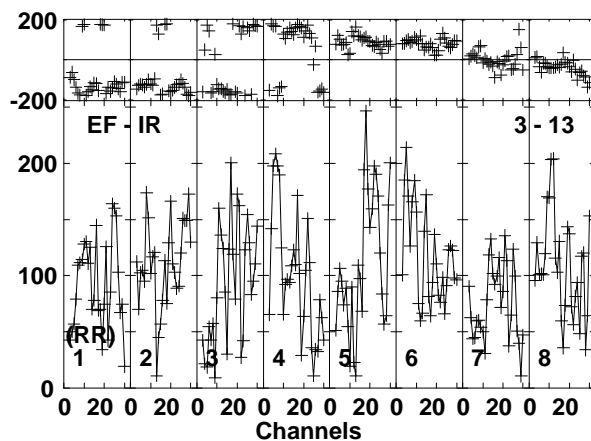
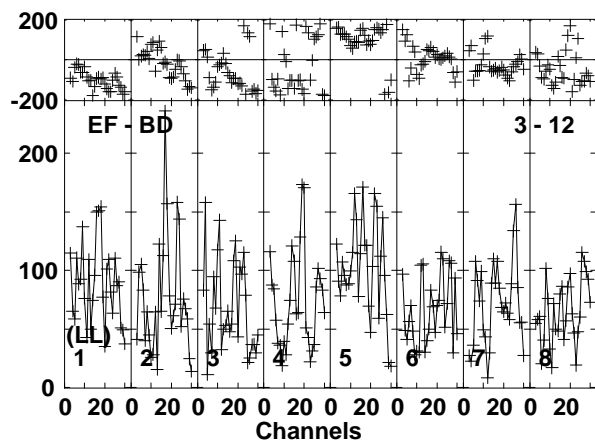
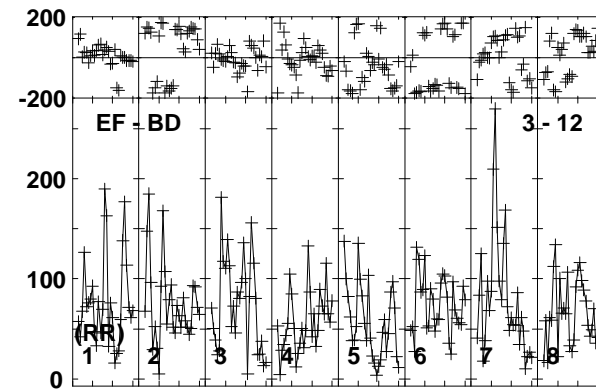
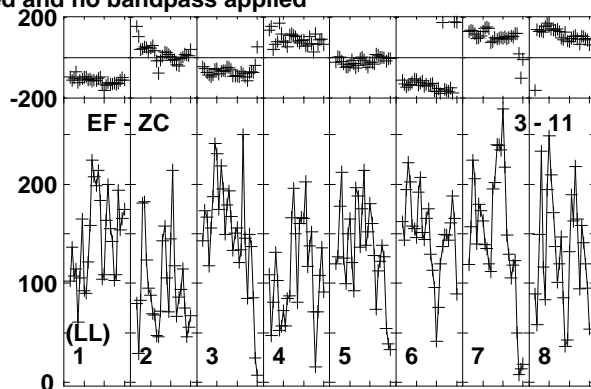
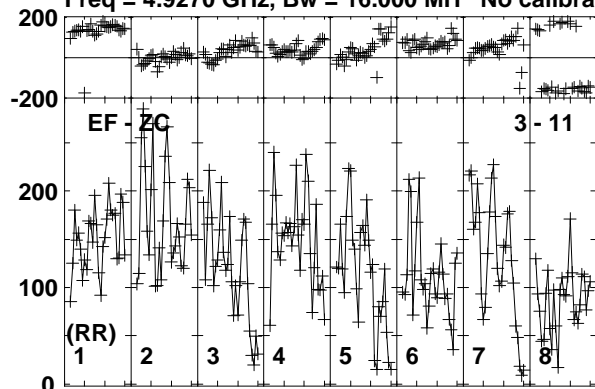

Lower frame: Micro Ampl Jy Top frame: Phas deg
Vector averaged cross-power spectrum Baseline: EF (03) - ZC (11)
Timerange: 00/08:01:21 to 00/08:05:19

Plot file version 442 created 17-FEB-2020 15:43:22

J1359+5544 EK047 2.UVDATA.1

Freq = 4.9270 GHz, Bw = 16.000 MH No calibration applied and no bandpass applied

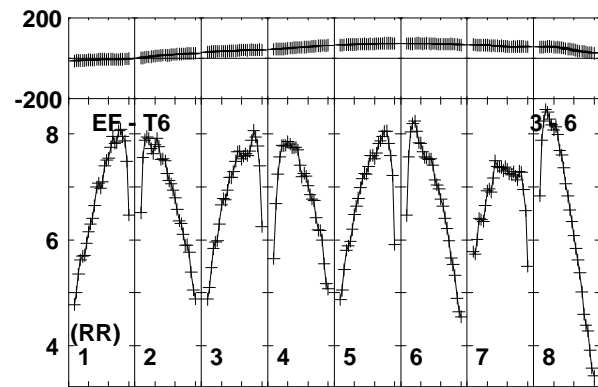
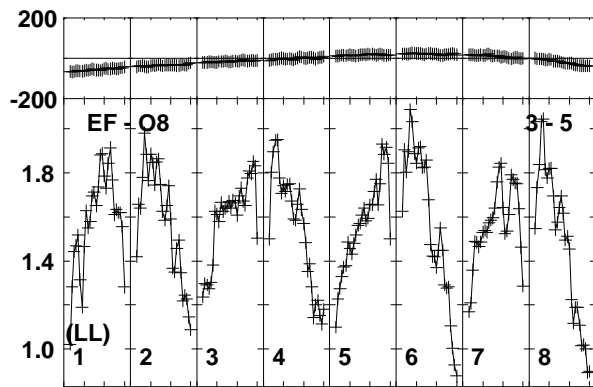
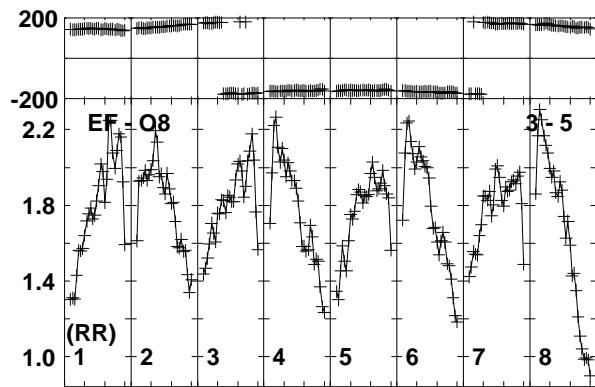
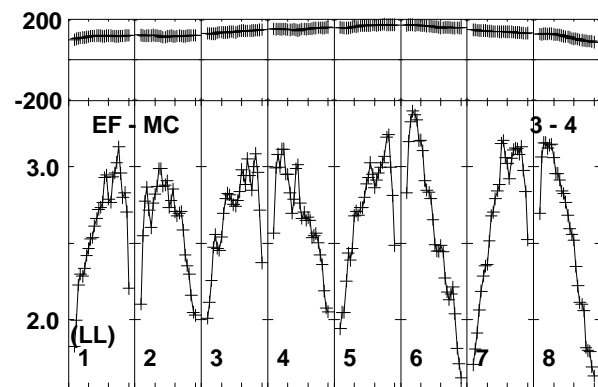
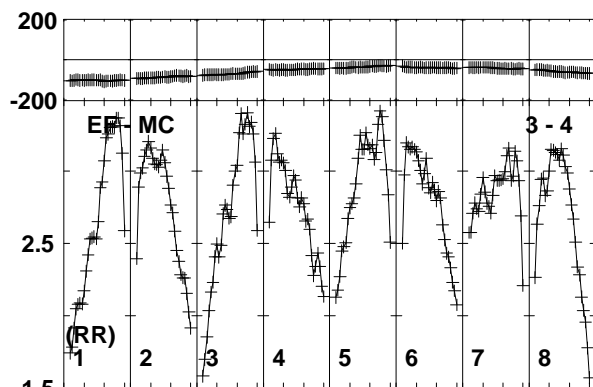
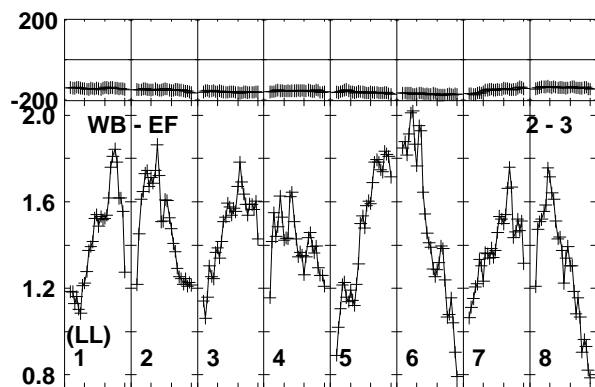
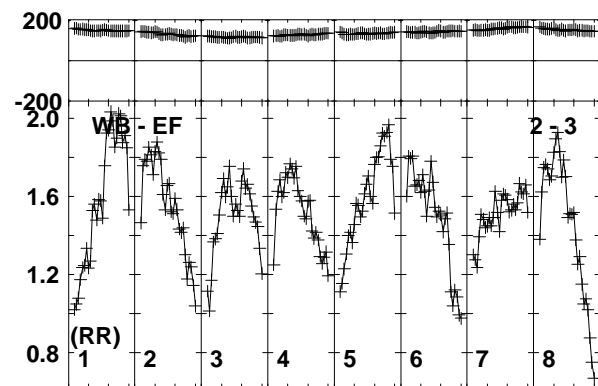
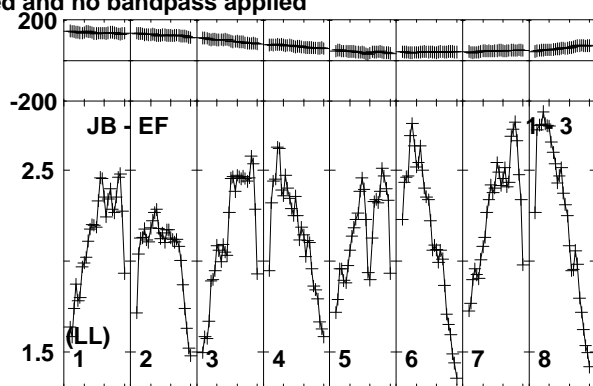
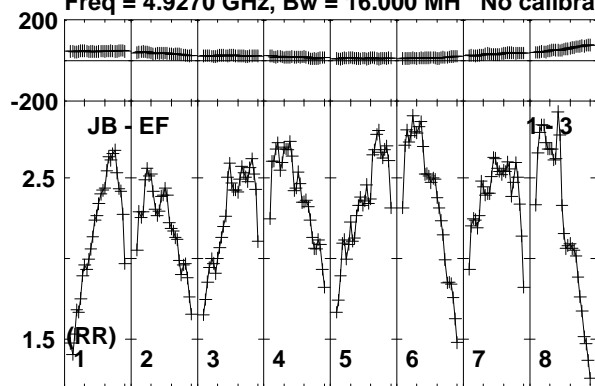

Lower frame: Milli Ampl Jy Top frame: Phas deg
Vector averaged cross-power spectrum Baseline: JB (01) - EF (03)
Timerange: 00/08:05:21 to 00/08:07:19

Plot file version 443 created 17-FEB-2020 15:43:22

J1359+5544 EK047 2.UVDATA.1

Freq = 4.9270 GHz, Bw = 16.000 MH No calibration applied and no bandpass applied

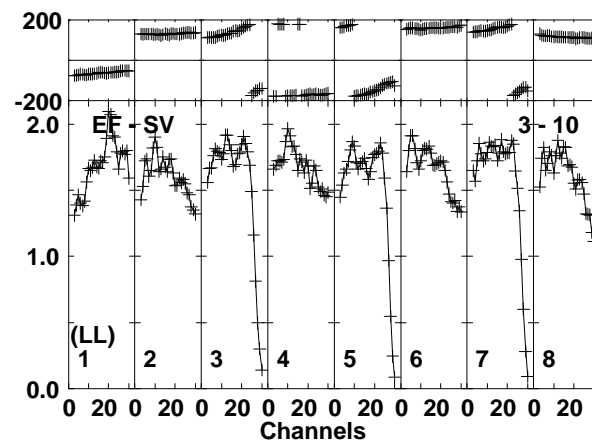
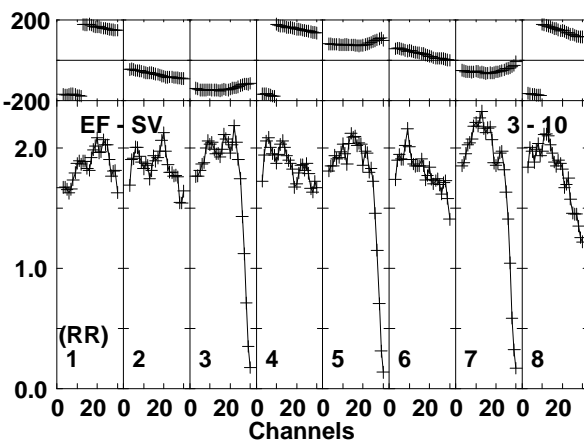
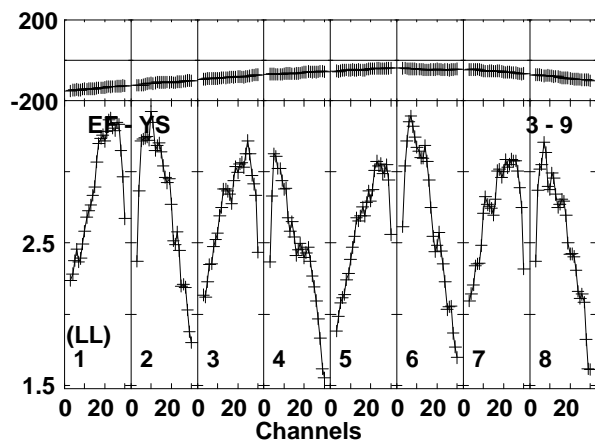
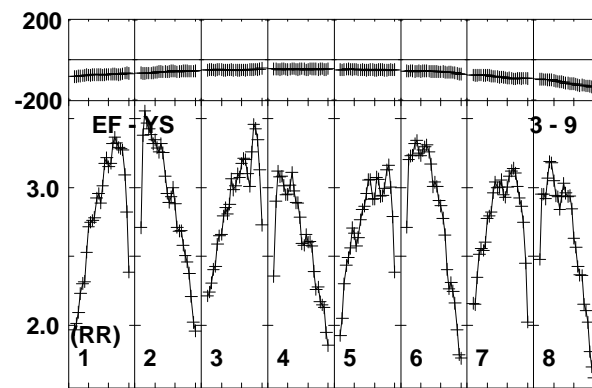
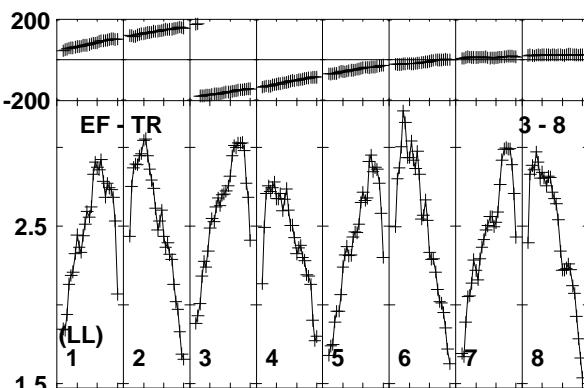
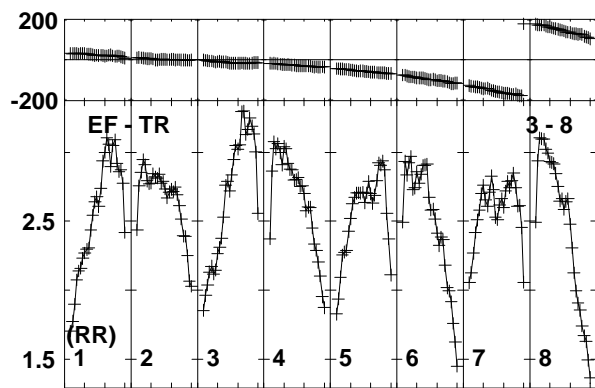
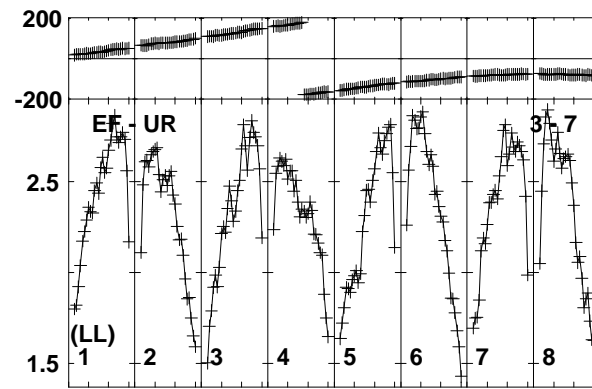
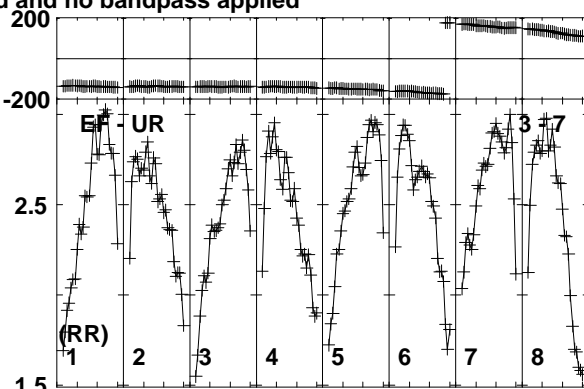
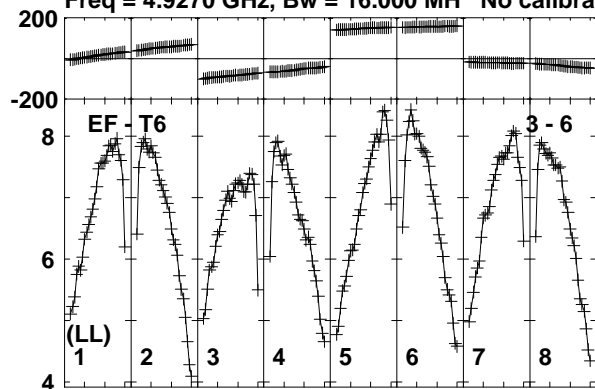

Lower frame: Milli Ampl Jy Top frame: Phas deg
Vector averaged cross-power spectrum Baseline: EF (03) - T6 (06)
Timerange: 00/08:05:21 to 00/08:07:19

Plot file version 444 created 17-FEB-2020 15:43:22

J1359+5544 EK047 2.UVDATA.1

Freq = 4.9270 GHz, Bw = 16.000 MH No calibration applied and no bandpass applied

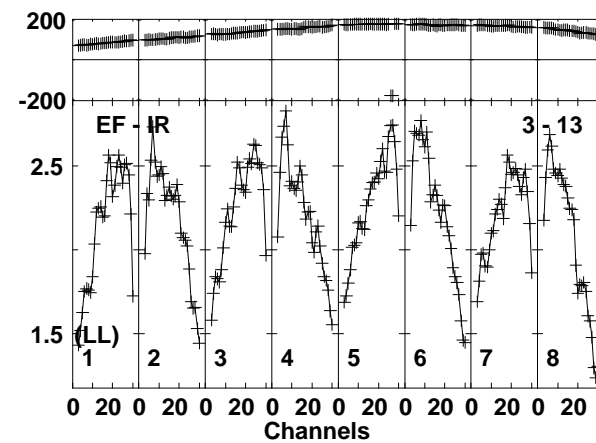
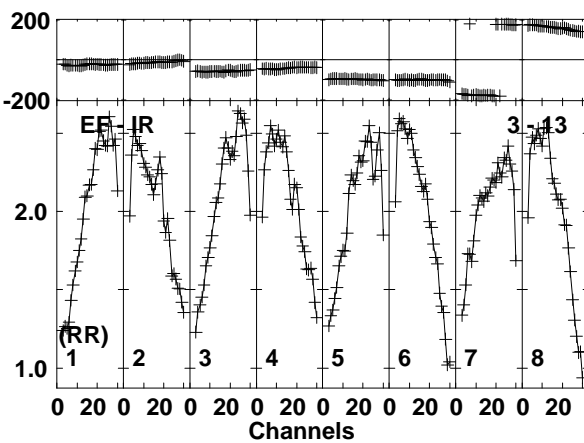
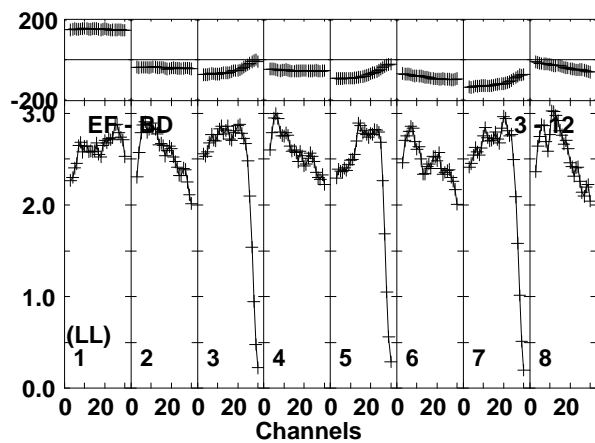
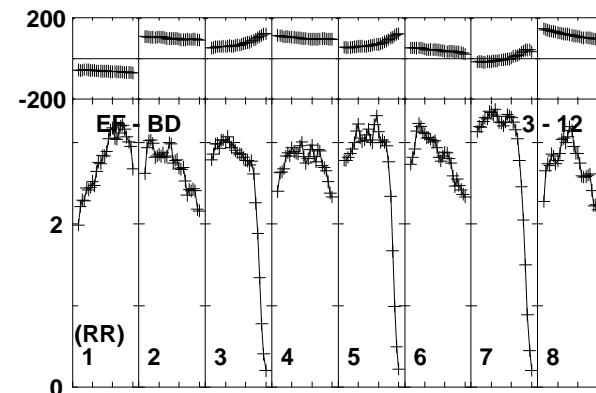
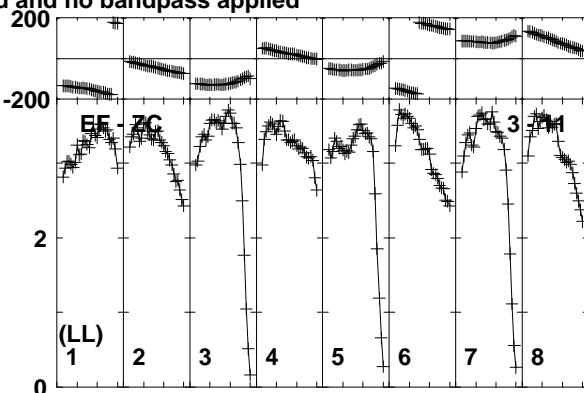
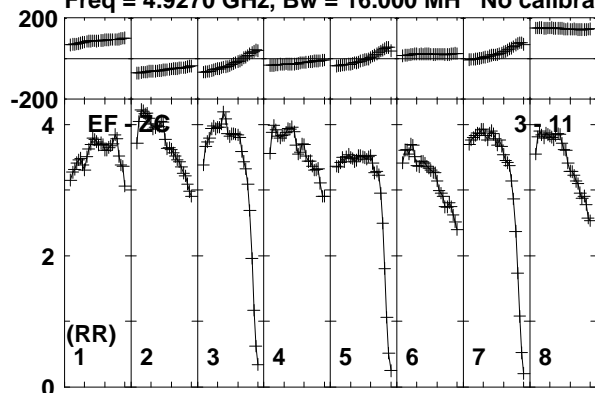

Lower frame: Milli Ampl Jy Top frame: Phas deg
Vector averaged cross-power spectrum Baseline: EF (03) - ZC (11)
Timerange: 00/08:05:21 to 00/08:07:19

Plot file version 445 created 17-FEB-2020 15:43:22

J1402+5347 EK047 2.UVDATA.1

Freq = 4.9270 GHz, Bw = 16.000 MH No calibration applied and no bandpass applied

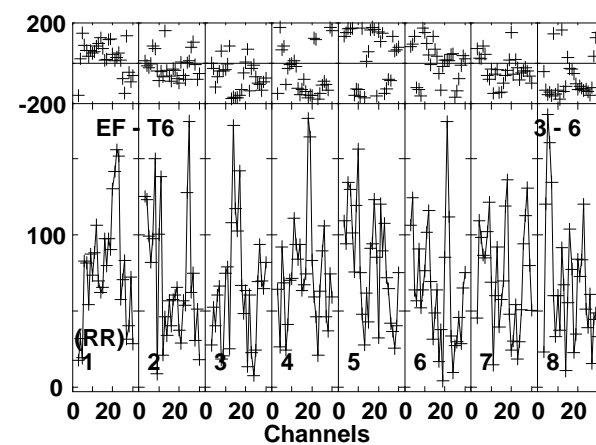
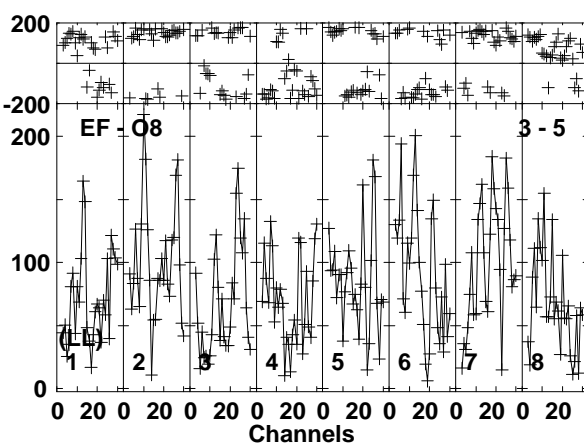
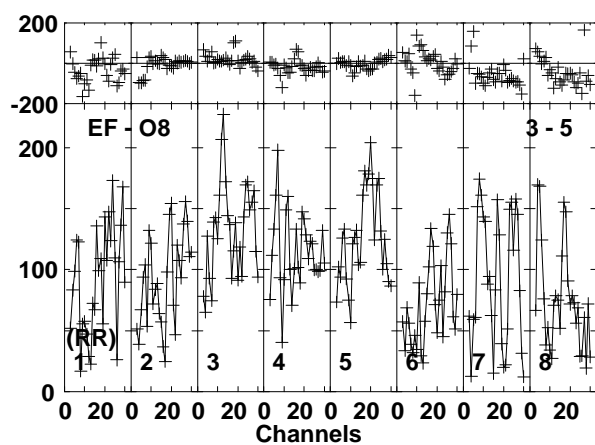
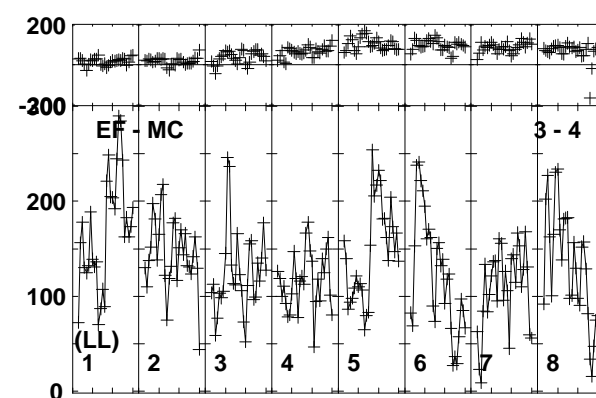
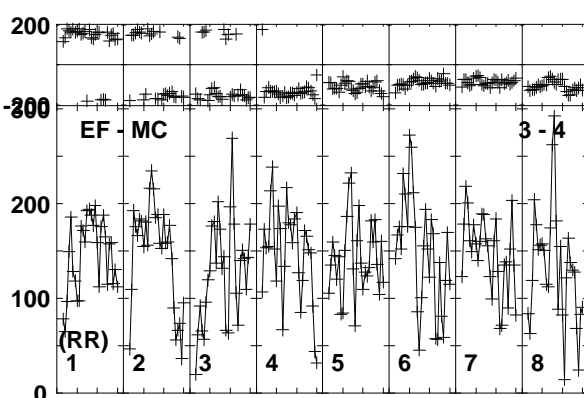
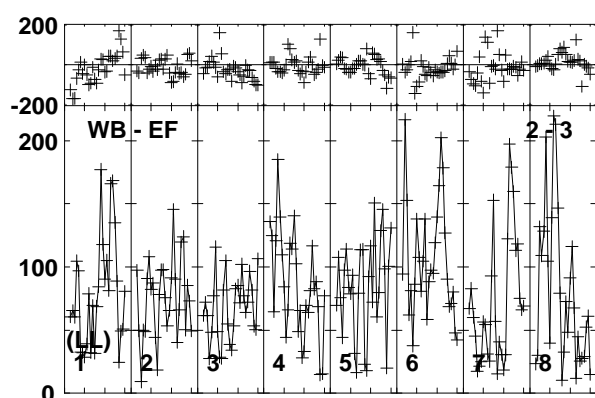
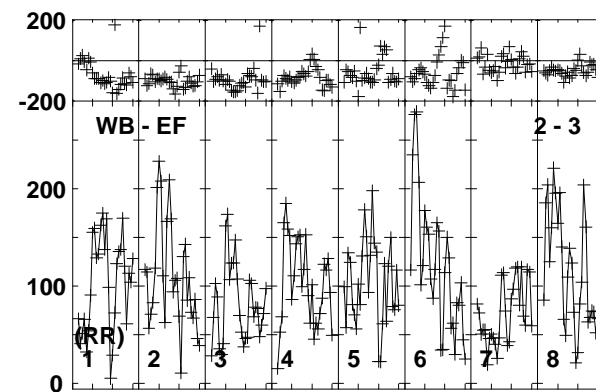
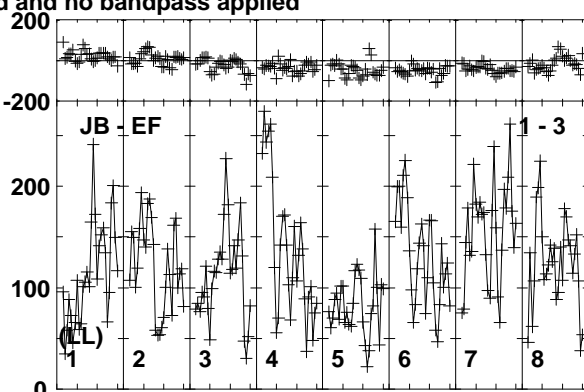
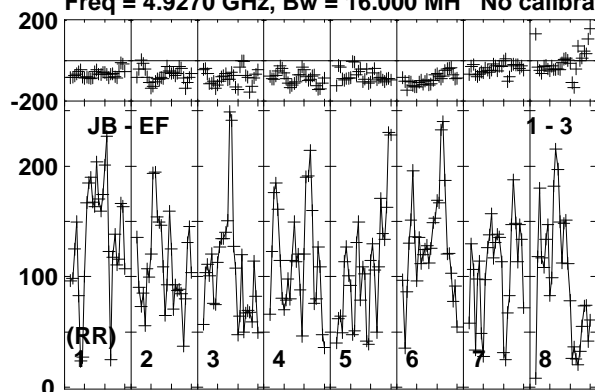

Lower frame: Micro Ampl Jy Top frame: Phas deg
Vector averaged cross-power spectrum Baseline: JB (01) - EF (03)
Timerange: 00/08:07:21 to 00/08:11:19

Plot file version 446 created 17-FEB-2020 15:43:22

J1402+5347 EK047 2.UVDATA.1

Freq = 4.9270 GHz, Bw = 16.000 MH No calibration applied and no bandpass applied

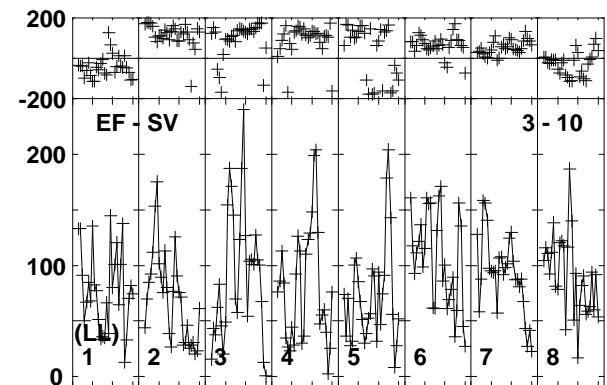
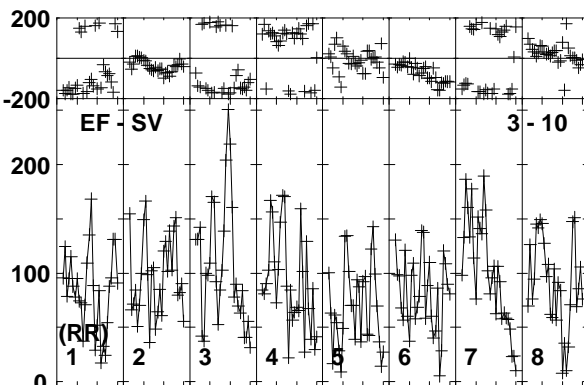
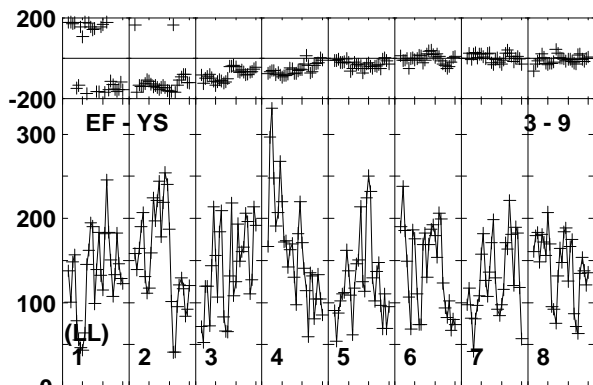
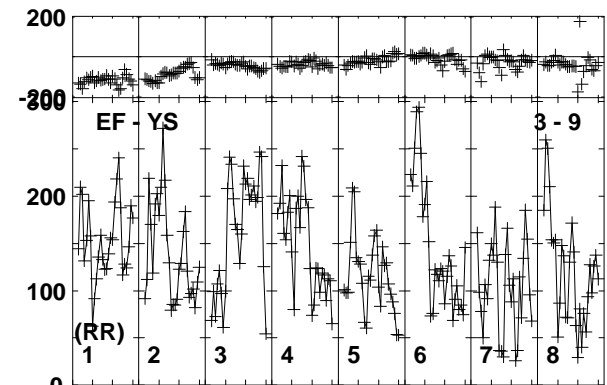
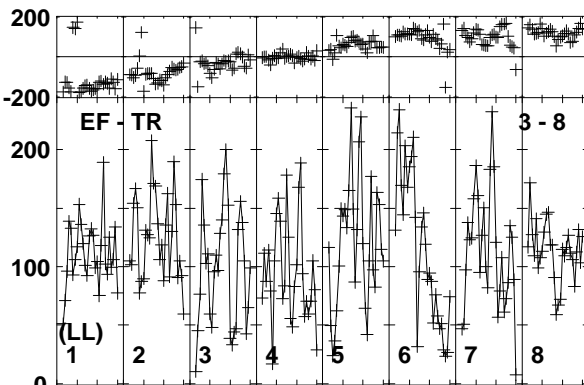
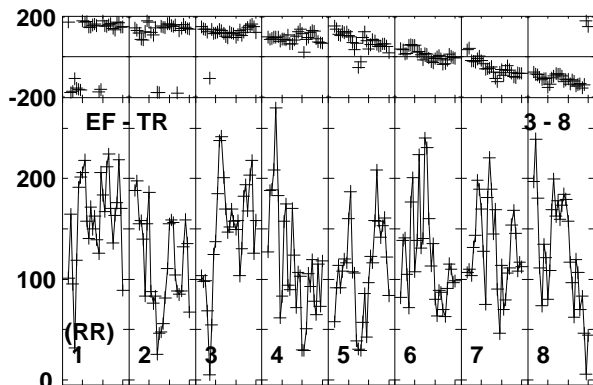
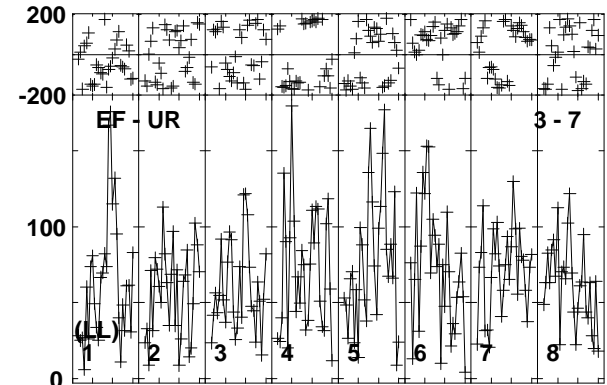
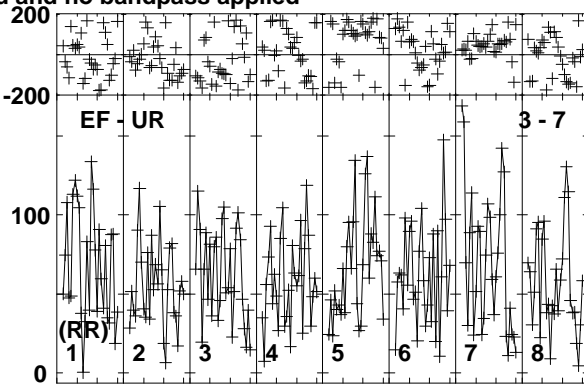
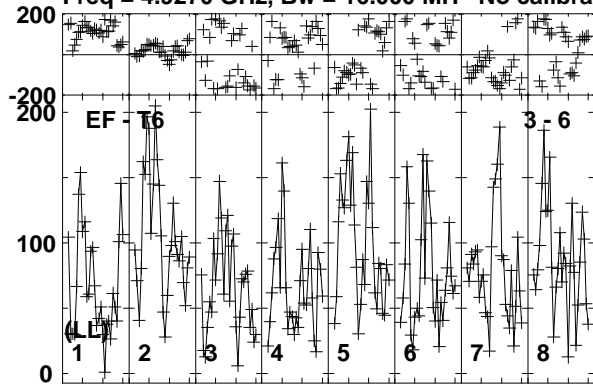

Lower frame: Micro Ampl Jy Top frame: Phas deg
Vector averaged cross-power spectrum Baseline: EF (03) - T6 (06)
Timerange: 00/08:07:21 to 00/08:11:19

Plot file version 447 created 17-FEB-2020 15:43:22

J1402+5347 EK047 2.UVDATA.1

Freq = 4.9270 GHz, Bw = 16.000 MH No calibration applied and no bandpass applied

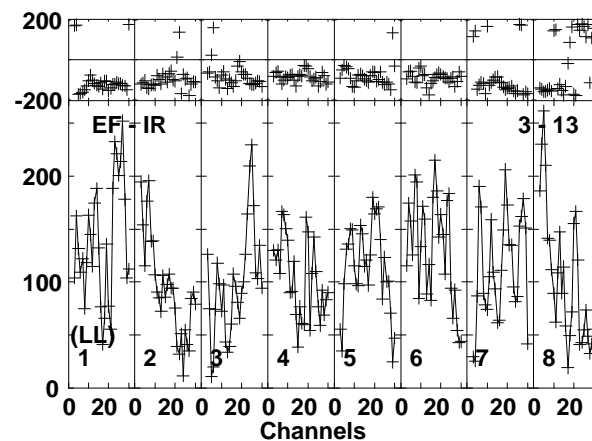
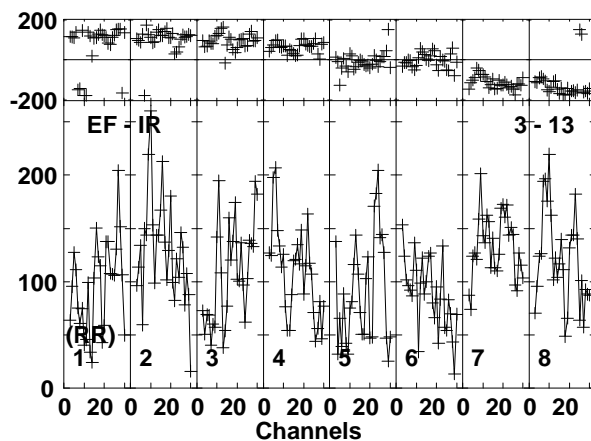
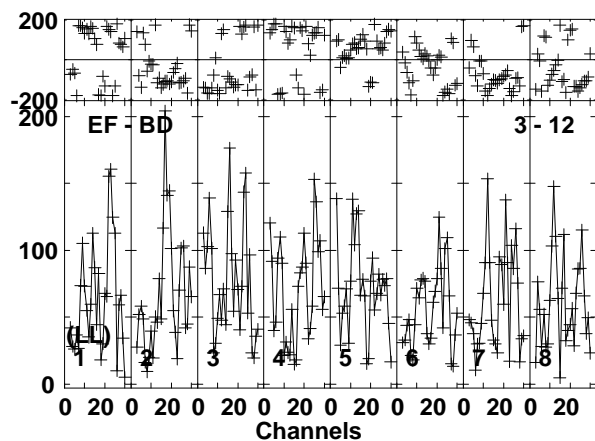
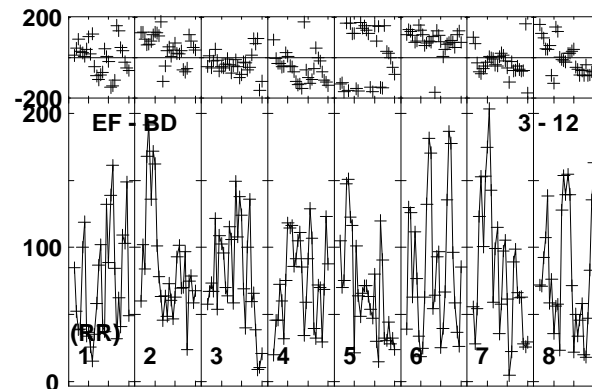
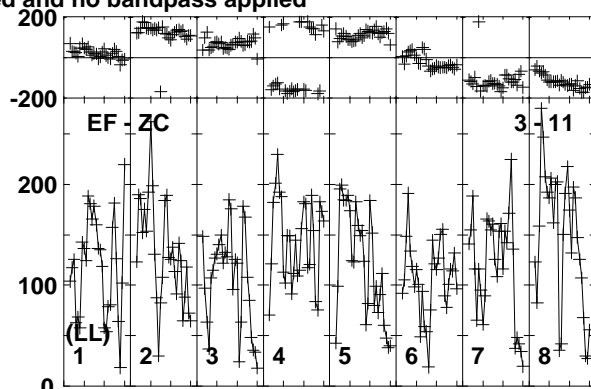
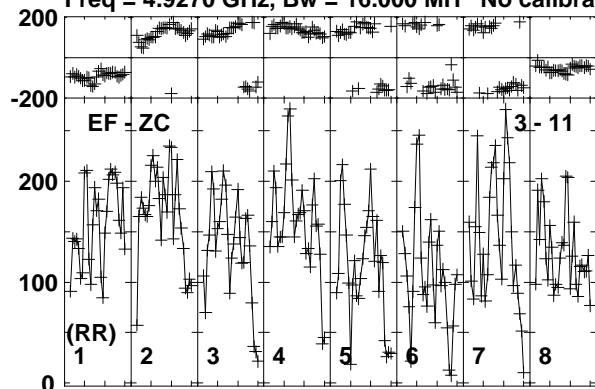

Lower frame: Micro Ampl Jy Top frame: Phas deg
Vector averaged cross-power spectrum Baseline: EF (03) - ZC (11)
Timerange: 00/08:07:21 to 00/08:11:19

Plot file version 448 created 17-FEB-2020 15:43:22

J1359+5544 EK047 2.UVDATA.1

Freq = 4.9270 GHz, Bw = 16.000 MH No calibration applied and no bandpass applied

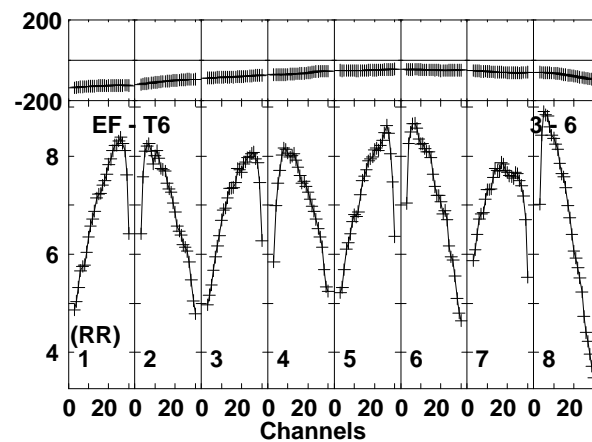
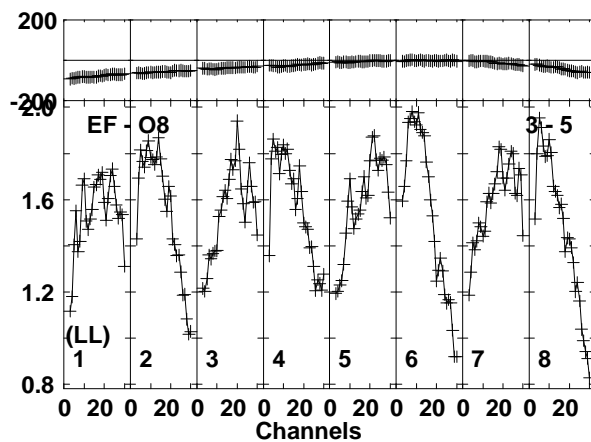
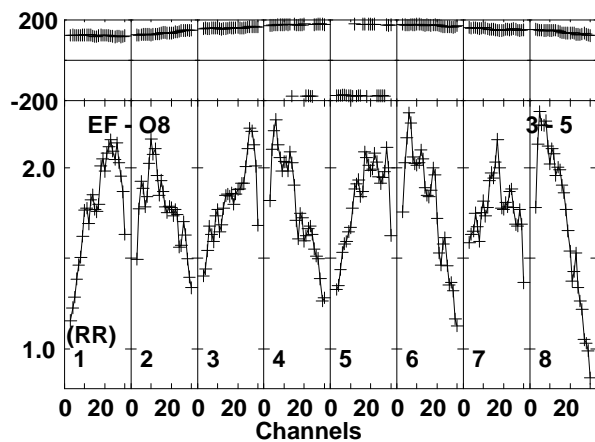
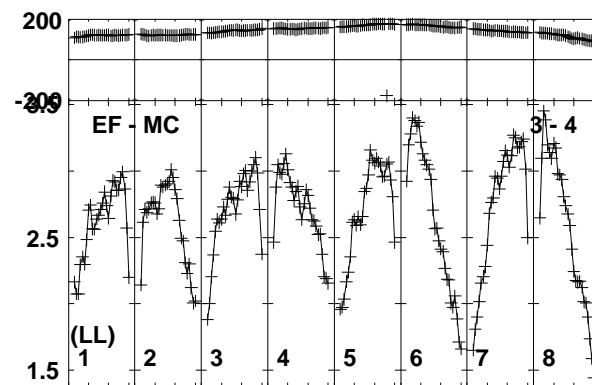
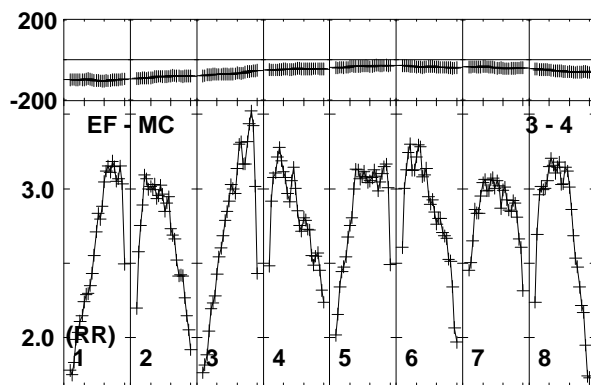
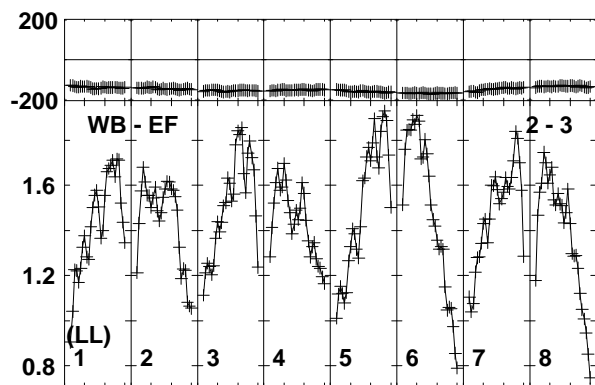
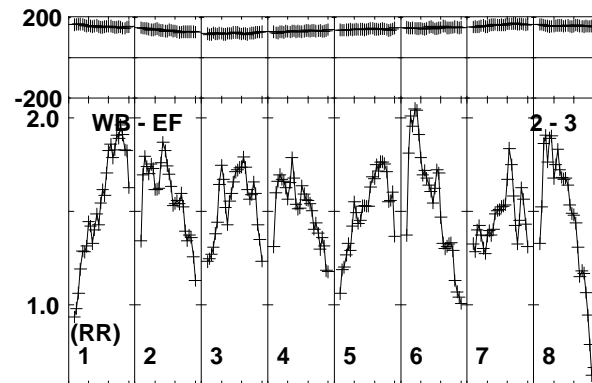
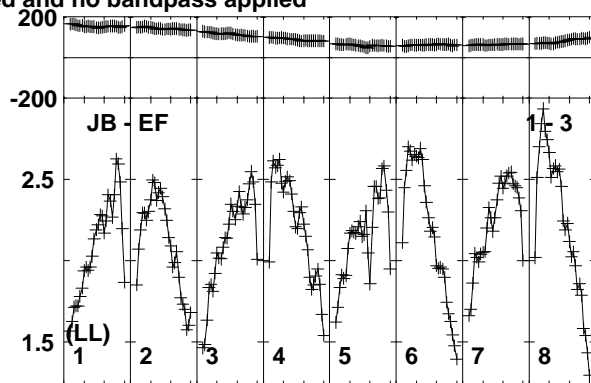
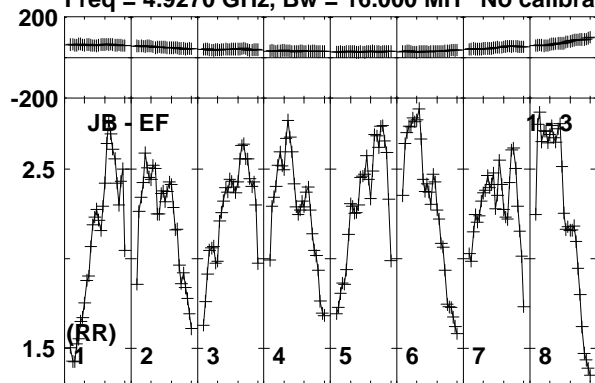

Lower frame: Milli Ampl Jy Top frame: Phas deg
Vector averaged cross-power spectrum Baseline: JB (01) - EF (03)
Timerange: 00/08:12:01 to 00/08:13:19

Plot file version 449 created 17-FEB-2020 15:43:22

J1359+5544 EK047 2.UVDATA.1

Freq = 4.9270 GHz, Bw = 16.000 MH No calibration applied and no bandpass applied

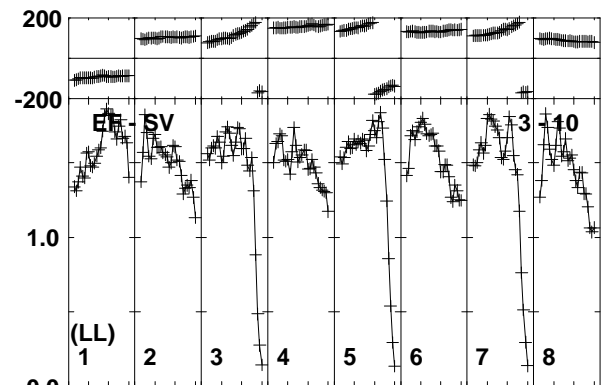
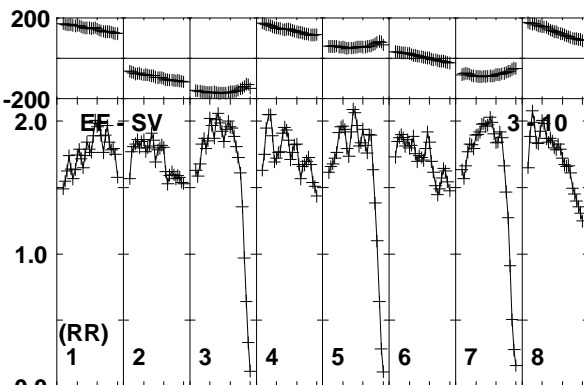
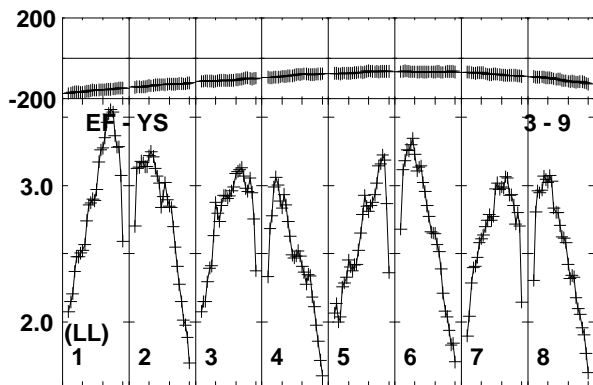
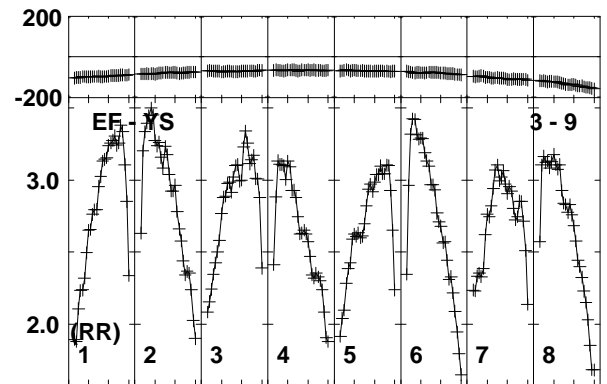
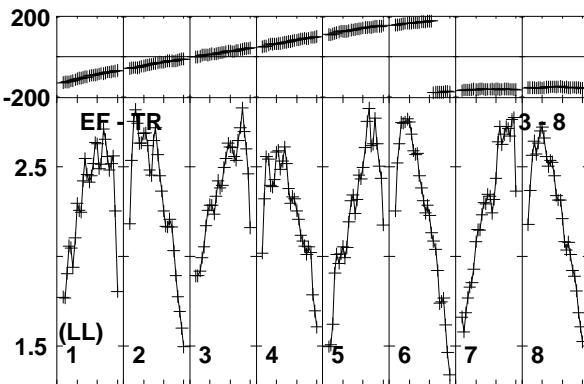
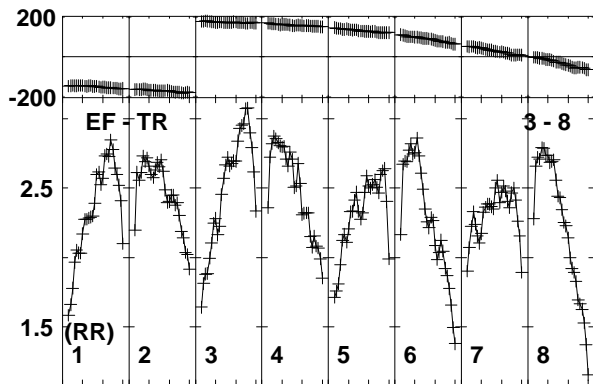
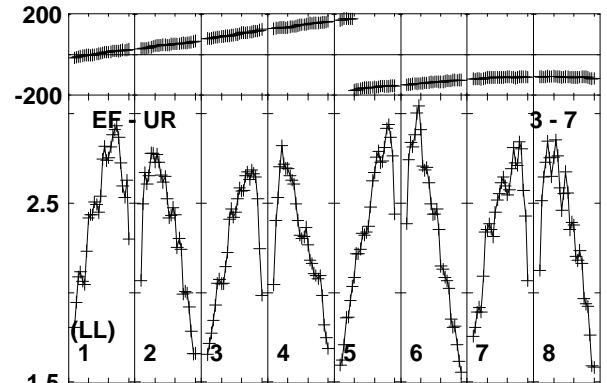
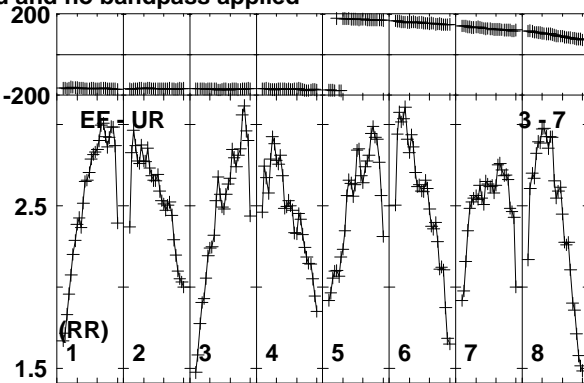
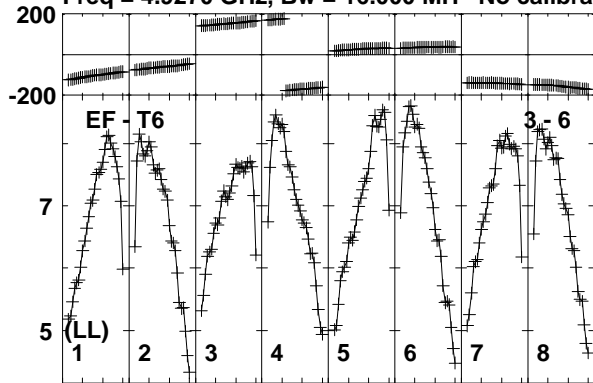

Lower frame: Milli Ampl Jy Top frame: Phas deg
Vector averaged cross-power spectrum Baseline: EF (03) - T6 (06)
Timerange: 00/08:12:01 to 00/08:13:19

Plot file version 450 created 17-FEB-2020 15:43:23

J1359+5544 EK047 2.UVDATA.1

Freq = 4.9270 GHz, Bw = 16.000 MH No calibration applied and no bandpass applied

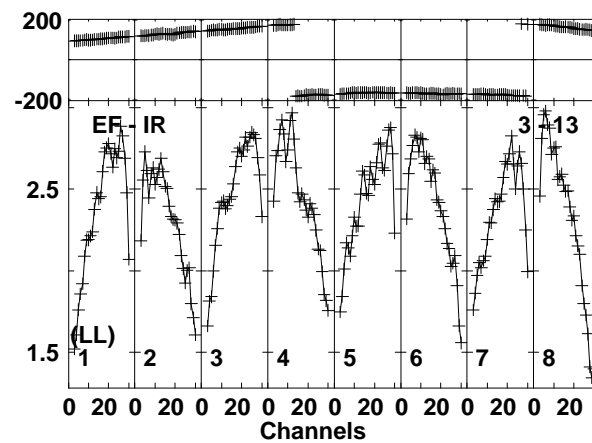
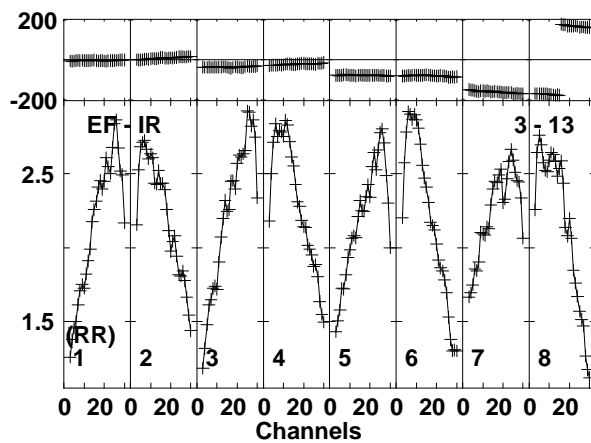
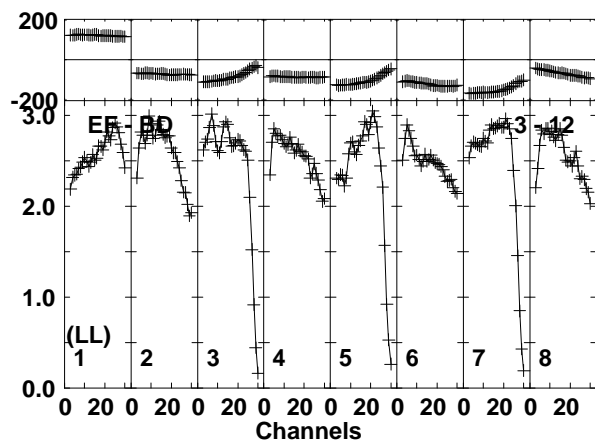
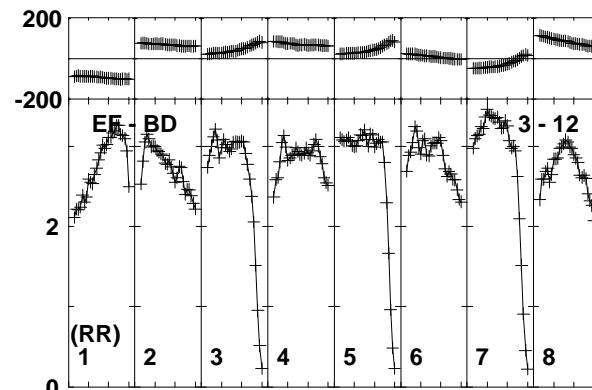
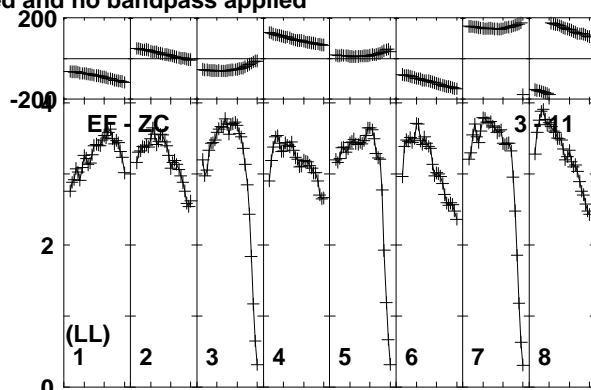
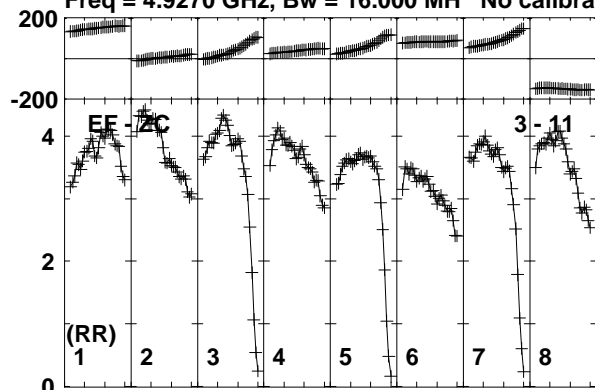

Lower frame: Milli Ampl Jy Top frame: Phas deg
Vector averaged cross-power spectrum Baseline: EF (03) - ZC (11)
Timerange: 00/08:12:01 to 00/08:13:19

Plot file version 451 created 17-FEB-2020 15:43:23

J1402+5347 EK047 2.UVDATA.1

Freq = 4.9270 GHz, Bw = 16.000 MH No calibration applied and no bandpass applied

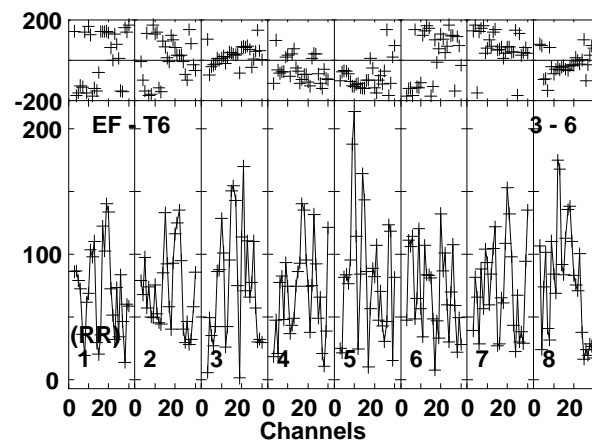
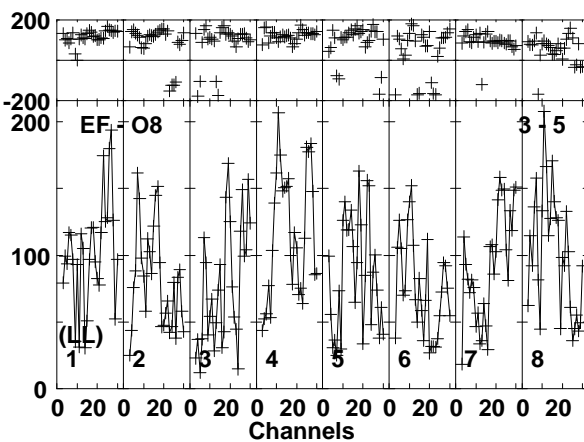
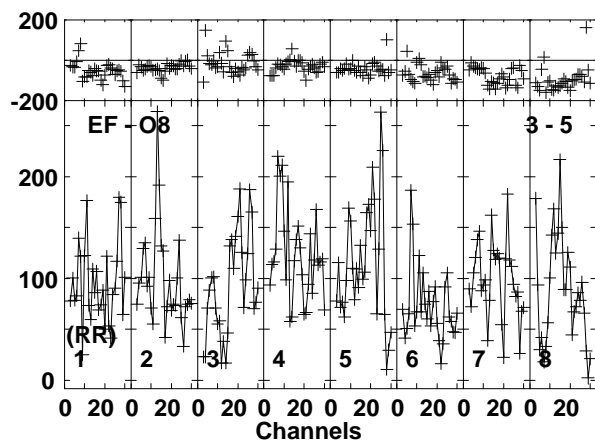
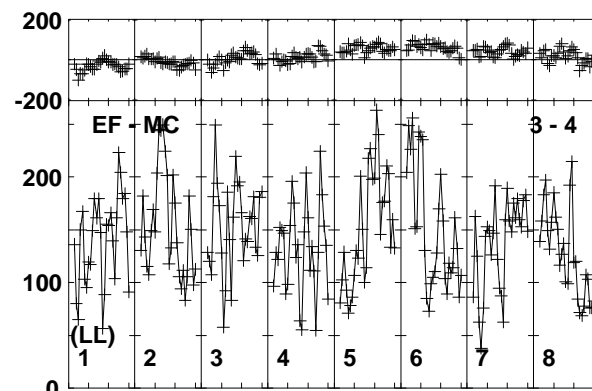
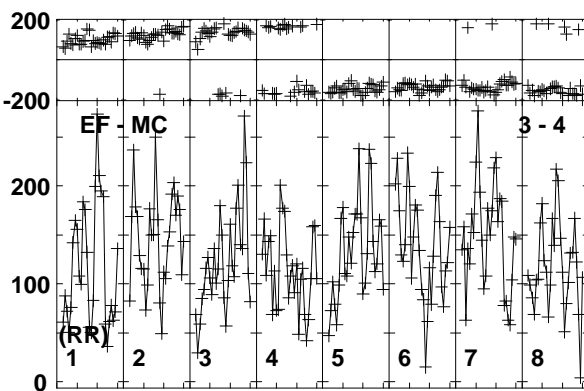
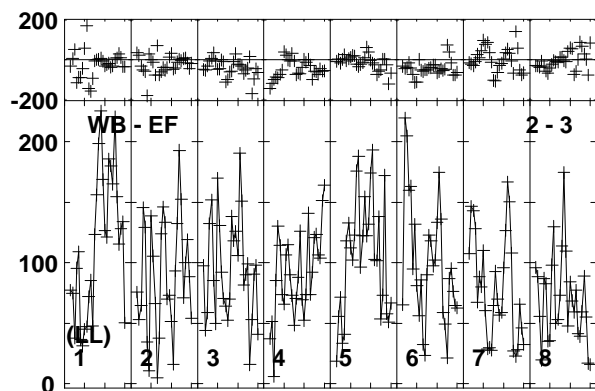
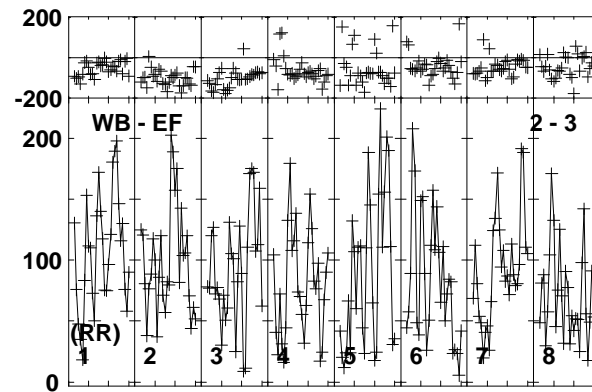
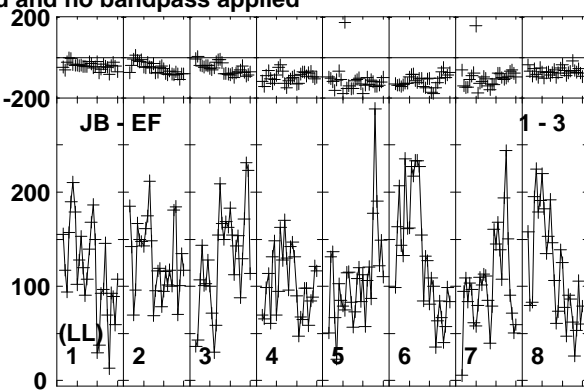
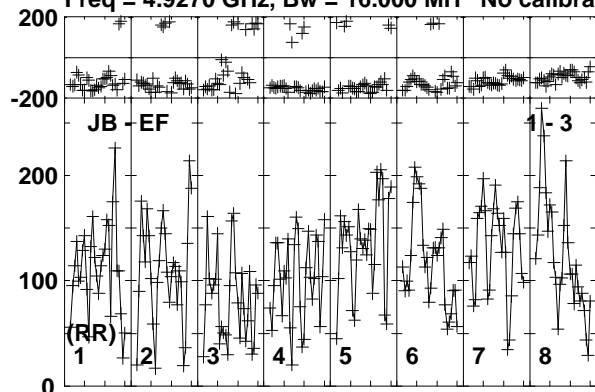

Lower frame: Micro Ampl Jy Top frame: Phas deg
Vector averaged cross-power spectrum Baseline: JB (01) - EF (03)
Timerange: 00/08:13:21 to 00/08:17:19

Plot file version 452 created 17-FEB-2020 15:43:23

J1402+5347 EK047 2.UVDATA.1

Freq = 4.9270 GHz, Bw = 16.000 MH No calibration applied and no bandpass applied

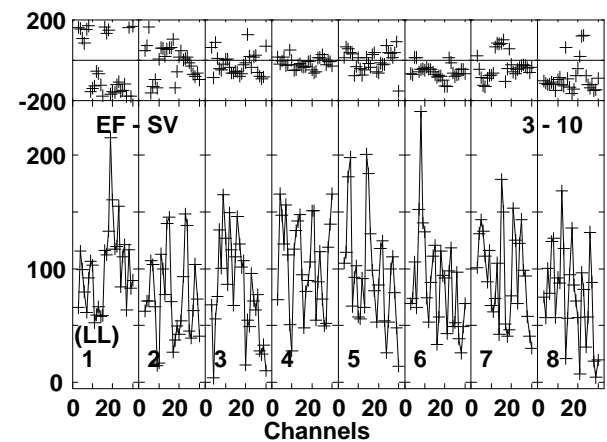
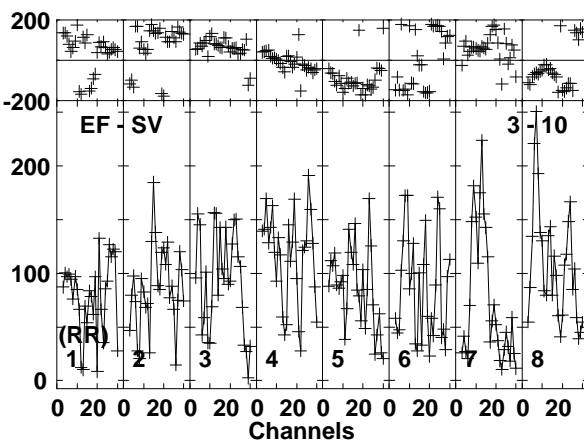
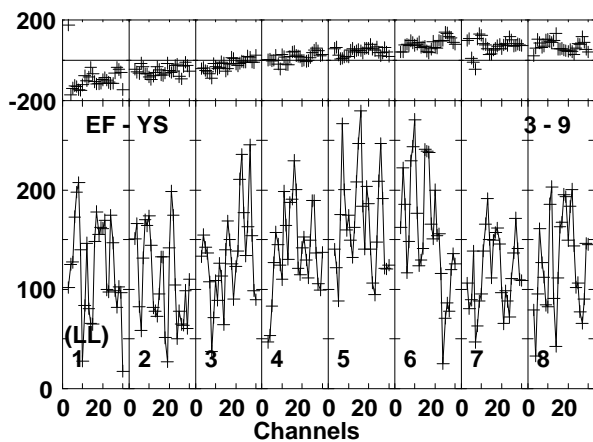
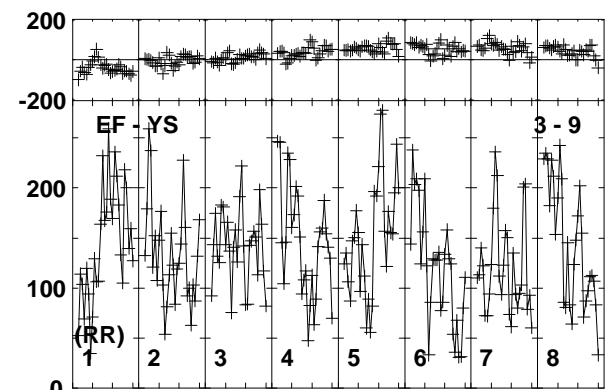
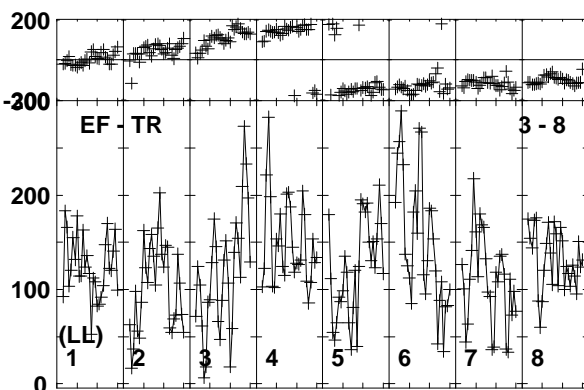
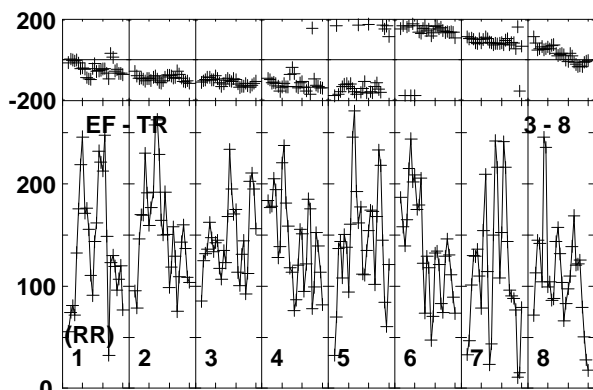
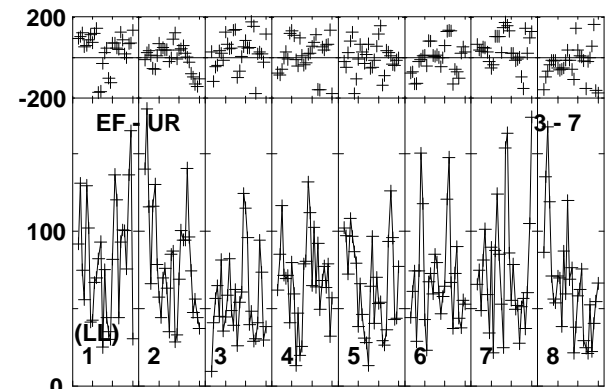
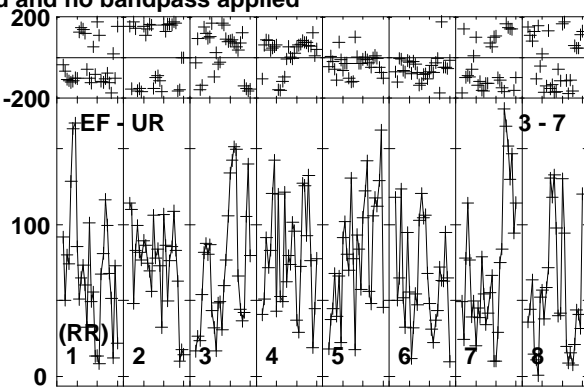
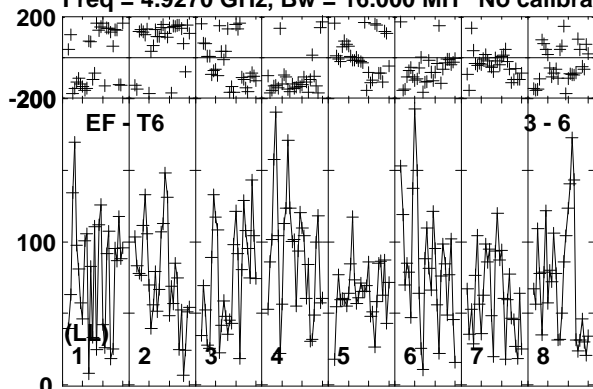

Lower frame: Micro Ampl Jy Top frame: Phas deg
Vector averaged cross-power spectrum Baseline: EF (03) - T6 (06)
Timerange: 00/08:13:21 to 00/08:17:19

Plot file version 453 created 17-FEB-2020 15:43:23

J1402+5347 EK047 2.UVDATA.1

Freq = 4.9270 GHz, Bw = 16.000 MH No calibration applied and no bandpass applied

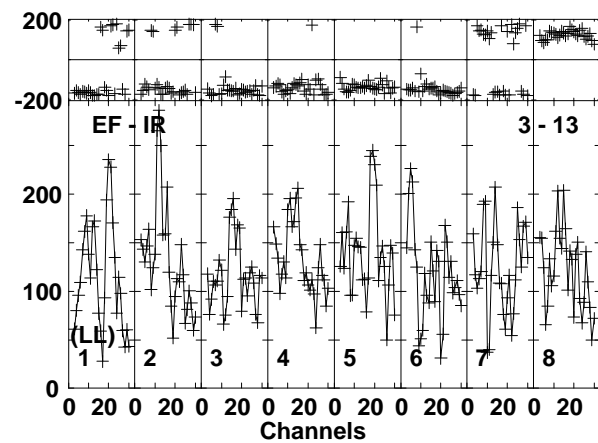
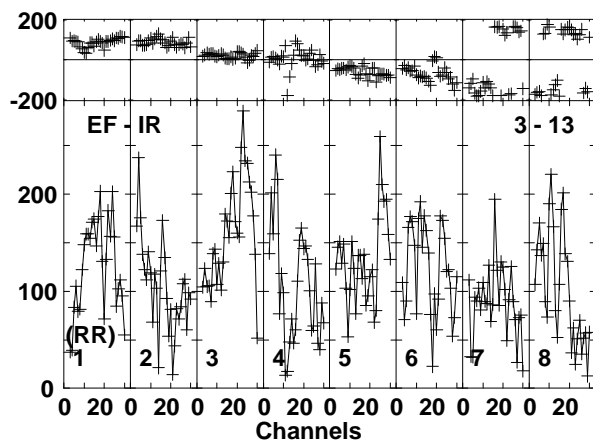
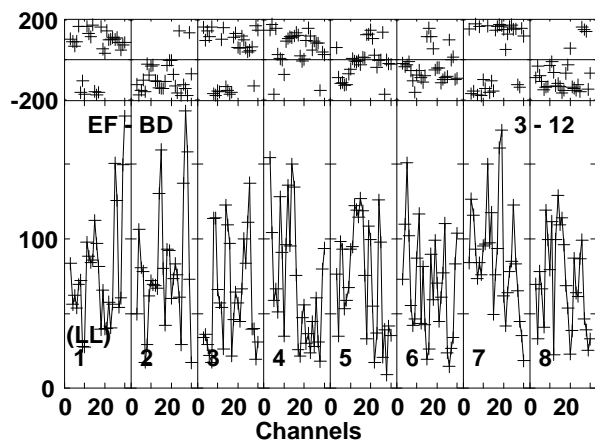
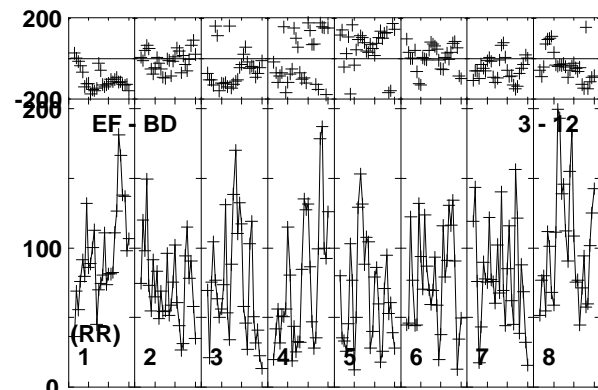
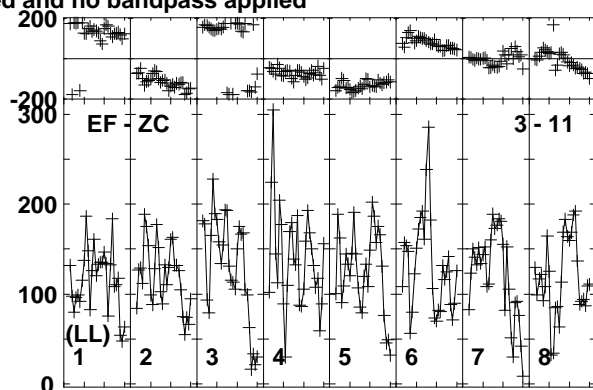
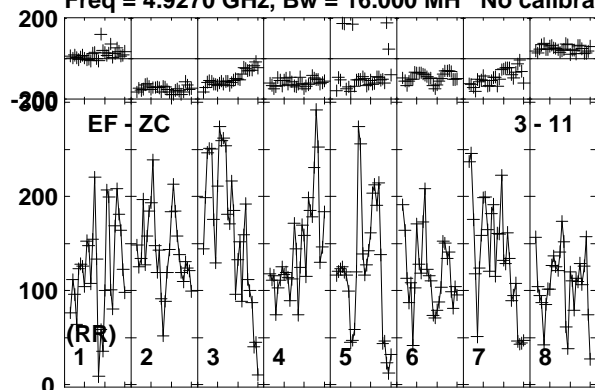

Lower frame: Micro Ampl Jy Top frame: Phas deg
Vector averaged cross-power spectrum Baseline: EF (03) - ZC (11)
Timerange: 00/08:13:21 to 00/08:17:19

Plot file version 454 created 17-FEB-2020 15:43:23

J1359+5544 EK047 2.UVDATA.1

Freq = 4.9270 GHz, Bw = 16.000 MH No calibration applied and no bandpass applied

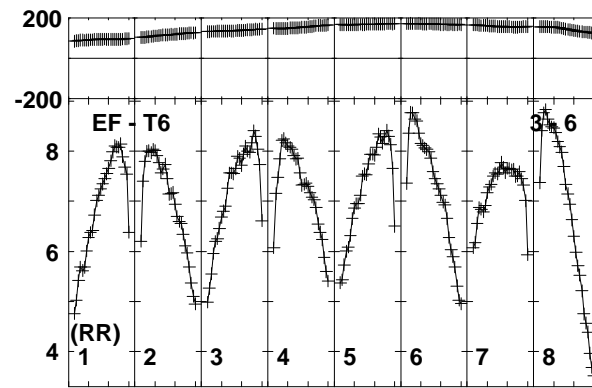
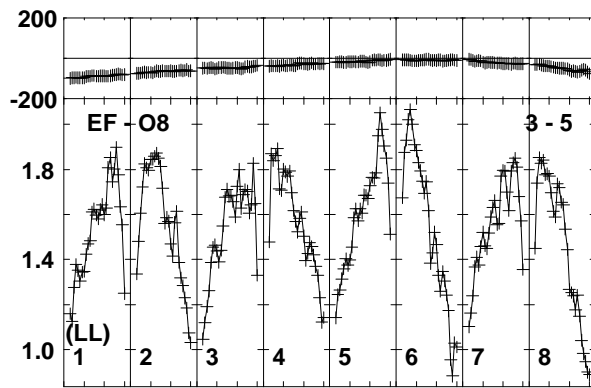
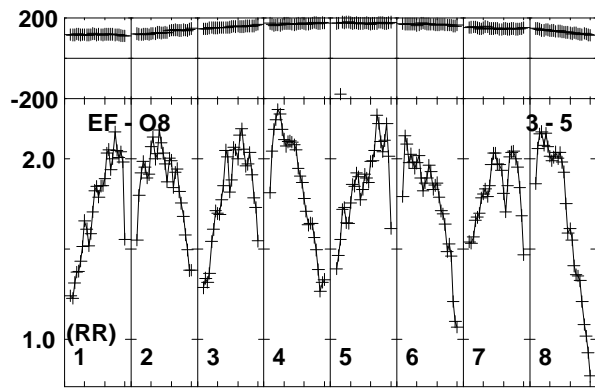
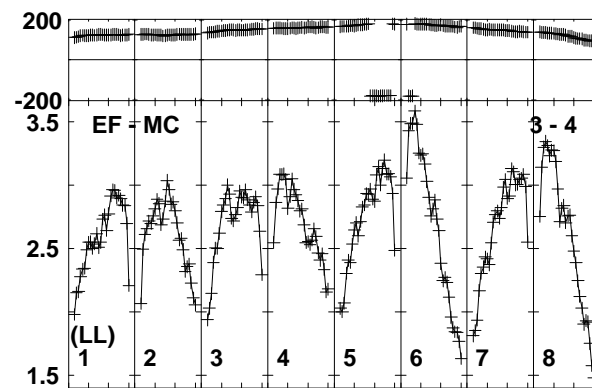
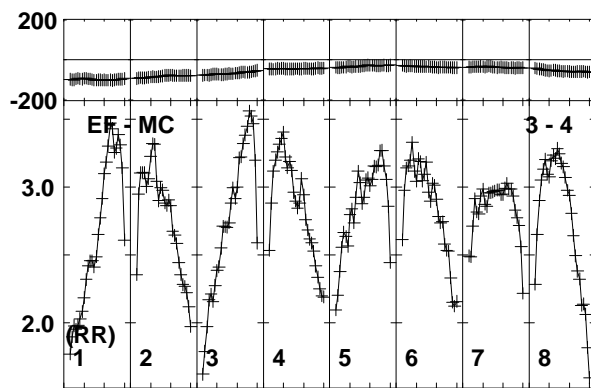
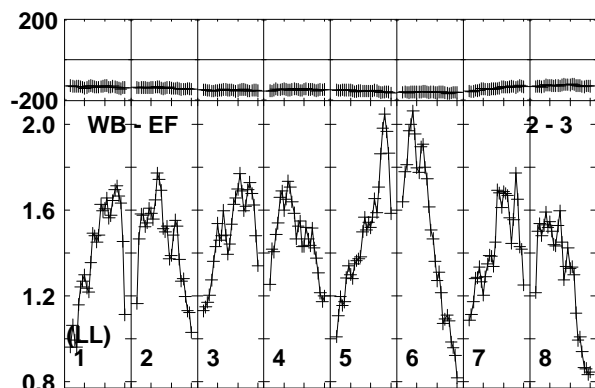
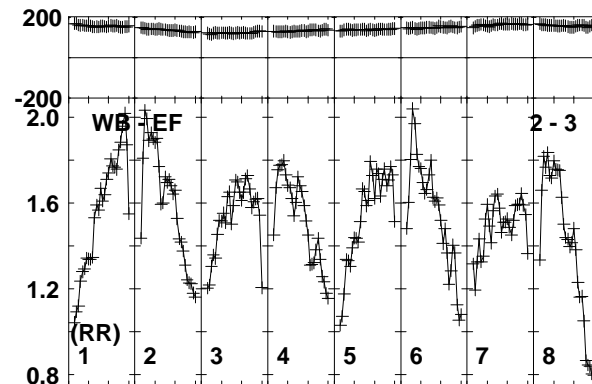
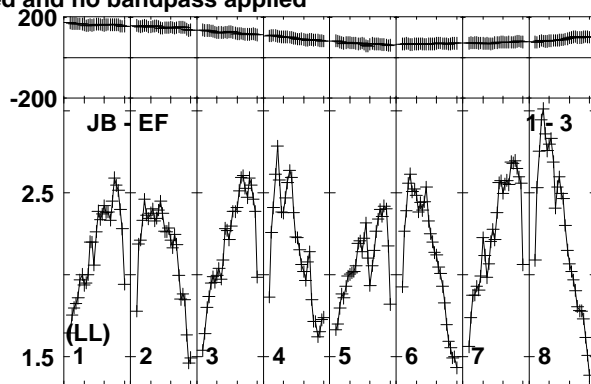
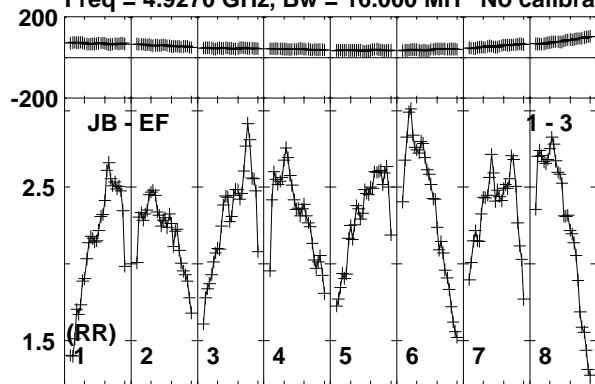

Lower frame: Milli Ampl Jy Top frame: Phas deg
Vector averaged cross-power spectrum Baseline: JB (01) - EF (03)
Timerange: 00/08:17:21 to 00/08:19:19

Plot file version 455 created 17-FEB-2020 15:43:23

J1359+5544 EK047 2.UVDATA.1

Freq = 4.9270 GHz, Bw = 16.000 MH No calibration applied and no bandpass applied

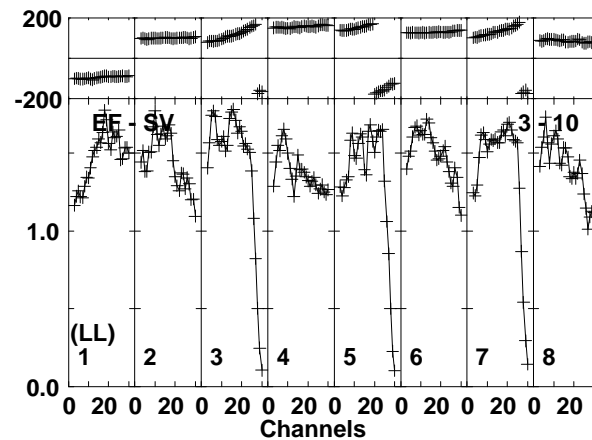
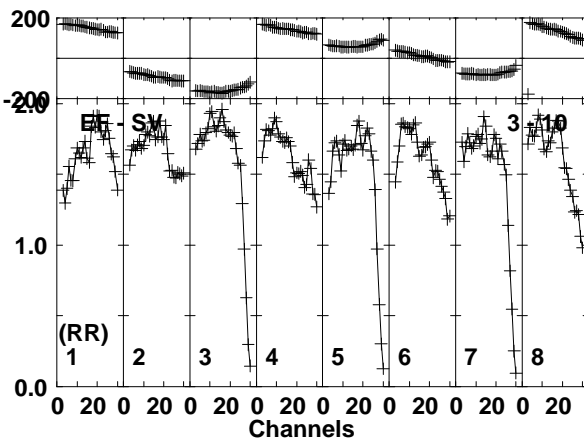
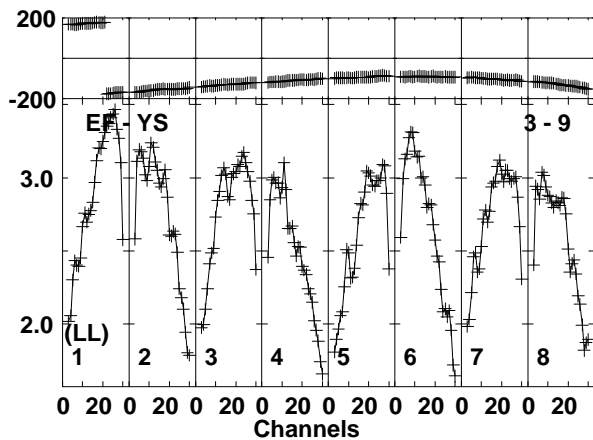
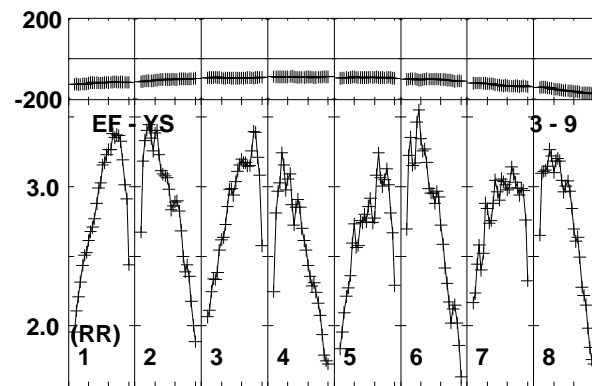
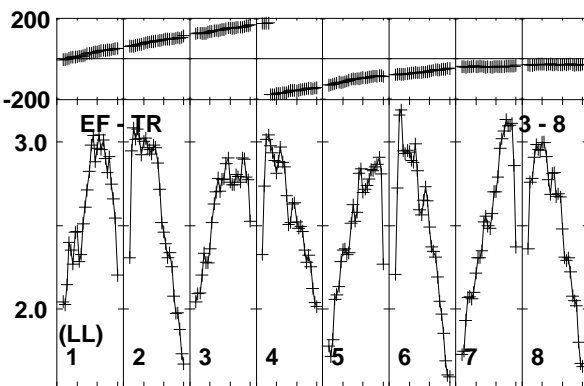
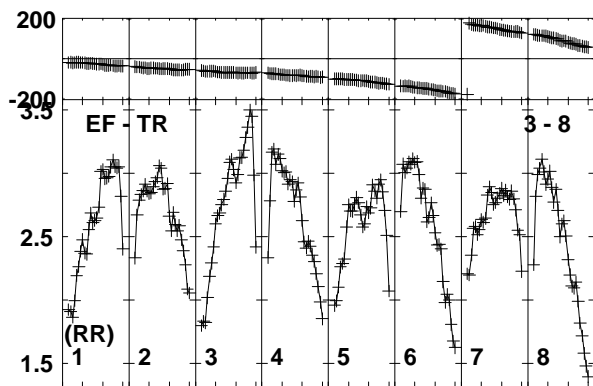
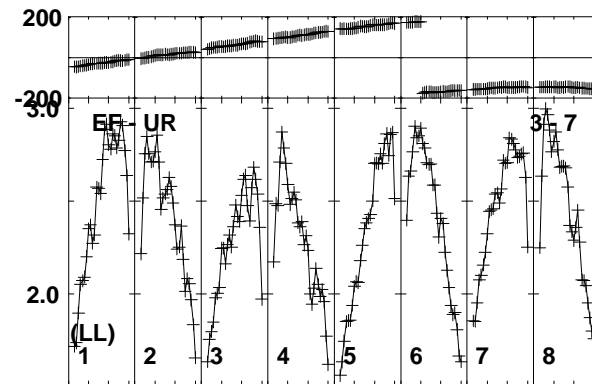
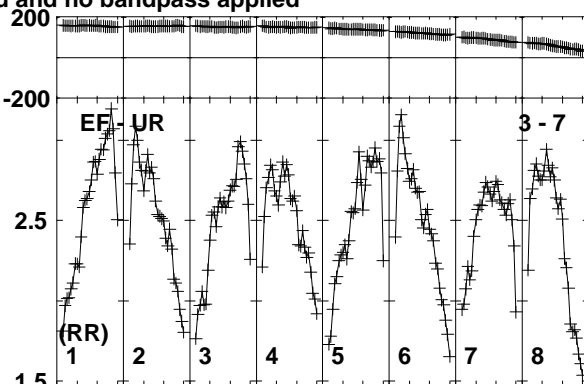
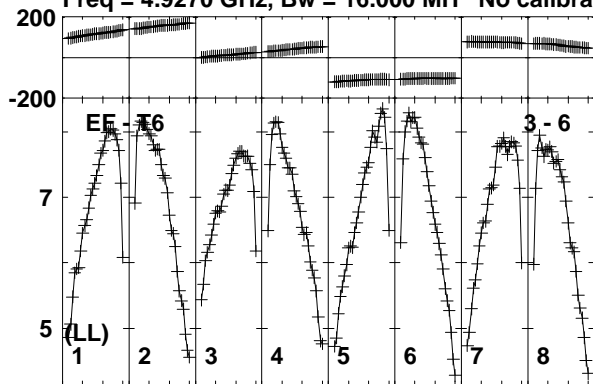

Lower frame: Milli Ampl Jy Top frame: Phas deg
Vector averaged cross-power spectrum Baseline: EF (03) - T6 (06)
Timerange: 00/08:17:21 to 00/08:19:19

Plot file version 456 created 17-FEB-2020 15:43:23

J1359+5544 EK047 2.UVDATA.1

Freq = 4.9270 GHz, Bw = 16.000 MH No calibration applied and no bandpass applied

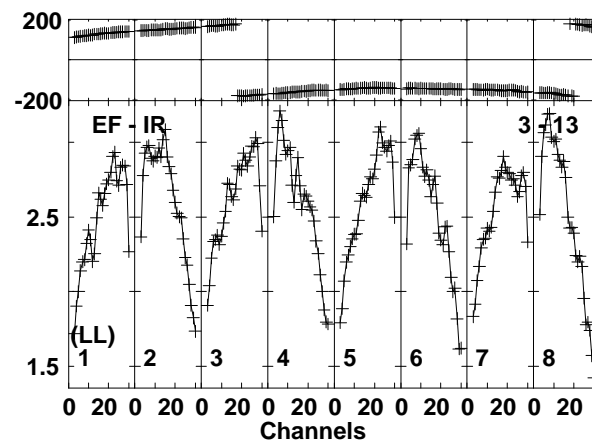
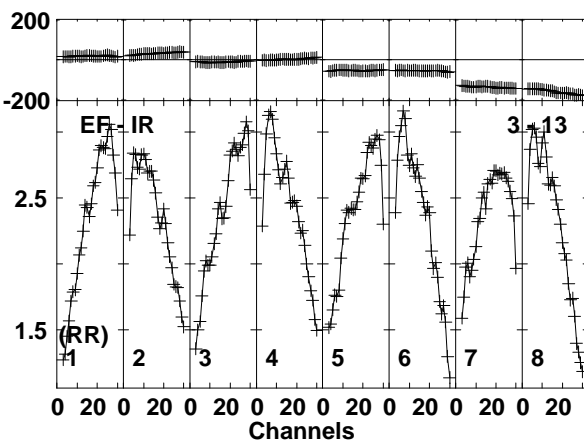
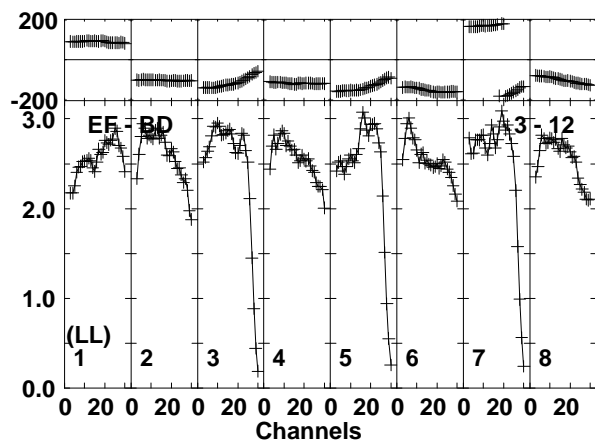
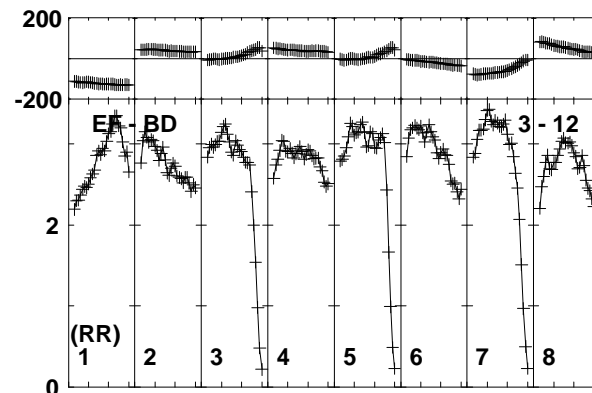
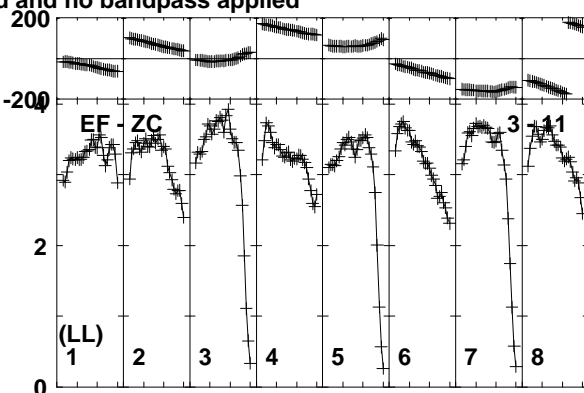
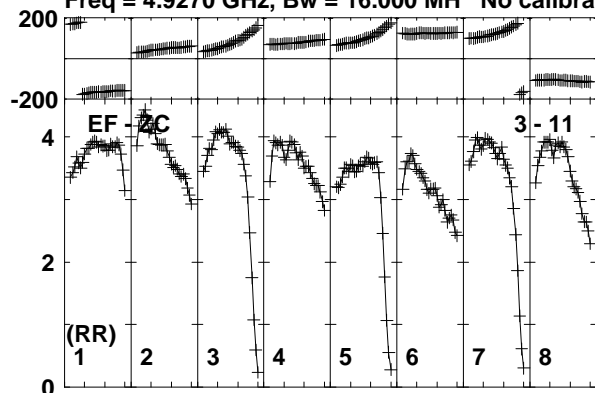

Lower frame: Milli Ampl Jy Top frame: Phas deg
Vector averaged cross-power spectrum Baseline: EF (03) - ZC (11)
Timerange: 00/08:17:21 to 00/08:19:19

Plot file version 457 created 17-FEB-2020 15:43:23

J1402+5347 EK047 2.UVDATA.1

Freq = 4.9270 GHz, Bw = 16.000 MH No calibration applied and no bandpass applied

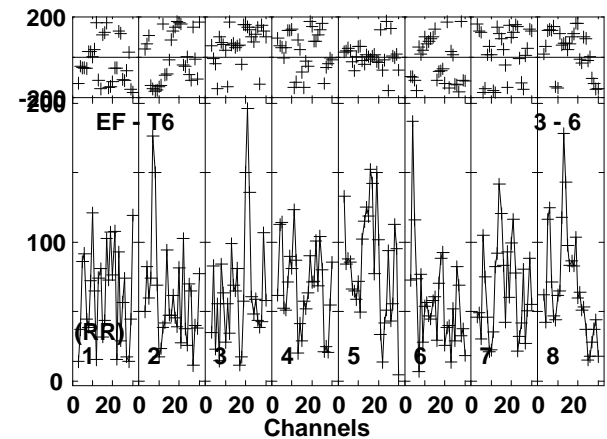
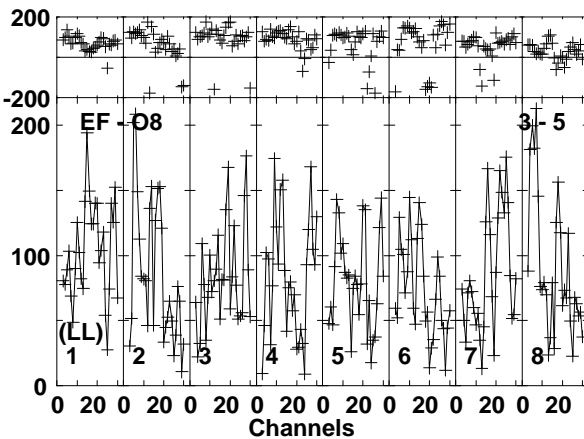
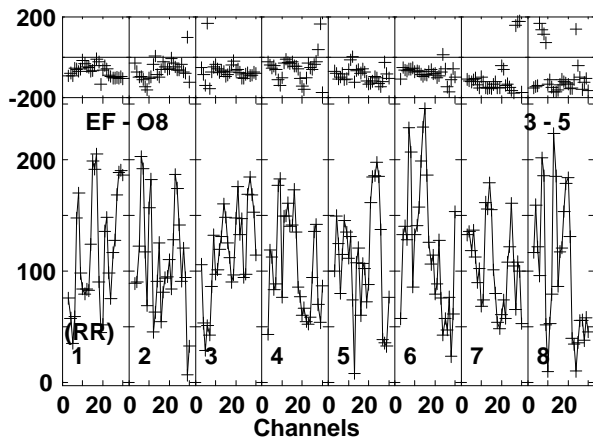
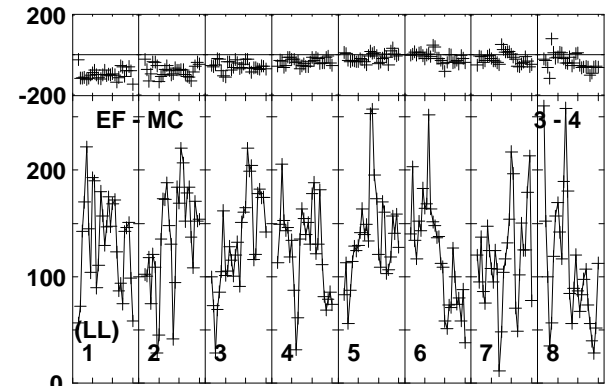
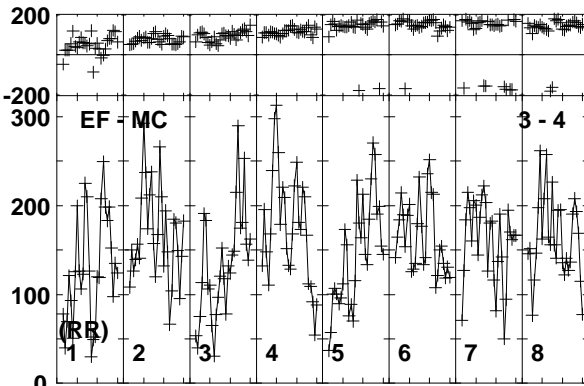
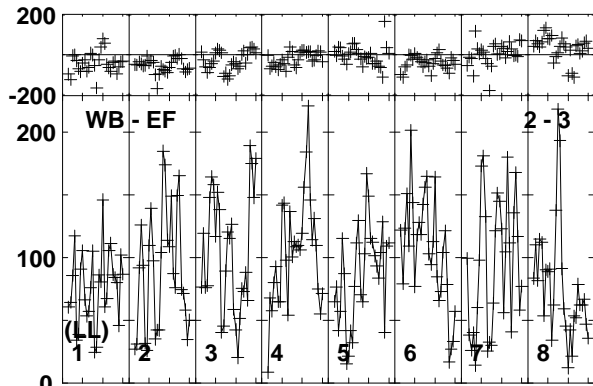
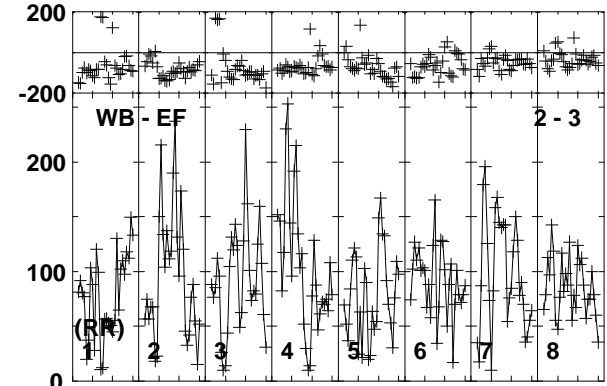
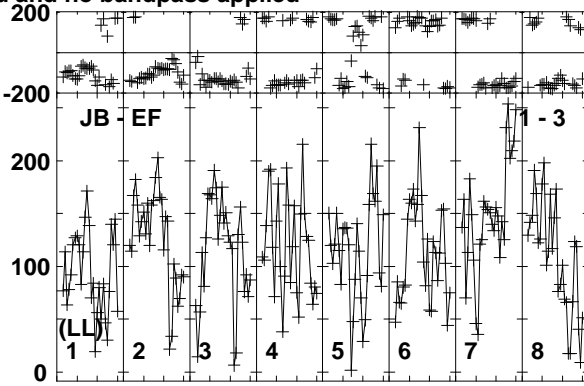
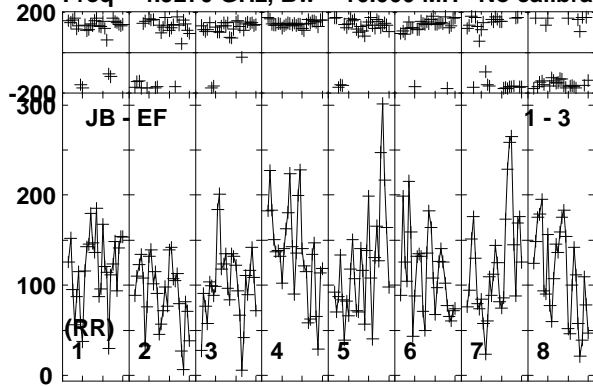

Lower frame: Micro Ampl Jy Top frame: Phas deg
Vector averaged cross-power spectrum Baseline: JB (01) - EF (03)
Timerange: 00/08:19:23 to 00/08:23:19

Plot file version 458 created 17-FEB-2020 15:43:23

J1402+5347 EK047 2.UVDATA.1

Freq = 4.9270 GHz, Bw = 16.000 MH No calibration applied and no bandpass applied

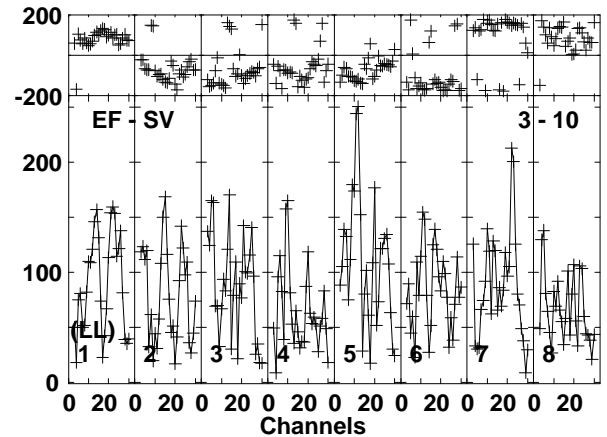
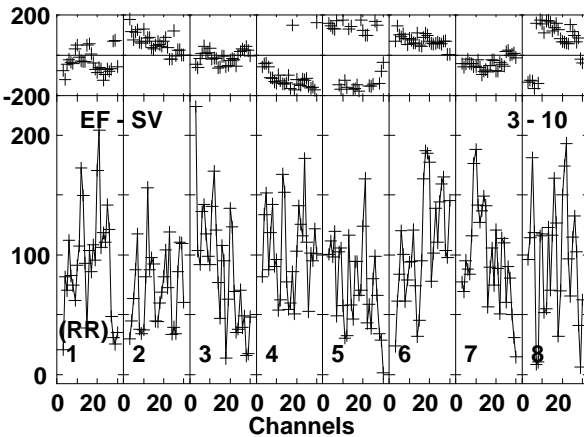
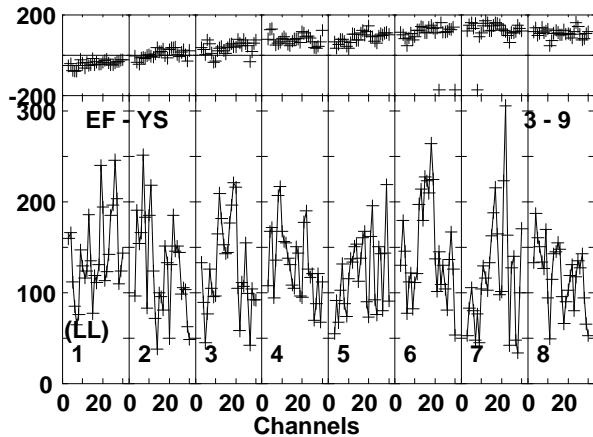
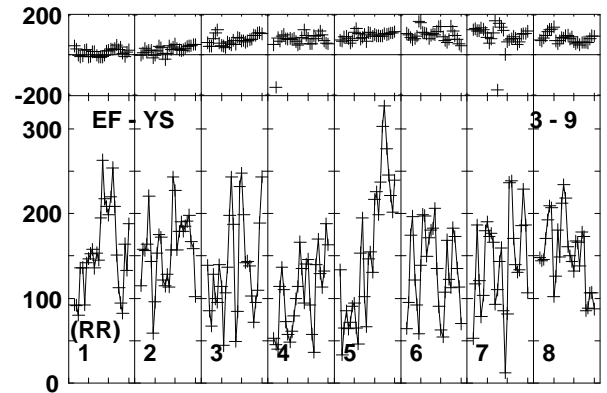
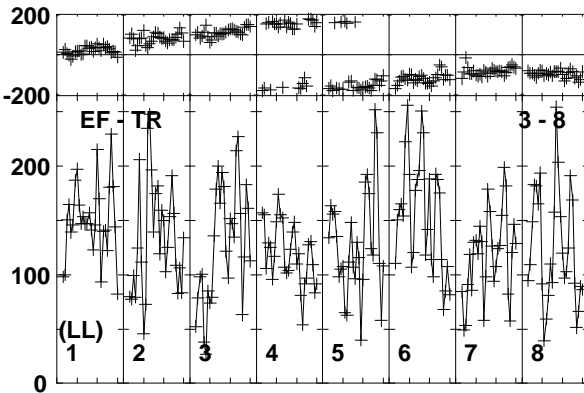
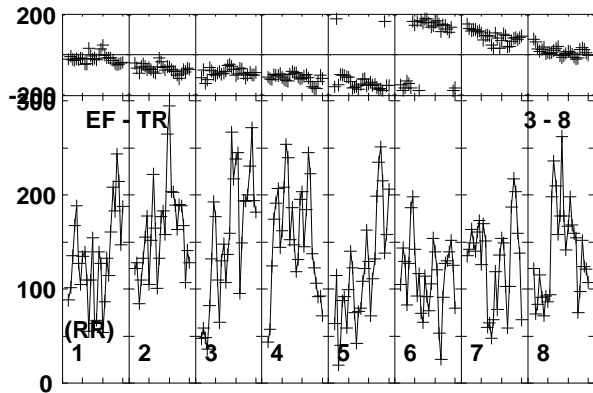
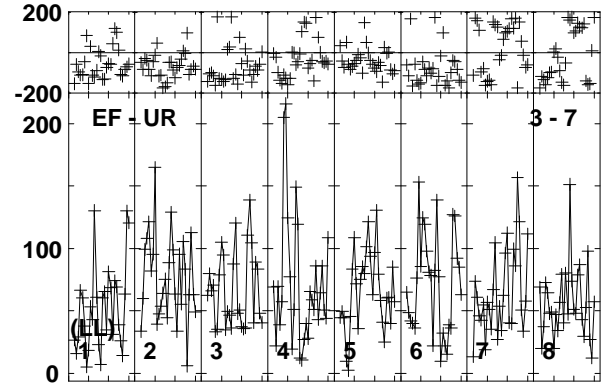
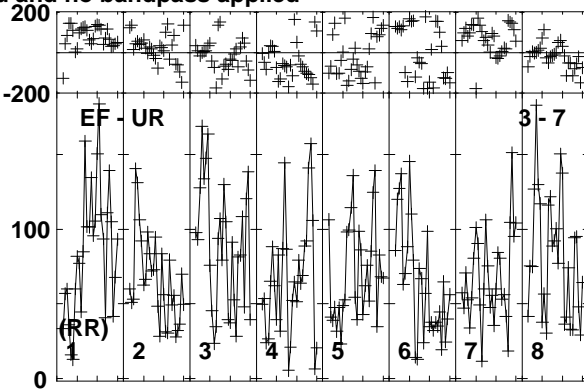
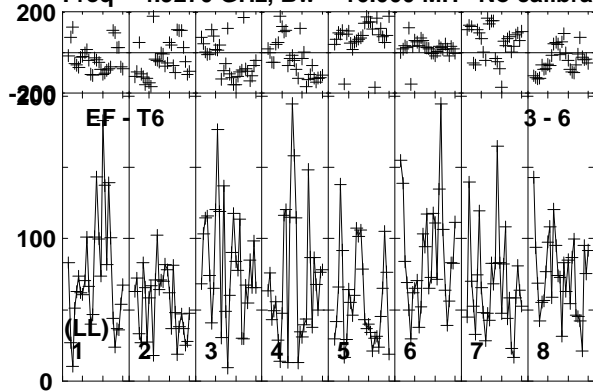

Lower frame: Micro Ampl Jy Top frame: Phas deg
Vector averaged cross-power spectrum Baseline: EF (03) - T6 (06)
Timerange: 00/08:19:23 to 00/08:23:19

Plot file version 459 created 17-FEB-2020 15:43:24

J1402+5347 EK047 2.UVDATA.1

Freq = 4.9270 GHz, Bw = 16.000 MH No calibration applied and no bandpass applied

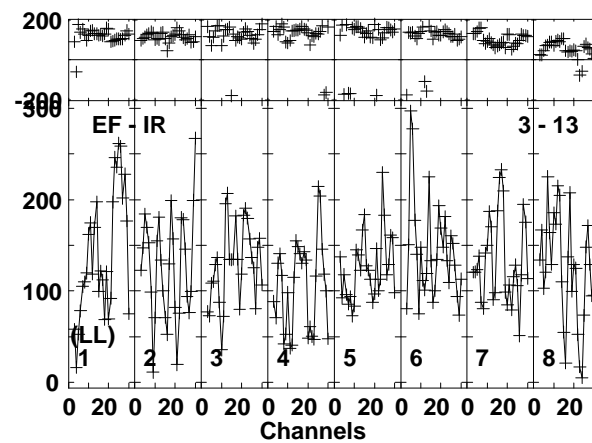
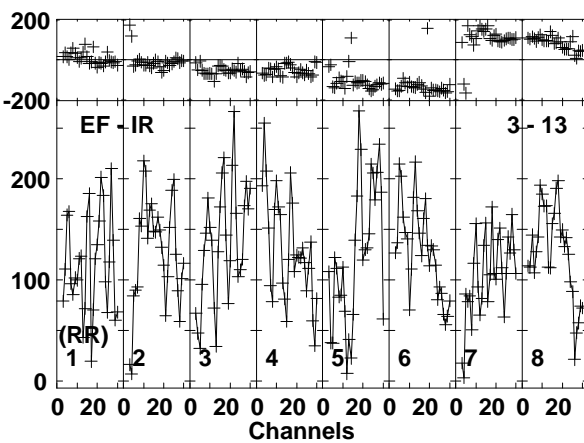
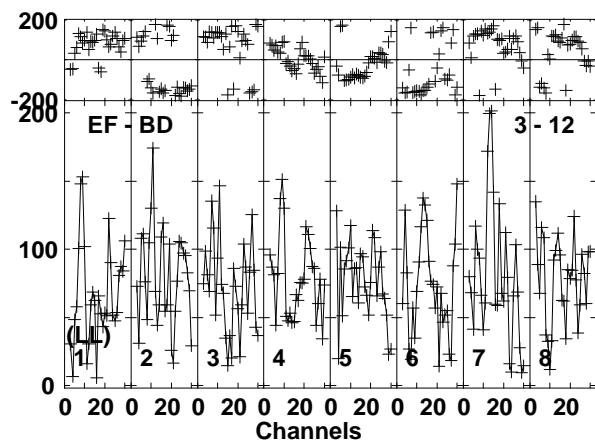
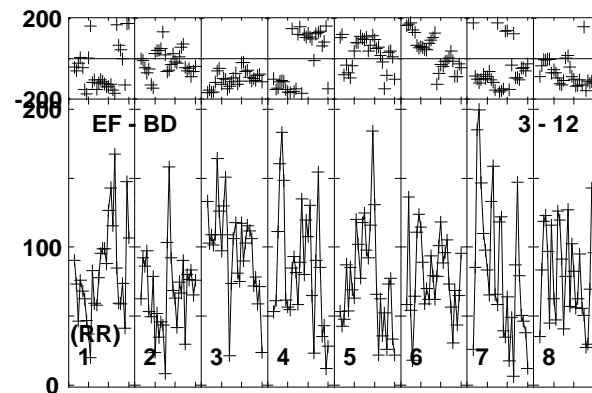
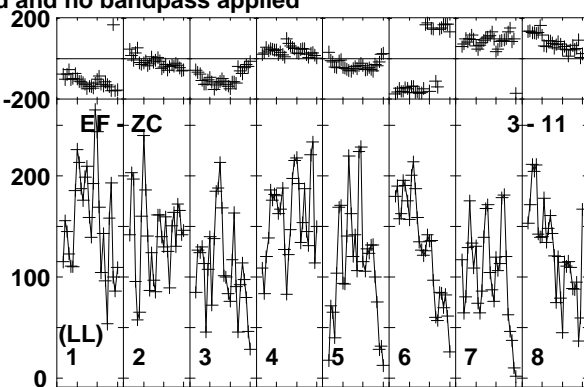
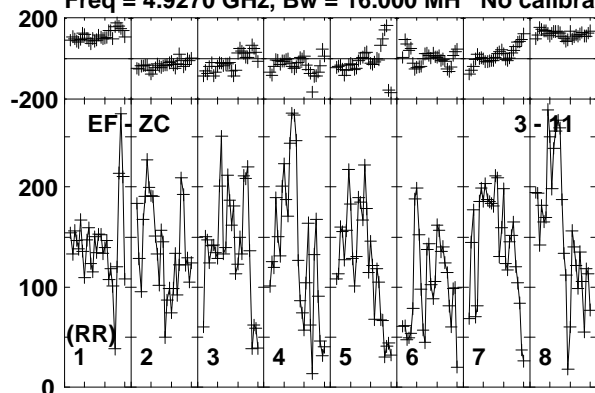

Lower frame: Micro Ampl Jy Top frame: Phas deg
Vector averaged cross-power spectrum Baseline: EF (03) - ZC (11)
Timerange: 00/08:19:23 to 00/08:23:19

Plot file version 460 created 17-FEB-2020 15:43:24

J1359+5544 EK047 2.UVDATA.1

Freq = 4.9270 GHz, Bw = 16.000 MH No calibration applied and no bandpass applied

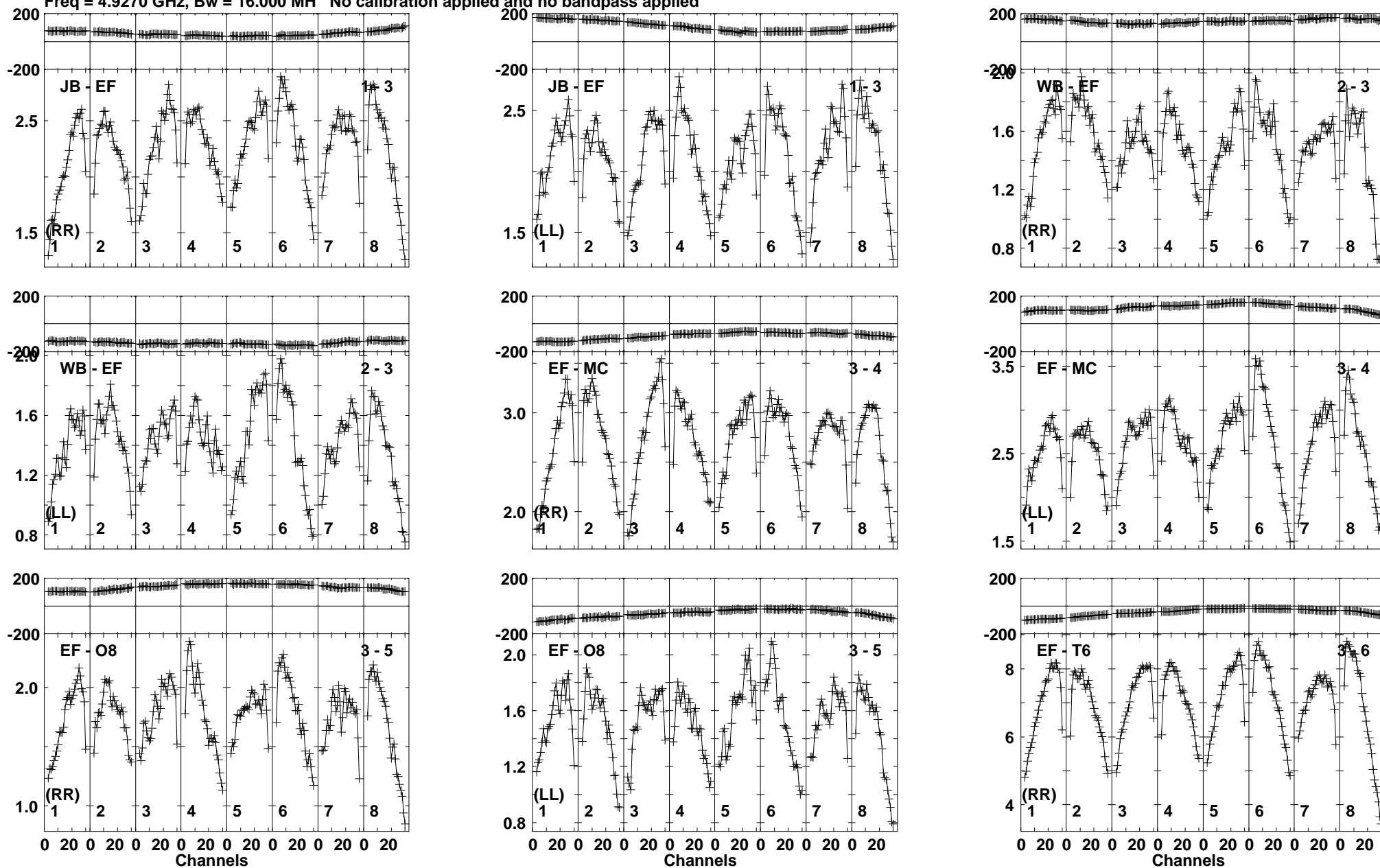

Lower frame: Milli Ampl Jy Top frame: Phas deg
Vector averaged cross-power spectrum Baseline: JB (01) - EF (03)
Timerange: 00/08:24:01 to 00/08:25:19

Plot file version 461 created 17-FEB-2020 15:43:24

J1359+5544 EK047 2.UVDATA.1

Freq = 4.9270 GHz, Bw = 16.000 MH No calibration applied and no bandpass applied

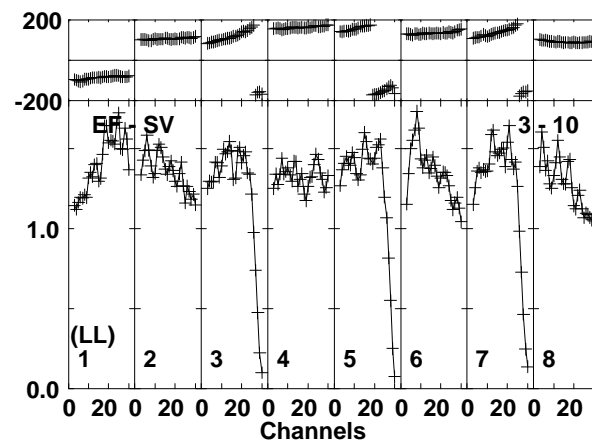
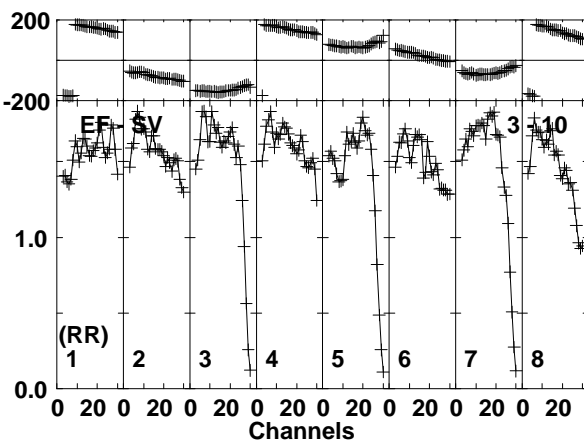
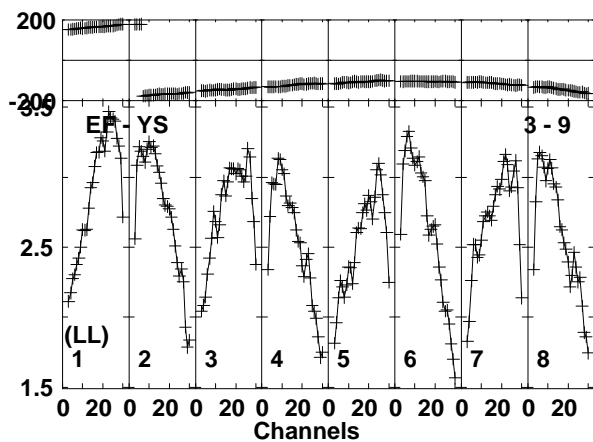
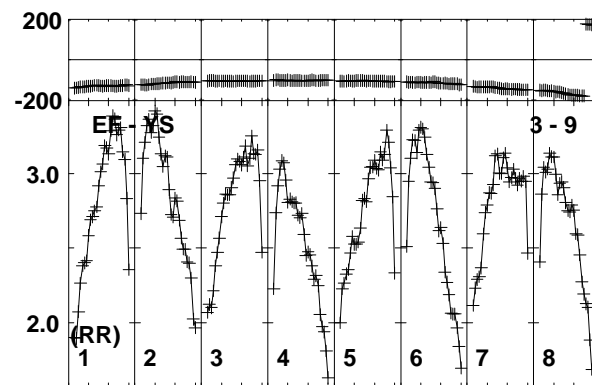
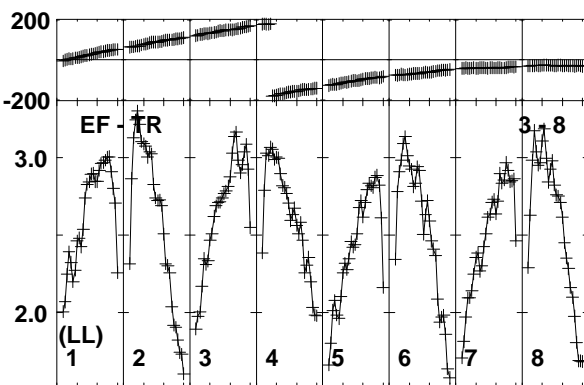
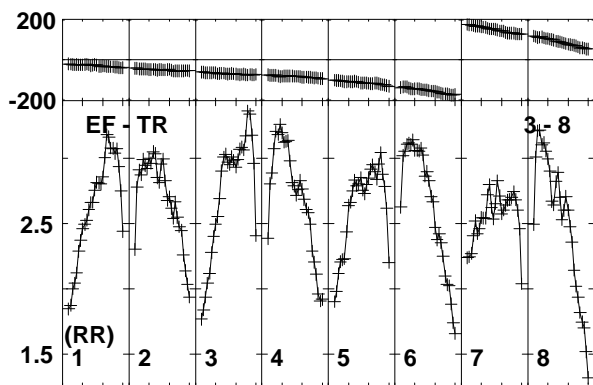
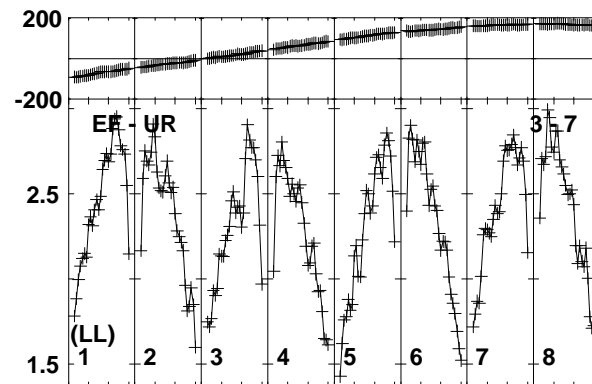
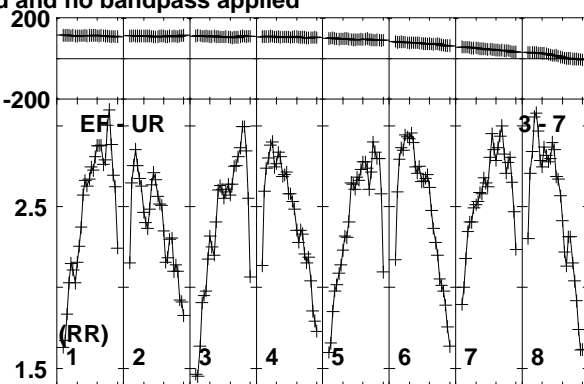
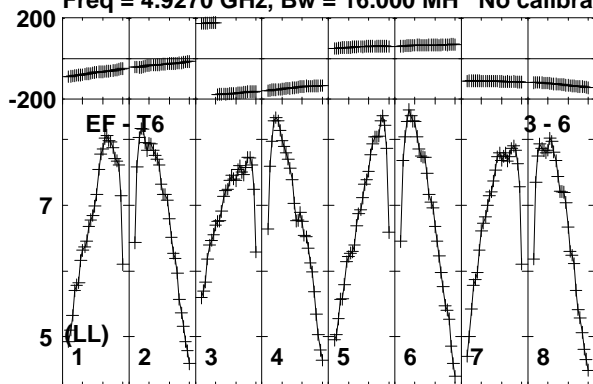

Lower frame: Milli Ampl Jy Top frame: Phas deg
Vector averaged cross-power spectrum Baseline: EF (03) - T6 (06)
Timerange: 00/08:24:01 to 00/08:25:19

Plot file version 462 created 17-FEB-2020 15:43:24

J1359+5544 EK047 2.UVDATA.1

Freq = 4.9270 GHz, Bw = 16.000 MH No calibration applied and no bandpass applied

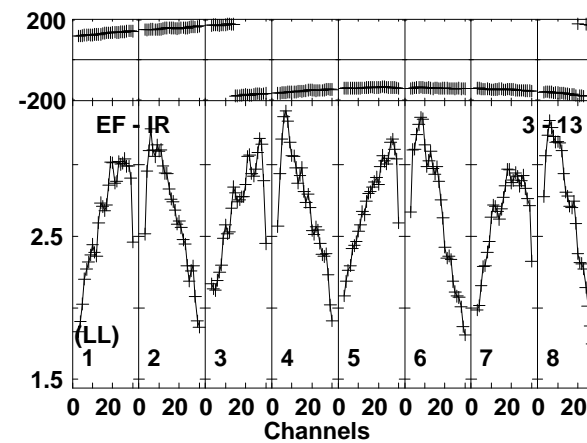
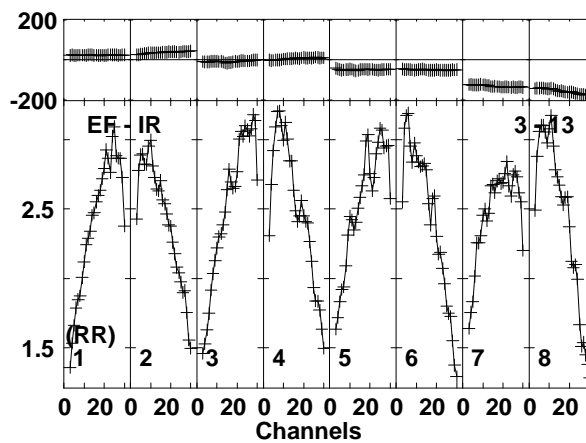
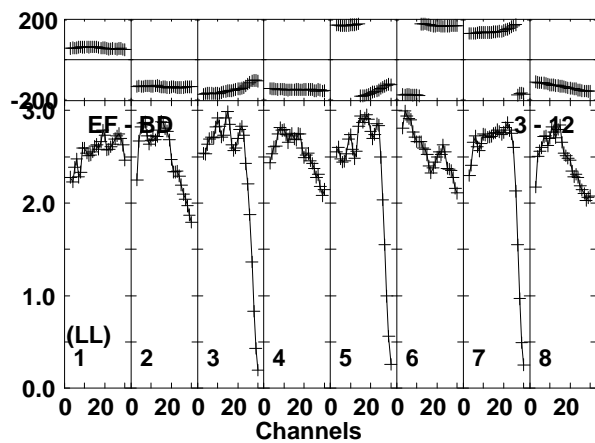
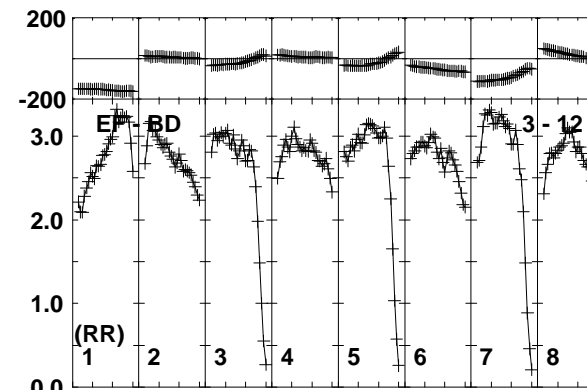
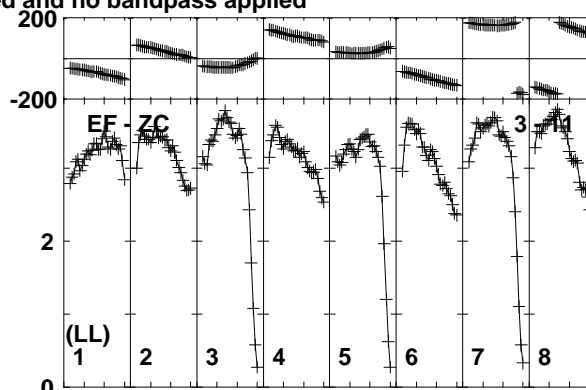
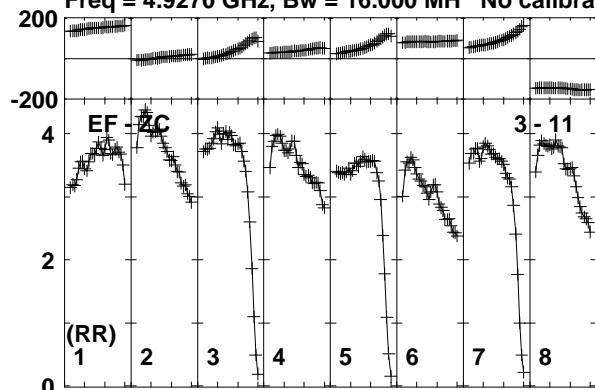

Lower frame: Milli Ampl Jy Top frame: Phas deg
Vector averaged cross-power spectrum Baseline: EF (03) - ZC (11)
Timerange: 00/08:24:01 to 00/08:25:19

Plot file version 463 created 17-FEB-2020 15:43:24

J1402+5347 EK047 2.UVDATA.1

Freq = 4.9270 GHz, Bw = 16.000 MH No calibration applied and no bandpass applied

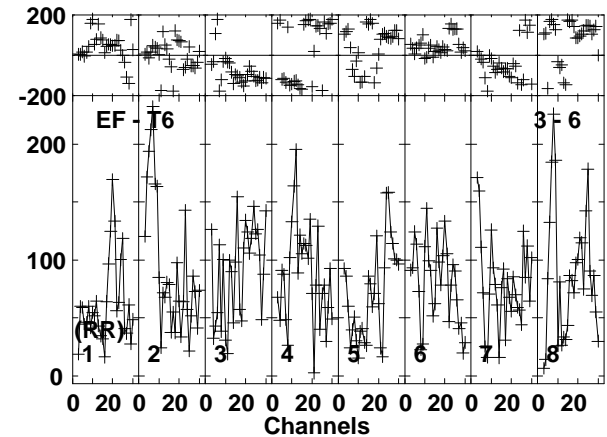
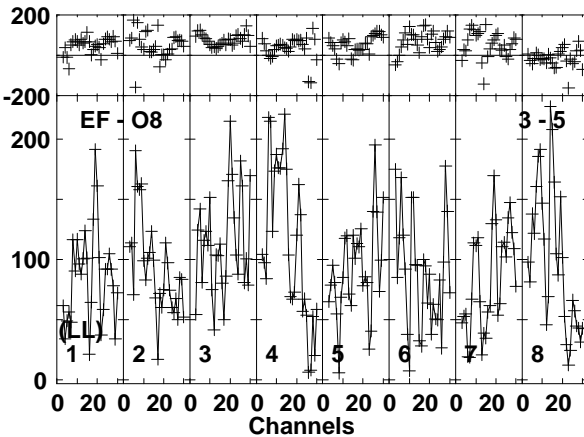
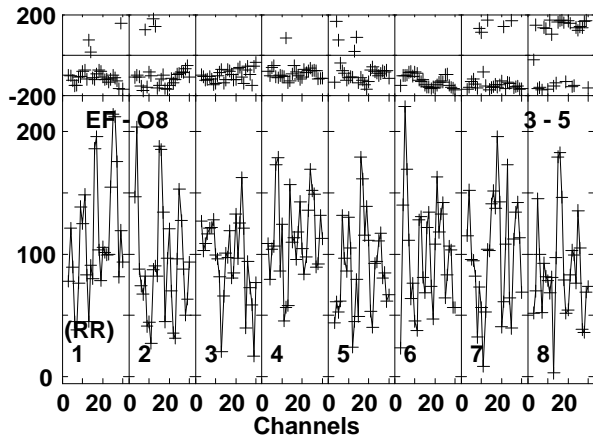
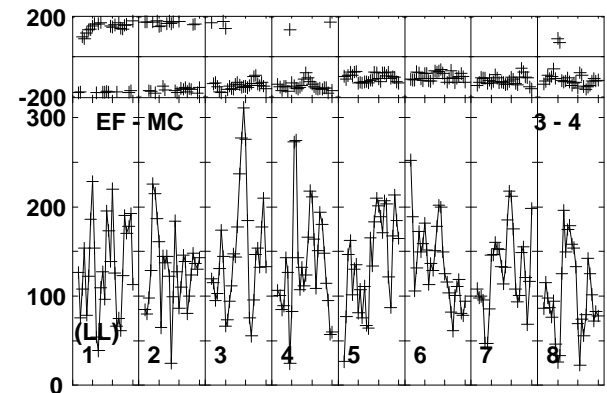
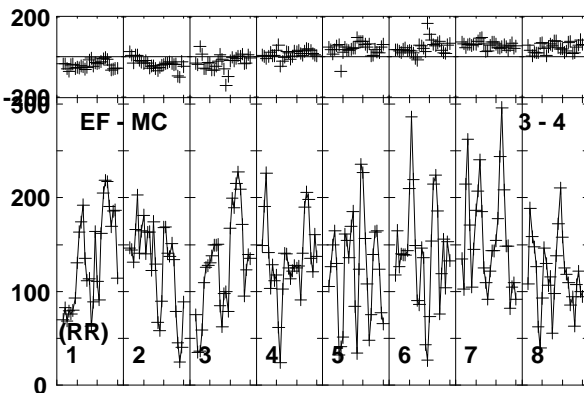
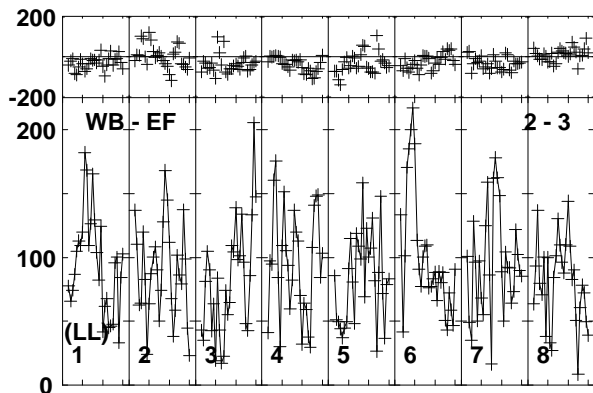
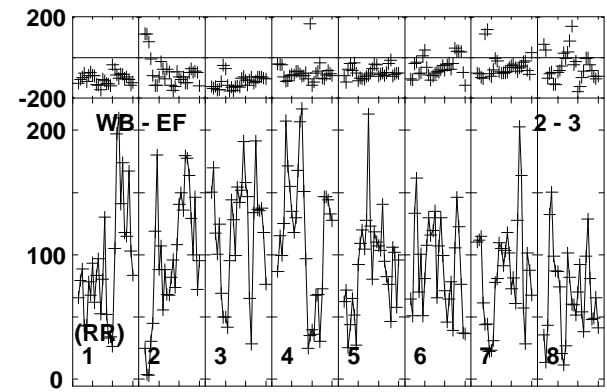
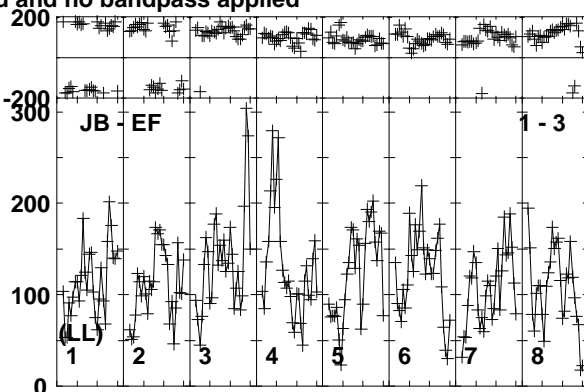
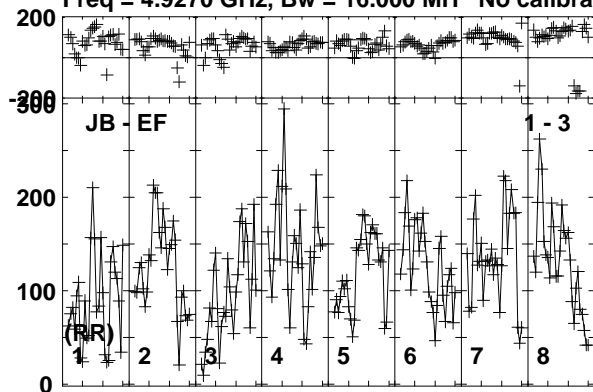

Lower frame: Micro Ampl Jy Top frame: Phas deg
Vector averaged cross-power spectrum Baseline: JB (01) - EF (03)
Timerange: 00/08:25:21 to 00/08:29:19

Plot file version 464 created 17-FEB-2020 15:43:24

J1402+5347 EK047 2.UVDATA.1

Freq = 4.9270 GHz, Bw = 16.000 MH No calibration applied and no bandpass applied

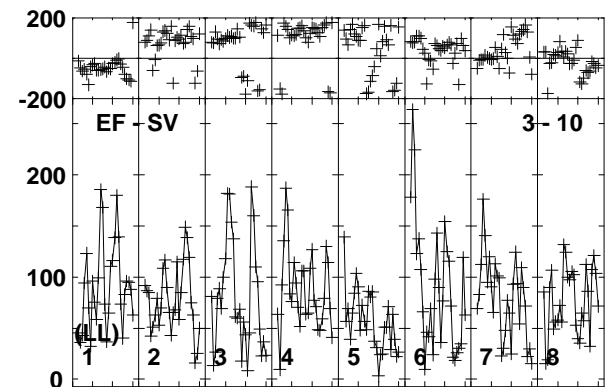
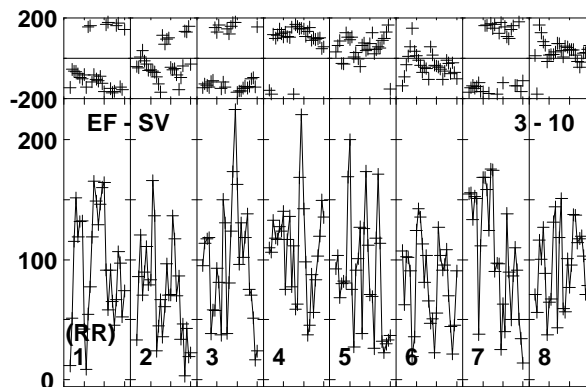
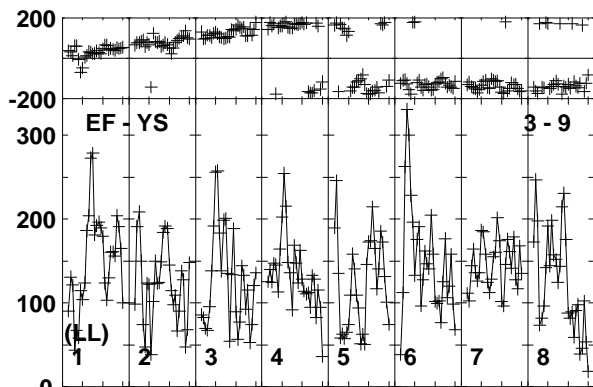
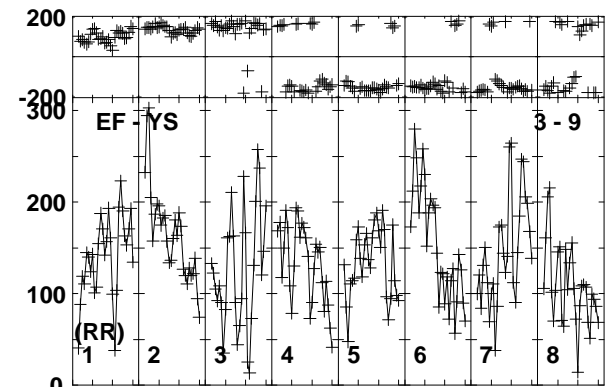
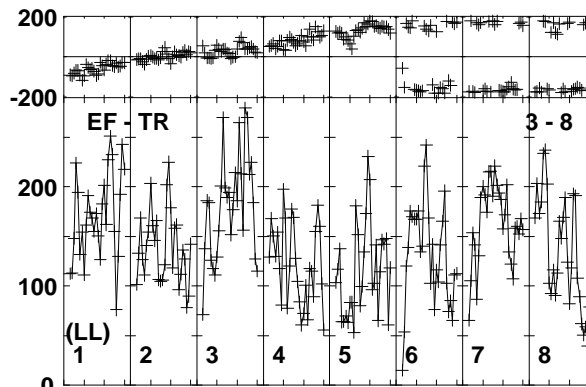
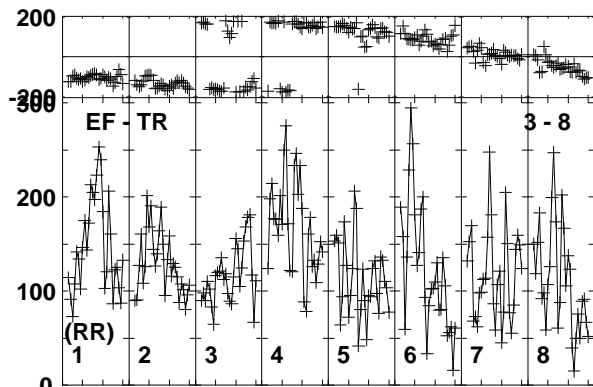
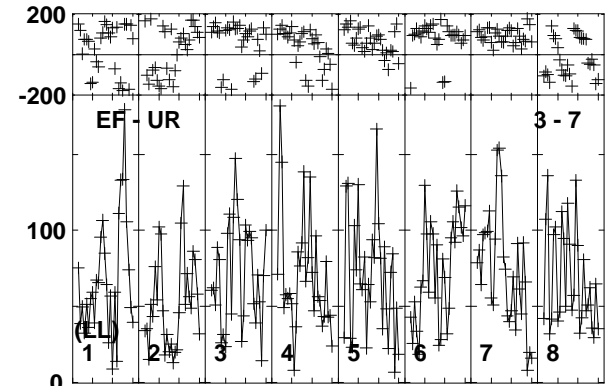
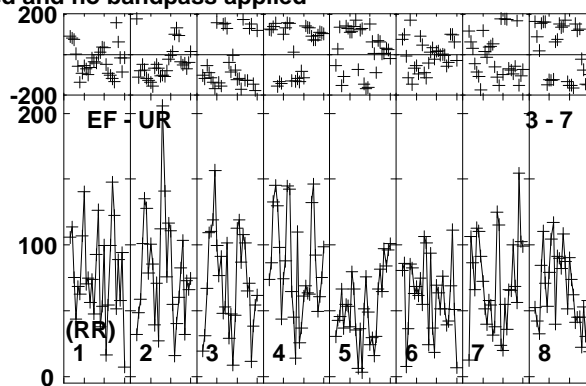
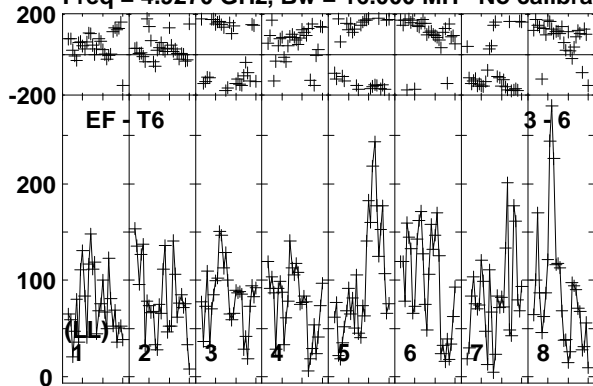

Lower frame: Micro Ampl Jy Top frame: Phas deg
Vector averaged cross-power spectrum Baseline: EF (03) - T6 (06)
Timerange: 00/08:25:21 to 00/08:29:19

Plot file version 465 created 17-FEB-2020 15:43:24

J1402+5347 EK047 2.UVDATA.1

Freq = 4.9270 GHz, Bw = 16.000 MH No calibration applied and no bandpass applied

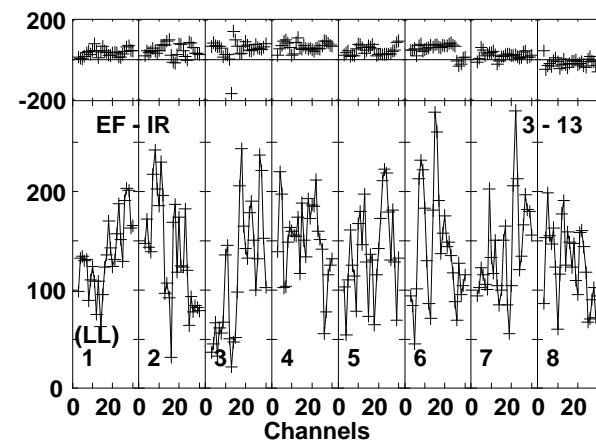
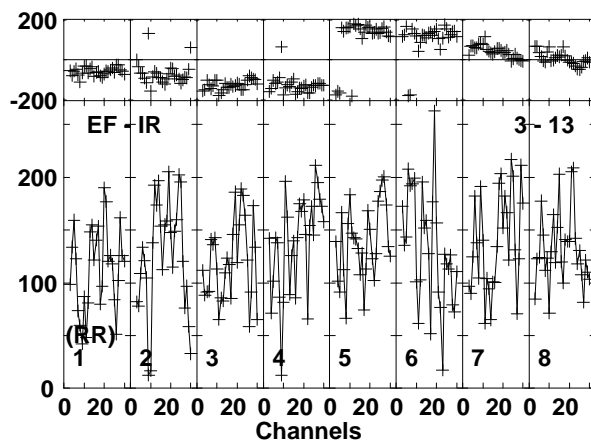
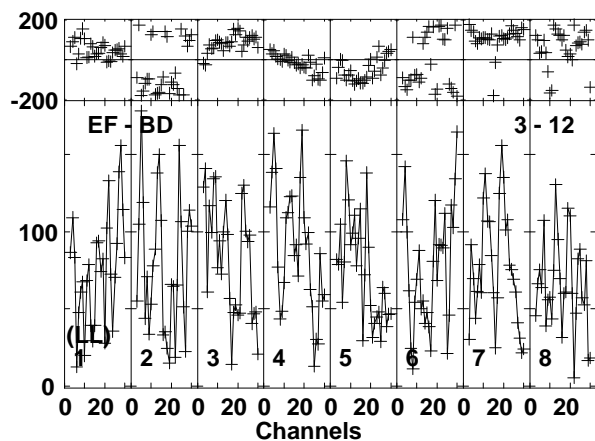
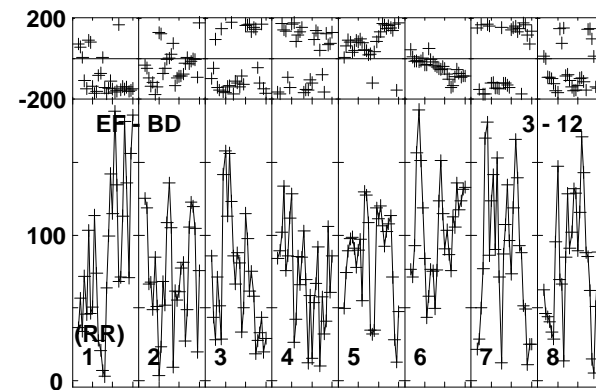
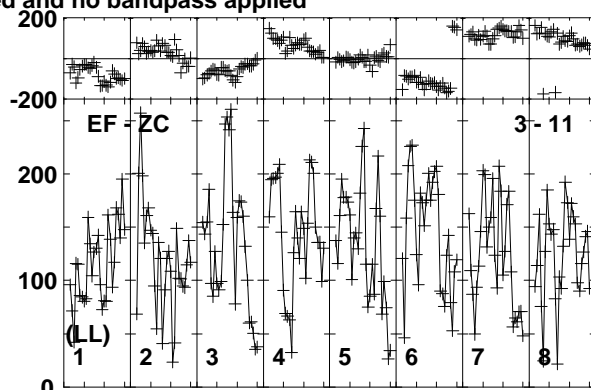
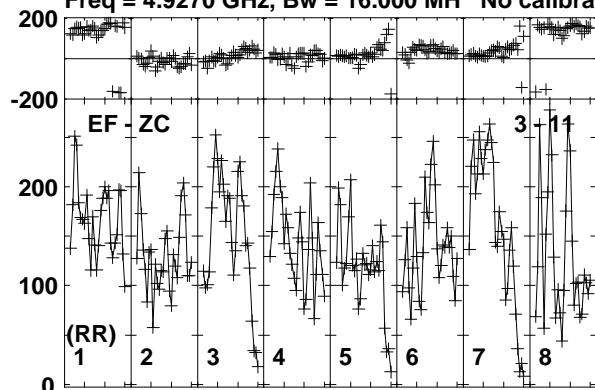

Lower frame: Micro Ampl Jy Top frame: Phas deg
Vector averaged cross-power spectrum Baseline: EF (03) - ZC (11)
Timerange: 00/08:25:21 to 00/08:29:19

Plot file version 466 created 17-FEB-2020 15:43:24
 J1359+5544 EK047 2.UVDATA.1

Freq = 4.9270 GHz, Bw = 16.000 MH No calibration applied and no bandpass applied

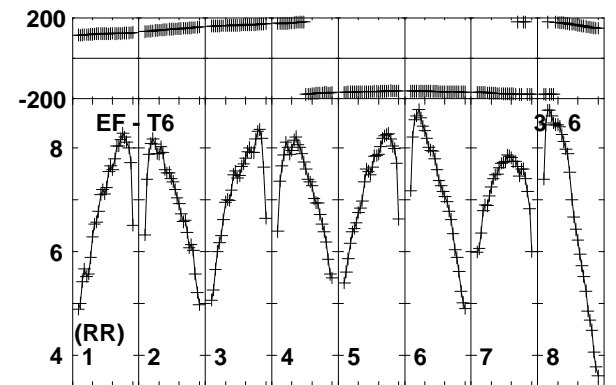
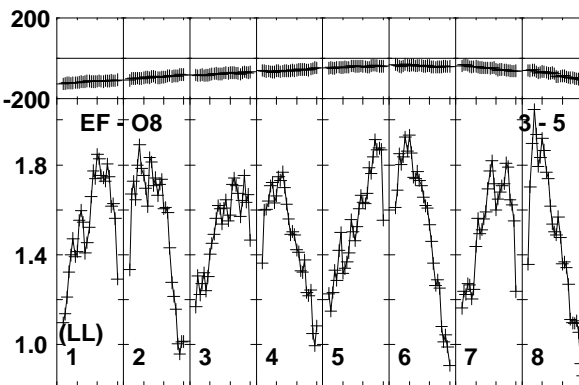
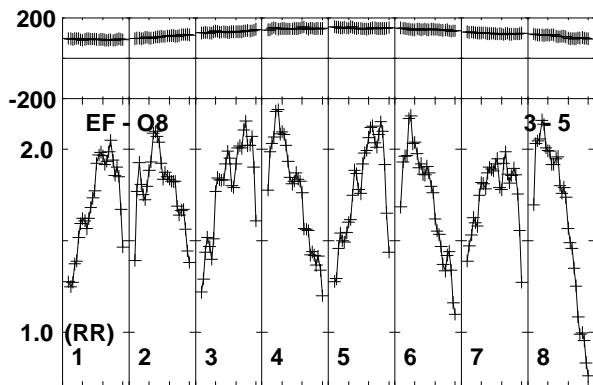
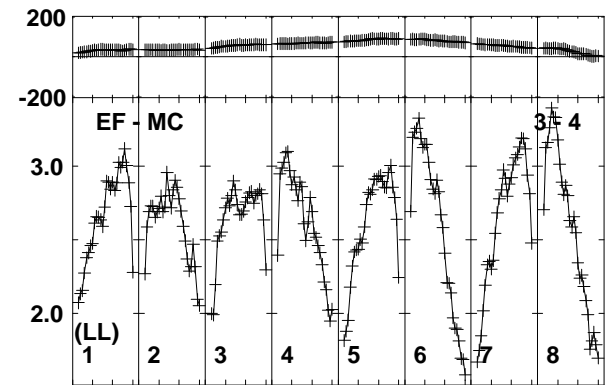
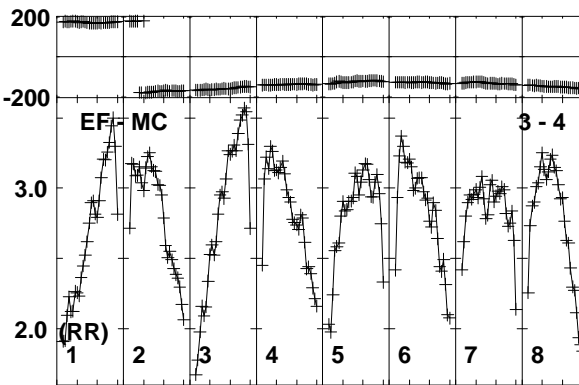
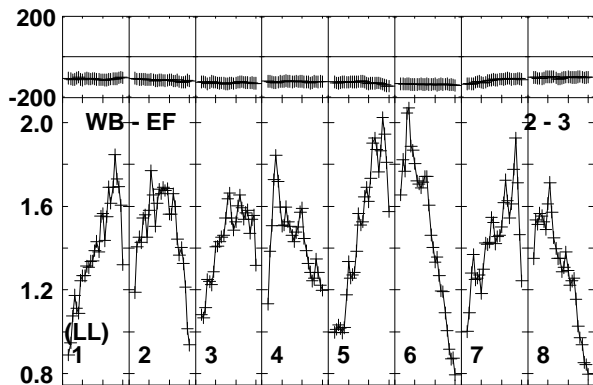
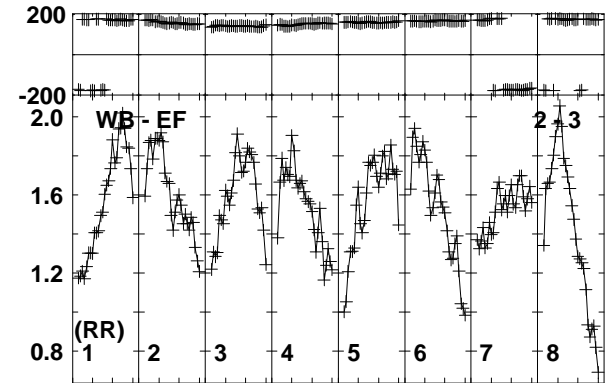
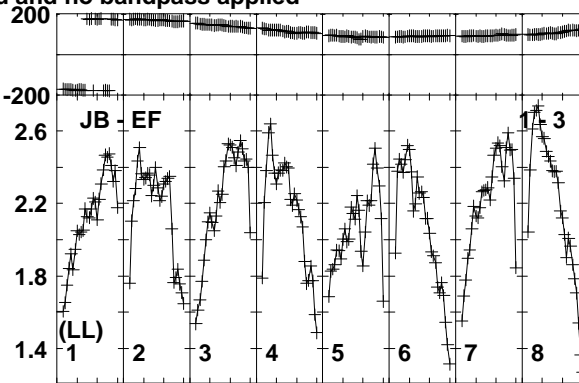
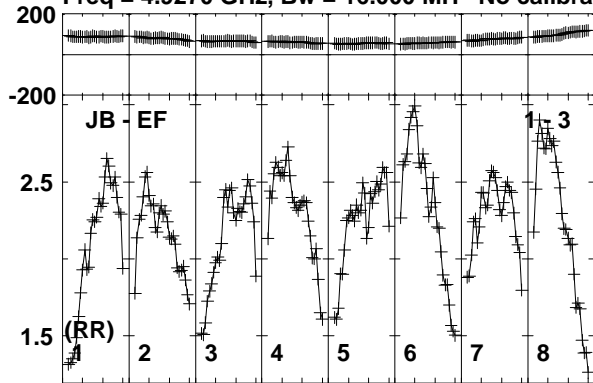

Lower frame: Milli Ampl Jy Top frame: Phas deg
 Vector averaged cross-power spectrum Baseline: JB (01) - EF (03)
 Timerange: 00/08:29:21 to 00/08:31:19

Plot file version 467 created 17-FEB-2020 15:43:24

J1359+5544 EK047 2.UVDATA.1

Freq = 4.9270 GHz, Bw = 16.000 MH No calibration applied and no bandpass applied

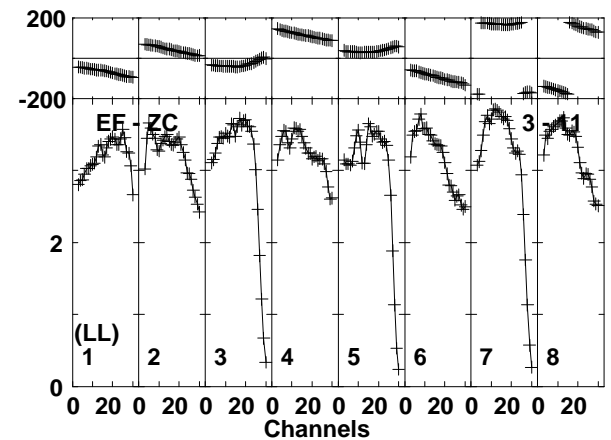
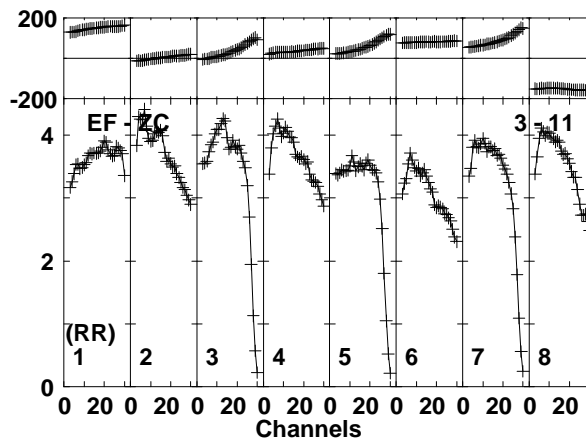
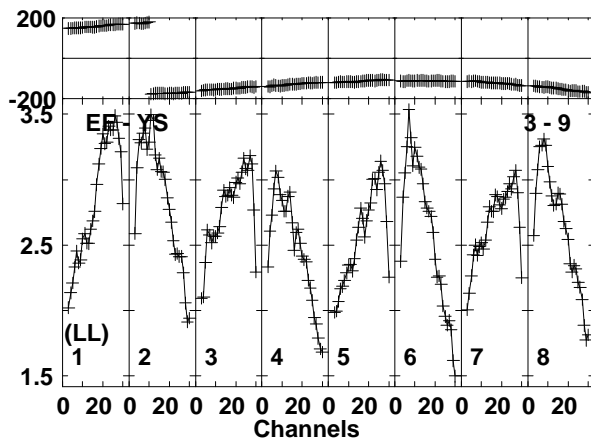
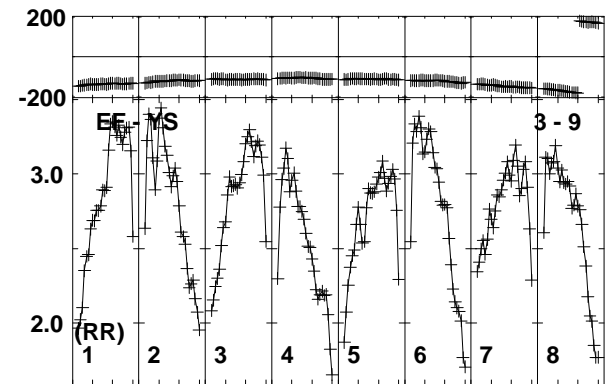
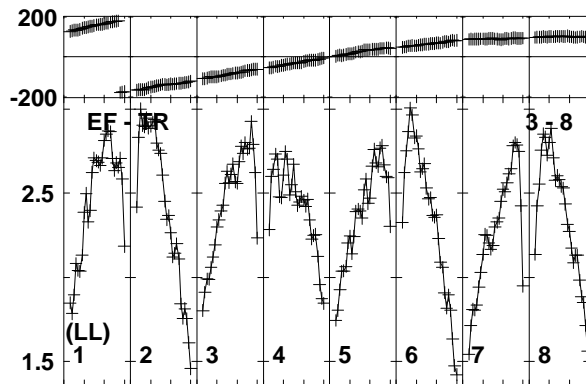
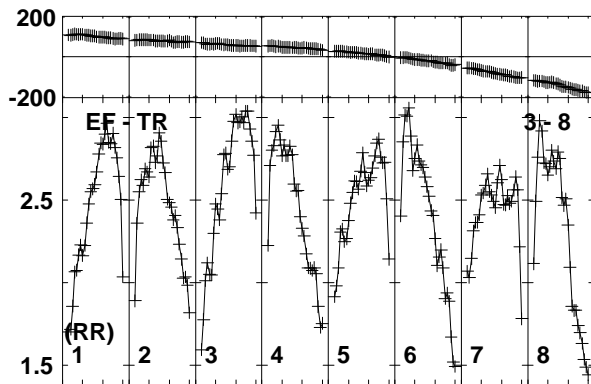
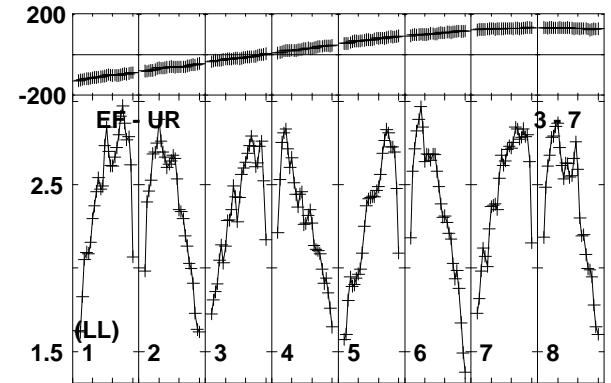
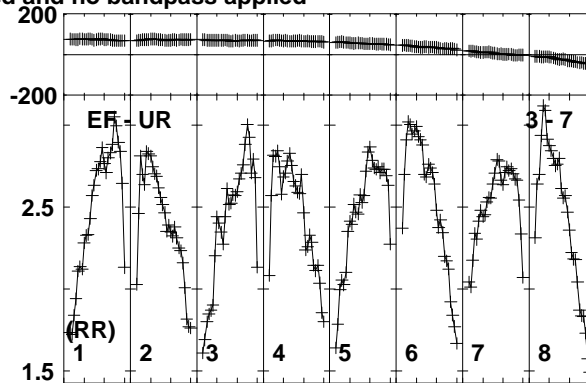
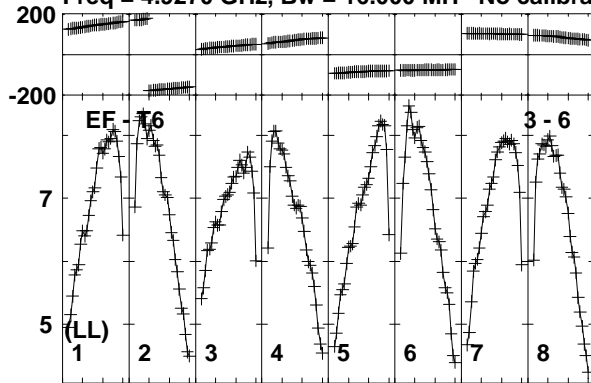

Lower frame: Milli Ampl Jy Top frame: Phas deg
Vector averaged cross-power spectrum Baseline: EF (03) - T6 (06)
Timerange: 00/08:29:21 to 00/08:31:19

Plot file version 468 created 17-FEB-2020 15:43:25

J1359+5544 EK047 2.UVDATA.1

Freq = 4.9270 GHz, Bw = 16.000 MH No calibration applied and no bandpass applied

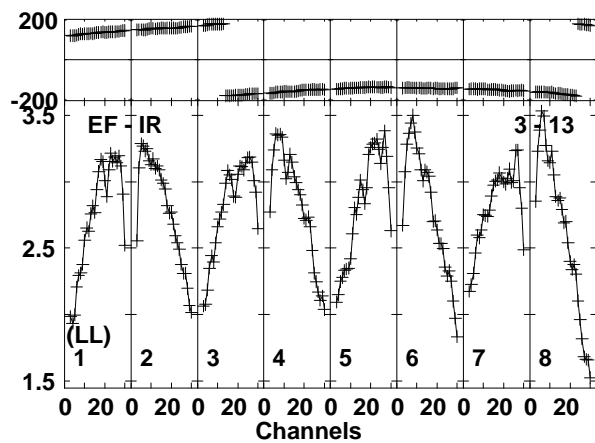
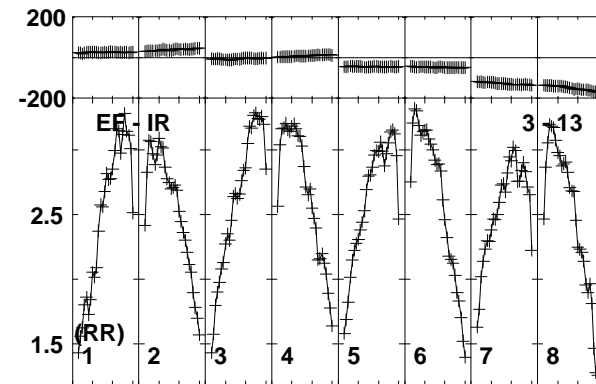
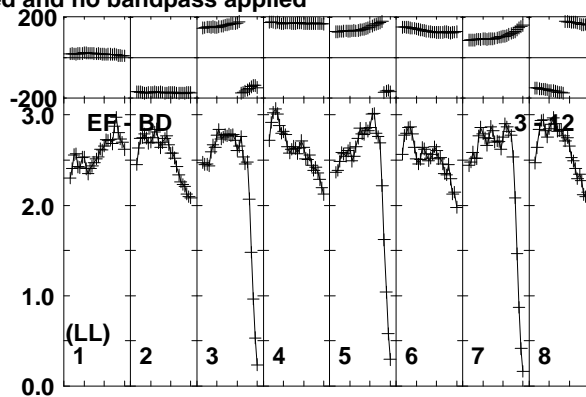
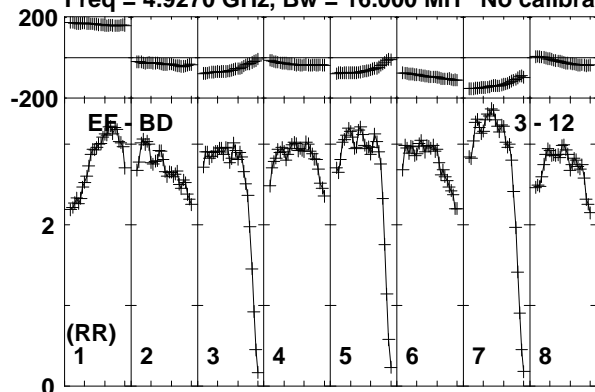

Lower frame: Milli Ampl Jy Top frame: Phas deg
Vector averaged cross-power spectrum Baseline: EF (03) - BD (12)
Timerange: 00/08:29:21 to 00/08:31:19

Plot file version 469 created 17-FEB-2020 15:43:25

J1402+5347 EK047 2.UVDATA.1

Freq = 4.9270 GHz, Bw = 16.000 MH No calibration applied and no bandpass applied

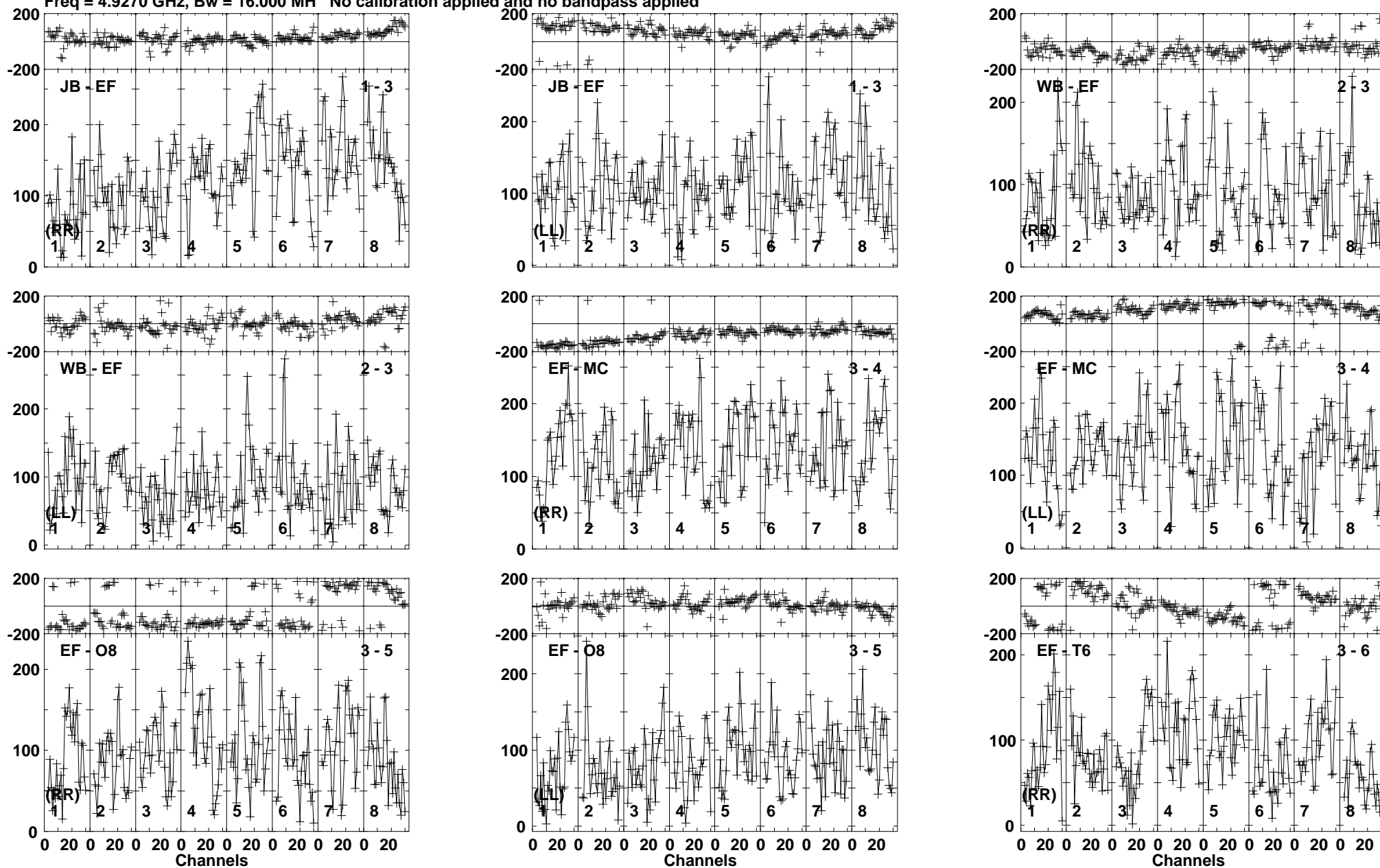

Lower frame: Micro Ampl Jy Top frame: Phas deg
Vector averaged cross-power spectrum Baseline: JB (01) - EF (03)
Timerange: 00/08:31:23 to 00/08:35:19

Plot file version 470 created 17-FEB-2020 15:43:25

J1402+5347 EK047 2.UVDATA.1

Freq = 4.9270 GHz, Bw = 16.000 MH No calibration applied and no bandpass applied

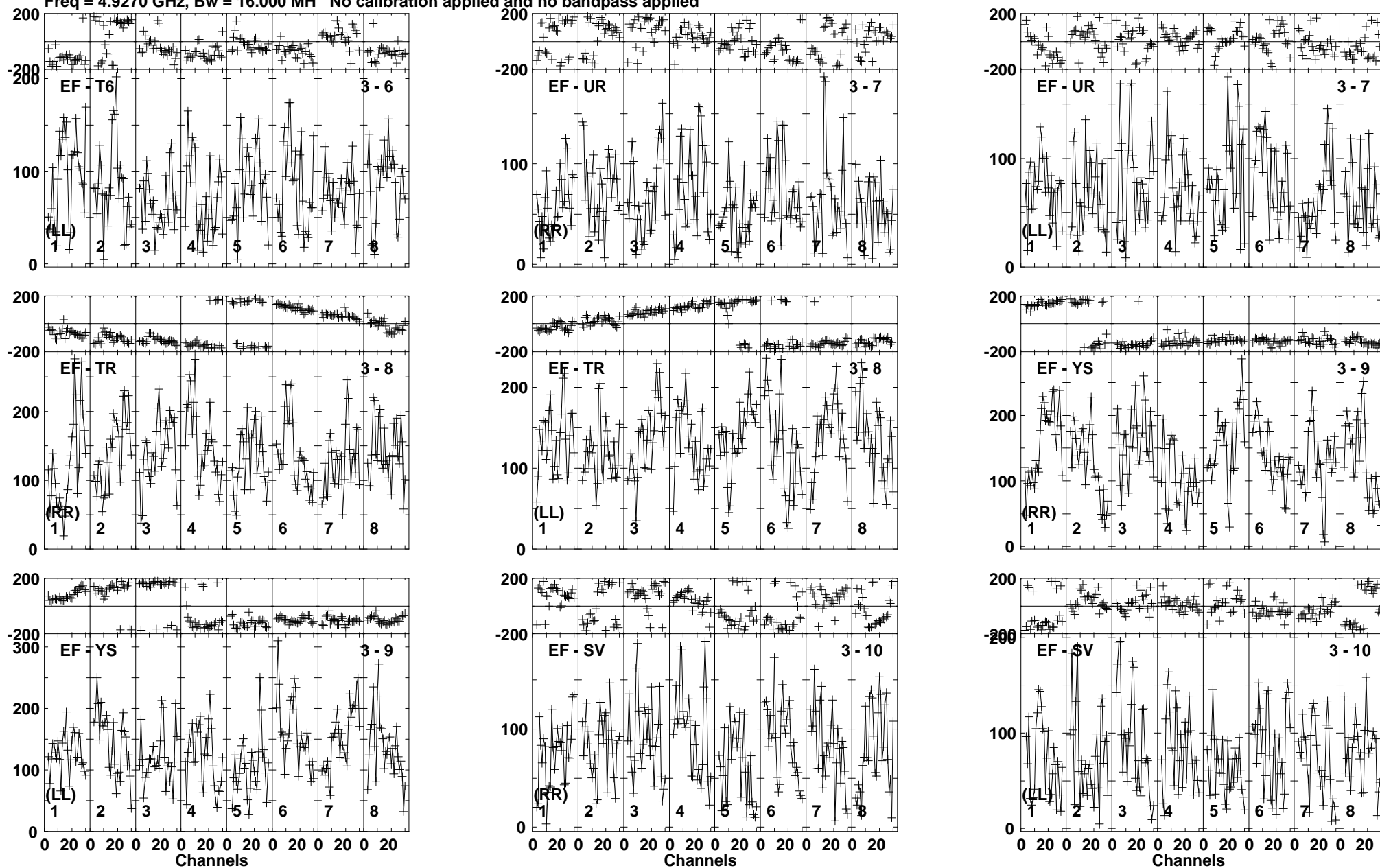

Lower frame: Micro Ampl Jy Top frame: Phas deg
Vector averaged cross-power spectrum Baseline: EF (03) - T6 (06)
Timerange: 00/08:31:23 to 00/08:35:19

Plot file version 471 created 17-FEB-2020 15:43:25

J1402+5347 EK047 2.UVDATA.1

Freq = 4.9270 GHz, Bw = 16.000 MH No calibration applied and no bandpass applied

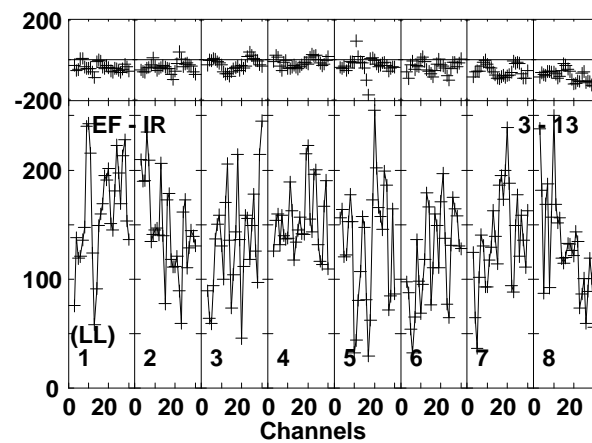
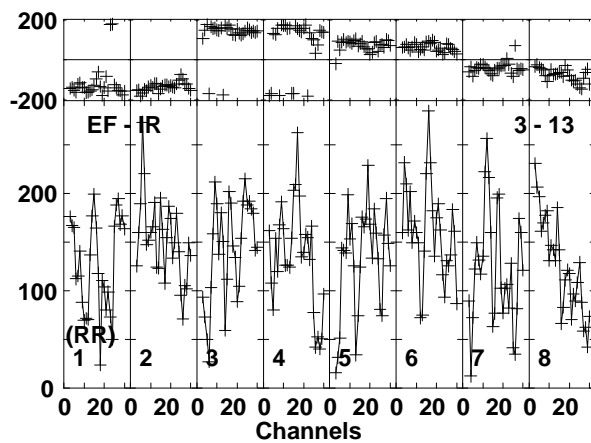
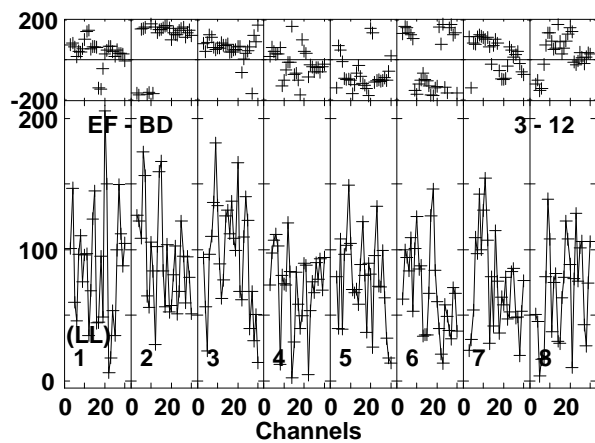
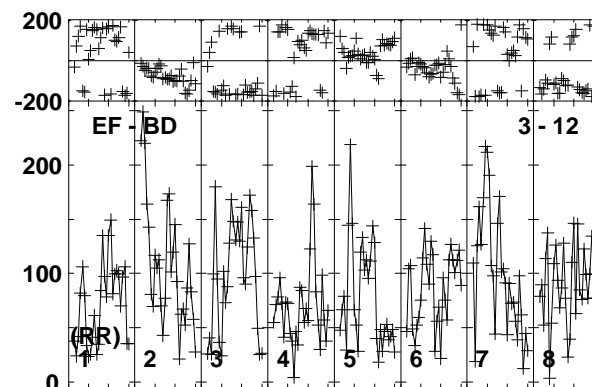
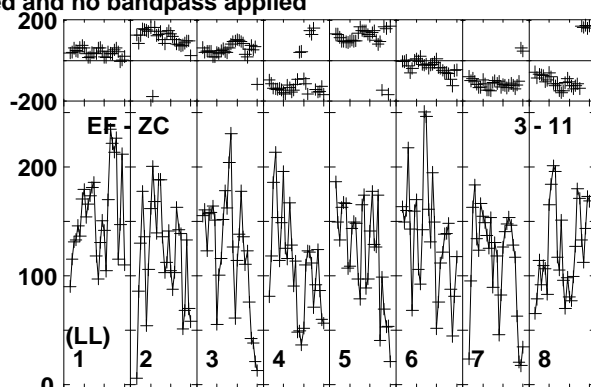
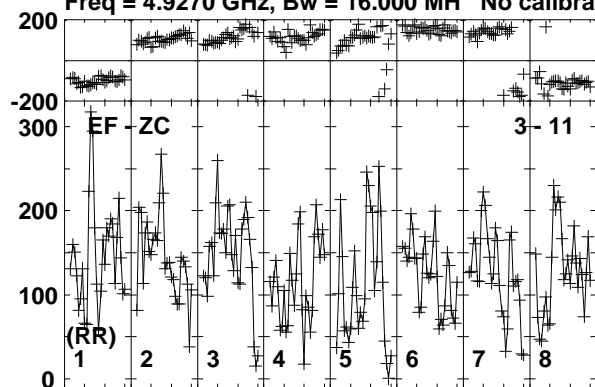

Lower frame: Micro Ampl Jy Top frame: Phas deg
Vector averaged cross-power spectrum Baseline: EF (03) - ZC (11)
Timerange: 00/08:31:23 to 00/08:35:19

Plot file version 472 created 17-FEB-2020 15:43:25

J1359+5544 EK047 2.UVDATA.1

Freq = 4.9270 GHz, Bw = 16.000 MH No calibration applied and no bandpass applied

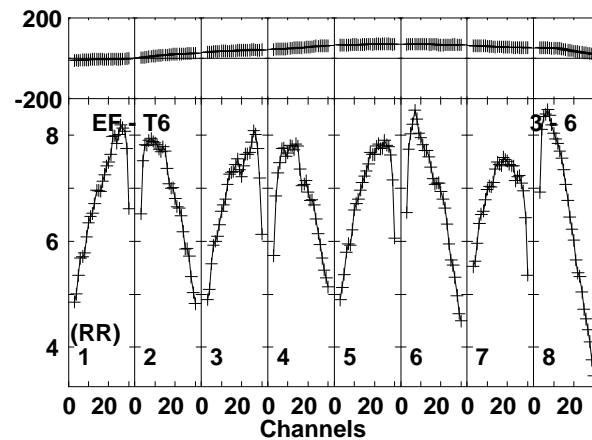
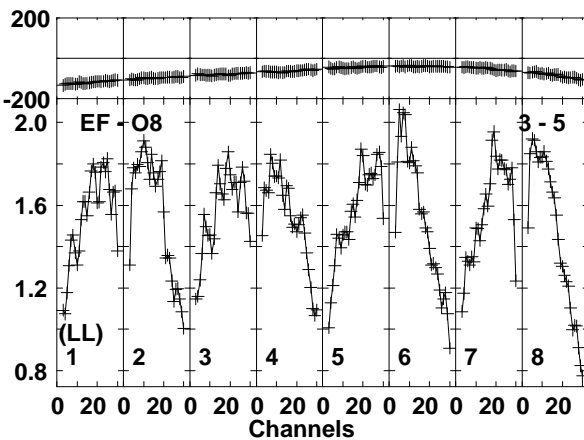
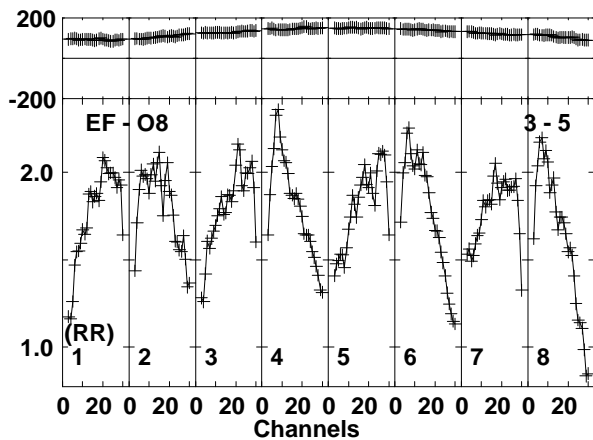
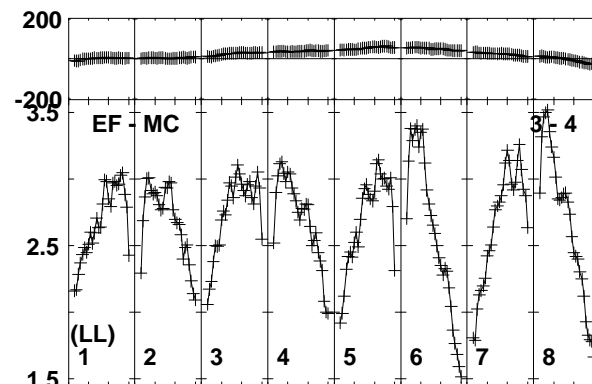
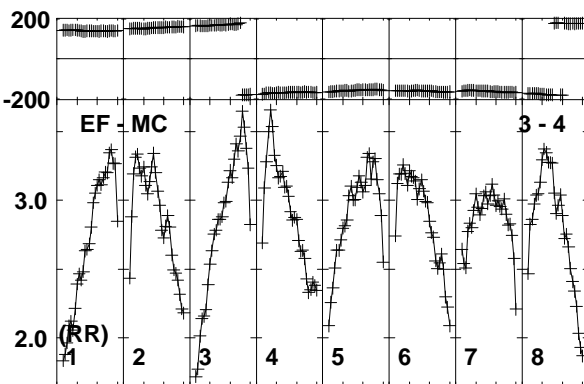
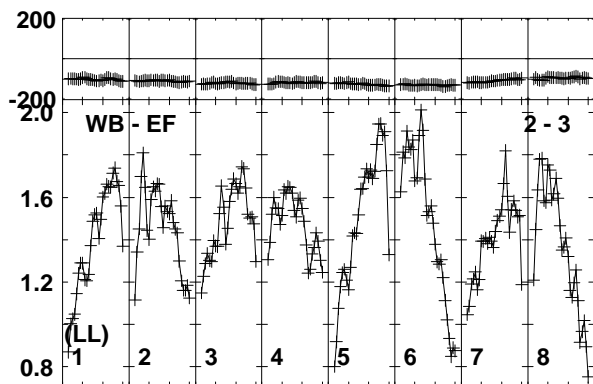
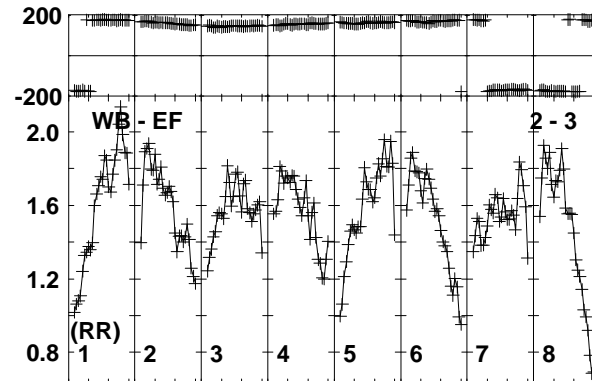
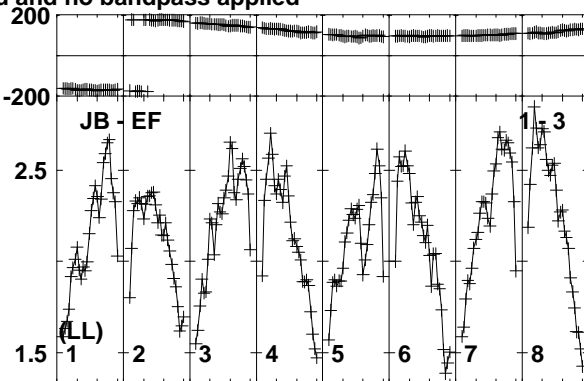
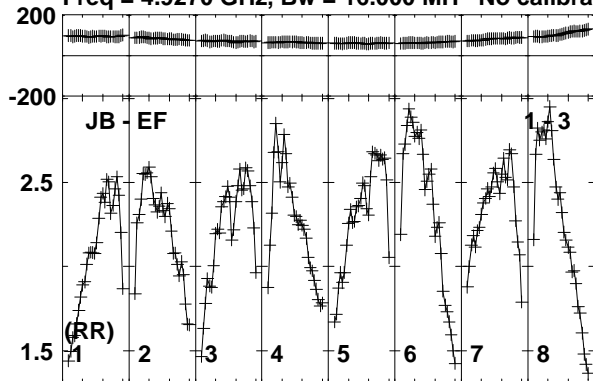

Lower frame: Milli Ampl Jy Top frame: Phas deg
Vector averaged cross-power spectrum Baseline: JB (01) - EF (03)
Timerange: 00/08:36:01 to 00/08:37:19

Plot file version 473 created 17-FEB-2020 15:43:25

J1359+5544 EK047 2.UVDATA.1

Freq = 4.9270 GHz, Bw = 16.000 MH No calibration applied and no bandpass applied

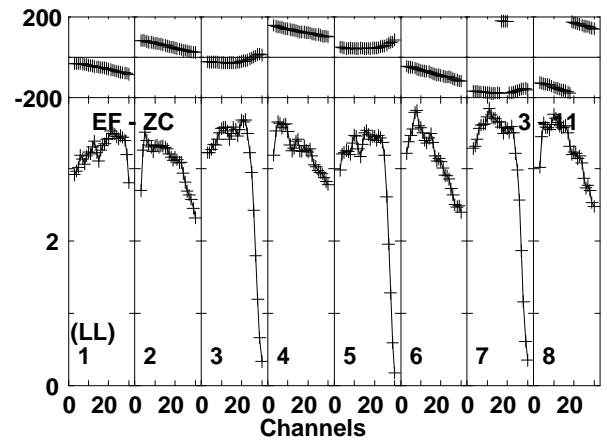
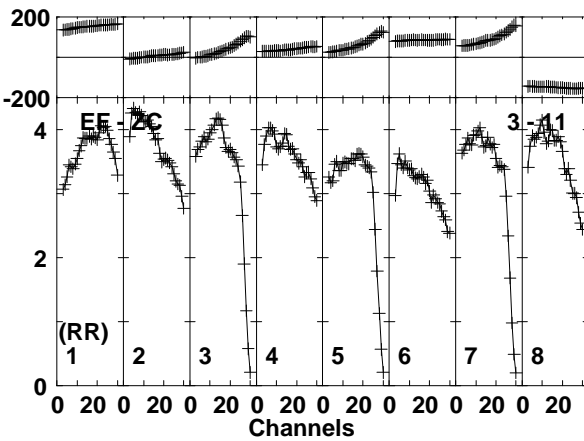
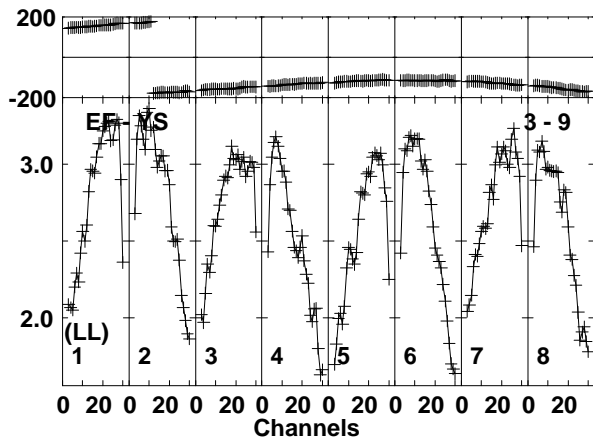
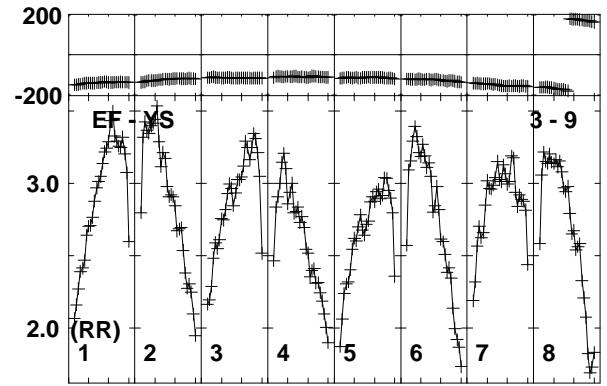
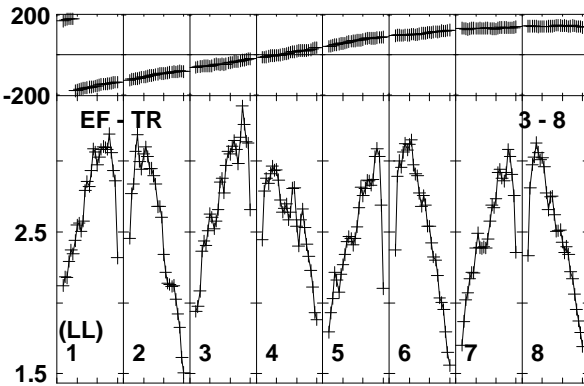
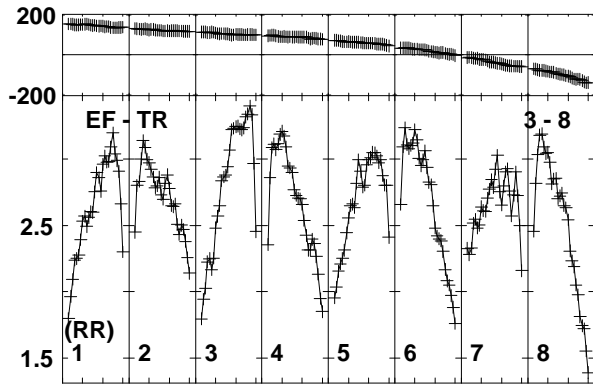
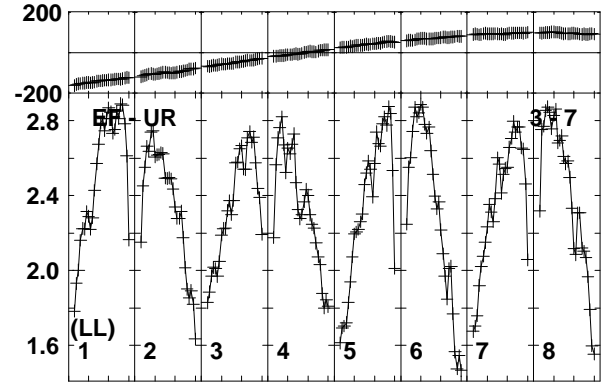
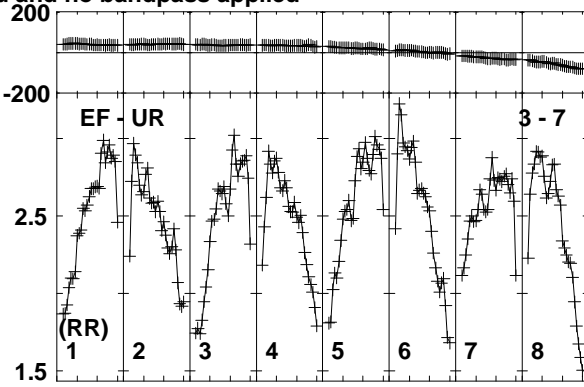
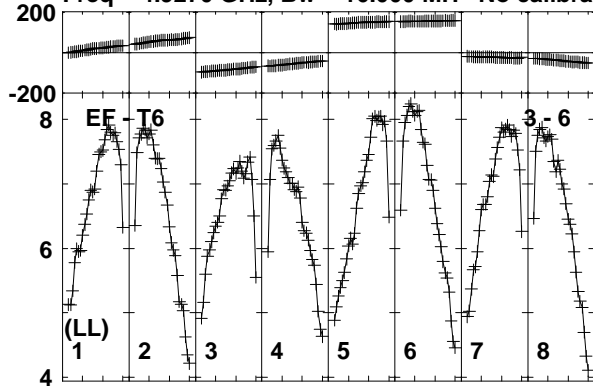

Lower frame: Milli Ampl Jy Top frame: Phas deg
Vector averaged cross-power spectrum Baseline: EF (03) - T6 (06)
Timerange: 00/08:36:01 to 00/08:37:19

Plot file version 474 created 17-FEB-2020 15:43:25

J1359+5544 EK047 2.UVDATA.1

Freq = 4.9270 GHz, Bw = 16.000 MH No calibration applied and no bandpass applied

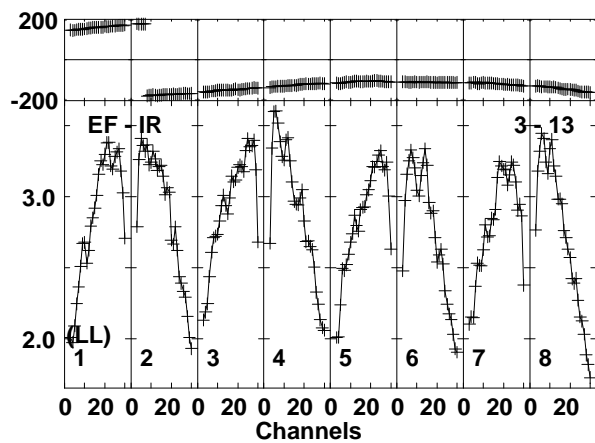
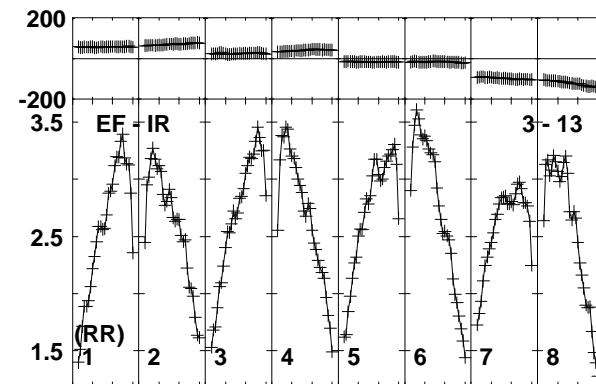
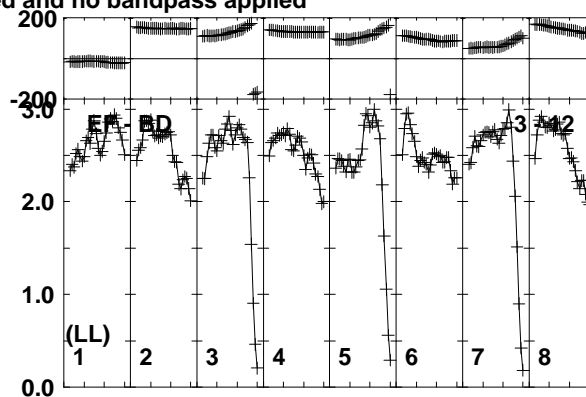
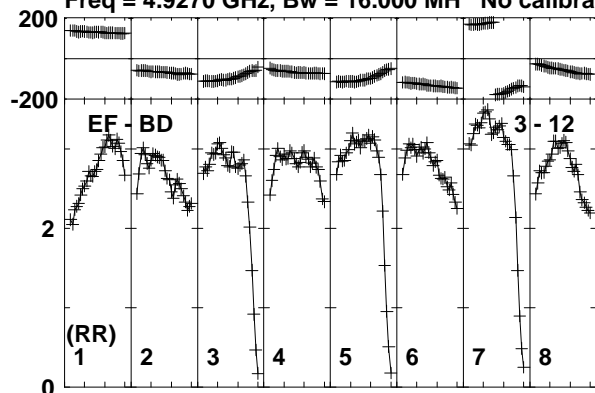

Lower frame: Milli Ampl Jy Top frame: Phas deg
Vector averaged cross-power spectrum Baseline: EF (03) - BD (12)
Timerange: 00/08:36:01 to 00/08:37:19

Plot file version 475 created 17-FEB-2020 15:43:25

J1402+5347 EK047 2.UVDATA.1

Freq = 4.9270 GHz, Bw = 16.000 MH No calibration applied and no bandpass applied

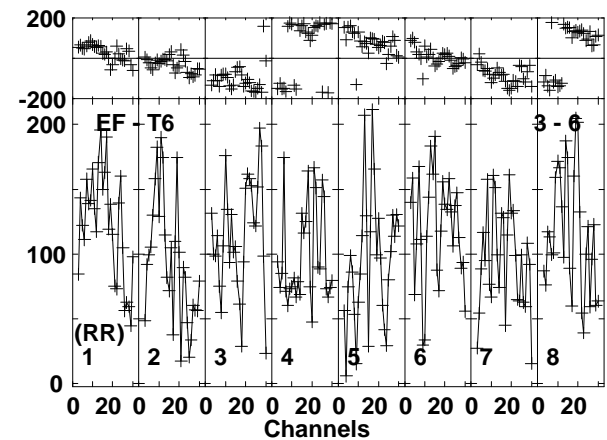
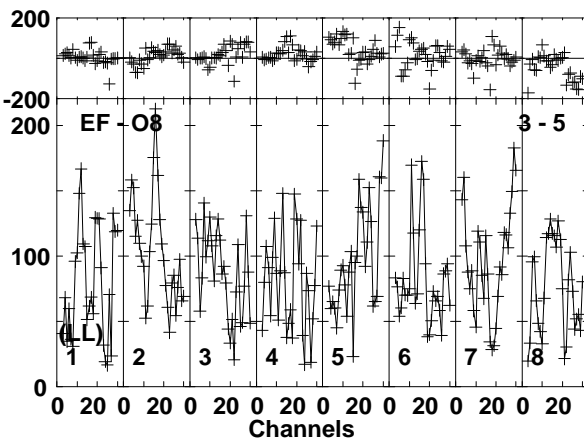
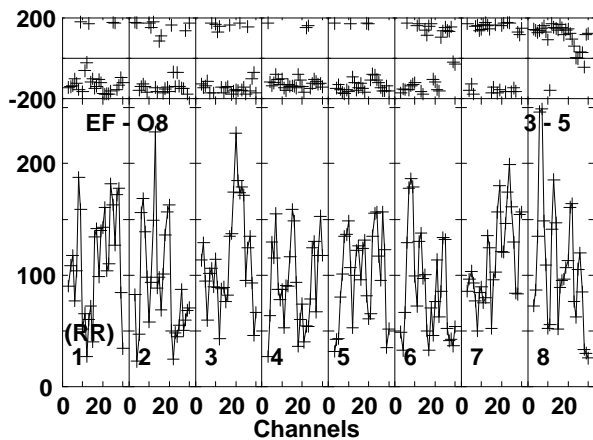
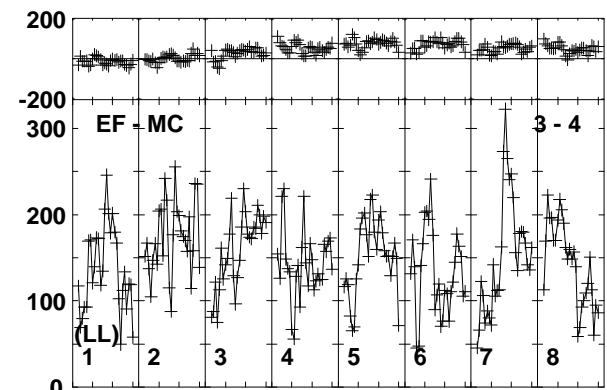
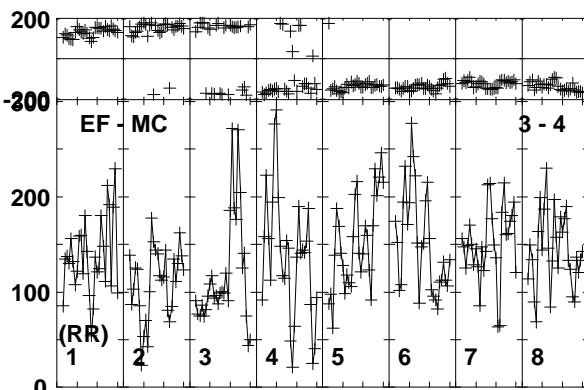
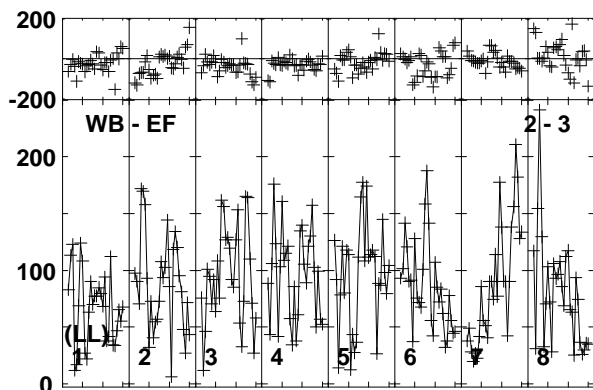
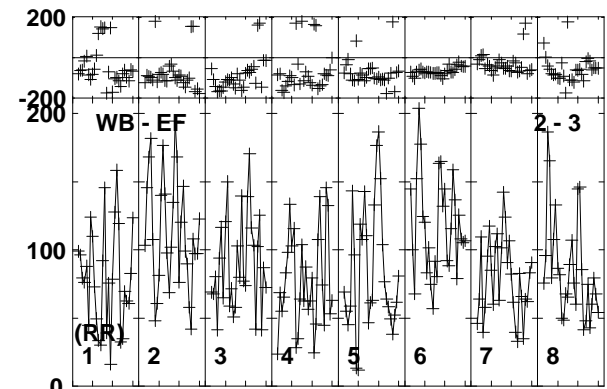
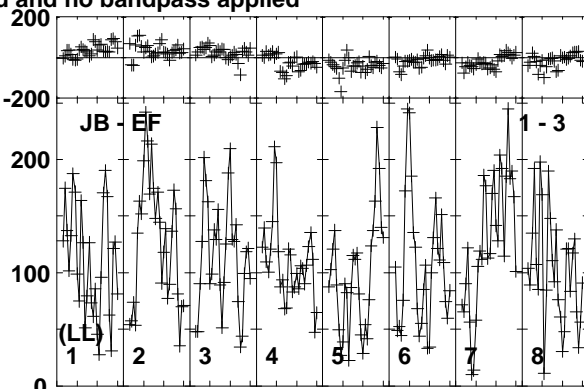
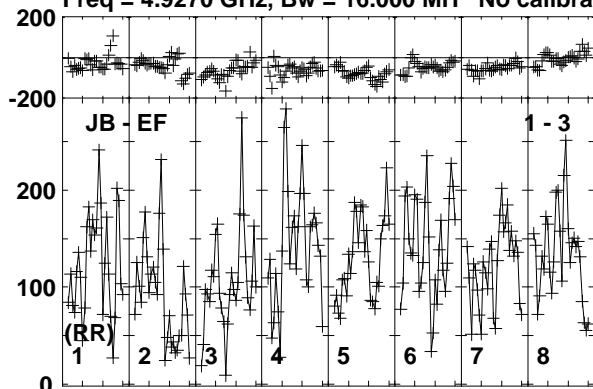

Lower frame: Micro Ampl Jy Top frame: Phas deg
Vector averaged cross-power spectrum Baseline: JB (01) - EF (03)
Timerange: 00/08:37:21 to 00/08:41:19

Plot file version 476 created 17-FEB-2020 15:43:25

J1402+5347 EK047 2.UVDATA.1

Freq = 4.9270 GHz, Bw = 16.000 MH No calibration applied and no bandpass applied

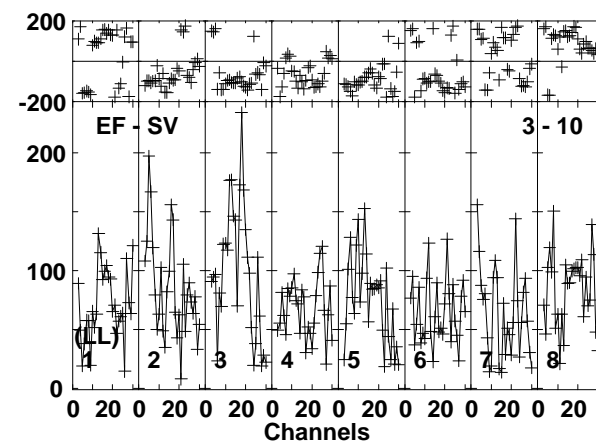
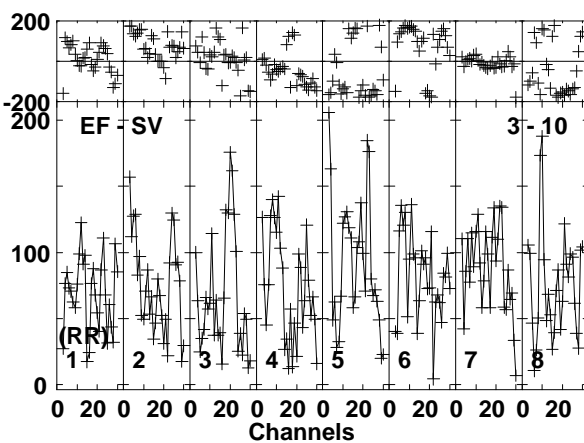
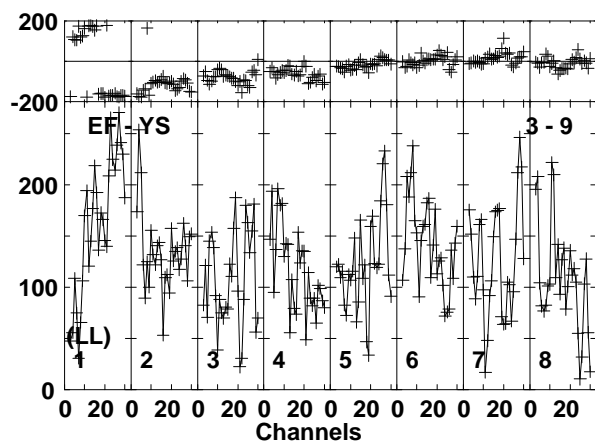
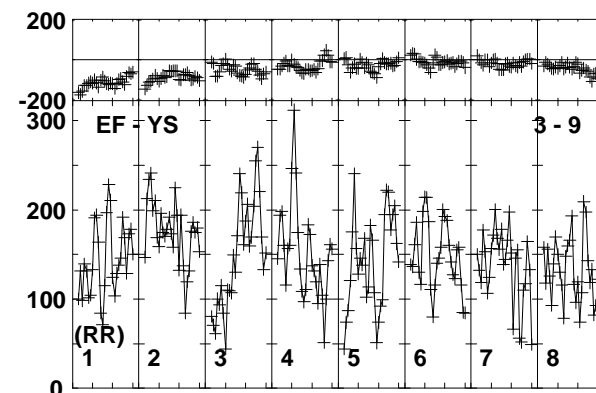
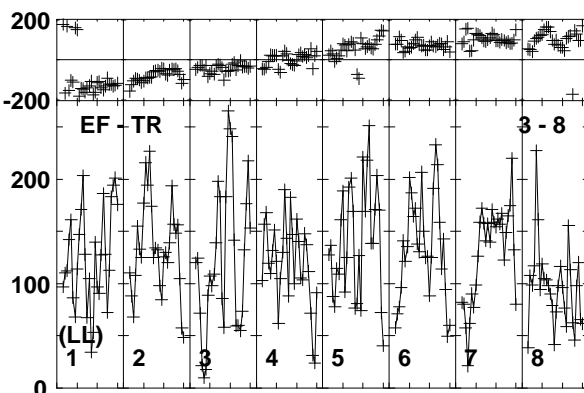
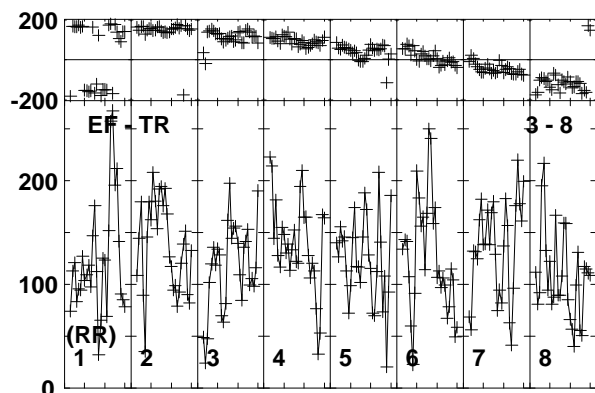
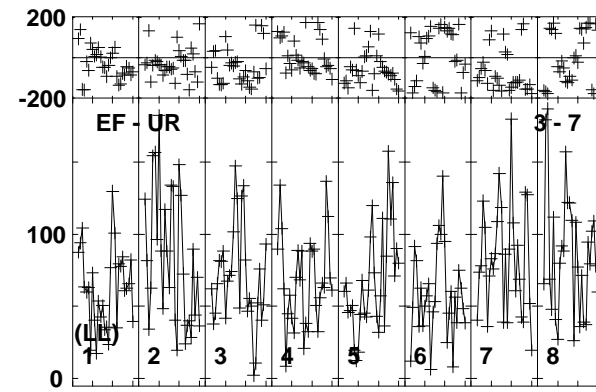
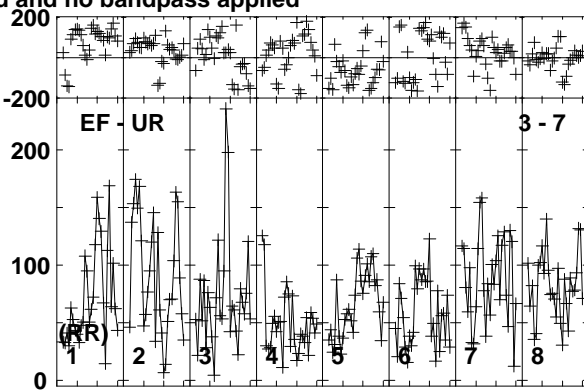
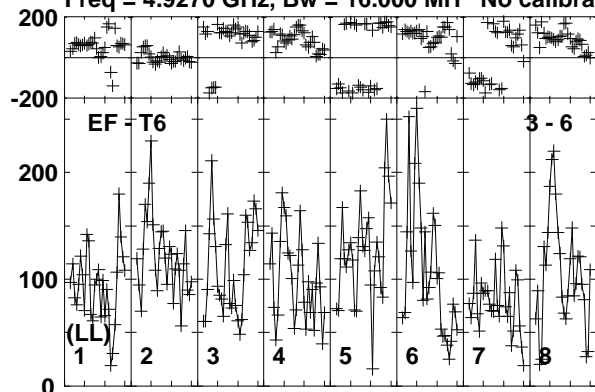

Lower frame: Micro Ampl Jy Top frame: Phas deg
Vector averaged cross-power spectrum Baseline: EF (03) - T6 (06)
Timerange: 00/08:37:21 to 00/08:41:19

Plot file version 477 created 17-FEB-2020 15:43:25

J1402+5347 EK047 2.UVDATA.1

Freq = 4.9270 GHz, Bw = 16.000 MH No calibration applied and no bandpass applied

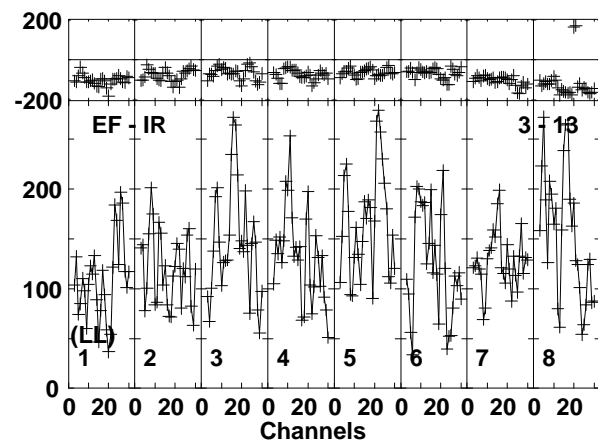
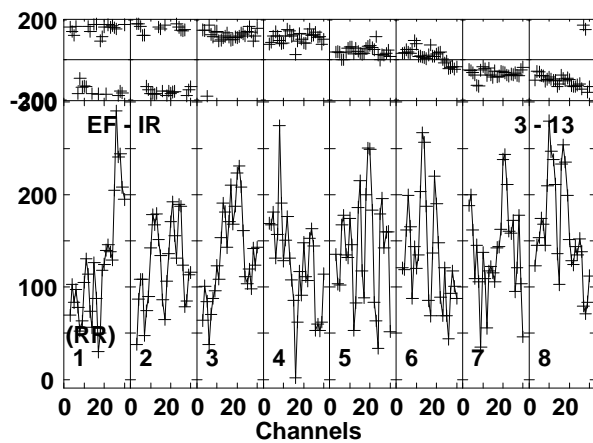
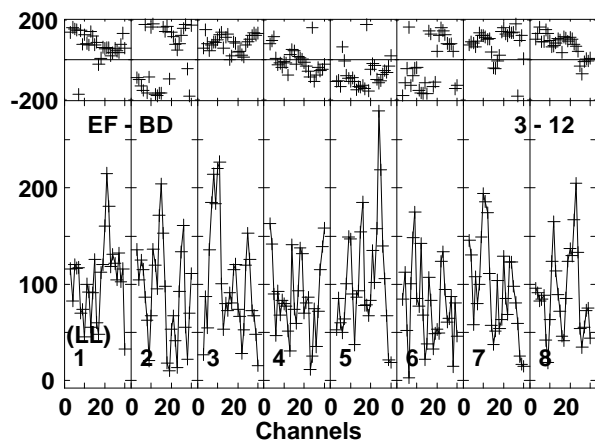
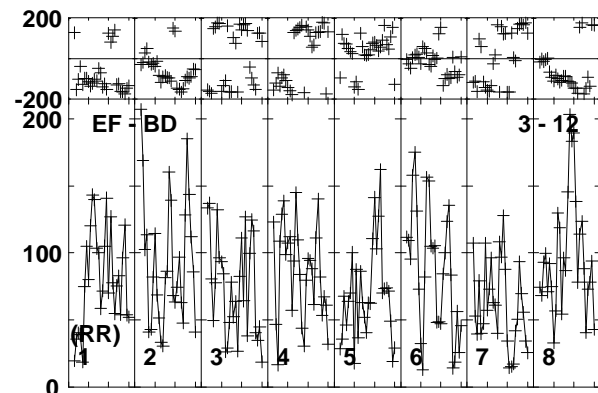
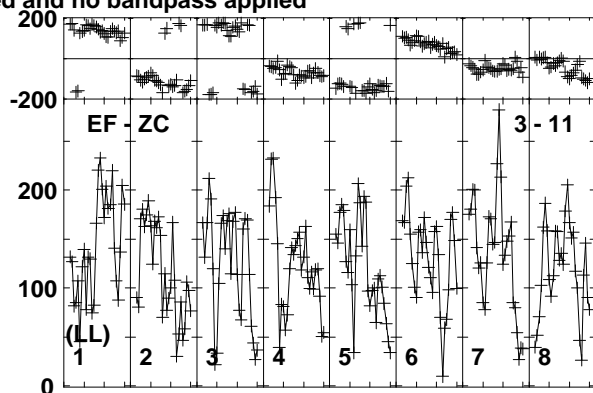
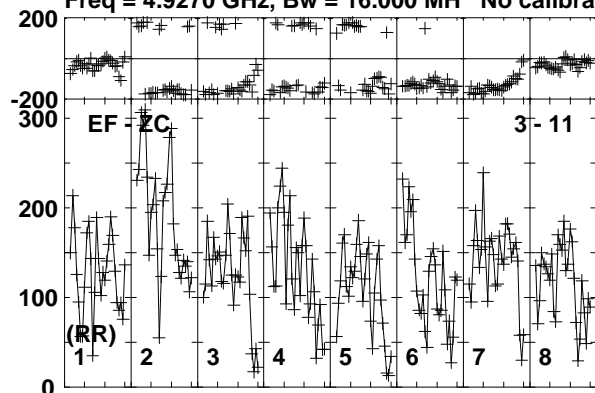

Lower frame: Micro Ampl Jy Top frame: Phas deg
Vector averaged cross-power spectrum Baseline: EF (03) - ZC (11)
Timerange: 00/08:37:21 to 00/08:41:19

Plot file version 478 created 17-FEB-2020 15:43:26

J1359+5544 EK047 2.UVDATA.1

Freq = 4.9270 GHz, Bw = 16.000 MH No calibration applied and no bandpass applied

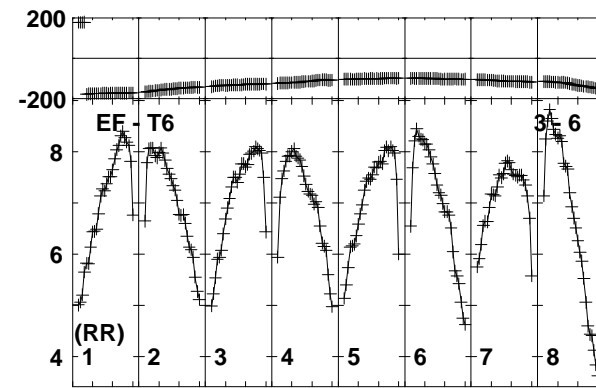
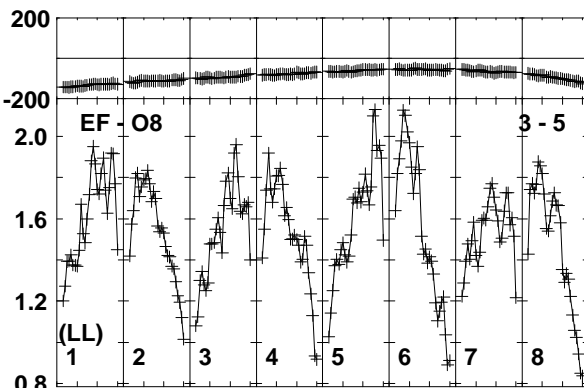
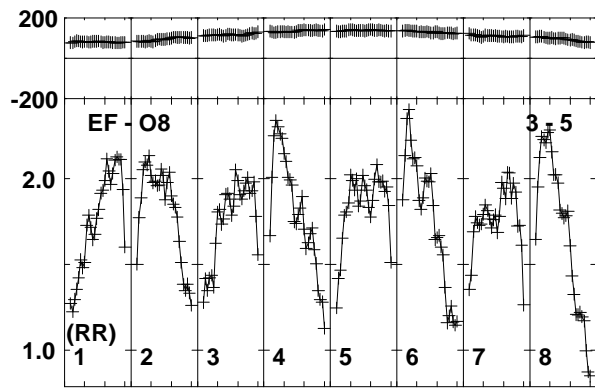
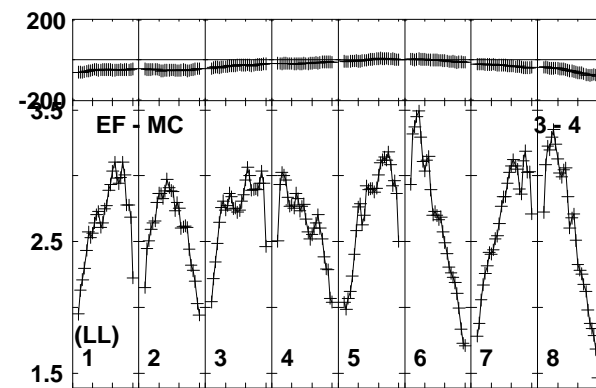
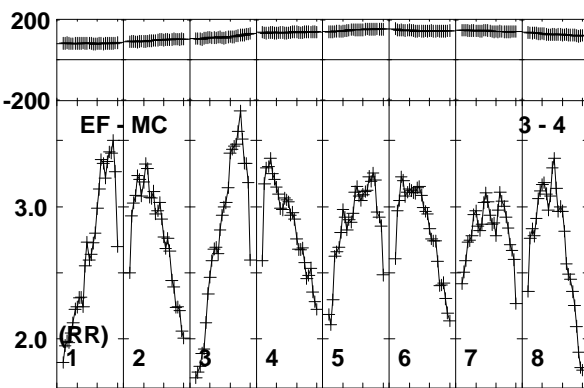
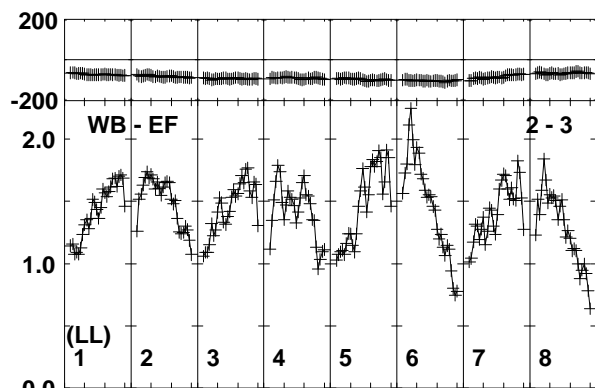
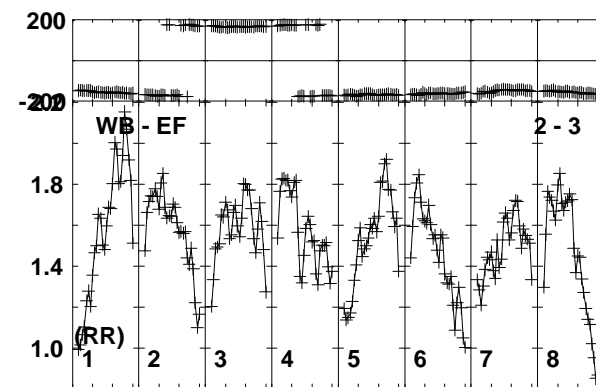
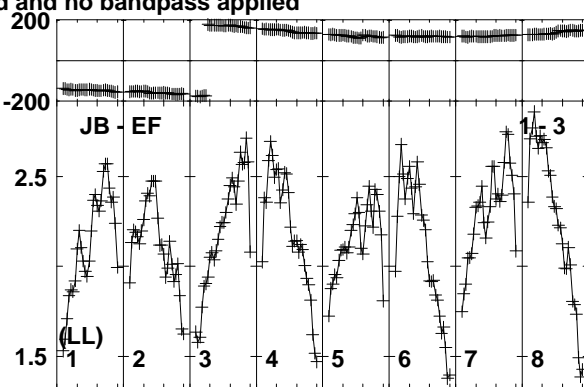
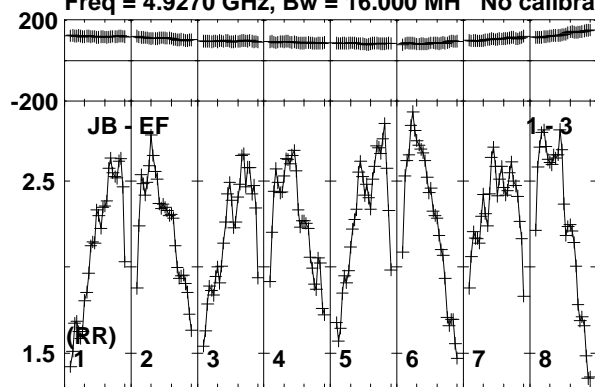

Lower frame: Milli Ampl Jy Top frame: Phas deg
Vector averaged cross-power spectrum Baseline: JB (01) - EF (03)
Timerange: 00/08:41:21 to 00/08:43:19

Plot file version 479 created 17-FEB-2020 15:43:26

J1359+5544 EK047 2.UVDATA.1

Freq = 4.9270 GHz, Bw = 16.000 MH No calibration applied and no bandpass applied

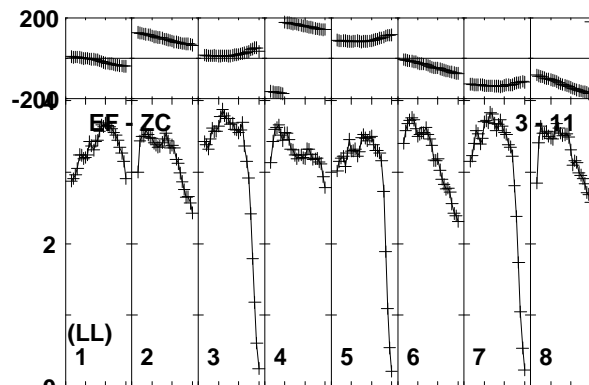
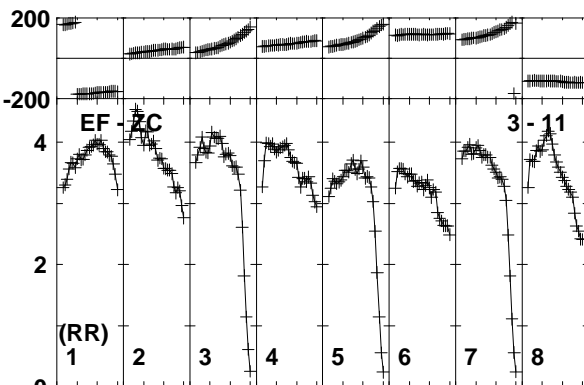
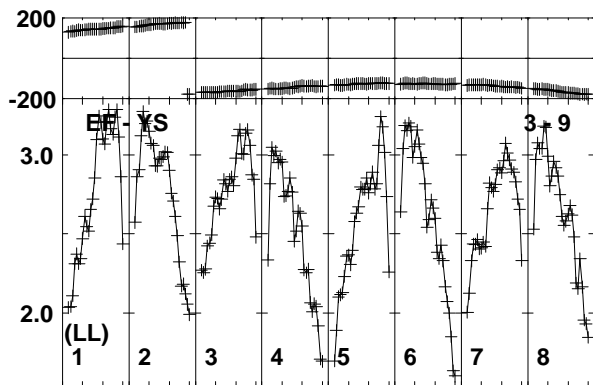
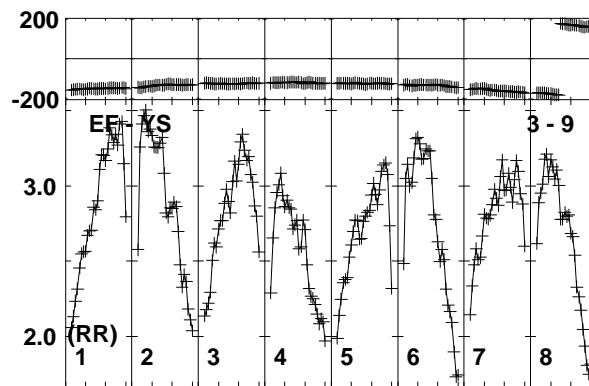
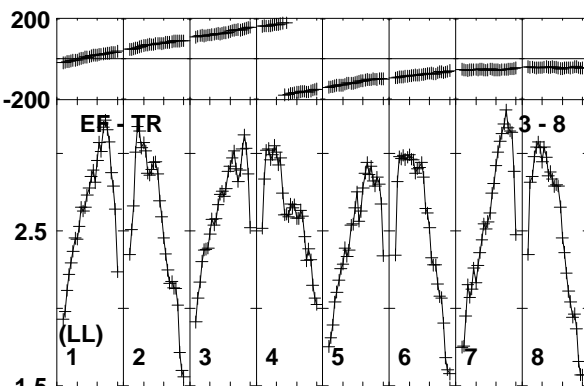
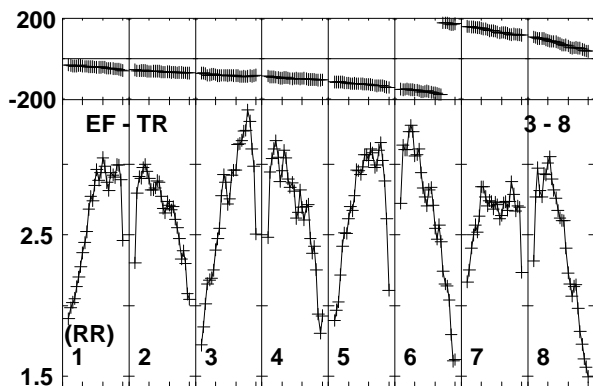
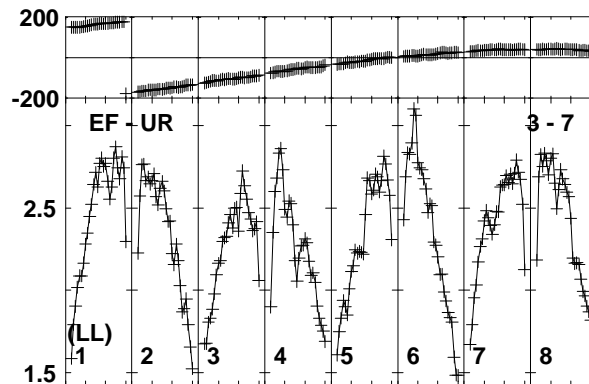
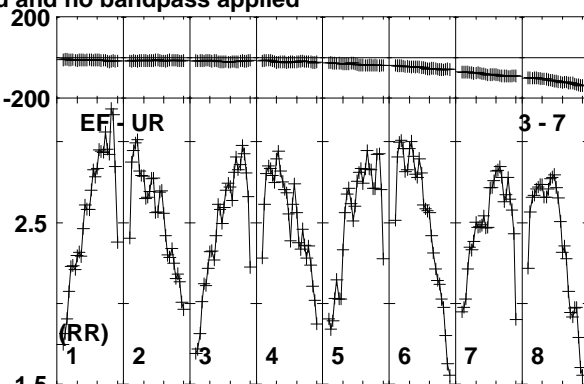
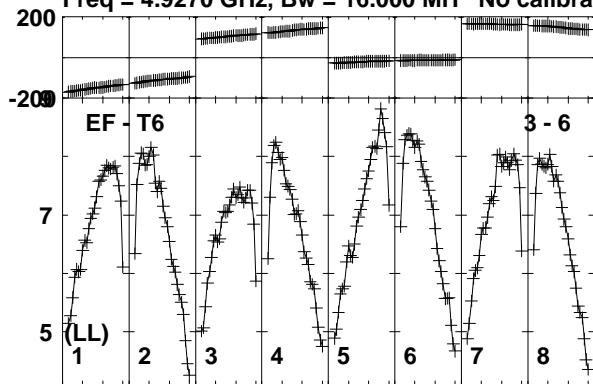

Lower frame: Milli Ampl Jy Top frame: Phas deg
Vector averaged cross-power spectrum Baseline: EF (03) - T6 (06)
Timerange: 00/08:41:21 to 00/08:43:19

Plot file version 480 created 17-FEB-2020 15:43:26

J1359+5544 EK047 2.UVDATA.1

Freq = 4.9270 GHz, Bw = 16.000 MH No calibration applied and no bandpass applied

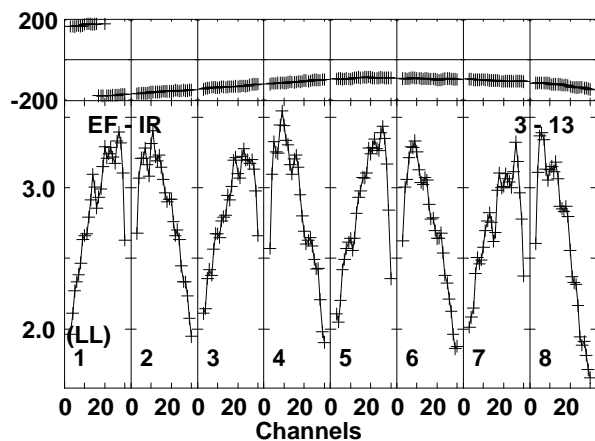
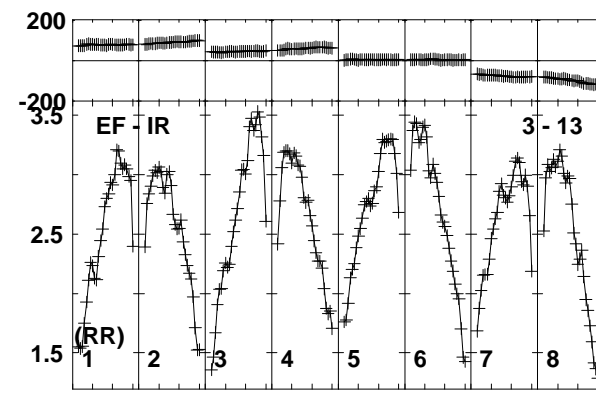
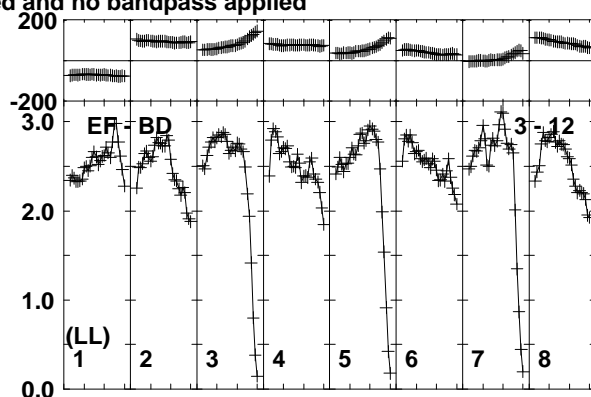
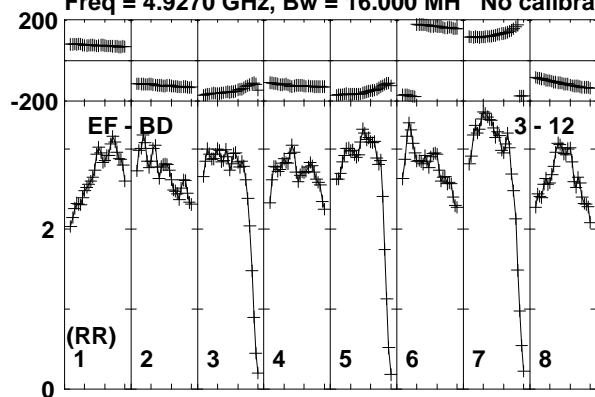

Lower frame: Milli Ampl Jy Top frame: Phas deg
Vector averaged cross-power spectrum Baseline: EF (03) - BD (12)
Timerange: 00/08:41:21 to 00/08:43:19

Plot file version 481 created 17-FEB-2020 15:43:26

J1402+5347 EK047 2.UVDATA.1

Freq = 4.9270 GHz, Bw = 16.000 MH No calibration applied and no bandpass applied

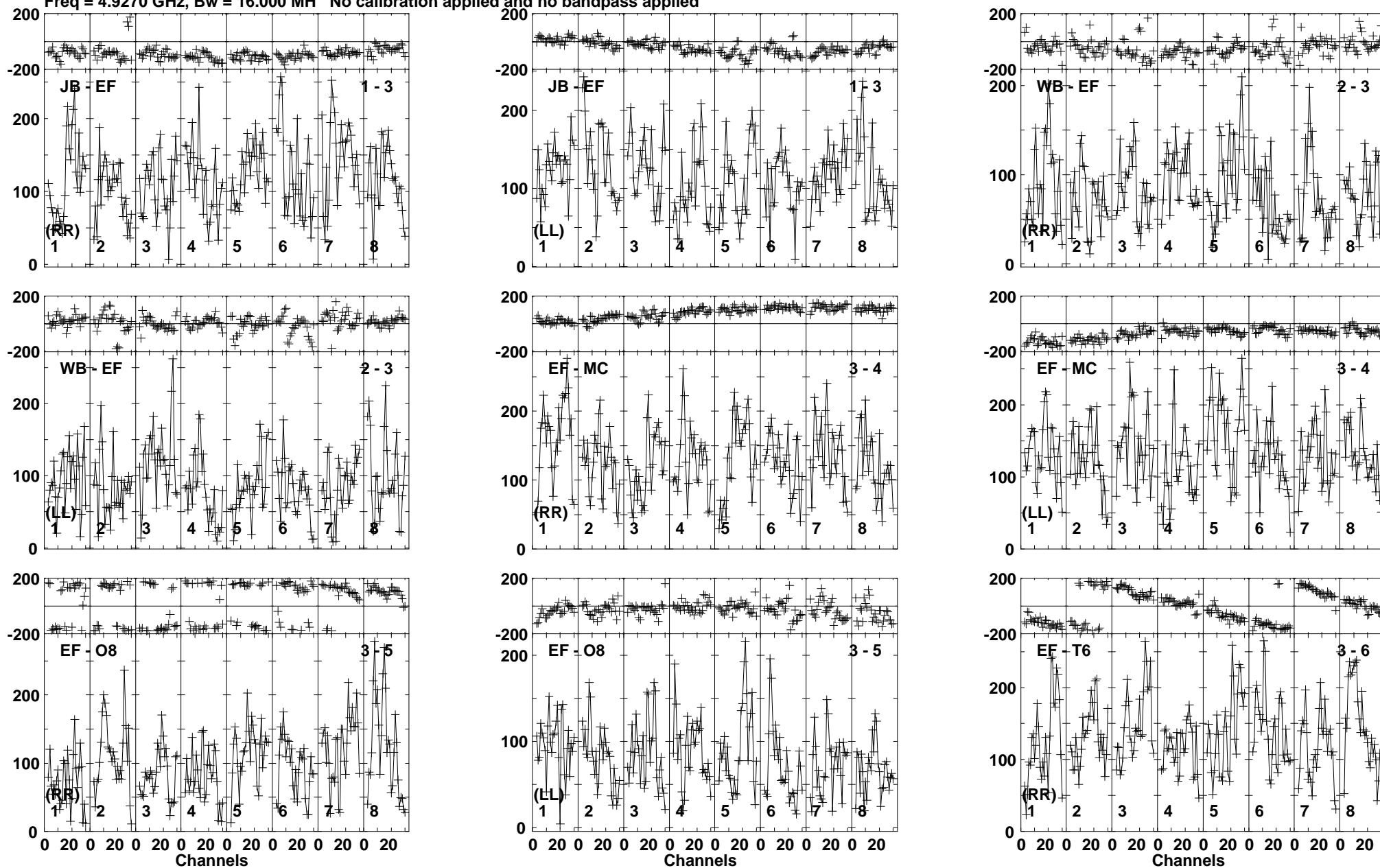

Lower frame: Micro Ampl Jy Top frame: Phas deg
Vector averaged cross-power spectrum Baseline: JB (01) - EF (03)
Timerange: 00/08:43:21 to 00/08:47:19

Plot file version 482 created 17-FEB-2020 15:43:26

J1402+5347 EK047 2.UVDATA.1

Freq = 4.9270 GHz, Bw = 16.000 MH No calibration applied and no bandpass applied

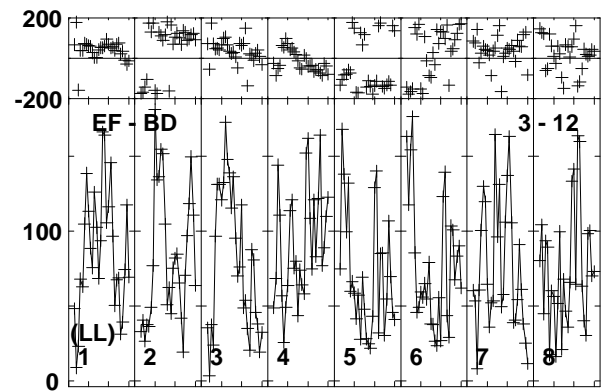
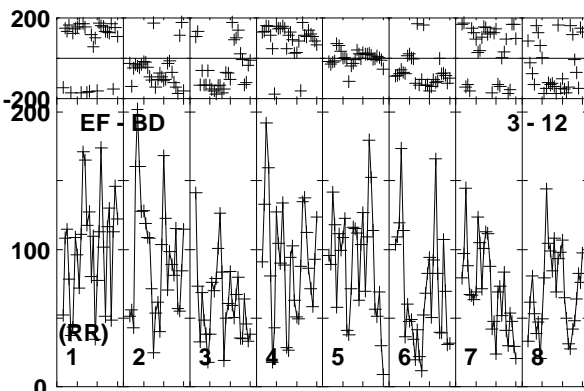
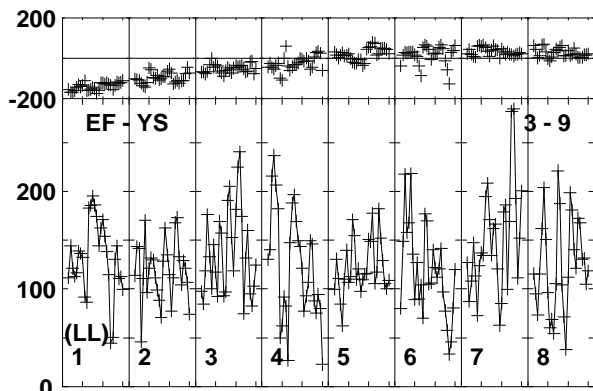
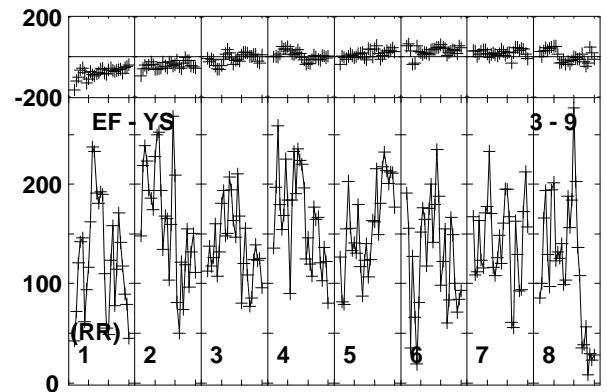
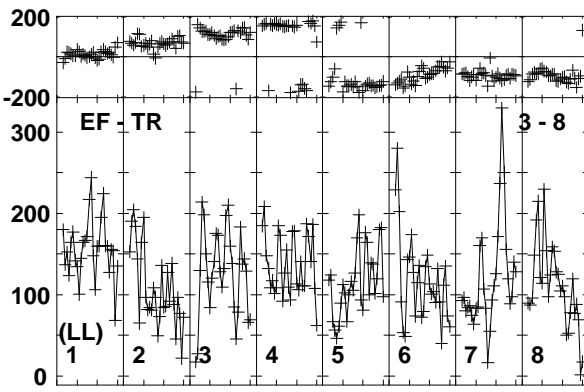
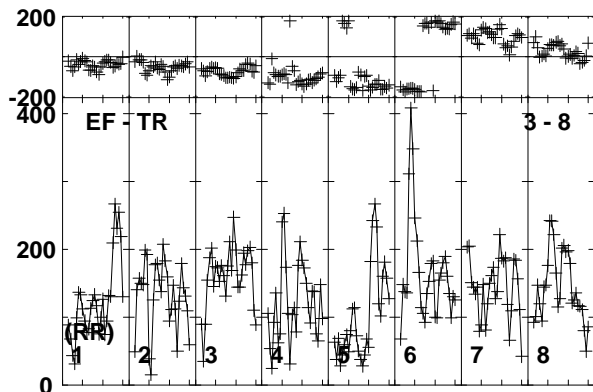
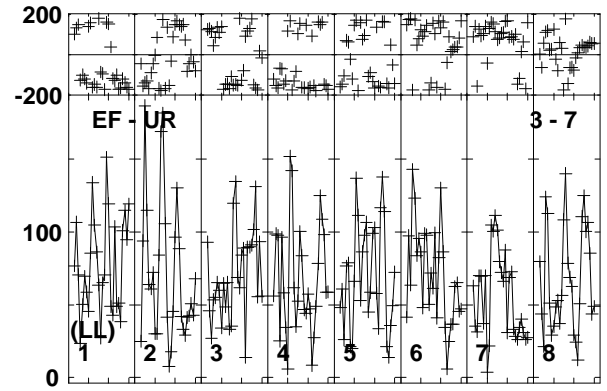
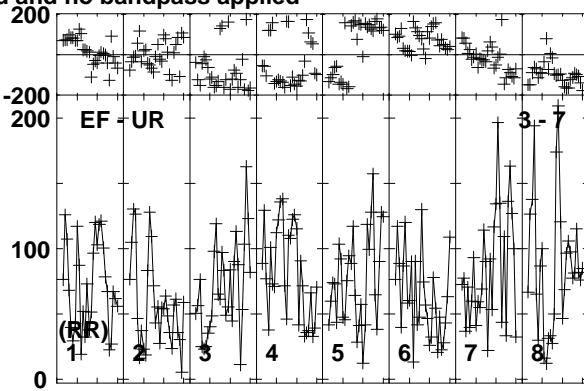
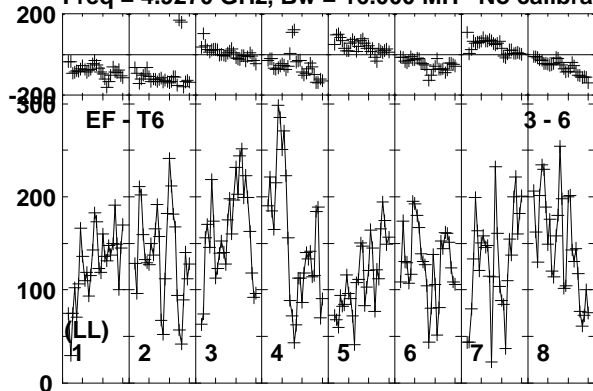

Lower frame: Micro Ampl Jy Top frame: Phas deg
Vector averaged cross-power spectrum Baseline: EF (03) - T6 (06)
Timerange: 00/08:43:21 to 00/08:47:19

Plot file version 483 created 17-FEB-2020 15:43:26

J1402+5347 EK047 2.UVDATA.1

Freq = 4.9270 GHz, Bw = 16.000 MH No calibration applied and no bandpass applied

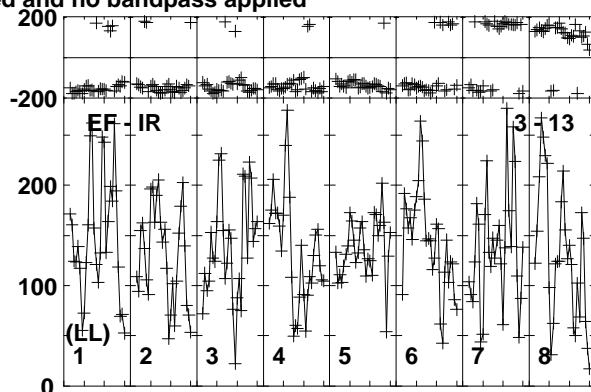
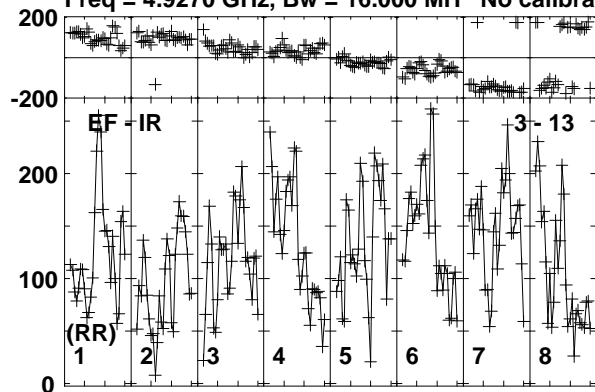

Lower frame: Micro Ampl Jy Top frame: Phas deg
Vector averaged cross-power spectrum Baseline: EF (03) - IR (13)
Timerange: 00/08:43:21 to 00/08:47:19

Plot file version 484 created 17-FEB-2020 15:43:26

J1359+5544 EK047 2.UVDATA.1

Freq = 4.9270 GHz, Bw = 16.000 MH No calibration applied and no bandpass applied

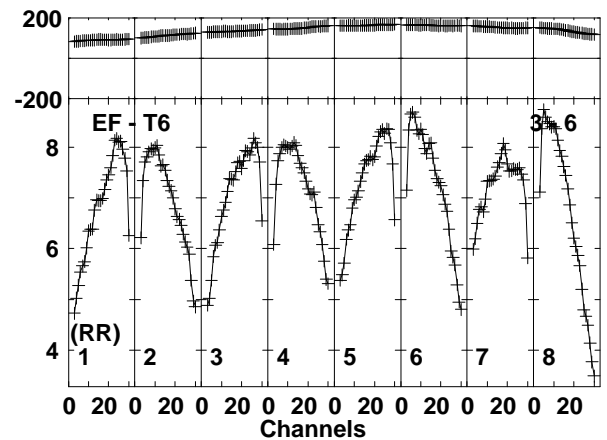
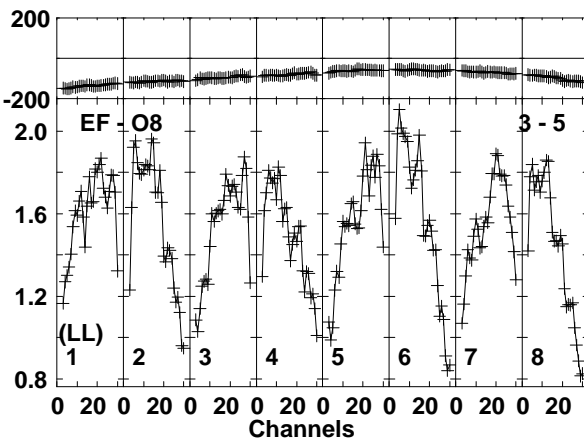
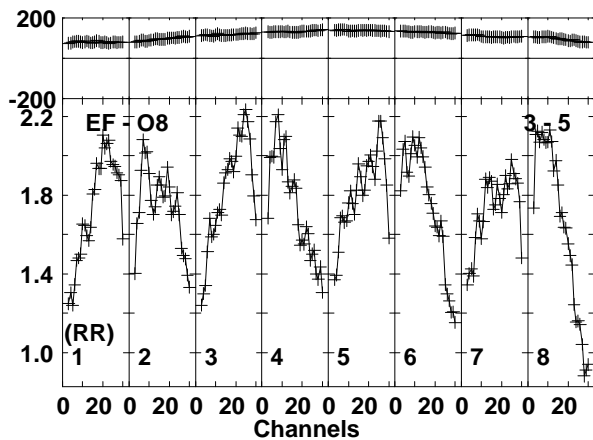
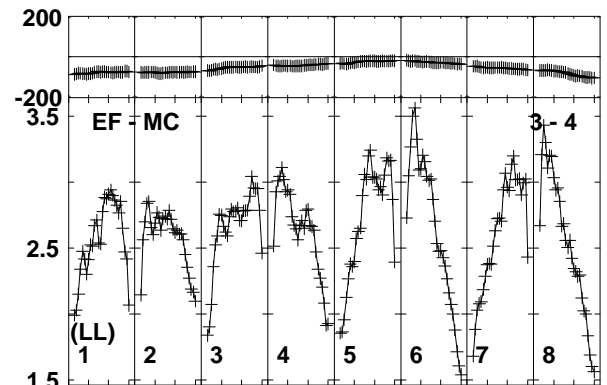
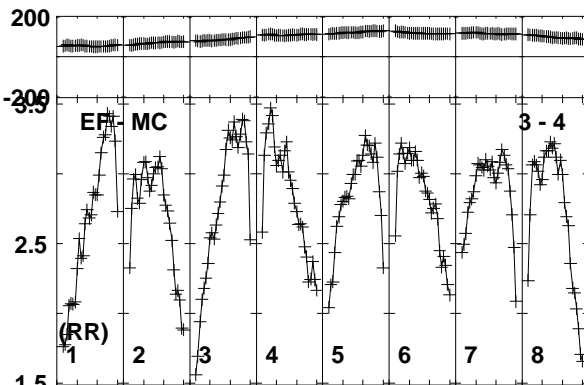
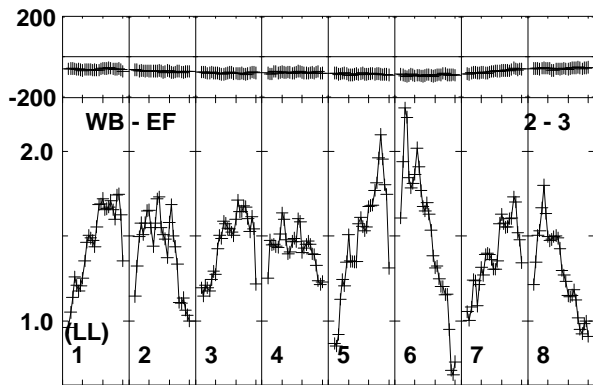
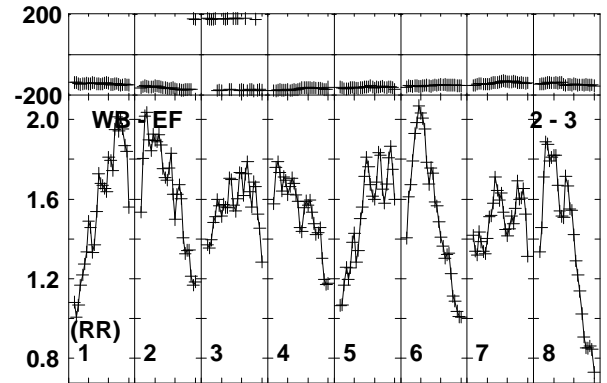
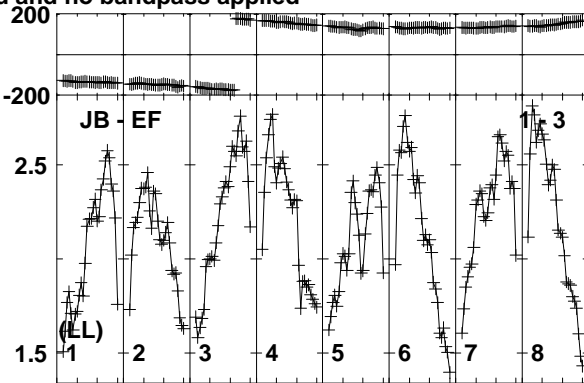
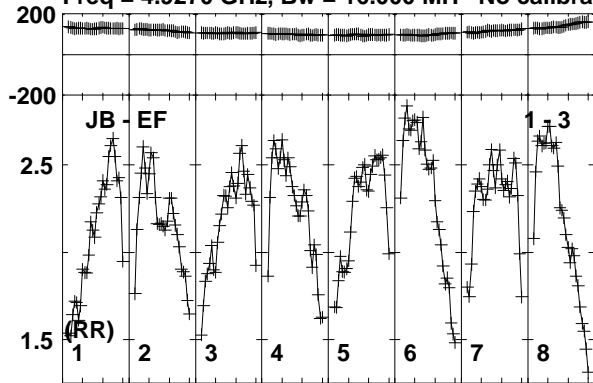

Lower frame: Milli Ampl Jy Top frame: Phas deg
Vector averaged cross-power spectrum Baseline: JB (01) - EF (03)
Timerange: 00/08:48:01 to 00/08:49:19

Plot file version 485 created 17-FEB-2020 15:43:26

J1359+5544 EK047 2.UVDATA.1

Freq = 4.9270 GHz, Bw = 16.000 MH No calibration applied and no bandpass applied

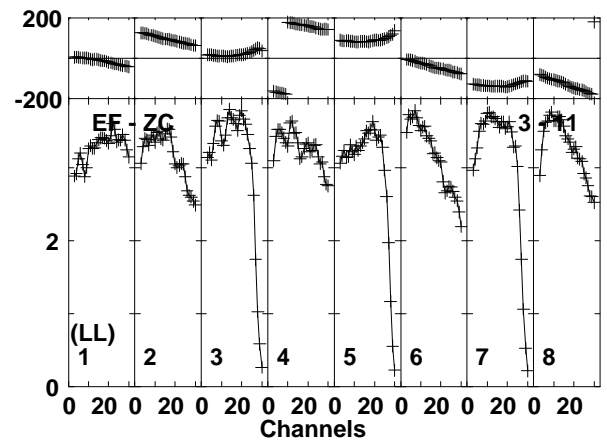
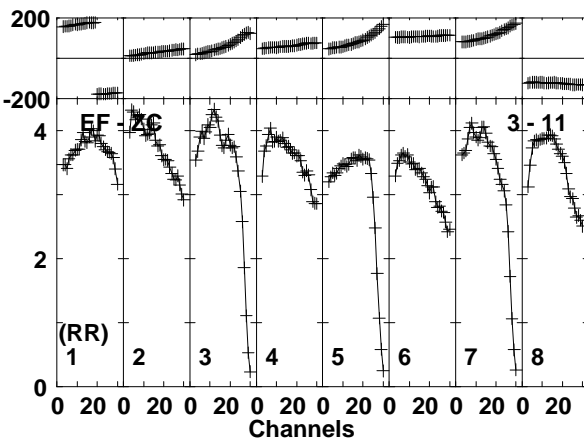
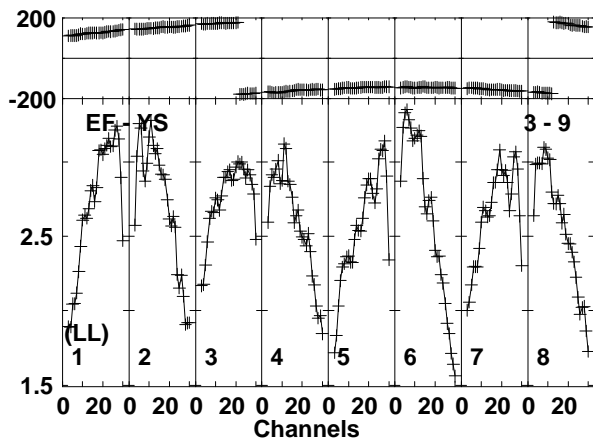
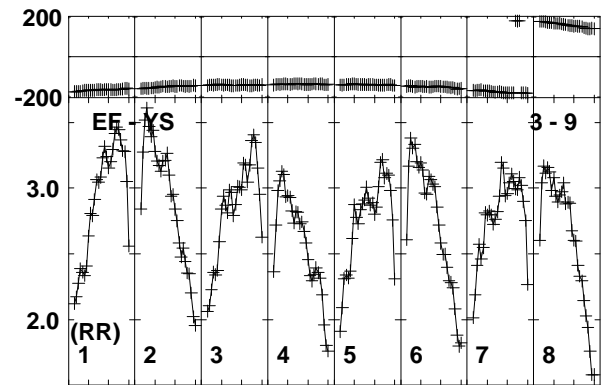
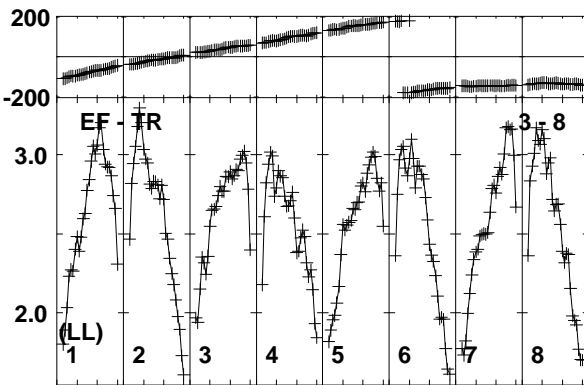
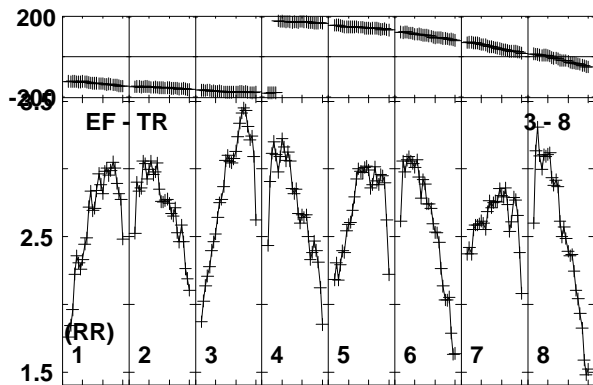
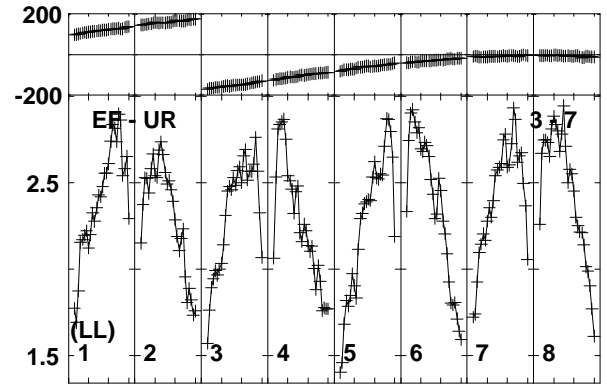
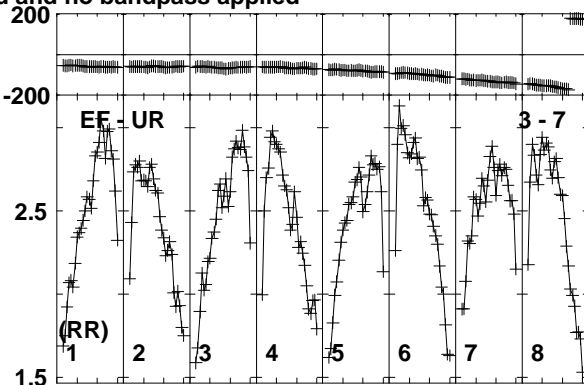
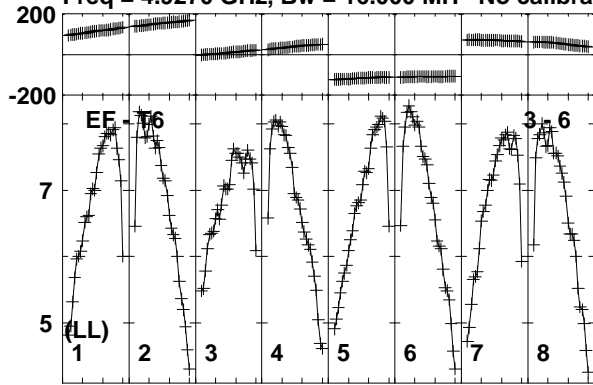

Lower frame: Milli Ampl Jy Top frame: Phas deg
Vector averaged cross-power spectrum Baseline: EF (03) - T6 (06)
Timerange: 00/08:48:01 to 00/08:49:19

Plot file version 486 created 17-FEB-2020 15:43:26

J1359+5544 EK047 2.UVDATA.1

Freq = 4.9270 GHz, Bw = 16.000 MH No calibration applied and no bandpass applied

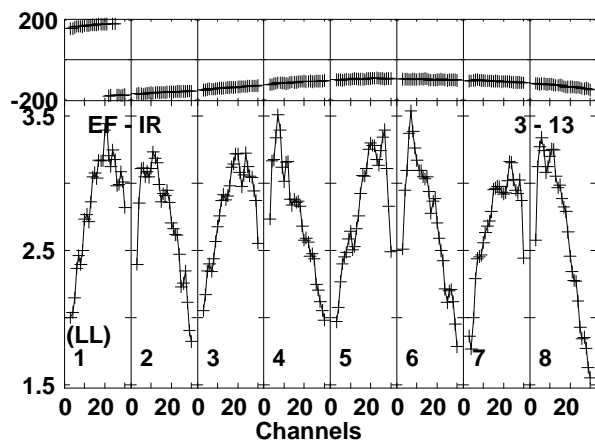
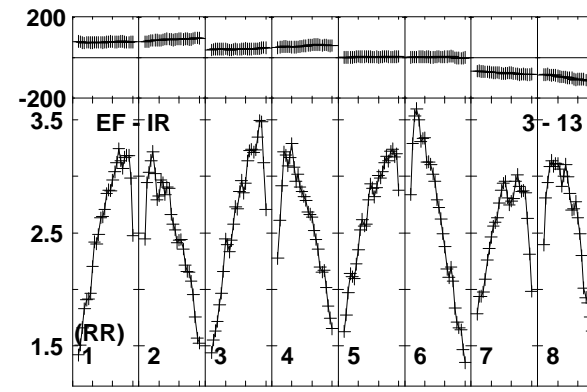
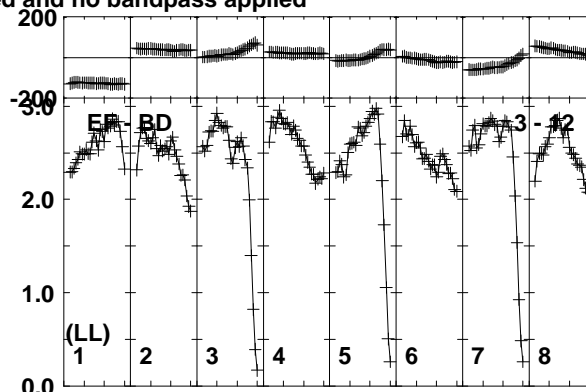
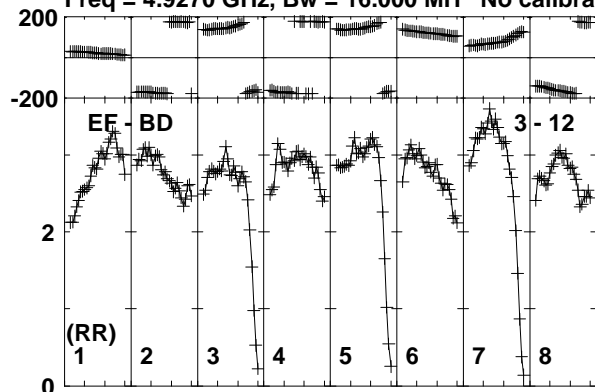

Lower frame: Milli Ampl Jy Top frame: Phas deg
Vector averaged cross-power spectrum Baseline: EF (03) - BD (12)
Timerange: 00/08:48:01 to 00/08:49:19

Plot file version 487 created 17-FEB-2020 15:43:26

J1402+5347 EK047 2.UVDATA.1

Freq = 4.9270 GHz, Bw = 16.000 MH No calibration applied and no bandpass applied

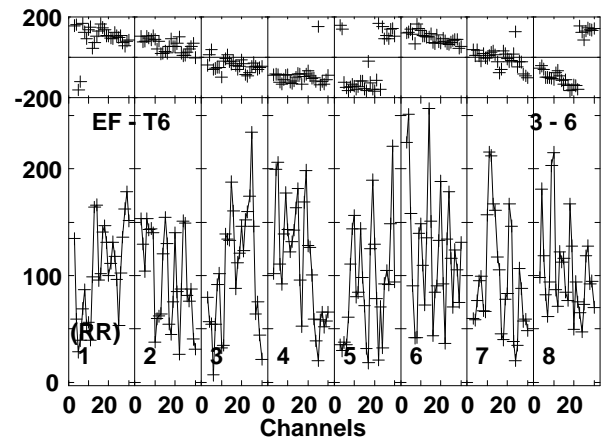
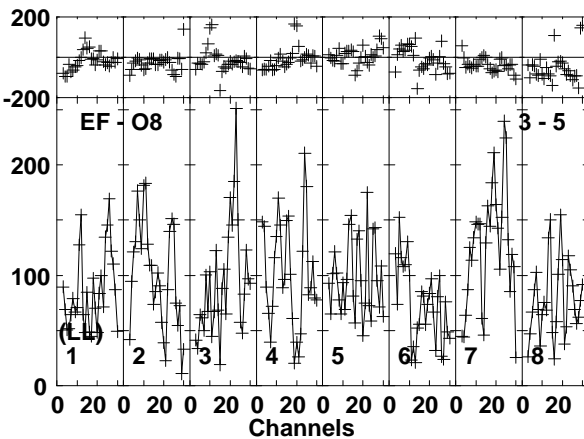
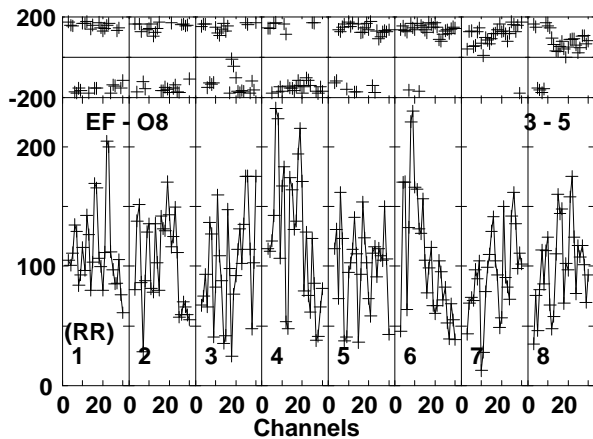
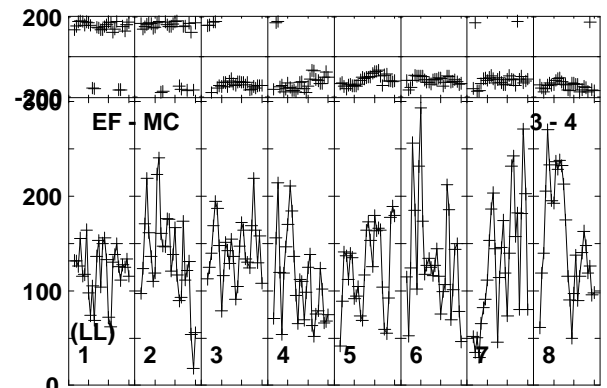
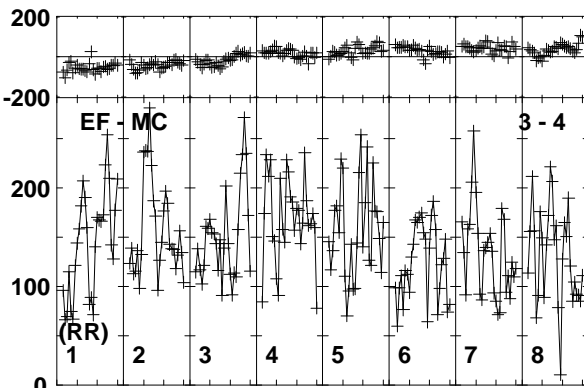
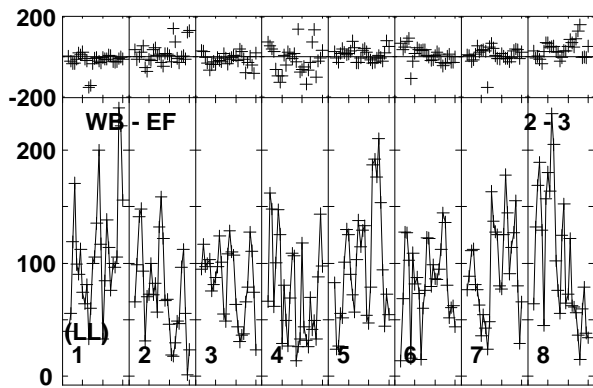
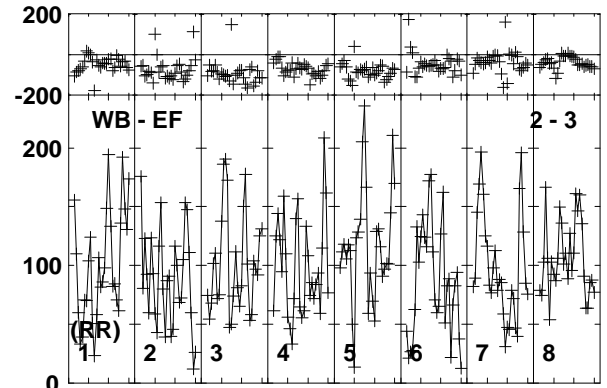
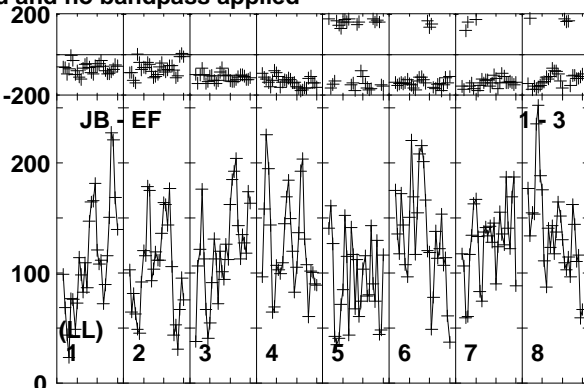
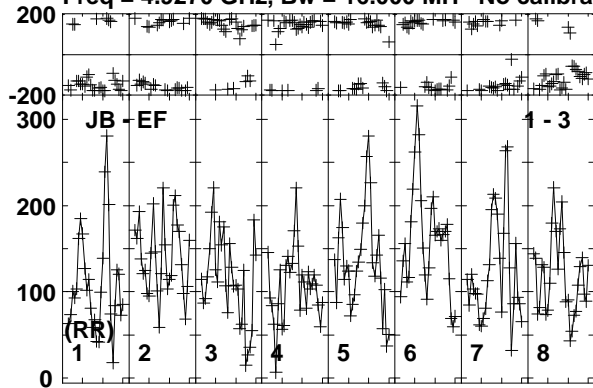

Lower frame: Micro Ampl Jy Top frame: Phas deg
Vector averaged cross-power spectrum Baseline: JB (01) - EF (03)
Timerange: 00/08:49:21 to 00/08:53:19

Plot file version 488 created 17-FEB-2020 15:43:26

J1402+5347 EK047 2.UVDATA.1

Freq = 4.9270 GHz, Bw = 16.000 MH No calibration applied and no bandpass applied

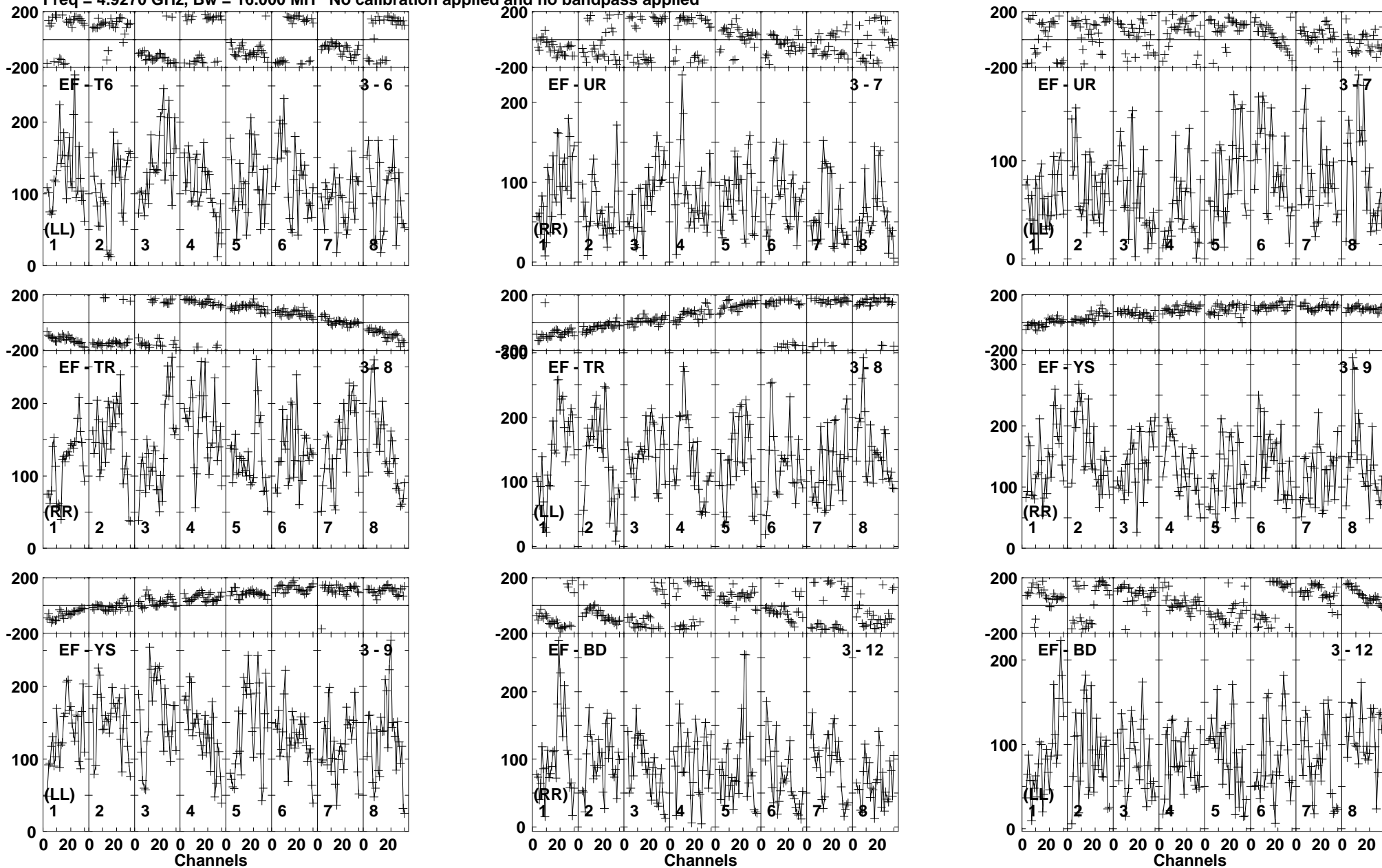

Lower frame: Micro Ampl Jy Top frame: Phas deg
Vector averaged cross-power spectrum Baseline: EF (03) - T6 (06)
Timerange: 00/08:49:21 to 00/08:53:19

Plot file version 489 created 17-FEB-2020 15:43:27

J1402+5347 EK047 2.UVDATA.1

Freq = 4.9270 GHz, Bw = 16.000 MH No calibration applied and no bandpass applied

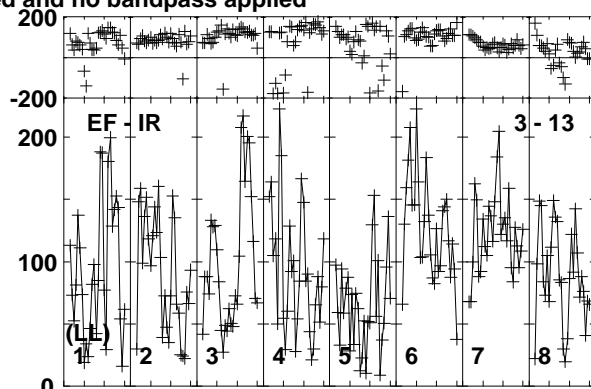
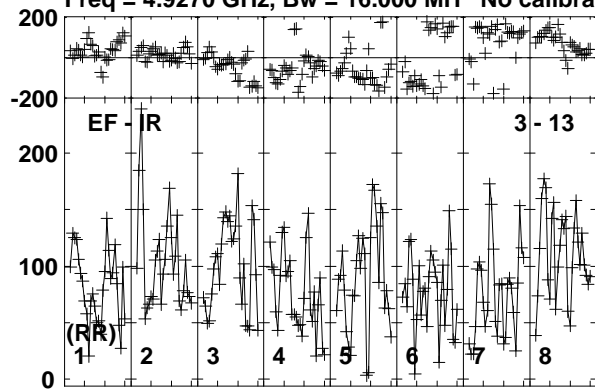

Lower frame: Micro Ampl Jy Top frame: Phas deg
Vector averaged cross-power spectrum Baseline: EF (03) - IR (13)
Timerange: 00/08:49:21 to 00/08:53:19

Plot file version 490 created 17-FEB-2020 15:43:27

J1359+5544 EK047 2.UVDATA.1

Freq = 4.9270 GHz, Bw = 16.000 MH No calibration applied and no bandpass applied

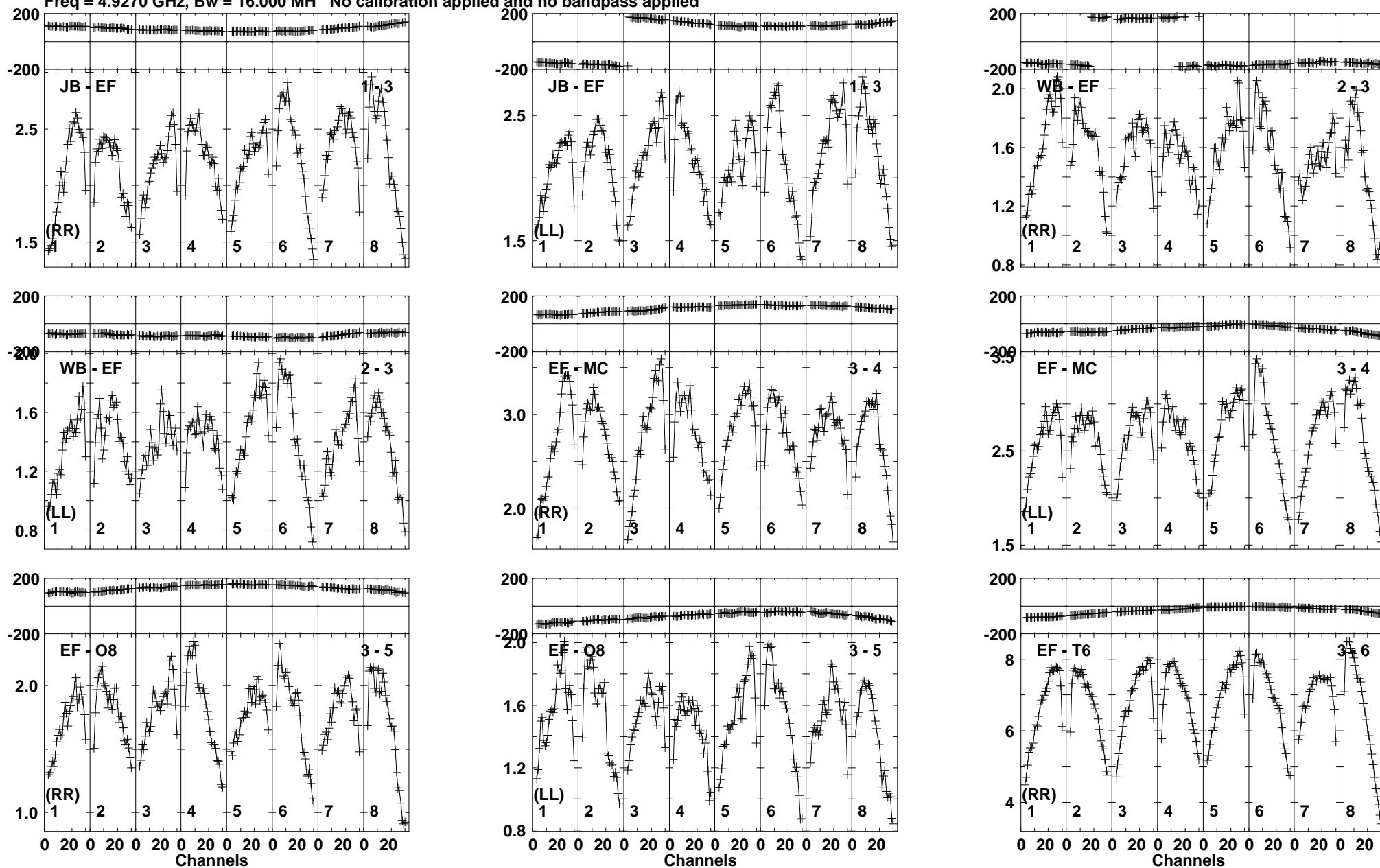

Lower frame: Milli Ampl Jy Top frame: Phas deg
Vector averaged cross-power spectrum Baseline: JB (01) - EF (03)
Timerange: 00/08:53:21 to 00/08:55:19

Plot file version 491 created 17-FEB-2020 15:43:27

J1359+5544 EK047 2.UVDATA.1

Freq = 4.9270 GHz, Bw = 16.000 MH No calibration applied and no bandpass applied

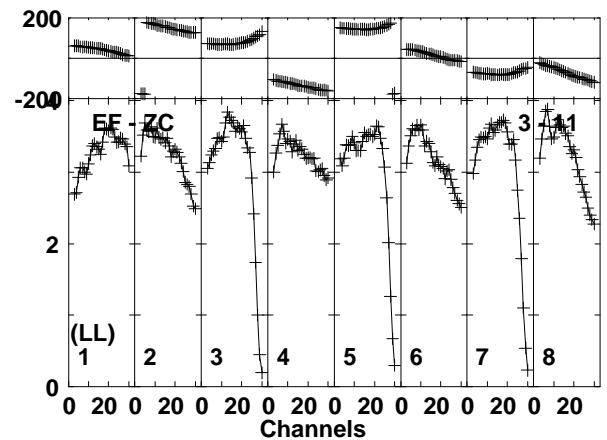
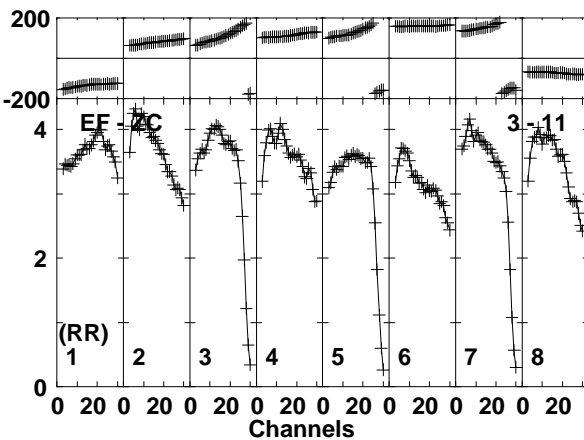
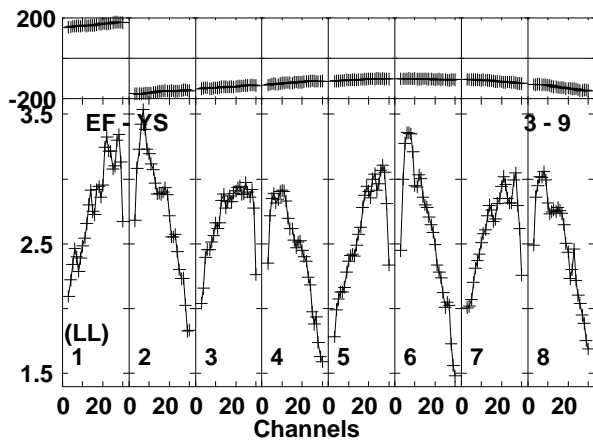
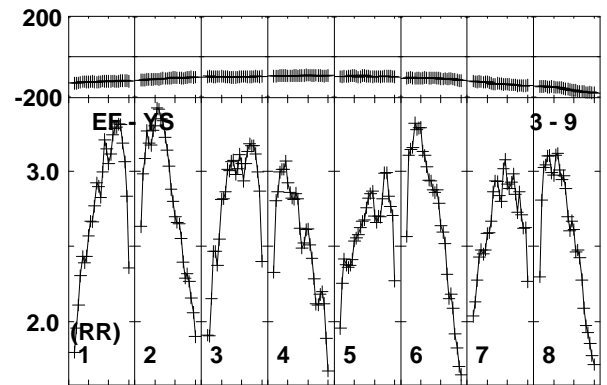
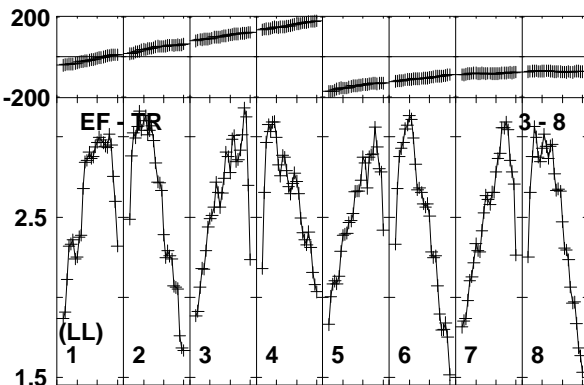
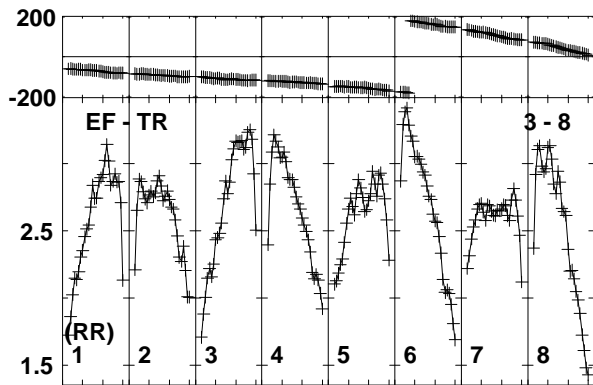
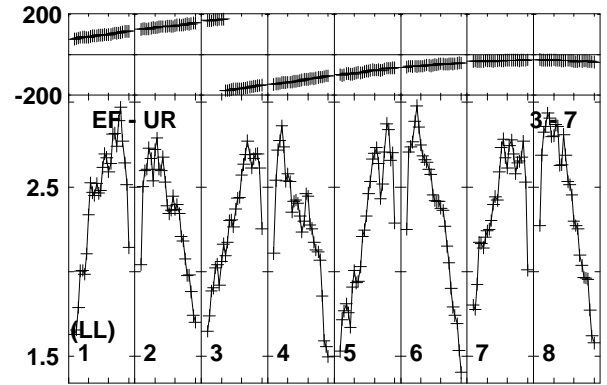
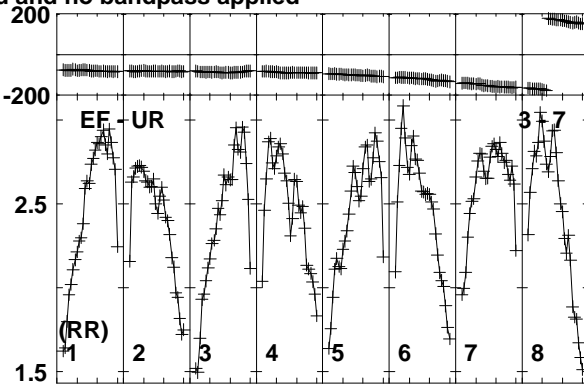
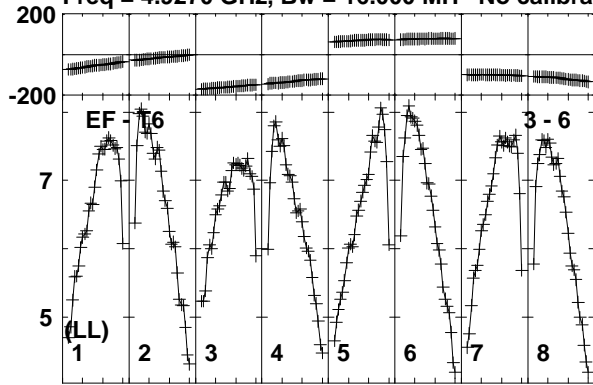

Lower frame: Milli Ampl Jy Top frame: Phas deg
Vector averaged cross-power spectrum Baseline: EF (03) - T6 (06)
Timerange: 00/08:53:21 to 00/08:55:19

Plot file version 492 created 17-FEB-2020 15:43:27

J1359+5544 EK047 2.UVDATA.1

Freq = 4.9270 GHz, Bw = 16.000 MH No calibration applied and no bandpass applied

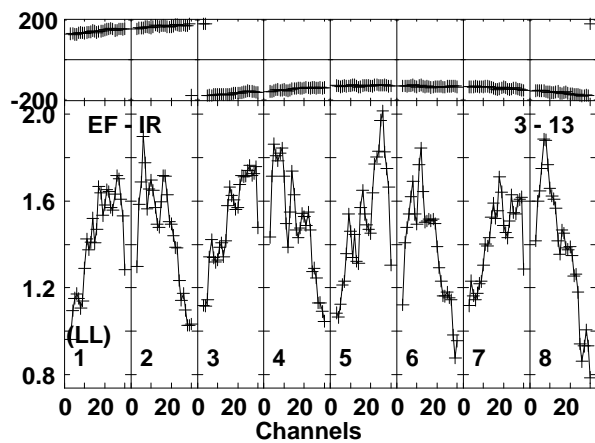
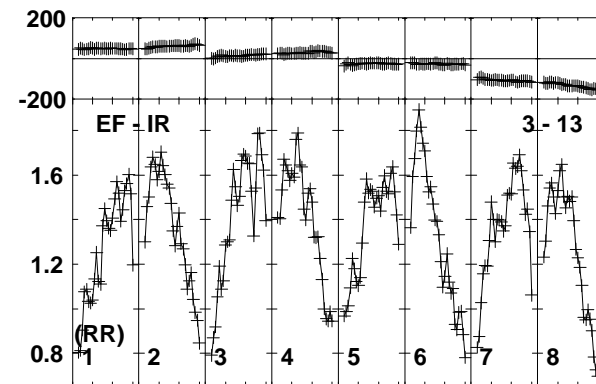
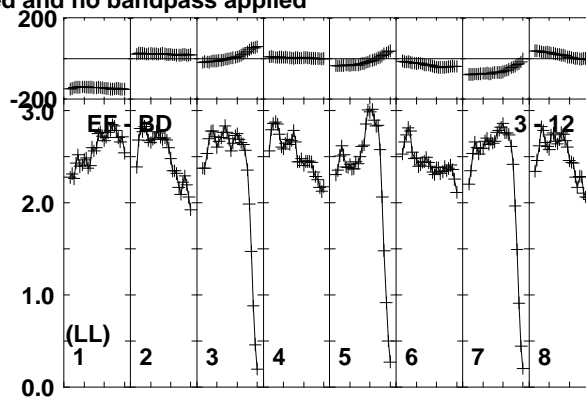
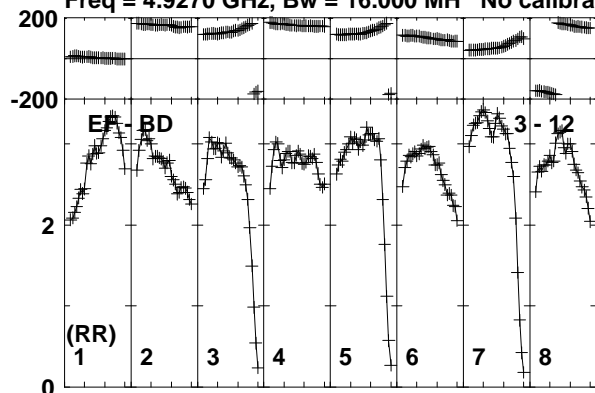

Lower frame: Milli Ampl Jy Top frame: Phas deg
Vector averaged cross-power spectrum Baseline: EF (03) - BD (12)
Timerange: 00/08:53:21 to 00/08:55:19

Plot file version 493 created 17-FEB-2020 15:43:27

J1402+5347 EK047 2.UVDATA.1

Freq = 4.9270 GHz, Bw = 16.000 MH No calibration applied and no bandpass applied

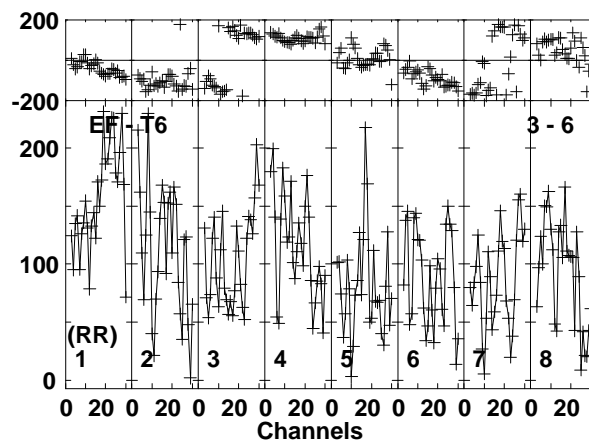
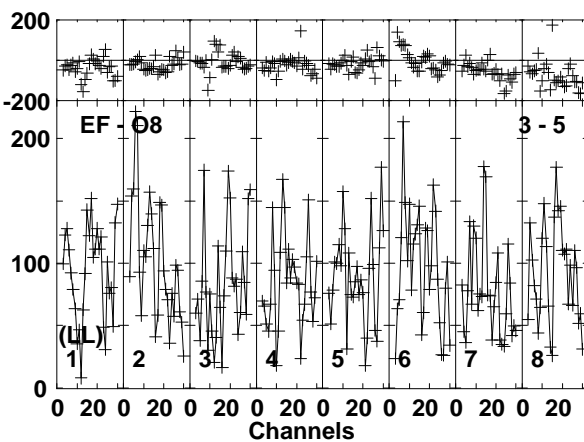
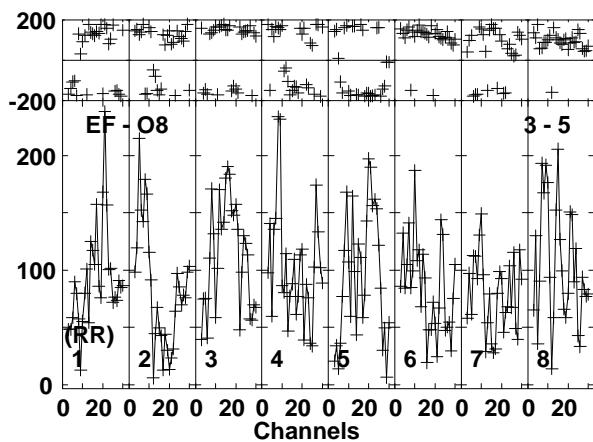
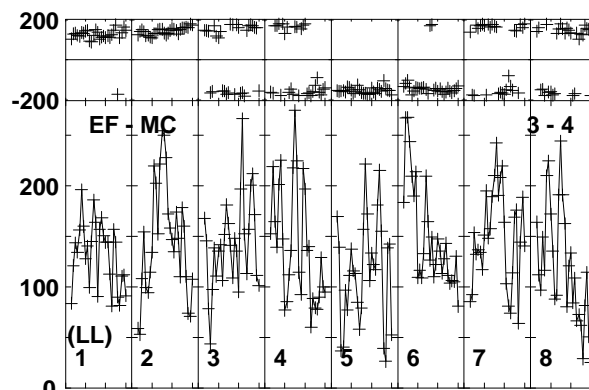
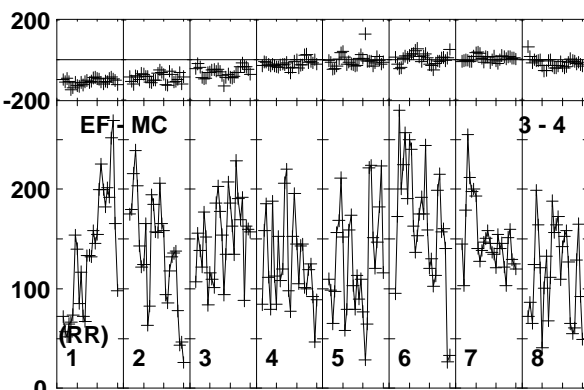
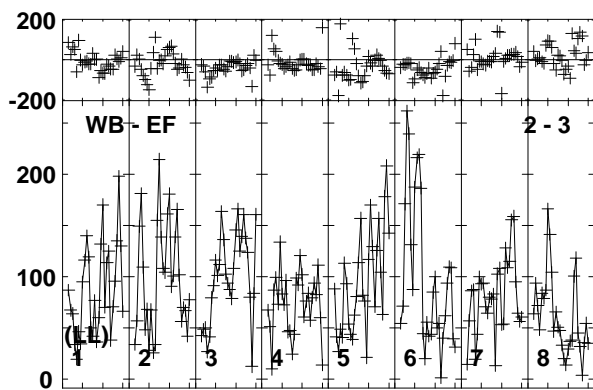
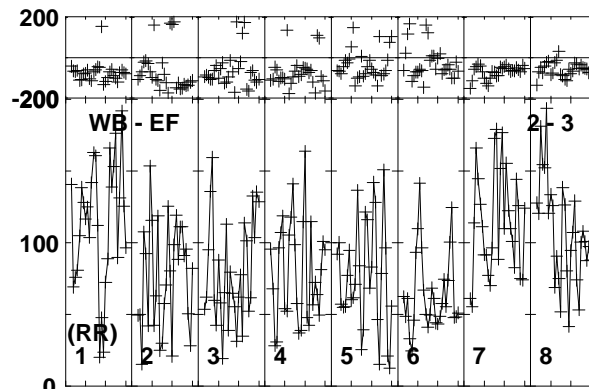
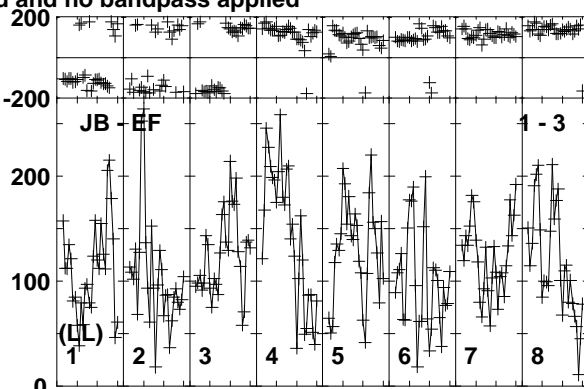
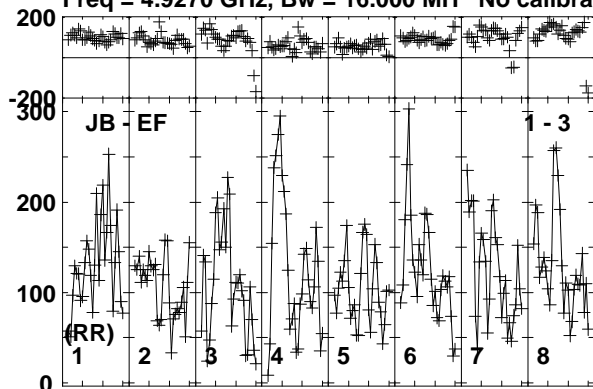

Lower frame: Micro Ampl Jy Top frame: Phas deg
Vector averaged cross-power spectrum Baseline: JB (01) - EF (03)
Timerange: 00/08:55:21 to 00/08:59:19

Plot file version 494 created 17-FEB-2020 15:43:27

J1402+5347 EK047 2.UVDATA.1

Freq = 4.9270 GHz, Bw = 16.000 MH No calibration applied and no bandpass applied

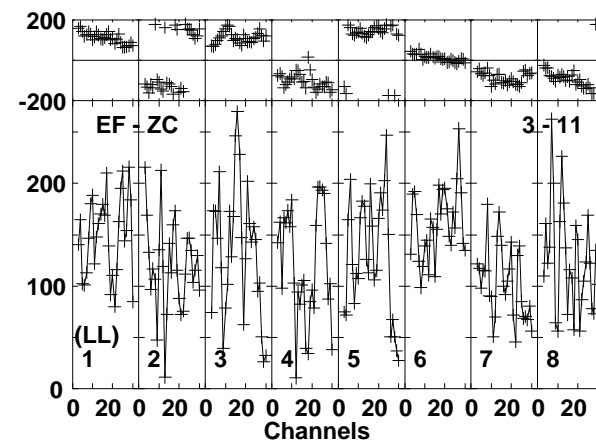
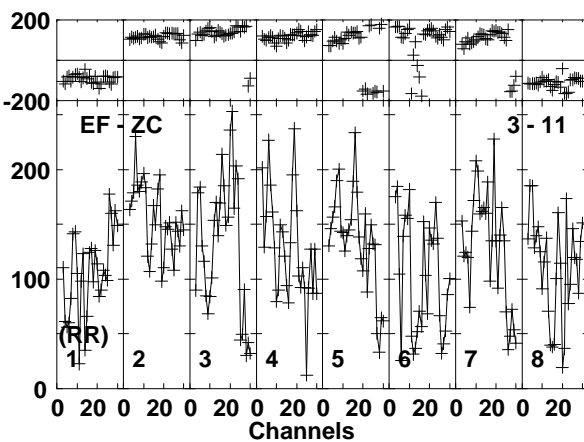
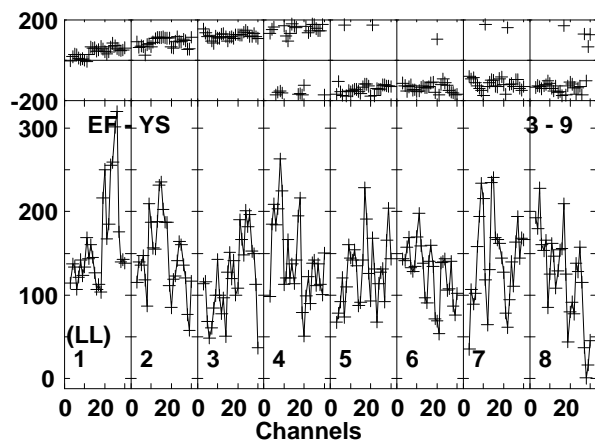
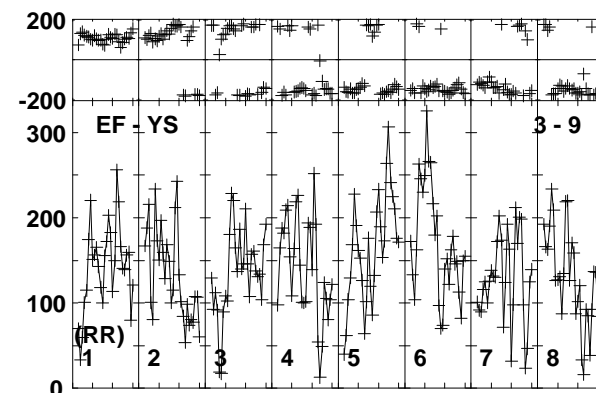
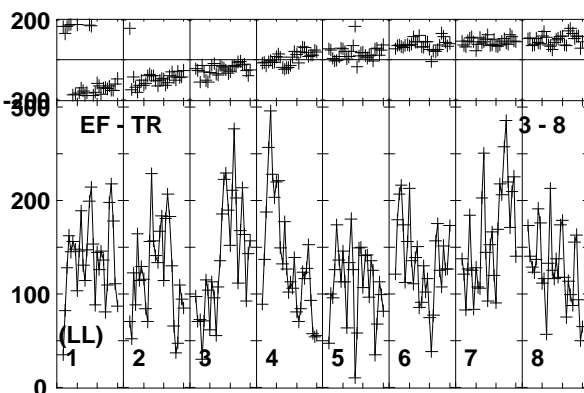
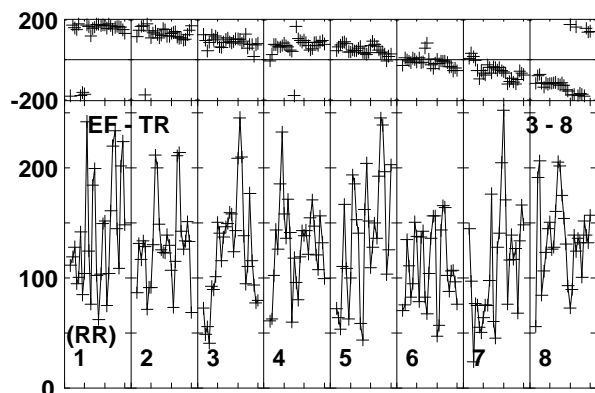
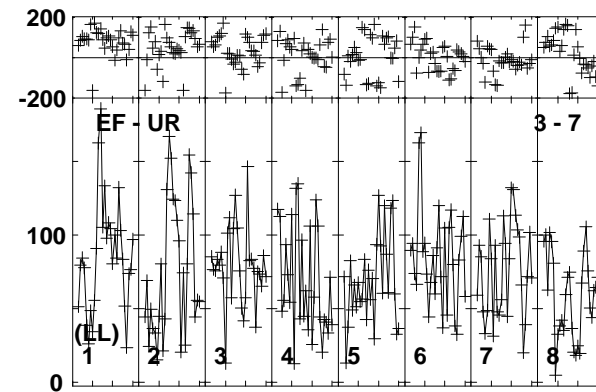
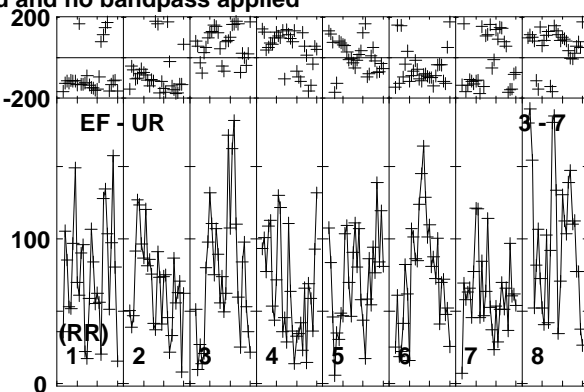
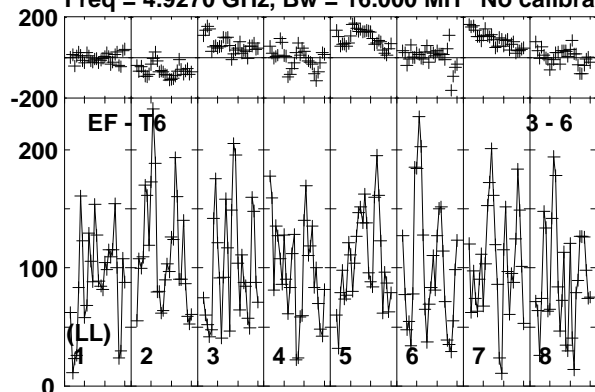

Lower frame: Micro Ampl Jy Top frame: Phas deg
Vector averaged cross-power spectrum Baseline: EF (03) - T6 (06)
Timerange: 00/08:55:21 to 00/08:59:19

Plot file version 495 created 17-FEB-2020 15:43:27

J1402+5347 EK047 2.UVDATA.1

Freq = 4.9270 GHz, Bw = 16.000 MH No calibration applied and no bandpass applied

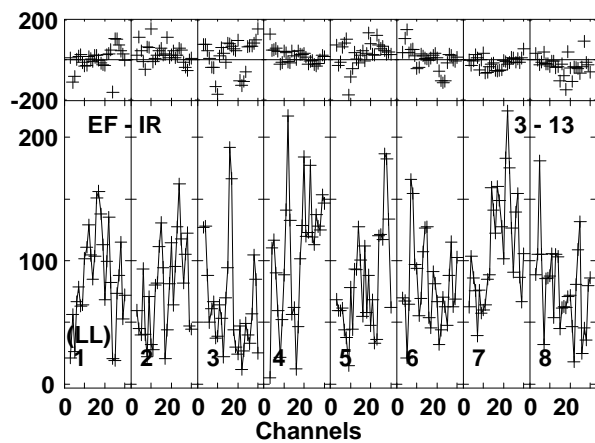
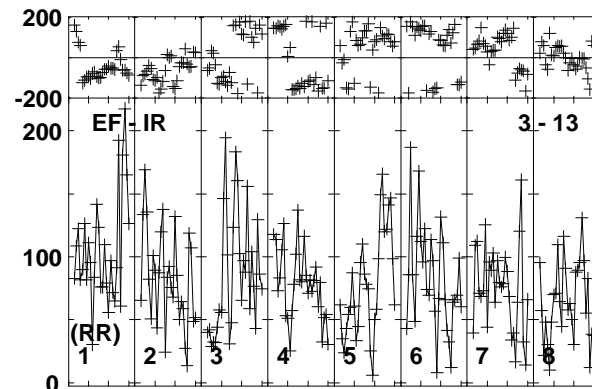
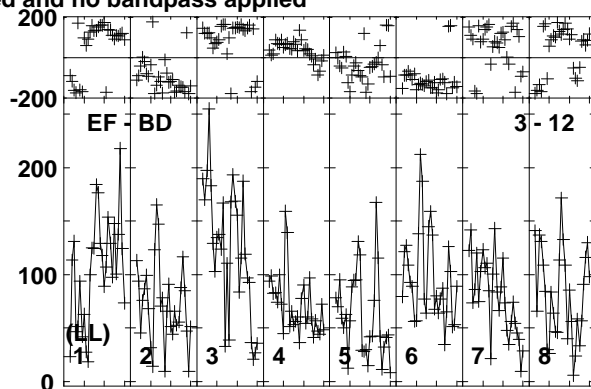
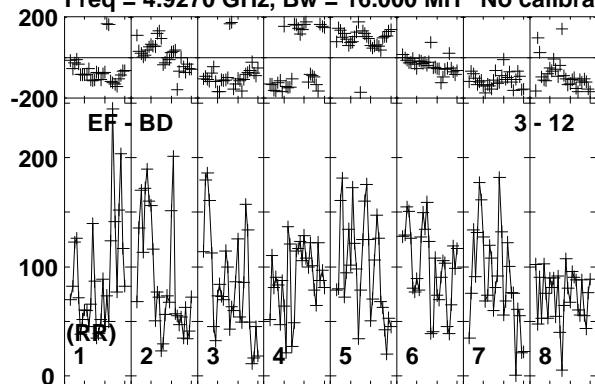

Lower frame: Micro Ampl Jy Top frame: Phas deg
Vector averaged cross-power spectrum Baseline: EF (03) - BD (12)
Timerange: 00/08:55:21 to 00/08:59:19

Plot file version 496 created 17-FEB-2020 15:43:27

J1359+5544 EK047 2.UVDATA.1

Freq = 4.9270 GHz, Bw = 16.000 MH No calibration applied and no bandpass applied

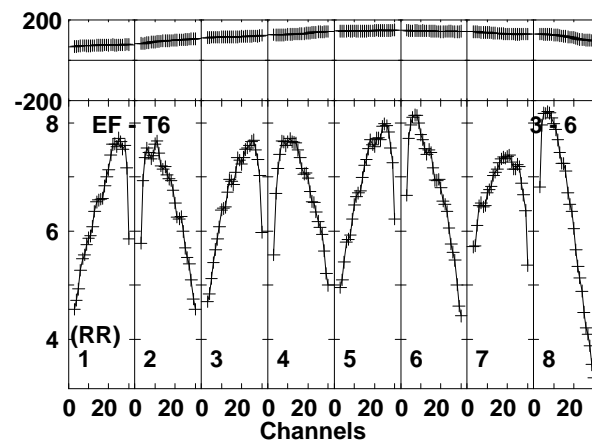
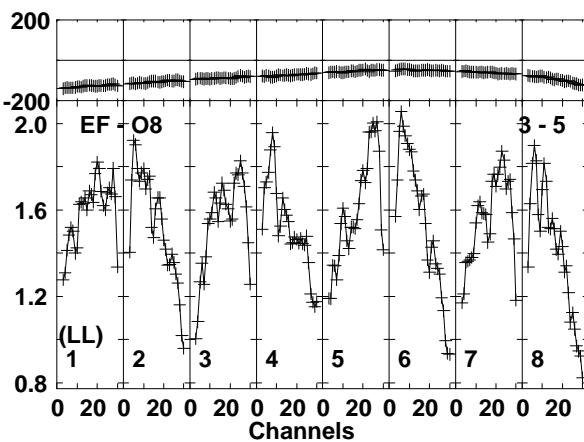
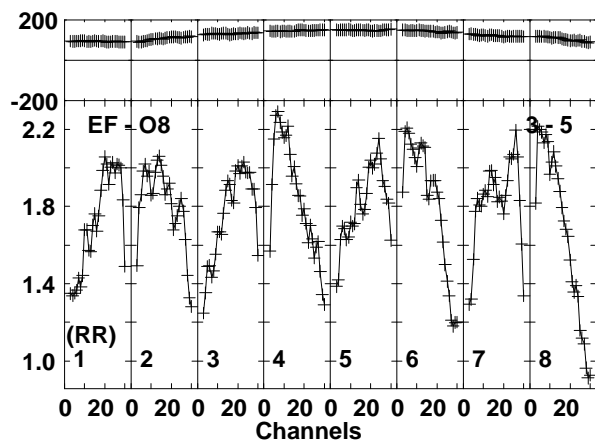
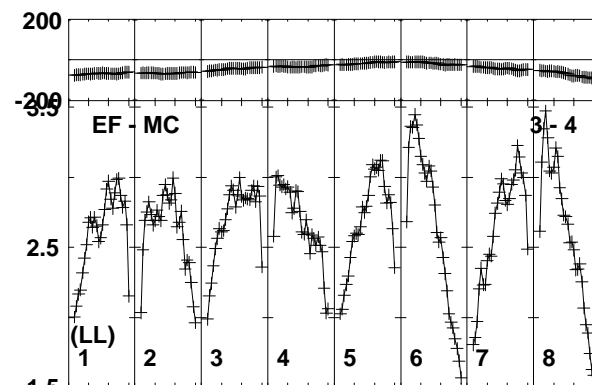
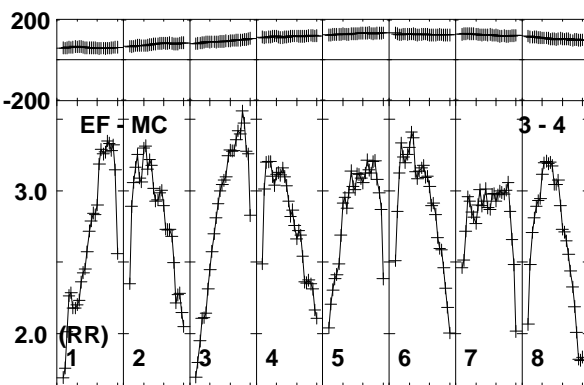
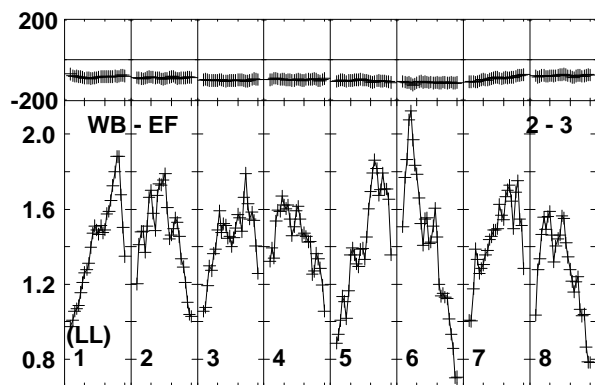
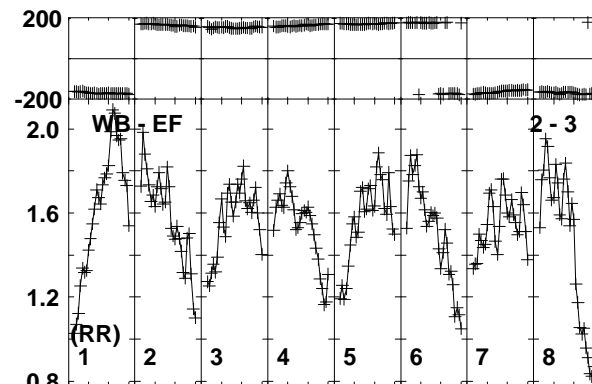
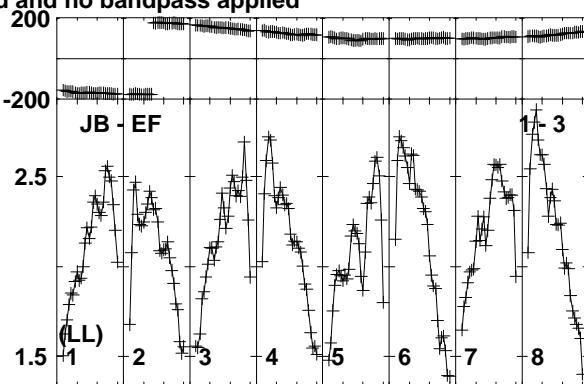
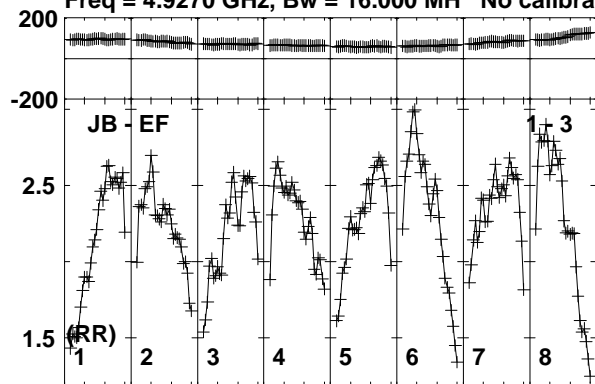

Lower frame: Milli Ampl Jy Top frame: Phas deg
Vector averaged cross-power spectrum Baseline: JB (01) - EF (03)
Timerange: 00/09:00:01 to 00/09:01:19

Plot file version 497 created 17-FEB-2020 15:43:27

J1359+5544 EK047 2.UVDATA.1

Freq = 4.9270 GHz, Bw = 16.000 MH No calibration applied and no bandpass applied

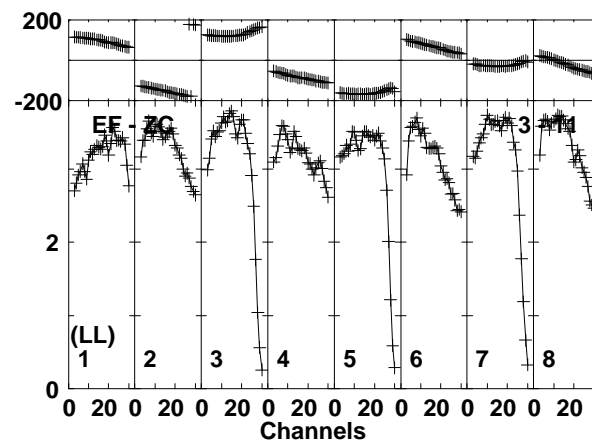
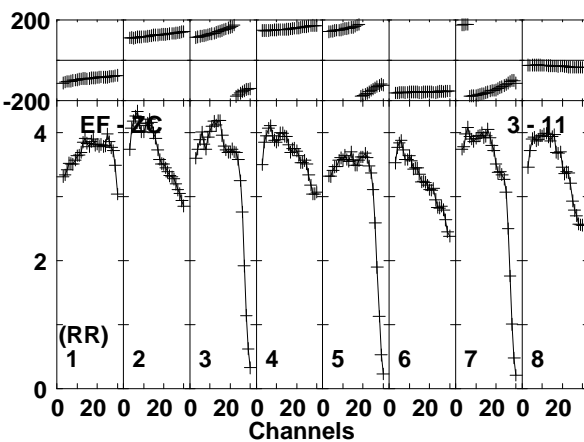
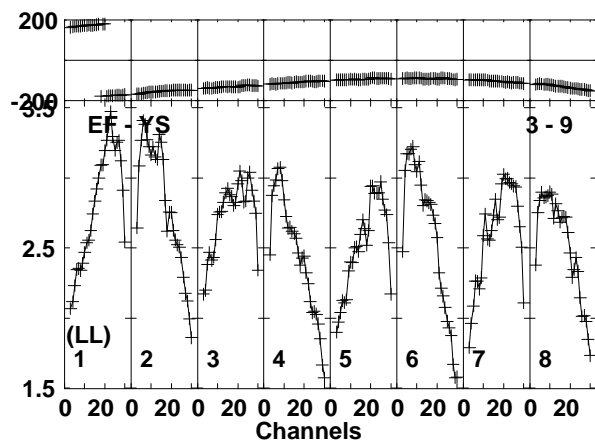
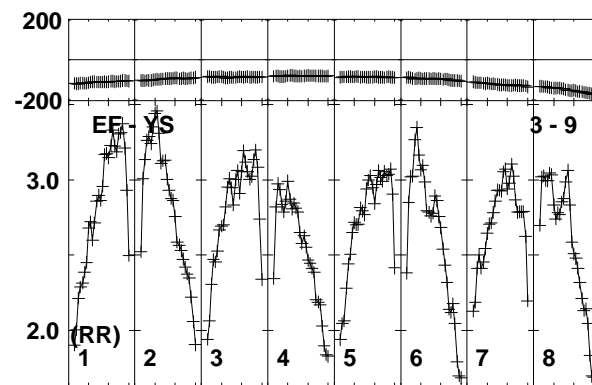
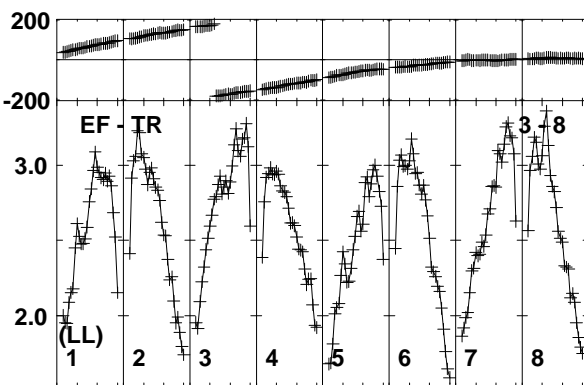
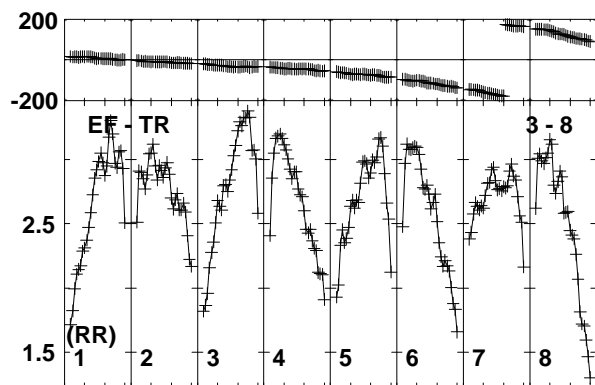
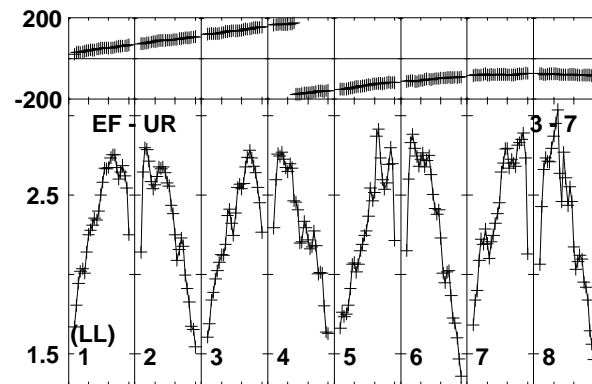
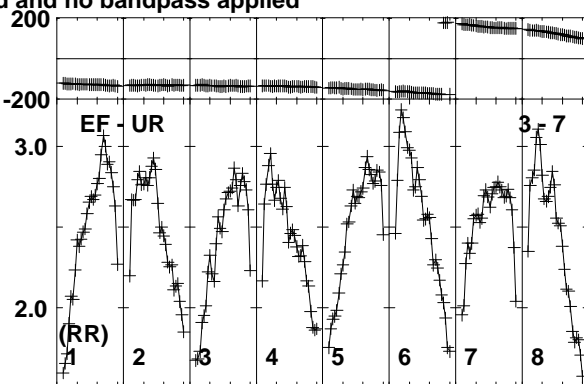
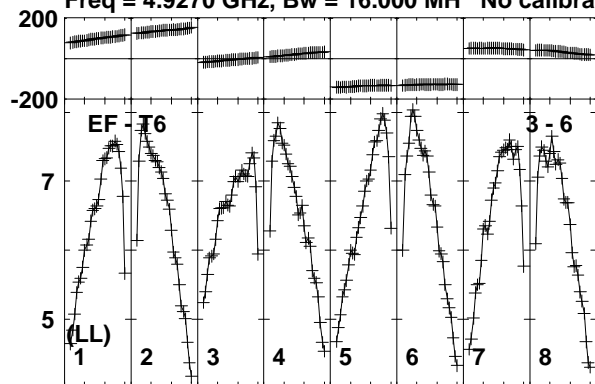

Lower frame: Milli Ampl Jy Top frame: Phas deg
Vector averaged cross-power spectrum Baseline: EF (03) - T6 (06)
Timerange: 00/09:00:01 to 00/09:01:19

Plot file version 498 created 17-FEB-2020 15:43:27

J1359+5544 EK047 2.UVDATA.1

Freq = 4.9270 GHz, Bw = 16.000 MH No calibration applied and no bandpass applied

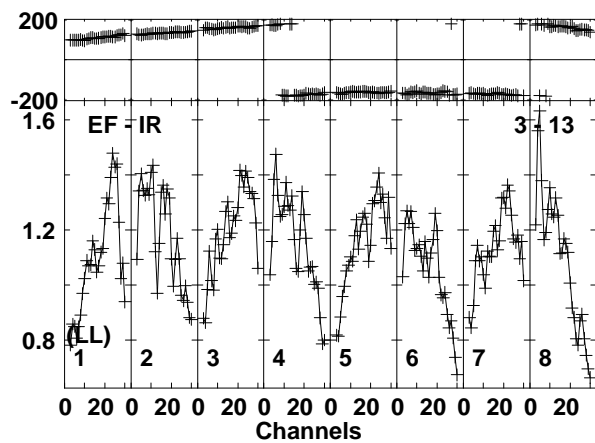
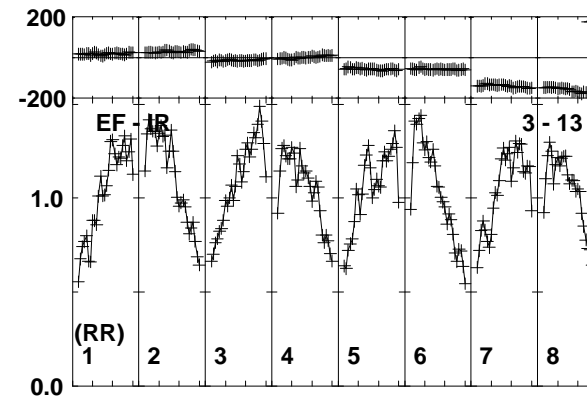
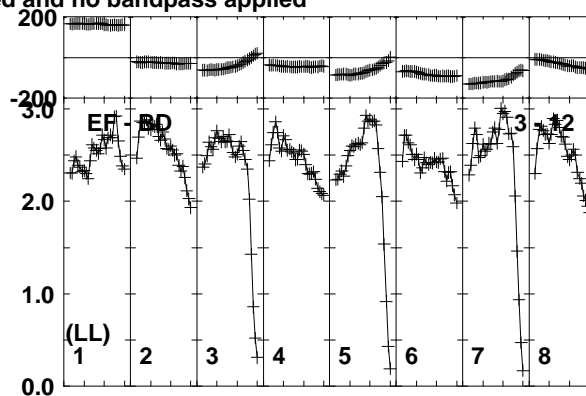
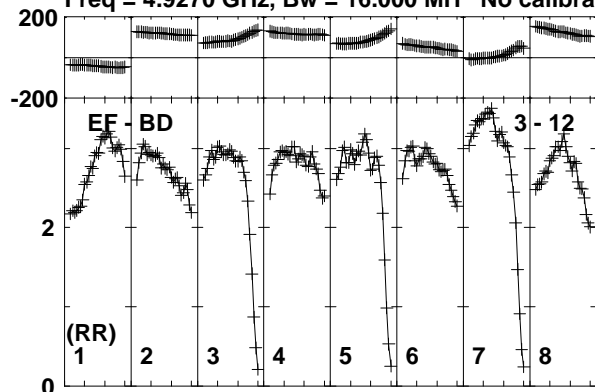

Lower frame: Milli Ampl Jy Top frame: Phas deg
Vector averaged cross-power spectrum Baseline: EF (03) - BD (12)
Timerange: 00/09:00:01 to 00/09:01:19

Plot file version 499 created 17-FEB-2020 15:43:27

J1402+5347 EK047 2.UVDATA.1

Freq = 4.9270 GHz, Bw = 16.000 MH No calibration applied and no bandpass applied

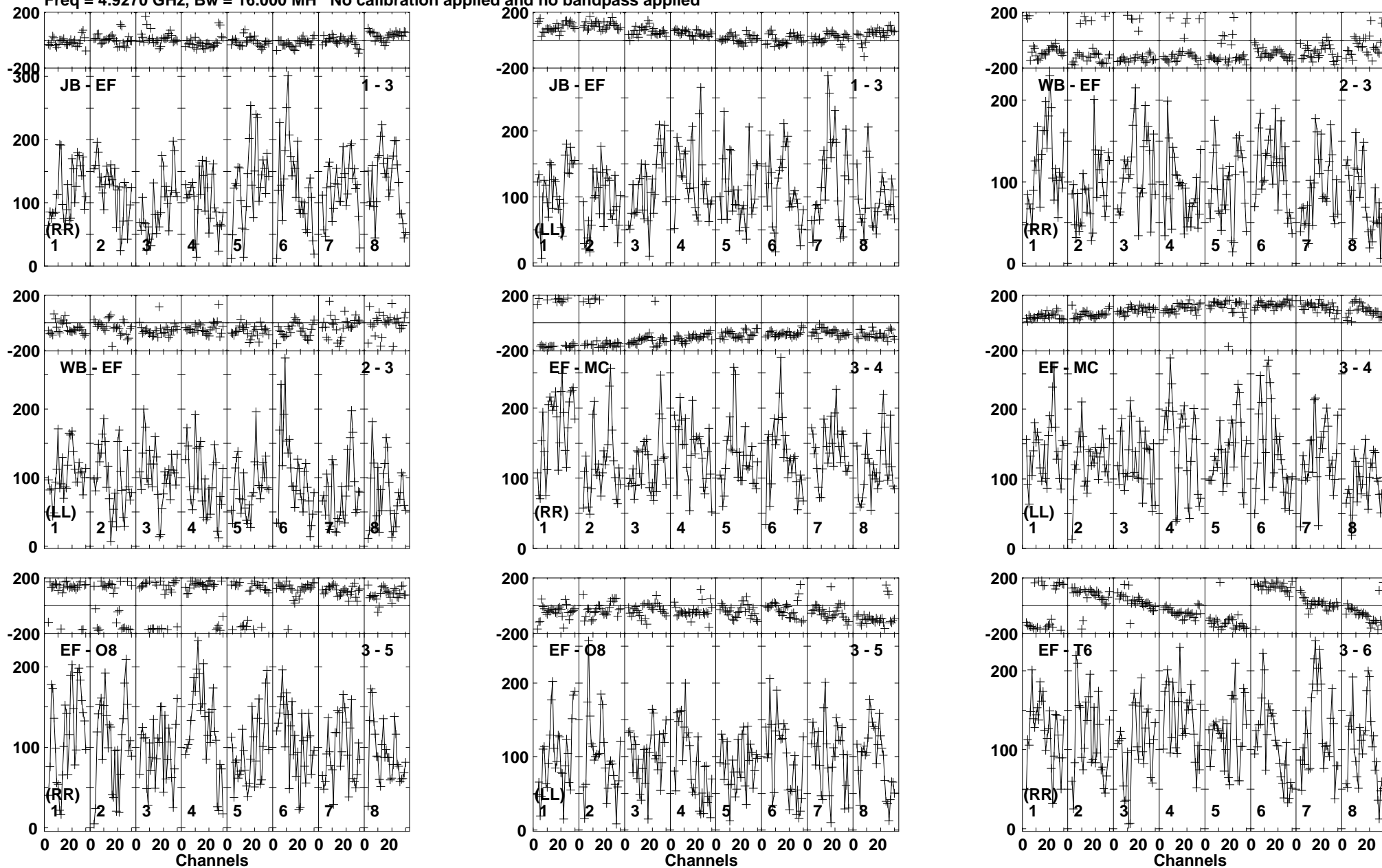

Lower frame: Micro Ampl Jy Top frame: Phas deg
Vector averaged cross-power spectrum Baseline: JB (01) - EF (03)
Timerange: 00/09:01:21 to 00/09:05:19

Plot file version 500 created 17-FEB-2020 15:43:28

J1402+5347 EK047 2.UVDATA.1

Freq = 4.9270 GHz, Bw = 16.000 MH No calibration applied and no bandpass applied

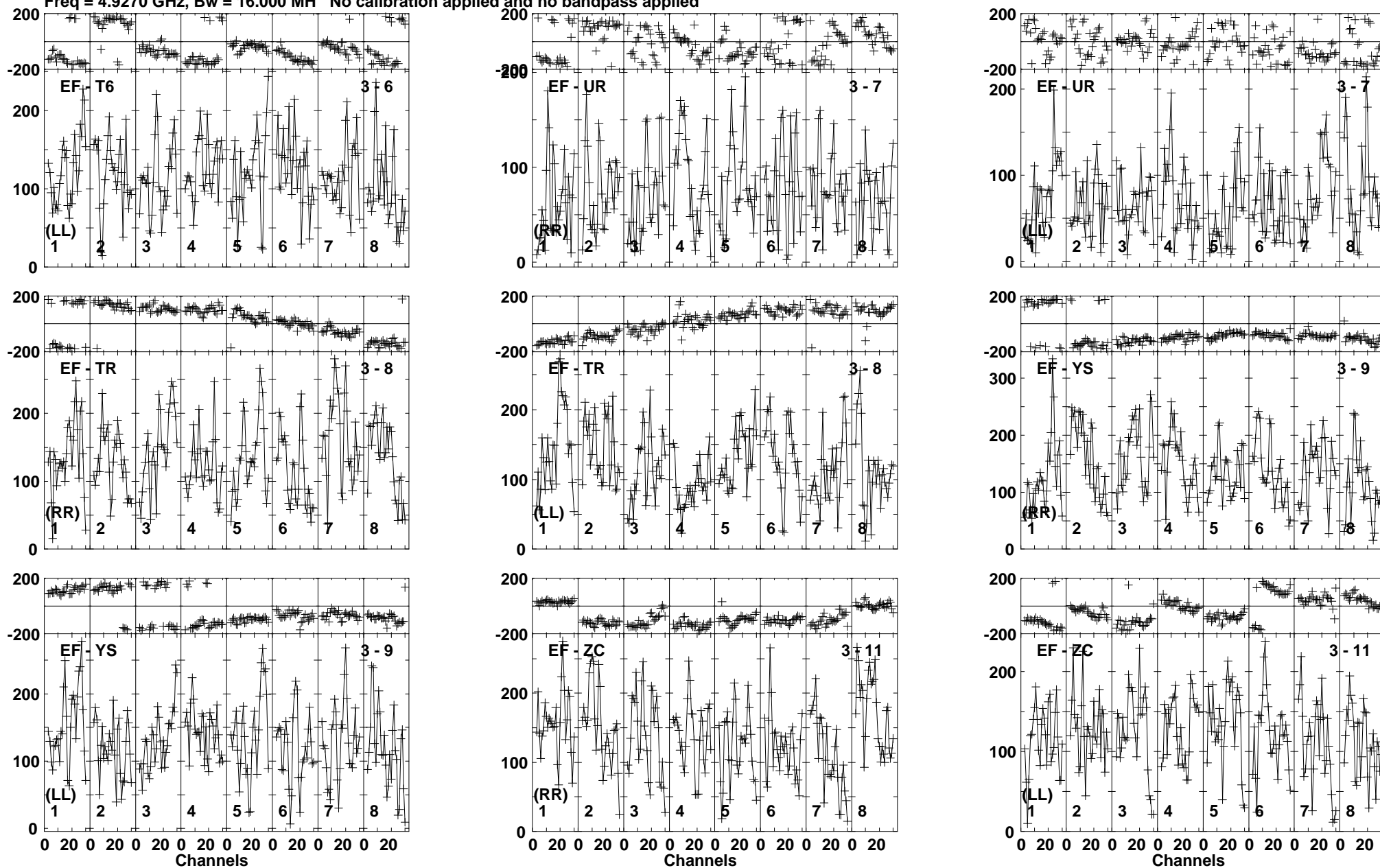

Lower frame: Micro Ampl Jy Top frame: Phas deg
Vector averaged cross-power spectrum Baseline: EF (03) - T6 (06)
Timerange: 00/09:01:21 to 00/09:05:19

Plot file version 501 created 17-FEB-2020 15:43:28

J1402+5347 EK047 2.UVDATA.1

Freq = 4.9270 GHz, Bw = 16.000 MH No calibration applied and no bandpass applied

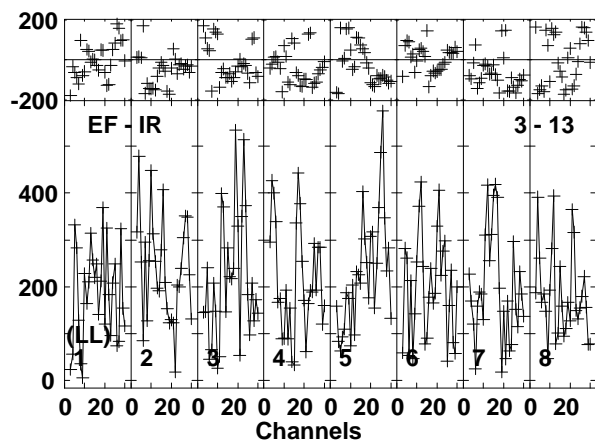
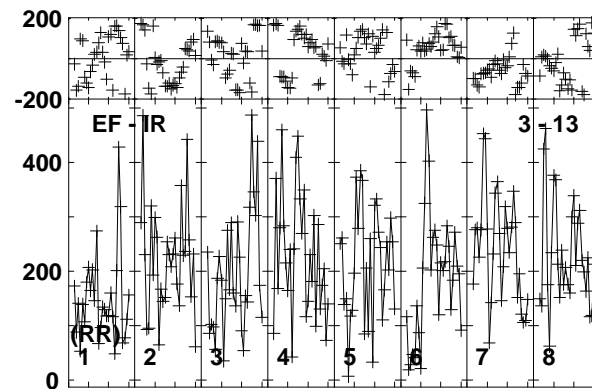
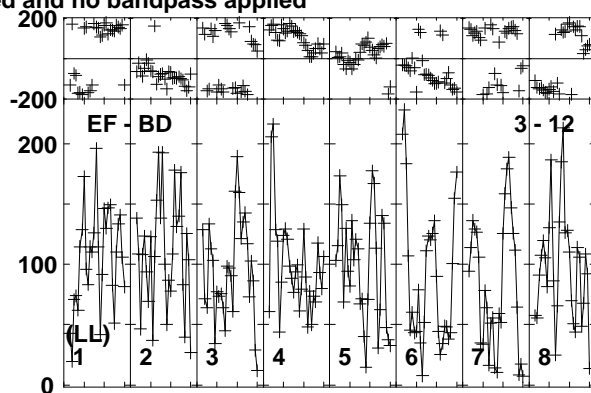
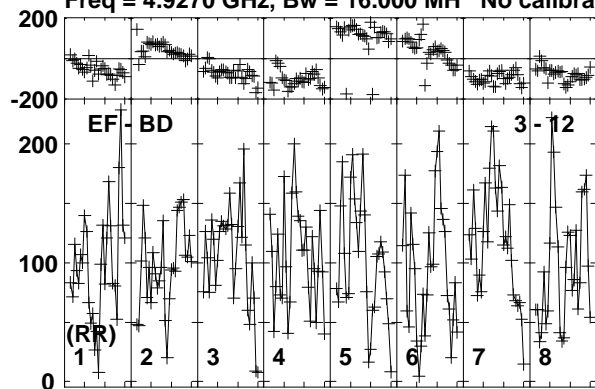

Lower frame: Micro Ampl Jy Top frame: Phas deg
Vector averaged cross-power spectrum Baseline: EF (03) - BD (12)
Timerange: 00/09:01:21 to 00/09:05:19

Plot file version 502 created 17-FEB-2020 15:43:28

J1359+5544 EK047 2.UVDATA.1

Freq = 4.9270 GHz, Bw = 16.000 MH No calibration applied and no bandpass applied

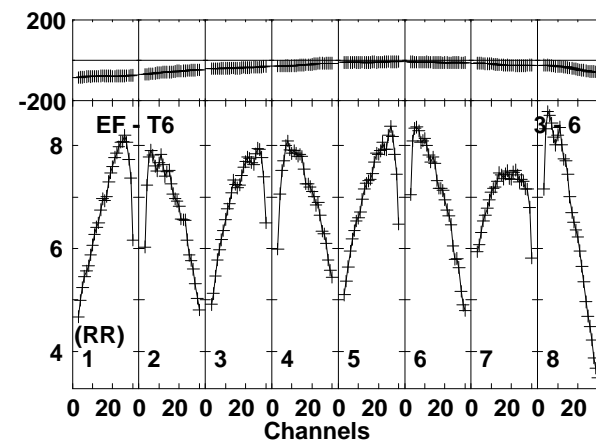
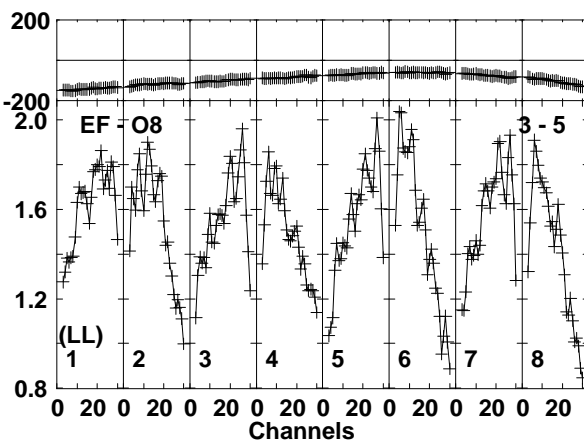
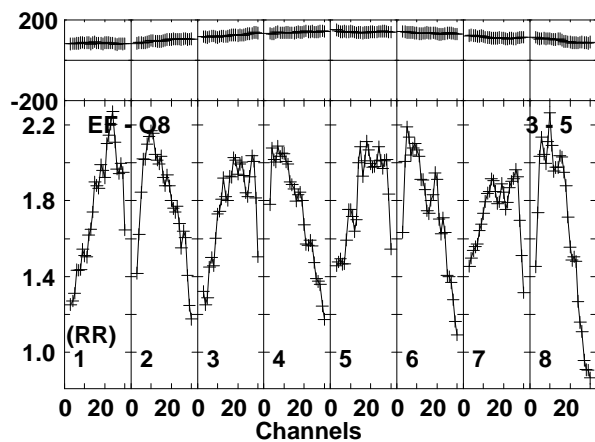
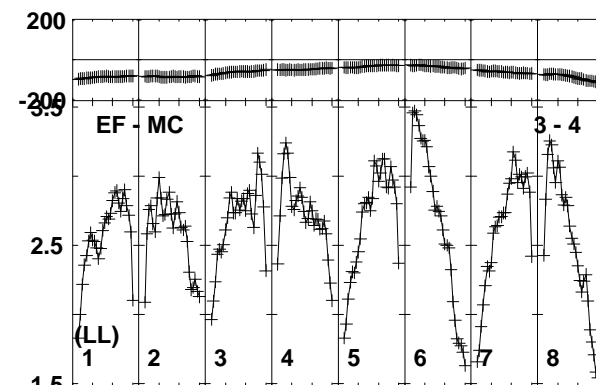
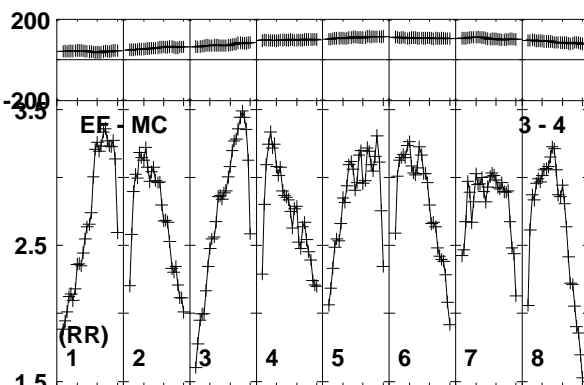
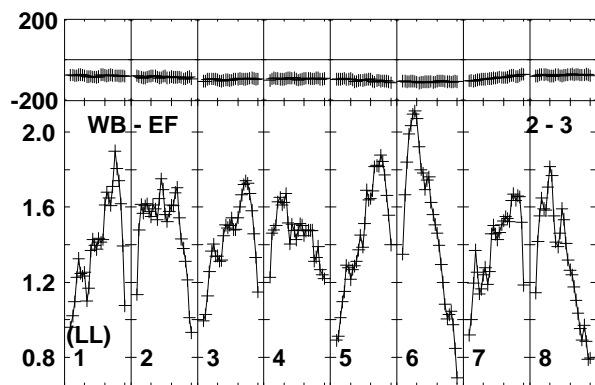
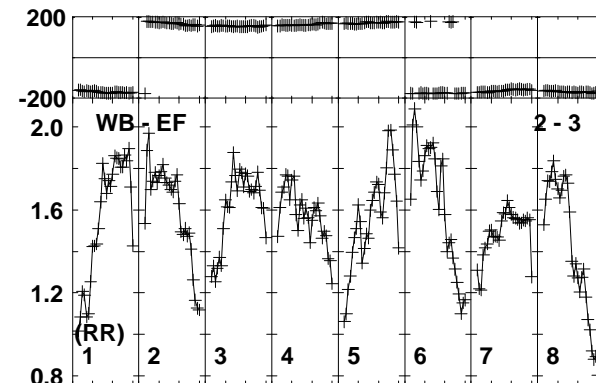
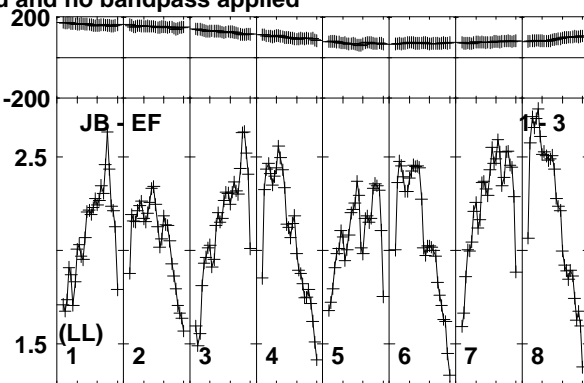
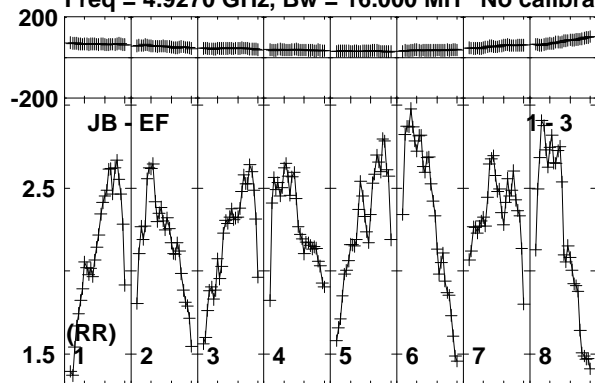

Lower frame: Milli Ampl Jy Top frame: Phas deg
Vector averaged cross-power spectrum Baseline: JB (01) - EF (03)
Timerange: 00/09:05:21 to 00/09:07:19

Plot file version 503 created 17-FEB-2020 15:43:28

J1359+5544 EK047 2.UVDATA.1

Freq = 4.9270 GHz, Bw = 16.000 MH No calibration applied and no bandpass applied

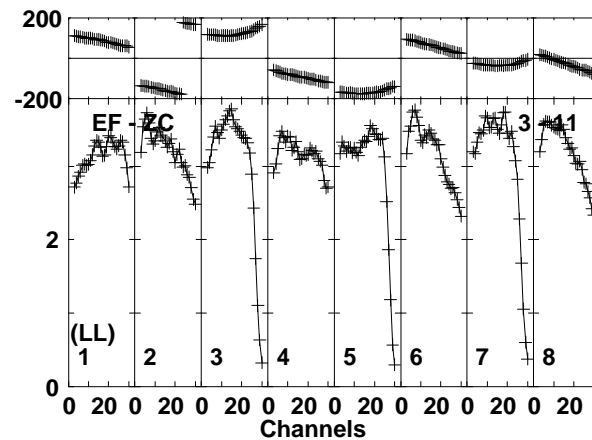
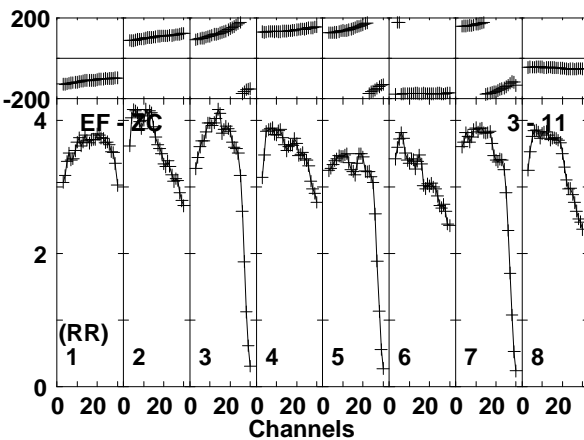
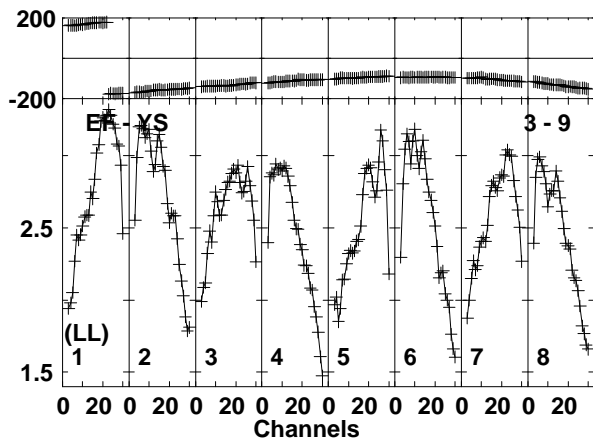
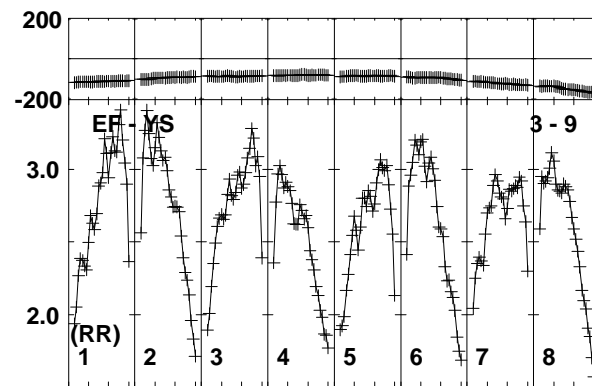
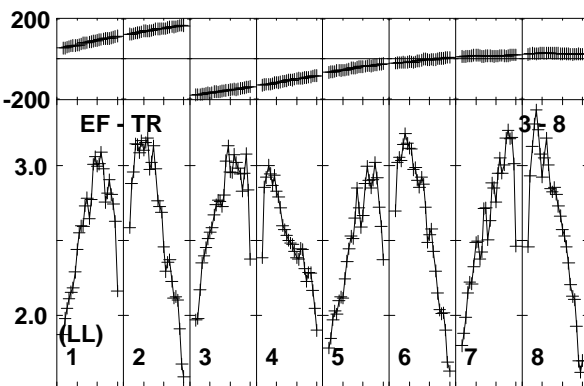
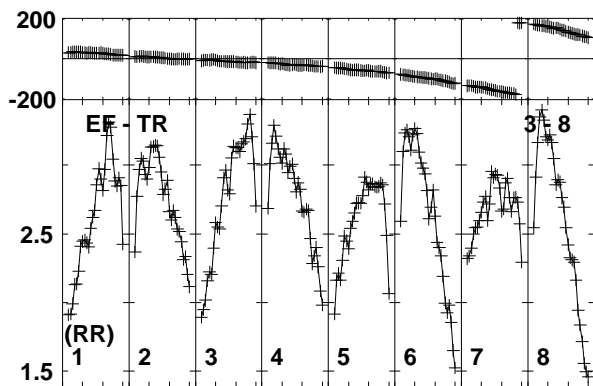
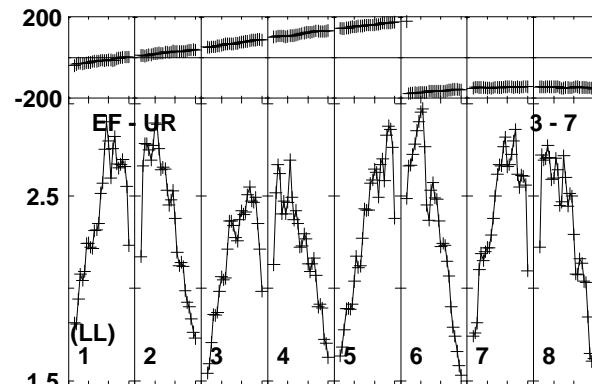
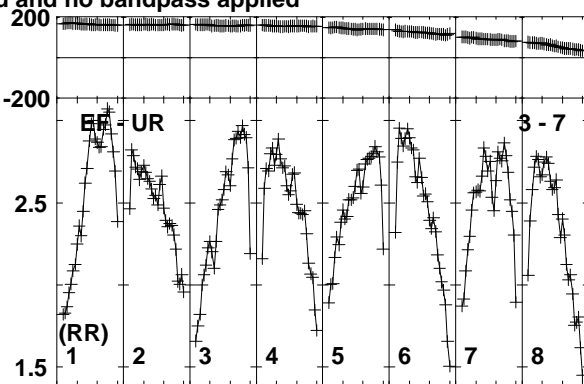
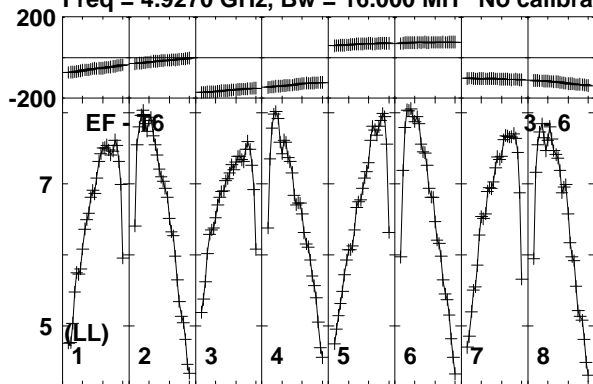

Lower frame: Milli Ampl Jy Top frame: Phas deg
Vector averaged cross-power spectrum Baseline: EF (03) - T6 (06)
Timerange: 00/09:05:21 to 00/09:07:19

Plot file version 504 created 17-FEB-2020 15:43:28

J1359+5544 EK047 2.UVDATA.1

Freq = 4.9270 GHz, Bw = 16.000 MH No calibration applied and no bandpass applied

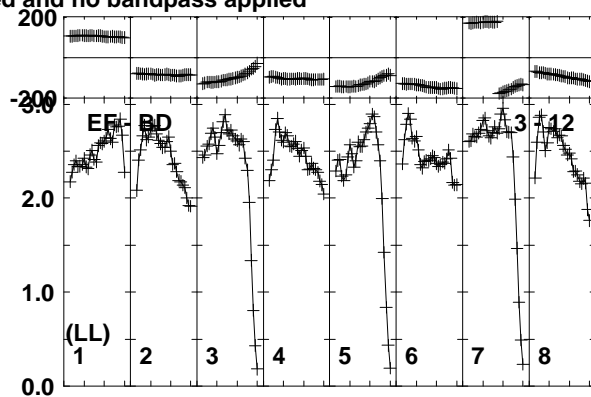
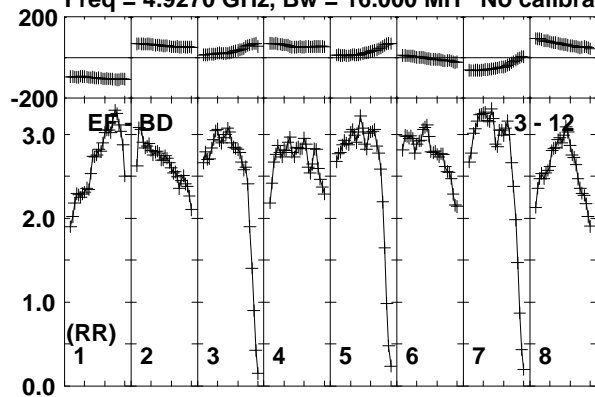

Lower frame: Milli Ampl Jy Top frame: Phas deg
Vector averaged cross-power spectrum Baseline: EF (03) - BD (12)
Timerange: 00/09:05:21 to 00/09:07:19

Plot file version 505 created 17-FEB-2020 15:43:28

J1402+5347 EK047 2.UVDATA.1

Freq = 4.9270 GHz, Bw = 16.000 MH No calibration applied and no bandpass applied

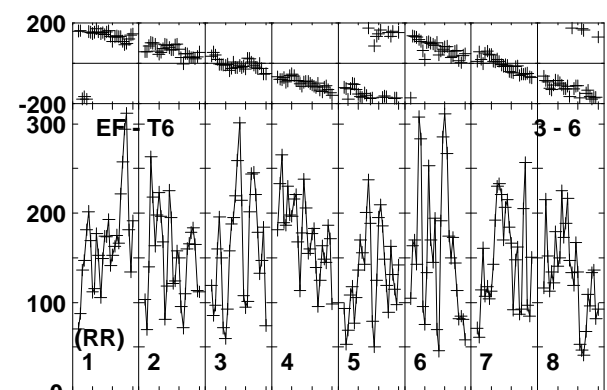
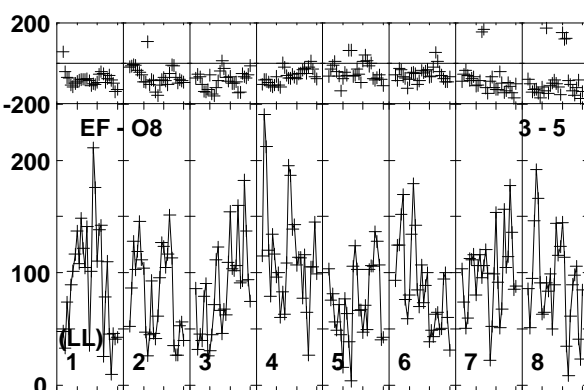
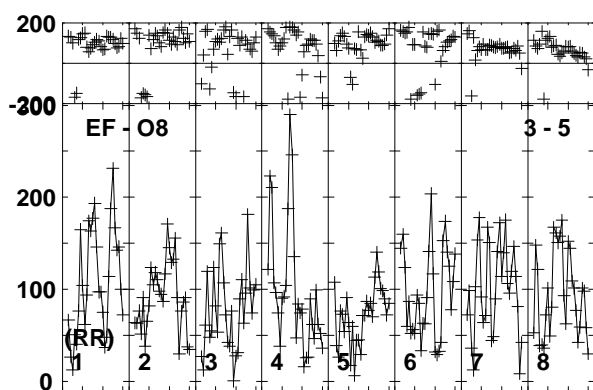
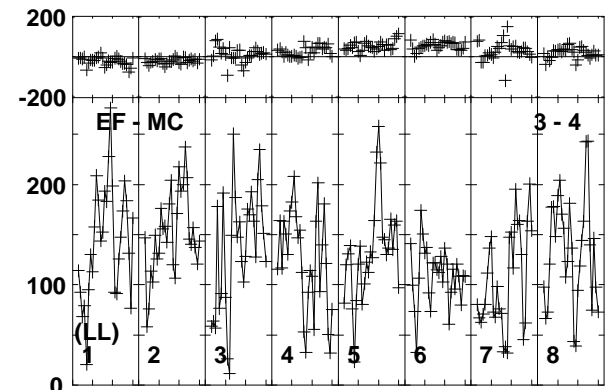
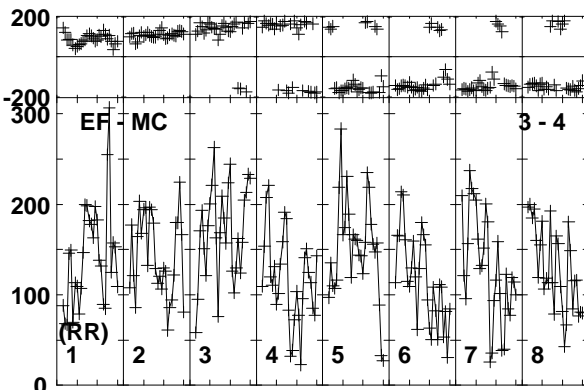
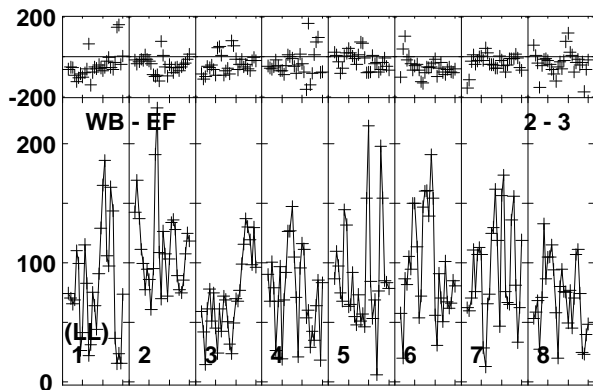
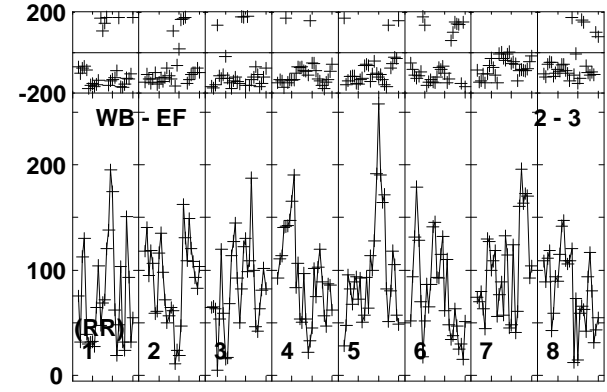
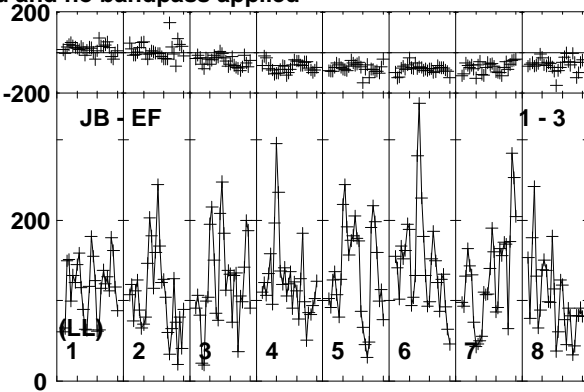
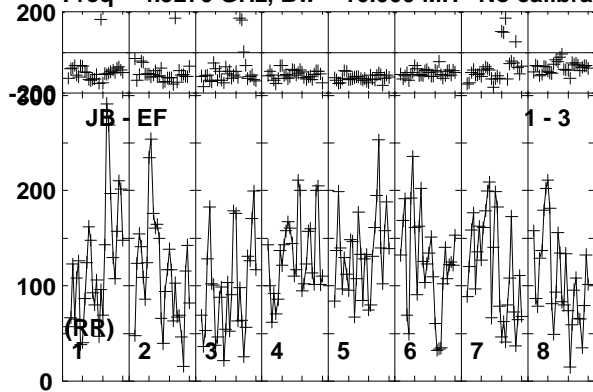

Lower frame: Micro Ampl Jy Top frame: Phas deg
Vector averaged cross-power spectrum Baseline: JB (01) - EF (03)
Timerange: 00/09:07:23 to 00/09:11:19

Plot file version 506 created 17-FEB-2020 15:43:28

J1402+5347 EK047 2.UVDATA.1

Freq = 4.9270 GHz, Bw = 16.000 MH No calibration applied and no bandpass applied

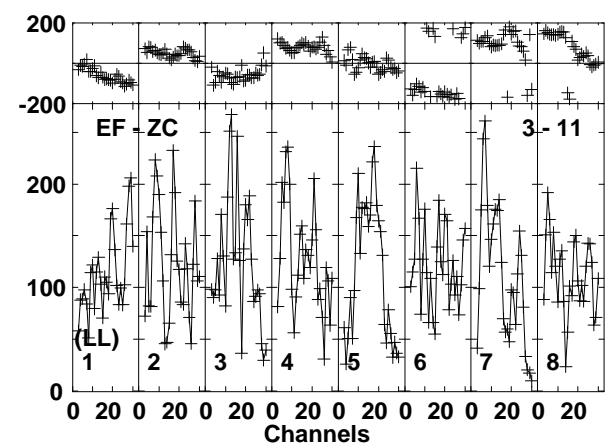
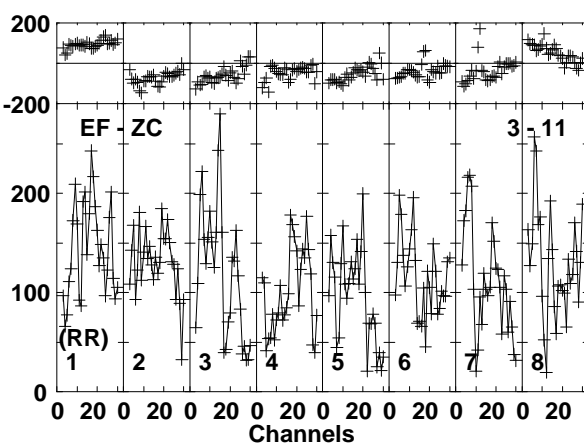
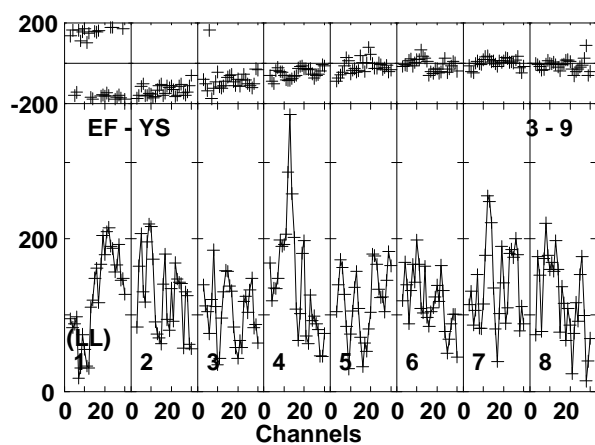
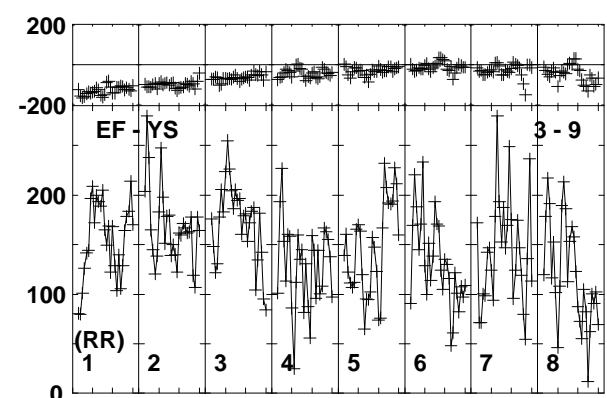
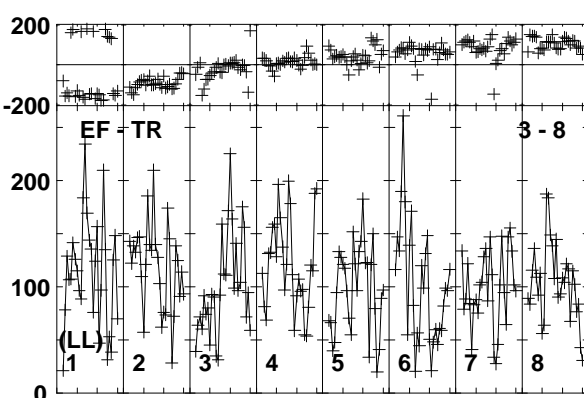
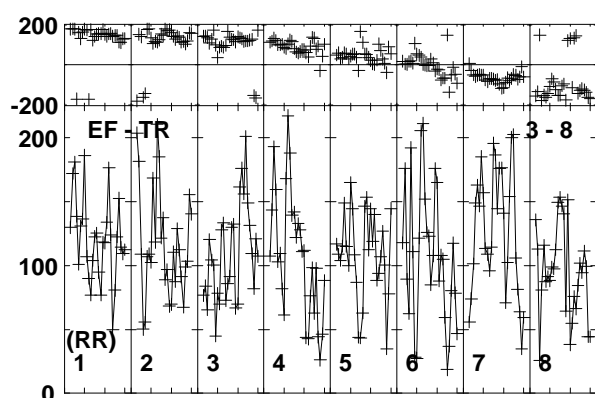
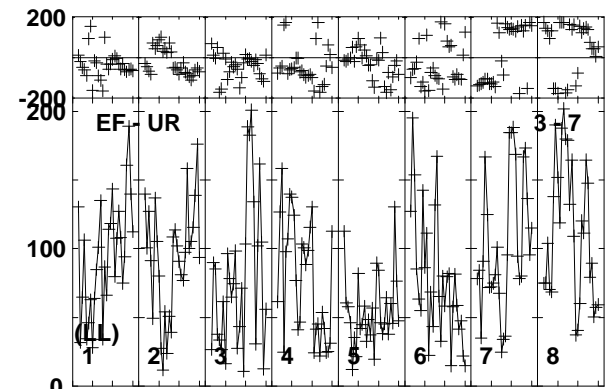
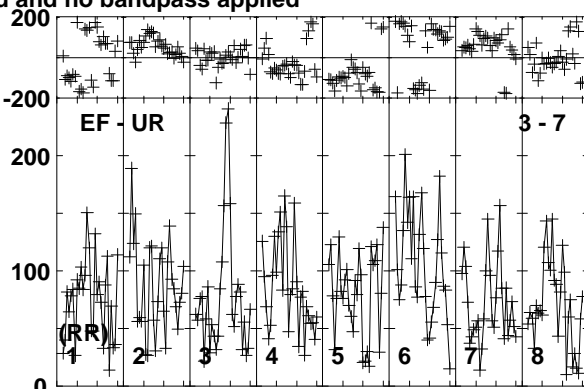
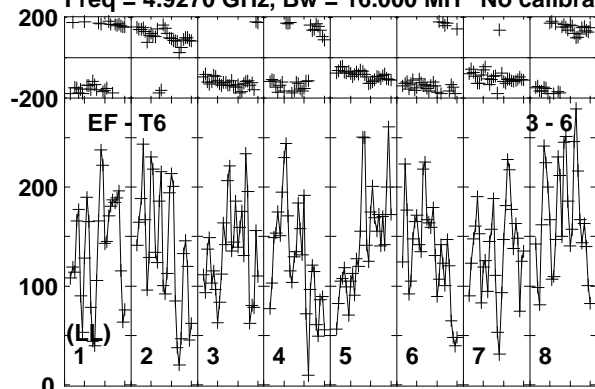

Lower frame: Micro Ampl Jy Top frame: Phas deg
Vector averaged cross-power spectrum Baseline: EF (03) - T6 (06)
Timerange: 00/09:07:23 to 00/09:11:19

Plot file version 507 created 17-FEB-2020 15:43:28

J1402+5347 EK047 2.UVDATA.1

Freq = 4.9270 GHz, Bw = 16.000 MH No calibration applied and no bandpass applied

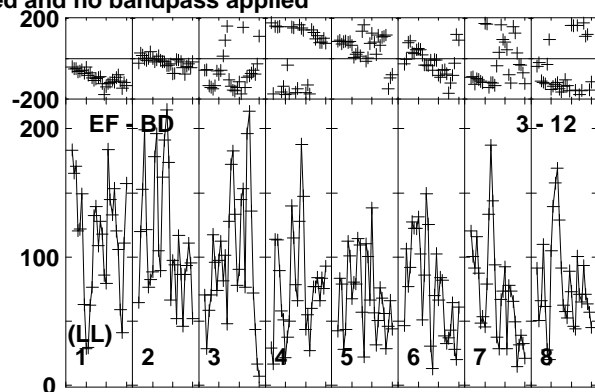
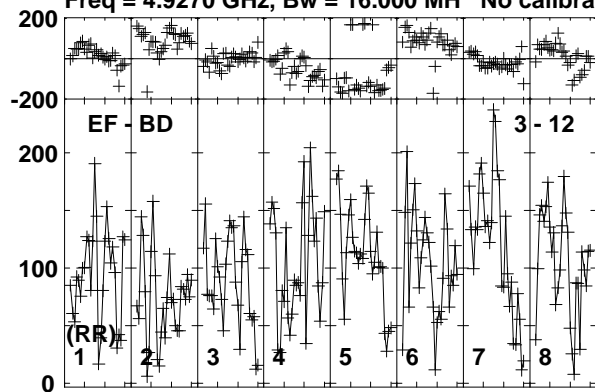

Lower frame: Micro Ampl Jy Top frame: Phas deg
Vector averaged cross-power spectrum Baseline: EF (03) - BD (12)
Timerange: 00/09:07:23 to 00/09:11:19

Plot file version 508 created 17-FEB-2020 15:43:28

J1359+5544 EK047 2.UVDATA.1

Freq = 4.9270 GHz, Bw = 16.000 MH No calibration applied and no bandpass applied

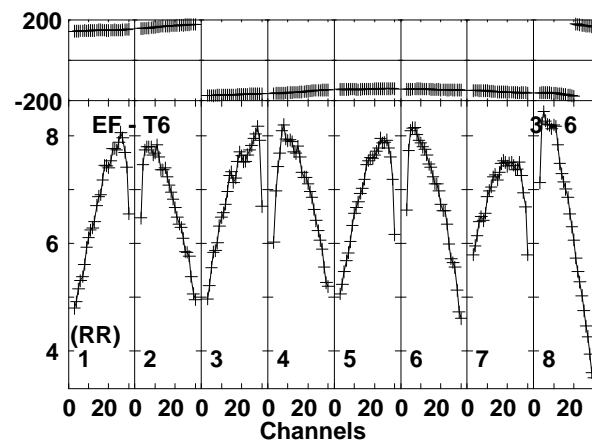
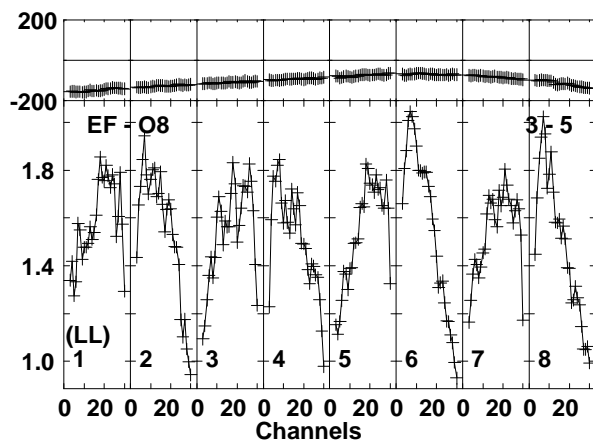
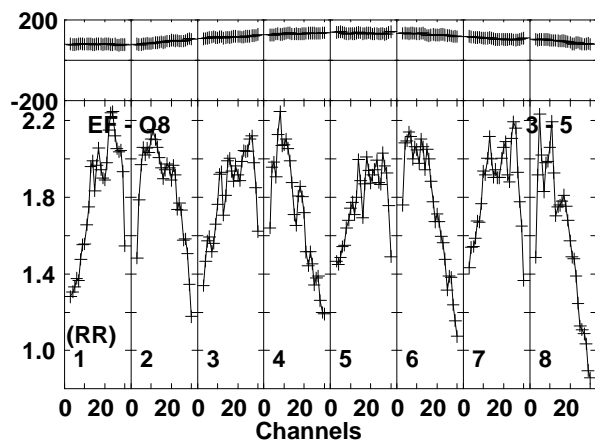
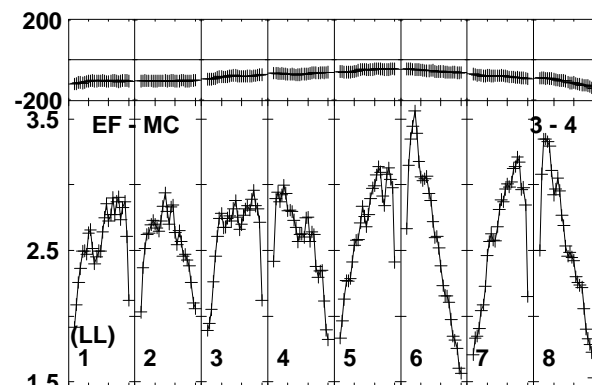
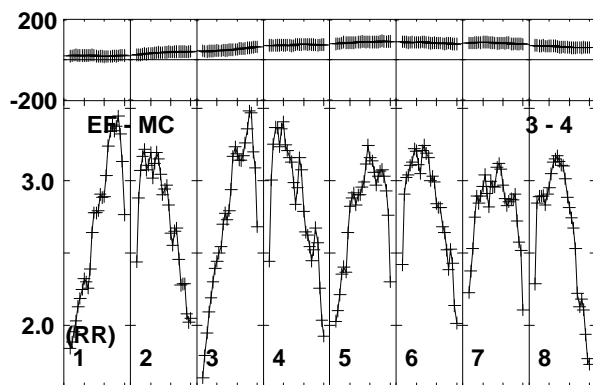
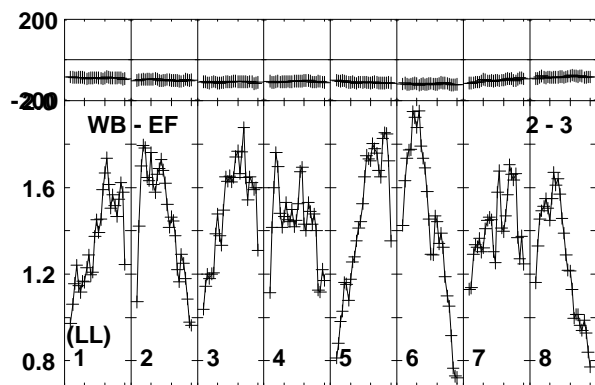
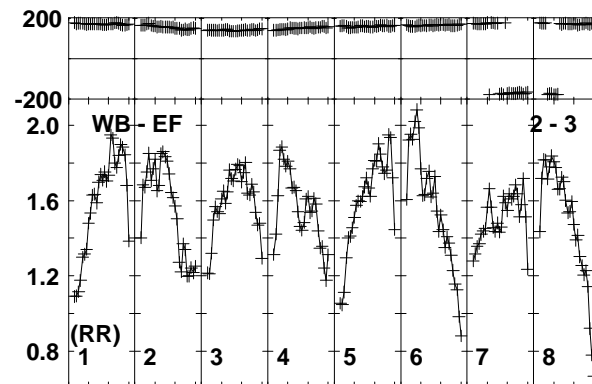
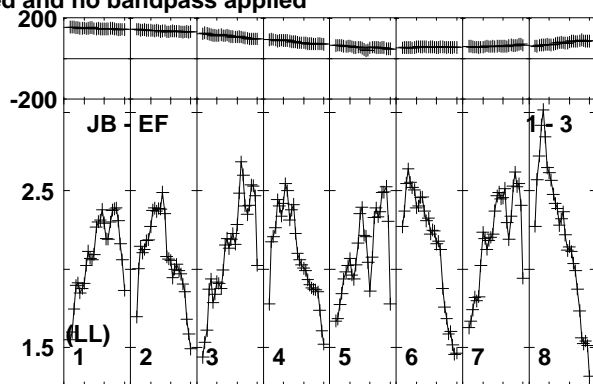
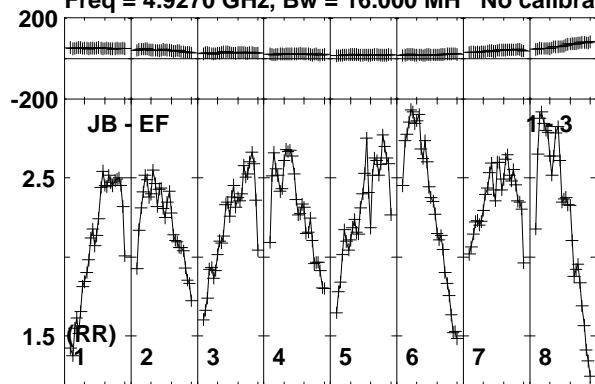

Lower frame: Milli Ampl Jy Top frame: Phas deg
Vector averaged cross-power spectrum Baseline: JB (01) - EF (03)
Timerange: 00/09:12:01 to 00/09:13:19

Plot file version 509 created 17-FEB-2020 15:43:28

J1359+5544 EK047 2.UVDATA.1

Freq = 4.9270 GHz, Bw = 16.000 MH No calibration applied and no bandpass applied

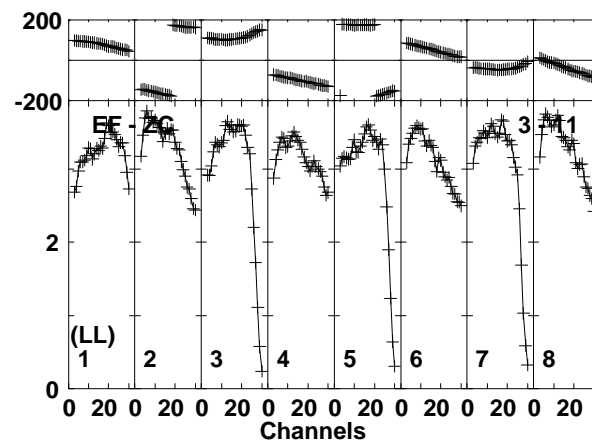
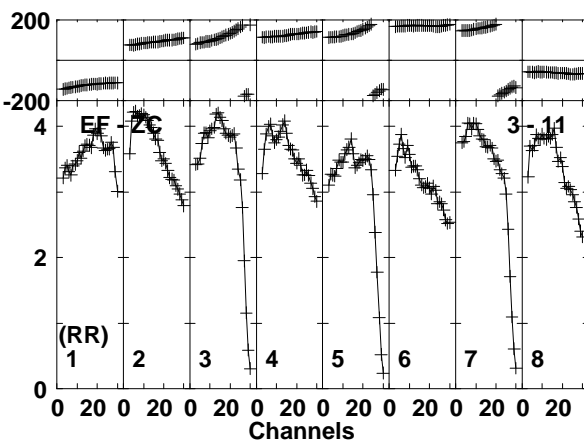
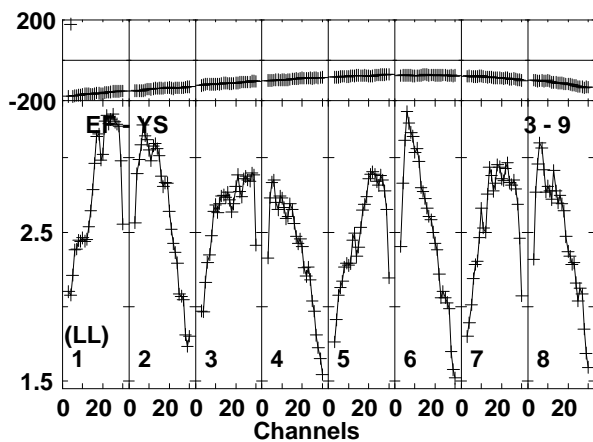
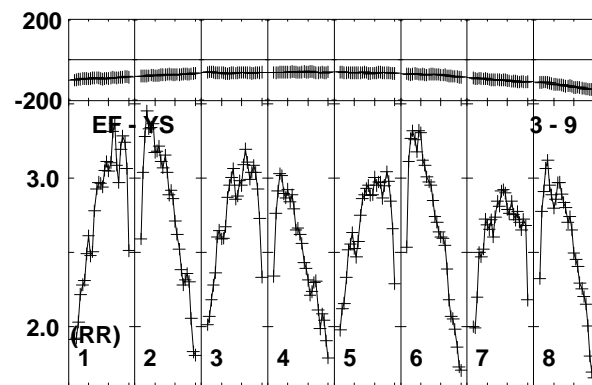
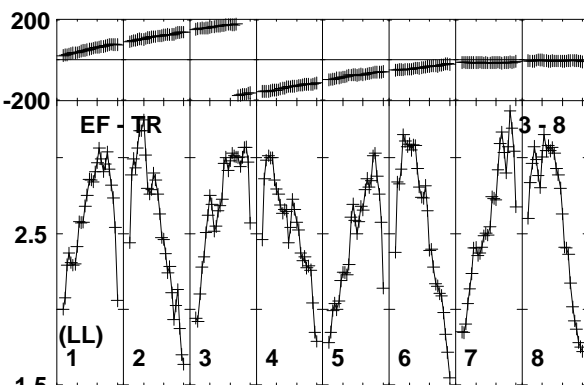
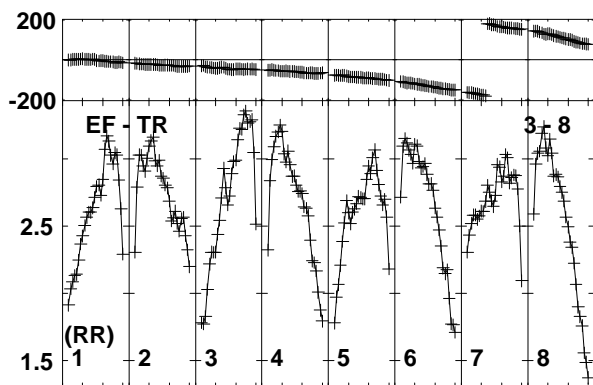
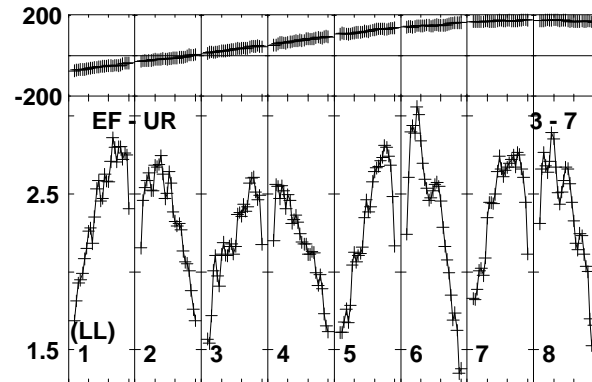
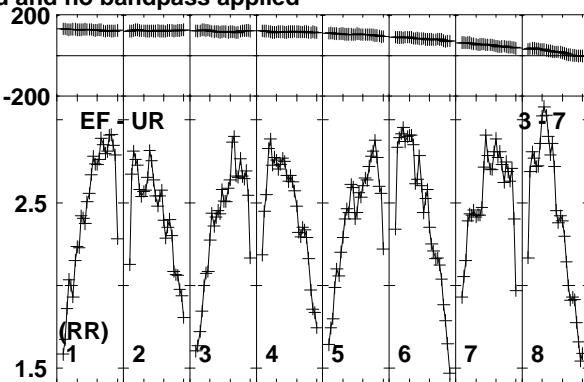
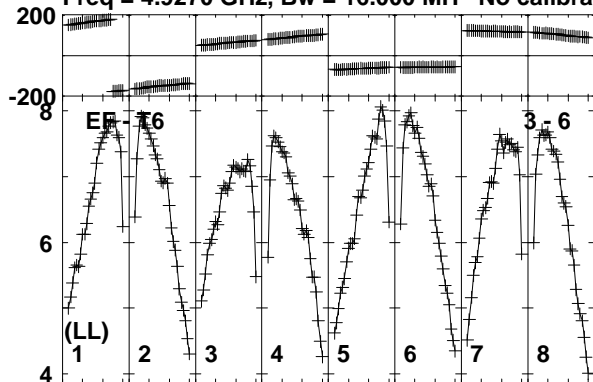

Lower frame: Milli Ampl Jy Top frame: Phas deg
Vector averaged cross-power spectrum Baseline: EF (03) - T6 (06)
Timerange: 00/09:12:01 to 00/09:13:19

Plot file version 510 created 17-FEB-2020 15:43:28

J1359+5544 EK047 2.UVDATA.1

Freq = 4.9270 GHz, Bw = 16.000 MH No calibration applied and no bandpass applied

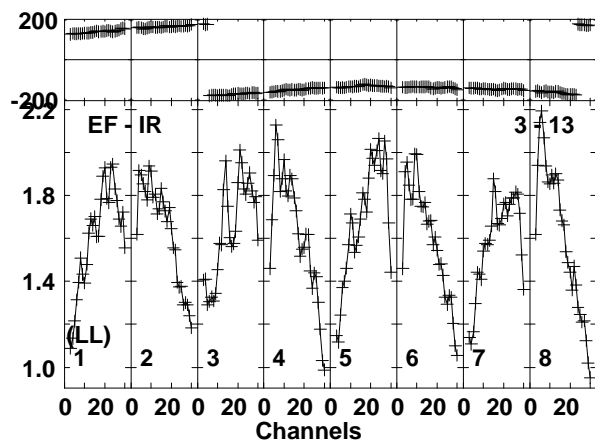
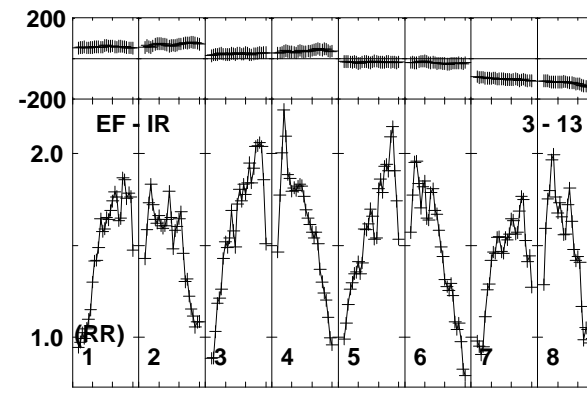
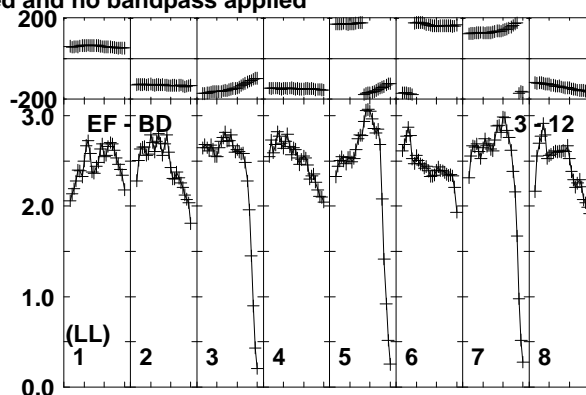
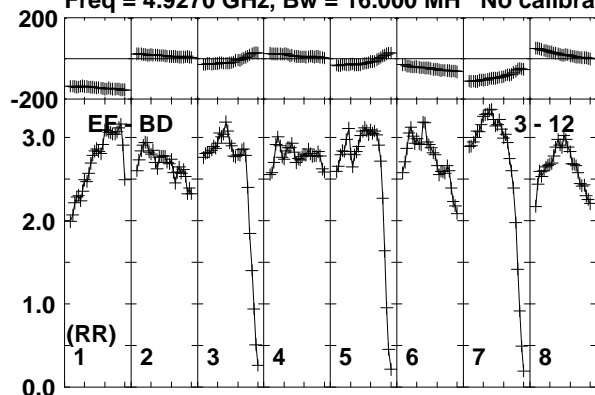

Lower frame: Milli Ampl Jy Top frame: Phas deg
Vector averaged cross-power spectrum Baseline: EF (03) - BD (12)
Timerange: 00/09:12:01 to 00/09:13:19

Plot file version 511 created 17-FEB-2020 15:43:29

J1402+5347 EK047 2.UVDATA.1

Freq = 4.9270 GHz, Bw = 16.000 MH No calibration applied and no bandpass applied

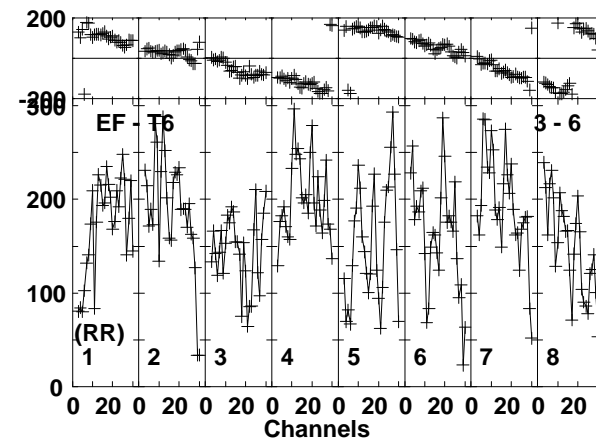
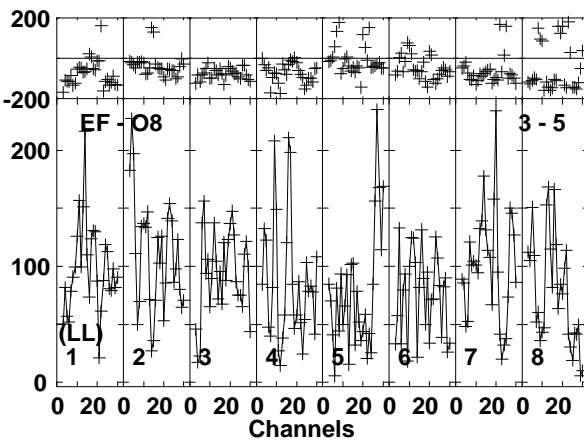
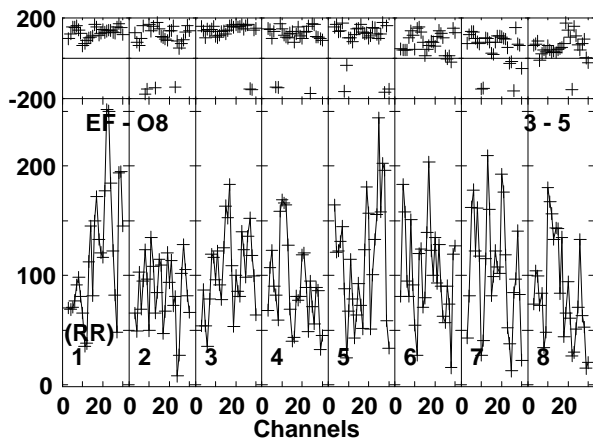
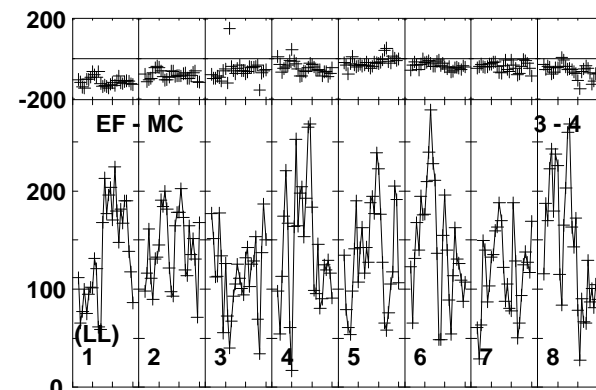
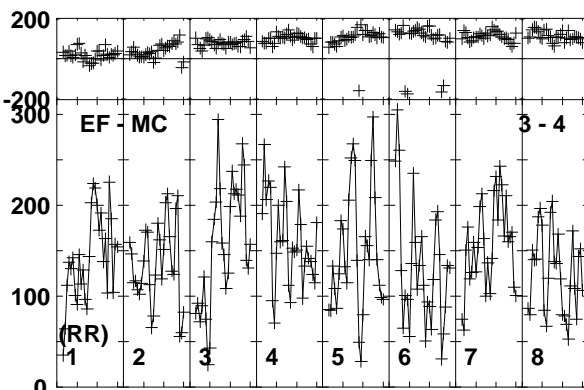
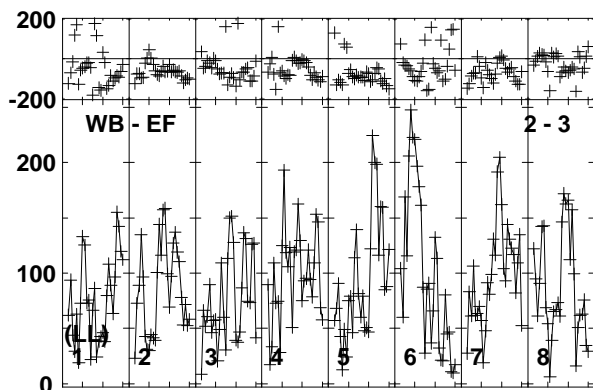
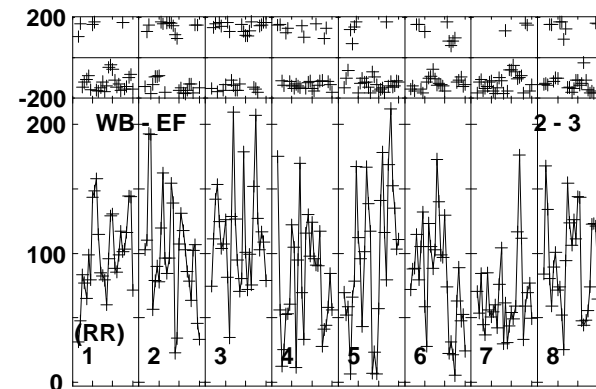
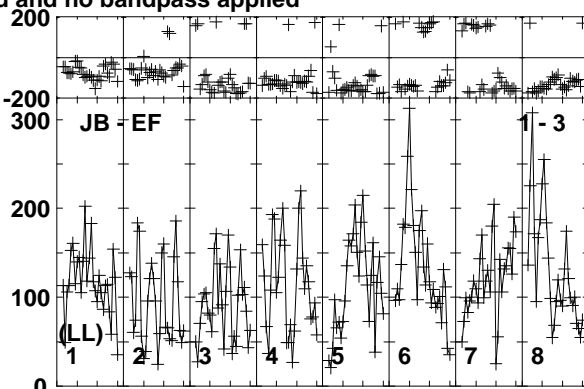
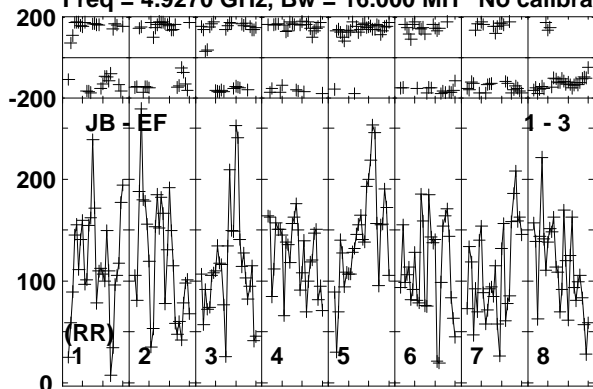

Lower frame: Micro Ampl Jy Top frame: Phas deg
Vector averaged cross-power spectrum Baseline: JB (01) - EF (03)
Timerange: 00/09:13:21 to 00/09:17:19

Plot file version 512 created 17-FEB-2020 15:43:29

J1402+5347 EK047 2.UVDATA.1

Freq = 4.9270 GHz, Bw = 16.000 MH No calibration applied and no bandpass applied

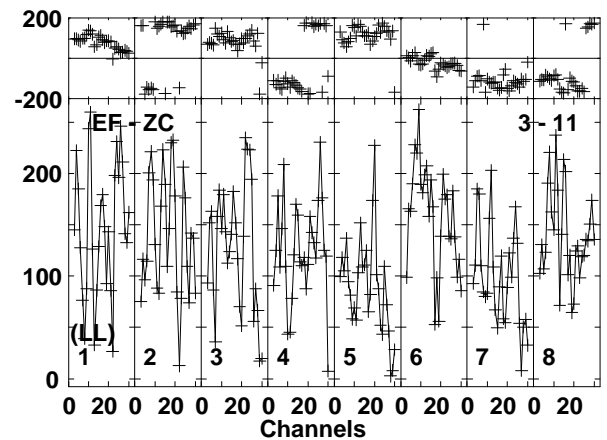
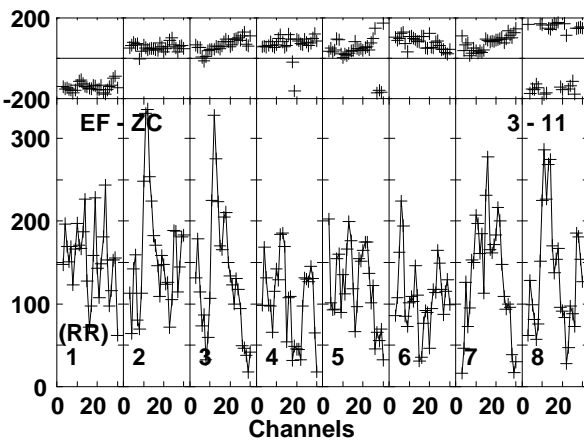
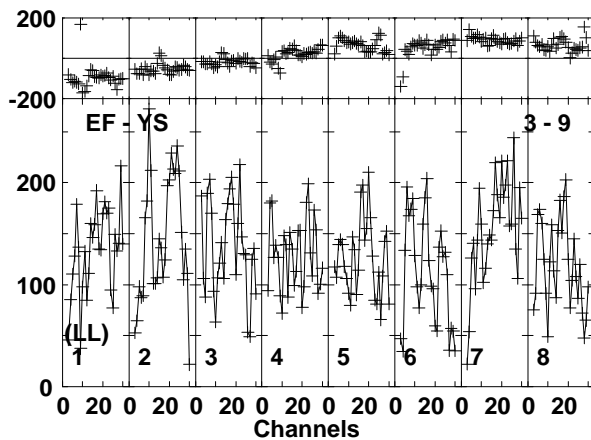
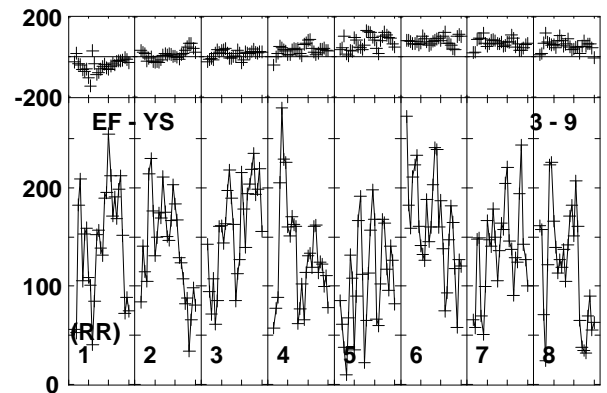
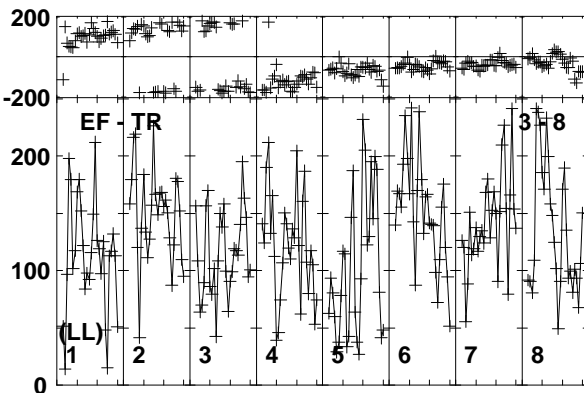
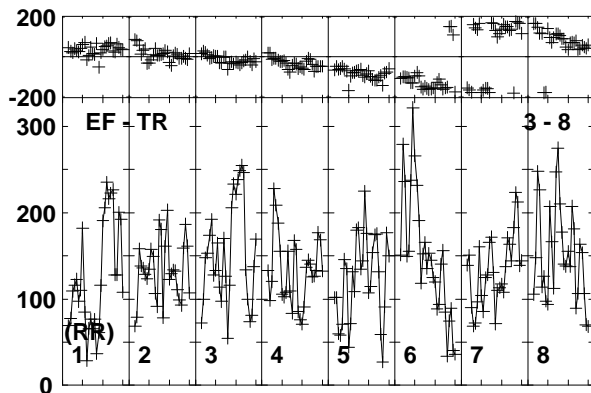
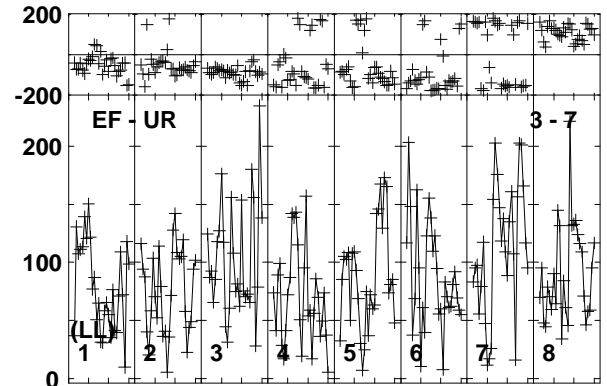
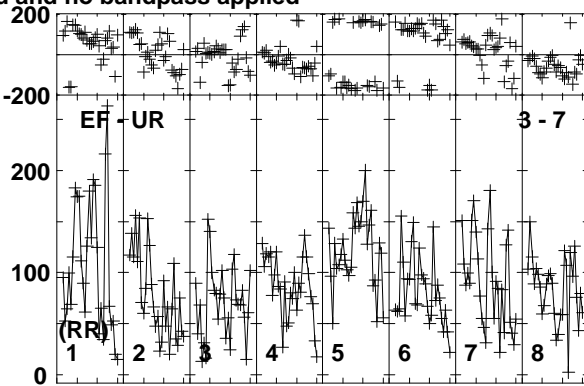
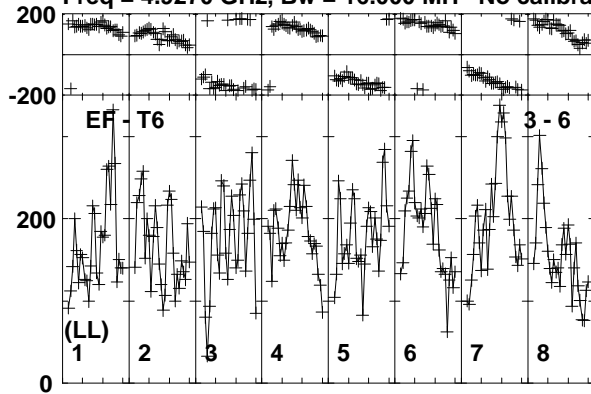

Lower frame: Micro Ampl Jy Top frame: Phas deg
Vector averaged cross-power spectrum Baseline: EF (03) - T6 (06)
Timerange: 00/09:13:21 to 00/09:17:19

Plot file version 514 created 17-FEB-2020 15:43:29

J1359+5544 EK047 2.UVDATA.1

Freq = 4.9270 GHz, Bw = 16.000 MH No calibration applied and no bandpass applied

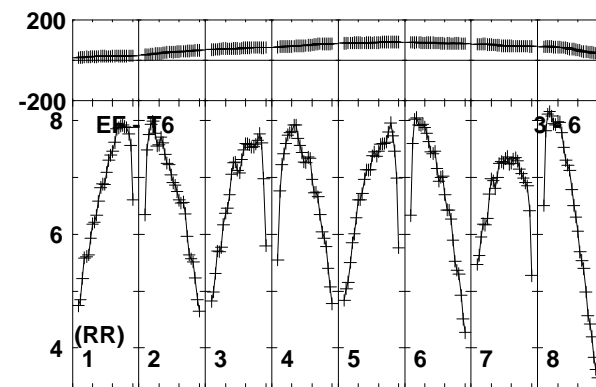
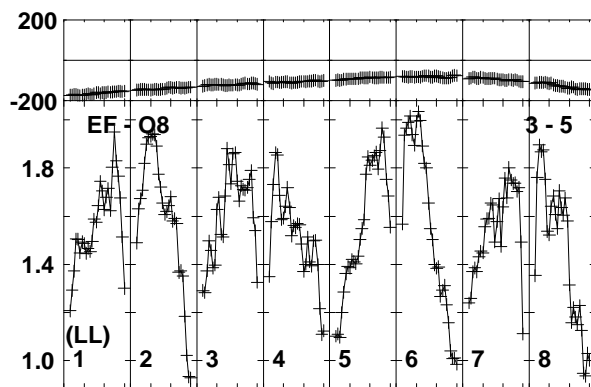
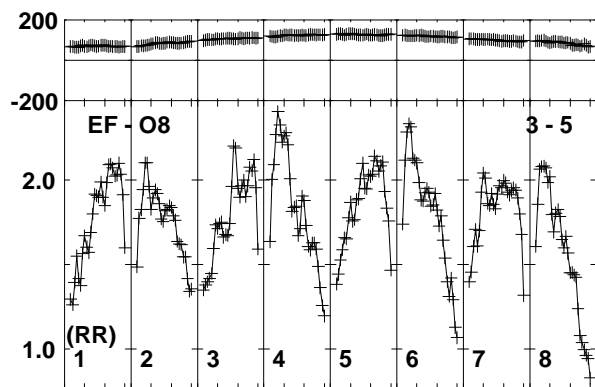
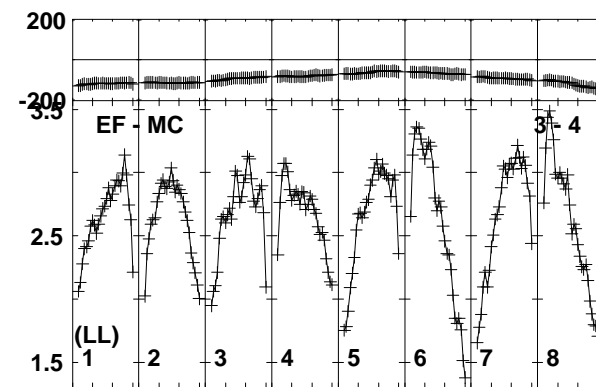
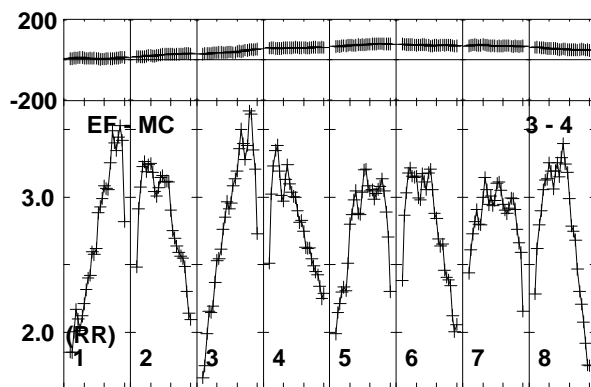
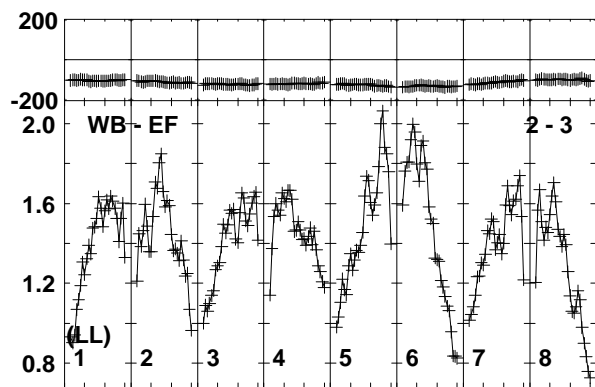
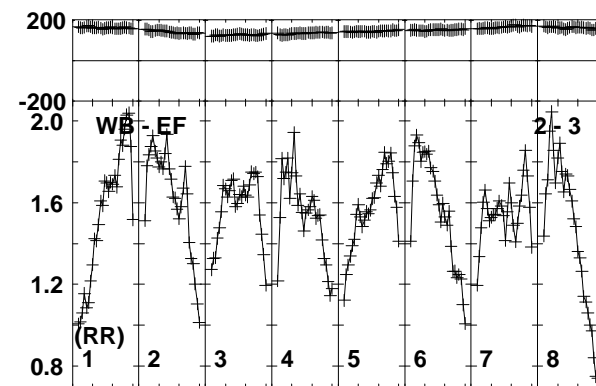
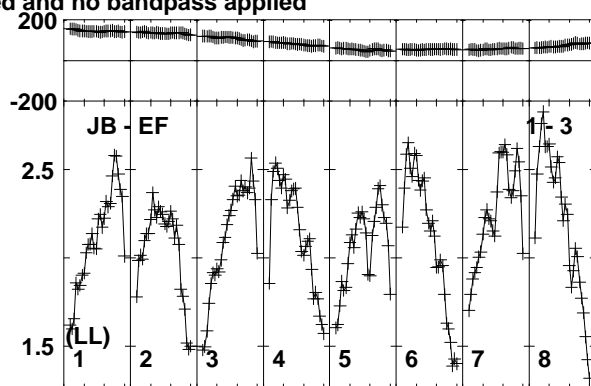
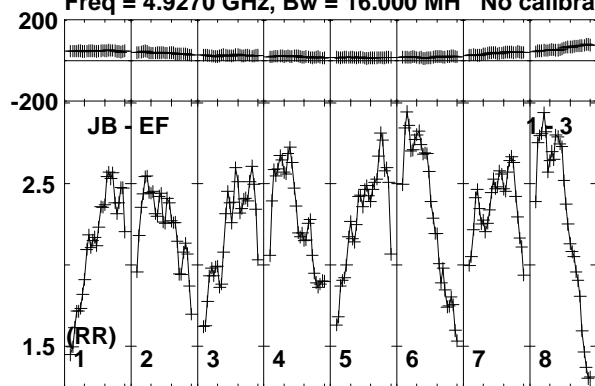

Lower frame: Milli Ampl Jy Top frame: Phas deg
Vector averaged cross-power spectrum Baseline: JB (01) - EF (03)
Timerange: 00/09:17:21 to 00/09:19:19

Plot file version 515 created 17-FEB-2020 15:43:29

J1359+5544 EK047 2.UVDATA.1

Freq = 4.9270 GHz, Bw = 16.000 MH No calibration applied and no bandpass applied

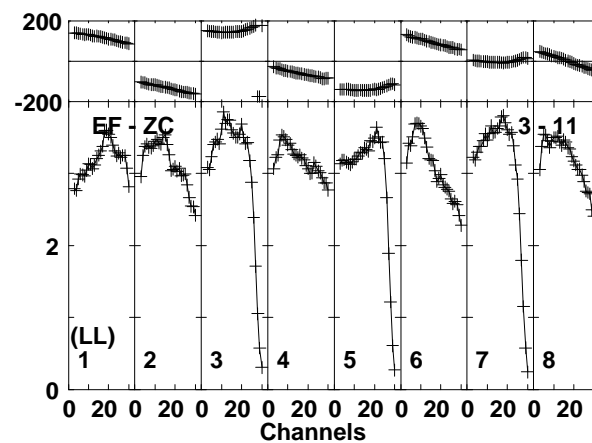
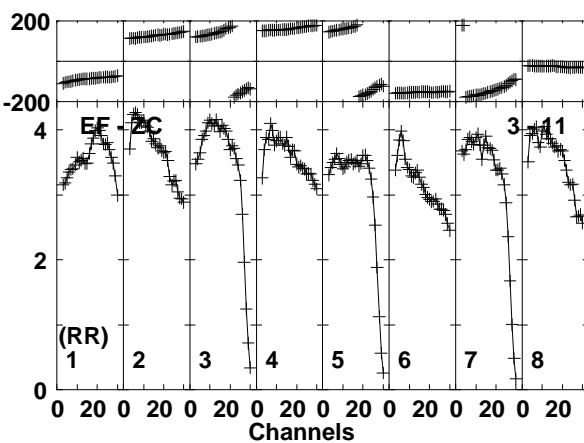
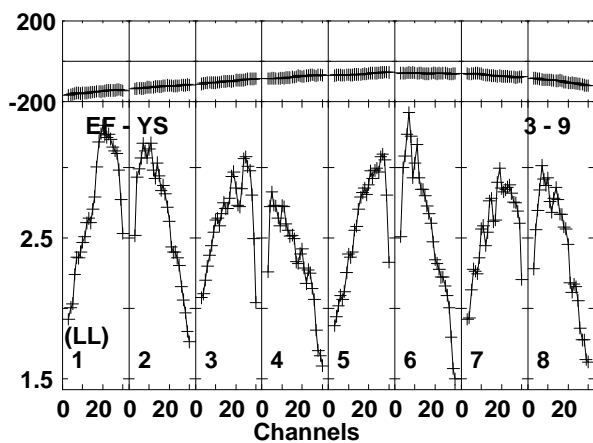
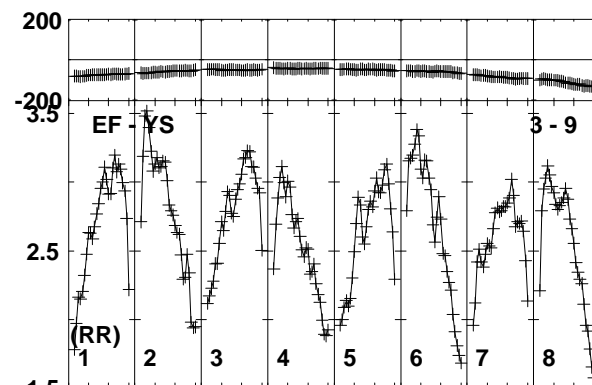
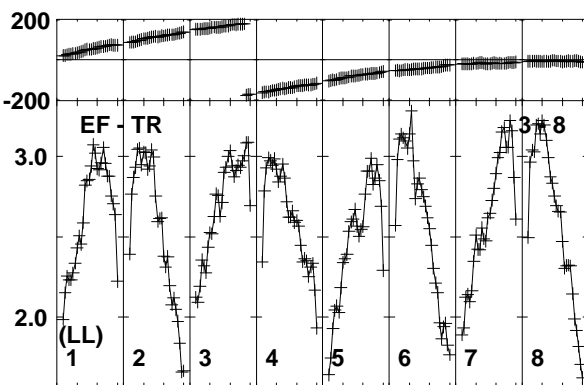
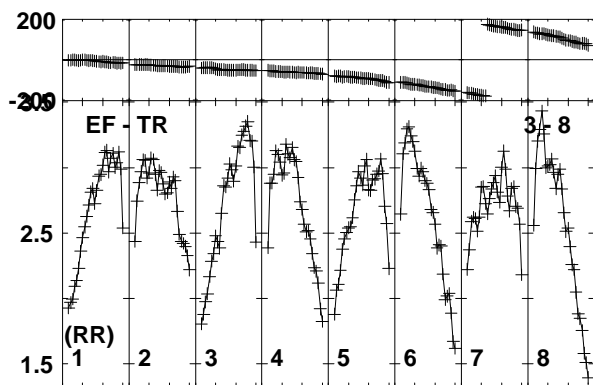
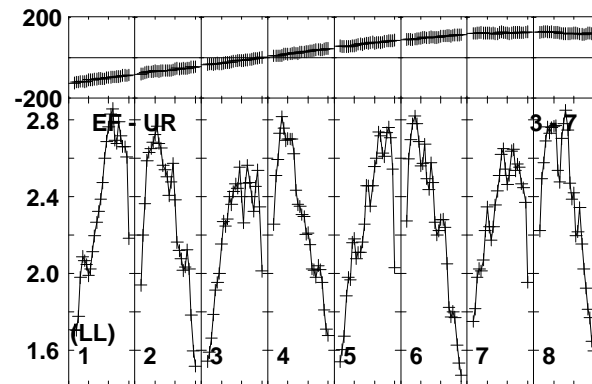
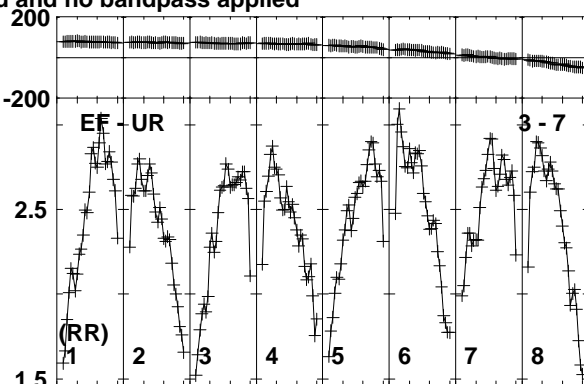
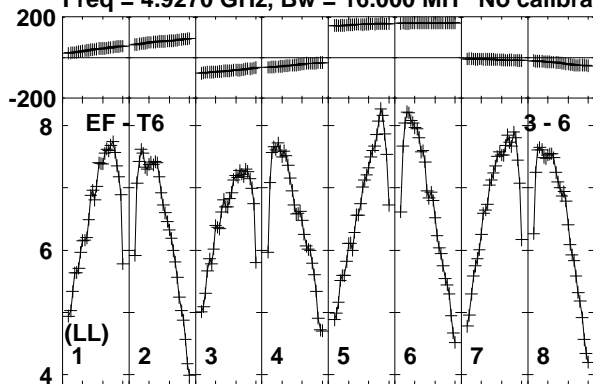

Lower frame: Milli Ampl Jy Top frame: Phas deg
Vector averaged cross-power spectrum Baseline: EF (03) - T6 (06)
Timerange: 00/09:17:21 to 00/09:19:19

Plot file version 516 created 17-FEB-2020 15:43:29

J1359+5544 EK047 2.UVDATA.1

Freq = 4.9270 GHz, Bw = 16.000 MH No calibration applied and no bandpass applied

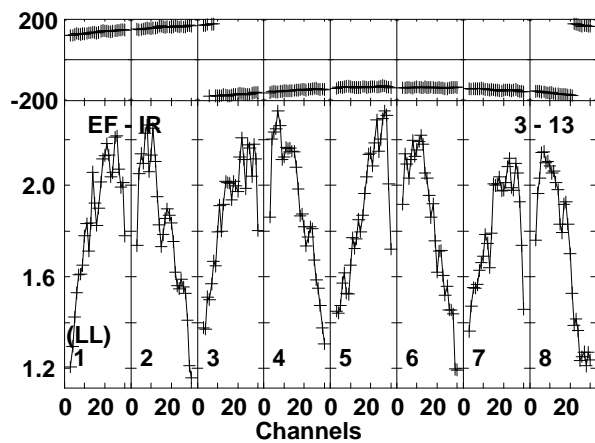
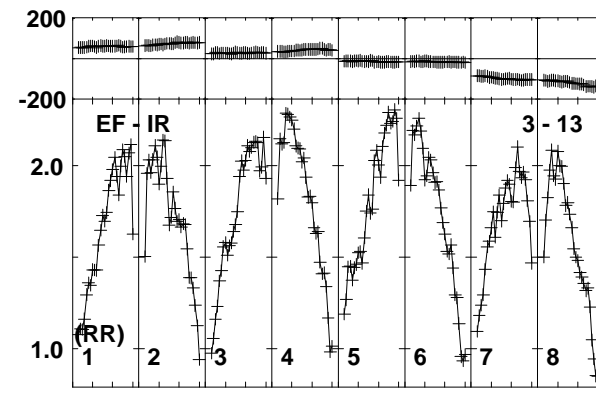
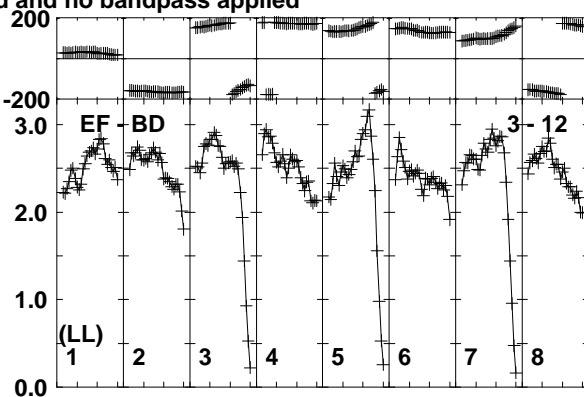
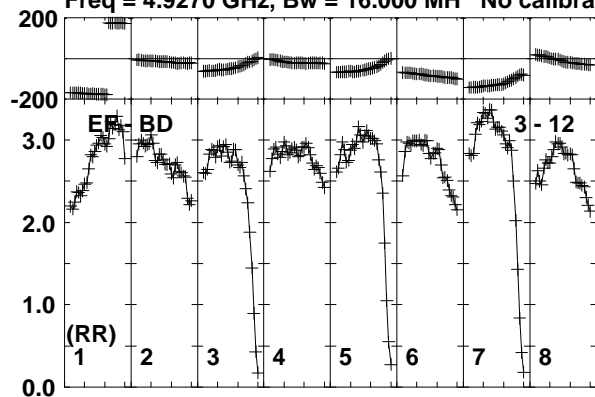

Lower frame: Milli Ampl Jy Top frame: Phas deg
Vector averaged cross-power spectrum Baseline: EF (03) - BD (12)
Timerange: 00/09:17:21 to 00/09:19:19

Plot file version 517 created 17-FEB-2020 15:43:29

J1402+5347 EK047 2.UVDATA.1

Freq = 4.9270 GHz, Bw = 16.000 MH No calibration applied and no bandpass applied

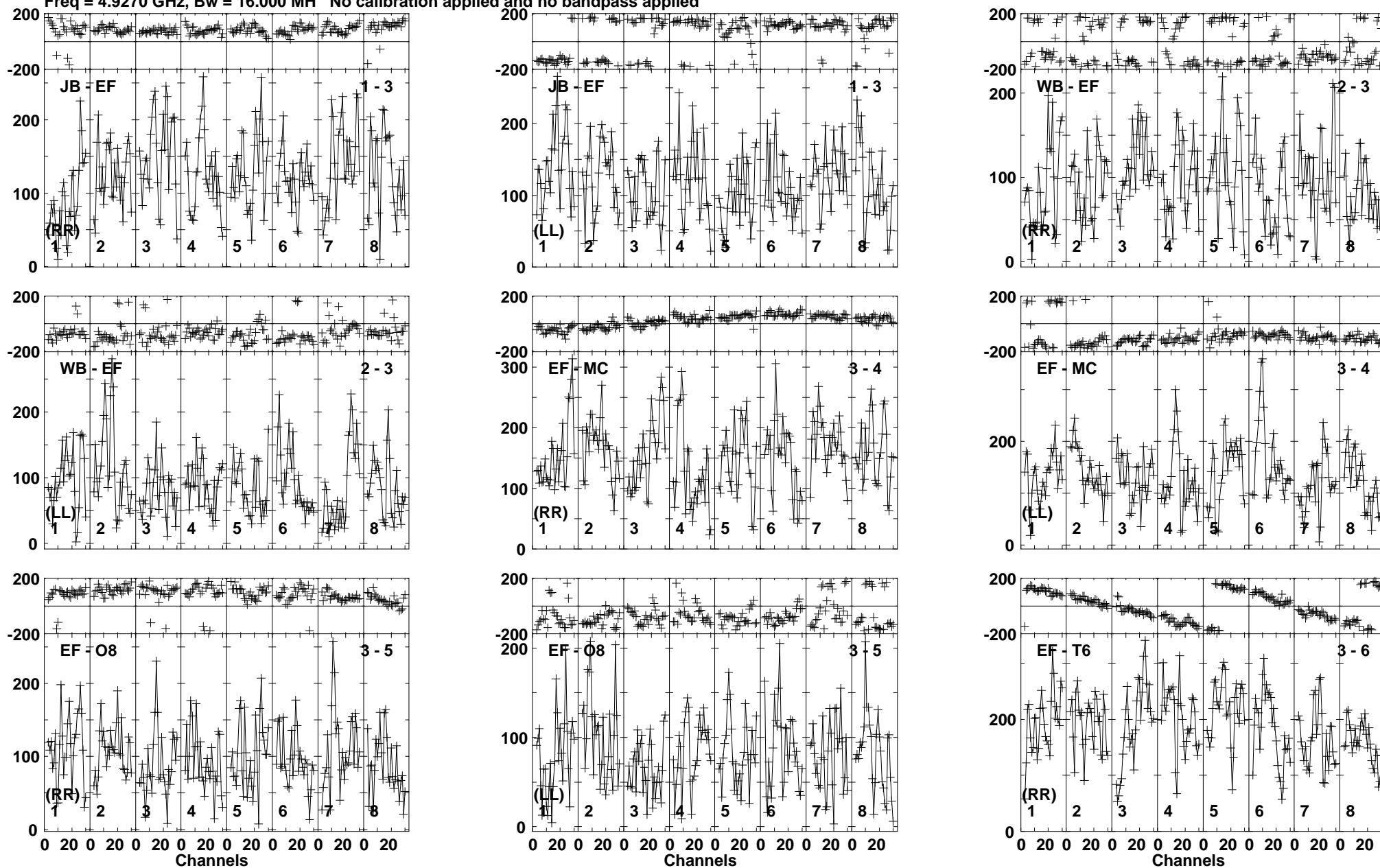

Lower frame: Micro Ampl Jy Top frame: Phas deg
Vector averaged cross-power spectrum Baseline: JB (01) - EF (03)
Timerange: 00/09:19:21 to 00/09:23:19

Plot file version 518 created 17-FEB-2020 15:43:29

J1402+5347 EK047 2.UVDATA.1

Freq = 4.9270 GHz, Bw = 16.000 MH No calibration applied and no bandpass applied

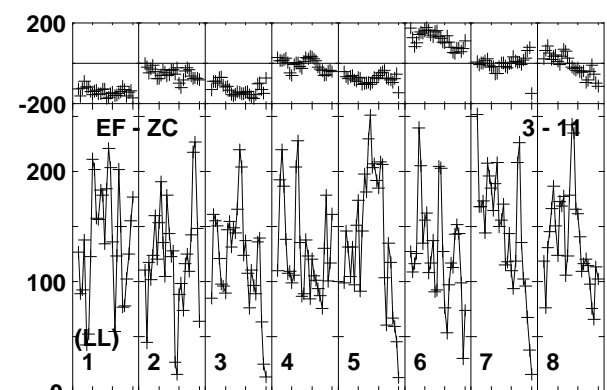
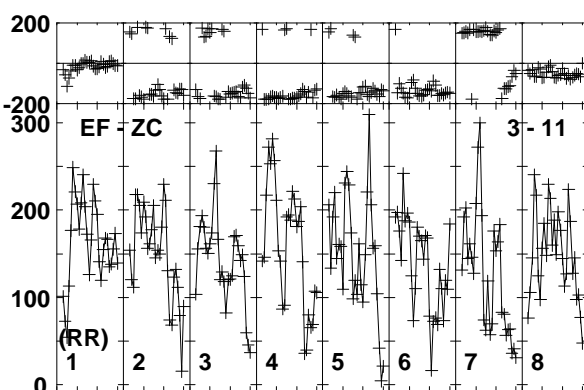
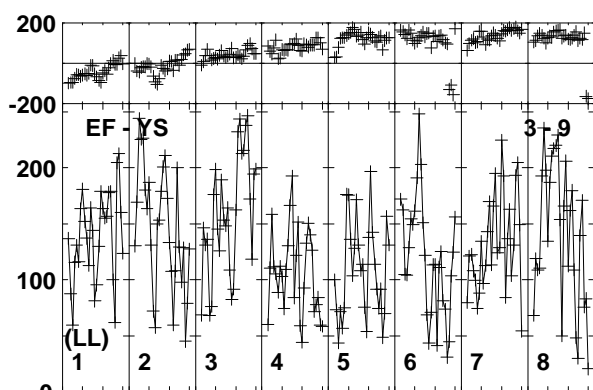
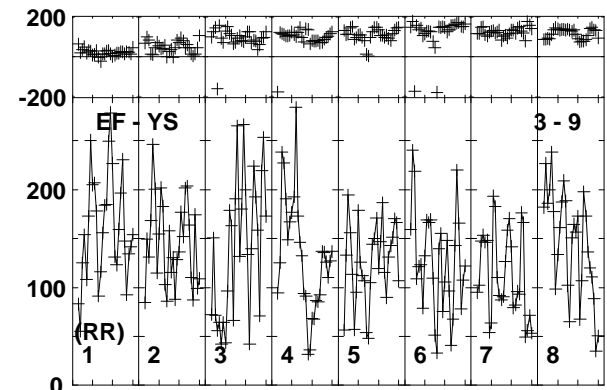
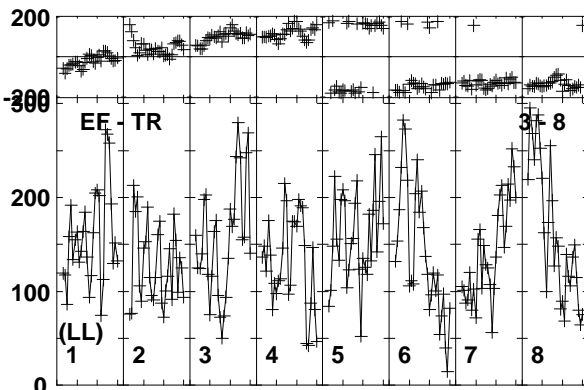
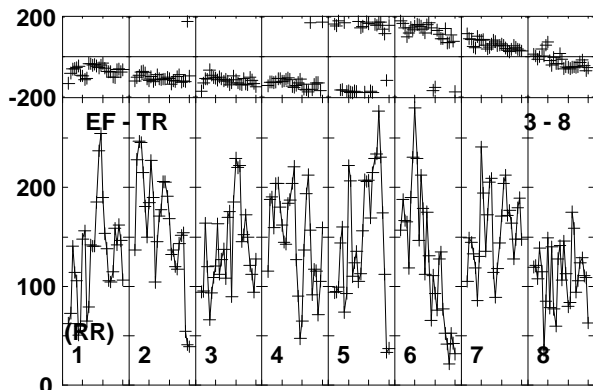
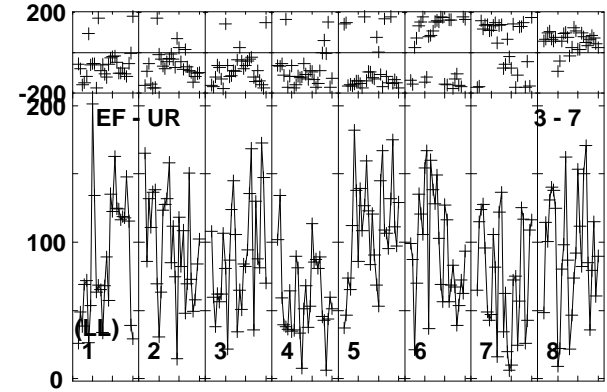
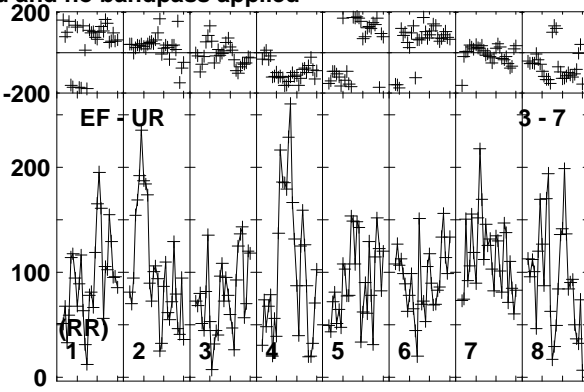
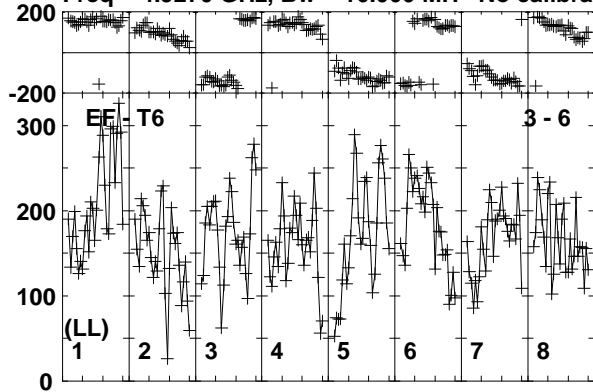

Lower frame: Micro Ampl Jy Top frame: Phas deg
Vector averaged cross-power spectrum Baseline: EF (03) - T6 (06)
Timerange: 00/09:19:21 to 00/09:23:19

Plot file version 519 created 17-FEB-2020 15:43:29

J1402+5347 EK047 2.UVDATA.1

Freq = 4.9270 GHz, Bw = 16.000 MH No calibration applied and no bandpass applied

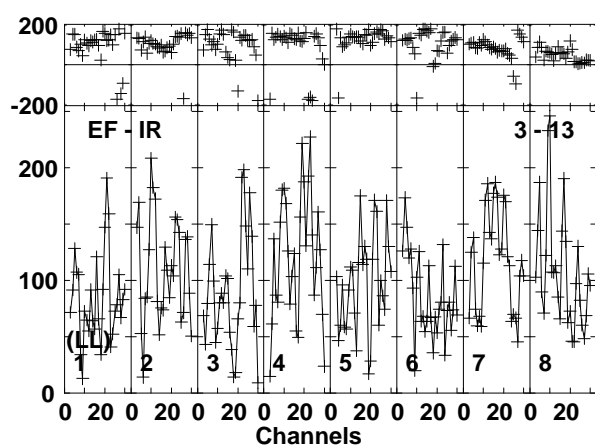
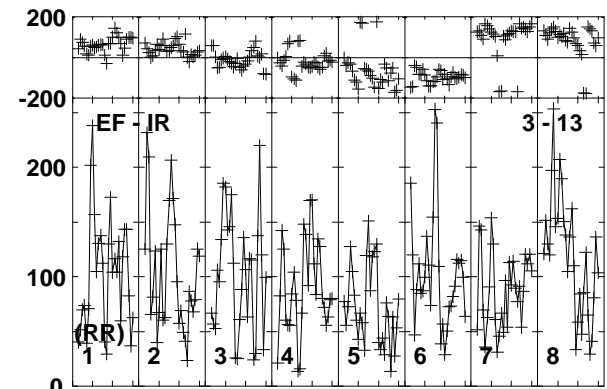
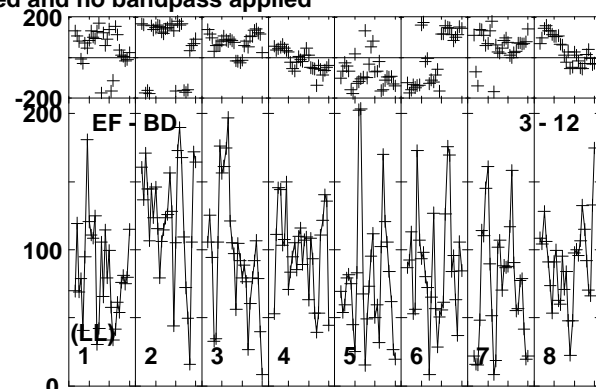
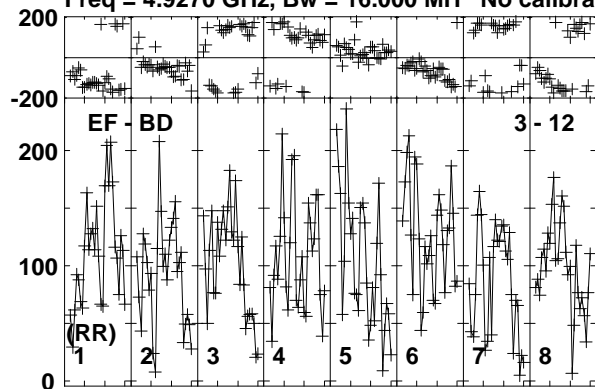

Lower frame: Micro Ampl Jy Top frame: Phas deg
Vector averaged cross-power spectrum Baseline: EF (03) - BD (12)
Timerange: 00/09:19:21 to 00/09:23:19

Plot file version 520 created 17-FEB-2020 15:43:29

J1359+5544 EK047 2.UVDATA.1

Freq = 4.9270 GHz, Bw = 16.000 MH No calibration applied and no bandpass applied

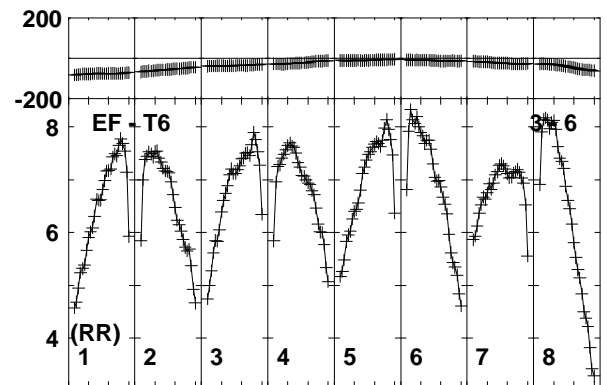
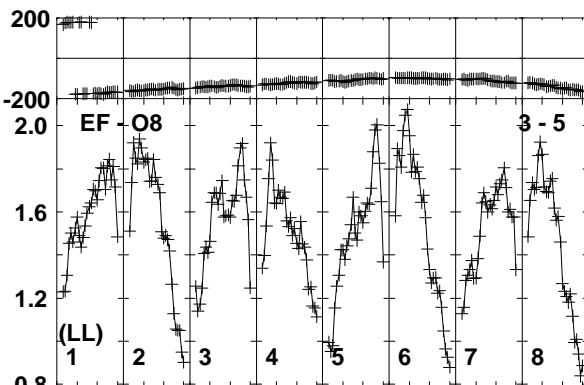
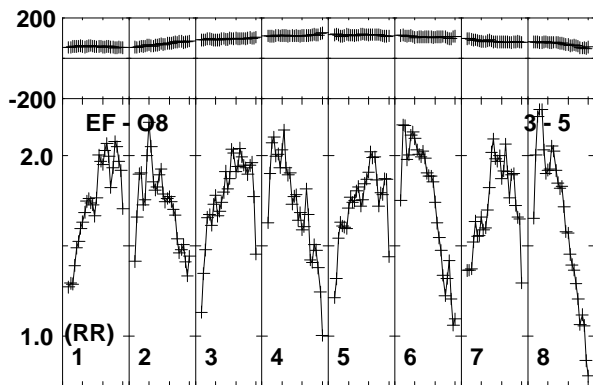
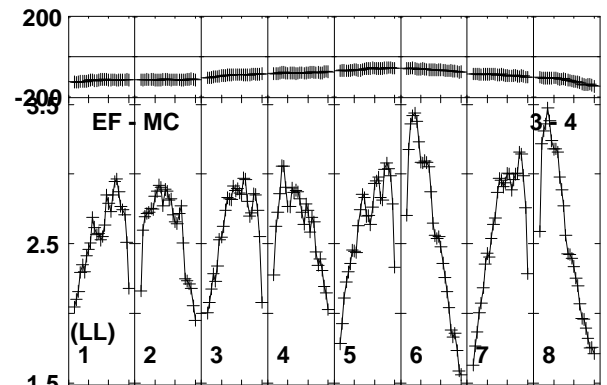
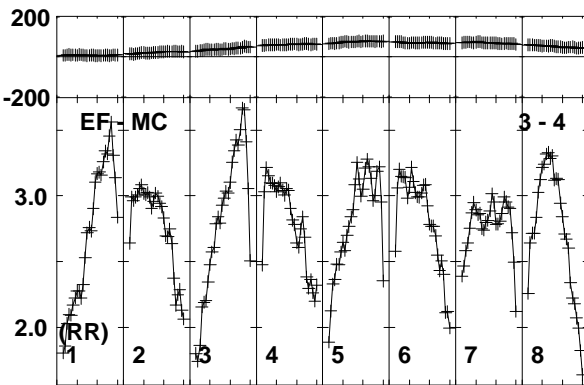
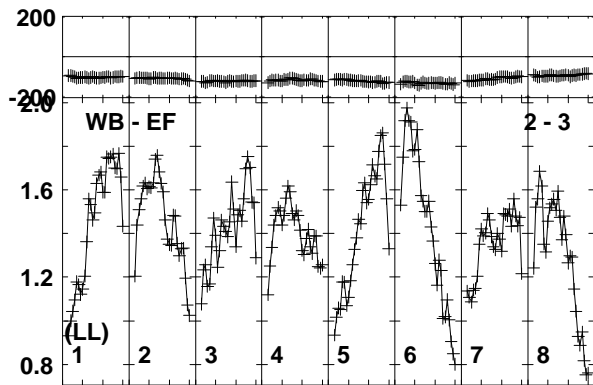
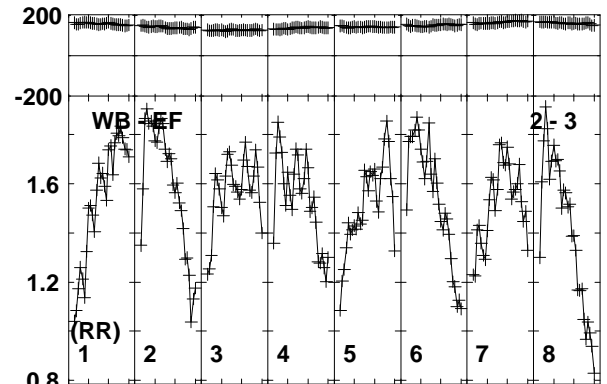
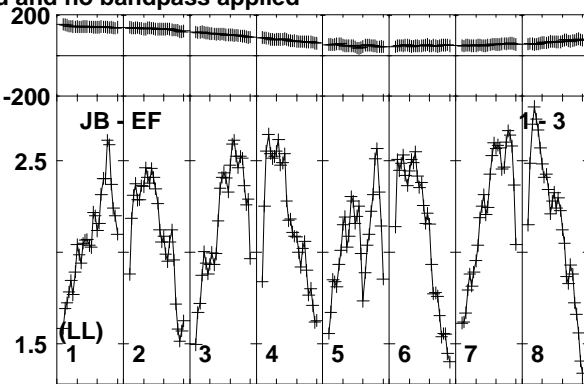
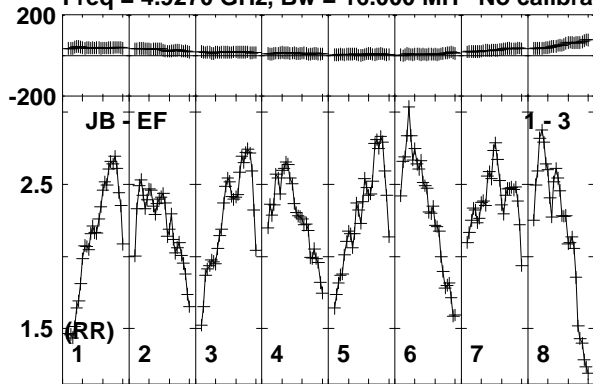

Lower frame: Milli Ampl Jy Top frame: Phas deg

Vector averaged cross-power spectrum Baseline: JB (01) - EF (03)

Timerange: 00/09:24:01 to 00/09:25:19

Plot file version 521 created 17-FEB-2020 15:43:29

J1359+5544 EK047 2.UVDATA.1

Freq = 4.9270 GHz, Bw = 16.000 MH No calibration applied and no bandpass applied

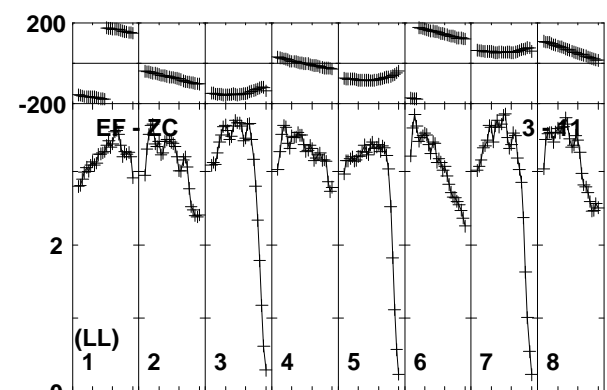
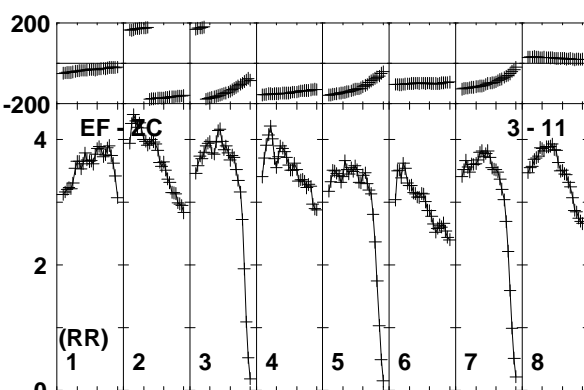
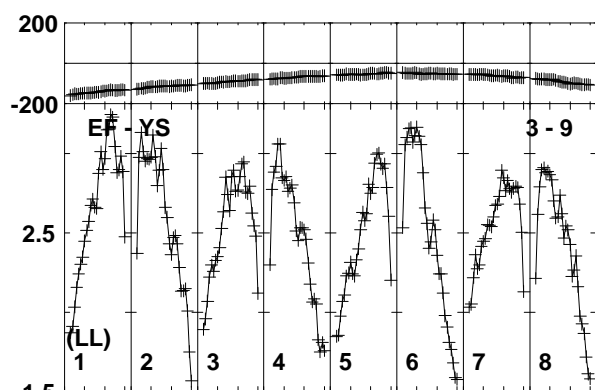
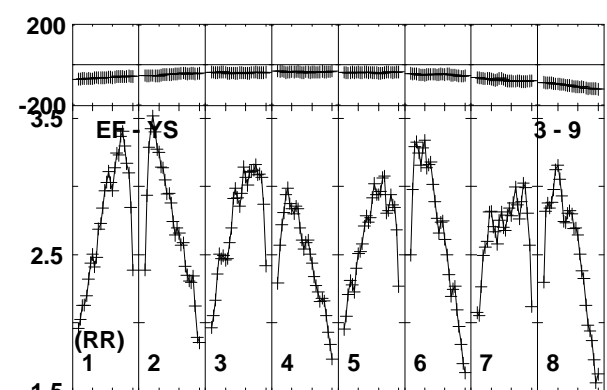
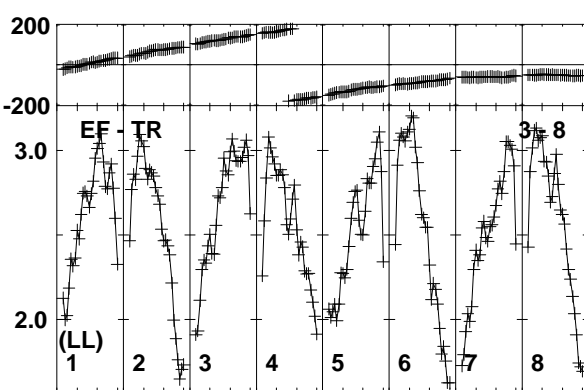
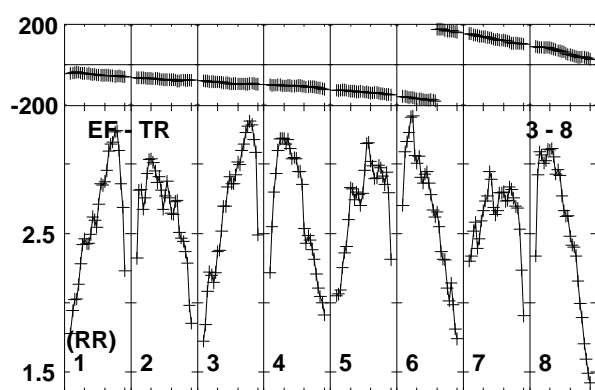
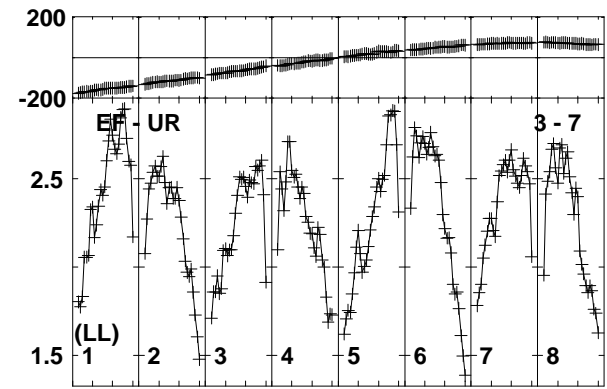
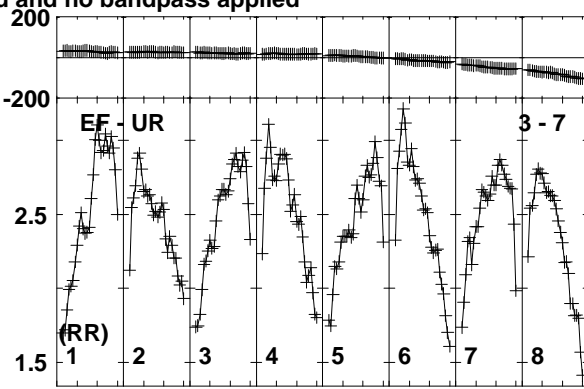
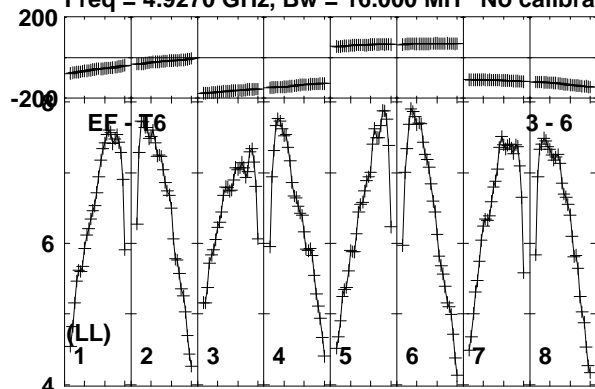

Lower frame: Milli Ampl Jy Top frame: Phas deg
Vector averaged cross-power spectrum Baseline: EF (03) - T6 (06)
Timerange: 00/09:24:01 to 00/09:25:19

Plot file version 522 created 17-FEB-2020 15:43:30

J1359+5544 EK047 2.UVDATA.1

Freq = 4.9270 GHz, Bw = 16.000 MH No calibration applied and no bandpass applied

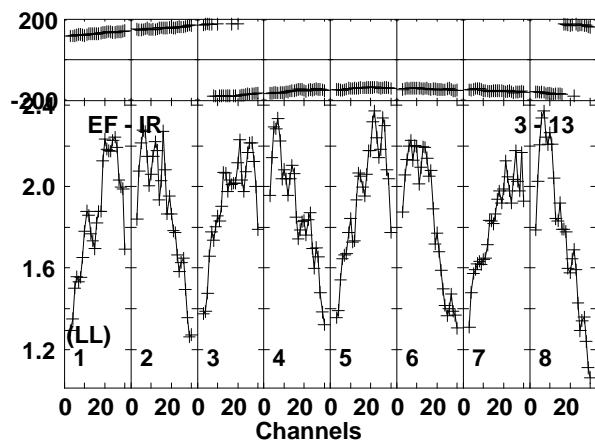
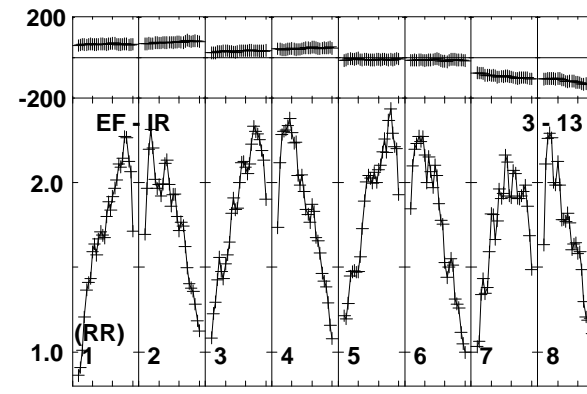
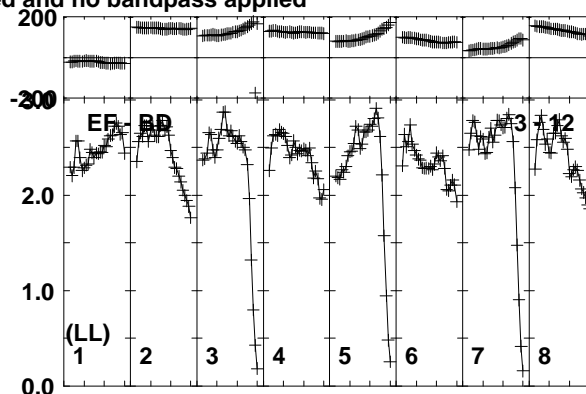
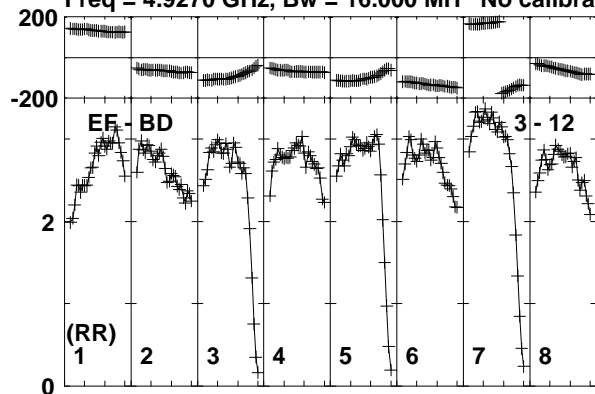

Lower frame: Milli Ampl Jy Top frame: Phas deg
Vector averaged cross-power spectrum Baseline: EF (03) - BD (12)
Timerange: 00/09:24:01 to 00/09:25:19

Plot file version 523 created 17-FEB-2020 15:43:30

J1402+5347 EK047 2.UVDATA.1

Freq = 4.9270 GHz, Bw = 16.000 MH No calibration applied and no bandpass applied

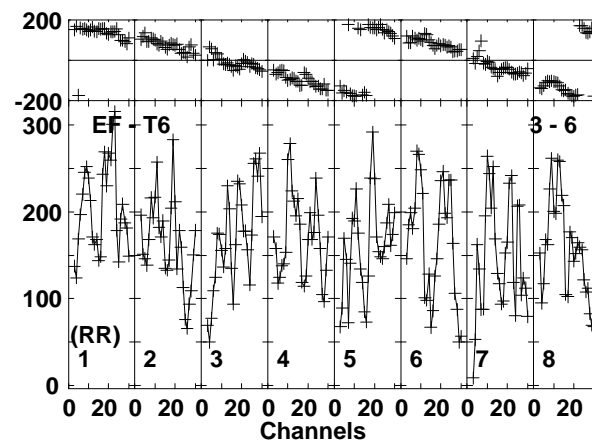
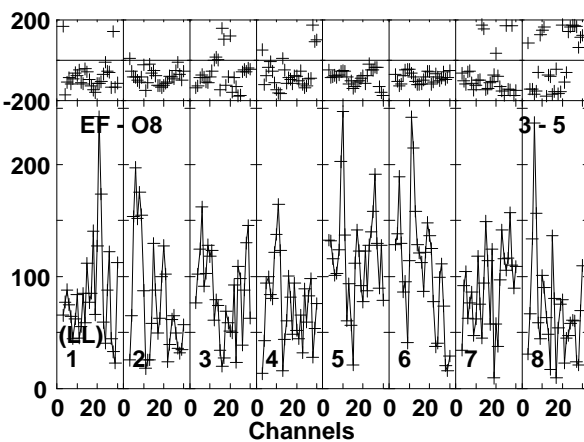
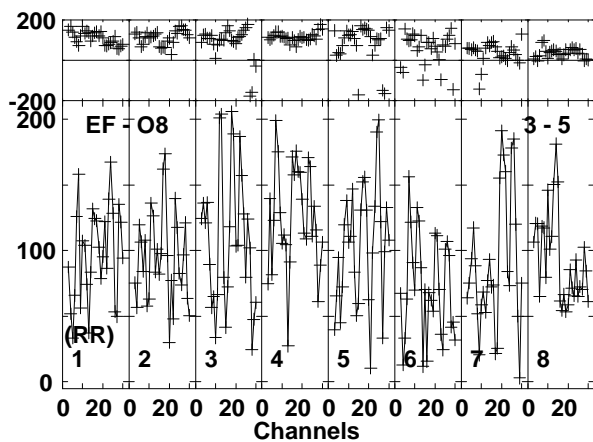
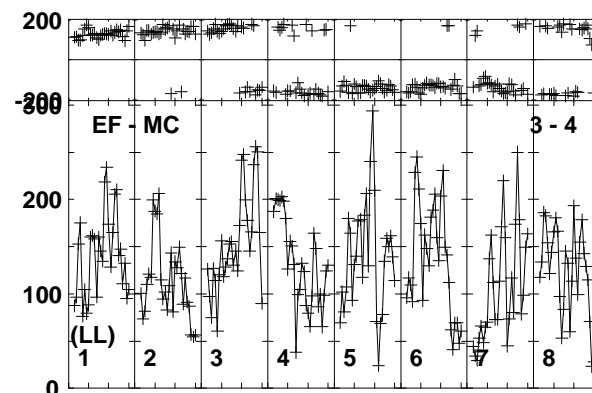
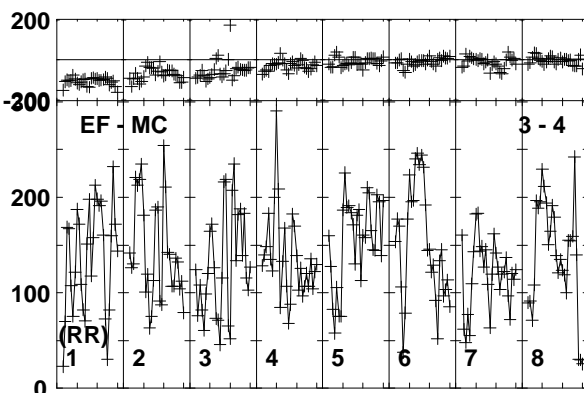
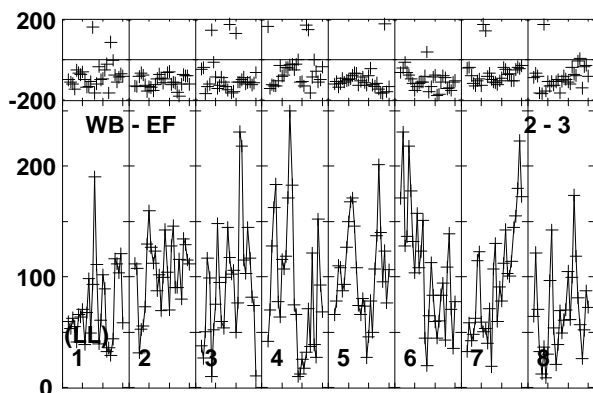
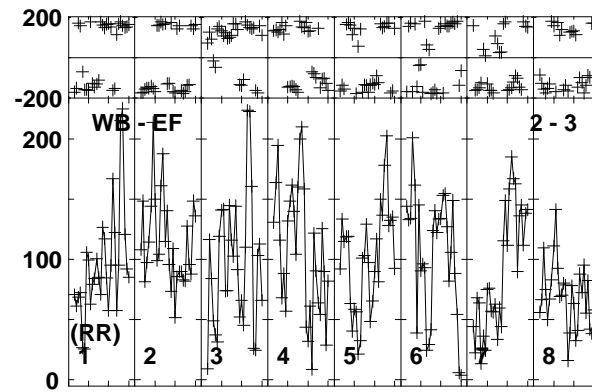
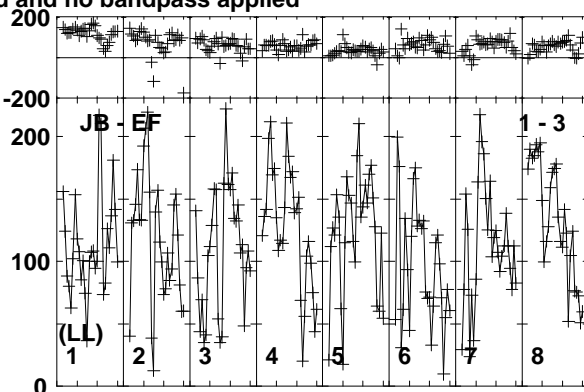
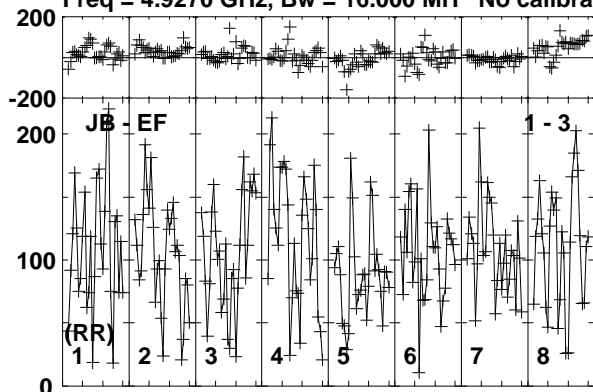

Lower frame: Micro Ampl Jy Top frame: Phas deg
Vector averaged cross-power spectrum Baseline: JB (01) - EF (03)
Timerange: 00/09:25:21 to 00/09:29:19

Plot file version 524 created 17-FEB-2020 15:43:30

J1402+5347 EK047 2.UVDATA.1

Freq = 4.9270 GHz, Bw = 16.000 MH No calibration applied and no bandpass applied

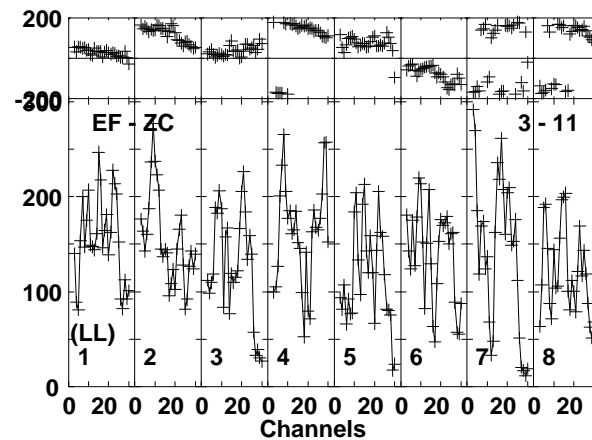
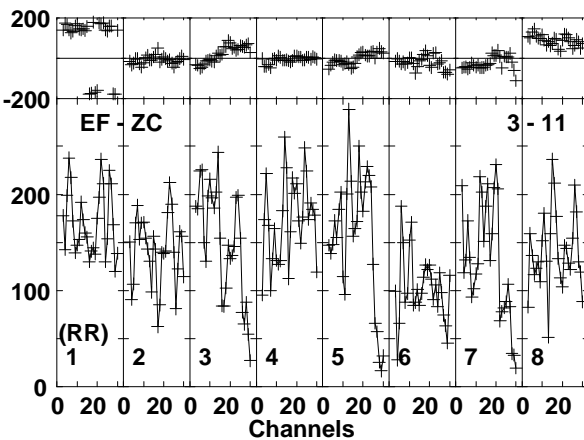
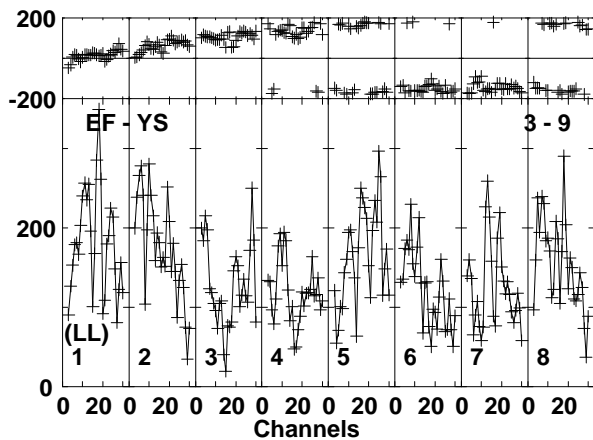
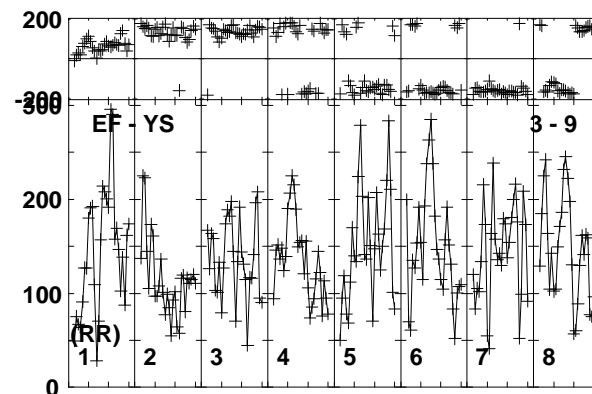
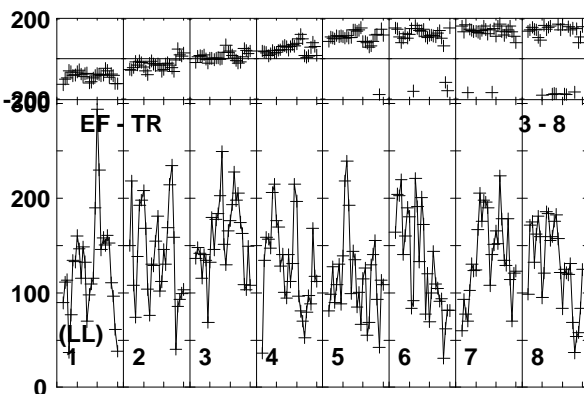
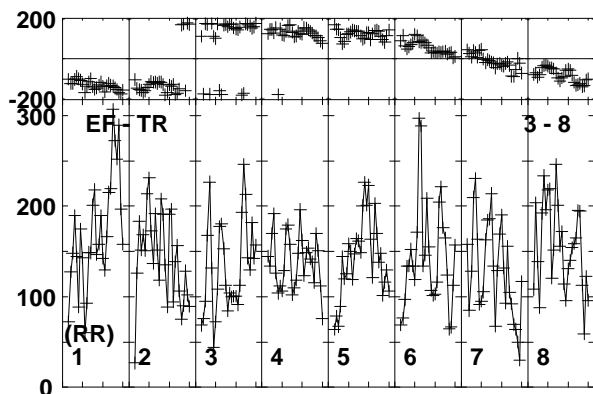
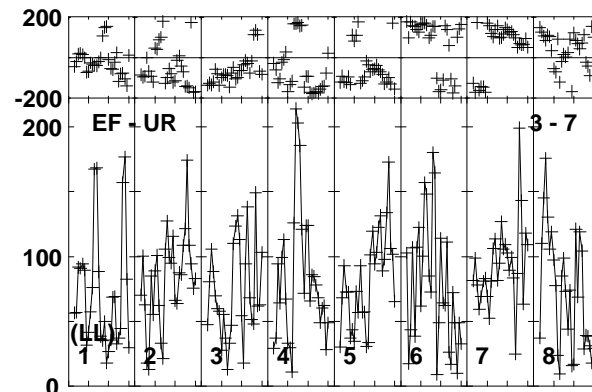
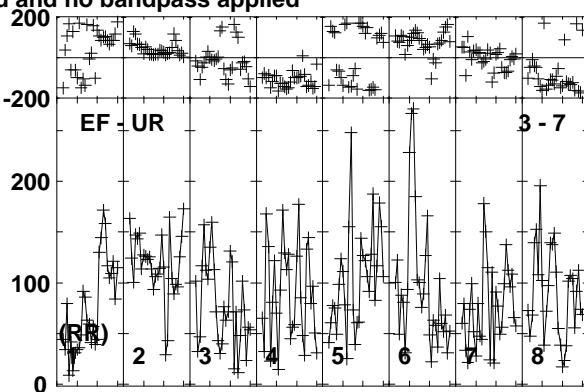
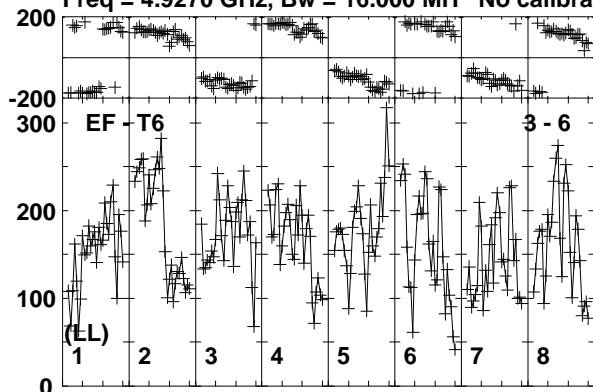

Lower frame: Micro Ampl Jy Top frame: Phas deg
Vector averaged cross-power spectrum Baseline: EF (03) - T6 (06)
Timerange: 00/09:25:21 to 00/09:29:19

Plot file version 525 created 17-FEB-2020 15:43:30

J1402+5347 EK047 2.UVDATA.1

Freq = 4.9270 GHz, Bw = 16.000 MH No calibration applied and no bandpass applied

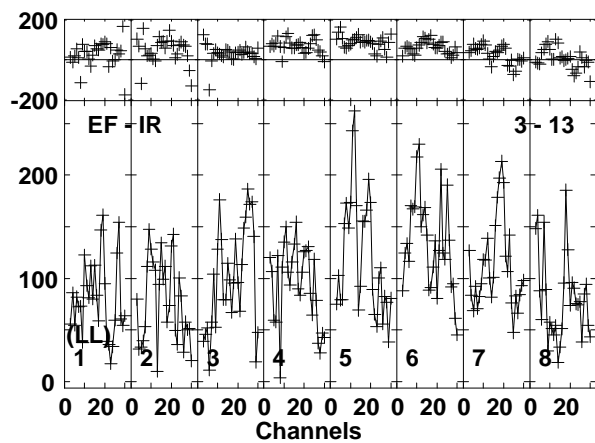
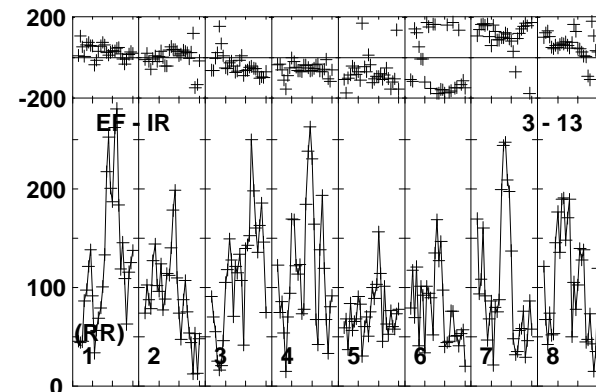
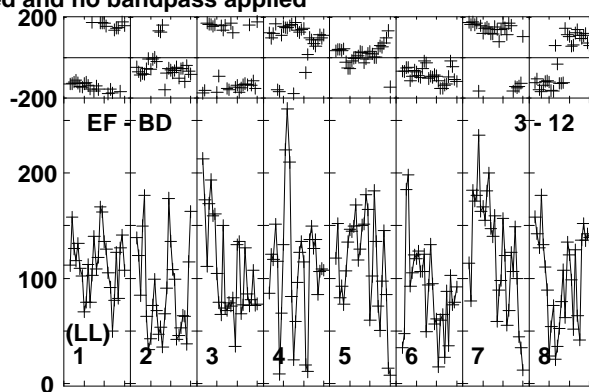
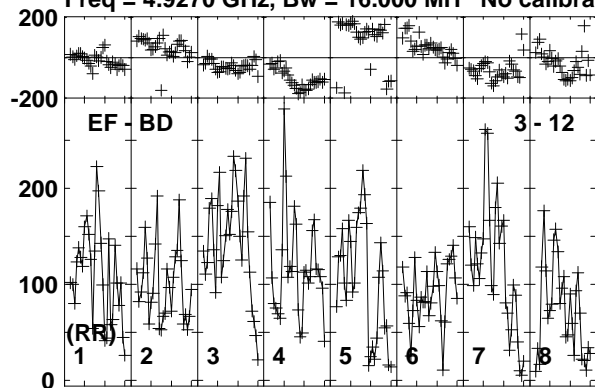

Lower frame: Micro Ampl Jy Top frame: Phas deg
Vector averaged cross-power spectrum Baseline: EF (03) - BD (12)
Timerange: 00/09:25:21 to 00/09:29:19

Plot file version 526 created 17-FEB-2020 15:43:30

J1359+5544 EK047 2.UVDATA.1

Freq = 4.9270 GHz, Bw = 16.000 MH No calibration applied and no bandpass applied

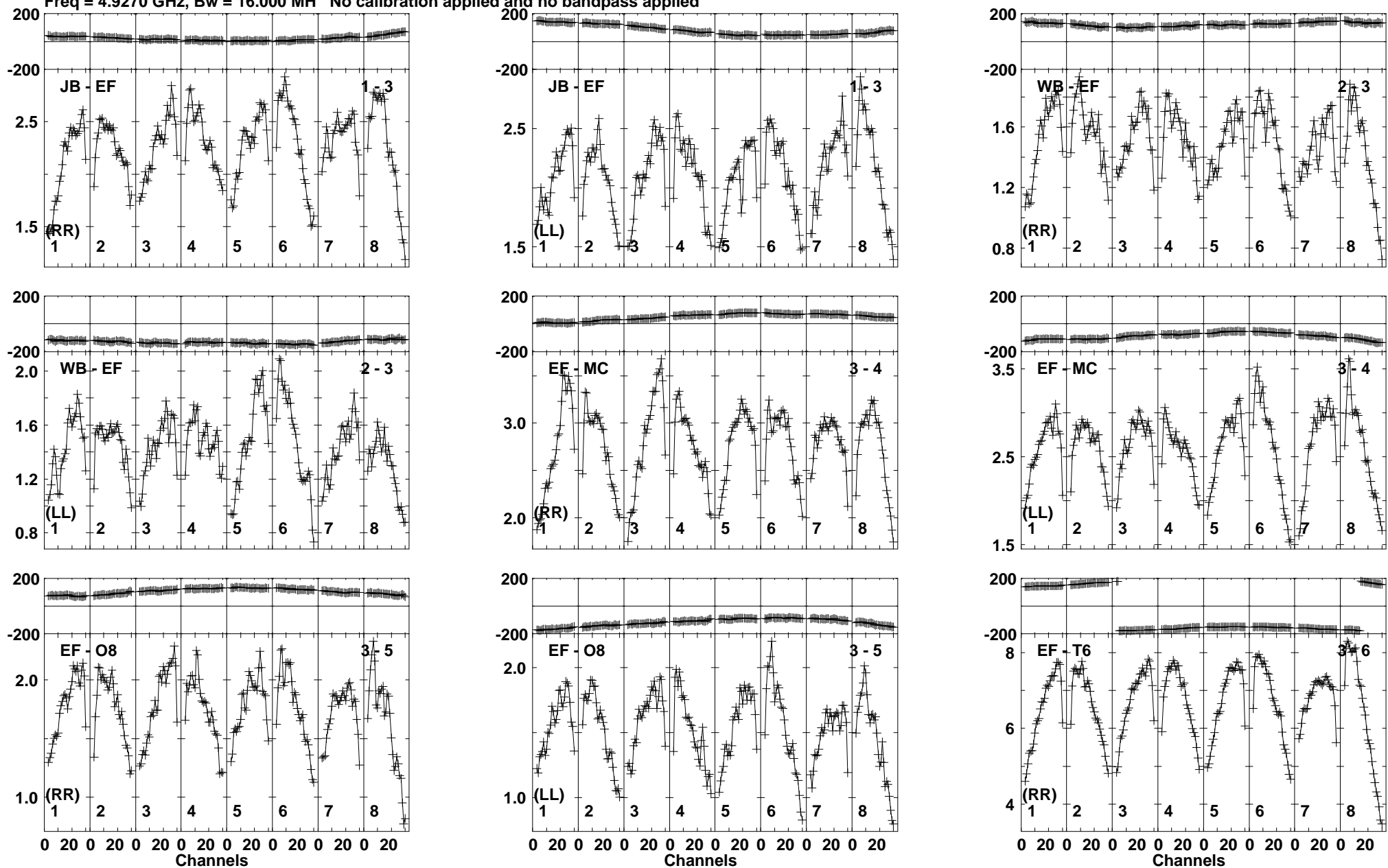

Lower frame: Milli Ampl Jy Top frame: Phas deg
Vector averaged cross-power spectrum Baseline: JB (01) - EF (03)
Timerange: 00/09:29:21 to 00/09:31:19

Plot file version 527 created 17-FEB-2020 15:43:30

J1359+5544 EK047 2.UVDATA.1

Freq = 4.9270 GHz, Bw = 16.000 MH No calibration applied and no bandpass applied

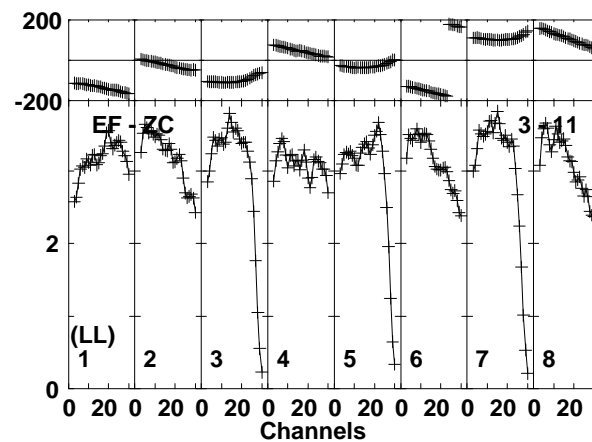
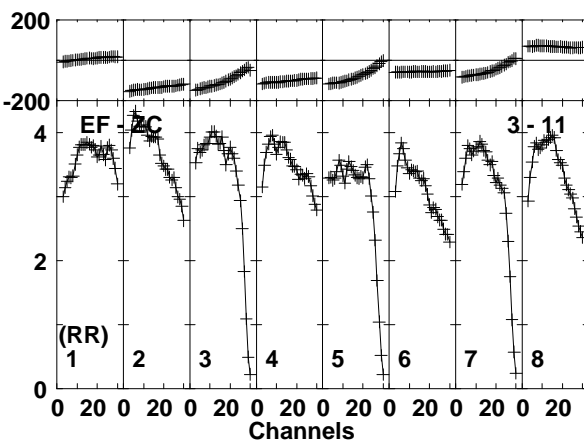
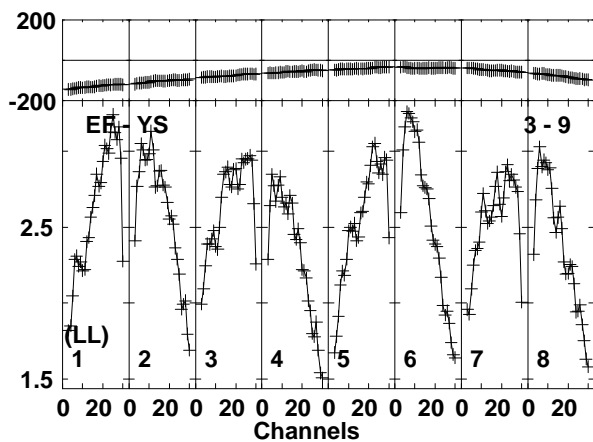
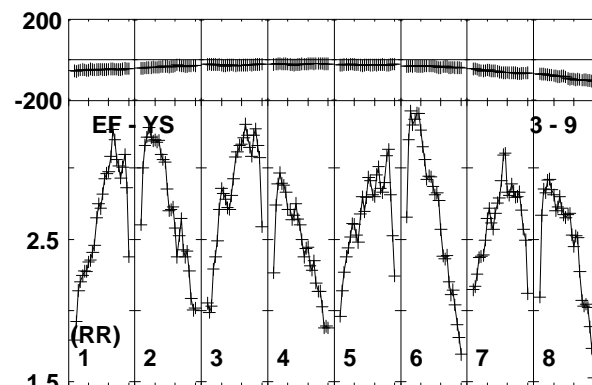
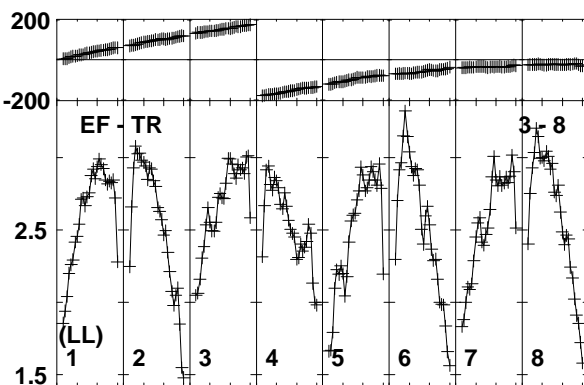
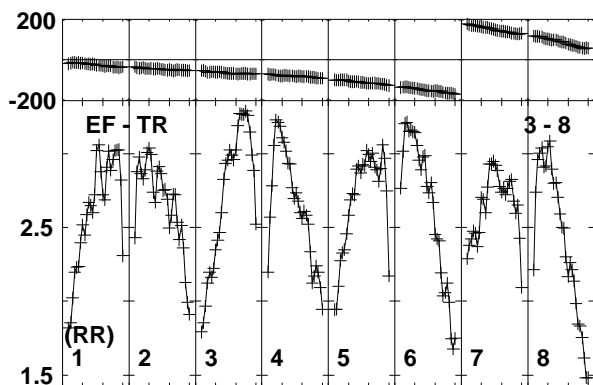
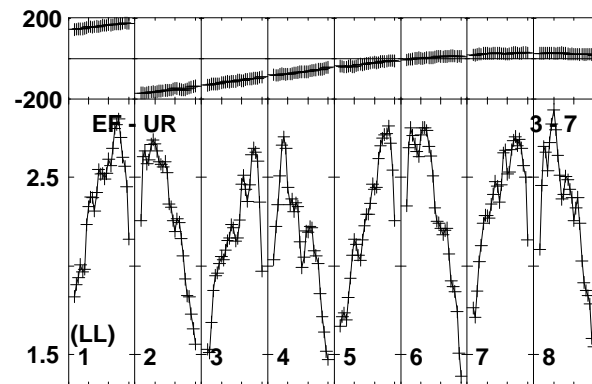
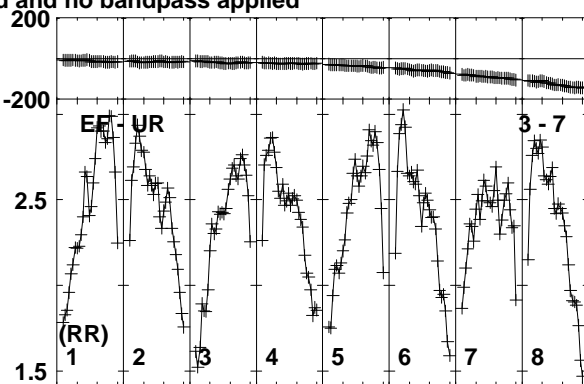
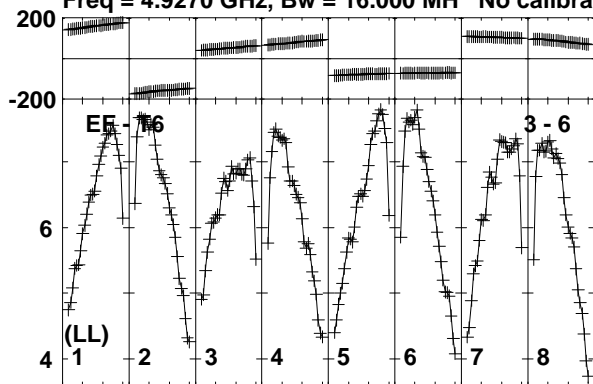

Lower frame: Milli Ampl Jy Top frame: Phas deg
Vector averaged cross-power spectrum Baseline: EF (03) - T6 (06)
Timerange: 00/09:29:21 to 00/09:31:19

Plot file version 528 created 17-FEB-2020 15:43:30
J1359+5544 EK047 2.UVDATA.1

Freq = 4.9270 GHz, Bw = 16.000 MH No calibration applied and no bandpass applied

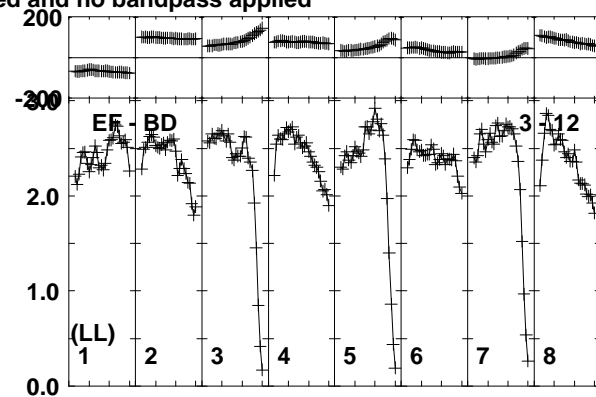
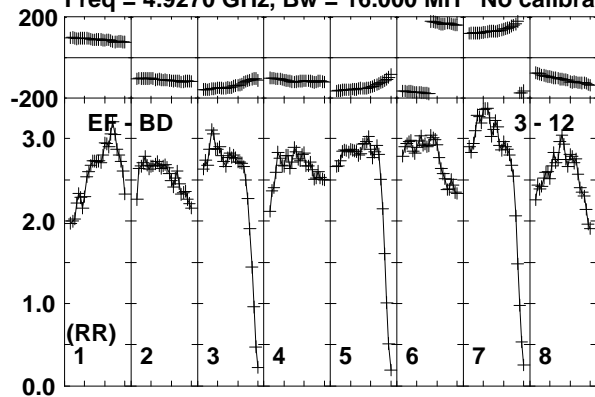

Lower frame: Milli Ampl Jy Top frame: Phas deg
Vector averaged cross-power spectrum Baseline: EF (03) - BD (12)
Timerange: 00/09:29:21 to 00/09:31:19

Plot file version 529 created 17-FEB-2020 15:43:30

J1402+5347 EK047 2.UVDATA.1

Freq = 4.9270 GHz, Bw = 16.000 MH No calibration applied and no bandpass applied

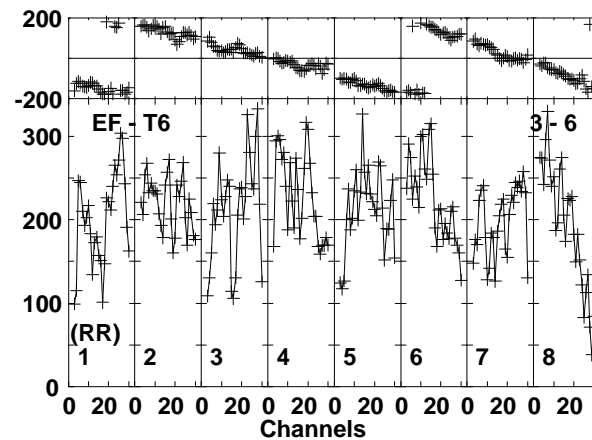
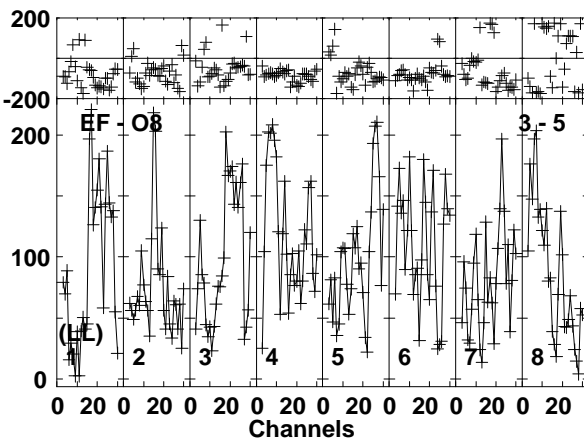
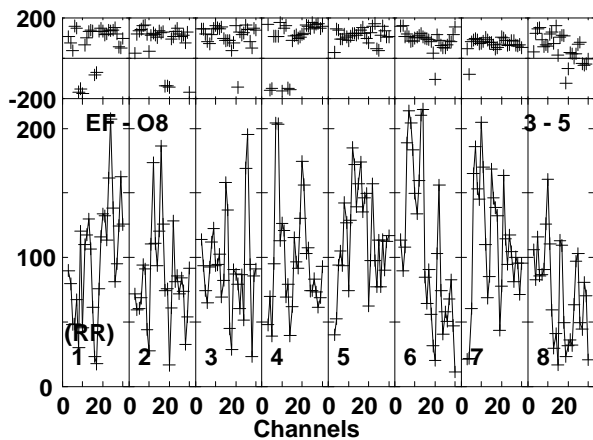
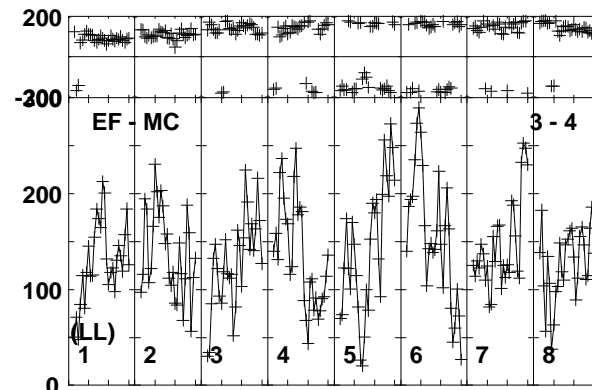
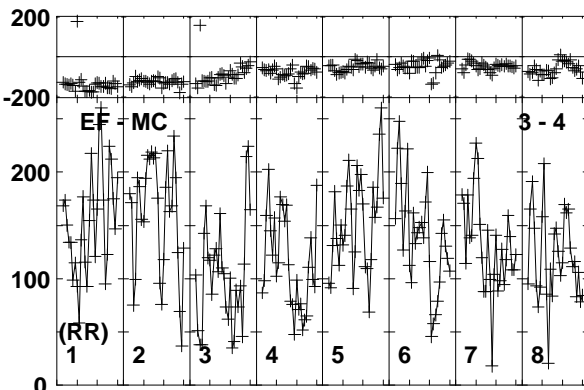
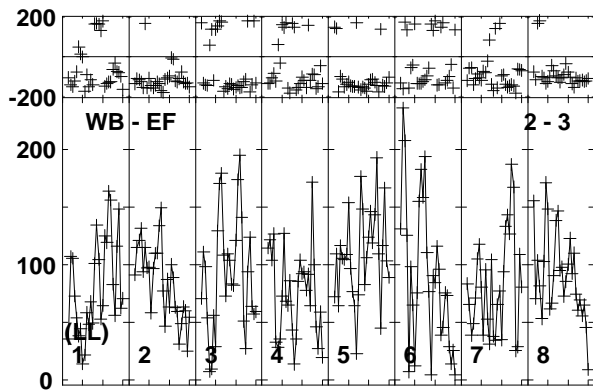
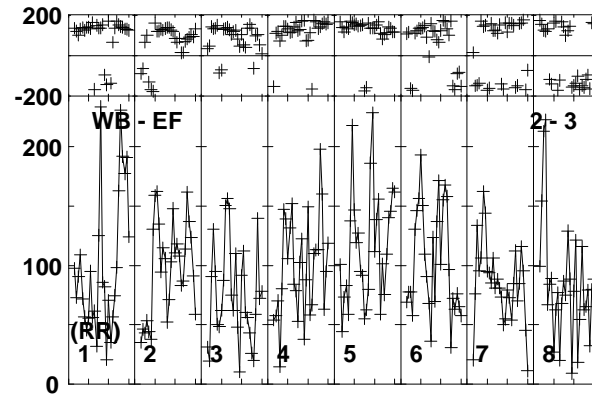
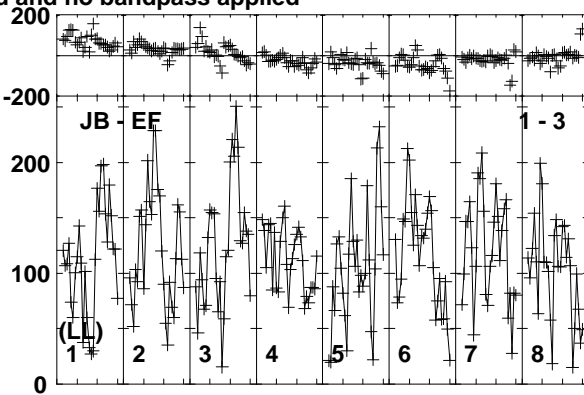
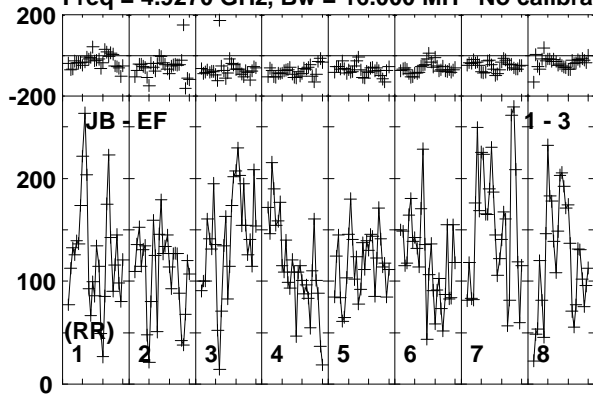

Lower frame: Micro Ampl Jy Top frame: Phas deg
Vector averaged cross-power spectrum Baseline: JB (01) - EF (03)
Timerange: 00/09:31:21 to 00/09:35:19

Plot file version 530 created 17-FEB-2020 15:43:30

J1402+5347 EK047 2.UVDATA.1

Freq = 4.9270 GHz, Bw = 16.000 MH No calibration applied and no bandpass applied

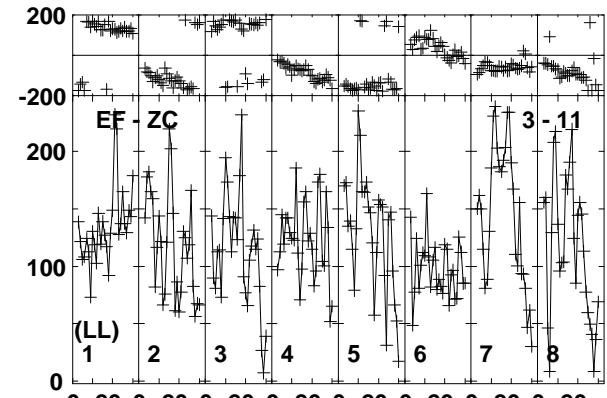
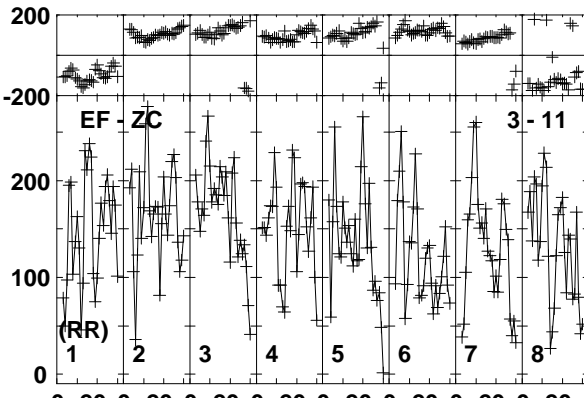
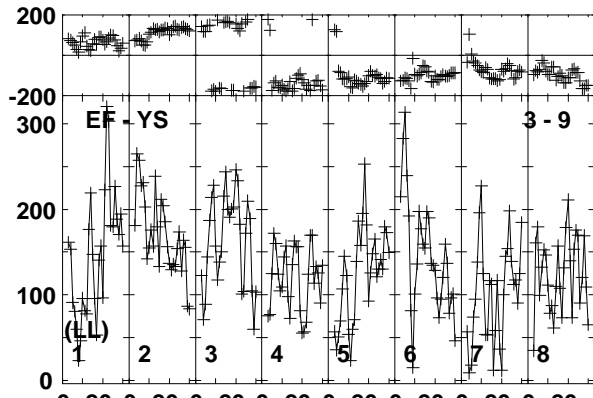
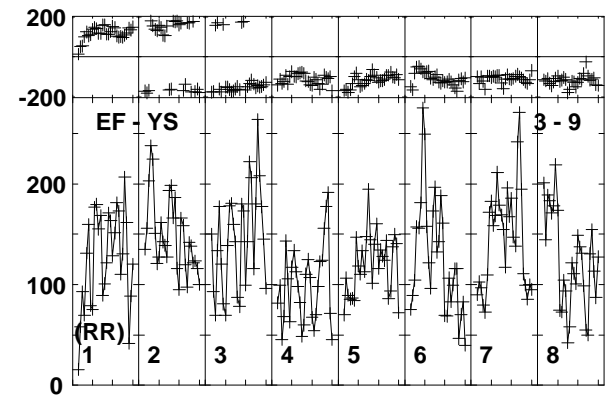
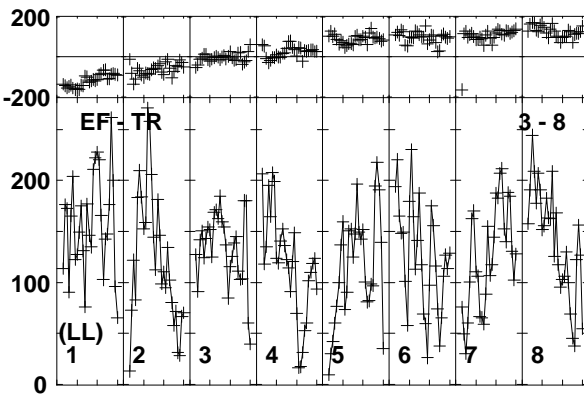
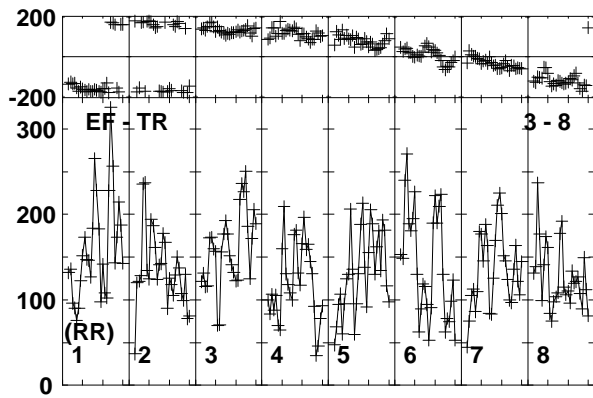
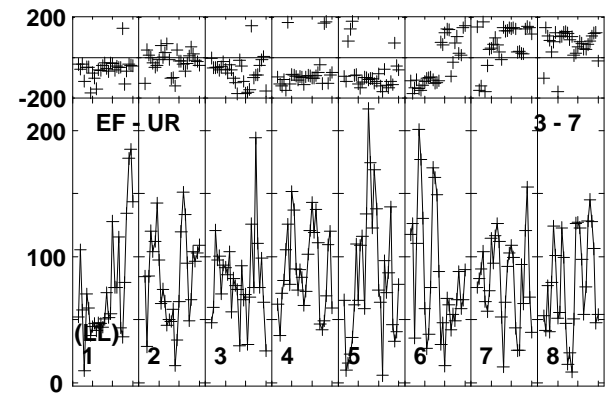
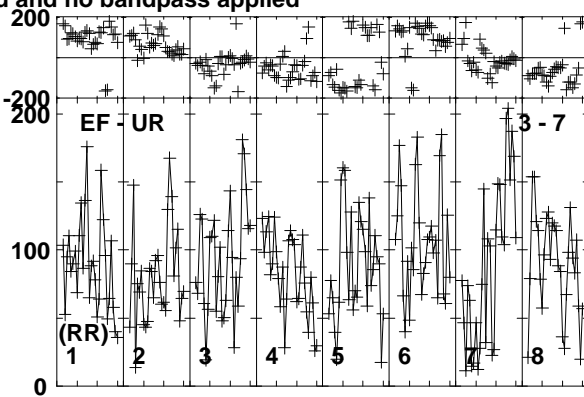
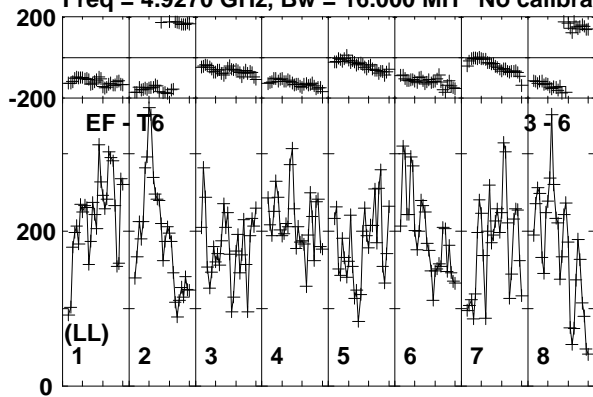

Lower frame: Micro Ampl Jy Top frame: Phas deg
Vector averaged cross-power spectrum Baseline: EF (03) - T6 (06)
Timerange: 00/09:31:21 to 00/09:35:19

Plot file version 531 created 17-FEB-2020 15:43:30

J1402+5347 EK047 2.UVDATA.1

Freq = 4.9270 GHz, Bw = 16.000 MH No calibration applied and no bandpass applied

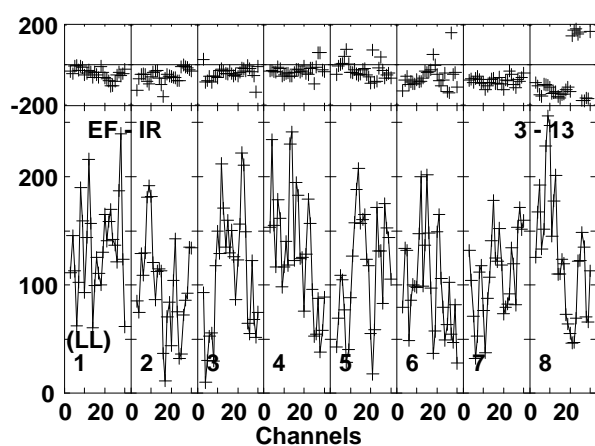
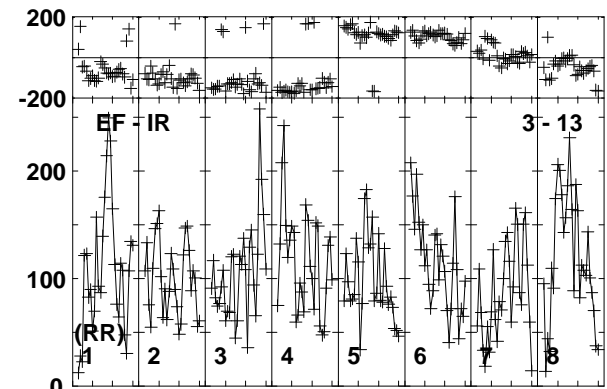
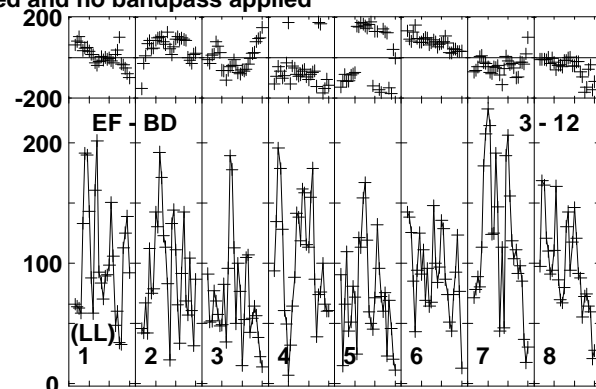
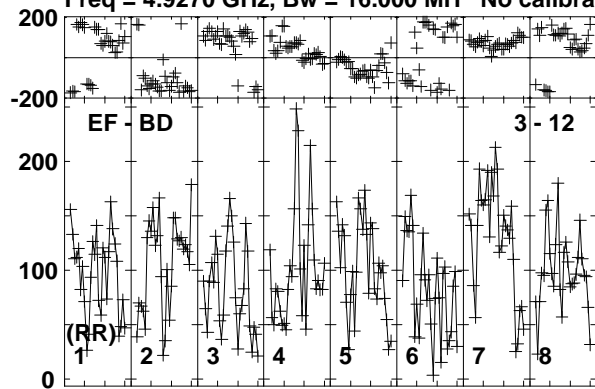

Lower frame: Micro Ampl Jy Top frame: Phas deg
Vector averaged cross-power spectrum Baseline: EF (03) - BD (12)
Timerange: 00/09:31:21 to 00/09:35:19

Plot file version 532 created 17-FEB-2020 15:43:31

J1359+5544 EK047 2.UVDATA.1

Freq = 4.9270 GHz, Bw = 16.000 MH No calibration applied and no bandpass applied

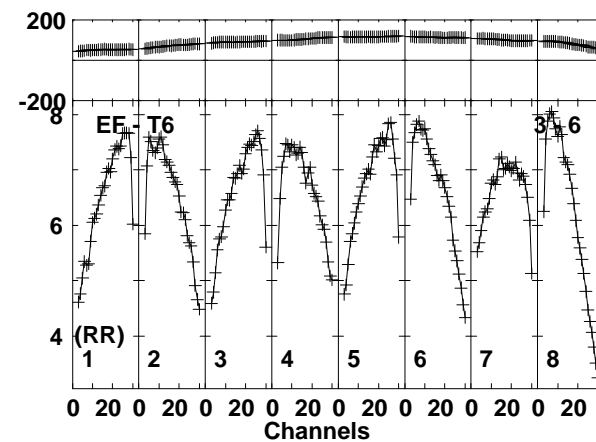
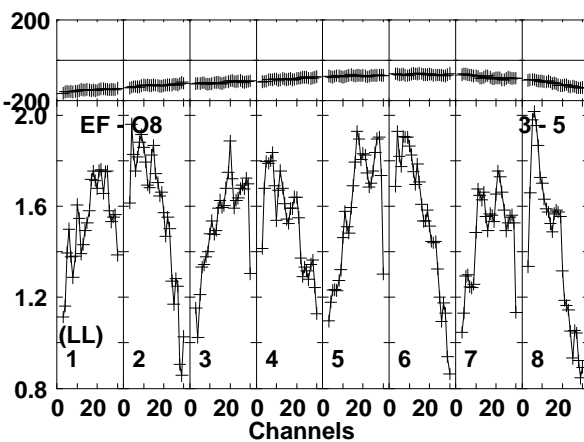
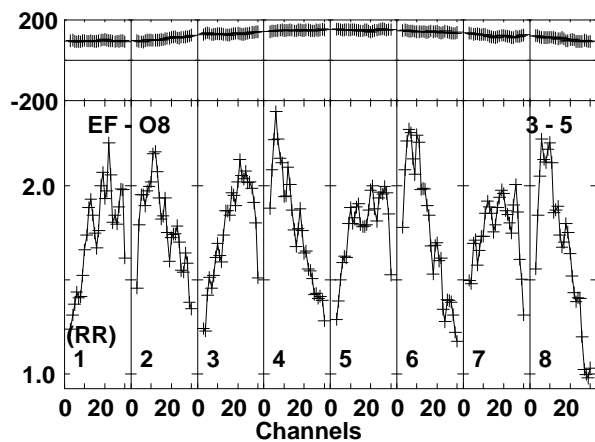
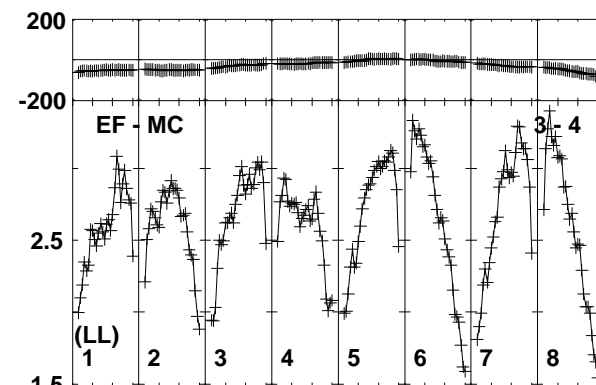
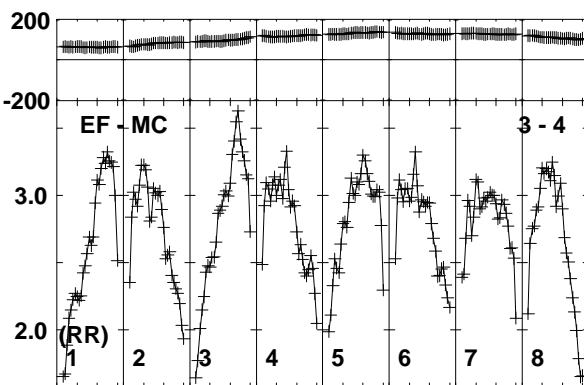
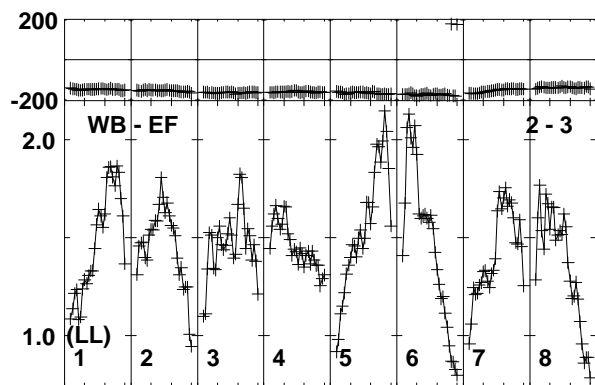
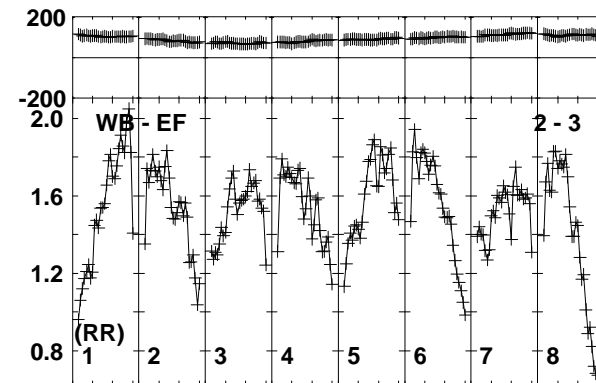
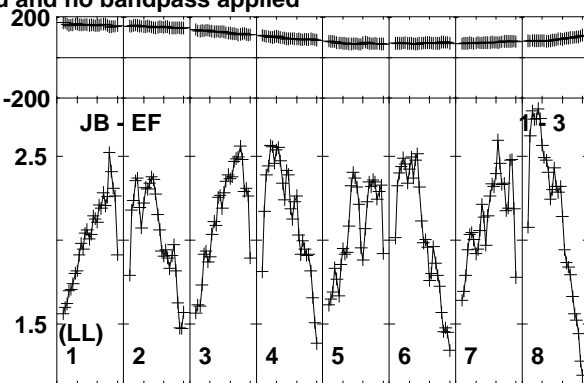
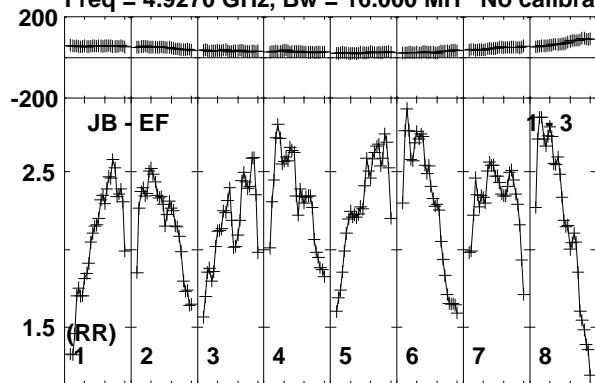

Lower frame: Milli Ampl Jy Top frame: Phas deg
Vector averaged cross-power spectrum Baseline: JB (01) - EF (03)
Timerange: 00/09:36:01 to 00/09:37:19

Plot file version 533 created 17-FEB-2020 15:43:31

J1359+5544 EK047 2.UVDATA.1

Freq = 4.9270 GHz, Bw = 16.000 MH No calibration applied and no bandpass applied

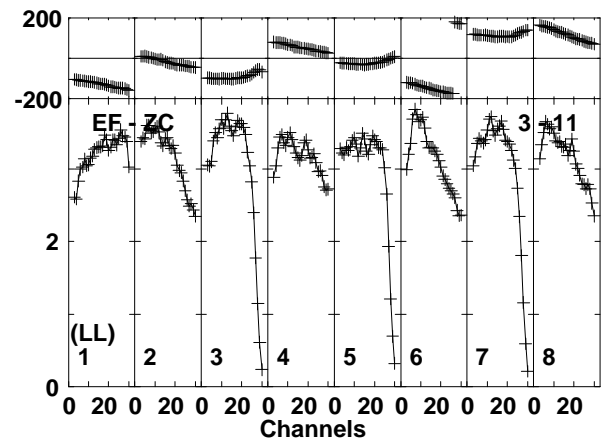
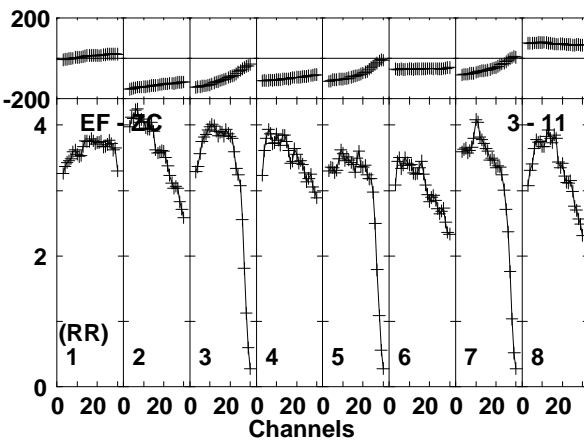
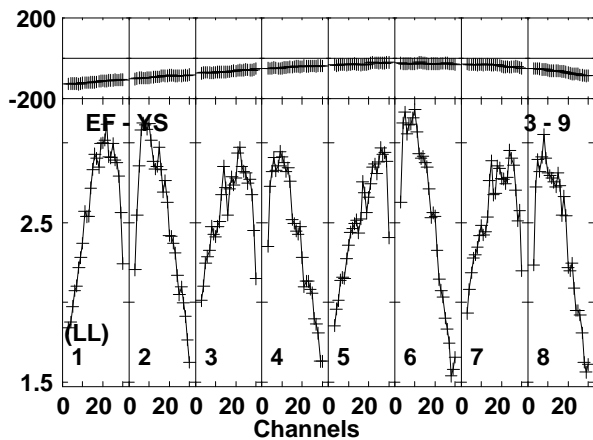
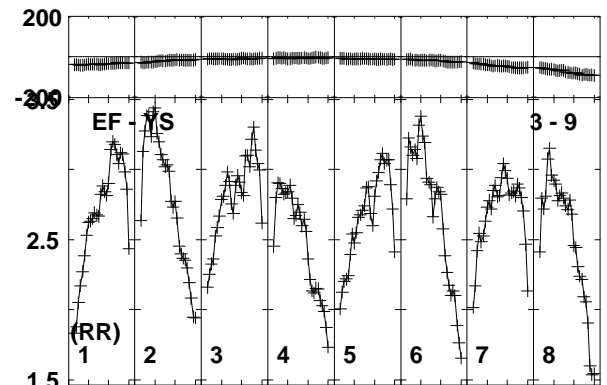
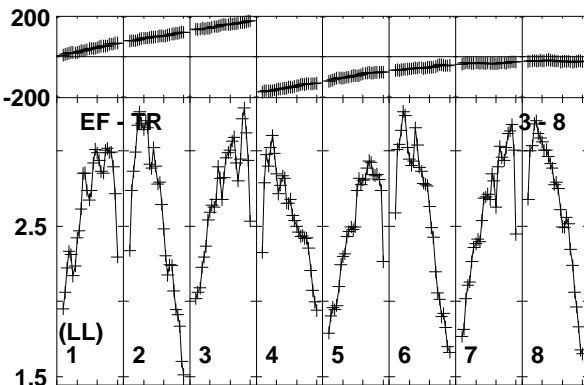
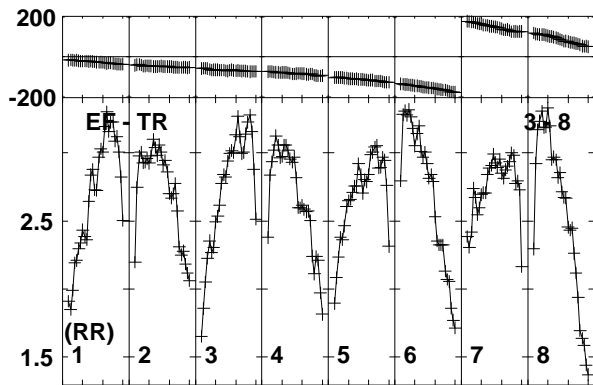
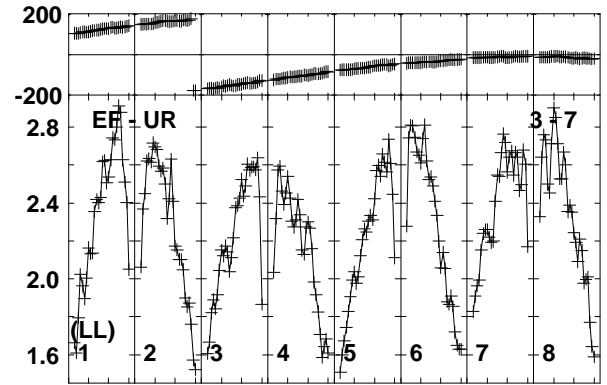
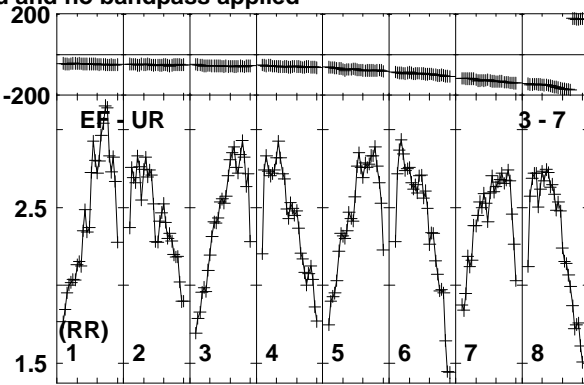
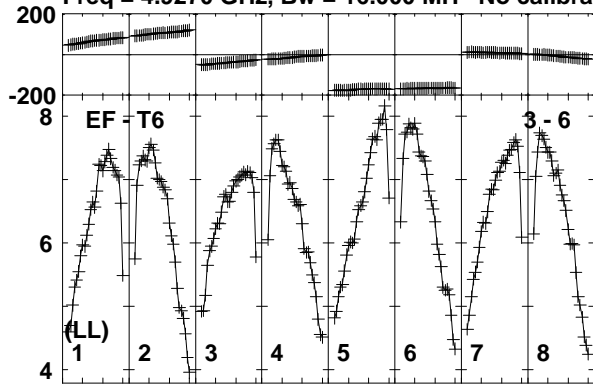

Lower frame: Milli Ampl Jy Top frame: Phas deg
Vector averaged cross-power spectrum Baseline: EF (03) - T6 (06)
Timerange: 00/09:36:01 to 00/09:37:19

Plot file version 534 created 17-FEB-2020 15:43:31

J1359+5544 EK047 2.UVDATA.1

Freq = 4.9270 GHz, Bw = 16.000 MH No calibration applied and no bandpass applied

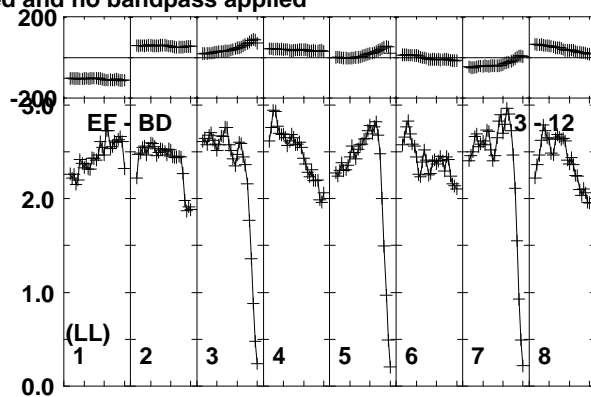
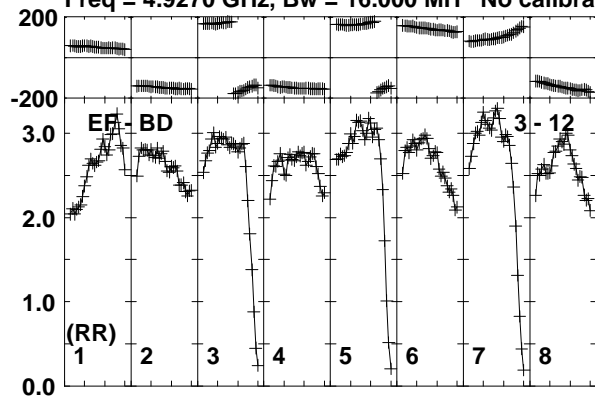

Lower frame: Milli Ampl Jy Top frame: Phas deg
Vector averaged cross-power spectrum Baseline: EF (03) - BD (12)
Timerange: 00/09:36:01 to 00/09:37:19

Plot file version 535 created 17-FEB-2020 15:43:31

J1402+5347 EK047 2.UVDATA.1

Freq = 4.9270 GHz, Bw = 16.000 MH No calibration applied and no bandpass applied

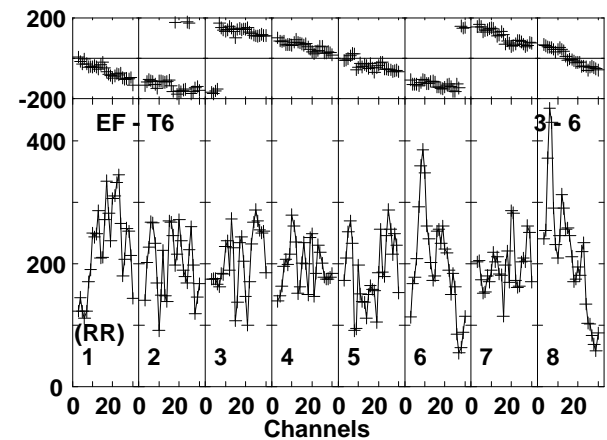
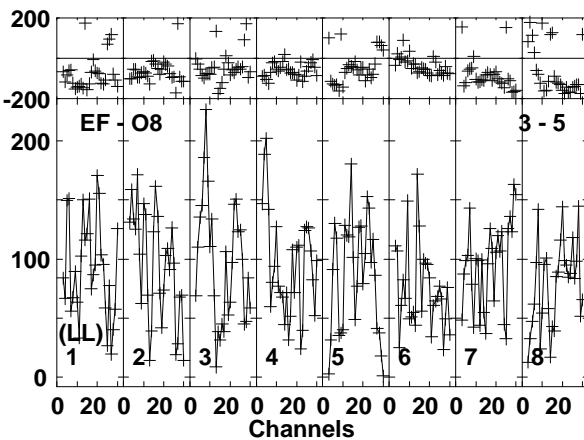
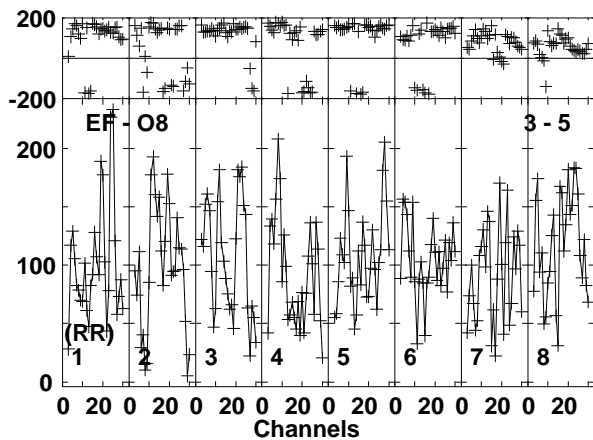
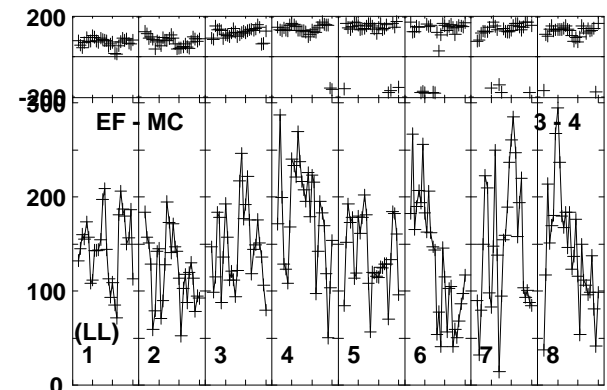
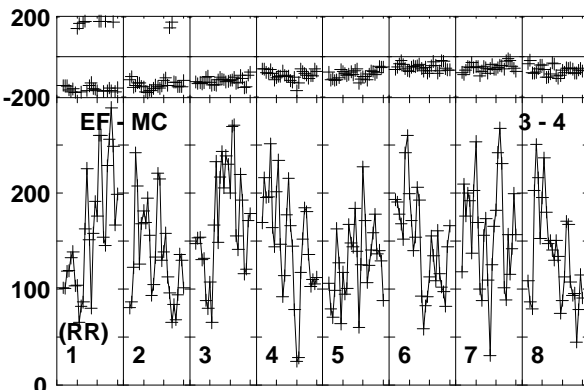
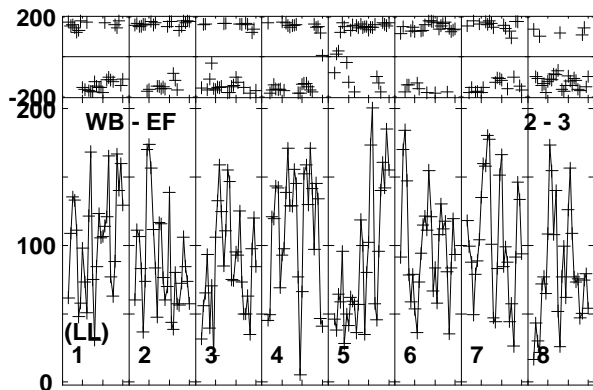
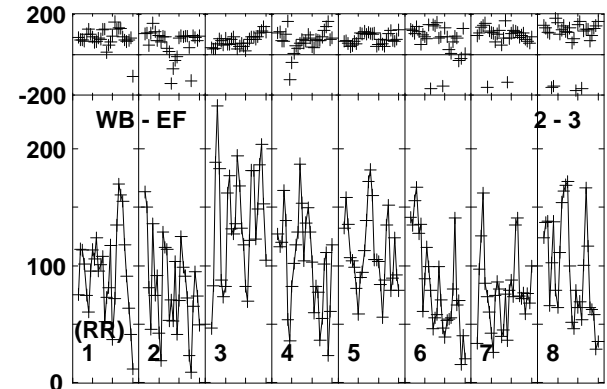
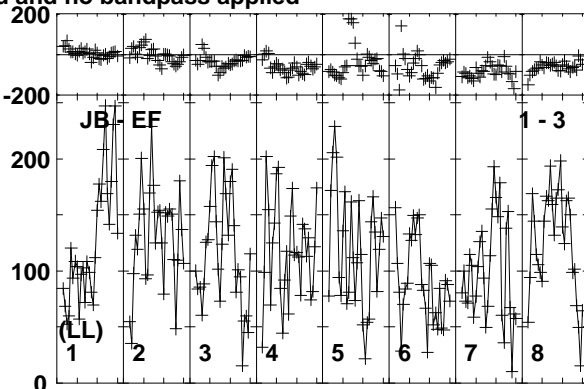
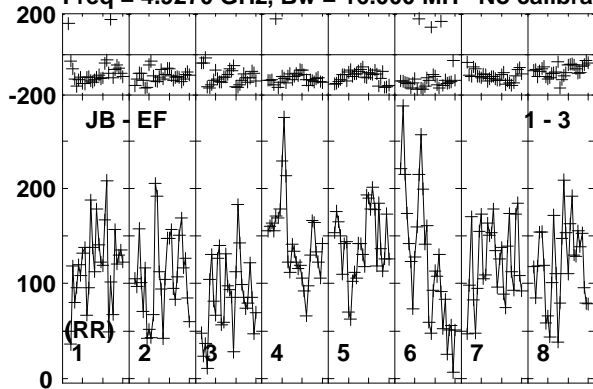

Lower frame: Micro Ampl Jy Top frame: Phas deg
Vector averaged cross-power spectrum Baseline: JB (01) - EF (03)
Timerange: 00/09:37:21 to 00/09:41:19

Plot file version 536 created 17-FEB-2020 15:43:31

J1402+5347 EK047 2.UVDATA.1

Freq = 4.9270 GHz, Bw = 16.000 MH No calibration applied and no bandpass applied

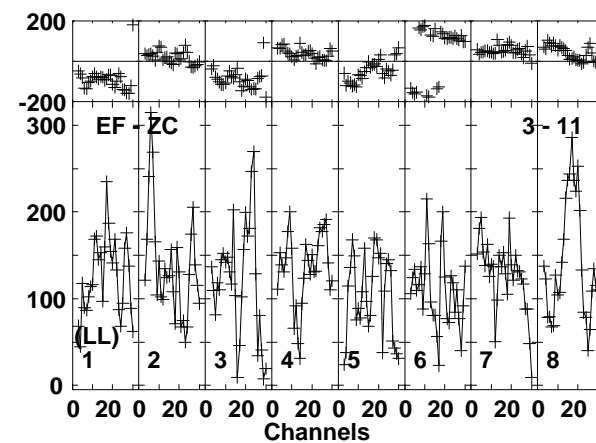
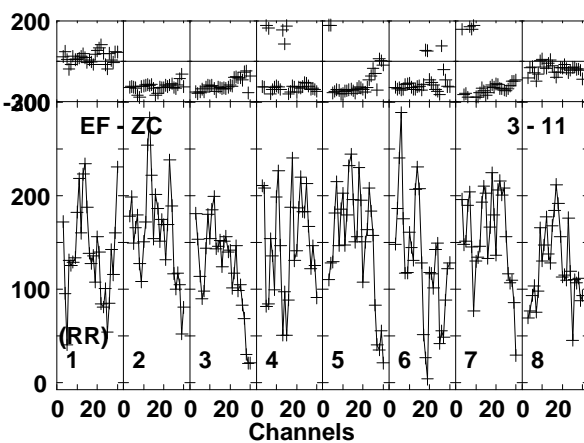
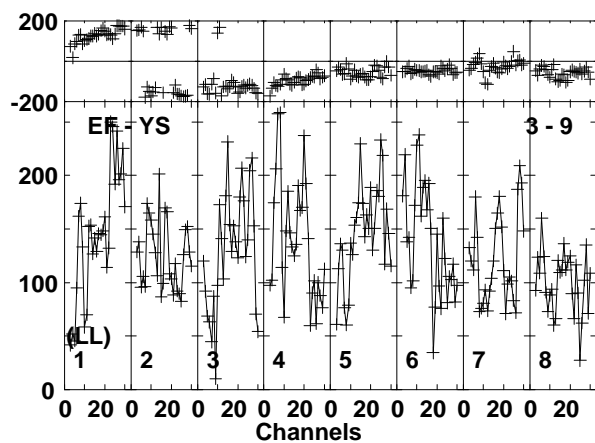
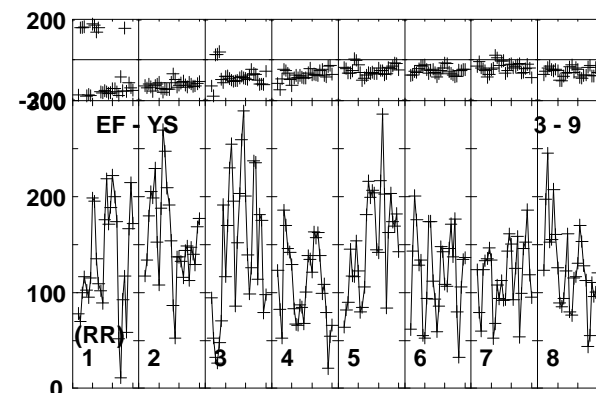
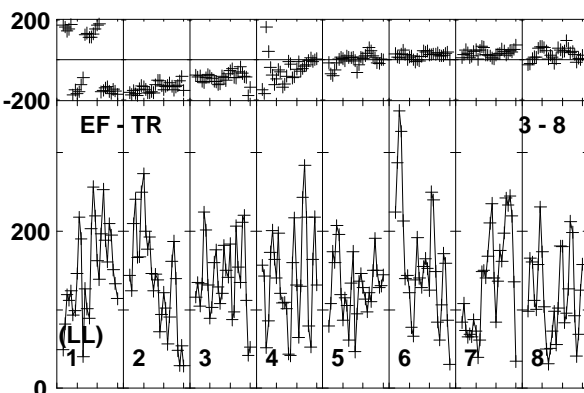
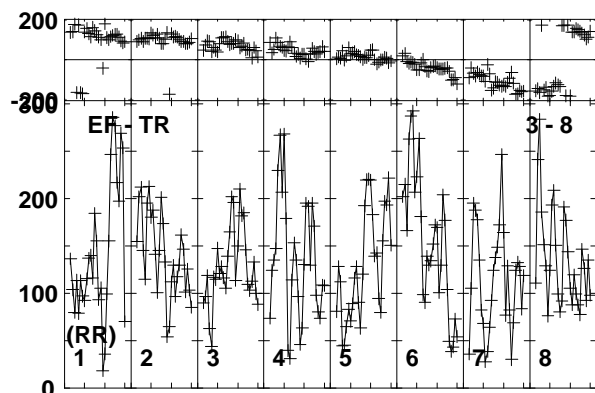
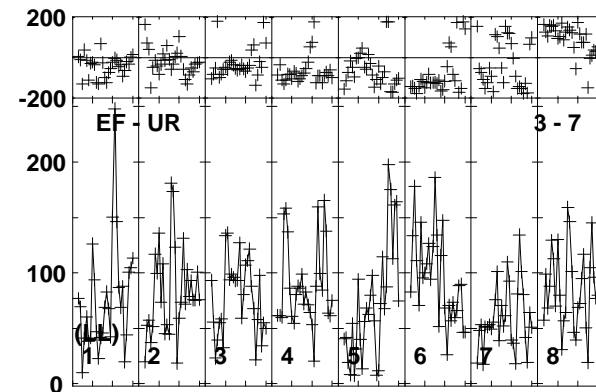
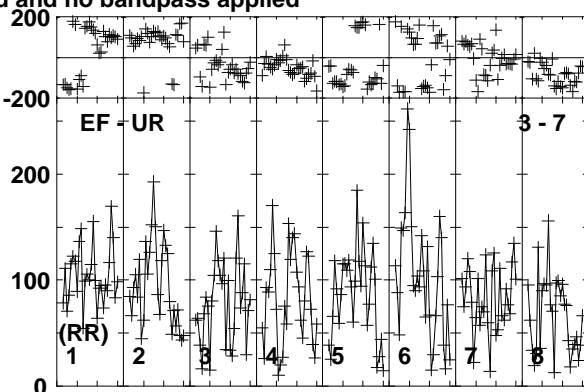
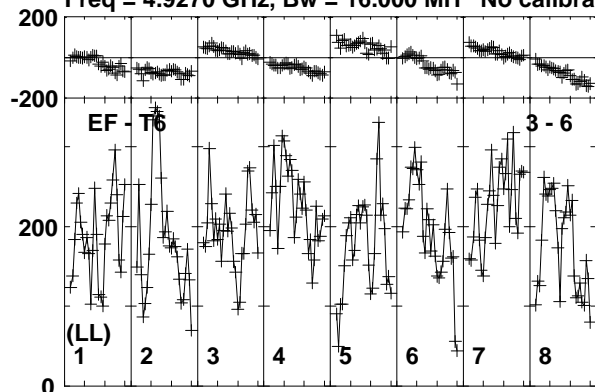

Lower frame: Micro Ampl Jy Top frame: Phas deg
Vector averaged cross-power spectrum Baseline: EF (03) - T6 (06)
Timerange: 00/09:37:21 to 00/09:41:19

Plot file version 537 created 17-FEB-2020 15:43:31

J1402+5347 EK047 2.UVDATA.1

Freq = 4.9270 GHz, Bw = 16.000 MH No calibration applied and no bandpass applied

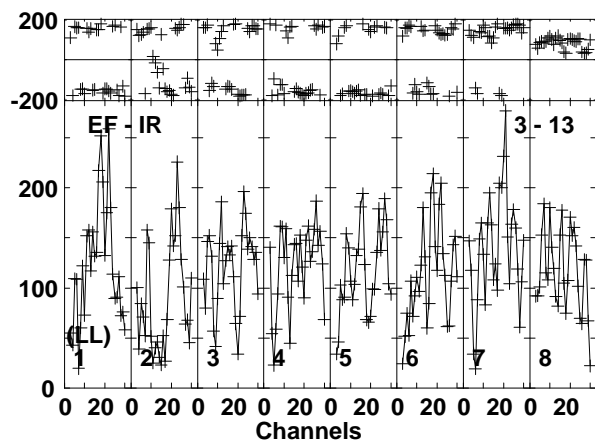
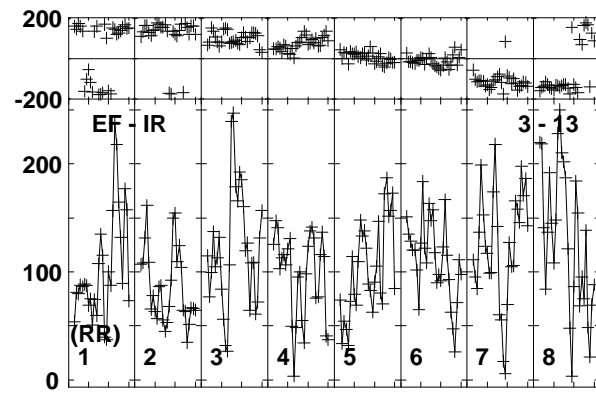
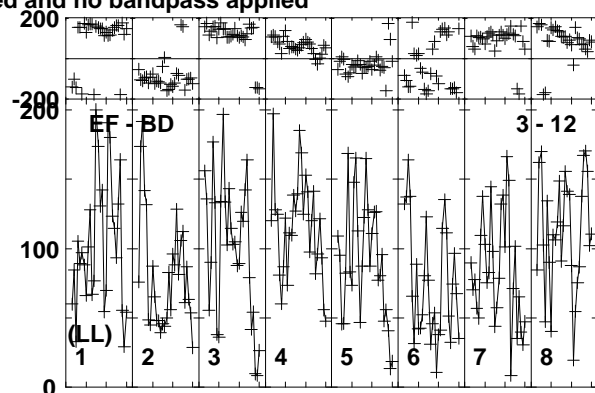
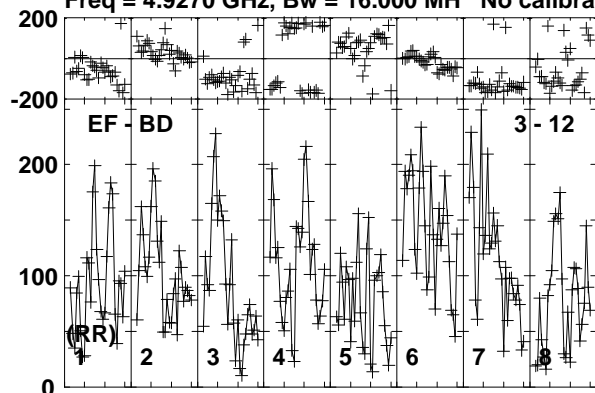

Lower frame: Micro Ampl Jy Top frame: Phas deg
Vector averaged cross-power spectrum Baseline: EF (03) - BD (12)
Timerange: 00/09:37:21 to 00/09:41:19

Plot file version 538 created 17-FEB-2020 15:43:31

J1359+5544 EK047 2.UVDATA.1

Freq = 4.9270 GHz, Bw = 16.000 MH No calibration applied and no bandpass applied

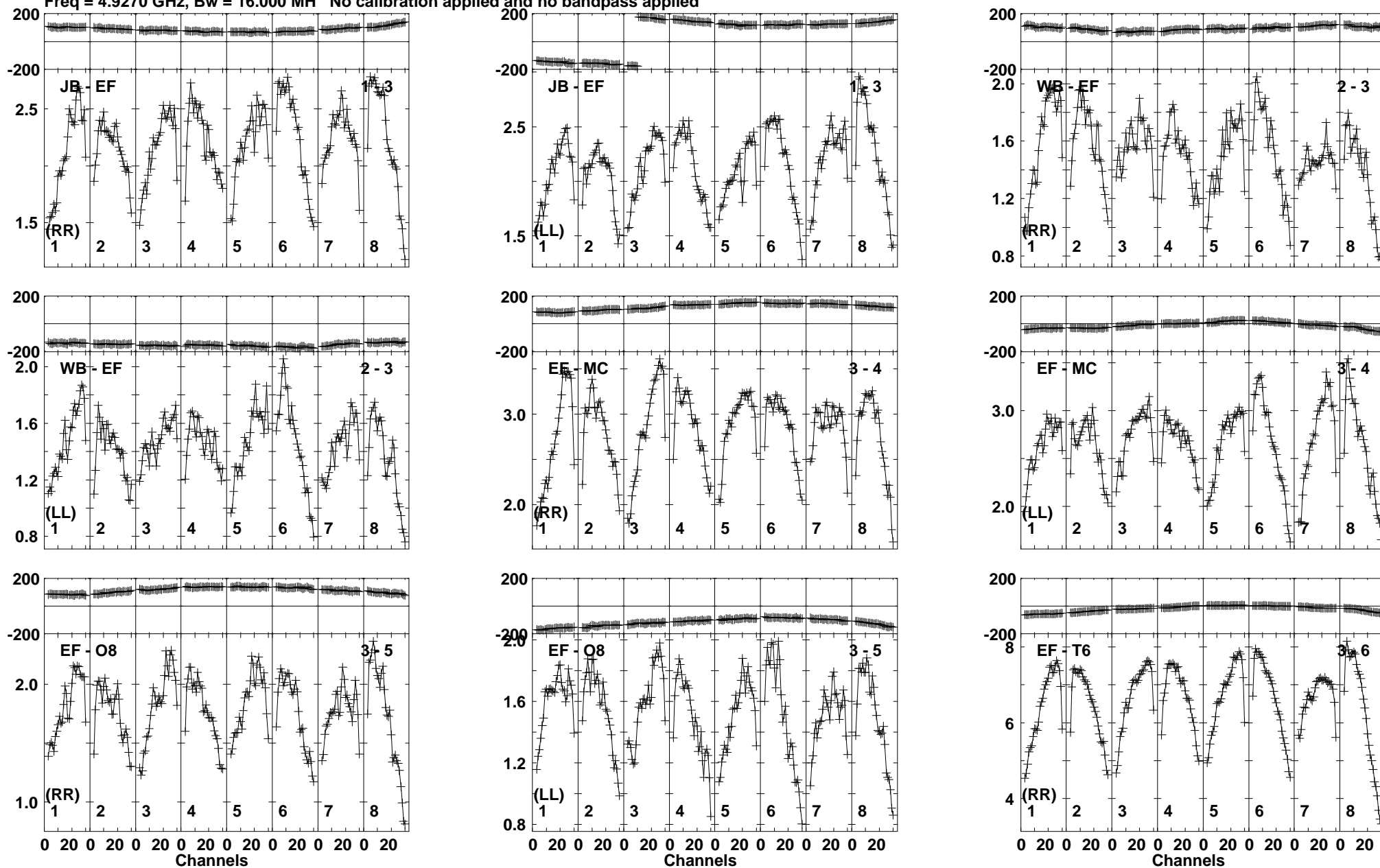

Lower frame: Milli Ampl Jy Top frame: Phas deg
Vector averaged cross-power spectrum Baseline: JB (01) - EF (03)
Timerange: 00/09:41:21 to 00/09:43:19

Plot file version 539 created 17-FEB-2020 15:43:31

J1359+5544 EK047 2.UVDATA.1

Freq = 4.9270 GHz, Bw = 16.000 MH No calibration applied and no bandpass applied

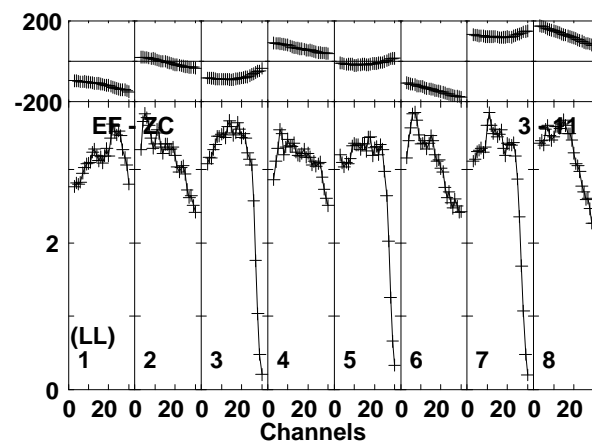
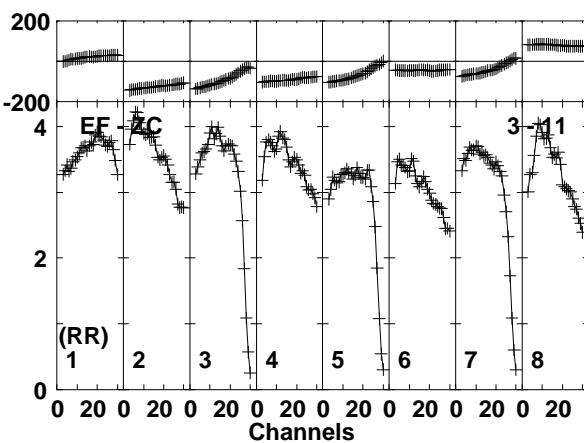
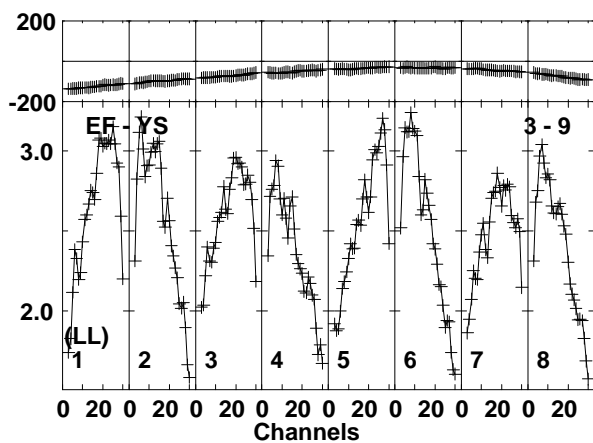
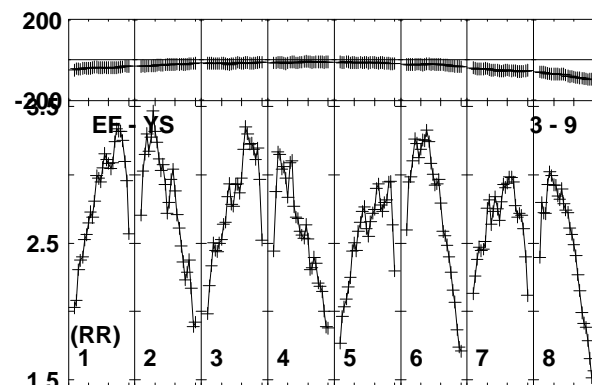
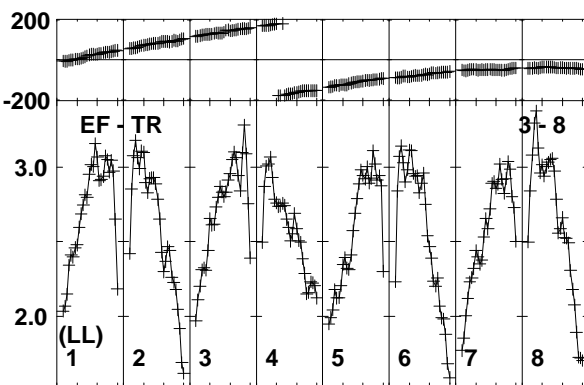
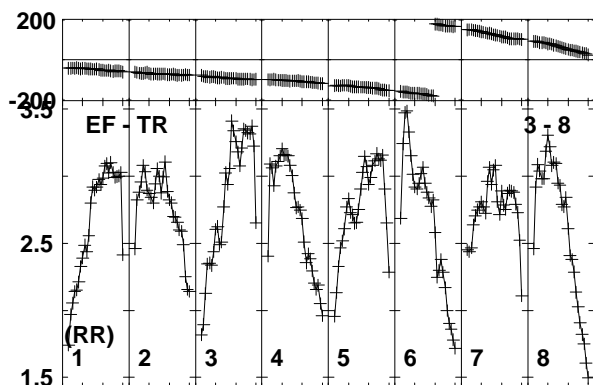
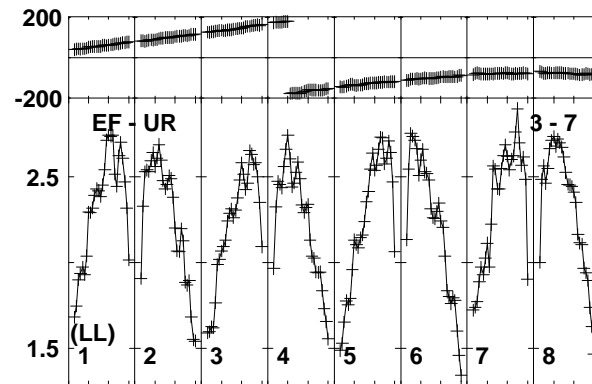
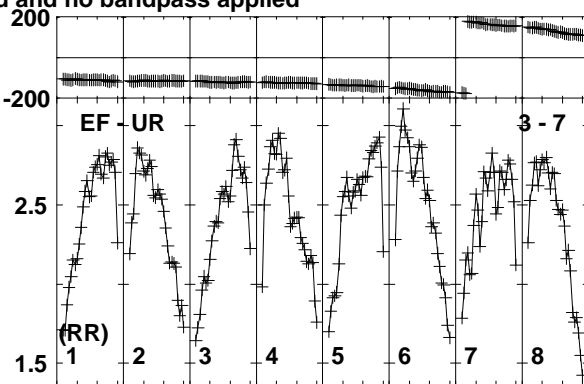
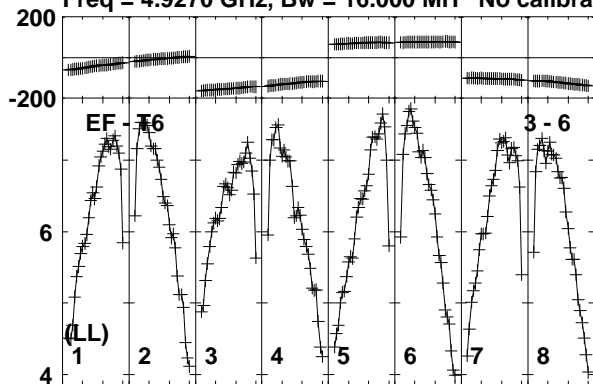

Lower frame: Milli Ampl Jy Top frame: Phas deg
Vector averaged cross-power spectrum Baseline: EF (03) - T6 (06)
Timerange: 00/09:41:21 to 00/09:43:19

Plot file version 540 created 17-FEB-2020 15:43:31

J1359+5544 EK047 2.UVDATA.1

Freq = 4.9270 GHz, Bw = 16.000 MH No calibration applied and no bandpass applied

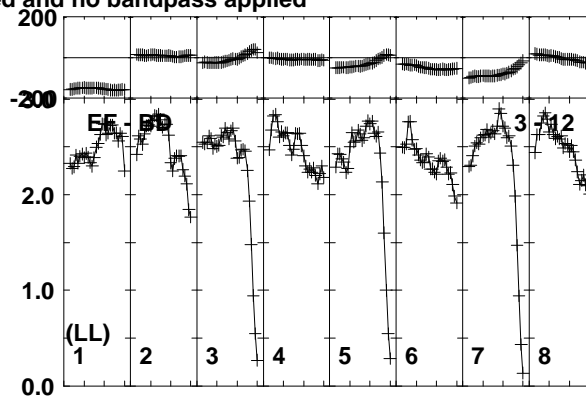
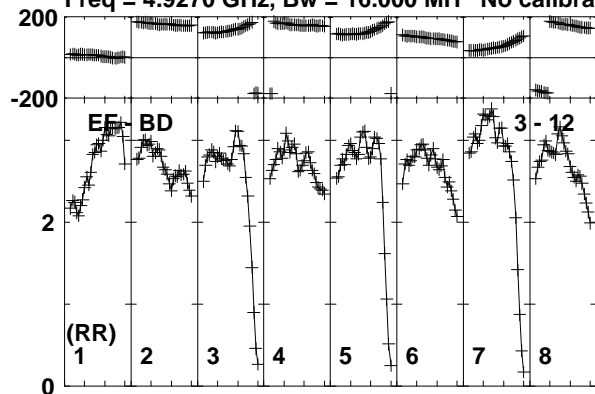

Lower frame: Milli Ampl Jy Top frame: Phas deg
Vector averaged cross-power spectrum Baseline: EF (03) - BD (12)
Timerange: 00/09:41:21 to 00/09:43:19

Plot file version 541 created 17-FEB-2020 15:43:31

J1402+5347 EK047 2.UVDATA.1

Freq = 4.9270 GHz, Bw = 16.000 MH No calibration applied and no bandpass applied

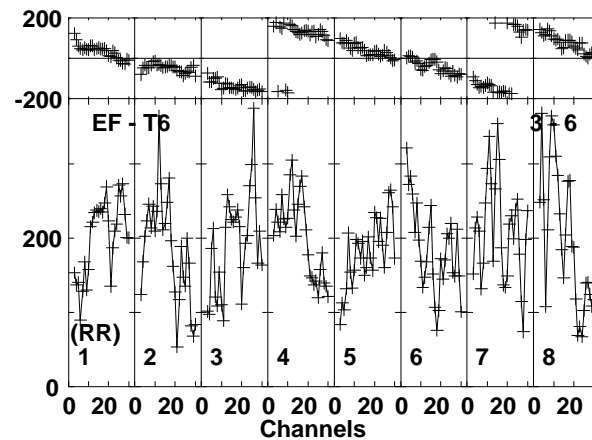
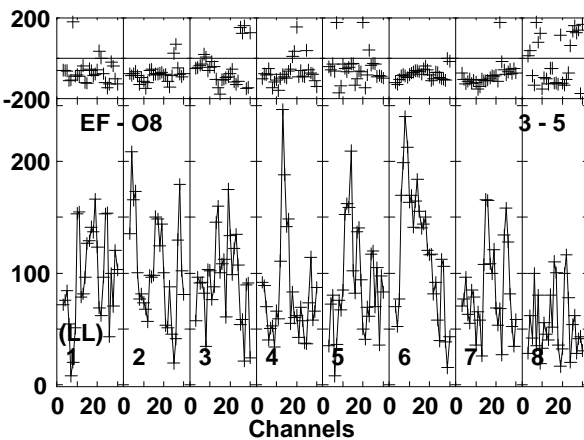
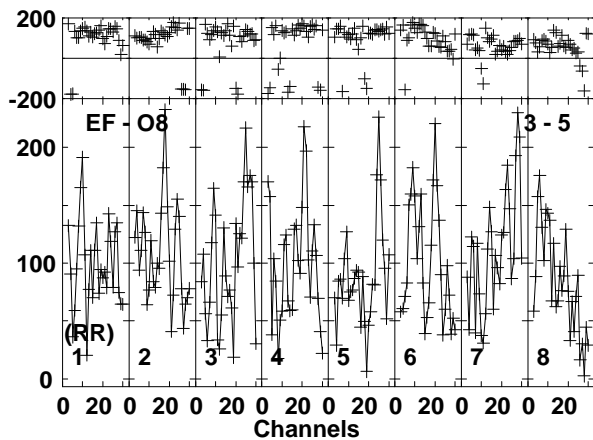
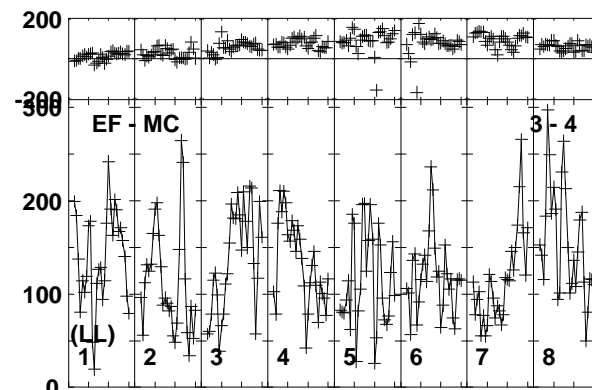
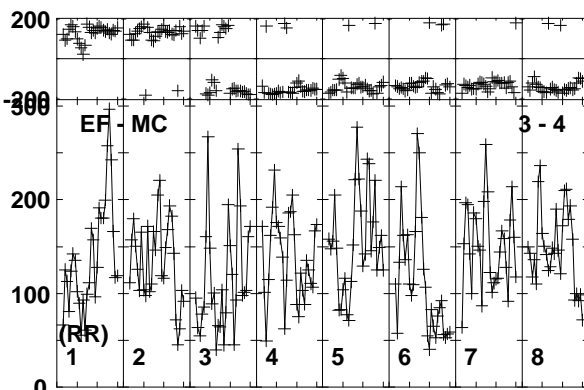
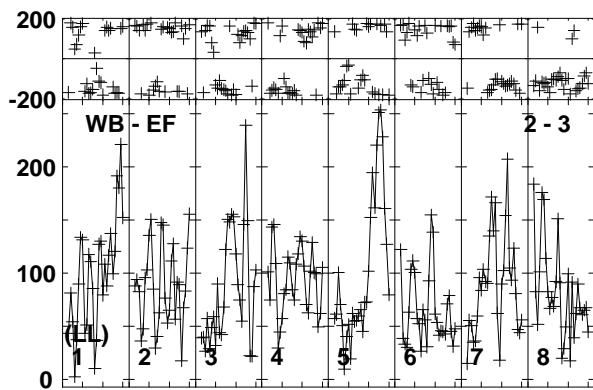
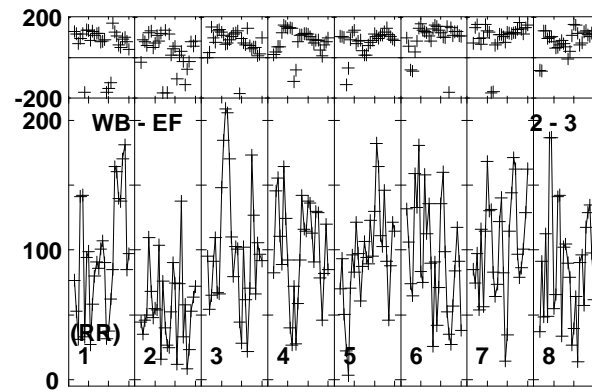
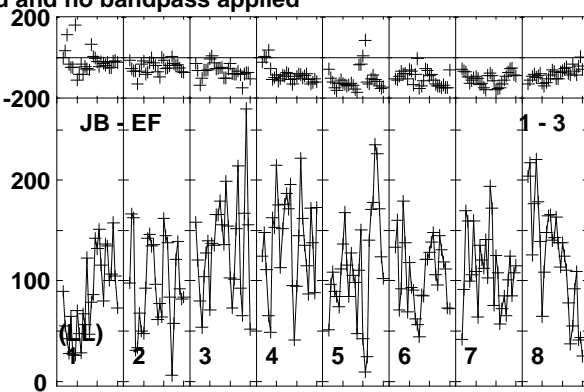
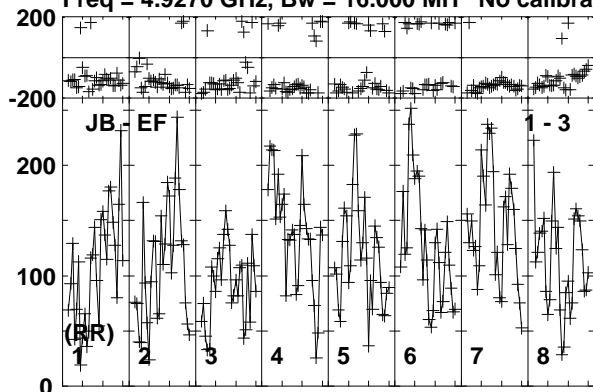

Lower frame: Micro Ampl Jy Top frame: Phas deg
Vector averaged cross-power spectrum Baseline: JB (01) - EF (03)
Timerange: 00/09:43:21 to 00/09:47:19

Plot file version 542 created 17-FEB-2020 15:43:31

J1402+5347 EK047 2.UVDATA.1

Freq = 4.9270 GHz, Bw = 16.000 MH No calibration applied and no bandpass applied

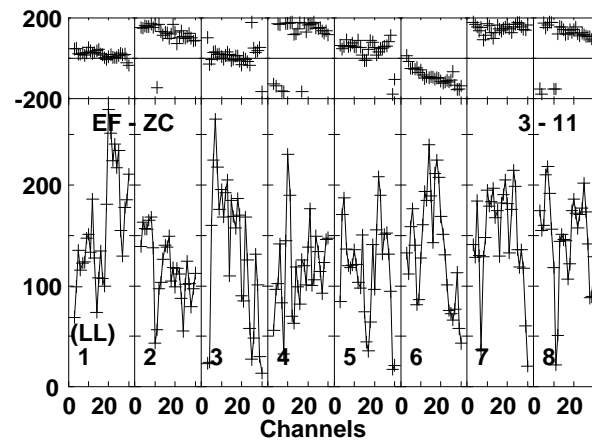
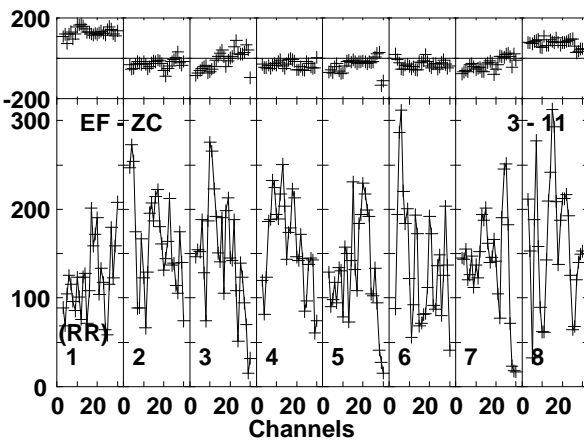
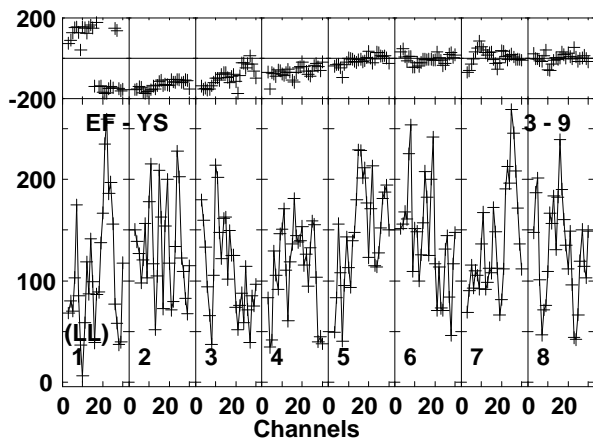
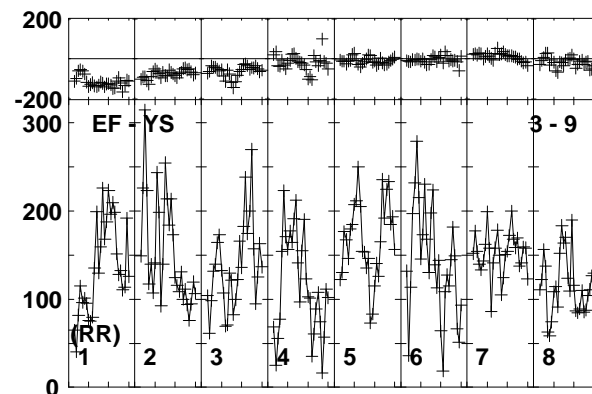
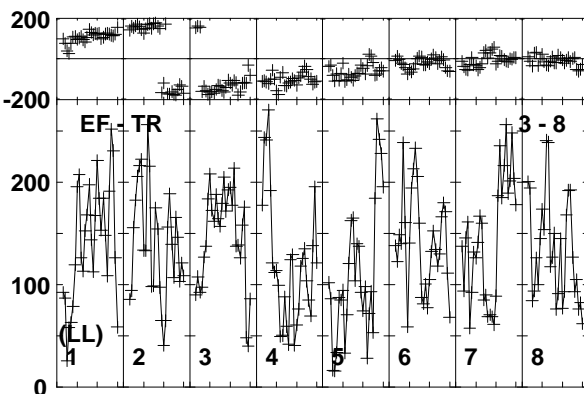
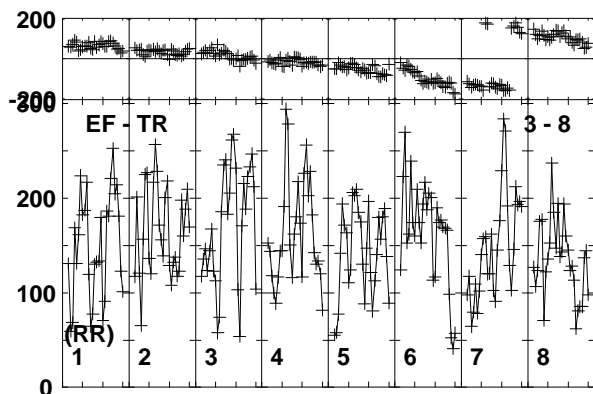
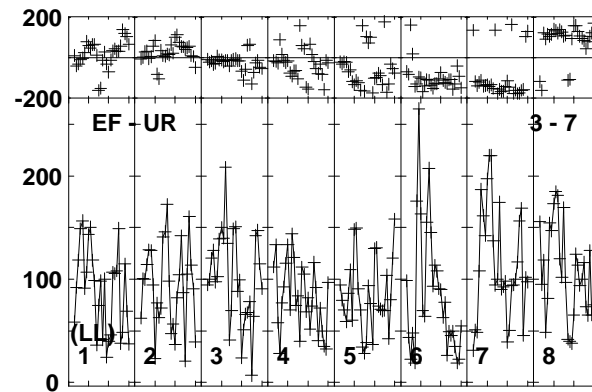
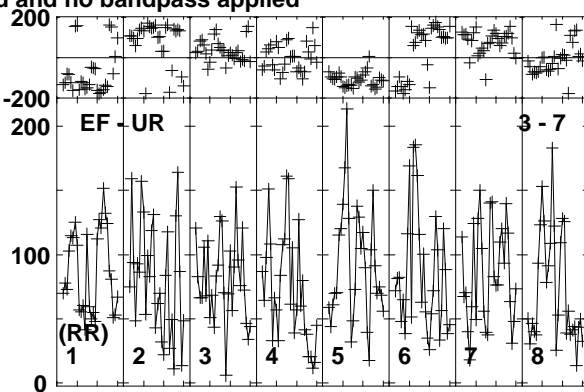
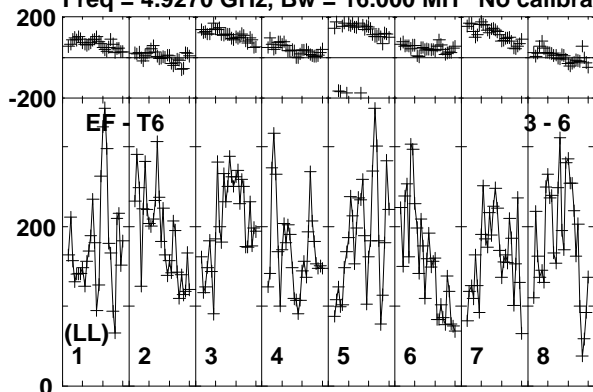

Lower frame: Micro Ampl Jy Top frame: Phas deg
Vector averaged cross-power spectrum Baseline: EF (03) - T6 (06)
Timerange: 00/09:43:21 to 00/09:47:19

Plot file version 543 created 17-FEB-2020 15:43:32

J1402+5347 EK047 2.UVDATA.1

Freq = 4.9270 GHz, Bw = 16.000 MH No calibration applied and no bandpass applied

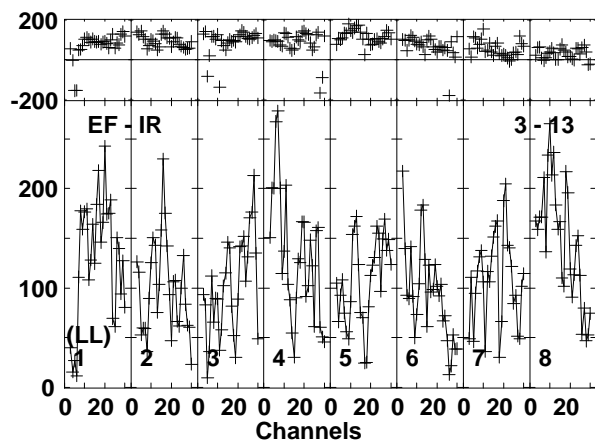
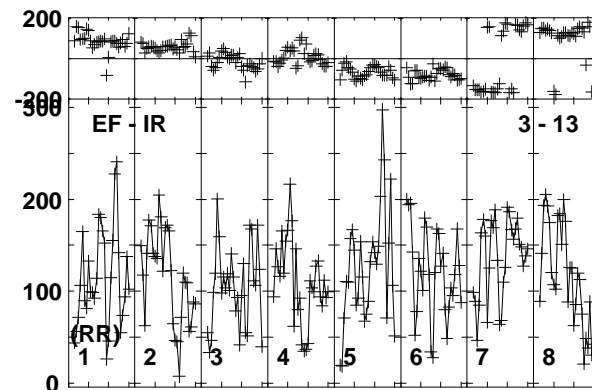
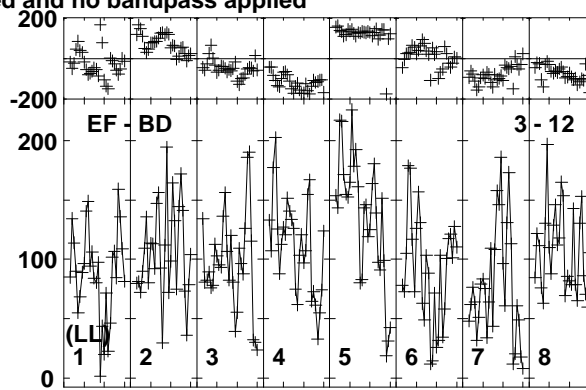
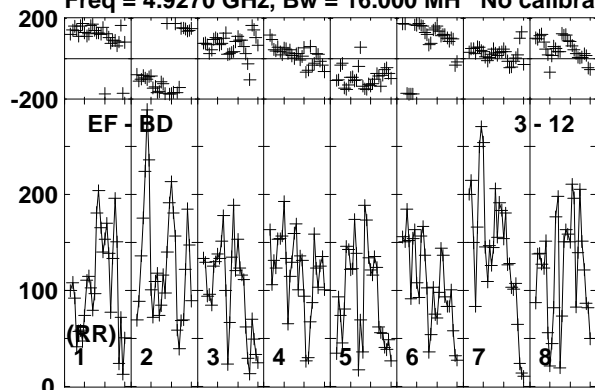

Lower frame: Micro Ampl Jy Top frame: Phas deg
Vector averaged cross-power spectrum Baseline: EF (03) - BD (12)
Timerange: 00/09:43:21 to 00/09:47:19

Plot file version 544 created 17-FEB-2020 15:43:32

J1359+5544 EK047 2.UVDATA.1

Freq = 4.9270 GHz, Bw = 16.000 MH No calibration applied and no bandpass applied

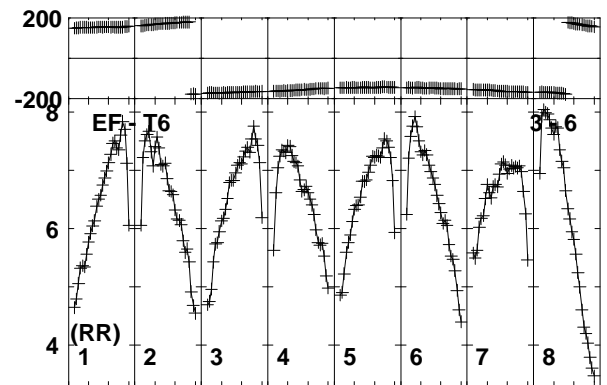
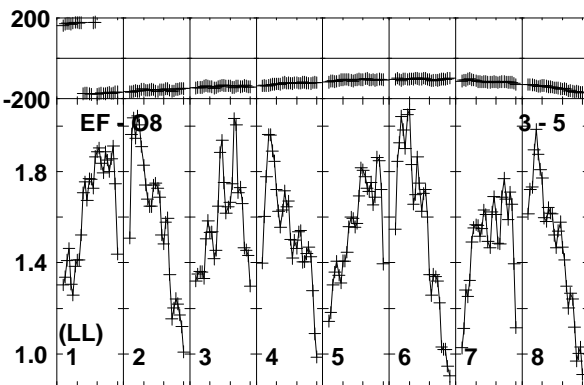
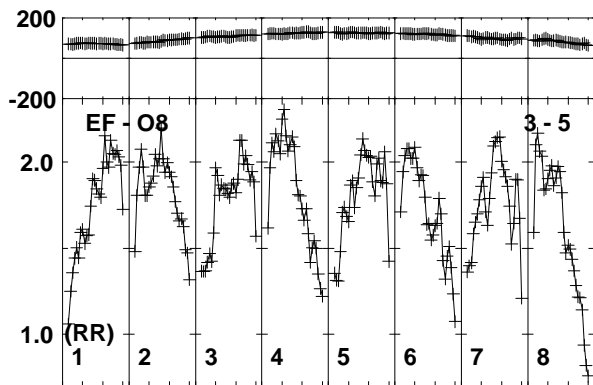
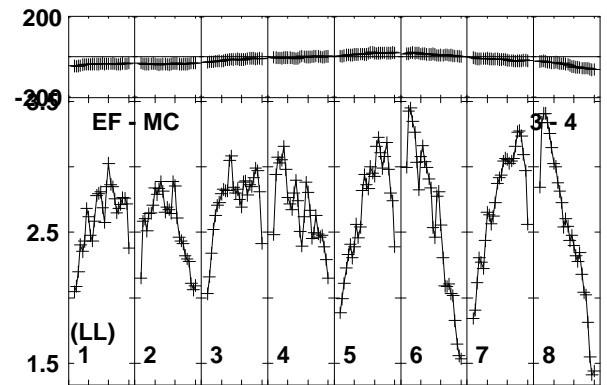
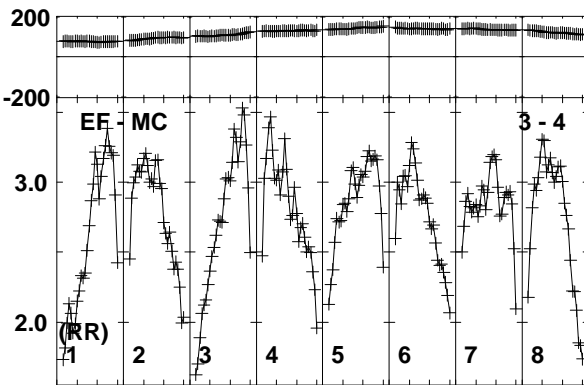
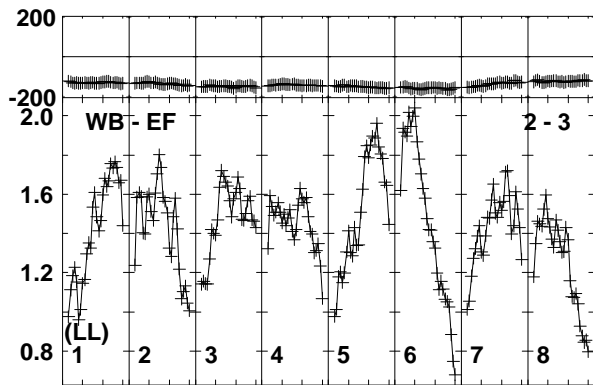
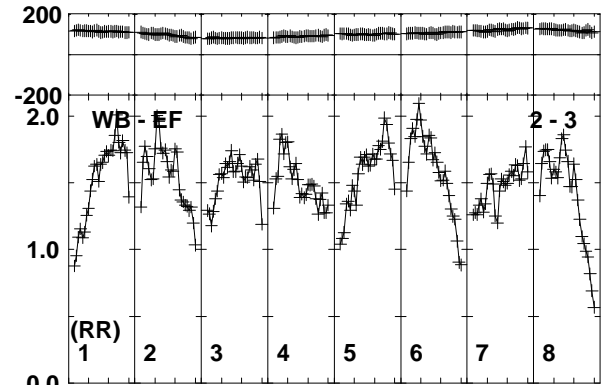
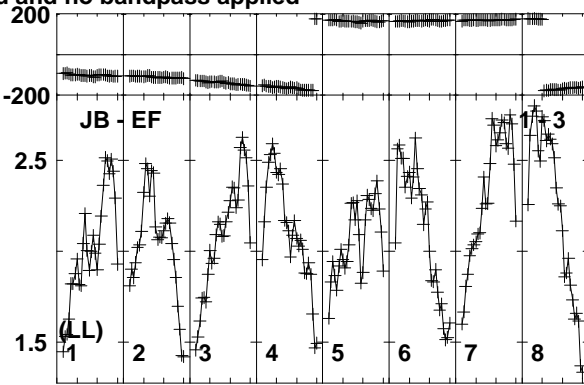
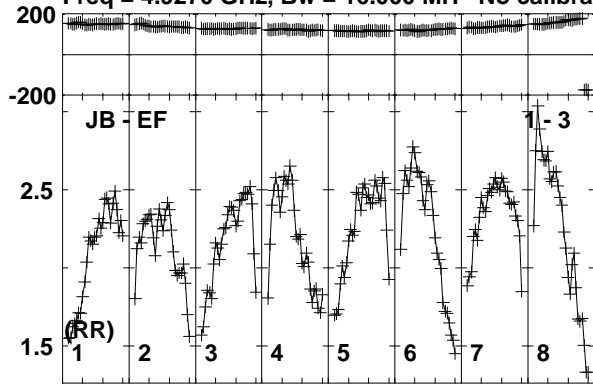

Lower frame: Milli Ampl Jy Top frame: Phas deg
Vector averaged cross-power spectrum Baseline: JB (01) - EF (03)
Timerange: 00/09:48:01 to 00/09:49:19

Plot file version 545 created 17-FEB-2020 15:43:32

J1359+5544 EK047 2.UVDATA.1

Freq = 4.9270 GHz, Bw = 16.000 MH No calibration applied and no bandpass applied

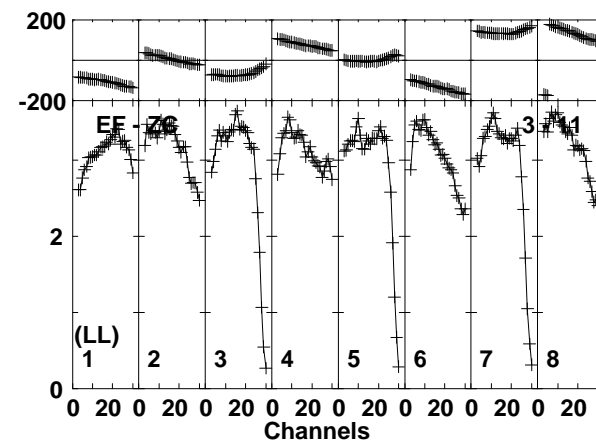
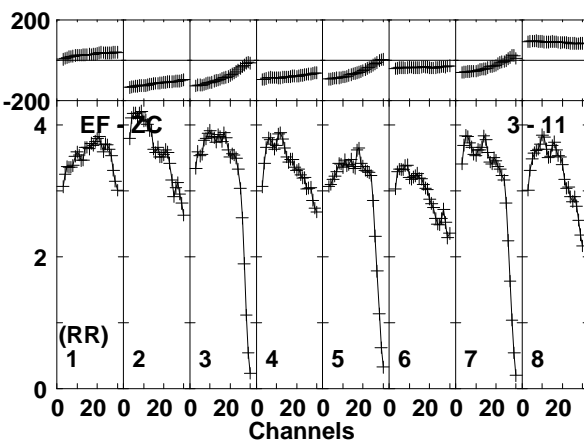
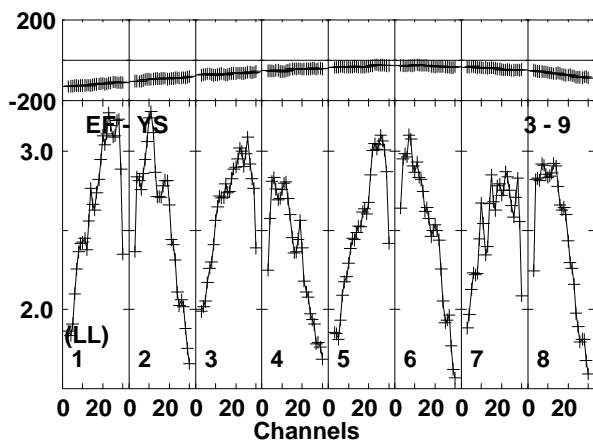
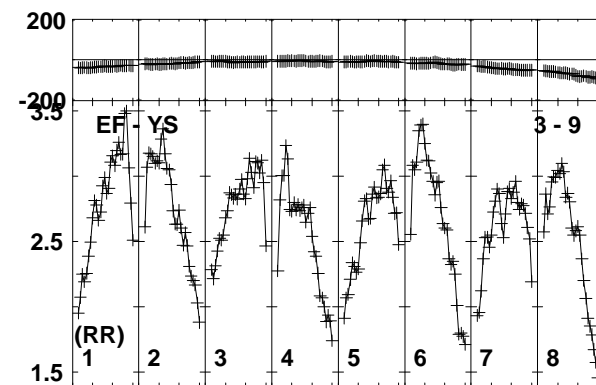
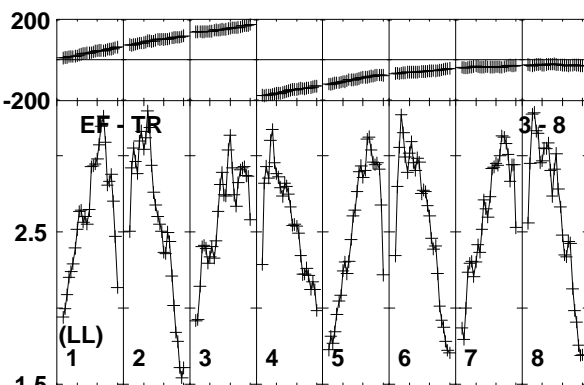
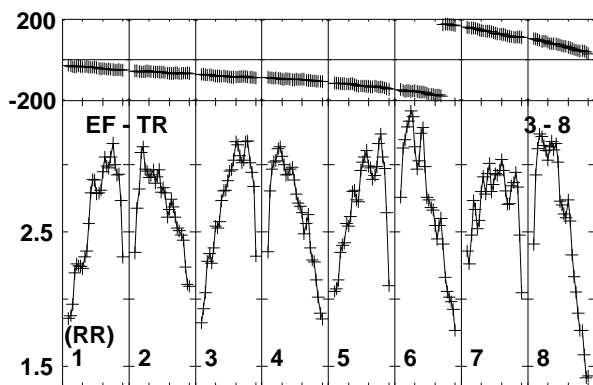
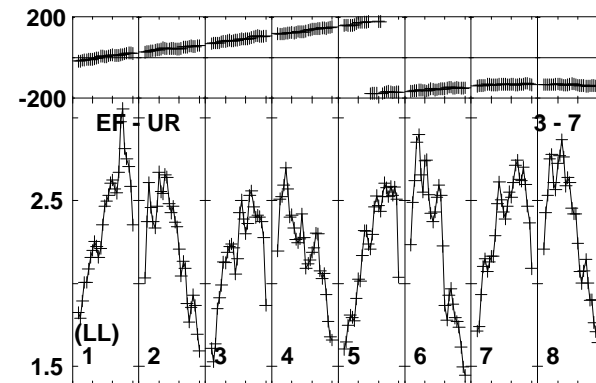
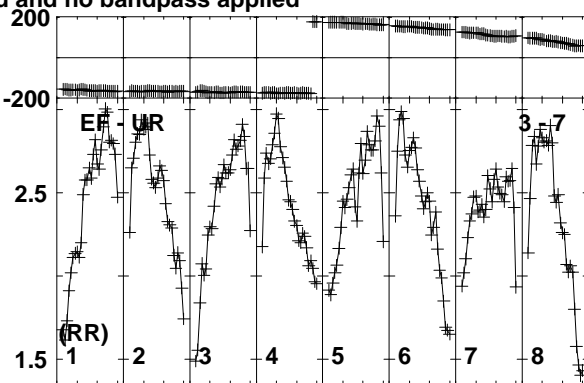
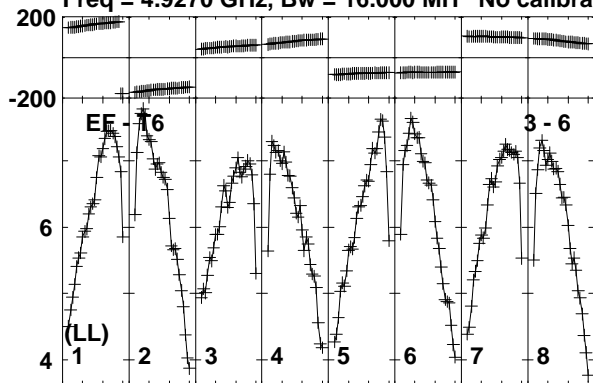

Lower frame: Milli Ampl Jy Top frame: Phas deg
Vector averaged cross-power spectrum Baseline: EF (03) - T6 (06)
Timerange: 00/09:48:01 to 00/09:49:19

Plot file version 546 created 17-FEB-2020 15:43:32

J1359+5544 EK047 2.UVDATA.1

Freq = 4.9270 GHz, Bw = 16.000 MH No calibration applied and no bandpass applied

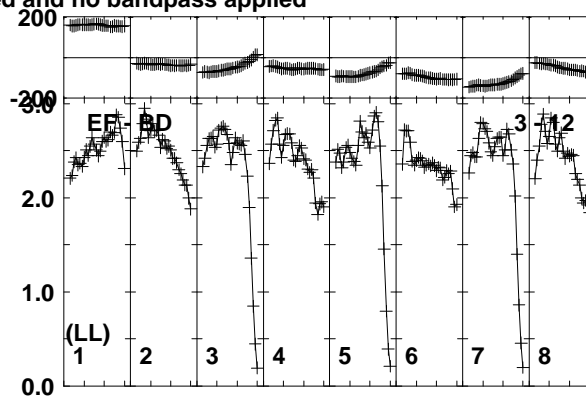
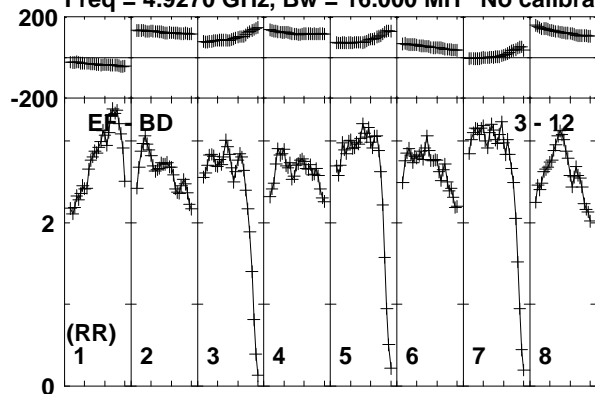

Lower frame: Milli Ampl Jy Top frame: Phas deg
Vector averaged cross-power spectrum Baseline: EF (03) - BD (12)
Timerange: 00/09:48:01 to 00/09:49:19

Plot file version 547 created 17-FEB-2020 15:43:32

J1402+5347 EK047 2.UVDATA.1

Freq = 4.9270 GHz, Bw = 16.000 MH No calibration applied and no bandpass applied

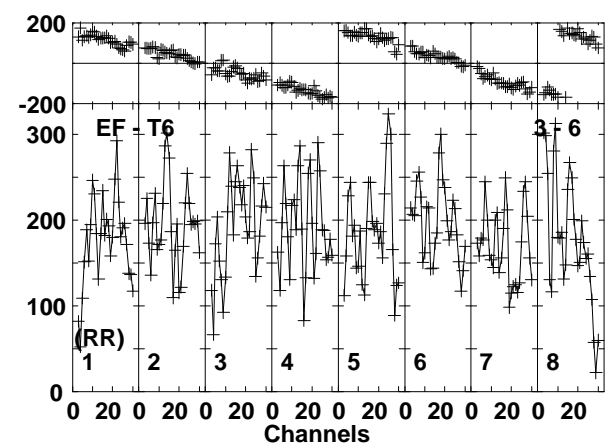
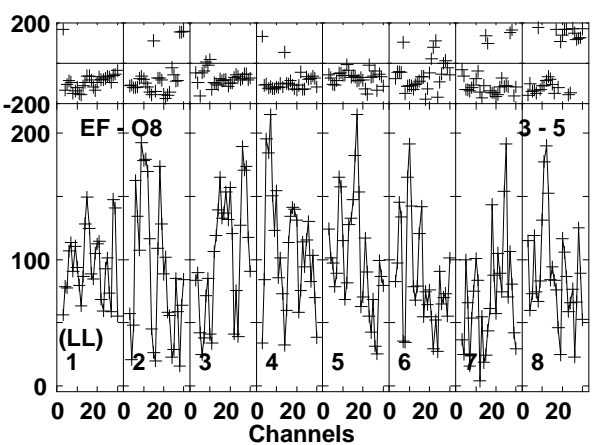
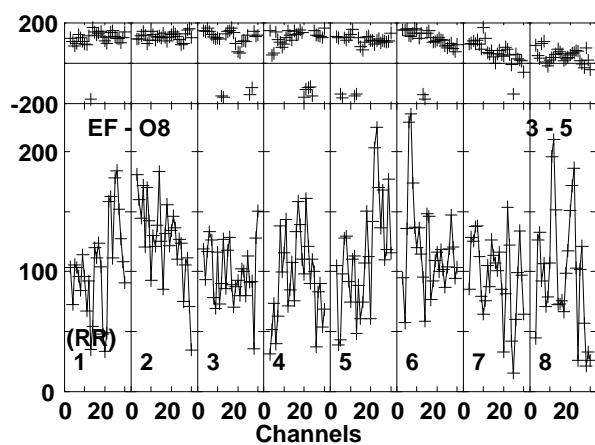
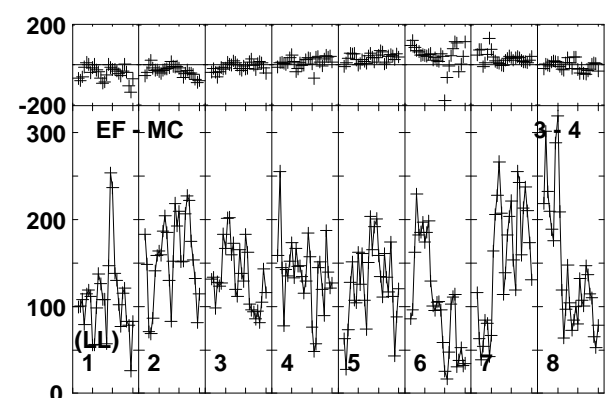
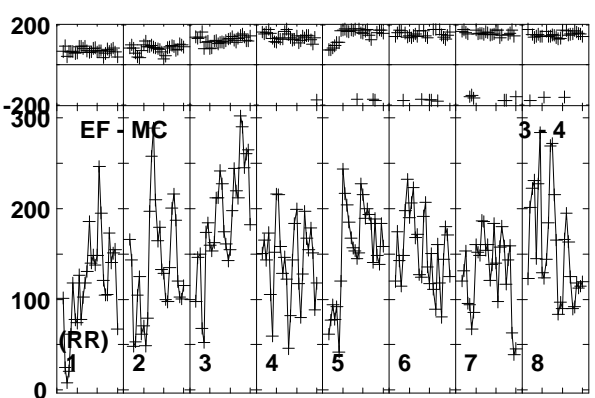
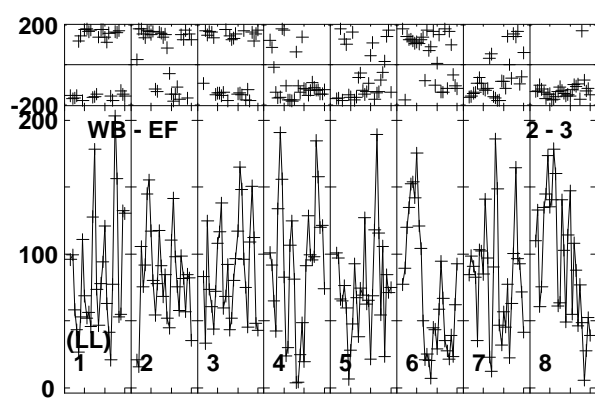
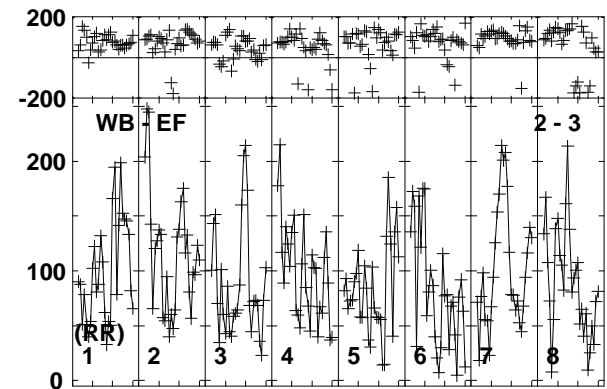
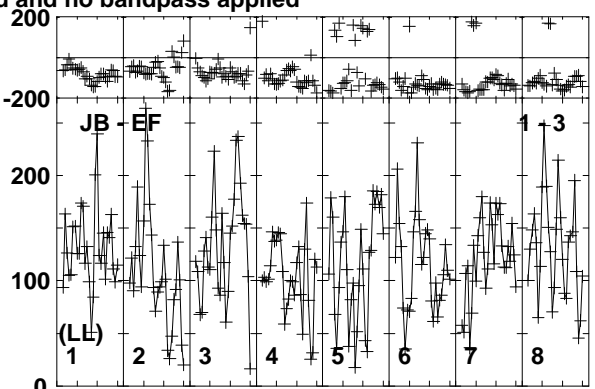
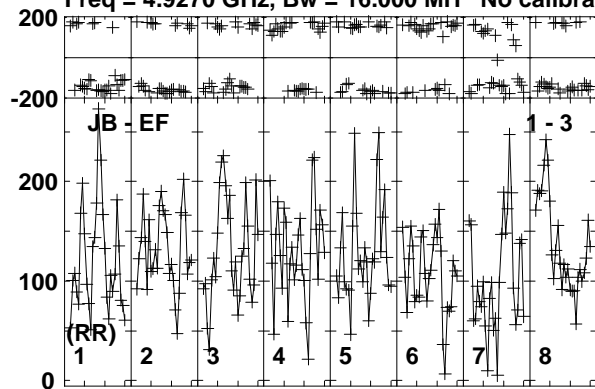

Lower frame: Micro Ampl Jy Top frame: Phas deg
Vector averaged cross-power spectrum Baseline: JB (01) - EF (03)
Timerange: 00/09:49:21 to 00/09:53:19

Plot file version 548 created 17-FEB-2020 15:43:32

J1402+5347 EK047 2.UVDATA.1

Freq = 4.9270 GHz, Bw = 16.000 MH No calibration applied and no bandpass applied

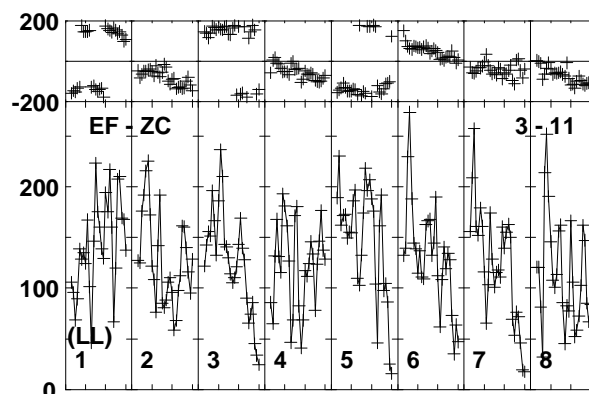
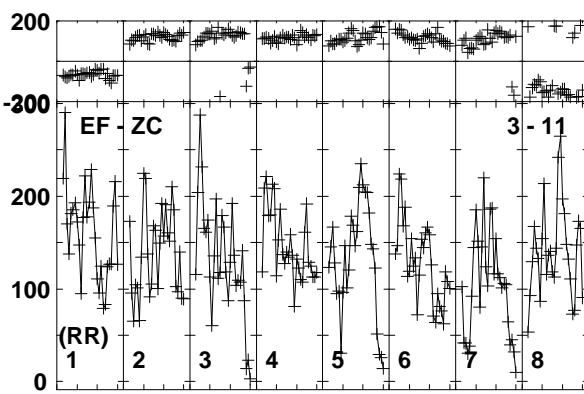
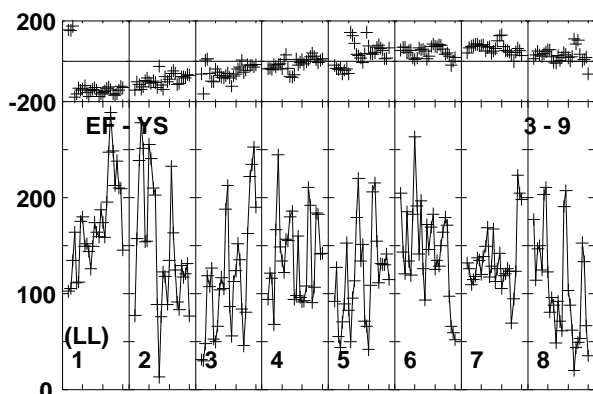
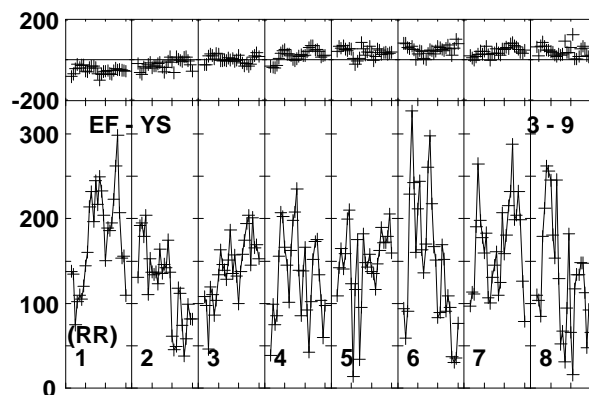
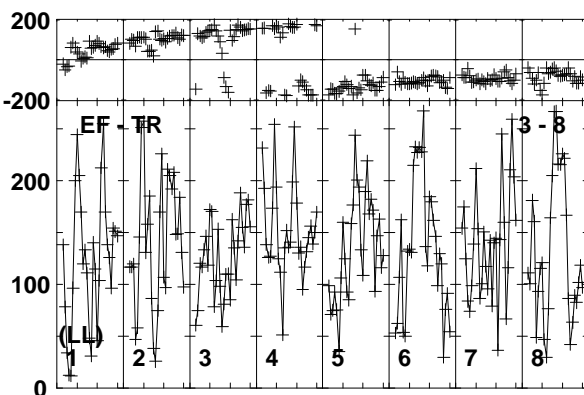
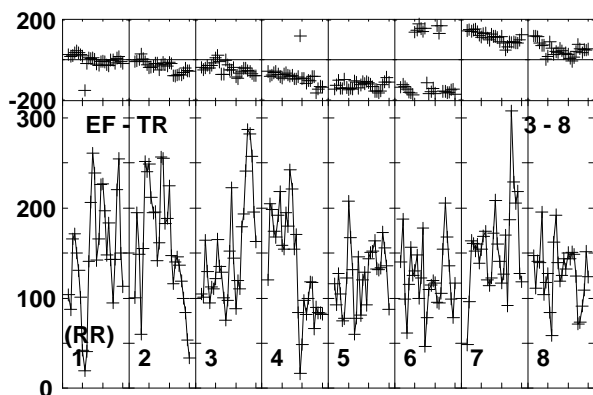
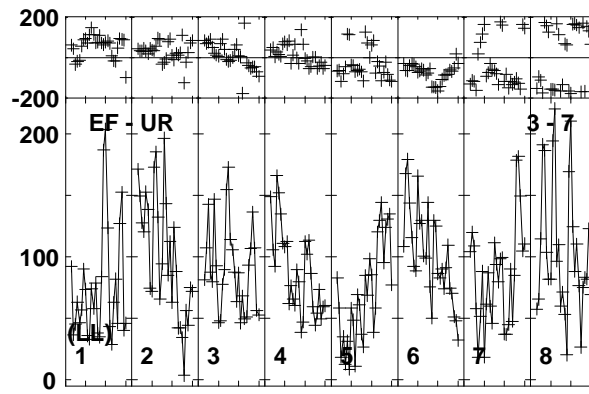
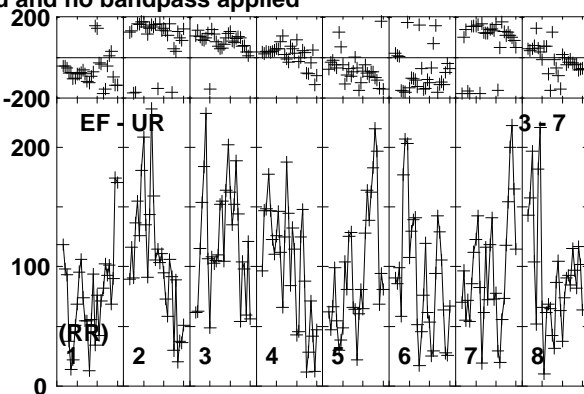
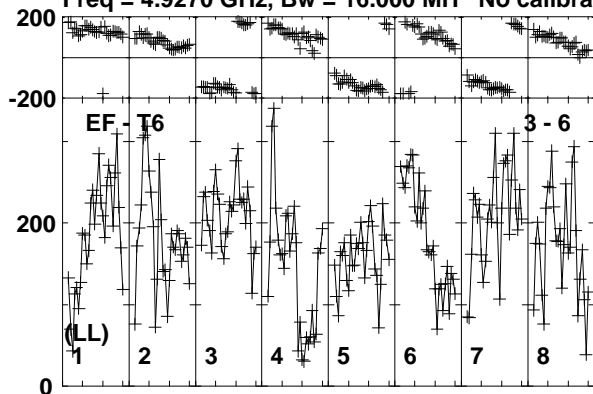

Lower frame: Micro Ampl Jy Top frame: Phas deg
Vector averaged cross-power spectrum Baseline: EF (03) - T6 (06)
Timerange: 00/09:49:21 to 00/09:53:19

Plot file version 549 created 17-FEB-2020 15:43:32

J1402+5347 EK047 2.UVDATA.1

Freq = 4.9270 GHz, Bw = 16.000 MH No calibration applied and no bandpass applied

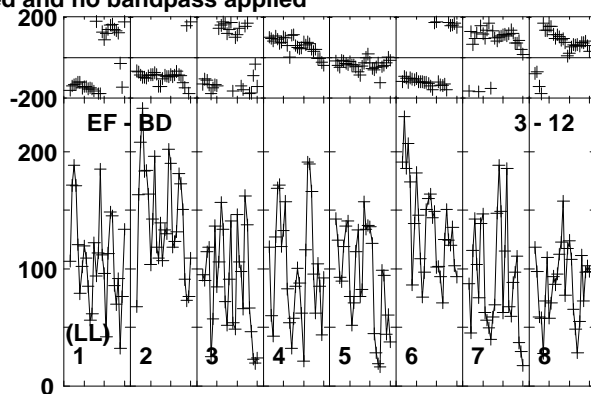
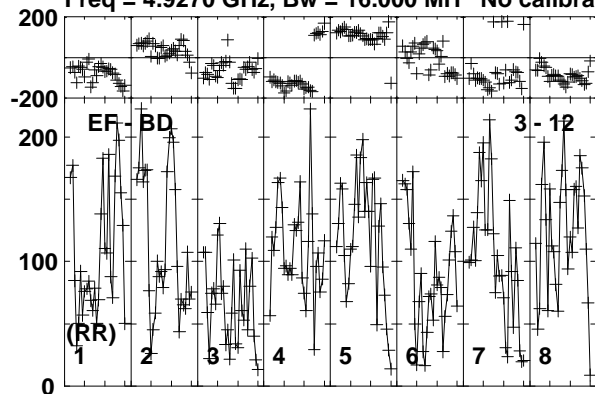

Lower frame: Micro Ampl Jy Top frame: Phas deg
Vector averaged cross-power spectrum Baseline: EF (03) - BD (12)
Timerange: 00/09:49:21 to 00/09:53:19

Plot file version 550 created 17-FEB-2020 15:43:32

J1359+5544 EK047 2.UVDATA.1

Freq = 4.9270 GHz, Bw = 16.000 MH No calibration applied and no bandpass applied

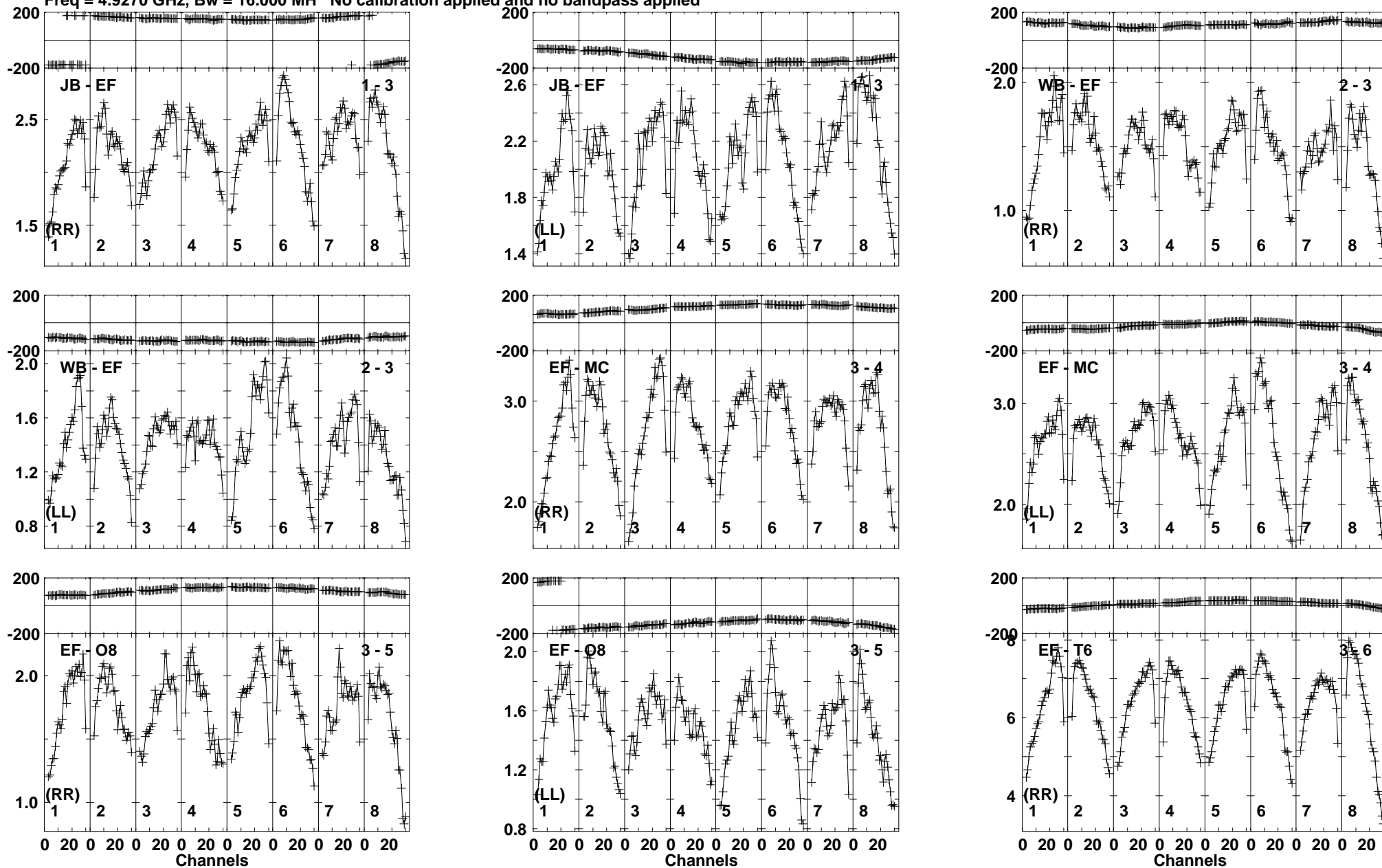

Lower frame: Milli Ampl Jy Top frame: Phas deg
Vector averaged cross-power spectrum Baseline: JB (01) - EF (03)
Timerange: 00/09:53:21 to 00/09:55:19

Plot file version 551 created 17-FEB-2020 15:43:32

J1359+5544 EK047 2.UVDATA.1

Freq = 4.9270 GHz, Bw = 16.000 MH No calibration applied and no bandpass applied

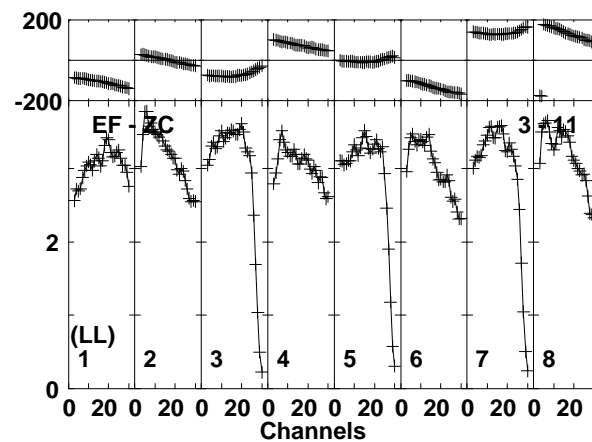
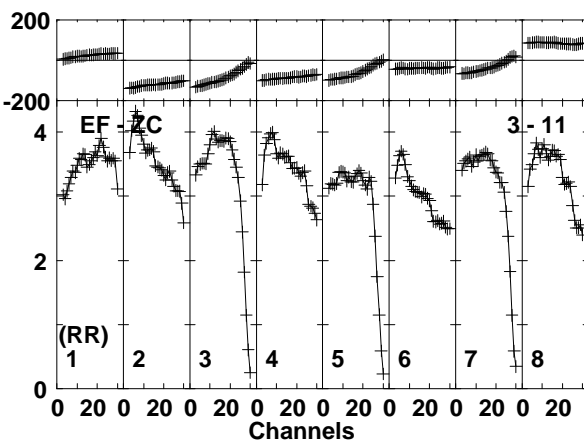
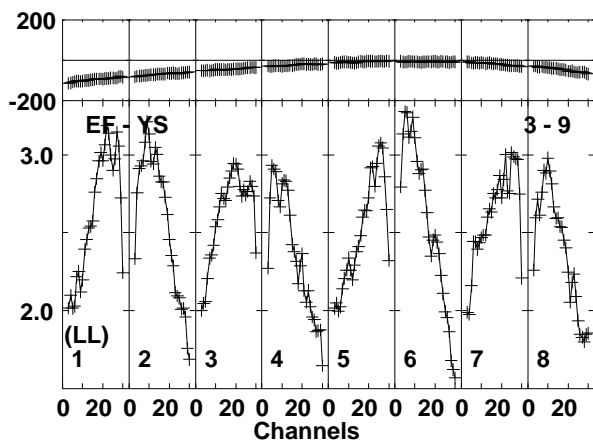
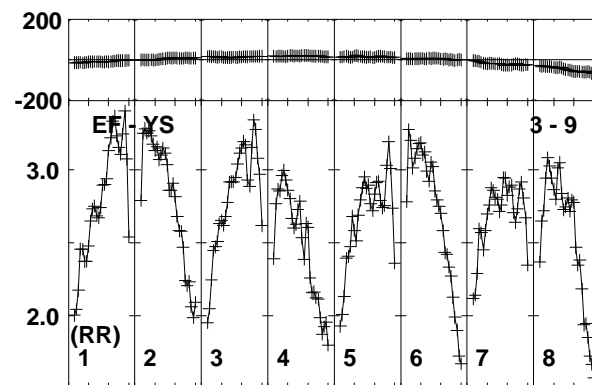
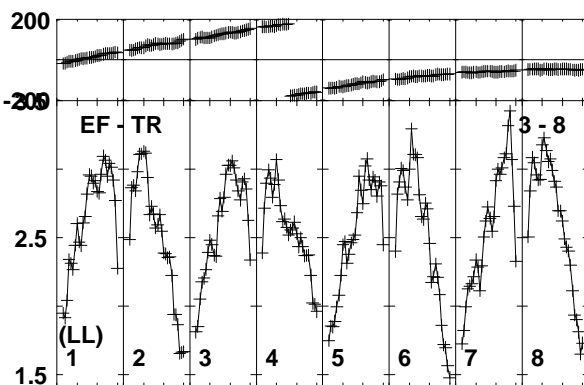
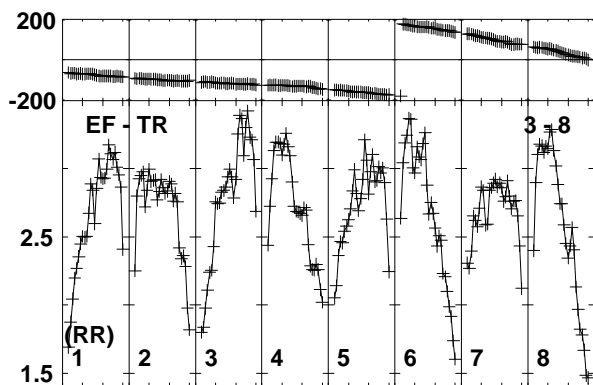
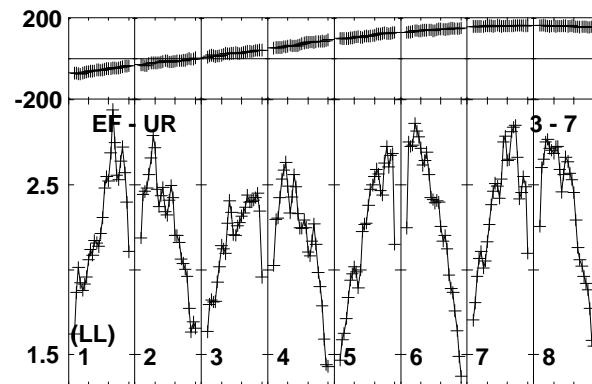
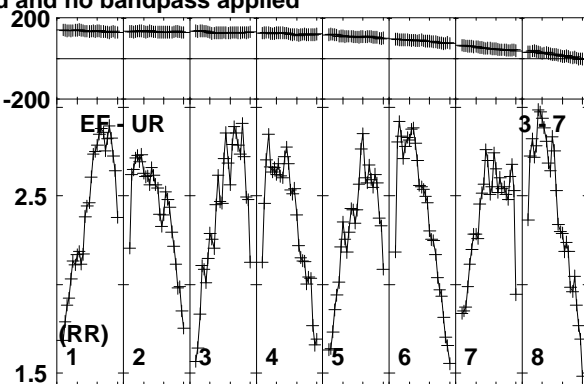
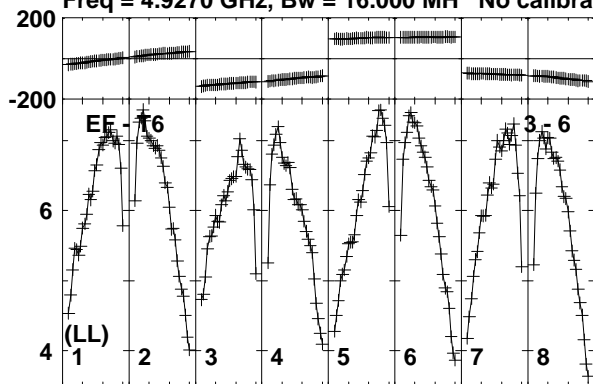

Lower frame: Milli Ampl Jy Top frame: Phas deg
Vector averaged cross-power spectrum Baseline: EF (03) - T6 (06)
Timerange: 00/09:53:21 to 00/09:55:19

Plot file version 552 created 17-FEB-2020 15:43:32

J1359+5544 EK047 2.UVDATA.1

Freq = 4.9270 GHz, Bw = 16.000 MH No calibration applied and no bandpass applied

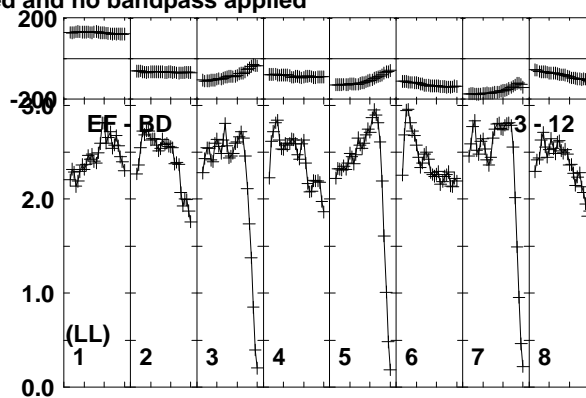
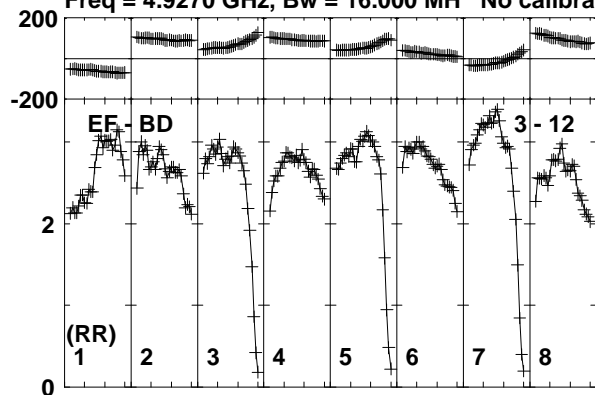

Lower frame: Milli Ampl Jy Top frame: Phas deg
Vector averaged cross-power spectrum Baseline: EF (03) - BD (12)
Timerange: 00/09:53:21 to 00/09:55:19

Plot file version 553 created 17-FEB-2020 15:43:32

J1402+5347 EK047 2.UVDATA.1

Freq = 4.9270 GHz, Bw = 16.000 MH No calibration applied and no bandpass applied

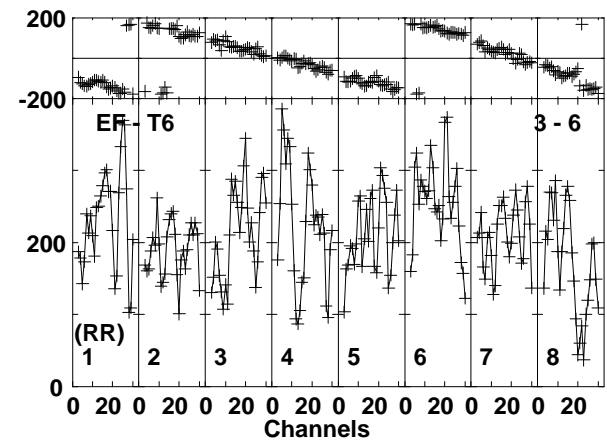
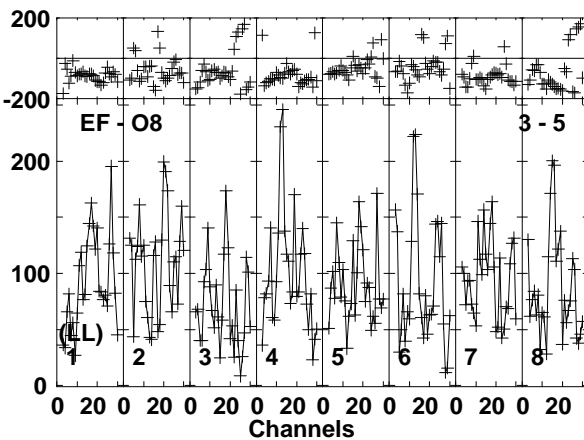
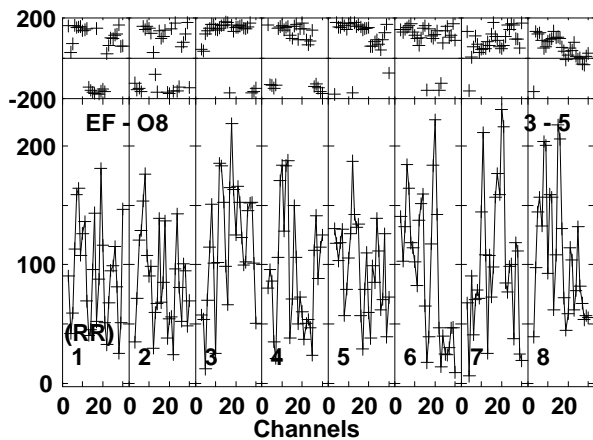
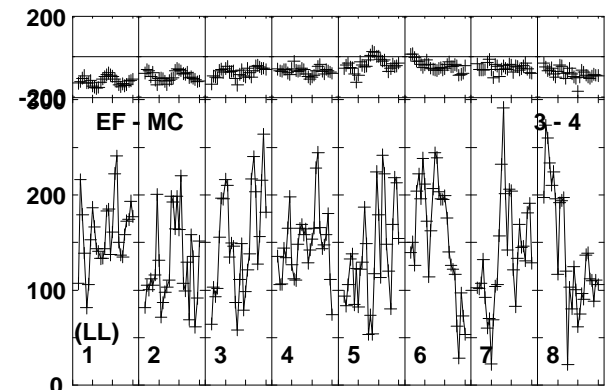
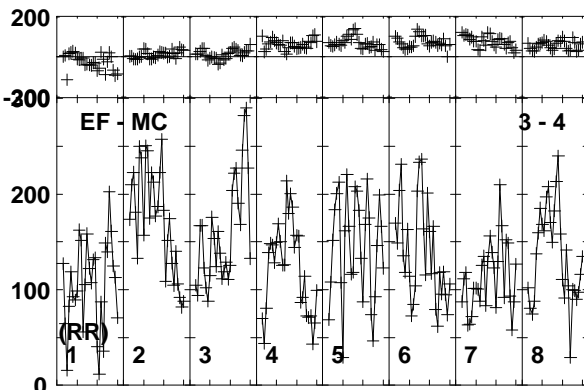
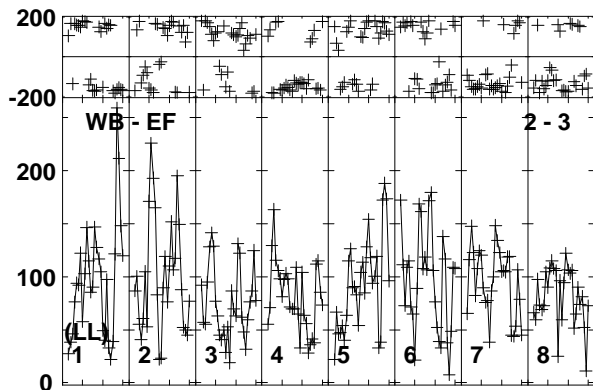
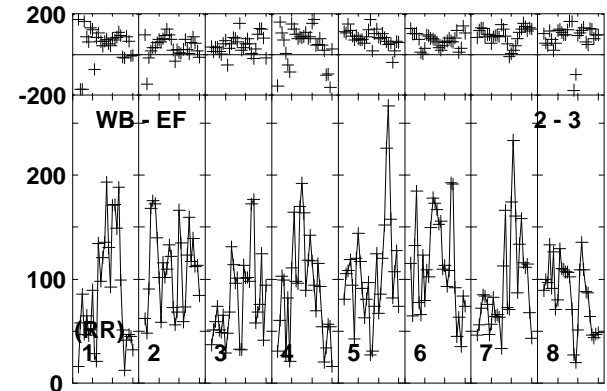
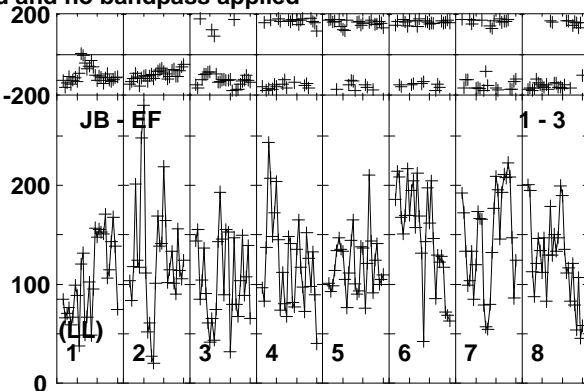
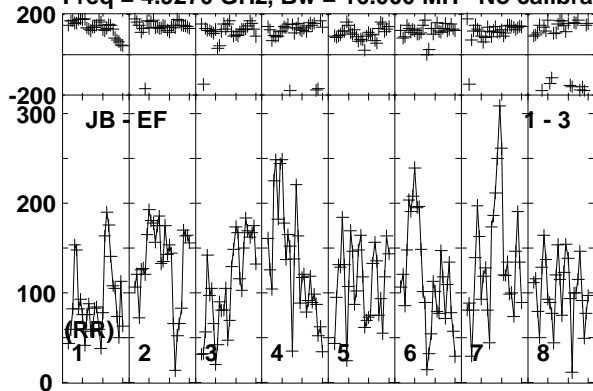

Lower frame: Micro Ampl Jy Top frame: Phas deg
Vector averaged cross-power spectrum Baseline: JB (01) - EF (03)
Timerange: 00/09:55:21 to 00/09:59:19

Plot file version 554 created 17-FEB-2020 15:43:33

J1402+5347 EK047 2.UVDATA.1

Freq = 4.9270 GHz, Bw = 16.000 MH No calibration applied and no bandpass applied

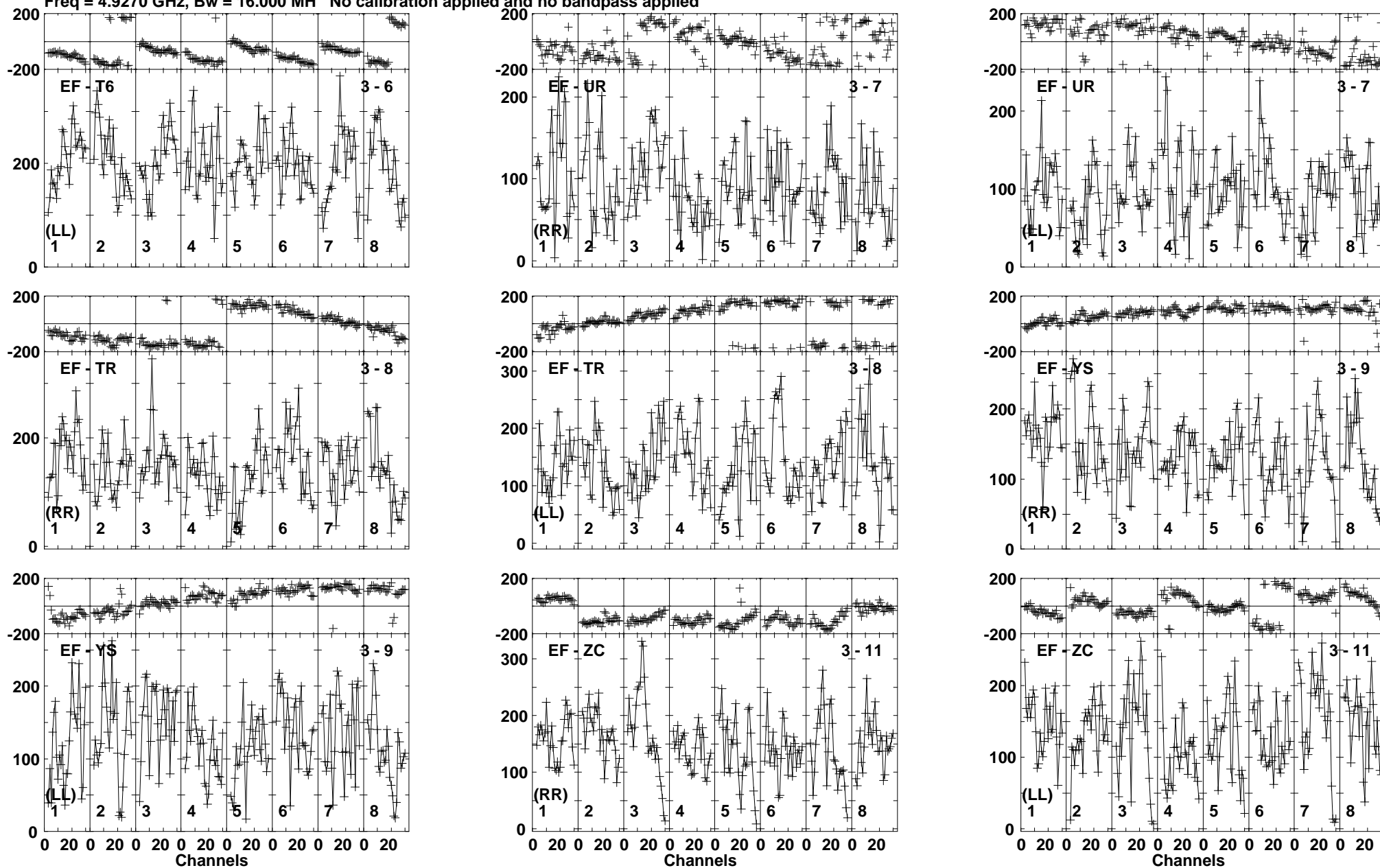

Lower frame: Micro Ampl Jy Top frame: Phas deg
Vector averaged cross-power spectrum Baseline: EF (03) - T6 (06)
Timerange: 00/09:55:21 to 00/09:59:19

Plot file version 555 created 17-FEB-2020 15:43:33

J1402+5347 EK047 2.UVDATA.1

Freq = 4.9270 GHz, Bw = 16.000 MH No calibration applied and no bandpass applied

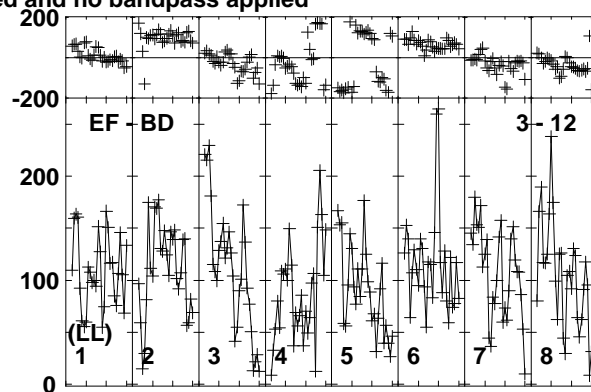
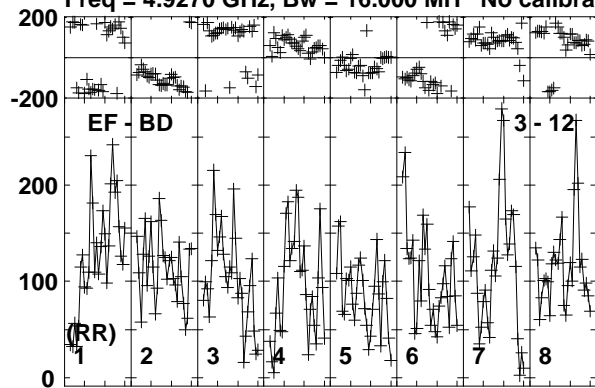

Lower frame: Micro Ampl Jy Top frame: Phas deg
Vector averaged cross-power spectrum Baseline: EF (03) - BD (12)
Timerange: 00/09:55:21 to 00/09:59:19

Plot file version 556 created 17-FEB-2020 15:43:33

J1359+5544 EK047 2.UVDATA.1

Freq = 4.9270 GHz, Bw = 16.000 MH No calibration applied and no bandpass applied

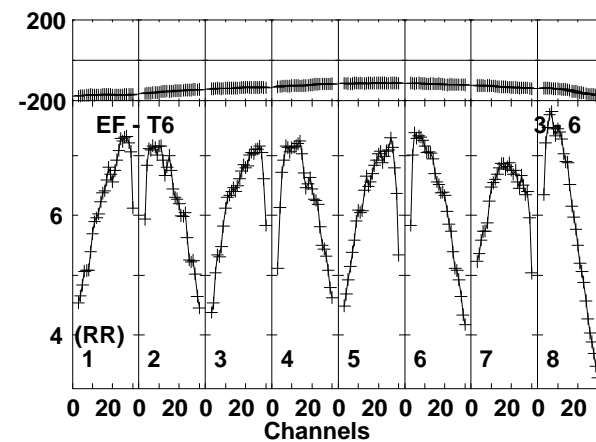
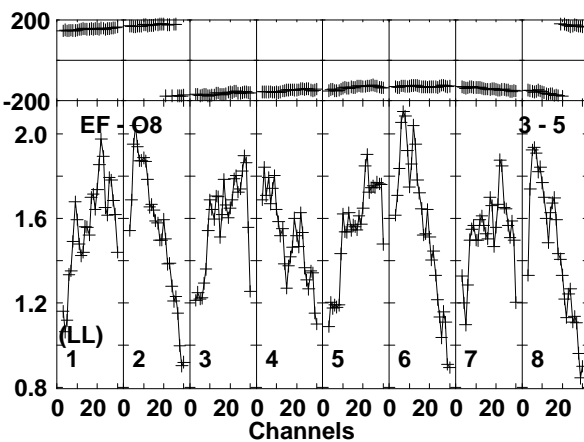
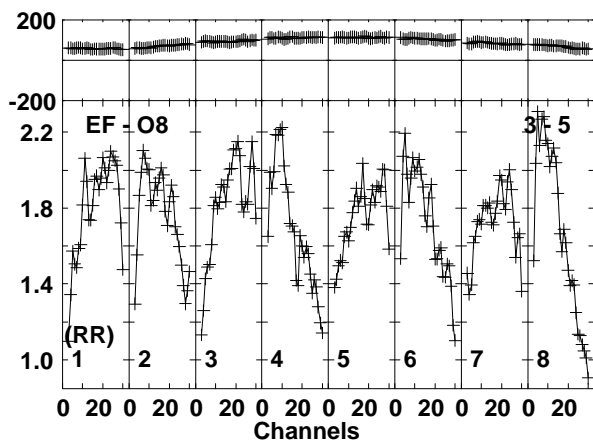
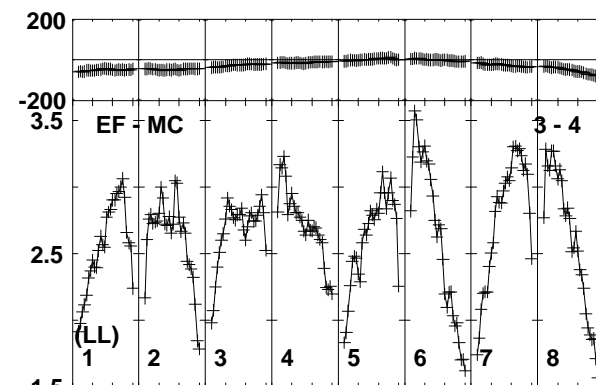
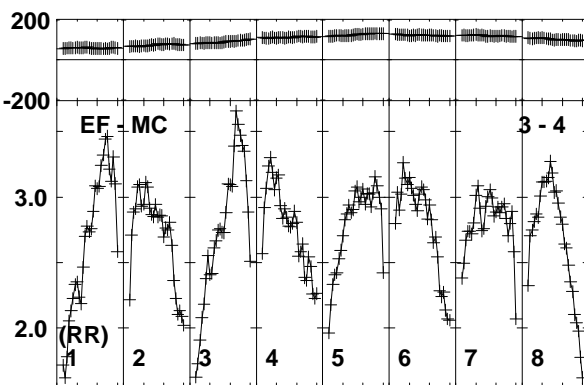
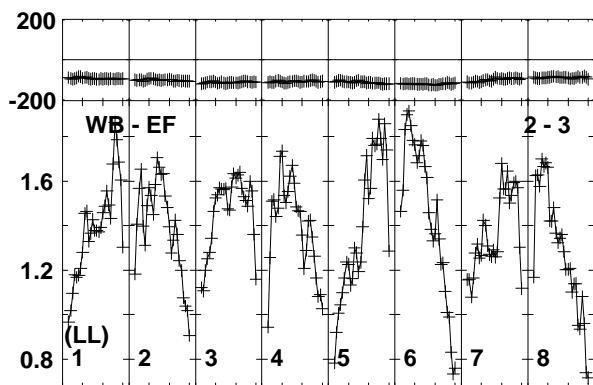
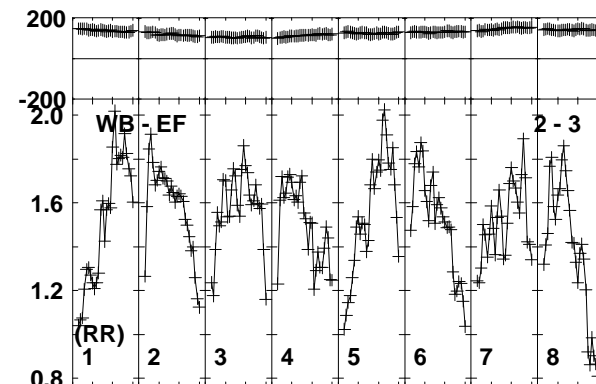
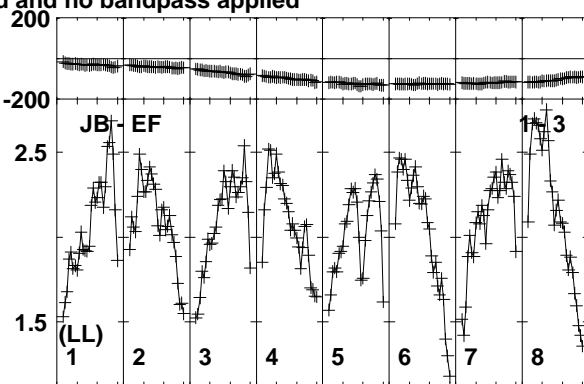
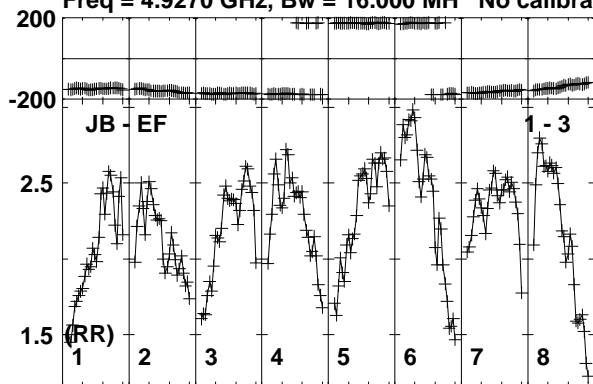

Lower frame: Milli Ampl Jy Top frame: Phas deg
Vector averaged cross-power spectrum Baseline: JB (01) - EF (03)
Timerange: 00/10:00:01 to 00/10:01:19

Plot file version 557 created 17-FEB-2020 15:43:33

J1359+5544 EK047 2.UVDATA.1

Freq = 4.9270 GHz, Bw = 16.000 MH No calibration applied and no bandpass applied

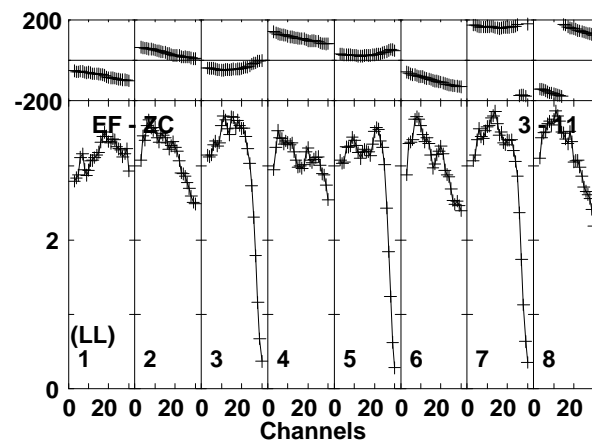
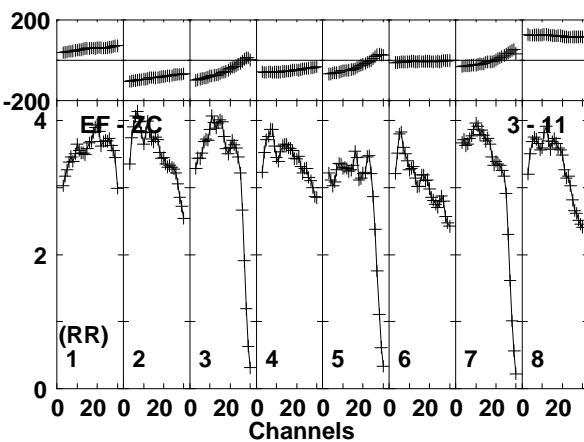
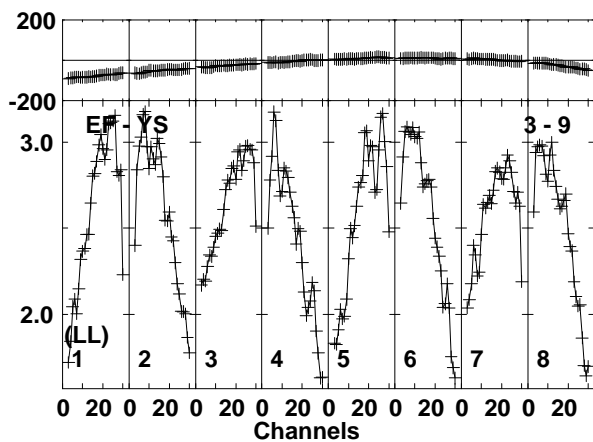
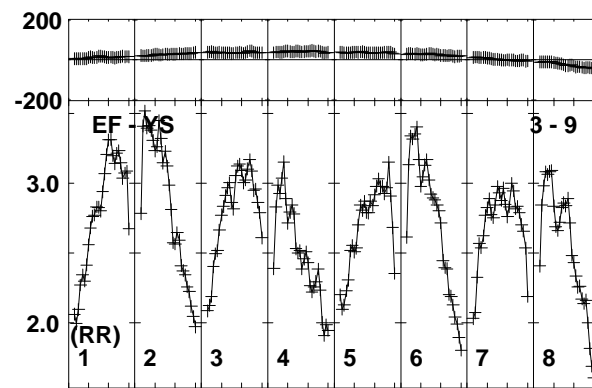
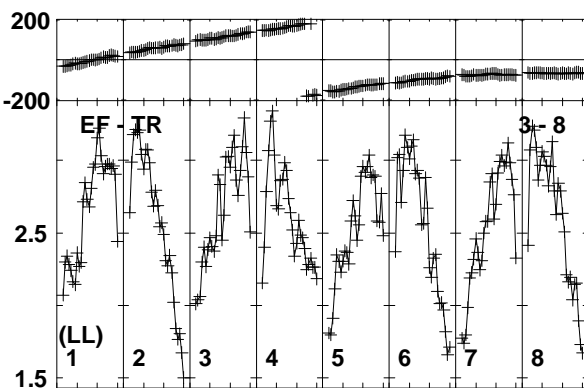
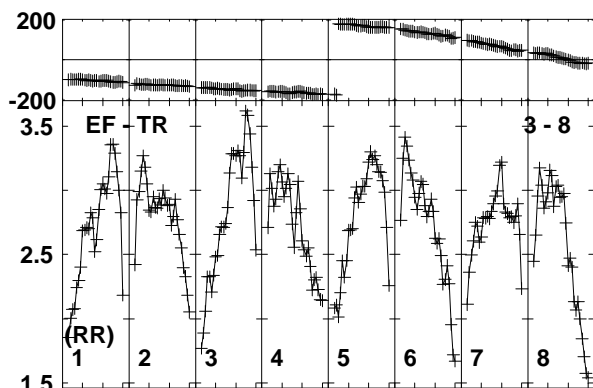
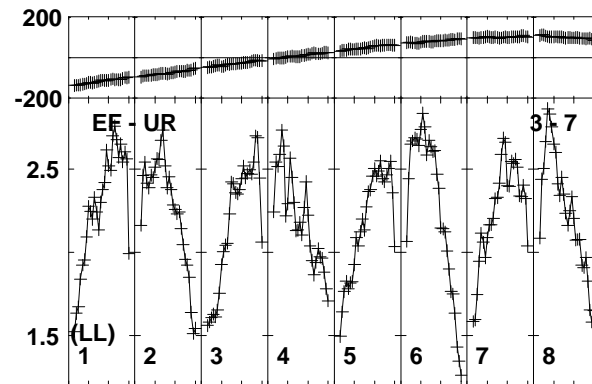
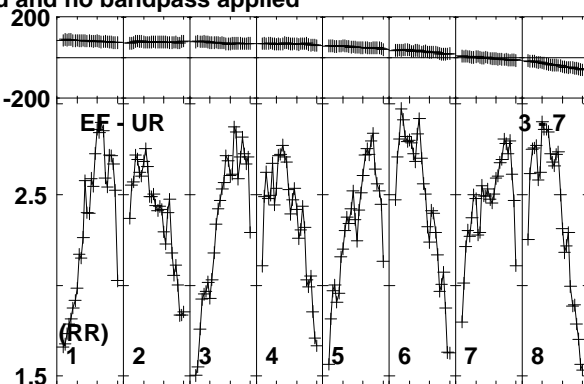
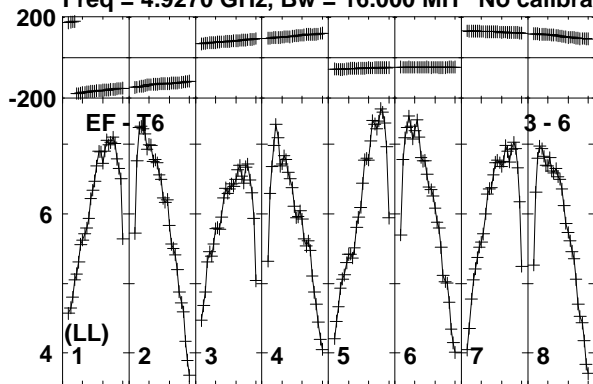

Lower frame: Milli Ampl Jy Top frame: Phas deg
Vector averaged cross-power spectrum Baseline: EF (03) - T6 (06)
Timerange: 00/10:00:01 to 00/10:01:19

Plot file version 558 created 17-FEB-2020 15:43:33

J1359+5544 EK047 2.UVDATA.1

Freq = 4.9270 GHz, Bw = 16.000 MH No calibration applied and no bandpass applied

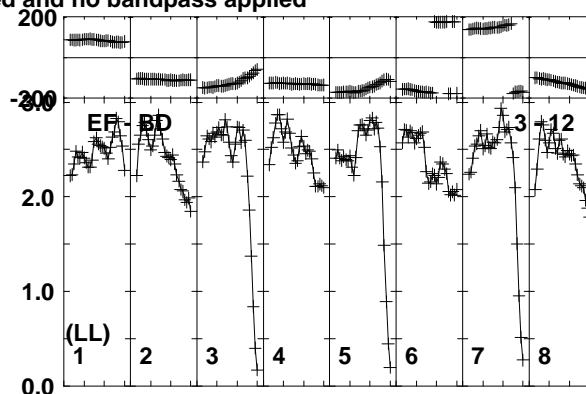
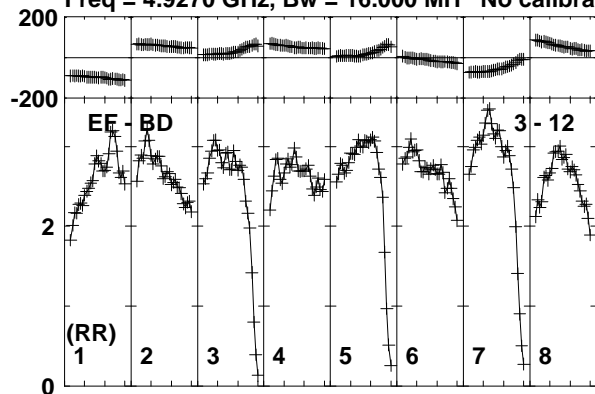

Lower frame: Milli Ampl Jy Top frame: Phas deg
Vector averaged cross-power spectrum Baseline: EF (03) - BD (12)
Timerange: 00/10:00:01 to 00/10:01:19

Plot file version 559 created 17-FEB-2020 15:43:33

J1402+5347 EK047 2.UVDATA.1

Freq = 4.9270 GHz, Bw = 16.000 MH No calibration applied and no bandpass applied

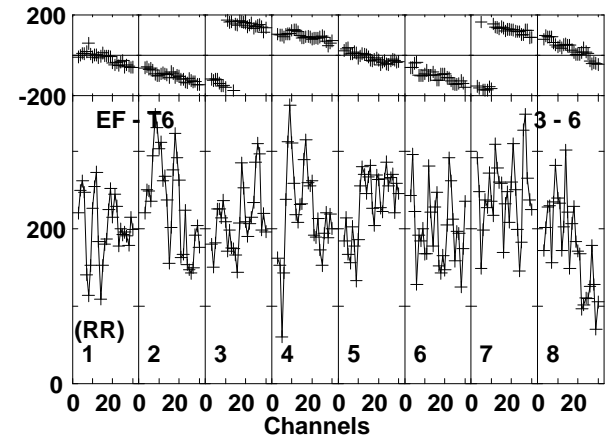
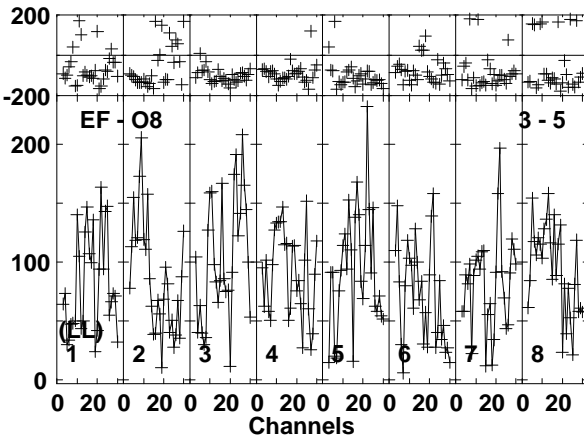
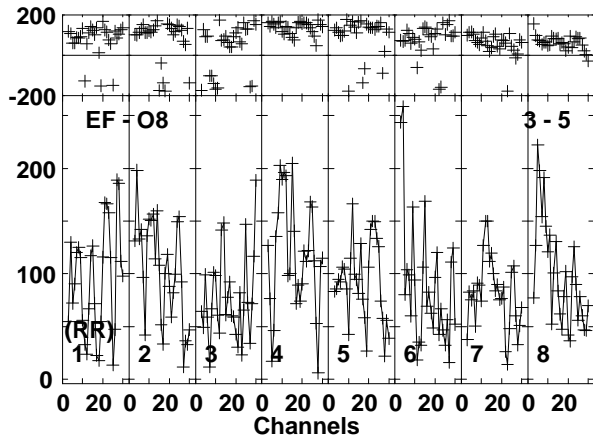
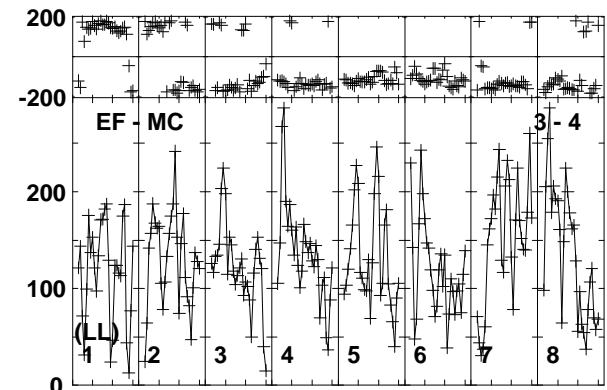
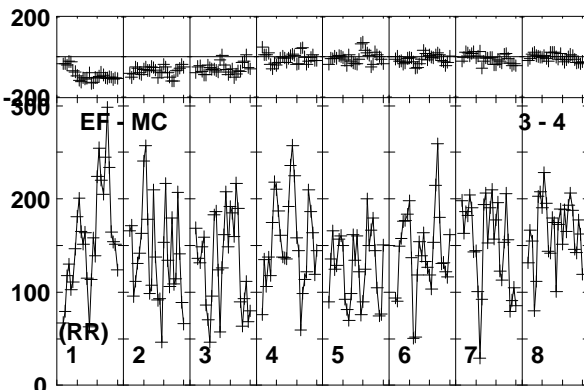
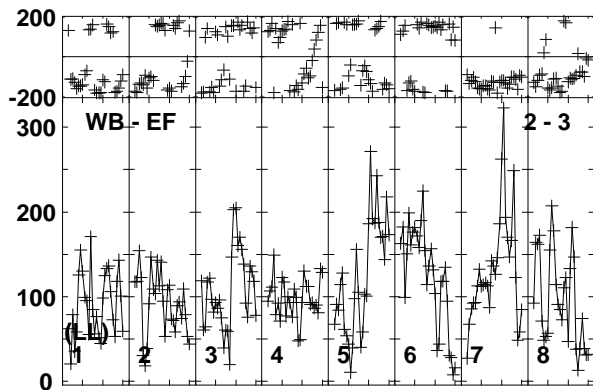
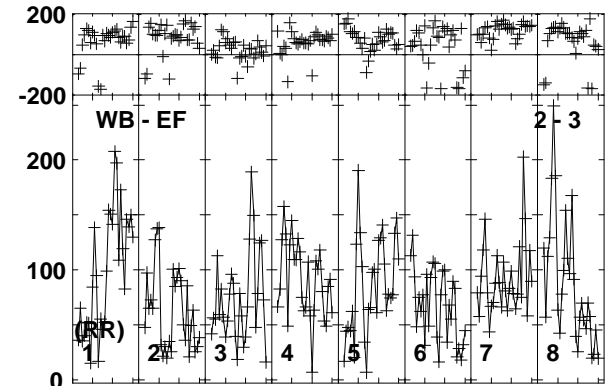
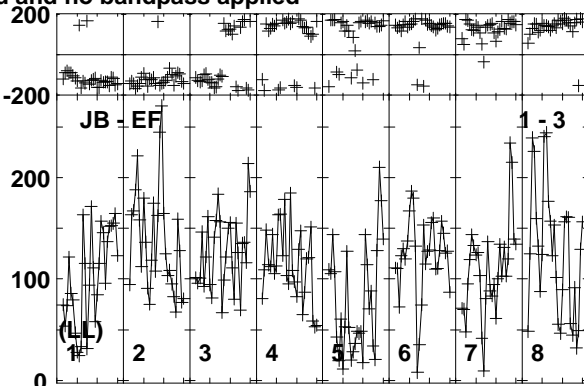
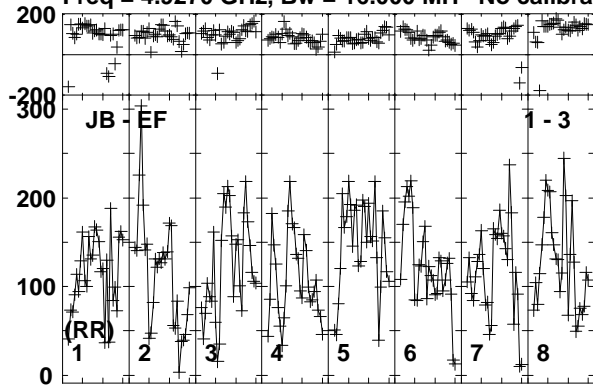

Lower frame: Micro Ampl Jy Top frame: Phas deg
Vector averaged cross-power spectrum Baseline: JB (01) - EF (03)
Timerange: 00/10:01:21 to 00/10:05:19

Plot file version 560 created 17-FEB-2020 15:43:33

J1402+5347 EK047 2.UVDATA.1

Freq = 4.9270 GHz, Bw = 16.000 MH No calibration applied and no bandpass applied

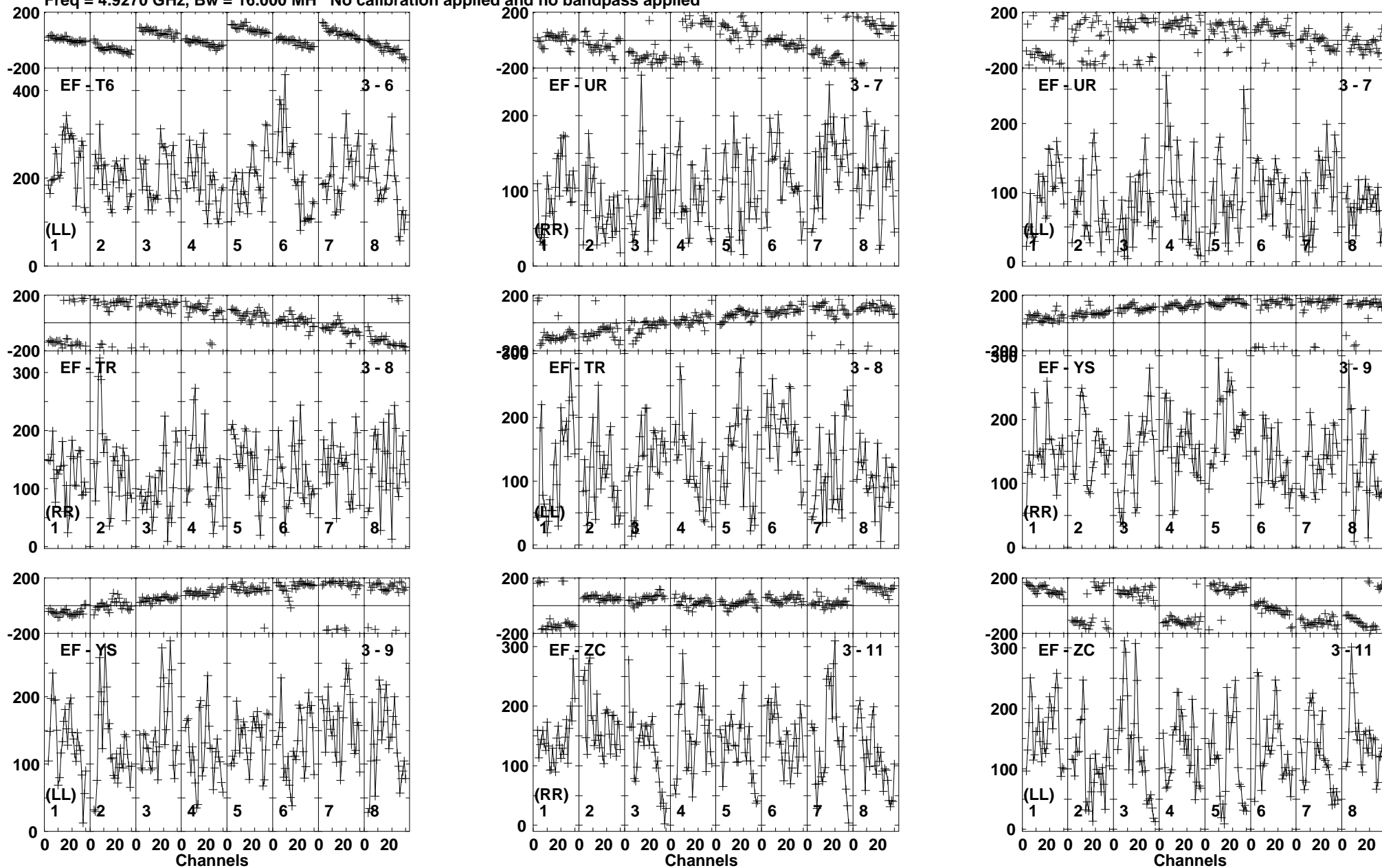

Lower frame: Micro Ampl Jy Top frame: Phas deg
Vector averaged cross-power spectrum Baseline: EF (03) - T6 (06)
Timerange: 00/10/01:21 to 00/10/05:19

Plot file version 561 created 17-FEB-2020 15:43:33

J1402+5347 EK047 2.UVDATA.1

Freq = 4.9270 GHz, Bw = 16.000 MH No calibration applied and no bandpass applied

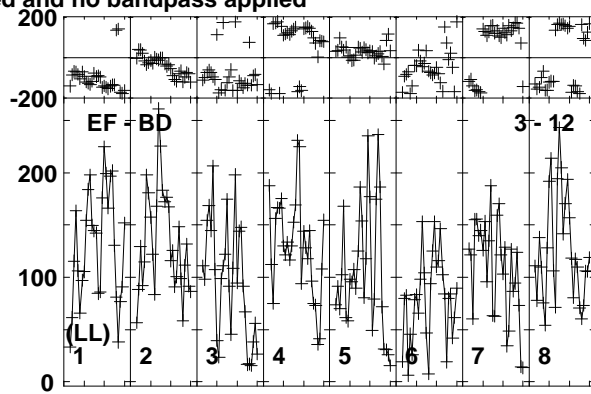
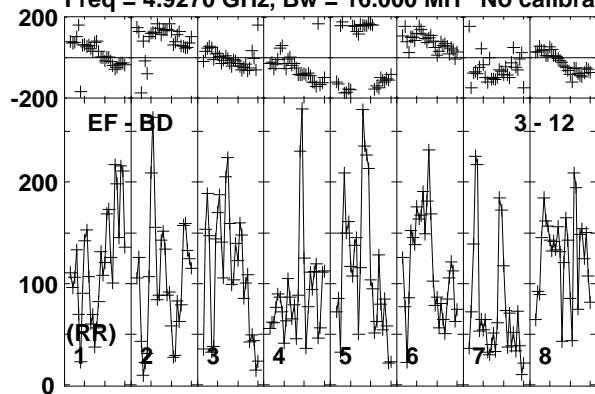

Lower frame: Micro Ampl Jy Top frame: Phas deg
Vector averaged cross-power spectrum Baseline: EF (03) - BD (12)
Timerange: 00/10:01:21 to 00/10:05:19

Plot file version 562 created 17-FEB-2020 15:43:33

J1359+5544 EK047 2.UVDATA.1

Freq = 4.9270 GHz, Bw = 16.000 MH No calibration applied and no bandpass applied

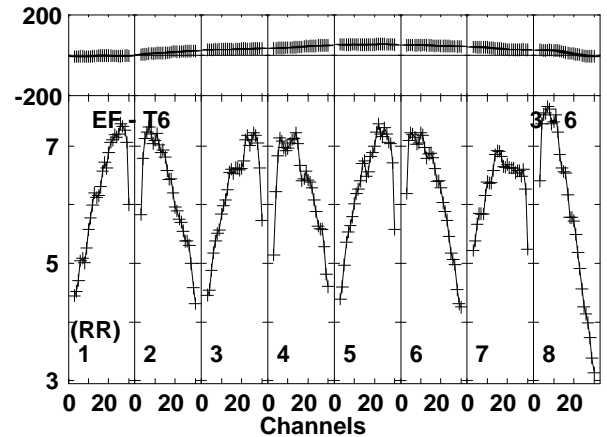
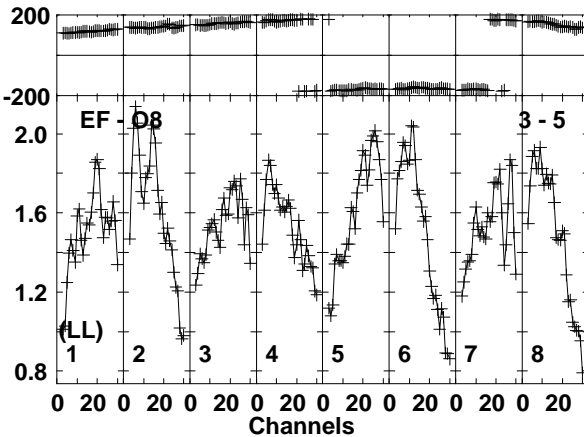
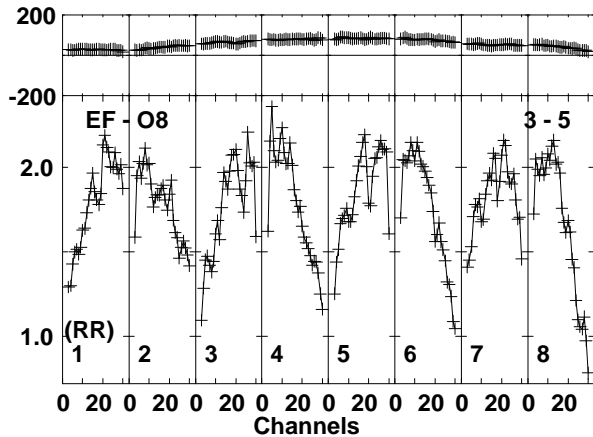
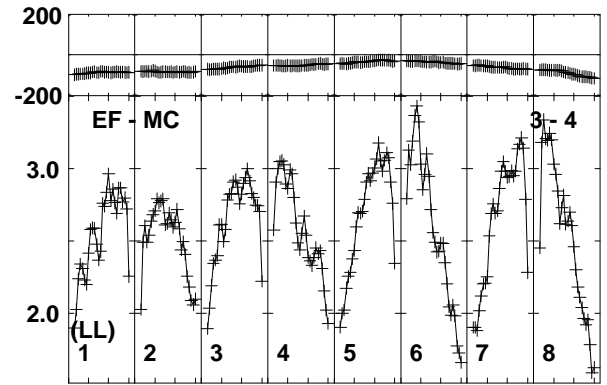
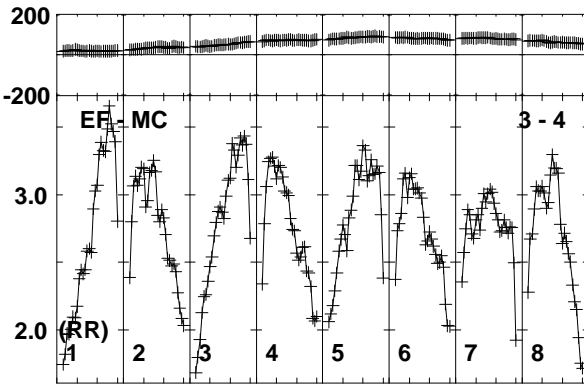
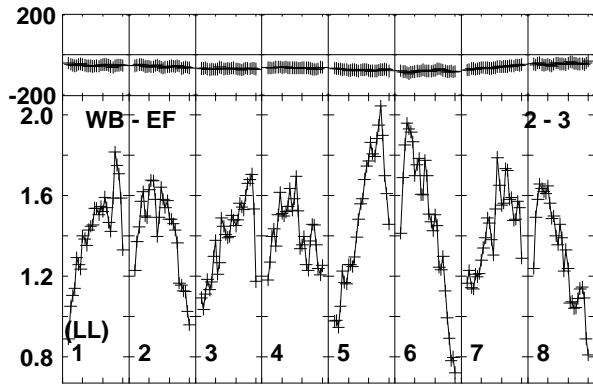
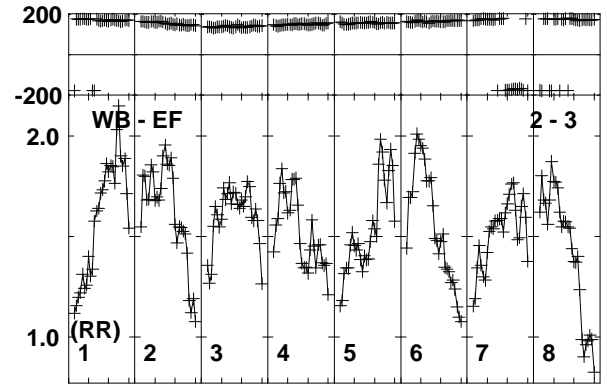
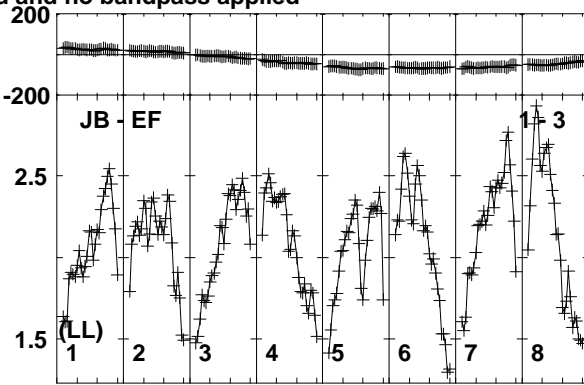
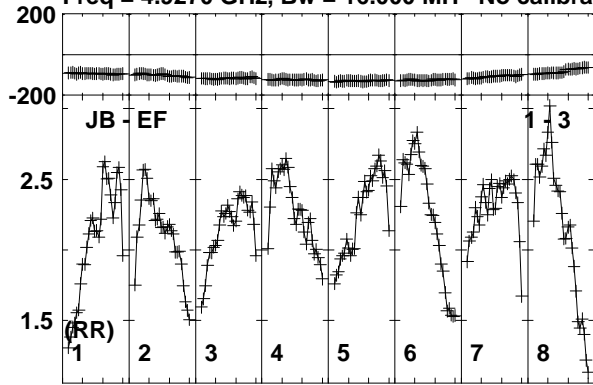

Lower frame: Milli Ampl Jy Top frame: Phas deg
Vector averaged cross-power spectrum Baseline: JB (01) - EF (03)
Timerange: 00/10:05:21 to 00/10:07:19

Plot file version 563 created 17-FEB-2020 15:43:33

J1359+5544 EK047 2.UVDATA.1

Freq = 4.9270 GHz, Bw = 16.000 MH No calibration applied and no bandpass applied

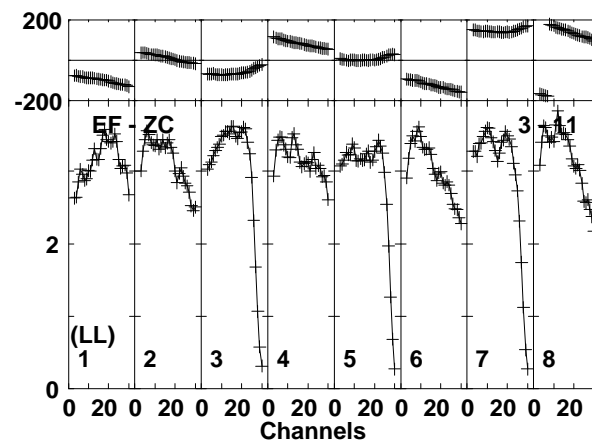
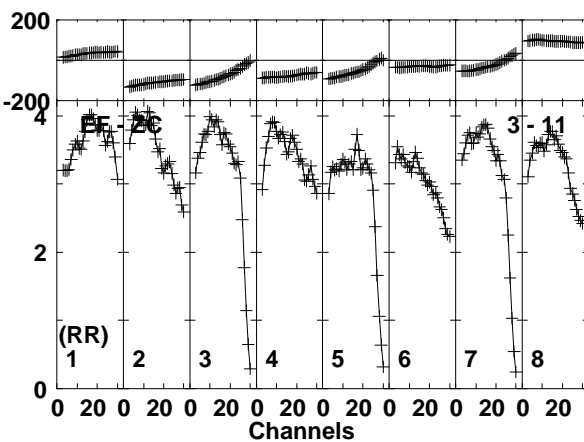
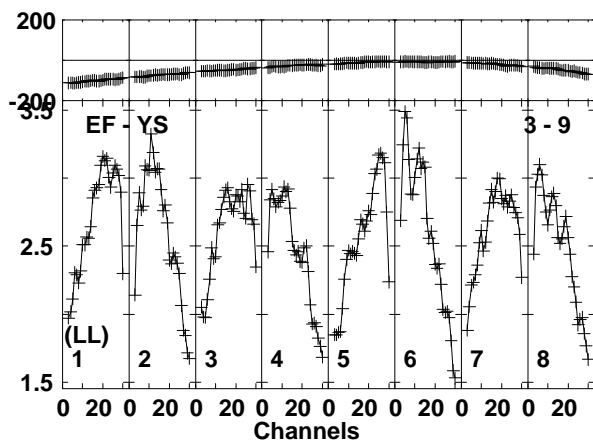
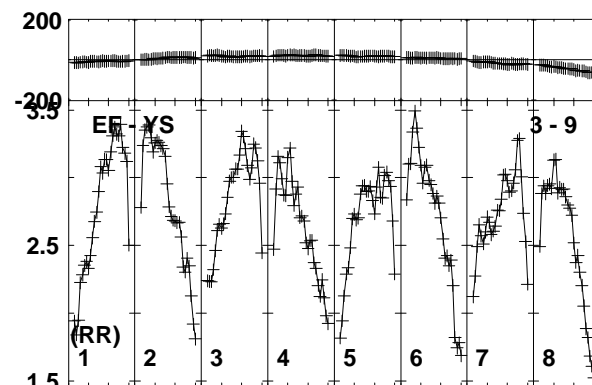
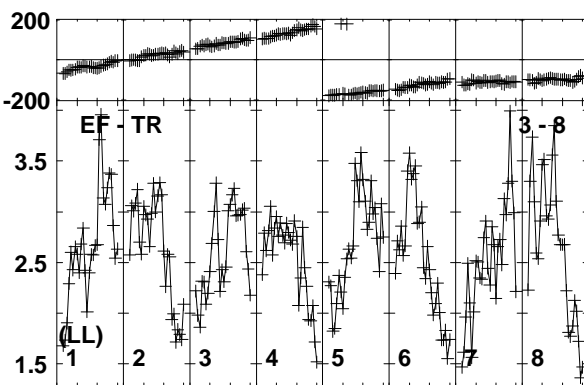
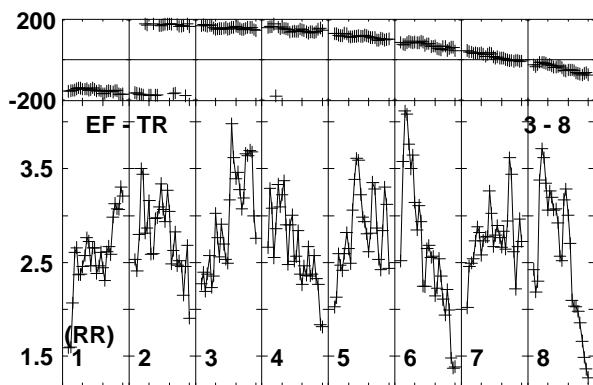
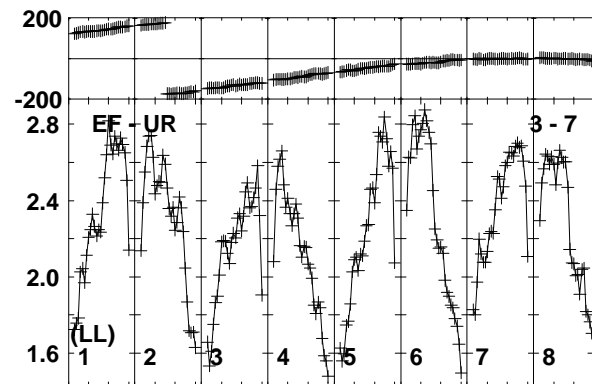
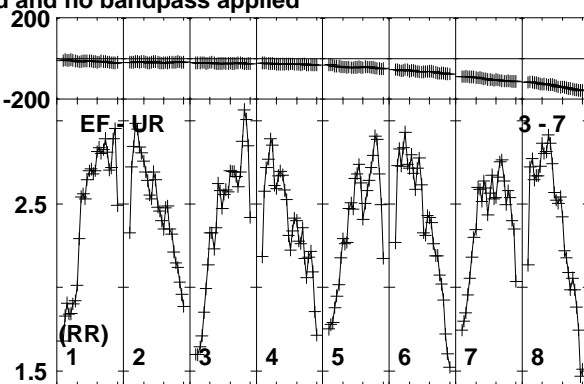
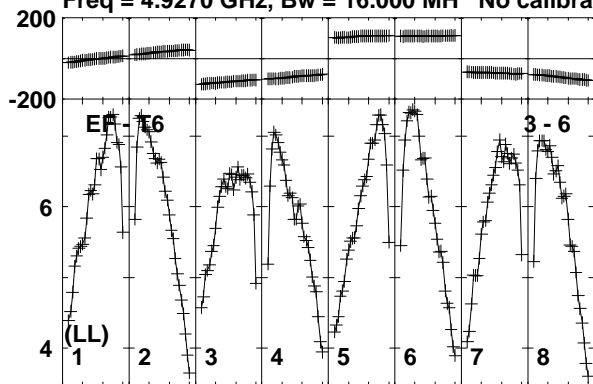

Lower frame: Milli Ampl Jy Top frame: Phas deg
Vector averaged cross-power spectrum Baseline: EF (03) - T6 (06)
Timerange: 00/10:05:21 to 00/10:07:19

Plot file version 564 created 17-FEB-2020 15:43:33

J1359+5544 EK047 2.UVDATA.1

Freq = 4.9270 GHz, Bw = 16.000 MH No calibration applied and no bandpass applied

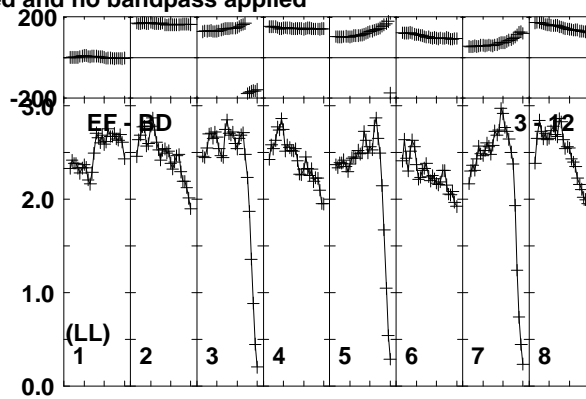
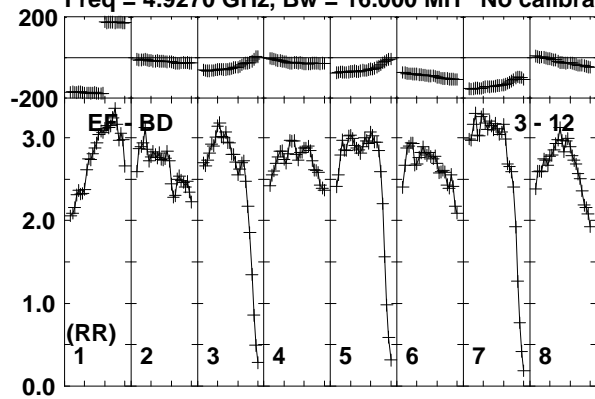

Lower frame: Milli Ampl Jy Top frame: Phas deg
Vector averaged cross-power spectrum Baseline: EF (03) - BD (12)
Timerange: 00/10:05:21 to 00/10:07:19

Plot file version 565 created 17-FEB-2020 15:43:33

J1402+5347 EK047 2.UVDATA.1

Freq = 4.9270 GHz, Bw = 16.000 MH No calibration applied and no bandpass applied

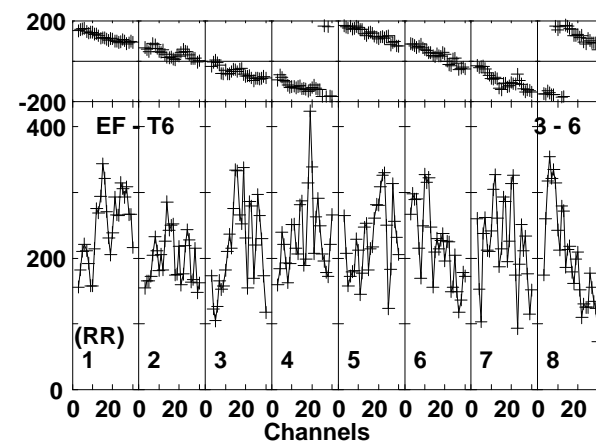
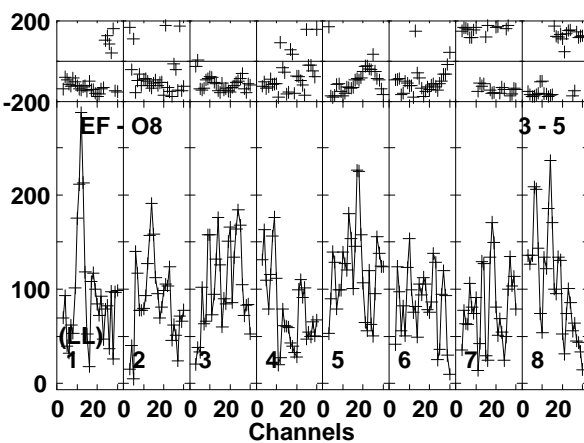
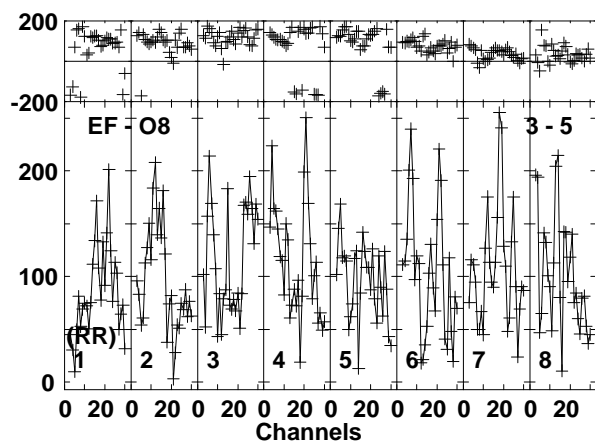
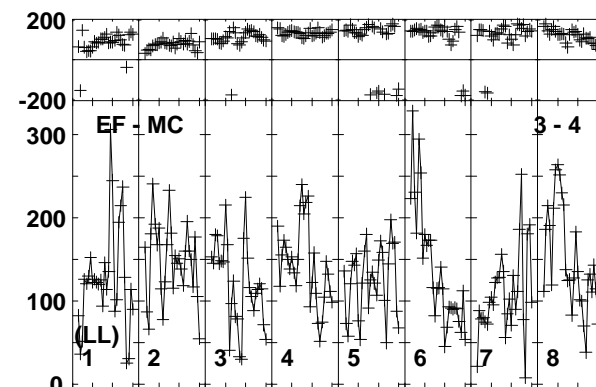
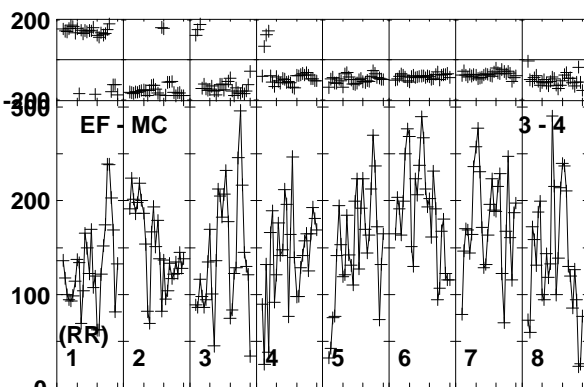
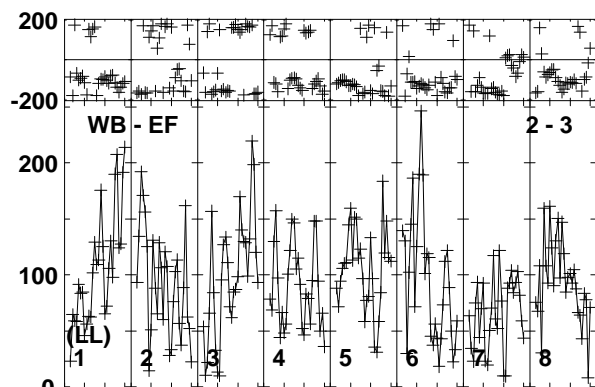
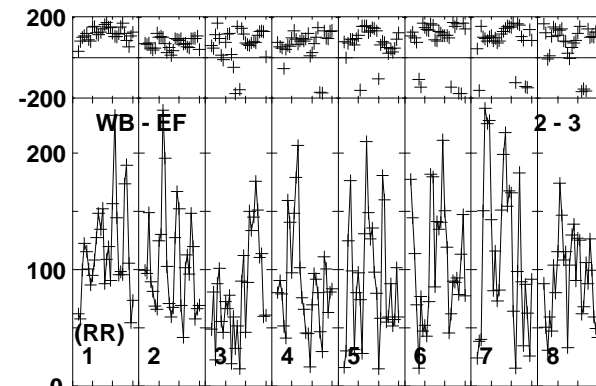
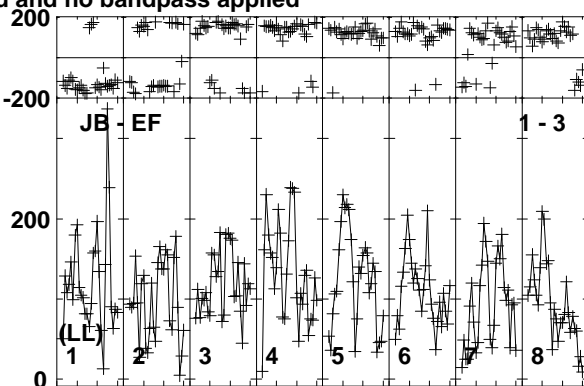
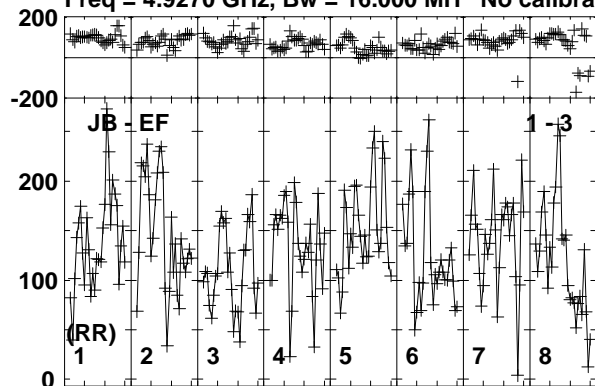

Lower frame: Micro Ampl Jy Top frame: Phas deg
Vector averaged cross-power spectrum Baseline: JB (01) - EF (03)
Timerange: 00/10:07:21 to 00/10:11:19

Plot file version 566 created 17-FEB-2020 15:43:34

J1402+5347 EK047 2.UVDATA.1

Freq = 4.9270 GHz, Bw = 16.000 MH No calibration applied and no bandpass applied

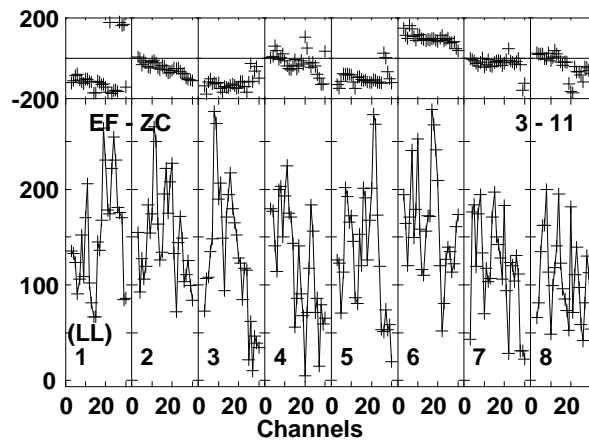
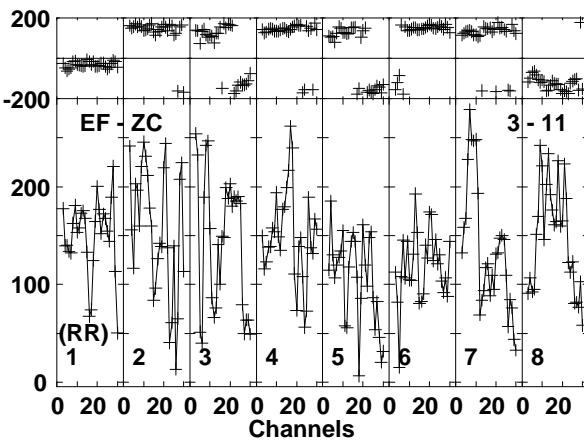
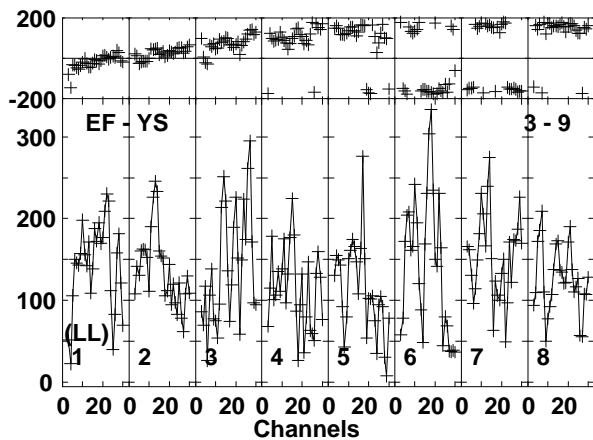
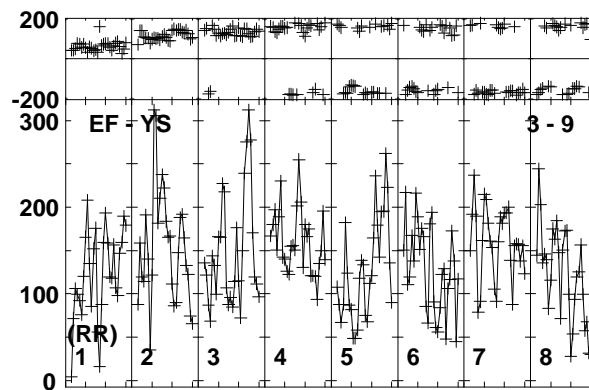
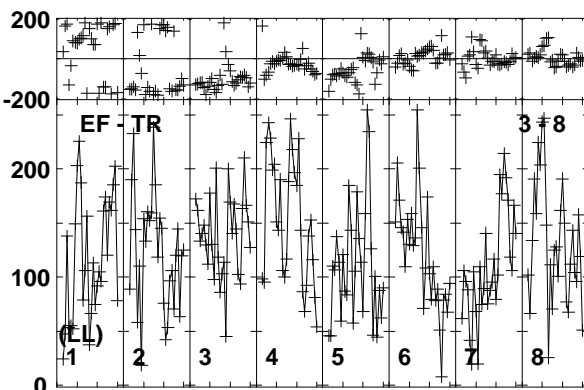
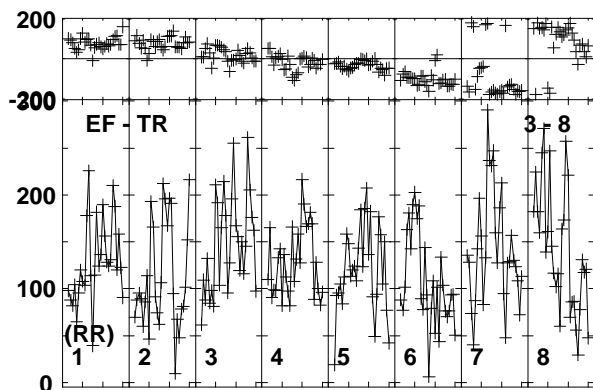
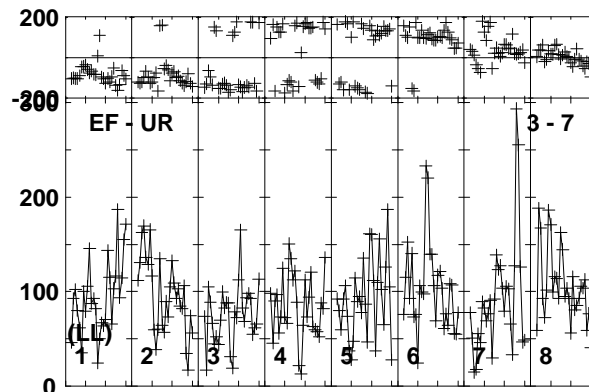
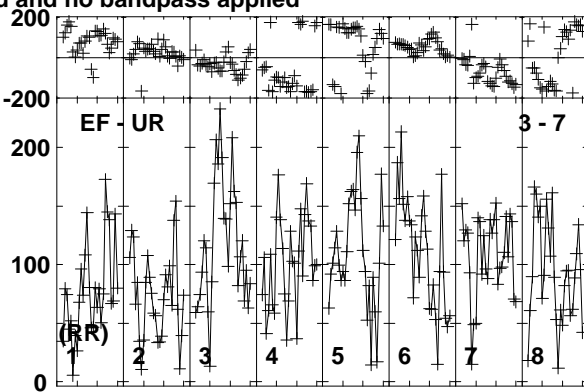
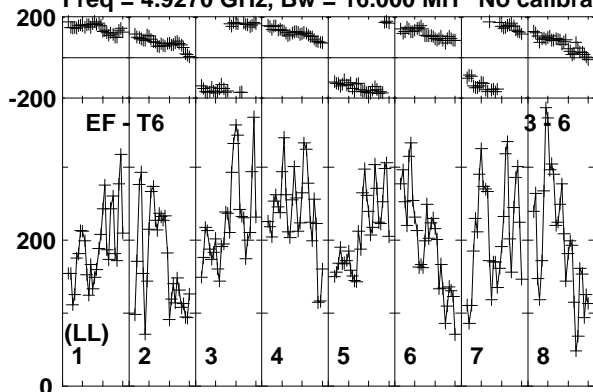

Lower frame: Micro Ampl Jy Top frame: Phas deg
Vector averaged cross-power spectrum Baseline: EF (03) - T6 (06)
Timerange: 00/10:07:21 to 00/10:11:19

Plot file version 567 created 17-FEB-2020 15:43:34

J1402+5347 EK047 2.UVDATA.1

Freq = 4.9270 GHz, Bw = 16.000 MH No calibration applied and no bandpass applied

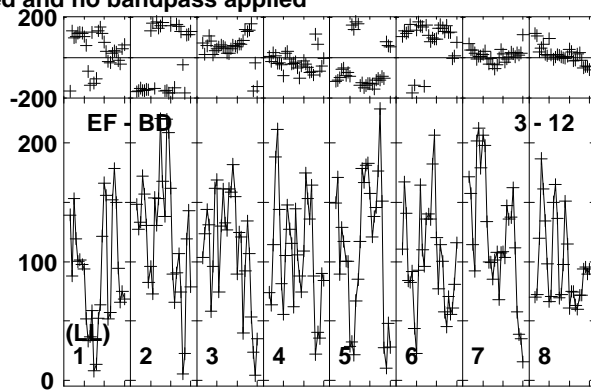
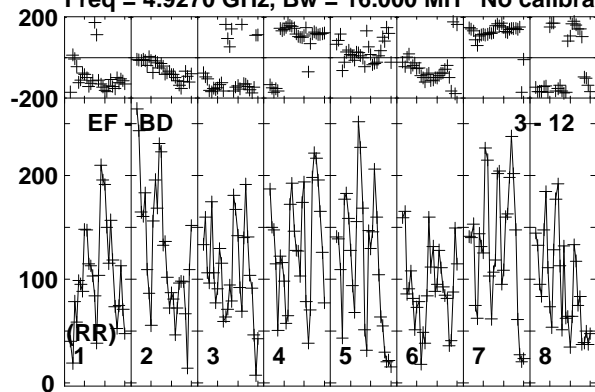

Lower frame: Micro Ampl Jy Top frame: Phas deg
Vector averaged cross-power spectrum Baseline: EF (03) - BD (12)
Timerange: 00/10:07:21 to 00/10:11:19

Plot file version 568 created 17-FEB-2020 15:43:34

J1359+5544 EK047 2.UVDATA.1

Freq = 4.9270 GHz, Bw = 16.000 MH No calibration applied and no bandpass applied

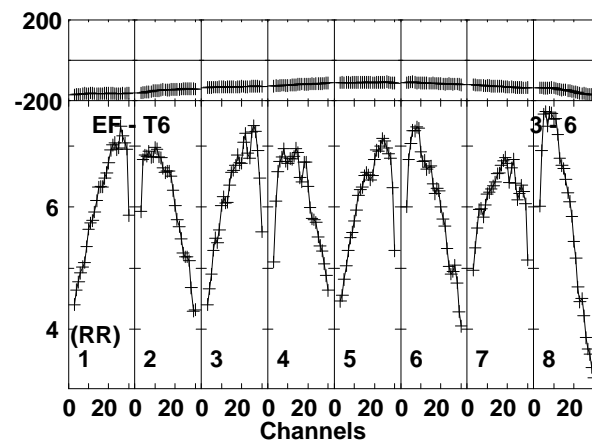
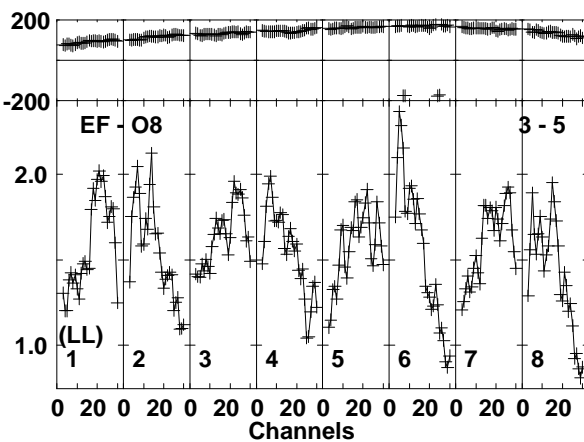
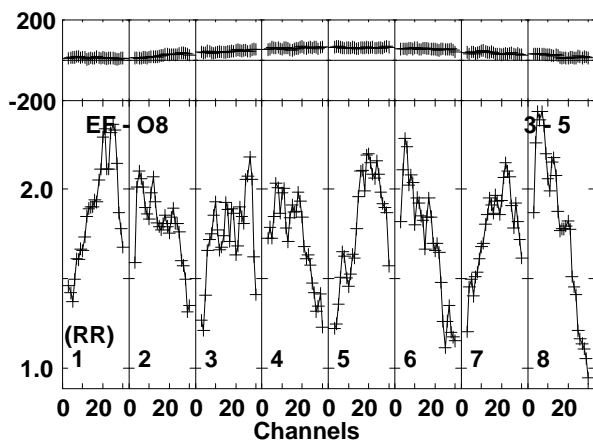
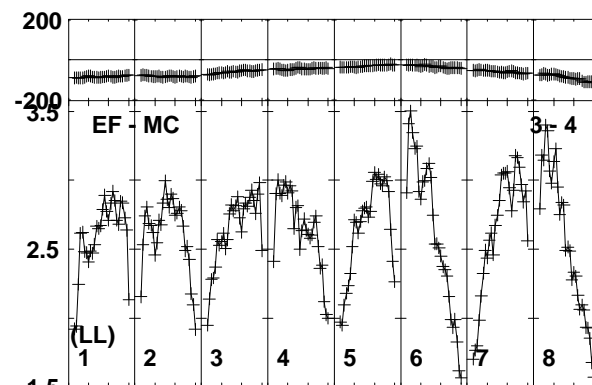
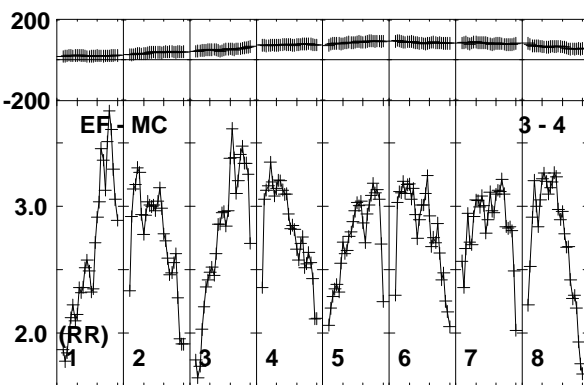
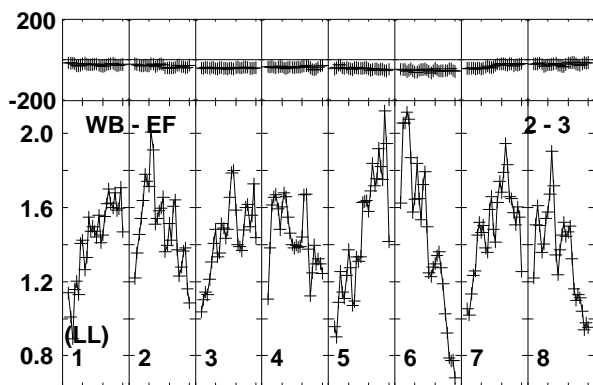
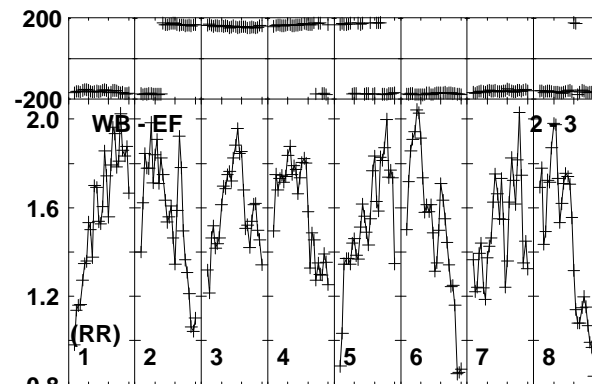
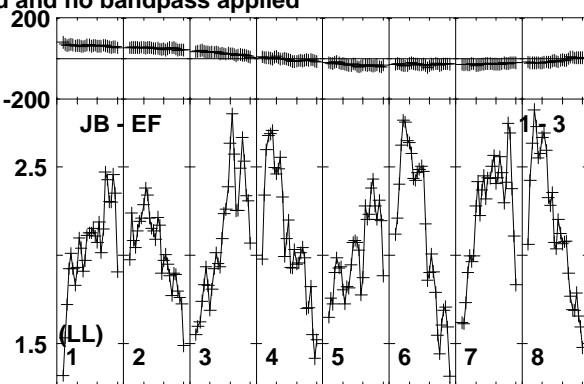
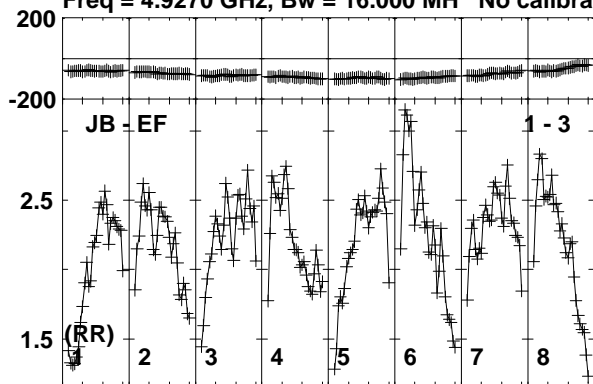

Lower frame: Milli Ampl Jy Top frame: Phas deg
Vector averaged cross-power spectrum Baseline: JB (01) - EF (03)
Timerange: 00/10:12:01 to 00/10:13:19

Plot file version 569 created 17-FEB-2020 15:43:34

J1359+5544 EK047 2.UVDATA.1

Freq = 4.9270 GHz, Bw = 16.000 MH No calibration applied and no bandpass applied

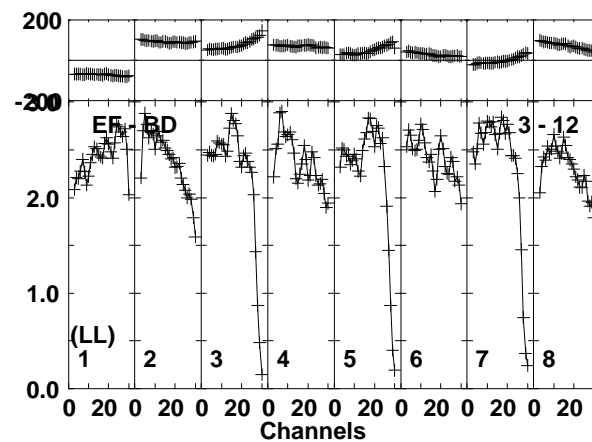
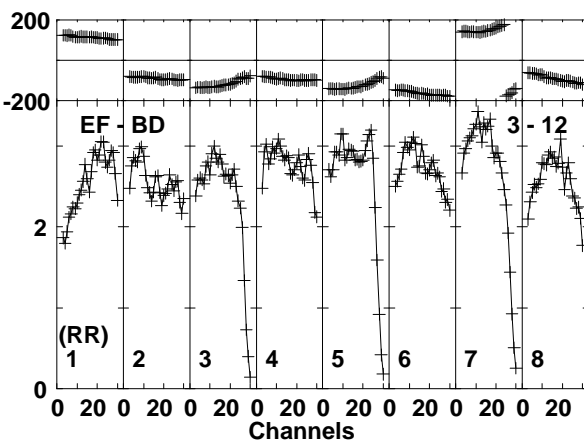
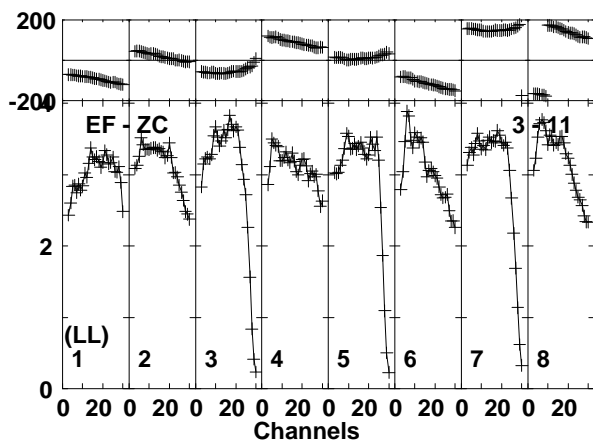
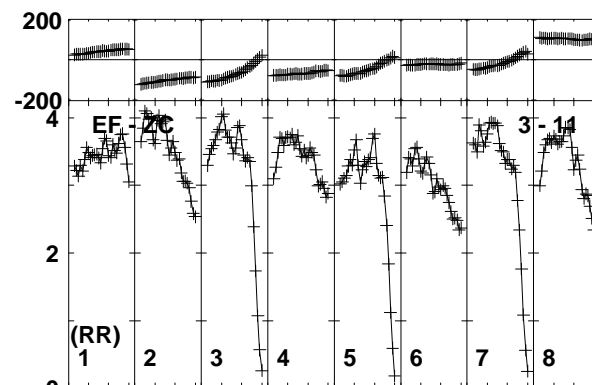
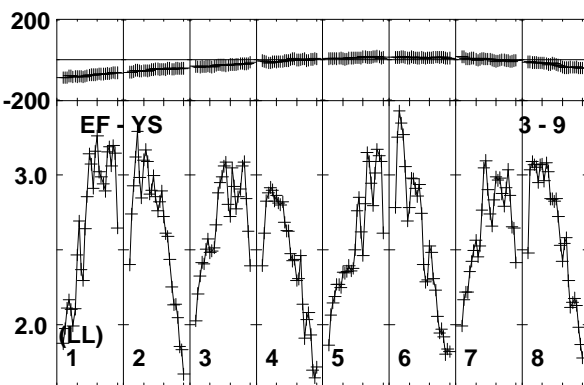
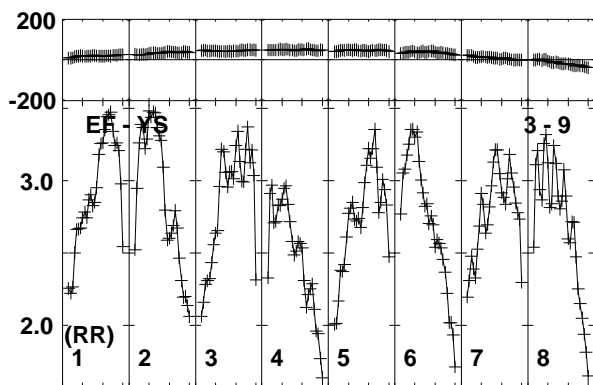
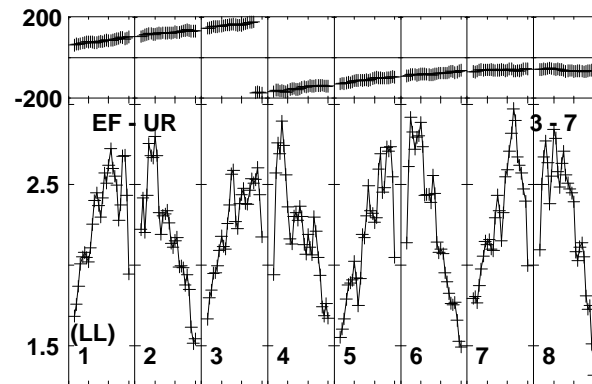
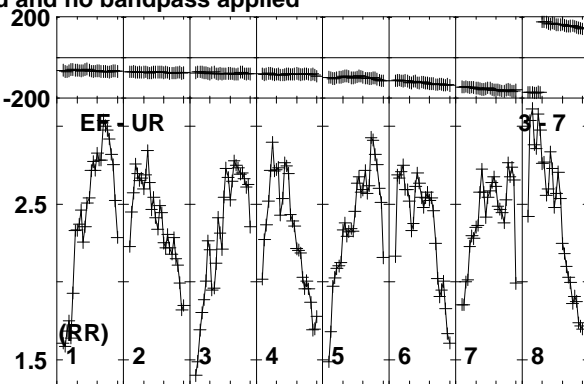
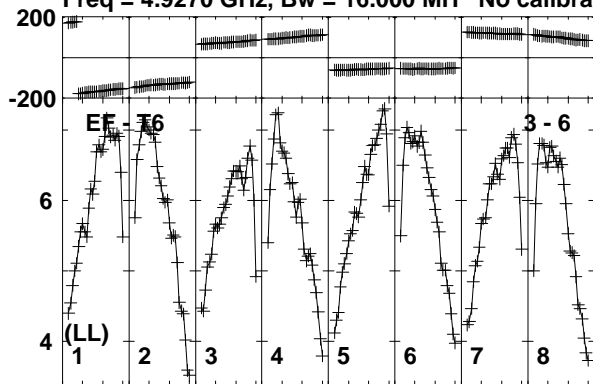

Lower frame: Milli Ampl Jy Top frame: Phas deg
Vector averaged cross-power spectrum Baseline: EF (03) - T6 (06)
Timerange: 00/10:12:01 to 00/10:13:19

Plot file version 570 created 17-FEB-2020 15:43:34

J1402+5347 EK047 2.UVDATA.1

Freq = 4.9270 GHz, Bw = 16.000 MH No calibration applied and no bandpass applied

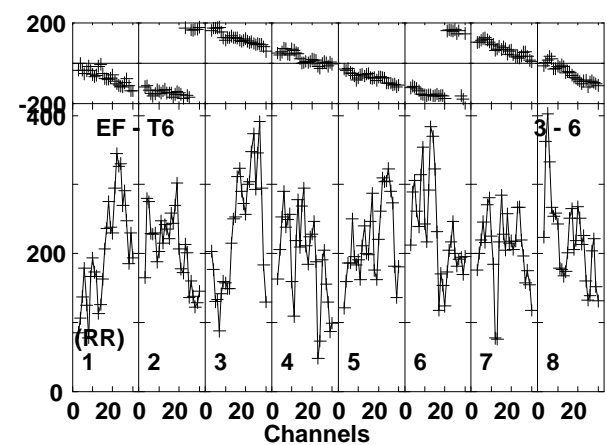
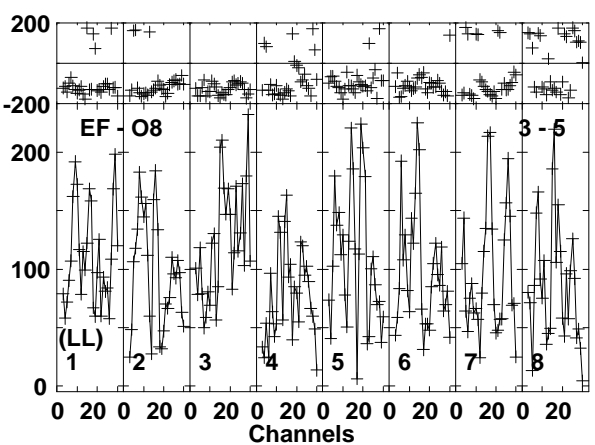
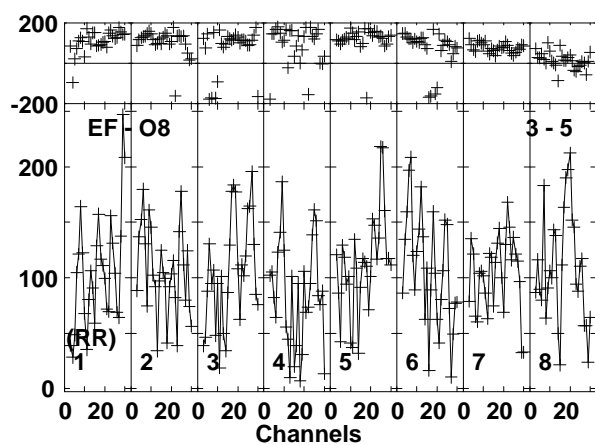
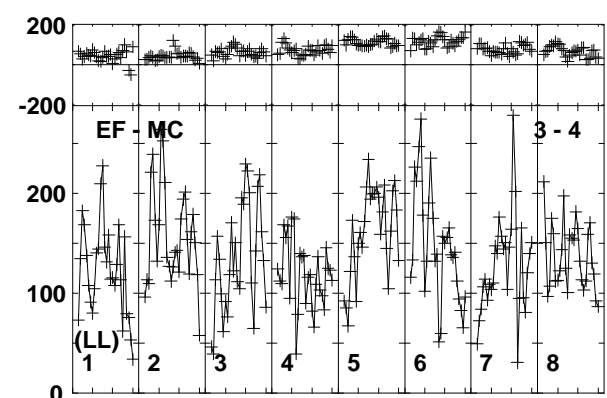
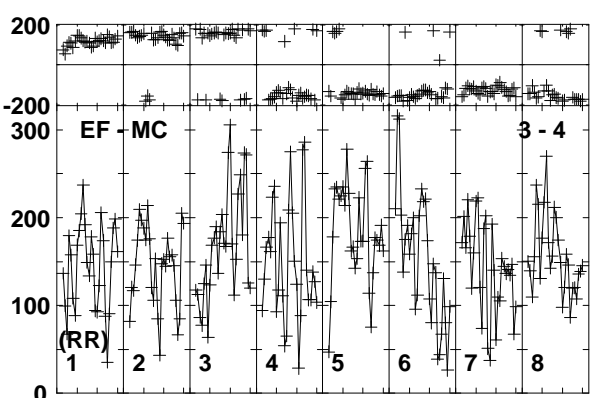
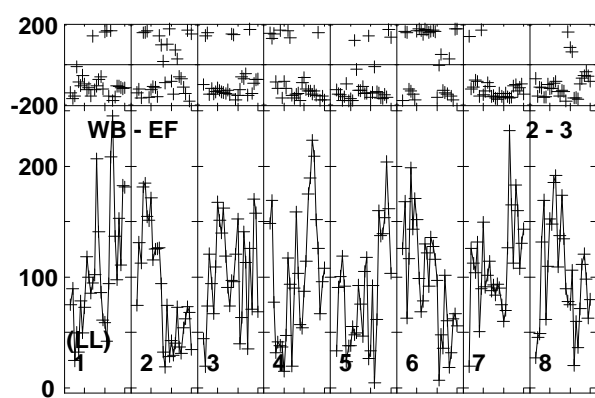
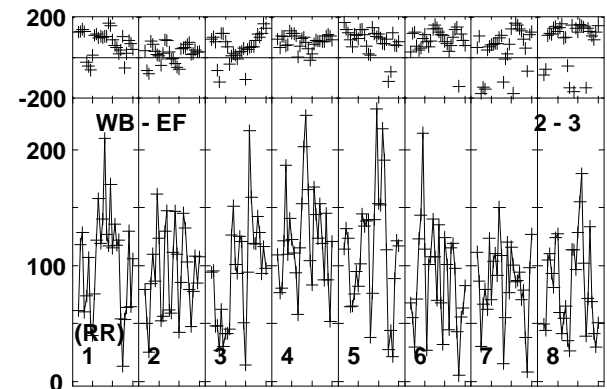
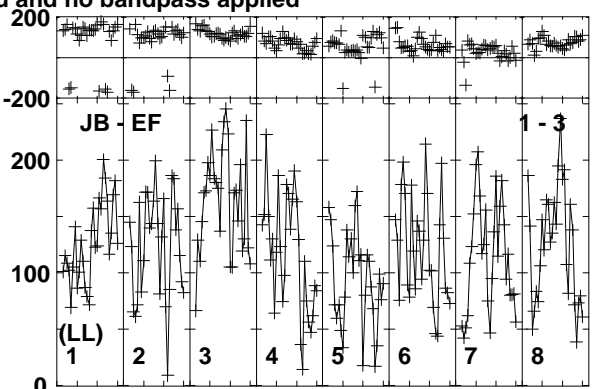
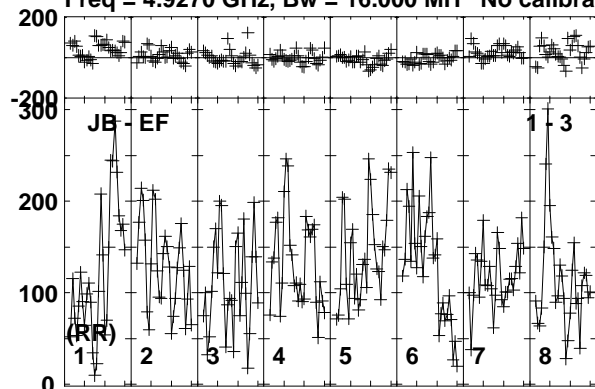

Lower frame: Micro Ampl Jy Top frame: Phas deg
Vector averaged cross-power spectrum Baseline: JB (01) - EF (03)
Timerange: 00/10:13:21 to 00/10:17:19

Plot file version 571 created 17-FEB-2020 15:43:34

J1402+5347 EK047 2.UVDATA.1

Freq = 4.9270 GHz, Bw = 16.000 MH No calibration applied and no bandpass applied

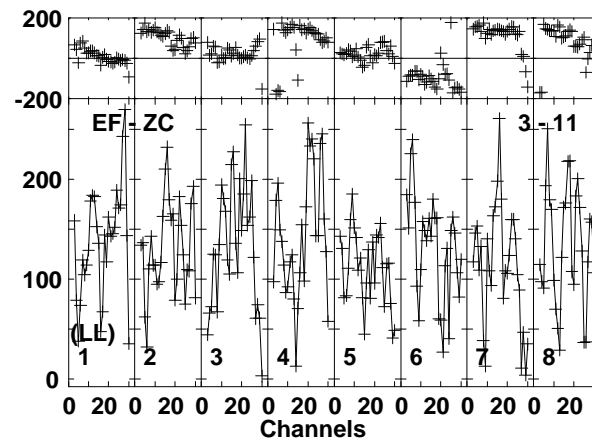
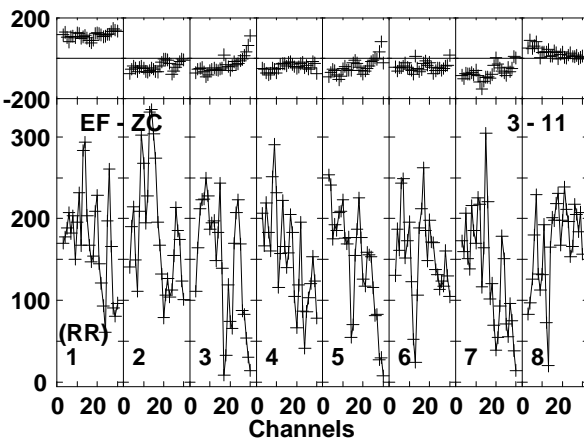
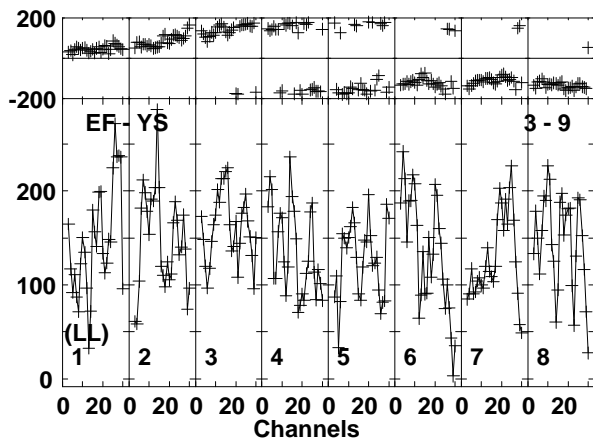
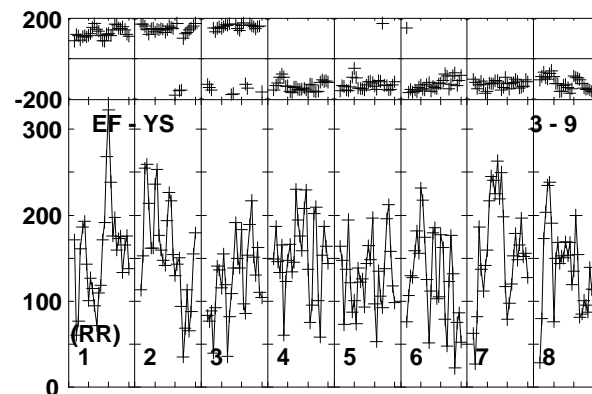
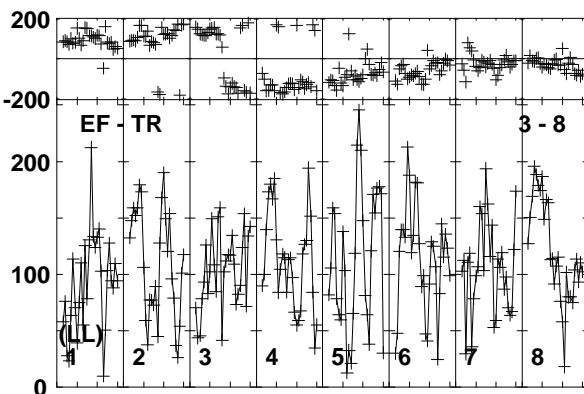
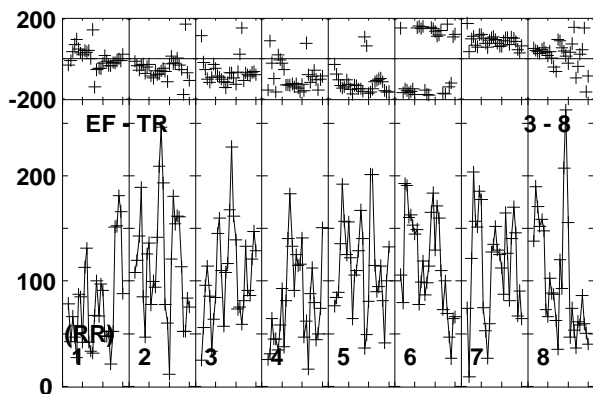
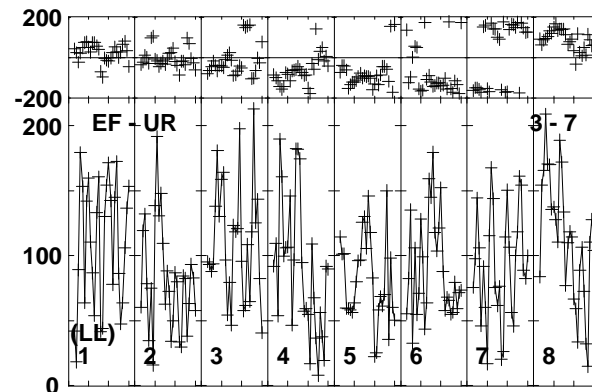
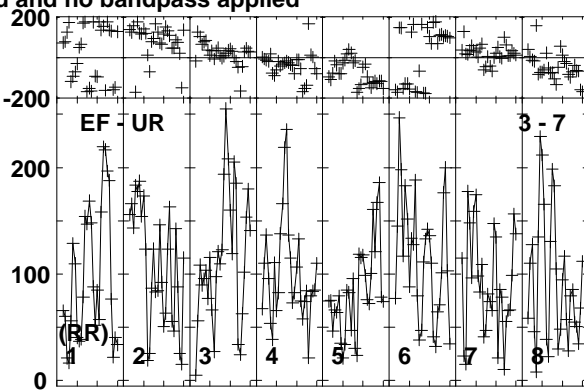
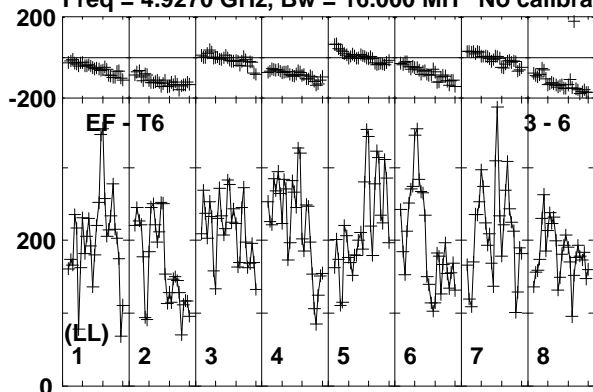

Lower frame: Micro Ampl Jy Top frame: Phas deg
Vector averaged cross-power spectrum Baseline: EF (03) - T6 (06)
Timerange: 00/10:13:21 to 00/10:17:19

Plot file version 572 created 17-FEB-2020 15:43:34

J1402+5347 EK047 2.UVDATA.1

Freq = 4.9270 GHz, Bw = 16.000 MH No calibration applied and no bandpass applied

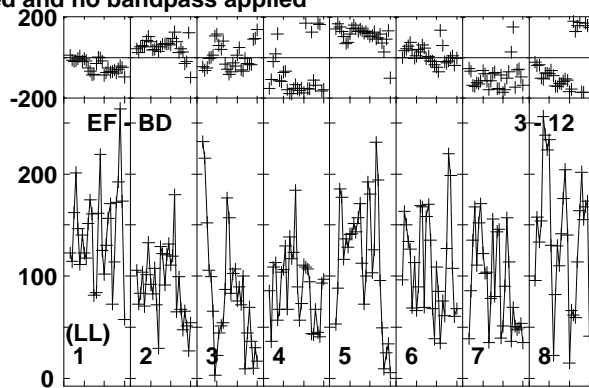
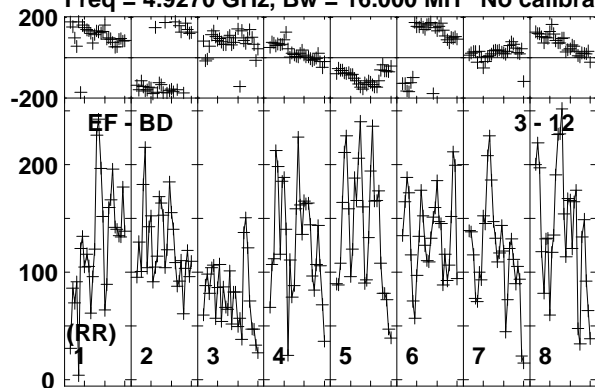

Lower frame: Micro Ampl Jy Top frame: Phas deg
Vector averaged cross-power spectrum Baseline: EF (03) - BD (12)
Timerange: 00/10:13:21 to 00/10:17:19

Plot file version 573 created 17-FEB-2020 15:43:34

J1359+5544 EK047 2.UVDATA.1

Freq = 4.9270 GHz, Bw = 16.000 MH No calibration applied and no bandpass applied

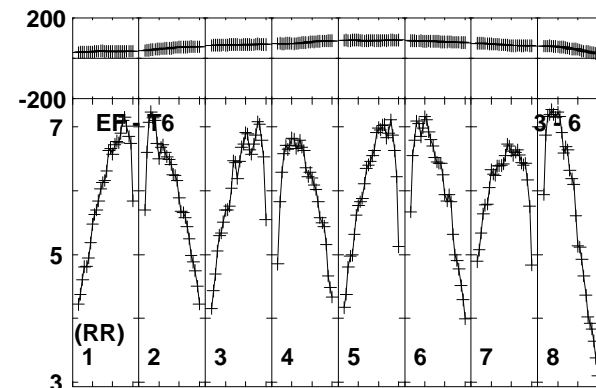
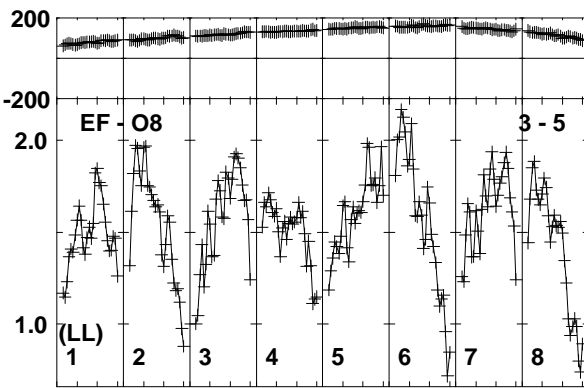
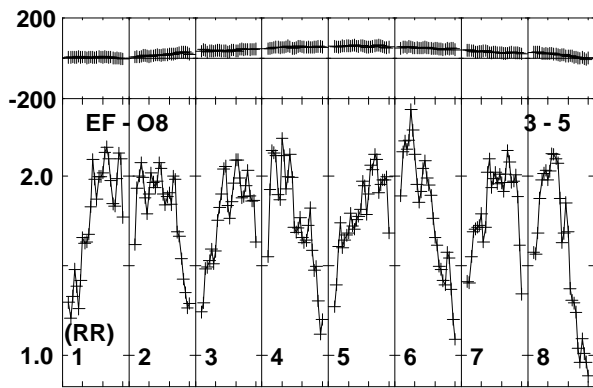
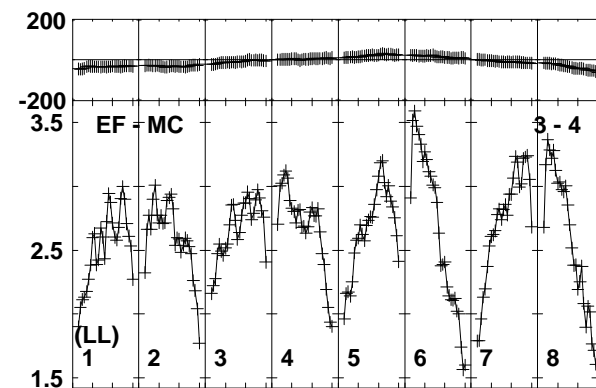
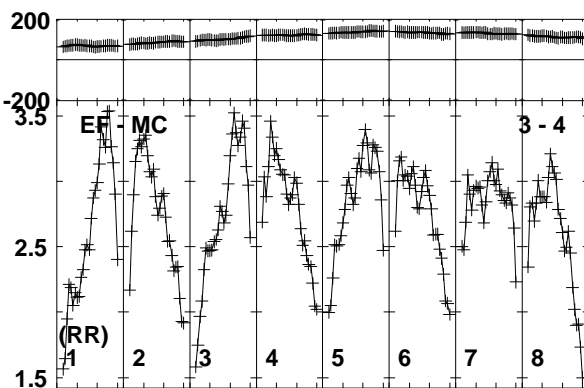
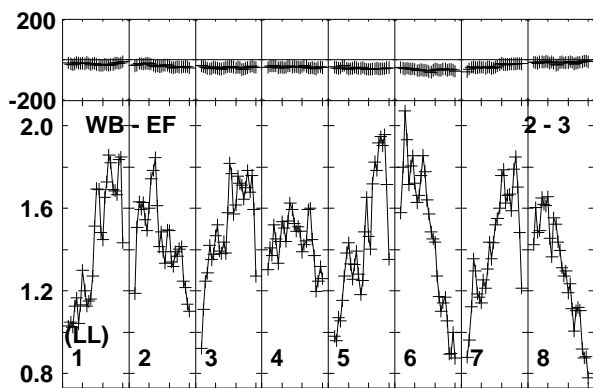
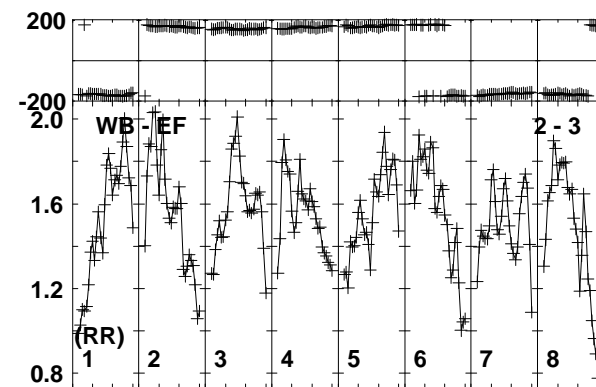
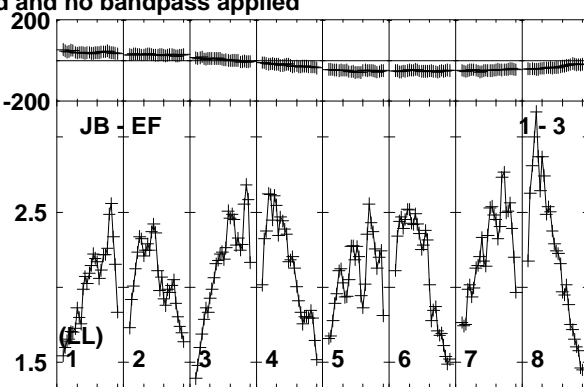
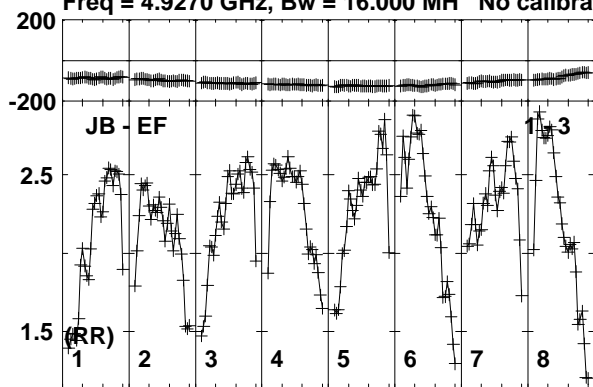

Lower frame: Milli Ampl Jy Top frame: Phas deg
Vector averaged cross-power spectrum Baseline: JB (01) - EF (03)
Timerange: 00/10:17:21 to 00/10:19:19

Plot file version 574 created 17-FEB-2020 15:43:34

J1359+5544 EK047 2.UVDATA.1

Freq = 4.9270 GHz, Bw = 16.000 MH No calibration applied and no bandpass applied

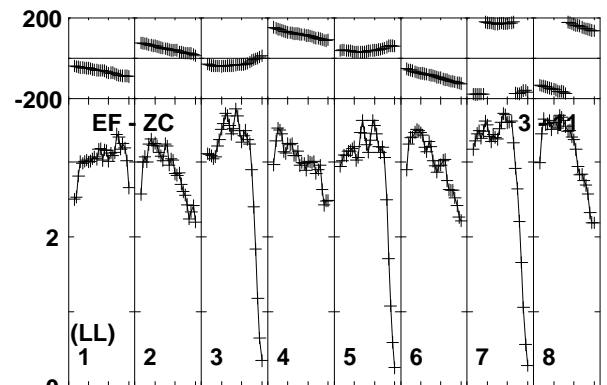
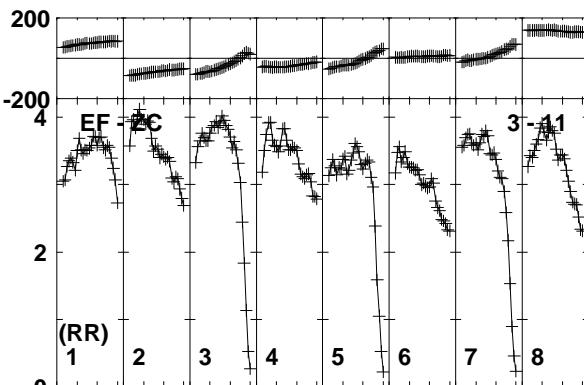
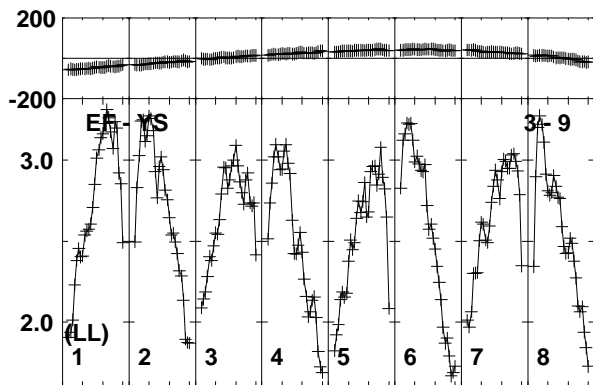
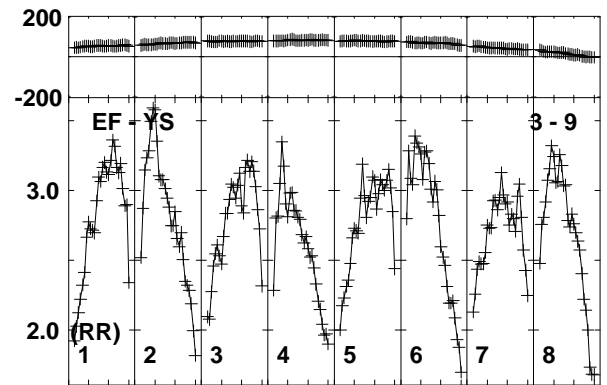
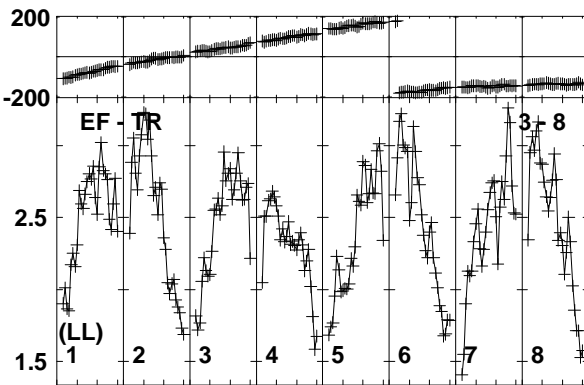
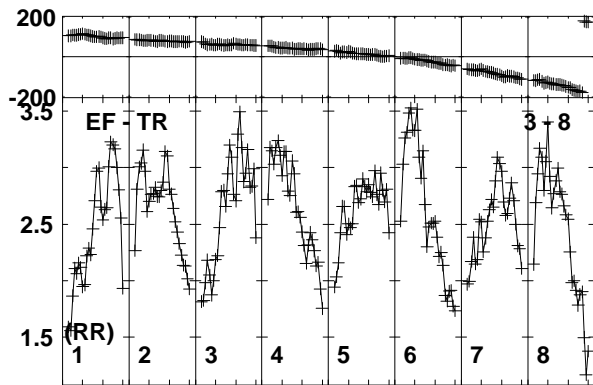
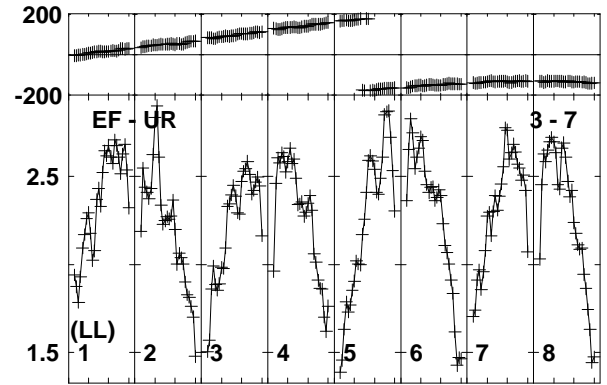
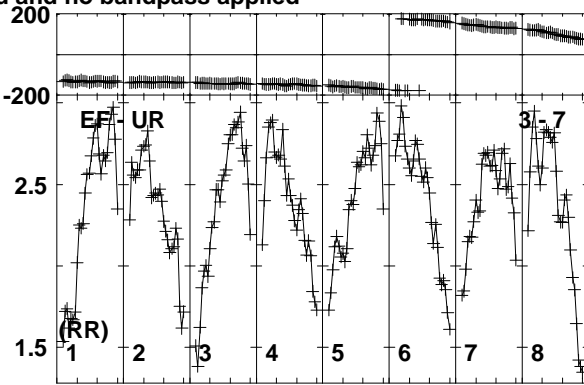
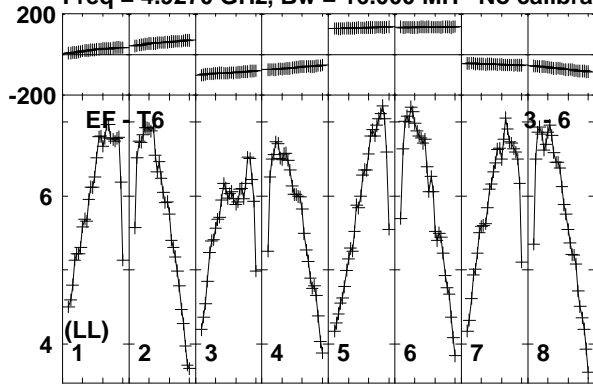

Lower frame: Milli Ampl Jy Top frame: Phas deg
Vector averaged cross-power spectrum Baseline: EF (03) - T6 (06)
Timerange: 00/10:17:21 to 00/10:19:19

Plot file version 575 created 17-FEB-2020 15:43:34

J1359+5544 EK047 2.UVDATA.1

Freq = 4.9270 GHz, Bw = 16.000 MH No calibration applied and no bandpass applied

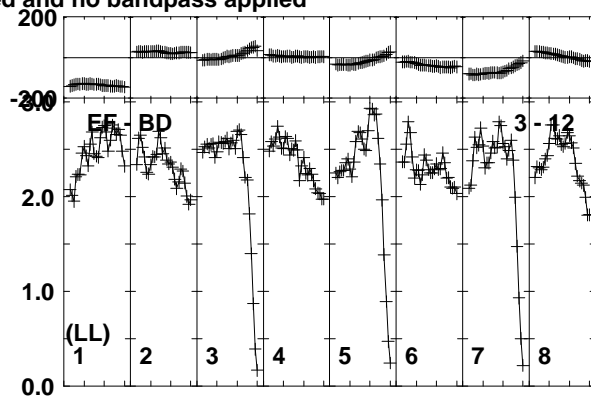
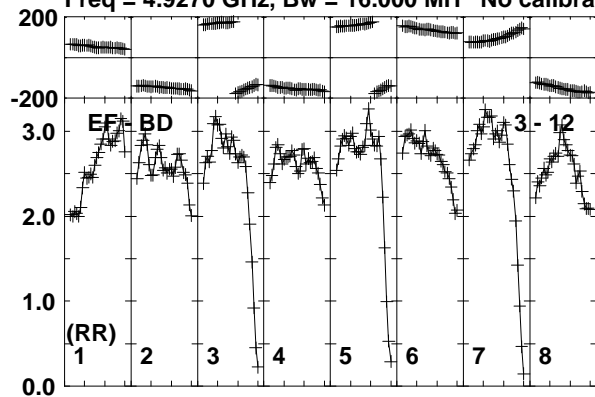

Lower frame: Milli Ampl Jy Top frame: Phas deg
Vector averaged cross-power spectrum Baseline: EF (03) - BD (12)
Timerange: 00/10:17:21 to 00/10:19:19

Plot file version 576 created 17-FEB-2020 15:43:34

J1402+5347 EK047 2.UVDATA.1

Freq = 4.9270 GHz, Bw = 16.000 MH No calibration applied and no bandpass applied

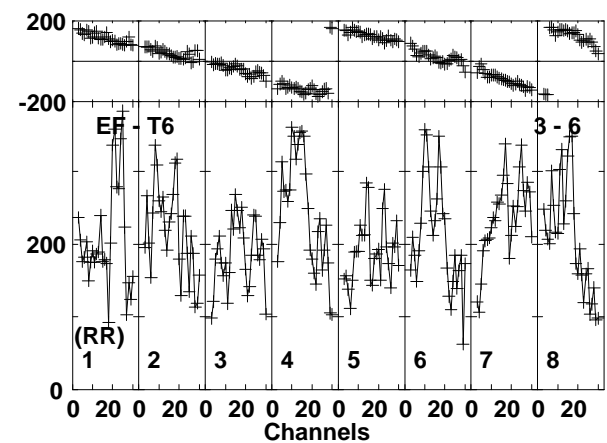
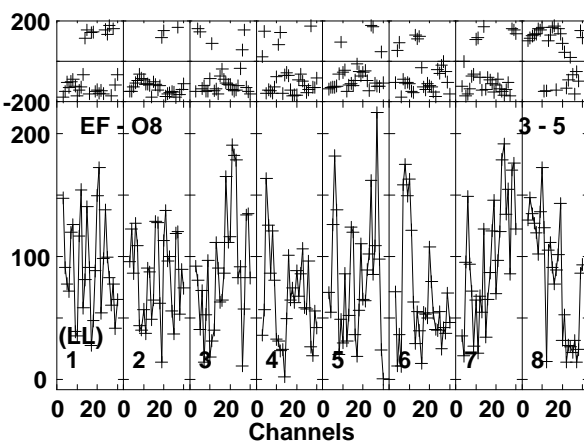
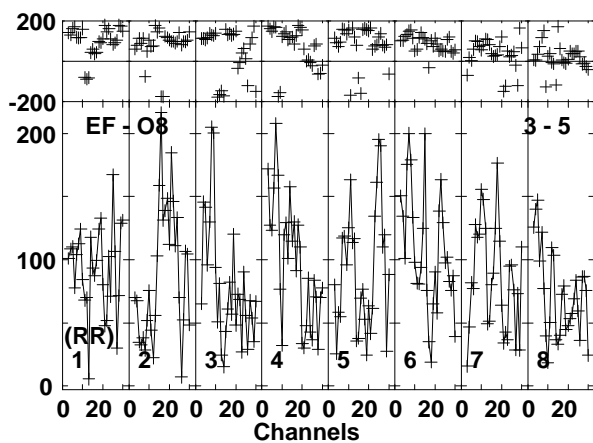
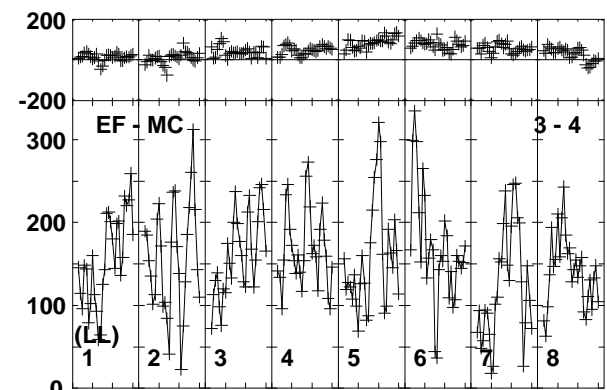
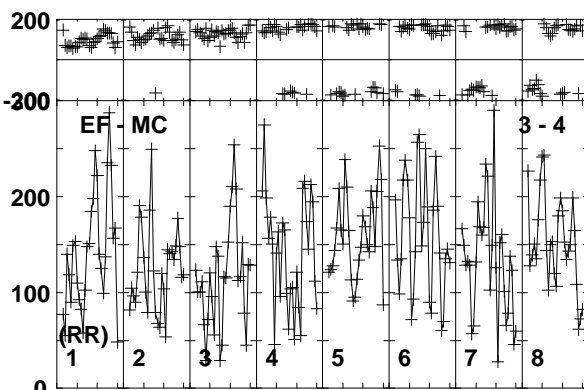
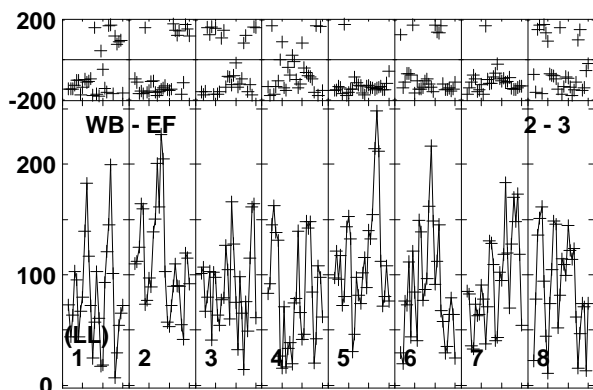
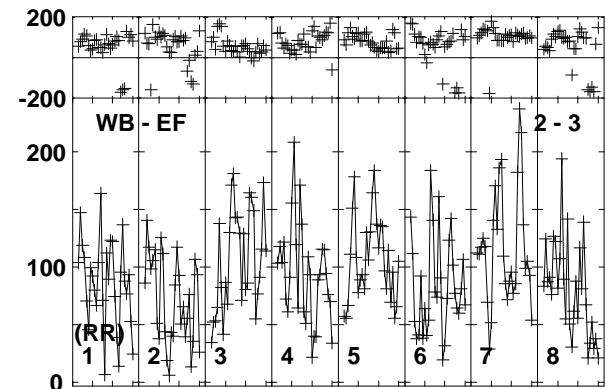
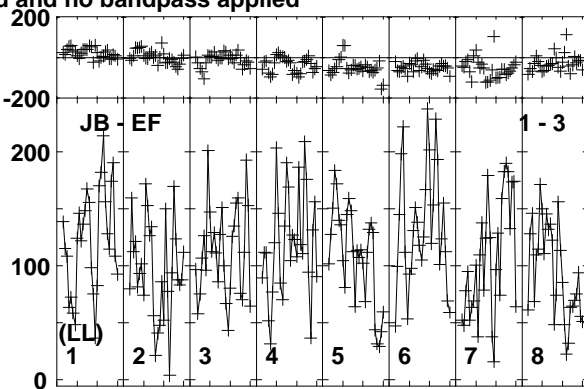
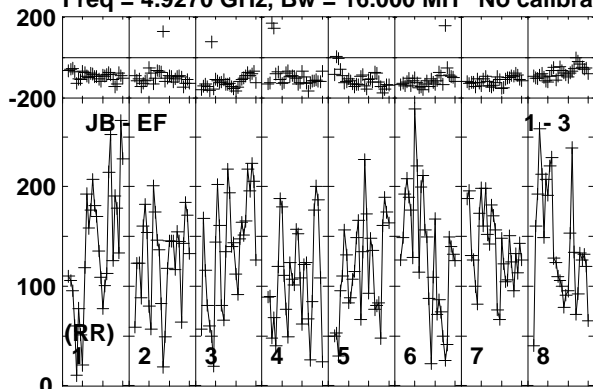

Lower frame: Micro Ampl Jy Top frame: Phas deg
Vector averaged cross-power spectrum Baseline: JB (01) - EF (03)
Timerange: 00/10:19:21 to 00/10:23:19

Plot file version 577 created 17-FEB-2020 15:43:35

J1402+5347 EK047 2.UVDATA.1

Freq = 4.9270 GHz, Bw = 16.000 MH No calibration applied and no bandpass applied

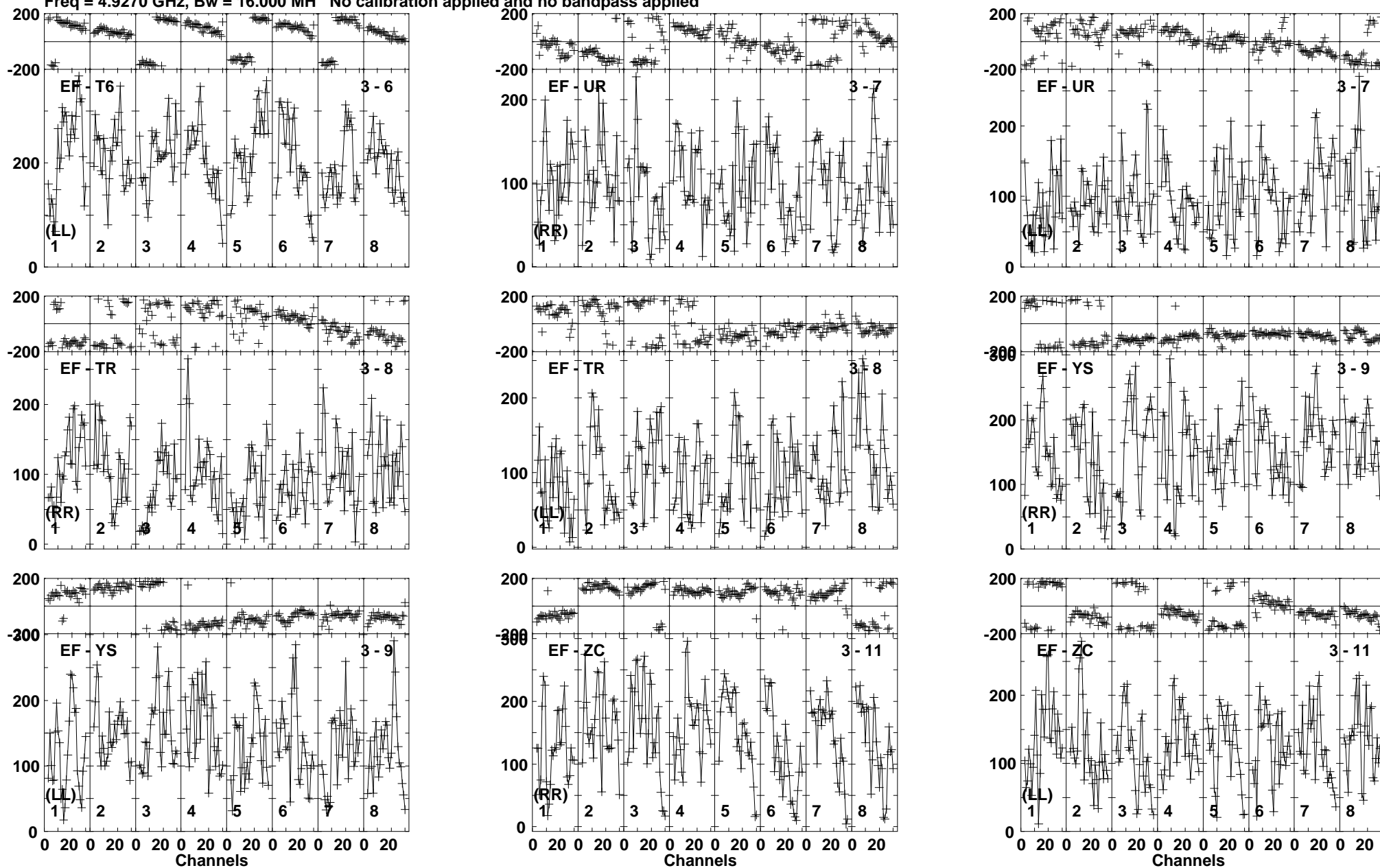

Lower frame: Micro Ampl Jy Top frame: Phas deg
Vector averaged cross-power spectrum Baseline: EF (03) - T6 (06)
Timerange: 00/10:19:21 to 00/10:23:19

Plot file version 578 created 17-FEB-2020 15:43:35

J1402+5347 EK047 2.UVDATA.1

Freq = 4.9270 GHz, Bw = 16.000 MH No calibration applied and no bandpass applied

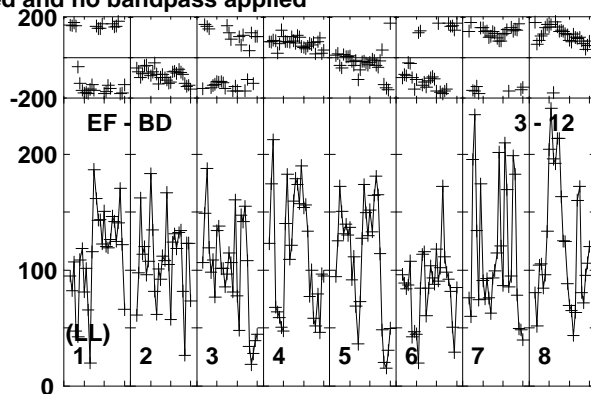
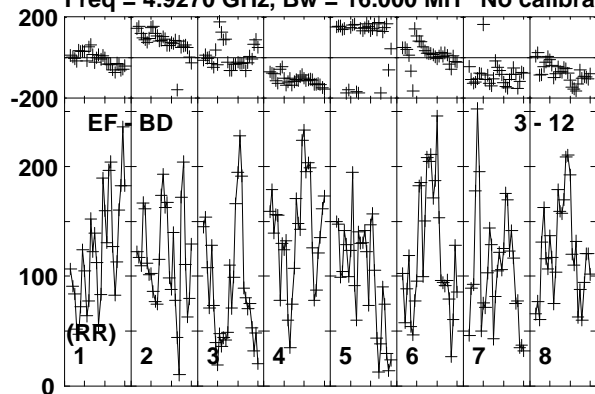

Lower frame: Micro Ampl Jy Top frame: Phas deg
Vector averaged cross-power spectrum Baseline: EF (03) - BD (12)
Timerange: 00/10:19:21 to 00/10:23:19

Plot file version 579 created 17-FEB-2020 15:43:35

J1359+5544 EK047 2.UVDATA.1

Freq = 4.9270 GHz, Bw = 16.000 MH No calibration applied and no bandpass applied

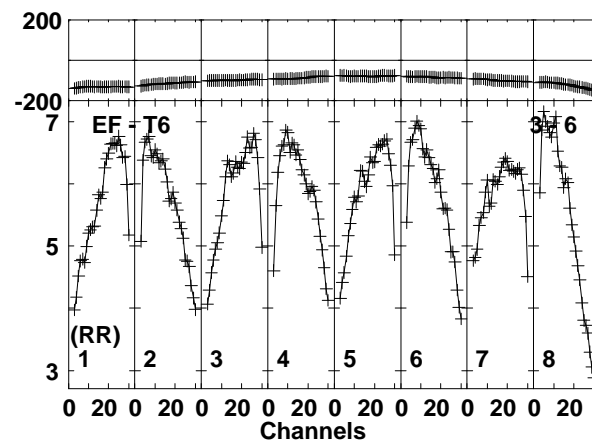
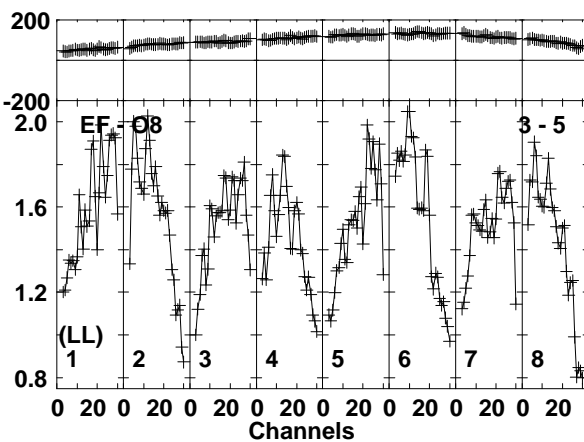
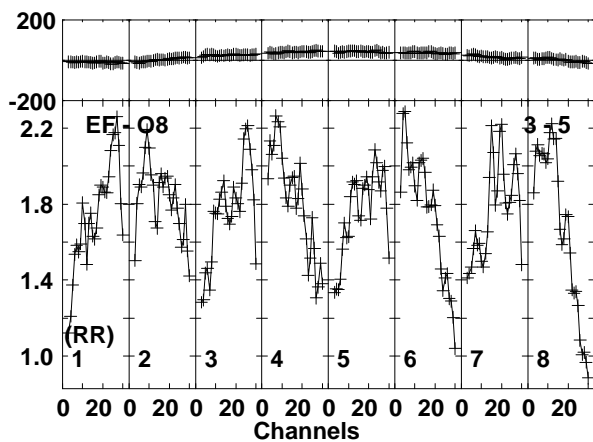
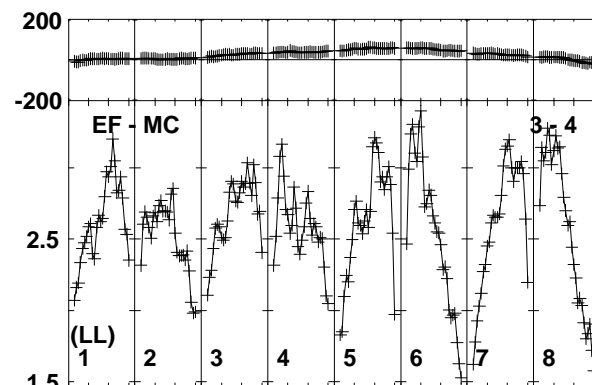
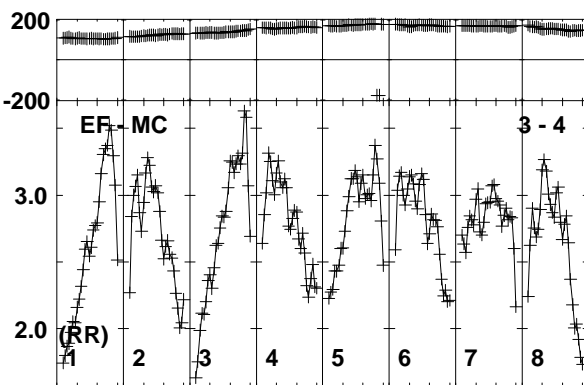
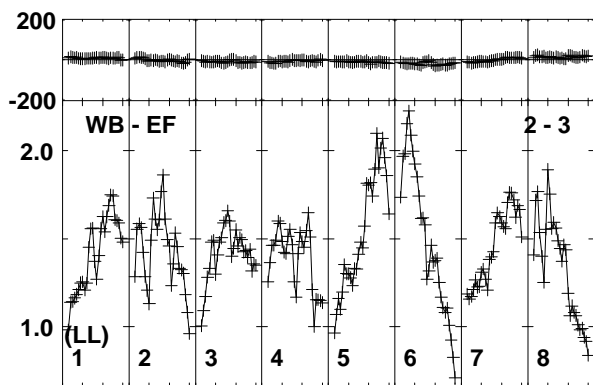
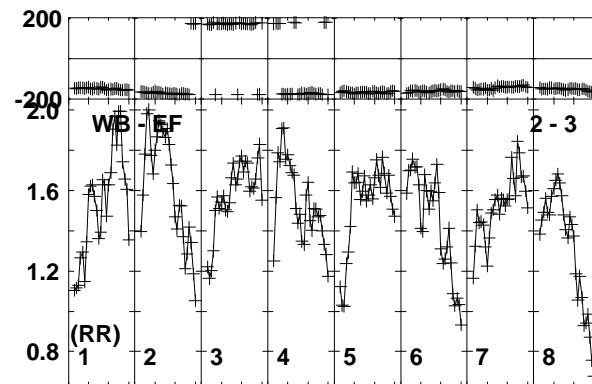
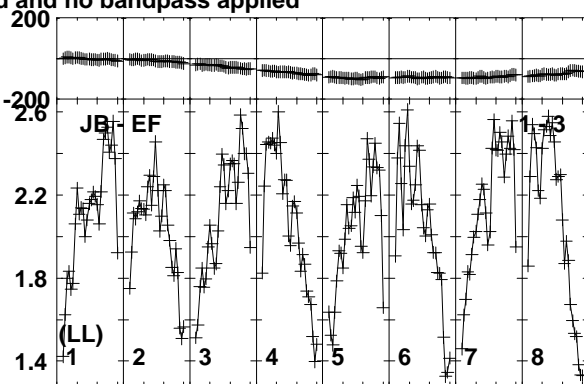
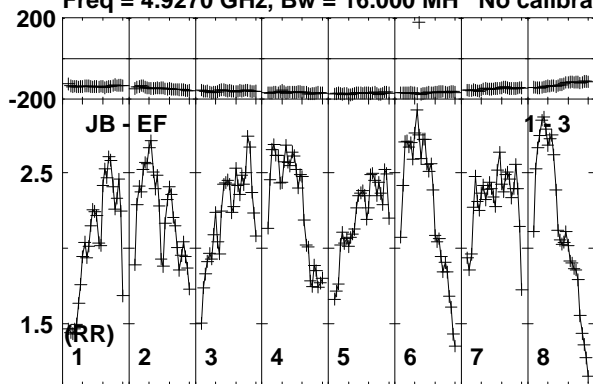

Lower frame: Milli Ampl Jy Top frame: Phas deg
Vector averaged cross-power spectrum Baseline: JB (01) - EF (03)
Timerange: 00/10:24:01 to 00/10:25:19

Plot file version 580 created 17-FEB-2020 15:43:35

J1359+5544 EK047 2.UVDATA.1

Freq = 4.9270 GHz, Bw = 16.000 MH No calibration applied and no bandpass applied

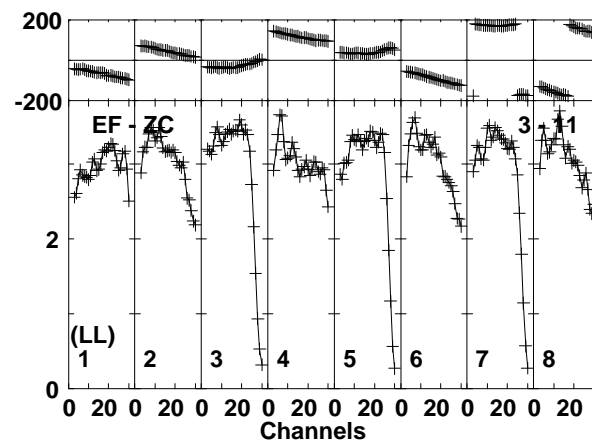
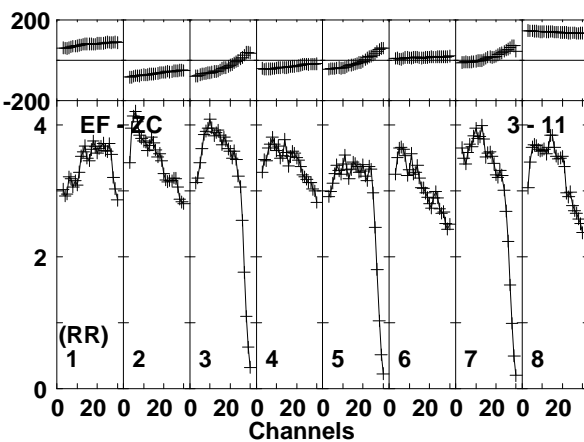
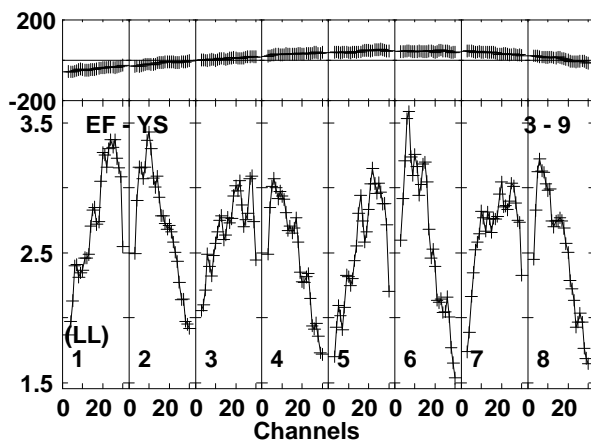
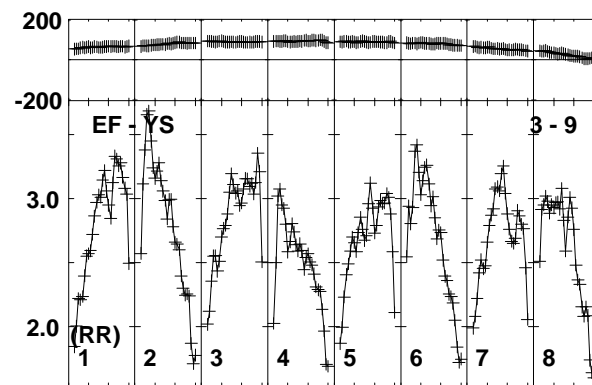
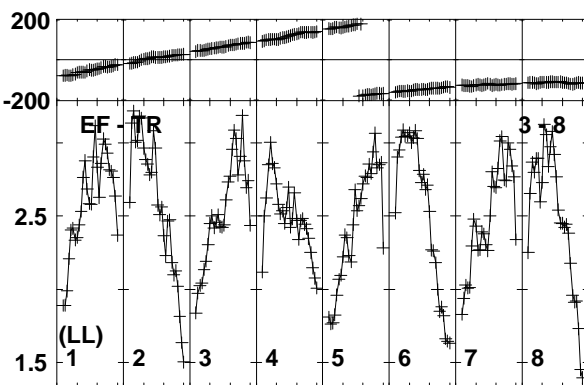
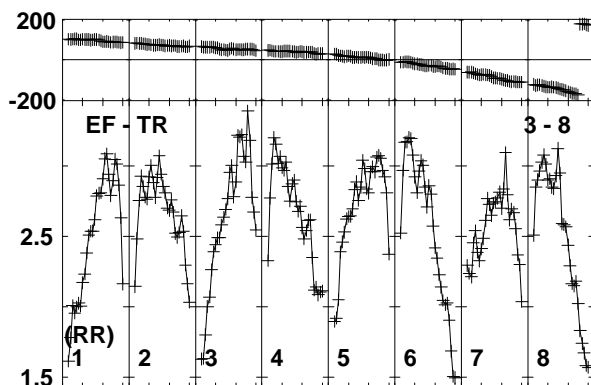
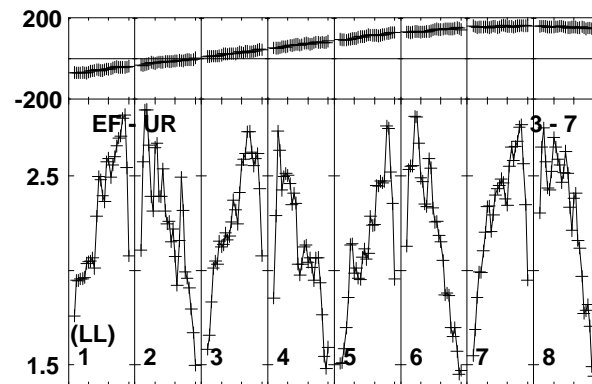
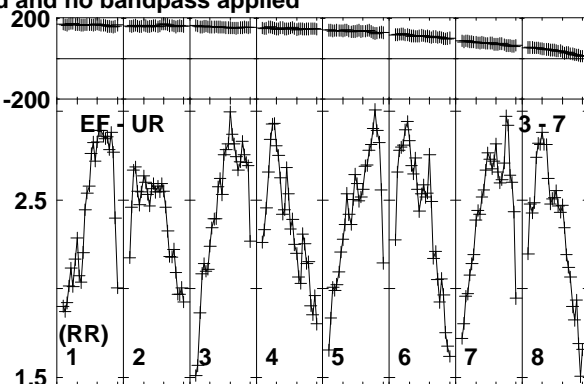
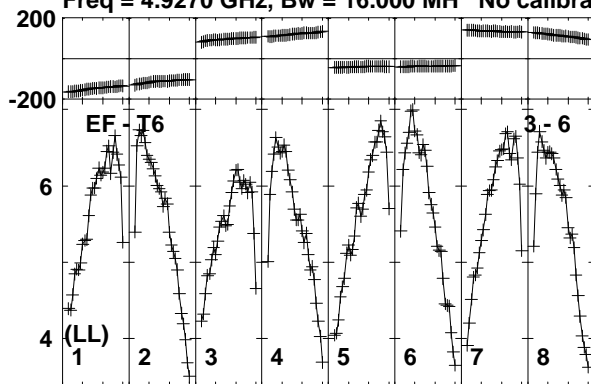

Lower frame: Milli Ampl Jy Top frame: Phas deg
Vector averaged cross-power spectrum Baseline: EF (03) - T6 (06)
Timerange: 00/10:24:01 to 00/10:25:19

Plot file version 581 created 17-FEB-2020 15:43:35

J1359+5544 EK047 2.UVDATA.1

Freq = 4.9270 GHz, Bw = 16.000 MH No calibration applied and no bandpass applied

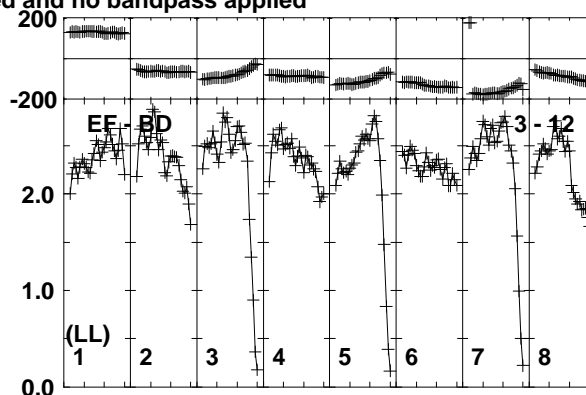
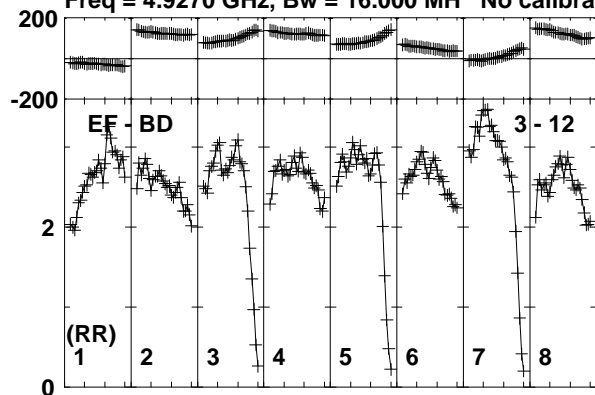

Lower frame: Milli Ampl Jy Top frame: Phas deg
Vector averaged cross-power spectrum Baseline: EF (03) - BD (12)
Timerange: 00/10:24:01 to 00/10:25:19

Plot file version 582 created 17-FEB-2020 15:43:35

J1642+6856 EK047 2.UVDATA.1

Freq = 4.9270 GHz, Bw = 16.000 MH No calibration applied and no bandpass applied

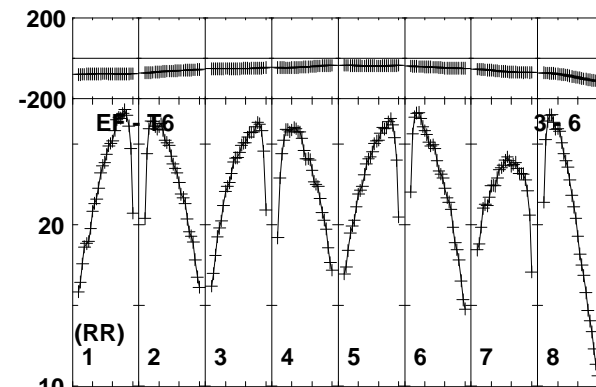
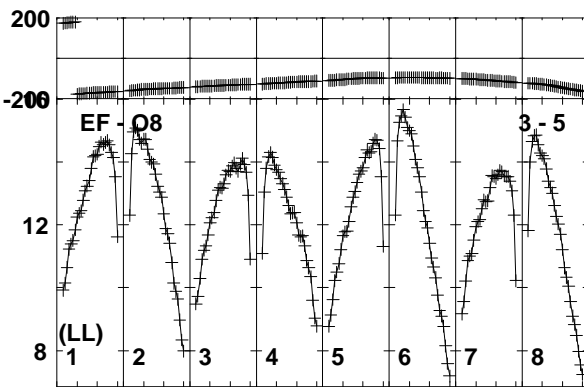
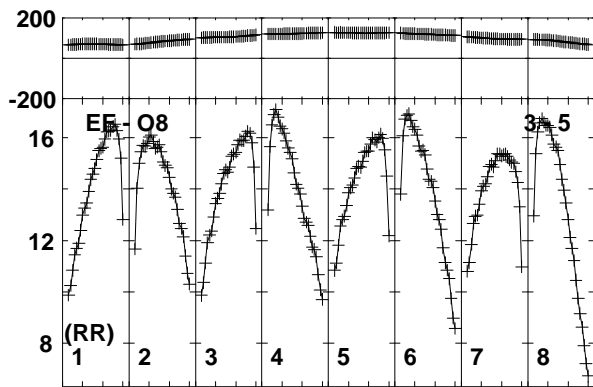
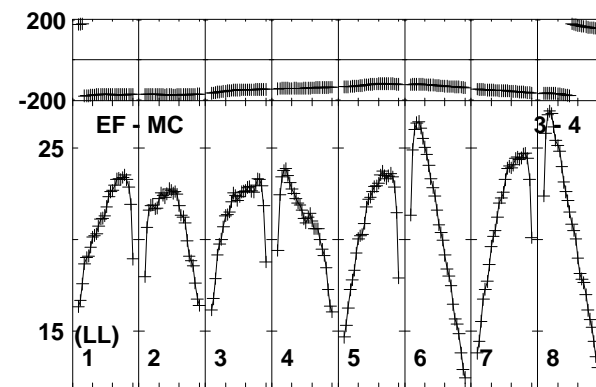
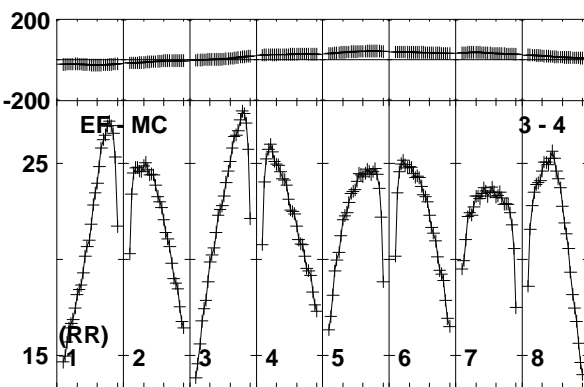
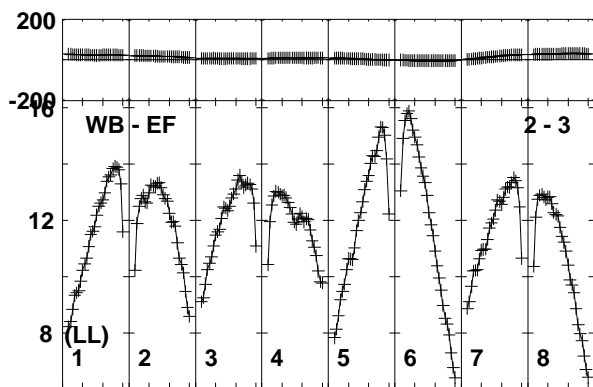
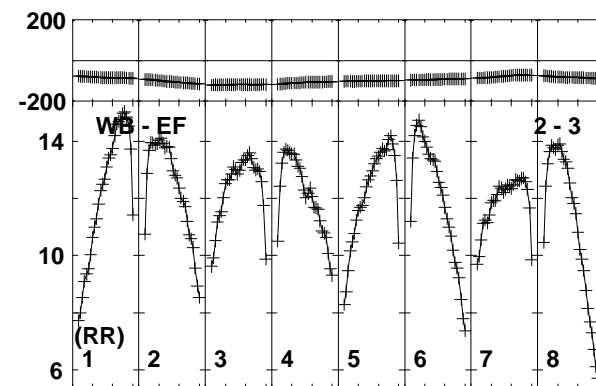
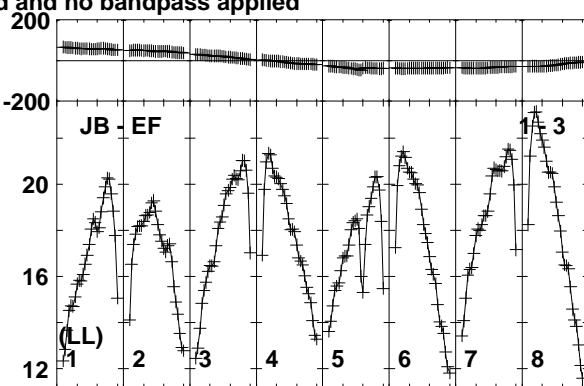
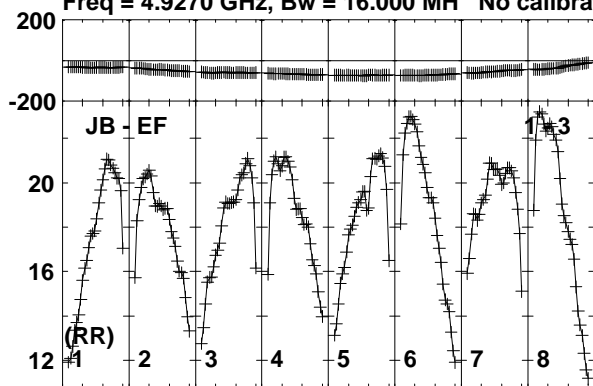

Lower frame: Milli Ampl Jy Top frame: Phas deg
Vector averaged cross-power spectrum Baseline: JB (01) - EF (03)
Timerange: 00/10:26:01 to 00/10:30:39

Plot file version 583 created 17-FEB-2020 15:43:35

J1642+6856 EK047 2.UVDATA.1

Freq = 4.9270 GHz, Bw = 16.000 MH No calibration applied and no bandpass applied

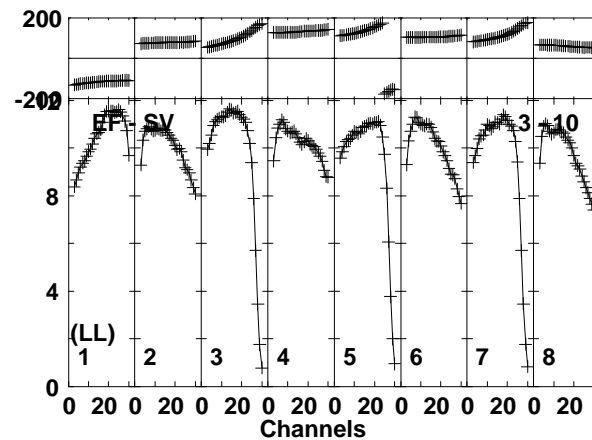
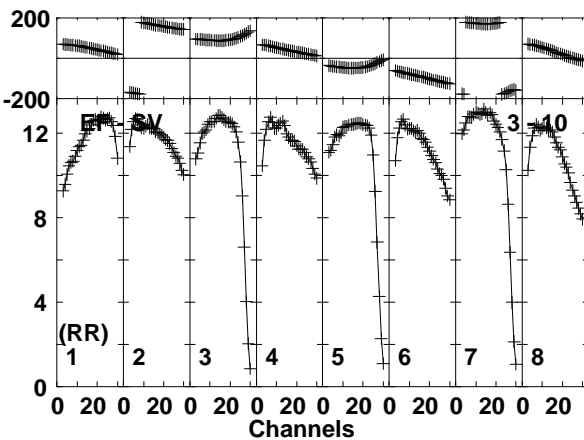
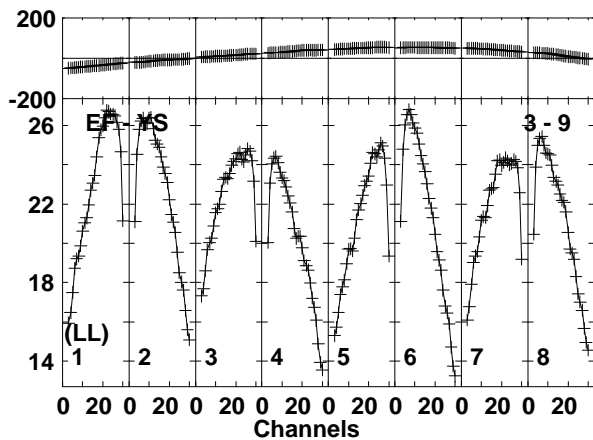
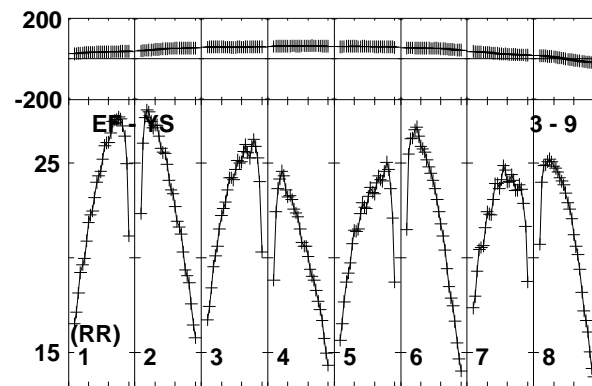
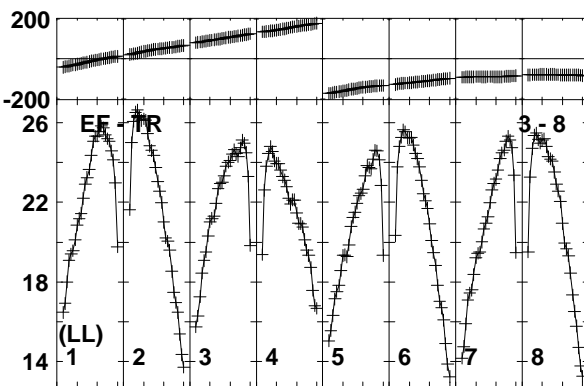
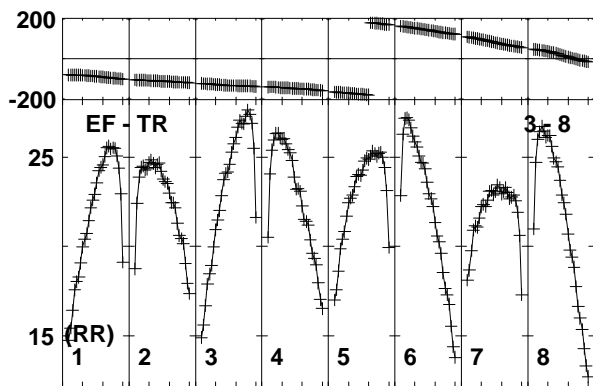
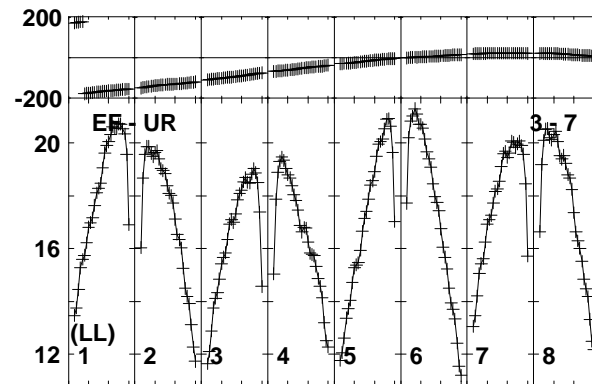
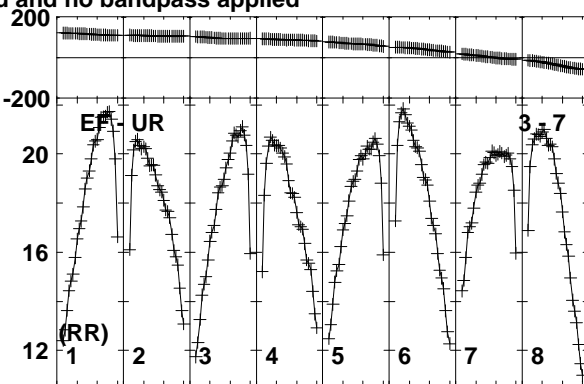
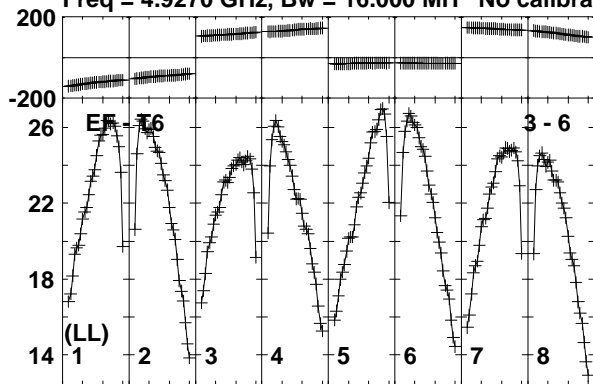

Lower frame: Milli Ampl Jy Top frame: Phas deg
Vector averaged cross-power spectrum Baseline: EF (03) - T6 (06)
Timerange: 00/10:26:01 to 00/10:30:39

Plot file version 584 created 17-FEB-2020 15:43:35

J1642+6856 EK047 2.UVDATA.1

Freq = 4.9270 GHz, Bw = 16.000 MH No calibration applied and no bandpass applied

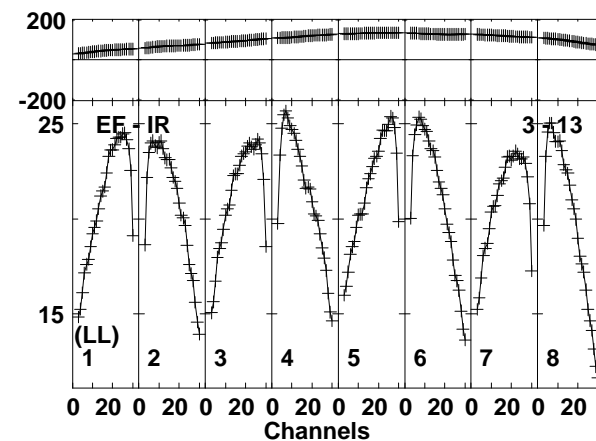
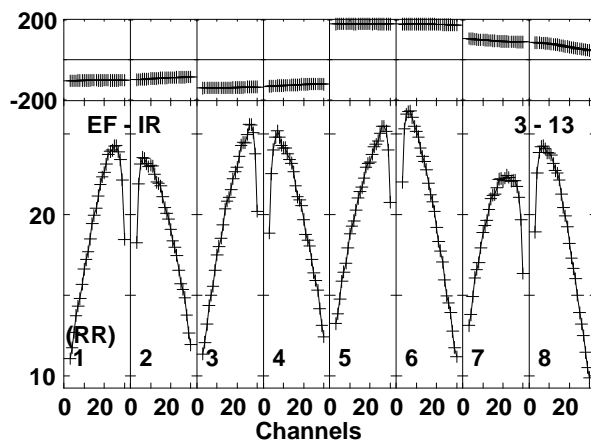
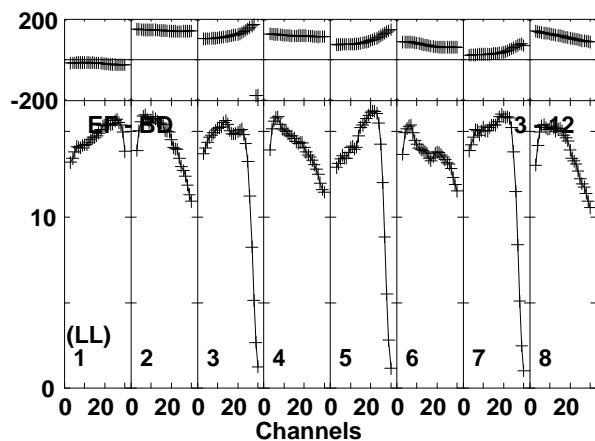
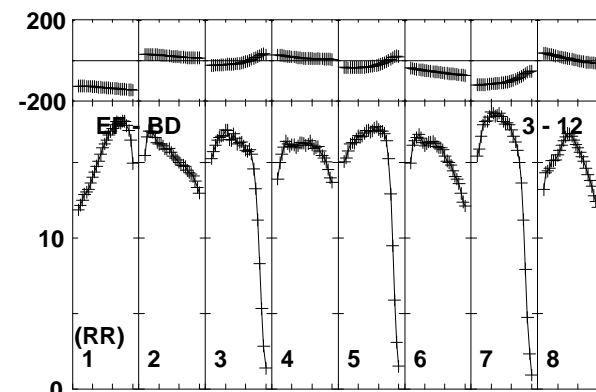
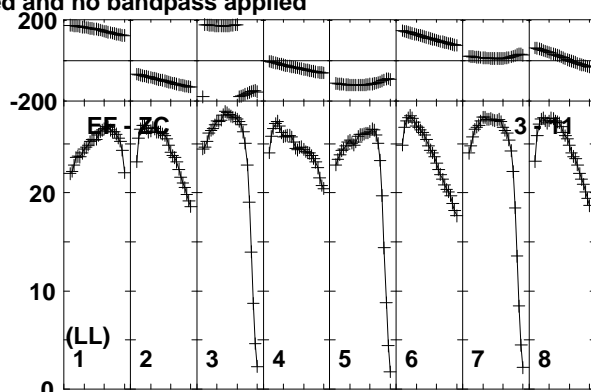
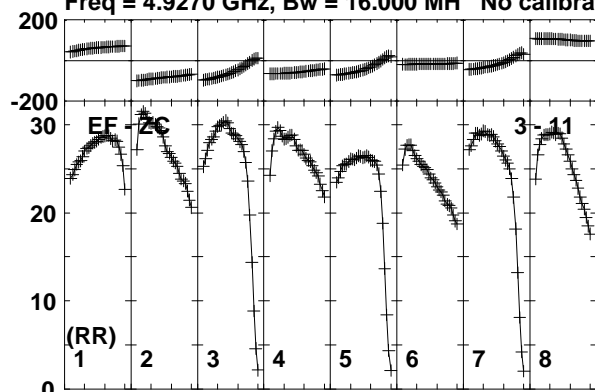

Lower frame: Milli Ampl Jy Top frame: Phas deg
Vector averaged cross-power spectrum Baseline: EF (03) - ZC (11)
Timerange: 00/10:26:01 to 00/10:30:39