

Plot file version 1 created 22-JUN-2006 20:02:04
 J1751+09 EM061A 1.UVDATA.1
 Freq = 6.6631 GHz, Bw = 2.000 MH No calibration applied and no bandpass applied

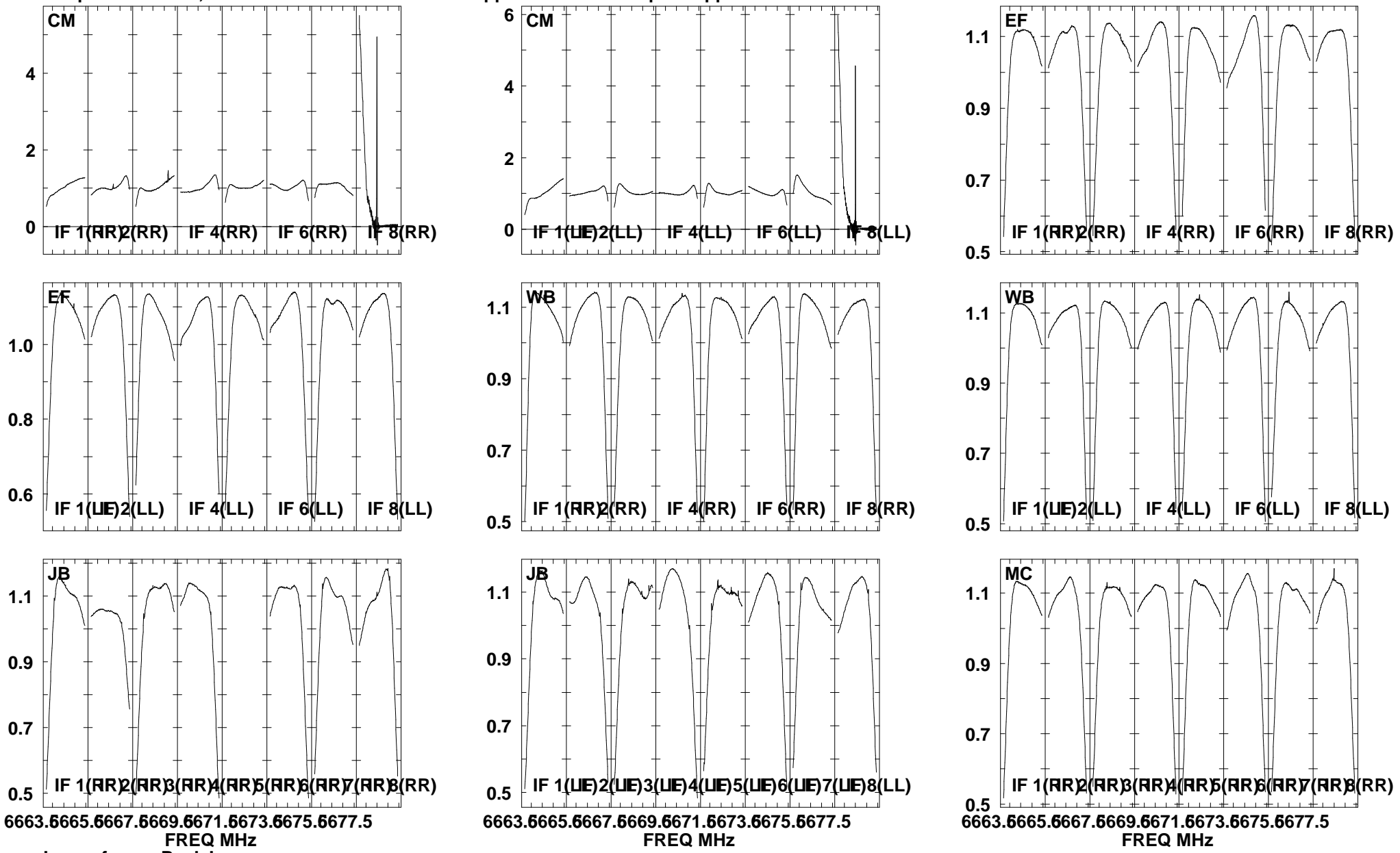

Lower frame: Real Jy
 Total-power spectrum Antenna: *
 Timerange: 00/04:30:18 to 00/04:34:59

Plot file version 2 created 22-JUN-2006 20:02:11
 J1751+09 EM061A 1.UVDATA.1
 Freq = 6.6631 GHz, Bw = 2.000 MH No calibration applied and no bandpass applied

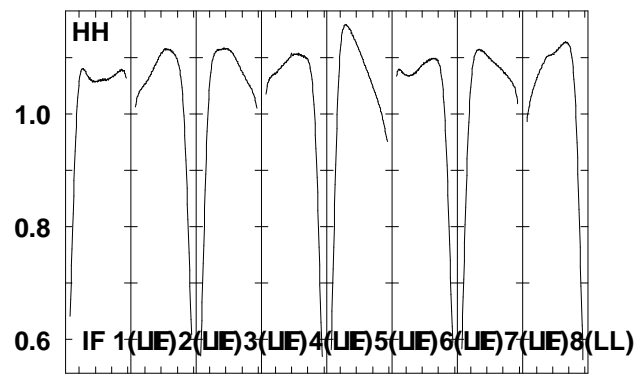
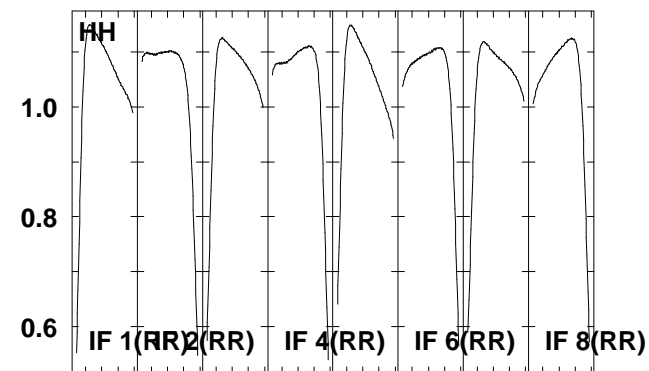
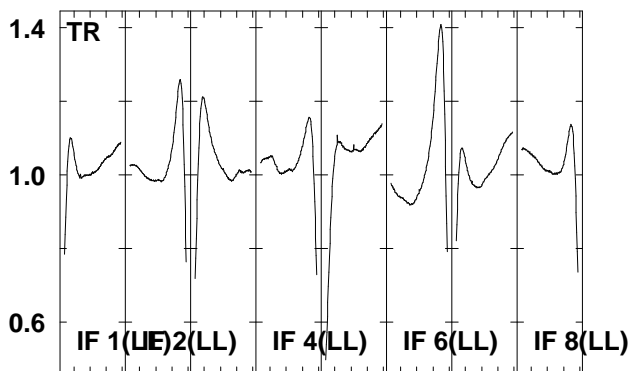
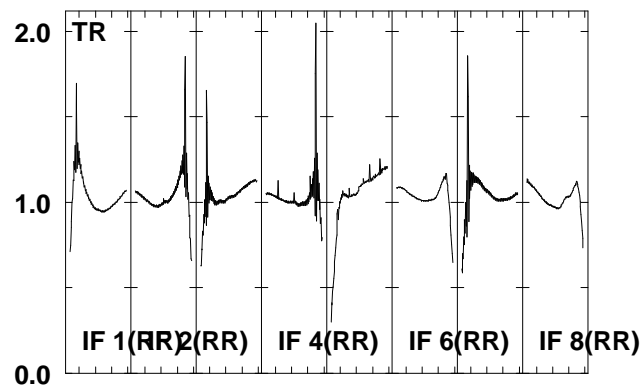
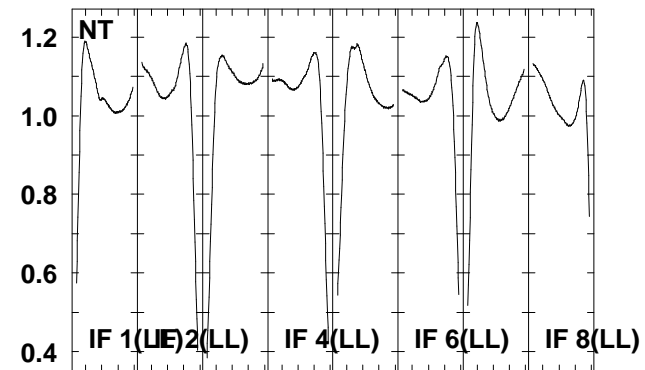
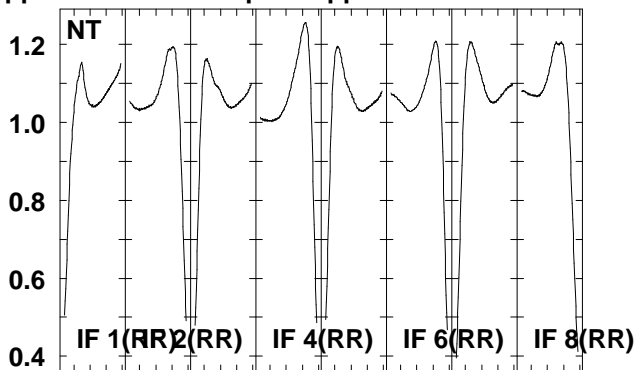
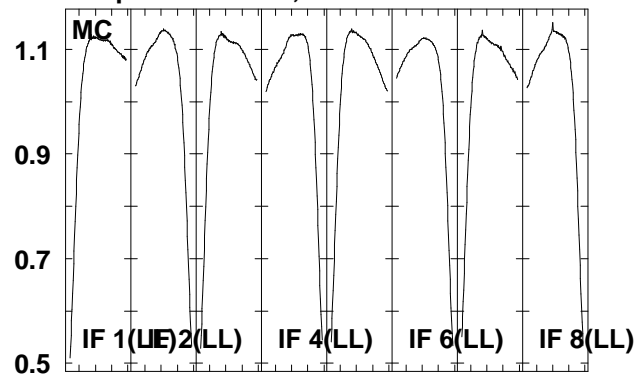

6663.6665.6667.6669.6671.6673.6675.6677.5
 FREQ MHz

Lower frame: Real Jy
 Total-power spectrum Antenna: *
 Timerange: 00/04:30:18 to 00/04:34:59

Plot file version 3 created 22-JUN-2006 20:02:17
 G16.59-0 EM061A 1.UVDATA.1
 Freq = 6.6631 GHz, Bw = 2.000 MH No calibration applied and no bandpass applied

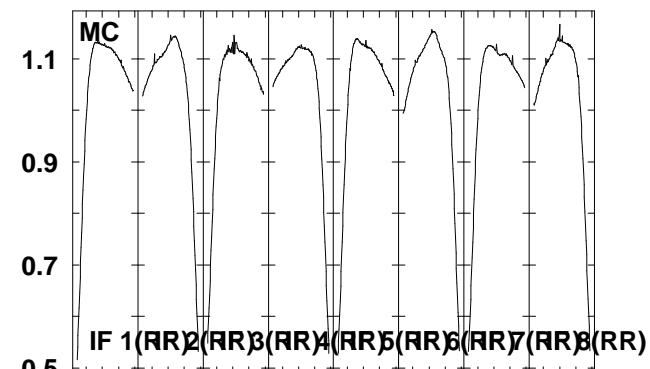
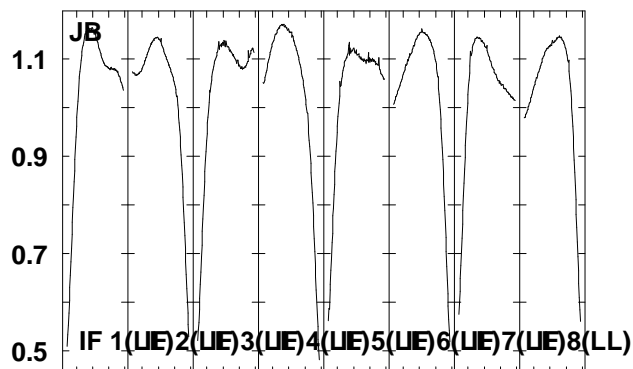
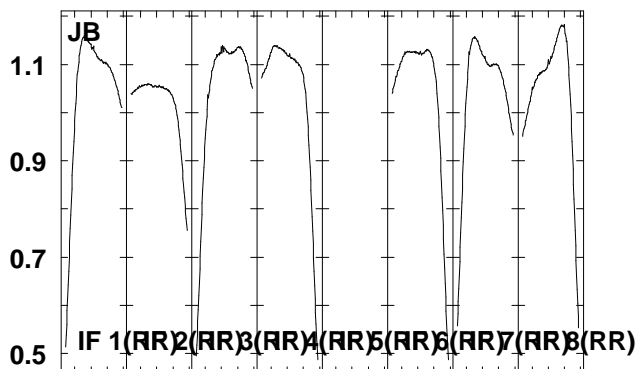
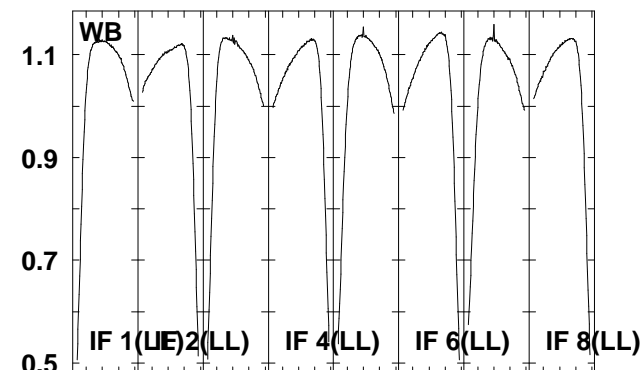
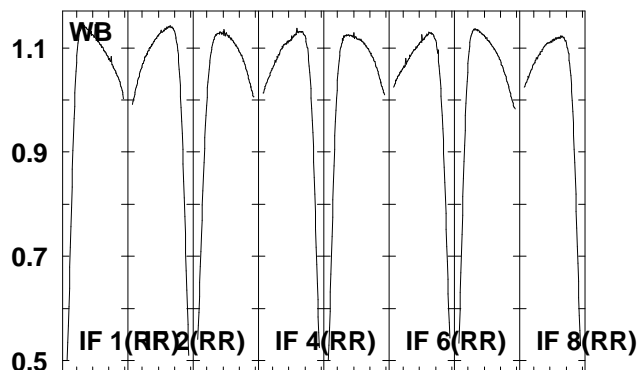
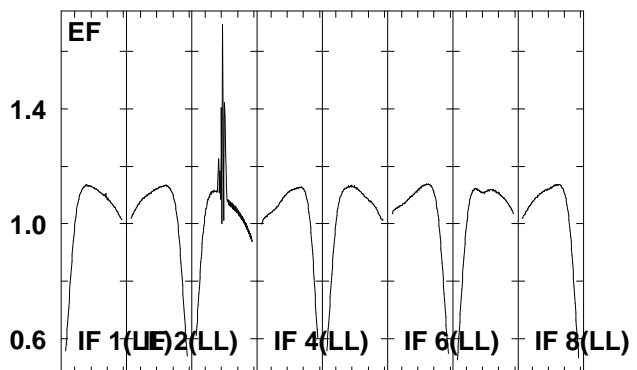
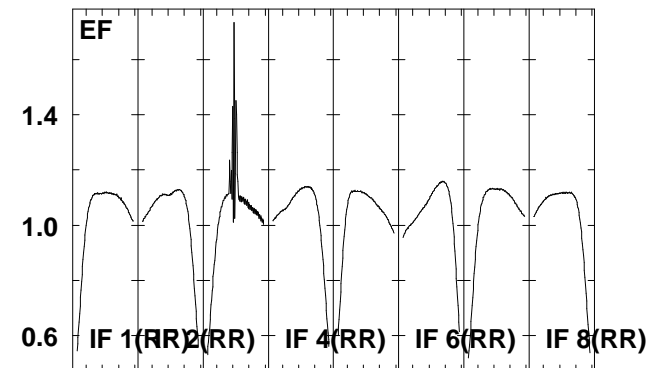
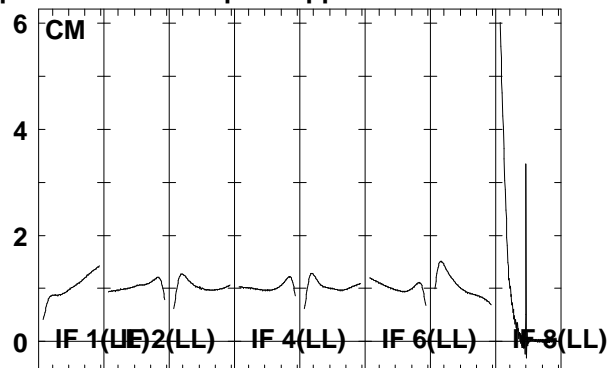
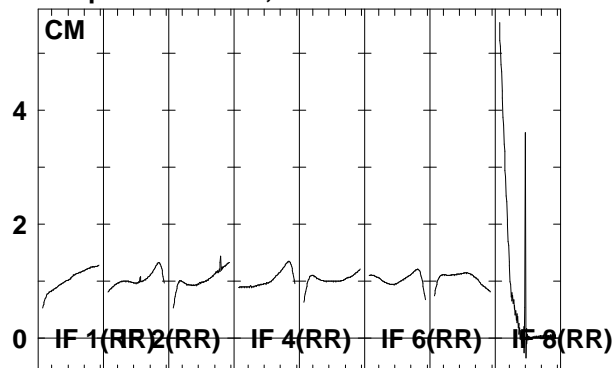

6663.6665.6667.6669.6671.6673.6675.6677.5
 FREQ MHz

6663.6665.6667.6669.6671.6673.6675.6677.5
 FREQ MHz

6663.6665.6667.6669.6671.6673.6675.6677.5
 FREQ MHz

Lower frame: Real Jy
 Total-power spectrum Antenna: *
 Timerange: 00/04:36:32 to 00/04:38:59

Plot file version 4 created 22-JUN-2006 20:02:20
 G16.59-0 EM061A 1.UVDATA.1
 Freq = 6.6631 GHz, Bw = 2.000 MH No calibration applied and no bandpass applied

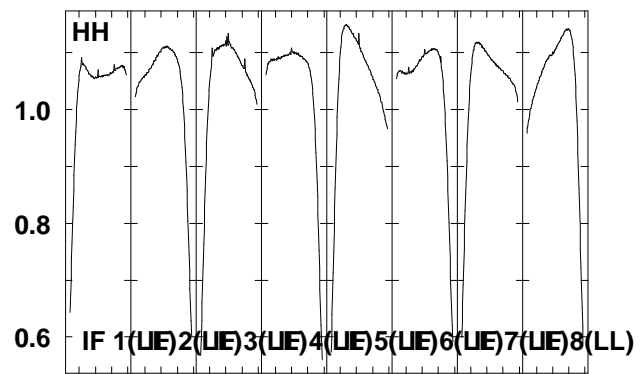
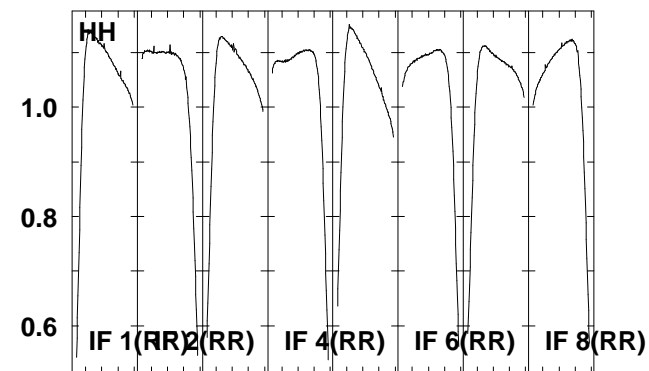
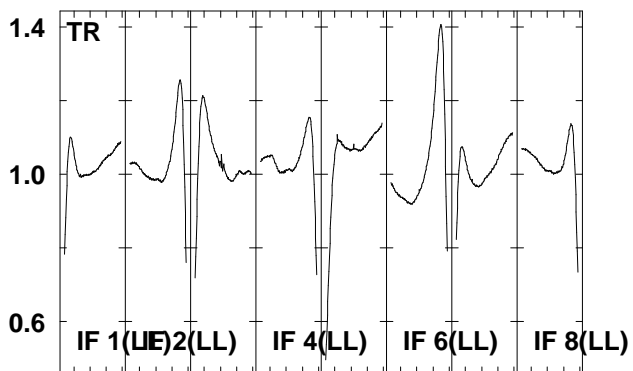
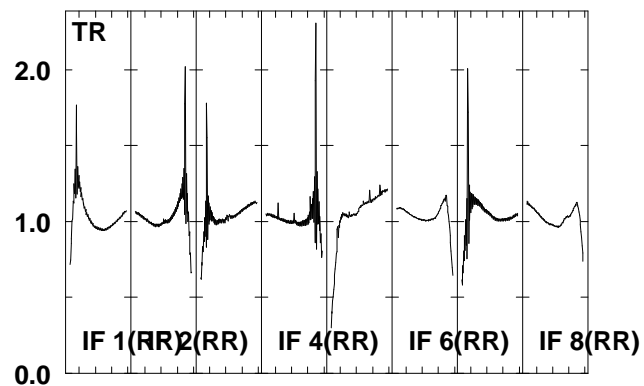
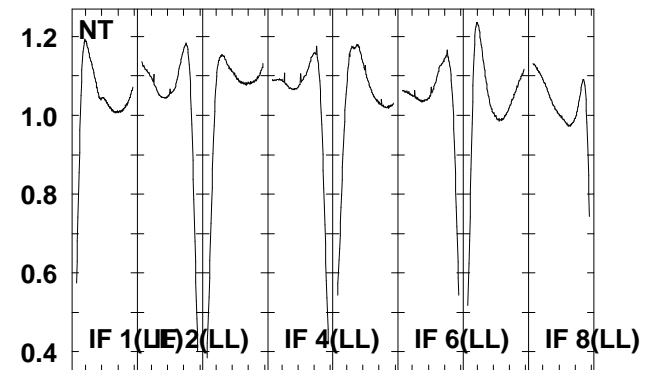
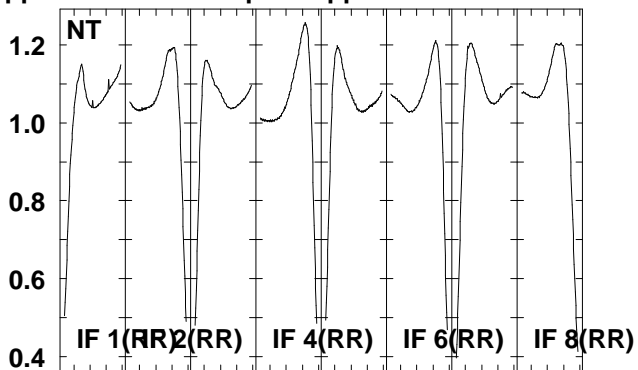
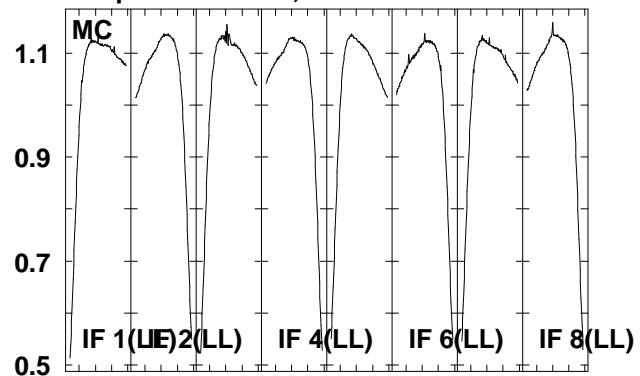

6663.6665.6667.6669.6671.6673.6675.6677.5
 FREQ MHz

Lower frame: Real Jy
 Total-power spectrum Antenna: *
 Timerange: 00/04:36:32 to 00/04:38:59

Plot file version 5 created 22-JUN-2006 20:02:23
 J1825-17 EM061A 1.UVDATA.1
 Freq = 6.6631 GHz, Bw = 2.000 MH No calibration applied and no bandpass applied

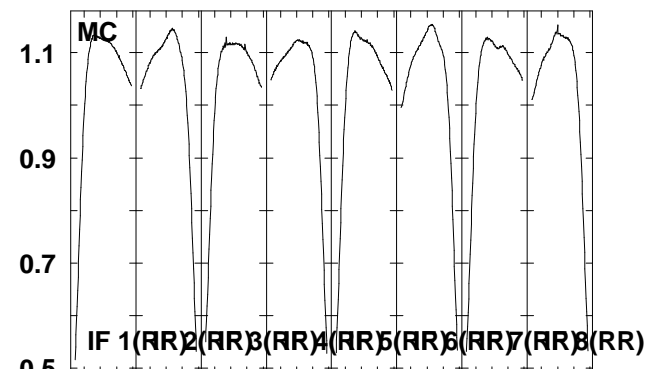
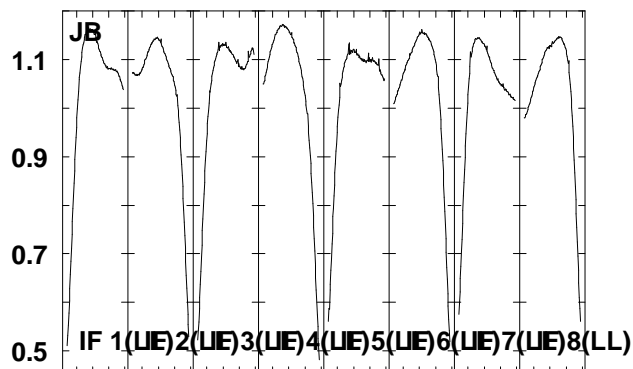
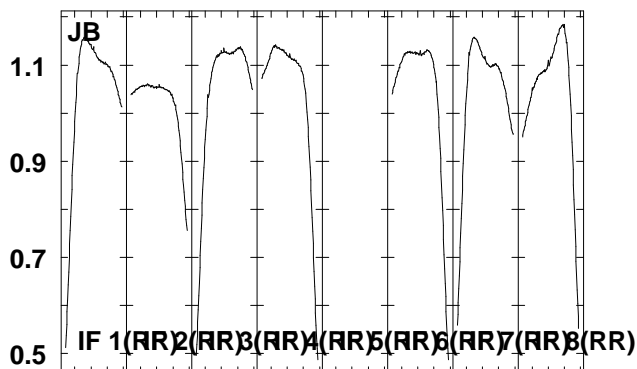
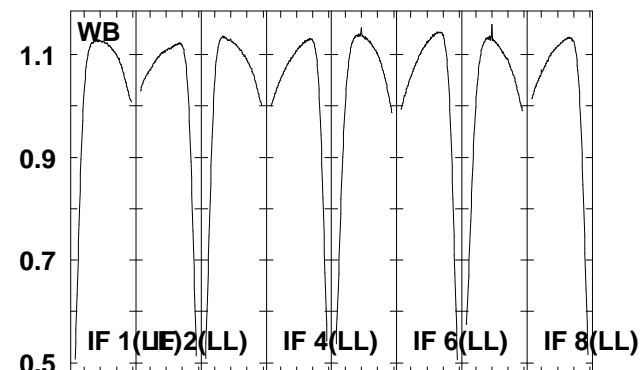
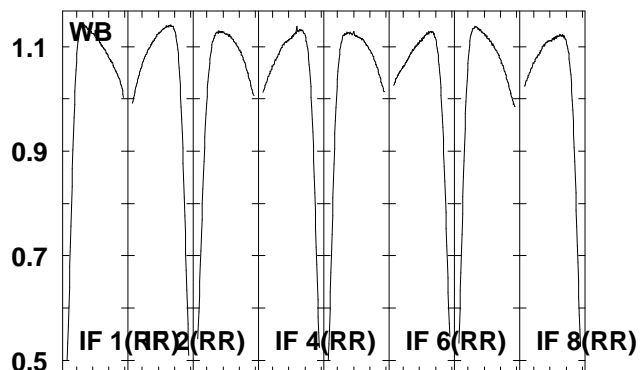
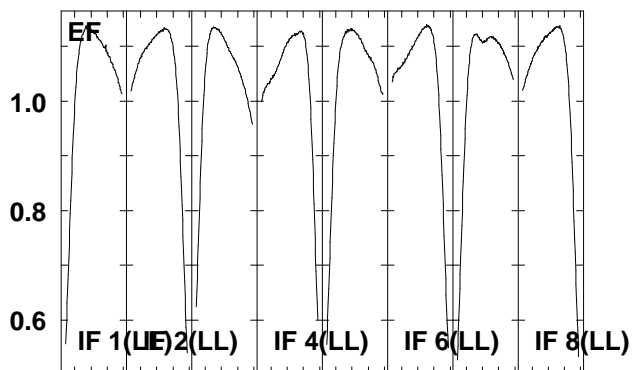
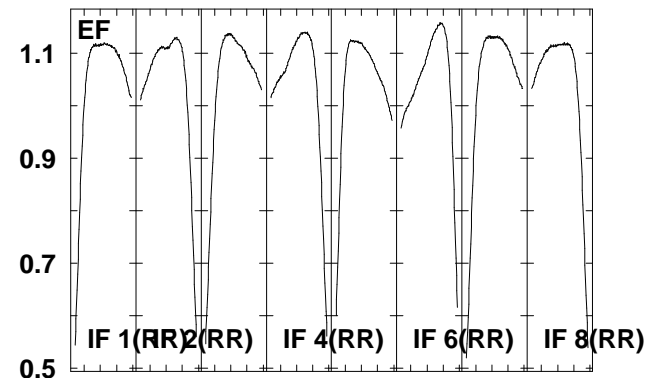
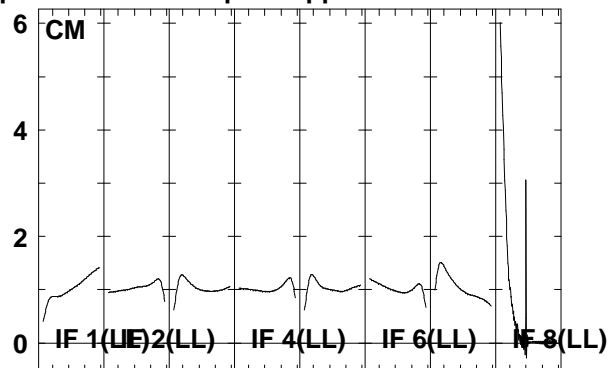
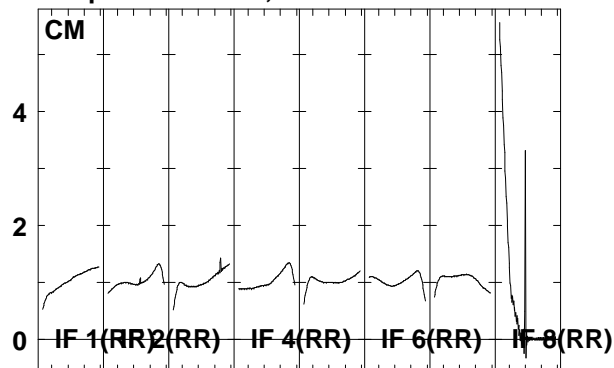

6663.6665.6667.6669.6671.6673.6675.6677.5
 FREQ MHz

6663.6665.6667.6669.6671.6673.6675.6677.5
 FREQ MHz

6663.6665.6667.6669.6671.6673.6675.6677.5
 FREQ MHz

Lower frame: Real Jy
 Total-power spectrum Antenna: *
 Timerange: 00/04:39:01 to 00/04:41:59

Plot file version 6 created 22-JUN-2006 20:02:27

J1825-17 EM061A 1.UVDATA.1

Freq = 6.6631 GHz, Bw = 2.000 MH No calibration applied and no bandpass applied

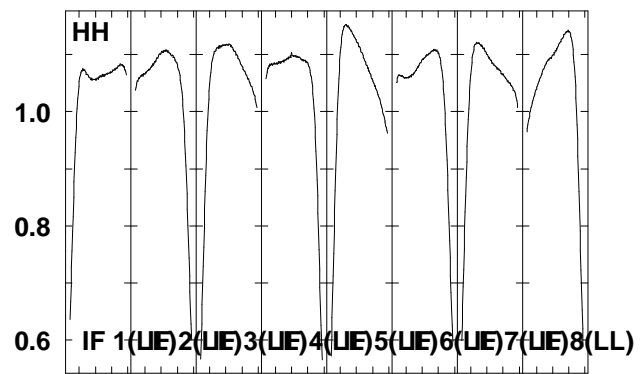
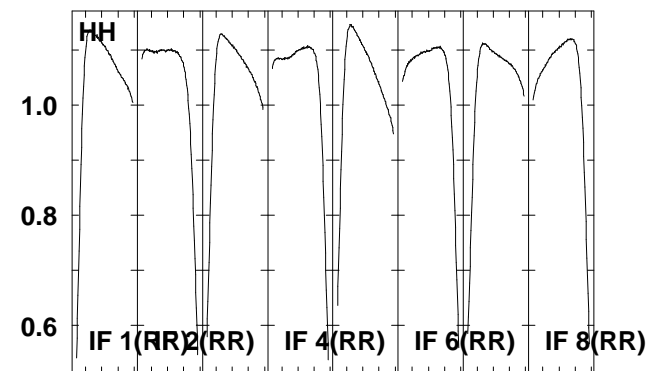
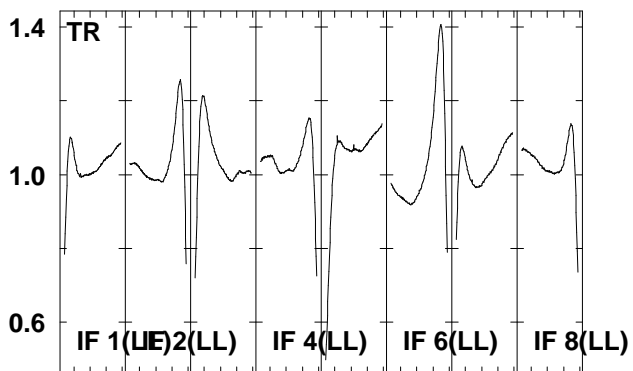
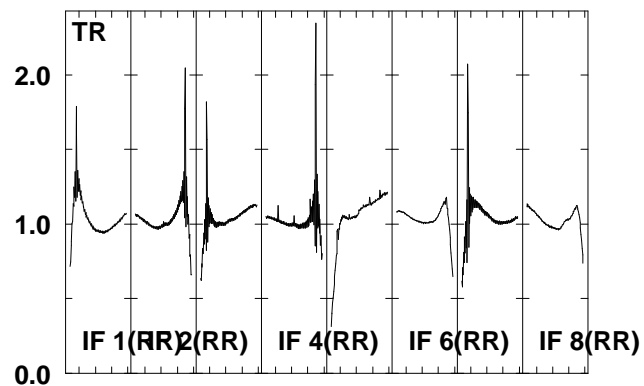
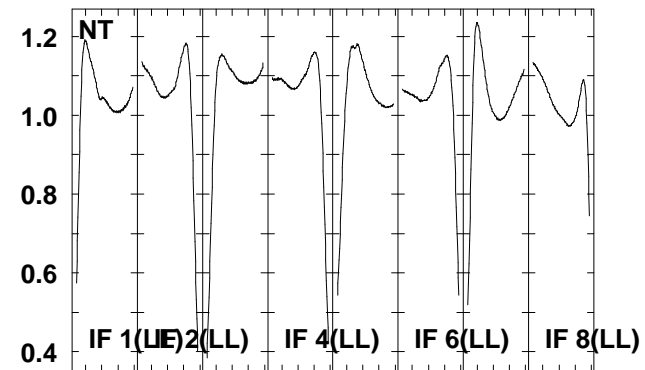
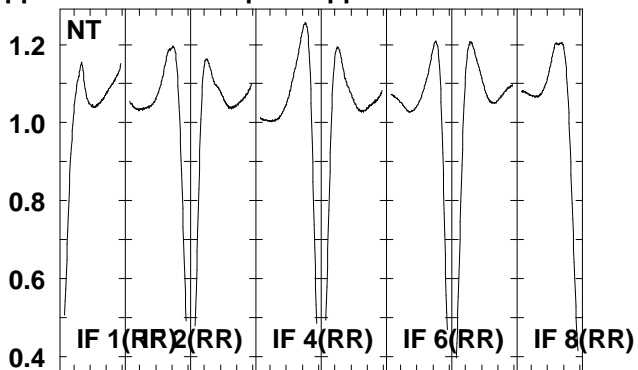
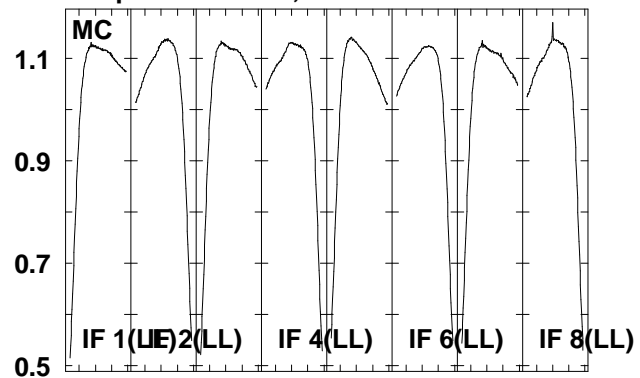

6663.6665.6667.6669.6671.6673.6675.6677.5

FREQ MHz

Lower frame: Real Jy

Total-power spectrum Antenna: *

Timerange: 00/04:39:01 to 00/04:41:59

Plot file version 7 created 22-JUN-2006 20:02:32
 G16.59-0 EM061A 1.UVDATA.1
 Freq = 6.6631 GHz, Bw = 2.000 MH No calibration applied and no bandpass applied

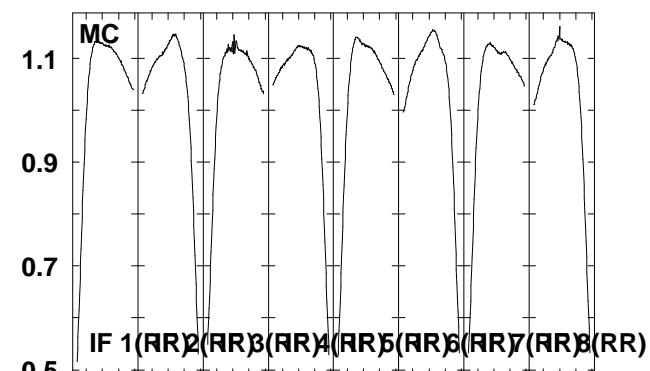
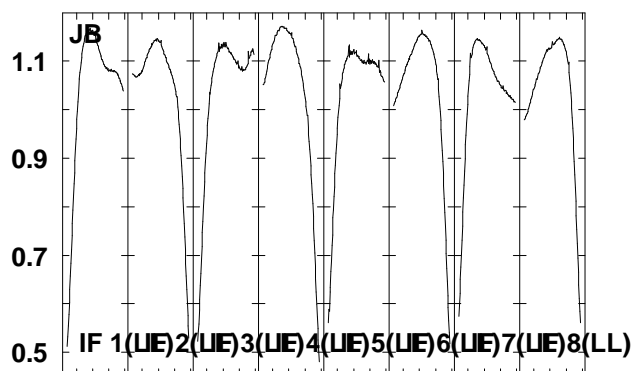
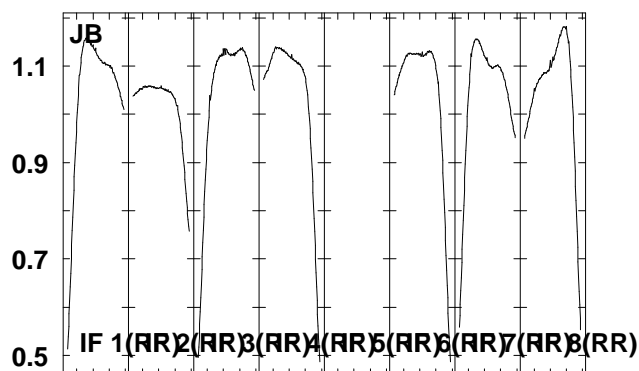
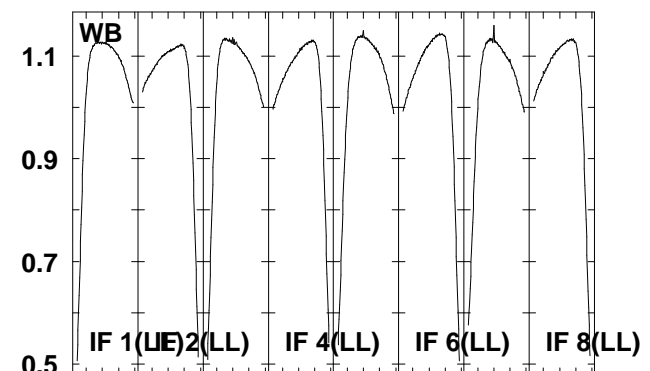
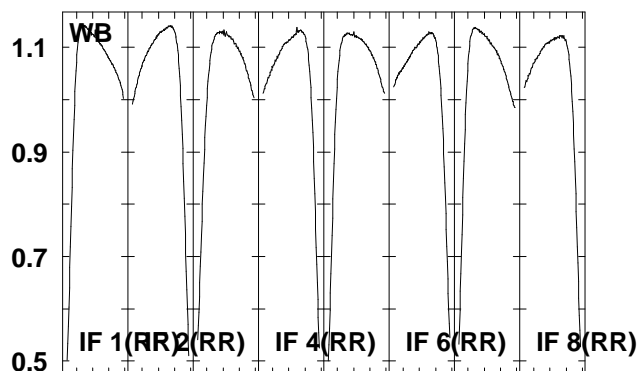
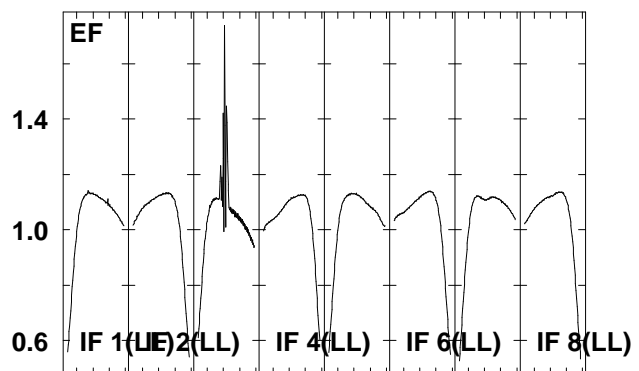
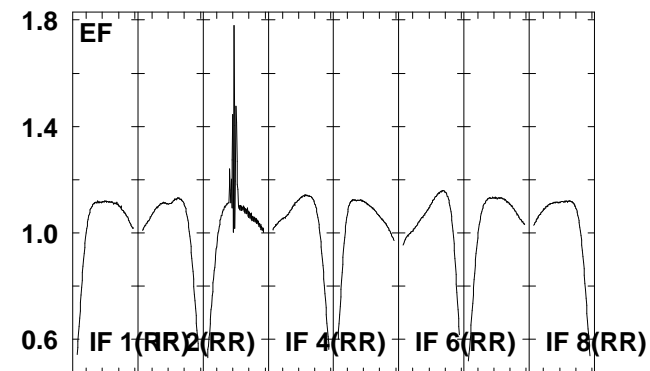
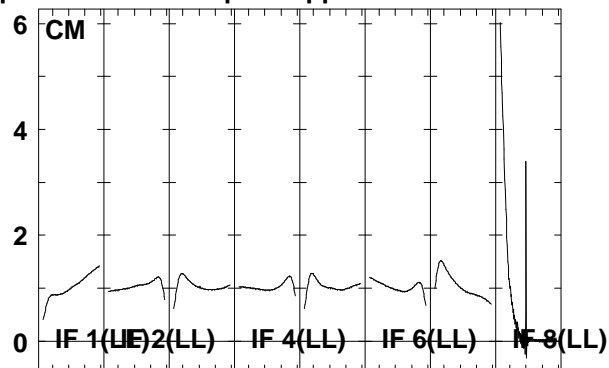
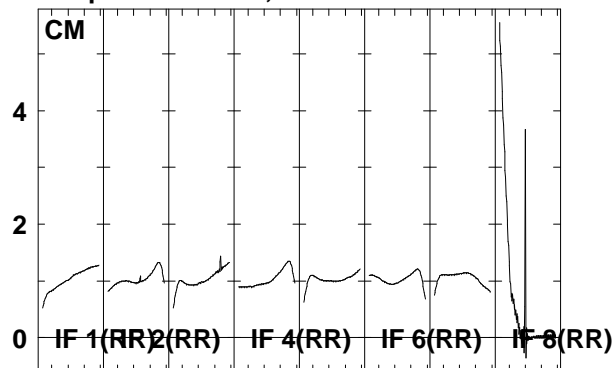

6663.6665.6667.6669.6671.6673.6675.6677.5
 FREQ MHz

6663.6665.6667.6669.6671.6673.6675.6677.5
 FREQ MHz

6663.6665.6667.6669.6671.6673.6675.6677.5
 FREQ MHz

Lower frame: Real Jy
 Total-power spectrum Antenna: *
 Timerange: 00/04:42:01 to 00/04:44:29

Plot file version 8 created 22-JUN-2006 20:02:36

G16.59-0 EM061A 1.UVDATA.1

Freq = 6.6631 GHz, Bw = 2.000 MH No calibration applied and no bandpass applied

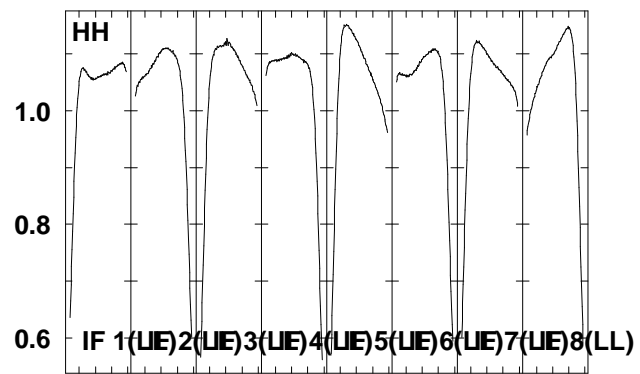
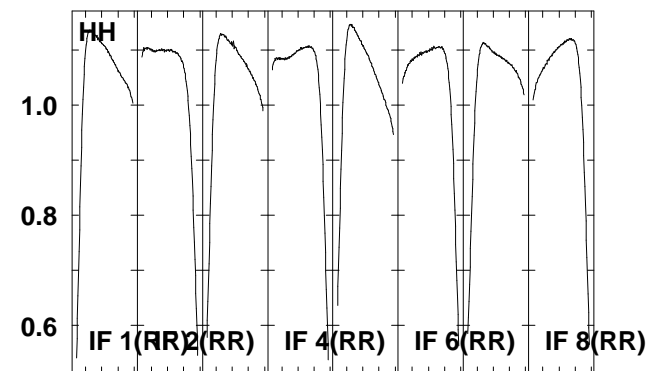
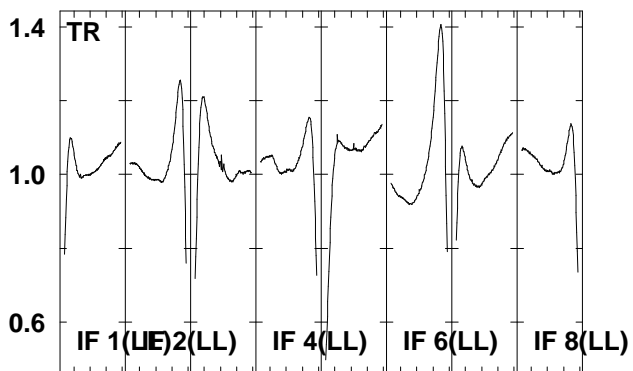
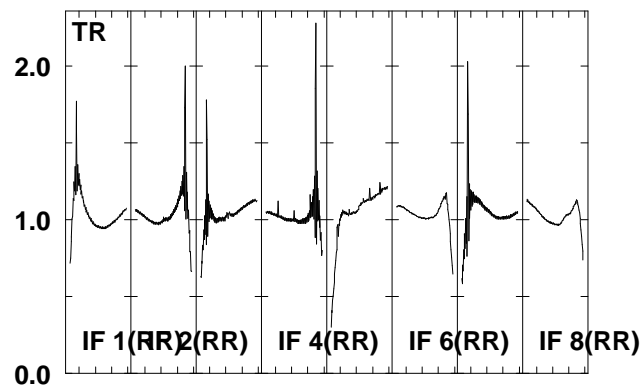
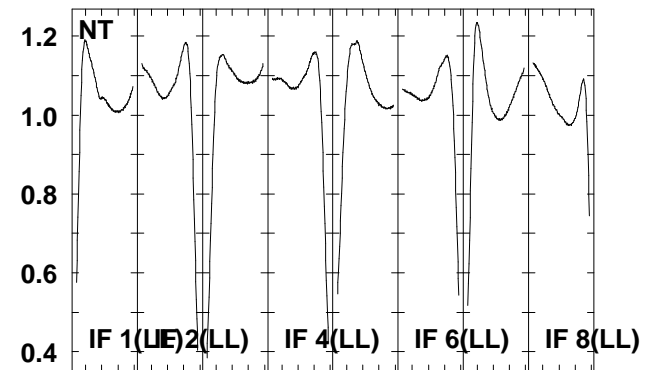
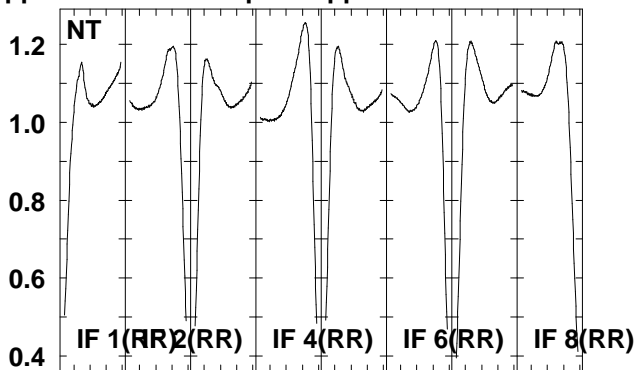
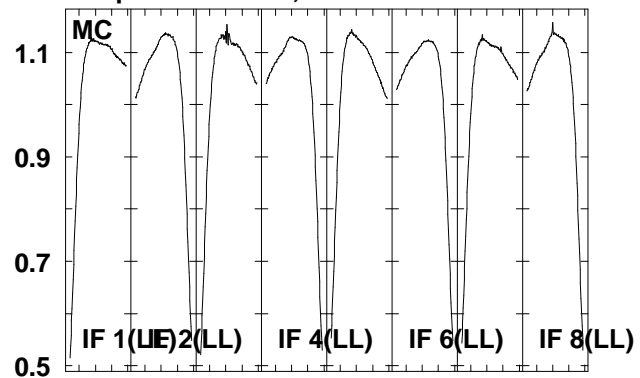

6663.6665.6667.6669.6671.6673.6675.6677.5

FREQ MHz

Lower frame: Real Jy

Total-power spectrum Antenna: *

Timerange: 00/04:42:01 to 00/04:44:29

Plot file version 9 created 22-JUN-2006 20:02:39
 J1825-17 EM061A 1.UVDATA.1
 Freq = 6.6631 GHz, Bw = 2.000 MH No calibration applied and no bandpass applied

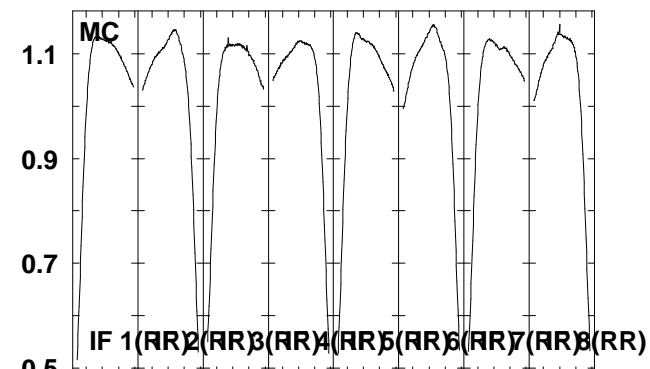
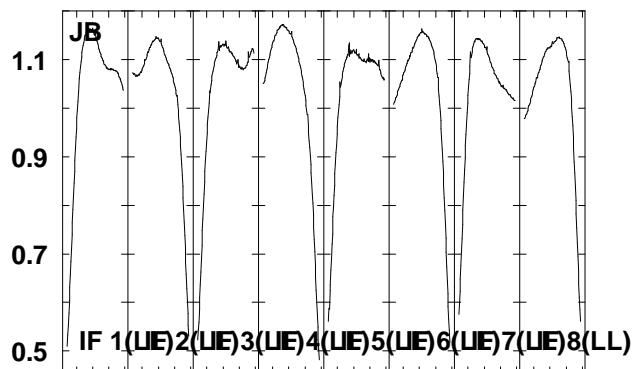
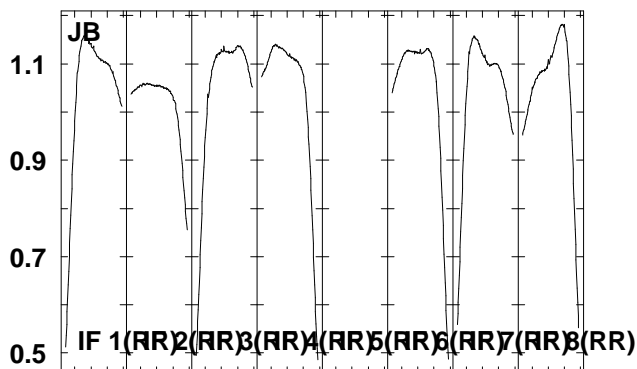
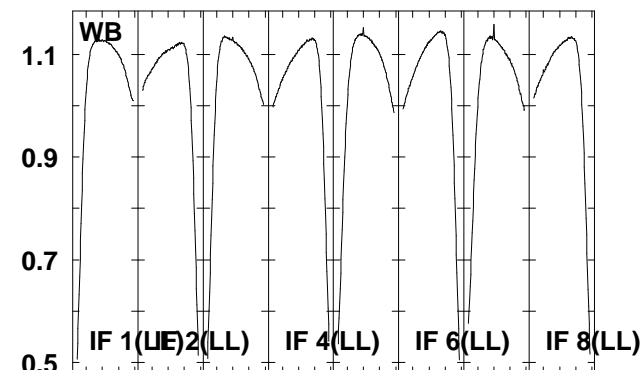
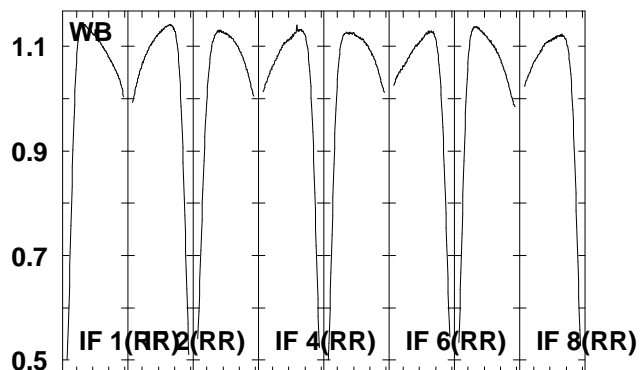
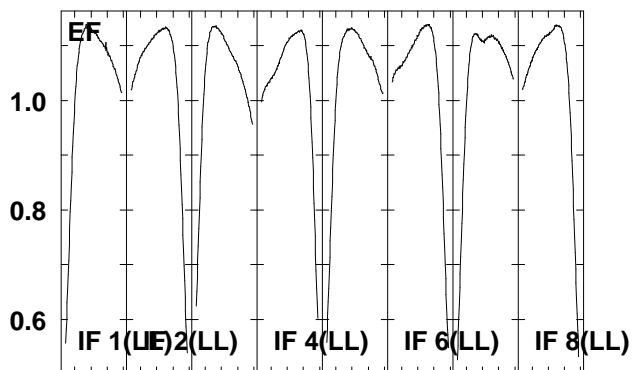
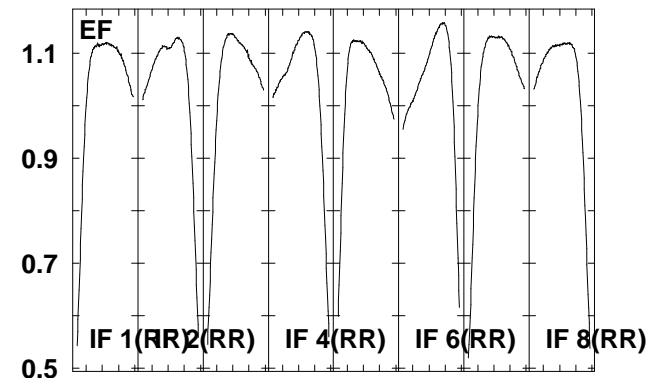
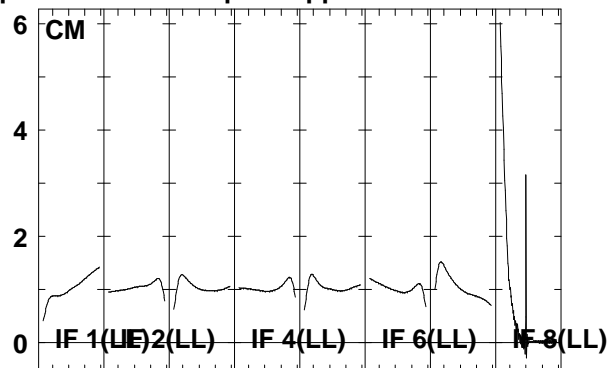
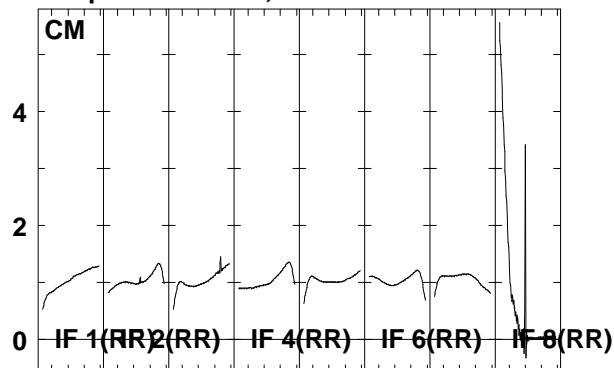

6663.6665.6667.6669.6671.6673.6675.6677.5
 FREQ MHz

6663.6665.6667.6669.6671.6673.6675.6677.5
 FREQ MHz

6663.6665.6667.6669.6671.6673.6675.6677.5
 FREQ MHz

Lower frame: Real Jy
 Total-power spectrum Antenna: *
 Timerange: 00/04:44:31 to 00/04:47:29

Plot file version 10 created 22-JUN-2006 20:02:43
 J1825-17 EM061A 1.UVDATA.1
 Freq = 6.6631 GHz, Bw = 2.000 MH No calibration applied and no bandpass applied

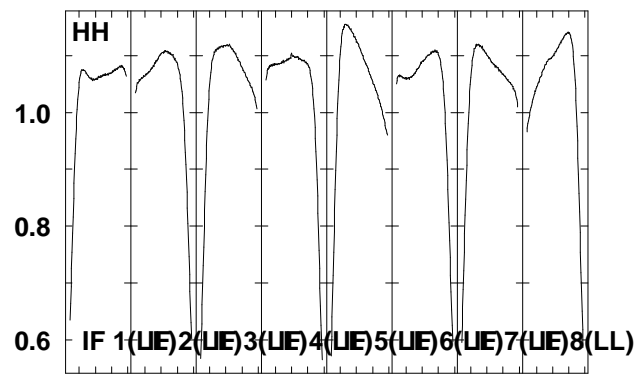
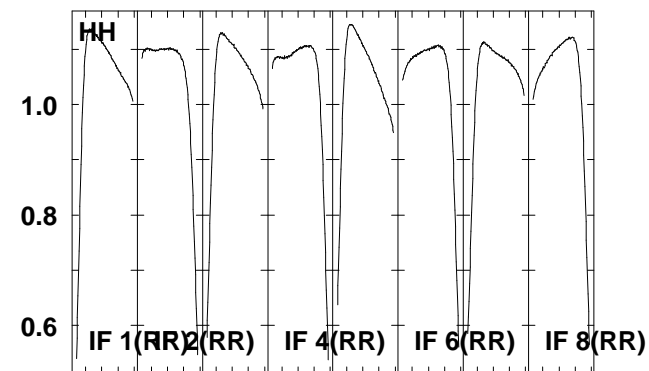
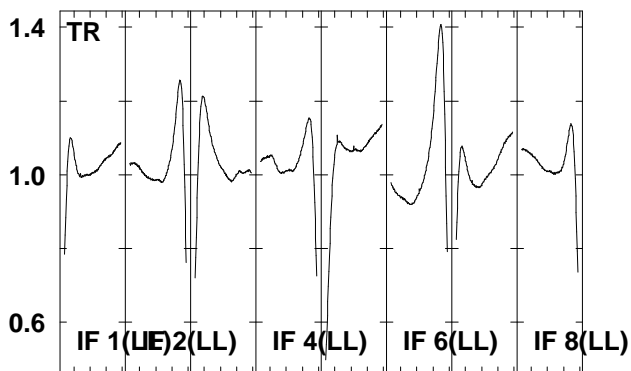
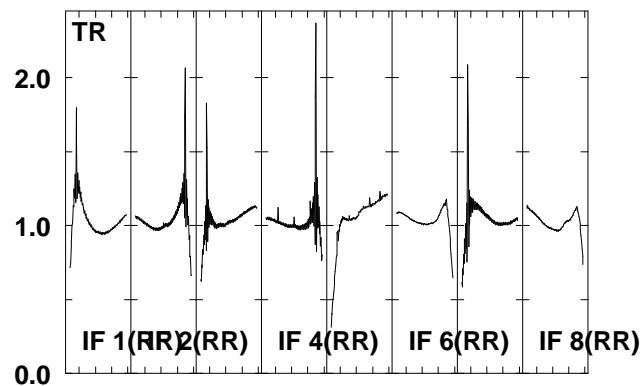
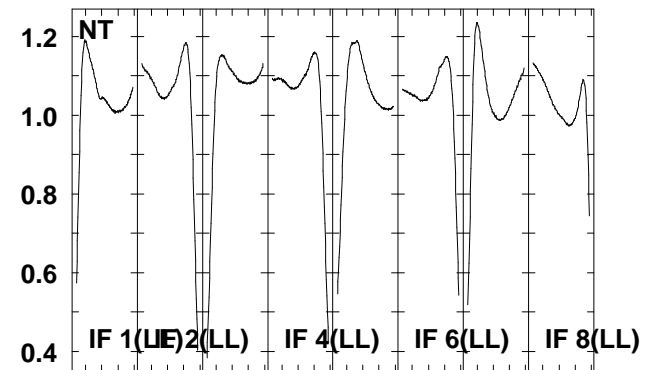
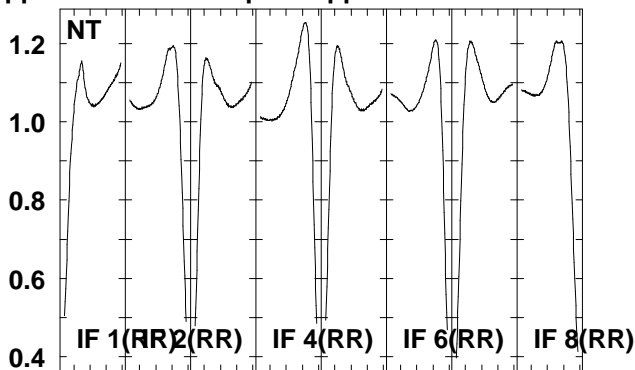
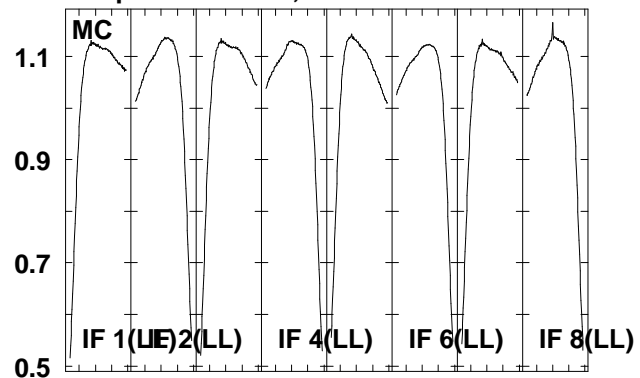

6663.6665.6667.6669.6671.6673.6675.6677.5
 FREQ MHz

Lower frame: Real Jy
 Total-power spectrum Antenna: *
 Timerange: 00/04:44:31 to 00/04:47:29

Plot file version 11 created 22-JUN-2006 20:02:48
 G16.59-0 EM061A 1.UVDATA.1
 Freq = 6.6631 GHz, Bw = 2.000 MH No calibration applied and no bandpass applied

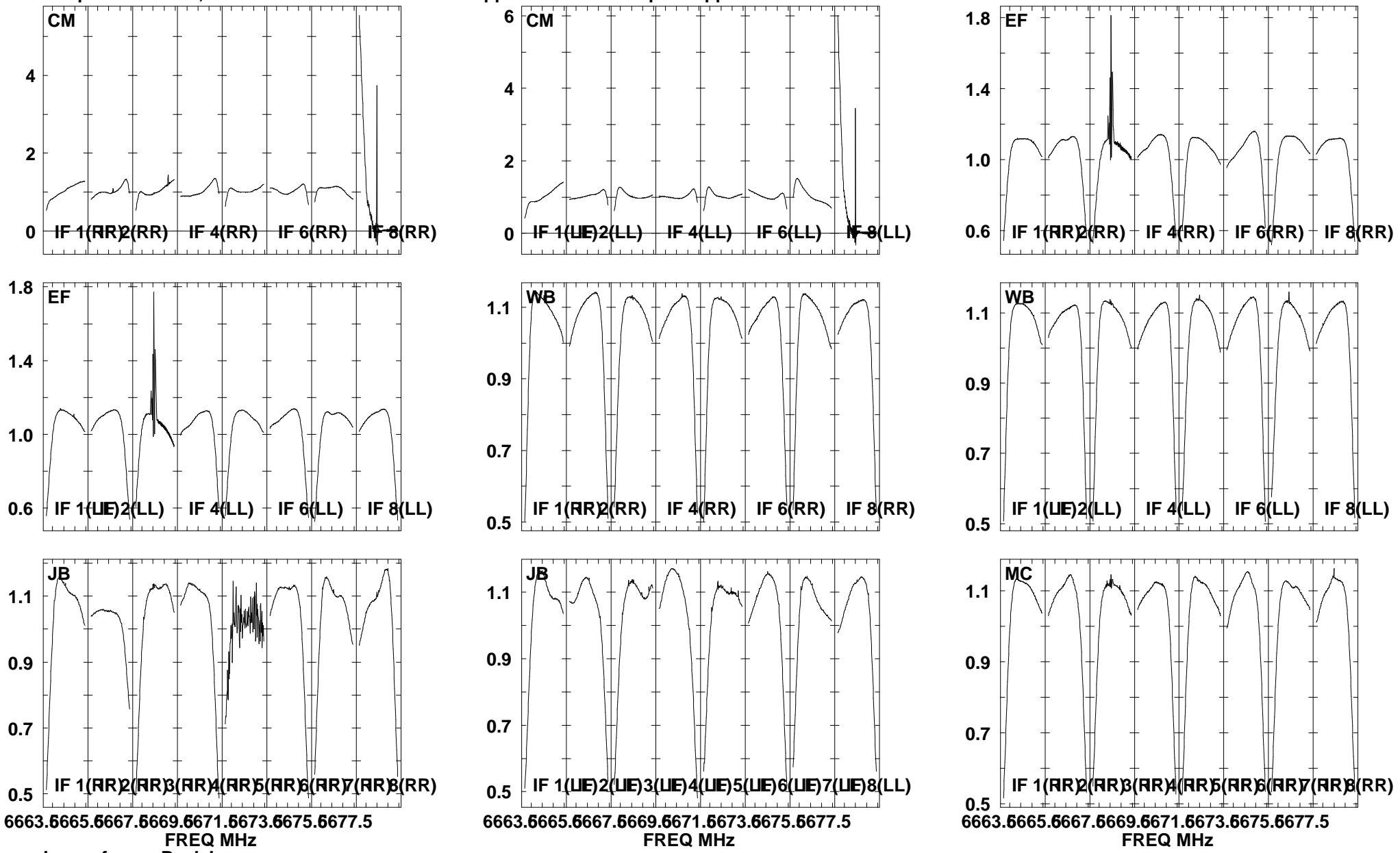

Lower frame: Real Jy
 Total-power spectrum Antenna: *
 Timerange: 00/04:47:31 to 00/04:49:59

Plot file version 12 created 22-JUN-2006 20:02:51
 G16.59-0 EM061A 1.UVDATA.1
 Freq = 6.6631 GHz, Bw = 2.000 MH No calibration applied and no bandpass applied

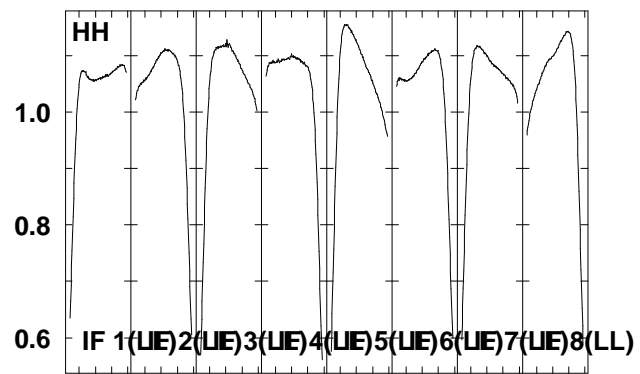
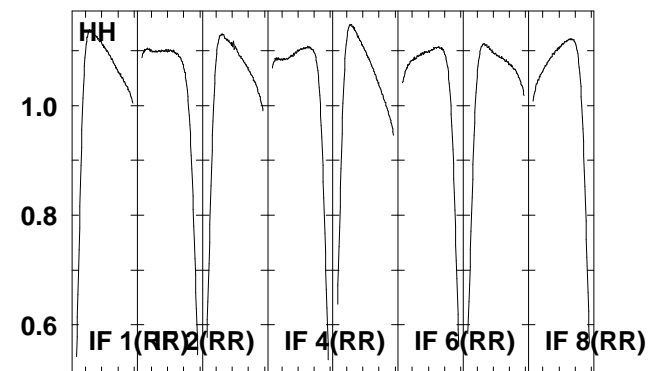
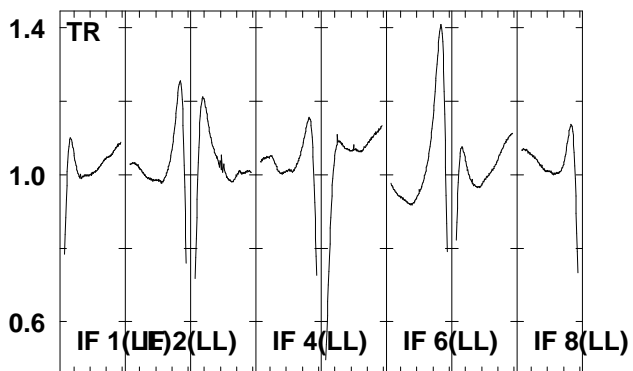
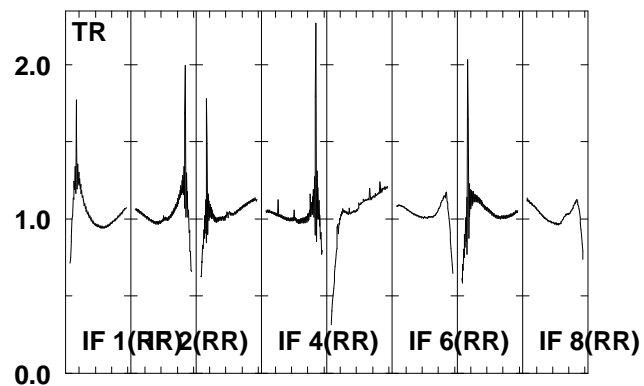
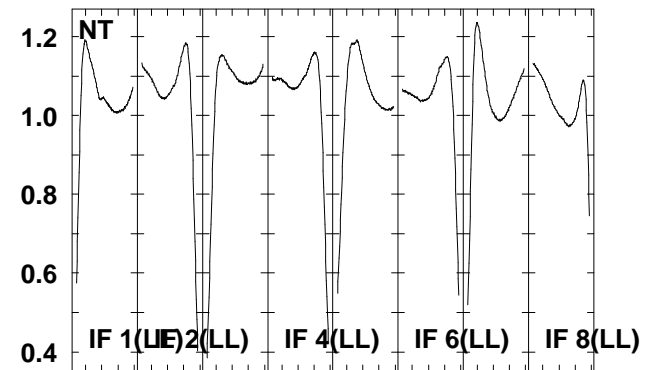
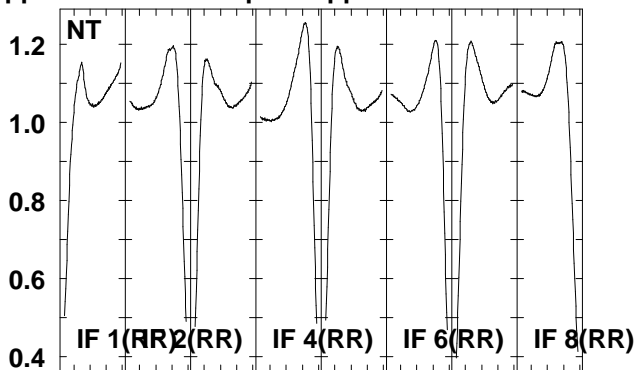
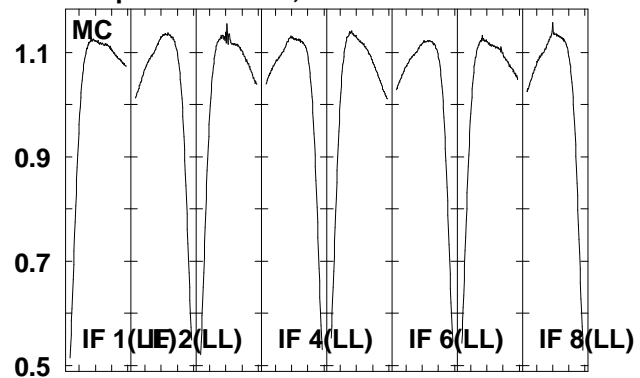

6663.6665.6667.6669.6671.6673.6675.6677.5
 FREQ MHz

Lower frame: Real Jy
 Total-power spectrum Antenna: *
 Timerange: 00/04:47:31 to 00/04:49:59

Plot file version 13 created 22-JUN-2006 20:02:56
 J1825-17 EM061A 1.UVDATA.1
 Freq = 6.6631 GHz, Bw = 2.000 MH No calibration applied and no bandpass applied

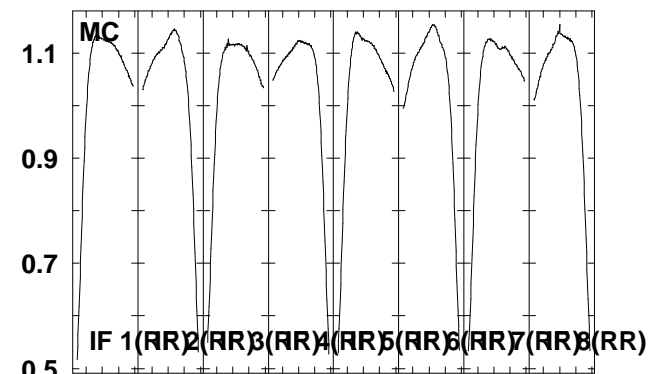
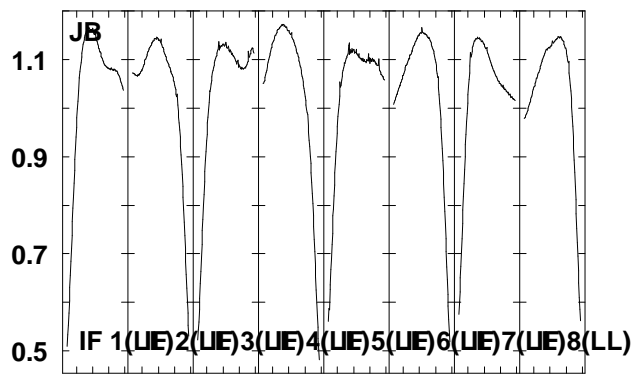
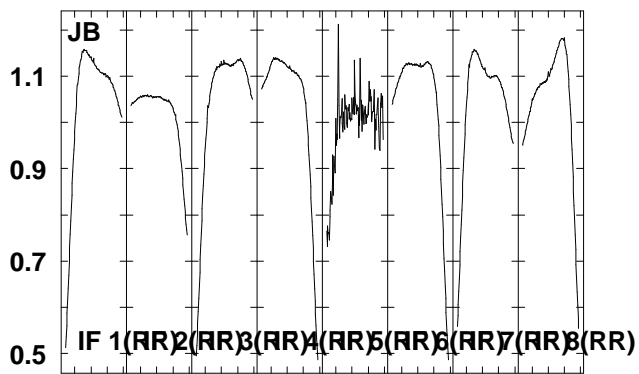
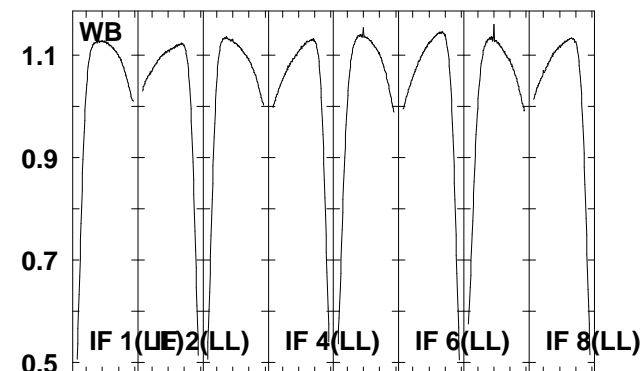
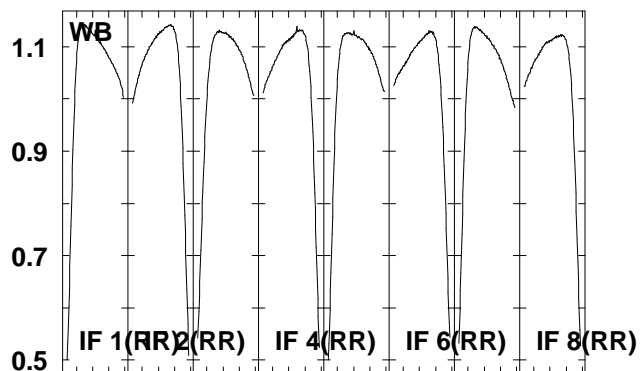
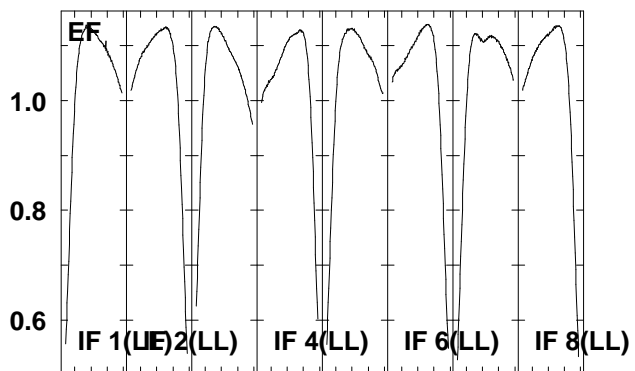
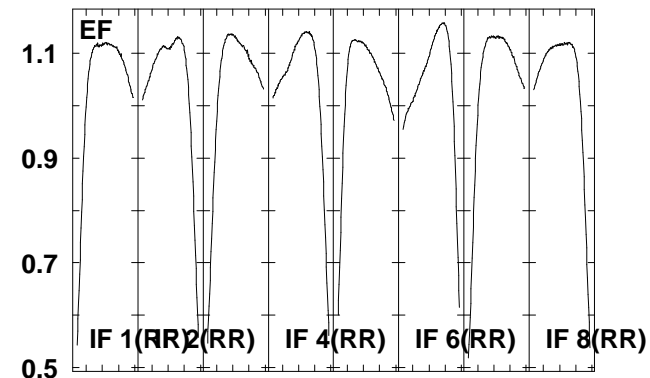
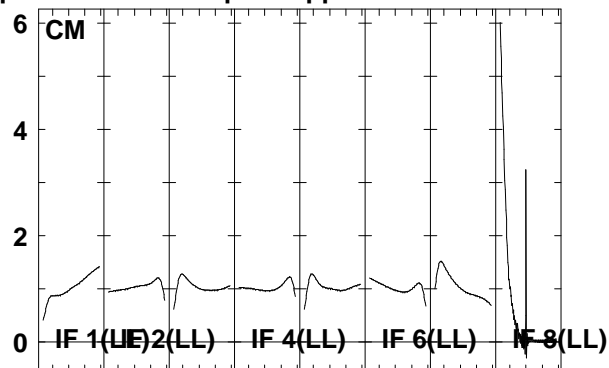
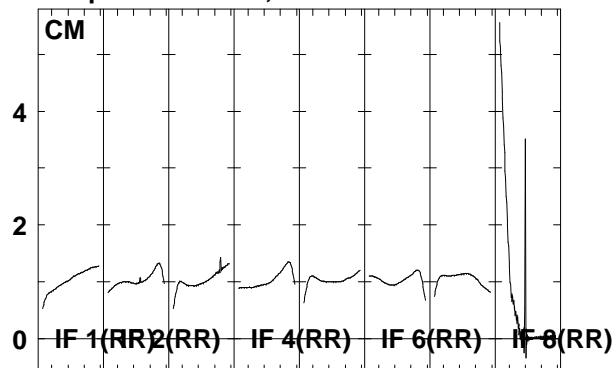

6663.6665.6667.6669.6671.6673.6675.6677.5
 FREQ MHz

6663.6665.6667.6669.6671.6673.6675.6677.5
 FREQ MHz

6663.6665.6667.6669.6671.6673.6675.6677.5
 FREQ MHz

Lower frame: Real Jy
 Total-power spectrum Antenna: *
 Timerange: 00/04:50:01 to 00/04:52:59

Plot file version 14 created 22-JUN-2006 20:02:59

J1825-17 EM061A 1.UVDATA.1

Freq = 6.6631 GHz, Bw = 2.000 MH No calibration applied and no bandpass applied

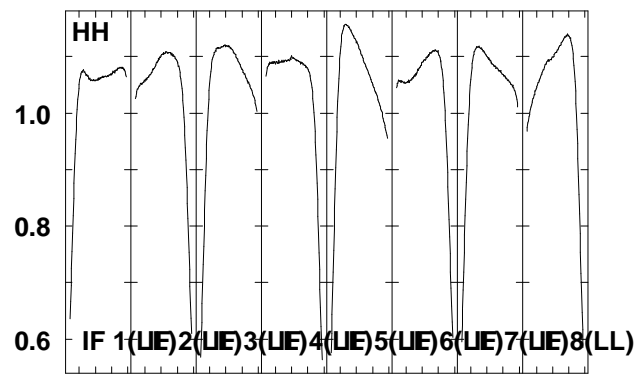
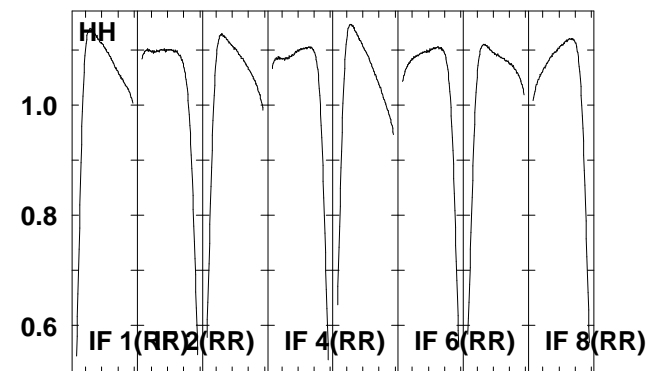
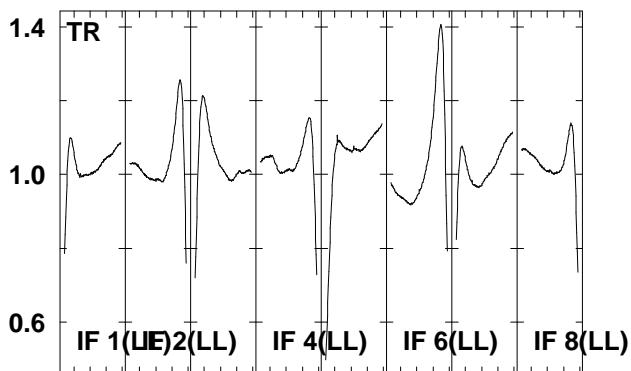
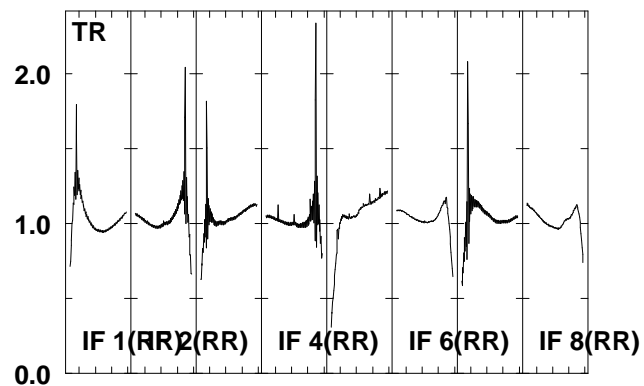
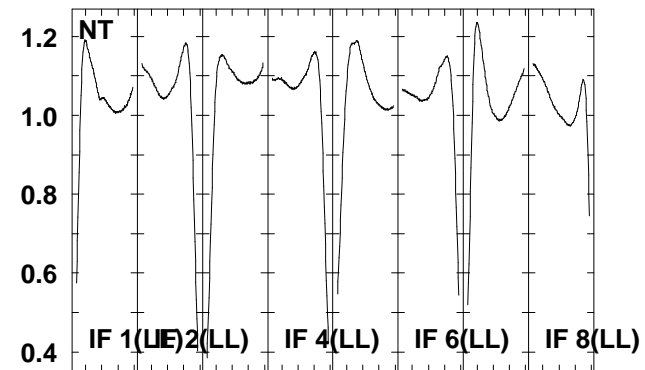
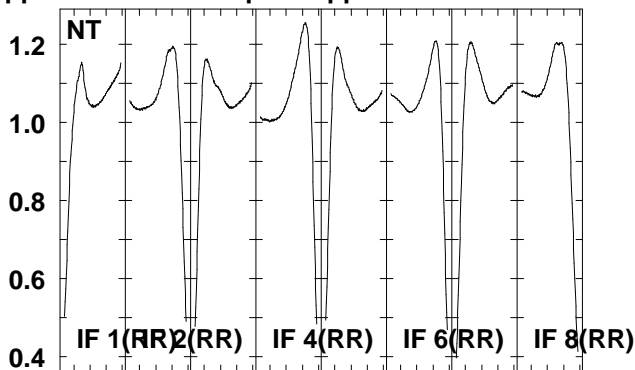
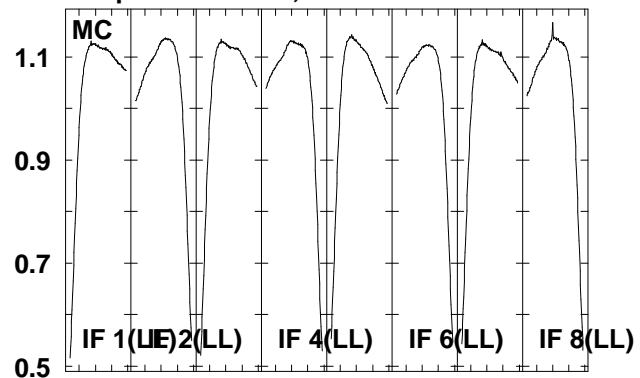

6663.6665.6667.6669.6671.6673.6675.6677.5

FREQ MHz

Lower frame: Real Jy

Total-power spectrum Antenna: *

Timerange: 00/04:50:01 to 00/04:52:59

Plot file version 15 created 22-JUN-2006 20:03:04
 G16.59-0 EM061A 1.UVDATA.1
 Freq = 6.6631 GHz, Bw = 2.000 MH No calibration applied and no bandpass applied

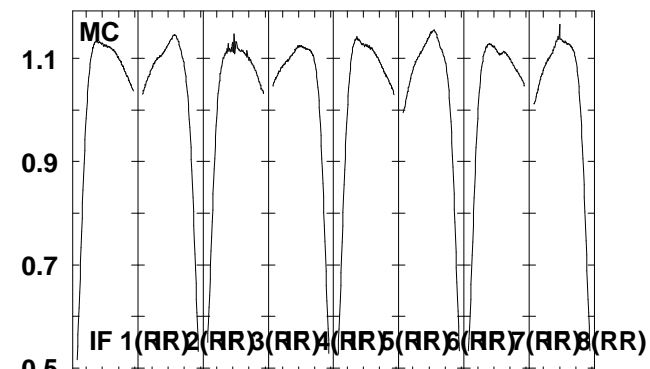
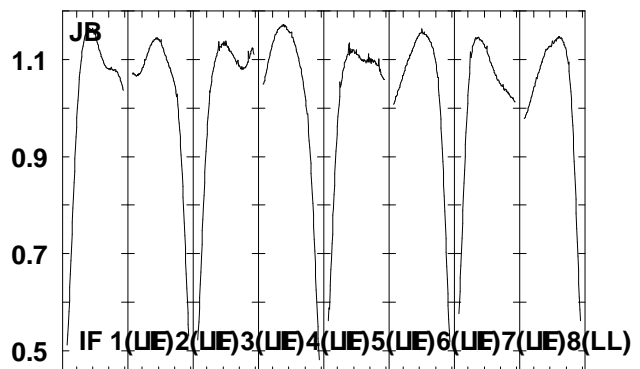
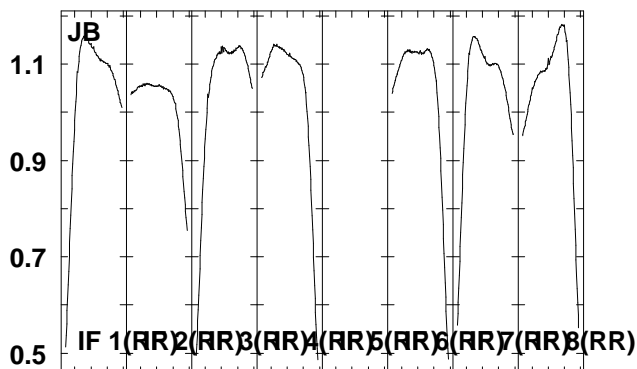
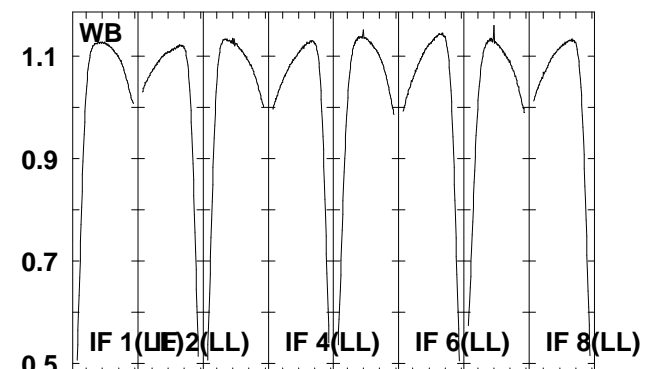
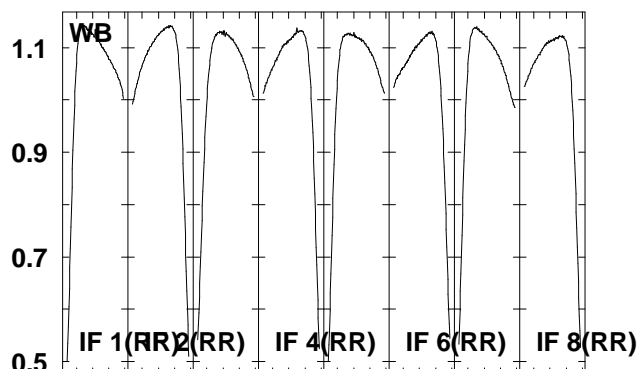
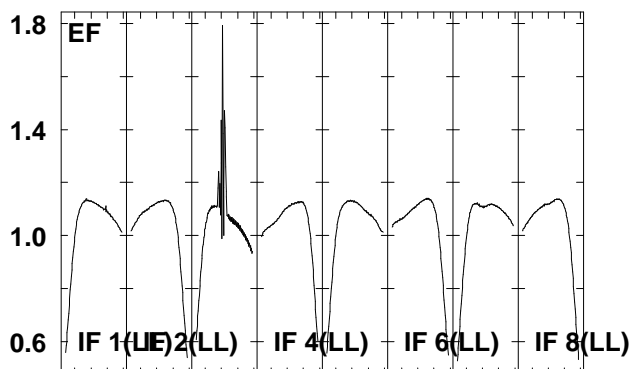
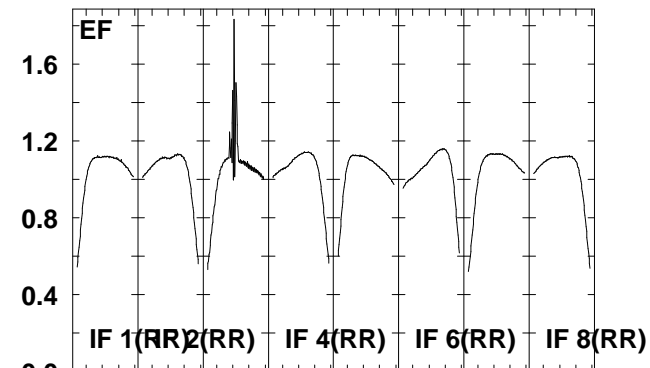
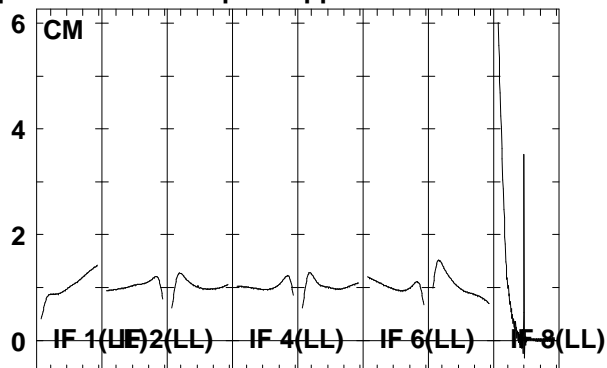
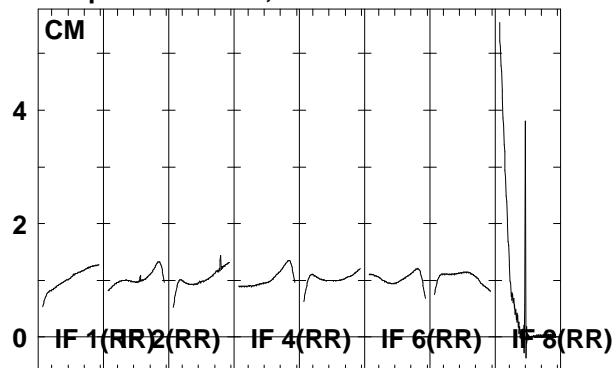

6663.6665.6667.6669.6671.6673.6675.6677.5
 FREQ MHz

6663.6665.6667.6669.6671.6673.6675.6677.5
 FREQ MHz

6663.6665.6667.6669.6671.6673.6675.6677.5
 FREQ MHz

Lower frame: Real Jy
 Total-power spectrum Antenna: *
 Timerange: 00/04:53:01 to 00/04:55:29

Plot file version 16 created 22-JUN-2006 20:03:07

G16.59-0 EM061A 1.UVDATA.1

Freq = 6.6631 GHz, Bw = 2.000 MH No calibration applied and no bandpass applied

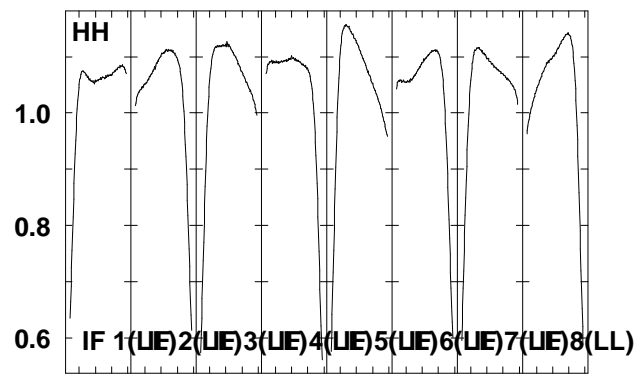
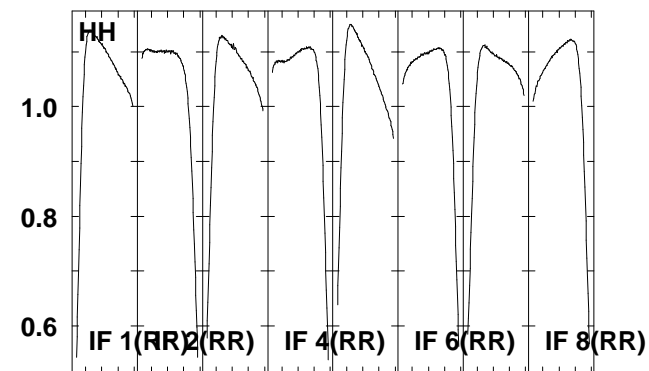
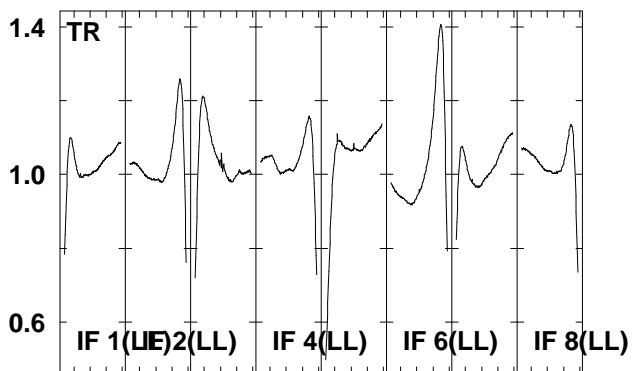
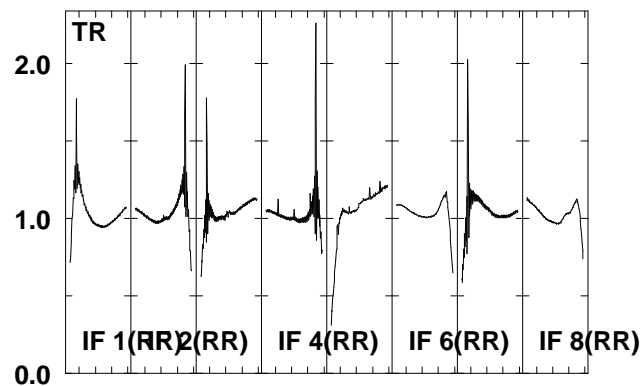
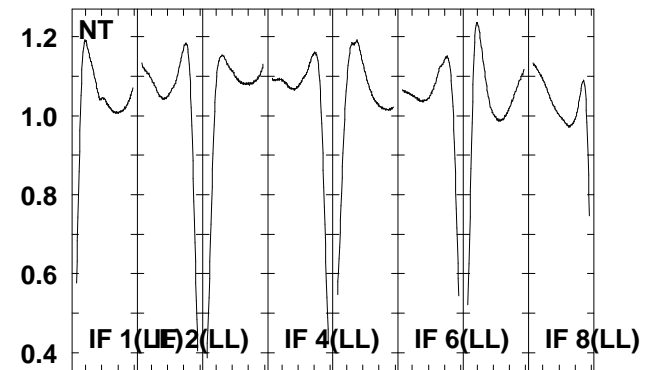
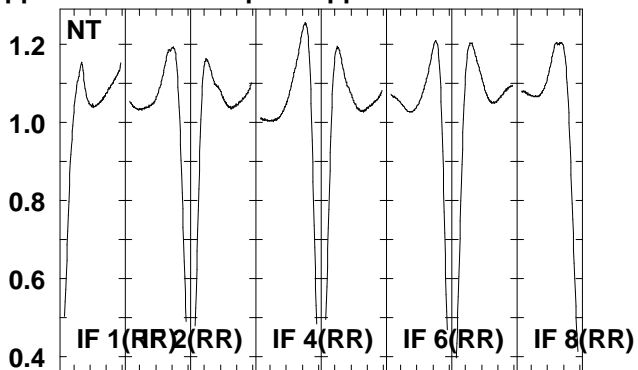
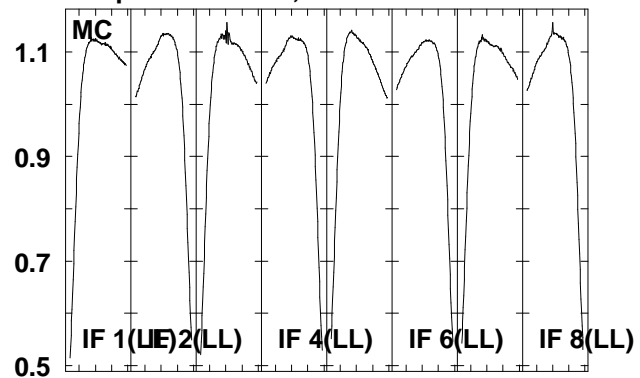

6663.6665.6667.6669.6671.6673.6675.6677.5

FREQ MHz

Lower frame: Real Jy

Total-power spectrum Antenna: *

Timerange: 00/04:53:01 to 00/04:55:29

Plot file version 17 created 22-JUN-2006 20:03:11
 J1825-17 EM061A 1.UVDATA.1
 Freq = 6.6631 GHz, Bw = 2.000 MH No calibration applied and no bandpass applied

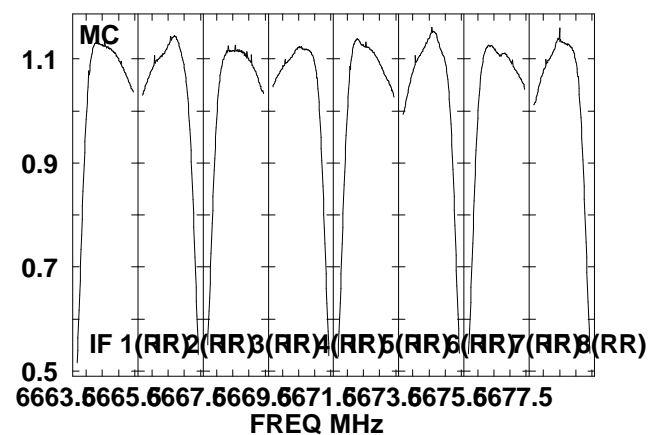
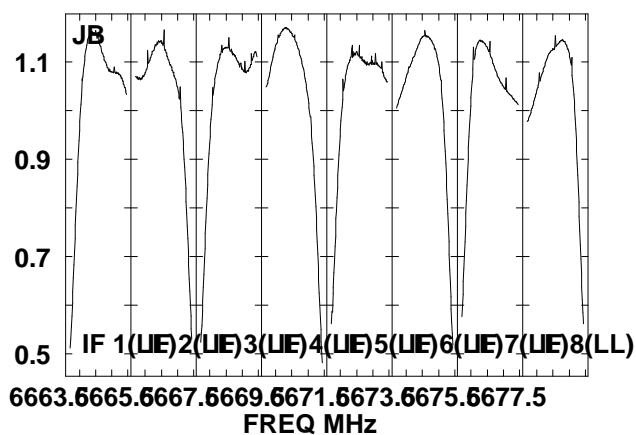
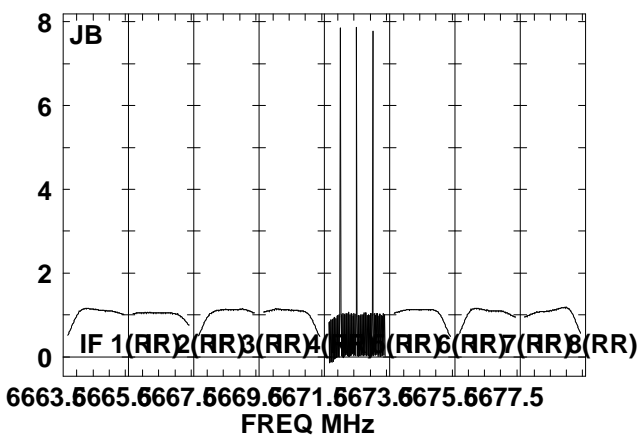
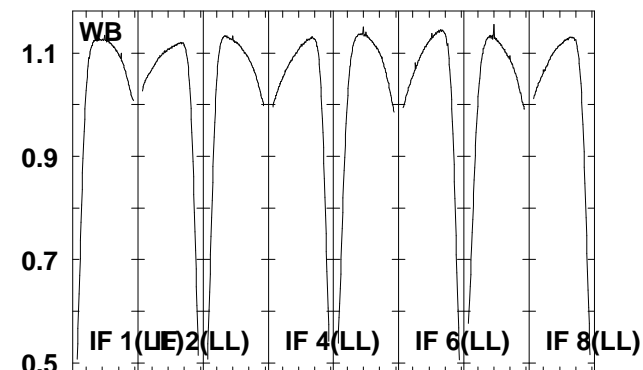
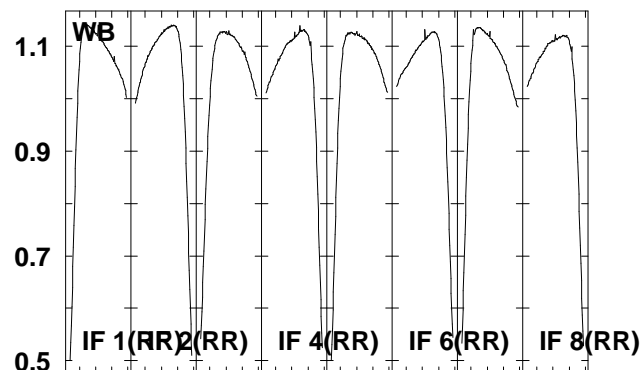
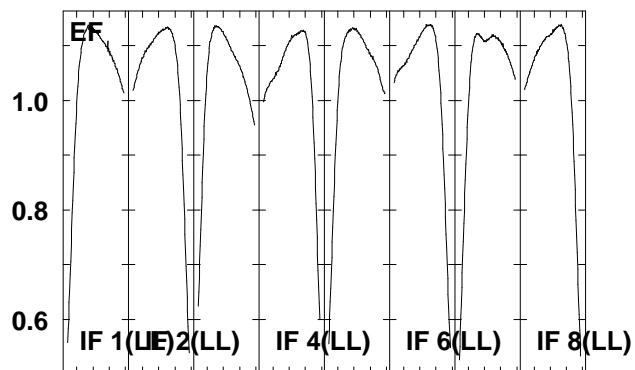
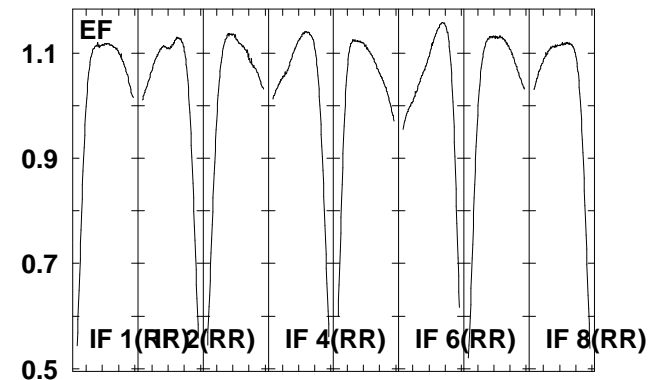
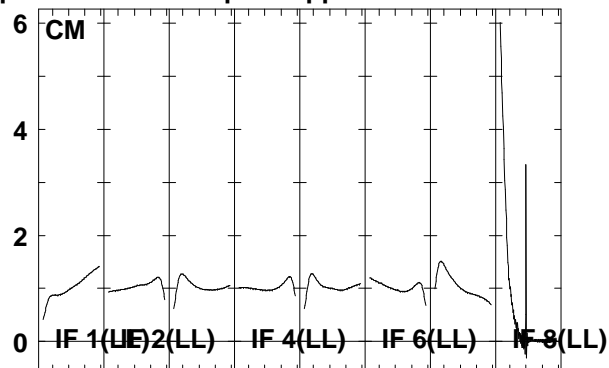
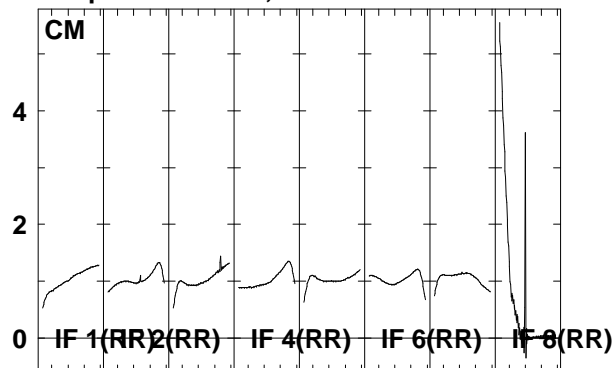

Lower frame: Real Jy
 Total-power spectrum Antenna: *
 Timerange: 00/04:57:02 to 00/04:59:59

Plot file version 18 created 22-JUN-2006 20:03:15

J1825-17 EM061A 1.UVDATA.1

Freq = 6.6631 GHz, Bw = 2.000 MH No calibration applied and no bandpass applied

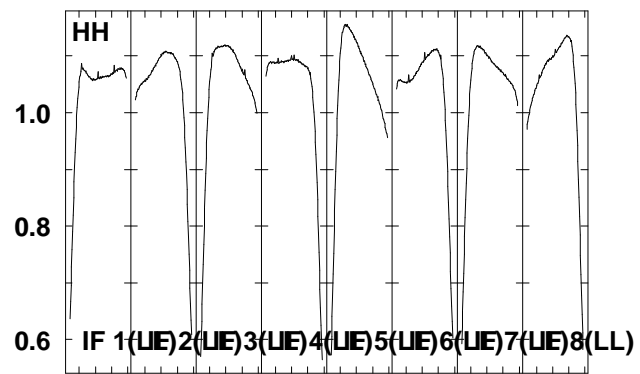
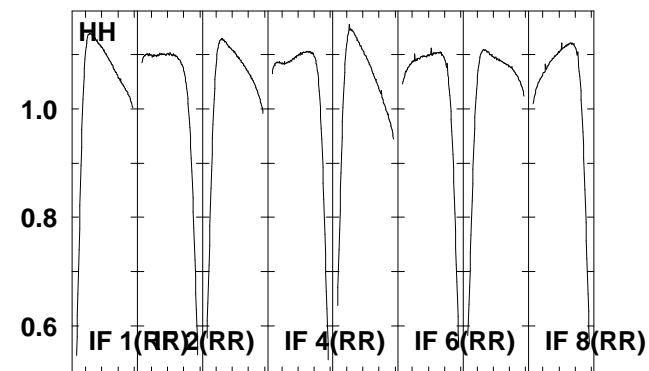
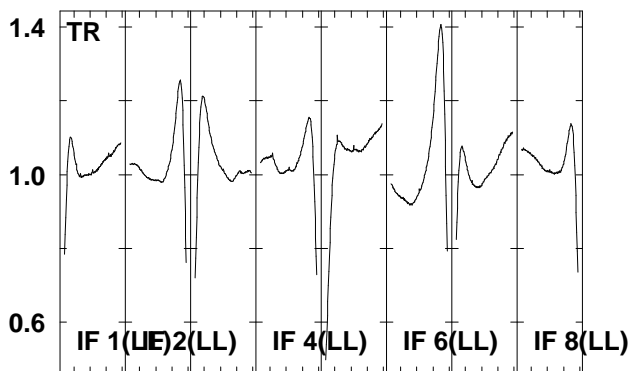
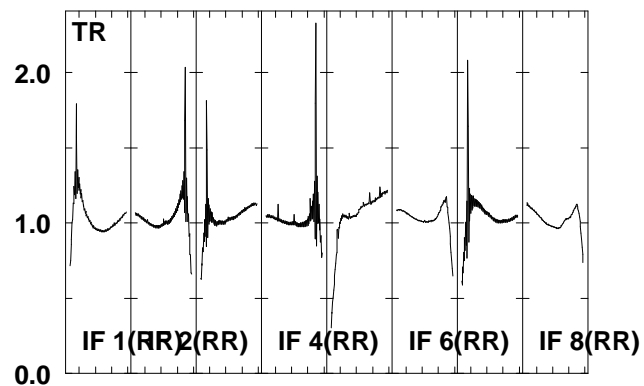
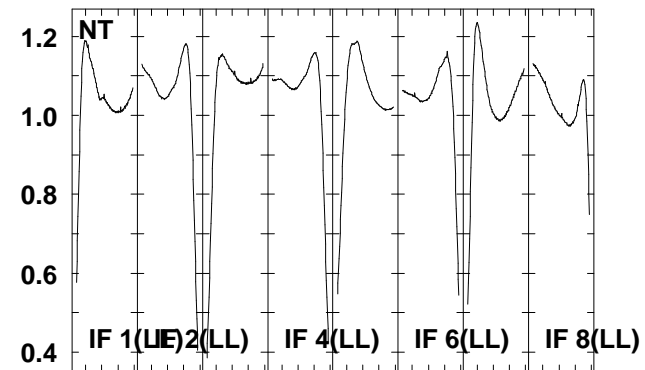
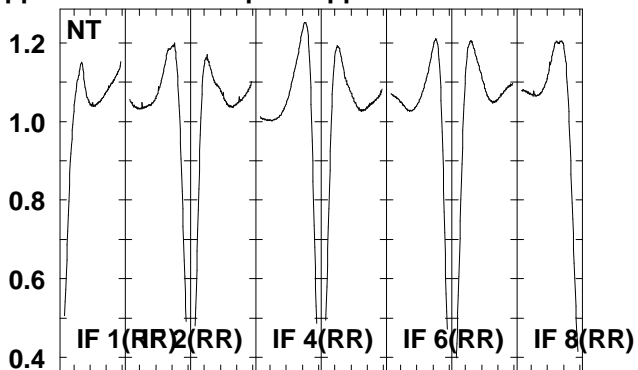
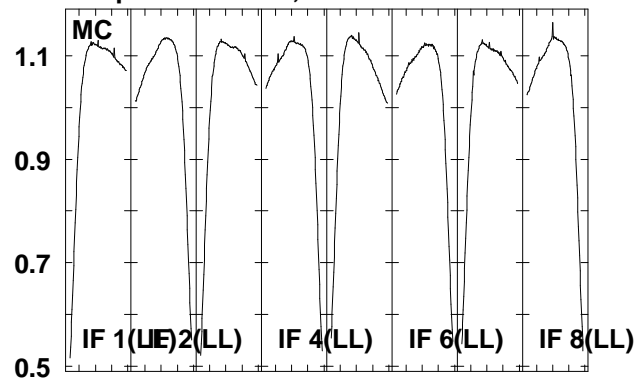

6663.6665.6667.6669.6671.6673.6675.6677.5

FREQ MHz

Lower frame: Real Jy

Total-power spectrum Antenna: *

Timerange: 00/04:57:02 to 00/04:59:59

Plot file version 19 created 22-JUN-2006 20:03:20
 G16.59-0 EM061A 1.UVDATA.1
 Freq = 6.6631 GHz, Bw = 2.000 MH No calibration applied and no bandpass applied

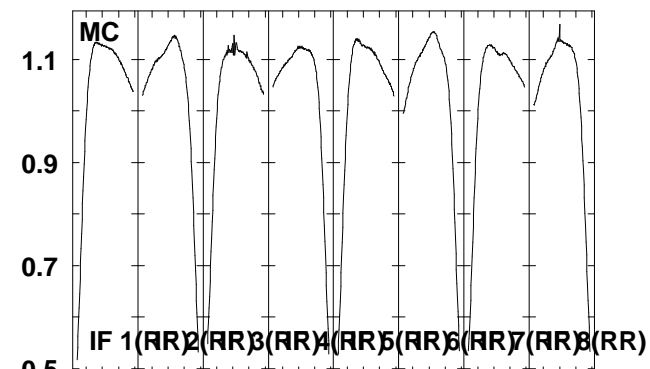
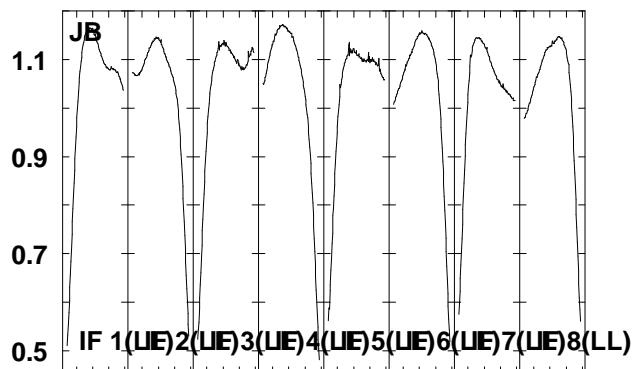
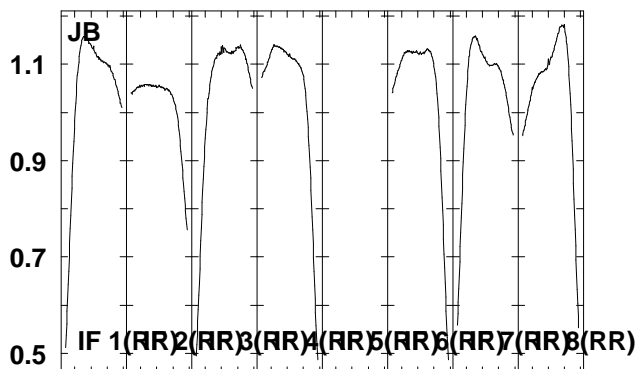
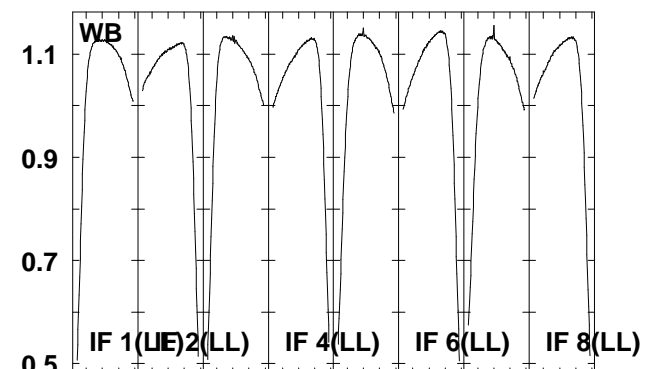
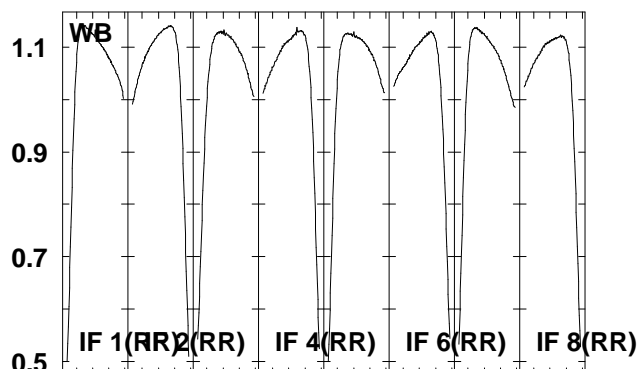
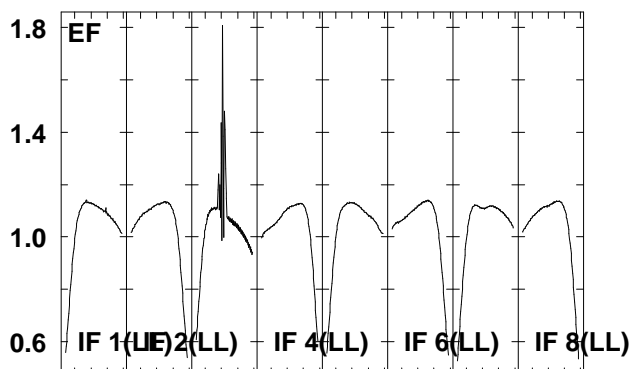
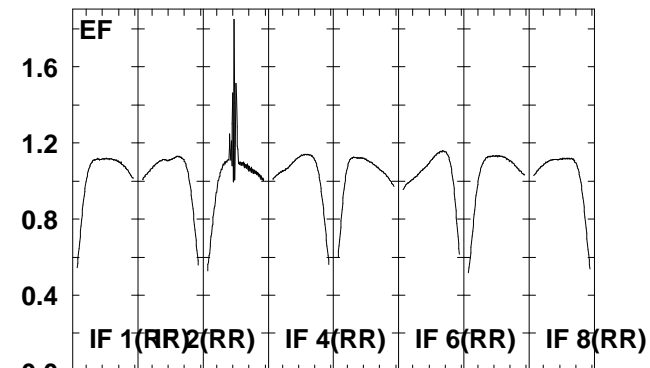
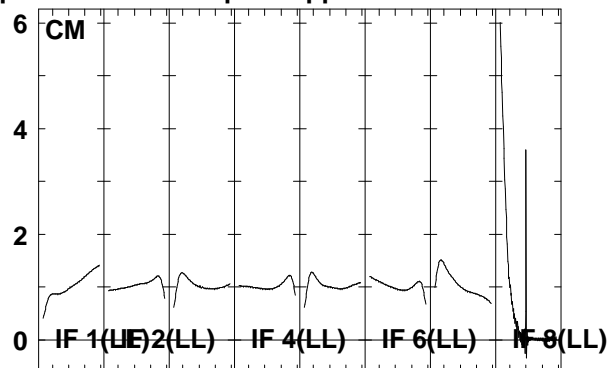
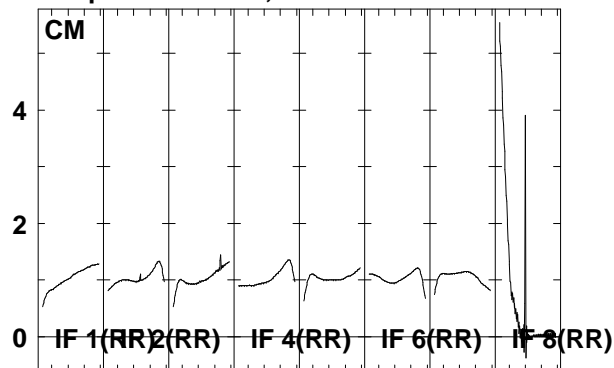

6663.6665.6667.6669.6671.6673.6675.6677.5
 FREQ MHz

6663.6665.6667.6669.6671.6673.6675.6677.5
 FREQ MHz

6663.6665.6667.6669.6671.6673.6675.6677.5
 FREQ MHz

Lower frame: Real Jy
 Total-power spectrum Antenna: *
 Timerange: 00/05:00:01 to 00/05:02:29

Plot file version 20 created 22-JUN-2006 20:03:24
 G16.59-0 EM061A 1.UVDATA.1
 Freq = 6.6631 GHz, Bw = 2.000 MH No calibration applied and no bandpass applied

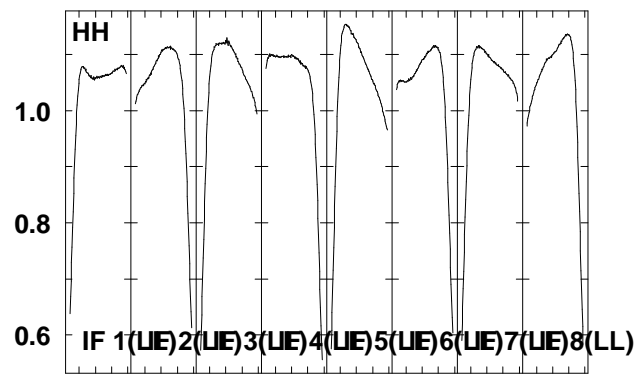
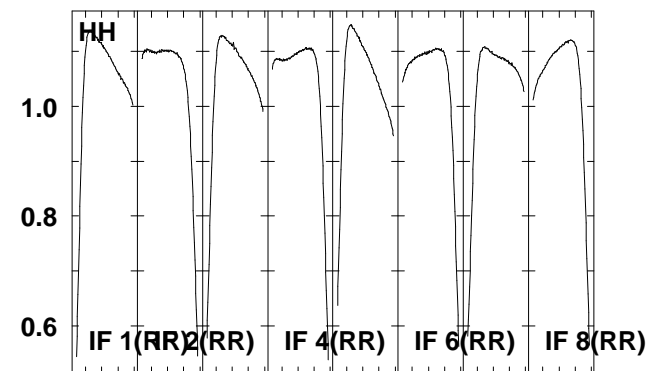
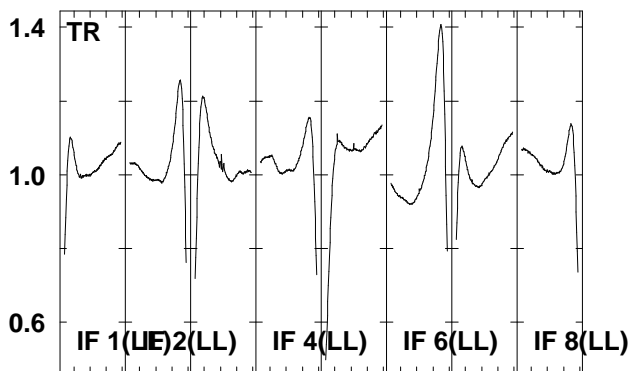
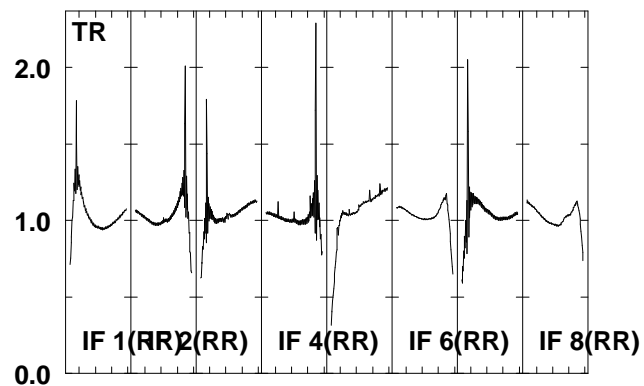
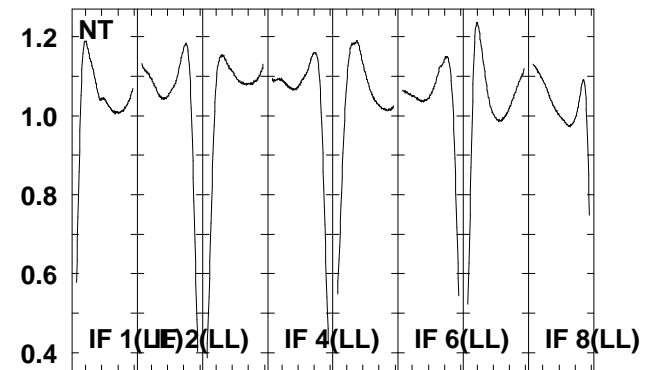
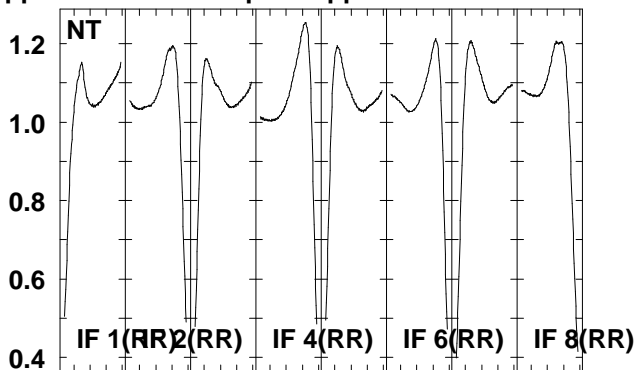
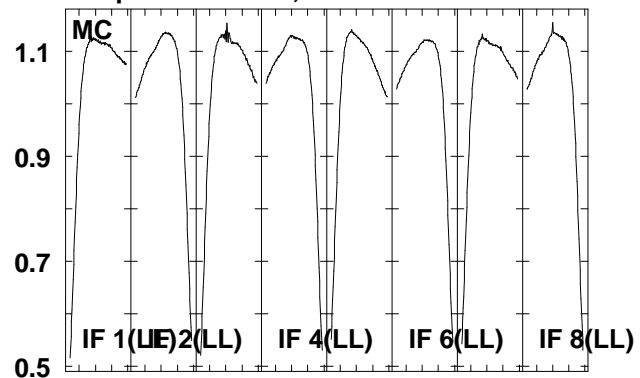

6663.6665.6667.6669.6671.6673.6675.6677.5
 FREQ MHz

Lower frame: Real Jy
 Total-power spectrum Antenna: *
 Timerange: 00/05:00:01 to 00/05:02:29

Plot file version 21 created 22-JUN-2006 20:03:28
 J1825-17 EM061A 1.UVDATA.1
 Freq = 6.6631 GHz, Bw = 2.000 MH No calibration applied and no bandpass applied

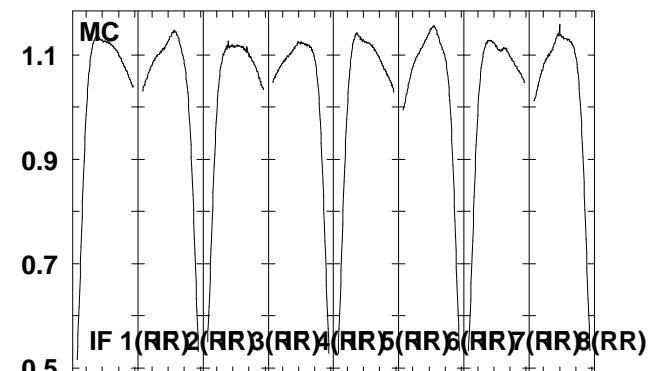
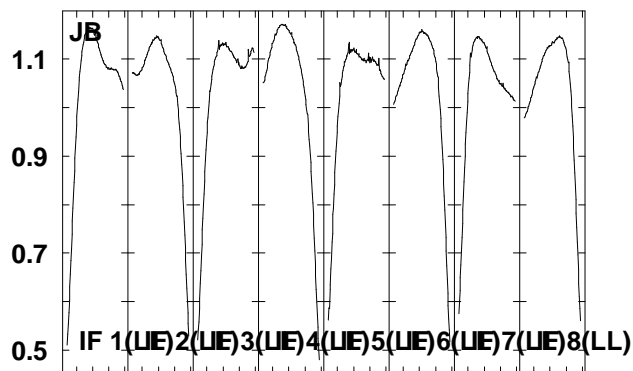
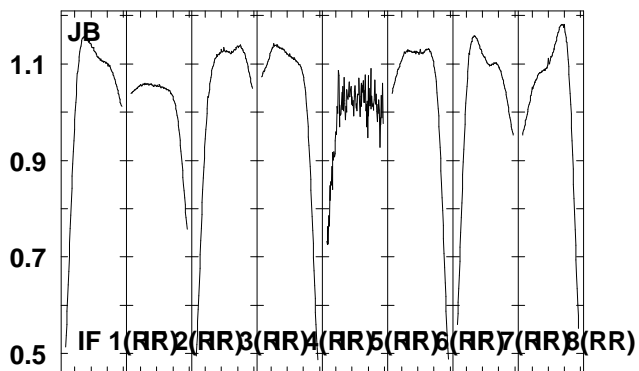
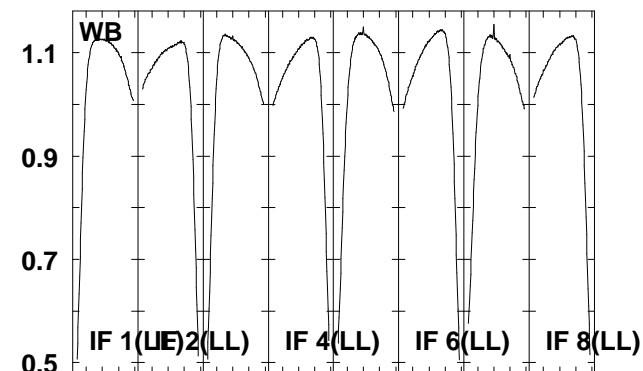
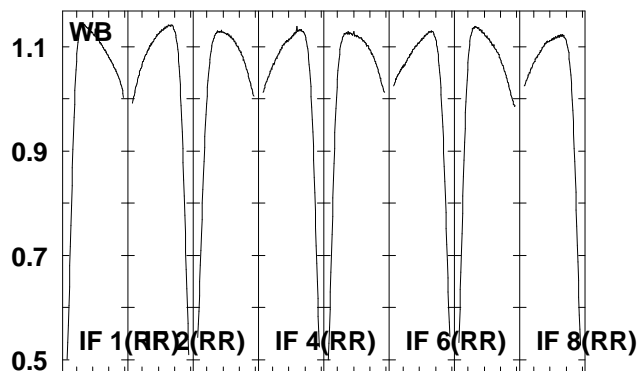
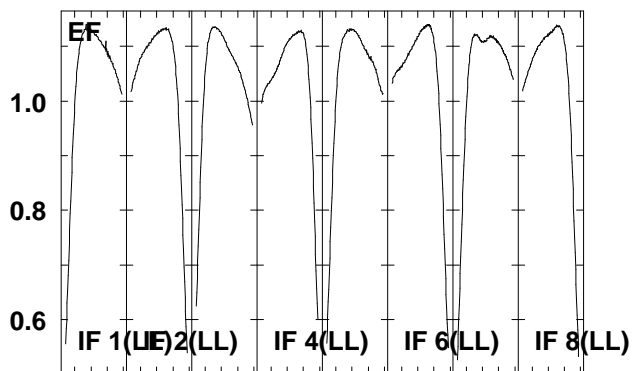
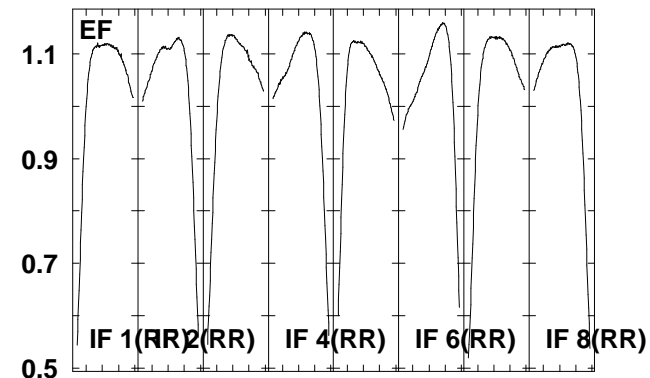
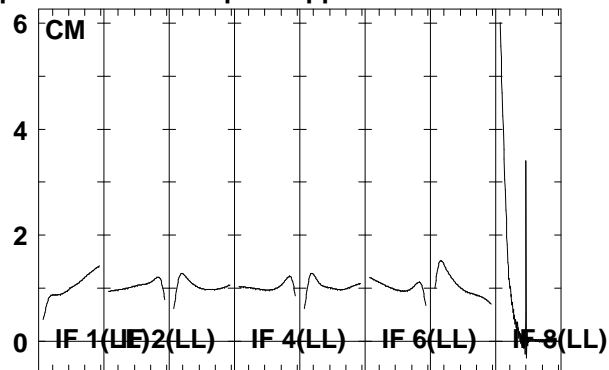
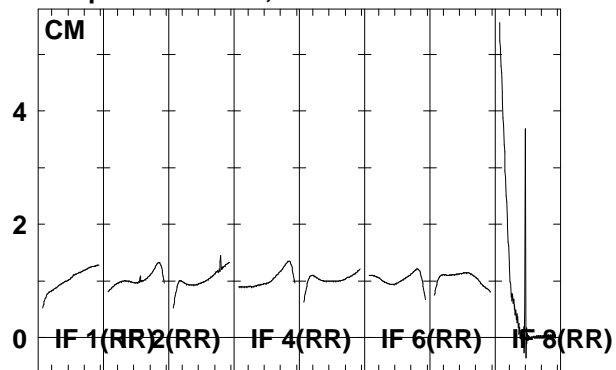

6663.6665.6667.6669.6671.6673.6675.6677.5
 FREQ MHz

6663.6665.6667.6669.6671.6673.6675.6677.5
 FREQ MHz

6663.6665.6667.6669.6671.6673.6675.6677.5
 FREQ MHz

Lower frame: Real Jy
 Total-power spectrum Antenna: *
 Timerange: 00/05:02:31 to 00/05:05:29

Plot file version 22 created 22-JUN-2006 20:03:32

J1825-17 EM061A 1.UVDATA.1

Freq = 6.6631 GHz, Bw = 2.000 MH No calibration applied and no bandpass applied

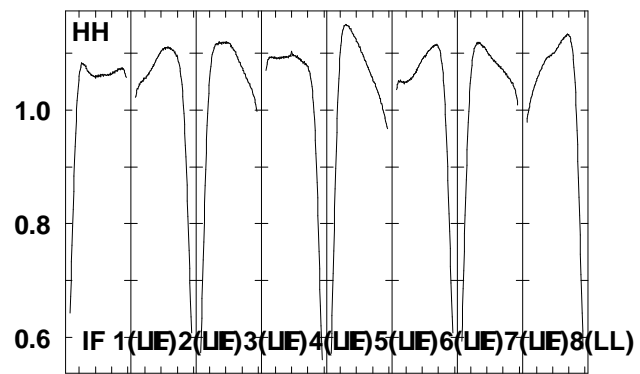
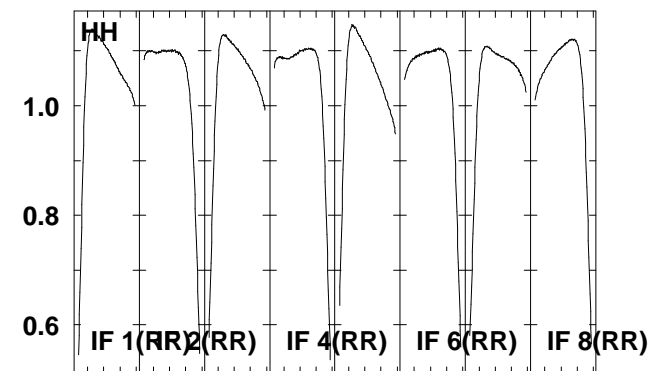
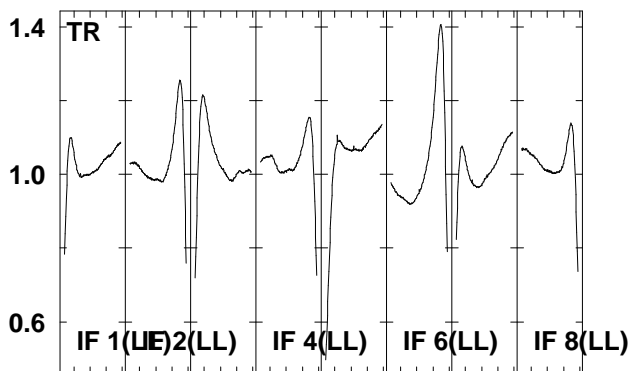
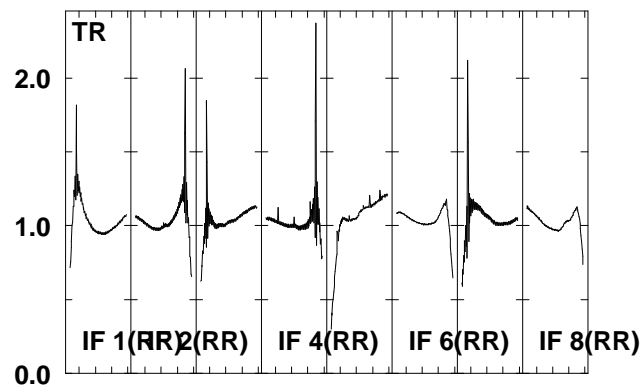
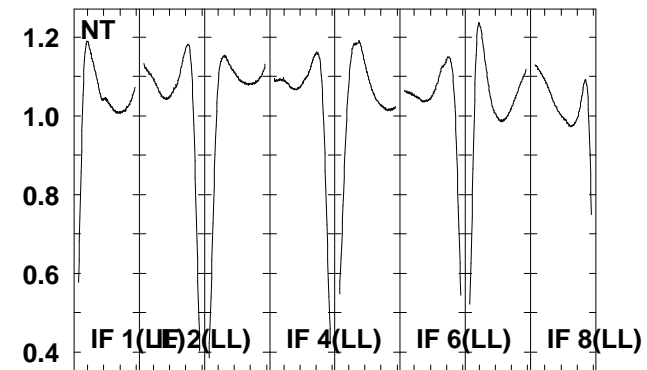
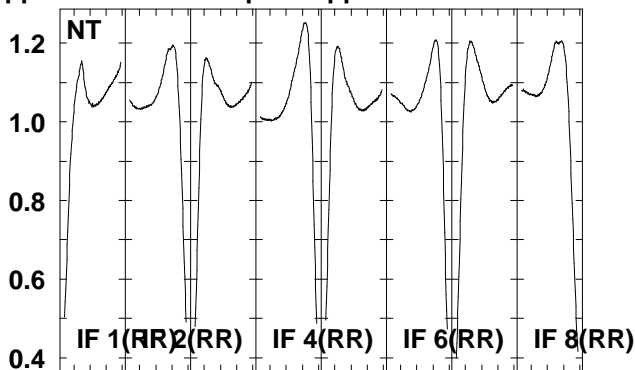
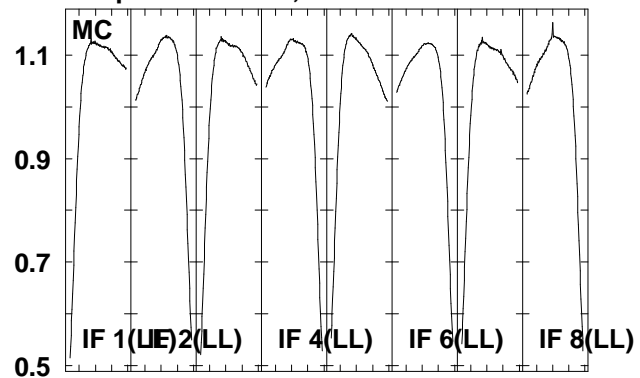

6663.6665.6667.6669.6671.6673.6675.6677.5

FREQ MHz

Lower frame: Real Jy

Total-power spectrum Antenna: *

Timerange: 00/05:02:31 to 00/05:05:29

Plot file version 23 created 22-JUN-2006 20:03:36
 G16.59-0 EM061A 1.UVDATA.1
 Freq = 6.6631 GHz, Bw = 2.000 MH No calibration applied and no bandpass applied

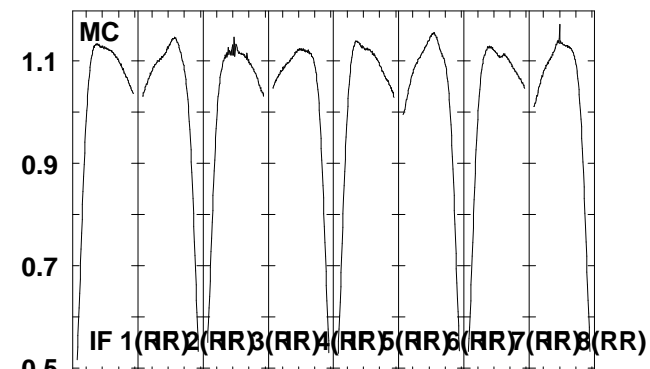
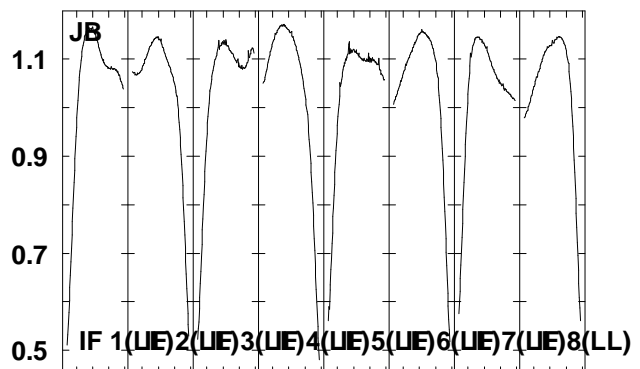
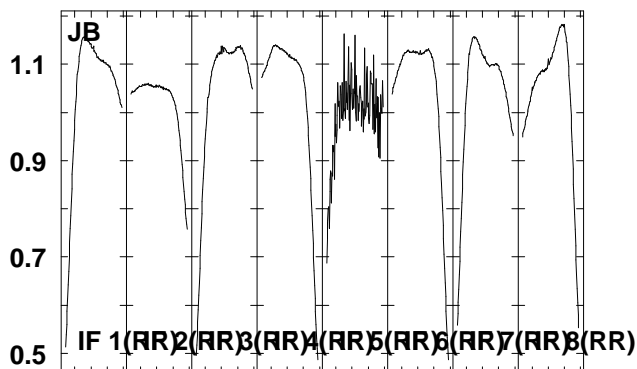
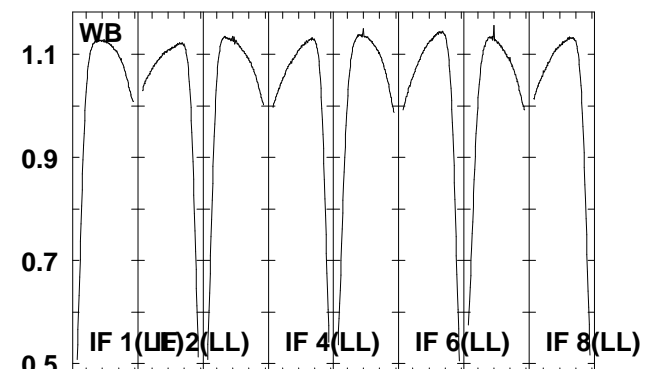
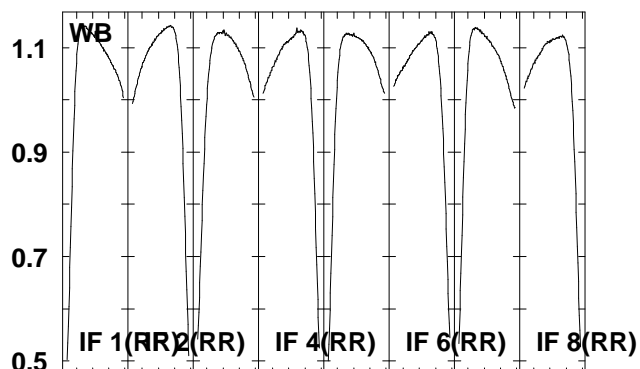
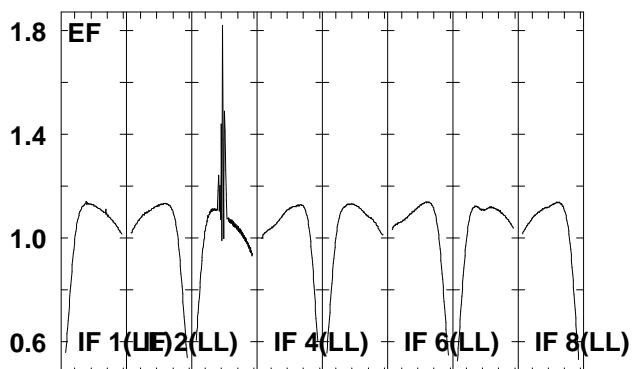
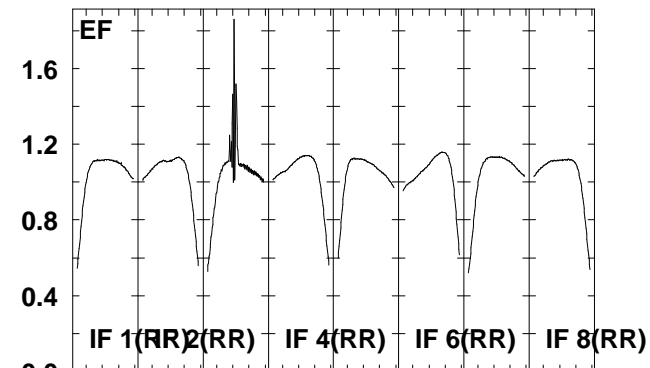
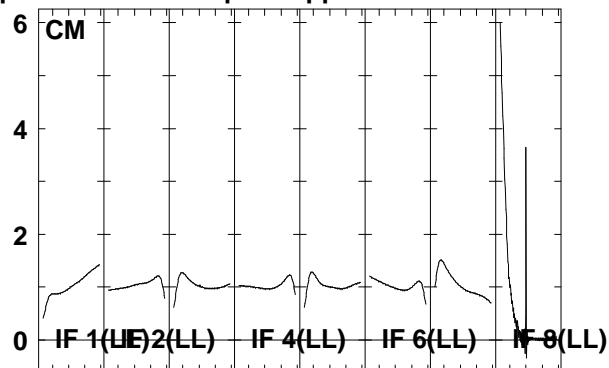
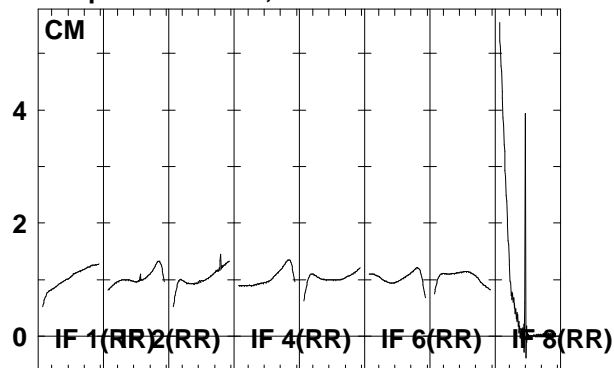

6663.6665.6667.6669.6671.6673.6675.6677.5
 FREQ MHz

6663.6665.6667.6669.6671.6673.6675.6677.5
 FREQ MHz

6663.6665.6667.6669.6671.6673.6675.6677.5
 FREQ MHz

Lower frame: Real Jy
 Total-power spectrum Antenna: *
 Timerange: 00/05:05:31 to 00/05:07:59

Plot file version 24 created 22-JUN-2006 20:03:39
 G16.59-0 EM061A 1.UVDATA.1
 Freq = 6.6631 GHz, Bw = 2.000 MH No calibration applied and no bandpass applied

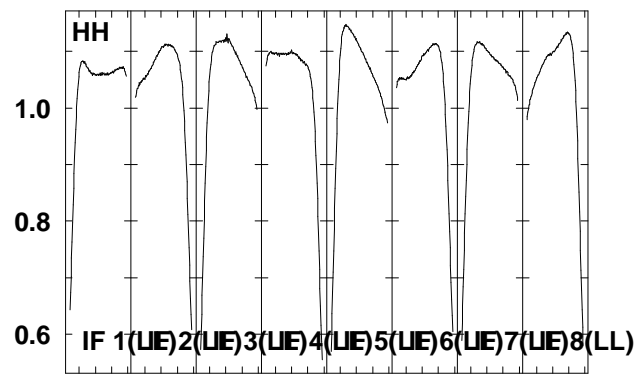
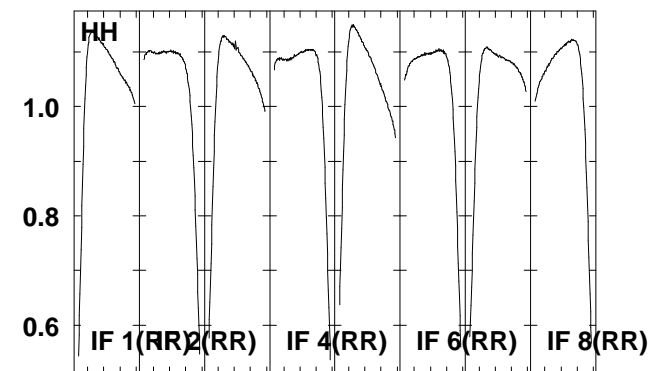
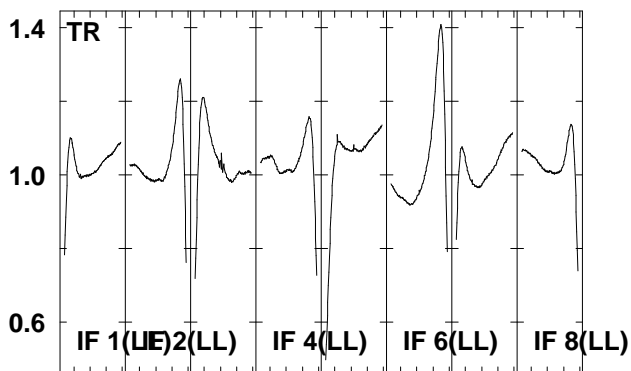
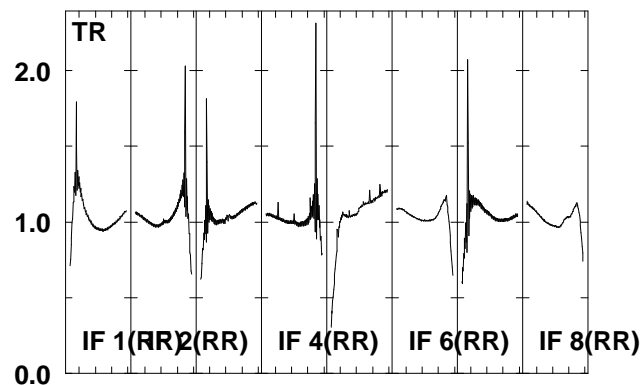
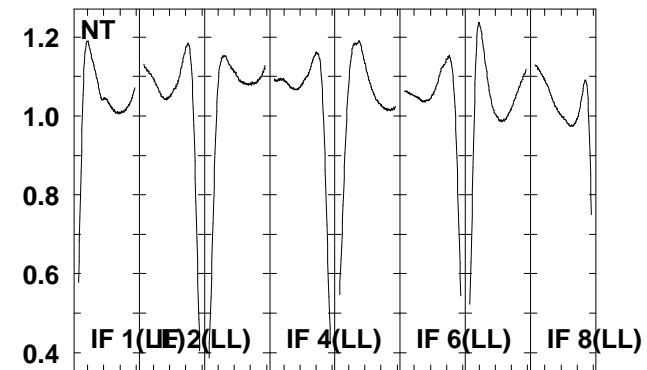
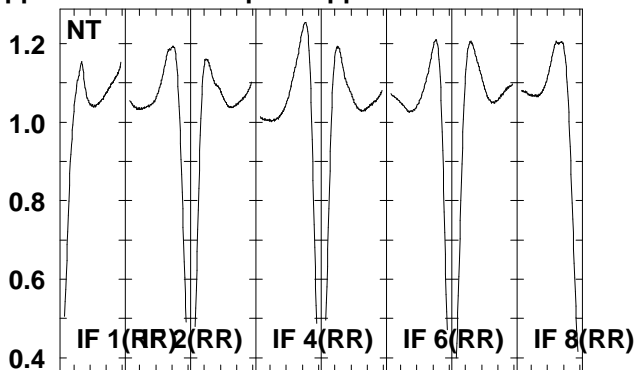
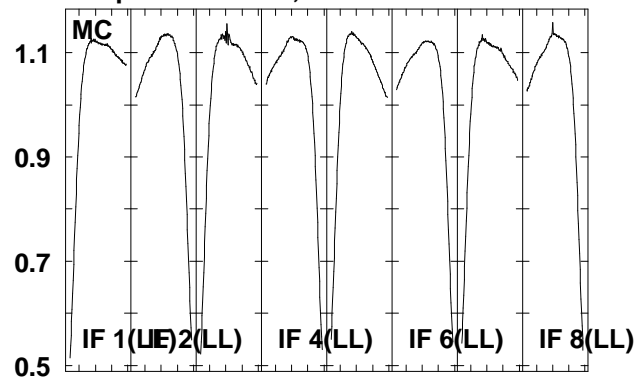

6663.6665.6667.6669.6671.6673.6675.6677.5
 FREQ MHz

Lower frame: Real Jy
 Total-power spectrum Antenna: *
 Timerange: 00/05:05:31 to 00/05:07:59

Plot file version 25 created 22-JUN-2006 20:03:41
 J1825-17 EM061A 1.UVDATA.1
 Freq = 6.6631 GHz, Bw = 2.000 MH No calibration applied and no bandpass applied

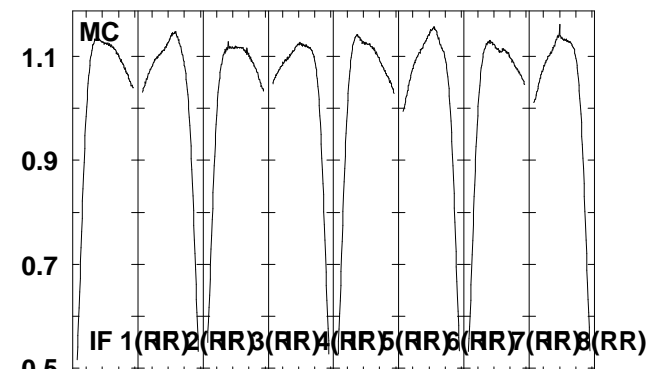
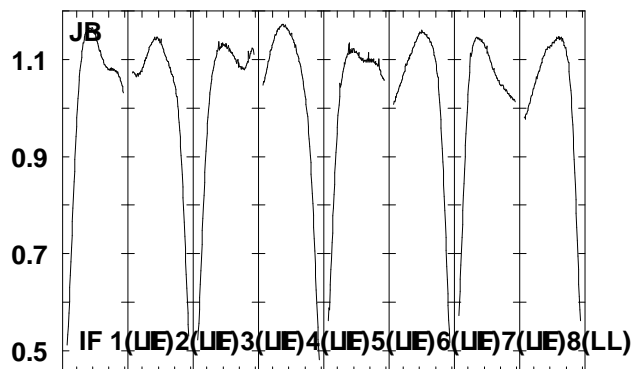
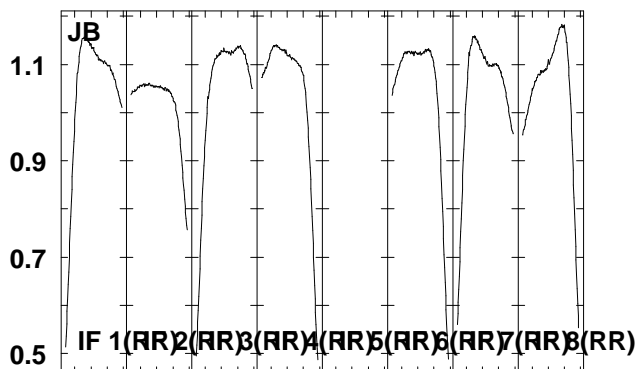
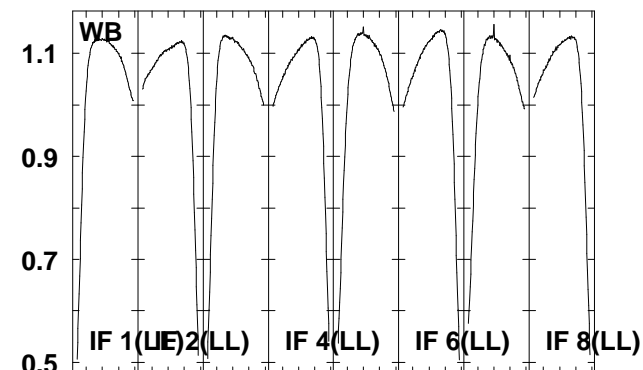
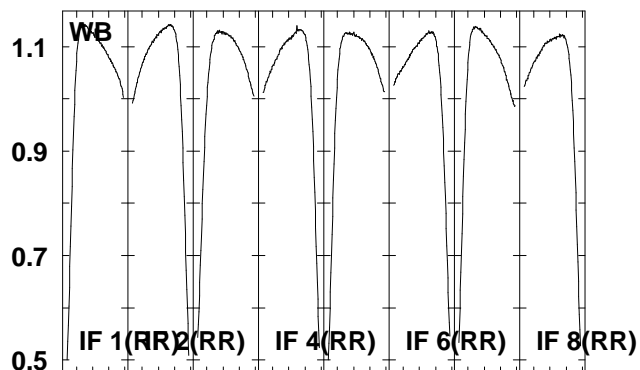
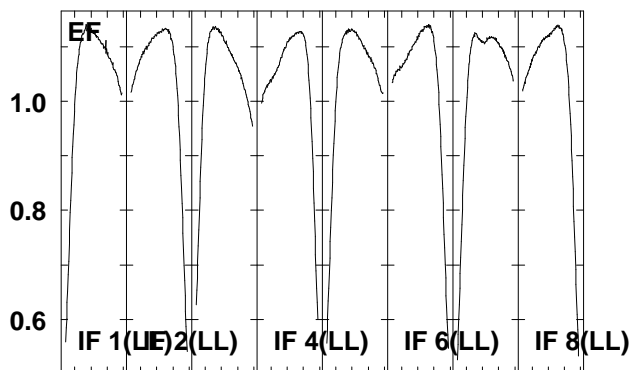
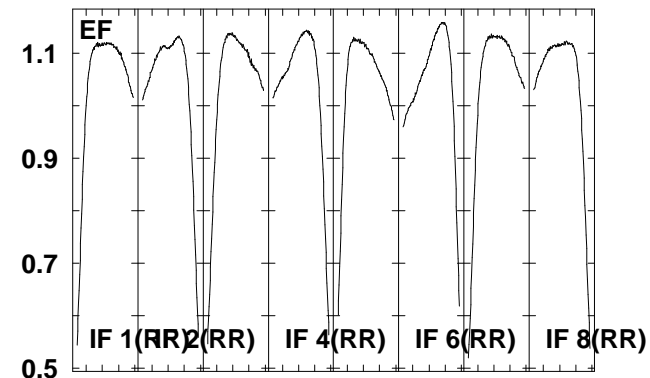
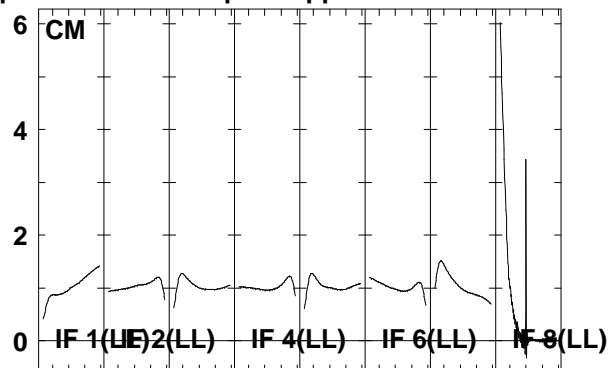
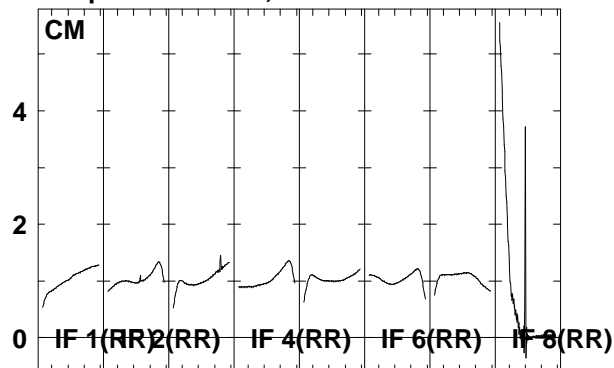

6663.6665.6667.6669.6671.6673.6675.6677.5
 FREQ MHz

6663.6665.6667.6669.6671.6673.6675.6677.5
 FREQ MHz

6663.6665.6667.6669.6671.6673.6675.6677.5
 FREQ MHz

Lower frame: Real Jy
 Total-power spectrum Antenna: *
 Timerange: 00/05:08:01 to 00/05:09:28

Plot file version 26 created 22-JUN-2006 20:03:43
 J1825-17 EM061A 1.UVDATA.1
 Freq = 6.6631 GHz, Bw = 2.000 MH No calibration applied and no bandpass applied

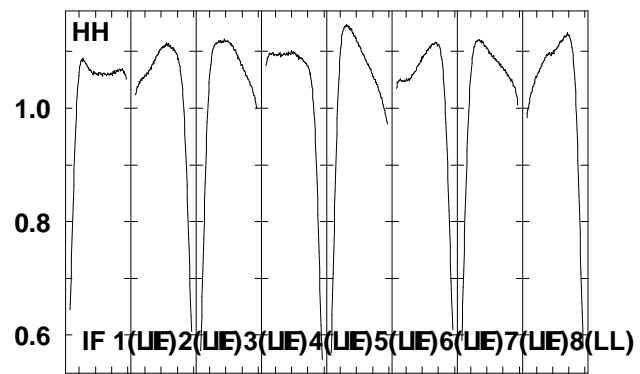
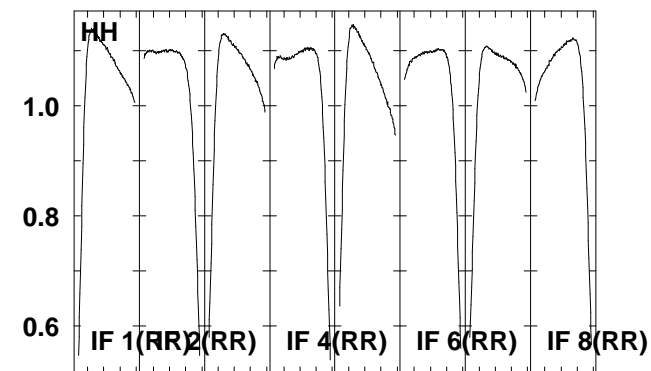
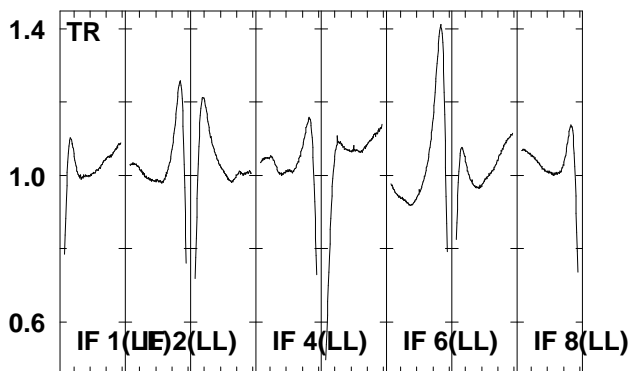
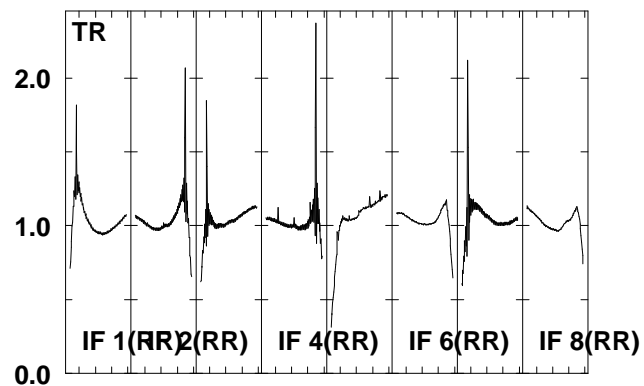
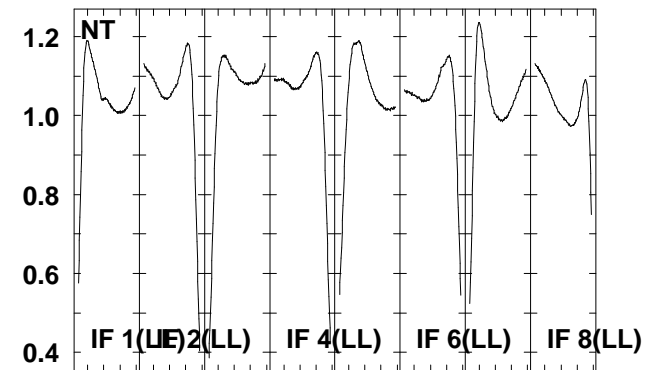
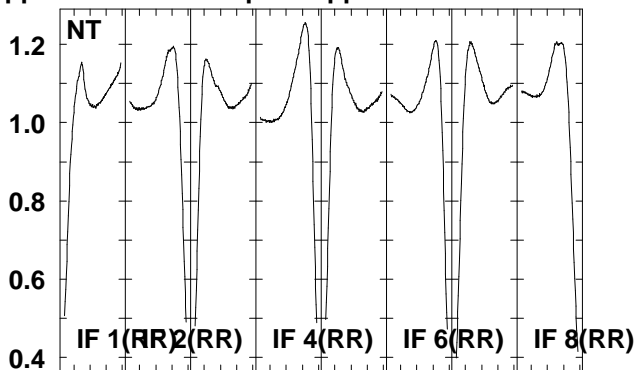
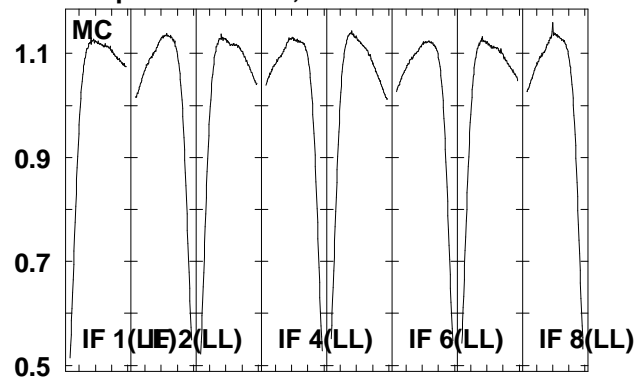

6663.6665.6667.6669.6671.6673.6675.6677.5
 FREQ MHz

Lower frame: Real Jy
 Total-power spectrum Antenna: *
 Timerange: 00/05:08:01 to 00/05:09:28

Plot file version 27 created 22-JUN-2006 20:03:45
 J1825-17 EM061A 1.UVDATA.1
 Freq = 6.6631 GHz, Bw = 2.000 MH No calibration applied and no bandpass applied

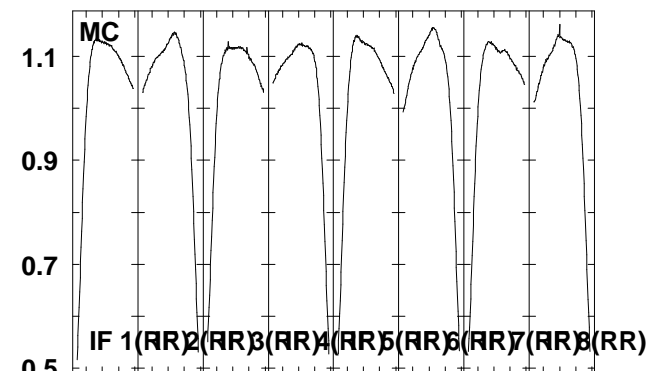
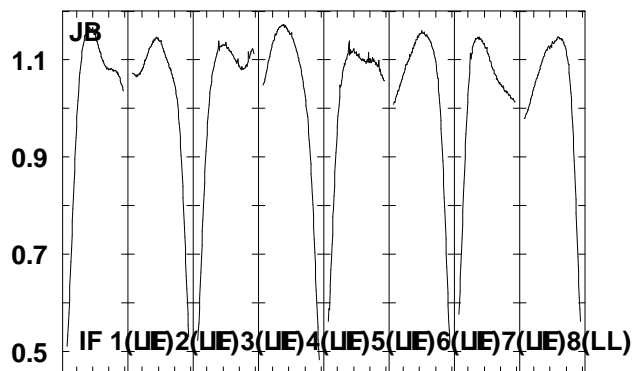
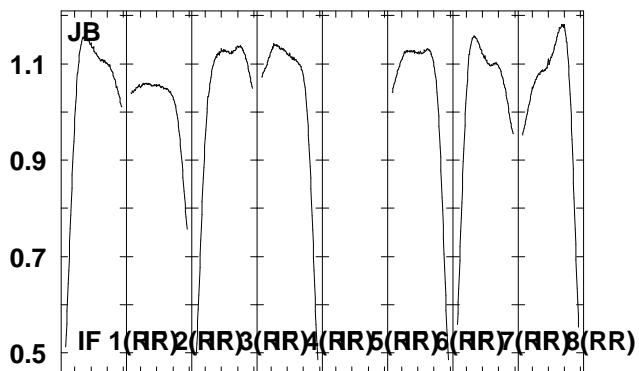
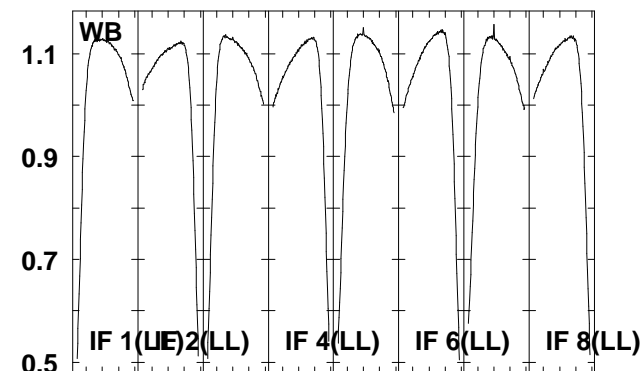
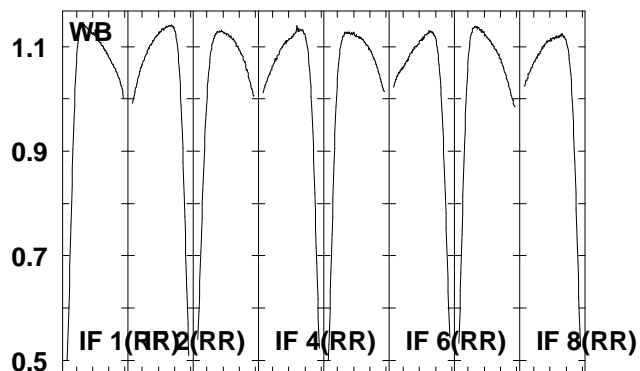
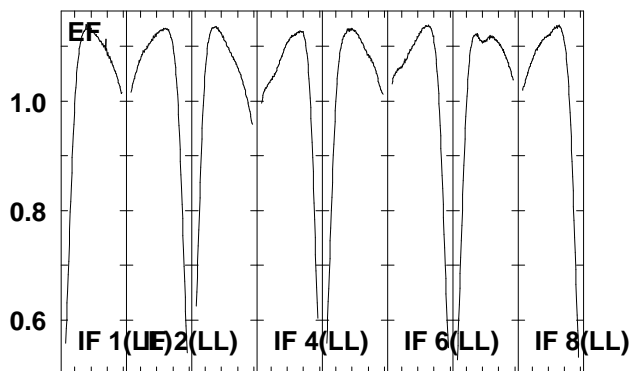
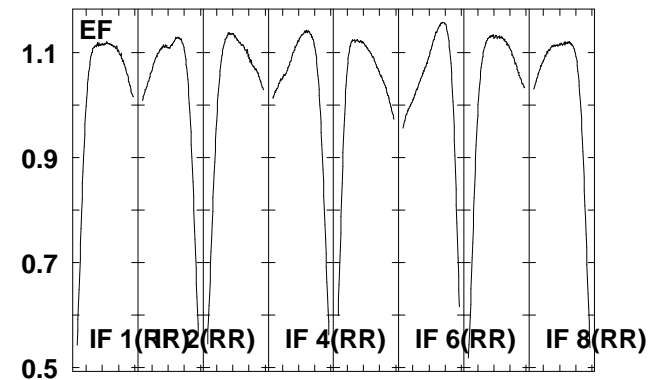
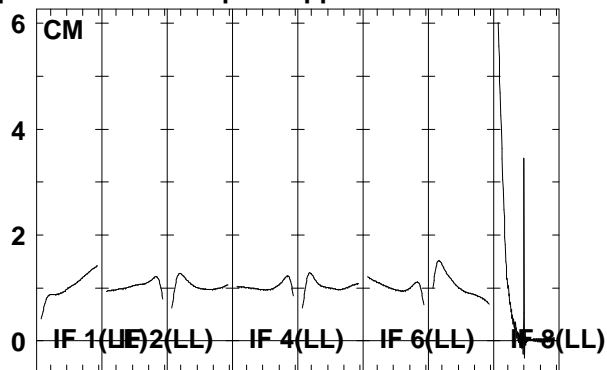
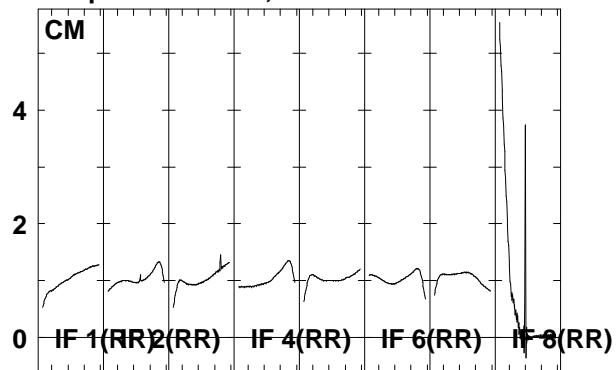

6663.6665.6667.6669.6671.6673.6675.6677.5
 FREQ MHz

6663.6665.6667.6669.6671.6673.6675.6677.5
 FREQ MHz

6663.6665.6667.6669.6671.6673.6675.6677.5
 FREQ MHz

Lower frame: Real Jy
 Total-power spectrum Antenna: *
 Timerange: 00/05:09:30 to 00/05:10:59

Plot file version 28 created 22-JUN-2006 20:03:47
 J1825-17 EM061A 1.UVDATA.1
 Freq = 6.6631 GHz, Bw = 2.000 MH No calibration applied and no bandpass applied

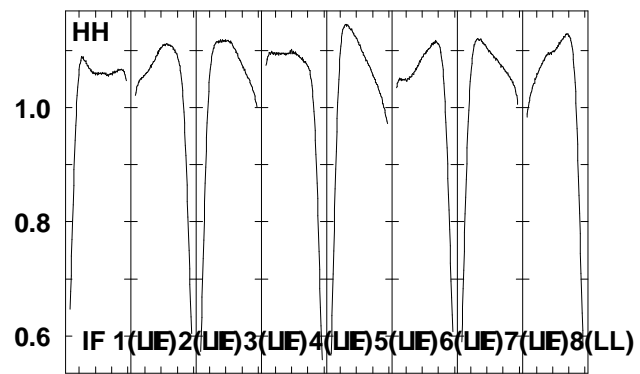
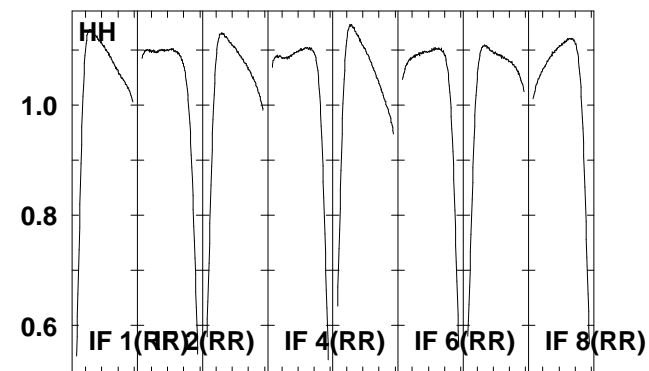
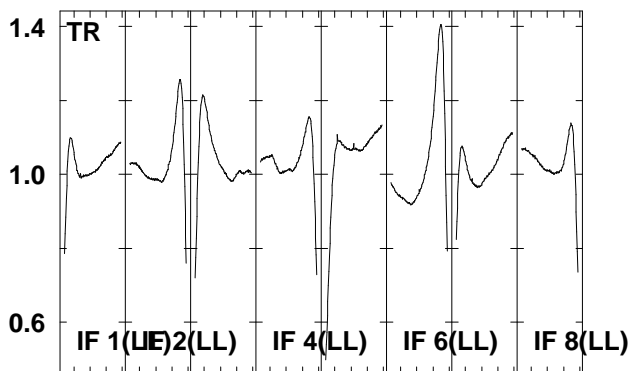
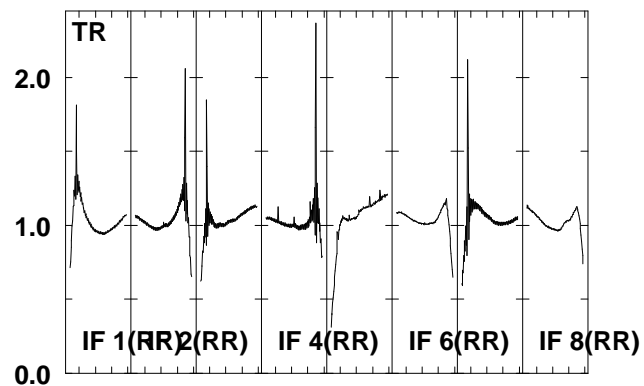
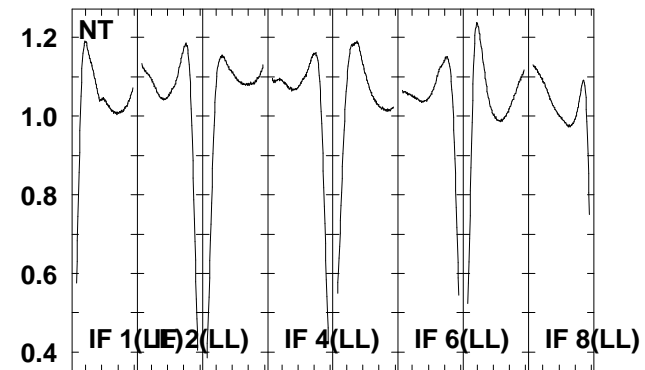
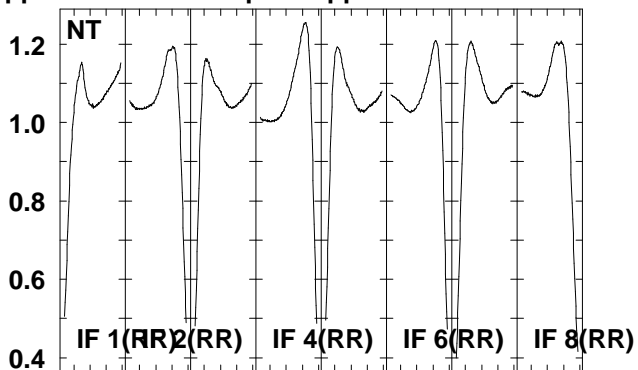
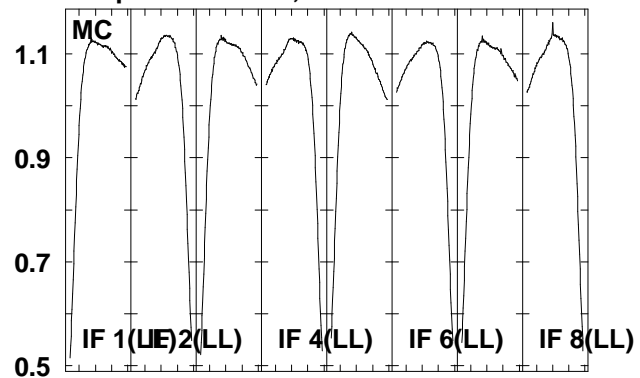

6663.6665.6667.6669.6671.6673.6675.6677.5
 FREQ MHz

Lower frame: Real Jy
 Total-power spectrum Antenna: *
 Timerange: 00/05:09:30 to 00/05:10:59

Plot file version 29 created 22-JUN-2006 20:03:51
 G16.59-0 EM061A 1.UVDATA.1
 Freq = 6.6631 GHz, Bw = 2.000 MH No calibration applied and no bandpass applied

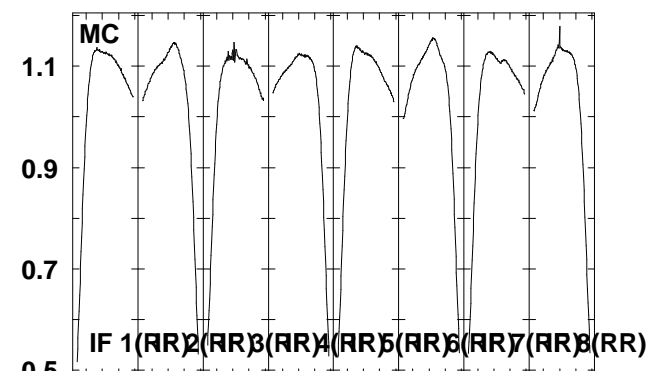
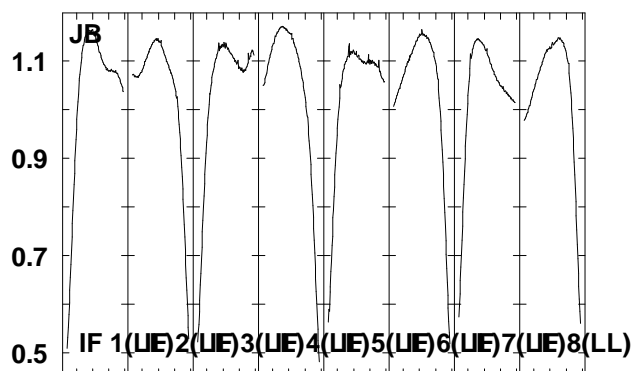
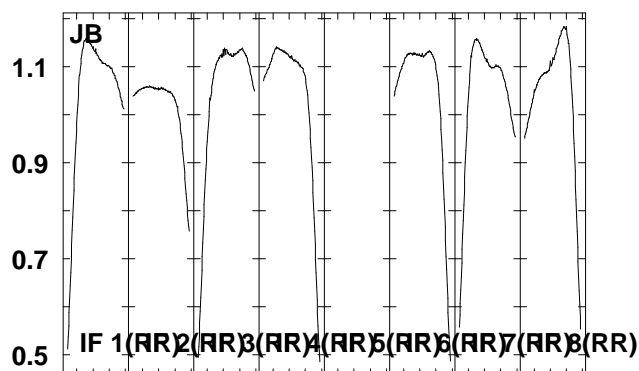
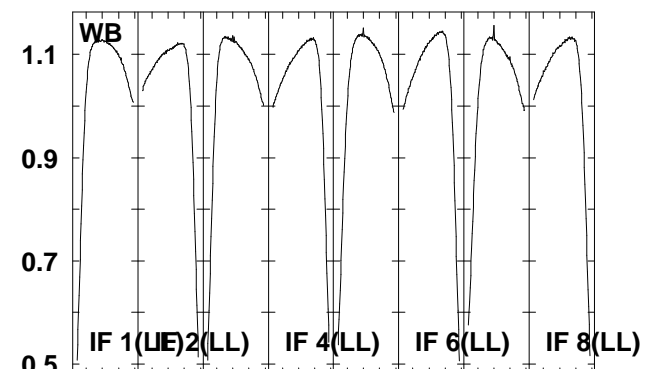
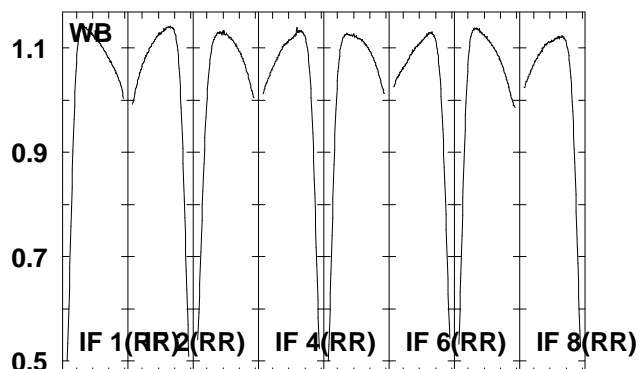
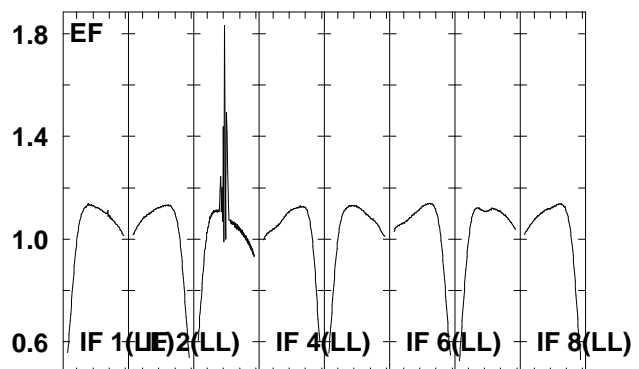
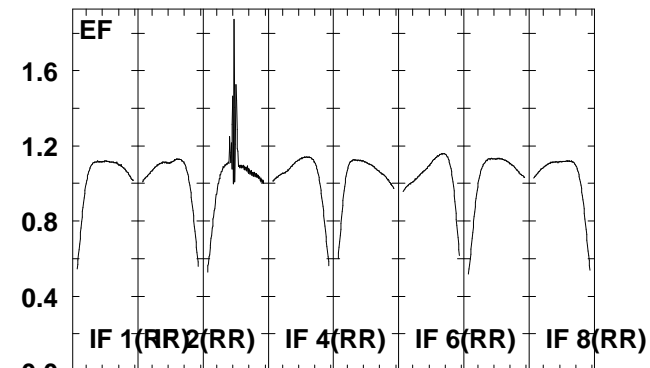
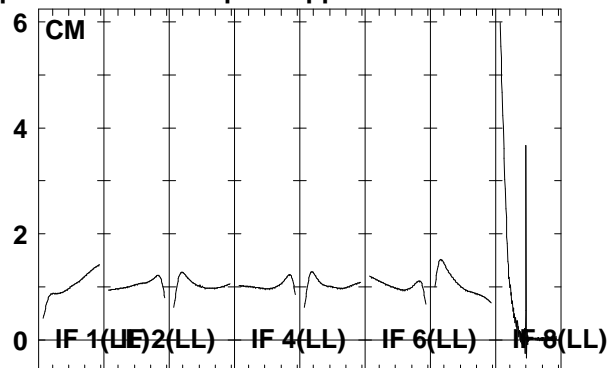
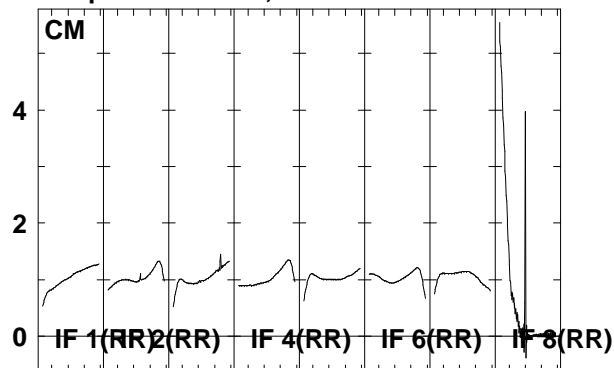

6663.6665.6667.6669.6671.6673.6675.6677.5
 FREQ MHz

6663.6665.6667.6669.6671.6673.6675.6677.5
 FREQ MHz

6663.6665.6667.6669.6671.6673.6675.6677.5
 FREQ MHz

Lower frame: Real Jy
 Total-power spectrum Antenna: *
 Timerange: 00/05:11:01 to 00/05:13:29

Plot file version 30 created 22-JUN-2006 20:03:54
 G16.59-0 EM061A 1.UVDATA.1
 Freq = 6.6631 GHz, Bw = 2.000 MH No calibration applied and no bandpass applied

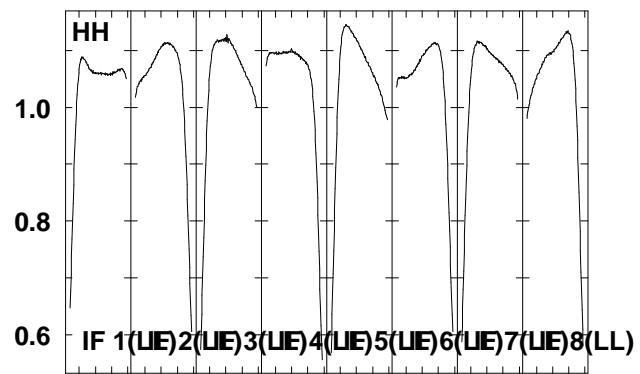
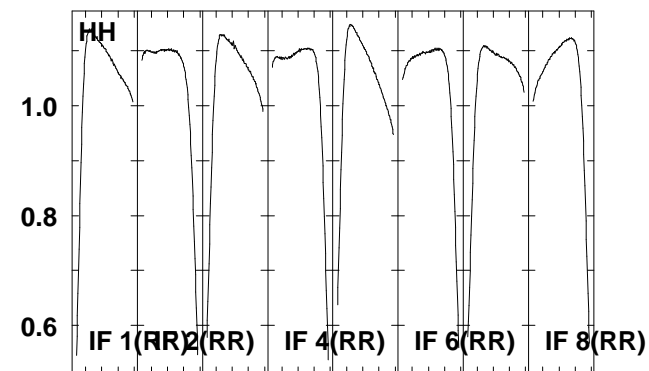
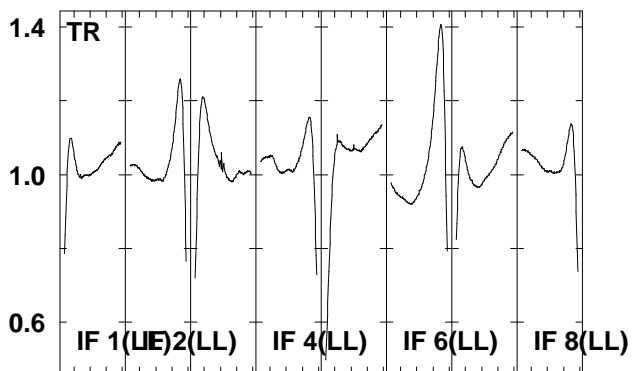
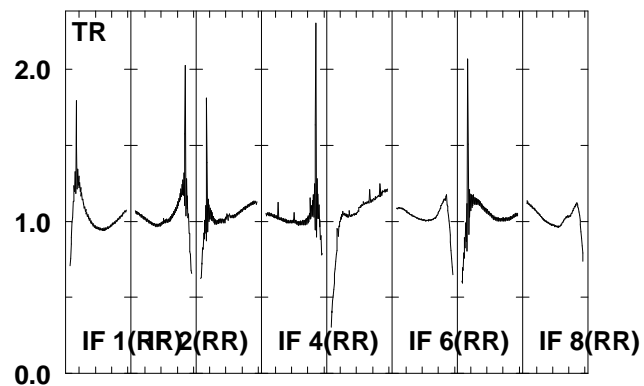
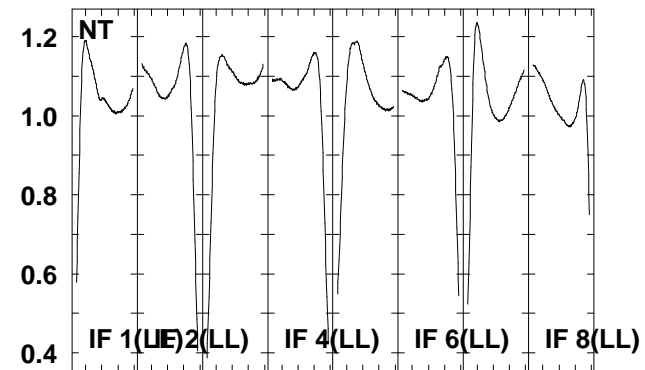
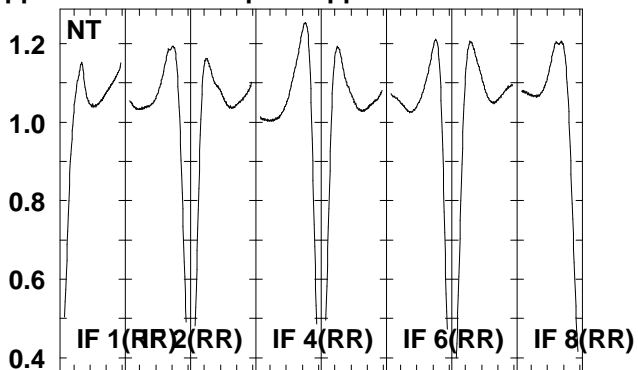
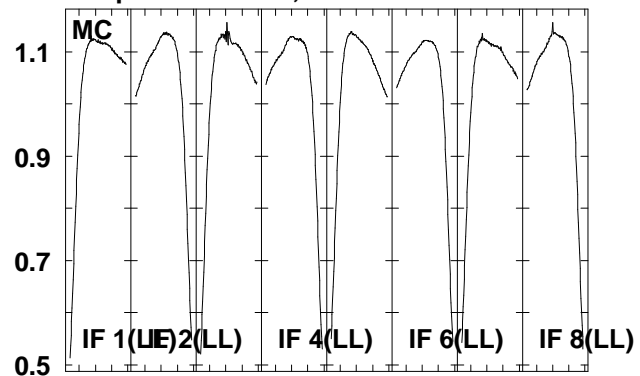

6663.6665.6667.6669.6671.6673.6675.6677.5
 FREQ MHz

Lower frame: Real Jy
 Total-power spectrum Antenna: *
 Timerange: 00/05:11:01 to 00/05:13:29

Plot file version 31 created 22-JUN-2006 20:03:58
 J1825-17 EM061A 1.UVDATA.1
 Freq = 6.6631 GHz, Bw = 2.000 MH No calibration applied and no bandpass applied

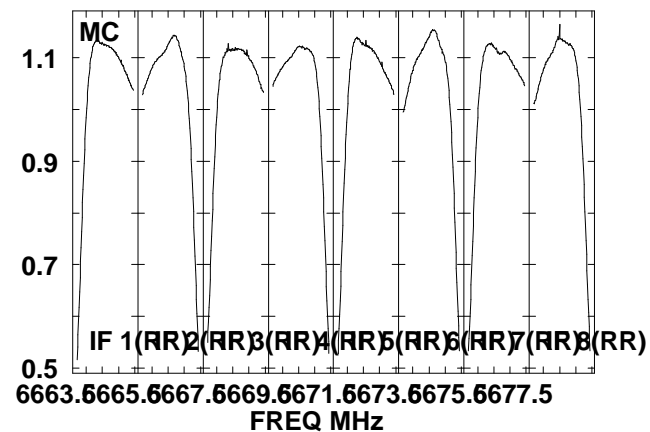
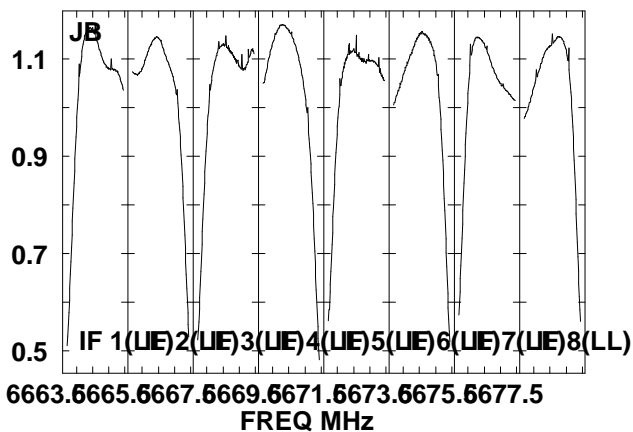
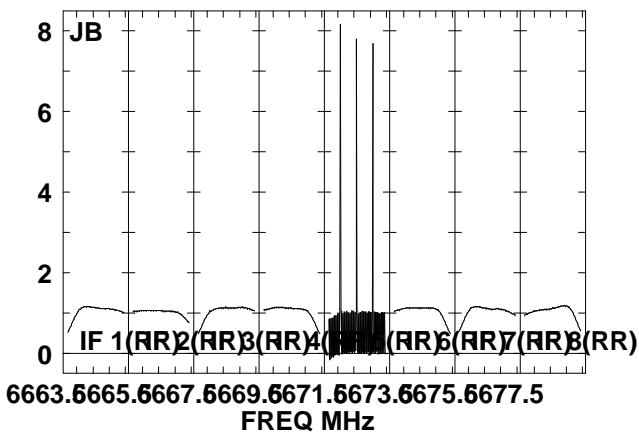
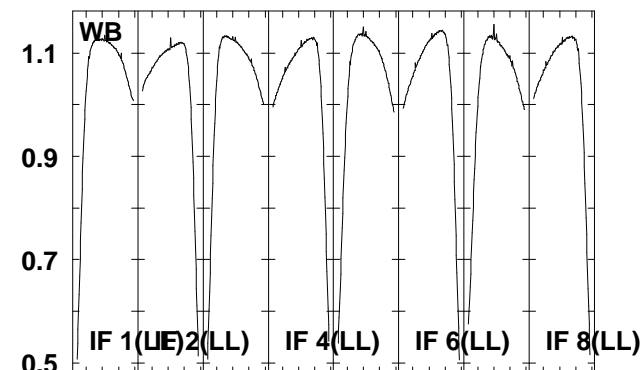
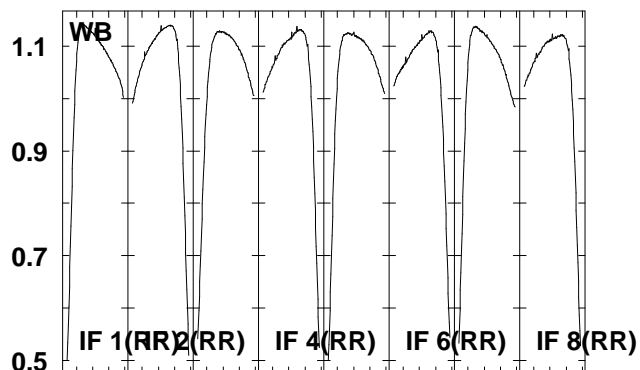
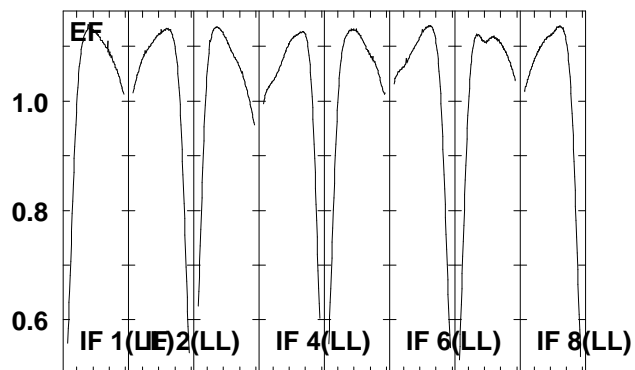
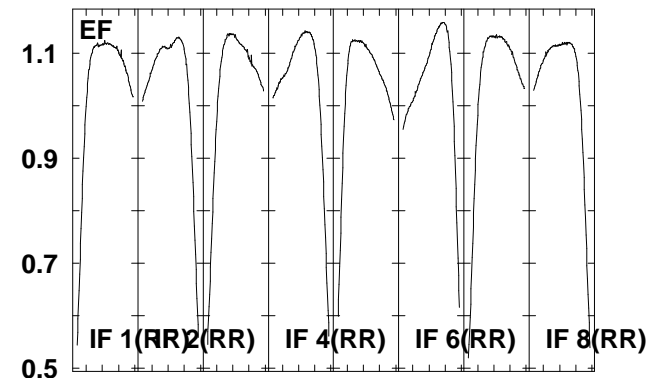
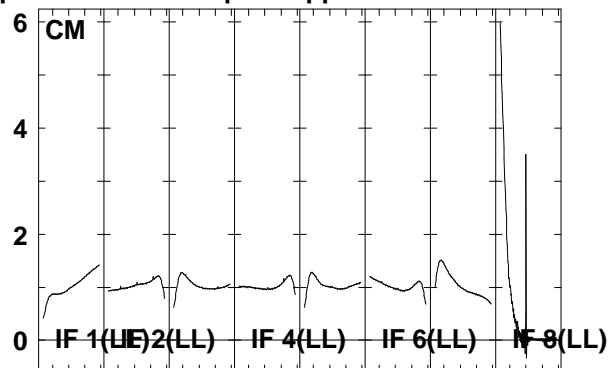
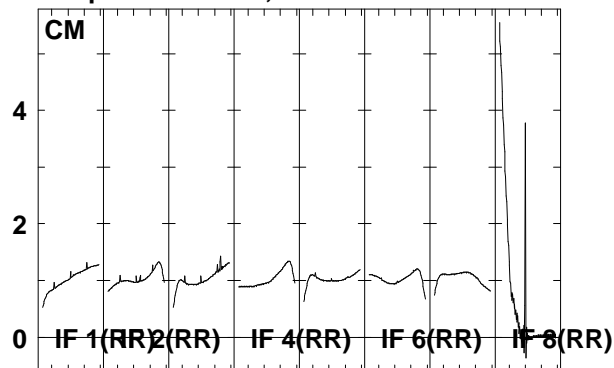

Lower frame: Real Jy
 Total-power spectrum Antenna: *
 Timerange: 00/05:15:02 to 00/05:17:59

Plot file version 32 created 22-JUN-2006 20:04:02
 J1825-17 EM061A 1.UVDATA.1
 Freq = 6.6631 GHz, Bw = 2.000 MH No calibration applied and no bandpass applied

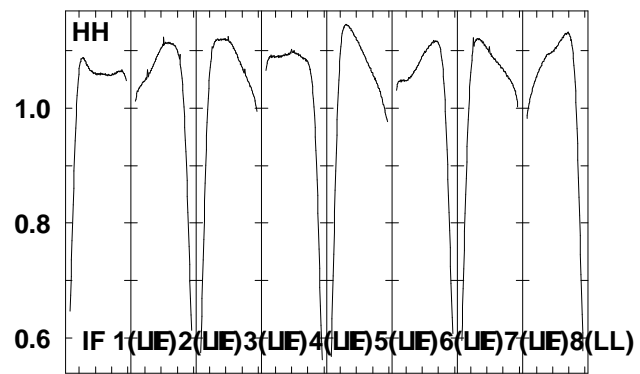
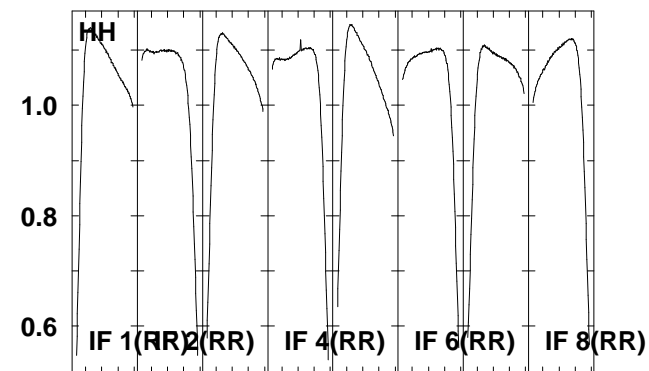
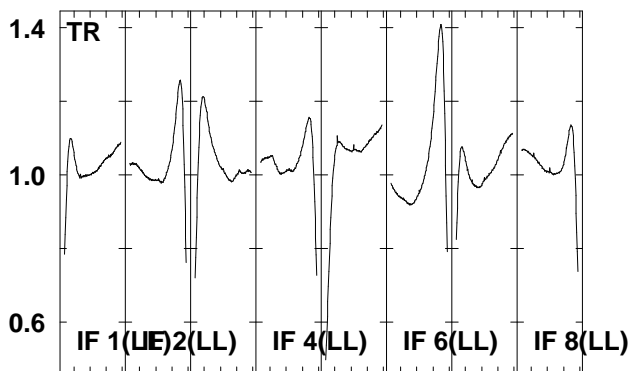
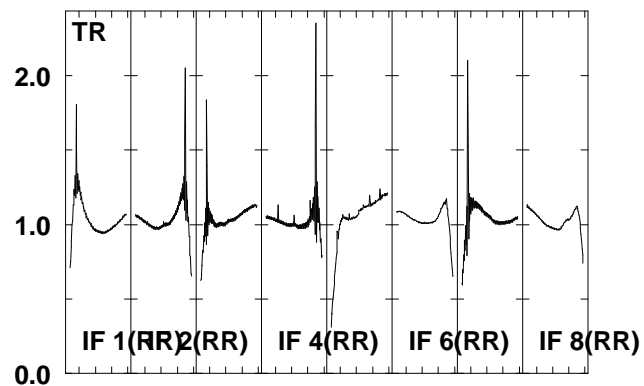
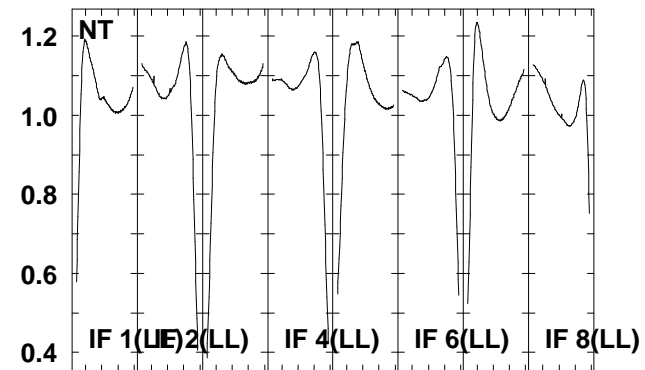
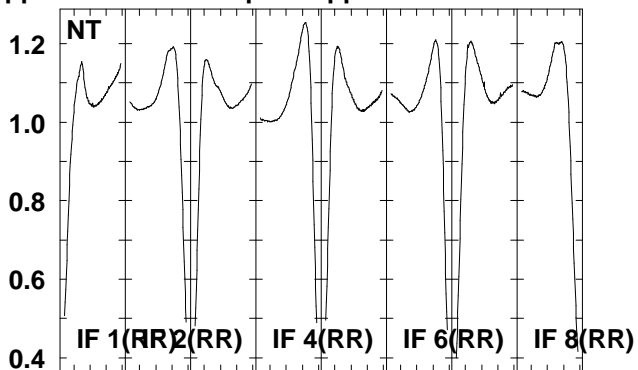
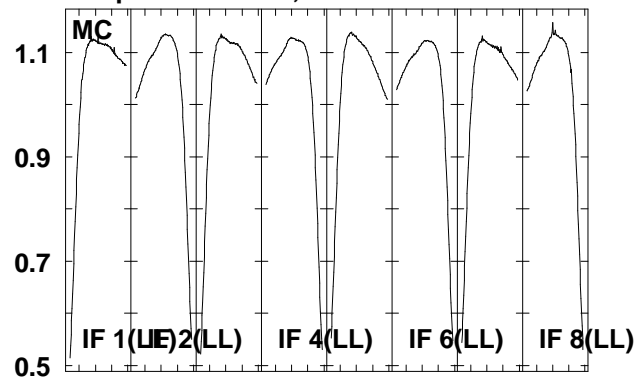

6663.6665.6667.6669.6671.6673.6675.6677.5
 FREQ MHz

Lower frame: Real Jy
 Total-power spectrum Antenna: *
 Timerange: 00/05:15:02 to 00/05:17:59

Plot file version 33 created 22-JUN-2006 20:04:06
 G16.59-0 EM061A 1.UVDATA.1
 Freq = 6.6631 GHz, Bw = 2.000 MH No calibration applied and no bandpass applied

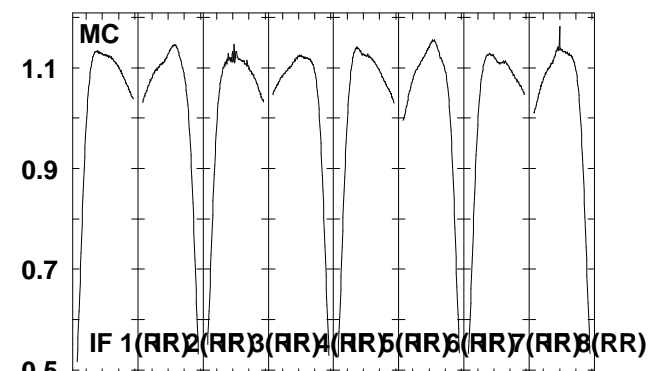
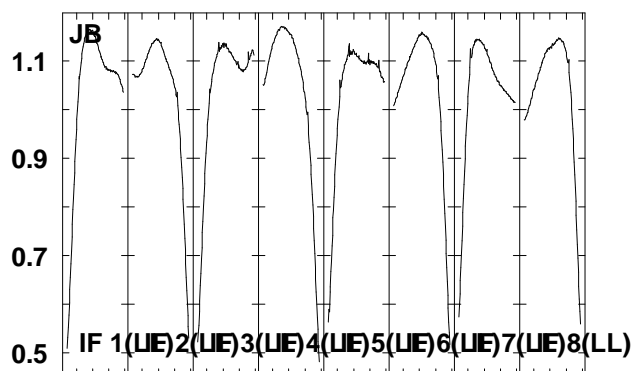
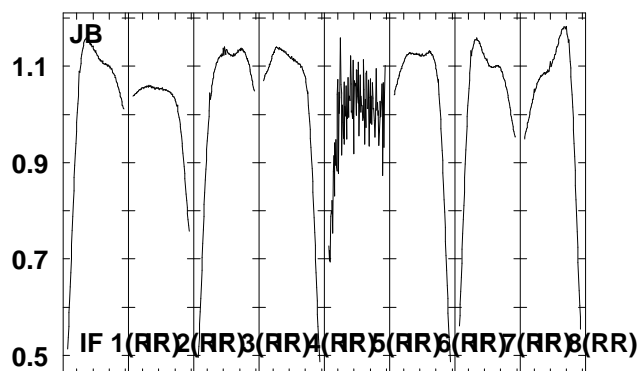
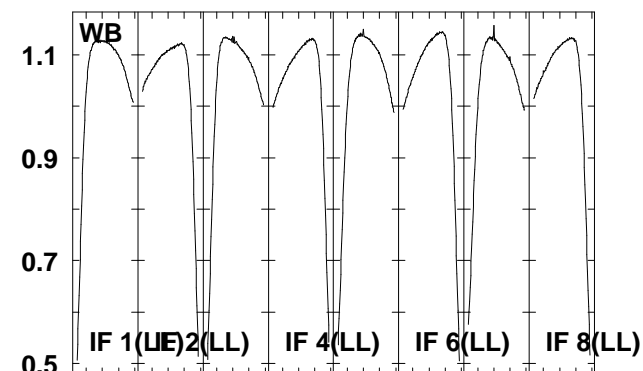
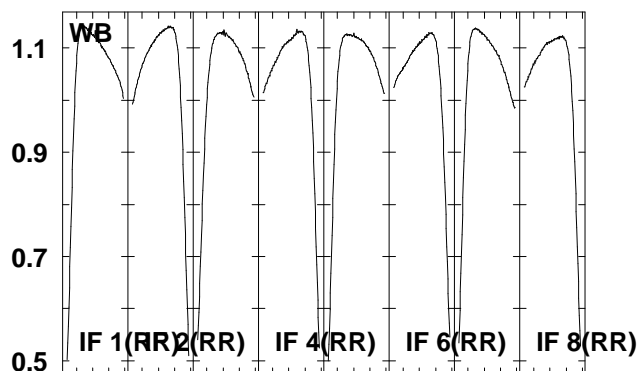
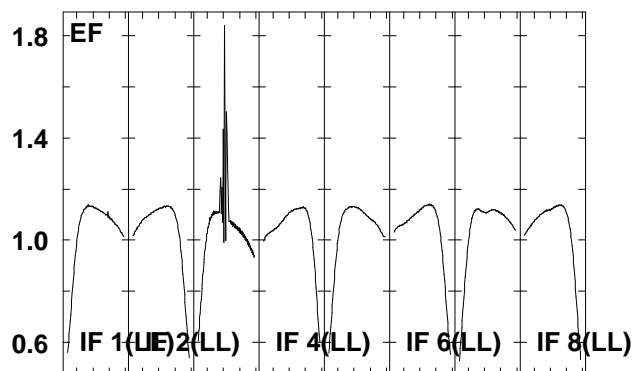
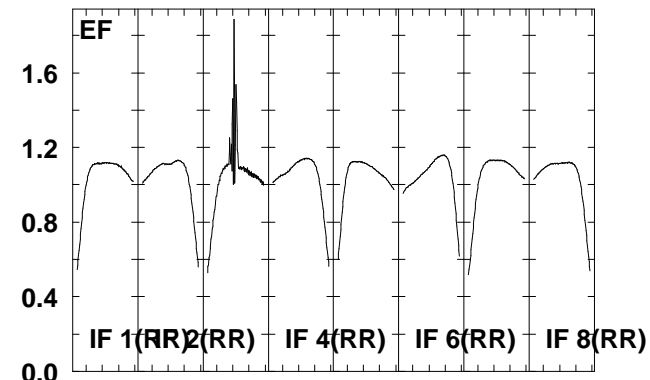
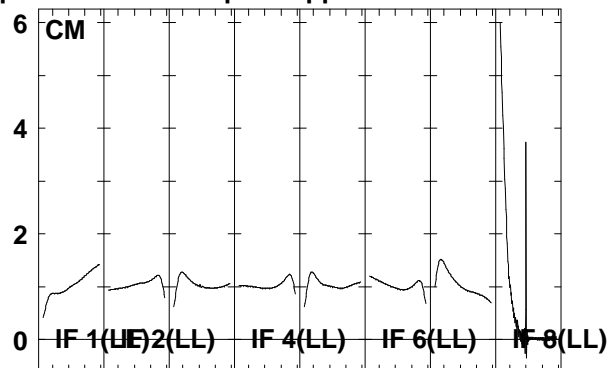
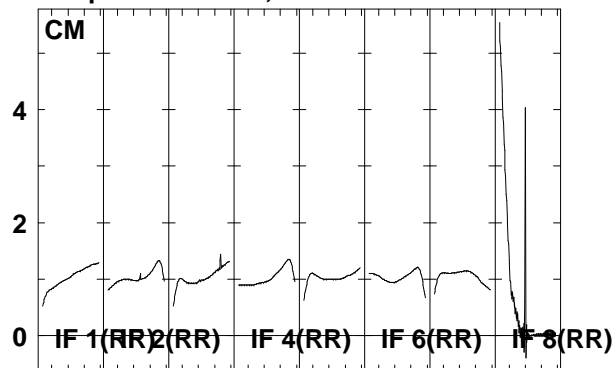

6663.6665.6667.6669.6671.6673.6675.6677.5
 FREQ MHz

6663.6665.6667.6669.6671.6673.6675.6677.5
 FREQ MHz

6663.6665.6667.6669.6671.6673.6675.6677.5
 FREQ MHz

Lower frame: Real Jy
 Total-power spectrum Antenna: *
 Timerange: 00/05:18:01 to 00/05:20:29

Plot file version 34 created 22-JUN-2006 20:04:10
 G16.59-0 EM061A 1.UVDATA.1
 Freq = 6.6631 GHz, Bw = 2.000 MH No calibration applied and no bandpass applied

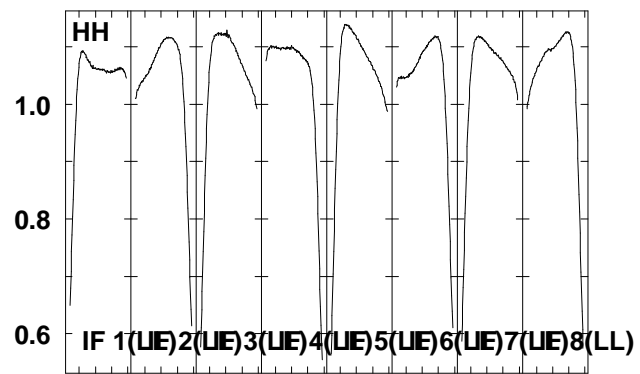
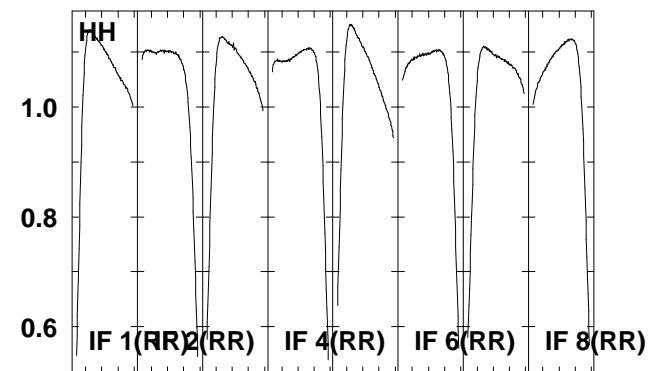
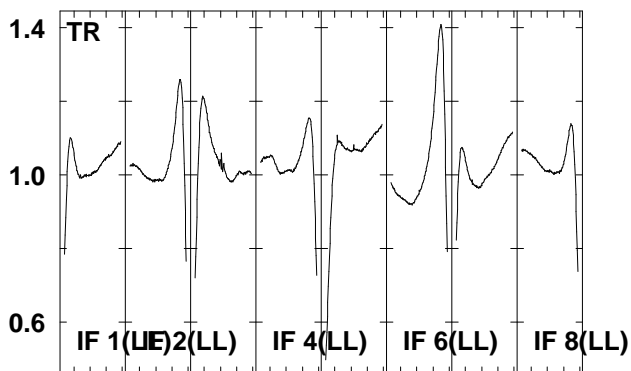
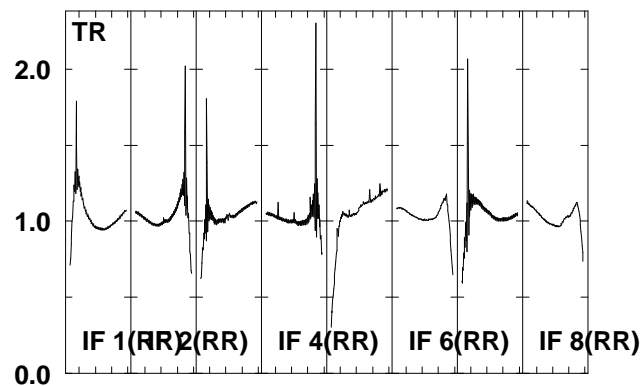
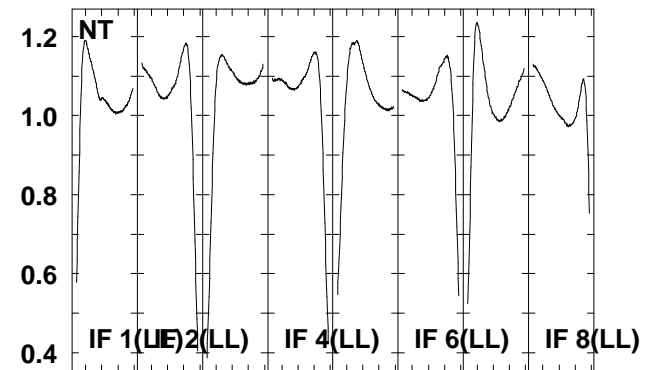
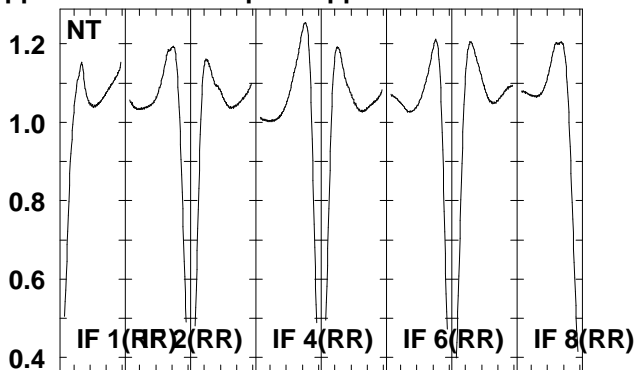
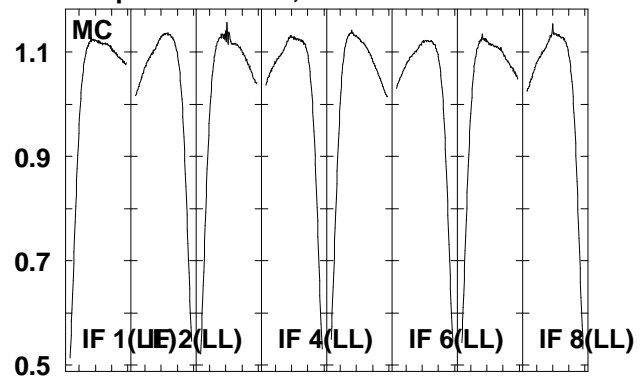

6663.6665.6667.6669.6671.6673.6675.6677.5
 FREQ MHz

Lower frame: Real Jy
 Total-power spectrum Antenna: *
 Timerange: 00/05:18:01 to 00/05:20:29

Plot file version 35 created 22-JUN-2006 20:04:13
 J1825-17 EM061A 1.UVDATA.1
 Freq = 6.6631 GHz, Bw = 2.000 MH No calibration applied and no bandpass applied

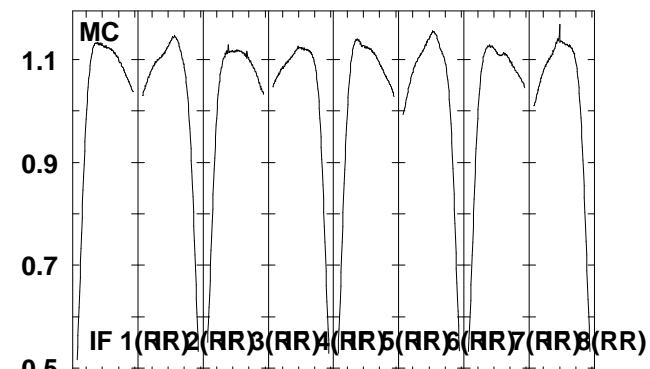
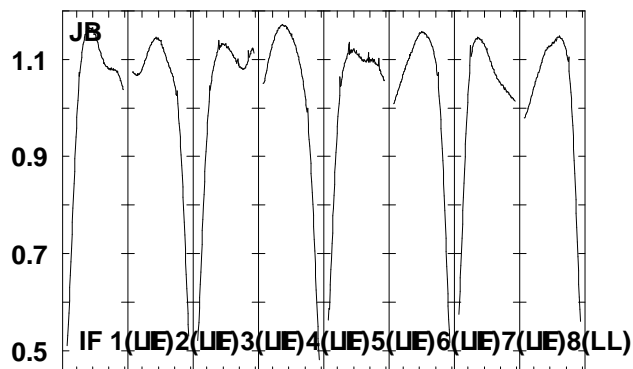
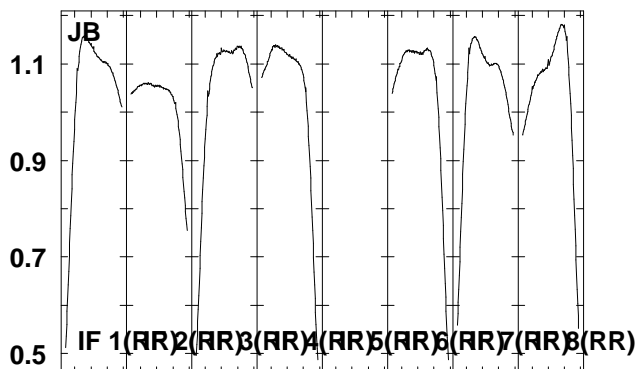
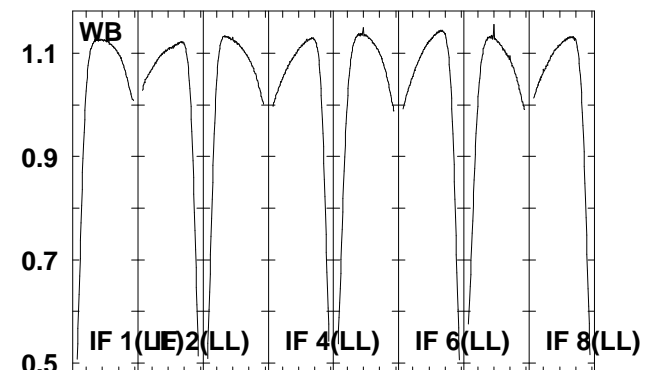
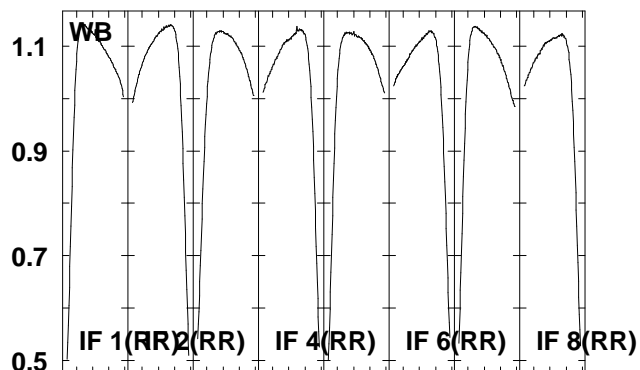
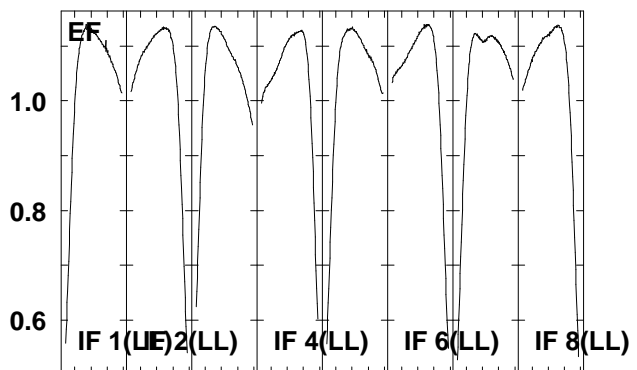
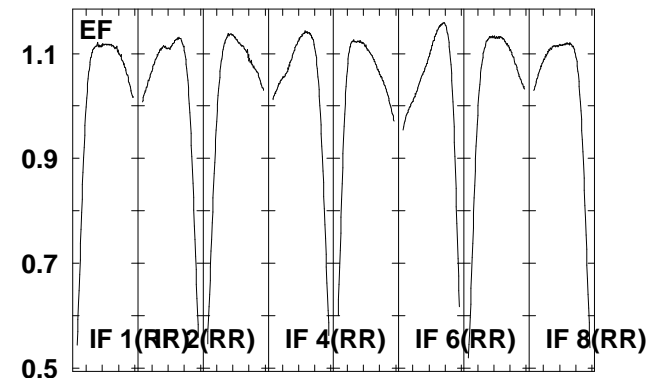
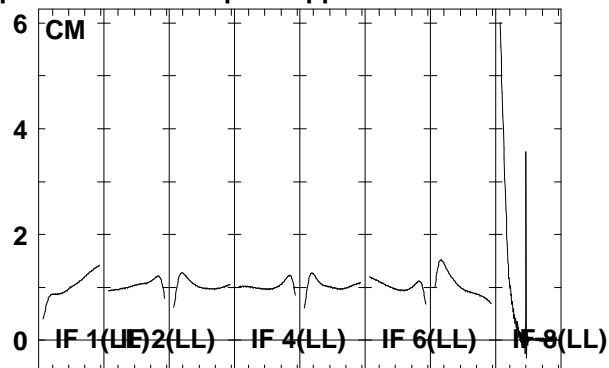
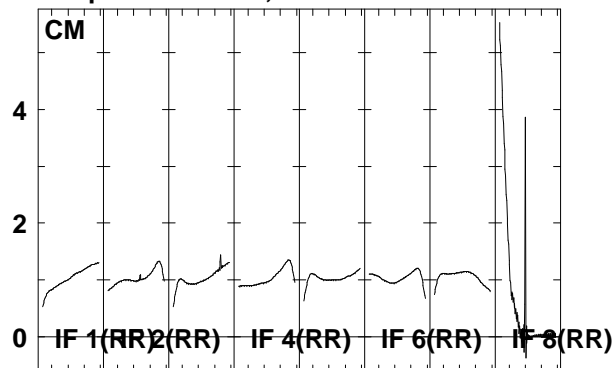

6663.6665.6667.6669.6671.6673.6675.6677.5
 FREQ MHz

6663.6665.6667.6669.6671.6673.6675.6677.5
 FREQ MHz

6663.6665.6667.6669.6671.6673.6675.6677.5
 FREQ MHz

Lower frame: Real Jy
 Total-power spectrum Antenna: *
 Timerange: 00/05:20:31 to 00/05:23:29

Plot file version 36 created 22-JUN-2006 20:04:16
 J1825-17 EM061A 1.UVDATA.1
 Freq = 6.6631 GHz, Bw = 2.000 MH No calibration applied and no bandpass applied

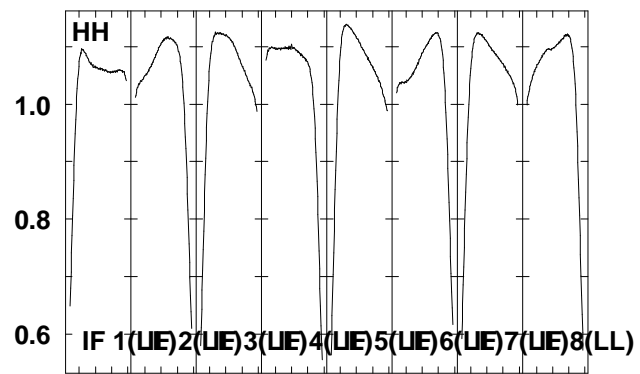
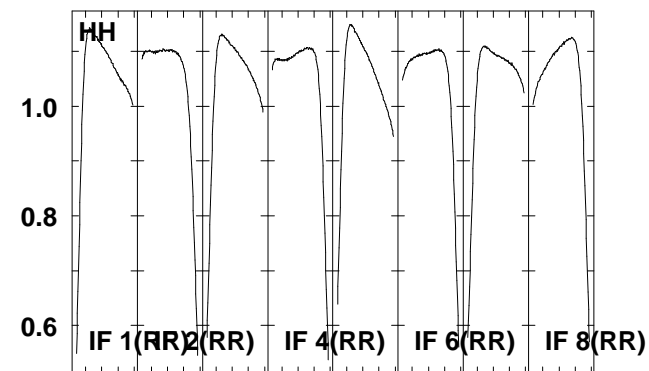
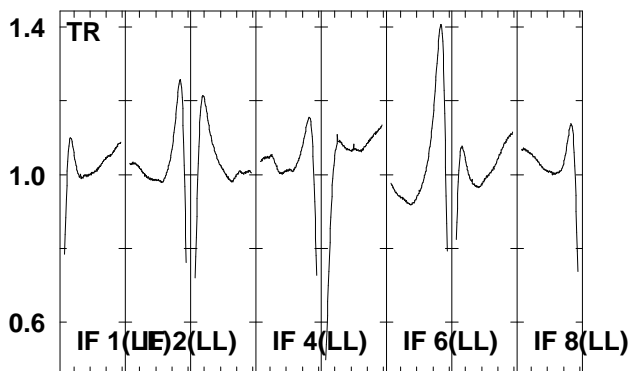
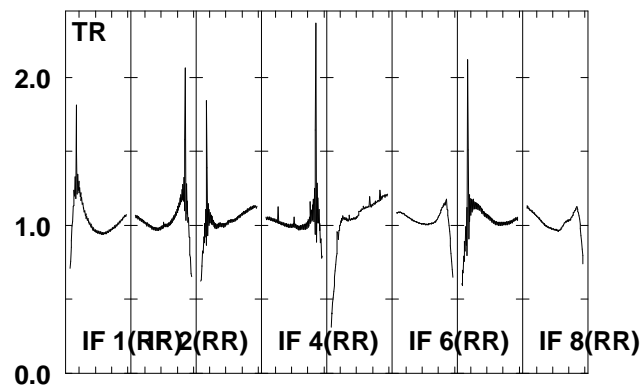
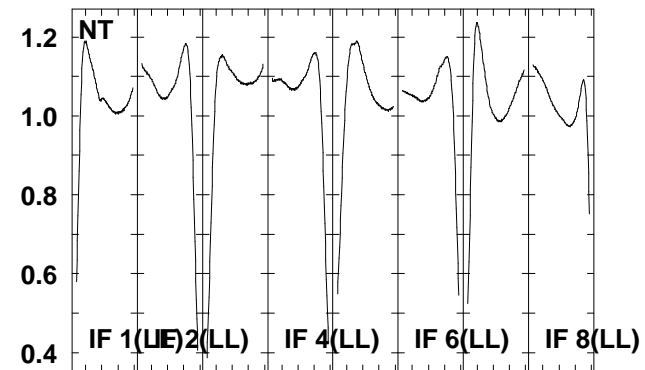
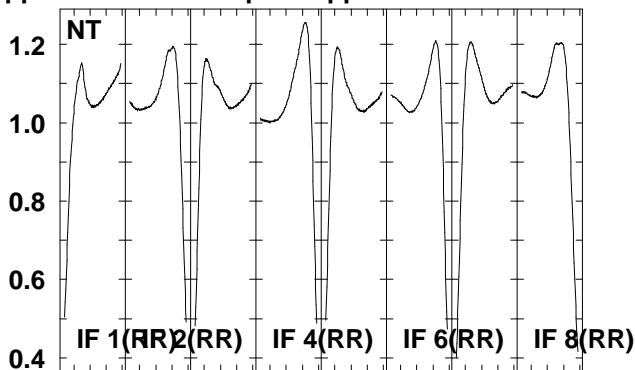
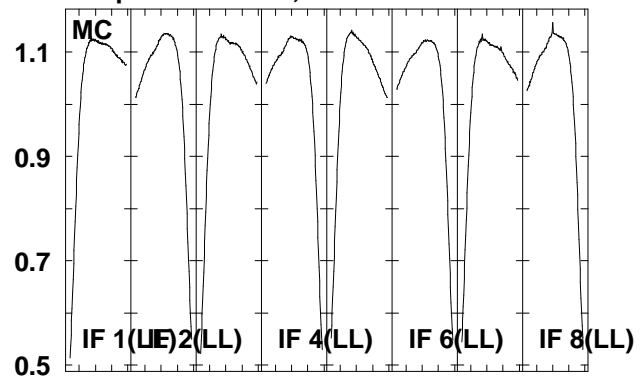

6663.6665.6667.6669.6671.6673.6675.6677.5
 FREQ MHz

Lower frame: Real Jy
 Total-power spectrum Antenna: *
 Timerange: 00/05:20:31 to 00/05:23:29

Plot file version 37 created 22-JUN-2006 20:04:21
 G16.59-0 EM061A 1.UVDATA.1
 Freq = 6.6631 GHz, Bw = 2.000 MH No calibration applied and no bandpass applied

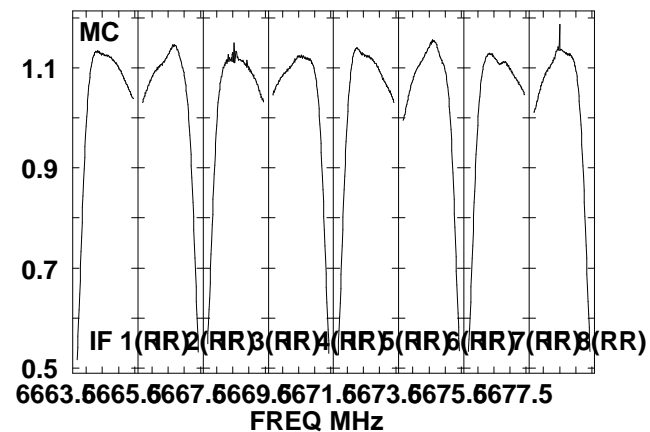
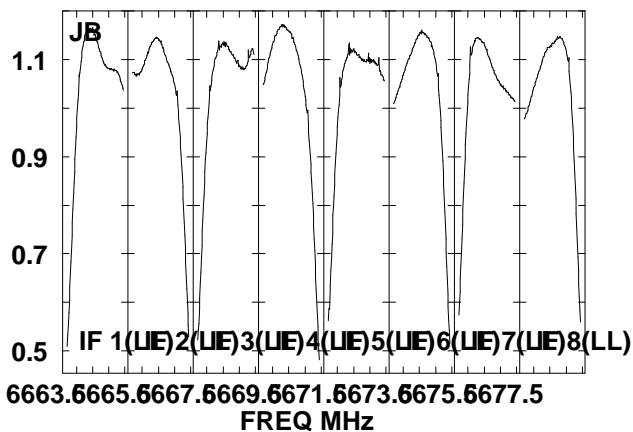
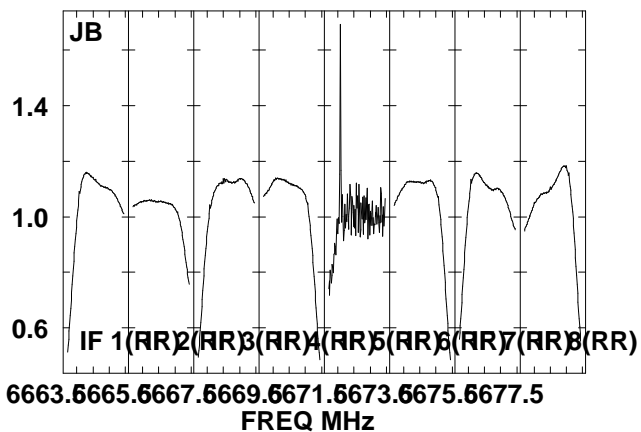
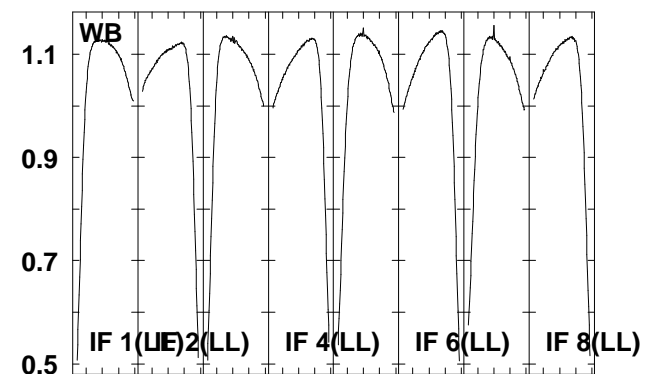
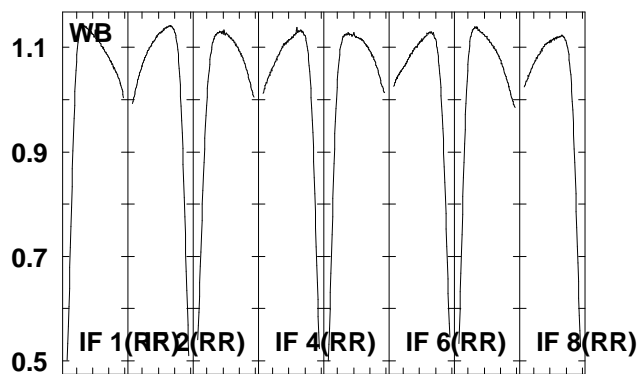
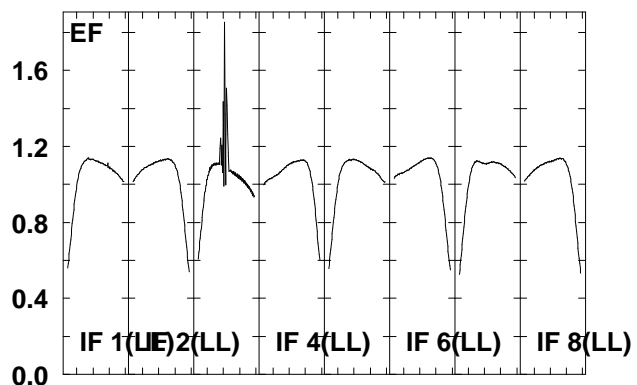
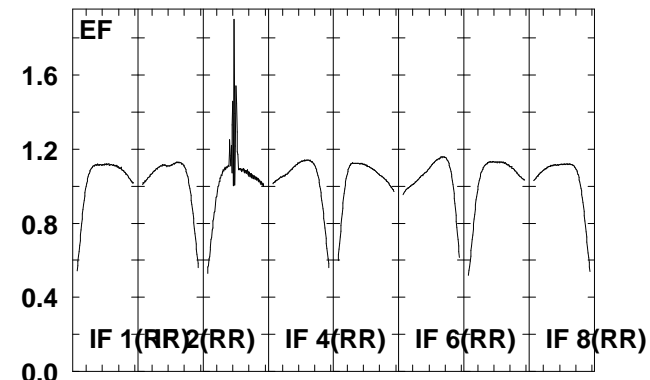
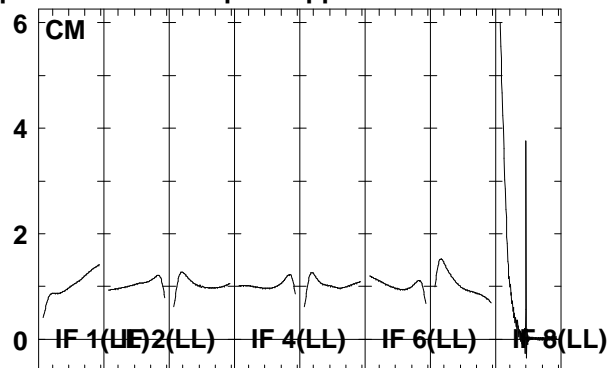
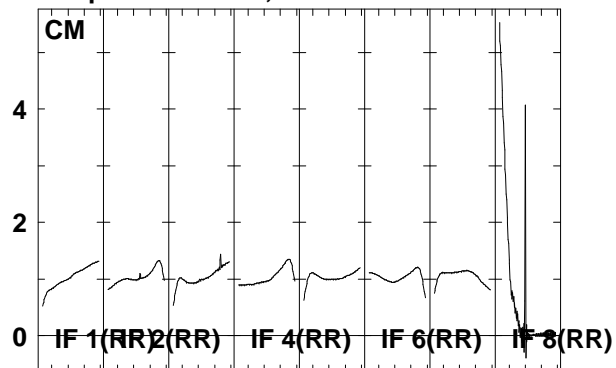

Lower frame: Real Jy
 Total-power spectrum Antenna: *
 Timerange: 00/05:23:31 to 00/05:25:59

Plot file version 38 created 22-JUN-2006 20:04:25
 G16.59-0 EM061A 1.UVDATA.1
 Freq = 6.6631 GHz, Bw = 2.000 MH No calibration applied and no bandpass applied

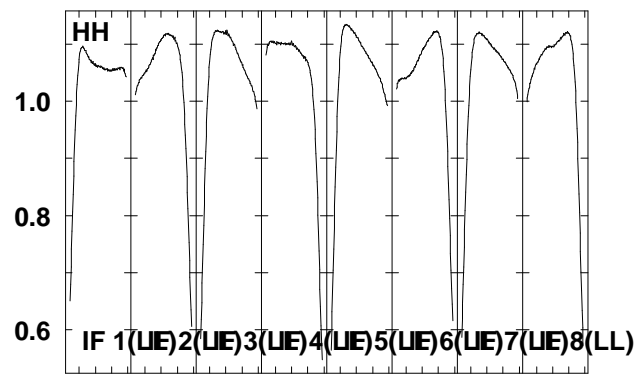
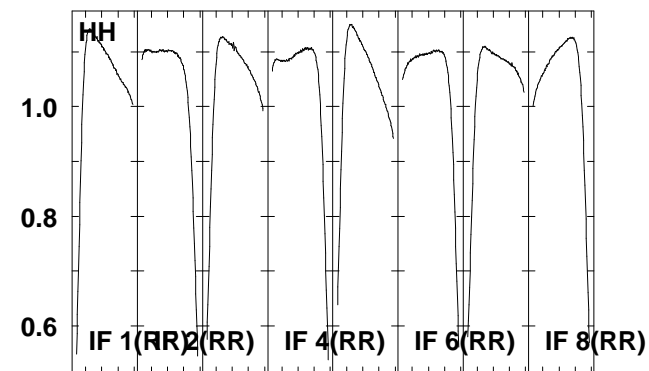
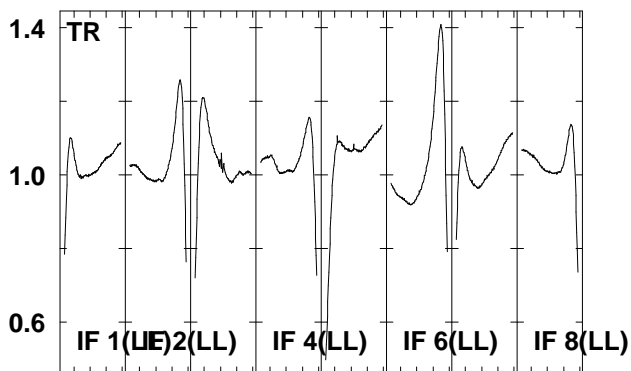
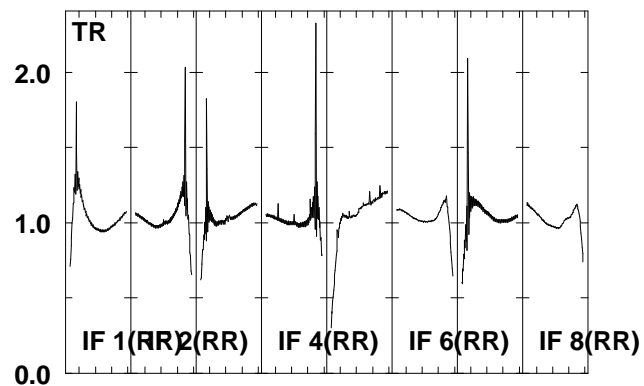
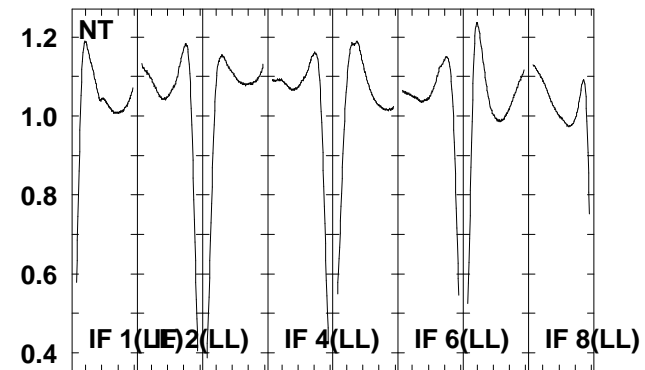
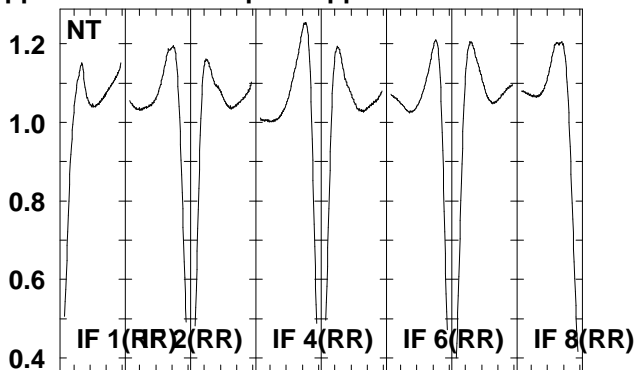
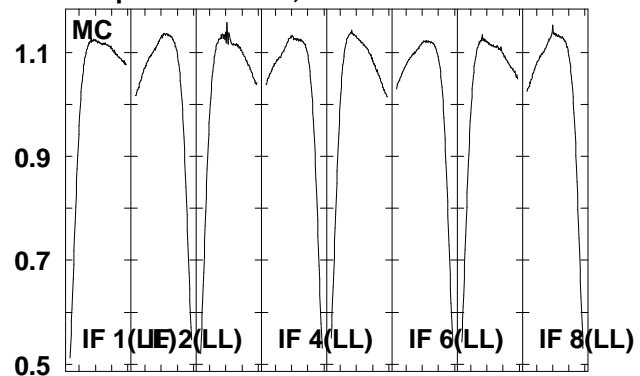

6663.6665.6667.6669.6671.6673.6675.6677.5
 FREQ MHz

Lower frame: Real Jy
 Total-power spectrum Antenna: *
 Timerange: 00/05:23:31 to 00/05:25:59

Plot file version 39 created 22-JUN-2006 20:04:29
 J1825-17 EM061A 1.UVDATA.1
 Freq = 6.6631 GHz, Bw = 2.000 MH No calibration applied and no bandpass applied

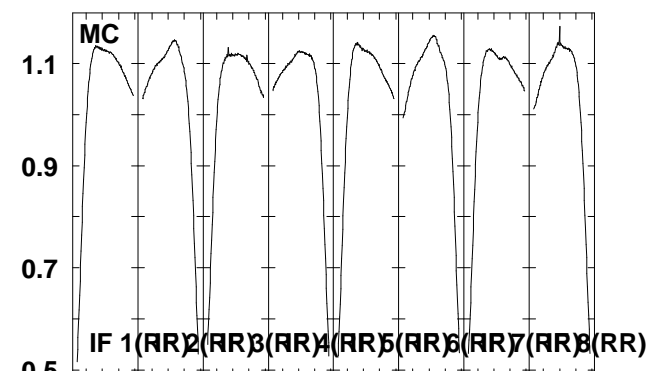
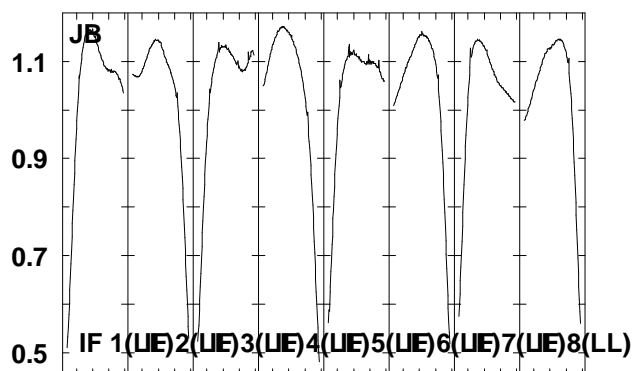
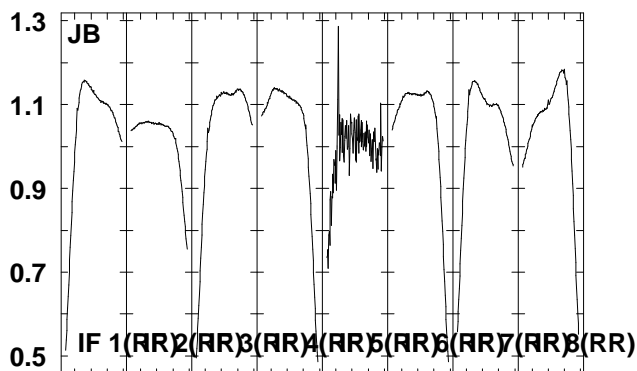
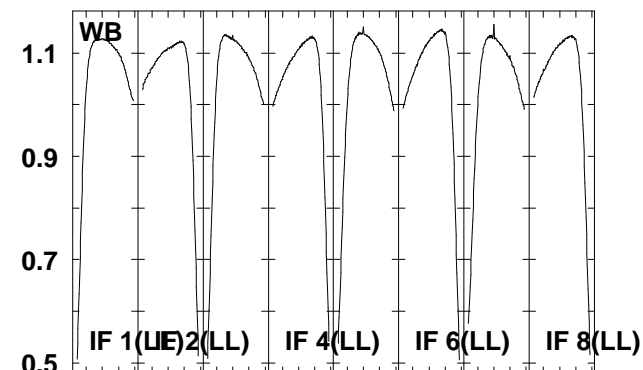
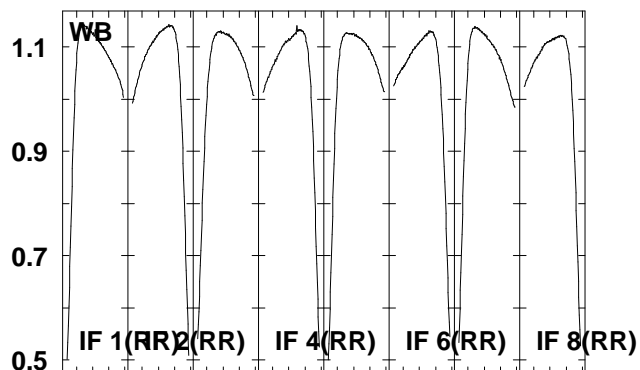
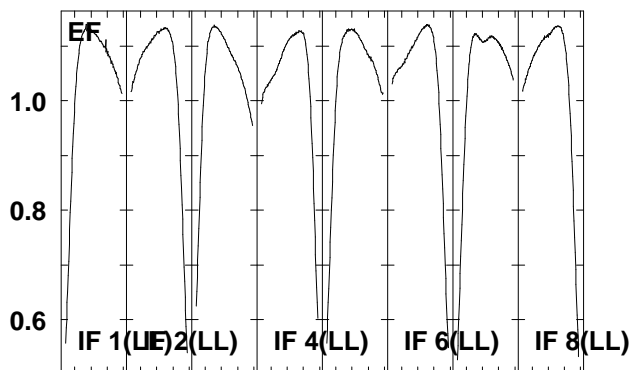
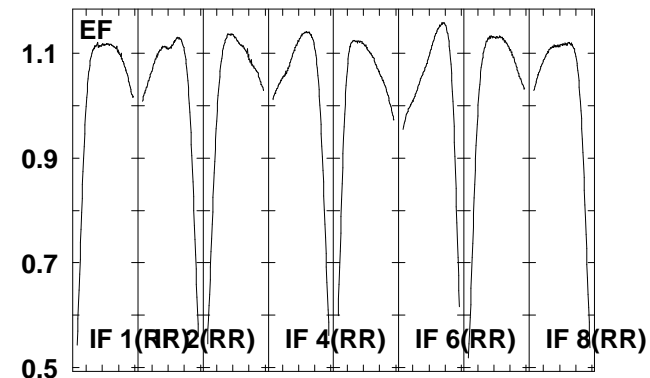
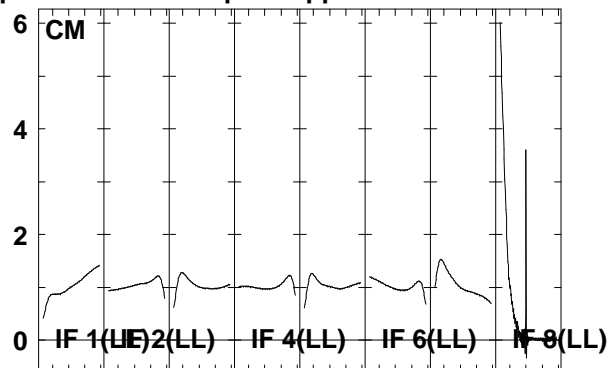
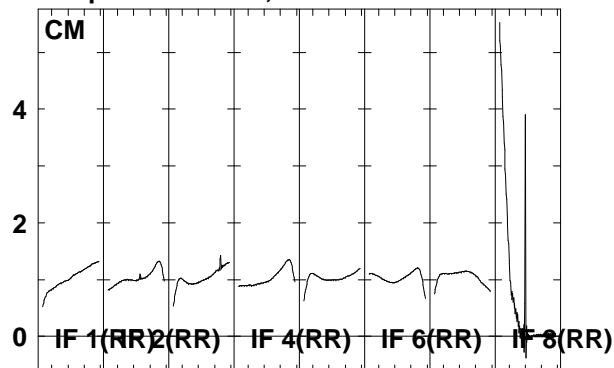

6663.6665.6667.6669.6671.6673.6675.6677.5
 FREQ MHz

6663.6665.6667.6669.6671.6673.6675.6677.5
 FREQ MHz

6663.6665.6667.6669.6671.6673.6675.6677.5
 FREQ MHz

Lower frame: Real Jy
 Total-power spectrum Antenna: *
 Timerange: 00/05:26:01 to 00/05:28:59

Plot file version 40 created 22-JUN-2006 20:04:33
 J1825-17 EM061A 1.UVDATA.1
 Freq = 6.6631 GHz, Bw = 2.000 MH No calibration applied and no bandpass applied

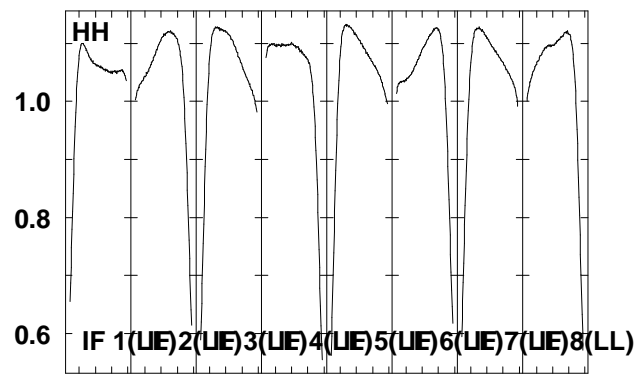
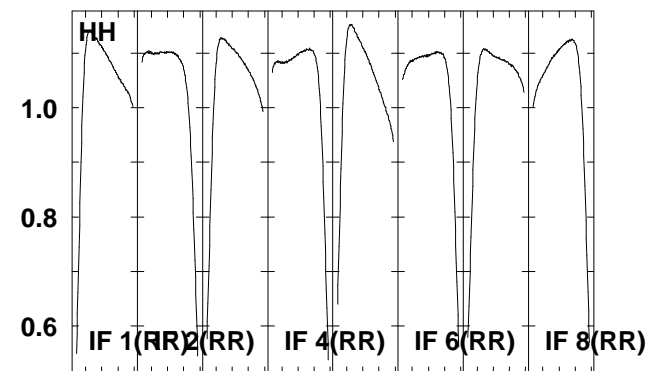
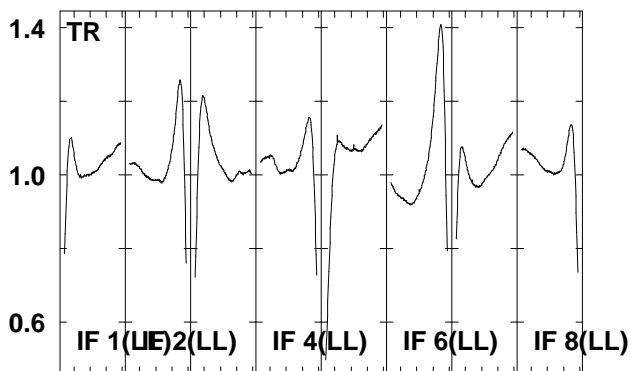
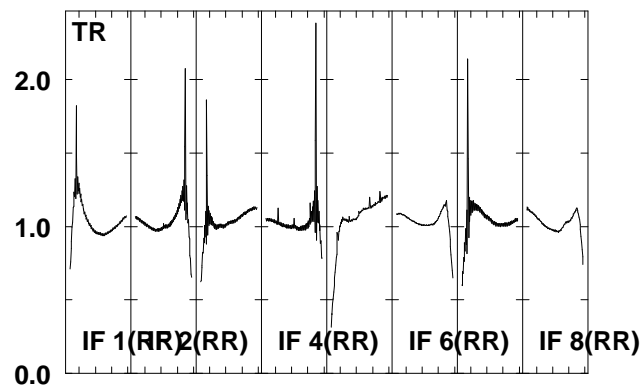
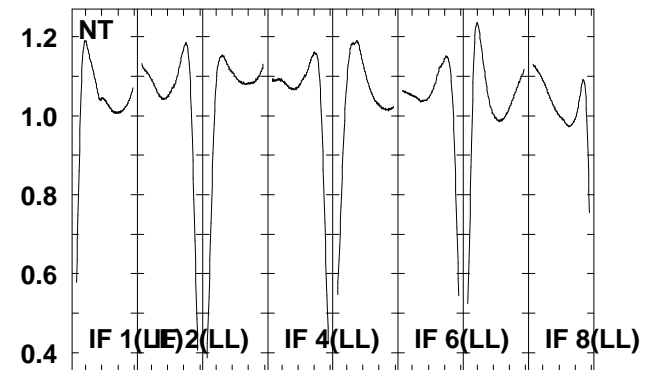
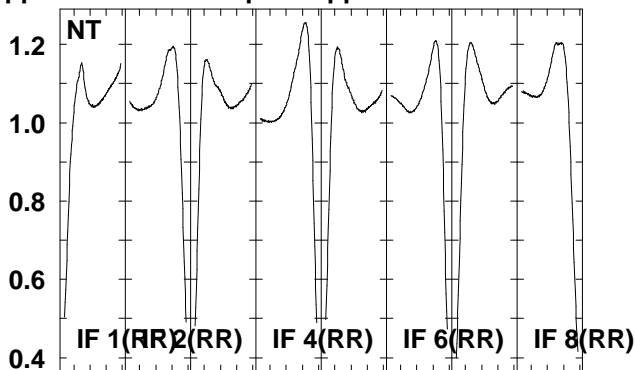
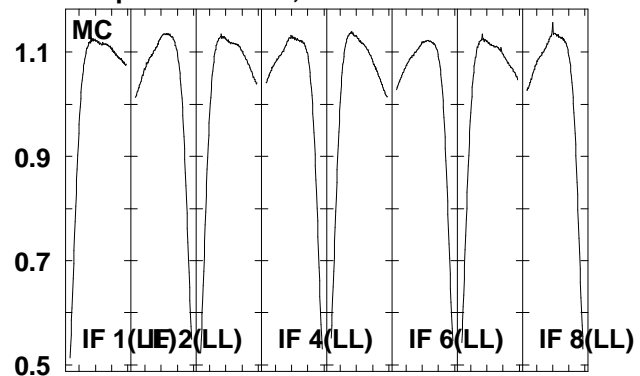

6663.6665.6667.6669.6671.6673.6675.6677.5
 FREQ MHz

Lower frame: Real Jy
 Total-power spectrum Antenna: *
 Timerange: 00/05:26:01 to 00/05:28:59

Plot file version 41 created 22-JUN-2006 20:04:38
 G16.59-0 EM061A 1.UVDATA.1
 Freq = 6.6631 GHz, Bw = 2.000 MH No calibration applied and no bandpass applied

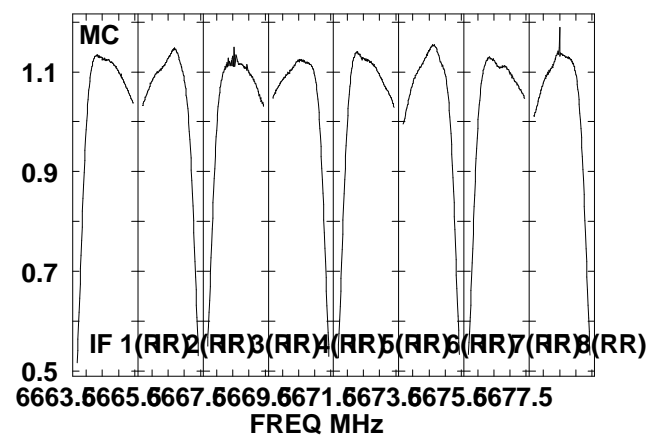
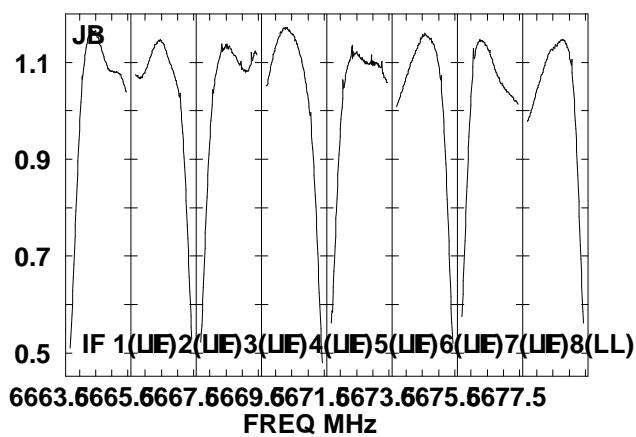
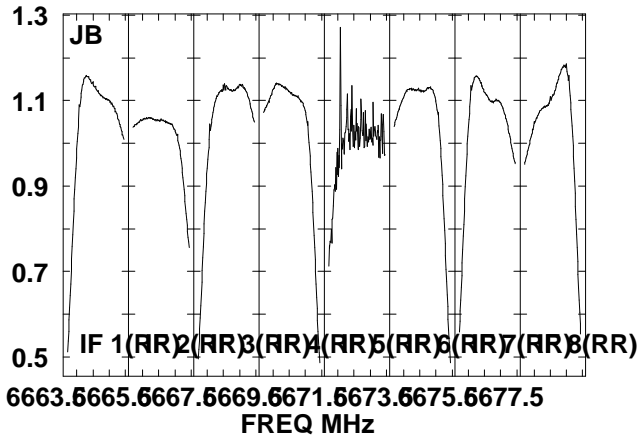
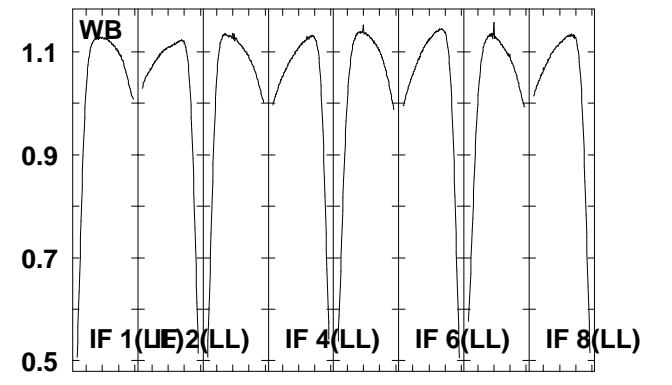
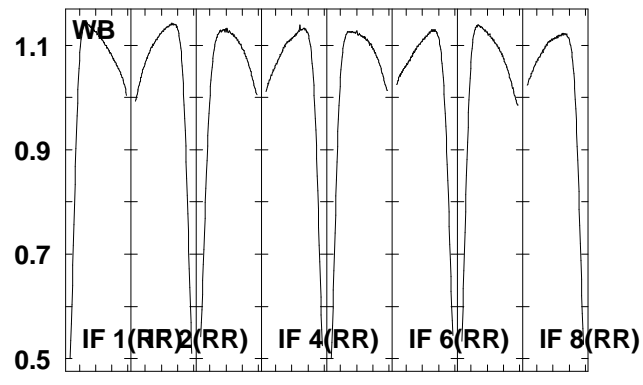
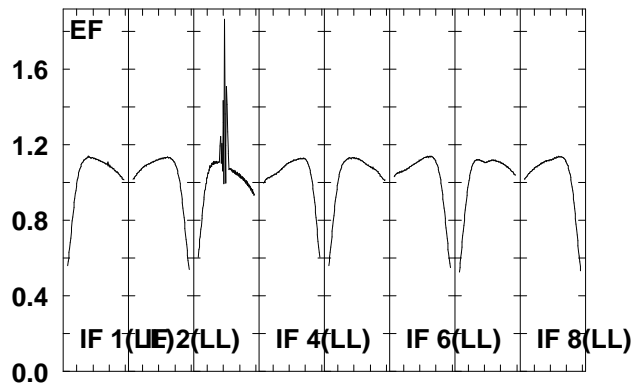
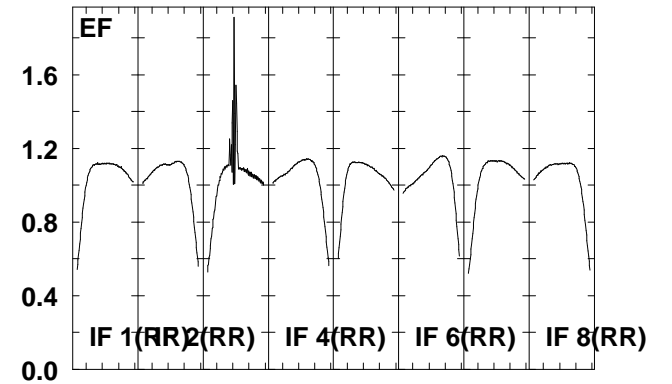
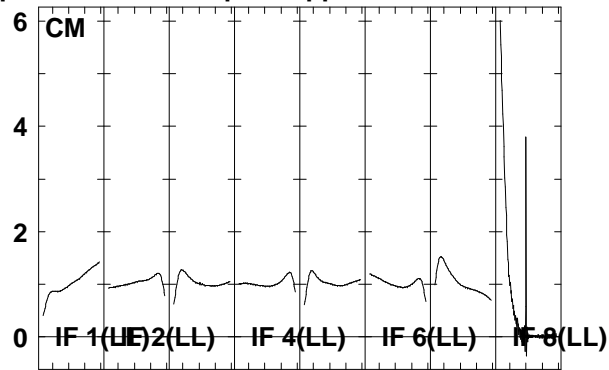
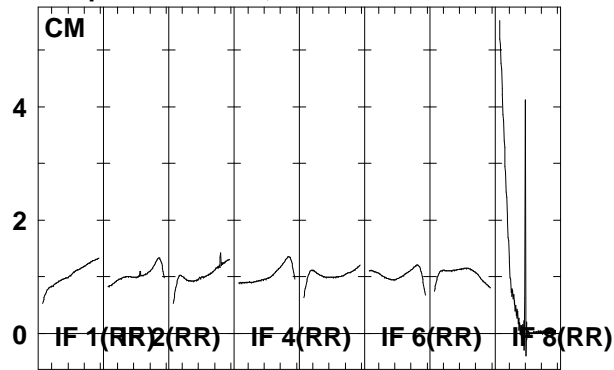

Lower frame: Real Jy
 Total-power spectrum Antenna: *
 Timerange: 00/05:29:01 to 00/05:31:29

Plot file version 42 created 22-JUN-2006 20:04:41
 G16.59-0 EM061A 1.UVDATA.1
 Freq = 6.6631 GHz, Bw = 2.000 MH No calibration applied and no bandpass applied

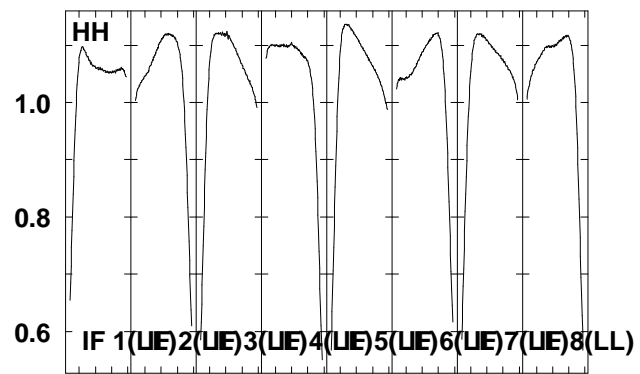
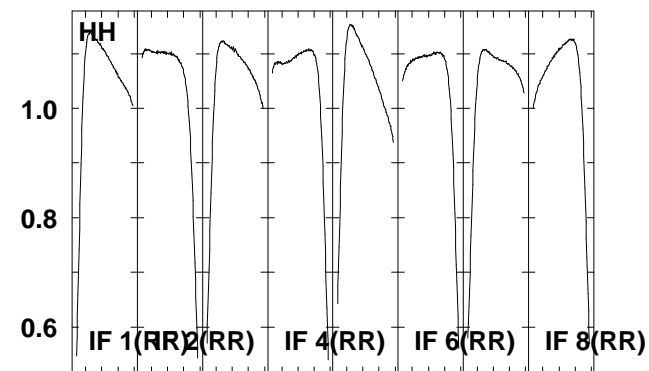
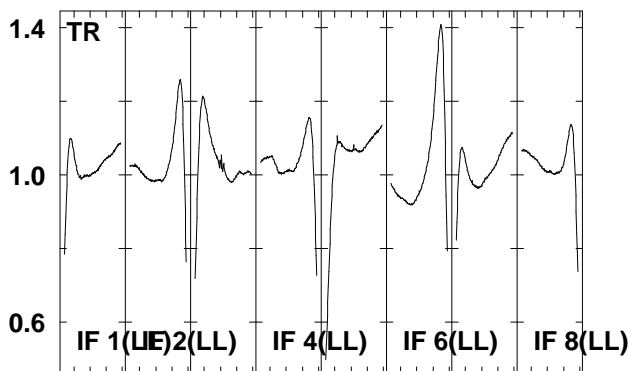
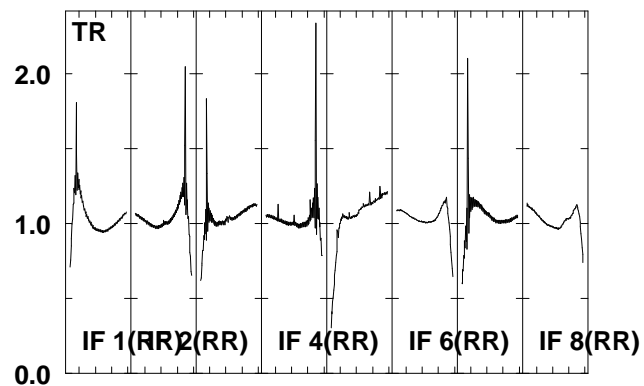
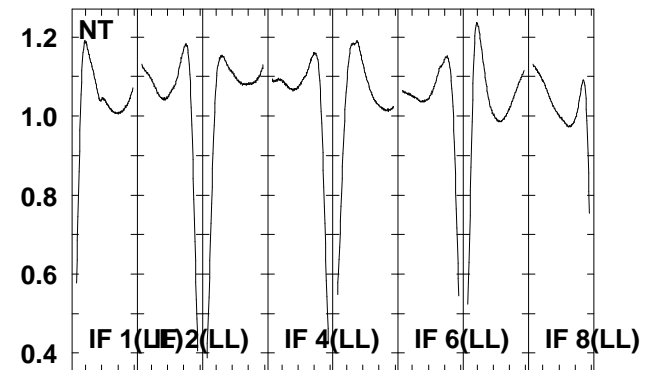
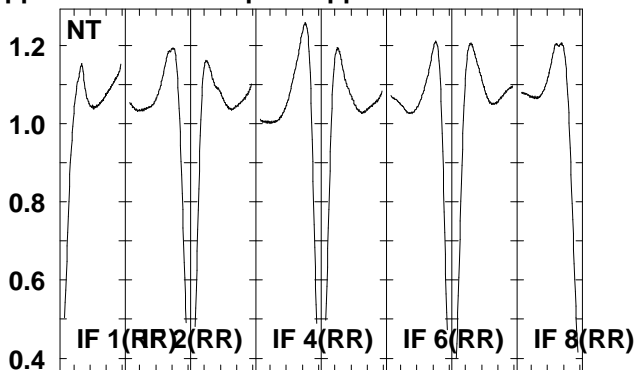
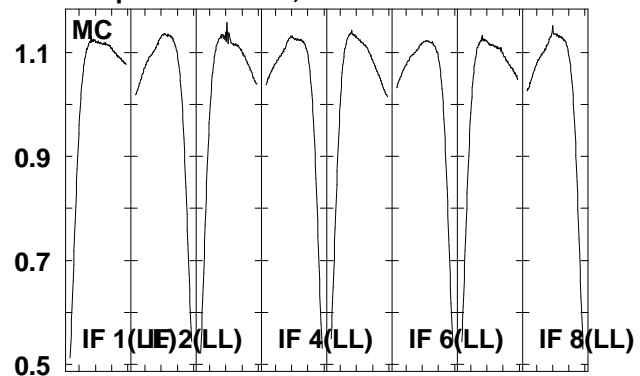

6663.6665.6667.6669.6671.6673.6675.6677.5
 FREQ MHz

Lower frame: Real Jy
 Total-power spectrum Antenna: *
 Timerange: 00/05:29:01 to 00/05:31:29

Plot file version 43 created 22-JUN-2006 20:04:46
 J1825-17 EM061A 1.UVDATA.1
 Freq = 6.6631 GHz, Bw = 2.000 MH No calibration applied and no bandpass applied

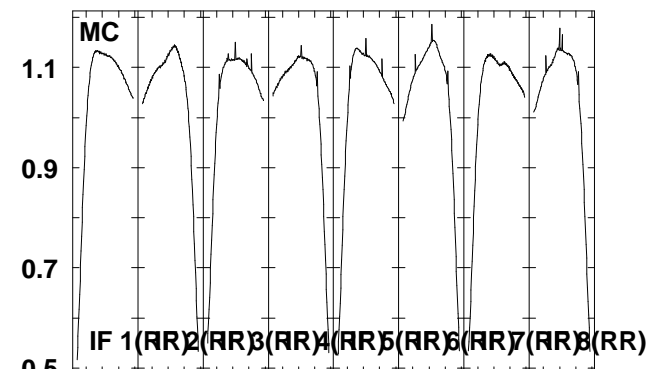
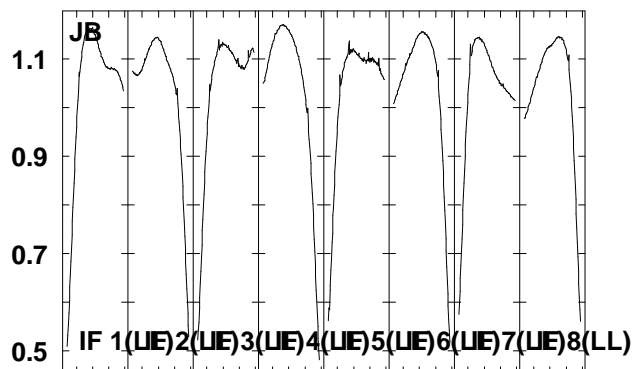
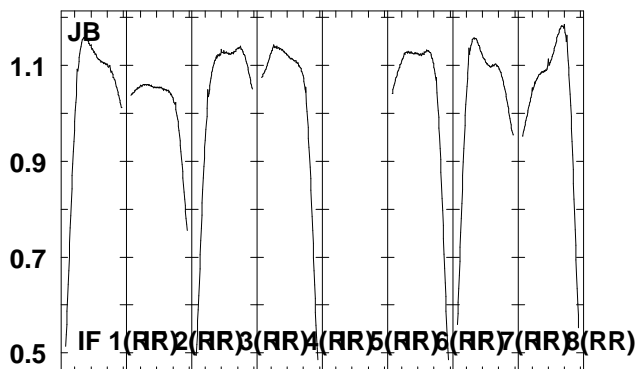
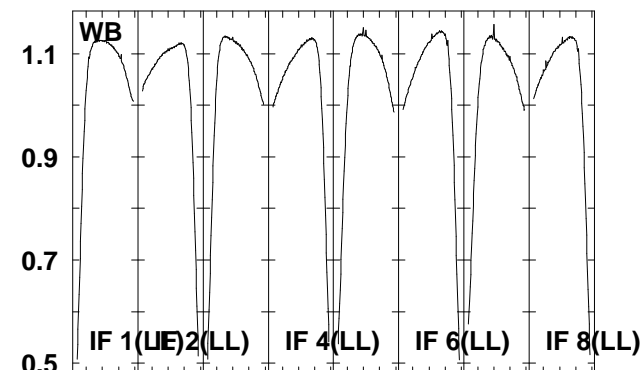
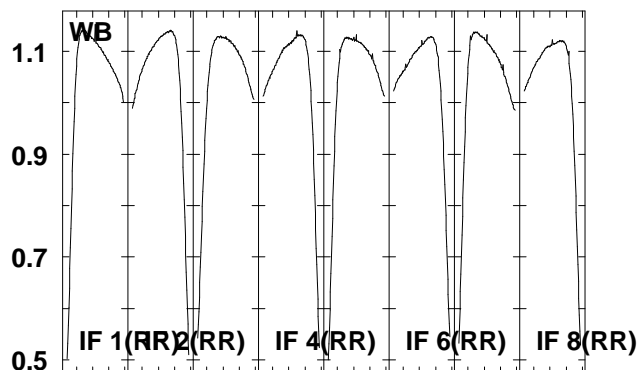
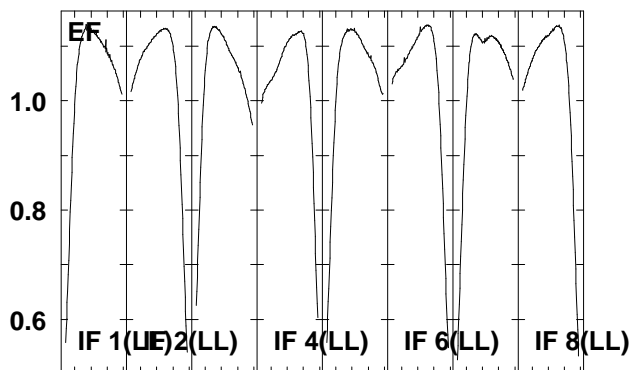
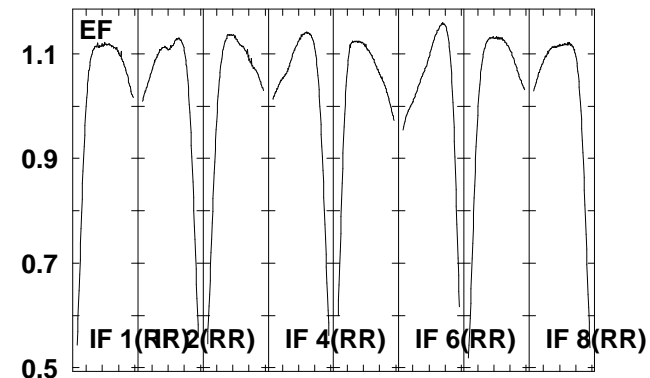
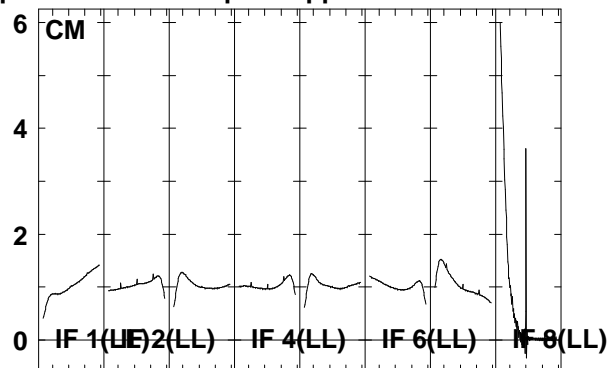
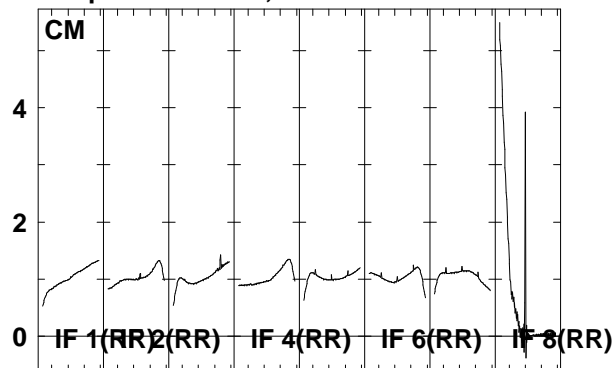

6663.6665.6667.6669.6671.6673.6675.6677.5
 FREQ MHz

6663.6665.6667.6669.6671.6673.6675.6677.5
 FREQ MHz

6663.6665.6667.6669.6671.6673.6675.6677.5
 FREQ MHz

Lower frame: Real Jy
 Total-power spectrum Antenna: *
 Timerange: 00/05:33:02 to 00/05:35:59

Plot file version 44 created 22-JUN-2006 20:04:50
 J1825-17 EM061A 1.UVDATA.1
 Freq = 6.6631 GHz, Bw = 2.000 MH No calibration applied and no bandpass applied

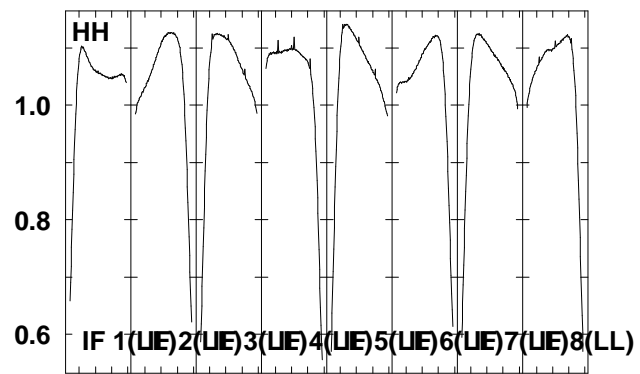
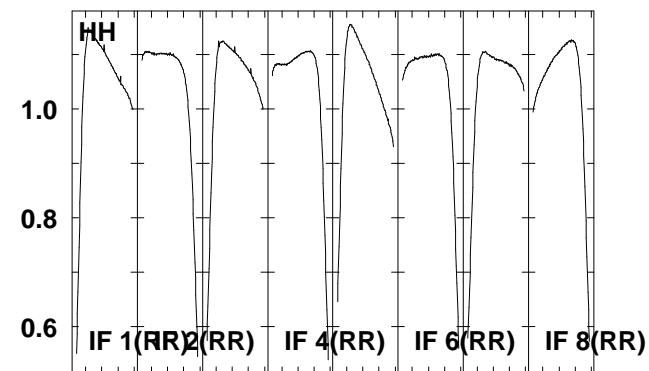
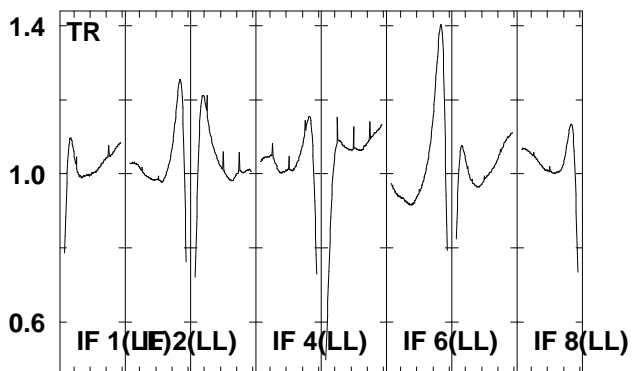
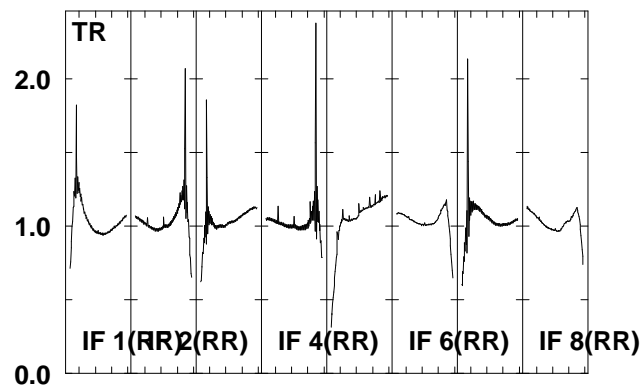
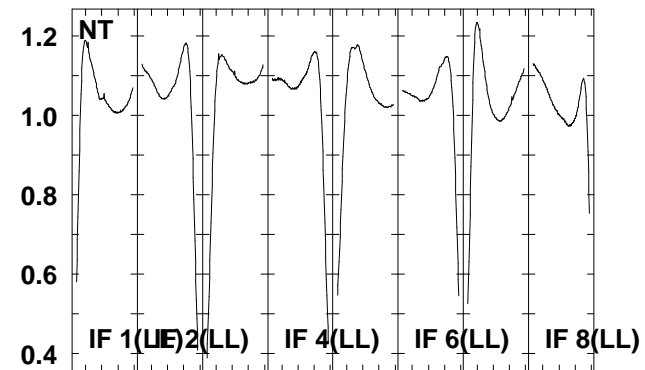
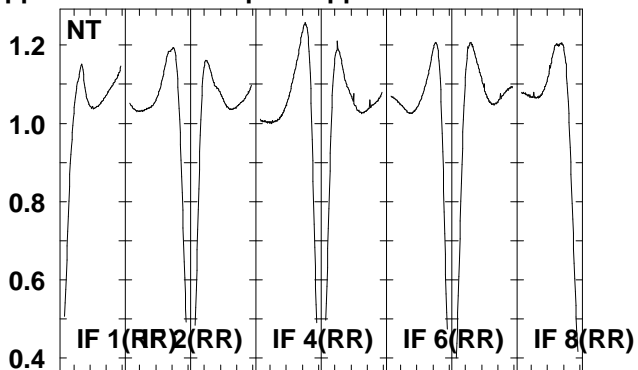
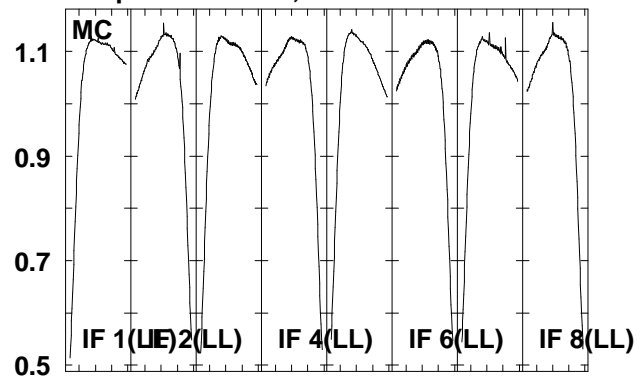

6663.6665.6667.6669.6671.6673.6675.6677.5
 FREQ MHz

Lower frame: Real Jy
 Total-power spectrum Antenna: *
 Timerange: 00/05:33:02 to 00/05:35:59

Plot file version 45 created 22-JUN-2006 20:04:54
 G16.59-0 EM061A 1.UVDATA.1
 Freq = 6.6631 GHz, Bw = 2.000 MH No calibration applied and no bandpass applied

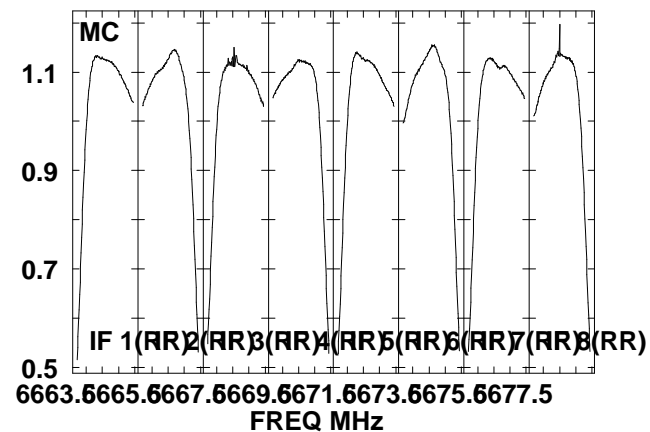
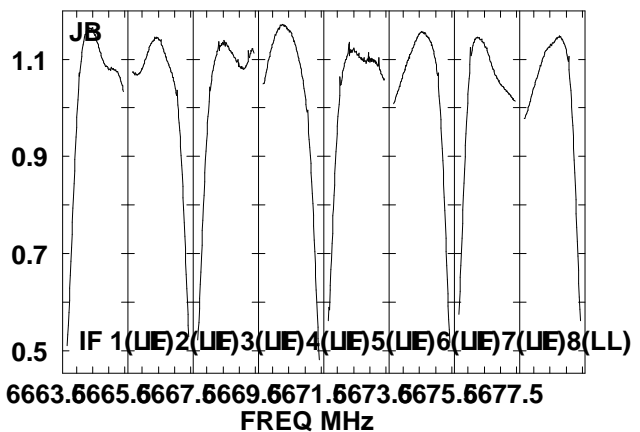
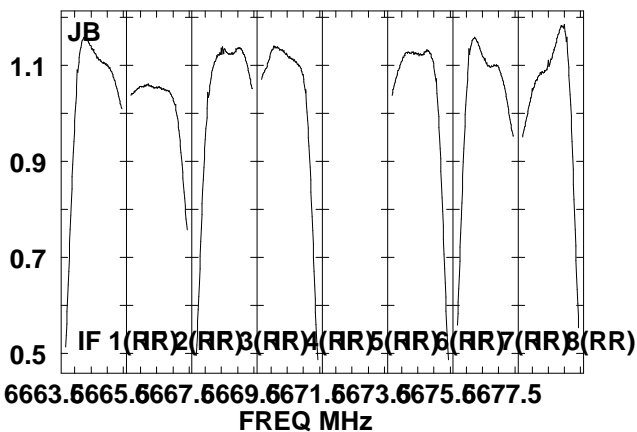
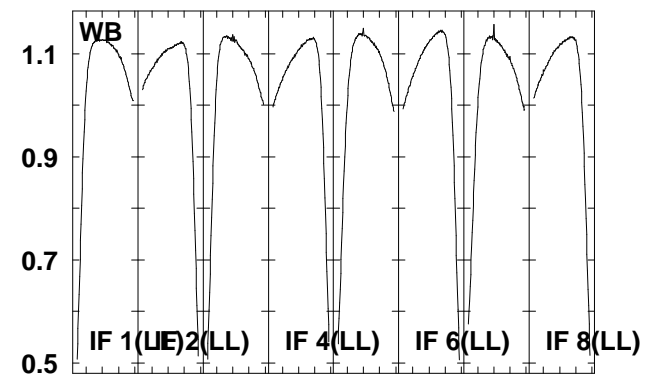
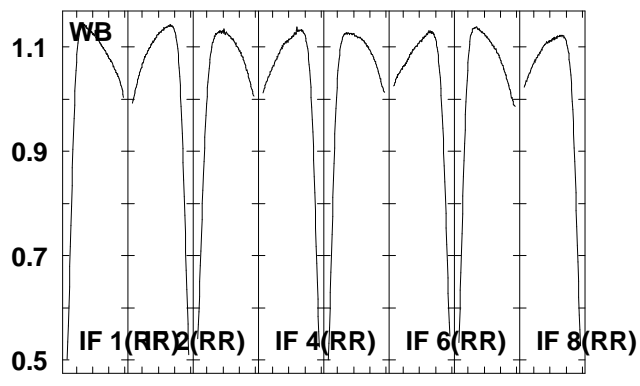
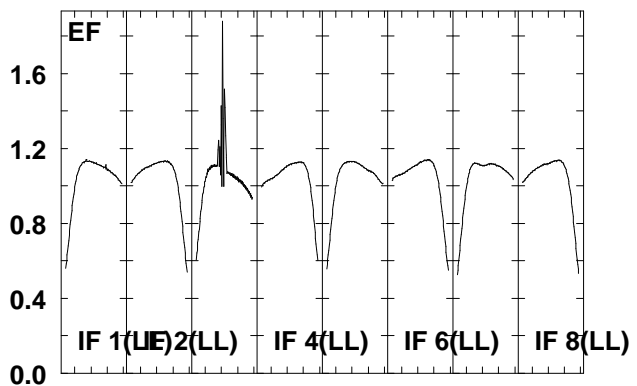
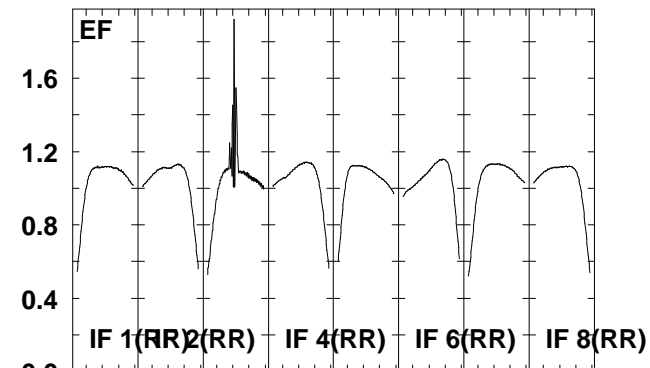
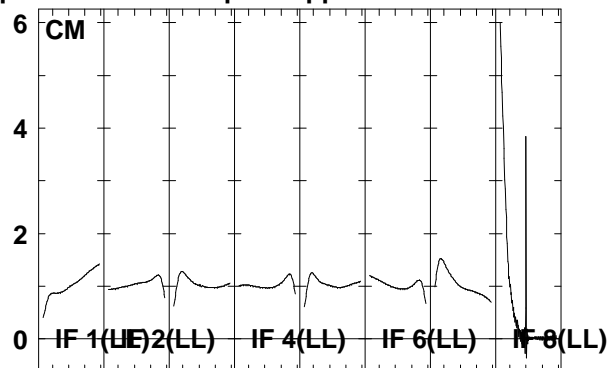
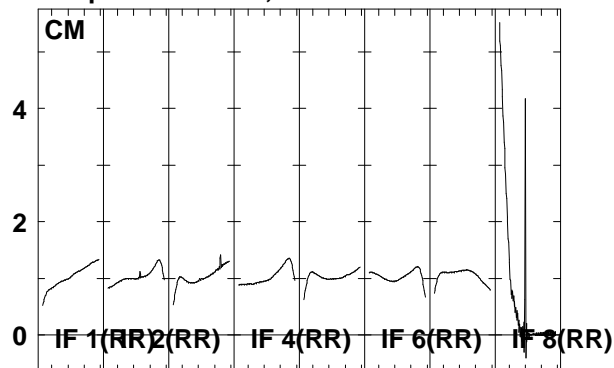

6663.6665.6667.6669.6671.6673.6675.6677.5
 FREQ MHz

6663.6665.6667.6669.6671.6673.6675.6677.5
 FREQ MHz

6663.6665.6667.6669.6671.6673.6675.6677.5
 FREQ MHz

Lower frame: Real Jy
 Total-power spectrum Antenna: *
 Timerange: 00/05:36:01 to 00/05:38:29

Plot file version 46 created 22-JUN-2006 20:04:58
 G16.59-0 EM061A 1.UVDATA.1
 Freq = 6.6631 GHz, Bw = 2.000 MH No calibration applied and no bandpass applied

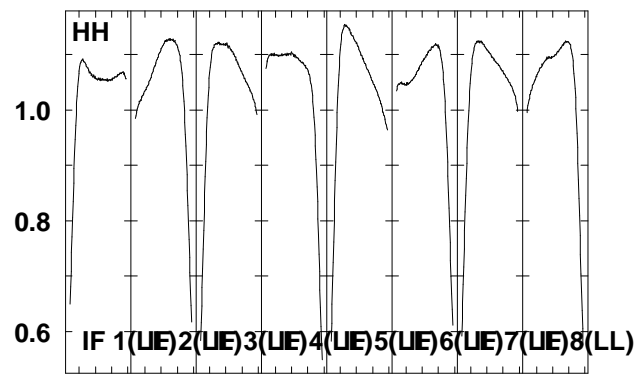
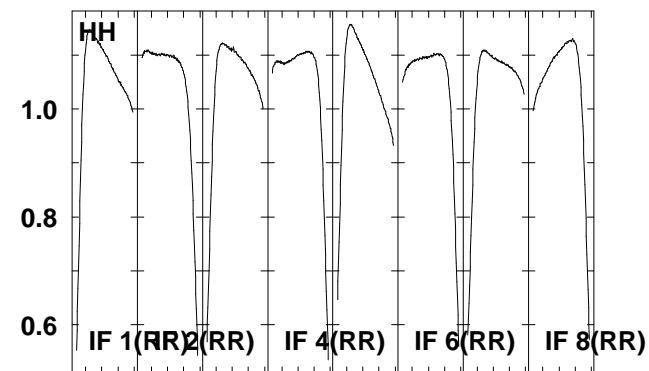
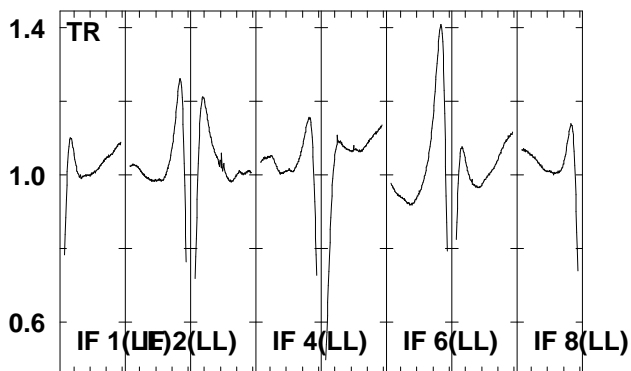
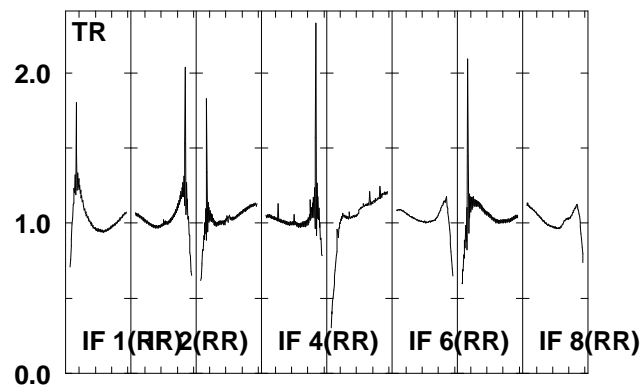
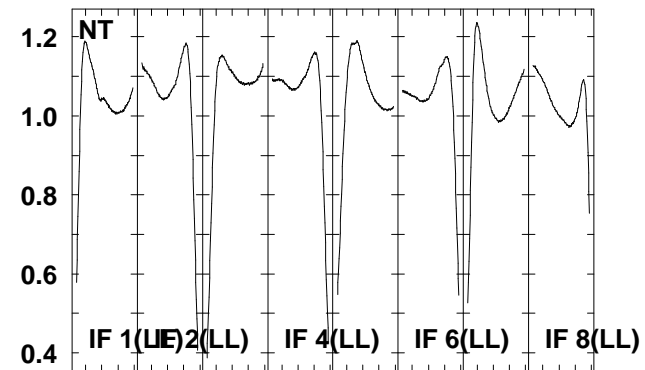
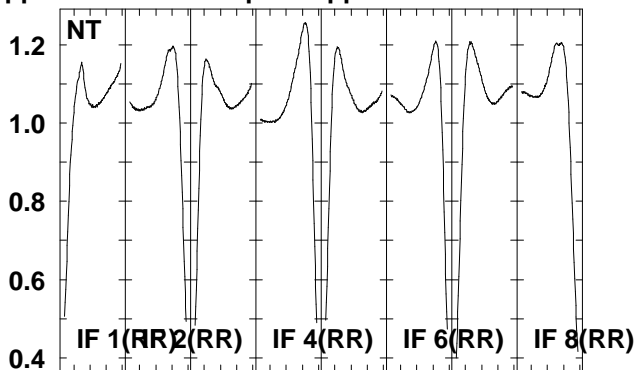
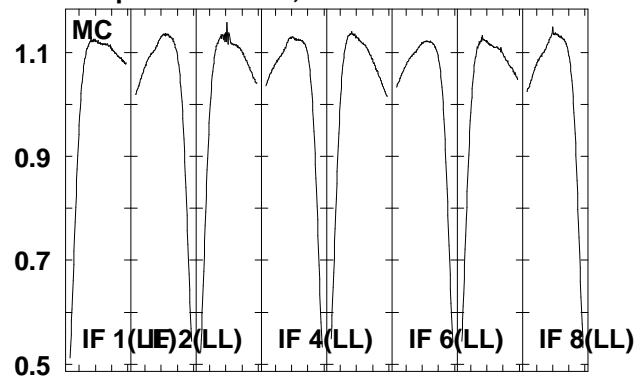

6663.6665.6667.6669.6671.6673.6675.6677.5
 FREQ MHz

Lower frame: Real Jy
 Total-power spectrum Antenna: *
 Timerange: 00/05:36:01 to 00/05:38:29

Plot file version 47 created 22-JUN-2006 20:05:02
 J1825-17 EM061A 1.UVDATA.1
 Freq = 6.6631 GHz, Bw = 2.000 MH No calibration applied and no bandpass applied

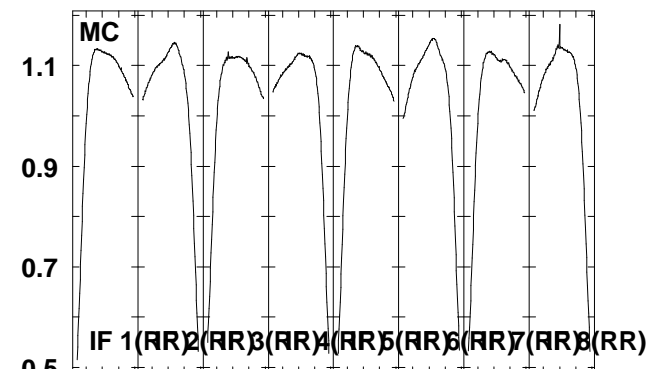
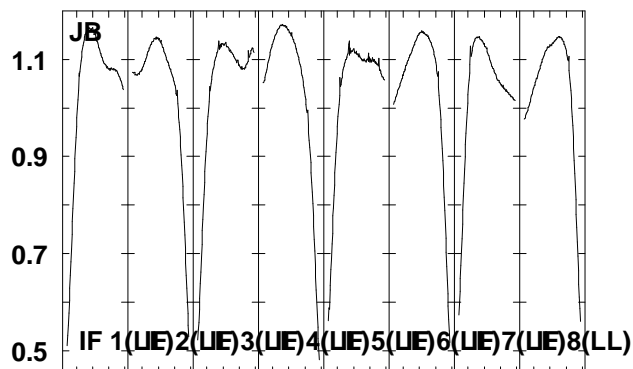
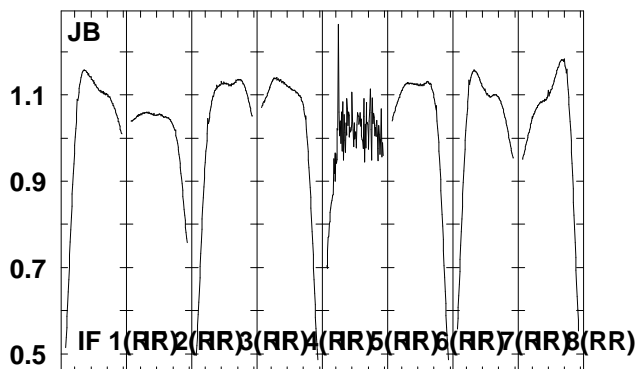
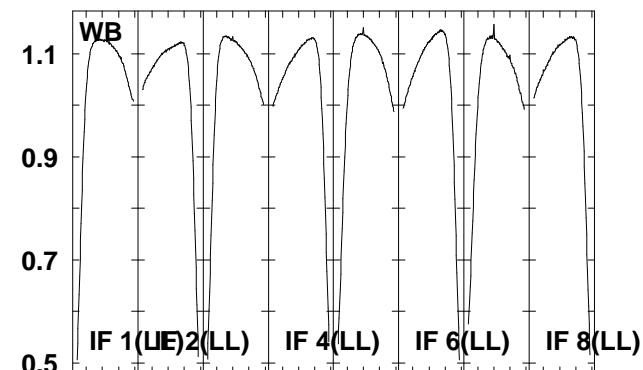
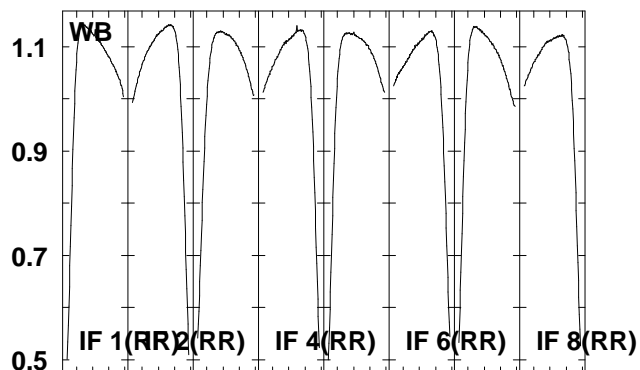
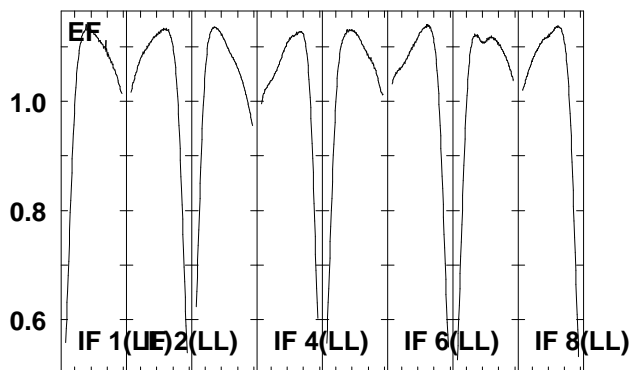
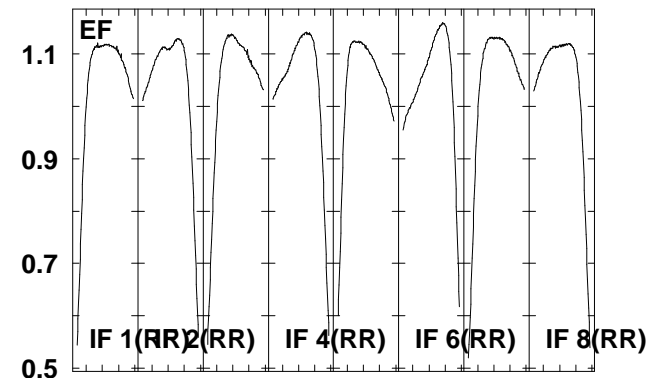
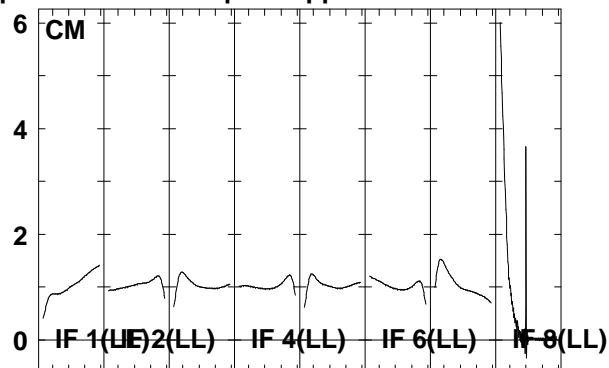
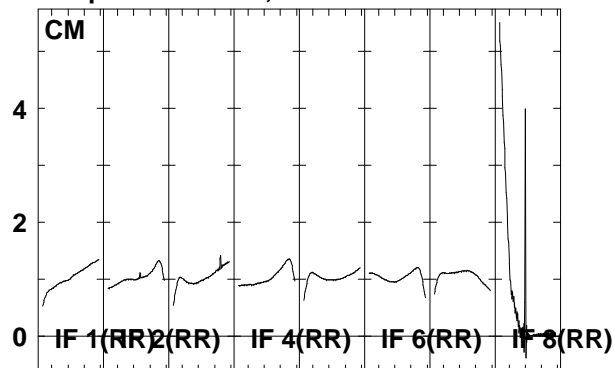

6663.6665.6667.6669.6671.6673.6675.6677.5
 FREQ MHz

6663.6665.6667.6669.6671.6673.6675.6677.5
 FREQ MHz

6663.6665.6667.6669.6671.6673.6675.6677.5
 FREQ MHz

Lower frame: Real Jy
 Total-power spectrum Antenna: *
 Timerange: 00/05:38:31 to 00/05:41:29

Plot file version 48 created 22-JUN-2006 20:05:05
 J1825-17 EM061A 1.UVDATA.1
 Freq = 6.6631 GHz, Bw = 2.000 MH No calibration applied and no bandpass applied

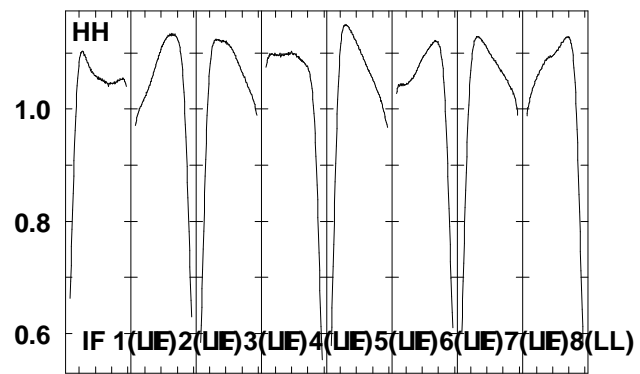
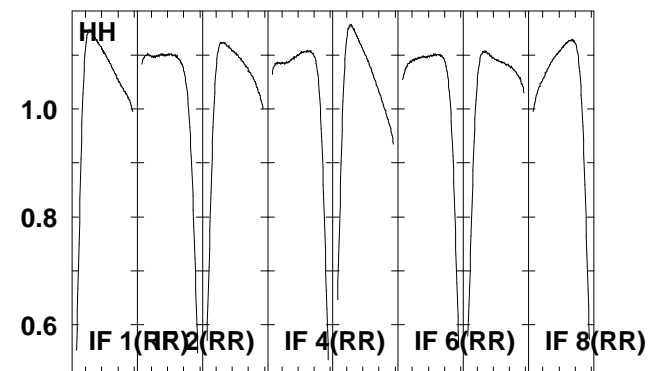
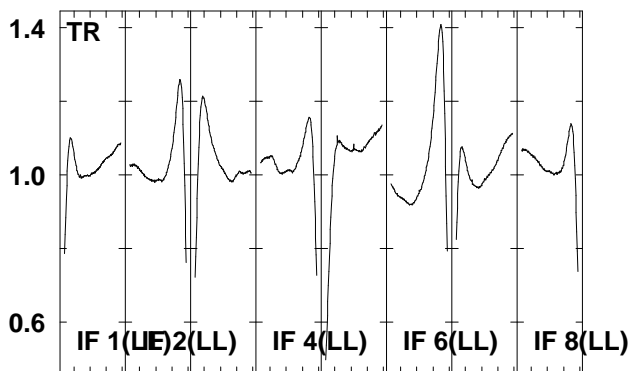
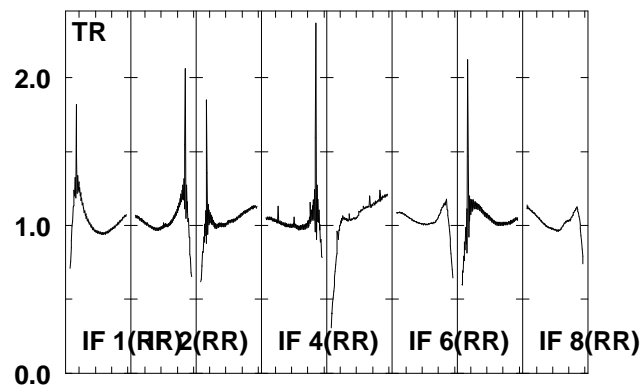
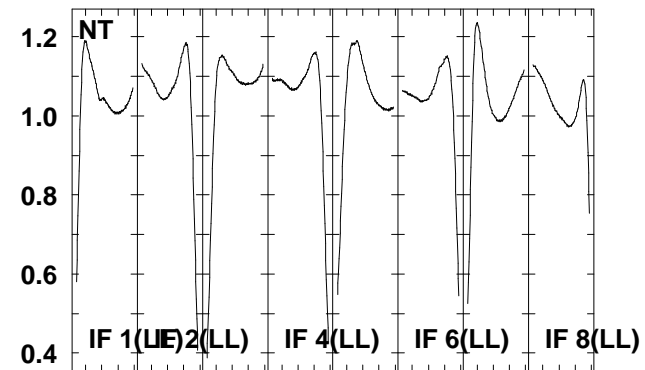
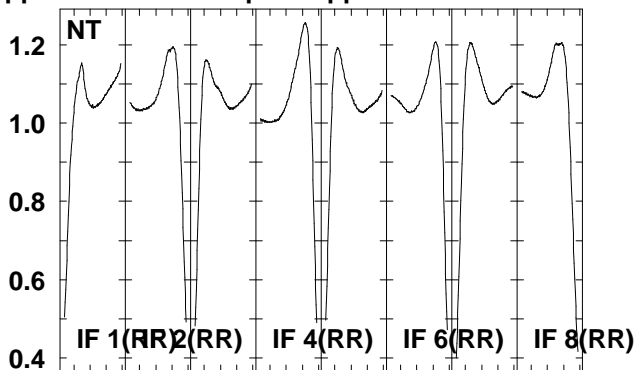
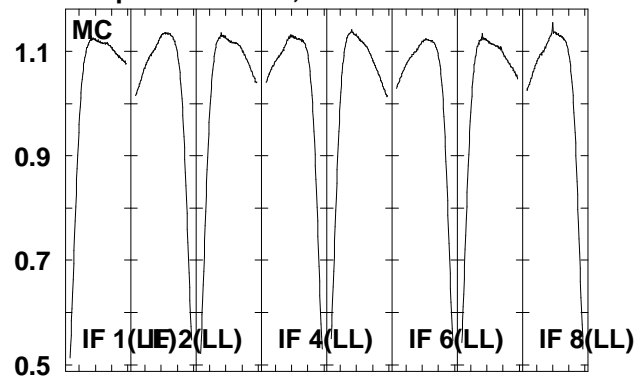

6663.6665.6667.6669.6671.6673.6675.6677.5
 FREQ MHz

Lower frame: Real Jy
 Total-power spectrum Antenna: *
 Timerange: 00/05:38:31 to 00/05:41:29

Plot file version 49 created 22-JUN-2006 20:05:09
 G16.59-0 EM061A 1.UVDATA.1
 Freq = 6.6631 GHz, Bw = 2.000 MH No calibration applied and no bandpass applied

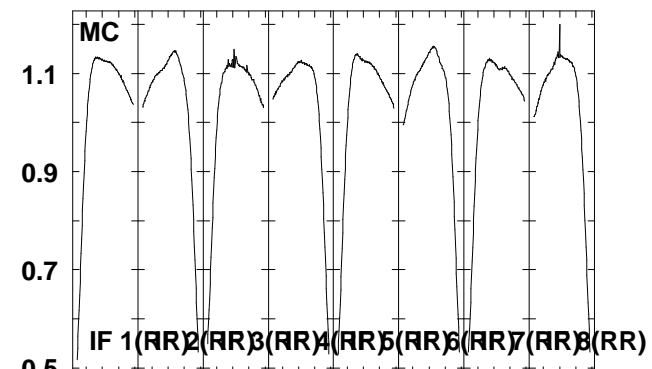
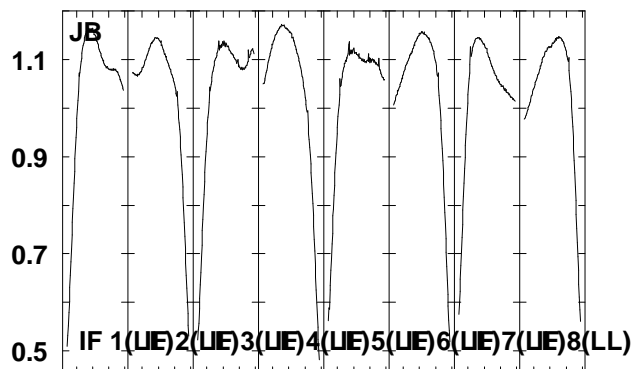
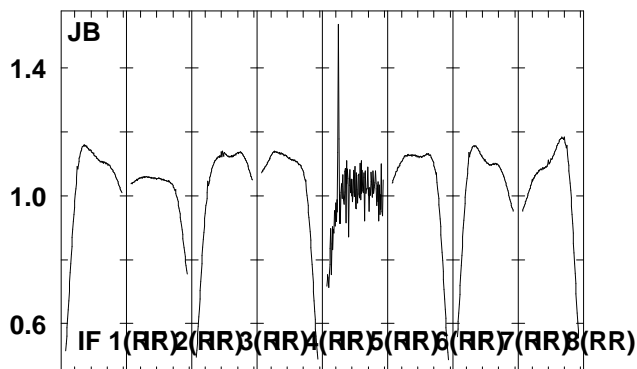
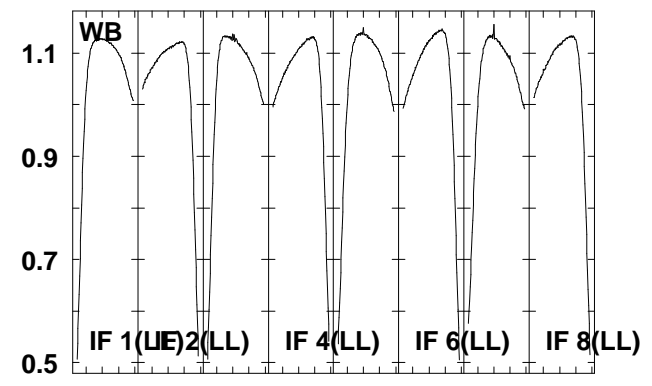
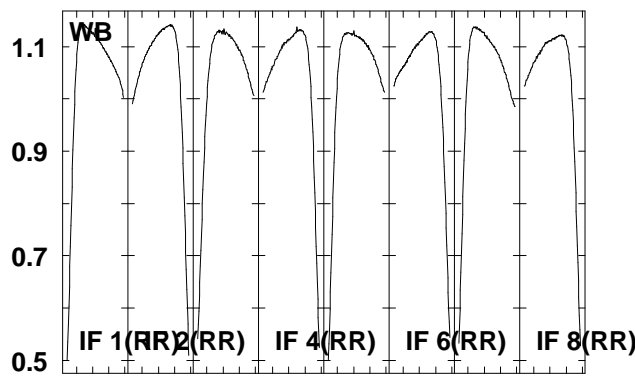
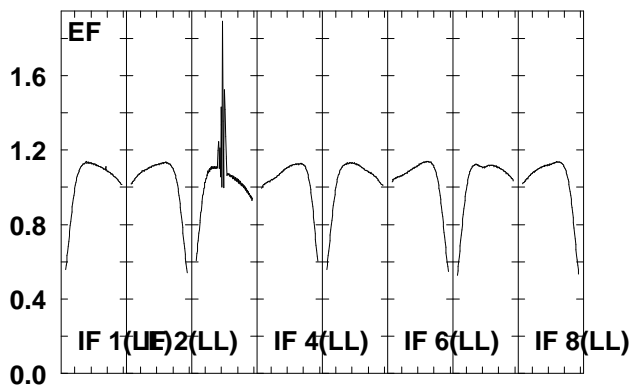
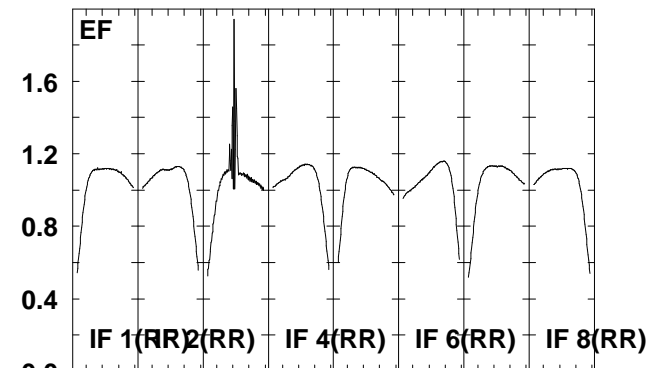
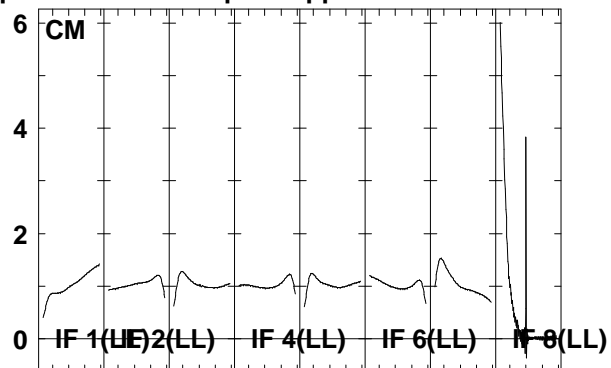
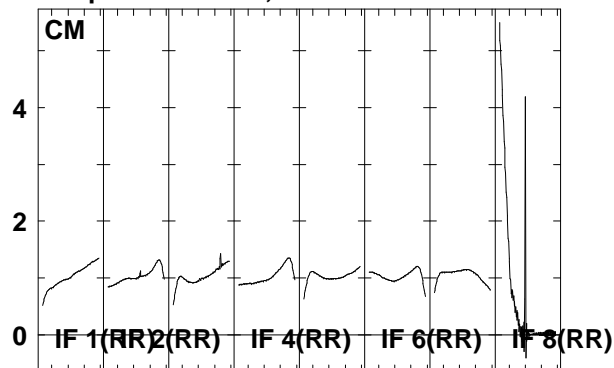

6663.6665.6667.6669.6671.6673.6675.6677.5
 FREQ MHz

6663.6665.6667.6669.6671.6673.6675.6677.5
 FREQ MHz

6663.6665.6667.6669.6671.6673.6675.6677.5
 FREQ MHz

Lower frame: Real Jy
 Total-power spectrum Antenna: *
 Timerange: 00/05:41:31 to 00/05:43:59

Plot file version 50 created 22-JUN-2006 20:05:13
 G16.59-0 EM061A 1.UVDATA.1
 Freq = 6.6631 GHz, Bw = 2.000 MH No calibration applied and no bandpass applied

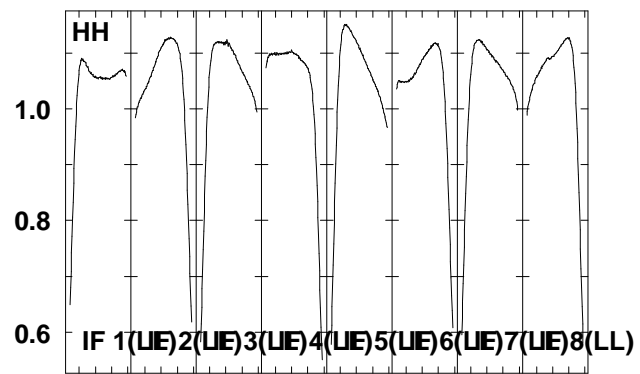
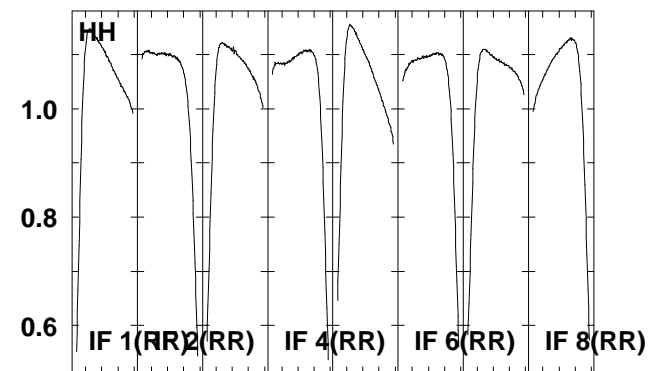
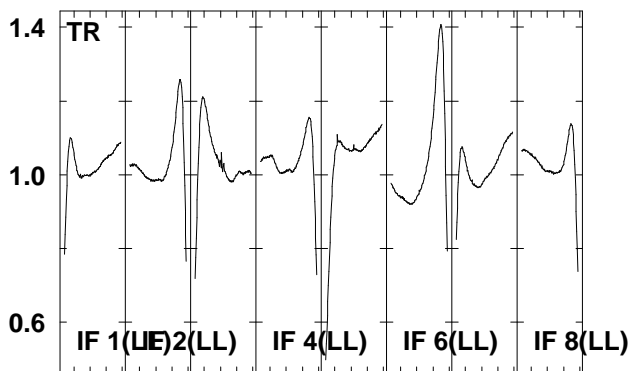
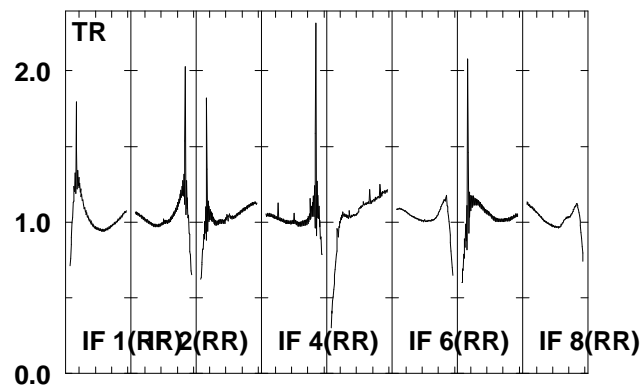
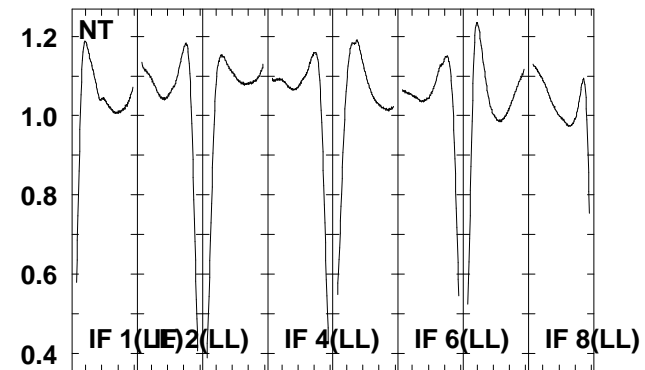
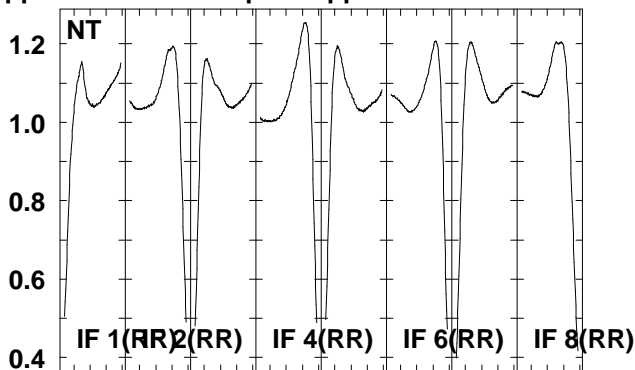
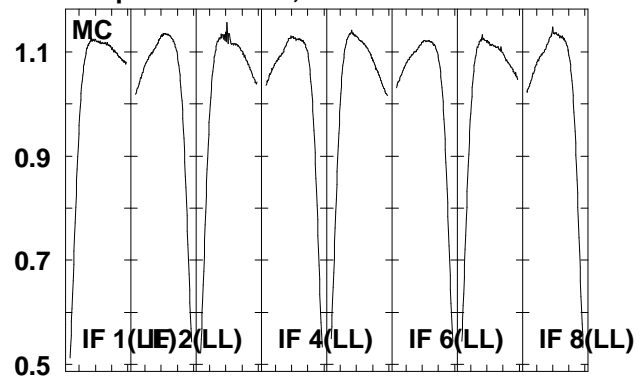

6663.6665.6667.6669.6671.6673.6675.6677.5
 FREQ MHz

Lower frame: Real Jy
 Total-power spectrum Antenna: *
 Timerange: 00/05:41:31 to 00/05:43:59

Plot file version 51 created 22-JUN-2006 20:05:17
 J1825-17 EM061A 1.UVDATA.1
 Freq = 6.6631 GHz, Bw = 2.000 MH No calibration applied and no bandpass applied

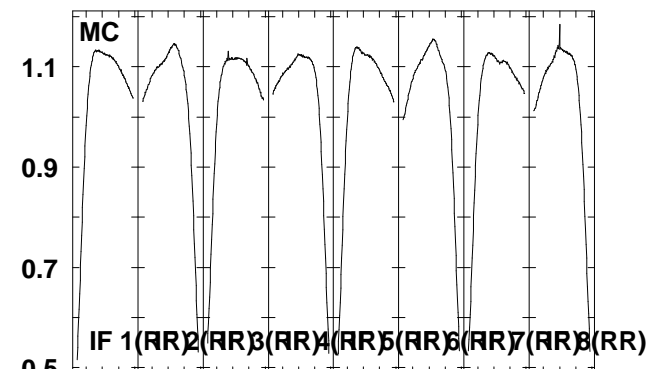
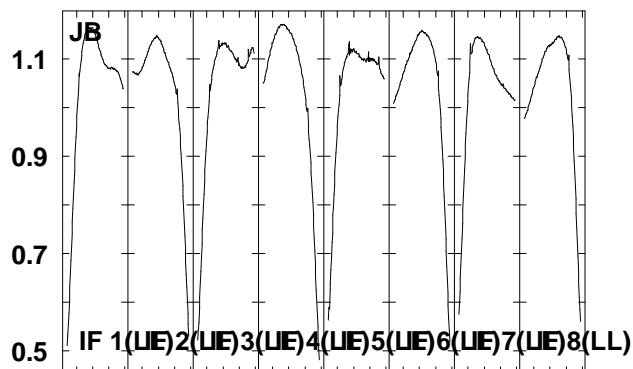
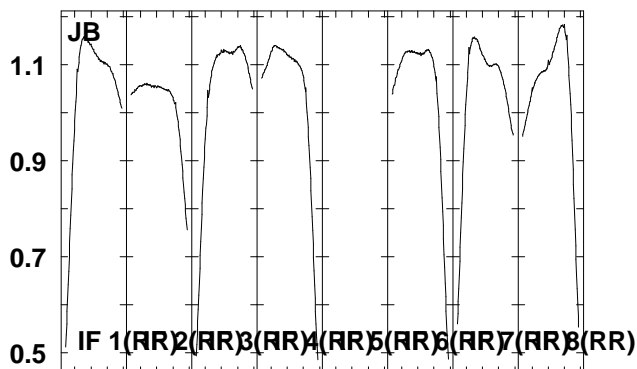
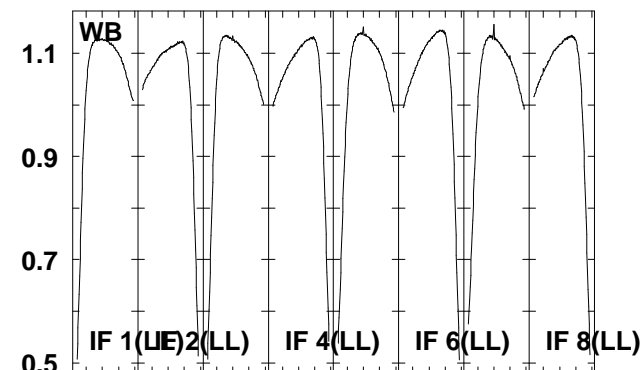
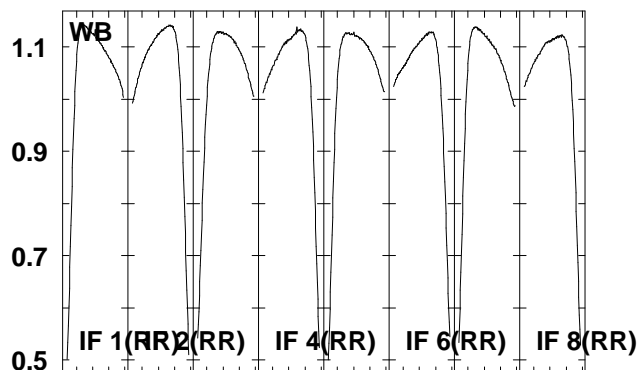
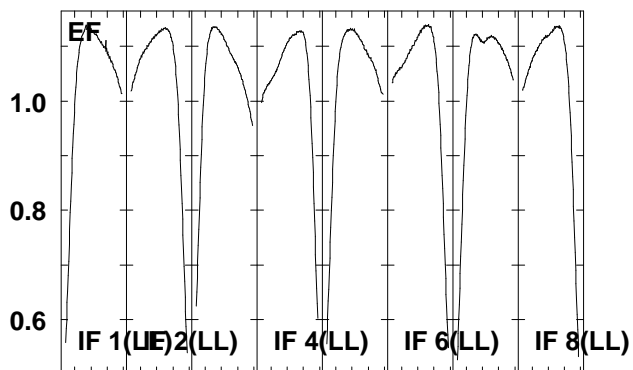
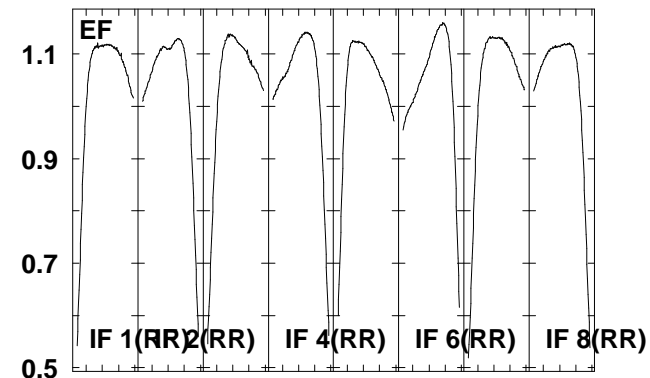
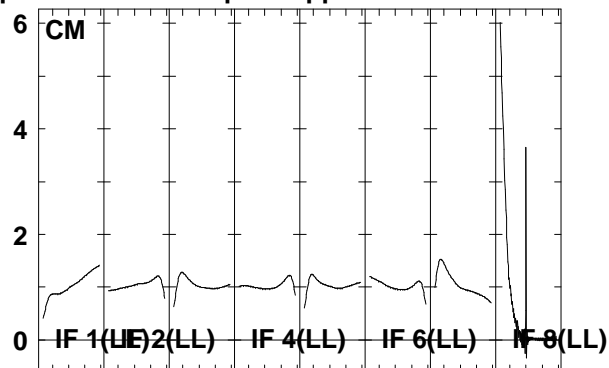
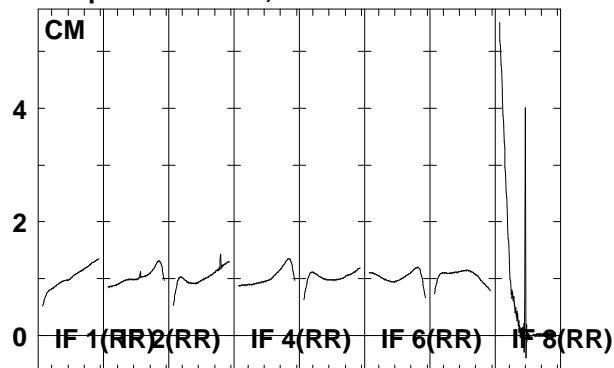

6663.6665.6667.6669.6671.6673.6675.6677.5
 FREQ MHz

6663.6665.6667.6669.6671.6673.6675.6677.5
 FREQ MHz

6663.6665.6667.6669.6671.6673.6675.6677.5
 FREQ MHz

Lower frame: Real Jy
 Total-power spectrum Antenna: *
 Timerange: 00/05:44:01 to 00/05:46:59

Plot file version 52 created 22-JUN-2006 20:05:20
 J1825-17 EM061A 1.UVDATA.1
 Freq = 6.6631 GHz, Bw = 2.000 MH No calibration applied and no bandpass applied

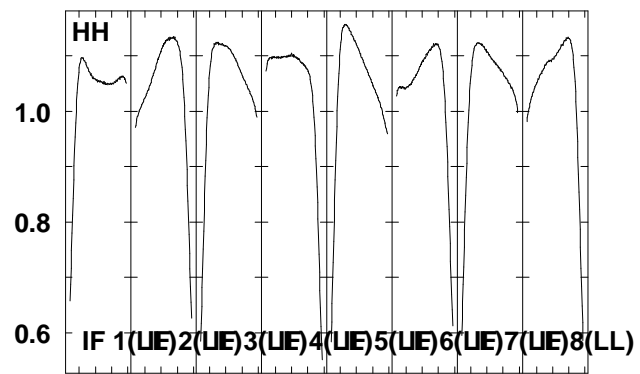
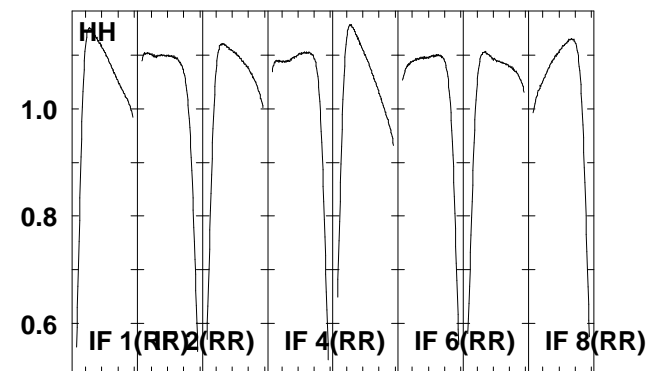
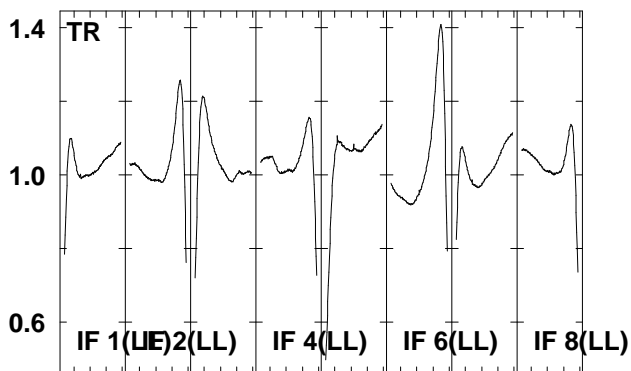
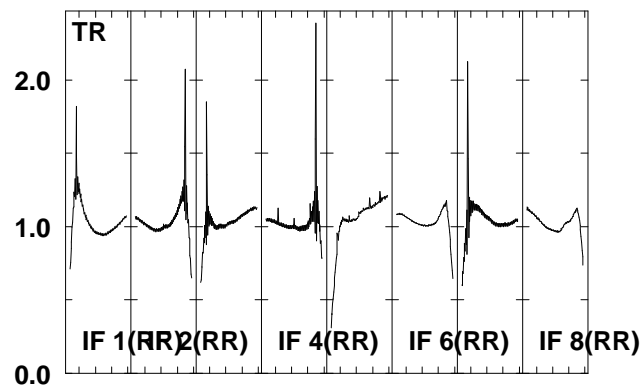
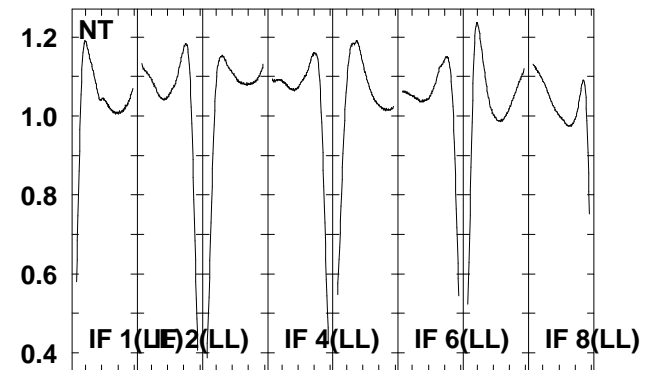
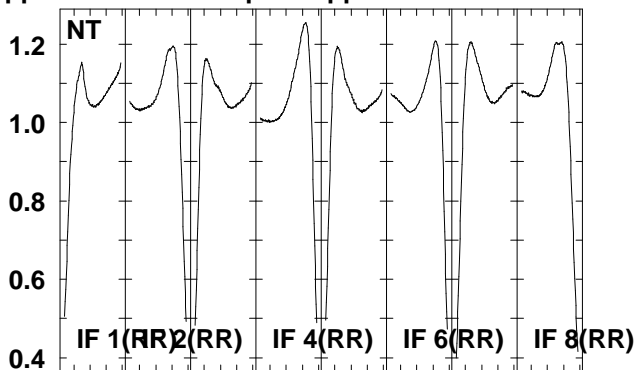
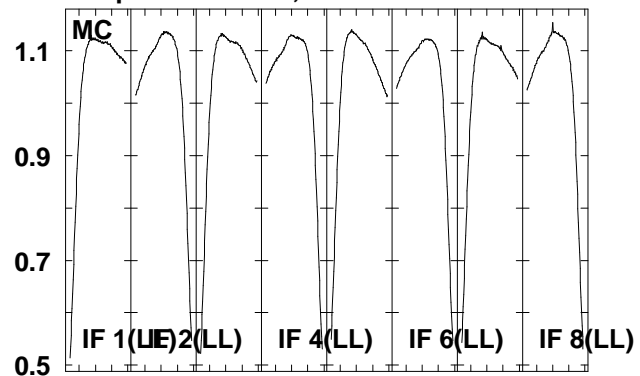

6663.6665.6667.6669.6671.6673.6675.6677.5
 FREQ MHz

Lower frame: Real Jy
 Total-power spectrum Antenna: *
 Timerange: 00/05:44:01 to 00/05:46:59

Plot file version 53 created 22-JUN-2006 20:05:22
 G16.59-0 EM061A 1.UVDATA.1
 Freq = 6.6631 GHz, Bw = 2.000 MH No calibration applied and no bandpass applied

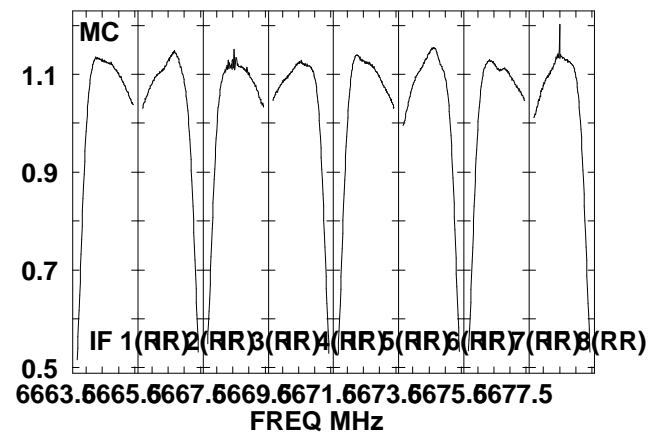
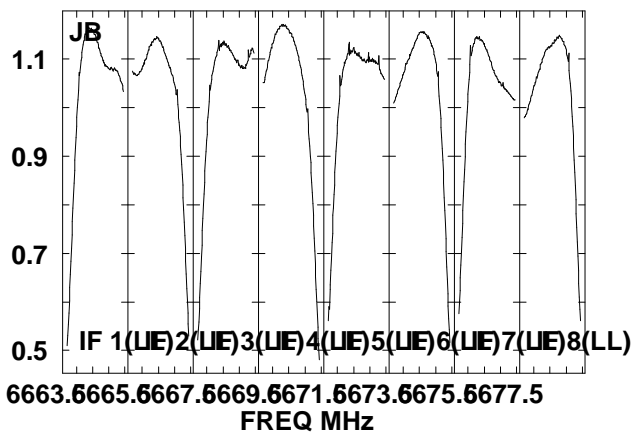
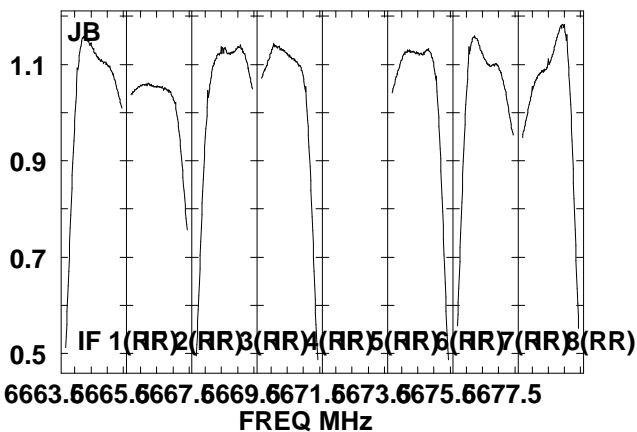
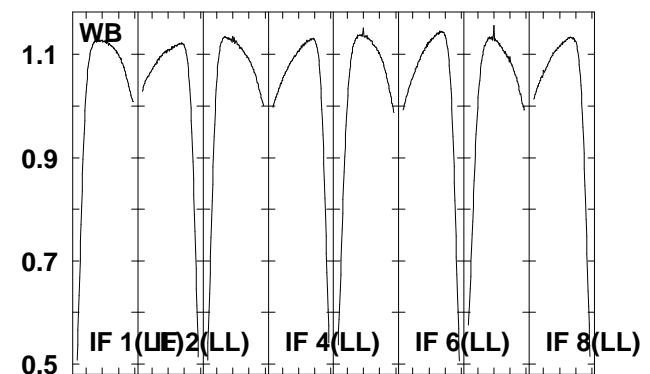
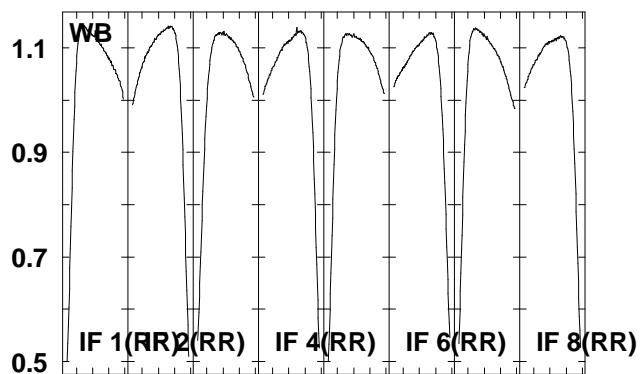
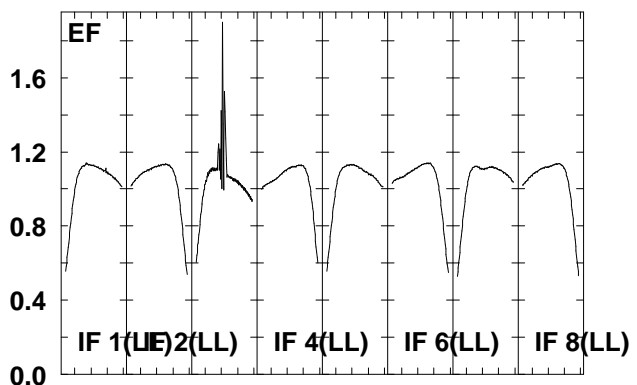
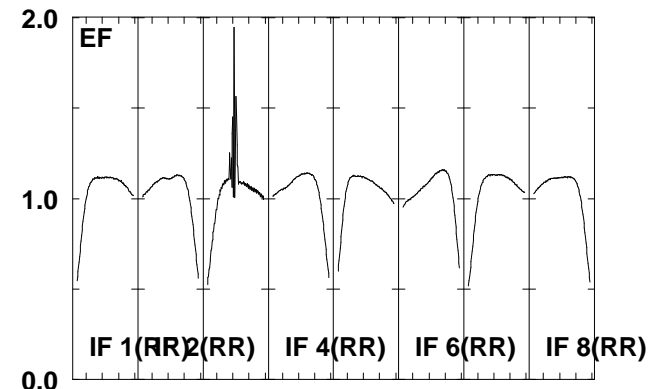
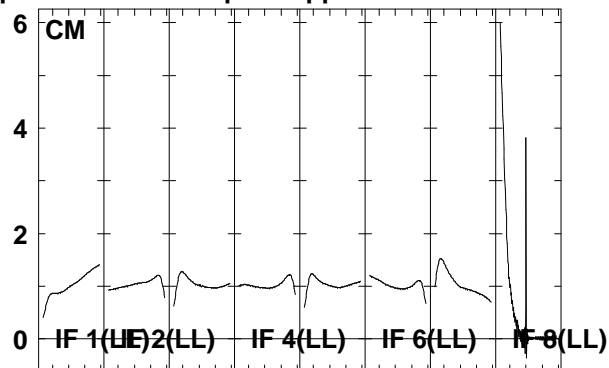
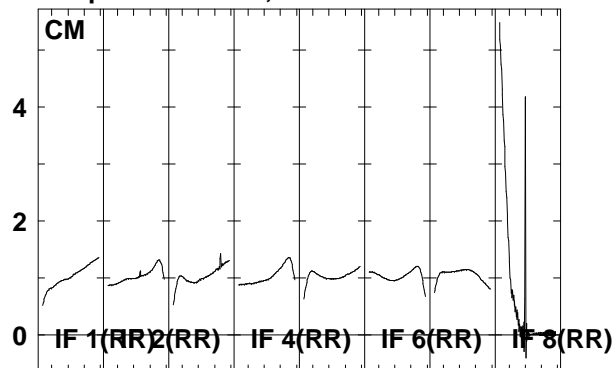

6663.6665.6667.6669.6671.6673.6675.6677.5
 FREQ MHz
 Lower frame: Real Jy
 Total-power spectrum Antenna: *
 Timerange: 00/05:47:01 to 00/05:48:40

Plot file version 54 created 22-JUN-2006 20:05:24
 G16.59-0 EM061A 1.UVDATA.1
 Freq = 6.6631 GHz, Bw = 2.000 MH No calibration applied and no bandpass applied

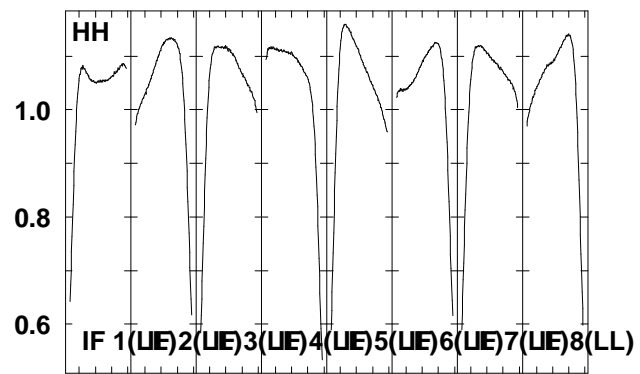
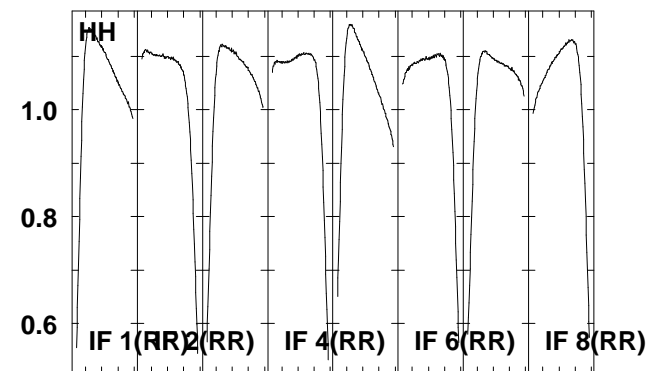
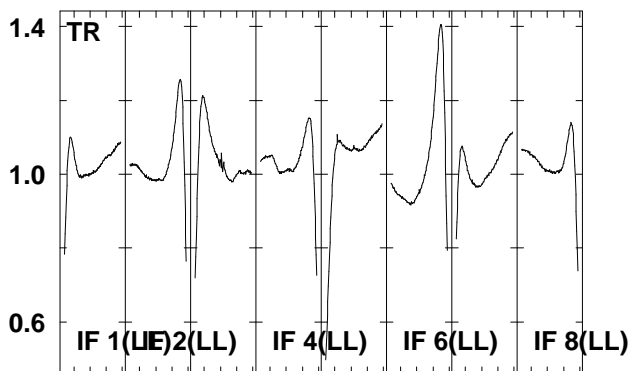
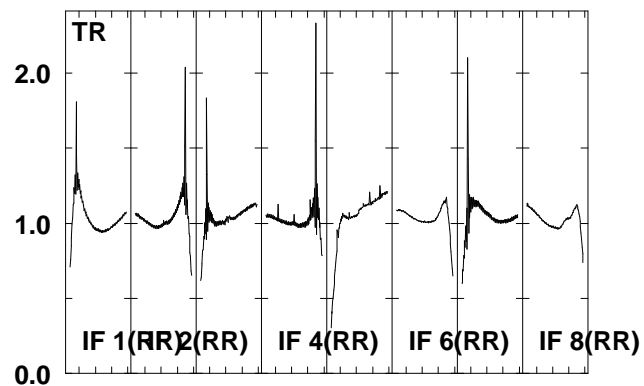
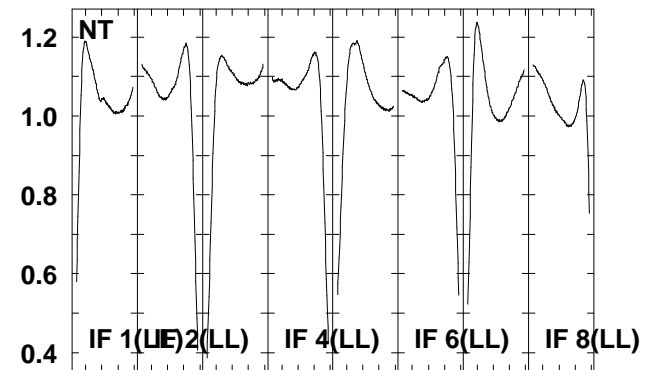
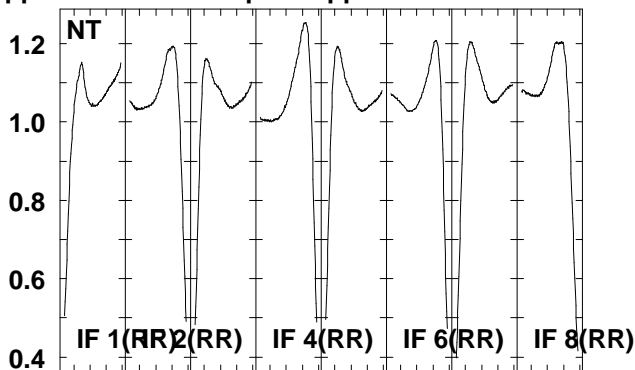
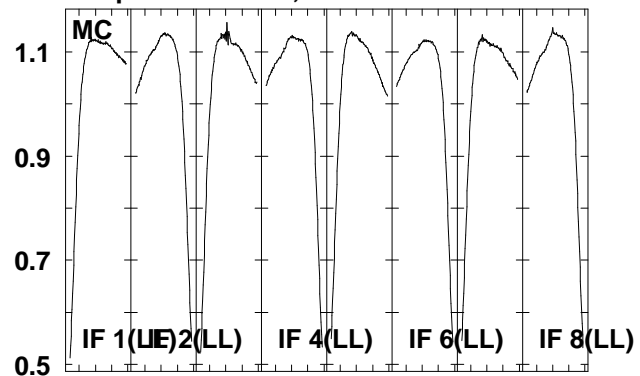

6663.6665.6667.6669.6671.6673.6675.6677.5
 FREQ MHz

Lower frame: Real Jy
 Total-power spectrum Antenna: *
 Timerange: 00/05:47:01 to 00/05:48:40

Plot file version 55 created 22-JUN-2006 20:05:27
 G16.59-0 EM061A 1.UVDATA.1
 Freq = 6.6631 GHz, Bw = 2.000 MH No calibration applied and no bandpass applied

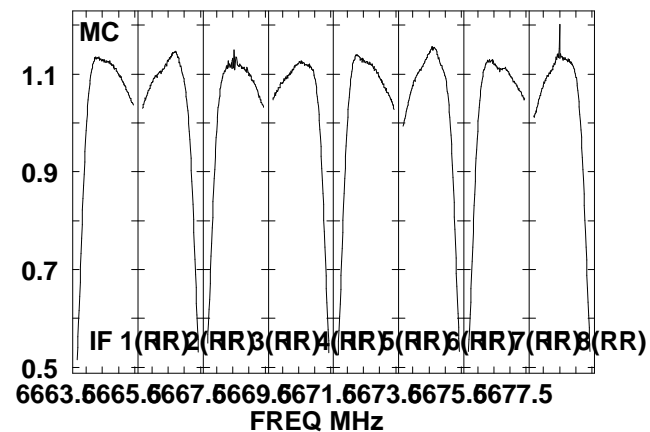
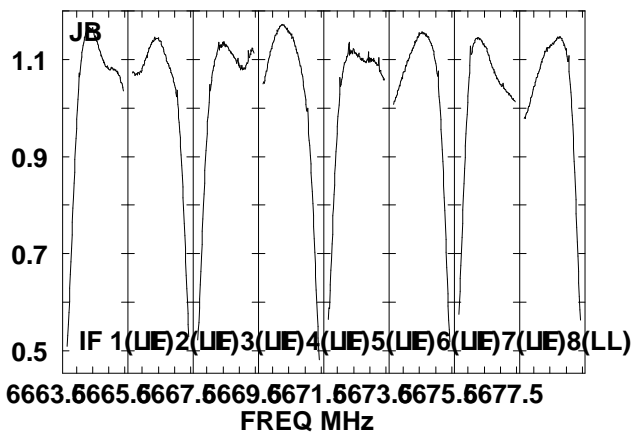
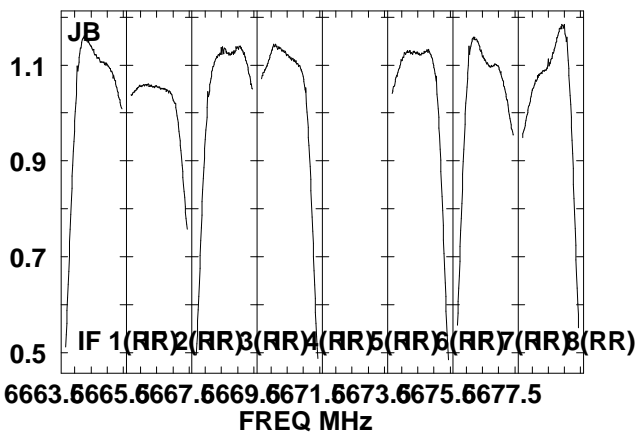
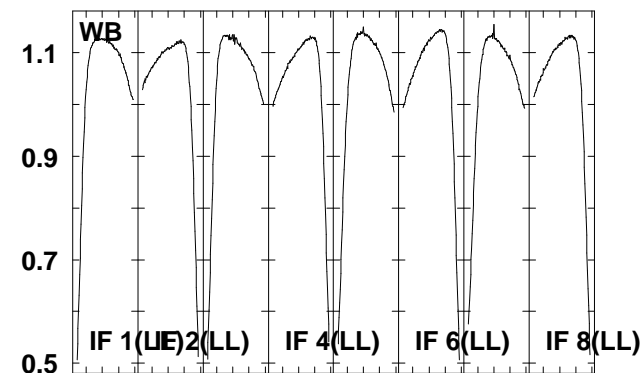
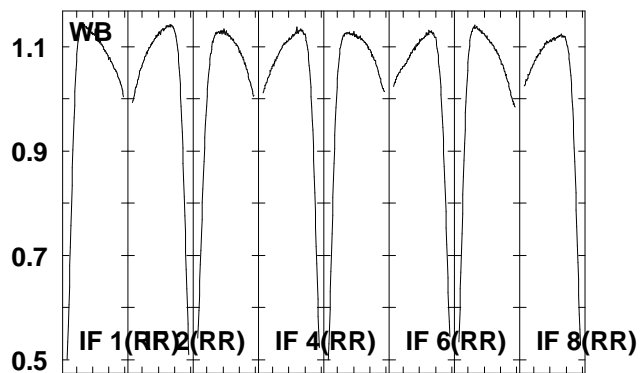
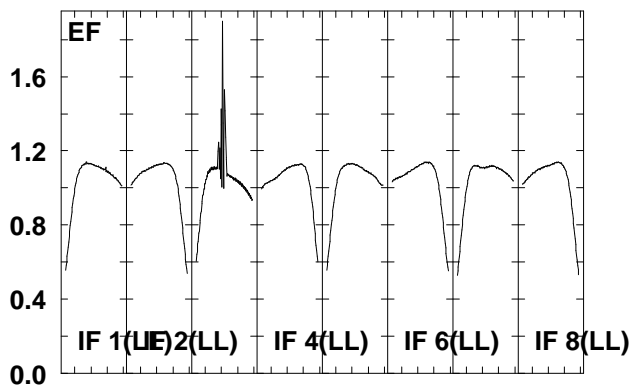
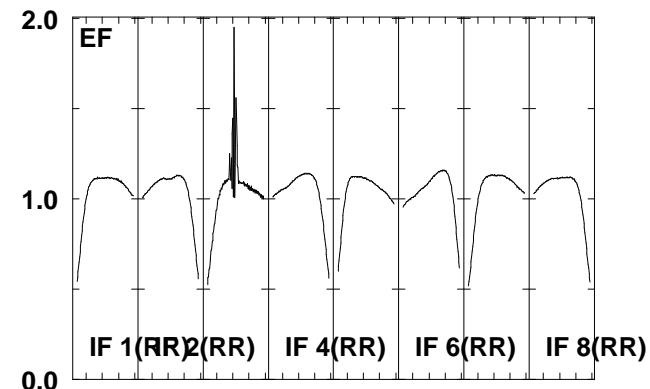
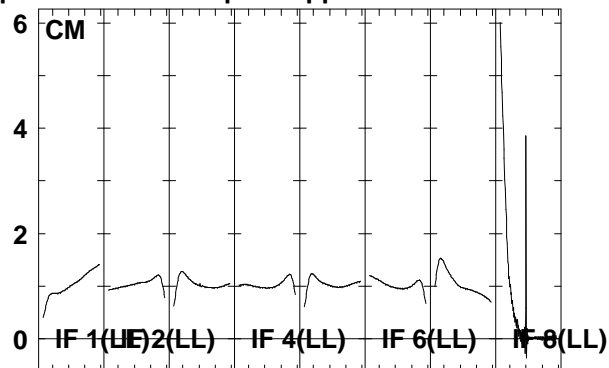
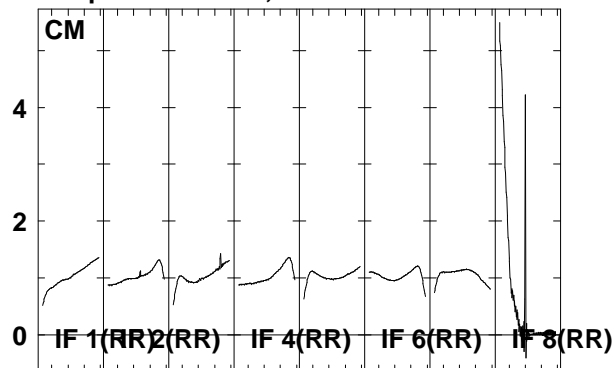

6663.6665.6667.6669.6671.6673.6675.6677.5
 FREQ MHz

6663.6665.6667.6669.6671.6673.6675.6677.5
 FREQ MHz

6663.6665.6667.6669.6671.6673.6675.6677.5
 FREQ MHz

Lower frame: Real Jy
 Total-power spectrum Antenna: *
 Timerange: 00/05:48:42 to 00/05:49:29

Plot file version 56 created 22-JUN-2006 20:05:28
 G16.59-0 EM061A 1.UVDATA.1
 Freq = 6.6631 GHz, Bw = 2.000 MH No calibration applied and no bandpass applied

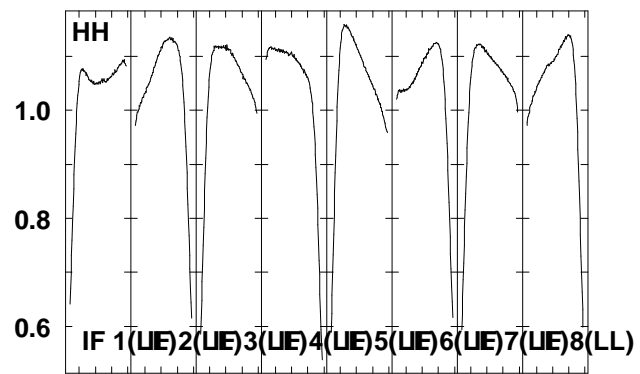
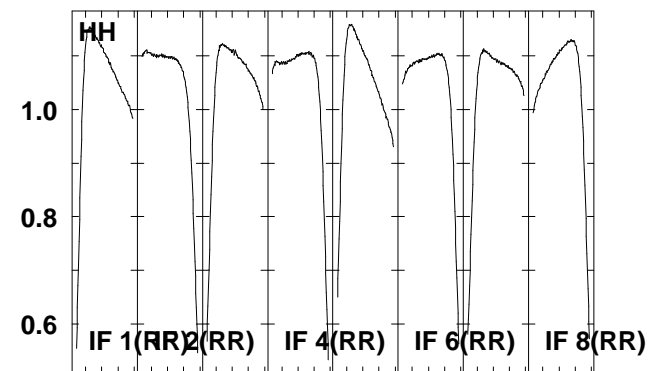
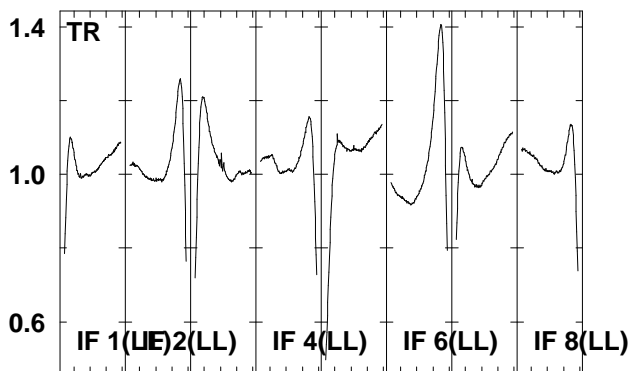
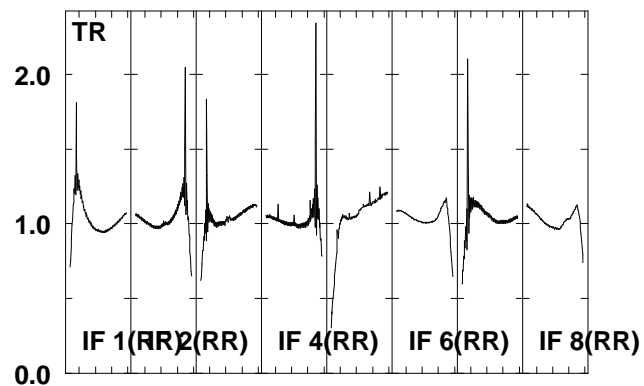
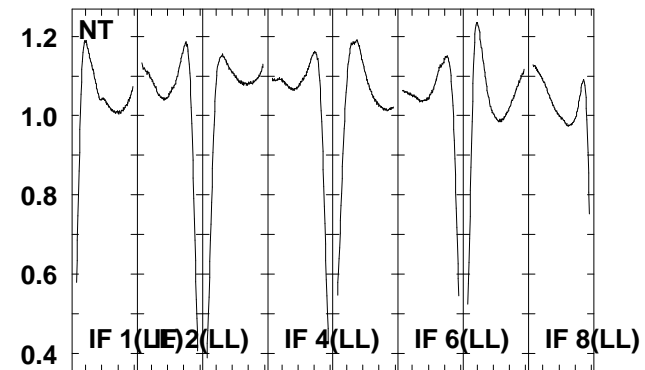
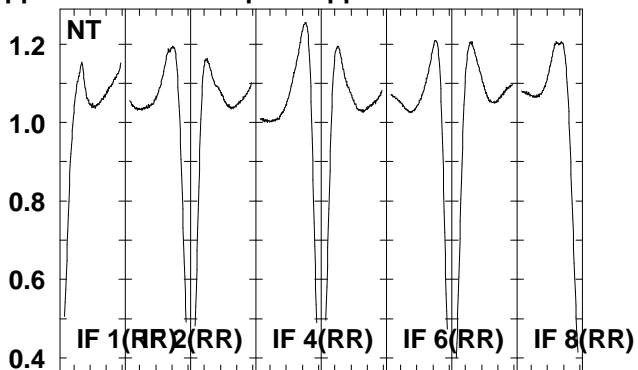
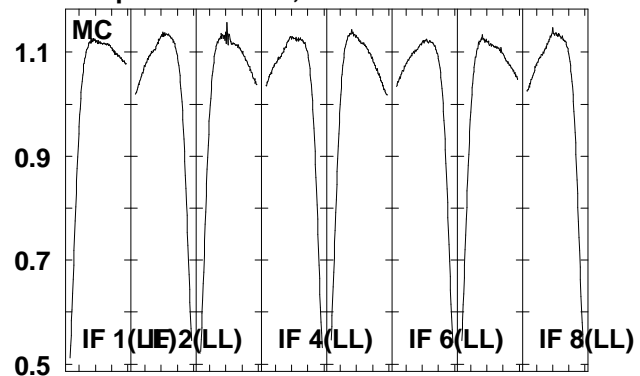

6663.6665.6667.6669.6671.6673.6675.6677.5
 FREQ MHz

Lower frame: Real Jy
 Total-power spectrum Antenna: *
 Timerange: 00/05:48:42 to 00/05:49:29

Plot file version 57 created 22-JUN-2006 20:05:31
 J1751+09 EM061A 1.UVDATA.1
 Freq = 6.6631 GHz, Bw = 2.000 MH No calibration applied and no bandpass applied

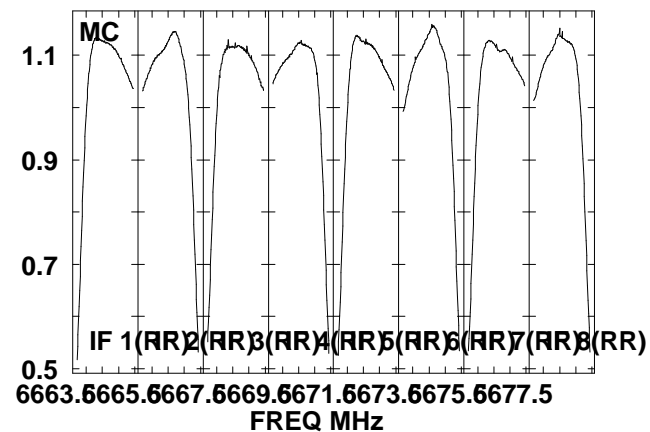
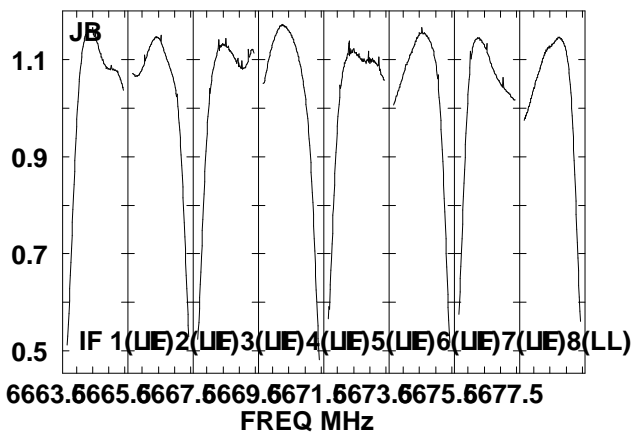
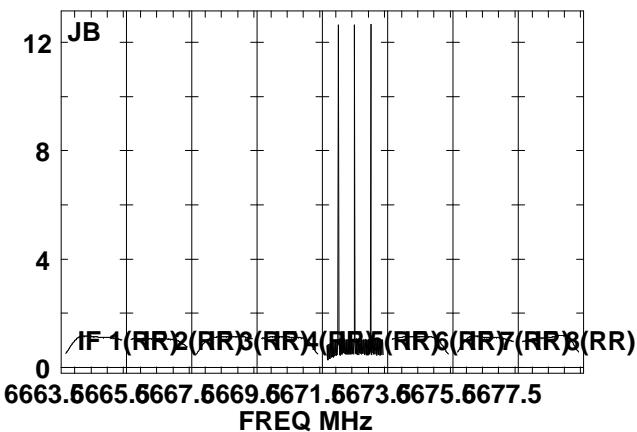
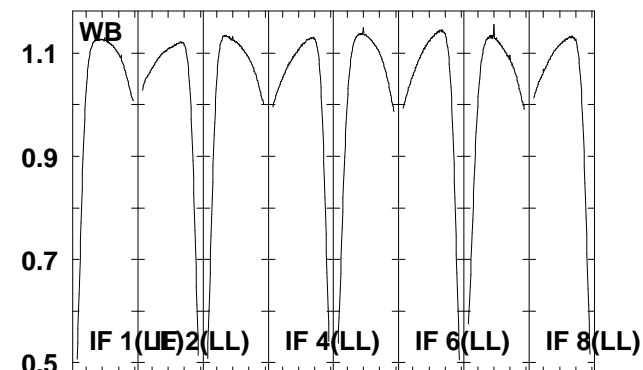
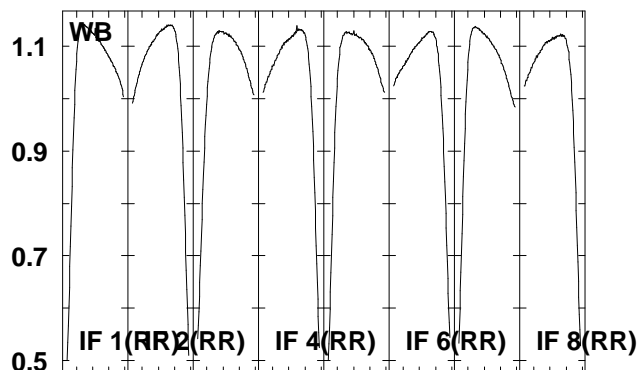
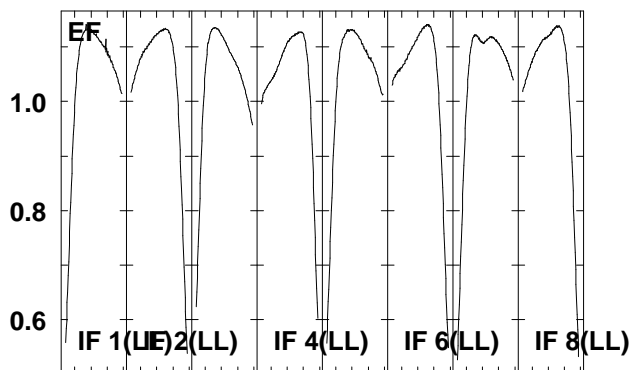
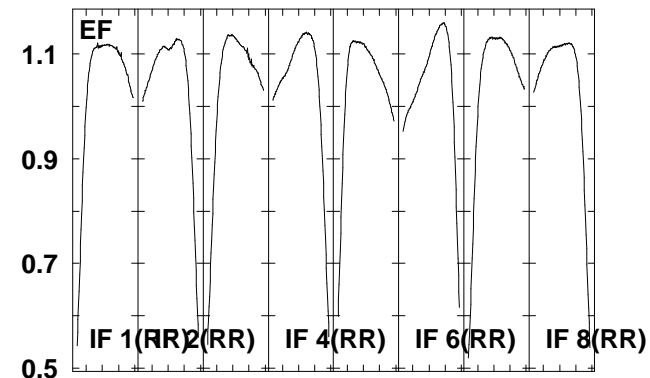
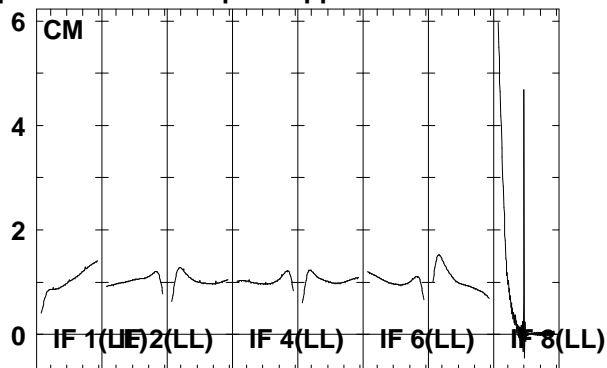
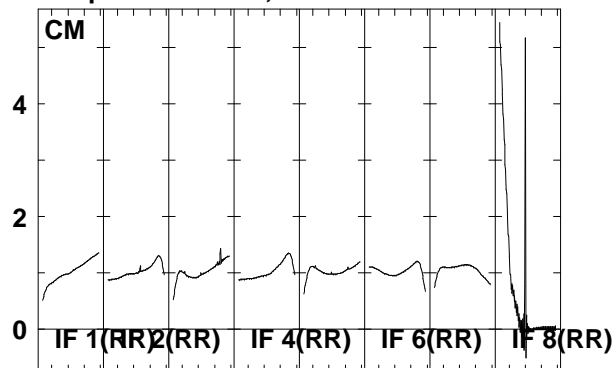

6663.6665.6667.6669.6671.6673.6675.6677.5
 FREQ MHz

6663.6665.6667.6669.6671.6673.6675.6677.5
 FREQ MHz

6663.6665.6667.6669.6671.6673.6675.6677.5
 FREQ MHz

Lower frame: Real Jy
 Total-power spectrum Antenna: *
 Timerange: 00/05:51:35 to 00/05:56:32

Plot file version 58 created 22-JUN-2006 20:05:36
 J1751+09 EM061A 1.UVDATA.1
 Freq = 6.6631 GHz, Bw = 2.000 MH No calibration applied and no bandpass applied

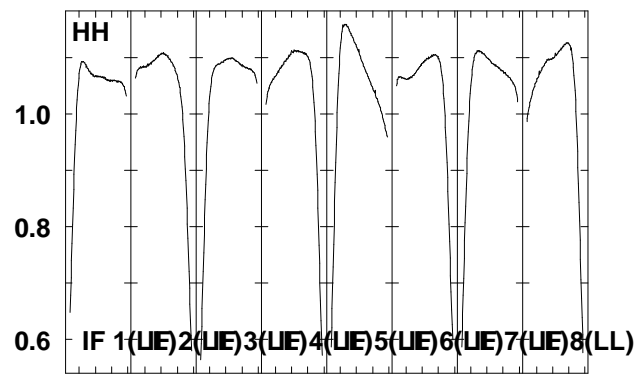
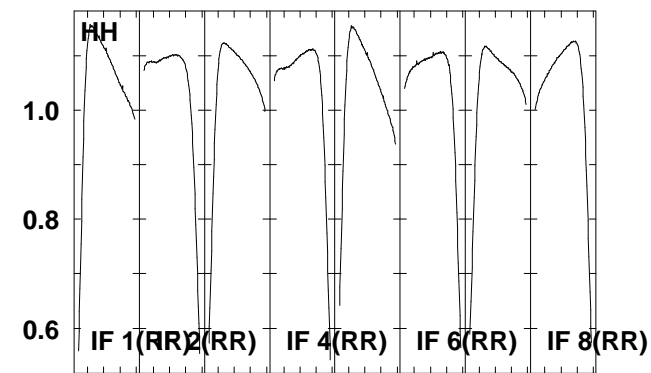
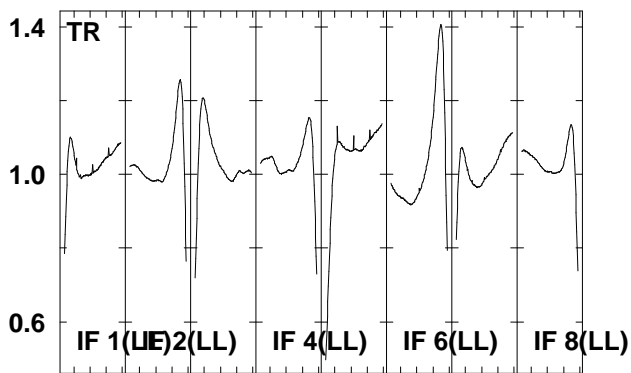
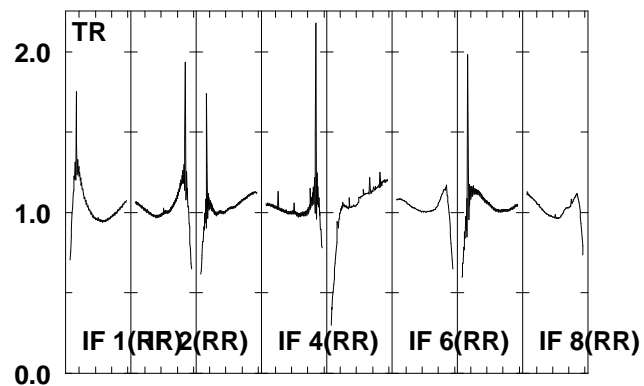
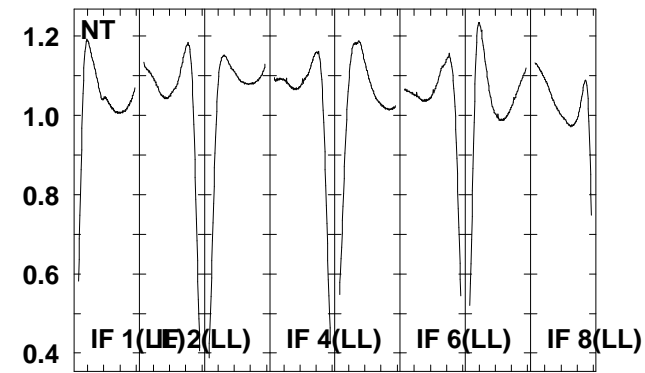
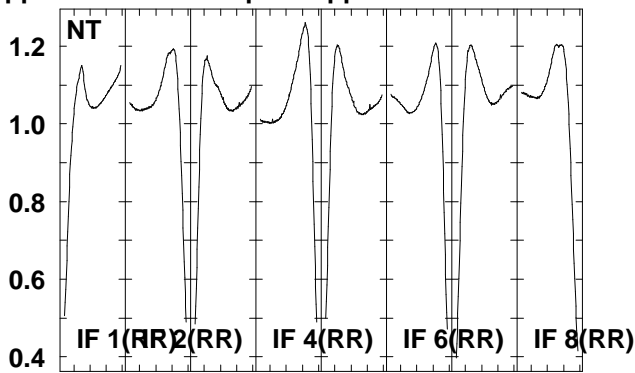
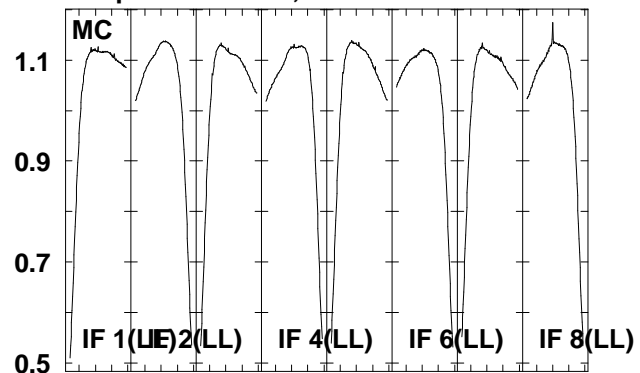

6663.6665.6667.6669.6671.6673.6675.6677.5
 FREQ MHz

Lower frame: Real Jy
 Total-power spectrum Antenna: *
 Timerange: 00/05:51:35 to 00/05:56:32

Plot file version 59 created 22-JUN-2006 20:05:41
 G16.59-0 EM061A 1.UVDATA.1
 Freq = 6.6631 GHz, Bw = 2.000 MH No calibration applied and no bandpass applied

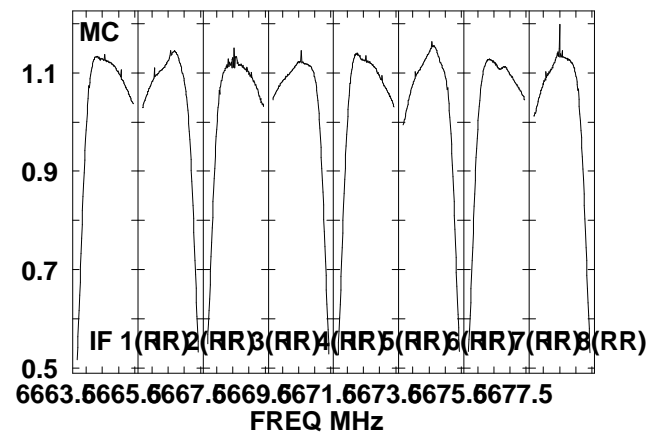
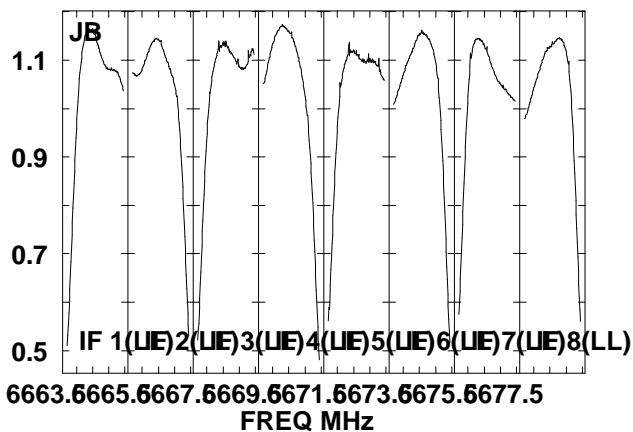
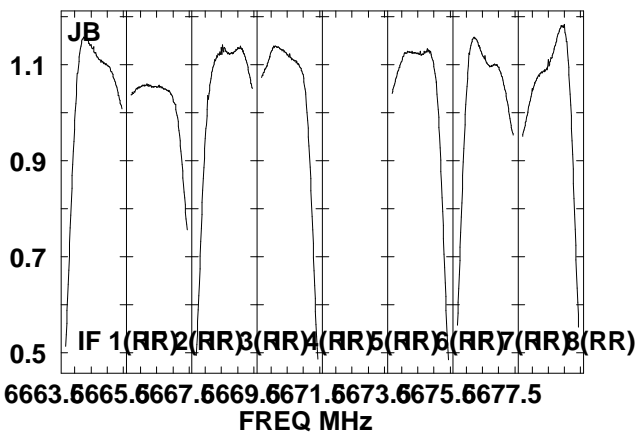
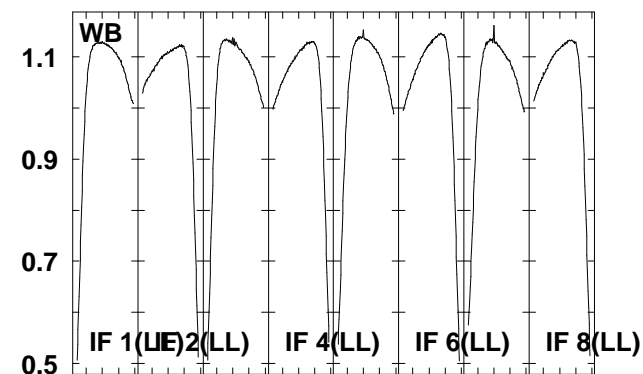
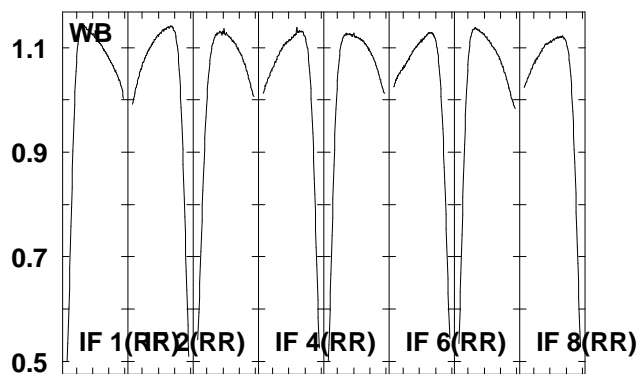
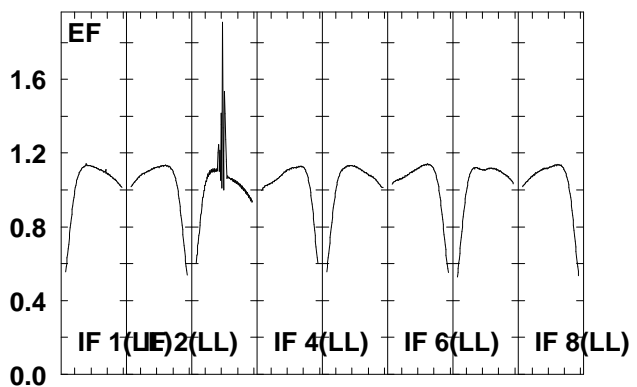
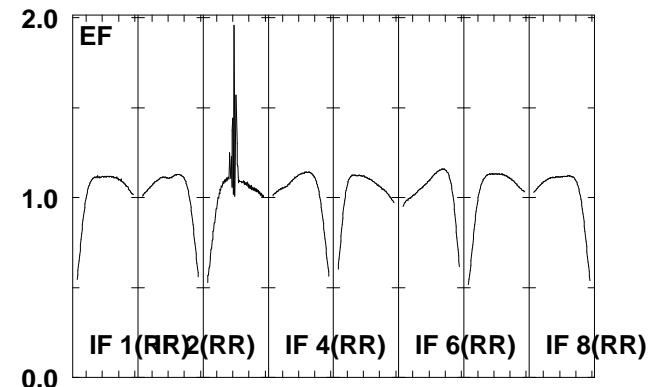
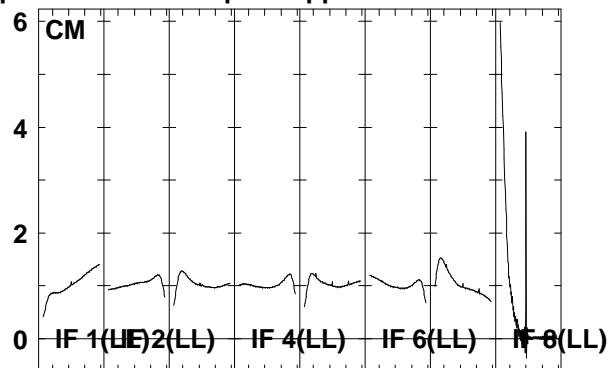
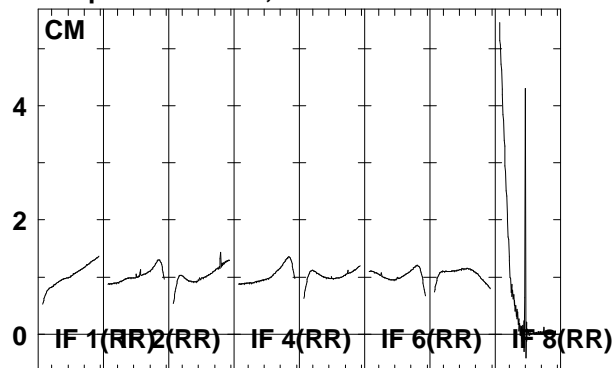

6663.6665.6667.6669.6671.6673.6675.6677.5
 FREQ MHz

6663.6665.6667.6669.6671.6673.6675.6677.5
 FREQ MHz

6663.6665.6667.6669.6671.6673.6675.6677.5
 FREQ MHz

Lower frame: Real Jy
 Total-power spectrum Antenna: *
 Timerange: 00/05:58:05 to 00/06:00:32

Plot file version 60 created 22-JUN-2006 20:05:44
 G16.59-0 EM061A 1.UVDATA.1
 Freq = 6.6631 GHz, Bw = 2.000 MH No calibration applied and no bandpass applied

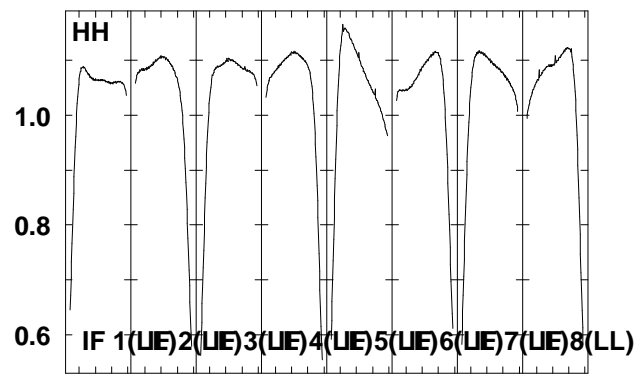
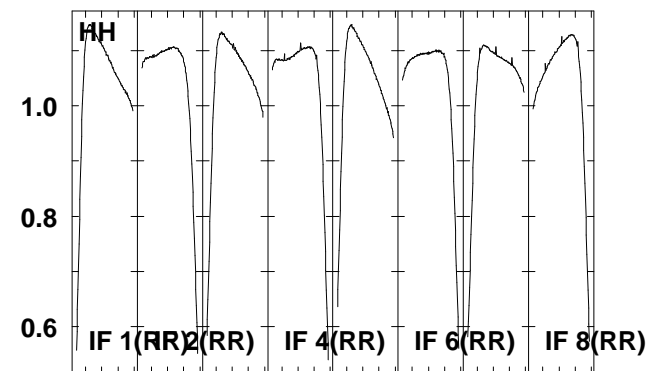
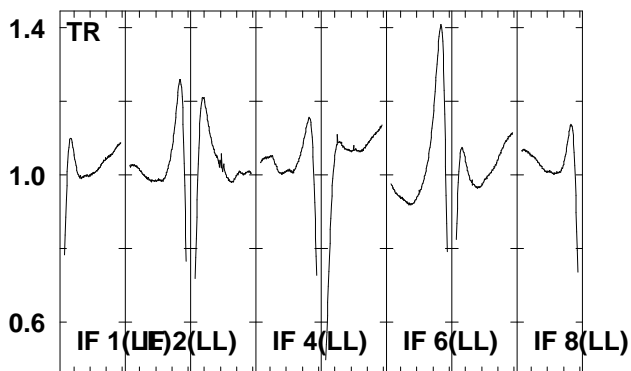
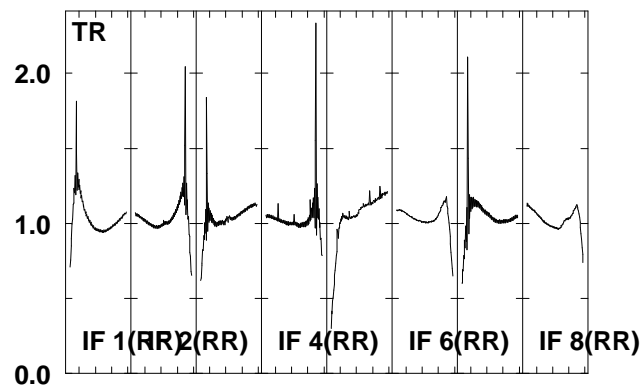
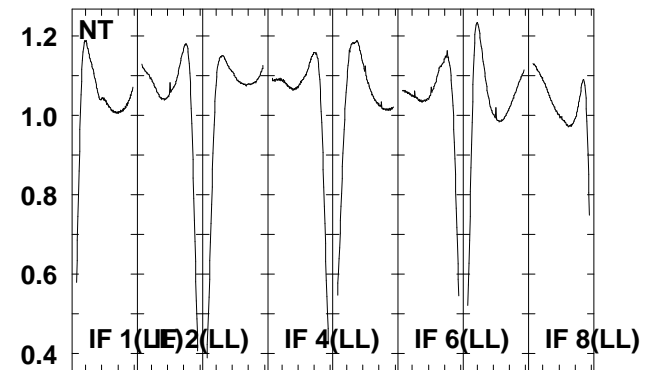
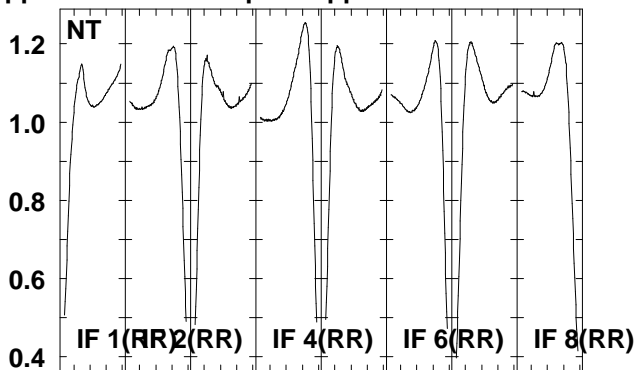
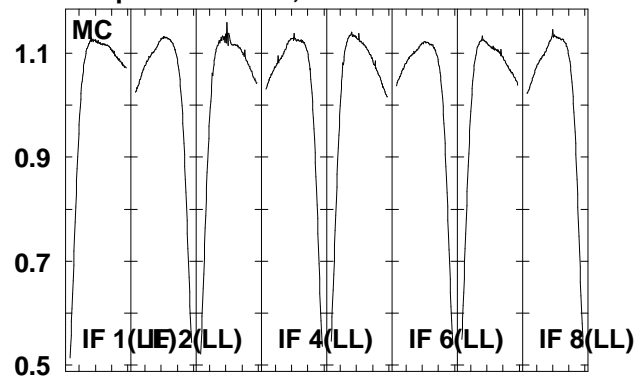

6663.6665.6667.6669.6671.6673.6675.6677.5
 FREQ MHz

Lower frame: Real Jy
 Total-power spectrum Antenna: *
 Timerange: 00/05:58:05 to 00/06:00:32

Plot file version 61 created 22-JUN-2006 20:05:47
 J1825-17 EM061A 1.UVDATA.1
 Freq = 6.6631 GHz, Bw = 2.000 MH No calibration applied and no bandpass applied

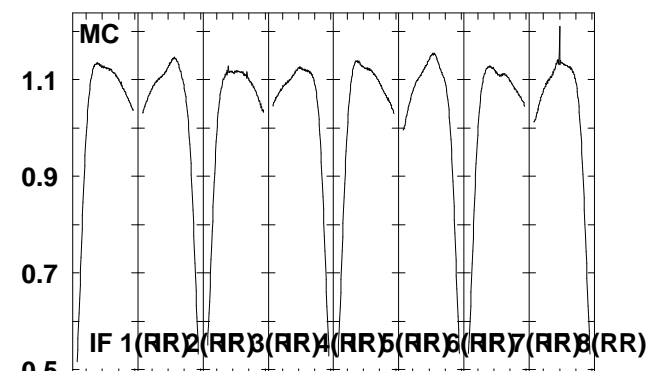
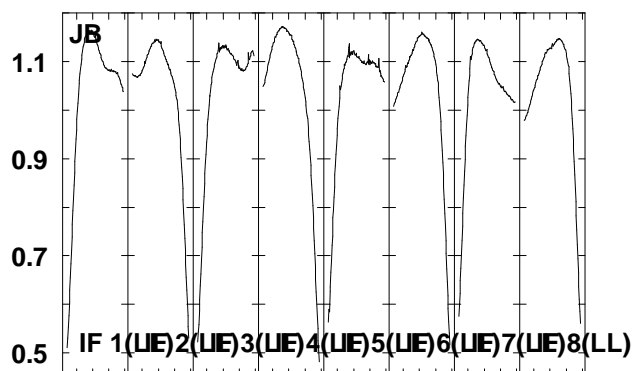
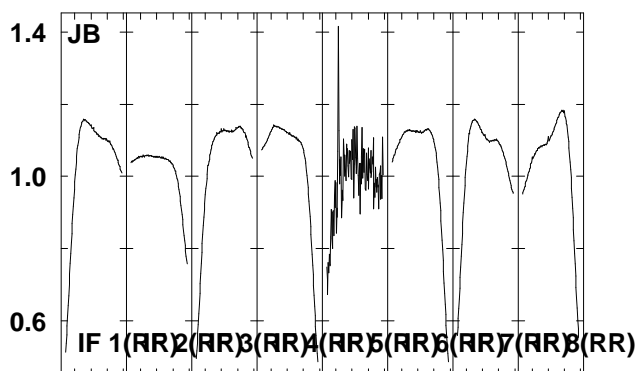
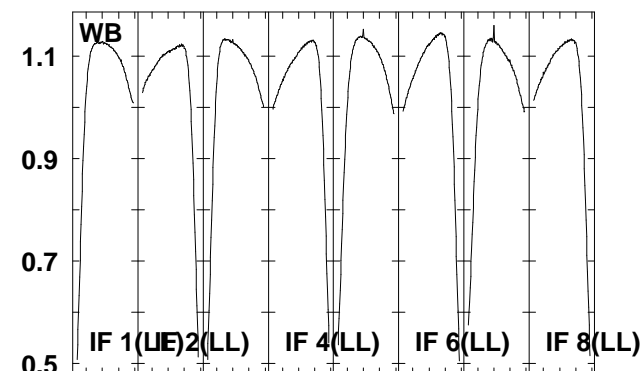
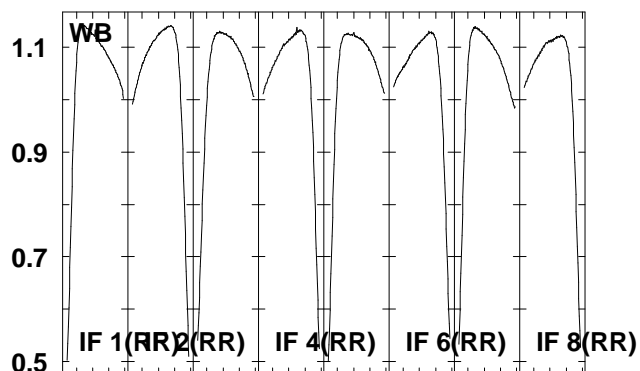
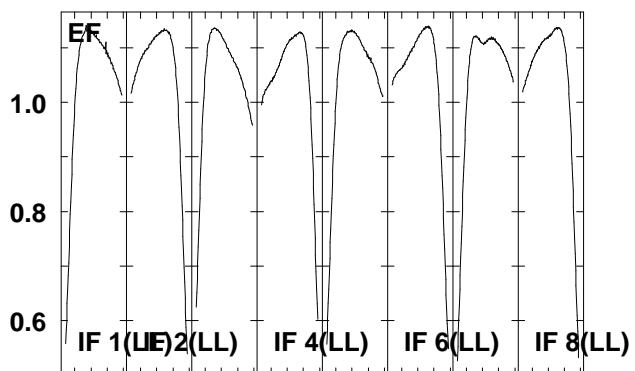
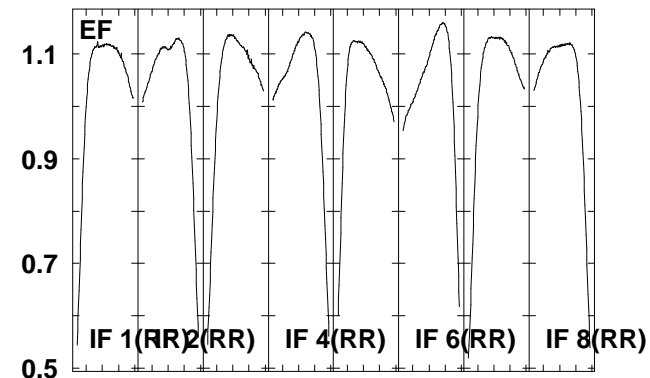
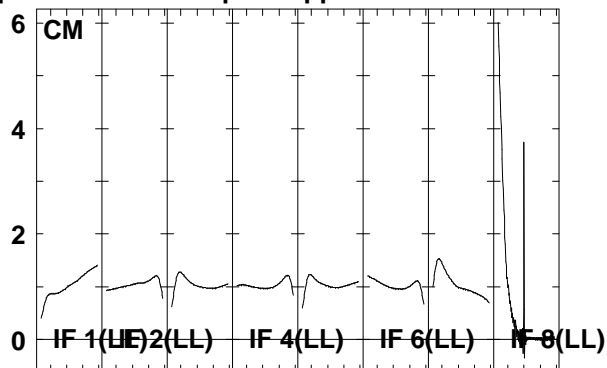
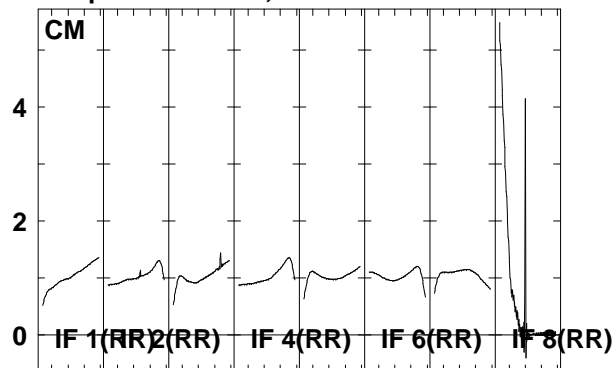

6663.6665.6667.6669.6671.6673.6675.6677.5
 FREQ MHz

6663.6665.6667.6669.6671.6673.6675.6677.5
 FREQ MHz

6663.6665.6667.6669.6671.6673.6675.6677.5
 FREQ MHz

Lower frame: Real Jy
 Total-power spectrum Antenna: *
 Timerange: 00/06:00:34 to 00/06:03:32

Plot file version 62 created 22-JUN-2006 20:05:50
 J1825-17 EM061A 1.UVDATA.1
 Freq = 6.6631 GHz, Bw = 2.000 MH No calibration applied and no bandpass applied

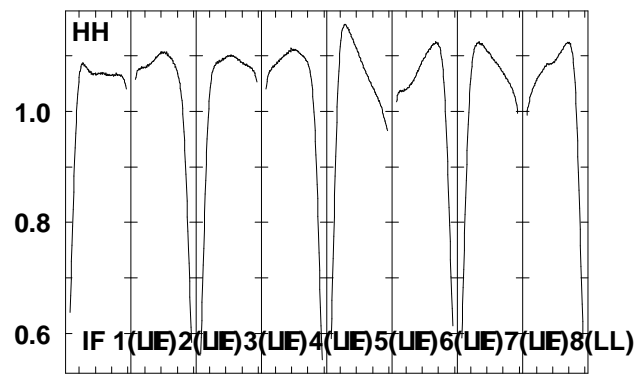
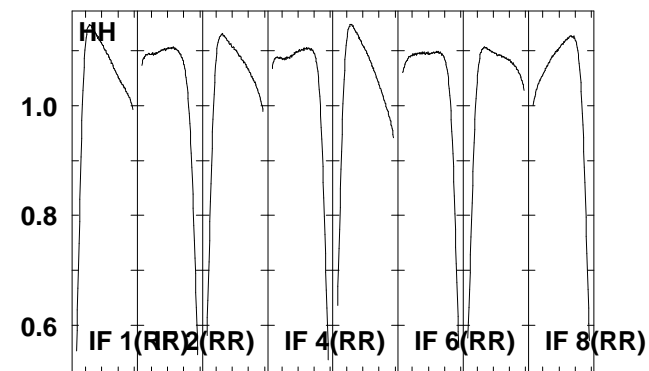
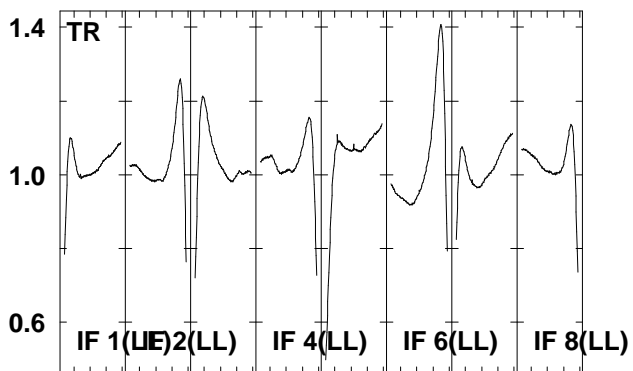
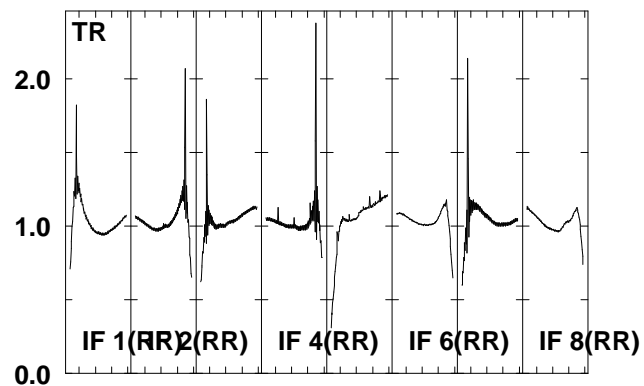
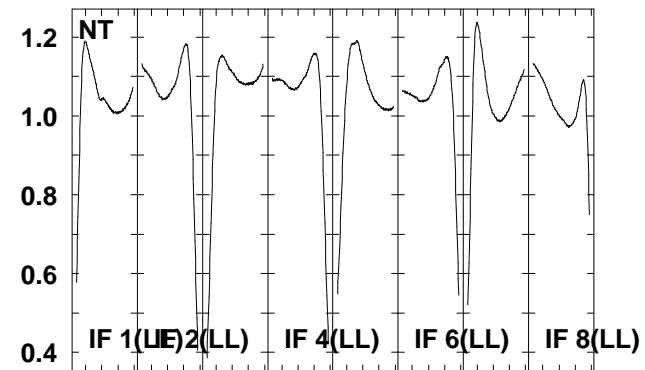
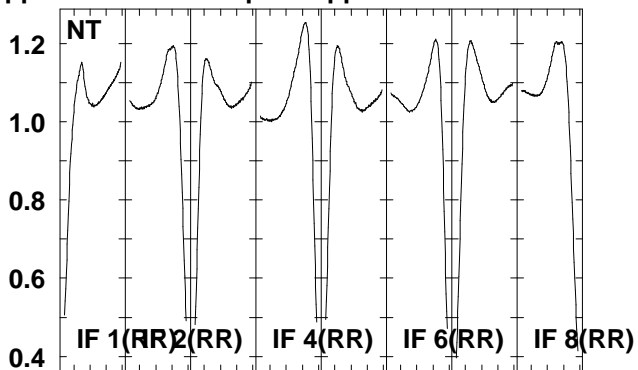
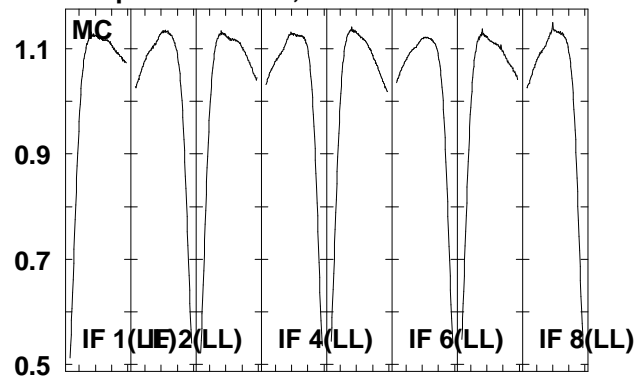

6663.6665.6667.6669.6671.6673.6675.6677.5
 FREQ MHz

Lower frame: Real Jy
 Total-power spectrum Antenna: *
 Timerange: 00/06:00:34 to 00/06:03:32

Plot file version 63 created 22-JUN-2006 20:05:53
 G16.59-0 EM061A 1.UVDATA.1
 Freq = 6.6631 GHz, Bw = 2.000 MH No calibration applied and no bandpass applied

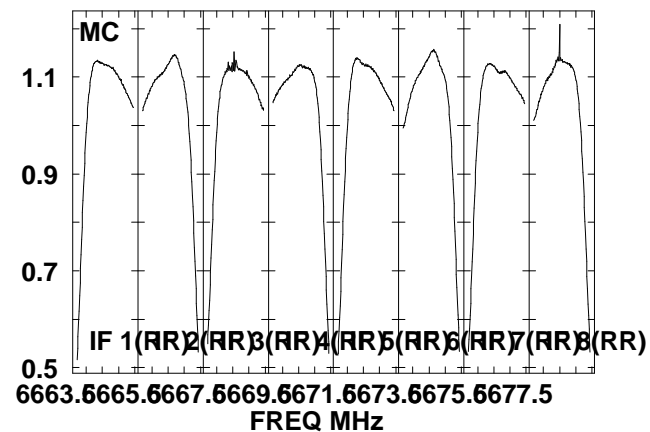
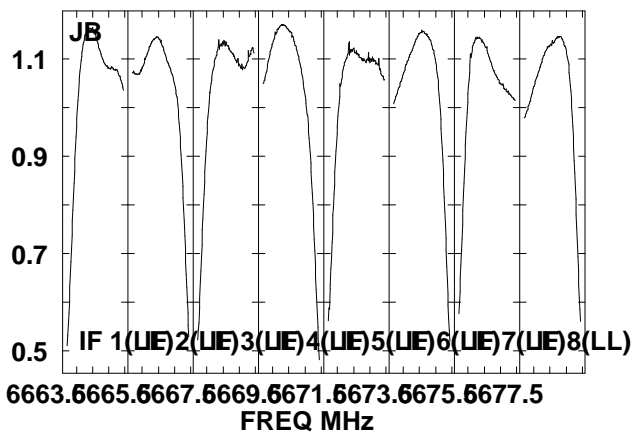
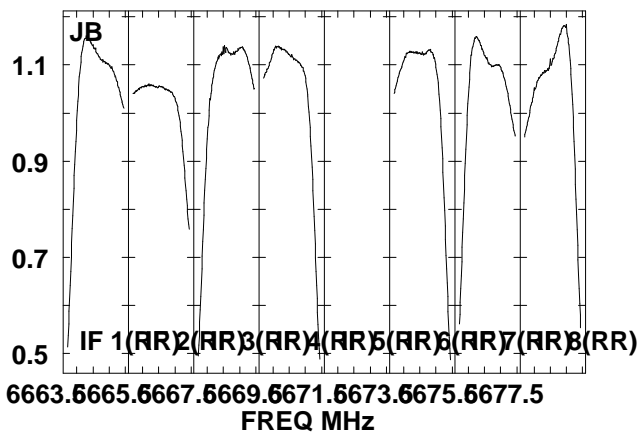
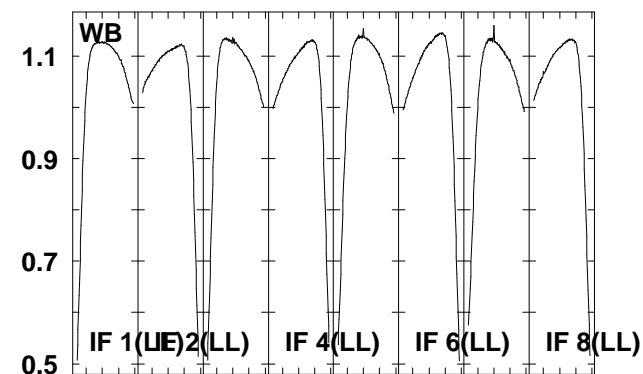
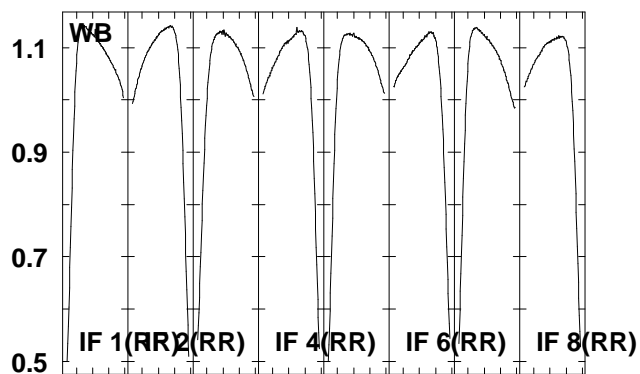
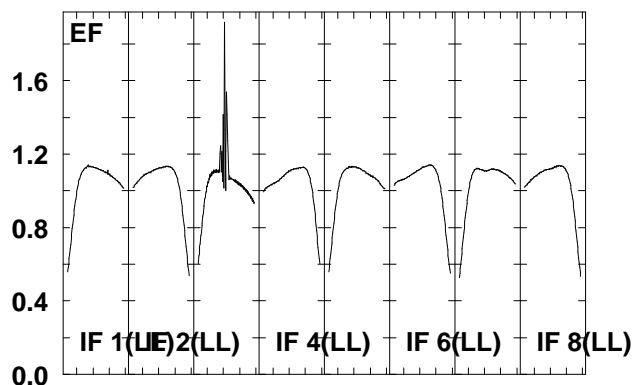
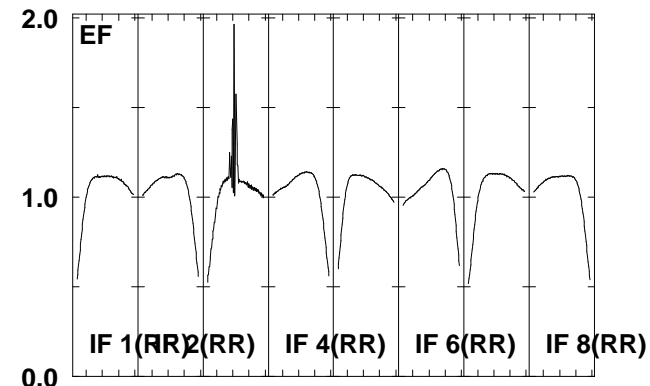
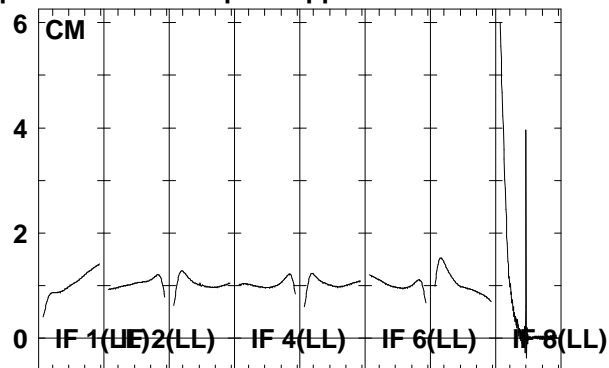
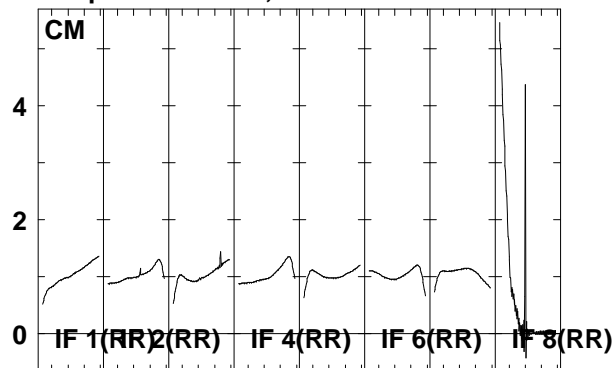

Lower frame: Real Jy
 Total-power spectrum Antenna: *
 Timerange: 00/06:03:34 to 00/06:06:02

Plot file version 64 created 22-JUN-2006 20:05:55
 G16.59-0 EM061A 1.UVDATA.1
 Freq = 6.6631 GHz, Bw = 2.000 MH No calibration applied and no bandpass applied

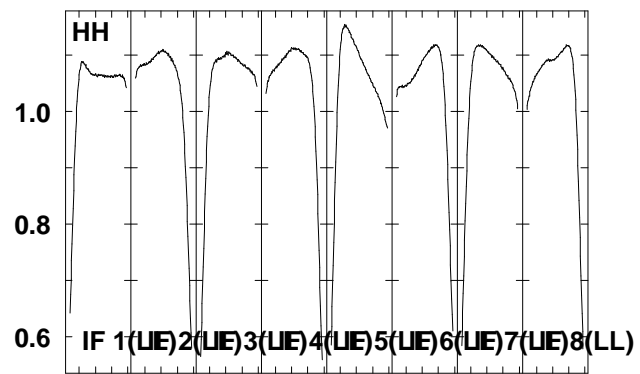
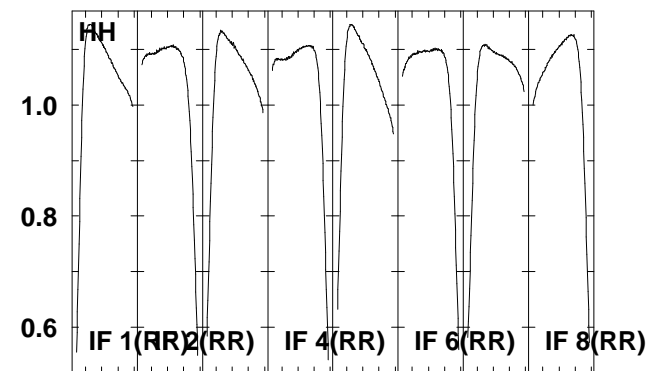
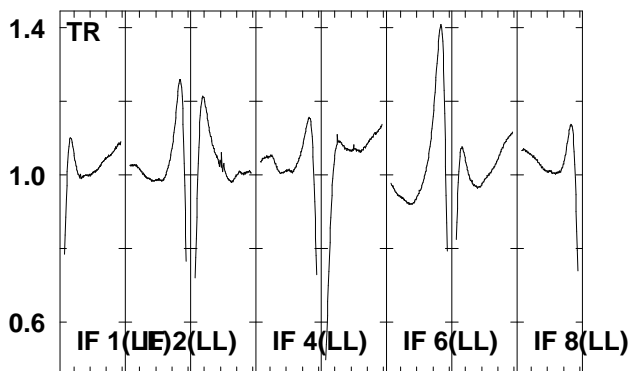
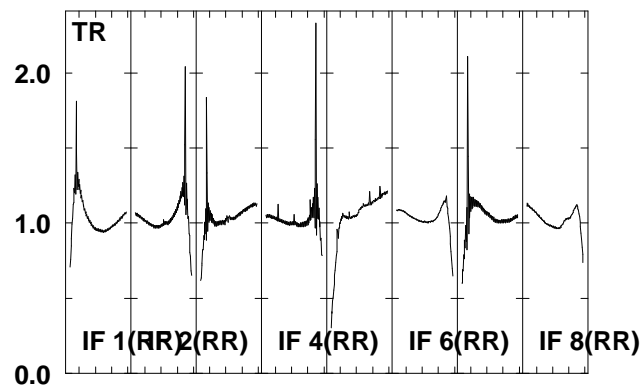
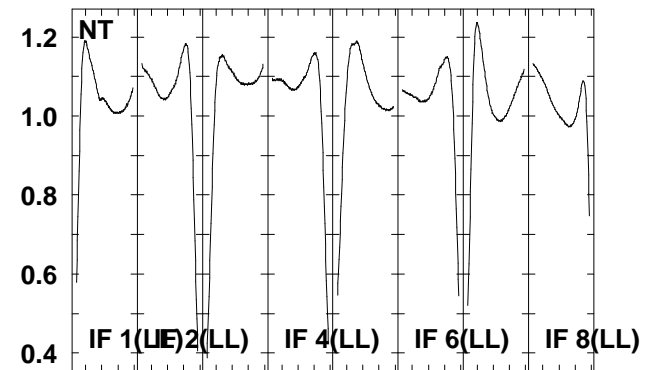
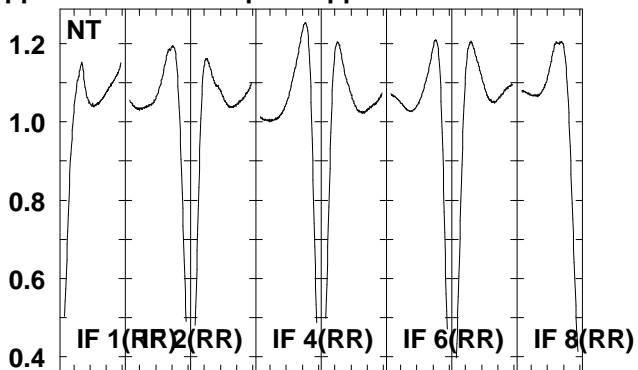
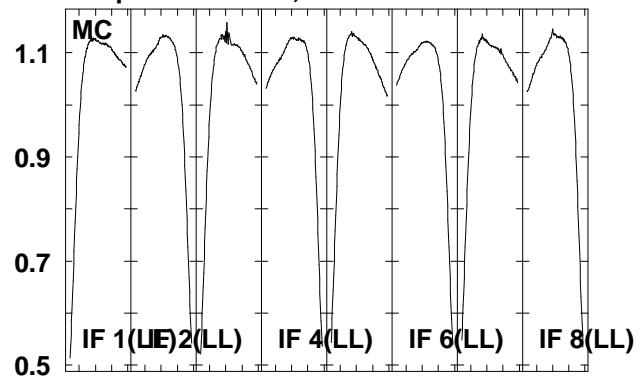

6663.6665.6667.6669.6671.6673.6675.6677.5
 FREQ MHz

Lower frame: Real Jy
 Total-power spectrum Antenna: *
 Timerange: 00/06:03:34 to 00/06:06:02

Plot file version 65 created 22-JUN-2006 20:05:59
 J1825-17 EM061A 1.UVDATA.1
 Freq = 6.6631 GHz, Bw = 2.000 MH No calibration applied and no bandpass applied

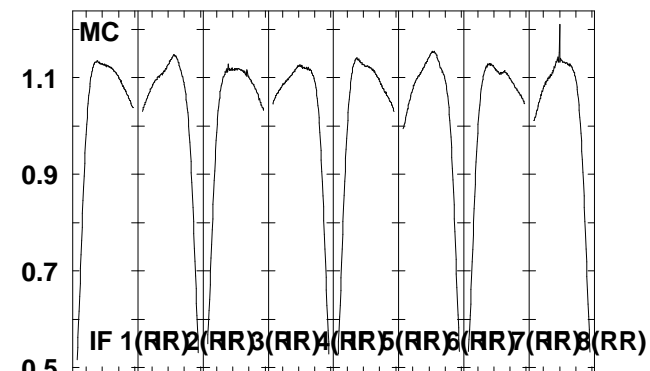
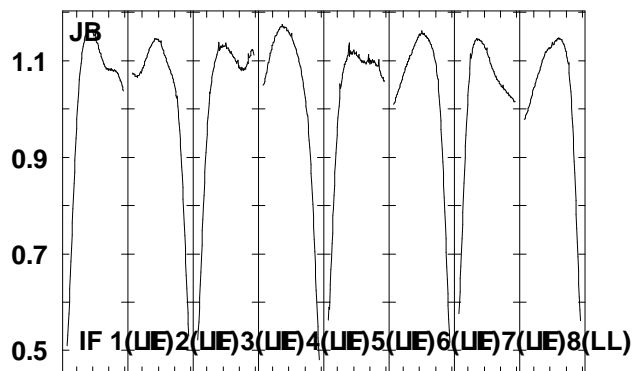
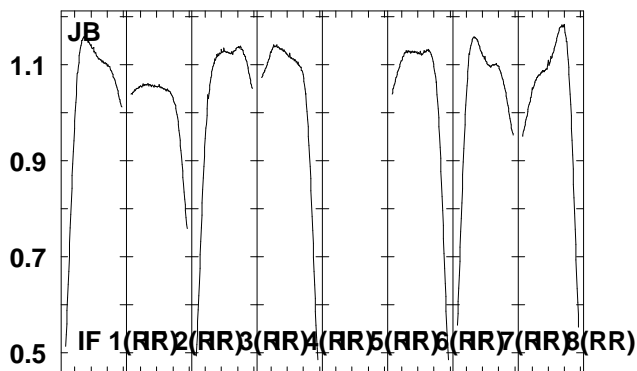
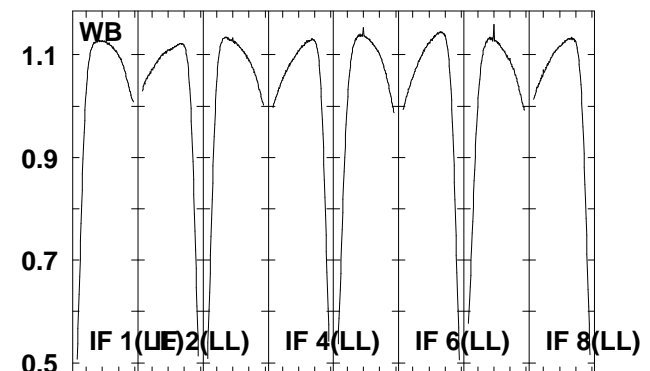
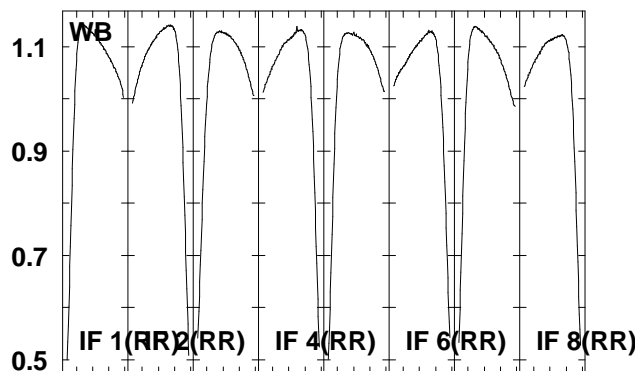
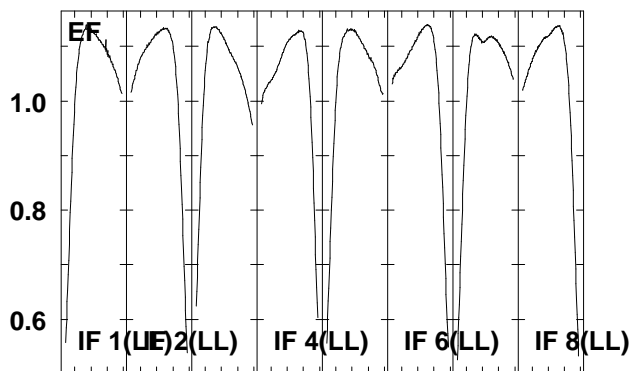
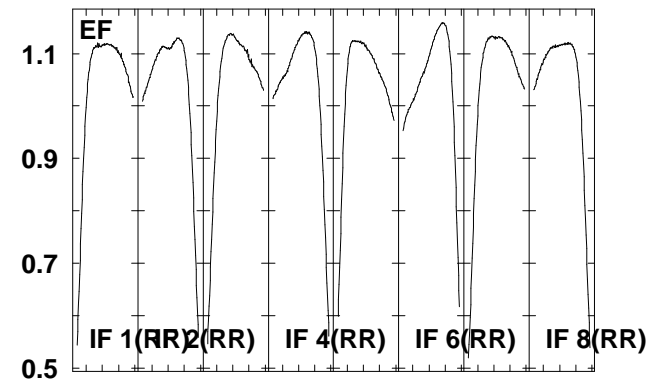
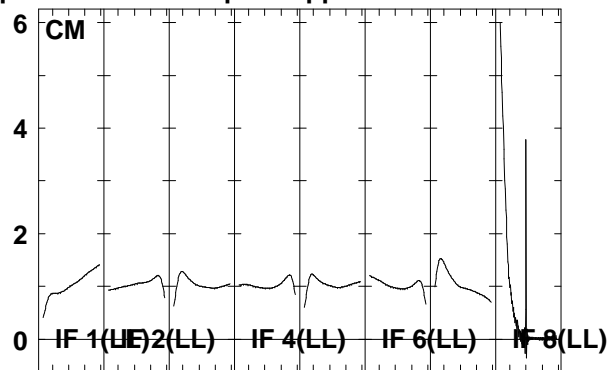
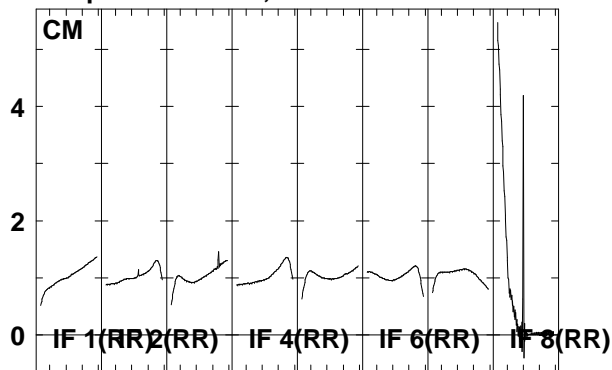

6663.6665.6667.6669.6671.6673.6675.6677.5
 FREQ MHz

6663.6665.6667.6669.6671.6673.6675.6677.5
 FREQ MHz

6663.6665.6667.6669.6671.6673.6675.6677.5
 FREQ MHz

Lower frame: Real Jy
 Total-power spectrum Antenna: *
 Timerange: 00/06:06:04 to 00/06:09:02

Plot file version 66 created 22-JUN-2006 20:06:02

J1825-17 EM061A 1.UVDATA.1

Freq = 6.6631 GHz, Bw = 2.000 MH No calibration applied and no bandpass applied

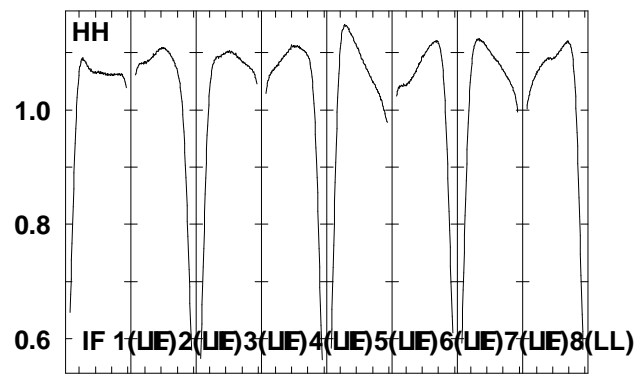
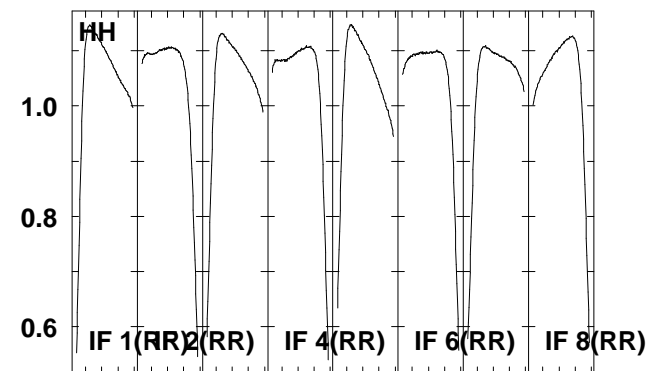
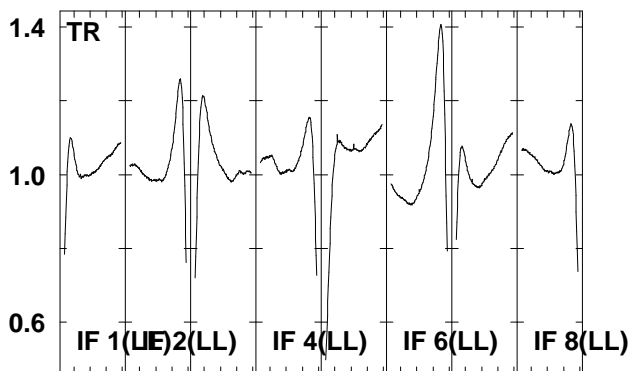
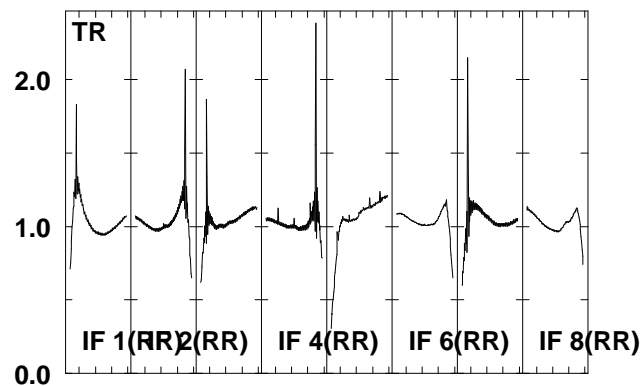
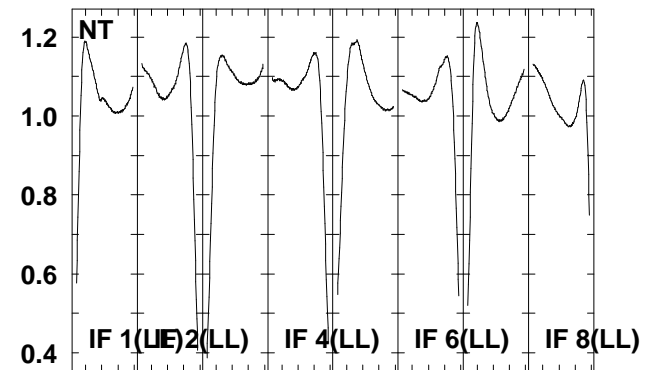
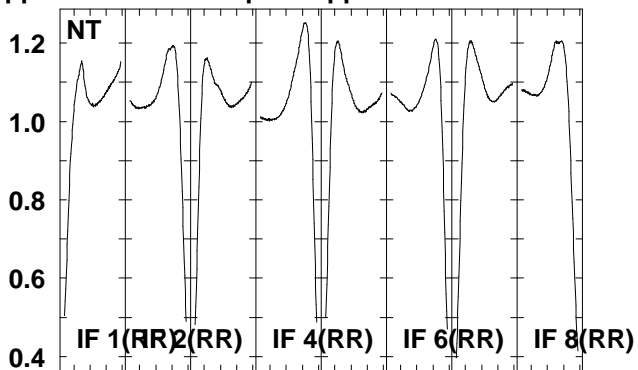
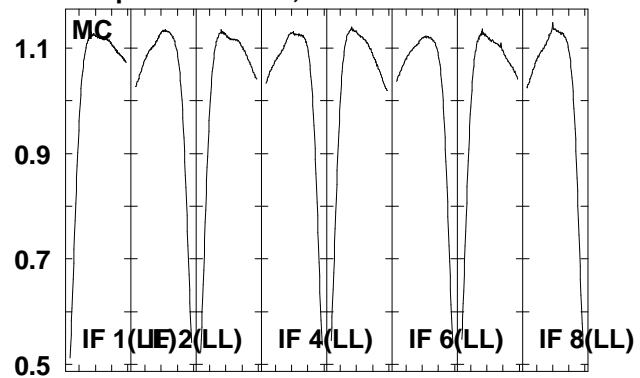

6663.6665.6667.6669.6671.6673.6675.6677.5

FREQ MHz

Lower frame: Real Jy

Total-power spectrum Antenna: *

Timerange: 00/06:06:04 to 00/06:09:02

Plot file version 67 created 22-JUN-2006 20:06:06
 G16.59-0 EM061A 1.UVDATA.1
 Freq = 6.6631 GHz, Bw = 2.000 MH No calibration applied and no bandpass applied

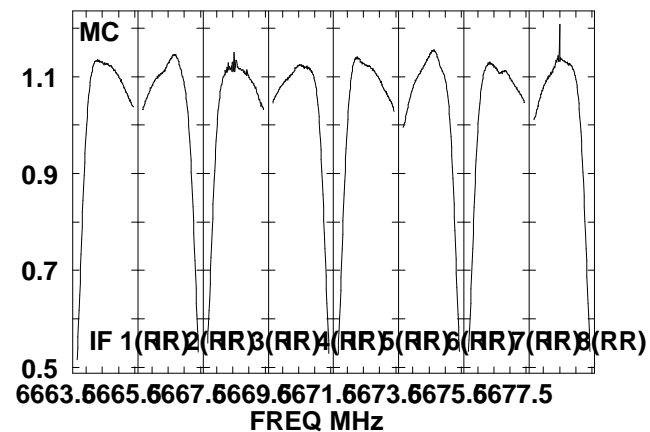
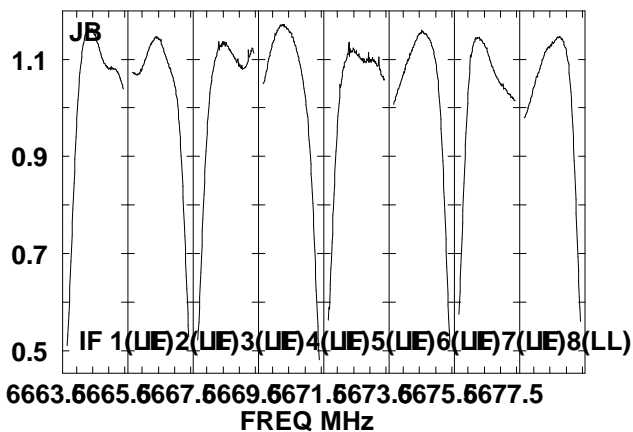
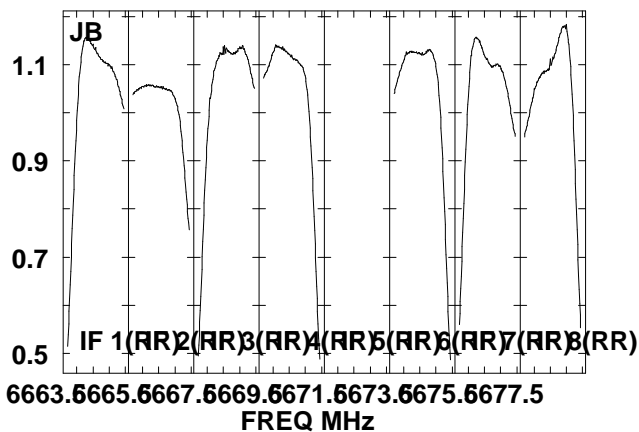
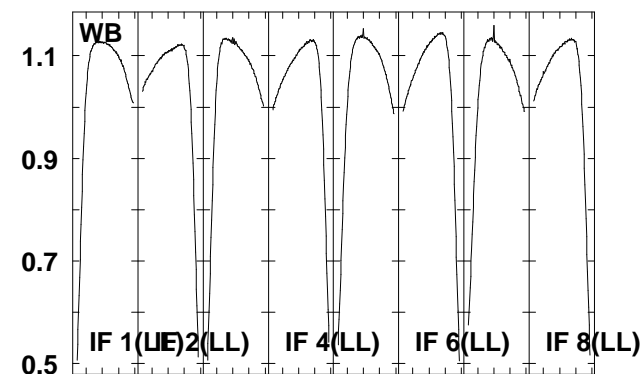
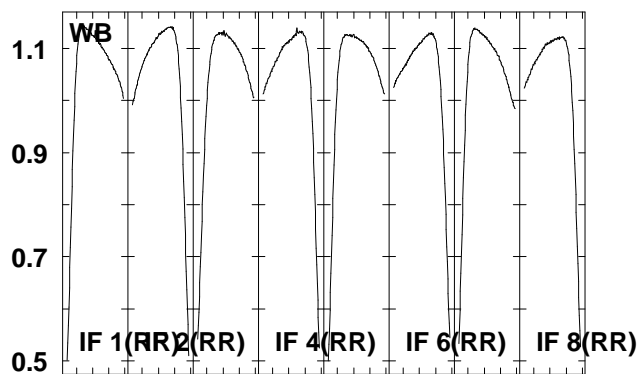
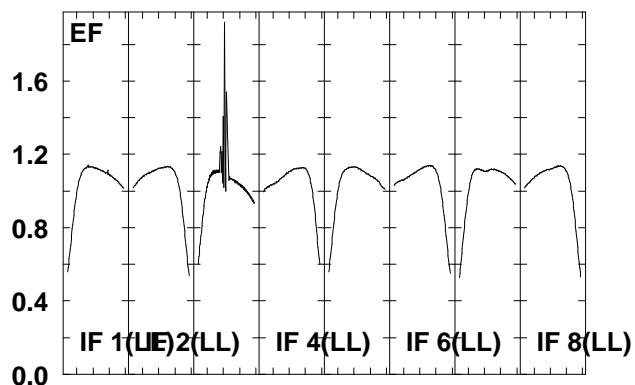
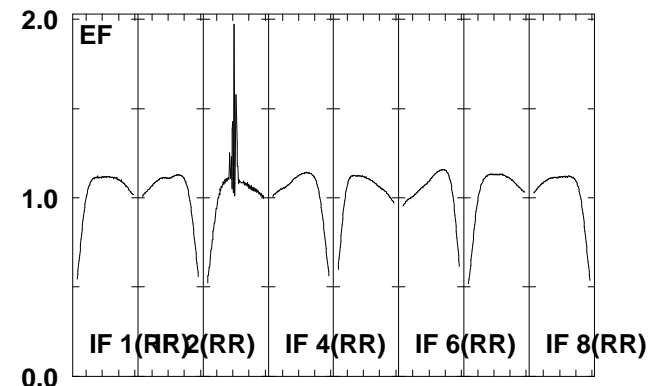
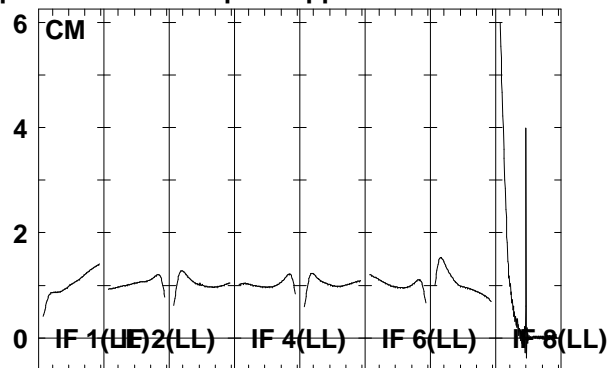
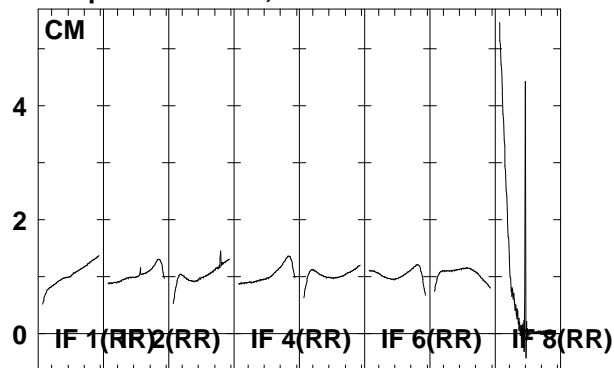

6663.6665.6667.6669.6671.6673.6675.6677.5
 FREQ MHz

6663.6665.6667.6669.6671.6673.6675.6677.5
 FREQ MHz

6663.6665.6667.6669.6671.6673.6675.6677.5
 FREQ MHz

Lower frame: Real Jy
 Total-power spectrum Antenna: *
 Timerange: 00/06:09:04 to 00/06:11:32

Plot file version 68 created 22-JUN-2006 20:06:09

G16.59-0 EM061A 1.UVDATA.1

Freq = 6.6631 GHz, Bw = 2.000 MH No calibration applied and no bandpass applied

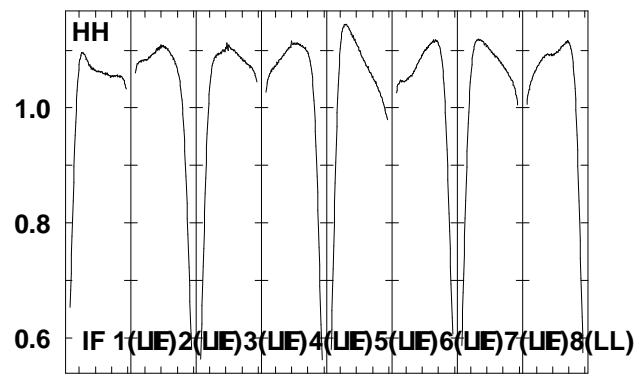
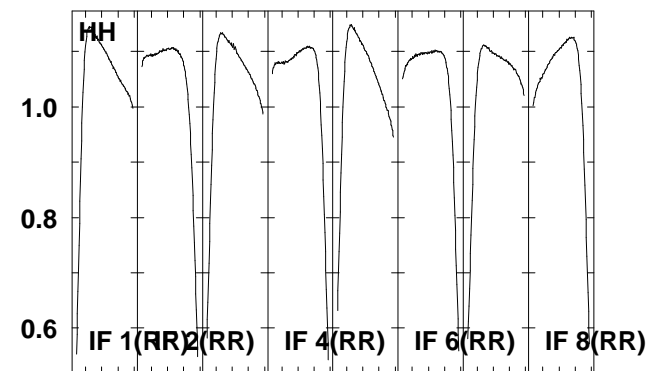
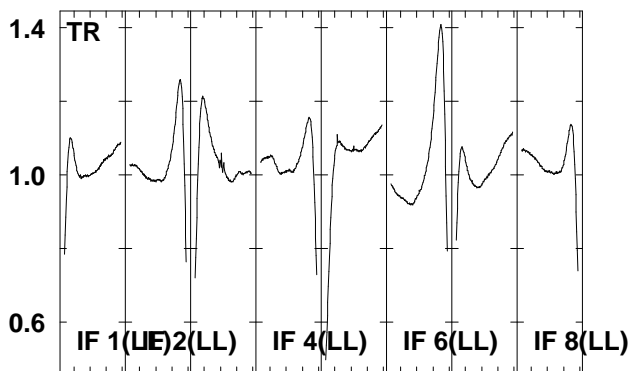
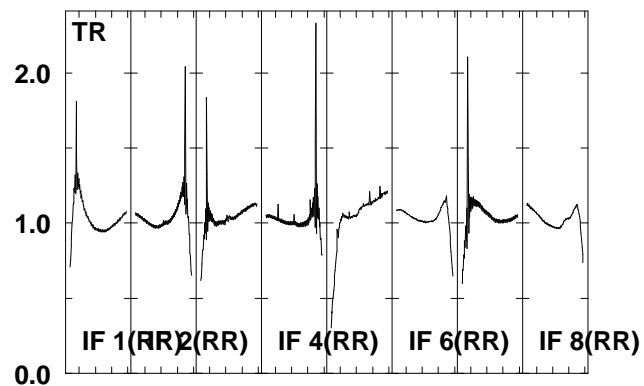
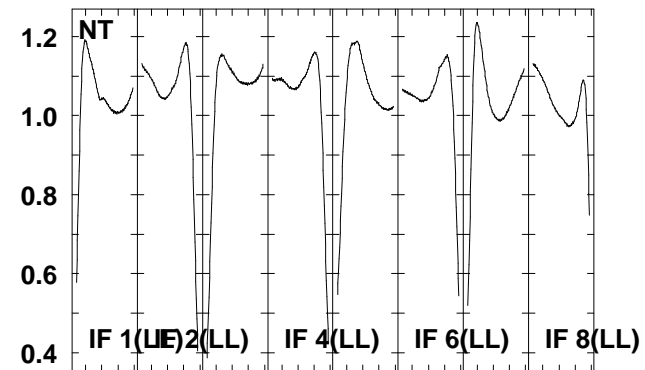
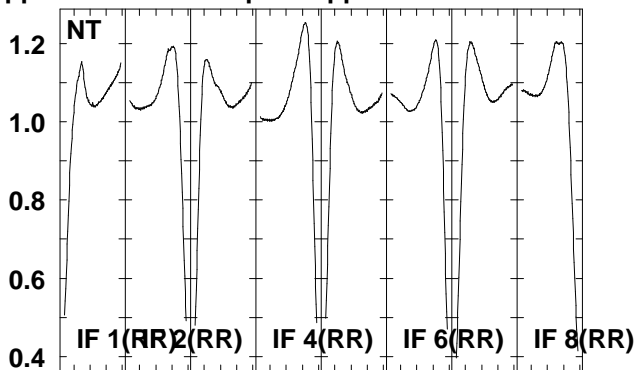
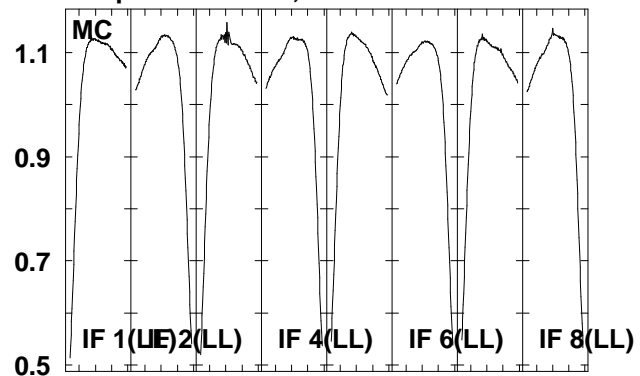

6663.6665.6667.6669.6671.6673.6675.6677.5

FREQ MHz

Lower frame: Real Jy

Total-power spectrum Antenna: *

Timerange: 00/06:09:04 to 00/06:11:32

Plot file version 69 created 22-JUN-2006 20:06:12
 J1825-17 EM061A 1.UVDATA.1
 Freq = 6.6631 GHz, Bw = 2.000 MH No calibration applied and no bandpass applied

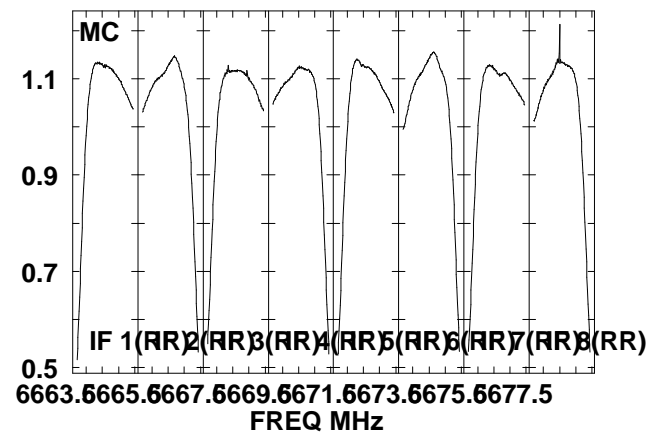
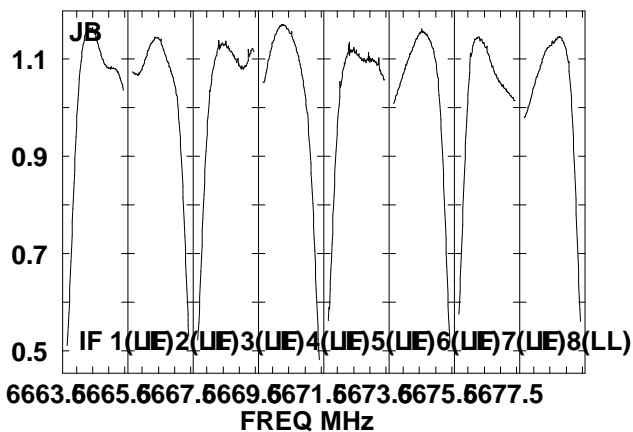
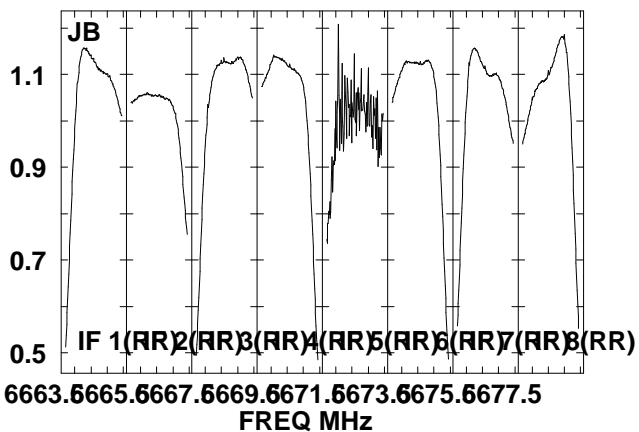
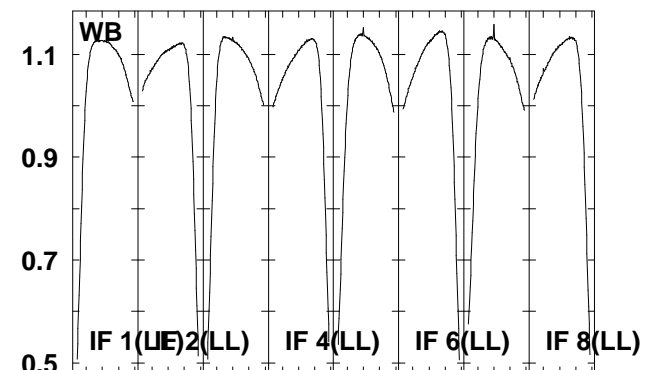
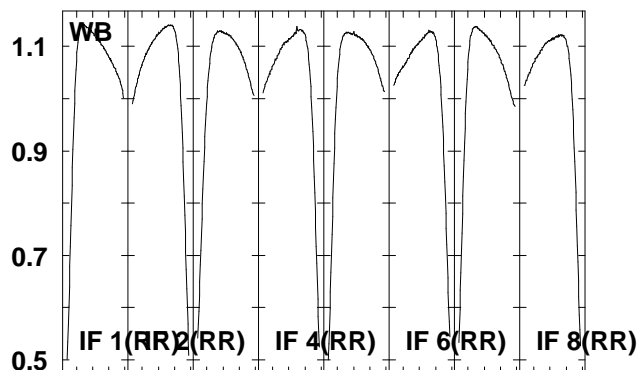
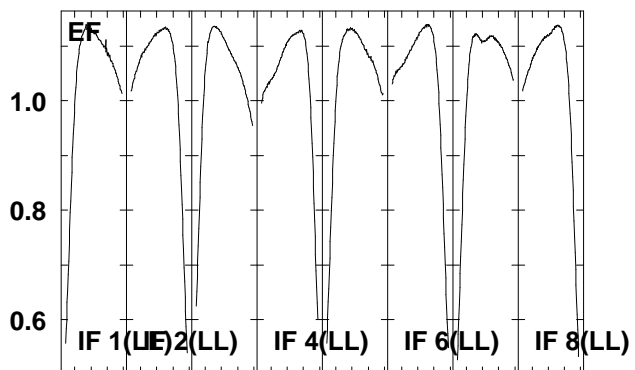
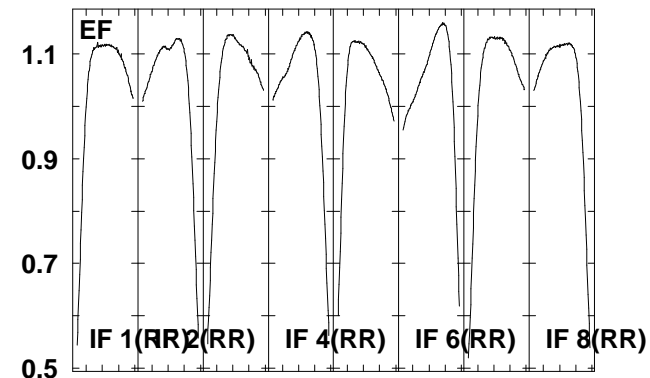
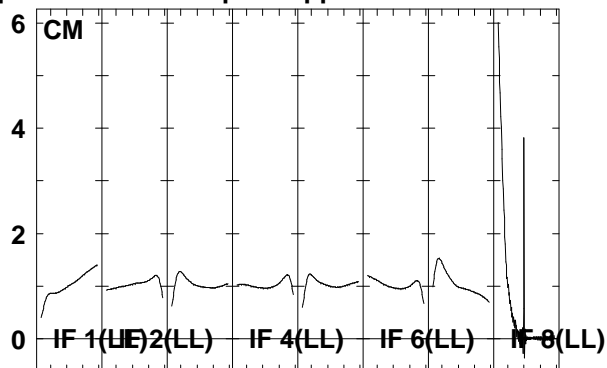
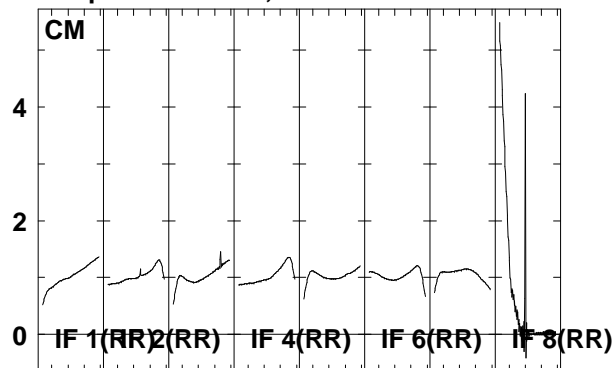

6663.6665.6667.6669.6671.6673.6675.6677.5
 FREQ MHz

6663.6665.6667.6669.6671.6673.6675.6677.5
 FREQ MHz

6663.6665.6667.6669.6671.6673.6675.6677.5
 FREQ MHz

Lower frame: Real Jy
 Total-power spectrum Antenna: *
 Timerange: 00/06:11:34 to 00/06:14:32

Plot file version 70 created 22-JUN-2006 20:06:15

J1825-17 EM061A 1.UVDATA.1

Freq = 6.6631 GHz, Bw = 2.000 MH No calibration applied and no bandpass applied

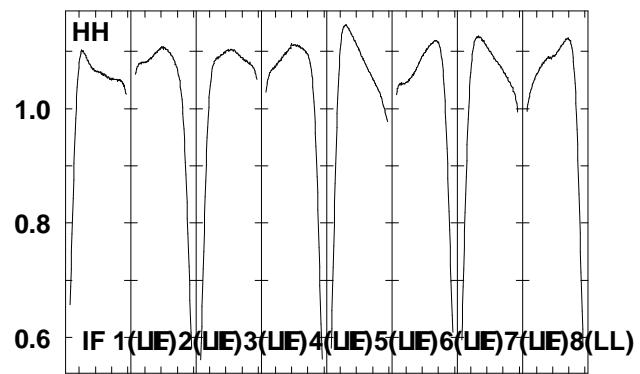
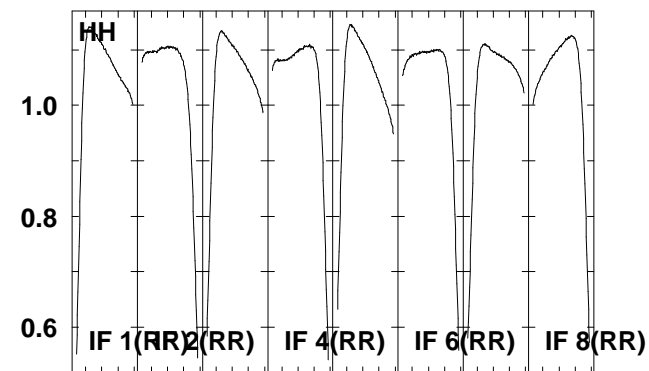
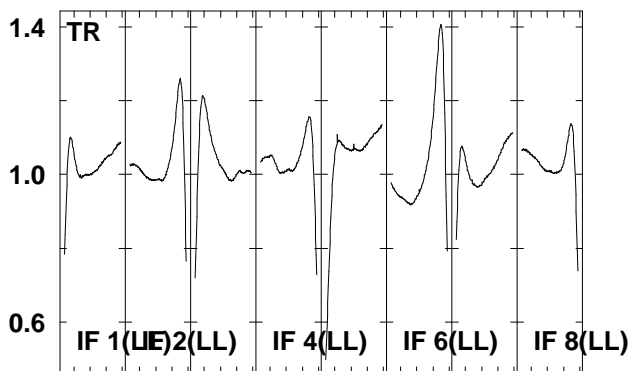
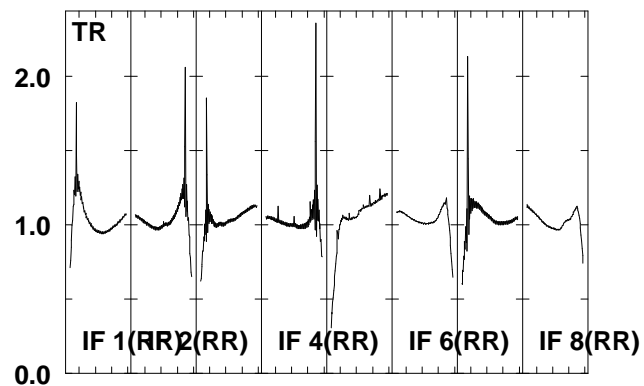
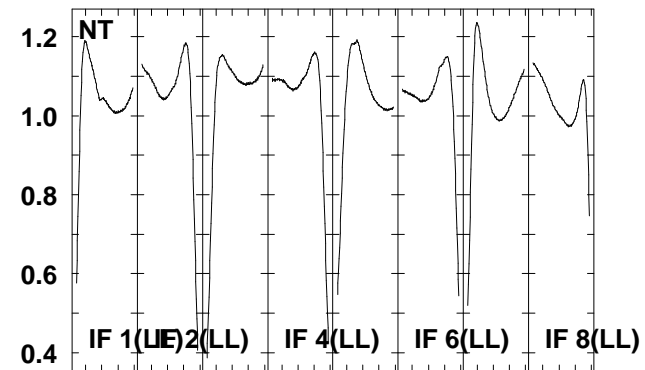
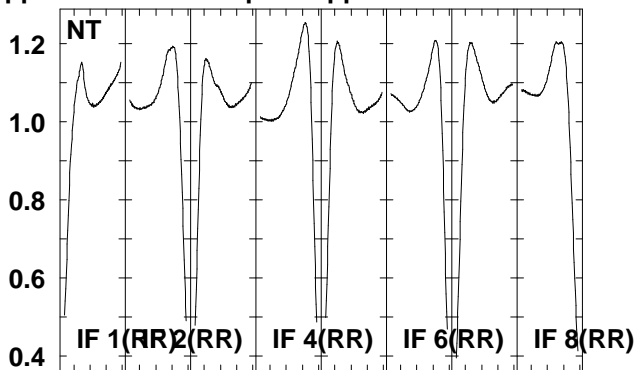
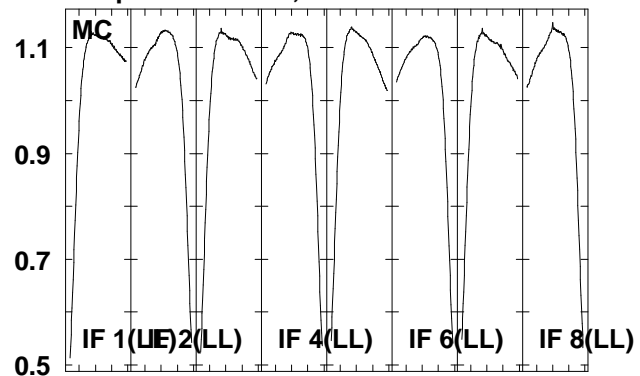

6663.6665.6667.6669.6671.6673.6675.6677.5

FREQ MHz

Lower frame: Real Jy

Total-power spectrum Antenna: *

Timerange: 00/06:11:34 to 00/06:14:32

Plot file version 71 created 22-JUN-2006 20:06:19
 G16.59-0 EM061A 1.UVDATA.1
 Freq = 6.6631 GHz, Bw = 2.000 MH No calibration applied and no bandpass applied

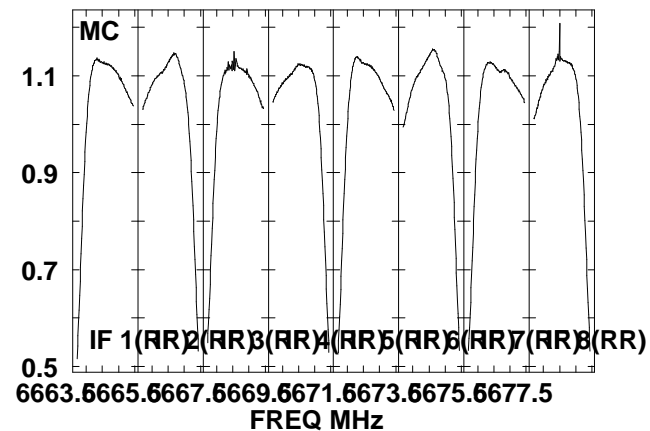
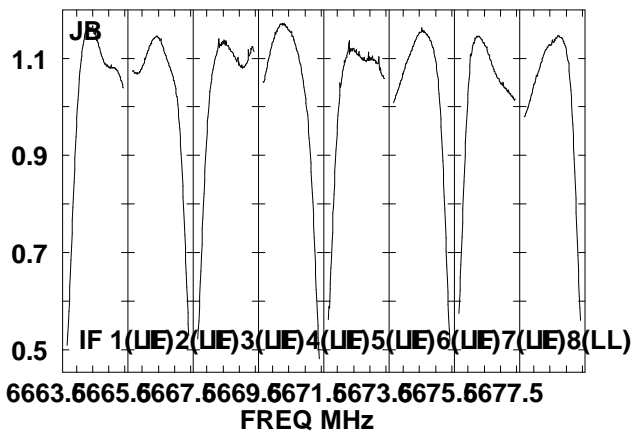
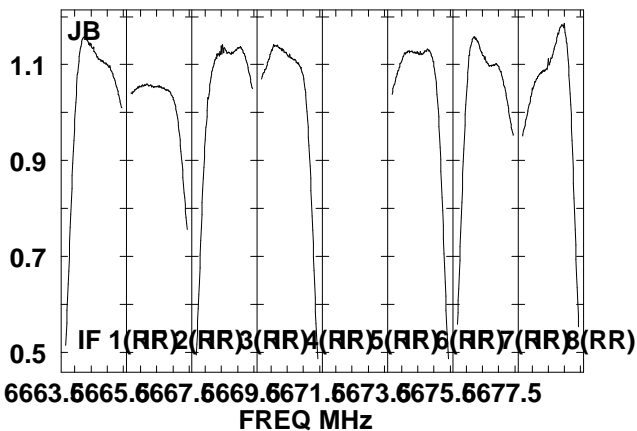
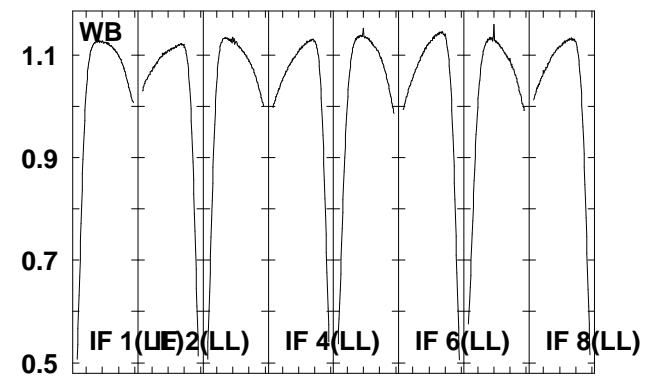
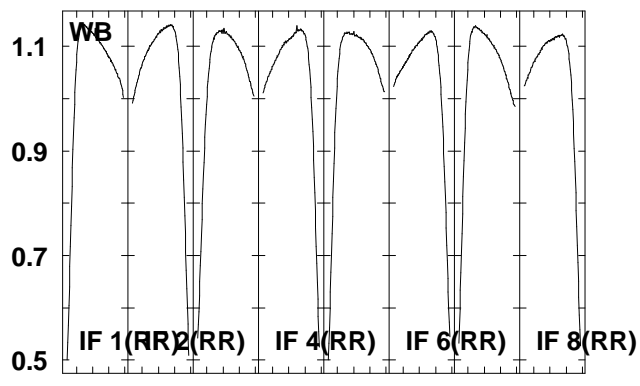
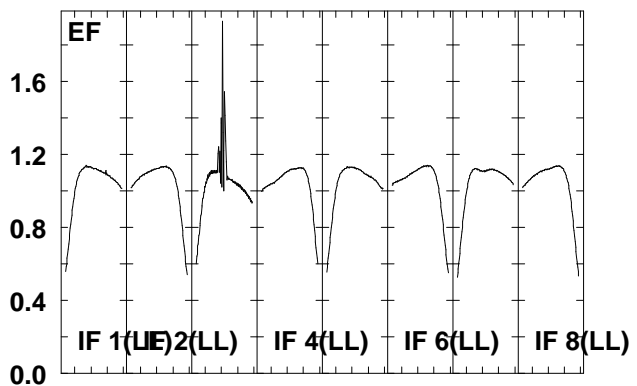
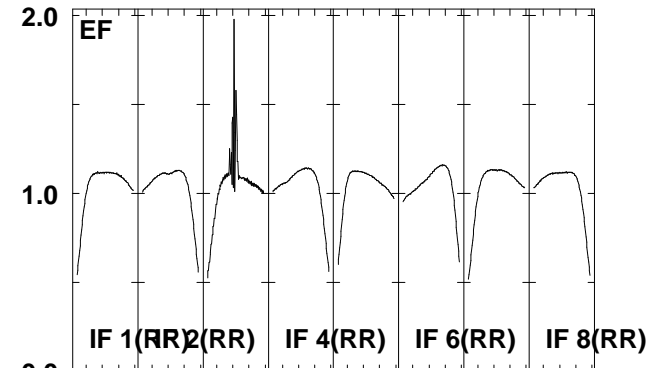
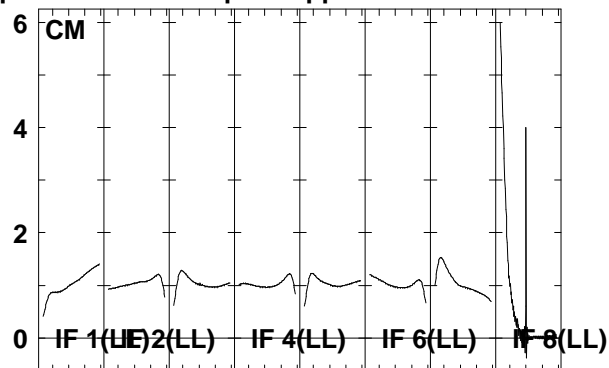
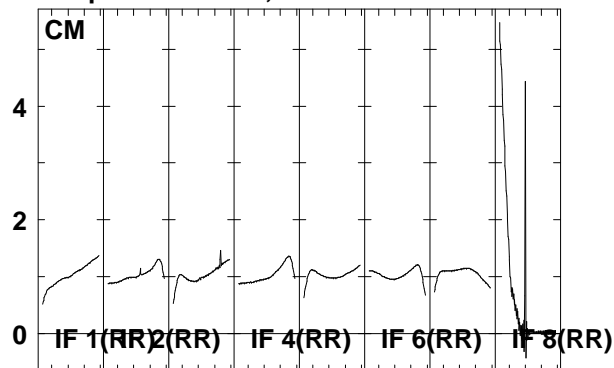

6663.6665.6667.6669.6671.6673.6675.6677.5
 FREQ MHz
 Lower frame: Real Jy
 Total-power spectrum Antenna: *
 Timerange: 00/06:14:34 to 00/06:17:02

Plot file version 72 created 22-JUN-2006 20:06:22
 G16.59-0 EM061A 1.UVDATA.1
 Freq = 6.6631 GHz, Bw = 2.000 MH No calibration applied and no bandpass applied

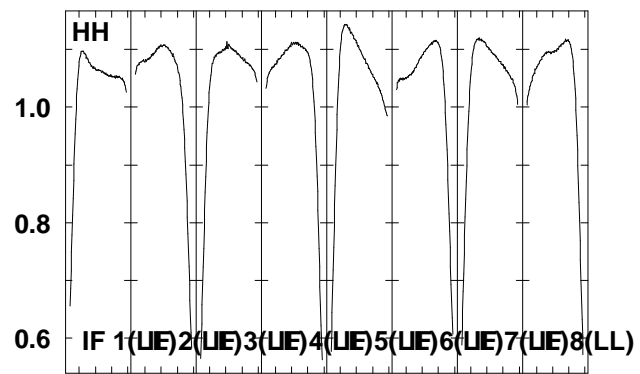
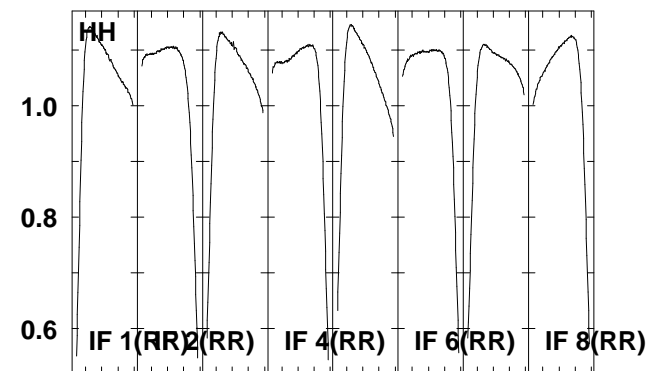
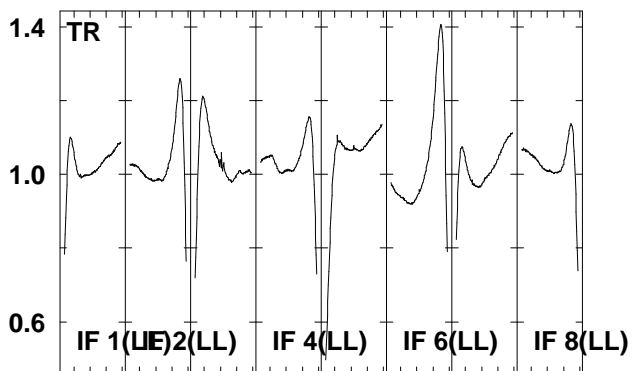
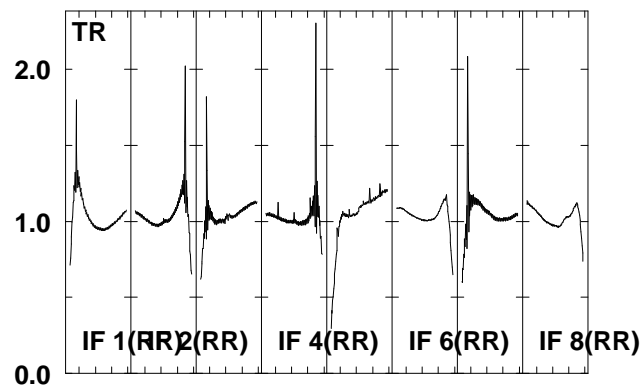
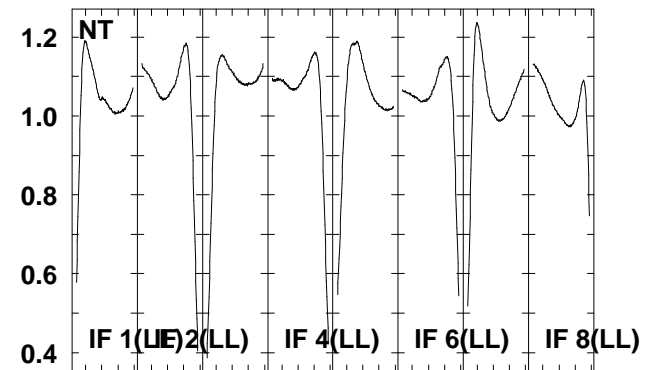
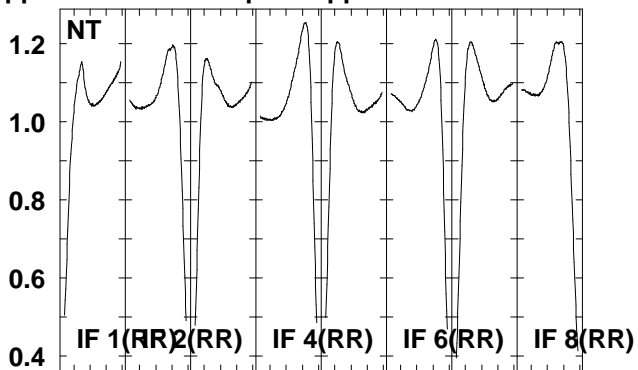
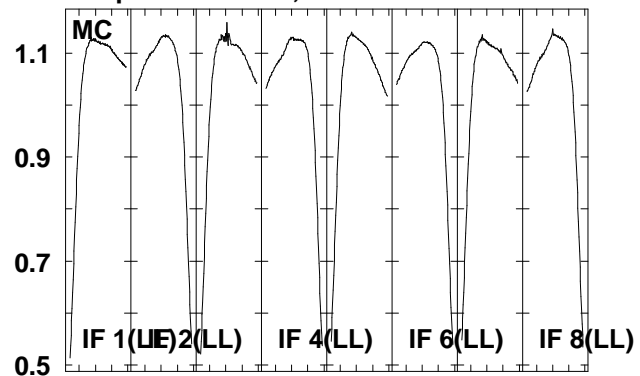

6663.6665.6667.6669.6671.6673.6675.6677.5
 FREQ MHz

Lower frame: Real Jy
 Total-power spectrum Antenna: *
 Timerange: 00/06:14:34 to 00/06:17:02

Plot file version 73 created 22-JUN-2006 20:06:25
 J1825-17 EM061A 1.UVDATA.1
 Freq = 6.6631 GHz, Bw = 2.000 MH No calibration applied and no bandpass applied

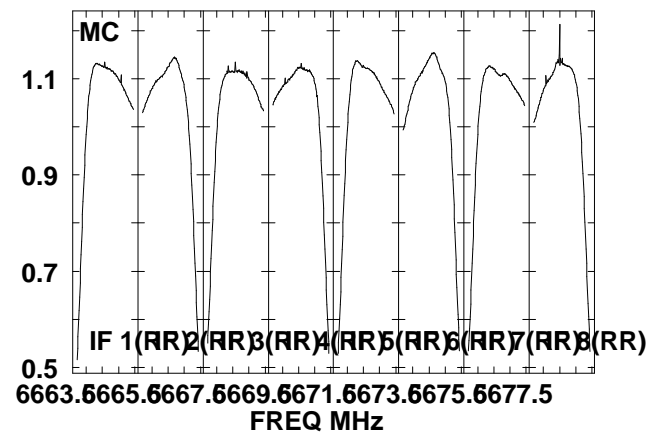
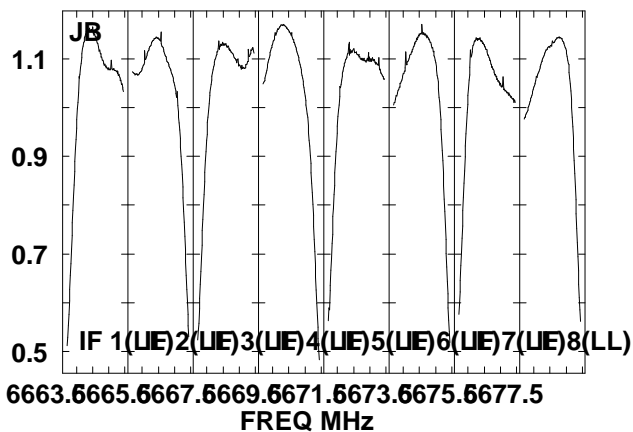
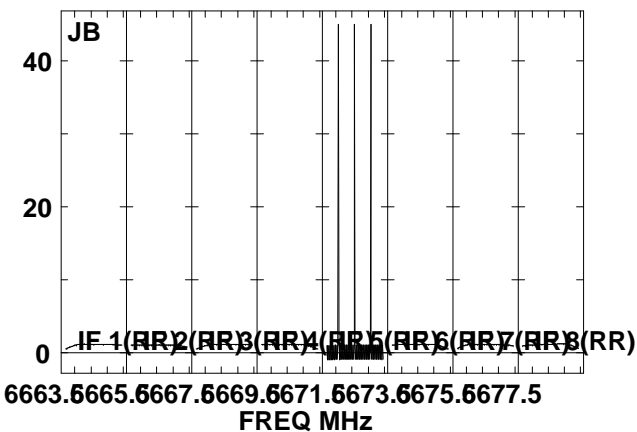
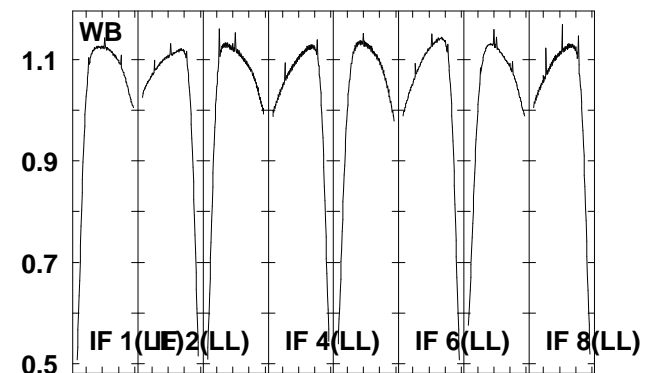
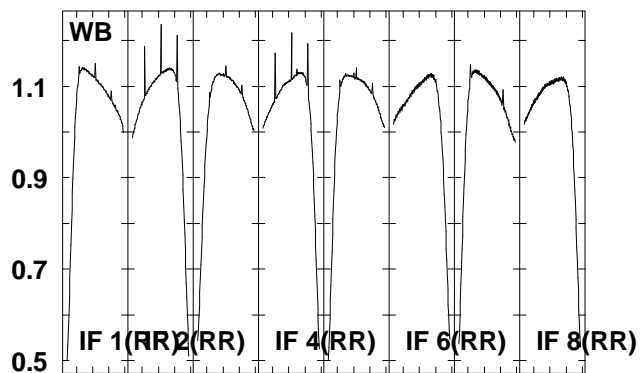
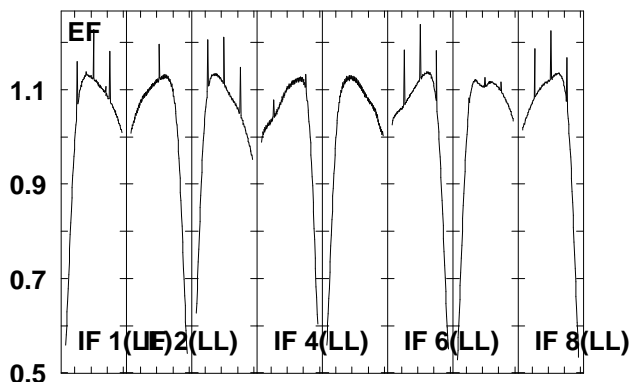
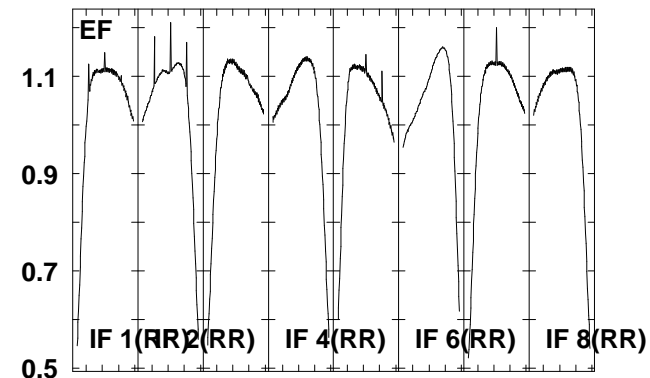
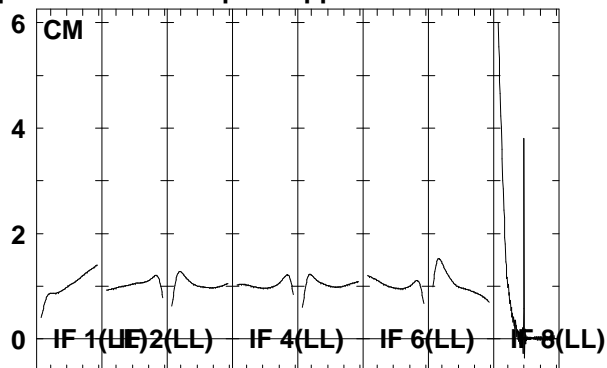
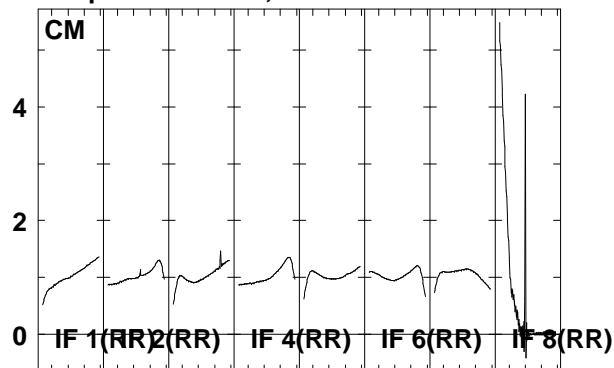

6663.6665.6667.6669.6671.6673.6675.6677.5
 FREQ MHz

6663.6665.6667.6669.6671.6673.6675.6677.5
 FREQ MHz

6663.6665.6667.6669.6671.6673.6675.6677.5
 FREQ MHz

Lower frame: Real Jy
 Total-power spectrum Antenna: *
 Timerange: 00/06:18:35 to 00/06:21:32

Plot file version 74 created 22-JUN-2006 20:06:28
 J1825-17 EM061A 1.UVDATA.1
 Freq = 6.6631 GHz, Bw = 2.000 MH No calibration applied and no bandpass applied

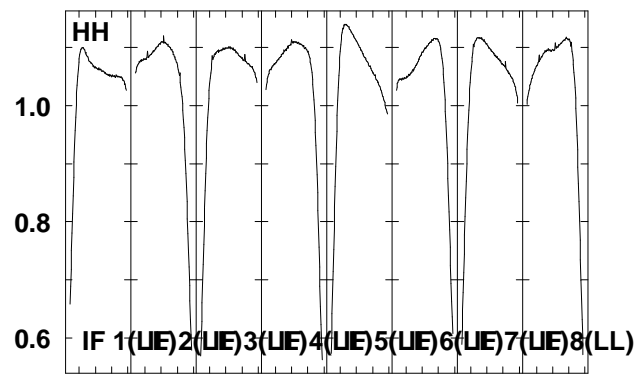
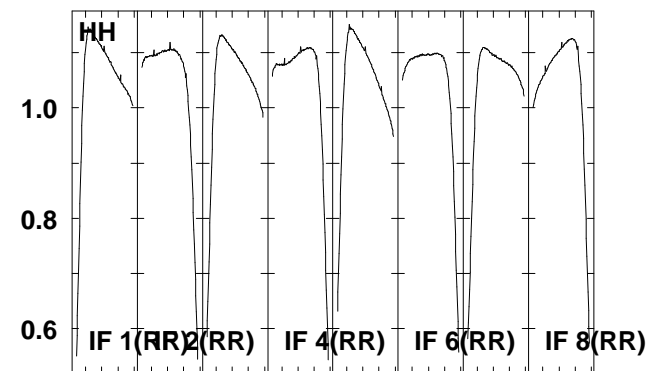
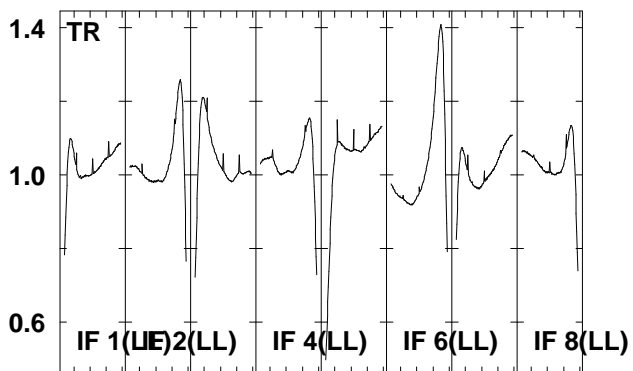
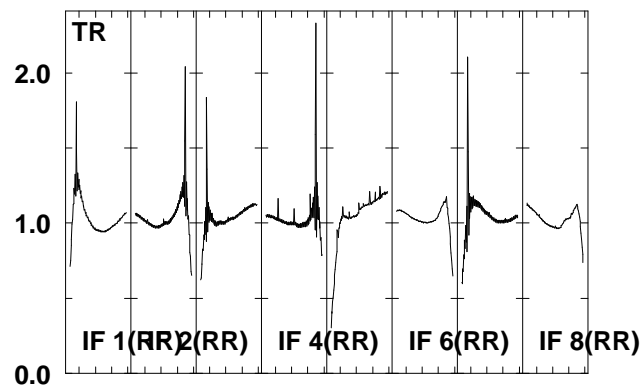
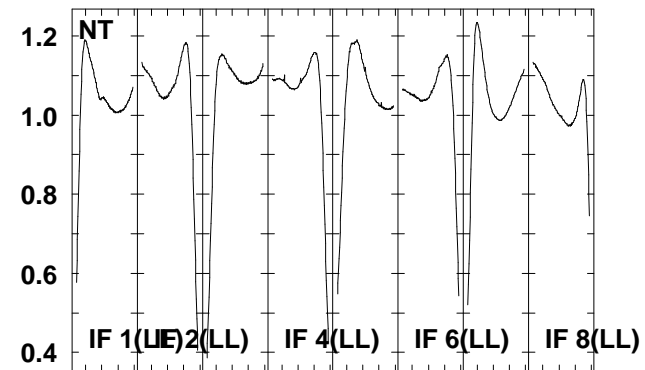
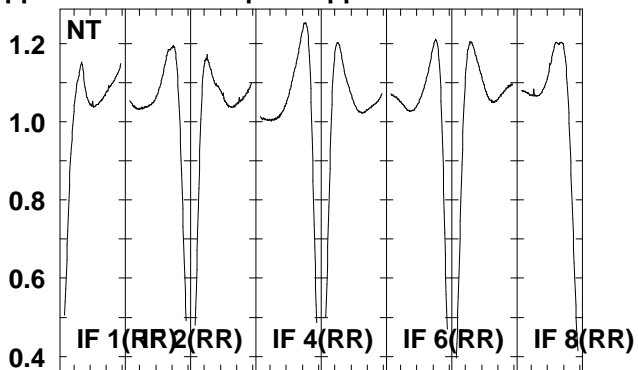
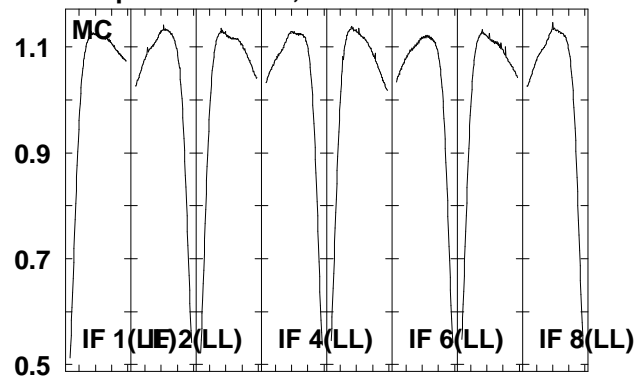

6663.6665.6667.6669.6671.6673.6675.6677.5
 FREQ MHz

Lower frame: Real Jy
 Total-power spectrum Antenna: *
 Timerange: 00/06:18:35 to 00/06:21:32

Plot file version 75 created 22-JUN-2006 20:06:32
 G16.59-0 EM061A 1.UVDATA.1
 Freq = 6.6631 GHz, Bw = 2.000 MH No calibration applied and no bandpass applied

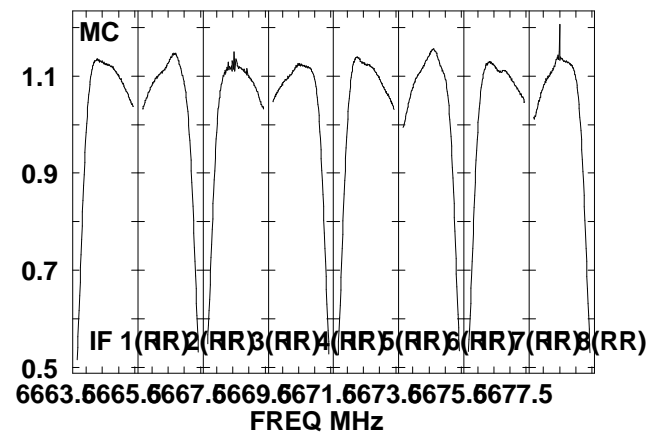
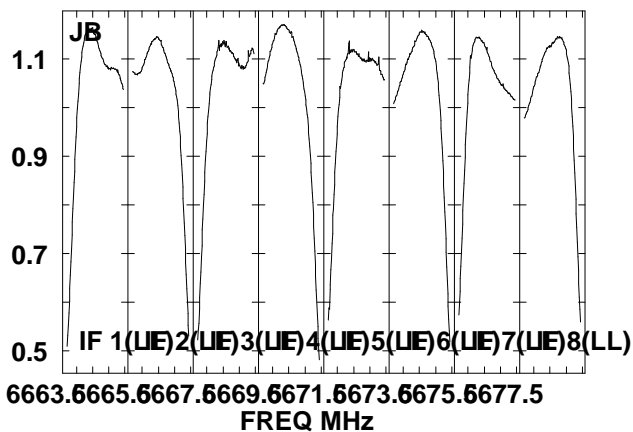
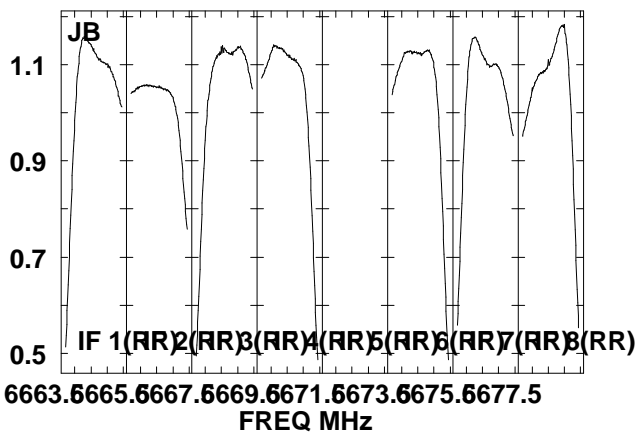
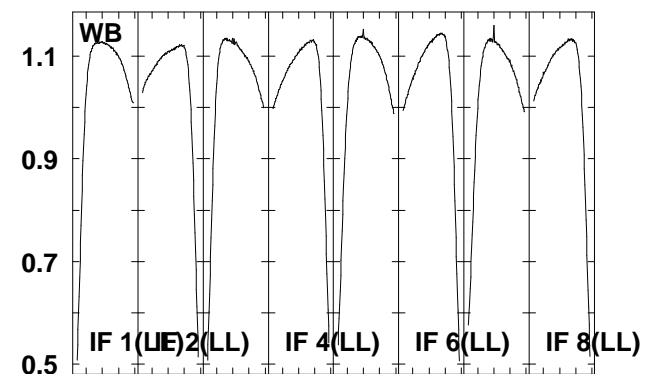
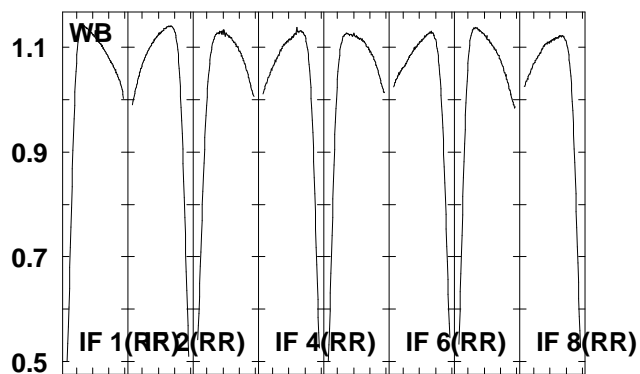
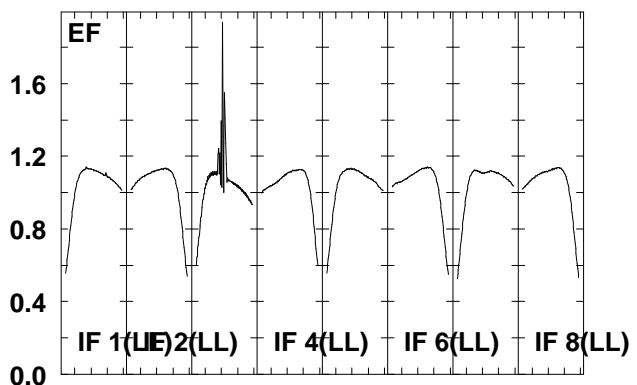
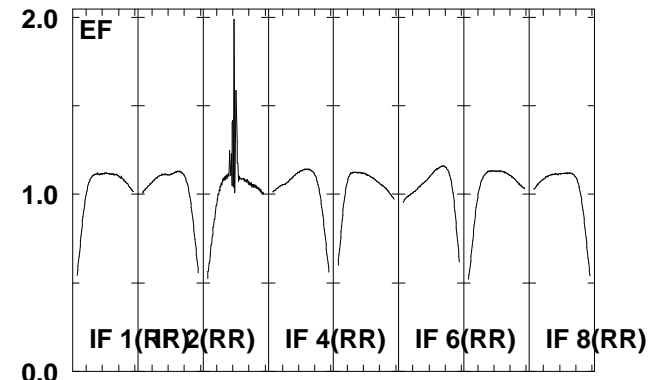
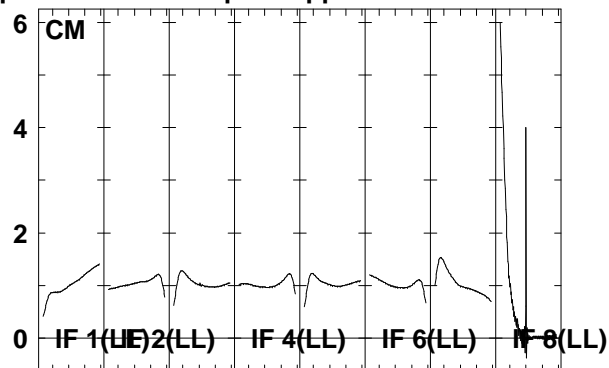
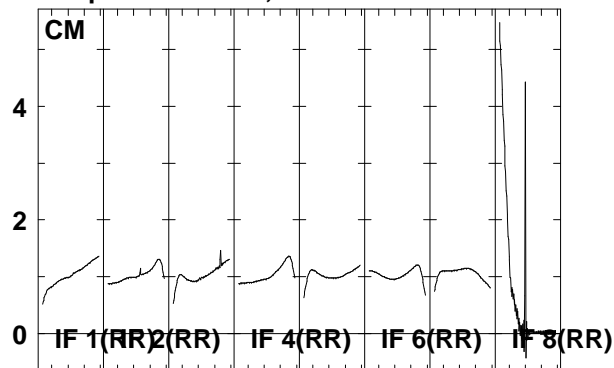

6663.6665.6667.6669.6671.6673.6675.6677.5
 FREQ MHz

6663.6665.6667.6669.6671.6673.6675.6677.5
 FREQ MHz

6663.6665.6667.6669.6671.6673.6675.6677.5
 FREQ MHz

Lower frame: Real Jy
 Total-power spectrum Antenna: *
 Timerange: 00/06:21:34 to 00/06:24:02

Plot file version 76 created 22-JUN-2006 20:06:35
 G16.59-0 EM061A 1.UVDATA.1
 Freq = 6.6631 GHz, Bw = 2.000 MH No calibration applied and no bandpass applied

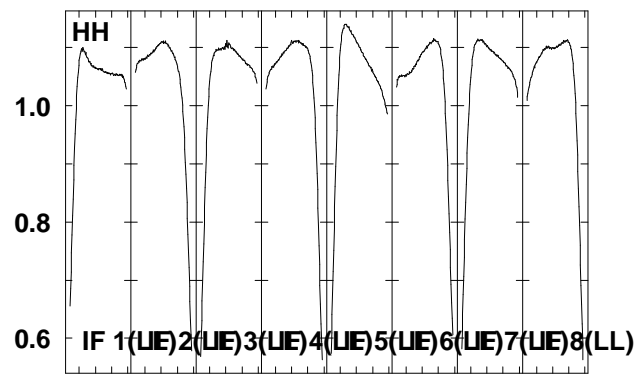
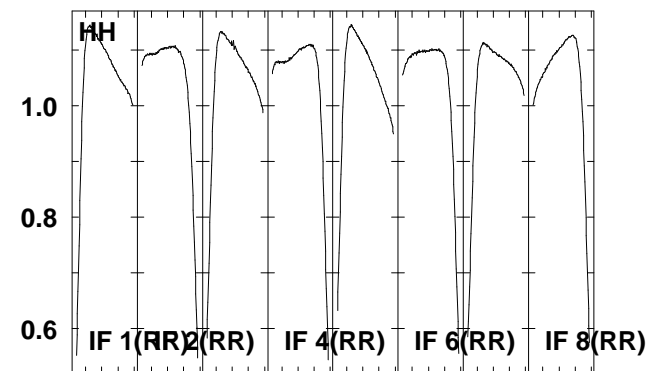
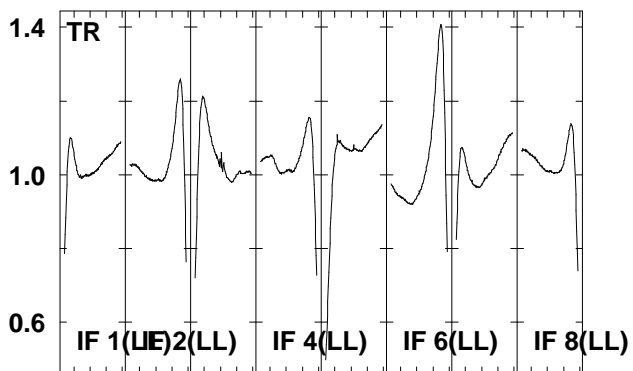
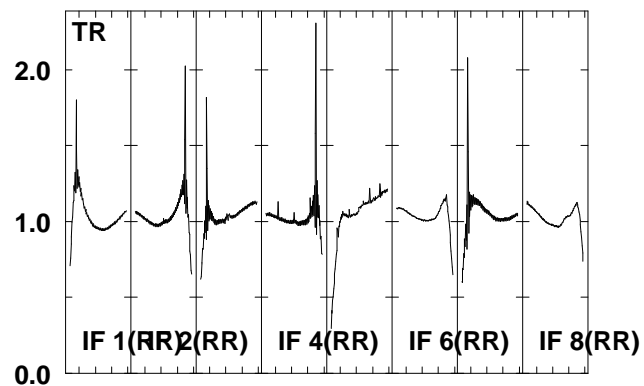
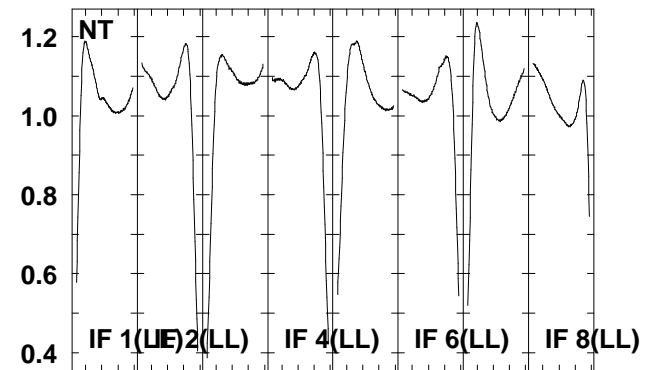
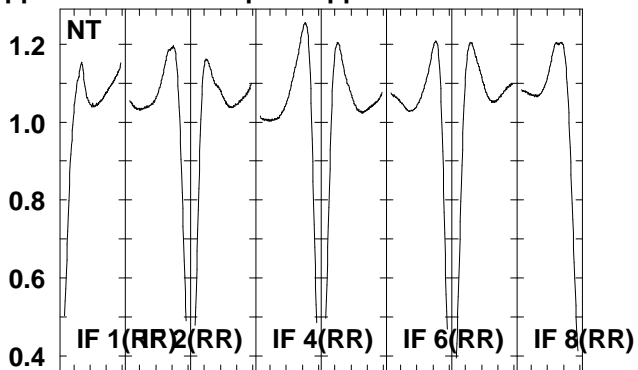
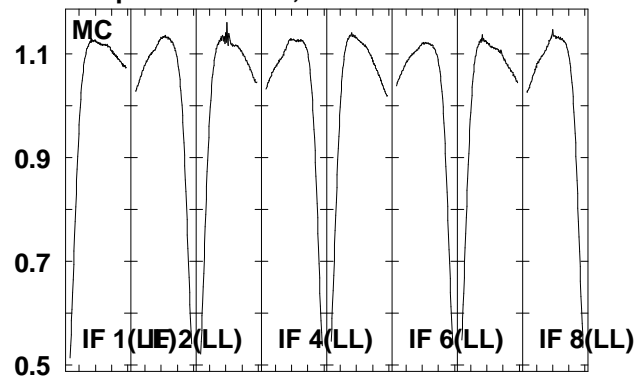

6663.6665.6667.6669.6671.6673.6675.6677.5
 FREQ MHz

Lower frame: Real Jy
 Total-power spectrum Antenna: *
 Timerange: 00/06:21:34 to 00/06:24:02

Plot file version 77 created 22-JUN-2006 20:06:37
 J1825-17 EM061A 1.UVDATA.1
 Freq = 6.6631 GHz, Bw = 2.000 MH No calibration applied and no bandpass applied

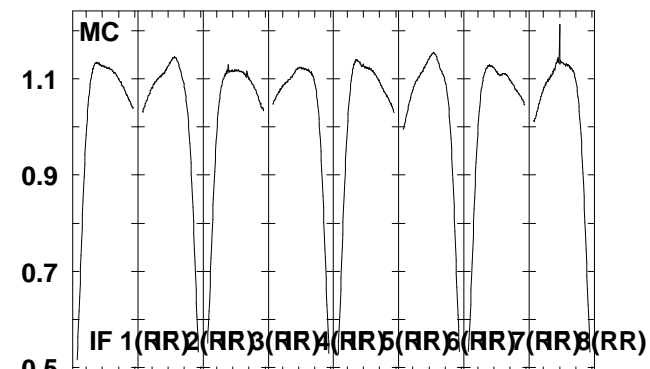
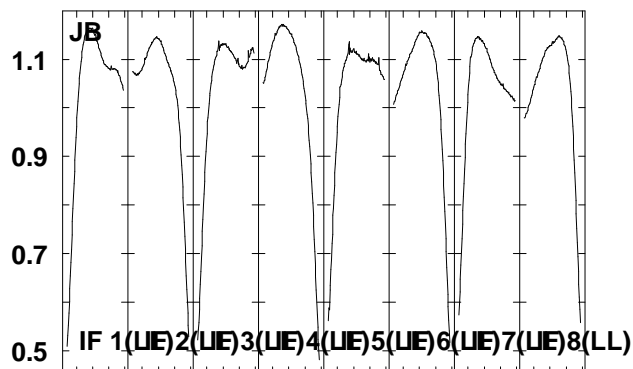
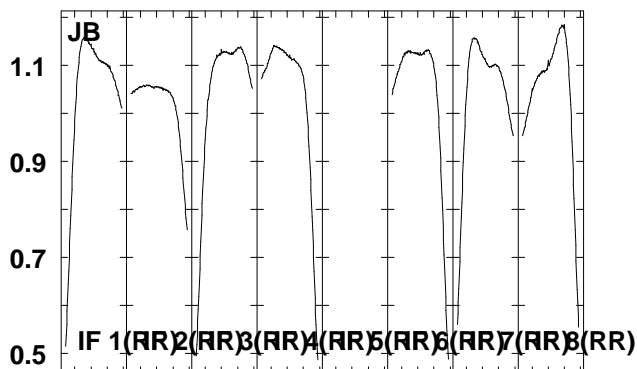
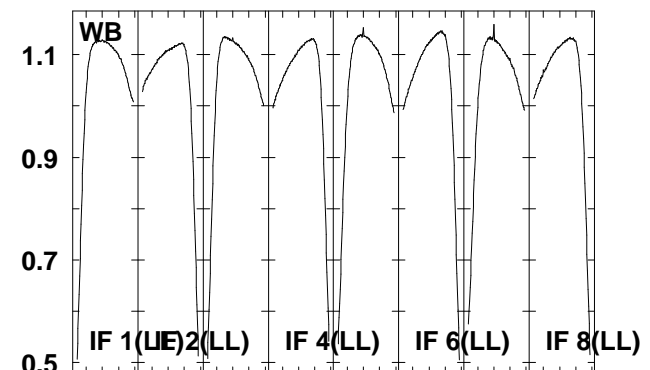
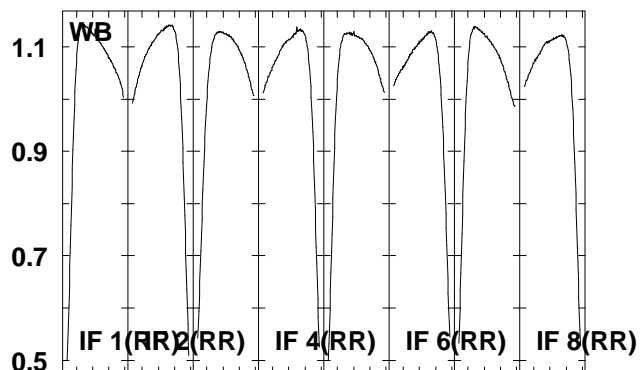
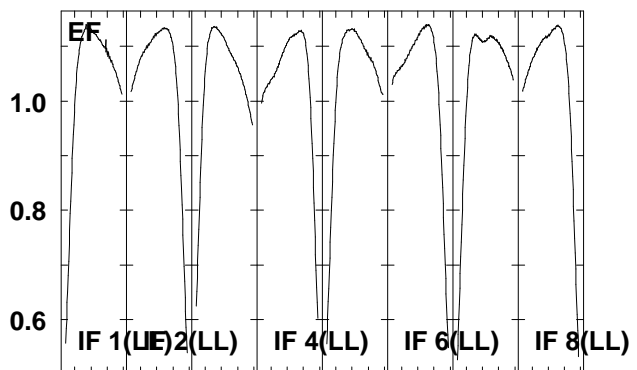
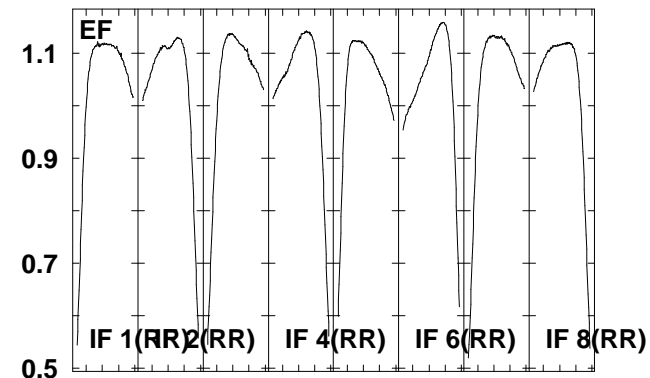
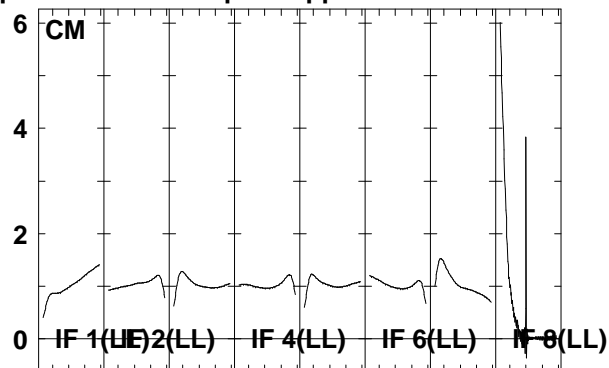
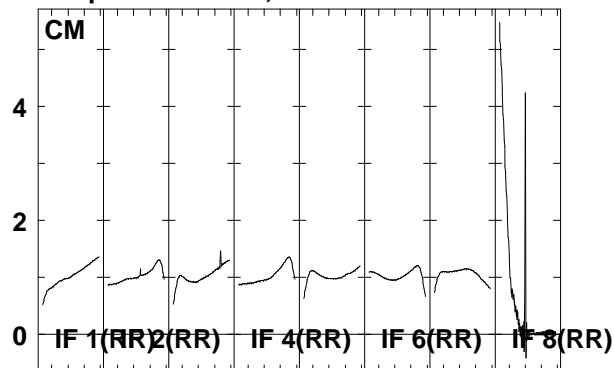

6663.6665.6667.6669.6671.6673.6675.6677.5
 FREQ MHz

6663.6665.6667.6669.6671.6673.6675.6677.5
 FREQ MHz

6663.6665.6667.6669.6671.6673.6675.6677.5
 FREQ MHz

Lower frame: Real Jy
 Total-power spectrum Antenna: *
 Timerange: 00/06:24:04 to 00/06:27:02

Plot file version 78 created 22-JUN-2006 20:06:40
 J1825-17 EM061A 1.UVDATA.1
 Freq = 6.6631 GHz, Bw = 2.000 MH No calibration applied and no bandpass applied

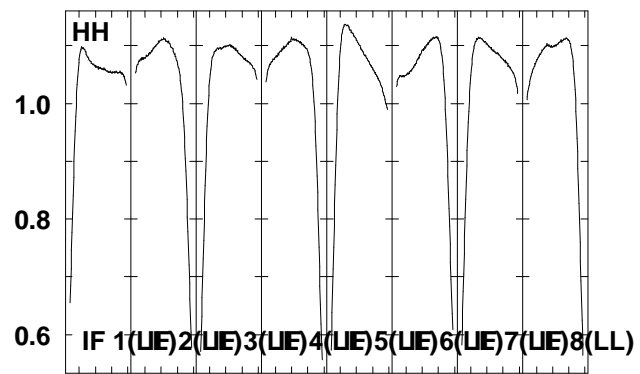
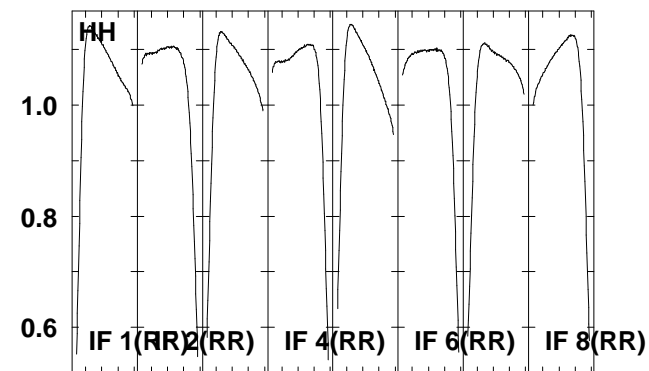
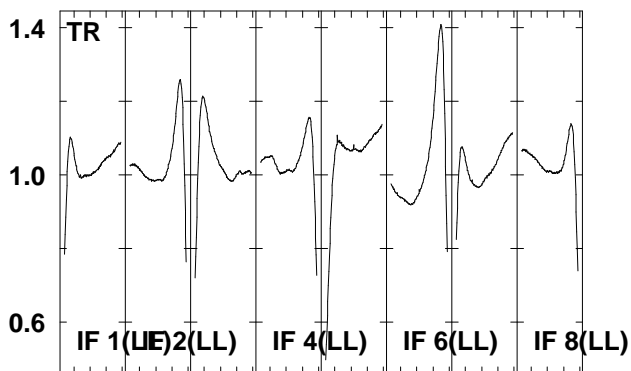
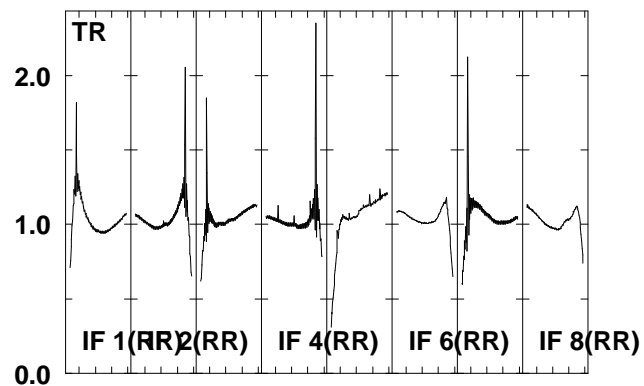
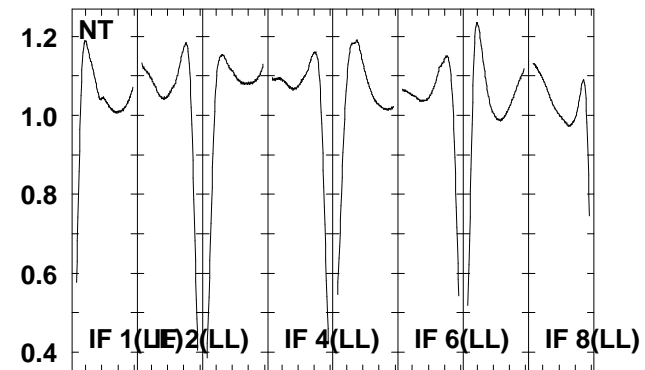
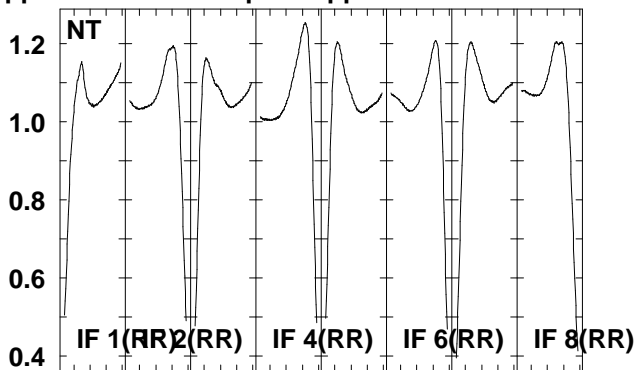
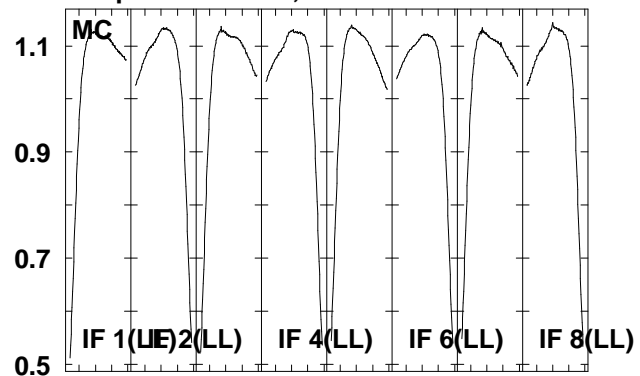

6663.6665.6667.6669.6671.6673.6675.6677.5
 FREQ MHz

Lower frame: Real Jy
 Total-power spectrum Antenna: *
 Timerange: 00/06:24:04 to 00/06:27:02

Plot file version 79 created 22-JUN-2006 20:06:44
 G16.59-0 EM061A 1.UVDATA.1
 Freq = 6.6631 GHz, Bw = 2.000 MH No calibration applied and no bandpass applied

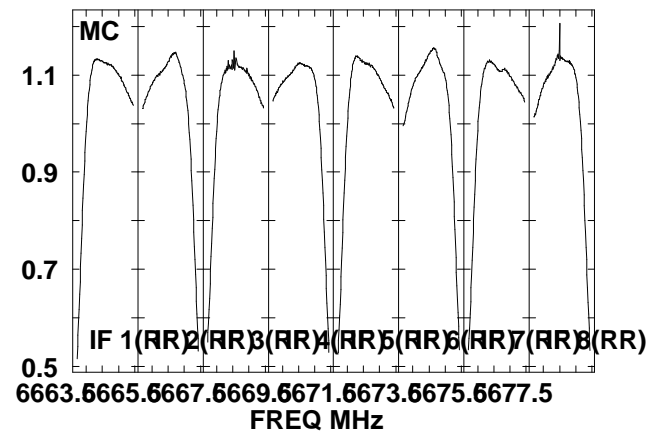
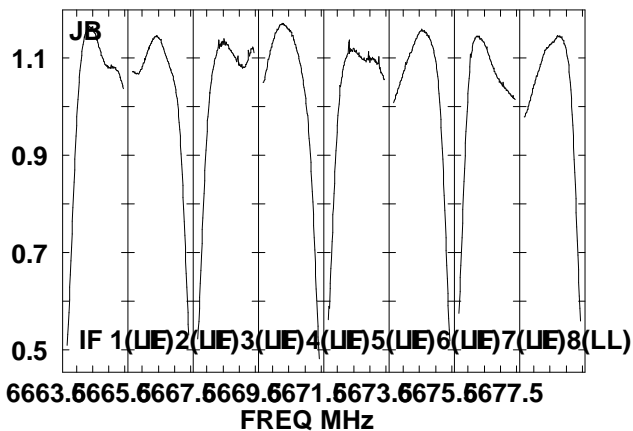
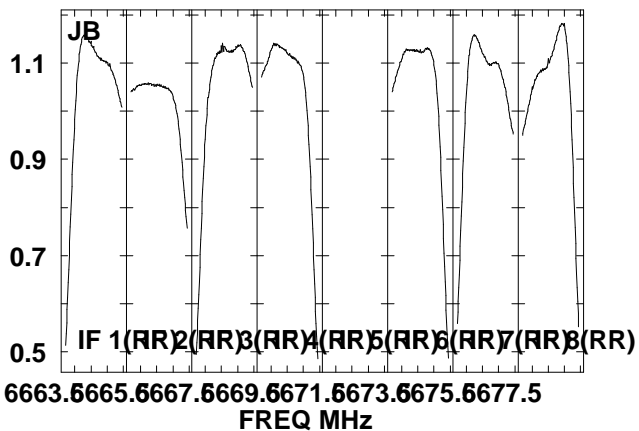
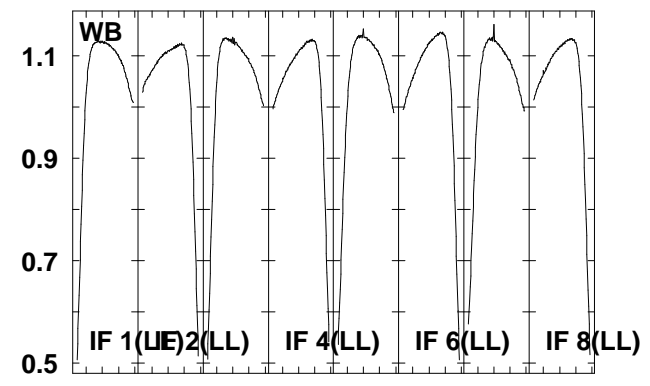
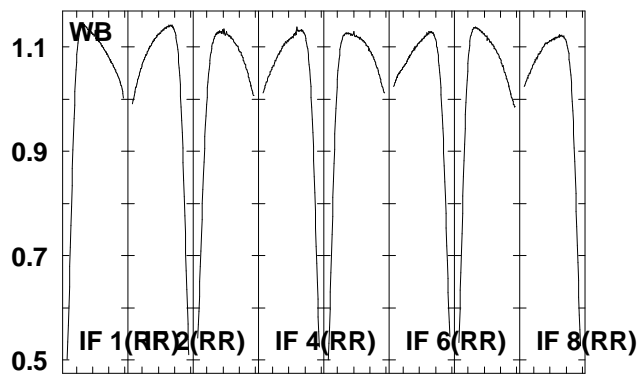
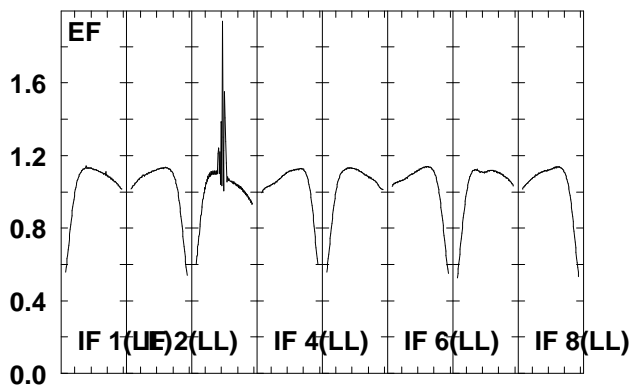
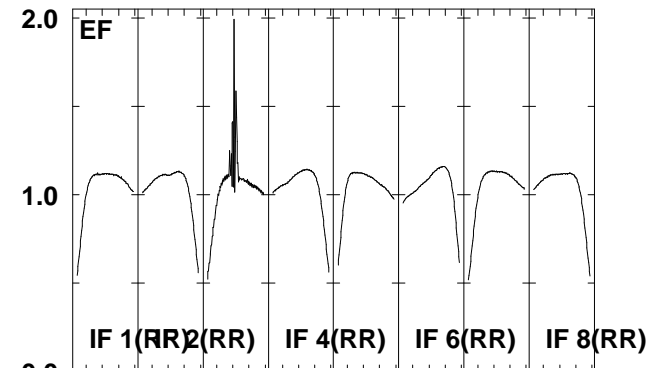
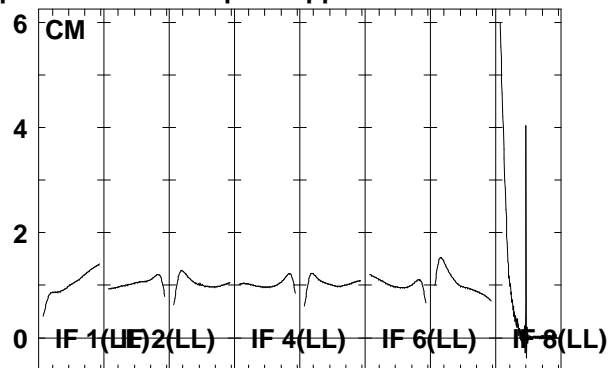
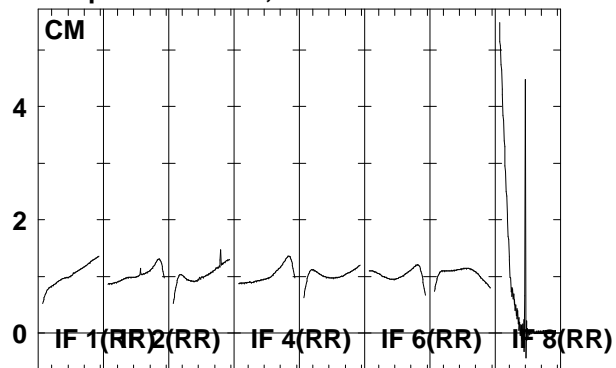

6663.6665.6667.6669.6671.6673.6675.6677.5
 FREQ MHz
 Lower frame: Real Jy
 Total-power spectrum Antenna: *
 Timerange: 00/06:27:04 to 00/06:29:32

Plot file version 80 created 22-JUN-2006 20:06:46
 G16.59-0 EM061A 1.UVDATA.1
 Freq = 6.6631 GHz, Bw = 2.000 MH No calibration applied and no bandpass applied

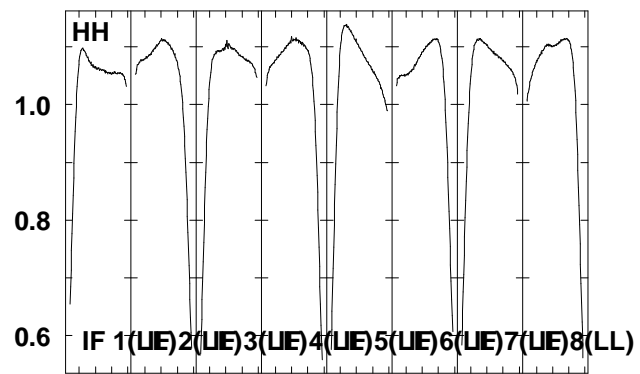
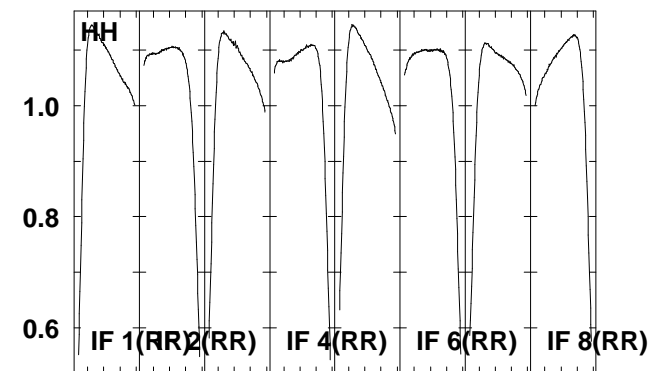
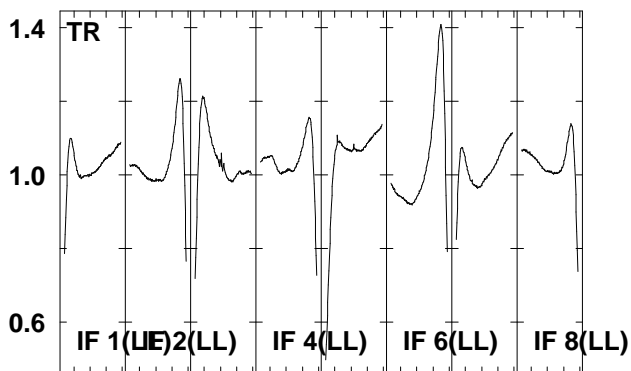
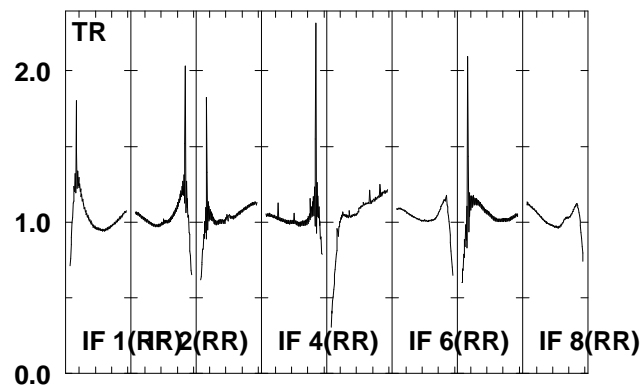
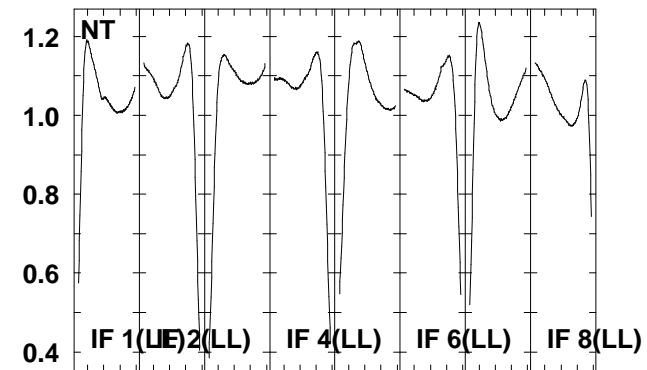
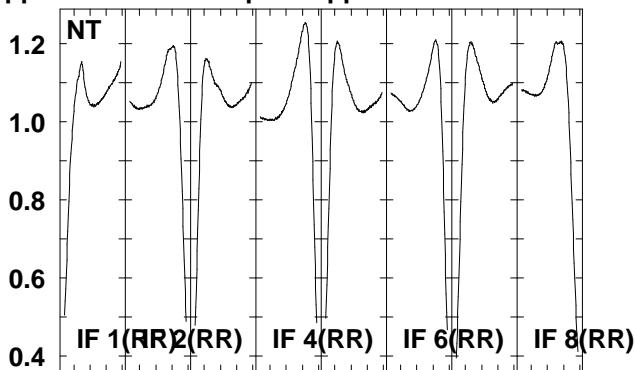
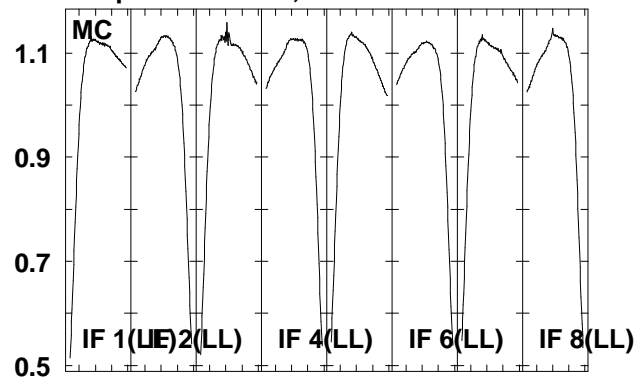

6663.6665.6667.6669.6671.6673.6675.6677.5
 FREQ MHz

Lower frame: Real Jy
 Total-power spectrum Antenna: *
 Timerange: 00/06:27:04 to 00/06:29:32

Plot file version 81 created 22-JUN-2006 20:06:49
 J1825-17 EM061A 1.UVDATA.1
 Freq = 6.6631 GHz, Bw = 2.000 MH No calibration applied and no bandpass applied

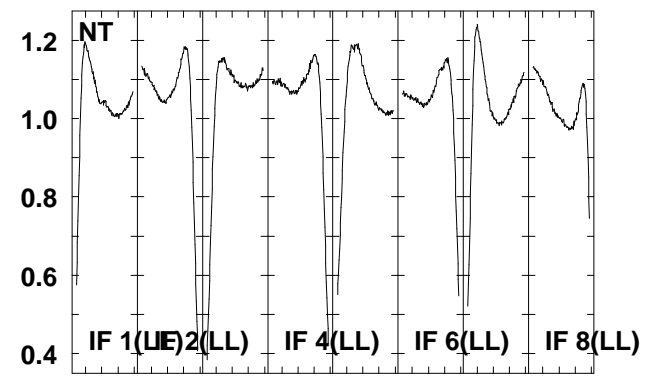
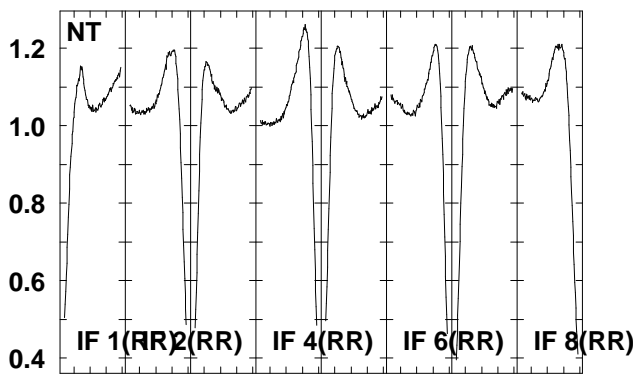
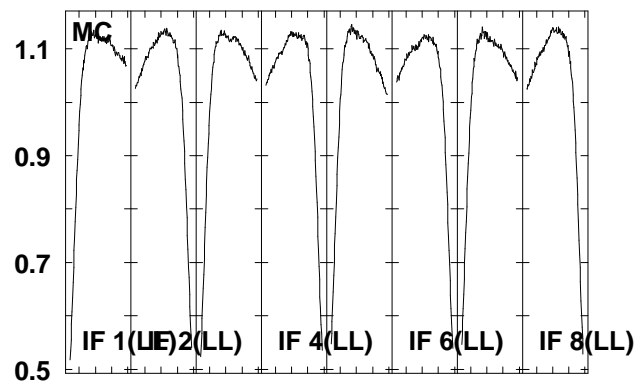
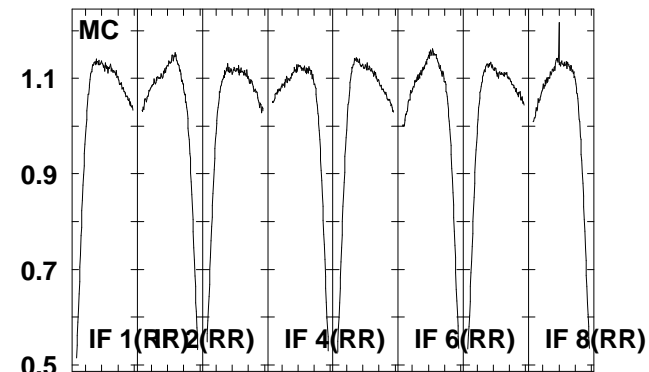
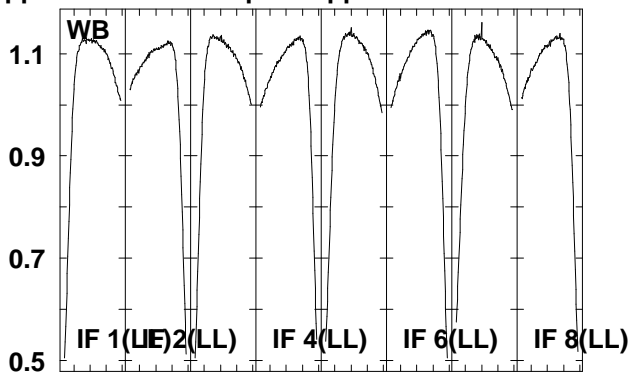
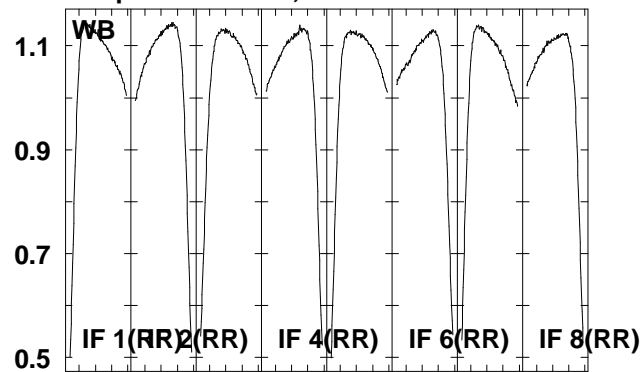

Lower frame: Real Jy
 Total-power spectrum Antenna: *
 Timerange: 00/06:29:34 to 00/06:29:55

Plot file version 82 created 22-JUN-2006 20:06:52
 J1825-17 EM061A 1.UVDATA.1
 Freq = 6.6631 GHz, Bw = 2.000 MH No calibration applied and no bandpass applied

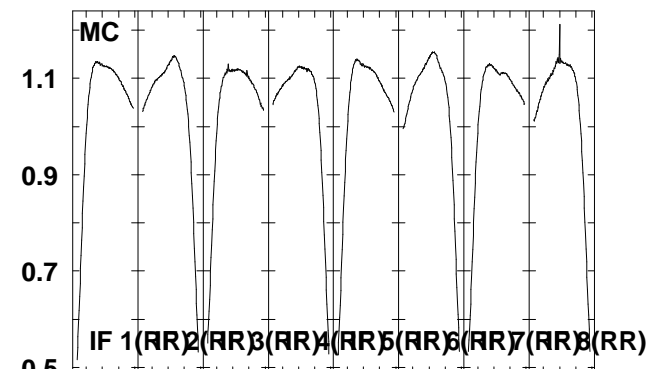
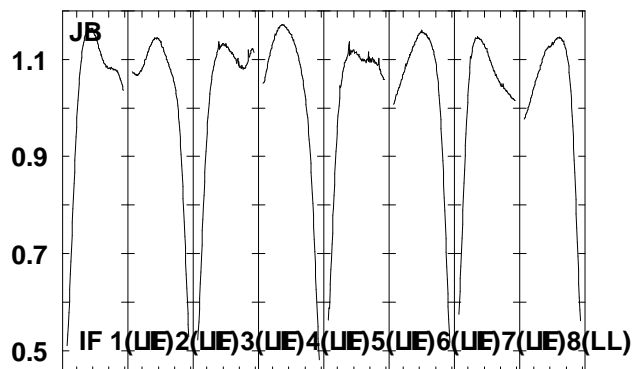
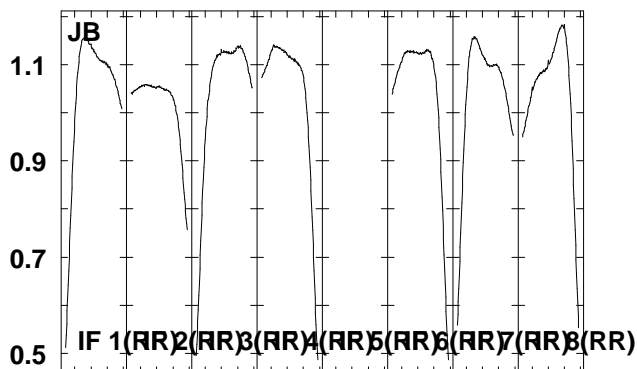
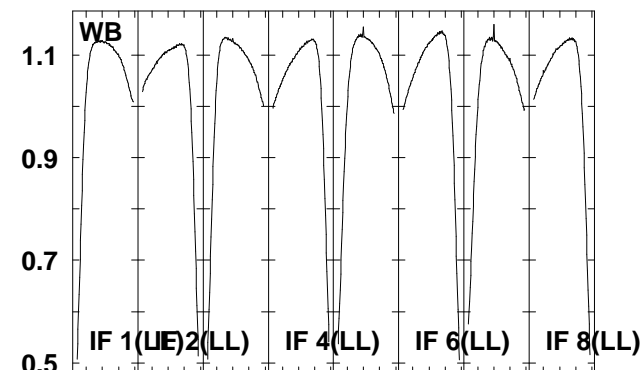
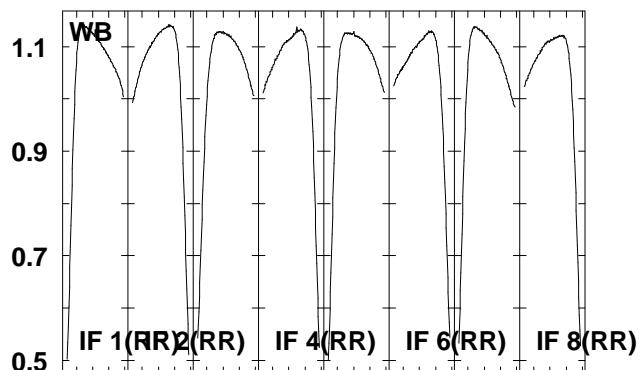
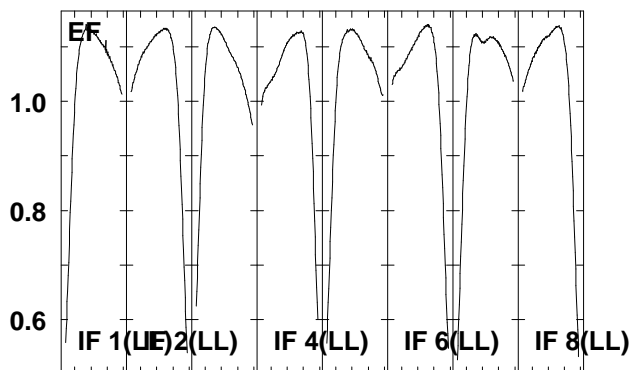
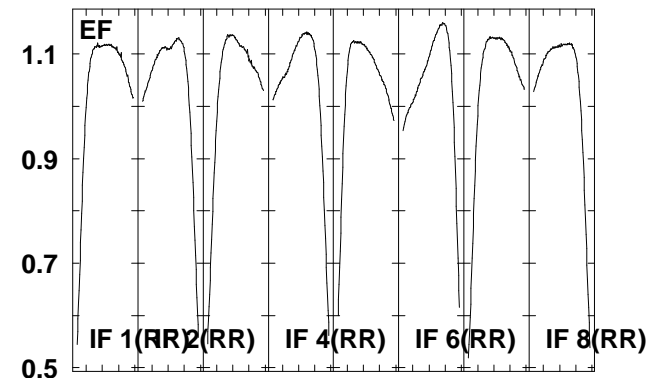
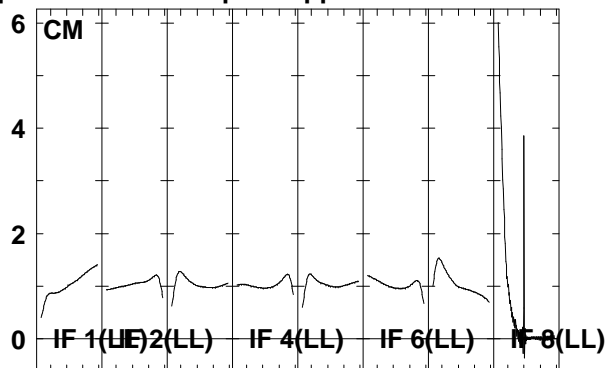
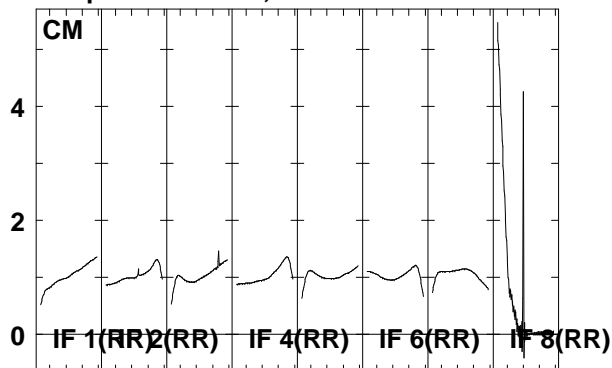

6663.6665.6667.6669.6671.6673.6675.6677.5
 FREQ MHz

6663.6665.6667.6669.6671.6673.6675.6677.5
 FREQ MHz

6663.6665.6667.6669.6671.6673.6675.6677.5
 FREQ MHz

Lower frame: Real Jy
 Total-power spectrum Antenna: *
 Timerange: 00/06:29:57 to 00/06:32:32

Plot file version 83 created 22-JUN-2006 20:06:54
 J1825-17 EM061A 1.UVDATA.1
 Freq = 6.6631 GHz, Bw = 2.000 MH No calibration applied and no bandpass applied

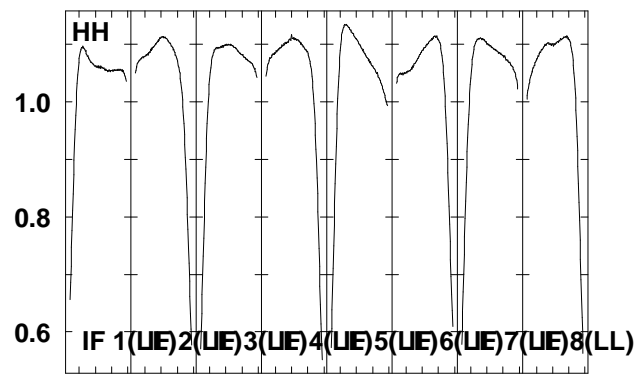
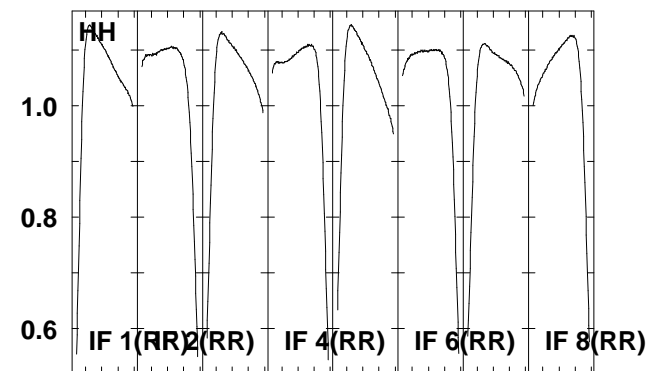
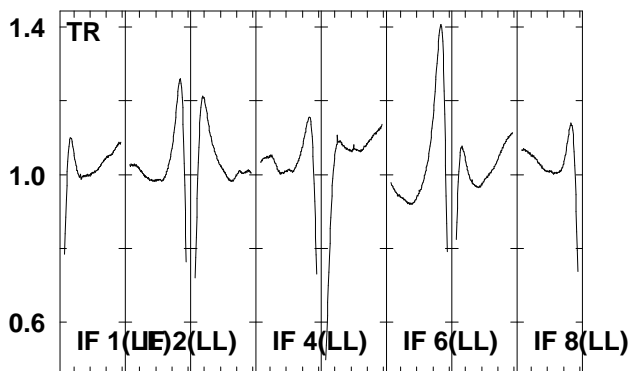
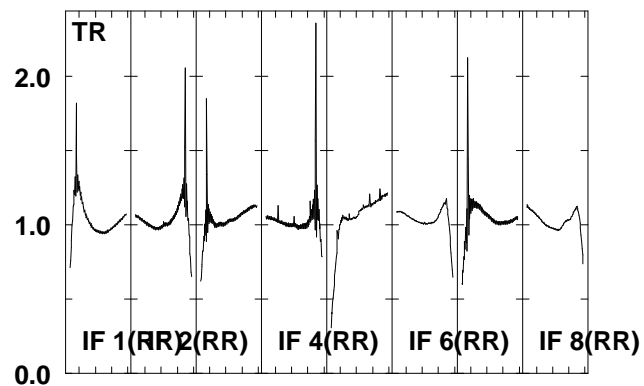
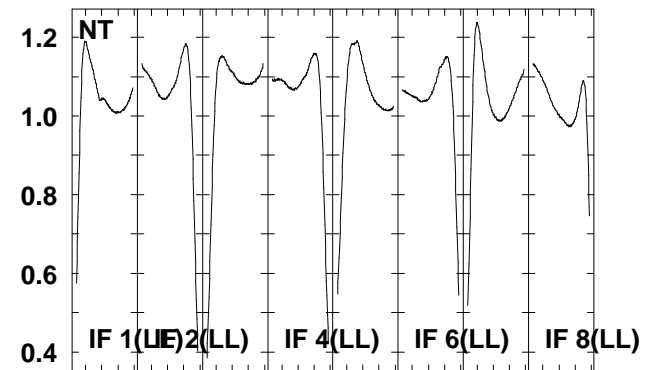
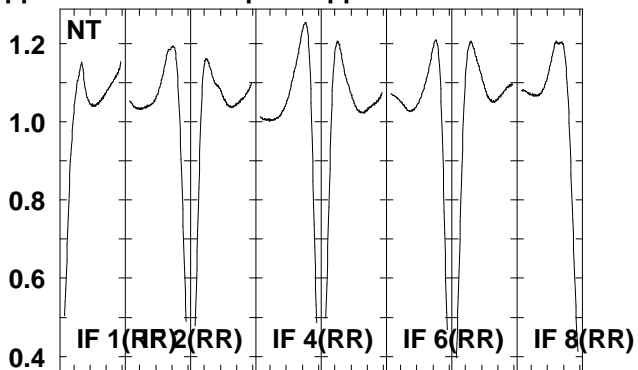
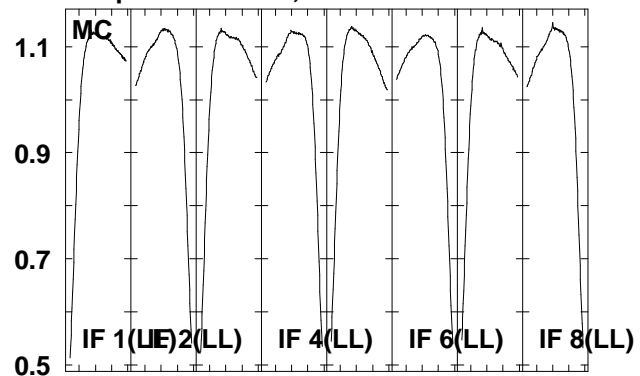

6663.6665.6667.6669.6671.6673.6675.6677.5
 FREQ MHz

Lower frame: Real Jy
 Total-power spectrum Antenna: *
 Timerange: 00/06:29:57 to 00/06:32:32

Plot file version 84 created 22-JUN-2006 20:06:58
 G16.59-0 EM061A 1.UVDATA.1
 Freq = 6.6631 GHz, Bw = 2.000 MH No calibration applied and no bandpass applied

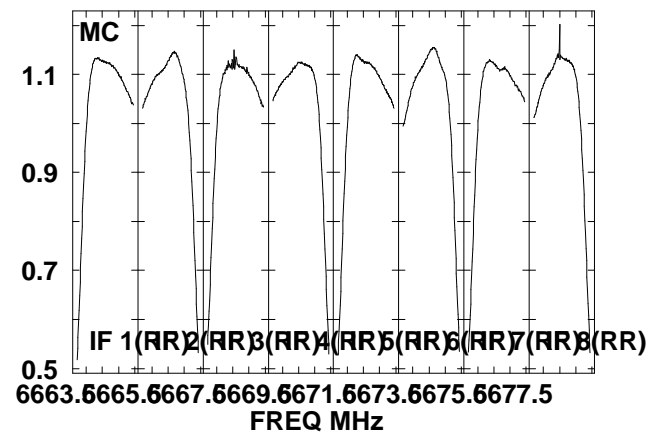
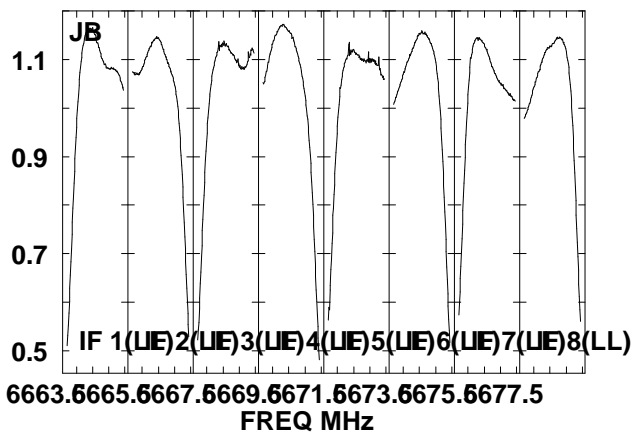
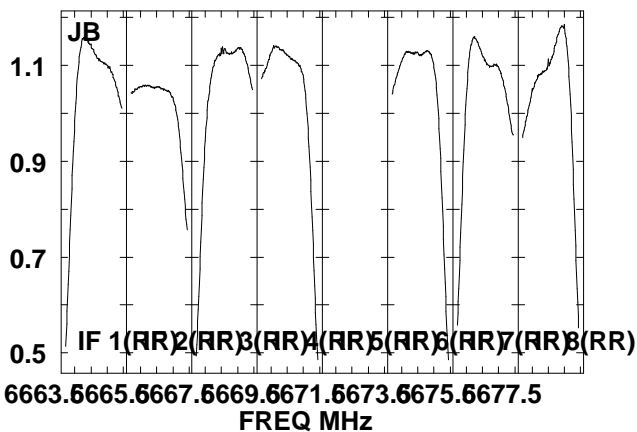
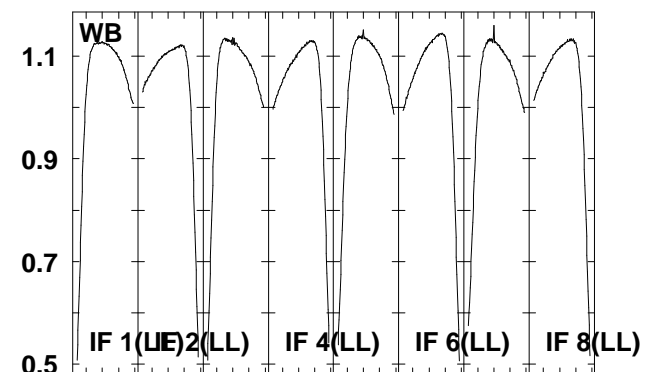
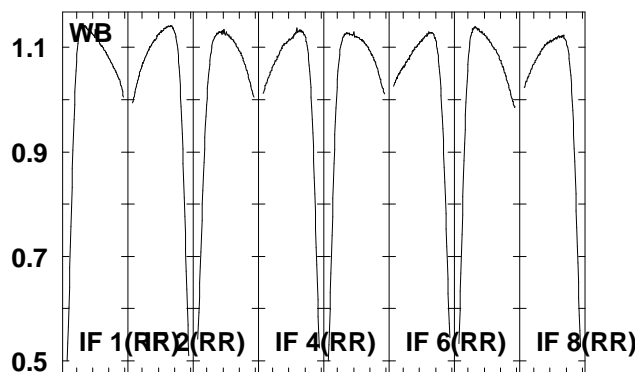
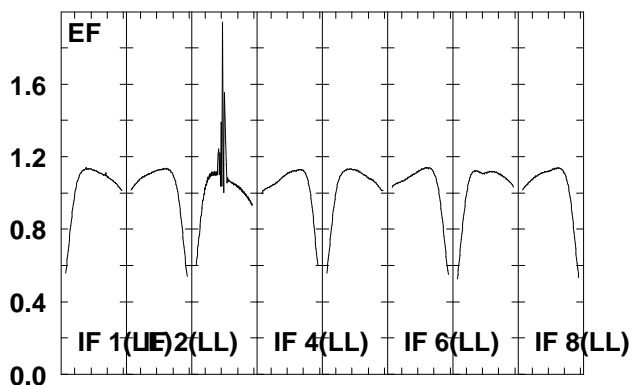
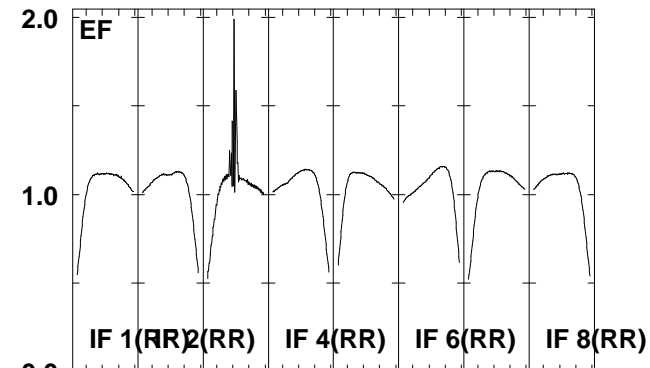
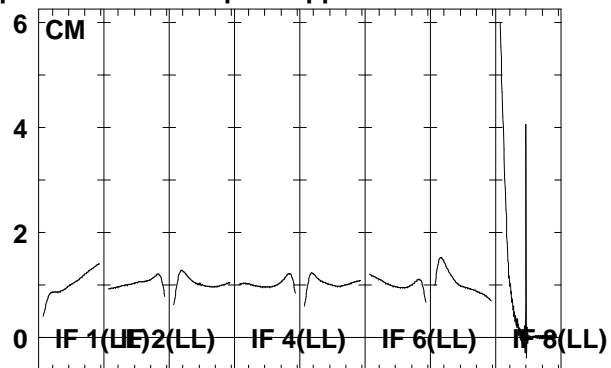
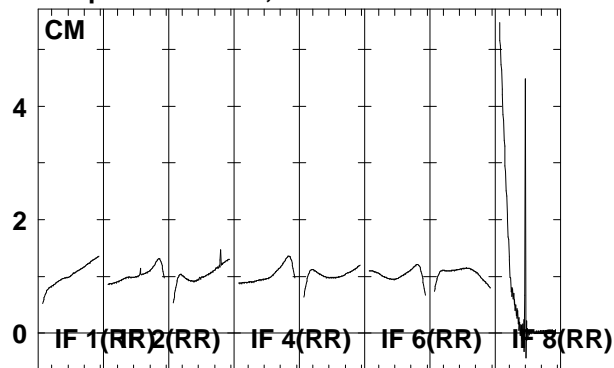

6663.6665.6667.6669.6671.6673.6675.6677.5
 FREQ MHz

6663.6665.6667.6669.6671.6673.6675.6677.5
 FREQ MHz

6663.6665.6667.6669.6671.6673.6675.6677.5
 FREQ MHz

Lower frame: Real Jy
 Total-power spectrum Antenna: *
 Timerange: 00/06:32:34 to 00/06:34:49

Plot file version 85 created 22-JUN-2006 20:07:01
 G16.59-0 EM061A 1.UVDATA.1
 Freq = 6.6631 GHz, Bw = 2.000 MH No calibration applied and no bandpass applied

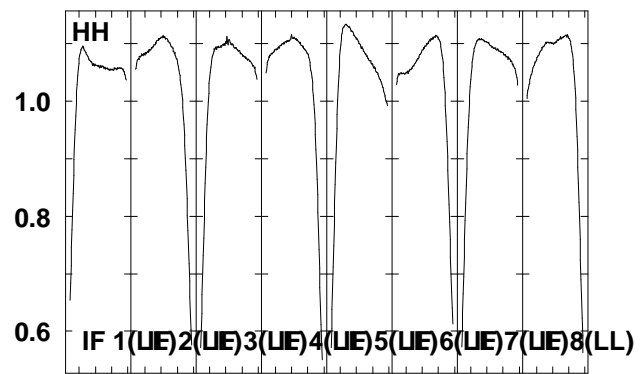
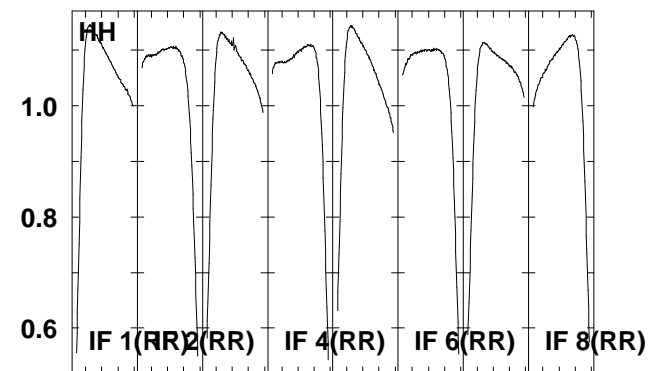
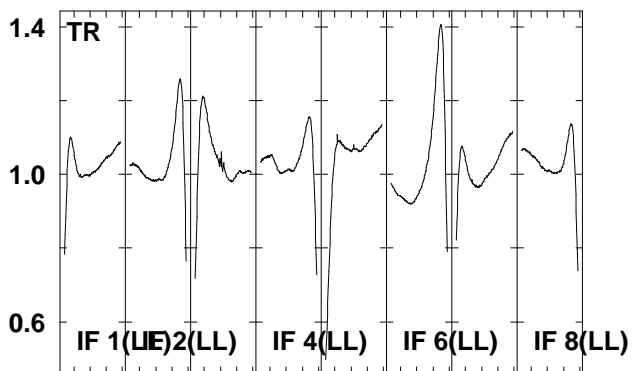
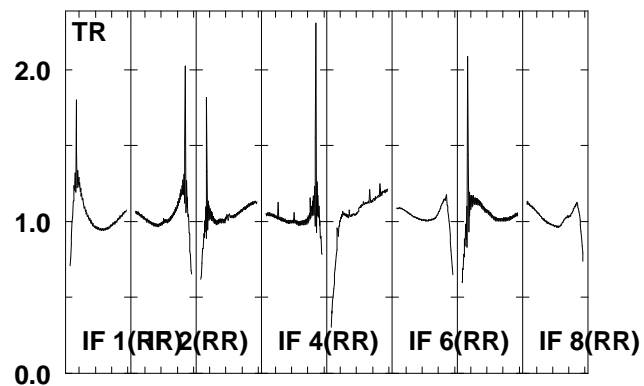
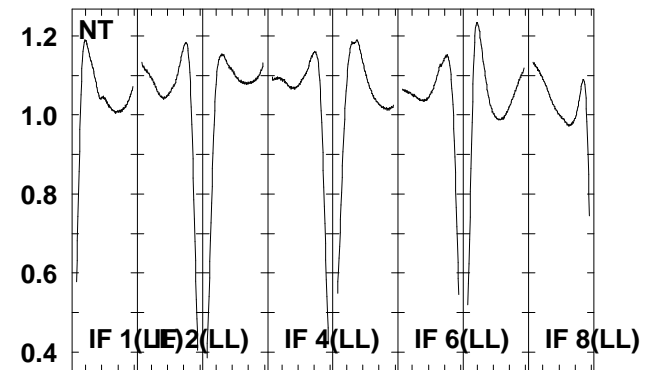
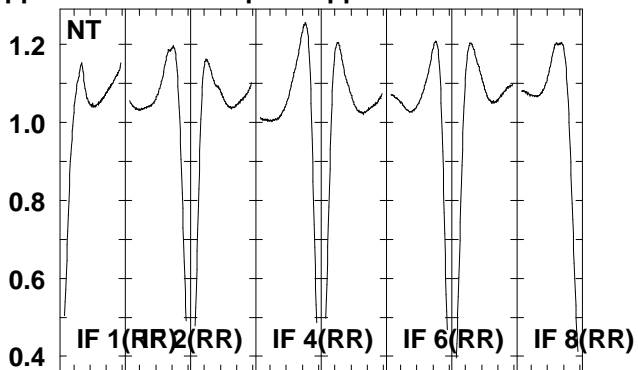
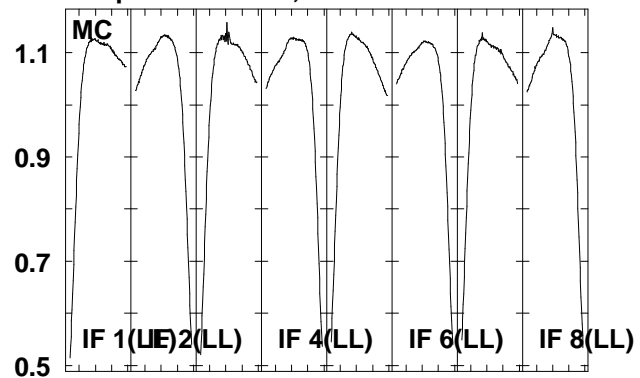

6663.6665.6667.6669.6671.6673.6675.6677.5
 FREQ MHz

Lower frame: Real Jy
 Total-power spectrum Antenna: *
 Timerange: 00/06:32:34 to 00/06:34:49

Plot file version 86 created 22-JUN-2006 20:07:04
 J1825-17 EM061A 1.UVDATA.1
 Freq = 6.6631 GHz, Bw = 2.000 MH No calibration applied and no bandpass applied

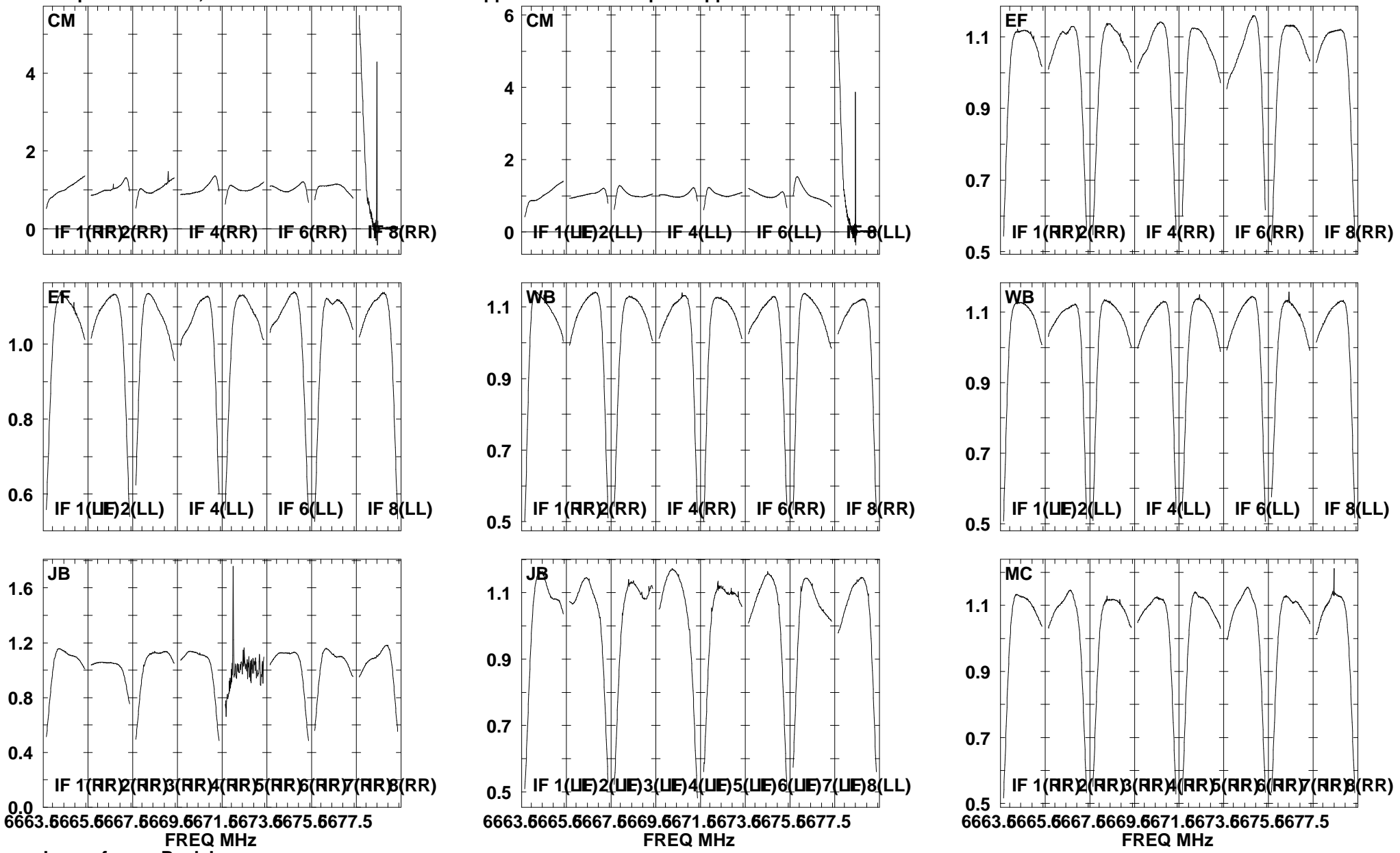

Lower frame: Real Jy
 Total-power spectrum Antenna: *
 Timerange: 00/06:36:52 to 00/06:39:32

Plot file version 87 created 22-JUN-2006 20:07:07

J1825-17 EM061A 1.UVDATA.1

Freq = 6.6631 GHz, Bw = 2.000 MH No calibration applied and no bandpass applied

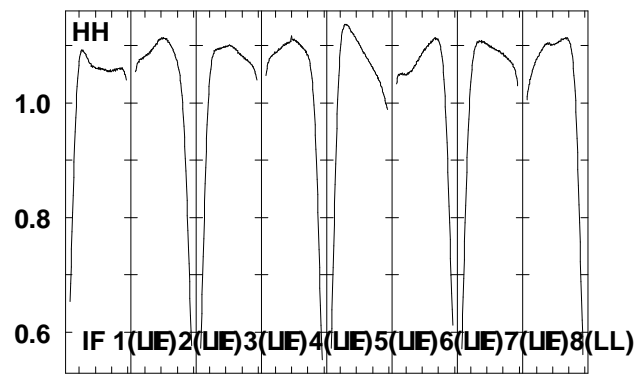
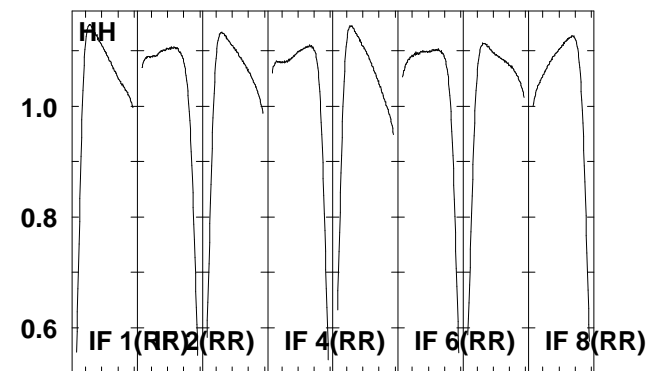
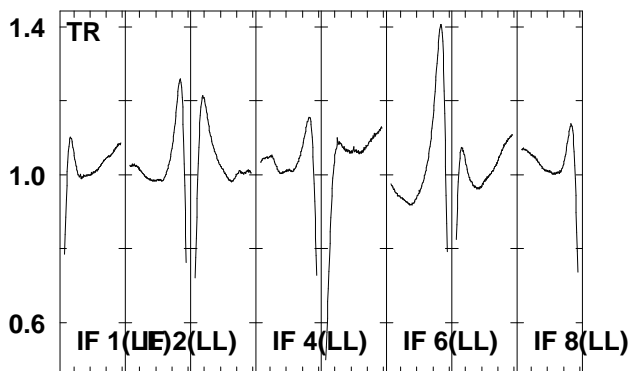
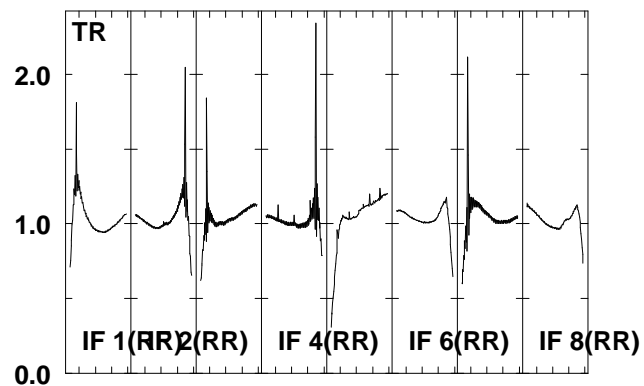
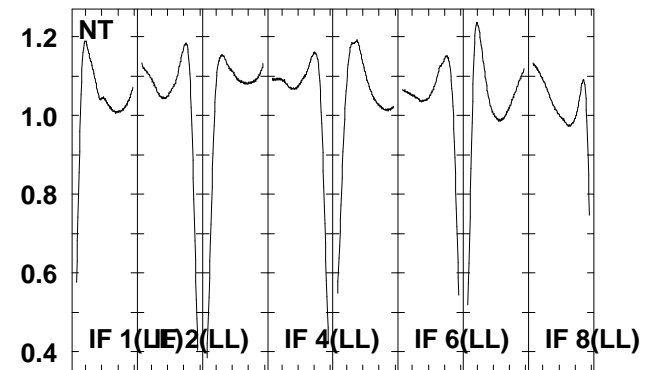
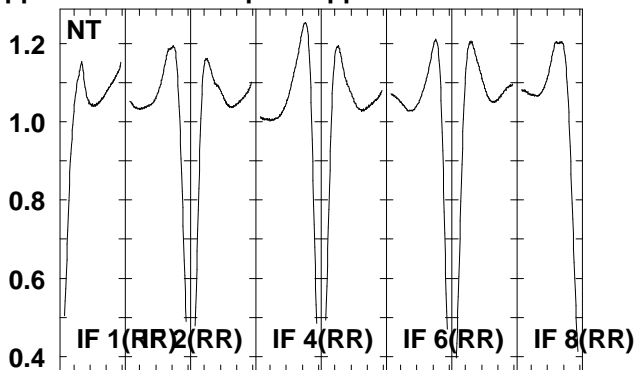
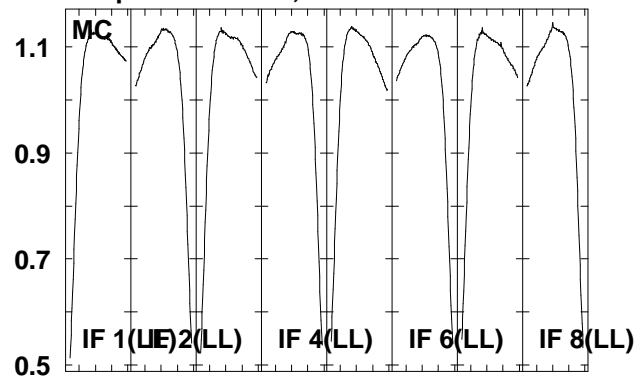

6663.6665.6667.6669.6671.6673.6675.6677.5

FREQ MHz

Lower frame: Real Jy

Total-power spectrum Antenna: *

Timerange: 00/06:36:52 to 00/06:39:32

Plot file version 88 created 22-JUN-2006 20:07:10
 G16.59-0 EM061A 1.UVDATA.1
 Freq = 6.6631 GHz, Bw = 2.000 MH No calibration applied and no bandpass applied

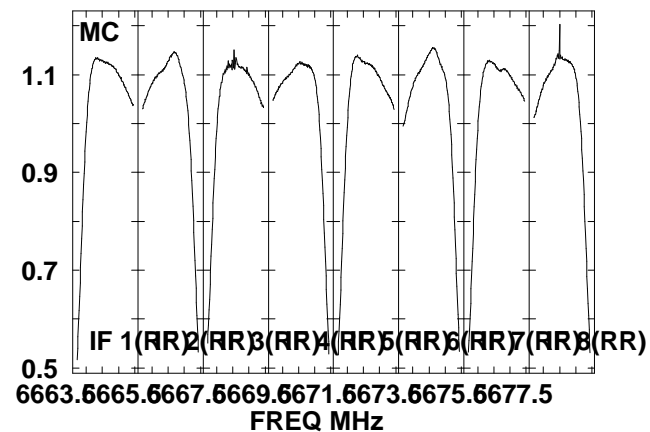
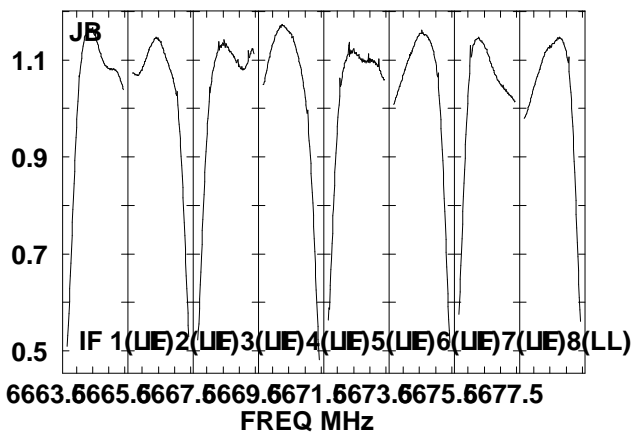
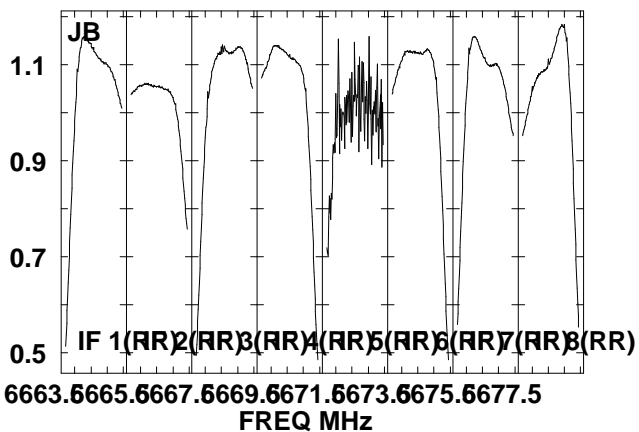
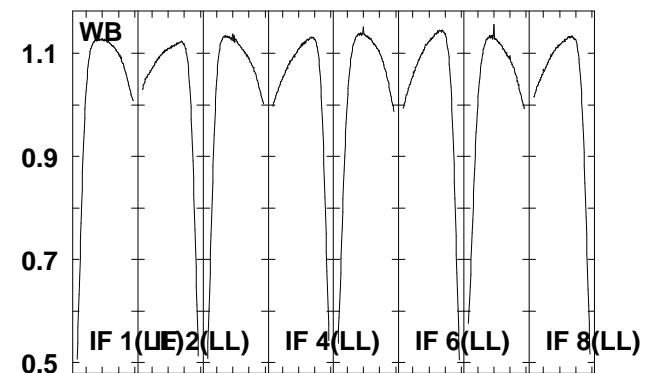
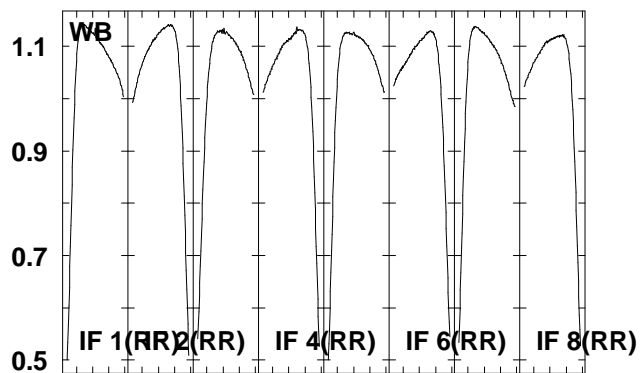
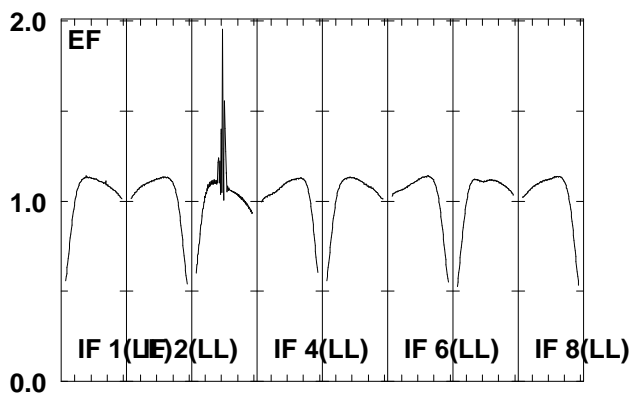
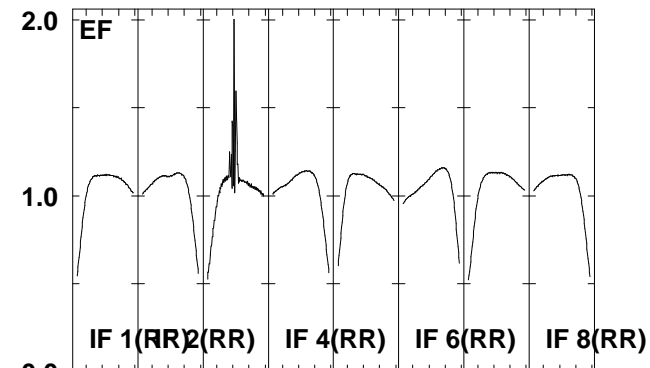
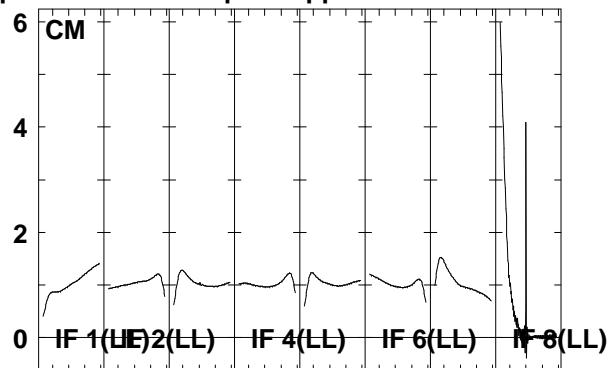
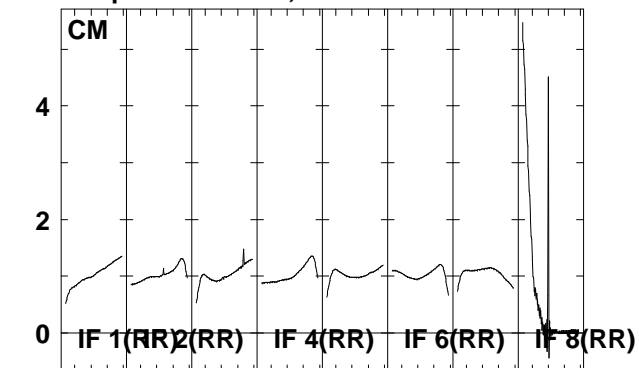

6663.6665.6667.6669.6671.6673.6675.6677.5
 FREQ MHz

6663.6665.6667.6669.6671.6673.6675.6677.5
 FREQ MHz

6663.6665.6667.6669.6671.6673.6675.6677.5
 FREQ MHz

Lower frame: Real Jy
 Total-power spectrum Antenna: *
 Timerange: 00/06:39:34 to 00/06:42:02

Plot file version 89 created 22-JUN-2006 20:07:13
 G16.59-0 EM061A 1.UVDATA.1
 Freq = 6.6631 GHz, Bw = 2.000 MH No calibration applied and no bandpass applied

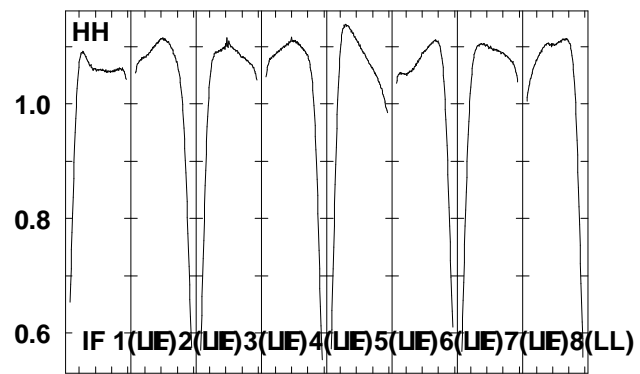
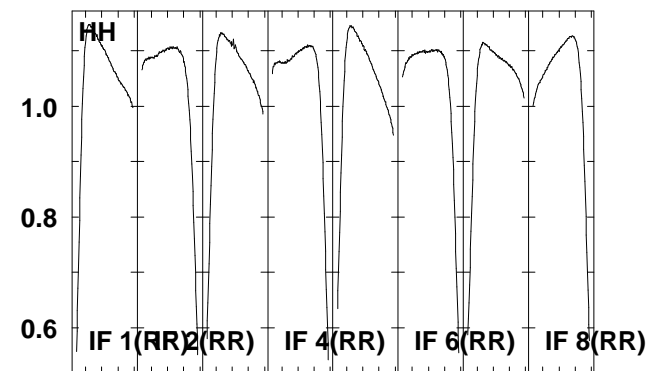
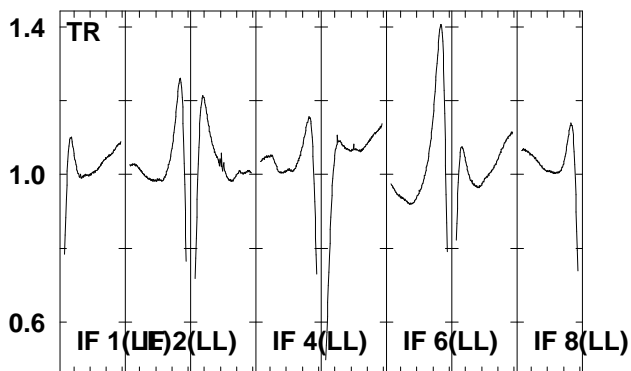
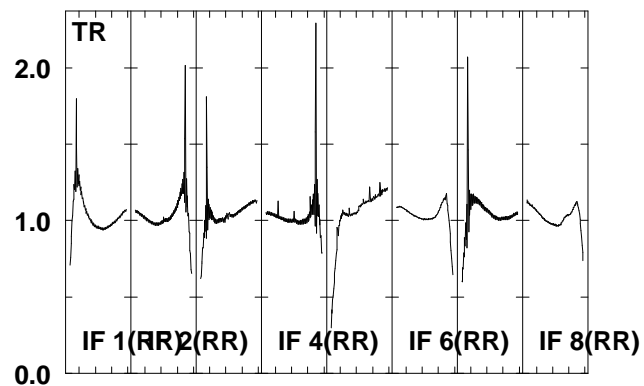
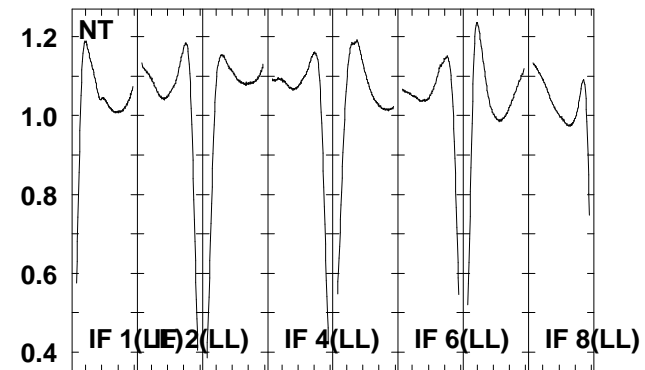
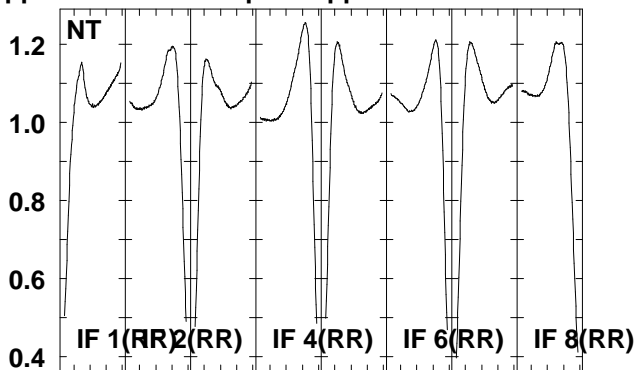
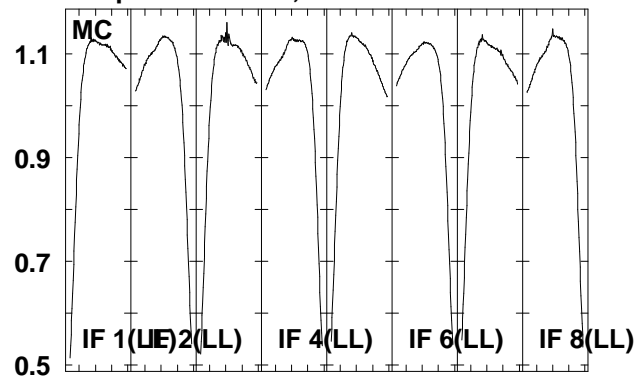

6663.6665.6667.6669.6671.6673.6675.6677.5
 FREQ MHz

Lower frame: Real Jy
 Total-power spectrum Antenna: *
 Timerange: 00/06:39:34 to 00/06:42:02

Plot file version 90 created 22-JUN-2006 20:07:18
 J1825-17 EM061A 1.UVDATA.1
 Freq = 6.6631 GHz, Bw = 2.000 MH No calibration applied and no bandpass applied

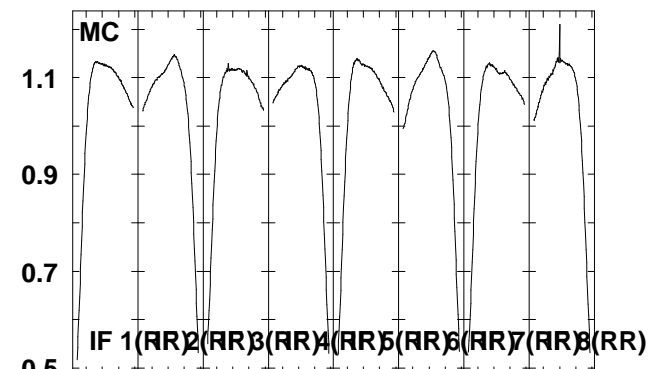
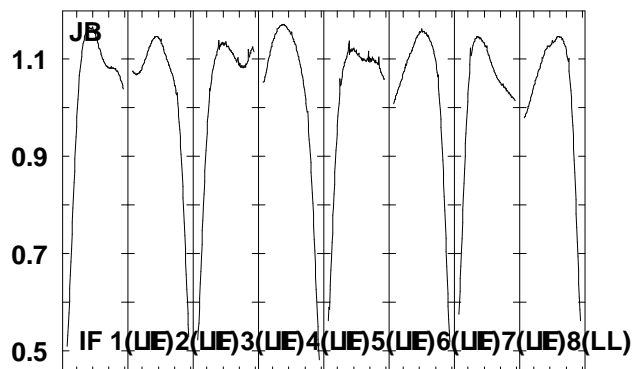
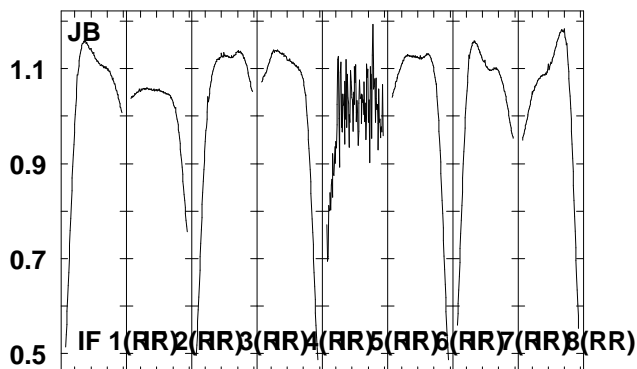
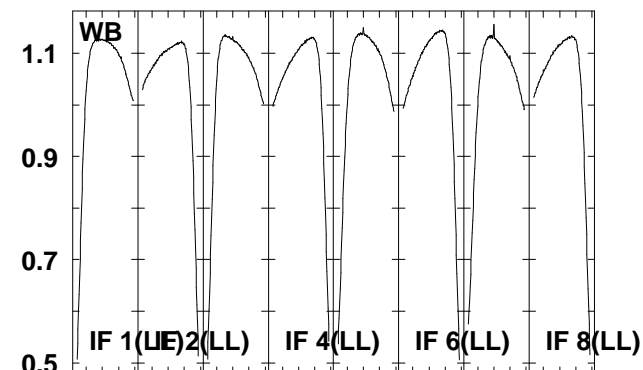
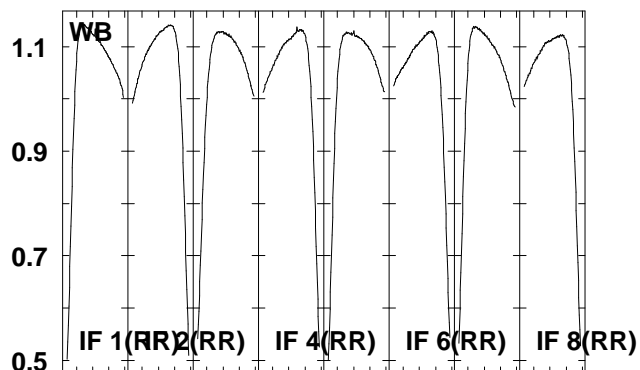
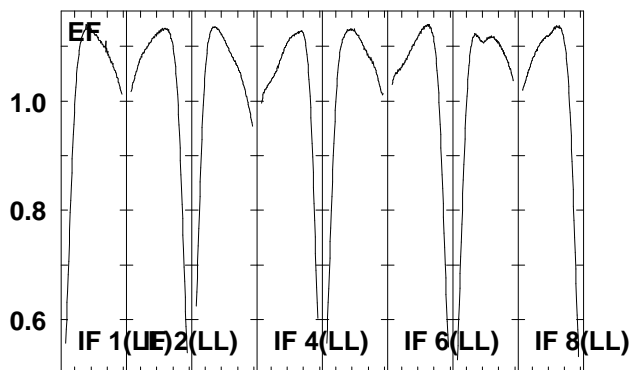
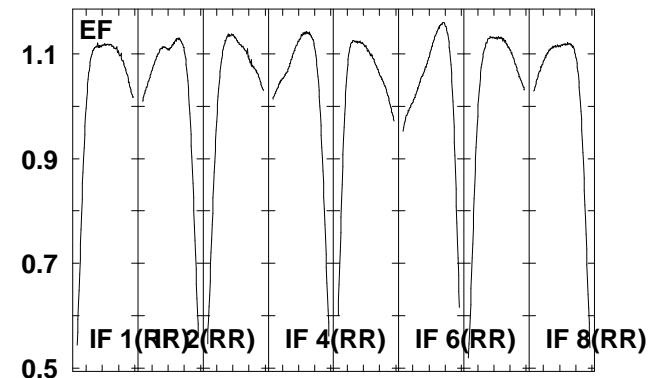
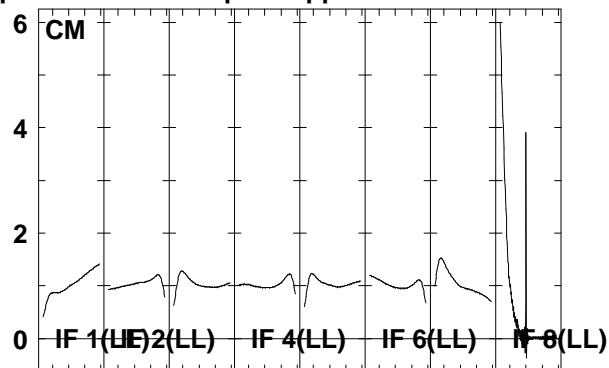
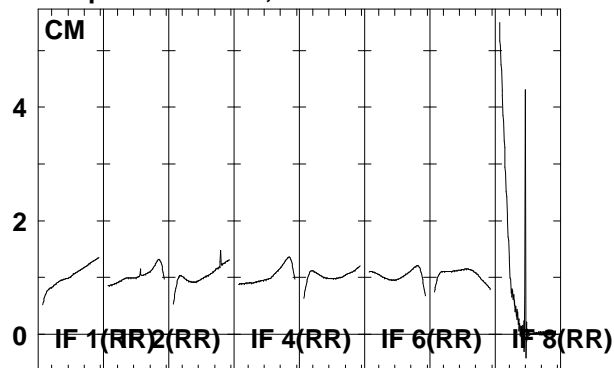

6663.6665.6667.6669.6671.6673.6675.6677.5
 FREQ MHz

6663.6665.6667.6669.6671.6673.6675.6677.5
 FREQ MHz

6663.6665.6667.6669.6671.6673.6675.6677.5
 FREQ MHz

Lower frame: Real Jy
 Total-power spectrum Antenna: *
 Timerange: 00/06:42:04 to 00/06:45:02

Plot file version 91 created 22-JUN-2006 20:07:21
 J1825-17 EM061A 1.UVDATA.1
 Freq = 6.6631 GHz, Bw = 2.000 MH No calibration applied and no bandpass applied

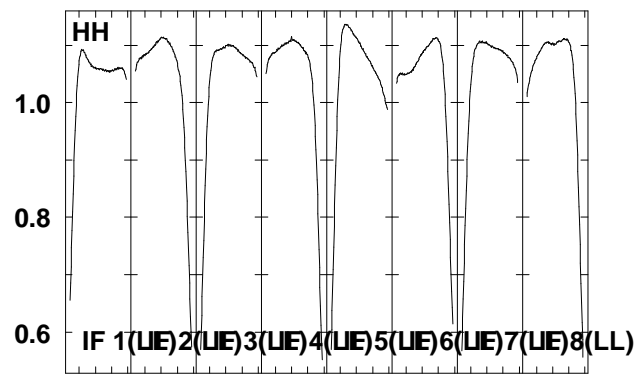
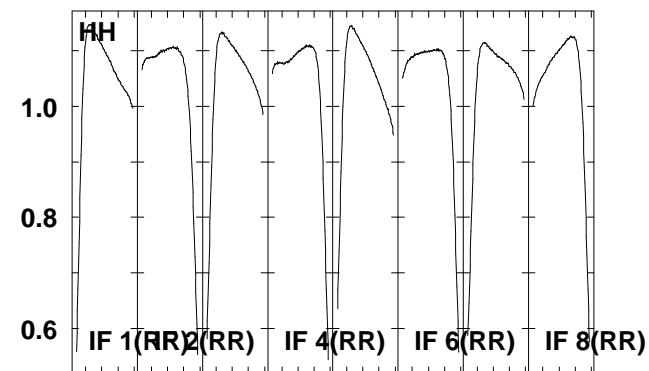
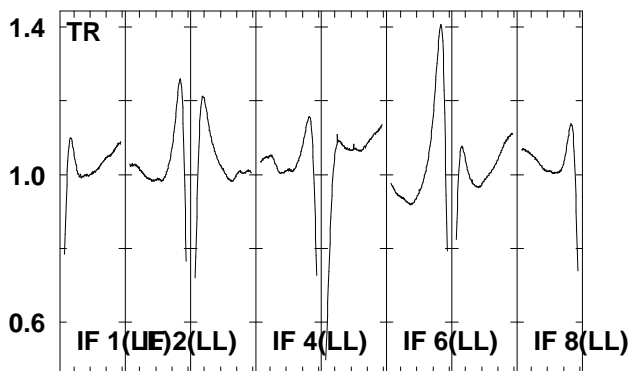
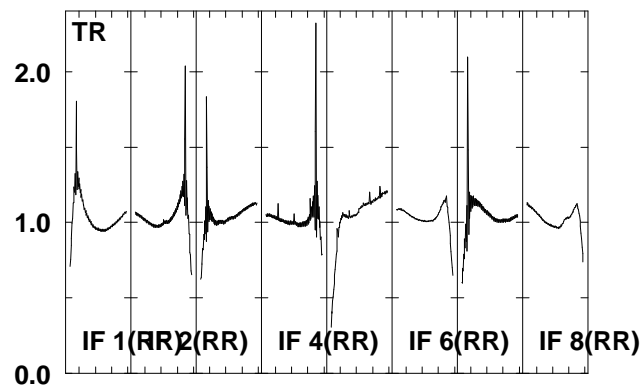
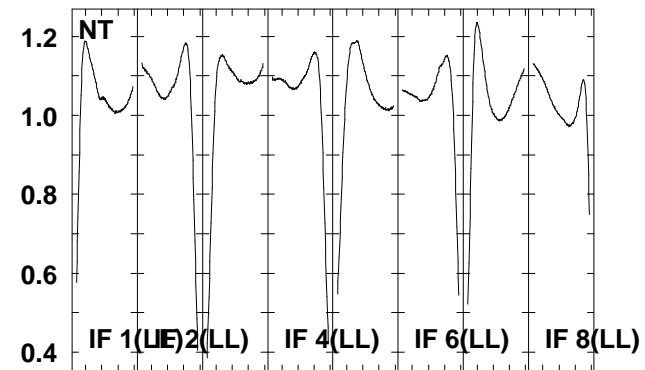
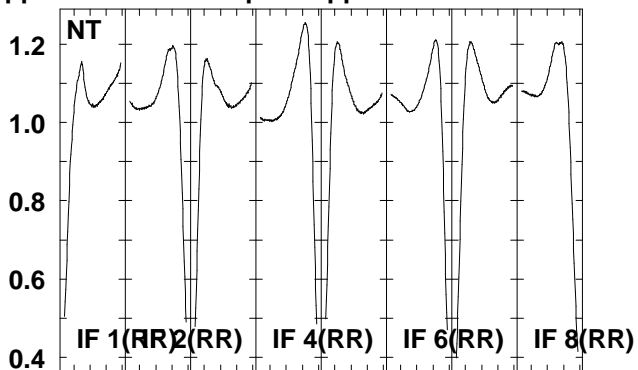
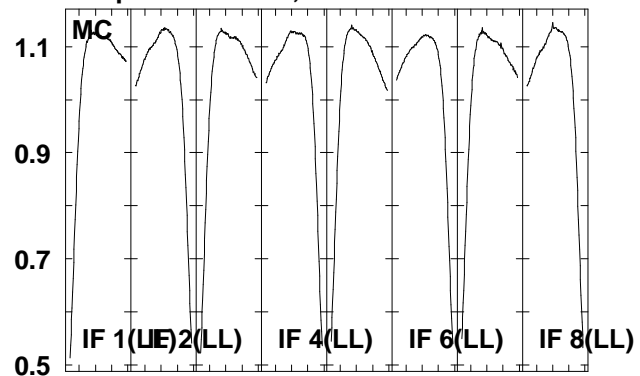

6663.6665.6667.6669.6671.6673.6675.6677.5
 FREQ MHz

Lower frame: Real Jy
 Total-power spectrum Antenna: *
 Timerange: 00/06:42:04 to 00/06:45:02

Plot file version 92 created 22-JUN-2006 20:07:24
 G16.59-0 EM061A 1.UVDATA.1
 Freq = 6.6631 GHz, Bw = 2.000 MH No calibration applied and no bandpass applied

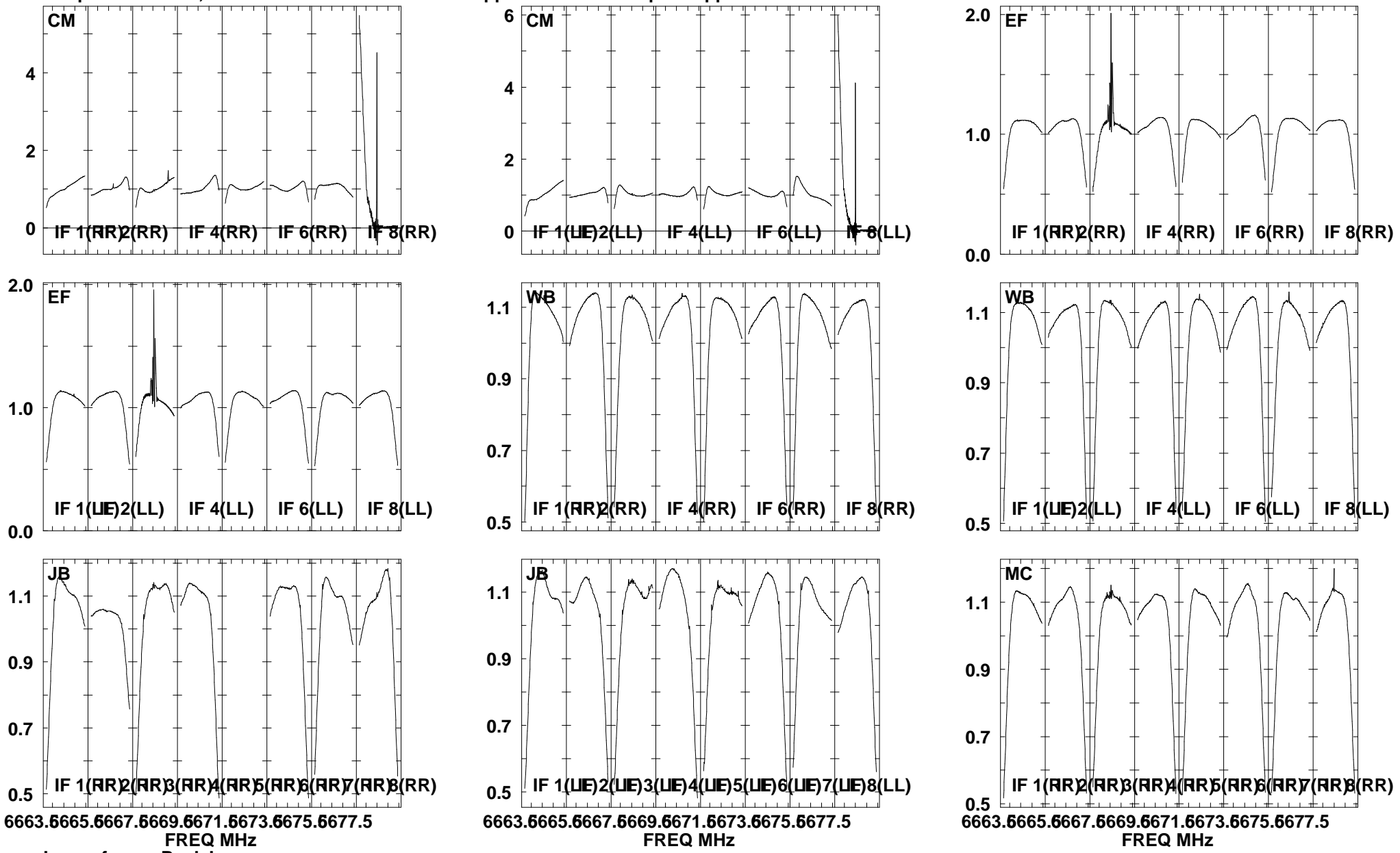

Lower frame: Real Jy
 Total-power spectrum Antenna: *
 Timerange: 00/06:45:04 to 00/06:47:32

Plot file version 93 created 22-JUN-2006 20:07:26
 G16.59-0 EM061A 1.UVDATA.1
 Freq = 6.6631 GHz, Bw = 2.000 MH No calibration applied and no bandpass applied

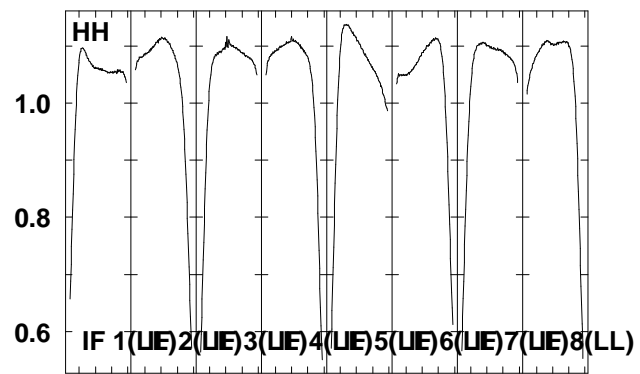
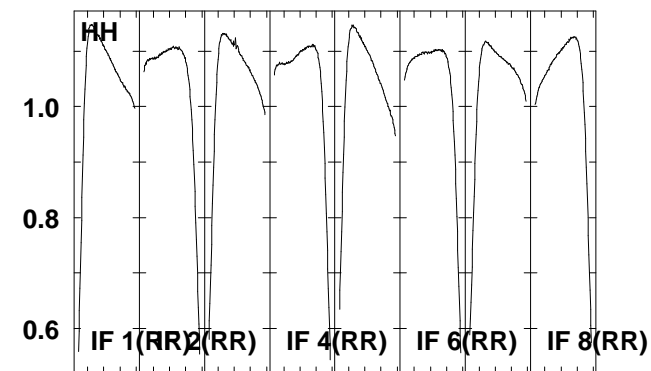
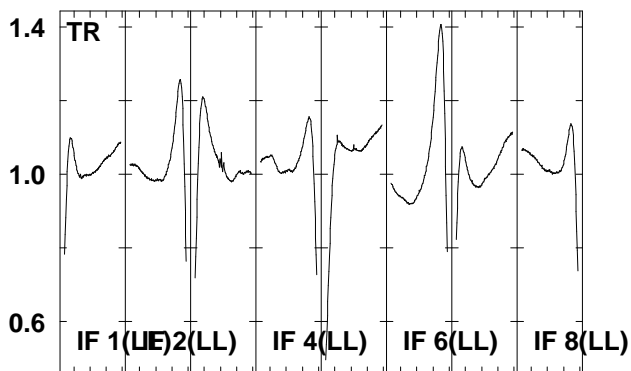
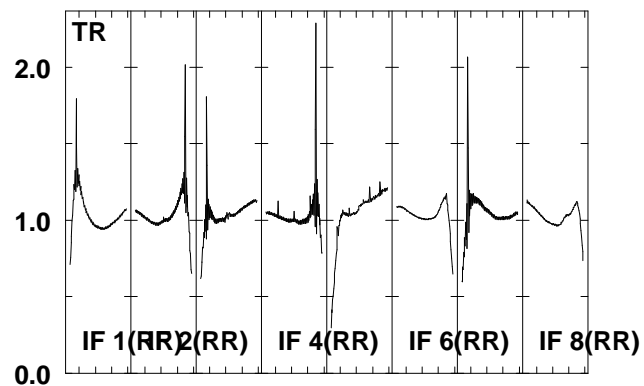
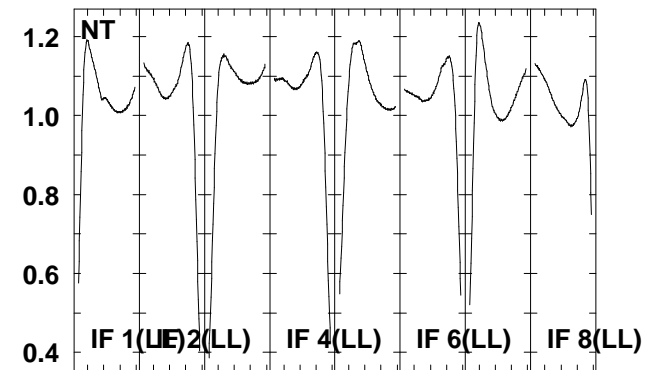
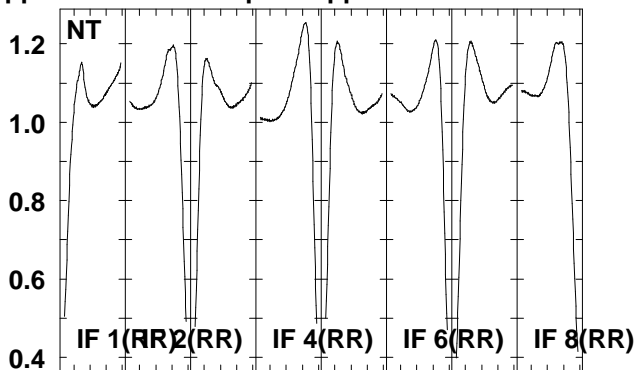
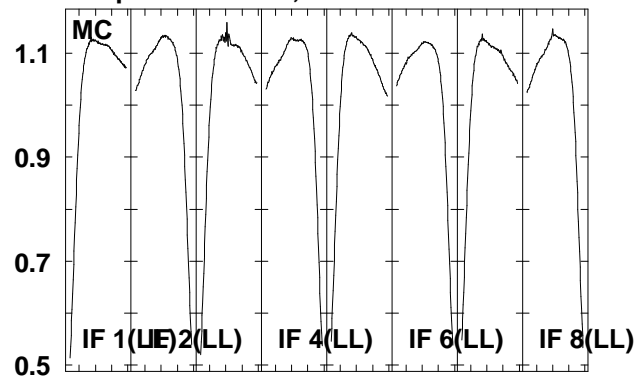

6663.6665.6667.6669.6671.6673.6675.6677.5
 FREQ MHz

Lower frame: Real Jy
 Total-power spectrum Antenna: *
 Timerange: 00/06:45:04 to 00/06:47:32

Plot file version 94 created 22-JUN-2006 20:07:30
 J1825-17 EM061A 1.UVDATA.1
 Freq = 6.6631 GHz, Bw = 2.000 MH No calibration applied and no bandpass applied

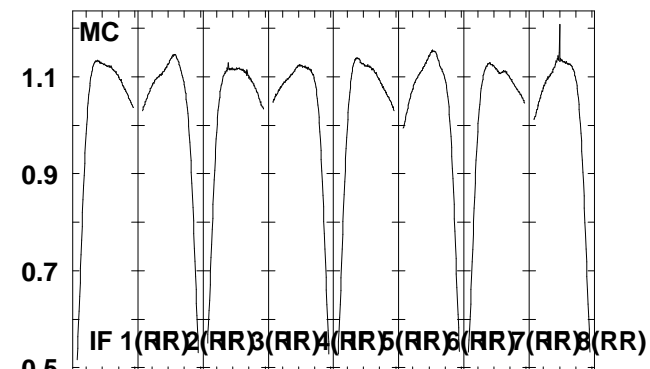
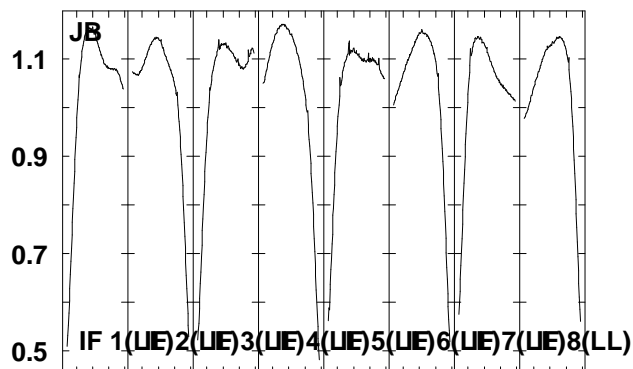
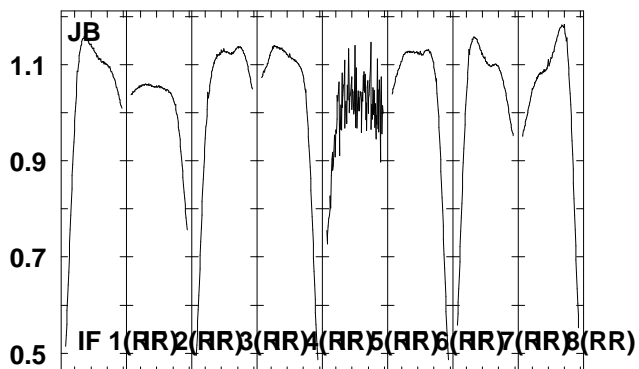
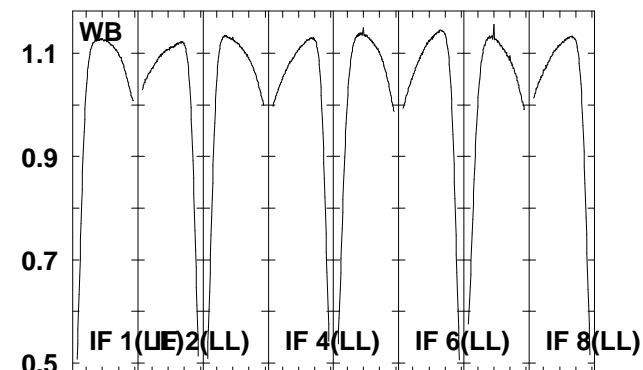
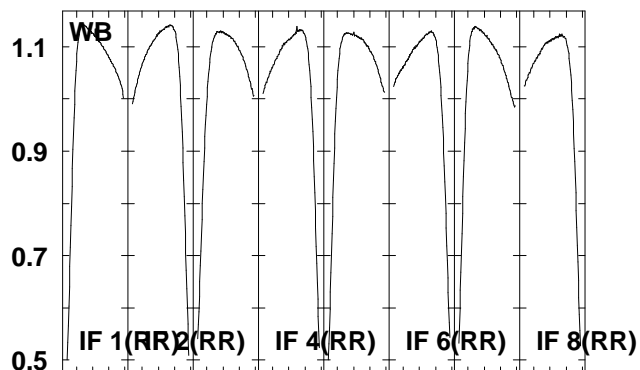
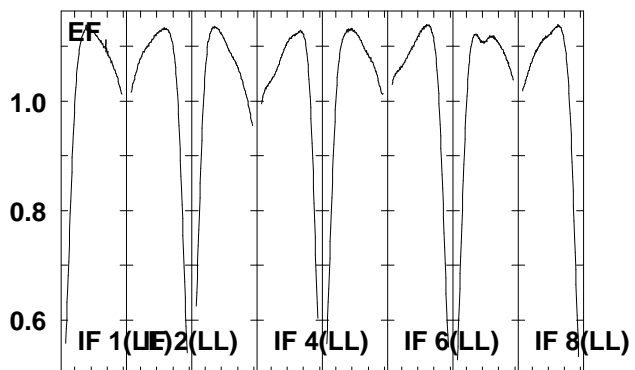
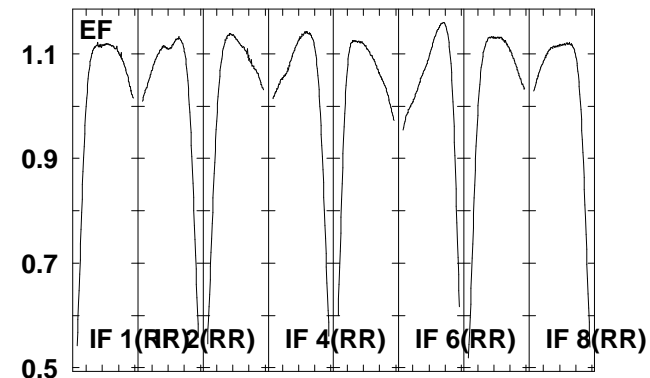
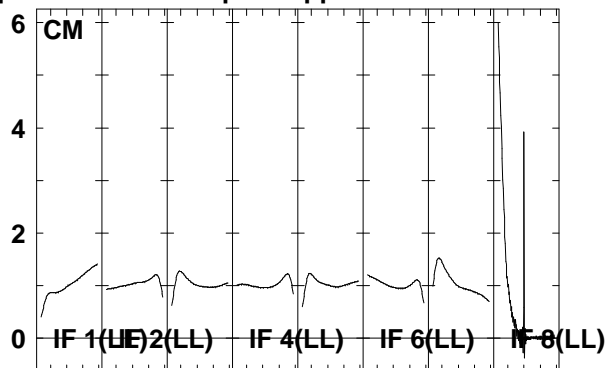
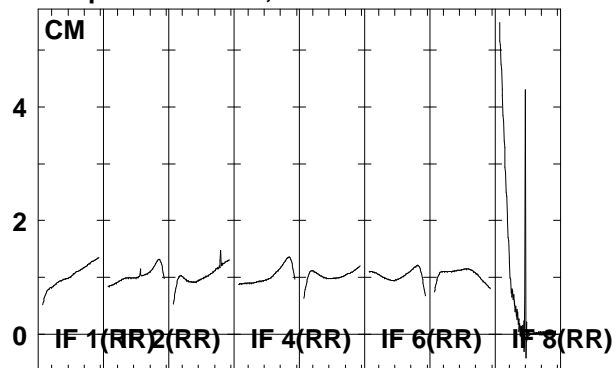

6663.6665.6667.6669.6671.6673.6675.6677.5
 FREQ MHz

6663.6665.6667.6669.6671.6673.6675.6677.5
 FREQ MHz

6663.6665.6667.6669.6671.6673.6675.6677.5
 FREQ MHz

Lower frame: Real Jy
 Total-power spectrum Antenna: *
 Timerange: 00/06:47:34 to 00/06:50:32

Plot file version 95 created 22-JUN-2006 20:07:34
 J1825-17 EM061A 1.UVDATA.1
 Freq = 6.6631 GHz, Bw = 2.000 MH No calibration applied and no bandpass applied

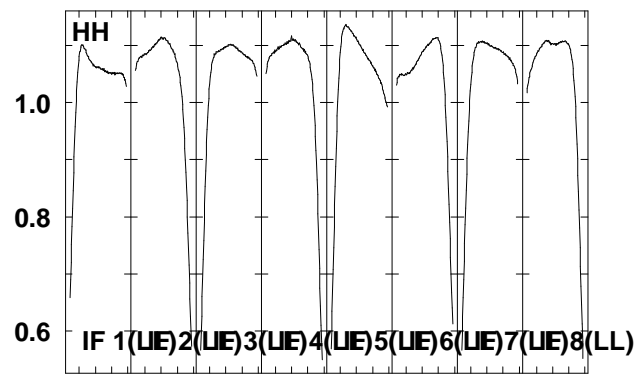
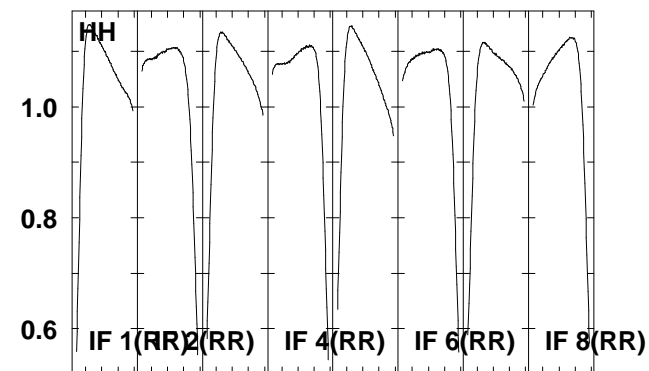
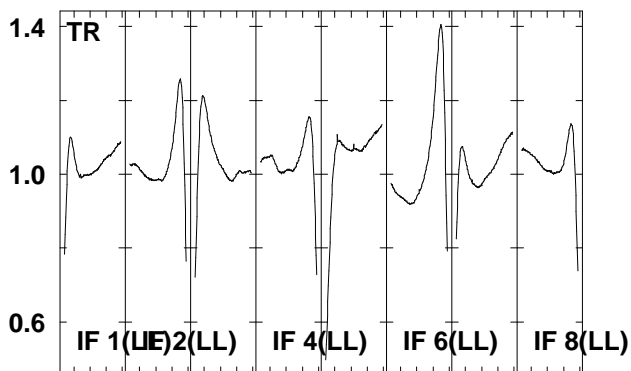
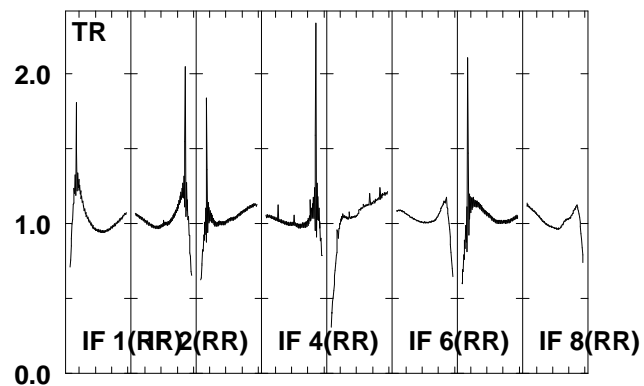
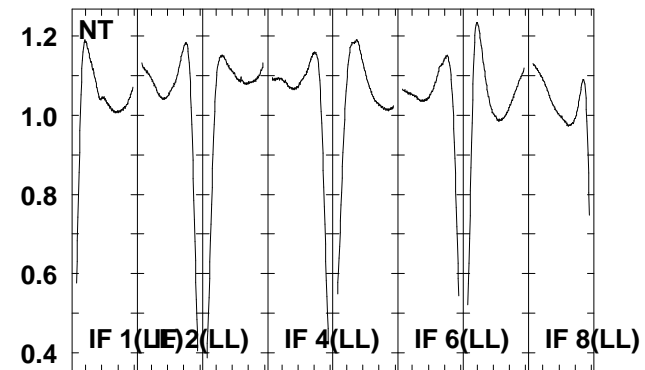
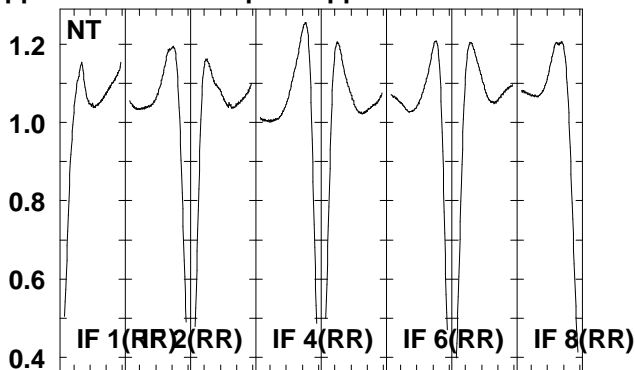
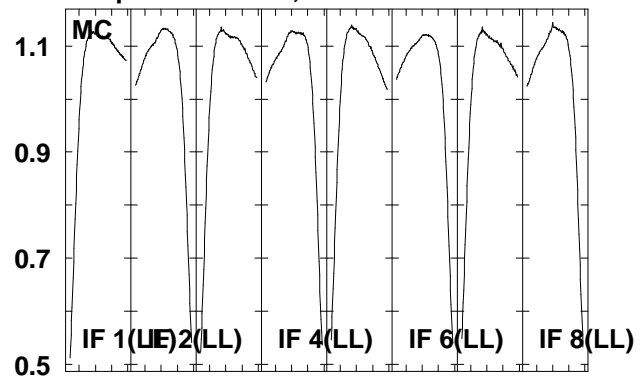

6663.6665.6667.6669.6671.6673.6675.6677.5
 FREQ MHz

Lower frame: Real Jy
 Total-power spectrum Antenna: *
 Timerange: 00/06:47:34 to 00/06:50:32

Plot file version 96 created 22-JUN-2006 20:07:38
 G16.59-0 EM061A 1.UVDATA.1
 Freq = 6.6631 GHz, Bw = 2.000 MH No calibration applied and no bandpass applied

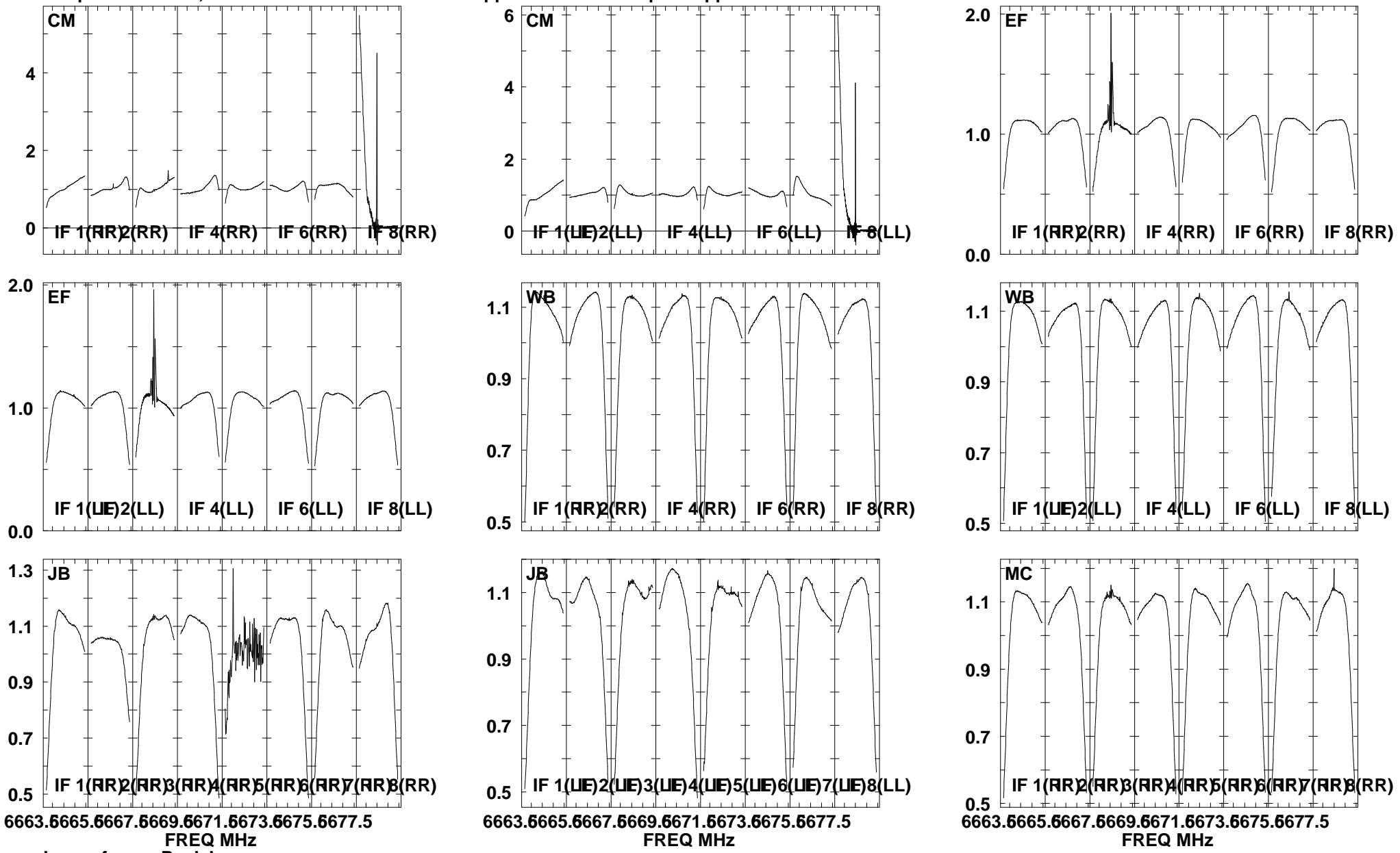

Lower frame: Real Jy
 Total-power spectrum Antenna: *
 Timerange: 00/06:50:34 to 00/06:53:02

Plot file version 97 created 22-JUN-2006 20:07:42
 G16.59-0 EM061A 1.UVDATA.1
 Freq = 6.6631 GHz, Bw = 2.000 MH No calibration applied and no bandpass applied

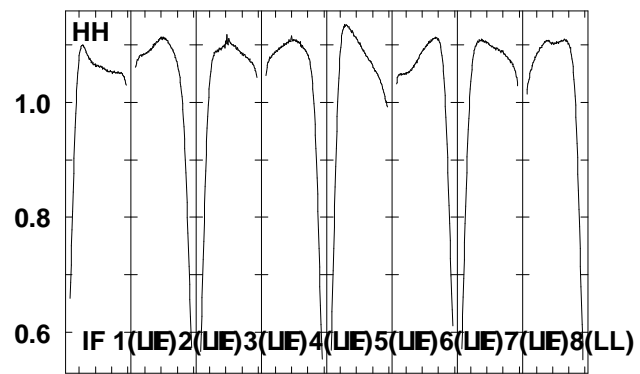
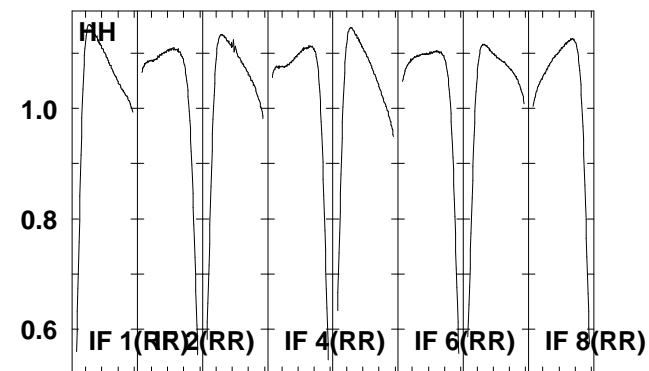
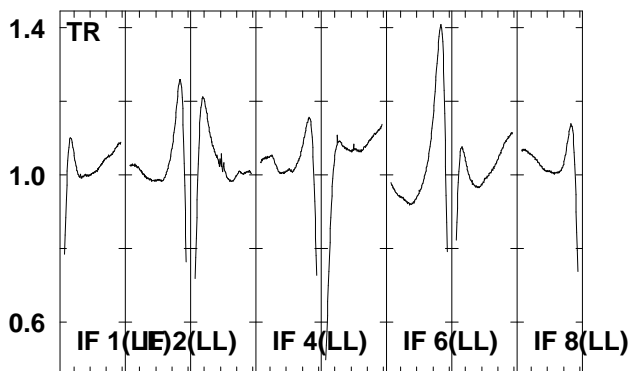
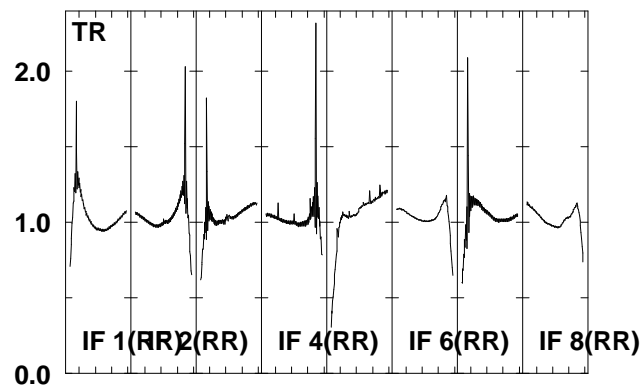
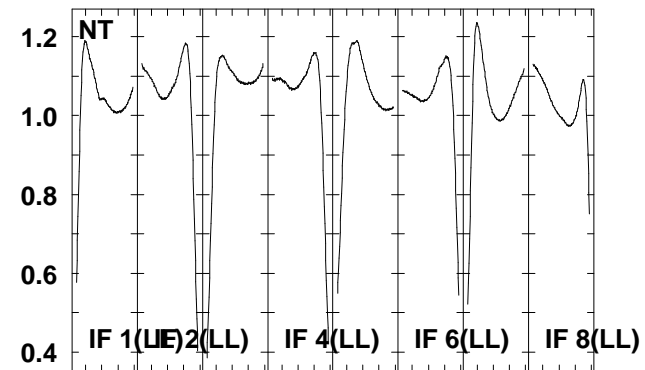
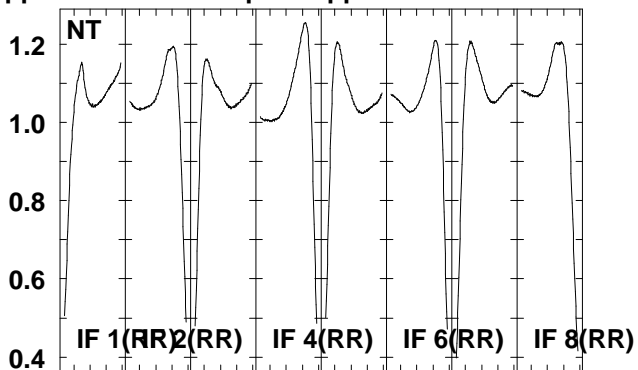
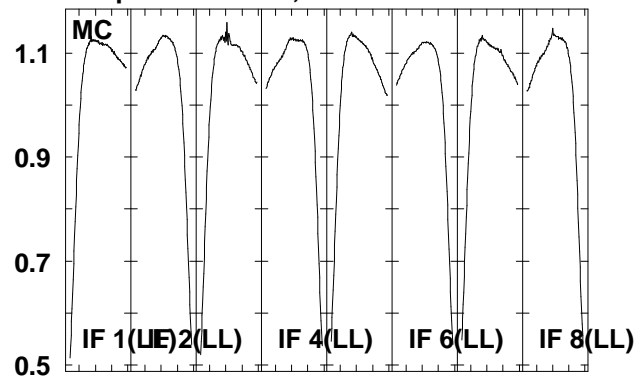

6663.6665.6667.6669.6671.6673.6675.6677.5
 FREQ MHz

Lower frame: Real Jy
 Total-power spectrum Antenna: *
 Timerange: 00/06:50:34 to 00/06:53:02

Plot file version 98 created 22-JUN-2006 20:07:46
 J1825-17 EM061A 1.UVDATA.1
 Freq = 6.6631 GHz, Bw = 2.000 MH No calibration applied and no bandpass applied

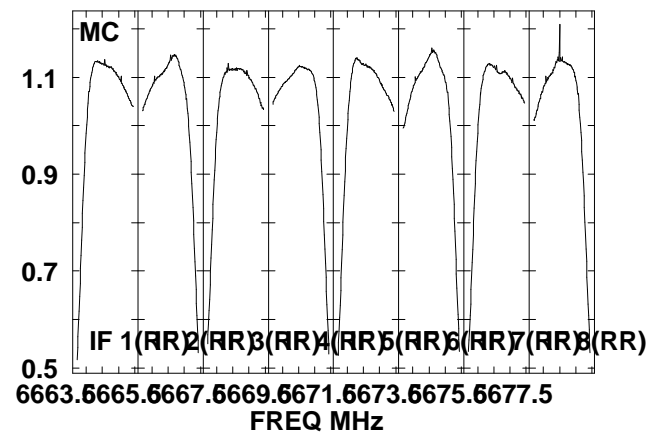
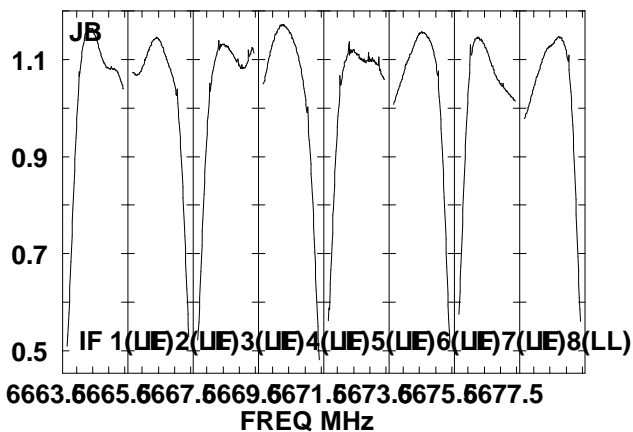
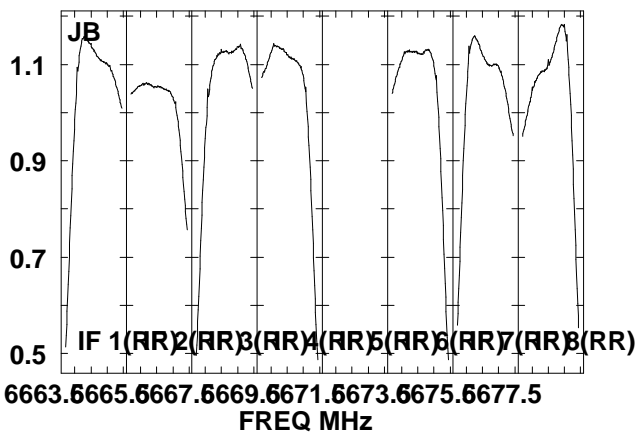
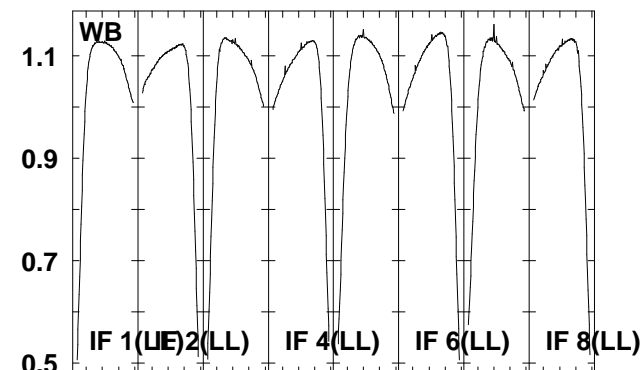
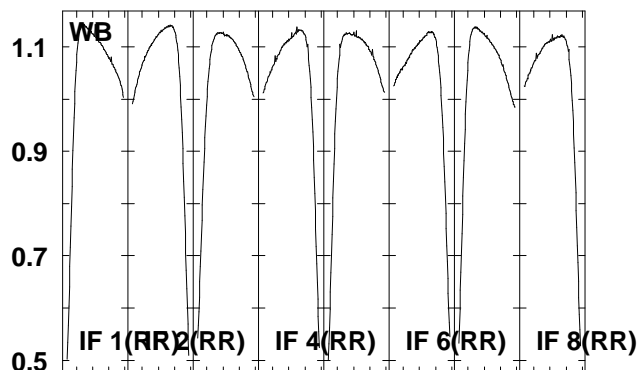
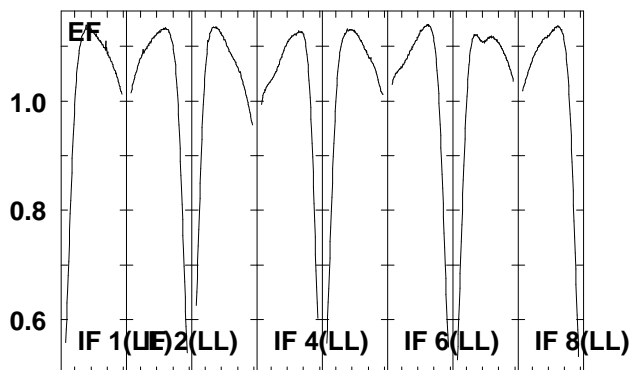
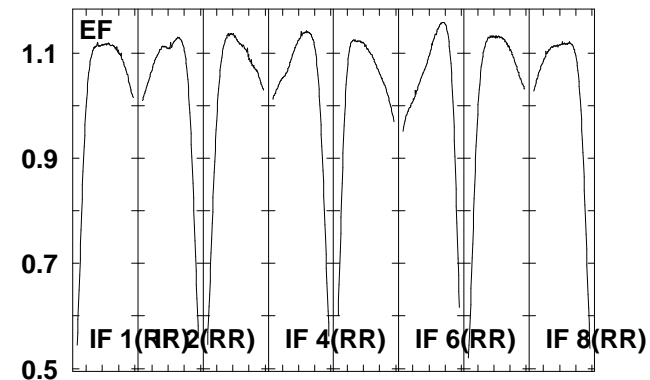
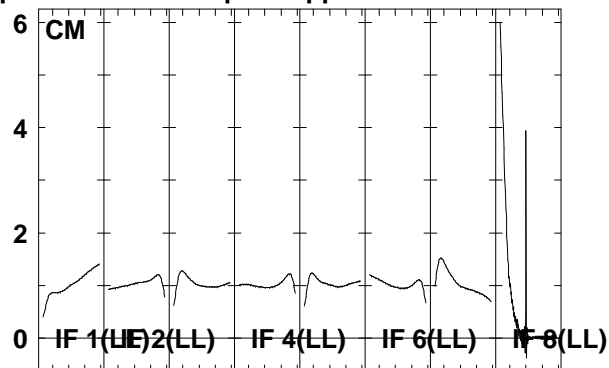
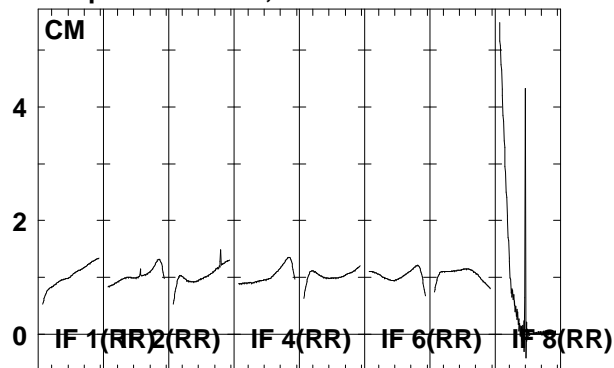

Lower frame: Real Jy
 Total-power spectrum Antenna: *
 Timerange: 00/06:54:35 to 00/06:57:32

Plot file version 99 created 22-JUN-2006 20:07:50
 J1825-17 EM061A 1.UVDATA.1
 Freq = 6.6631 GHz, Bw = 2.000 MH No calibration applied and no bandpass applied

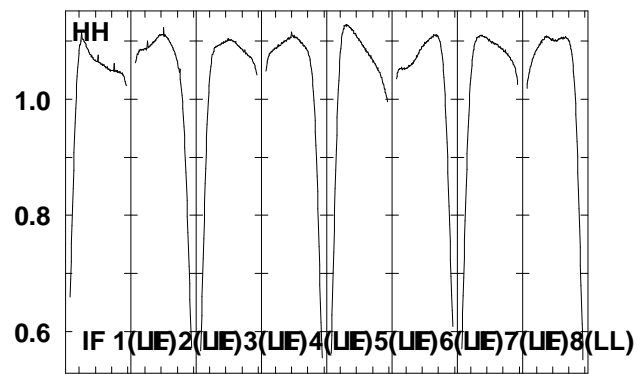
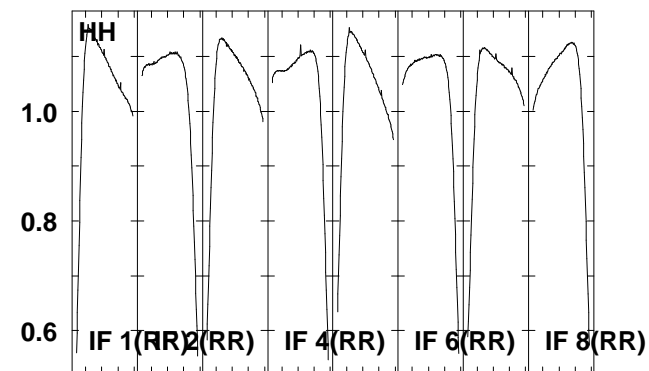
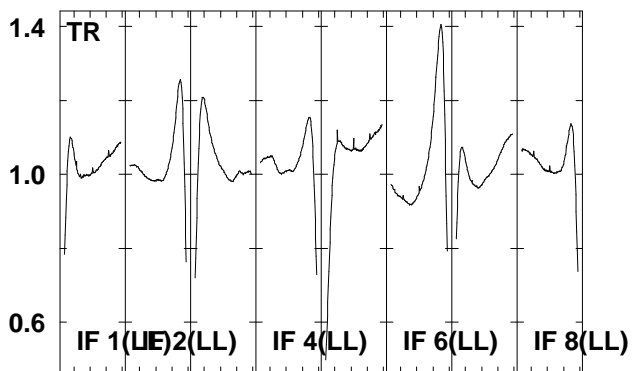
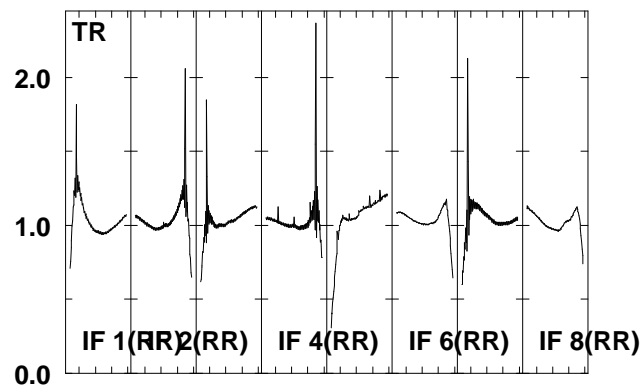
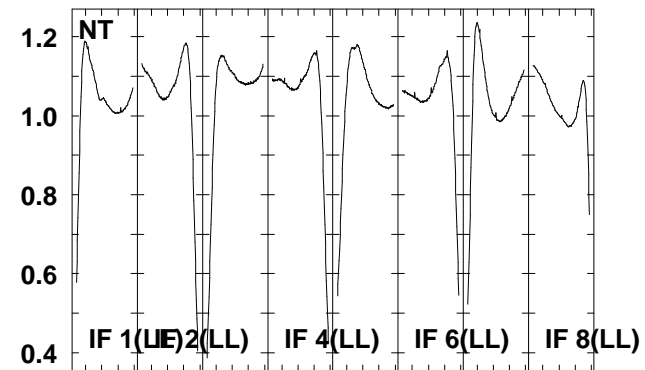
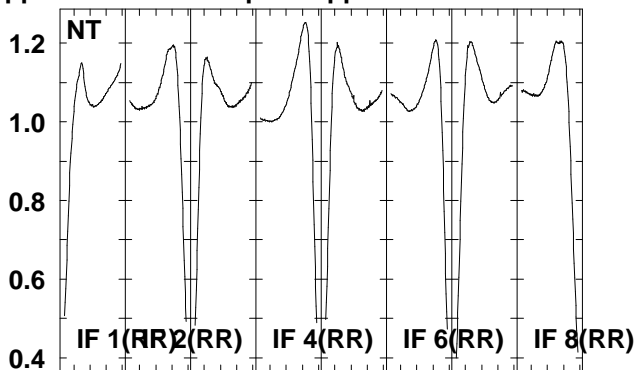
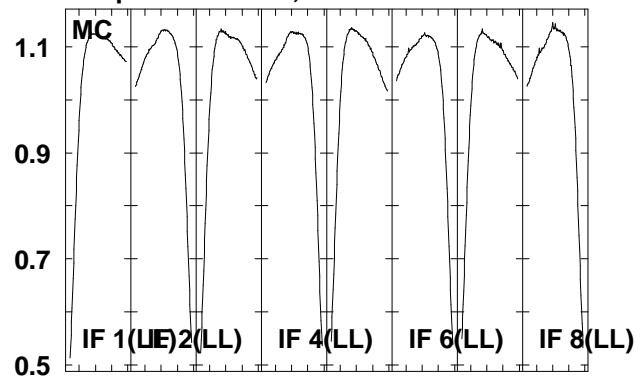

6663.6665.6667.6669.6671.6673.6675.6677.5
 FREQ MHz

Lower frame: Real Jy
 Total-power spectrum Antenna: *
 Timerange: 00/06:54:35 to 00/06:57:32

Plot file version 100 created 22-JUN-2006 20:07:55
 G16.59-0 EM061A 1.UVDATA.1
 Freq = 6.6631 GHz, Bw = 2.000 MH No calibration applied and no bandpass applied

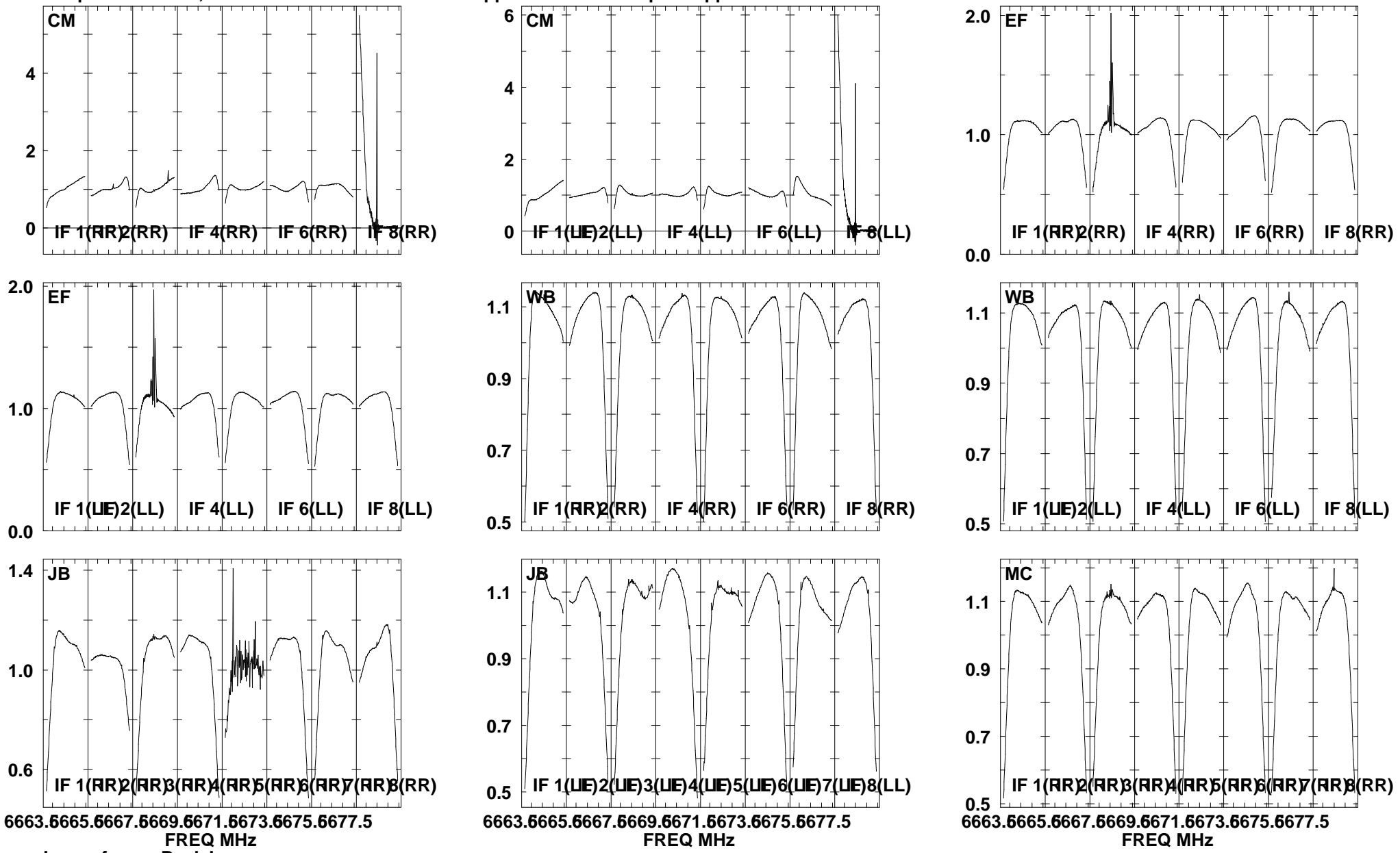

Lower frame: Real Jy
 Total-power spectrum Antenna: *
 Timerange: 00/06:57:34 to 00/07:00:02

Plot file version 101 created 22-JUN-2006 20:07:58
 G16.59-0 EM061A 1.UVDATA.1
 Freq = 6.6631 GHz, Bw = 2.000 MH No calibration applied and no bandpass applied

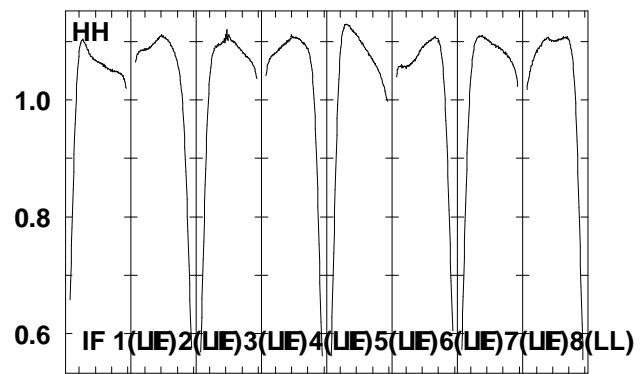
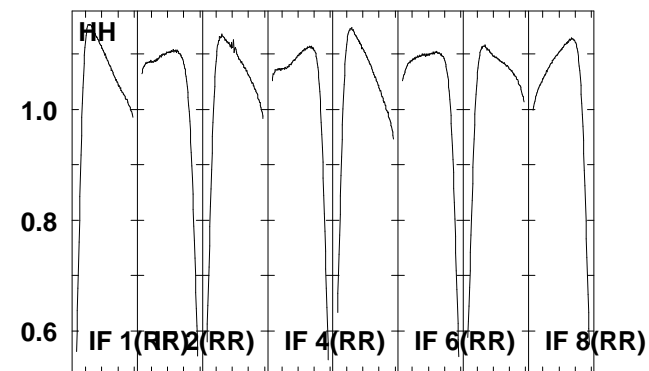
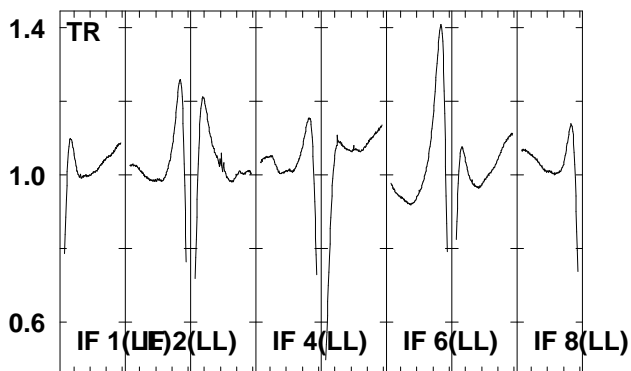
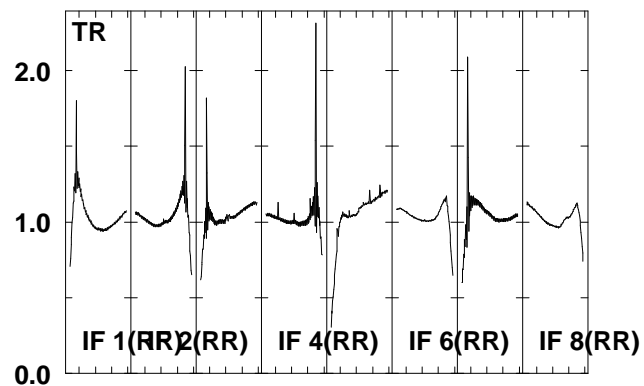
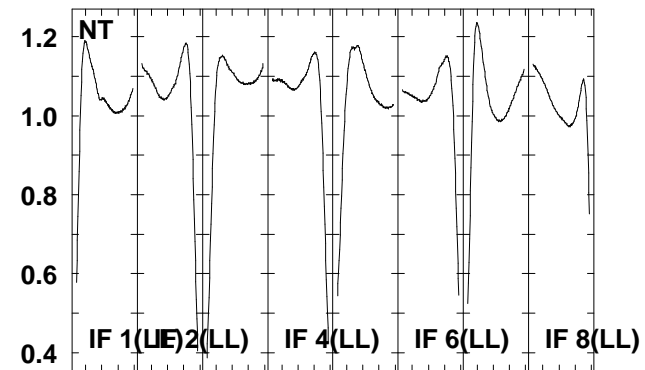
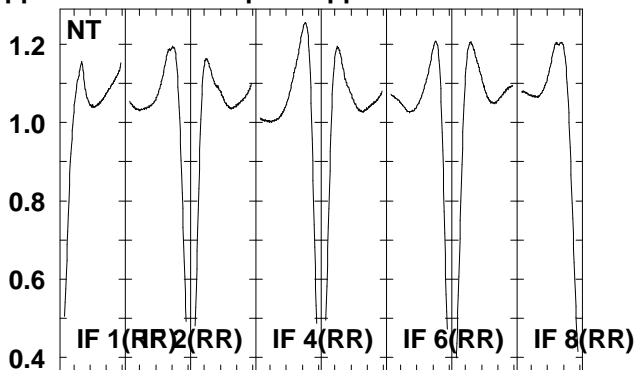
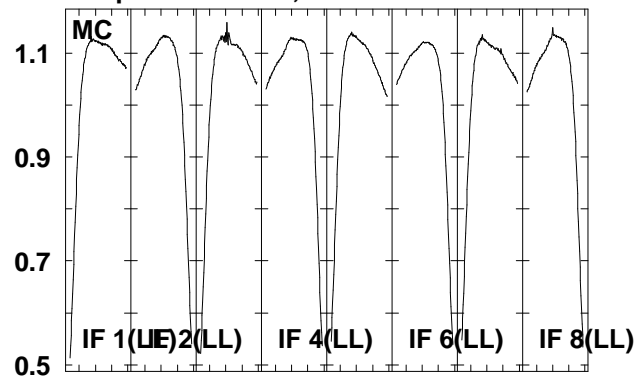

6663.6665.6667.6669.6671.6673.6675.6677.5
 FREQ MHz

Lower frame: Real Jy
 Total-power spectrum Antenna: *
 Timerange: 00/06:57:34 to 00/07:00:02

Plot file version 102 created 22-JUN-2006 20:08:03
 J1825-17 EM061A 1.UVDATA.1
 Freq = 6.6631 GHz, Bw = 2.000 MH No calibration applied and no bandpass applied

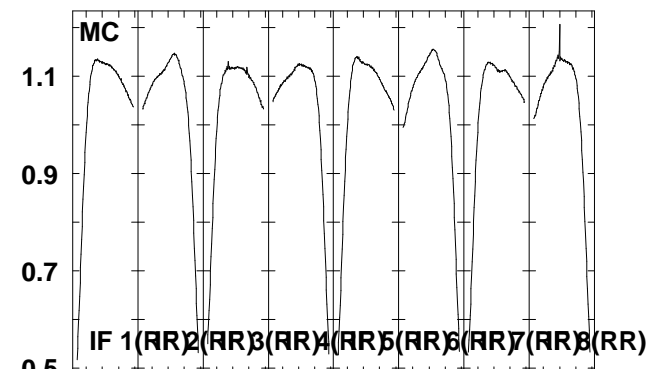
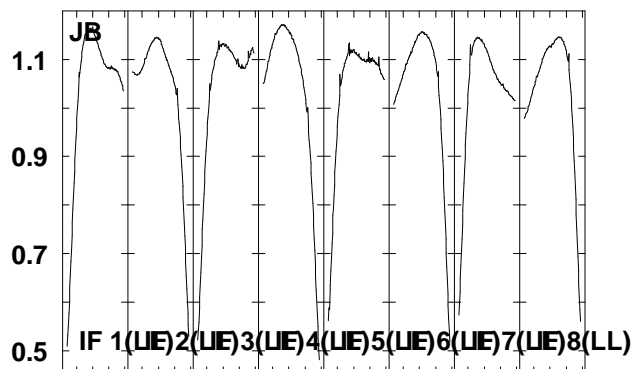
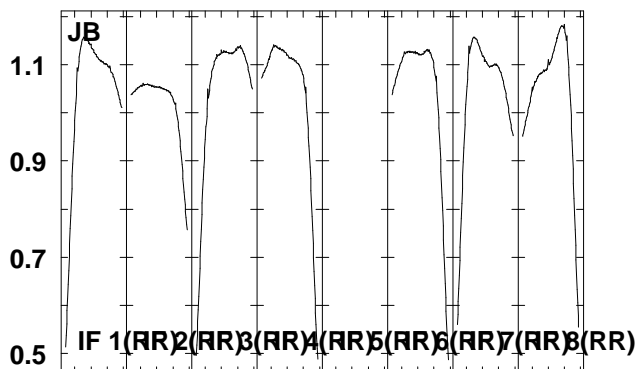
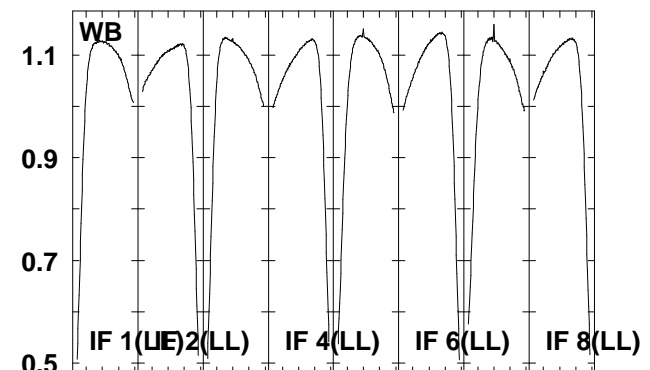
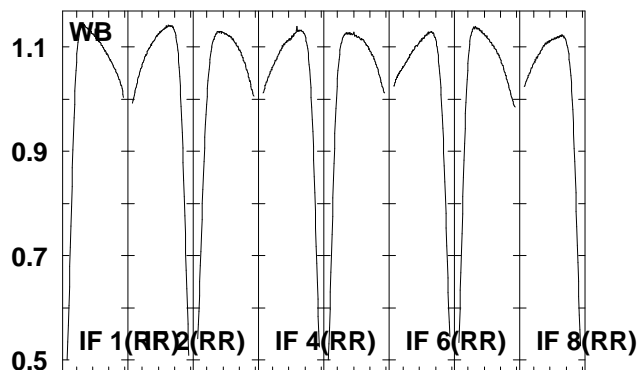
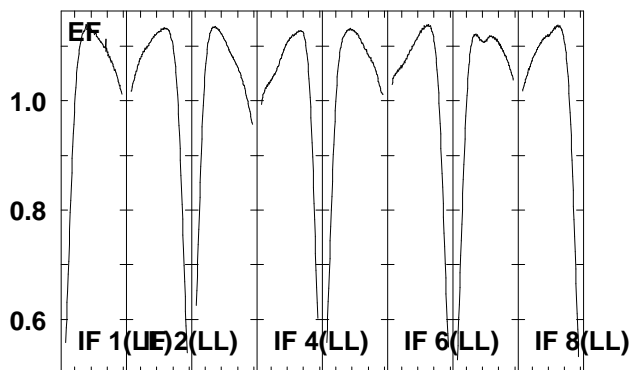
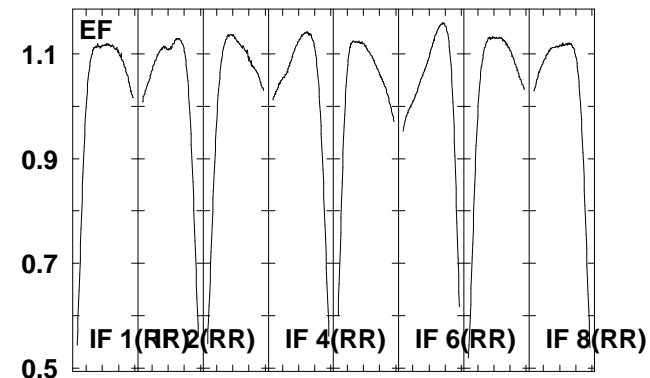
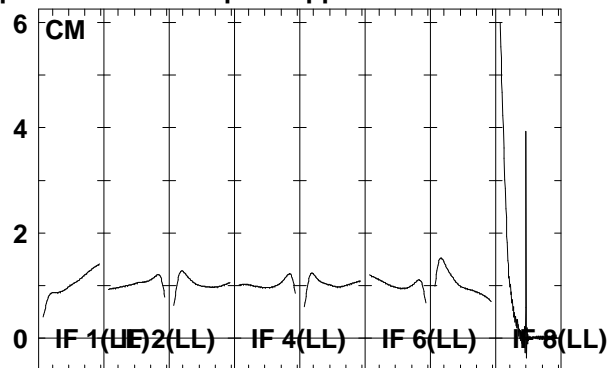
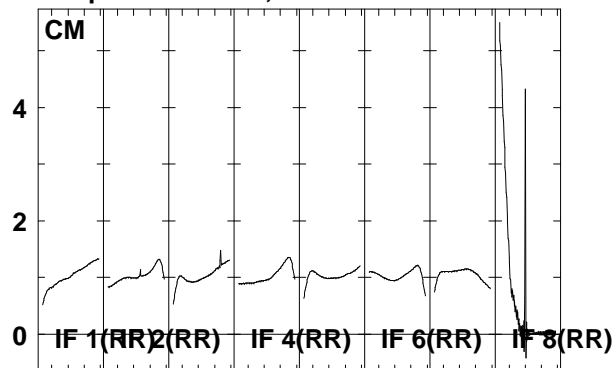

6663.6665.6667.6669.6671.6673.6675.6677.5
 FREQ MHz

6663.6665.6667.6669.6671.6673.6675.6677.5
 FREQ MHz

6663.6665.6667.6669.6671.6673.6675.6677.5
 FREQ MHz

Lower frame: Real Jy
 Total-power spectrum Antenna: *
 Timerange: 00/07:00:04 to 00/07:03:02

Plot file version 103 created 22-JUN-2006 20:08:07

J1825-17 EM061A 1.UVDATA.1

Freq = 6.6631 GHz, Bw = 2.000 MH No calibration applied and no bandpass applied

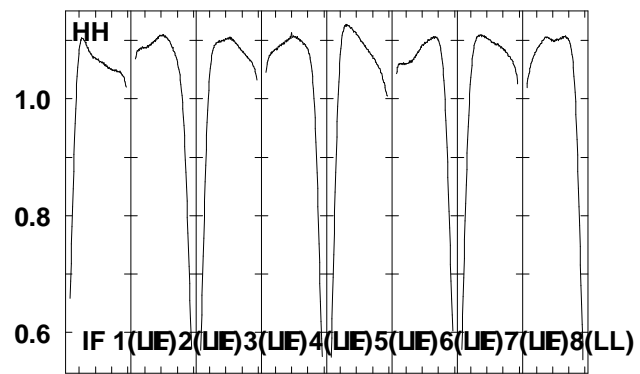
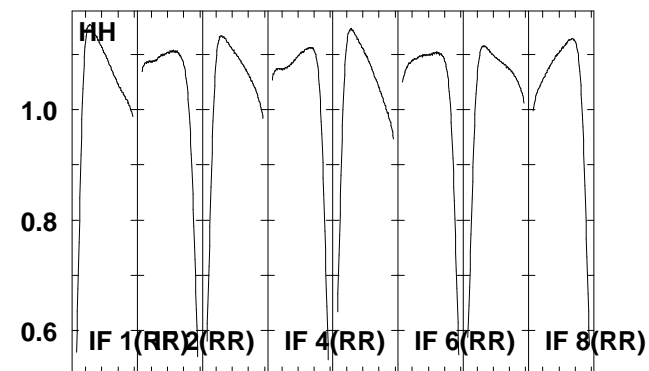
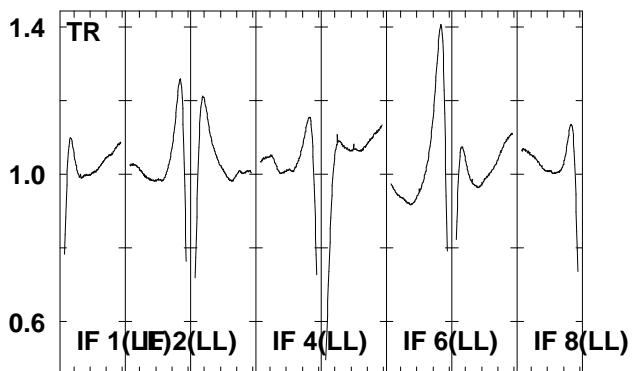
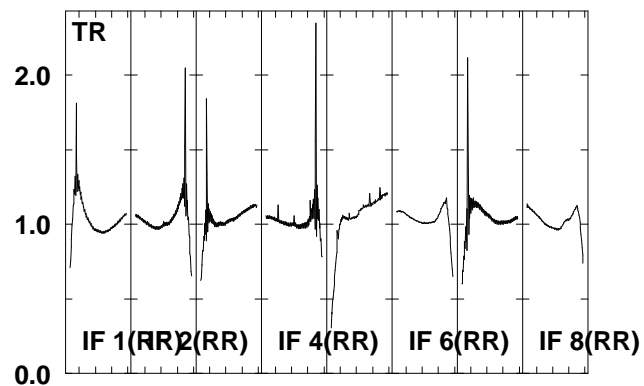
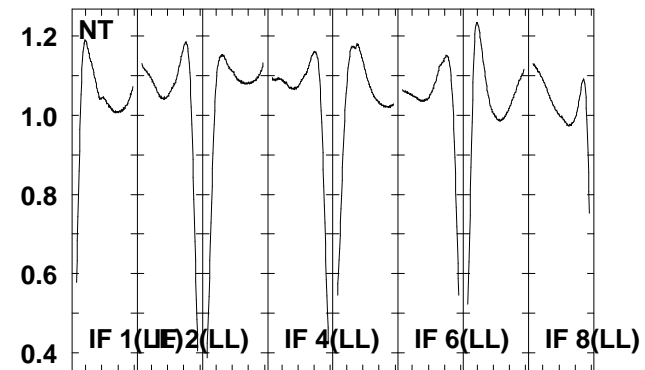
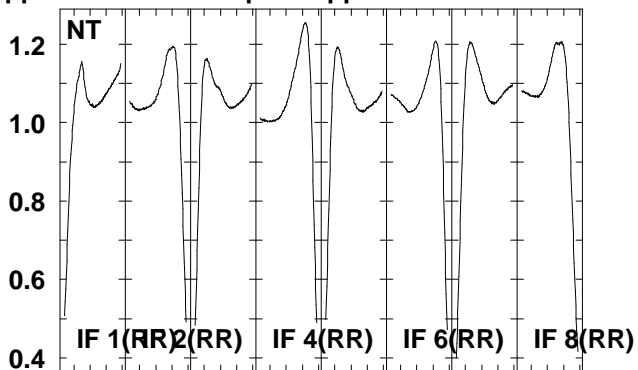
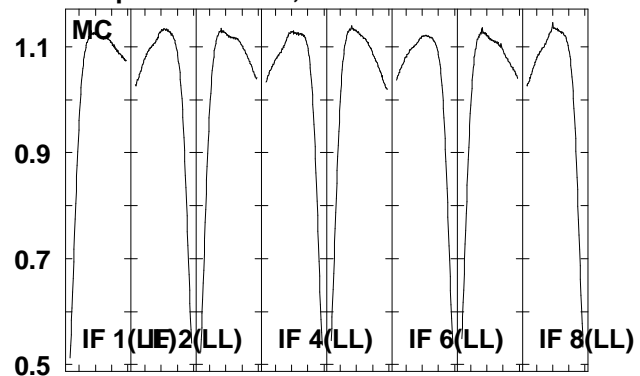

6663.6665.6667.6669.6671.6673.6675.6677.5

FREQ MHz

Lower frame: Real Jy

Total-power spectrum Antenna: *

Timerange: 00/07:00:04 to 00/07:03:02

Plot file version 104 created 22-JUN-2006 20:08:11
 G16.59-0 EM061A 1.UVDATA.1
 Freq = 6.6631 GHz, Bw = 2.000 MH No calibration applied and no bandpass applied

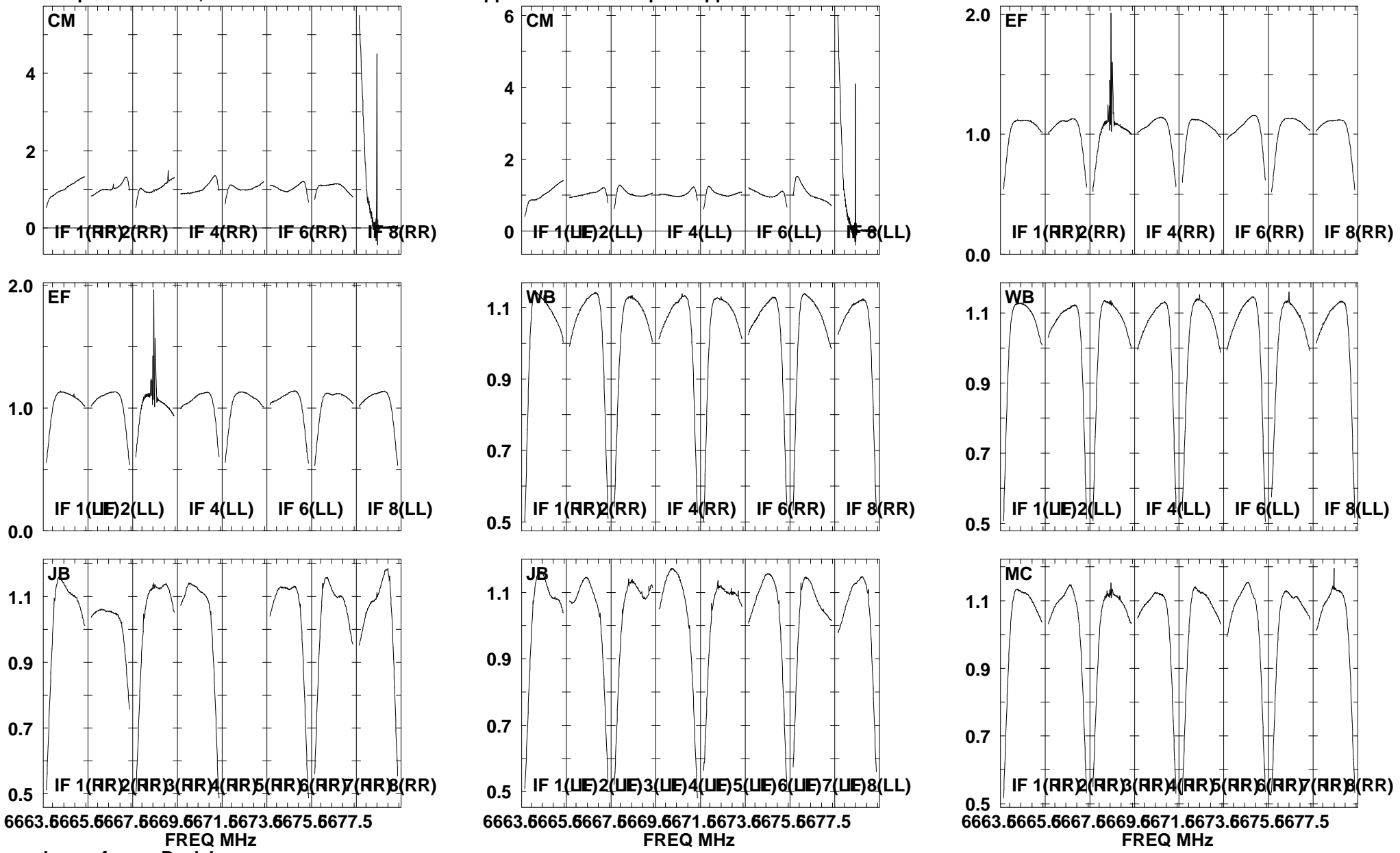

Lower frame: Real Jy
 Total-power spectrum Antenna: *
 Timerange: 00/07:03:04 to 00/07:05:32

Plot file version 105 created 22-JUN-2006 20:08:15
 G16.59-0 EM061A 1.UVDATA.1
 Freq = 6.6631 GHz, Bw = 2.000 MH No calibration applied and no bandpass applied

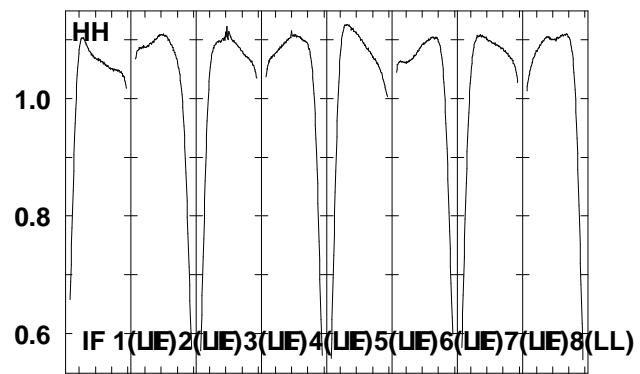
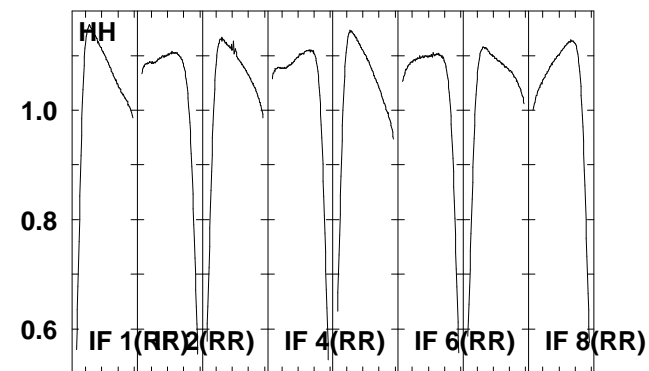
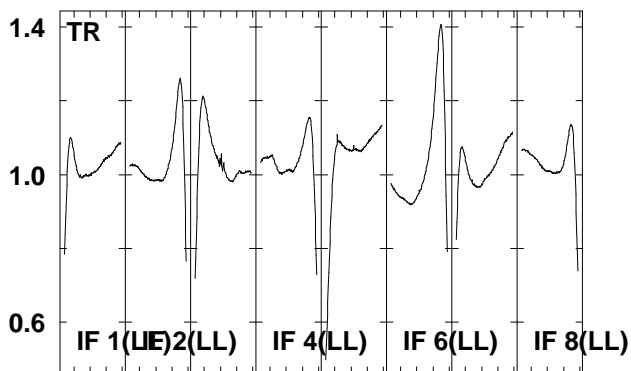
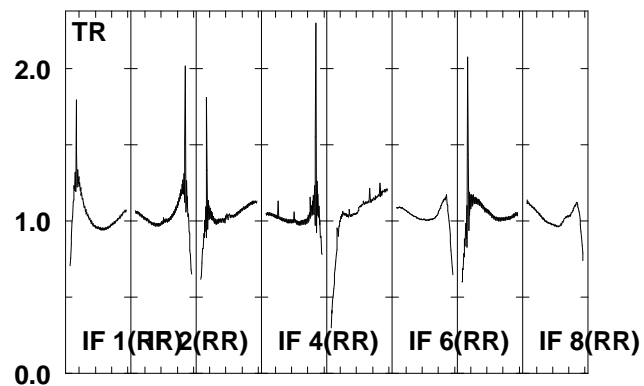
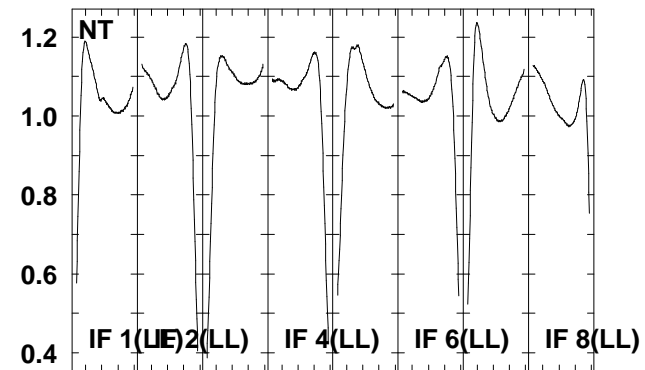
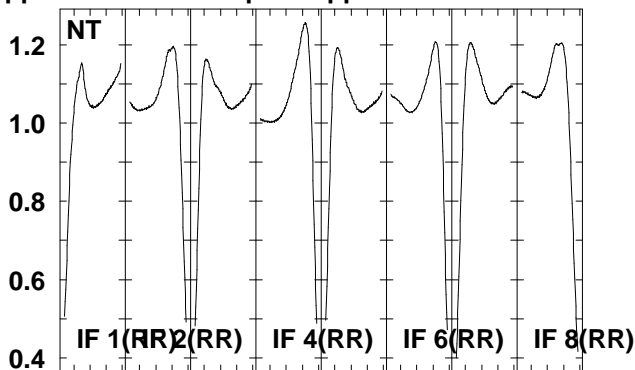
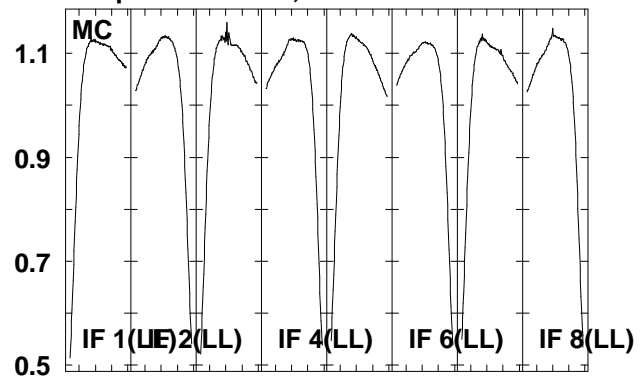

6663.6665.6667.6669.6671.6673.6675.6677.5
 FREQ MHz

Lower frame: Real Jy
 Total-power spectrum Antenna: *
 Timerange: 00/07:03:04 to 00/07:05:32

Plot file version 106 created 22-JUN-2006 20:08:18
 J1825-17 EM061A 1.UVDATA.1
 Freq = 6.6631 GHz, Bw = 2.000 MH No calibration applied and no bandpass applied

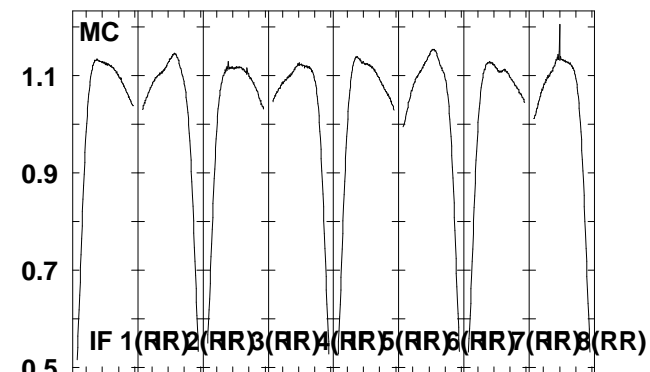
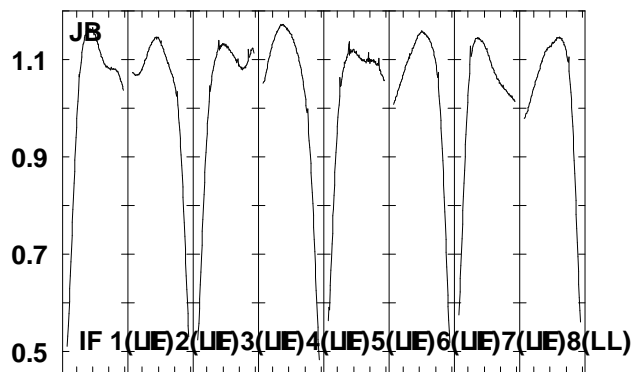
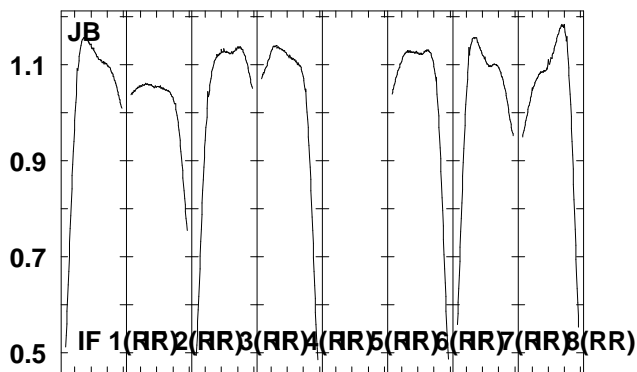
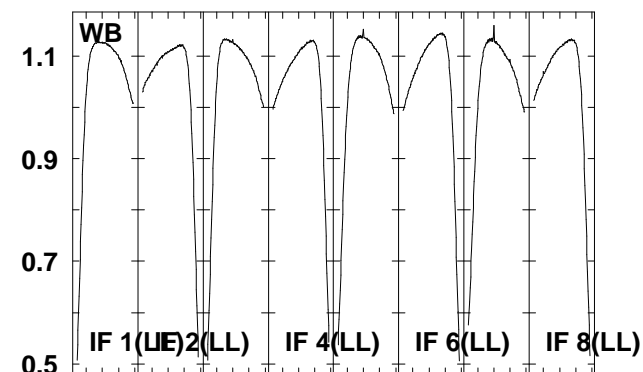
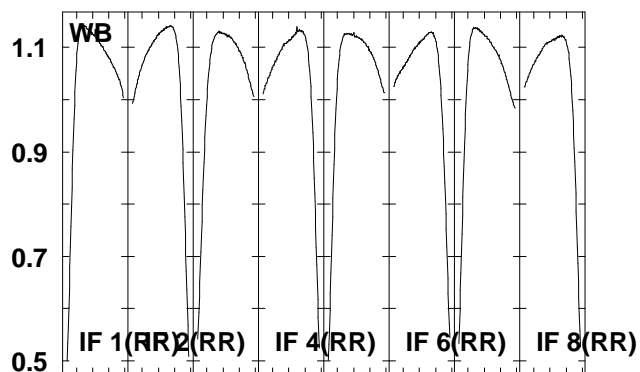
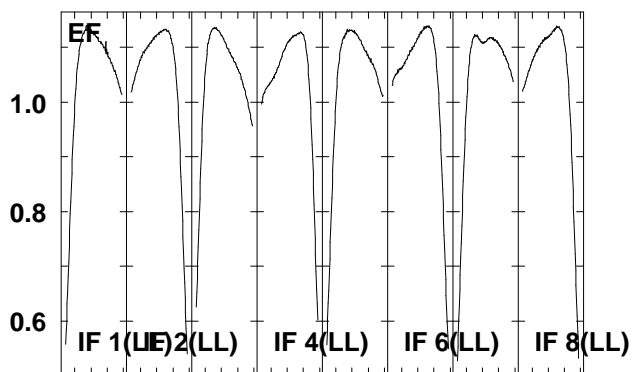
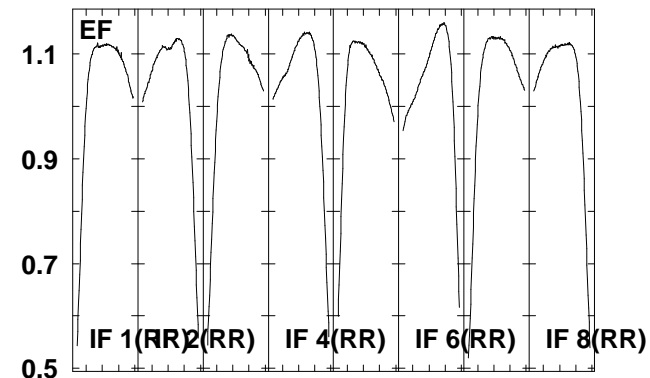
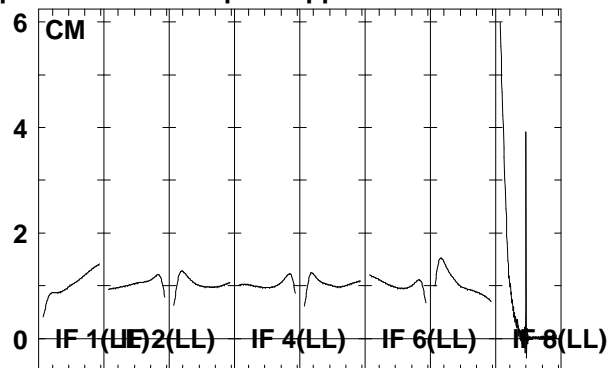
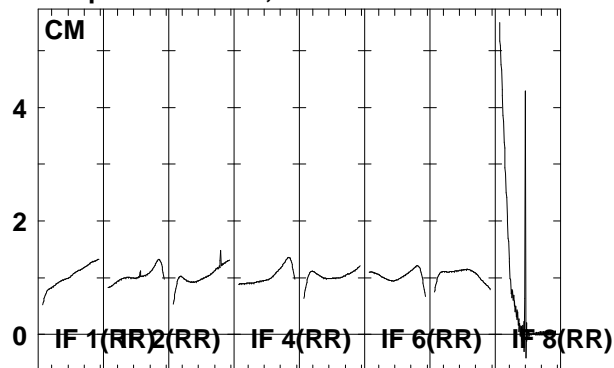

6663.6665.6667.6669.6671.6673.6675.6677.5
 FREQ MHz

6663.6665.6667.6669.6671.6673.6675.6677.5
 FREQ MHz

6663.6665.6667.6669.6671.6673.6675.6677.5
 FREQ MHz

Lower frame: Real Jy
 Total-power spectrum Antenna: *
 Timerange: 00/07:05:34 to 00/07:08:32

Plot file version 107 created 22-JUN-2006 20:08:22

J1825-17 EM061A 1.UVDATA.1

Freq = 6.6631 GHz, Bw = 2.000 MH No calibration applied and no bandpass applied

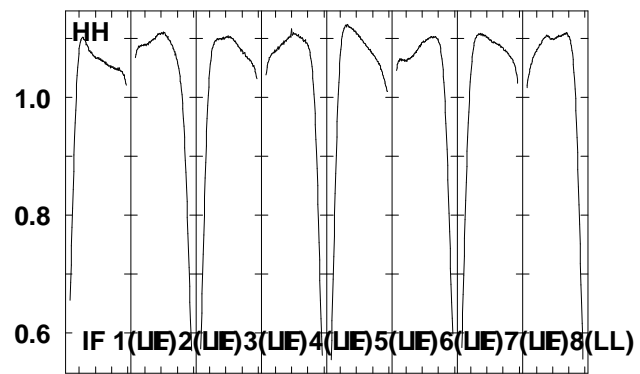
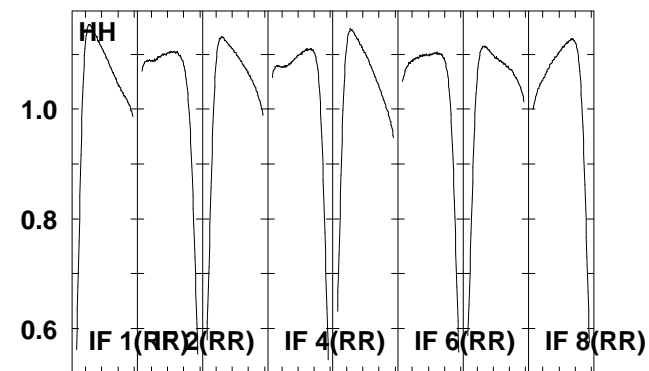
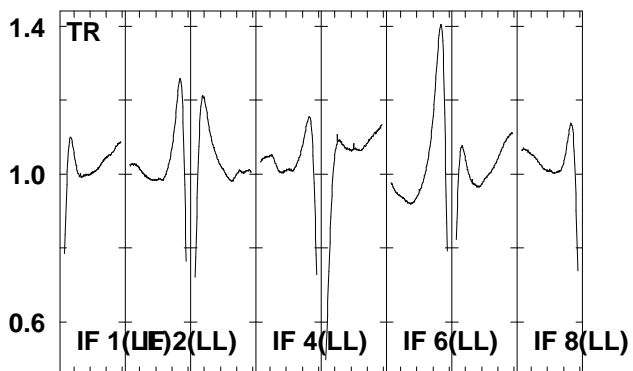
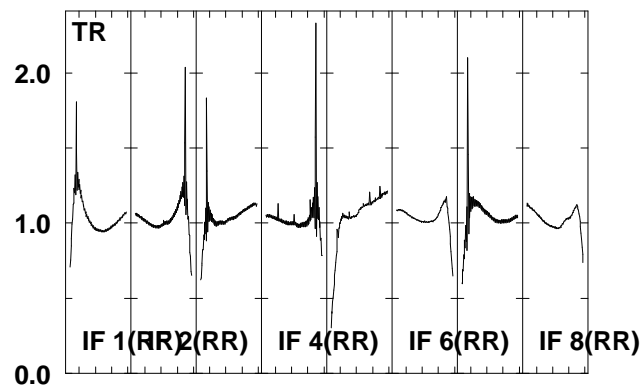
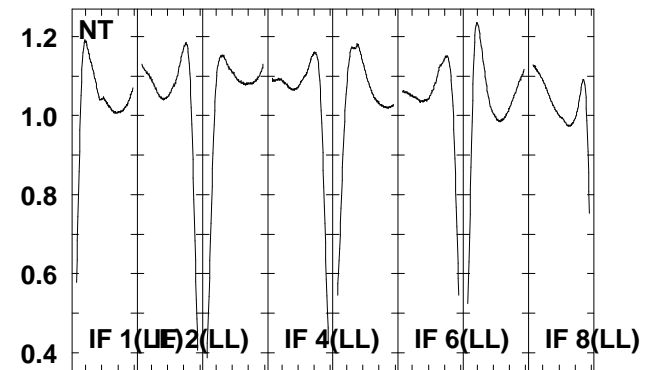
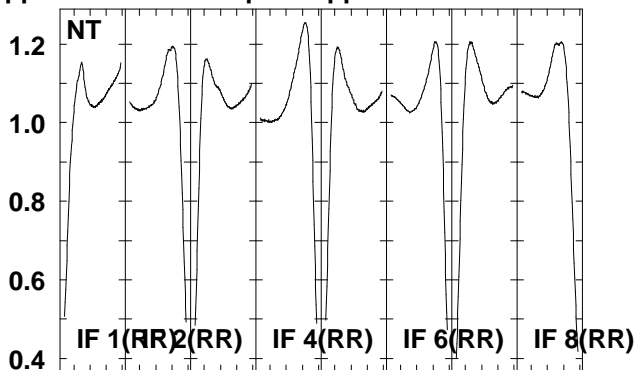
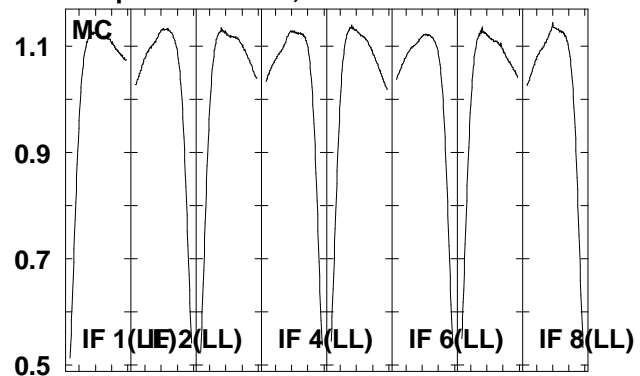

6663.6665.6667.6669.6671.6673.6675.6677.5

FREQ MHz

Lower frame: Real Jy

Total-power spectrum Antenna: *

Timerange: 00/07:05:34 to 00/07:08:32

Plot file version 108 created 22-JUN-2006 20:08:25
 G16.59-0 EM061A 1.UVDATA.1
 Freq = 6.6631 GHz, Bw = 2.000 MH No calibration applied and no bandpass applied

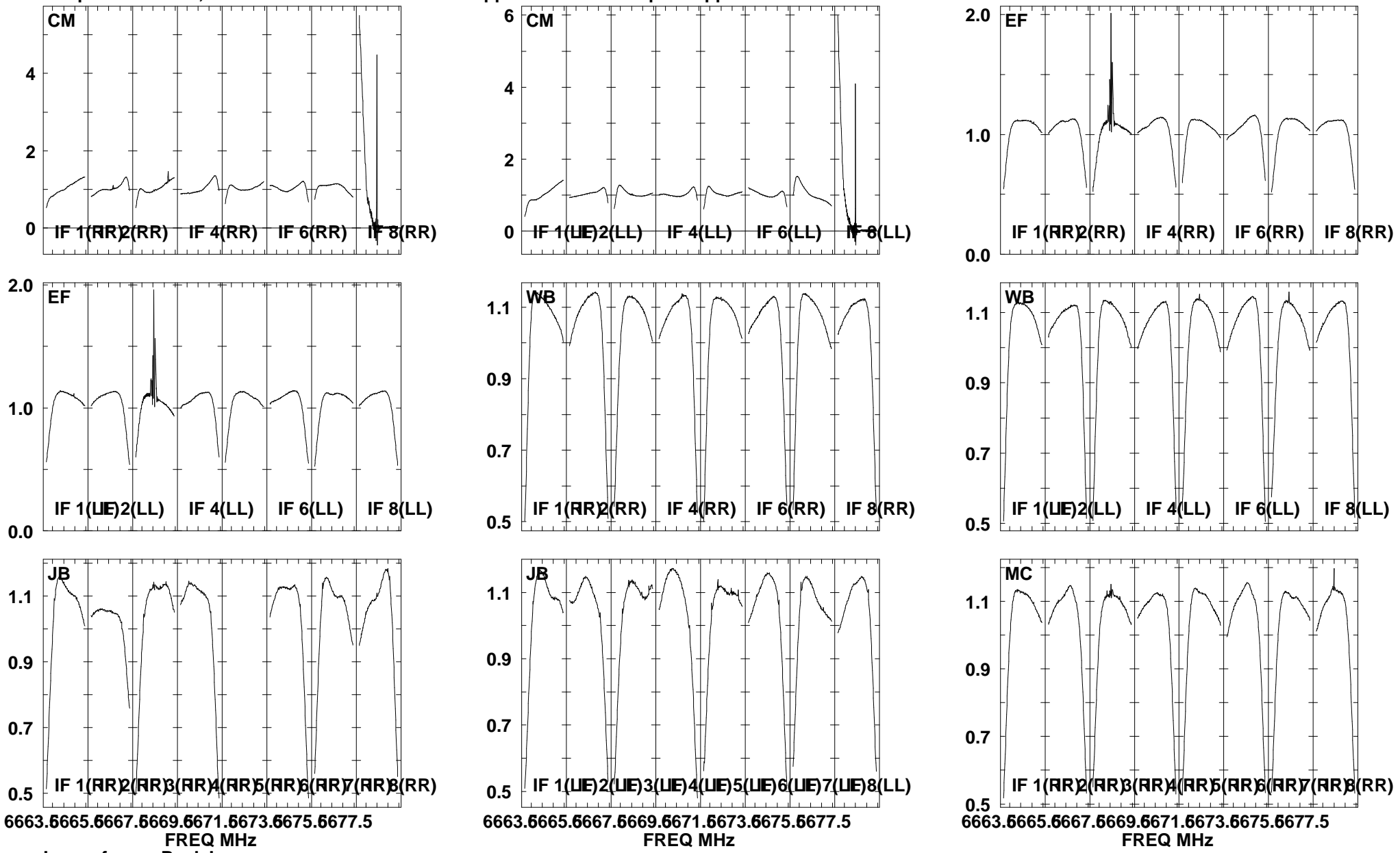

Lower frame: Real Jy
 Total-power spectrum Antenna: *
 Timerange: 00/07:08:34 to 00/07:09:39

Plot file version 109 created 22-JUN-2006 20:08:27
 G16.59-0 EM061A 1.UVDATA.1
 Freq = 6.6631 GHz, Bw = 2.000 MH No calibration applied and no bandpass applied

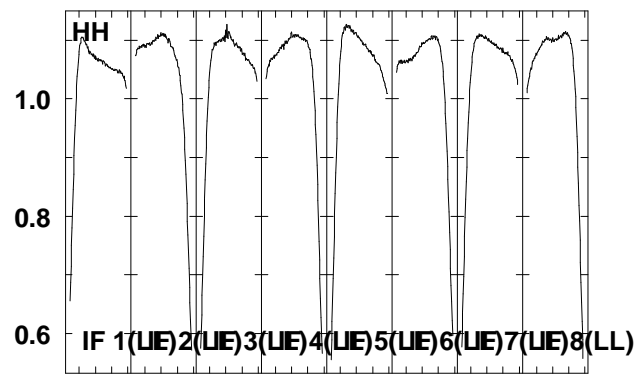
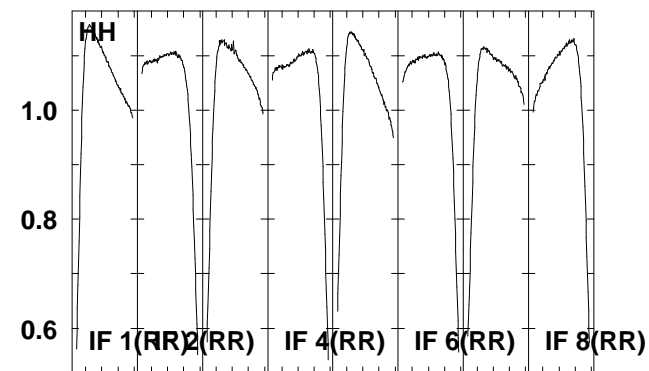
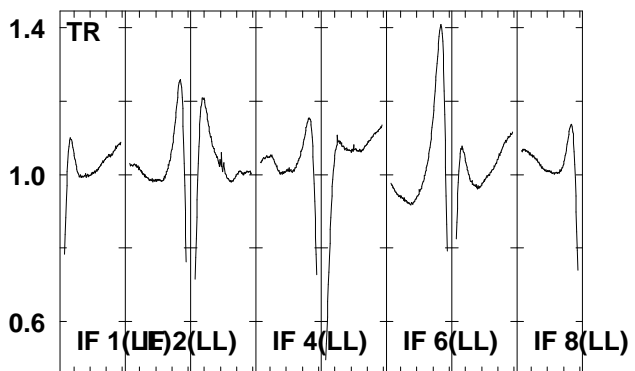
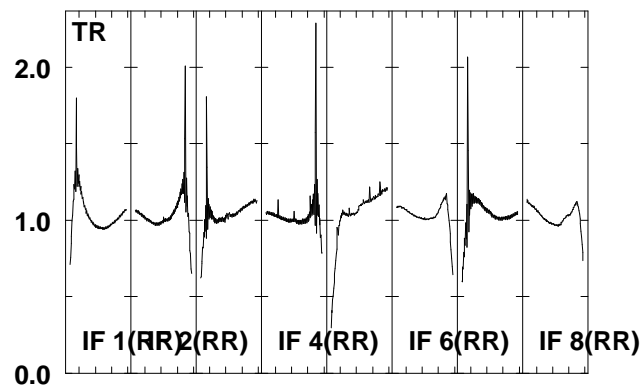
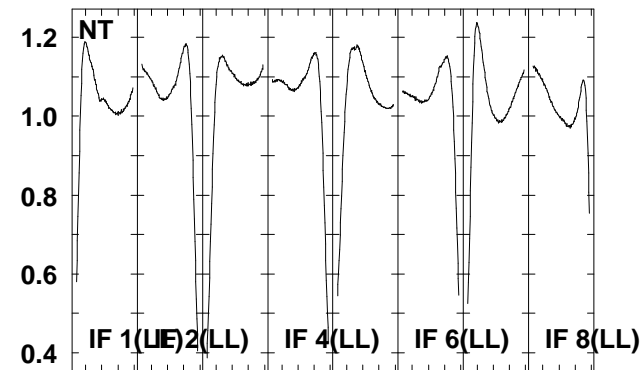
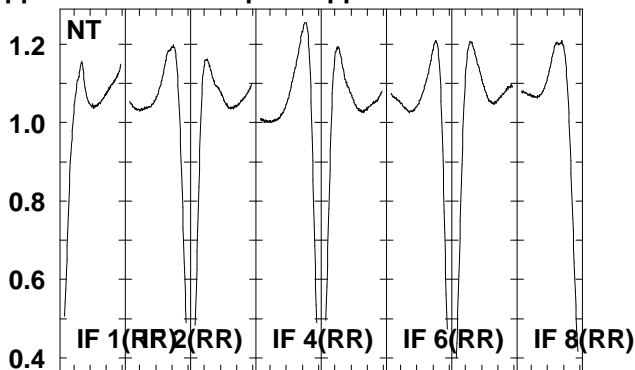
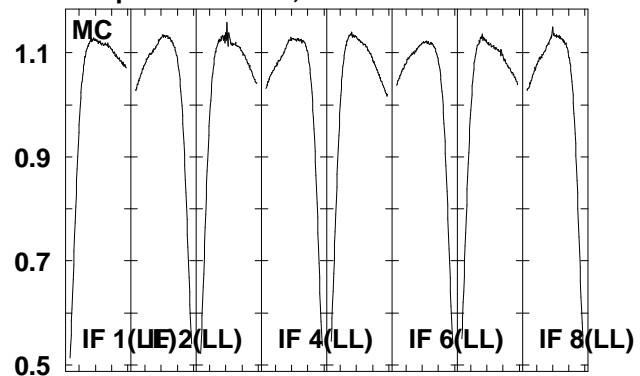

6663.6665.6667.6669.6671.6673.6675.6677.5
 FREQ MHz

Lower frame: Real Jy
 Total-power spectrum Antenna: *
 Timerange: 00/07:08:34 to 00/07:09:39

Plot file version 110 created 22-JUN-2006 20:08:31
 G16.59-0 EM061A 1.UVDATA.1
 Freq = 6.6631 GHz, Bw = 2.000 MH No calibration applied and no bandpass applied

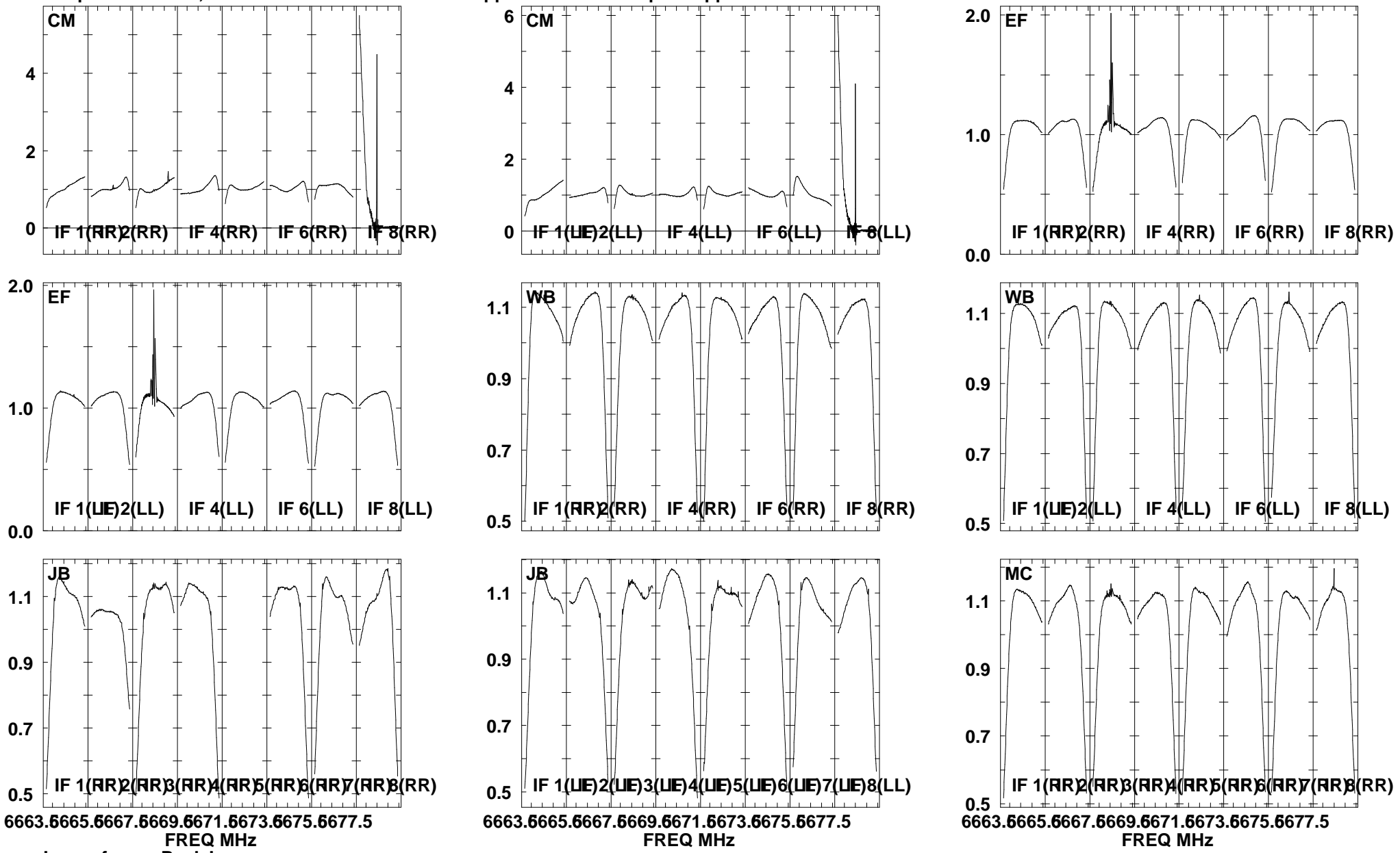

Lower frame: Real Jy
 Total-power spectrum Antenna: *
 Timerange: 00/07:09:40 to 00/07:11:02

Plot file version 111 created 22-JUN-2006 20:08:34
 G16.59-0 EM061A 1.UVDATA.1
 Freq = 6.6631 GHz, Bw = 2.000 MH No calibration applied and no bandpass applied

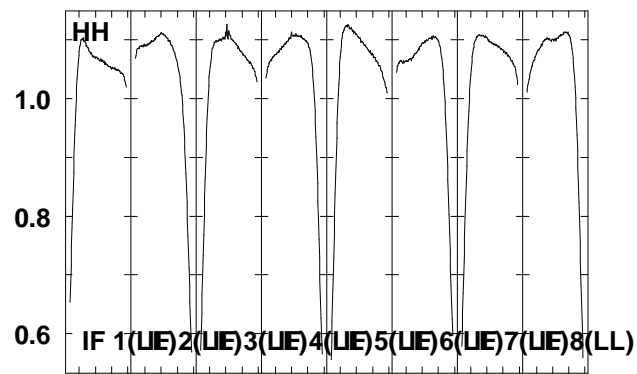
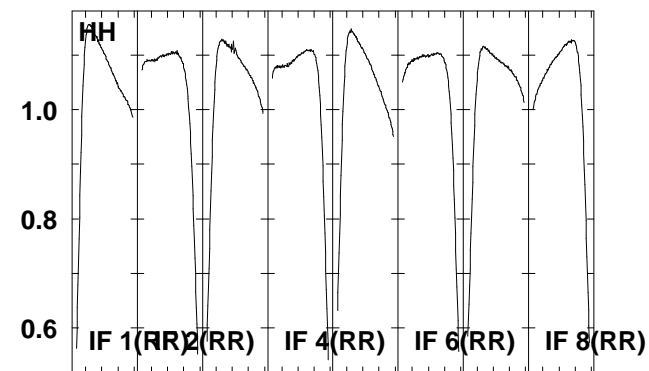
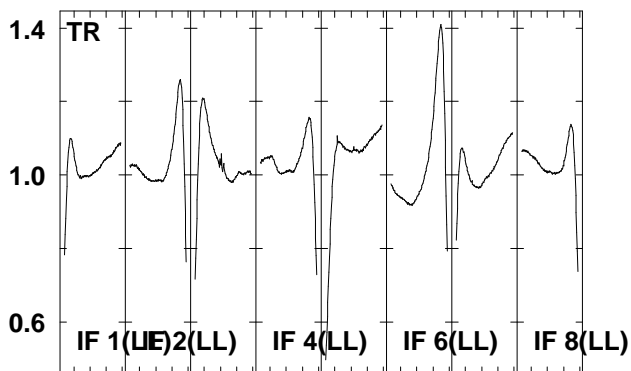
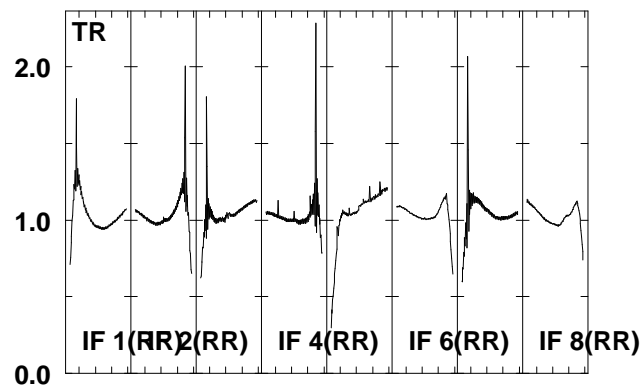
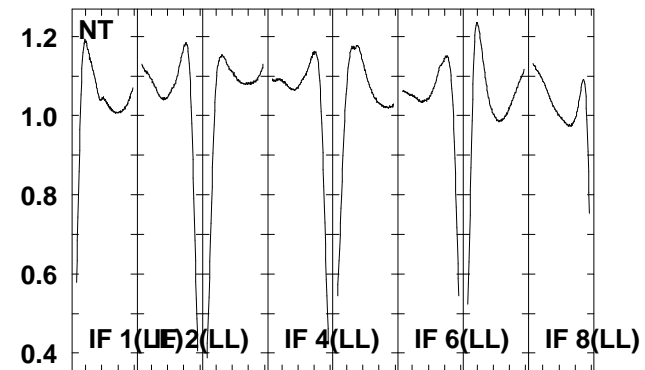
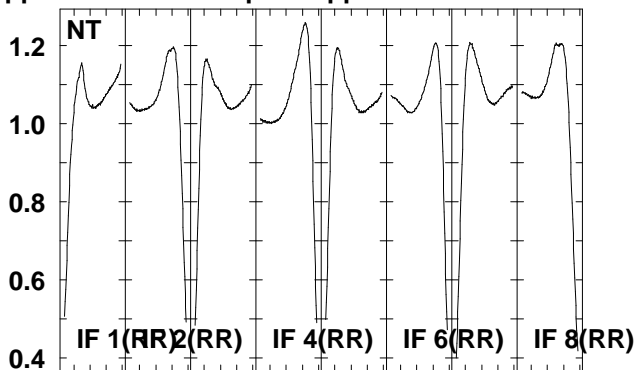
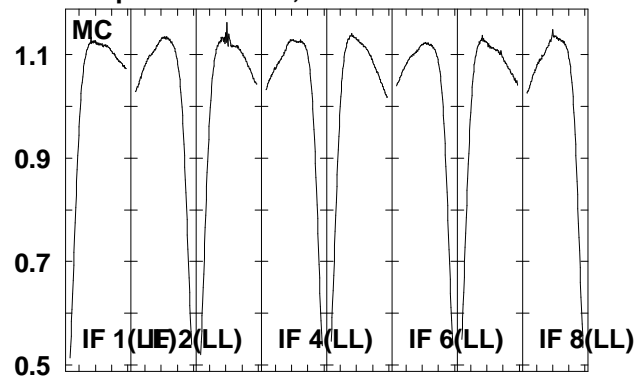

6663.6665.6667.6669.6671.6673.6675.6677.5
 FREQ MHz

Lower frame: Real Jy
 Total-power spectrum Antenna: *
 Timerange: 00/07:09:40 to 00/07:11:02

Plot file version 112 created 22-JUN-2006 20:08:39
 J2253+16 EM061A 1.UVDATA.1
 Freq = 6.6631 GHz, Bw = 2.000 MH No calibration applied and no bandpass applied

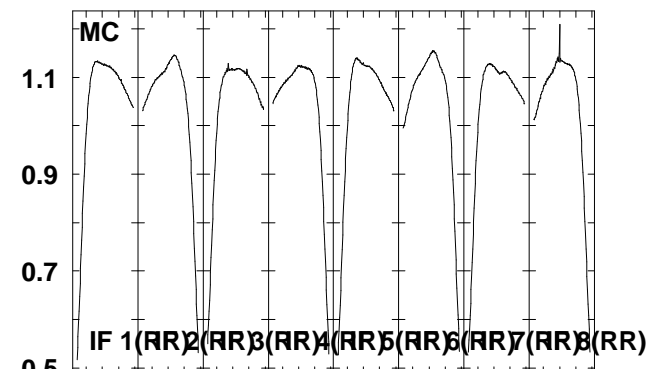
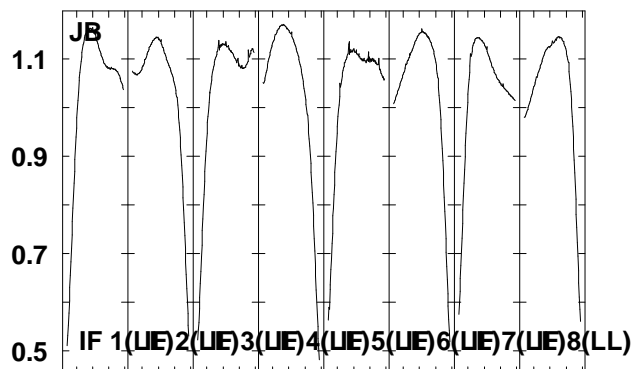
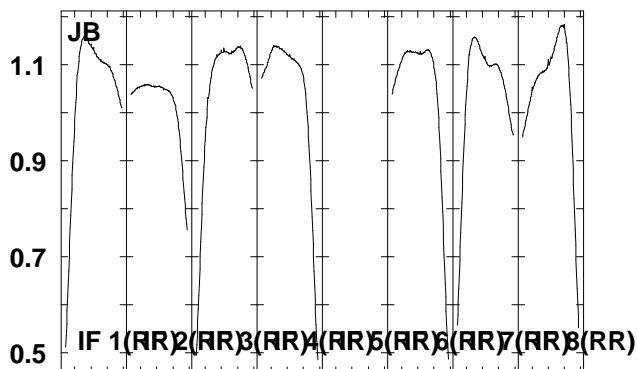
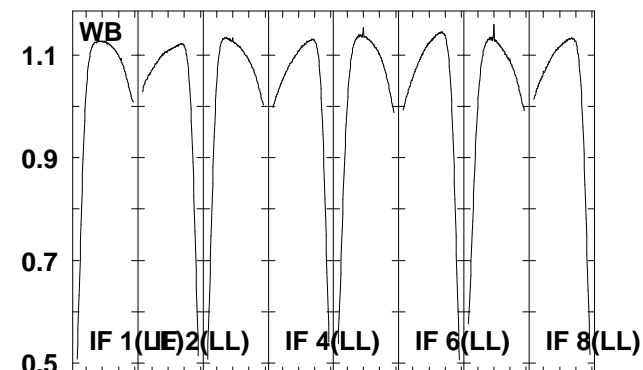
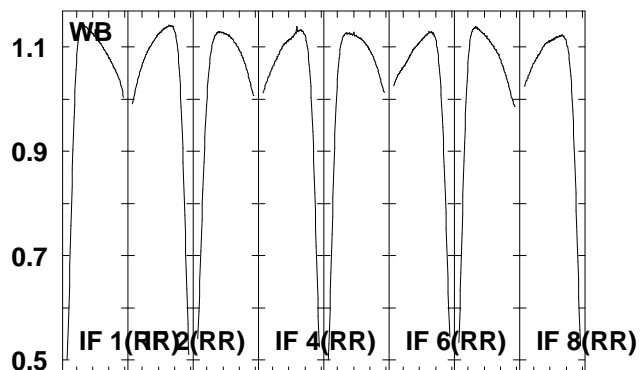
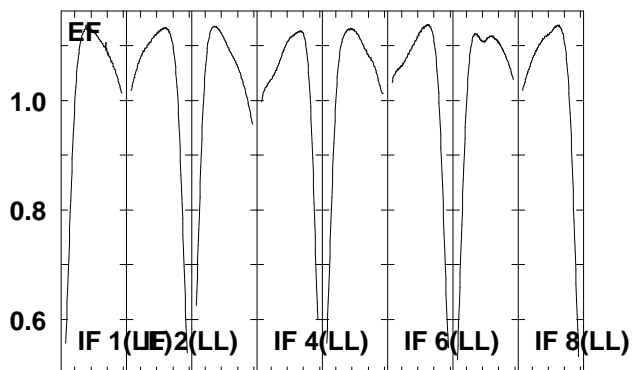
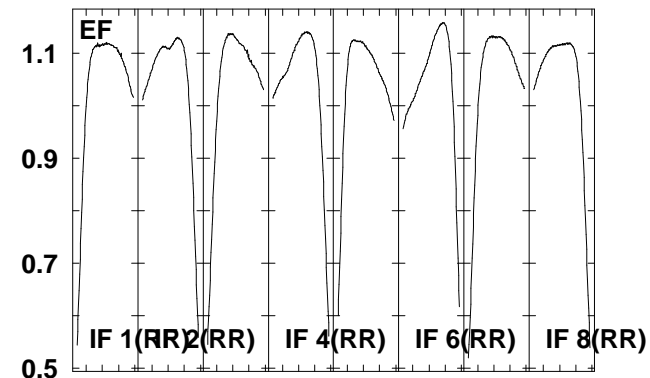
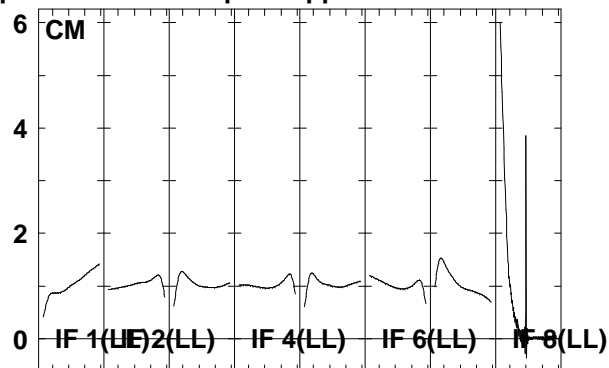
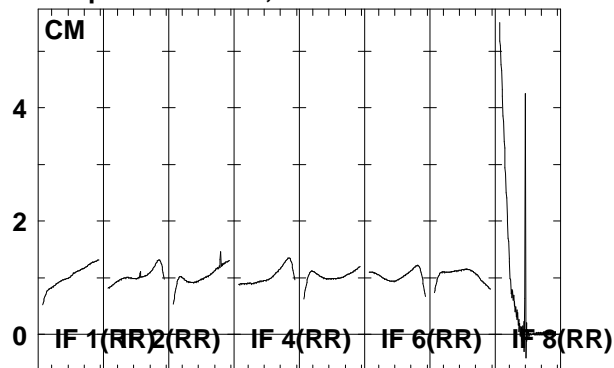

6663.6665.6667.6669.6671.6673.6675.6677.5
 FREQ MHz

6663.6665.6667.6669.6671.6673.6675.6677.5
 FREQ MHz

6663.6665.6667.6669.6671.6673.6675.6677.5
 FREQ MHz

Lower frame: Real Jy
 Total-power spectrum Antenna: *
 Timerange: 00/07:15:52 to 00/07:23:32

Plot file version 113 created 22-JUN-2006 20:08:49
 J2253+16 EM061A 1.UVDATA.1
 Freq = 6.6631 GHz, Bw = 2.000 MH No calibration applied and no bandpass applied

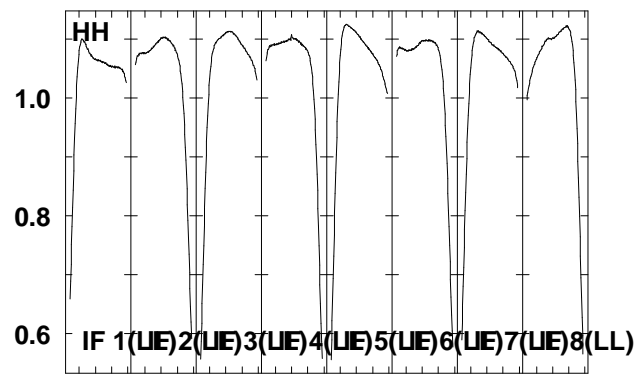
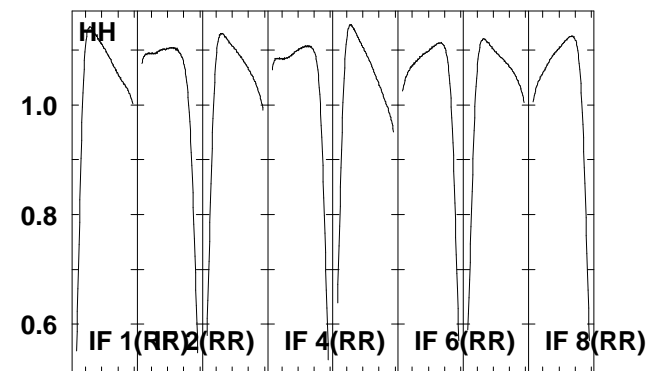
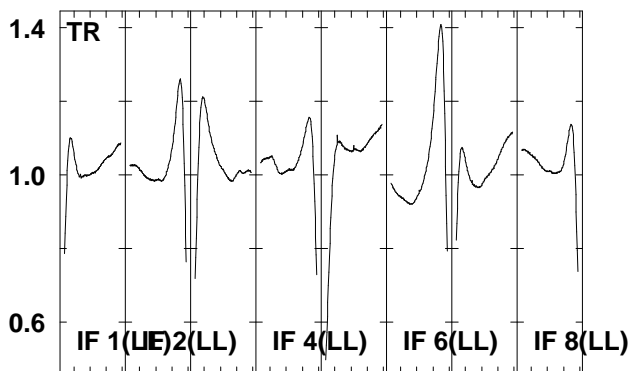
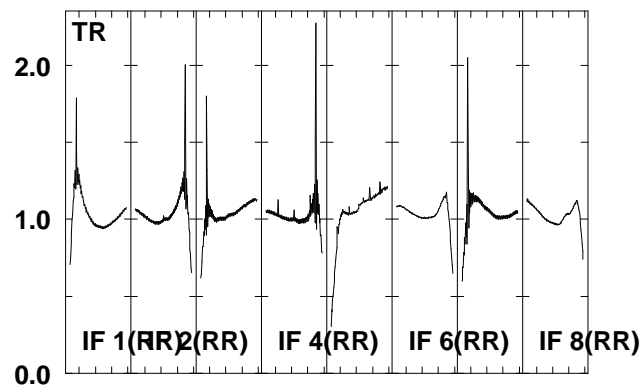
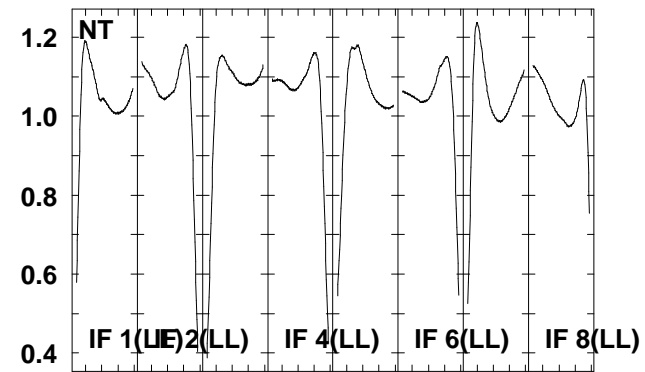
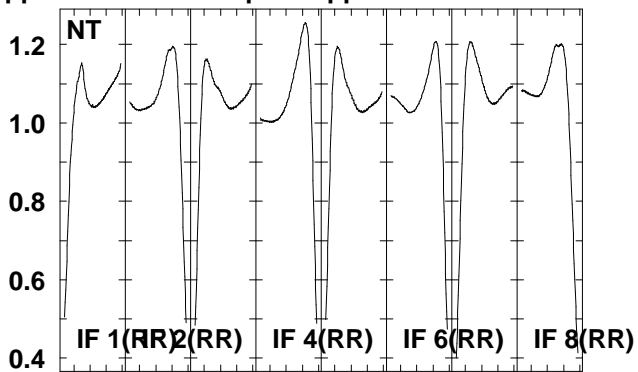
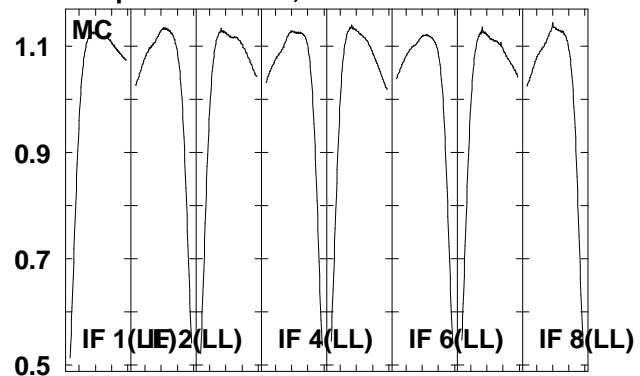

6663.6665.6667.6669.6671.6673.6675.6677.5
 FREQ MHz

Lower frame: Real Jy
 Total-power spectrum Antenna: *
 Timerange: 00/07:15:52 to 00/07:23:32

Plot file version 114 created 22-JUN-2006 20:08:57
 G16.59-0 EM061A 1.UVDATA.1
 Freq = 6.6631 GHz, Bw = 2.000 MH No calibration applied and no bandpass applied

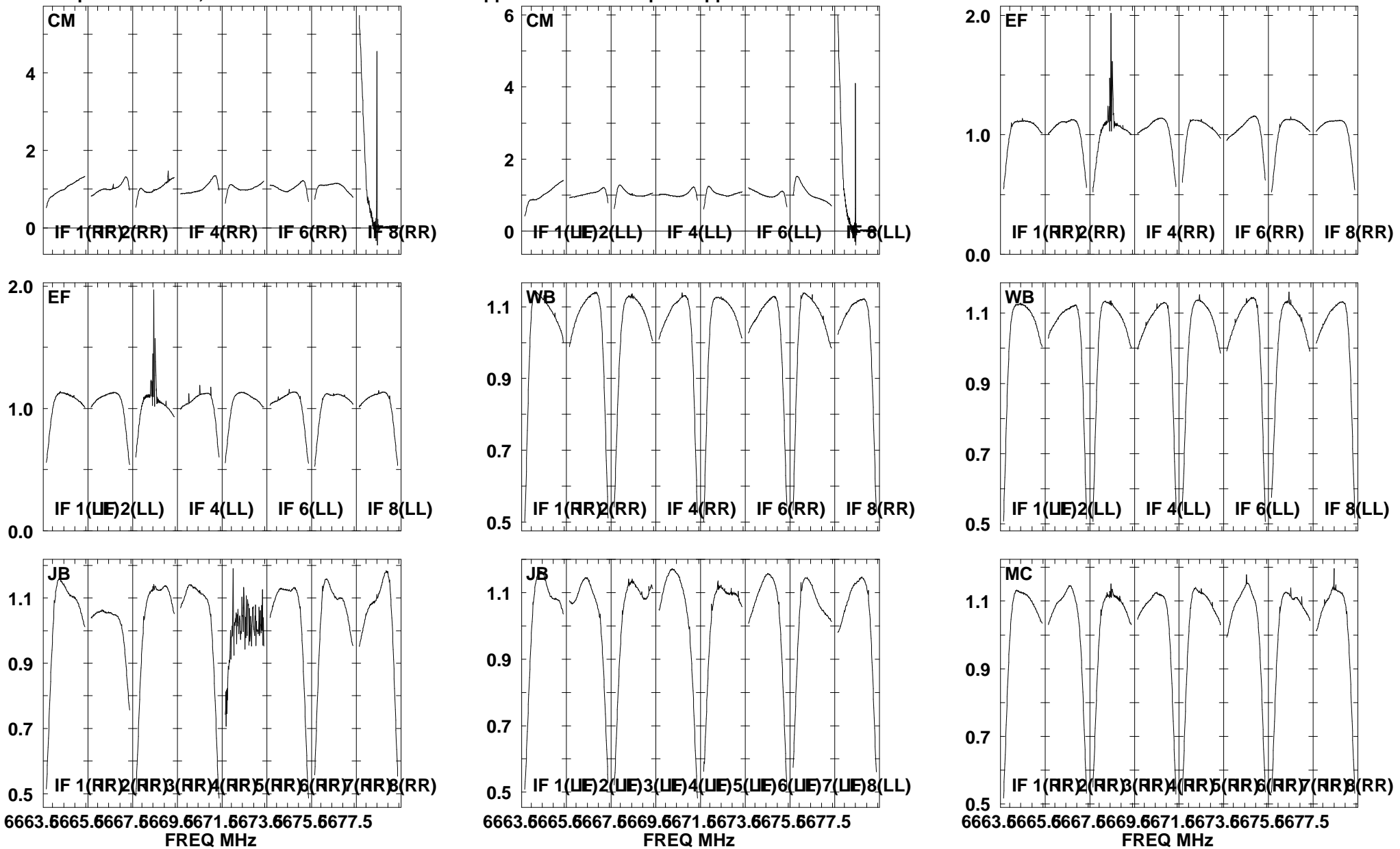

Lower frame: Real Jy
 Total-power spectrum Antenna: *
 Timerange: 00/07:27:35 to 00/07:30:02

Plot file version 115 created 22-JUN-2006 20:09:00
 G16.59-0 EM061A 1.UVDATA.1
 Freq = 6.6631 GHz, Bw = 2.000 MH No calibration applied and no bandpass applied

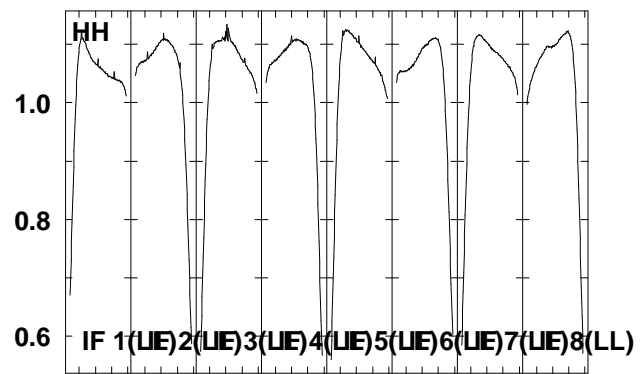
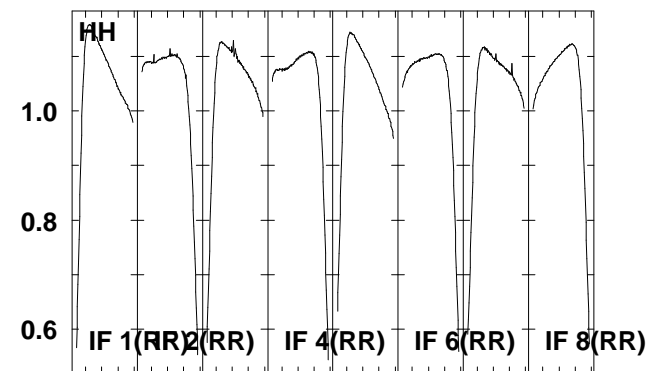
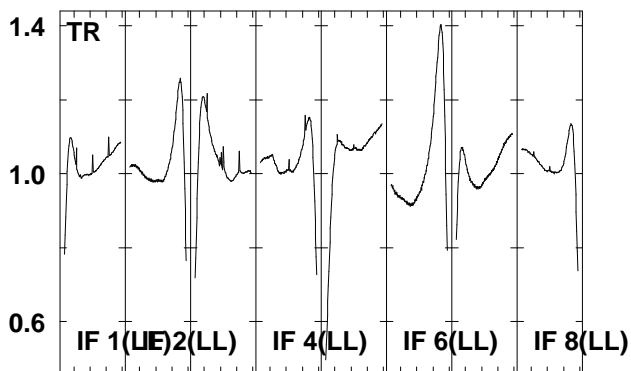
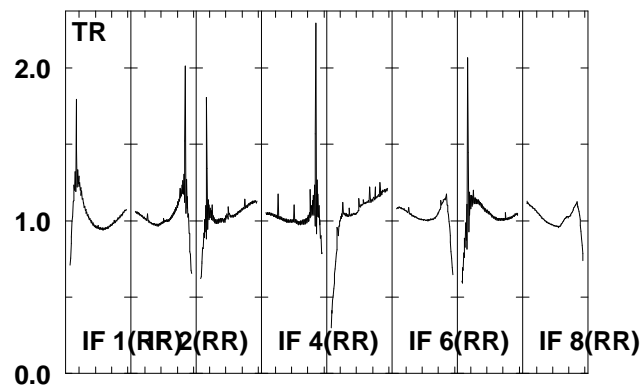
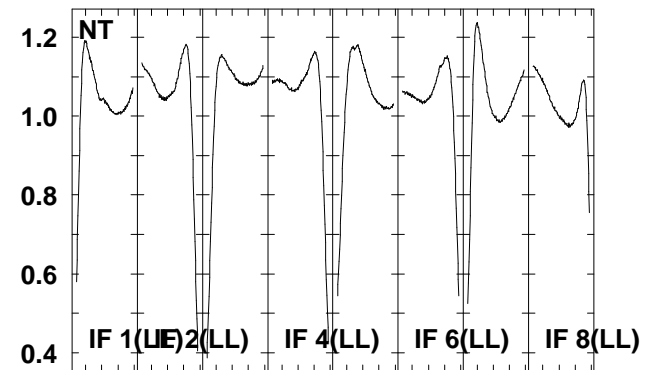
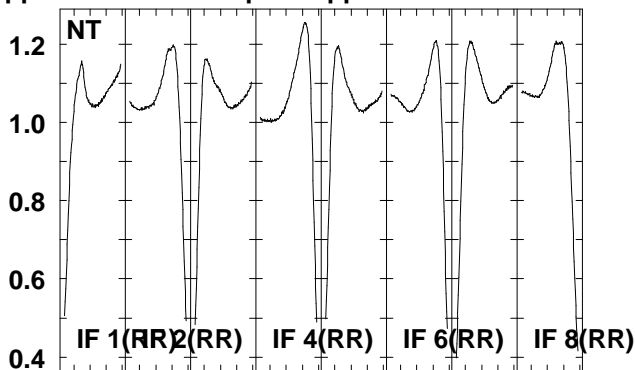
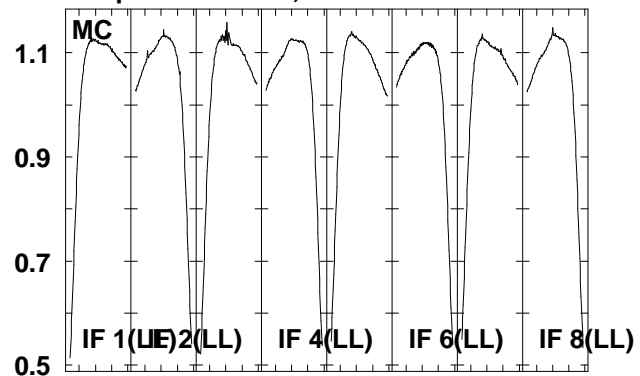

6663.6665.6667.6669.6671.6673.6675.6677.5
 FREQ MHz

Lower frame: Real Jy
 Total-power spectrum Antenna: *
 Timerange: 00/07:27:35 to 00/07:30:02

Plot file version 116 created 22-JUN-2006 20:09:05
 J1825-17 EM061A 1.UVDATA.1
 Freq = 6.6631 GHz, Bw = 2.000 MH No calibration applied and no bandpass applied

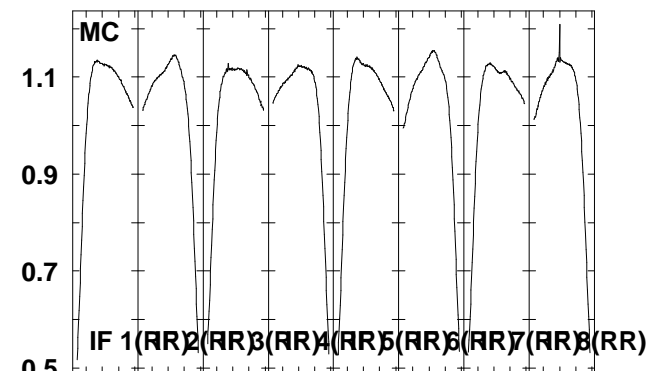
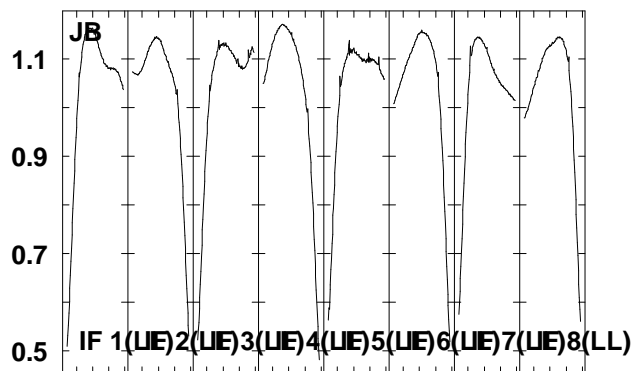
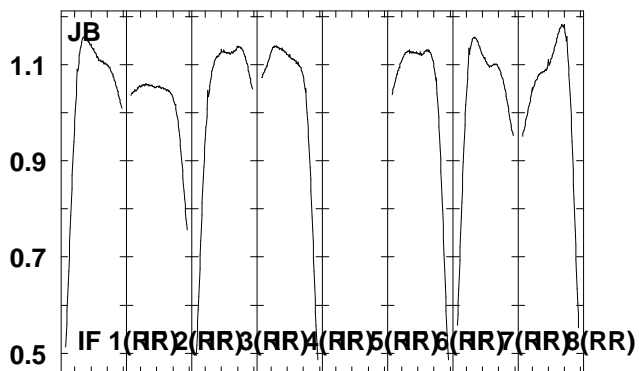
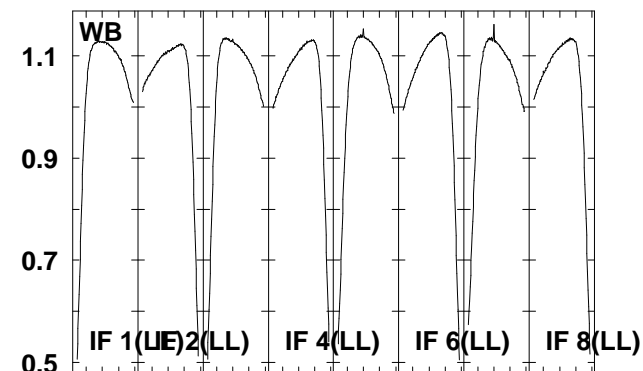
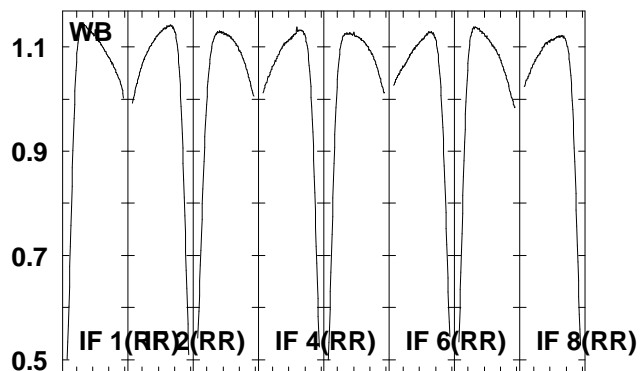
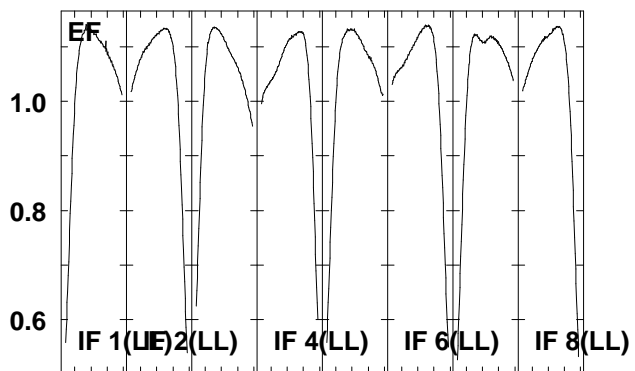
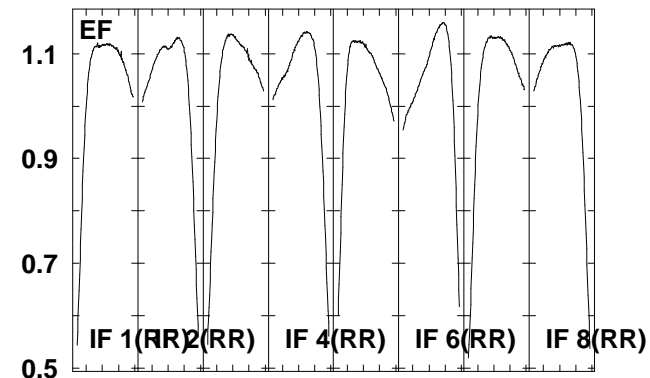
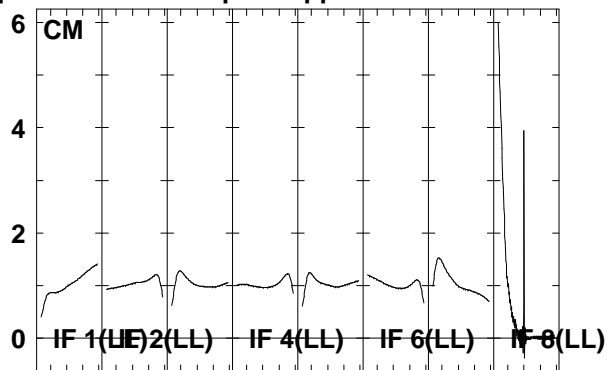
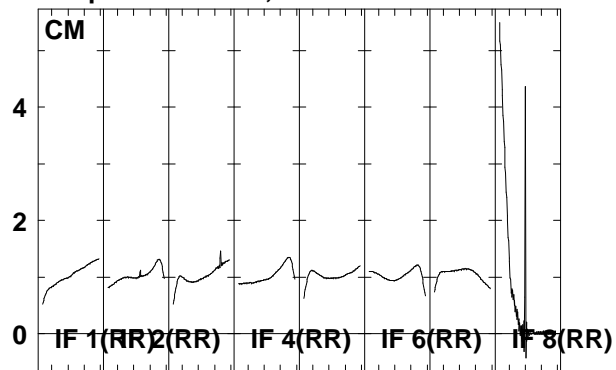

6663.6665.6667.6669.6671.6673.6675.6677.5
 FREQ MHz

6663.6665.6667.6669.6671.6673.6675.6677.5
 FREQ MHz

6663.6665.6667.6669.6671.6673.6675.6677.5
 FREQ MHz

Lower frame: Real Jy
 Total-power spectrum Antenna: *
 Timerange: 00/07:30:04 to 00/07:33:02

Plot file version 117 created 22-JUN-2006 20:09:08

J1825-17 EM061A 1.UVDATA.1

Freq = 6.6631 GHz, Bw = 2.000 MH No calibration applied and no bandpass applied

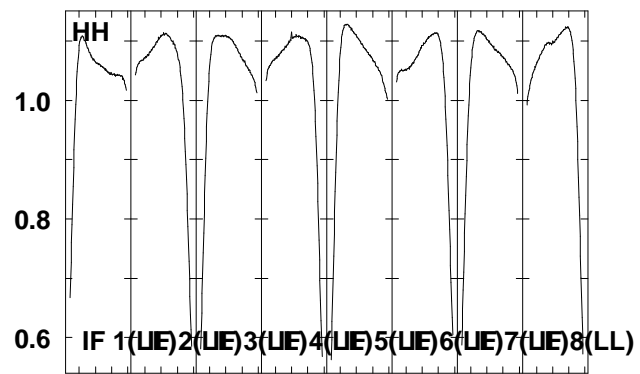
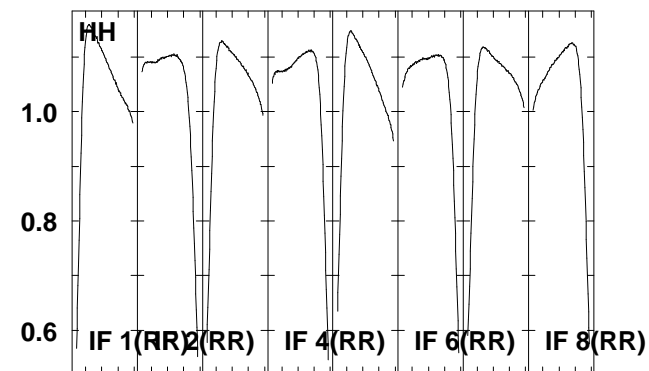
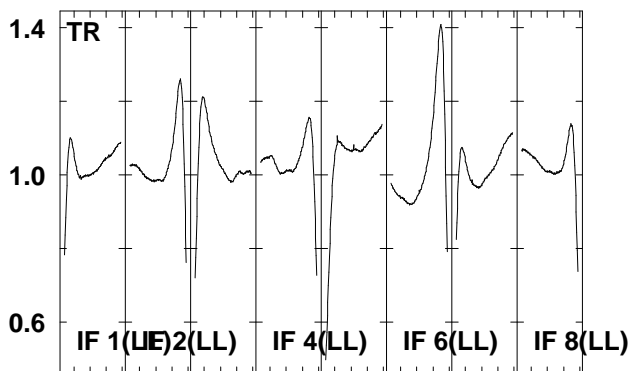
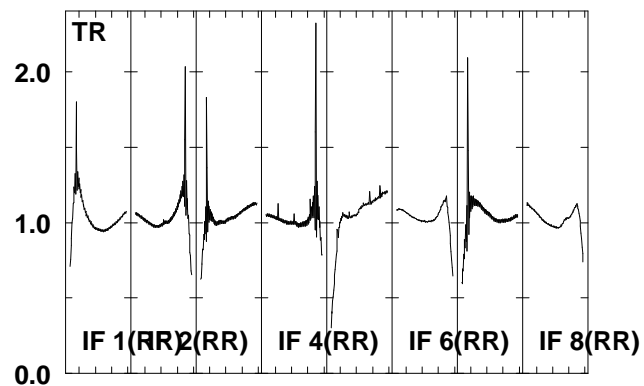
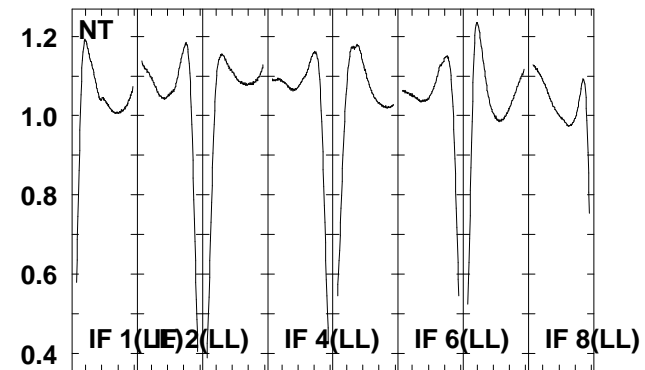
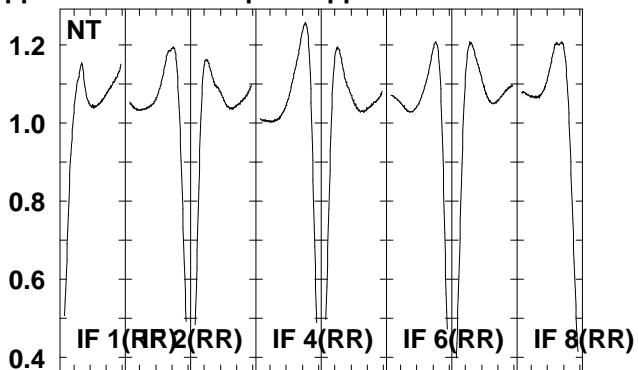
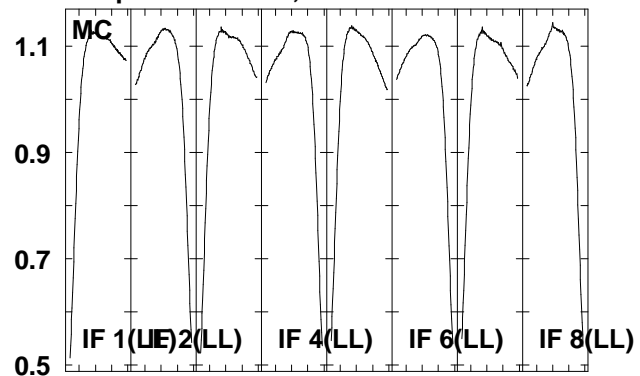

6663.6665.6667.6669.6671.6673.6675.6677.5

FREQ MHz

Lower frame: Real Jy

Total-power spectrum Antenna: *

Timerange: 00/07:30:04 to 00/07:33:02

Plot file version 118 created 22-JUN-2006 20:09:12
 G16.59-0 EM061A 1.UVDATA.1
 Freq = 6.6631 GHz, Bw = 2.000 MH No calibration applied and no bandpass applied

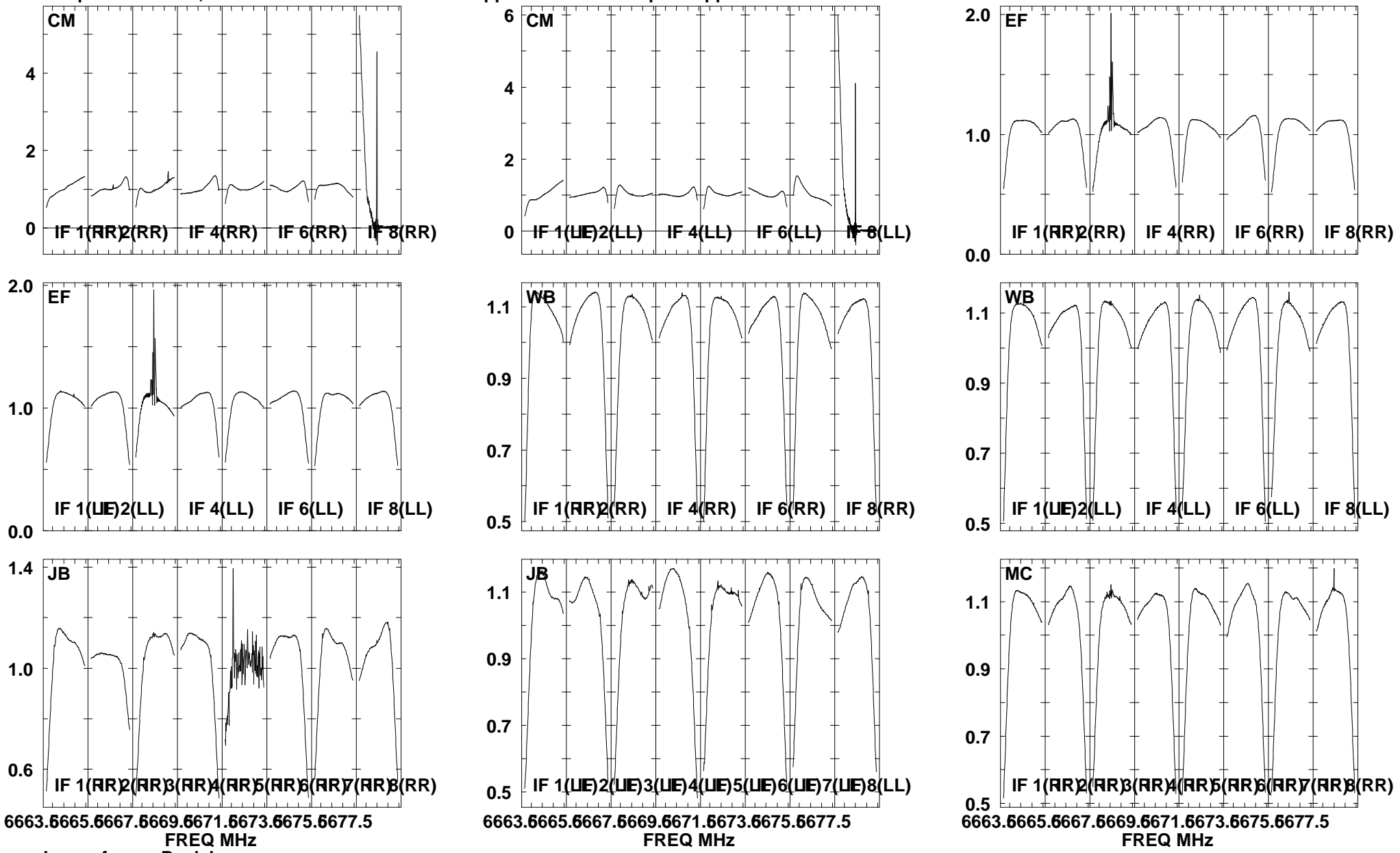

Lower frame: Real Jy
 Total-power spectrum Antenna: *
 Timerange: 00/07:33:04 to 00/07:35:32

Plot file version 119 created 22-JUN-2006 20:09:15
 G16.59-0 EM061A 1.UVDATA.1
 Freq = 6.6631 GHz, Bw = 2.000 MH No calibration applied and no bandpass applied

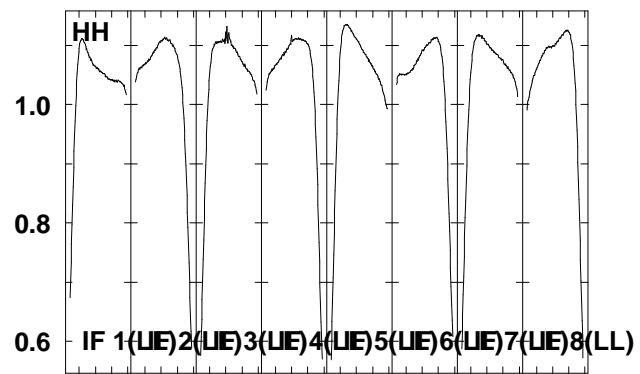
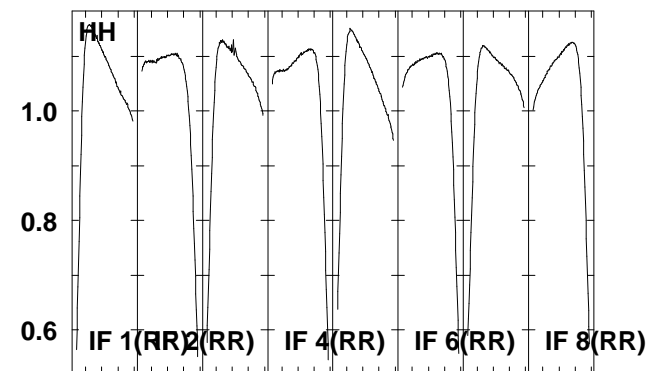
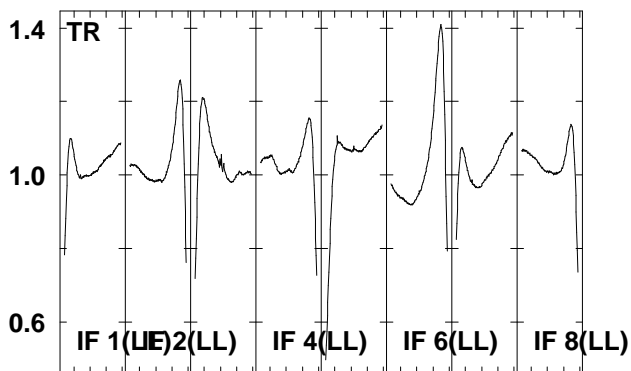
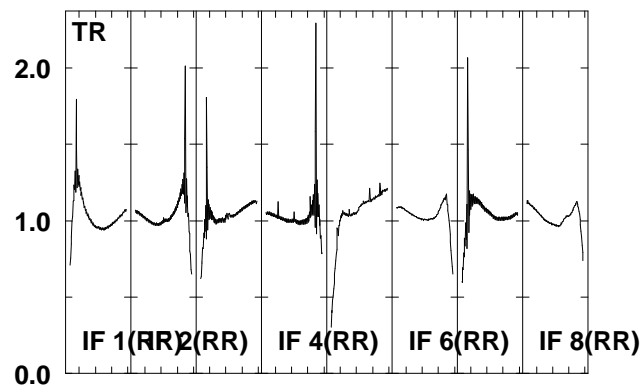
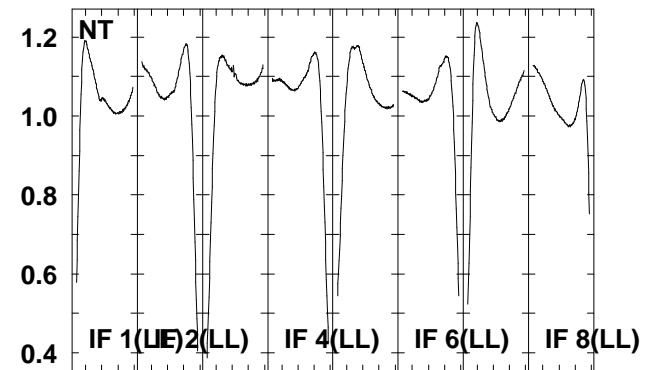
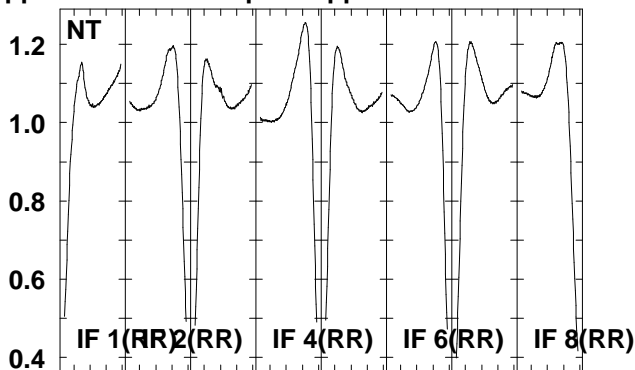
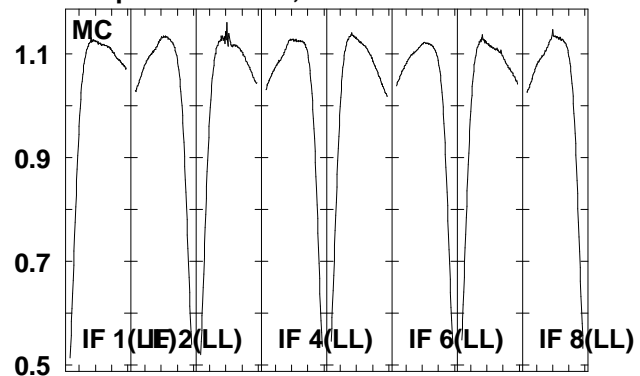

6663.6665.6667.6669.6671.6673.6675.6677.5
 FREQ MHz

Lower frame: Real Jy
 Total-power spectrum Antenna: *
 Timerange: 00/07:33:04 to 00/07:35:32

Plot file version 120 created 22-JUN-2006 20:09:19
 J1825-17 EM061A 1.UVDATA.1
 Freq = 6.6631 GHz, Bw = 2.000 MH No calibration applied and no bandpass applied

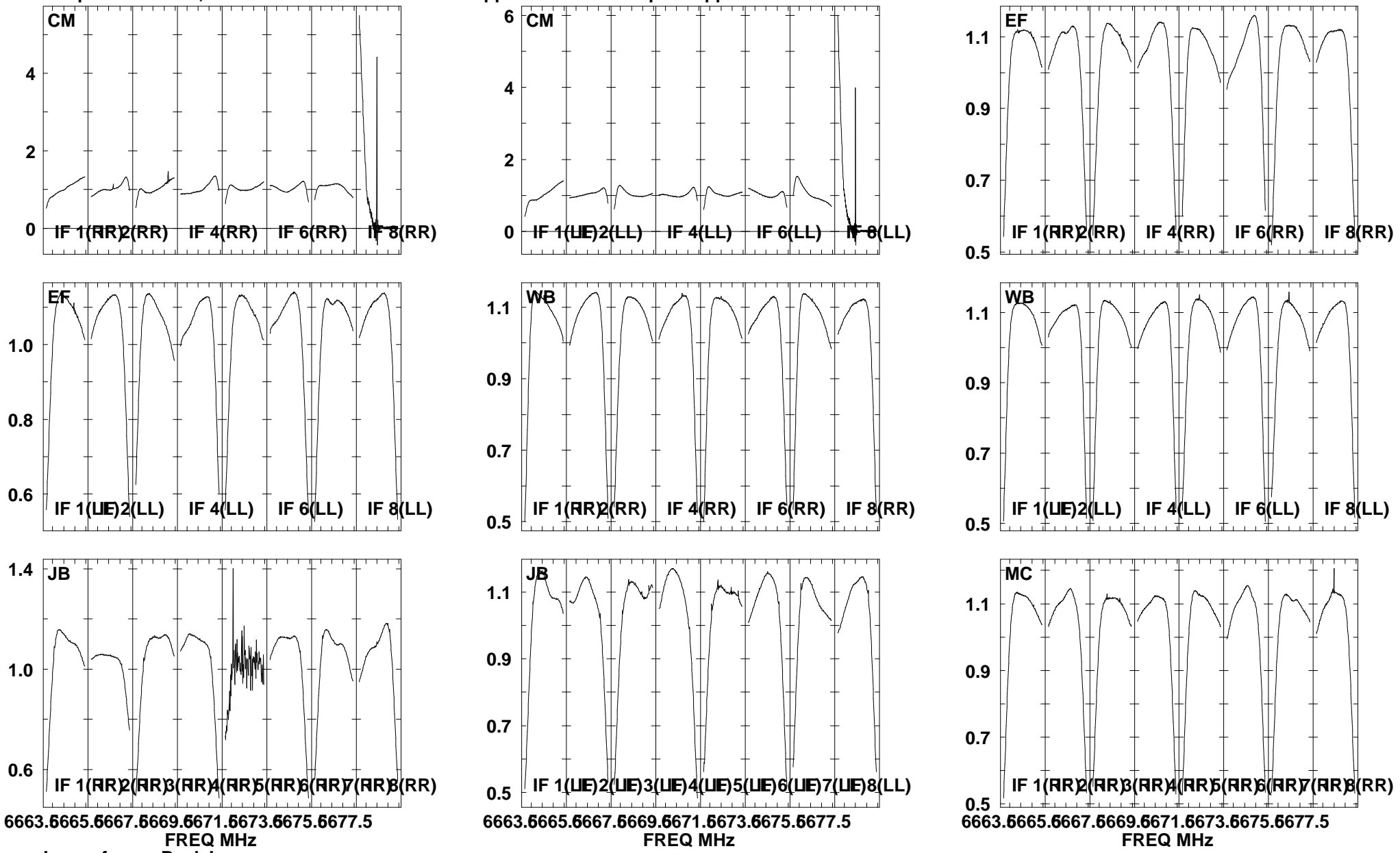

Lower frame: Real Jy
 Total-power spectrum Antenna: *
 Timerange: 00/07:35:34 to 00/07:38:32

Plot file version 121 created 22-JUN-2006 20:09:23

J1825-17 EM061A 1.UVDATA.1

Freq = 6.6631 GHz, Bw = 2.000 MH No calibration applied and no bandpass applied

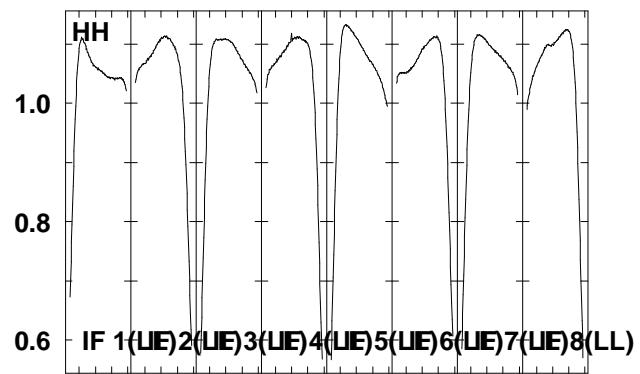
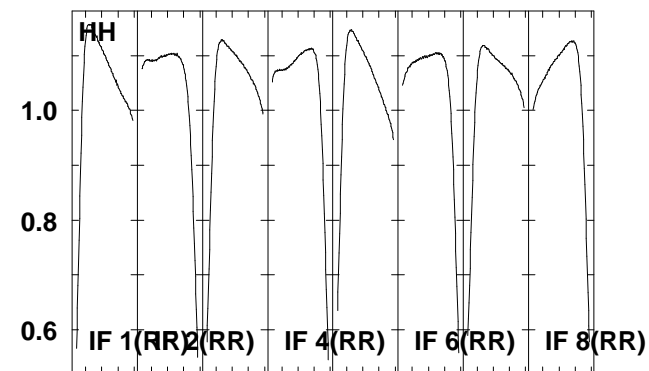
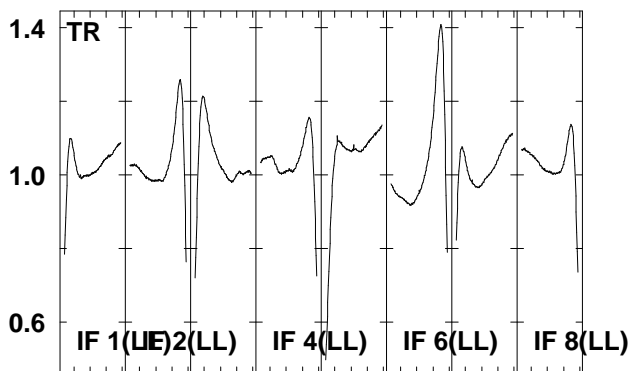
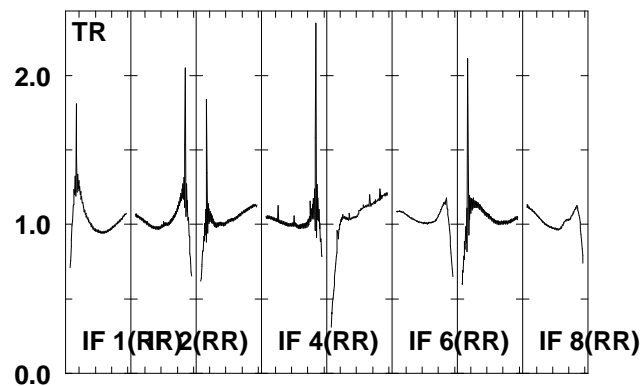
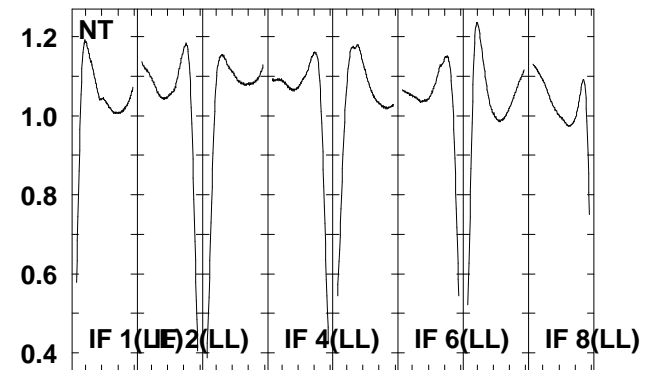
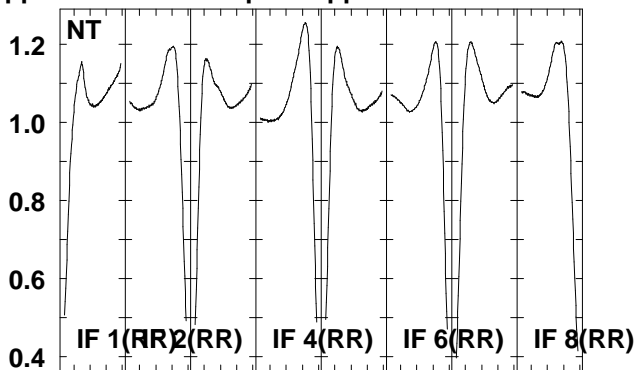
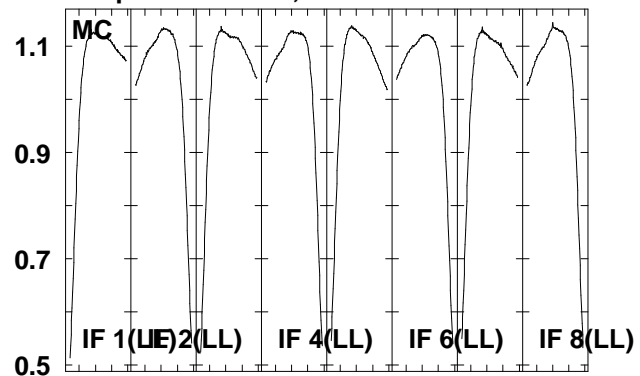

6663.6665.6667.6669.6671.6673.6675.6677.5

FREQ MHz

Lower frame: Real Jy

Total-power spectrum Antenna: *

Timerange: 00/07:35:34 to 00/07:38:32

Plot file version 122 created 22-JUN-2006 20:09:27
 G16.59-0 EM061A 1.UVDATA.1
 Freq = 6.6631 GHz, Bw = 2.000 MH No calibration applied and no bandpass applied

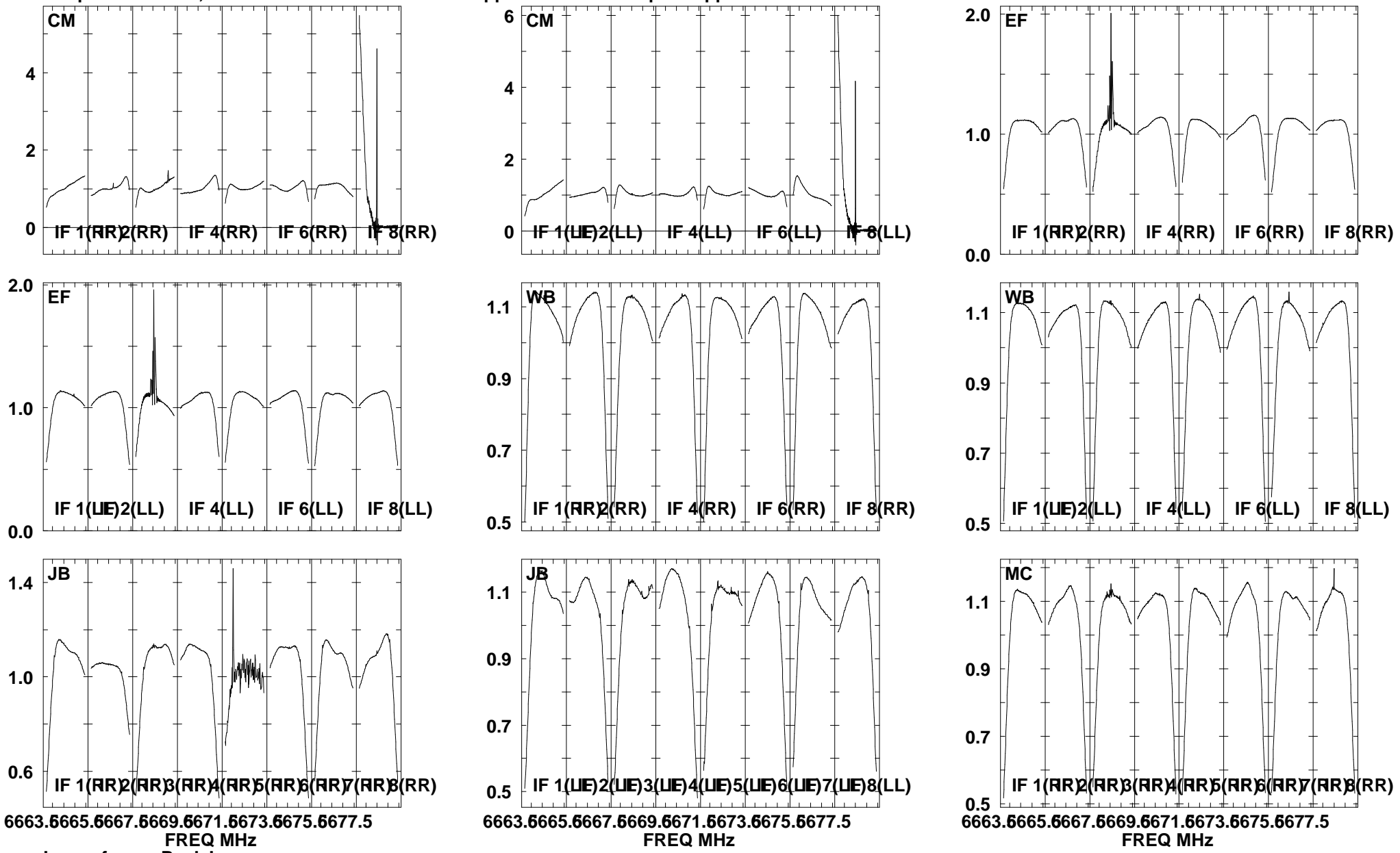

Lower frame: Real Jy
 Total-power spectrum Antenna: *
 Timerange: 00/07:38:34 to 00/07:41:02

Plot file version 123 created 22-JUN-2006 20:09:31
G16.59-0 EM061A 1.UVDATA.1
Freq = 6.6631 GHz, Bw = 2.000 MH No calibration applied and no bandpass applied

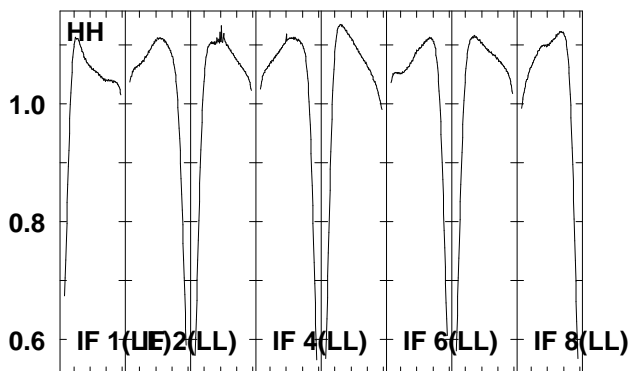
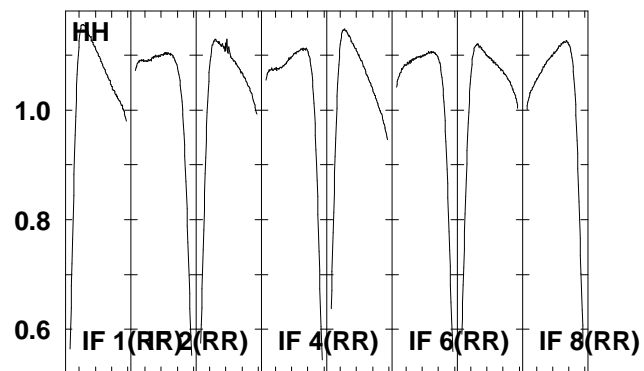
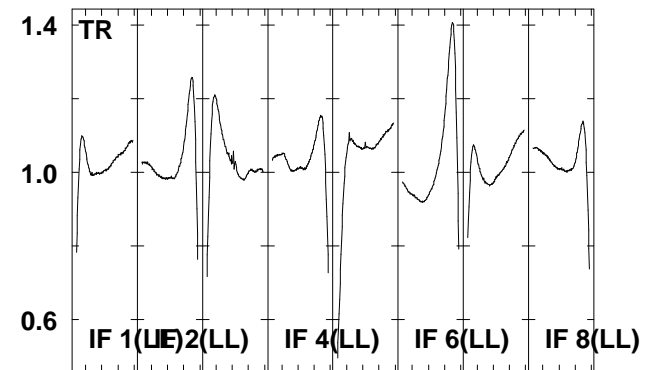
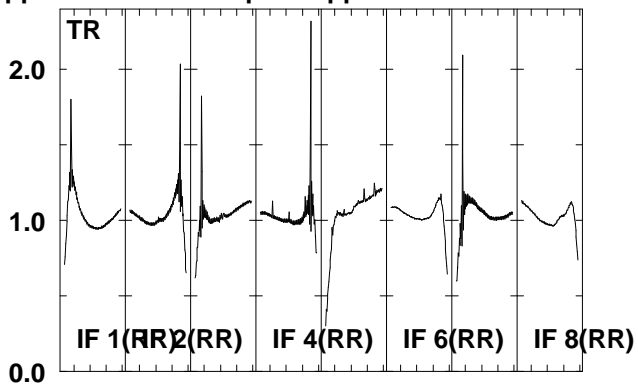
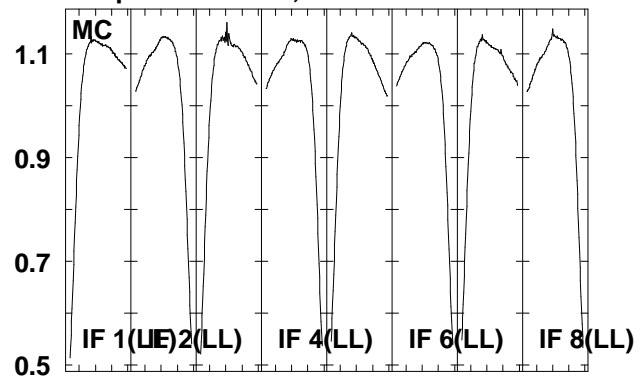

Lower frame: Real Jy
Total-power spectrum Antenna: *
Timerange: 00/07:38:34 to 00/07:41:02

Plot file version 124 created 22-JUN-2006 20:09:34
 J1825-17 EM061A 1.UVDATA.1
 Freq = 6.6631 GHz, Bw = 2.000 MH No calibration applied and no bandpass applied

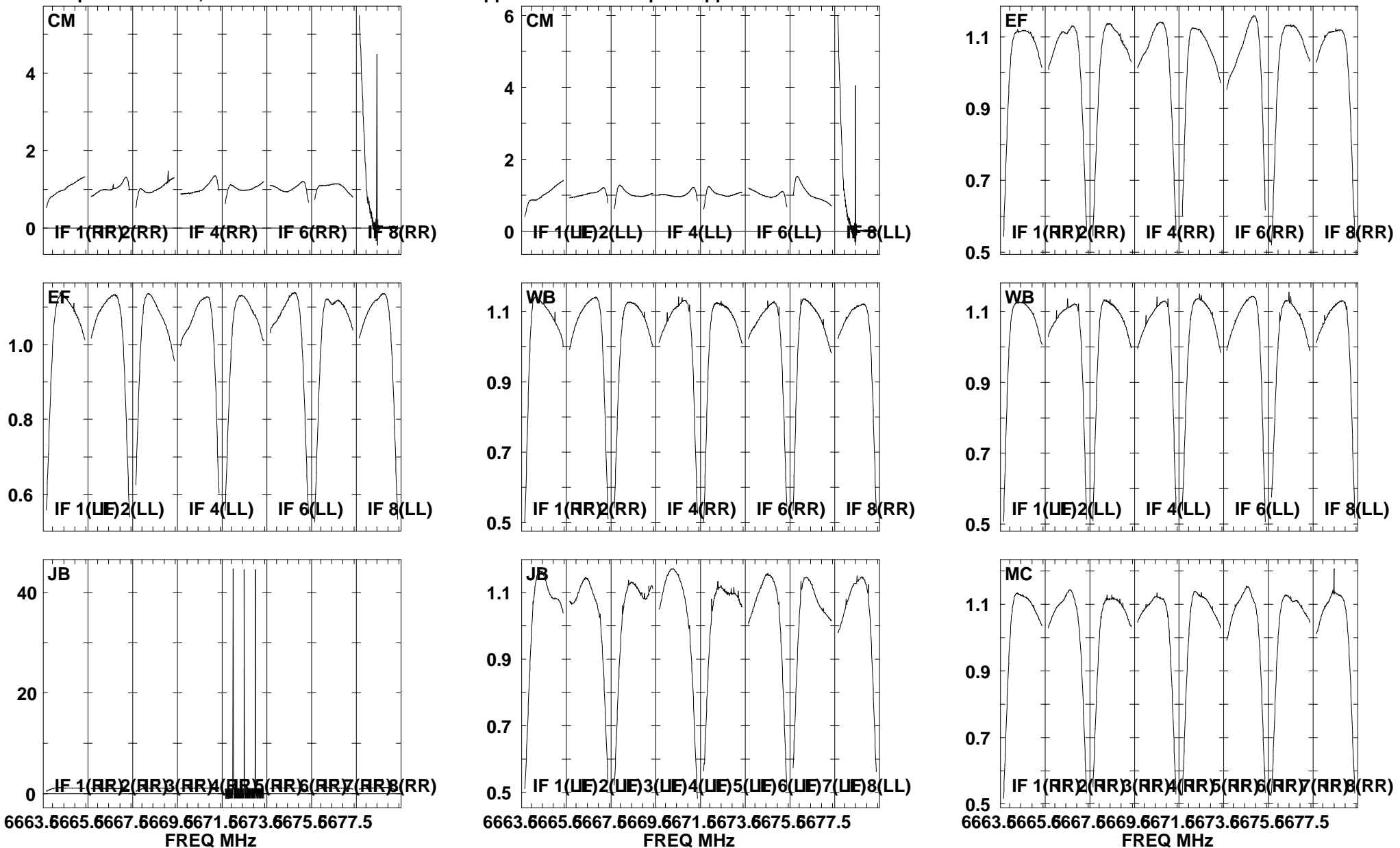

Lower frame: Real Jy
 Total-power spectrum Antenna: *
 Timerange: 00/07:42:34 to 00/07:45:32

Plot file version 125 created 22-JUN-2006 20:09:37

J1825-17 EM061A 1.UVDATA.1

Freq = 6.6631 GHz, Bw = 2.000 MH No calibration applied and no bandpass applied

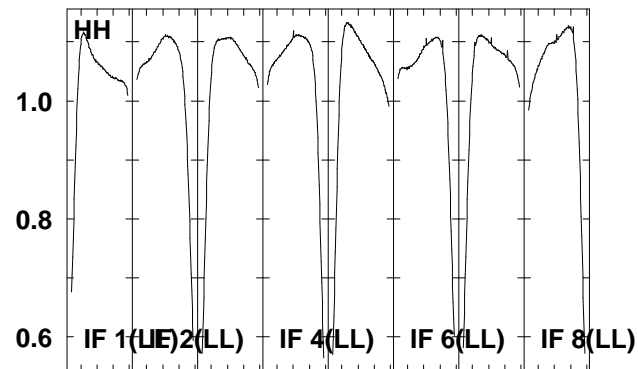
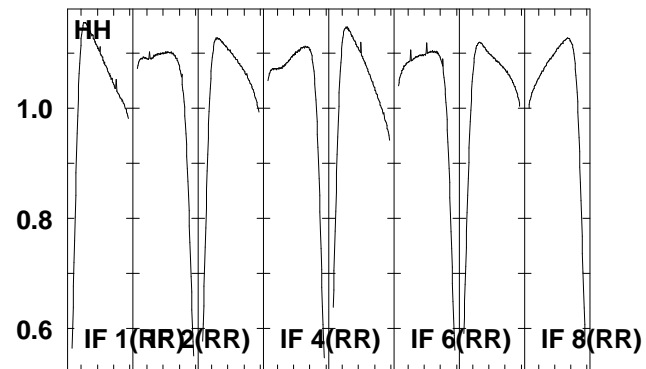
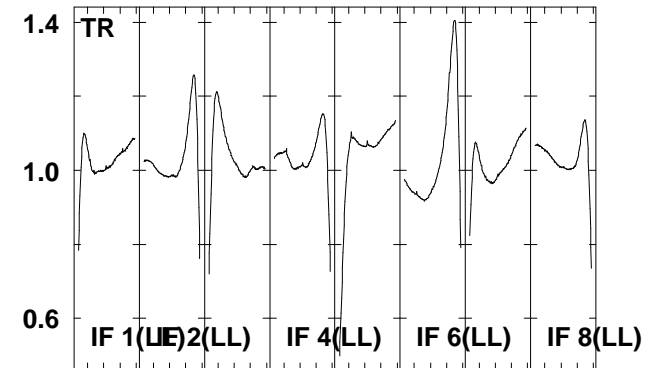
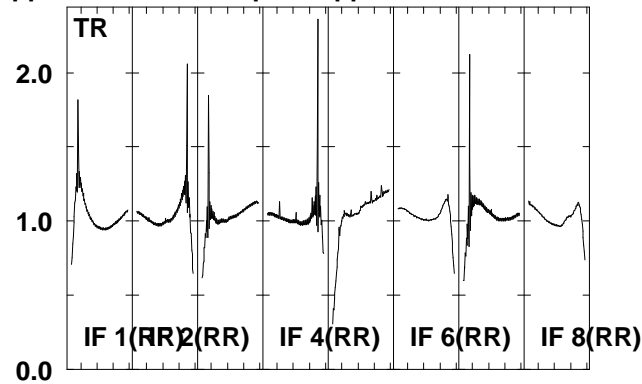
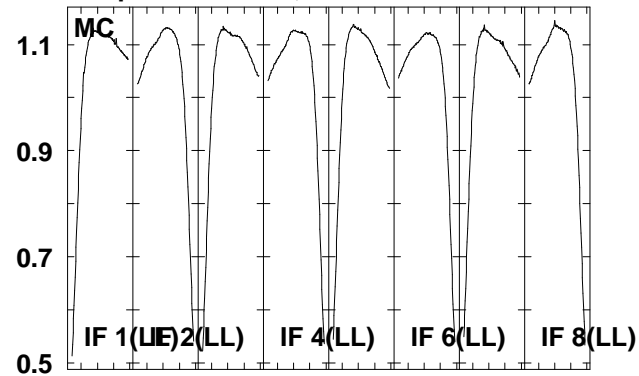

Lower frame: Real Jy
Total-power spectrum Antenna: *
Timerange: 00/07:42:34 to 00/07:45:32

Plot file version 126 created 22-JUN-2006 20:09:40
 G16.59-0 EM061A 1.UVDATA.1
 Freq = 6.6631 GHz, Bw = 2.000 MH No calibration applied and no bandpass applied

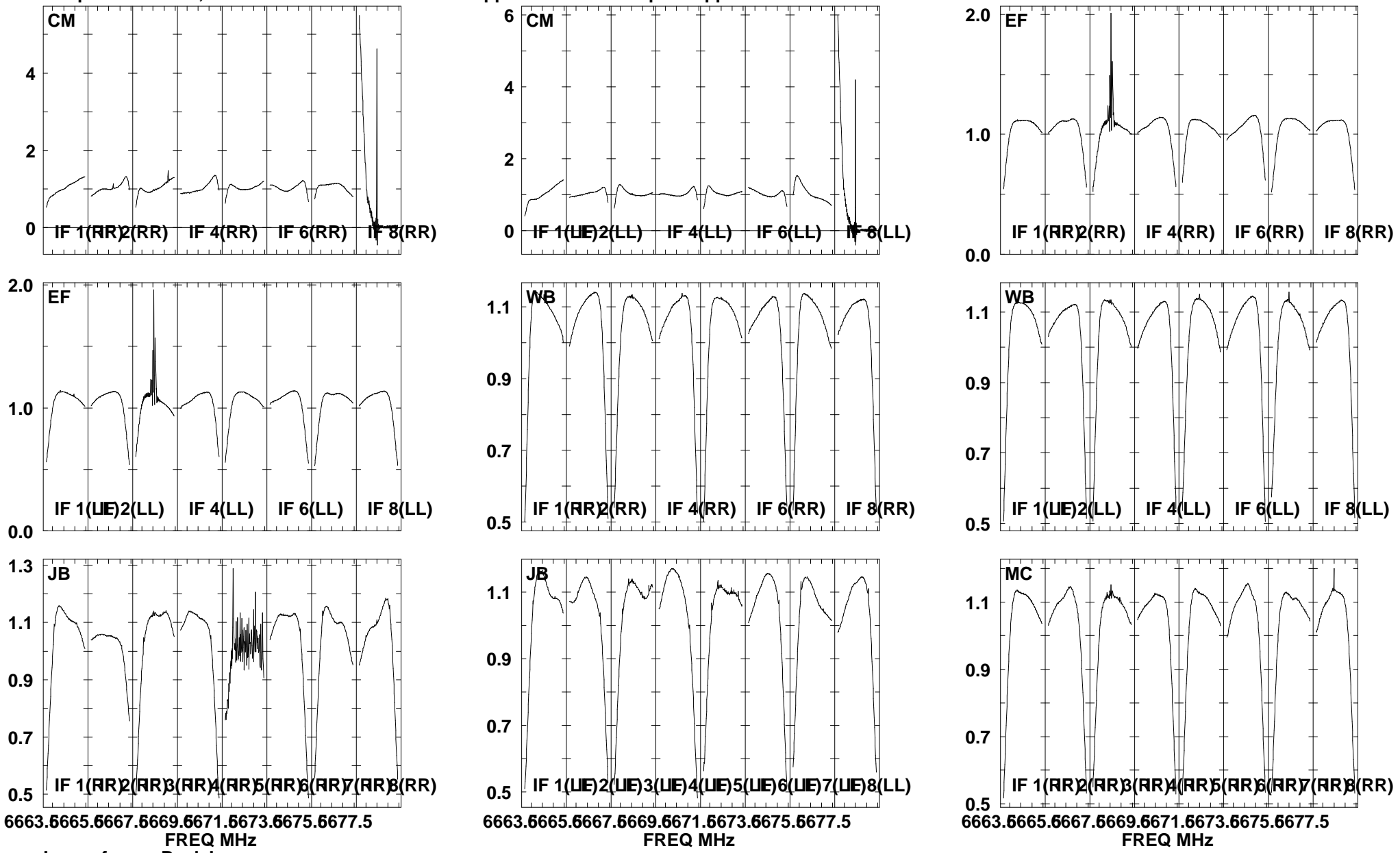

Lower frame: Real Jy
 Total-power spectrum Antenna: *
 Timerange: 00/07:45:34 to 00/07:48:02

Plot file version 127 created 22-JUN-2006 20:09:42
 G16.59-0 EM061A 1.UVDATA.1
 Freq = 6.6631 GHz, Bw = 2.000 MH No calibration applied and no bandpass applied

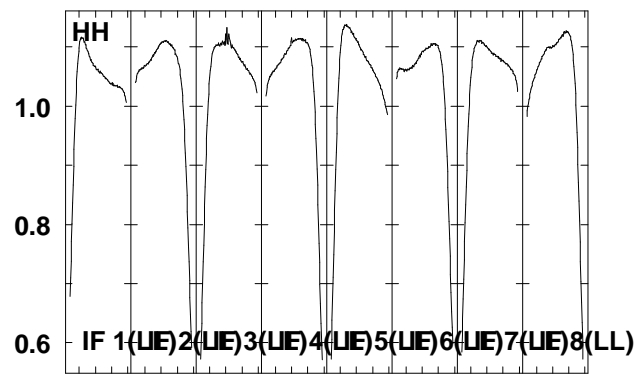
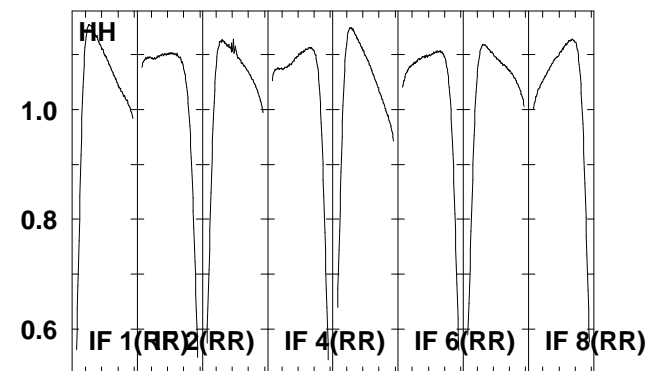
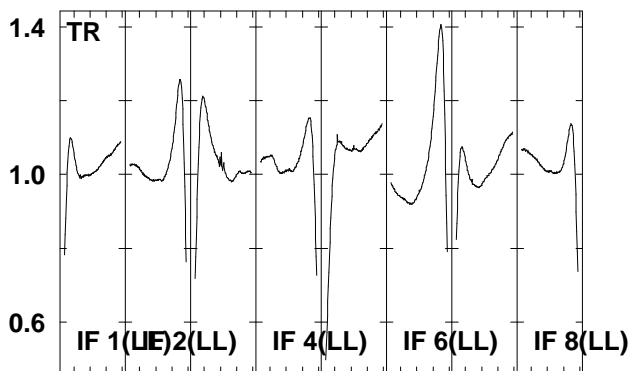
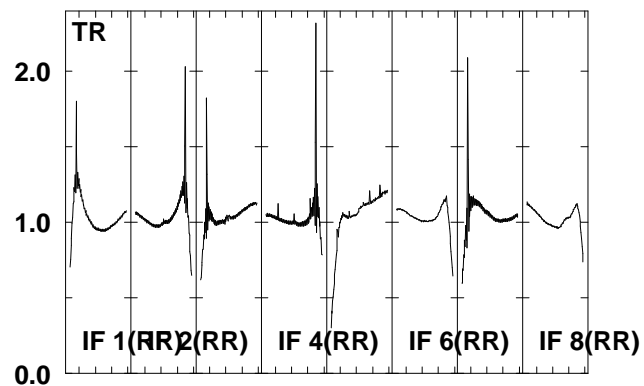
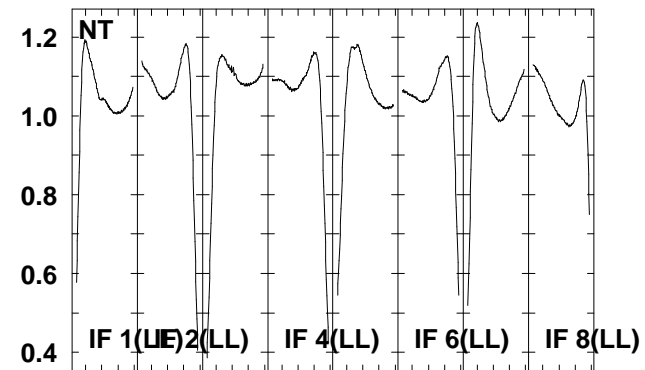
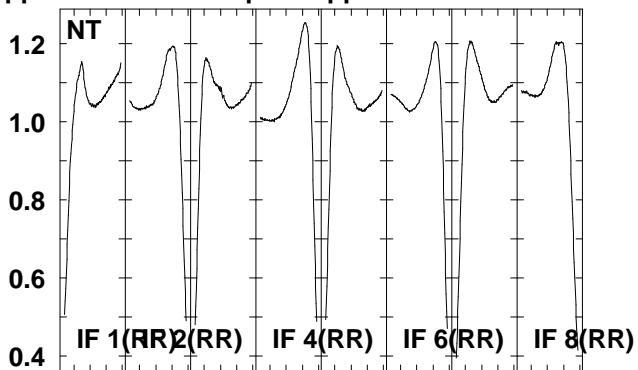
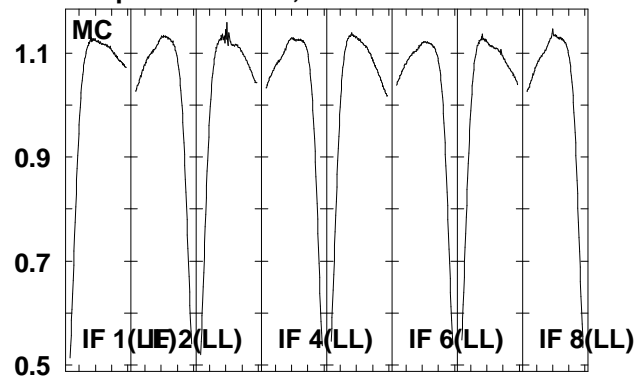

6663.6665.6667.6669.6671.6673.6675.6677.5
 FREQ MHz

Lower frame: Real Jy
 Total-power spectrum Antenna: *
 Timerange: 00/07:45:34 to 00/07:48:02

Plot file version 128 created 22-JUN-2006 20:09:45
 J1825-17 EM061A 1.UVDATA.1
 Freq = 6.6631 GHz, Bw = 2.000 MH No calibration applied and no bandpass applied

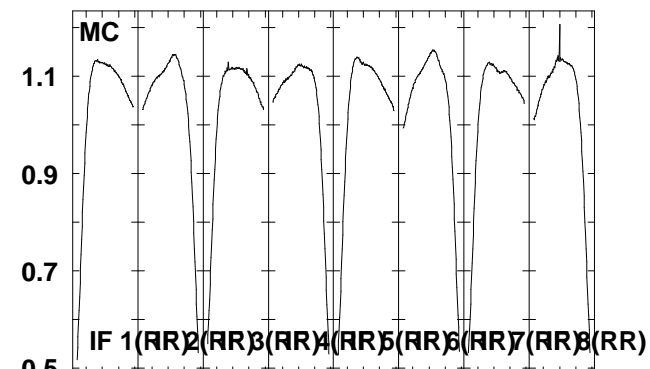
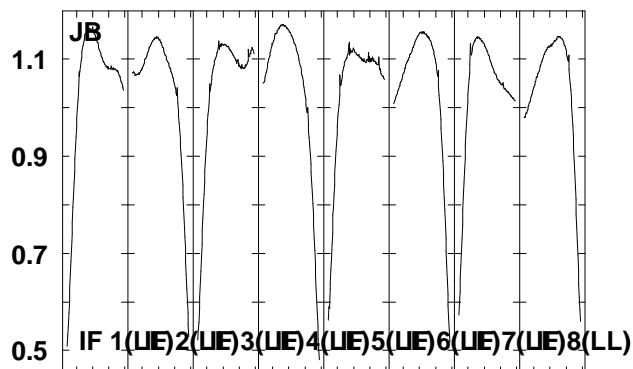
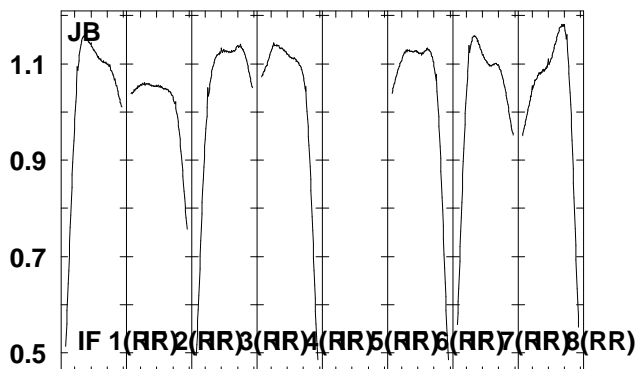
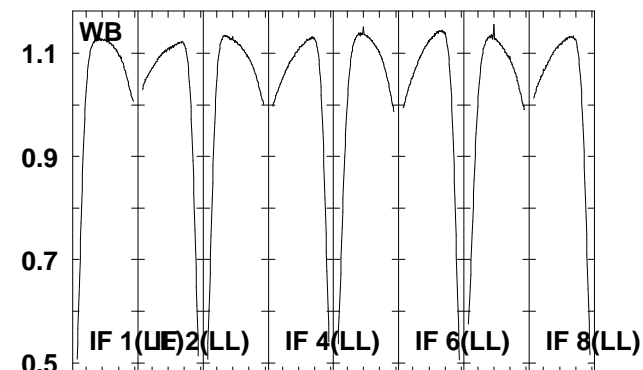
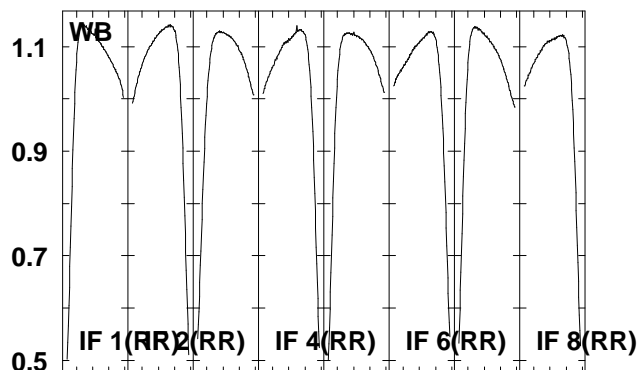
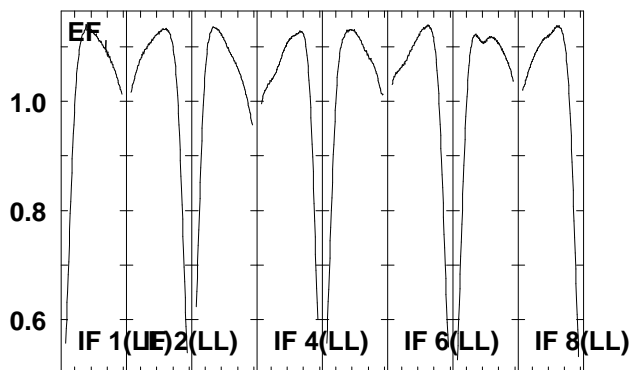
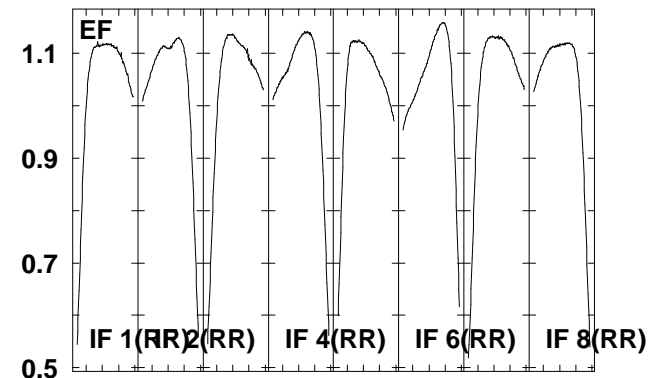
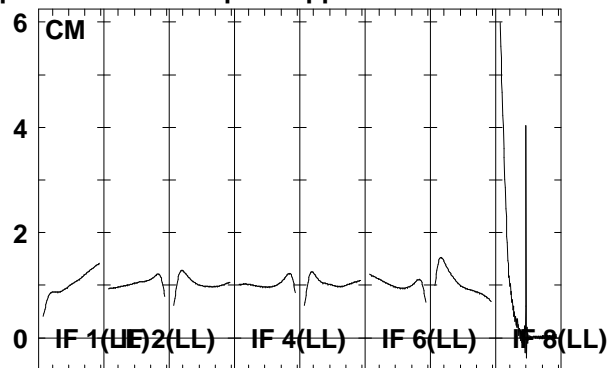
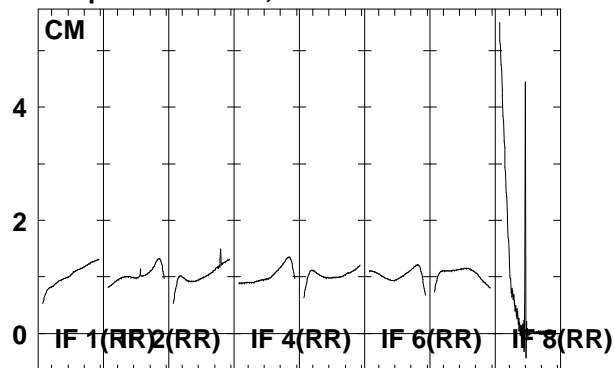

6663.6665.6667.6669.6671.6673.6675.6677.5
 FREQ MHz

6663.6665.6667.6669.6671.6673.6675.6677.5
 FREQ MHz

6663.6665.6667.6669.6671.6673.6675.6677.5
 FREQ MHz

Lower frame: Real Jy
 Total-power spectrum Antenna: *
 Timerange: 00/07:48:04 to 00/07:51:02

Plot file version 129 created 22-JUN-2006 20:09:48

J1825-17 EM061A 1.UVDATA.1

Freq = 6.6631 GHz, Bw = 2.000 MH No calibration applied and no bandpass applied

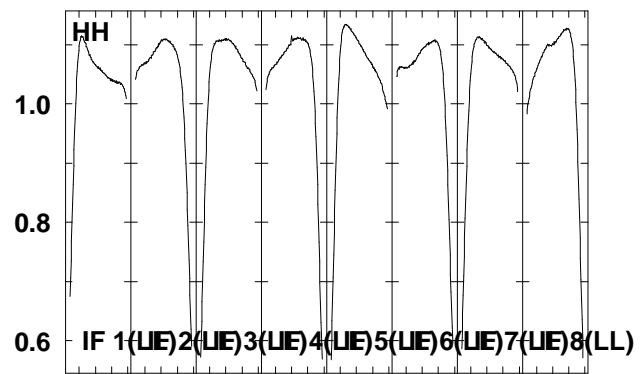
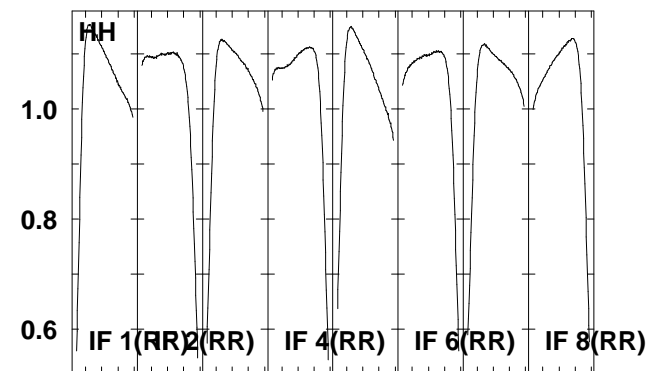
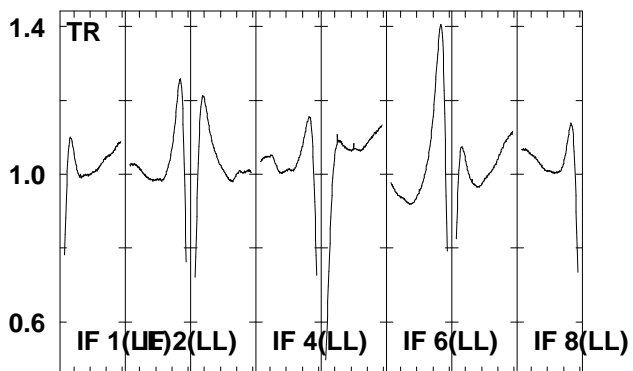
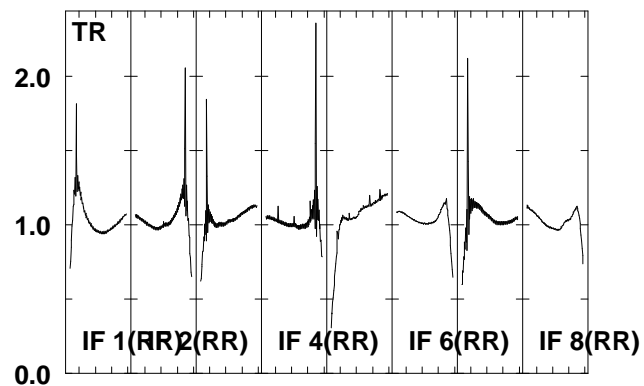
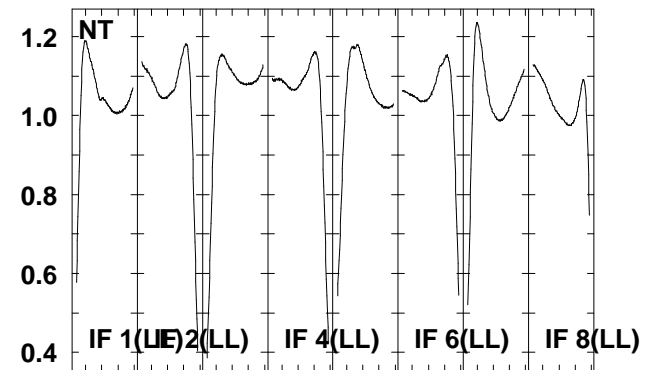
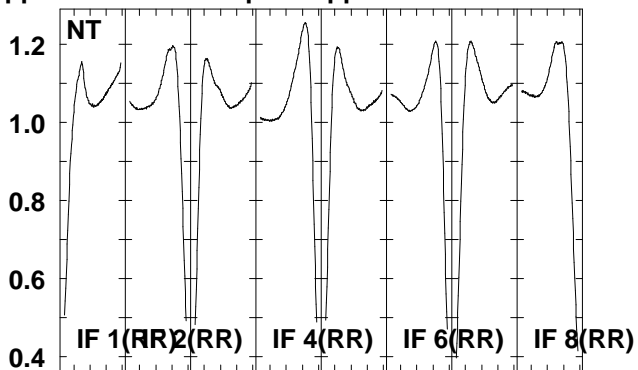
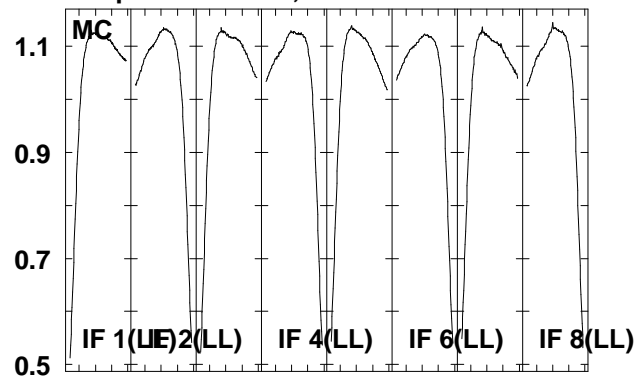

6663.6665.6667.6669.6671.6673.6675.6677.5

FREQ MHz

Lower frame: Real Jy

Total-power spectrum Antenna: *

Timerange: 00/07:48:04 to 00/07:51:02

Plot file version 130 created 22-JUN-2006 20:09:52
 G16.59-0 EM061A 1.UVDATA.1
 Freq = 6.6631 GHz, Bw = 2.000 MH No calibration applied and no bandpass applied

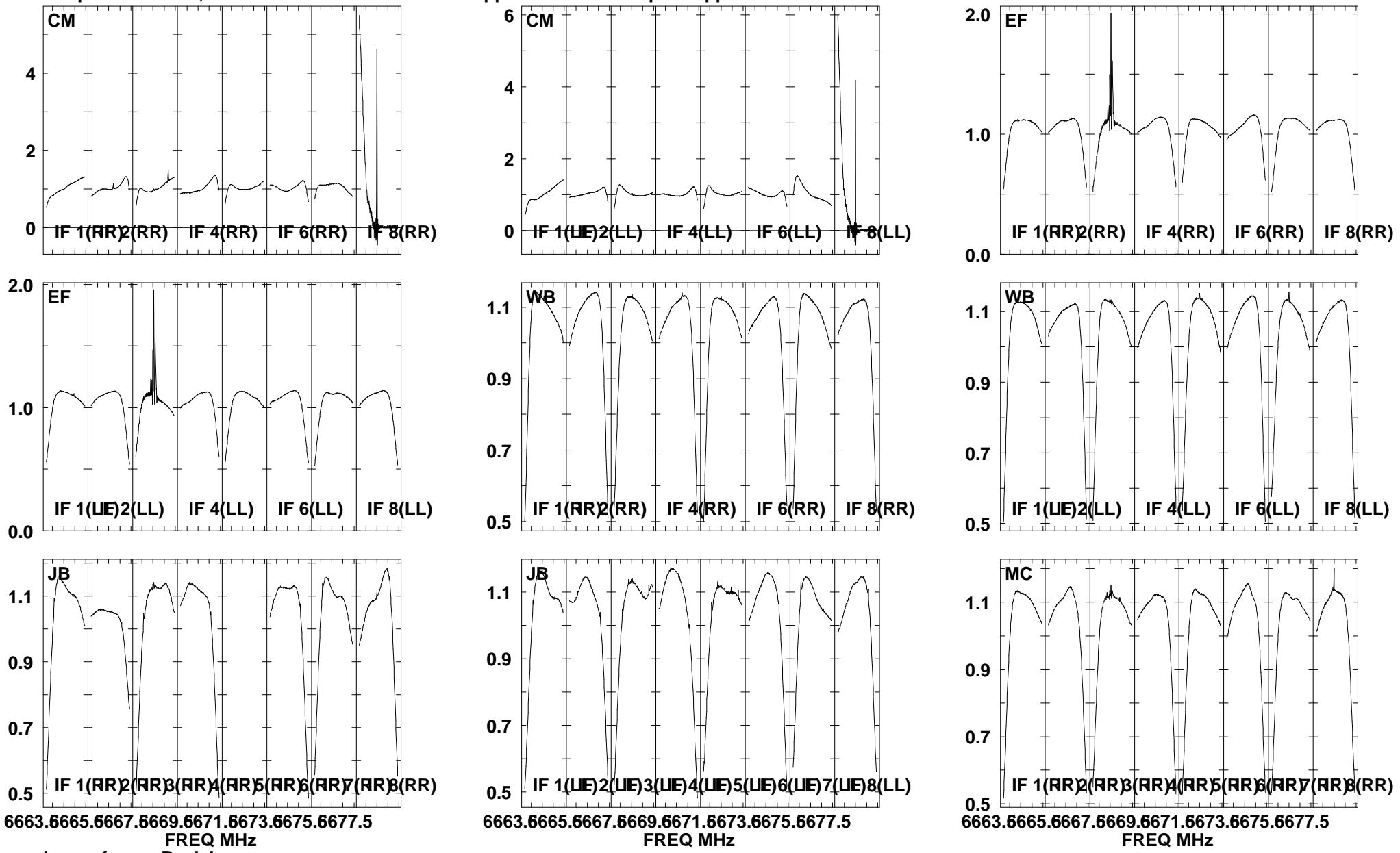

Lower frame: Real Jy
 Total-power spectrum Antenna: *
 Timerange: 00/07:51:04 to 00/07:53:32

Plot file version 131 created 22-JUN-2006 20:09:56
 G16.59-0 EM061A 1.UVDATA.1
 Freq = 6.6631 GHz, Bw = 2.000 MH No calibration applied and no bandpass applied

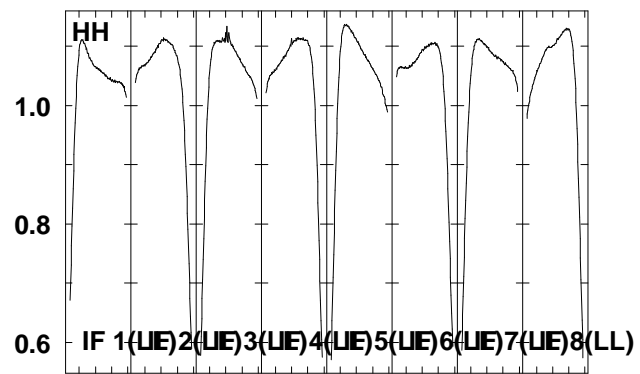
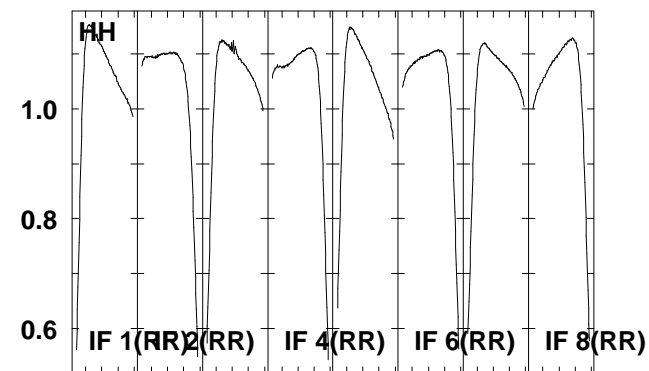
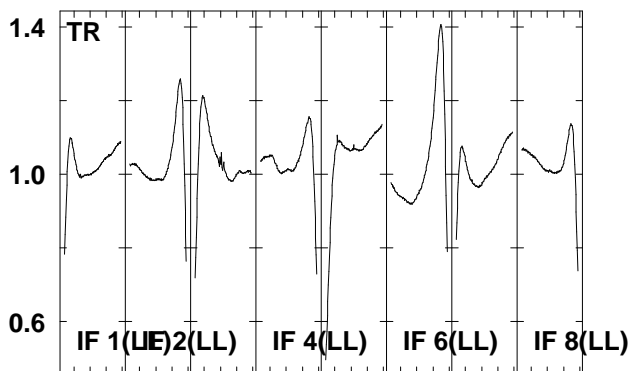
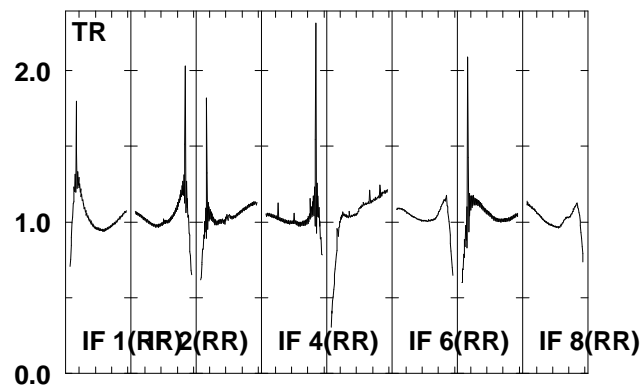
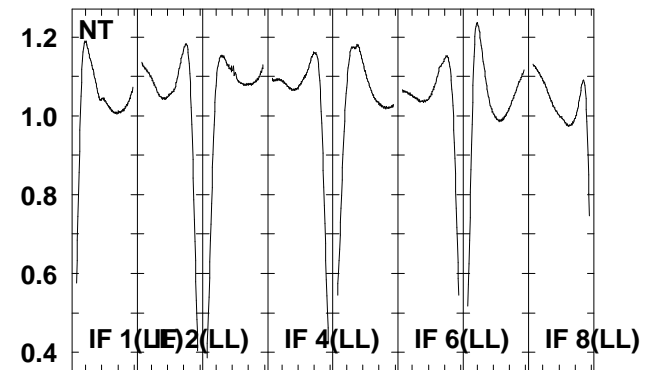
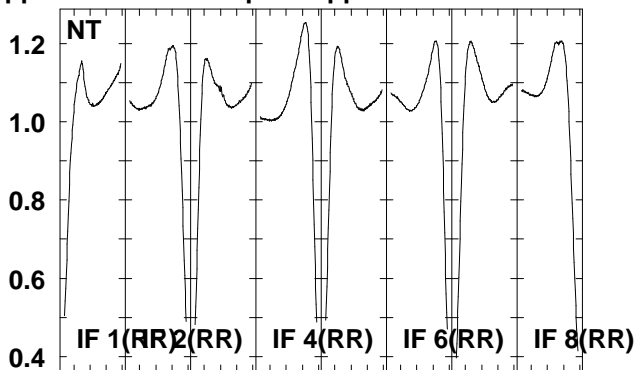
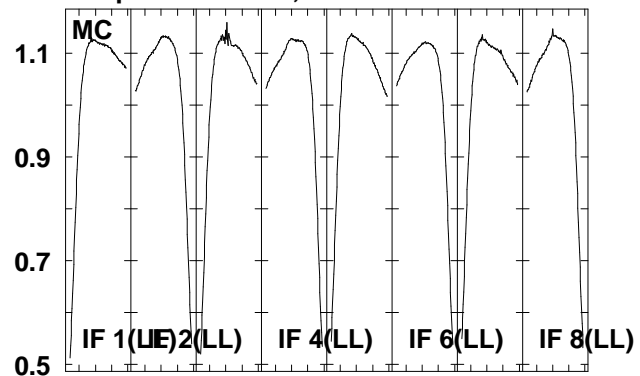

6663.6665.6667.6669.6671.6673.6675.6677.5
 FREQ MHz

Lower frame: Real Jy
 Total-power spectrum Antenna: *
 Timerange: 00/07:51:04 to 00/07:53:32

Plot file version 132 created 22-JUN-2006 20:09:59
 J1825-17 EM061A 1.UVDATA.1
 Freq = 6.6631 GHz, Bw = 2.000 MH No calibration applied and no bandpass applied

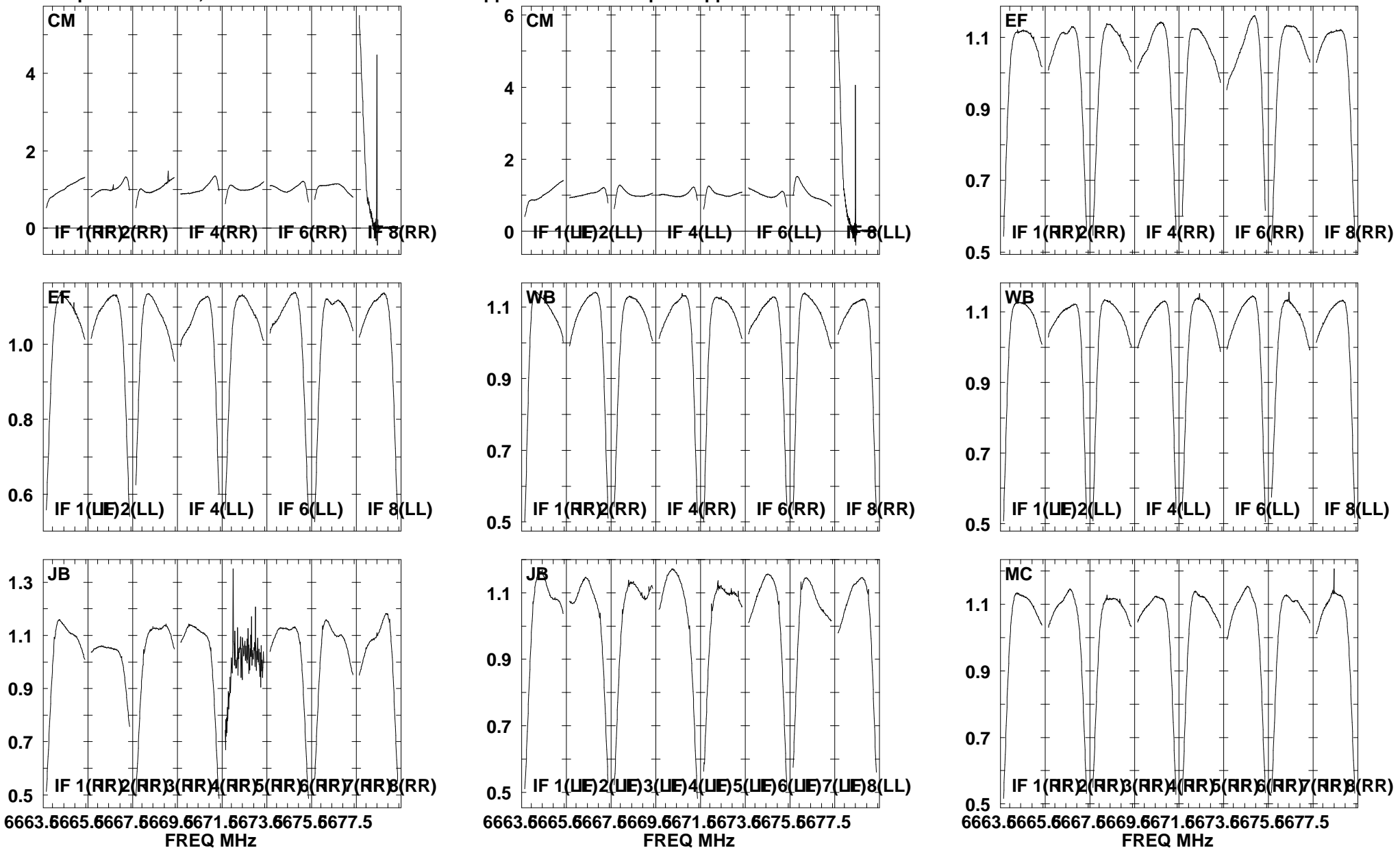

Lower frame: Real Jy
 Total-power spectrum Antenna: *
 Timerange: 00/07:53:34 to 00/07:56:07

Plot file version 133 created 22-JUN-2006 20:10:02

J1825-17 EM061A 1.UVDATA.1

Freq = 6.6631 GHz, Bw = 2.000 MH No calibration applied and no bandpass applied

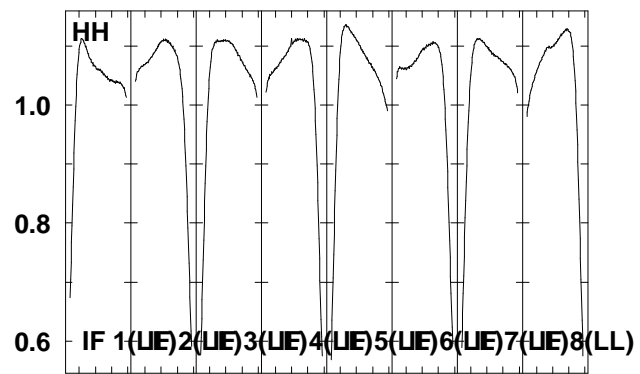
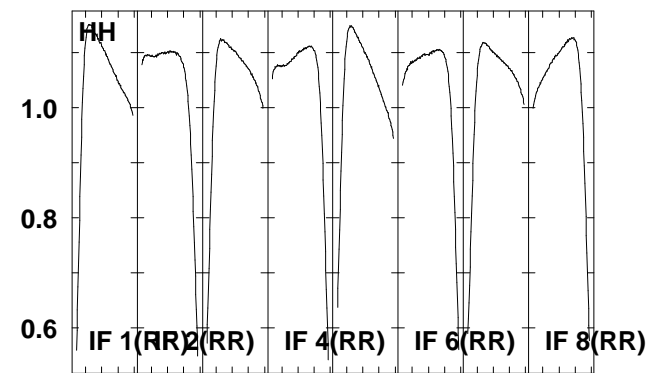
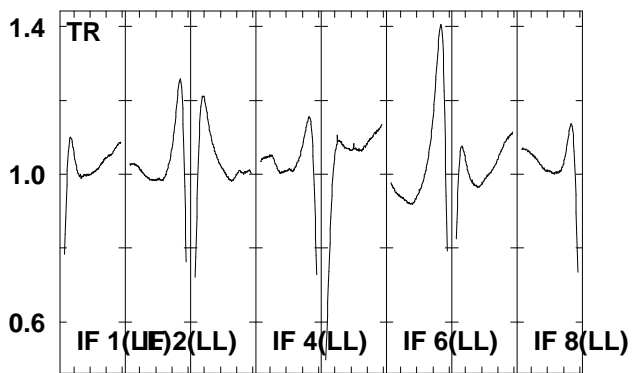
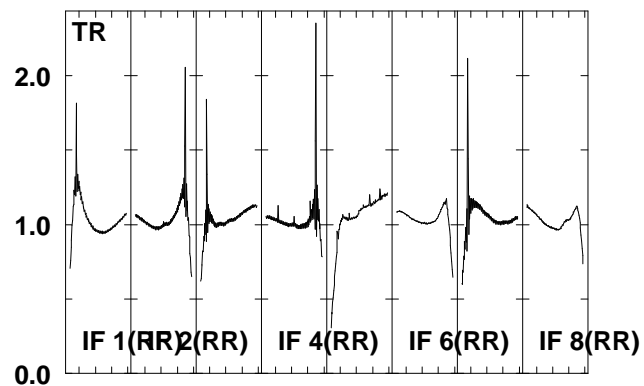
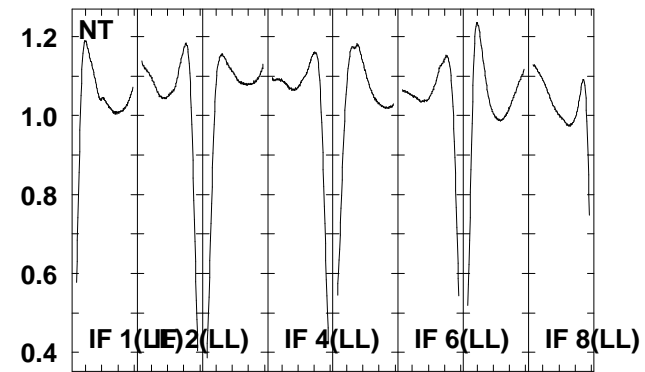
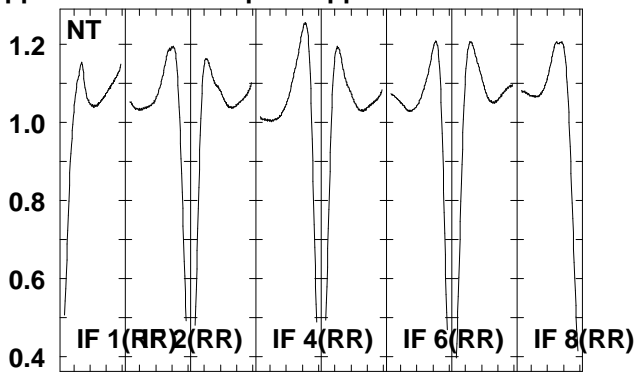
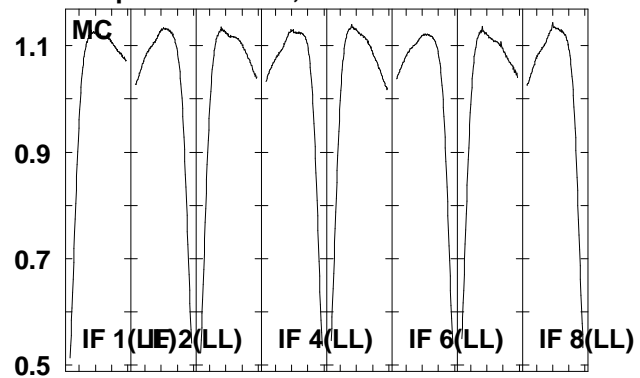

6663.6665.6667.6669.6671.6673.6675.6677.5

FREQ MHz

Lower frame: Real Jy

Total-power spectrum Antenna: *

Timerange: 00/07:53:34 to 00/07:56:07

Plot file version 134 created 22-JUN-2006 20:10:05
 J1825-17 EM061A 1.UVDATA.1
 Freq = 6.6631 GHz, Bw = 2.000 MH No calibration applied and no bandpass applied

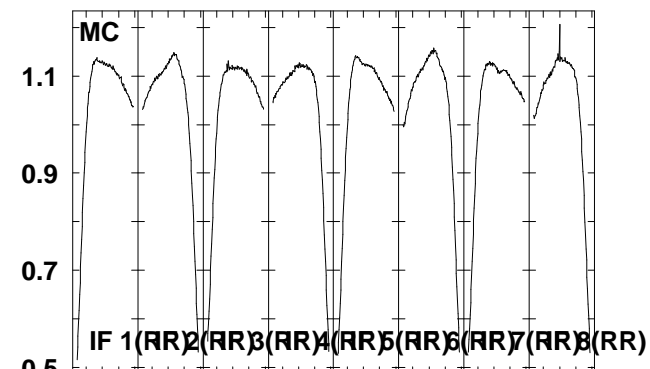
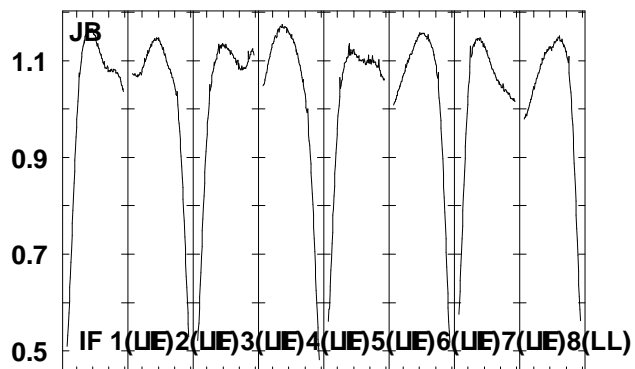
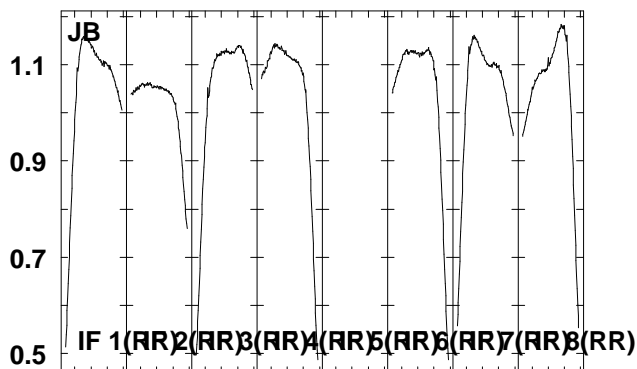
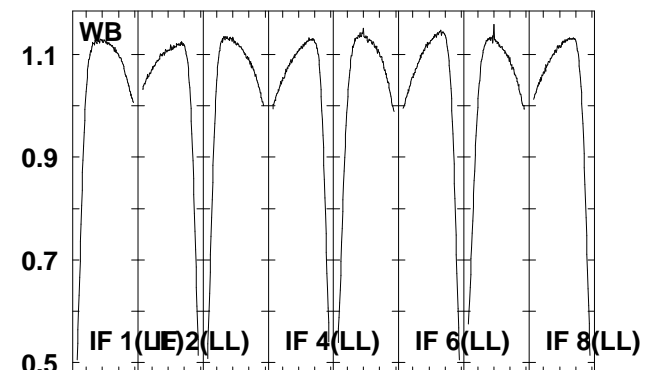
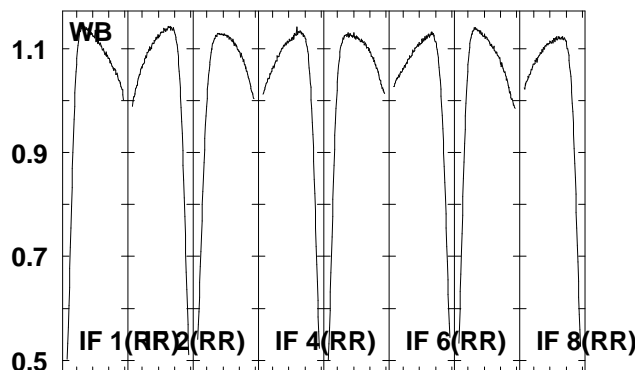
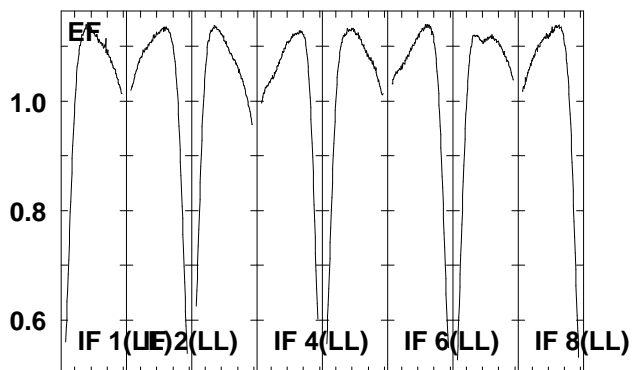
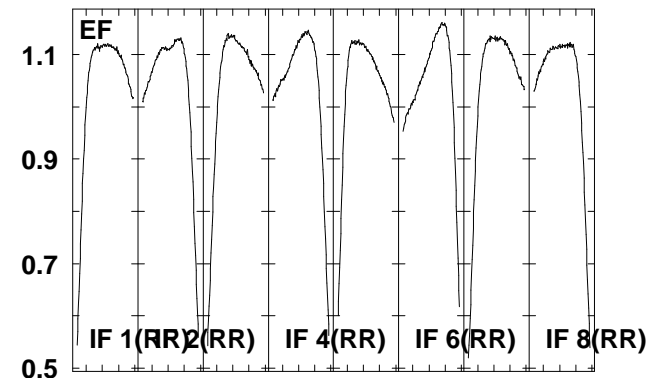
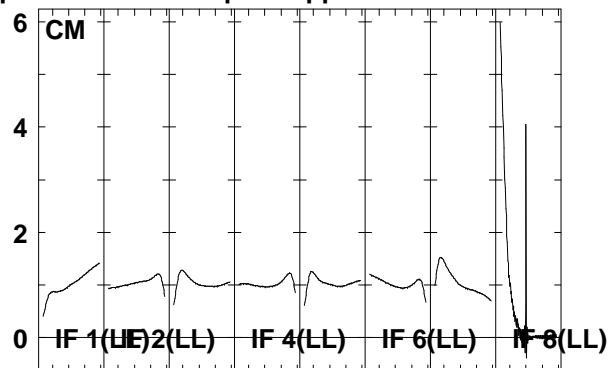
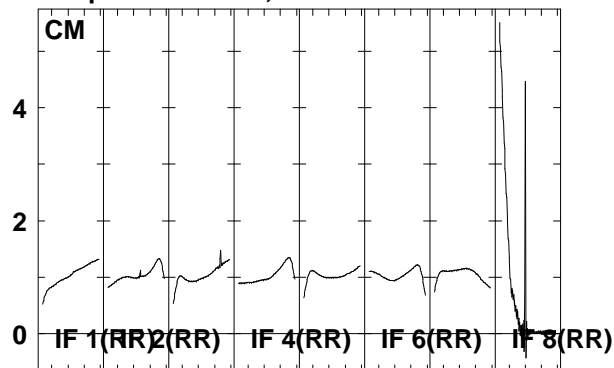

6663.6665.6667.6669.6671.6673.6675.6677.5
 FREQ MHz

6663.6665.6667.6669.6671.6673.6675.6677.5
 FREQ MHz

6663.6665.6667.6669.6671.6673.6675.6677.5
 FREQ MHz

Lower frame: Real Jy
 Total-power spectrum Antenna: *
 Timerange: 00/07:56:09 to 00/07:56:32

Plot file version 135 created 22-JUN-2006 20:10:06

J1825-17 EM061A 1.UVDATA.1

Freq = 6.6631 GHz, Bw = 2.000 MH No calibration applied and no bandpass applied

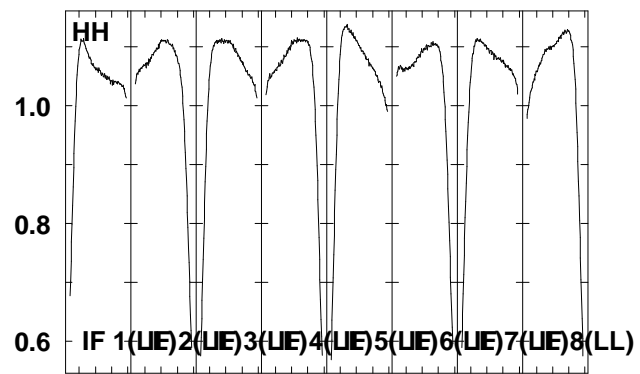
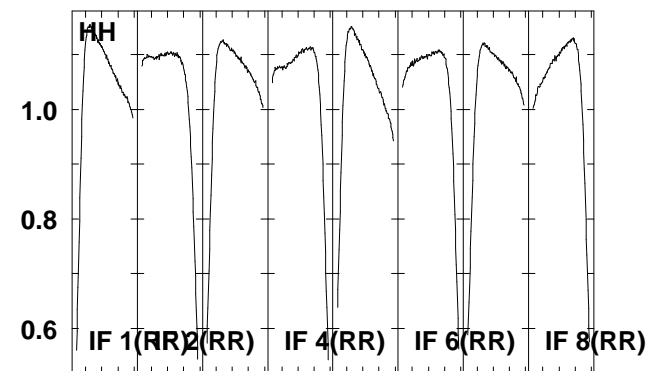
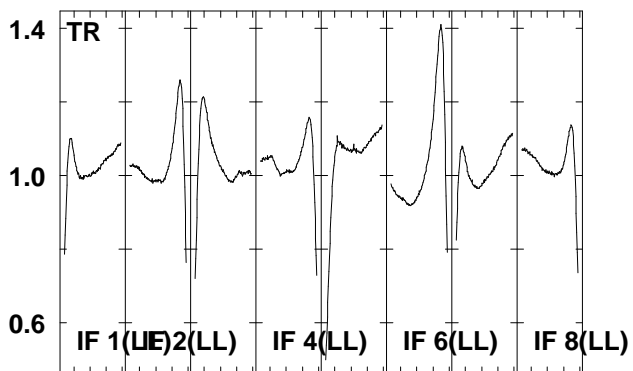
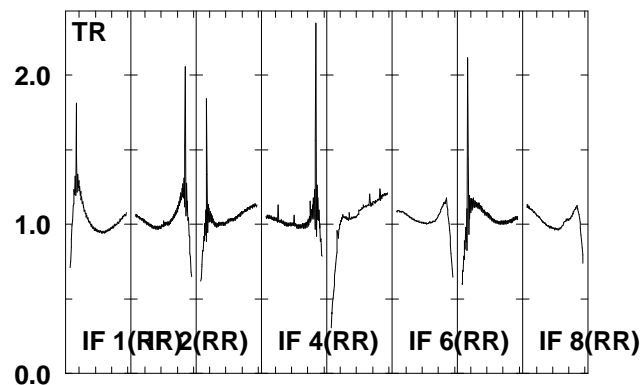
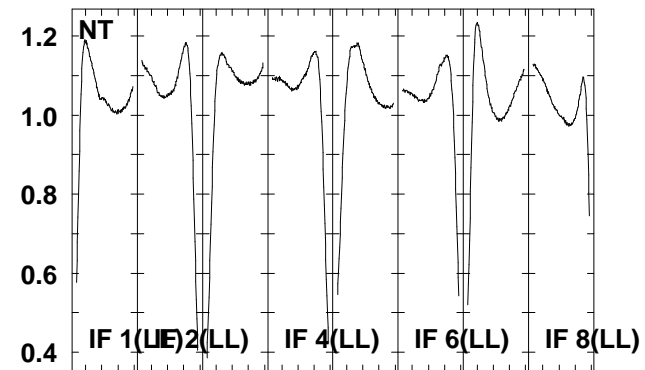
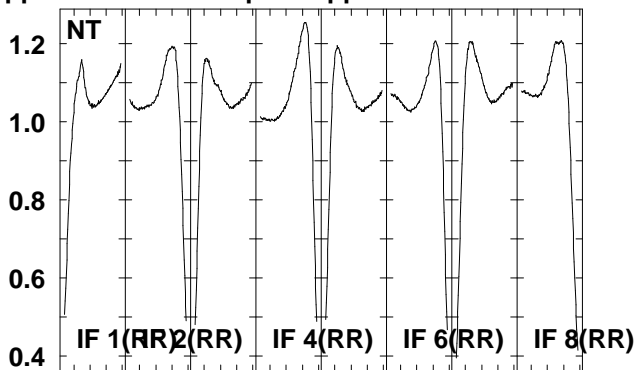
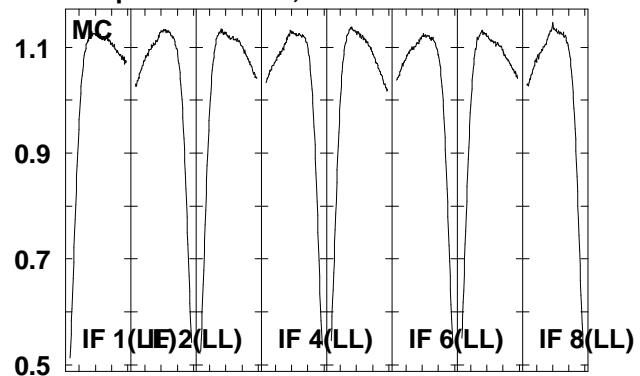

6663.6665.6667.6669.6671.6673.6675.6677.5

FREQ MHz

Lower frame: Real Jy

Total-power spectrum Antenna: *

Timerange: 00/07:56:09 to 00/07:56:32

Plot file version 136 created 22-JUN-2006 20:10:08
 G16.59-0 EM061A 1.UVDATA.1
 Freq = 6.6631 GHz, Bw = 2.000 MH No calibration applied and no bandpass applied

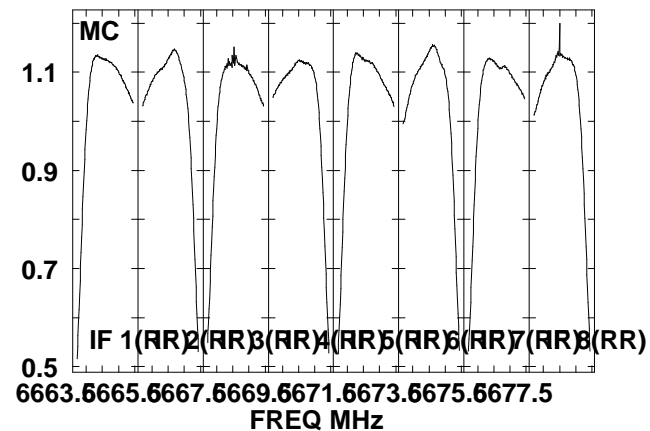
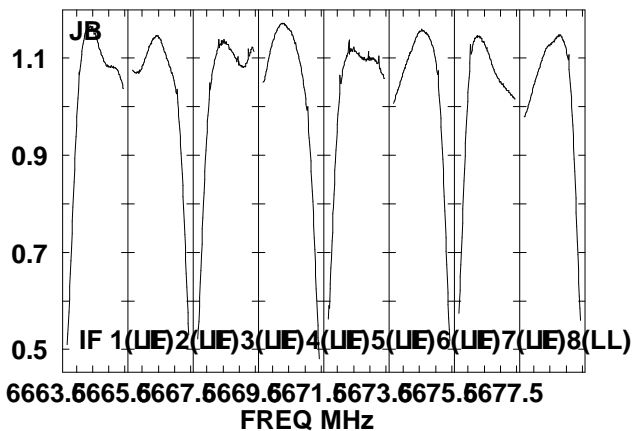
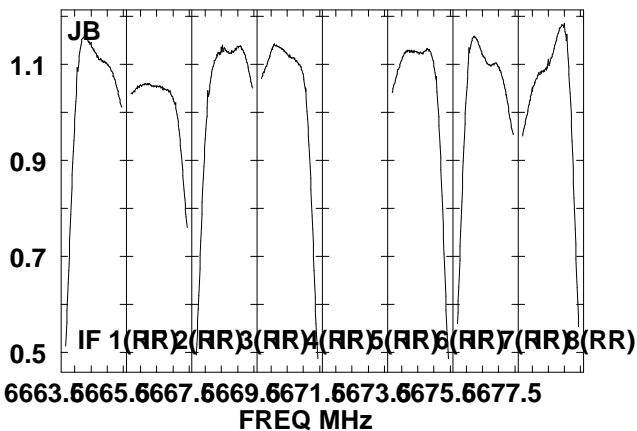
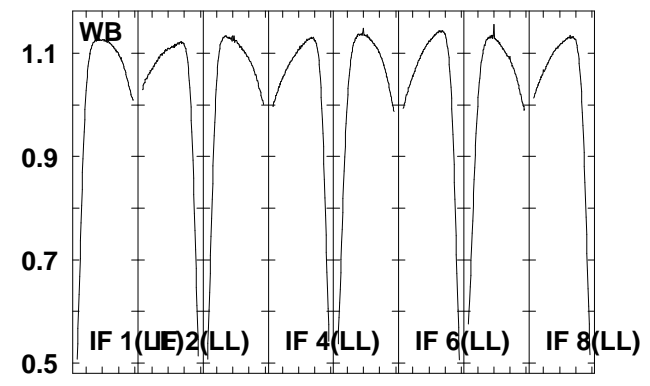
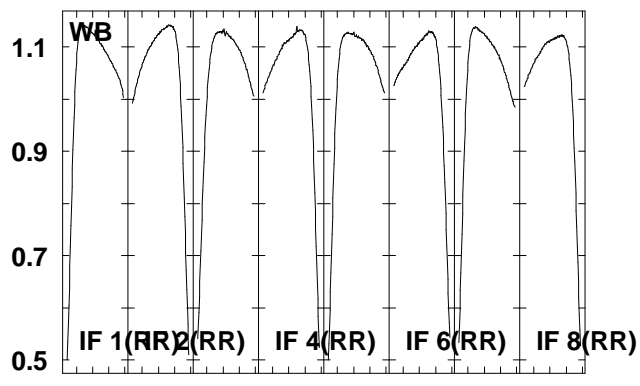
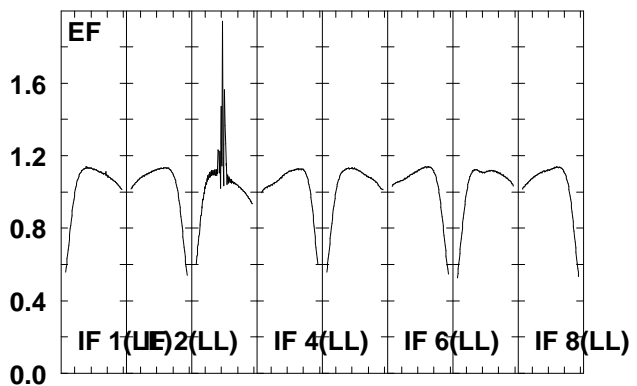
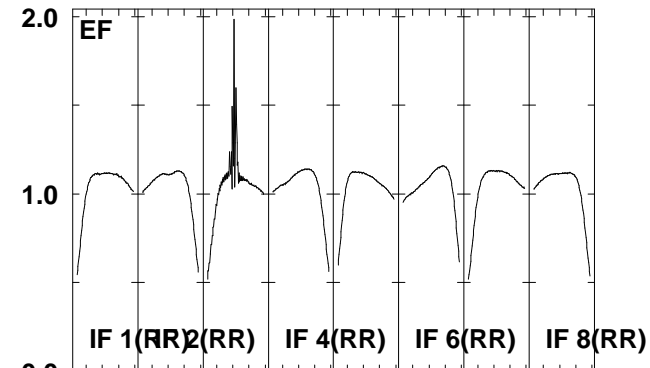
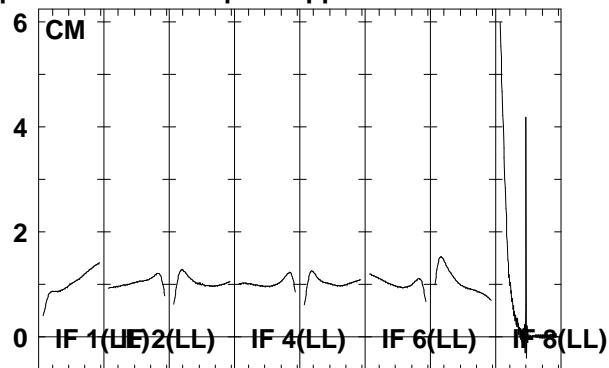
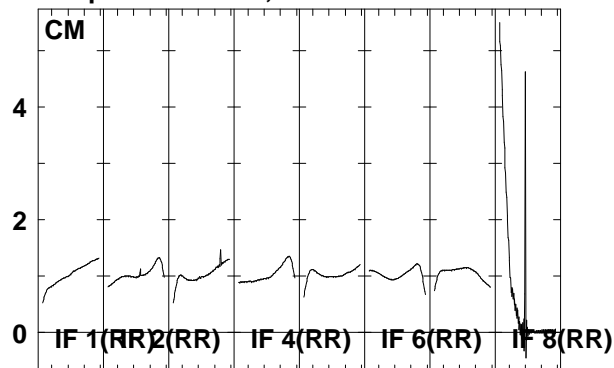

6663.6665.6667.6669.6671.6673.6675.6677.5
 FREQ MHz
 Lower frame: Real Jy
 Total-power spectrum Antenna: *
 Timerange: 00/07:56:34 to 00/07:59:02

Plot file version 137 created 22-JUN-2006 20:10:11
 G16.59-0 EM061A 1.UVDATA.1
 Freq = 6.6631 GHz, Bw = 2.000 MH No calibration applied and no bandpass applied

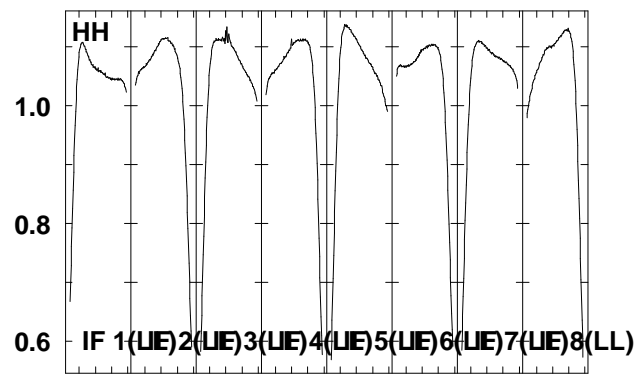
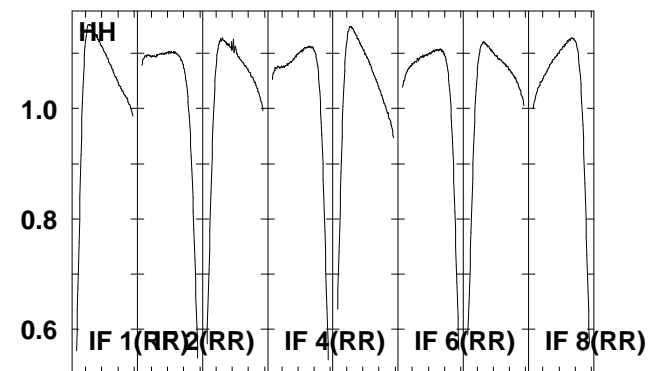
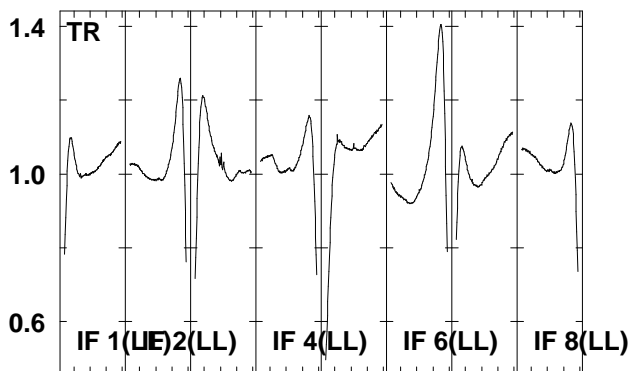
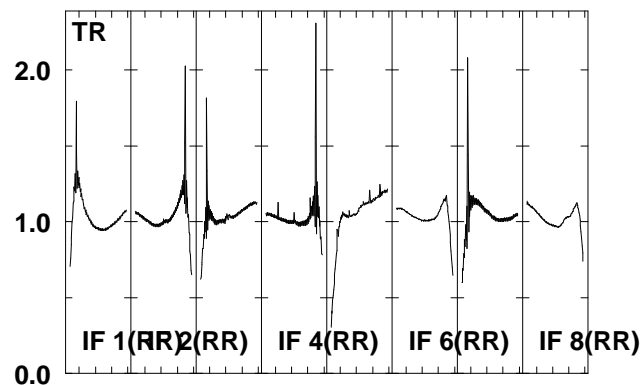
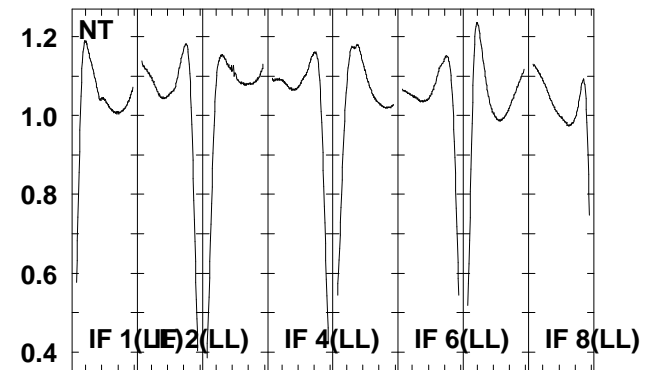
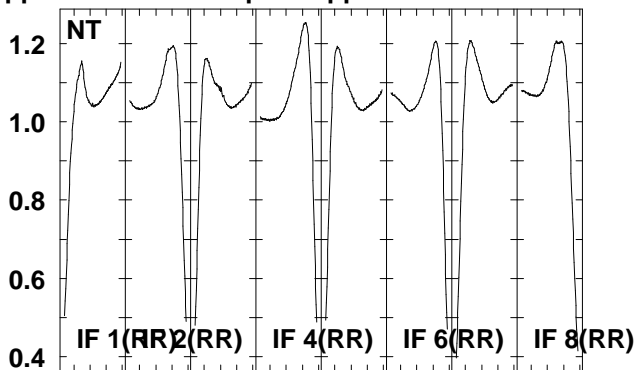
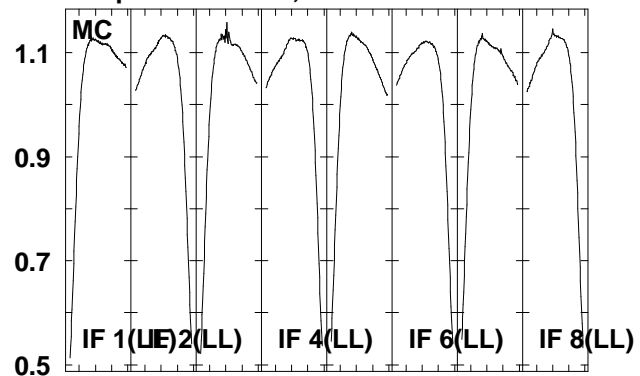

6663.6665.6667.6669.6671.6673.6675.6677.5
 FREQ MHz

Lower frame: Real Jy
 Total-power spectrum Antenna: *
 Timerange: 00/07:56:34 to 00/07:59:02

Plot file version 138 created 22-JUN-2006 20:10:16
 J1825-17 EM061A 1.UVDATA.1
 Freq = 6.6631 GHz, Bw = 2.000 MH No calibration applied and no bandpass applied

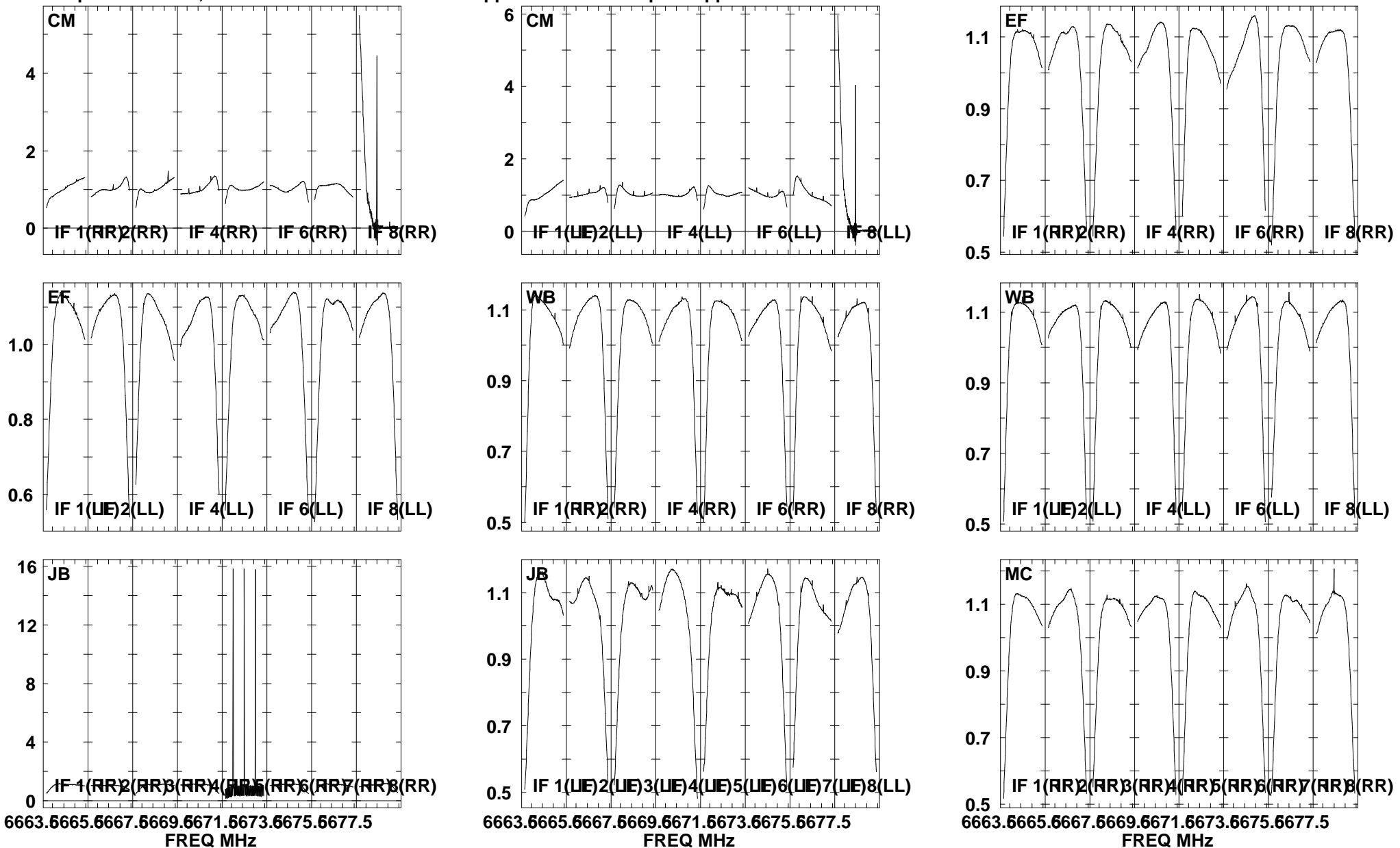

Lower frame: Real Jy
 Total-power spectrum Antenna: *
 Timerange: 00/08:00:35 to 00/08:03:32

Plot file version 139 created 22-JUN-2006 20:10:20
 J1825-17 EM061A 1.UVDATA.1
 Freq = 6.6631 GHz, Bw = 2.000 MH No calibration applied and no bandpass applied

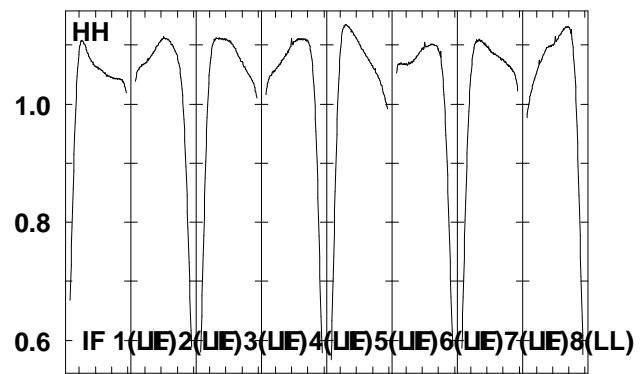
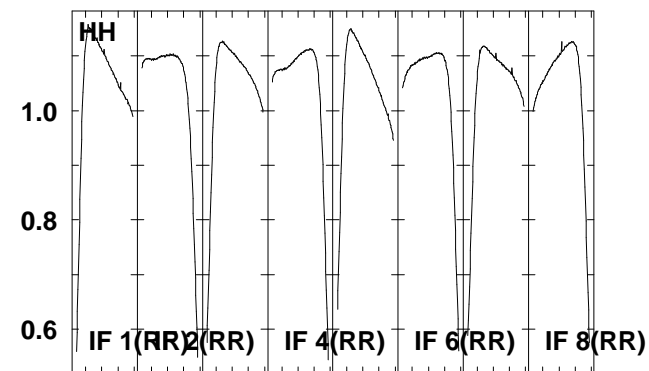
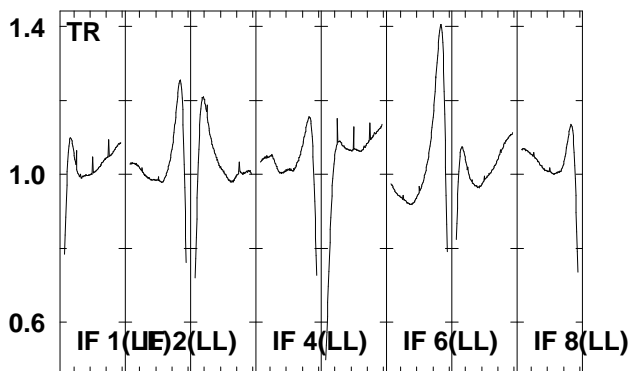
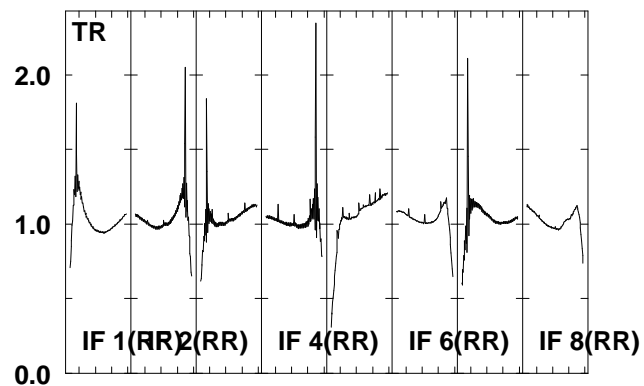
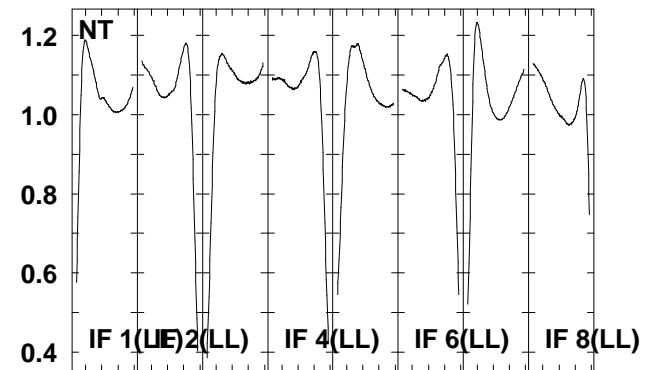
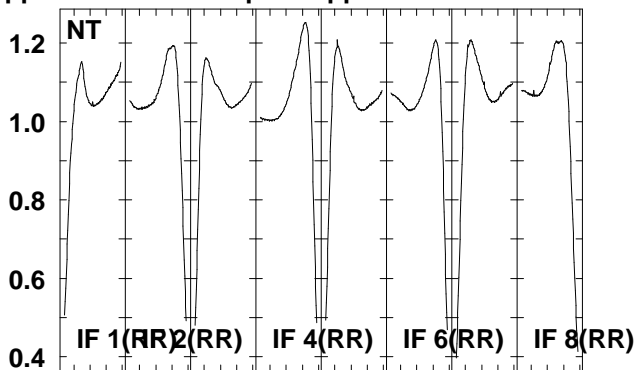
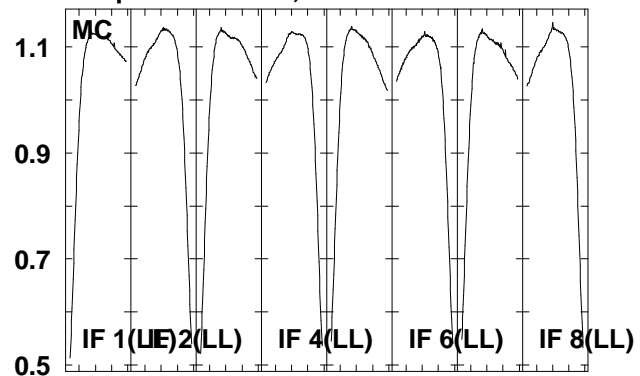

6663.6665.6667.6669.6671.6673.6675.6677.5
 FREQ MHz

Lower frame: Real Jy
 Total-power spectrum Antenna: *
 Timerange: 00/08:00:35 to 00/08:03:32

Plot file version 140 created 22-JUN-2006 20:10:24
 G16.59-0 EM061A 1.UVDATA.1
 Freq = 6.6631 GHz, Bw = 2.000 MH No calibration applied and no bandpass applied

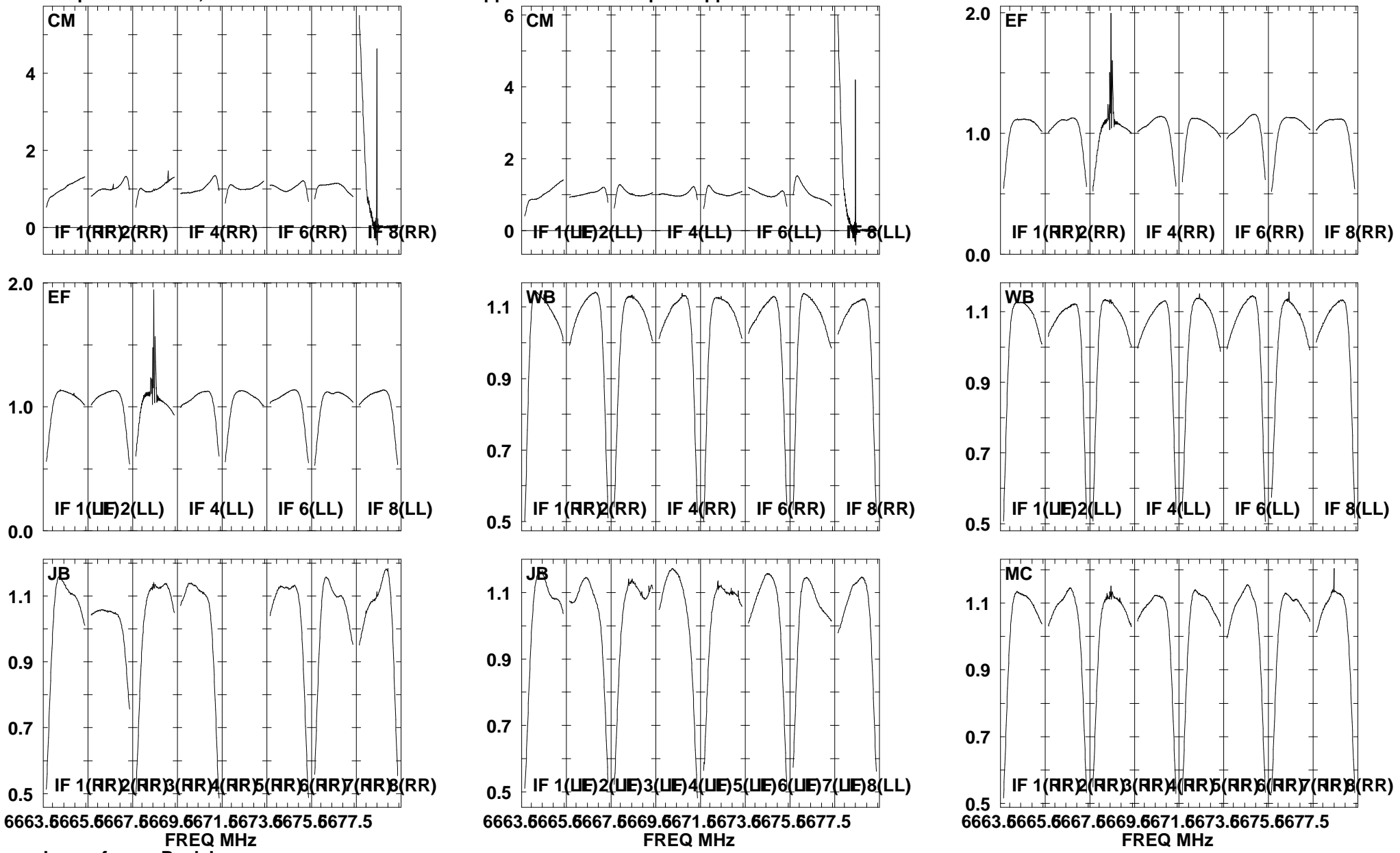

Lower frame: Real Jy
 Total-power spectrum Antenna: *
 Timerange: 00/08:03:34 to 00/08:06:02

Plot file version 141 created 22-JUN-2006 20:10:28
 G16.59-0 EM061A 1.UVDATA.1
 Freq = 6.6631 GHz, Bw = 2.000 MH No calibration applied and no bandpass applied

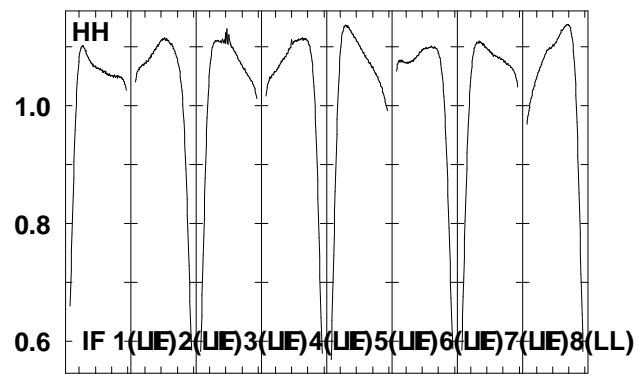
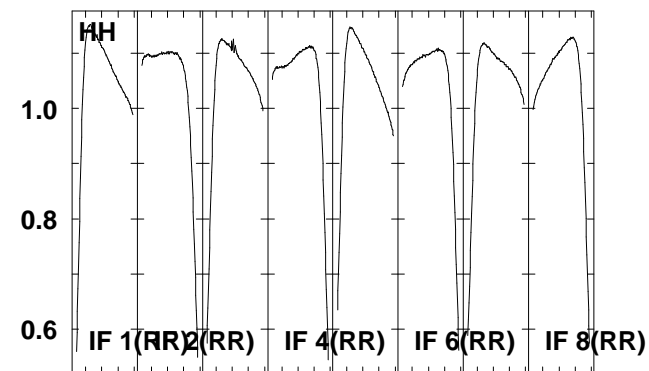
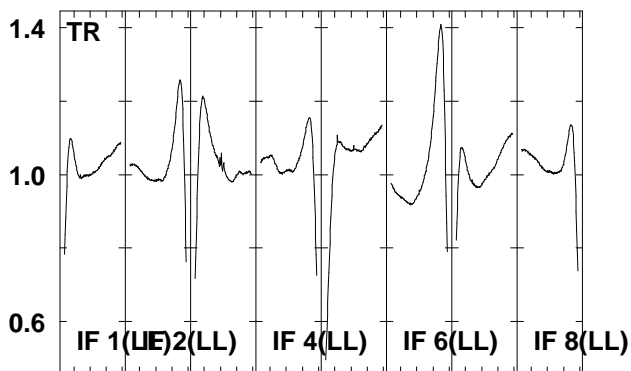
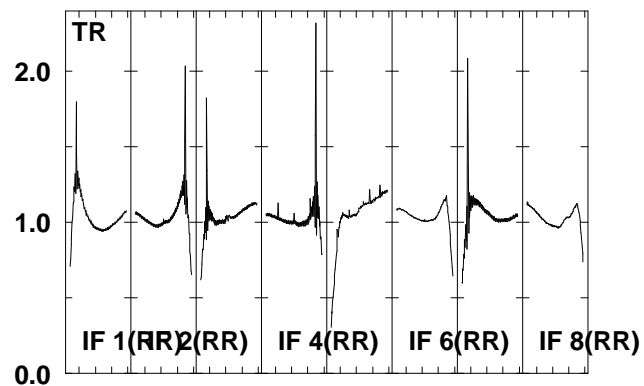
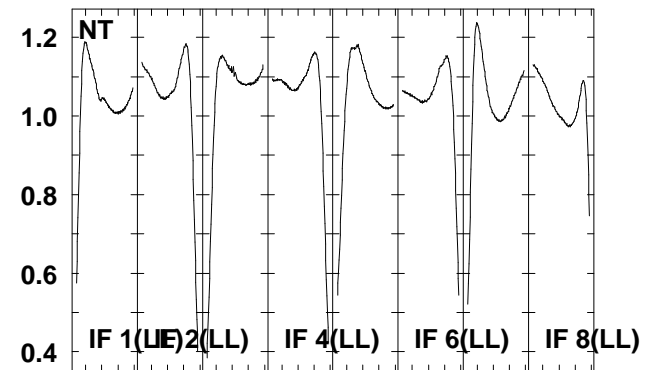
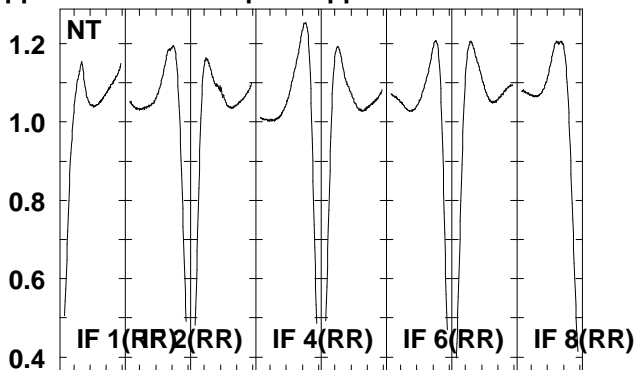
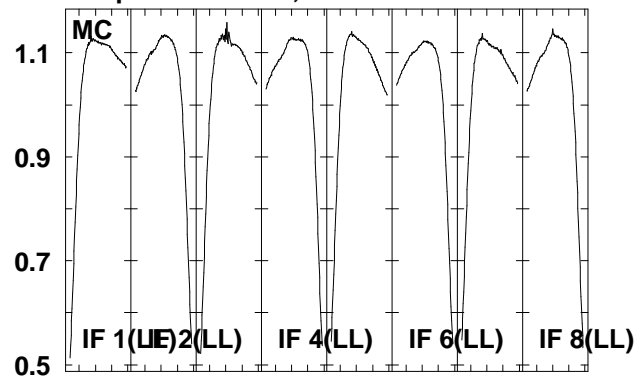

6663.6665.6667.6669.6671.6673.6675.6677.5
 FREQ MHz

Lower frame: Real Jy
 Total-power spectrum Antenna: *
 Timerange: 00/08:03:34 to 00/08:06:02

Plot file version 142 created 22-JUN-2006 20:10:32
 J1825-17 EM061A 1.UVDATA.1
 Freq = 6.6631 GHz, Bw = 2.000 MH No calibration applied and no bandpass applied

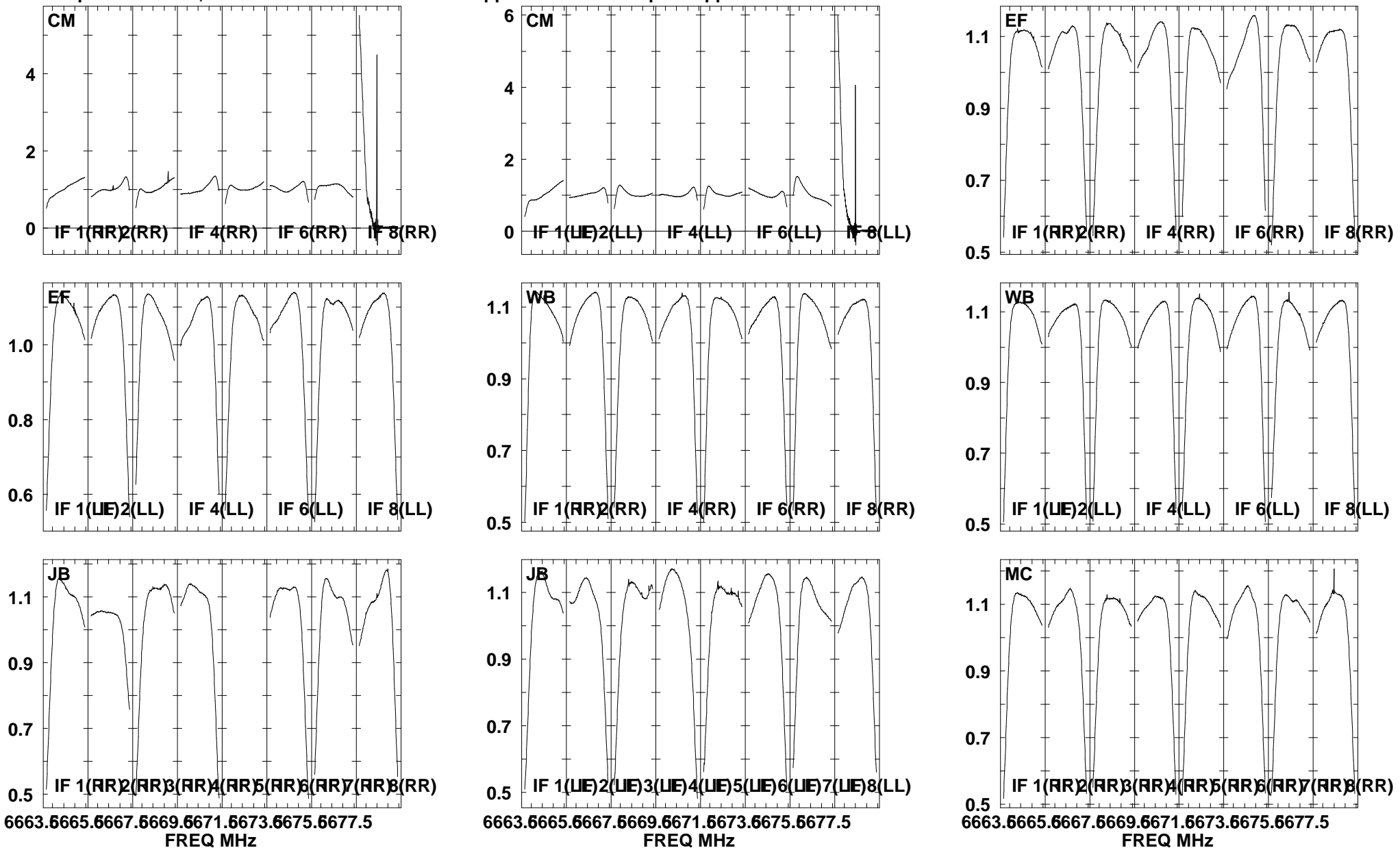

Lower frame: Real Jy
 Total-power spectrum Antenna: *
 Timerange: 00/08:06:04 to 00/08:09:02

Plot file version 143 created 22-JUN-2006 20:10:36

J1825-17 EM061A 1.UVDATA.1

Freq = 6.6631 GHz, Bw = 2.000 MH No calibration applied and no bandpass applied

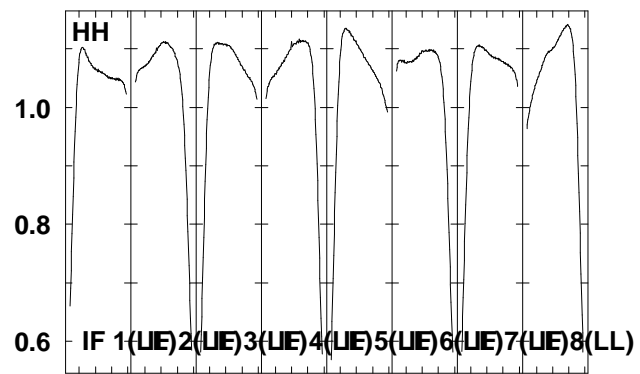
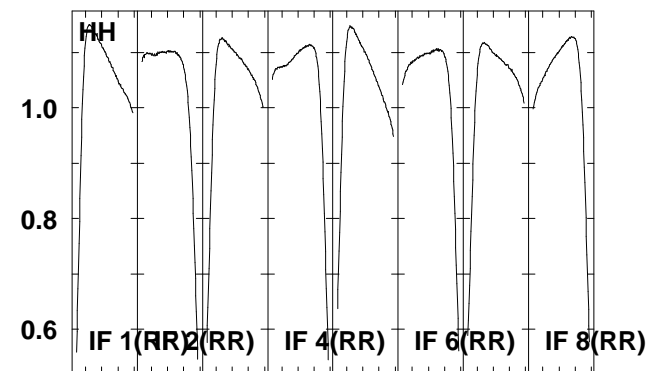
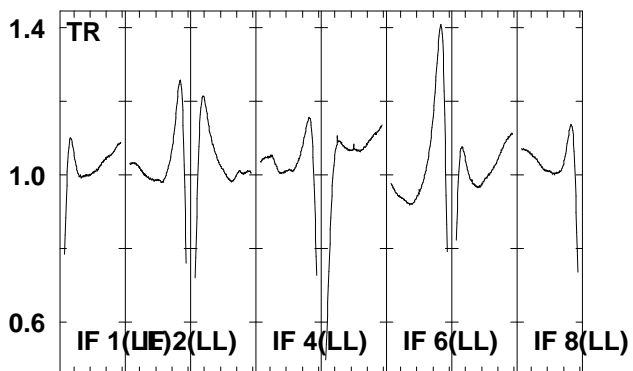
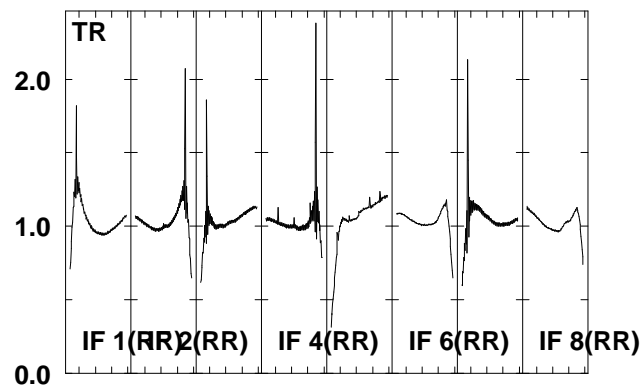
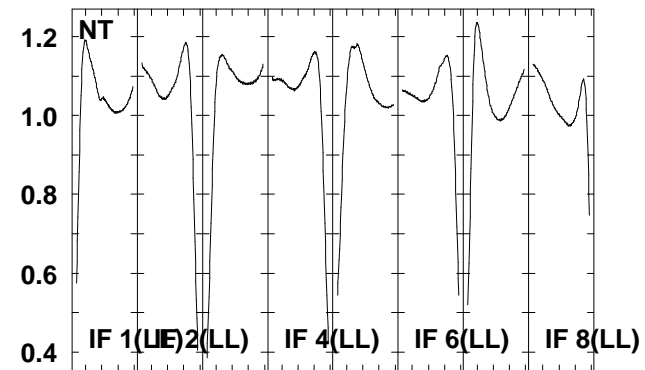
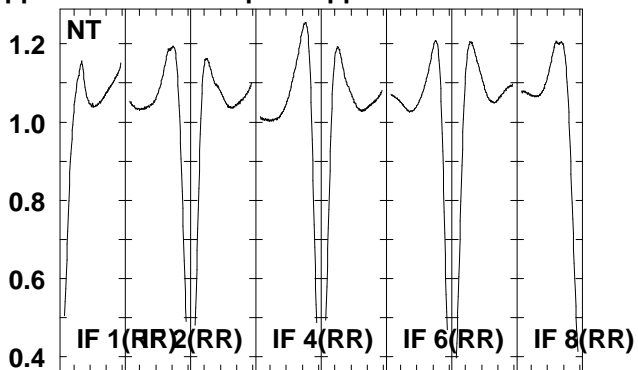
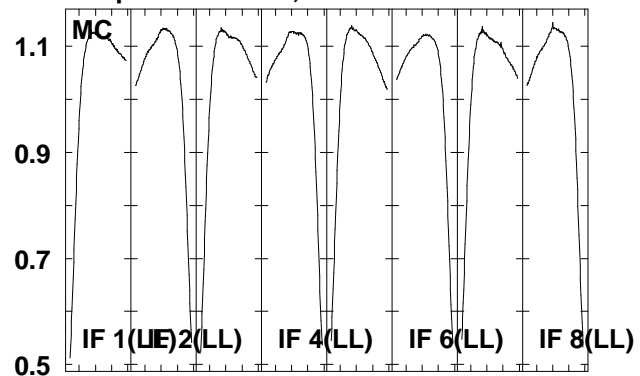

6663.6665.6667.6669.6671.6673.6675.6677.5

FREQ MHz

Lower frame: Real Jy

Total-power spectrum Antenna: *

Timerange: 00/08:06:04 to 00/08:09:02

Plot file version 144 created 22-JUN-2006 20:10:40
 G16.59-0 EM061A 1.UVDATA.1
 Freq = 6.6631 GHz, Bw = 2.000 MH No calibration applied and no bandpass applied

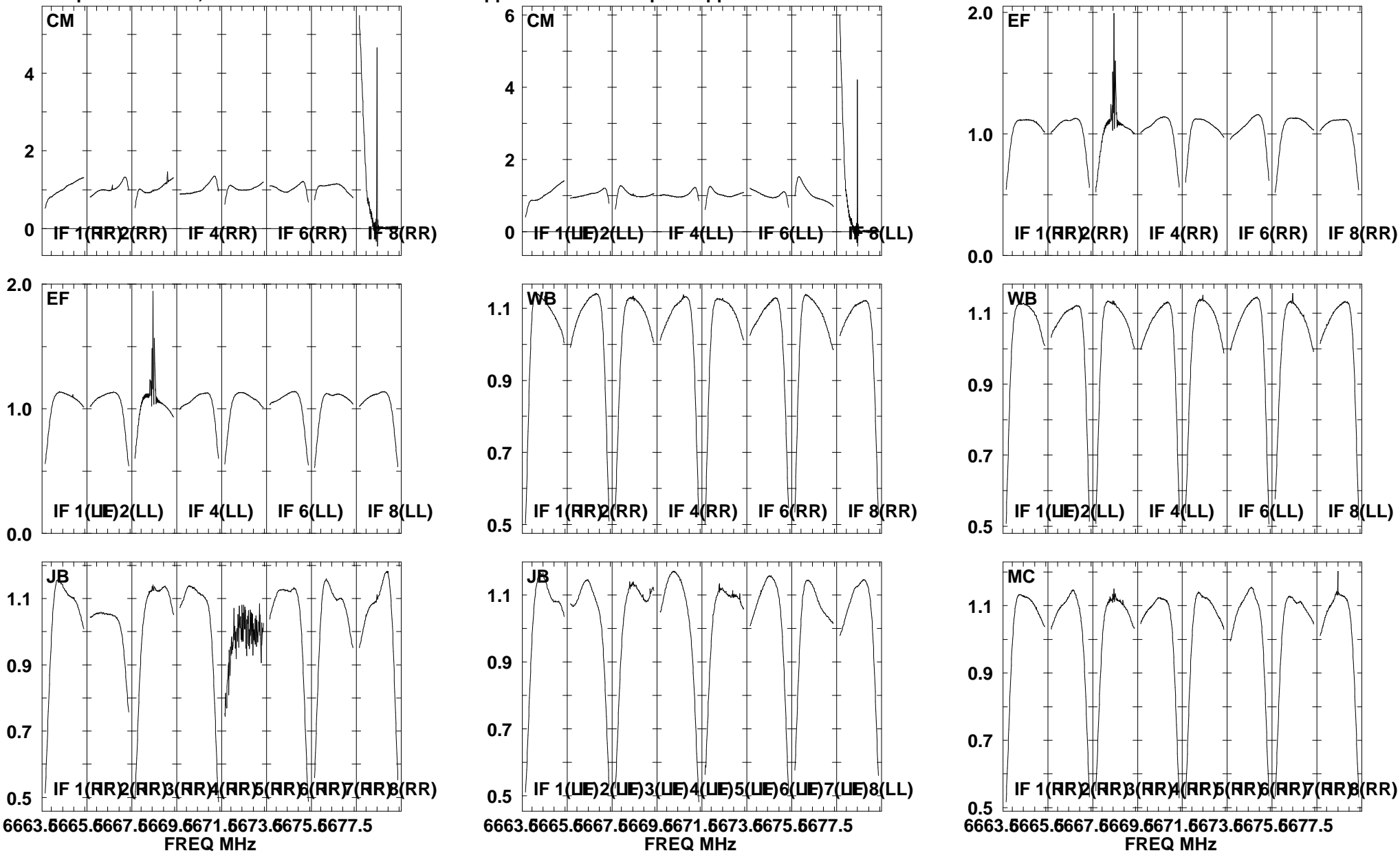

Lower frame: Real Jy
 Total-power spectrum Antenna: *
 Timerange: 00/08:09:04 to 00/08:11:32

Plot file version 145 created 22-JUN-2006 20:10:43
 G16.59-0 EM061A 1.UVDATA.1
 Freq = 6.6631 GHz, Bw = 2.000 MH No calibration applied and no bandpass applied

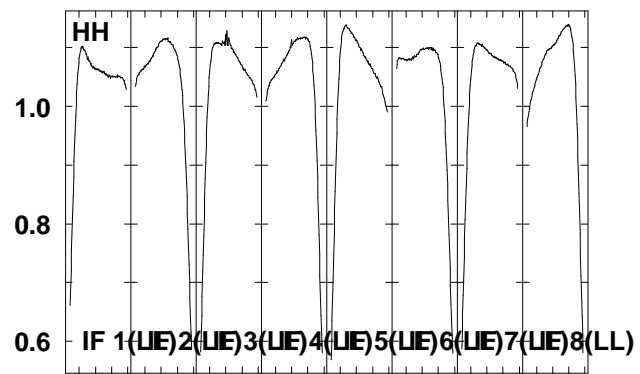
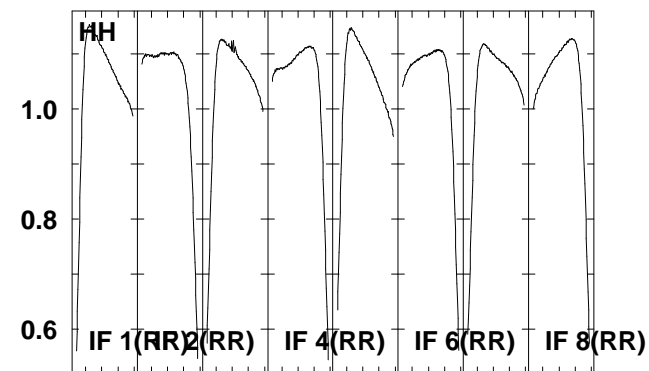
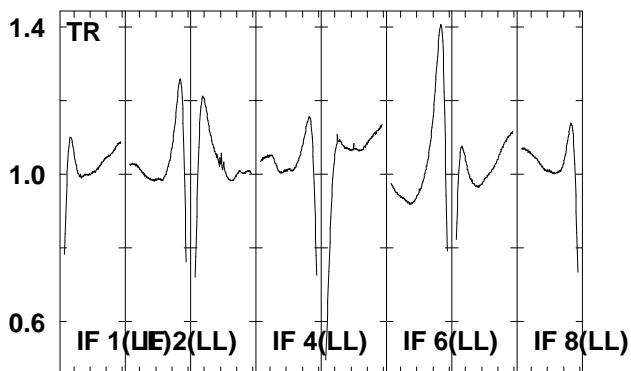
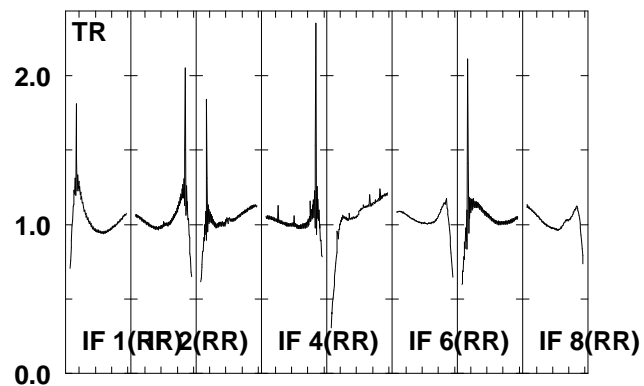
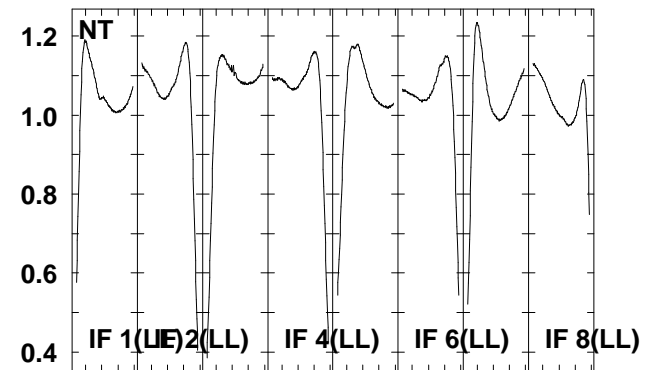
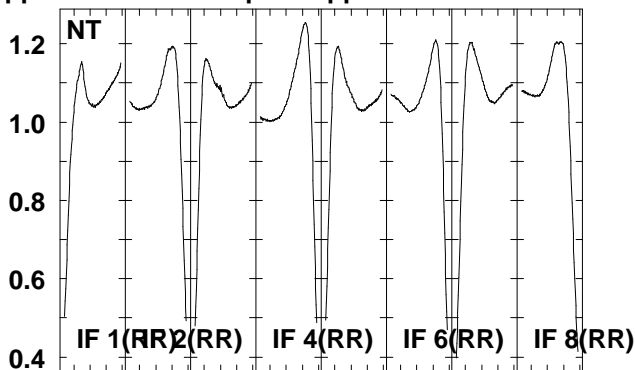
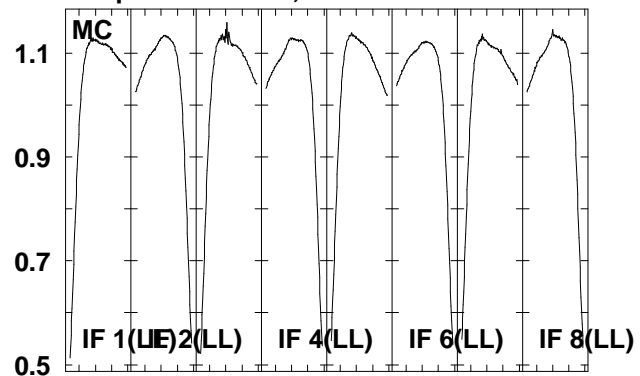

6663.6665.6667.6669.6671.6673.6675.6677.5
 FREQ MHz

Lower frame: Real Jy
 Total-power spectrum Antenna: *
 Timerange: 00/08:09:04 to 00/08:11:32

Plot file version 146 created 22-JUN-2006 20:10:47
 J1825-17 EM061A 1.UVDATA.1
 Freq = 6.6631 GHz, Bw = 2.000 MH No calibration applied and no bandpass applied

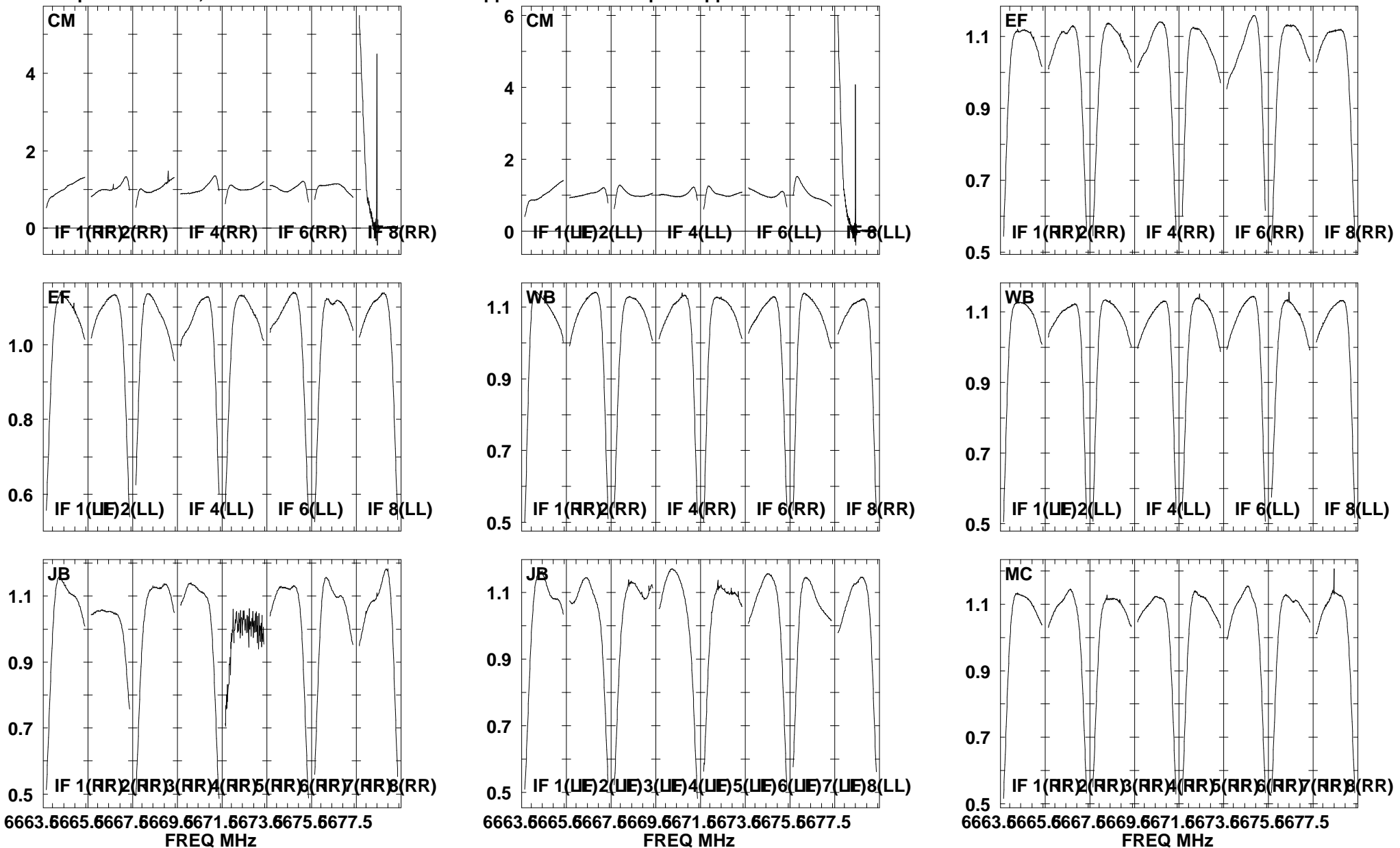

Lower frame: Real Jy
 Total-power spectrum Antenna: *
 Timerange: 00/08:11:34 to 00/08:14:32

Plot file version 147 created 22-JUN-2006 20:10:50
 J1825-17 EM061A 1.UVDATA.1
 Freq = 6.6631 GHz, Bw = 2.000 MH No calibration applied and no bandpass applied

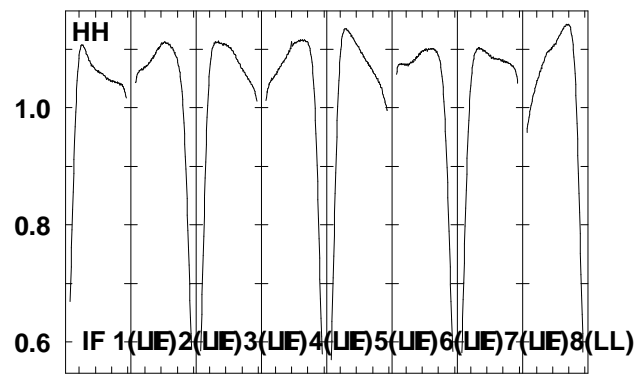
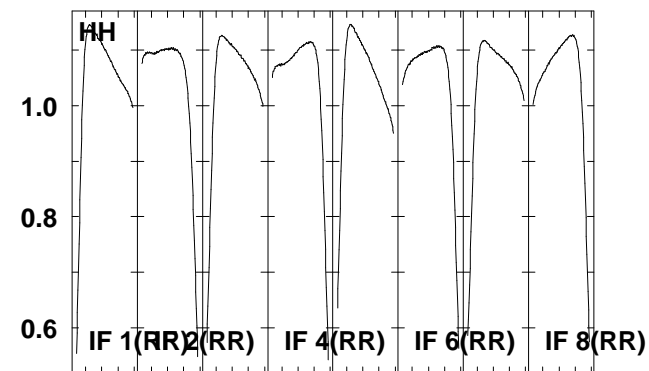
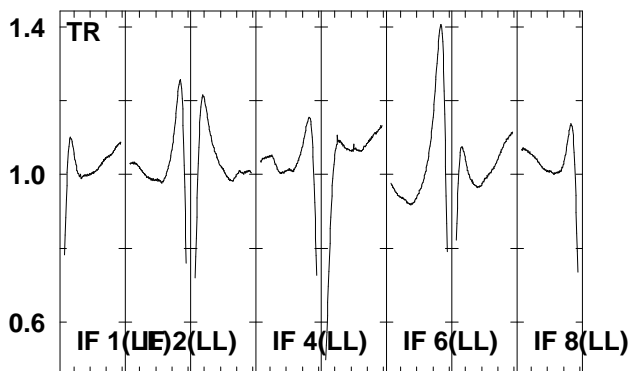
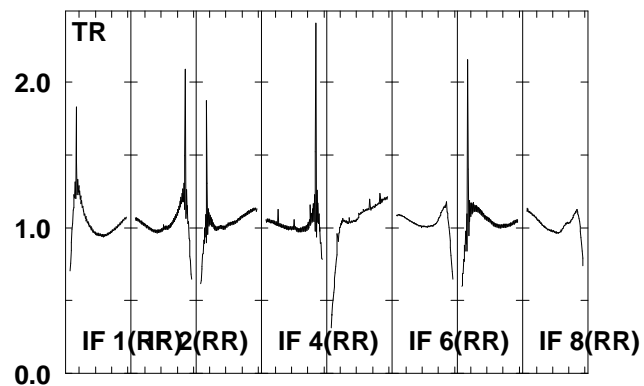
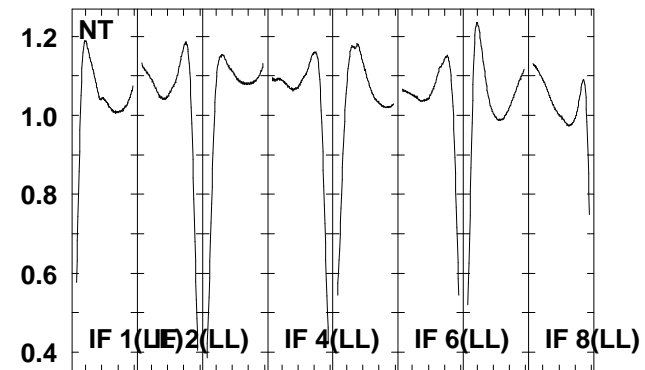
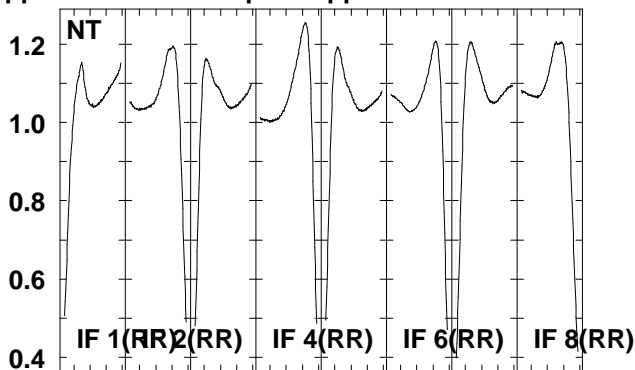
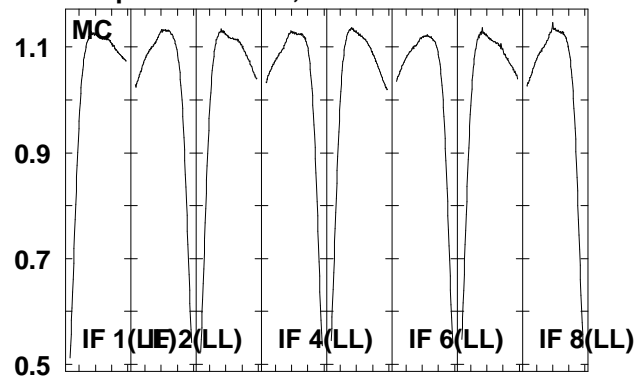

6663.6665.6667.6669.6671.6673.6675.6677.5
 FREQ MHz

Lower frame: Real Jy
 Total-power spectrum Antenna: *
 Timerange: 00/08:11:34 to 00/08:14:32

Plot file version 148 created 22-JUN-2006 20:10:54
 G16.59-0 EM061A 1.UVDATA.1
 Freq = 6.6631 GHz, Bw = 2.000 MH No calibration applied and no bandpass applied

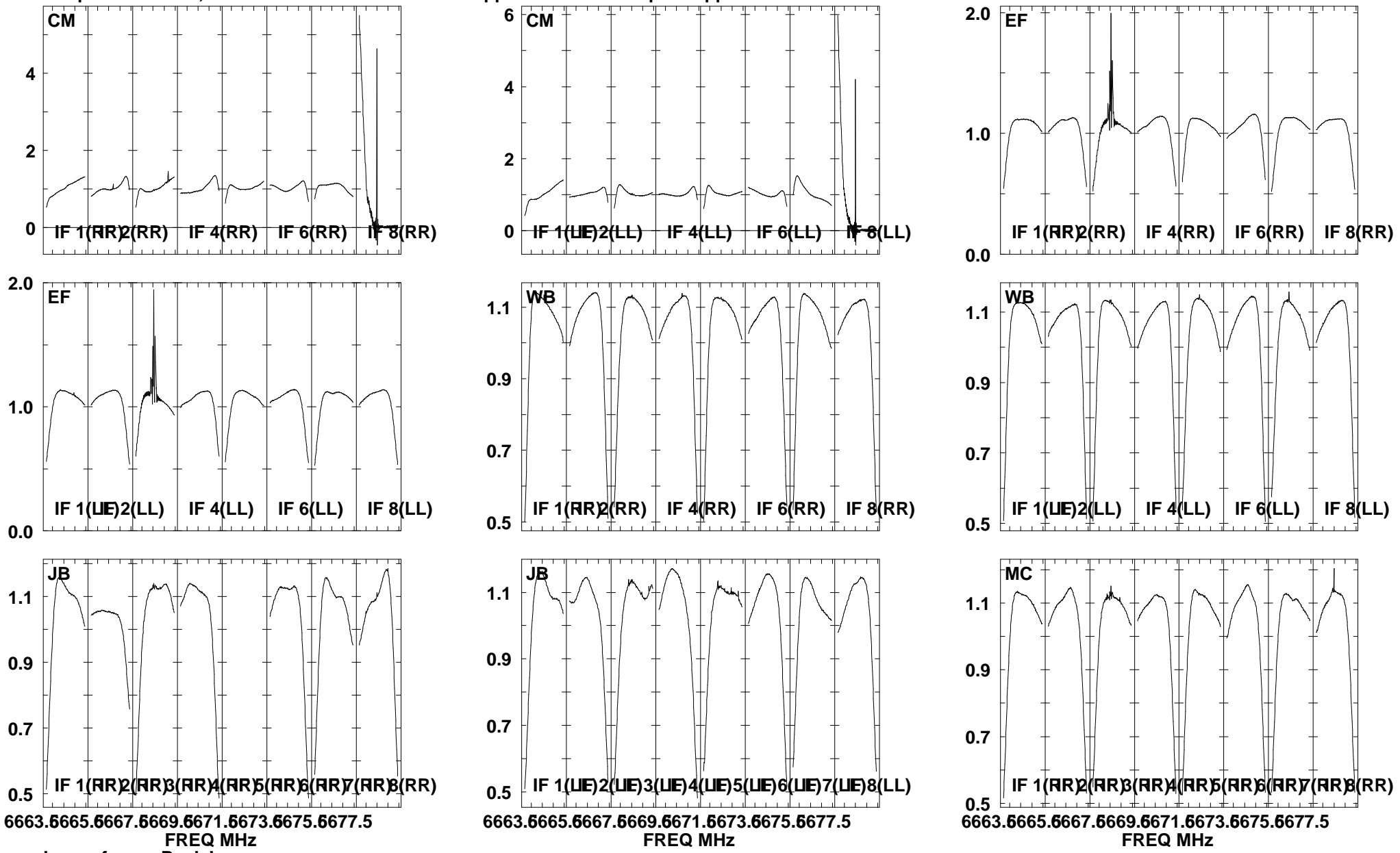

Lower frame: Real Jy
 Total-power spectrum Antenna: *
 Timerange: 00/08:14:34 to 00/08:17:02

Plot file version 149 created 22-JUN-2006 20:10:57
 G16.59-0 EM061A 1.UVDATA.1
 Freq = 6.6631 GHz, Bw = 2.000 MH No calibration applied and no bandpass applied

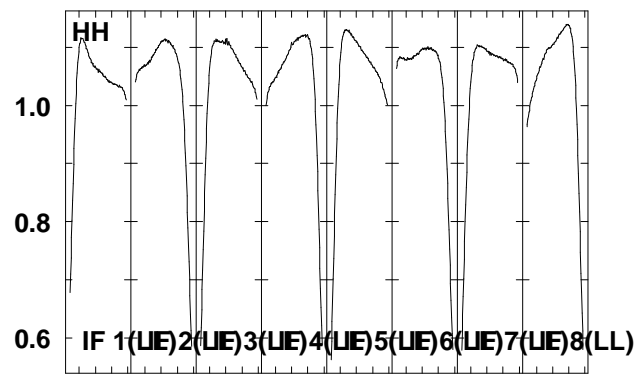
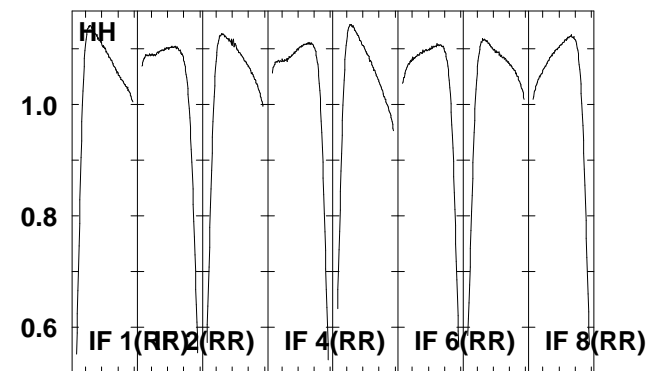
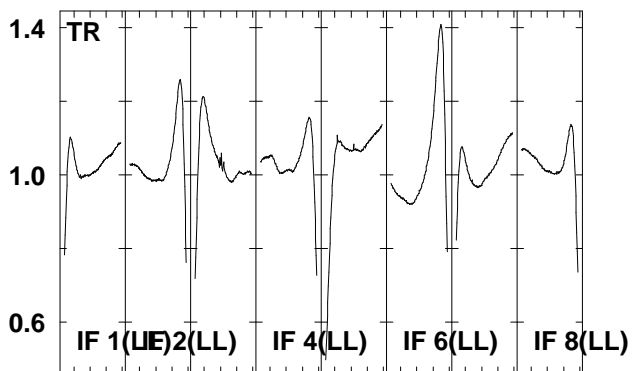
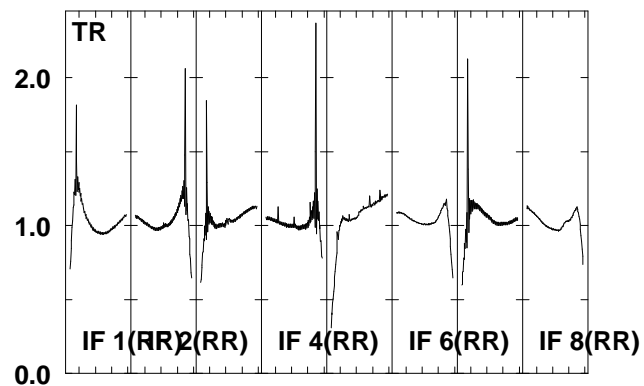
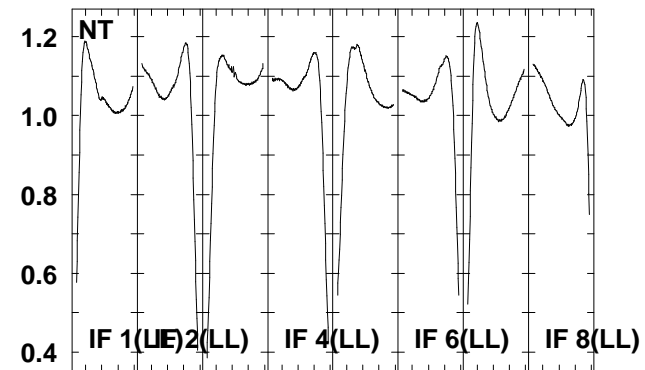
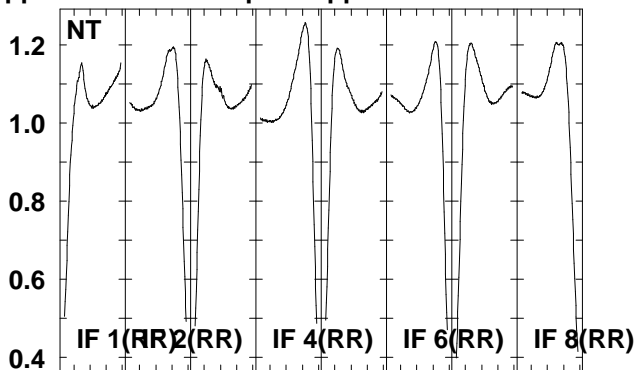
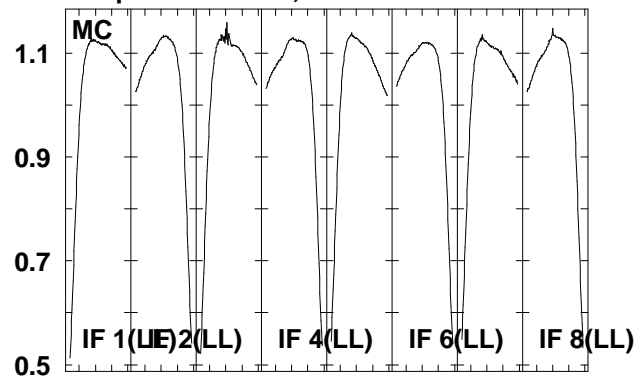

6663.6665.6667.6669.6671.6673.6675.6677.5
 FREQ MHz

Lower frame: Real Jy
 Total-power spectrum Antenna: *
 Timerange: 00/08:14:34 to 00/08:17:02

Plot file version 150 created 22-JUN-2006 20:11:00
 J1825-17 EM061A 1.UVDATA.1
 Freq = 6.6631 GHz, Bw = 2.000 MH No calibration applied and no bandpass applied

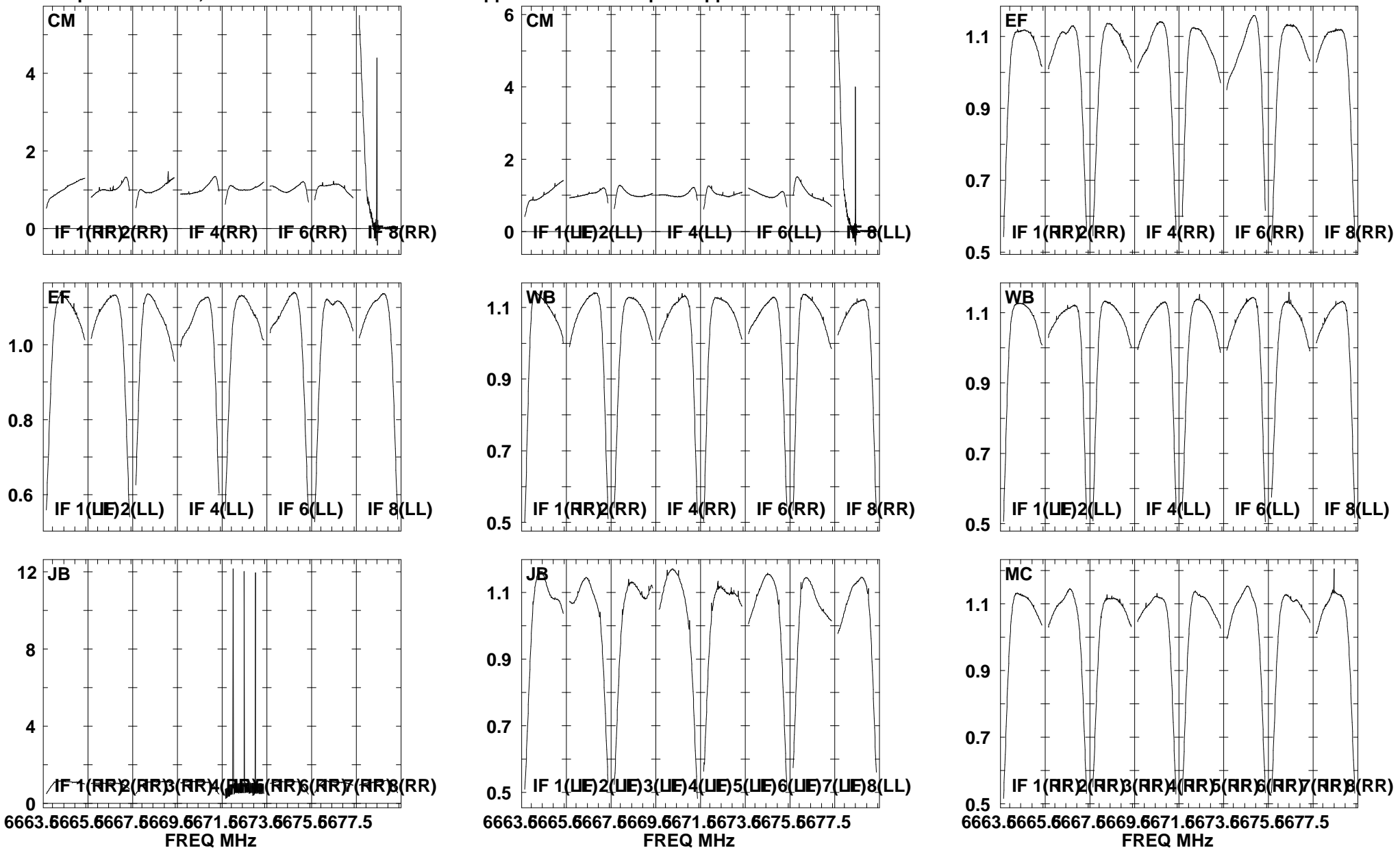

Lower frame: Real Jy
 Total-power spectrum Antenna: *
 Timerange: 00/08:18:35 to 00/08:21:32

Plot file version 151 created 22-JUN-2006 20:11:04

J1825-17 EM061A 1.UVDATA.1

Freq = 6.6631 GHz, Bw = 2.000 MH No calibration applied and no bandpass applied

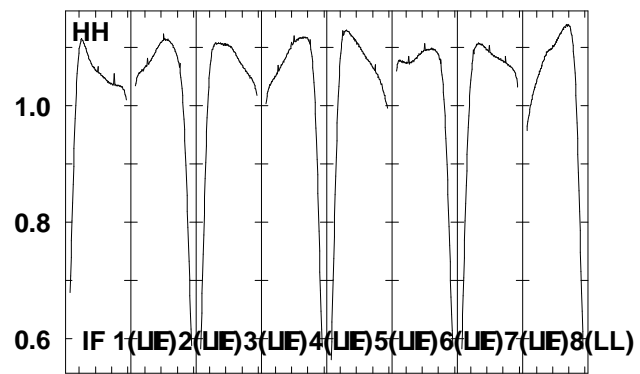
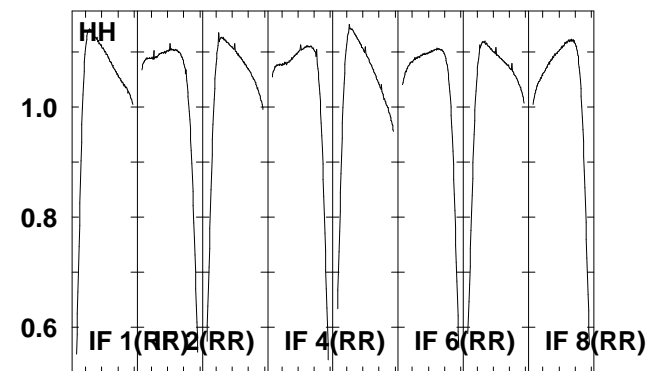
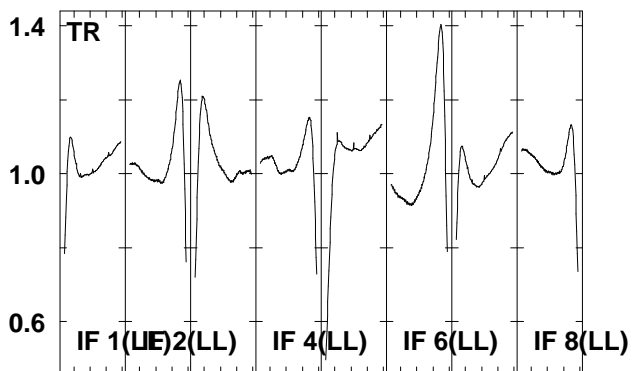
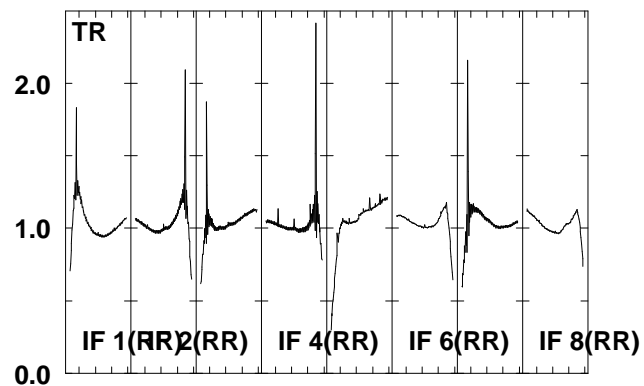
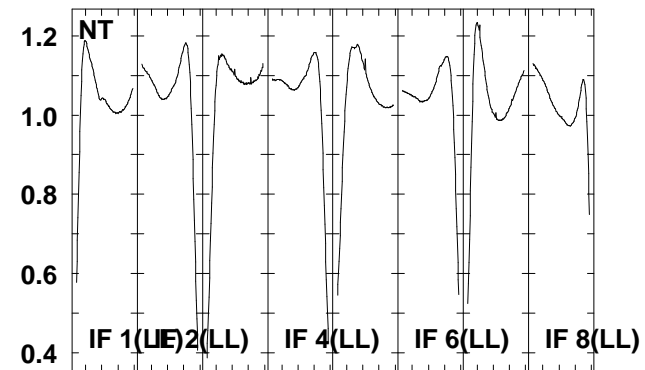
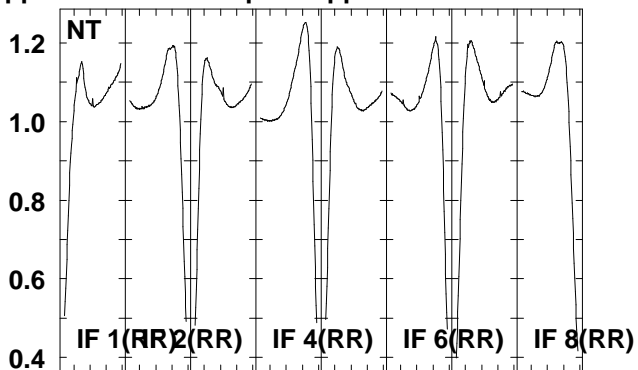
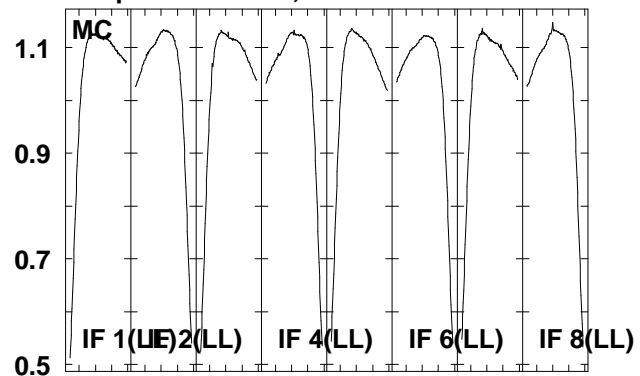

6663.6665.6667.6669.6671.6673.6675.6677.5

FREQ MHz

Lower frame: Real Jy

Total-power spectrum Antenna: *

Timerange: 00/08:18:35 to 00/08:21:32

Plot file version 152 created 22-JUN-2006 20:11:08
 G16.59-0 EM061A 1.UVDATA.1
 Freq = 6.6631 GHz, Bw = 2.000 MH No calibration applied and no bandpass applied

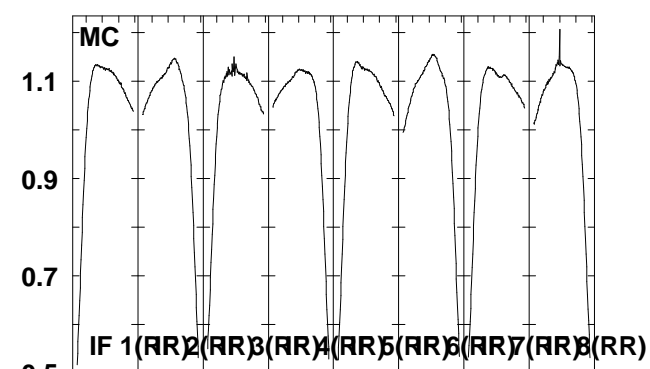
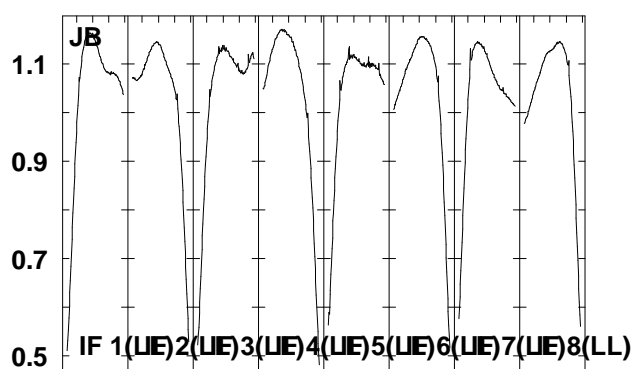
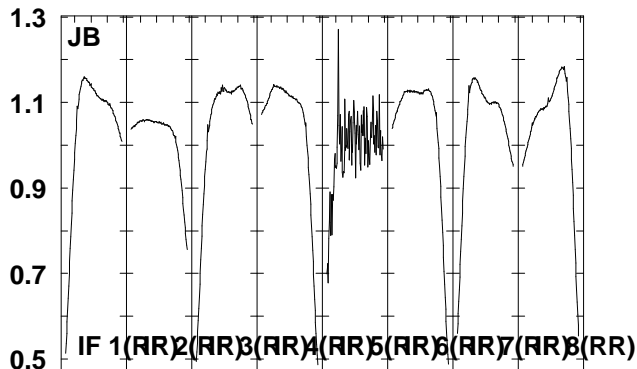
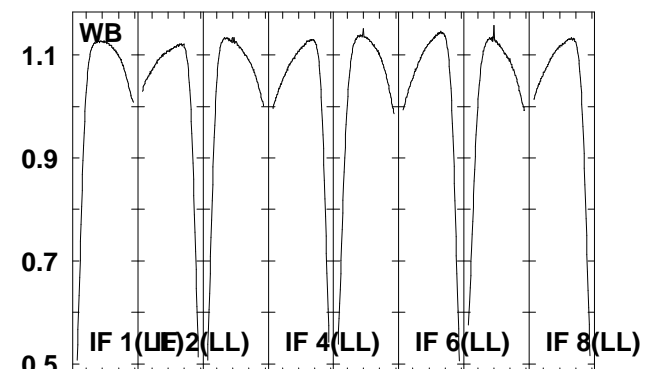
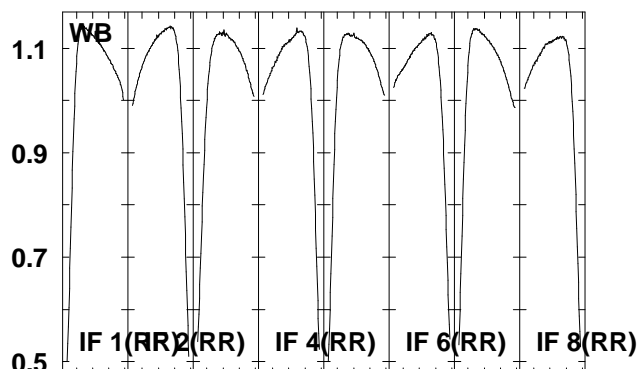
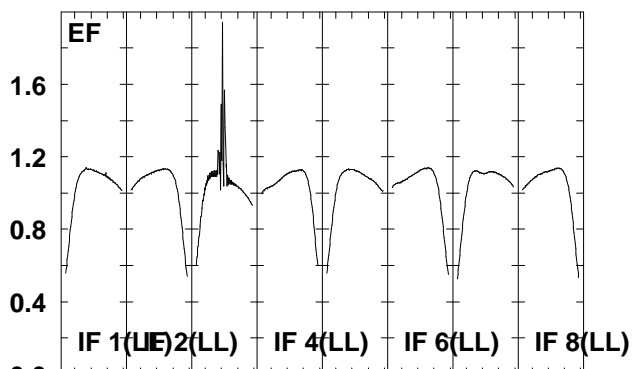
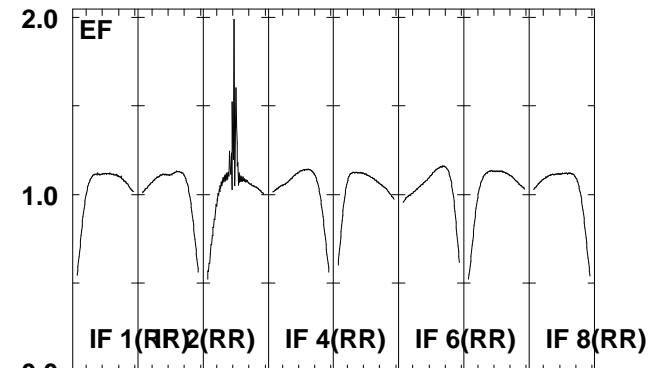
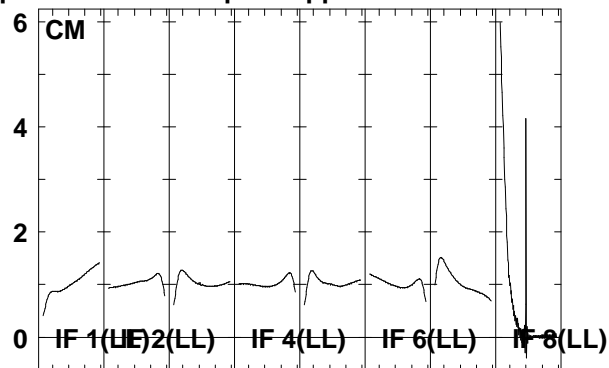
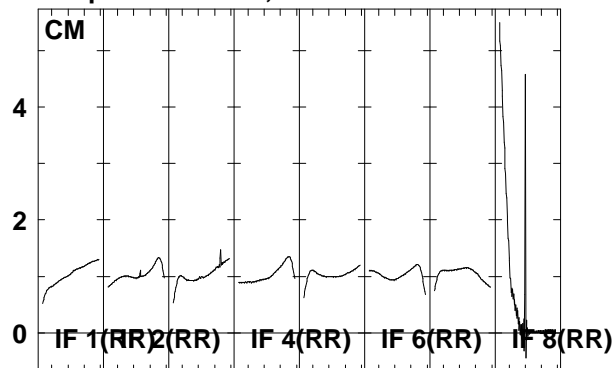

6663.6665.6667.6669.6671.6673.6675.6677.5
 FREQ MHz

6663.6665.6667.6669.6671.6673.6675.6677.5
 FREQ MHz

6663.6665.6667.6669.6671.6673.6675.6677.5
 FREQ MHz

Lower frame: Real Jy
 Total-power spectrum Antenna: *
 Timerange: 00/08:21:34 to 00/08:24:02

Plot file version 153 created 22-JUN-2006 20:11:10
 G16.59-0 EM061A 1.UVDATA.1
 Freq = 6.6631 GHz, Bw = 2.000 MH No calibration applied and no bandpass applied

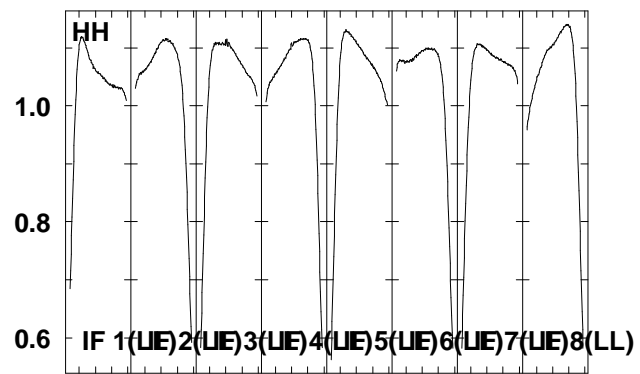
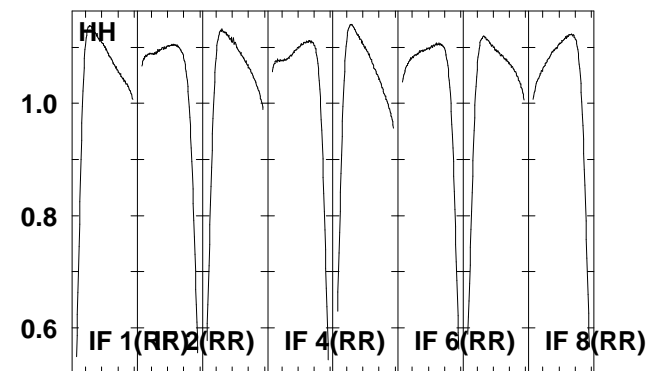
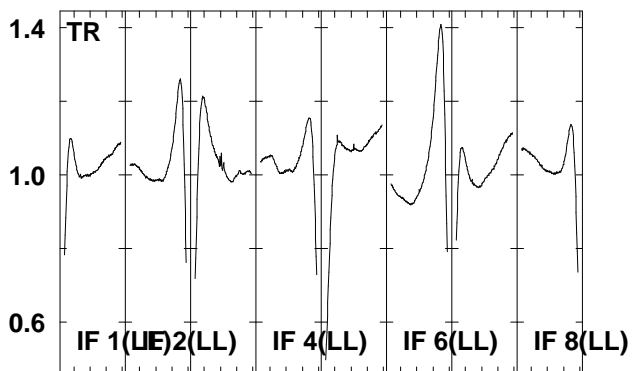
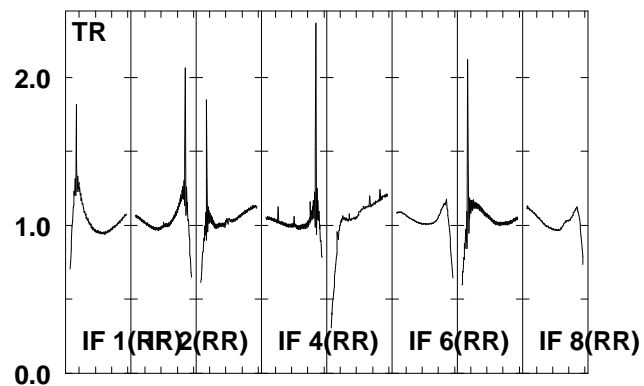
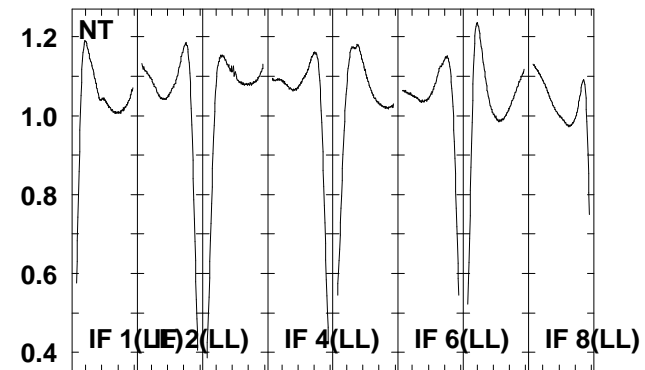
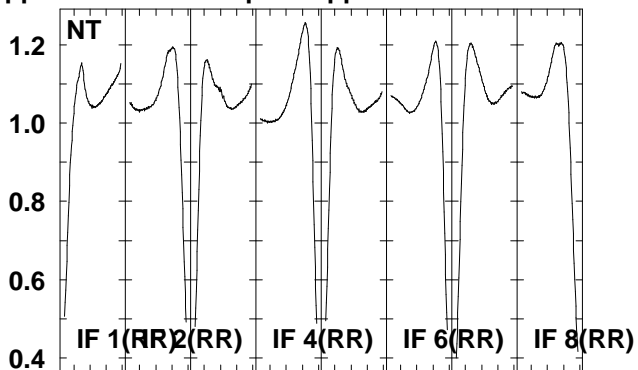
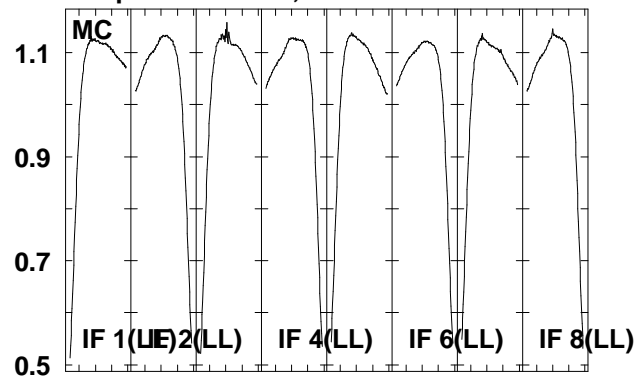

6663.6665.6667.6669.6671.6673.6675.6677.5
 FREQ MHz

Lower frame: Real Jy
 Total-power spectrum Antenna: *
 Timerange: 00/08:21:34 to 00/08:24:02

Plot file version 154 created 22-JUN-2006 20:11:15
 J1825-17 EM061A 1.UVDATA.1
 Freq = 6.6631 GHz, Bw = 2.000 MH No calibration applied and no bandpass applied

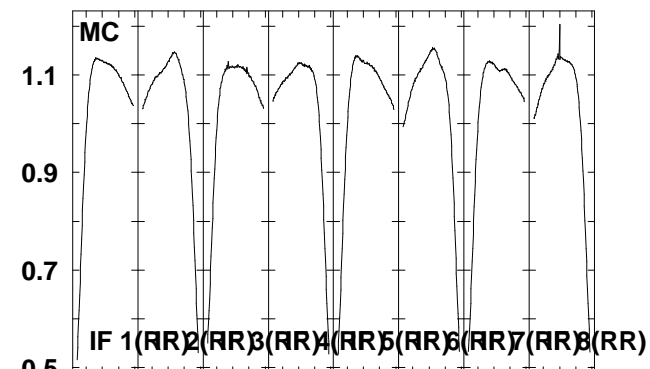
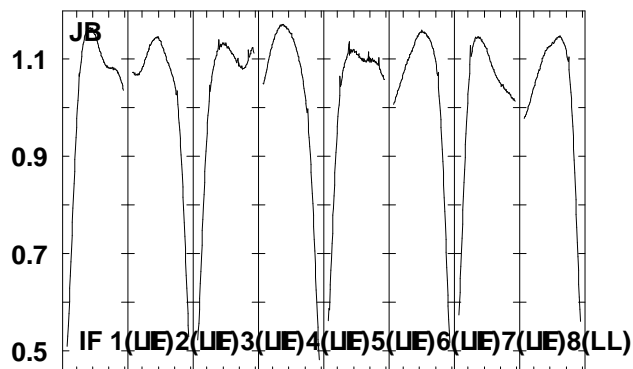
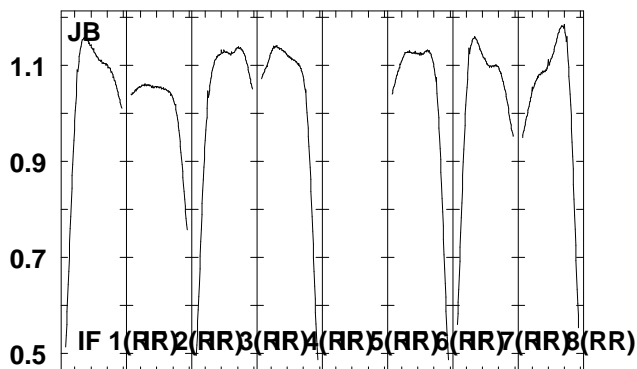
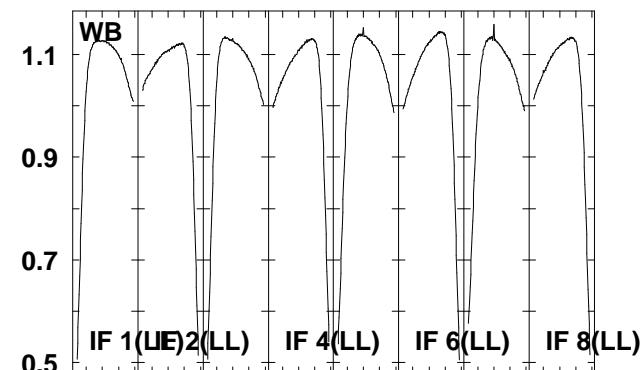
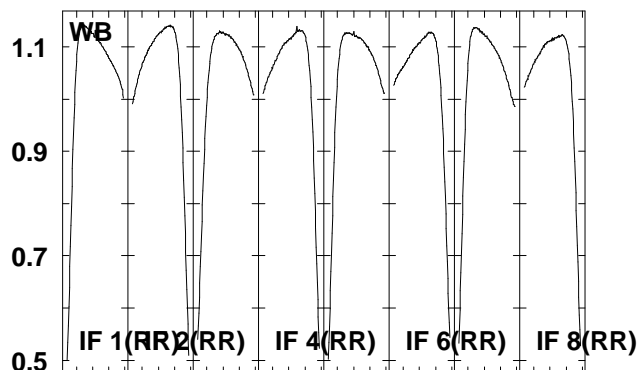
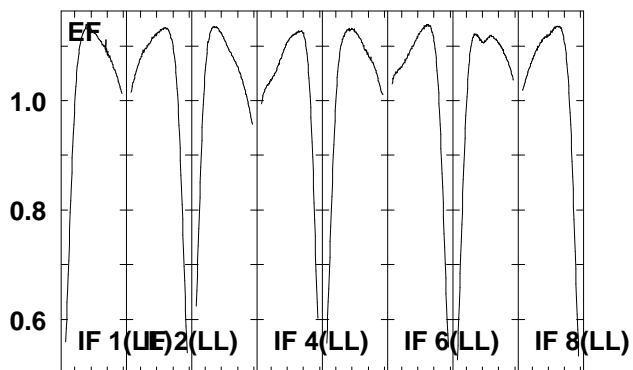
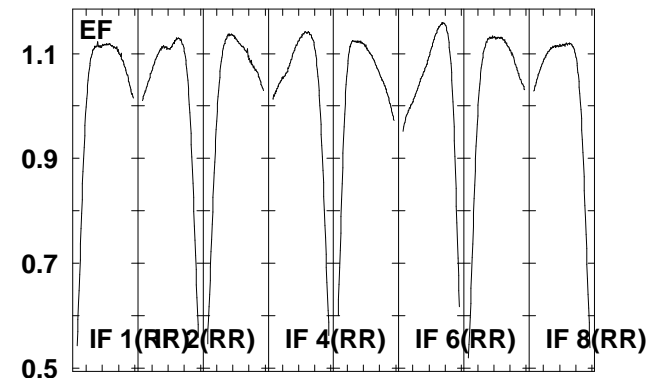
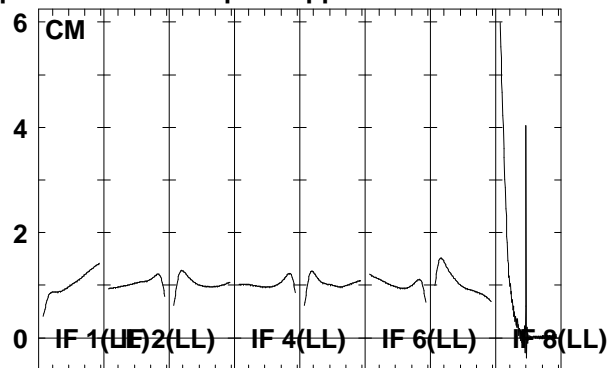
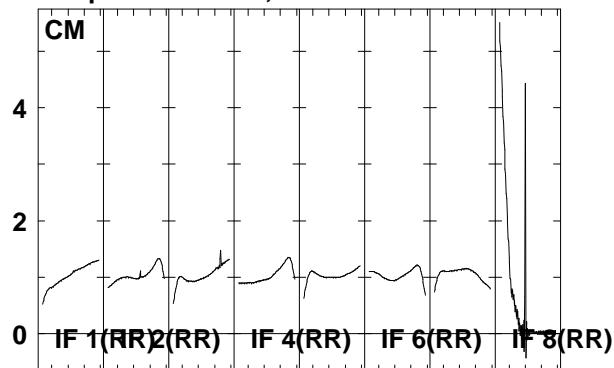

6663.6665.6667.6669.6671.6673.6675.6677.5
 FREQ MHz

6663.6665.6667.6669.6671.6673.6675.6677.5
 FREQ MHz

6663.6665.6667.6669.6671.6673.6675.6677.5
 FREQ MHz

Lower frame: Real Jy
 Total-power spectrum Antenna: *
 Timerange: 00/08:24:04 to 00/08:27:02

Plot file version 155 created 22-JUN-2006 20:11:18
 J1825-17 EM061A 1.UVDATA.1
 Freq = 6.6631 GHz, Bw = 2.000 MH No calibration applied and no bandpass applied

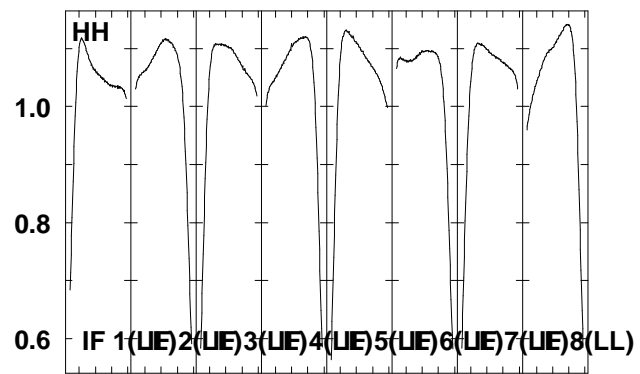
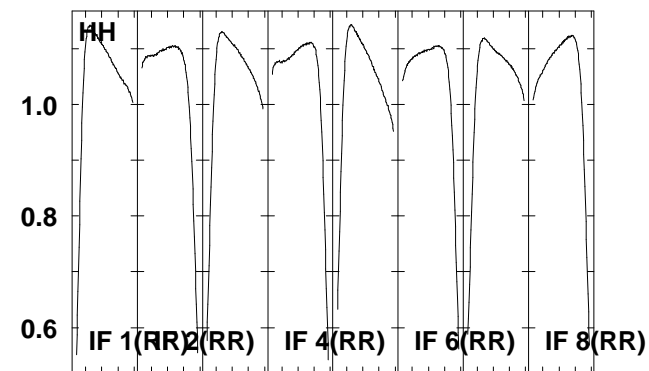
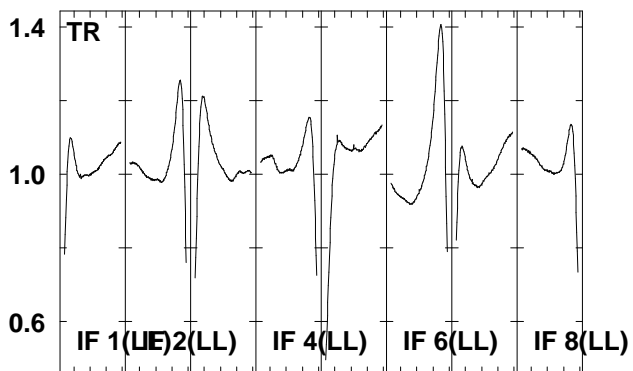
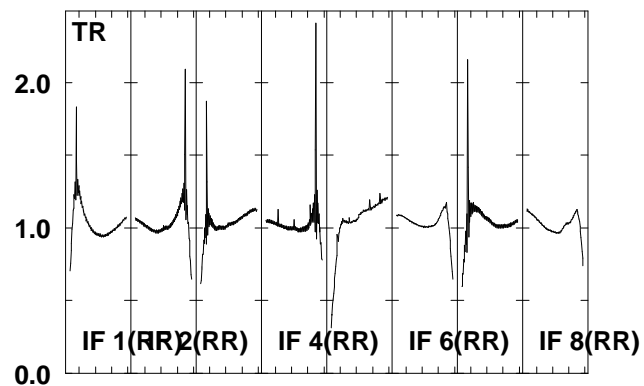
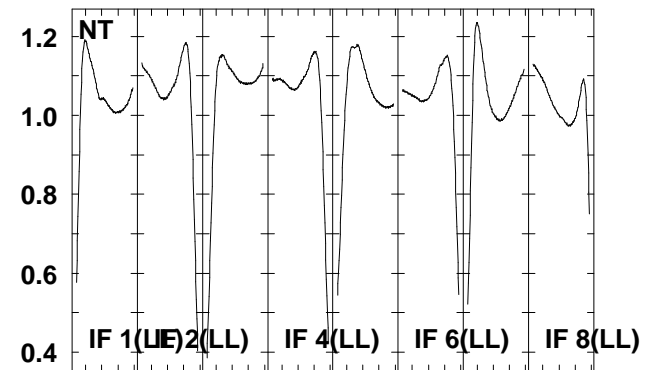
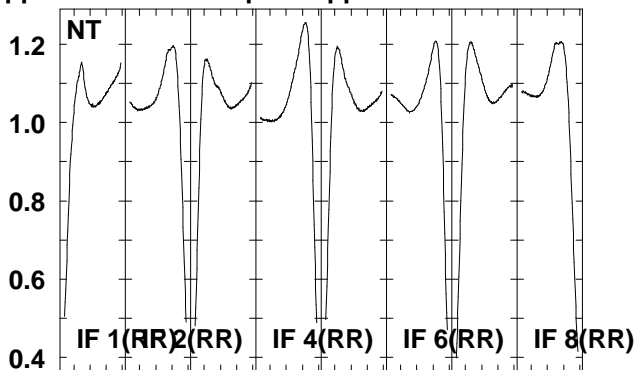
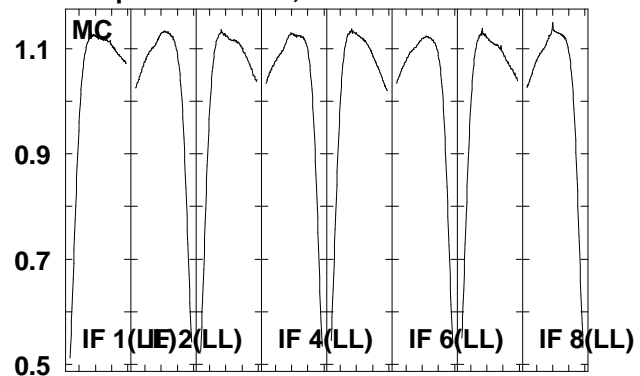

6663.6665.6667.6669.6671.6673.6675.6677.5
 FREQ MHz

Lower frame: Real Jy
 Total-power spectrum Antenna: *
 Timerange: 00/08:24:04 to 00/08:27:02

Plot file version 156 created 22-JUN-2006 20:11:22
 G16.59-0 EM061A 1.UVDATA.1
 Freq = 6.6631 GHz, Bw = 2.000 MH No calibration applied and no bandpass applied

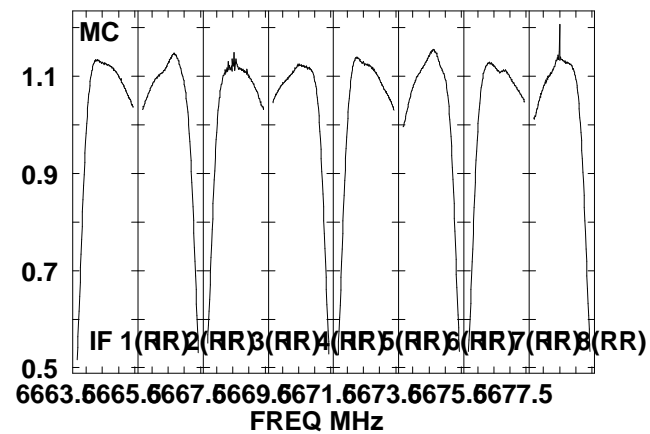
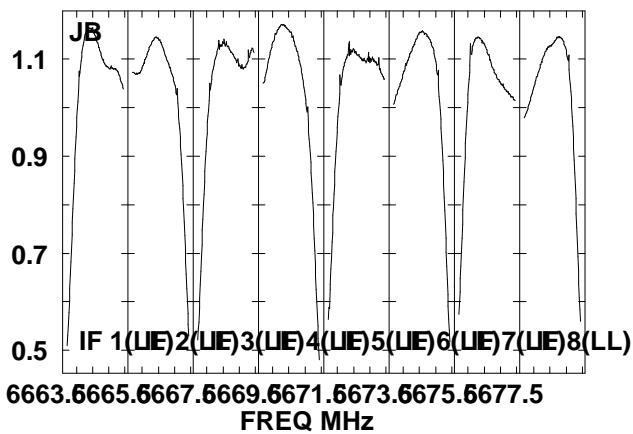
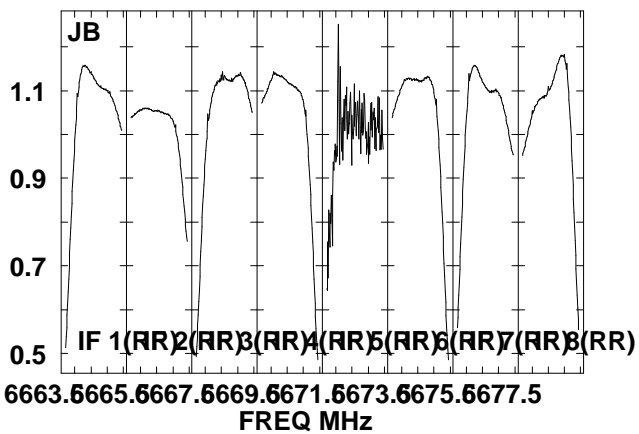
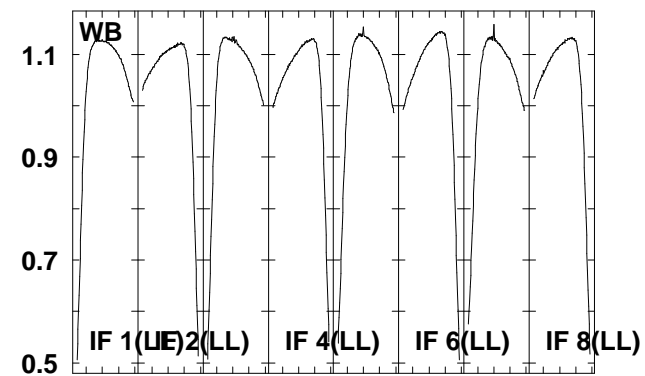
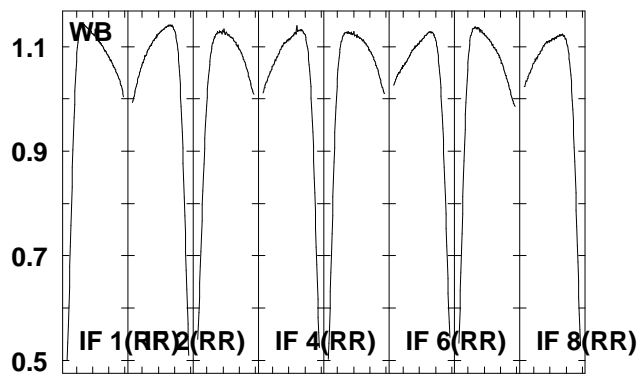
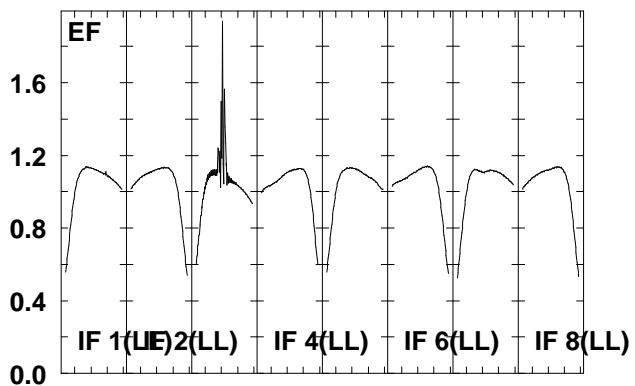
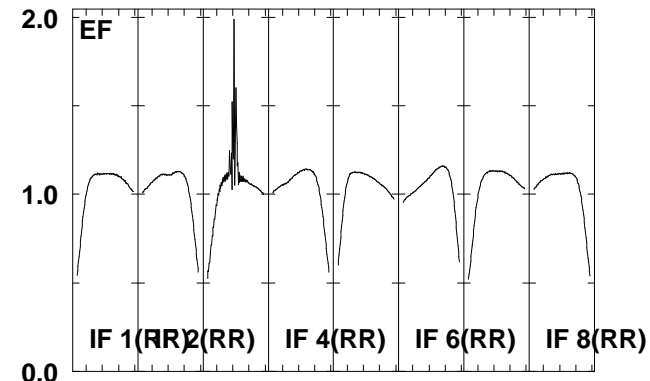
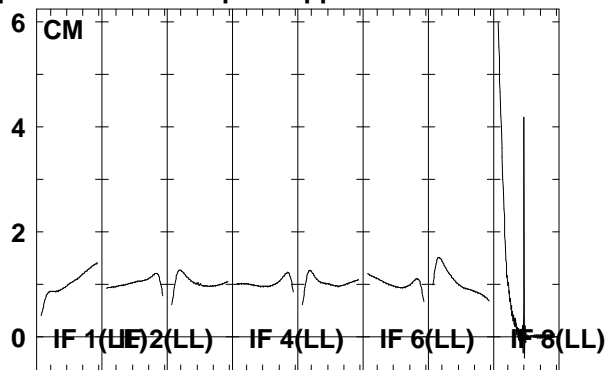
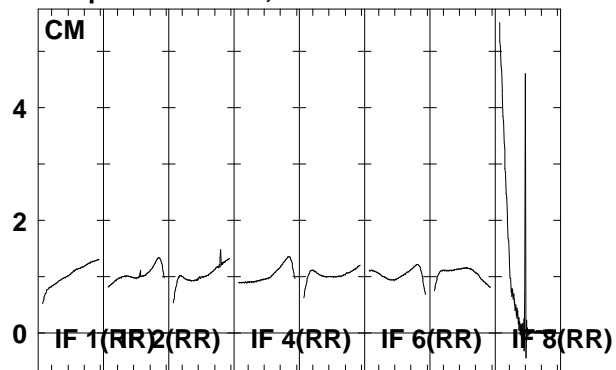

6663.6665.6667.6669.6671.6673.6675.6677.5
 FREQ MHz

6663.6665.6667.6669.6671.6673.6675.6677.5
 FREQ MHz

6663.6665.6667.6669.6671.6673.6675.6677.5
 FREQ MHz

Lower frame: Real Jy
 Total-power spectrum Antenna: *
 Timerange: 00/08:27:04 to 00/08:29:32

Plot file version 157 created 22-JUN-2006 20:11:24
 G16.59-0 EM061A 1.UVDATA.1
 Freq = 6.6631 GHz, Bw = 2.000 MH No calibration applied and no bandpass applied

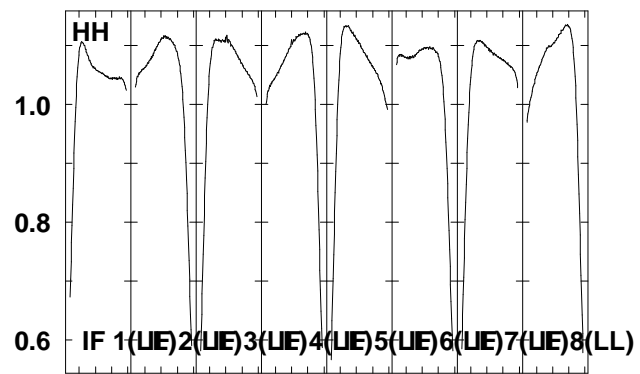
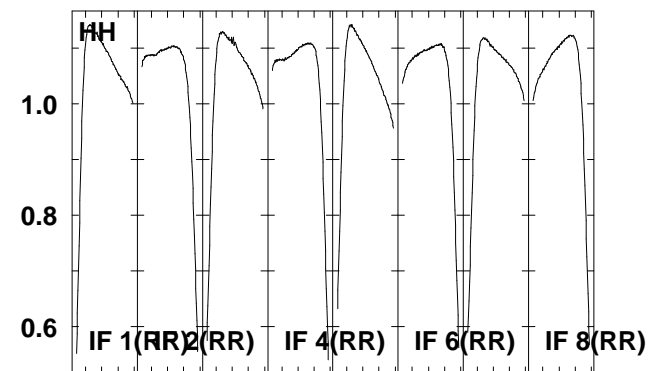
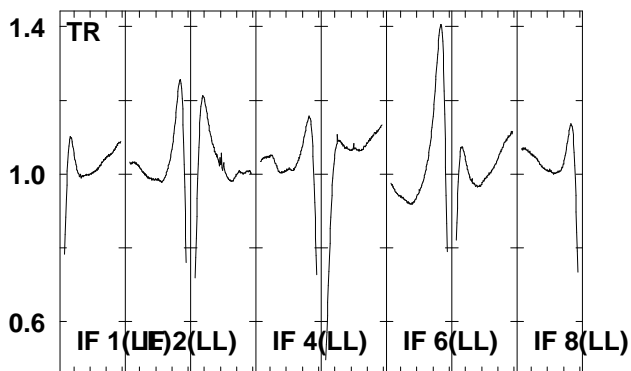
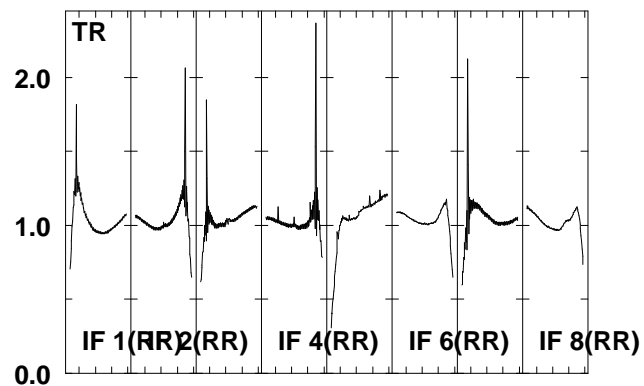
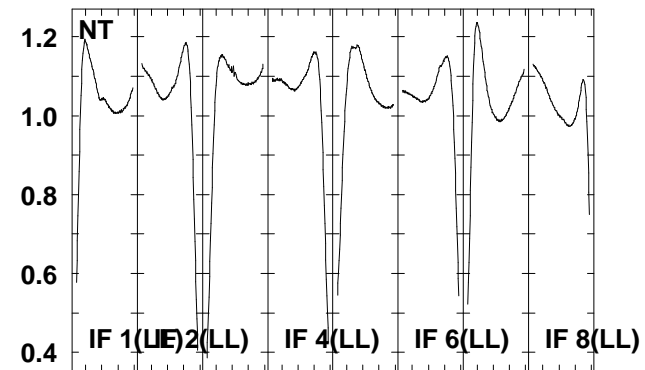
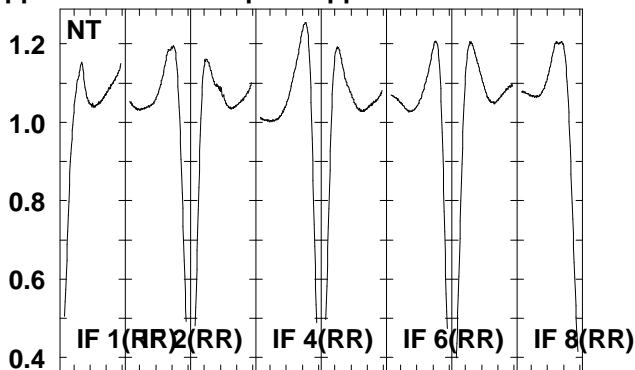
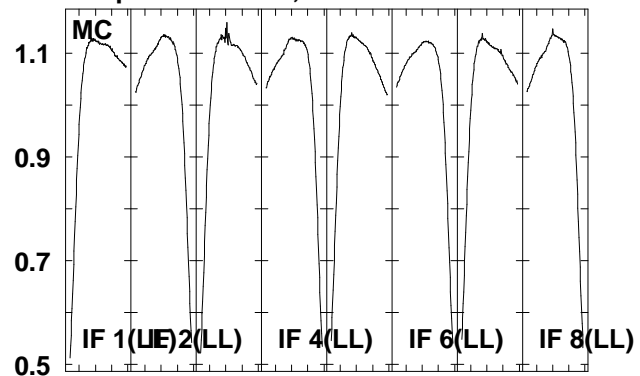

6663.6665.6667.6669.6671.6673.6675.6677.5
 FREQ MHz

Lower frame: Real Jy
 Total-power spectrum Antenna: *
 Timerange: 00/08:27:04 to 00/08:29:32

Plot file version 158 created 22-JUN-2006 20:11:27
 J1825-17 EM061A 1.UVDATA.1
 Freq = 6.6631 GHz, Bw = 2.000 MH No calibration applied and no bandpass applied

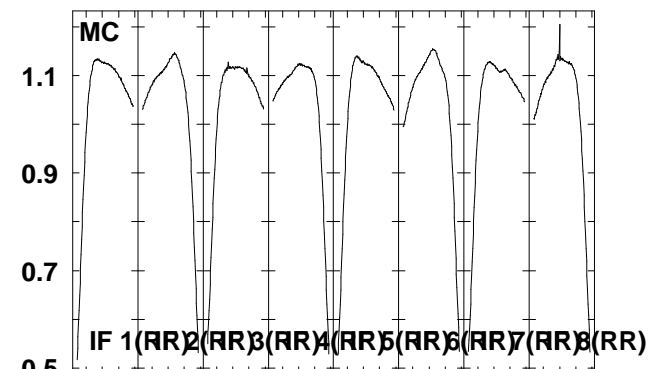
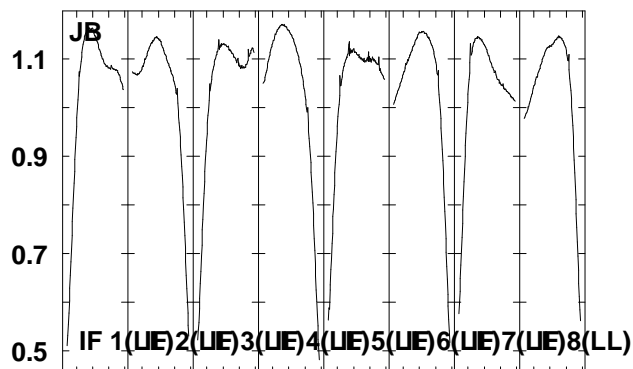
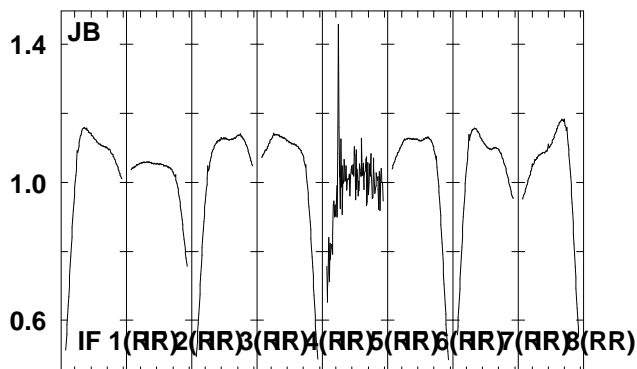
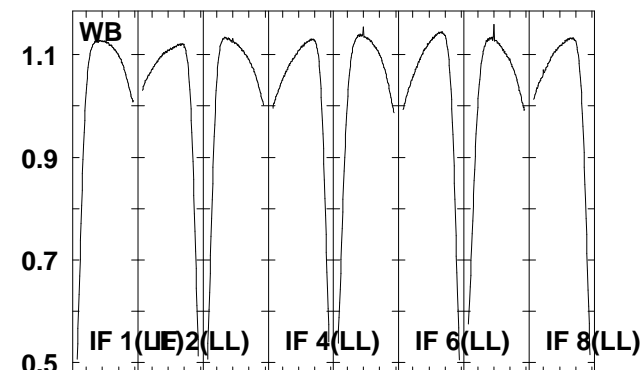
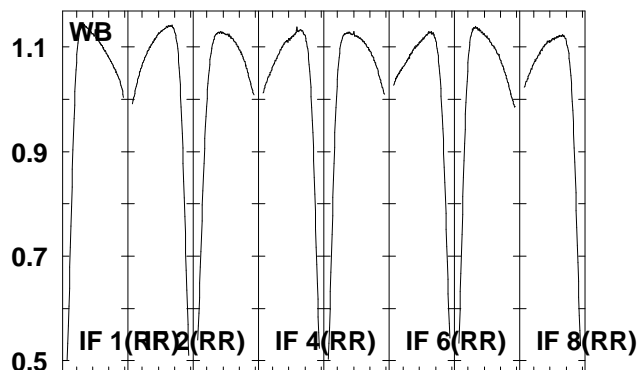
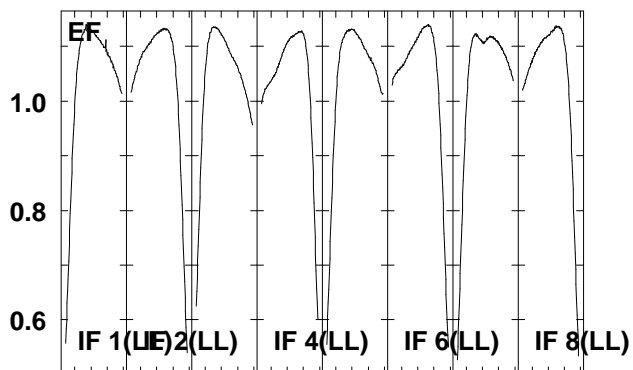
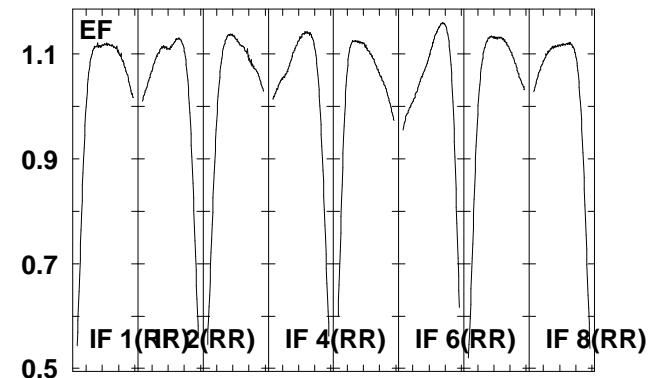
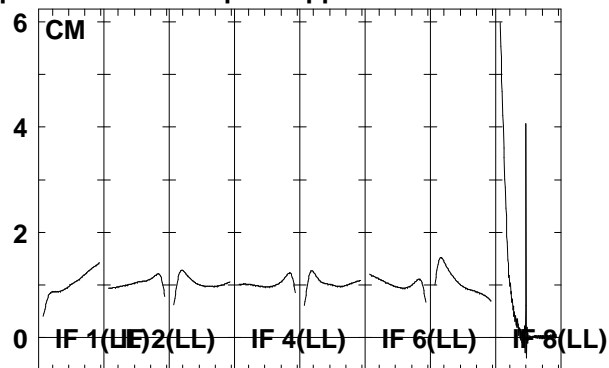
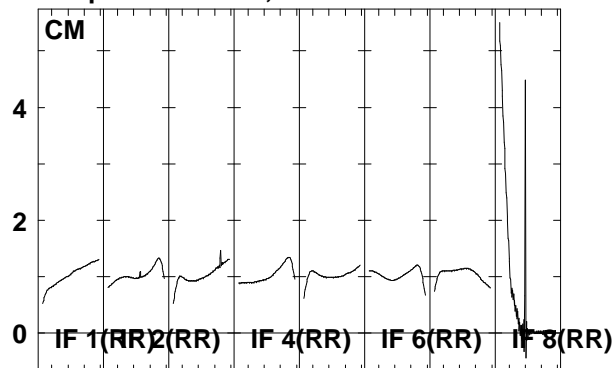

6663.6665.6667.6669.6671.6673.6675.6677.5
 FREQ MHz

6663.6665.6667.6669.6671.6673.6675.6677.5
 FREQ MHz

6663.6665.6667.6669.6671.6673.6675.6677.5
 FREQ MHz

Lower frame: Real Jy
 Total-power spectrum Antenna: *
 Timerange: 00/08:29:34 to 00/08:32:32

Plot file version 159 created 22-JUN-2006 20:11:31
 J1825-17 EM061A 1.UVDATA.1
 Freq = 6.6631 GHz, Bw = 2.000 MH No calibration applied and no bandpass applied

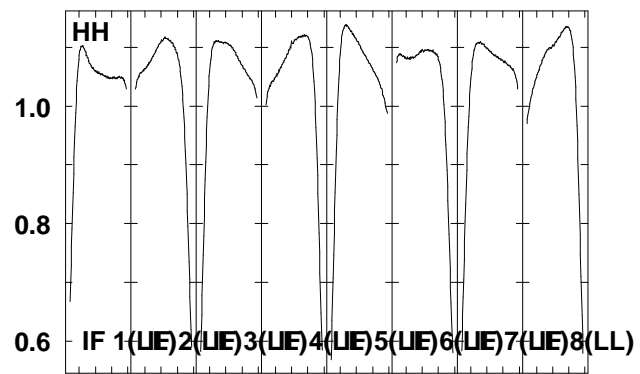
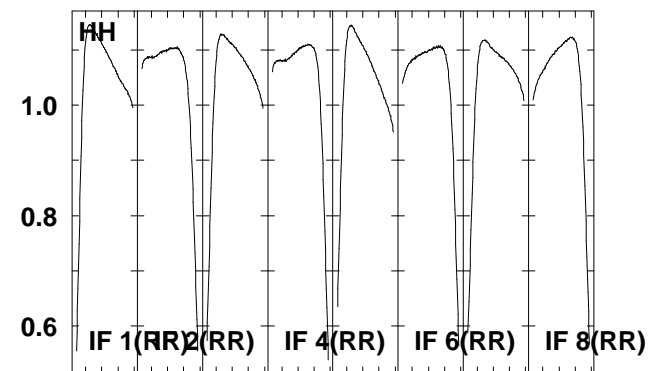
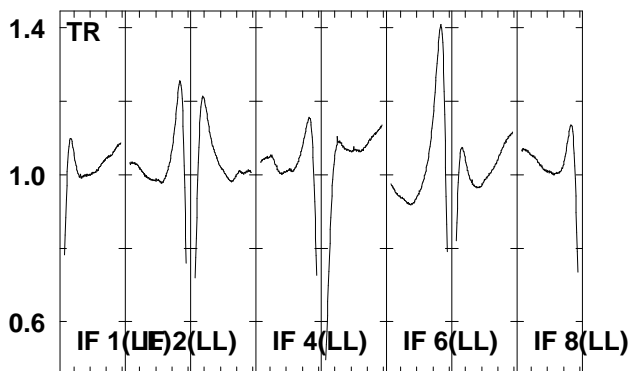
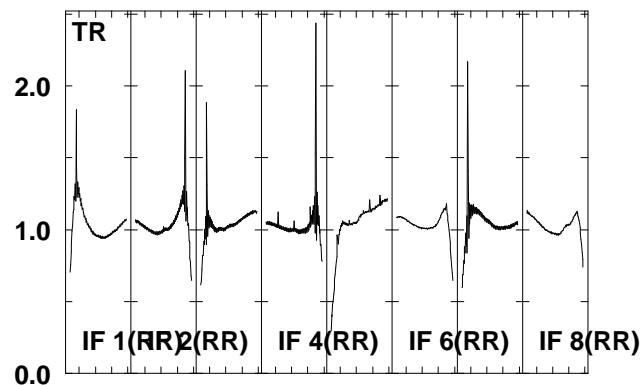
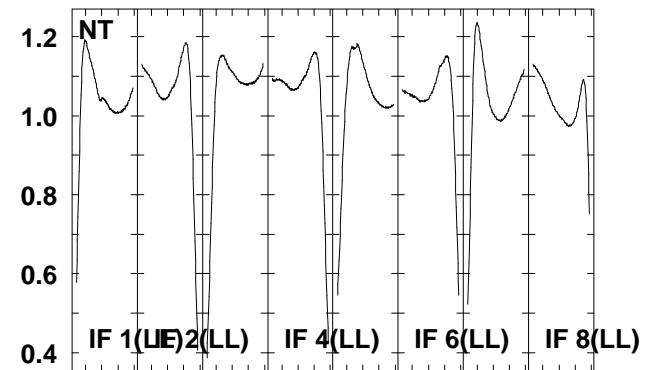
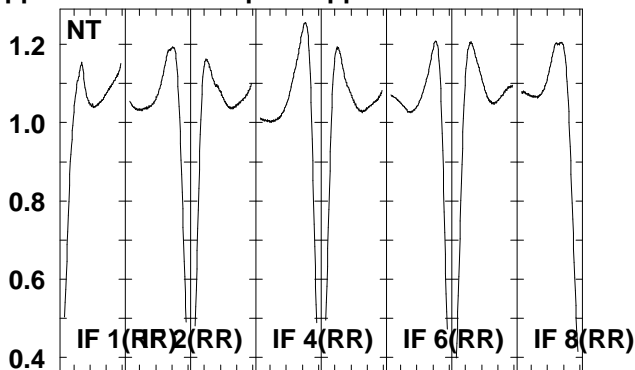
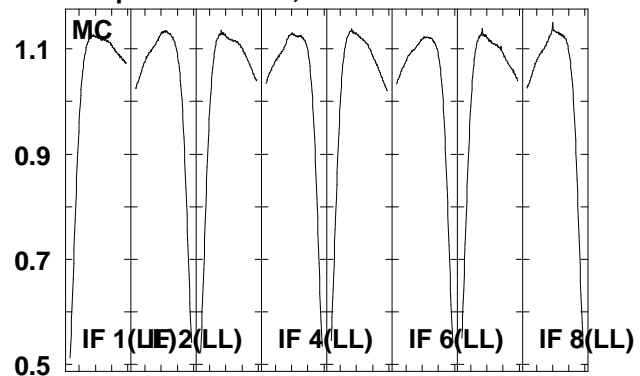

6663.6665.6667.6669.6671.6673.6675.6677.5
 FREQ MHz

Lower frame: Real Jy
 Total-power spectrum Antenna: *
 Timerange: 00/08:29:34 to 00/08:32:32

Plot file version 160 created 22-JUN-2006 20:11:35
 G16.59-0 EM061A 1.UVDATA.1
 Freq = 6.6631 GHz, Bw = 2.000 MH No calibration applied and no bandpass applied

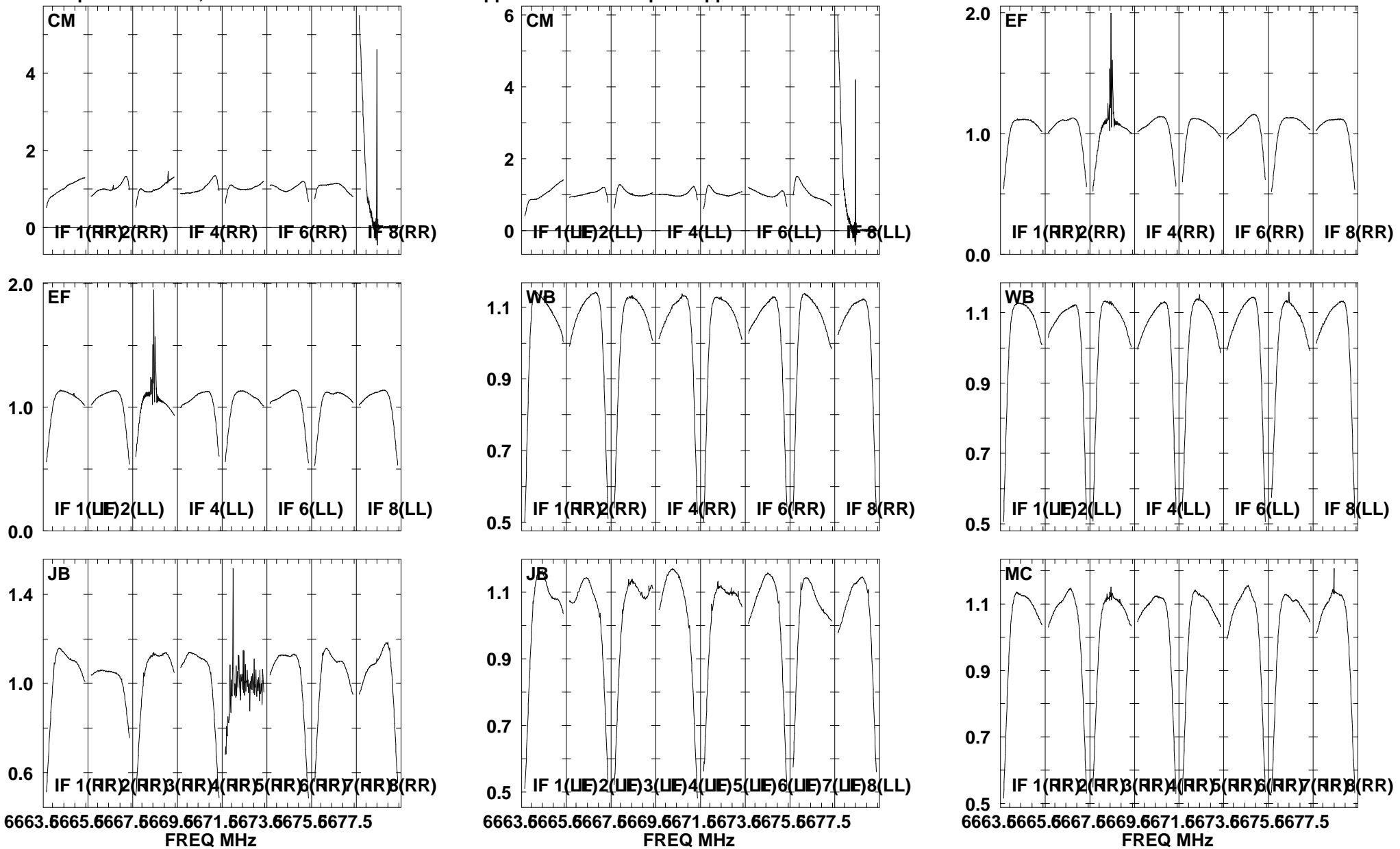

Lower frame: Real Jy
 Total-power spectrum Antenna: *
 Timerange: 00/08:32:34 to 00/08:35:02

Plot file version 161 created 22-JUN-2006 20:11:37

G16.59-0 EM061A 1.UVDATA.1

Freq = 6.6631 GHz, Bw = 2.000 MH No calibration applied and no bandpass applied

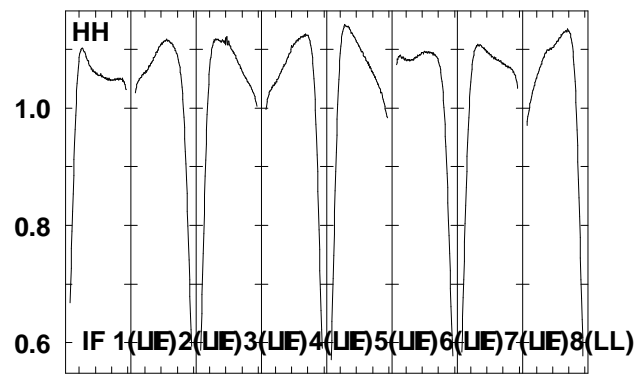
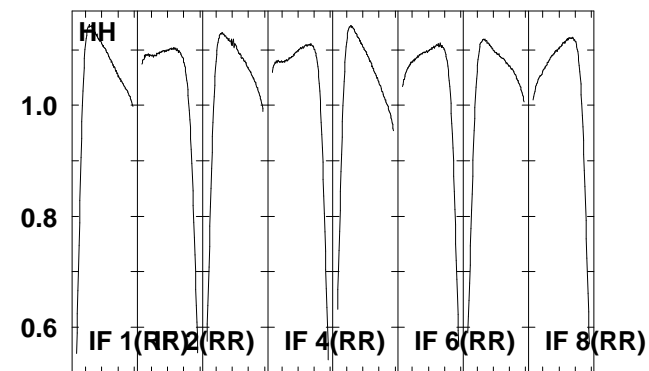
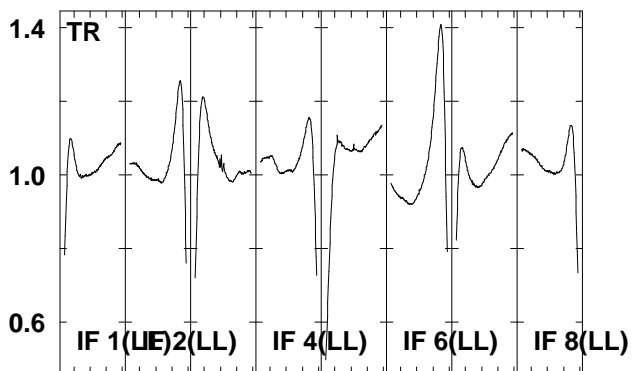
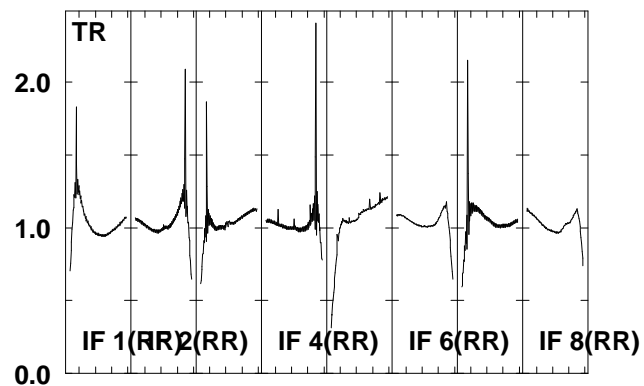
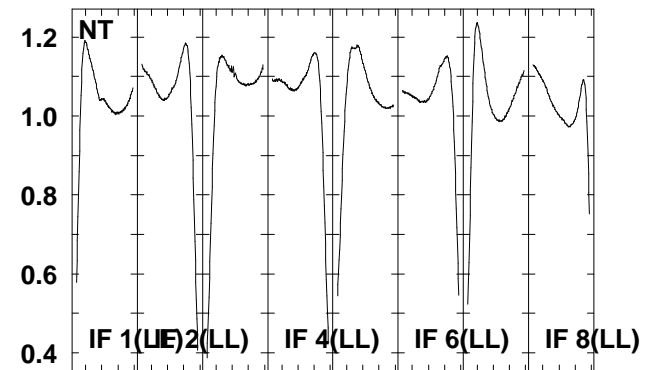
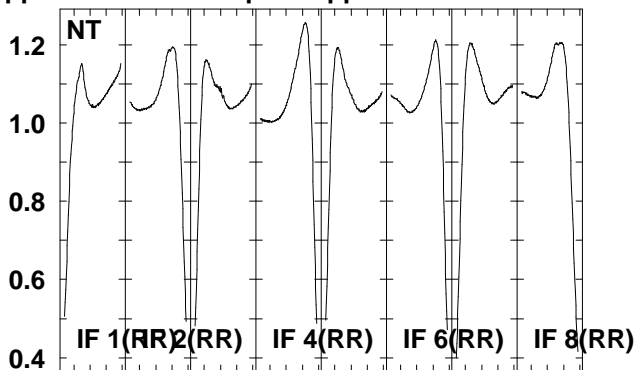
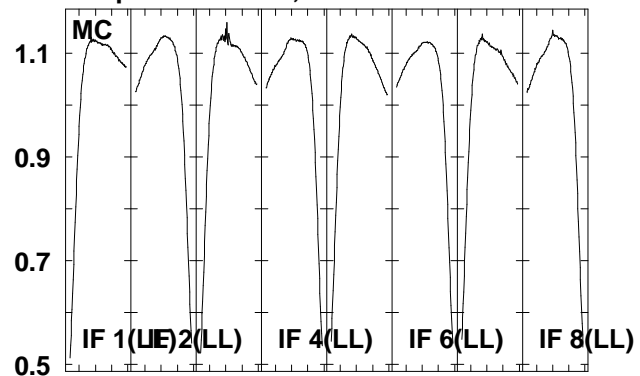

6663.6665.6667.6669.6671.6673.6675.6677.5

FREQ MHz

Lower frame: Real Jy

Total-power spectrum Antenna: *

Timerange: 00/08:32:34 to 00/08:35:02

Plot file version 162 created 22-JUN-2006 20:11:40
 J1825-17 EM061A 1.UVDATA.1
 Freq = 6.6631 GHz, Bw = 2.000 MH No calibration applied and no bandpass applied

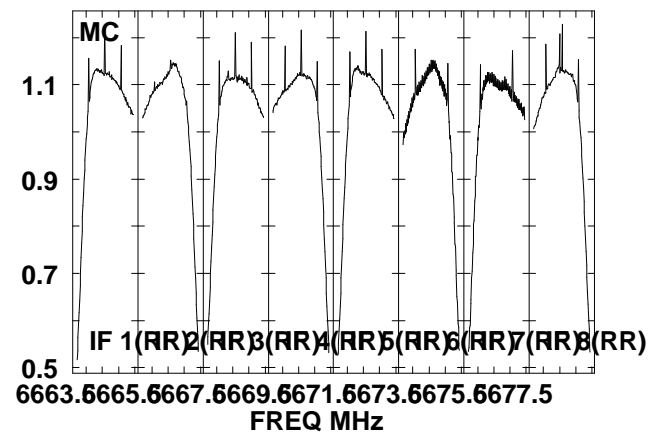
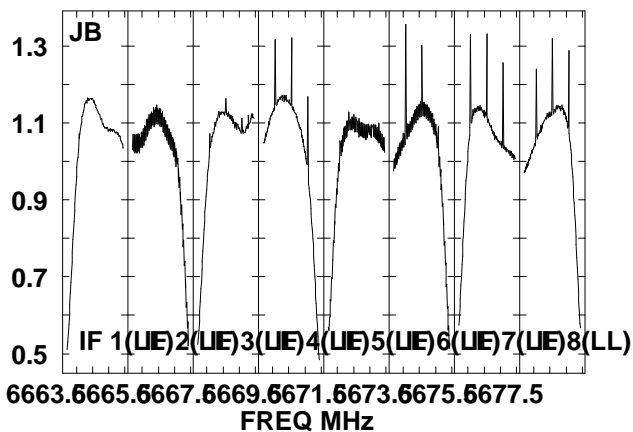
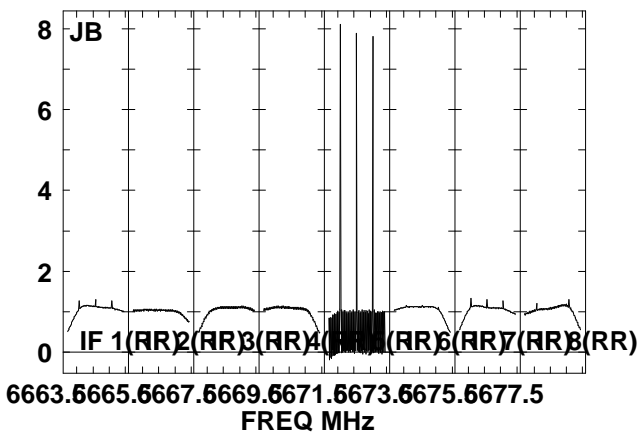
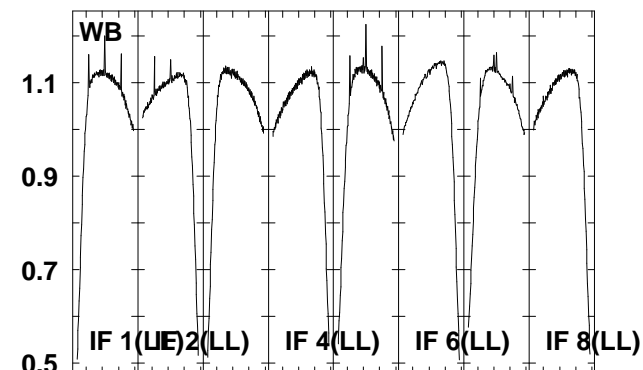
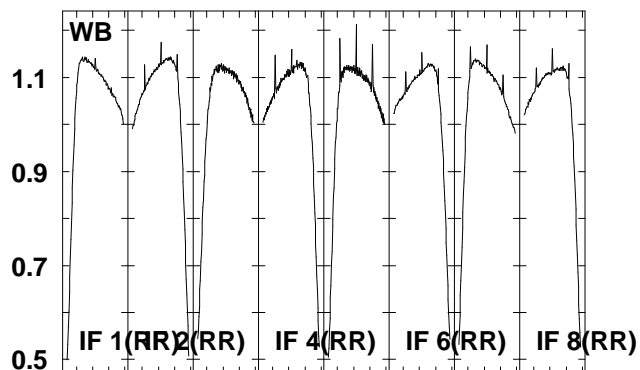
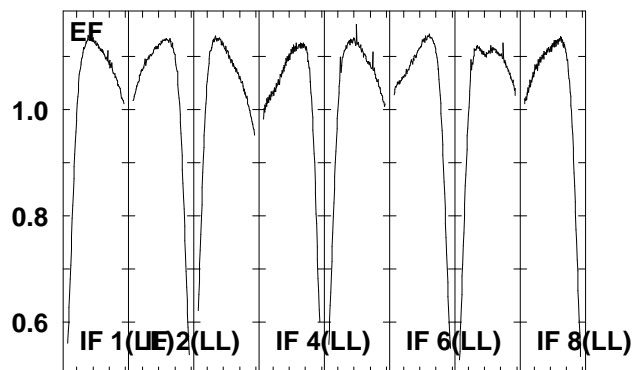
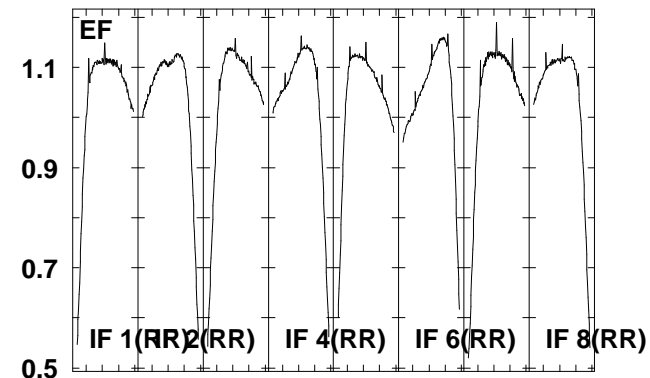
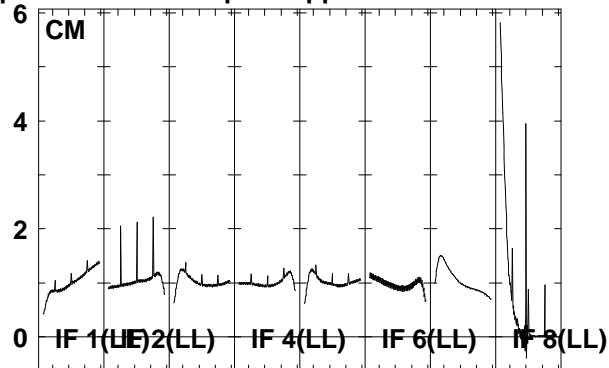
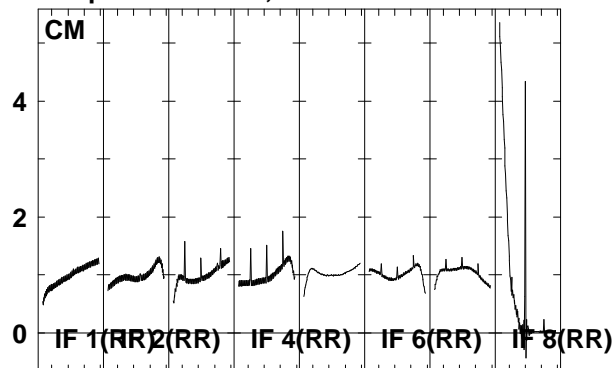

6663.6665.6667.6669.6671.6673.6675.6677.5
 FREQ MHz

6663.6665.6667.6669.6671.6673.6675.6677.5
 FREQ MHz

6663.6665.6667.6669.6671.6673.6675.6677.5
 FREQ MHz

Lower frame: Real Jy
 Total-power spectrum Antenna: *
 Timerange: 00/08:36:35 to 00/08:36:50

Plot file version 163 created 22-JUN-2006 20:11:41
 J1825-17 EM061A 1.UVDATA.1
 Freq = 6.6631 GHz, Bw = 2.000 MH No calibration applied and no bandpass applied

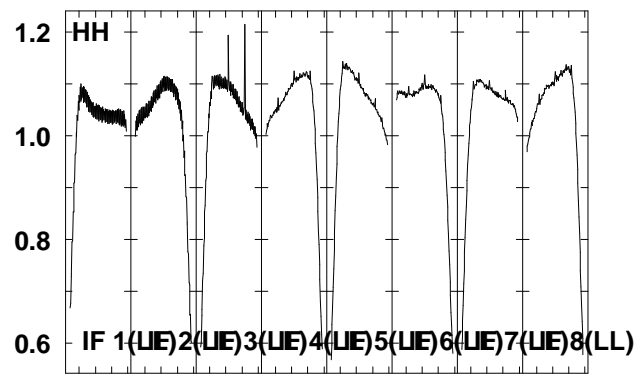
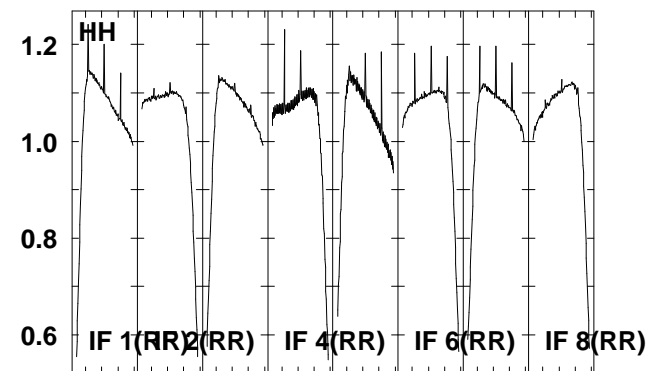
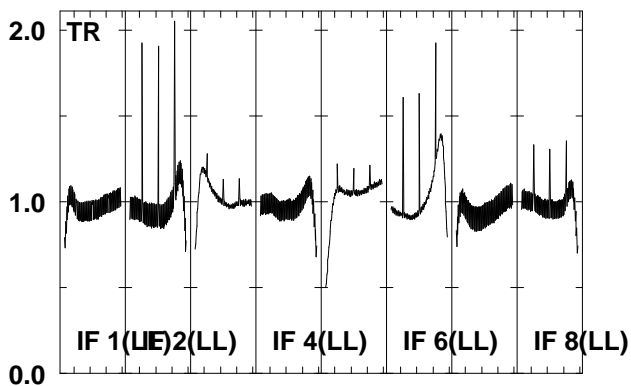
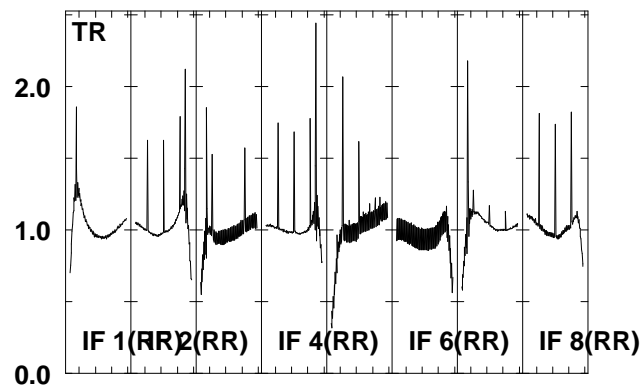
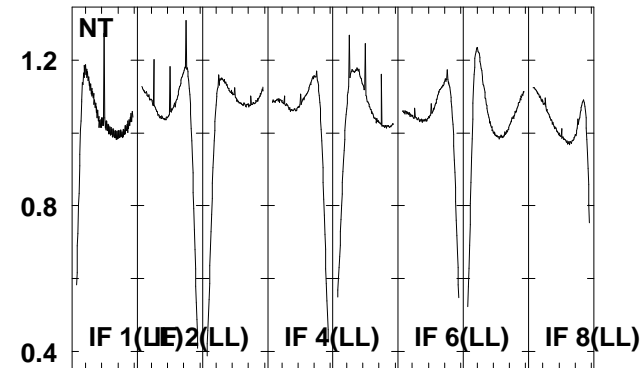
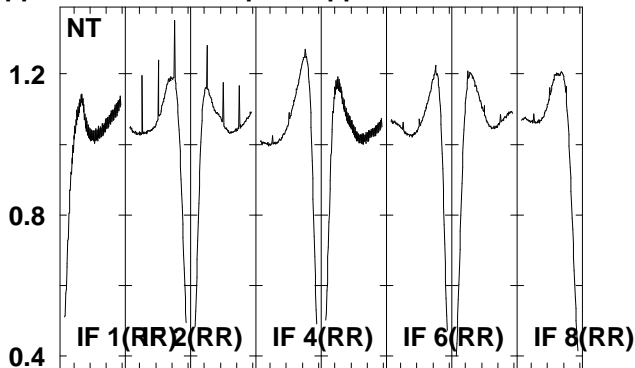
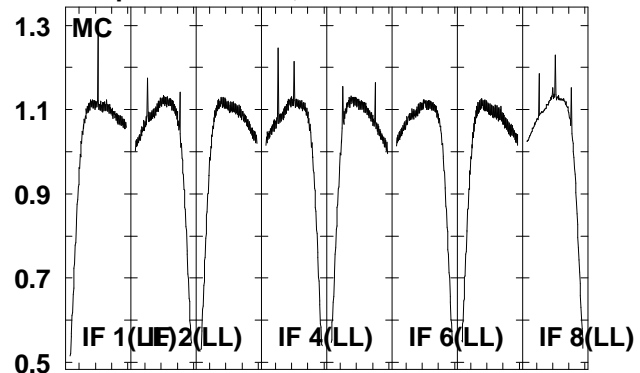

6663.6665.6667.6669.6671.6673.6675.6677.5
 FREQ MHz

Lower frame: Real Jy
 Total-power spectrum Antenna: *
 Timerange: 00/08:36:35 to 00/08:36:50

Plot file version 164 created 22-JUN-2006 20:11:43
 J1825-17 EM061A 1.UVDATA.1
 Freq = 6.6631 GHz, Bw = 2.000 MH No calibration applied and no bandpass applied

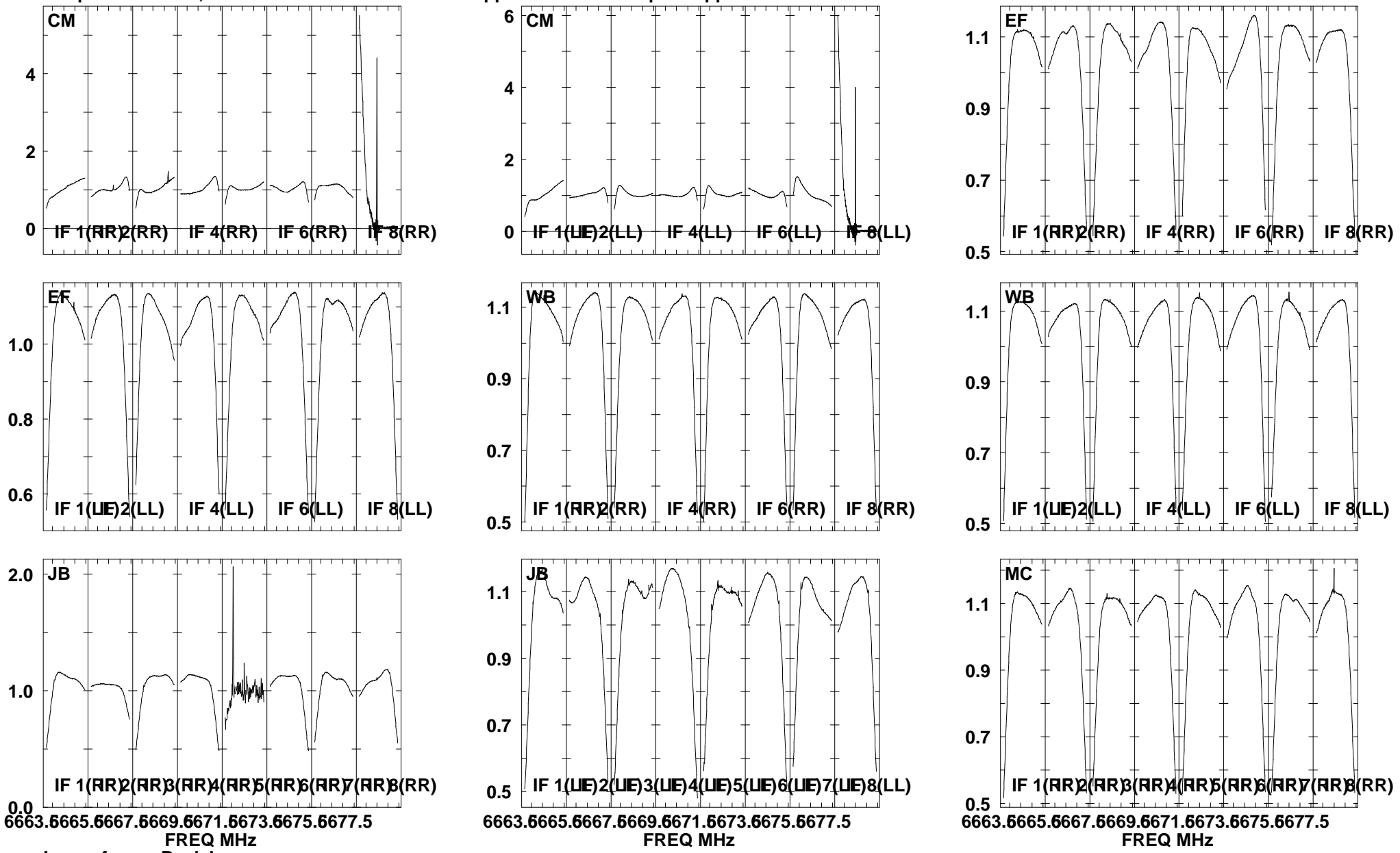

Lower frame: Real Jy
 Total-power spectrum Antenna: *
 Timerange: 00/08:36:52 to 00/08:39:32

Plot file version 165 created 22-JUN-2006 20:11:46

J1825-17 EM061A 1.UVDATA.1

Freq = 6.6631 GHz, Bw = 2.000 MH No calibration applied and no bandpass applied

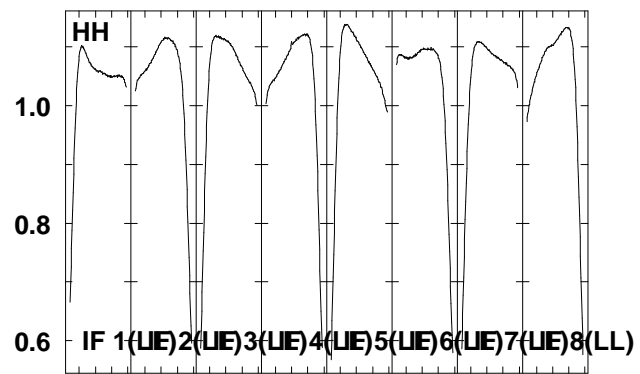
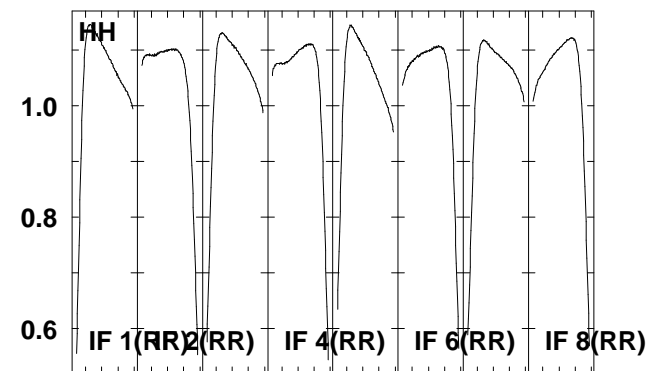
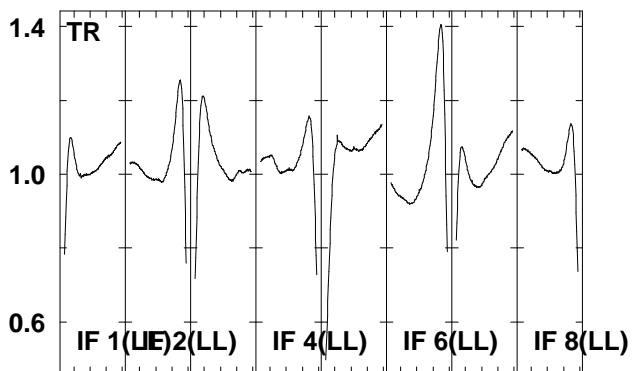
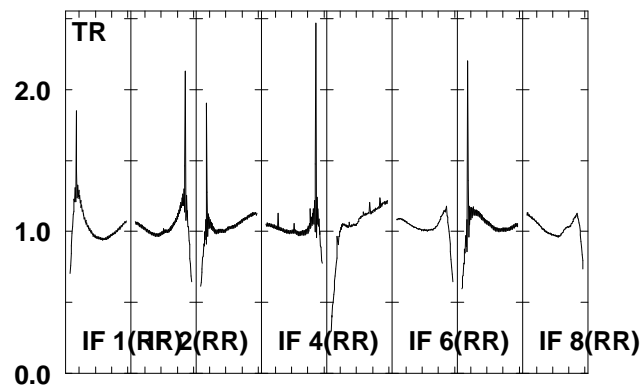
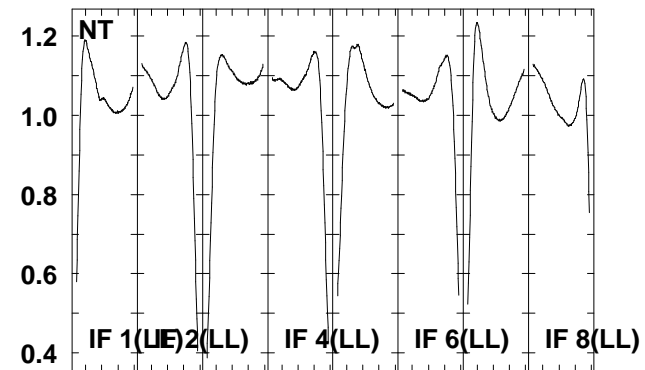
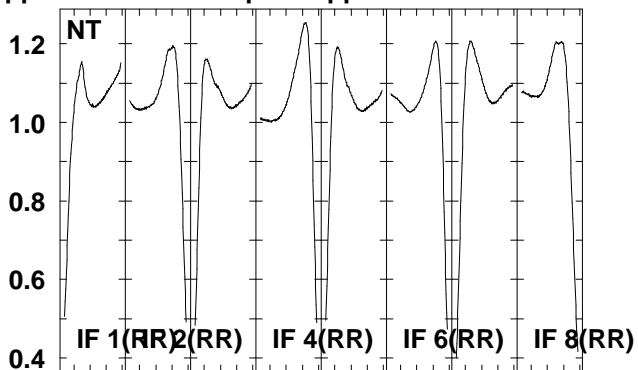
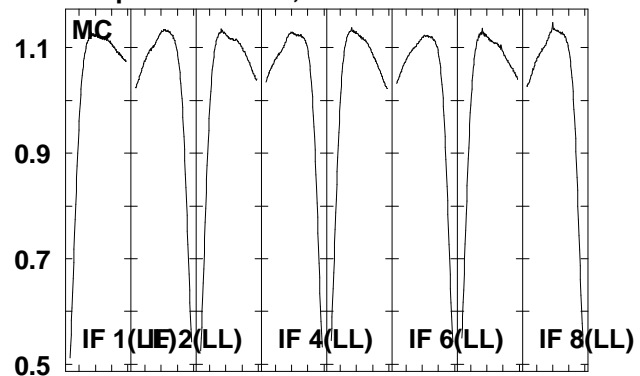

6663.6665.6667.6669.6671.6673.6675.6677.5

FREQ MHz

Lower frame: Real Jy

Total-power spectrum Antenna: *

Timerange: 00/08:36:52 to 00/08:39:32

Plot file version 166 created 22-JUN-2006 20:11:50
 G16.59-0 EM061A 1.UVDATA.1
 Freq = 6.6631 GHz, Bw = 2.000 MH No calibration applied and no bandpass applied

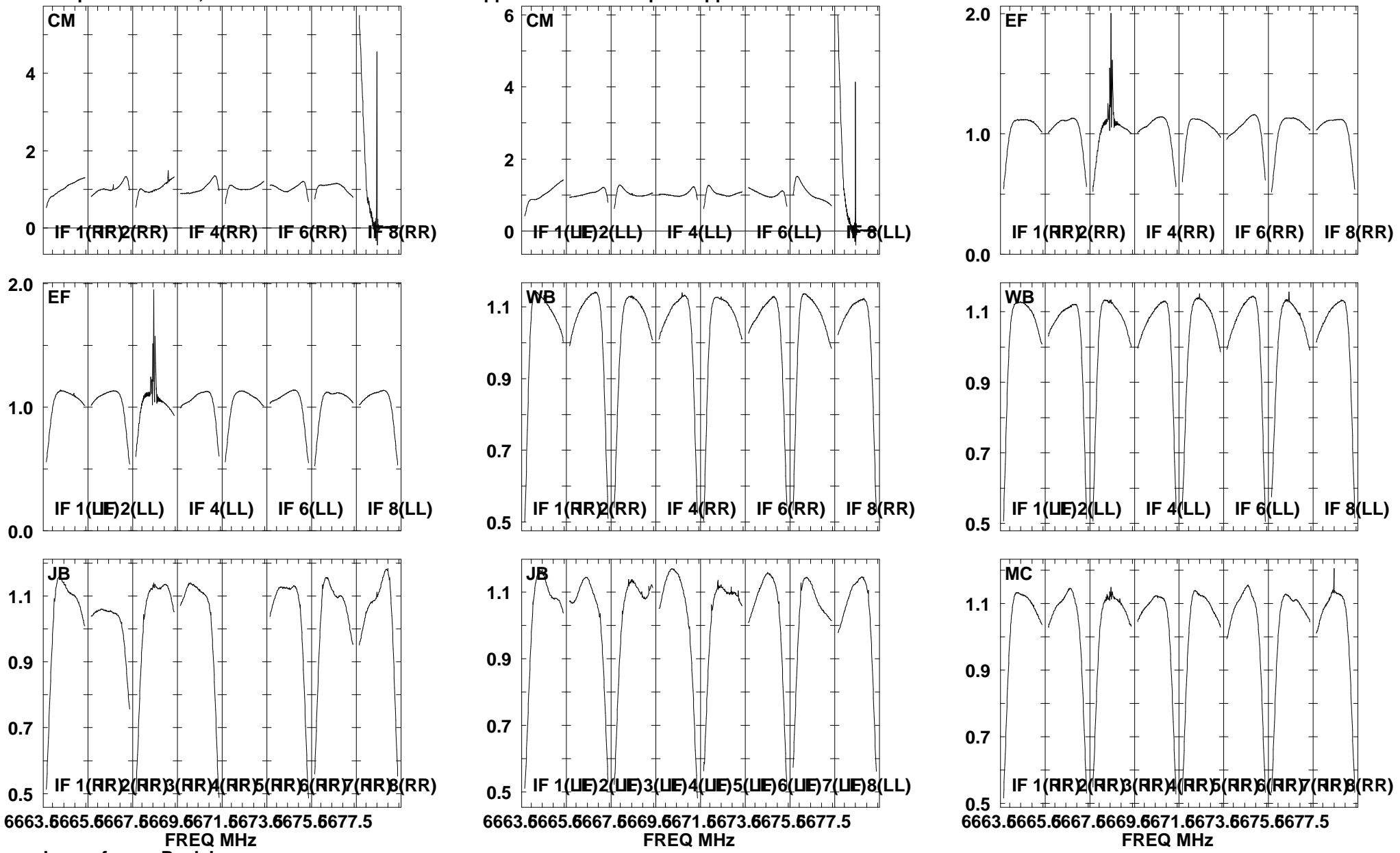

Lower frame: Real Jy
 Total-power spectrum Antenna: *
 Timerange: 00/08:39:34 to 00/08:42:02

Plot file version 167 created 22-JUN-2006 20:11:53
 G16.59-0 EM061A 1.UVDATA.1
 Freq = 6.6631 GHz, Bw = 2.000 MH No calibration applied and no bandpass applied

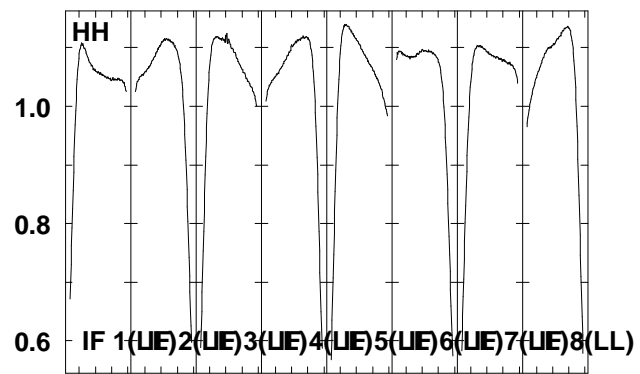
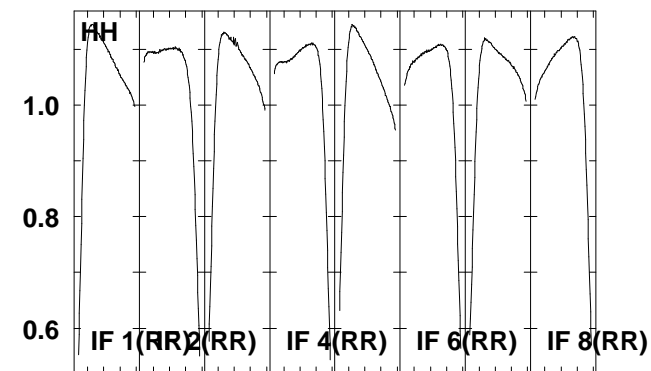
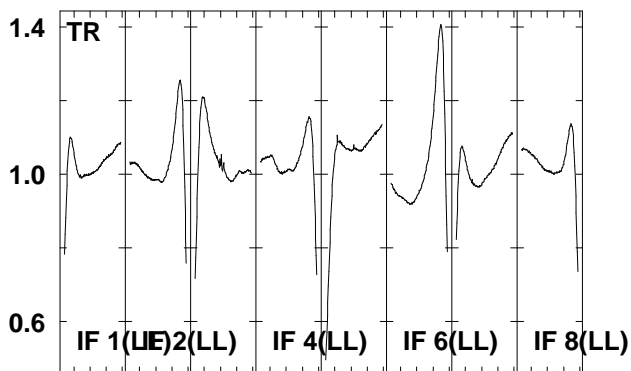
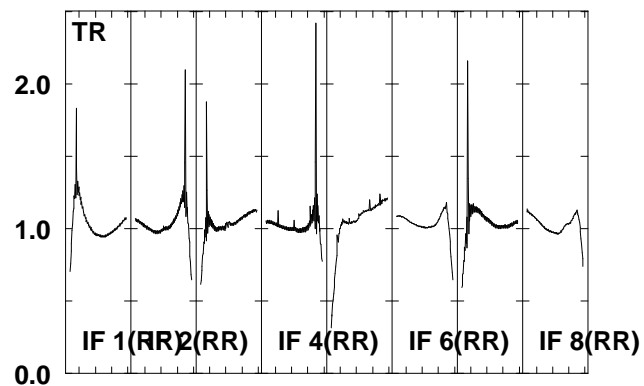
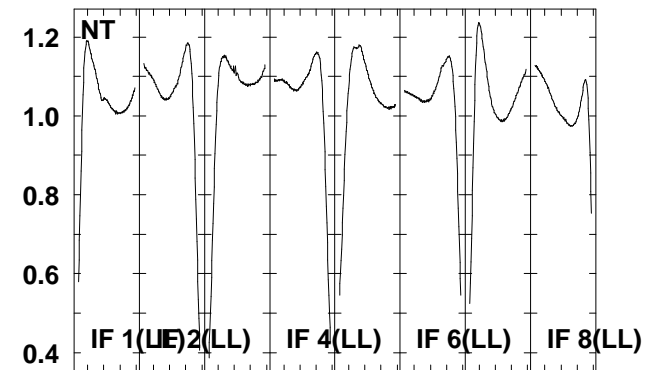
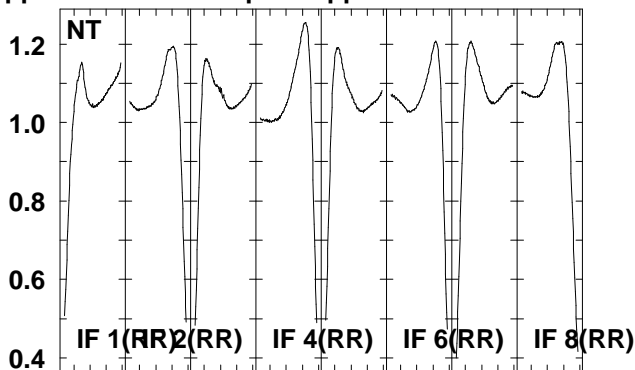
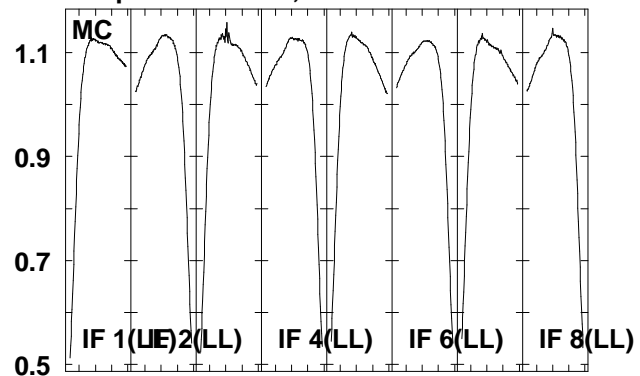

6663.6665.6667.6669.6671.6673.6675.6677.5
 FREQ MHz

Lower frame: Real Jy
 Total-power spectrum Antenna: *
 Timerange: 00/08:39:34 to 00/08:42:02

Plot file version 168 created 22-JUN-2006 20:11:56
 J1825-17 EM061A 1.UVDATA.1
 Freq = 6.6631 GHz, Bw = 2.000 MH No calibration applied and no bandpass applied

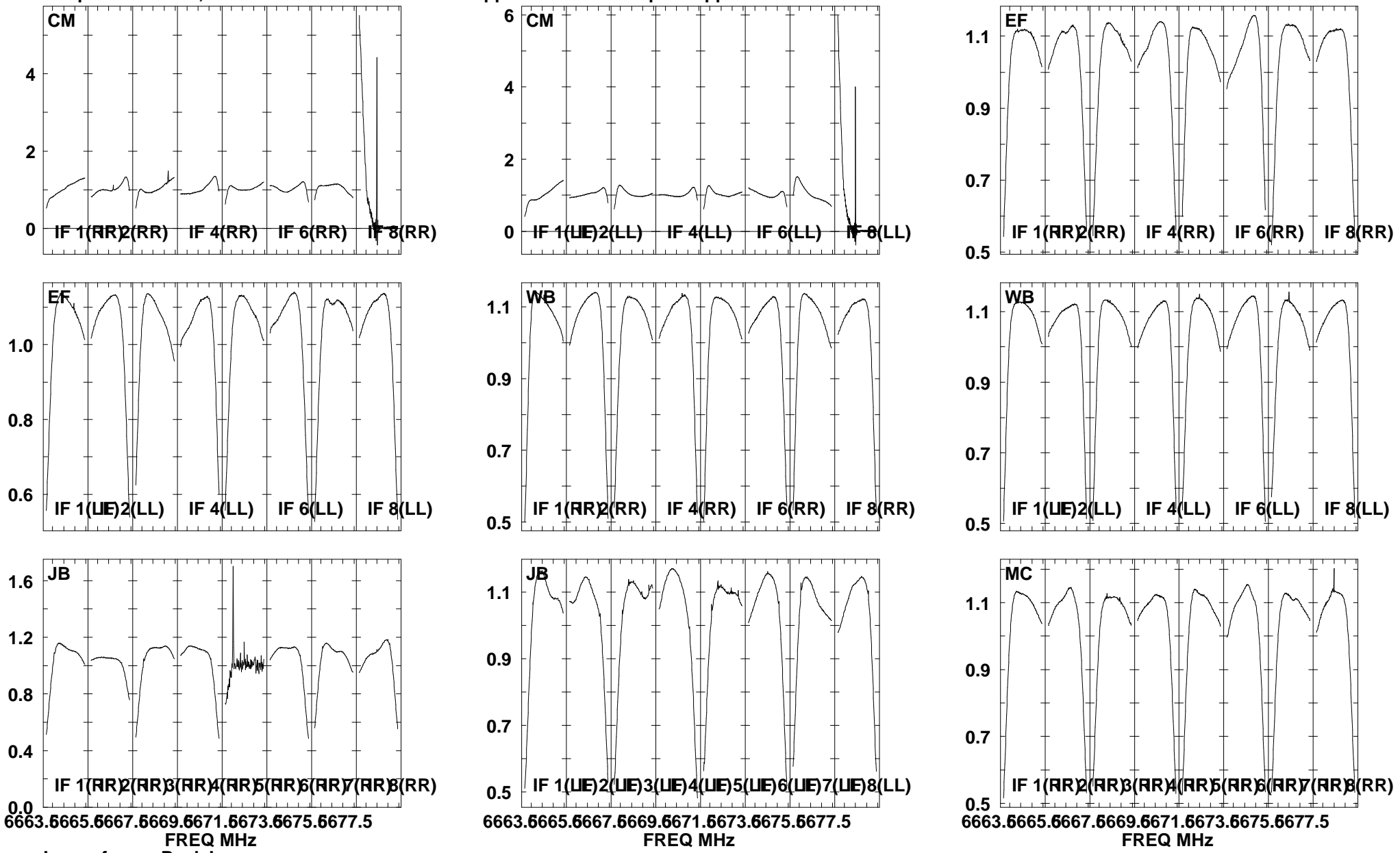

Lower frame: Real Jy
 Total-power spectrum Antenna: *
 Timerange: 00/08:42:04 to 00/08:45:02

Plot file version 169 created 22-JUN-2006 20:12:00
 J1825-17 EM061A 1.UVDATA.1
 Freq = 6.6631 GHz, Bw = 2.000 MH No calibration applied and no bandpass applied

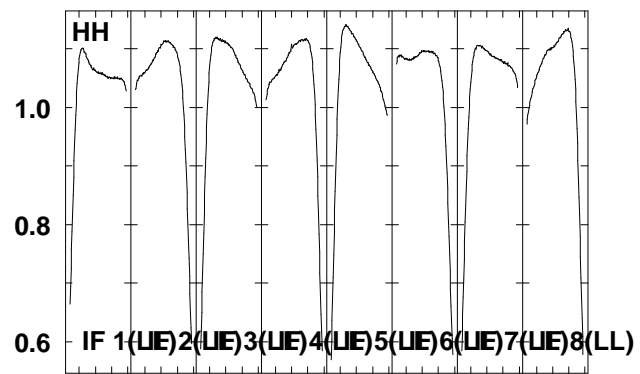
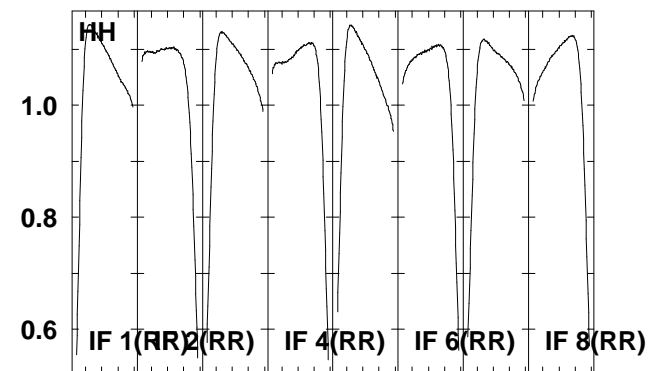
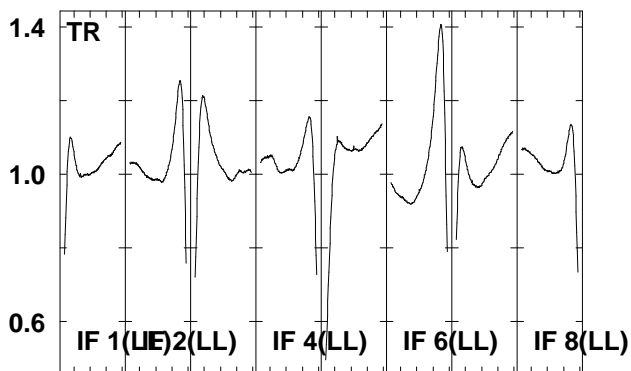
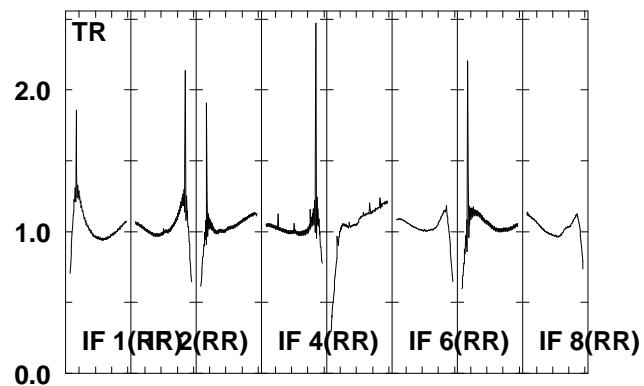
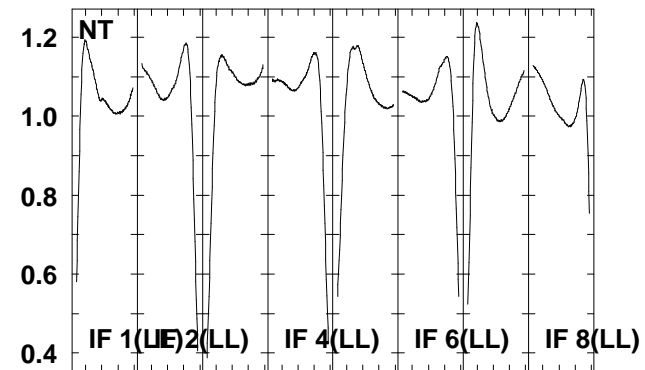
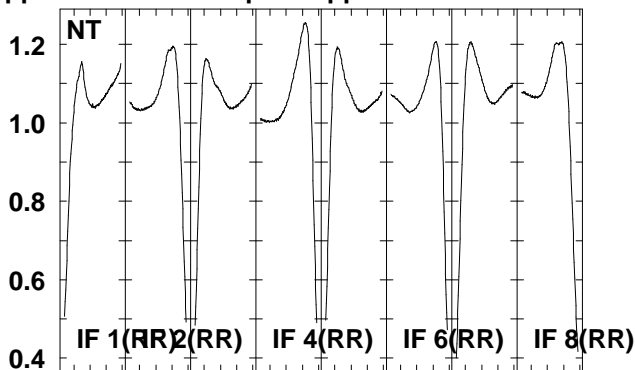
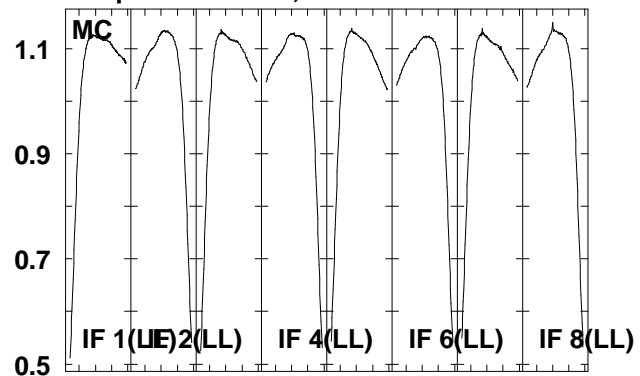

6663.6665.6667.6669.6671.6673.6675.6677.5
 FREQ MHz

Lower frame: Real Jy
 Total-power spectrum Antenna: *
 Timerange: 00/08:42:04 to 00/08:45:02

Plot file version 170 created 22-JUN-2006 20:12:04
 G16.59-0 EM061A 1.UVDATA.1
 Freq = 6.6631 GHz, Bw = 2.000 MH No calibration applied and no bandpass applied

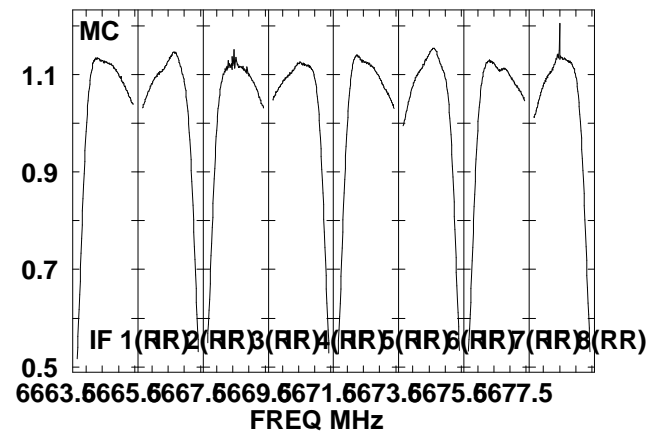
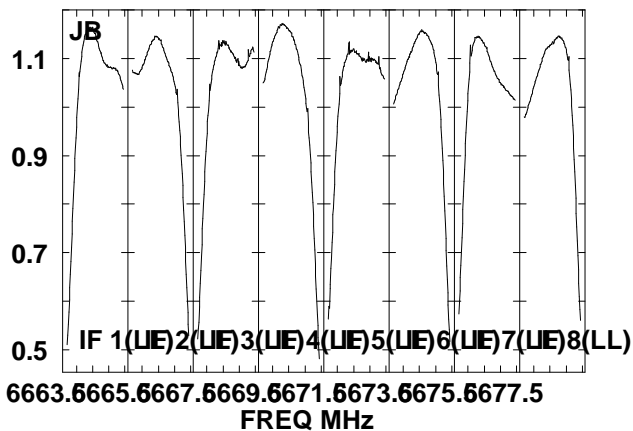
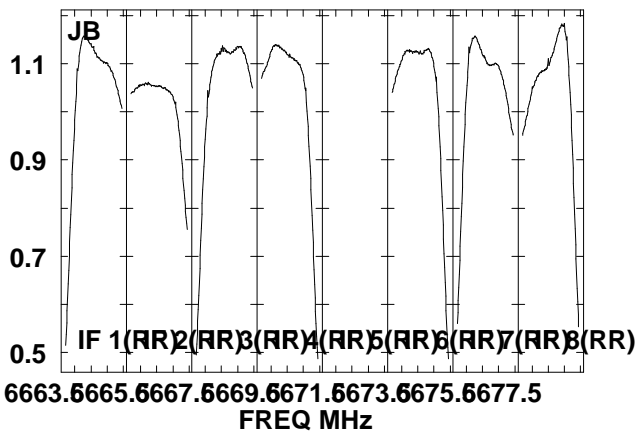
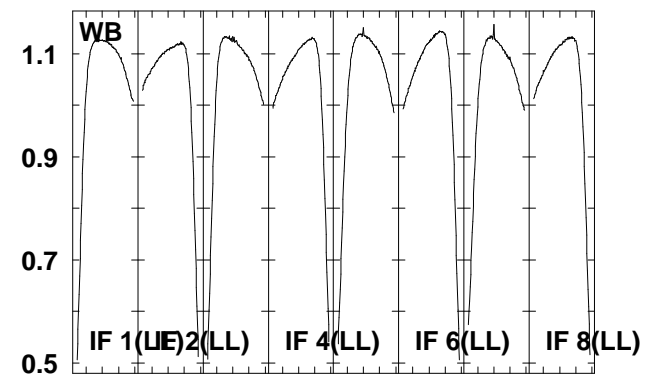
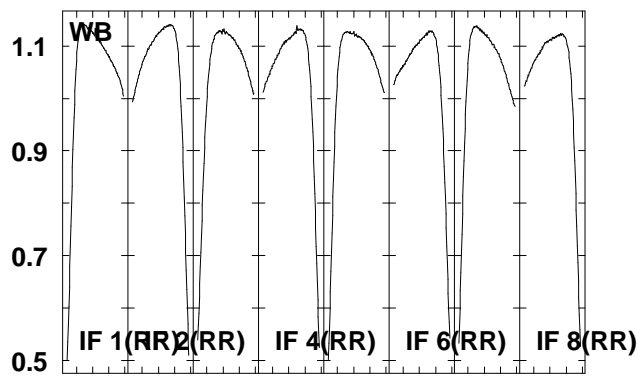
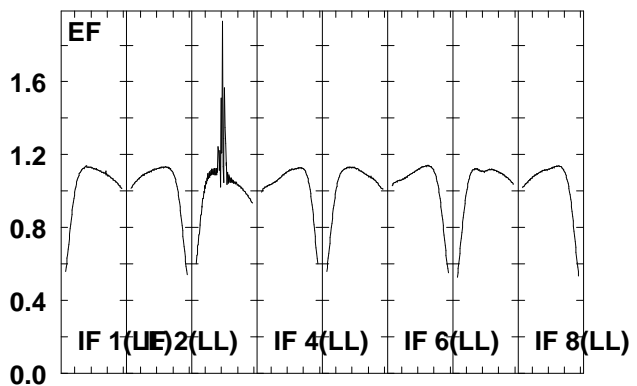
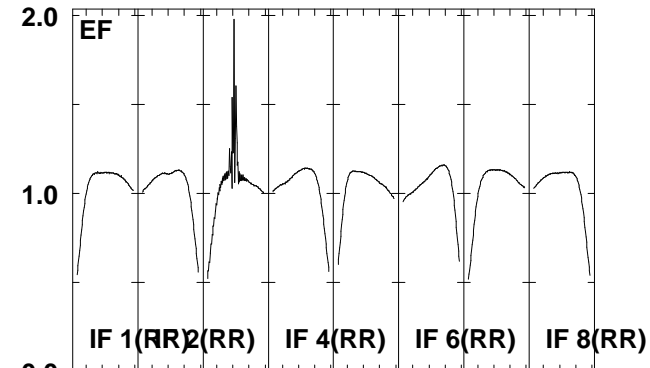
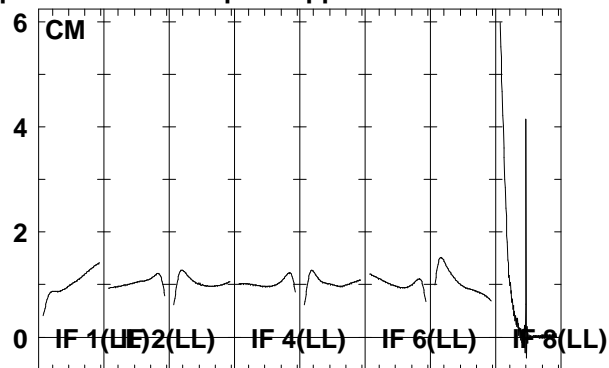
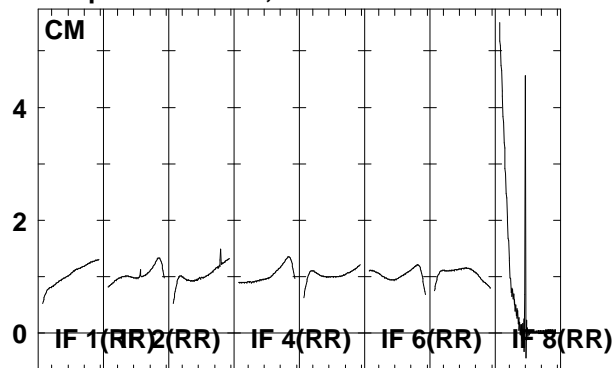

6663.6665.6667.6669.6671.6673.6675.6677.5
 FREQ MHz
 Lower frame: Real Jy
 Total-power spectrum Antenna: *
 Timerange: 00/08:45:04 to 00/08:47:32

Plot file version 171 created 22-JUN-2006 20:12:07
 G16.59-0 EM061A 1.UVDATA.1
 Freq = 6.6631 GHz, Bw = 2.000 MH No calibration applied and no bandpass applied

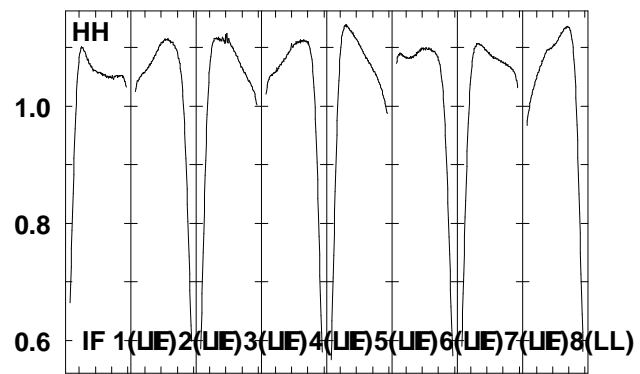
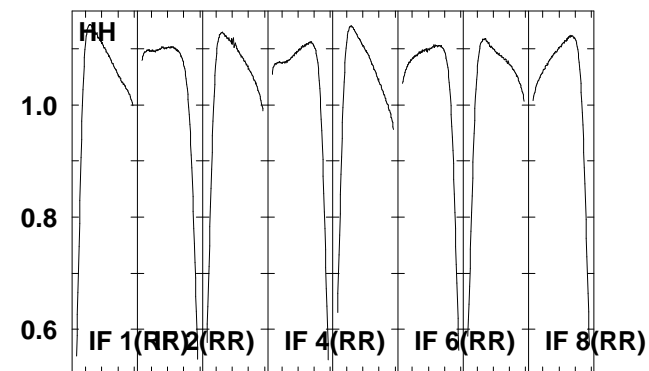
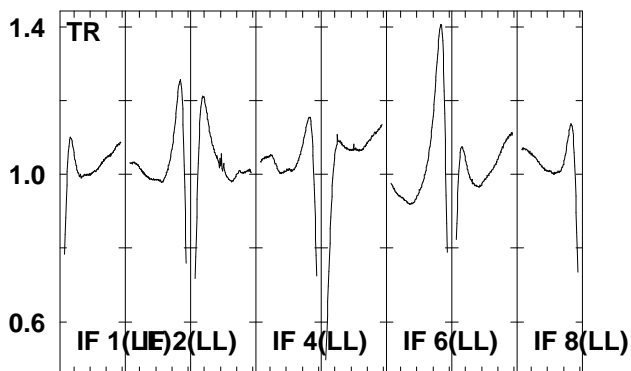
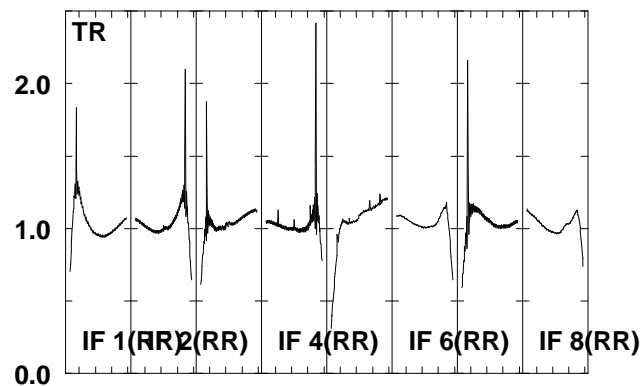
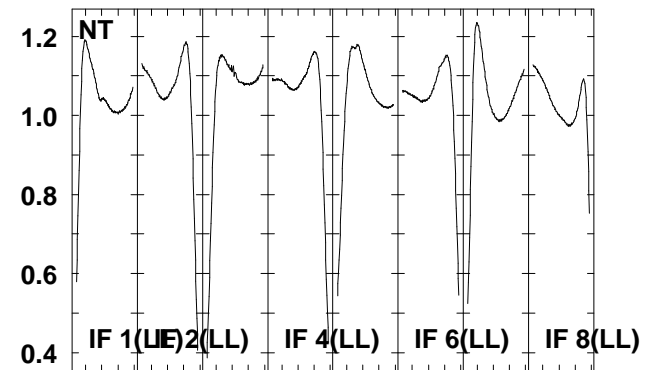
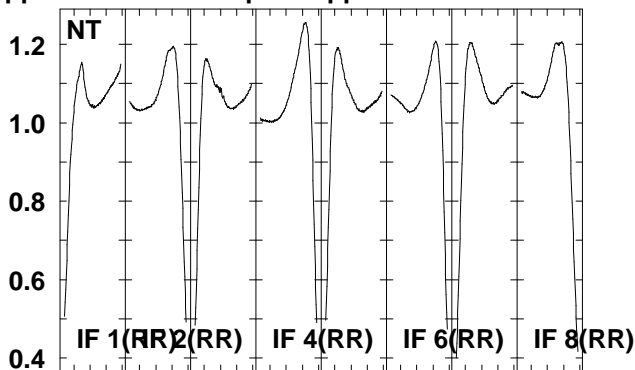
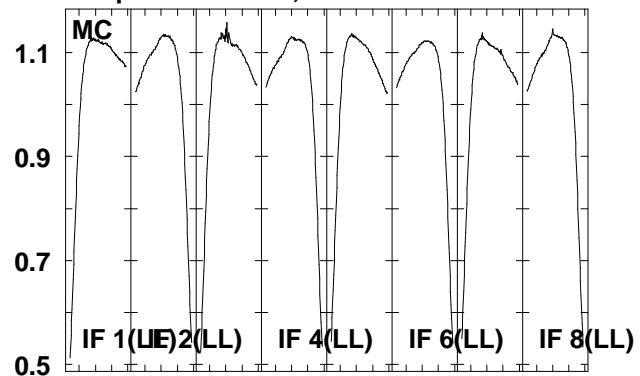

6663.6665.6667.6669.6671.6673.6675.6677.5
 FREQ MHz

Lower frame: Real Jy
 Total-power spectrum Antenna: *
 Timerange: 00/08:45:04 to 00/08:47:32

Plot file version 172 created 22-JUN-2006 20:12:11
 J1825-17 EM061A 1.UVDATA.1
 Freq = 6.6631 GHz, Bw = 2.000 MH No calibration applied and no bandpass applied

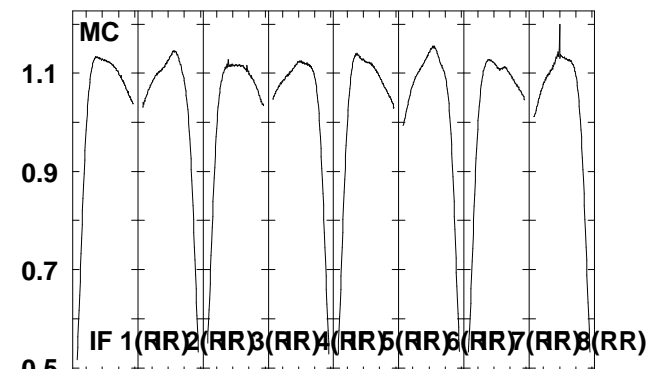
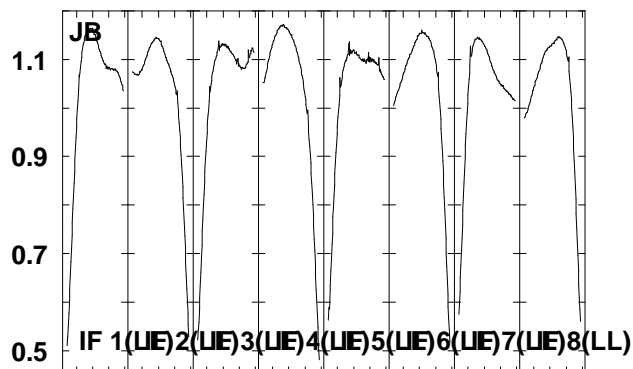
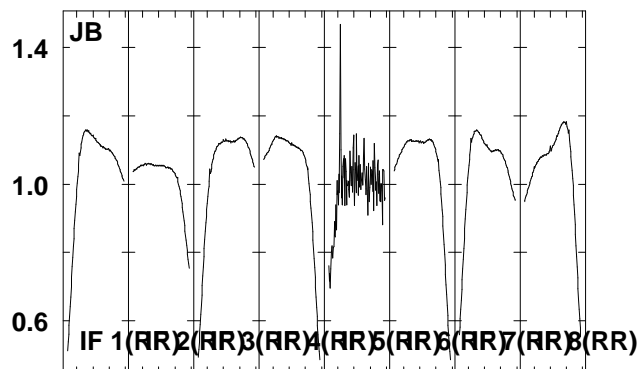
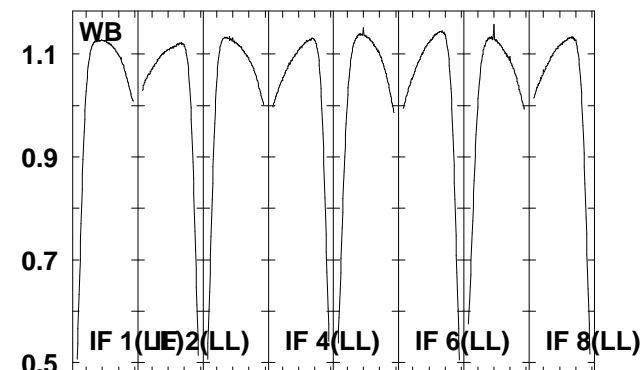
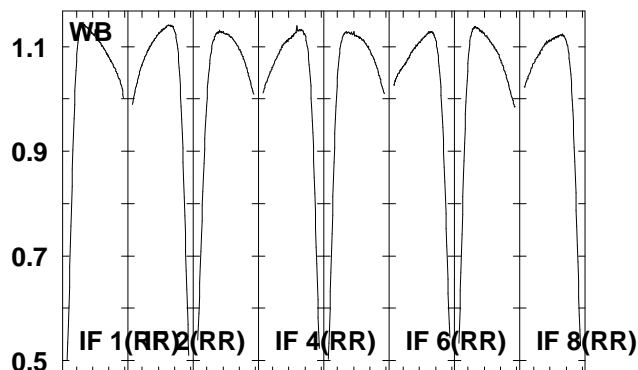
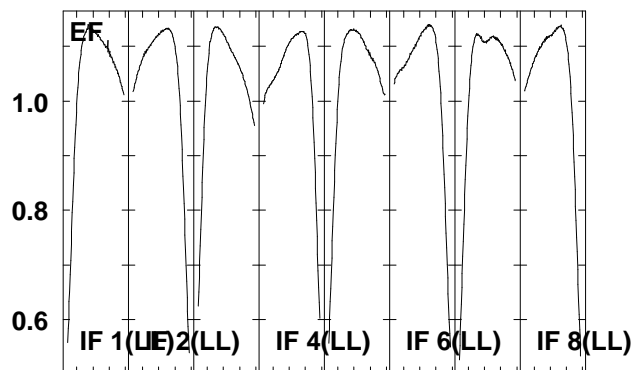
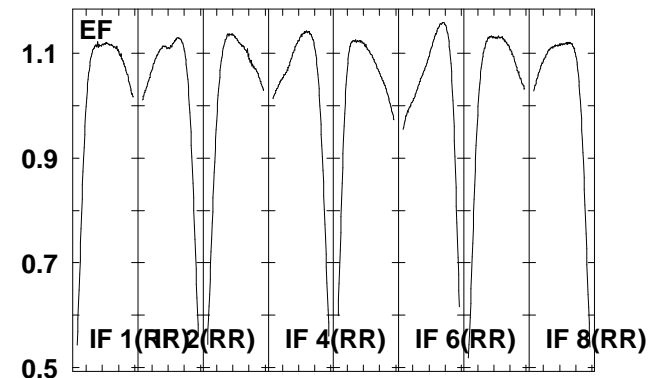
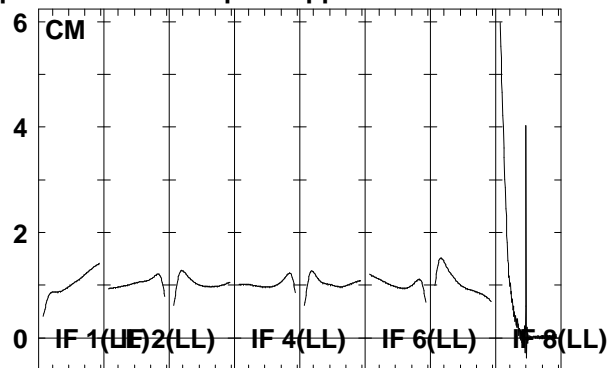
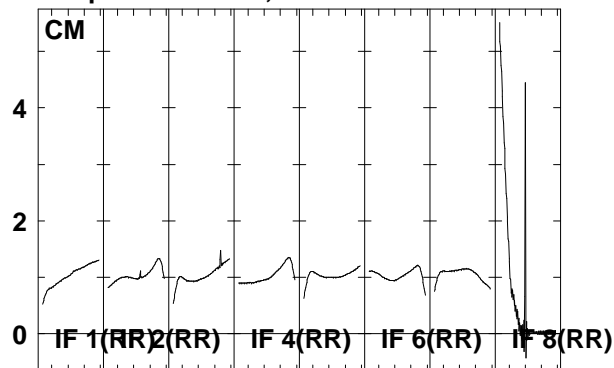

6663.6665.6667.6669.6671.6673.6675.6677.5
 FREQ MHz

6663.6665.6667.6669.6671.6673.6675.6677.5
 FREQ MHz

6663.6665.6667.6669.6671.6673.6675.6677.5
 FREQ MHz

Lower frame: Real Jy
 Total-power spectrum Antenna: *
 Timerange: 00/08:47:34 to 00/08:50:32

Plot file version 173 created 22-JUN-2006 20:12:15
 J1825-17 EM061A 1.UVDATA.1
 Freq = 6.6631 GHz, Bw = 2.000 MH No calibration applied and no bandpass applied

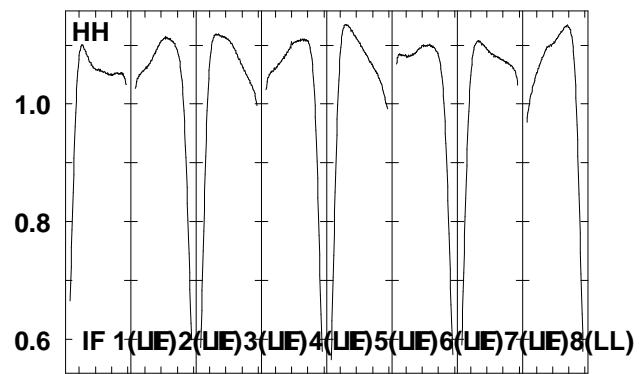
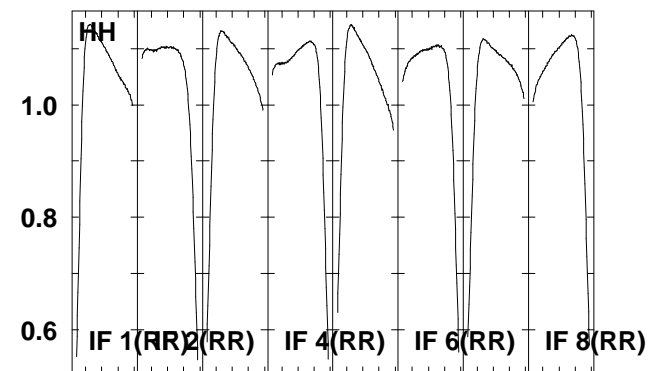
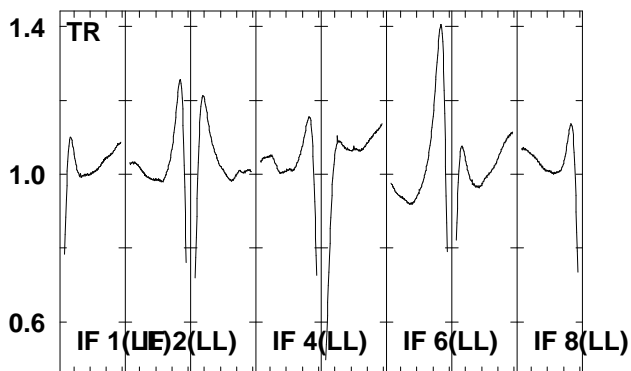
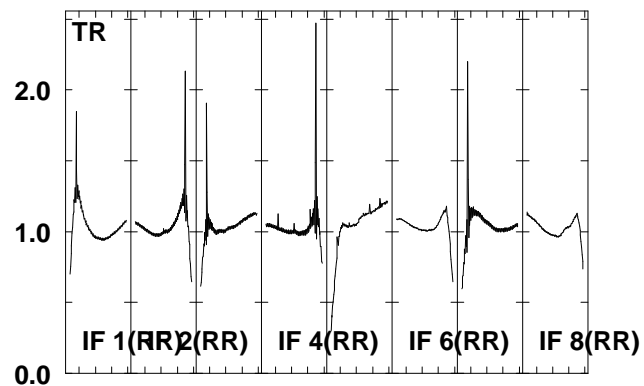
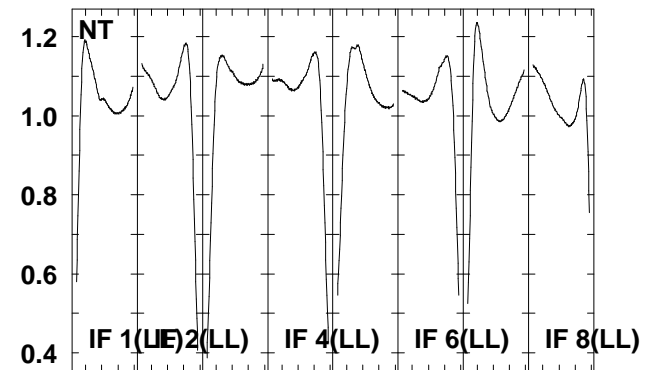
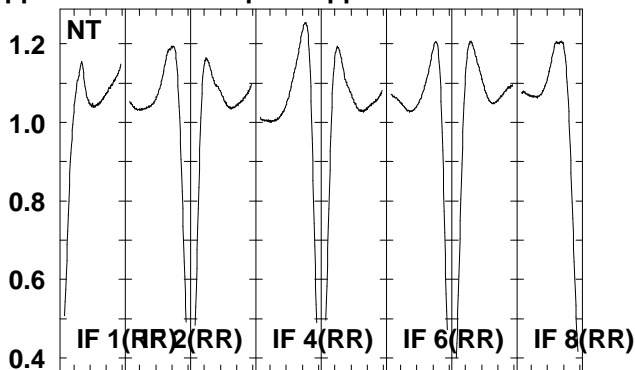
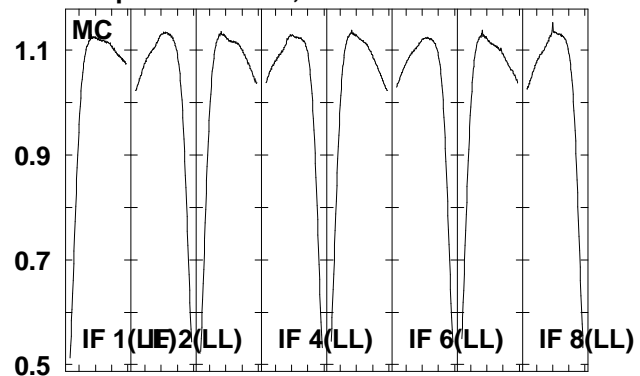

6663.6665.6667.6669.6671.6673.6675.6677.5
 FREQ MHz

Lower frame: Real Jy
 Total-power spectrum Antenna: *
 Timerange: 00/08:47:34 to 00/08:50:32

Plot file version 174 created 22-JUN-2006 20:12:18
 G16.59-0 EM061A 1.UVDATA.1
 Freq = 6.6631 GHz, Bw = 2.000 MH No calibration applied and no bandpass applied

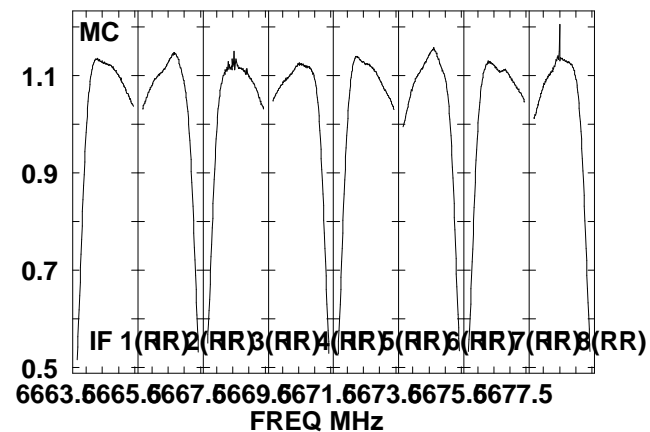
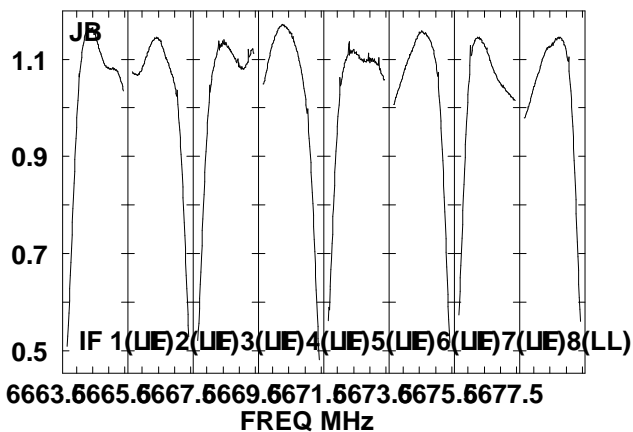
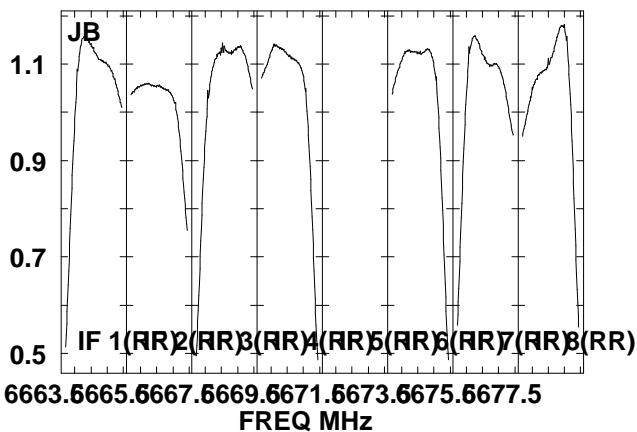
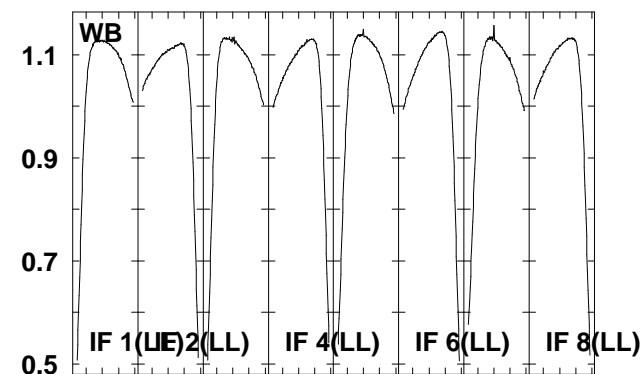
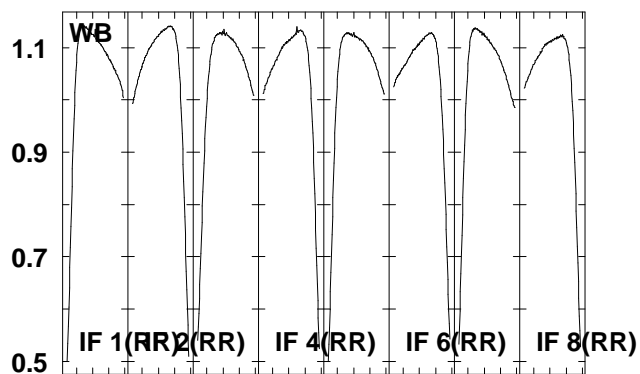
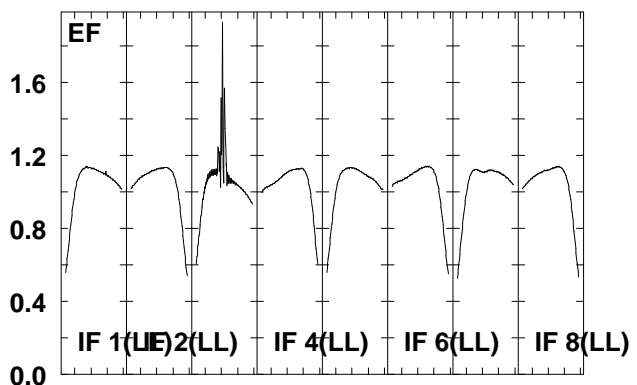
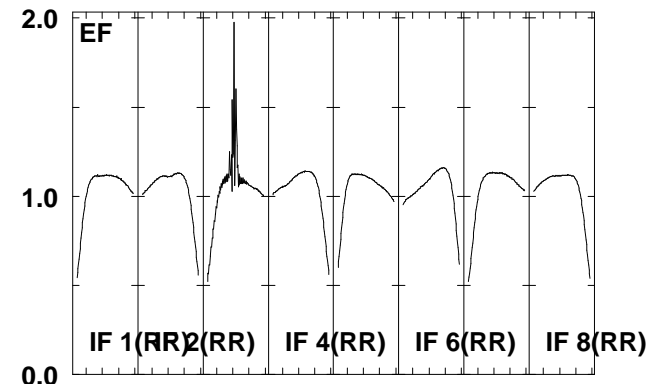
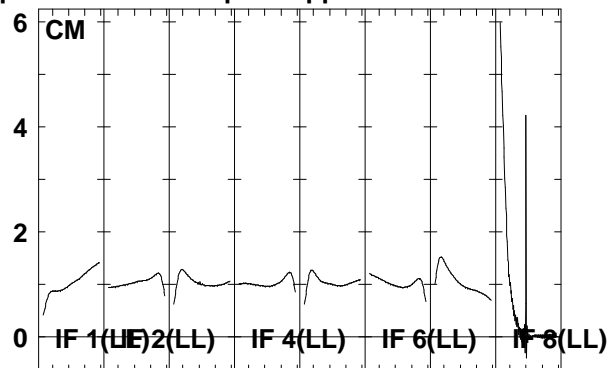
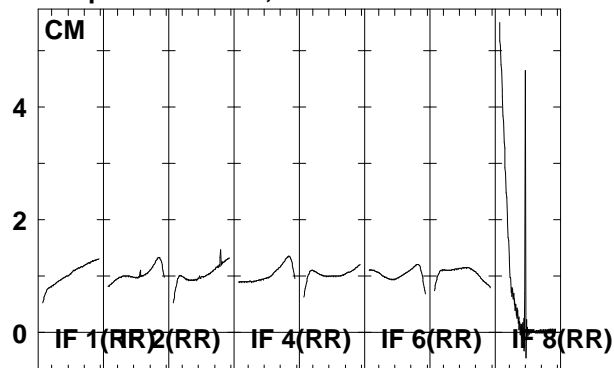

6663.6665.6667.6669.6671.6673.6675.6677.5
 FREQ MHz
 Lower frame: Real Jy
 Total-power spectrum Antenna: *
 Timerange: 00/08:50:34 to 00/08:53:02

Plot file version 175 created 22-JUN-2006 20:12:21
 G16.59-0 EM061A 1.UVDATA.1
 Freq = 6.6631 GHz, Bw = 2.000 MH No calibration applied and no bandpass applied

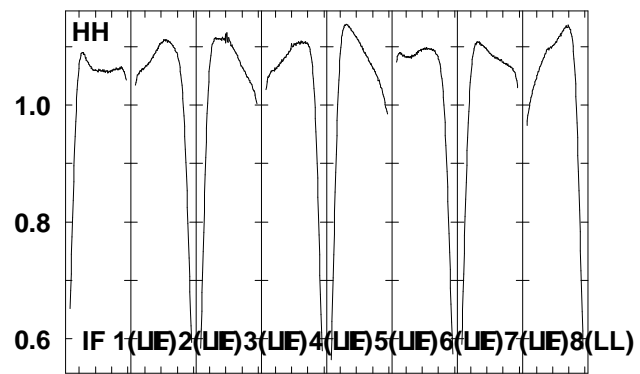
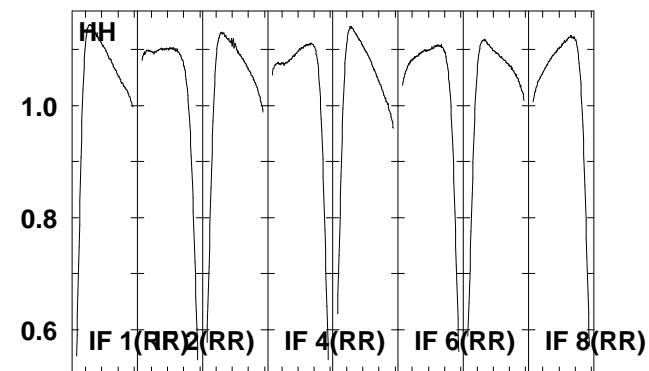
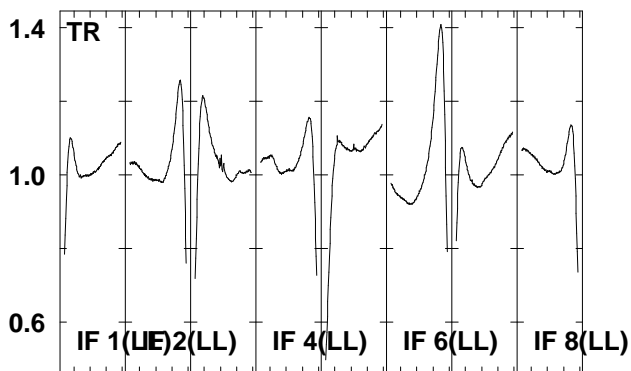
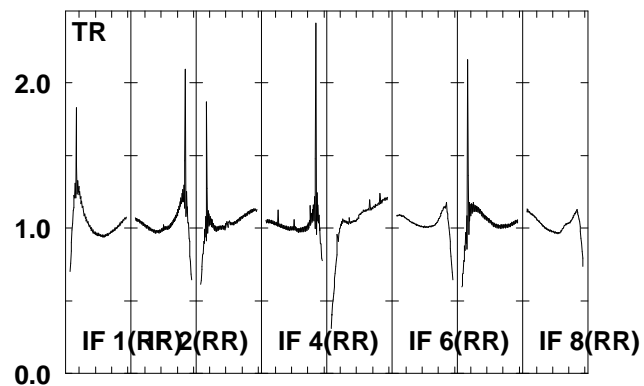
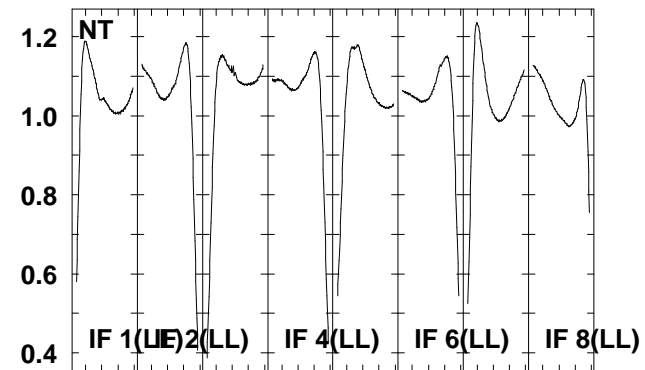
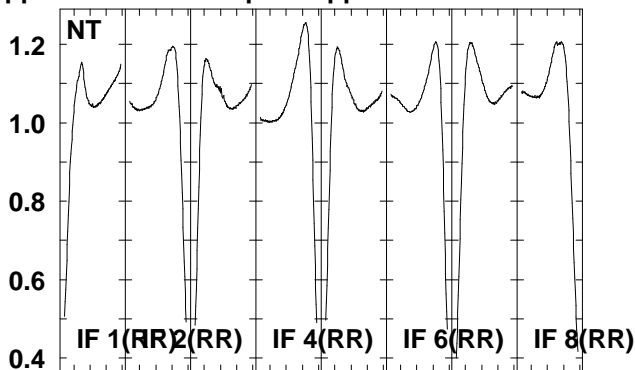
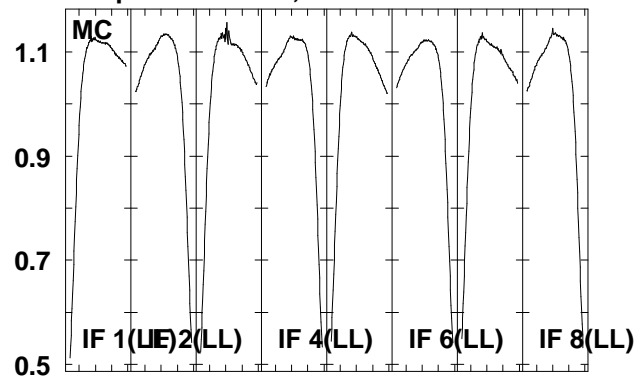

6663.6665.6667.6669.6671.6673.6675.6677.5
 FREQ MHz

Lower frame: Real Jy
 Total-power spectrum Antenna: *
 Timerange: 00/08:50:34 to 00/08:53:02

Plot file version 176 created 22-JUN-2006 20:12:28
 J2253+16 EM061A 1.UVDATA.1
 Freq = 6.6631 GHz, Bw = 2.000 MH No calibration applied and no bandpass applied

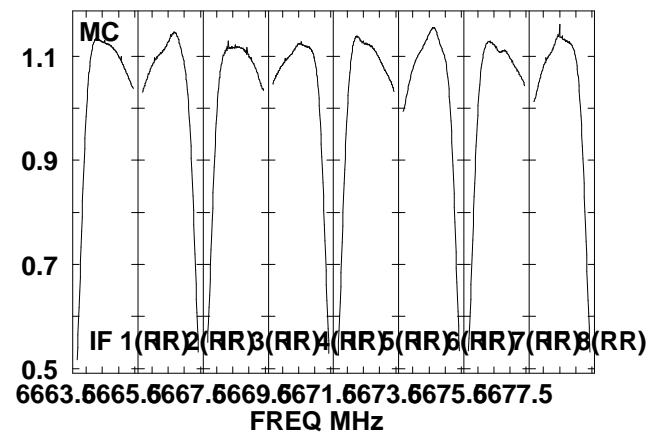
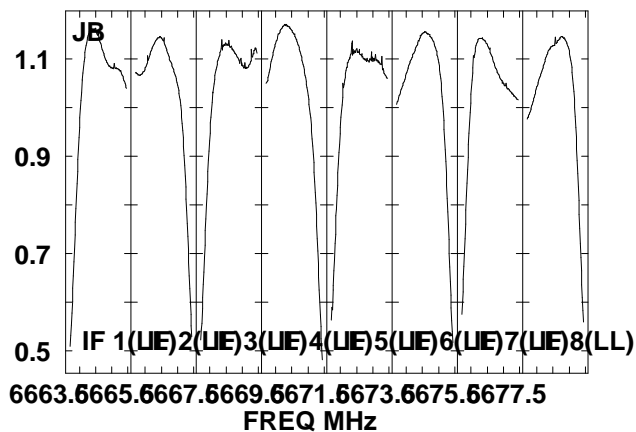
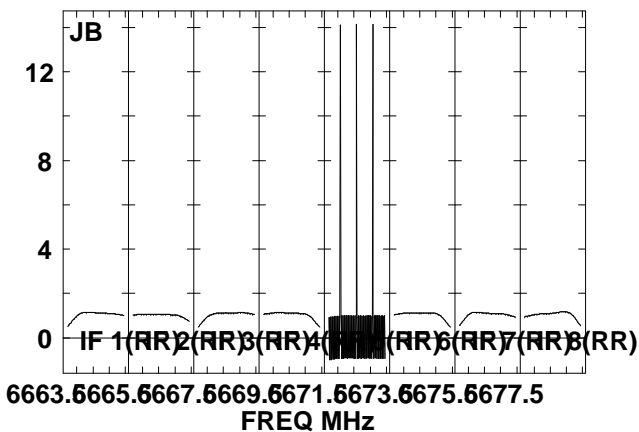
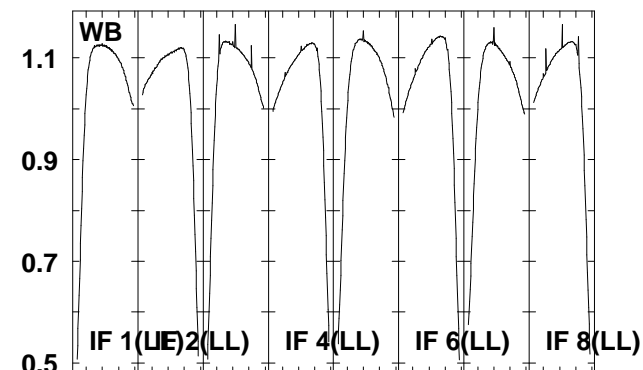
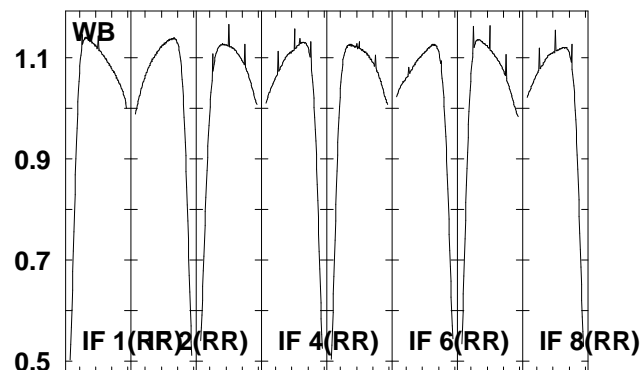
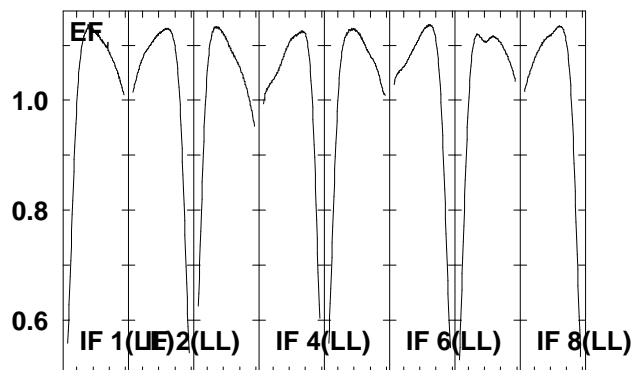
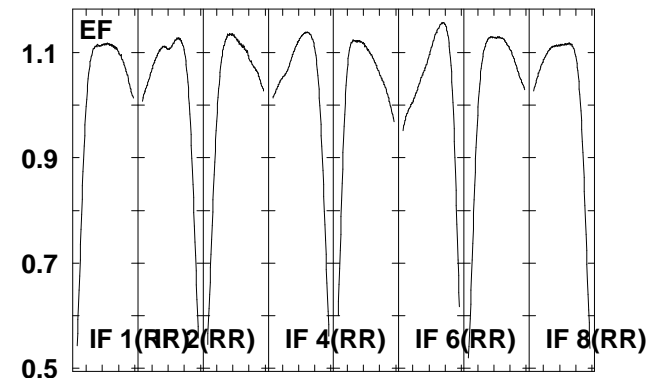
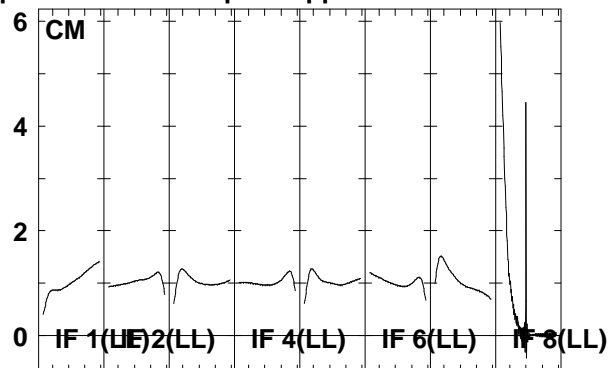
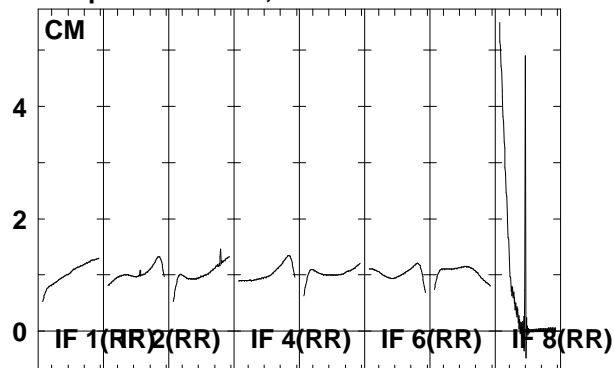

Lower frame: Real Jy
 Total-power spectrum Antenna: *
 Timerange: 00/09:01:05 to 00/09:09:02

Plot file version 177 created 22-JUN-2006 20:12:38
 J2253+16 EM061A 1.UVDATA.1
 Freq = 6.6631 GHz, Bw = 2.000 MH No calibration applied and no bandpass applied

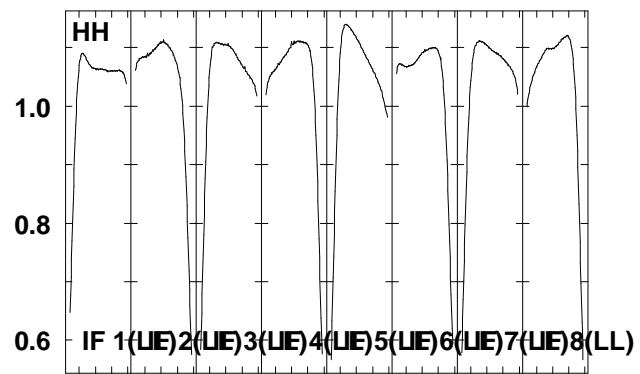
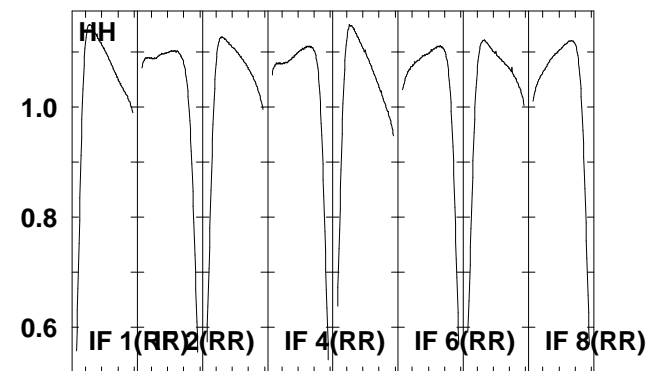
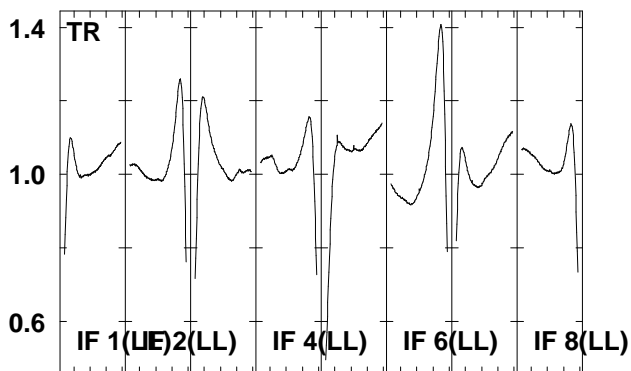
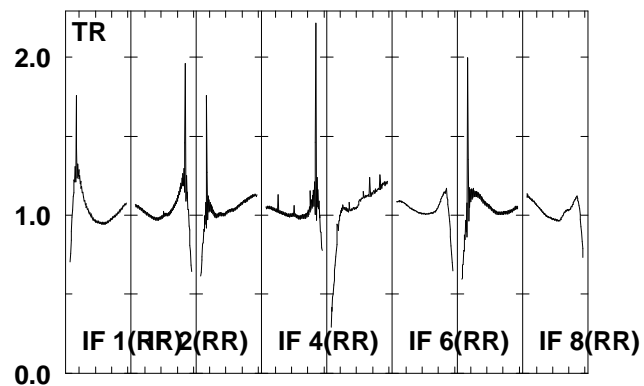
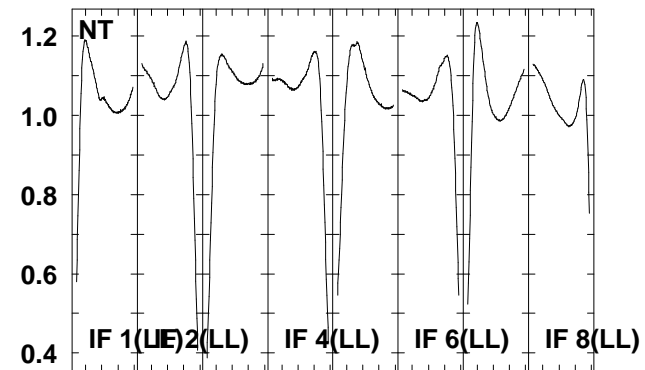
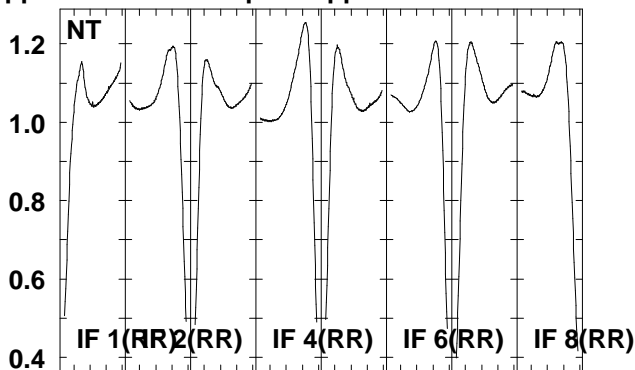
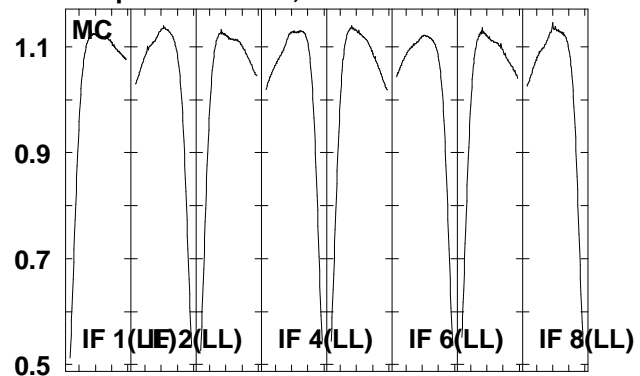

6663.6665.6667.6669.6671.6673.6675.6677.5
 FREQ MHz

Lower frame: Real Jy
 Total-power spectrum Antenna: *
 Timerange: 00/09:01:05 to 00/09:09:02

Plot file version 178 created 22-JUN-2006 20:12:46
 G16.59-0 EM061A 1.UVDATA.1
 Freq = 6.6631 GHz, Bw = 2.000 MH No calibration applied and no bandpass applied

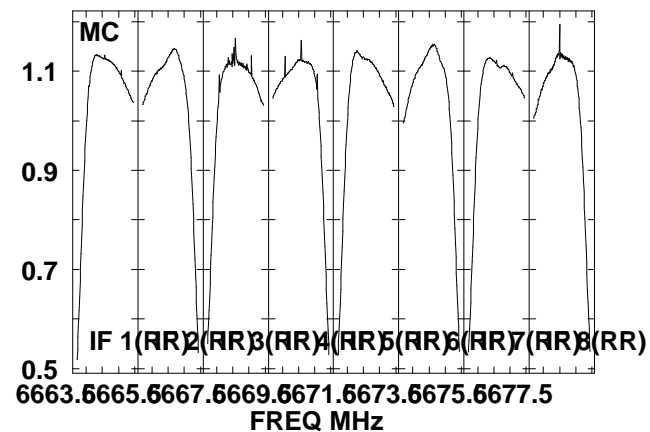
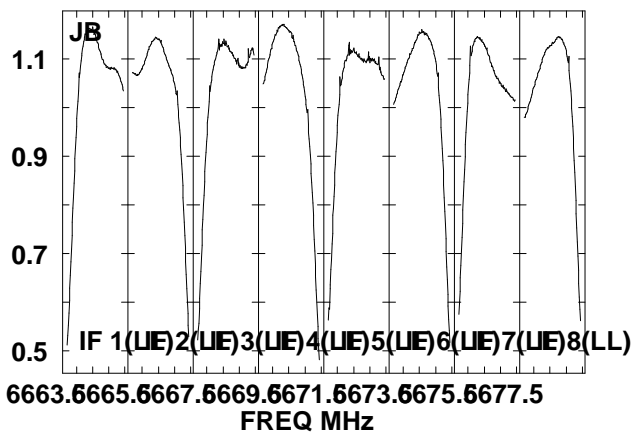
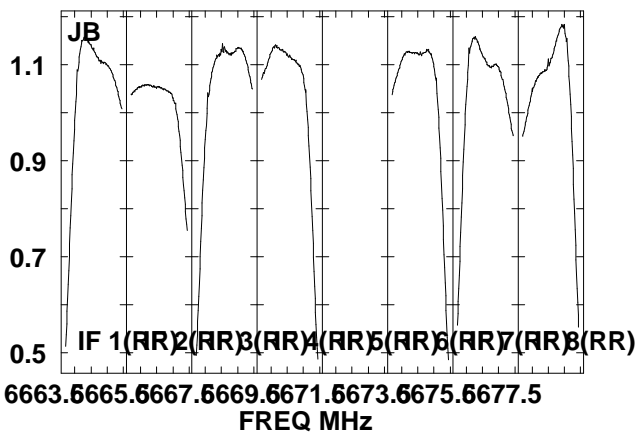
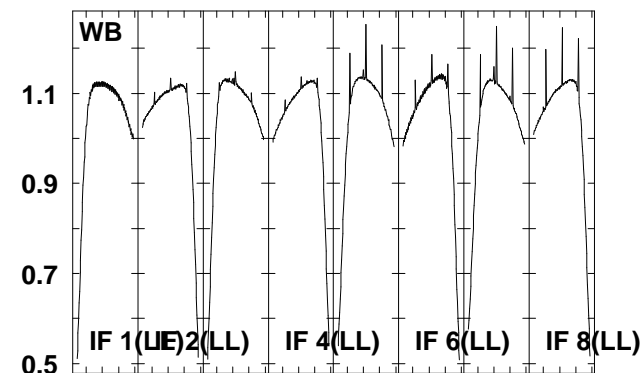
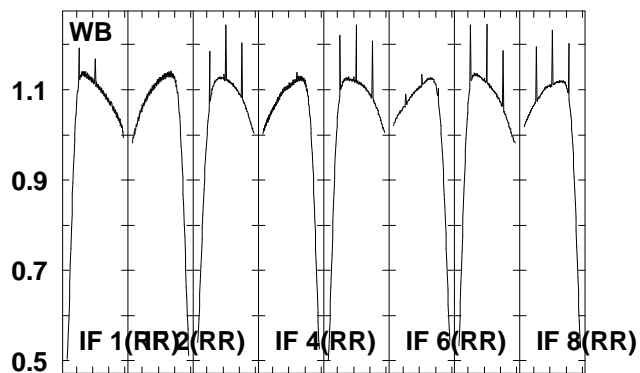
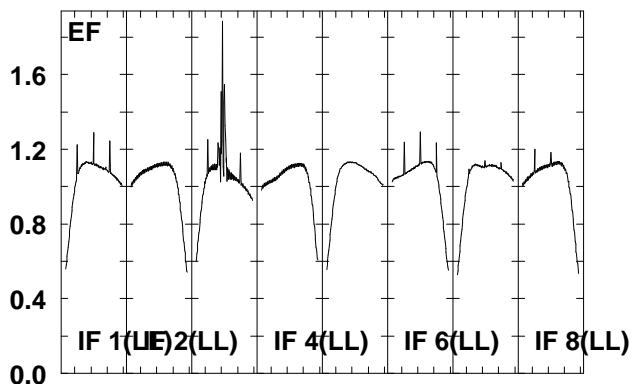
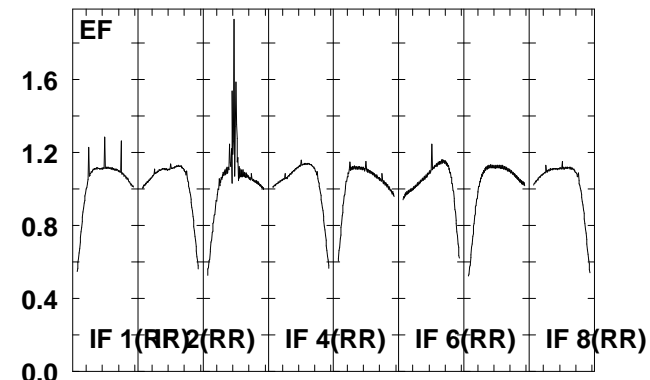
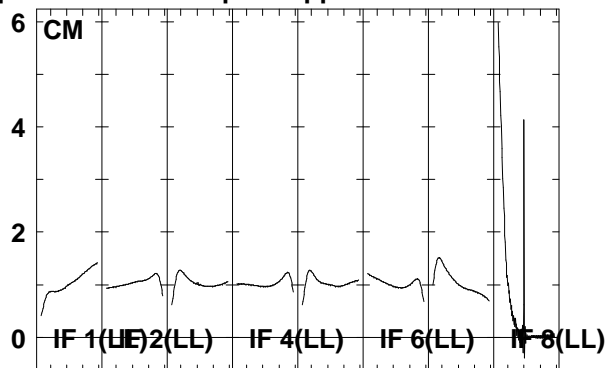
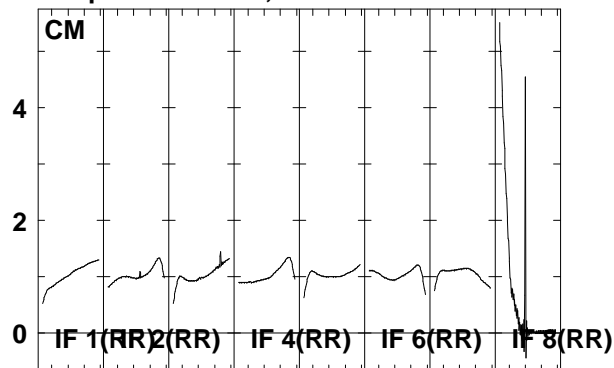

Lower frame: Real Jy
 Total-power spectrum Antenna: *
 Timerange: 00/09:13:05 to 00/09:15:32

Plot file version 179 created 22-JUN-2006 20:12:48
 G16.59-0 EM061A 1.UVDATA.1
 Freq = 6.6631 GHz, Bw = 2.000 MH No calibration applied and no bandpass applied

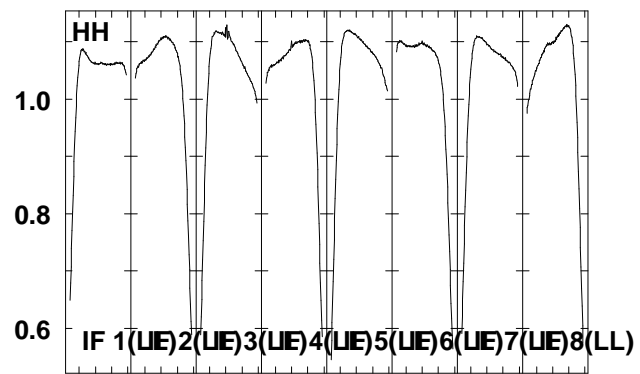
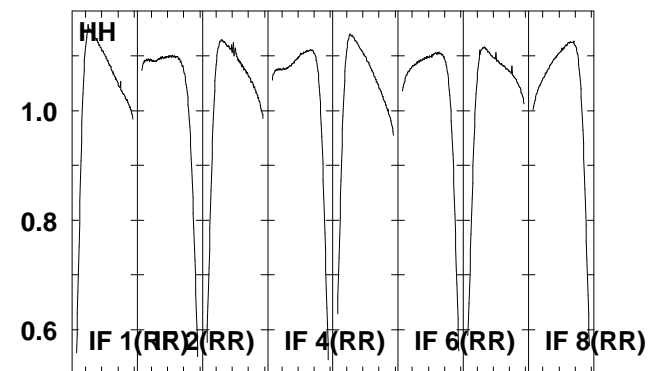
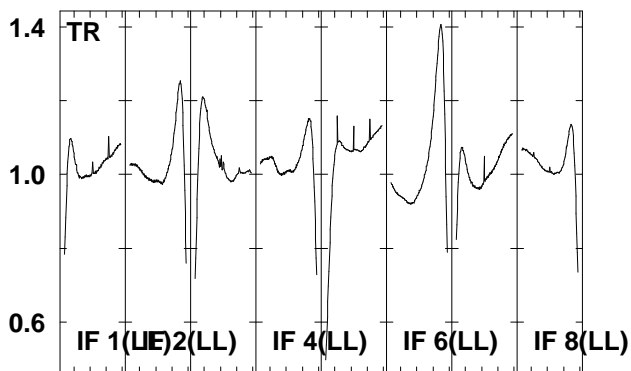
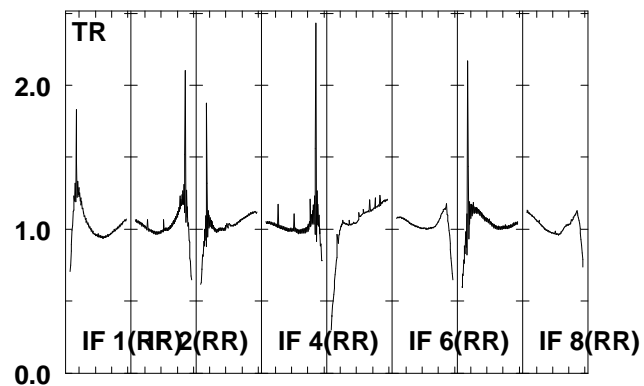
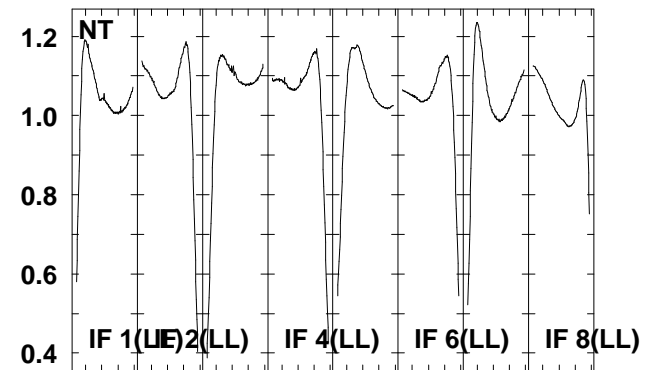
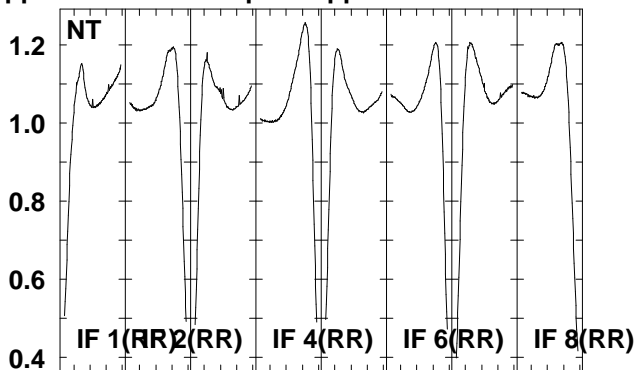
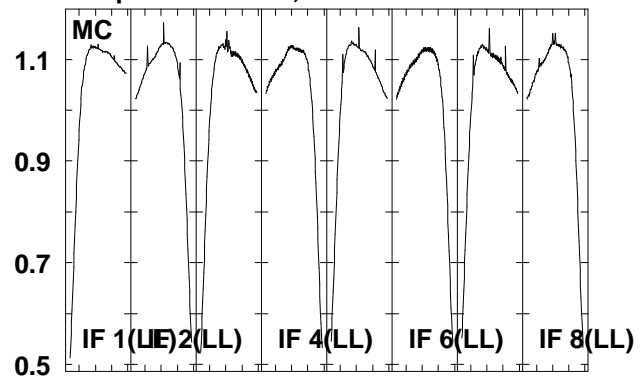

6663.6665.6667.6669.6671.6673.6675.6677.5
 FREQ MHz

Lower frame: Real Jy
 Total-power spectrum Antenna: *
 Timerange: 00/09:13:05 to 00/09:15:32

Plot file version 180 created 22-JUN-2006 20:12:52
 J1825-17 EM061A 1.UVDATA.1
 Freq = 6.6631 GHz, Bw = 2.000 MH No calibration applied and no bandpass applied

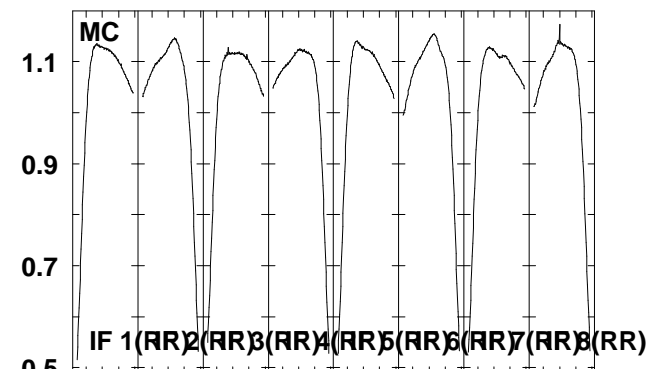
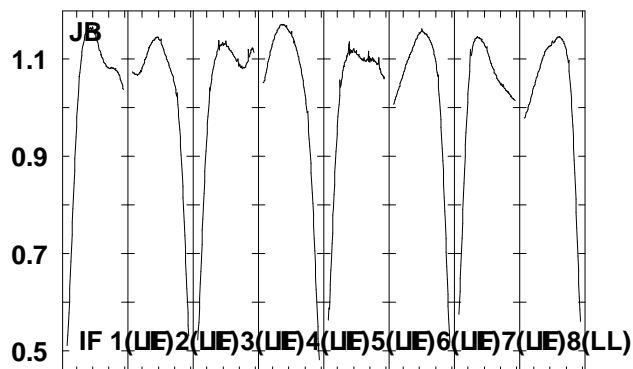
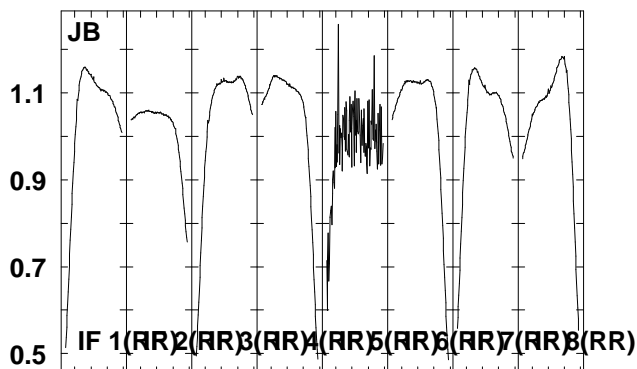
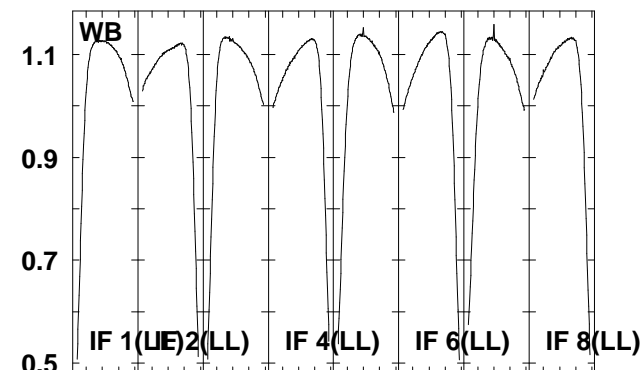
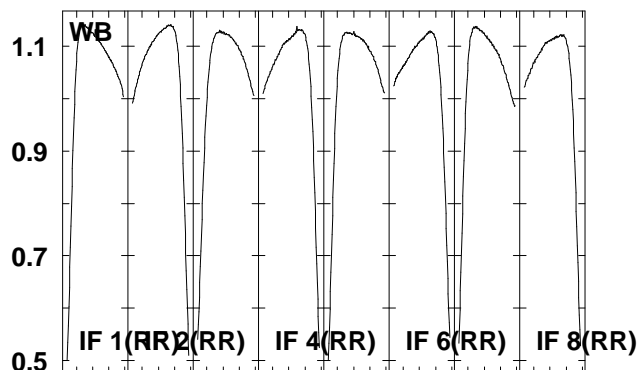
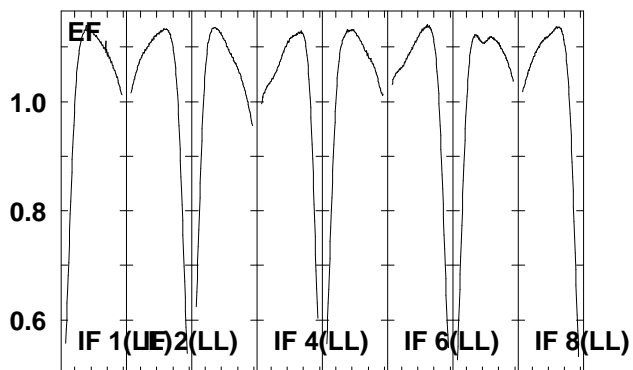
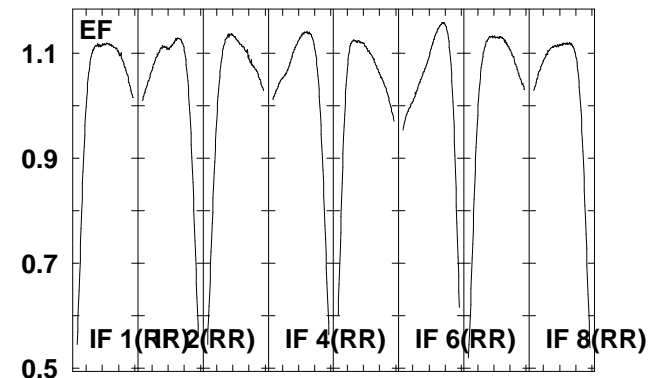
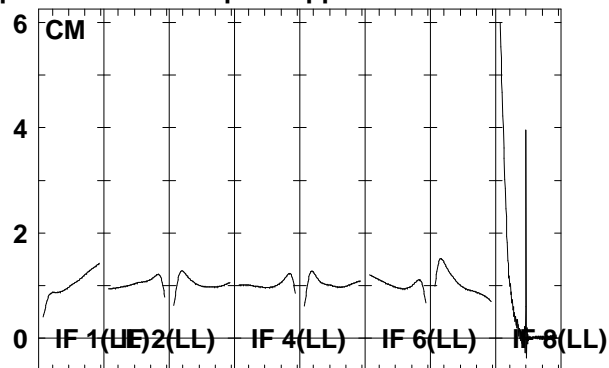
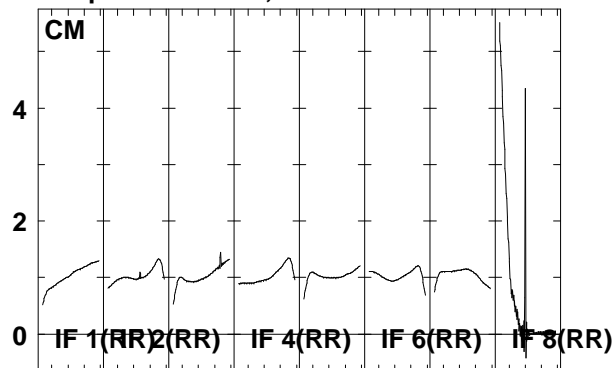

6663.6665.6667.6669.6671.6673.6675.6677.5
 FREQ MHz

6663.6665.6667.6669.6671.6673.6675.6677.5
 FREQ MHz

6663.6665.6667.6669.6671.6673.6675.6677.5
 FREQ MHz

Lower frame: Real Jy
 Total-power spectrum Antenna: *
 Timerange: 00/09:15:34 to 00/09:18:32

Plot file version 181 created 22-JUN-2006 20:12:56
J1825-17 EM061A 1.UVDATA.1
Freq = 6.6631 GHz, Bw = 2.000 MH No calibration applied and no bandpass applied

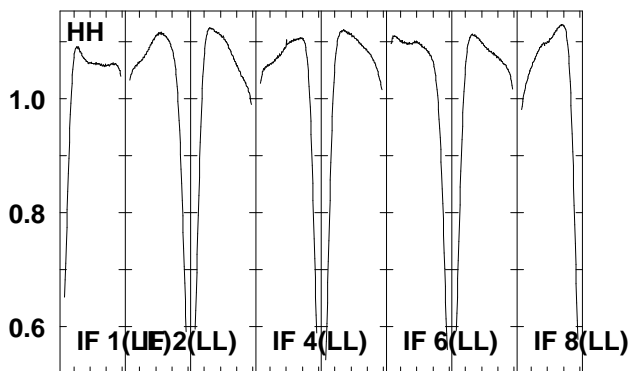
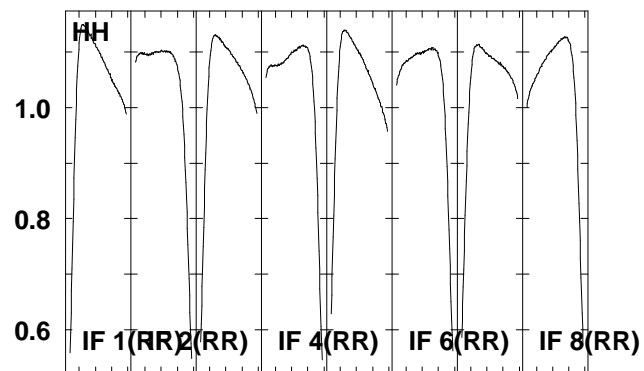
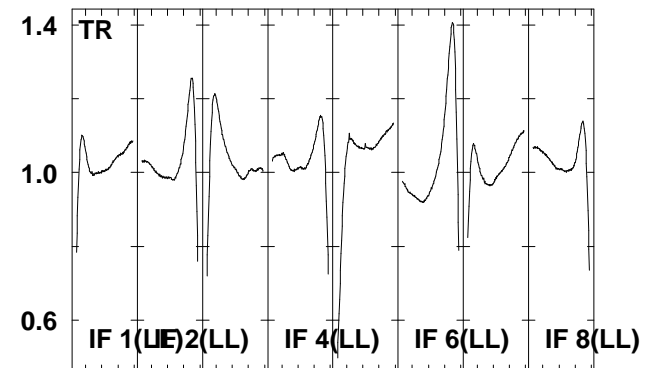
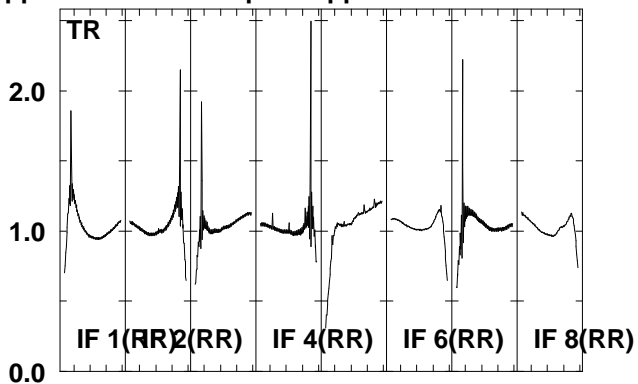
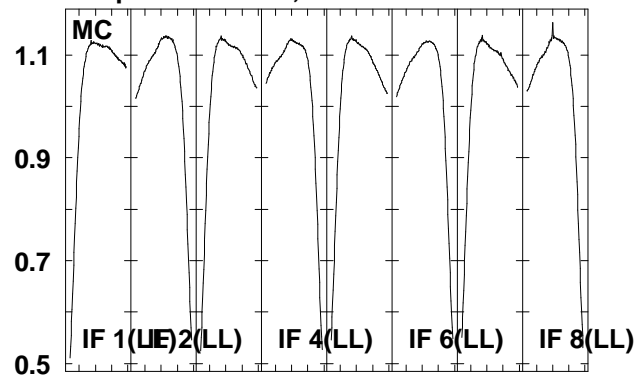

Lower frame: Real Jy
Total-power spectrum Antenna: *
Timerange: 00/09:15:34 to 00/09:18:32

Plot file version 182 created 22-JUN-2006 20:13:01
 G16.59-0 EM061A 1.UVDATA.1
 Freq = 6.6631 GHz, Bw = 2.000 MH No calibration applied and no bandpass applied

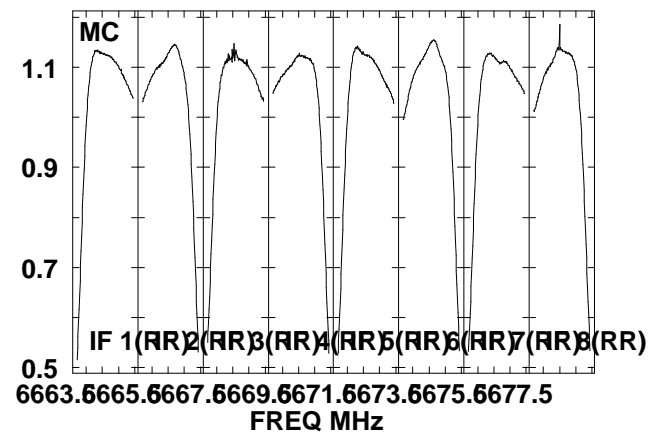
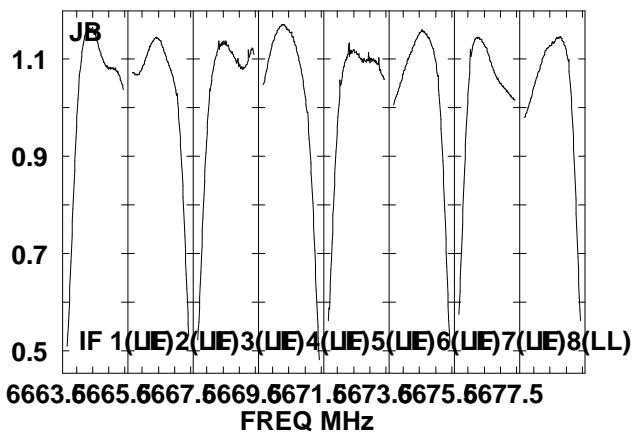
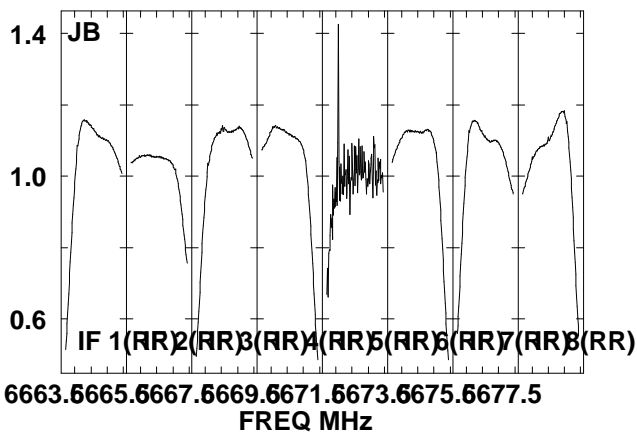
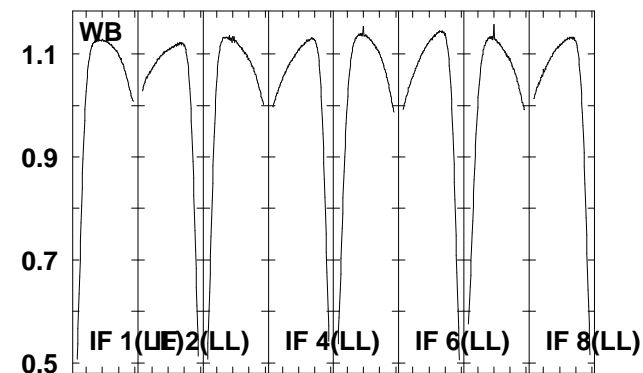
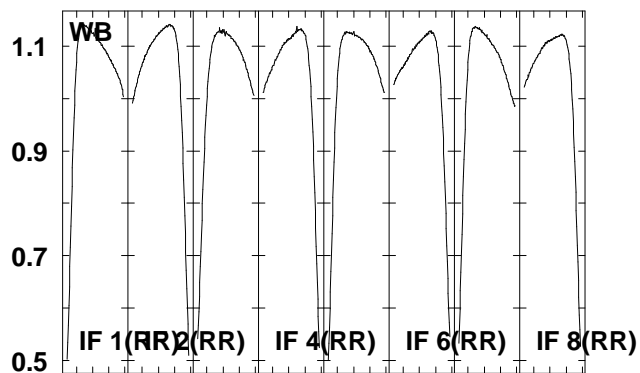
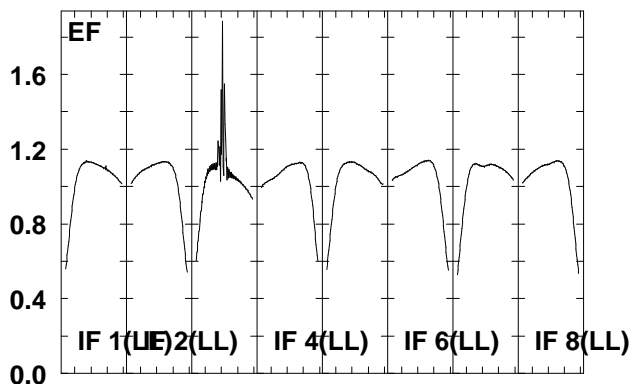
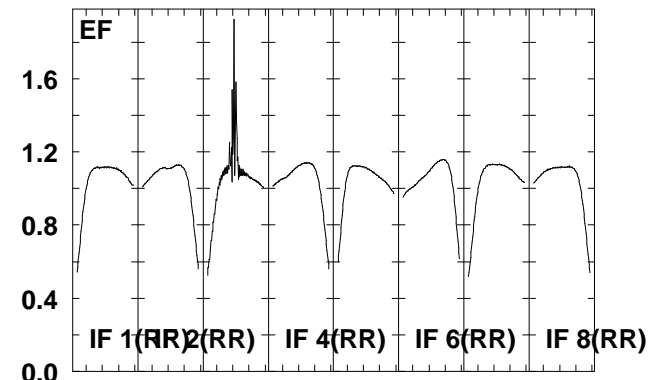
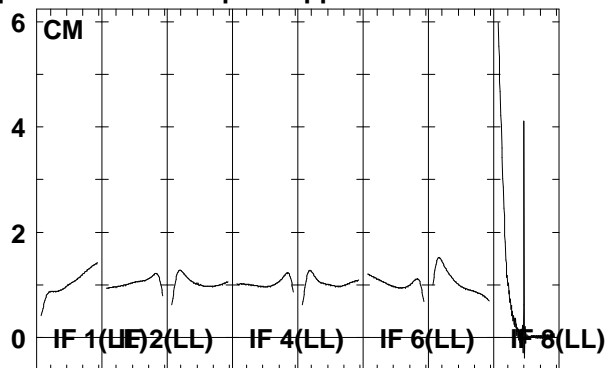
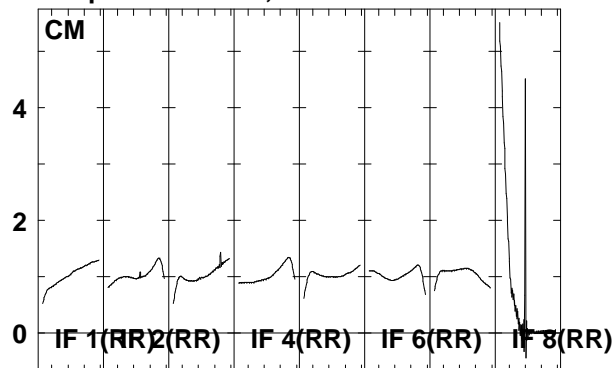

6663.6665.6667.6669.6671.6673.6675.6677.5
 FREQ MHz

6663.6665.6667.6669.6671.6673.6675.6677.5
 FREQ MHz

6663.6665.6667.6669.6671.6673.6675.6677.5
 FREQ MHz

Lower frame: Real Jy
 Total-power spectrum Antenna: *
 Timerange: 00/09:18:34 to 00/09:21:02

Plot file version 183 created 22-JUN-2006 20:13:04
G16.59-0 EM061A 1.UVDATA.1
Freq = 6.6631 GHz, Bw = 2.000 MH No calibration applied and no bandpass applied

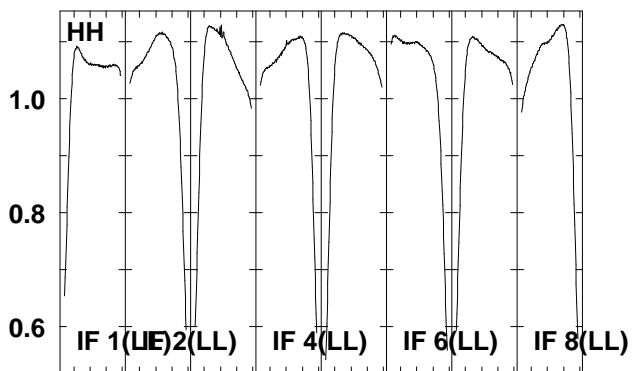
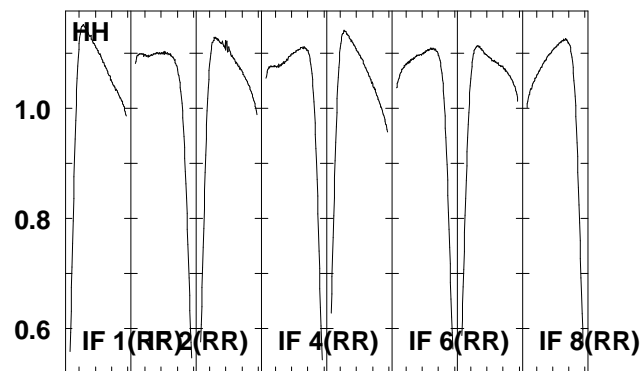
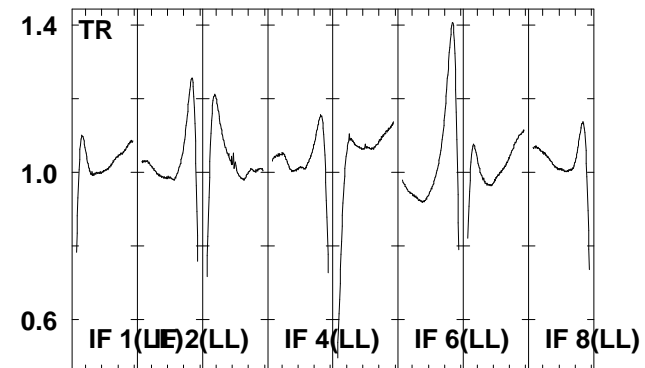
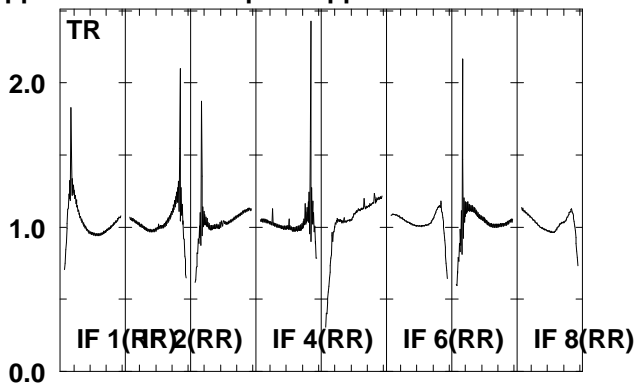
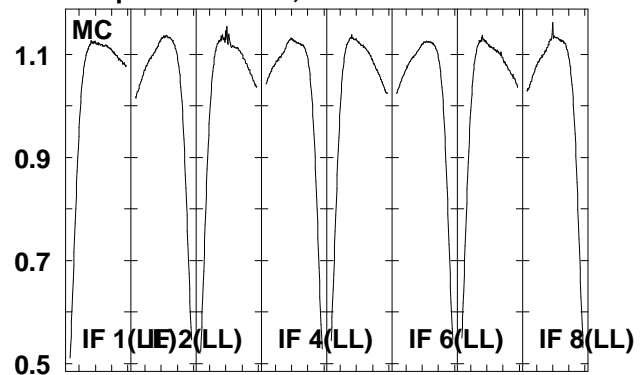

Lower frame: Real Jy
Total-power spectrum Antenna: *
Timerange: 00/09:18:34 to 00/09:21:02

Plot file version 184 created 22-JUN-2006 20:13:08
 J1825-17 EM061A 1.UVDATA.1
 Freq = 6.6631 GHz, Bw = 2.000 MH No calibration applied and no bandpass applied

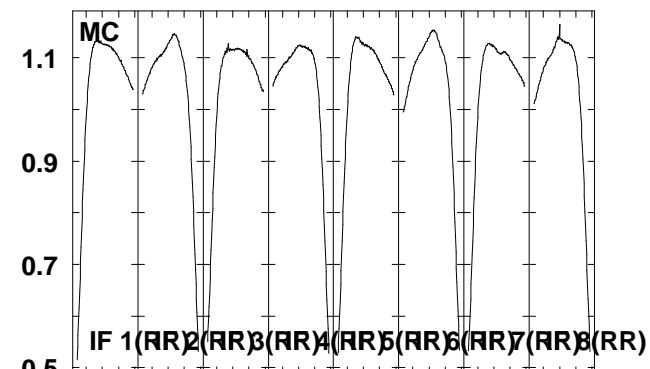
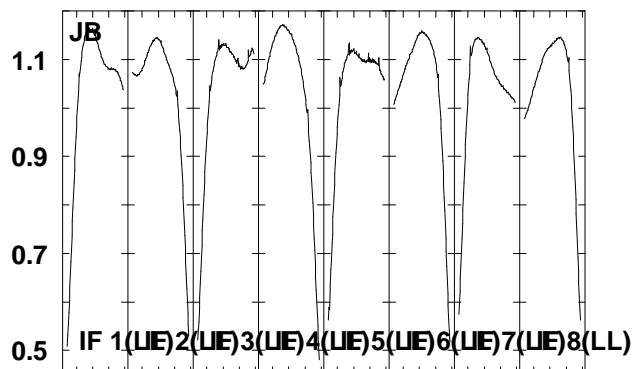
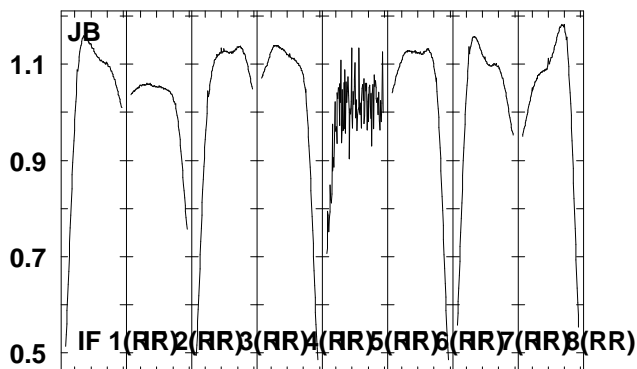
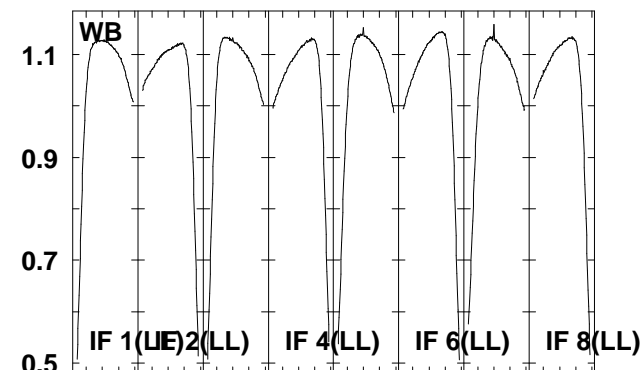
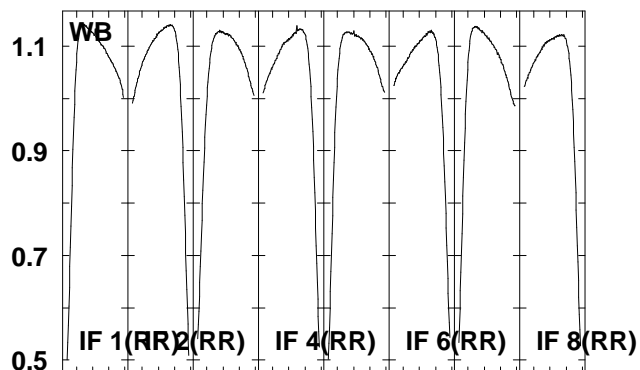
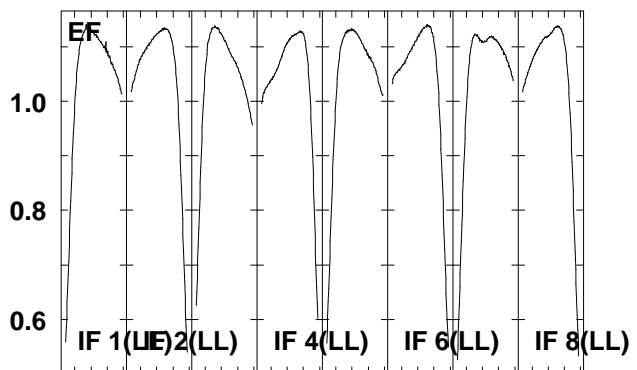
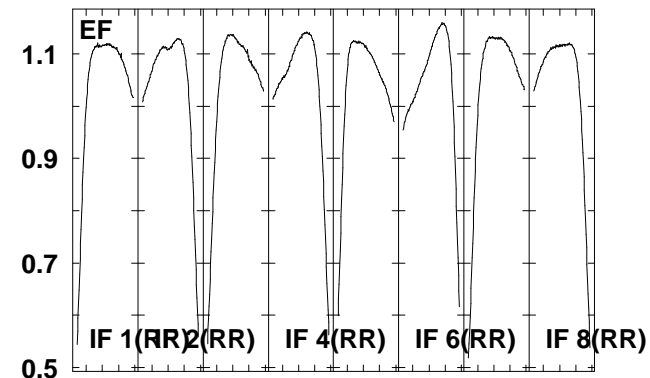
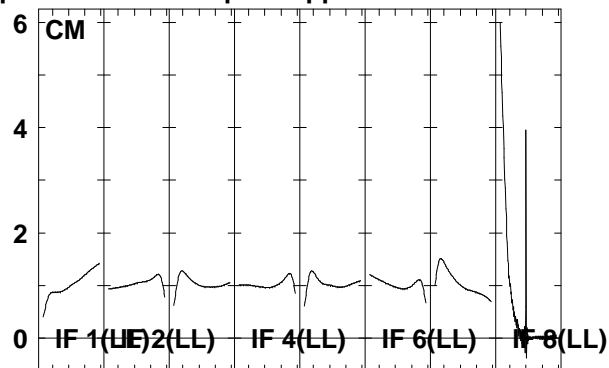
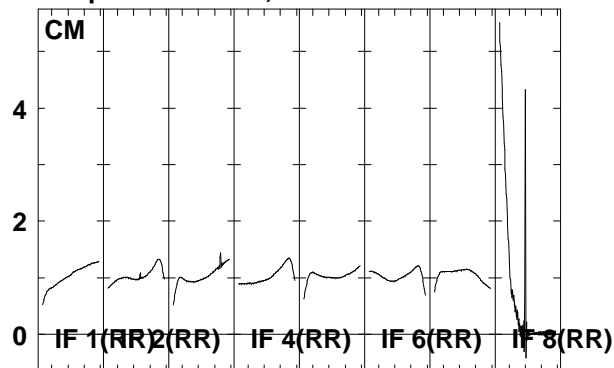

6663.6665.6667.6669.6671.6673.6675.6677.5
 FREQ MHz

6663.6665.6667.6669.6671.6673.6675.6677.5
 FREQ MHz

6663.6665.6667.6669.6671.6673.6675.6677.5
 FREQ MHz

Lower frame: Real Jy
 Total-power spectrum Antenna: *
 Timerange: 00/09:21:04 to 00/09:24:02

Plot file version 185 created 22-JUN-2006 20:13:10
J1825-17 EM061A 1.UVDATA.1
Freq = 6.6631 GHz, Bw = 2.000 MH No calibration applied and no bandpass applied

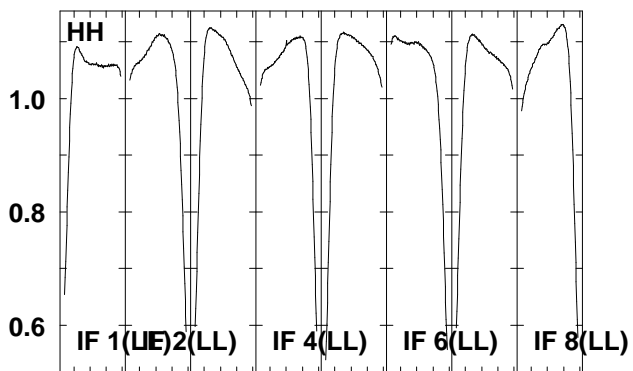
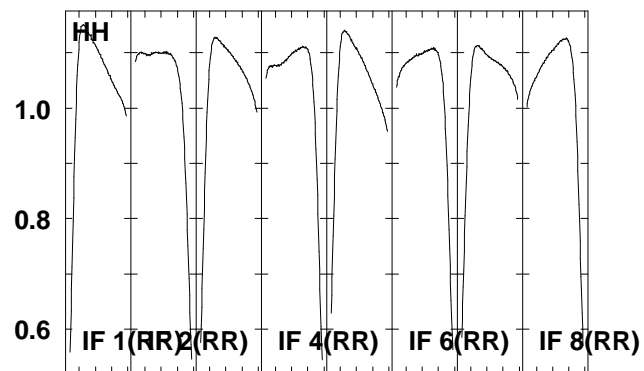
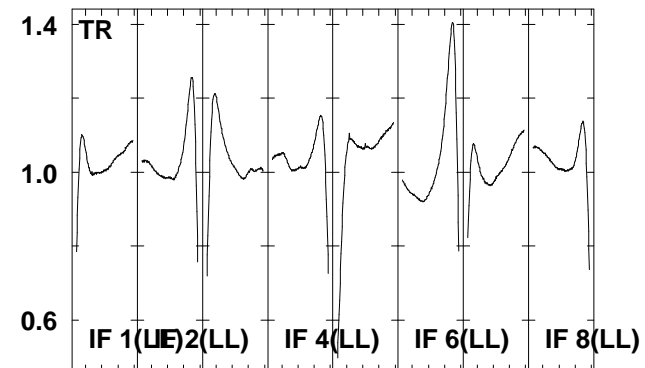
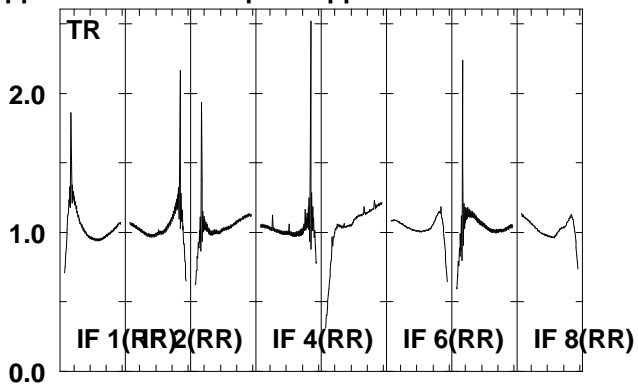
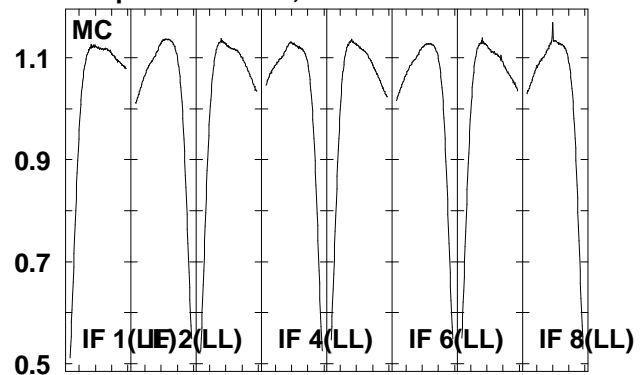

Lower frame: Real Jy
Total-power spectrum Antenna: *
Timerange: 00/09:21:04 to 00/09:24:02

Plot file version 186 created 22-JUN-2006 20:13:13
 G16.59-0 EM061A 1.UVDATA.1
 Freq = 6.6631 GHz, Bw = 2.000 MH No calibration applied and no bandpass applied

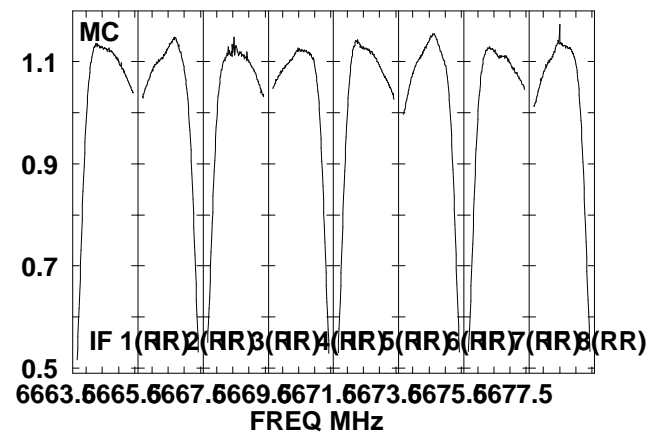
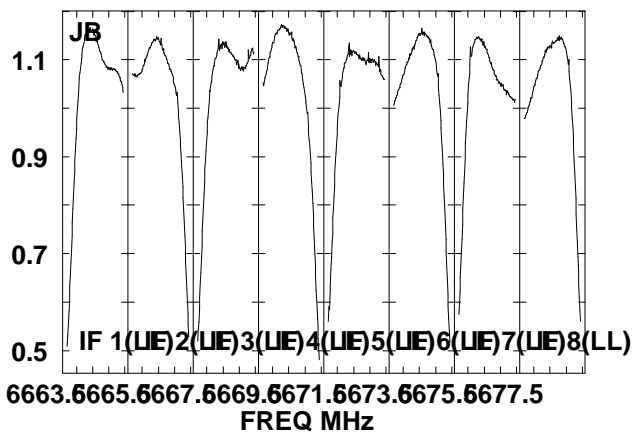
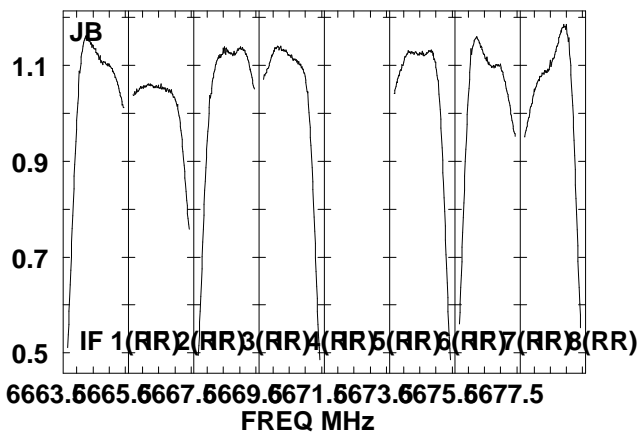
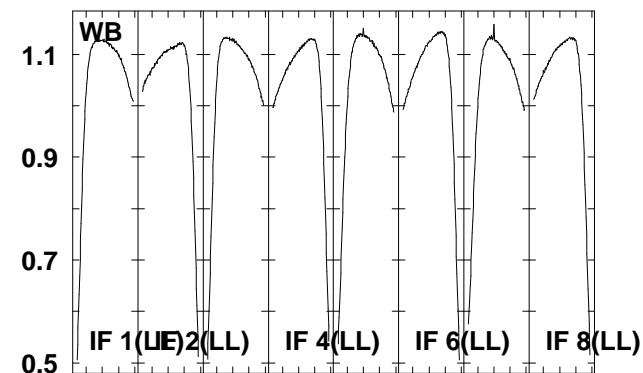
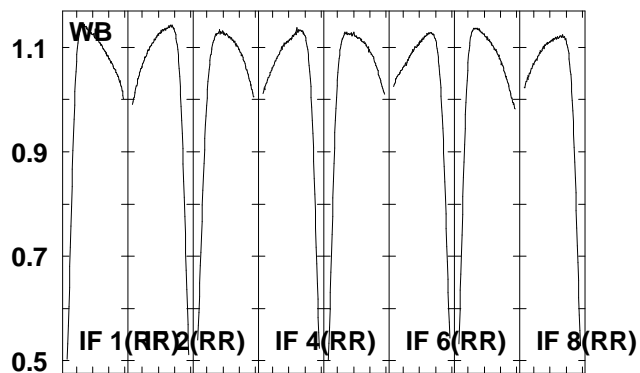
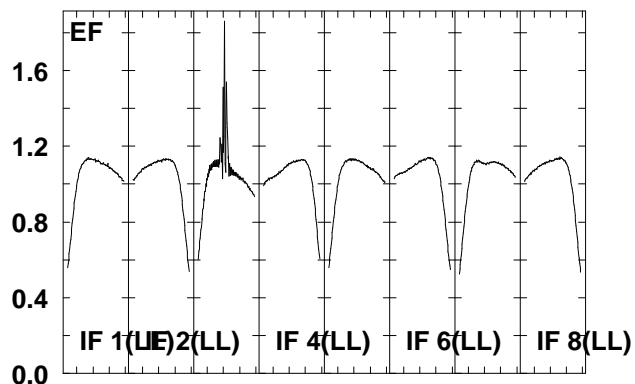
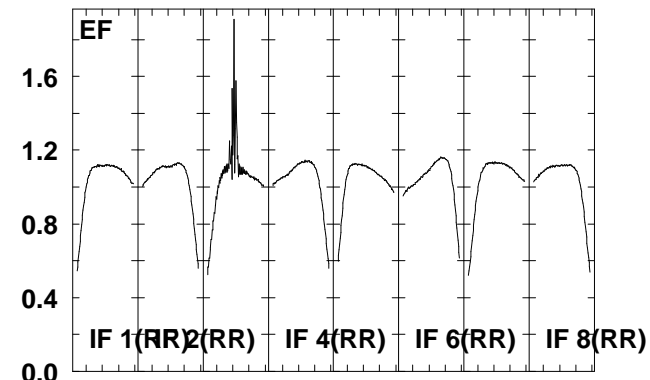
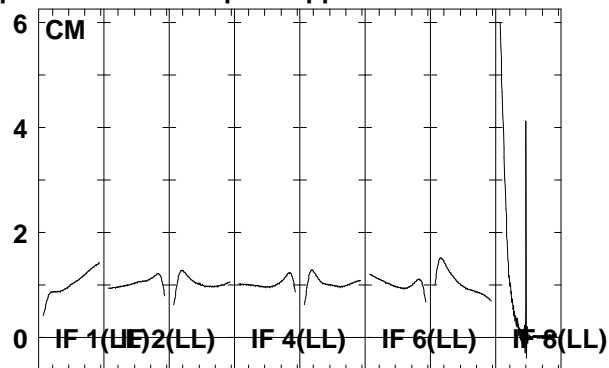
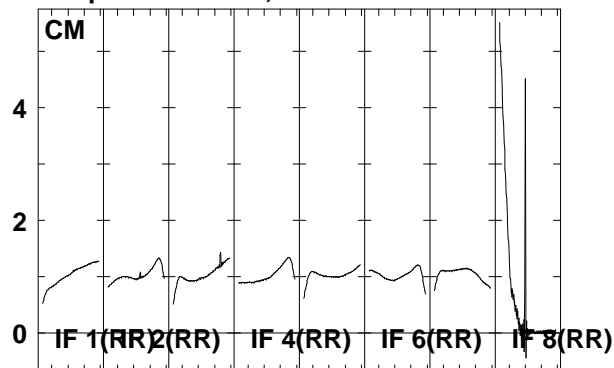

Lower frame: Real Jy
 Total-power spectrum Antenna: *
 Timerange: 00/09:24:04 to 00/09:25:01

Plot file version 187 created 22-JUN-2006 20:13:15
G16.59-0 EM061A 1.UVDATA.1
Freq = 6.6631 GHz, Bw = 2.000 MH No calibration applied and no bandpass applied

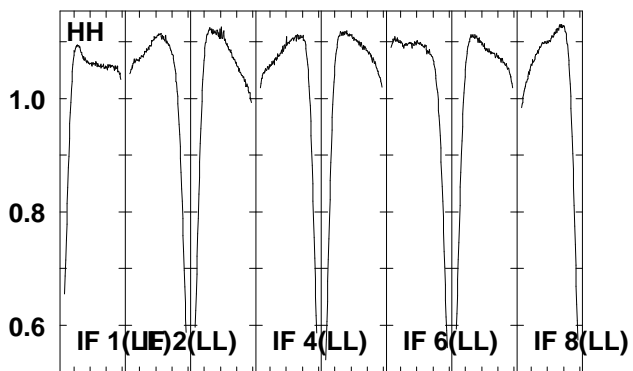
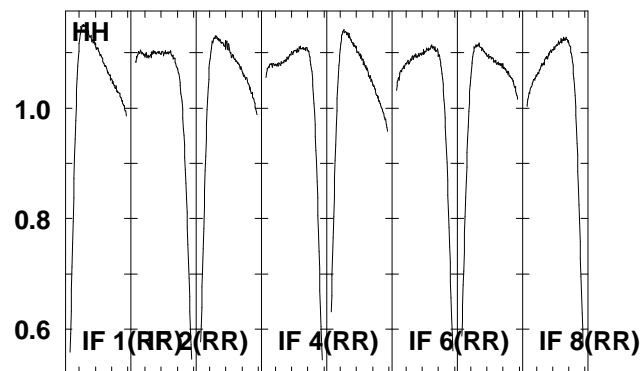
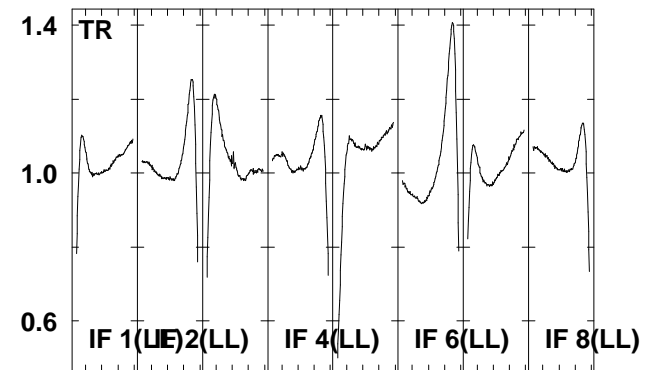
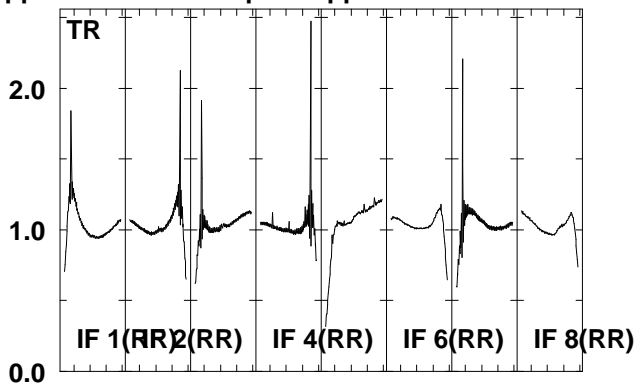
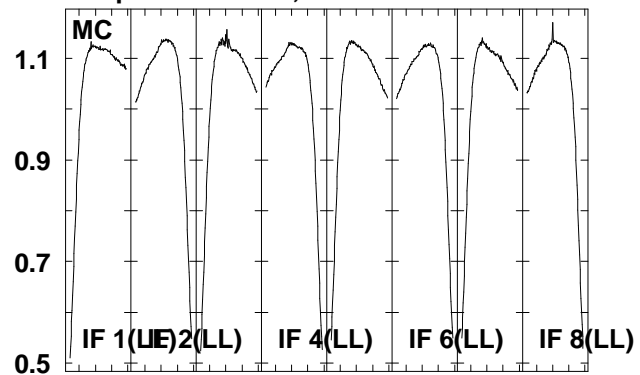

Lower frame: Real Jy
Total-power spectrum Antenna: *
Timerange: 00/09:24:04 to 00/09:25:01

Plot file version 188 created 22-JUN-2006 20:13:17
 G16.59-0 EM061A 1.UVDATA.1
 Freq = 6.6631 GHz, Bw = 2.000 MH No calibration applied and no bandpass applied

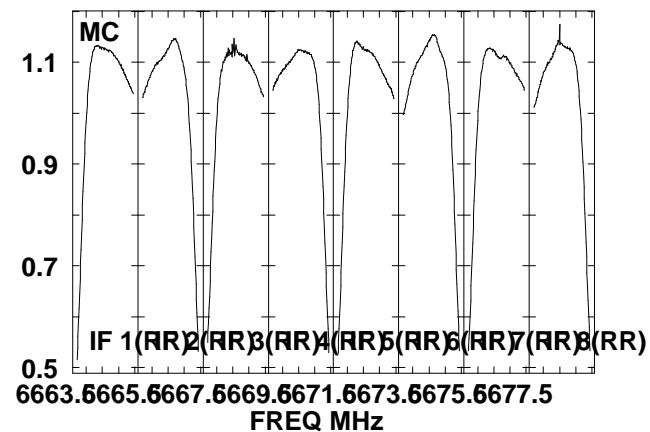
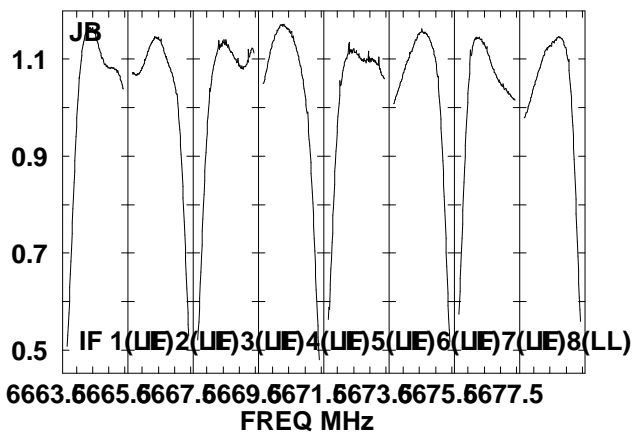
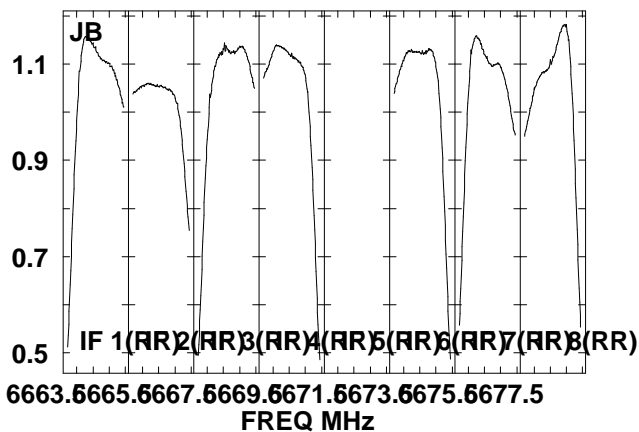
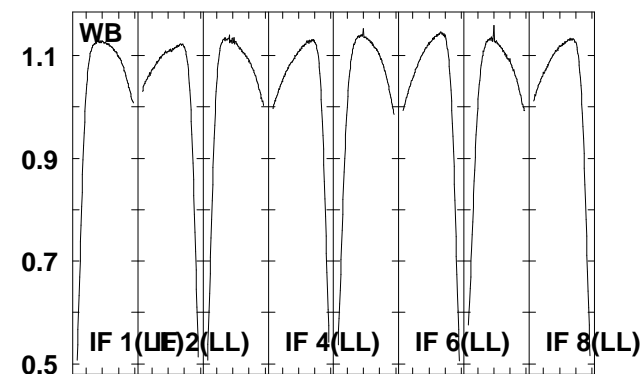
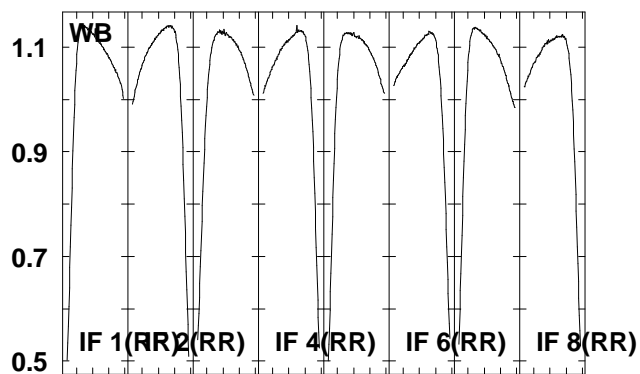
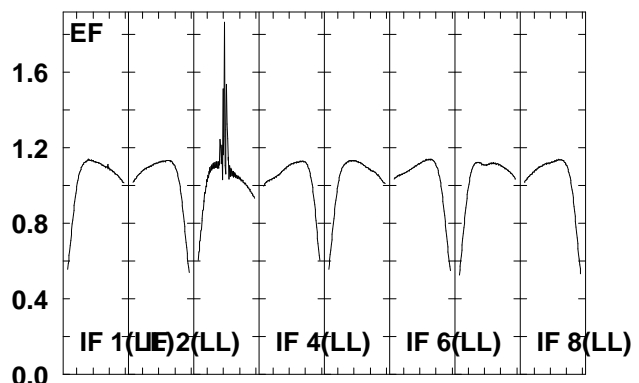
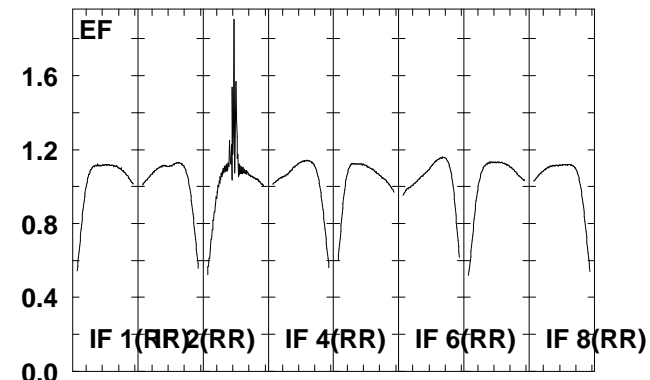
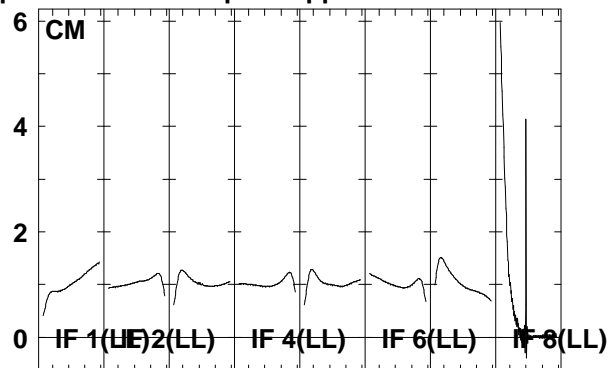
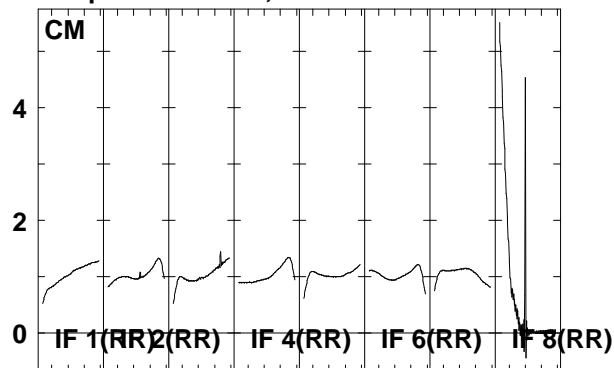

Lower frame: Real Jy
 Total-power spectrum Antenna: *
 Timerange: 00/09:25:02 to 00/09:26:32

Plot file version 189 created 22-JUN-2006 20:13:19
G16.59-0 EM061A 1.UVDATA.1
Freq = 6.6631 GHz, Bw = 2.000 MH No calibration applied and no bandpass applied

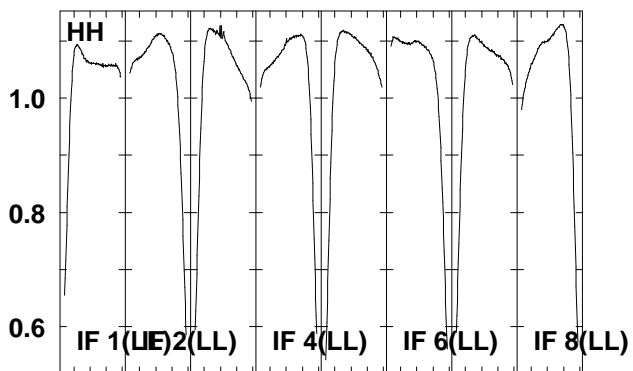
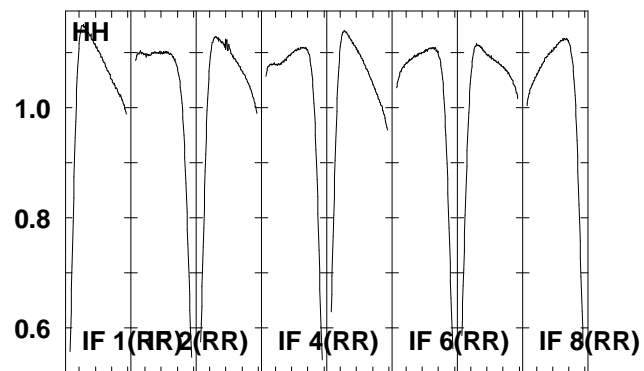
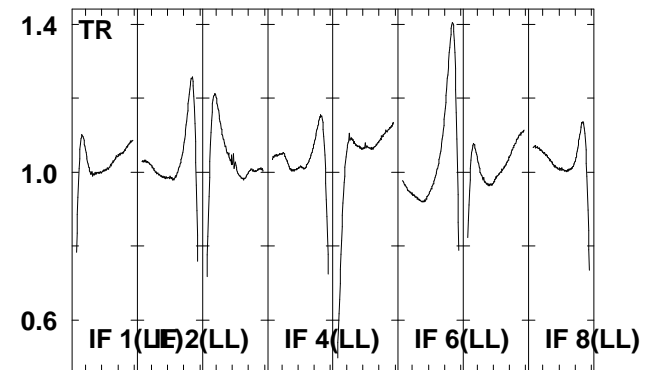
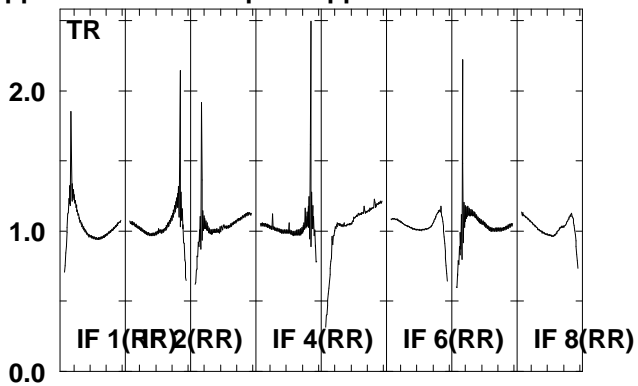
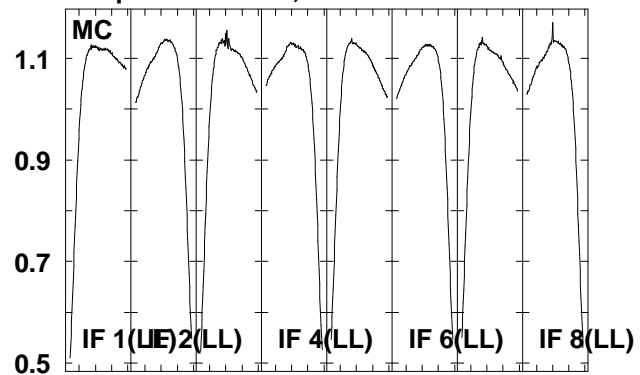

Lower frame: Real Jy
Total-power spectrum Antenna: *
Timerange: 00/09:25:02 to 00/09:26:32

Plot file version 190 created 22-JUN-2006 20:13:22
 J1825-17 EM061A 1.UVDATA.1
 Freq = 6.6631 GHz, Bw = 2.000 MH No calibration applied and no bandpass applied

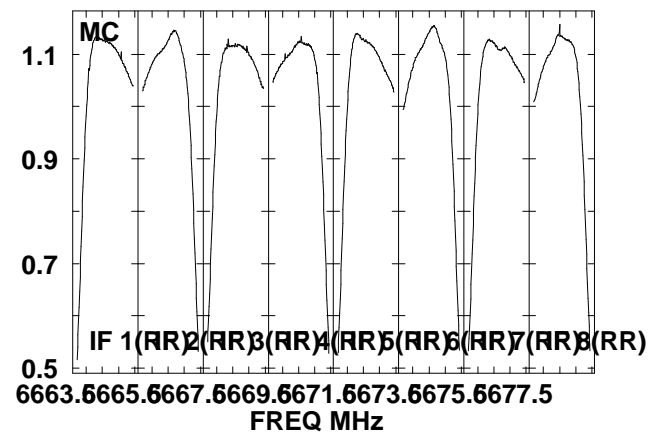
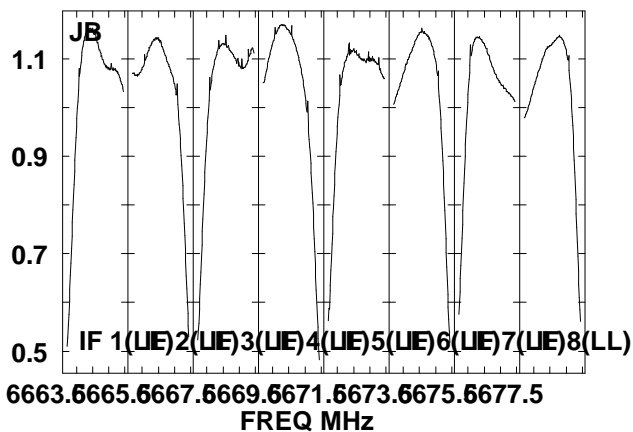
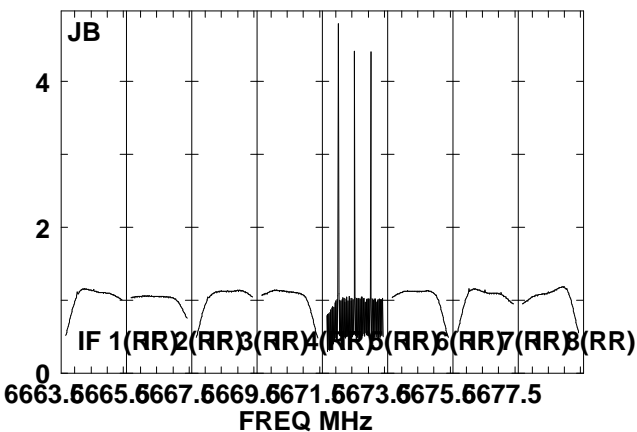
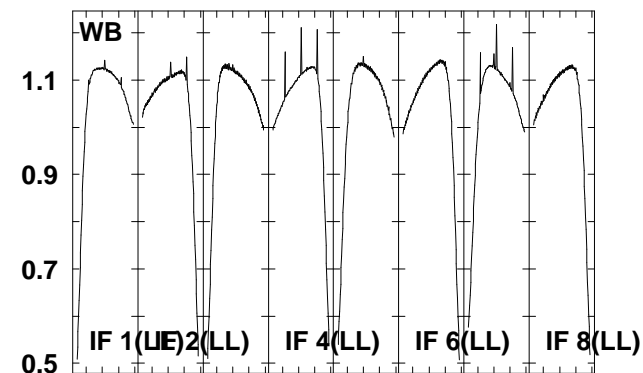
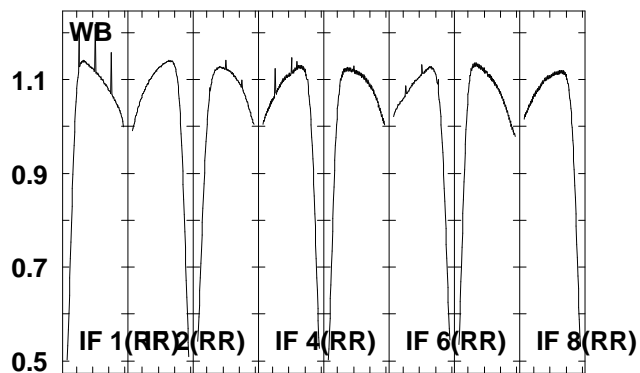
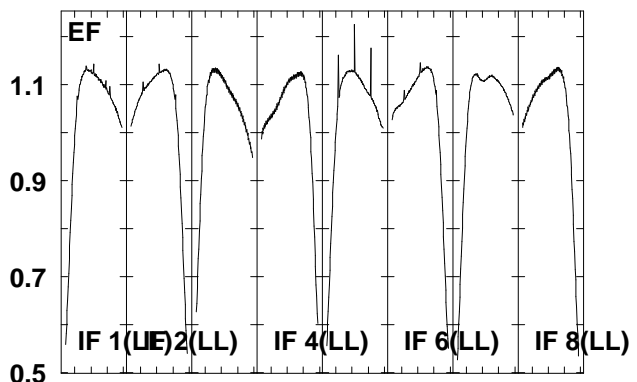
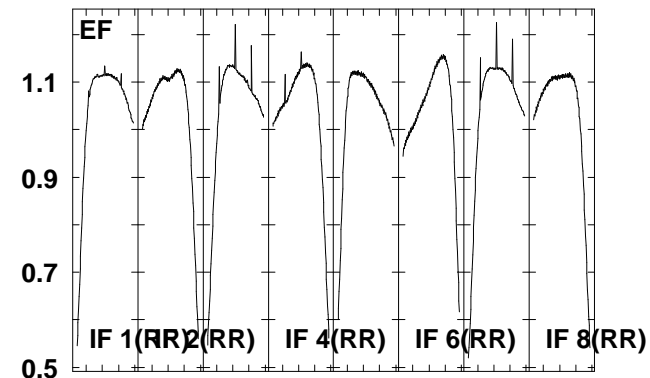
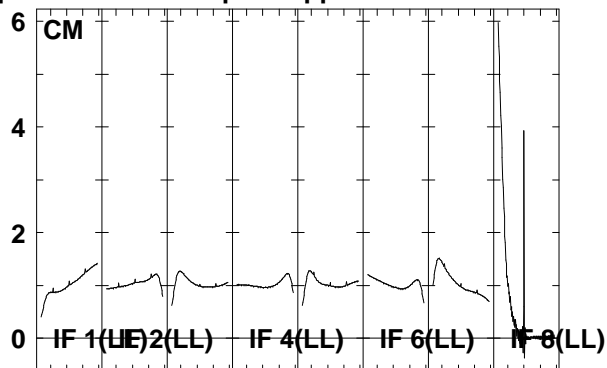
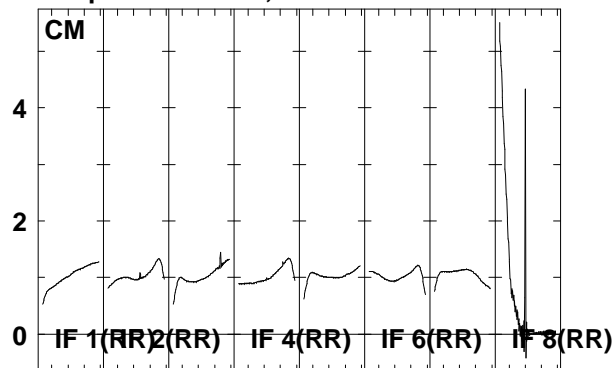

6663.6665.6667.6669.6671.6673.6675.6677.5
 FREQ MHz
 Lower frame: Real Jy
 Total-power spectrum Antenna: *
 Timerange: 00/09:28:05 to 00/09:31:02

Plot file version 191 created 22-JUN-2006 20:13:25
 J1825-17 EM061A 1.UVDATA.1
 Freq = 6.6631 GHz, Bw = 2.000 MH No calibration applied and no bandpass applied

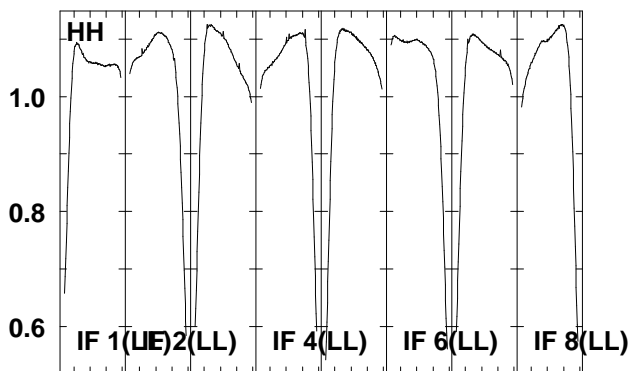
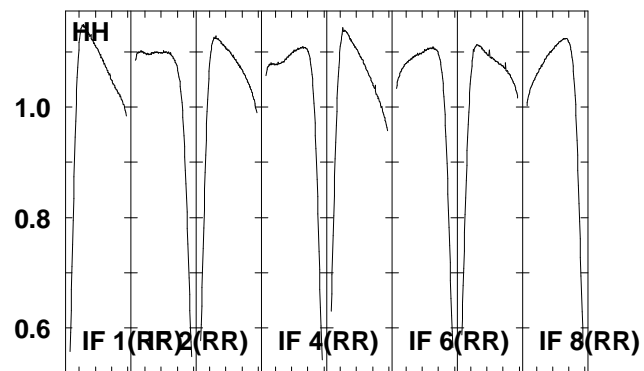
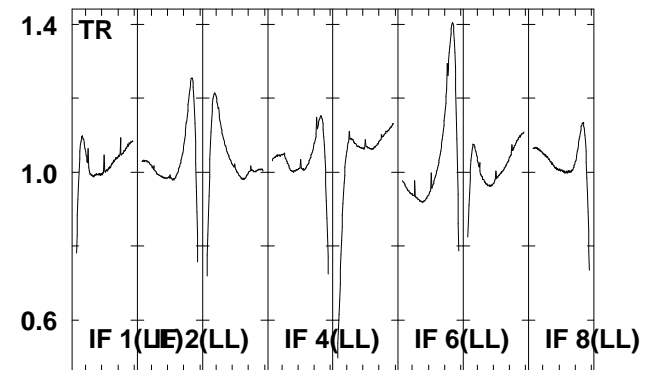
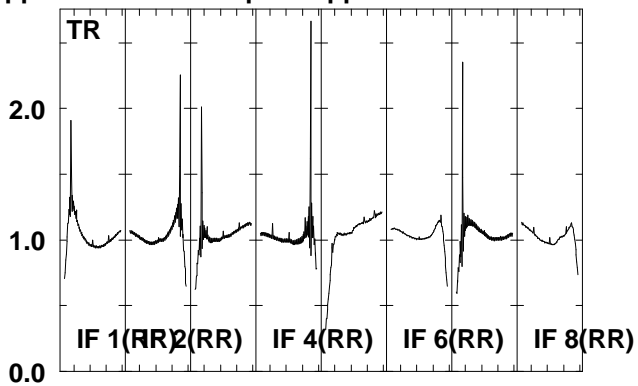
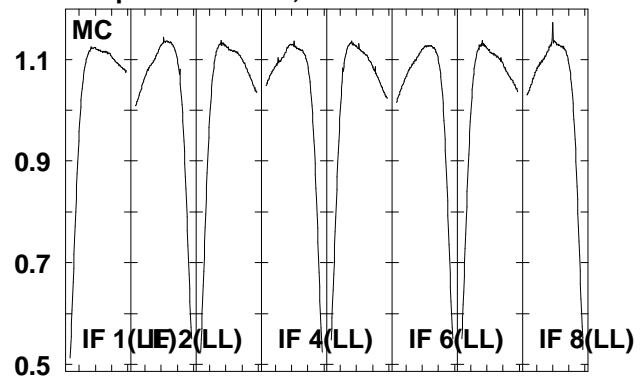

Lower frame: Real Jy
 Total-power spectrum Antenna: *
 Timerange: 00/09:28:05 to 00/09:31:02

Plot file version 192 created 22-JUN-2006 20:13:30
 G16.59-0 EM061A 1.UVDATA.1
 Freq = 6.6631 GHz, Bw = 2.000 MH No calibration applied and no bandpass applied

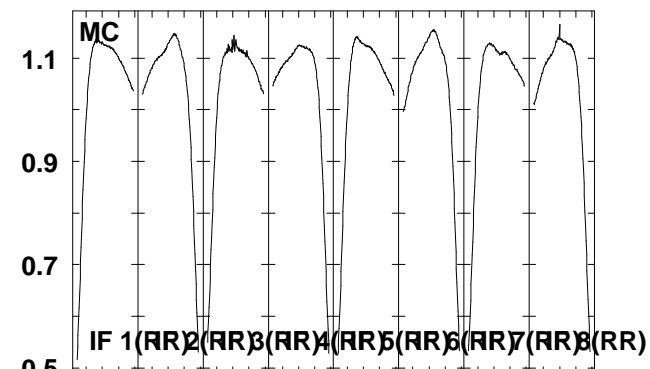
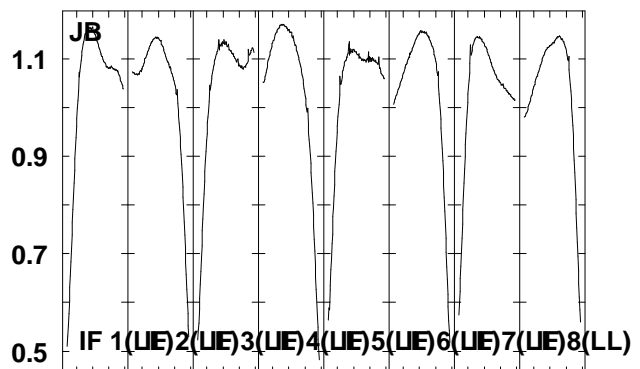
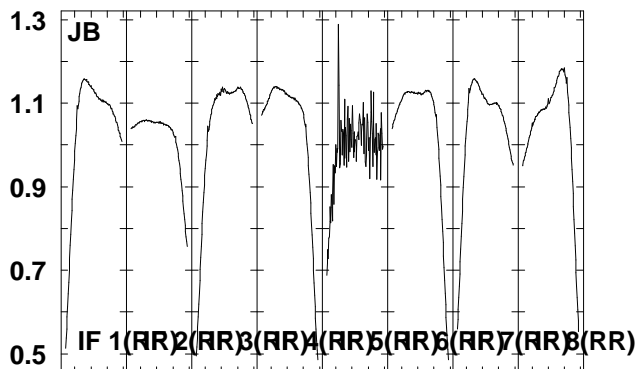
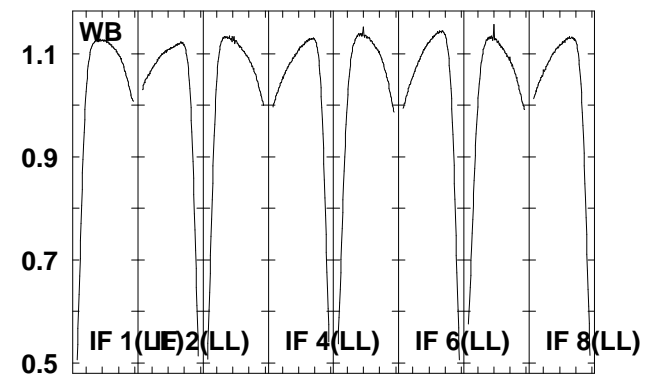
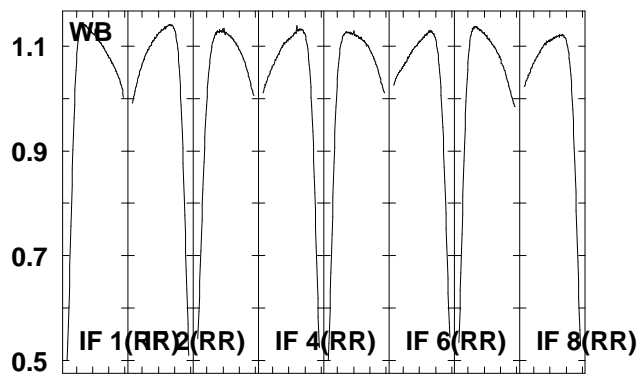
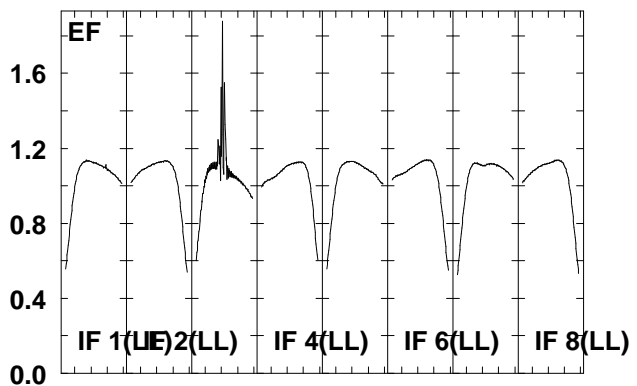
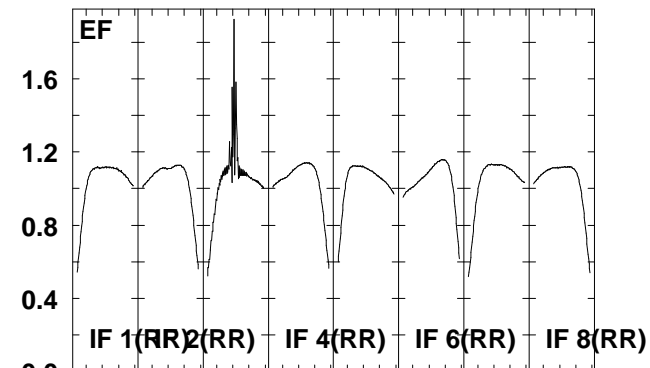
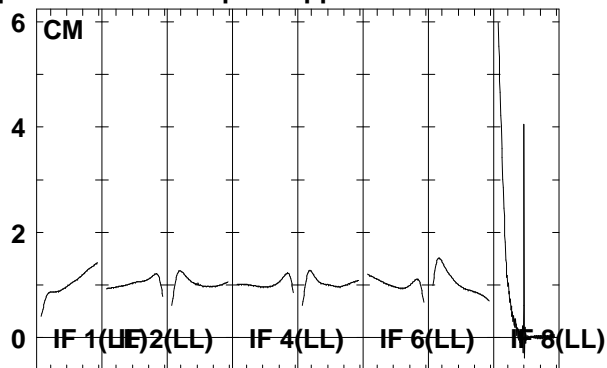
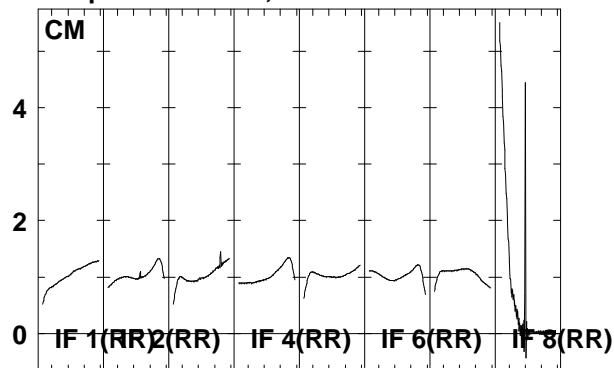

6663.6665.6667.6669.6671.6673.6675.6677.5
 FREQ MHz

6663.6665.6667.6669.6671.6673.6675.6677.5
 FREQ MHz

6663.6665.6667.6669.6671.6673.6675.6677.5
 FREQ MHz

Lower frame: Real Jy
 Total-power spectrum Antenna: *
 Timerange: 00/09:31:04 to 00/09:33:32

Plot file version 193 created 22-JUN-2006 20:13:32
G16.59-0 EM061A 1.UVDATA.1
Freq = 6.6631 GHz, Bw = 2.000 MH No calibration applied and no bandpass applied

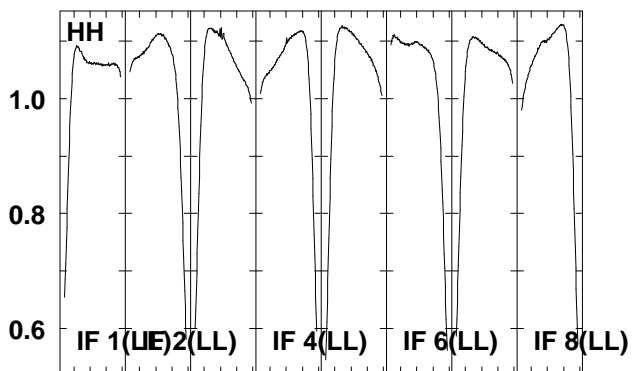
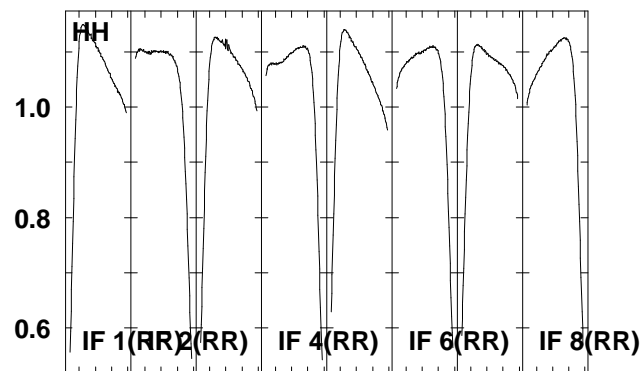
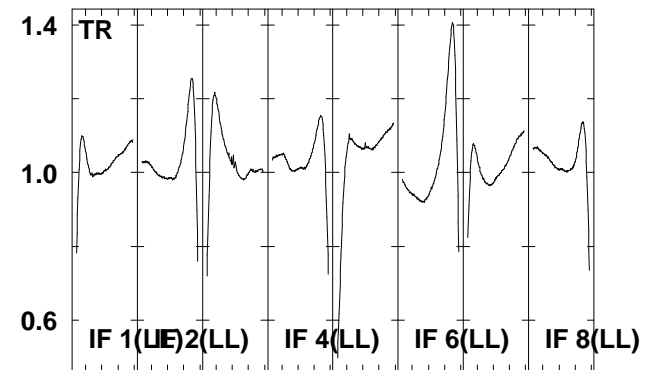
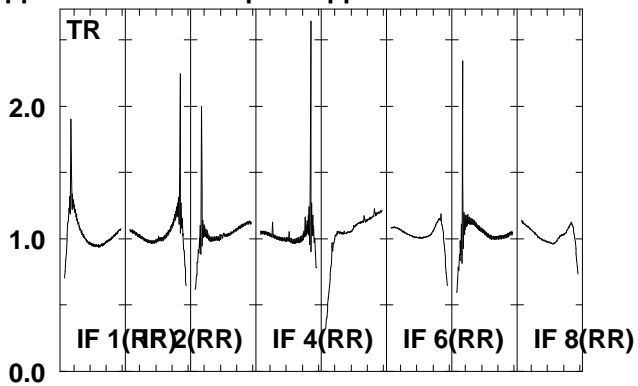
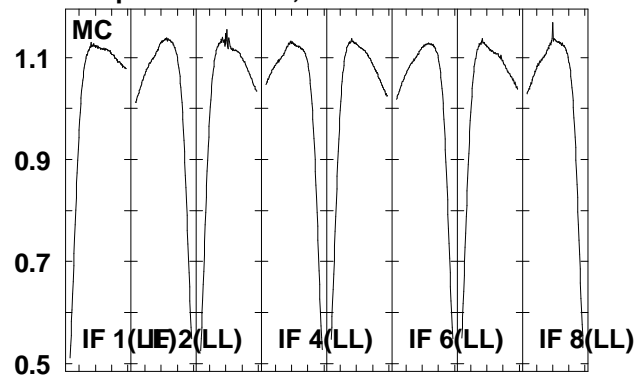

Lower frame: Real Jy
Total-power spectrum Antenna: *
Timerange: 00/09:31:04 to 00/09:33:32

Plot file version 194 created 22-JUN-2006 20:13:35
 J1825-17 EM061A 1.UVDATA.1
 Freq = 6.6631 GHz, Bw = 2.000 MH No calibration applied and no bandpass applied

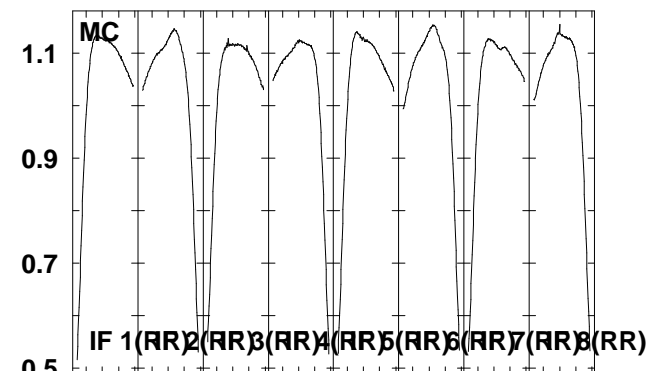
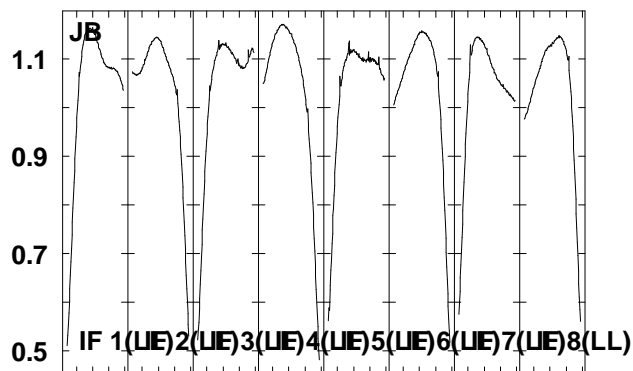
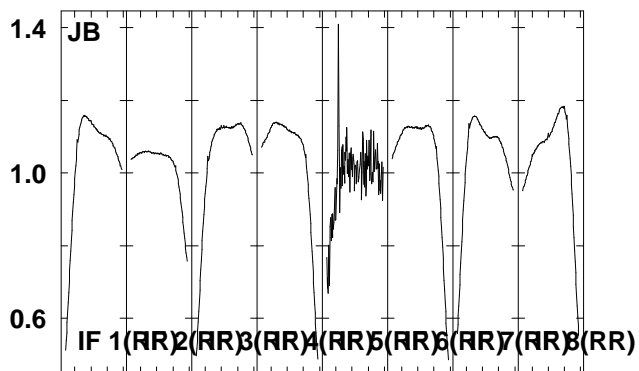
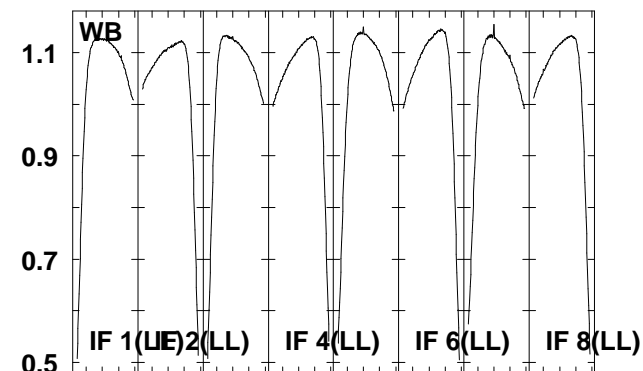
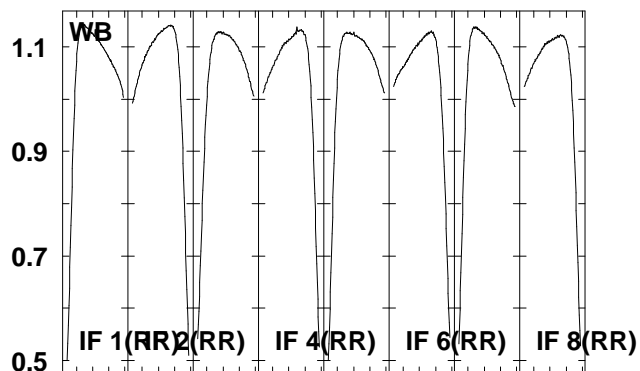
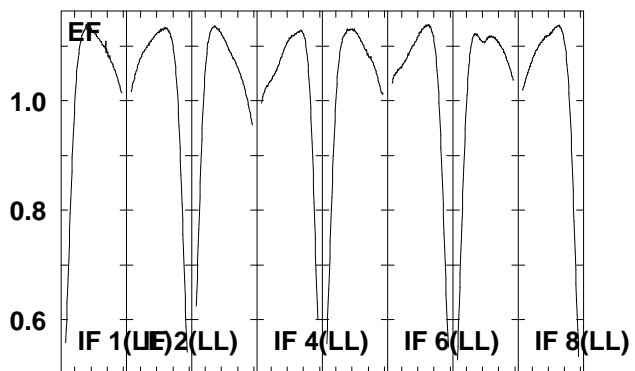
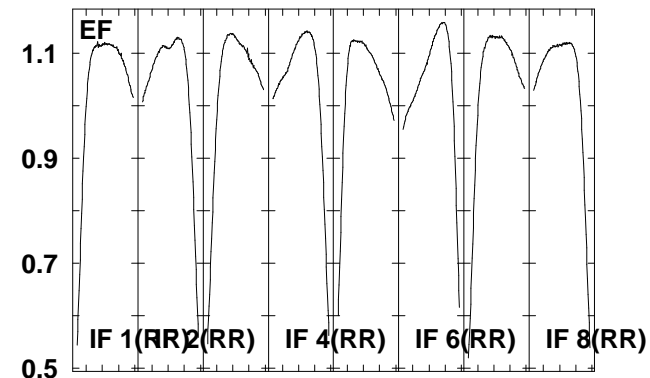
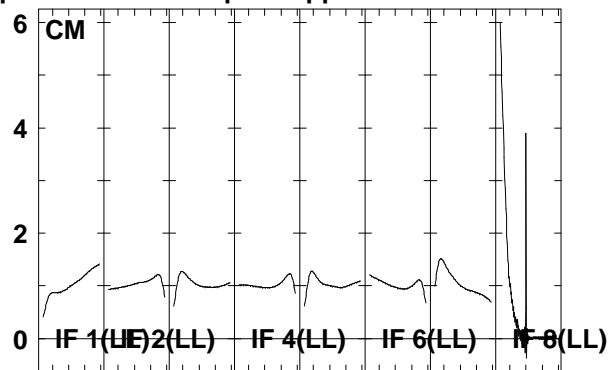
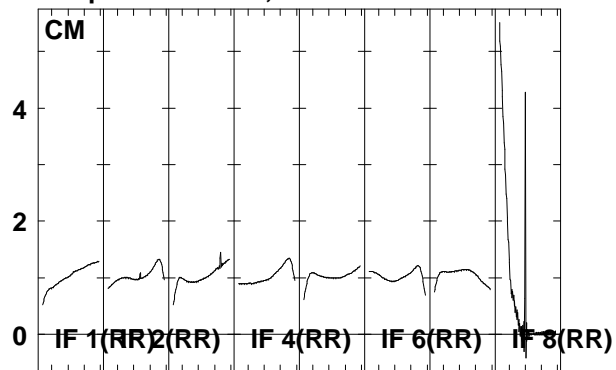

6663.6665.6667.6669.6671.6673.6675.6677.5
 FREQ MHz

6663.6665.6667.6669.6671.6673.6675.6677.5
 FREQ MHz

6663.6665.6667.6669.6671.6673.6675.6677.5
 FREQ MHz

Lower frame: Real Jy
 Total-power spectrum Antenna: *
 Timerange: 00/09:33:34 to 00/09:36:32

Plot file version 195 created 22-JUN-2006 20:13:37

J1825-17 EM061A 1.UVDATA.1

Freq = 6.6631 GHz, Bw = 2.000 MH No calibration applied and no bandpass applied

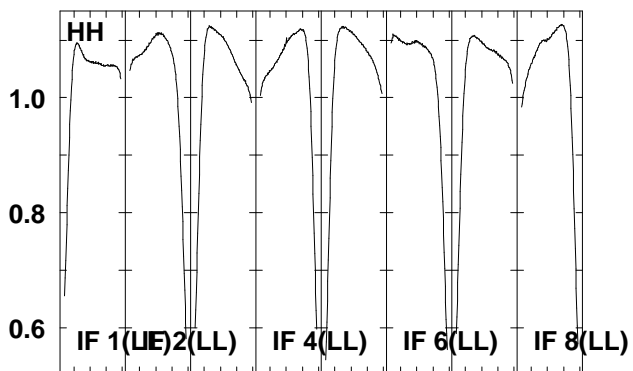
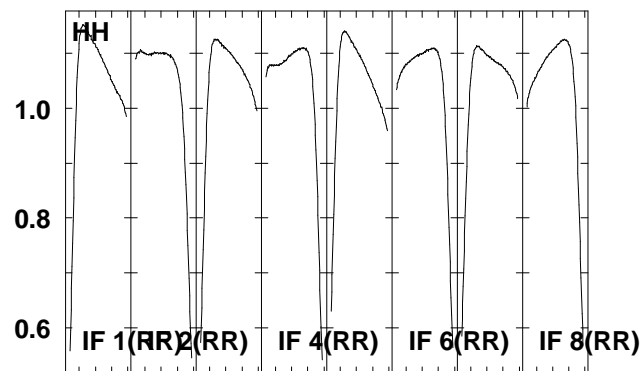
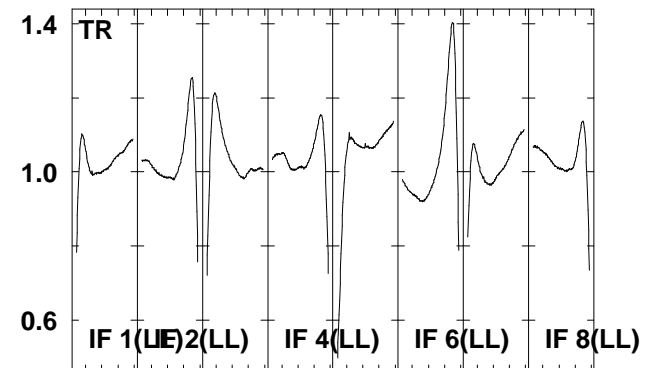
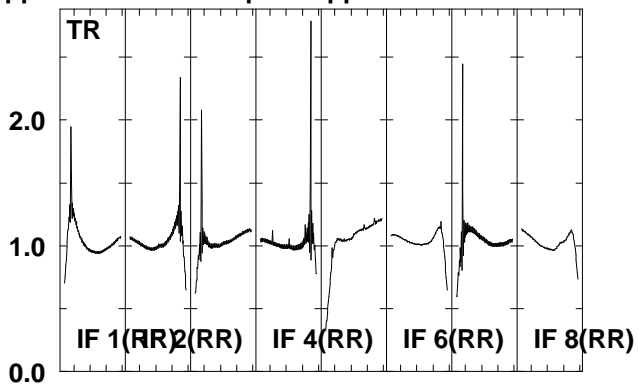
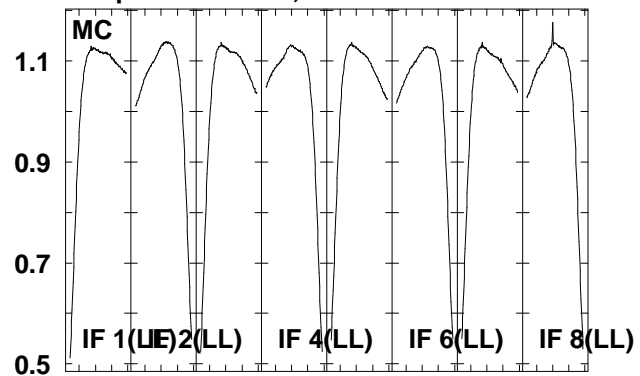

Lower frame: Real Jy
Total-power spectrum Antenna: *
Timerange: 00/09:33:34 to 00/09:36:32

Plot file version 196 created 22-JUN-2006 20:13:42
 G16.59-0 EM061A 1.UVDATA.1
 Freq = 6.6631 GHz, Bw = 2.000 MH No calibration applied and no bandpass applied

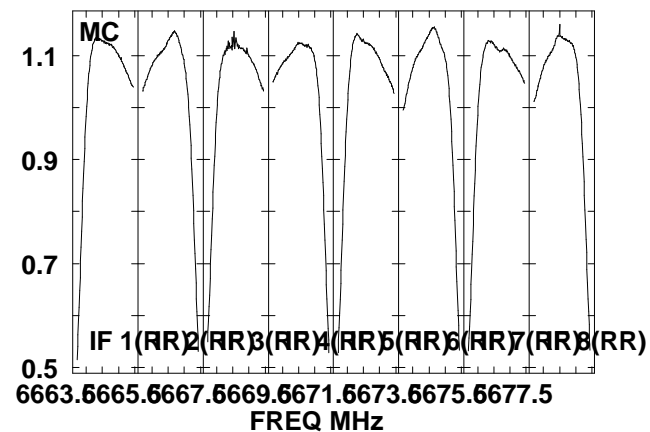
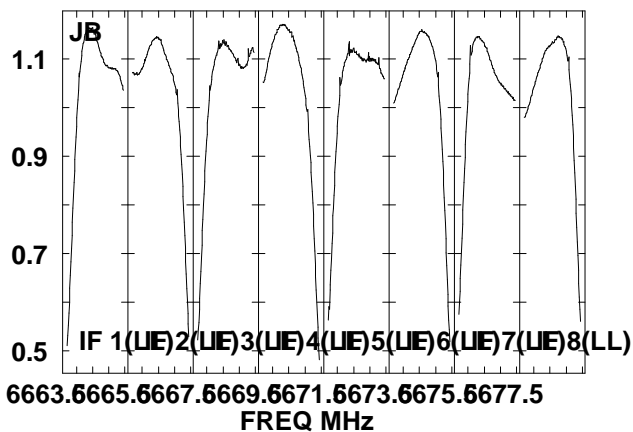
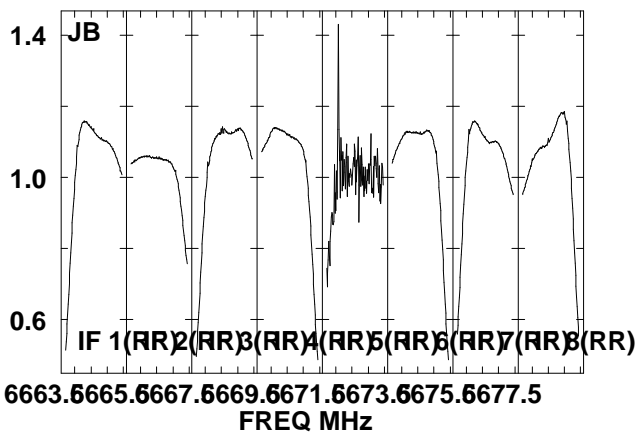
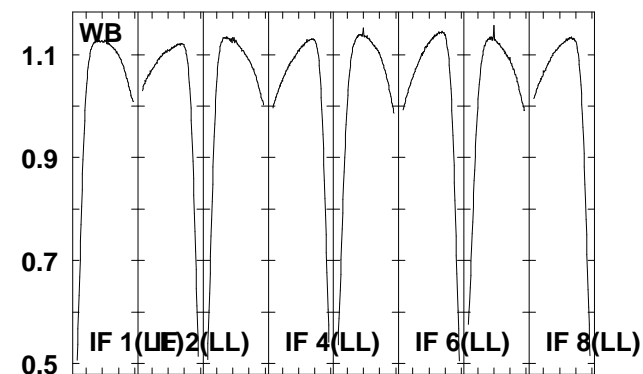
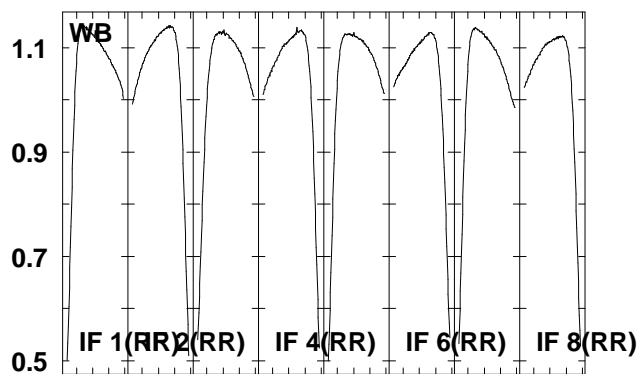
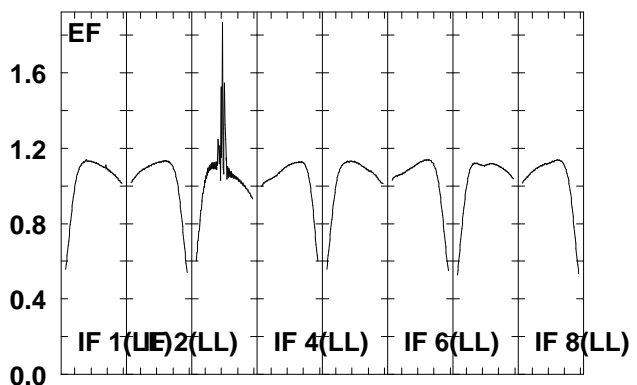
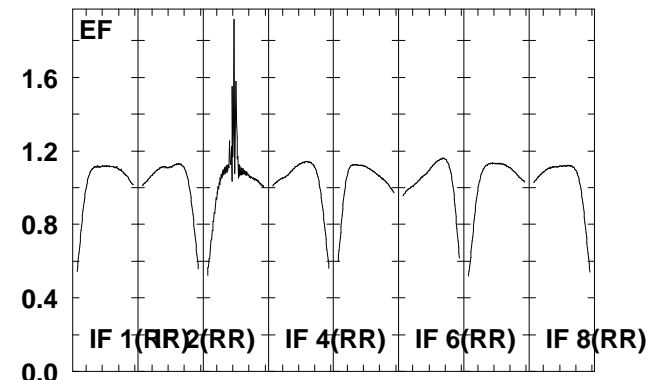
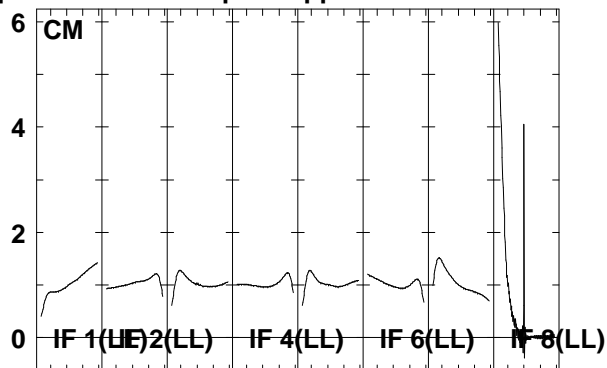
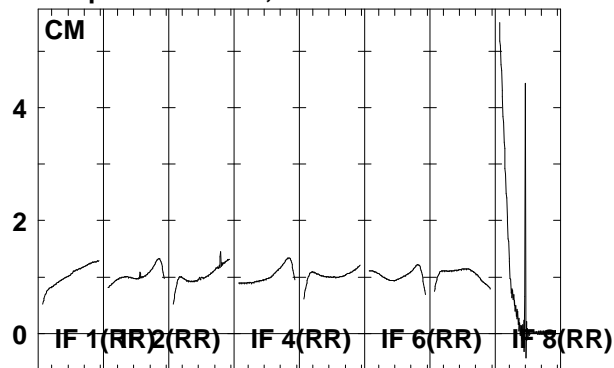

6663.6665.6667.6669.6671.6673.6675.6677.5
 FREQ MHz

6663.6665.6667.6669.6671.6673.6675.6677.5
 FREQ MHz

6663.6665.6667.6669.6671.6673.6675.6677.5
 FREQ MHz

Lower frame: Real Jy
 Total-power spectrum Antenna: *
 Timerange: 00/09:36:34 to 00/09:39:02

Plot file version 197 created 22-JUN-2006 20:13:45
G16.59-0 EM061A 1.UVDATA.1
Freq = 6.6631 GHz, Bw = 2.000 MH No calibration applied and no bandpass applied

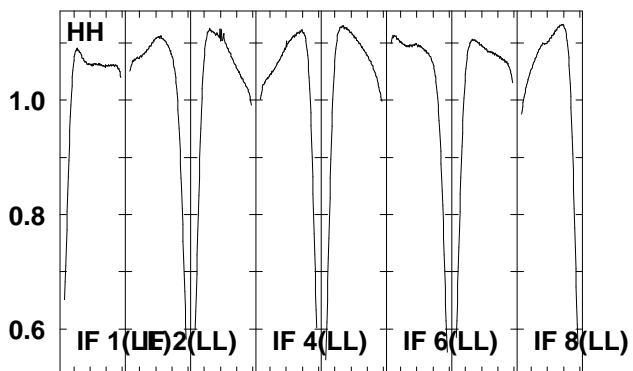
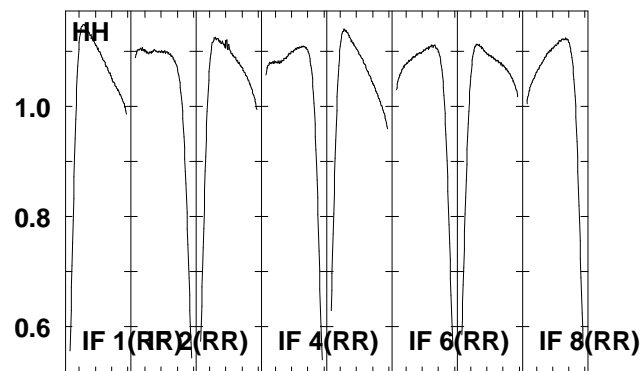
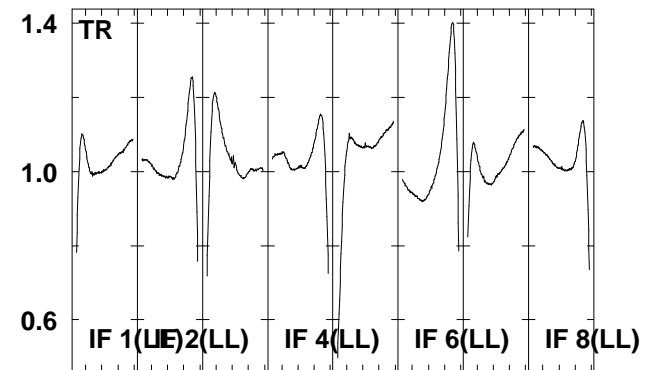
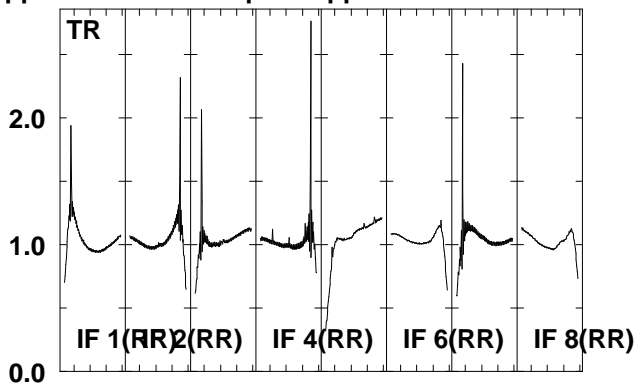
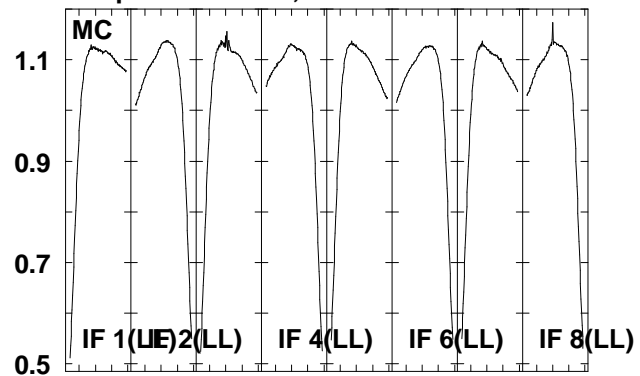

Lower frame: Real Jy
Total-power spectrum Antenna: *
Timerange: 00/09:36:34 to 00/09:39:02

Plot file version 198 created 22-JUN-2006 20:13:48
 J1825-17 EM061A 1.UVDATA.1
 Freq = 6.6631 GHz, Bw = 2.000 MH No calibration applied and no bandpass applied

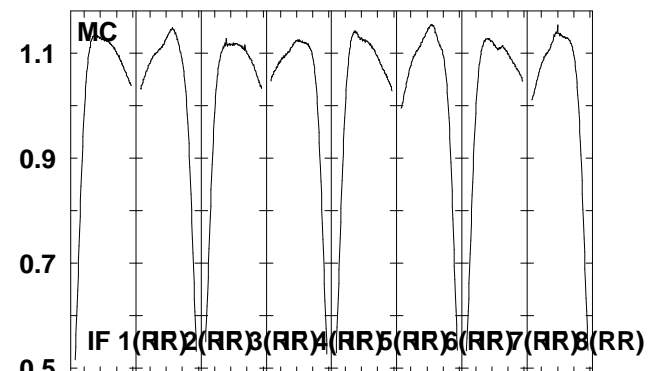
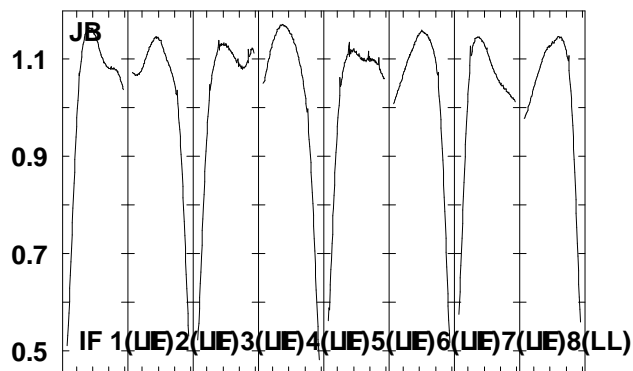
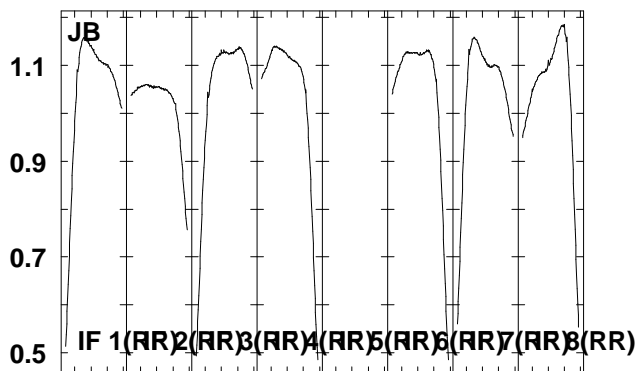
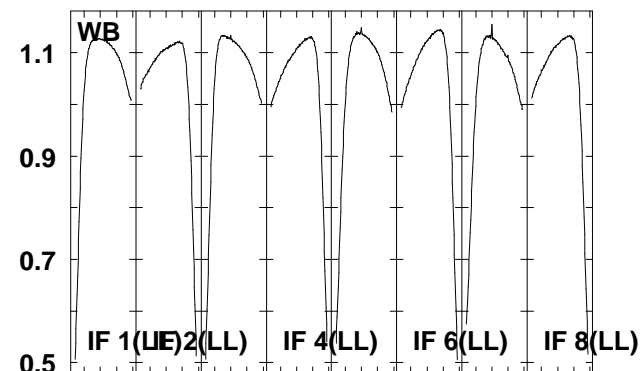
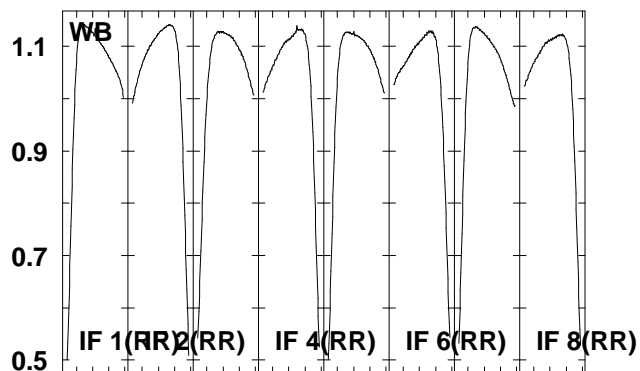
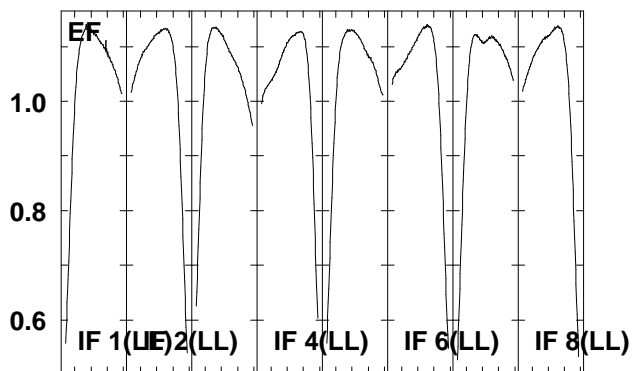
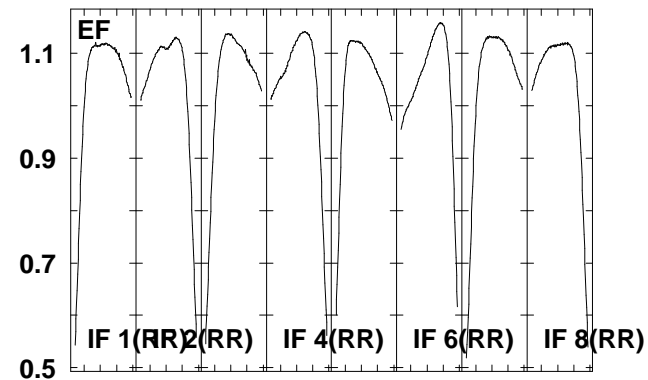
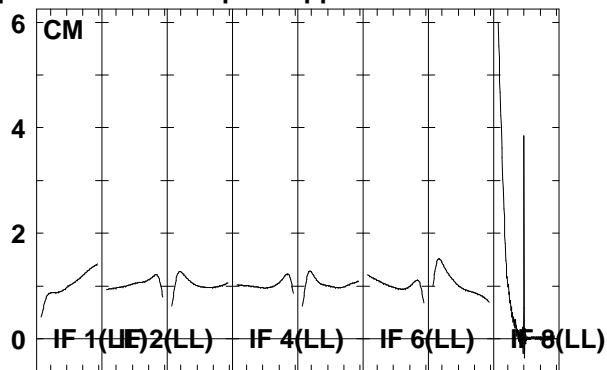
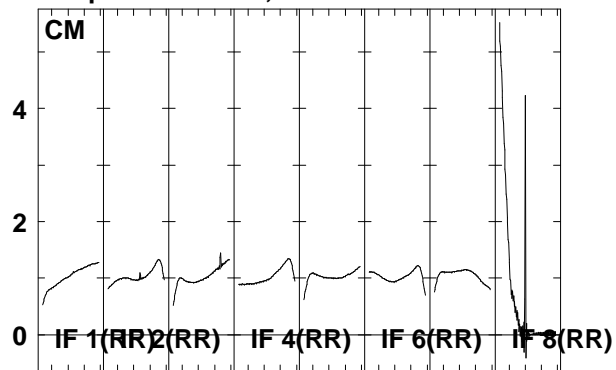

6663.6665.6667.6669.6671.6673.6675.6677.5
 FREQ MHz

6663.6665.6667.6669.6671.6673.6675.6677.5
 FREQ MHz

6663.6665.6667.6669.6671.6673.6675.6677.5
 FREQ MHz

Lower frame: Real Jy
 Total-power spectrum Antenna: *
 Timerange: 00/09:39:04 to 00/09:42:02

Plot file version 199 created 22-JUN-2006 20:13:51
 J1825-17 EM061A 1.UVDATA.1
 Freq = 6.6631 GHz, Bw = 2.000 MH No calibration applied and no bandpass applied

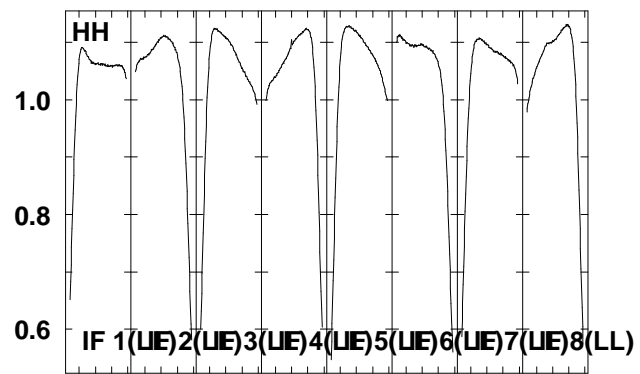
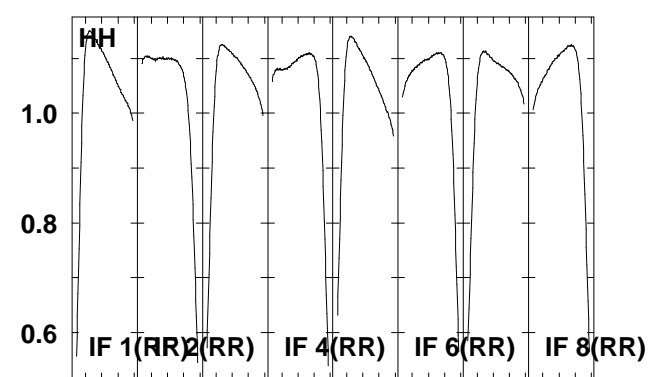
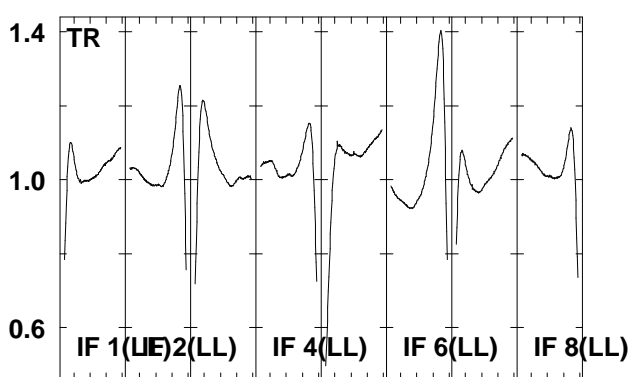
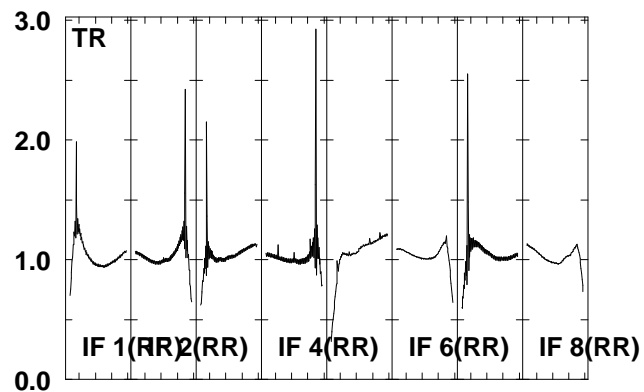
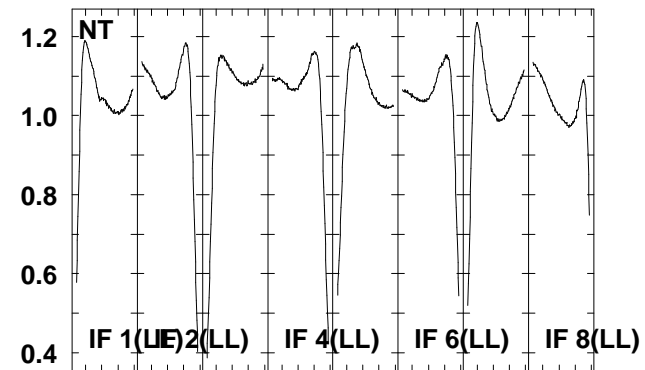
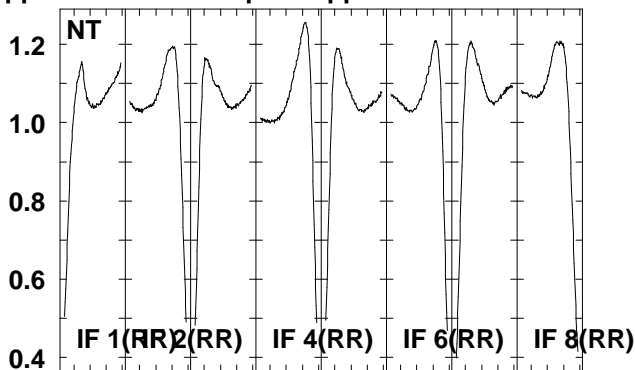
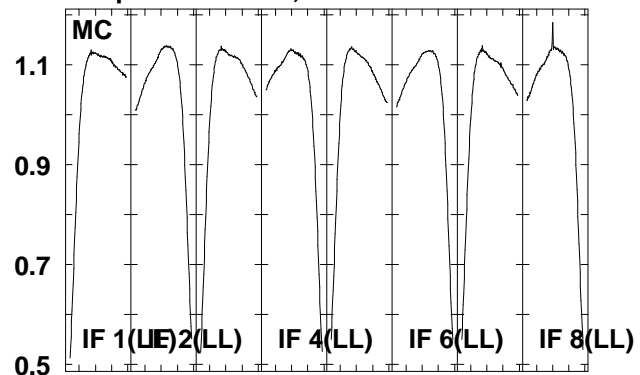

6663.6665.6667.6669.6671.6673.6675.6677.5
 FREQ MHz

Lower frame: Real Jy
 Total-power spectrum Antenna: *
 Timerange: 00/09:39:04 to 00/09:42:02

Plot file version 200 created 22-JUN-2006 20:13:56
 G16.59-0 EM061A 1.UVDATA.1
 Freq = 6.6631 GHz, Bw = 2.000 MH No calibration applied and no bandpass applied

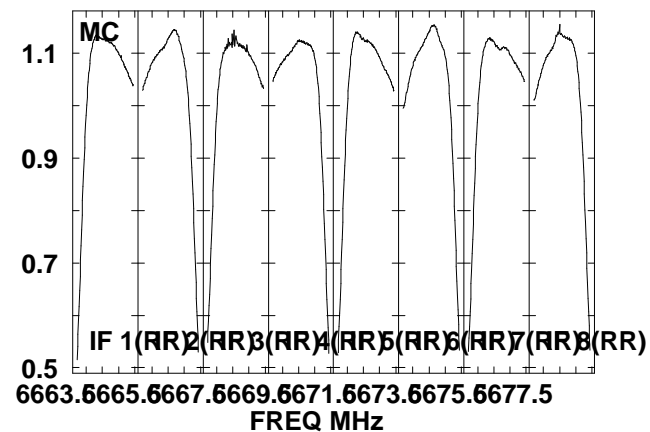
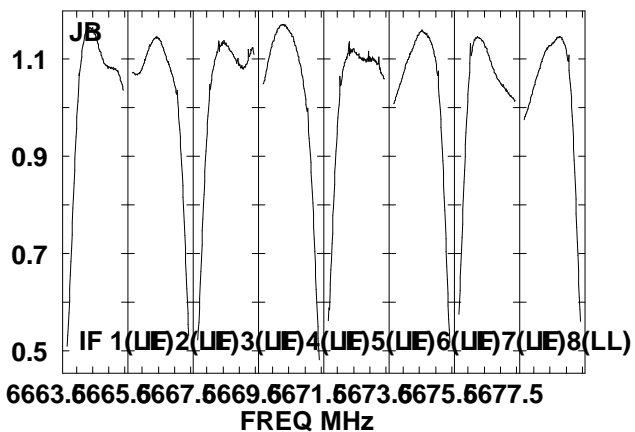
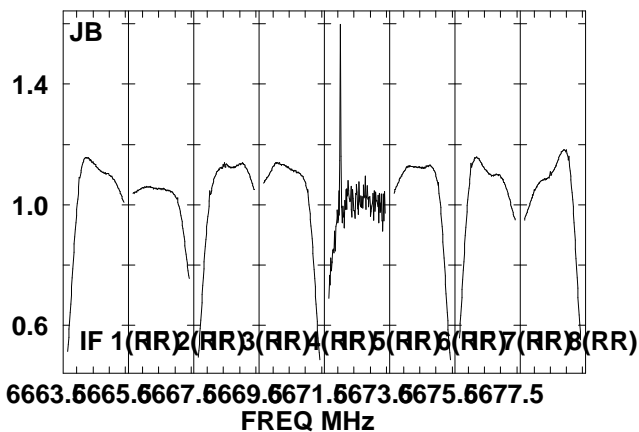
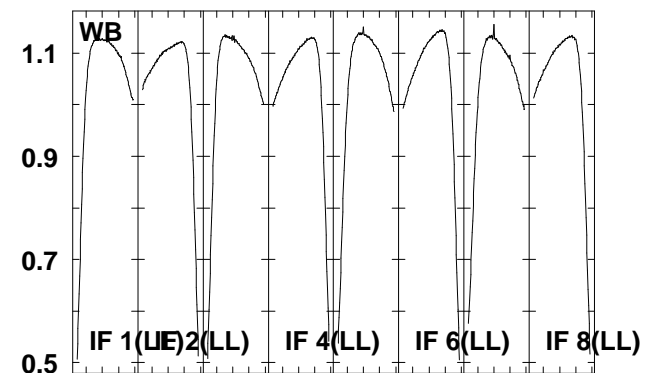
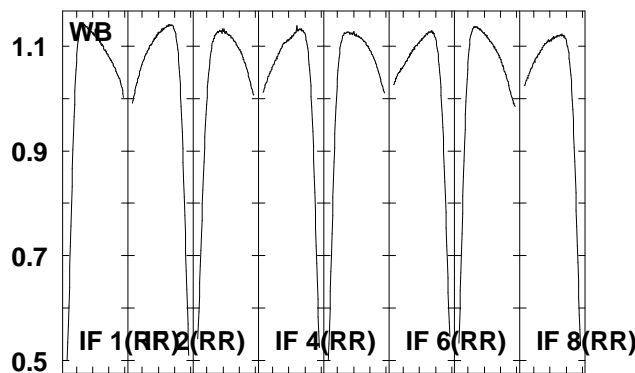
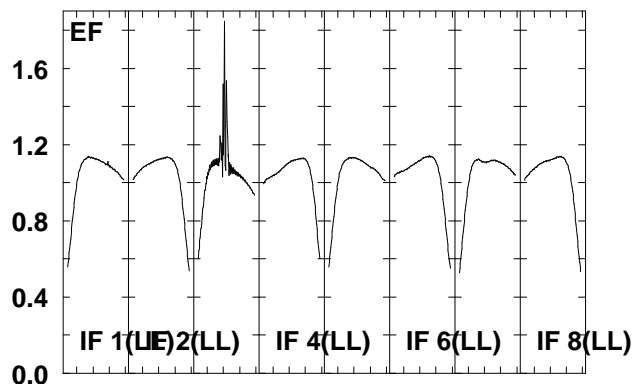
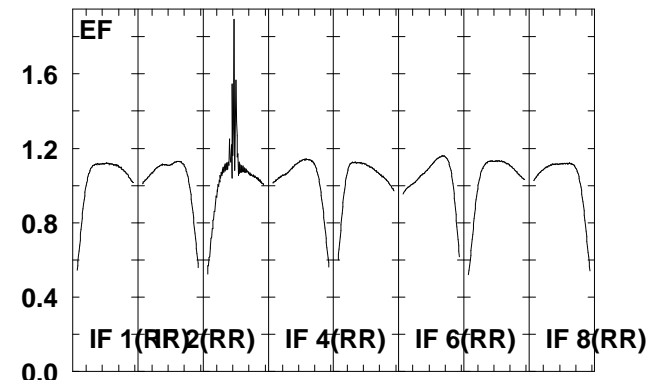
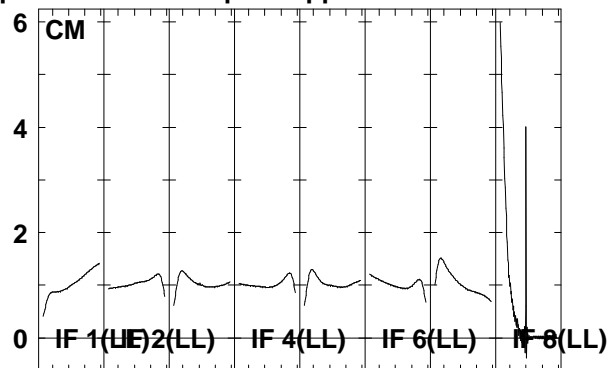
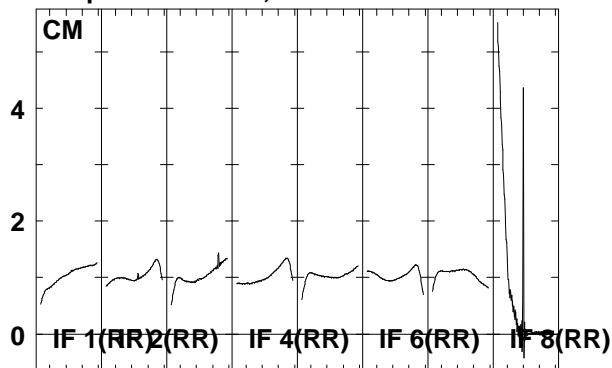

Lower frame: Real Jy
 Total-power spectrum Antenna: *
 Timerange: 00/09:42:04 to 00/09:44:32

Plot file version 201 created 22-JUN-2006 20:13:59
 G16.59-0 EM061A 1.UVDATA.1
 Freq = 6.6631 GHz, Bw = 2.000 MH No calibration applied and no bandpass applied

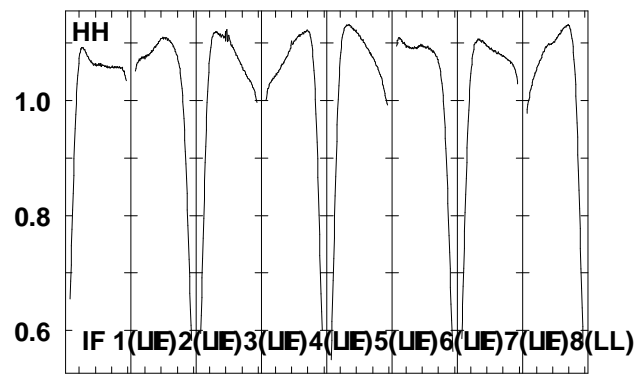
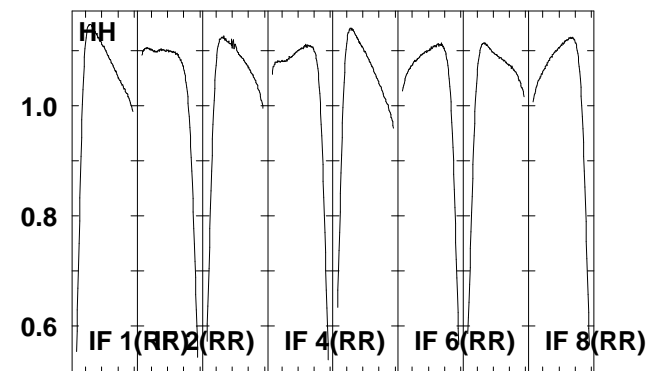
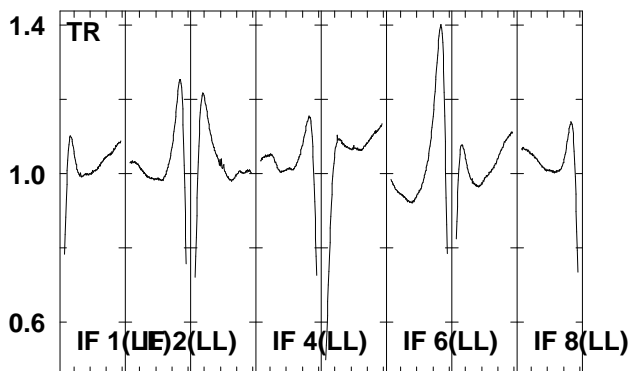
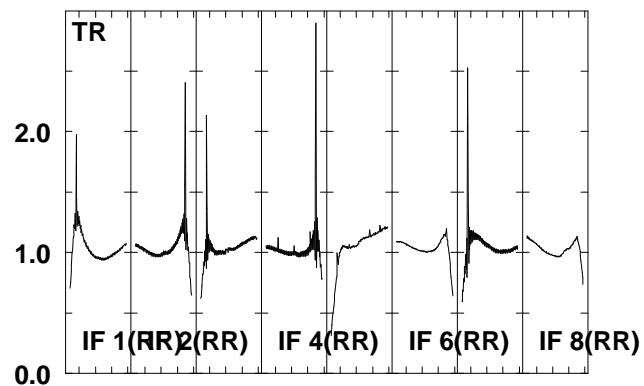
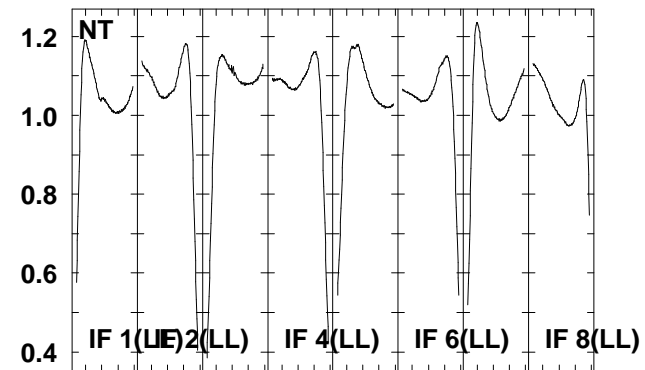
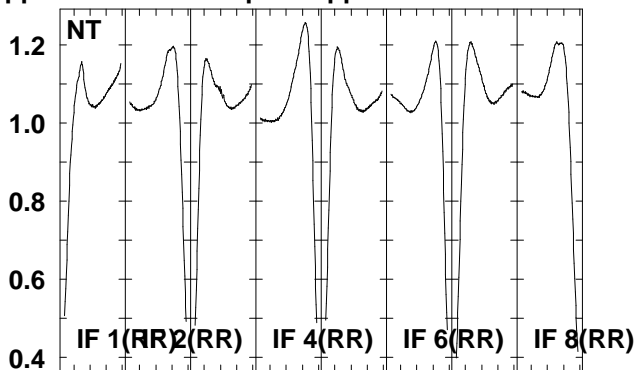
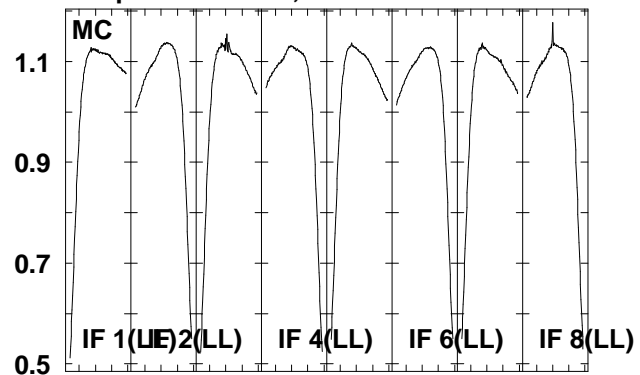

6663.6665.6667.6669.6671.6673.6675.6677.5
 FREQ MHz

Lower frame: Real Jy
 Total-power spectrum Antenna: *
 Timerange: 00/09:42:04 to 00/09:44:32

Plot file version 202 created 22-JUN-2006 20:14:04
 J1825-17 EM061A 1.UVDATA.1
 Freq = 6.6631 GHz, Bw = 2.000 MH No calibration applied and no bandpass applied

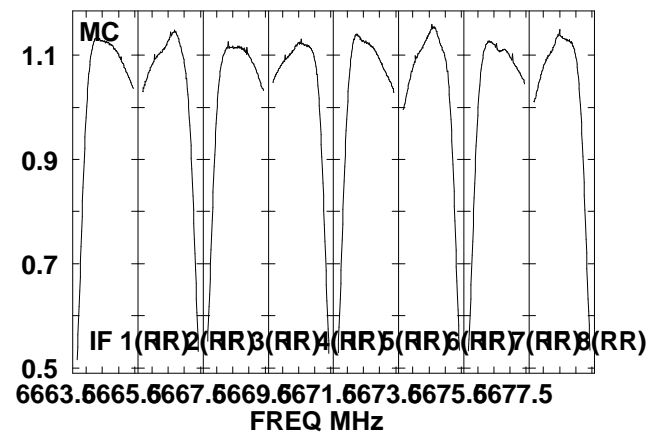
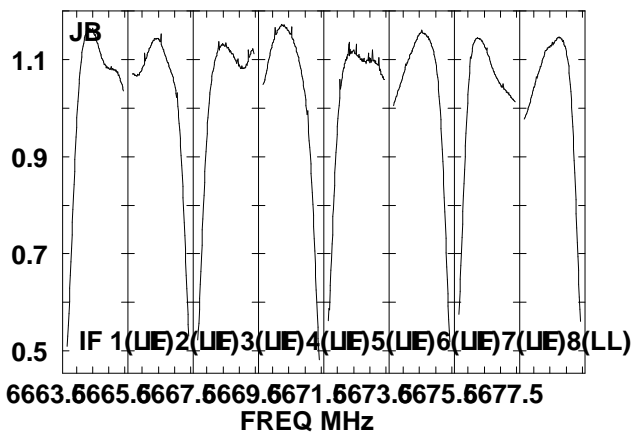
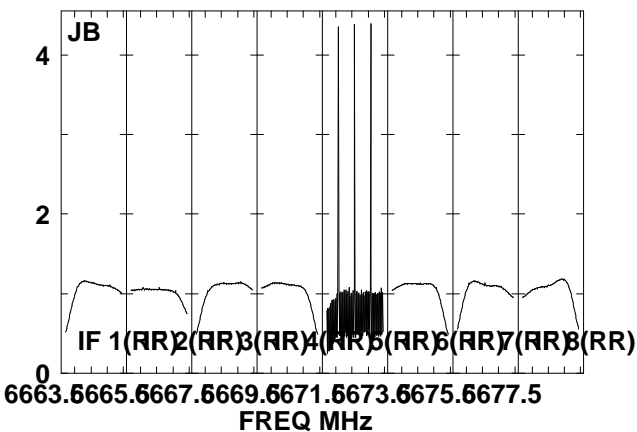
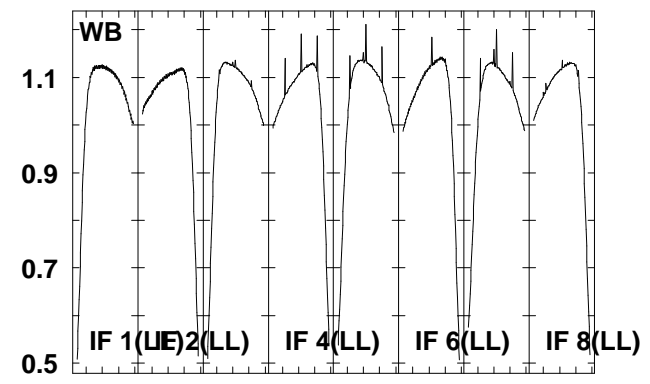
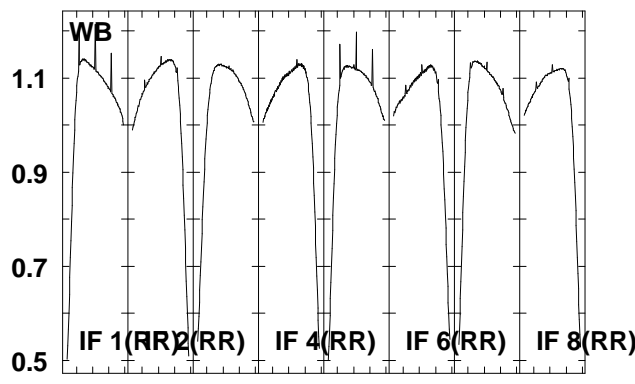
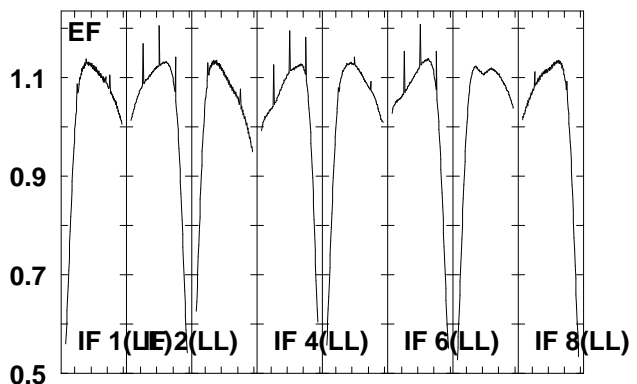
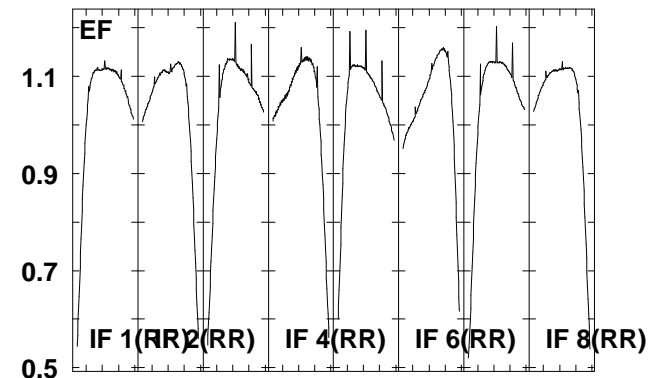
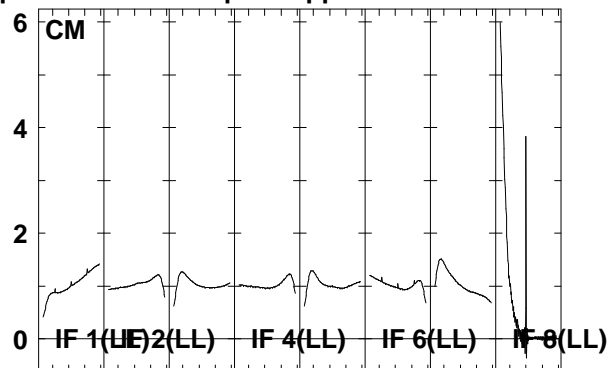
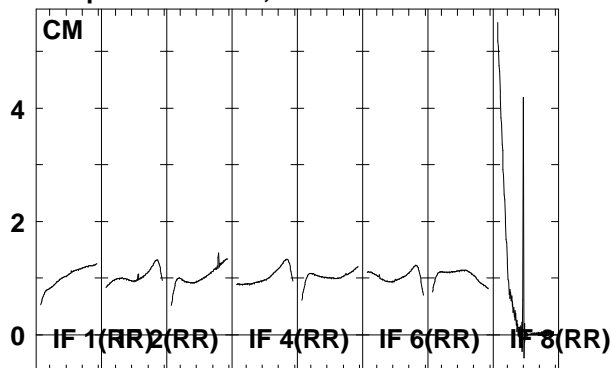

6663.6665.6667.6669.6671.6673.6675.6677.5
 FREQ MHz
 Lower frame: Real Jy
 Total-power spectrum Antenna: *
 Timerange: 00/09:46:05 to 00/09:49:02

Plot file version 203 created 22-JUN-2006 20:14:08
 J1825-17 EM061A 1.UVDATA.1
 Freq = 6.6631 GHz, Bw = 2.000 MH No calibration applied and no bandpass applied

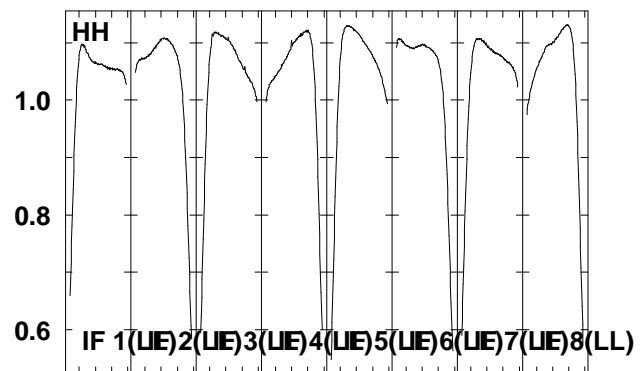
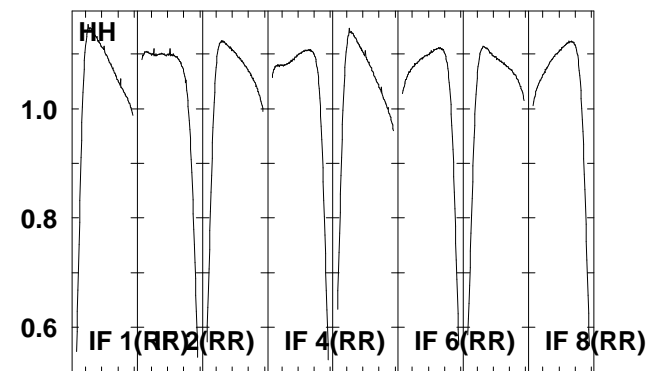
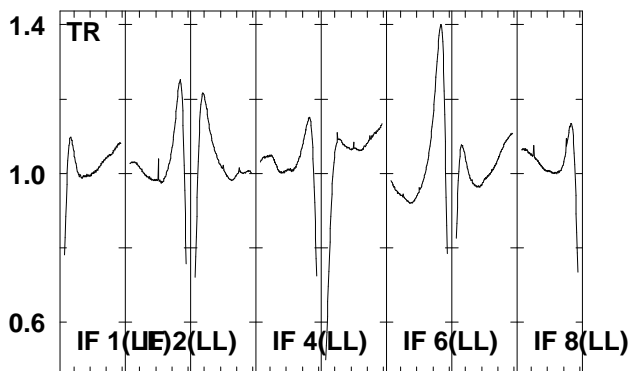
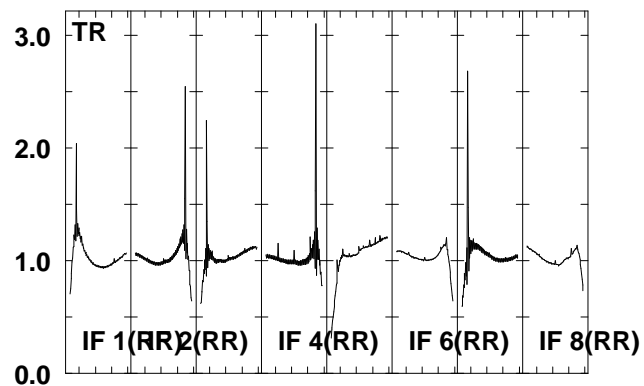
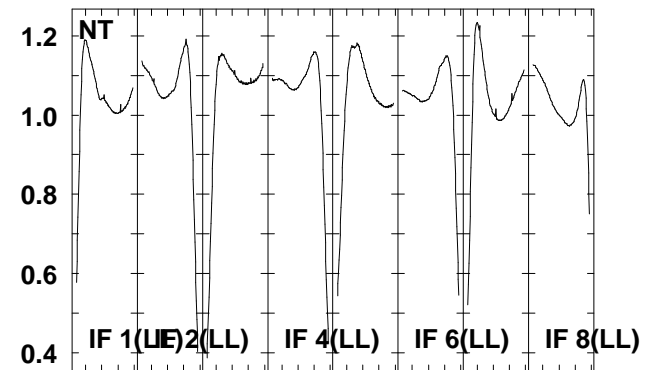
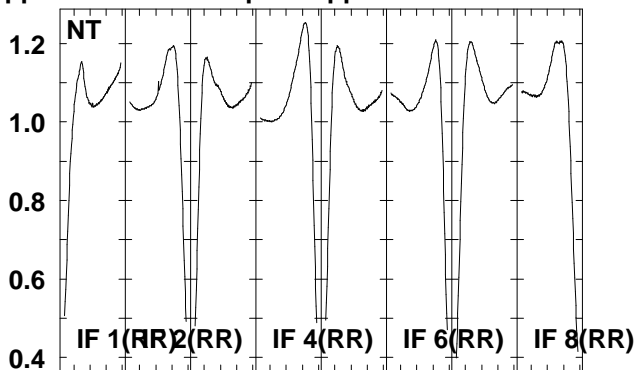
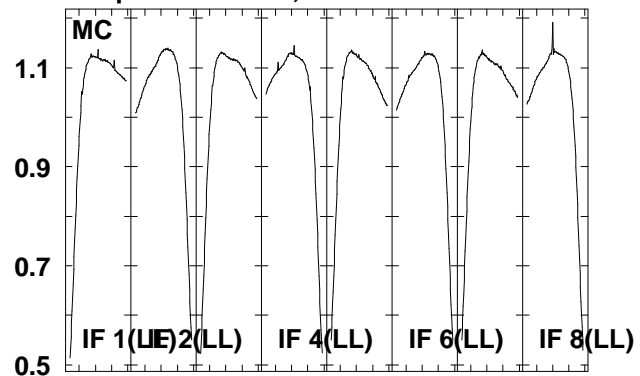

6663.6665.6667.6669.6671.6673.6675.6677.5
 FREQ MHz

Lower frame: Real Jy
 Total-power spectrum Antenna: *
 Timerange: 00/09:46:05 to 00/09:49:02

Plot file version 204 created 22-JUN-2006 20:14:12
 G16.59-0 EM061A 1.UVDATA.1
 Freq = 6.6631 GHz, Bw = 2.000 MH No calibration applied and no bandpass applied

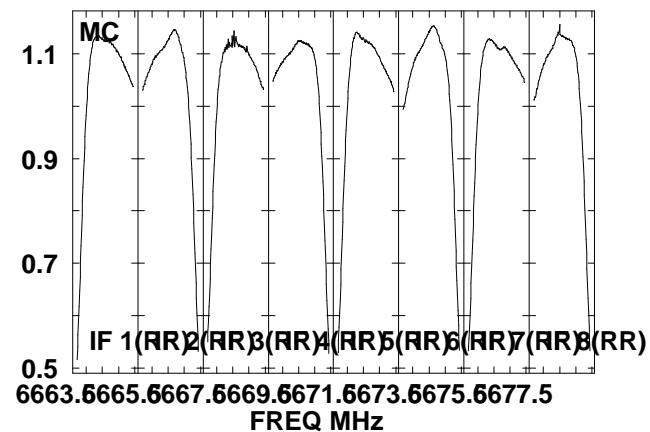
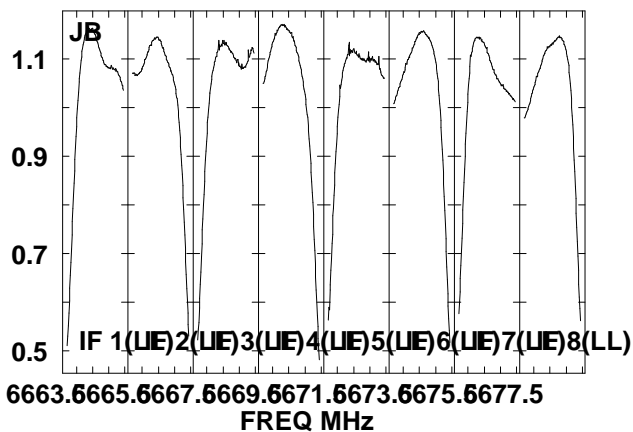
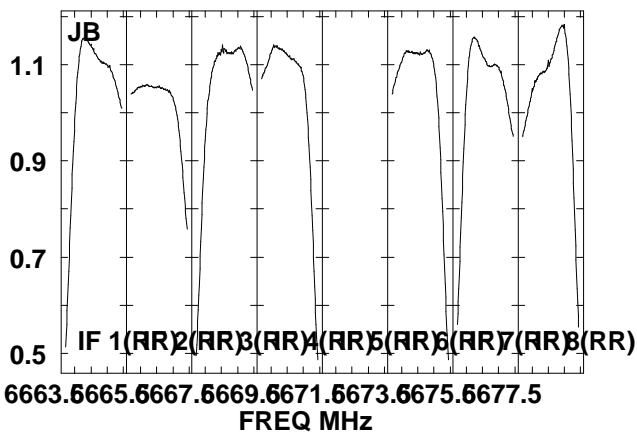
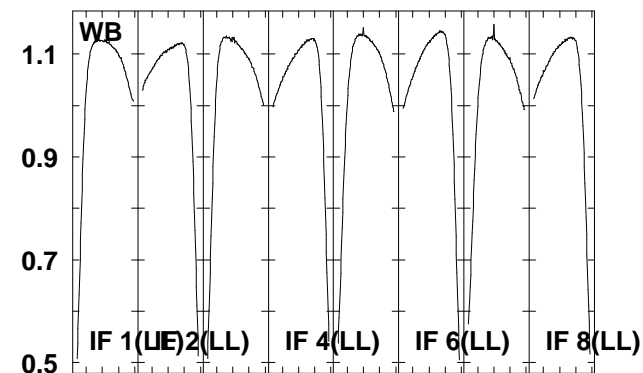
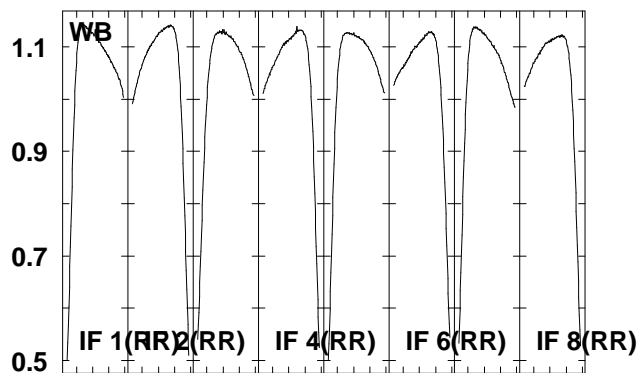
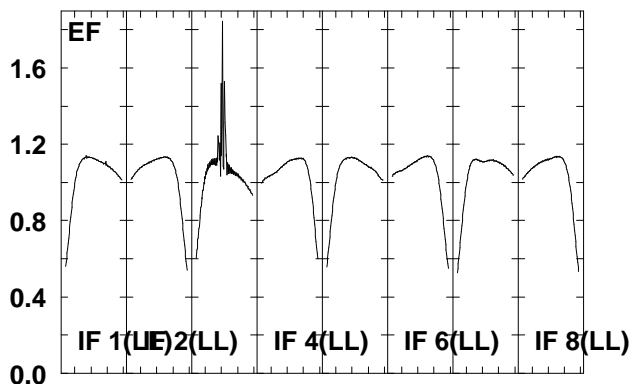
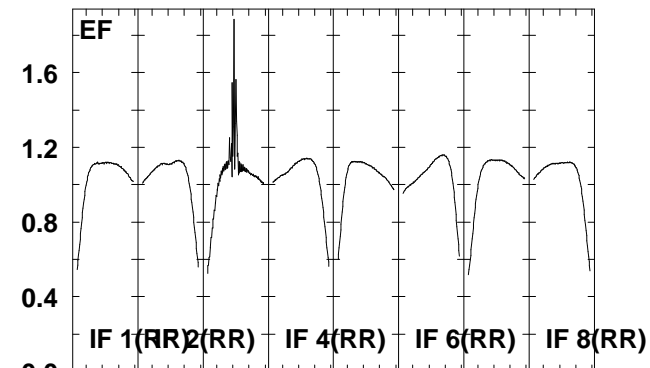
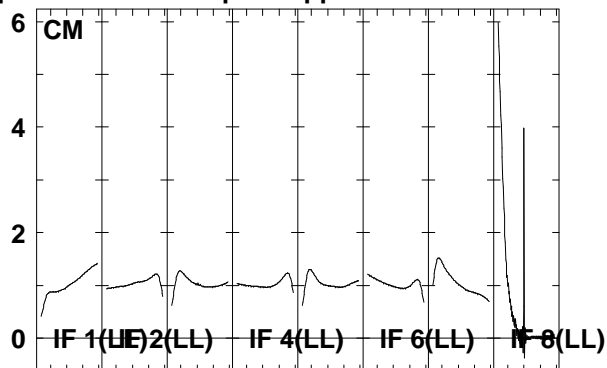
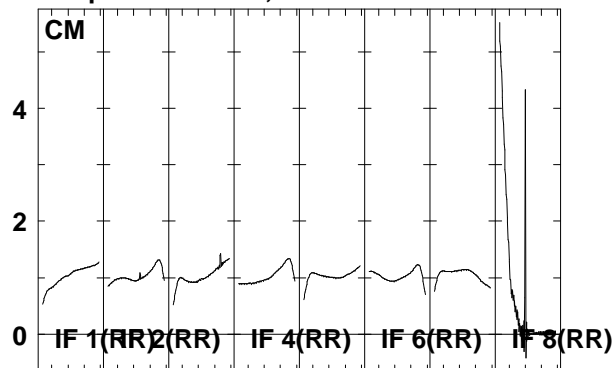

6663.6665.6667.6669.6671.6673.6675.6677.5
 FREQ MHz

6663.6665.6667.6669.6671.6673.6675.6677.5
 FREQ MHz

6663.6665.6667.6669.6671.6673.6675.6677.5
 FREQ MHz

Lower frame: Real Jy
 Total-power spectrum Antenna: *
 Timerange: 00/09:49:04 to 00/09:51:32

Plot file version 205 created 22-JUN-2006 20:14:16
 G16.59-0 EM061A 1.UVDATA.1
 Freq = 6.6631 GHz, Bw = 2.000 MH No calibration applied and no bandpass applied

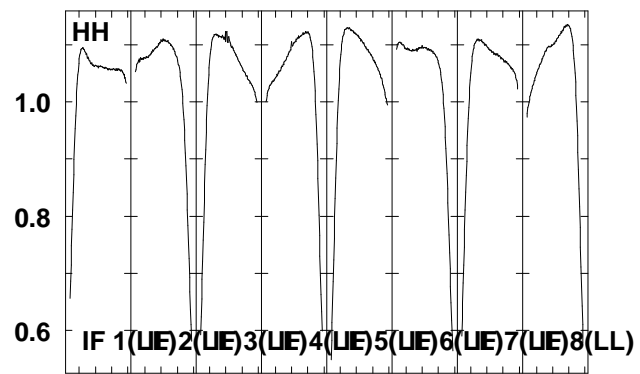
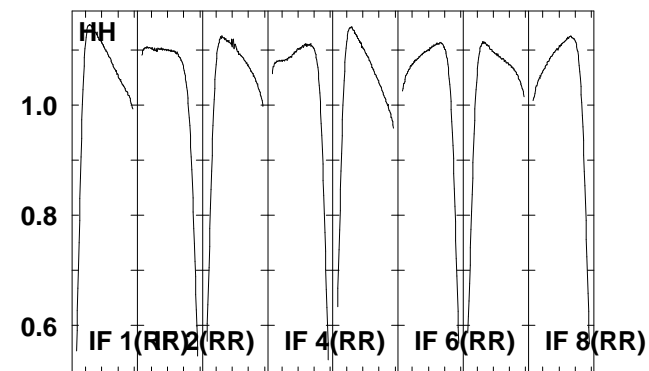
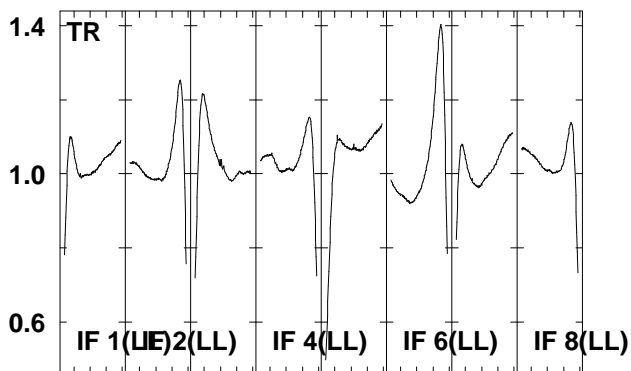
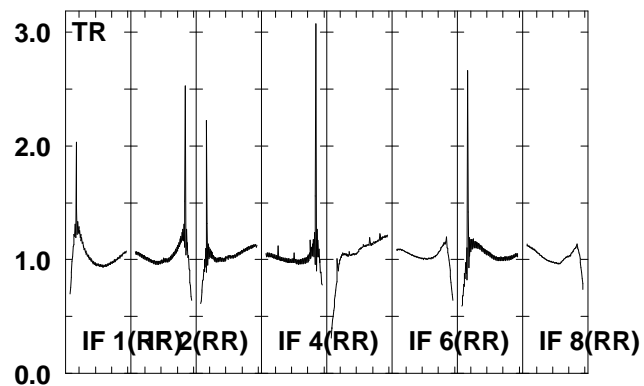
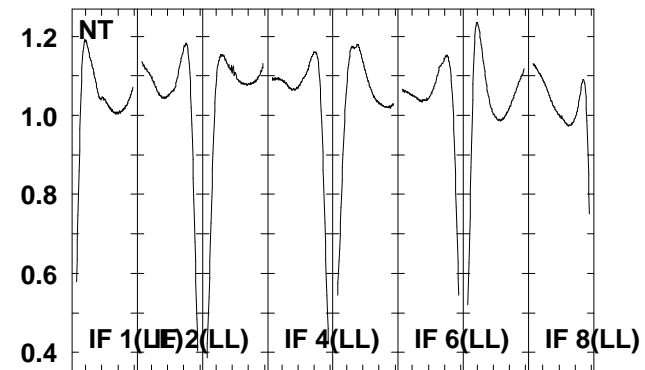
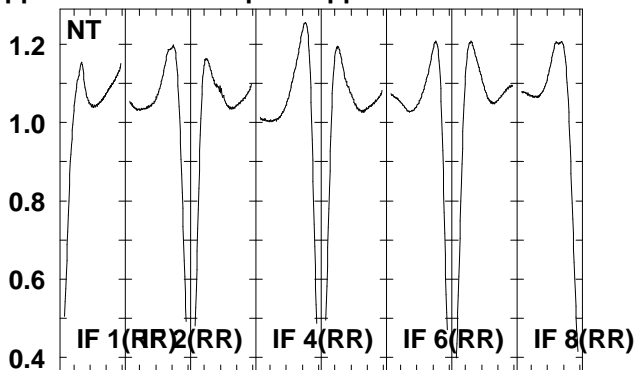
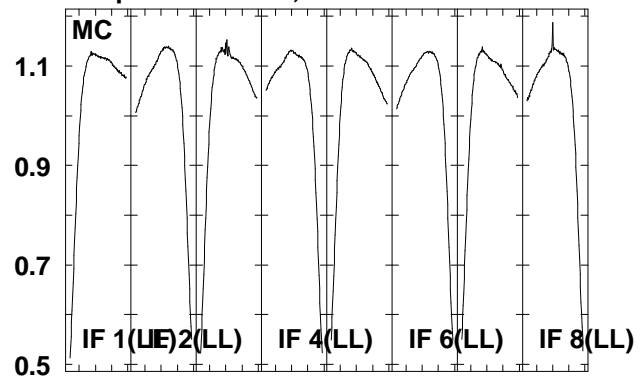

6663.6665.6667.6669.6671.6673.6675.6677.5
 FREQ MHz

Lower frame: Real Jy
 Total-power spectrum Antenna: *
 Timerange: 00/09:49:04 to 00/09:51:32

Plot file version 206 created 22-JUN-2006 20:14:20
 J1825-17 EM061A 1.UVDATA.1
 Freq = 6.6631 GHz, Bw = 2.000 MH No calibration applied and no bandpass applied

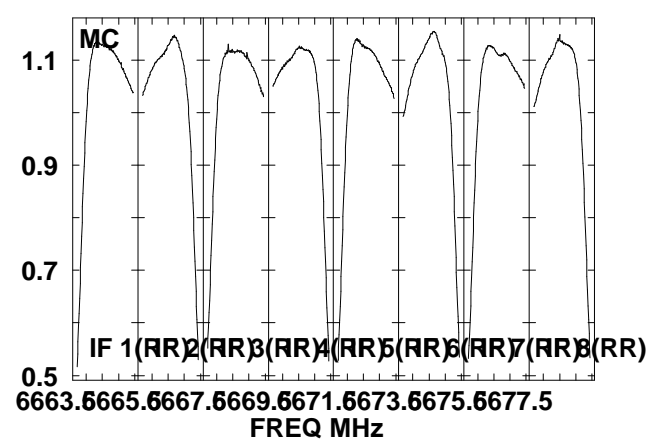
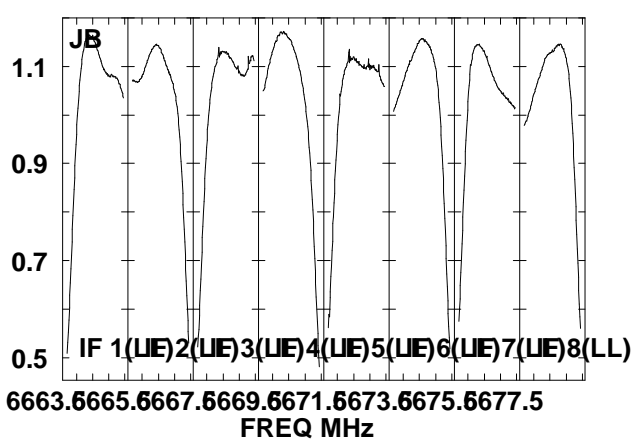
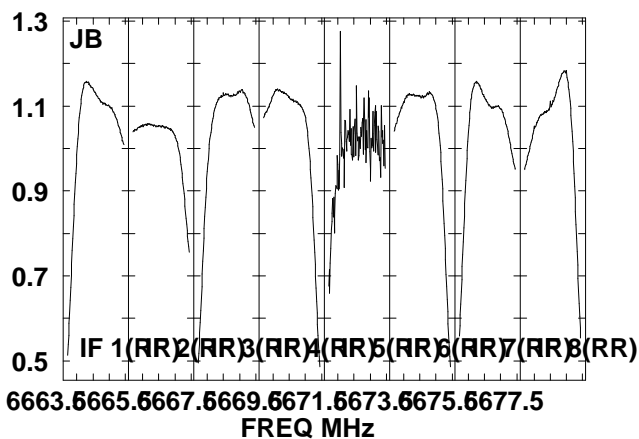
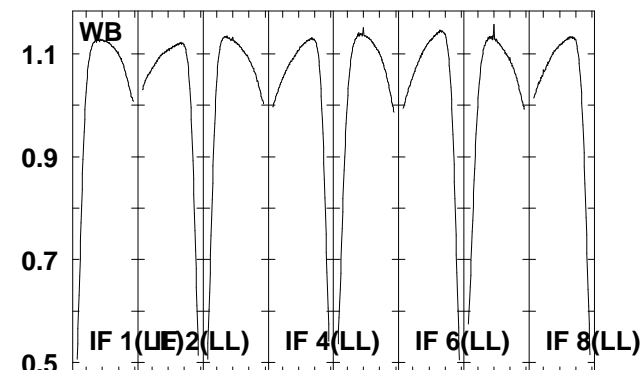
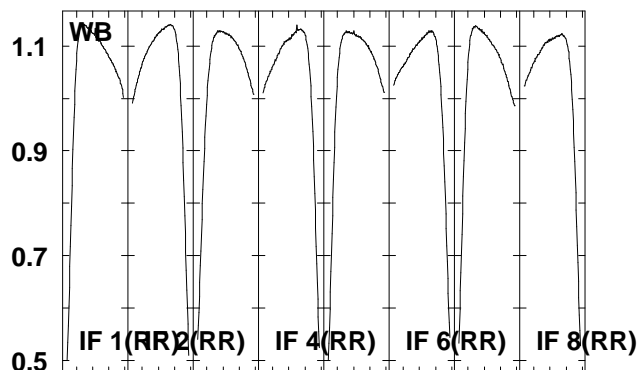
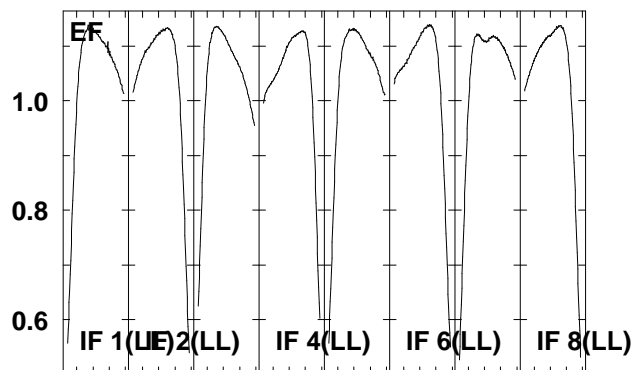
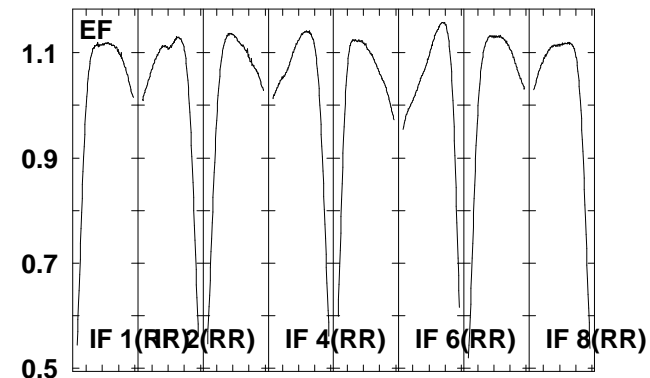
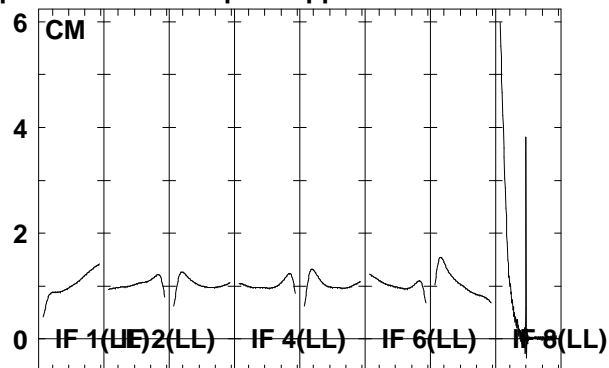
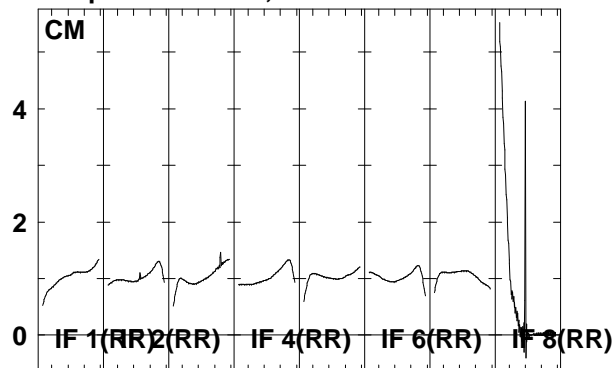

Lower frame: Real Jy
 Total-power spectrum Antenna: *
 Timerange: 00/09:51:34 to 00/09:54:32

Plot file version 207 created 22-JUN-2006 20:14:24
 J1825-17 EM061A 1.UVDATA.1
 Freq = 6.6631 GHz, Bw = 2.000 MH No calibration applied and no bandpass applied

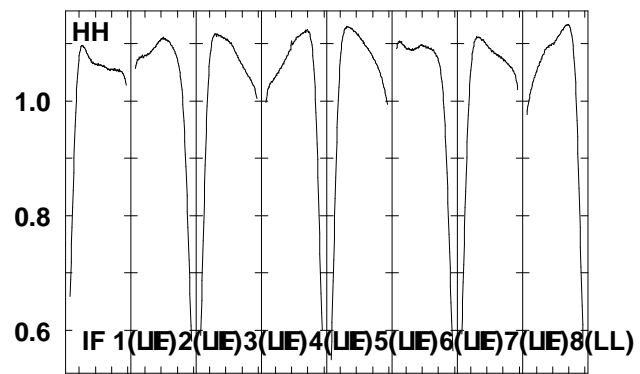
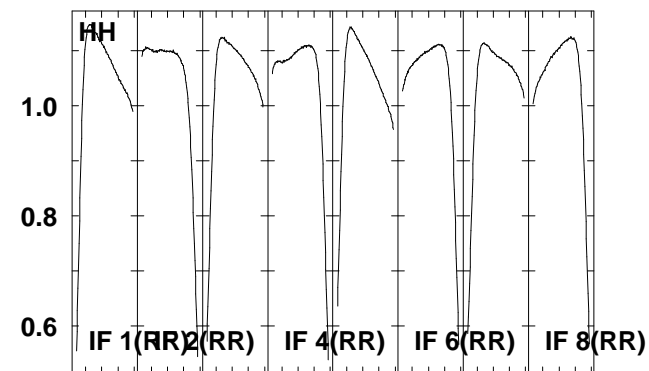
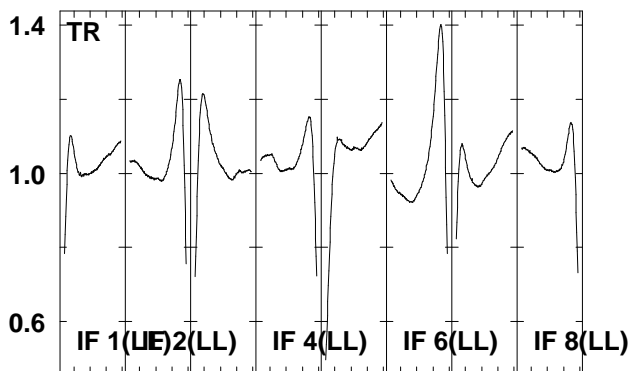
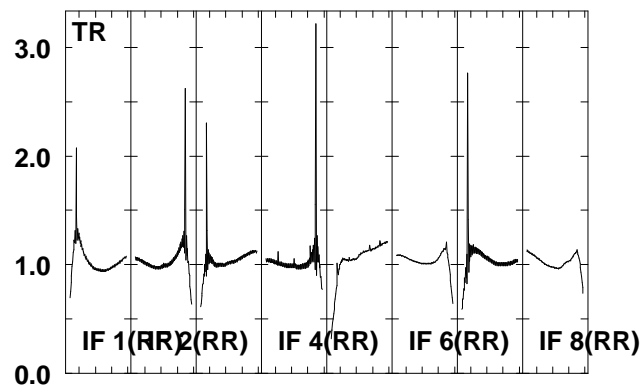
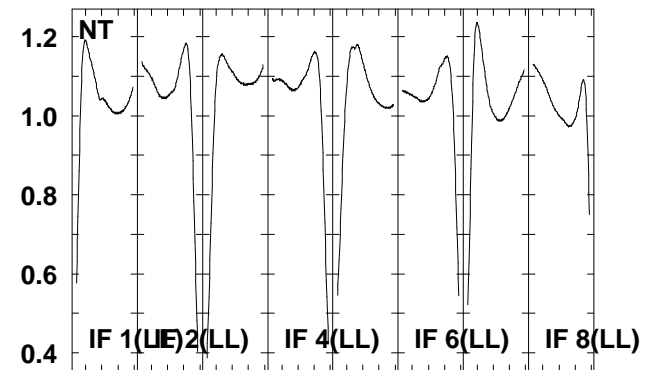
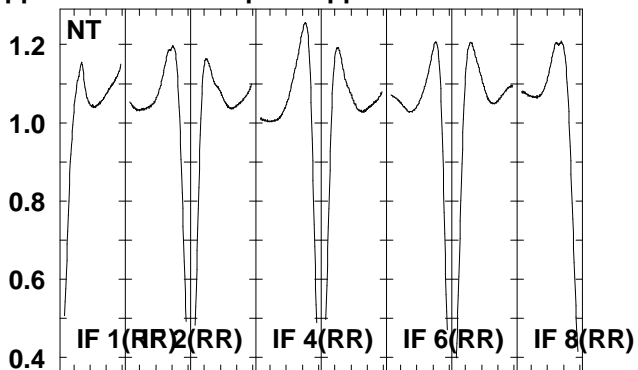
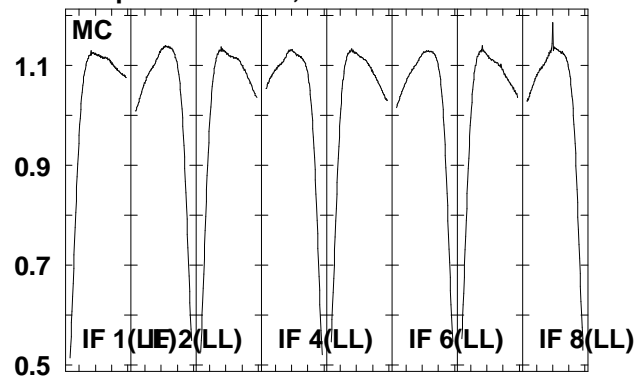

6663.6665.6667.6669.6671.6673.6675.6677.5
 FREQ MHz

Lower frame: Real Jy
 Total-power spectrum Antenna: *
 Timerange: 00/09:51:34 to 00/09:54:32

Plot file version 208 created 22-JUN-2006 20:14:28
 G16.59-0 EM061A 1.UVDATA.1
 Freq = 6.6631 GHz, Bw = 2.000 MH No calibration applied and no bandpass applied

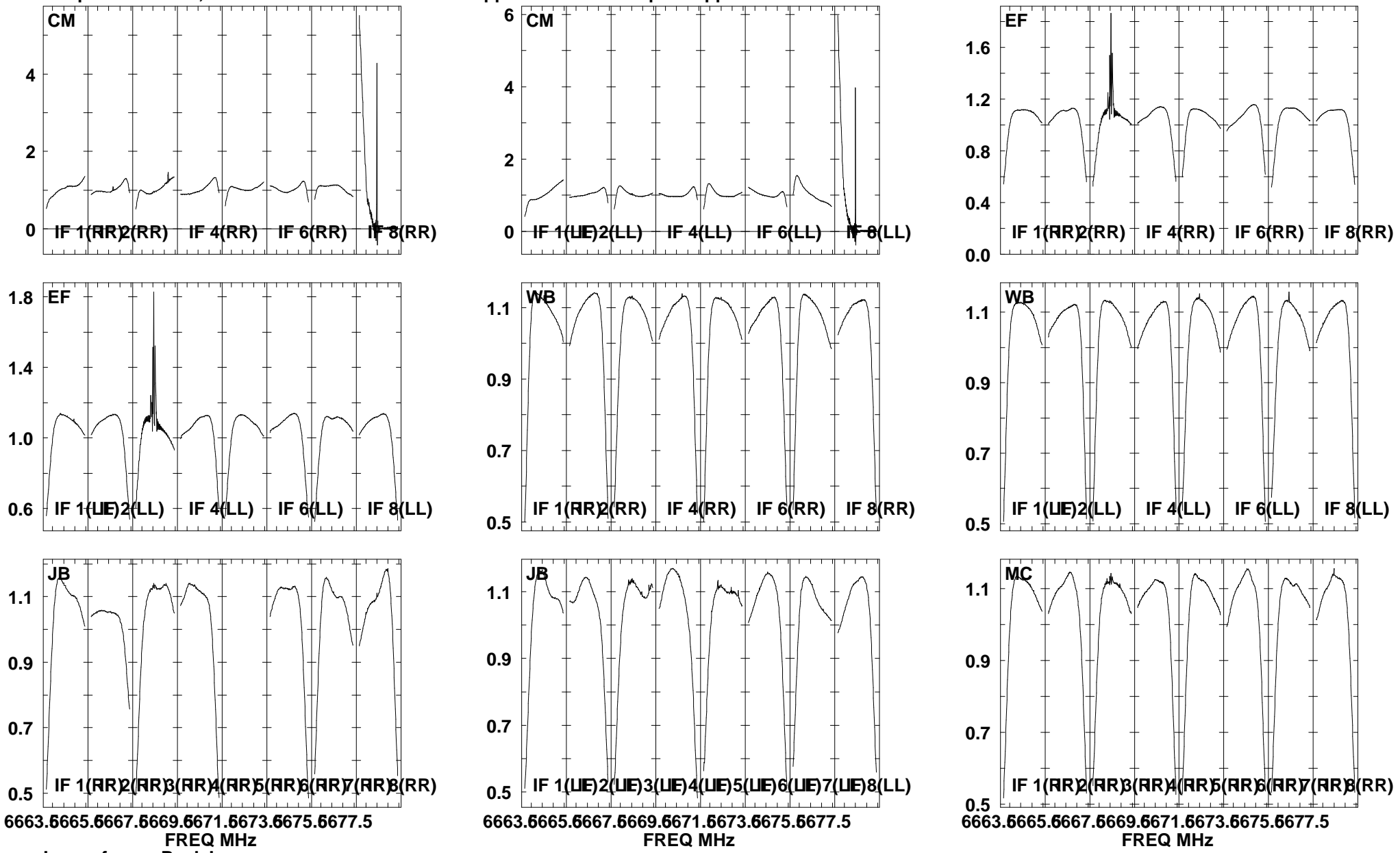

Lower frame: Real Jy
 Total-power spectrum Antenna: *
 Timerange: 00/09:54:34 to 00/09:57:02

Plot file version 209 created 22-JUN-2006 20:14:31
 G16.59-0 EM061A 1.UVDATA.1
 Freq = 6.6631 GHz, Bw = 2.000 MH No calibration applied and no bandpass applied

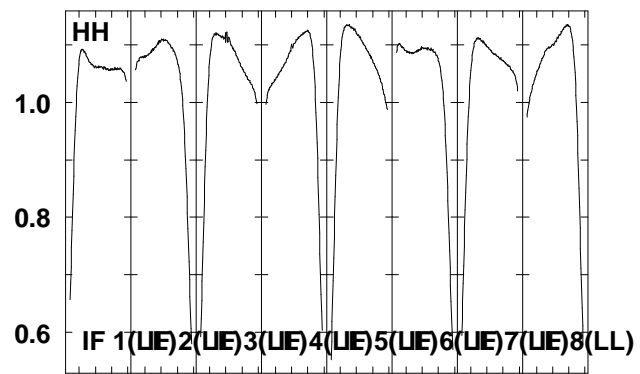
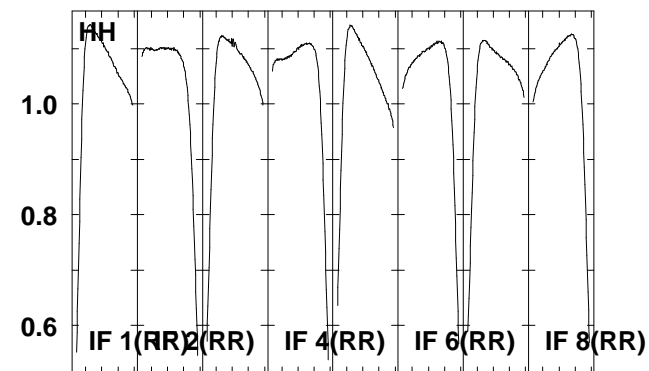
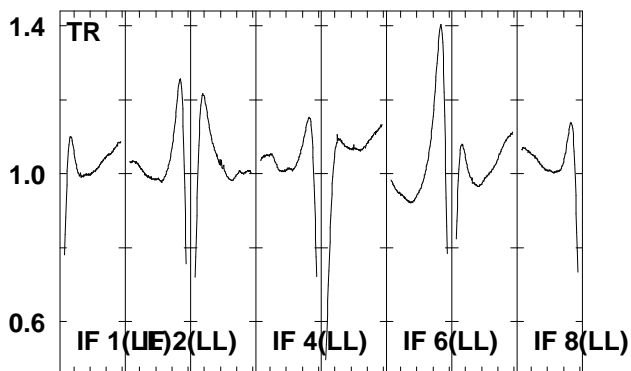
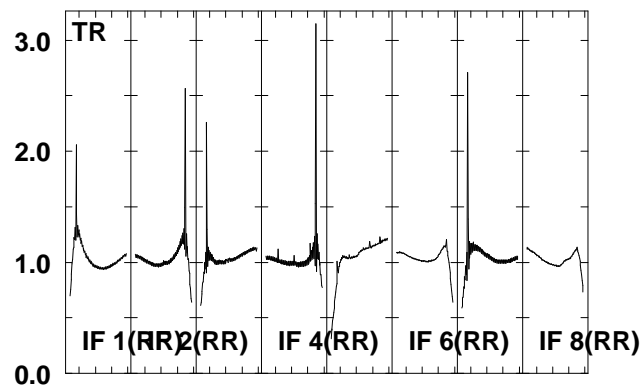
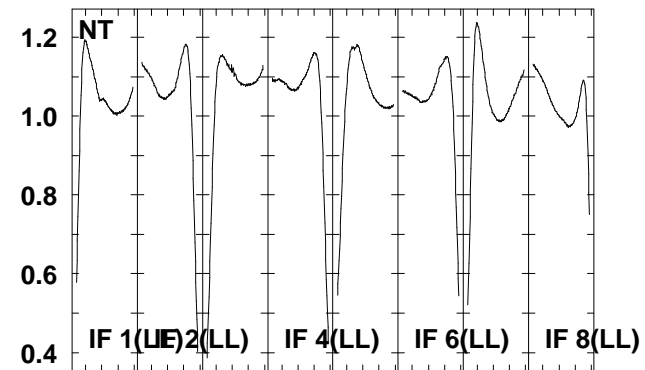
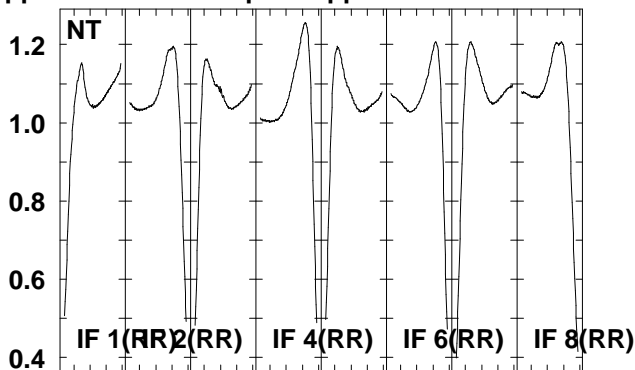
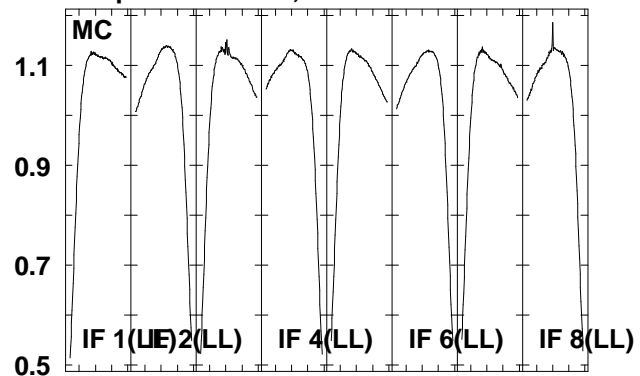

6663.6665.6667.6669.6671.6673.6675.6677.5
 FREQ MHz

Lower frame: Real Jy
 Total-power spectrum Antenna: *
 Timerange: 00/09:54:34 to 00/09:57:02

Plot file version 210 created 22-JUN-2006 20:14:36
 J1825-17 EM061A 1.UVDATA.1
 Freq = 6.6631 GHz, Bw = 2.000 MH No calibration applied and no bandpass applied

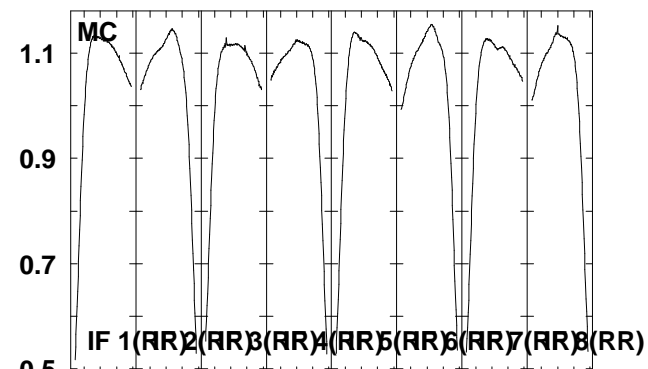
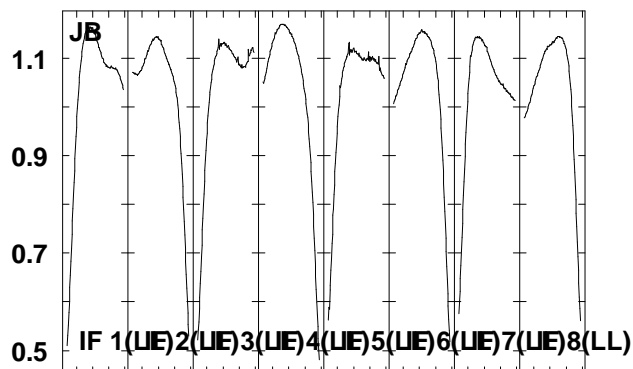
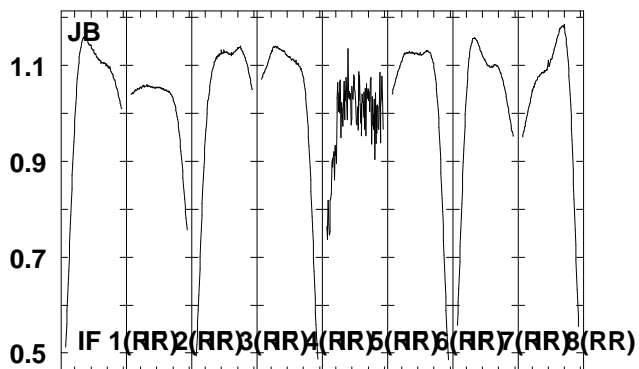
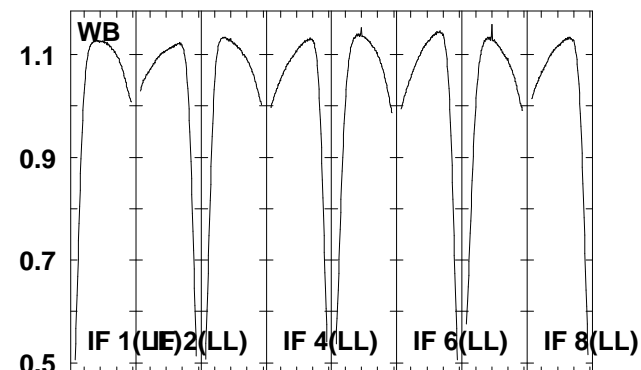
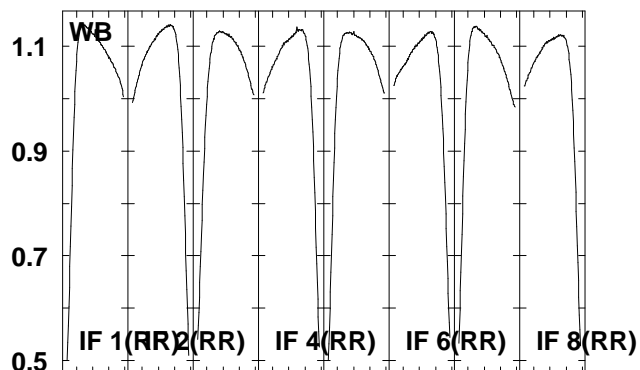
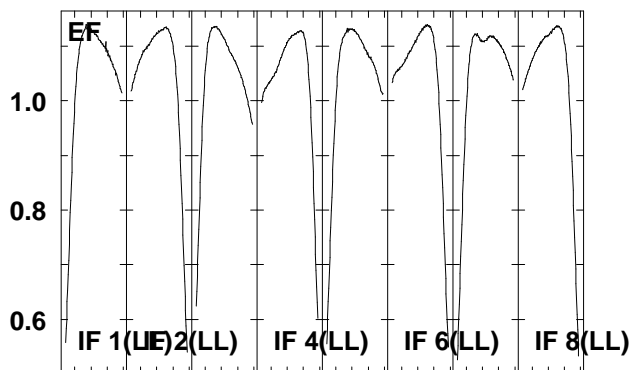
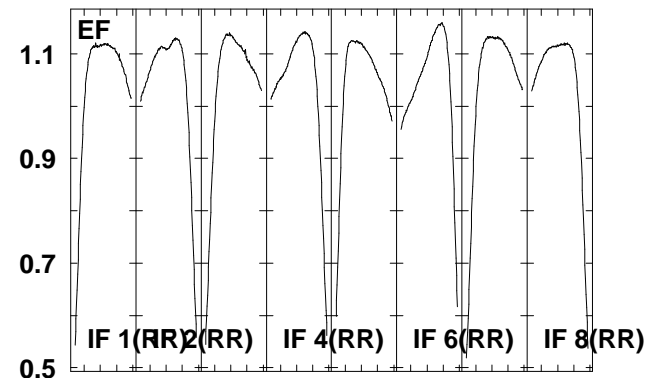
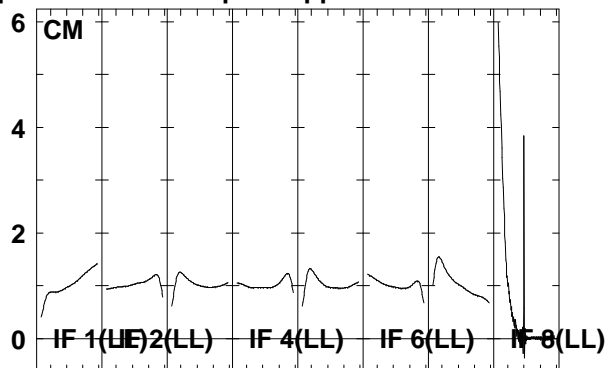
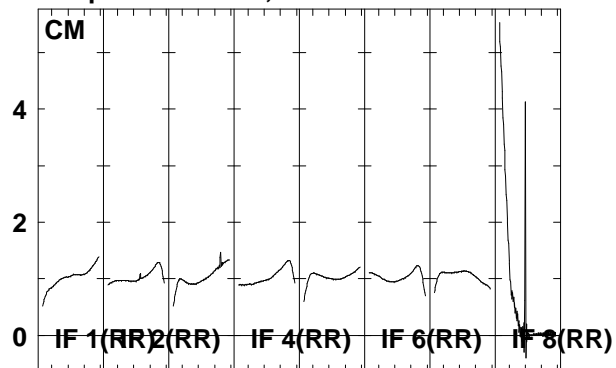

6663.6665.6667.6669.6671.6673.6675.6677.5
 FREQ MHz

6663.6665.6667.6669.6671.6673.6675.6677.5
 FREQ MHz

6663.6665.6667.6669.6671.6673.6675.6677.5
 FREQ MHz

Lower frame: Real Jy
 Total-power spectrum Antenna: *
 Timerange: 00/09:57:04 to 00/10:00:02

Plot file version 211 created 22-JUN-2006 20:14:40
 J1825-17 EM061A 1.UVDATA.1
 Freq = 6.6631 GHz, Bw = 2.000 MH No calibration applied and no bandpass applied

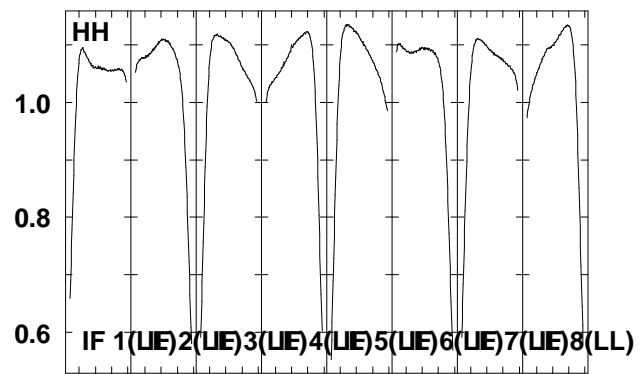
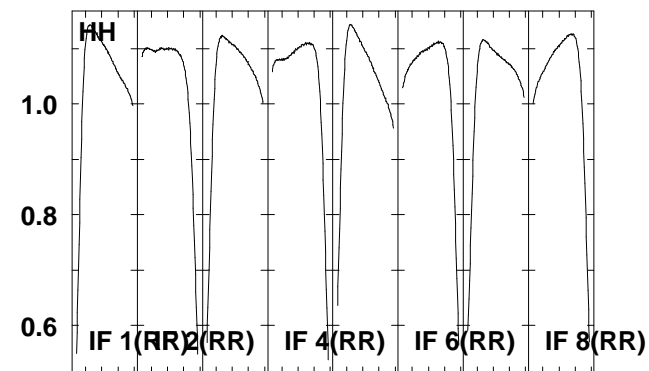
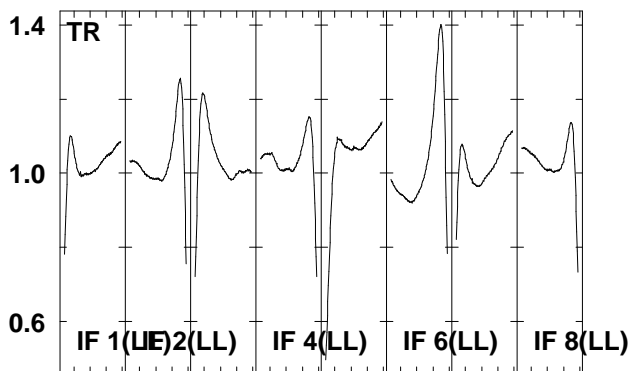
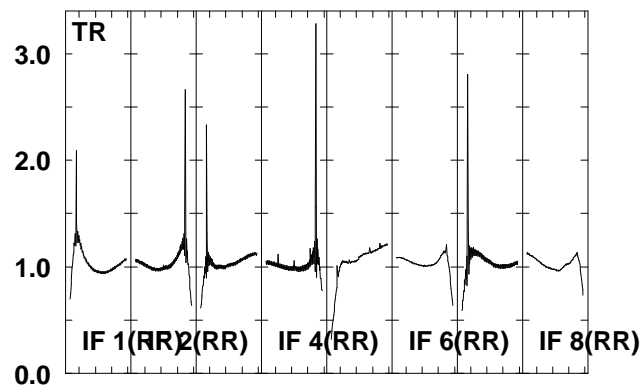
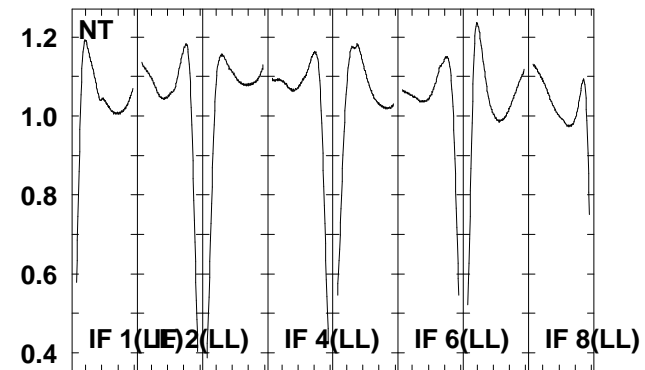
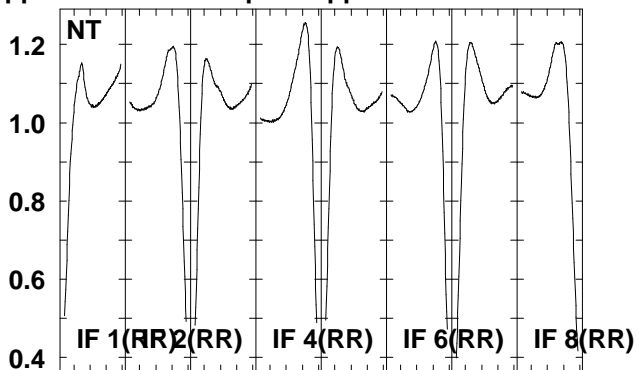
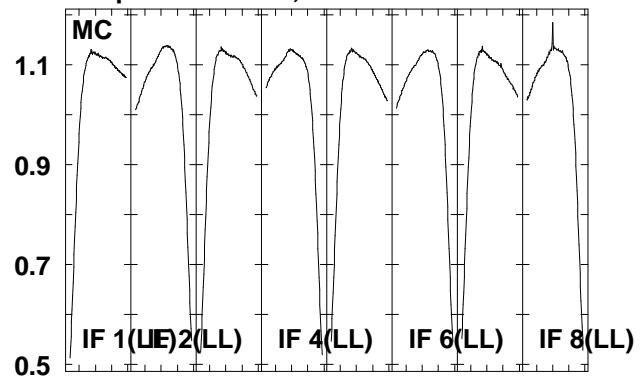

6663.6665.6667.6669.6671.6673.6675.6677.5
 FREQ MHz

Lower frame: Real Jy
 Total-power spectrum Antenna: *
 Timerange: 00/09:57:04 to 00/10:00:02

Plot file version 212 created 22-JUN-2006 20:14:44
 G16.59-0 EM061A 1.UVDATA.1
 Freq = 6.6631 GHz, Bw = 2.000 MH No calibration applied and no bandpass applied

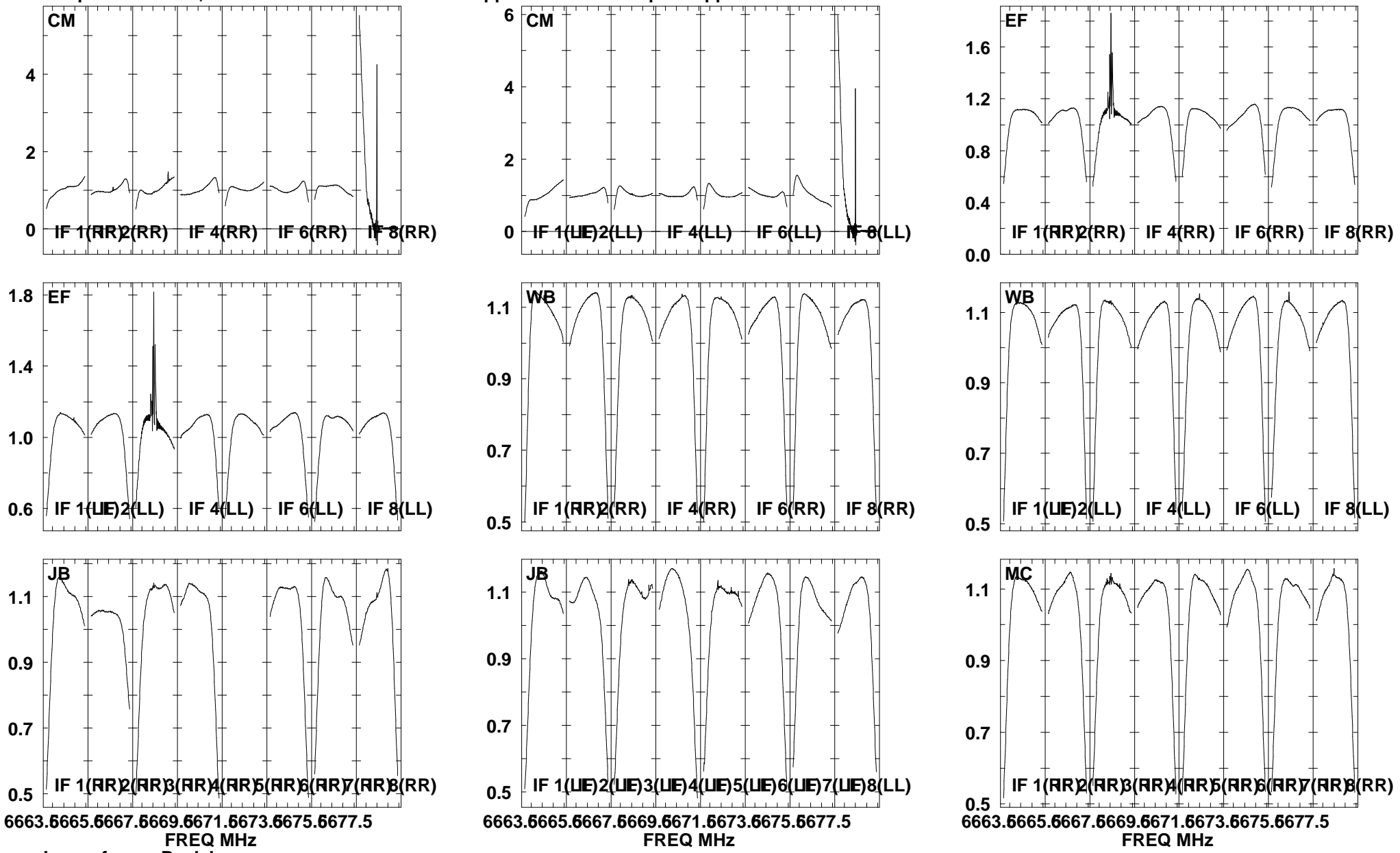

Lower frame: Real Jy
 Total-power spectrum Antenna: *
 Timerange: 00/10:00:04 to 00/10:02:32

Plot file version 213 created 22-JUN-2006 20:14:47
 G16.59-0 EM061A 1.UVDATA.1
 Freq = 6.6631 GHz, Bw = 2.000 MH No calibration applied and no bandpass applied

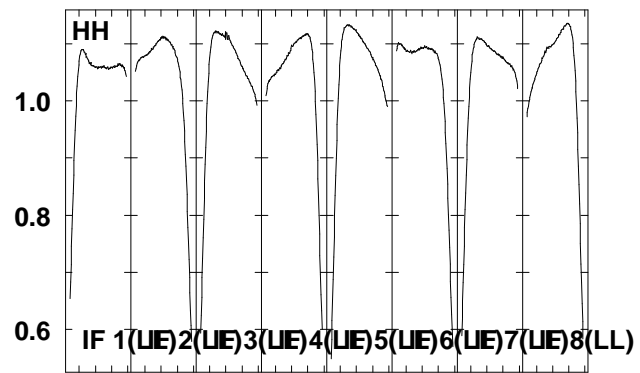
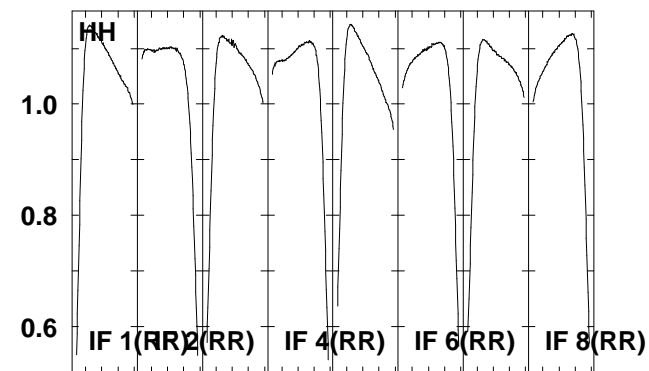
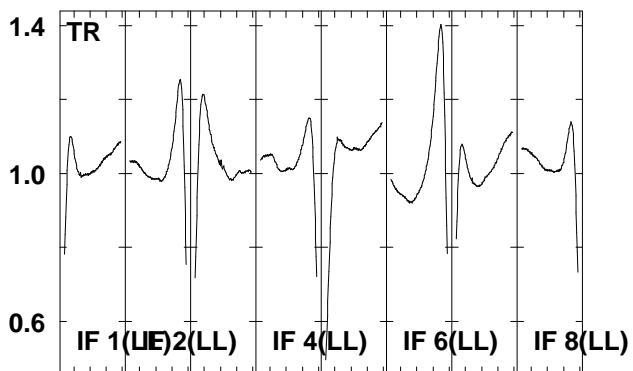
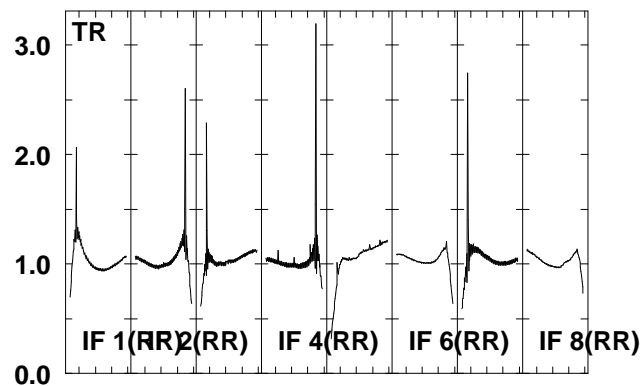
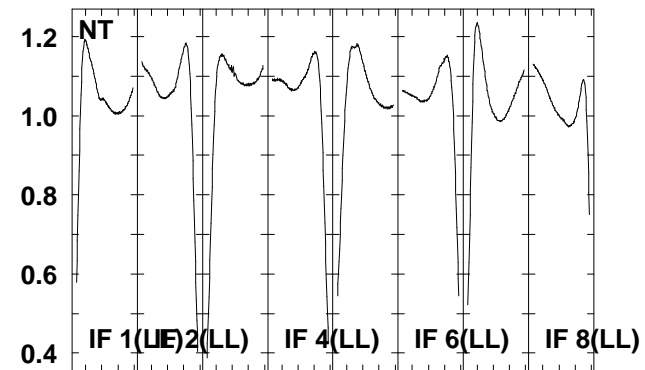
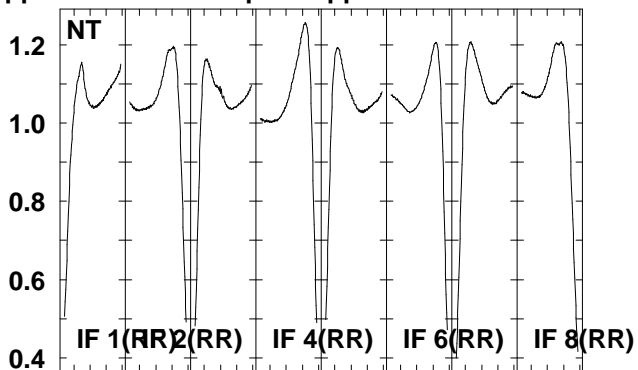
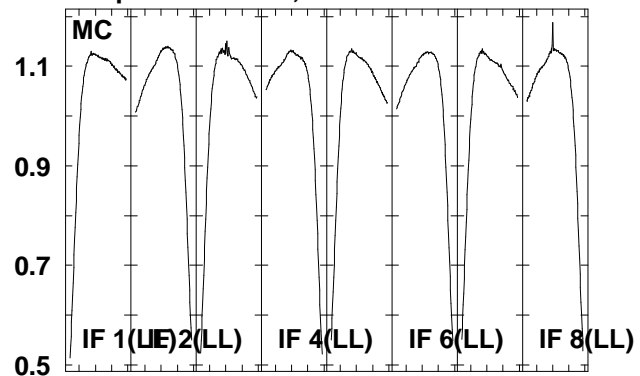

6663.6665.6667.6669.6671.6673.6675.6677.5
 FREQ MHz

Lower frame: Real Jy
 Total-power spectrum Antenna: *
 Timerange: 00/10:00:04 to 00/10:02:32

Plot file version 214 created 22-JUN-2006 20:14:51
 J1825-17 EM061A 1.UVDATA.1
 Freq = 6.6631 GHz, Bw = 2.000 MH No calibration applied and no bandpass applied

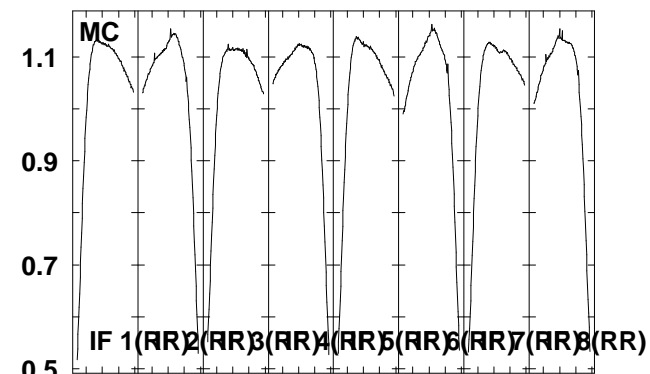
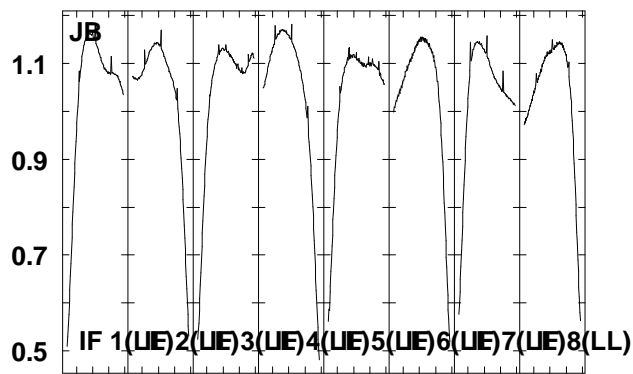
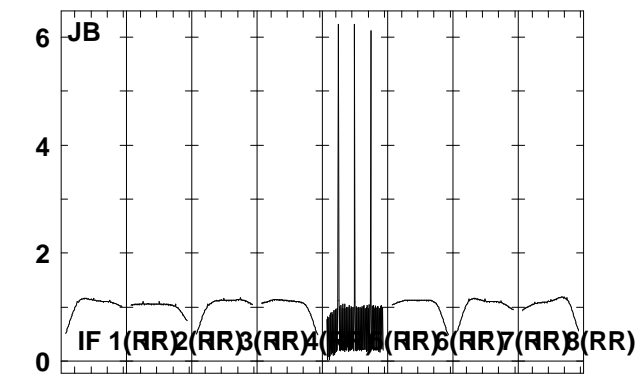
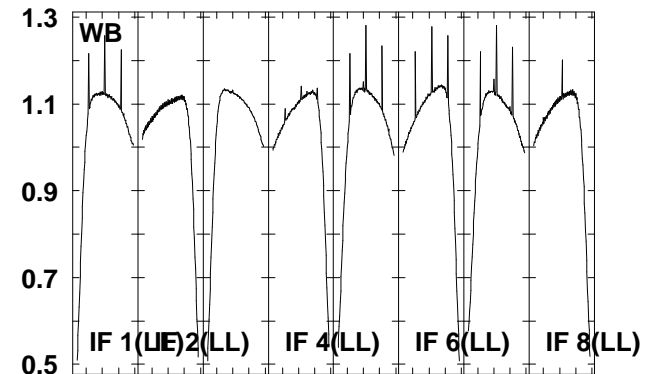
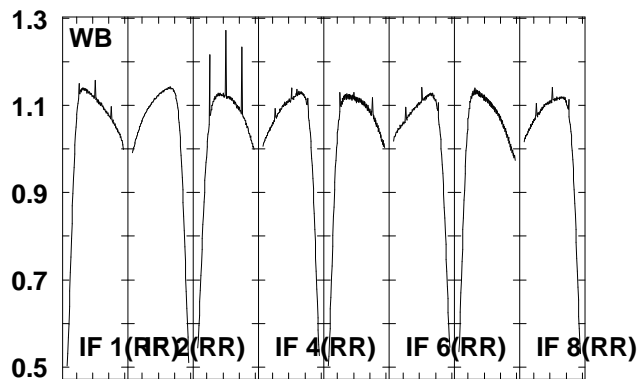
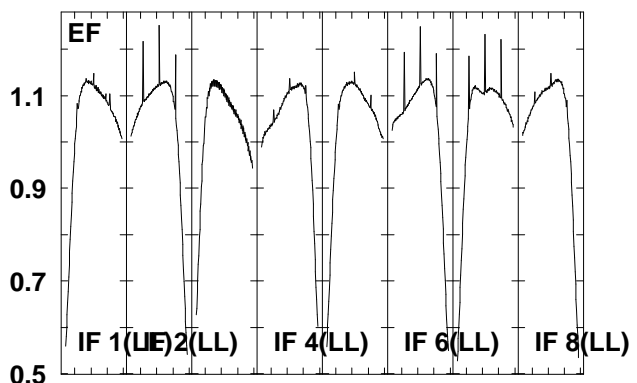
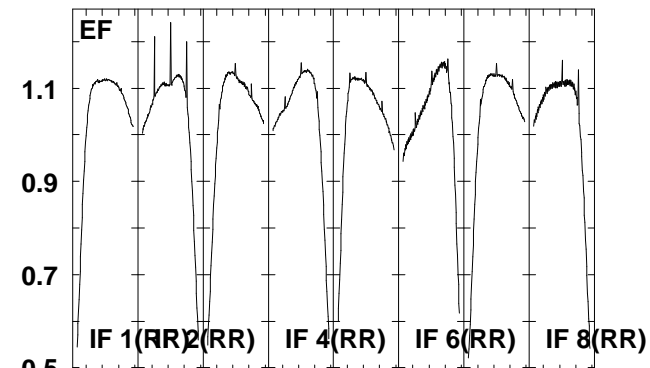
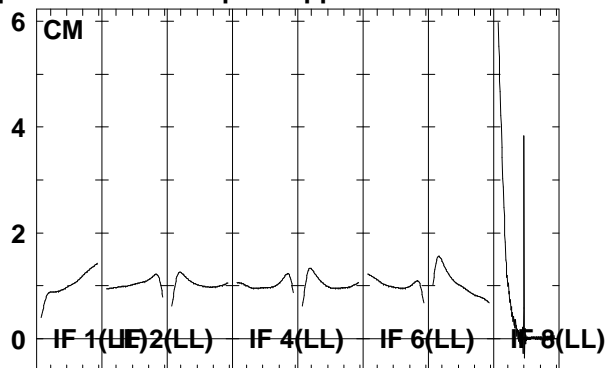
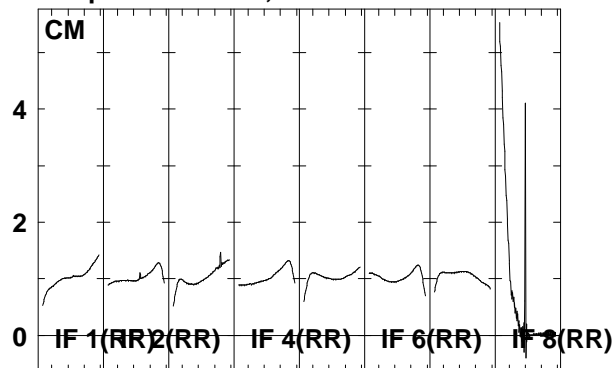

6663.6665.6667.6669.6671.6673.6675.6677.5
 FREQ MHz

6663.6665.6667.6669.6671.6673.6675.6677.5
 FREQ MHz

6663.6665.6667.6669.6671.6673.6675.6677.5
 FREQ MHz

Lower frame: Real Jy
 Total-power spectrum Antenna: *
 Timerange: 00/10:04:05 to 00/10:05:43

Plot file version 215 created 22-JUN-2006 20:14:53
 J1825-17 EM061A 1.UVDATA.1
 Freq = 6.6631 GHz, Bw = 2.000 MH No calibration applied and no bandpass applied

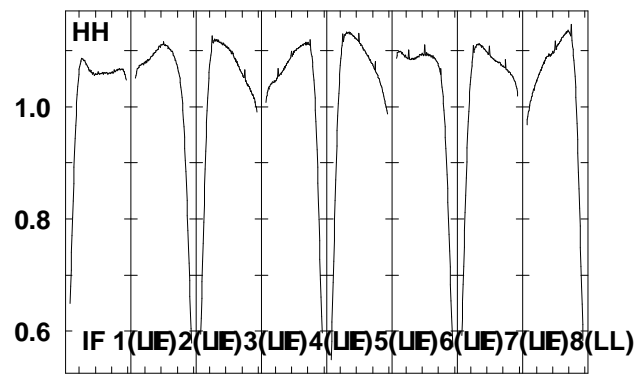
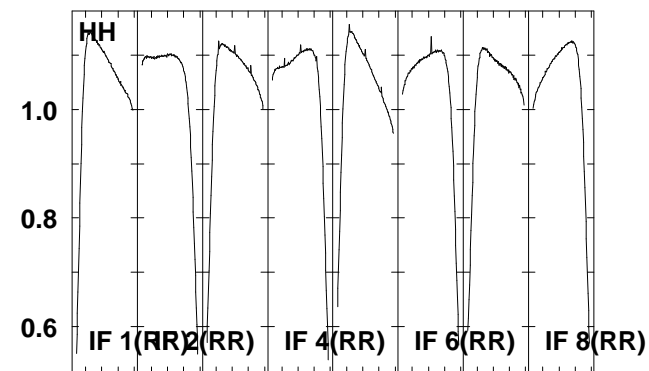
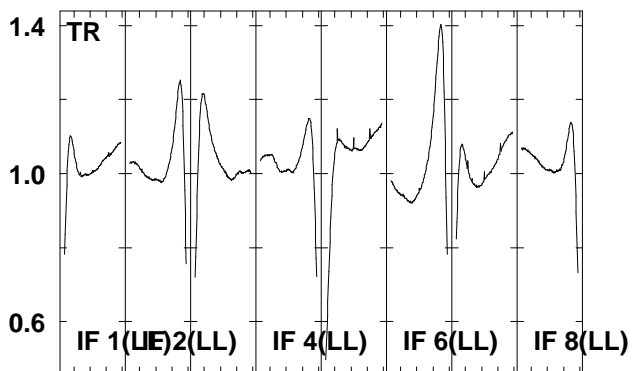
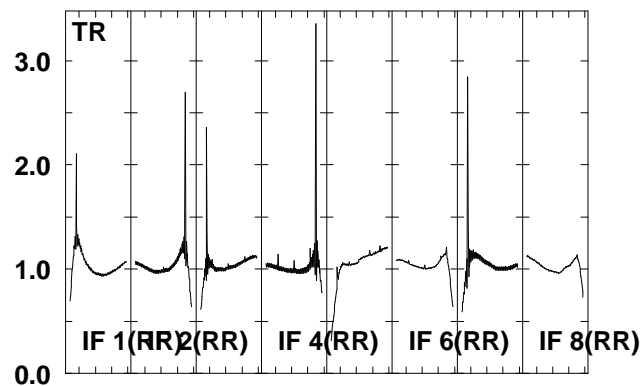
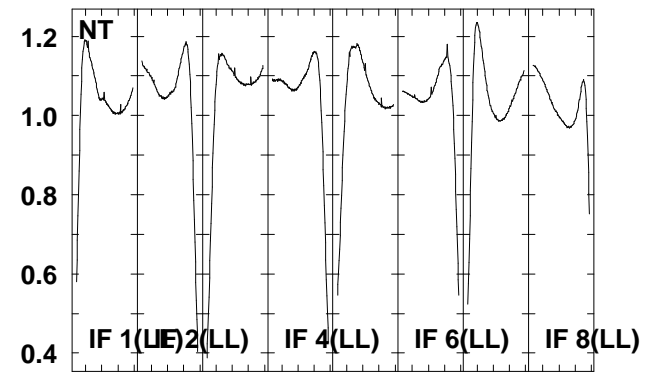
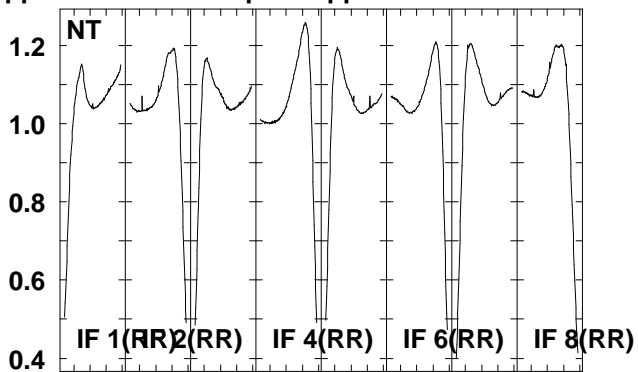
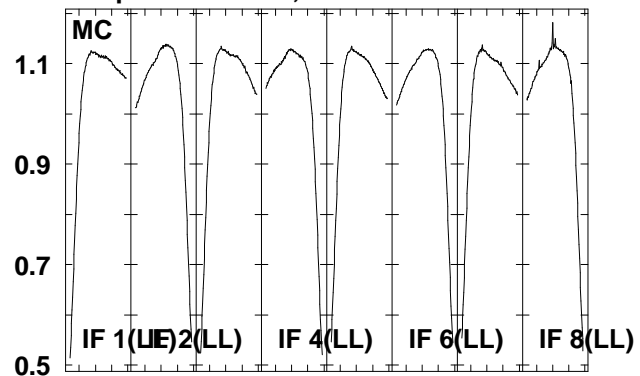

6663.6665.6667.6669.6671.6673.6675.6677.5
 FREQ MHz

Lower frame: Real Jy
 Total-power spectrum Antenna: *
 Timerange: 00/10:04:05 to 00/10:05:43

Plot file version 216 created 22-JUN-2006 20:14:55
 J1825-17 EM061A 1.UVDATA.1
 Freq = 6.6631 GHz, Bw = 2.000 MH No calibration applied and no bandpass applied

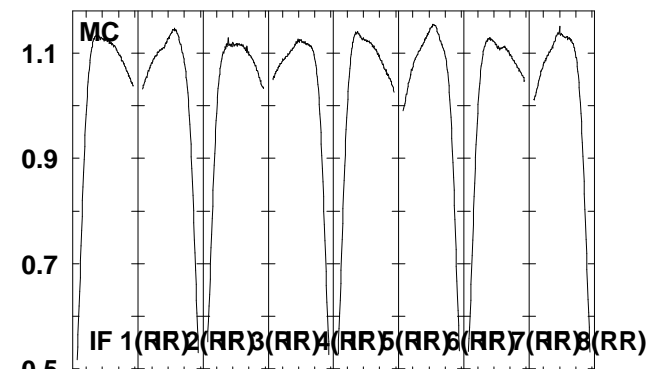
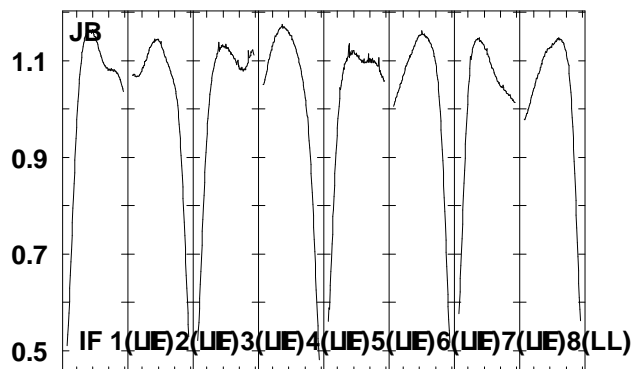
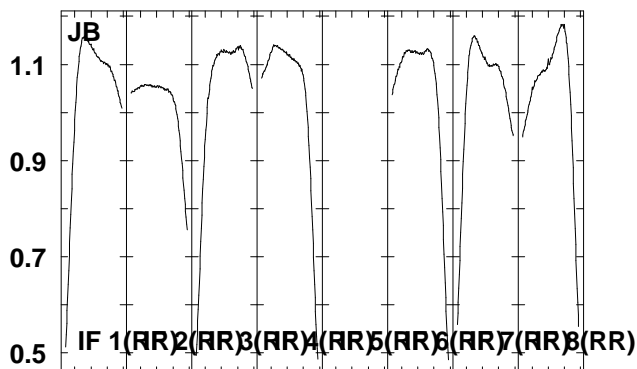
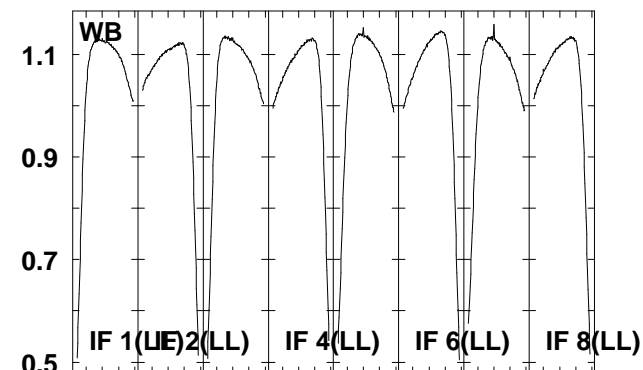
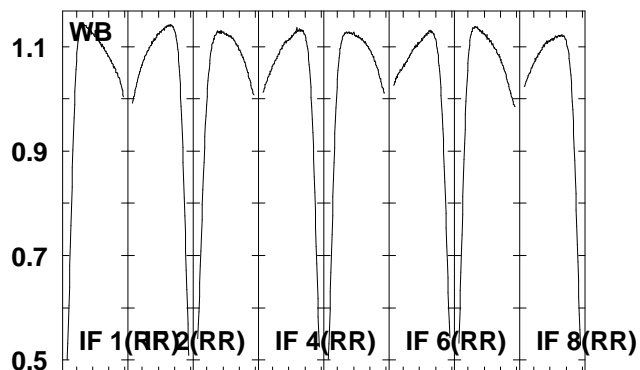
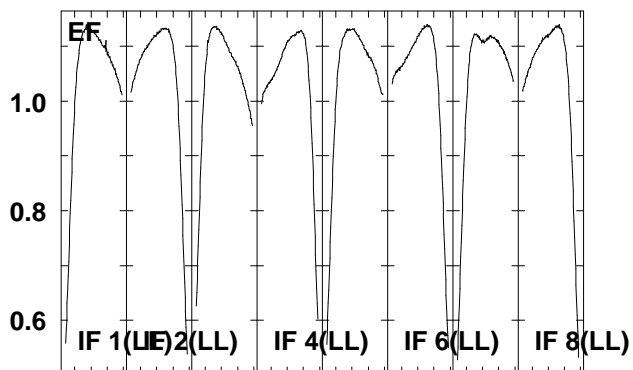
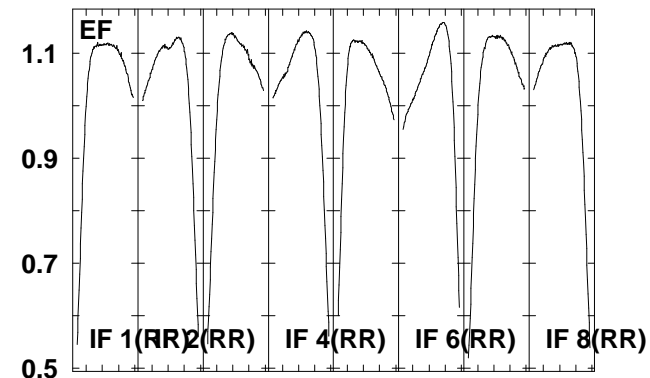
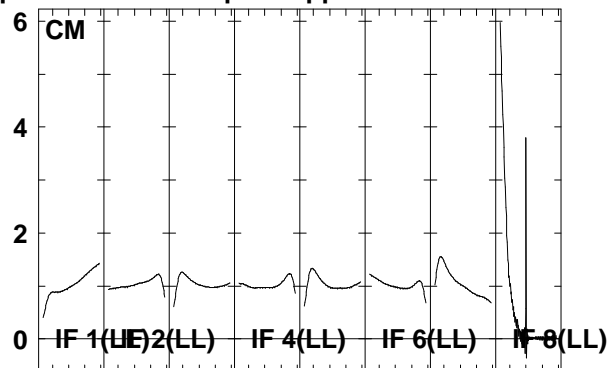
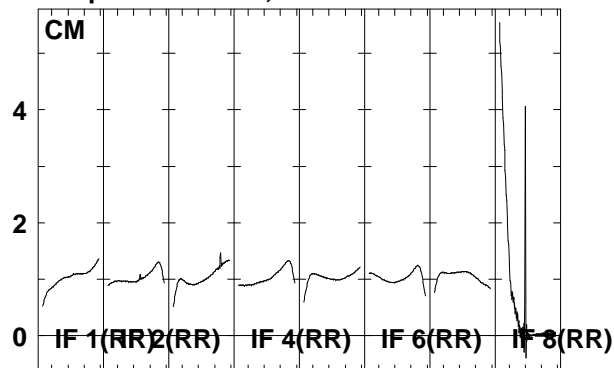

6663.6665.6667.6669.6671.6673.6675.6677.5
 FREQ MHz

6663.6665.6667.6669.6671.6673.6675.6677.5
 FREQ MHz

6663.6665.6667.6669.6671.6673.6675.6677.5
 FREQ MHz

Lower frame: Real Jy
 Total-power spectrum Antenna: *
 Timerange: 00/10:05:45 to 00/10:07:02

Plot file version 217 created 22-JUN-2006 20:14:57
 J1825-17 EM061A 1.UVDATA.1
 Freq = 6.6631 GHz, Bw = 2.000 MH No calibration applied and no bandpass applied

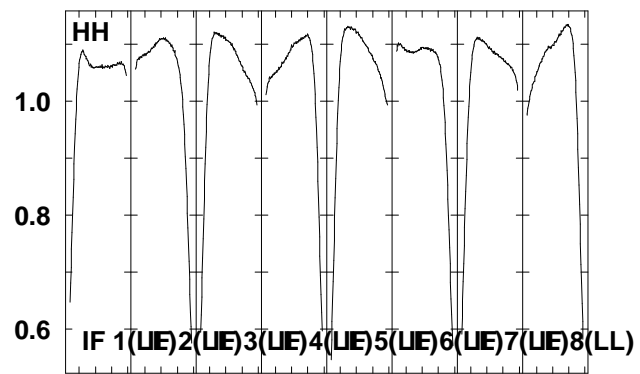
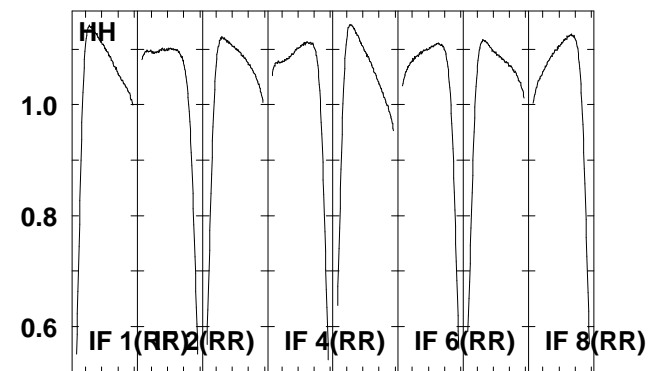
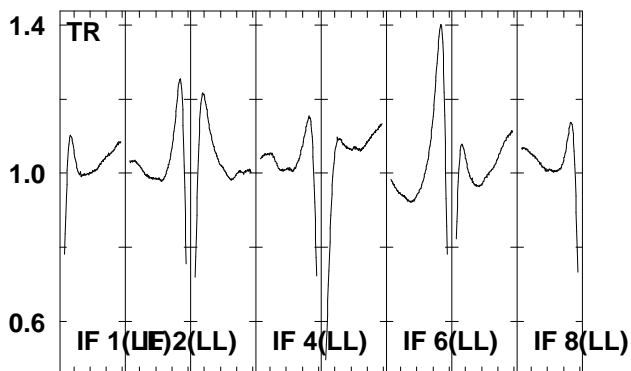
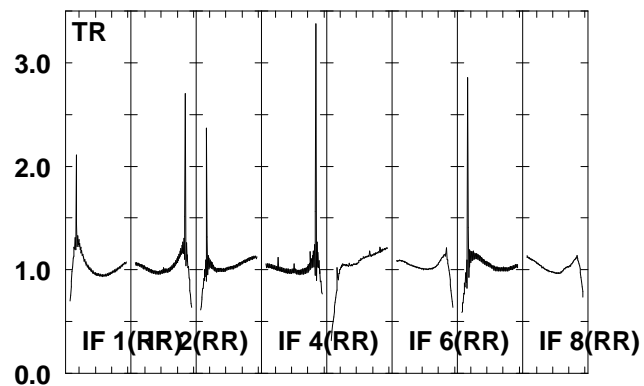
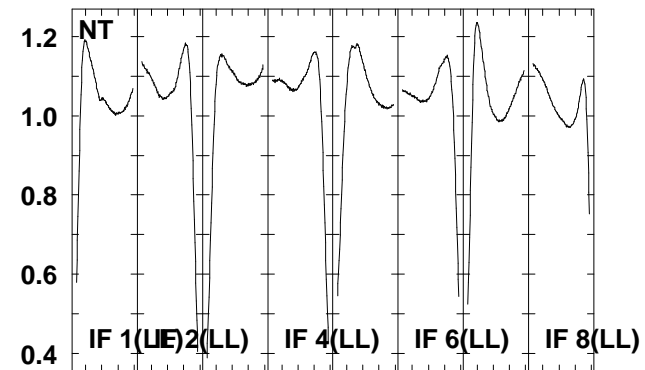
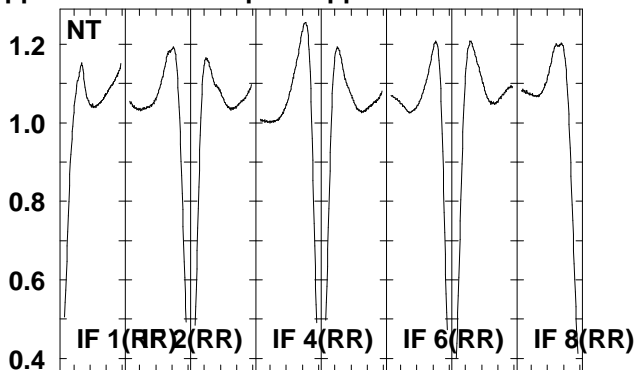
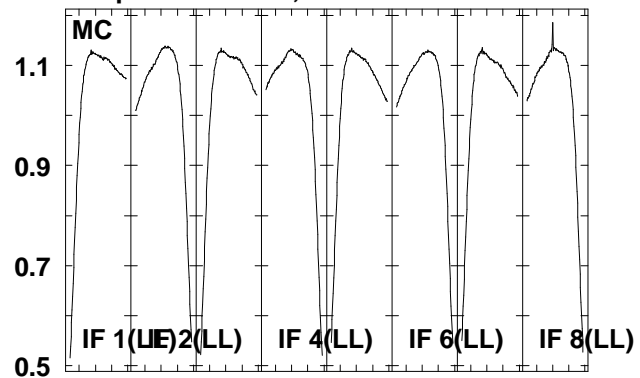

6663.6665.6667.6669.6671.6673.6675.6677.5
 FREQ MHz

Lower frame: Real Jy
 Total-power spectrum Antenna: *
 Timerange: 00/10:05:45 to 00/10:07:02

Plot file version 218 created 22-JUN-2006 20:15:01
 G16.59-0 EM061A 1.UVDATA.1
 Freq = 6.6631 GHz, Bw = 2.000 MH No calibration applied and no bandpass applied

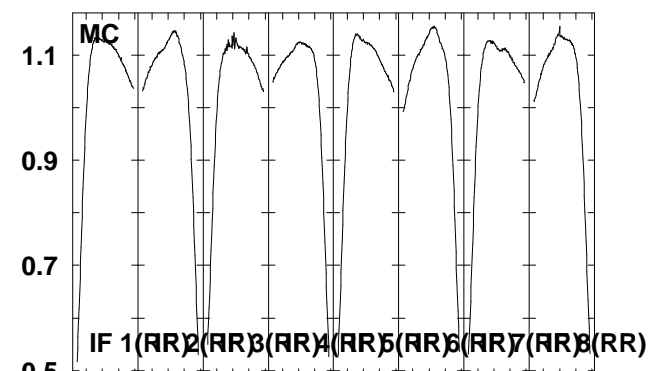
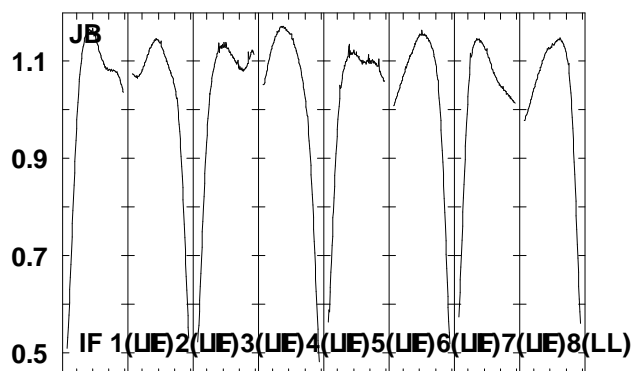
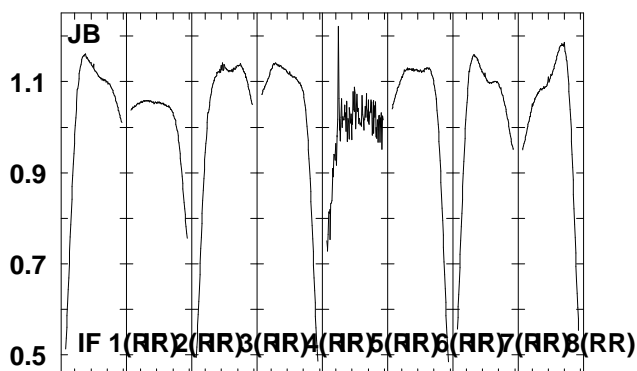
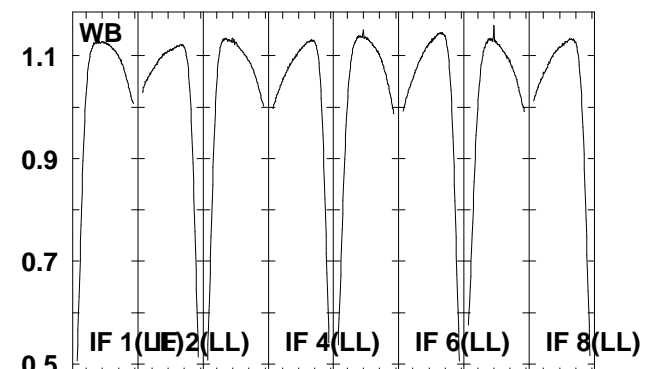
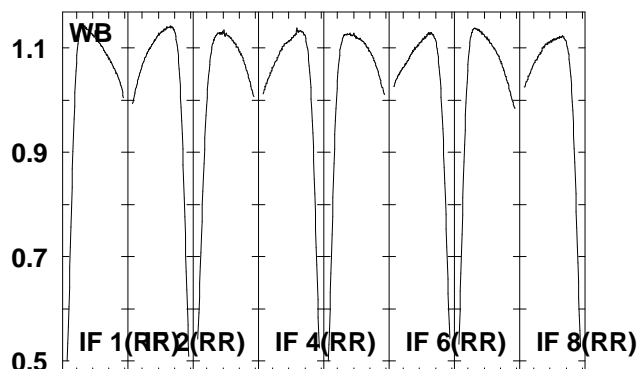
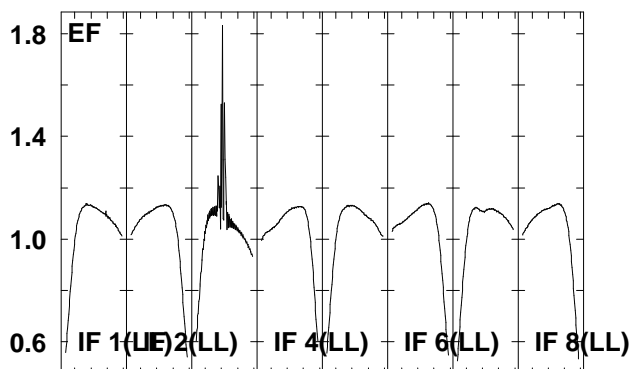
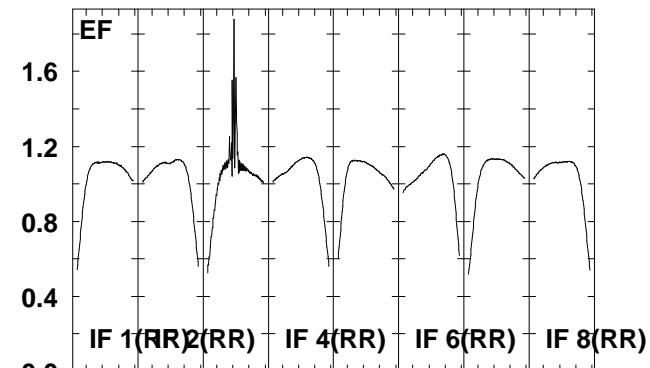
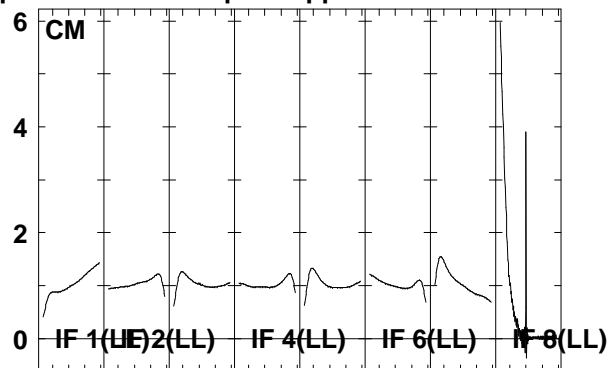
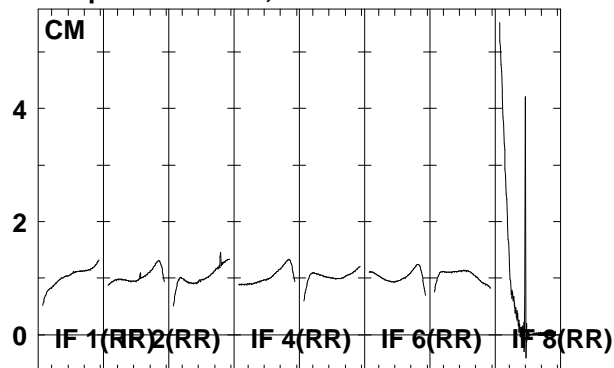

6663.6665.6667.6669.6671.6673.6675.6677.5
 FREQ MHz

6663.6665.6667.6669.6671.6673.6675.6677.5
 FREQ MHz

6663.6665.6667.6669.6671.6673.6675.6677.5
 FREQ MHz

Lower frame: Real Jy
 Total-power spectrum Antenna: *
 Timerange: 00/10:07:04 to 00/10:09:32

Plot file version 219 created 22-JUN-2006 20:15:04
 G16.59-0 EM061A 1.UVDATA.1
 Freq = 6.6631 GHz, Bw = 2.000 MH No calibration applied and no bandpass applied

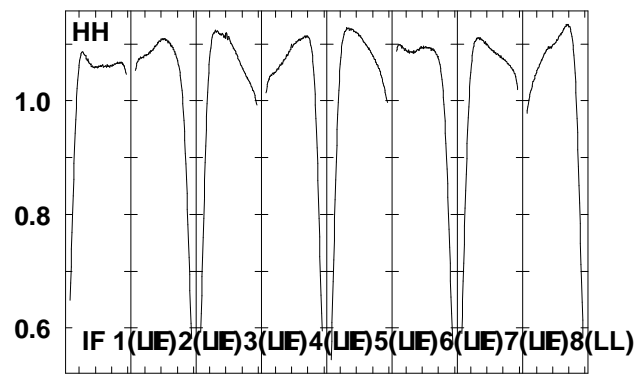
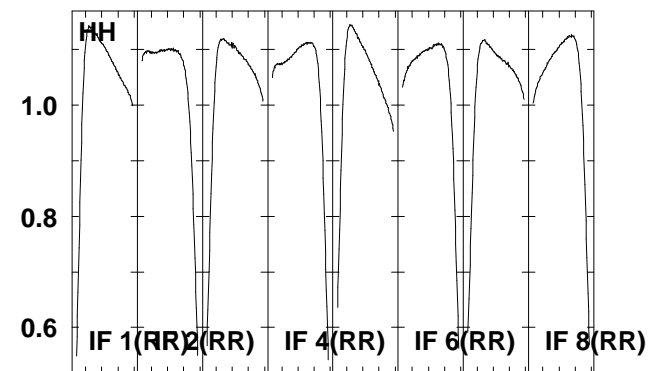
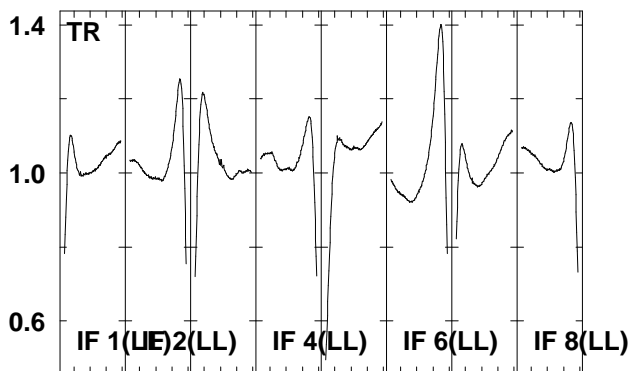
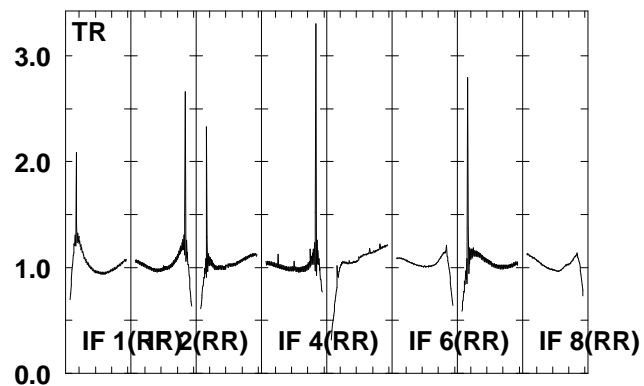
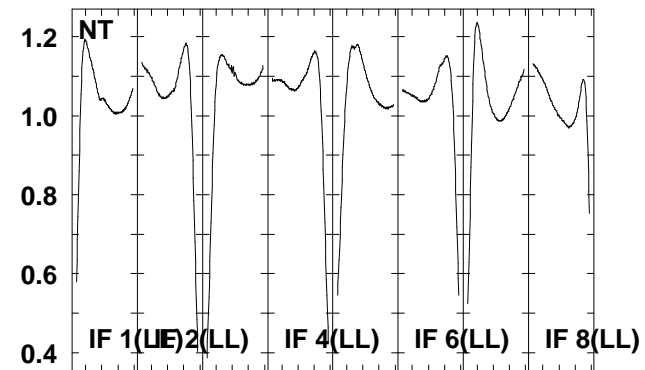
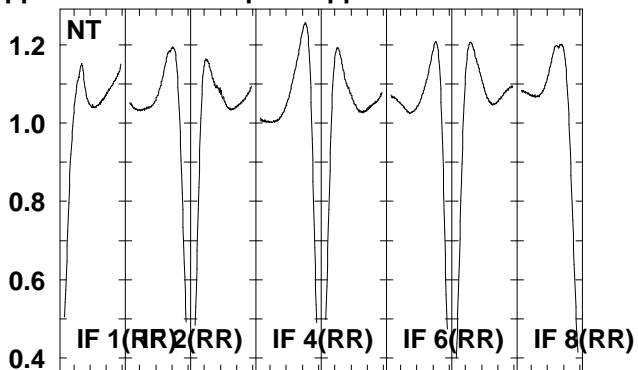
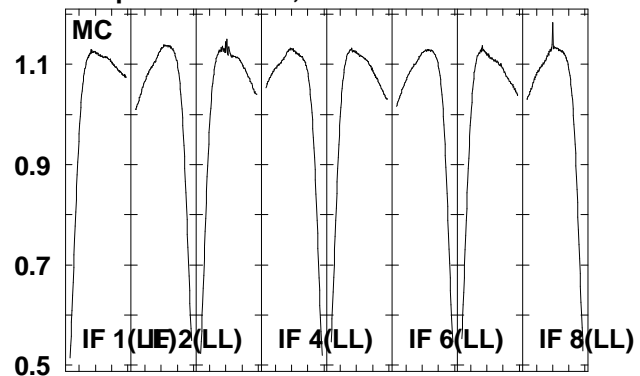

6663.6665.6667.6669.6671.6673.6675.6677.5
 FREQ MHz

Lower frame: Real Jy
 Total-power spectrum Antenna: *
 Timerange: 00/10:07:04 to 00/10:09:32

Plot file version 220 created 22-JUN-2006 20:15:09
 J1825-17 EM061A 1.UVDATA.1
 Freq = 6.6631 GHz, Bw = 2.000 MH No calibration applied and no bandpass applied

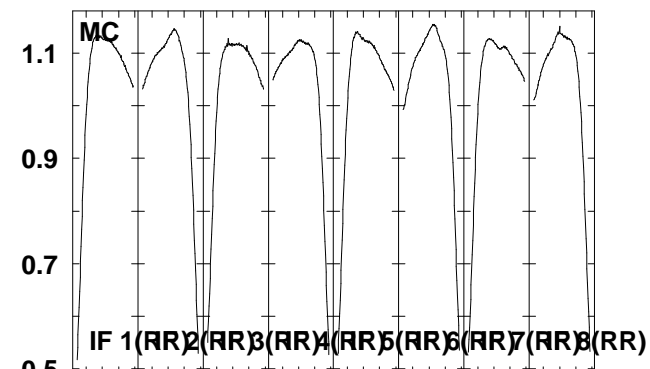
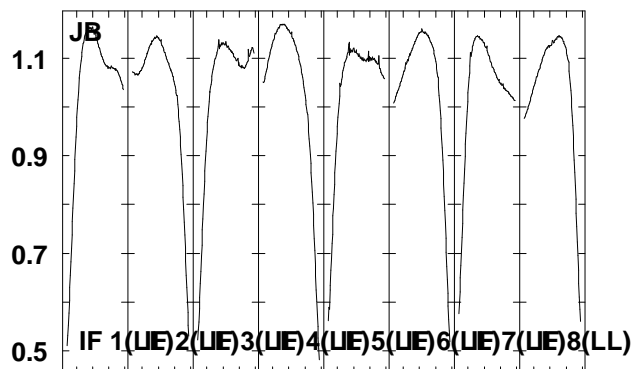
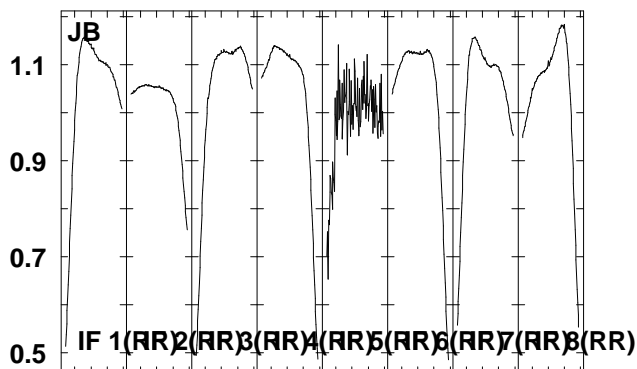
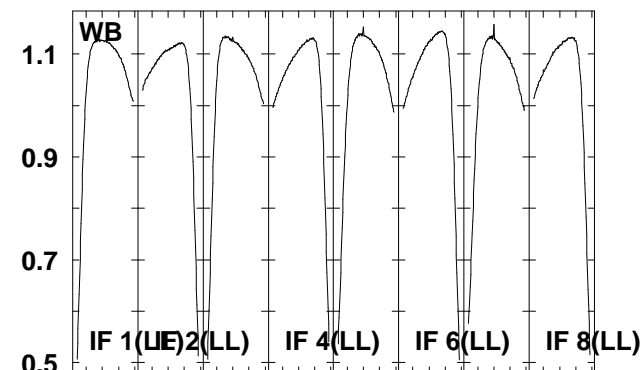
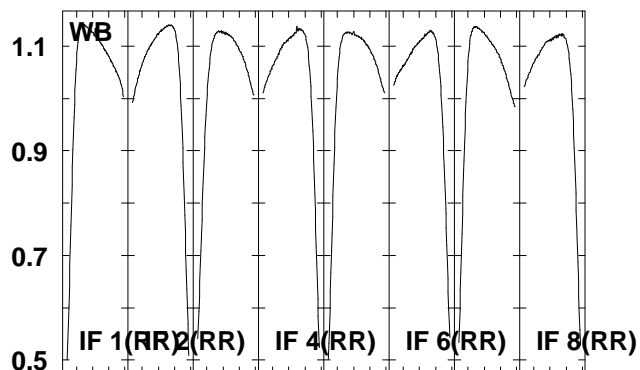
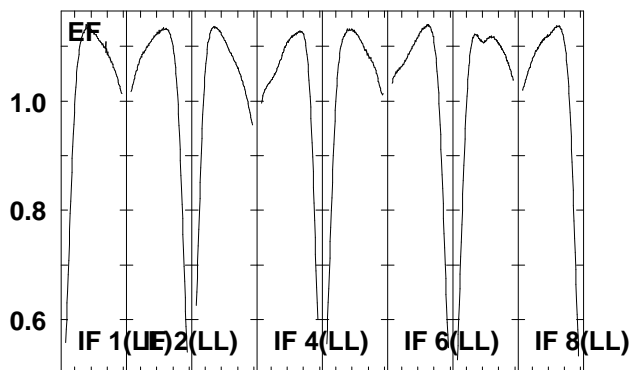
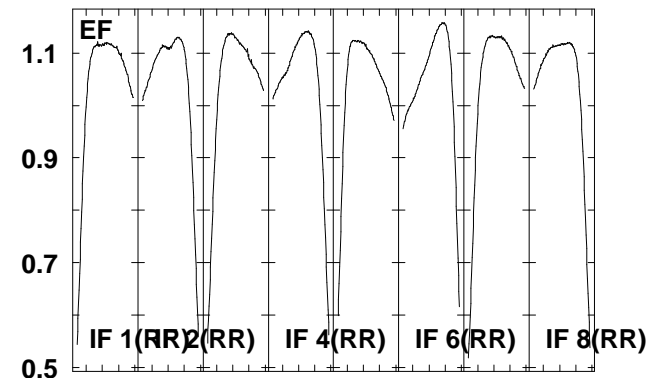
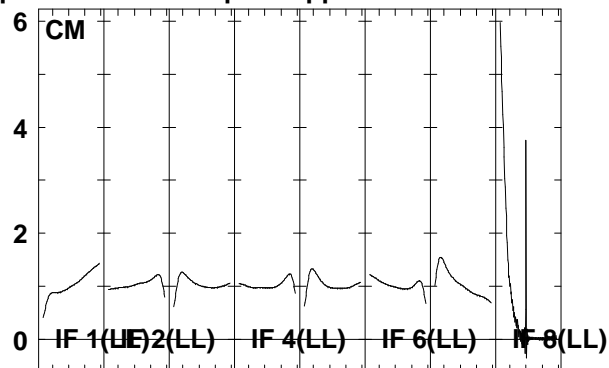
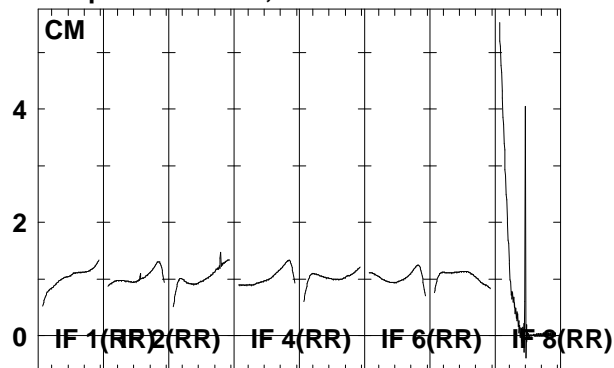

6663.6665.6667.6669.6671.6673.6675.6677.5
 FREQ MHz

6663.6665.6667.6669.6671.6673.6675.6677.5
 FREQ MHz

6663.6665.6667.6669.6671.6673.6675.6677.5
 FREQ MHz

Lower frame: Real Jy
 Total-power spectrum Antenna: *
 Timerange: 00/10:09:34 to 00/10:12:32

Plot file version 221 created 22-JUN-2006 20:15:12
 J1825-17 EM061A 1.UVDATA.1
 Freq = 6.6631 GHz, Bw = 2.000 MH No calibration applied and no bandpass applied

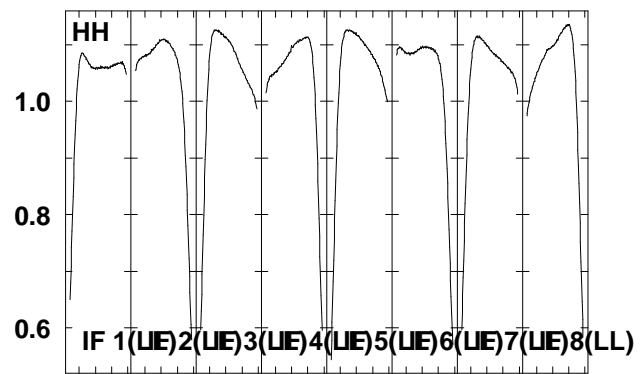
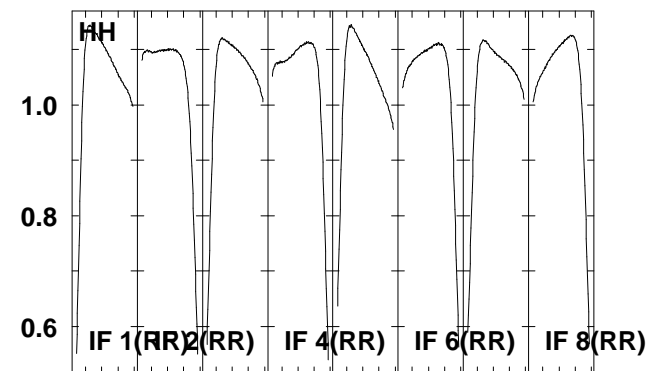
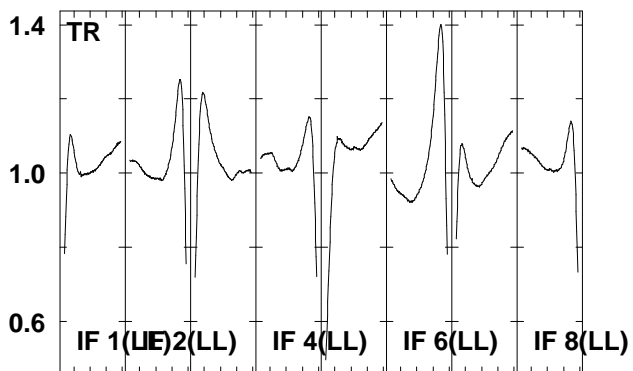
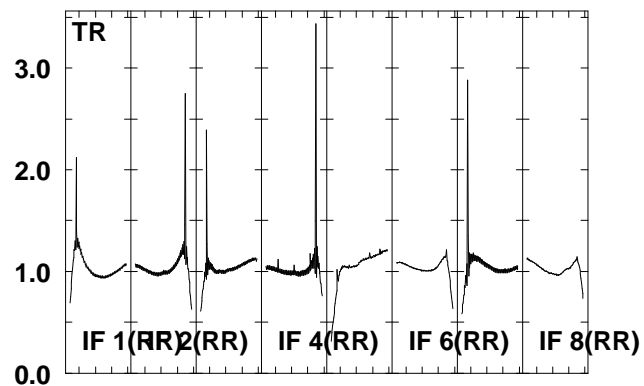
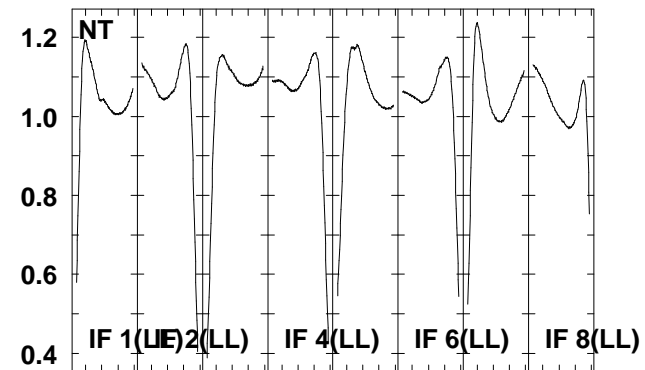
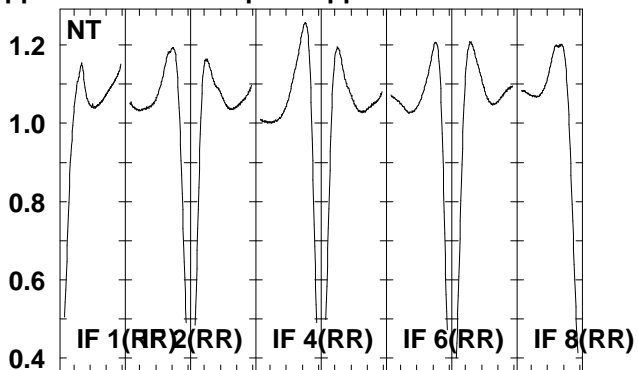
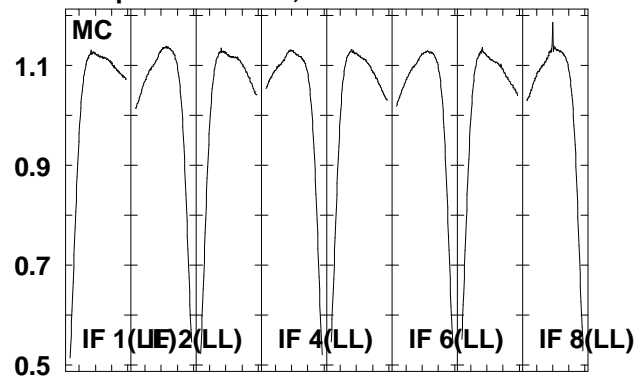

6663.6665.6667.6669.6671.6673.6675.6677.5
 FREQ MHz

Lower frame: Real Jy
 Total-power spectrum Antenna: *
 Timerange: 00/10:09:34 to 00/10:12:32

Plot file version 222 created 22-JUN-2006 20:15:16
 G16.59-0 EM061A 1.UVDATA.1
 Freq = 6.6631 GHz, Bw = 2.000 MH No calibration applied and no bandpass applied

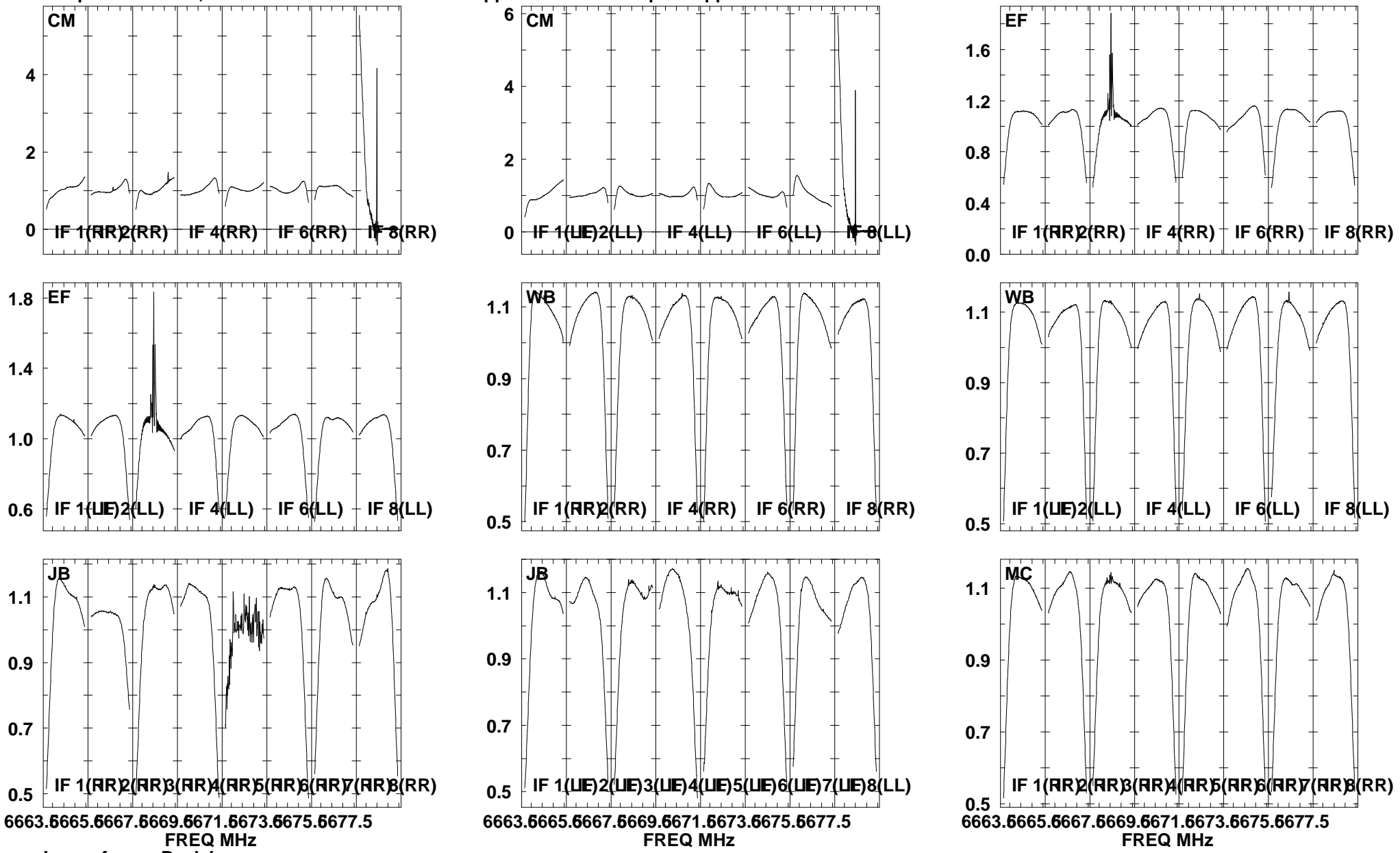

Lower frame: Real Jy
 Total-power spectrum Antenna: *
 Timerange: 00/10:12:34 to 00/10:15:02

Plot file version 223 created 22-JUN-2006 20:15:20
 G16.59-0 EM061A 1.UVDATA.1
 Freq = 6.6631 GHz, Bw = 2.000 MH No calibration applied and no bandpass applied

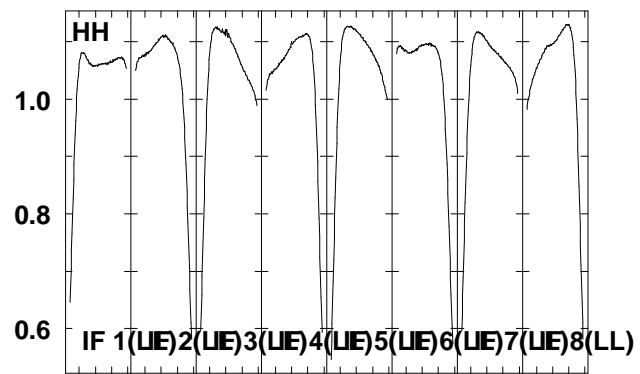
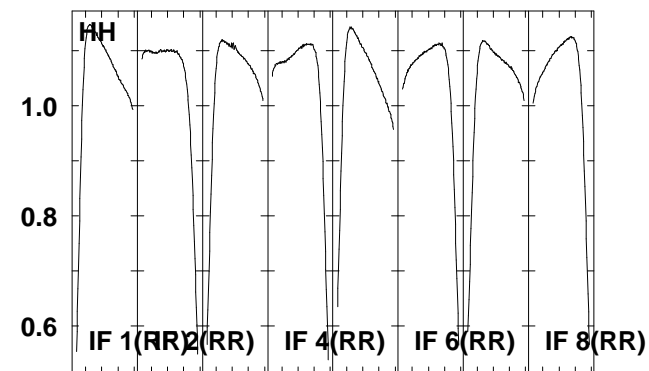
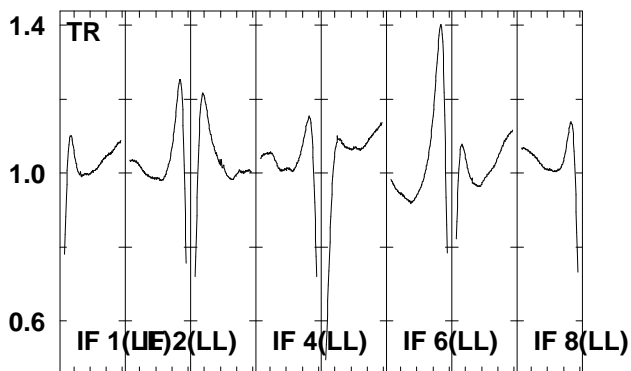
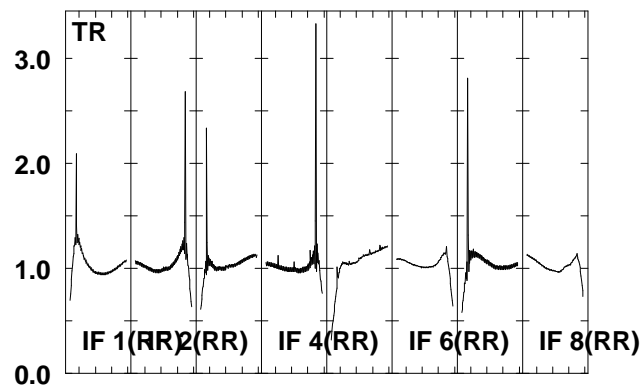
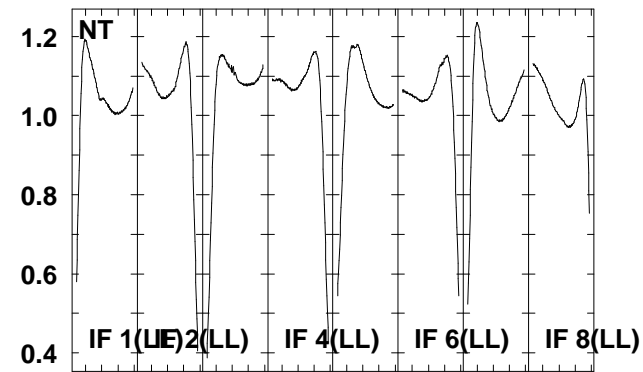
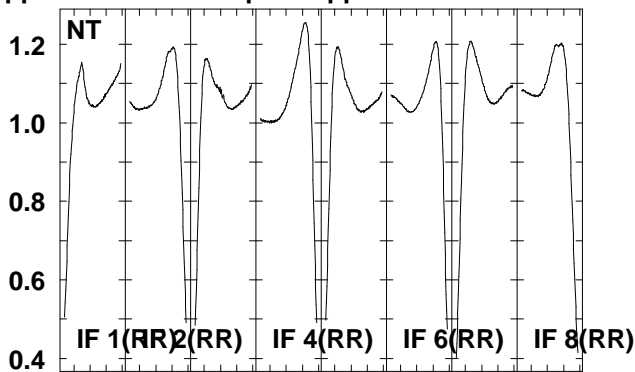
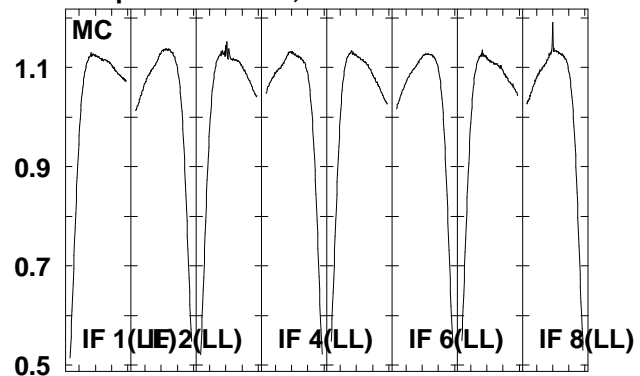

6663.6665.6667.6669.6671.6673.6675.6677.5
 FREQ MHz

Lower frame: Real Jy
 Total-power spectrum Antenna: *
 Timerange: 00/10:12:34 to 00/10:15:02

Plot file version 224 created 22-JUN-2006 20:15:23
 J1825-17 EM061A 1.UVDATA.1
 Freq = 6.6631 GHz, Bw = 2.000 MH No calibration applied and no bandpass applied

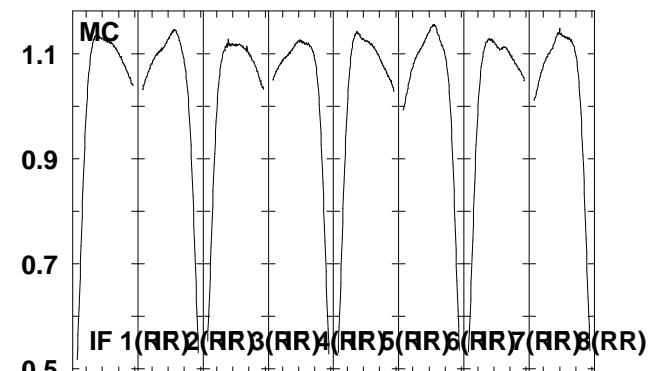
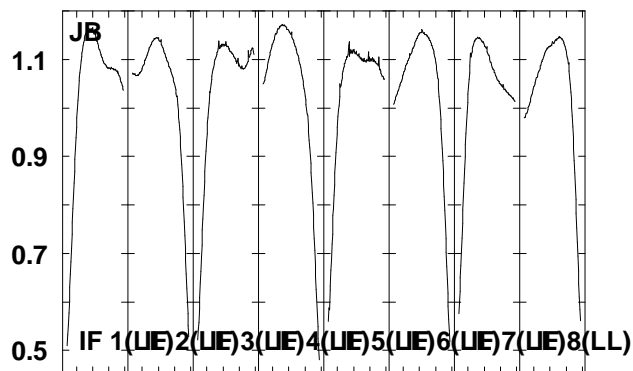
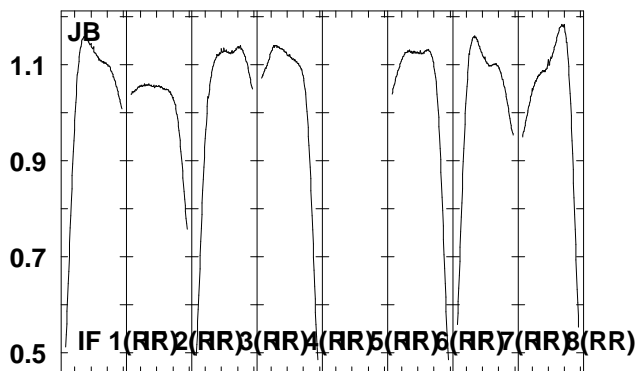
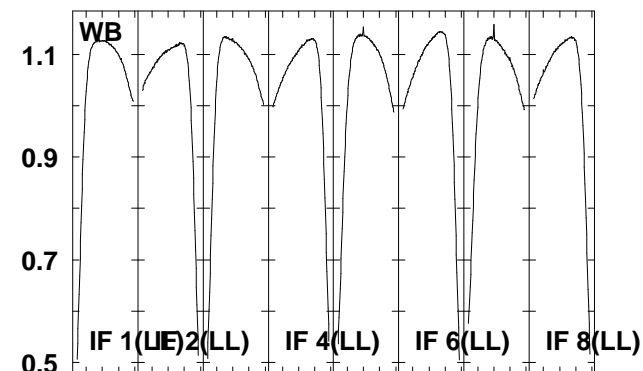
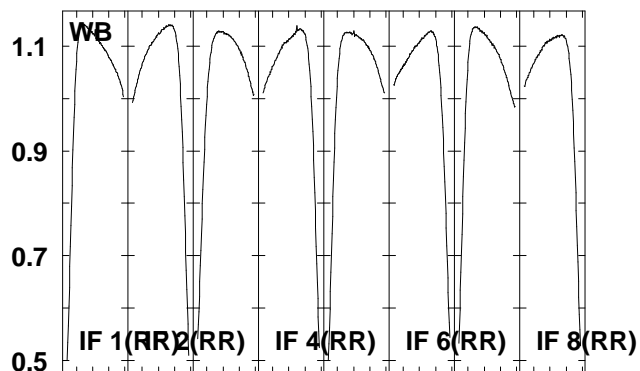
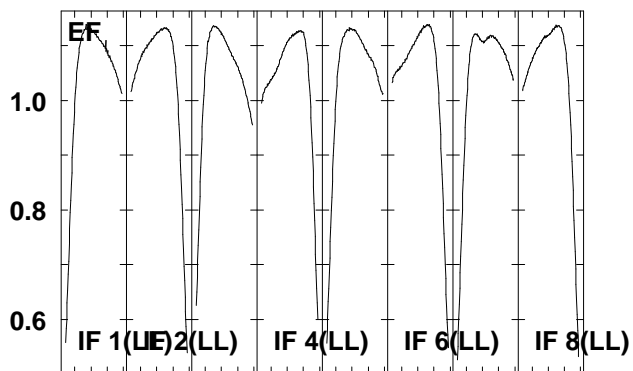
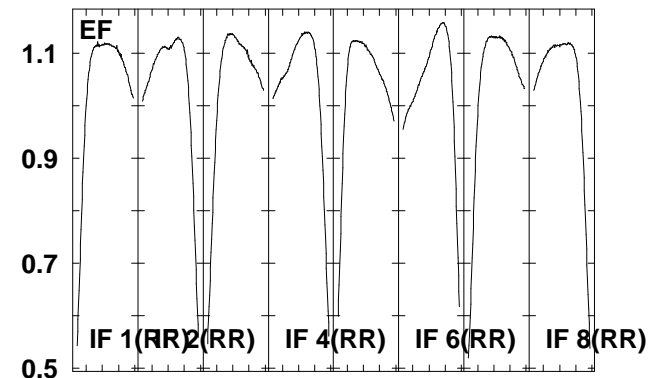
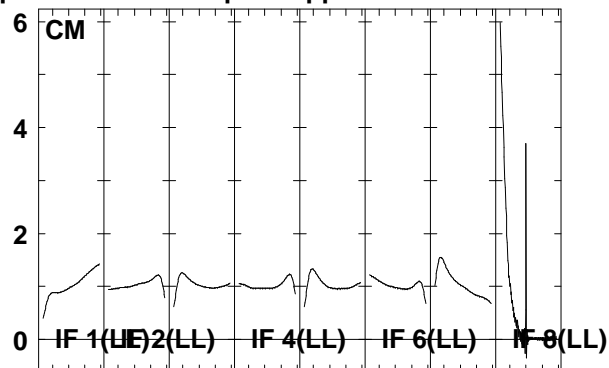
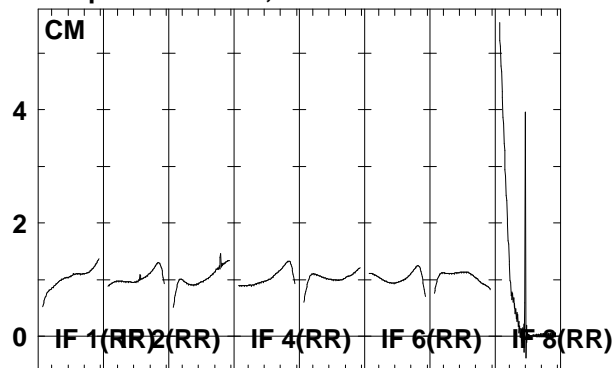

6663.6665.6667.6669.6671.6673.6675.6677.5
 FREQ MHz

6663.6665.6667.6669.6671.6673.6675.6677.5
 FREQ MHz

6663.6665.6667.6669.6671.6673.6675.6677.5
 FREQ MHz

Lower frame: Real Jy
 Total-power spectrum Antenna: *
 Timerange: 00/10:15:04 to 00/10:18:02

Plot file version 225 created 22-JUN-2006 20:15:27

J1825-17 EM061A 1.UVDATA.1

Freq = 6.6631 GHz, Bw = 2.000 MH No calibration applied and no bandpass applied

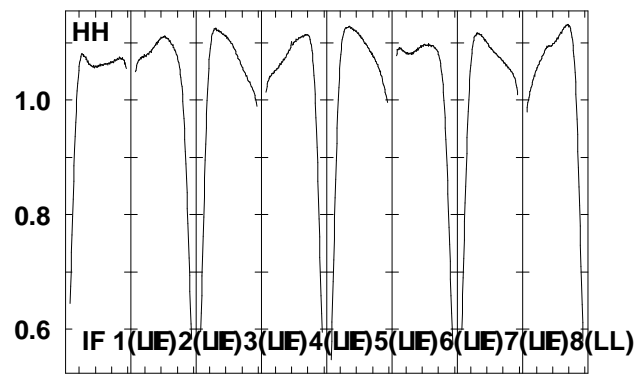
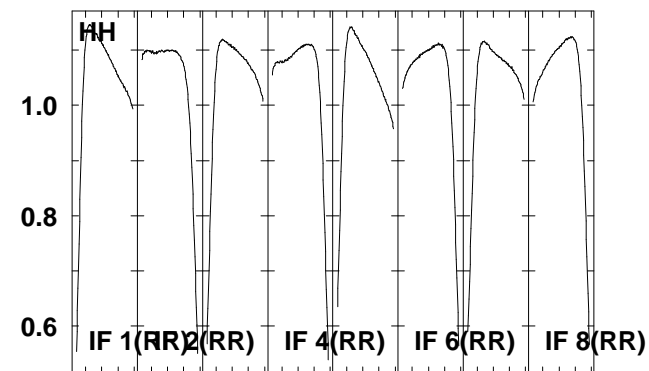
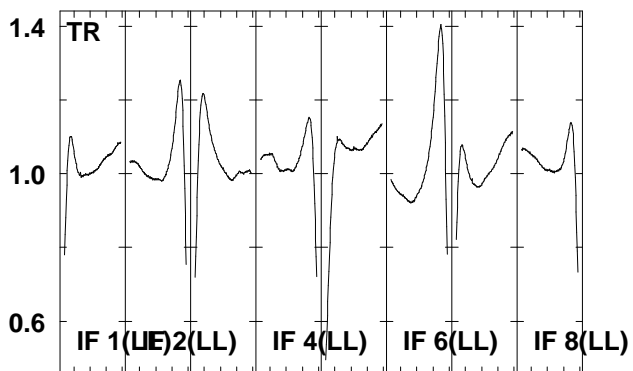
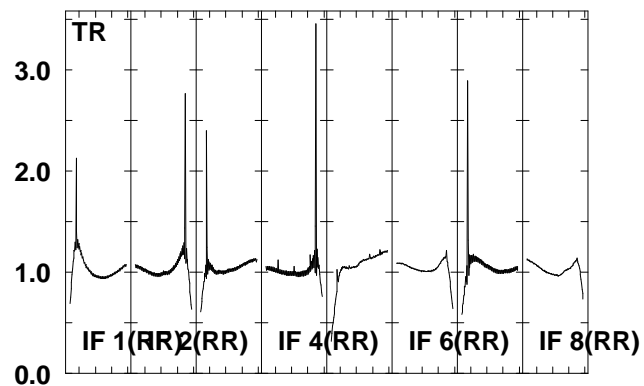
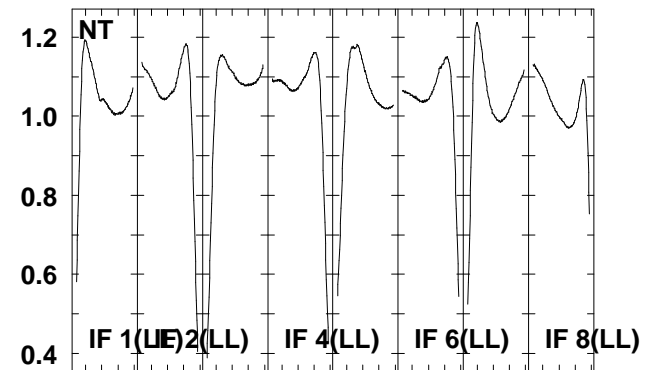
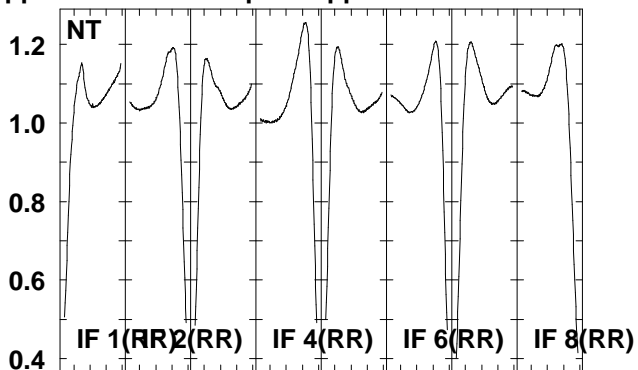
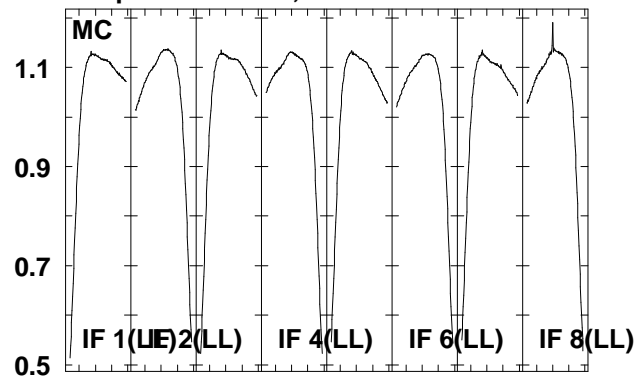

6663.6665.6667.6669.6671.6673.6675.6677.5

FREQ MHz

Lower frame: Real Jy

Total-power spectrum Antenna: *

Timerange: 00/10:15:04 to 00/10:18:02

Plot file version 226 created 22-JUN-2006 20:15:30
 G16.59-0 EM061A 1.UVDATA.1
 Freq = 6.6631 GHz, Bw = 2.000 MH No calibration applied and no bandpass applied

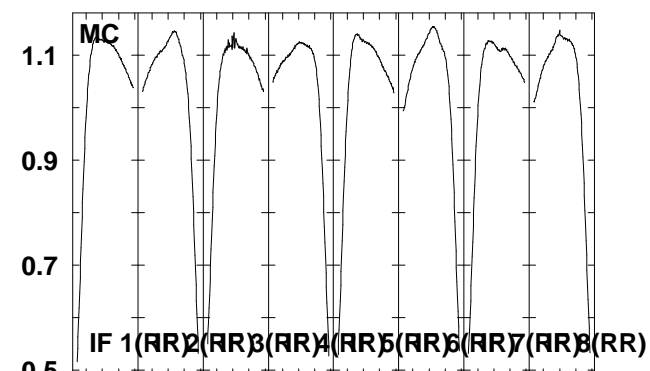
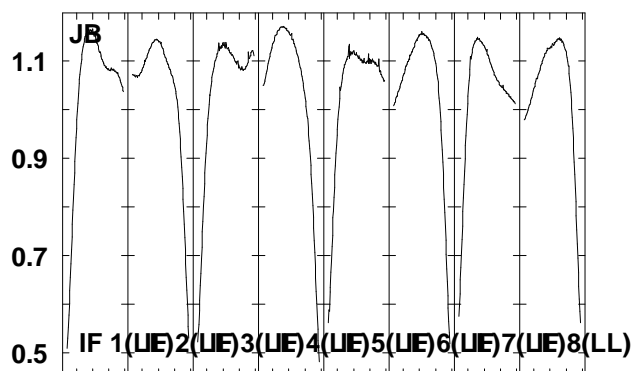
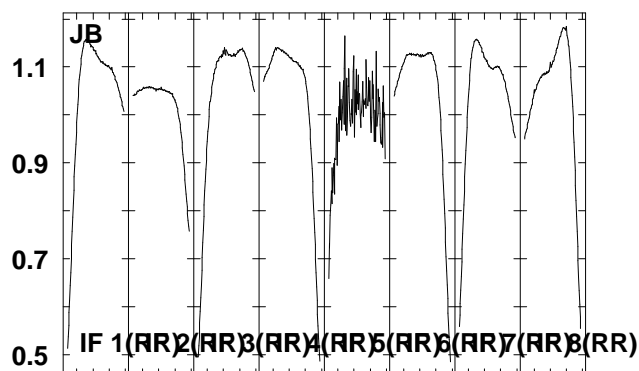
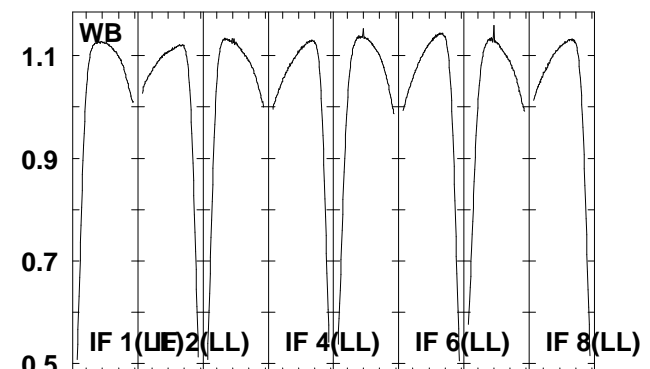
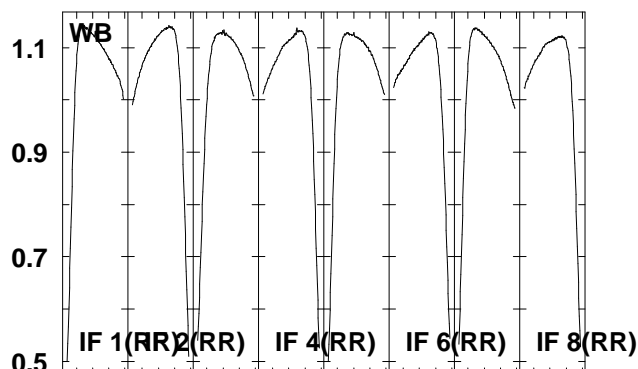
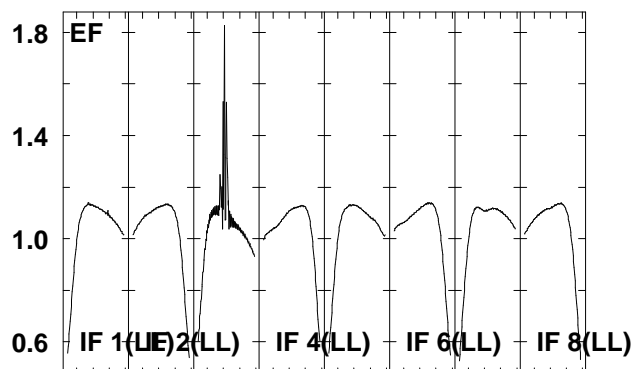
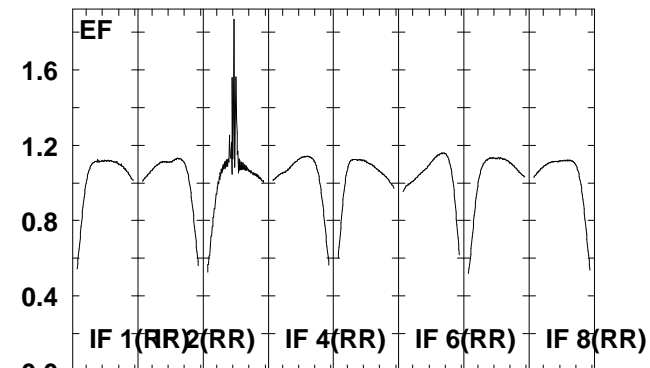
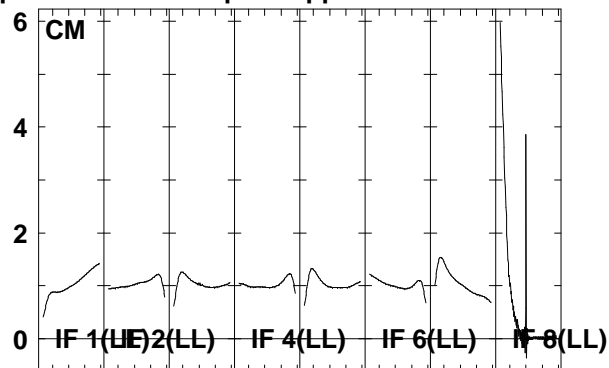
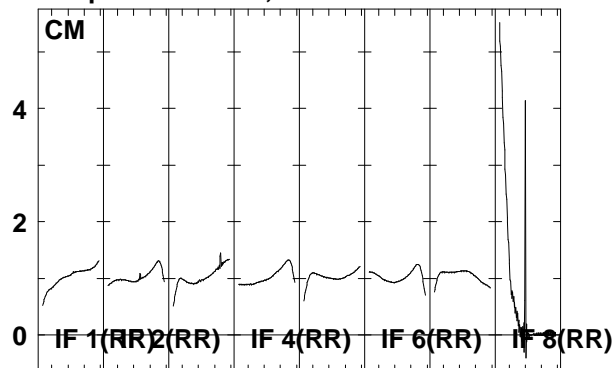

6663.6665.6667.6669.6671.6673.6675.6677.5
 FREQ MHz

6663.6665.6667.6669.6671.6673.6675.6677.5
 FREQ MHz

6663.6665.6667.6669.6671.6673.6675.6677.5
 FREQ MHz

Lower frame: Real Jy
 Total-power spectrum Antenna: *
 Timerange: 00/10:18:04 to 00/10:20:32

Plot file version 227 created 22-JUN-2006 20:15:33
 G16.59-0 EM061A 1.UVDATA.1
 Freq = 6.6631 GHz, Bw = 2.000 MH No calibration applied and no bandpass applied

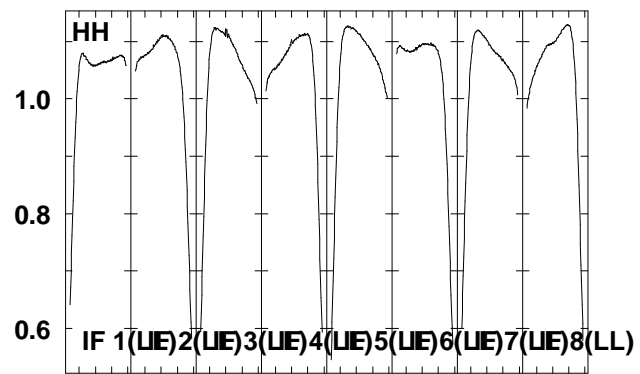
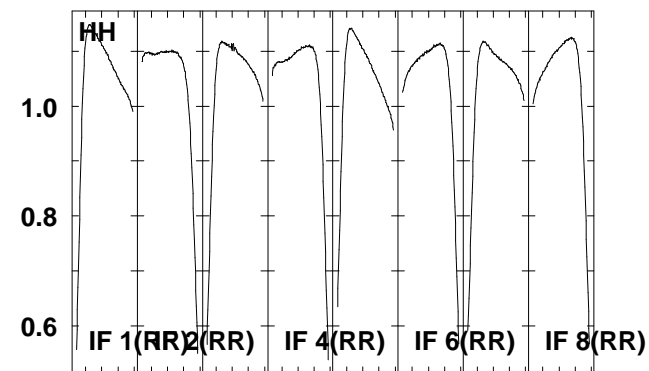
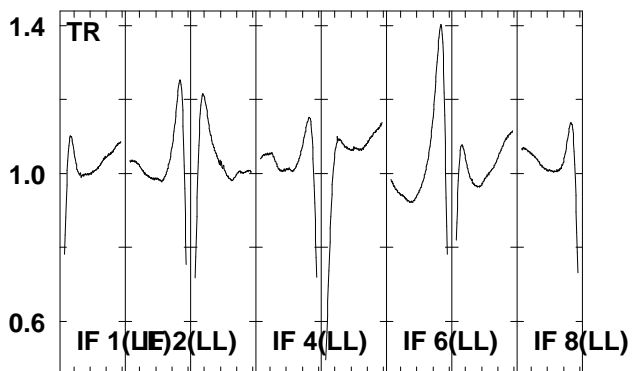
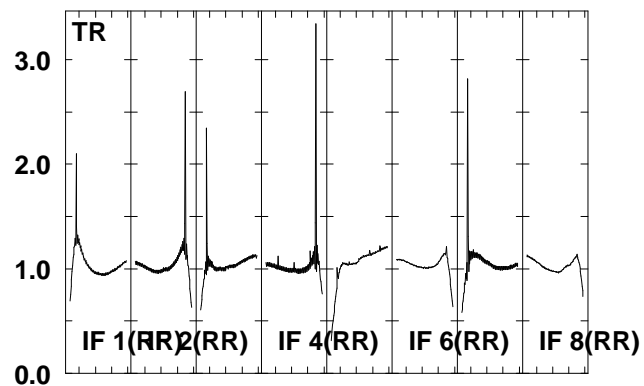
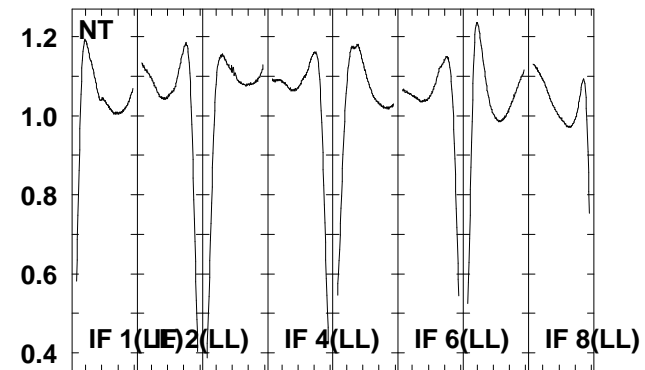
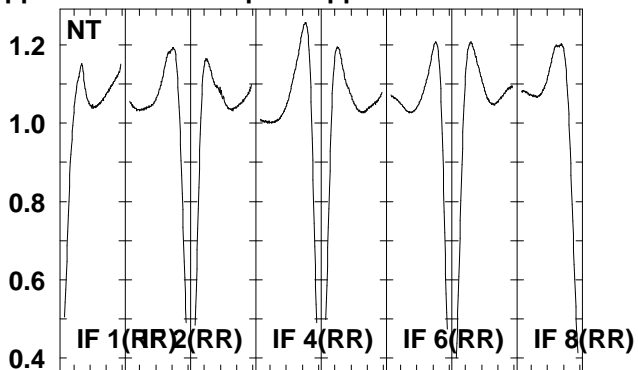
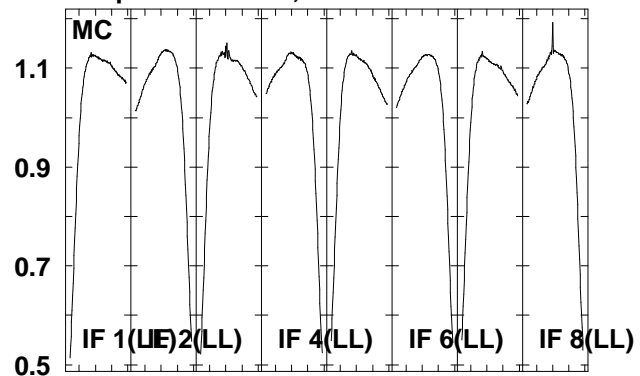

6663.6665.6667.6669.6671.6673.6675.6677.5
 FREQ MHz

Lower frame: Real Jy
 Total-power spectrum Antenna: *
 Timerange: 00/10:18:04 to 00/10:20:32

Plot file version 228 created 22-JUN-2006 20:15:39
 J1825-17 EM061A 1.UVDATA.1
 Freq = 6.6631 GHz, Bw = 2.000 MH No calibration applied and no bandpass applied

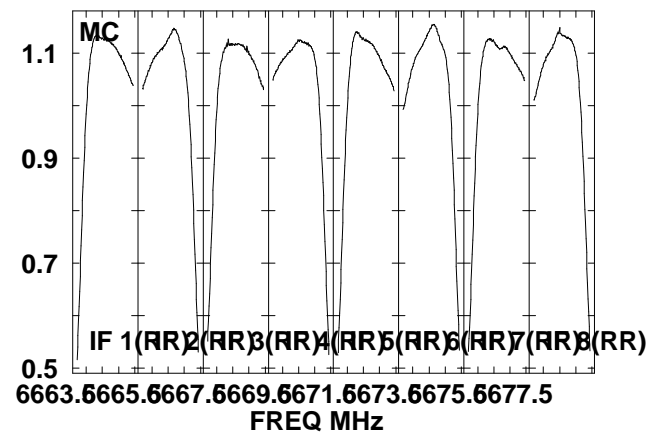
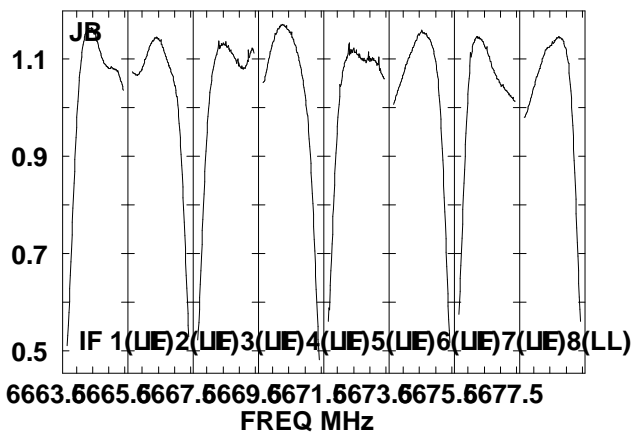
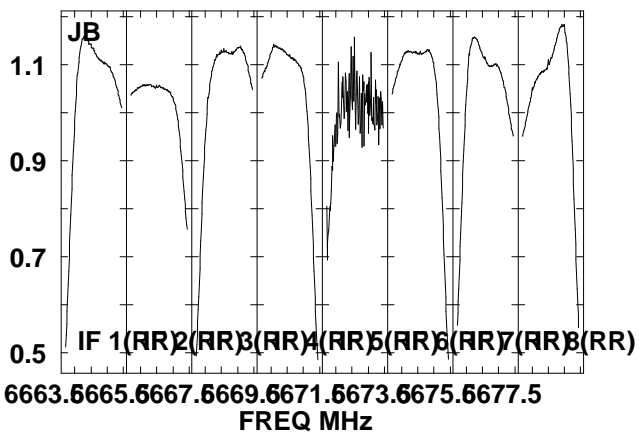
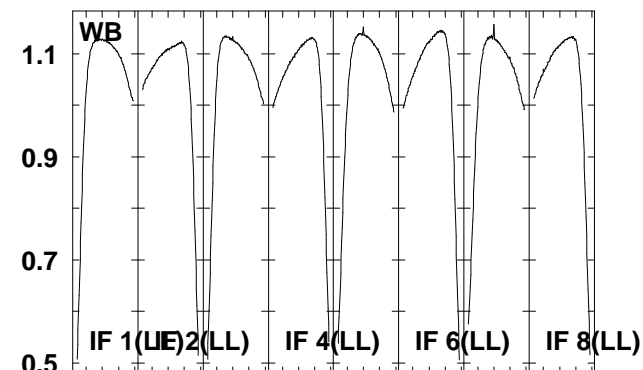
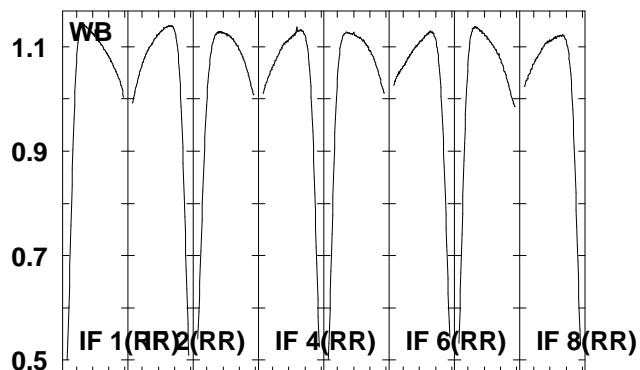
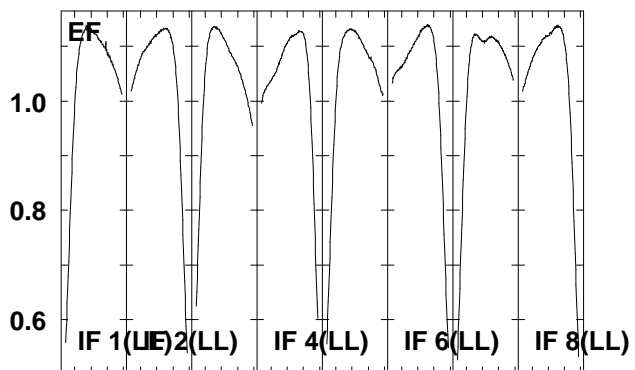
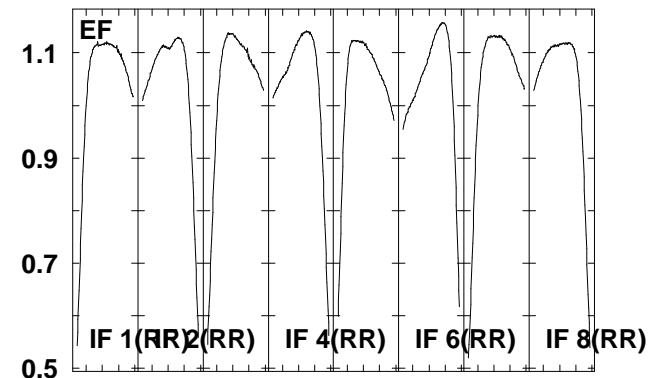
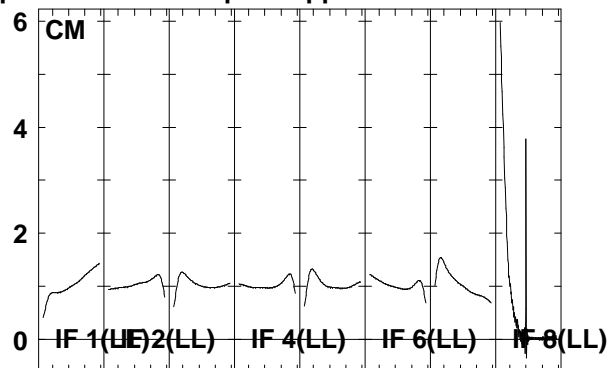
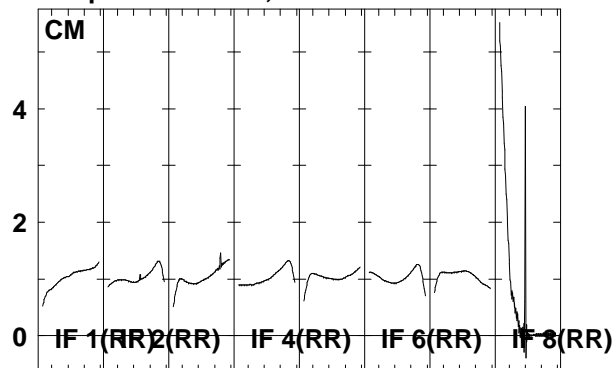

6663.6665.6667.6669.6671.6673.6675.6677.5
 FREQ MHz

6663.6665.6667.6669.6671.6673.6675.6677.5
 FREQ MHz

6663.6665.6667.6669.6671.6673.6675.6677.5
 FREQ MHz

Lower frame: Real Jy
 Total-power spectrum Antenna: *
 Timerange: 00/10:20:34 to 00/10:23:32

Plot file version 229 created 22-JUN-2006 20:15:42
 J1825-17 EM061A 1.UVDATA.1
 Freq = 6.6631 GHz, Bw = 2.000 MH No calibration applied and no bandpass applied

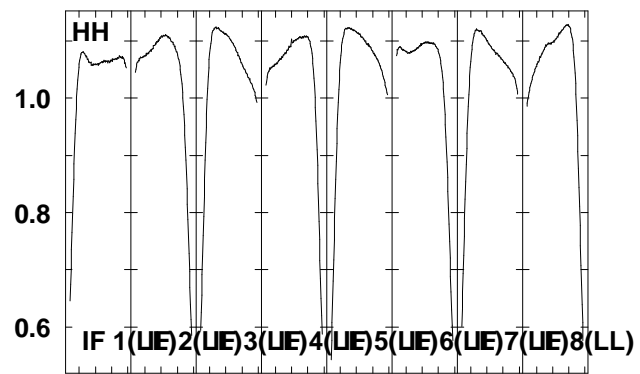
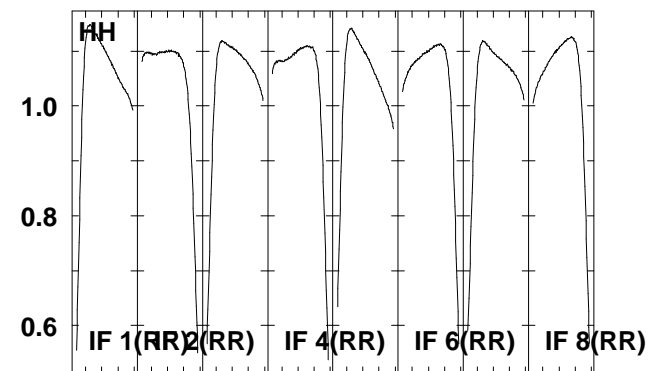
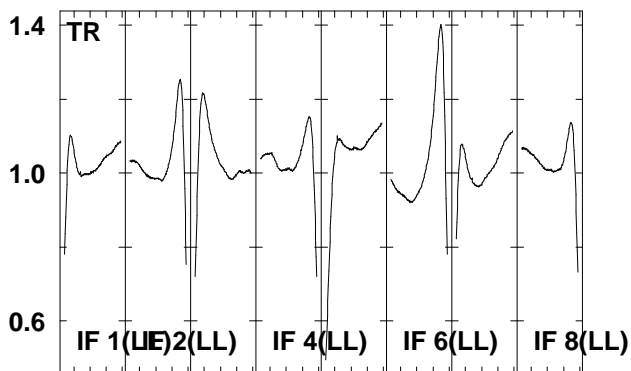
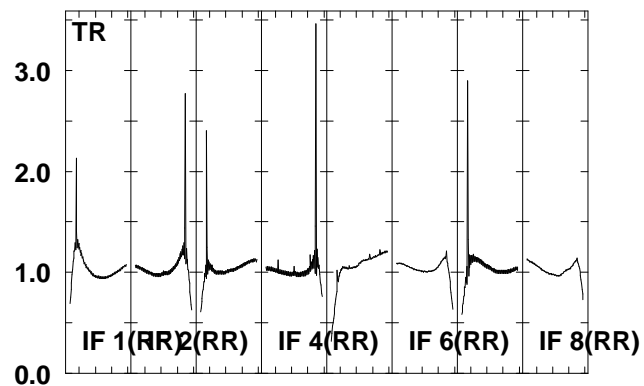
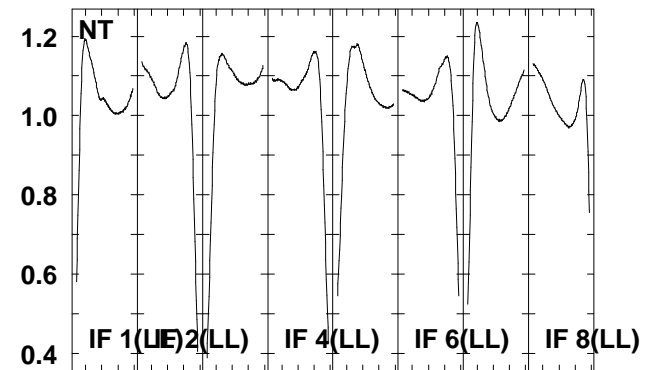
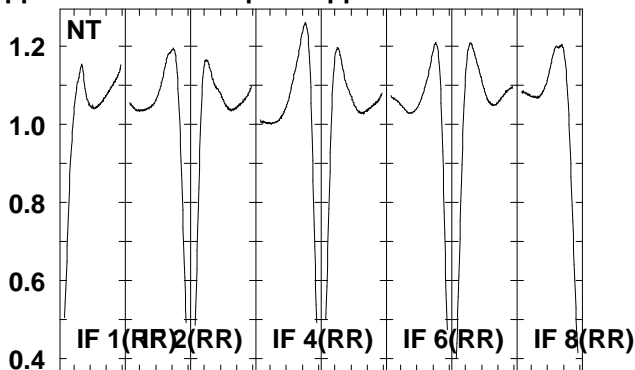
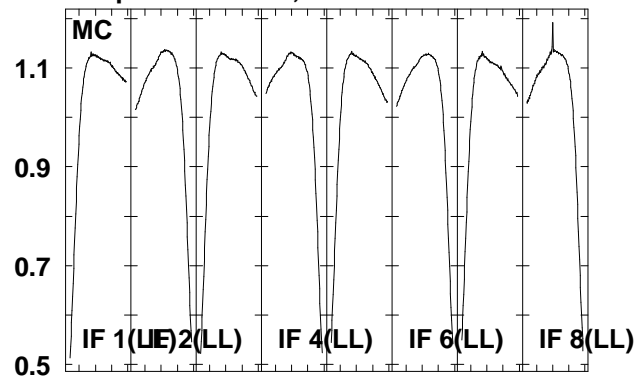

6663.6665.6667.6669.6671.6673.6675.6677.5
 FREQ MHz

Lower frame: Real Jy
 Total-power spectrum Antenna: *
 Timerange: 00/10:20:34 to 00/10:23:32

Plot file version 230 created 22-JUN-2006 20:15:46
 G16.59-0 EM061A 1.UVDATA.1
 Freq = 6.6631 GHz, Bw = 2.000 MH No calibration applied and no bandpass applied

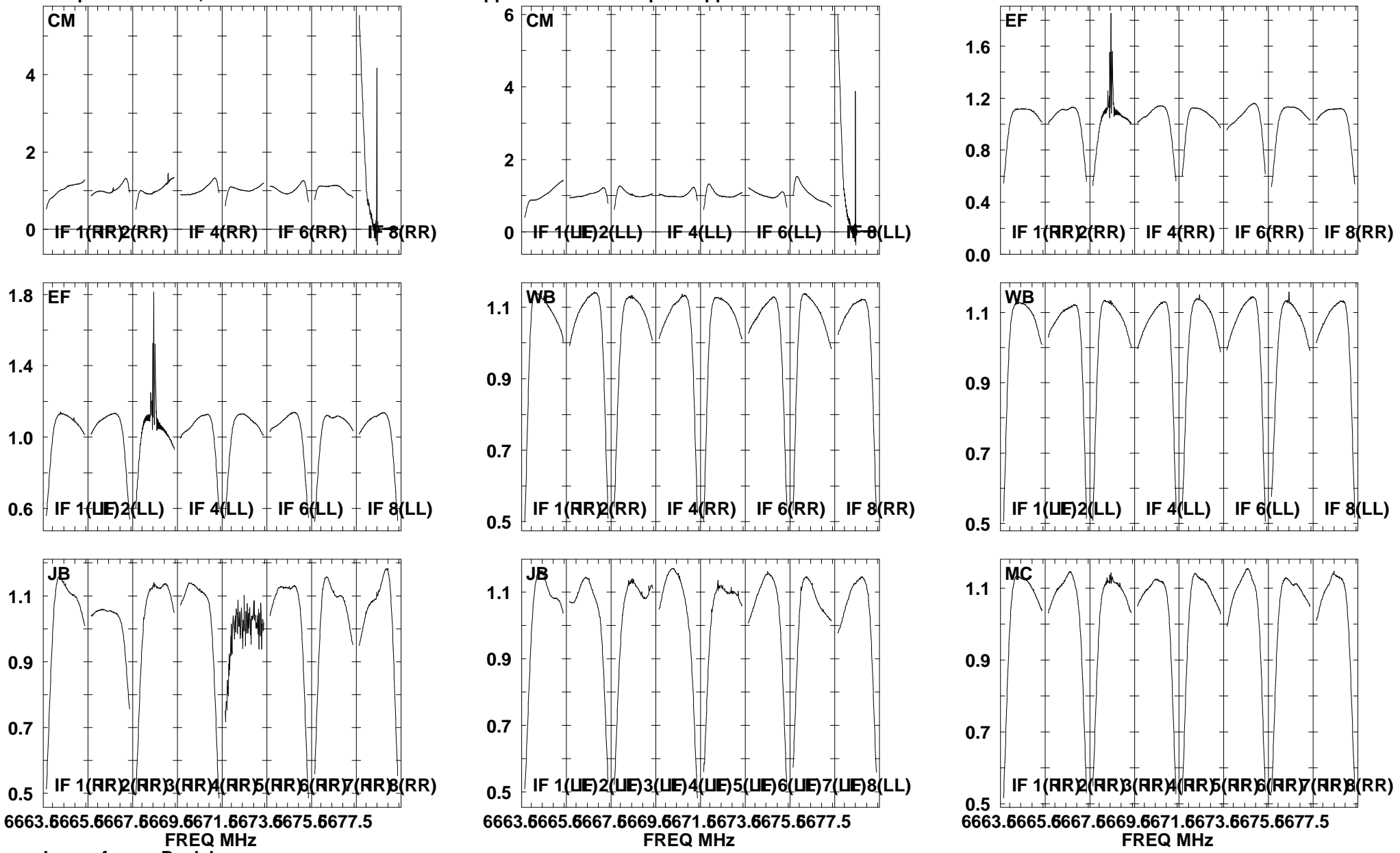

Lower frame: Real Jy
 Total-power spectrum Antenna: *
 Timerange: 00/10:23:34 to 00/10:26:02

Plot file version 231 created 22-JUN-2006 20:15:49
 G16.59-0 EM061A 1.UVDATA.1
 Freq = 6.6631 GHz, Bw = 2.000 MH No calibration applied and no bandpass applied

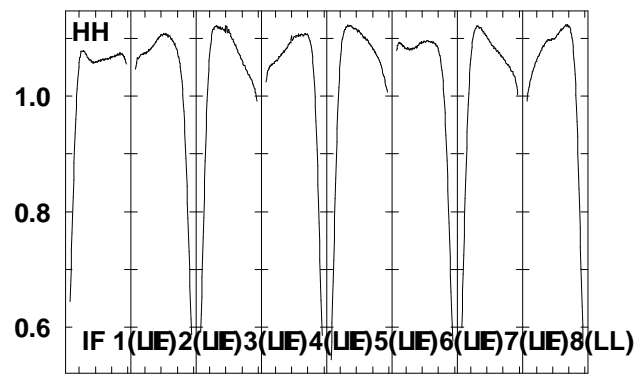
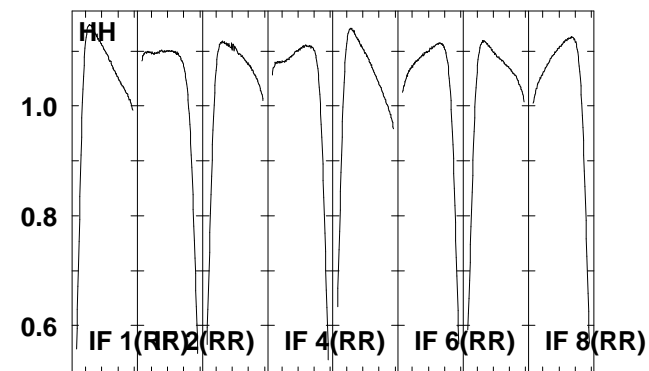
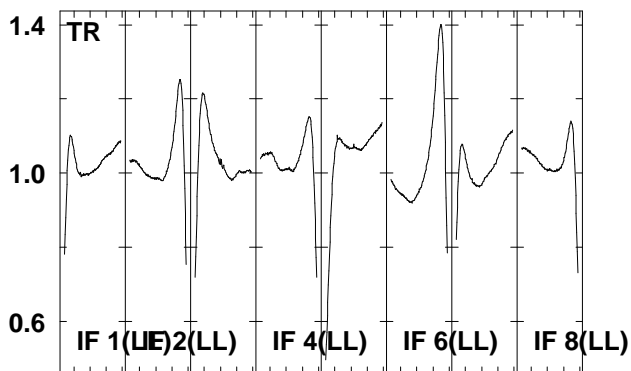
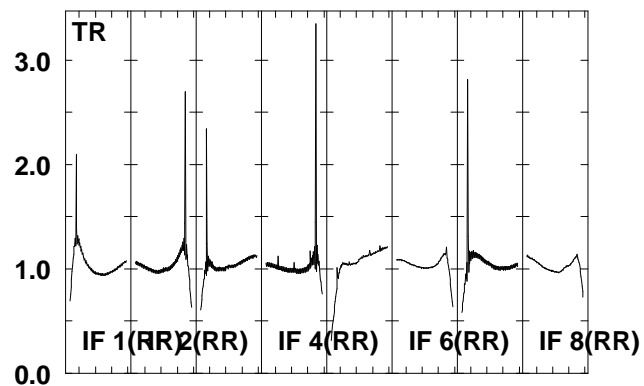
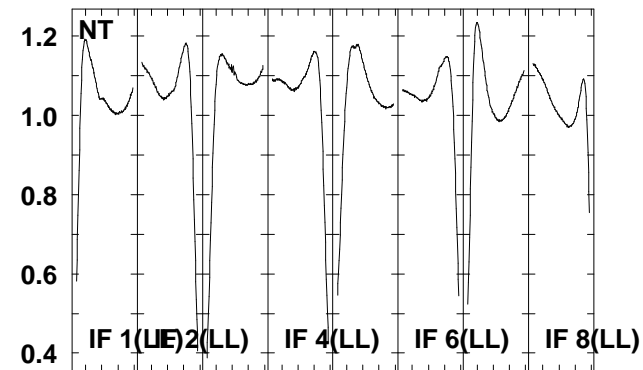
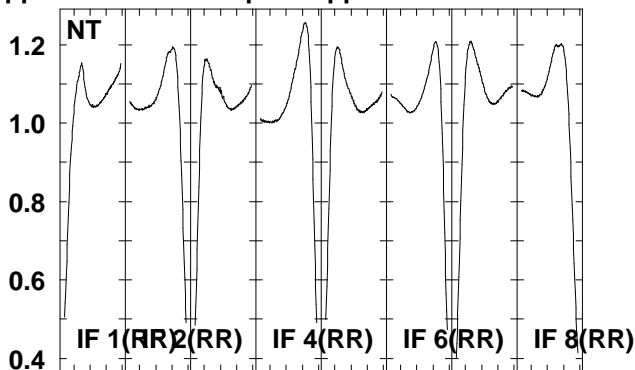
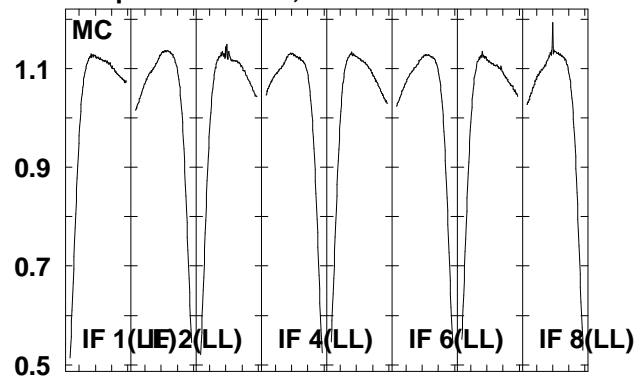

6663.6665.6667.6669.6671.6673.6675.6677.5
 FREQ MHz

Lower frame: Real Jy
 Total-power spectrum Antenna: *
 Timerange: 00/10:23:34 to 00/10:26:02

Plot file version 232 created 22-JUN-2006 20:15:52
 J2101+03 EM061A 1.UVDATA.1
 Freq = 6.6631 GHz, Bw = 2.000 MH No calibration applied and no bandpass applied

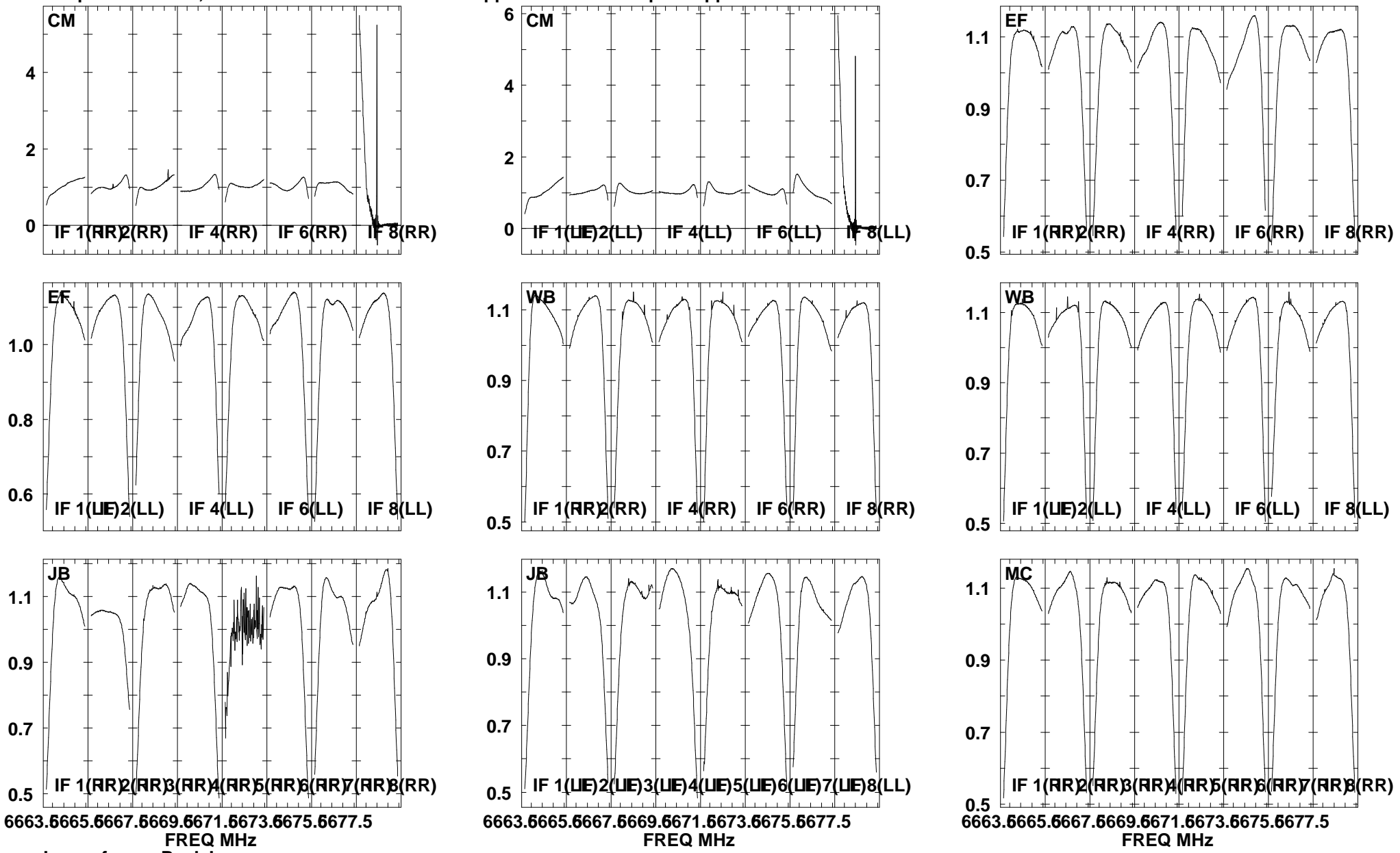

Lower frame: Real Jy
 Total-power spectrum Antenna: *
 Timerange: 00/10:28:30 to 00/10:33:27

Plot file version 233 created 22-JUN-2006 20:15:57
 J2101+03 EM061A 1.UVDATA.1
 Freq = 6.6631 GHz, Bw = 2.000 MH No calibration applied and no bandpass applied

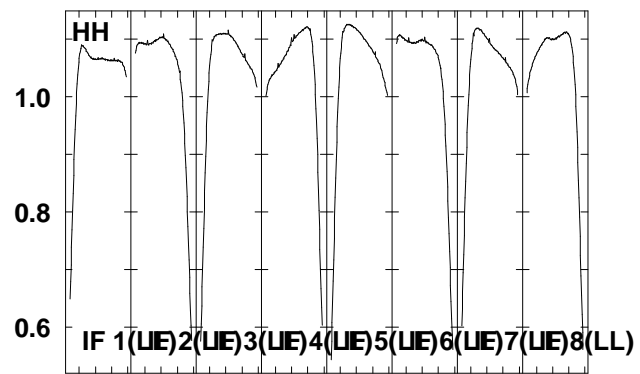
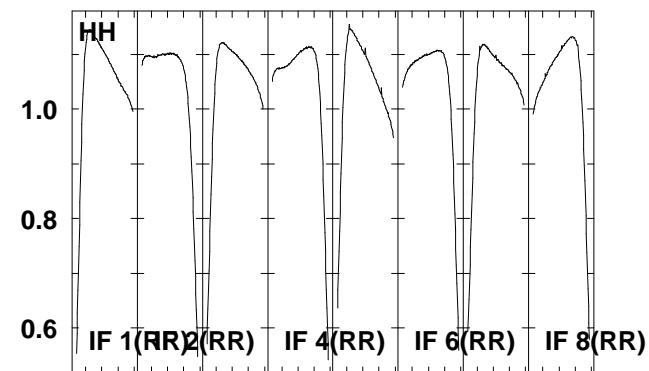
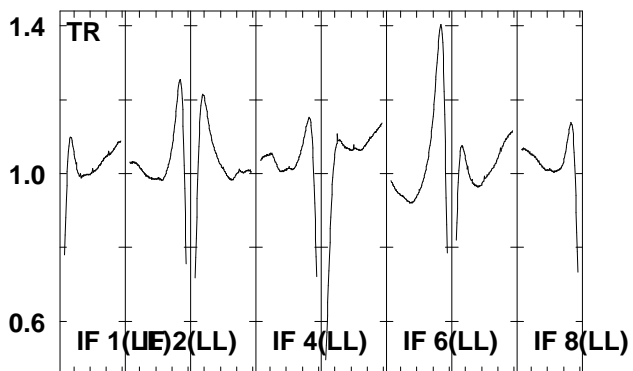
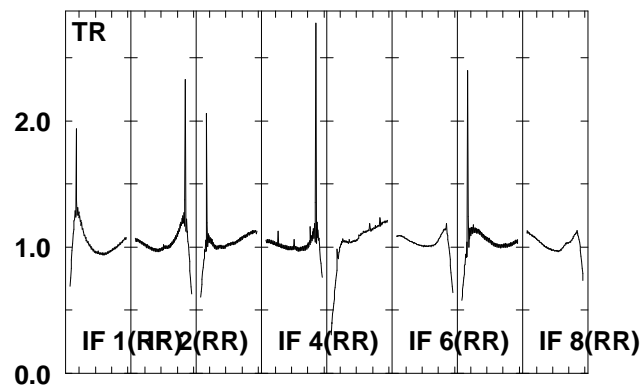
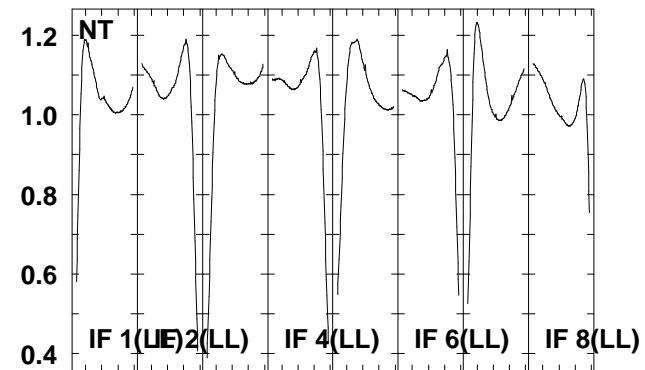
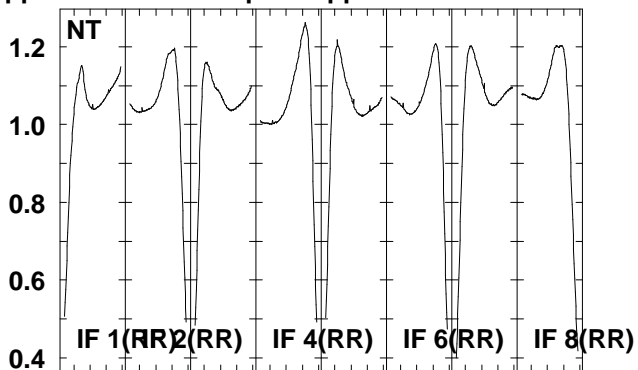
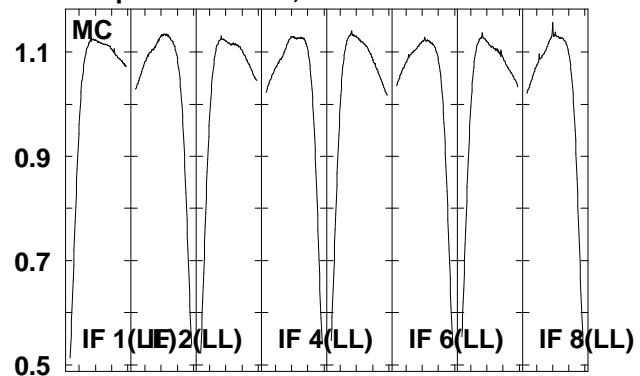

6663.6665.6667.6669.6671.6673.6675.6677.5
 FREQ MHz

Lower frame: Real Jy
 Total-power spectrum Antenna: *
 Timerange: 00/10:28:30 to 00/10:33:27