

Plot file version 1 created 08-JUL-2010 13:07:24

DA193 EM079.UVDATA.1

Freq = 4.9415 GHz, Bw = 16.000 MH No calibration applied and no bandpass applied

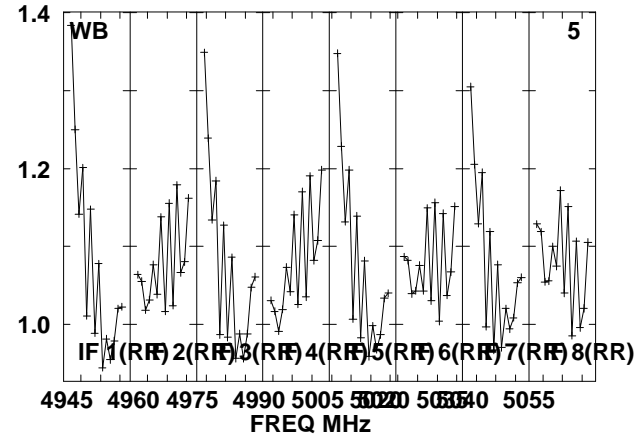
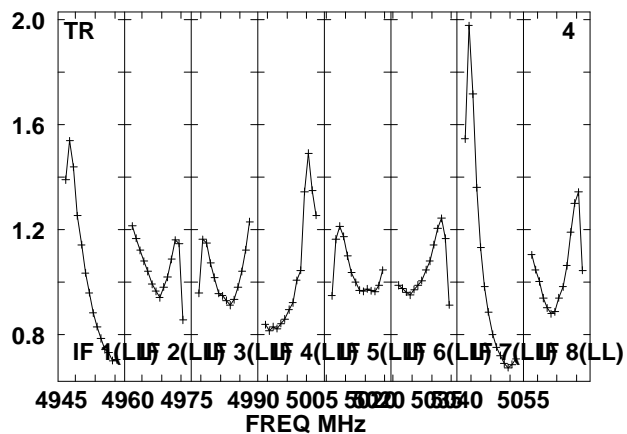
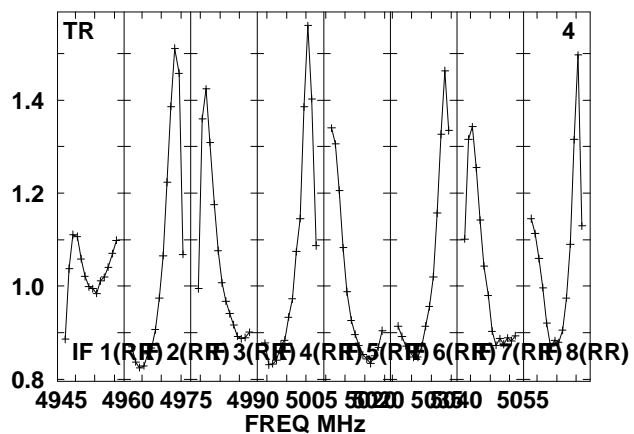
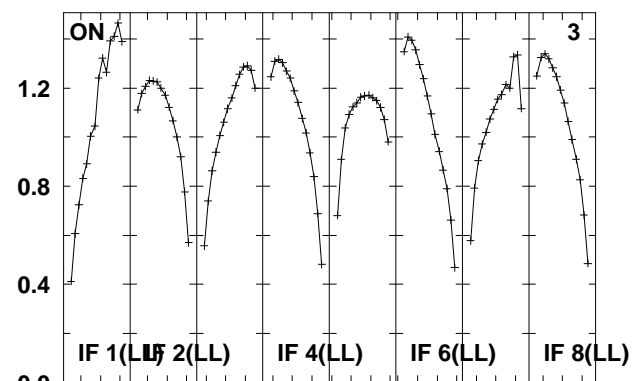
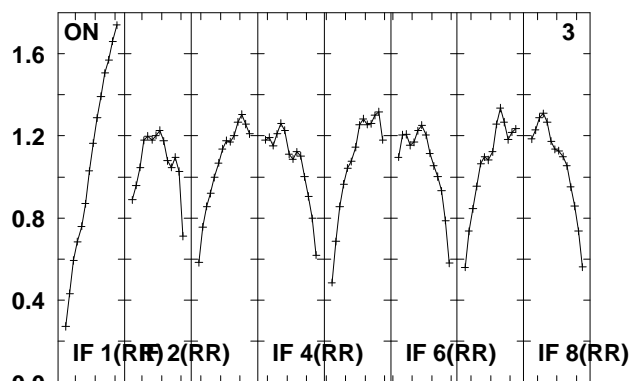
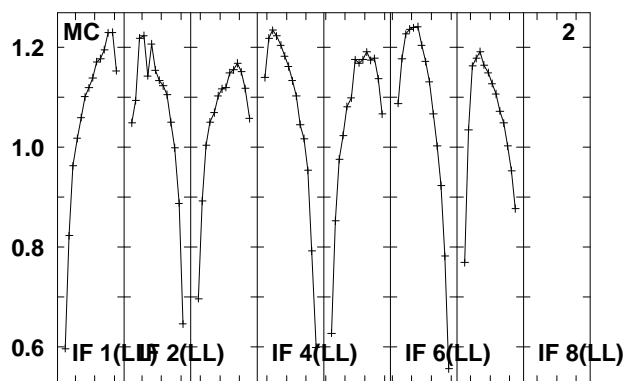
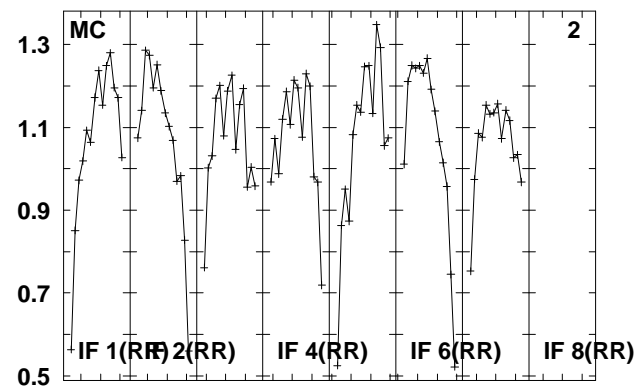
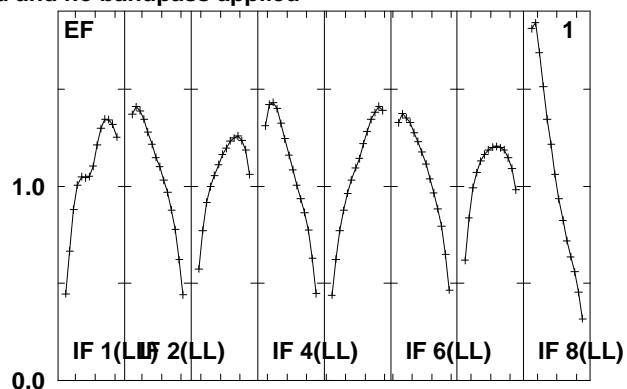
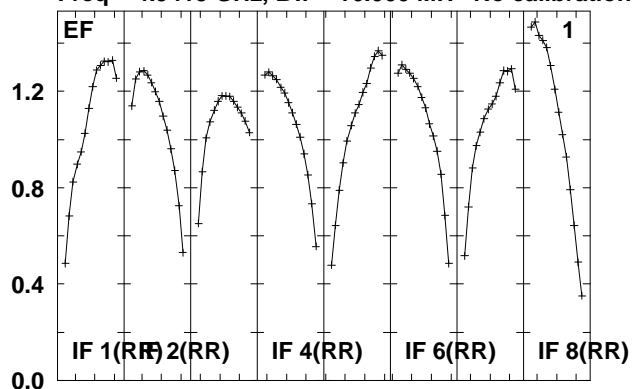

Lower frame: Real Jy
Total-power spectrum Antenna: *
Timerange: 00/07:34:16 to 00/07:56:15

Plot file version 2 created 08-JUL-2010 13:07:26

DA193 EM079.UVDATA.1

Freq = 4.9415 GHz, Bw = 16.000 MH No calibration applied and no bandpass applied

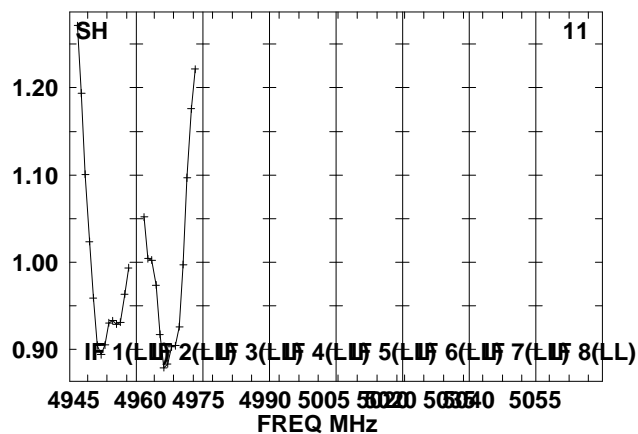
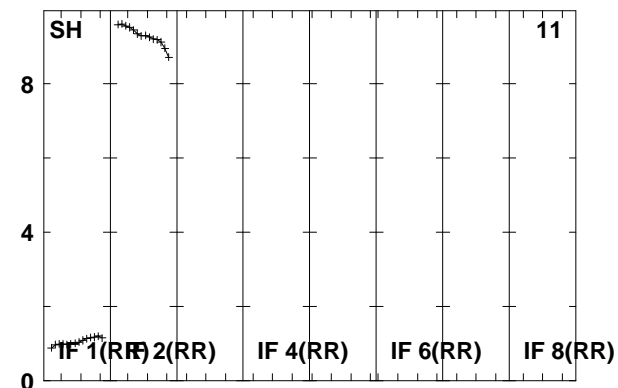
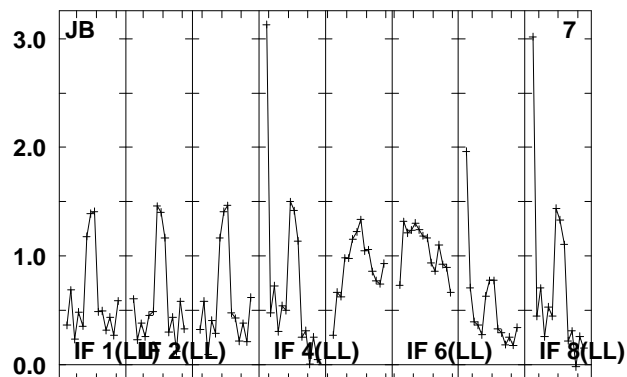
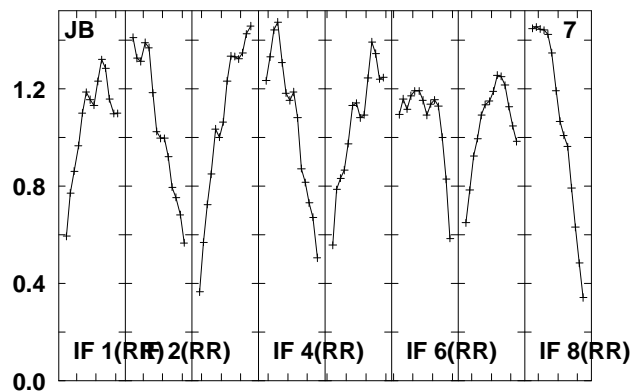
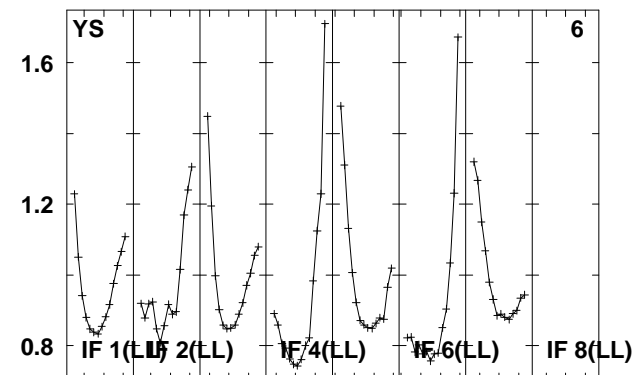
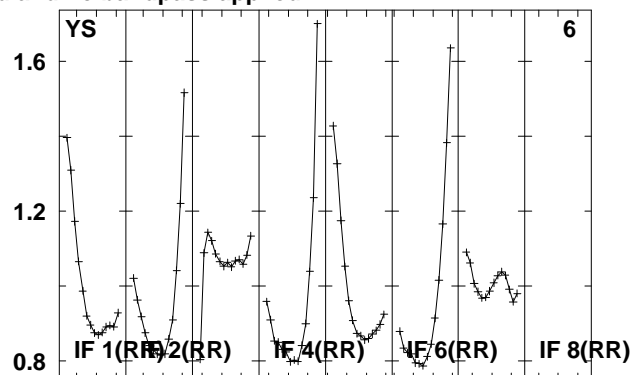
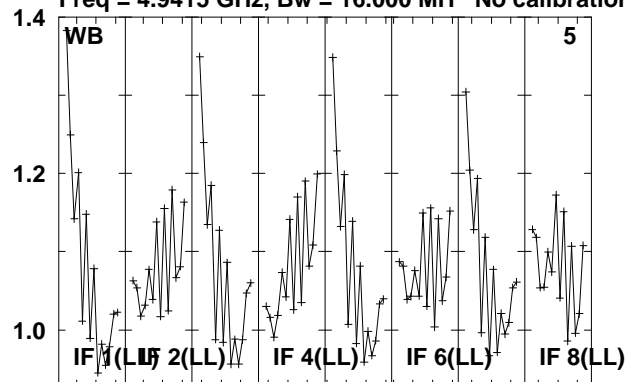

Lower frame: Real Jy

Total-power spectrum Antenna: *

Timerange: 00/07:34:16 to 00/07:56:15

Plot file version 3 created 08-JUL-2010 13:07:30

DA193 EM079.UVDATA.1

Freq = 4.9415 GHz, Bw = 16.000 MH No calibration applied and no bandpass applied

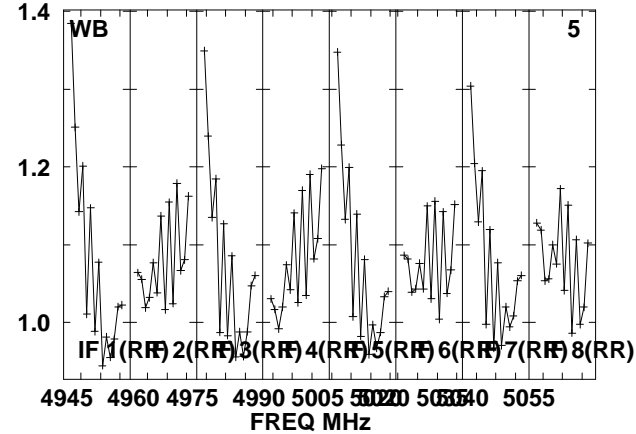
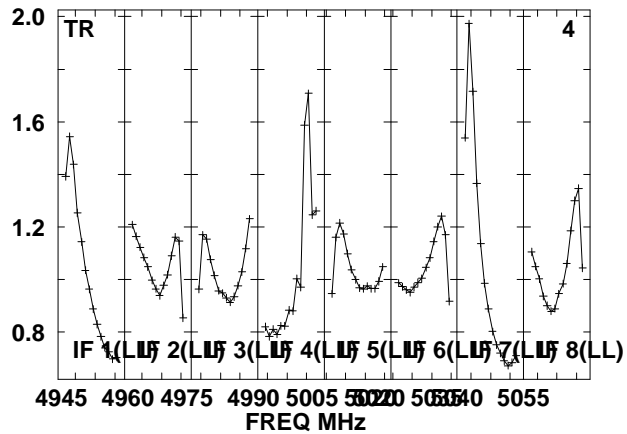
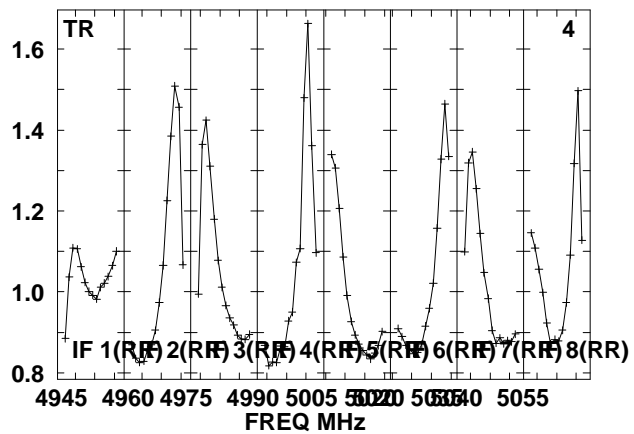
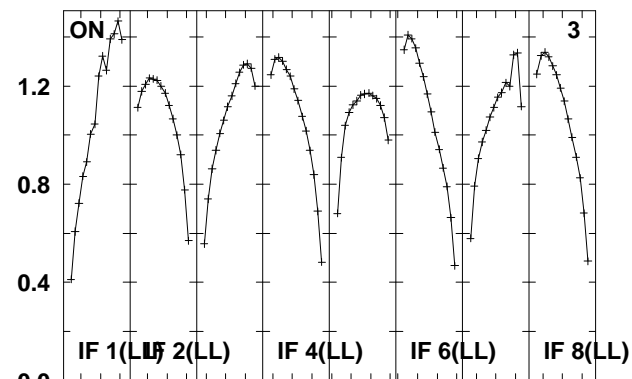
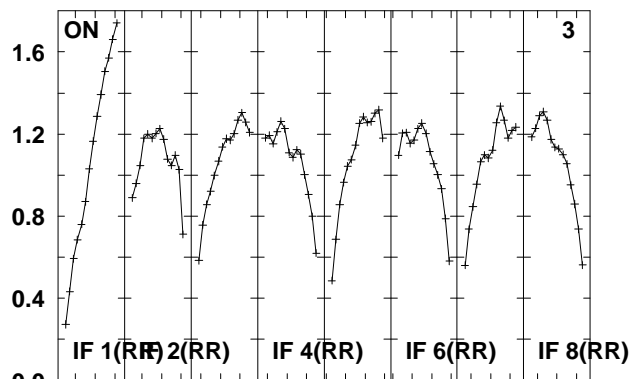
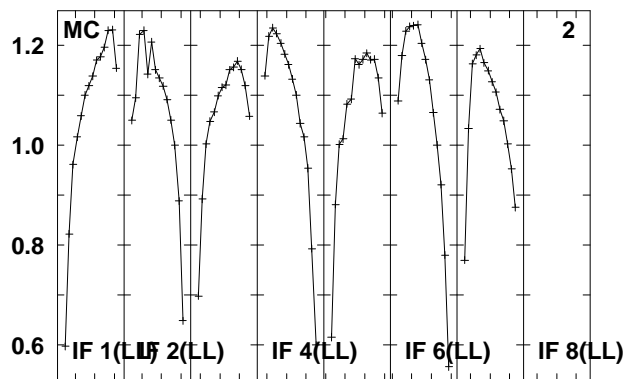
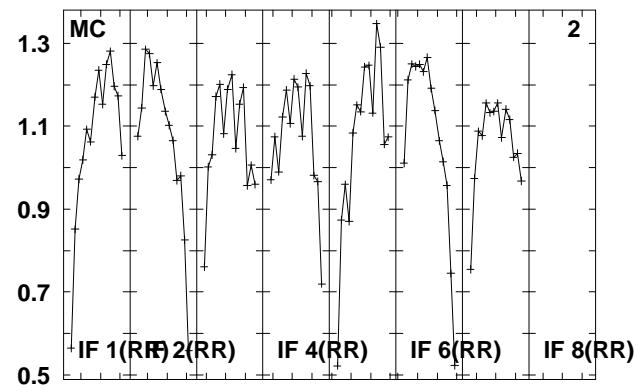
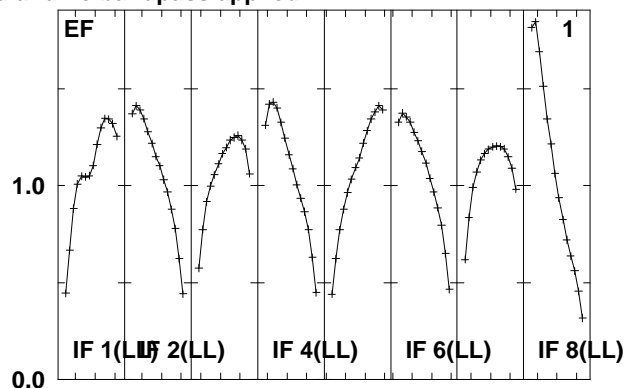
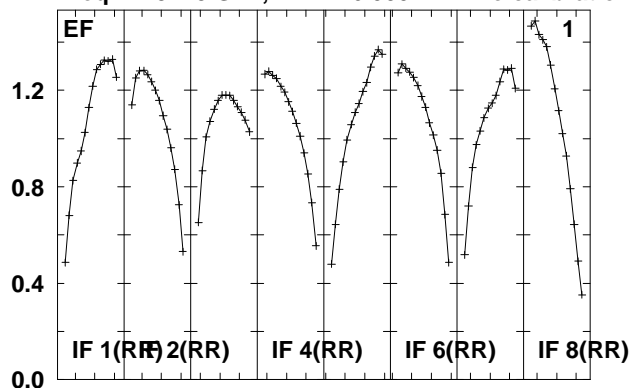

Lower frame: Real Jy
Total-power spectrum Antenna: *
Timerange: 00/07:56:17 to 00/08:18:17

Plot file version 4 created 08-JUL-2010 13:07:33

DA193 EM079.UVDATA.1

Freq = 4.9415 GHz, Bw = 16.000 MH No calibration applied and no bandpass applied

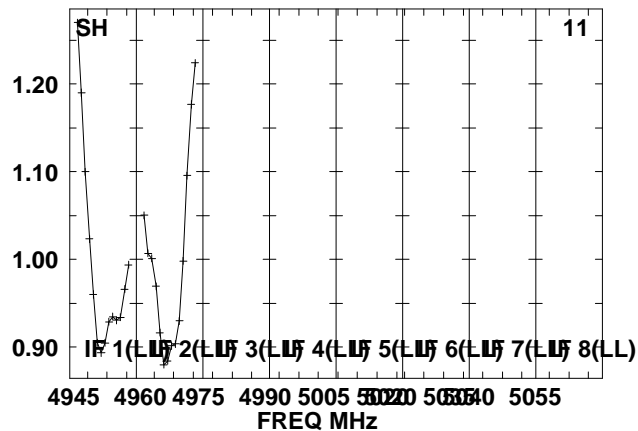
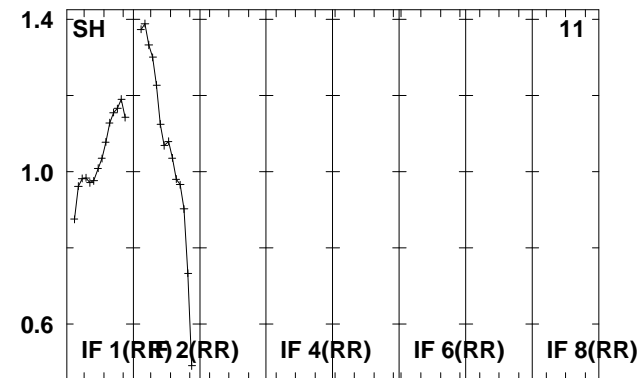
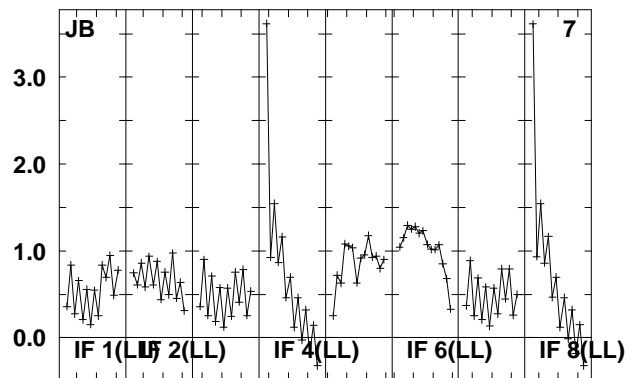
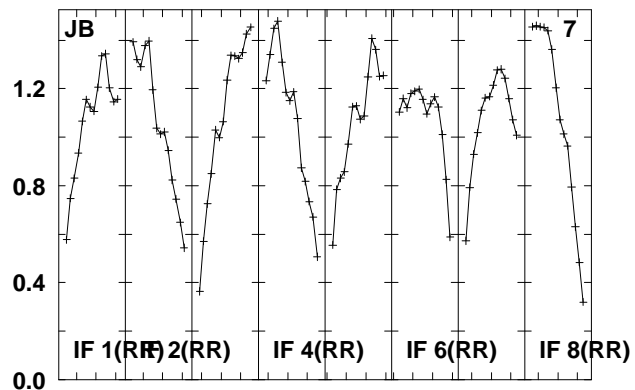
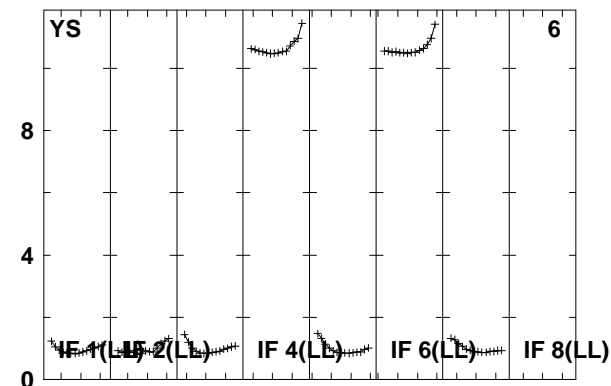
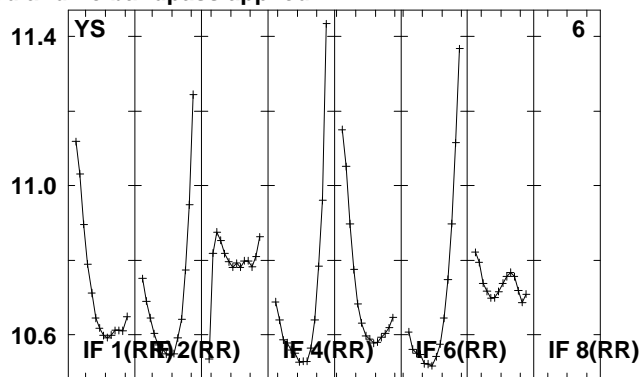
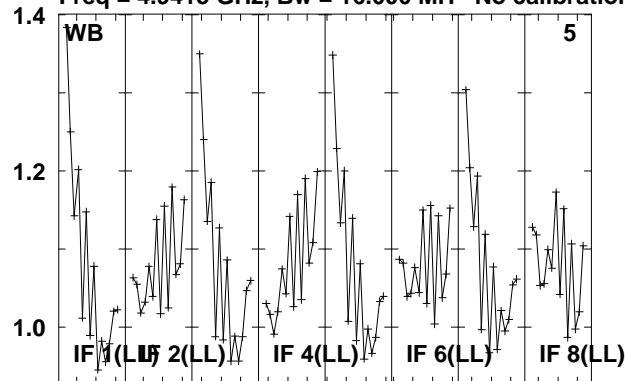

Lower frame: Real Jy

Total-power spectrum Antenna: *

Timerange: 00/07:56:17 to 00/08:18:17

Plot file version 5 created 08-JUL-2010 13:07:43

DA193 EM079.UVDATA.1

Freq = 4.9415 GHz, Bw = 16.000 MH No calibration applied and no bandpass applied

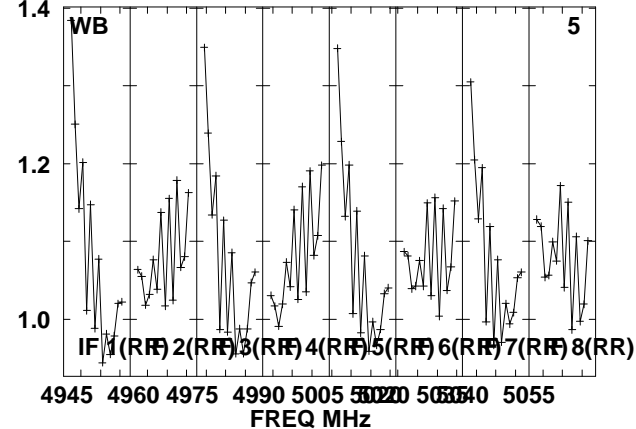
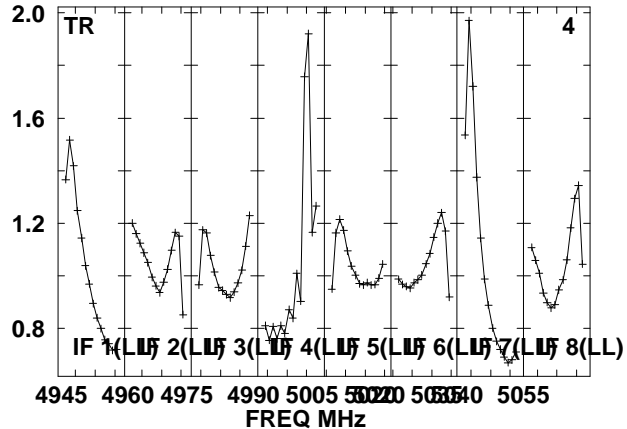
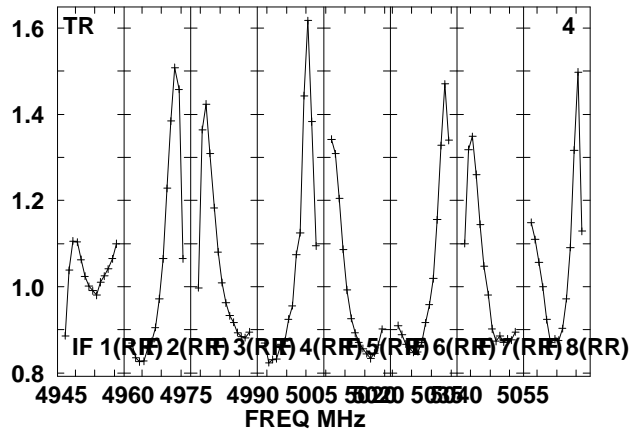
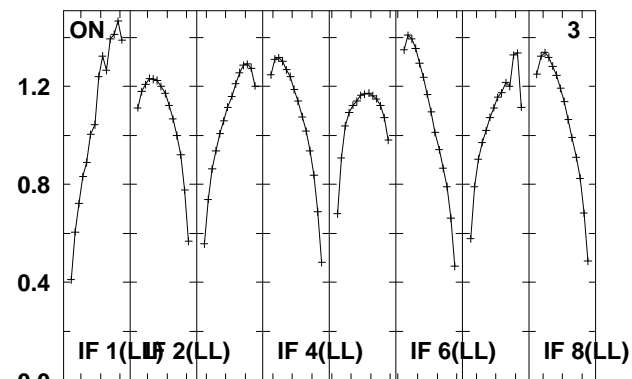
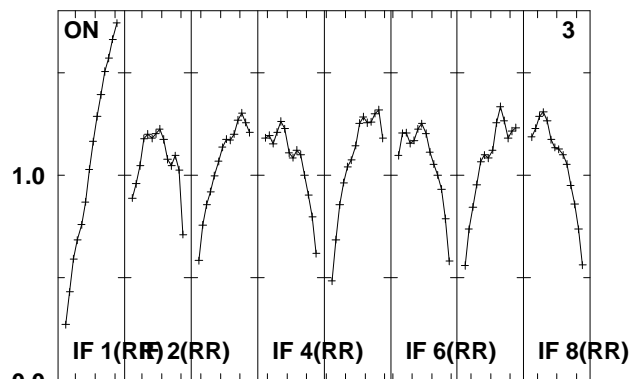
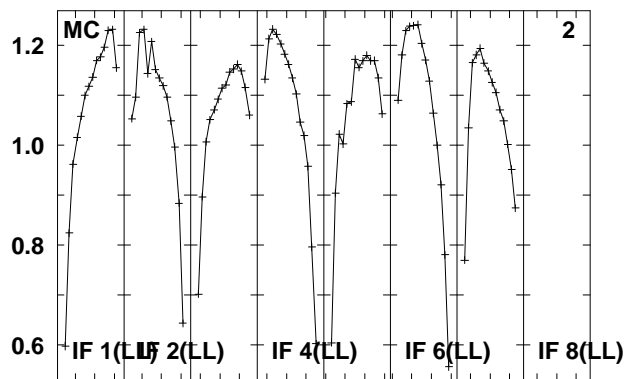
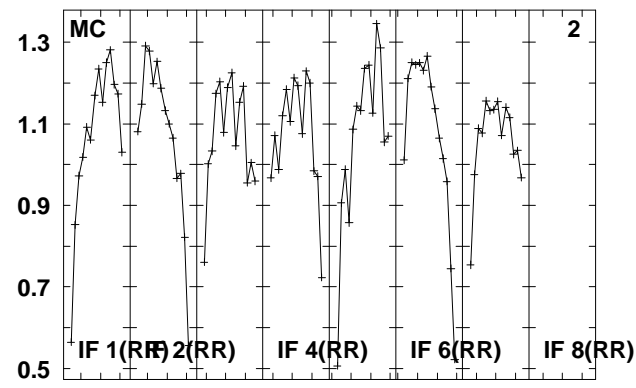
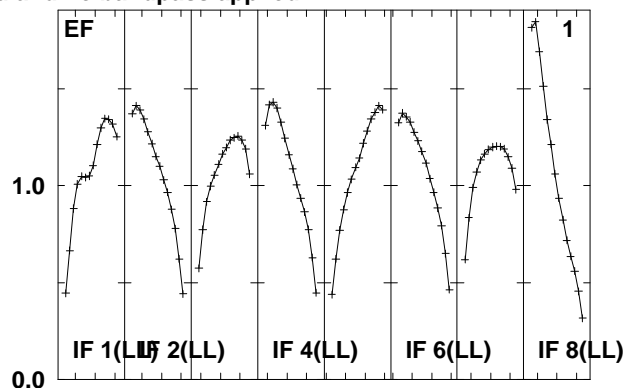
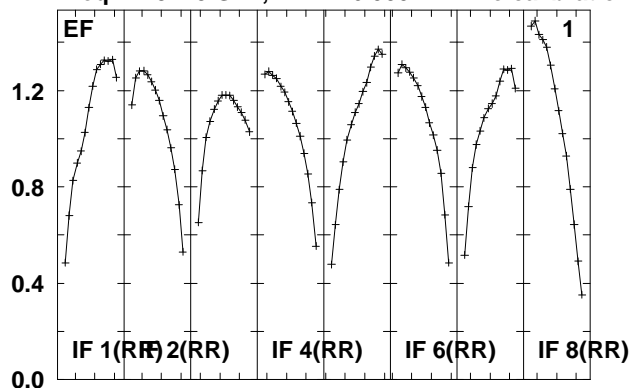

Lower frame: Real Jy
Total-power spectrum Antenna: *
Timerange: 00/08:18:19 to 00/08:27:57

Plot file version 6 created 08-JUL-2010 13:07:45

DA193 EM079.UVDATA.1

Freq = 4.9415 GHz, Bw = 16.000 MH No calibration applied and no bandpass applied

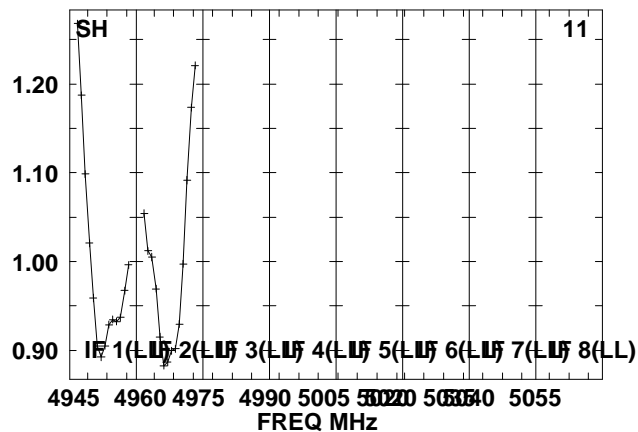
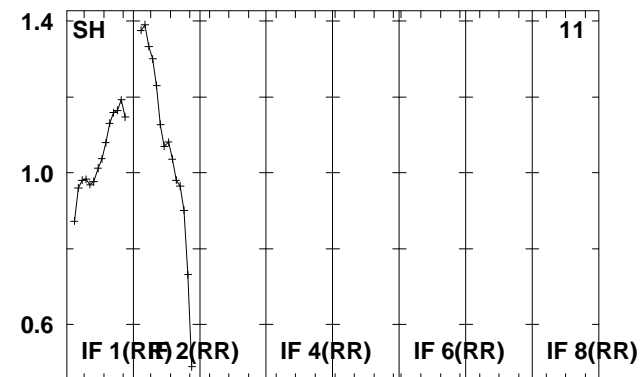
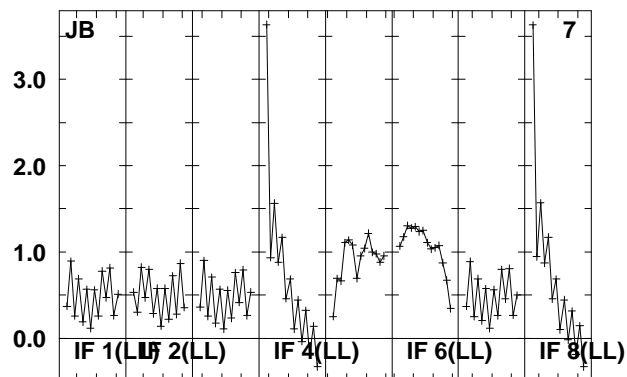
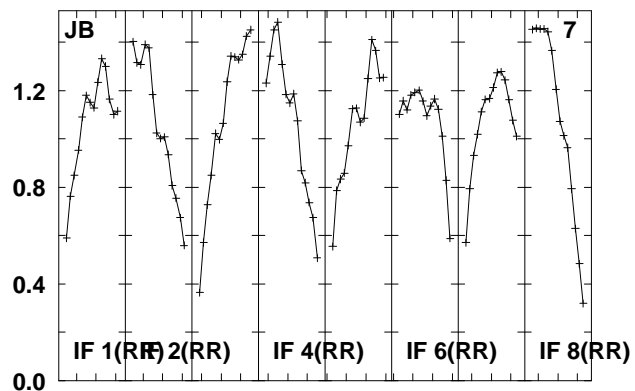
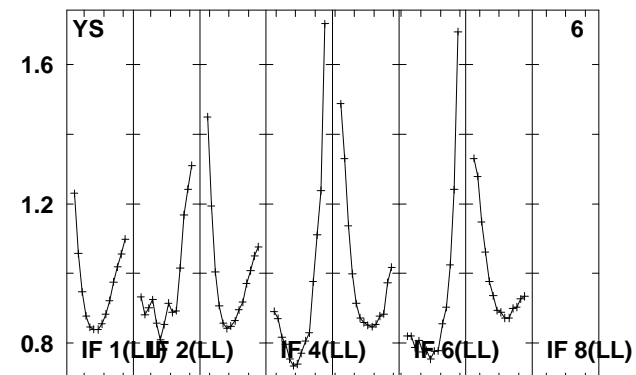
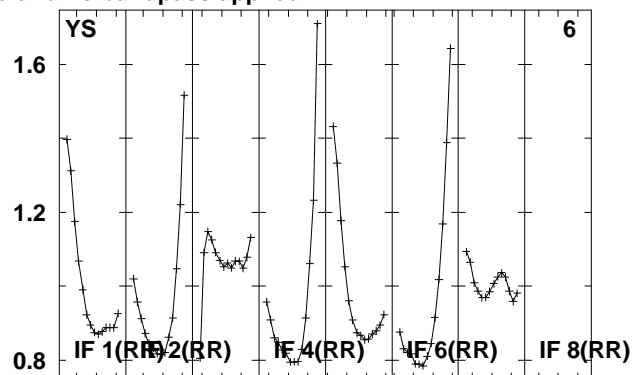
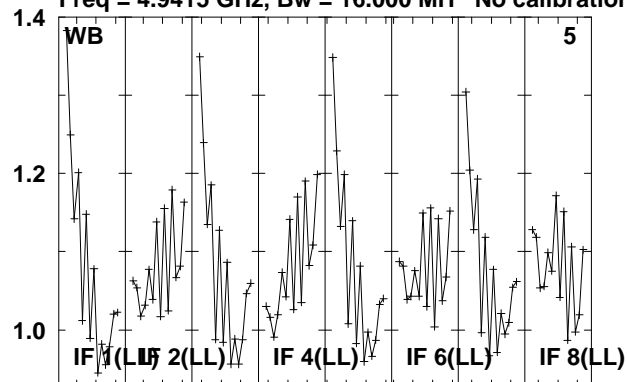

Lower frame: Real Jy

Total-power spectrum Antenna: *

Timerange: 00/08:18:19 to 00/08:27:57

Plot file version 7 created 08-JUL-2010 13:07:48

DA193 EM079.UVDATA.1

Freq = 4.9415 GHz, Bw = 16.000 MH No calibration applied and no bandpass applied

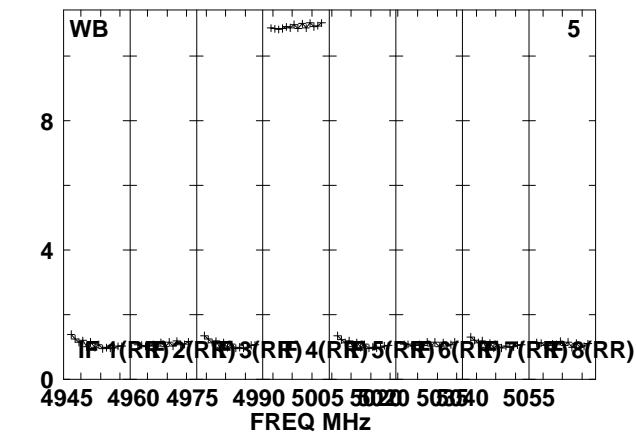
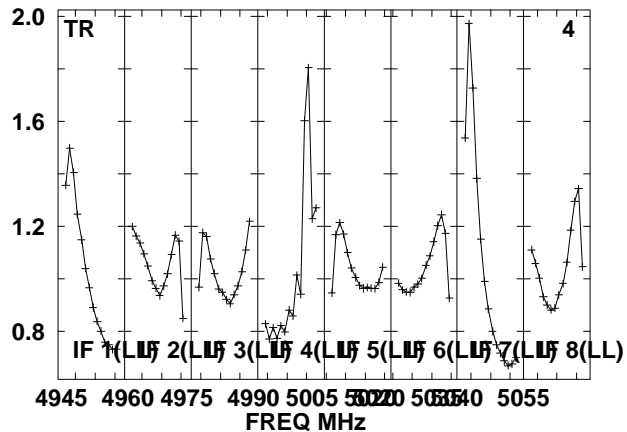
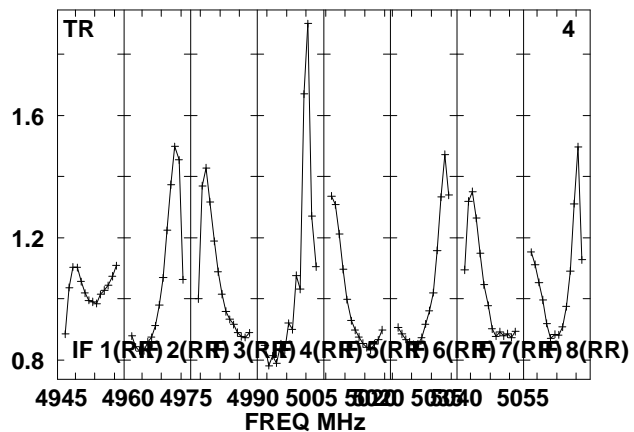
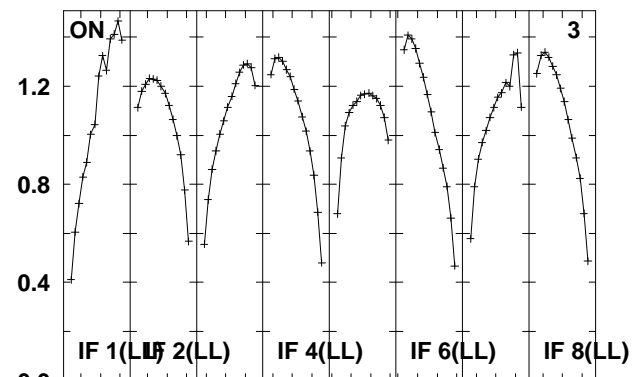
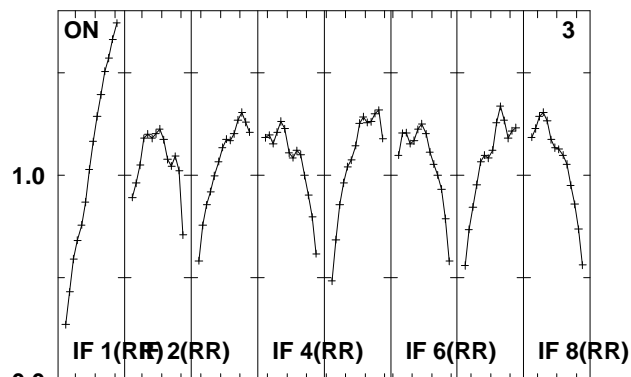
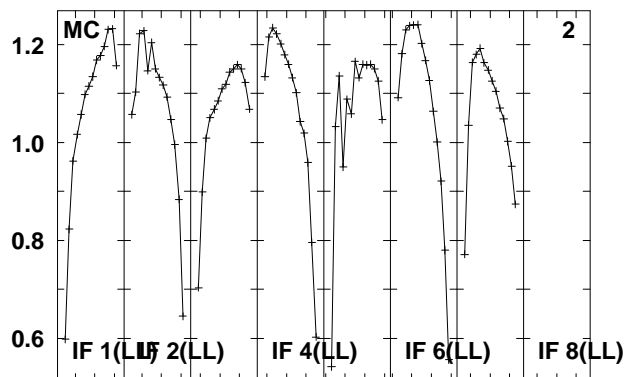
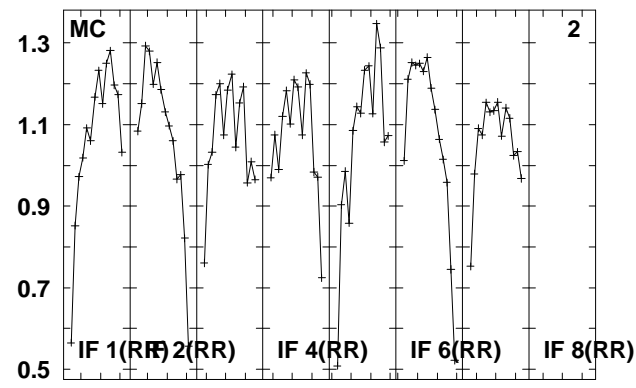
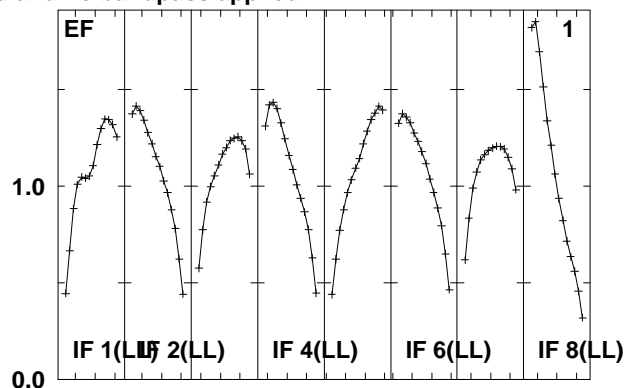
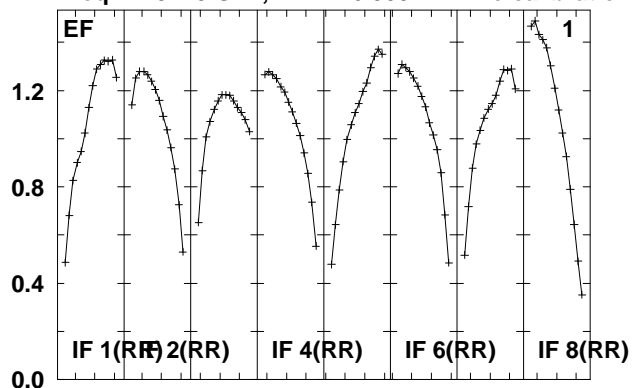

Lower frame: Real Jy
Total-power spectrum Antenna: *
Timerange: 00/08:48:16 to 00/09:10:16

Plot file version 8 created 08-JUL-2010 13:07:51

DA193 EM079.UVDATA.1

Freq = 4.9415 GHz, Bw = 16.000 MH No calibration applied and no bandpass applied

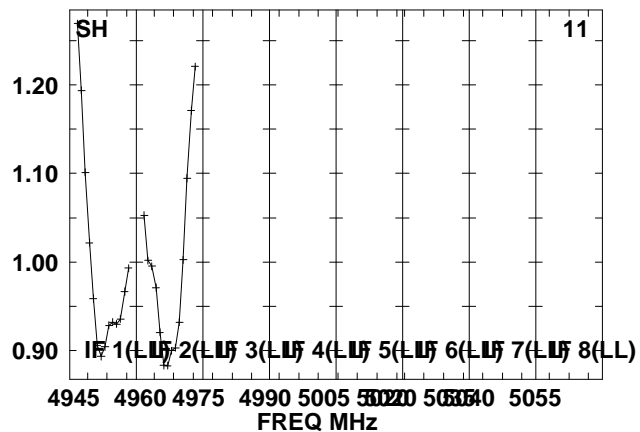
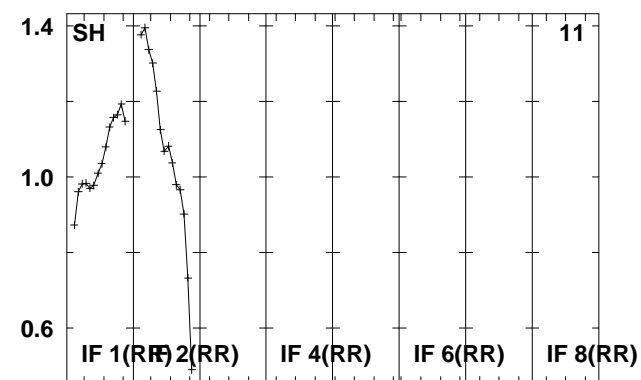
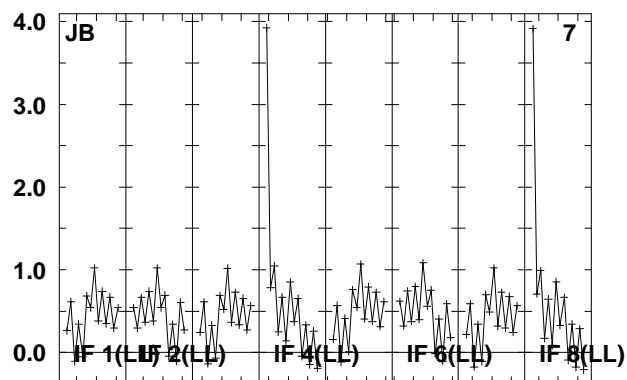
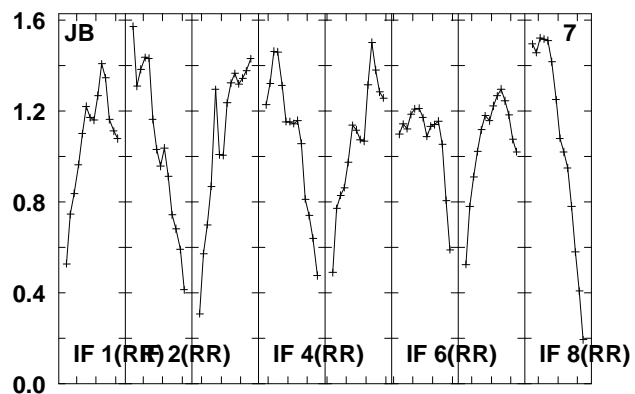
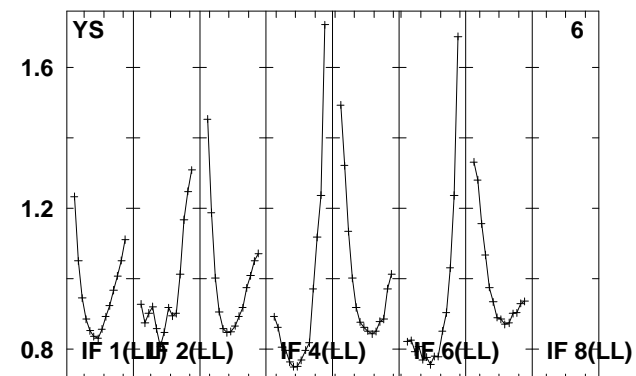
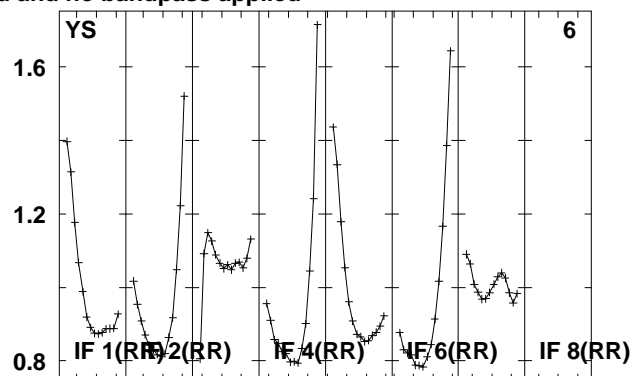
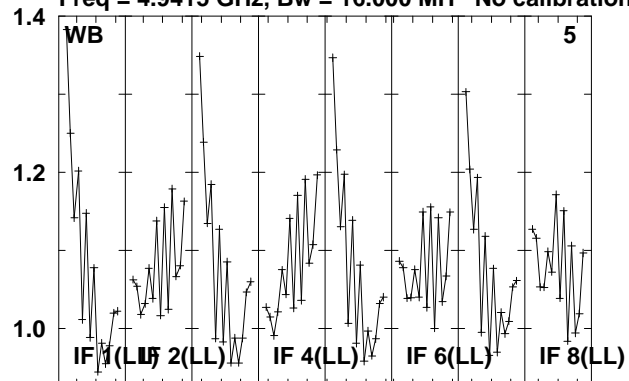

Lower frame: Real Jy

Total-power spectrum Antenna: *

Timerange: 00/08:48:16 to 00/09:10:16

Plot file version 9 created 08-JUL-2010 13:07:55

DA193 EM079.UVDATA.1

Freq = 4.9415 GHz, Bw = 16.000 MH No calibration applied and no bandpass applied

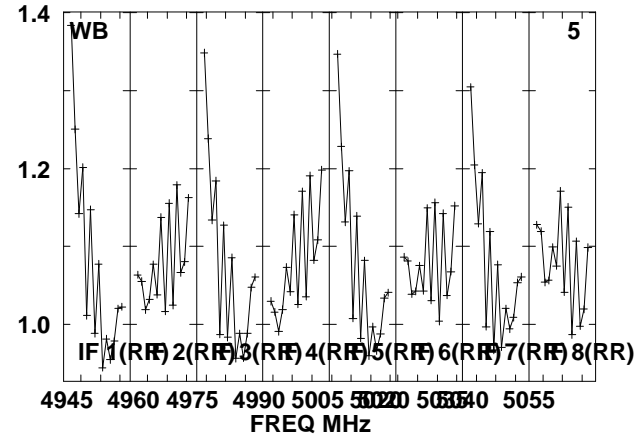
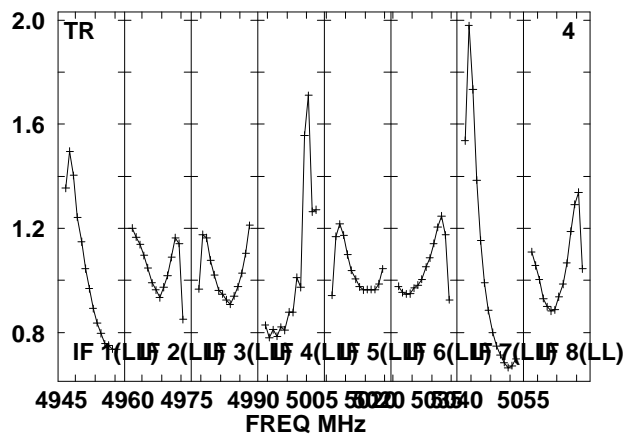
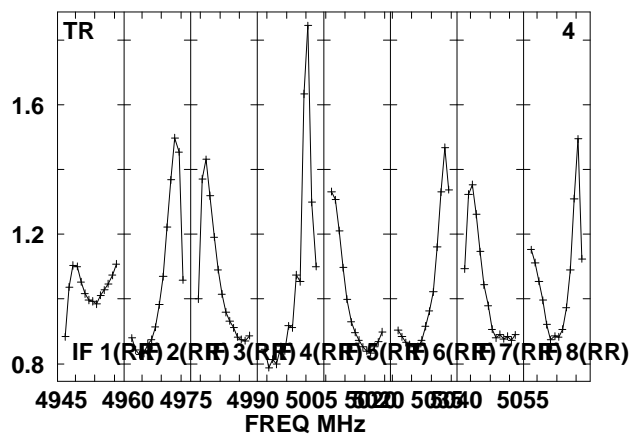
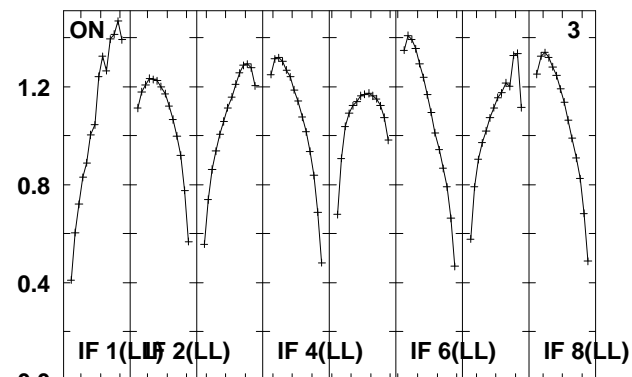
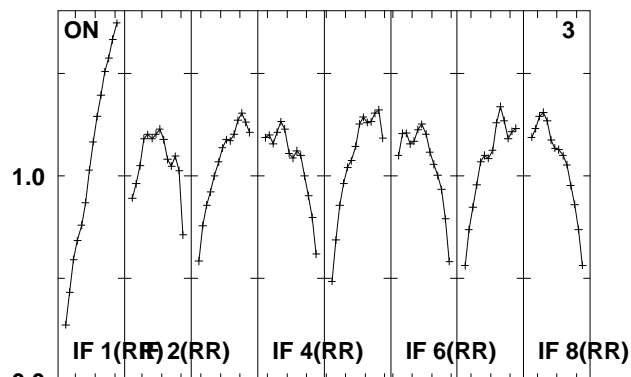
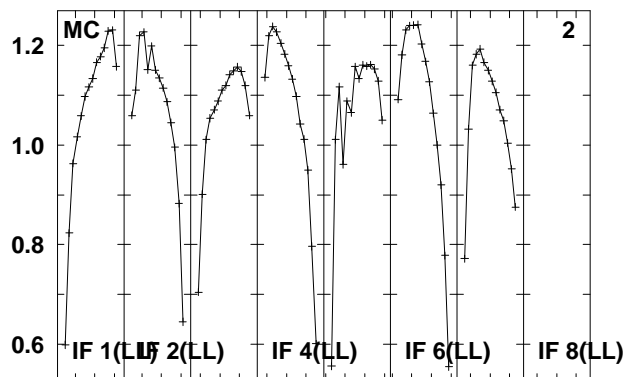
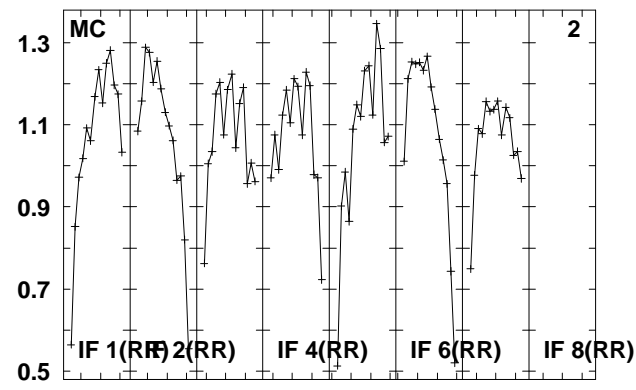
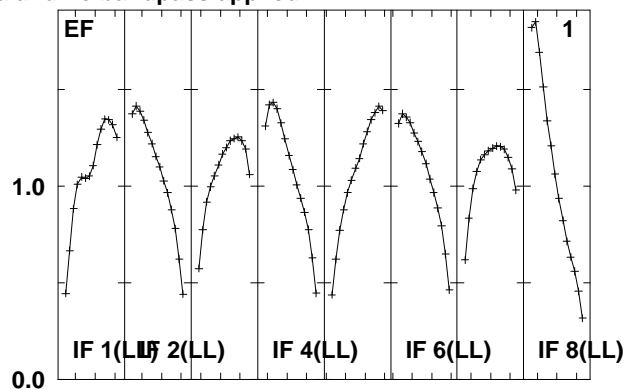
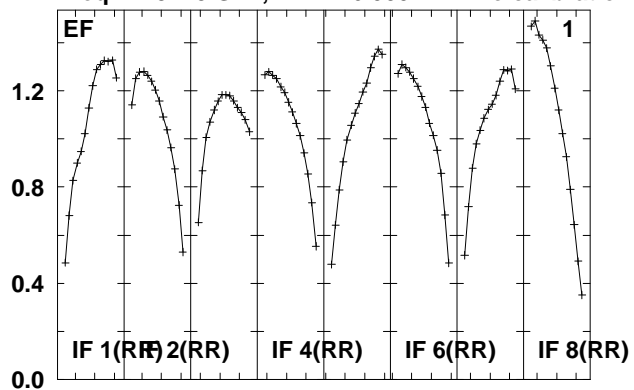

Lower frame: Real Jy
Total-power spectrum Antenna: *
Timerange: 00/09:10:18 to 00/09:14:58

Plot file version 10 created 08-JUL-2010 13:07:56

DA193 EM079.UVDATA.1

Freq = 4.9415 GHz, Bw = 16.000 MH No calibration applied and no bandpass applied

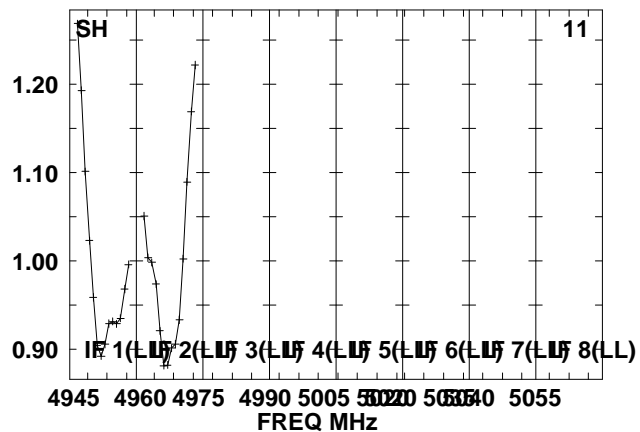
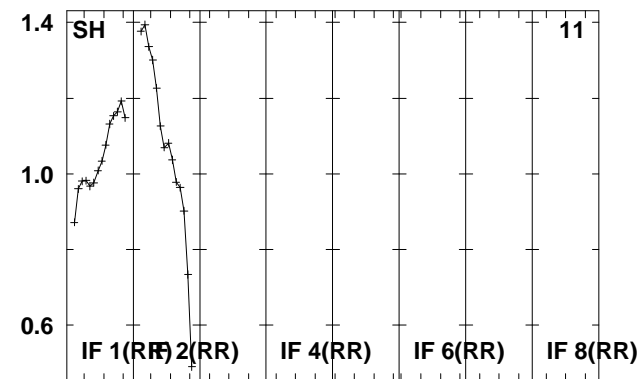
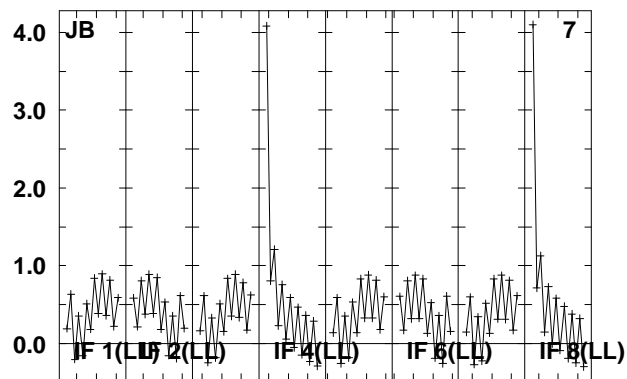
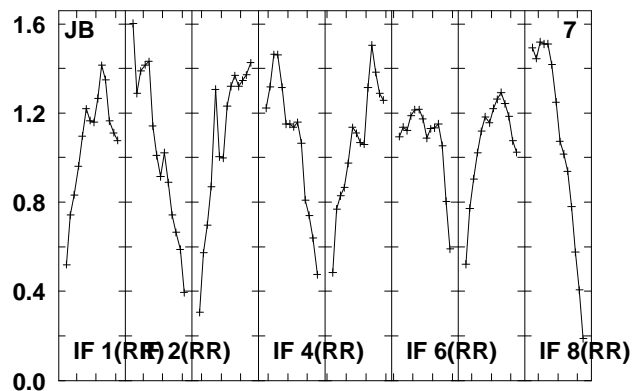
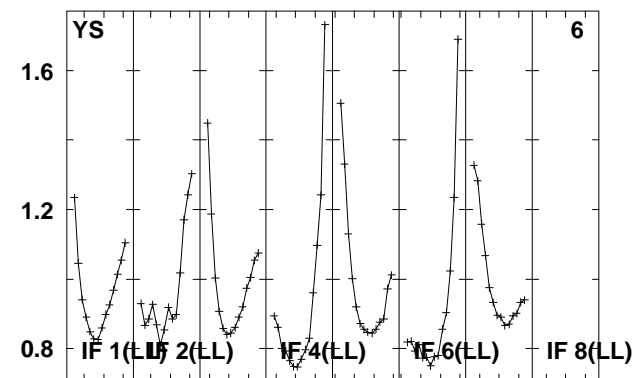
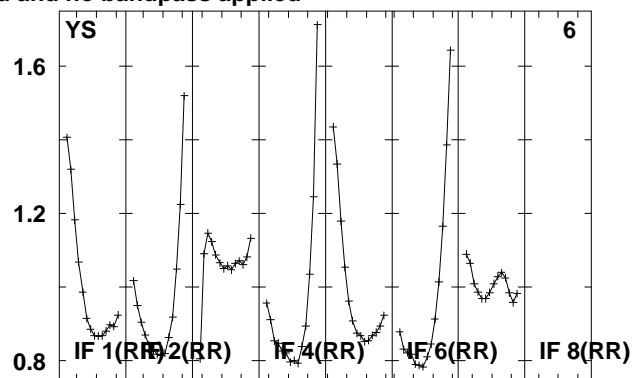
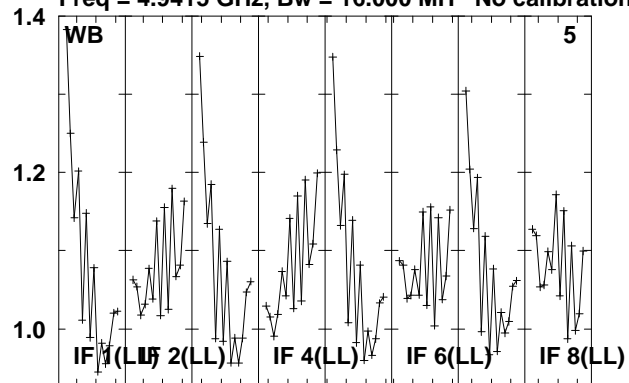

Lower frame: Real Jy

Total-power spectrum Antenna: *

Timerange: 00/09:10:18 to 00/09:14:58

Plot file version 11 created 08-JUL-2010 13:07:57

J0731+24 EM079.UVDATA.1

Freq = 4.9415 GHz, Bw = 16.000 MH No calibration applied and no bandpass applied

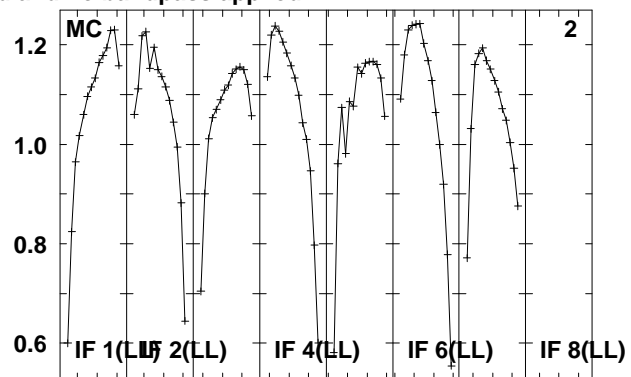
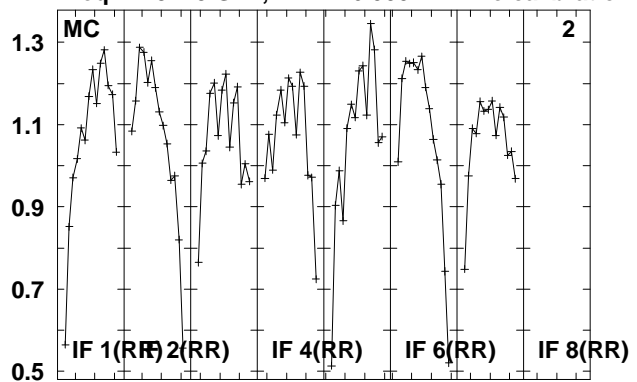

Lower frame: Real Jy
Total-power spectrum Antenna: *
Timerange: 00/09:15:00 to 00/09:15:00

Plot file version 12 created 08-JUL-2010 13:07:57

J0731+24 EM079.UVDATA.1

Freq = 4.9415 GHz, Bw = 16.000 MH No calibration applied and no bandpass applied

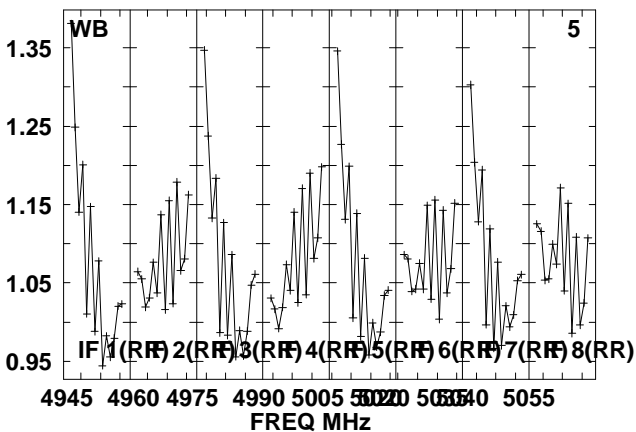
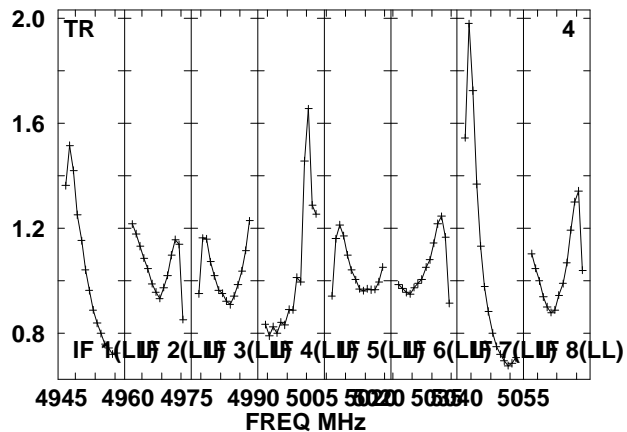
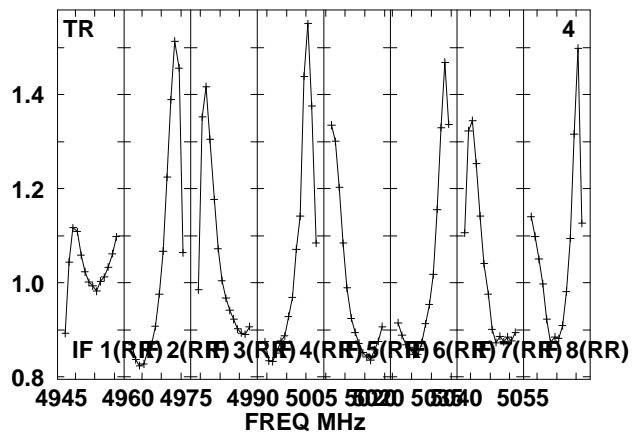
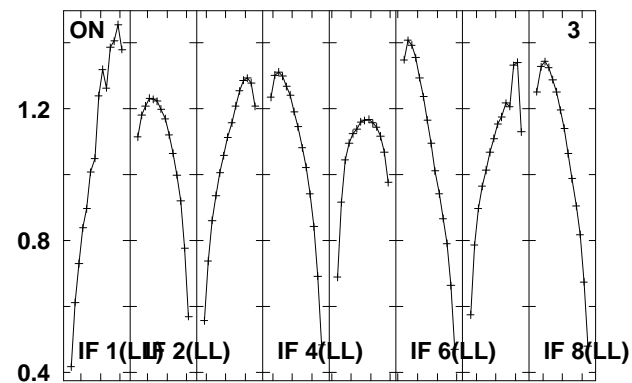
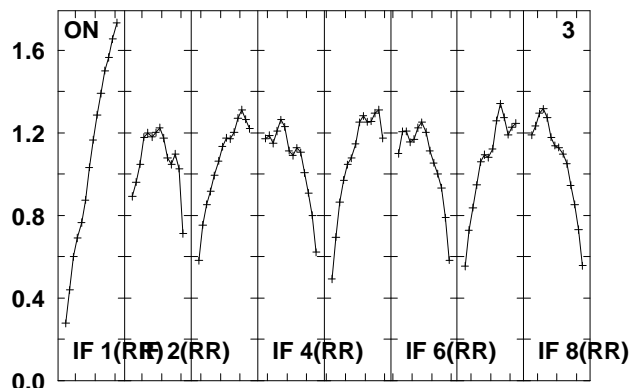
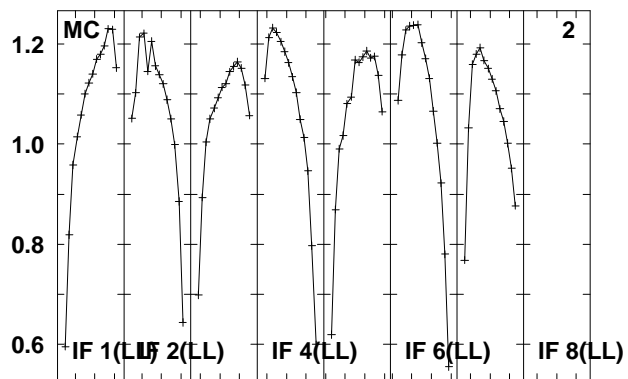
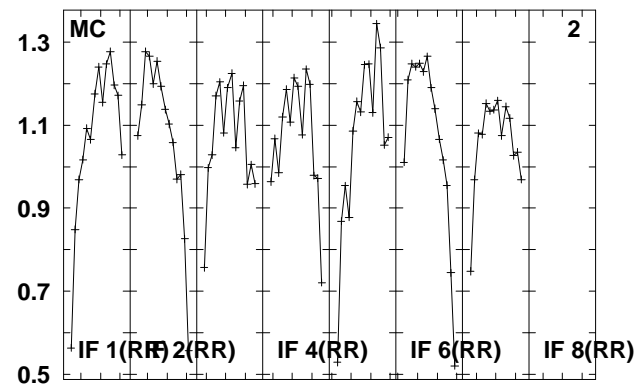
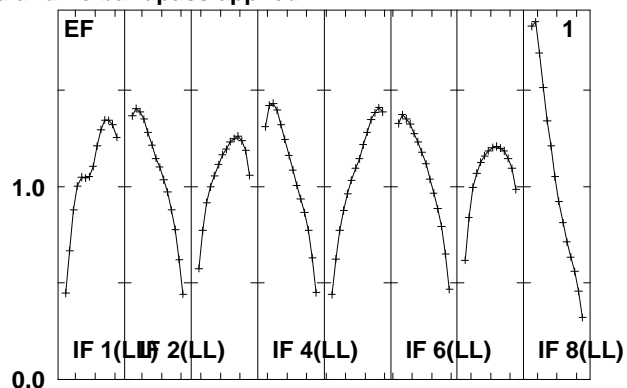
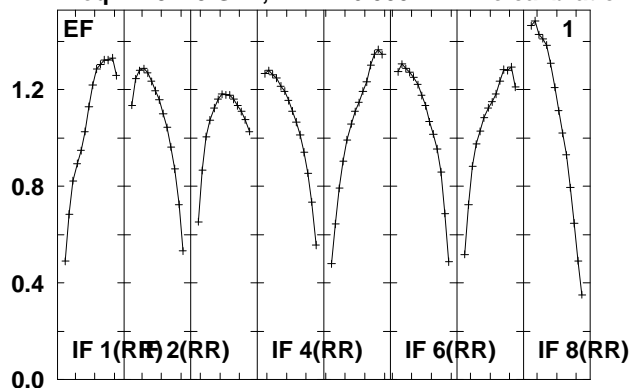

Lower frame: Real Jy
Total-power spectrum Antenna: *
Timerange: 00/09:25:00 to 00/09:32:38

Plot file version 13 created 08-JUL-2010 13:07:58

J0731+24 EM079.UVDATA.1

Freq = 4.9415 GHz, Bw = 16.000 MH No calibration applied and no bandpass applied

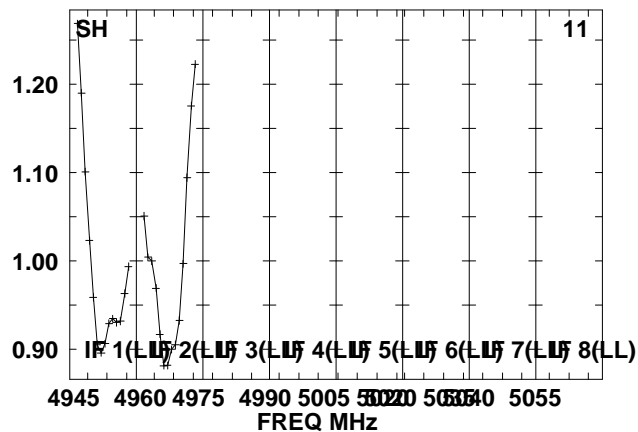
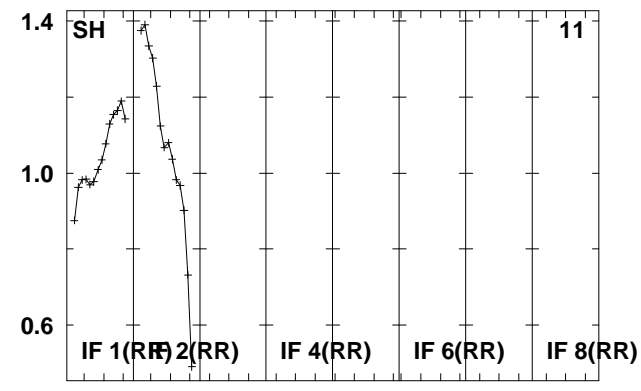
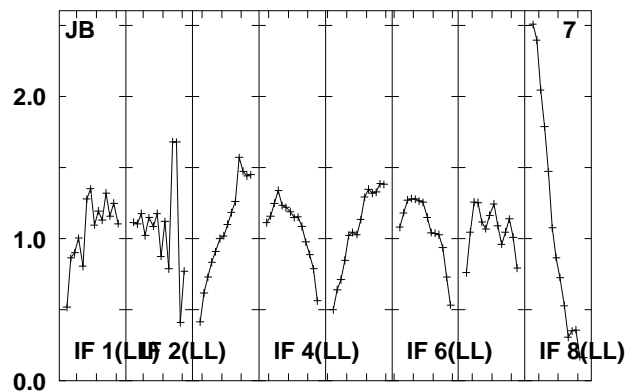
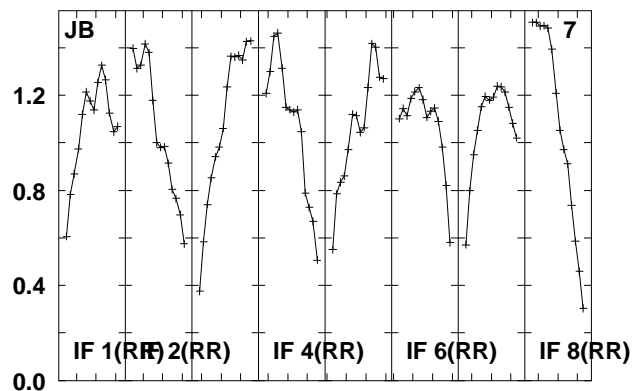
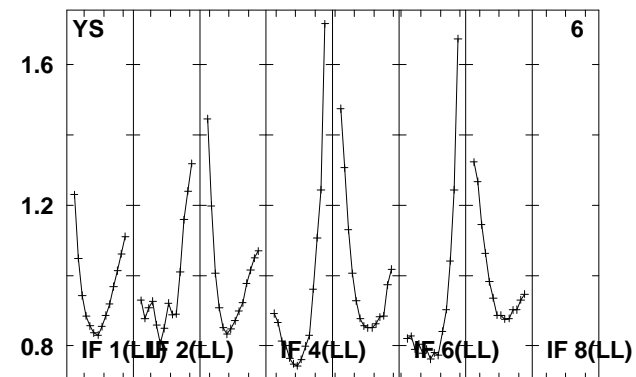
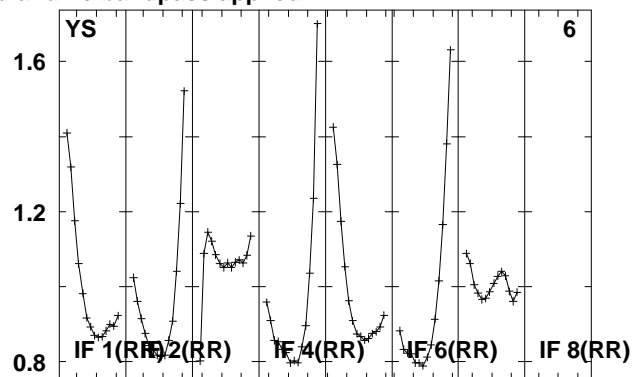
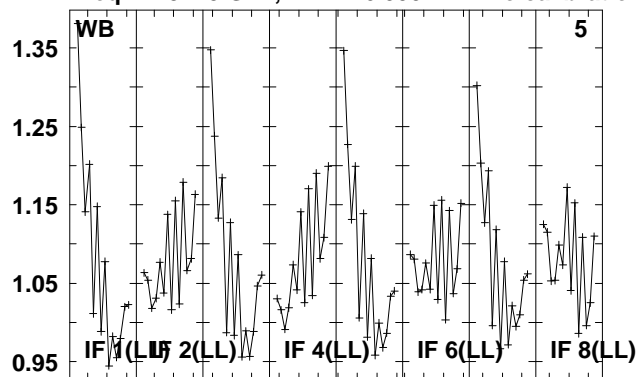

4945 4960 4975 4990 5005 5020 5035 5050 5055
FREQ MHz

Lower frame: Real Jy

Total-power spectrum Antenna: *

Timerange: 00/09:25:00 to 00/09:32:38

Plot file version 14 created 08-JUL-2010 13:08:00

B0726+25 EM079.UVDATA.1

Freq = 4.9415 GHz, Bw = 16.000 MH No calibration applied and no bandpass applied

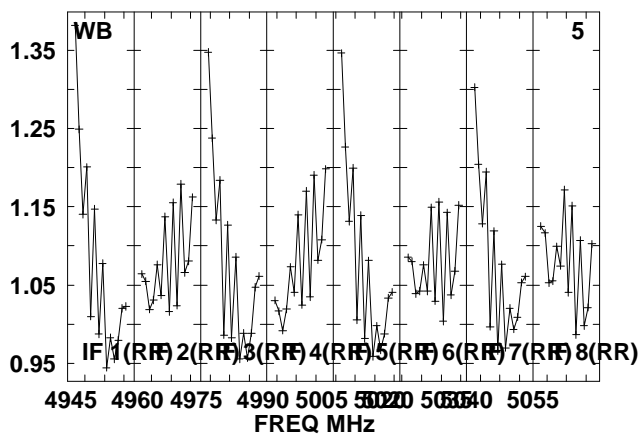
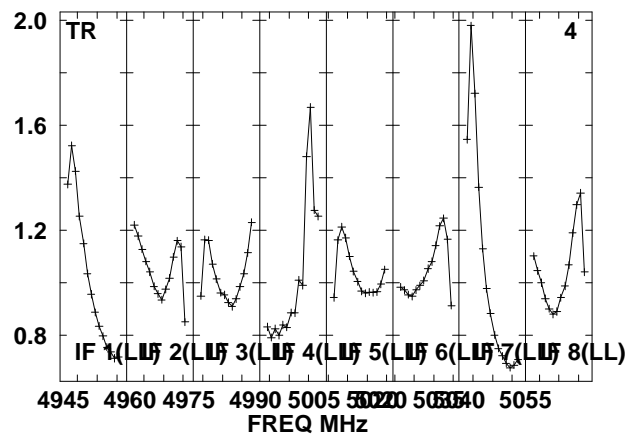
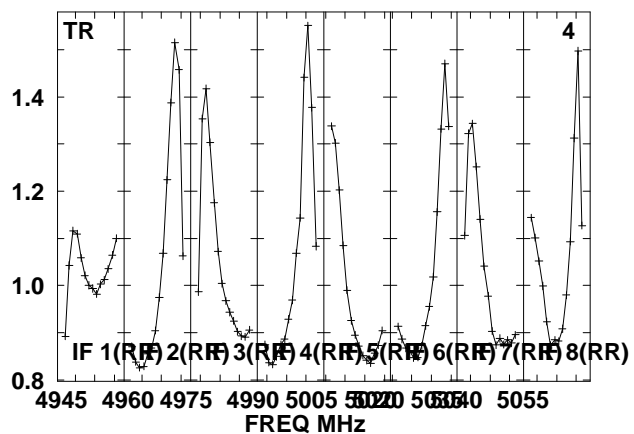
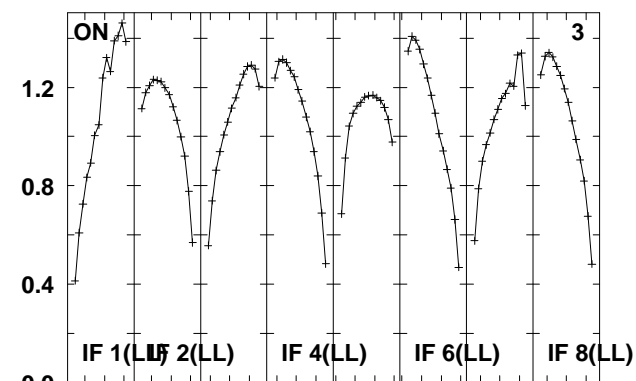
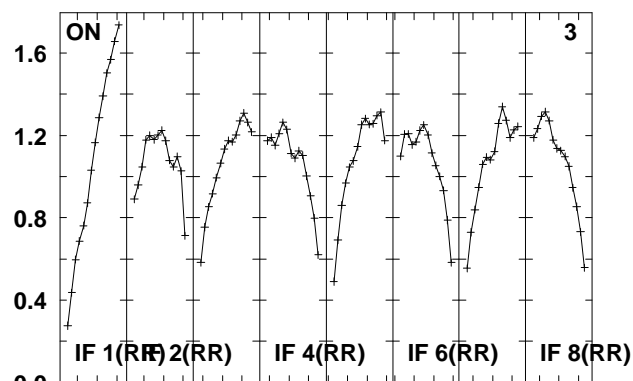
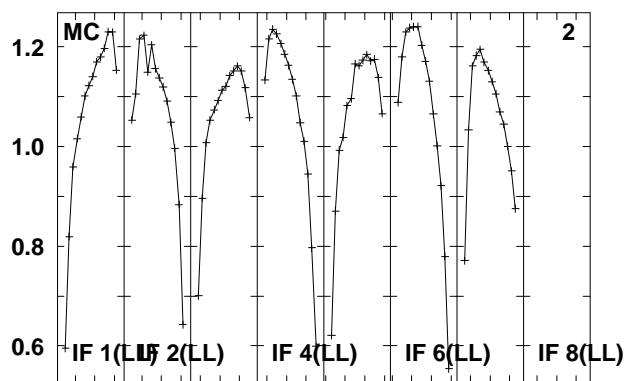
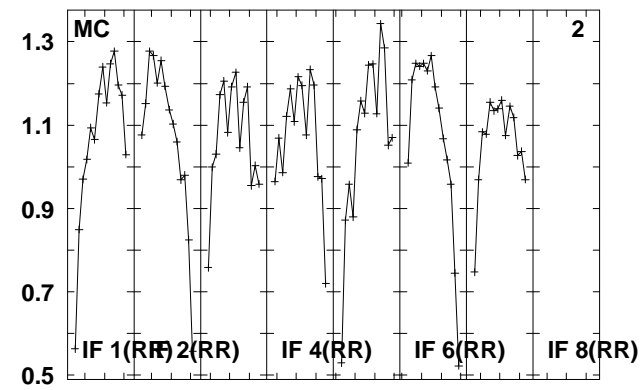
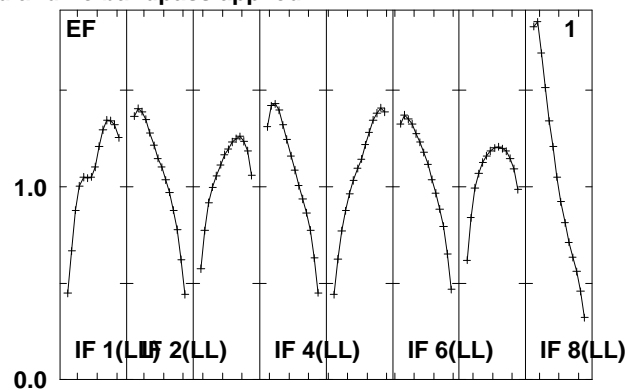
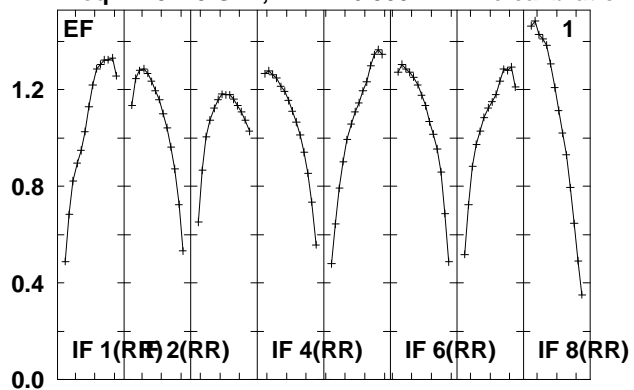

Lower frame: Real Jy

Total-power spectrum Antenna: *

Timerange: 00/09:32:40 to 00/09:43:24

Plot file version 15 created 08-JUL-2010 13:08:01

B0726+25 EM079.UVDATA.1

Freq = 4.9415 GHz, Bw = 16.000 MH No calibration applied and no bandpass applied

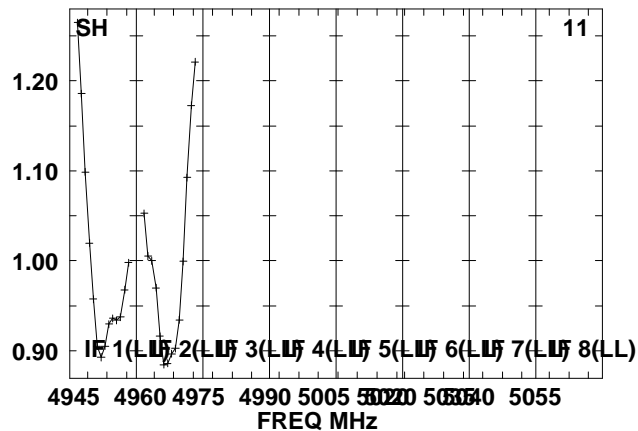
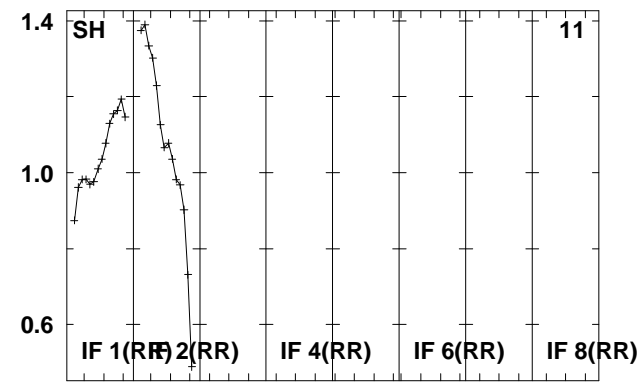
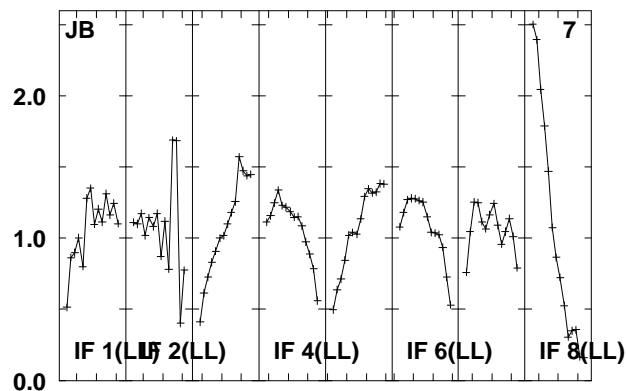
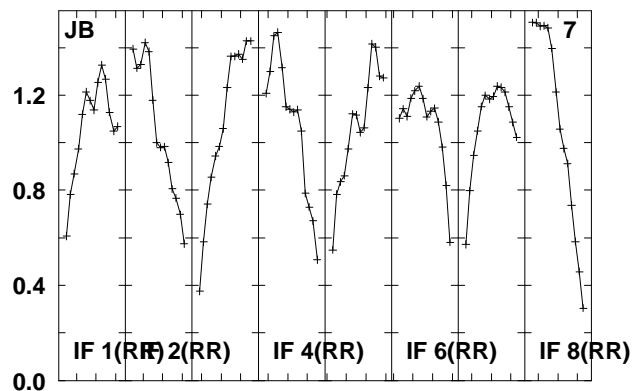
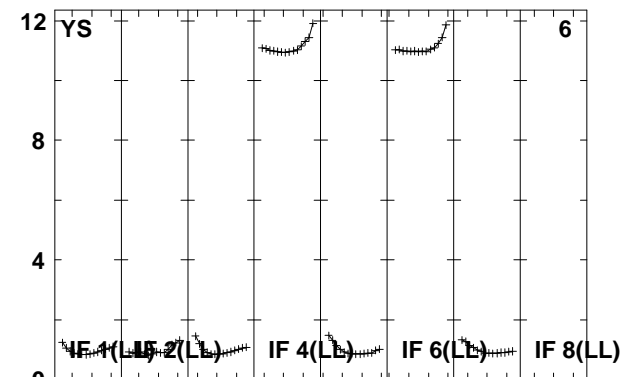
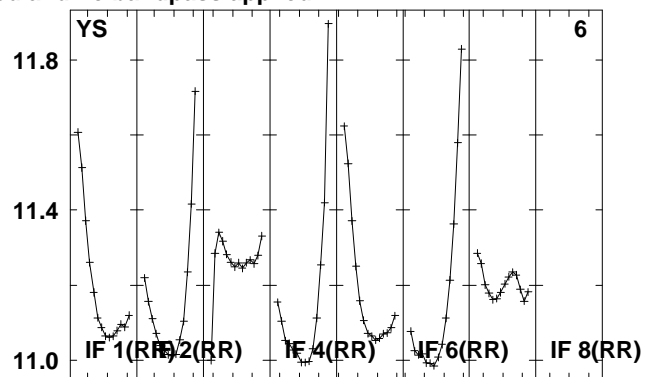
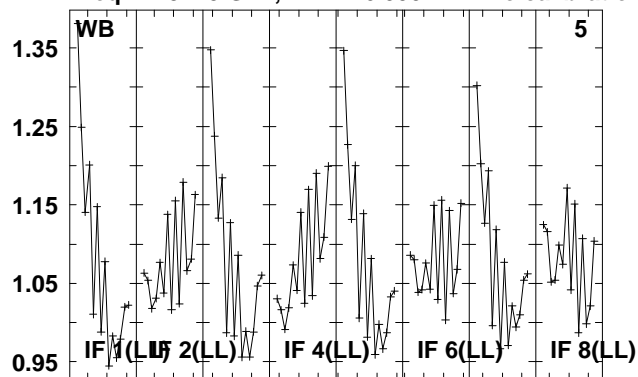

Lower frame: Real Jy

Total-power spectrum Antenna: *

Timerange: 00/09:32:40 to 00/09:43:24

Plot file version 16 created 08-JUL-2010 13:08:03

J0731+24 EM079.UVDATA.1

Freq = 4.9415 GHz, Bw = 16.000 MH No calibration applied and no bandpass applied

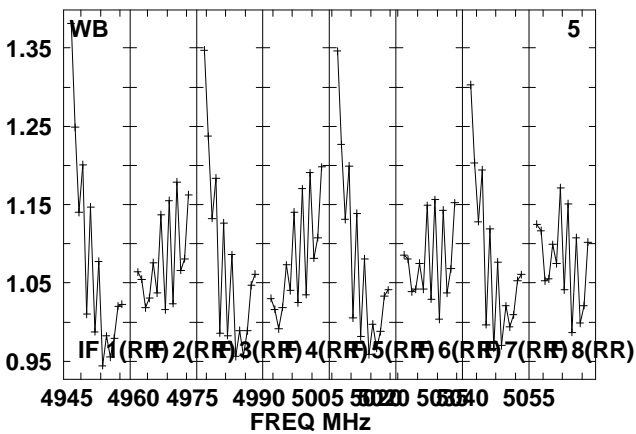
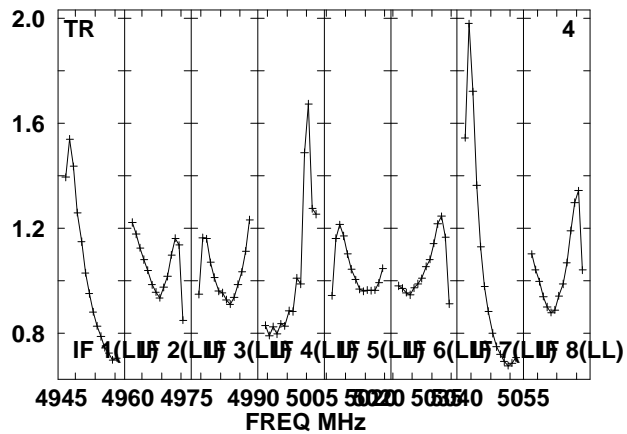
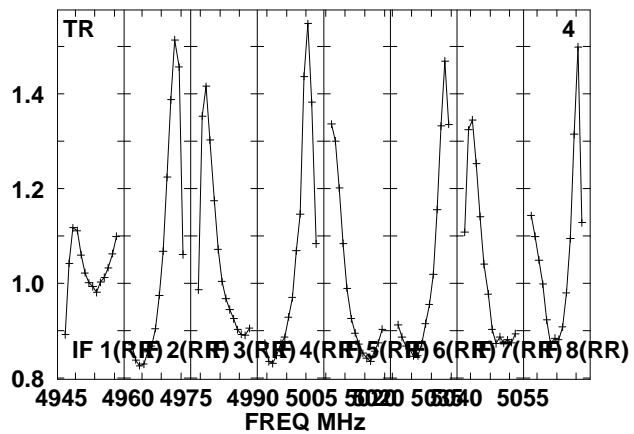
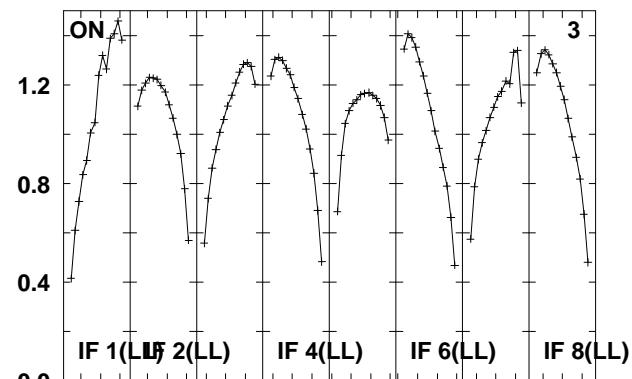
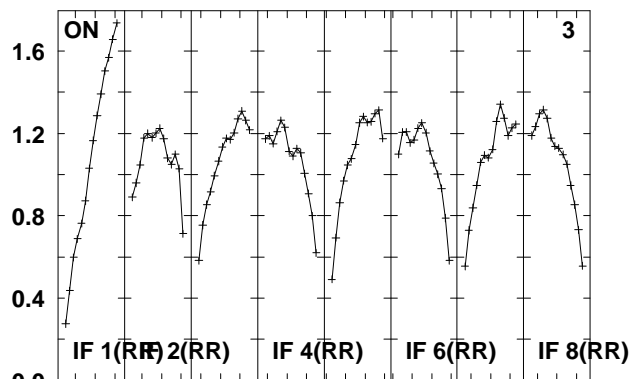
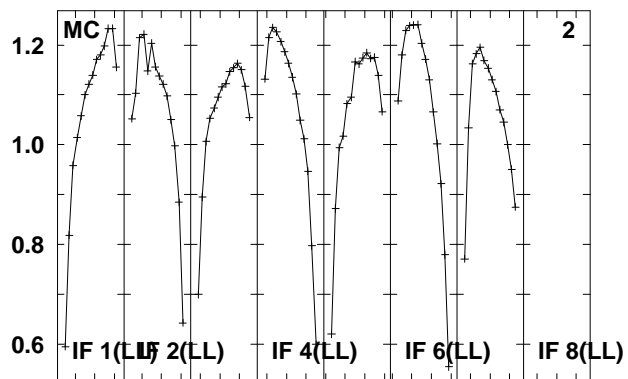
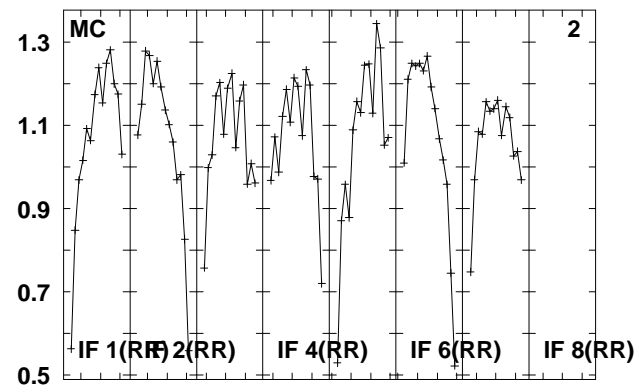
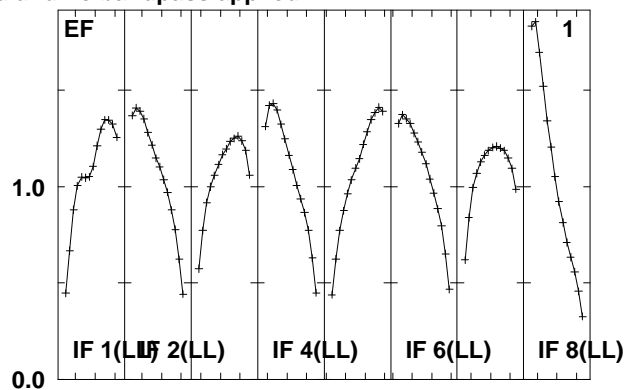
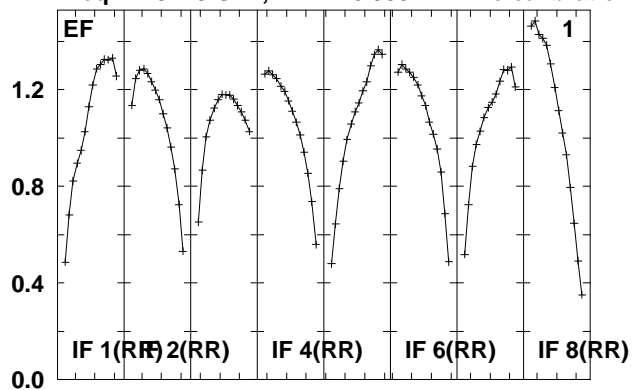

Lower frame: Real Jy
Total-power spectrum Antenna: *
Timerange: 00/09:43:26 to 00/09:45:24

Plot file version 17 created 08-JUL-2010 13:08:03

J0731+24 EM079.UVDATA.1

Freq = 4.9415 GHz, Bw = 16.000 MH No calibration applied and no bandpass applied

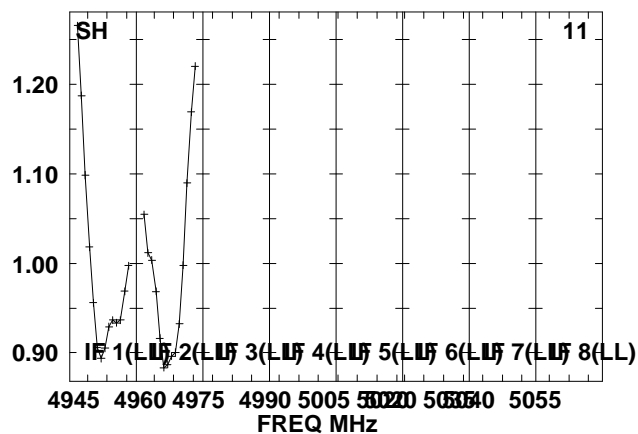
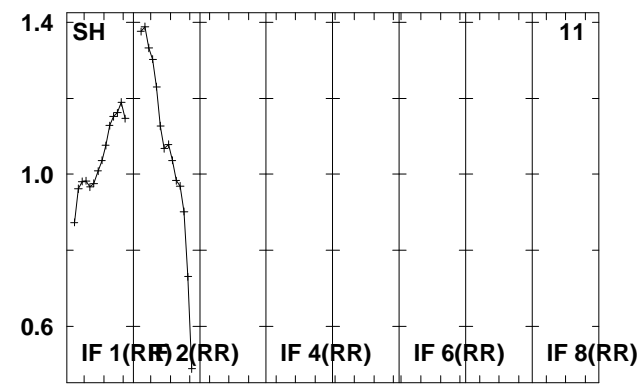
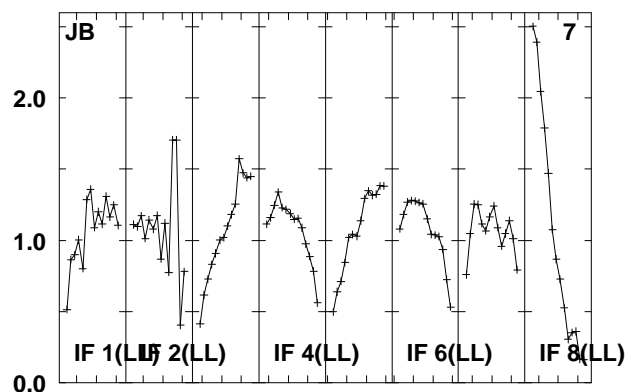
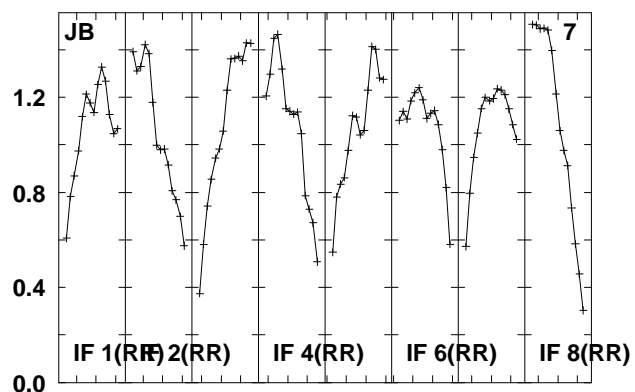
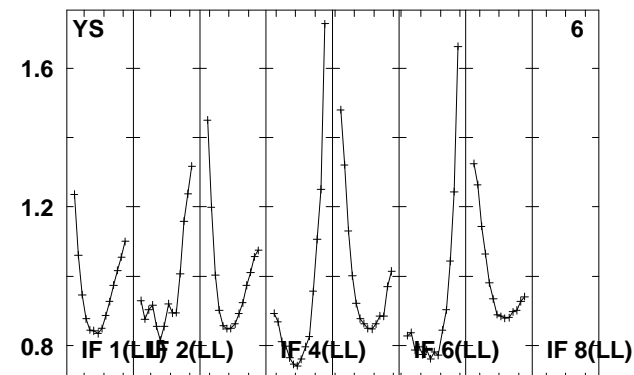
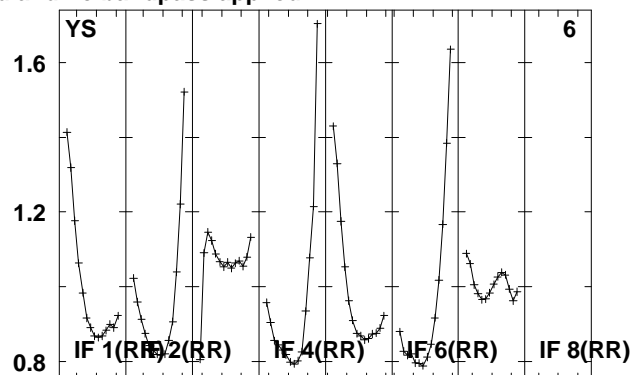
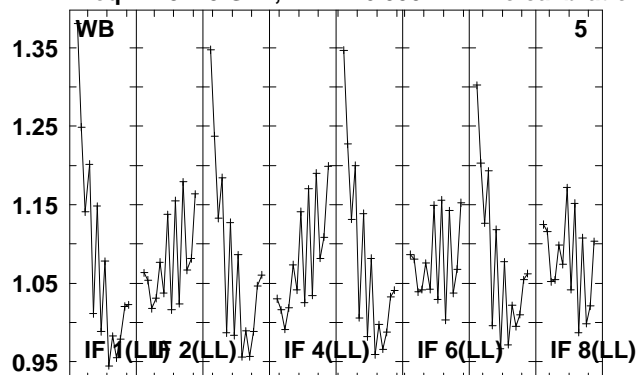

Lower frame: Real Jy

Total-power spectrum Antenna: *

Timerange: 00/09:43:26 to 00/09:45:24

Plot file version 18 created 08-JUL-2010 13:08:04

B0726+25 EM079.UVDATA.1

Freq = 4.9415 GHz, Bw = 16.000 MH No calibration applied and no bandpass applied

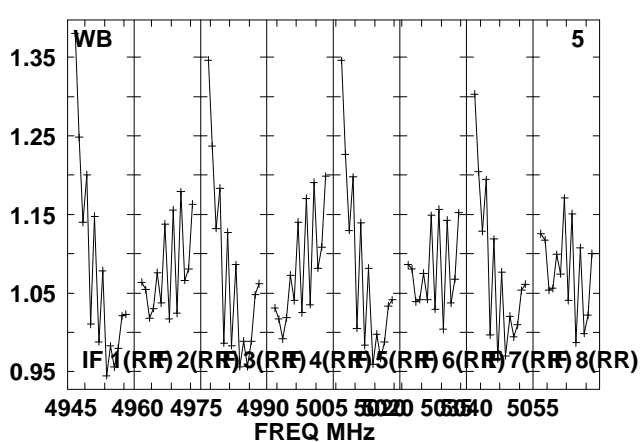
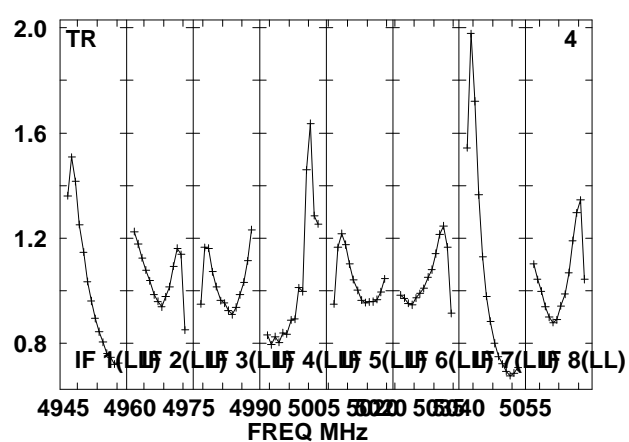
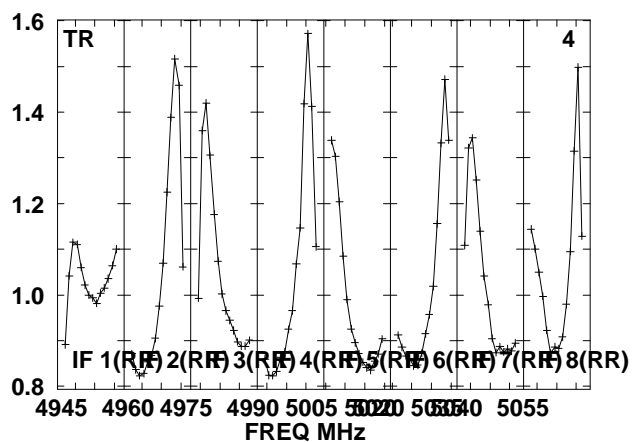
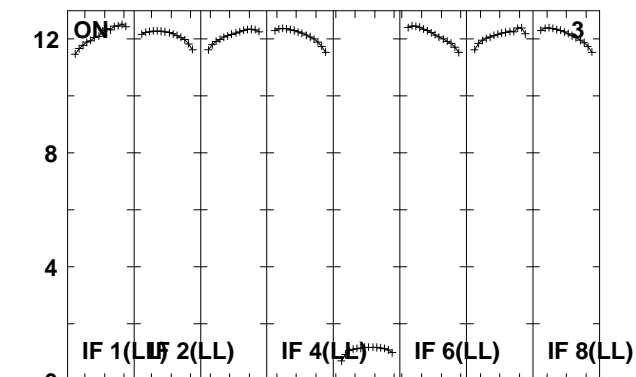
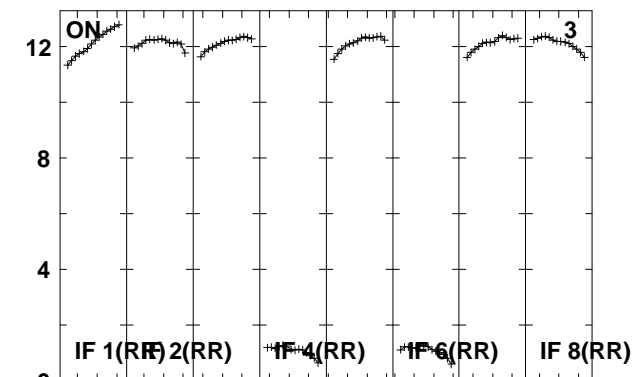
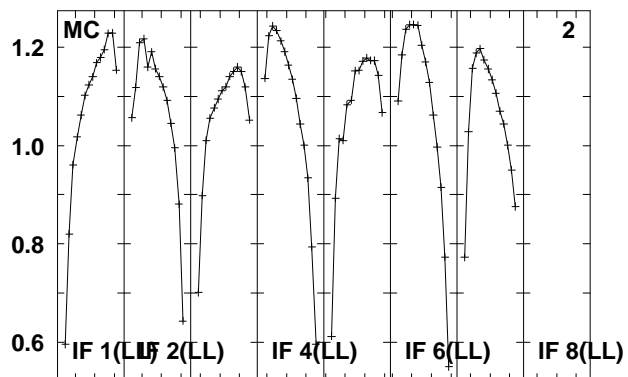
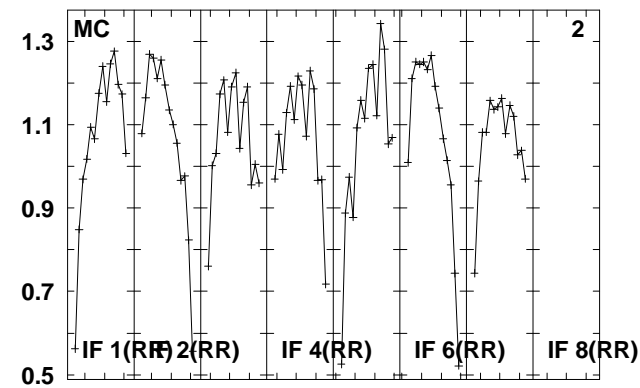
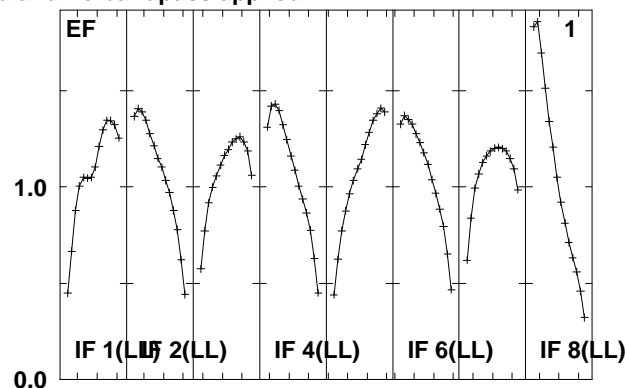
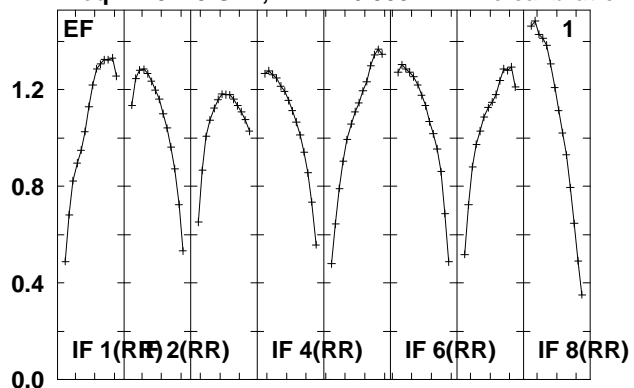

Lower frame: Real Jy
Total-power spectrum Antenna: *
Timerange: 00/09:45:26 to 00/09:56:08

Plot file version 19 created 08-JUL-2010 13:08:05

B0726+25 EM079.UVDATA.1

Freq = 4.9415 GHz, Bw = 16.000 MH No calibration applied and no bandpass applied

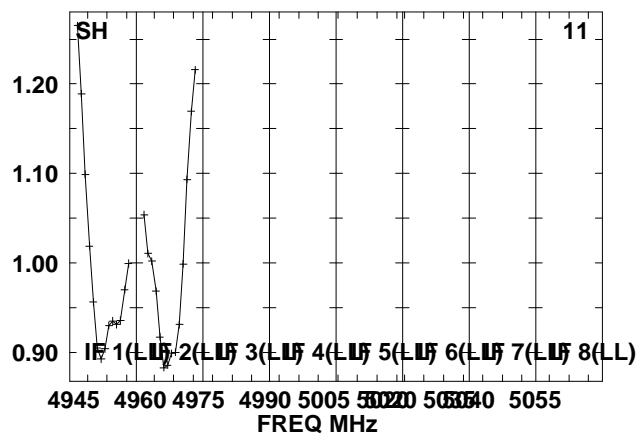
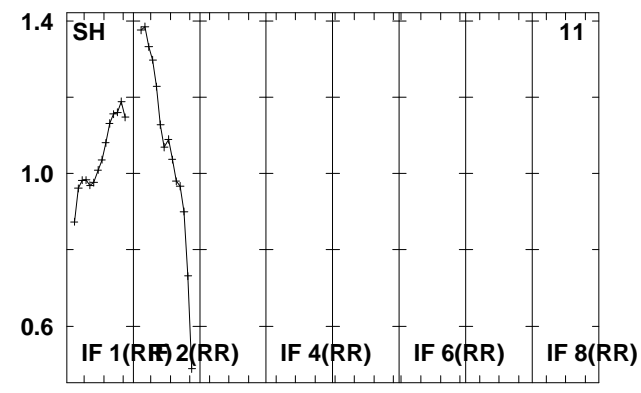
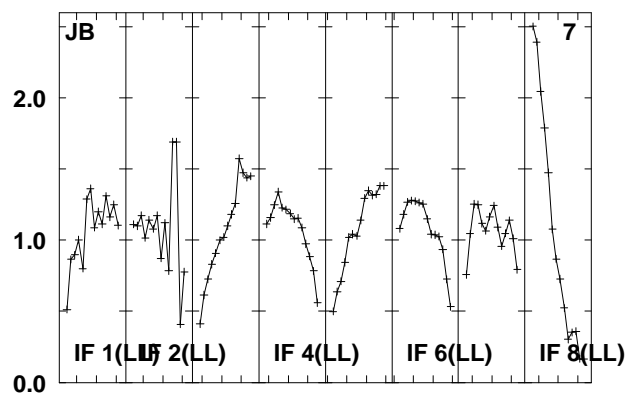
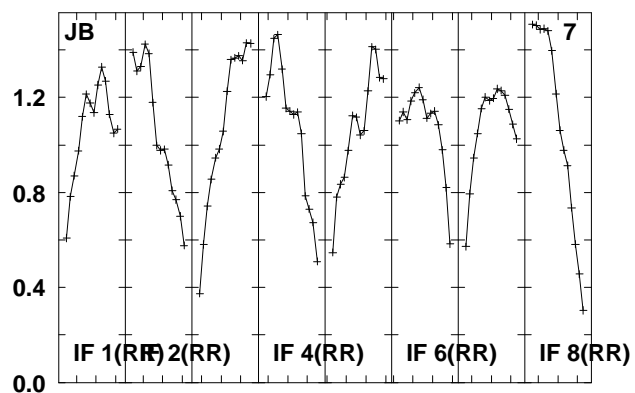
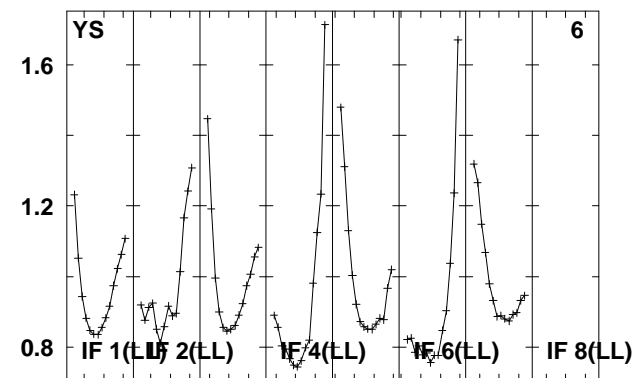
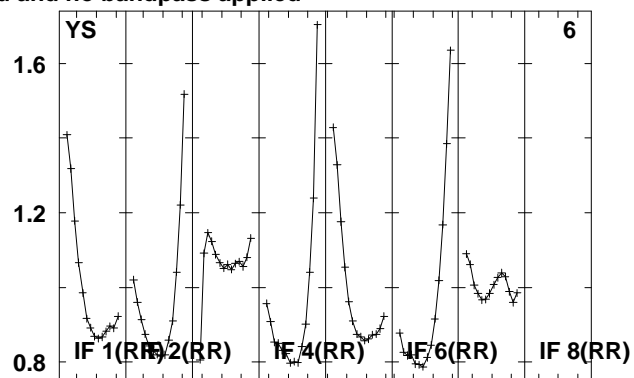
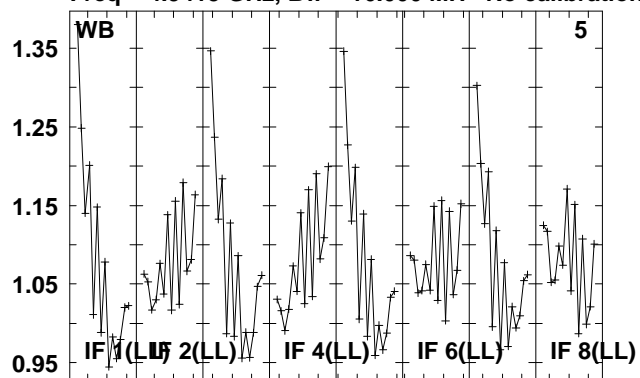

4945 4960 4975 4990 5005 5020 5035 5050 5055
FREQ MHz

Lower frame: Real Jy

Total-power spectrum Antenna: *

Timerange: 00/09:45:26 to 00/09:56:08

Plot file version 20 created 08-JUL-2010 13:08:07

J0731+24 EM079.UVDATA.1

Freq = 4.9415 GHz, Bw = 16.000 MH No calibration applied and no bandpass applied

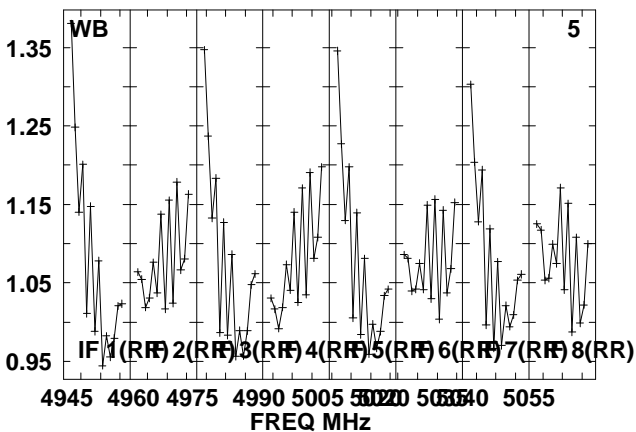
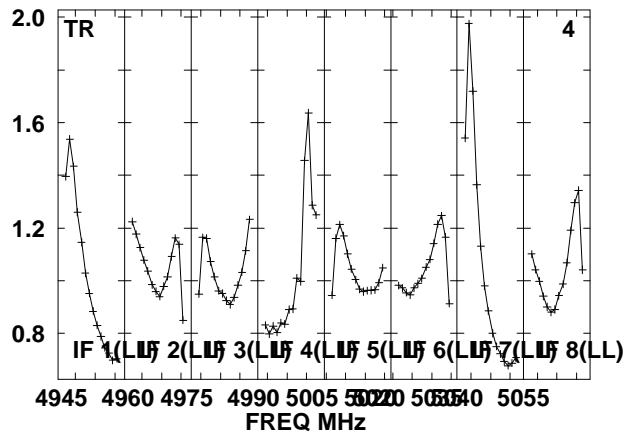
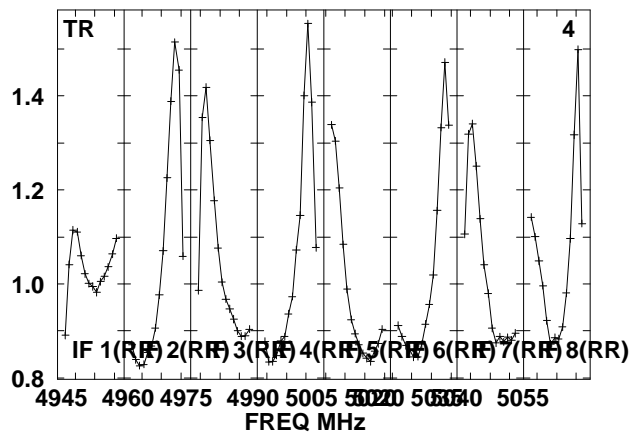
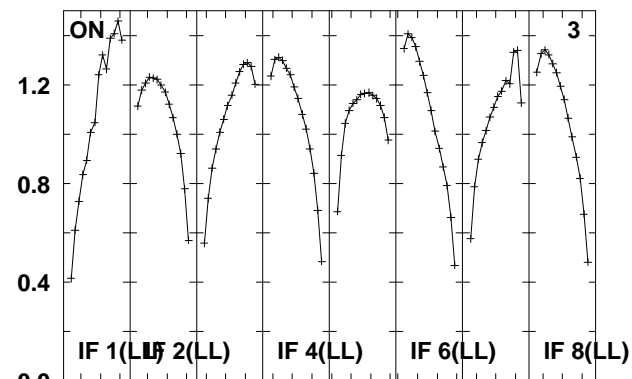
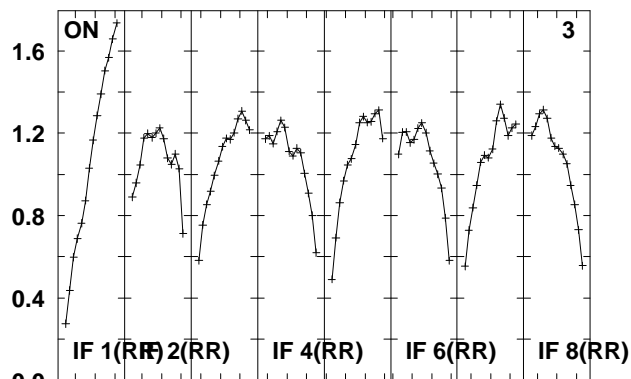
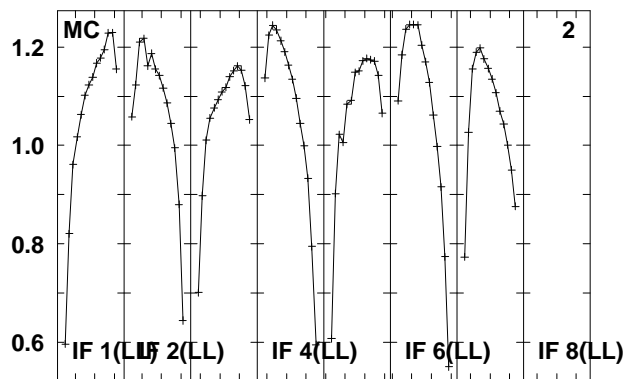
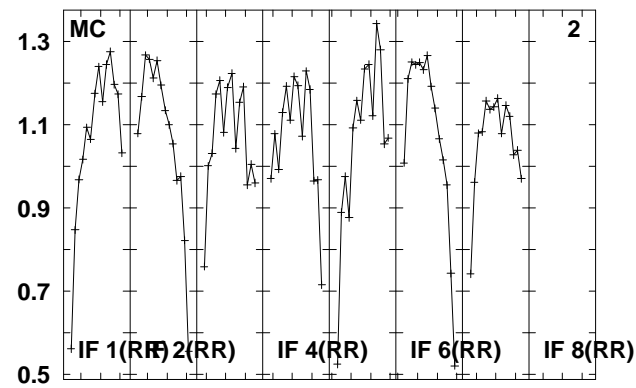
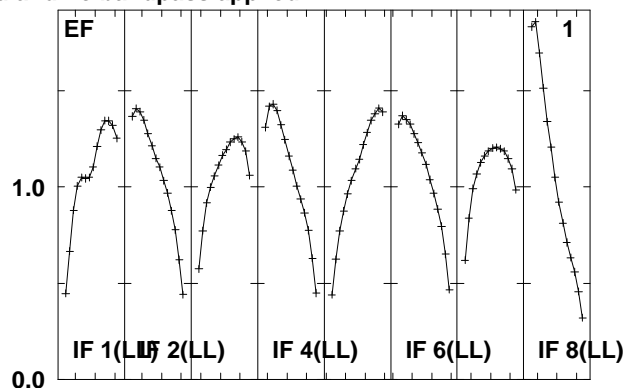
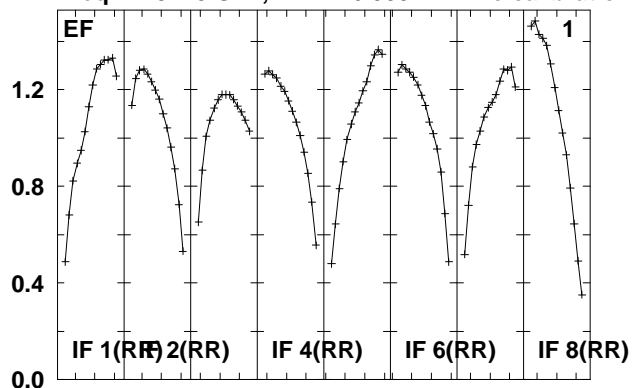

Lower frame: Real Jy
Total-power spectrum Antenna: *
Timerange: 00/09:56:10 to 00/09:58:08

Plot file version 21 created 08-JUL-2010 13:08:08

J0731+24 EM079.UVDATA.1

Freq = 4.9415 GHz, Bw = 16.000 MH No calibration applied and no bandpass applied

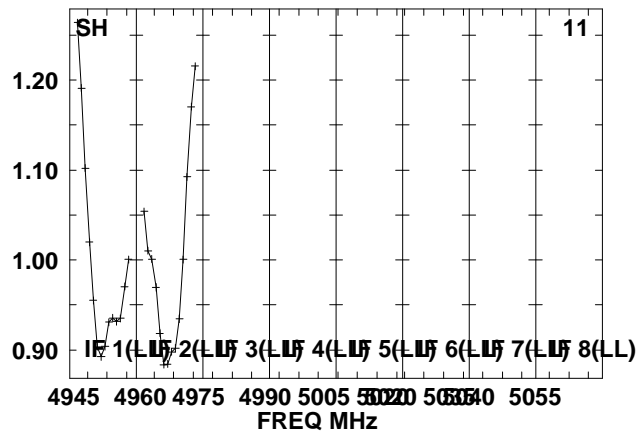
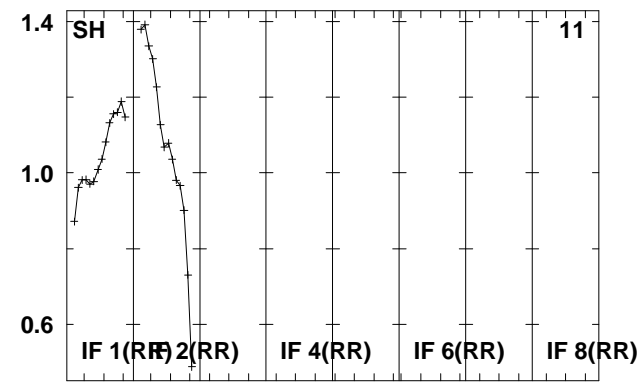
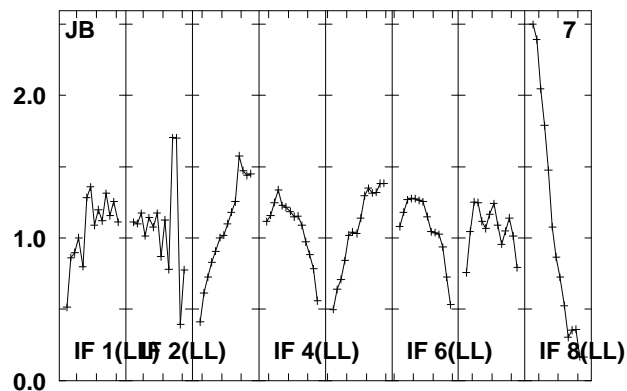
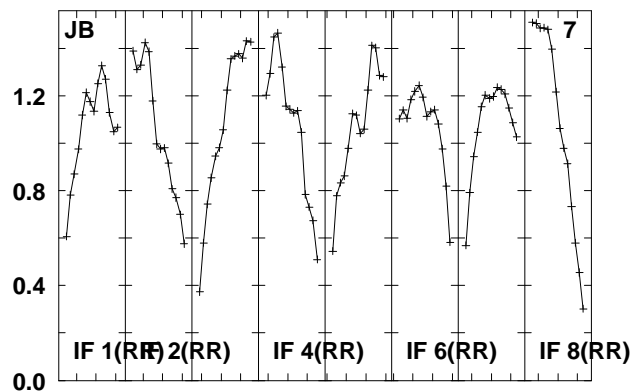
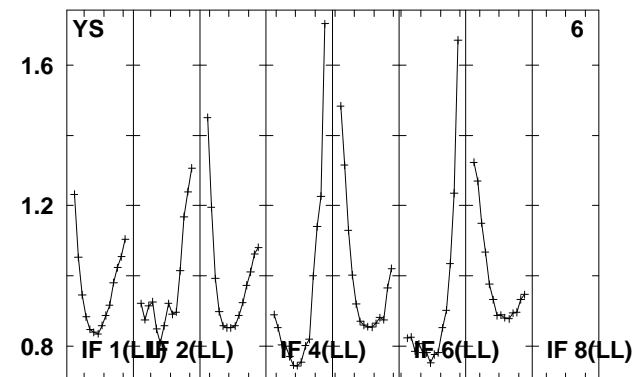
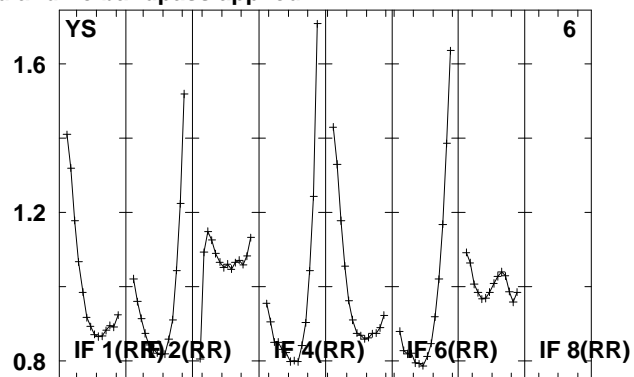
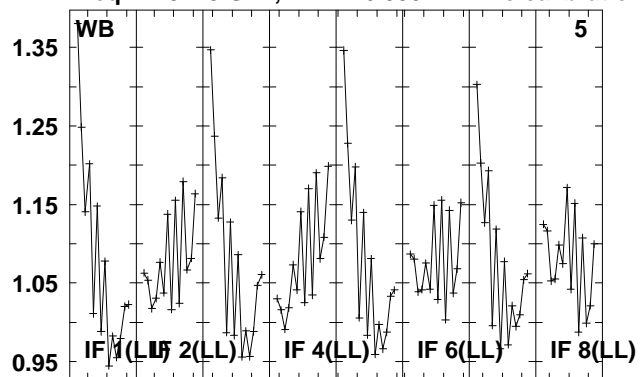

4945 4960 4975 4990 5005 5020 5035 5050 5055
FREQ MHz

Lower frame: Real Jy

Total-power spectrum Antenna: *

Timerange: 00/09:56:10 to 00/09:58:08

Plot file version 22 created 08-JUL-2010 13:08:09

B0726+25 EM079.UVDATA.1

Freq = 4.9415 GHz, Bw = 16.000 MH No calibration applied and no bandpass applied

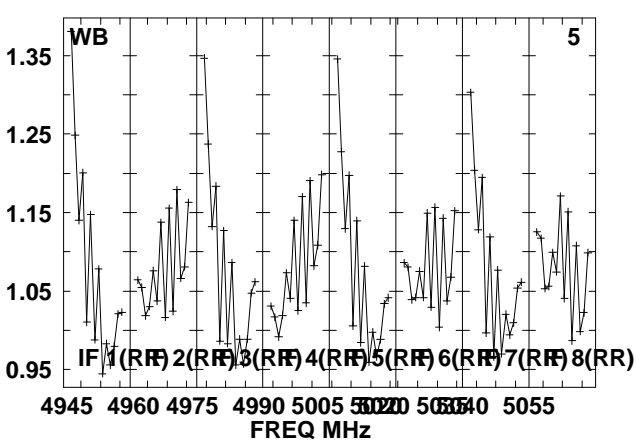
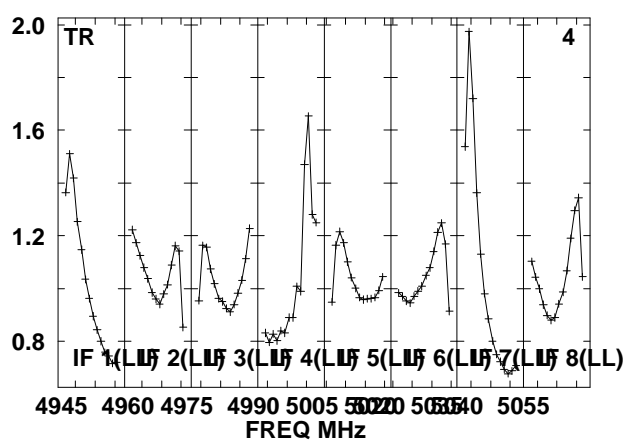
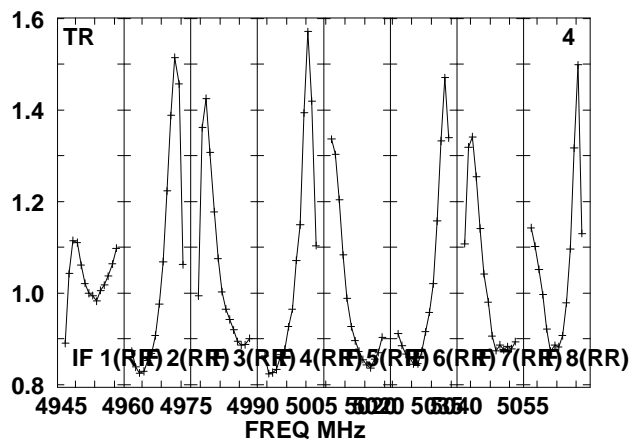
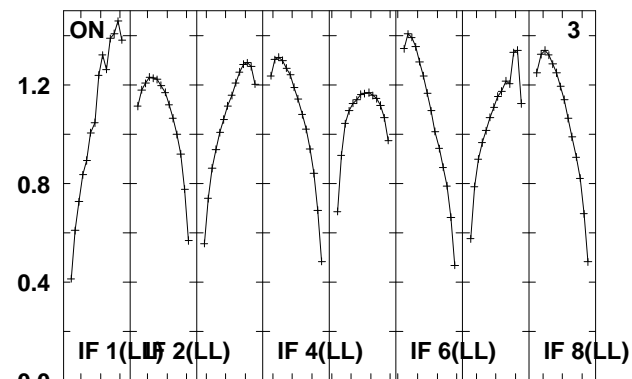
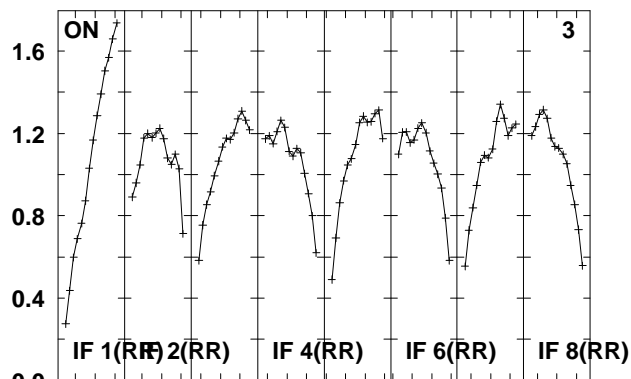
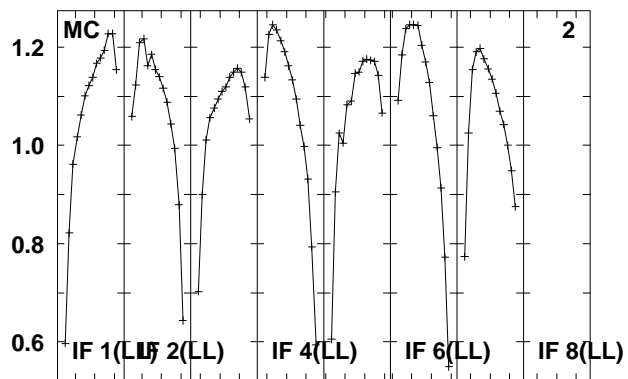
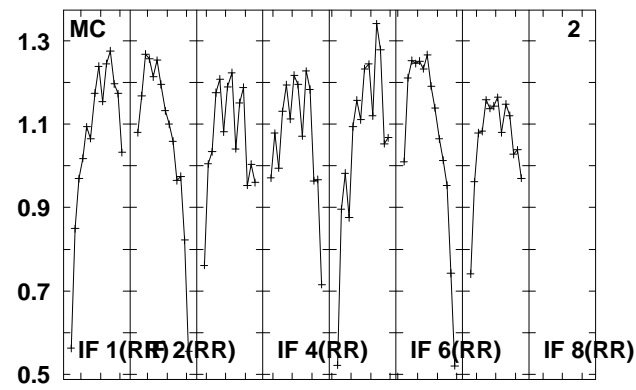
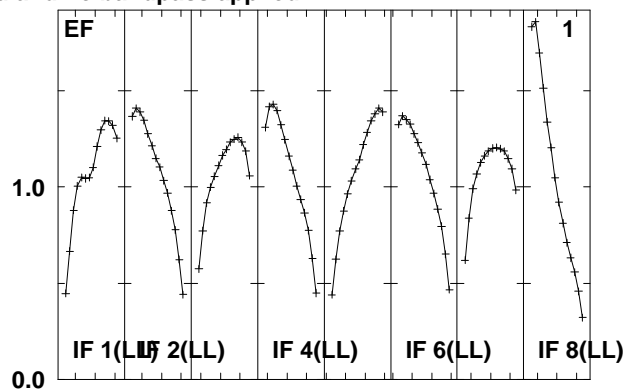
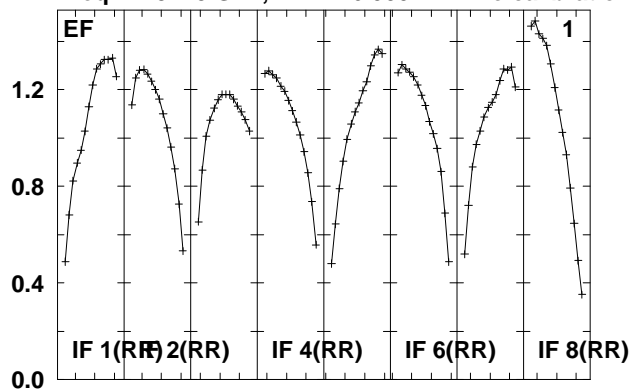

Lower frame: Real Jy
Total-power spectrum Antenna: *
Timerange: 00/09:58:10 to 00/10:08:54

Plot file version 23 created 08-JUL-2010 13:08:10

B0726+25 EM079.UVDATA.1

Freq = 4.9415 GHz, Bw = 16.000 MH No calibration applied and no bandpass applied

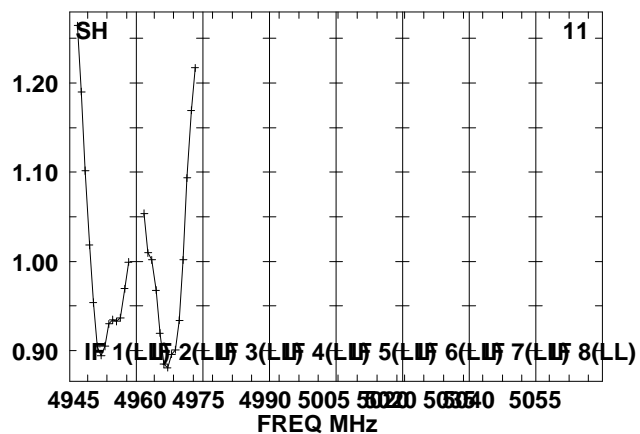
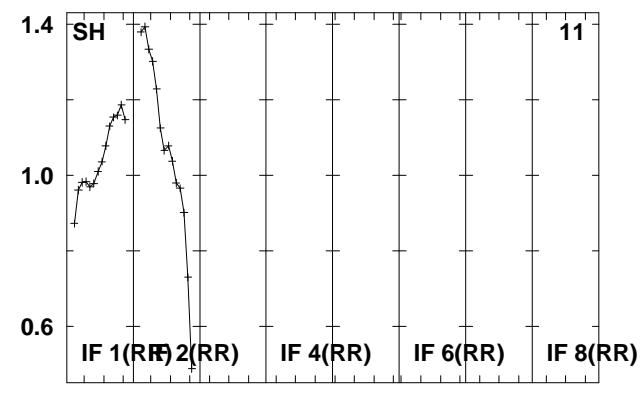
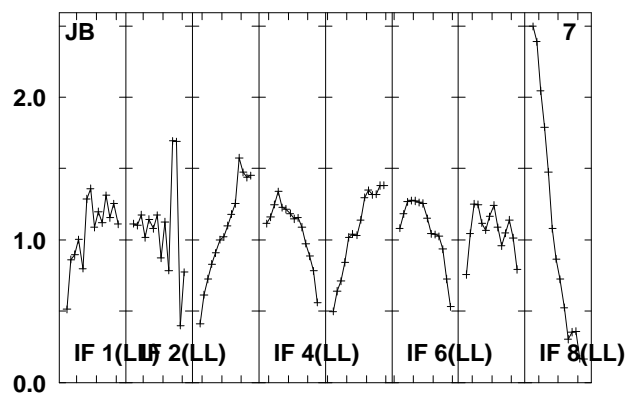
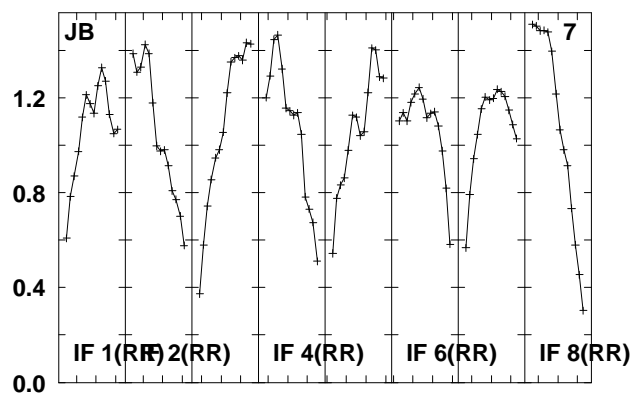
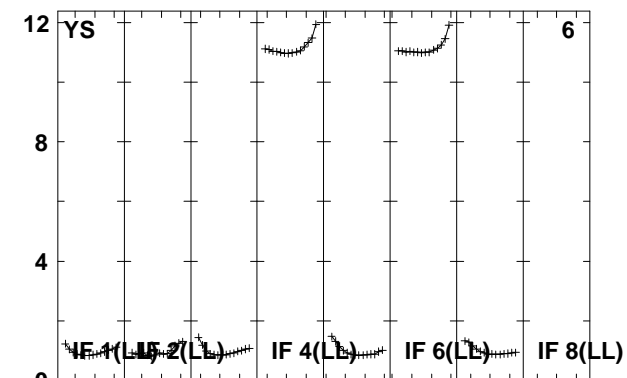
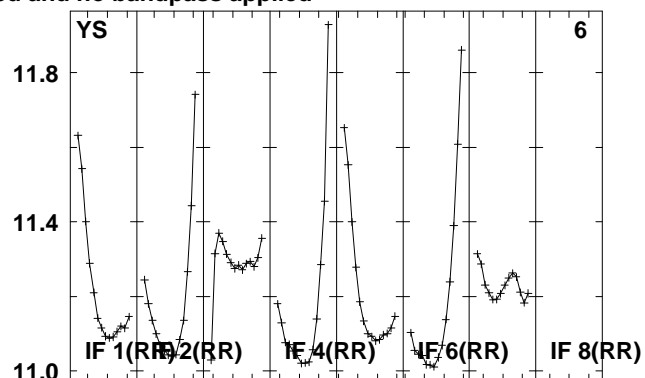
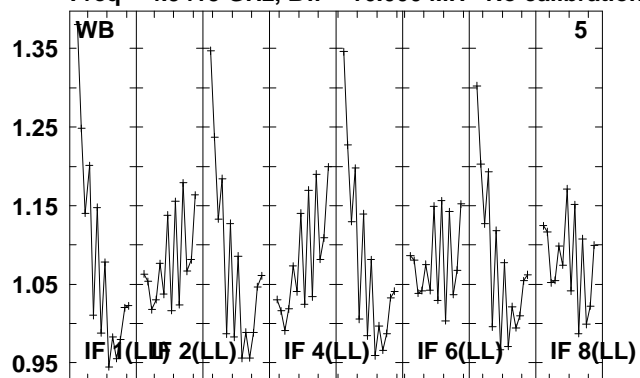

Lower frame: Real Jy

Total-power spectrum Antenna: *

Timerange: 00/09:58:10 to 00/10:08:54

Plot file version 24 created 08-JUL-2010 13:08:12

J0731+24 EM079.UVDATA.1

Freq = 4.9415 GHz, Bw = 16.000 MH No calibration applied and no bandpass applied

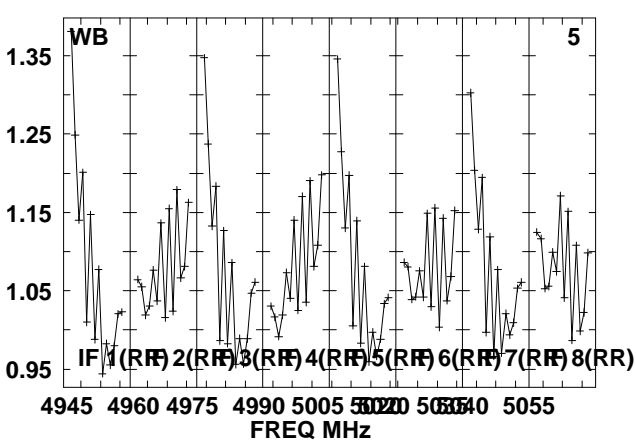
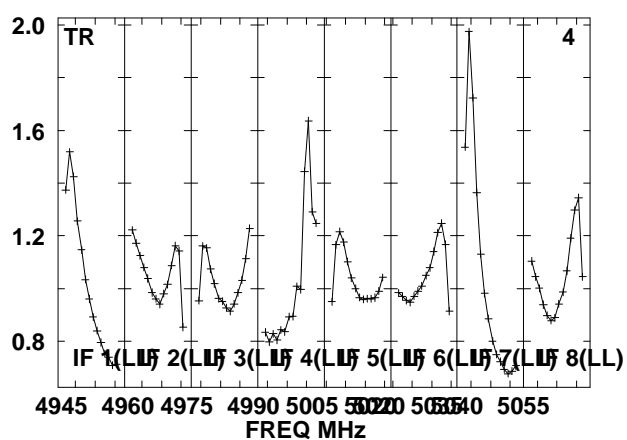
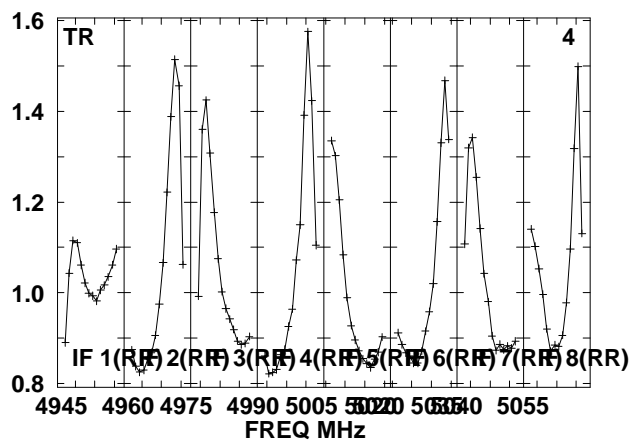
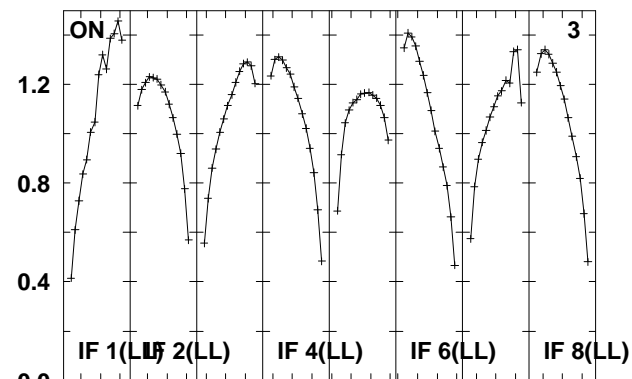
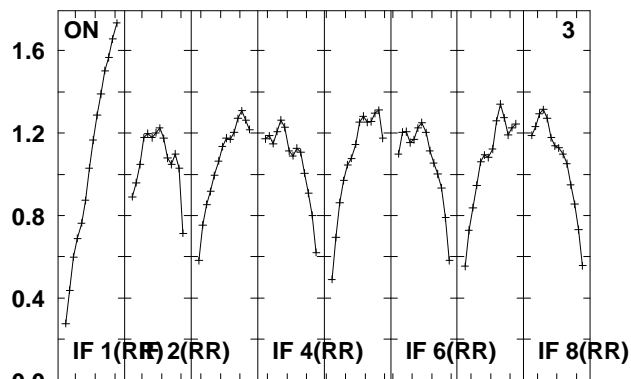
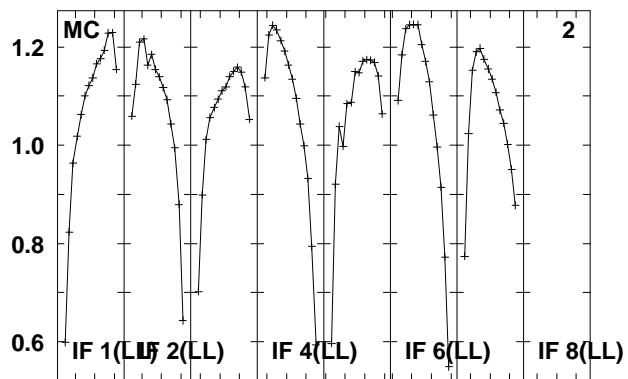
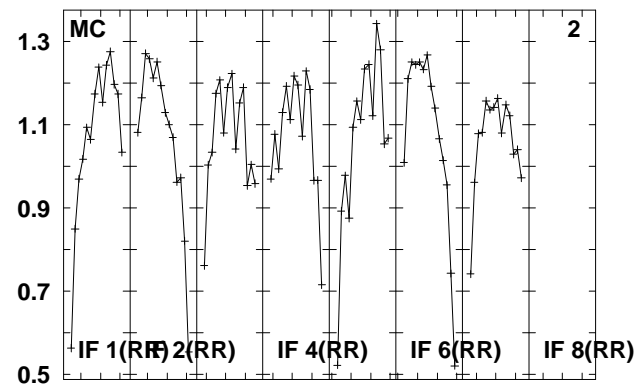
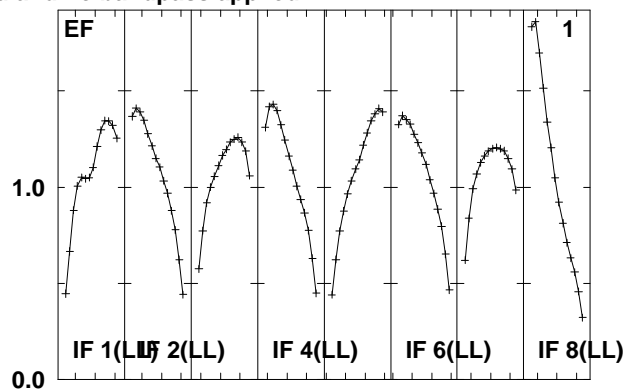
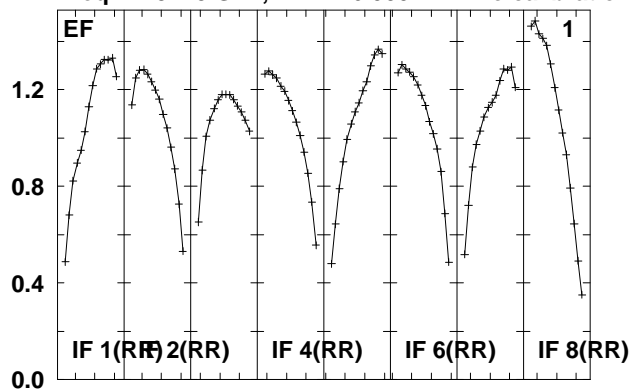

Lower frame: Real Jy
Total-power spectrum Antenna: *
Timerange: 00/10:08:56 to 00/10:10:54

Plot file version 25 created 08-JUL-2010 13:08:12

J0731+24 EM079.UVDATA.1

Freq = 4.9415 GHz, Bw = 16.000 MH No calibration applied and no bandpass applied

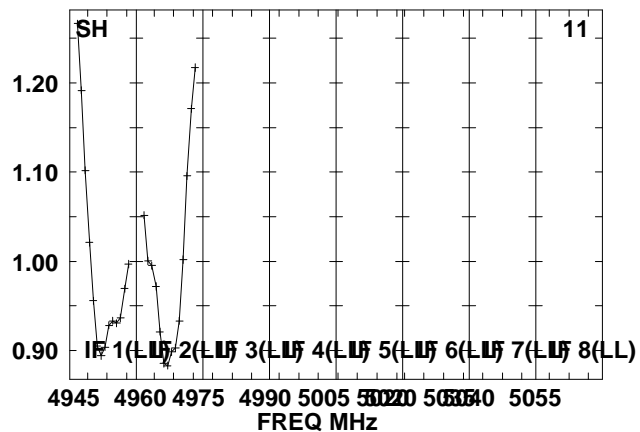
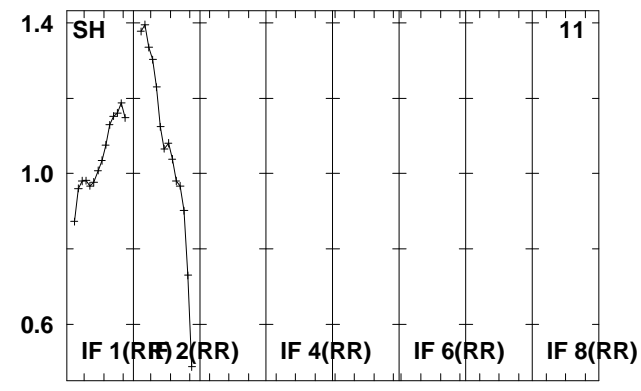
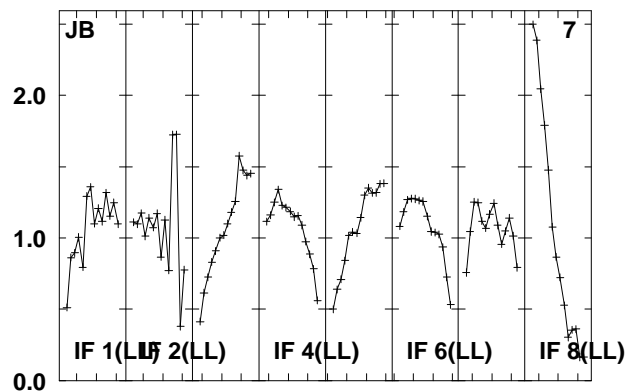
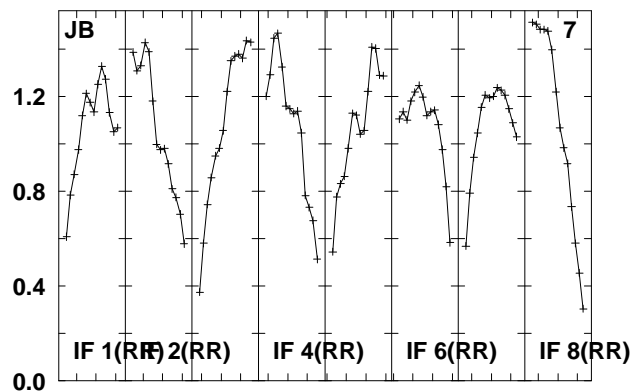
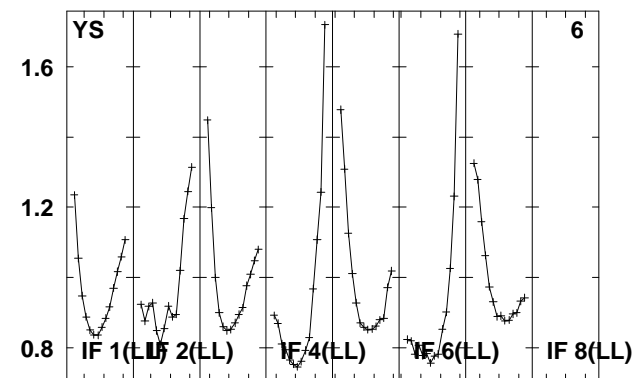
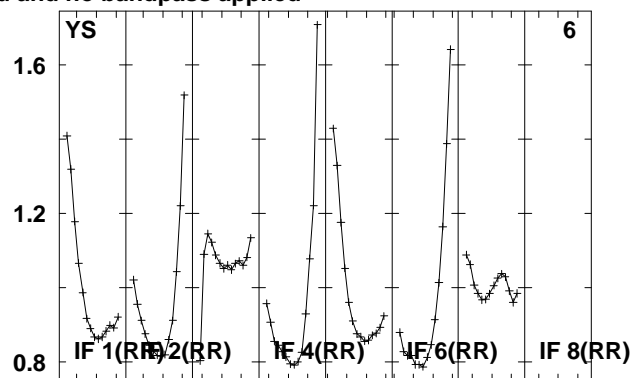
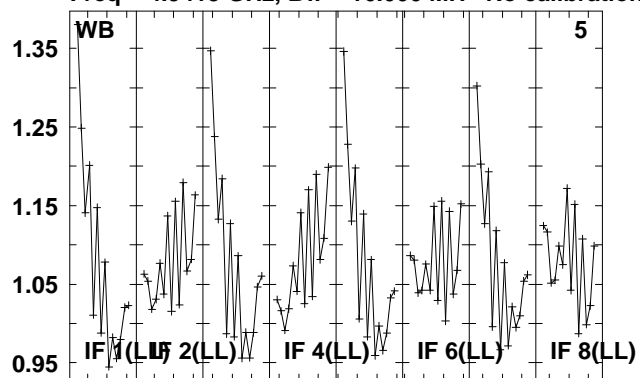

Lower frame: Real Jy

Total-power spectrum Antenna: *

Timerange: 00/10:08:56 to 00/10:10:54

Plot file version 26 created 08-JUL-2010 13:08:13

B0726+25 EM079.UVDATA.1

Freq = 4.9415 GHz, Bw = 16.000 MH No calibration applied and no bandpass applied

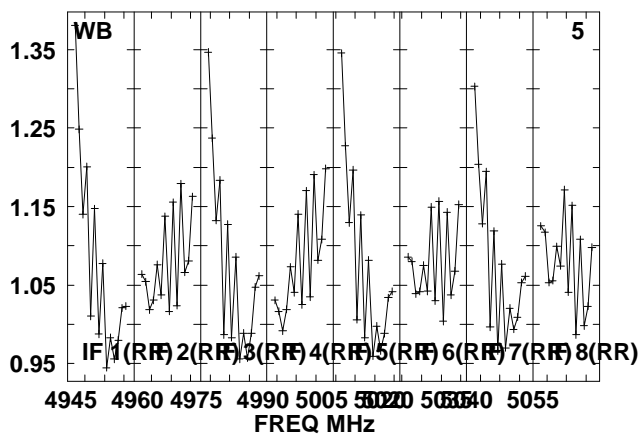
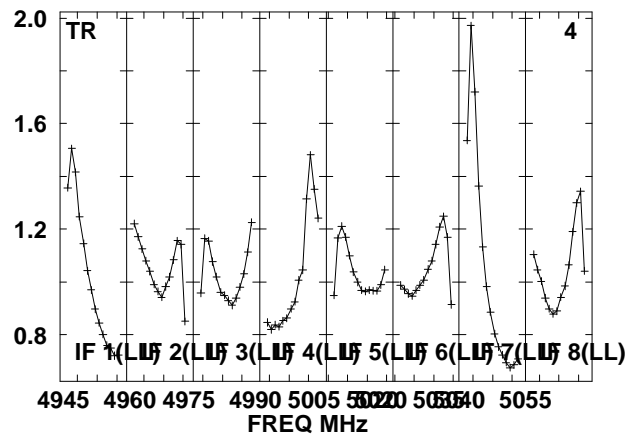
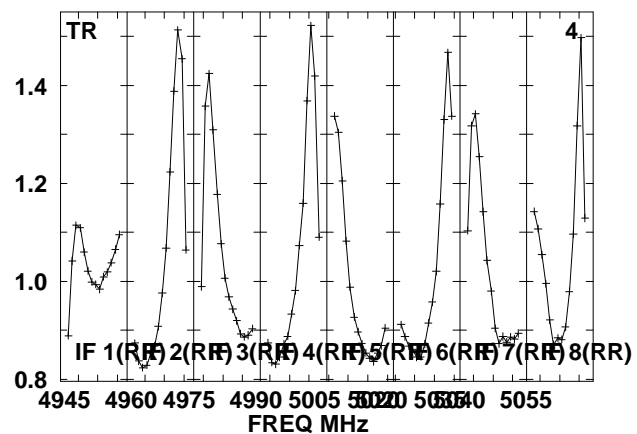
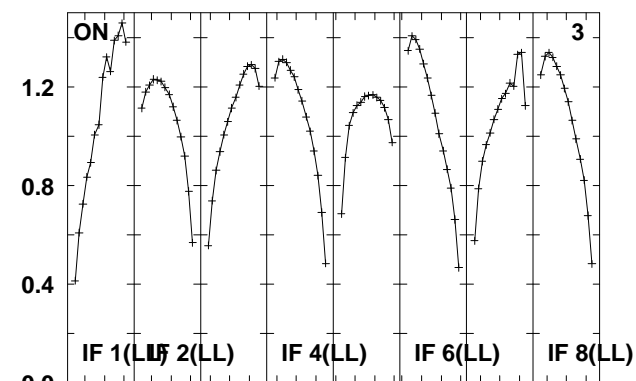
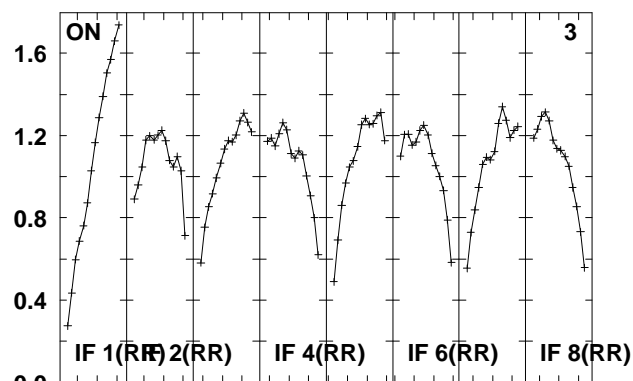
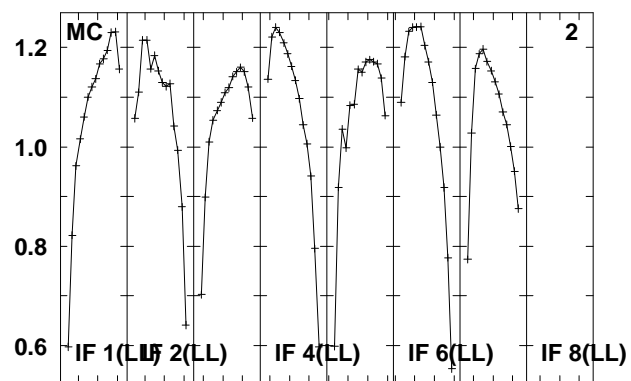
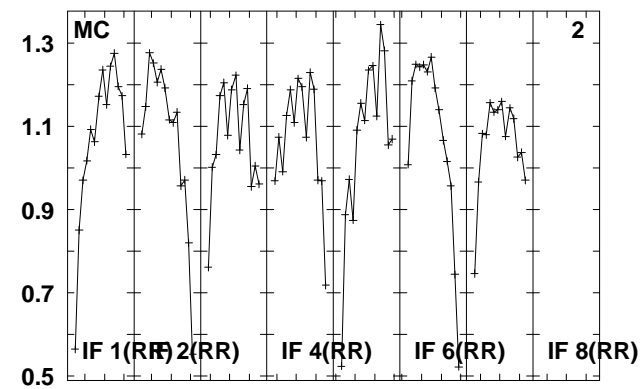
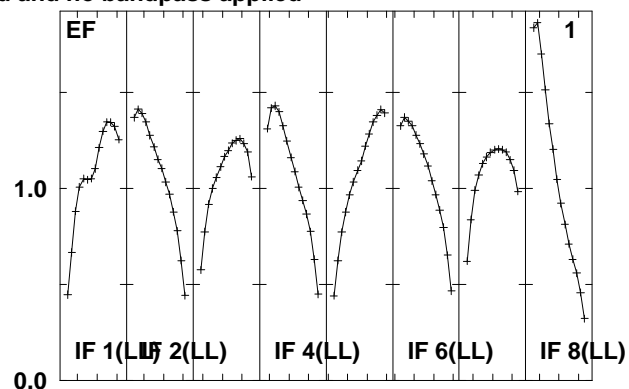
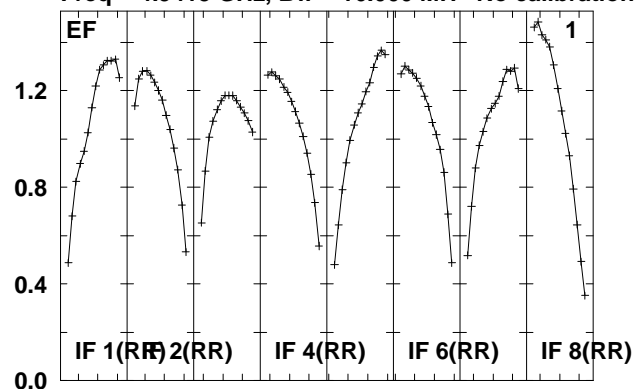

Lower frame: Real Jy
Total-power spectrum Antenna: *
Timerange: 00/10:10:56 to 00/10:21:38

Plot file version 27 created 08-JUL-2010 13:08:14
 B0726+25 EM079.UVDATA.1
 Freq = 4.9415 GHz, Bw = 16.000 MH No calibration applied and no bandpass applied

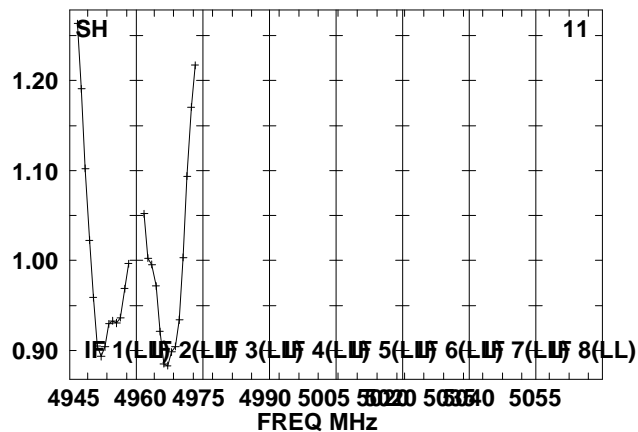
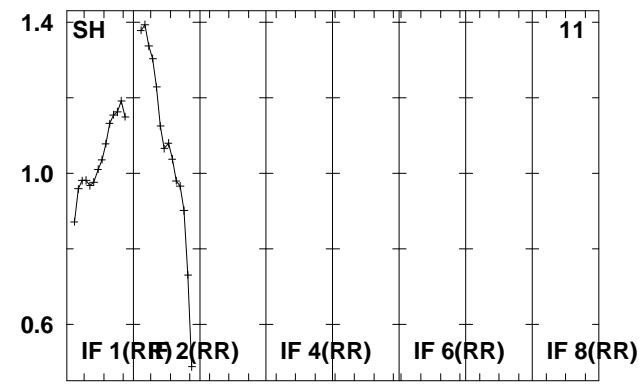
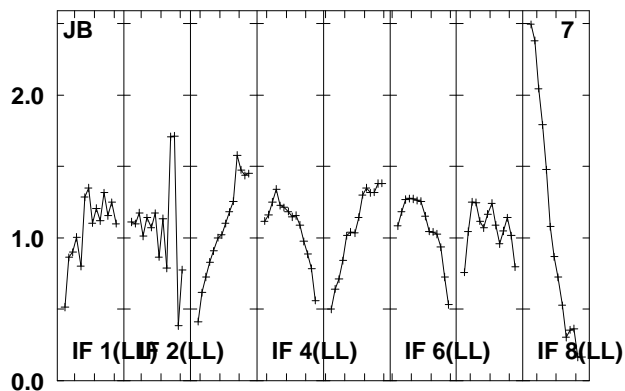
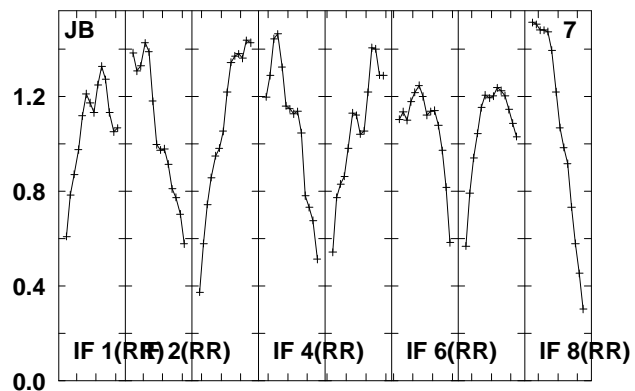
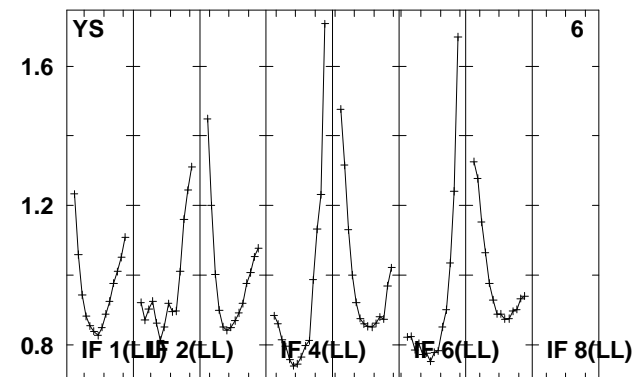
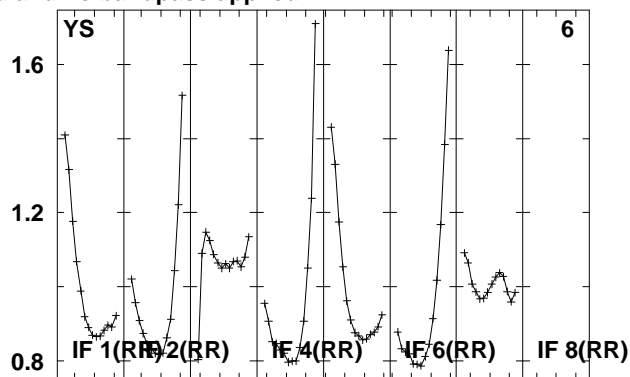
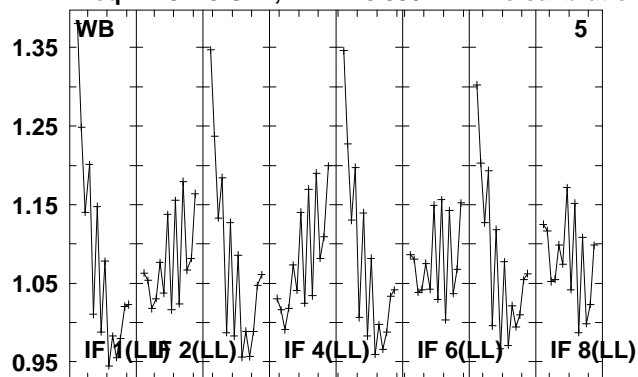

4945 4960 4975 4990 5005 5020 5035 5050 5055
 FREQ MHz

Lower frame: Real Jy
 Total-power spectrum Antenna: *
 Timerange: 00/10:10:56 to 00/10:21:38

Plot file version 28 created 08-JUL-2010 13:08:15

J0731+24 EM079.UVDATA.1

Freq = 4.9415 GHz, Bw = 16.000 MH No calibration applied and no bandpass applied

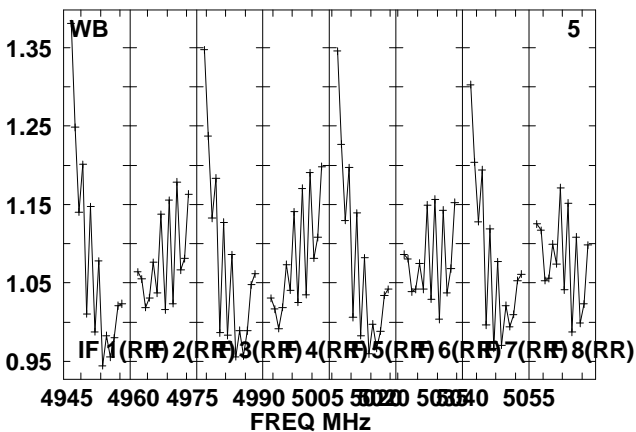
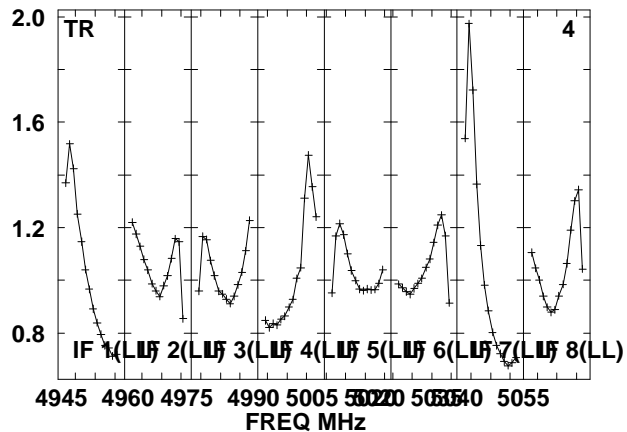
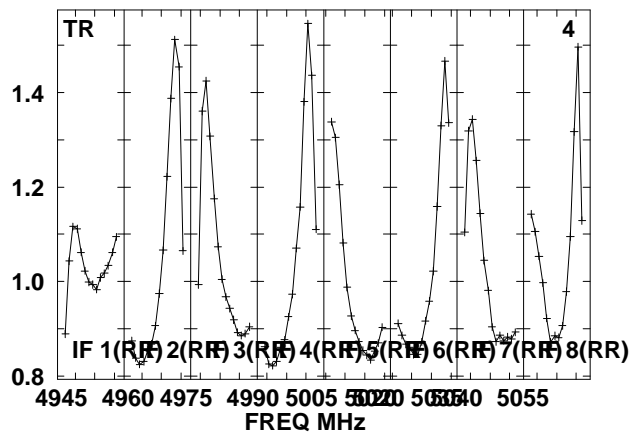
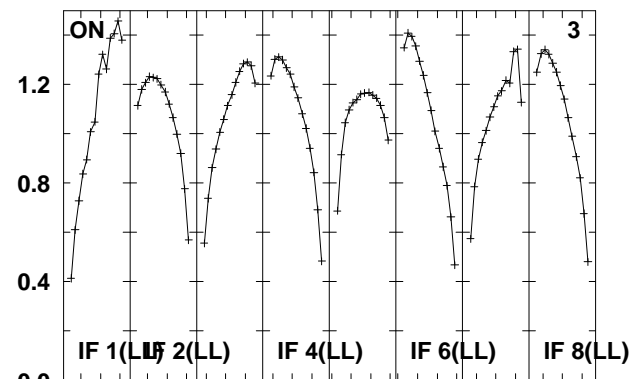
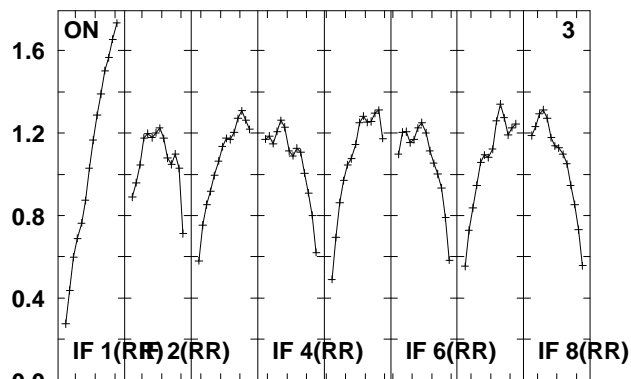
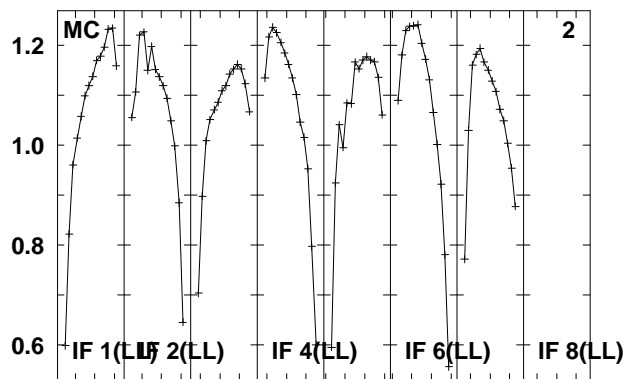
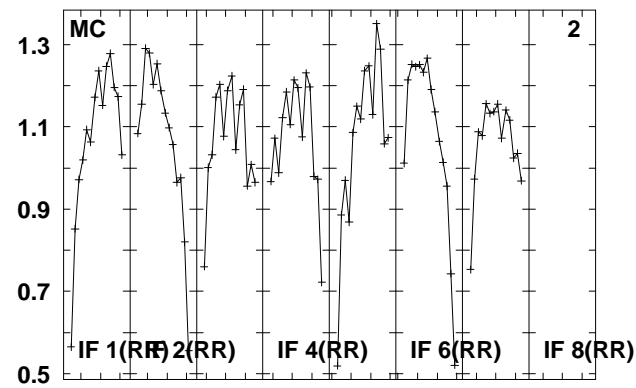
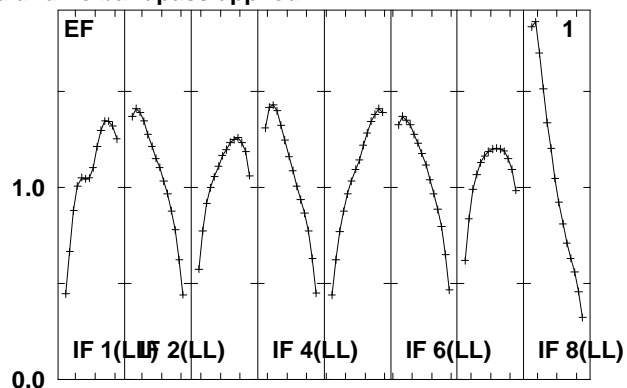
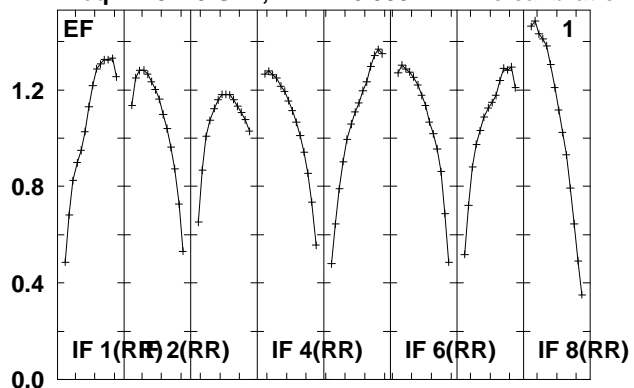

Lower frame: Real Jy
Total-power spectrum Antenna: *
Timerange: 00/10:21:40 to 00/10:23:38

Plot file version 29 created 08-JUL-2010 13:08:16

J0731+24 EM079.UVDATA.1

Freq = 4.9415 GHz, Bw = 16.000 MH No calibration applied and no bandpass applied

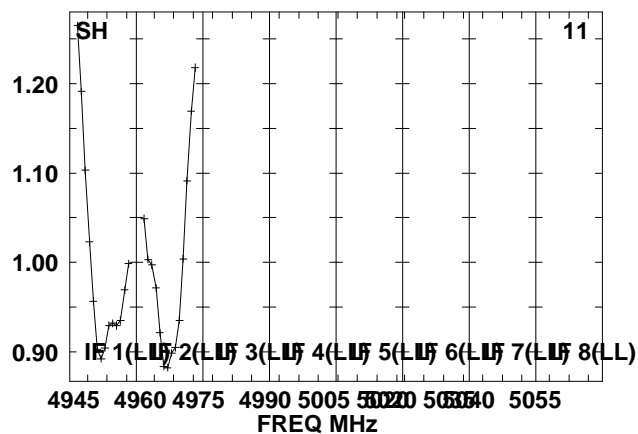
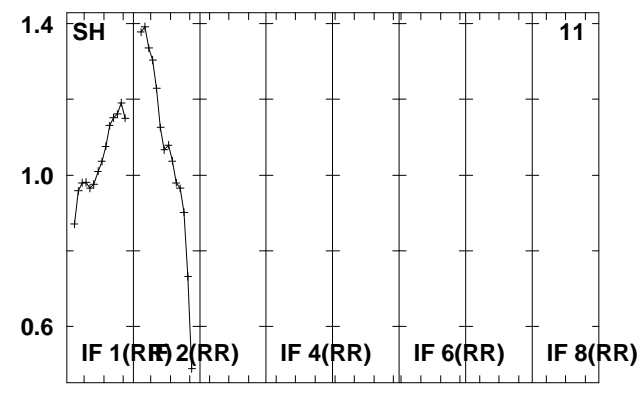
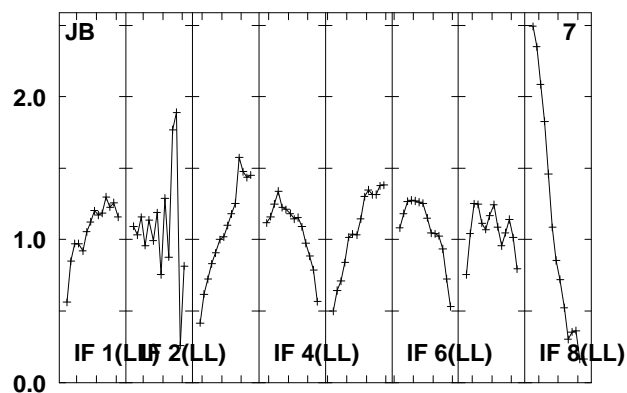
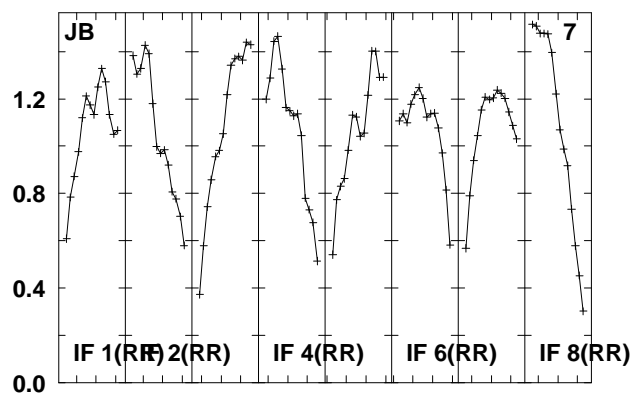
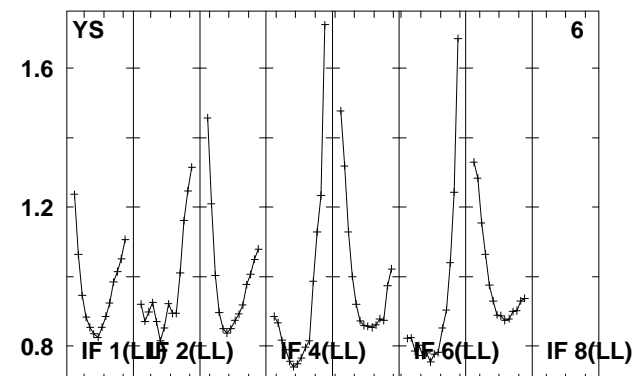
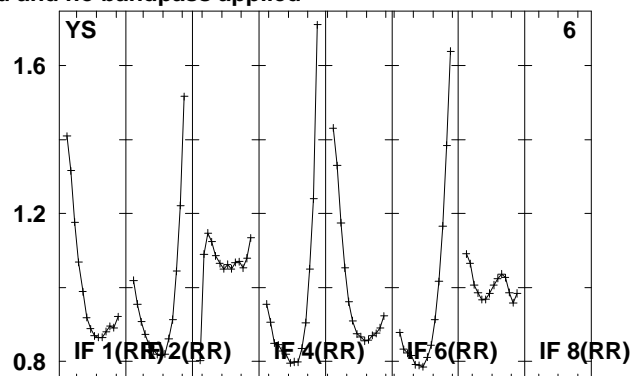
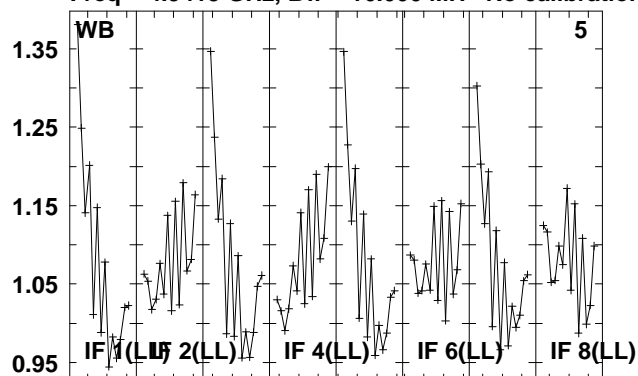

4945 4960 4975 4990 5005 5020 5035 5050 5055
FREQ MHz

Lower frame: Real Jy

Total-power spectrum Antenna: *

Timerange: 00/10:21:40 to 00/10:23:38

Plot file version 30 created 08-JUL-2010 13:08:17

B0726+25 EM079.UVDATA.1

Freq = 4.9415 GHz, Bw = 16.000 MH No calibration applied and no bandpass applied

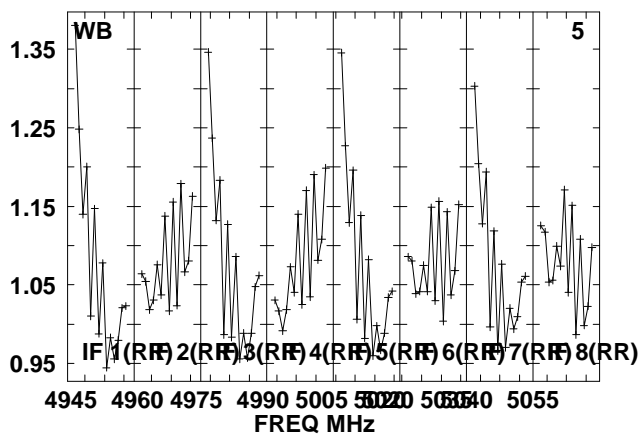
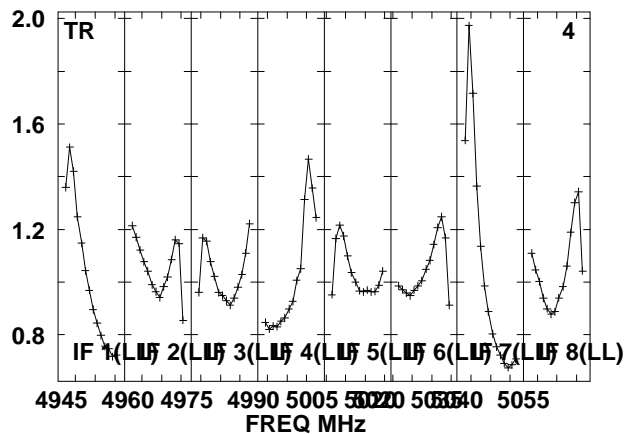
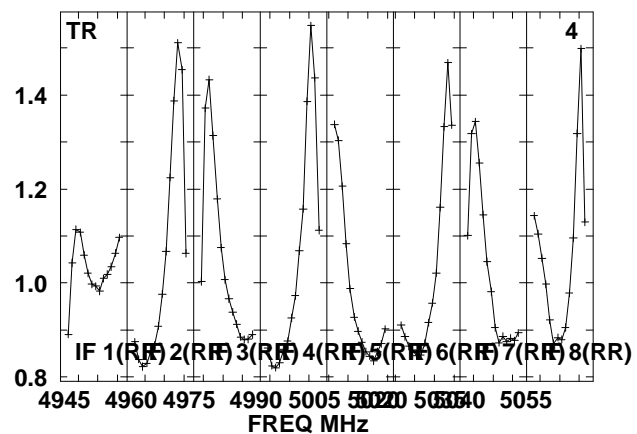
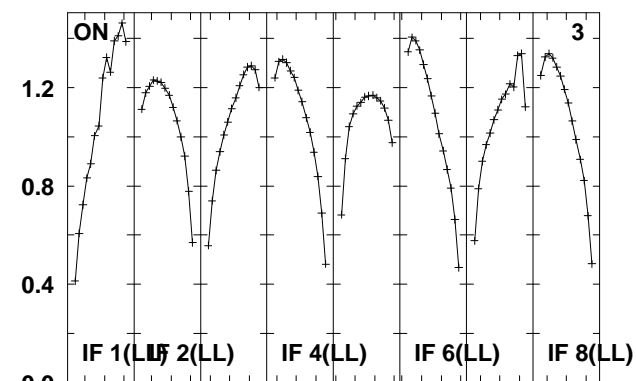
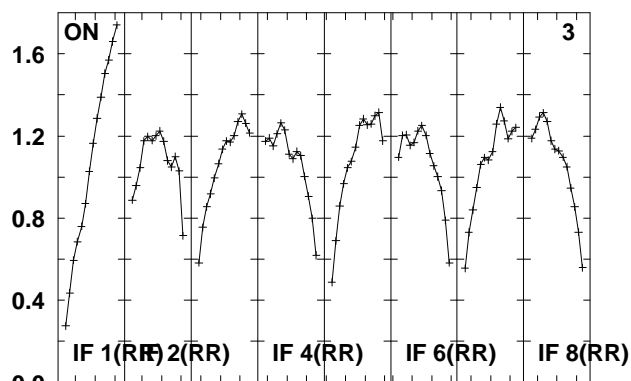
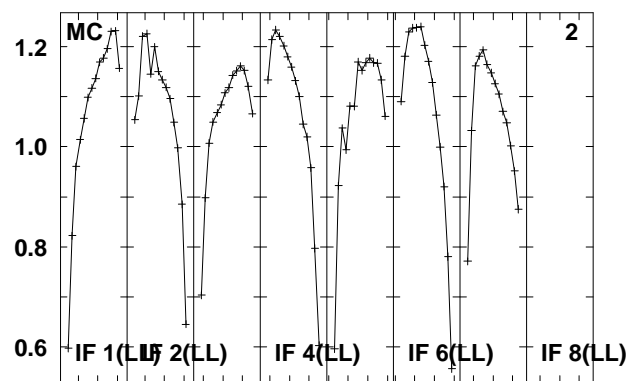
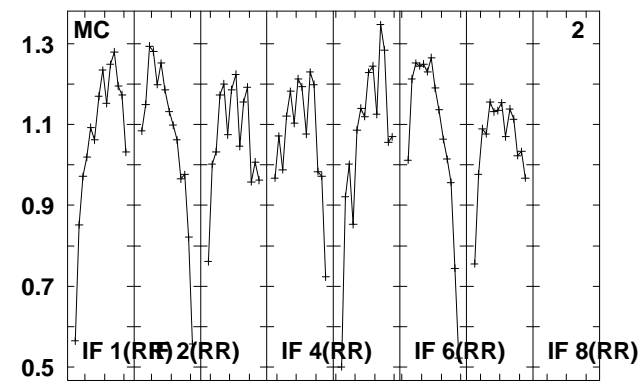
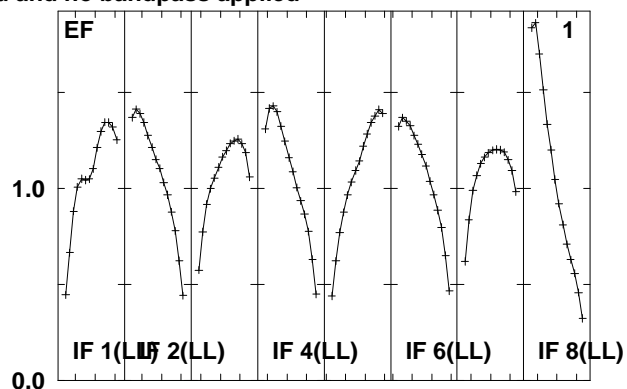
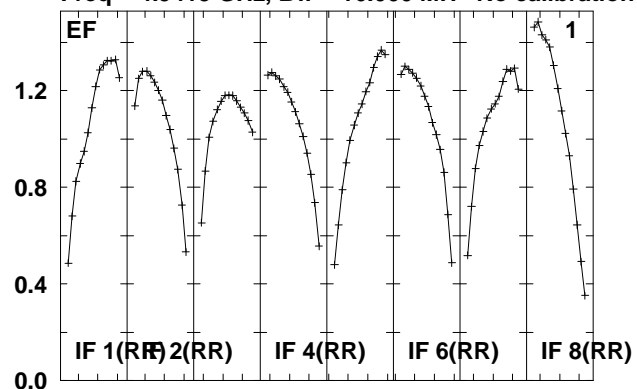

Lower frame: Real Jy
Total-power spectrum Antenna: *
Timerange: 00/10:23:40 to 00/10:34:24

Plot file version 31 created 08-JUL-2010 13:08:18
 B0726+25 EM079.UVDATA.1
 Freq = 4.9415 GHz, Bw = 16.000 MH No calibration applied and no bandpass applied

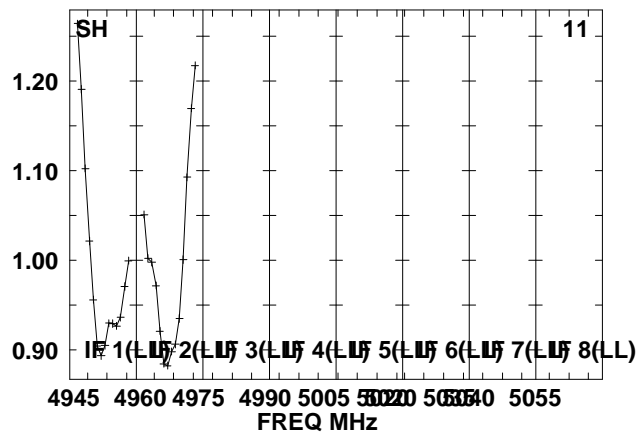
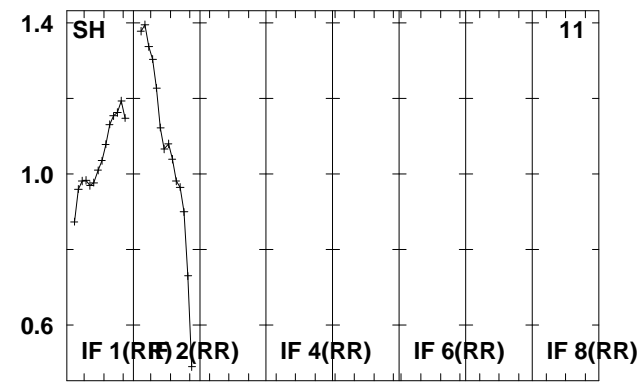
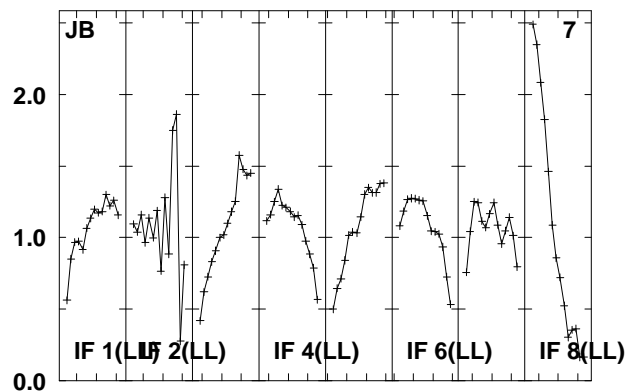
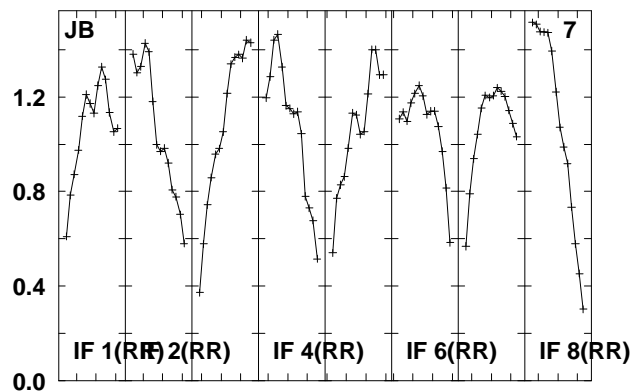
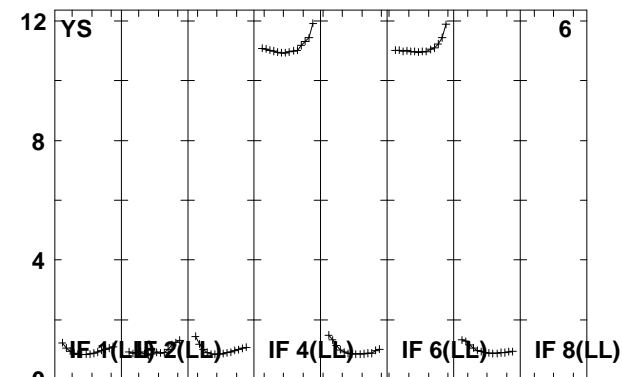
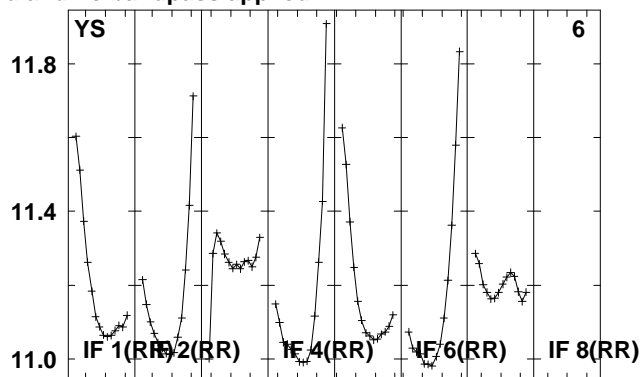
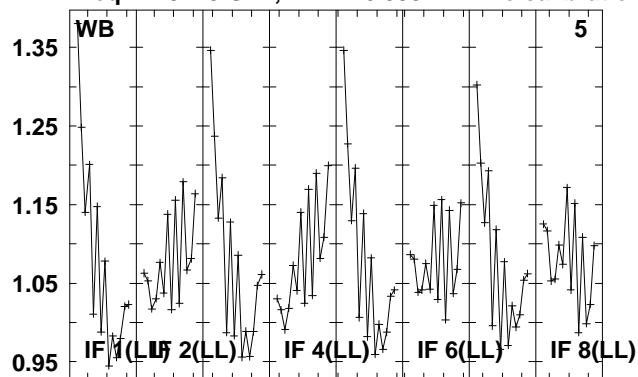

Lower frame: Real Jy
 Total-power spectrum Antenna: *
 Timerange: 00/10:23:40 to 00/10:34:24

Plot file version 32 created 08-JUL-2010 13:08:20

J0731+24 EM079.UVDATA.1

Freq = 4.9415 GHz, Bw = 16.000 MH No calibration applied and no bandpass applied

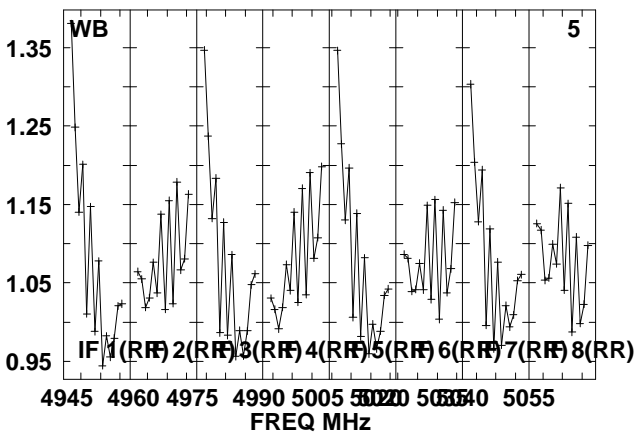
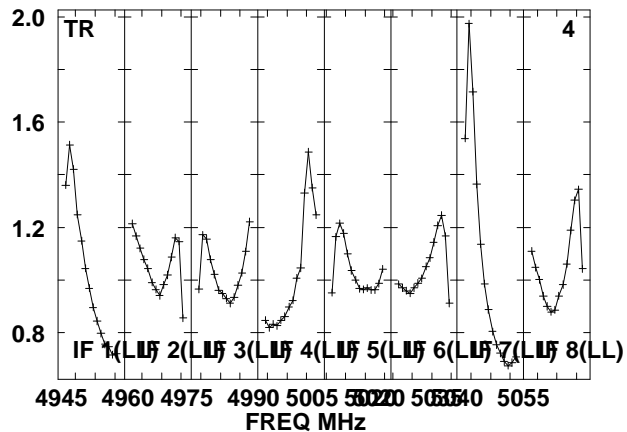
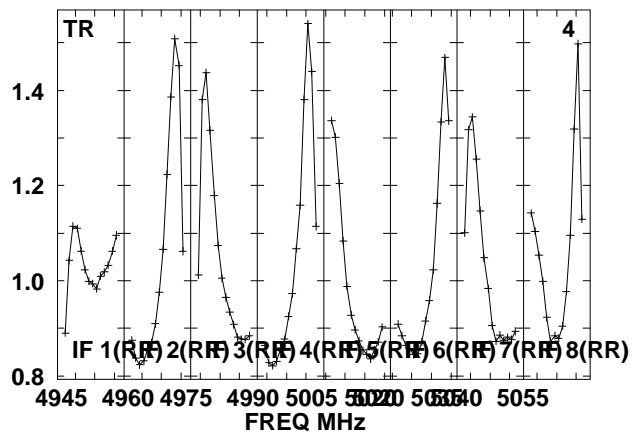
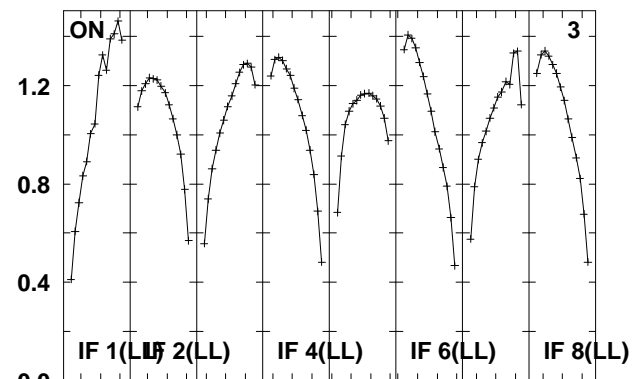
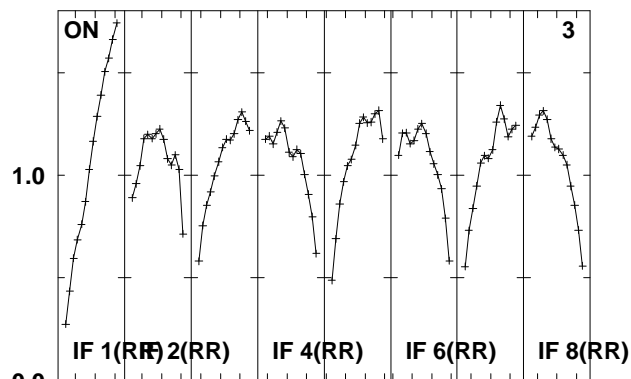
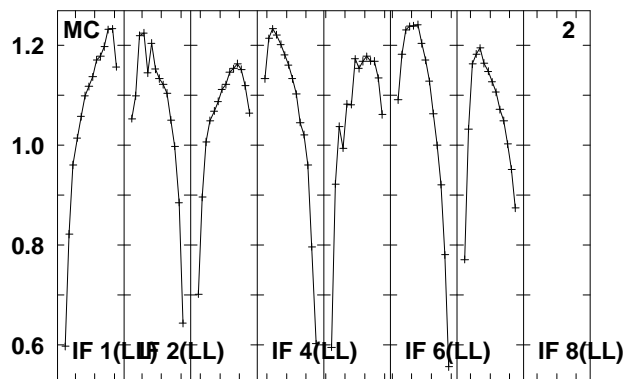
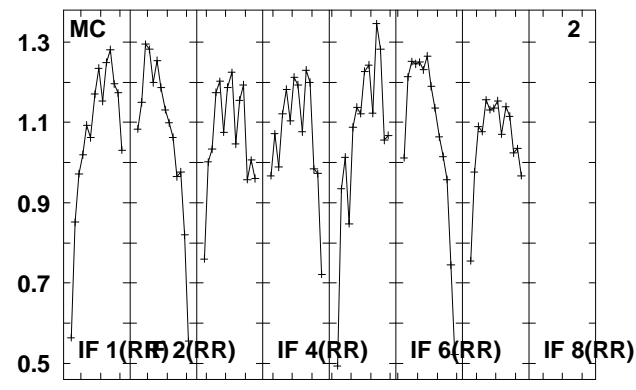
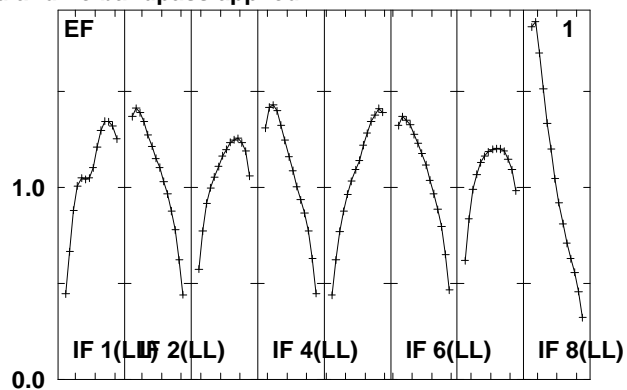
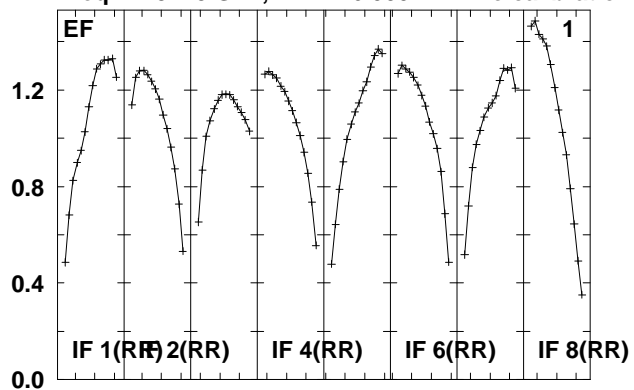

Lower frame: Real Jy
Total-power spectrum Antenna: *
Timerange: 00/10:34:26 to 00/10:36:24

Plot file version 33 created 08-JUL-2010 13:08:20

J0731+24 EM079.UVDATA.1

Freq = 4.9415 GHz, Bw = 16.000 MH No calibration applied and no bandpass applied

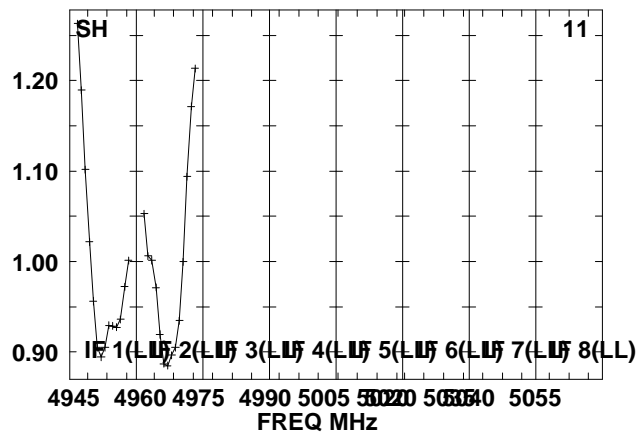
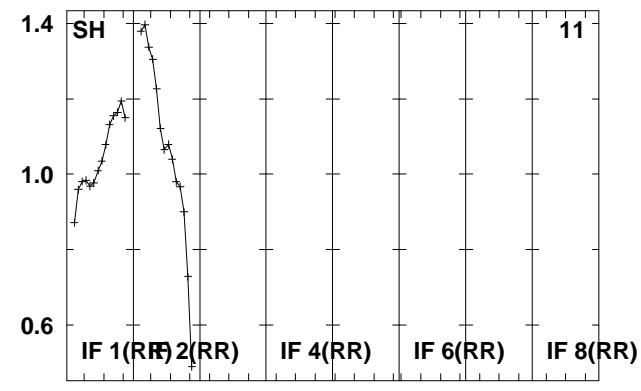
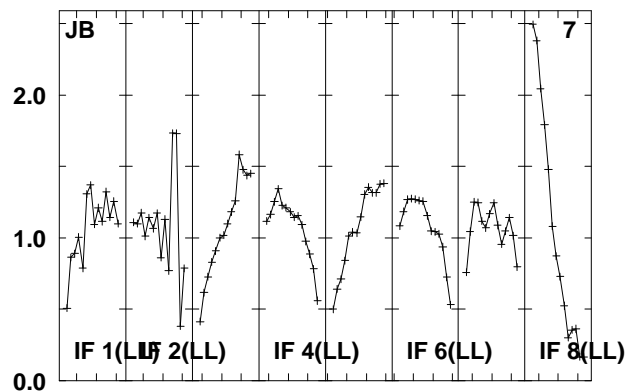
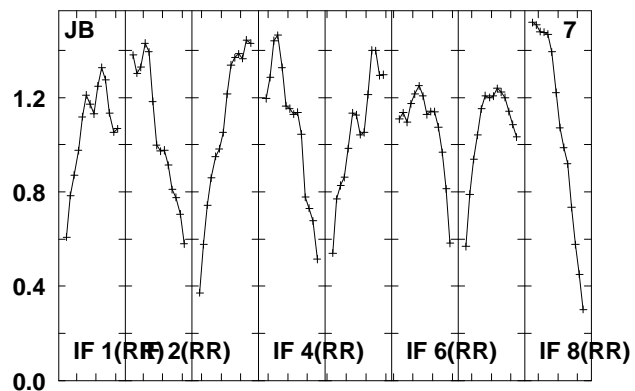
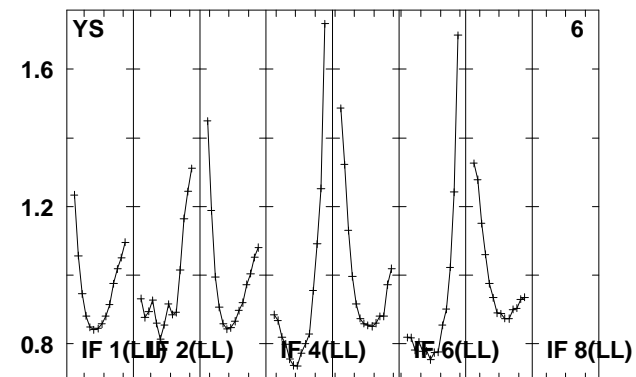
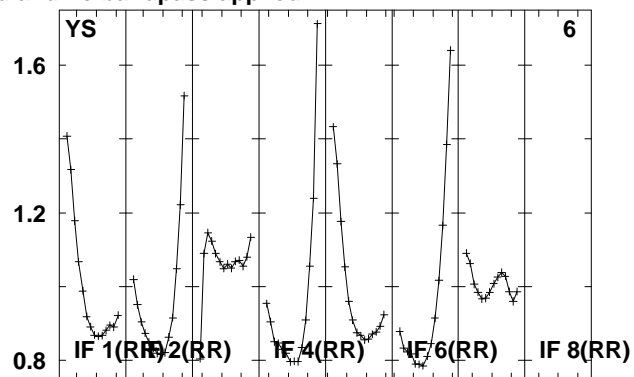
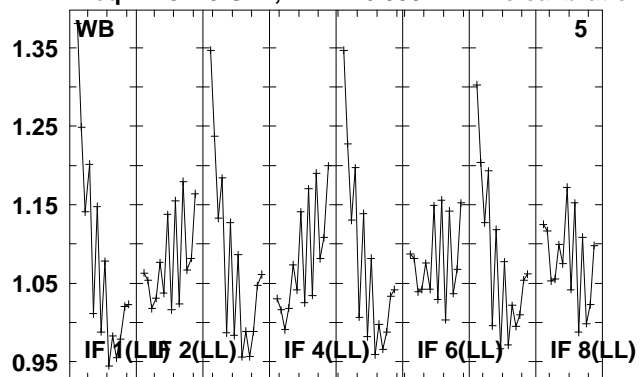

Lower frame: Real Jy

Total-power spectrum Antenna: *

Timerange: 00/10:34:26 to 00/10:36:24

Plot file version 34 created 08-JUL-2010 13:08:21

B0726+25 EM079.UVDATA.1

Freq = 4.9415 GHz, Bw = 16.000 MH No calibration applied and no bandpass applied

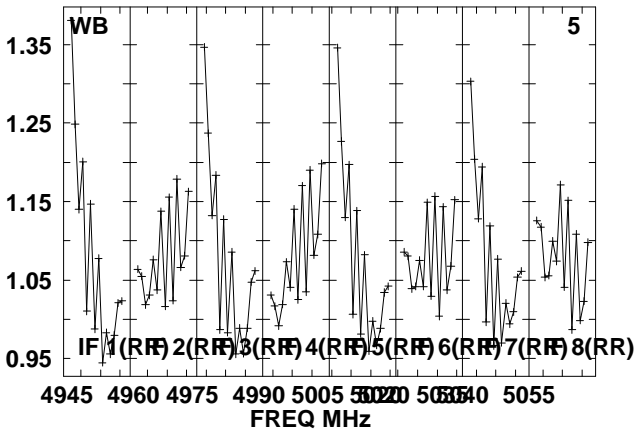
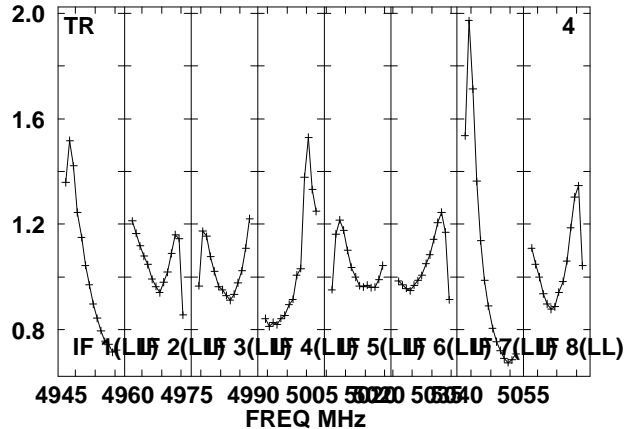
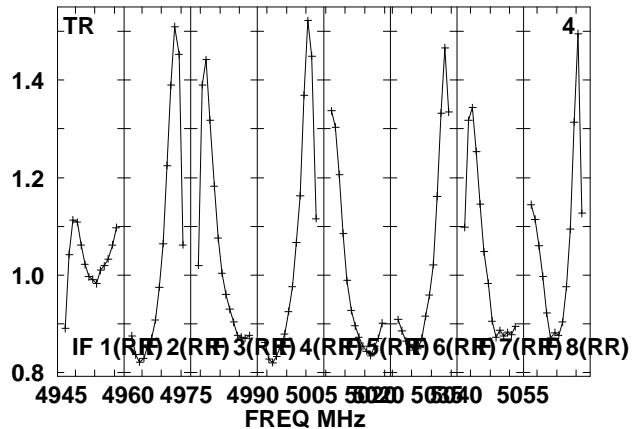
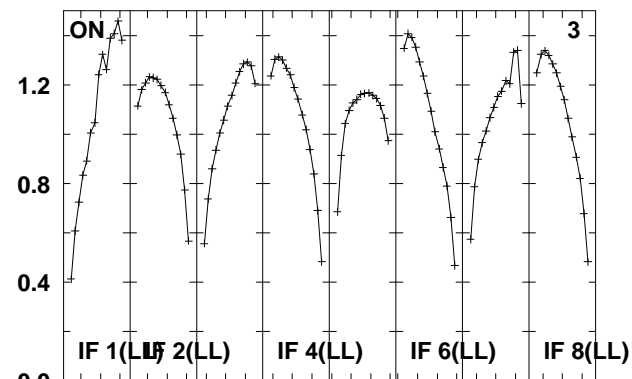
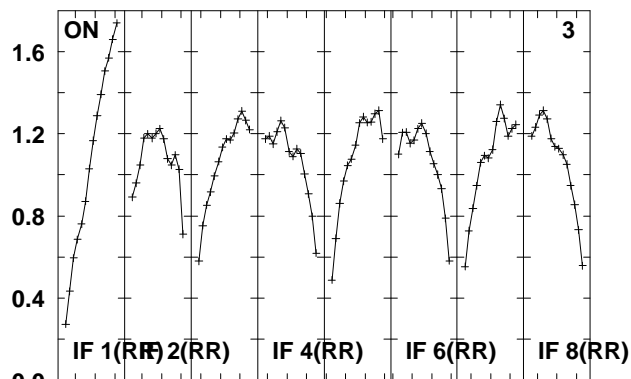
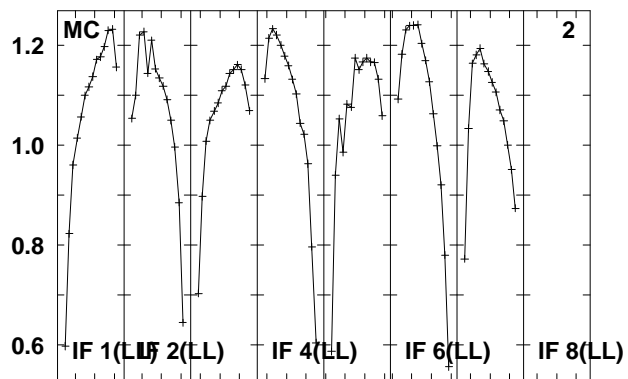
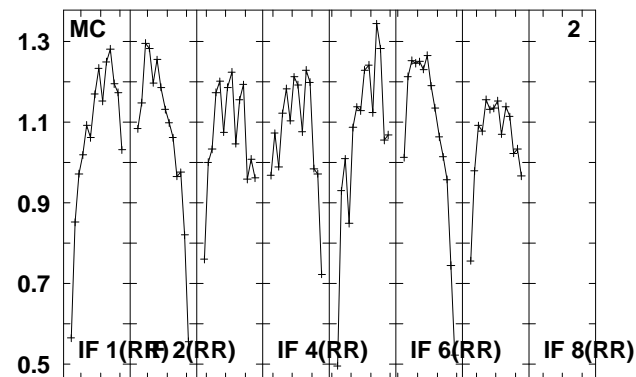
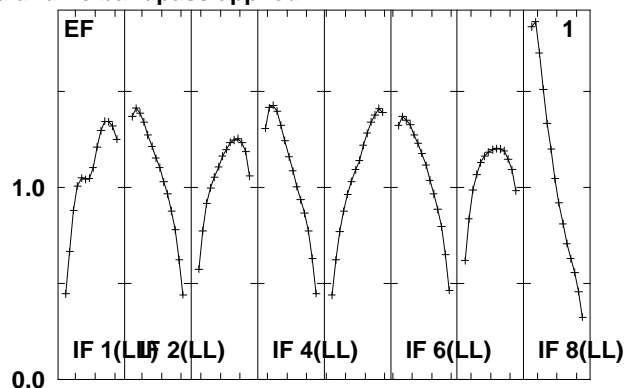
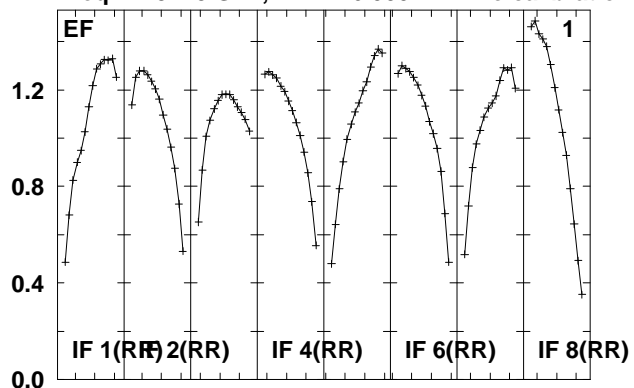

Lower frame: Real Jy
Total-power spectrum Antenna: *
Timerange: 00/10:36:26 to 00/10:47:08

Plot file version 35 created 08-JUL-2010 13:08:22
 B0726+25 EM079.UVDATA.1
 Freq = 4.9415 GHz, Bw = 16.000 MH No calibration applied and no bandpass applied

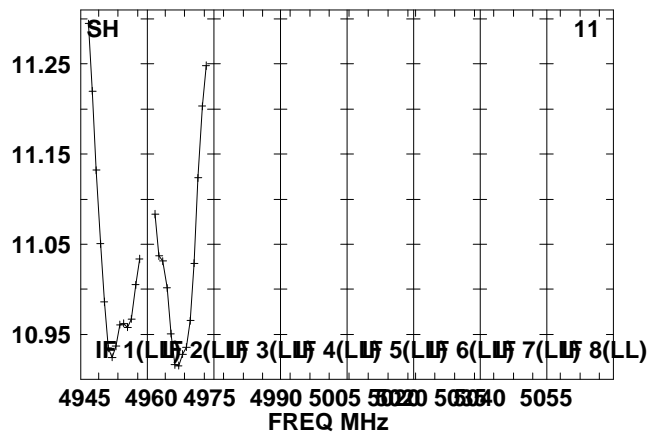
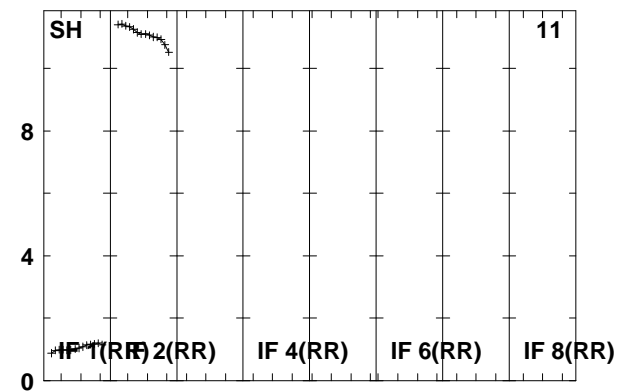
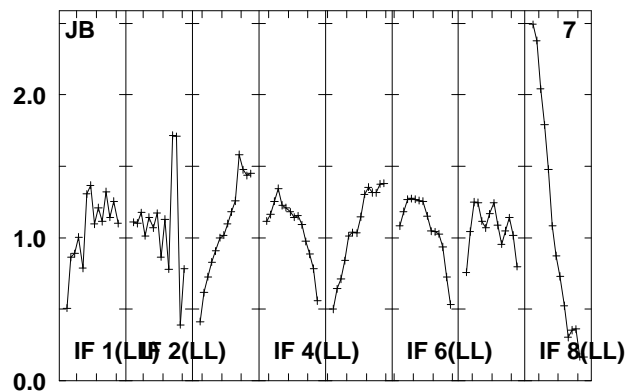
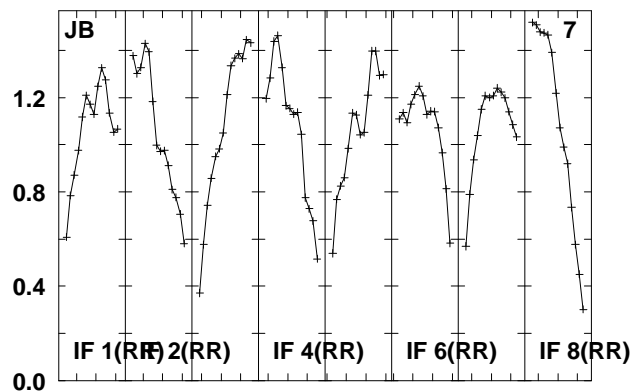
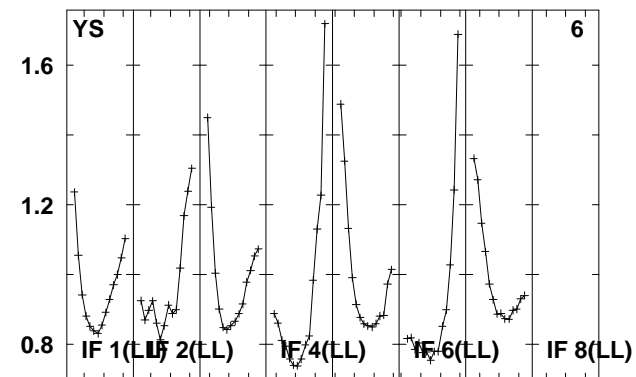
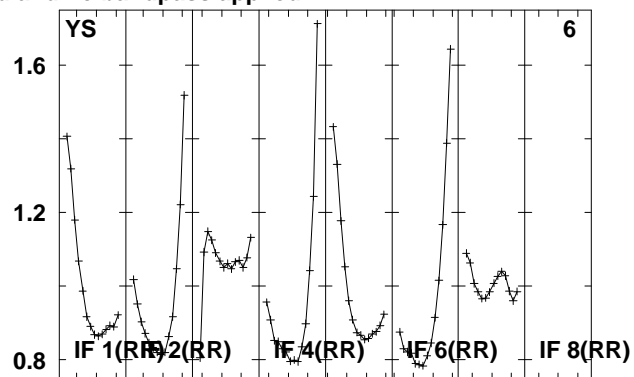
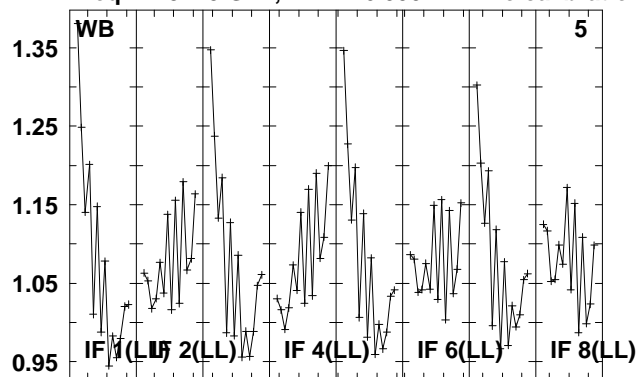

4945 4960 4975 4990 5005 5020 5035 5050 5065
 FREQ MHz

Lower frame: Real Jy
 Total-power spectrum Antenna: *
 Timerange: 00/10:36:26 to 00/10:47:08

Plot file version 36 created 08-JUL-2010 13:08:24

J0731+24 EM079.UVDATA.1

Freq = 4.9415 GHz, Bw = 16.000 MH No calibration applied and no bandpass applied

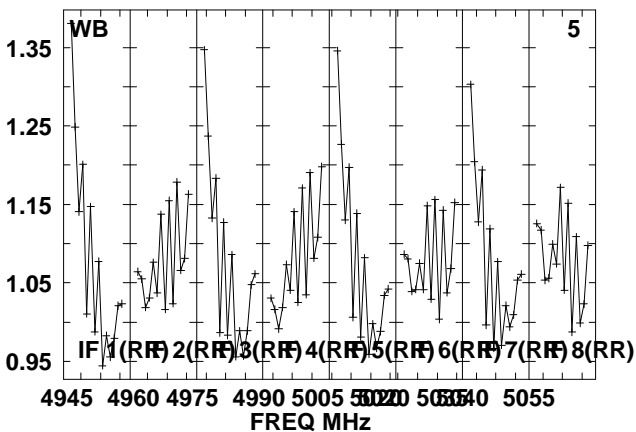
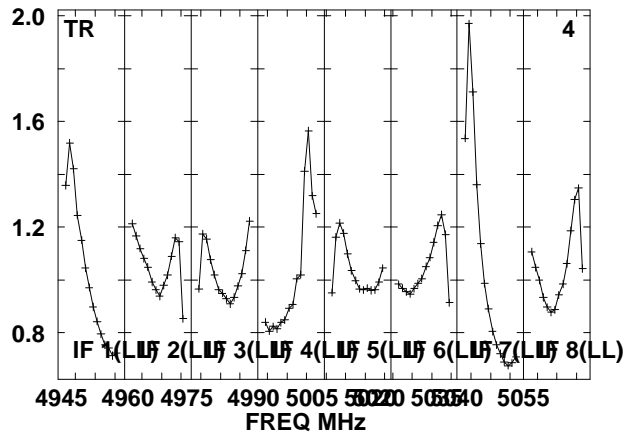
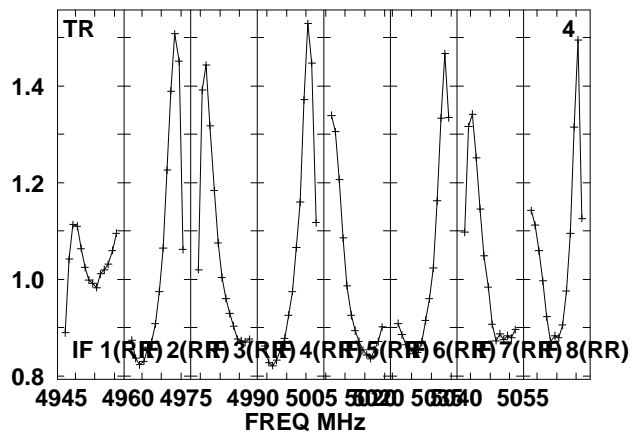
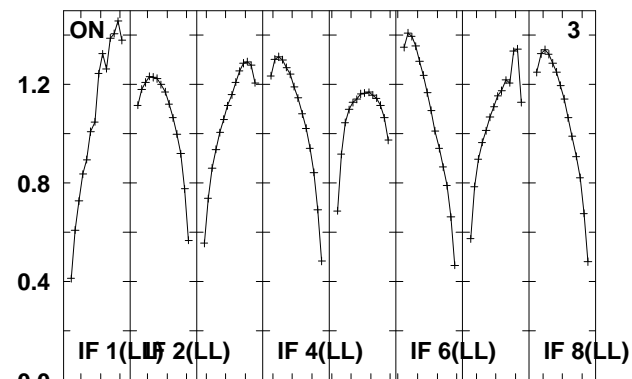
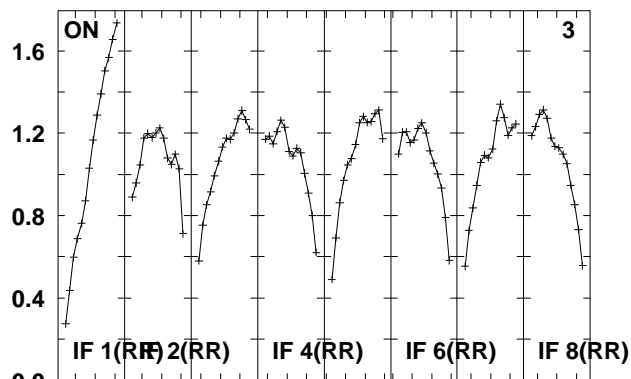
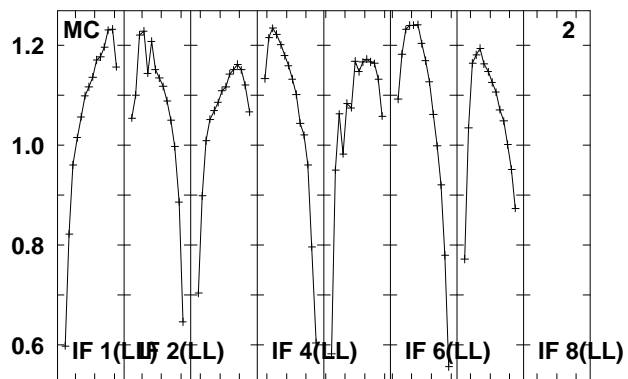
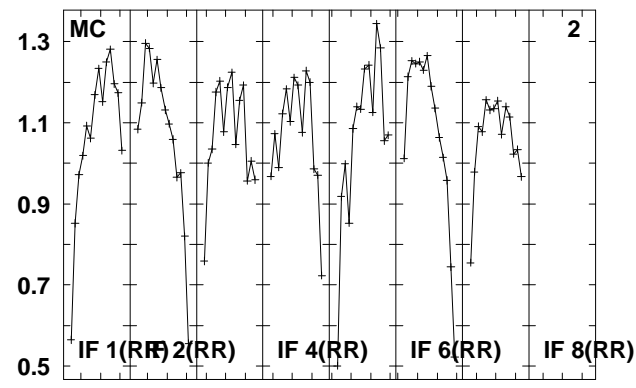
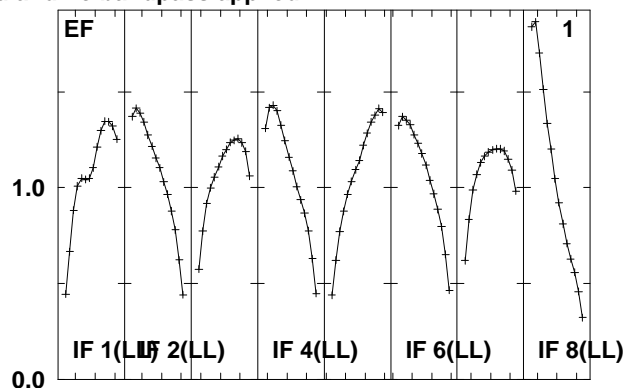
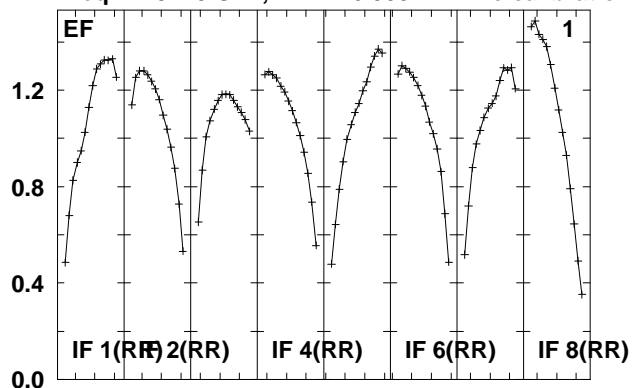

Lower frame: Real Jy
Total-power spectrum Antenna: *
Timerange: 00/10:47:10 to 00/10:49:08

Plot file version 37 created 08-JUL-2010 13:08:24

J0731+24 EM079.UVDATA.1

Freq = 4.9415 GHz, Bw = 16.000 MH No calibration applied and no bandpass applied

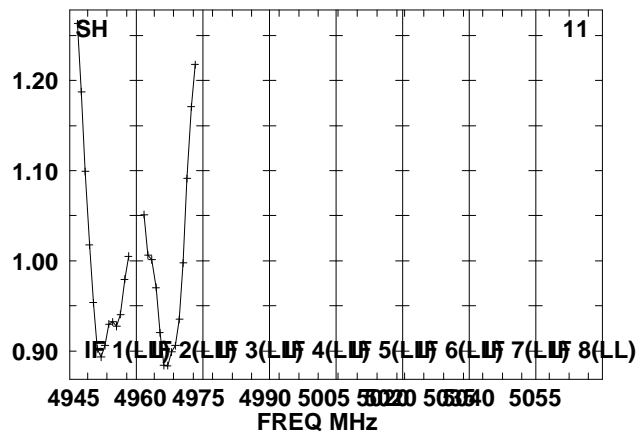
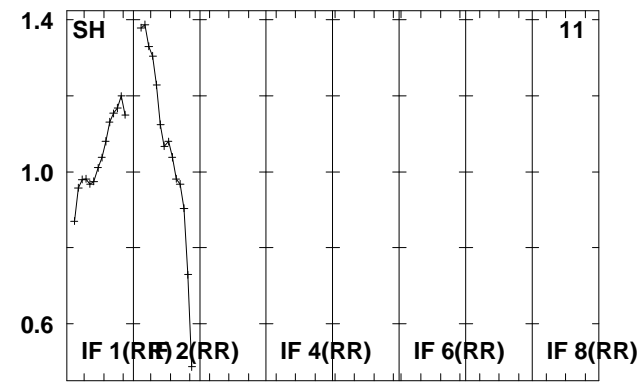
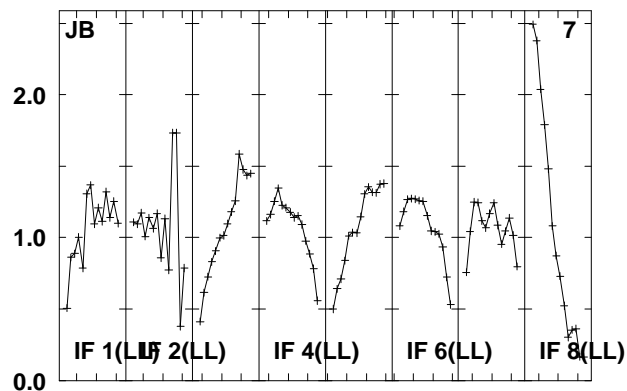
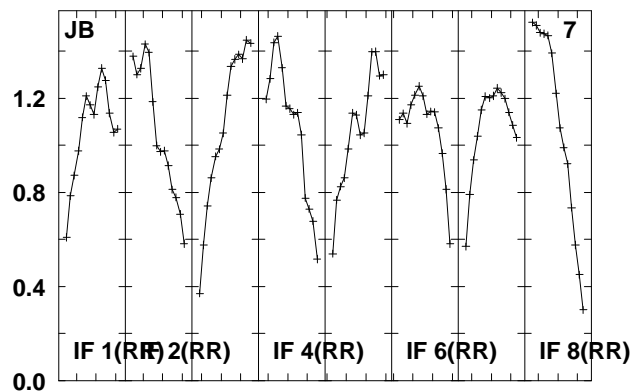
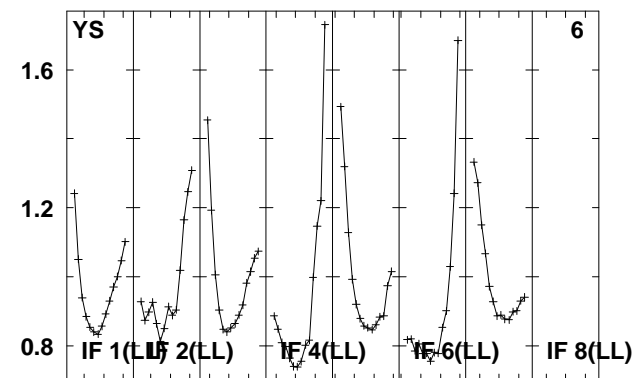
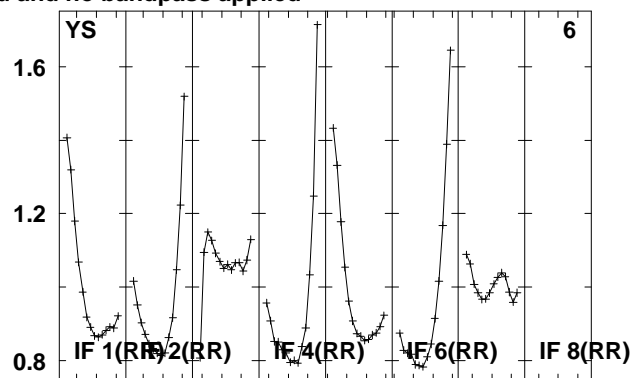
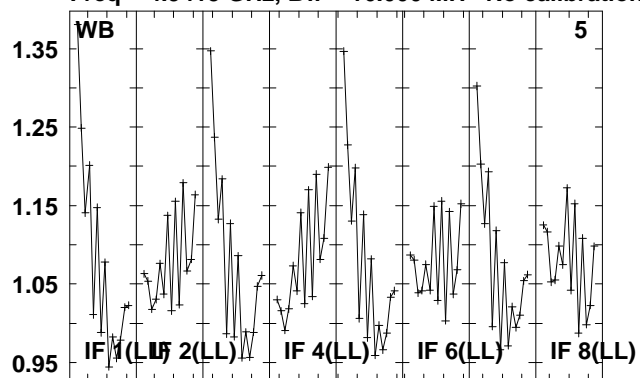

Lower frame: Real Jy

Total-power spectrum Antenna: *

Timerange: 00/10:47:10 to 00/10:49:08

Plot file version 38 created 08-JUL-2010 13:08:25

B0726+25 EM079.UVDATA.1

Freq = 4.9415 GHz, Bw = 16.000 MH No calibration applied and no bandpass applied

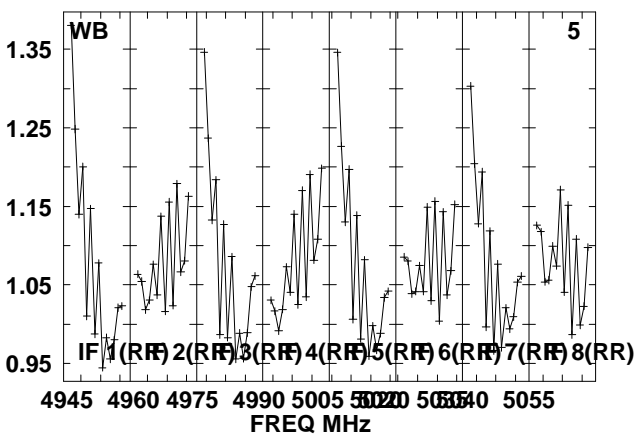
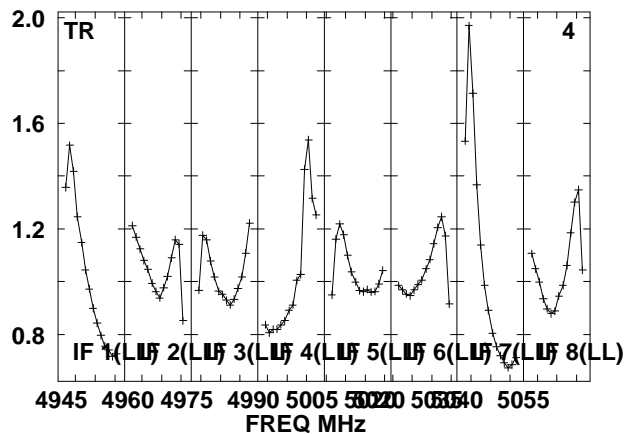
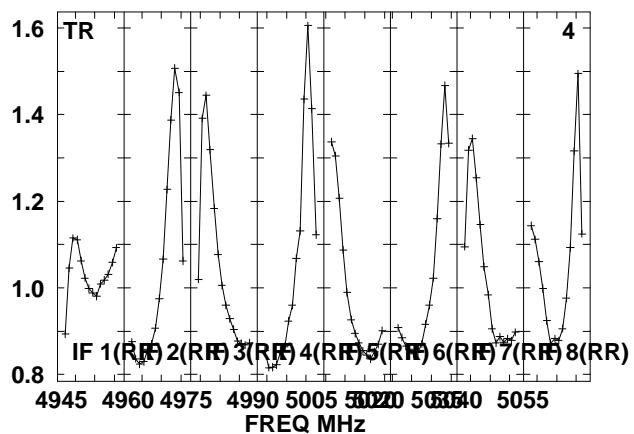
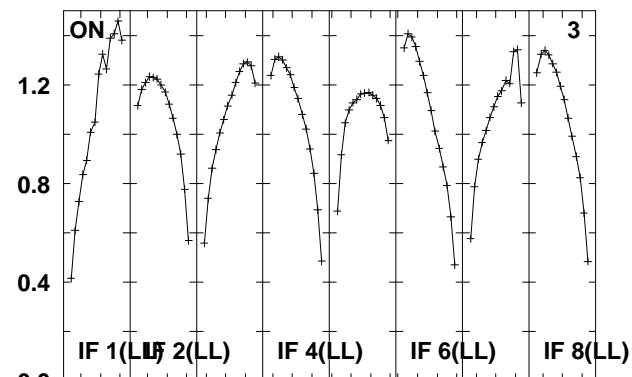
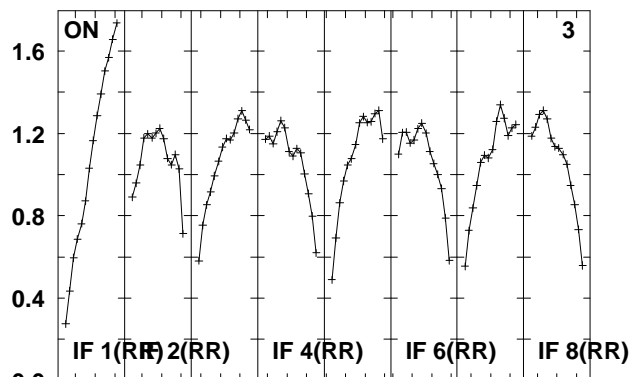
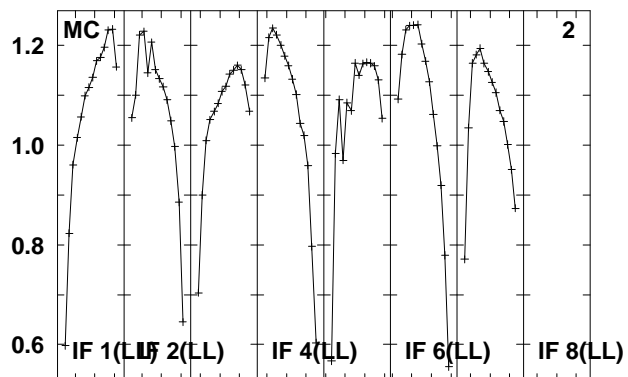
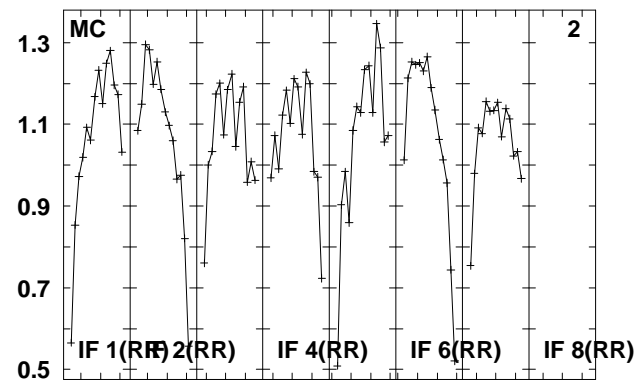
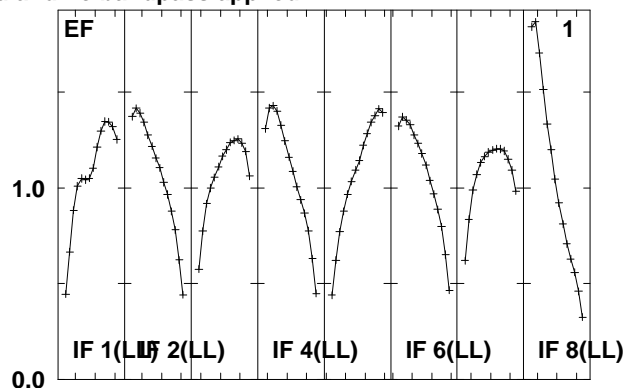
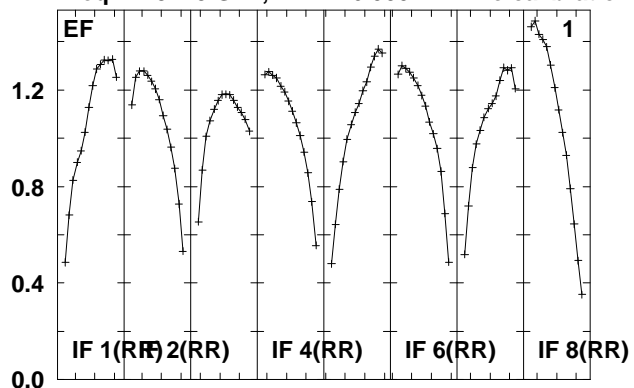

Lower frame: Real Jy
Total-power spectrum Antenna: *
Timerange: 00/10:49:10 to 00/10:59:54

Plot file version 39 created 08-JUL-2010 13:08:26
 B0726+25 EM079.UVDATA.1
 Freq = 4.9415 GHz, Bw = 16.000 MH No calibration applied and no bandpass applied

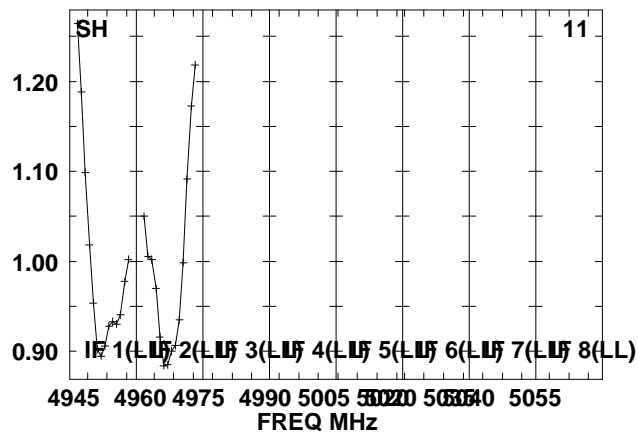
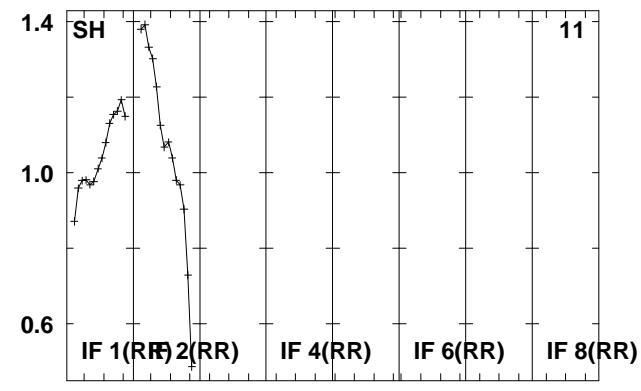
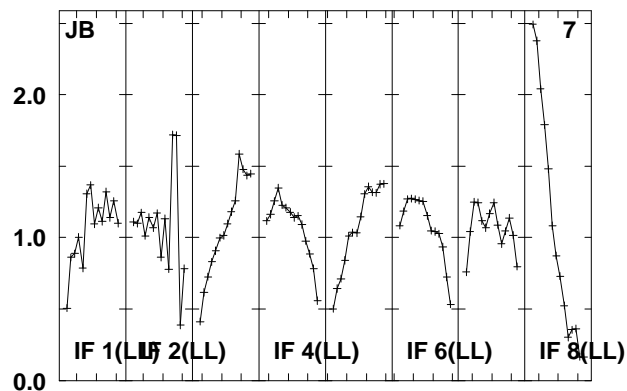
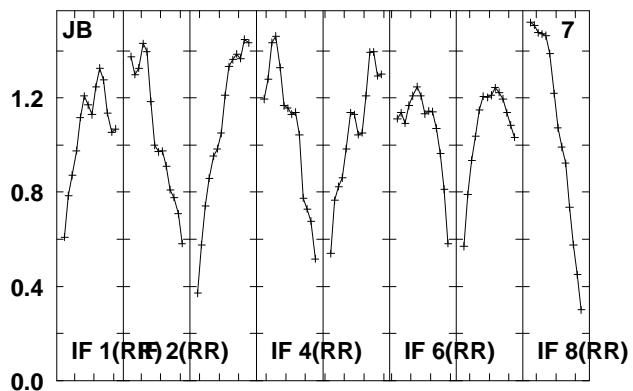
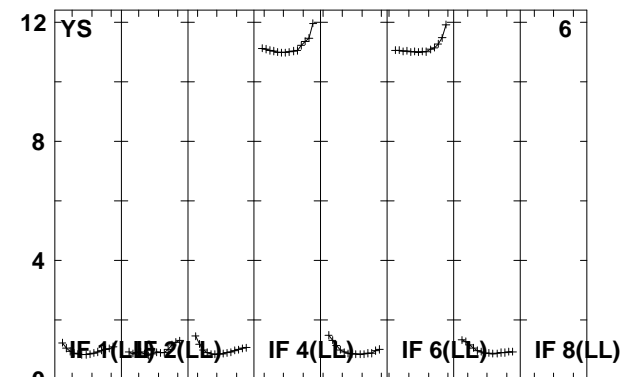
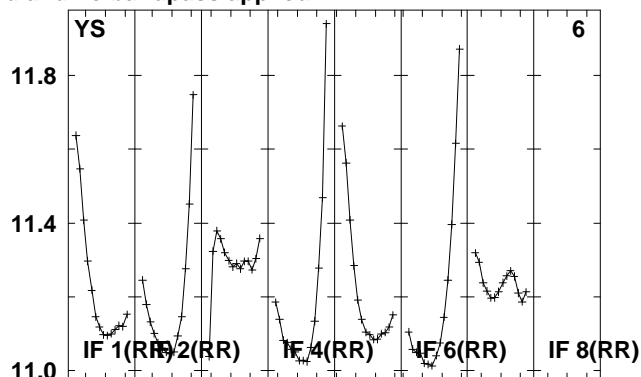
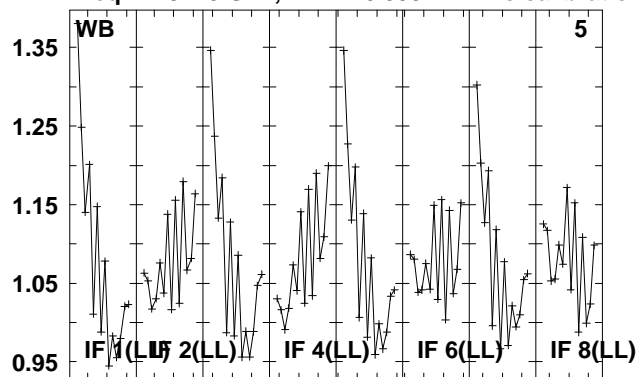

4945 4960 4975 4990 5005 5020 5035 5050 5065
 FREQ MHz

Lower frame: Real Jy
 Total-power spectrum Antenna: *
 Timerange: 00/10:49:10 to 00/10:59:54

Plot file version 40 created 08-JUL-2010 13:08:28

J0731+24 EM079.UVDATA.1

Freq = 4.9415 GHz, Bw = 16.000 MH No calibration applied and no bandpass applied

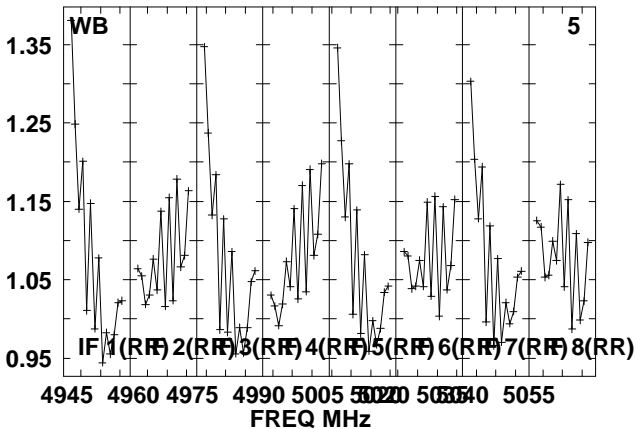
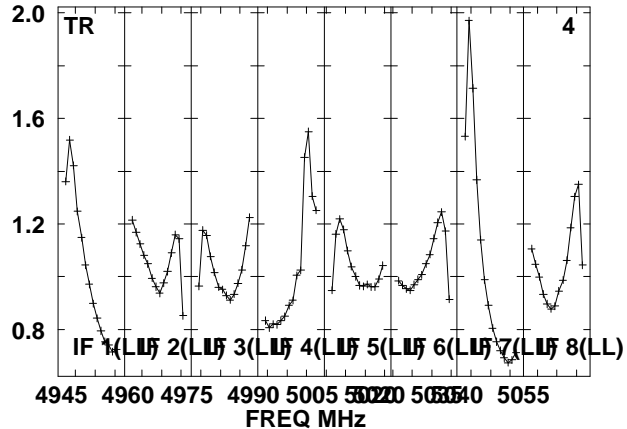
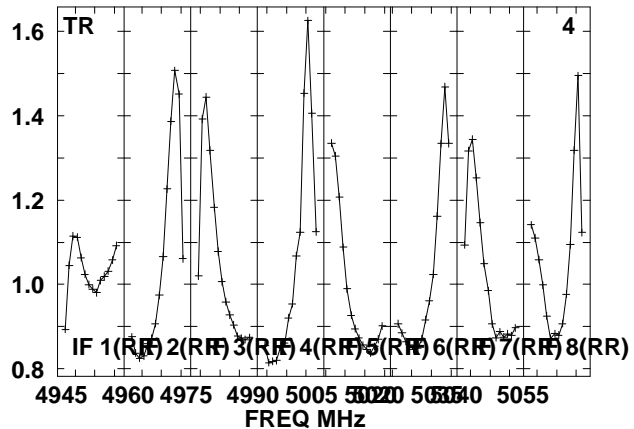
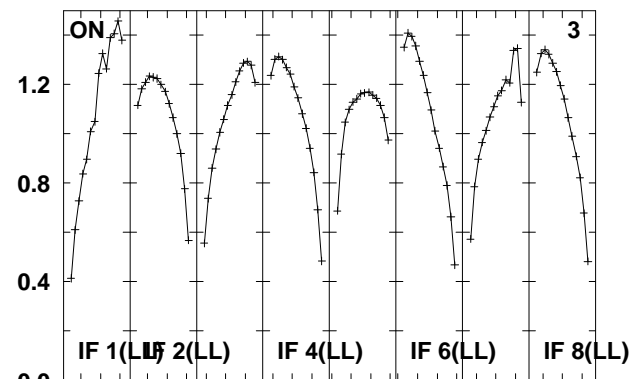
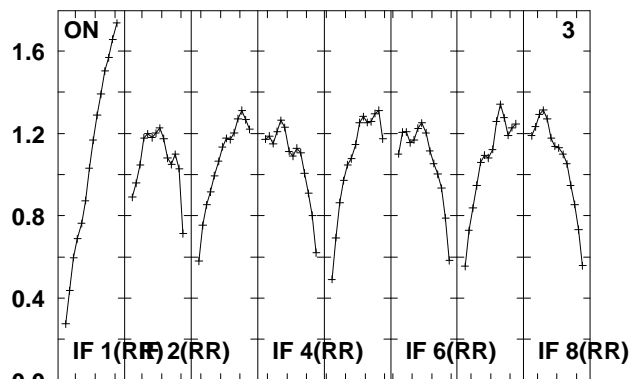
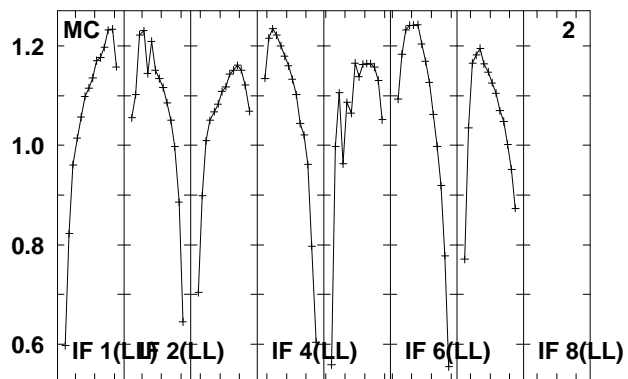
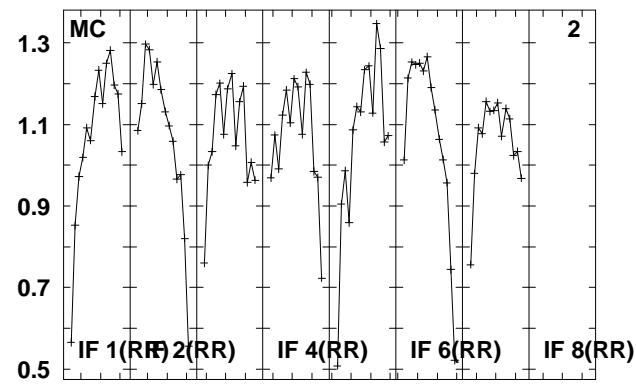
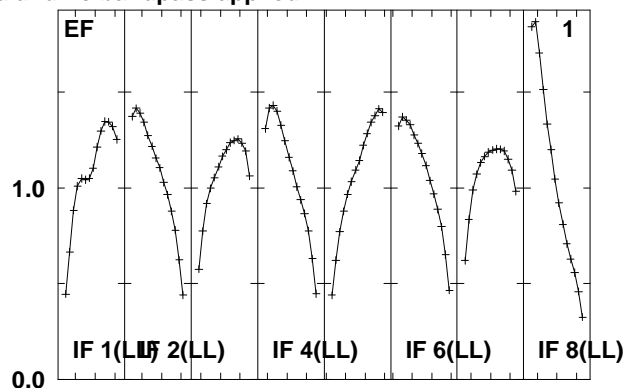
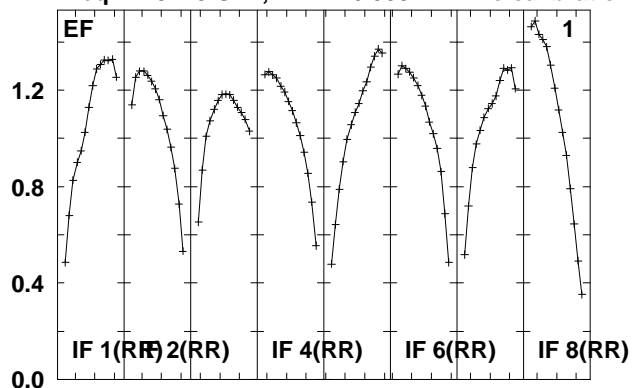

Lower frame: Real Jy
Total-power spectrum Antenna: *
Timerange: 00/10:59:56 to 00/11:01:54

Plot file version 41 created 08-JUL-2010 13:08:28

J0731+24 EM079.UVDATA.1

Freq = 4.9415 GHz, Bw = 16.000 MH No calibration applied and no bandpass applied

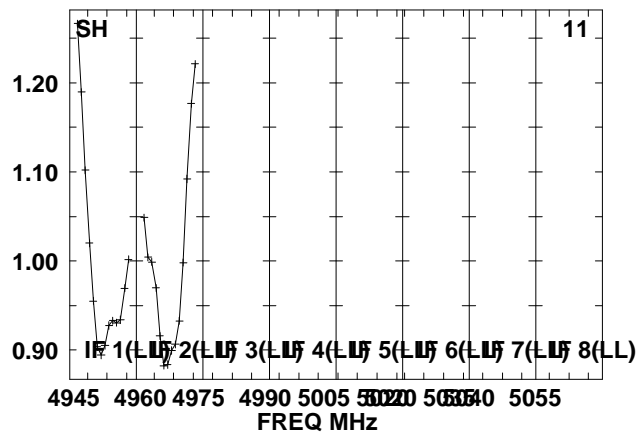
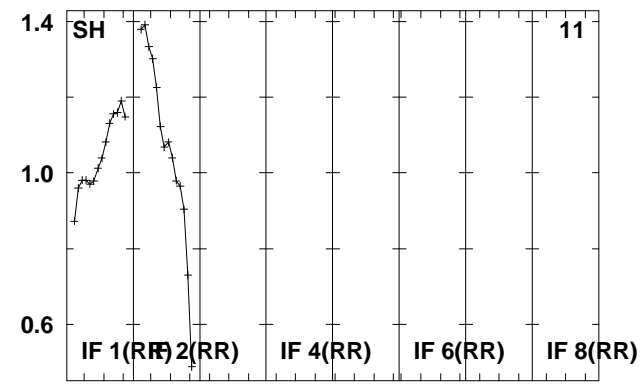
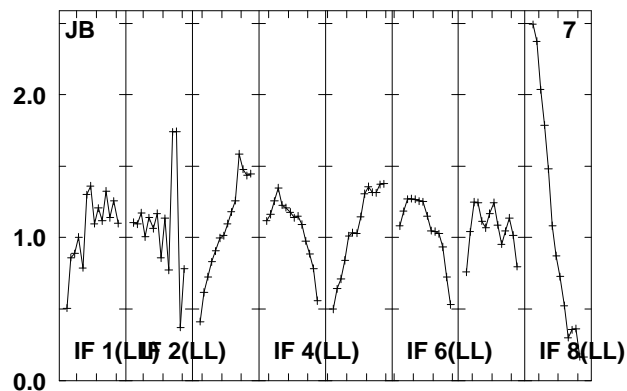
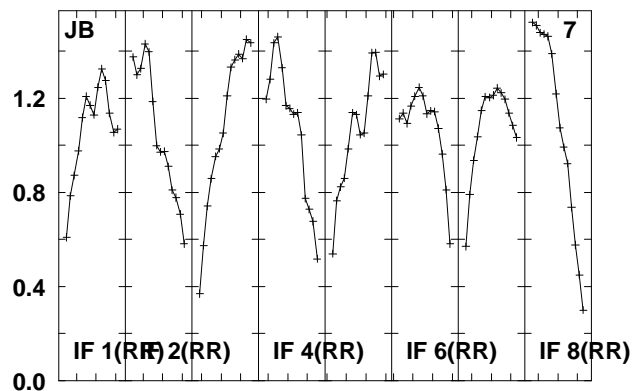
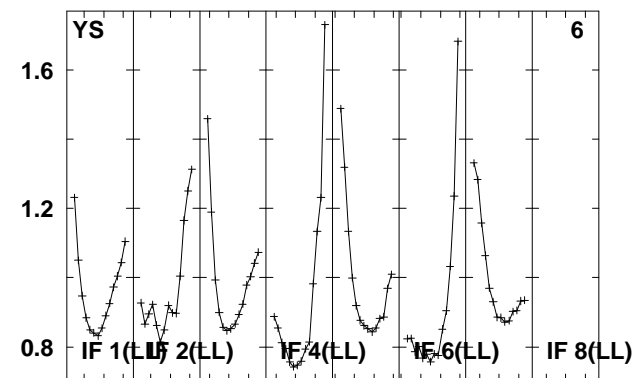
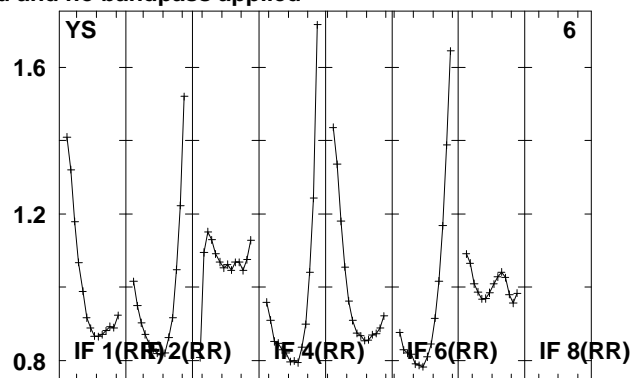
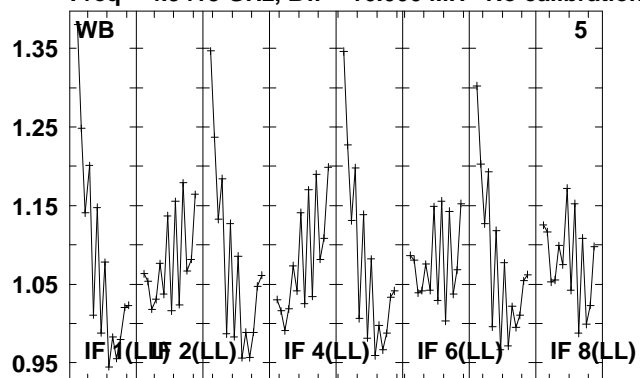

4945 4960 4975 4990 5005 5020 5035 5050 5055
FREQ MHz

Lower frame: Real Jy

Total-power spectrum Antenna: *

Timerange: 00/10:59:56 to 00/11:01:54

Plot file version 42 created 08-JUL-2010 13:08:29

B0726+25 EM079.UVDATA.1

Freq = 4.9415 GHz, Bw = 16.000 MH No calibration applied and no bandpass applied

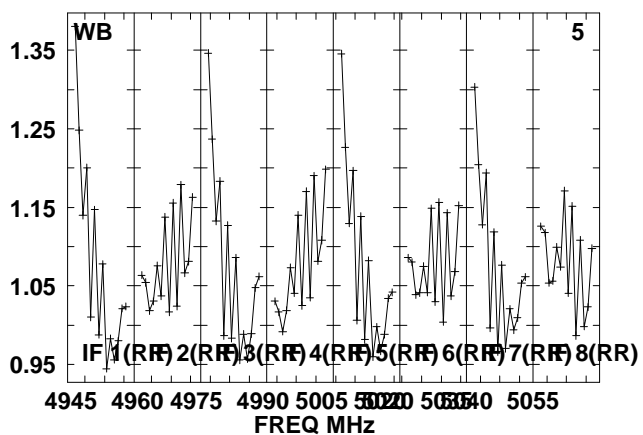
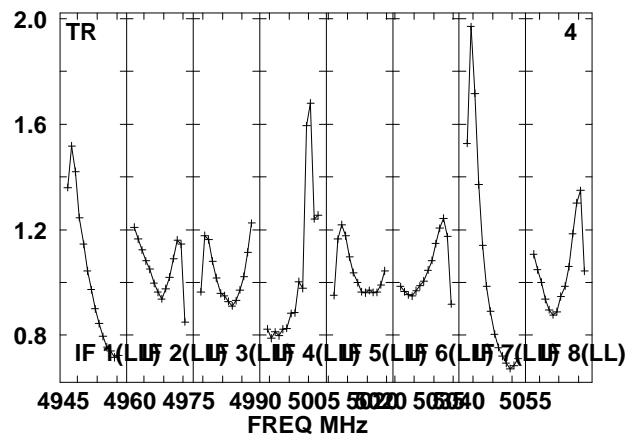
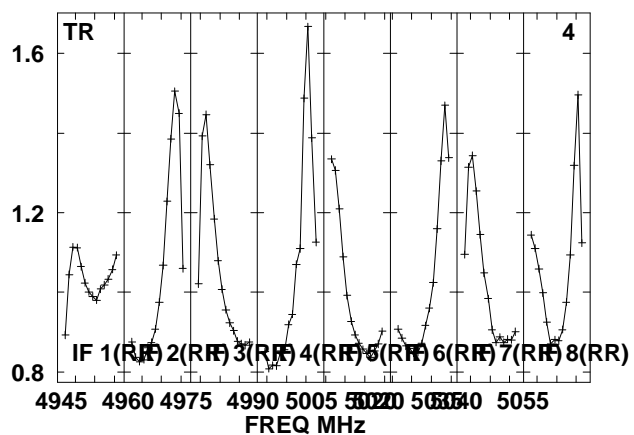
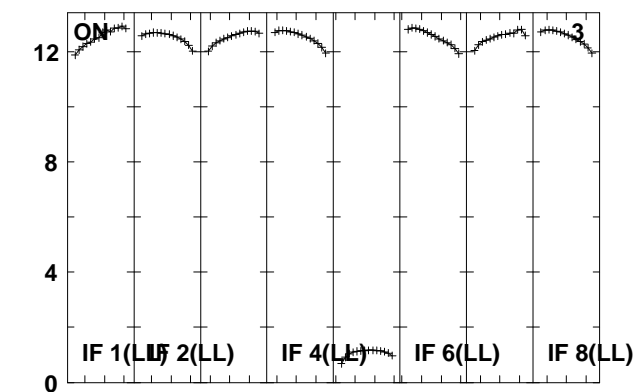
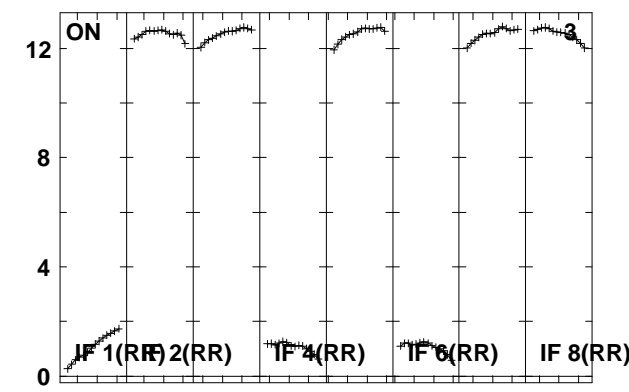
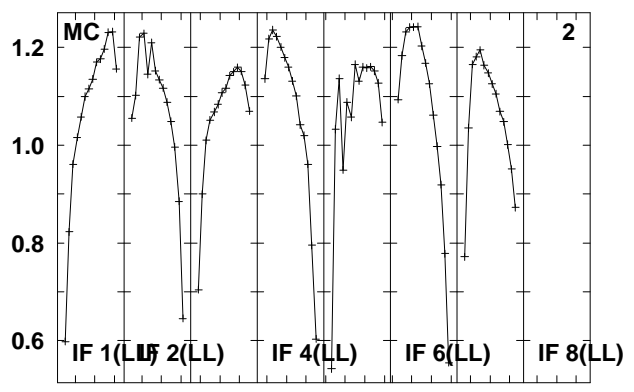
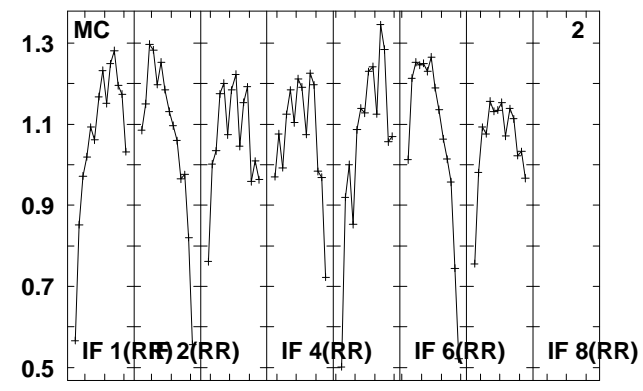
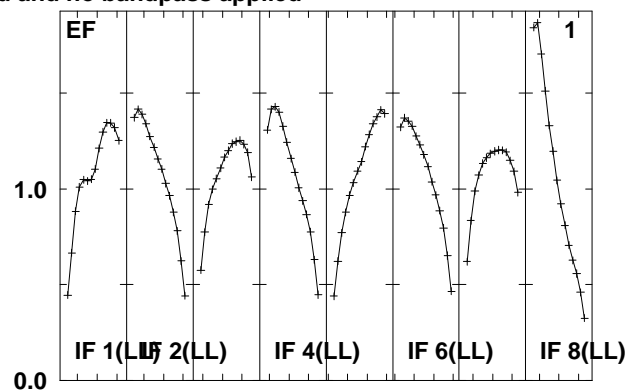
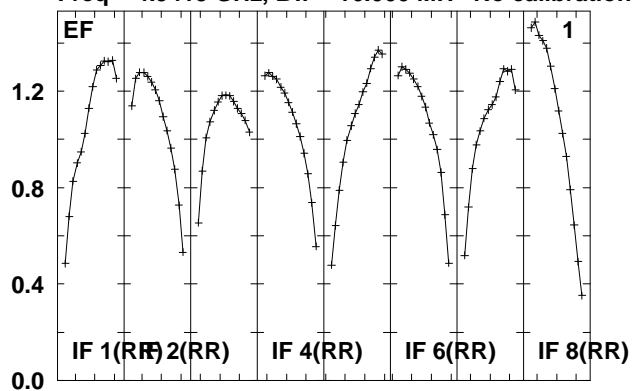

Lower frame: Real Jy
Total-power spectrum Antenna: *
Timerange: 00/11:01:56 to 00/11:12:38

Plot file version 43 created 08-JUL-2010 13:08:30
 B0726+25 EM079.UVDATA.1
 Freq = 4.9415 GHz, Bw = 16.000 MH No calibration applied and no bandpass applied

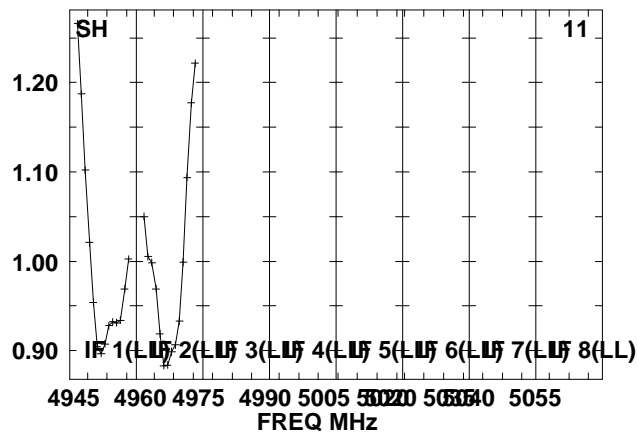
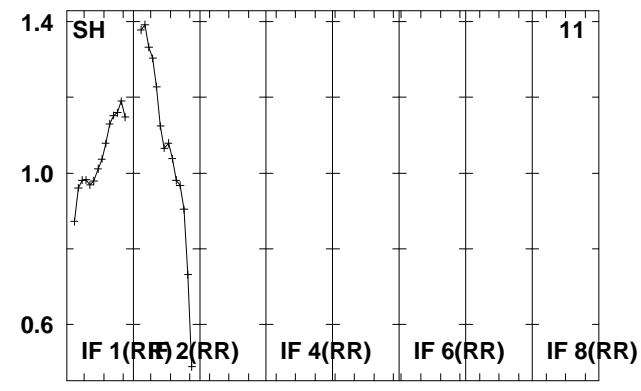
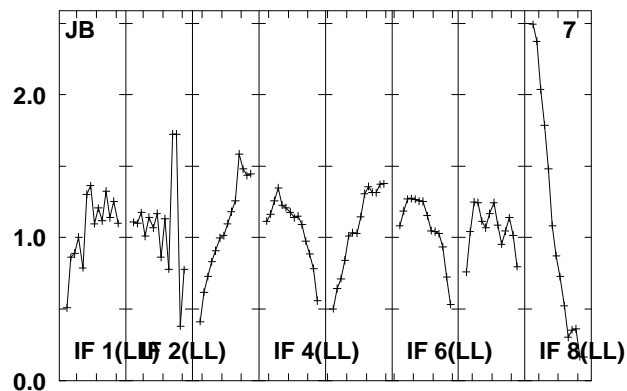
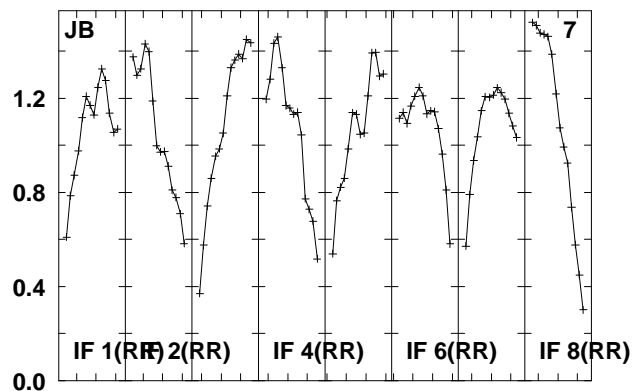
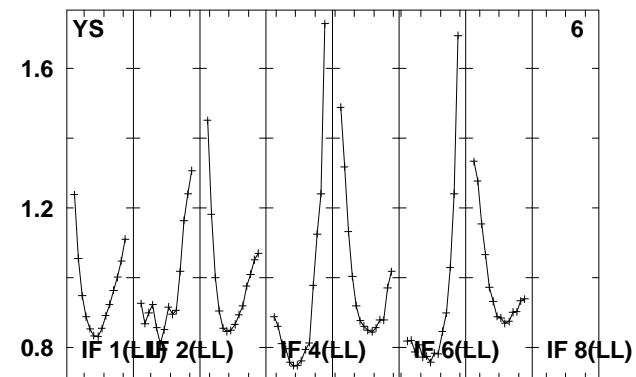
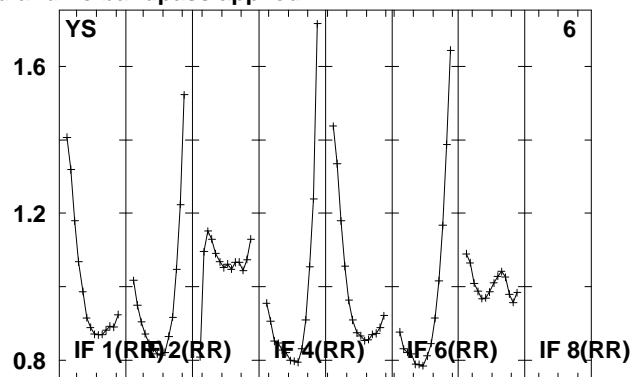
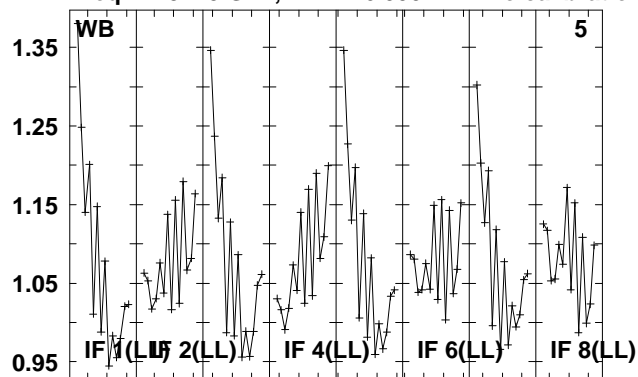

Lower frame: Real Jy
 Total-power spectrum Antenna: *
 Timerange: 00/11:01:56 to 00/11:12:38

Plot file version 44 created 08-JUL-2010 13:08:32

J0731+24 EM079.UVDATA.1

Freq = 4.9415 GHz, Bw = 16.000 MH No calibration applied and no bandpass applied

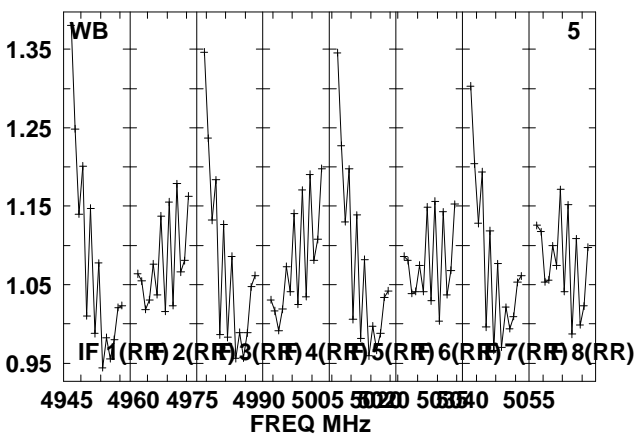
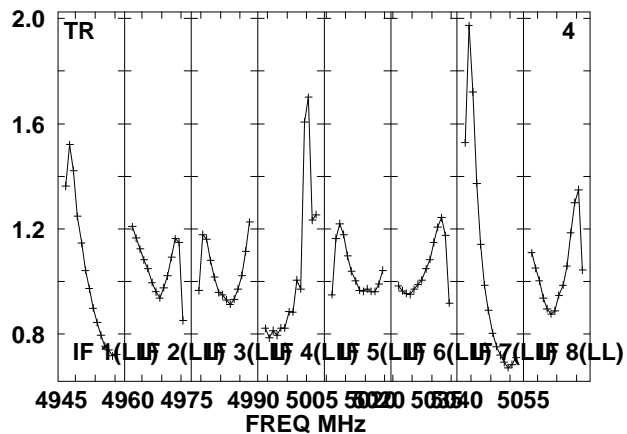
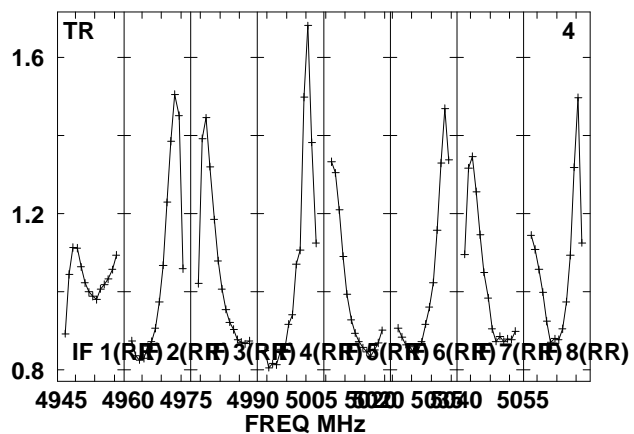
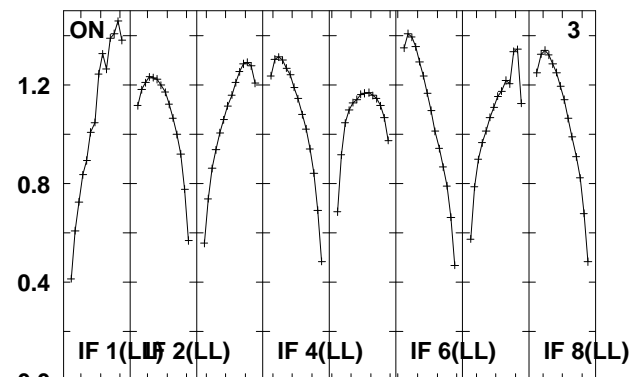
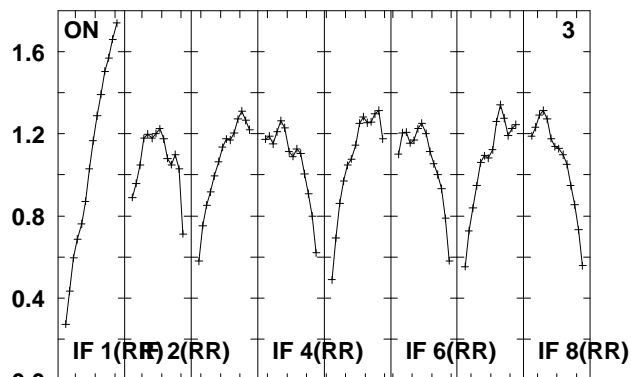
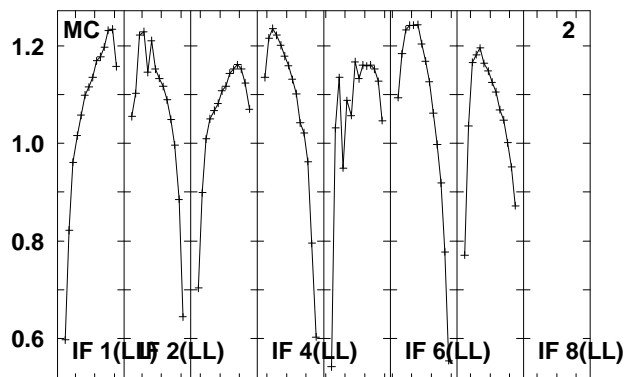
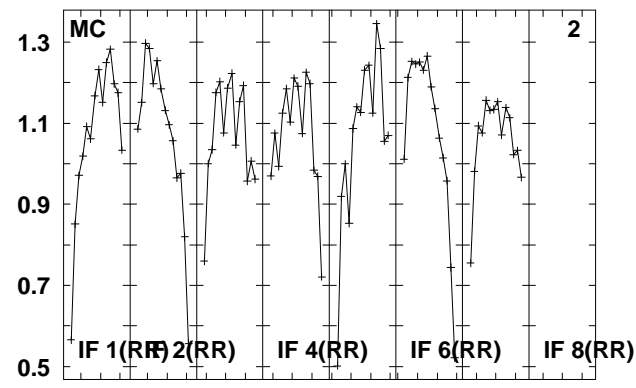
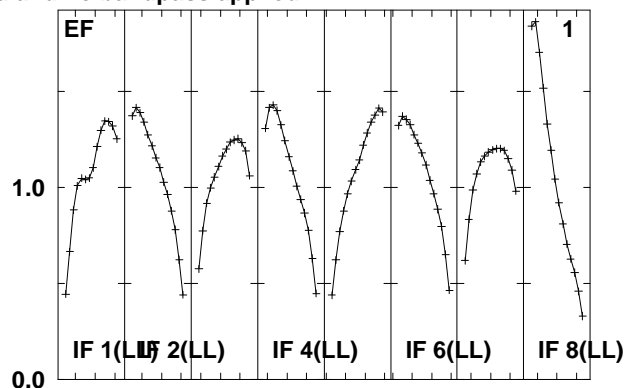
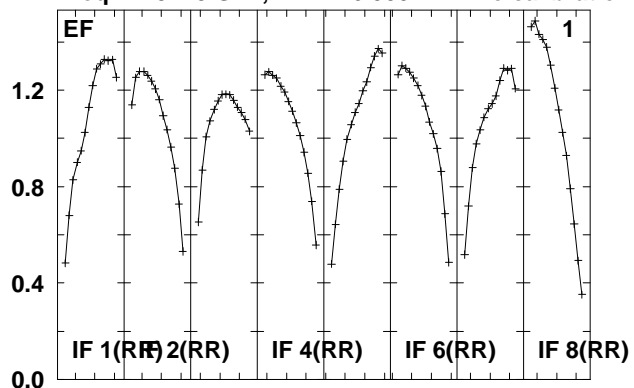

Lower frame: Real Jy
Total-power spectrum Antenna: *
Timerange: 00/11:12:40 to 00/11:14:38

Plot file version 45 created 08-JUL-2010 13:08:32

J0731+24 EM079.UVDATA.1

Freq = 4.9415 GHz, Bw = 16.000 MH No calibration applied and no bandpass applied

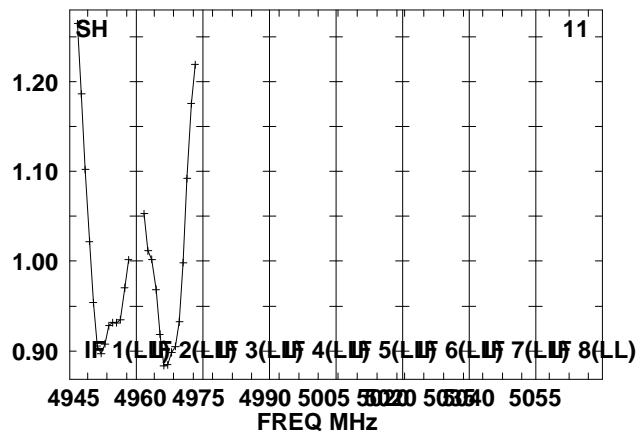
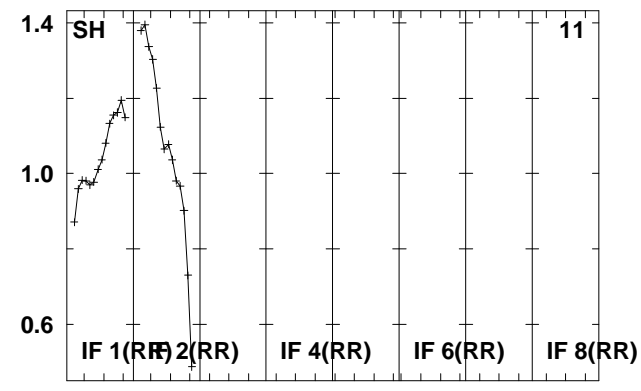
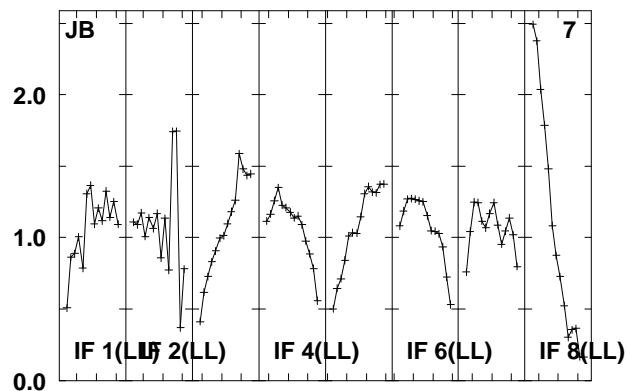
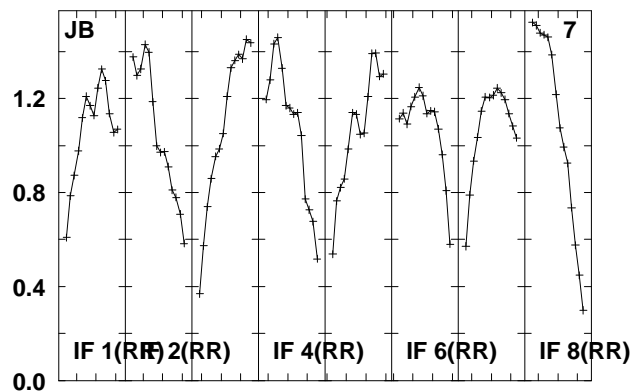
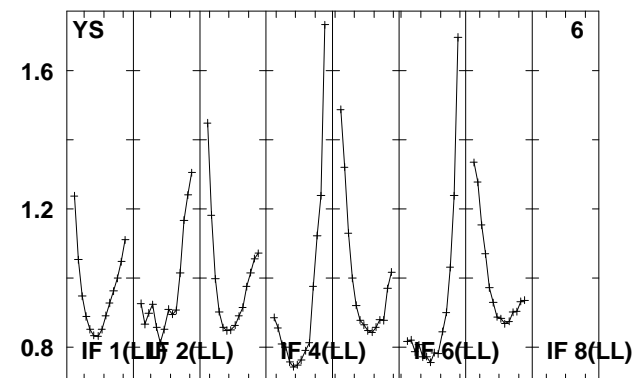
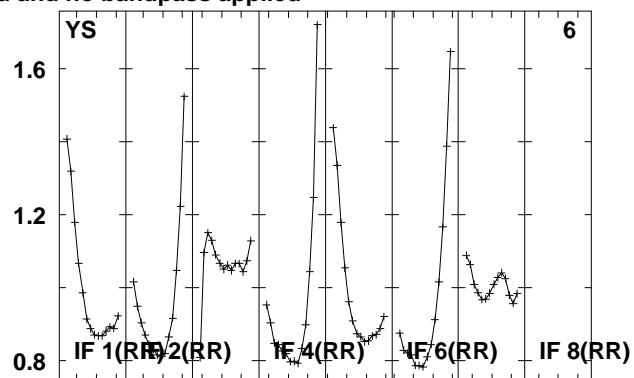
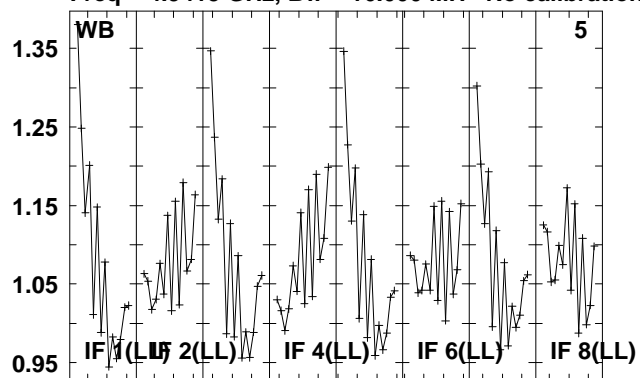

Lower frame: Real Jy

Total-power spectrum Antenna: *

Timerange: 00/11:12:40 to 00/11:14:38

Plot file version 46 created 08-JUL-2010 13:08:33

B0726+25 EM079.UVDATA.1

Freq = 4.9415 GHz, Bw = 16.000 MH No calibration applied and no bandpass applied

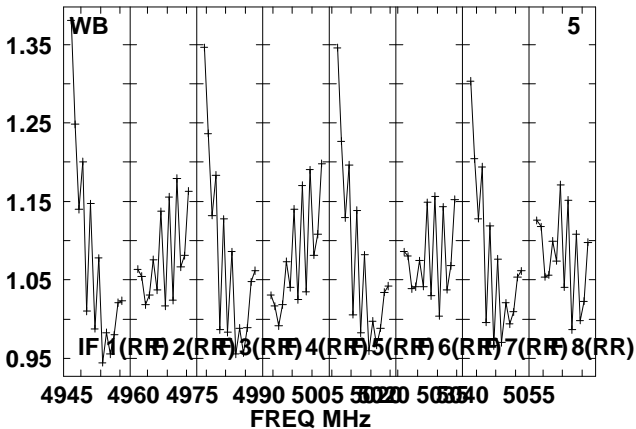
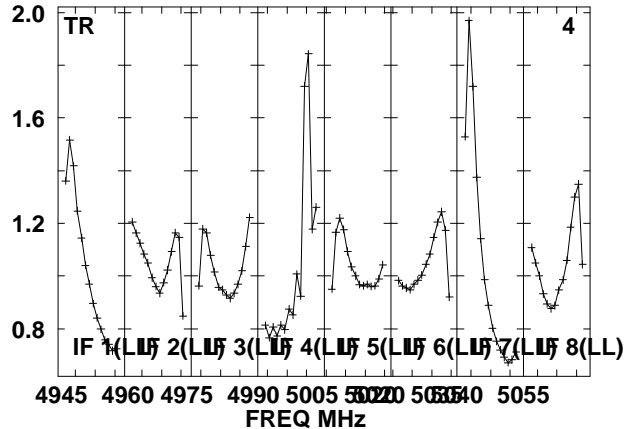
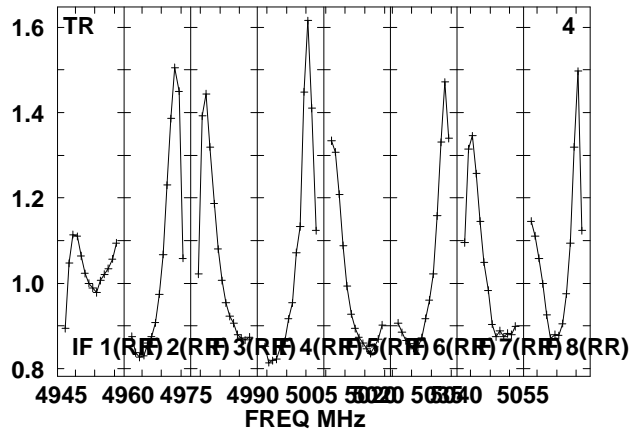
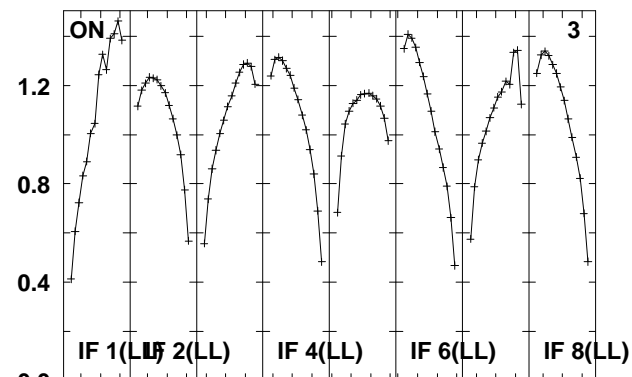
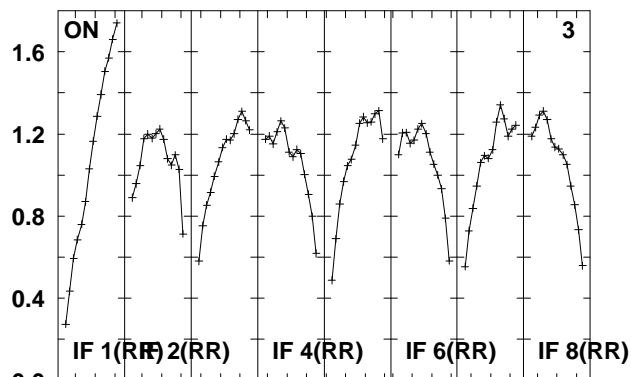
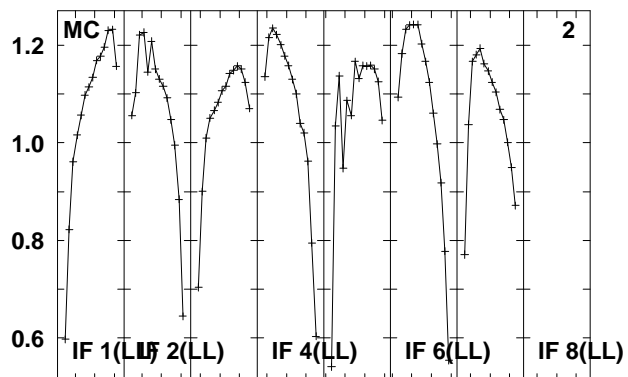
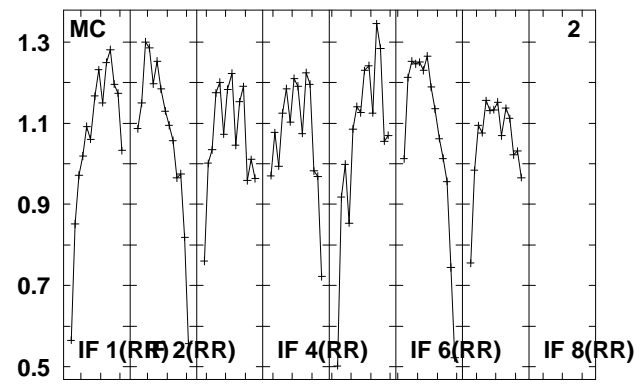
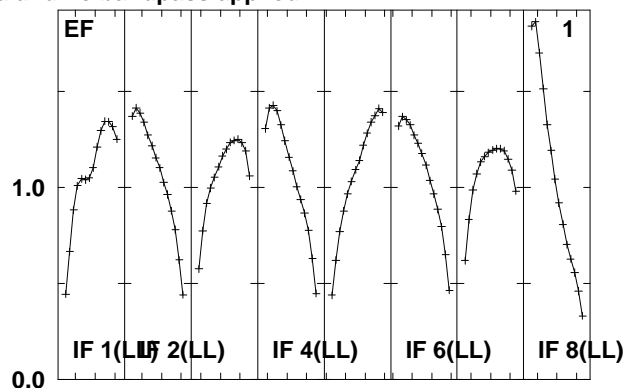
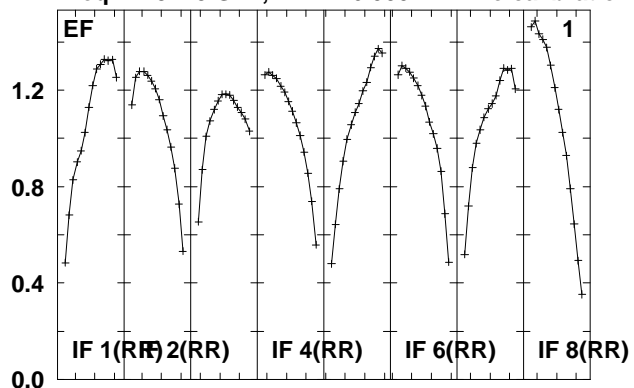

Lower frame: Real Jy
Total-power spectrum Antenna: *
Timerange: 00/11:14:40 to 00/11:25:24

Plot file version 47 created 08-JUL-2010 13:08:34

B0726+25 EM079.UVDATA.1

Freq = 4.9415 GHz, Bw = 16.000 MH No calibration applied and no bandpass applied

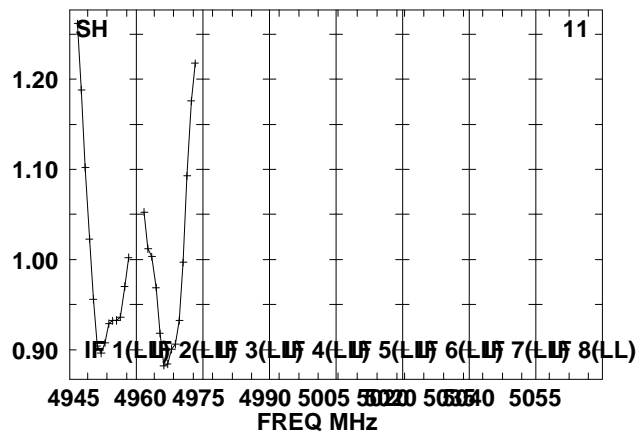
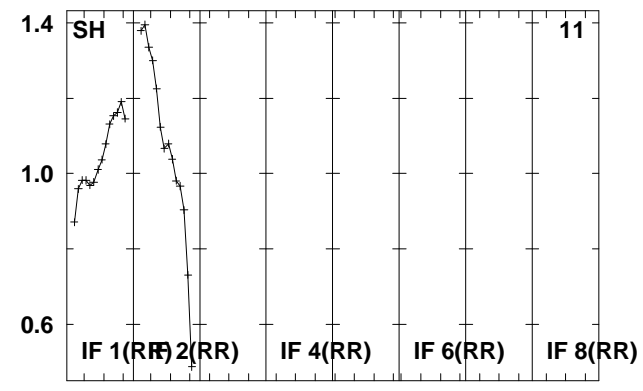
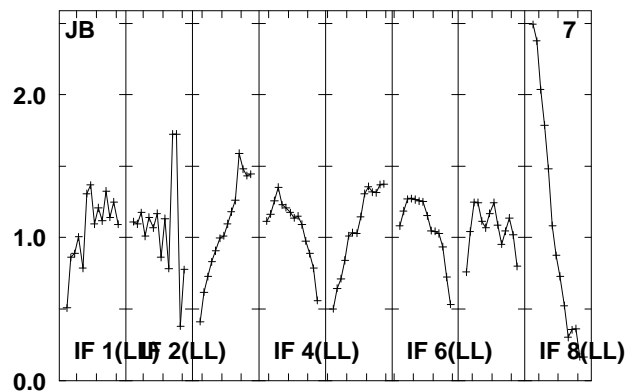
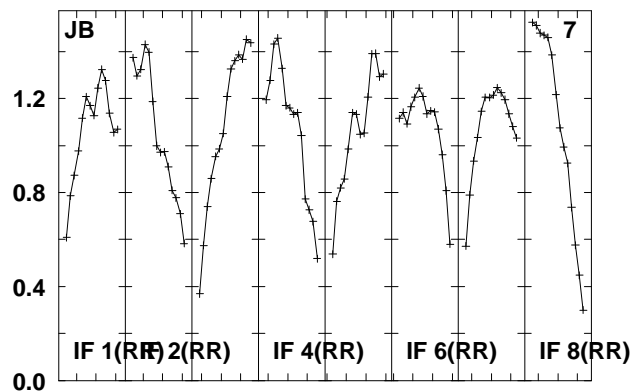
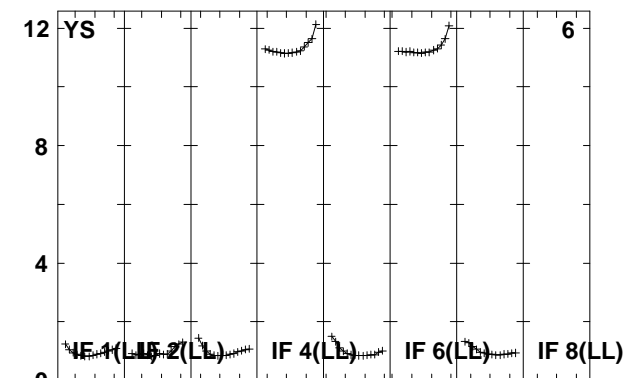
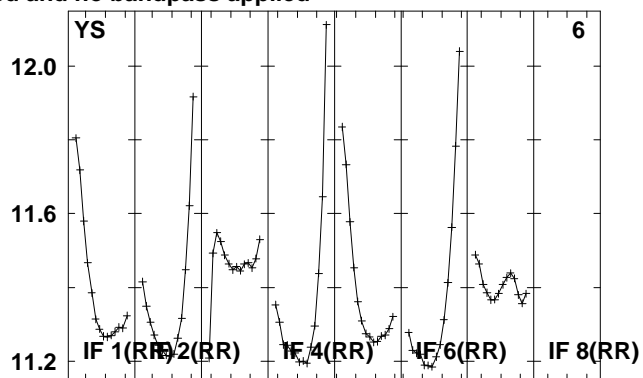
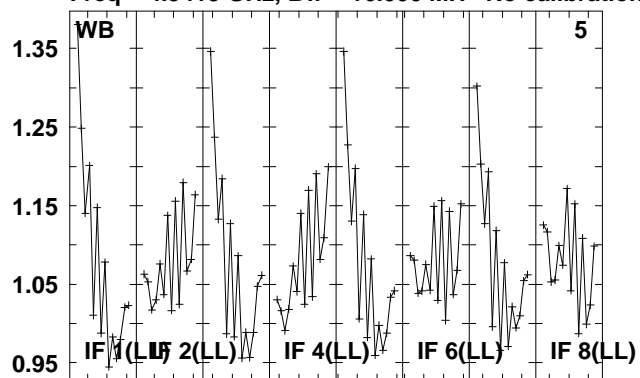

Lower frame: Real Jy

Total-power spectrum Antenna: *

Timerange: 00/11:14:40 to 00/11:25:24

Plot file version 48 created 08-JUL-2010 13:08:41

J0731+24 EM079.UVDATA.1

Freq = 4.9415 GHz, Bw = 16.000 MH No calibration applied and no bandpass applied

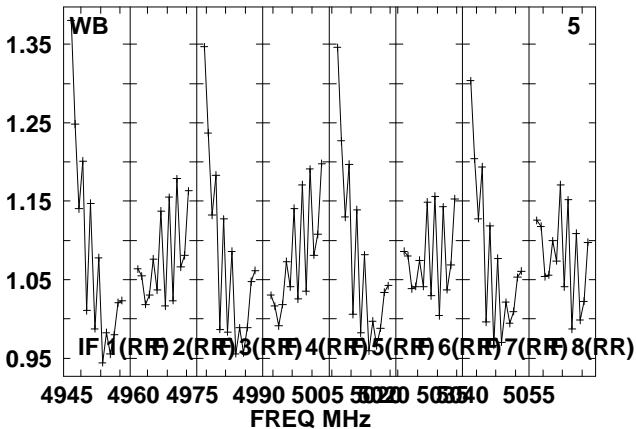
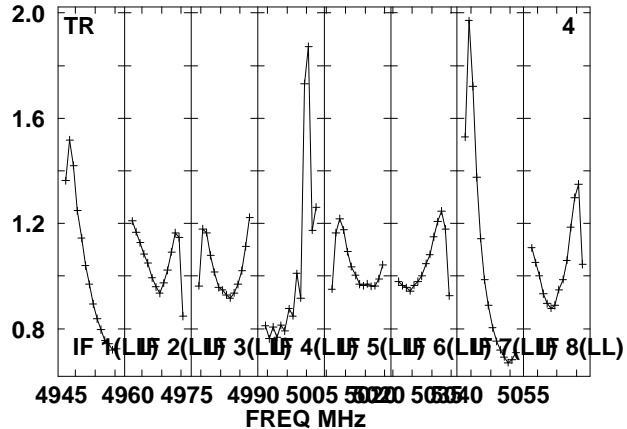
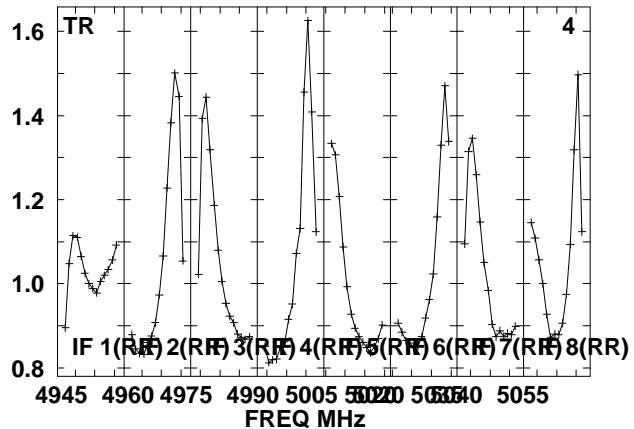
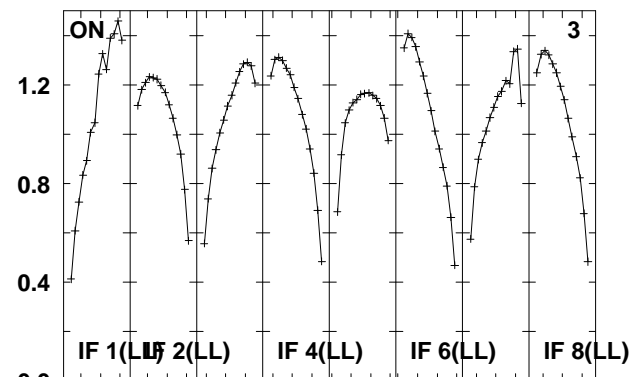
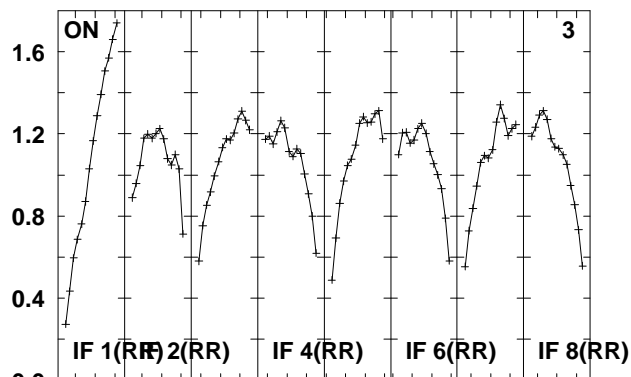
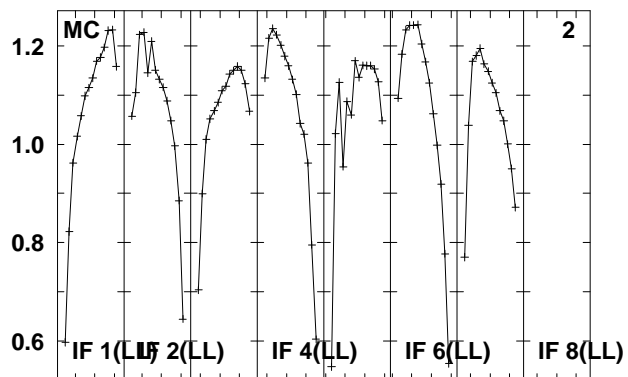
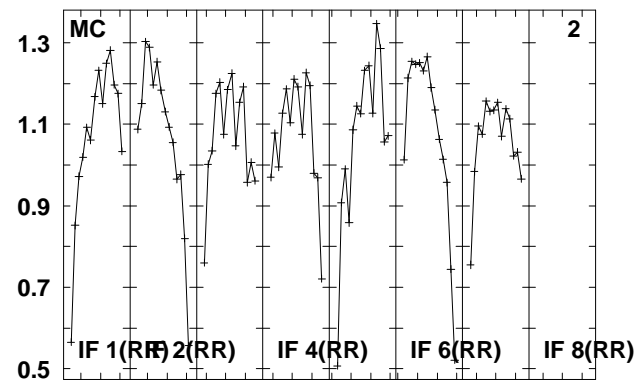
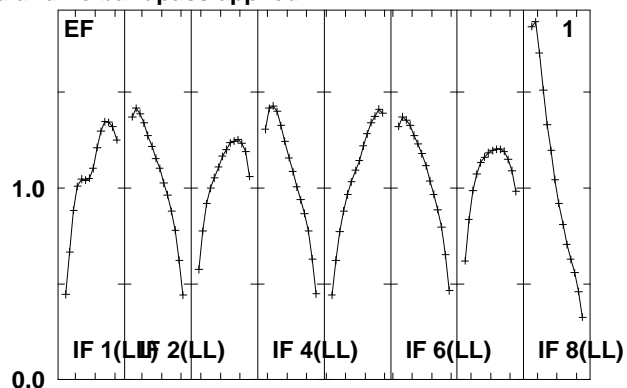
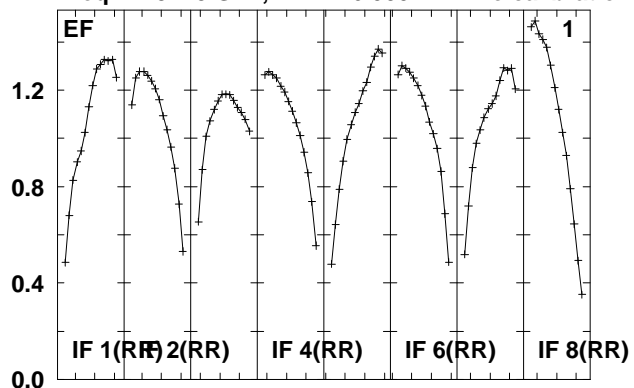

Lower frame: Real Jy
Total-power spectrum Antenna: *
Timerange: 00/11:25:26 to 00/11:27:24

Plot file version 49 created 08-JUL-2010 13:08:42

J0731+24 EM079.UVDATA.1

Freq = 4.9415 GHz, Bw = 16.000 MH No calibration applied and no bandpass applied

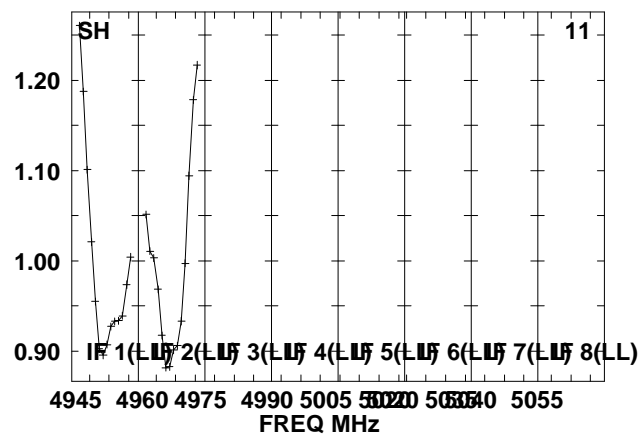
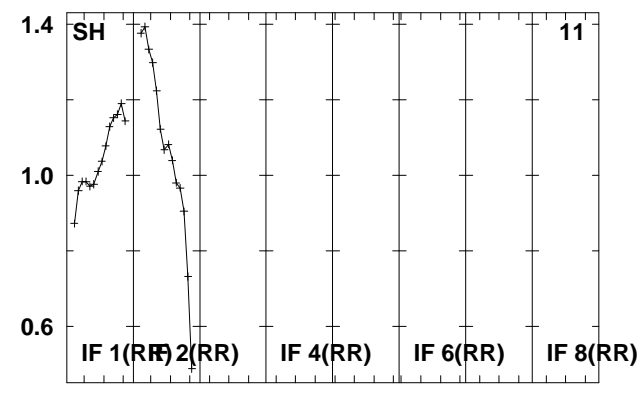
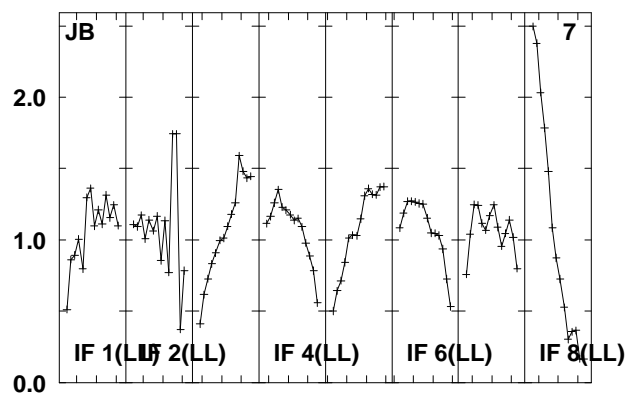
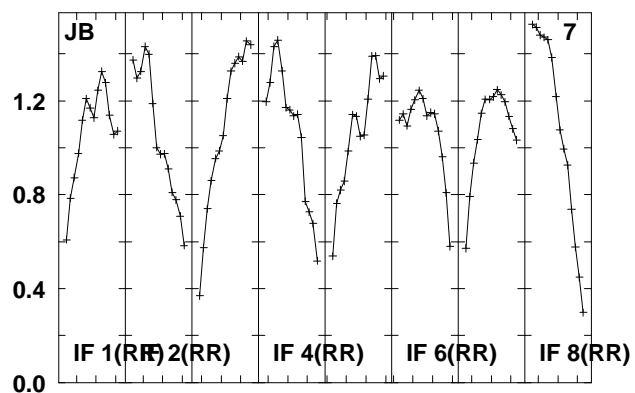
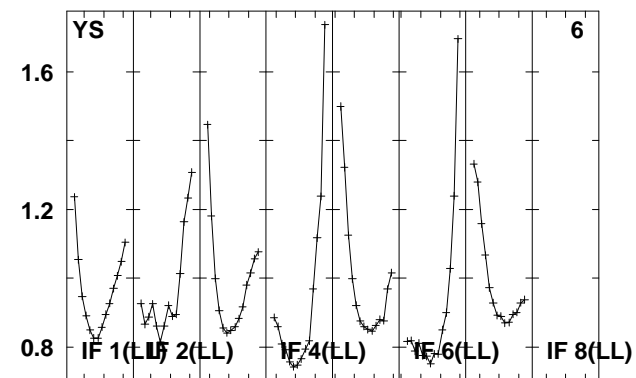
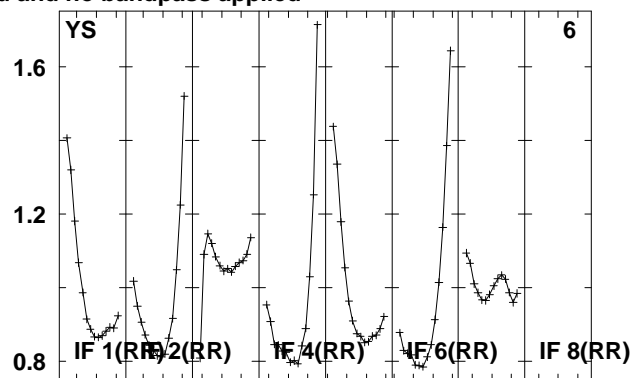
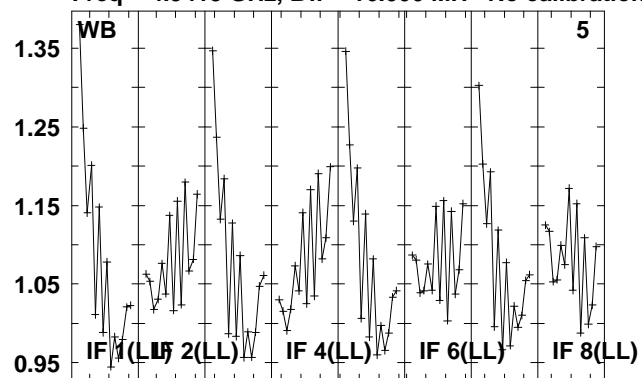

Lower frame: Real Jy

Total-power spectrum Antenna: *

Timerange: 00/11:25:26 to 00/11:27:24

Plot file version 50 created 08-JUL-2010 13:08:42

B0726+25 EM079.UVDATA.1

Freq = 4.9415 GHz, Bw = 16.000 MH No calibration applied and no bandpass applied

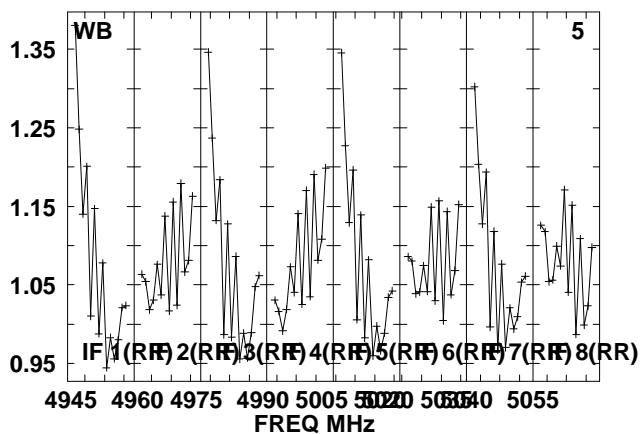
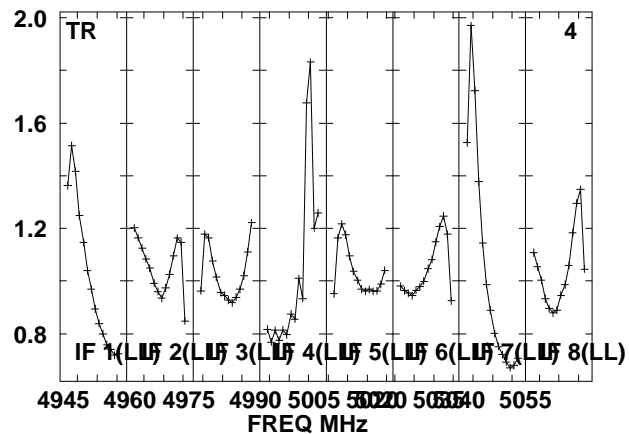
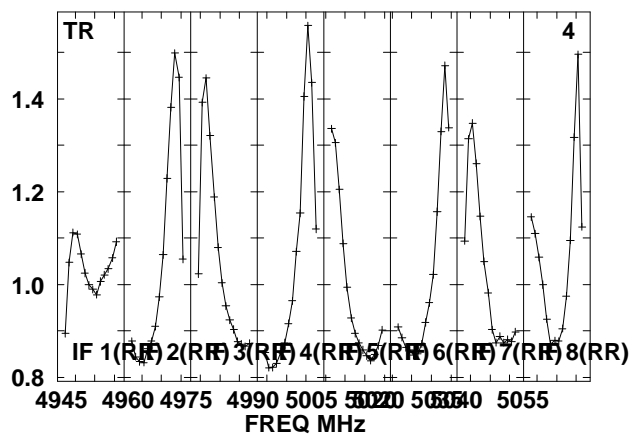
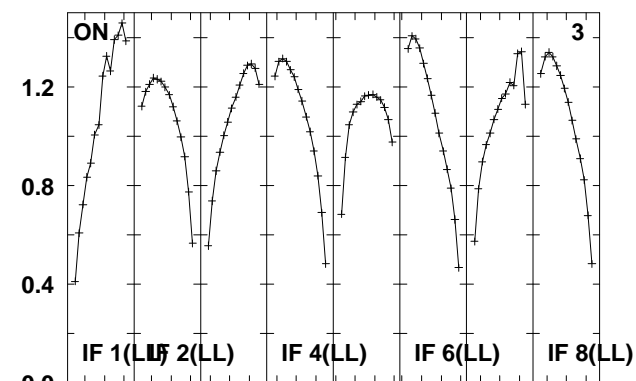
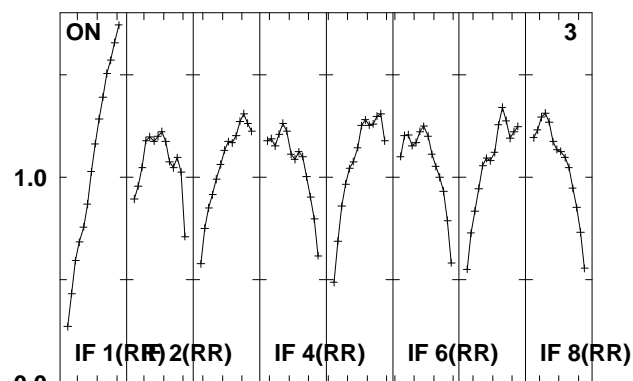
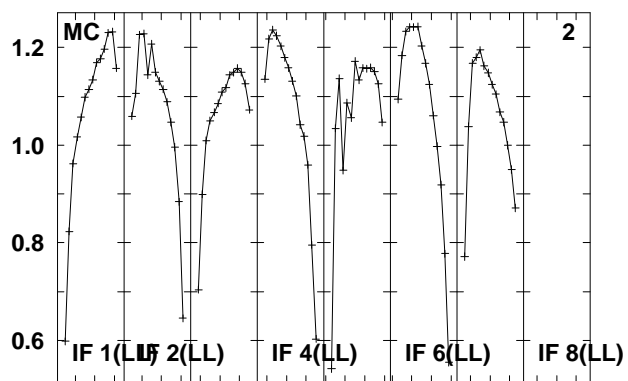
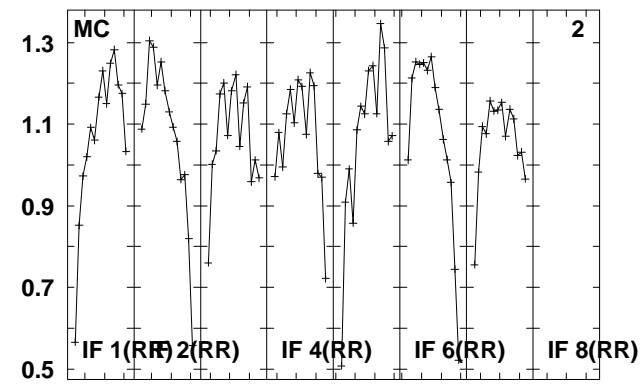
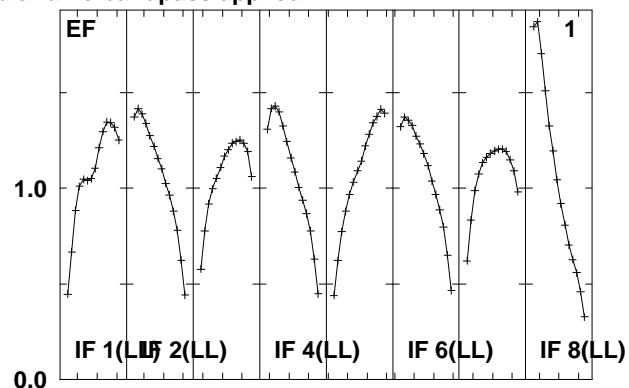
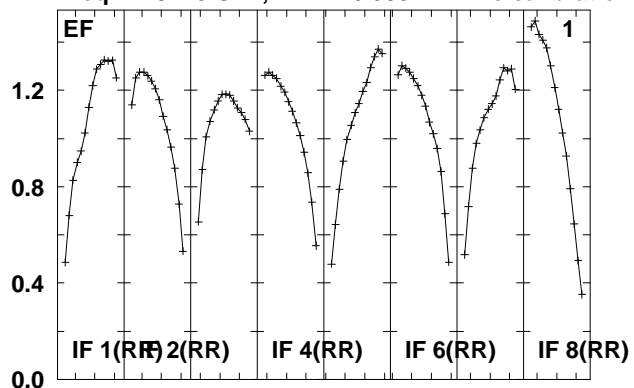

Lower frame: Real Jy
Total-power spectrum Antenna: *
Timerange: 00/11:27:26 to 00/11:38:08

Plot file version 51 created 08-JUL-2010 13:08:43
 B0726+25 EM079.UVDATA.1
 Freq = 4.9415 GHz, Bw = 16.000 MH No calibration applied and no bandpass applied

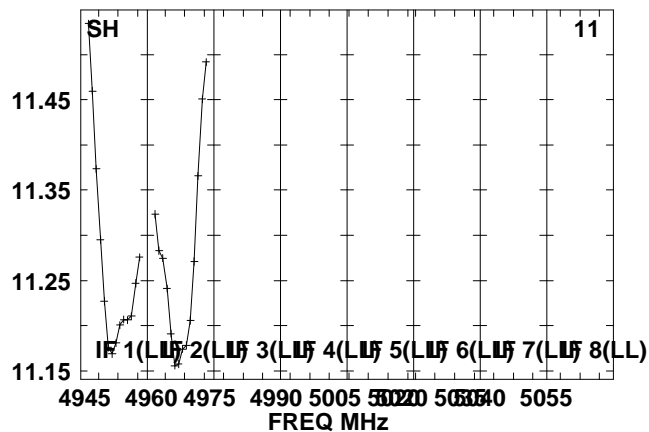
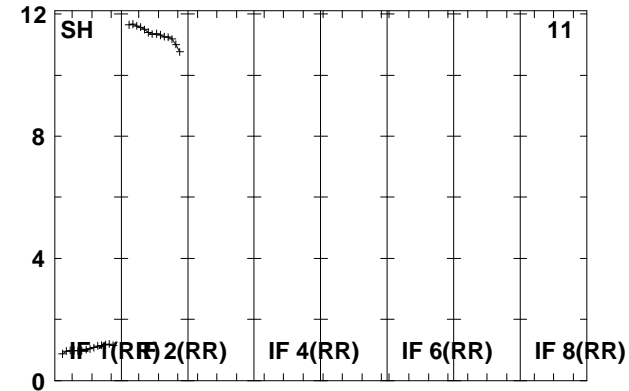
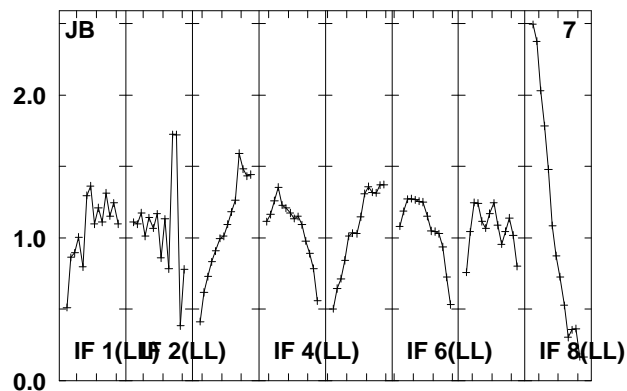
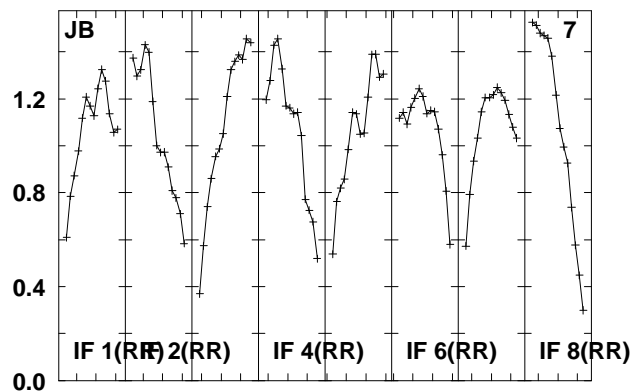
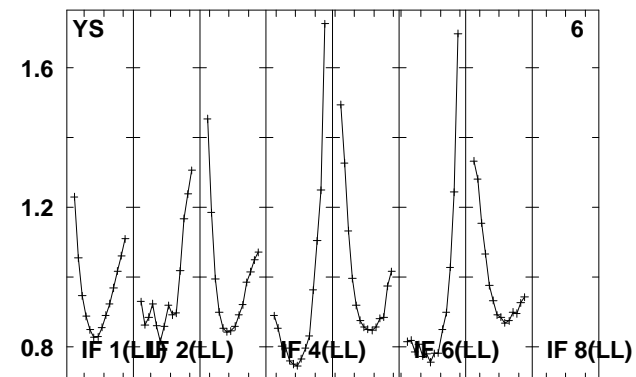
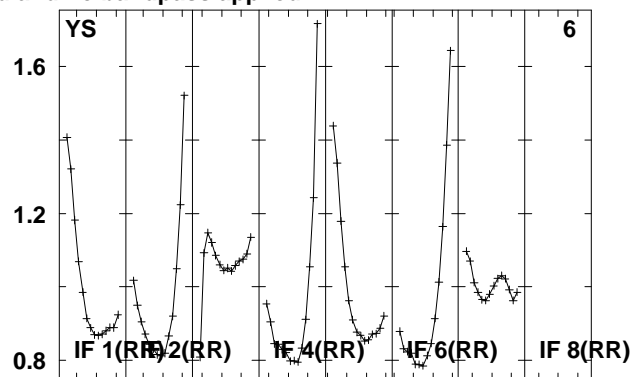
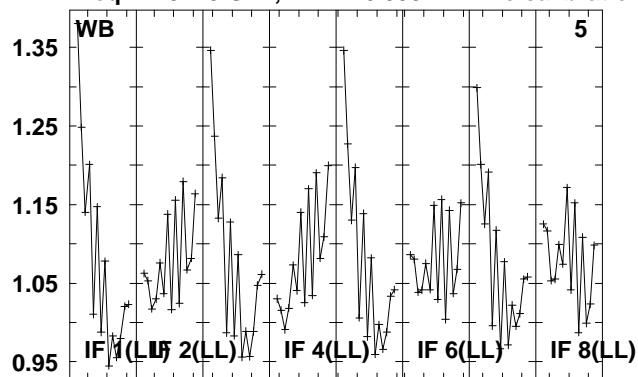

Lower frame: Real Jy
 Total-power spectrum Antenna: *
 Timerange: 00/11:27:26 to 00/11:38:08

Plot file version 52 created 08-JUL-2010 13:08:45

J0731+24 EM079.UVDATA.1

Freq = 4.9415 GHz, Bw = 16.000 MH No calibration applied and no bandpass applied

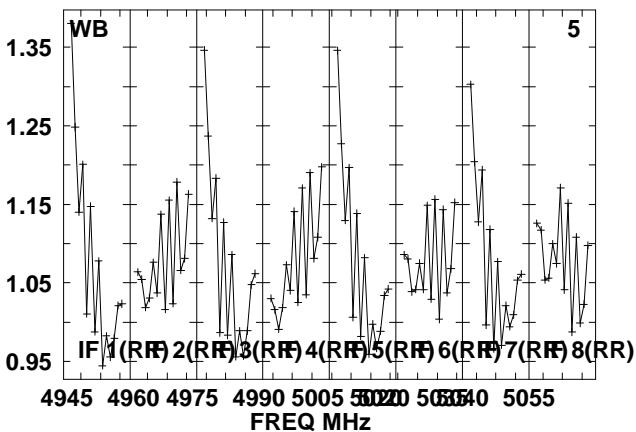
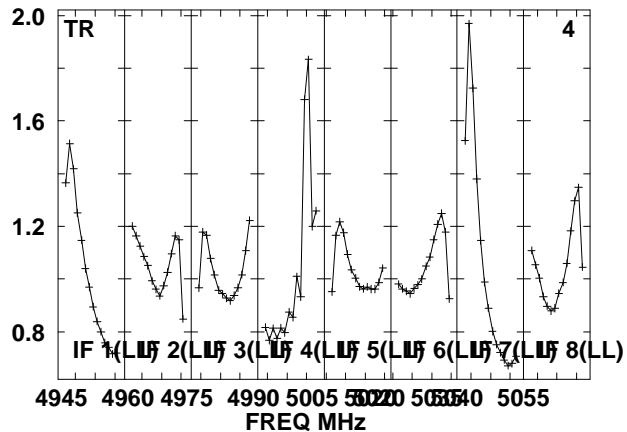
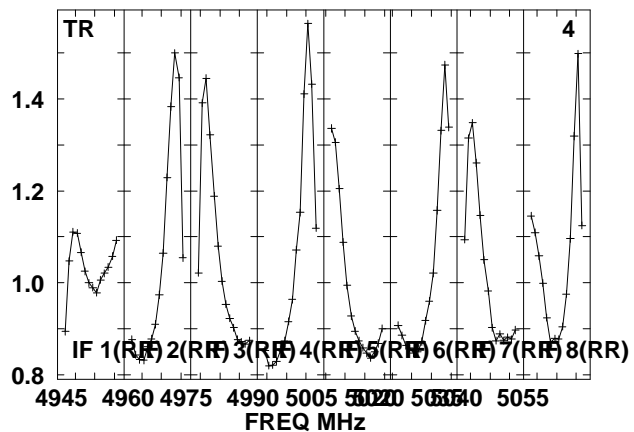
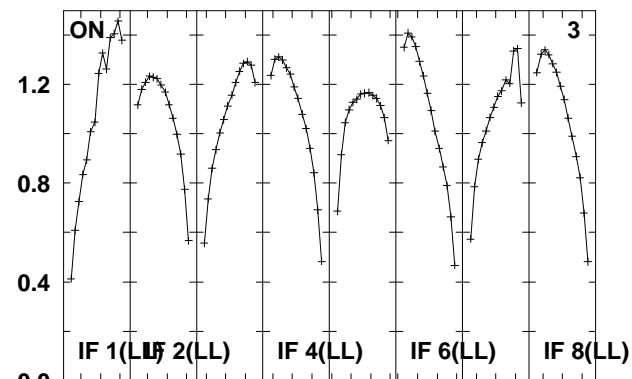
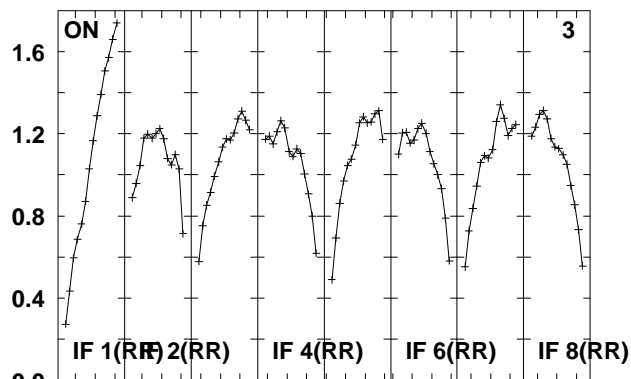
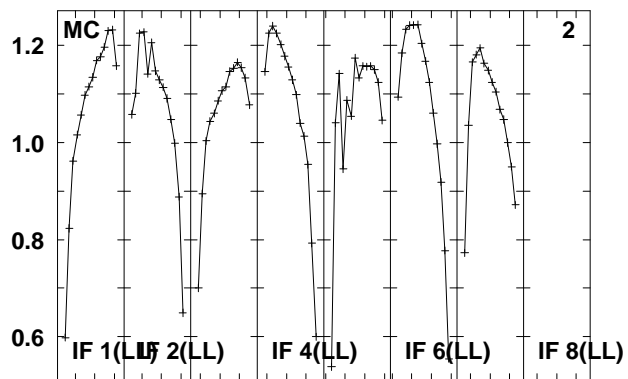
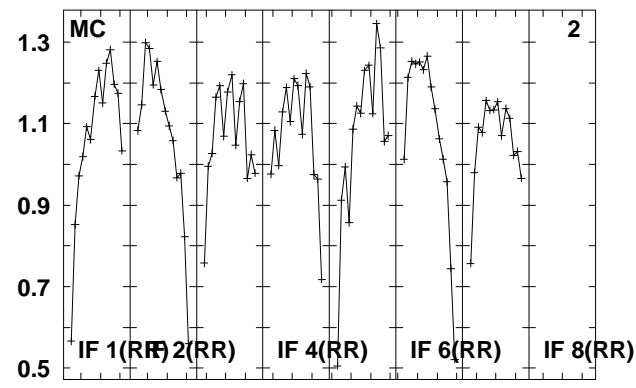
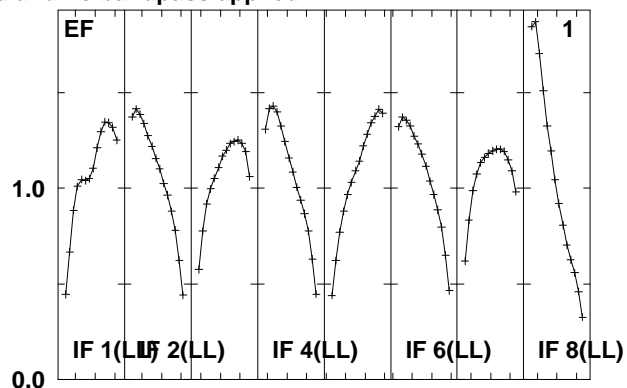
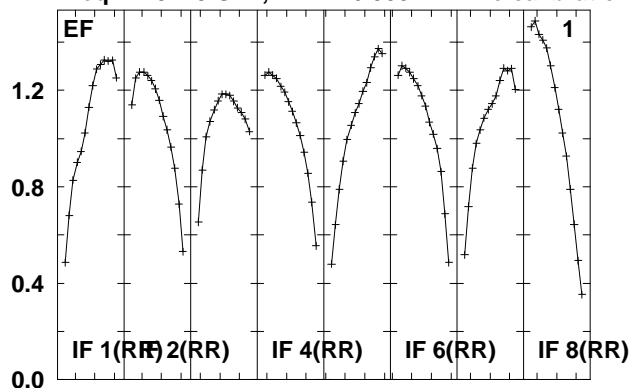

Lower frame: Real Jy
Total-power spectrum Antenna: *
Timerange: 00/11:38:10 to 00/11:40:08

Plot file version 53 created 08-JUL-2010 13:08:46

J0731+24 EM079.UVDATA.1

Freq = 4.9415 GHz, Bw = 16.000 MH No calibration applied and no bandpass applied

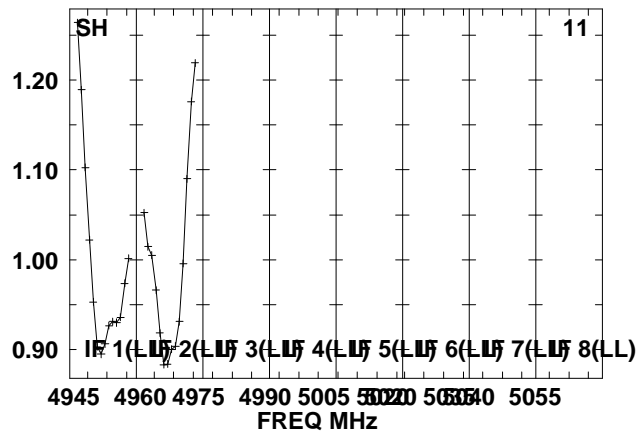
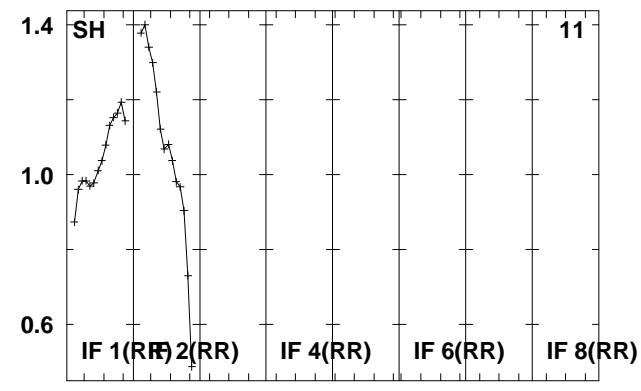
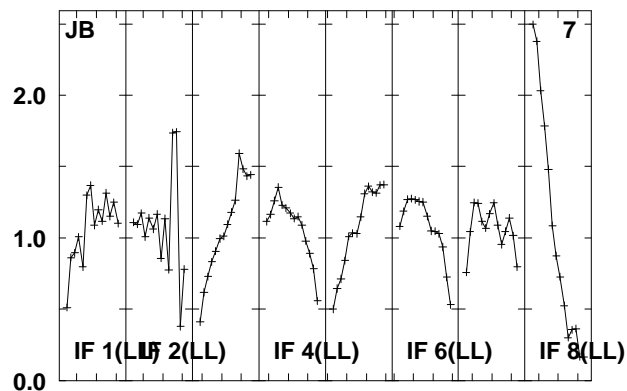
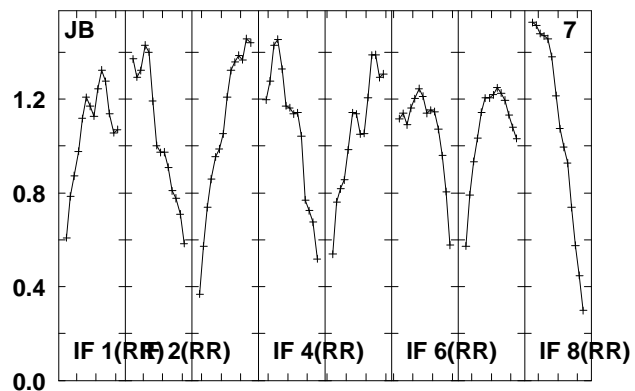
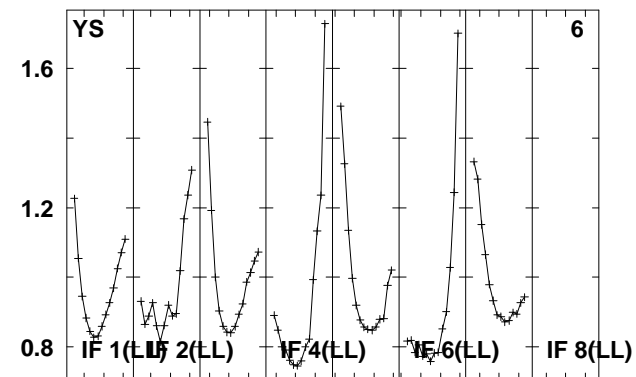
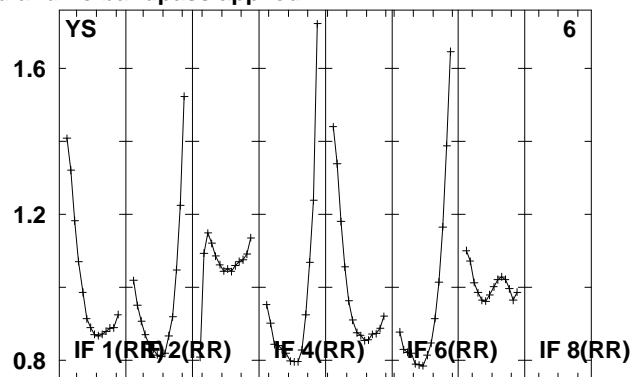
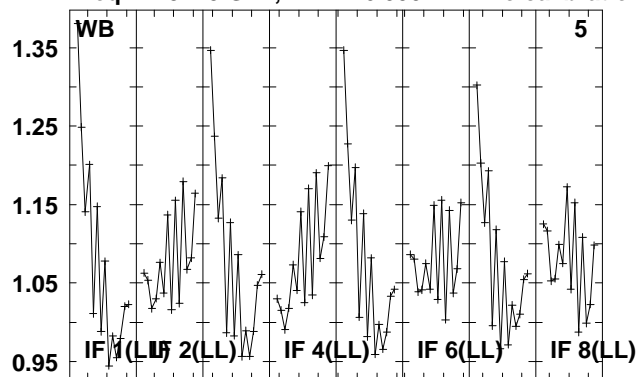

4945 4960 4975 4990 5005 5020 5035 5050 5055
FREQ MHz

Lower frame: Real Jy

Total-power spectrum Antenna: *

Timerange: 00/11:38:10 to 00/11:40:08

Plot file version 54 created 08-JUL-2010 13:08:46

B0726+25 EM079.UVDATA.1

Freq = 4.9415 GHz, Bw = 16.000 MH No calibration applied and no bandpass applied

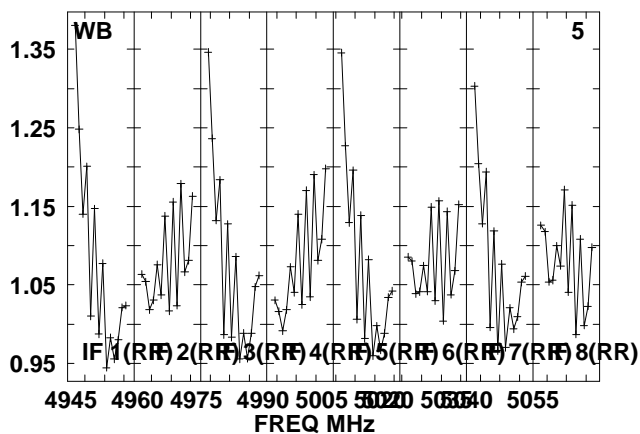
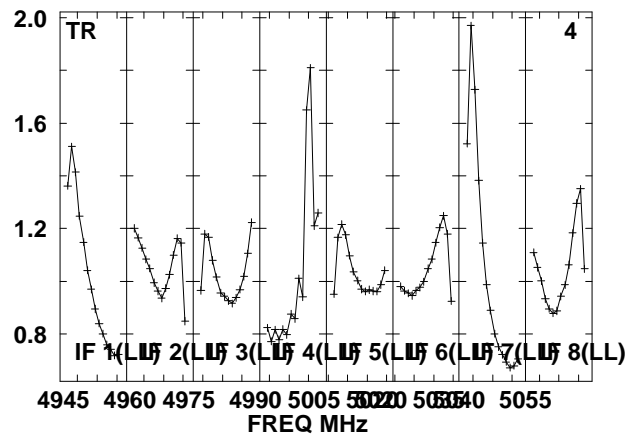
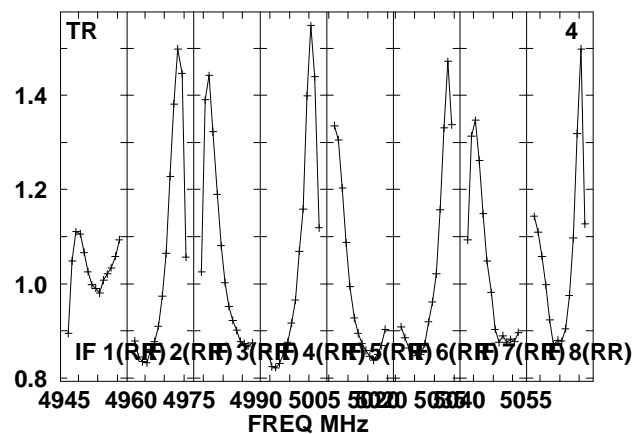
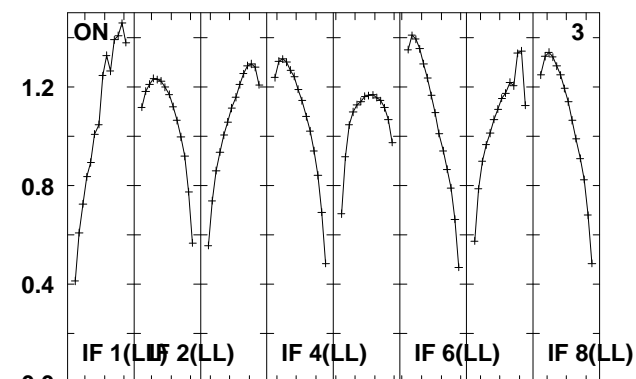
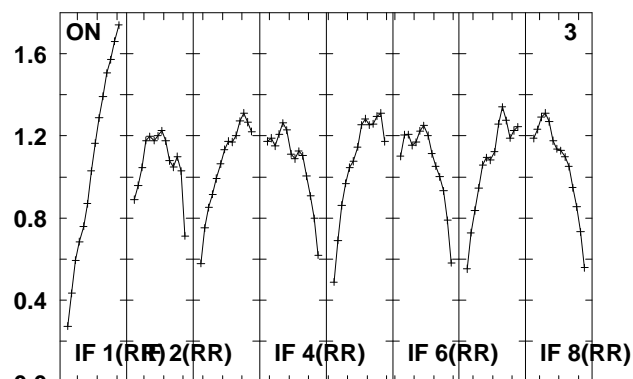
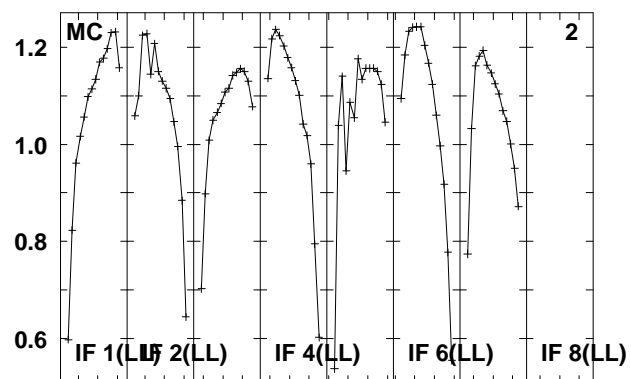
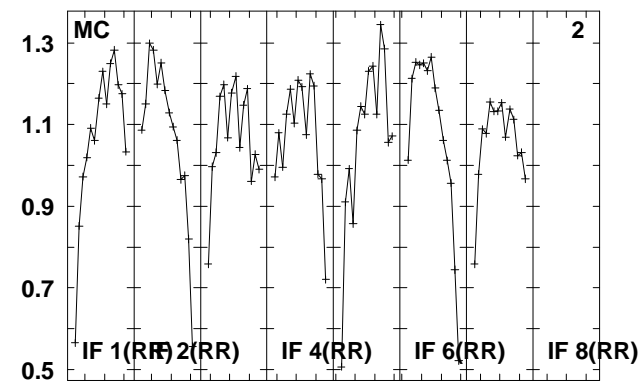
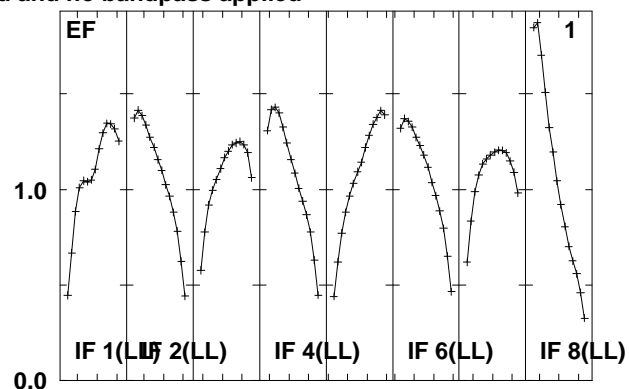
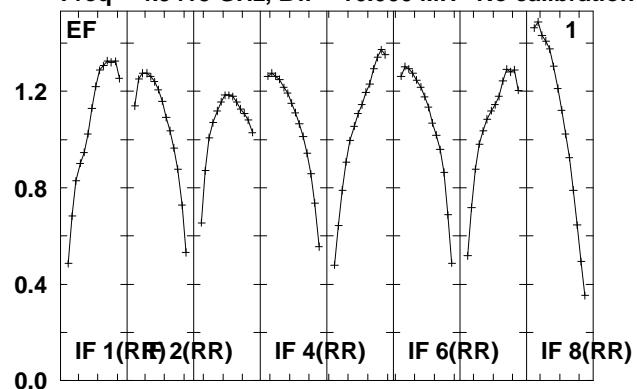

Lower frame: Real Jy
Total-power spectrum Antenna: *
Timerange: 00/11:40:10 to 00/11:50:54

Plot file version 55 created 08-JUL-2010 13:08:48
 B0726+25 EM079.UVDATA.1
 Freq = 4.9415 GHz, Bw = 16.000 MH No calibration applied and no bandpass applied

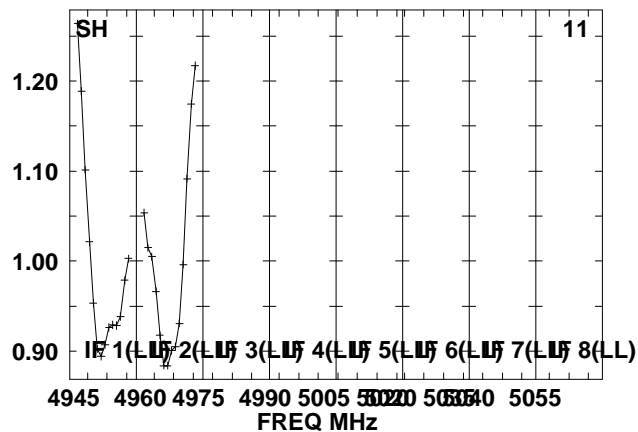
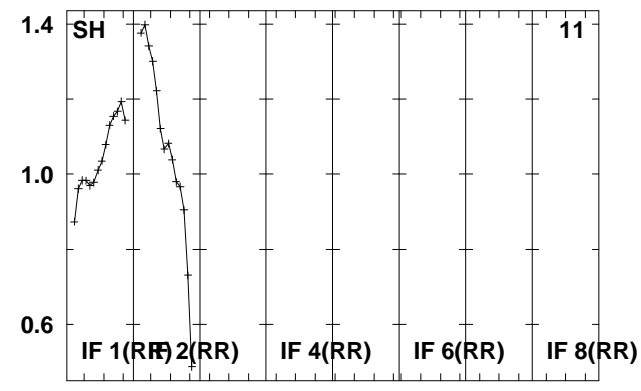
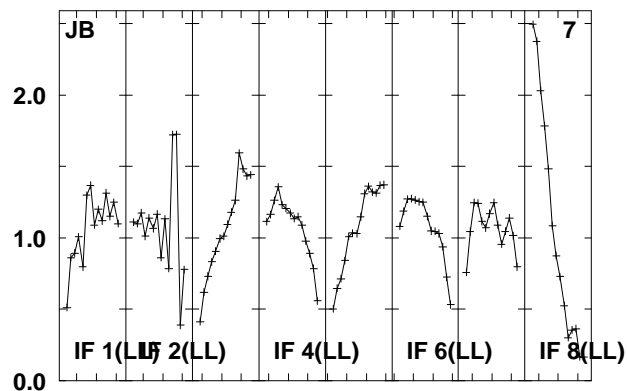
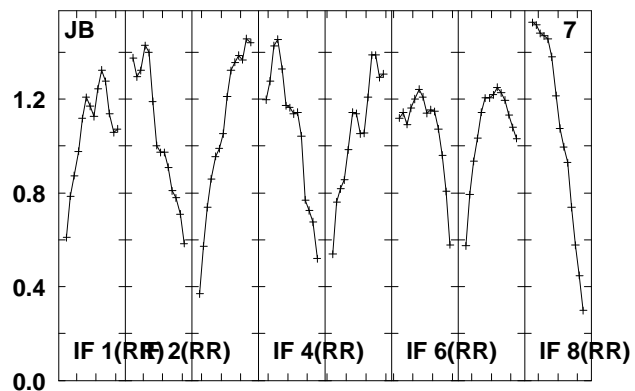
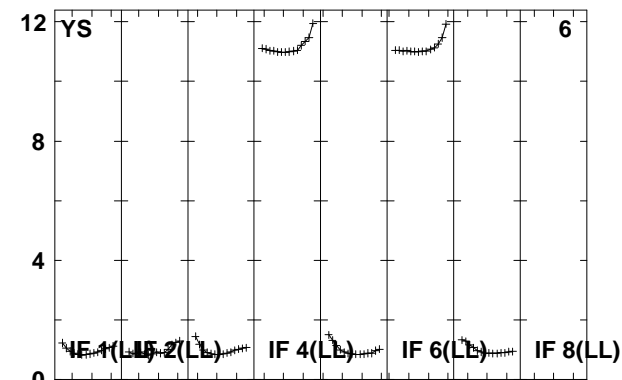
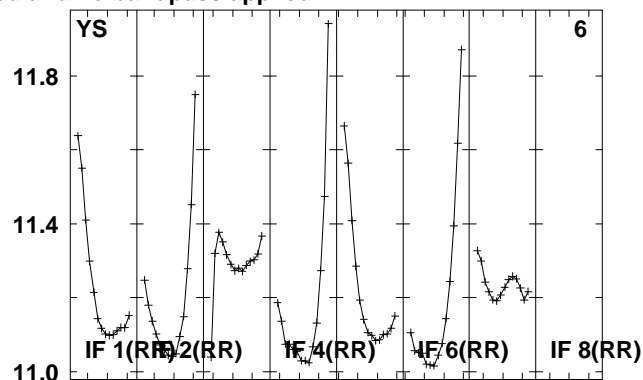
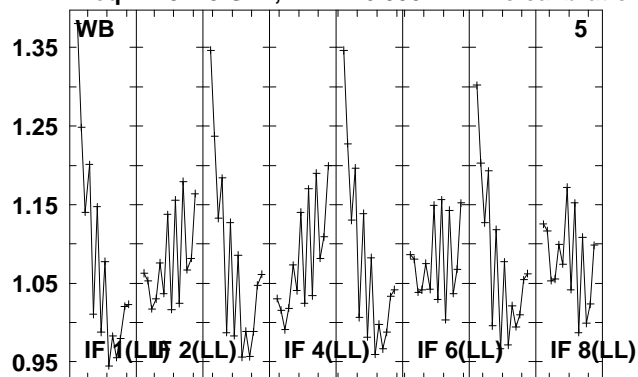

4945 4960 4975 4990 5005 5020 5035 5050 5055
 FREQ MHz

Lower frame: Real Jy
 Total-power spectrum Antenna: *
 Timerange: 00/11:40:10 to 00/11:50:54

Plot file version 56 created 08-JUL-2010 13:08:49

J0731+24 EM079.UVDATA.1

Freq = 4.9415 GHz, Bw = 16.000 MH No calibration applied and no bandpass applied

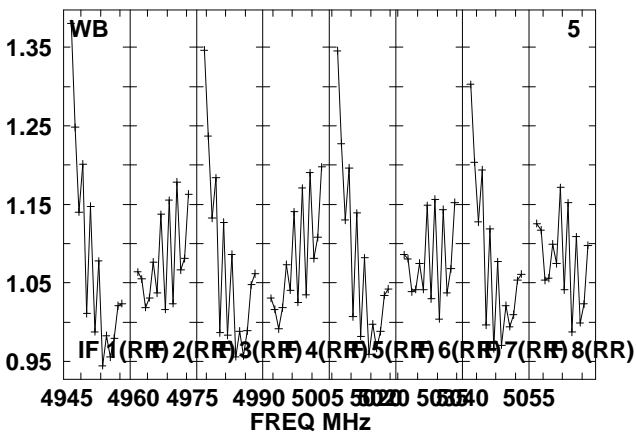
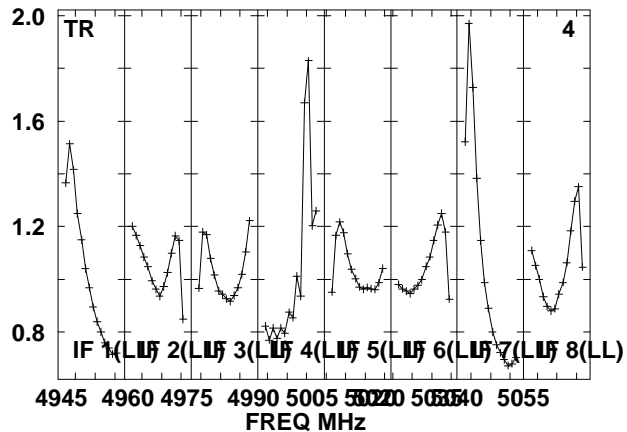
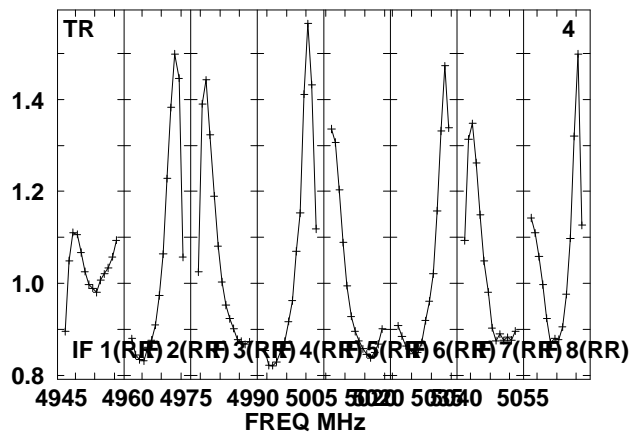
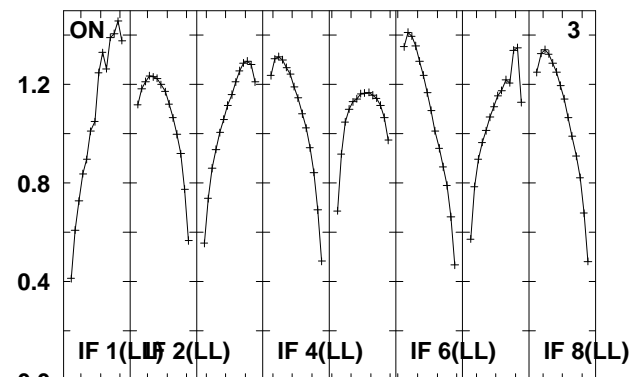
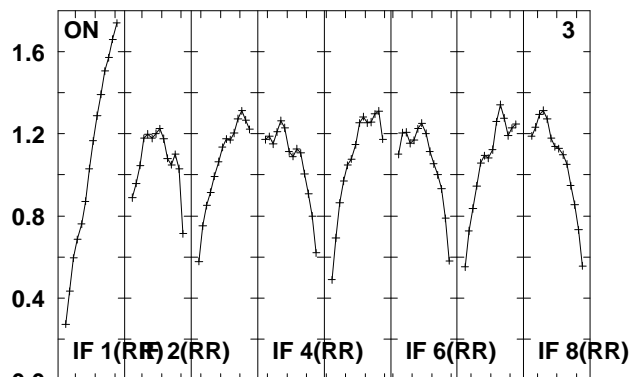
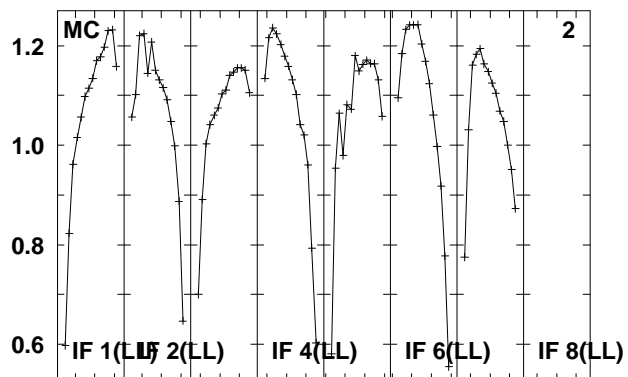
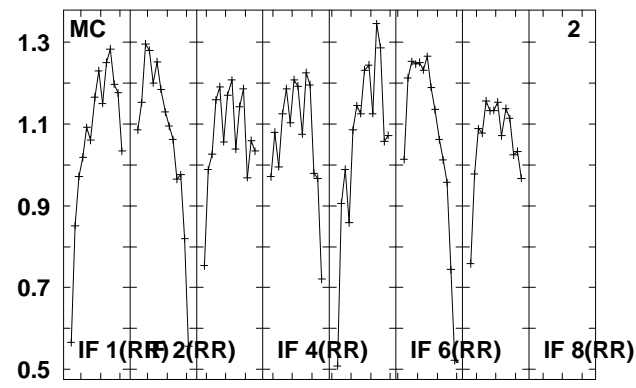
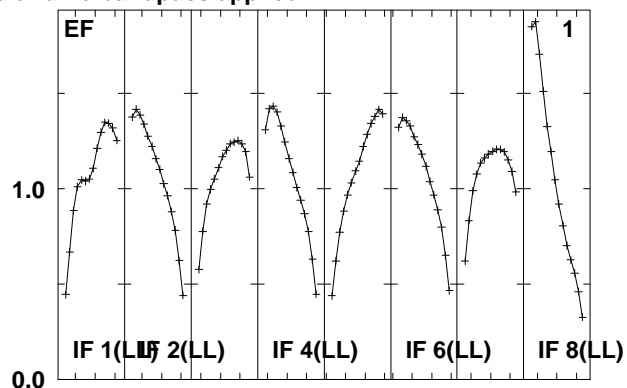
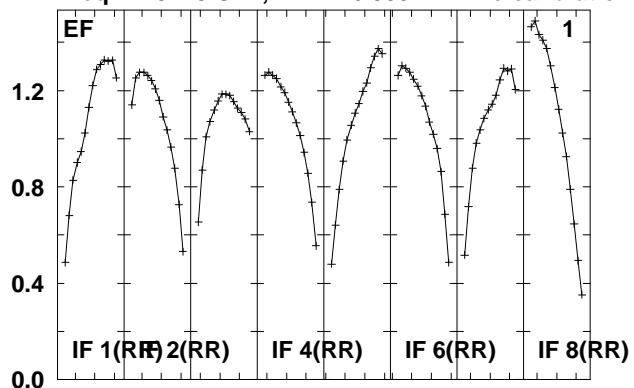

Lower frame: Real Jy
Total-power spectrum Antenna: *
Timerange: 00/11:50:56 to 00/11:52:54

Plot file version 57 created 08-JUL-2010 13:08:50

J0731+24 EM079.UVDATA.1

Freq = 4.9415 GHz, Bw = 16.000 MH No calibration applied and no bandpass applied

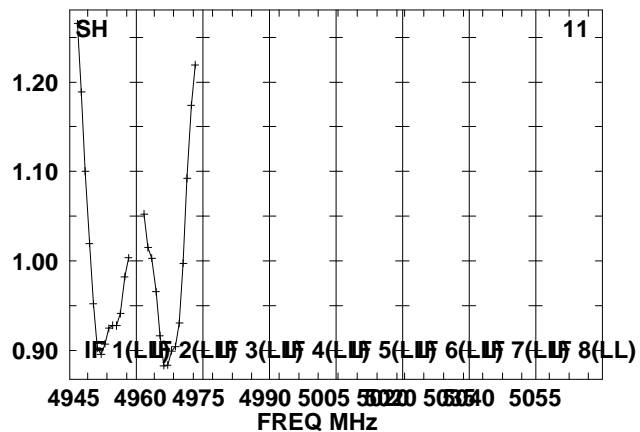
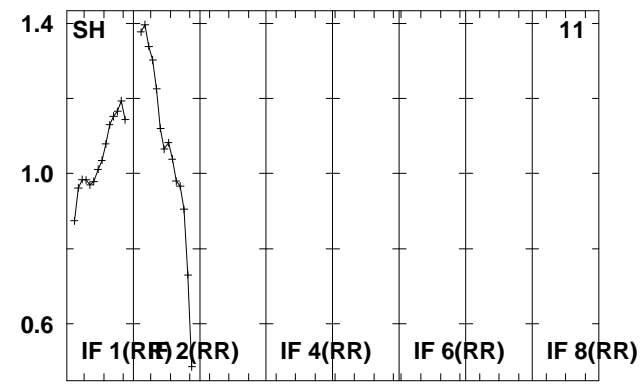
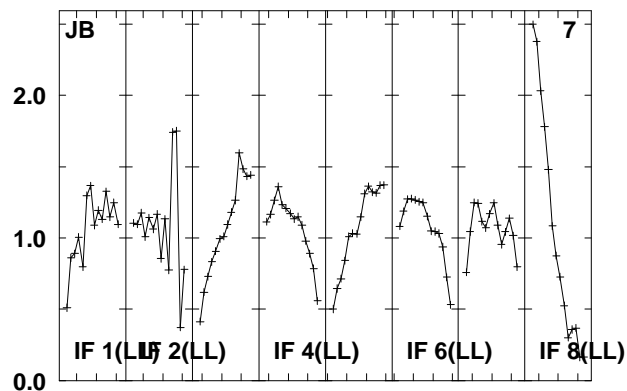
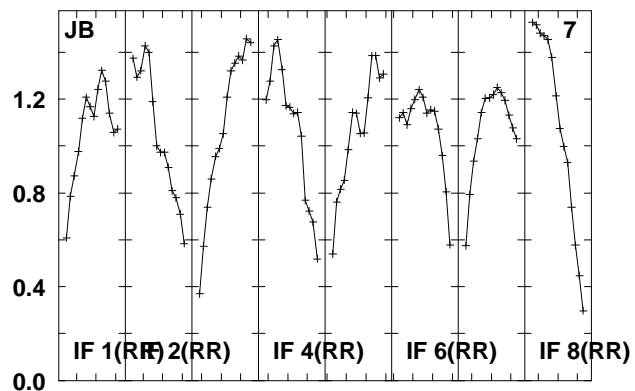
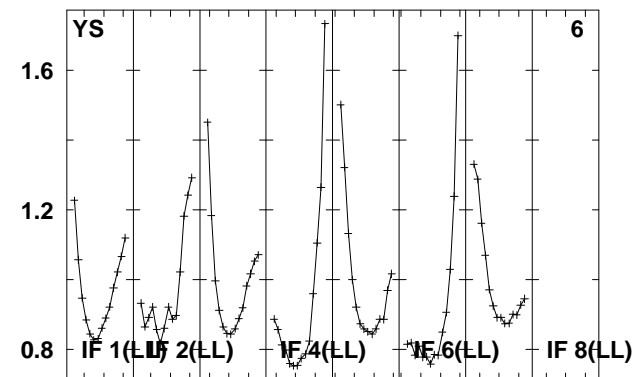
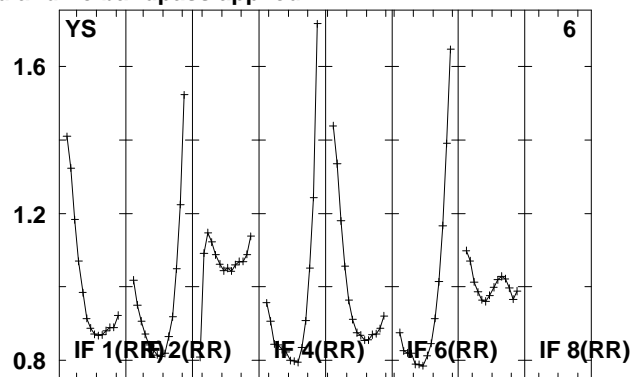
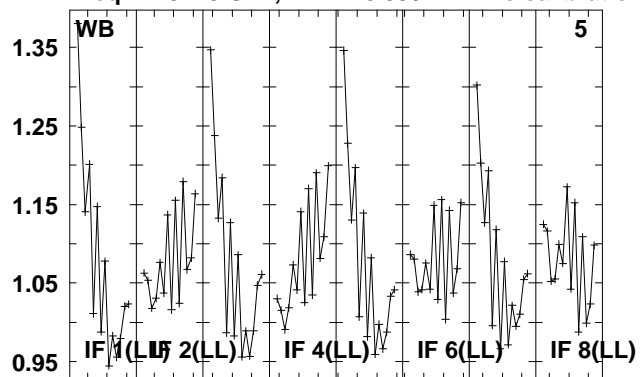

Lower frame: Real Jy

Total-power spectrum Antenna: *

Timerange: 00/11:50:56 to 00/11:52:54

Plot file version 58 created 08-JUL-2010 13:08:50

B0726+25 EM079.UVDATA.1

Freq = 4.9415 GHz, Bw = 16.000 MH No calibration applied and no bandpass applied

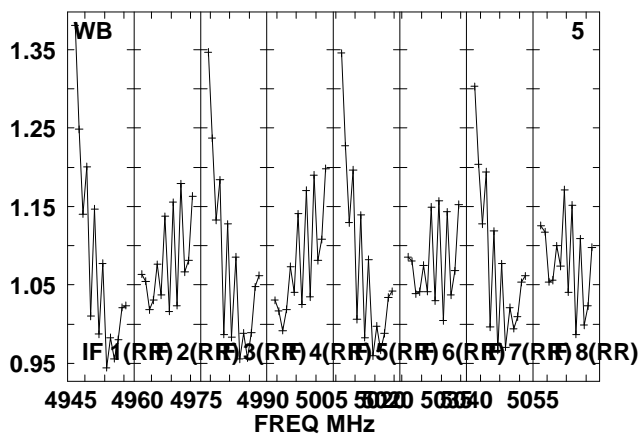
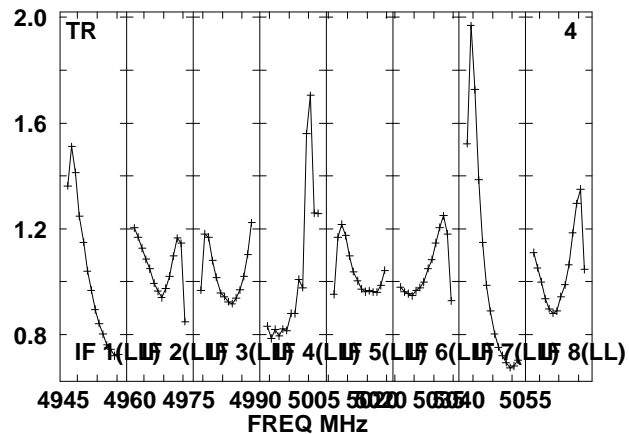
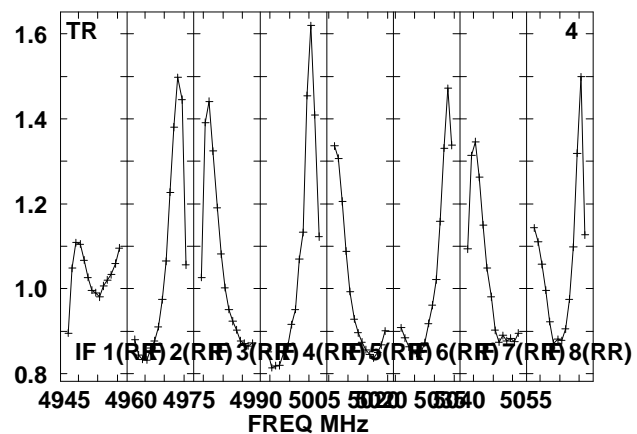
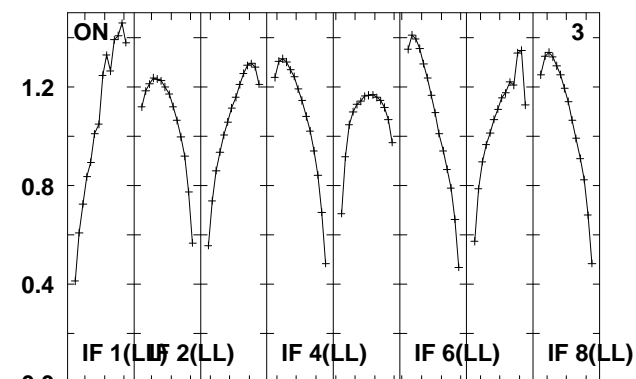
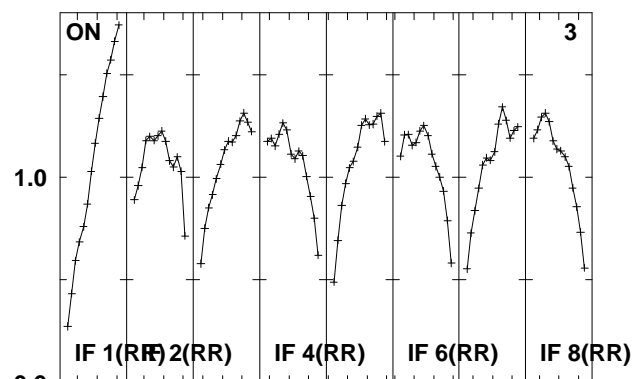
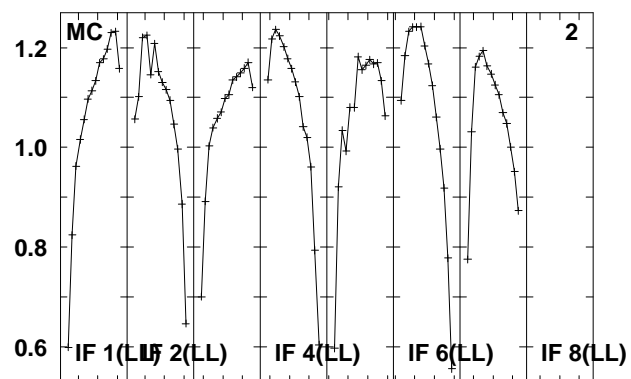
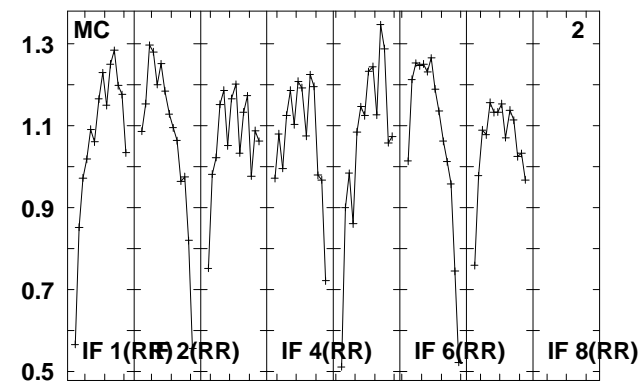
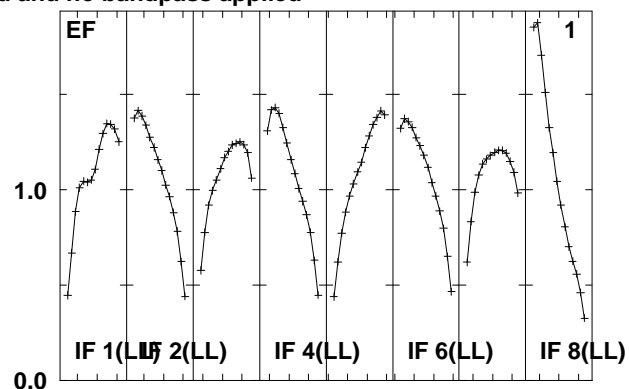
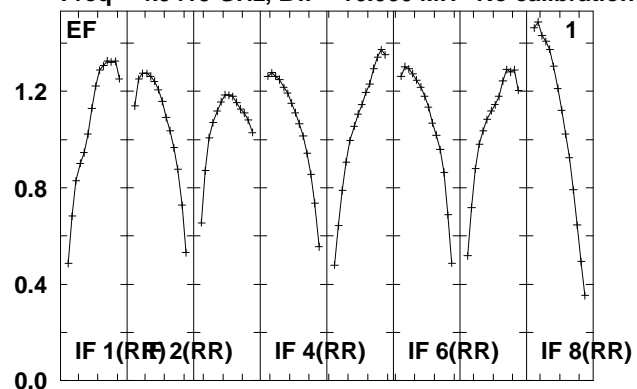

Lower frame: Real Jy
Total-power spectrum Antenna: *
Timerange: 00/11:52:56 to 00/12:03:38

Plot file version 59 created 08-JUL-2010 13:08:52

B0726+25 EM079.UVDATA.1

Freq = 4.9415 GHz, Bw = 16.000 MH No calibration applied and no bandpass applied

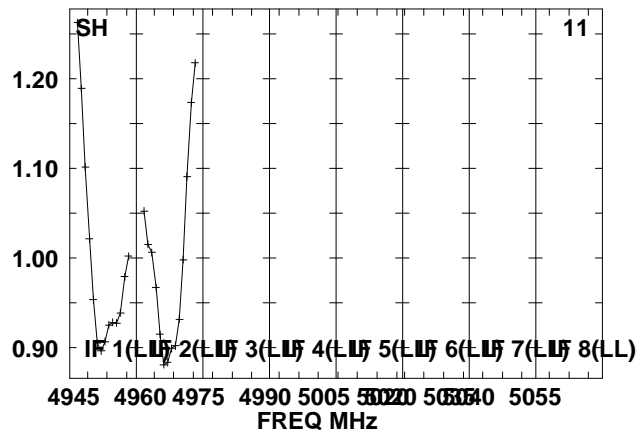
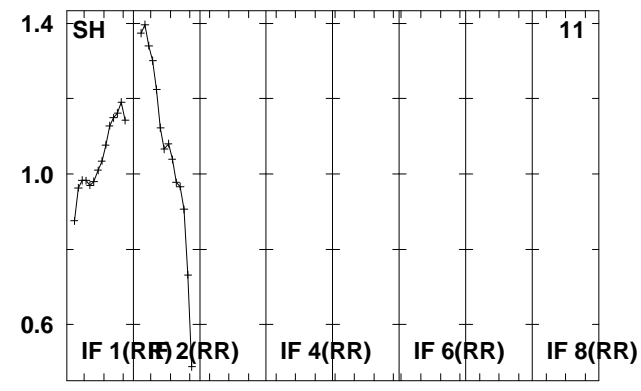
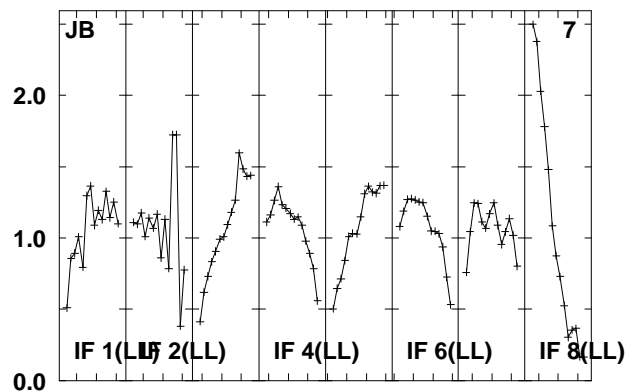
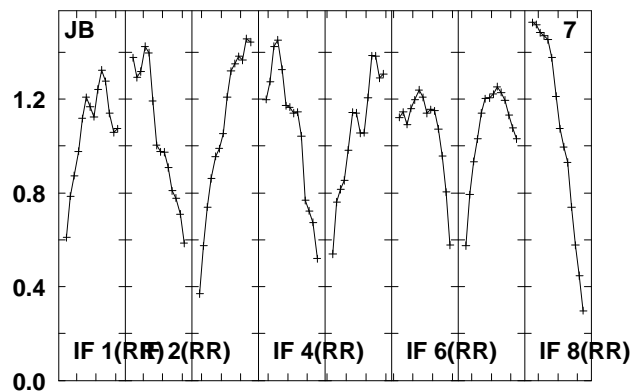
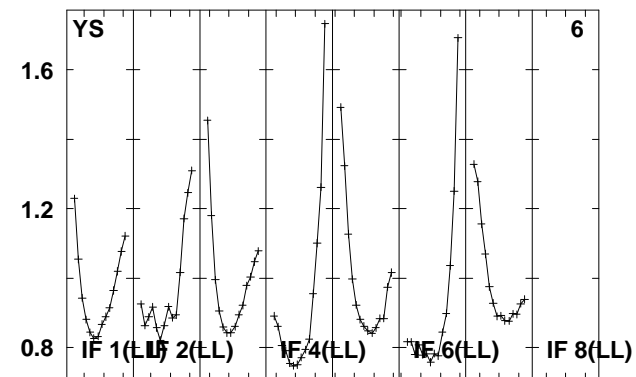
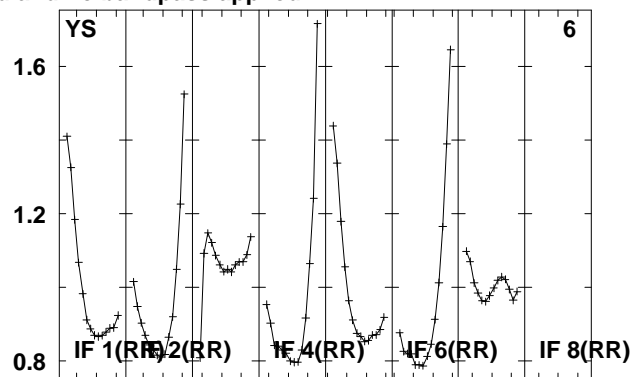
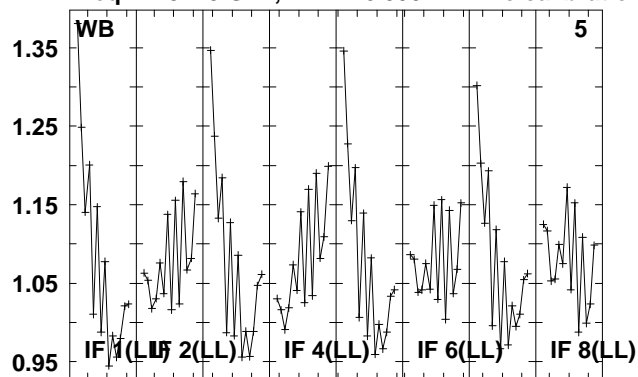

4945 4960 4975 4990 5005 5020 5035 5050 5055
FREQ MHz

Lower frame: Real Jy

Total-power spectrum Antenna: *

Timerange: 00/11:52:56 to 00/12:03:38

Plot file version 60 created 08-JUL-2010 13:08:53

J0731+24 EM079.UVDATA.1

Freq = 4.9415 GHz, Bw = 16.000 MH No calibration applied and no bandpass applied

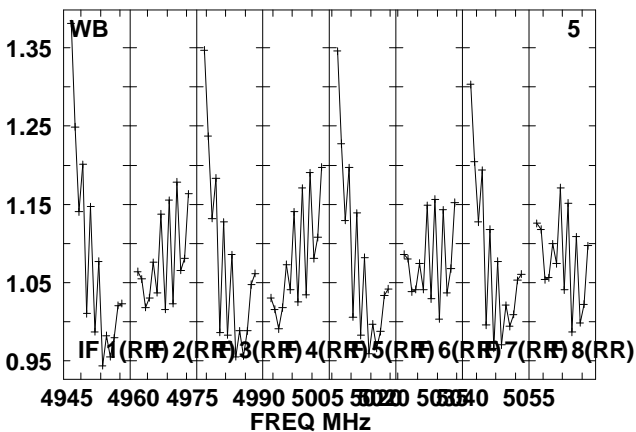
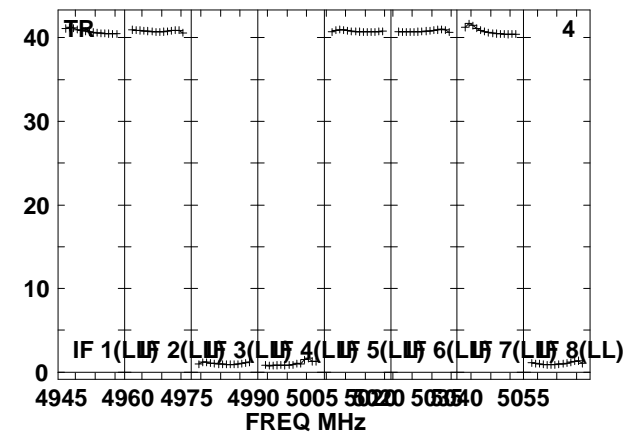
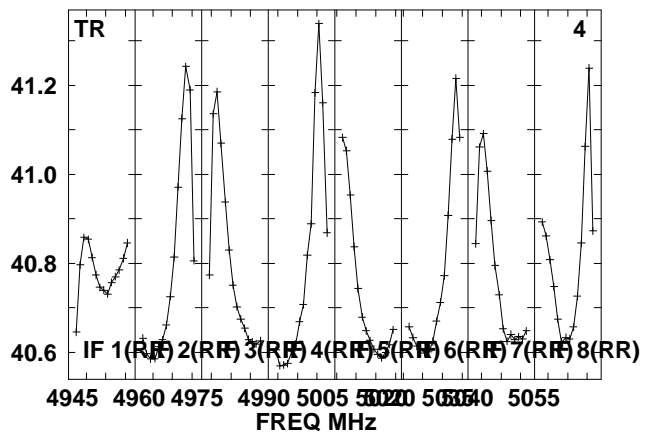
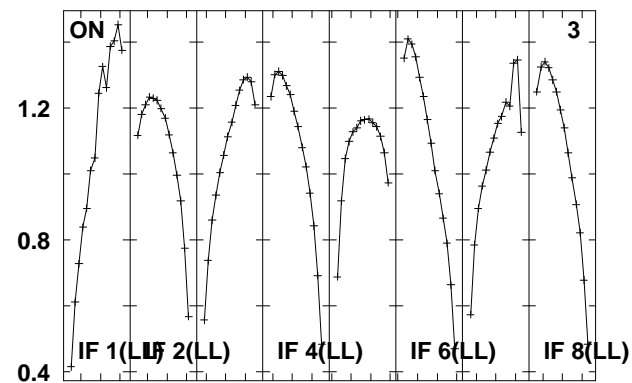
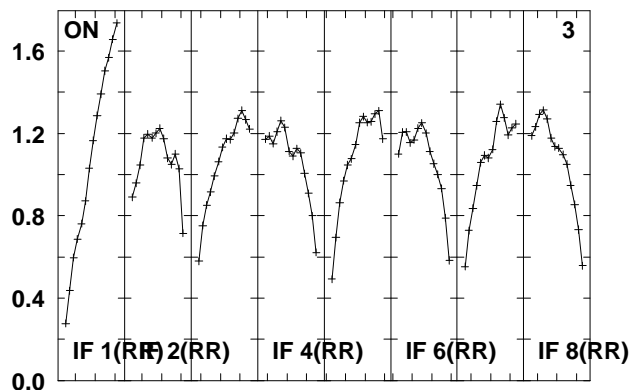
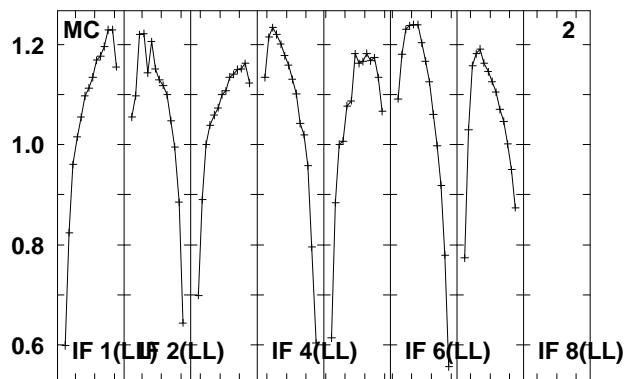
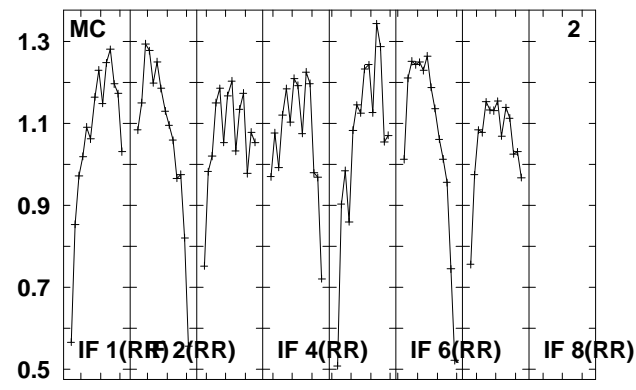
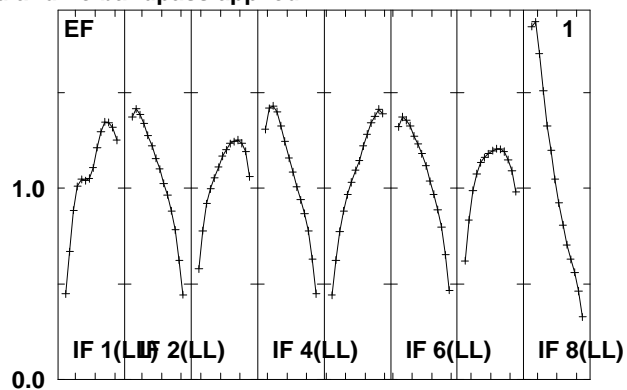
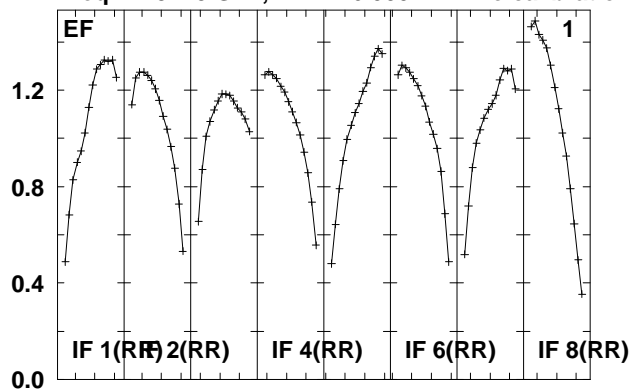

Lower frame: Real Jy
Total-power spectrum Antenna: *
Timerange: 00/12:03:40 to 00/12:07:38

Plot file version 61 created 08-JUL-2010 13:08:54

J0731+24 EM079.UVDATA.1

Freq = 4.9415 GHz, Bw = 16.000 MH No calibration applied and no bandpass applied

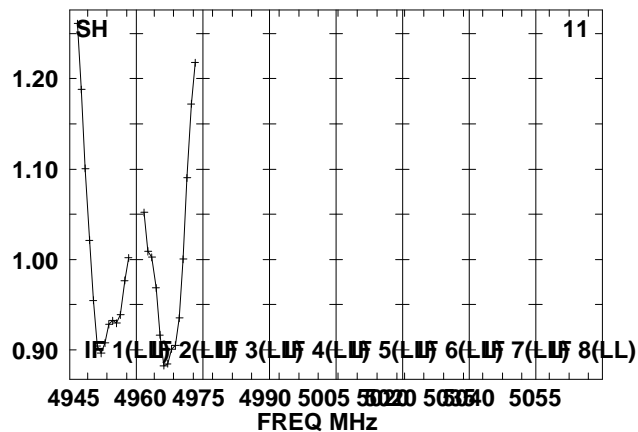
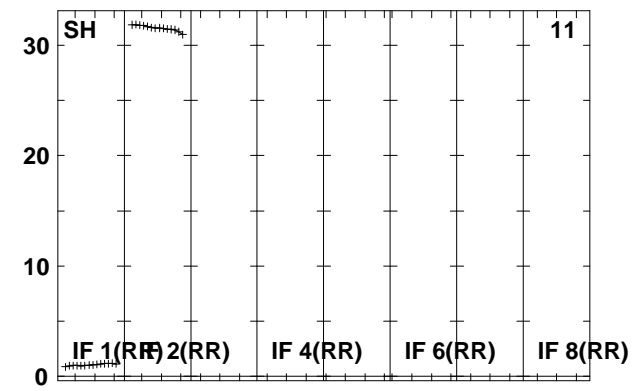
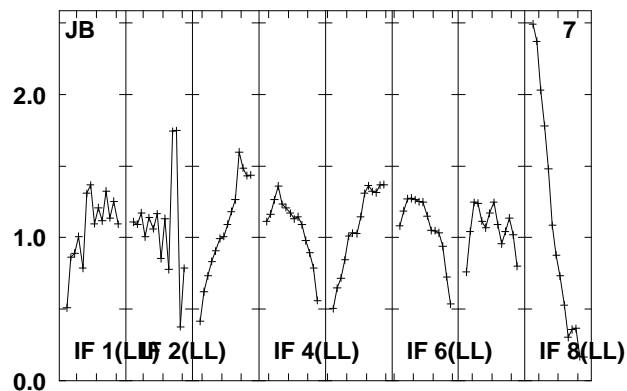
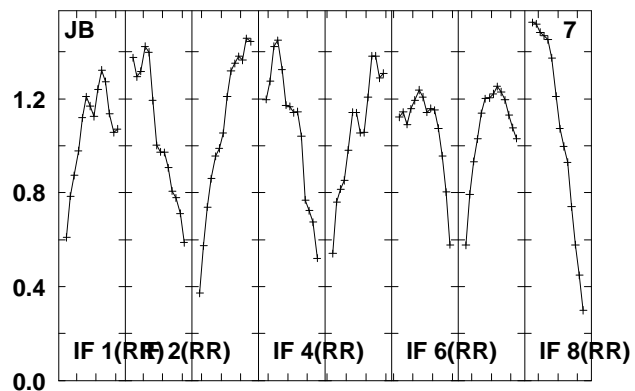
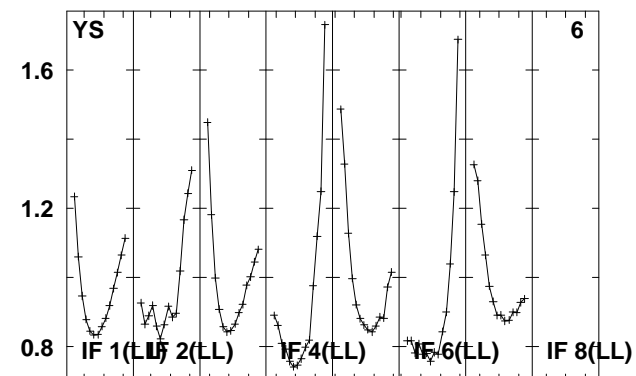
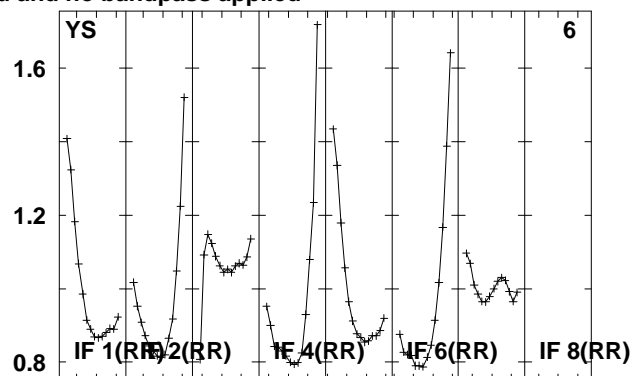
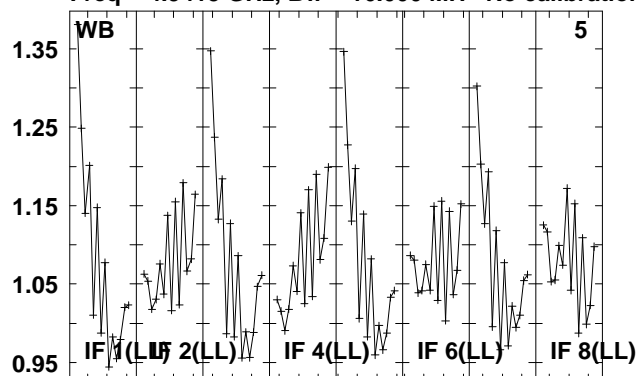

4945 4960 4975 4990 5005 5020 5035 5050 5055
FREQ MHz

Lower frame: Real Jy

Total-power spectrum Antenna: *

Timerange: 00/12:03:40 to 00/12:07:38

Plot file version 62 created 08-JUL-2010 13:08:55

OJ287 EM079.UVDATA.1

Freq = 4.9415 GHz, Bw = 16.000 MH No calibration applied and no bandpass applied

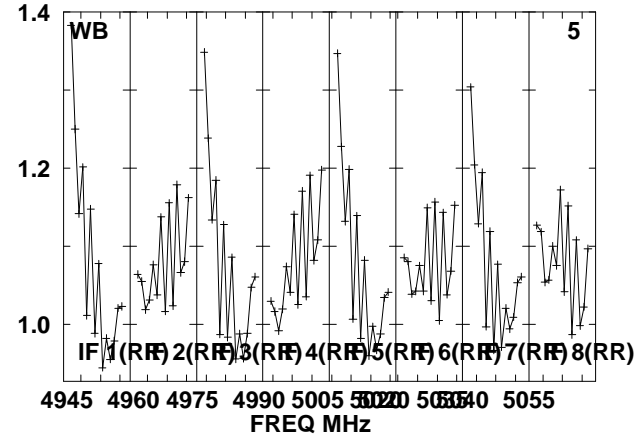
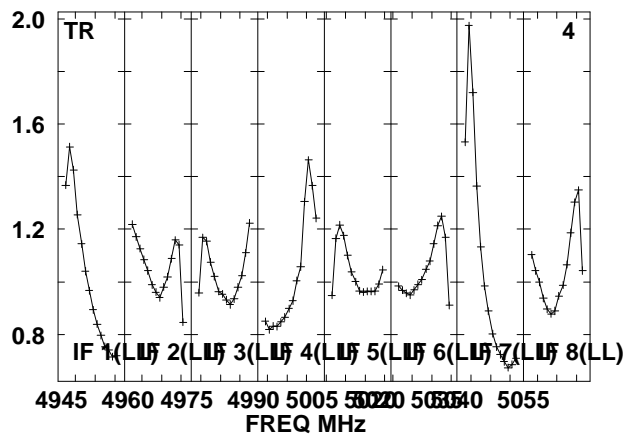
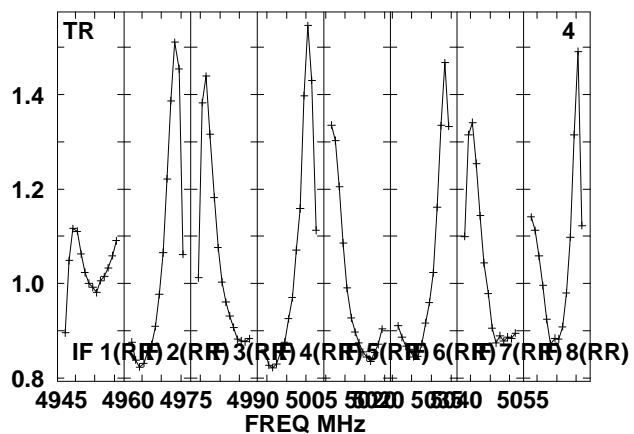
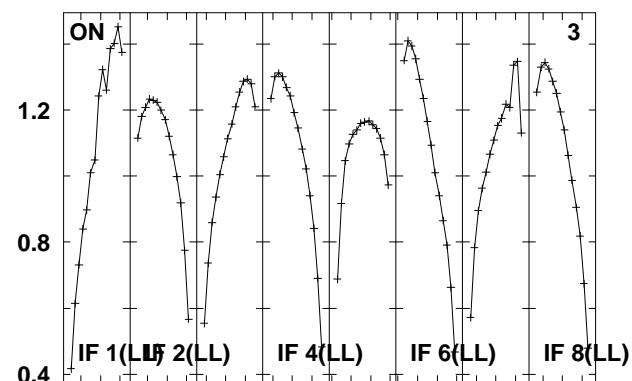
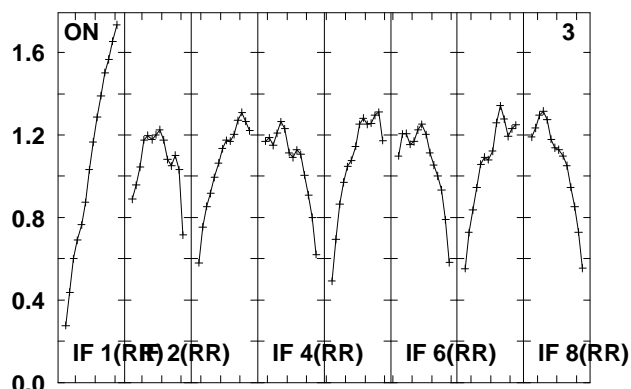
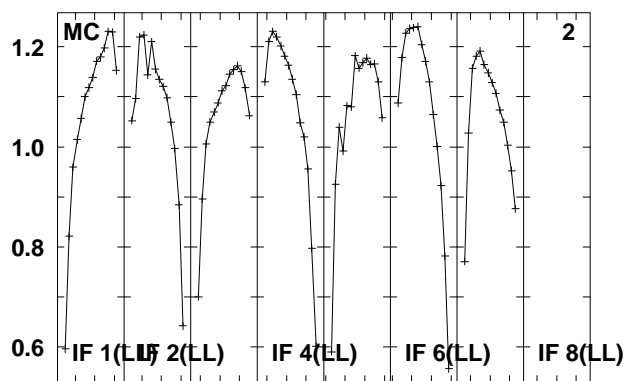
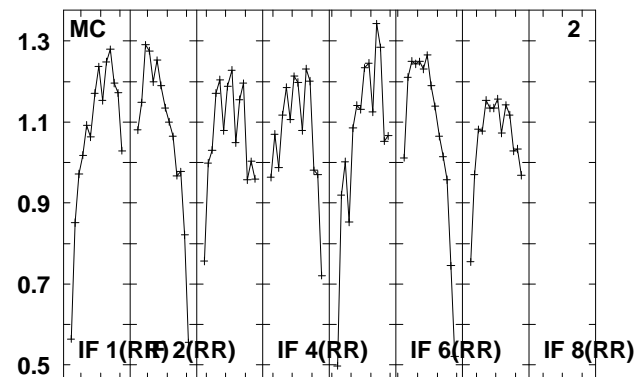
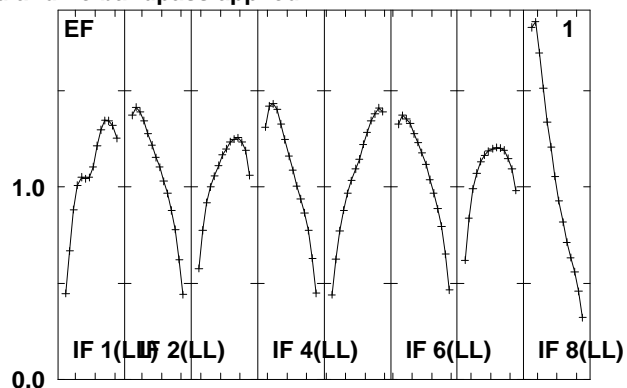
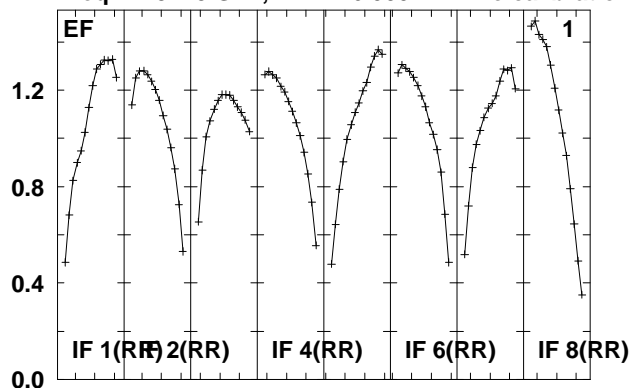

Lower frame: Real Jy
Total-power spectrum Antenna: *
Timerange: 00/12:07:40 to 00/12:16:38

Plot file version 63 created 08-JUL-2010 13:08:56

OJ287 EM079.UVDATA.1

Freq = 4.9415 GHz, Bw = 16.000 MH No calibration applied and no bandpass applied

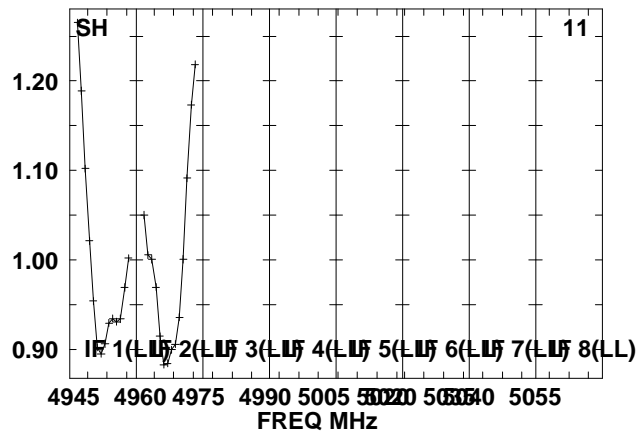
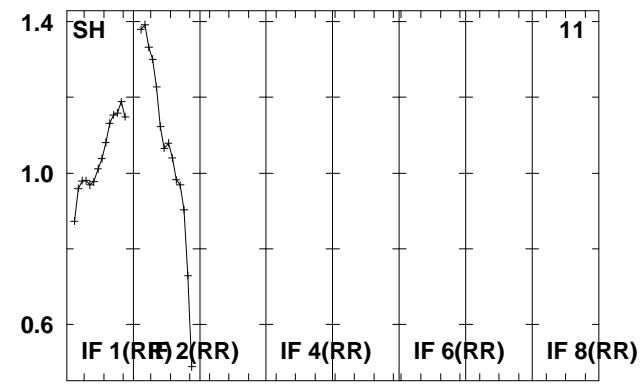
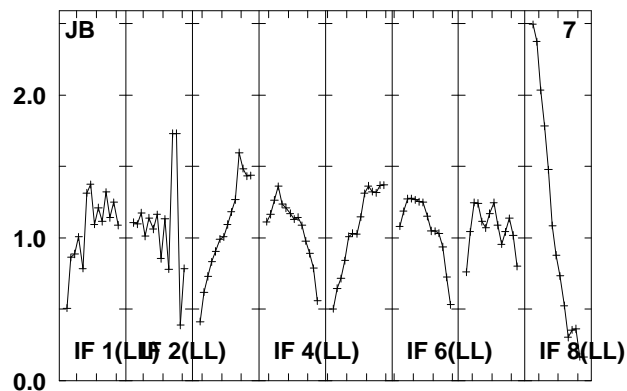
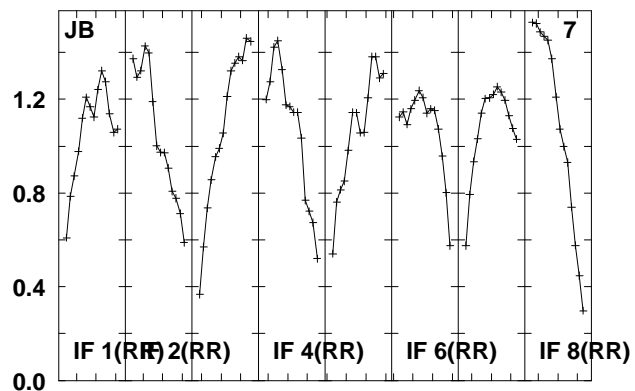
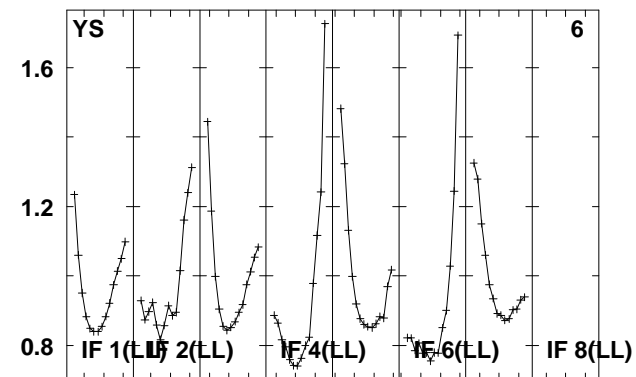
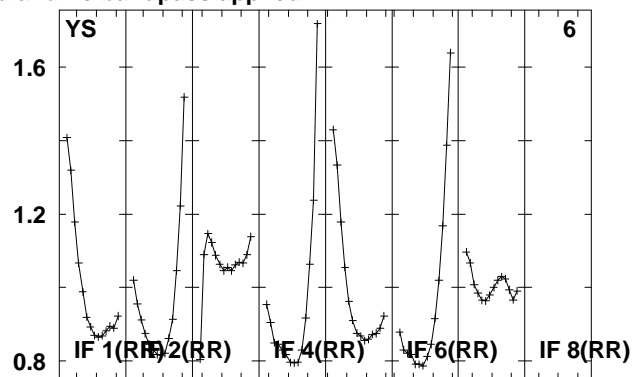
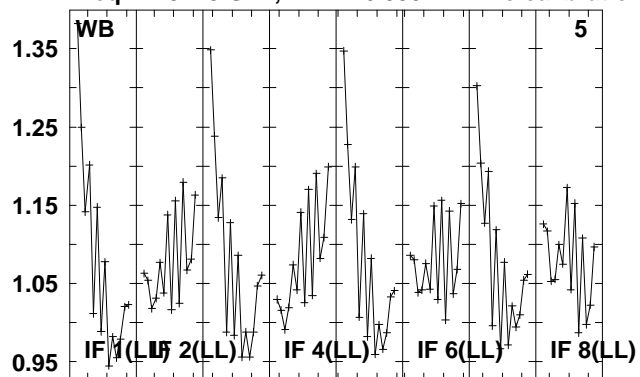

Lower frame: Real Jy

Total-power spectrum Antenna: *

Timerange: 00/12:07:40 to 00/12:16:38

Plot file version 64 created 08-JUL-2010 13:08:57

J0948+00 EM079.UVDATA.1

Freq = 4.9415 GHz, Bw = 16.000 MH No calibration applied and no bandpass applied

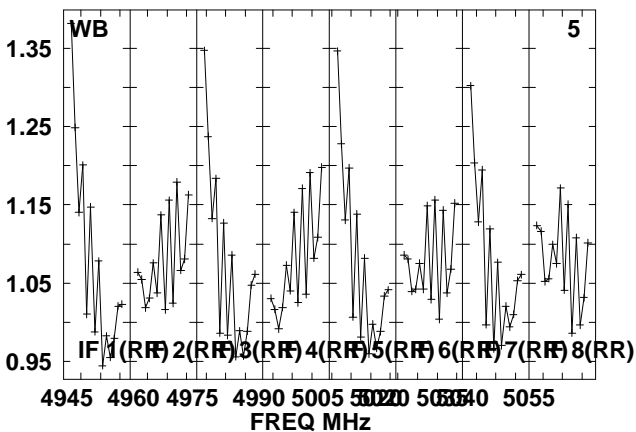
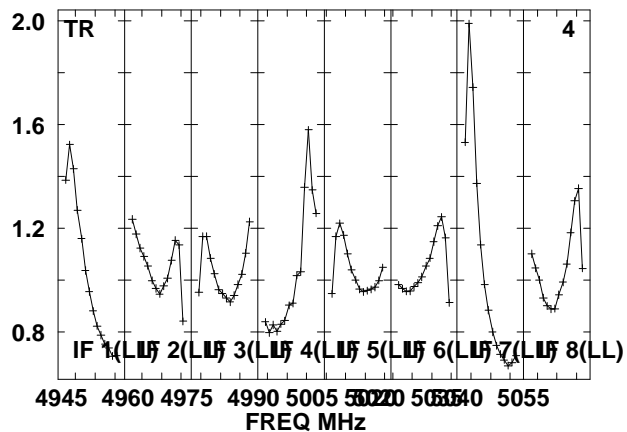
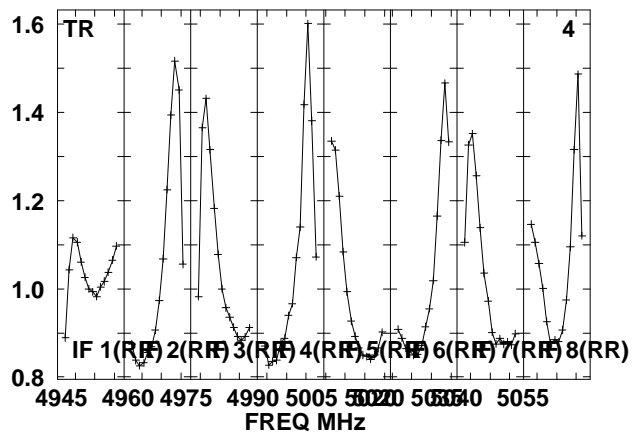
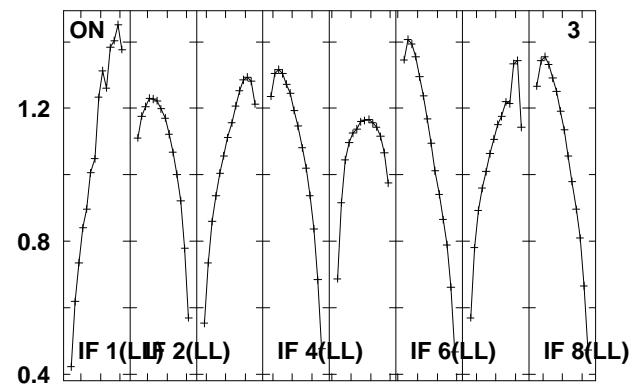
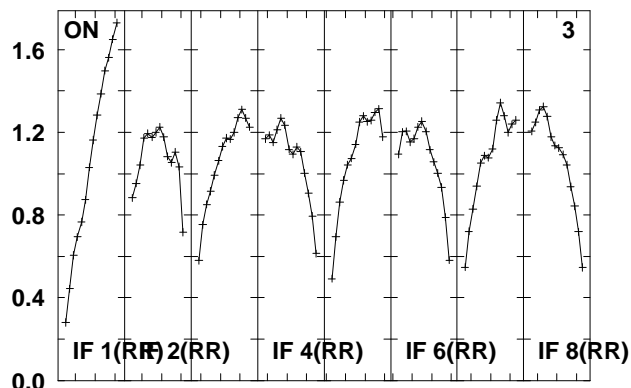
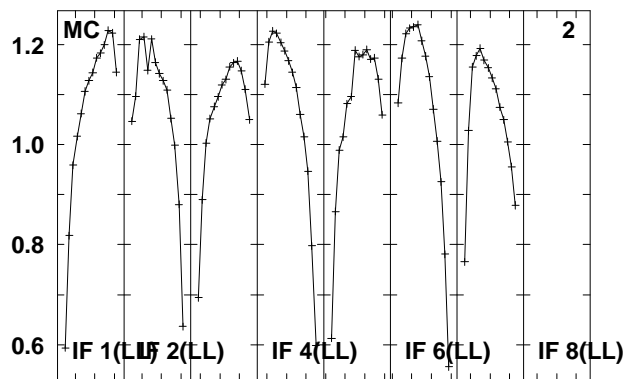
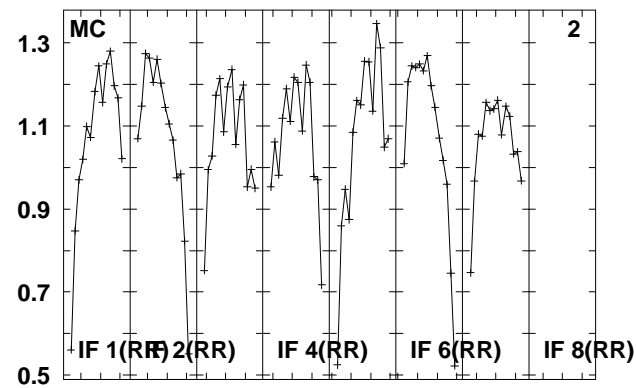
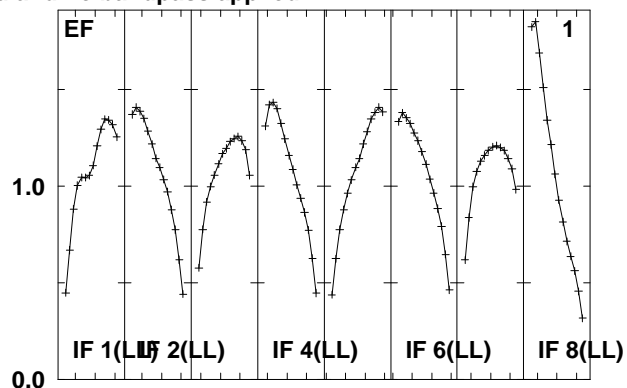
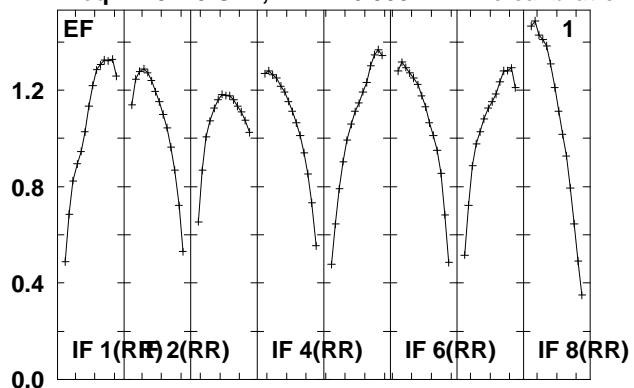

Lower frame: Real Jy
Total-power spectrum Antenna: *
Timerange: 00/12:16:40 to 00/12:18:38

Plot file version 65 created 08-JUL-2010 13:08:58

J0948+00 EM079.UVDATA.1

Freq = 4.9415 GHz, Bw = 16.000 MH No calibration applied and no bandpass applied

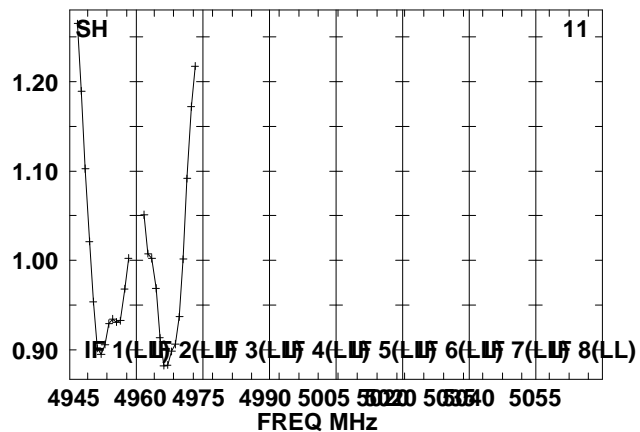
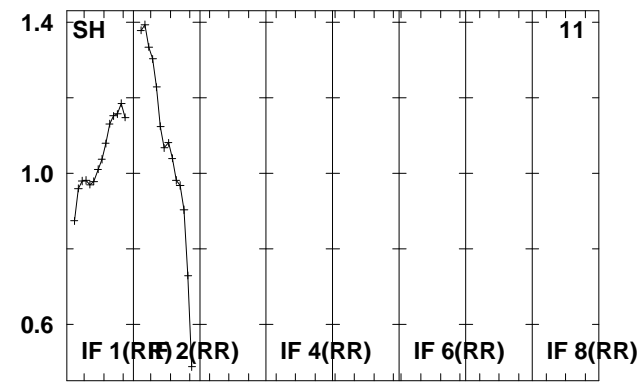
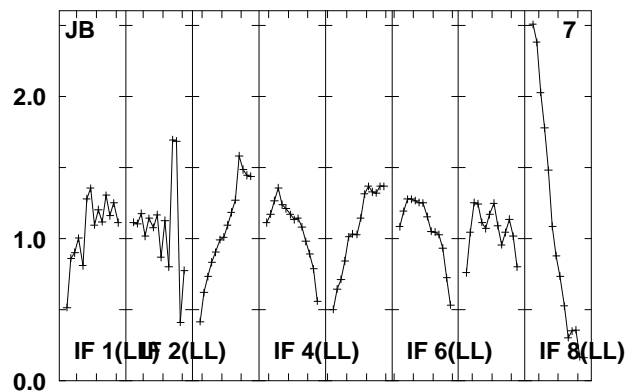
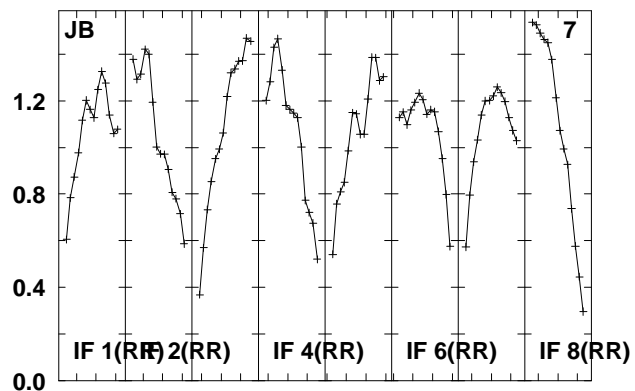
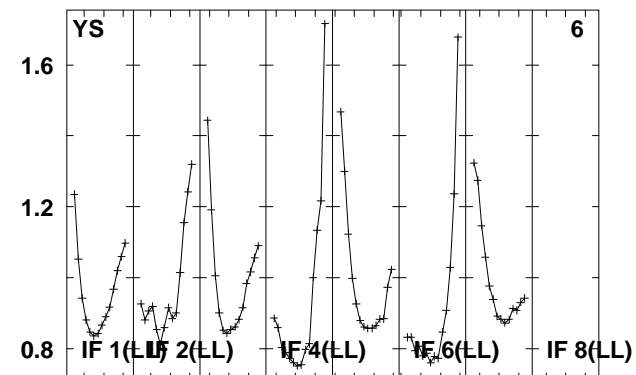
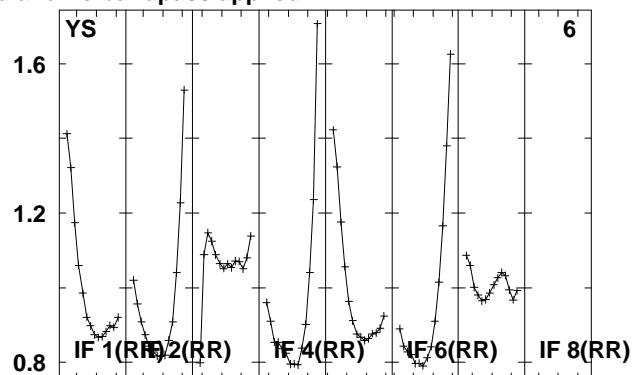
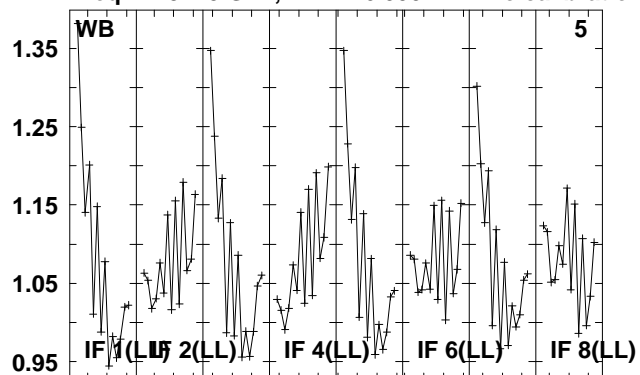

4945 4960 4975 4990 5005 5020 5035 5050 5055
FREQ MHz

Lower frame: Real Jy

Total-power spectrum Antenna: *

Timerange: 00/12:16:40 to 00/12:18:38

Plot file version 66 created 08-JUL-2010 13:08:58

B0940+00 EM079.UVDATA.1

Freq = 4.9415 GHz, Bw = 16.000 MH No calibration applied and no bandpass applied

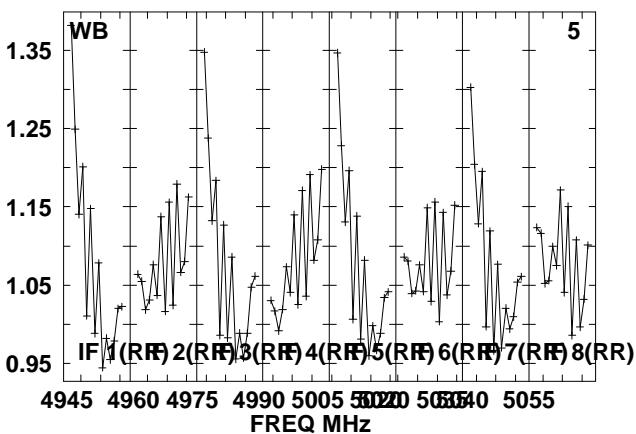
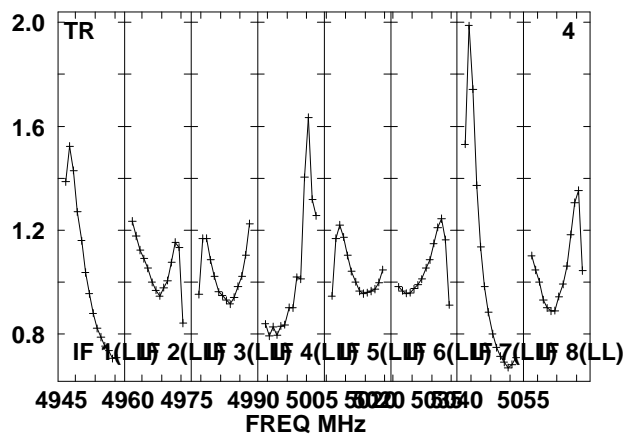
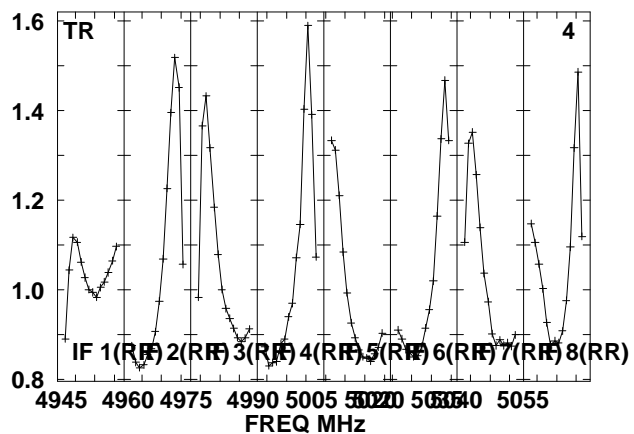
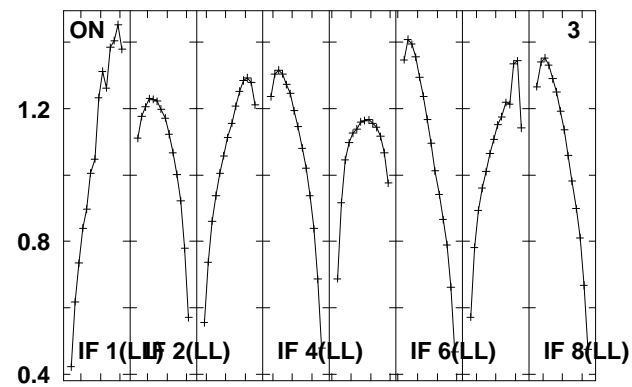
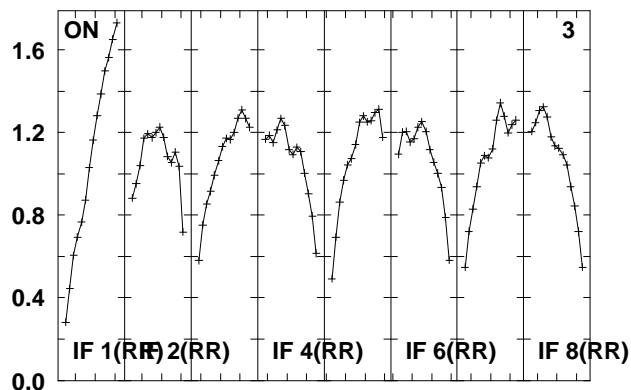
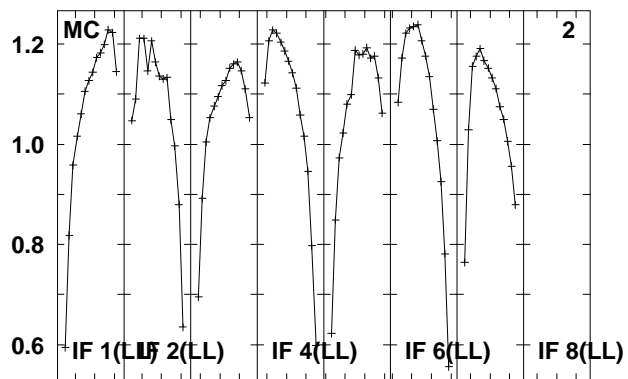
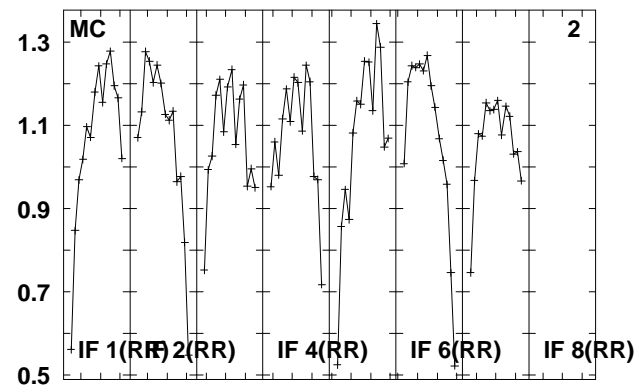
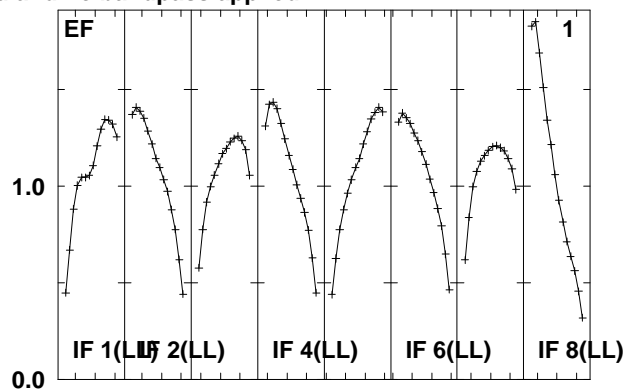
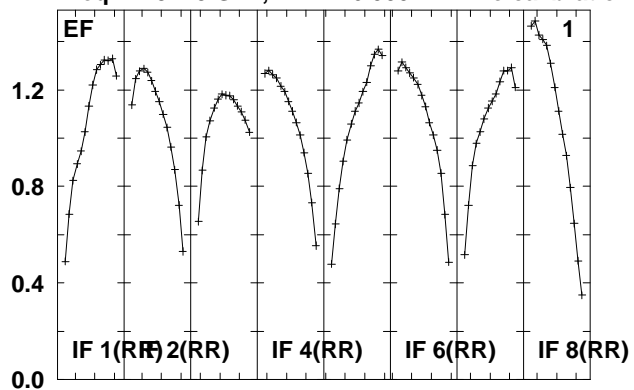

Lower frame: Real Jy
Total-power spectrum Antenna: *
Timerange: 00/12:18:40 to 00/12:29:24

Plot file version 67 created 08-JUL-2010 13:08:59

B0940+00 EM079.UVDATA.1

Freq = 4.9415 GHz, Bw = 16.000 MH No calibration applied and no bandpass applied

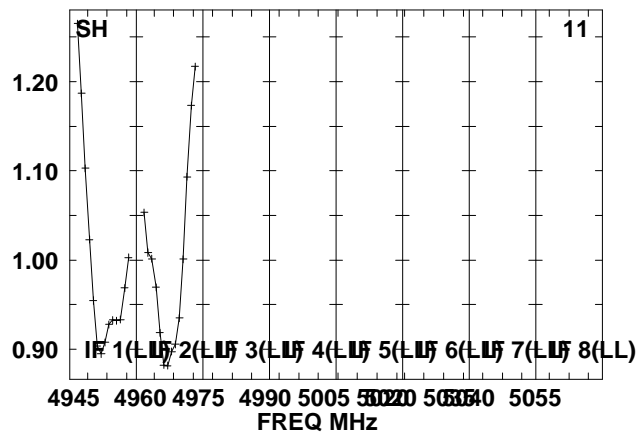
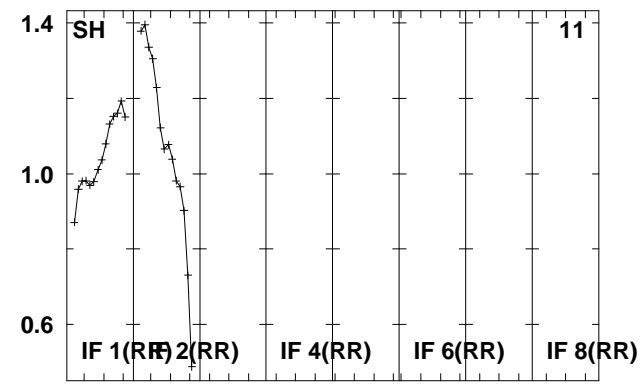
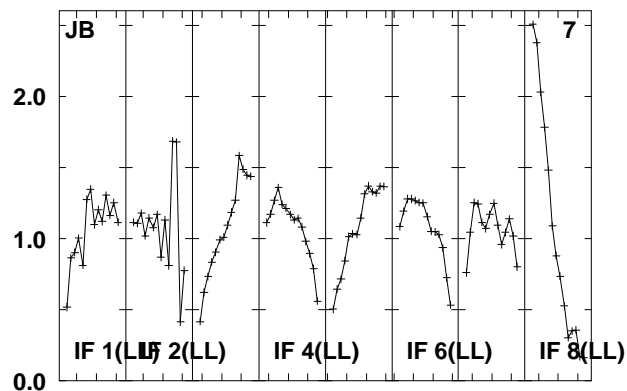
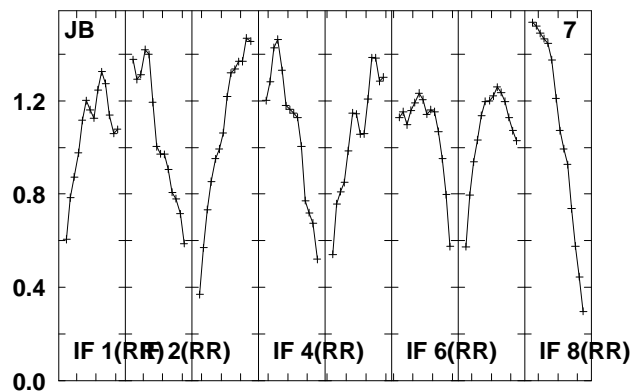
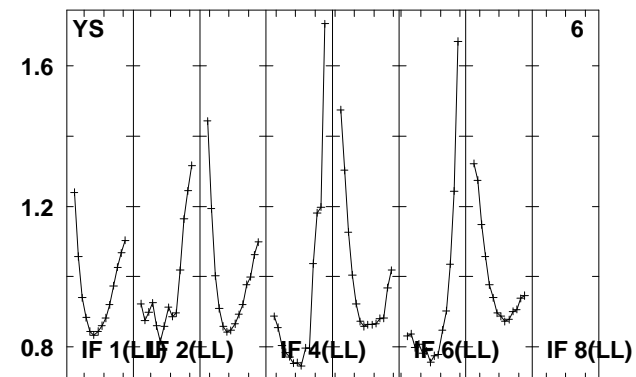
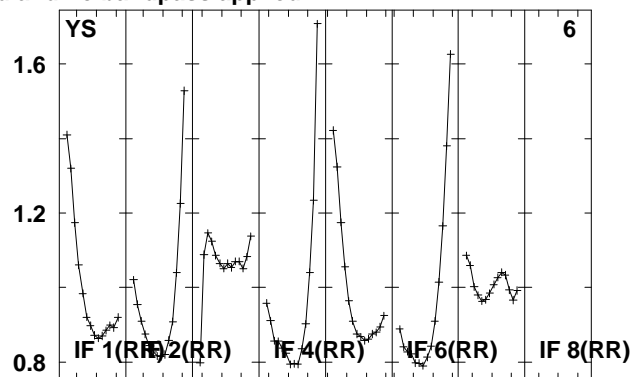
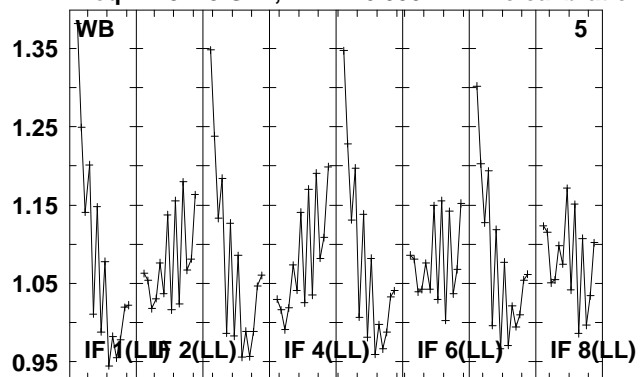

4945 4960 4975 4990 5005 5020 5035 5050 5055
FREQ MHz

Lower frame: Real Jy

Total-power spectrum Antenna: *

Timerange: 00/12:18:40 to 00/12:29:24

Plot file version 68 created 08-JUL-2010 13:09:01

J0948+00 EM079.UVDATA.1

Freq = 4.9415 GHz, Bw = 16.000 MH No calibration applied and no bandpass applied

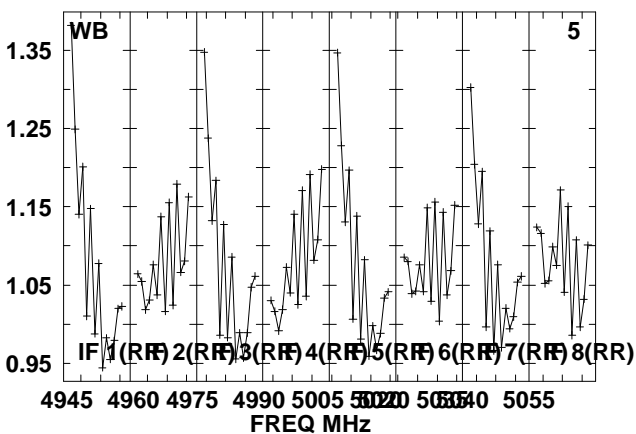
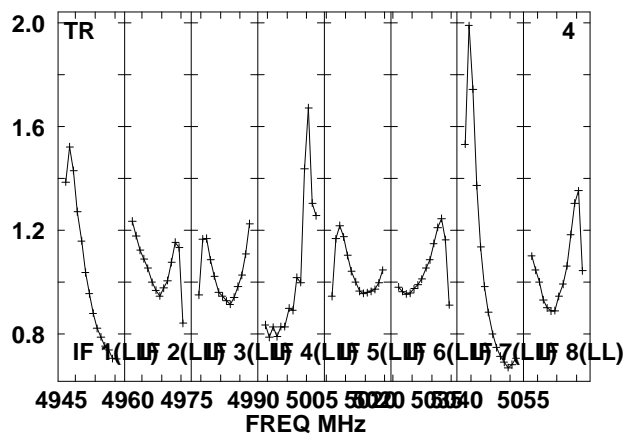
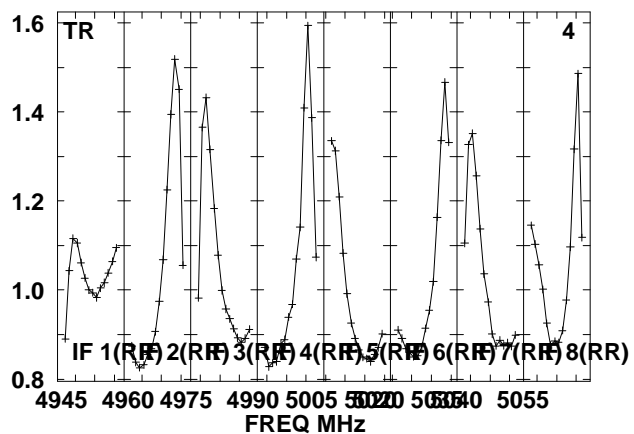
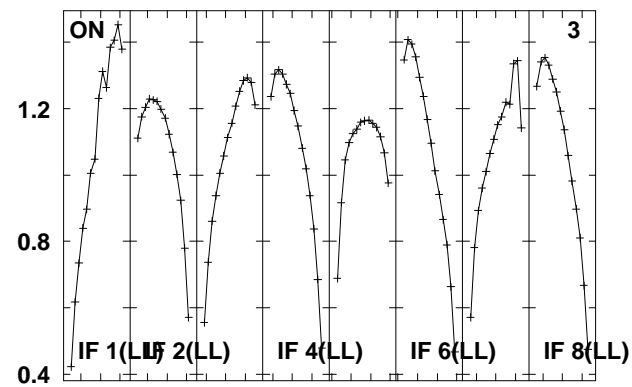
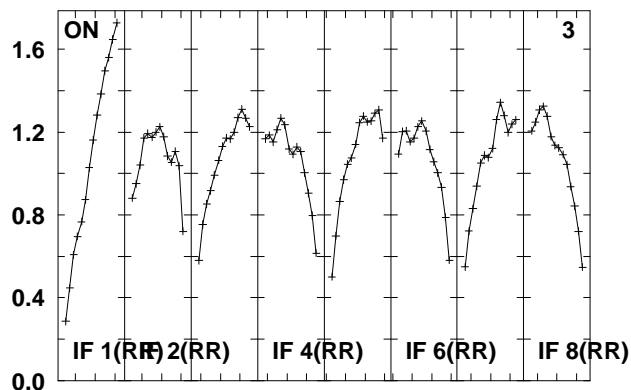
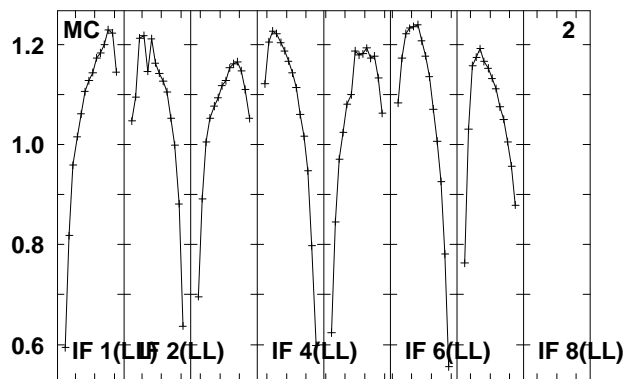
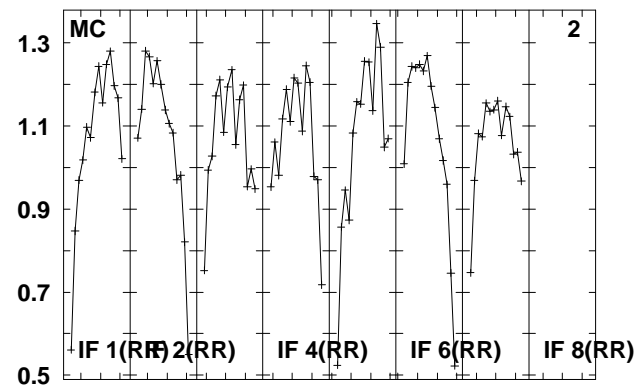
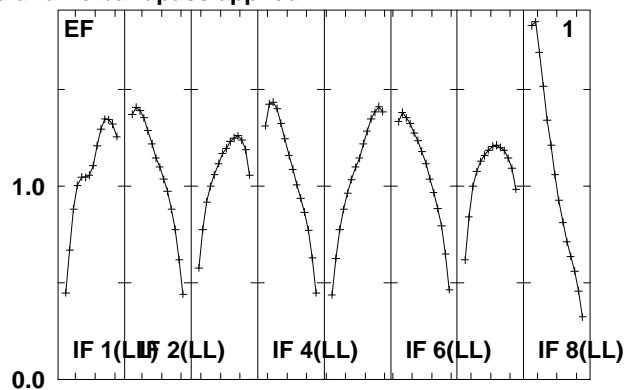
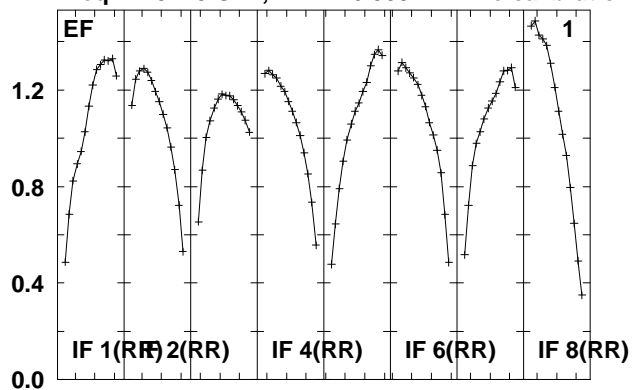

Lower frame: Real Jy
Total-power spectrum Antenna: *
Timerange: 00/12:29:26 to 00/12:31:24

Plot file version 69 created 08-JUL-2010 13:09:01

J0948+00 EM079.UVDATA.1

Freq = 4.9415 GHz, Bw = 16.000 MH No calibration applied and no bandpass applied

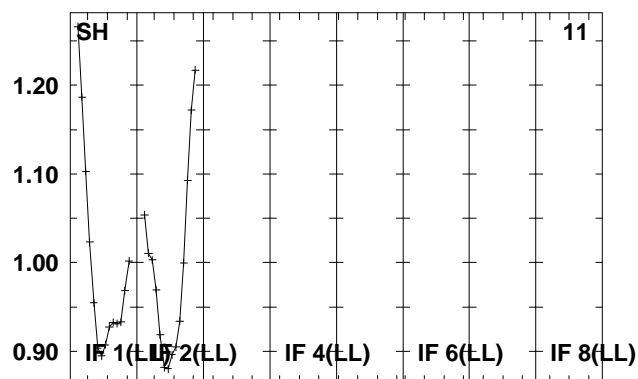
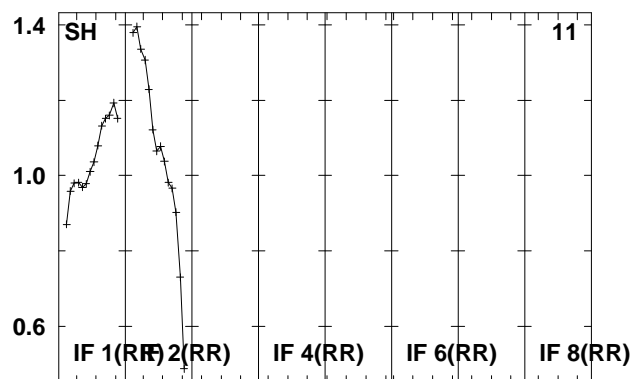
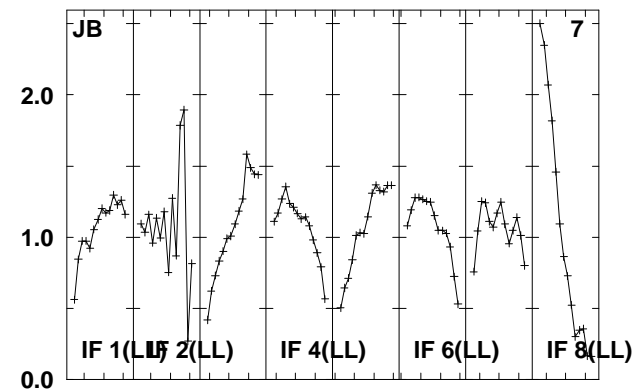
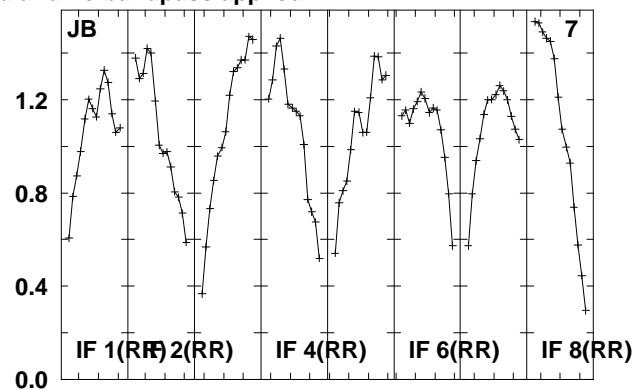
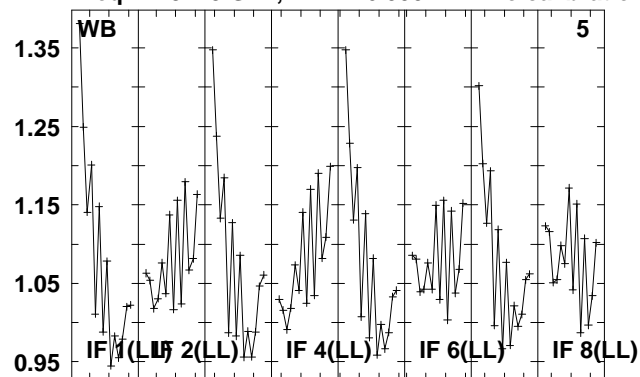

Lower frame: Real Jy
Total-power spectrum Antenna: *
Timerange: 00/12:29:26 to 00/12:31:24

Plot file version 70 created 08-JUL-2010 13:09:02

B0940+00 EM079.UVDATA.1

Freq = 4.9415 GHz, Bw = 16.000 MH No calibration applied and no bandpass applied

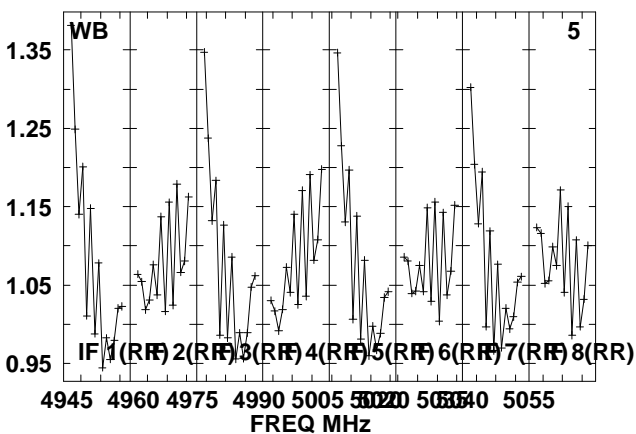
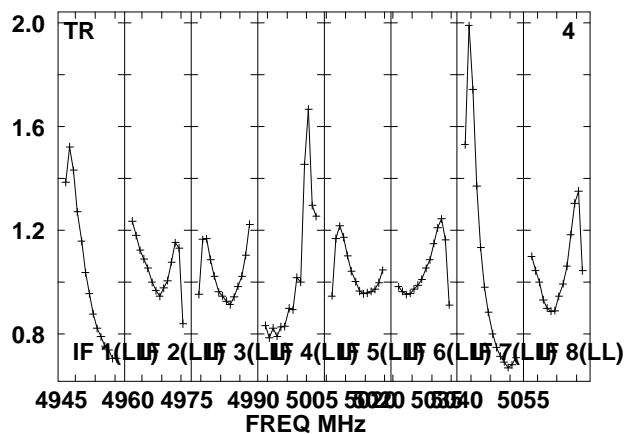
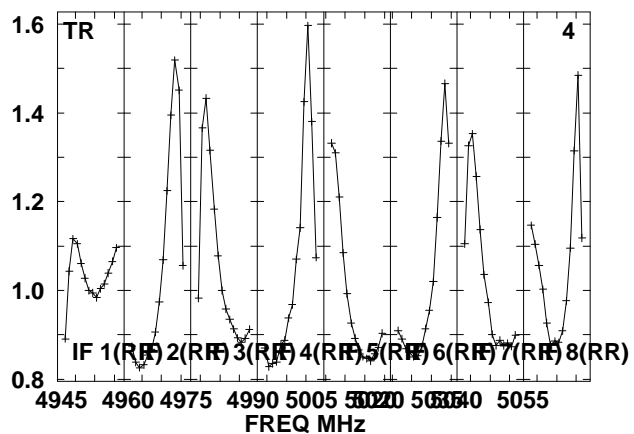
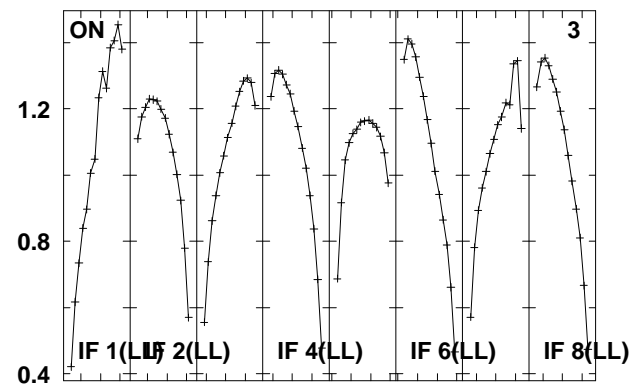
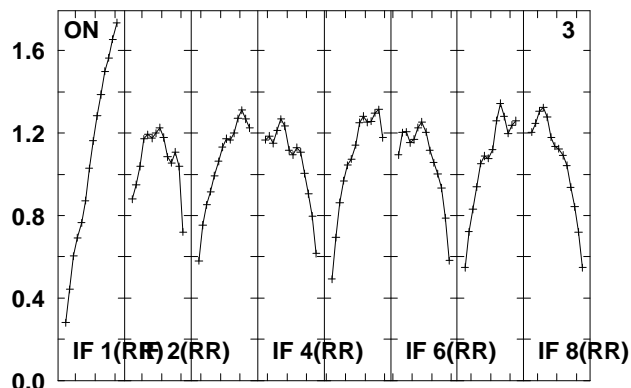
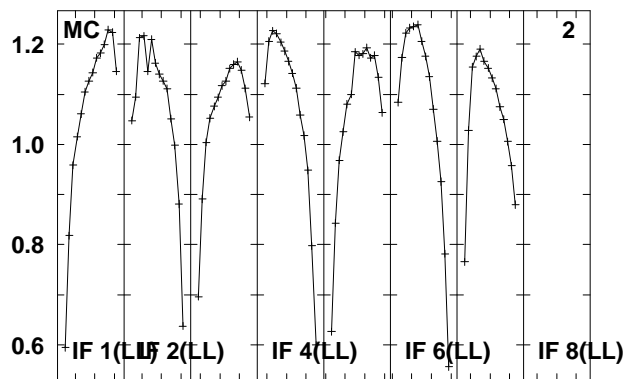
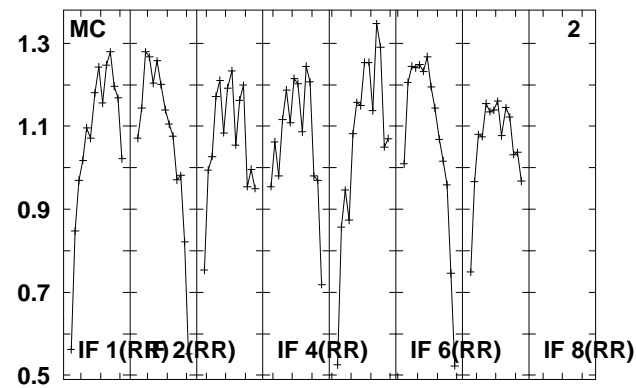
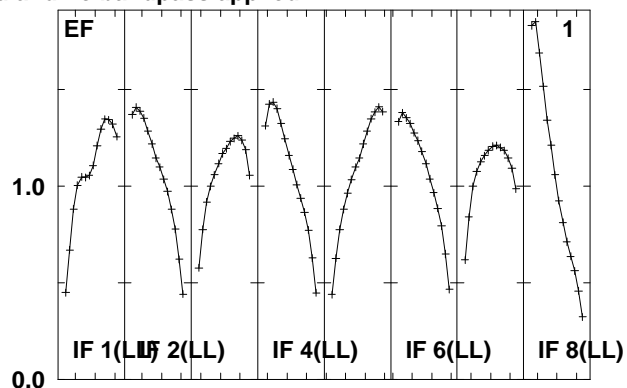
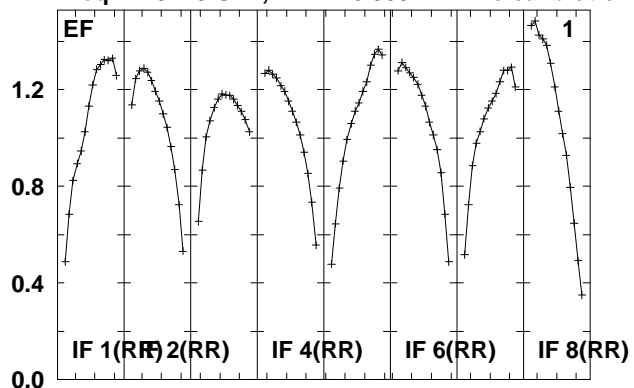

Lower frame: Real Jy

Total-power spectrum Antenna: *

Timerange: 00/12:31:26 to 00/12:42:08

Plot file version 71 created 08-JUL-2010 13:09:03
 B0940+00 EM079.UVDATA.1
 Freq = 4.9415 GHz, Bw = 16.000 MH No calibration applied and no bandpass applied

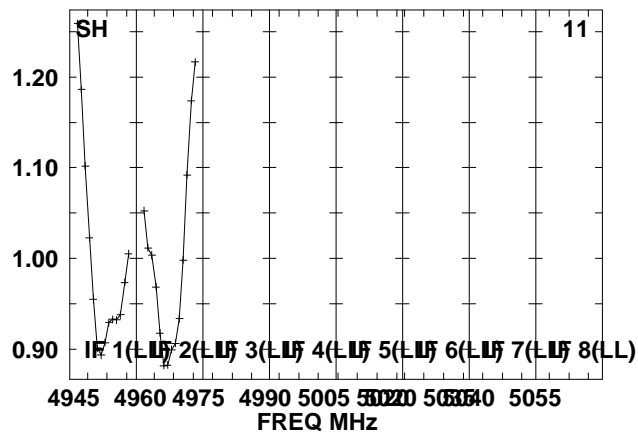
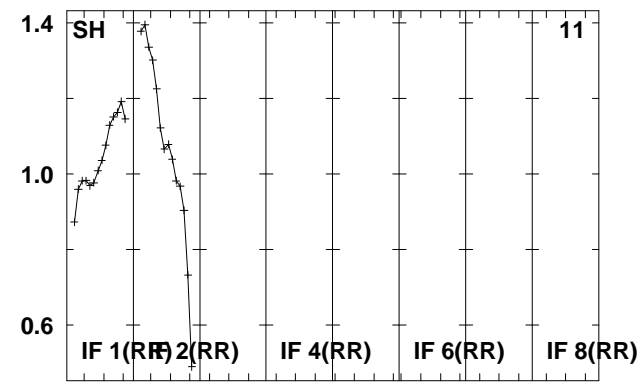
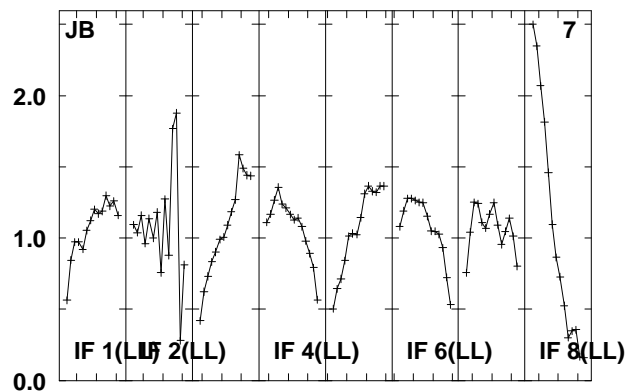
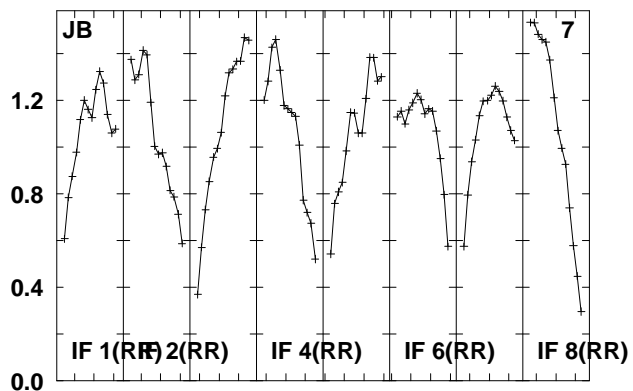
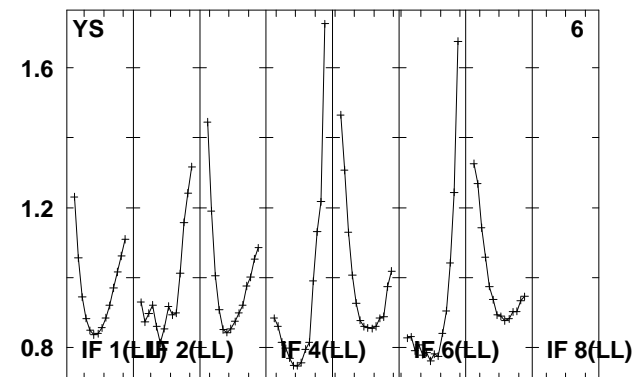
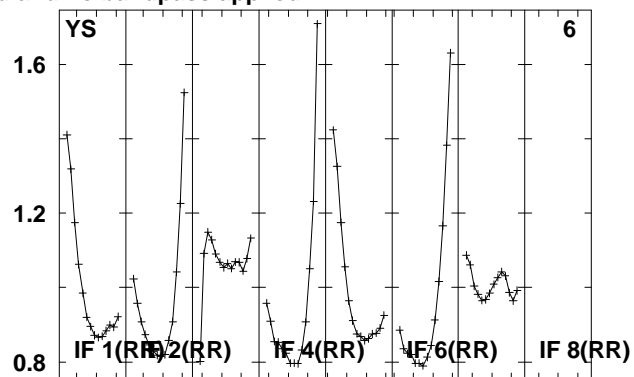
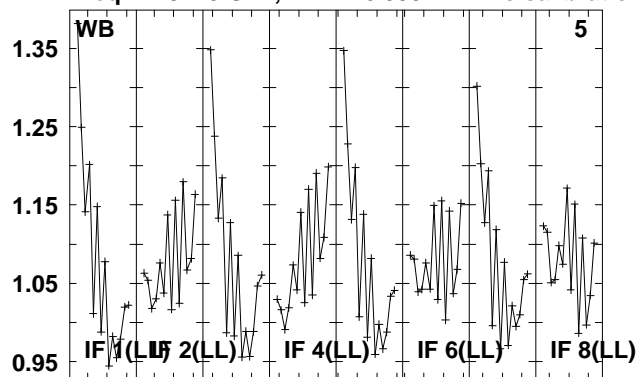

4945 4960 4975 4990 5005 5020 5035 5050 5055
 FREQ MHz

Lower frame: Real Jy
 Total-power spectrum Antenna: *
 Timerange: 00/12:31:26 to 00/12:42:08

Plot file version 72 created 08-JUL-2010 13:09:05

J0948+00 EM079.UVDATA.1

Freq = 4.9415 GHz, Bw = 16.000 MH No calibration applied and no bandpass applied

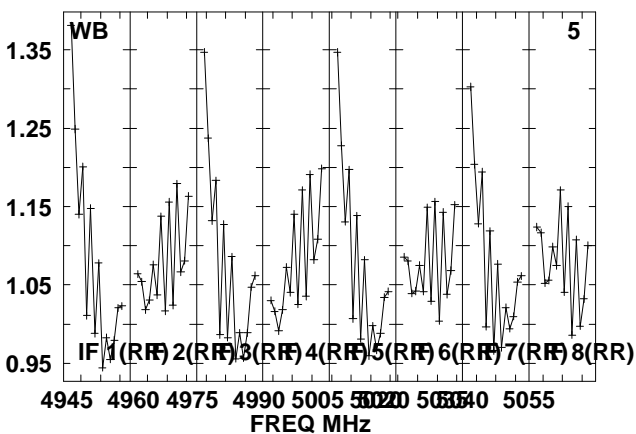
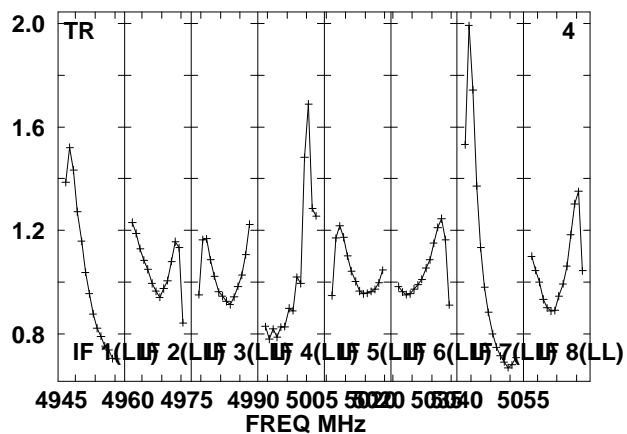
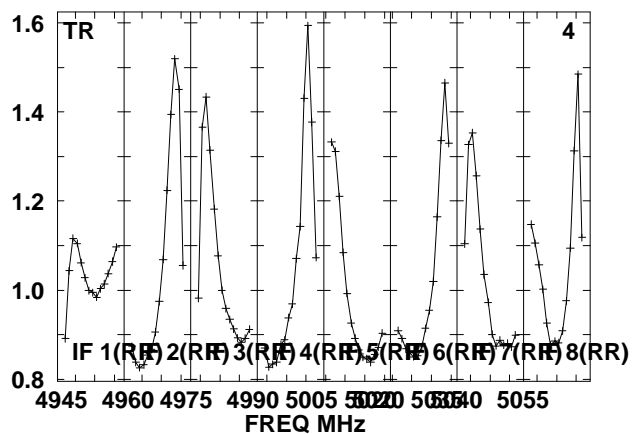
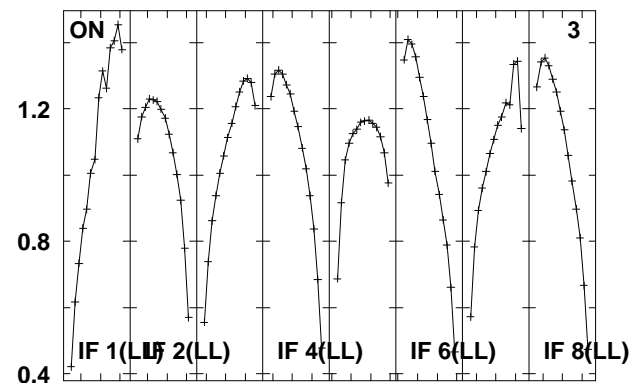
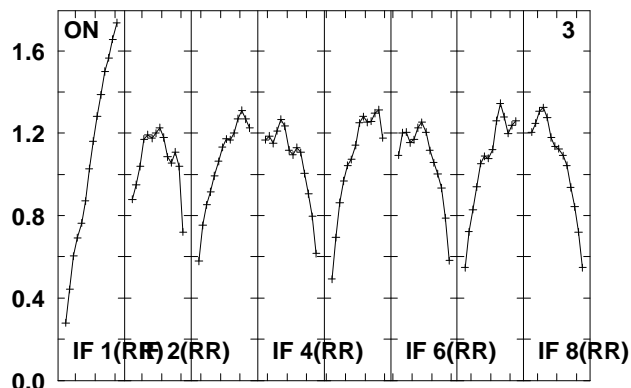
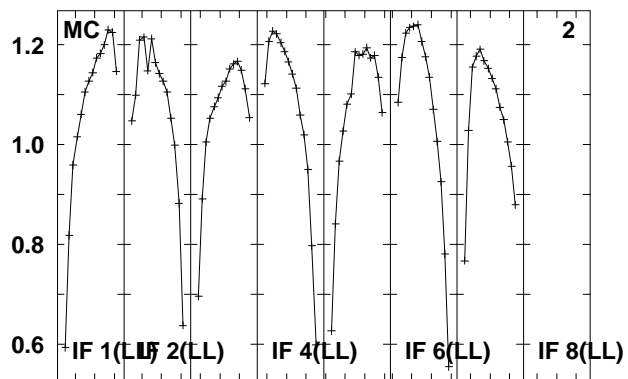
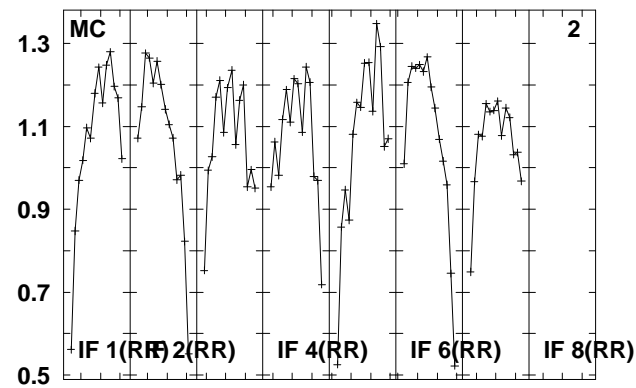
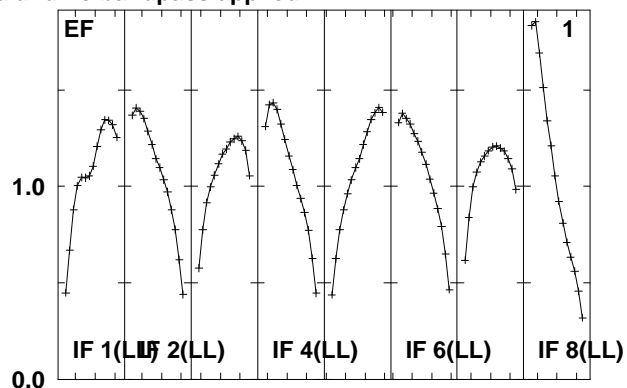
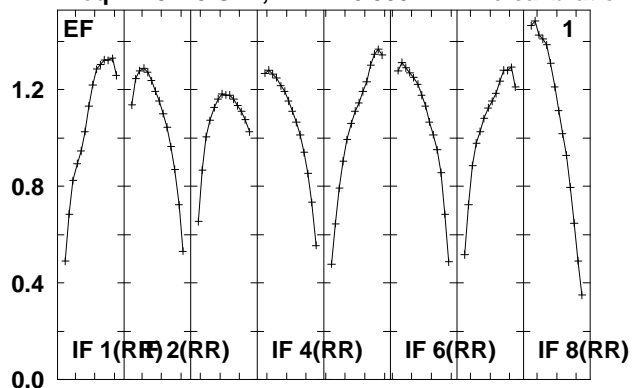

Lower frame: Real Jy
Total-power spectrum Antenna: *
Timerange: 00/12:42:10 to 00/12:44:08

Plot file version 73 created 08-JUL-2010 13:09:05

J0948+00 EM079.UVDATA.1

Freq = 4.9415 GHz, Bw = 16.000 MH No calibration applied and no bandpass applied

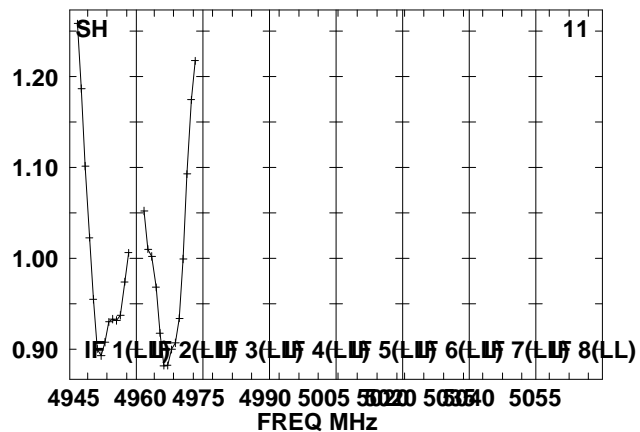
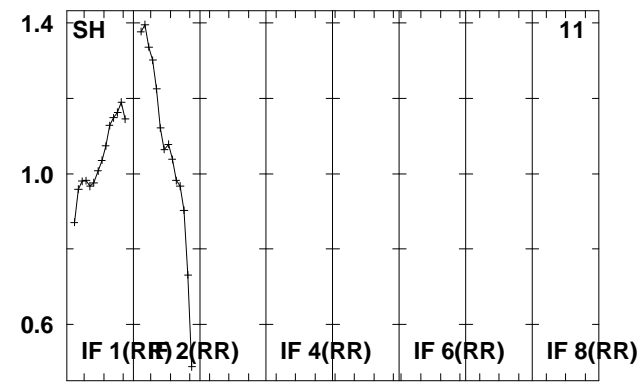
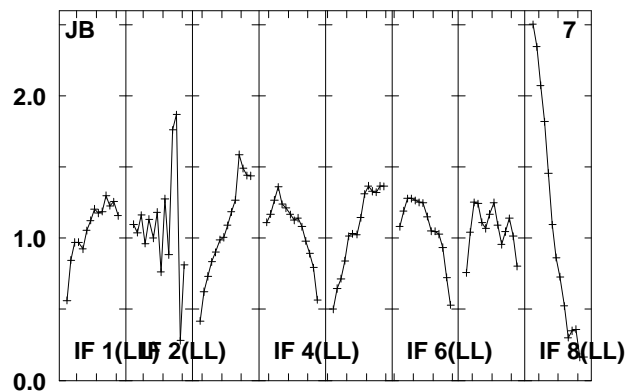
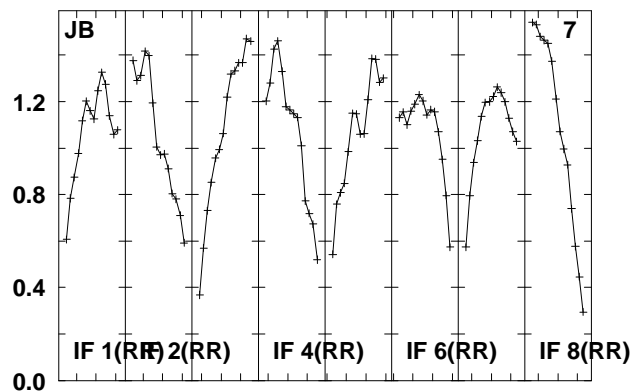
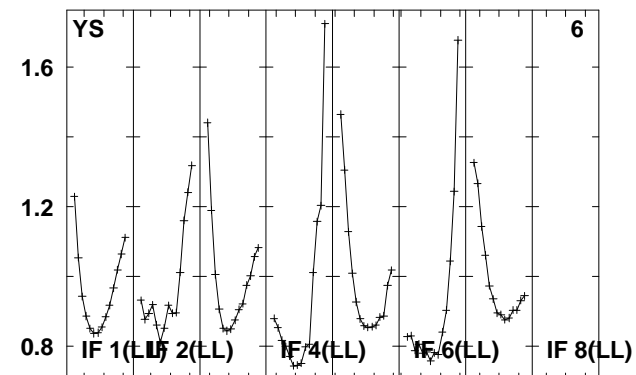
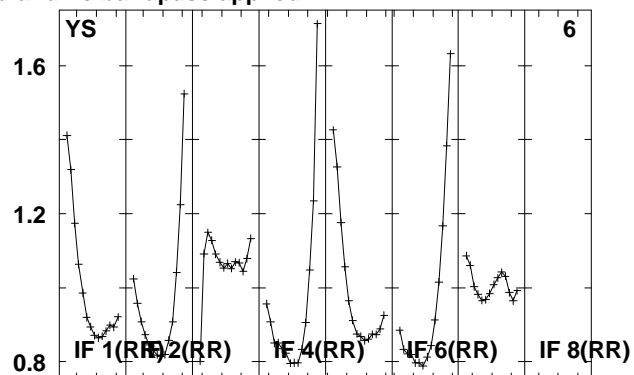
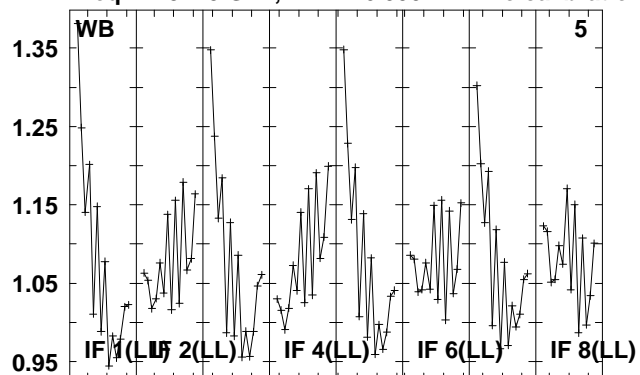

Lower frame: Real Jy

Total-power spectrum Antenna: *

Timerange: 00/12:42:10 to 00/12:44:08

Plot file version 74 created 08-JUL-2010 13:09:06

B0940+00 EM079.UVDATA.1

Freq = 4.9415 GHz, Bw = 16.000 MH No calibration applied and no bandpass applied

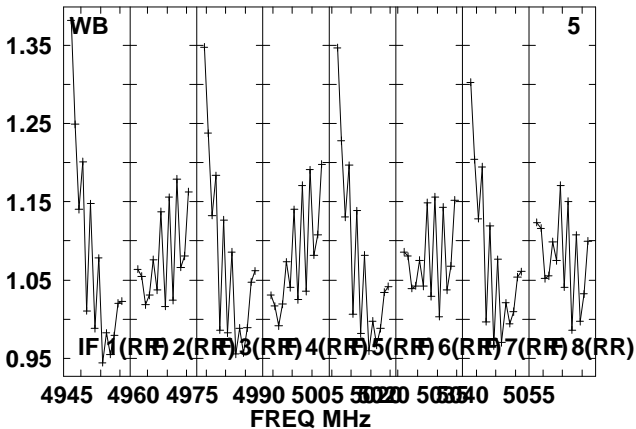
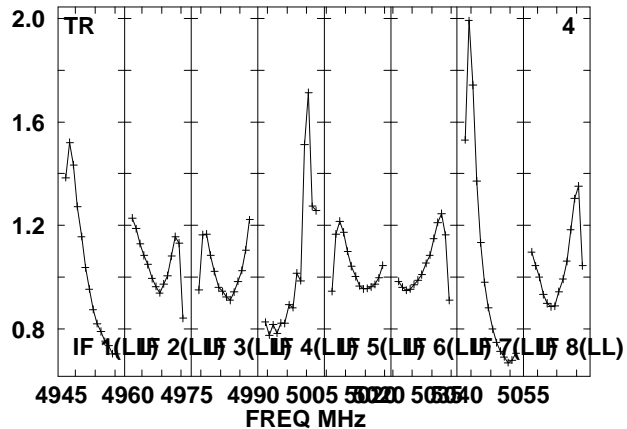
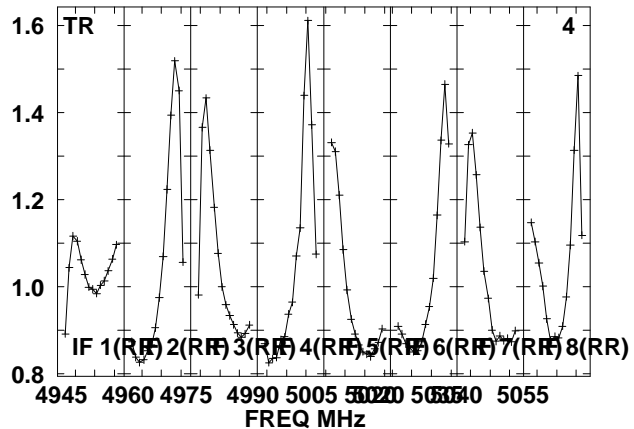
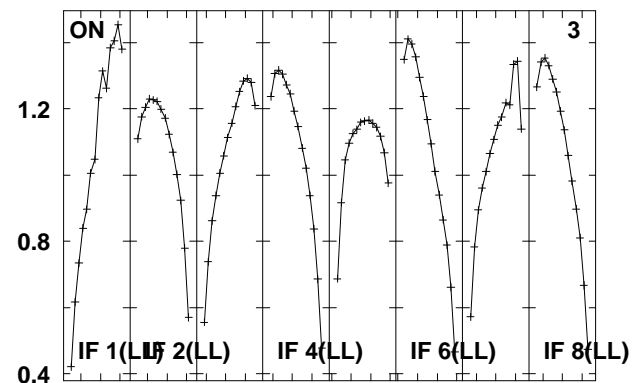
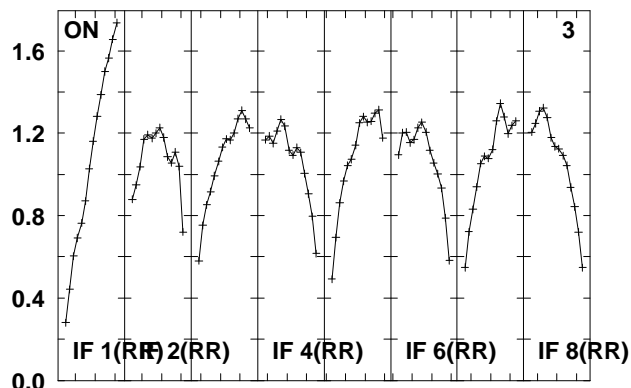
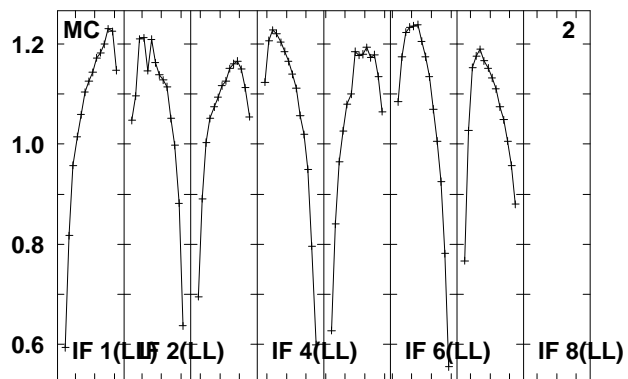
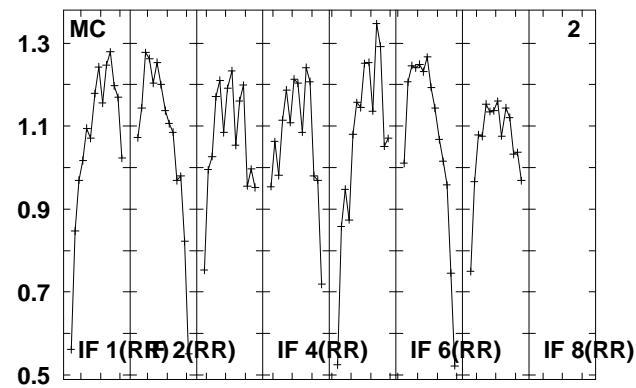
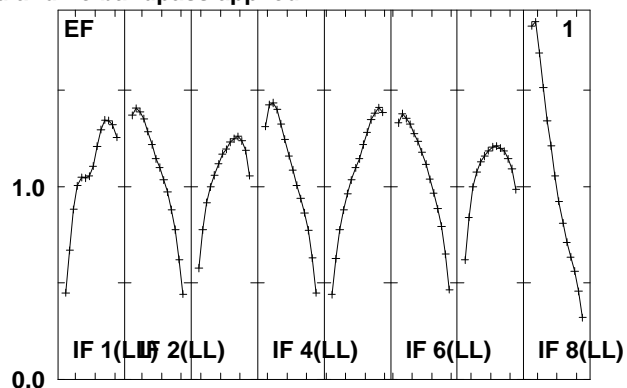
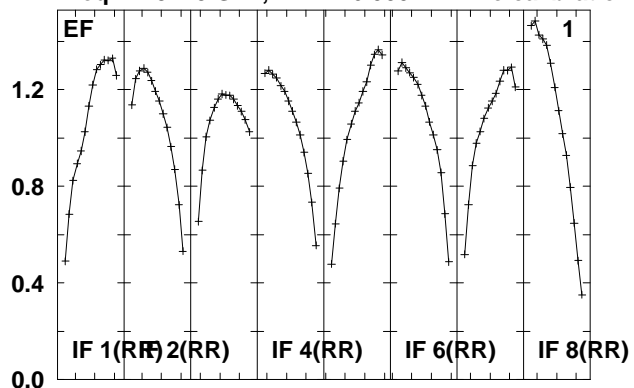

Lower frame: Real Jy
Total-power spectrum Antenna: *
Timerange: 00/12:44:10 to 00/12:54:54

Plot file version 75 created 08-JUL-2010 13:09:07
 B0940+00 EM079.UVDATA.1
 Freq = 4.9415 GHz, Bw = 16.000 MH No calibration applied and no bandpass applied

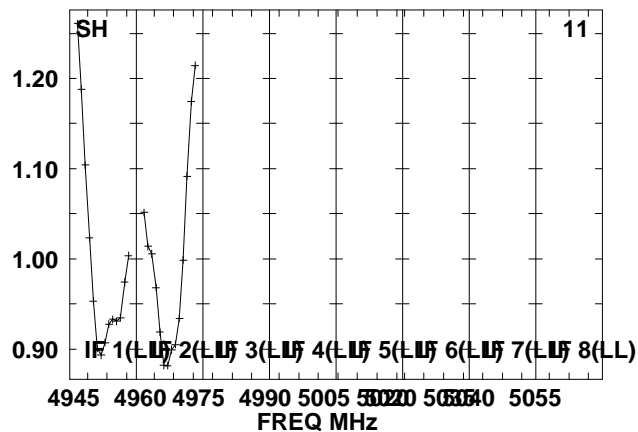
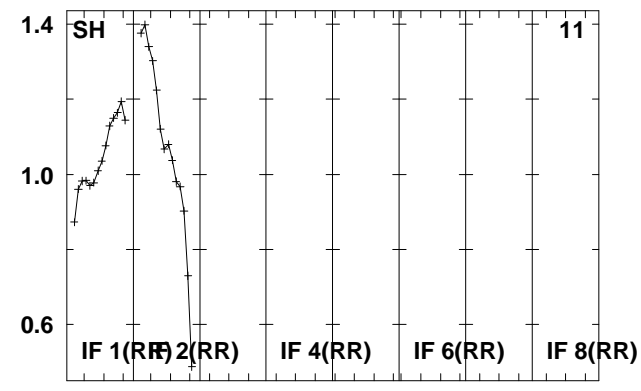
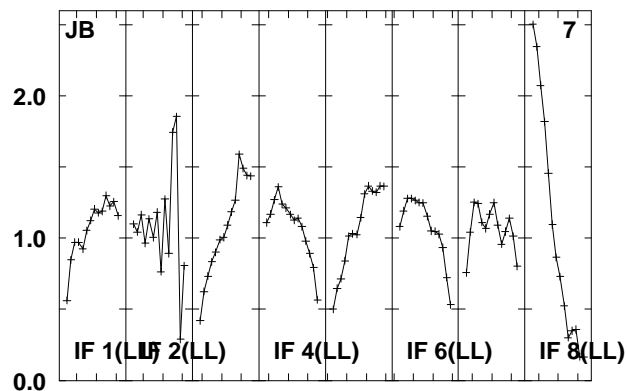
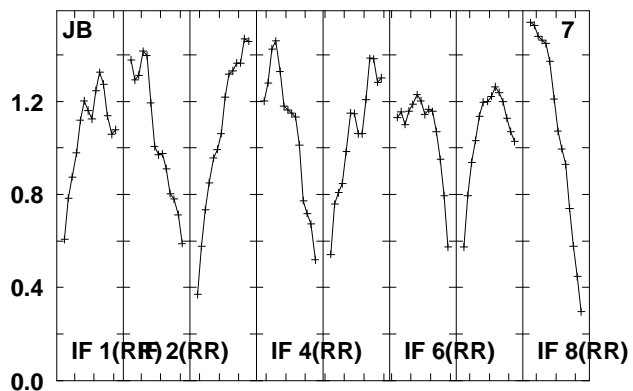
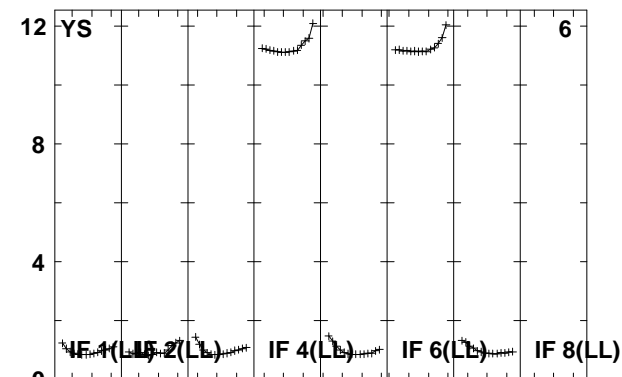
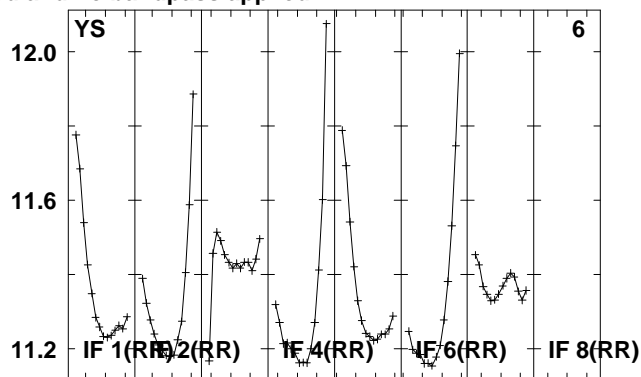
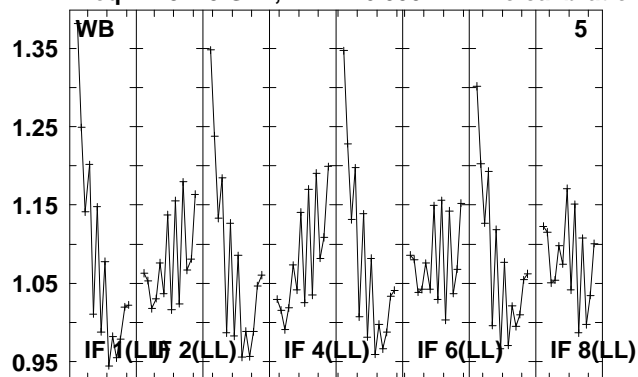

Lower frame: Real Jy
 Total-power spectrum Antenna: *
 Timerange: 00/12:44:10 to 00/12:54:54

Plot file version 76 created 08-JUL-2010 13:09:10

J0948+00 EM079.UVDATA.1

Freq = 4.9415 GHz, Bw = 16.000 MH No calibration applied and no bandpass applied

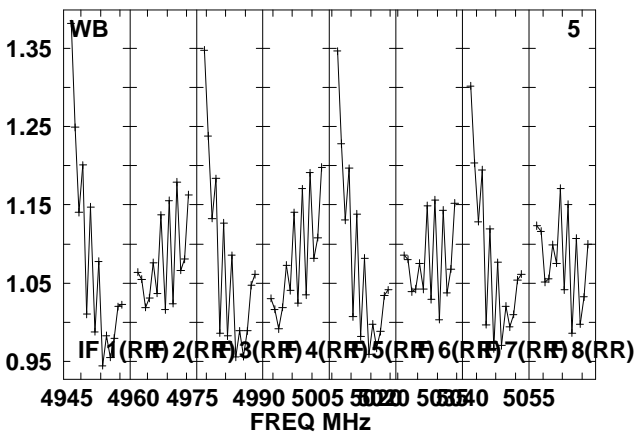
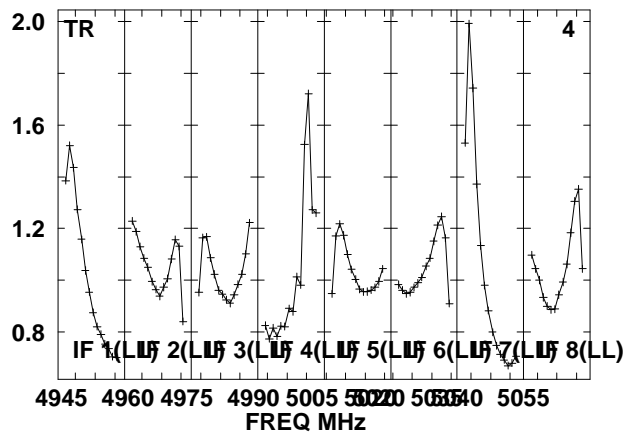
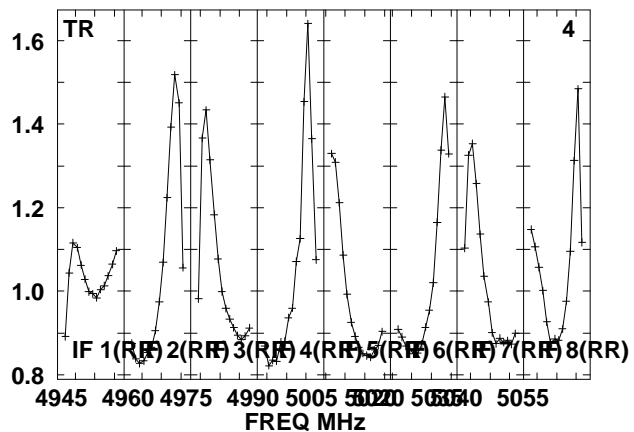
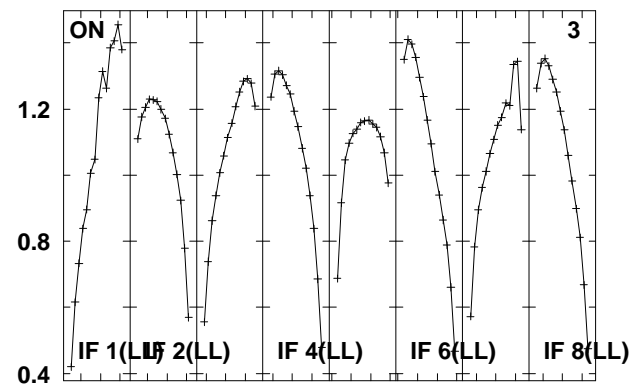
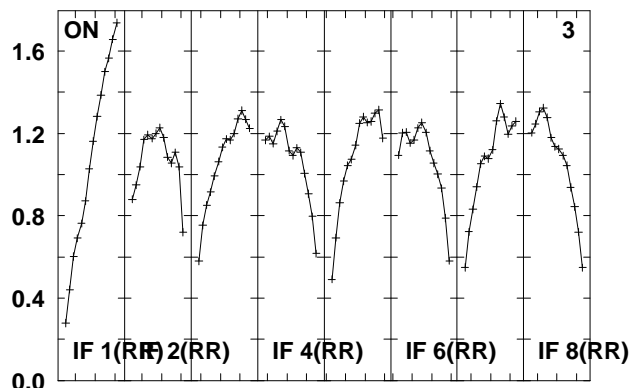
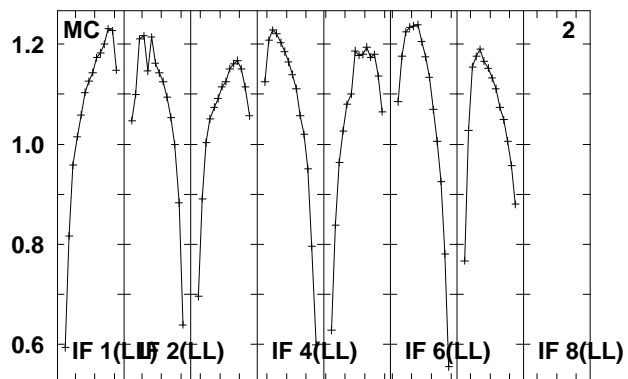
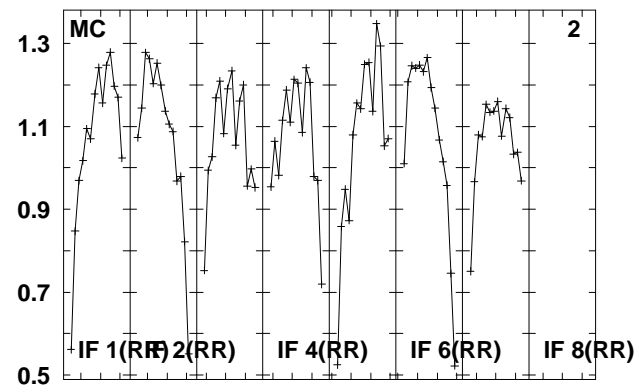
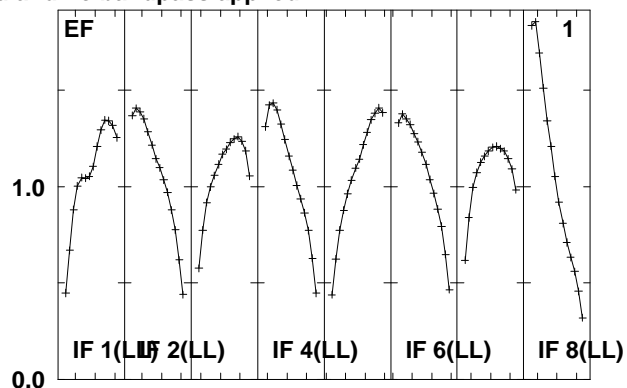
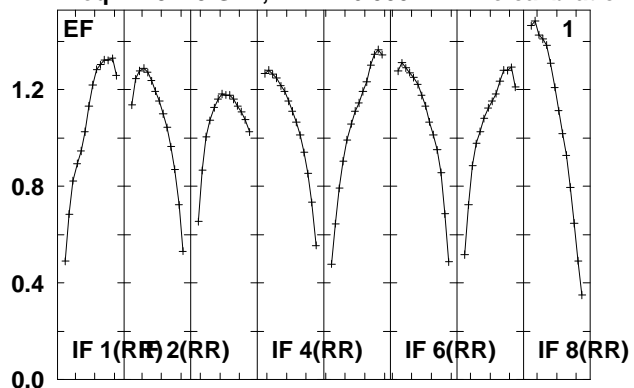

Lower frame: Real Jy
Total-power spectrum Antenna: *
Timerange: 00/12:54:56 to 00/12:56:54

Plot file version 77 created 08-JUL-2010 13:09:10

J0948+00 EM079.UVDATA.1

Freq = 4.9415 GHz, Bw = 16.000 MH No calibration applied and no bandpass applied

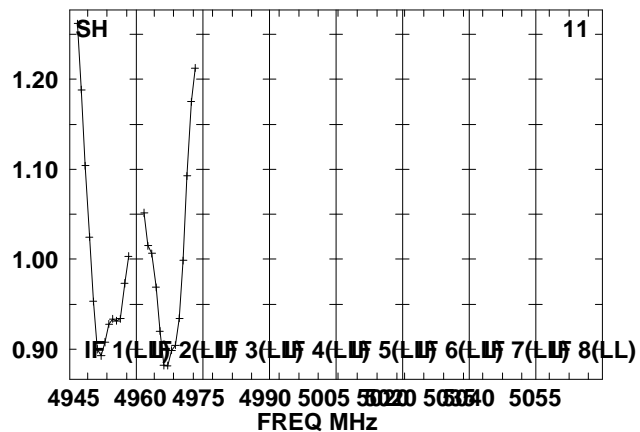
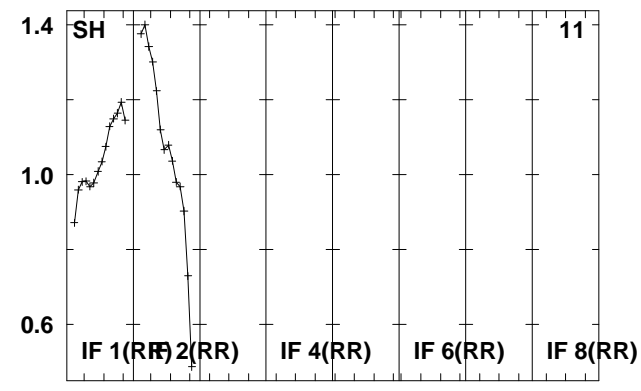
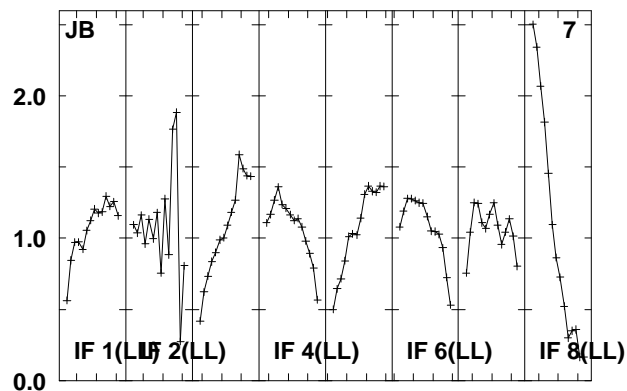
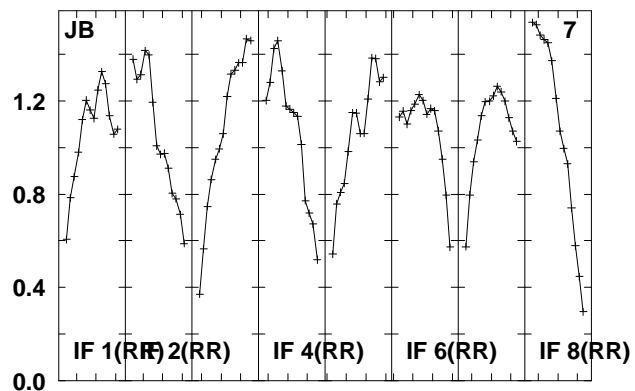
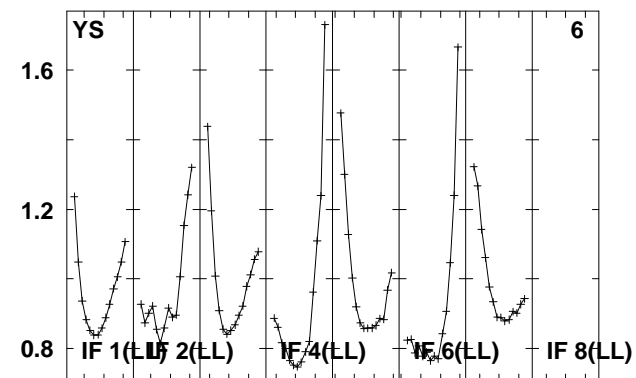
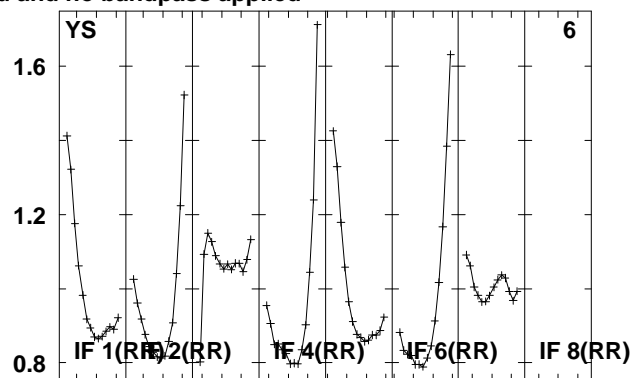
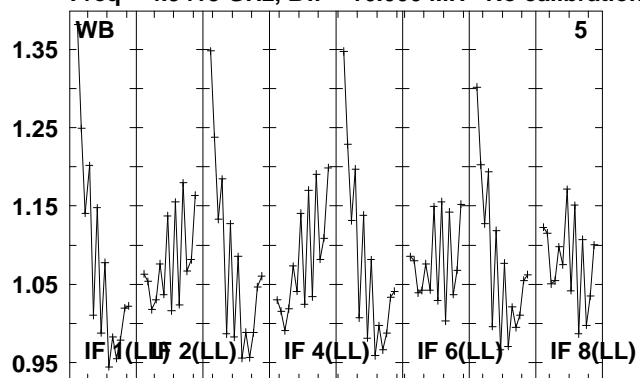

4945 4960 4975 4990 5005 5020 5035 5050 5055
FREQ MHz

Lower frame: Real Jy

Total-power spectrum Antenna: *

Timerange: 00/12:54:56 to 00/12:56:54

Plot file version 78 created 08-JUL-2010 13:09:11

B0940+00 EM079.UVDATA.1

Freq = 4.9415 GHz, Bw = 16.000 MH No calibration applied and no bandpass applied

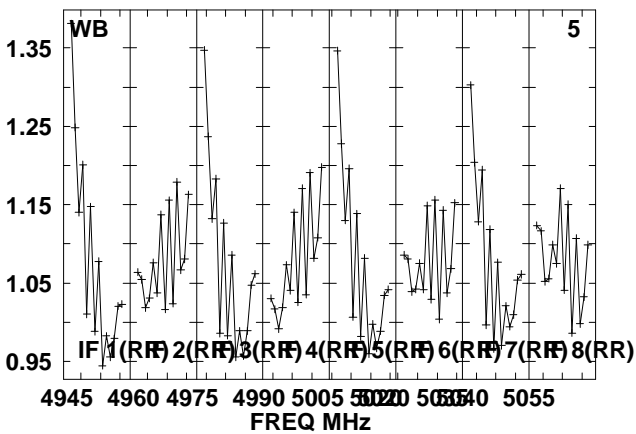
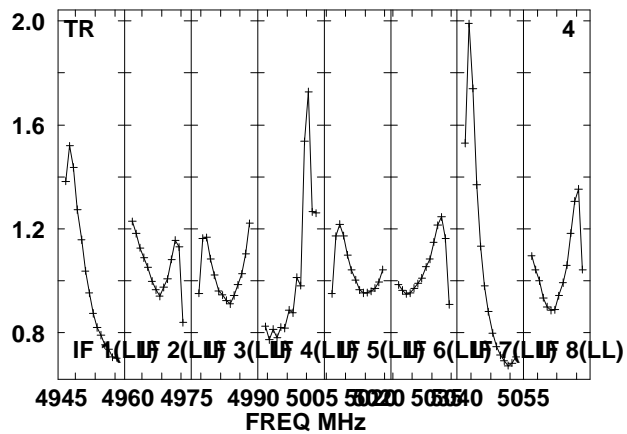
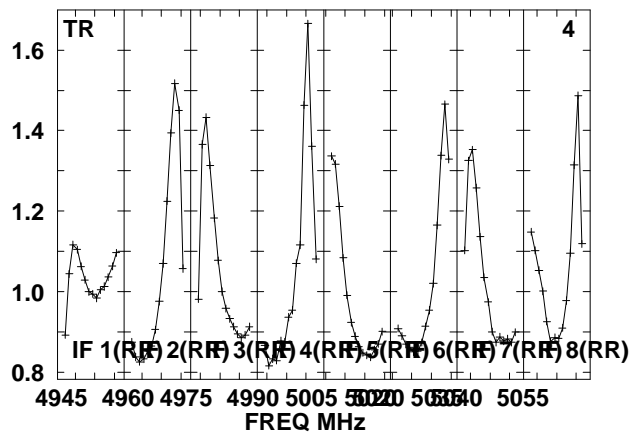
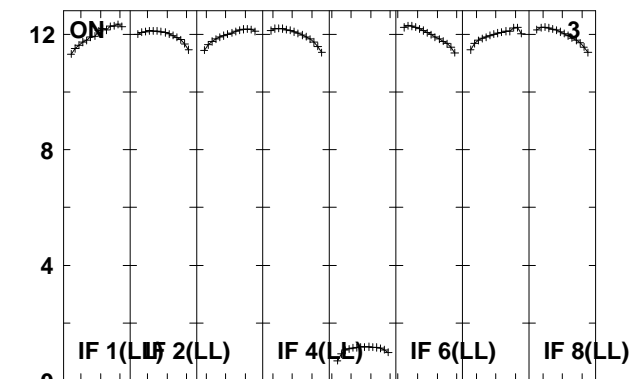
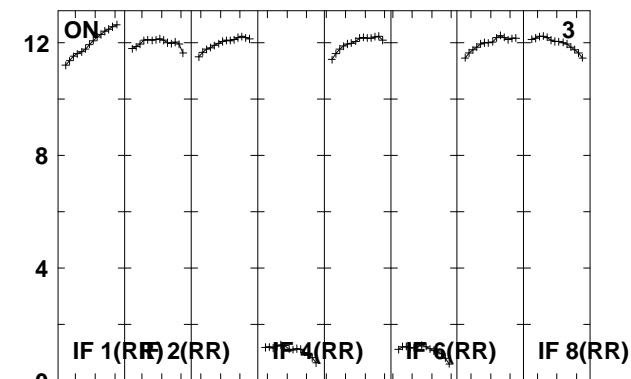
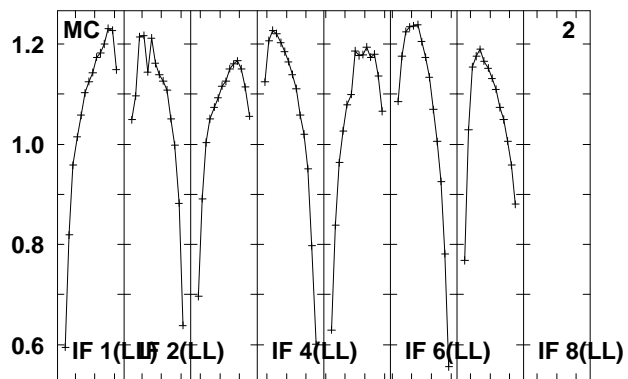
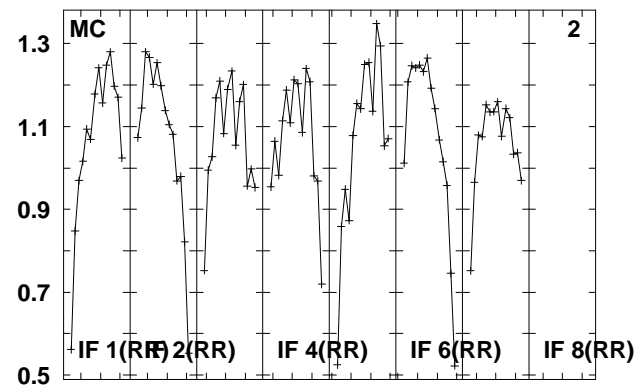
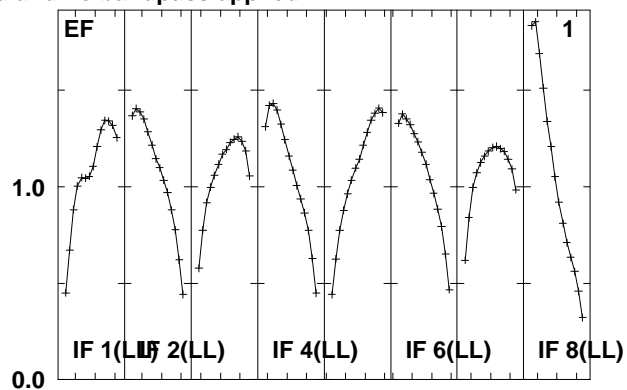
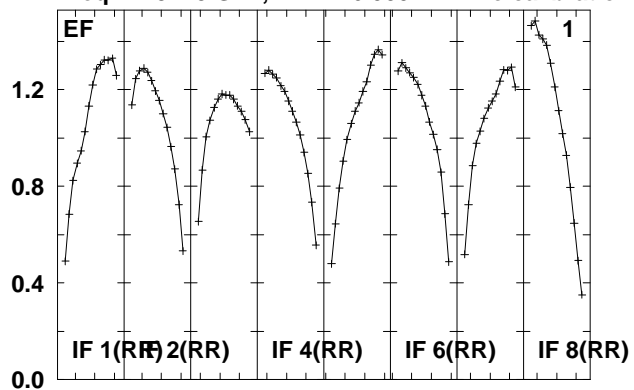

Lower frame: Real Jy
Total-power spectrum Antenna: *
Timerange: 00/12:56:56 to 00/13:07:38

Plot file version 79 created 08-JUL-2010 13:09:12

B0940+00 EM079.UVDATA.1

Freq = 4.9415 GHz, Bw = 16.000 MH No calibration applied and no bandpass applied

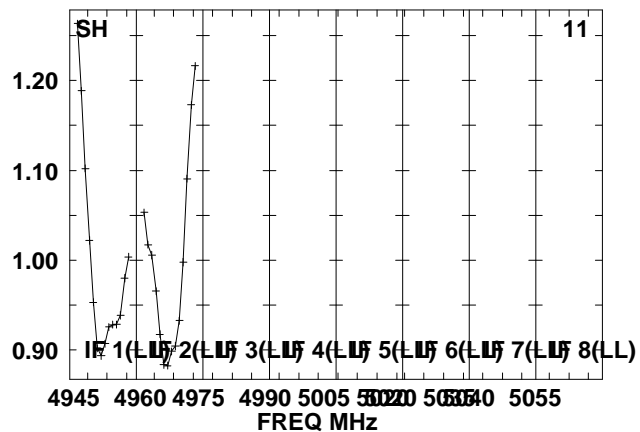
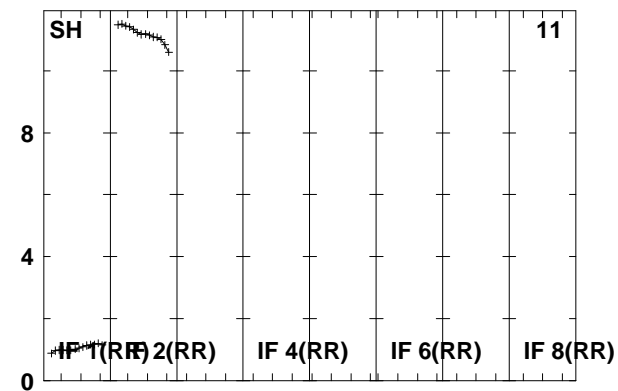
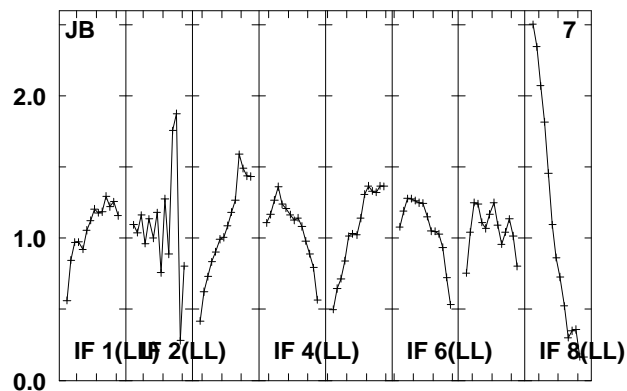
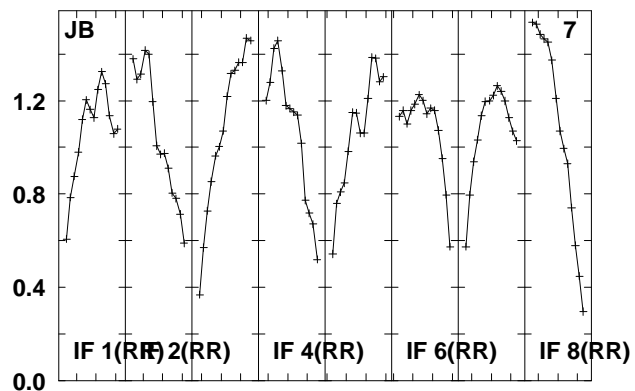
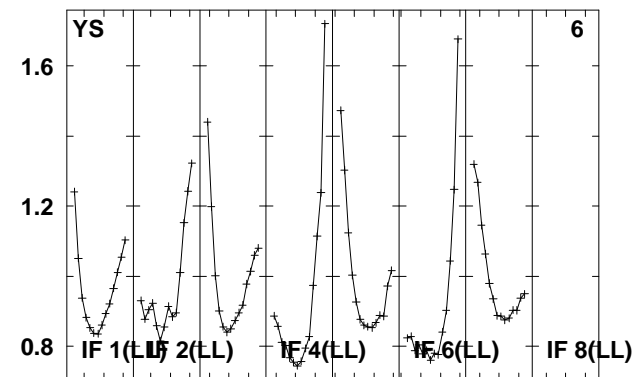
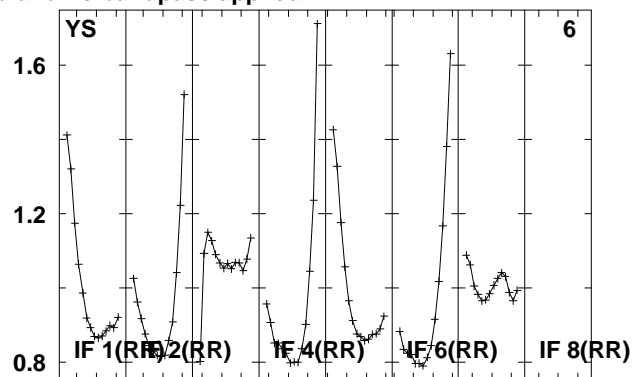
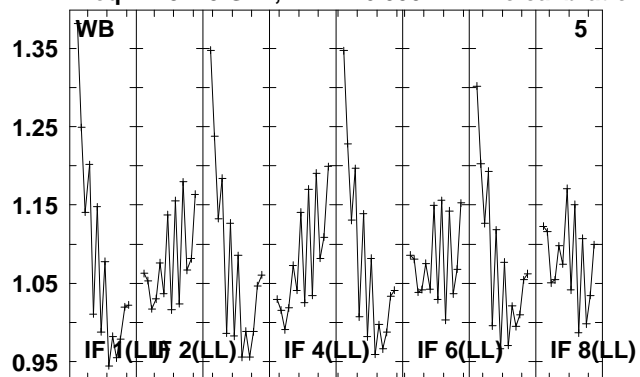

4945 4960 4975 4990 5005 5020 5035 5050 5055
FREQ MHz

Lower frame: Real Jy

Total-power spectrum Antenna: *

Timerange: 00/12:56:56 to 00/13:07:38

Plot file version 80 created 08-JUL-2010 13:09:14

J0948+00 EM079.UVDATA.1

Freq = 4.9415 GHz, Bw = 16.000 MH No calibration applied and no bandpass applied

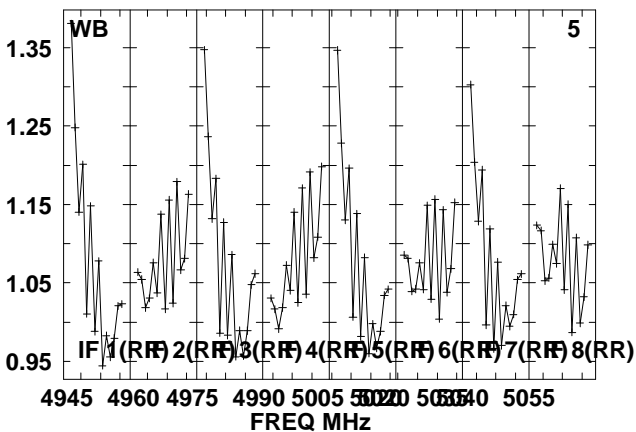
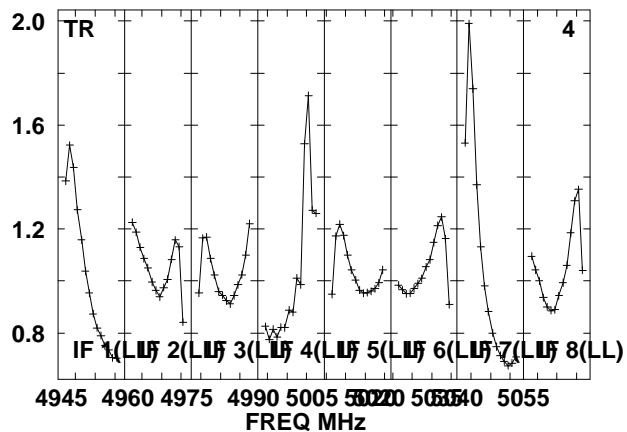
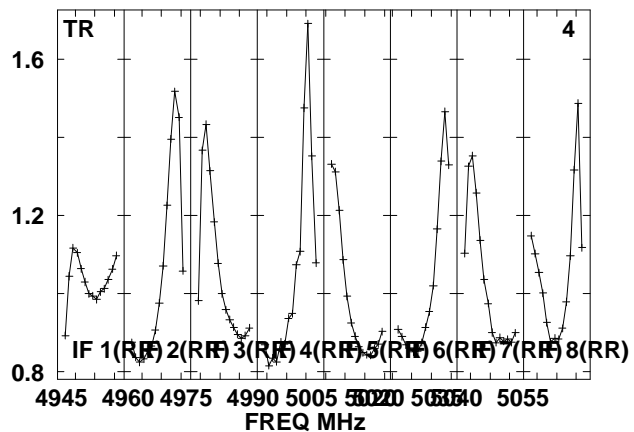
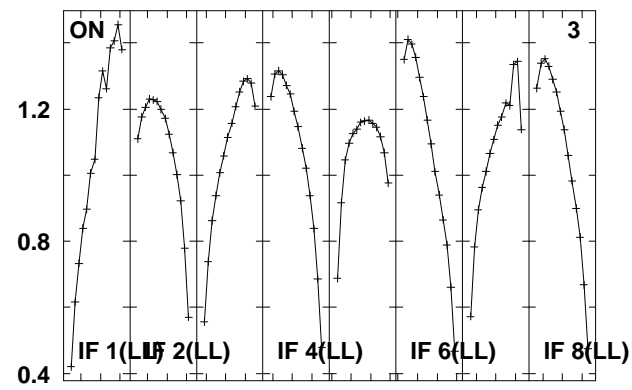
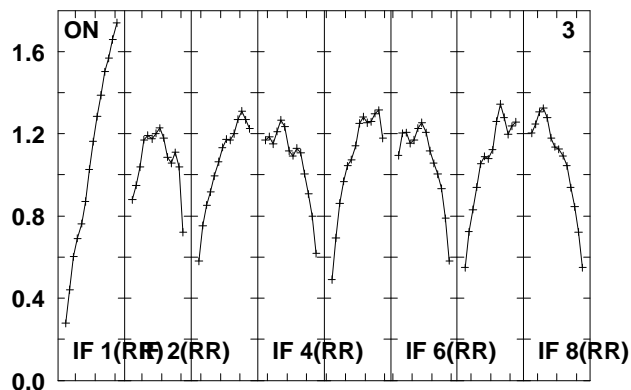
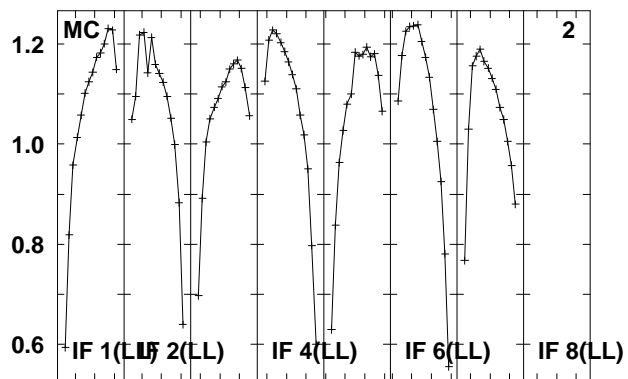
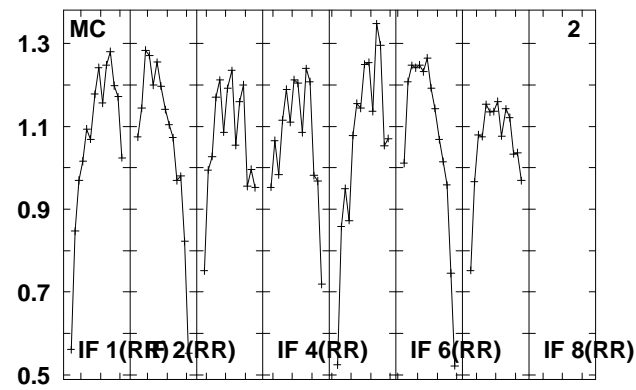
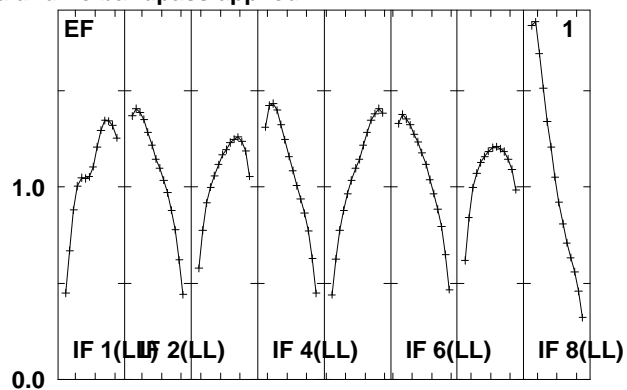
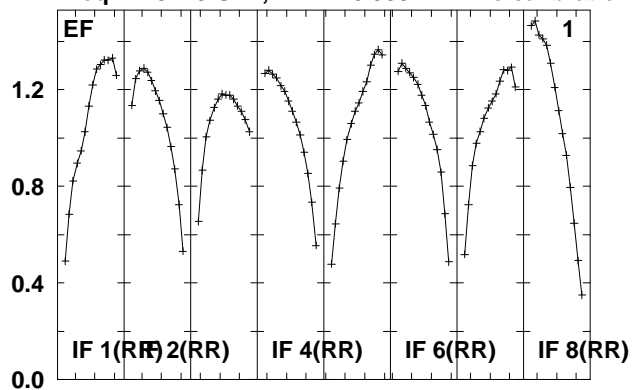

Lower frame: Real Jy
Total-power spectrum Antenna: *
Timerange: 00/13:07:40 to 00/13:09:38

Plot file version 81 created 08-JUL-2010 13:09:14

J0948+00 EM079.UVDATA.1

Freq = 4.9415 GHz, Bw = 16.000 MH No calibration applied and no bandpass applied

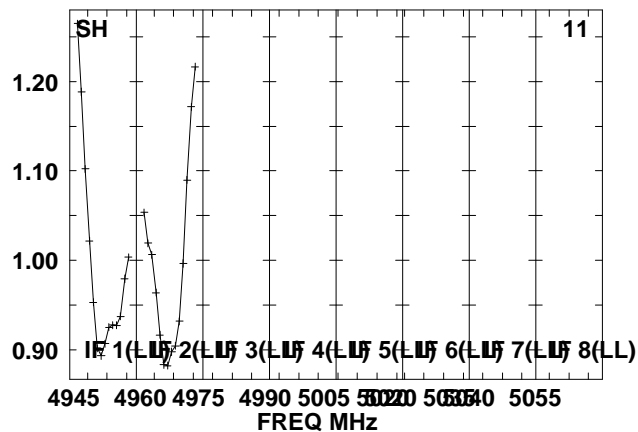
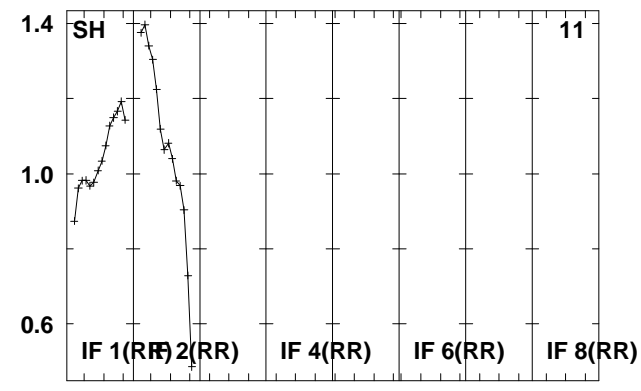
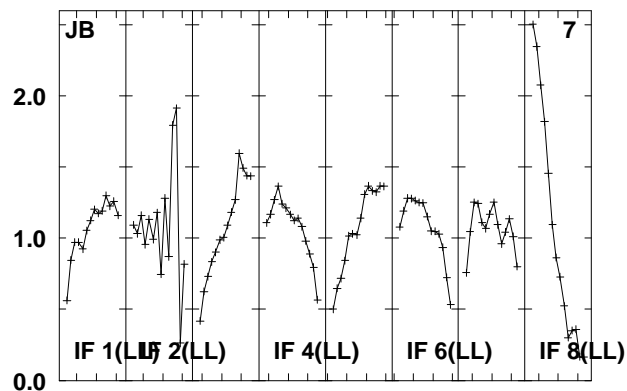
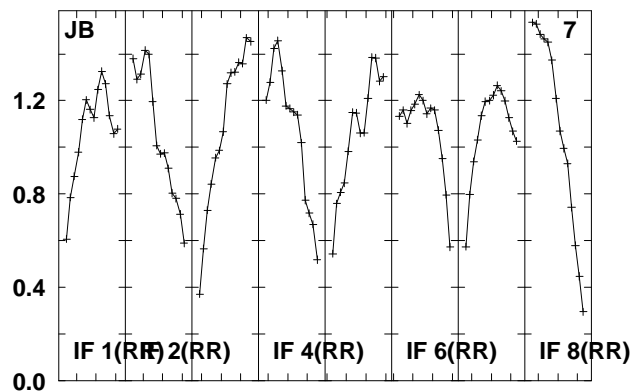
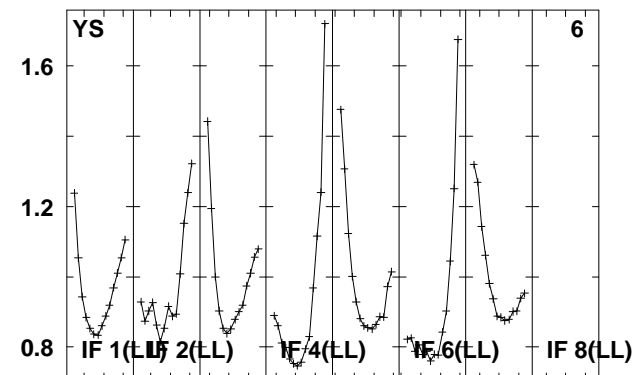
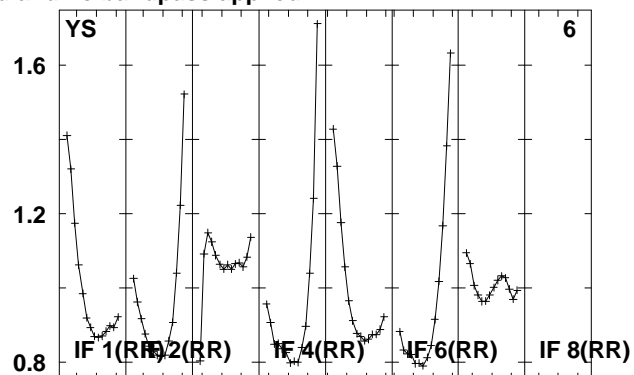
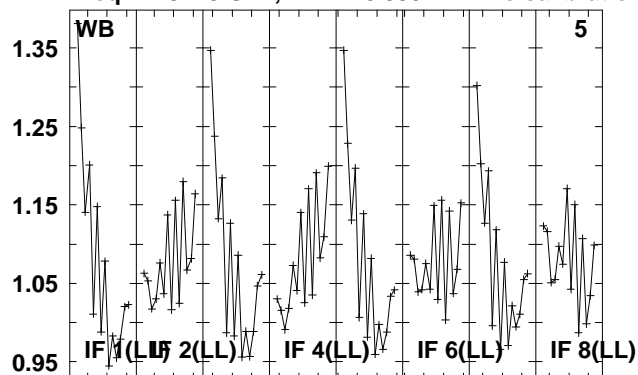

Lower frame: Real Jy

Total-power spectrum Antenna: *

Timerange: 00/13:07:40 to 00/13:09:38

Plot file version 82 created 08-JUL-2010 13:09:15

B0940+00 EM079.UVDATA.1

Freq = 4.9415 GHz, Bw = 16.000 MH No calibration applied and no bandpass applied

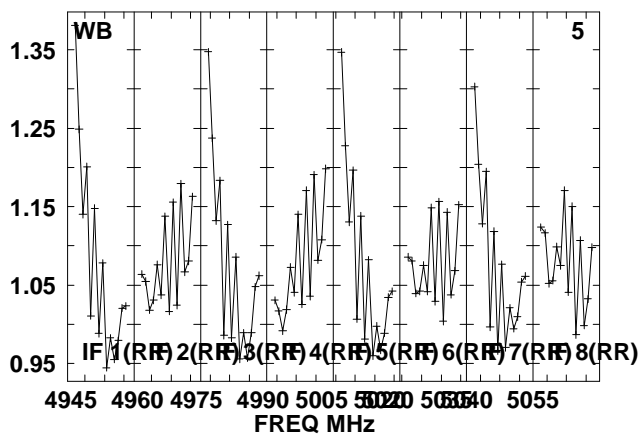
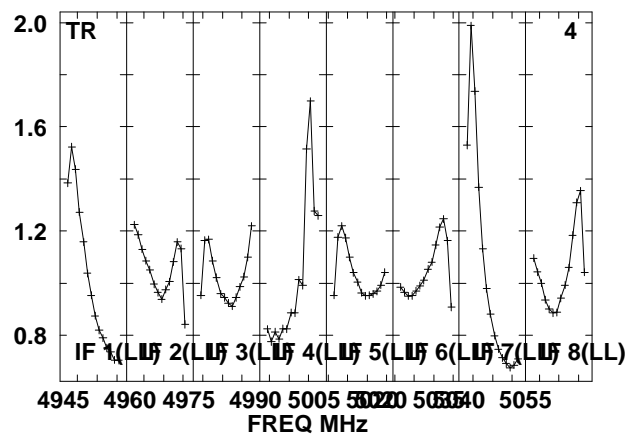
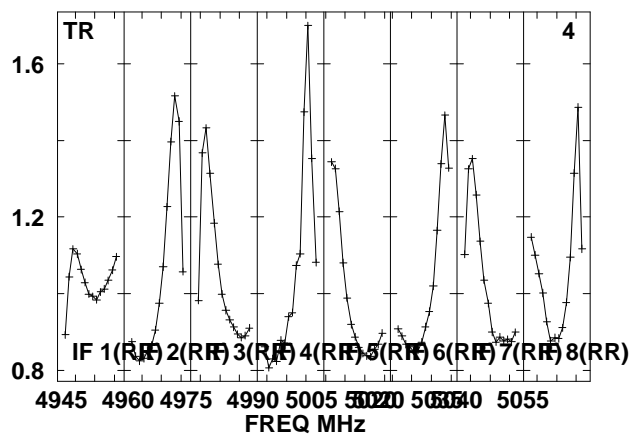
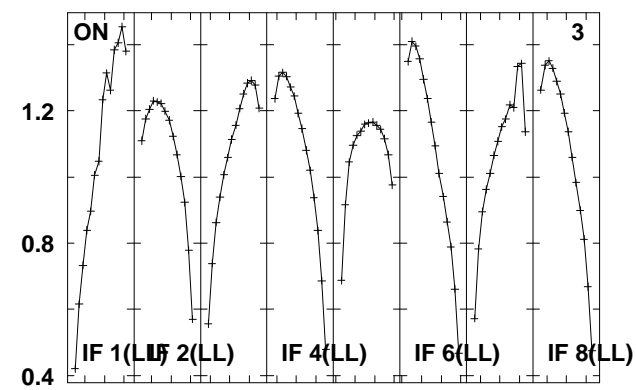
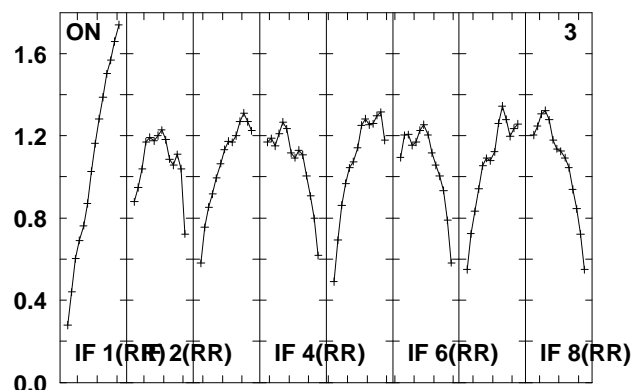
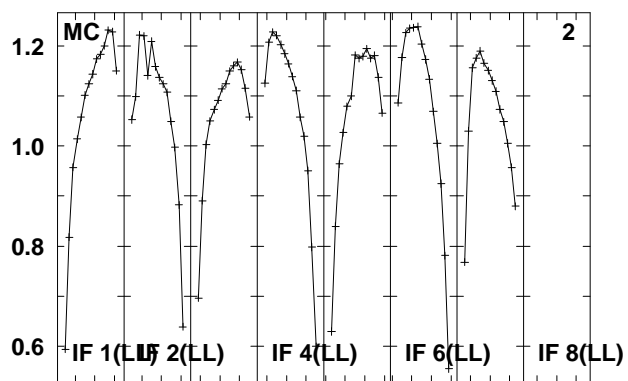
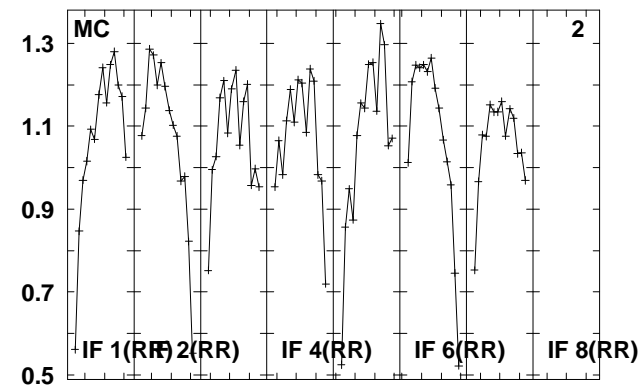
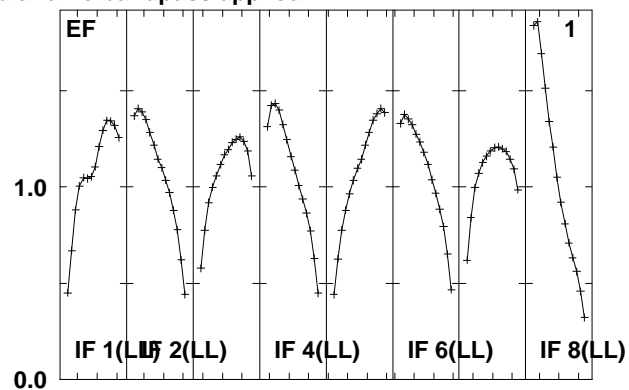
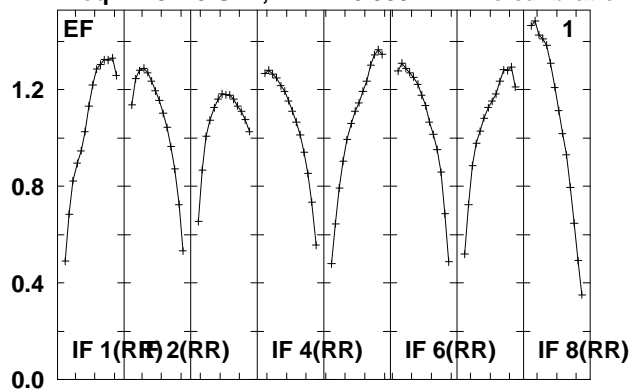

Lower frame: Real Jy
Total-power spectrum Antenna: *
Timerange: 00/13:09:40 to 00/13:20:24

Plot file version 83 created 08-JUL-2010 13:09:16
 B0940+00 EM079.UVDATA.1
 Freq = 4.9415 GHz, Bw = 16.000 MH No calibration applied and no bandpass applied

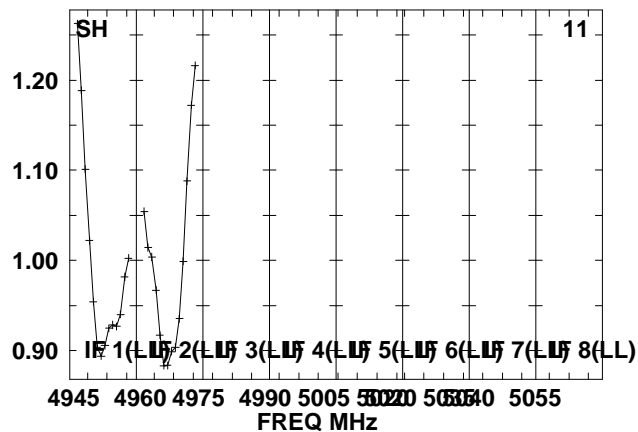
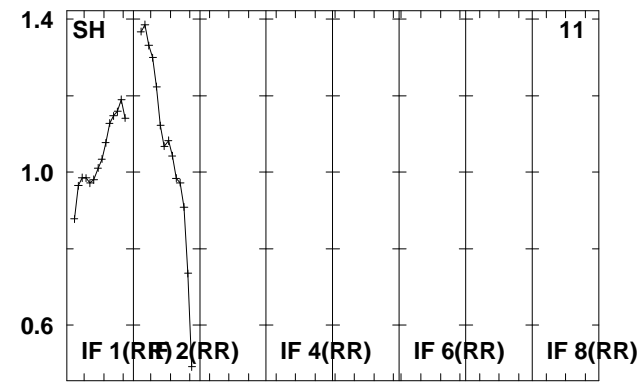
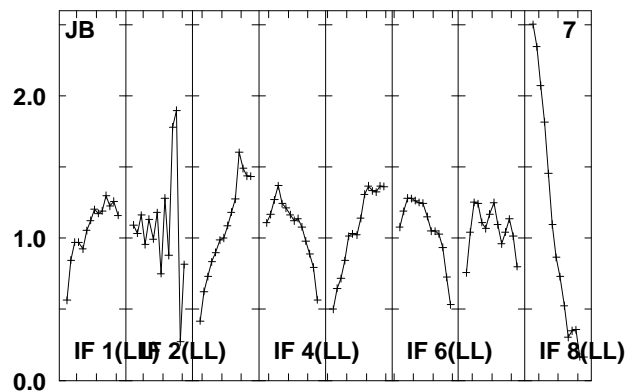
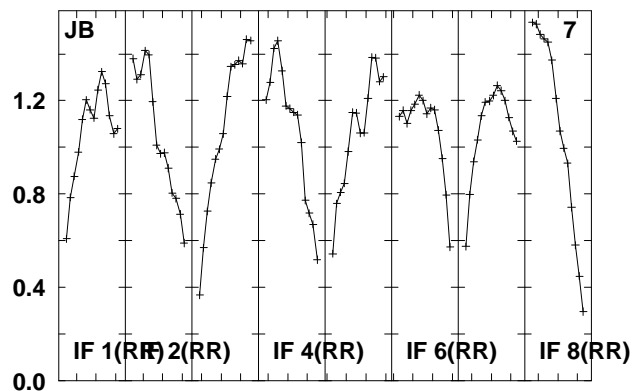
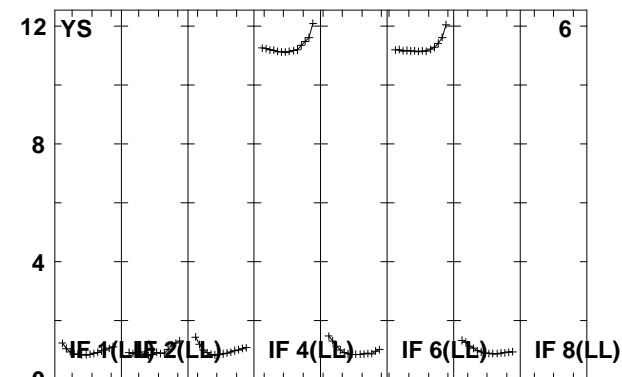
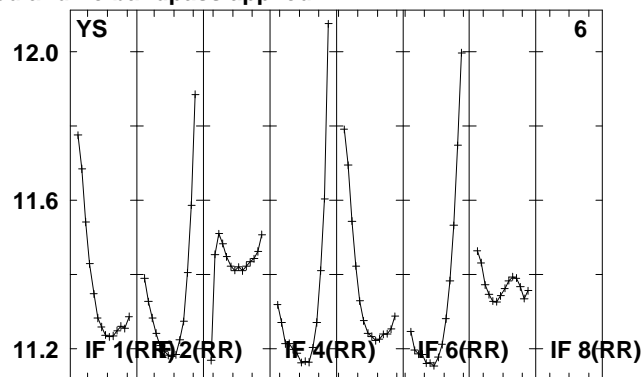
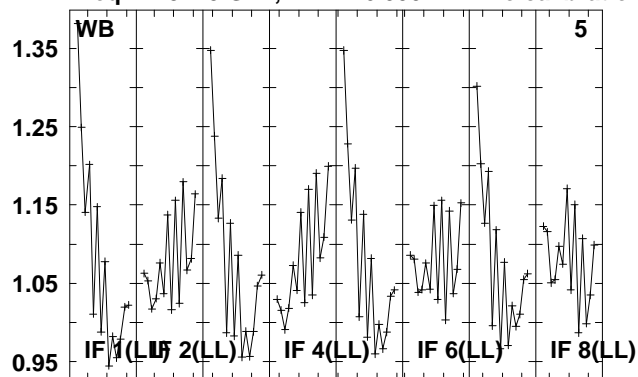

4945 4960 4975 4990 5005 5020 5035 5050 5055
 FREQ MHz

Lower frame: Real Jy
 Total-power spectrum Antenna: *
 Timerange: 00/13:09:40 to 00/13:20:24

Plot file version 84 created 08-JUL-2010 13:09:18

J0948+00 EM079.UVDATA.1

Freq = 4.9415 GHz, Bw = 16.000 MH No calibration applied and no bandpass applied

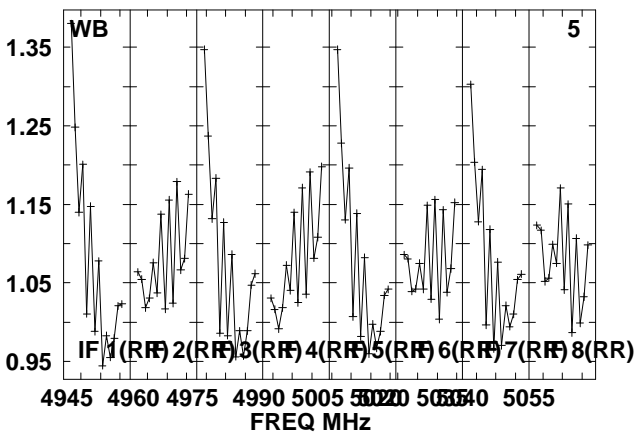
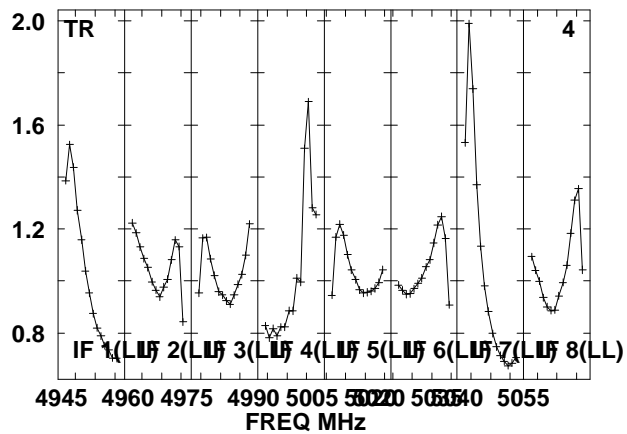
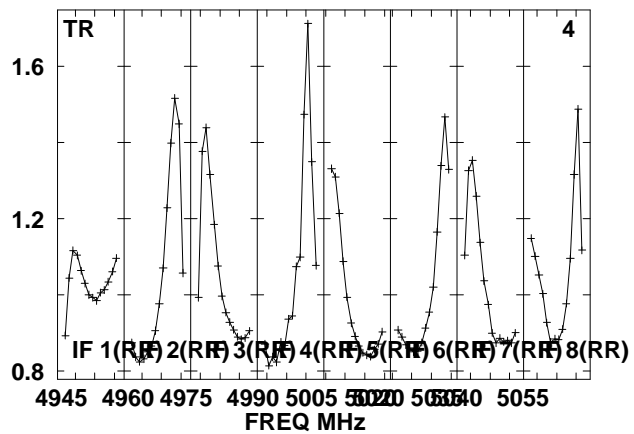
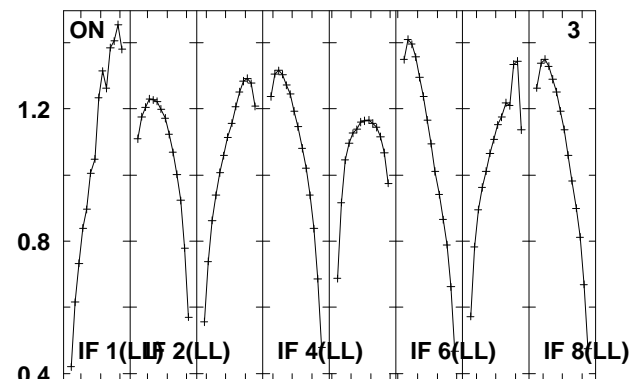
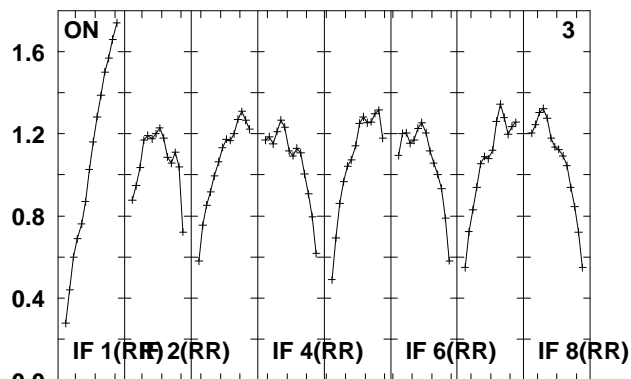
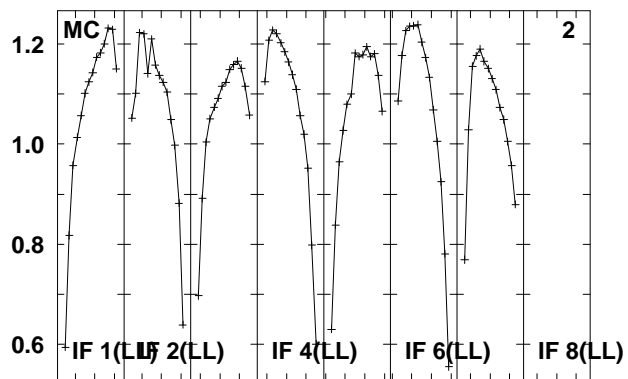
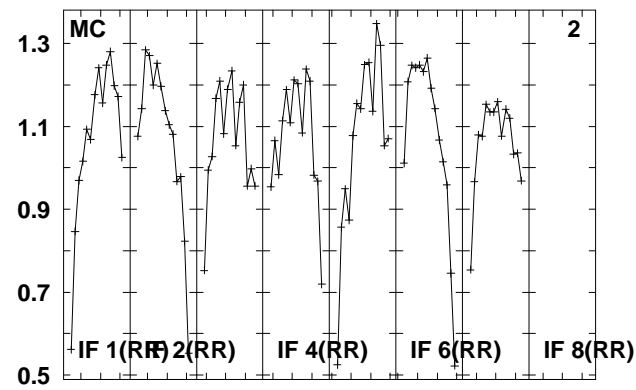
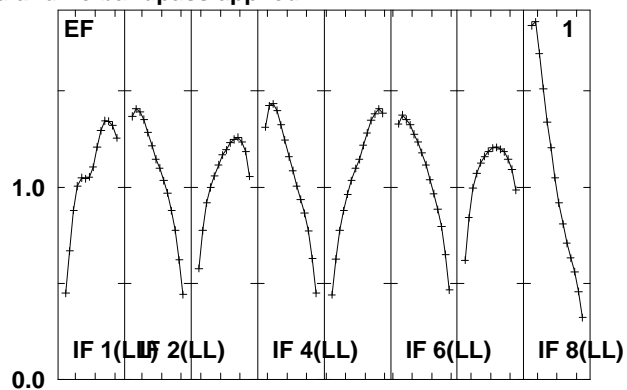
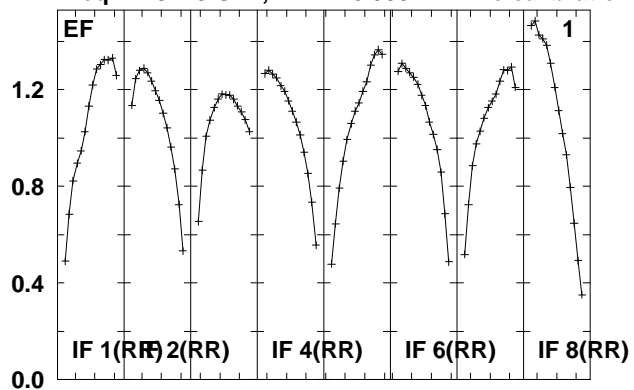

Lower frame: Real Jy
Total-power spectrum Antenna: *
Timerange: 00/13:20:26 to 00/13:22:24

Plot file version 85 created 08-JUL-2010 13:09:18

J0948+00 EM079.UVDATA.1

Freq = 4.9415 GHz, Bw = 16.000 MH No calibration applied and no bandpass applied

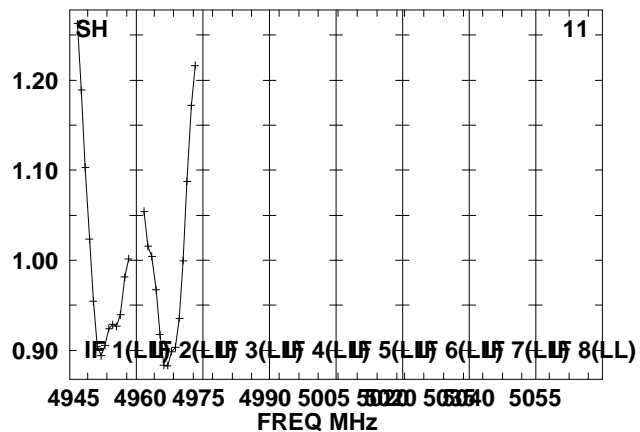
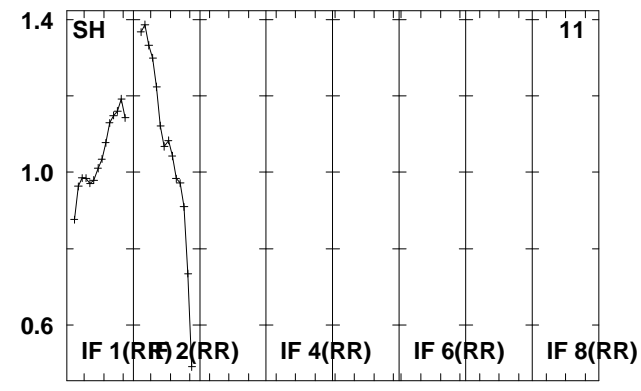
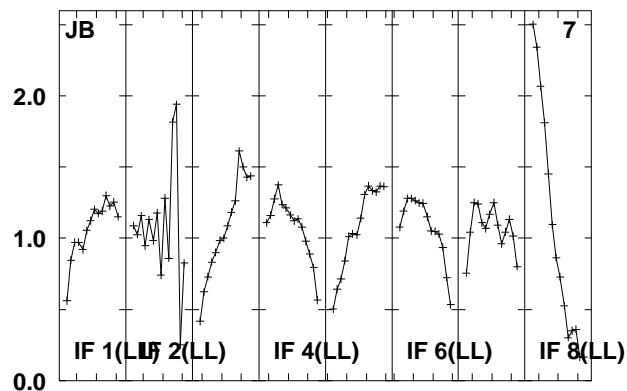
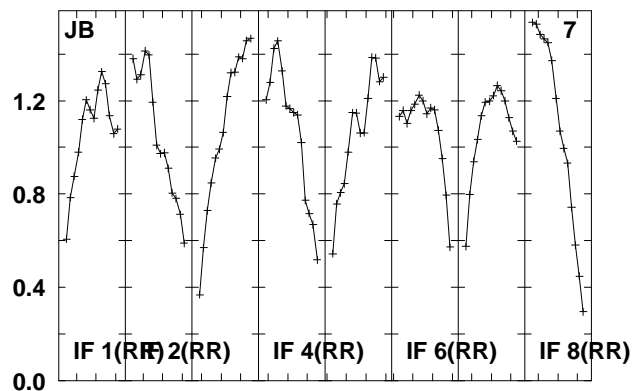
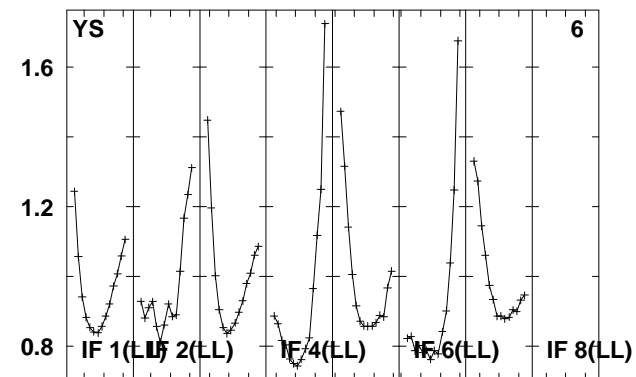
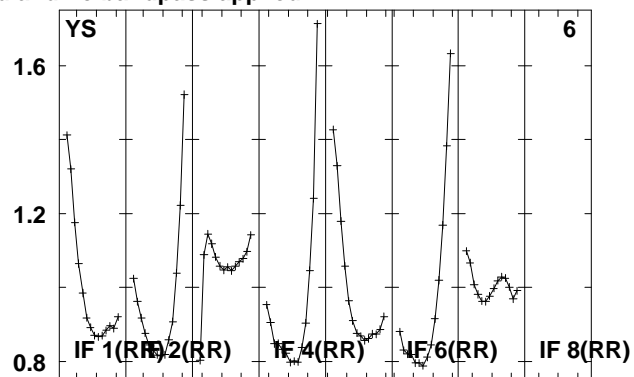
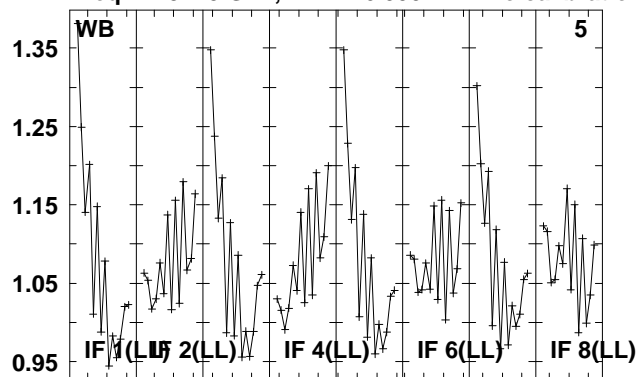

4945 4960 4975 4990 5005 5020 5035 5050 5055
FREQ MHz

Lower frame: Real Jy

Total-power spectrum Antenna: *

Timerange: 00/13:20:26 to 00/13:22:24

Plot file version 86 created 08-JUL-2010 13:09:19

B0940+00 EM079.UVDATA.1

Freq = 4.9415 GHz, Bw = 16.000 MH No calibration applied and no bandpass applied

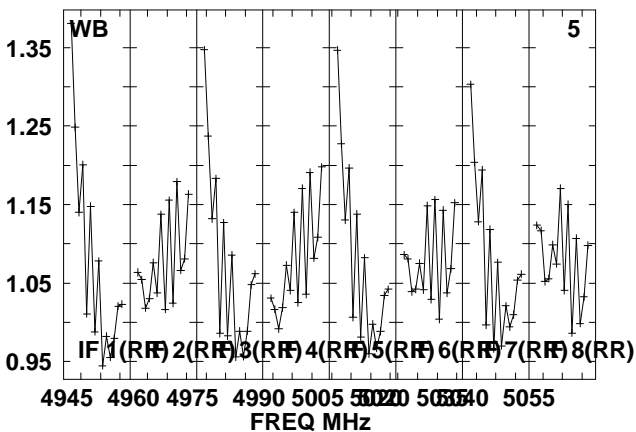
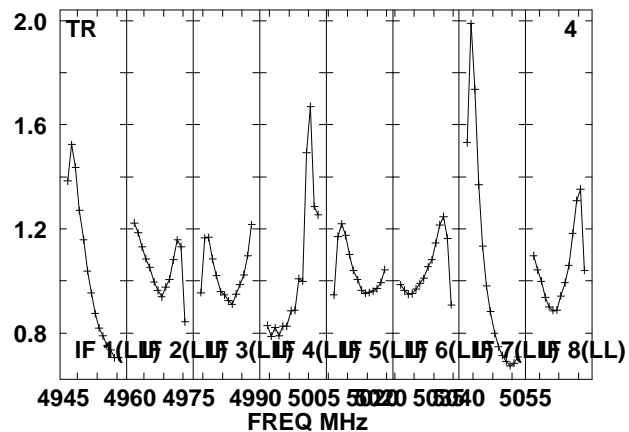
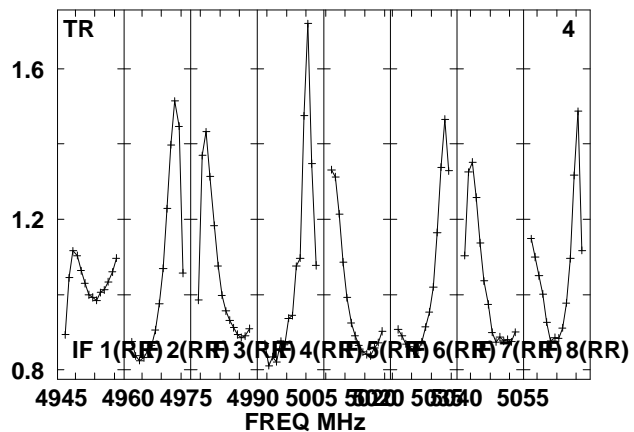
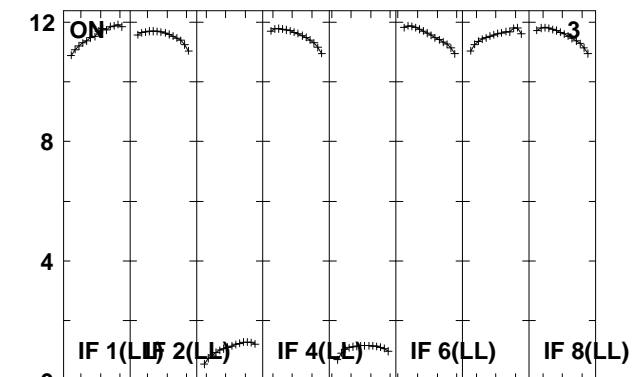
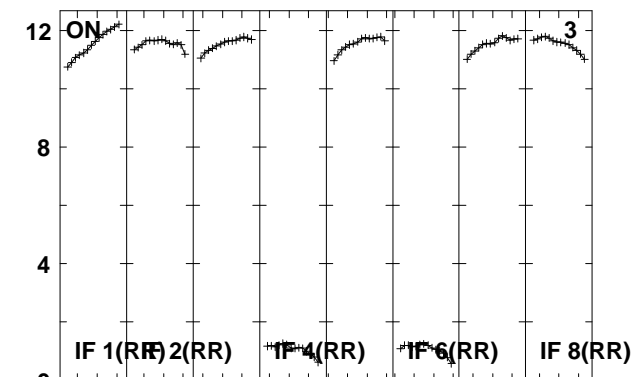
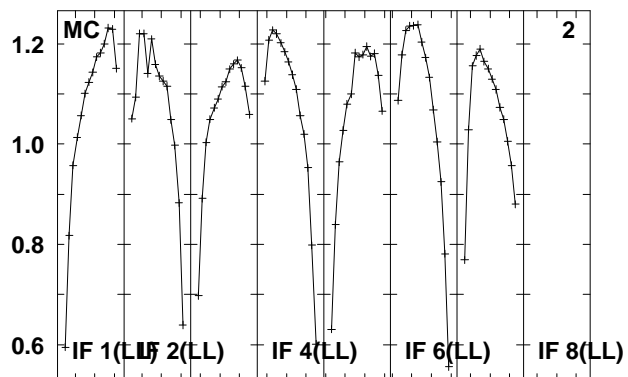
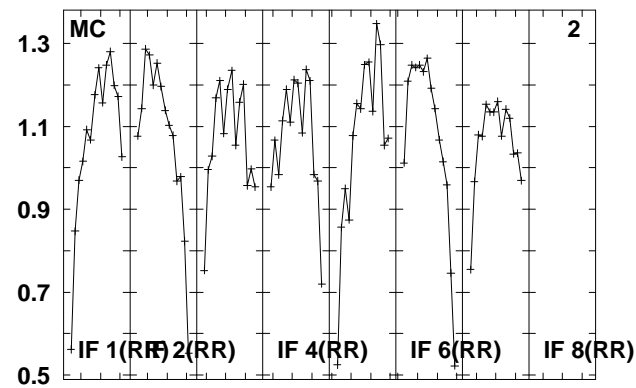
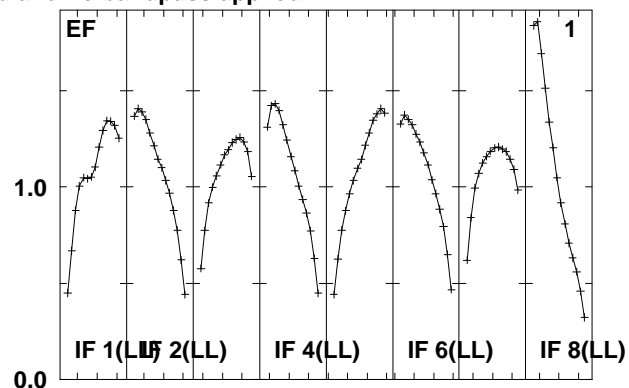
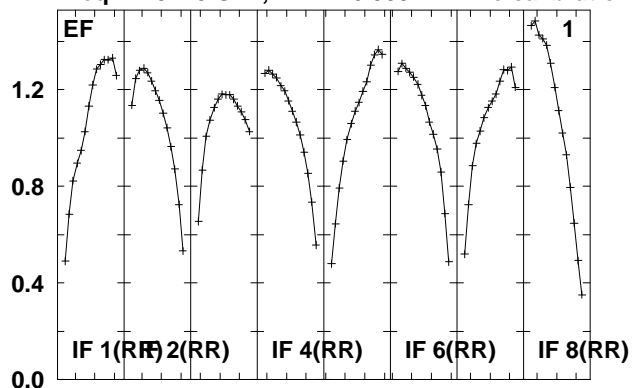

Lower frame: Real Jy
Total-power spectrum Antenna: *
Timerange: 00/13:22:26 to 00/13:33:08

Plot file version 87 created 08-JUL-2010 13:09:20

B0940+00 EM079.UVDATA.1

Freq = 4.9415 GHz, Bw = 16.000 MH No calibration applied and no bandpass applied

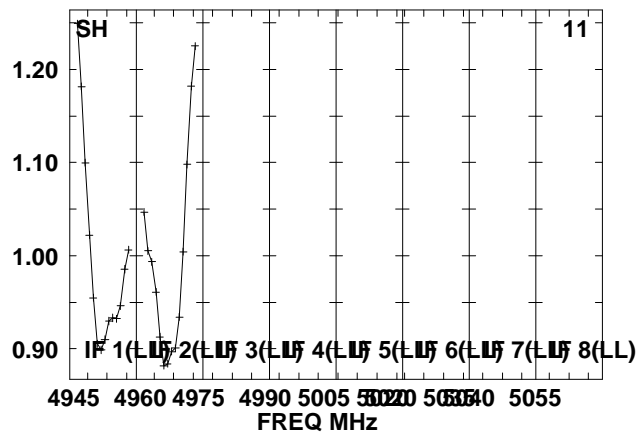
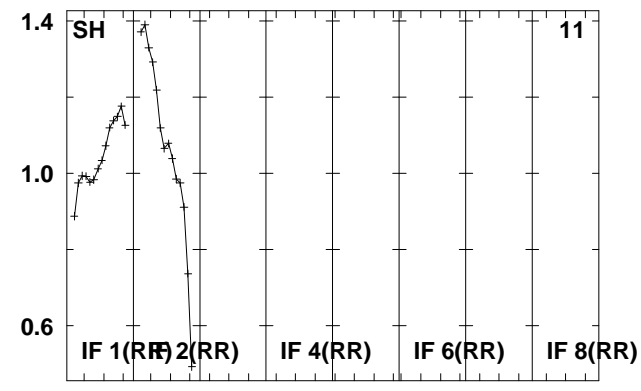
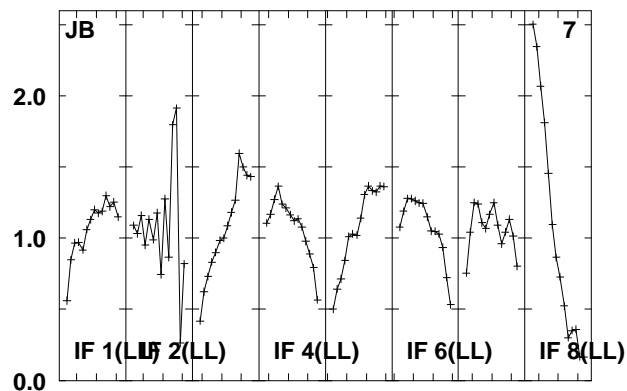
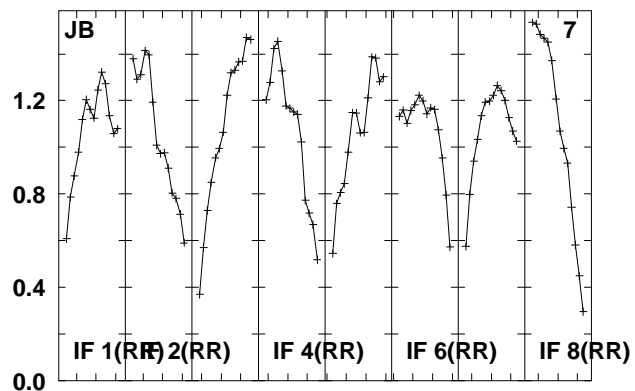
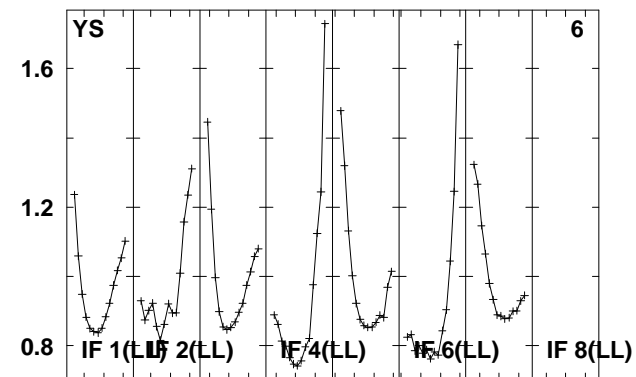
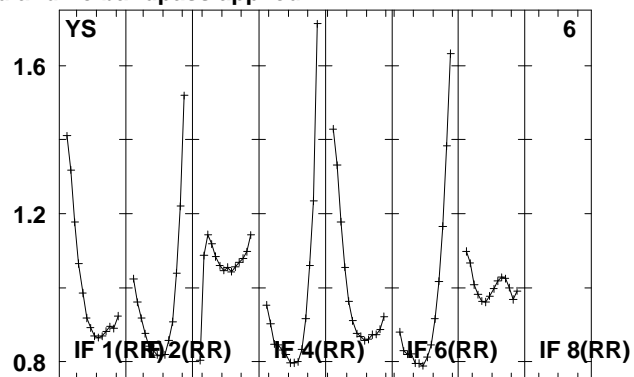
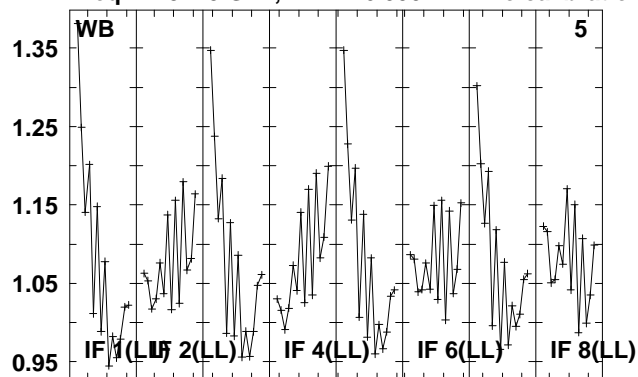

4945 4960 4975 4990 5005 5020 5035 5050 5055
FREQ MHz

Lower frame: Real Jy

Total-power spectrum Antenna: *

Timerange: 00/13:22:26 to 00/13:33:08

Plot file version 88 created 08-JUL-2010 13:09:22

J0948+00 EM079.UVDATA.1

Freq = 4.9415 GHz, Bw = 16.000 MH No calibration applied and no bandpass applied

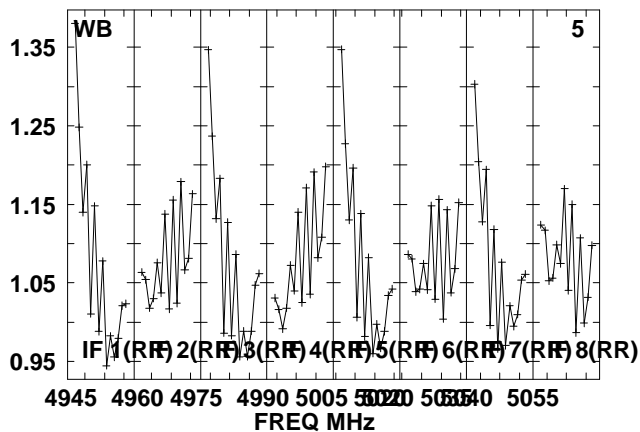
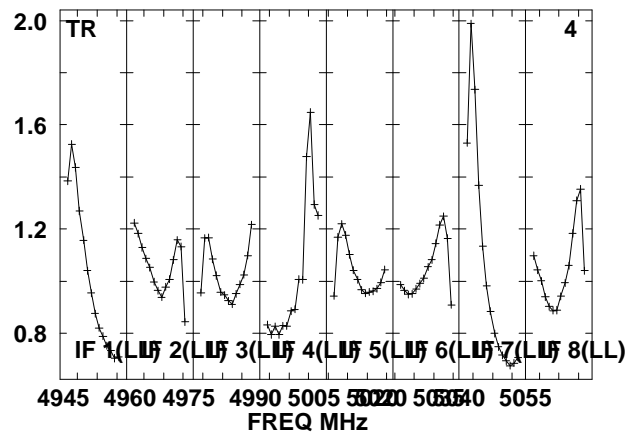
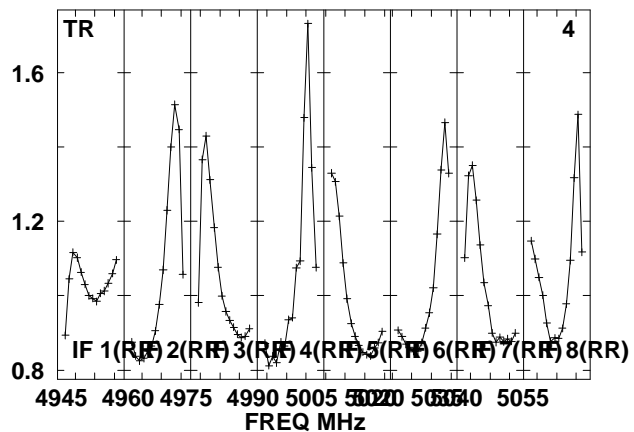
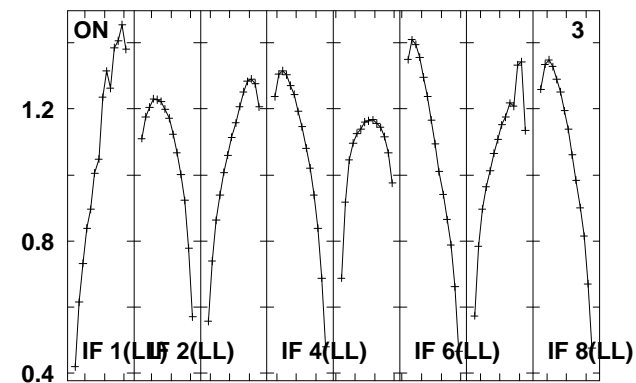
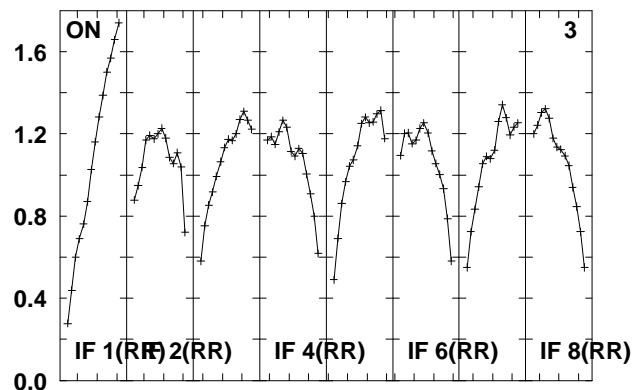
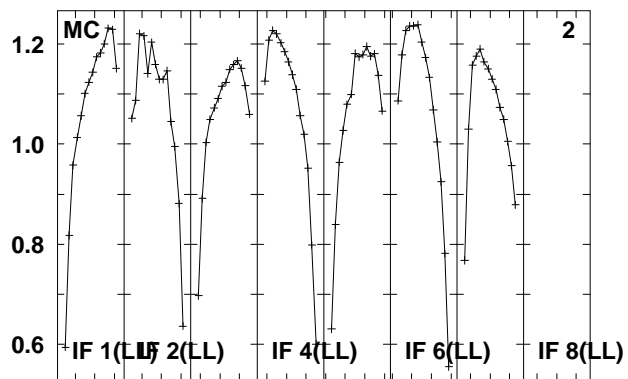
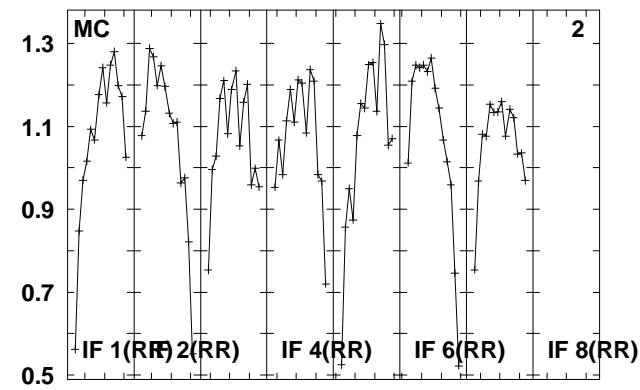
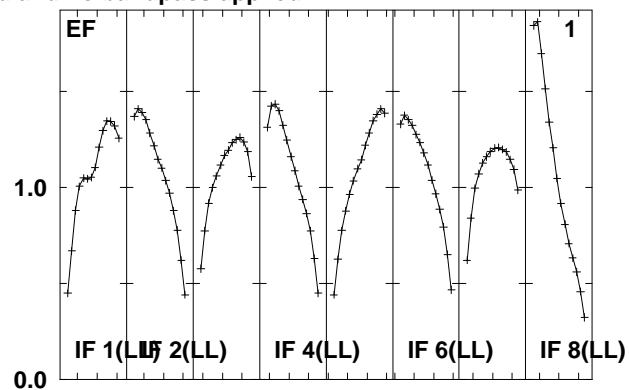
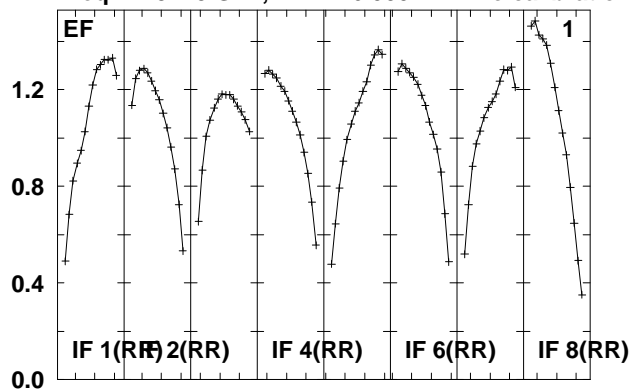

Lower frame: Real Jy
Total-power spectrum Antenna: *
Timerange: 00/13:33:10 to 00/13:35:08

Plot file version 89 created 08-JUL-2010 13:09:22

J0948+00 EM079.UVDATA.1

Freq = 4.9415 GHz, Bw = 16.000 MH No calibration applied and no bandpass applied

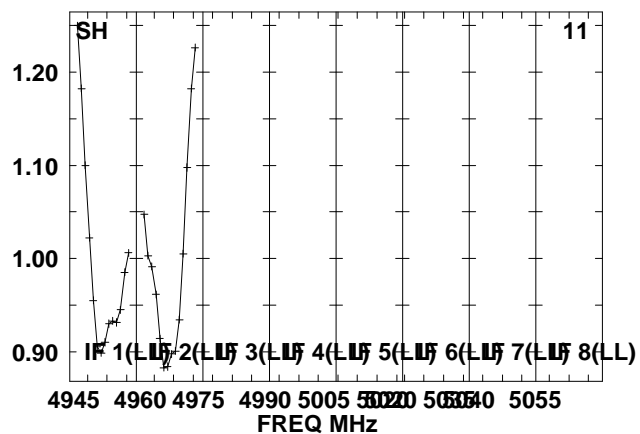
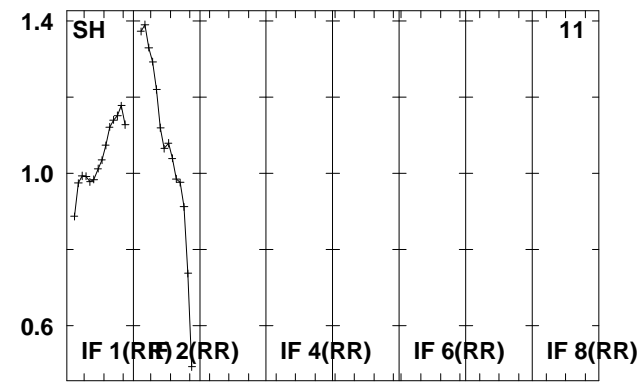
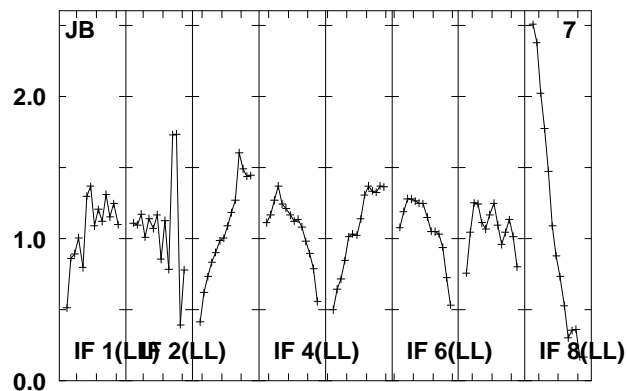
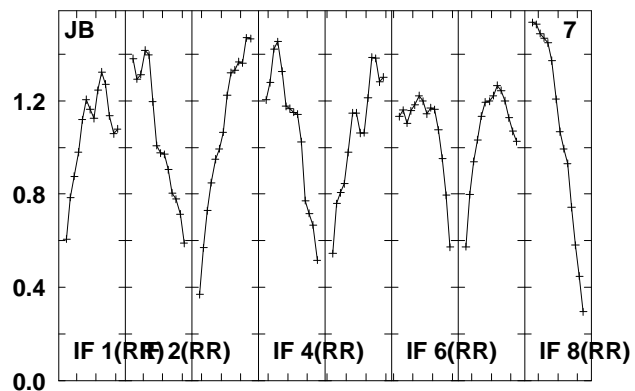
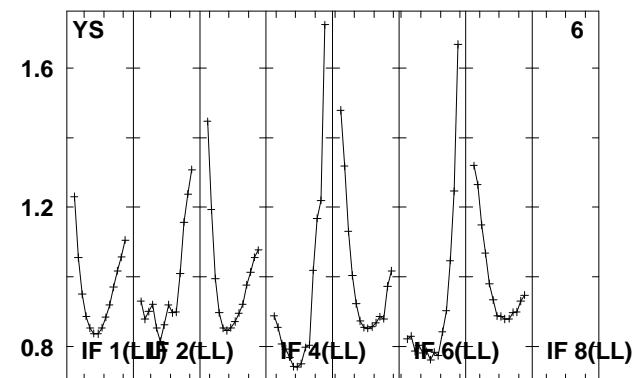
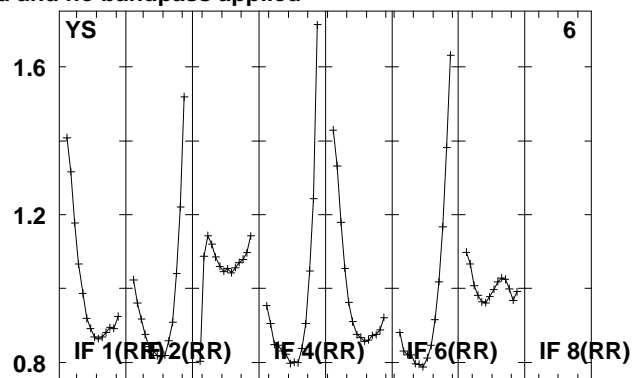
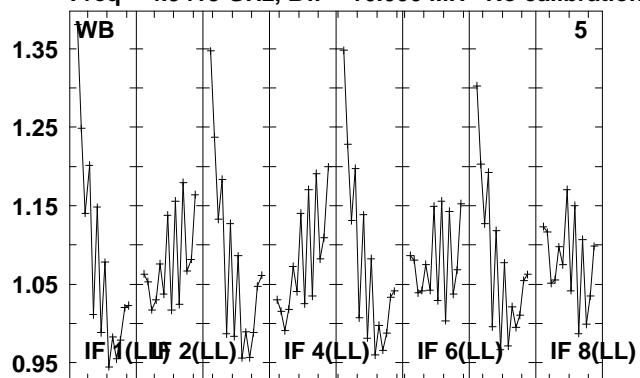

4945 4960 4975 4990 5005 5020 5035 5050 5055
FREQ MHz

Lower frame: Real Jy

Total-power spectrum Antenna: *

Timerange: 00/13:33:10 to 00/13:35:08

Plot file version 90 created 08-JUL-2010 13:09:23

4C39.25 EM079.UVDATA.1

Freq = 4.9415 GHz, Bw = 16.000 MH No calibration applied and no bandpass applied

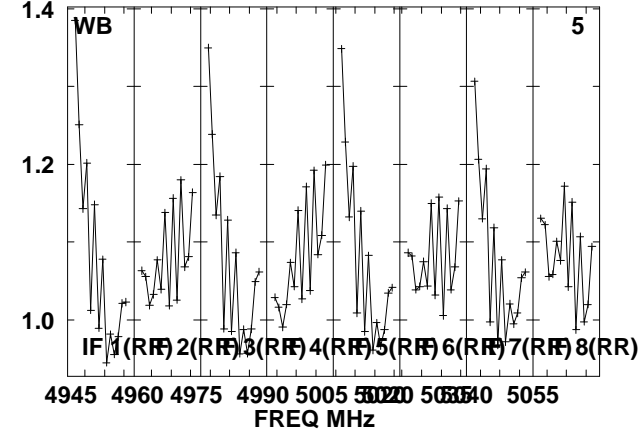
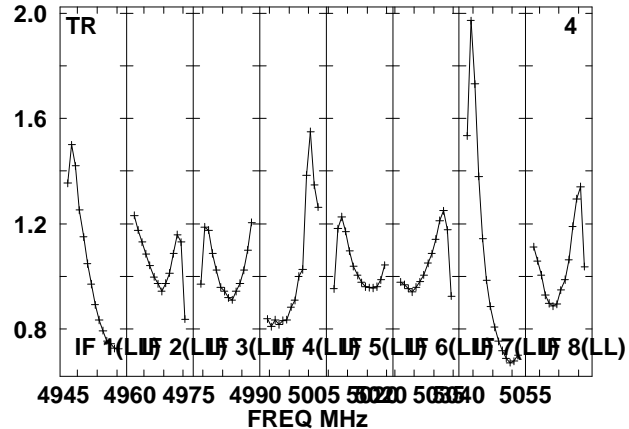
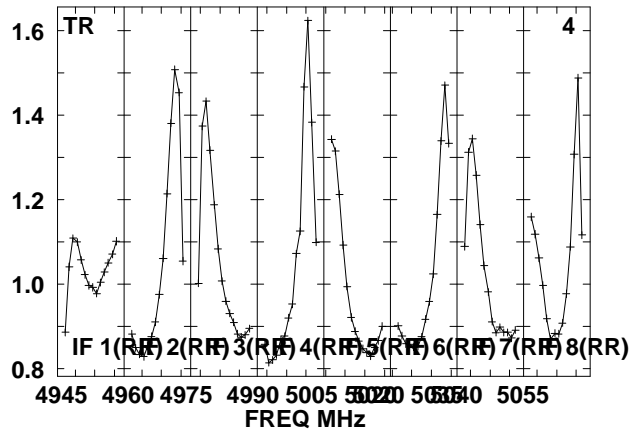
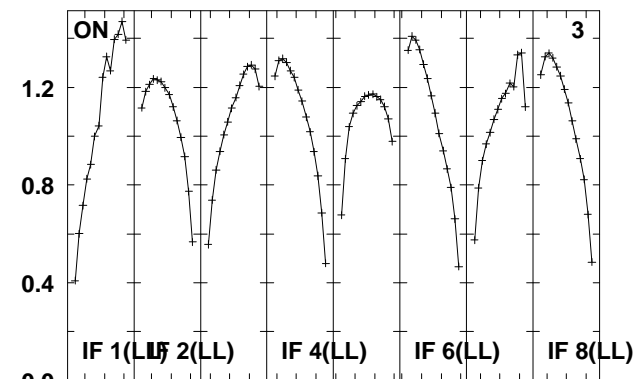
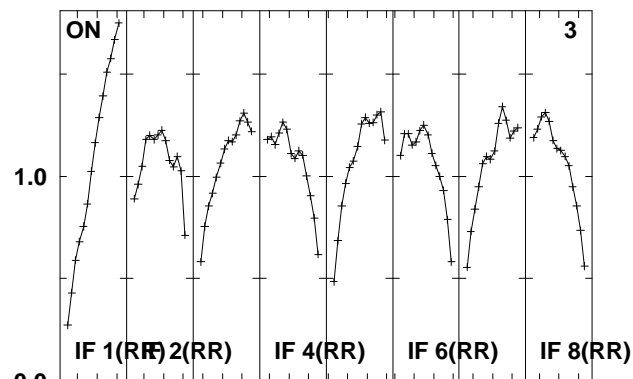
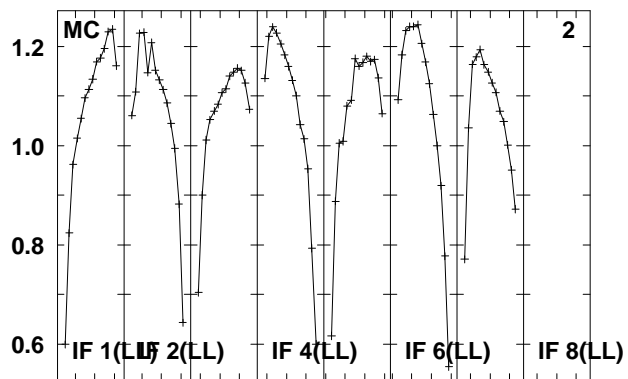
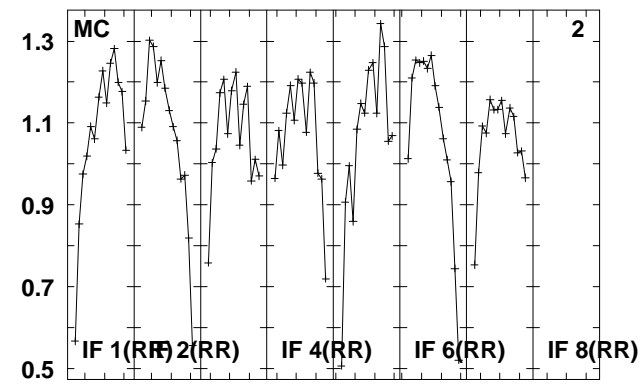
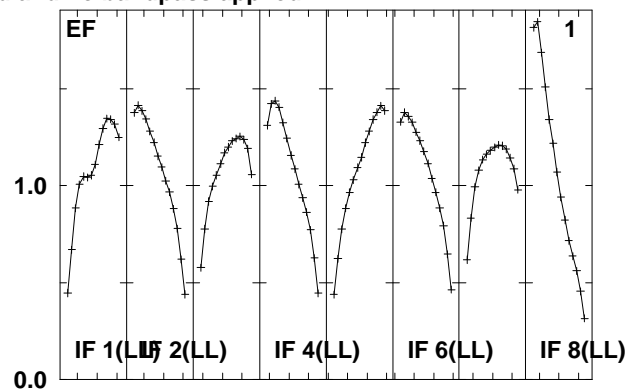
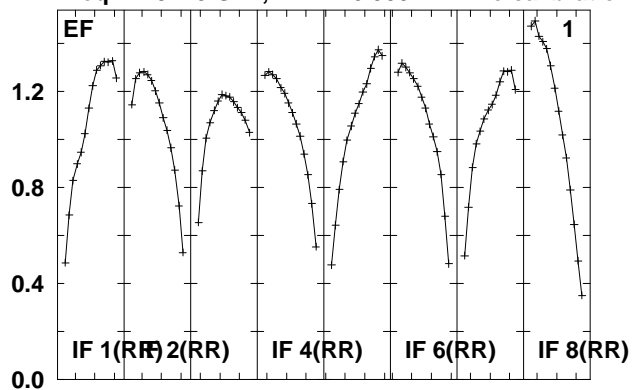

Lower frame: Real Jy

Total-power spectrum Antenna: *

Timerange: 00/13:35:10 to 00/13:45:08

Plot file version 91 created 08-JUL-2010 13:09:24
 4C39.25 EM079.UVDATA.1
 Freq = 4.9415 GHz, Bw = 16.000 MH No calibration applied and no bandpass applied

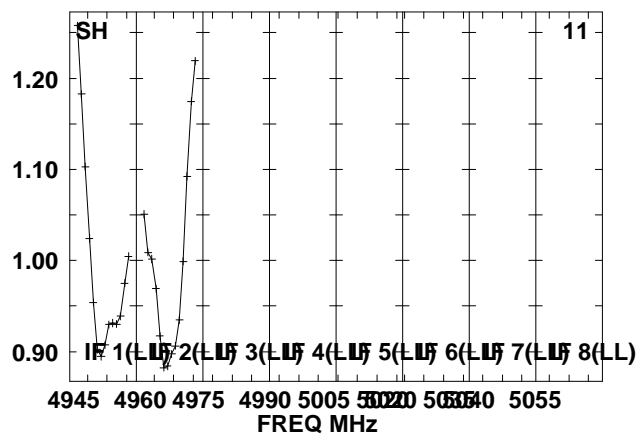
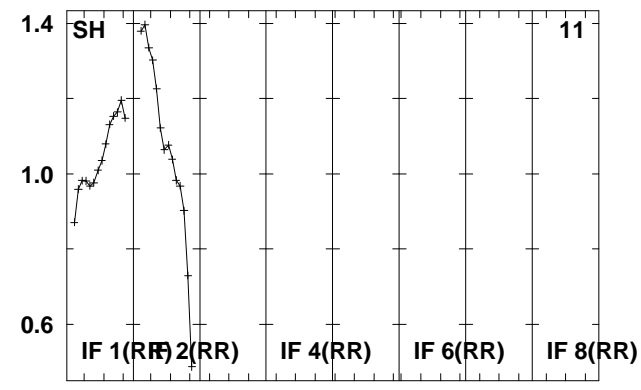
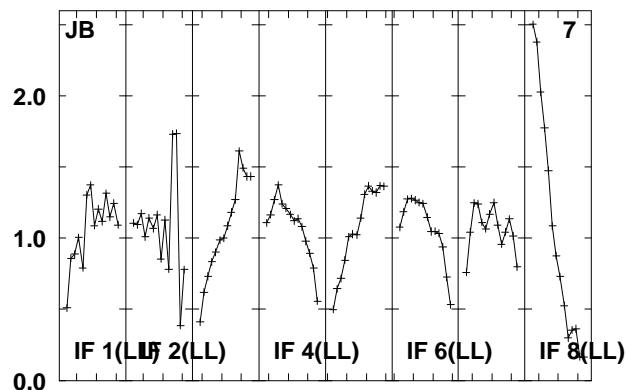
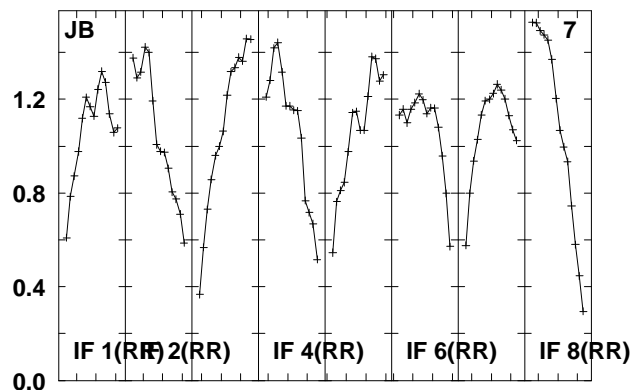
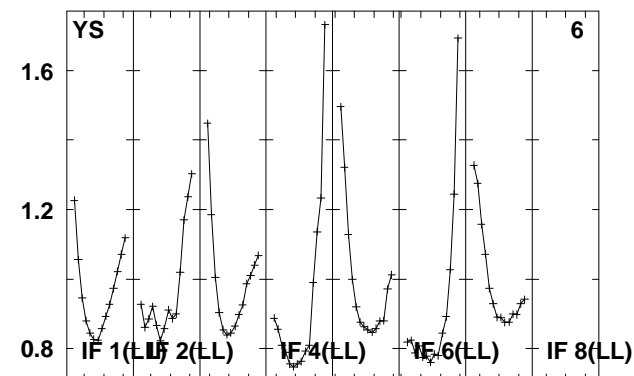
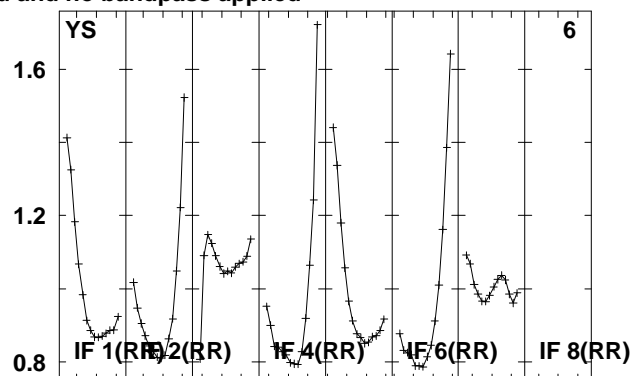
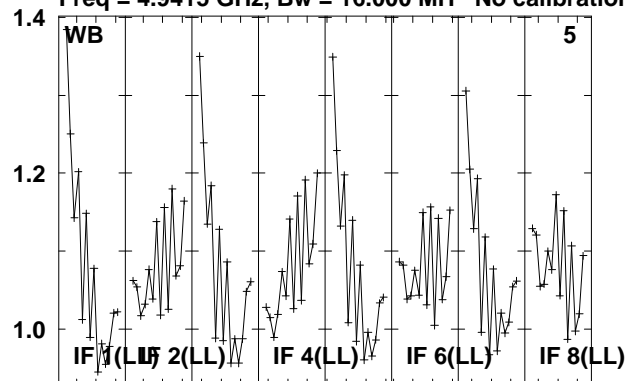

4945 4960 4975 4990 5005 5020 5035 5050 5065
 FREQ MHz

Lower frame: Real Jy
 Total-power spectrum Antenna: *
 Timerange: 00/13:35:10 to 00/13:45:08

Plot file version 92 created 08-JUL-2010 13:09:26

J0957+55 EM079.UVDATA.1

Freq = 4.9415 GHz, Bw = 16.000 MH No calibration applied and no bandpass applied

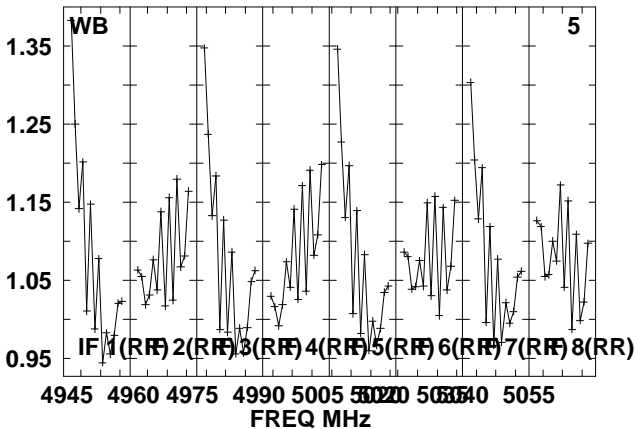
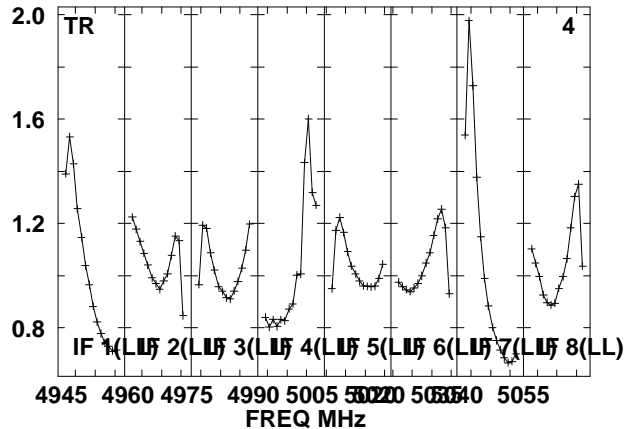
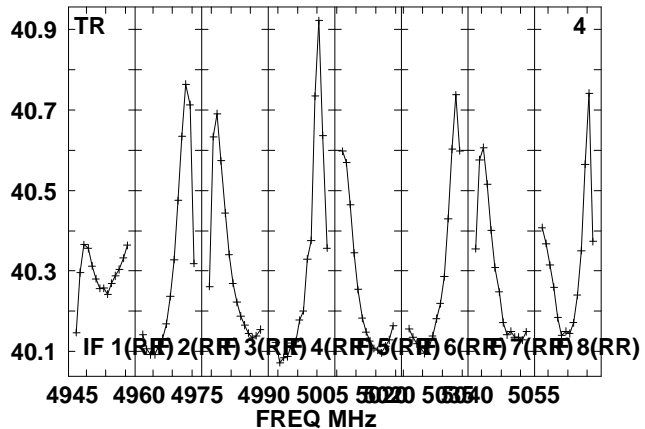
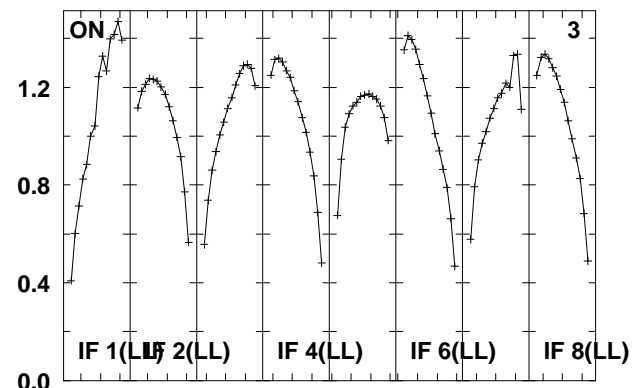
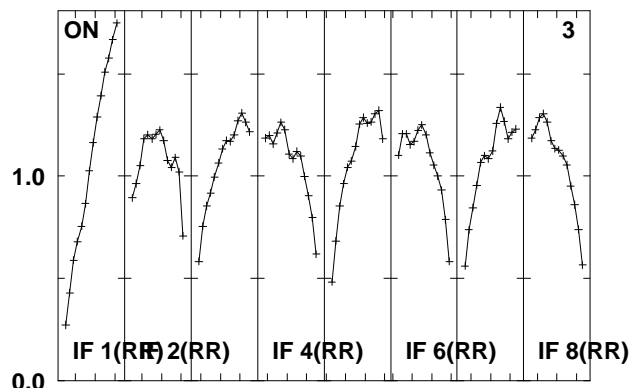
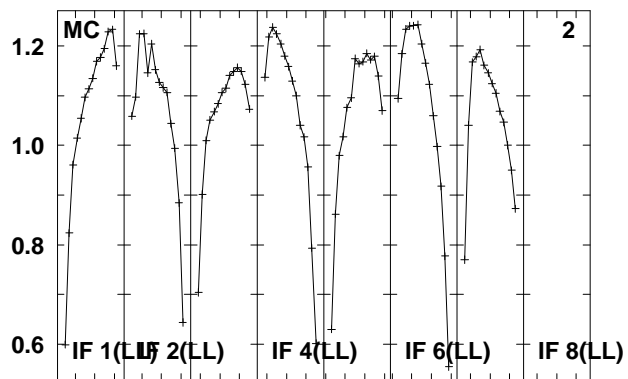
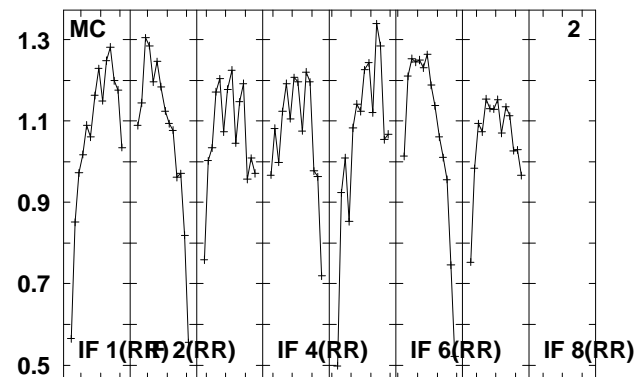
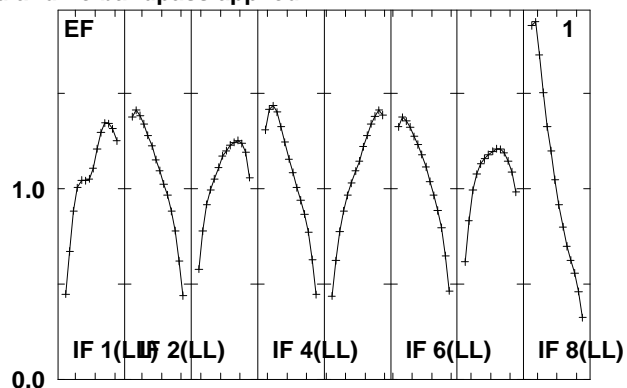
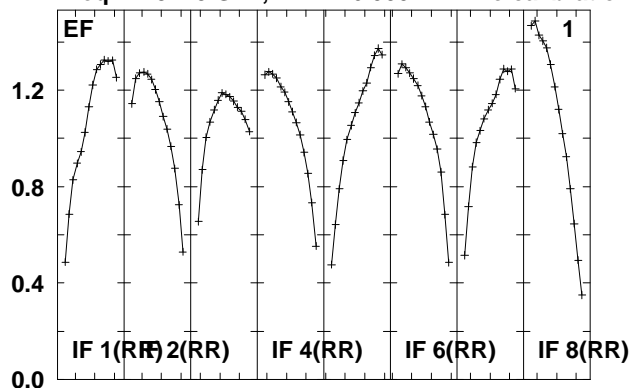

Lower frame: Real Jy
Total-power spectrum Antenna: *
Timerange: 00/13:45:10 to 00/13:50:48

Plot file version 93 created 08-JUL-2010 13:09:27

J0957+55 EM079.UVDATA.1

Freq = 4.9415 GHz, Bw = 16.000 MH No calibration applied and no bandpass applied

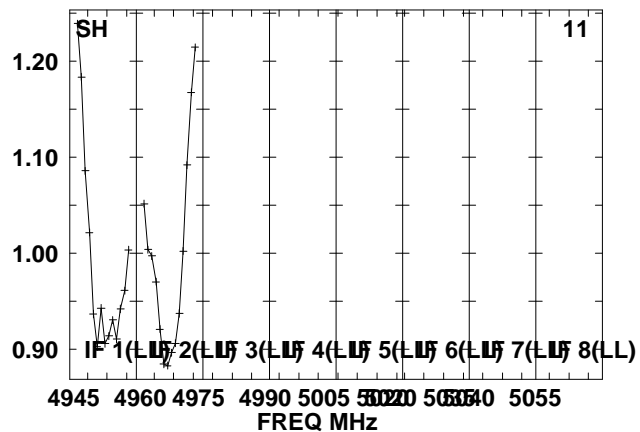
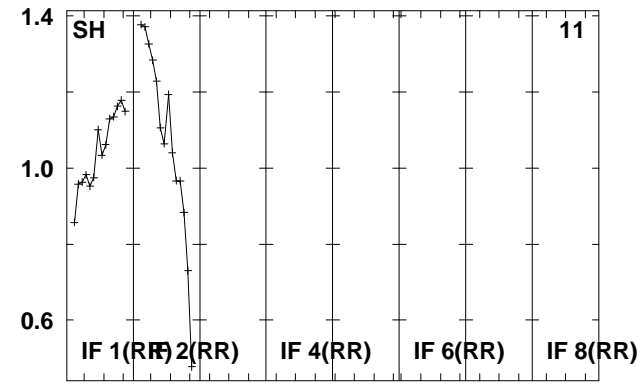
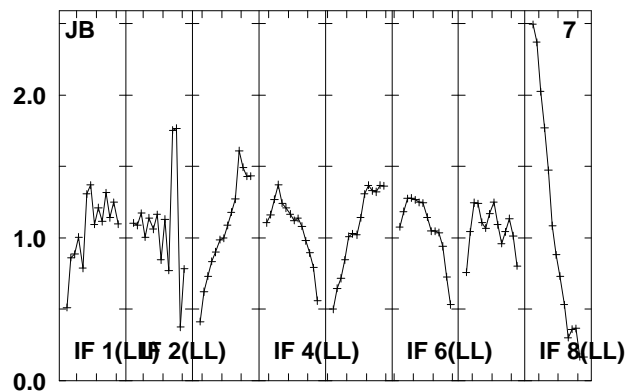
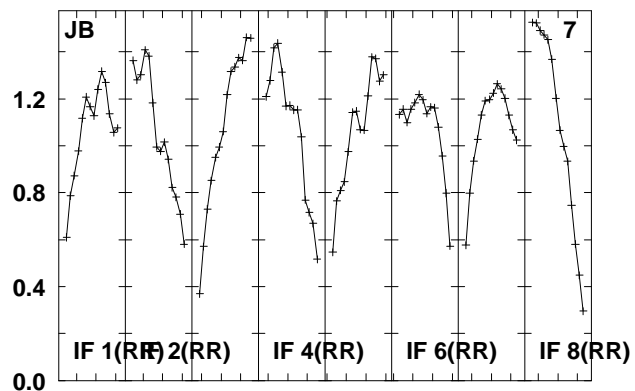
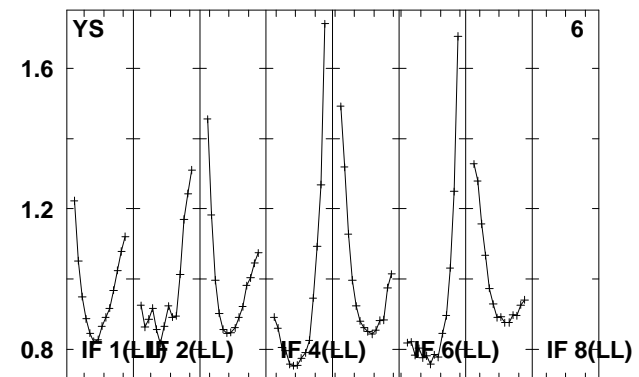
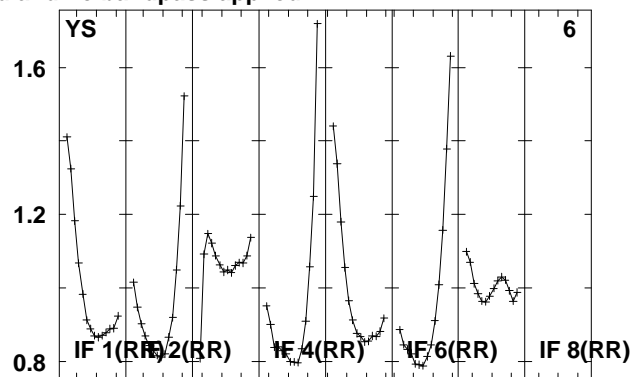
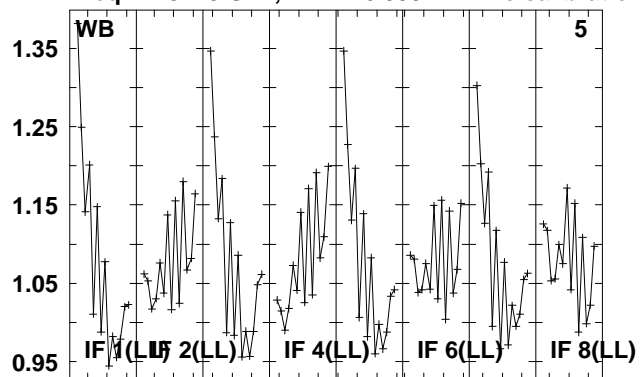

Lower frame: Real Jy

Total-power spectrum Antenna: *

Timerange: 00/13:45:10 to 00/13:50:48

Plot file version 94 created 08-JUL-2010 13:09:28

B1002+55 EM079.UVDATA.1

Freq = 4.9415 GHz, Bw = 16.000 MH No calibration applied and no bandpass applied

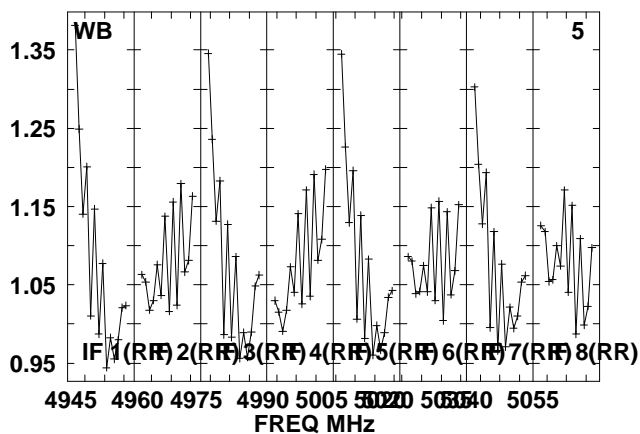
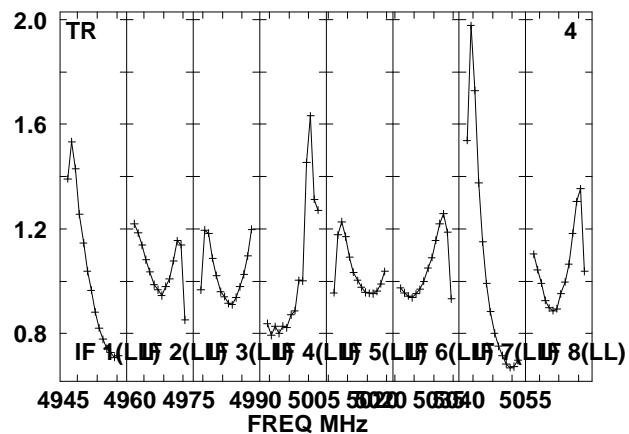
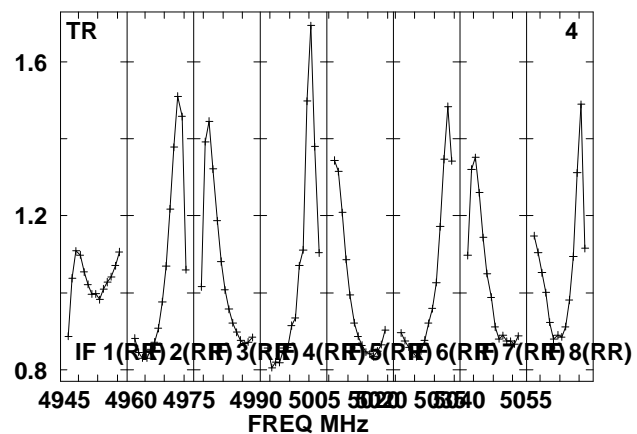
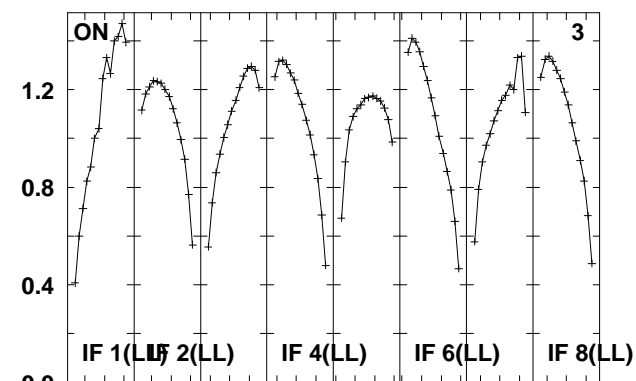
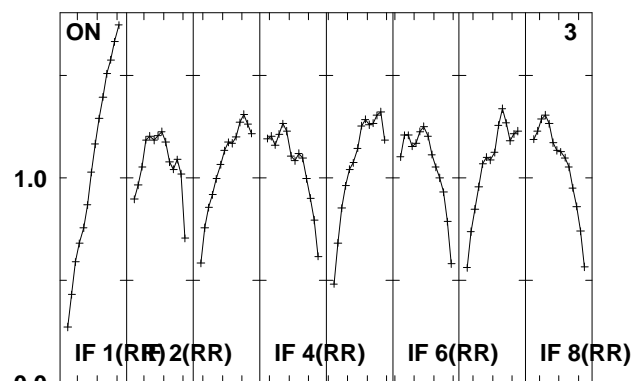
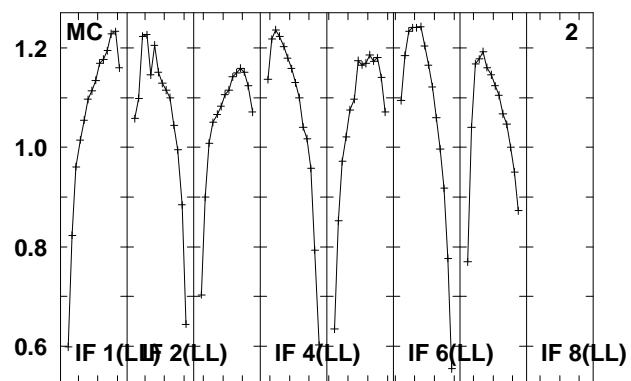
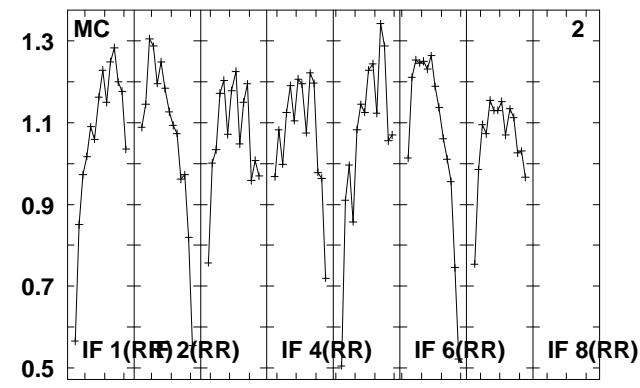
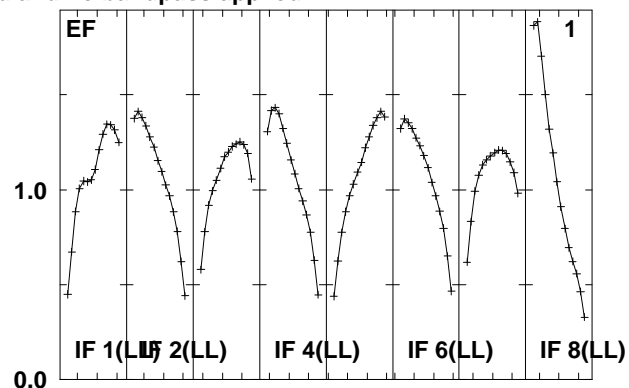
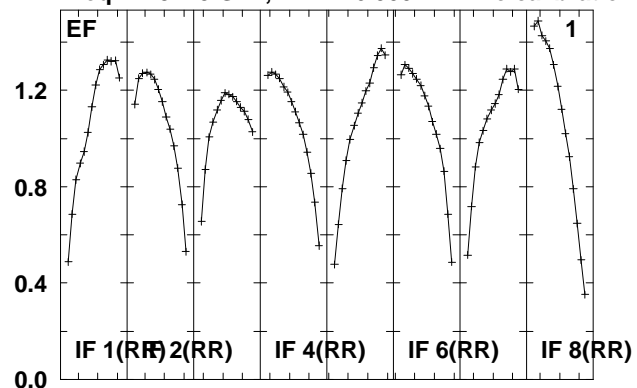

Lower frame: Real Jy
Total-power spectrum Antenna: *
Timerange: 00/13:50:50 to 00/14:01:34

Plot file version 95 created 08-JUL-2010 13:09:29

B1002+55 EM079.UVDATA.1

Freq = 4.9415 GHz, Bw = 16.000 MH No calibration applied and no bandpass applied

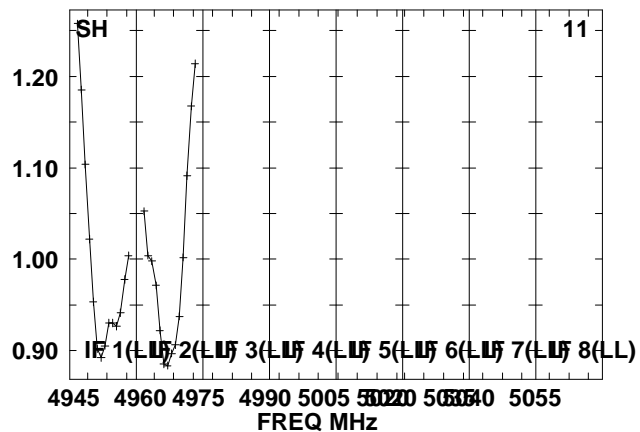
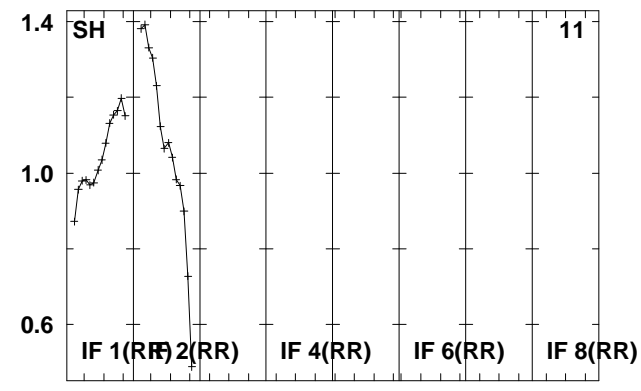
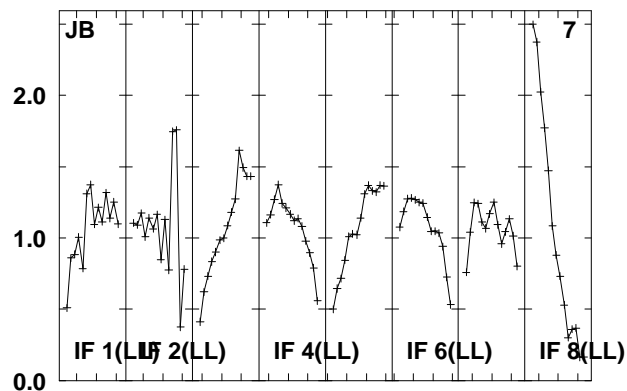
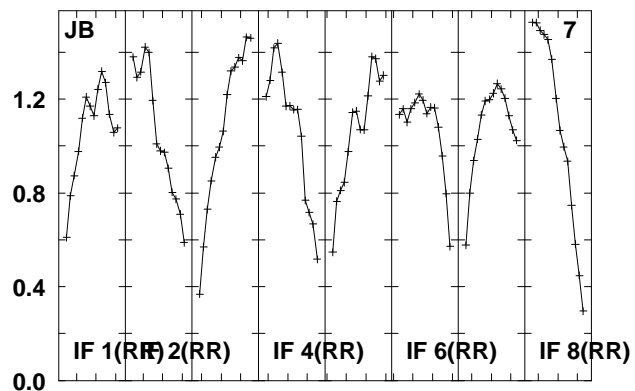
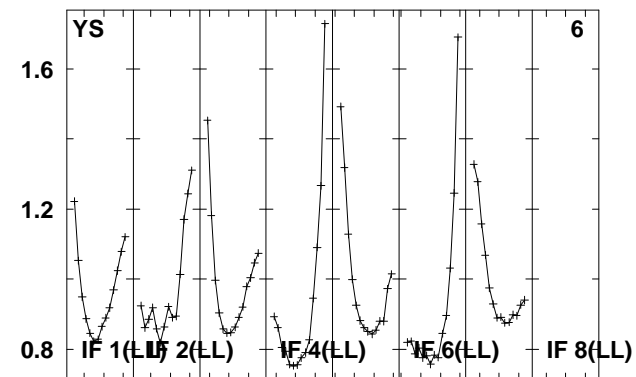
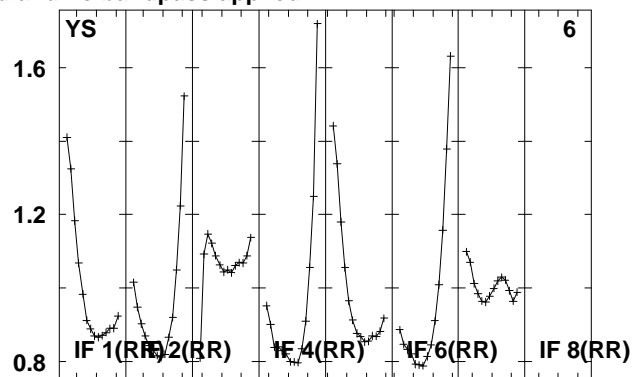
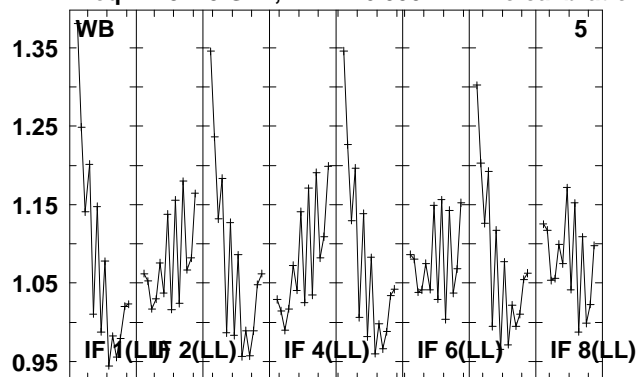

Lower frame: Real Jy

Total-power spectrum Antenna: *

Timerange: 00/13:50:50 to 00/14:01:34

Plot file version 96 created 08-JUL-2010 13:09:31

J0957+55 EM079.UVDATA.1

Freq = 4.9415 GHz, Bw = 16.000 MH No calibration applied and no bandpass applied

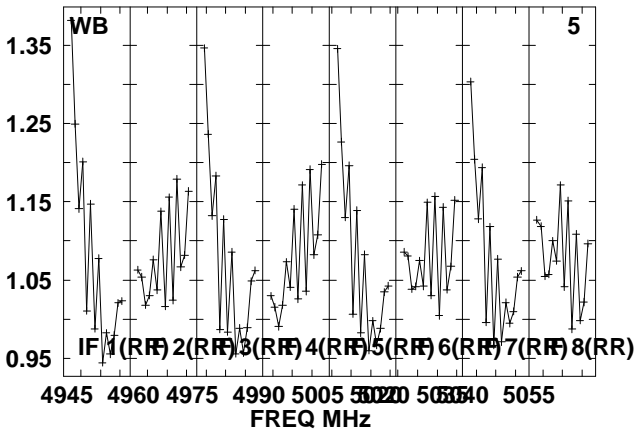
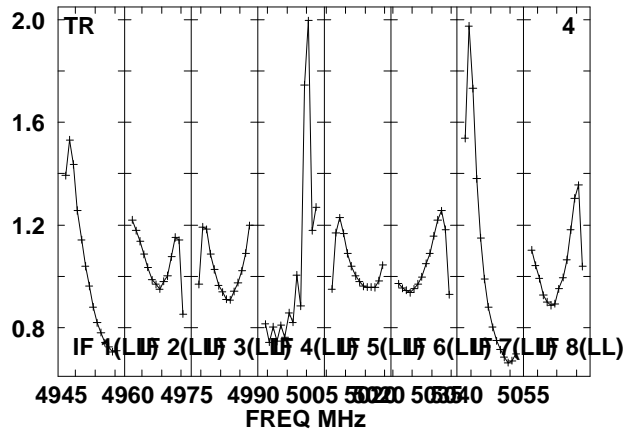
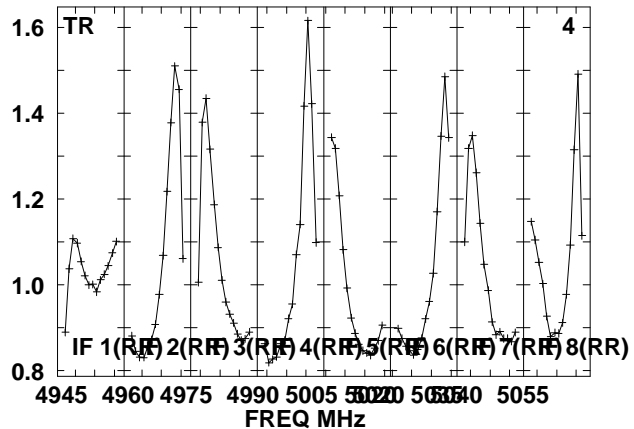
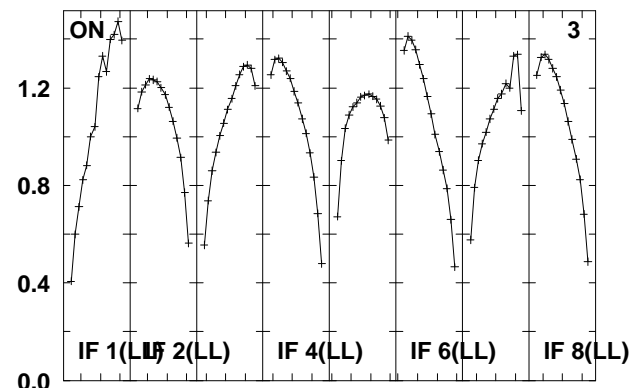
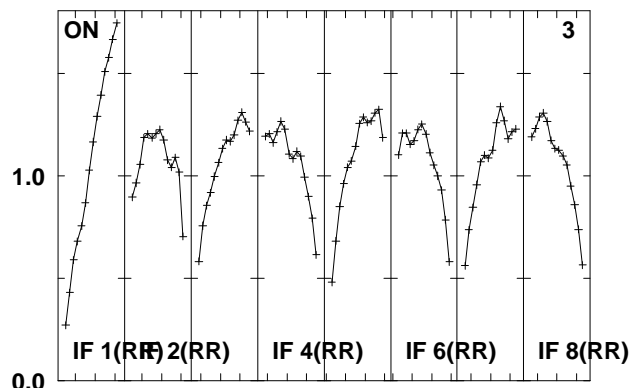
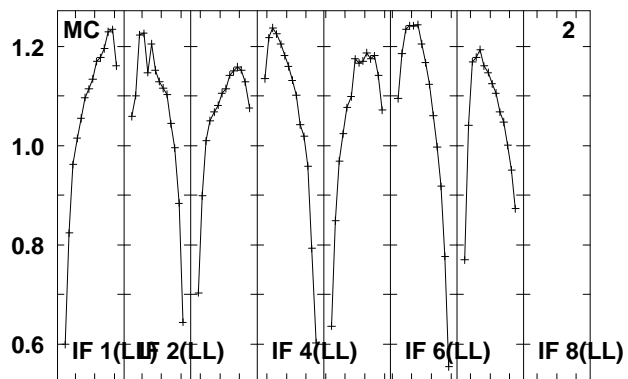
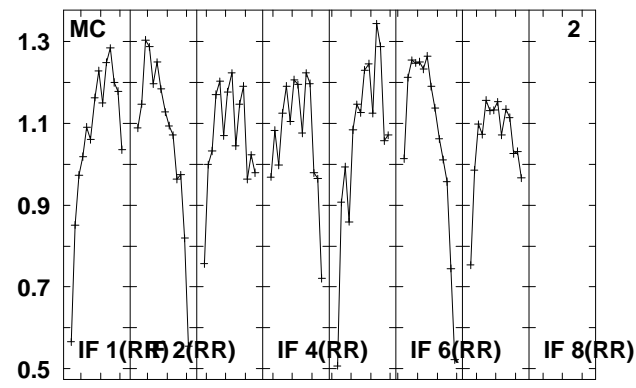
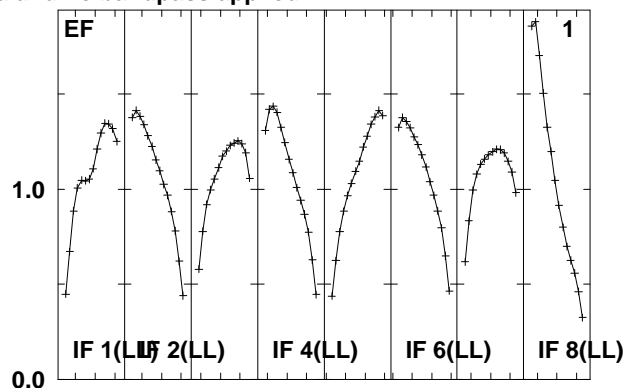
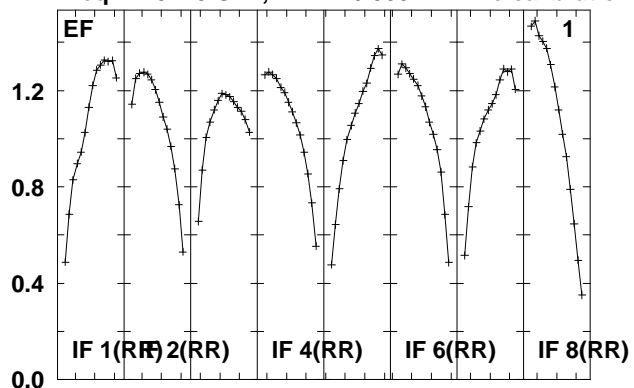

Lower frame: Real Jy
Total-power spectrum Antenna: *
Timerange: 00/14:01:36 to 00/14:03:34

Plot file version 97 created 08-JUL-2010 13:09:31

J0957+55 EM079.UVDATA.1

Freq = 4.9415 GHz, Bw = 16.000 MH No calibration applied and no bandpass applied

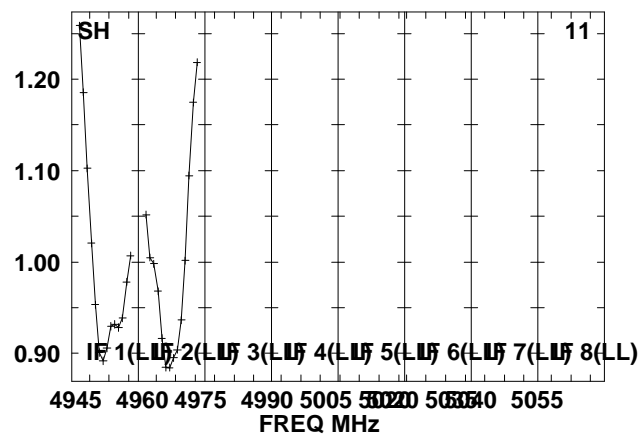
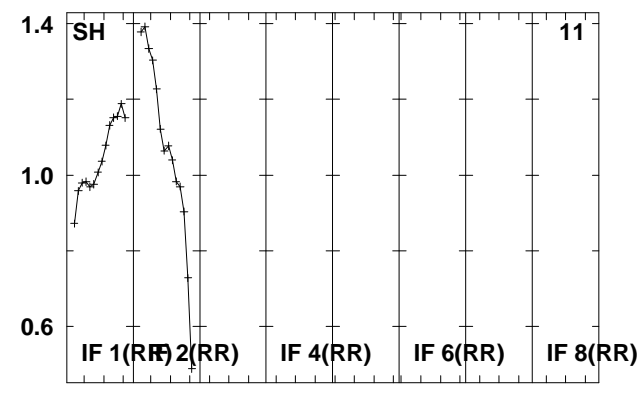
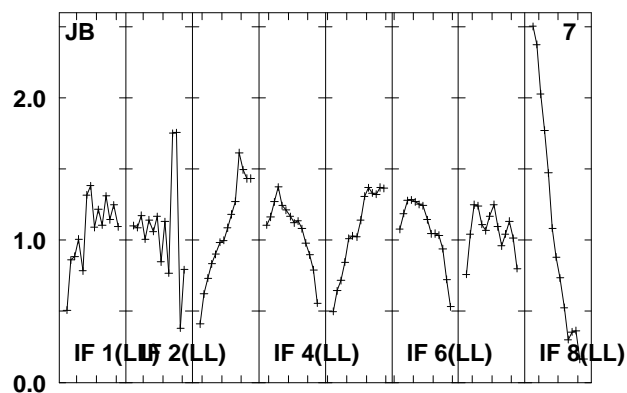
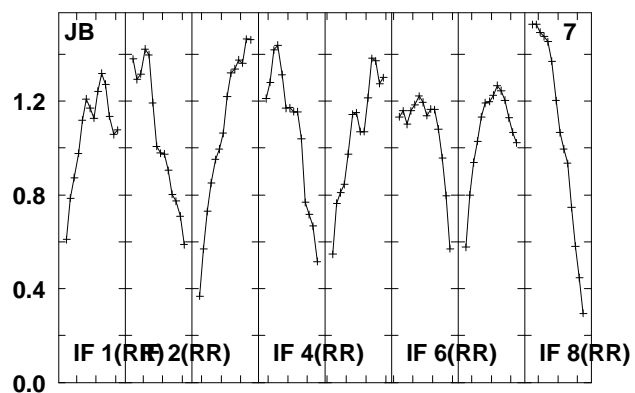
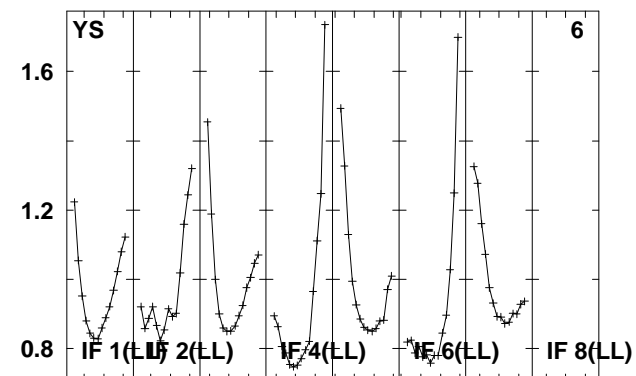
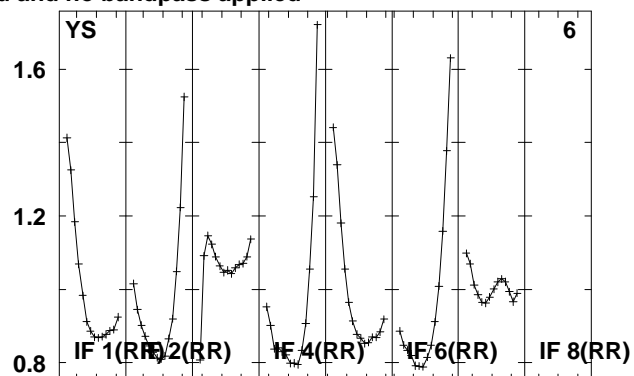
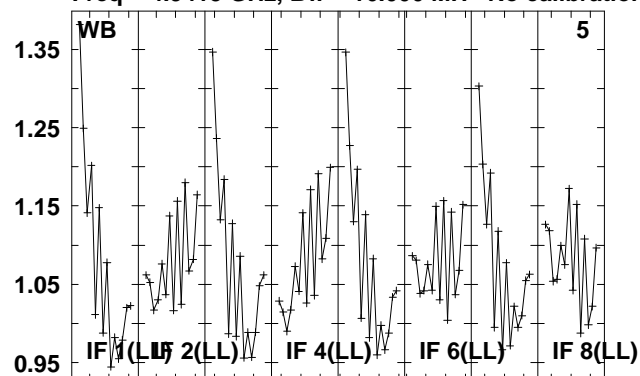

4945 4960 4975 4990 5005 5020 5035 5050 5055
FREQ MHz

Lower frame: Real Jy

Total-power spectrum Antenna: *

Timerange: 00/14:01:36 to 00/14:03:34

Plot file version 98 created 08-JUL-2010 13:09:32

B1002+55 EM079.UVDATA.1

Freq = 4.9415 GHz, Bw = 16.000 MH No calibration applied and no bandpass applied

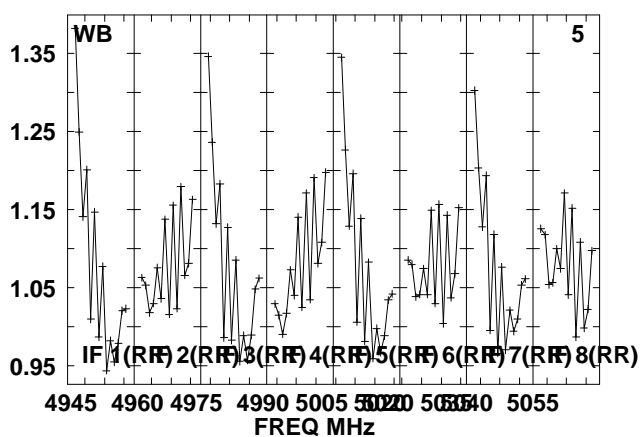
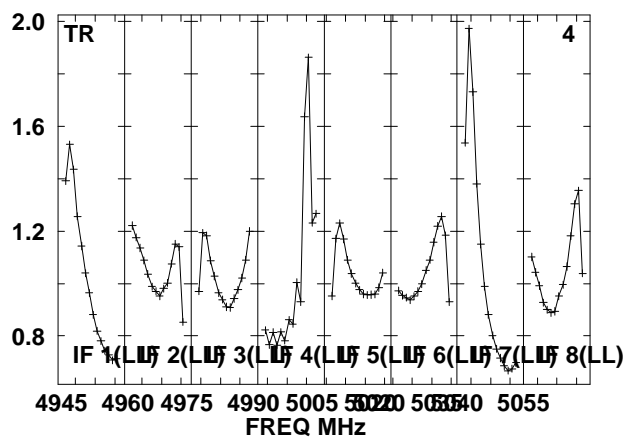
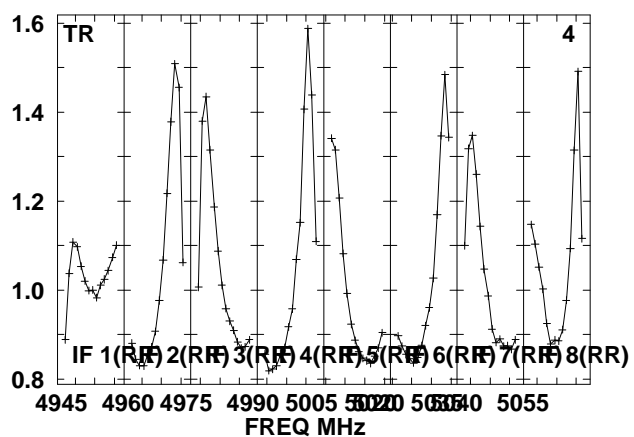
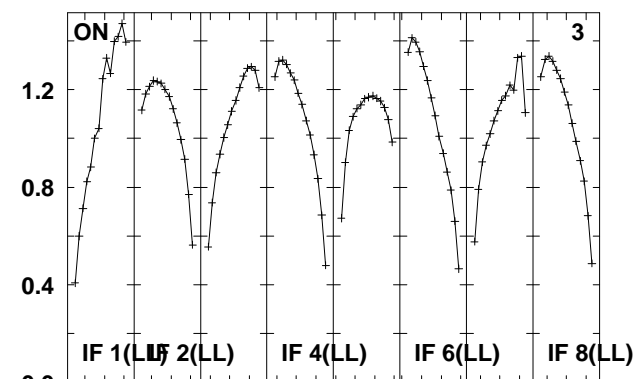
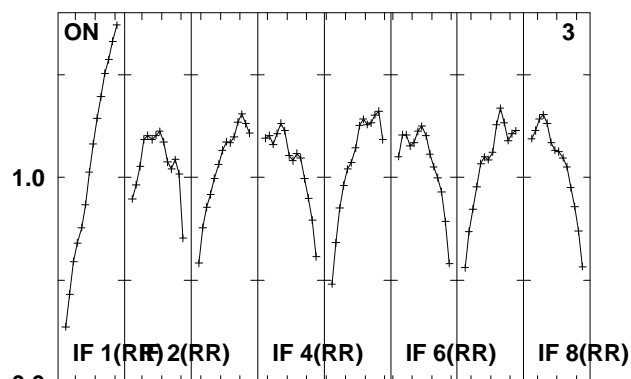
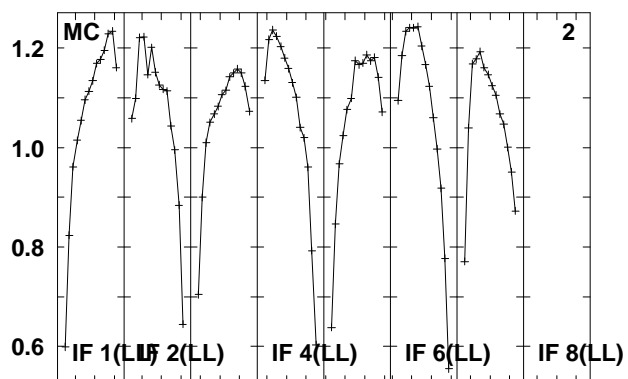
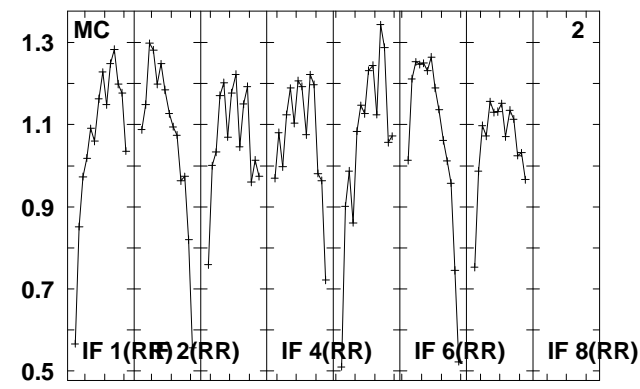
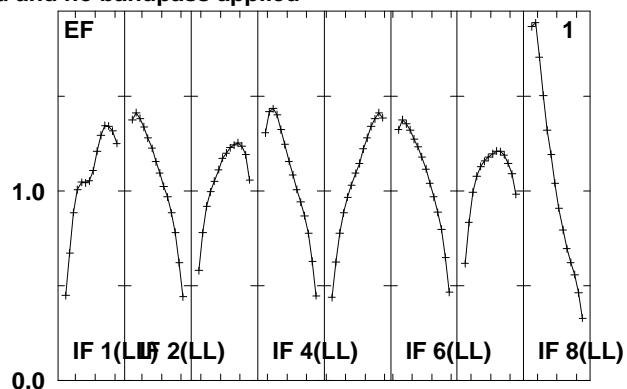
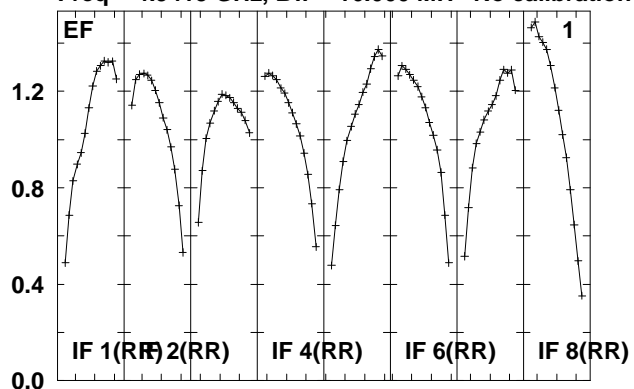

Lower frame: Real Jy
Total-power spectrum Antenna: *
Timerange: 00/14:03:36 to 00/14:14:18

Plot file version 99 created 08-JUL-2010 13:09:34
 B1002+55 EM079.UVDATA.1
 Freq = 4.9415 GHz, Bw = 16.000 MH No calibration applied and no bandpass applied

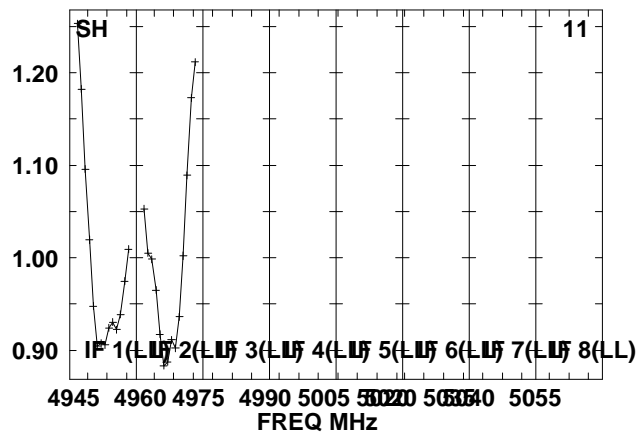
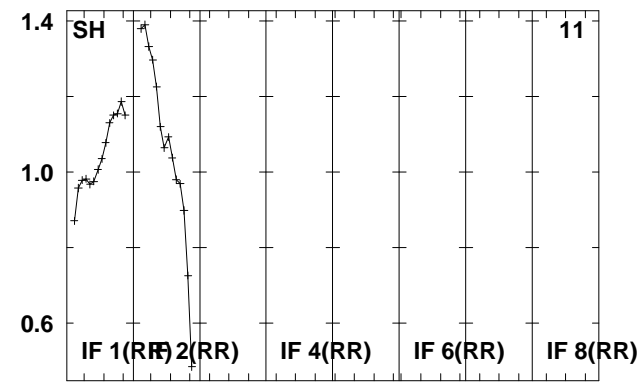
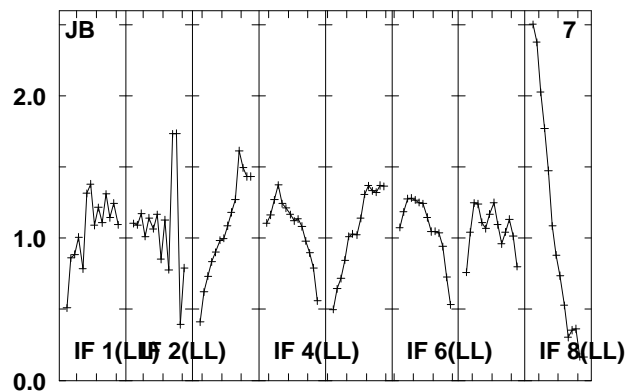
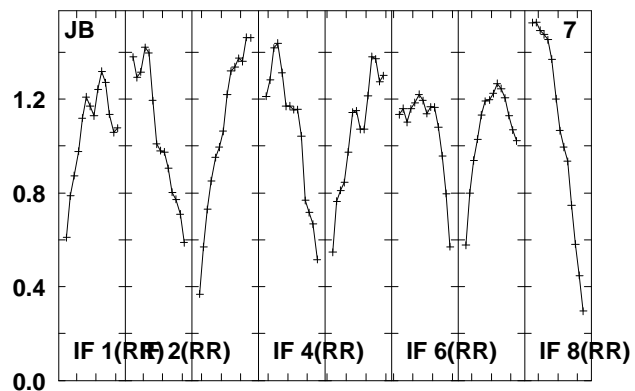
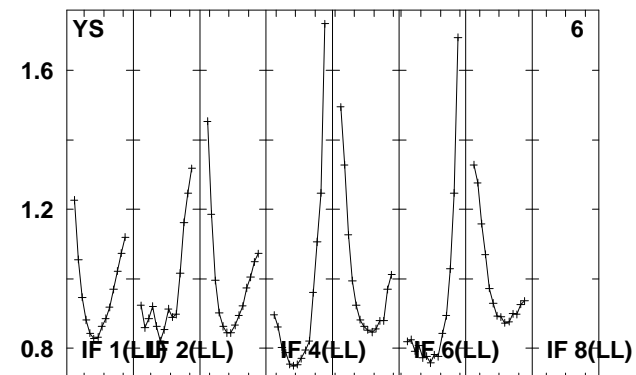
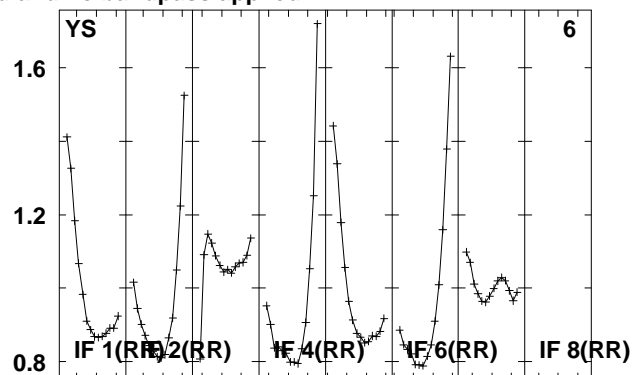
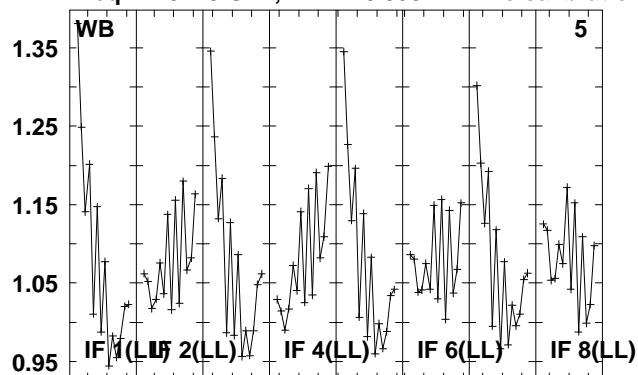

4945 4960 4975 4990 5005 5020 5035 5050 5055
 FREQ MHz

Lower frame: Real Jy
 Total-power spectrum Antenna: *
 Timerange: 00/14:03:36 to 00/14:14:18

Plot file version 100 created 08-JUL-2010 13:09:35

J0957+55 EM079.UVDATA.1

Freq = 4.9415 GHz, Bw = 16.000 MH No calibration applied and no bandpass applied

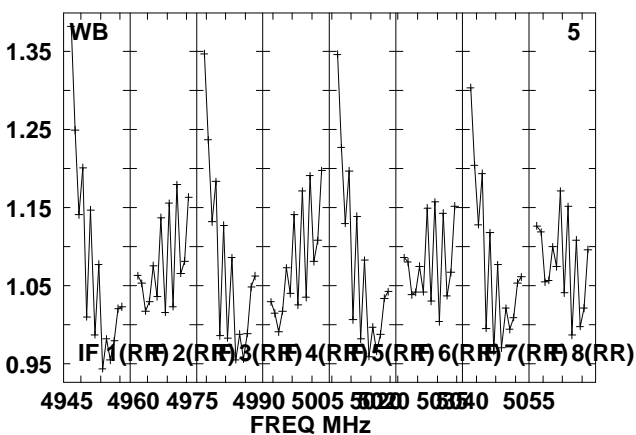
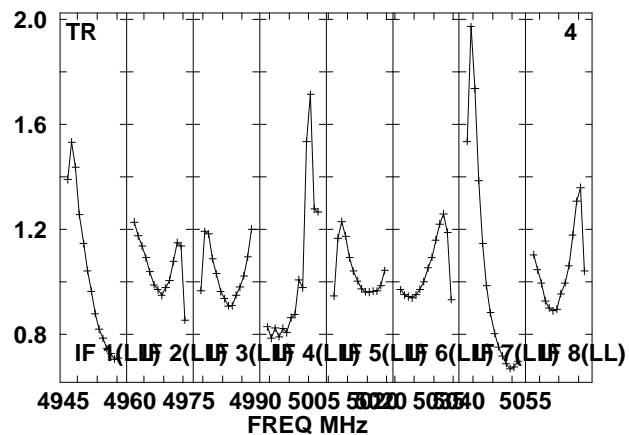
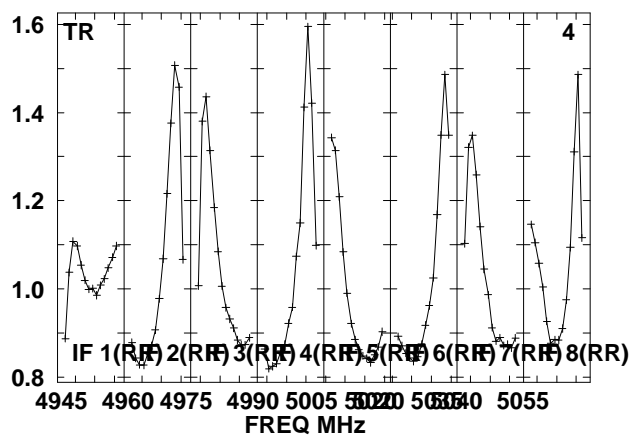
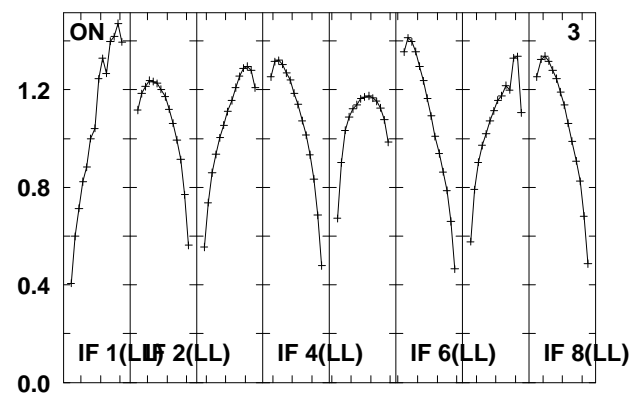
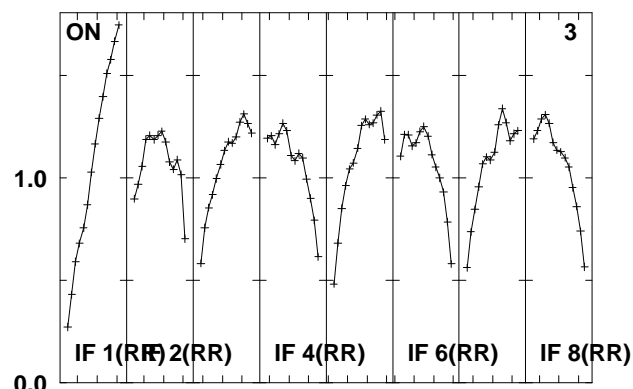
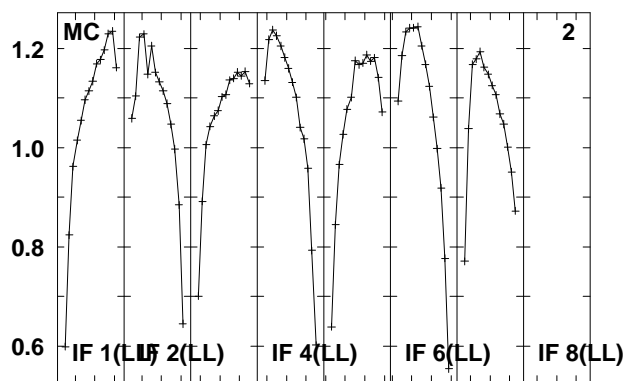
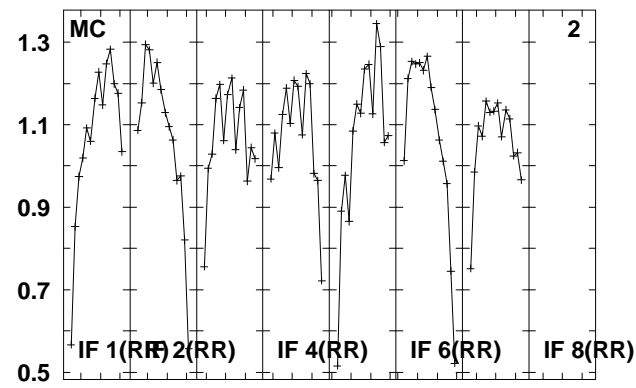
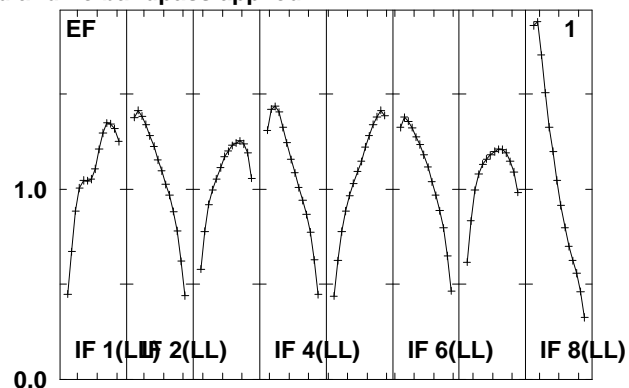
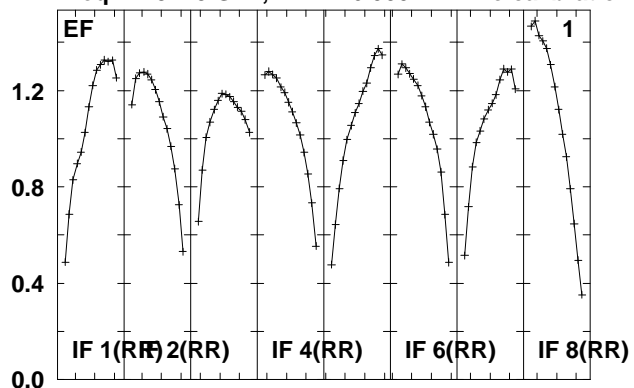

Lower frame: Real Jy

Total-power spectrum Antenna: *

Timerange: 00/14:14:20 to 00/14:16:18

Plot file version 101 created 08-JUL-2010 13:09:36

J0957+55 EM079.UVDATA.1

Freq = 4.9415 GHz, Bw = 16.000 MH No calibration applied and no bandpass applied

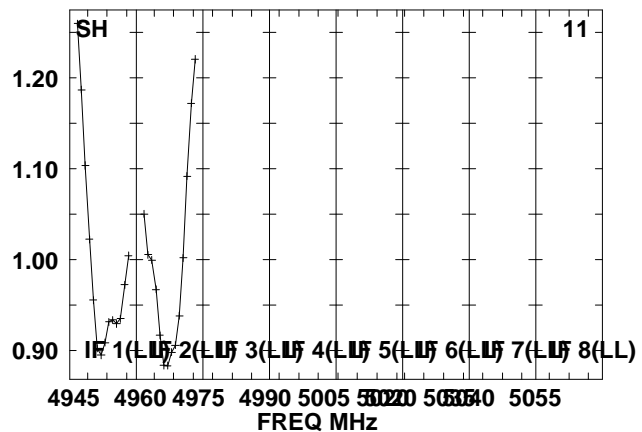
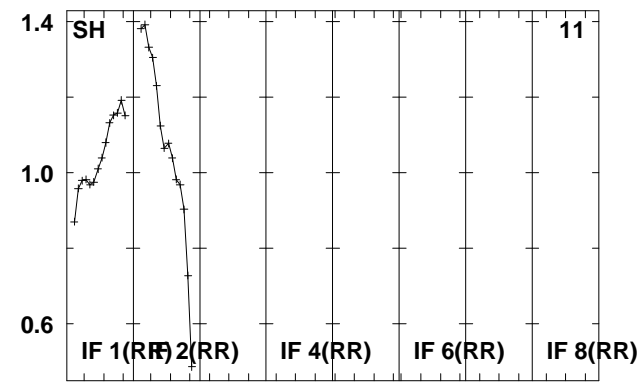
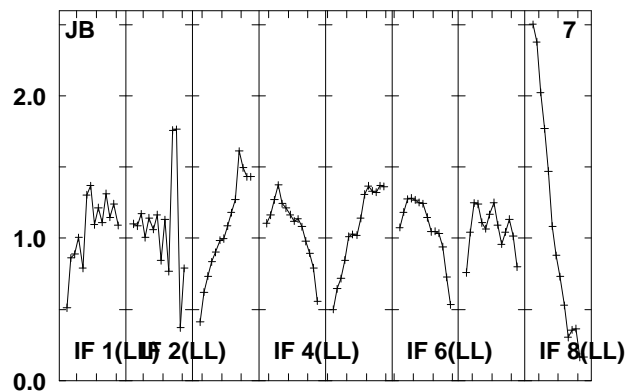
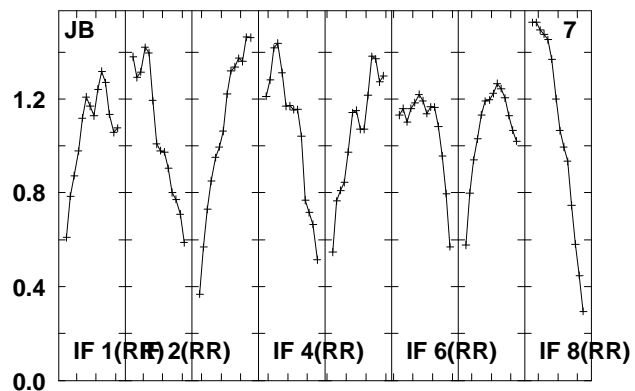
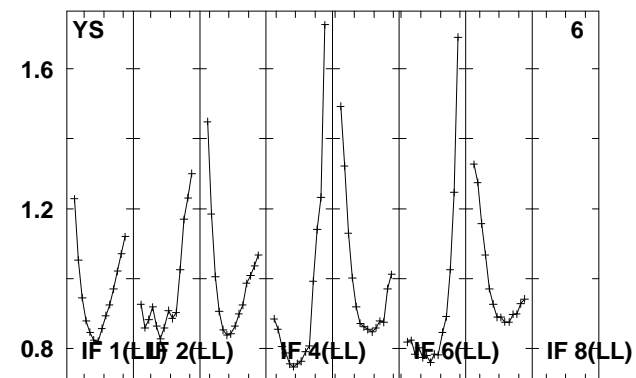
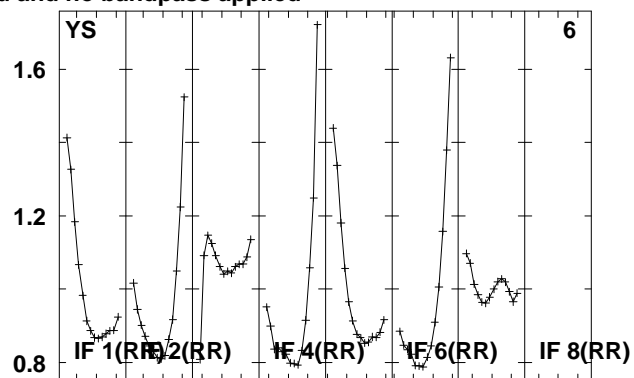
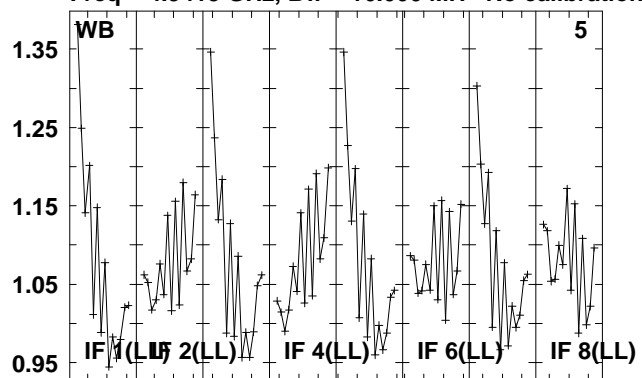

4945 4960 4975 4990 5005 5020 5035 5050 5055
FREQ MHz

Lower frame: Real Jy

Total-power spectrum Antenna: *

Timerange: 00/14:14:20 to 00/14:16:18

Plot file version 102 created 08-JUL-2010 13:09:36

B1002+55 EM079.UVDATA.1

Freq = 4.9415 GHz, Bw = 16.000 MH No calibration applied and no bandpass applied

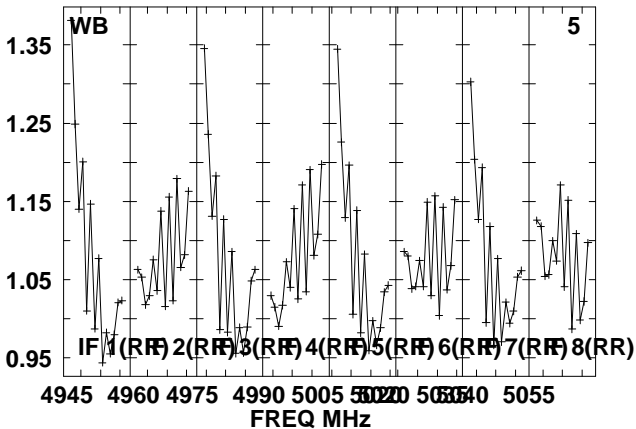
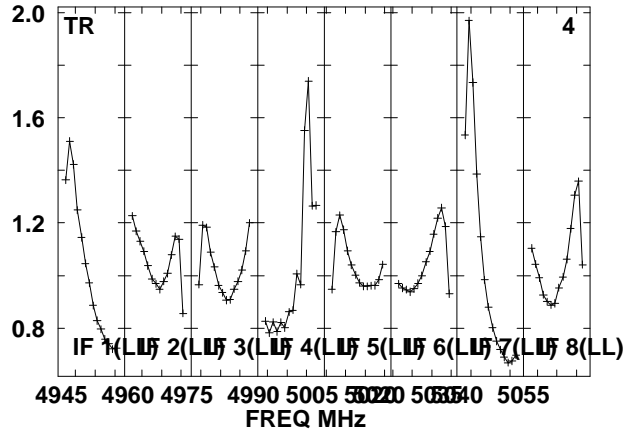
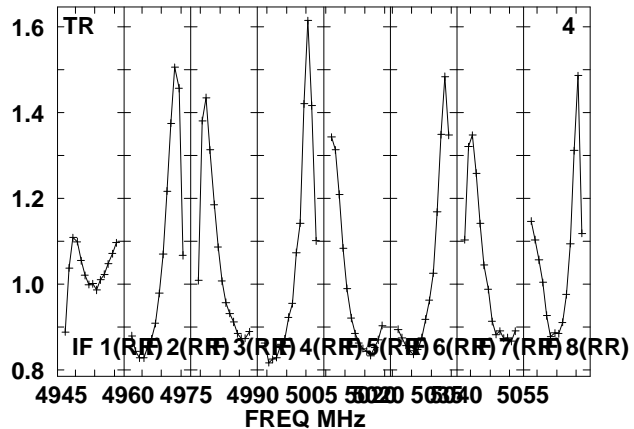
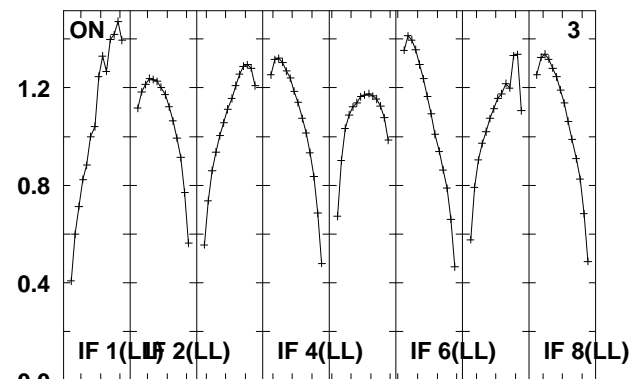
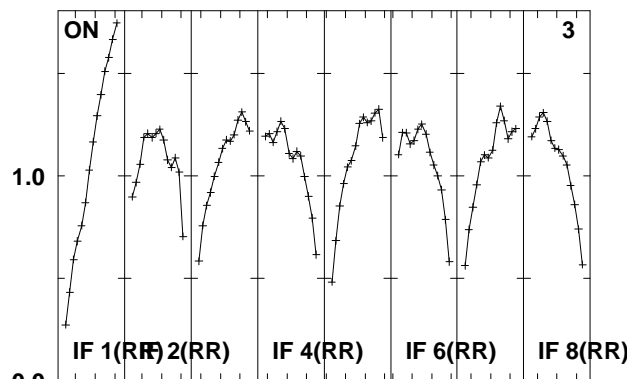
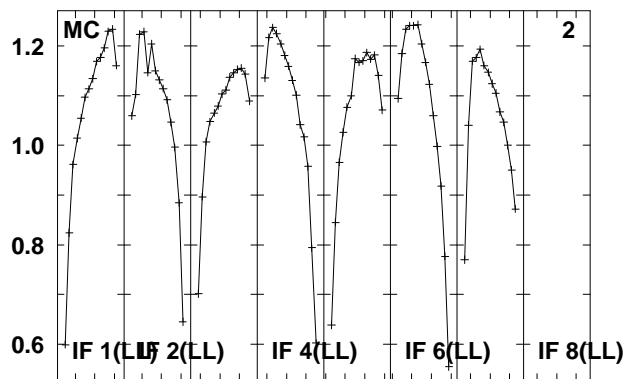
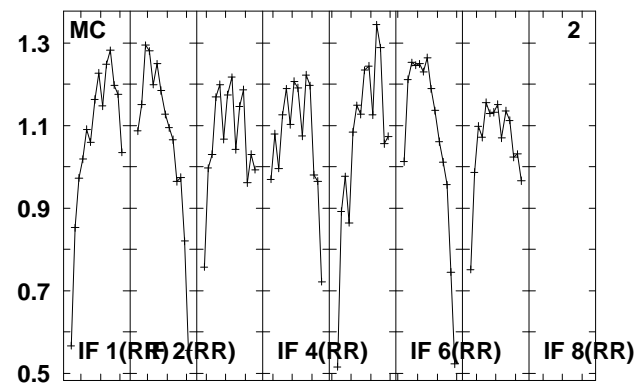
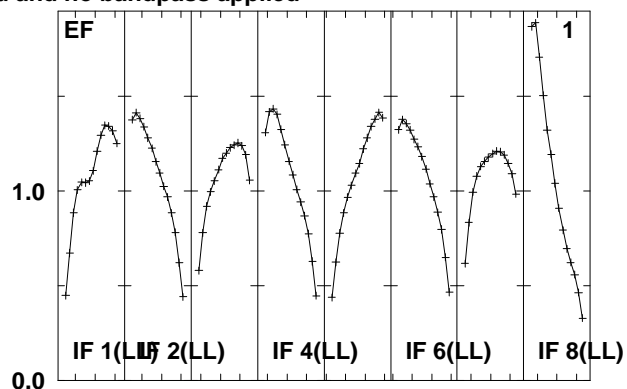
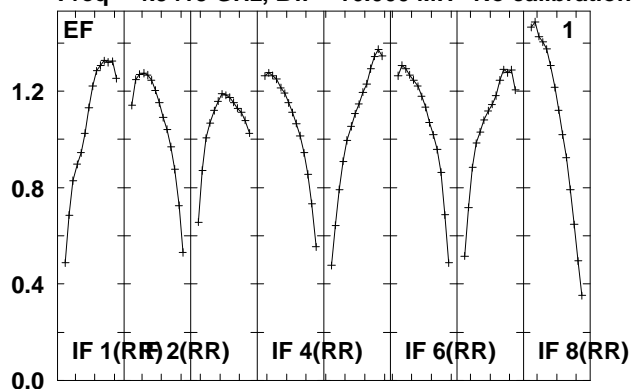

Lower frame: Real Jy
Total-power spectrum Antenna: *
Timerange: 00/14:16:20 to 00/14:27:04

Plot file version 103 created 08-JUL-2010 13:09:37

B1002+55 EM079.UVDATA.1

Freq = 4.9415 GHz, Bw = 16.000 MH No calibration applied and no bandpass applied

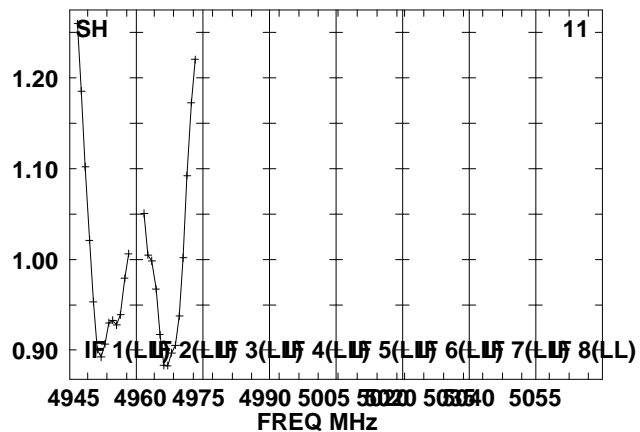
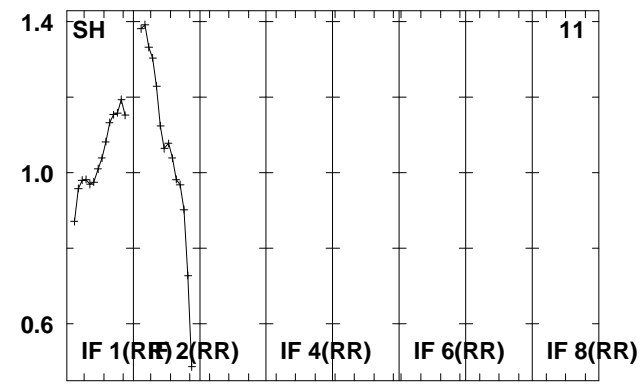
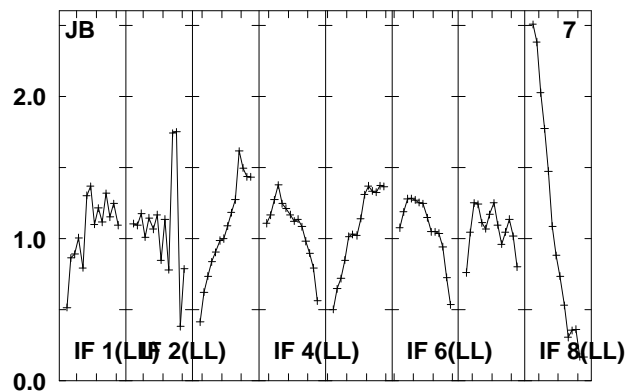
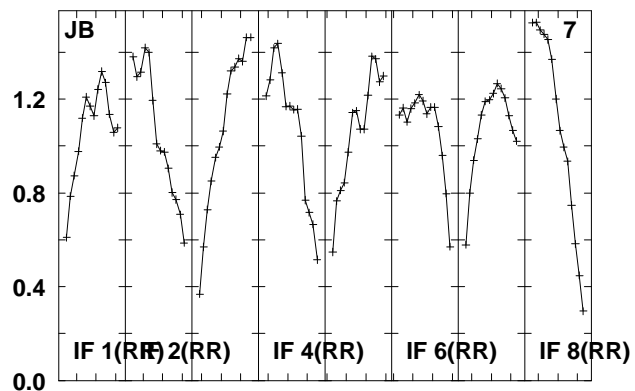
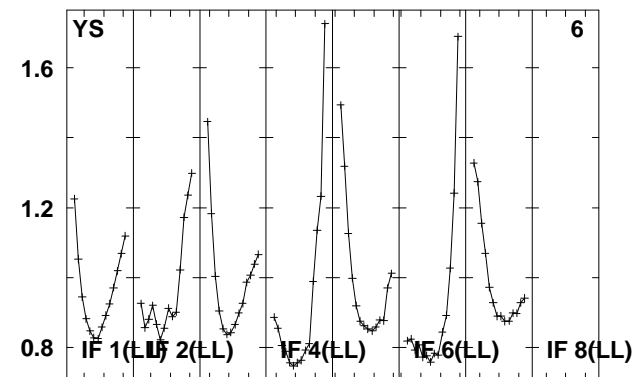
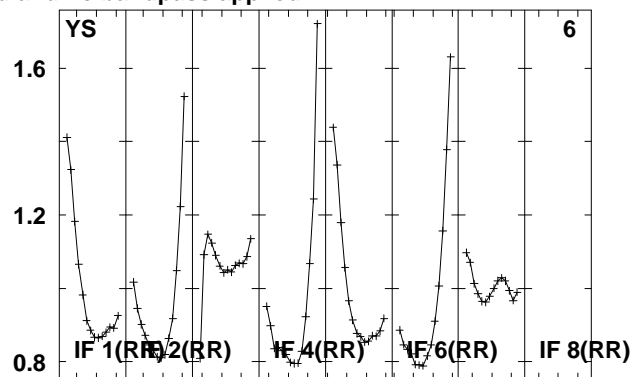
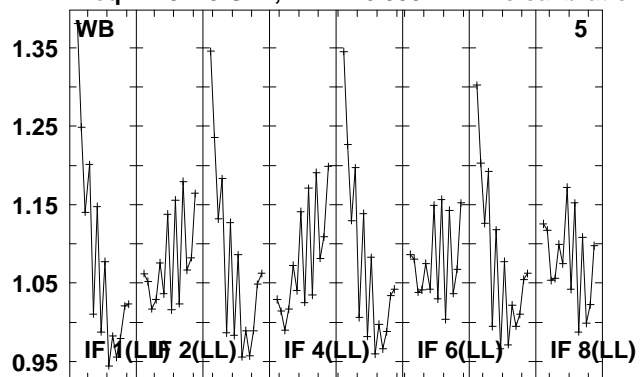

4945 4960 4975 4990 5005 5020 5035 5050 5055
FREQ MHz

Lower frame: Real Jy

Total-power spectrum Antenna: *

Timerange: 00/14:16:20 to 00/14:27:04

Plot file version 104 created 08-JUL-2010 13:09:39

J0957+55 EM079.UVDATA.1

Freq = 4.9415 GHz, Bw = 16.000 MH No calibration applied and no bandpass applied

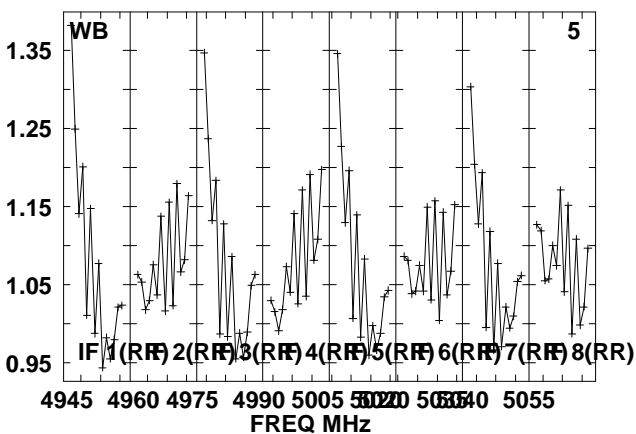
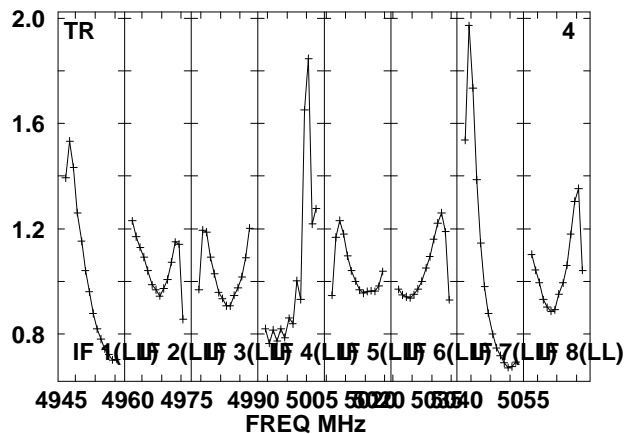
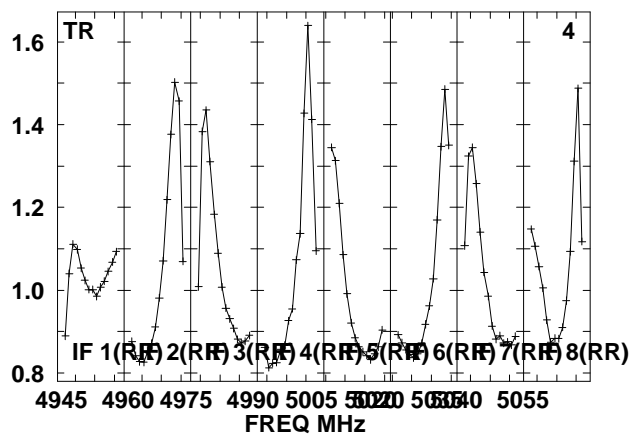
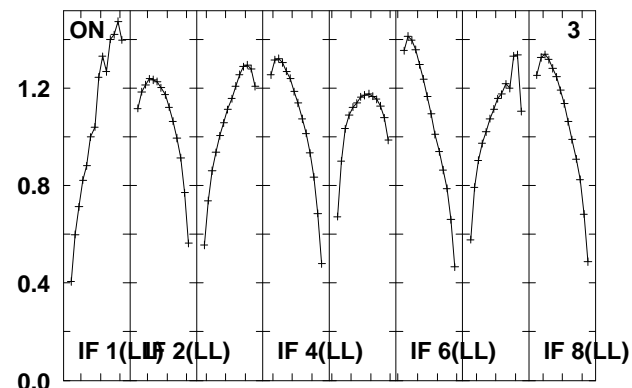
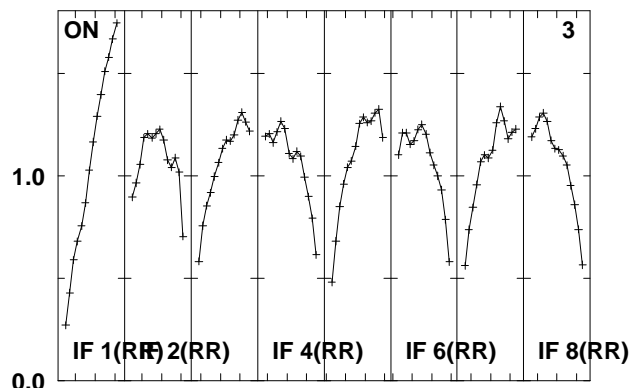
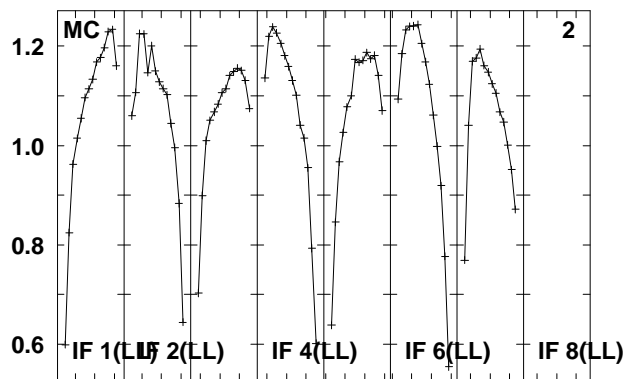
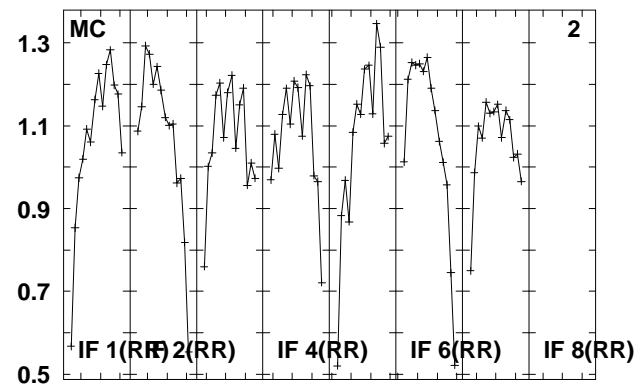
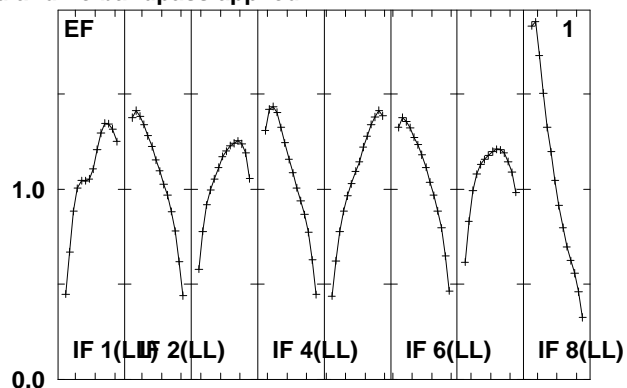
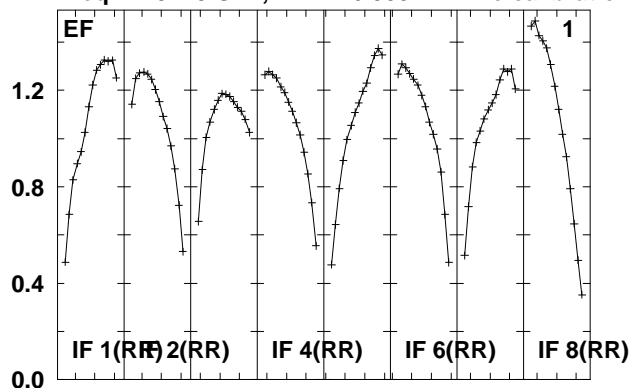

Lower frame: Real Jy
Total-power spectrum Antenna: *
Timerange: 00/14:27:06 to 00/14:29:04

Plot file version 105 created 08-JUL-2010 13:09:39

J0957+55 EM079.UVDATA.1

Freq = 4.9415 GHz, Bw = 16.000 MH No calibration applied and no bandpass applied

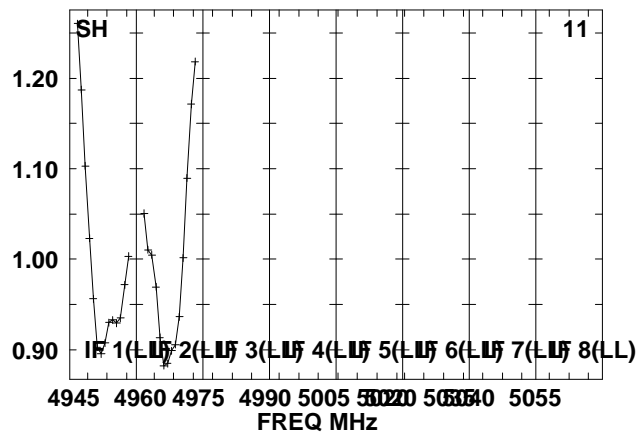
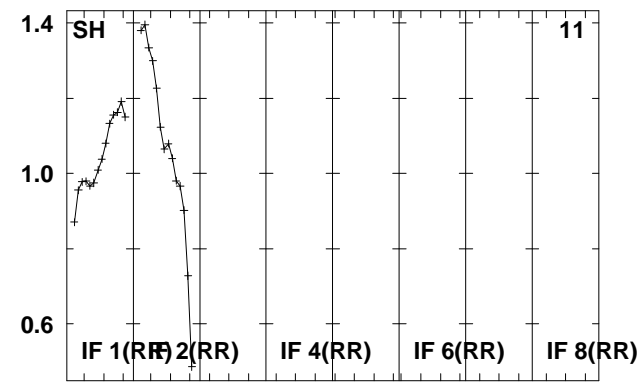
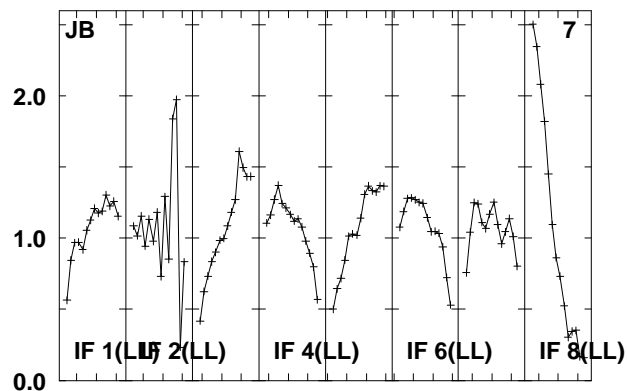
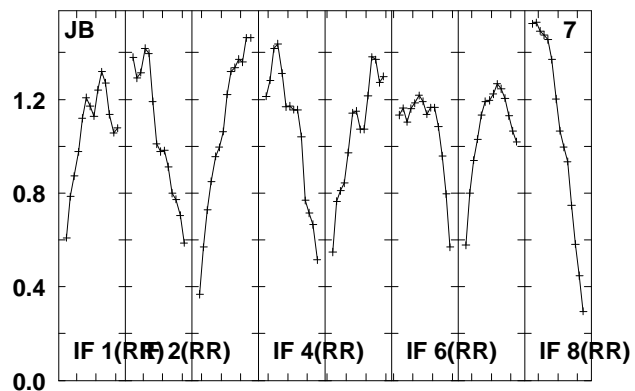
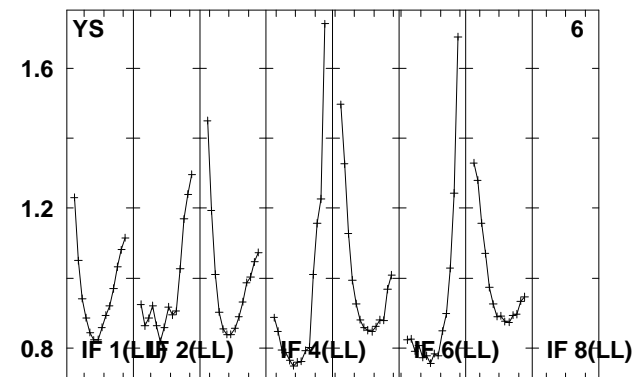
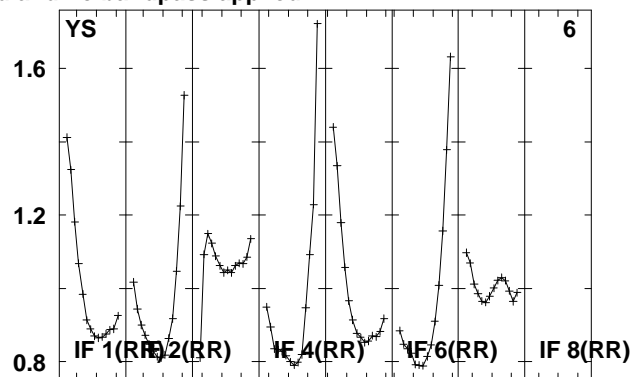
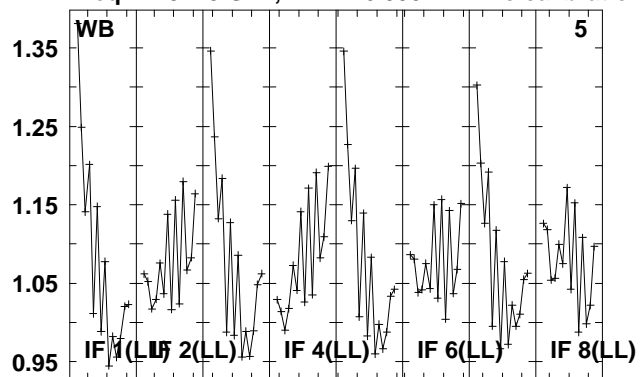

Lower frame: Real Jy

Total-power spectrum Antenna: *

Timerange: 00/14:27:06 to 00/14:29:04

Plot file version 106 created 08-JUL-2010 13:09:40

B1002+55 EM079.UVDATA.1

Freq = 4.9415 GHz, Bw = 16.000 MH No calibration applied and no bandpass applied

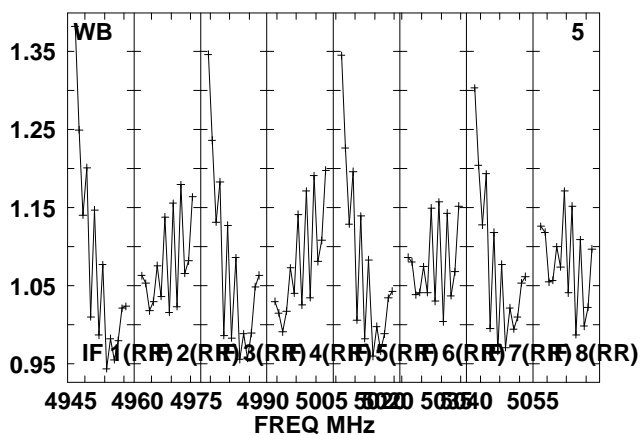
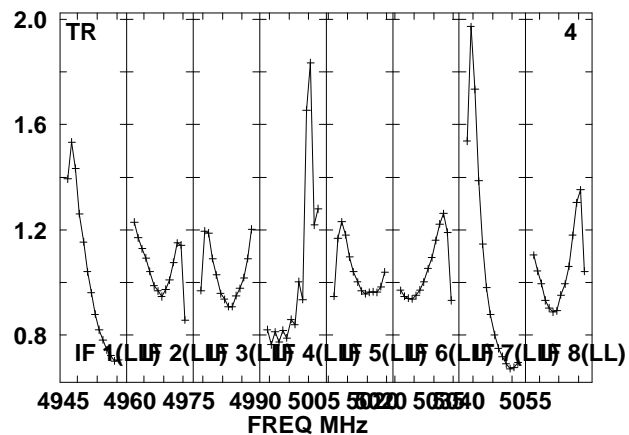
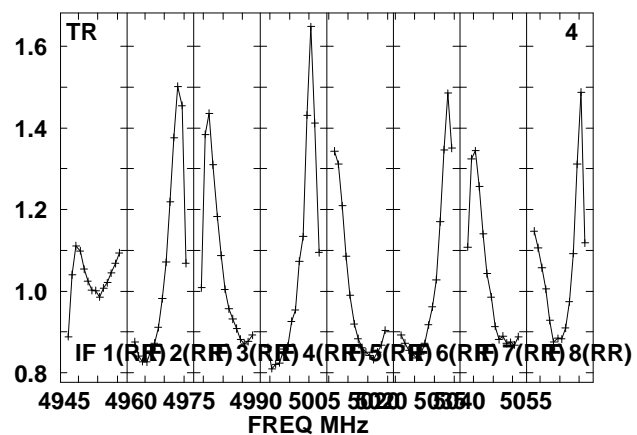
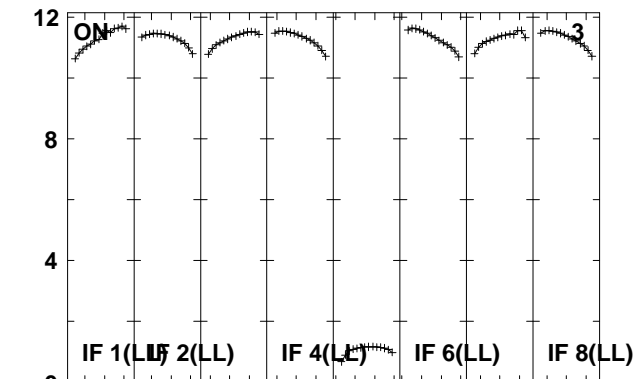
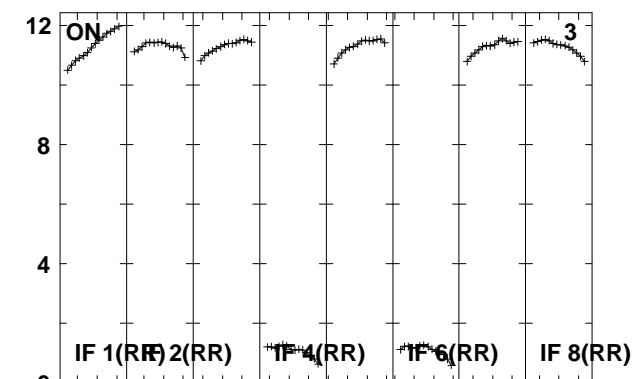
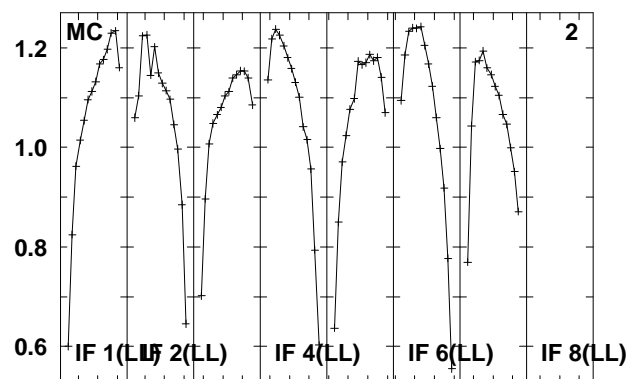
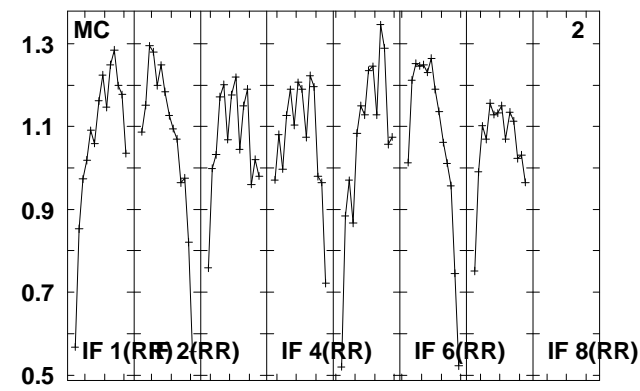
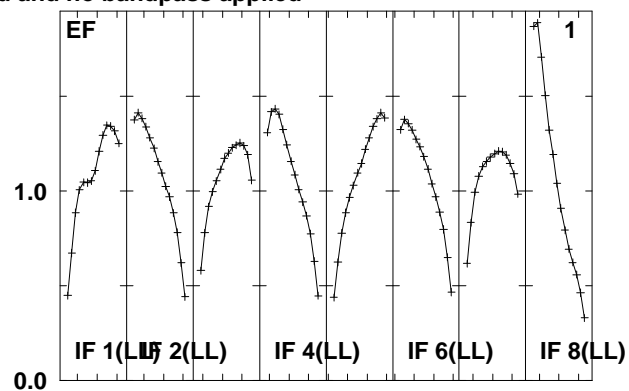
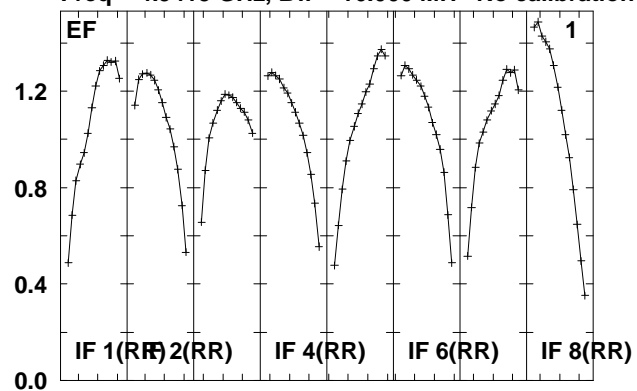

Lower frame: Real Jy
Total-power spectrum Antenna: *
Timerange: 00/14:29:06 to 00/14:39:48

Plot file version 107 created 08-JUL-2010 13:09:41

B1002+55 EM079.UVDATA.1

Freq = 4.9415 GHz, Bw = 16.000 MH No calibration applied and no bandpass applied

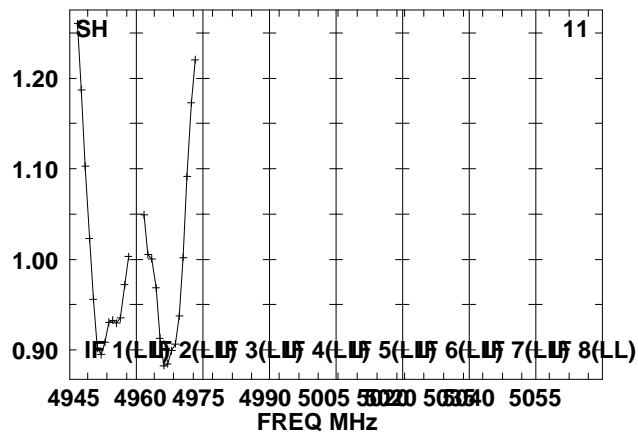
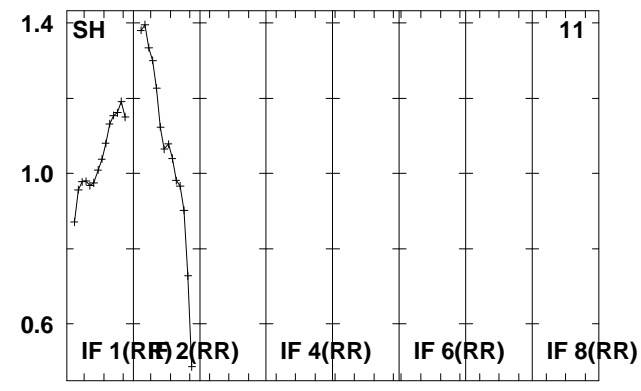
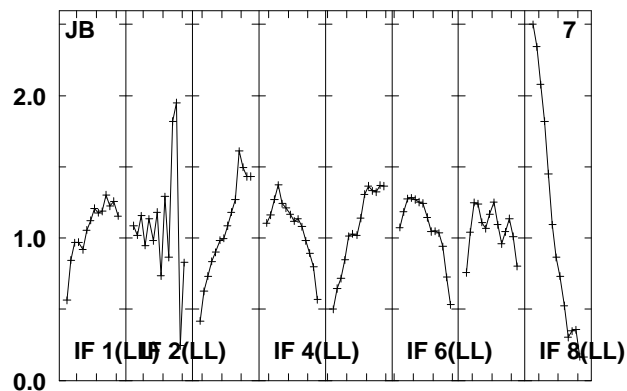
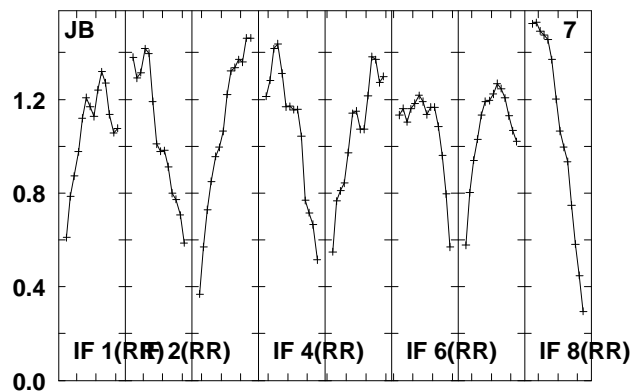
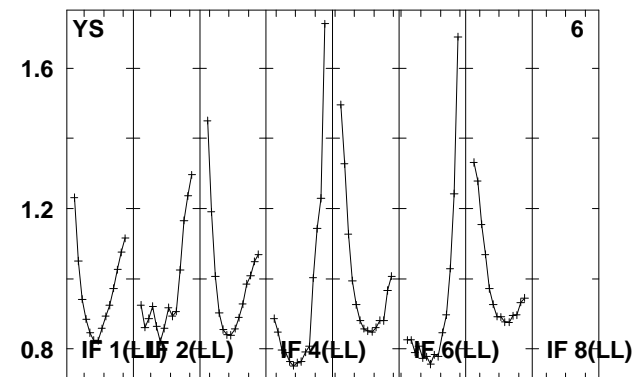
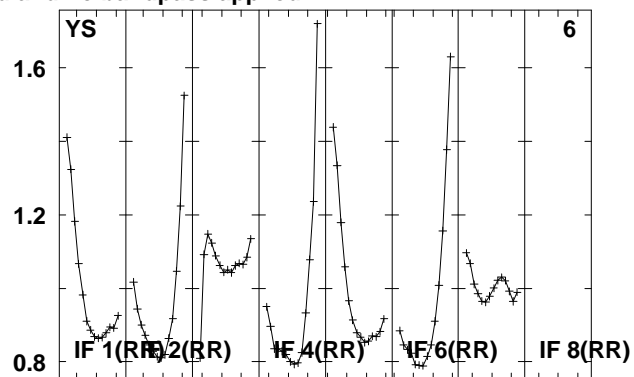
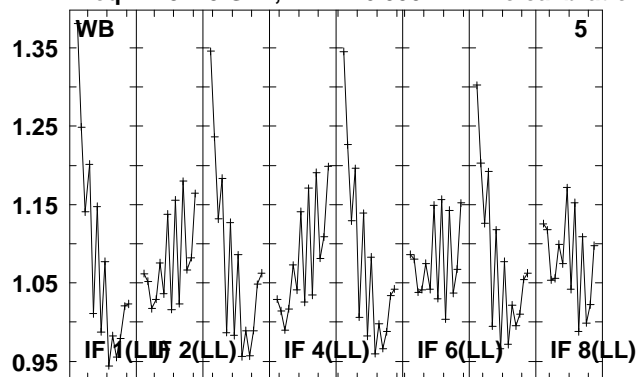

4945 4960 4975 4990 5005 5020 5035 5050 5055
FREQ MHz

Lower frame: Real Jy

Total-power spectrum Antenna: *

Timerange: 00/14:29:06 to 00/14:39:48

Plot file version 108 created 08-JUL-2010 13:09:43

J0957+55 EM079.UVDATA.1

Freq = 4.9415 GHz, Bw = 16.000 MH No calibration applied and no bandpass applied

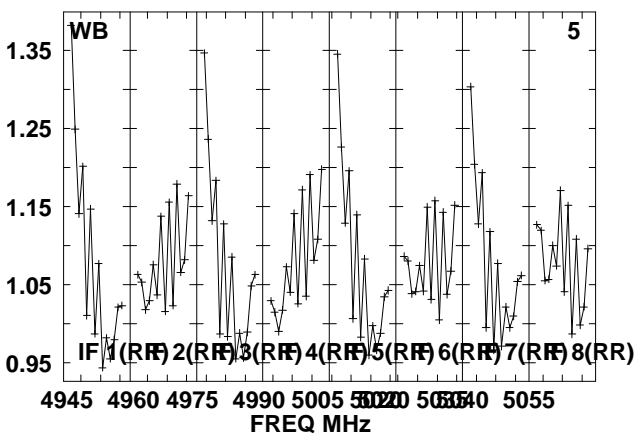
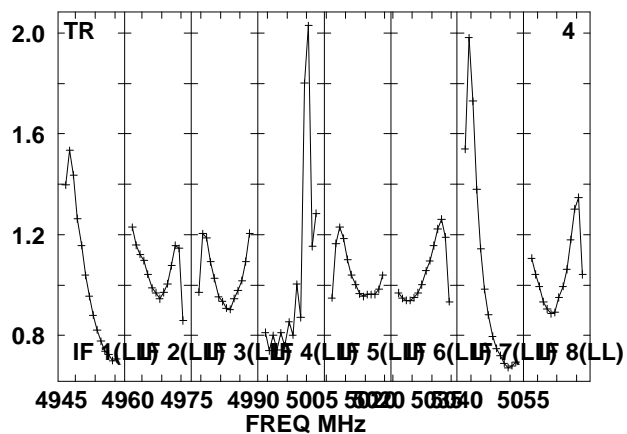
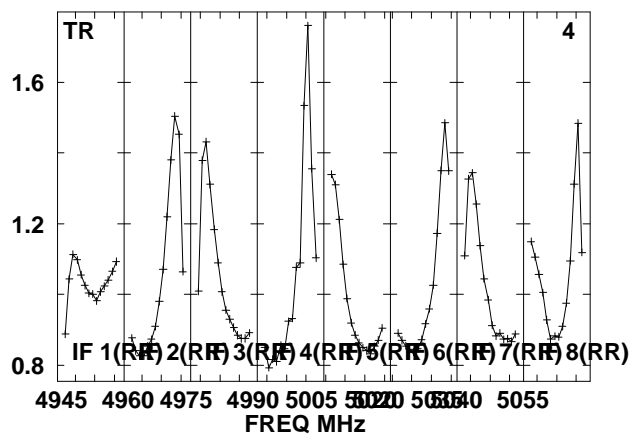
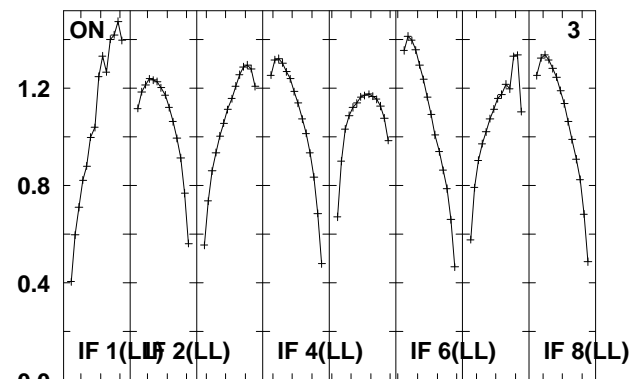
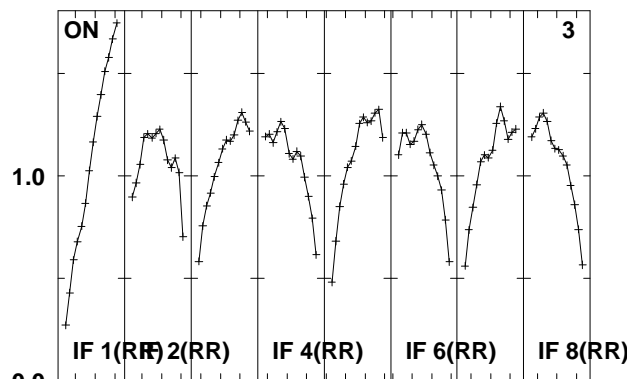
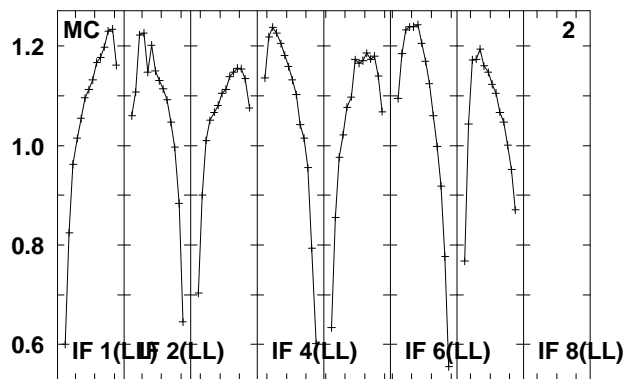
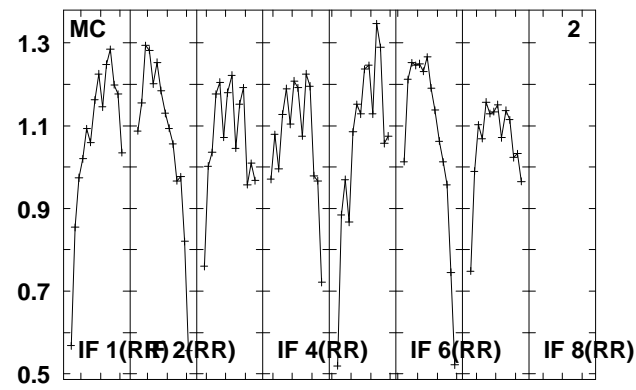
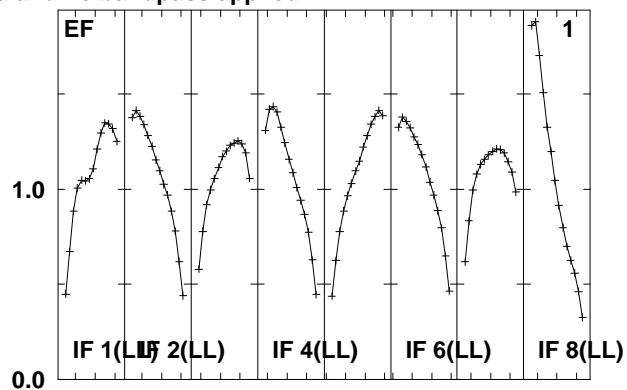
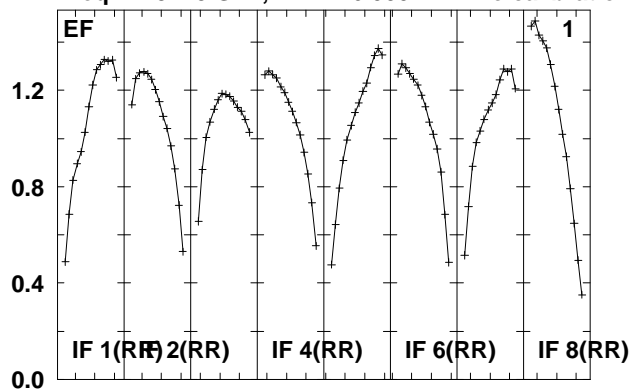

Lower frame: Real Jy
Total-power spectrum Antenna: *
Timerange: 00/14:39:50 to 00/14:41:48

Plot file version 109 created 08-JUL-2010 13:09:43

J0957+55 EM079.UVDATA.1

Freq = 4.9415 GHz, Bw = 16.000 MH No calibration applied and no bandpass applied

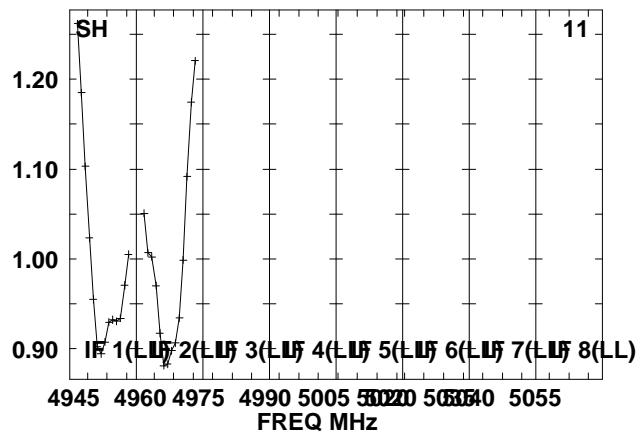
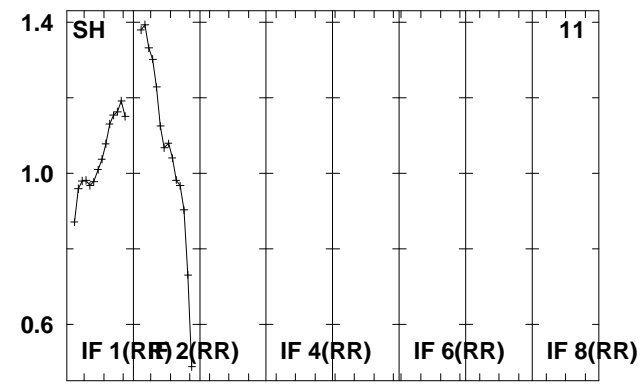
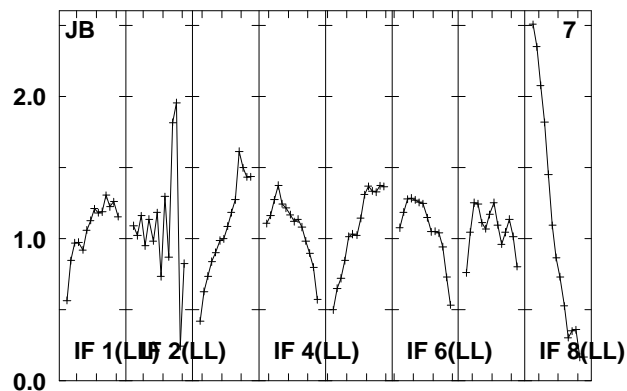
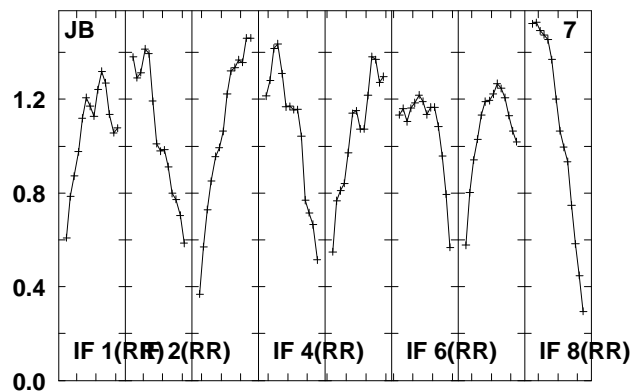
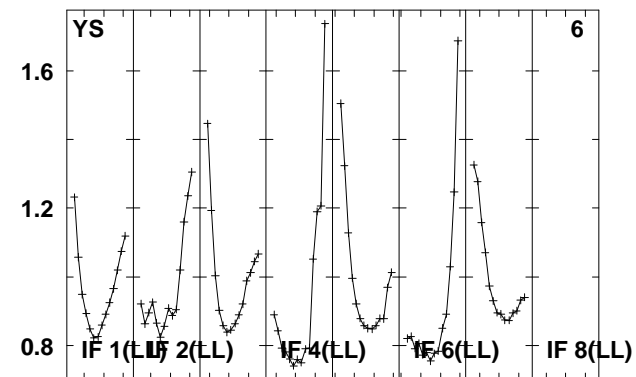
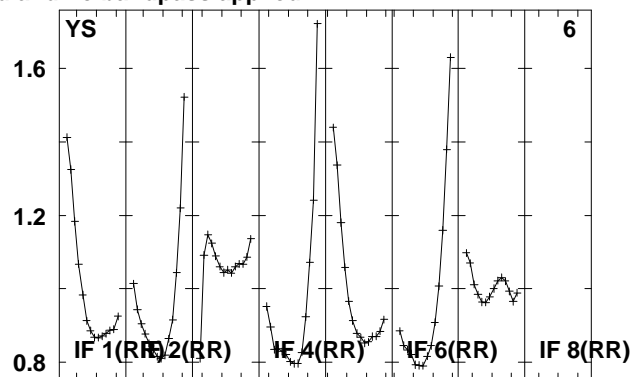
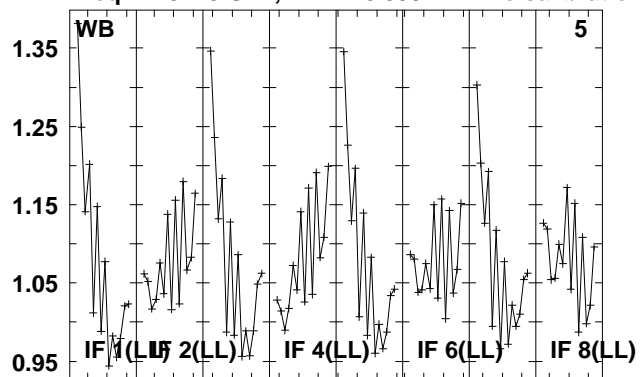

4945 4960 4975 4990 5005 5020 5035 5050 5055
FREQ MHz

Lower frame: Real Jy

Total-power spectrum Antenna: *

Timerange: 00/14:39:50 to 00/14:41:48

Plot file version 110 created 08-JUL-2010 13:09:44

B1002+55 EM079.UVDATA.1

Freq = 4.9415 GHz, Bw = 16.000 MH No calibration applied and no bandpass applied

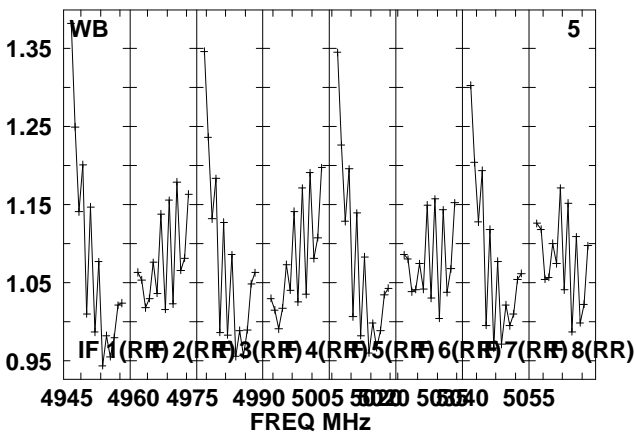
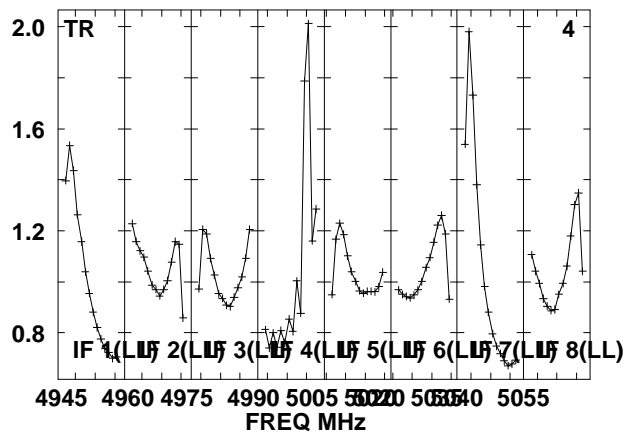
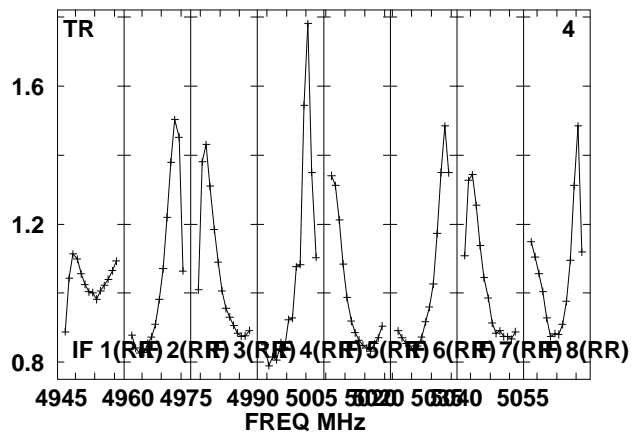
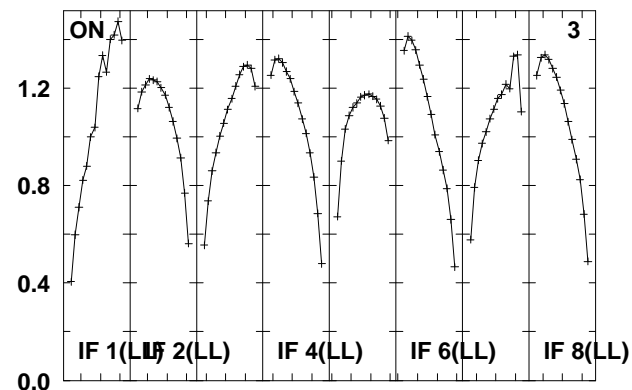
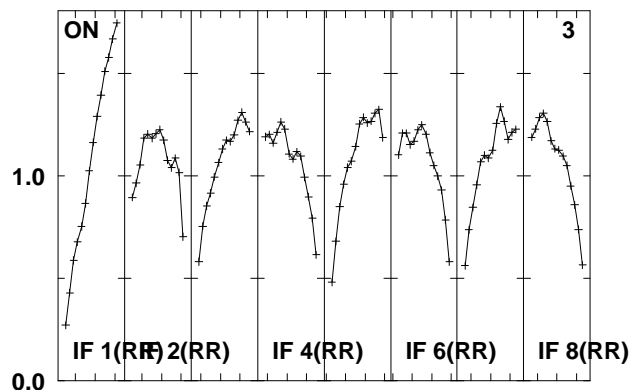
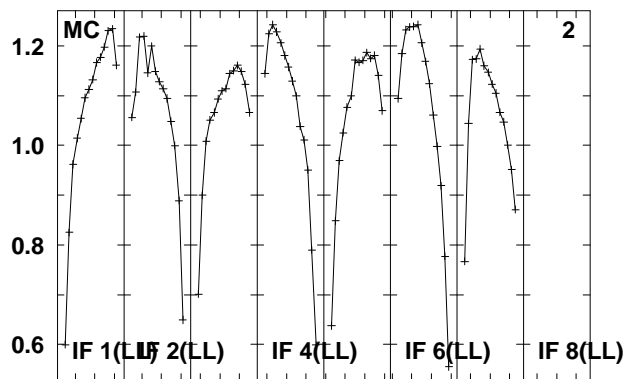
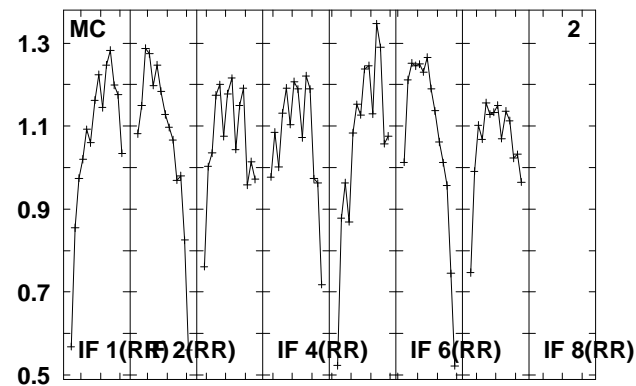
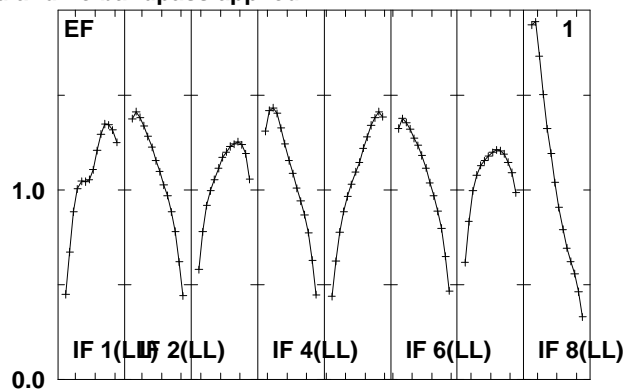
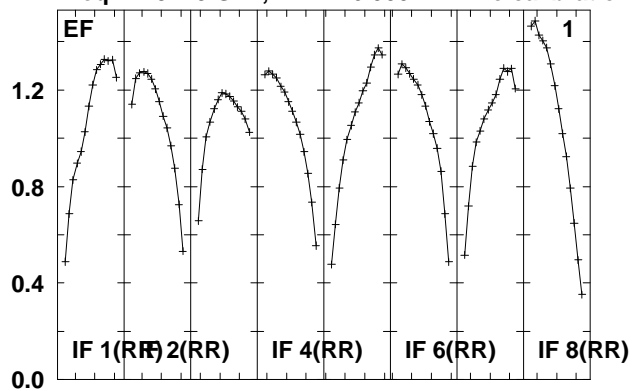

Lower frame: Real Jy
Total-power spectrum Antenna: *
Timerange: 00/14:41:50 to 00/14:52:34

Plot file version 111 created 08-JUL-2010 13:09:45

B1002+55 EM079.UVDATA.1

Freq = 4.9415 GHz, Bw = 16.000 MH No calibration applied and no bandpass applied

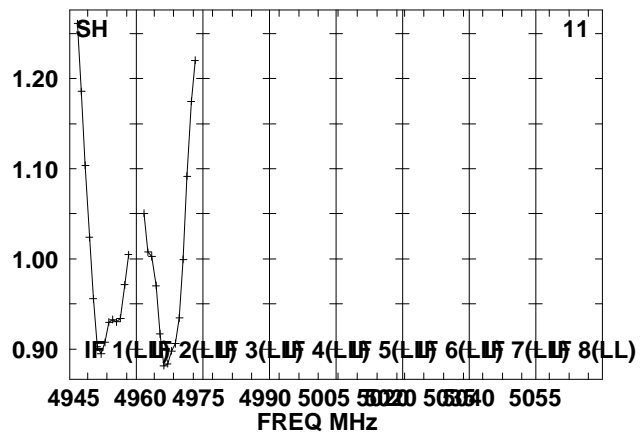
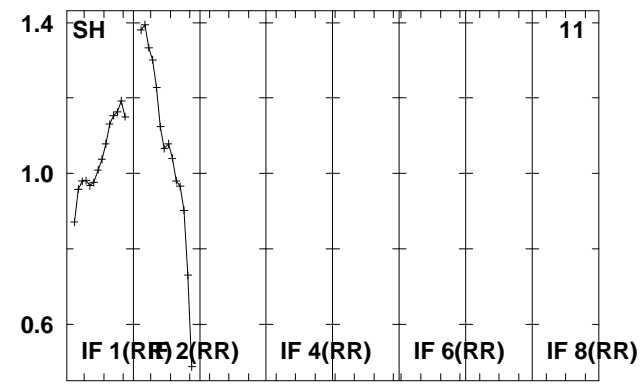
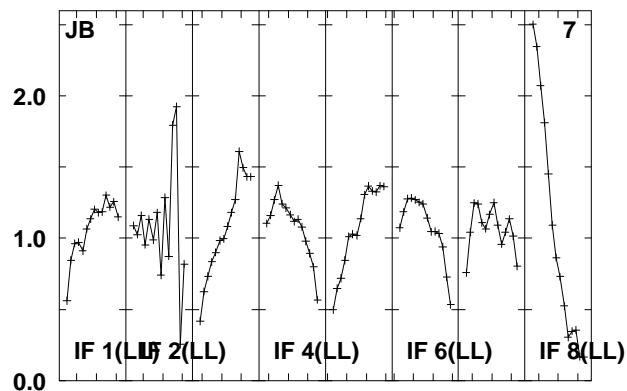
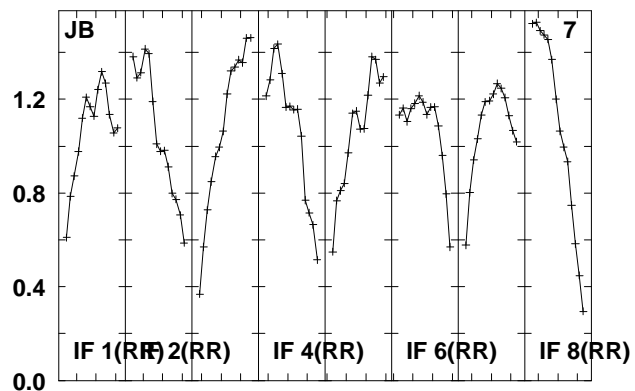
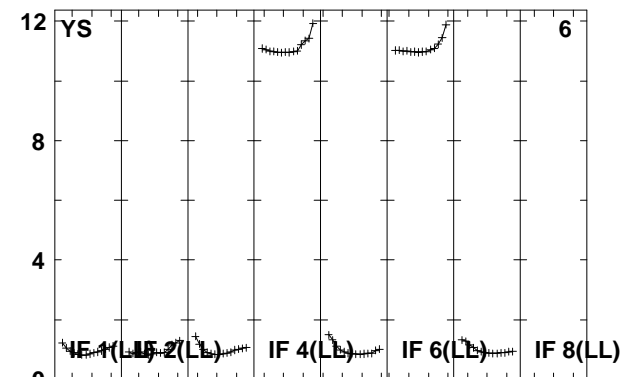
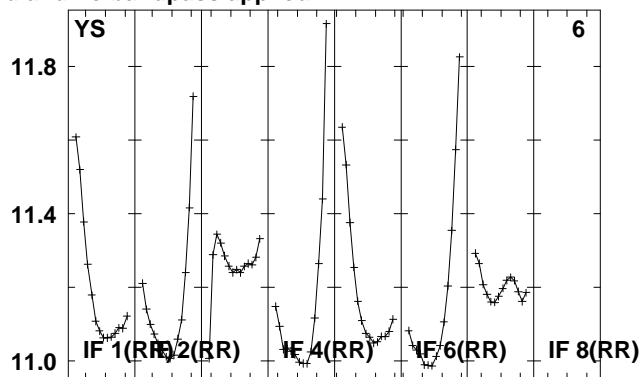
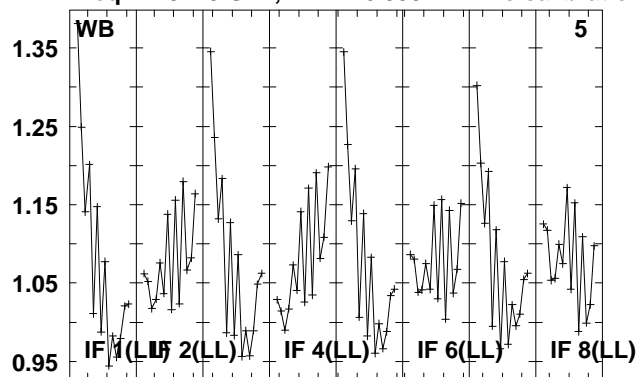

4945 4960 4975 4990 5005 5020 5035 5050 5055
FREQ MHz

Lower frame: Real Jy

Total-power spectrum Antenna: *

Timerange: 00/14:41:50 to 00/14:52:34

Plot file version 112 created 08-JUL-2010 13:09:47

J0957+55 EM079.UVDATA.1

Freq = 4.9415 GHz, Bw = 16.000 MH No calibration applied and no bandpass applied

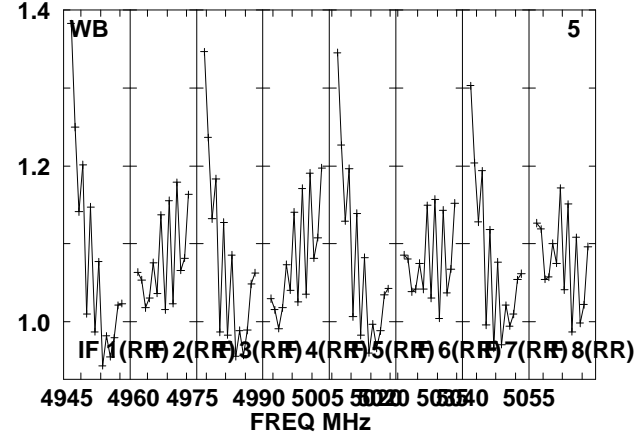
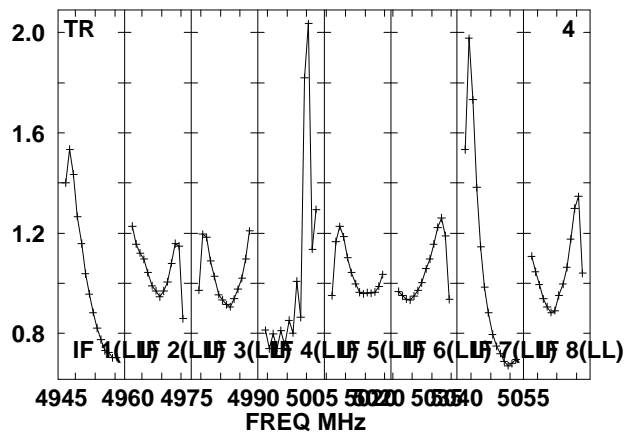
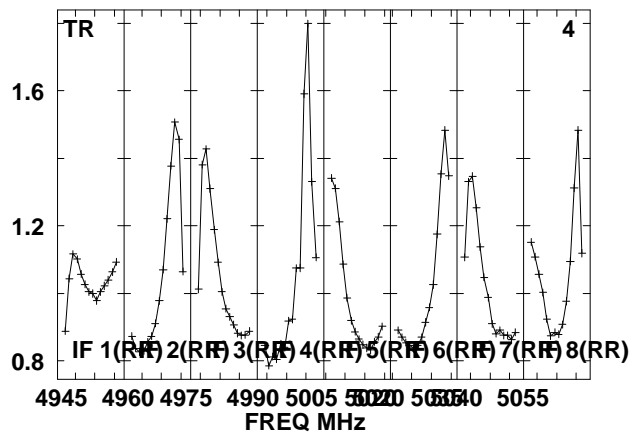
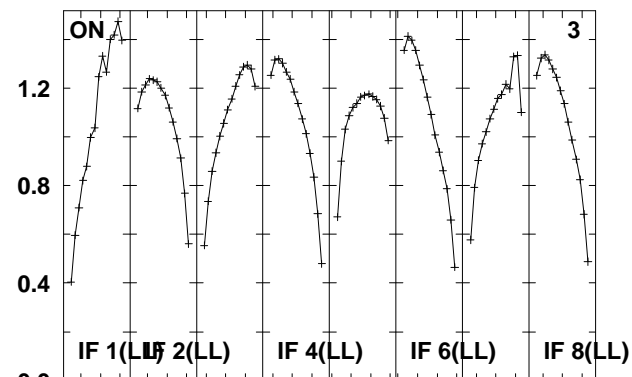
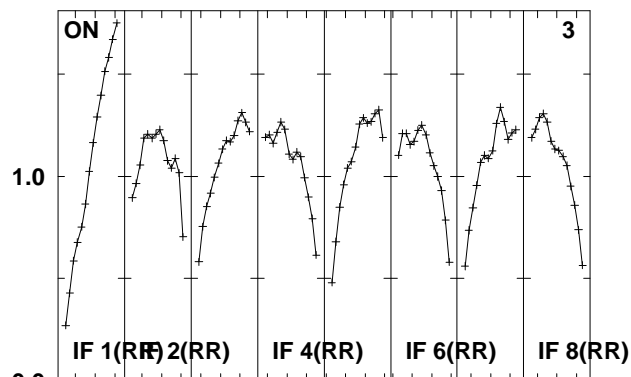
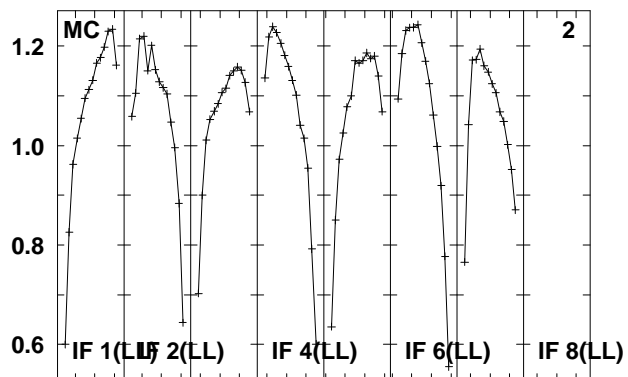
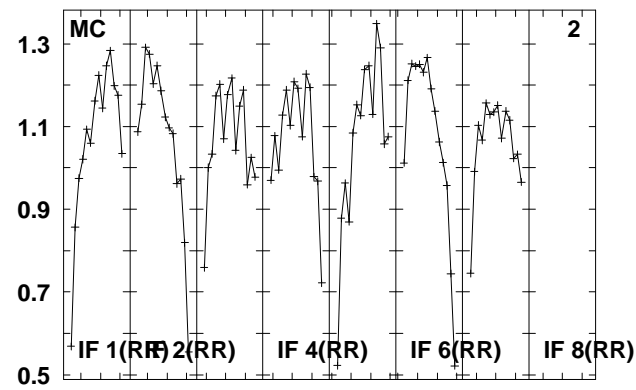
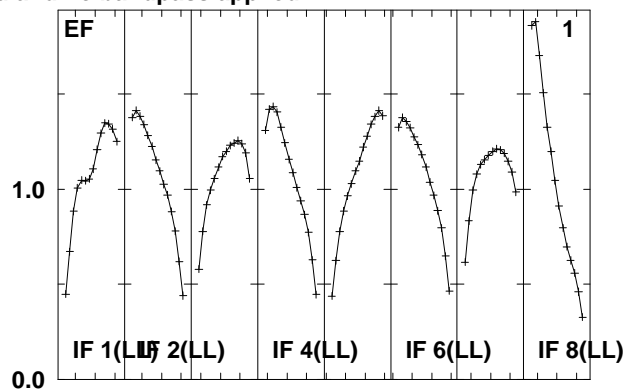
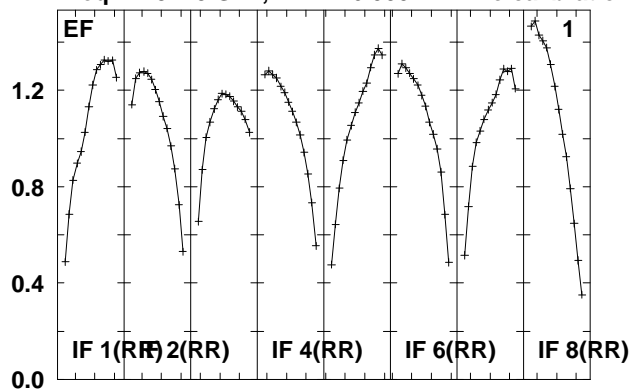

Lower frame: Real Jy

Total-power spectrum Antenna: *

Timerange: 00/14:52:36 to 00/14:54:34

Plot file version 113 created 08-JUL-2010 13:09:48

J0957+55 EM079.UVDATA.1

Freq = 4.9415 GHz, Bw = 16.000 MH No calibration applied and no bandpass applied

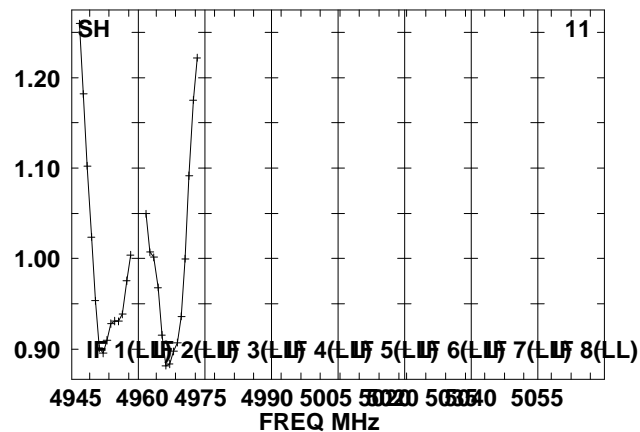
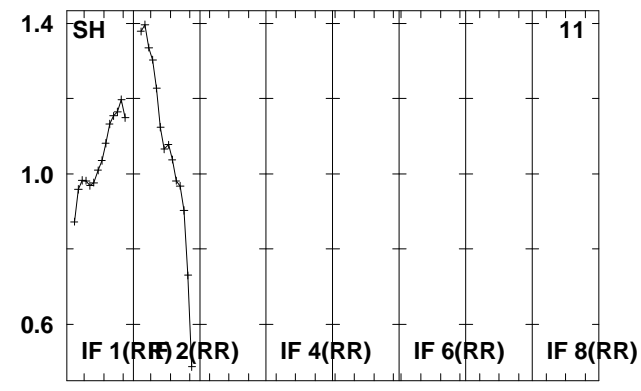
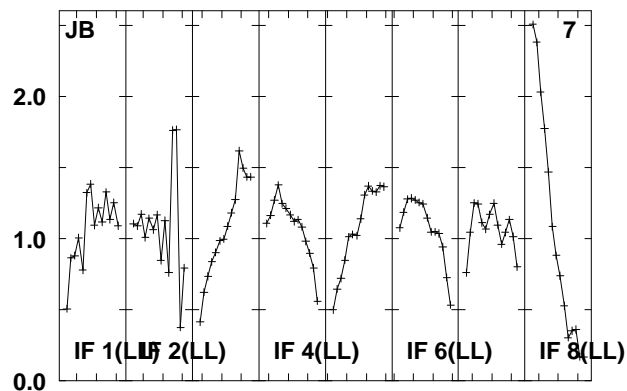
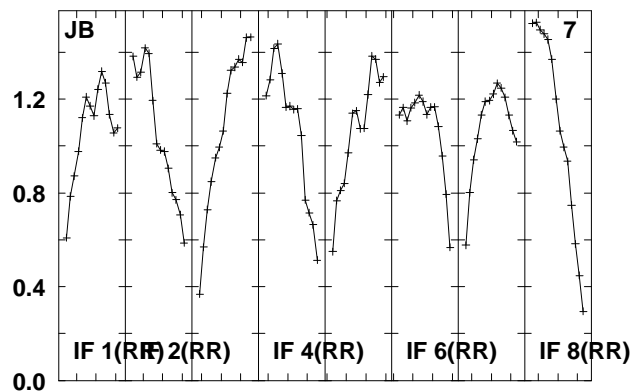
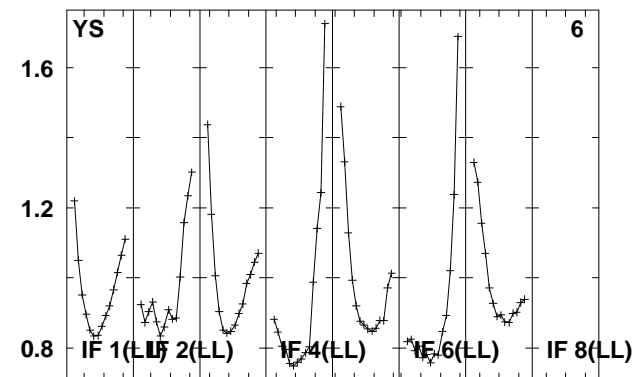
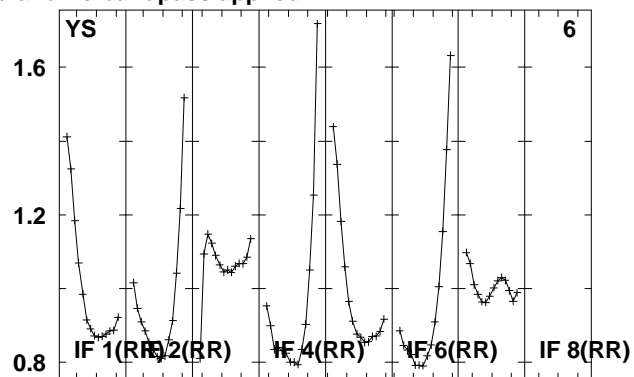
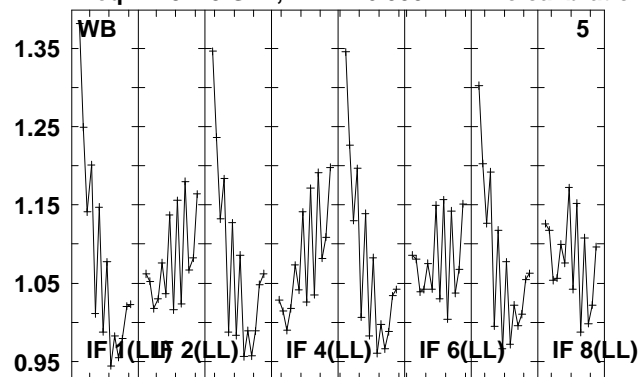

Lower frame: Real Jy

Total-power spectrum Antenna: *

Timerange: 00/14:52:36 to 00/14:54:34

Plot file version 114 created 08-JUL-2010 13:09:48

B1002+55 EM079.UVDATA.1

Freq = 4.9415 GHz, Bw = 16.000 MH No calibration applied and no bandpass applied

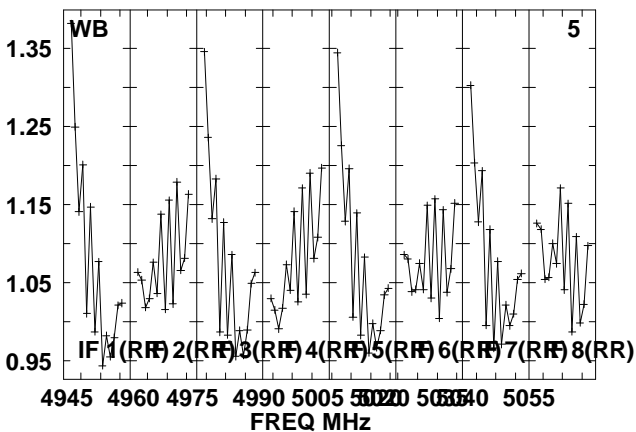
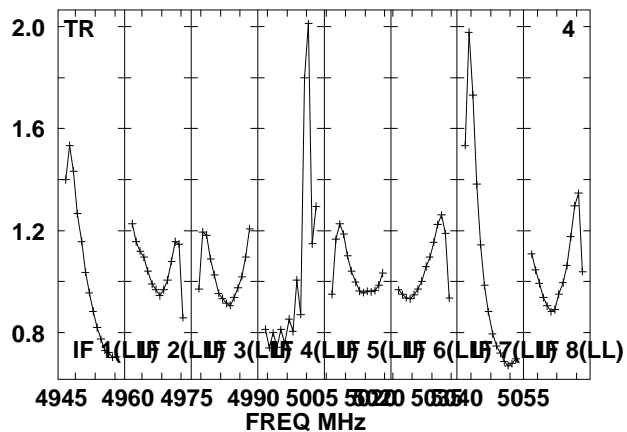
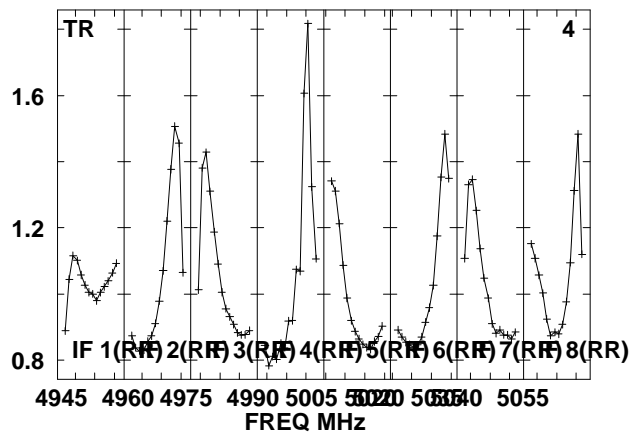
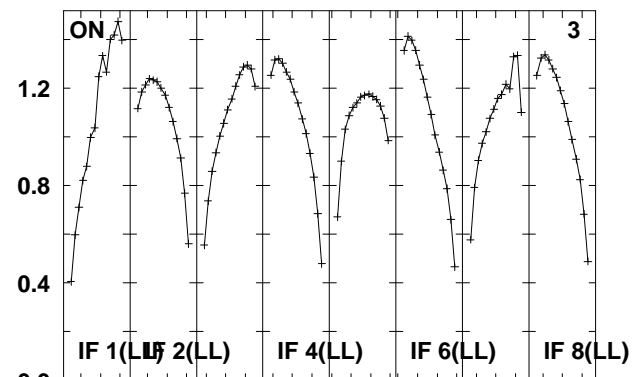
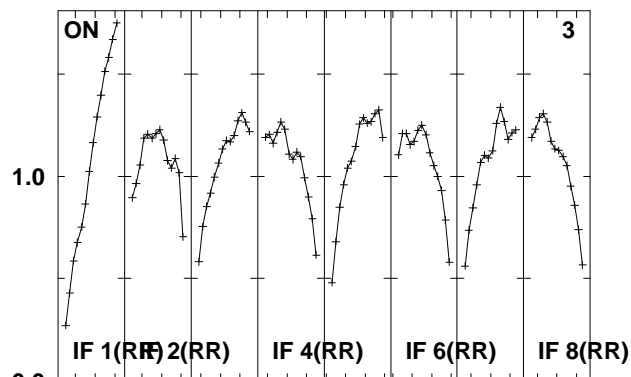
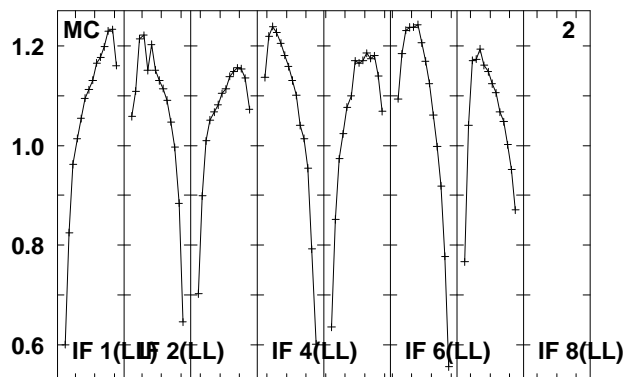
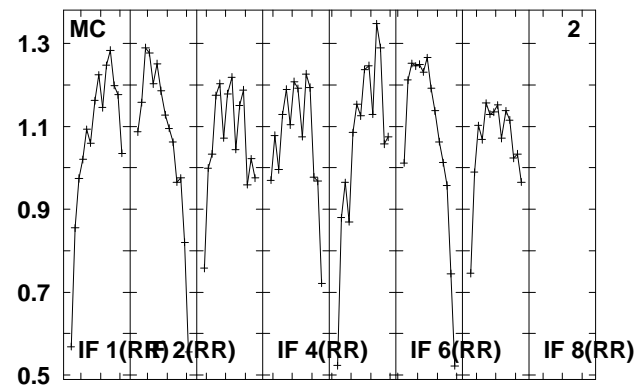
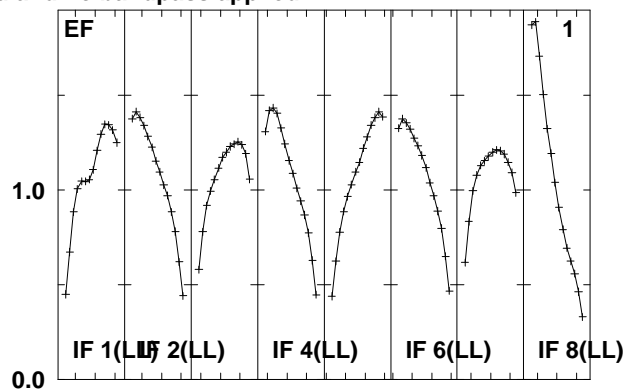
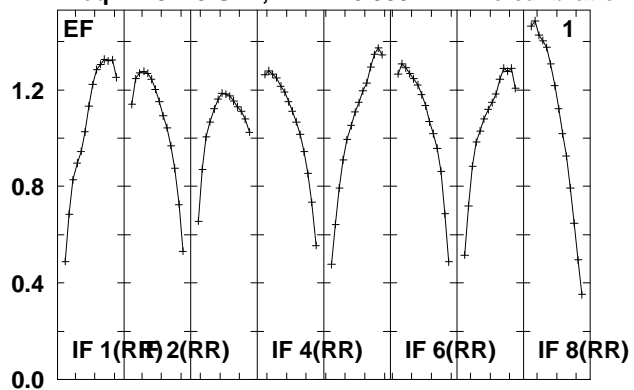

Lower frame: Real Jy
Total-power spectrum Antenna: *
Timerange: 00/14:54:36 to 00/15:05:34

Plot file version 115 created 08-JUL-2010 13:09:50
 B1002+55 EM079.UVDATA.1
 Freq = 4.9415 GHz, Bw = 16.000 MH No calibration applied and no bandpass applied

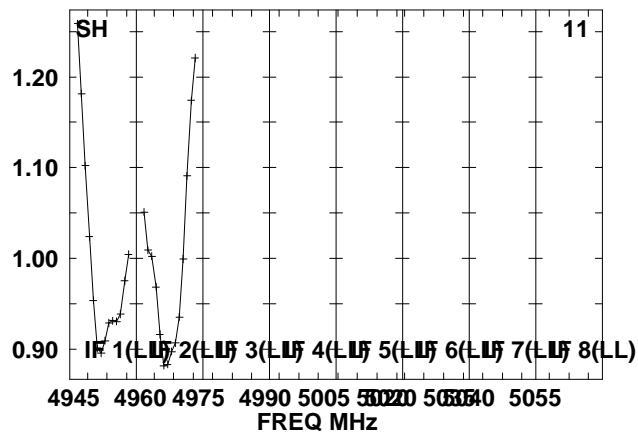
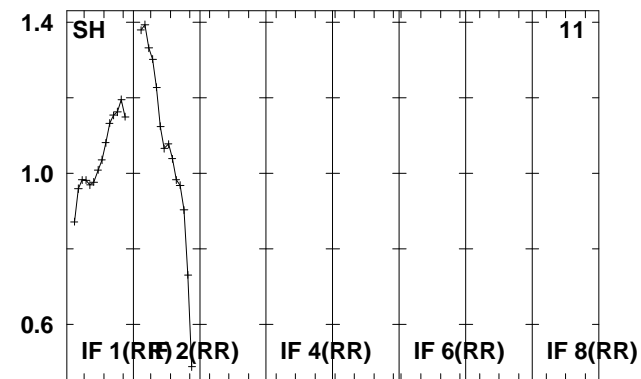
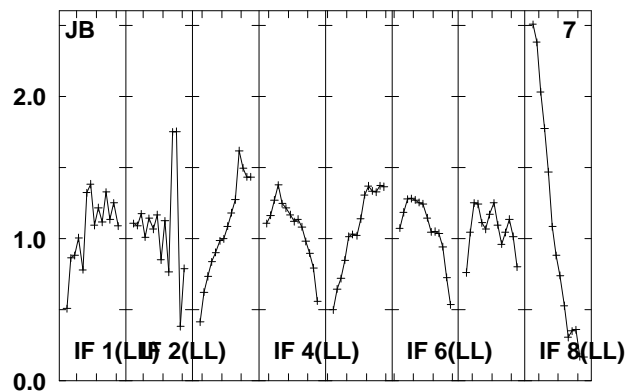
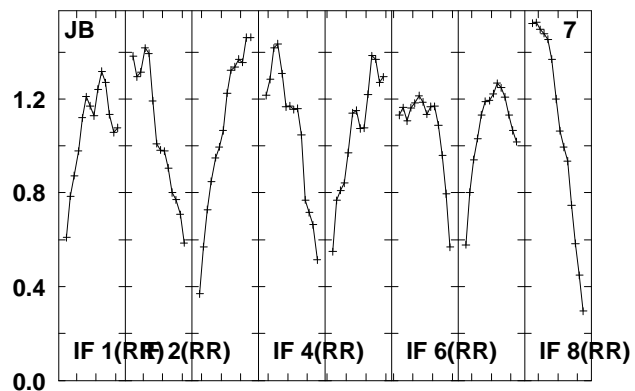
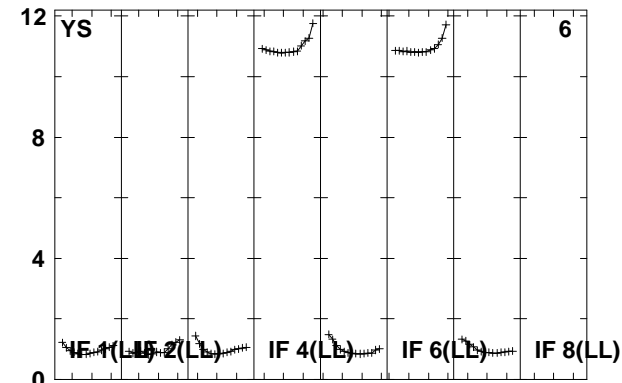
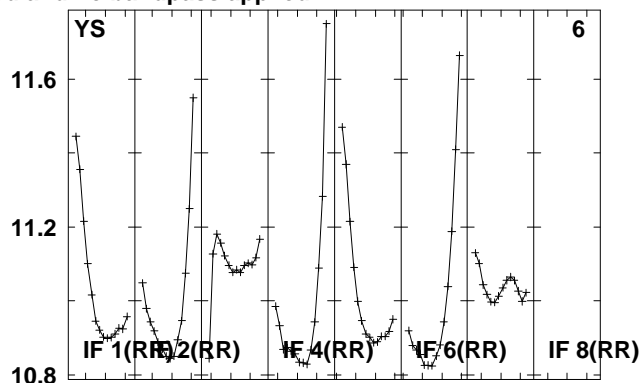
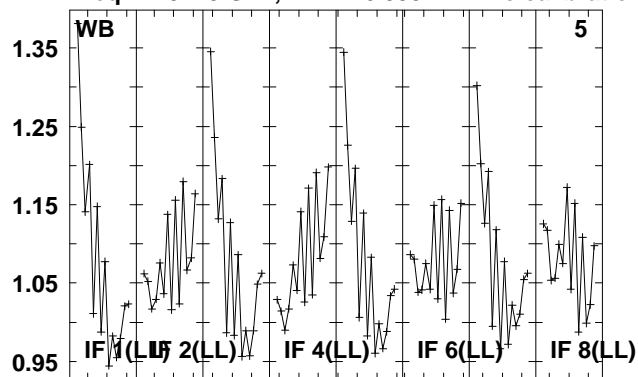

4945 4960 4975 4990 5005 5020 5035 5050
 FREQ MHz

Lower frame: Real Jy
 Total-power spectrum Antenna: *
 Timerange: 00/14:54:36 to 00/15:05:34

Plot file version 116 created 08-JUL-2010 13:09:51

J0957+55 EM079.UVDATA.1

Freq = 4.9415 GHz, Bw = 16.000 MH No calibration applied and no bandpass applied

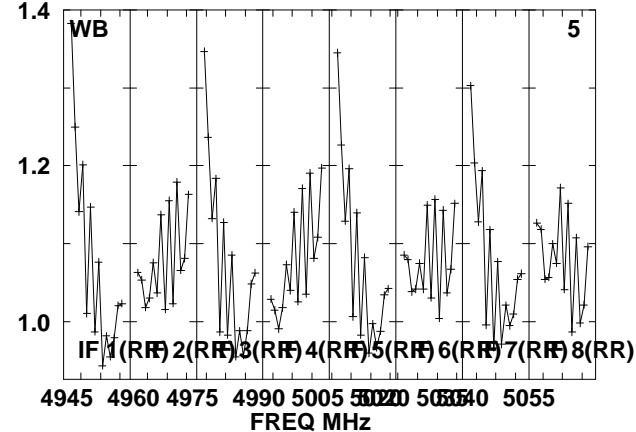
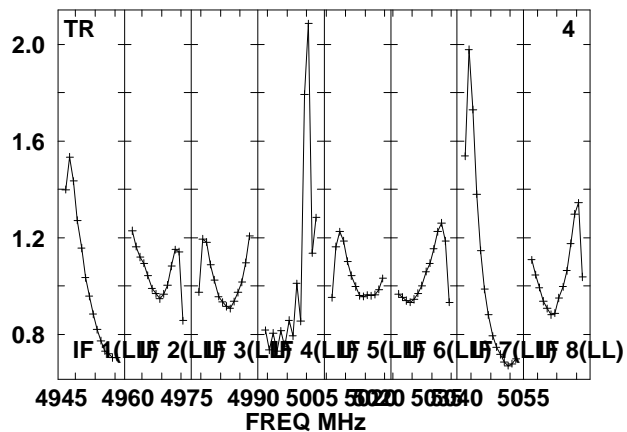
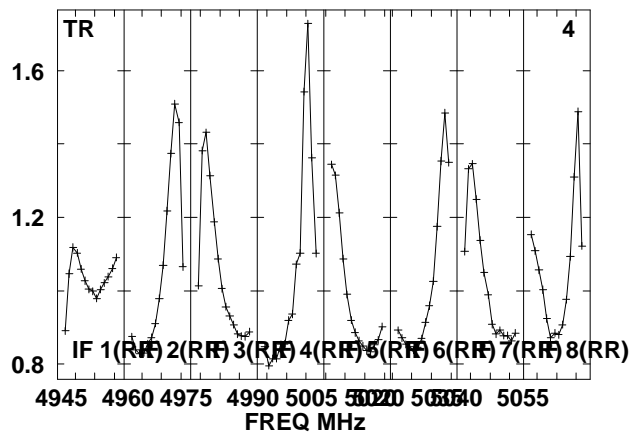
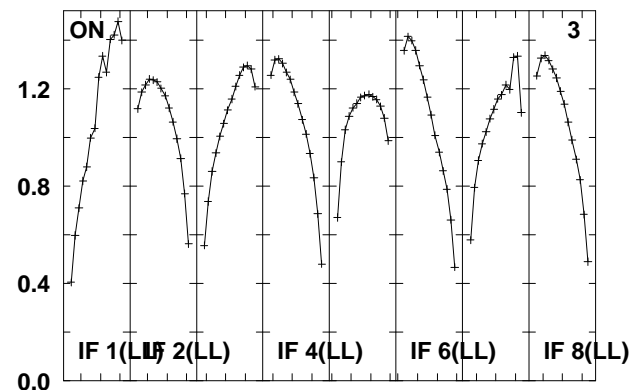
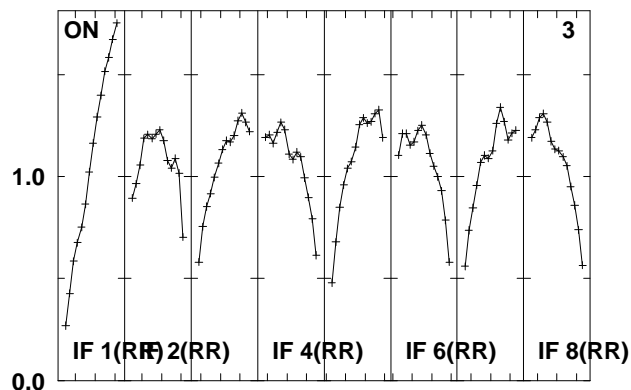
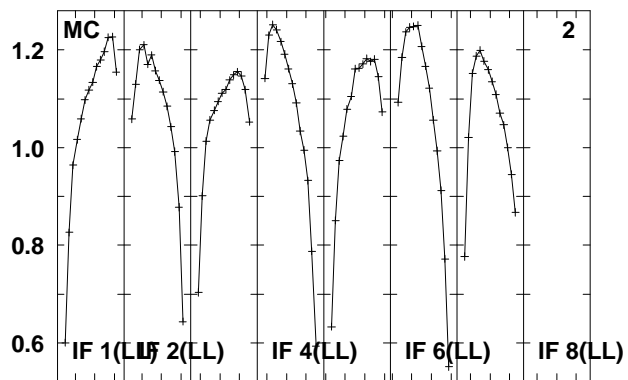
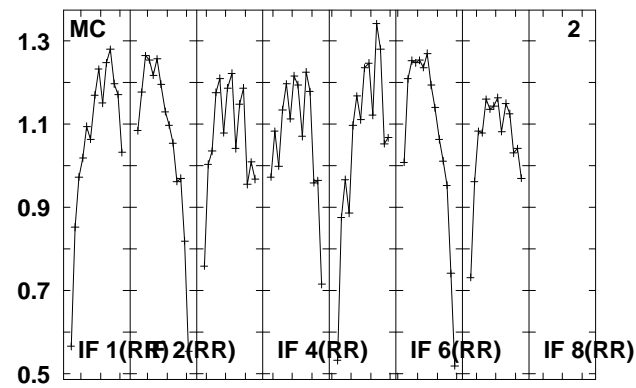
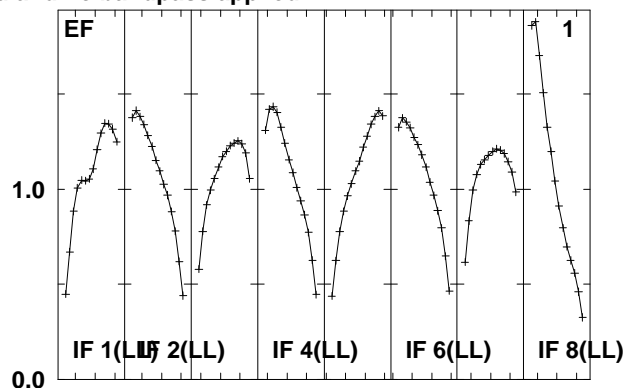
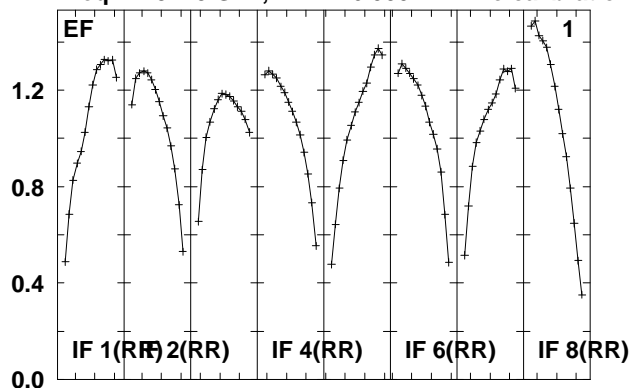

Lower frame: Real Jy
Total-power spectrum Antenna: *
Timerange: 00/15:05:36 to 00/15:07:34

Plot file version 117 created 08-JUL-2010 13:09:52

J0957+55 EM079.UVDATA.1

Freq = 4.9415 GHz, Bw = 16.000 MH No calibration applied and no bandpass applied

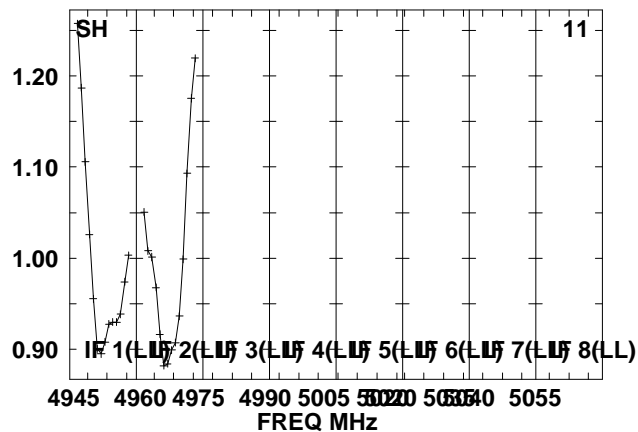
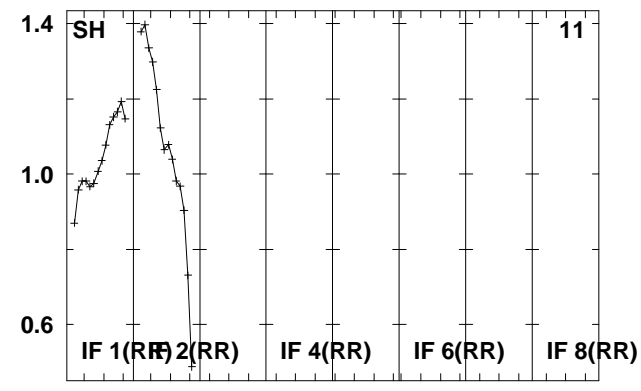
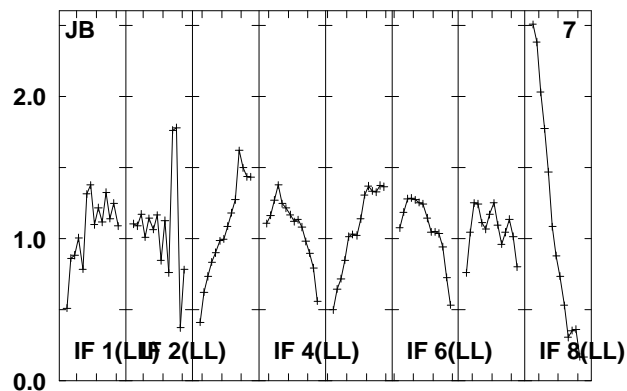
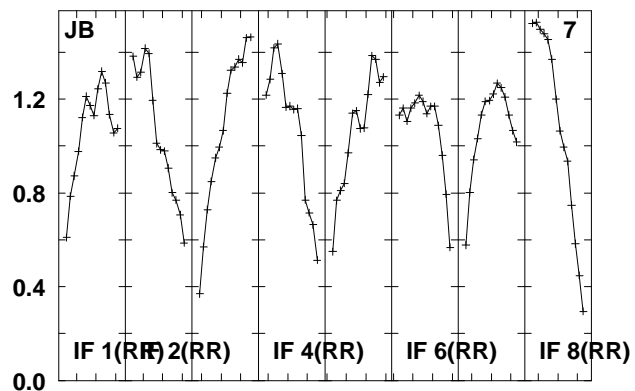
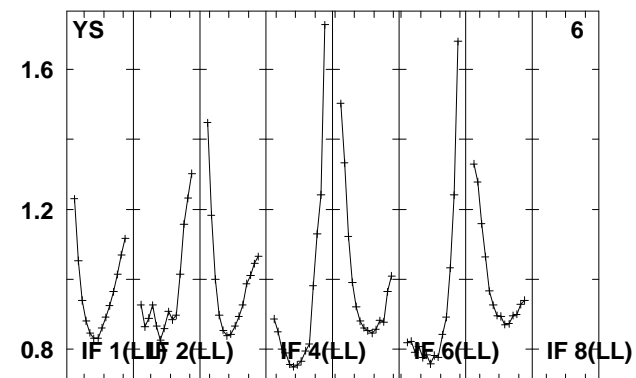
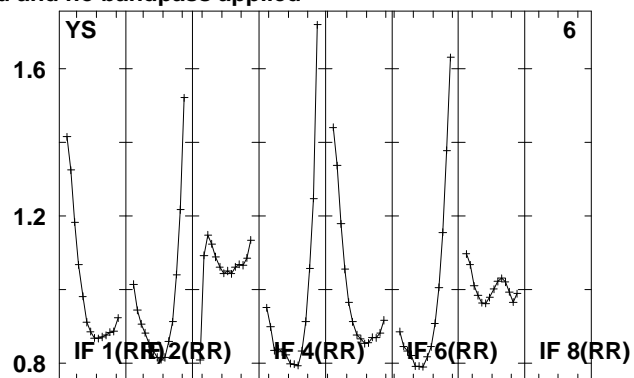
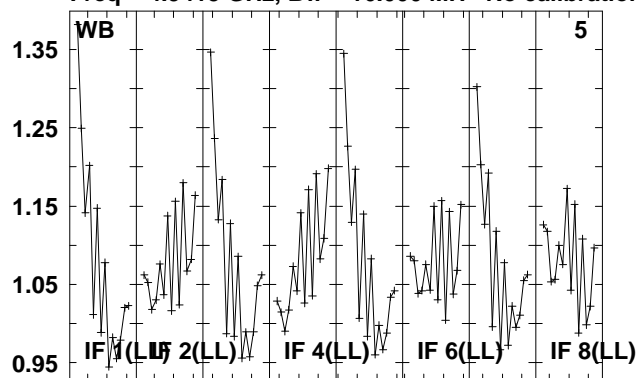

4945 4960 4975 4990 5005 5020 5035 5050 5065
FREQ MHz

Lower frame: Real Jy

Total-power spectrum Antenna: *

Timerange: 00/15:05:36 to 00/15:07:34

Plot file version 118 created 08-JUL-2010 13:09:53

B1002+55 EM079.UVDATA.1

Freq = 4.9415 GHz, Bw = 16.000 MH No calibration applied and no bandpass applied

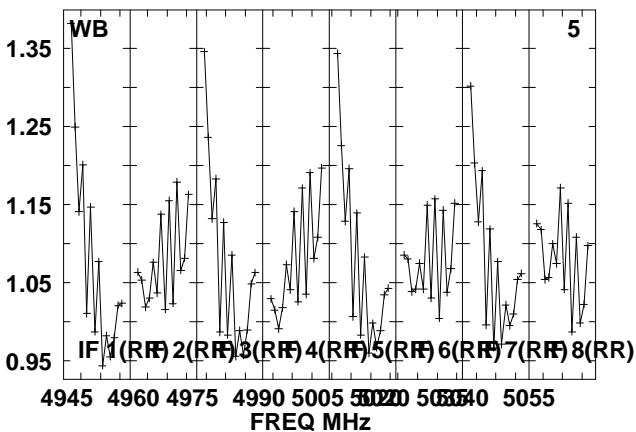
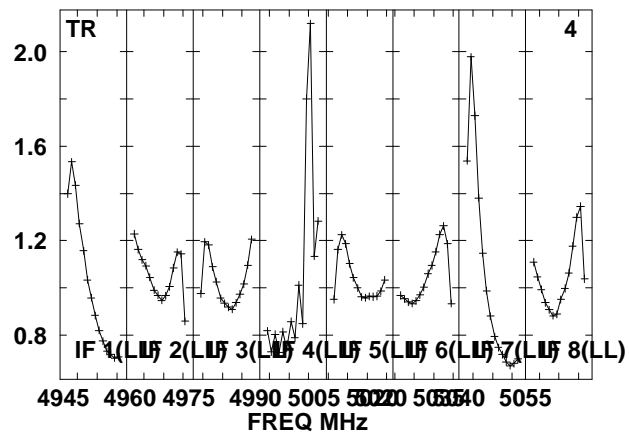
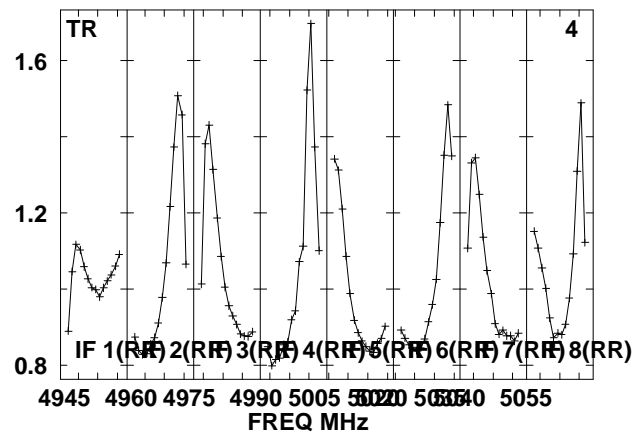
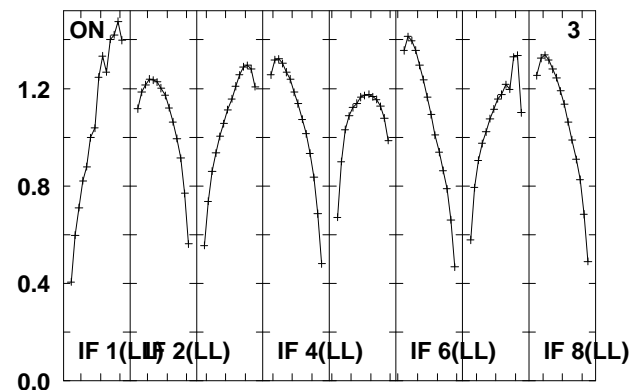
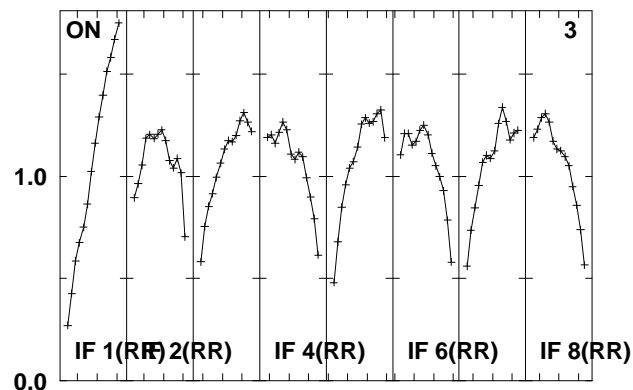
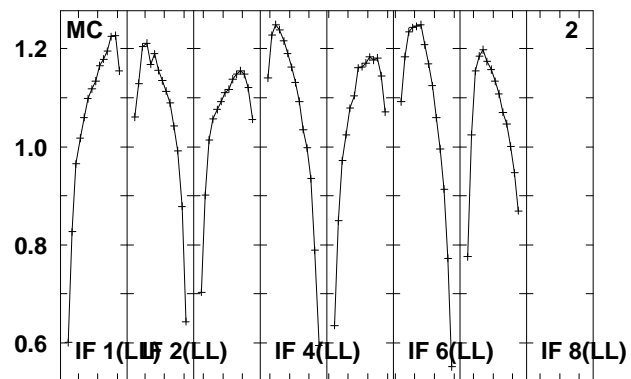
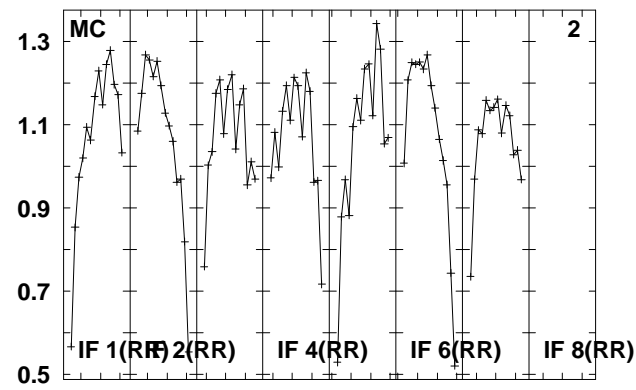
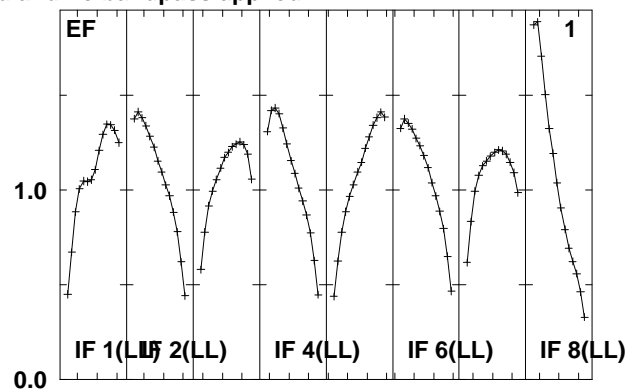
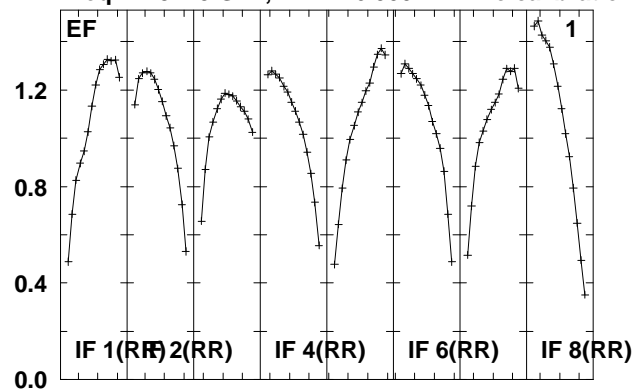

Lower frame: Real Jy
Total-power spectrum Antenna: *
Timerange: 00/15:07:36 to 00/15:18:34

Plot file version 119 created 08-JUL-2010 13:09:54

B1002+55 EM079.UVDATA.1

Freq = 4.9415 GHz, Bw = 16.000 MH No calibration applied and no bandpass applied

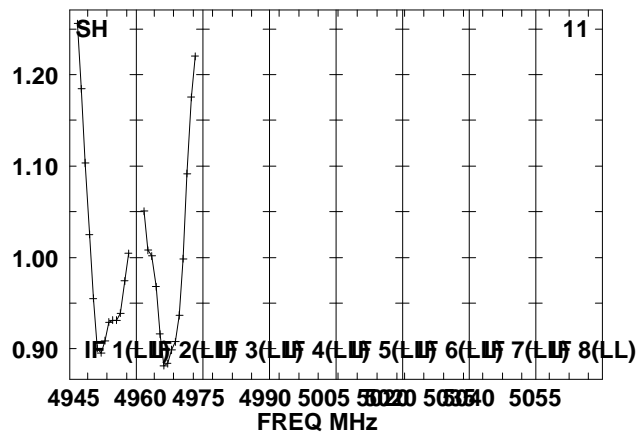
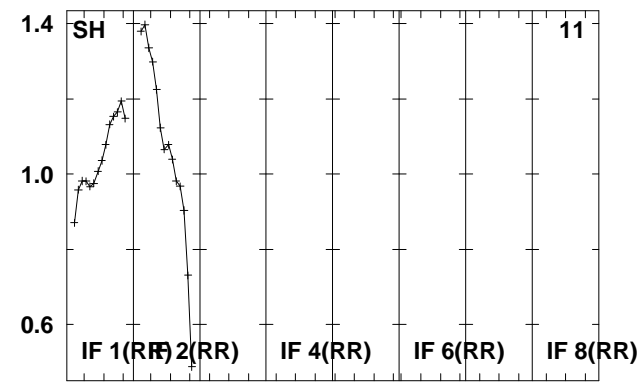
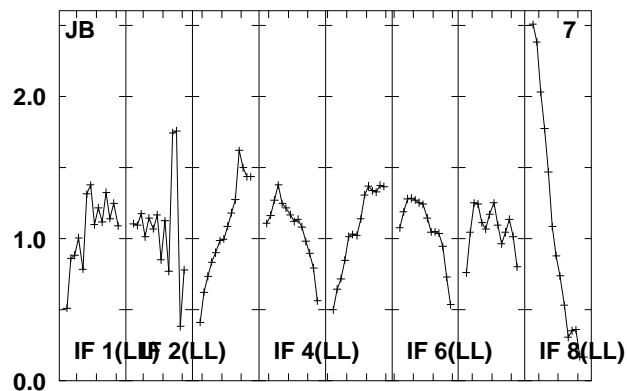
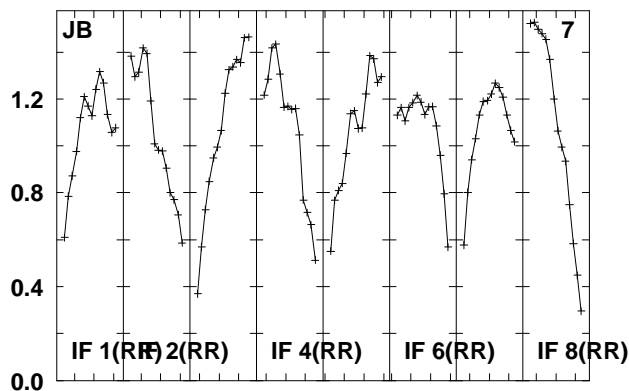
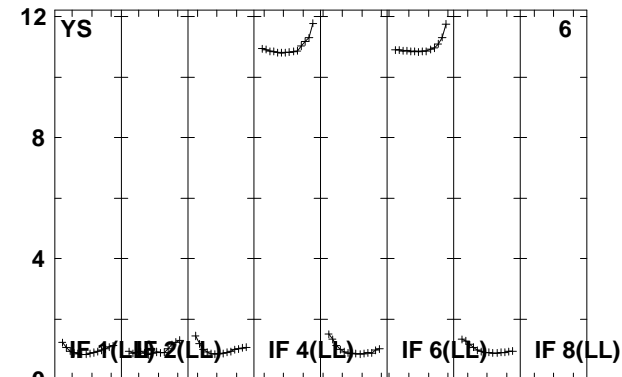
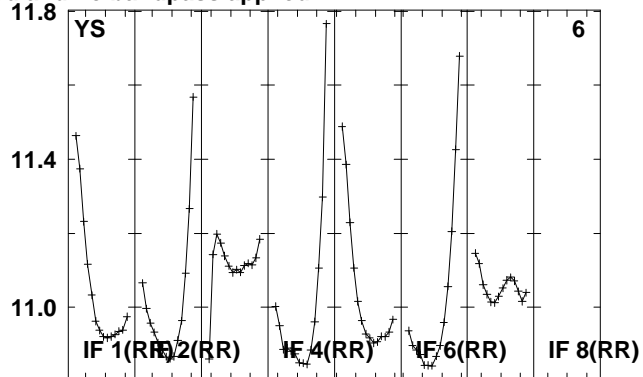
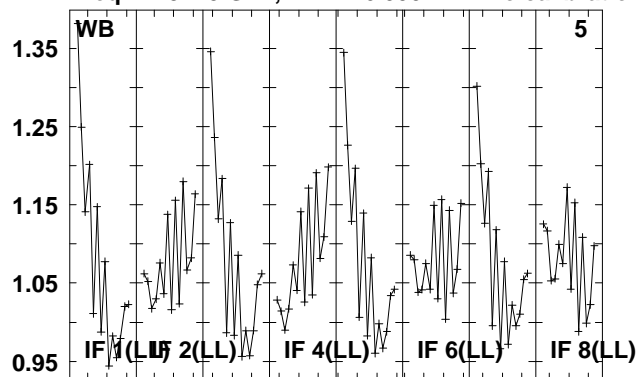

Lower frame: Real Jy

Total-power spectrum Antenna: *

Timerange: 00/15:07:36 to 00/15:18:34

Plot file version 120 created 08-JUL-2010 13:09:56

J0957+55 EM079.UVDATA.1

Freq = 4.9415 GHz, Bw = 16.000 MH No calibration applied and no bandpass applied

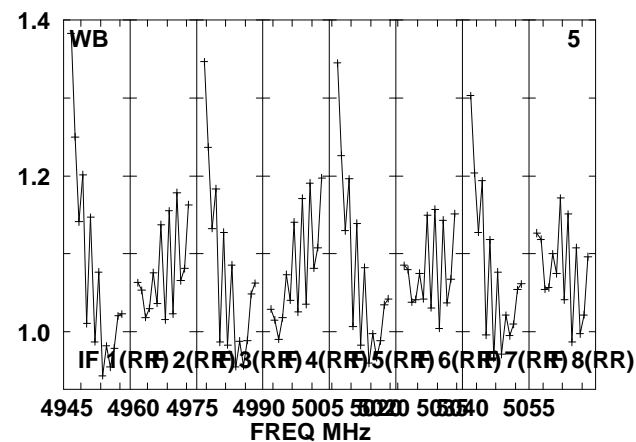
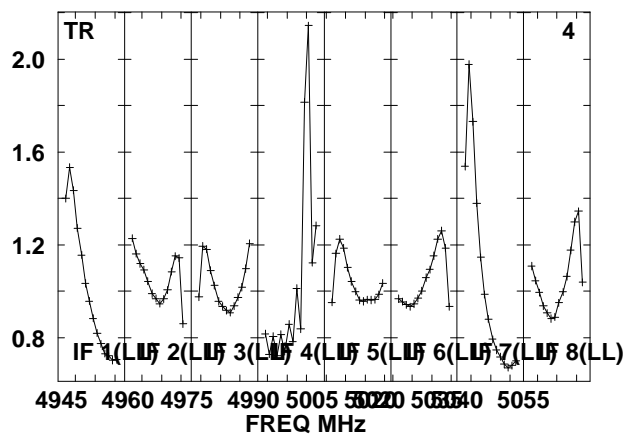
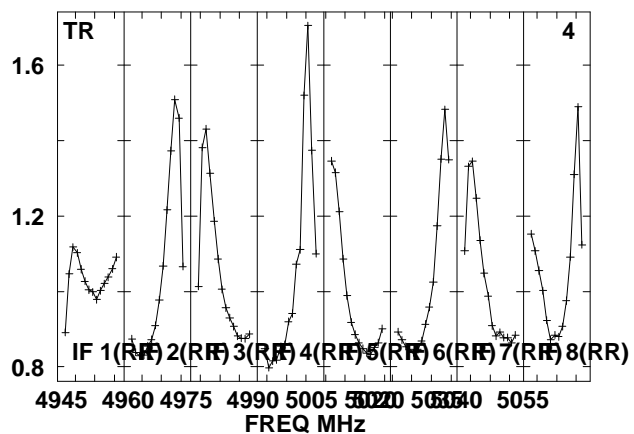
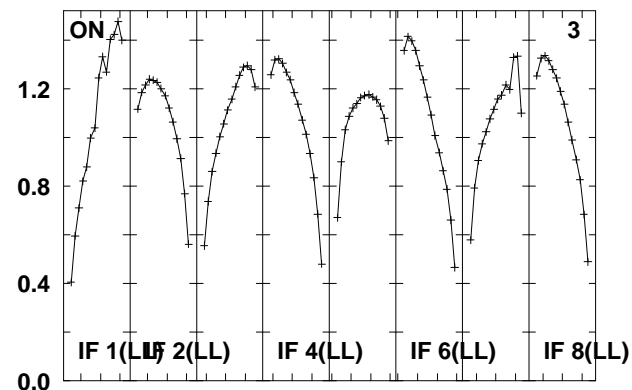
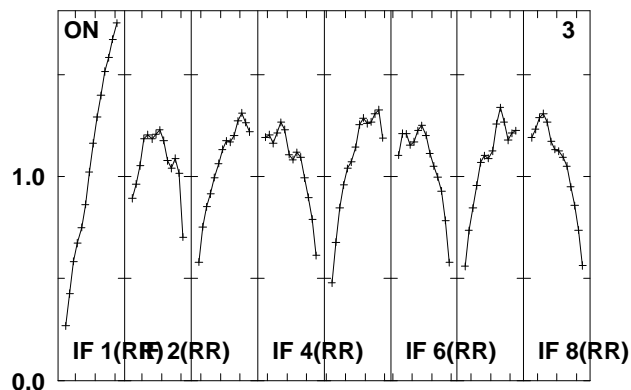
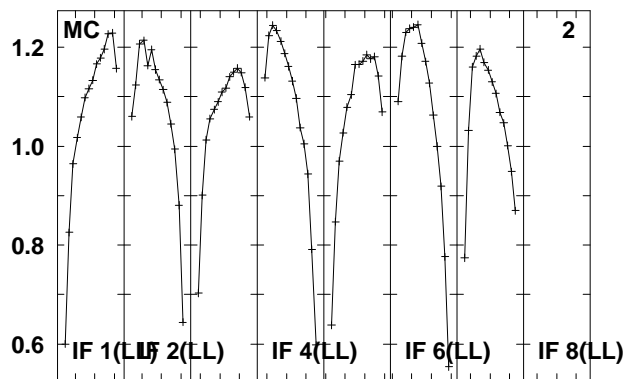
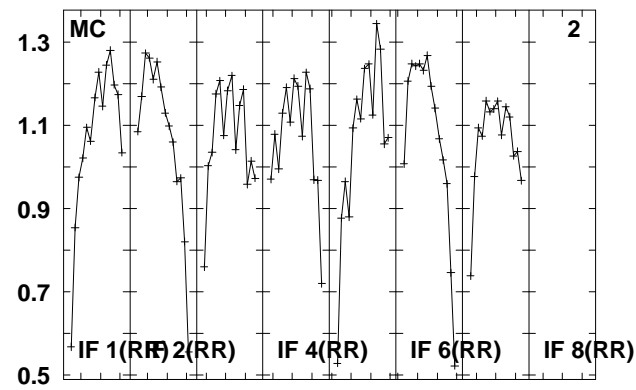
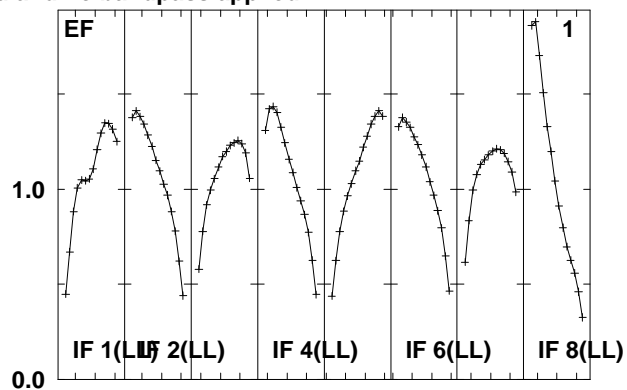
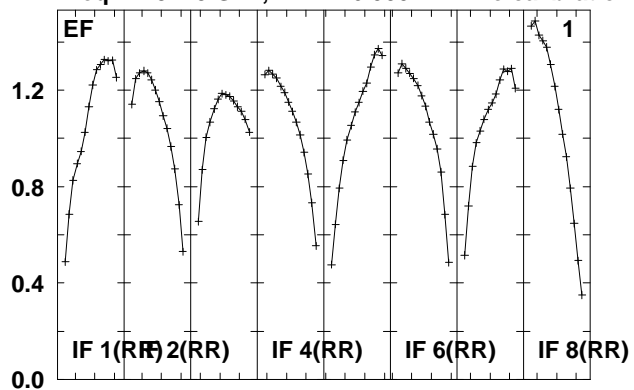

Lower frame: Real Jy
Total-power spectrum Antenna: *
Timerange: 00/15:18:36 to 00/15:20:34

Plot file version 121 created 08-JUL-2010 13:09:58

J0957+55 EM079.UVDATA.1

Freq = 4.9415 GHz, Bw = 16.000 MH No calibration applied and no bandpass applied

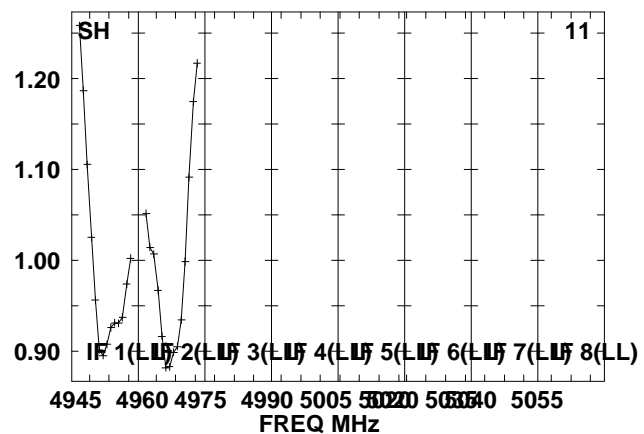
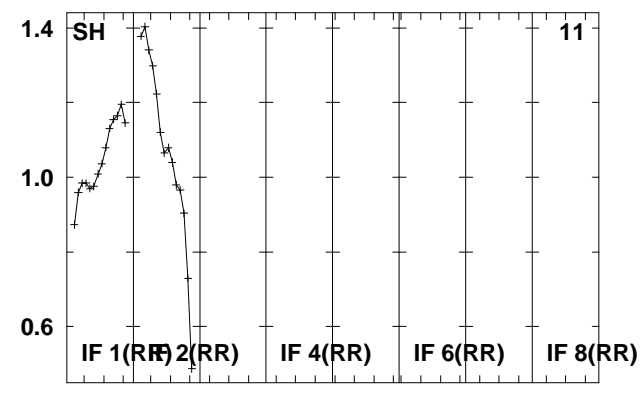
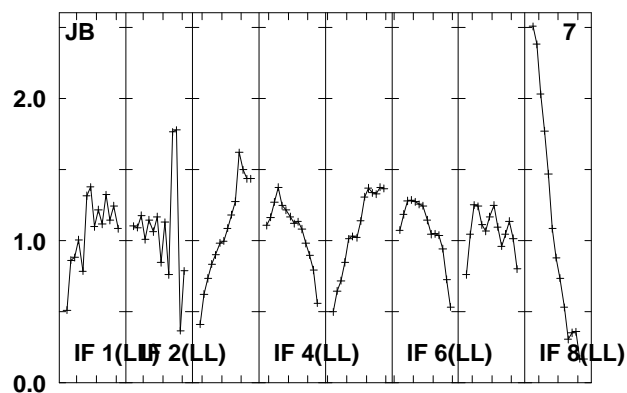
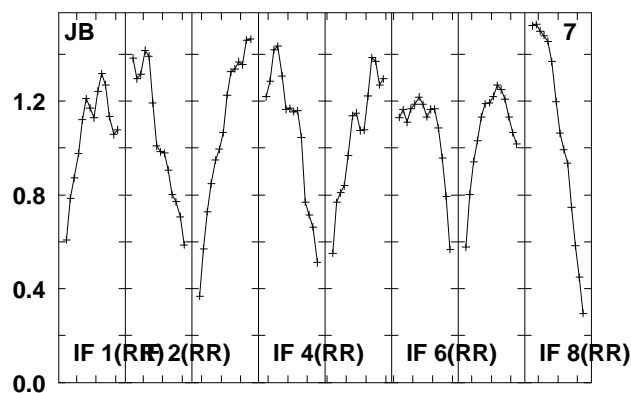
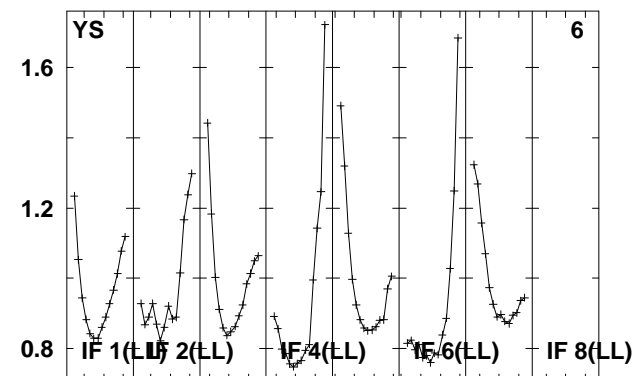
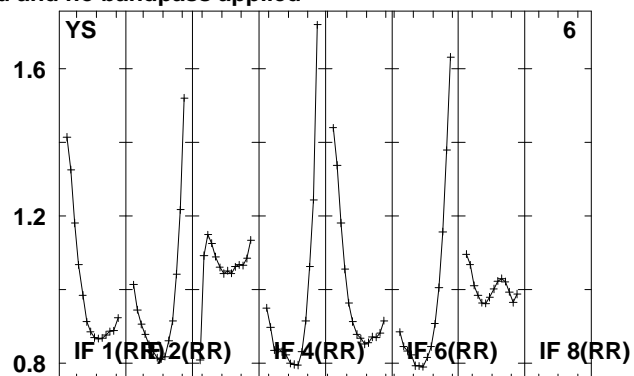
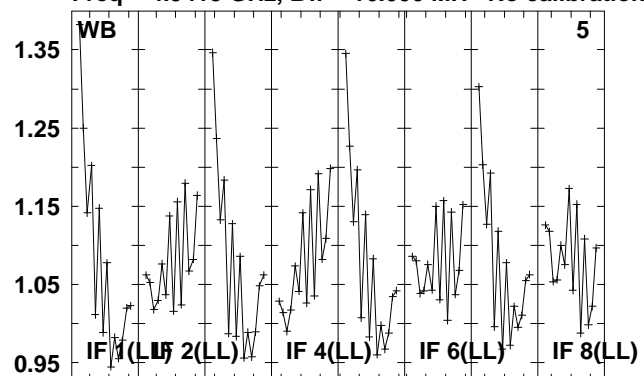

Lower frame: Real Jy

Total-power spectrum Antenna: *

Timerange: 00/15:18:36 to 00/15:20:34

Plot file version 122 created 08-JUL-2010 13:10:02

B1002+55 EM079.UVDATA.1

Freq = 4.9415 GHz, Bw = 16.000 MH No calibration applied and no bandpass applied

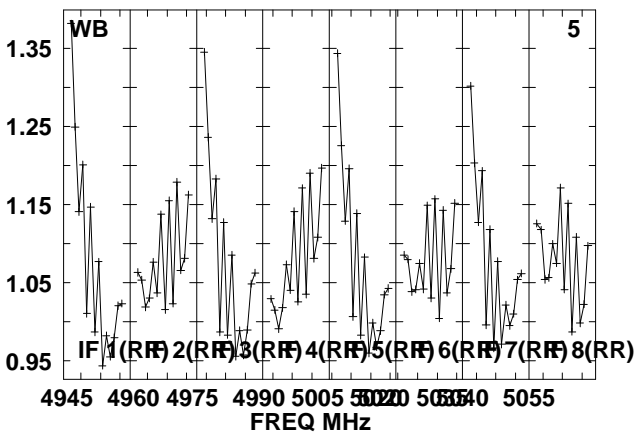
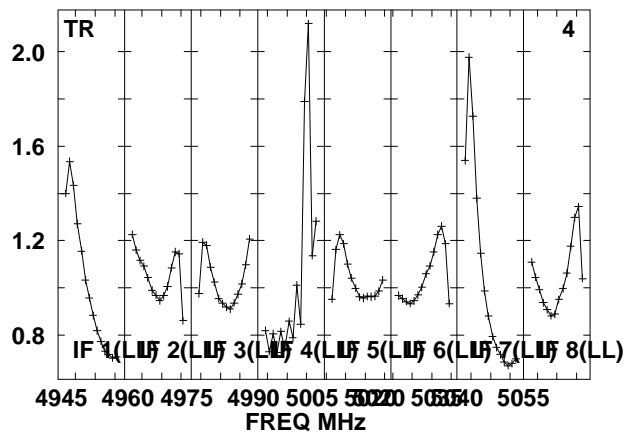
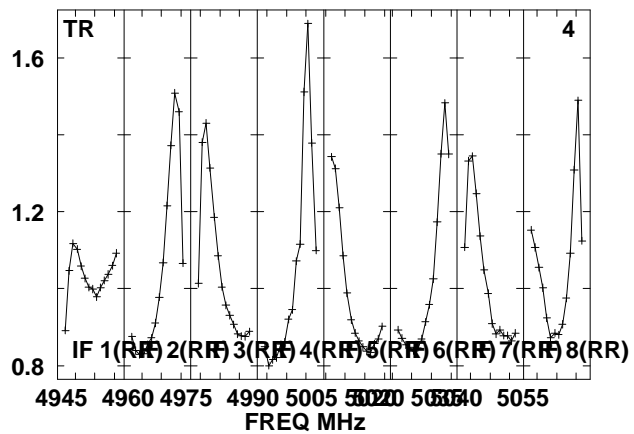
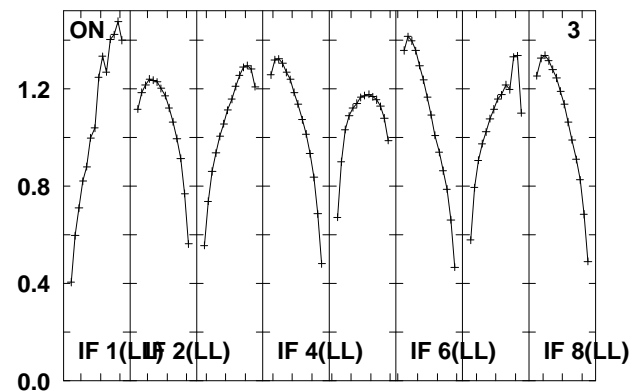
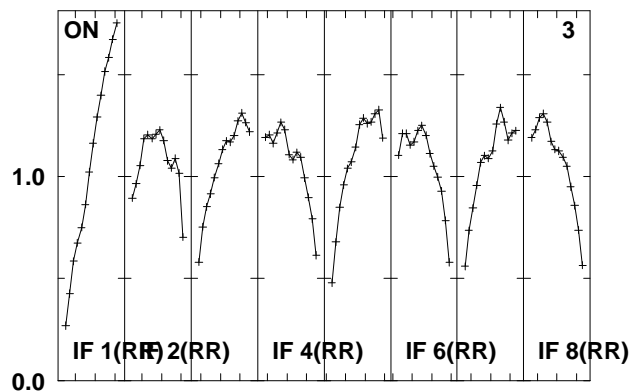
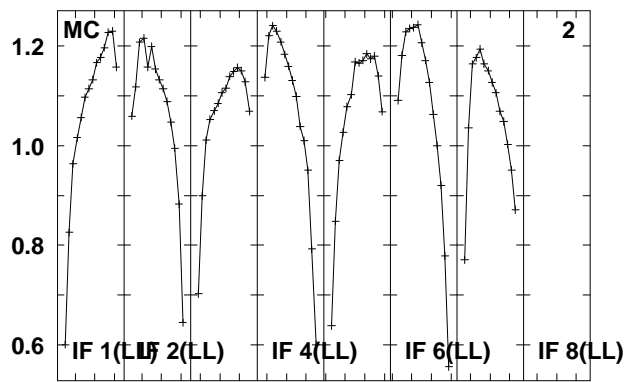
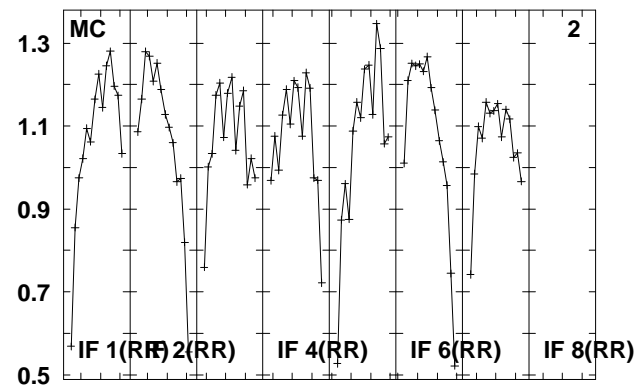
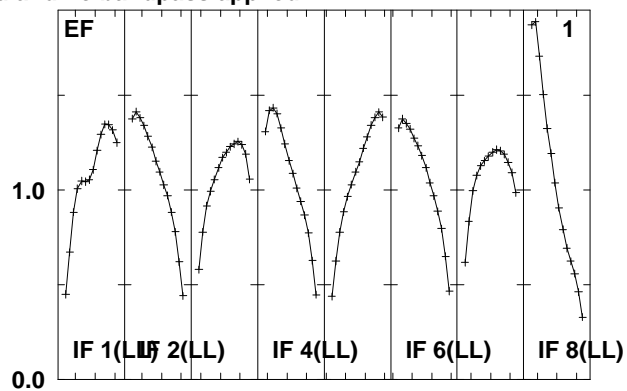
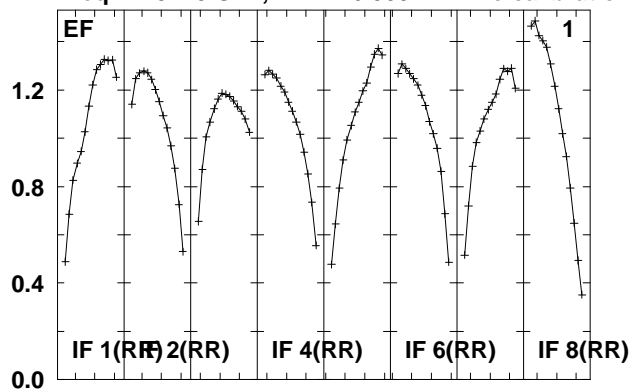

Lower frame: Real Jy
Total-power spectrum Antenna: *
Timerange: 00/15:20:36 to 00/15:31:34

Plot file version 123 created 08-JUL-2010 13:10:03

B1002+55 EM079.UVDATA.1

Freq = 4.9415 GHz, Bw = 16.000 MH No calibration applied and no bandpass applied

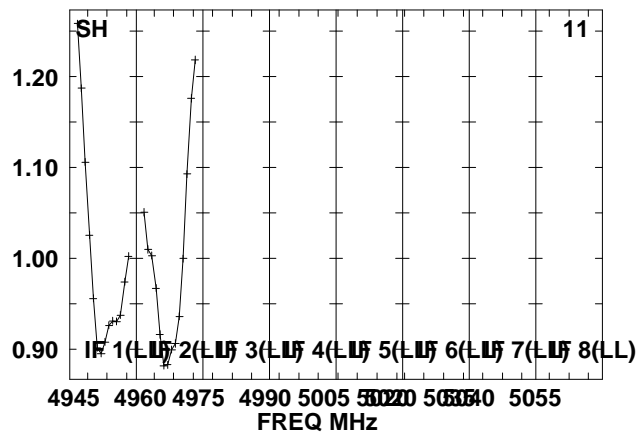
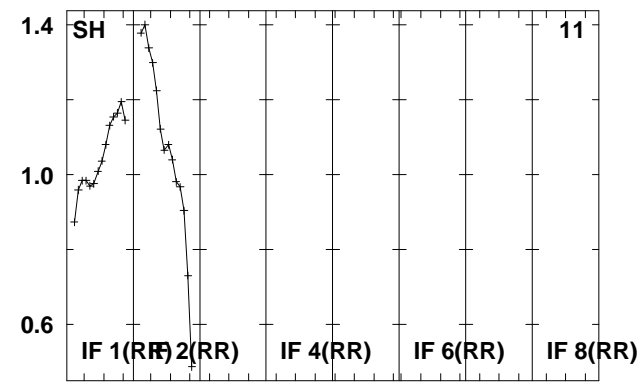
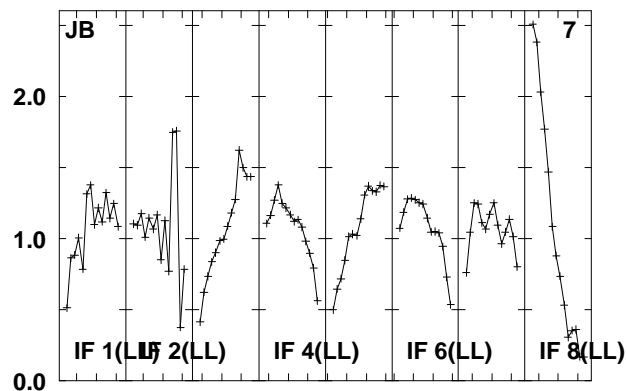
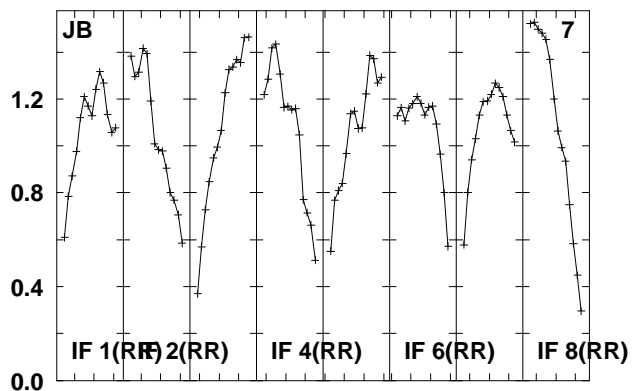
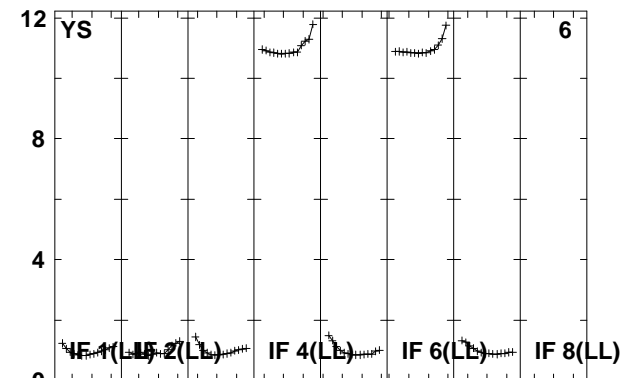
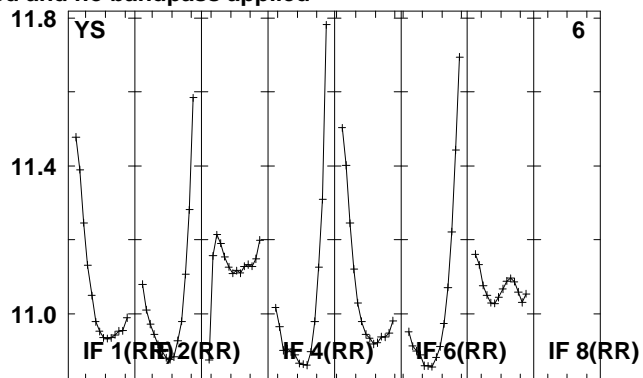
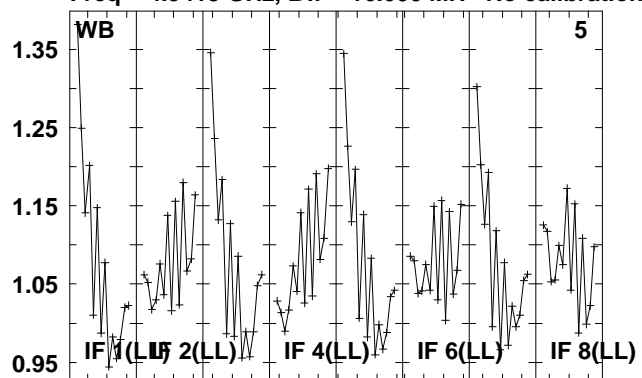

Lower frame: Real Jy

Total-power spectrum Antenna: *

Timerange: 00/15:20:36 to 00/15:31:34

Plot file version 124 created 08-JUL-2010 13:10:05

J0957+55 EM079.UVDATA.1

Freq = 4.9415 GHz, Bw = 16.000 MH No calibration applied and no bandpass applied

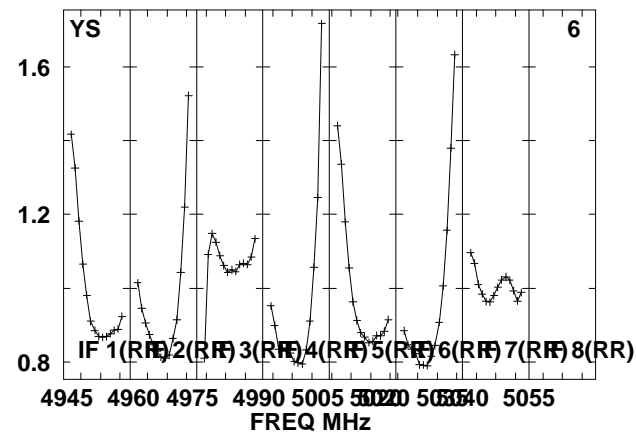
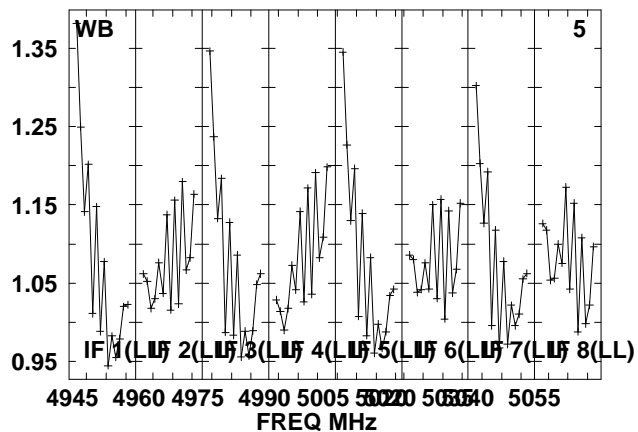
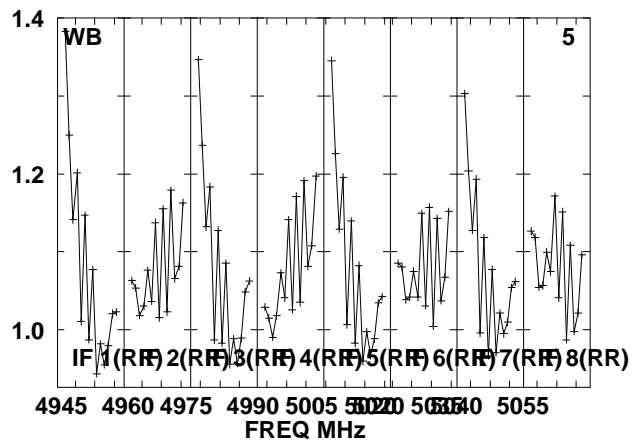
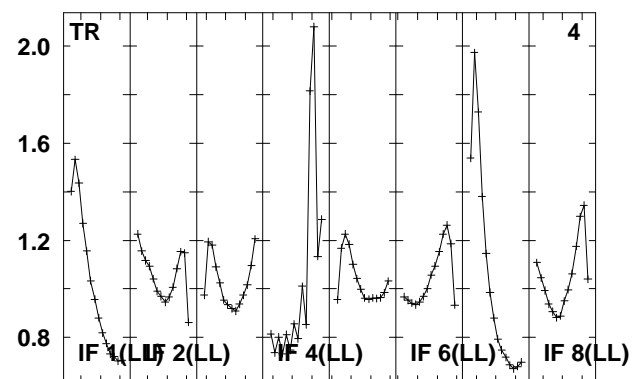
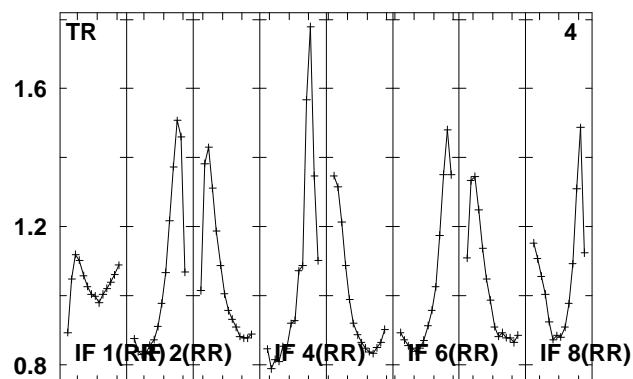
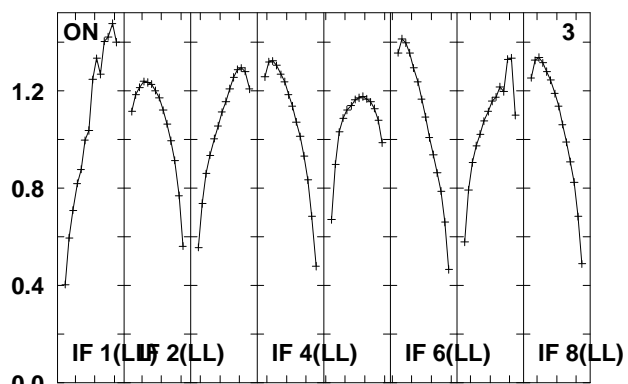
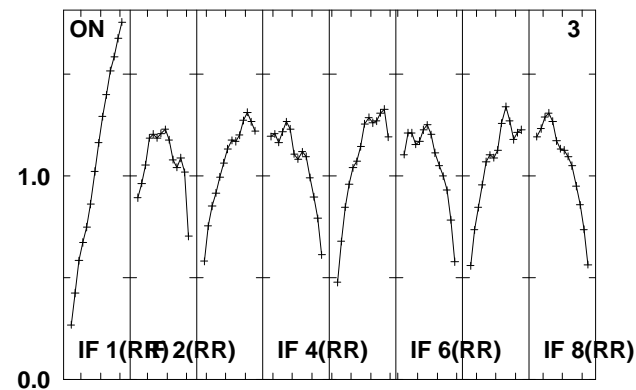
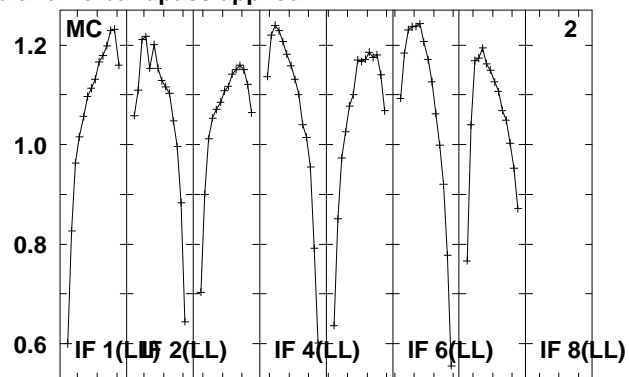
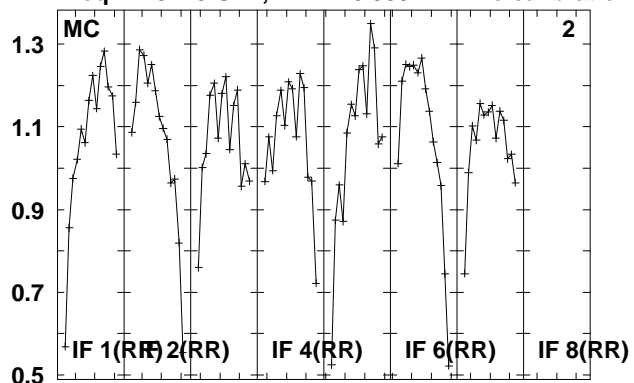

Lower frame: Real Jy

Total-power spectrum Antenna: *

Timerange: 00/15:31:36 to 00/15:33:34

Plot file version 125 created 08-JUL-2010 13:10:06

J0957+55 EM079.UVDATA.1

Freq = 4.9415 GHz, Bw = 16.000 MH No calibration applied and no bandpass applied

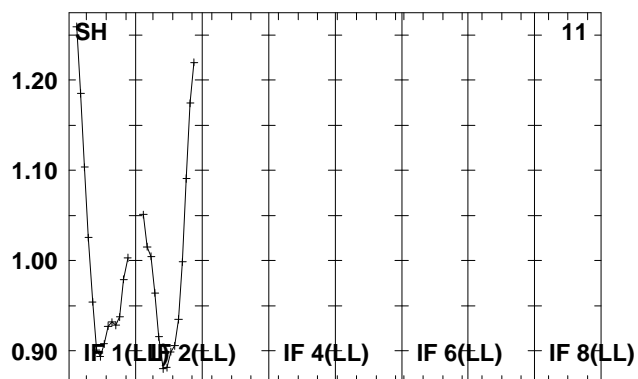
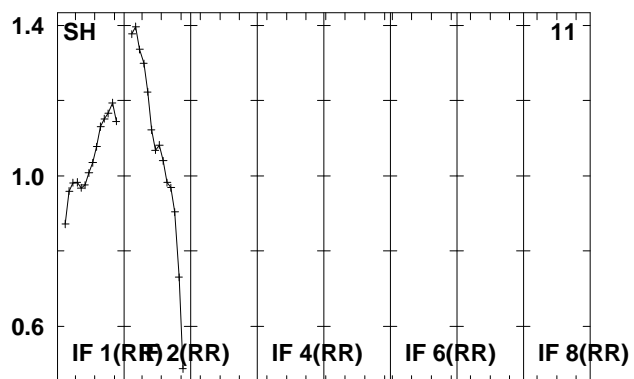
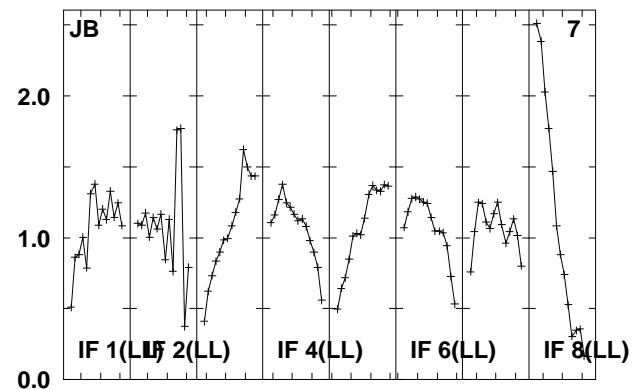
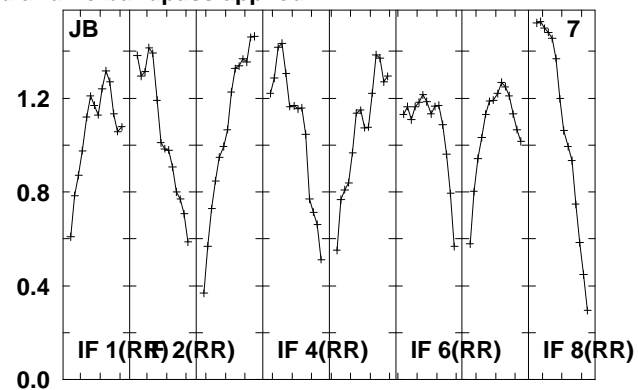
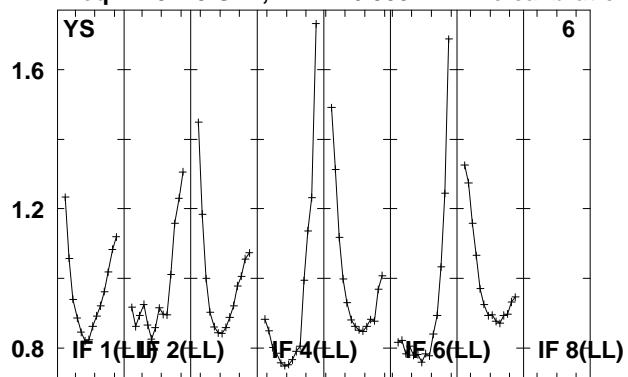

Lower frame: Real Jy
Total-power spectrum Antenna: *
Timerange: 00/15:31:36 to 00/15:33:34

Plot file version 126 created 08-JUL-2010 13:10:07

B1002+55 EM079.UVDATA.1

Freq = 4.9415 GHz, Bw = 16.000 MH No calibration applied and no bandpass applied

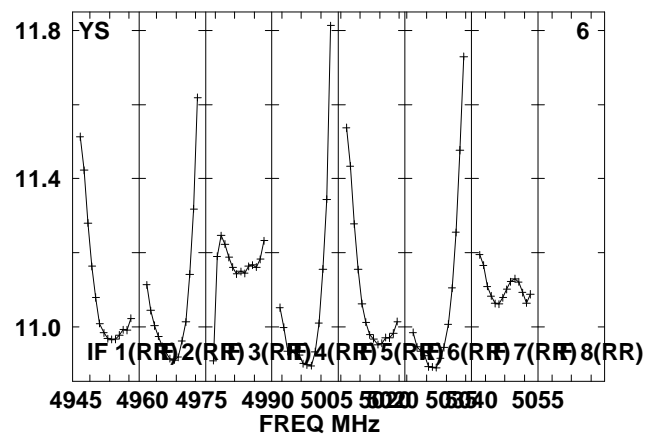
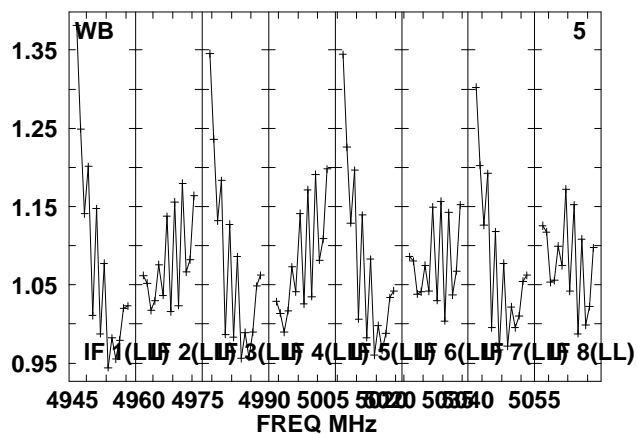
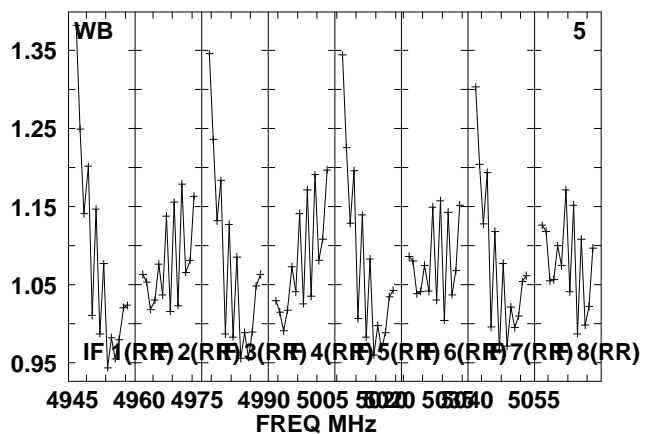
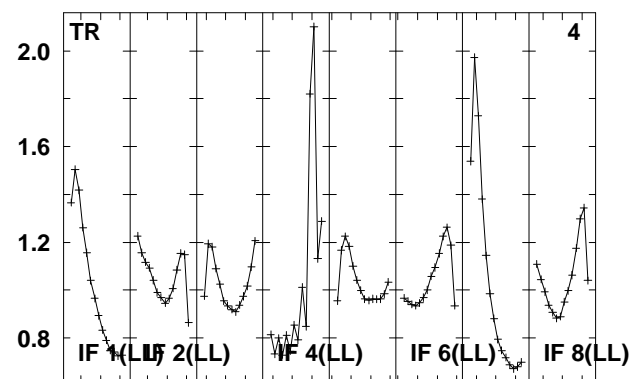
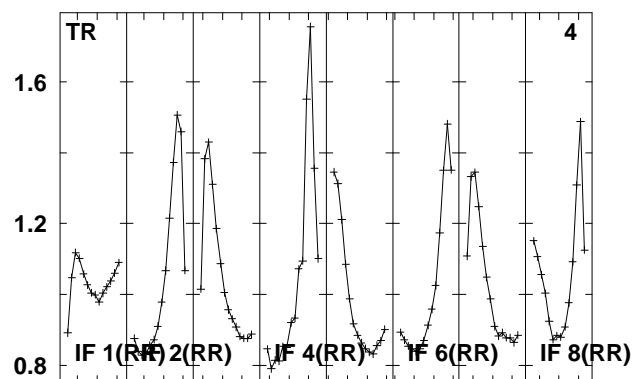
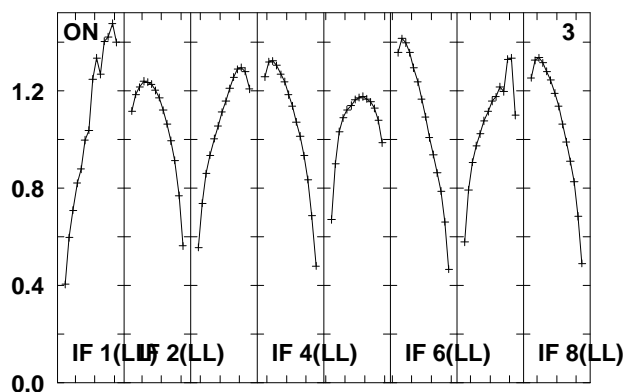
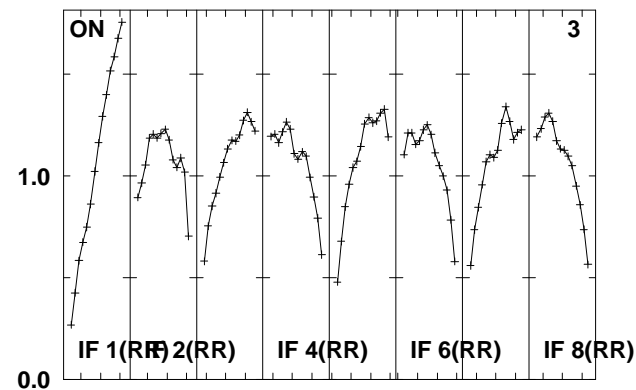
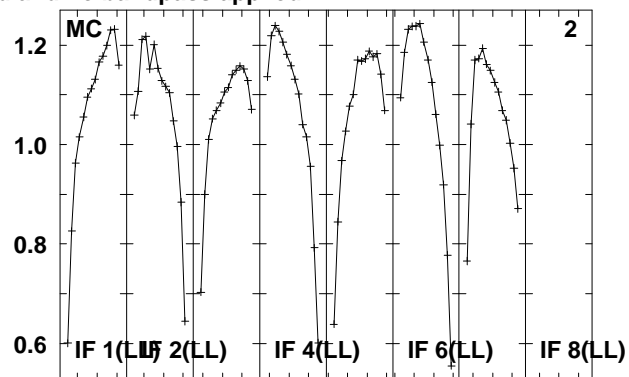
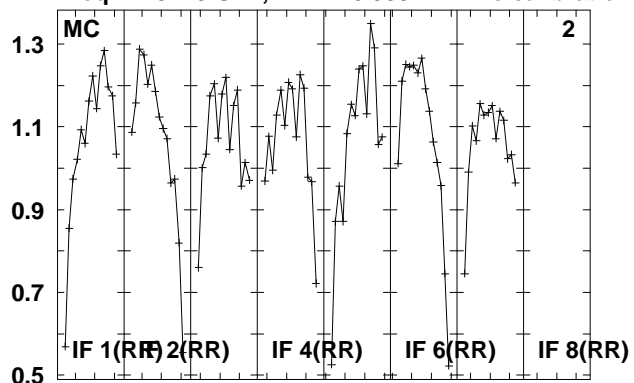

Lower frame: Real Jy
Total-power spectrum Antenna: *
Timerange: 00/15:33:36 to 00/15:44:34

Plot file version 127 created 08-JUL-2010 13:10:08

B1002+55 EM079.UVDATA.1

Freq = 4.9415 GHz, Bw = 16.000 MH No calibration applied and no bandpass applied

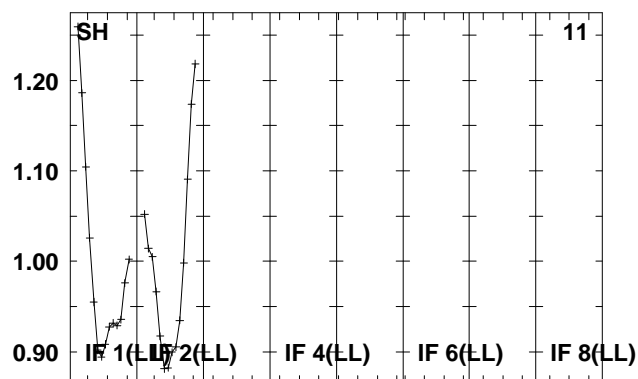
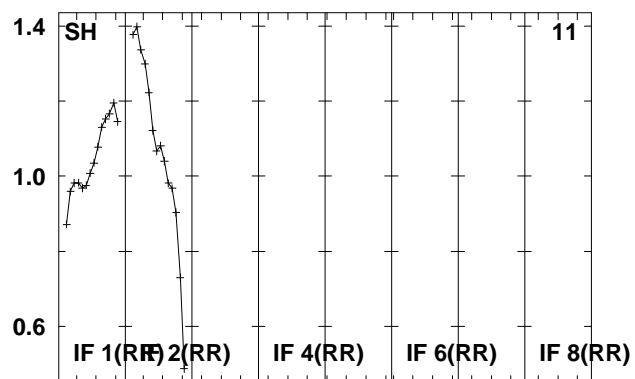
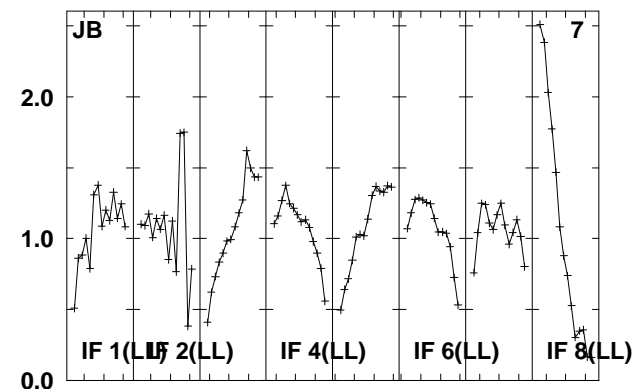
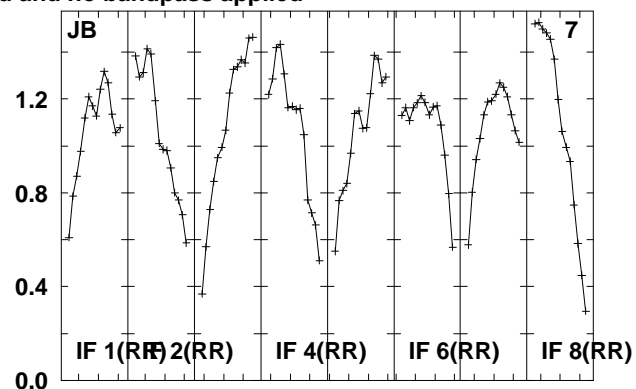
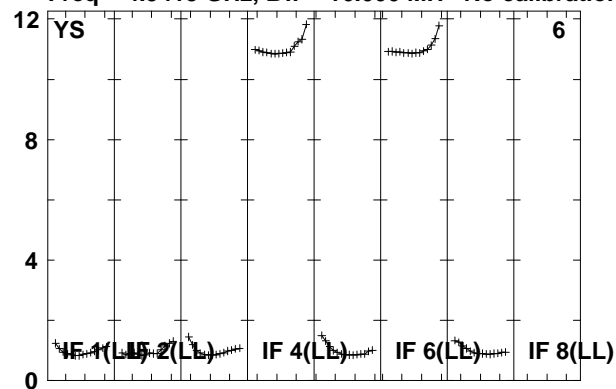

Lower frame: Real Jy
Total-power spectrum Antenna: *
Timerange: 00/15:33:36 to 00/15:44:34

Plot file version 128 created 08-JUL-2010 13:10:09

J0957+55 EM079.UVDATA.1

Freq = 4.9415 GHz, Bw = 16.000 MH No calibration applied and no bandpass applied

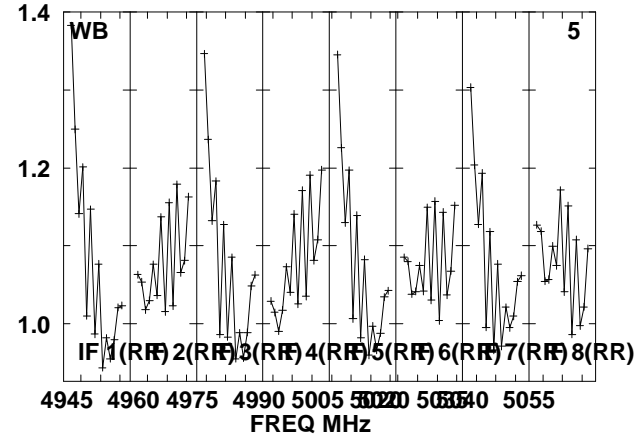
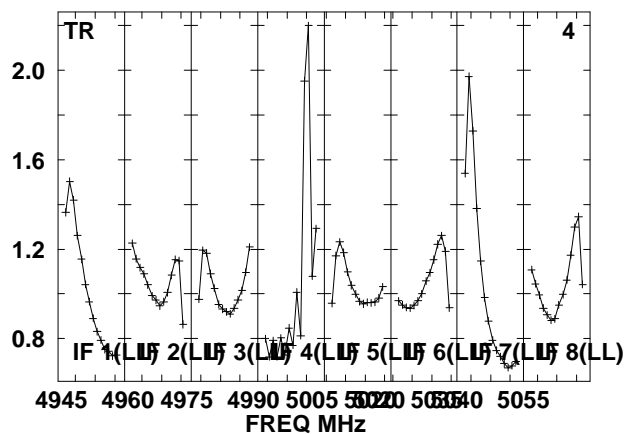
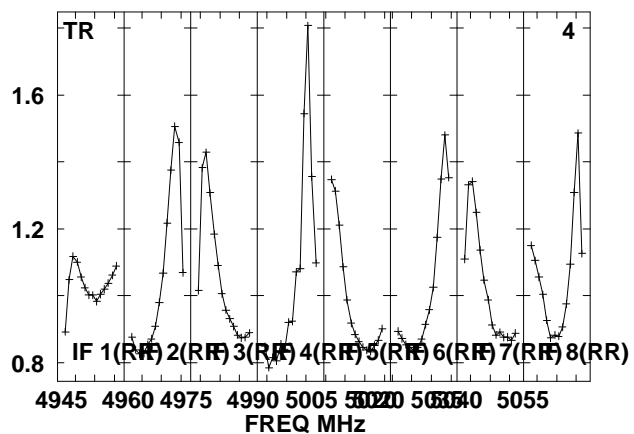
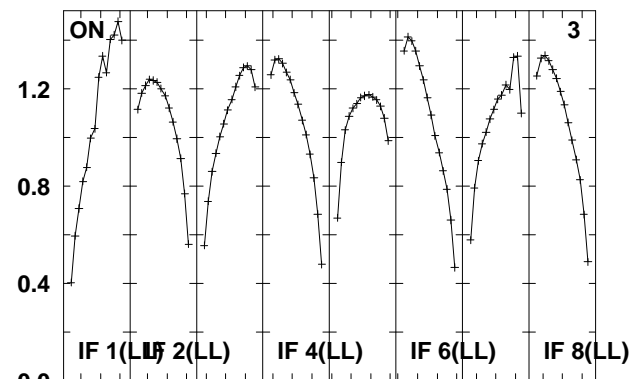
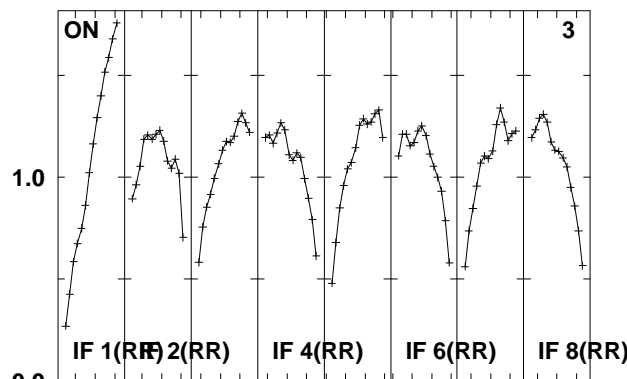
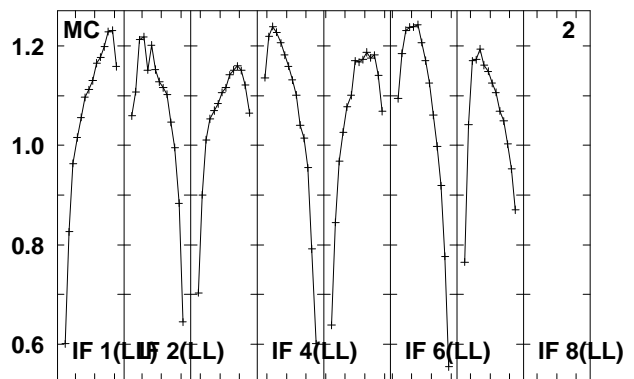
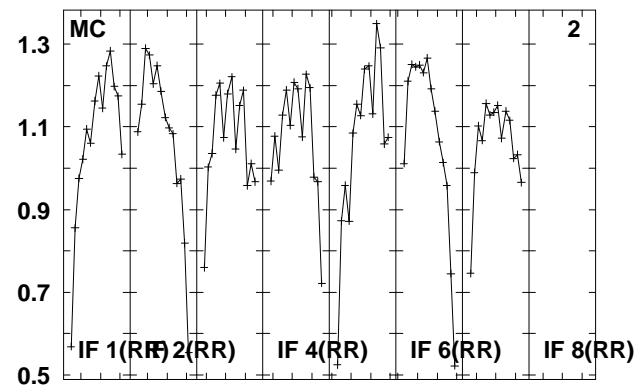
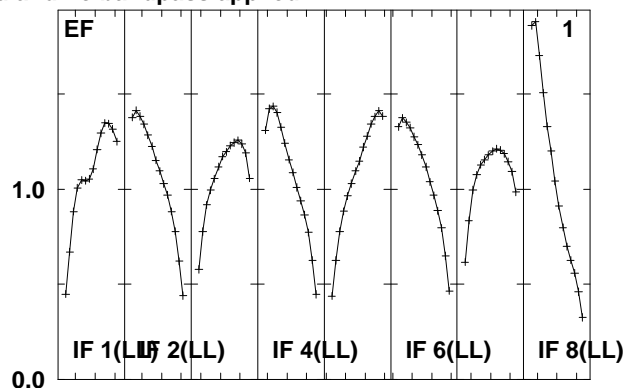
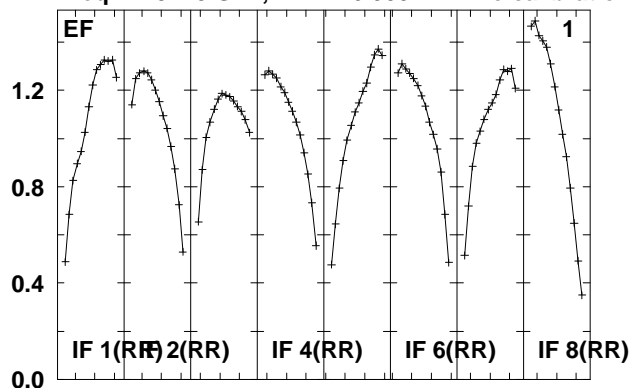

Lower frame: Real Jy
Total-power spectrum Antenna: *
Timerange: 00/15:44:36 to 00/15:46:34

Plot file version 129 created 08-JUL-2010 13:10:10

J0957+55 EM079.UVDATA.1

Freq = 4.9415 GHz, Bw = 16.000 MH No calibration applied and no bandpass applied

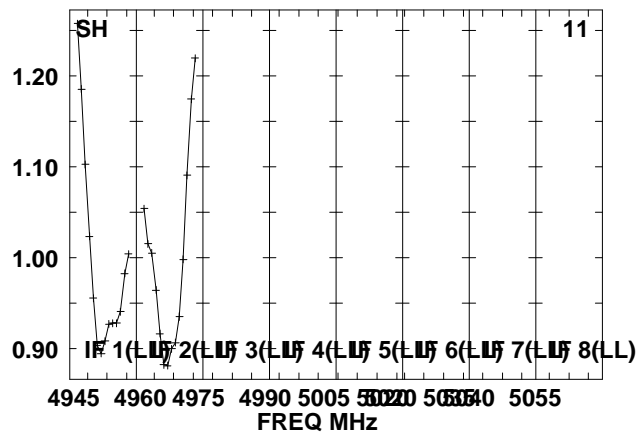
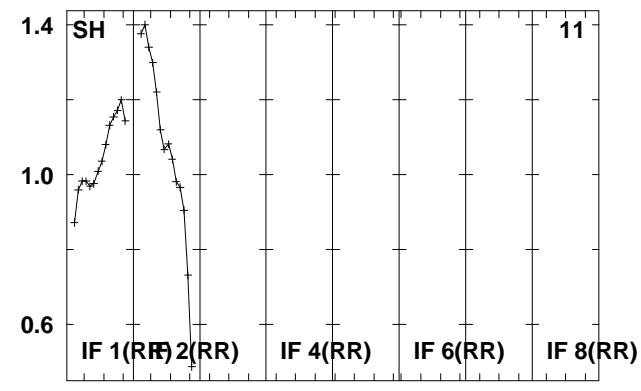
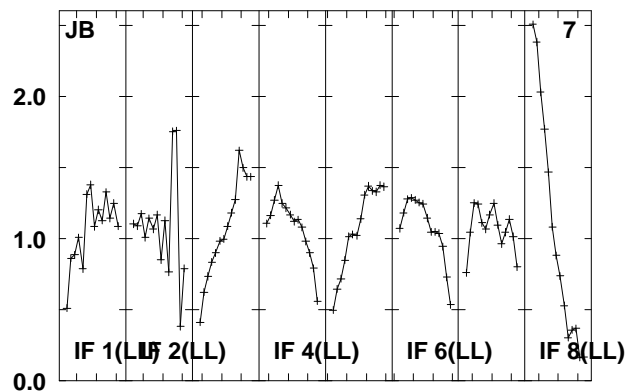
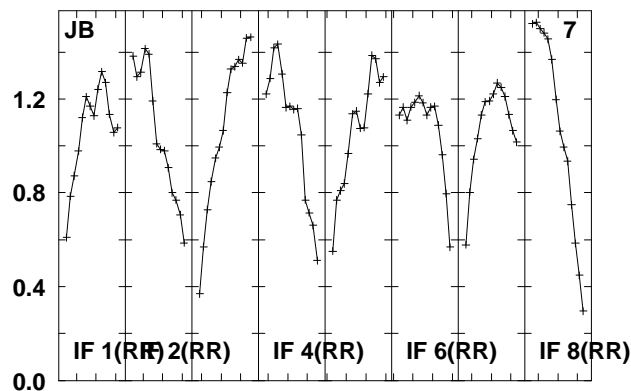
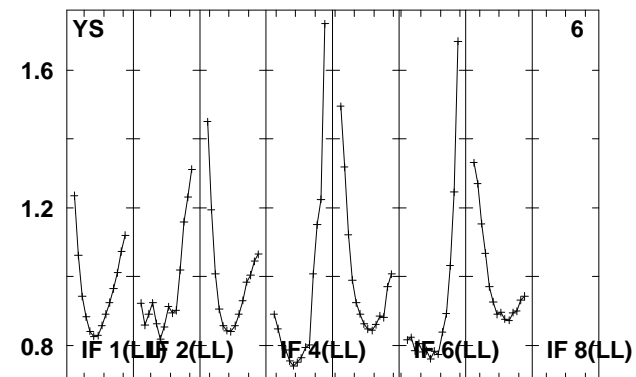
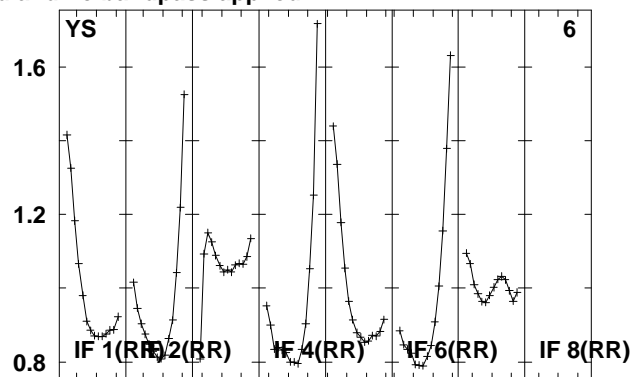
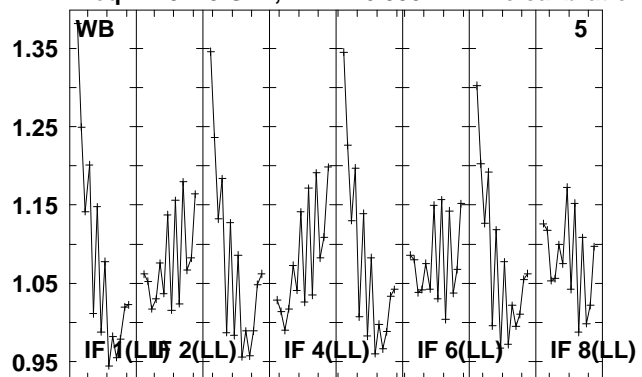

4945 4960 4975 4990 5005 5020 5035 5050 5055
FREQ MHz

Lower frame: Real Jy

Total-power spectrum Antenna: *

Timerange: 00/15:44:36 to 00/15:46:34

Plot file version 130 created 08-JUL-2010 13:10:11

B1002+55 EM079.UVDATA.1

Freq = 4.9415 GHz, Bw = 16.000 MH No calibration applied and no bandpass applied

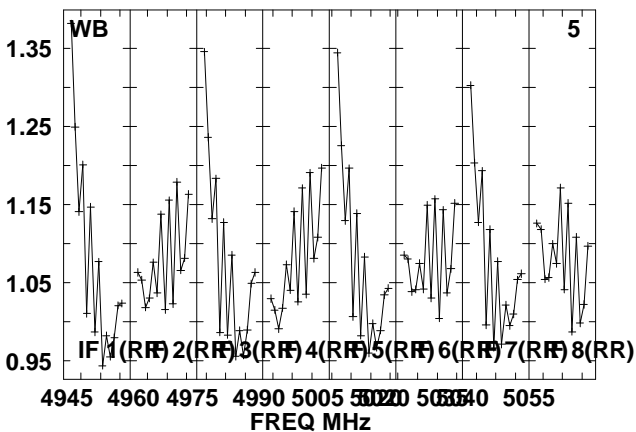
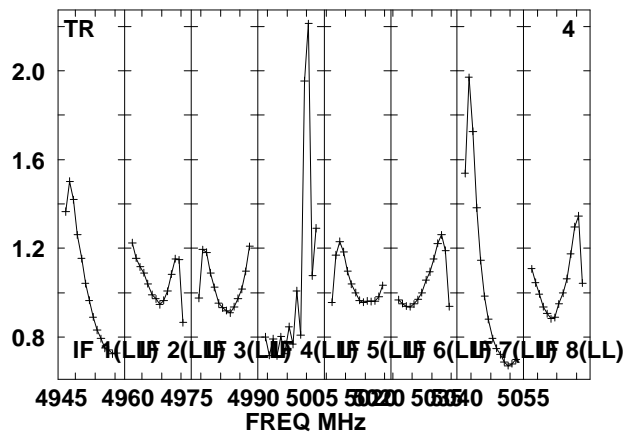
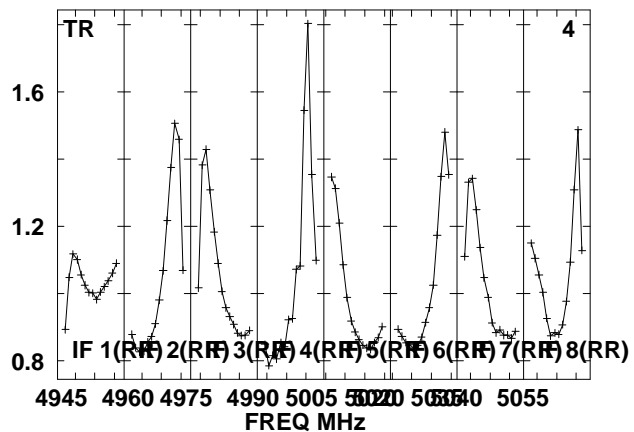
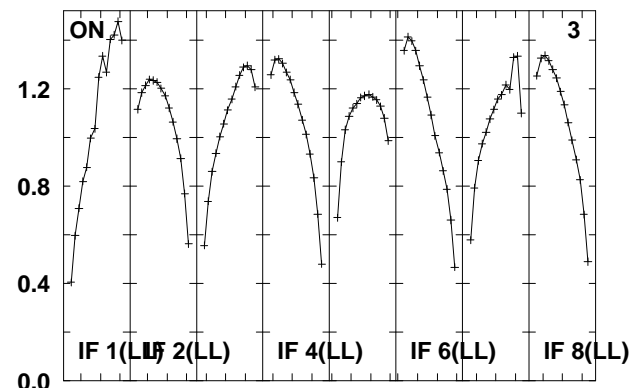
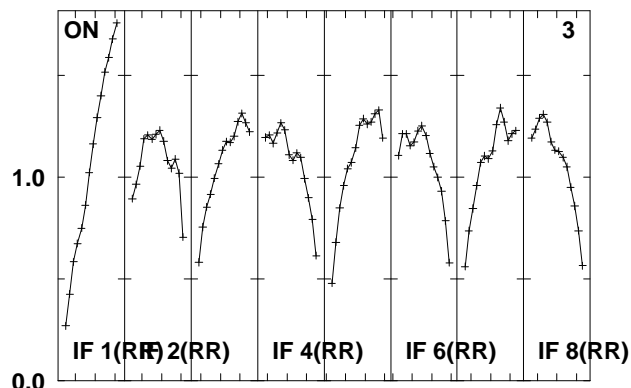
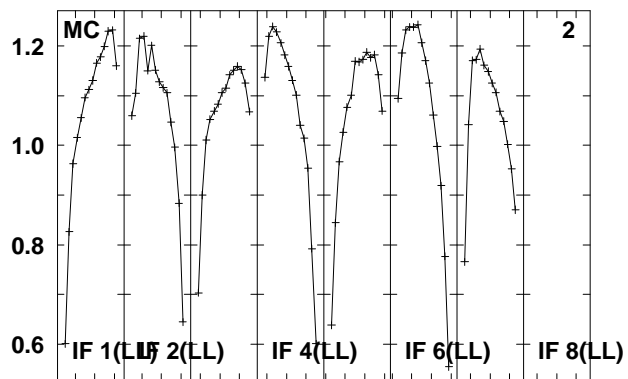
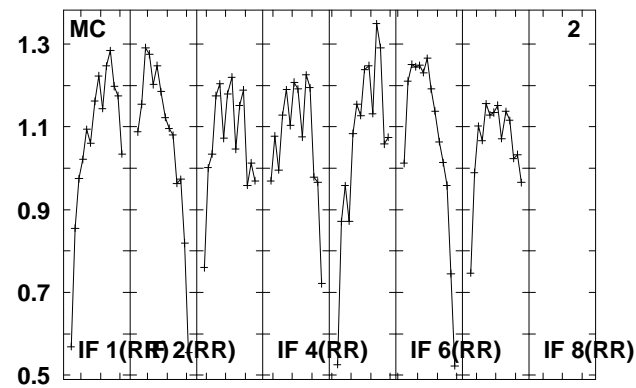
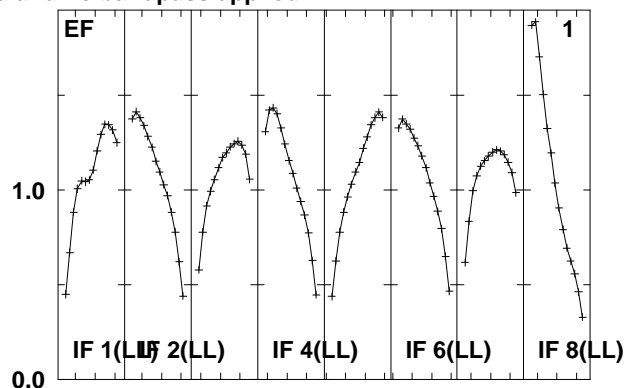
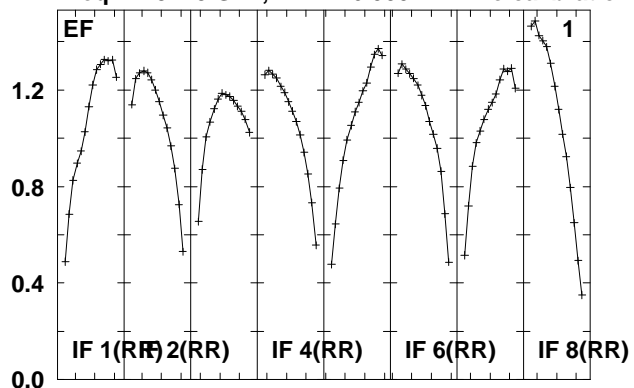

Lower frame: Real Jy
Total-power spectrum Antenna: *
Timerange: 00/15:46:36 to 00/15:57:34

Plot file version 131 created 08-JUL-2010 13:10:12

B1002+55 EM079.UVDATA.1

Freq = 4.9415 GHz, Bw = 16.000 MH No calibration applied and no bandpass applied

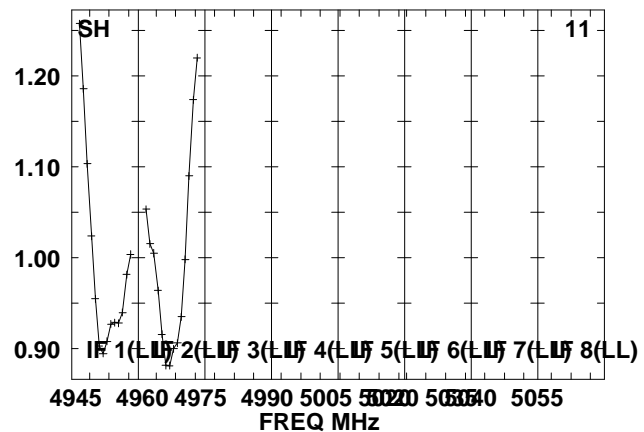
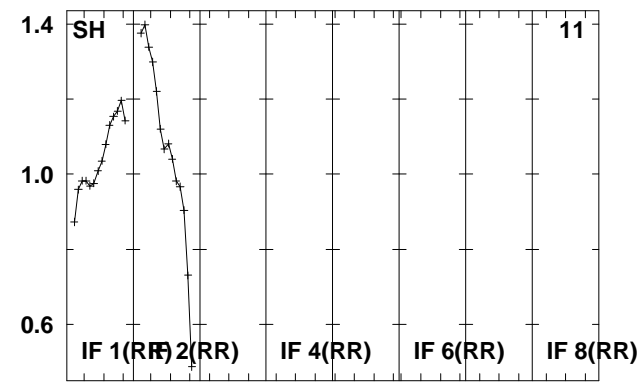
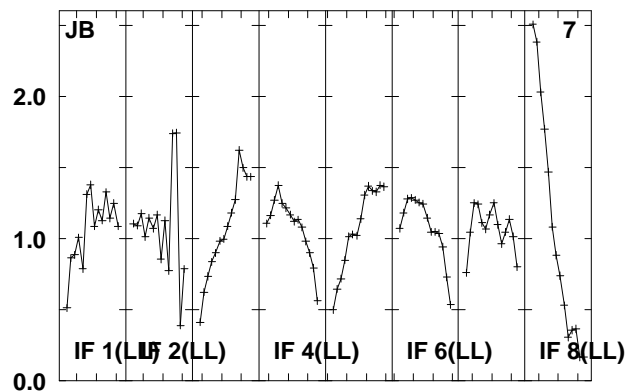
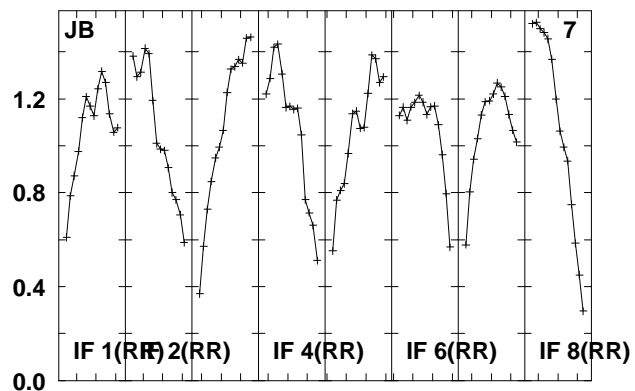
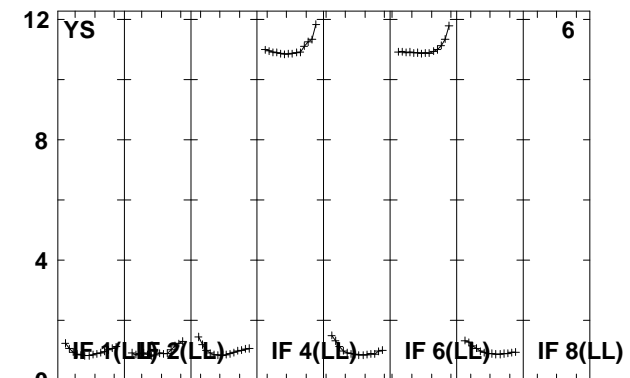
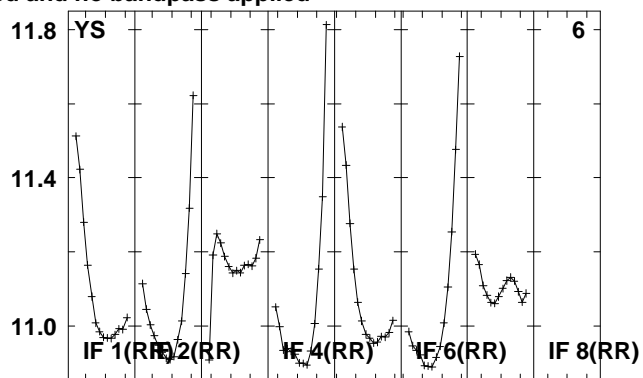
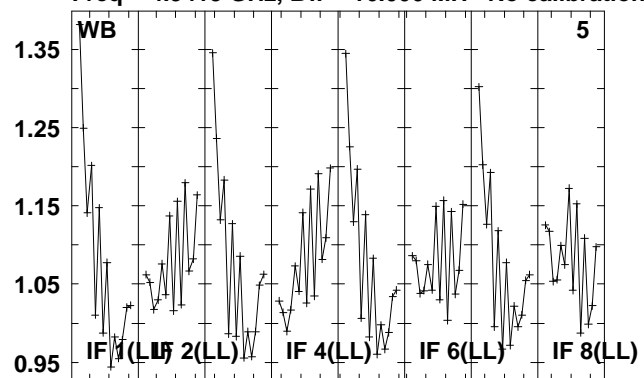

Lower frame: Real Jy

Total-power spectrum Antenna: *

Timerange: 00/15:46:36 to 00/15:57:34

Plot file version 132 created 08-JUL-2010 13:10:14

J0957+55 EM079.UVDATA.1

Freq = 4.9415 GHz, Bw = 16.000 MH No calibration applied and no bandpass applied

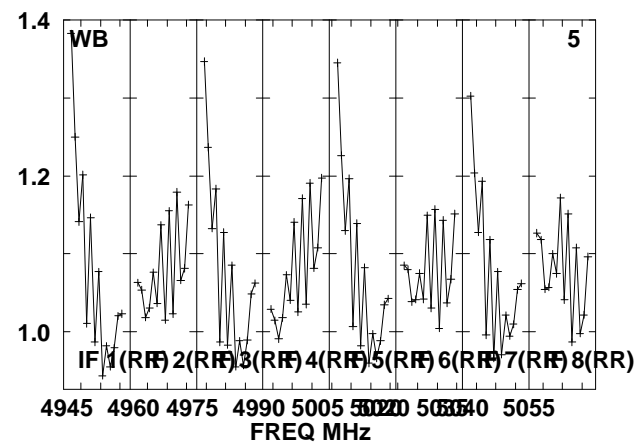
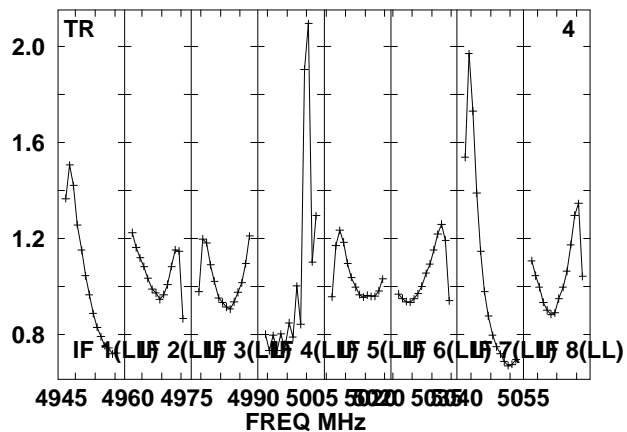
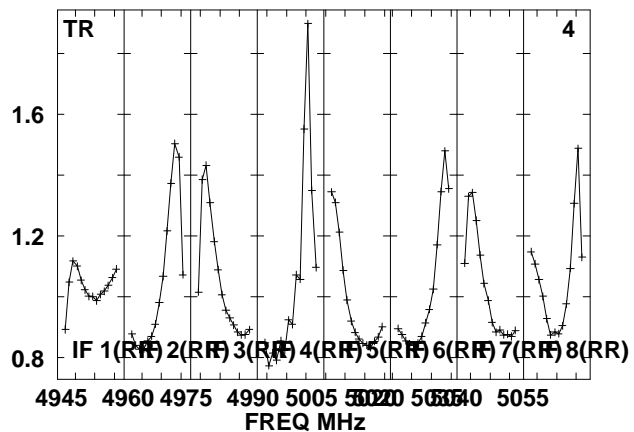
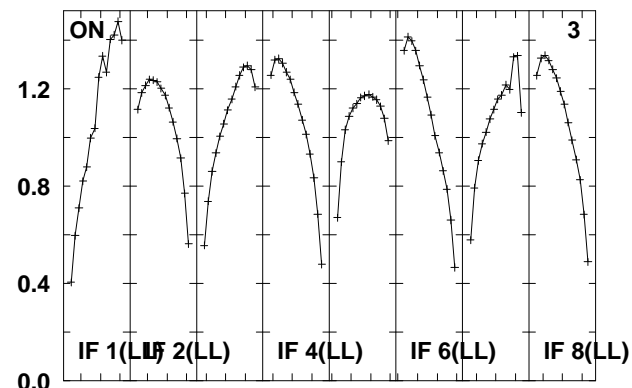
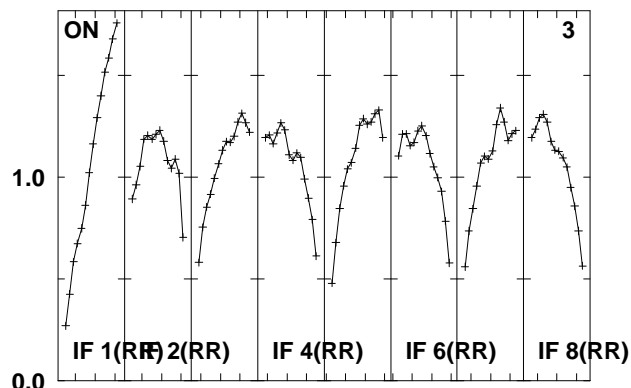
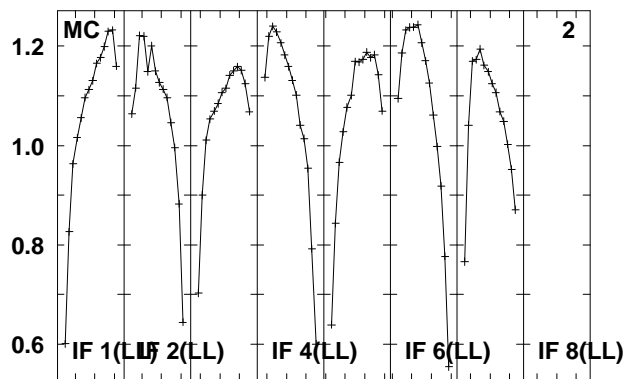
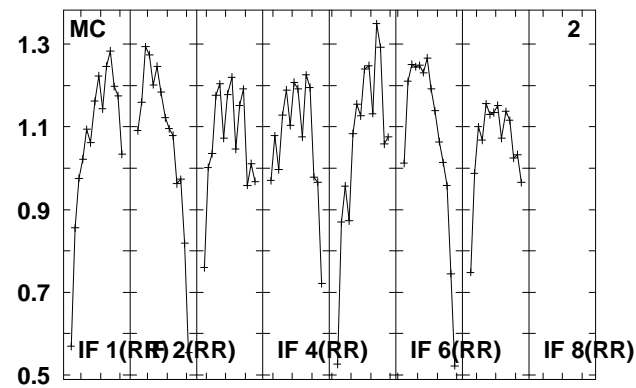
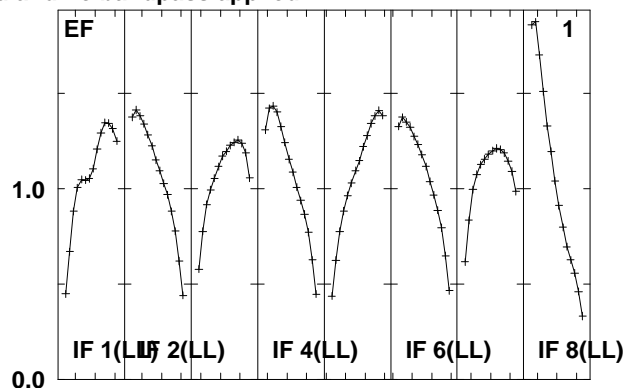
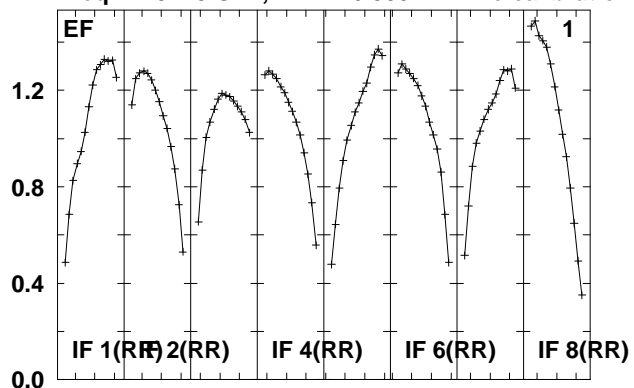

Lower frame: Real Jy
Total-power spectrum Antenna: *
Timerange: 00/15:57:36 to 00/15:59:34

Plot file version 133 created 08-JUL-2010 13:10:14

J0957+55 EM079.UVDATA.1

Freq = 4.9415 GHz, Bw = 16.000 MH No calibration applied and no bandpass applied

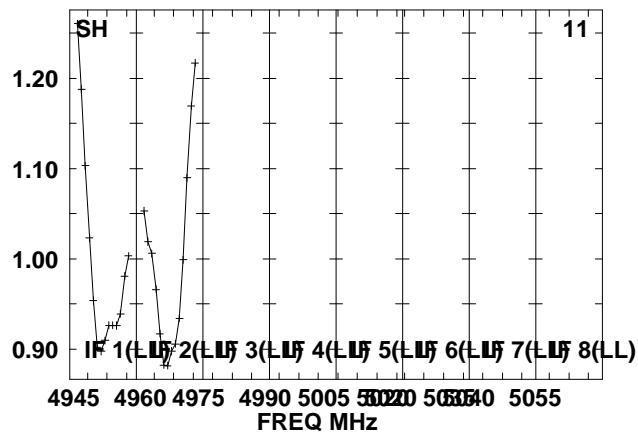
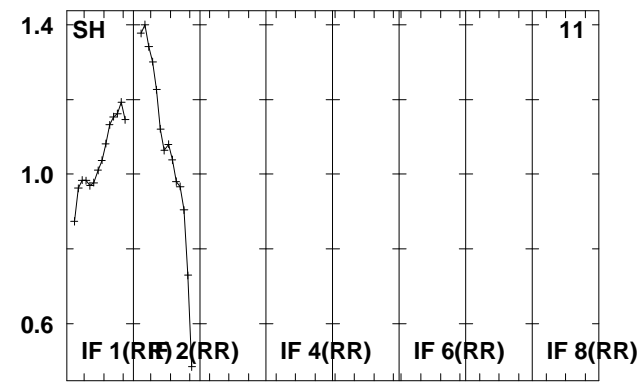
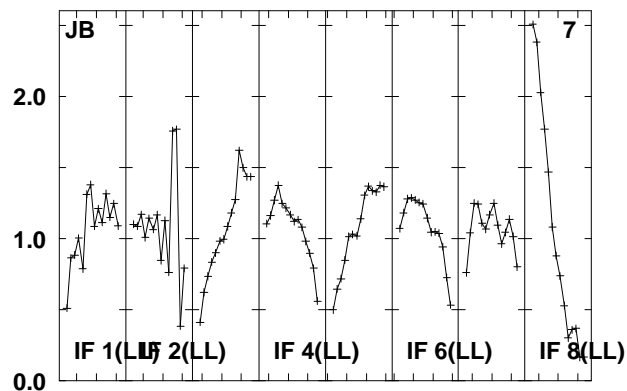
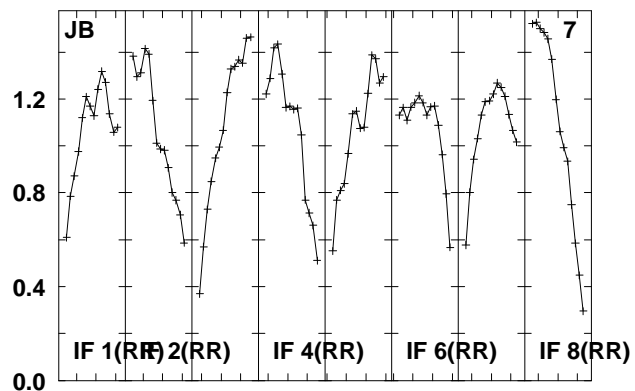
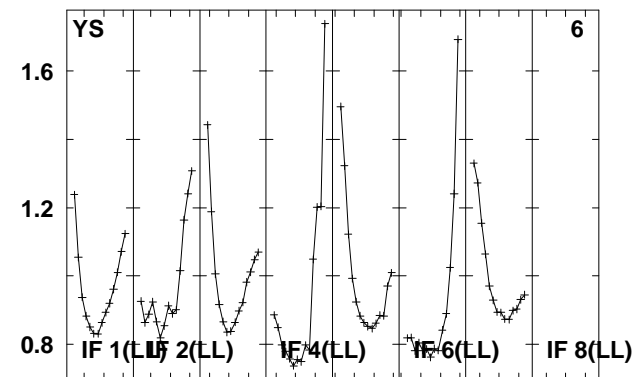
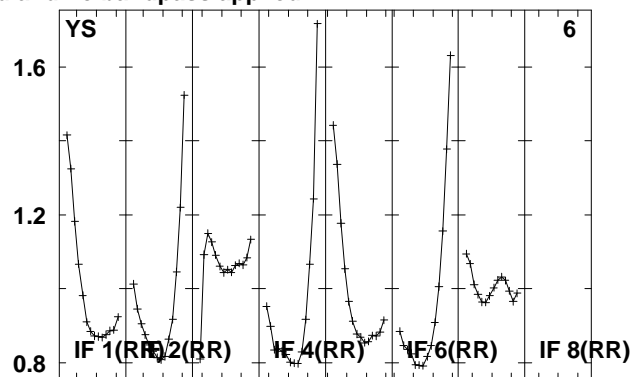
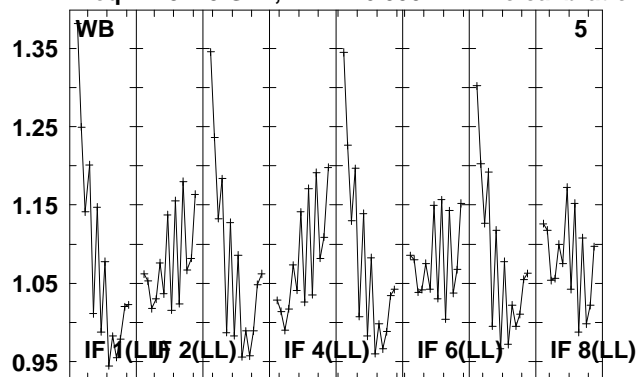

Lower frame: Real Jy

Total-power spectrum Antenna: *

Timerange: 00/15:57:36 to 00/15:59:34

Plot file version 134 created 08-JUL-2010 13:10:15

B1002+55 EM079.UVDATA.1

Freq = 4.9415 GHz, Bw = 16.000 MH No calibration applied and no bandpass applied

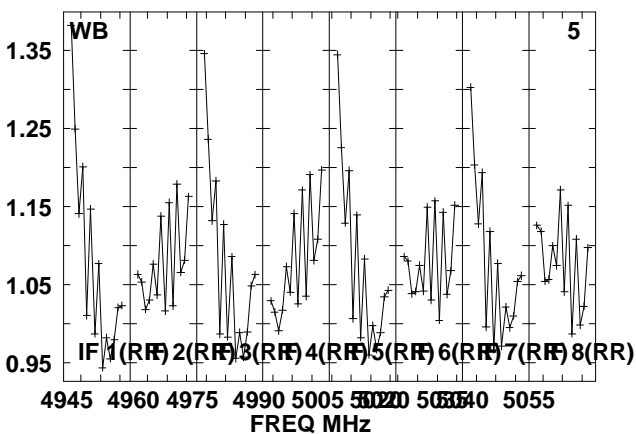
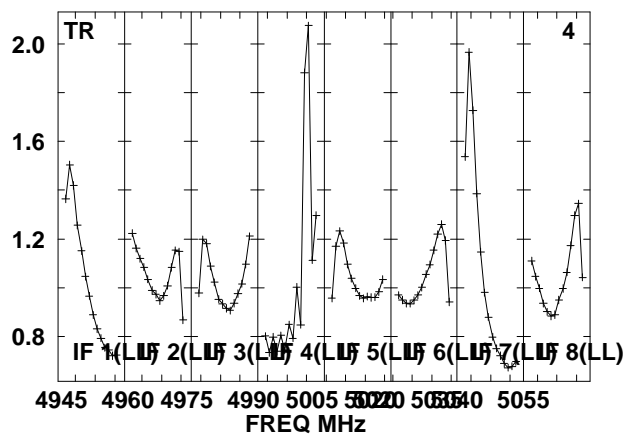
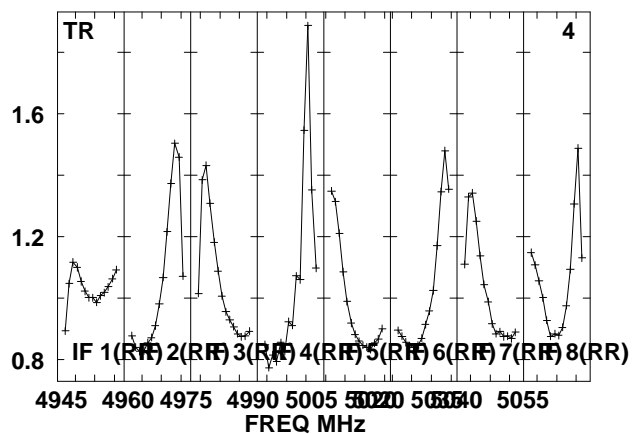
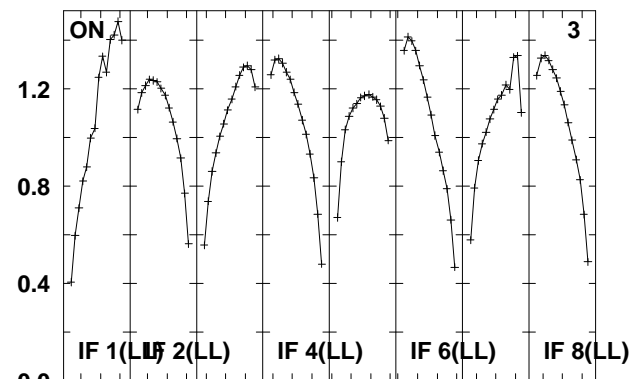
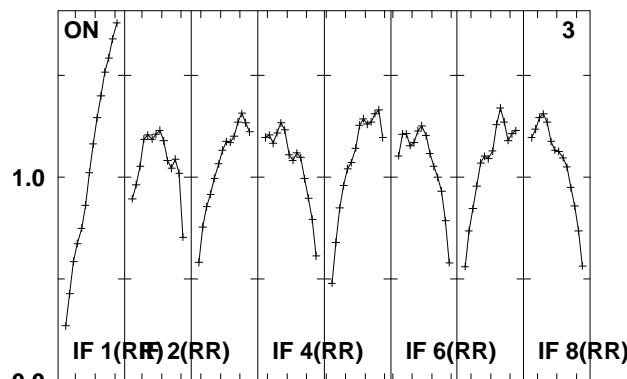
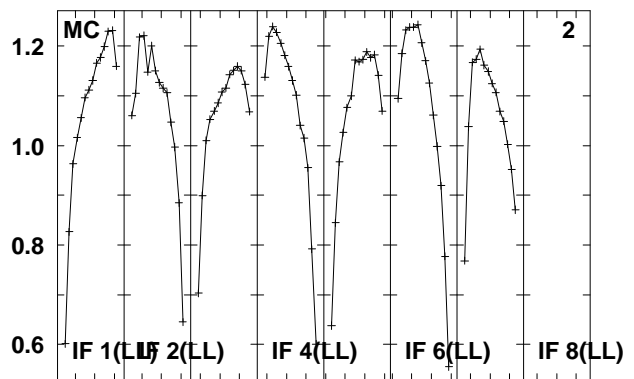
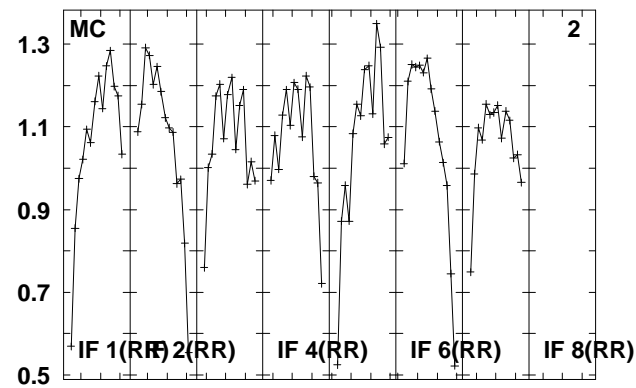
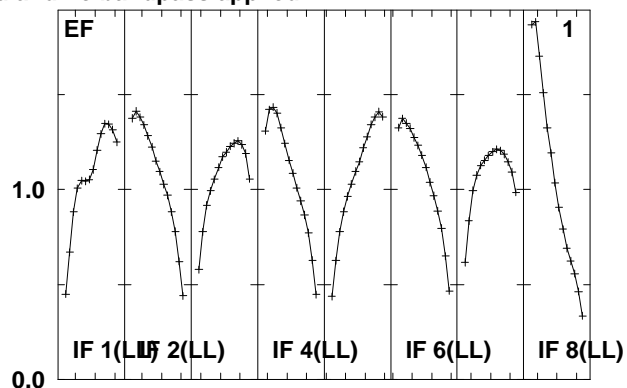
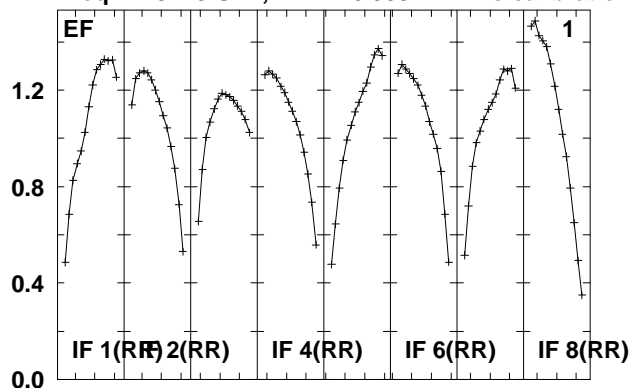

Lower frame: Real Jy
Total-power spectrum Antenna: *
Timerange: 00/15:59:36 to 00/16:10:34

Plot file version 135 created 08-JUL-2010 13:10:16

B1002+55 EM079.UVDATA.1

Freq = 4.9415 GHz, Bw = 16.000 MH No calibration applied and no bandpass applied

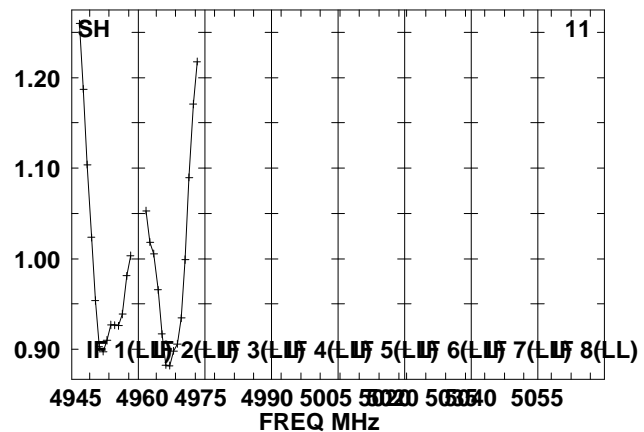
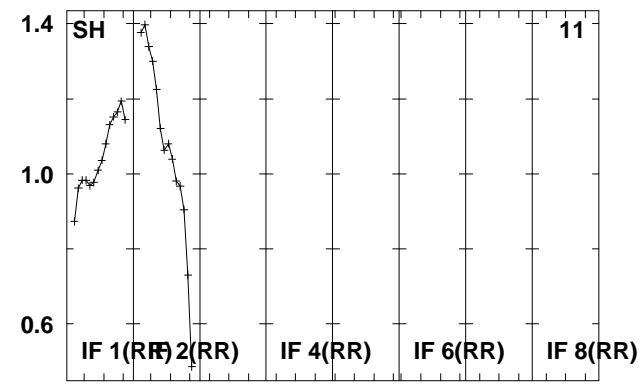
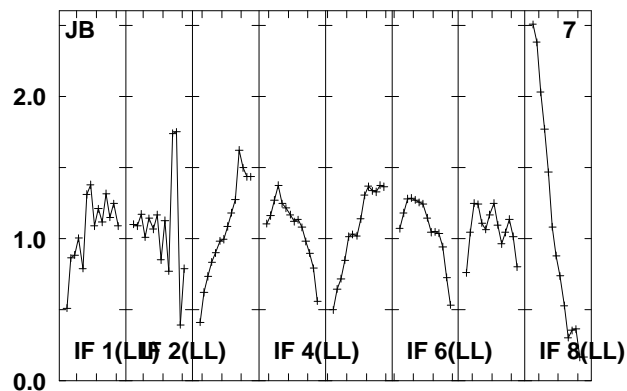
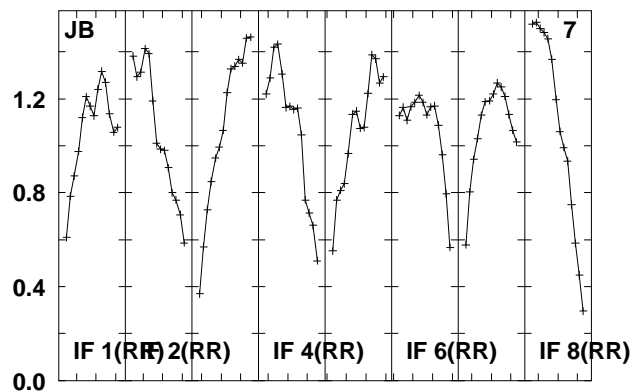
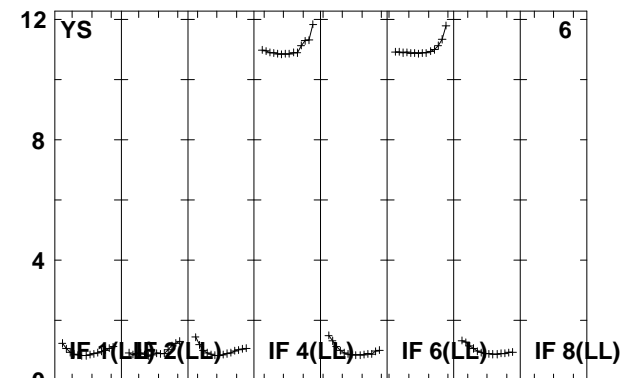
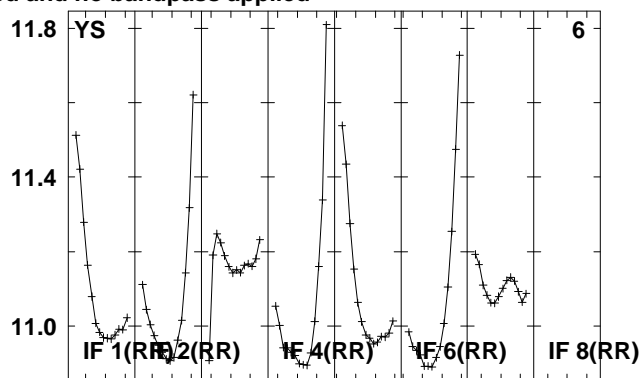
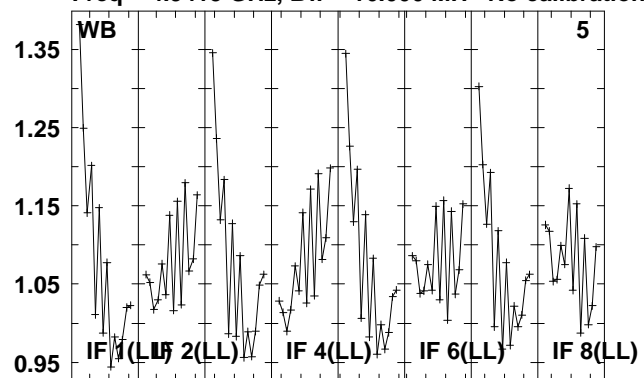

4945 4960 4975 4990 5005 5020 5035 5050 5055
FREQ MHz

Lower frame: Real Jy

Total-power spectrum Antenna: *

Timerange: 00/15:59:36 to 00/16:10:34

Plot file version 136 created 08-JUL-2010 13:10:18

J0957+55 EM079.UVDATA.1

Freq = 4.9415 GHz, Bw = 16.000 MH No calibration applied and no bandpass applied

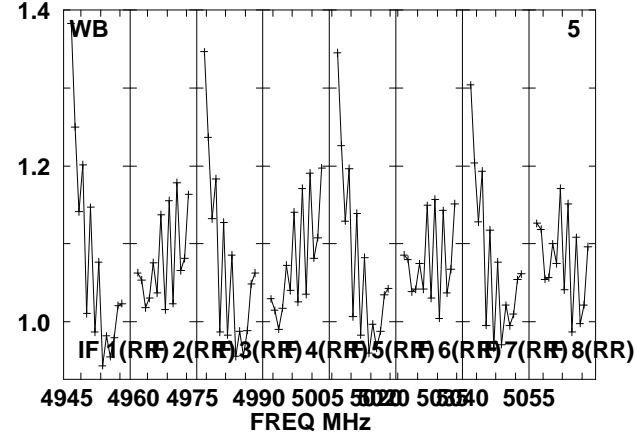
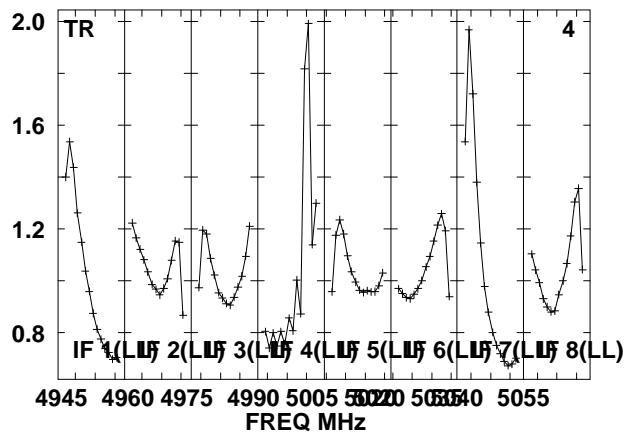
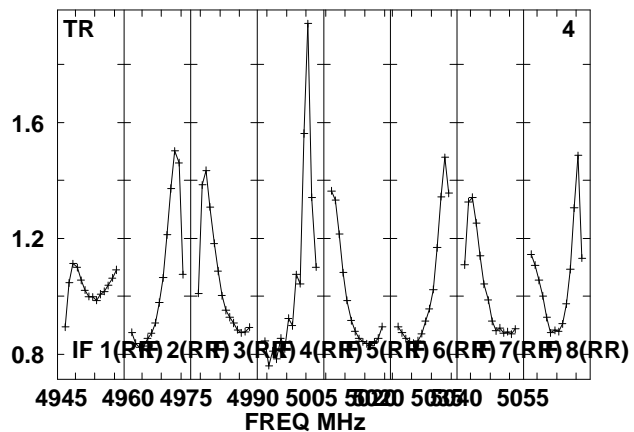
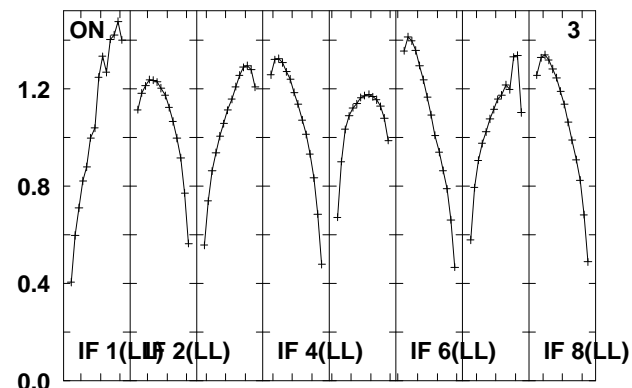
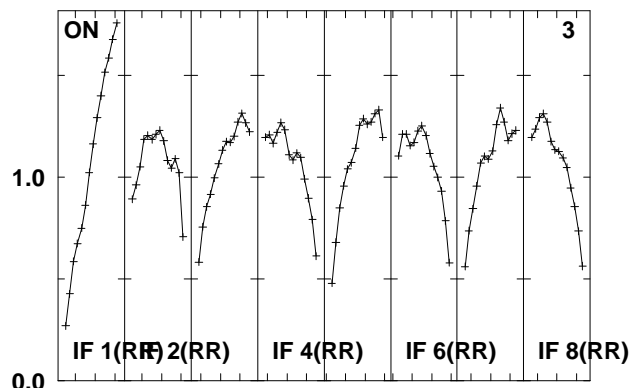
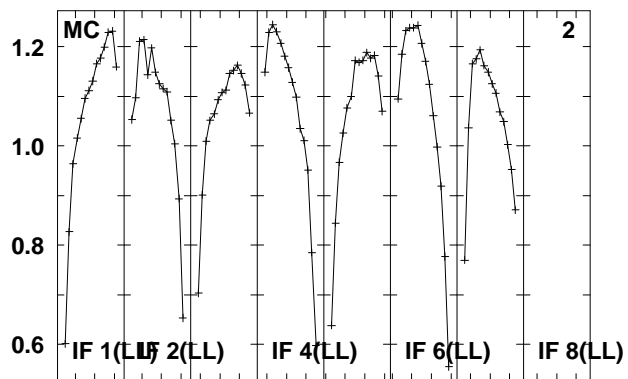
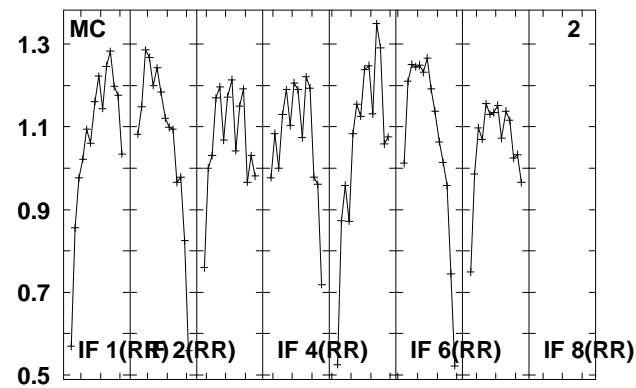
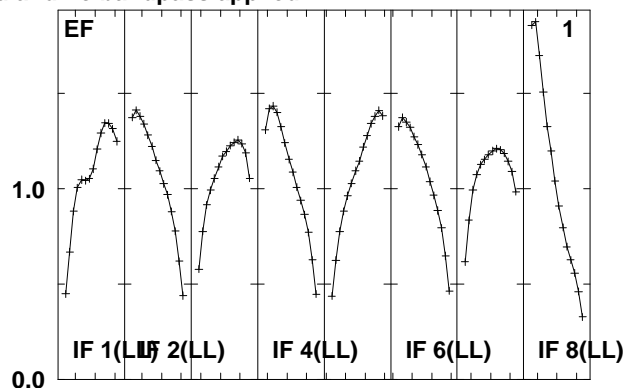
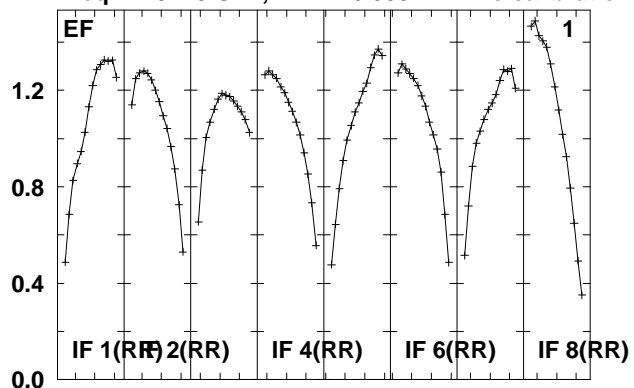

Lower frame: Real Jy
Total-power spectrum Antenna: *
Timerange: 00/16:10:36 to 00/16:12:34

Plot file version 137 created 08-JUL-2010 13:10:18

J0957+55 EM079.UVDATA.1

Freq = 4.9415 GHz, Bw = 16.000 MH No calibration applied and no bandpass applied

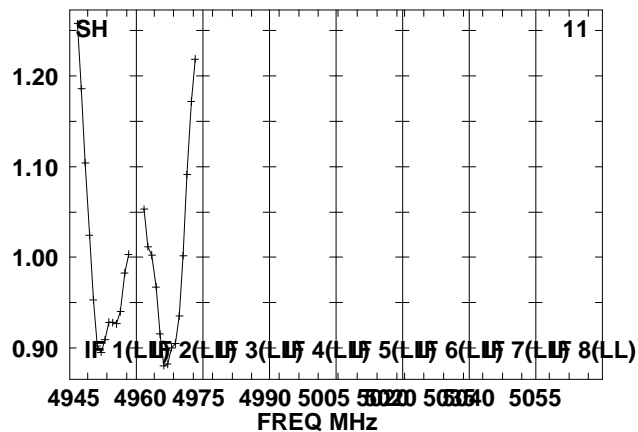
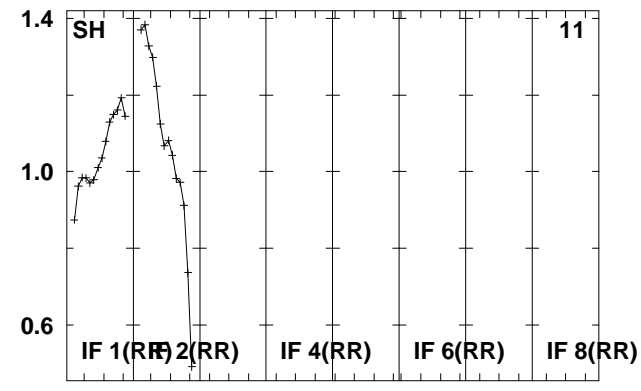
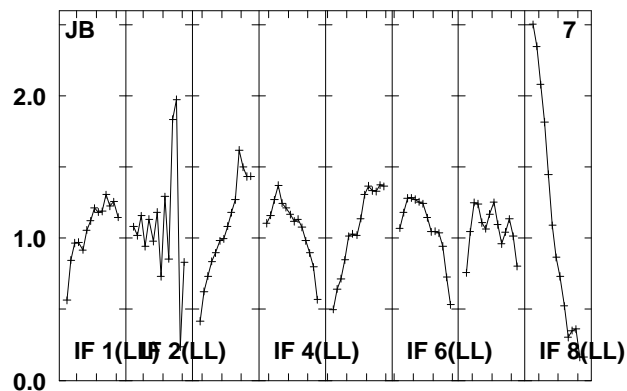
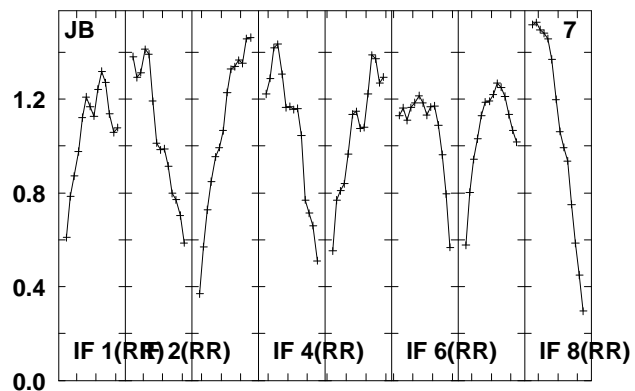
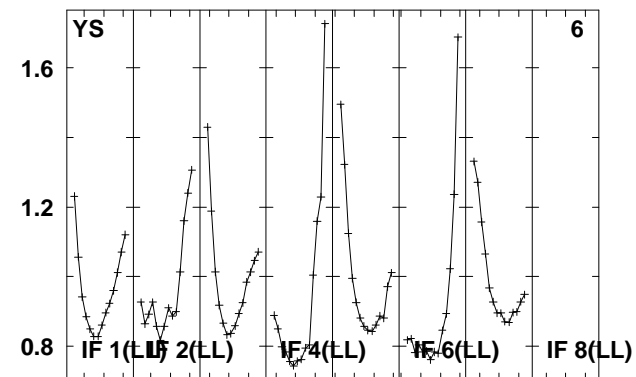
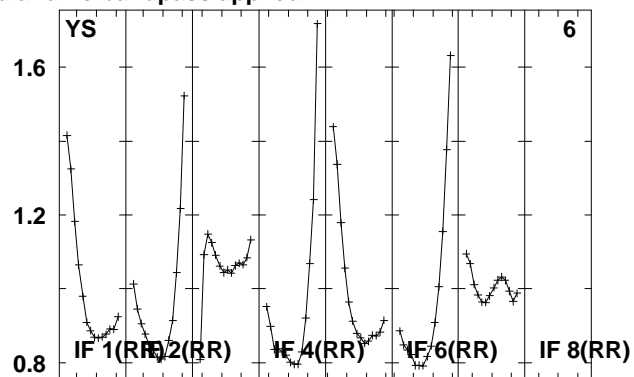
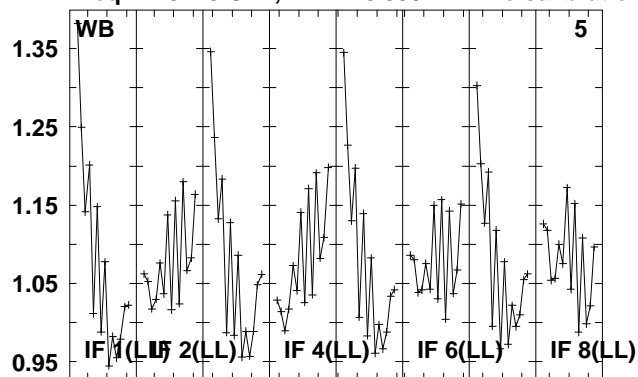

4945 4960 4975 4990 5005 5020 5035 5050 5055
FREQ MHz

Lower frame: Real Jy

Total-power spectrum Antenna: *

Timerange: 00/16:10:36 to 00/16:12:34

Plot file version 138 created 08-JUL-2010 13:10:19

B1002+55 EM079.UVDATA.1

Freq = 4.9415 GHz, Bw = 16.000 MH No calibration applied and no bandpass applied

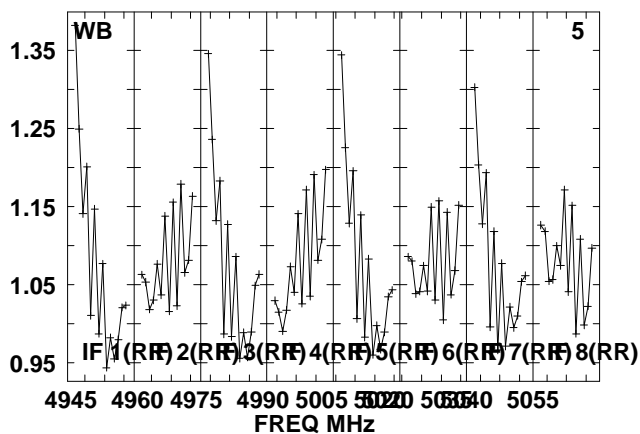
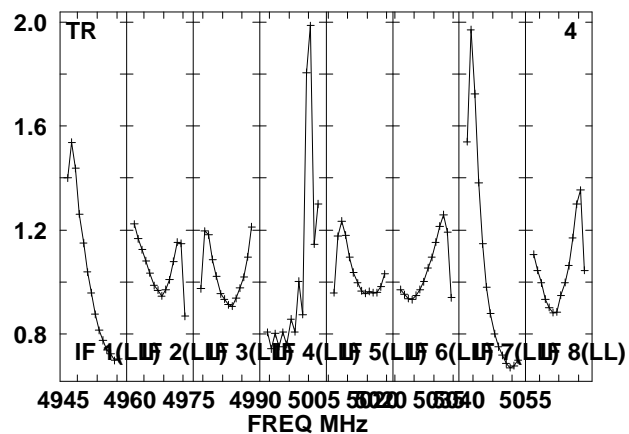
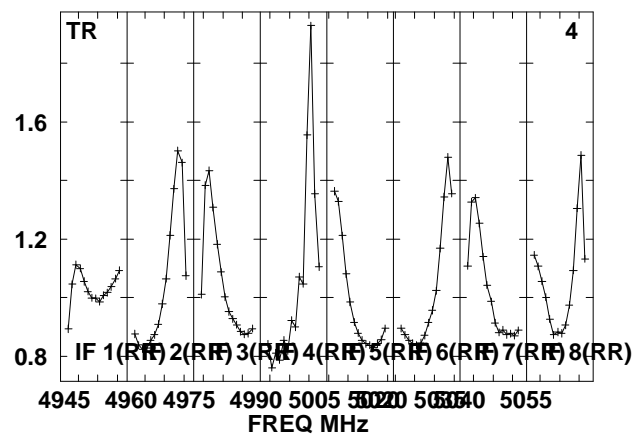
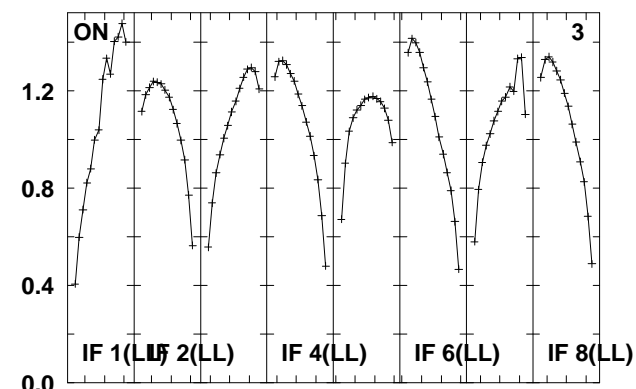
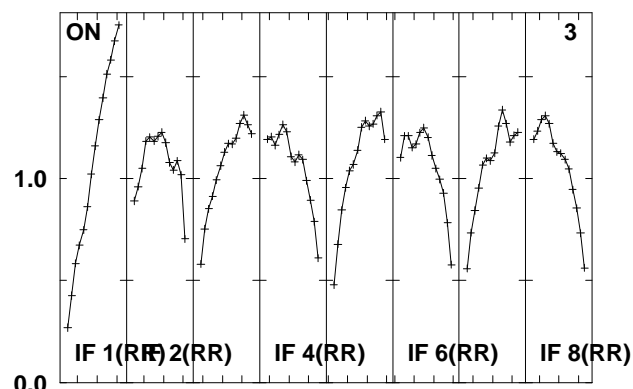
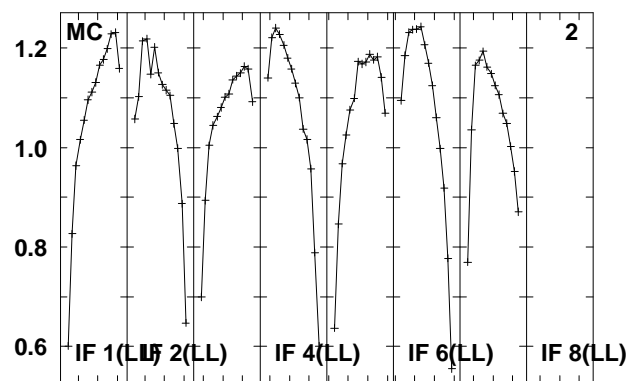
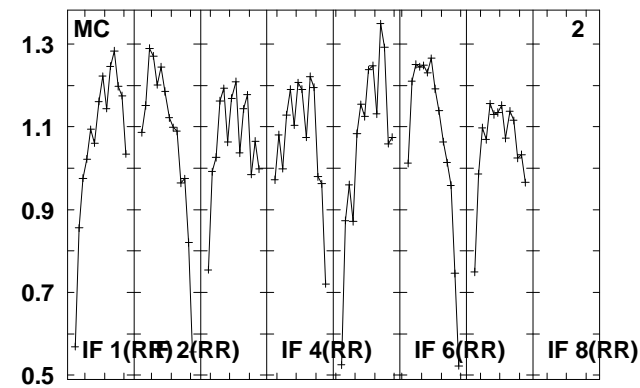
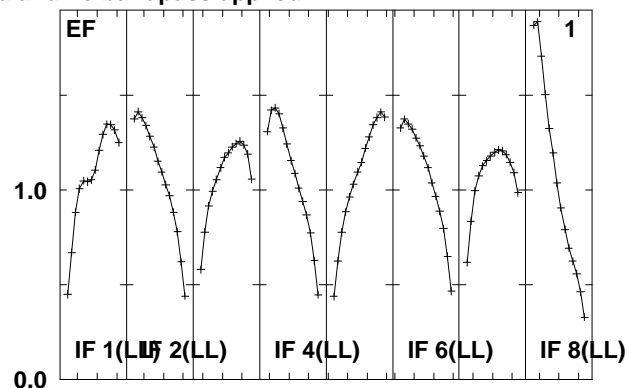
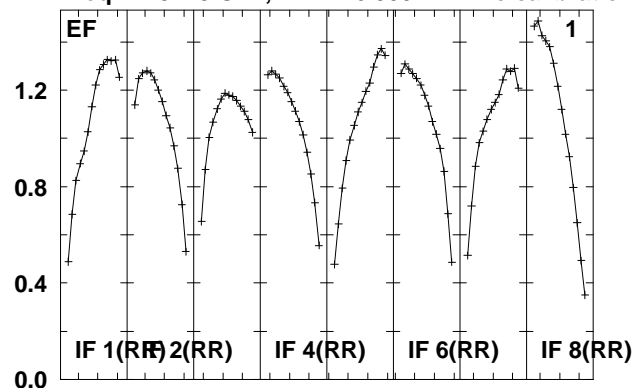

Lower frame: Real Jy
Total-power spectrum Antenna: *
Timerange: 00/16:12:36 to 00/16:23:34

Plot file version 139 created 08-JUL-2010 13:10:20

B1002+55 EM079.UVDATA.1

Freq = 4.9415 GHz, Bw = 16.000 MH No calibration applied and no bandpass applied

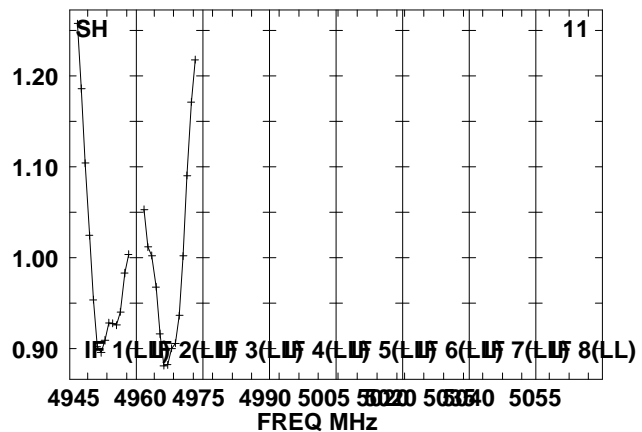
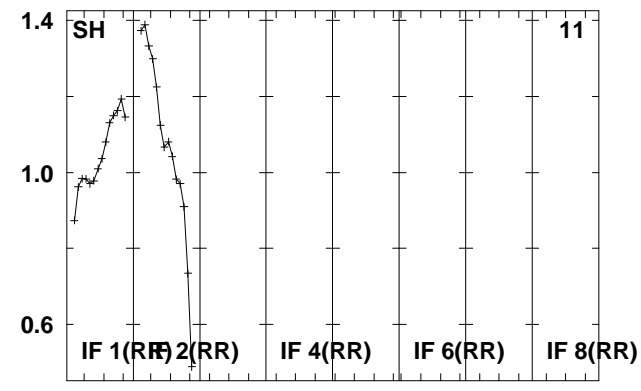
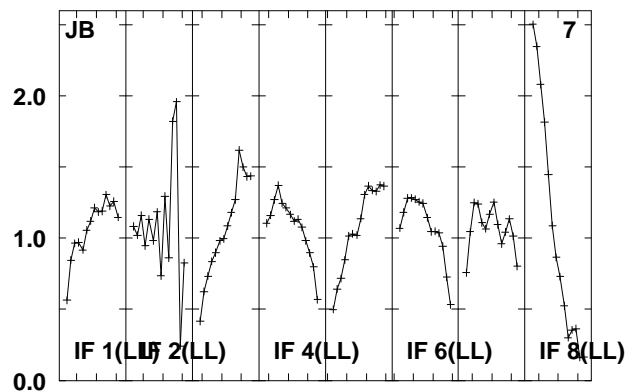
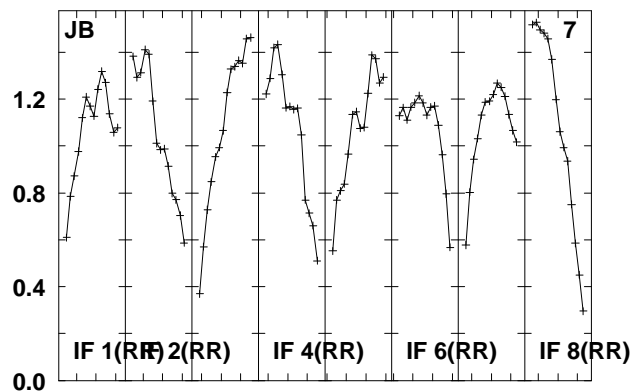
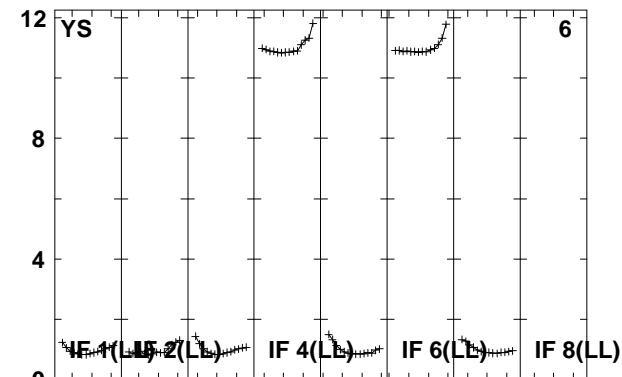
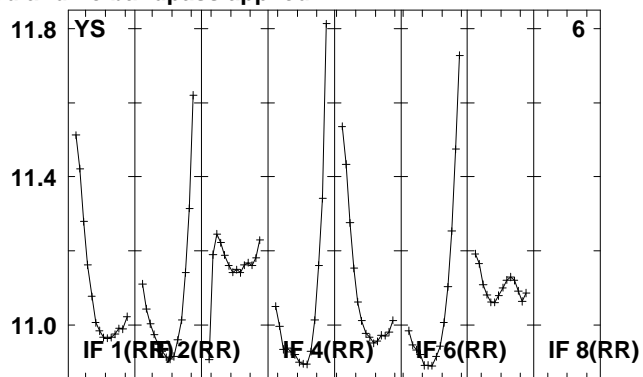
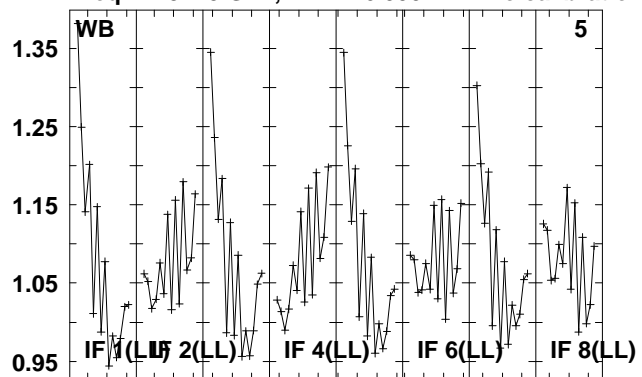

Lower frame: Real Jy

Total-power spectrum Antenna: *

Timerange: 00/16:12:36 to 00/16:23:34

Plot file version 140 created 08-JUL-2010 13:10:22

J0957+55 EM079.UVDATA.1

Freq = 4.9415 GHz, Bw = 16.000 MH No calibration applied and no bandpass applied

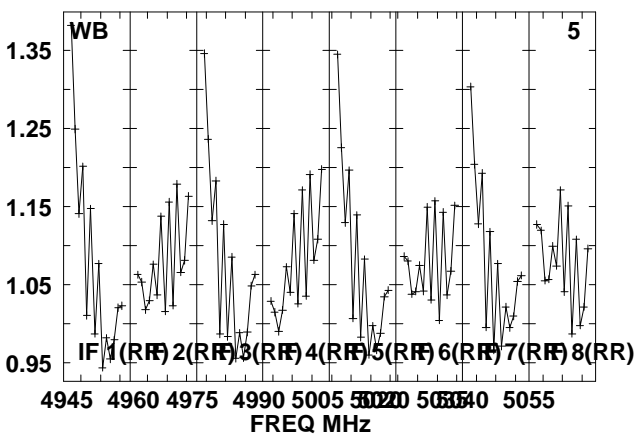
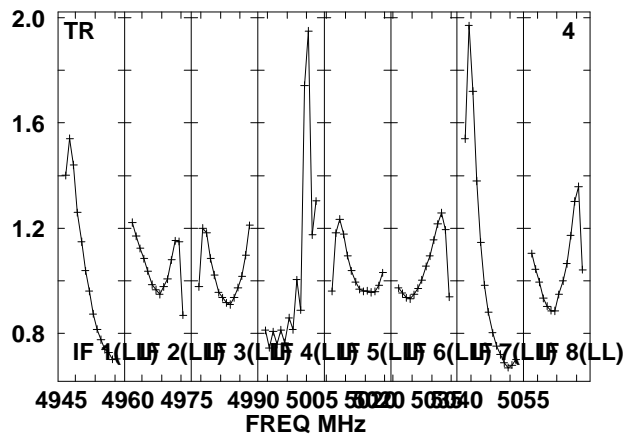
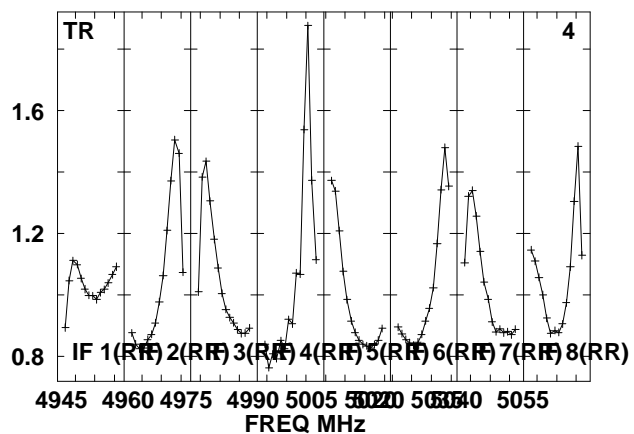
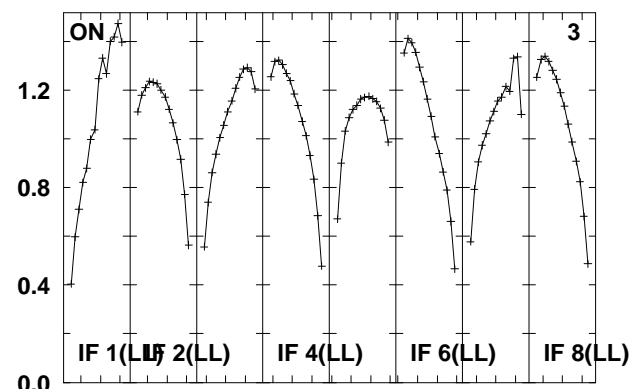
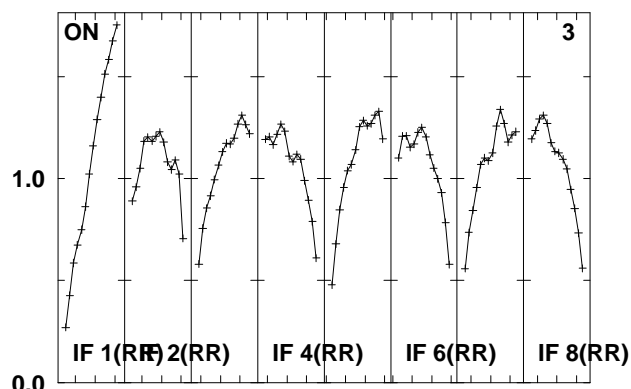
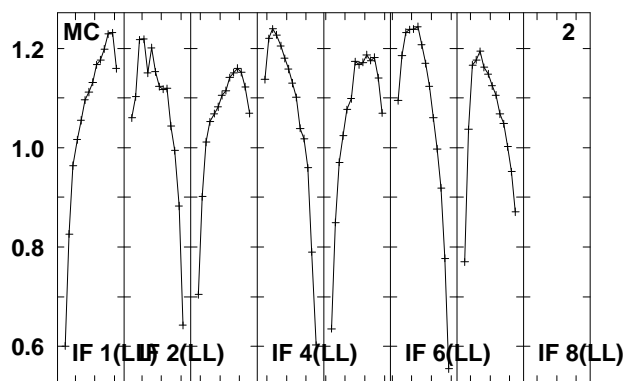
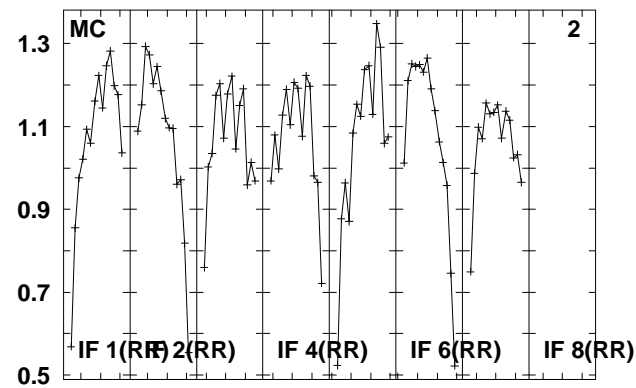
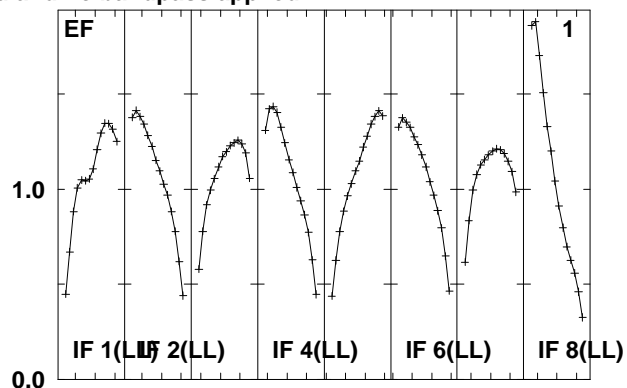
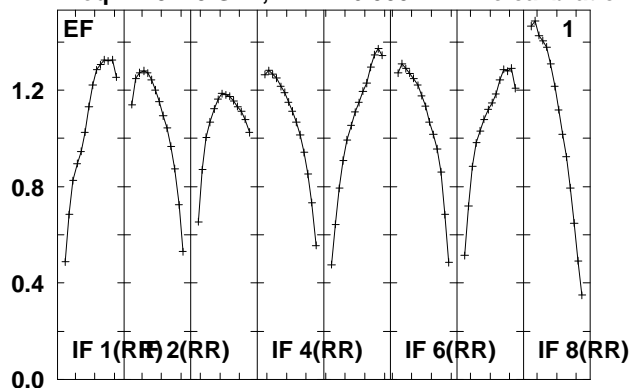

Lower frame: Real Jy
Total-power spectrum Antenna: *
Timerange: 00/16:23:36 to 00/16:25:34

Plot file version 141 created 08-JUL-2010 13:10:22

J0957+55 EM079.UVDATA.1

Freq = 4.9415 GHz, Bw = 16.000 MH No calibration applied and no bandpass applied

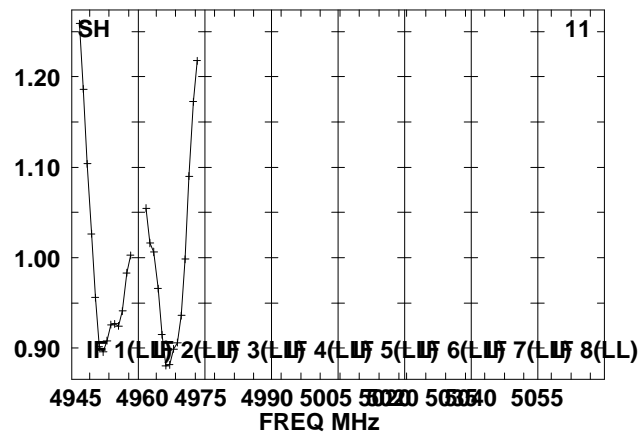
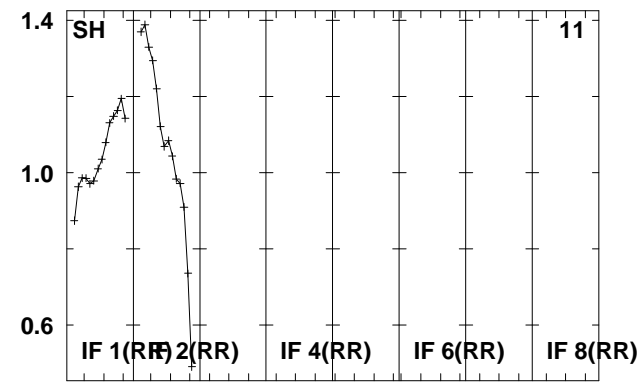
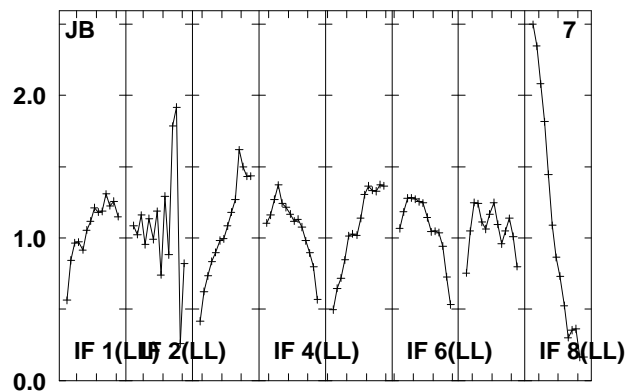
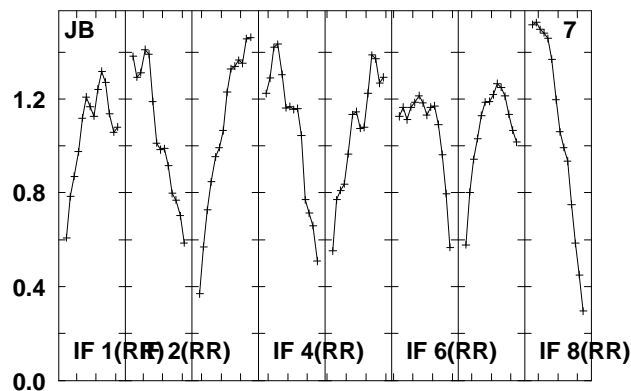
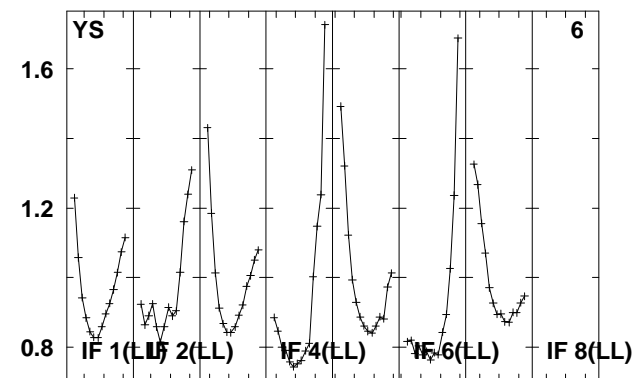
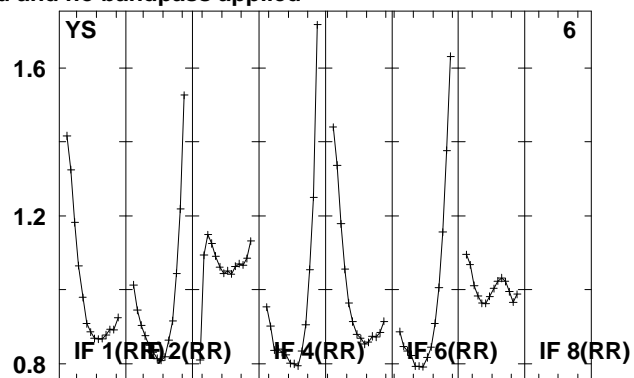
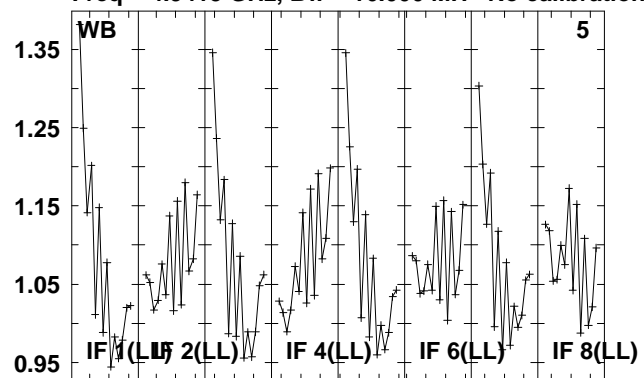

4945 4960 4975 4990 5005 5020 5035 5050 5055
FREQ MHz

Lower frame: Real Jy

Total-power spectrum Antenna: *

Timerange: 00/16:23:36 to 00/16:25:34

Plot file version 142 created 08-JUL-2010 13:10:23

B1002+55 EM079.UVDATA.1

Freq = 4.9415 GHz, Bw = 16.000 MH No calibration applied and no bandpass applied

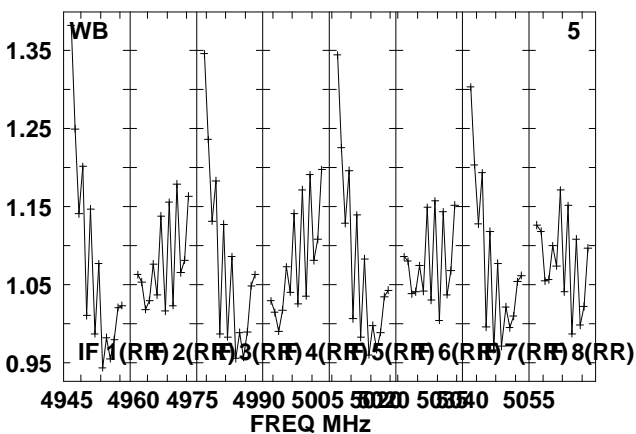
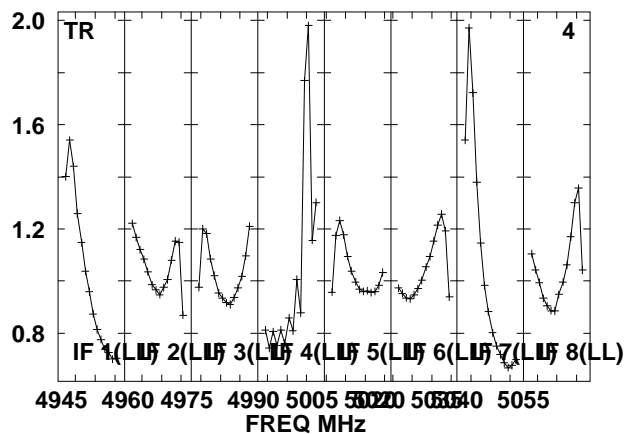
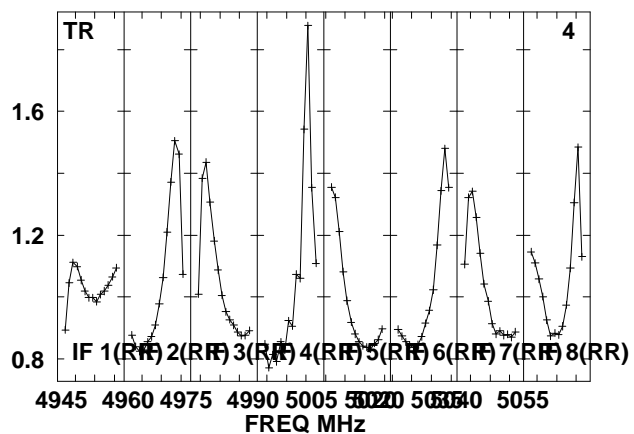
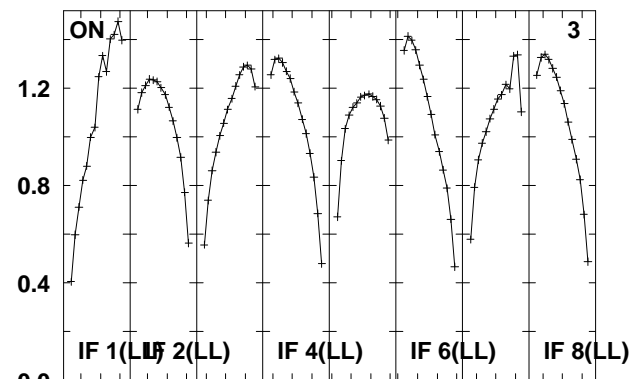
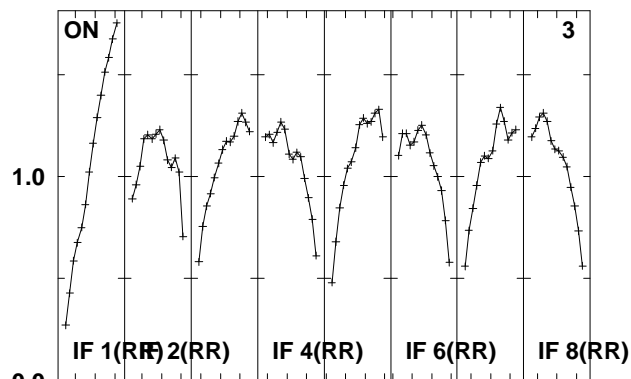
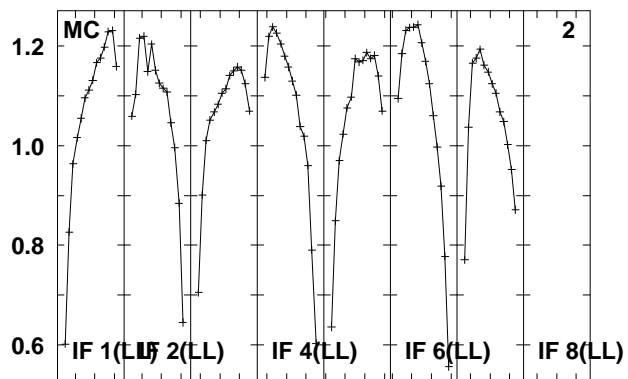
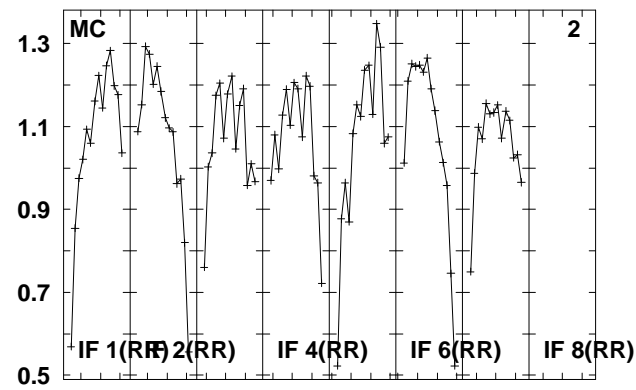
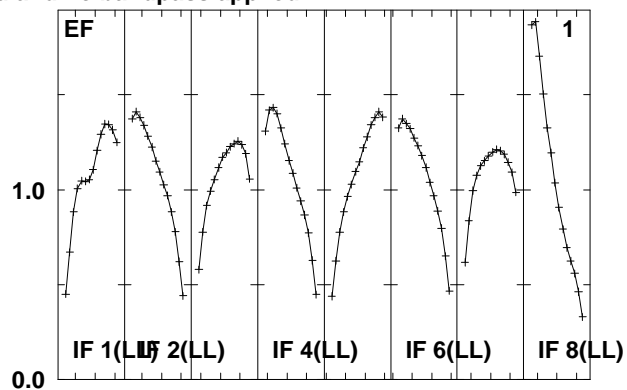
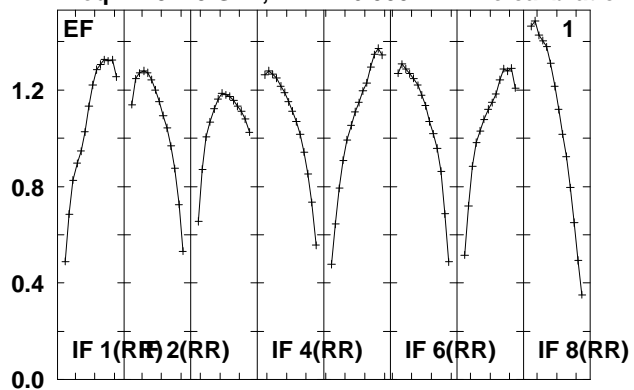

Lower frame: Real Jy
Total-power spectrum Antenna: *
Timerange: 00/16:25:36 to 00/16:36:34

Plot file version 143 created 08-JUL-2010 13:10:25

B1002+55 EM079.UVDATA.1

Freq = 4.9415 GHz, Bw = 16.000 MH No calibration applied and no bandpass applied

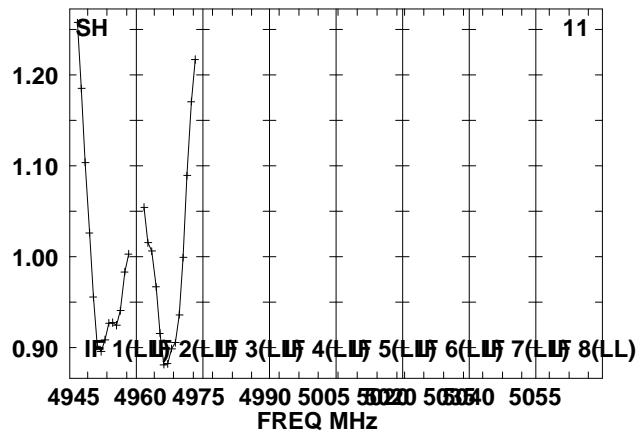
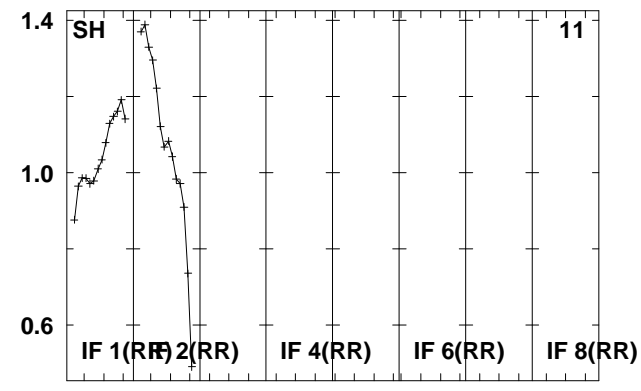
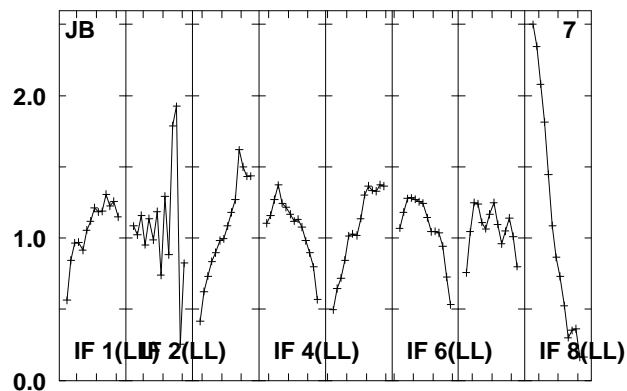
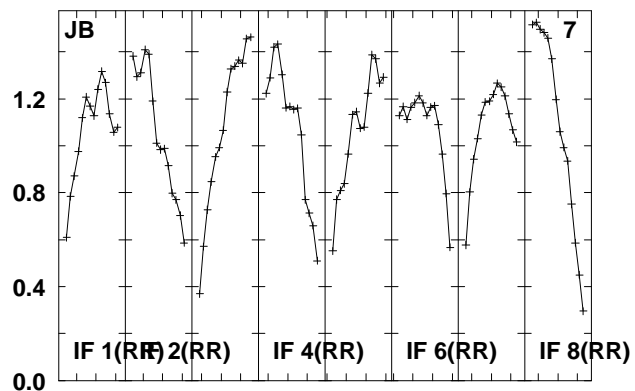
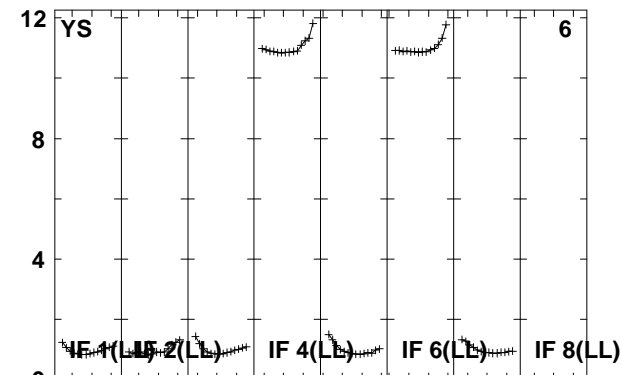
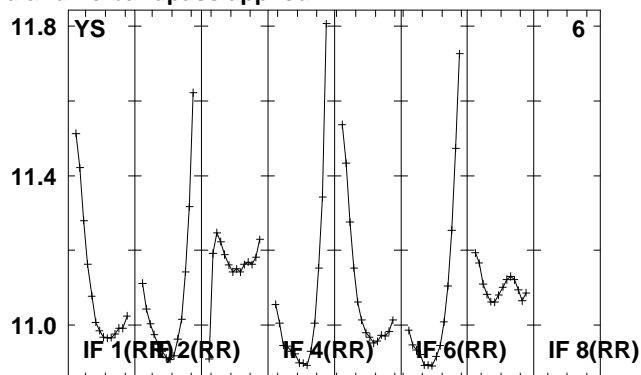
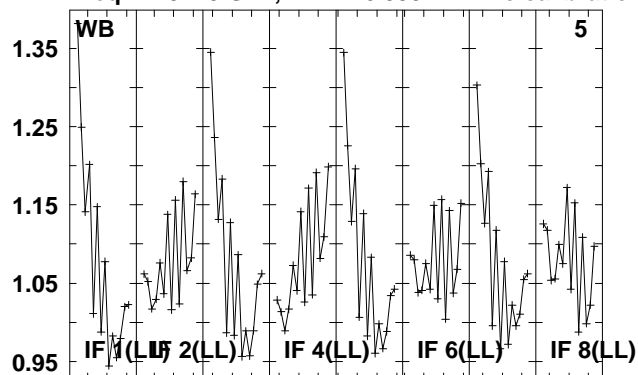

Lower frame: Real Jy

Total-power spectrum Antenna: *

Timerange: 00/16:25:36 to 00/16:36:34

Plot file version 144 created 08-JUL-2010 13:10:26

J0957+55 EM079.UVDATA.1

Freq = 4.9415 GHz, Bw = 16.000 MH No calibration applied and no bandpass applied

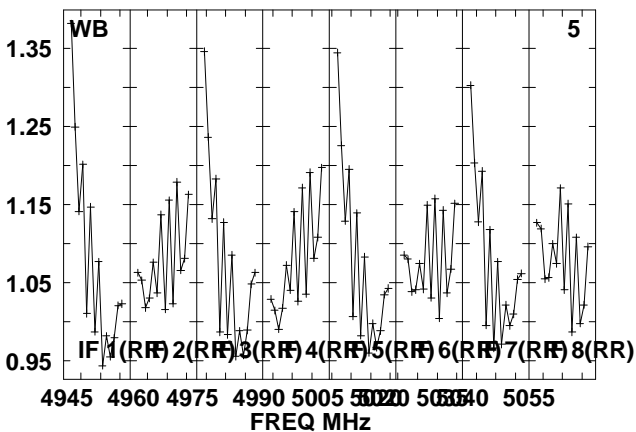
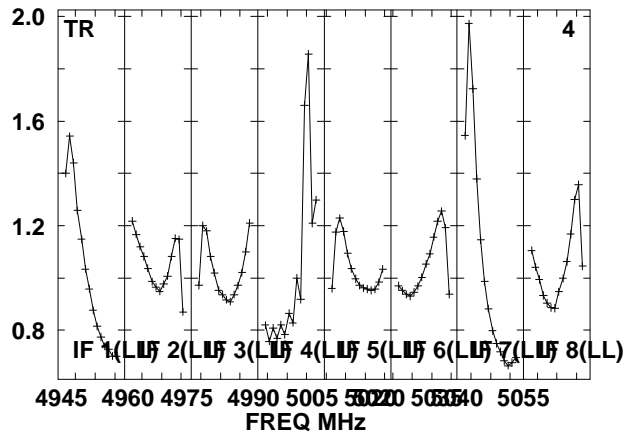
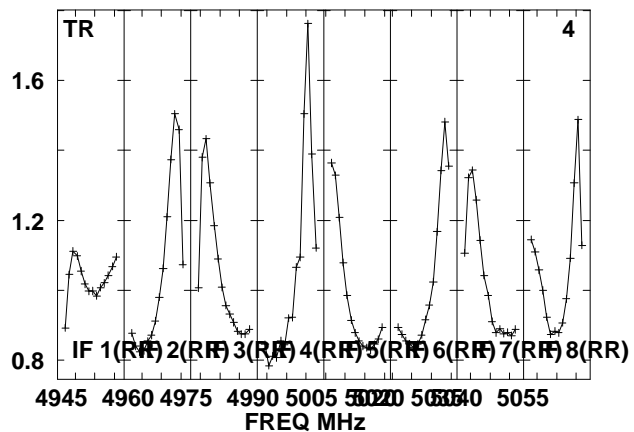
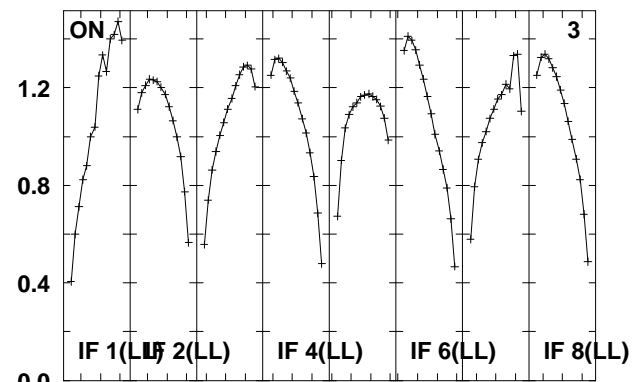
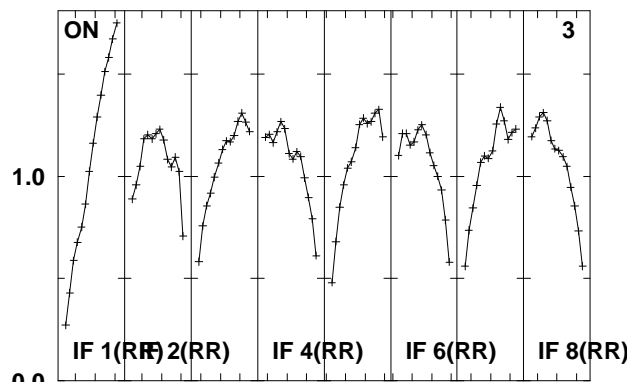
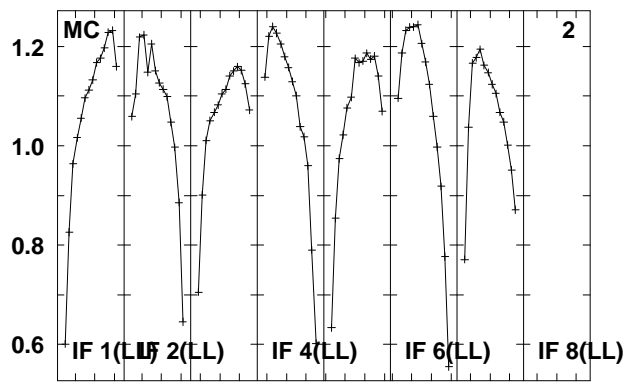
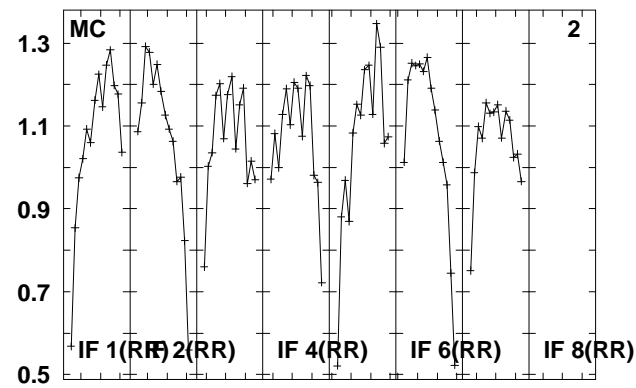
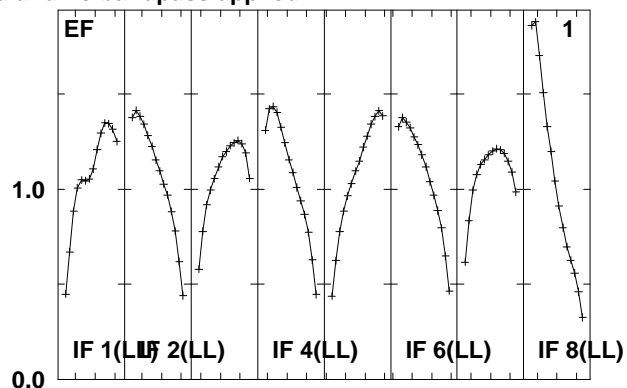
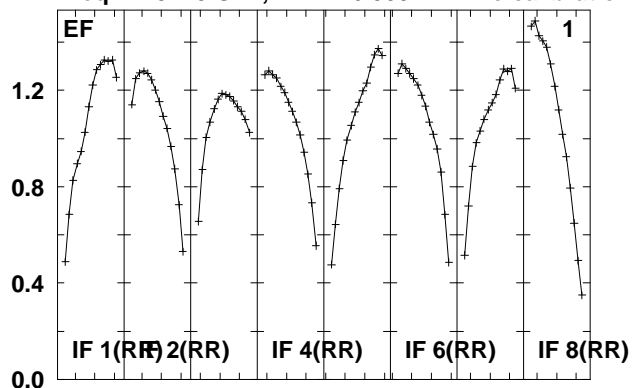

Lower frame: Real Jy
Total-power spectrum Antenna: *
Timerange: 00/16:36:36 to 00/16:38:34

Plot file version 145 created 08-JUL-2010 13:10:27

J0957+55 EM079.UVDATA.1

Freq = 4.9415 GHz, Bw = 16.000 MH No calibration applied and no bandpass applied

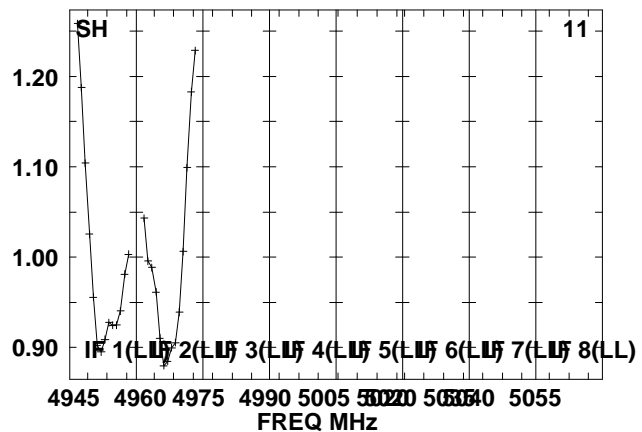
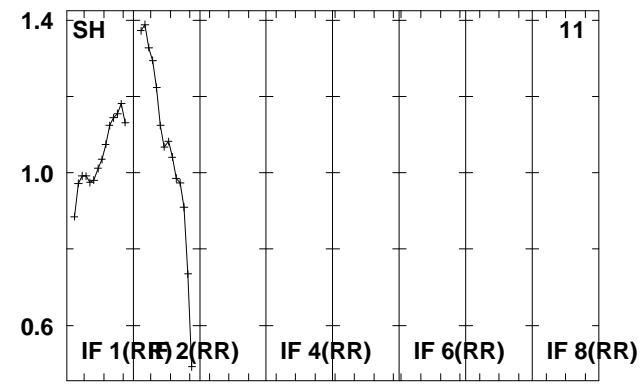
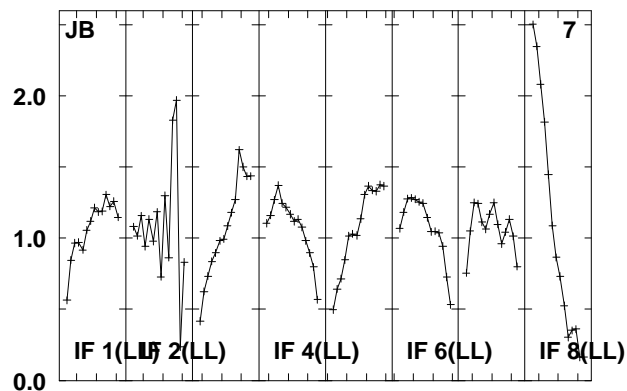
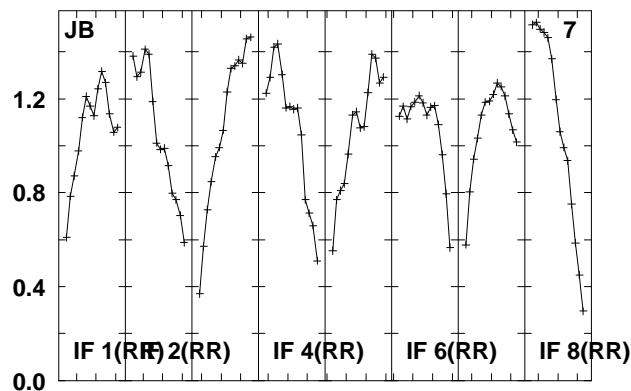
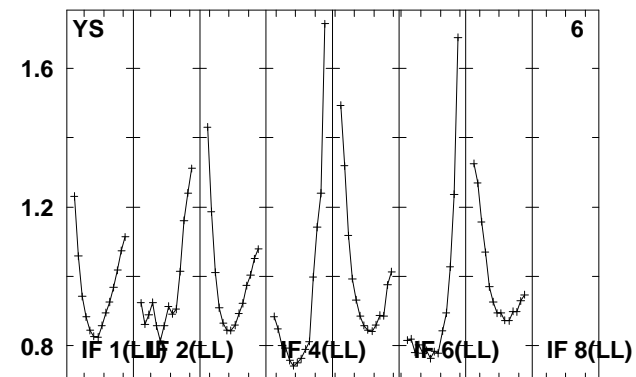
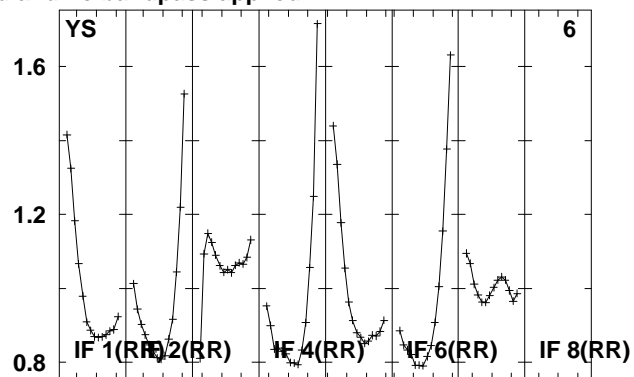
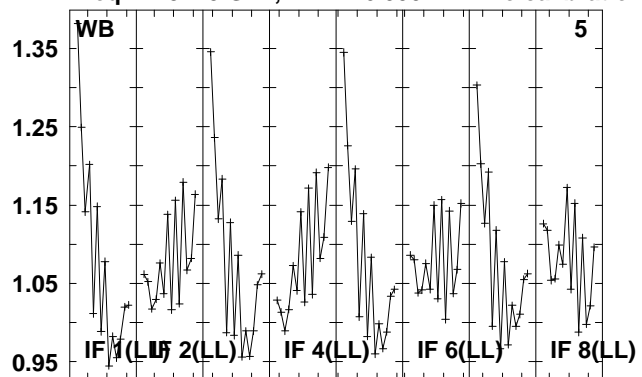

Lower frame: Real Jy

Total-power spectrum Antenna: *

Timerange: 00/16:36:36 to 00/16:38:34

Plot file version 146 created 08-JUL-2010 13:10:28

B1002+55 EM079.UVDATA.1

Freq = 4.9415 GHz, Bw = 16.000 MH No calibration applied and no bandpass applied

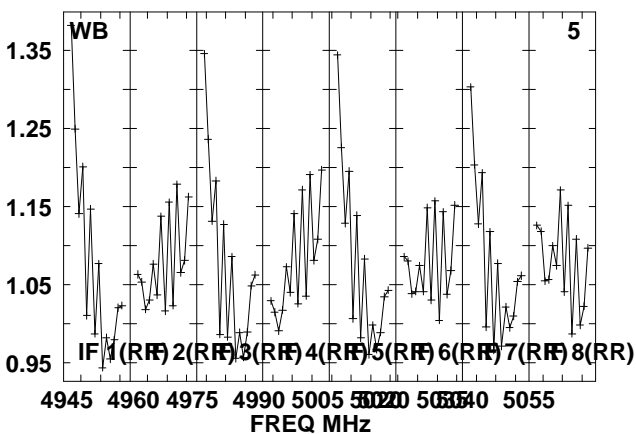
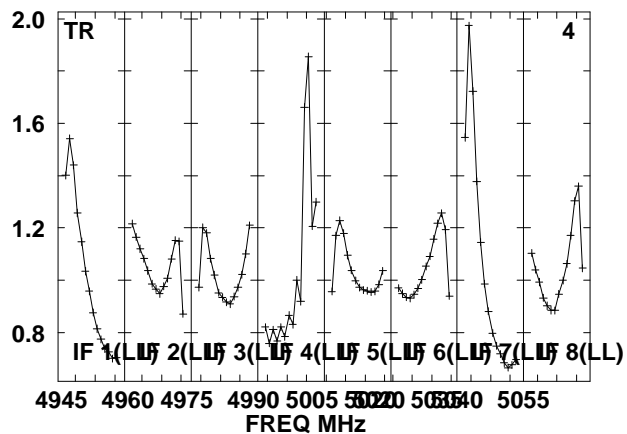
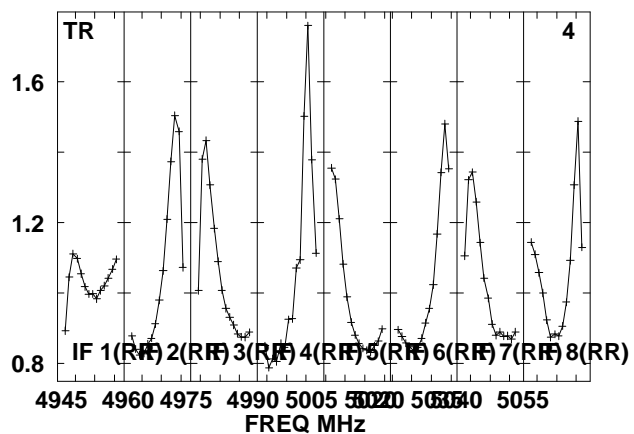
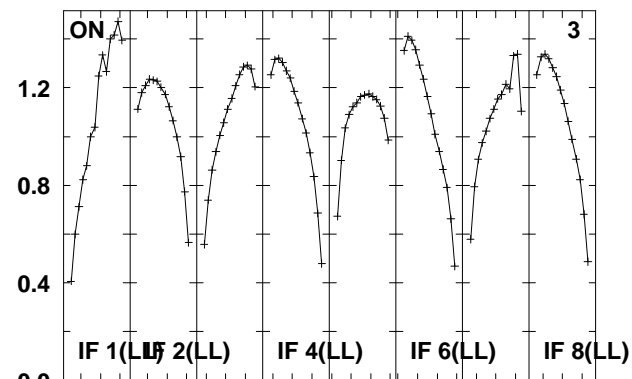
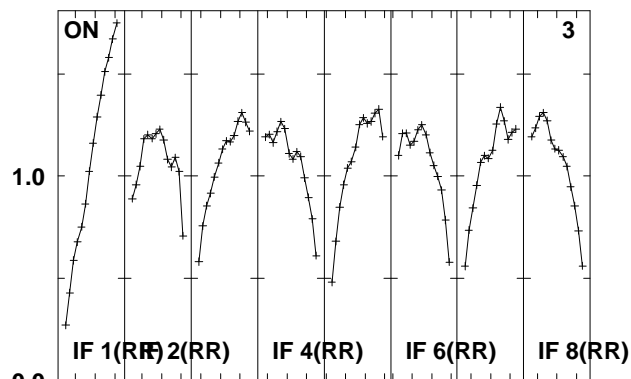
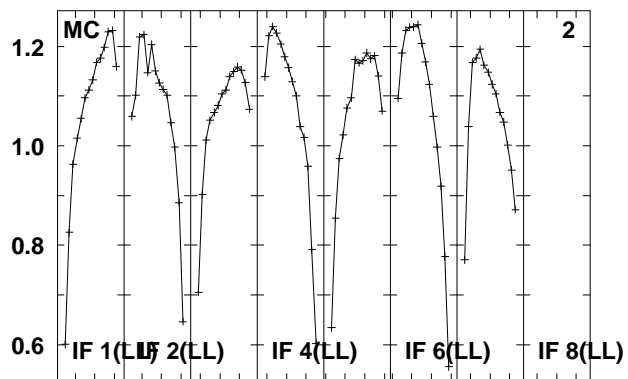
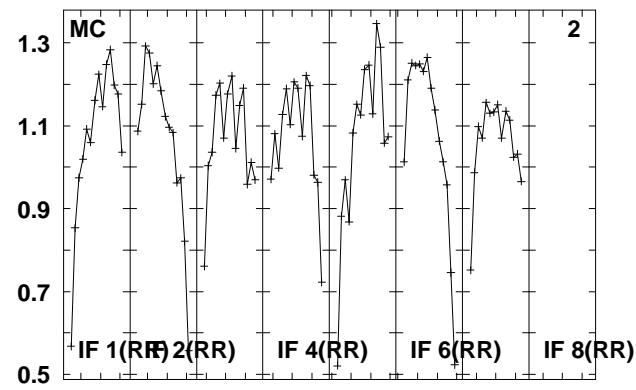
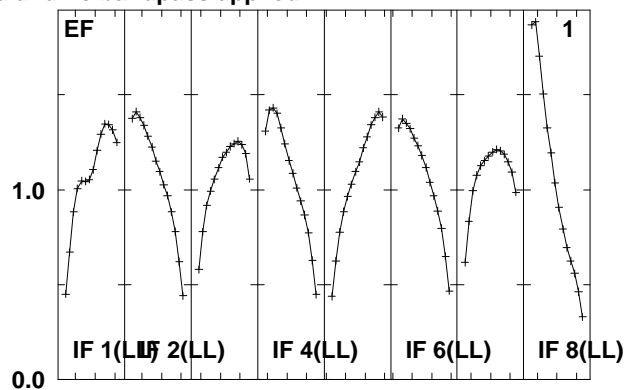
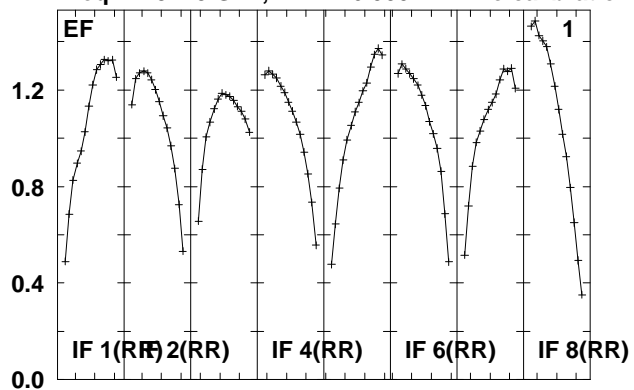

Lower frame: Real Jy
Total-power spectrum Antenna: *
Timerange: 00/16:38:36 to 00/16:49:34

Plot file version 147 created 08-JUL-2010 13:10:29

B1002+55 EM079.UVDATA.1

Freq = 4.9415 GHz, Bw = 16.000 MH No calibration applied and no bandpass applied

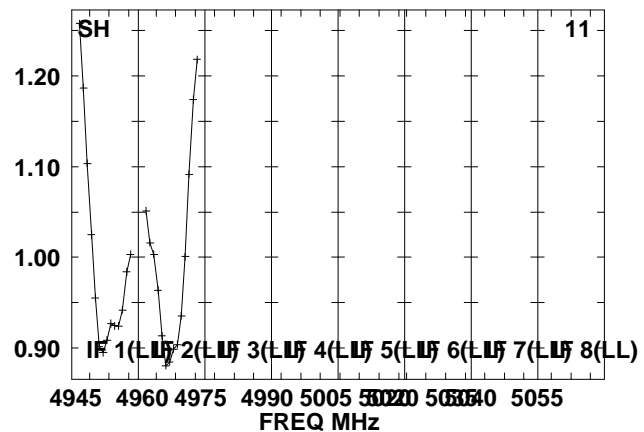
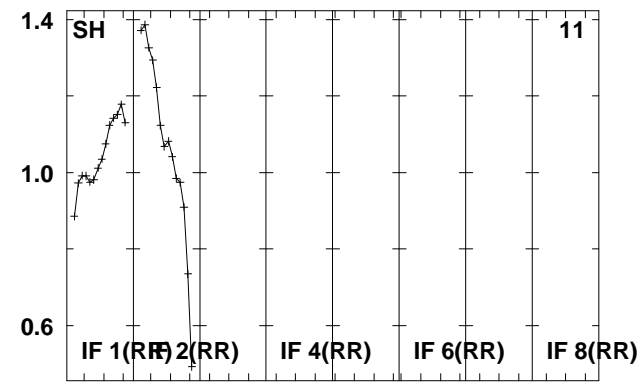
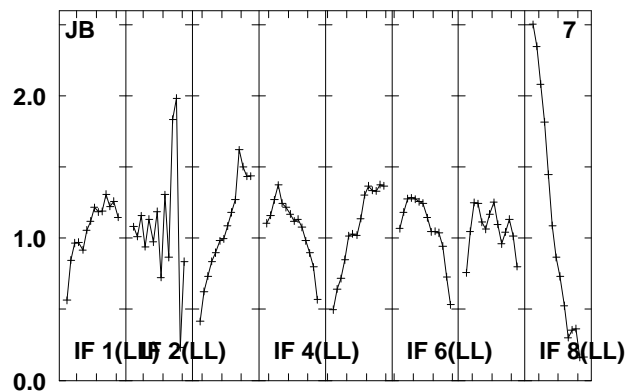
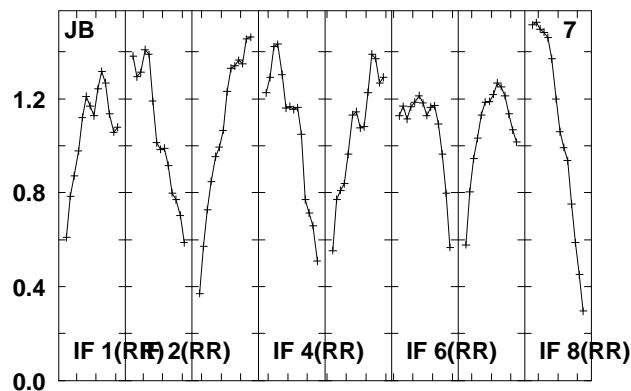
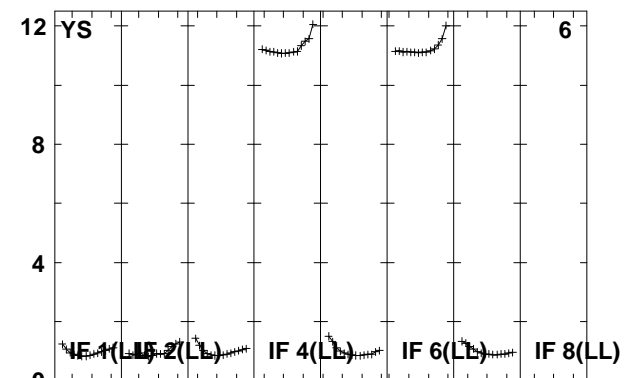
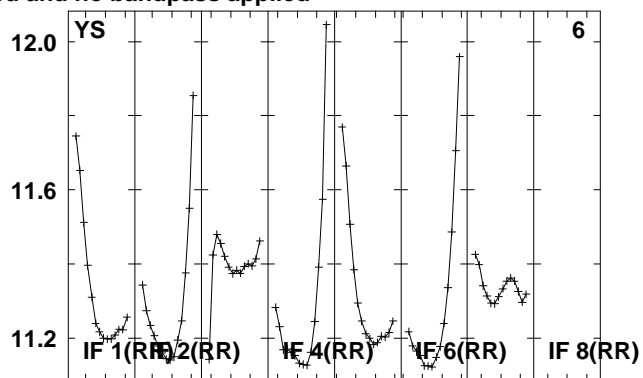
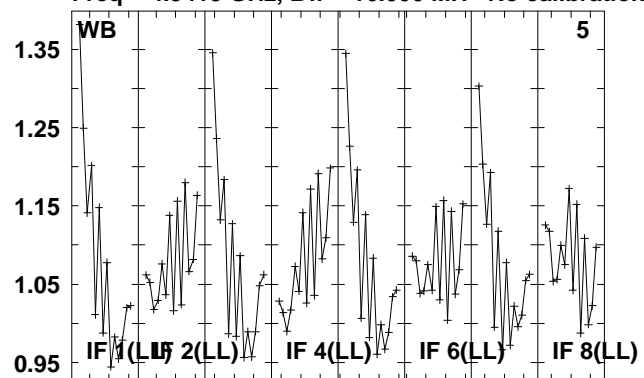

Lower frame: Real Jy

Total-power spectrum Antenna: *

Timerange: 00/16:38:36 to 00/16:49:34

Plot file version 148 created 08-JUL-2010 13:10:30

J0957+55 EM079.UVDATA.1

Freq = 4.9415 GHz, Bw = 16.000 MH No calibration applied and no bandpass applied

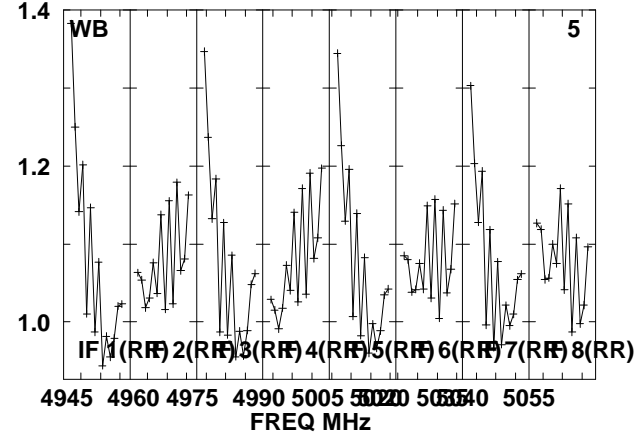
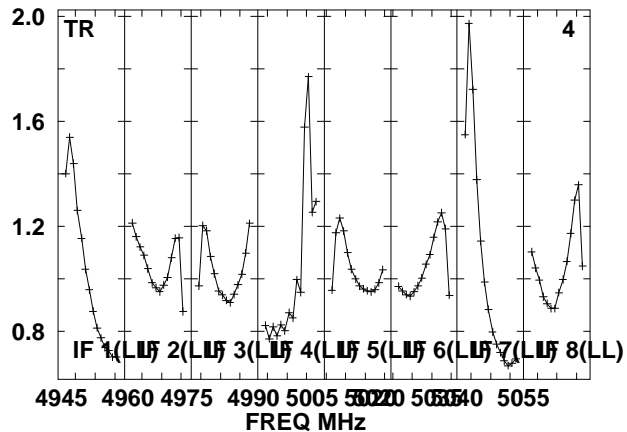
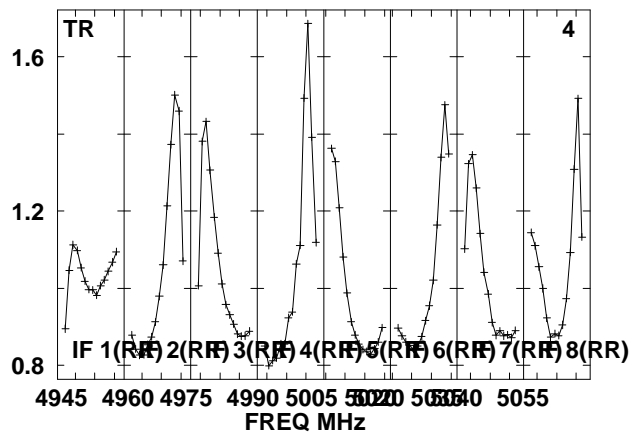
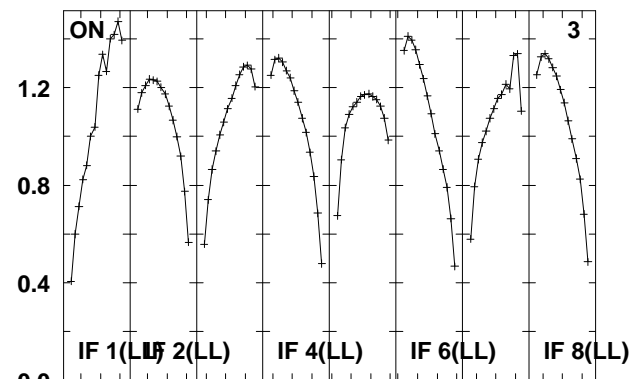
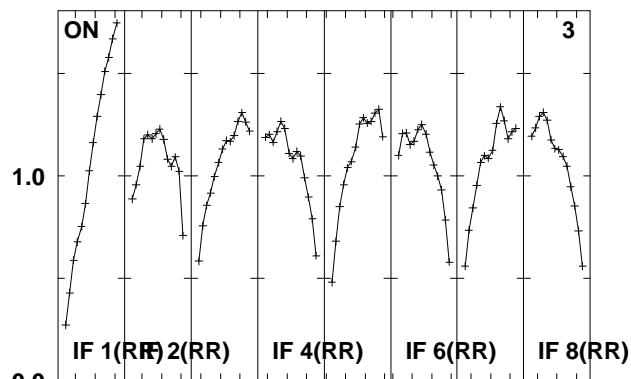
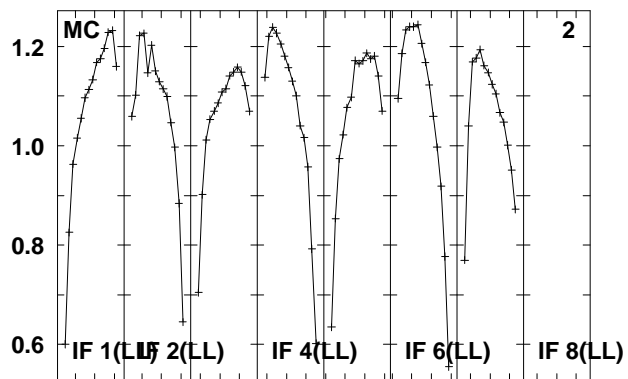
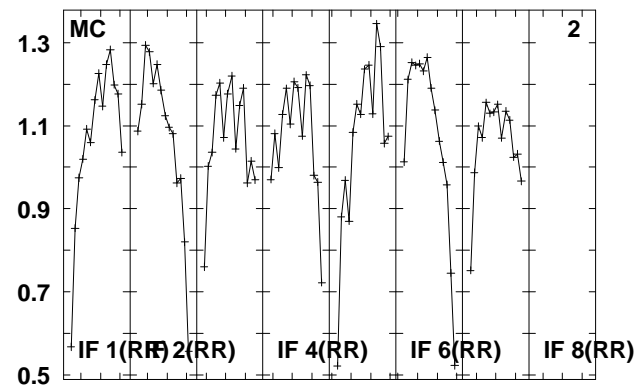
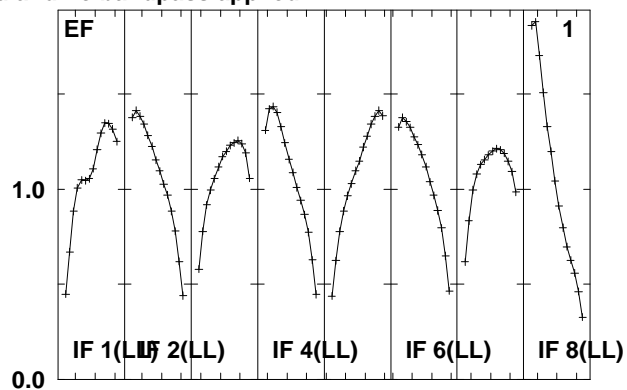
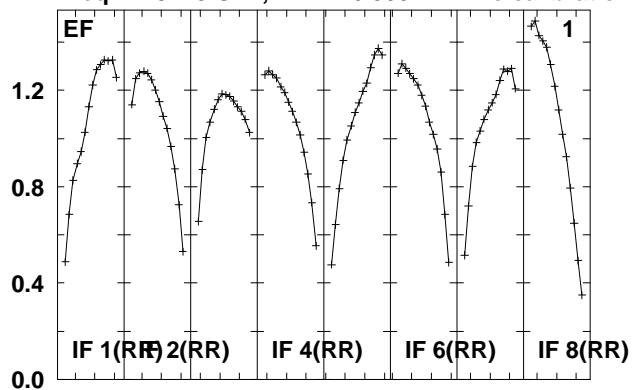

Lower frame: Real Jy
Total-power spectrum Antenna: *
Timerange: 00/16:49:36 to 00/16:51:34

Plot file version 149 created 08-JUL-2010 13:10:31

J0957+55 EM079.UVDATA.1

Freq = 4.9415 GHz, Bw = 16.000 MH No calibration applied and no bandpass applied

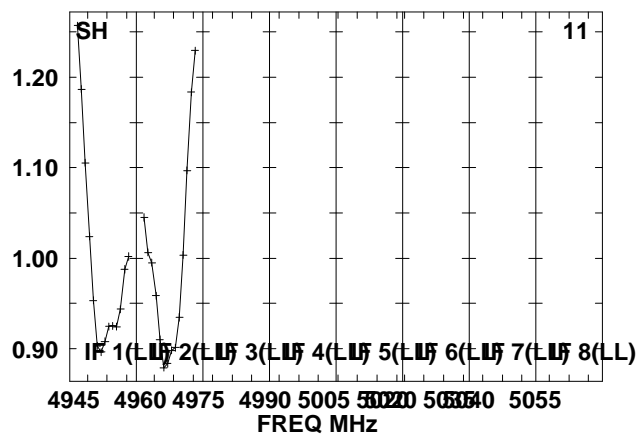
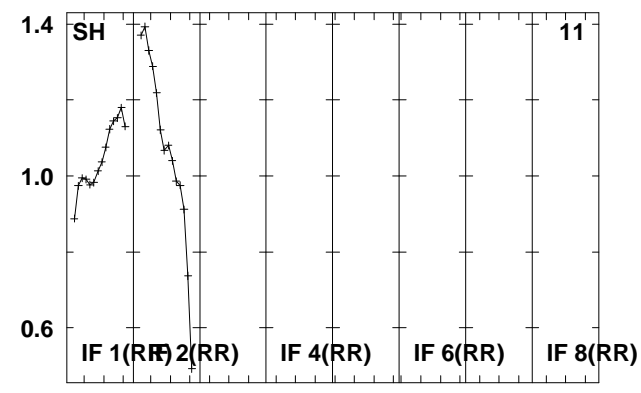
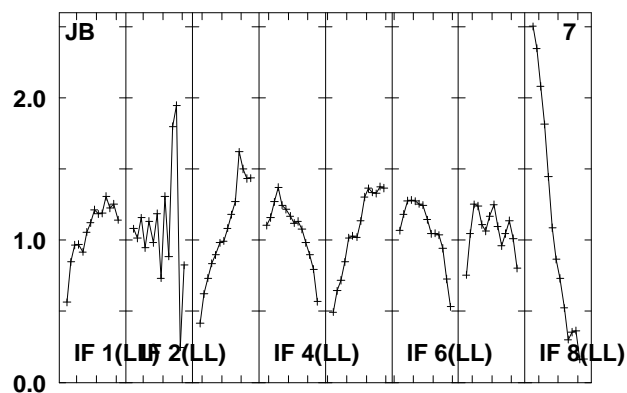
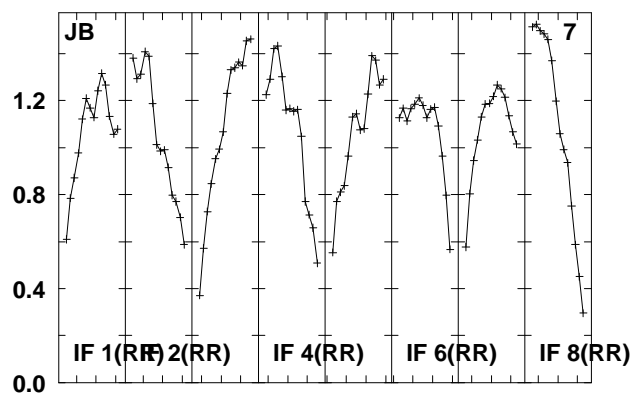
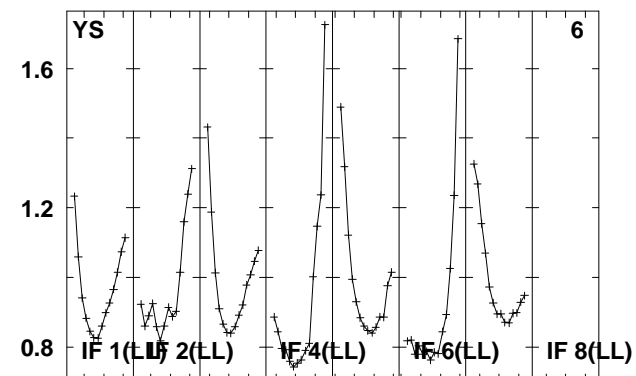
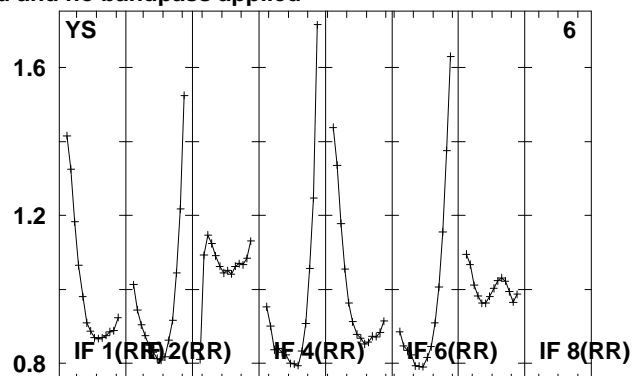
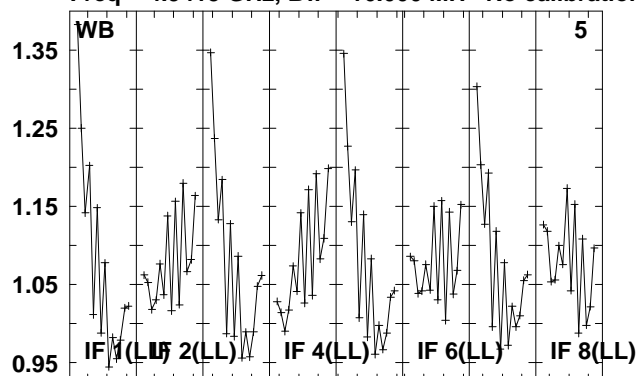

Lower frame: Real Jy

Total-power spectrum Antenna: *

Timerange: 00/16:49:36 to 00/16:51:34

Plot file version 150 created 08-JUL-2010 13:10:32

B1002+55 EM079.UVDATA.1

Freq = 4.9415 GHz, Bw = 16.000 MH No calibration applied and no bandpass applied

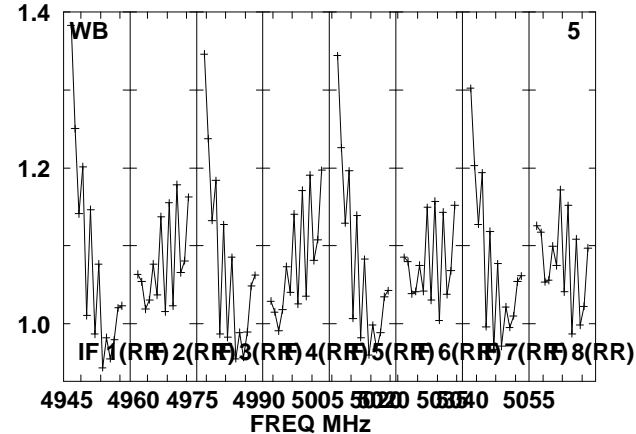
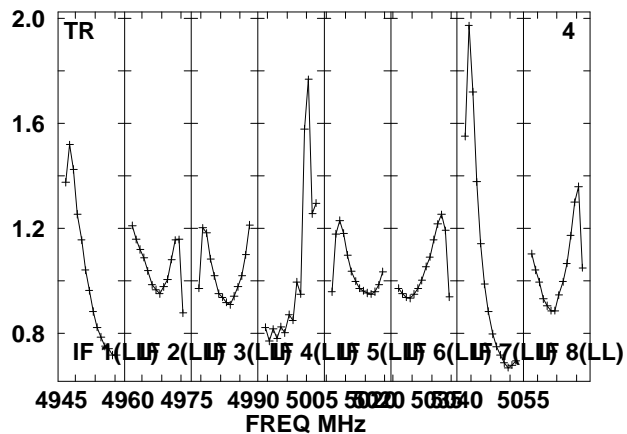
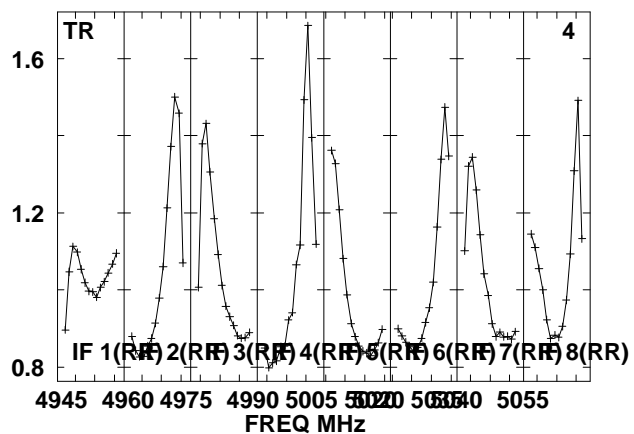
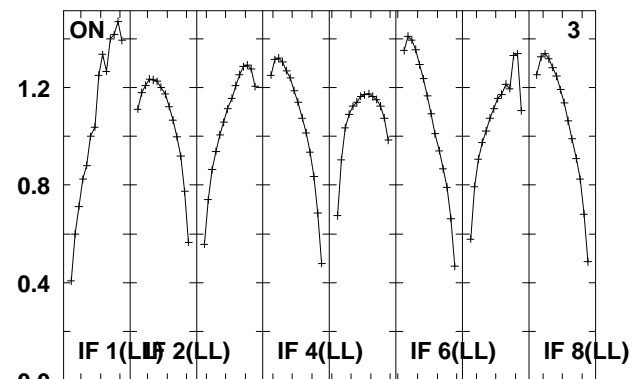
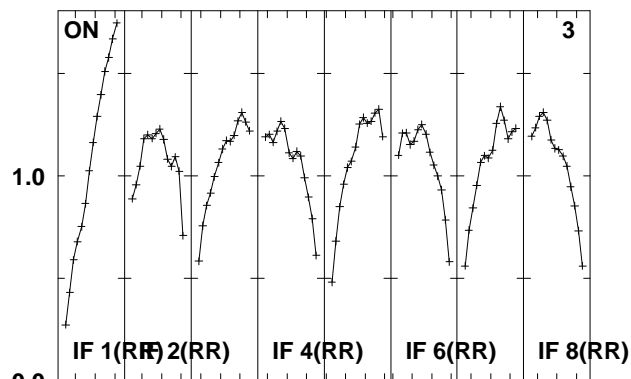
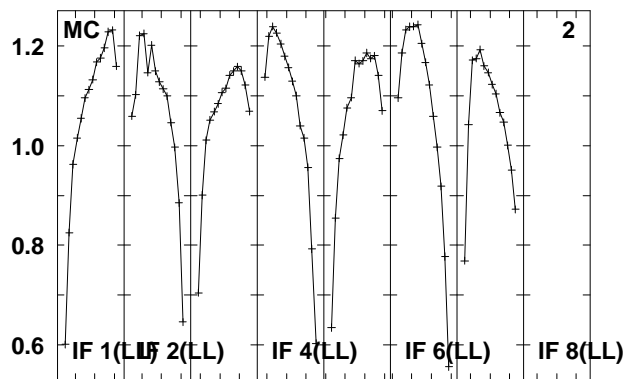
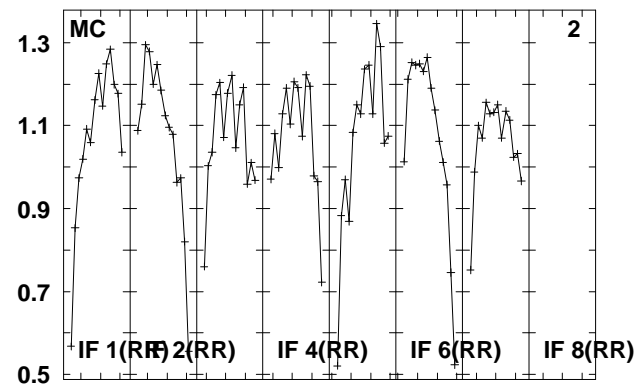
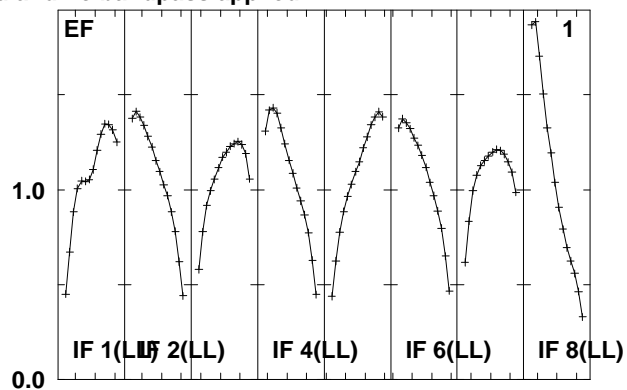
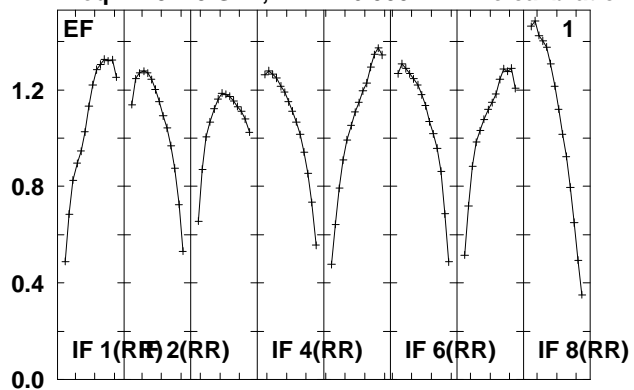

Lower frame: Real Jy

Total-power spectrum Antenna: *

Timerange: 00/16:51:36 to 00/17:02:34

Plot file version 151 created 08-JUL-2010 13:10:33

B1002+55 EM079.UVDATA.1

Freq = 4.9415 GHz, Bw = 16.000 MH No calibration applied and no bandpass applied

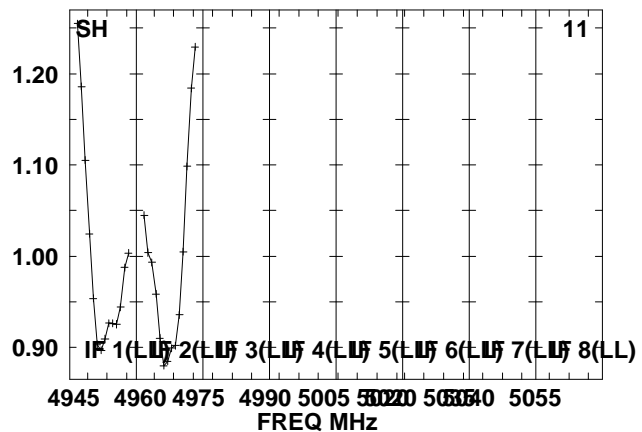
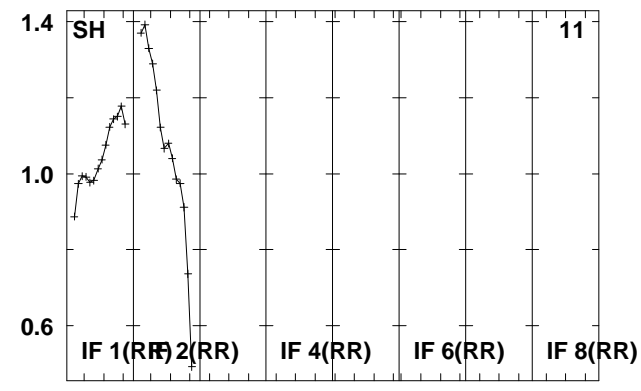
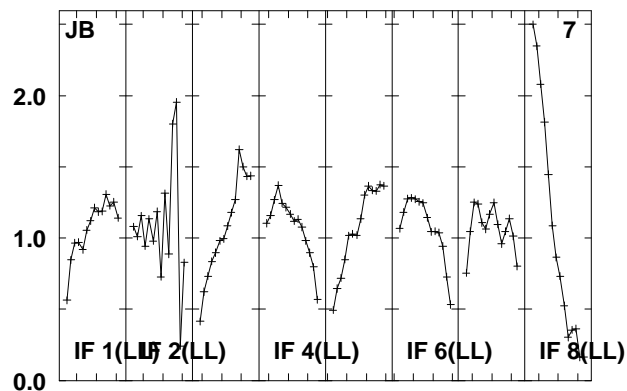
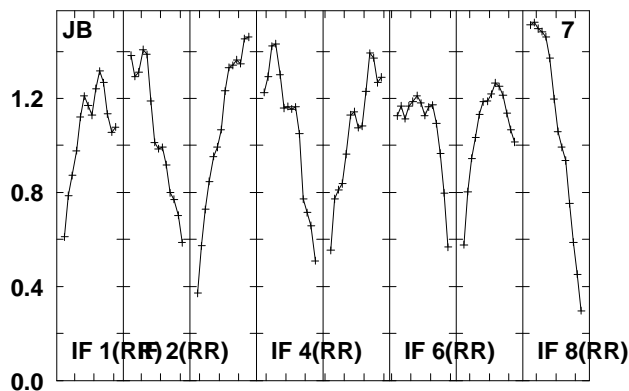
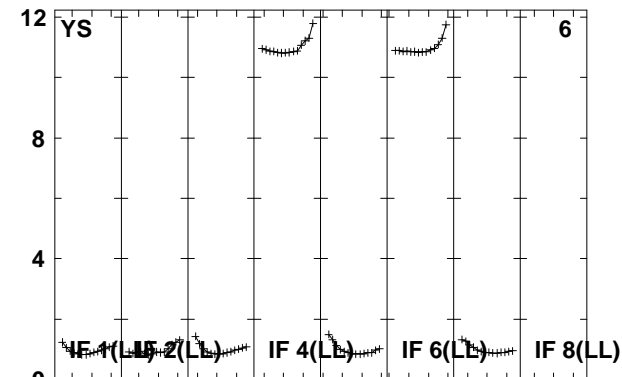
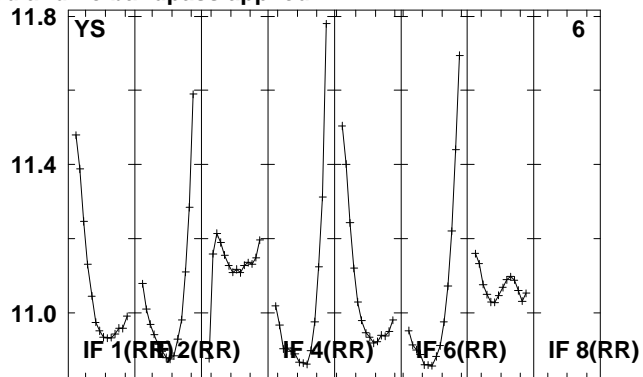
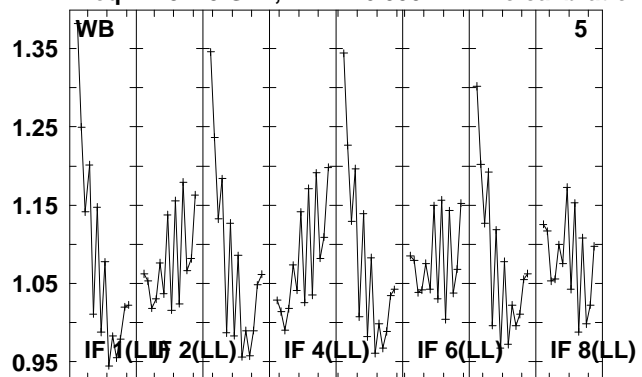

Lower frame: Real Jy

Total-power spectrum Antenna: *

Timerange: 00/16:51:36 to 00/17:02:34

Plot file version 152 created 08-JUL-2010 13:10:35

J0957+55 EM079.UVDATA.1

Freq = 4.9415 GHz, Bw = 16.000 MH No calibration applied and no bandpass applied

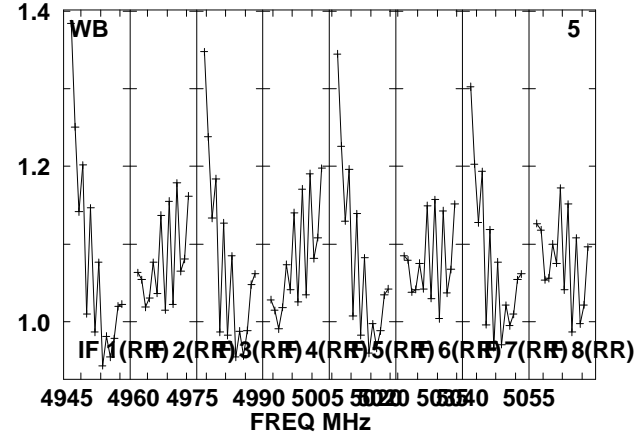
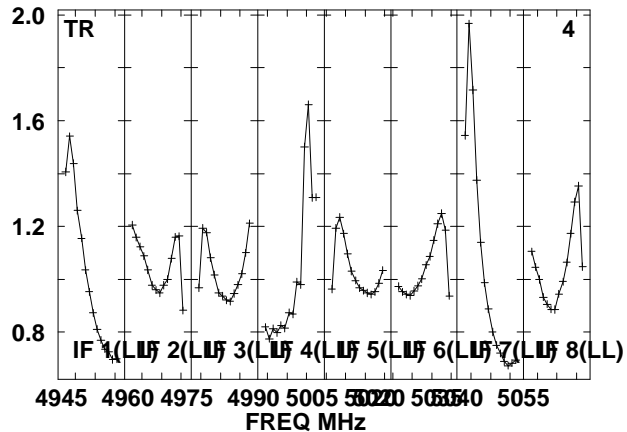
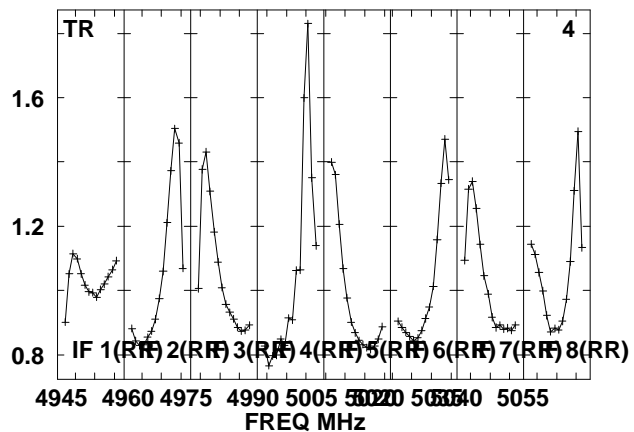
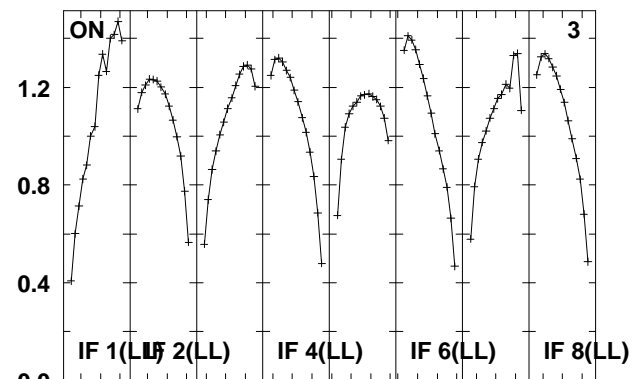
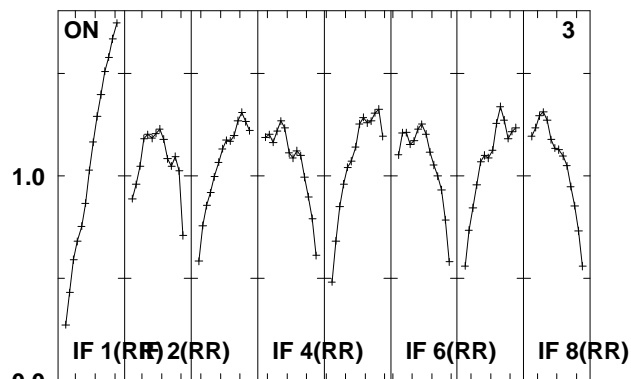
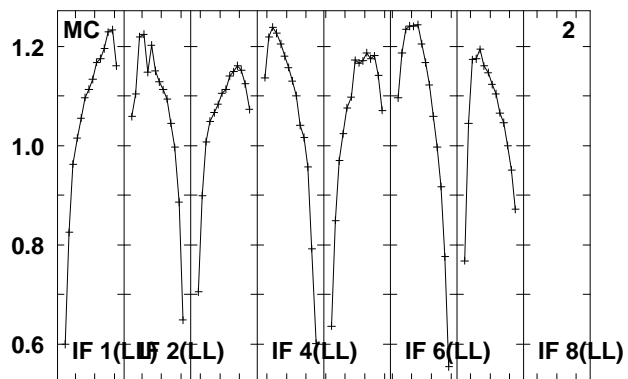
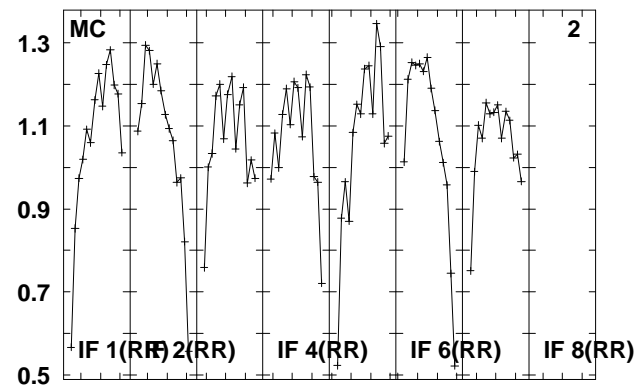
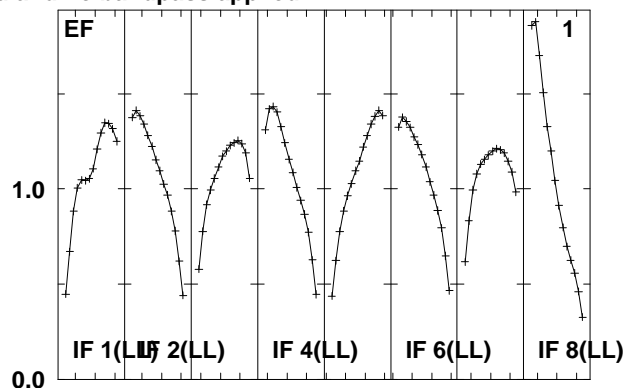
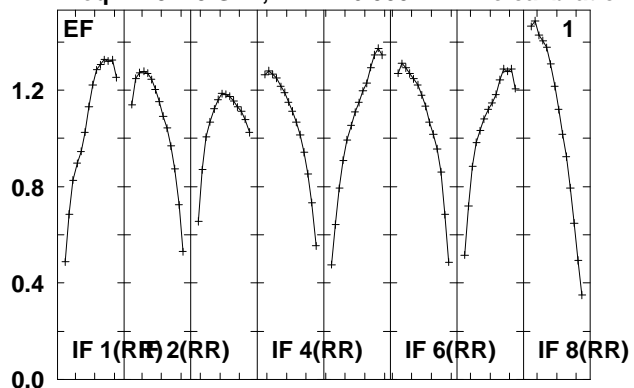

Lower frame: Real Jy

Total-power spectrum Antenna: *

Timerange: 00/17:02:36 to 00/17:04:34

Plot file version 153 created 08-JUL-2010 13:10:35

J0957+55 EM079.UVDATA.1

Freq = 4.9415 GHz, Bw = 16.000 MH No calibration applied and no bandpass applied

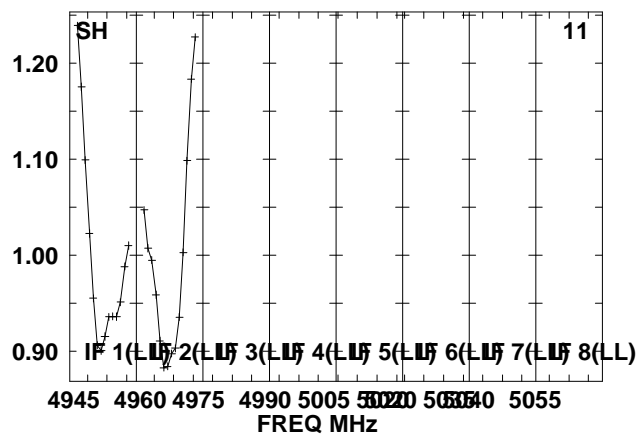
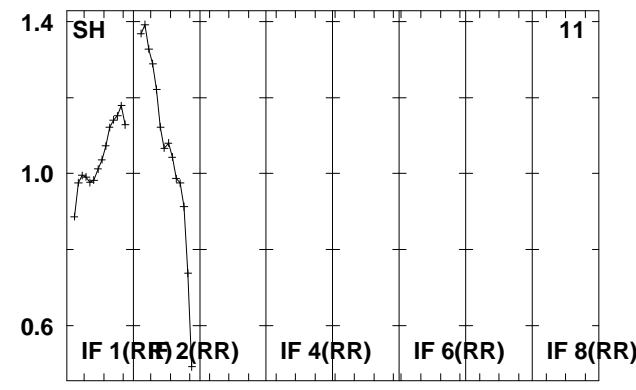
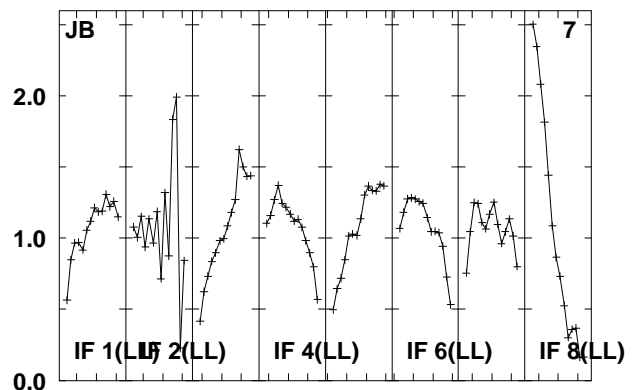
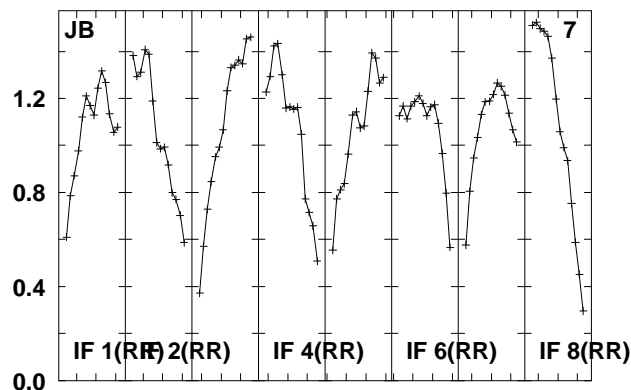
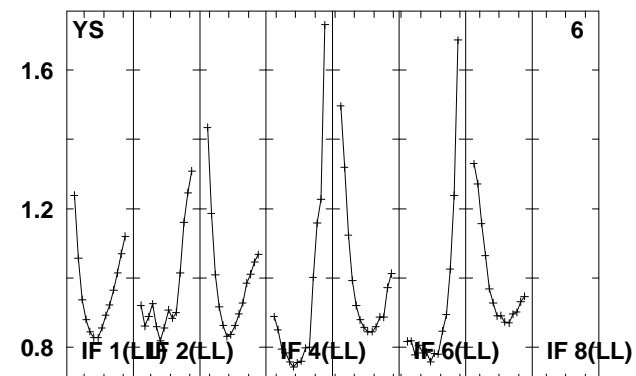
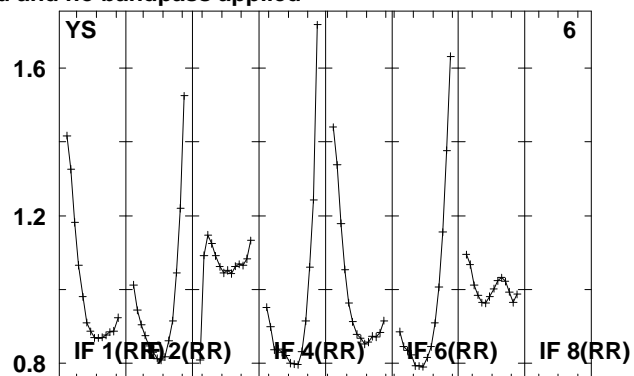
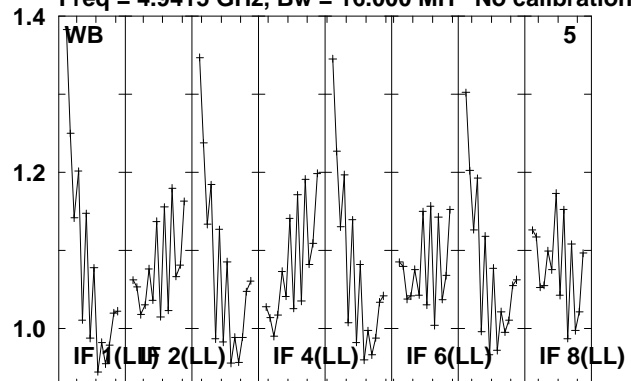

Lower frame: Real Jy

Total-power spectrum Antenna: *

Timerange: 00/17:02:36 to 00/17:04:34

Plot file version 154 created 08-JUL-2010 13:10:36

QQ208 EM079.UVDATA.1

Freq = 4.9415 GHz, Bw = 16.000 MH No calibration applied and no bandpass applied

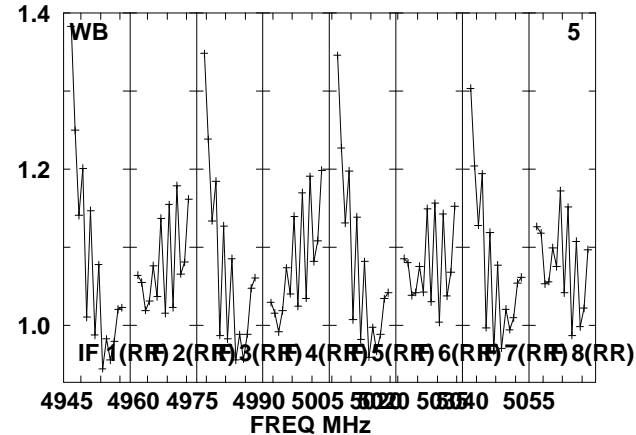
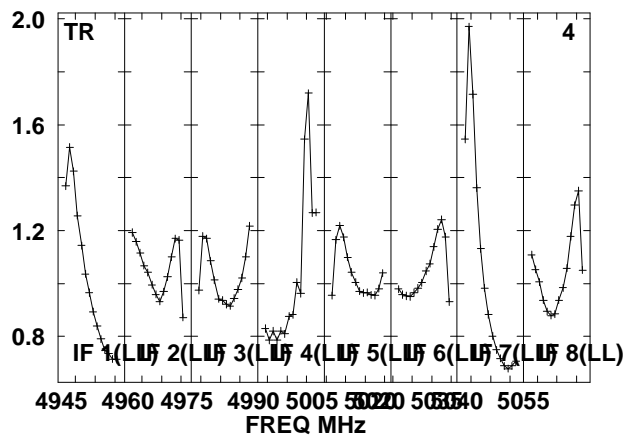
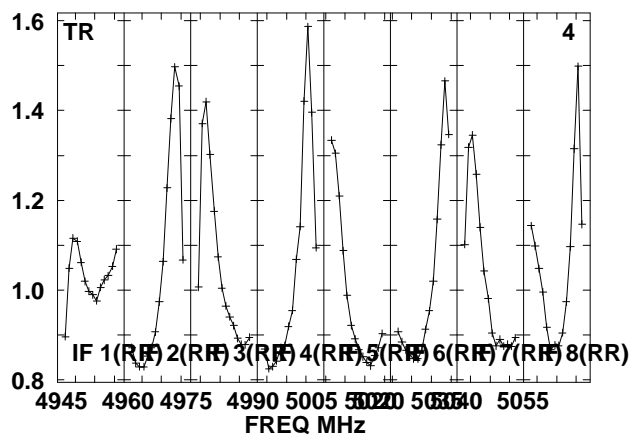
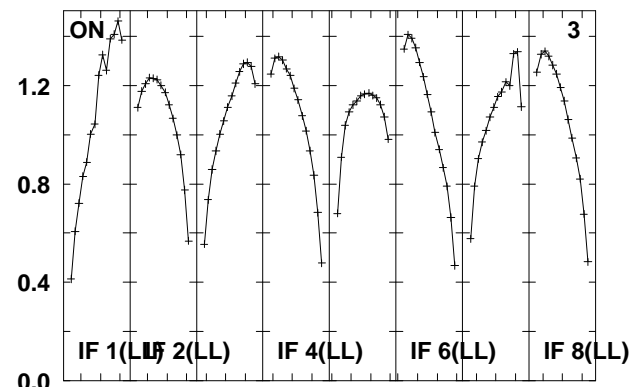
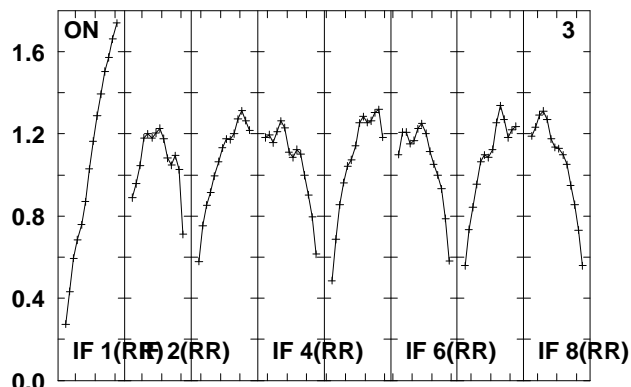
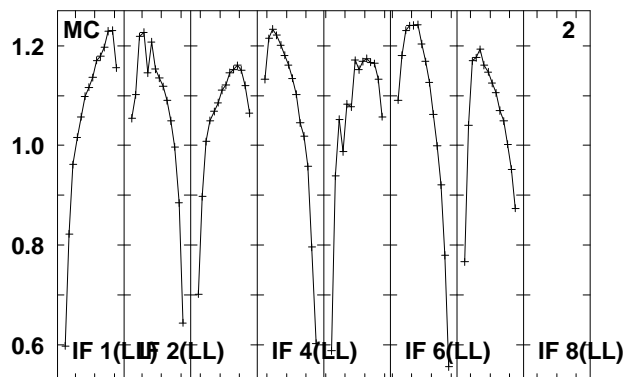
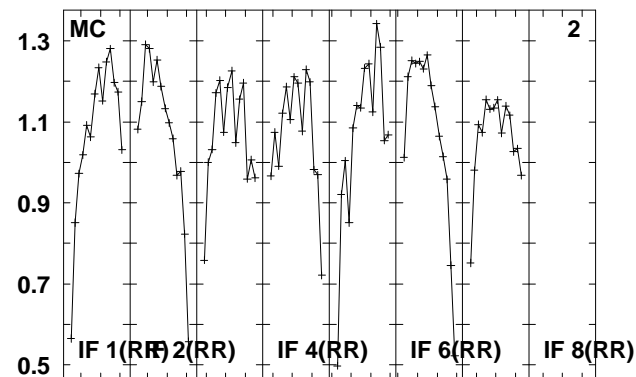
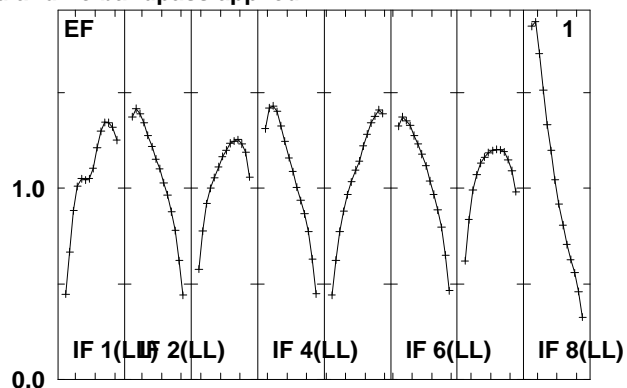
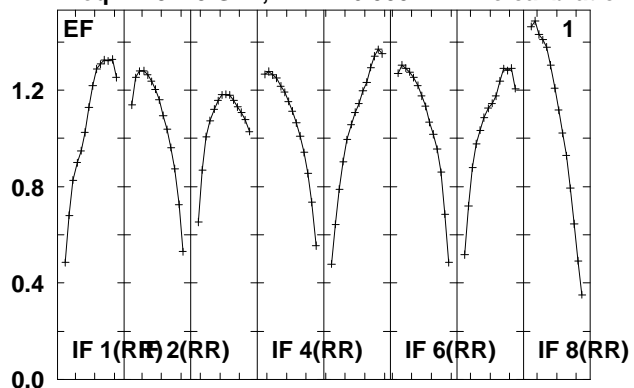

Lower frame: Real Jy
Total-power spectrum Antenna: *
Timerange: 00/17:04:36 to 00/17:16:34

Plot file version 155 created 08-JUL-2010 13:10:37

OQ208 EM079.UVDATA.1

Freq = 4.9415 GHz, Bw = 16.000 MH No calibration applied and no bandpass applied

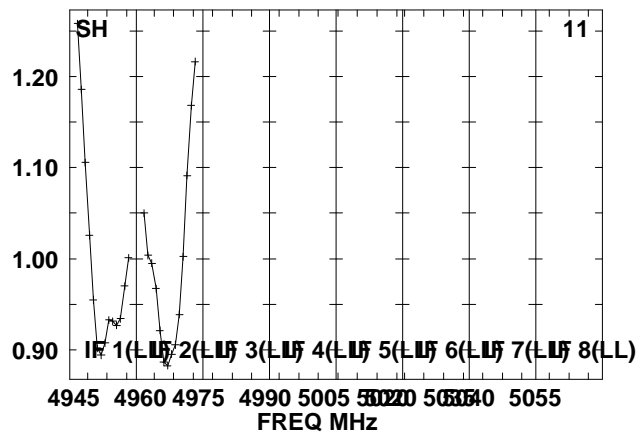
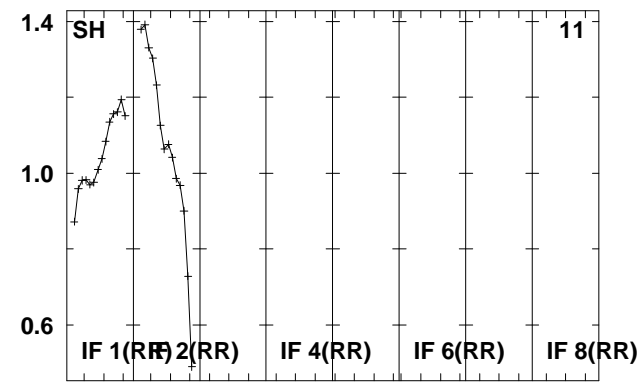
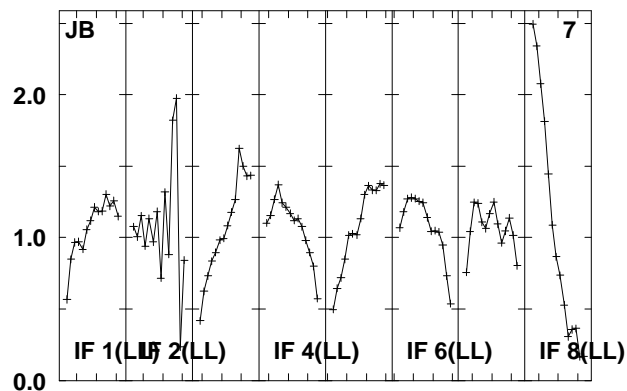
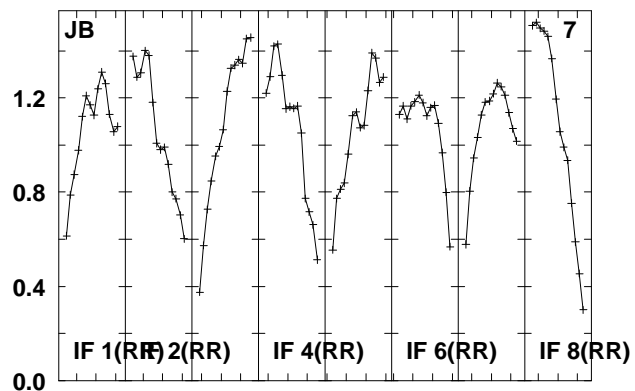
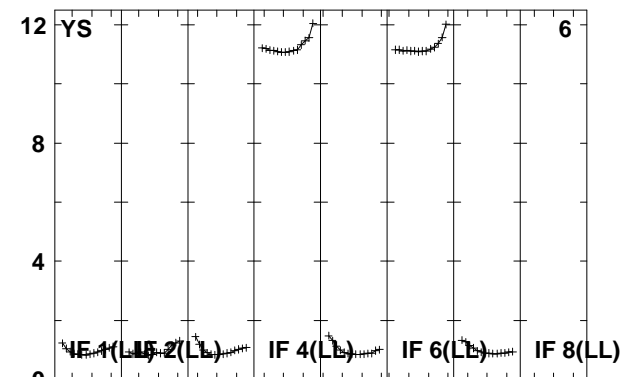
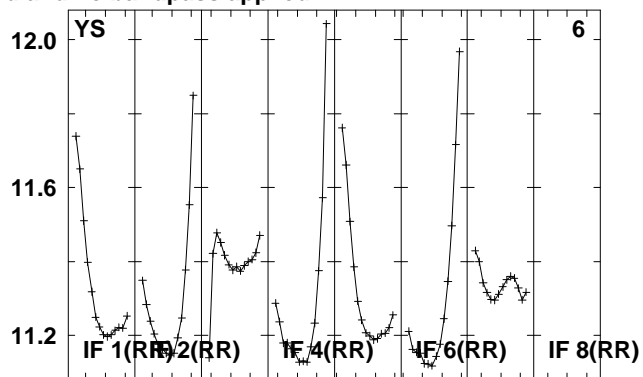
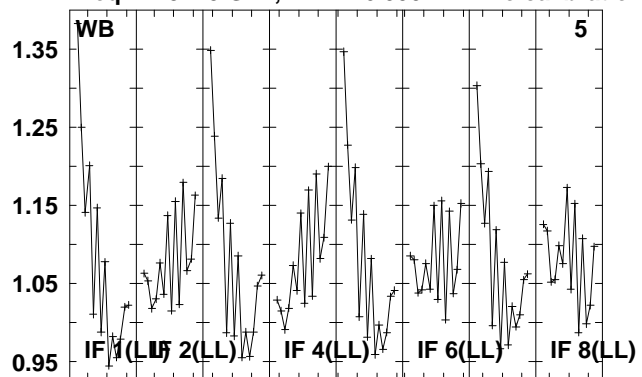

4945 4960 4975 4990 5005 5020 5035 5050 5055
FREQ MHz

Lower frame: Real Jy

Total-power spectrum Antenna: *

Timerange: 00/17:04:36 to 00/17:16:34

Plot file version 156 created 08-JUL-2010 13:10:39

J1521+04 EM079.UVDATA.1

Freq = 4.9415 GHz, Bw = 16.000 MH No calibration applied and no bandpass applied

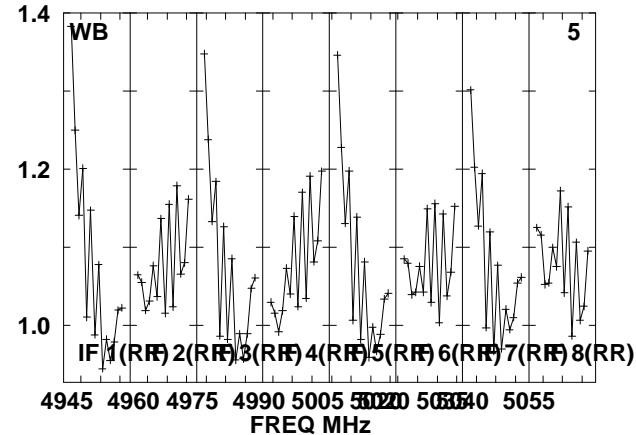
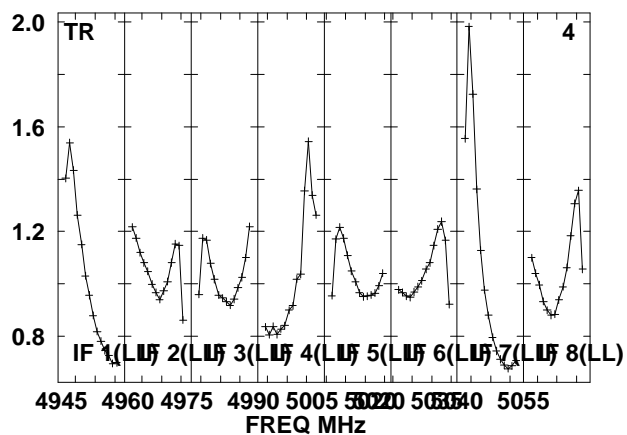
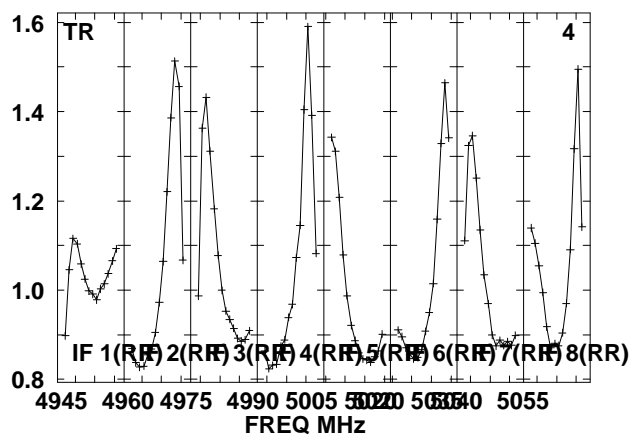
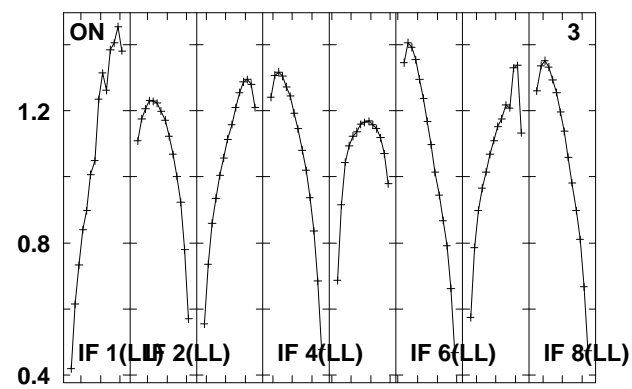
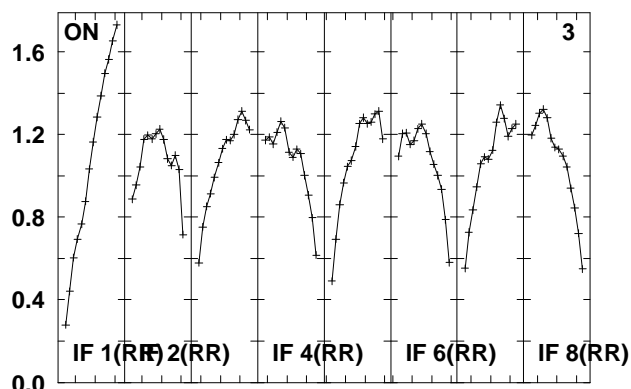
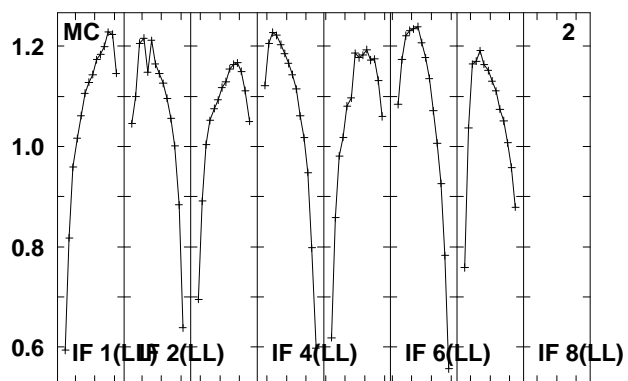
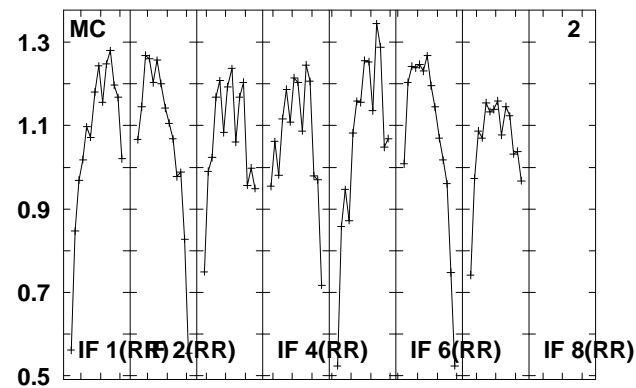
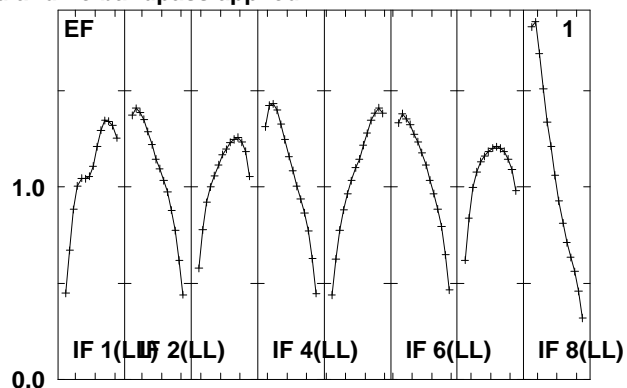
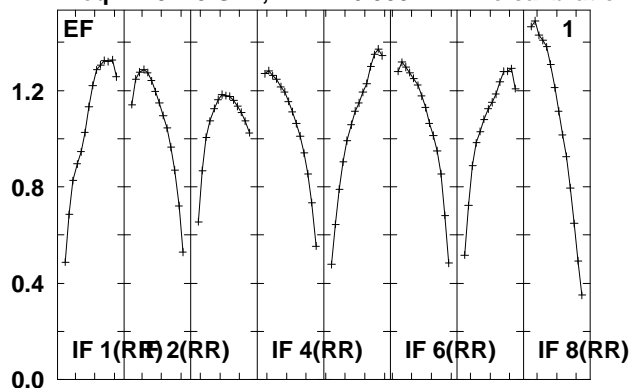

Lower frame: Real Jy
Total-power spectrum Antenna: *
Timerange: 00/17:16:36 to 00/17:18:34

Plot file version 157 created 08-JUL-2010 13:10:40

J1521+04 EM079.UVDATA.1

Freq = 4.9415 GHz, Bw = 16.000 MH No calibration applied and no bandpass applied

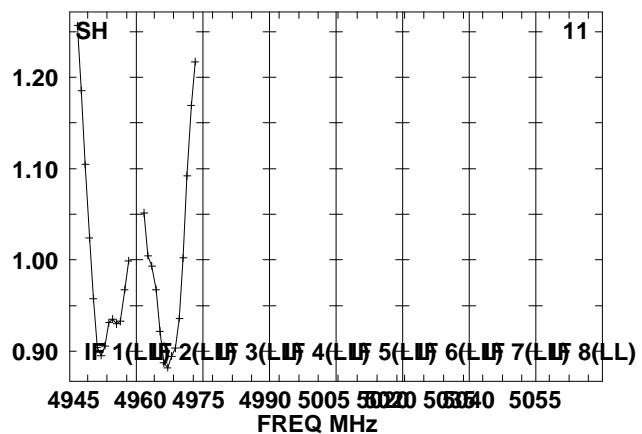
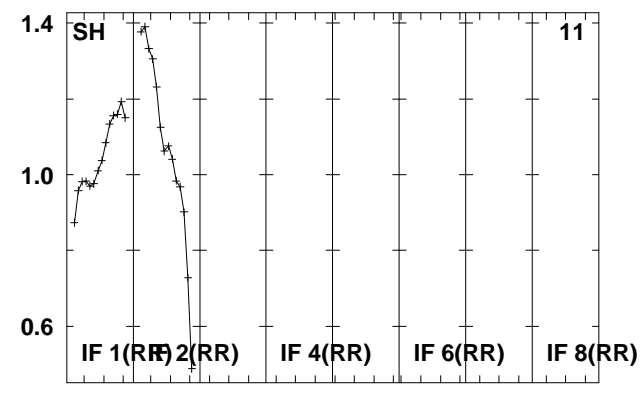
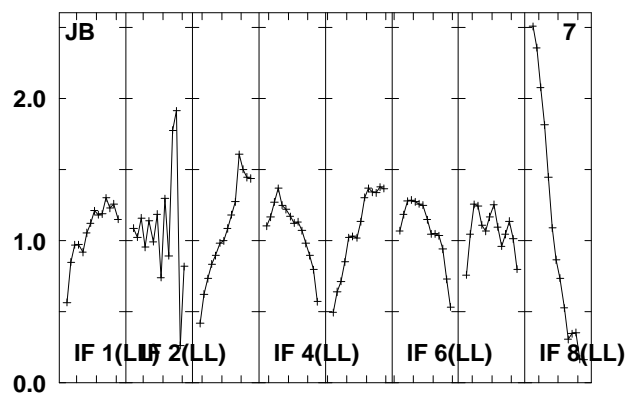
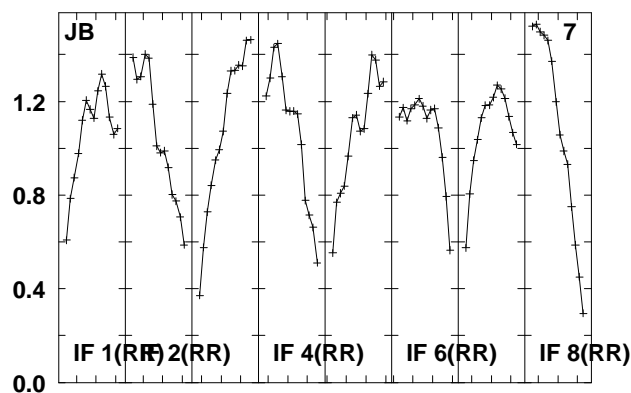
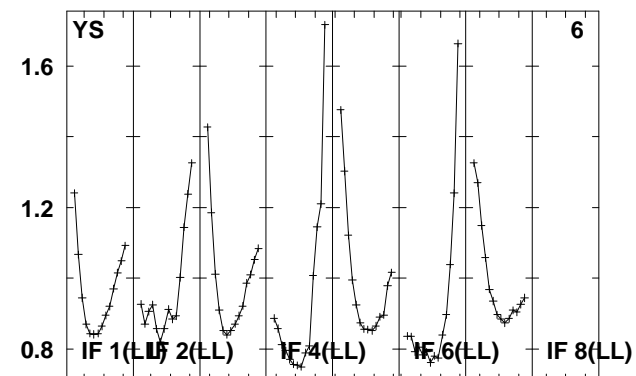
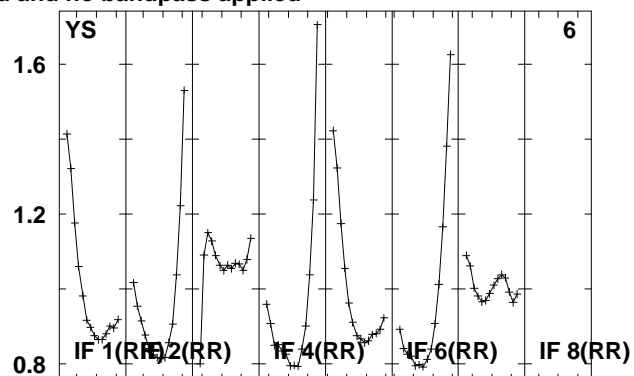
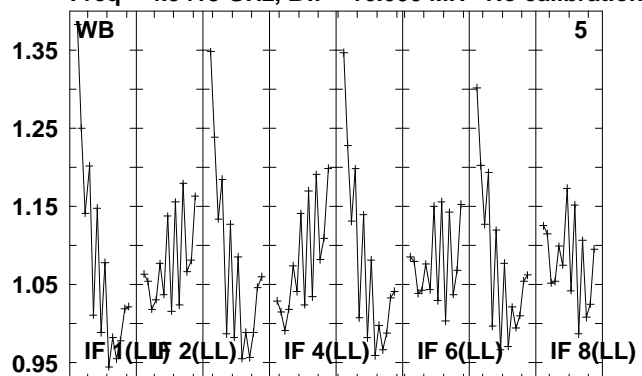

Lower frame: Real Jy

Total-power spectrum Antenna: *

Timerange: 00/17:16:36 to 00/17:18:34

Plot file version 158 created 08-JUL-2010 13:10:40

J1525+05 EM079.UVDATA.1

Freq = 4.9415 GHz, Bw = 16.000 MH No calibration applied and no bandpass applied

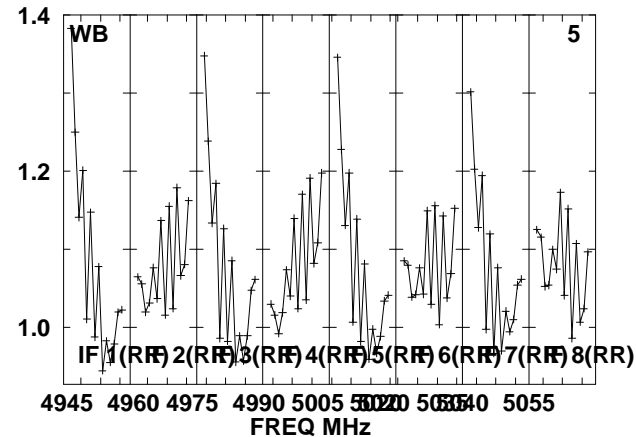
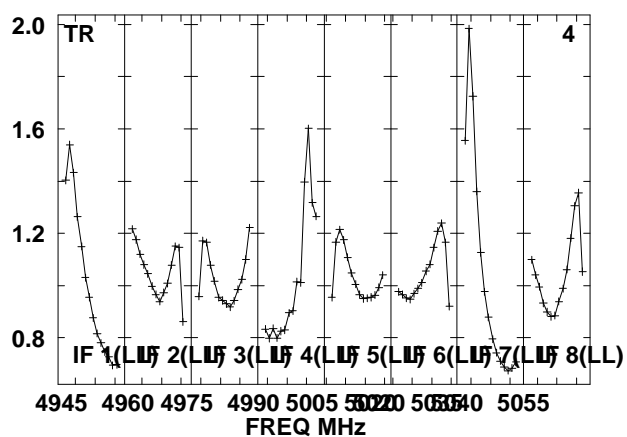
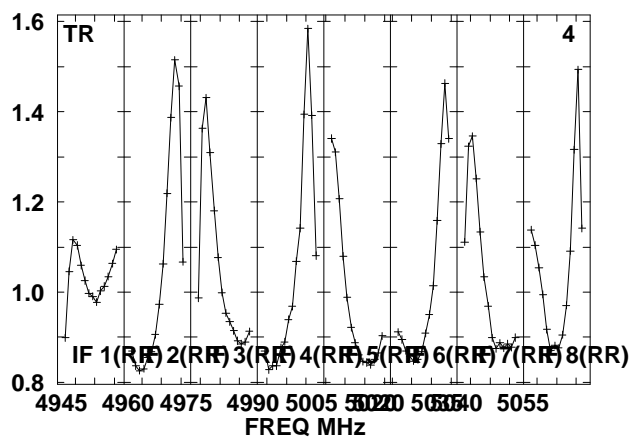
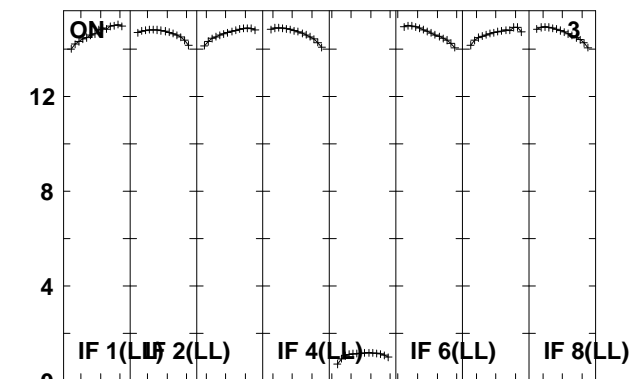
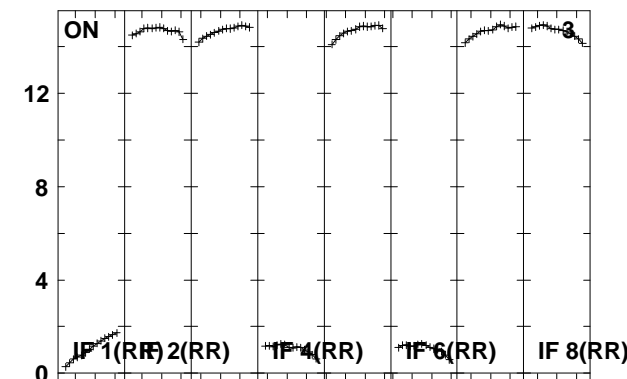
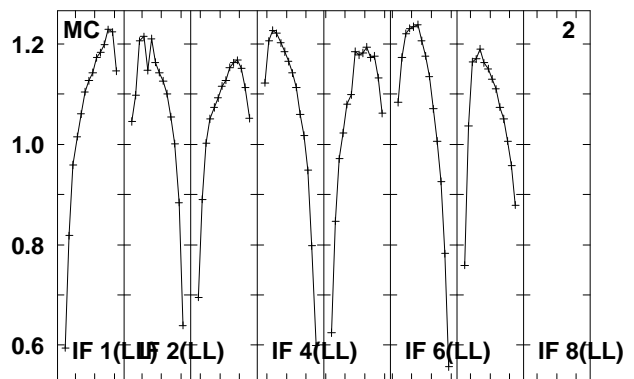
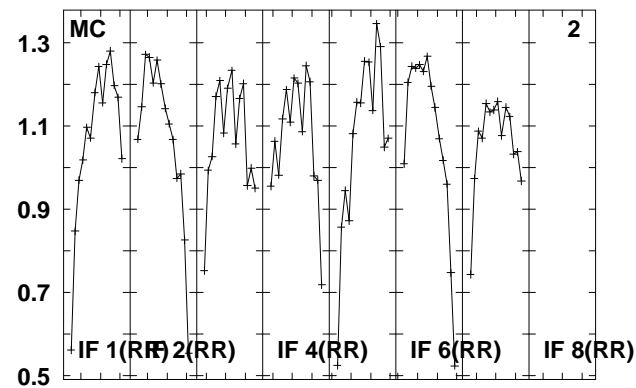
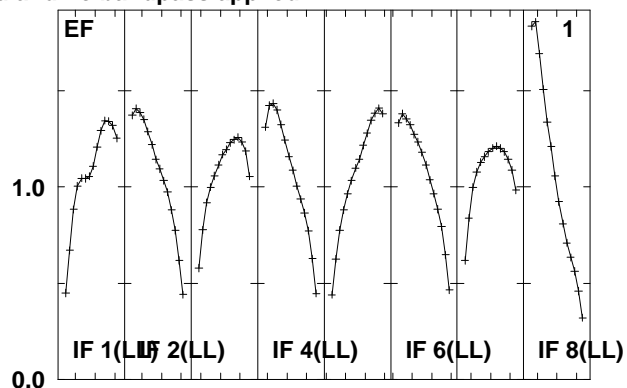
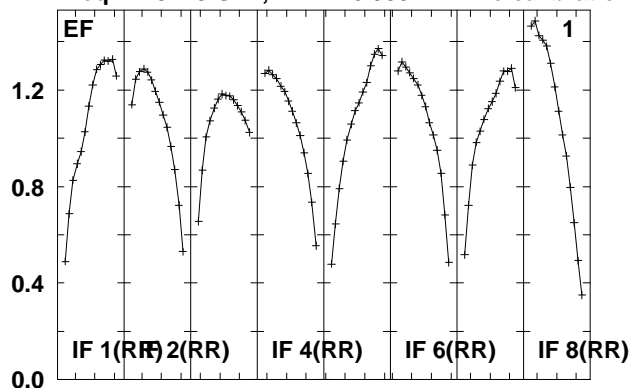

Lower frame: Real Jy
Total-power spectrum Antenna: *
Timerange: 00/17:18:36 to 00/17:29:18

Plot file version 159 created 08-JUL-2010 13:10:42

J1525+05 EM079.UVDATA.1

Freq = 4.9415 GHz, Bw = 16.000 MH No calibration applied and no bandpass applied

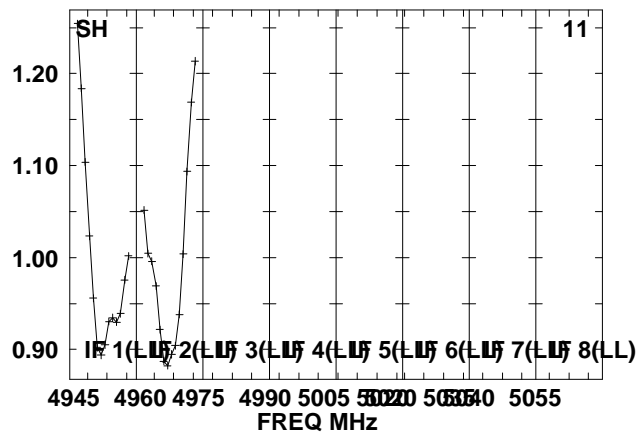
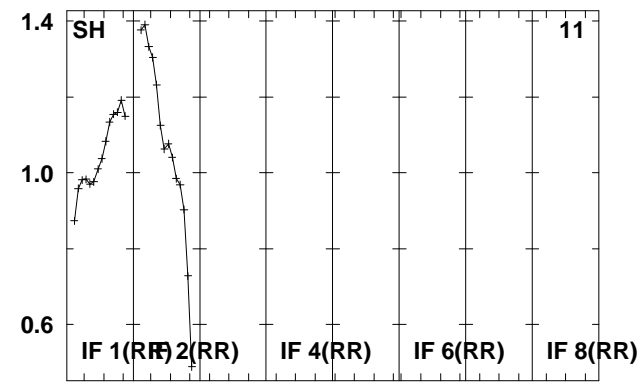
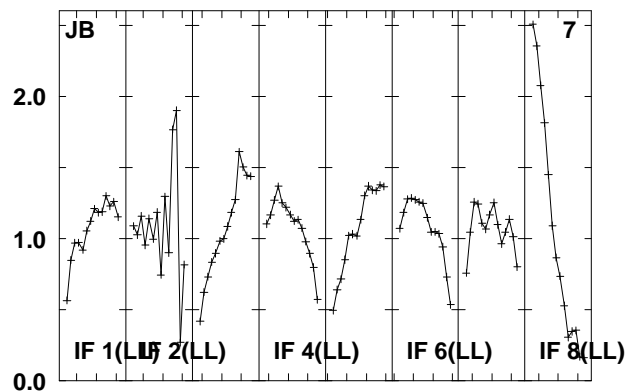
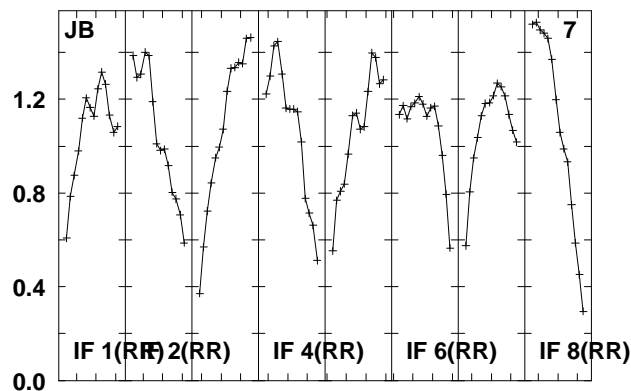
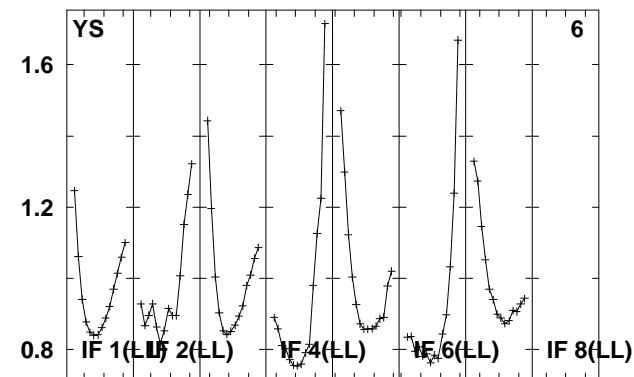
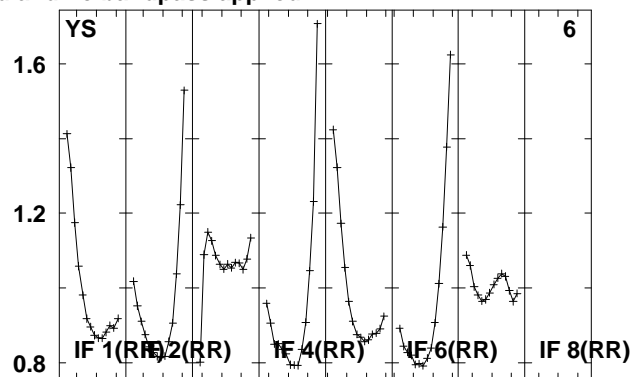
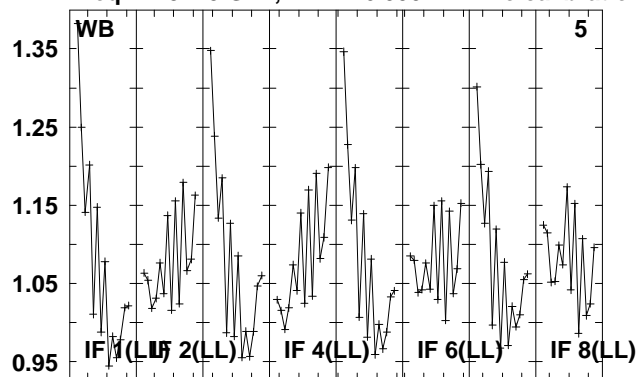

4945 4960 4975 4990 5005 5020 5035 5050 5055
FREQ MHz

Lower frame: Real Jy

Total-power spectrum Antenna: *

Timerange: 00/17:18:36 to 00/17:29:18

Plot file version 160 created 08-JUL-2010 13:10:43

J1521+04 EM079.UVDATA.1

Freq = 4.9415 GHz, Bw = 16.000 MH No calibration applied and no bandpass applied

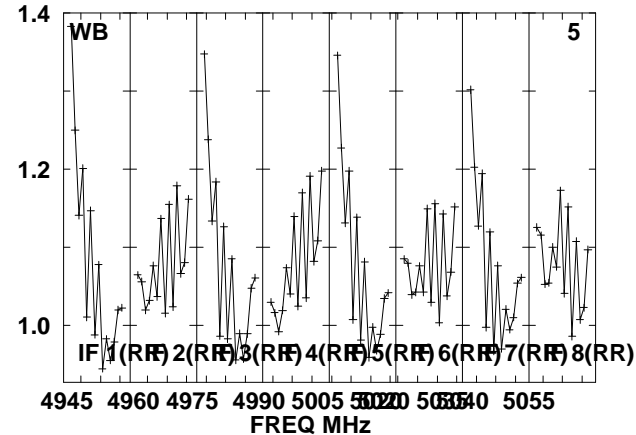
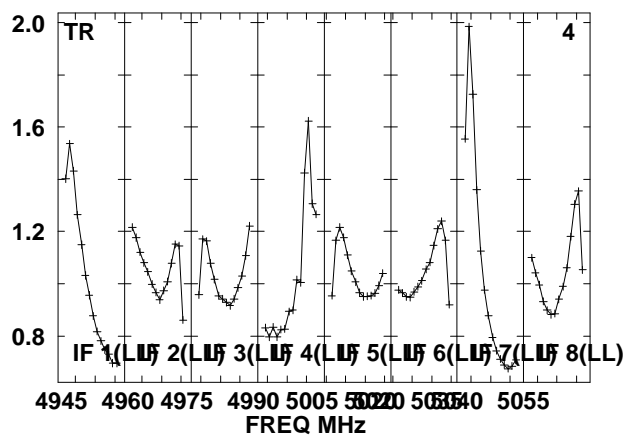
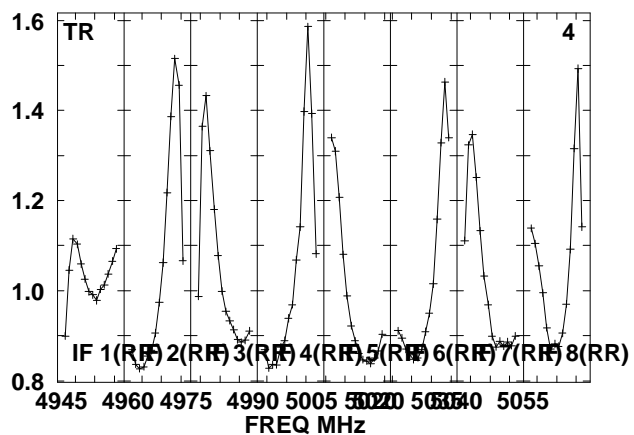
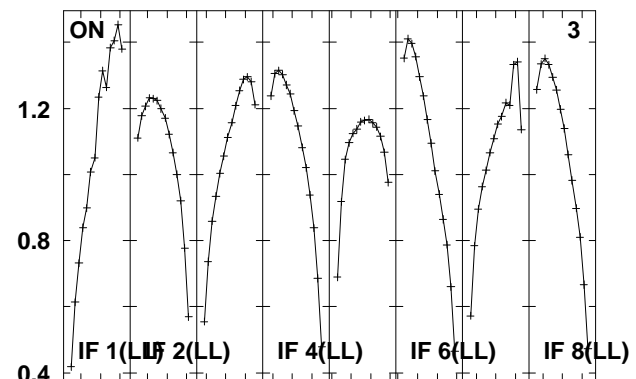
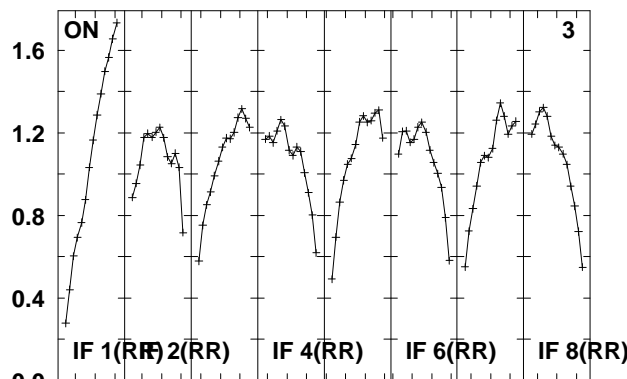
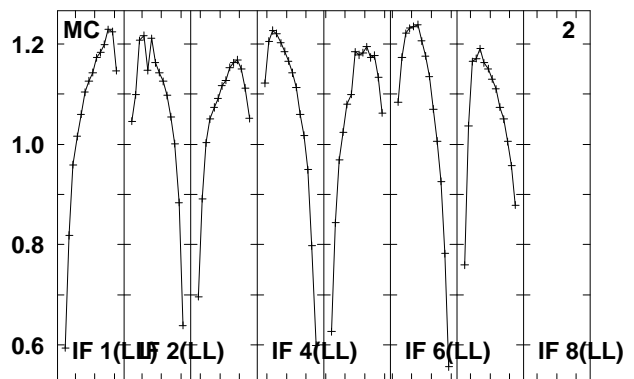
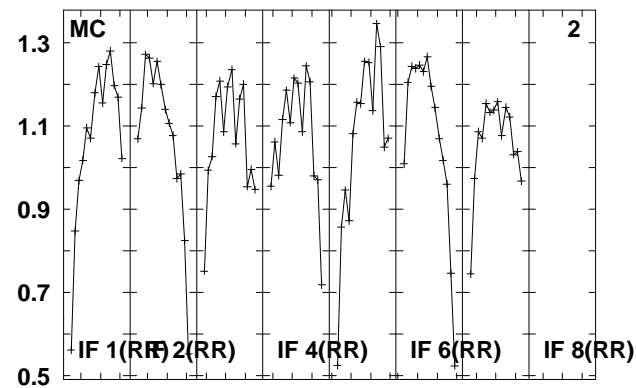
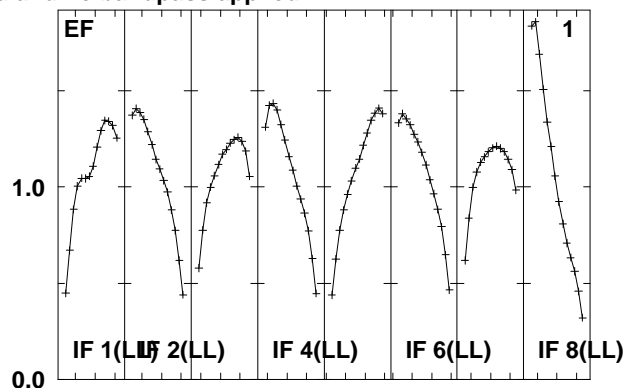
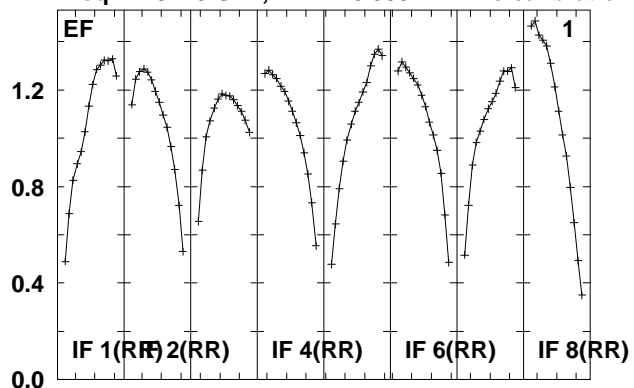

Lower frame: Real Jy
Total-power spectrum Antenna: *
Timerange: 00/17:29:20 to 00/17:31:18

Plot file version 161 created 08-JUL-2010 13:10:44

J1521+04 EM079.UVDATA.1

Freq = 4.9415 GHz, Bw = 16.000 MH No calibration applied and no bandpass applied

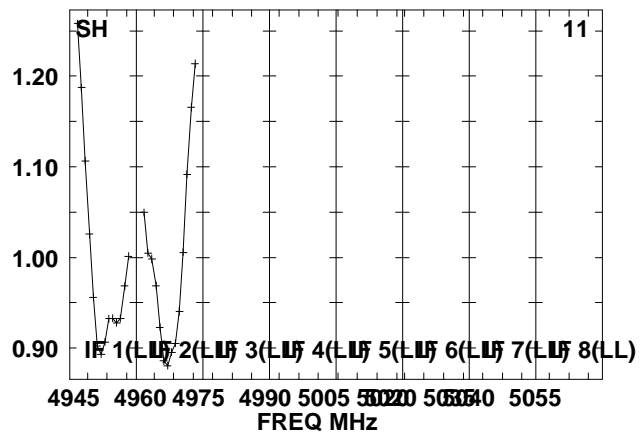
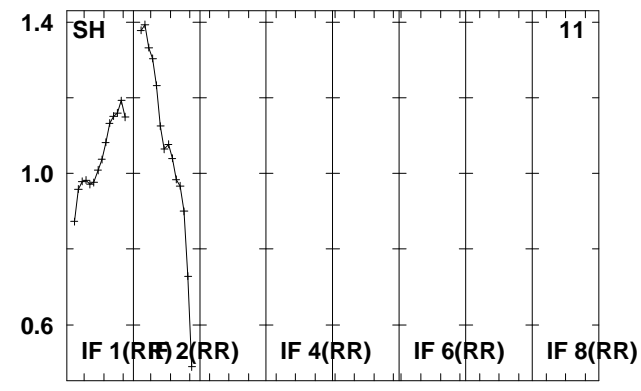
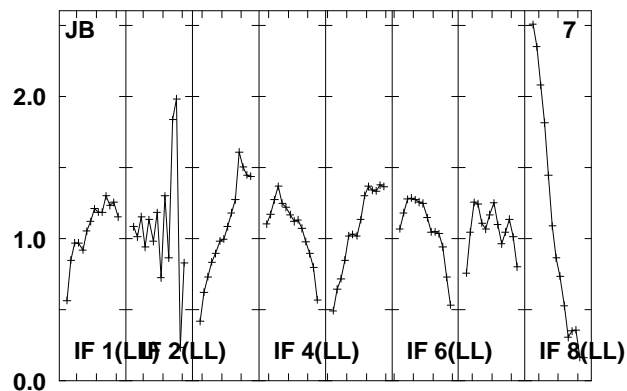
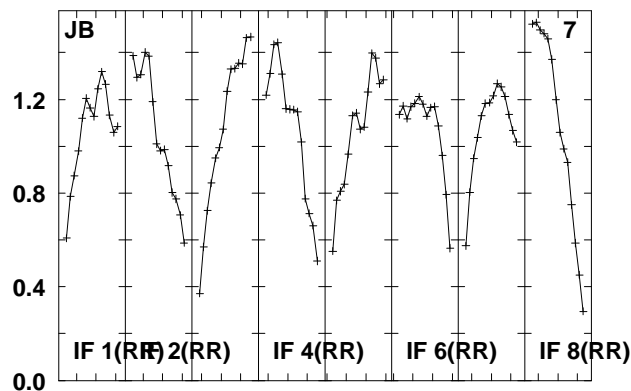
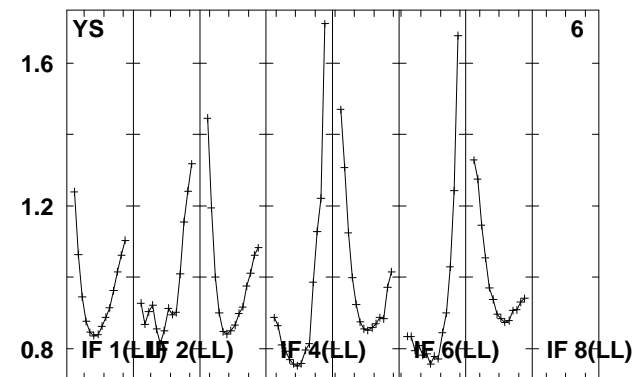
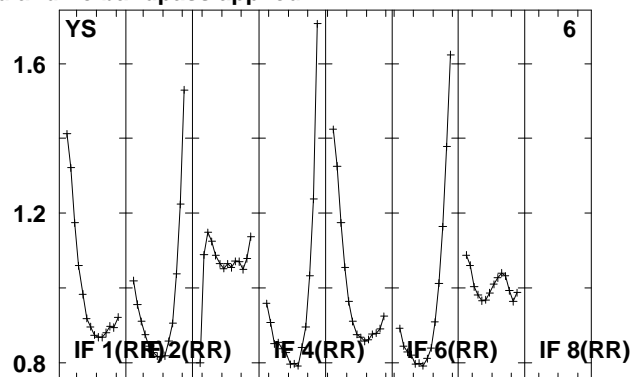
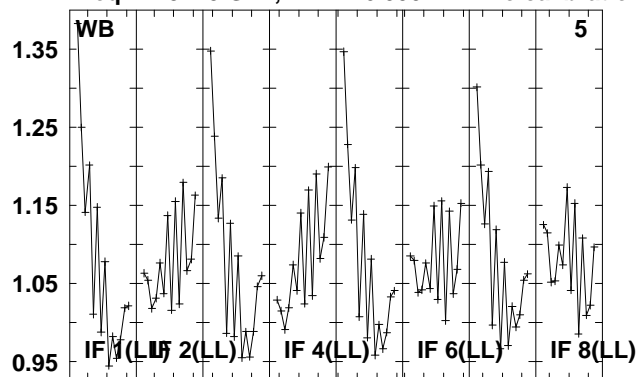

4945 4960 4975 4990 5005 5020 5035 5050 5055
FREQ MHz

Lower frame: Real Jy

Total-power spectrum Antenna: *

Timerange: 00/17:29:20 to 00/17:31:18

Plot file version 162 created 08-JUL-2010 13:10:44

J1525+05 EM079.UVDATA.1

Freq = 4.9415 GHz, Bw = 16.000 MH No calibration applied and no bandpass applied

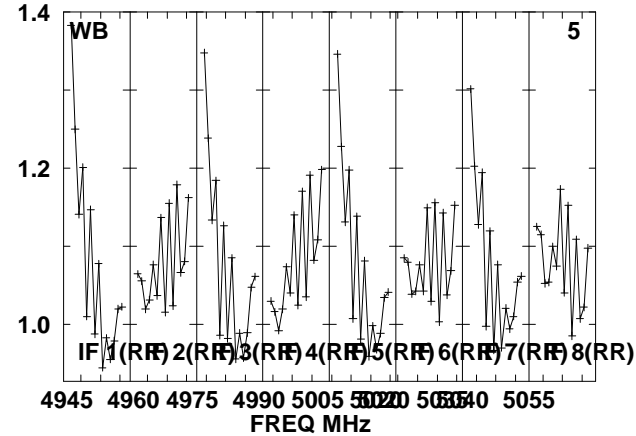
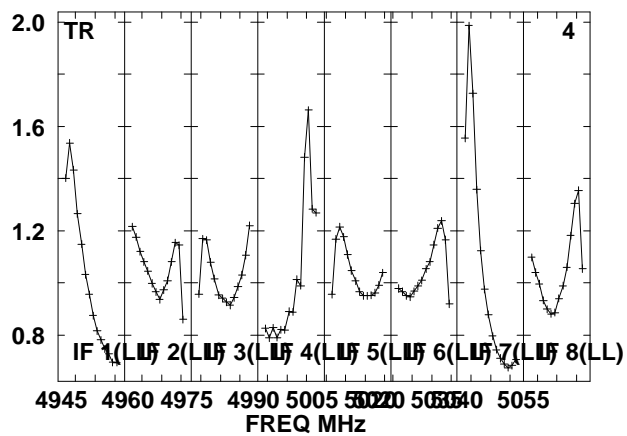
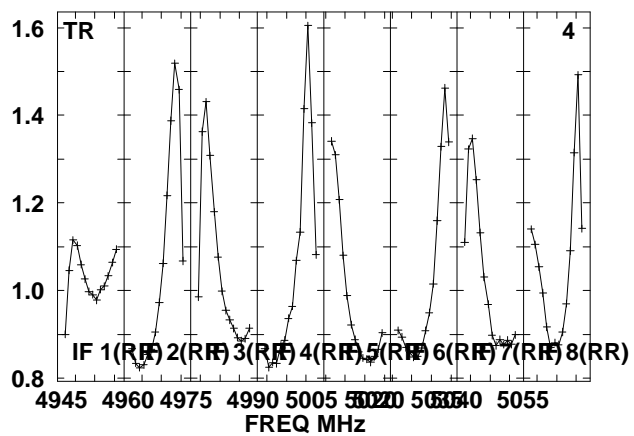
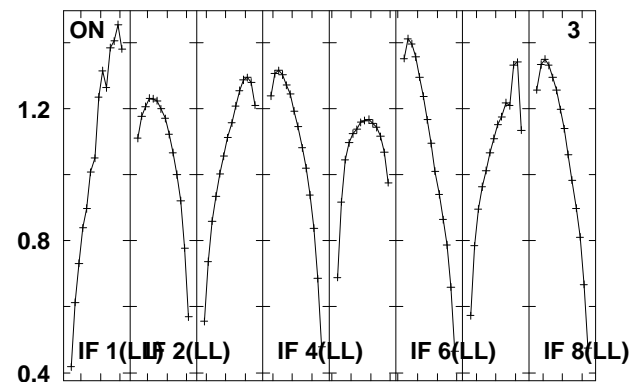
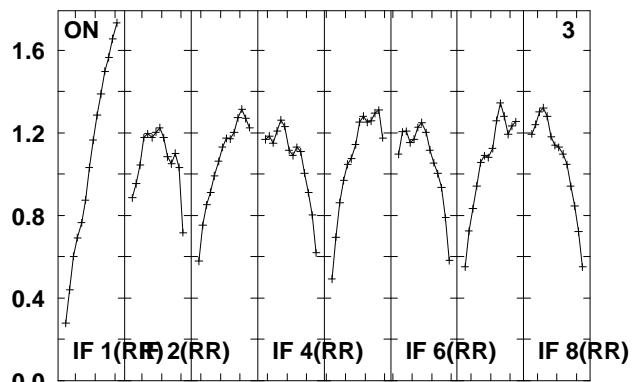
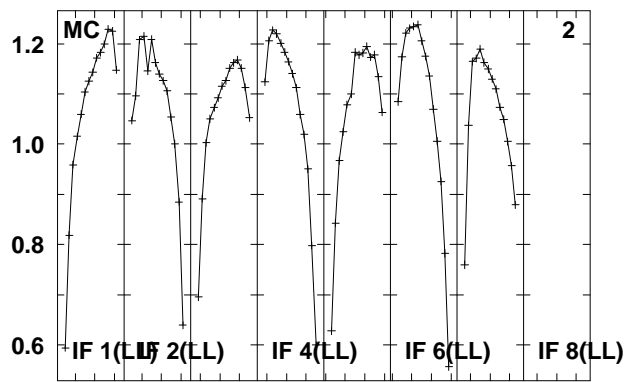
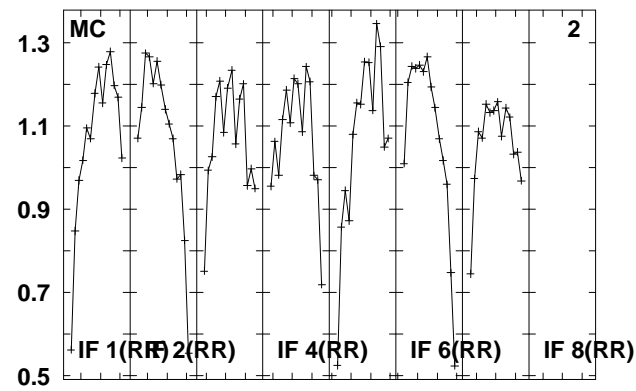
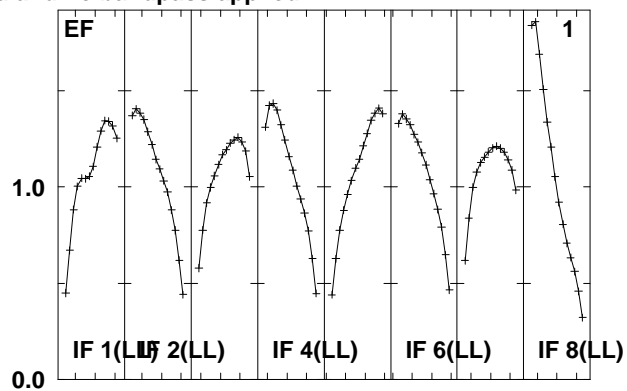
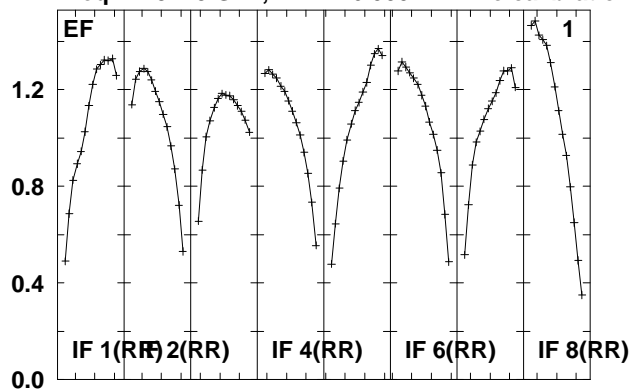

Lower frame: Real Jy
Total-power spectrum Antenna: *
Timerange: 00/17:31:20 to 00/17:42:04

Plot file version 163 created 08-JUL-2010 13:10:46

J1525+05 EM079.UVDATA.1

Freq = 4.9415 GHz, Bw = 16.000 MH No calibration applied and no bandpass applied

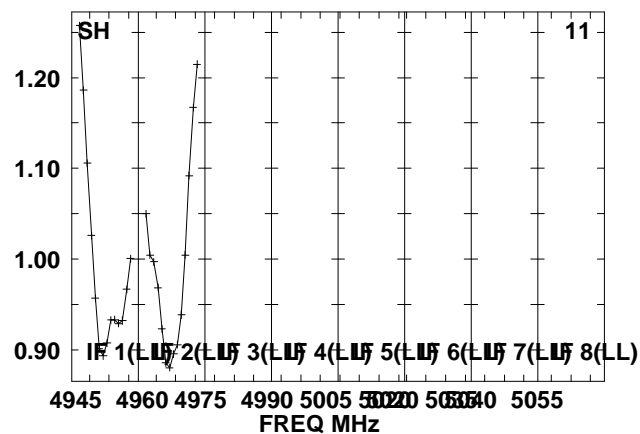
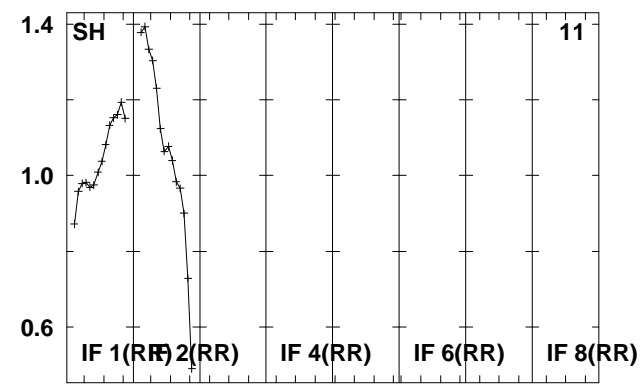
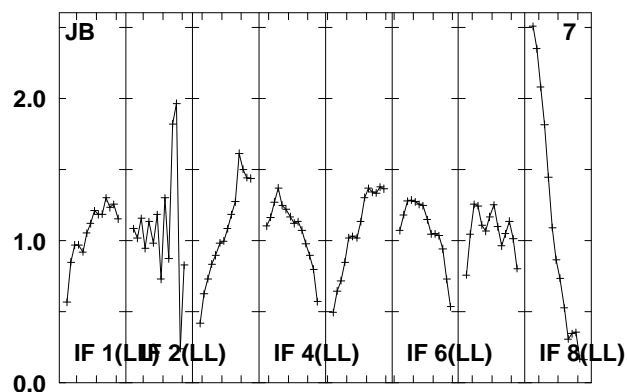
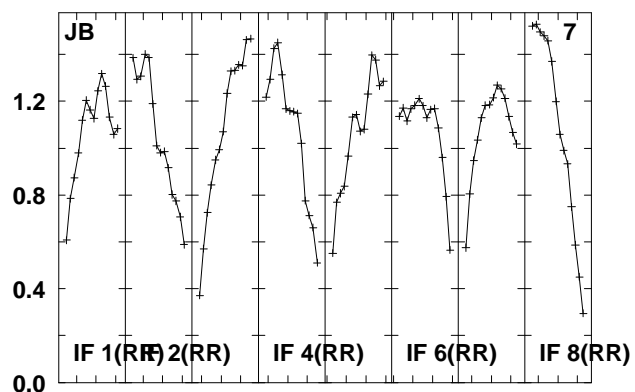
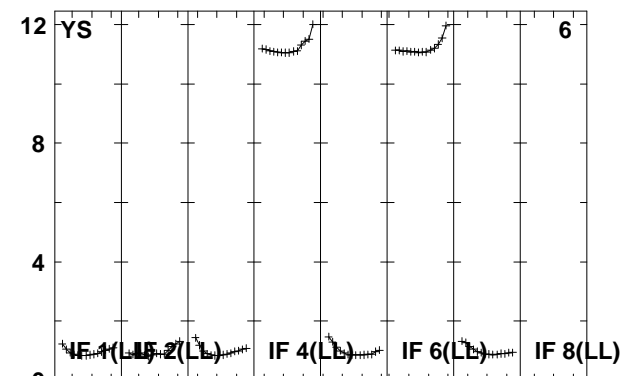
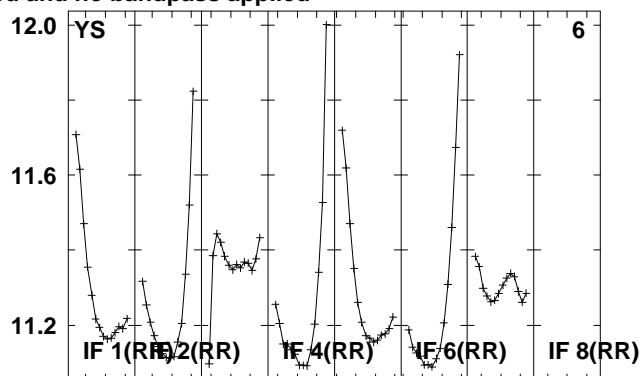
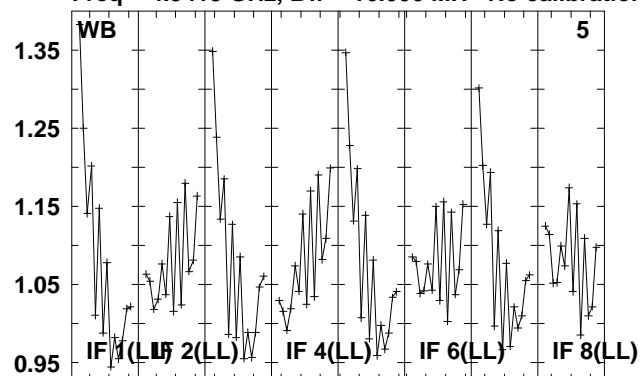

4945 4960 4975 4990 5005 5020 5035 5050 5055
FREQ MHz

Lower frame: Real Jy

Total-power spectrum Antenna: *

Timerange: 00/17:31:20 to 00/17:42:04

Plot file version 164 created 08-JUL-2010 13:10:52

J1521+04 EM079.UVDATA.1

Freq = 4.9415 GHz, Bw = 16.000 MH No calibration applied and no bandpass applied

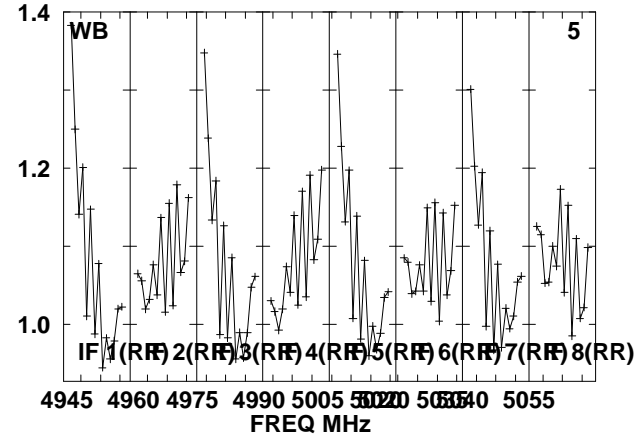
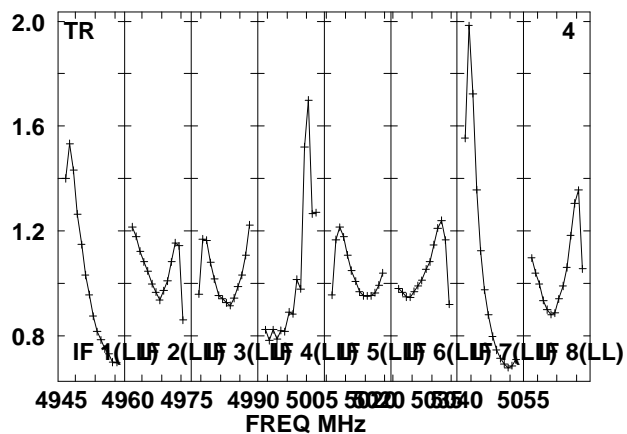
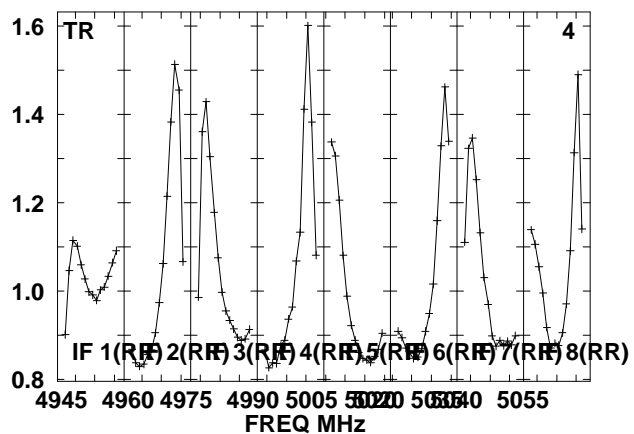
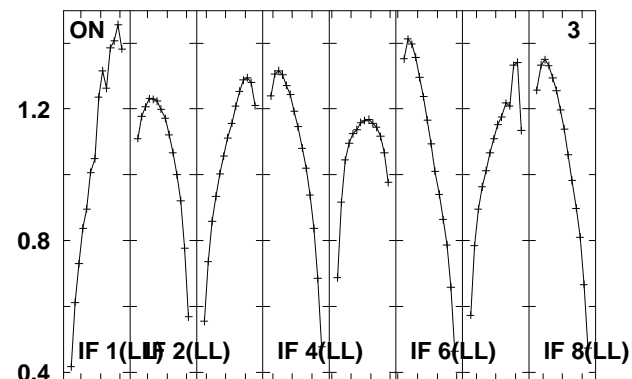
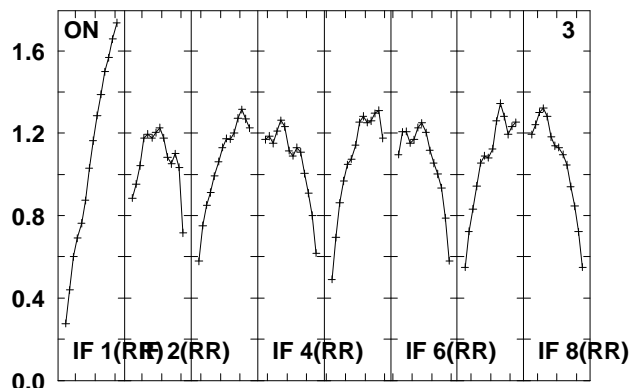
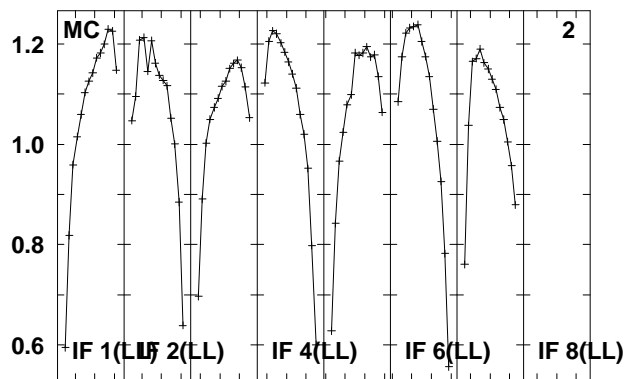
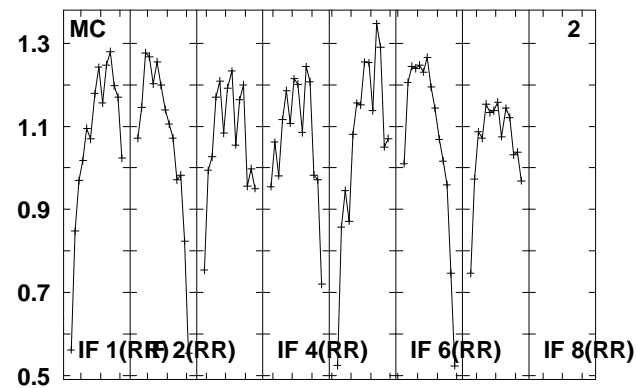
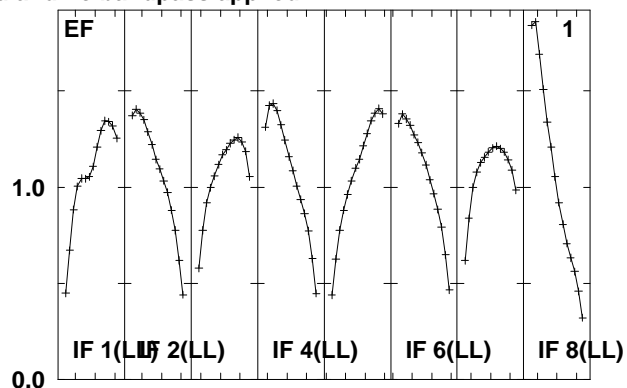
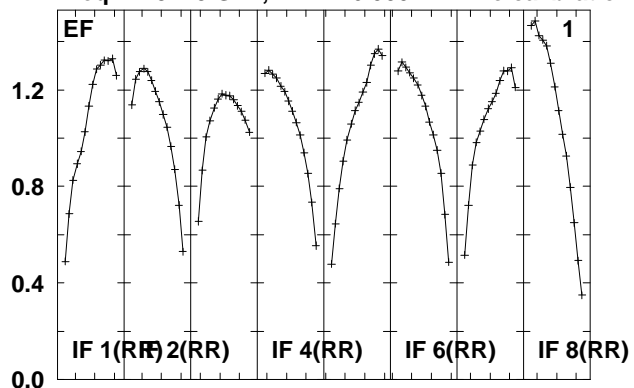

Lower frame: Real Jy
Total-power spectrum Antenna: *
Timerange: 00/17:42:06 to 00/17:44:04

Plot file version 165 created 08-JUL-2010 13:10:53

J1521+04 EM079.UVDATA.1

Freq = 4.9415 GHz, Bw = 16.000 MH No calibration applied and no bandpass applied

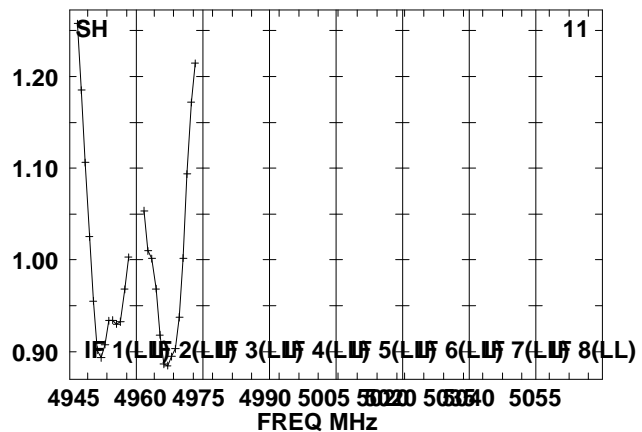
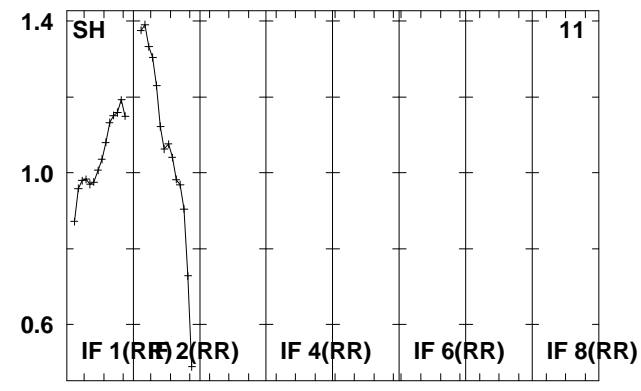
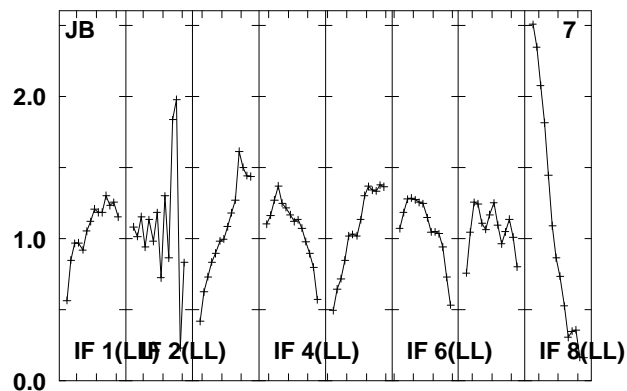
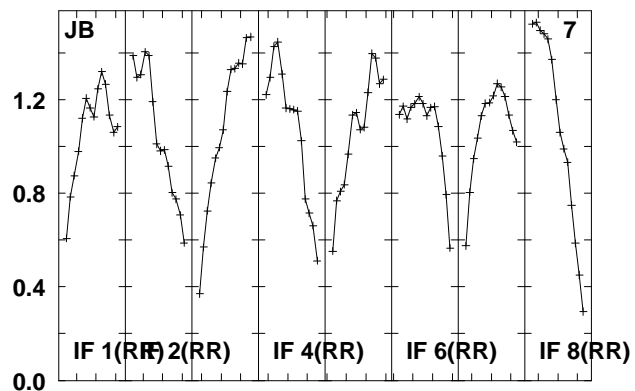
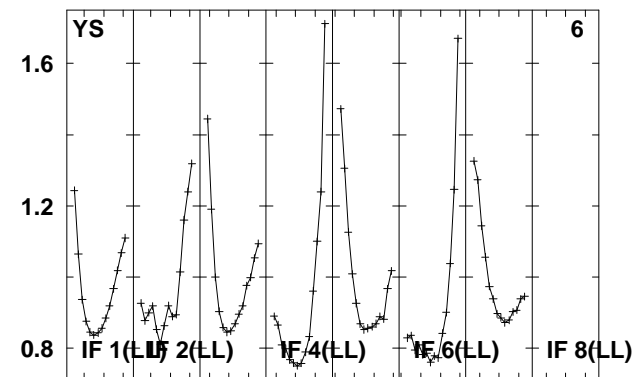
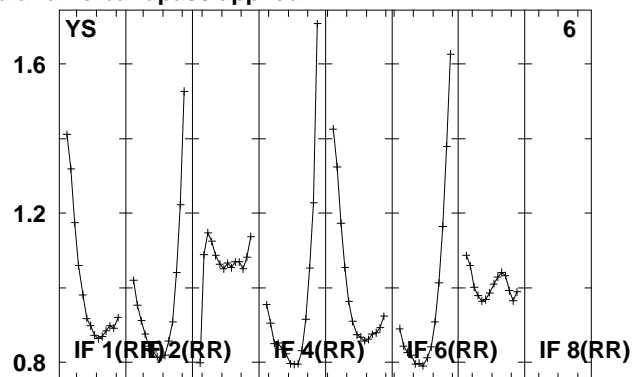
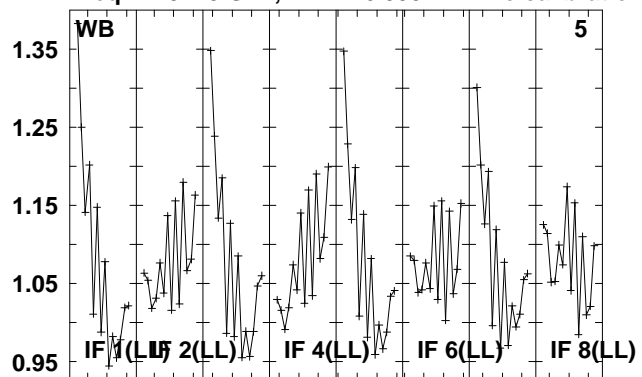

Lower frame: Real Jy

Total-power spectrum Antenna: *

Timerange: 00/17:42:06 to 00/17:44:04

Plot file version 166 created 08-JUL-2010 13:10:54

J1525+05 EM079.UVDATA.1

Freq = 4.9415 GHz, Bw = 16.000 MH No calibration applied and no bandpass applied

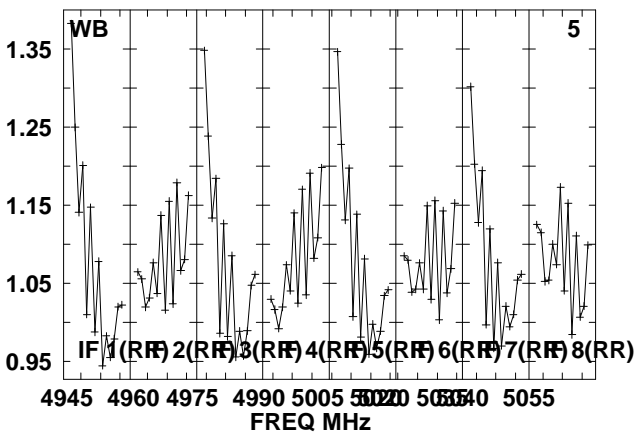
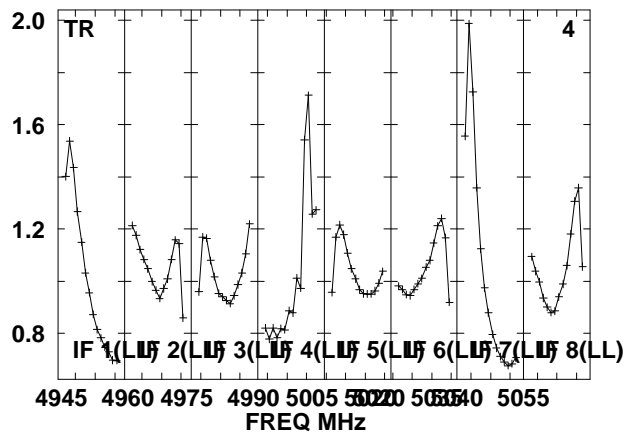
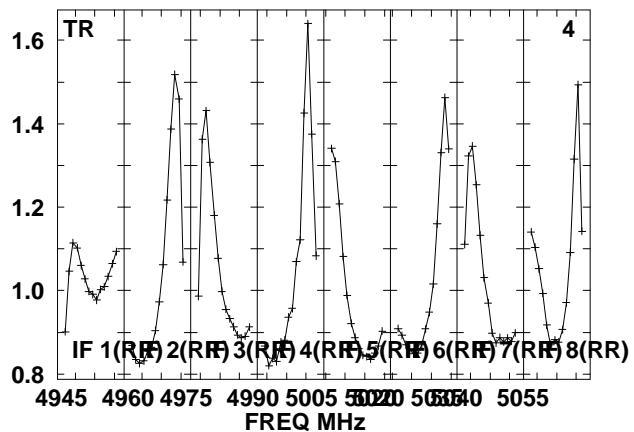
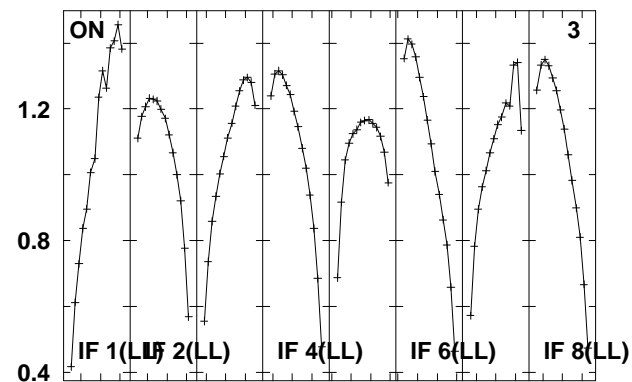
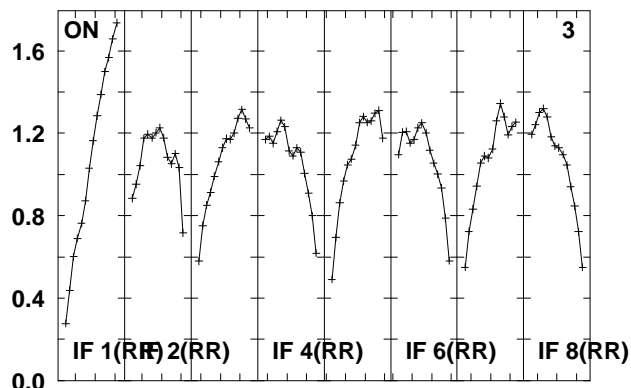
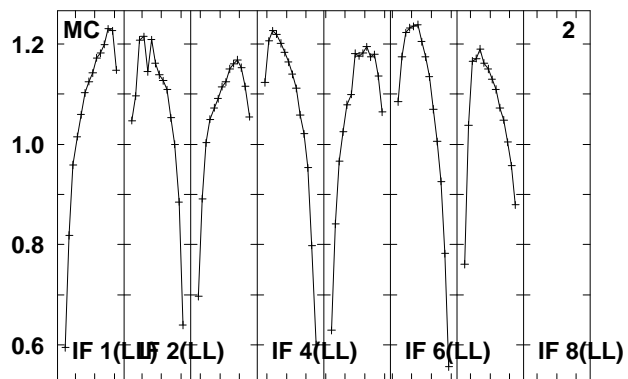
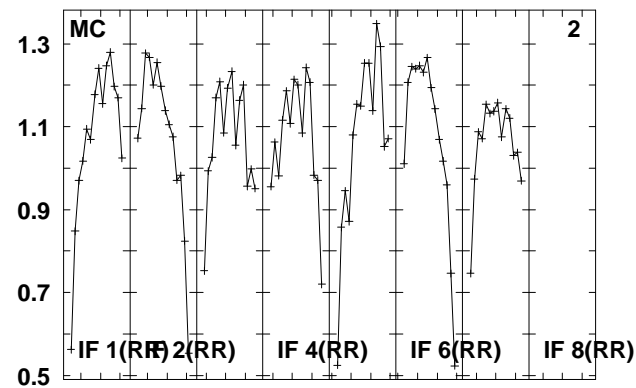
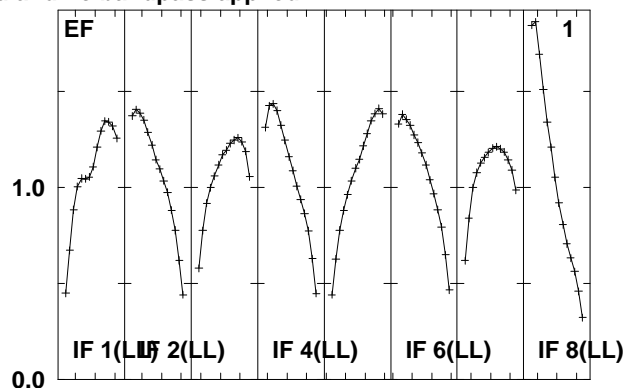
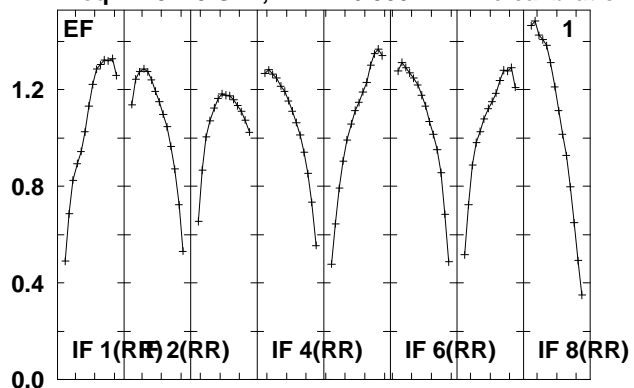

Lower frame: Real Jy
Total-power spectrum Antenna: *
Timerange: 00/17:44:06 to 00/17:54:48

Plot file version 167 created 08-JUL-2010 13:10:55

J1525+05 EM079.UVDATA.1

Freq = 4.9415 GHz, Bw = 16.000 MH No calibration applied and no bandpass applied

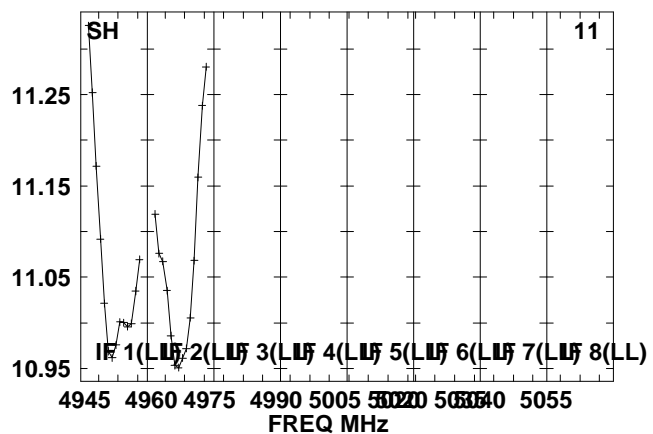
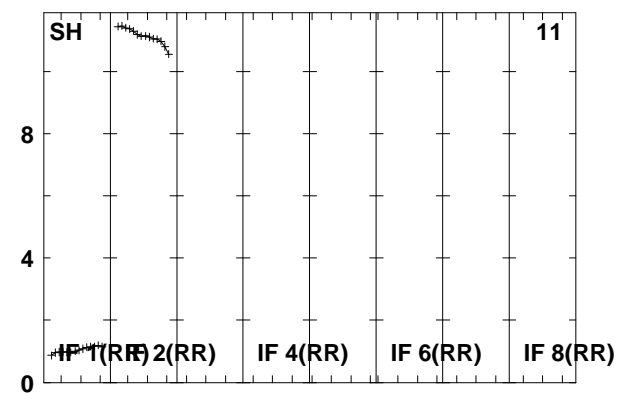
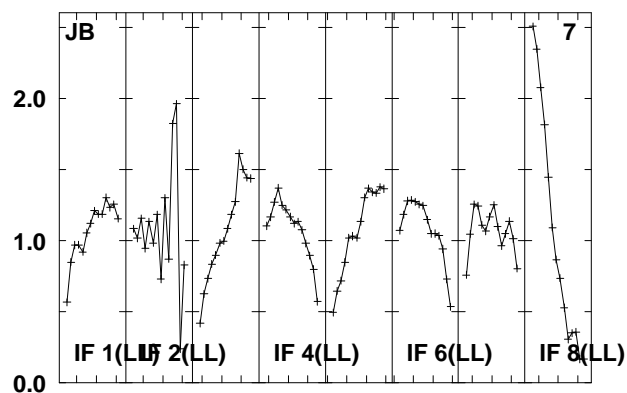
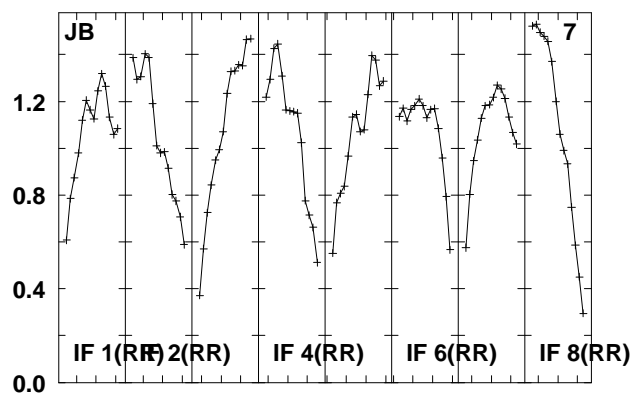
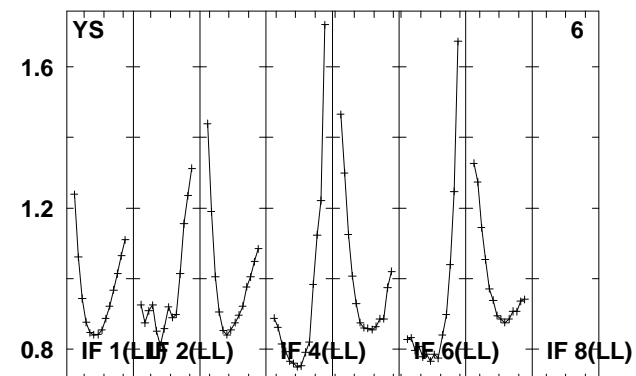
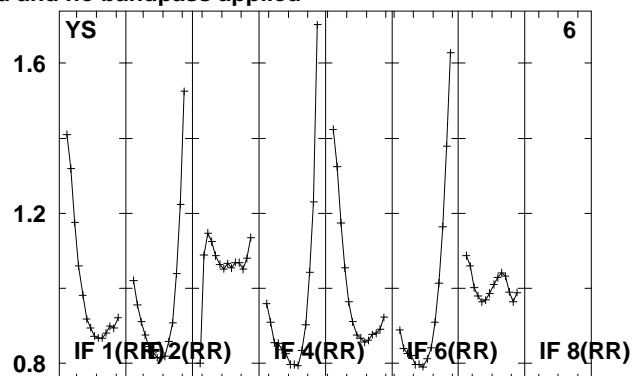
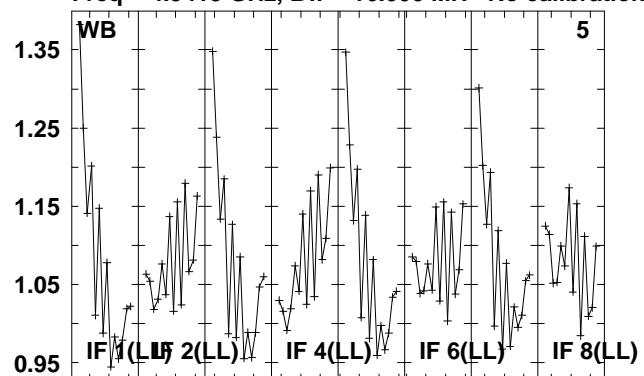

Lower frame: Real Jy

Total-power spectrum Antenna: *

Timerange: 00/17:44:06 to 00/17:54:48

Plot file version 168 created 08-JUL-2010 13:10:57

J1521+04 EM079.UVDATA.1

Freq = 4.9415 GHz, Bw = 16.000 MH No calibration applied and no bandpass applied

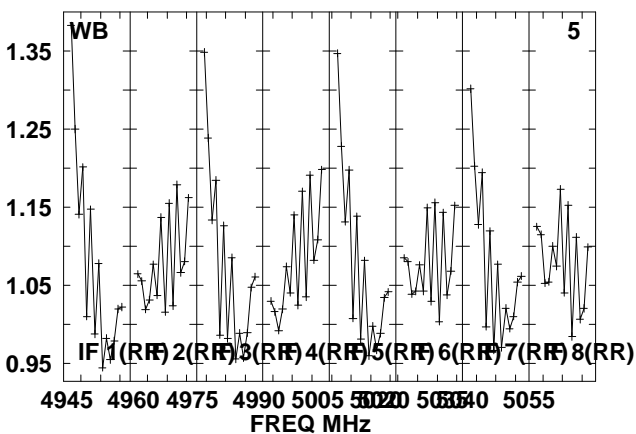
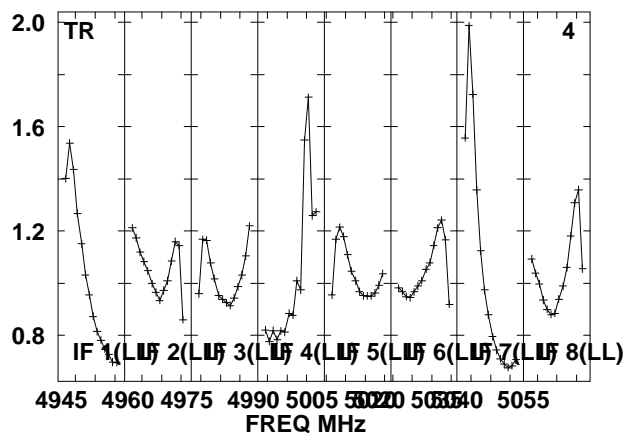
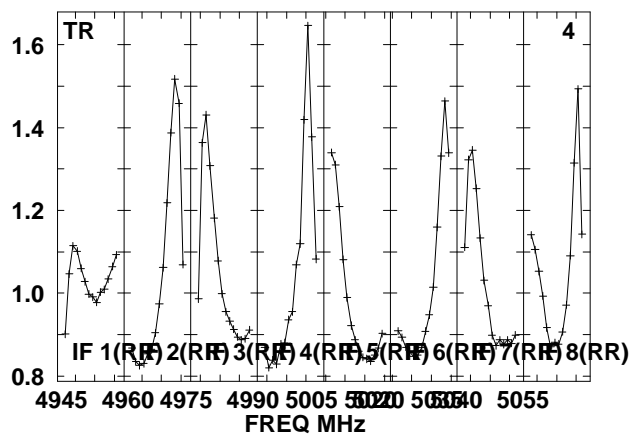
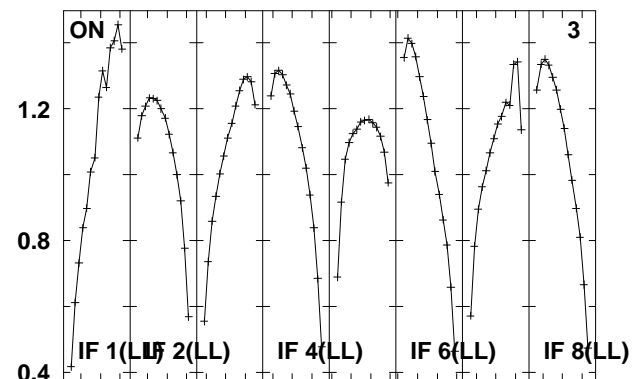
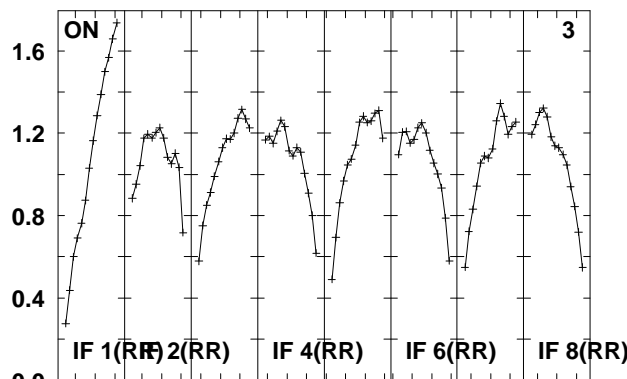
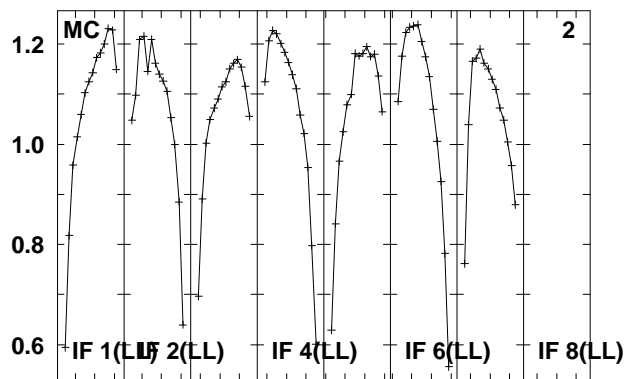
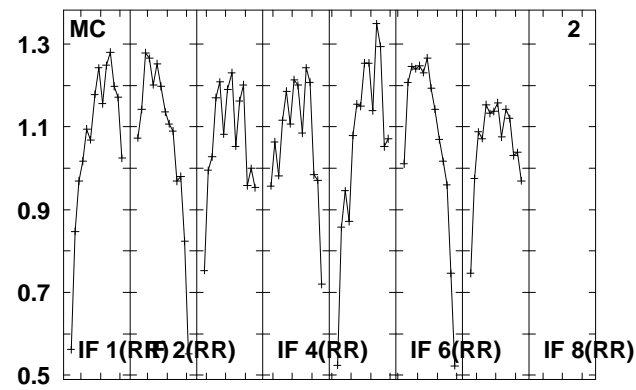
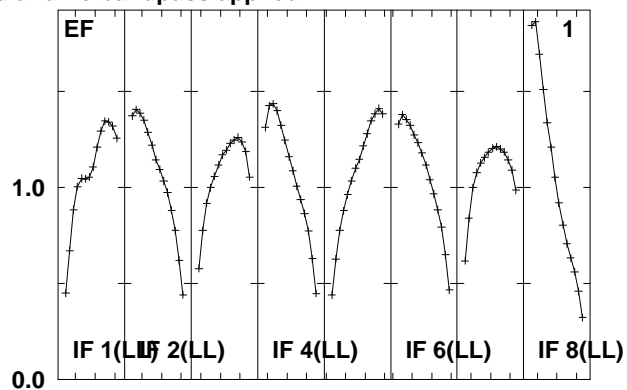
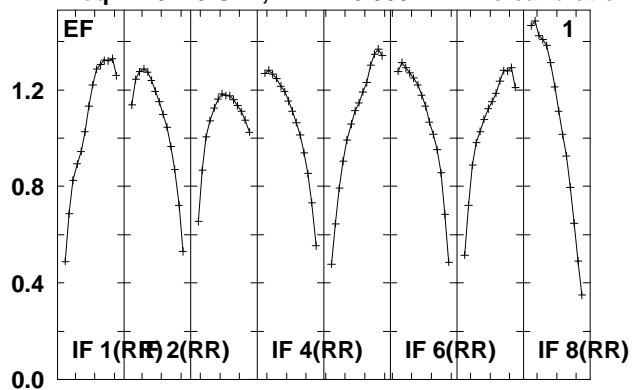

Lower frame: Real Jy
Total-power spectrum Antenna: *
Timerange: 00/17:54:50 to 00/17:56:48

Plot file version 169 created 08-JUL-2010 13:10:57

J1521+04 EM079.UVDATA.1

Freq = 4.9415 GHz, Bw = 16.000 MH No calibration applied and no bandpass applied

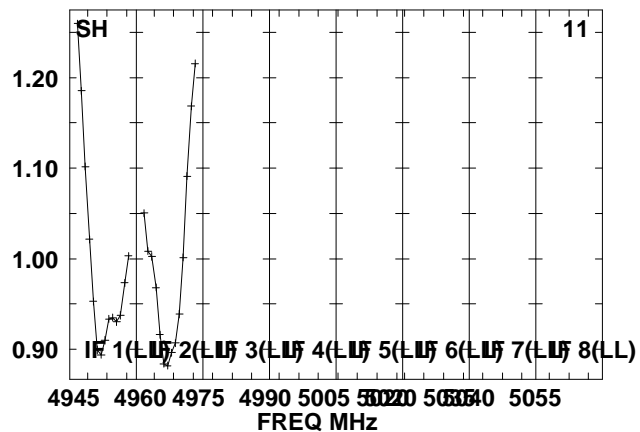
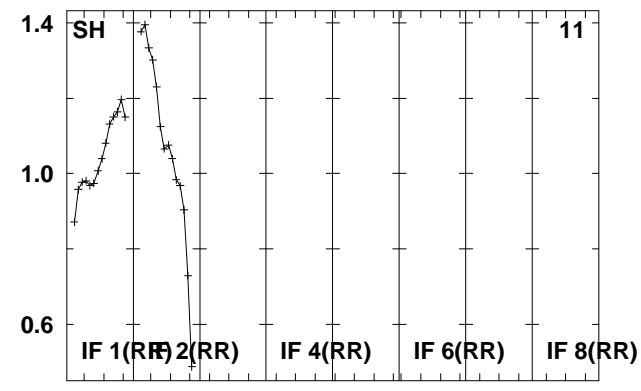
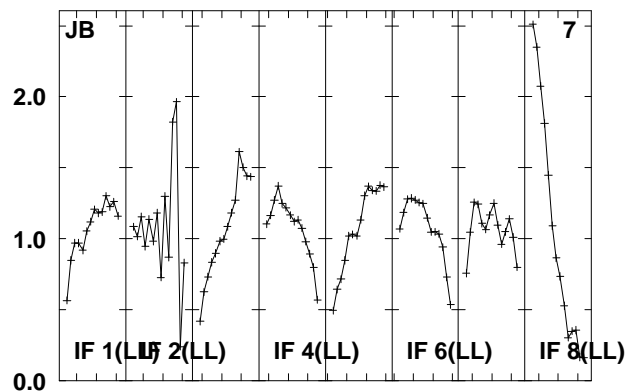
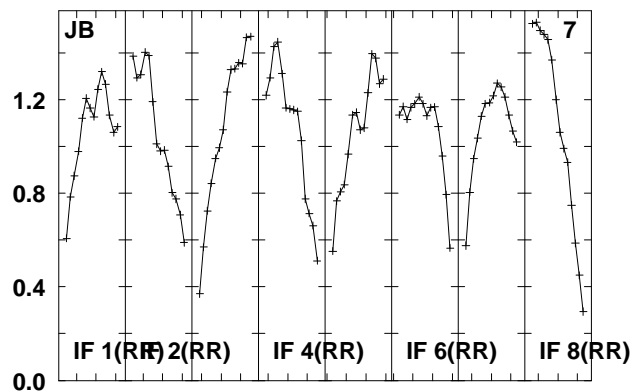
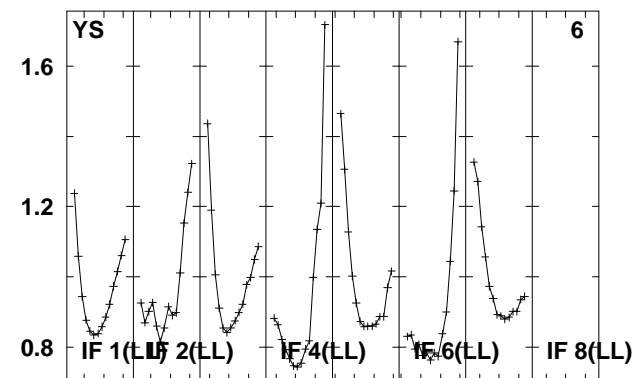
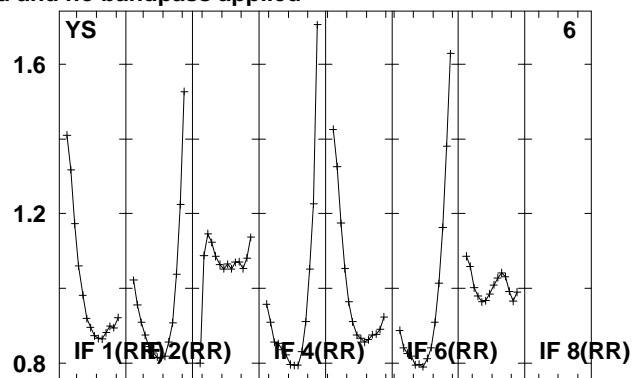
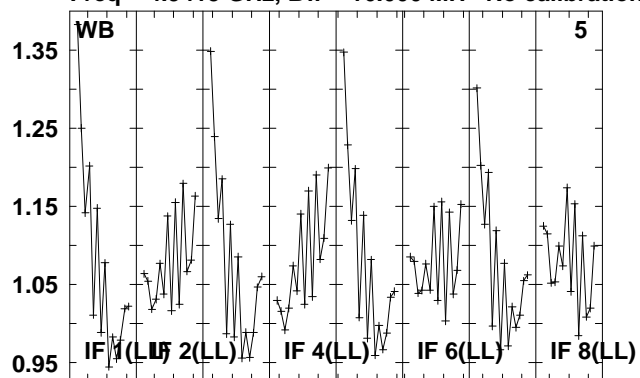

4945 4960 4975 4990 5005 5020 5035 5050 5055
FREQ MHz

Lower frame: Real Jy

Total-power spectrum Antenna: *

Timerange: 00/17:54:50 to 00/17:56:48

Plot file version 170 created 08-JUL-2010 13:10:58

J1525+05 EM079.UVDATA.1

Freq = 4.9415 GHz, Bw = 16.000 MH No calibration applied and no bandpass applied

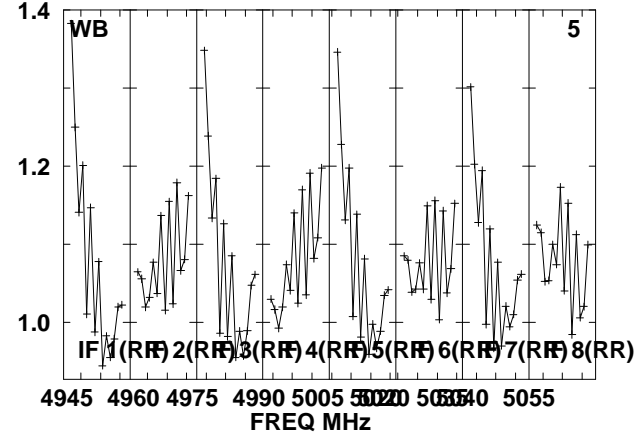
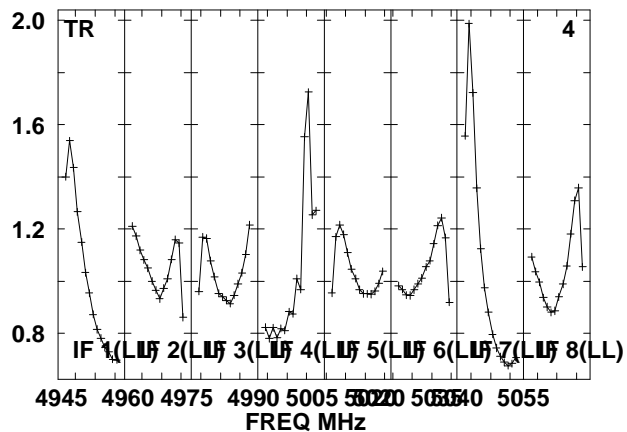
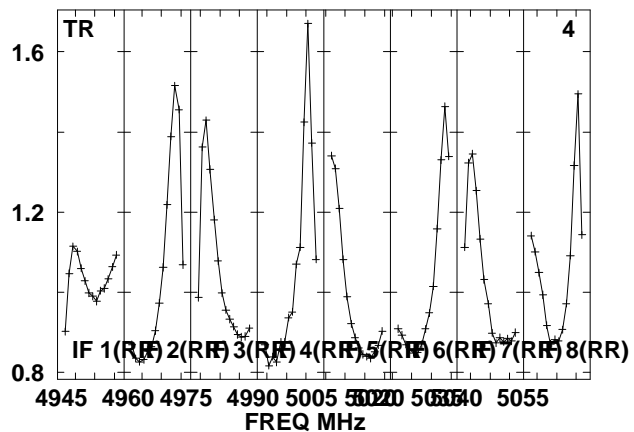
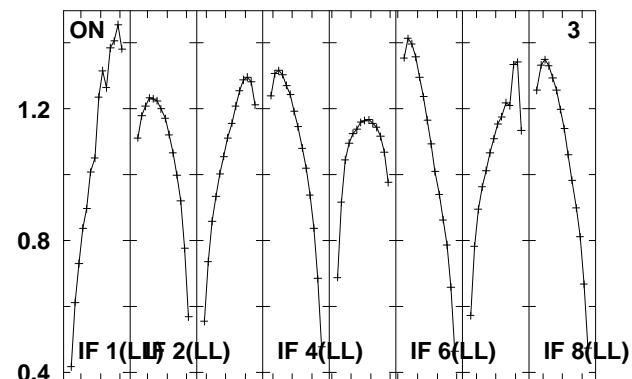
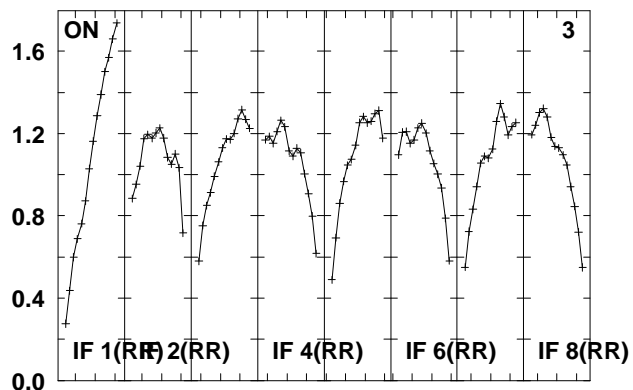
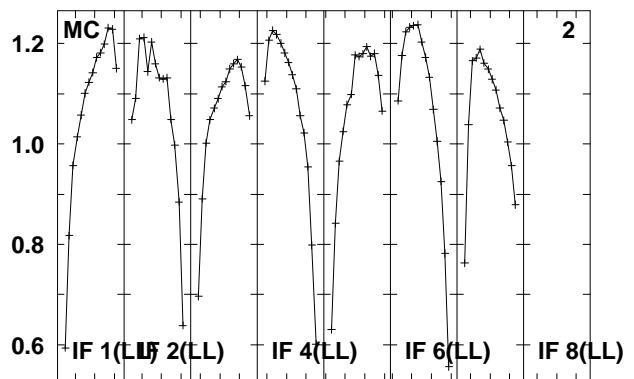
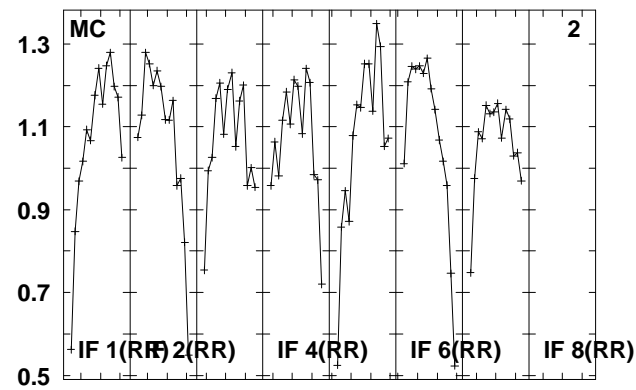
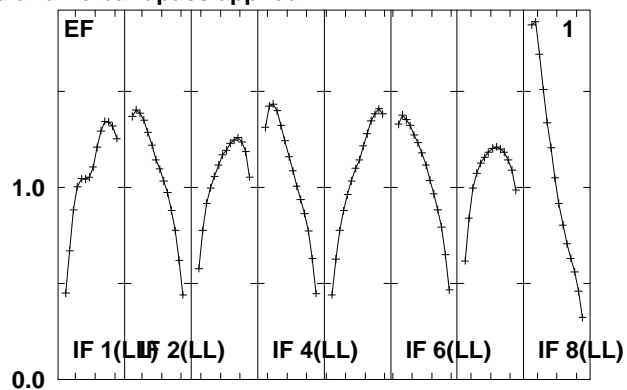
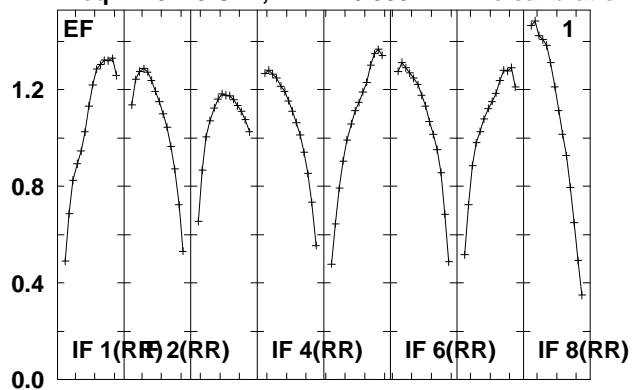

Lower frame: Real Jy
Total-power spectrum Antenna: *
Timerange: 00/17:56:50 to 00/18:07:34

Plot file version 171 created 08-JUL-2010 13:10:59

J1525+05 EM079.UVDATA.1

Freq = 4.9415 GHz, Bw = 16.000 MH No calibration applied and no bandpass applied

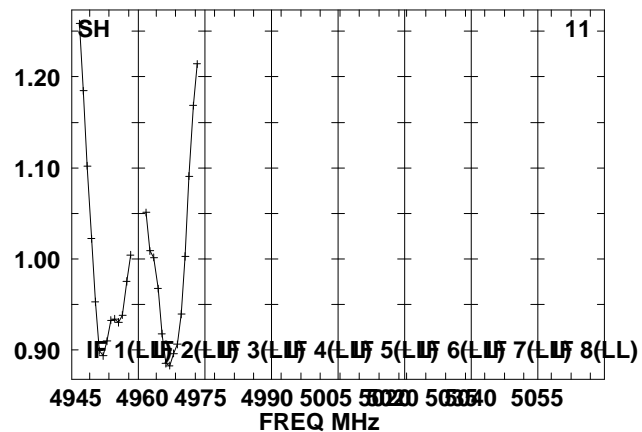
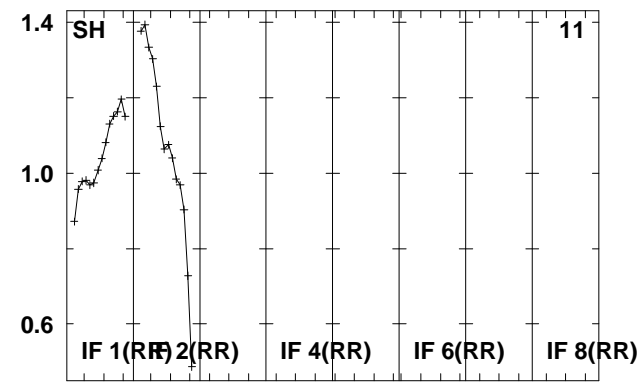
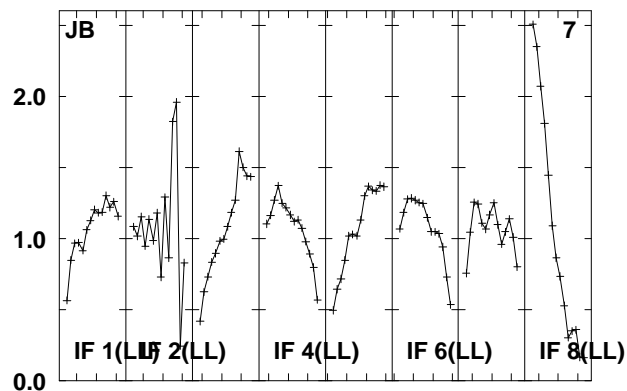
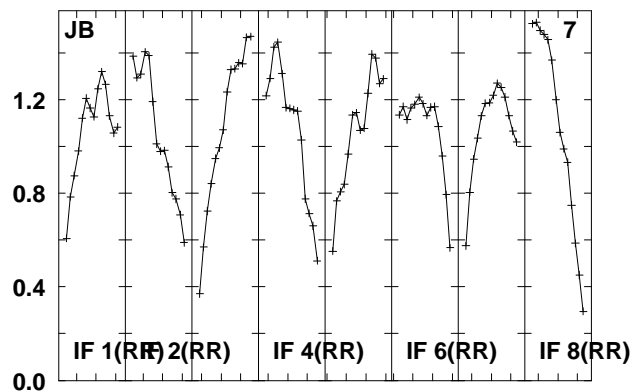
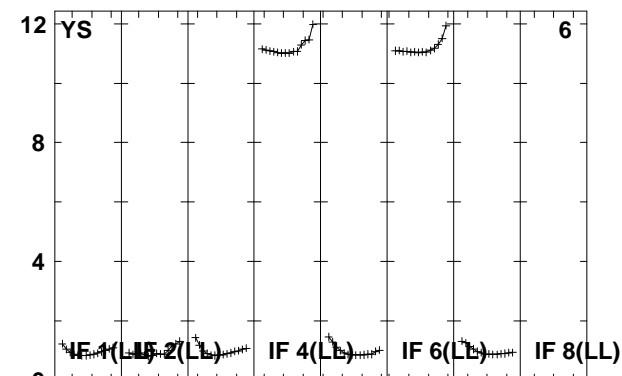
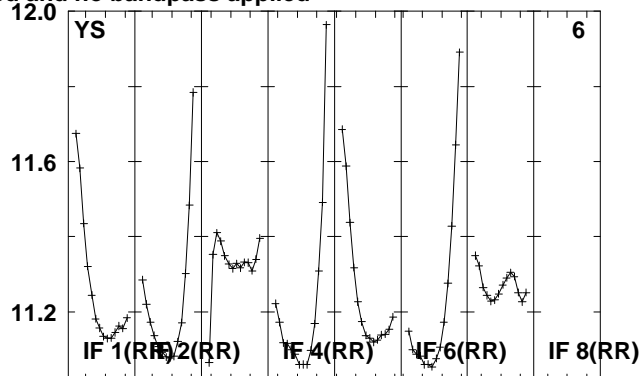
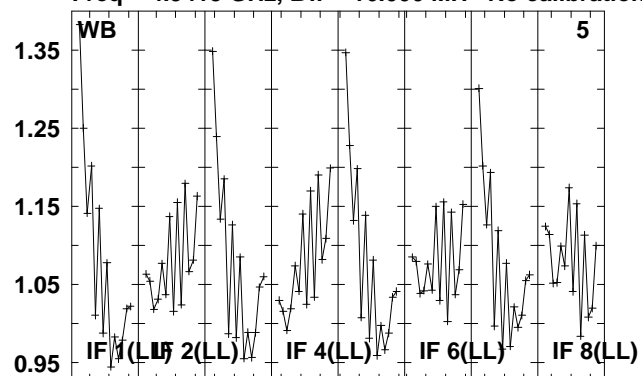

4945 4960 4975 4990 5005 5020 5035 5050 5055
FREQ MHz

Lower frame: Real Jy

Total-power spectrum Antenna: *

Timerange: 00/17:56:50 to 00/18:07:34

Plot file version 172 created 08-JUL-2010 13:11:01

J1521+04 EM079.UVDATA.1

Freq = 4.9415 GHz, Bw = 16.000 MH No calibration applied and no bandpass applied

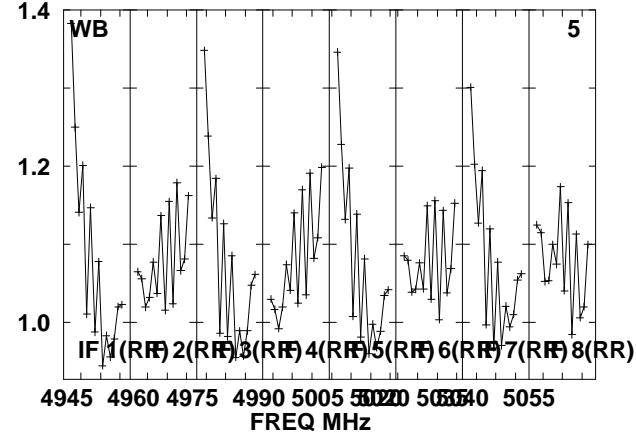
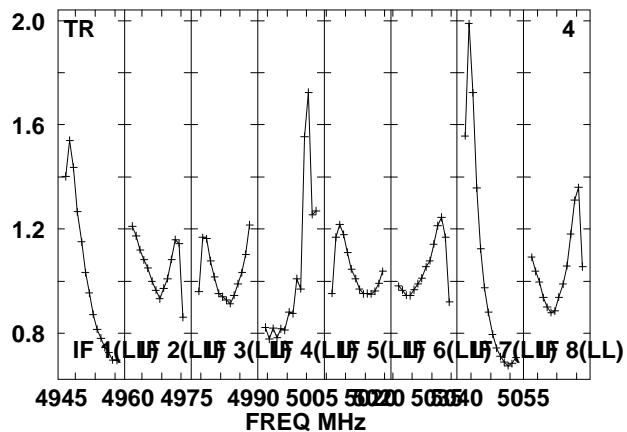
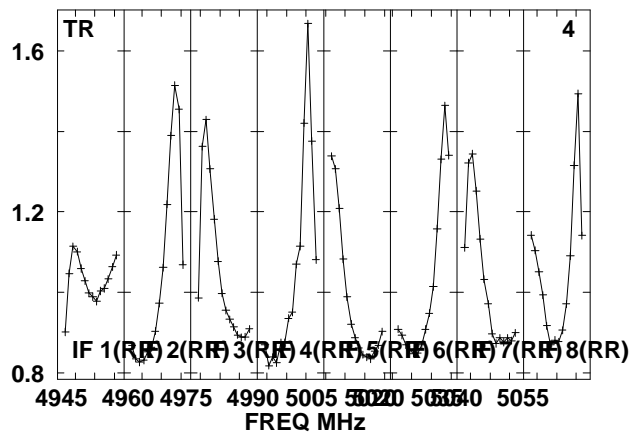
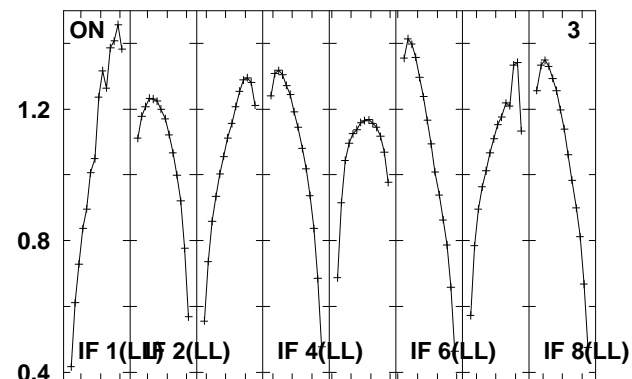
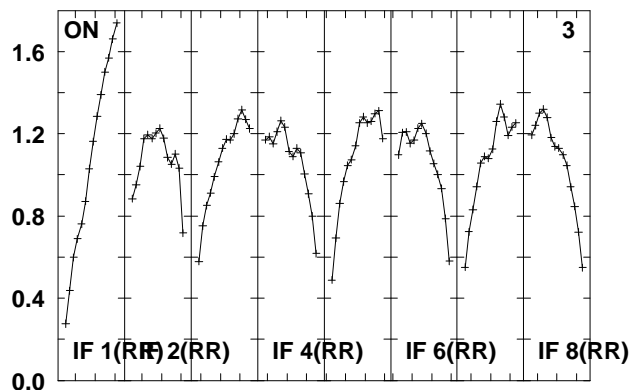
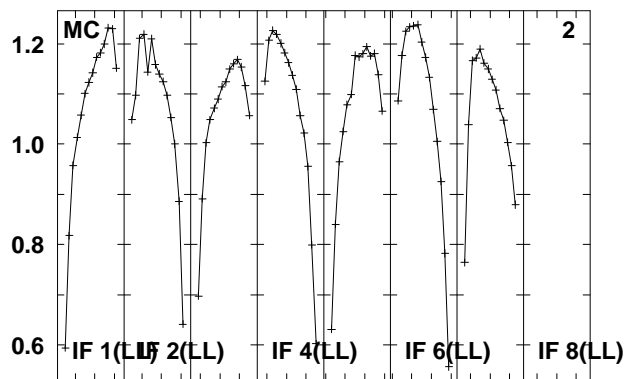
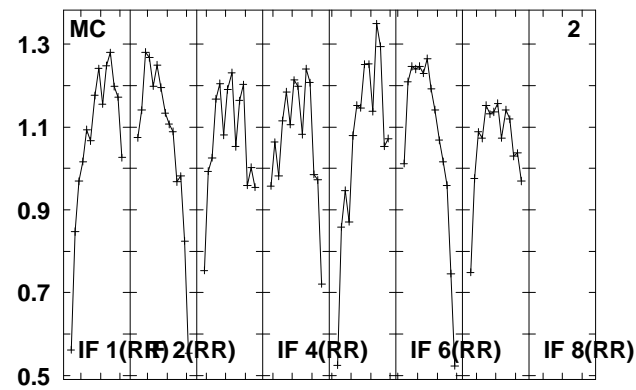
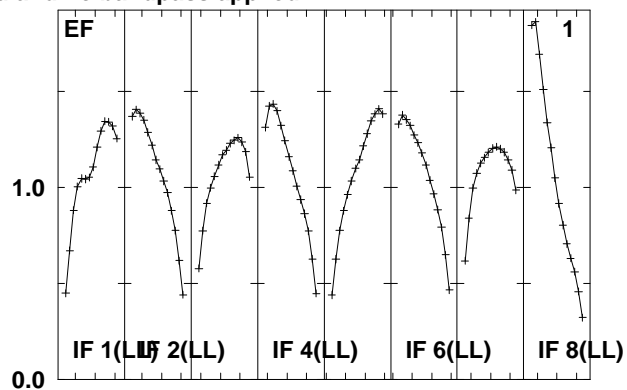
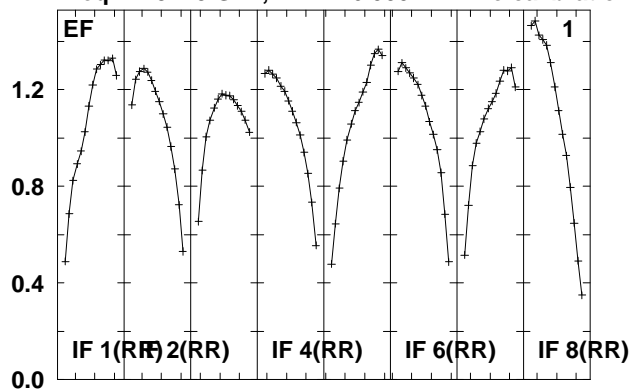

Lower frame: Real Jy
Total-power spectrum Antenna: *
Timerange: 00/18:07:36 to 00/18:09:34

Plot file version 173 created 08-JUL-2010 13:11:01

J1521+04 EM079.UVDATA.1

Freq = 4.9415 GHz, Bw = 16.000 MH No calibration applied and no bandpass applied

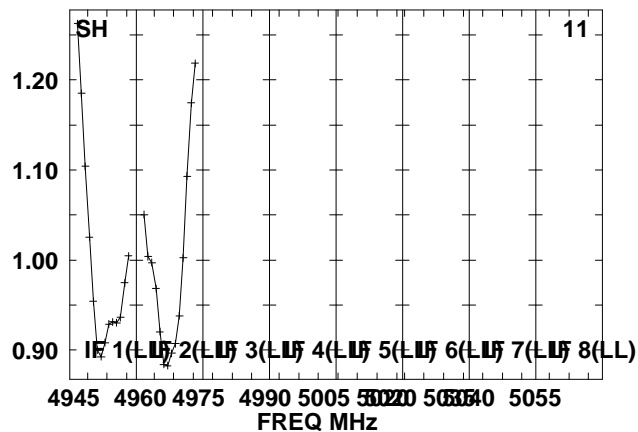
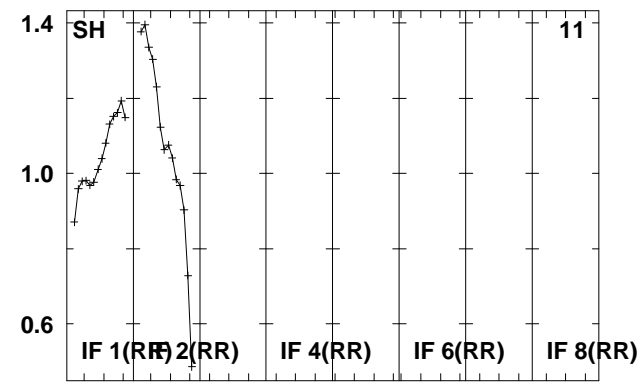
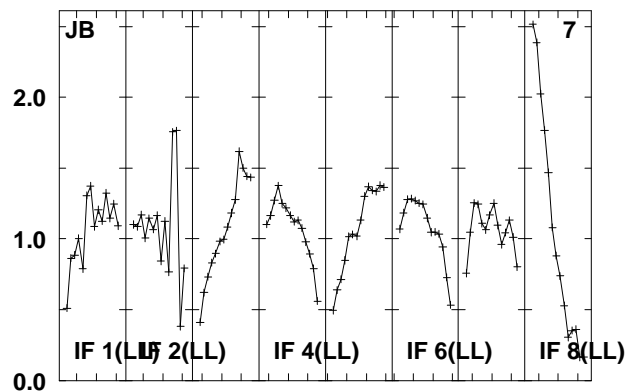
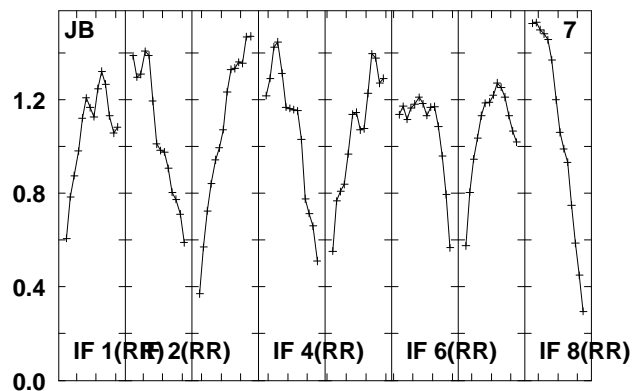
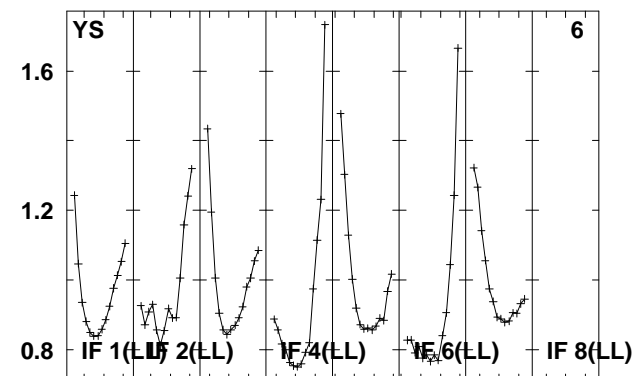
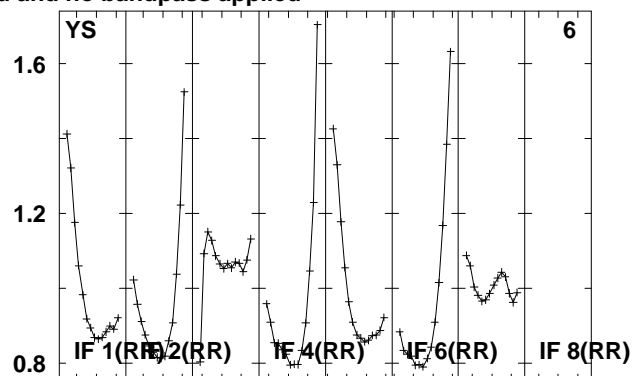
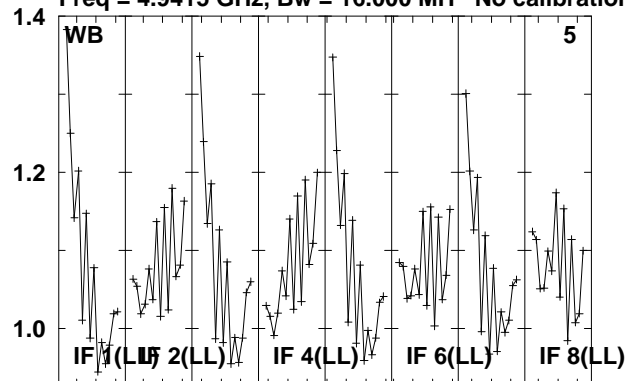

Lower frame: Real Jy

Total-power spectrum Antenna: *

Timerange: 00/18:07:36 to 00/18:09:34

Plot file version 174 created 08-JUL-2010 13:11:02

J1525+05 EM079.UVDATA.1

Freq = 4.9415 GHz, Bw = 16.000 MH No calibration applied and no bandpass applied

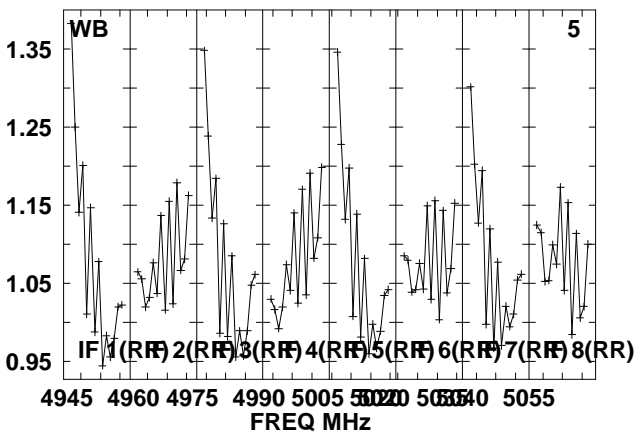
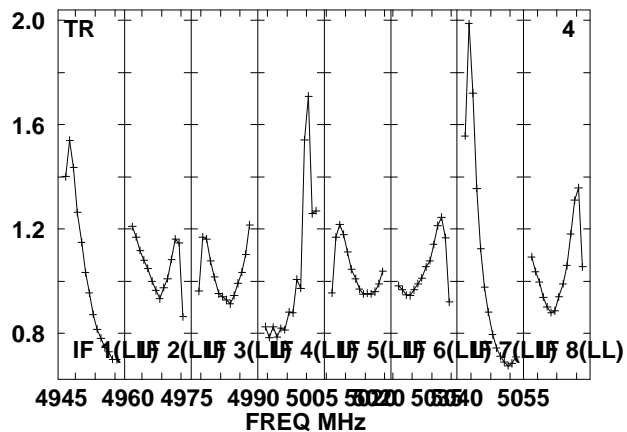
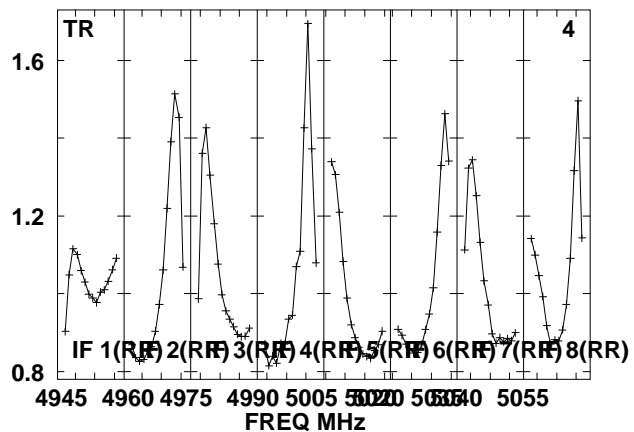
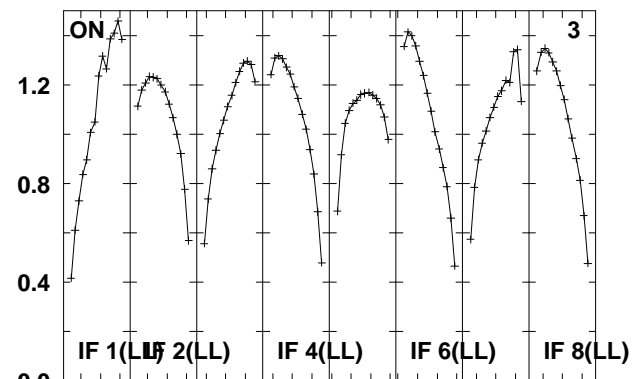
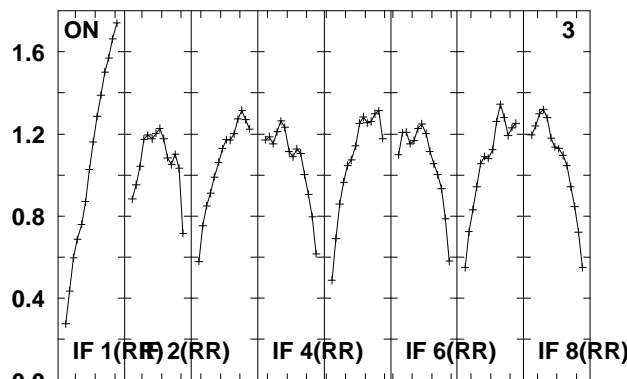
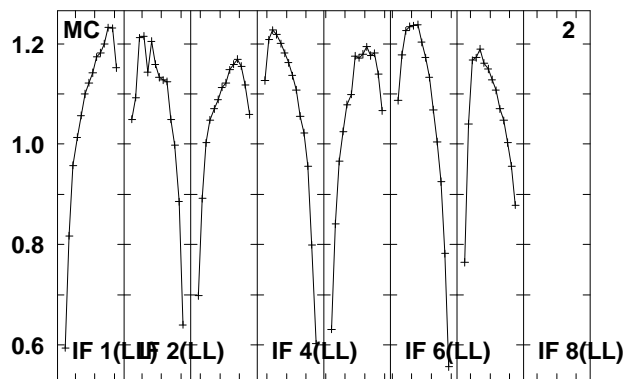
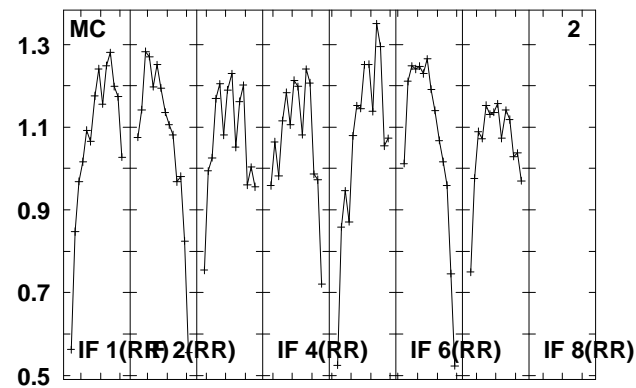
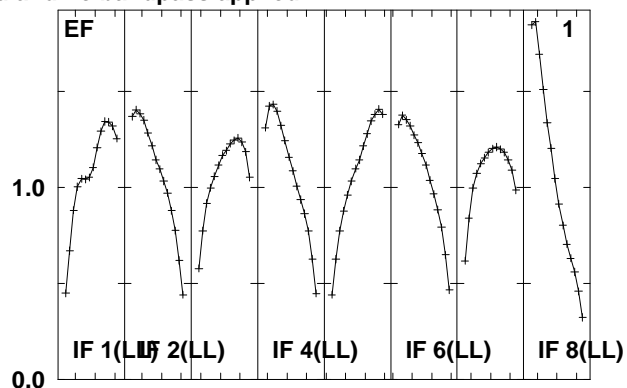
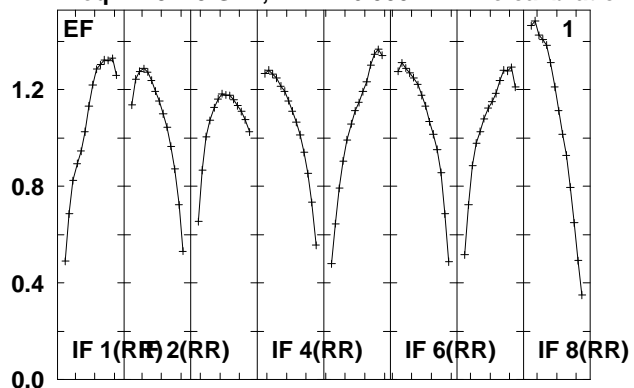

Lower frame: Real Jy
Total-power spectrum Antenna: *
Timerange: 00/18:09:36 to 00/18:20:18

Plot file version 175 created 08-JUL-2010 13:11:03

J1525+05 EM079.UVDATA.1

Freq = 4.9415 GHz, Bw = 16.000 MH No calibration applied and no bandpass applied

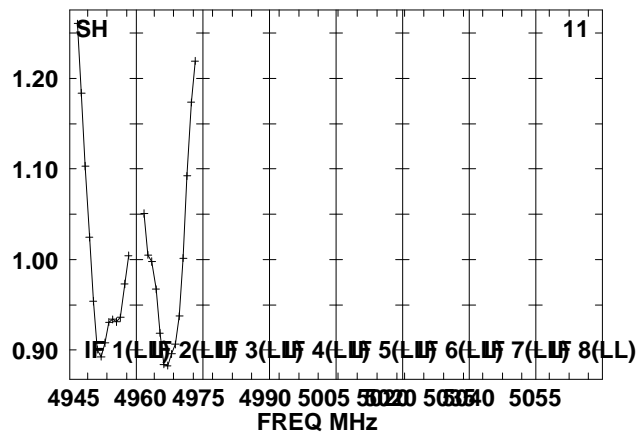
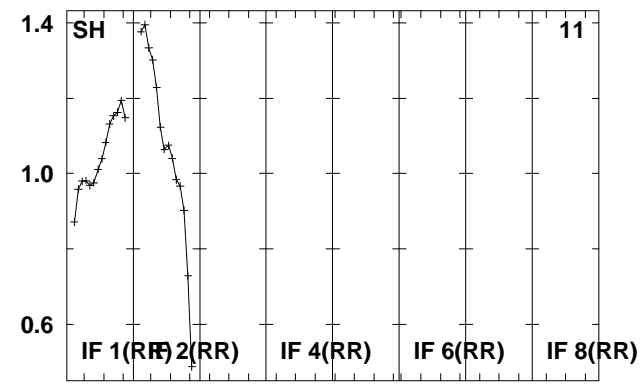
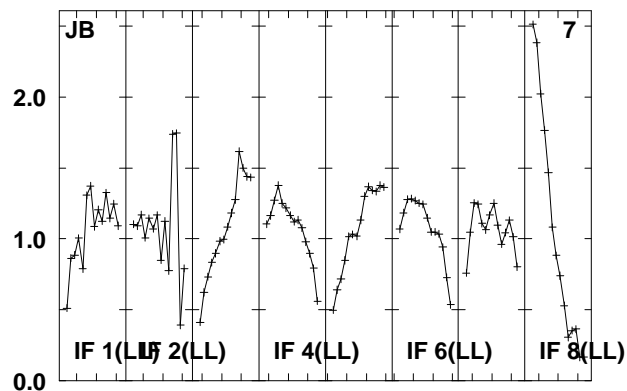
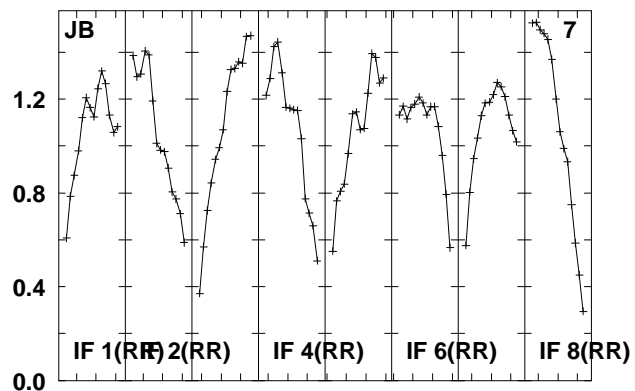
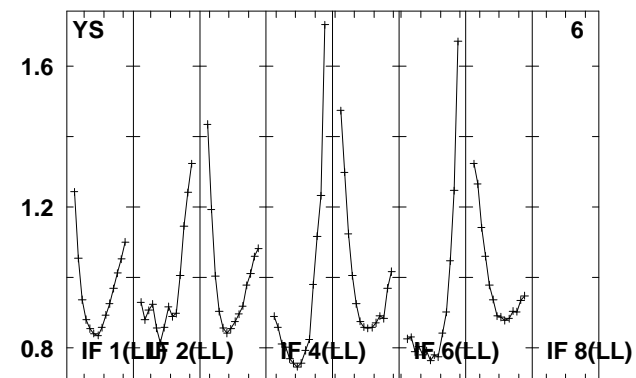
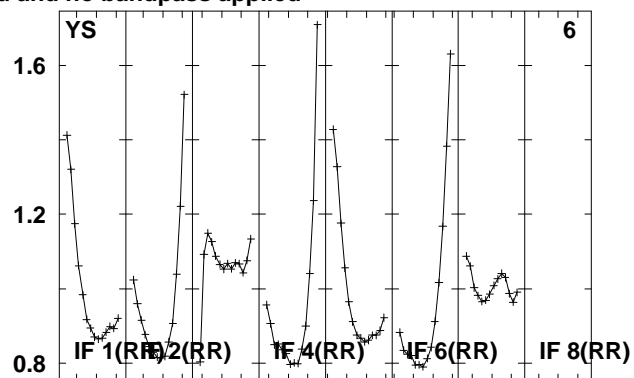
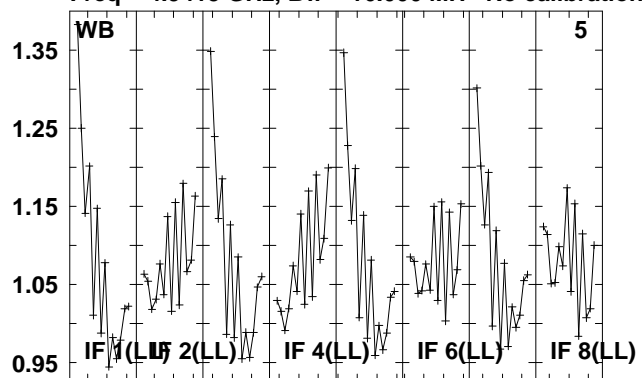

4945 4960 4975 4990 5005 5020 5035 5050 5055
FREQ MHz

Lower frame: Real Jy

Total-power spectrum Antenna: *

Timerange: 00/18:09:36 to 00/18:20:18

Plot file version 176 created 08-JUL-2010 13:11:05

J1521+04 EM079.UVDATA.1

Freq = 4.9415 GHz, Bw = 16.000 MH No calibration applied and no bandpass applied

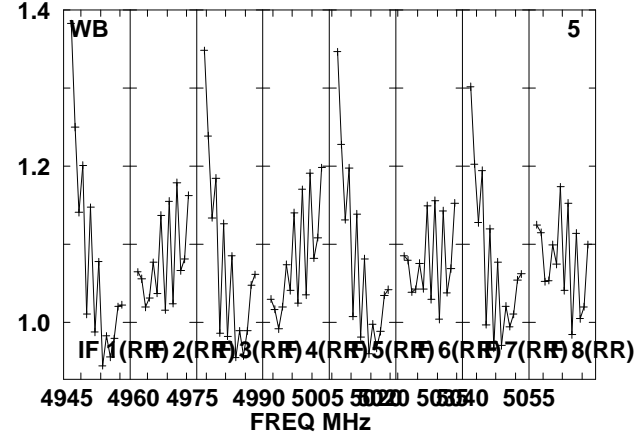
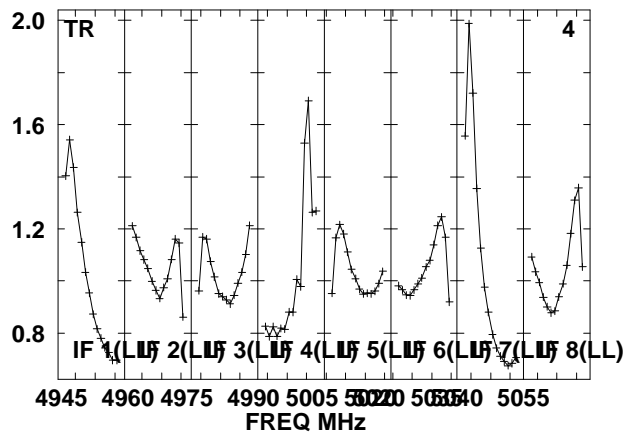
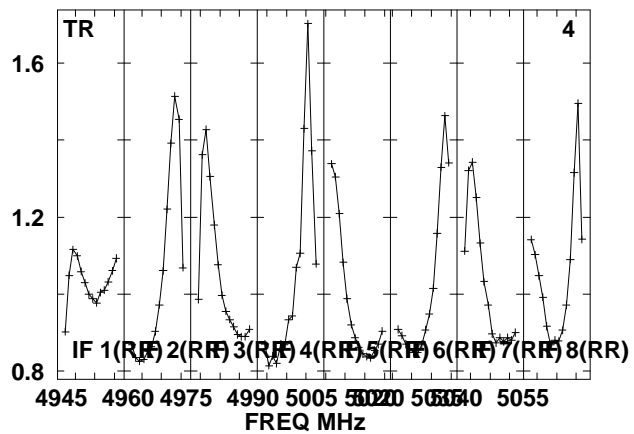
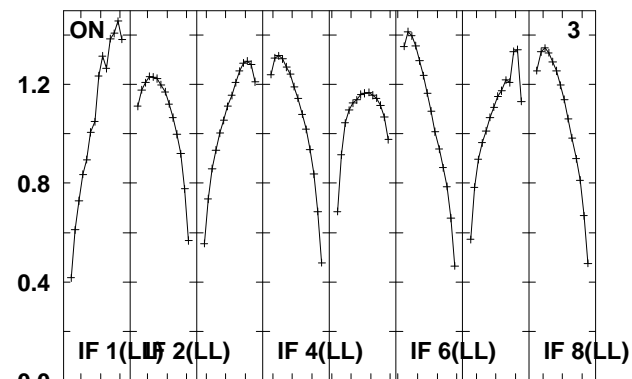
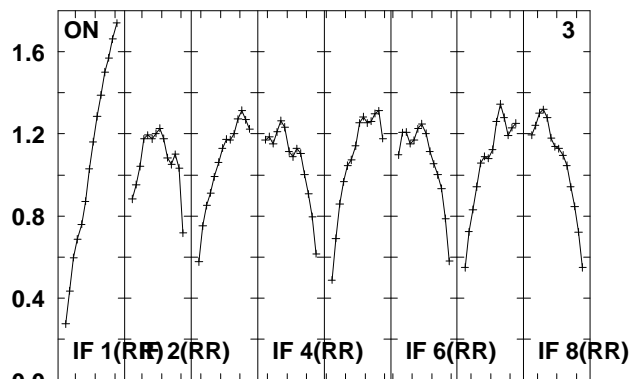
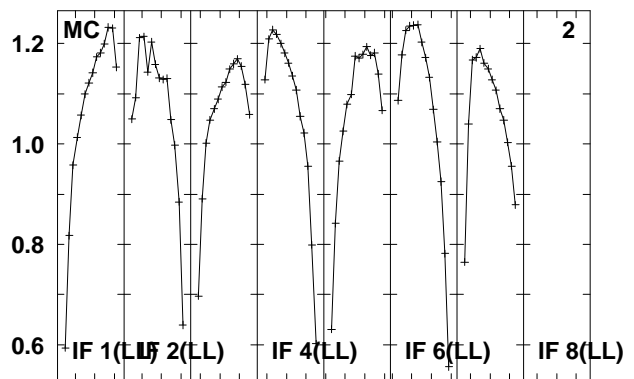
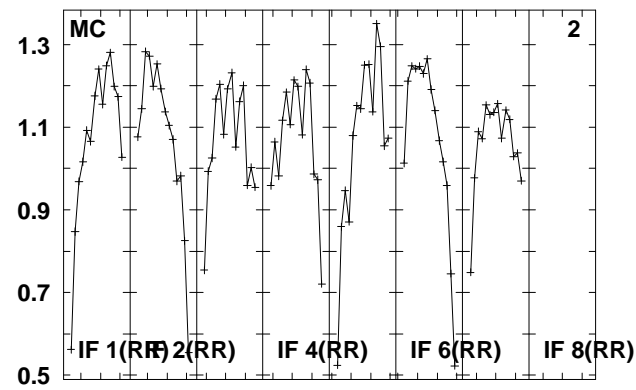
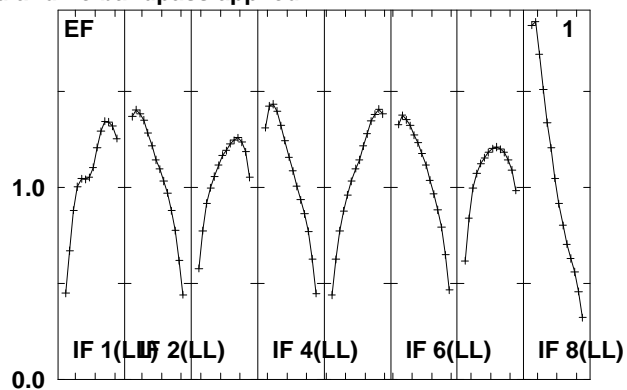
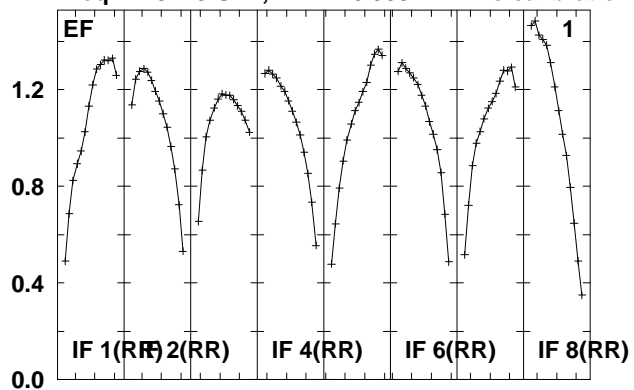

Lower frame: Real Jy
Total-power spectrum Antenna: *
Timerange: 00/18:20:20 to 00/18:22:18

Plot file version 177 created 08-JUL-2010 13:11:05
 J1521+04 EM079.UVDATA.1
 Freq = 4.9415 GHz, Bw = 16.000 MH No calibration applied and no bandpass applied

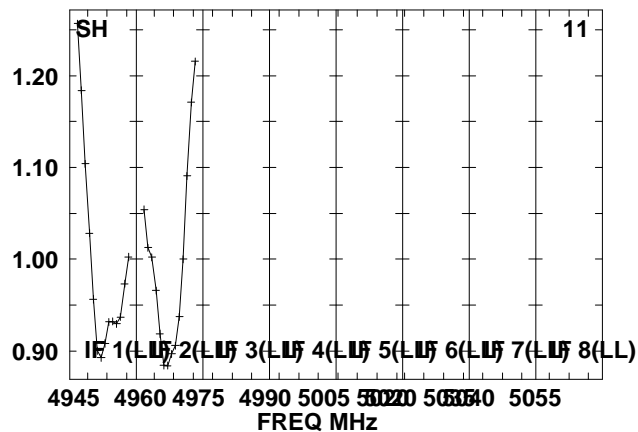
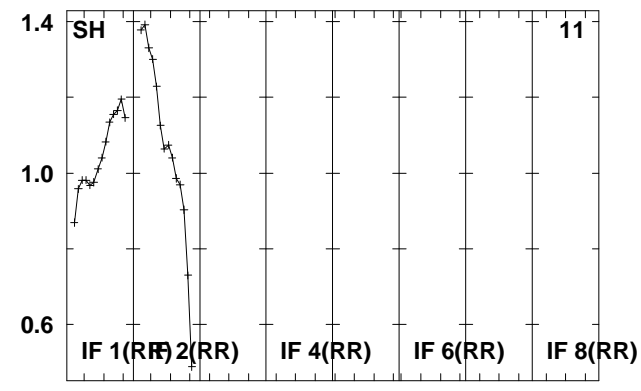
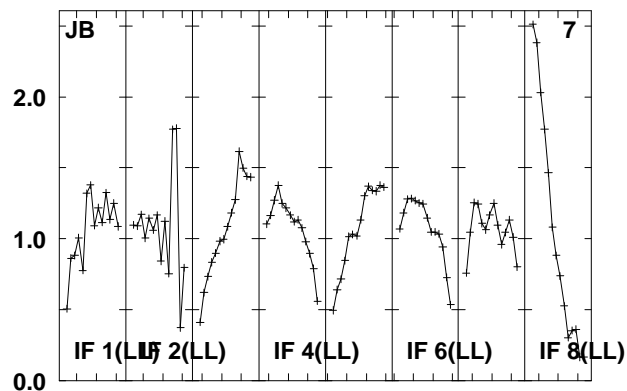
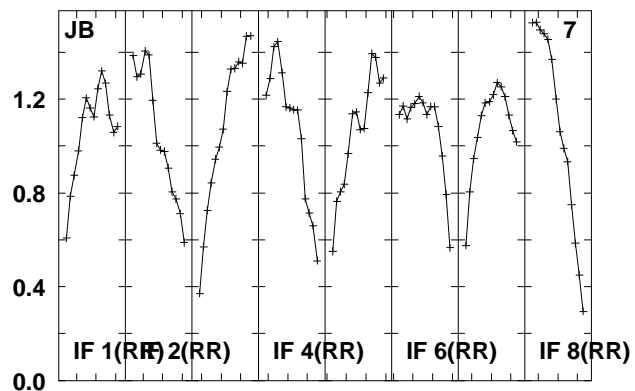
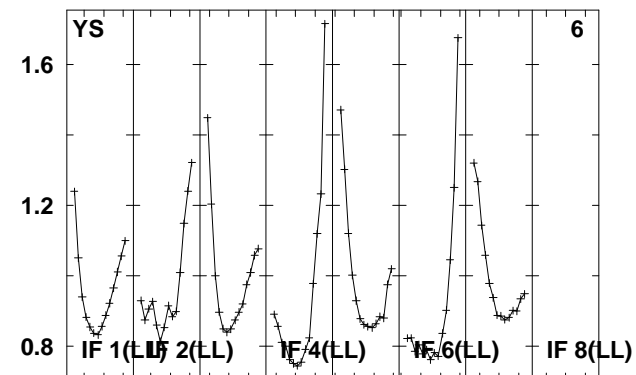
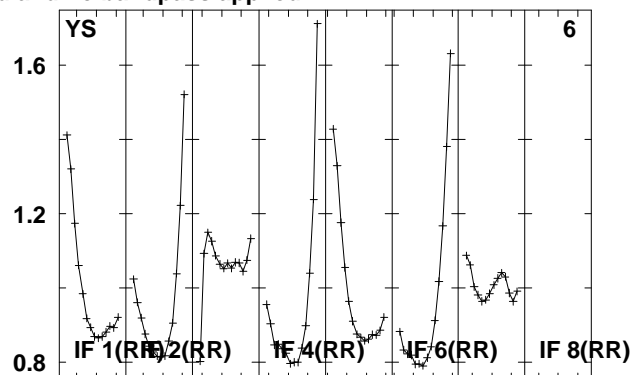
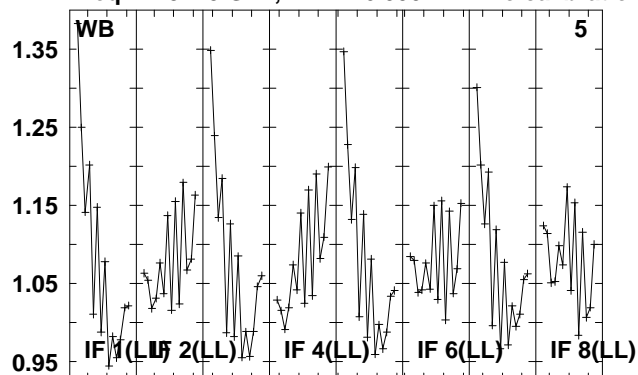

4945 4960 4975 4990 5005 5020 5035 5050 5055
 FREQ MHz

Lower frame: Real Jy
 Total-power spectrum Antenna: *
 Timerange: 00/18:20:20 to 00/18:22:18

Plot file version 178 created 08-JUL-2010 13:11:06

J1525+05 EM079.UVDATA.1

Freq = 4.9415 GHz, Bw = 16.000 MH No calibration applied and no bandpass applied

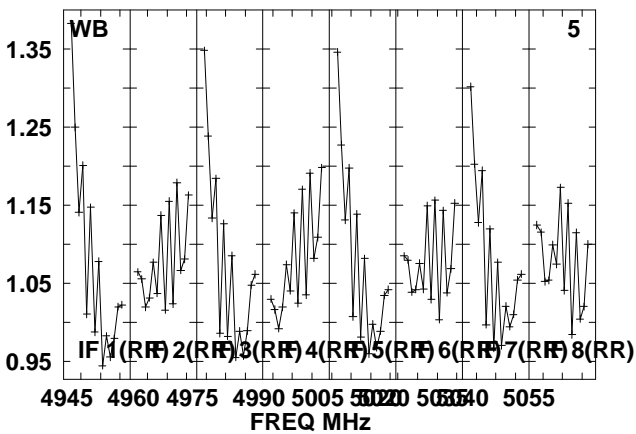
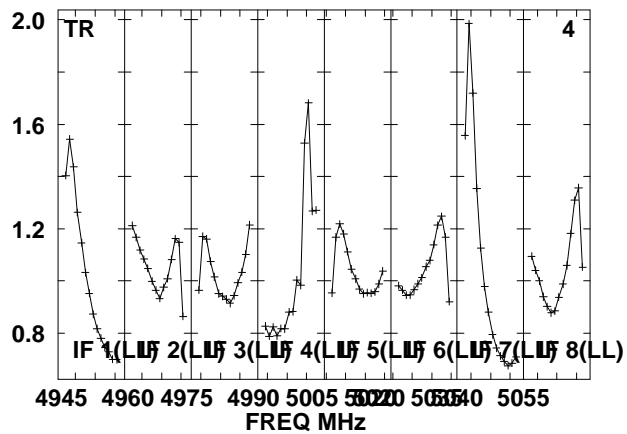
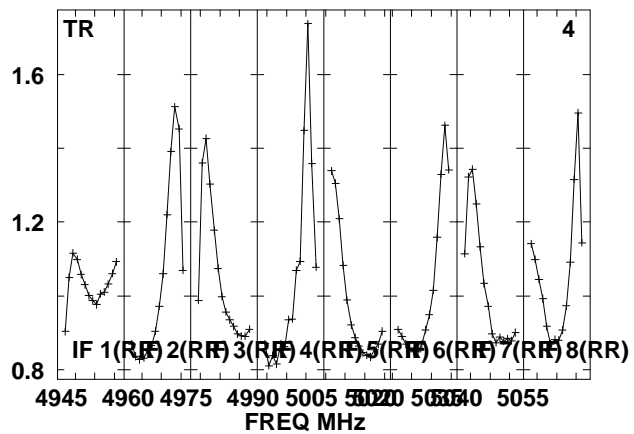
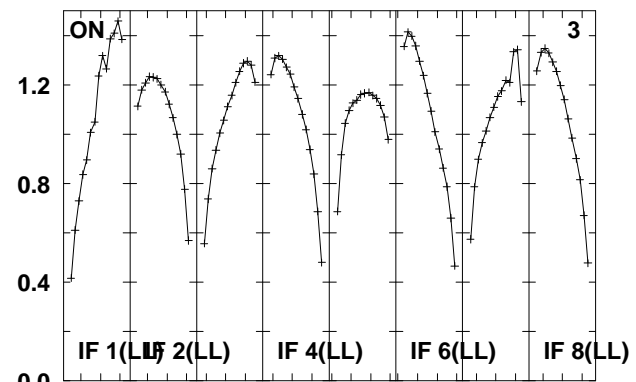
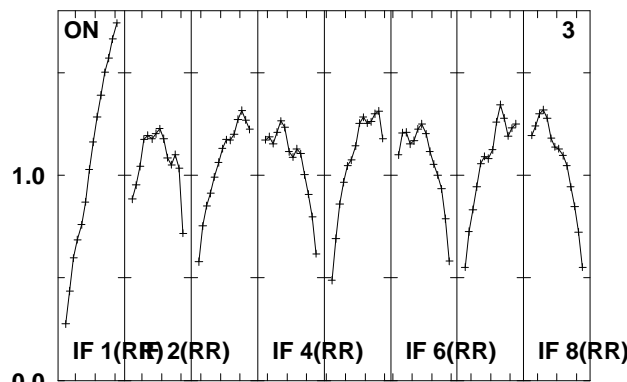
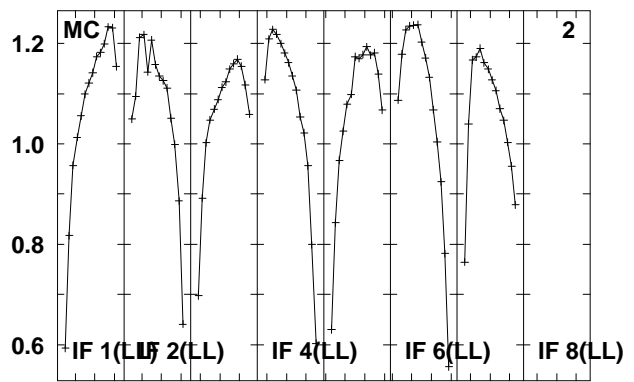
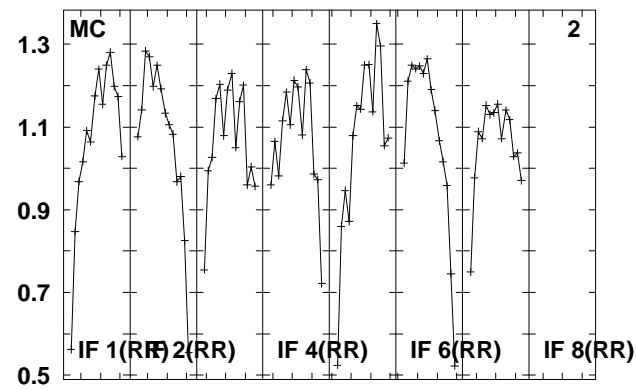
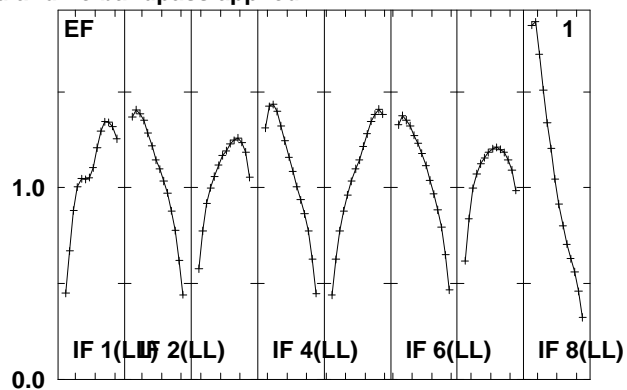
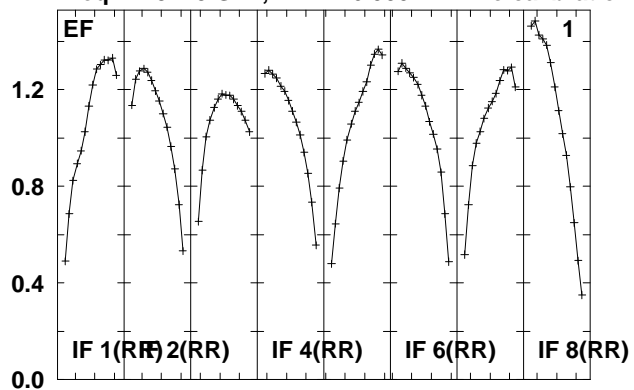

Lower frame: Real Jy
Total-power spectrum Antenna: *
Timerange: 00/18:22:20 to 00/18:33:04

Plot file version 179 created 08-JUL-2010 13:11:08

J1525+05 EM079.UVDATA.1

Freq = 4.9415 GHz, Bw = 16.000 MH No calibration applied and no bandpass applied

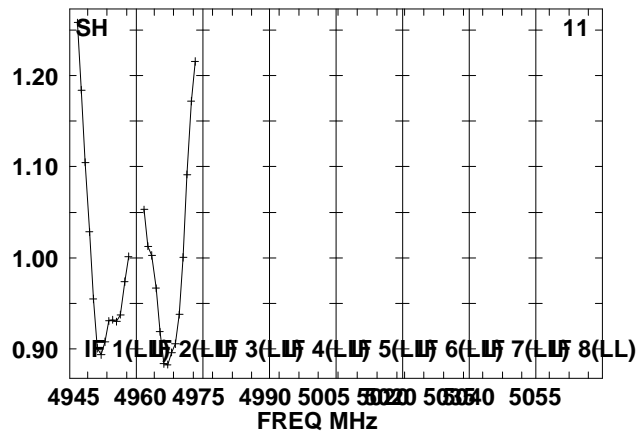
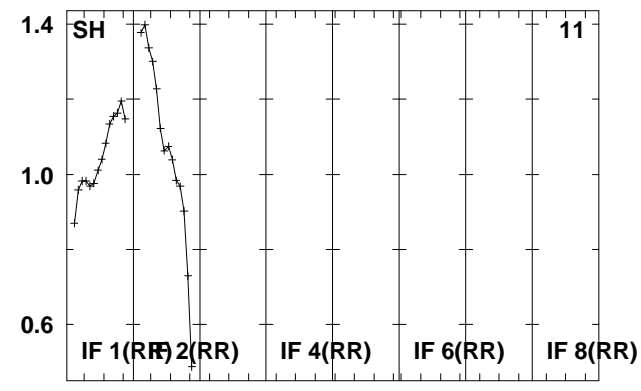
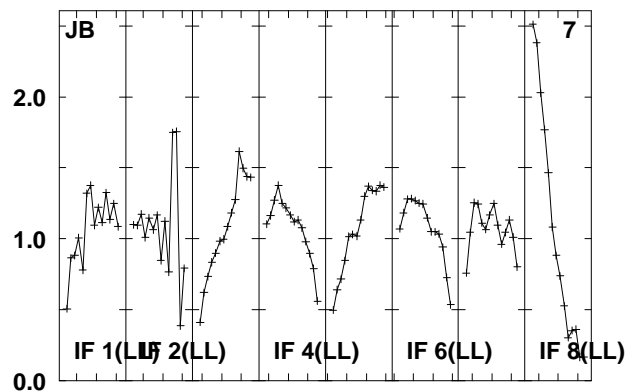
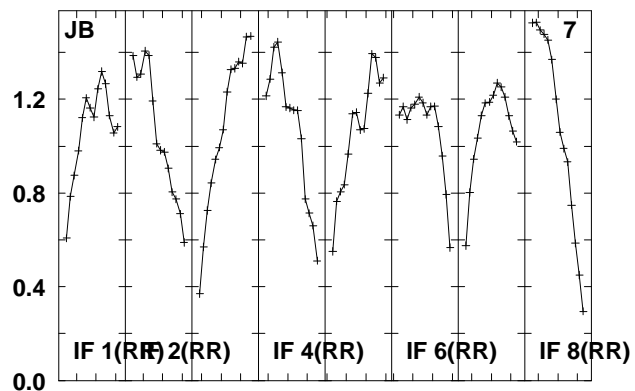
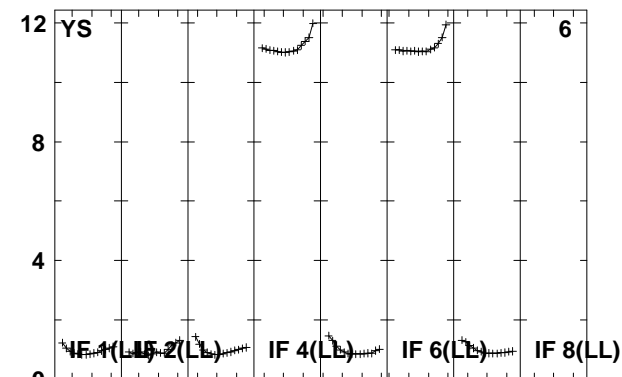
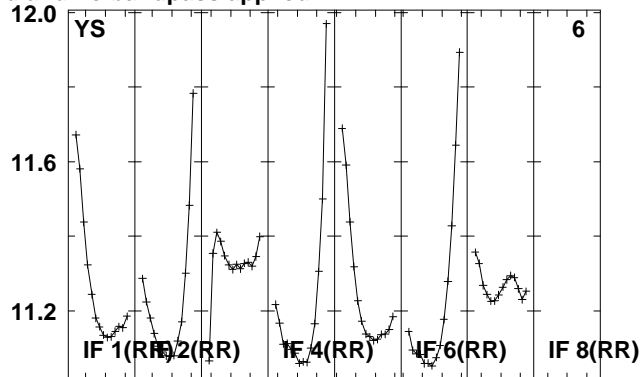
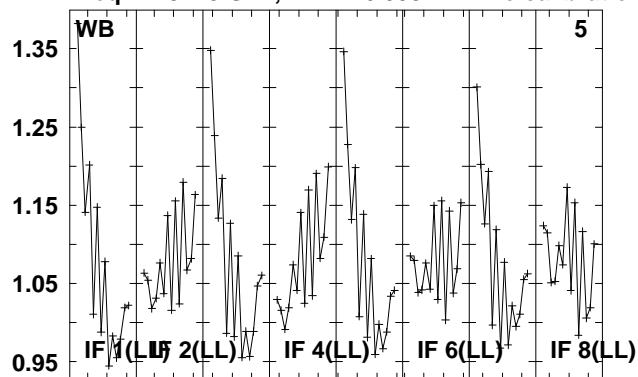

Lower frame: Real Jy

Total-power spectrum Antenna: *

Timerange: 00/18:22:20 to 00/18:33:04

Plot file version 180 created 08-JUL-2010 13:11:09

J1521+04 EM079.UVDATA.1

Freq = 4.9415 GHz, Bw = 16.000 MH No calibration applied and no bandpass applied

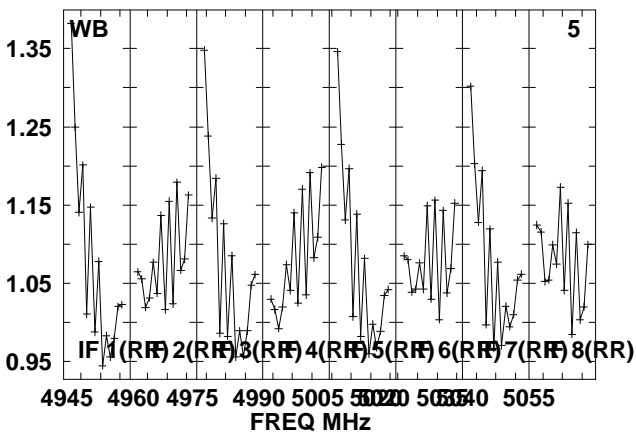
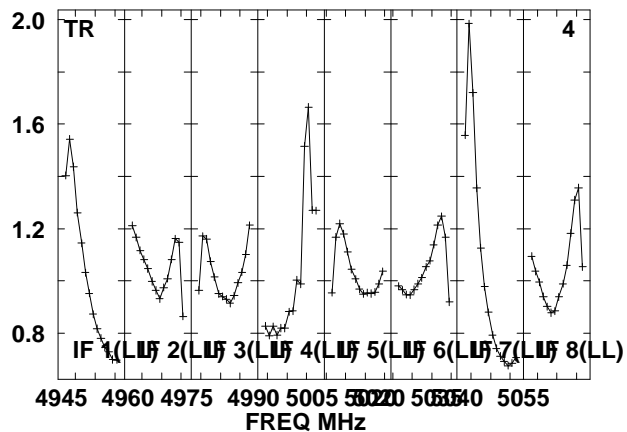
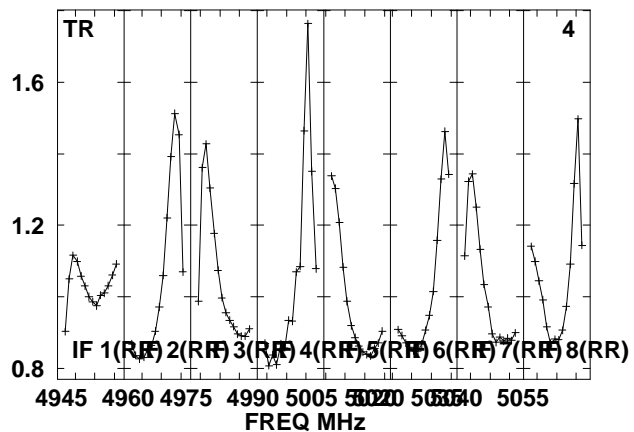
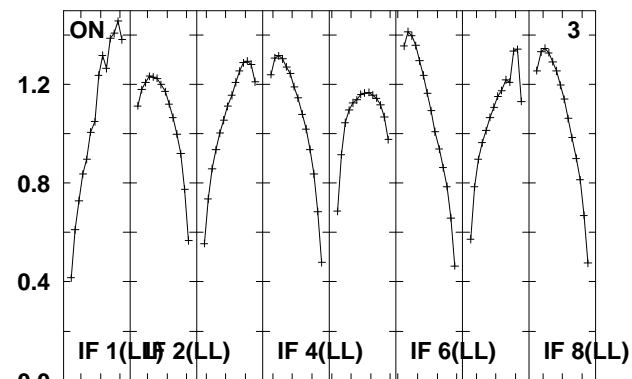
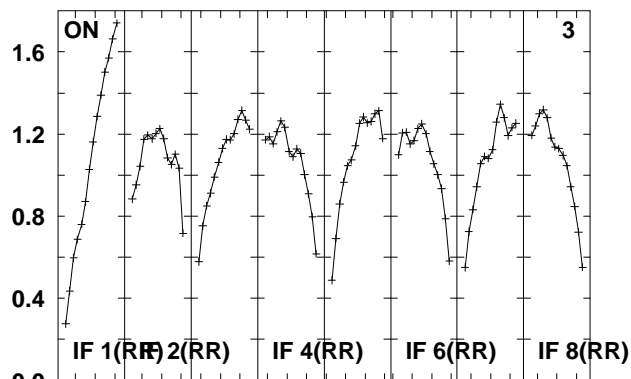
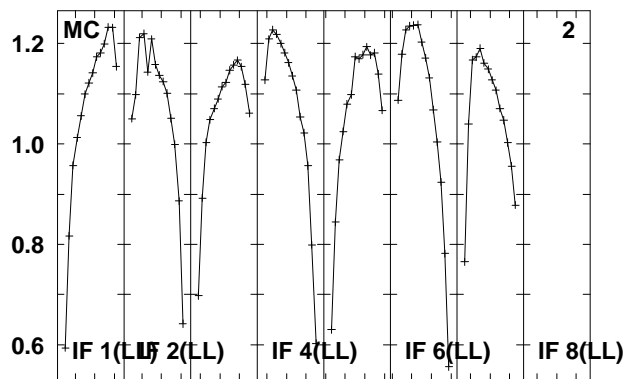
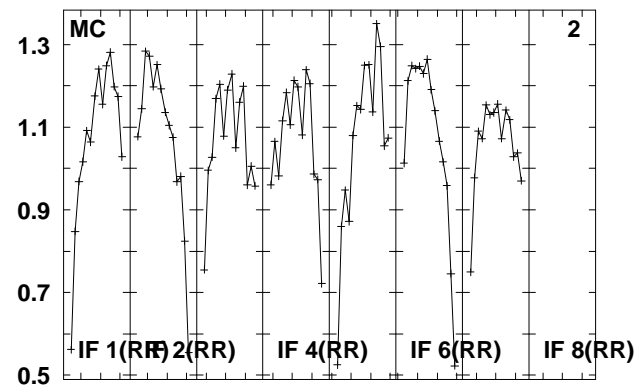
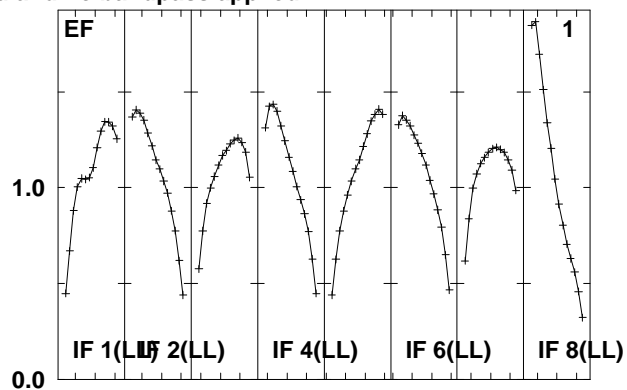
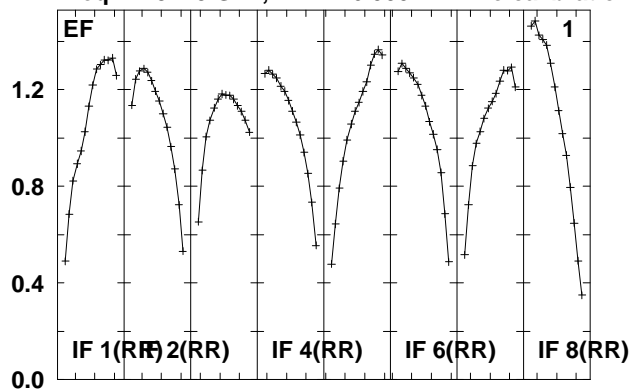

Lower frame: Real Jy
Total-power spectrum Antenna: *
Timerange: 00/18:33:06 to 00/18:35:04

Plot file version 181 created 08-JUL-2010 13:11:10

J1521+04 EM079.UVDATA.1

Freq = 4.9415 GHz, Bw = 16.000 MH No calibration applied and no bandpass applied

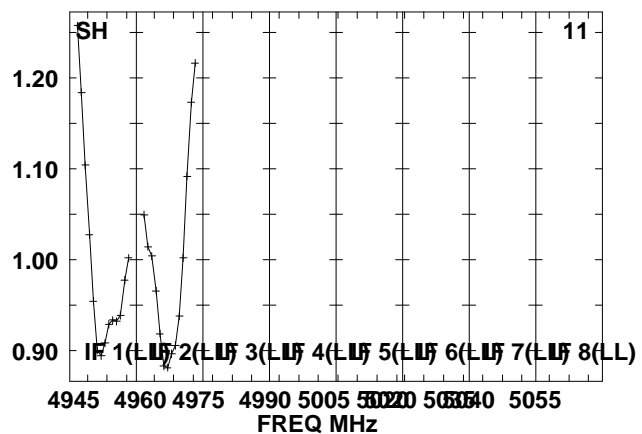
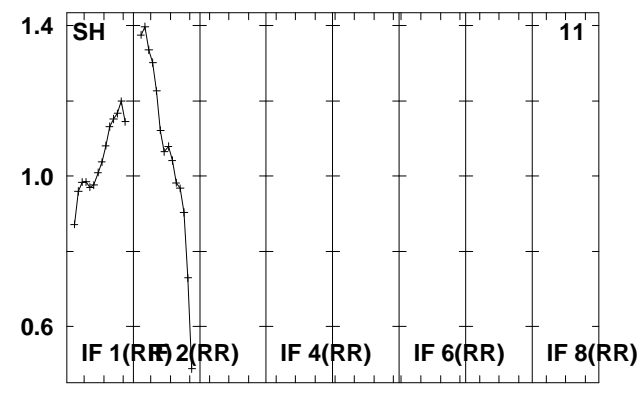
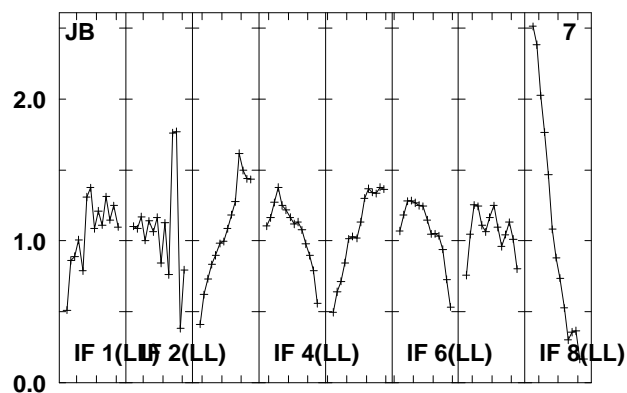
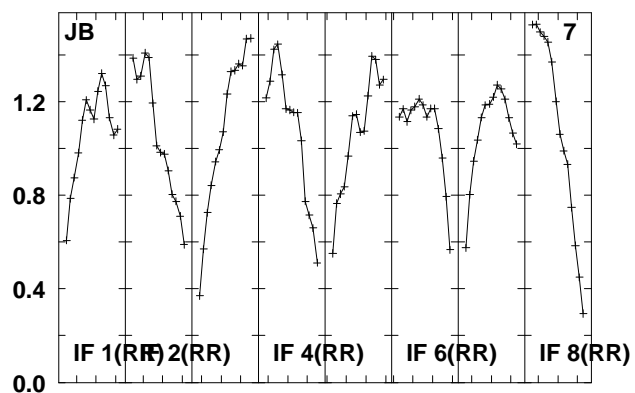
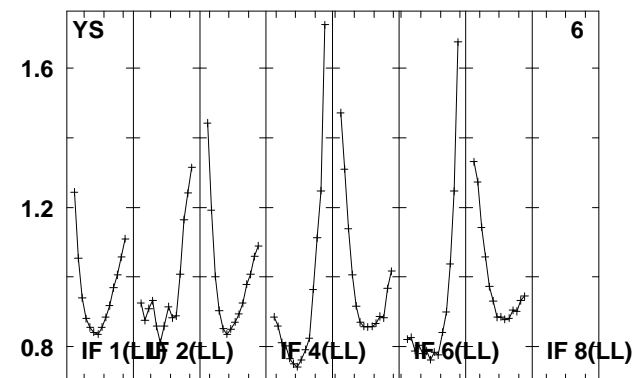
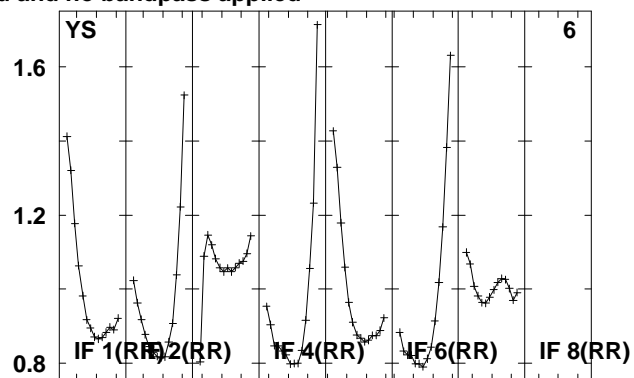
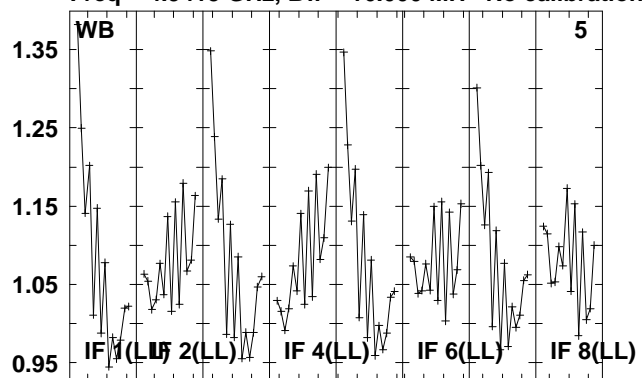

4945 4960 4975 4990 5005 5020 5035 5050 5055
FREQ MHz

Lower frame: Real Jy

Total-power spectrum Antenna: *

Timerange: 00/18:33:06 to 00/18:35:04

Plot file version 182 created 08-JUL-2010 13:11:10

J1312+48 EM079.UVDATA.1

Freq = 4.9415 GHz, Bw = 16.000 MH No calibration applied and no bandpass applied

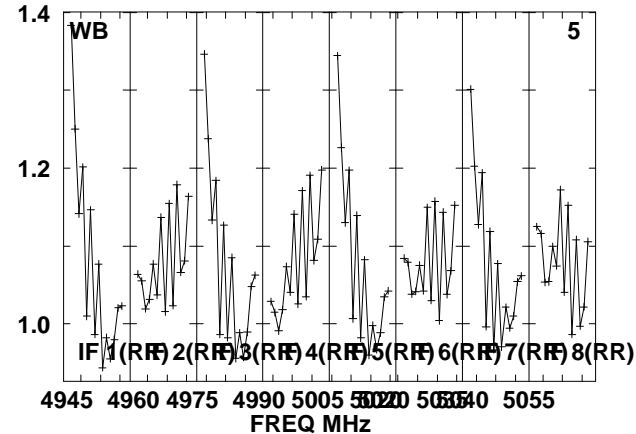
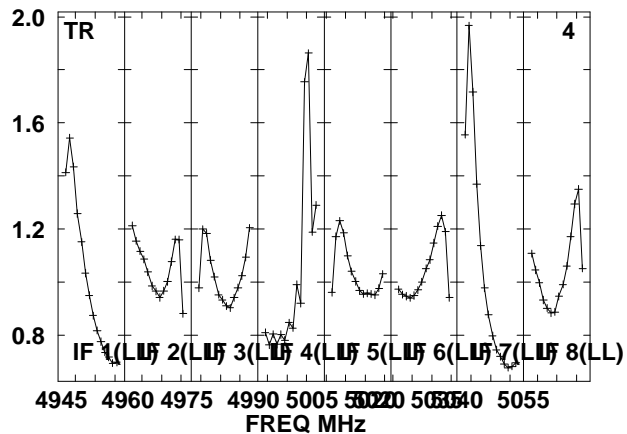
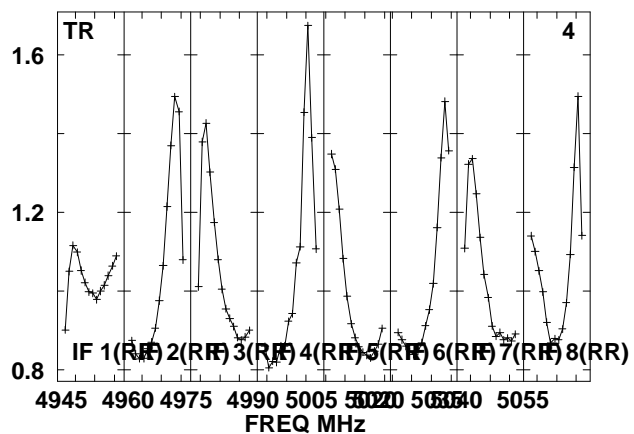
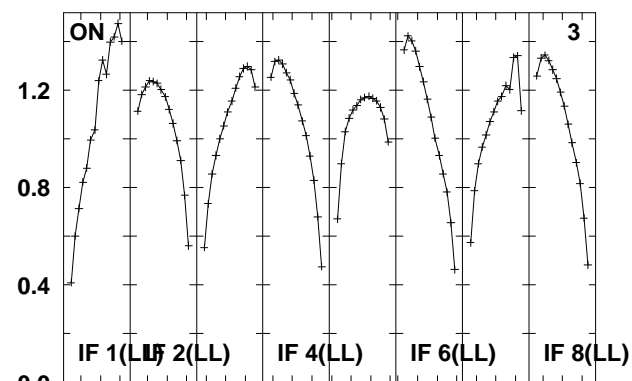
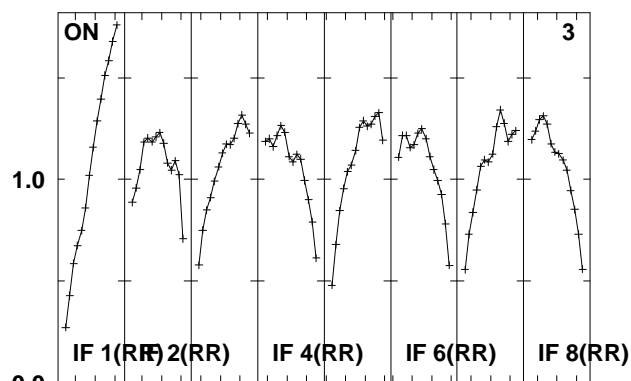
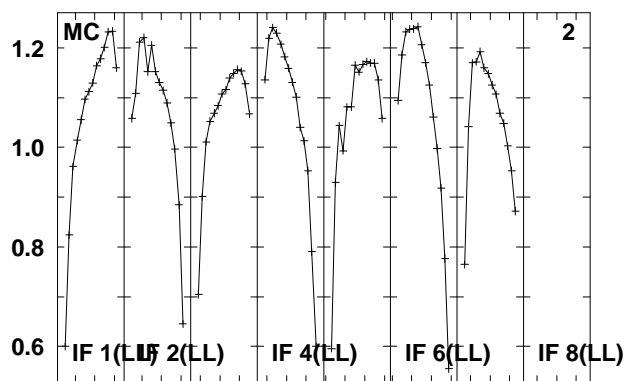
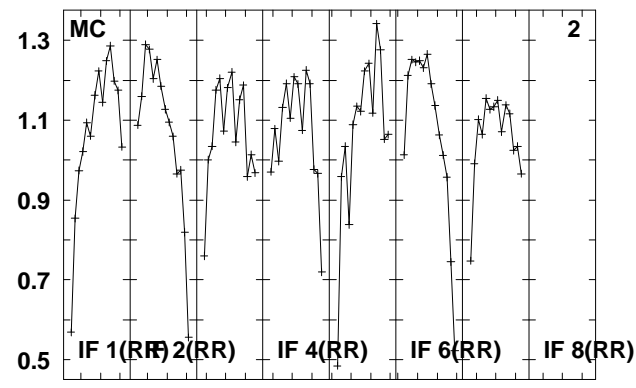
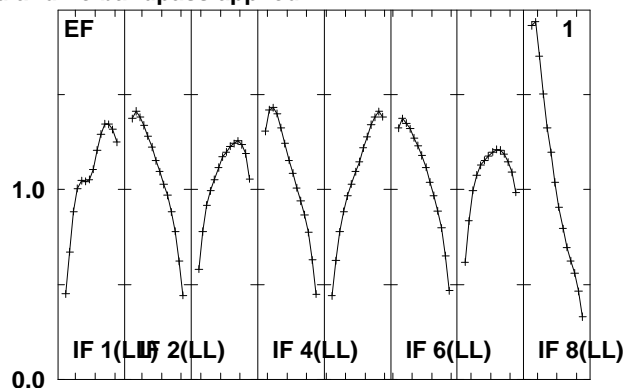
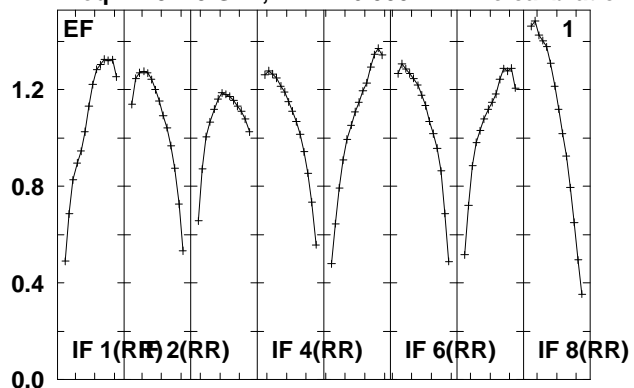

Lower frame: Real Jy
Total-power spectrum Antenna: *
Timerange: 00/18:35:06 to 00/18:41:44

Plot file version 183 created 08-JUL-2010 13:11:11

J1312+48 EM079.UVDATA.1

Freq = 4.9415 GHz, Bw = 16.000 MH No calibration applied and no bandpass applied

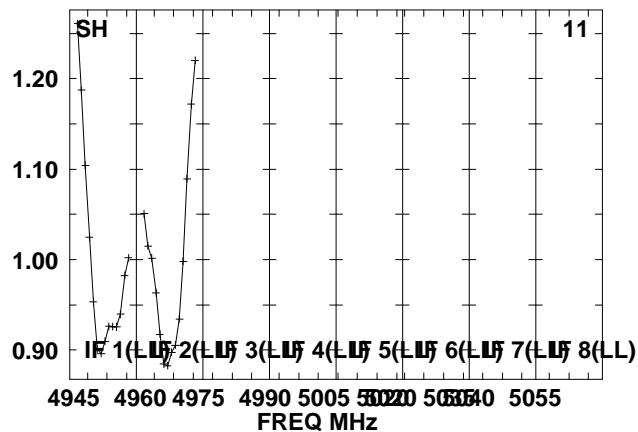
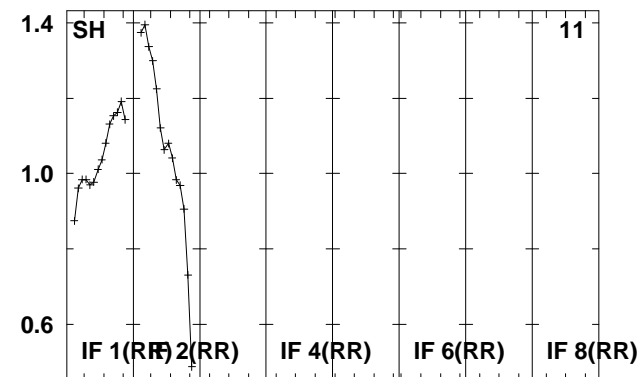
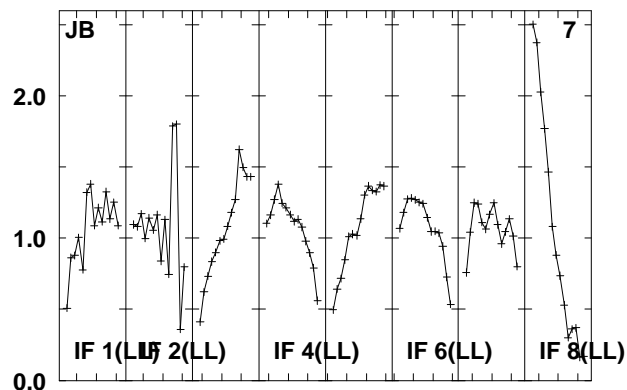
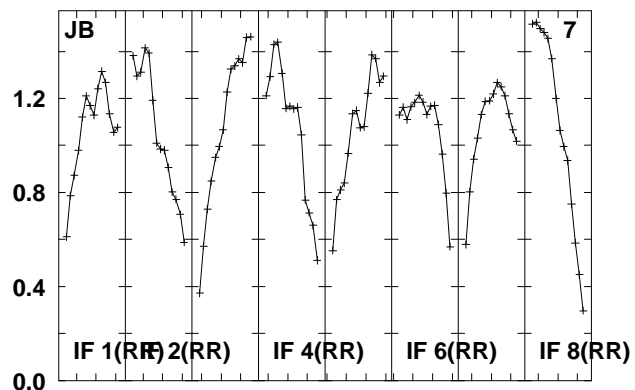
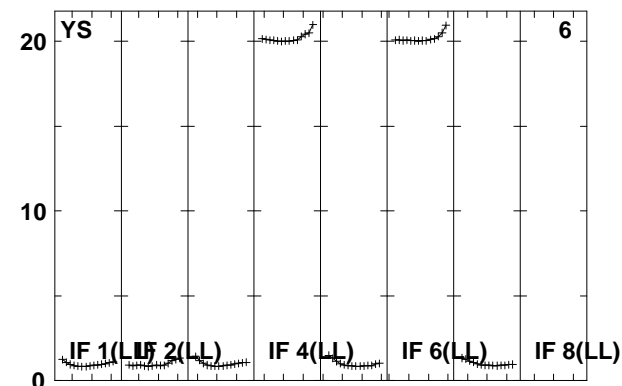
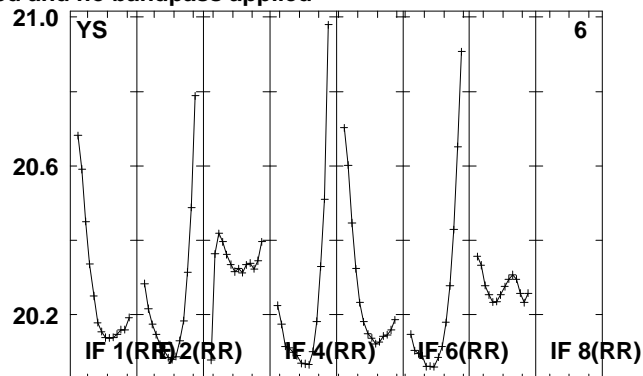
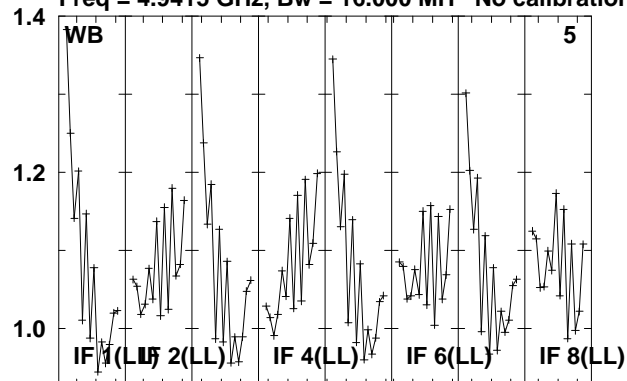

Lower frame: Real Jy

Total-power spectrum Antenna: *

Timerange: 00/18:35:06 to 00/18:41:44

Plot file version 184 created 08-JUL-2010 13:11:13

B1309+48 EM079.UVDATA.1

Freq = 4.9415 GHz, Bw = 16.000 MH No calibration applied and no bandpass applied

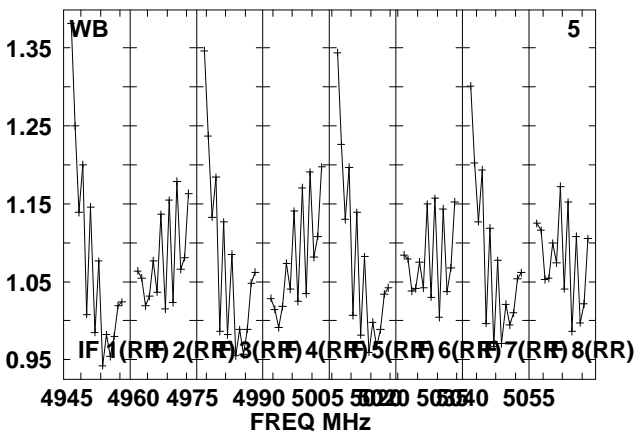
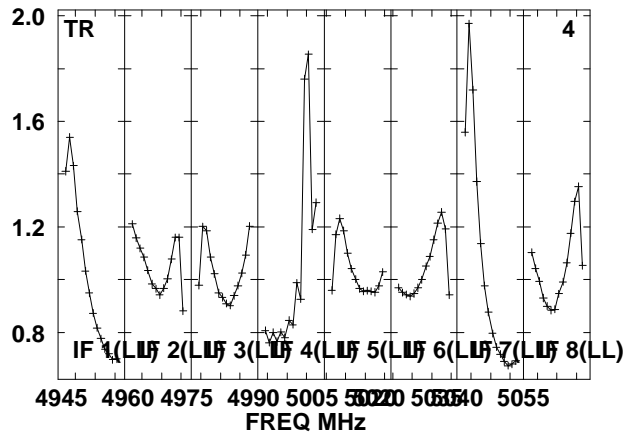
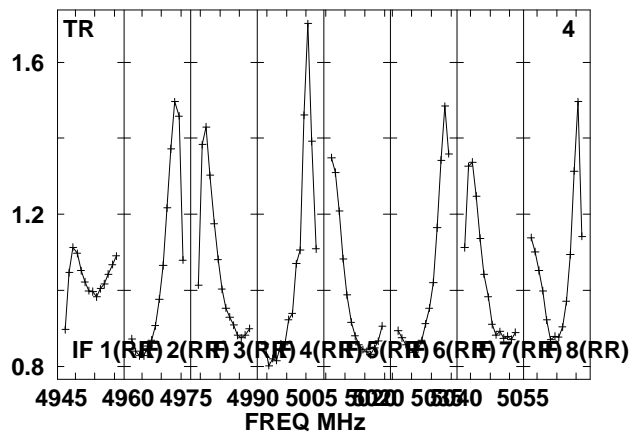
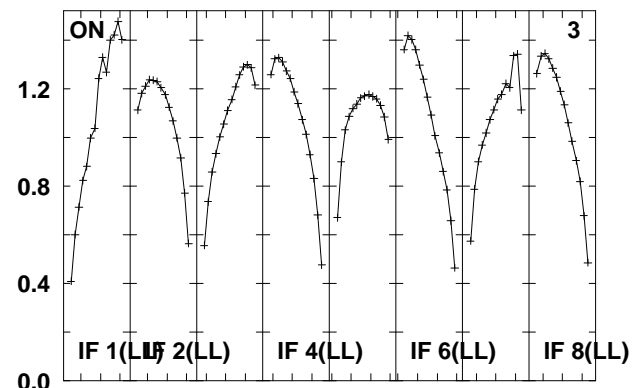
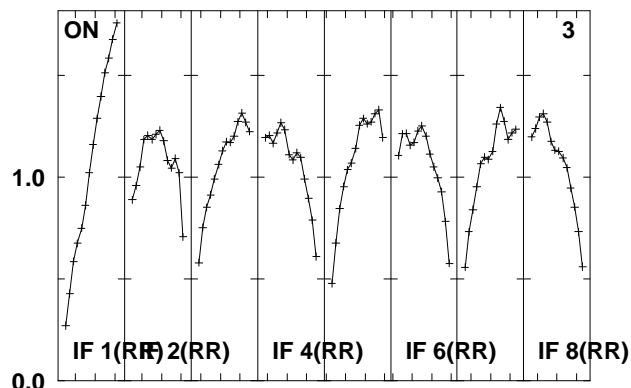
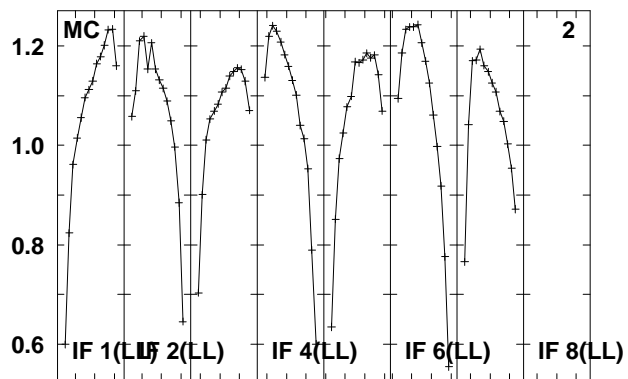
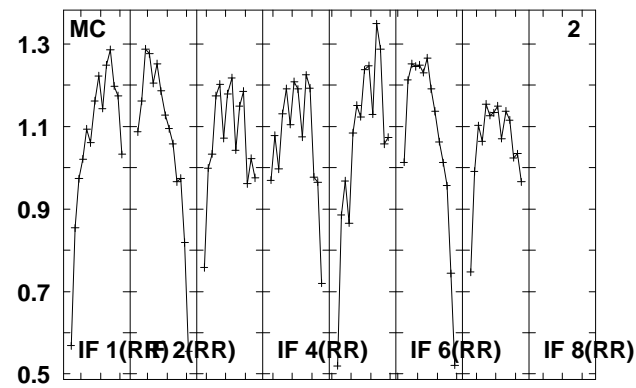
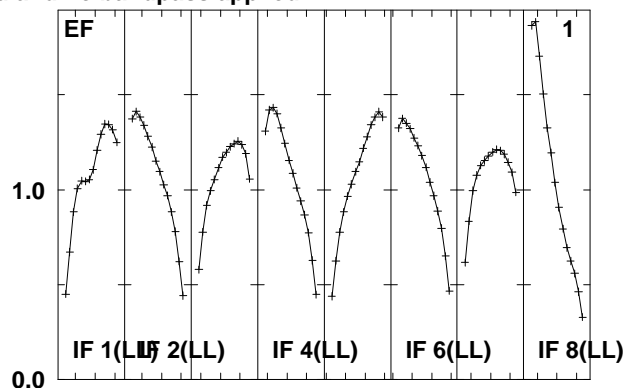
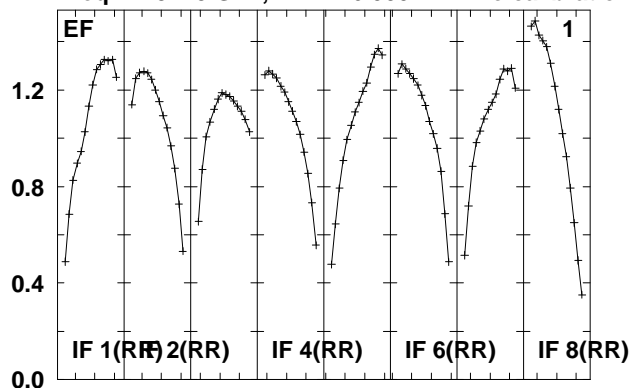

Lower frame: Real Jy
Total-power spectrum Antenna: *
Timerange: 00/18:41:46 to 00/18:52:34

Plot file version 185 created 08-JUL-2010 13:11:14

B1309+48 EM079.UVDATA.1

Freq = 4.9415 GHz, Bw = 16.000 MH No calibration applied and no bandpass applied

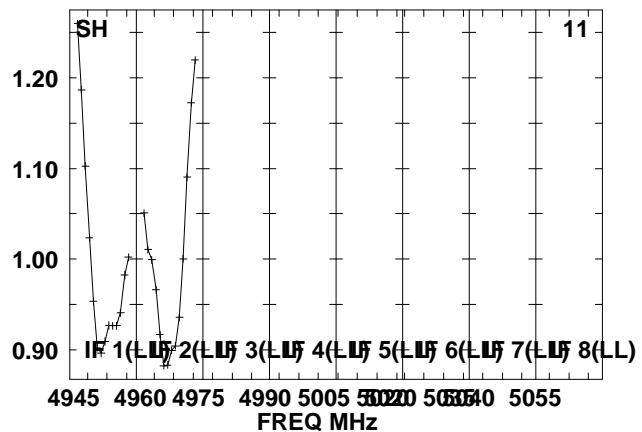
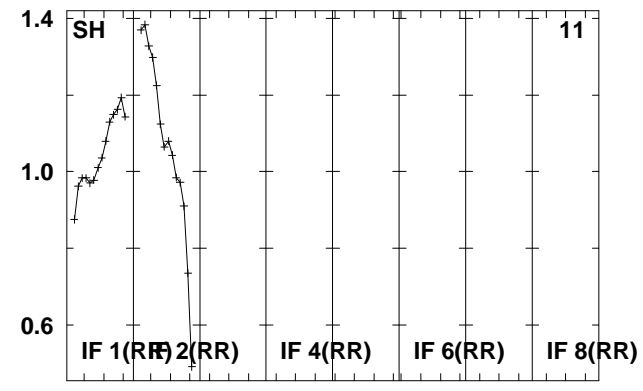
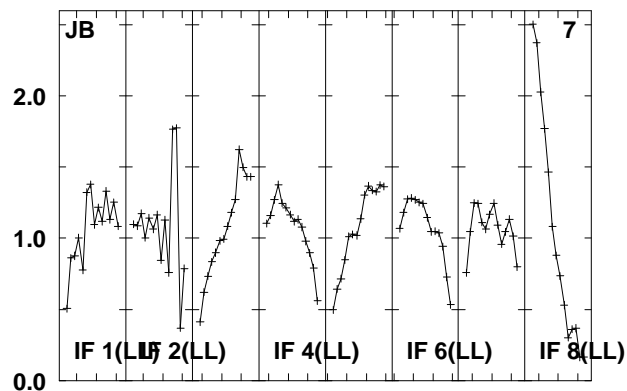
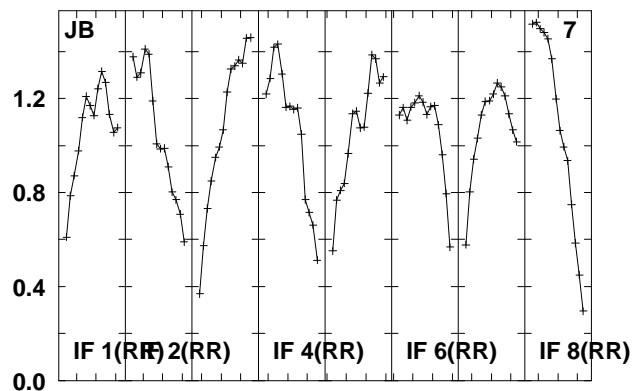
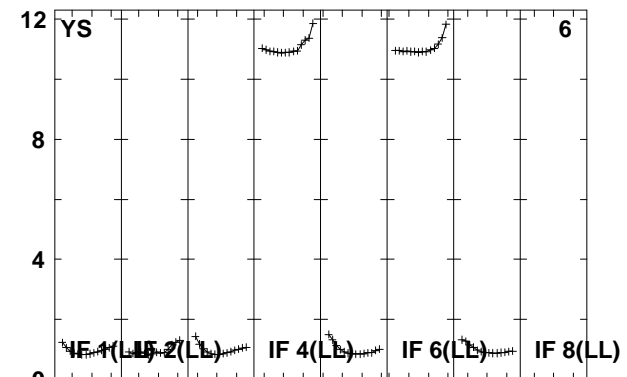
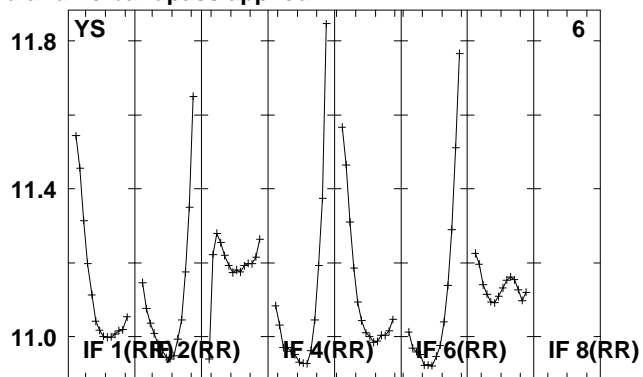
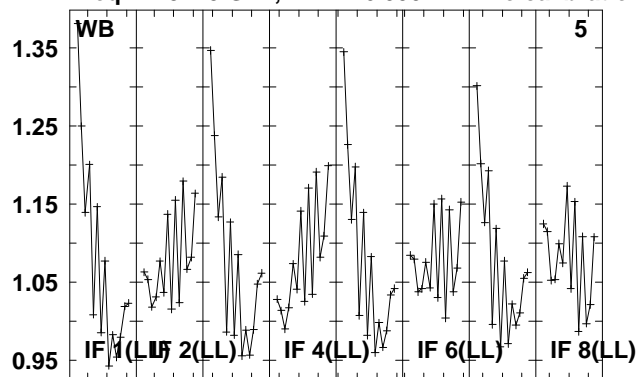

Lower frame: Real Jy

Total-power spectrum Antenna: *

Timerange: 00/18:41:46 to 00/18:52:34

Plot file version 186 created 08-JUL-2010 13:11:16

J1312+48 EM079.UVDATA.1

Freq = 4.9415 GHz, Bw = 16.000 MH No calibration applied and no bandpass applied

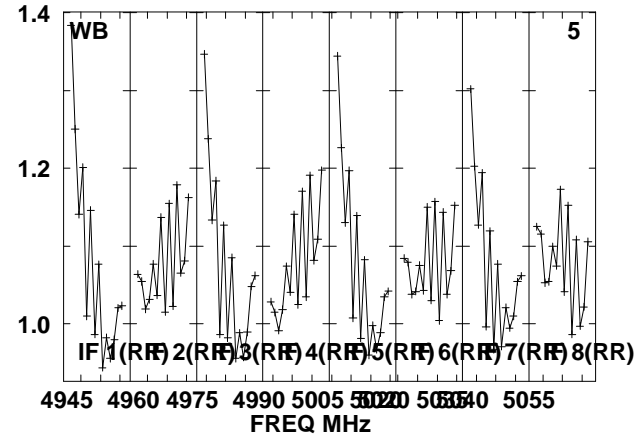
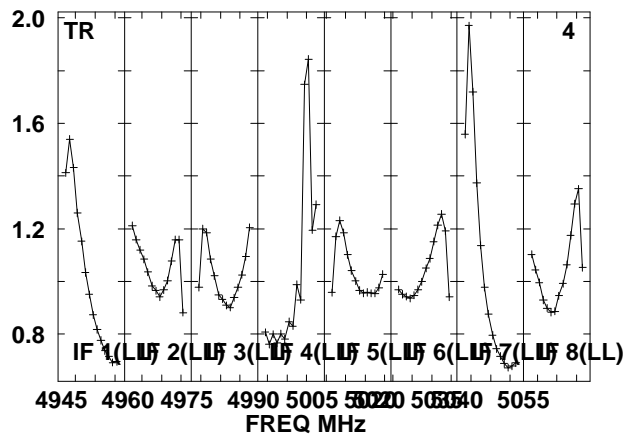
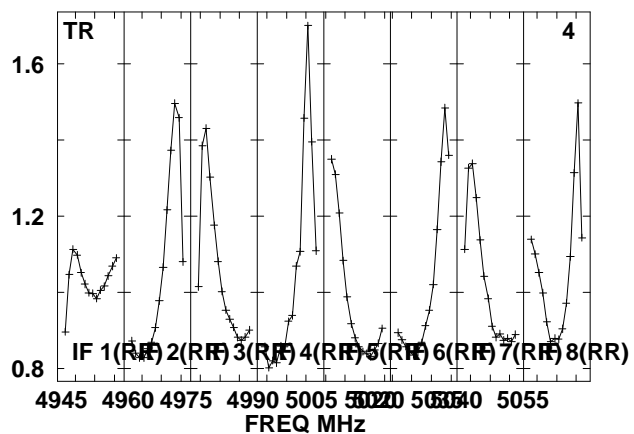
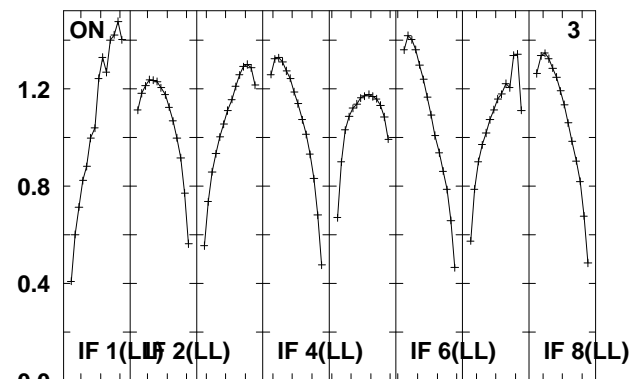
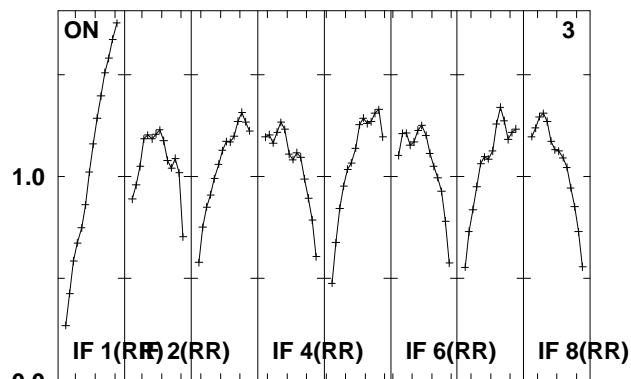
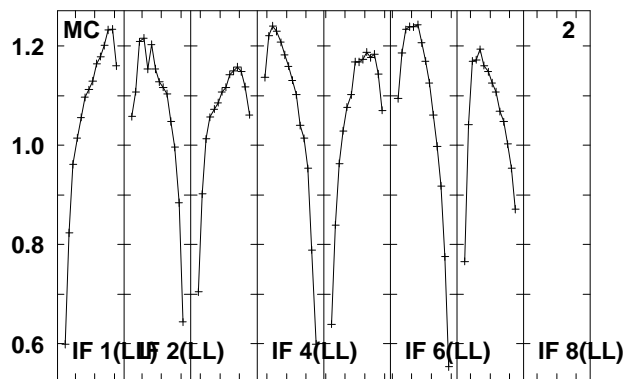
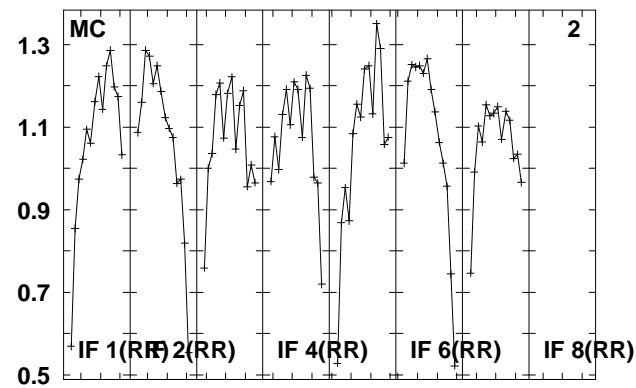
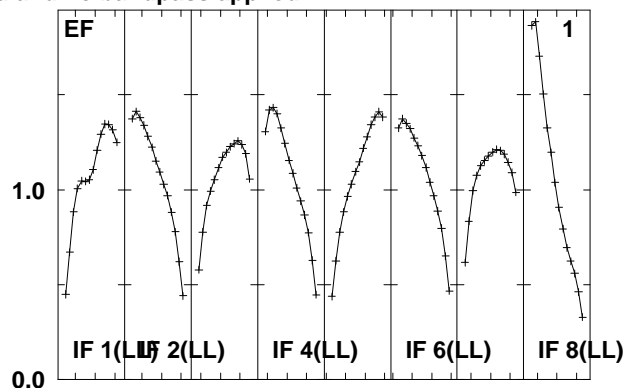
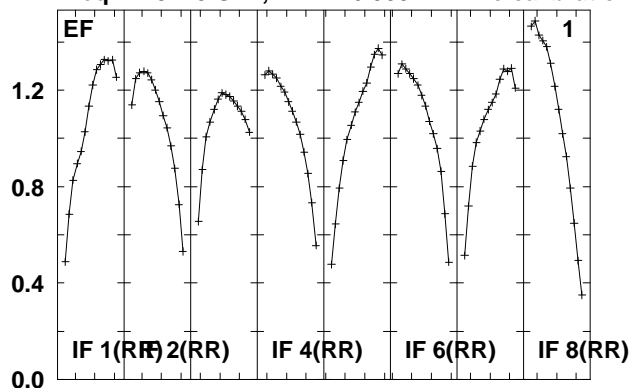

Lower frame: Real Jy
Total-power spectrum Antenna: *
Timerange: 00/18:52:36 to 00/18:54:34

Plot file version 187 created 08-JUL-2010 13:11:16

J1312+48 EM079.UVDATA.1

Freq = 4.9415 GHz, Bw = 16.000 MH No calibration applied and no bandpass applied

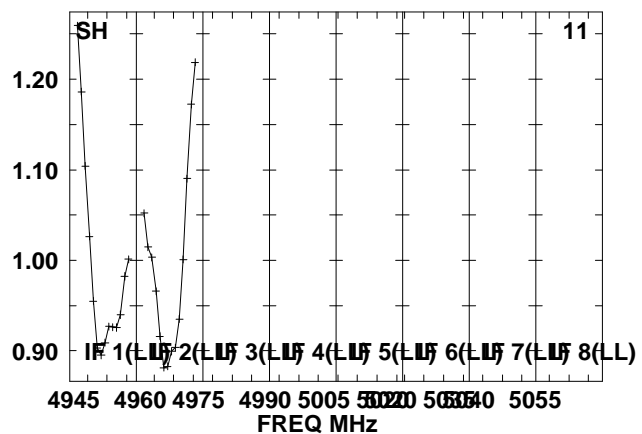
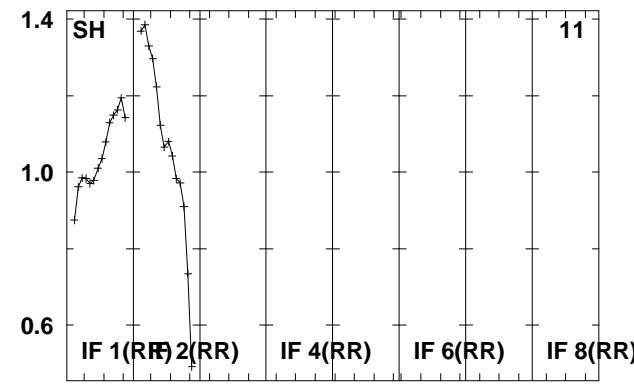
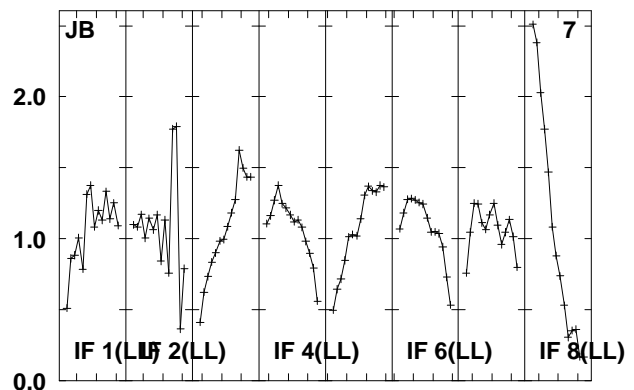
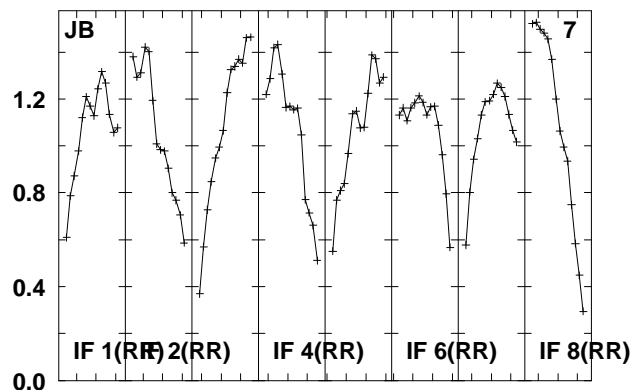
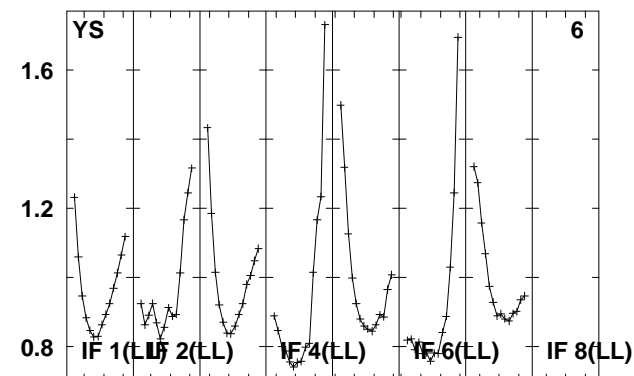
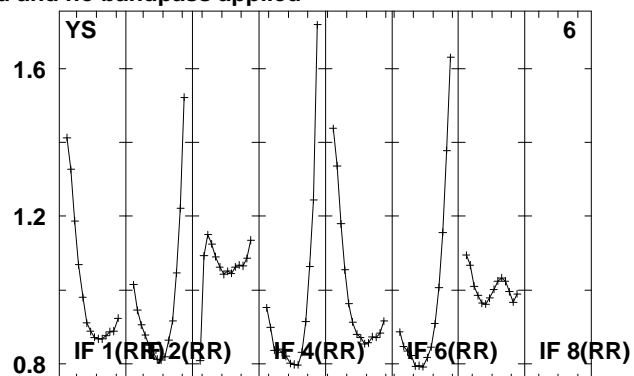
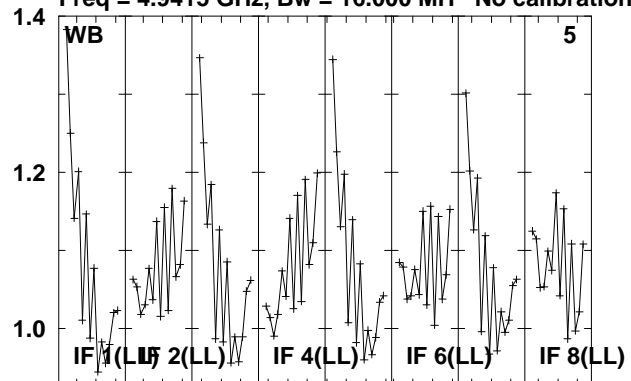

Lower frame: Real Jy

Total-power spectrum Antenna: *

Timerange: 00/18:52:36 to 00/18:54:34

Plot file version 188 created 08-JUL-2010 13:11:17

B1309+48 EM079.UVDATA.1

Freq = 4.9415 GHz, Bw = 16.000 MH No calibration applied and no bandpass applied

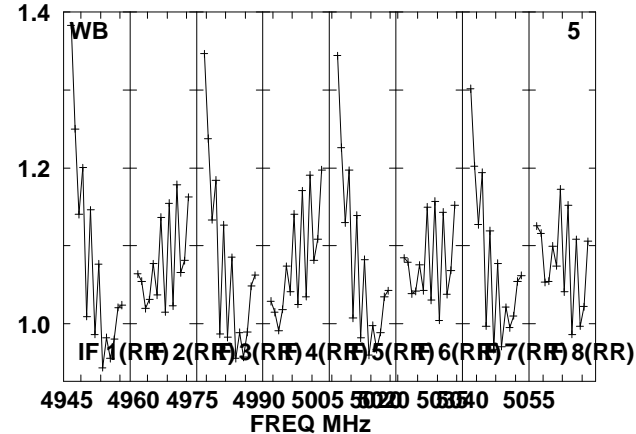
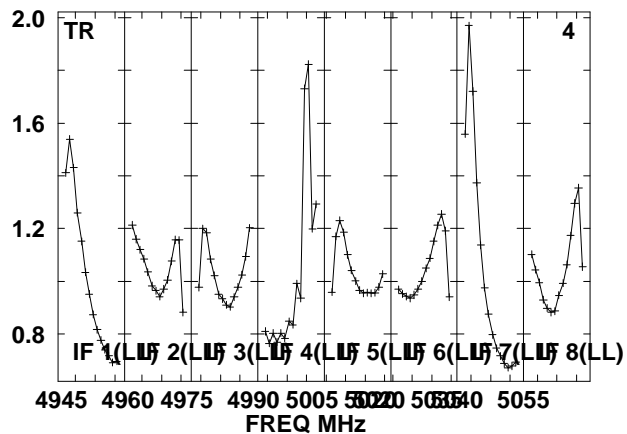
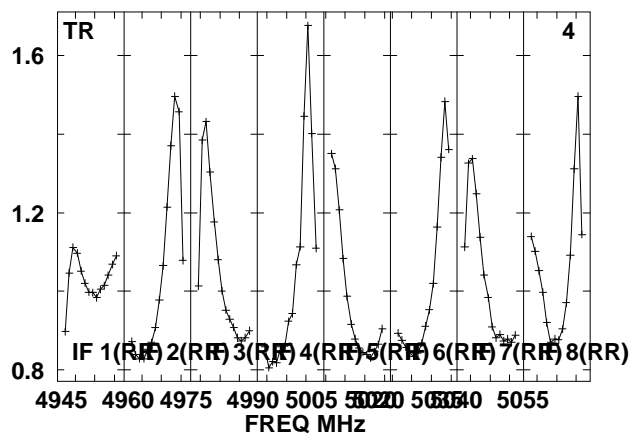
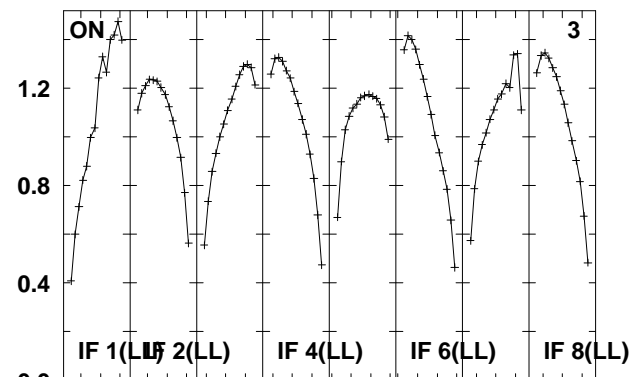
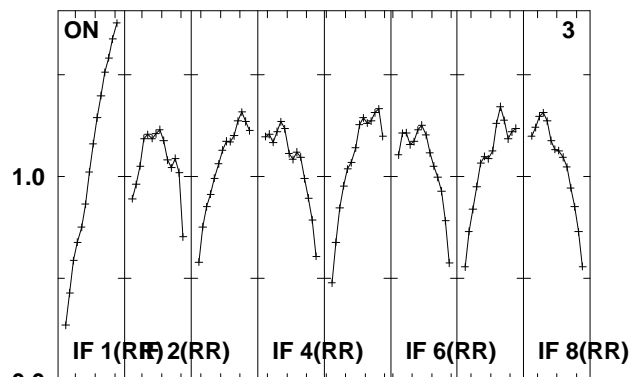
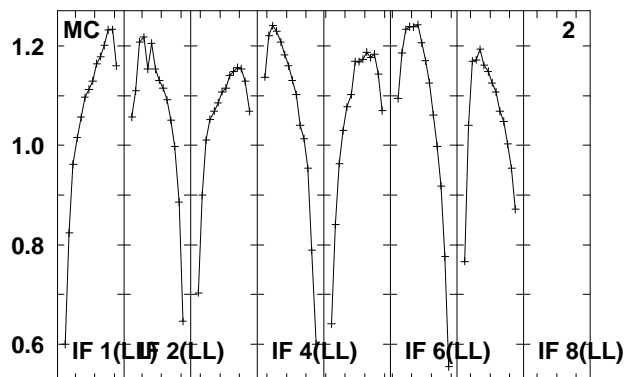
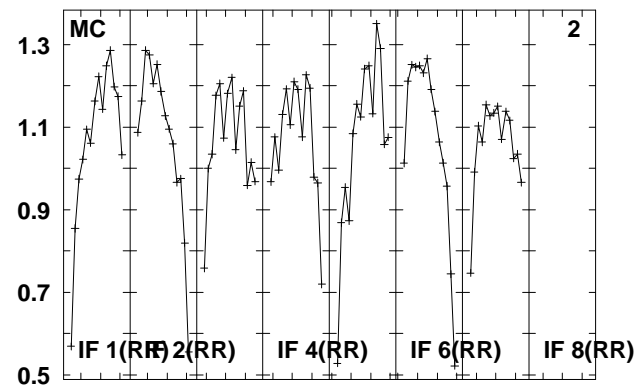
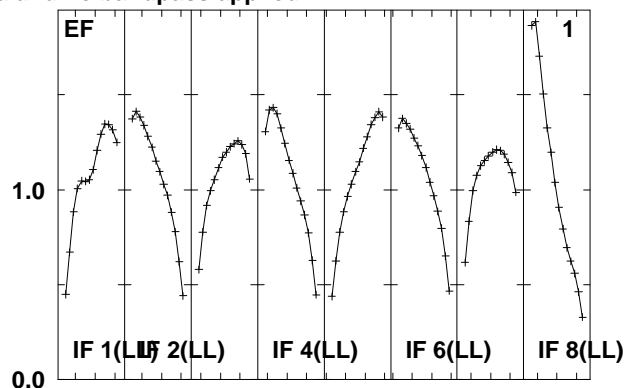
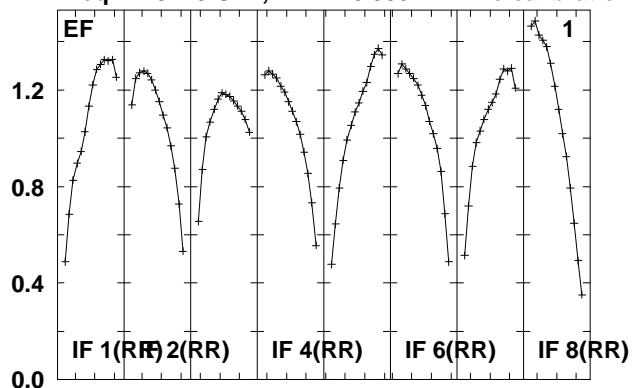

Lower frame: Real Jy
Total-power spectrum Antenna: *
Timerange: 00/18:54:36 to 00/19:05:24

Plot file version 189 created 08-JUL-2010 13:11:18

B1309+48 EM079.UVDATA.1

Freq = 4.9415 GHz, Bw = 16.000 MH No calibration applied and no bandpass applied

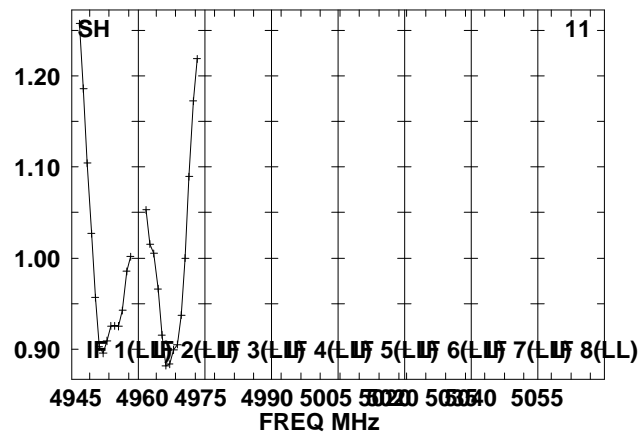
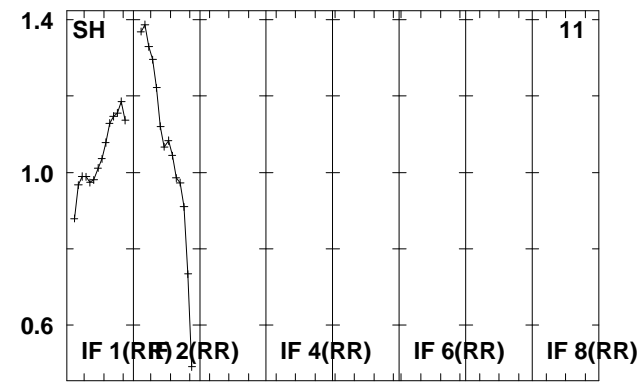
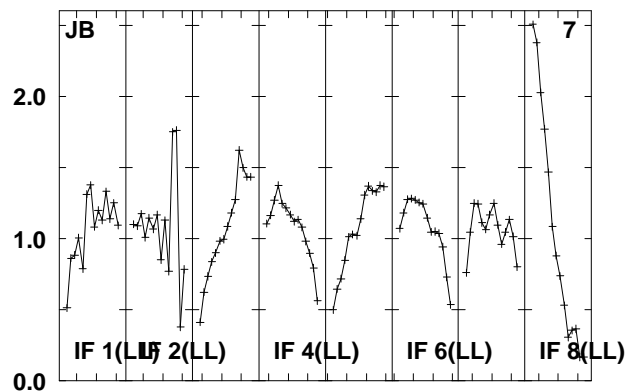
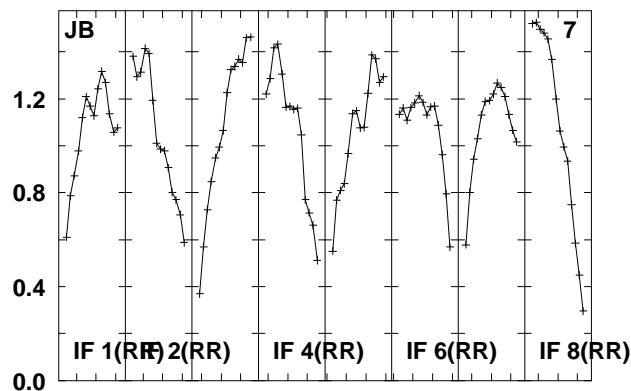
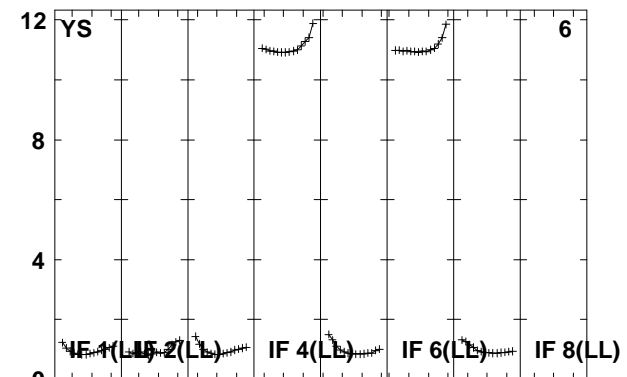
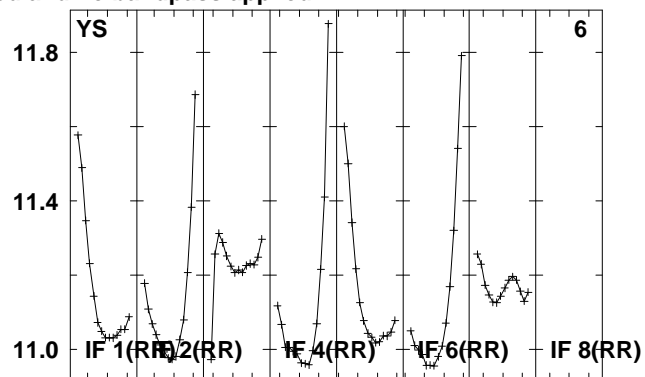
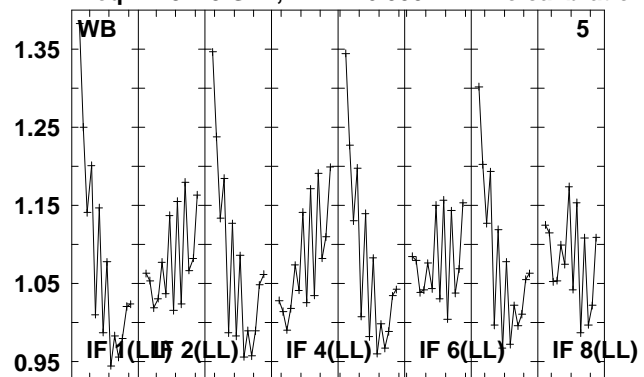

Lower frame: Real Jy

Total-power spectrum Antenna: *

Timerange: 00/18:54:36 to 00/19:05:24

Plot file version 190 created 08-JUL-2010 13:11:20

J1312+48 EM079.UVDATA.1

Freq = 4.9415 GHz, Bw = 16.000 MH No calibration applied and no bandpass applied

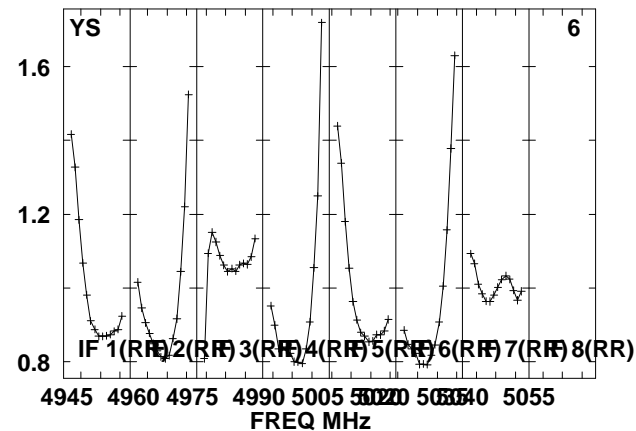
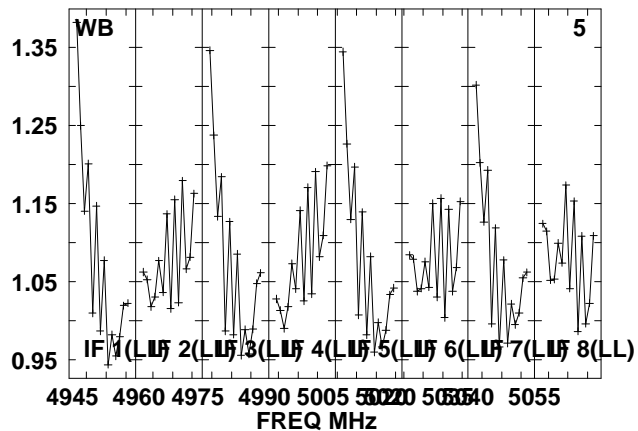
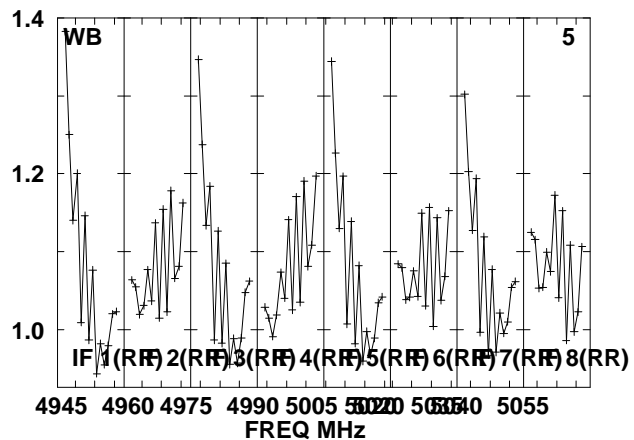
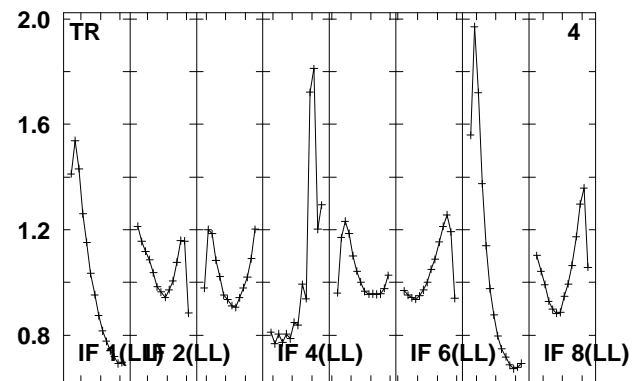
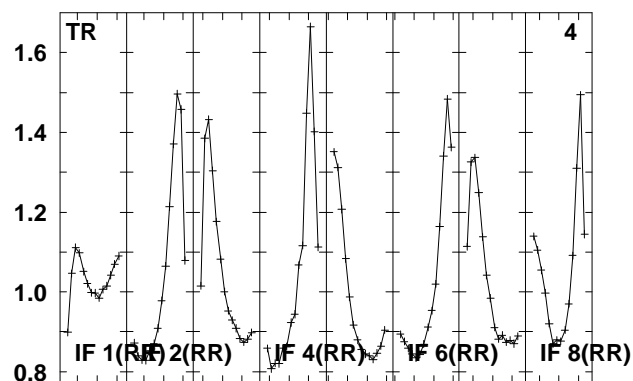
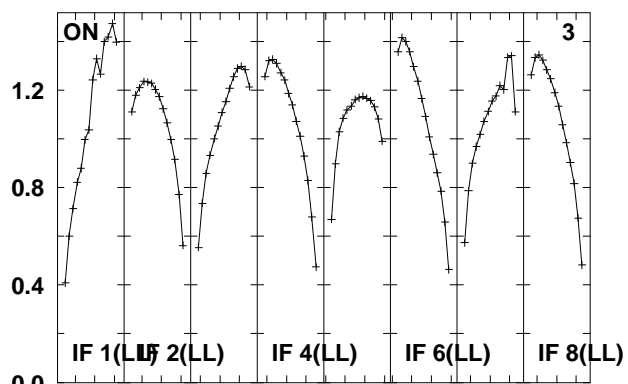
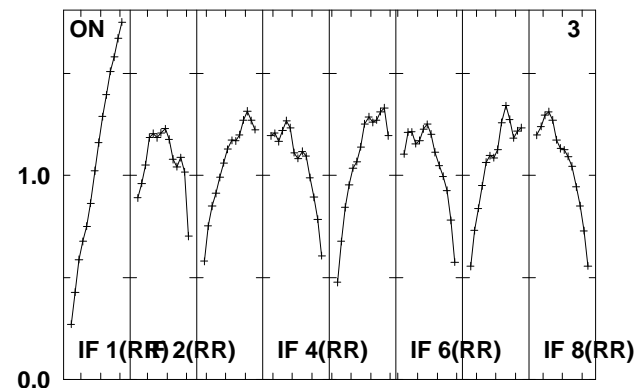
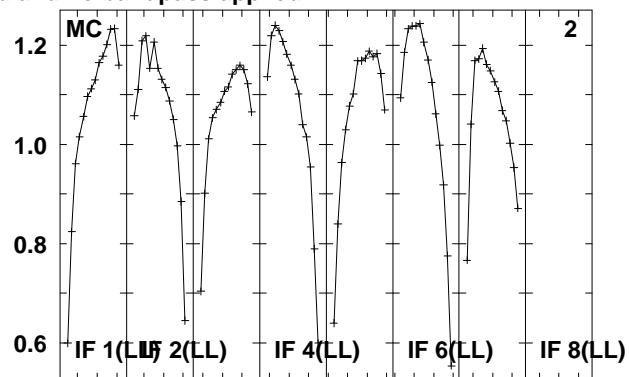
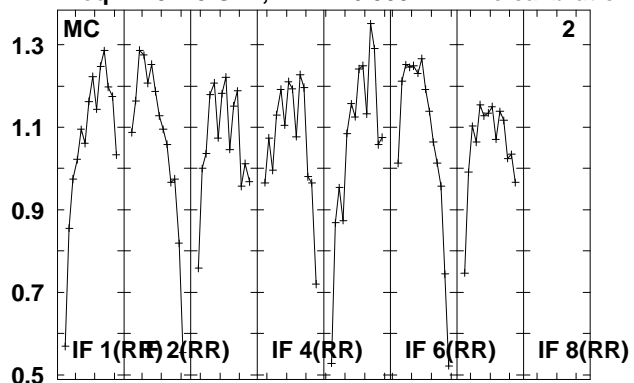

Lower frame: Real Jy

Total-power spectrum Antenna: *

Timerange: 00/19:05:26 to 00/19:07:24

Plot file version 191 created 08-JUL-2010 13:11:21

J1312+48 EM079.UVDATA.1

Freq = 4.9415 GHz, Bw = 16.000 MH No calibration applied and no bandpass applied

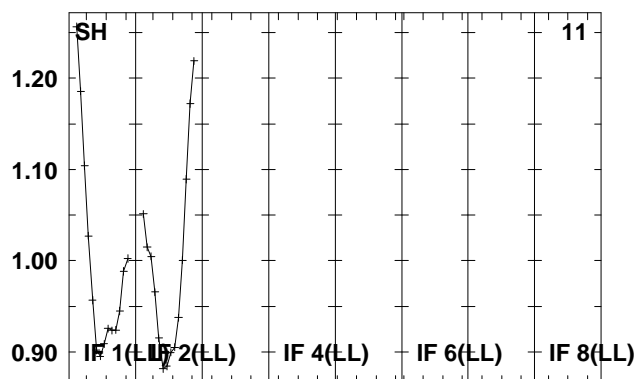
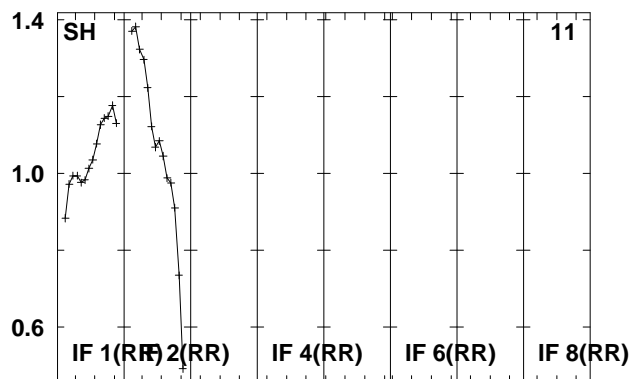
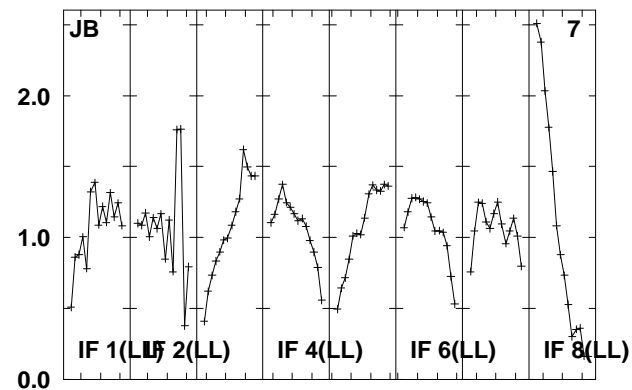
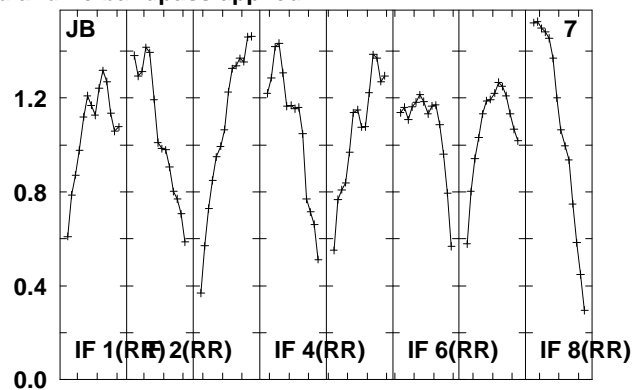
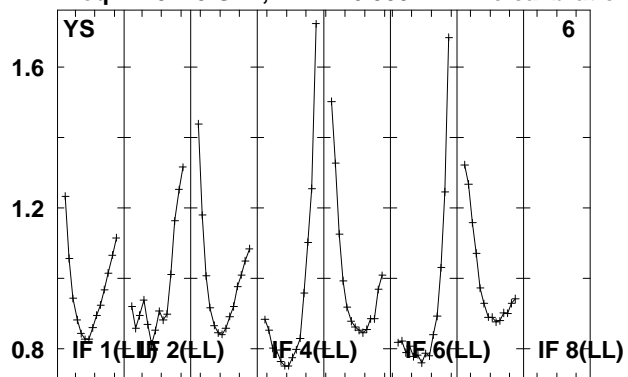

Lower frame: Real Jy
Total-power spectrum Antenna: *
Timerange: 00/19:05:26 to 00/19:07:24

Plot file version 192 created 08-JUL-2010 13:11:21

B1309+48 EM079.UVDATA.1

Freq = 4.9415 GHz, Bw = 16.000 MH No calibration applied and no bandpass applied

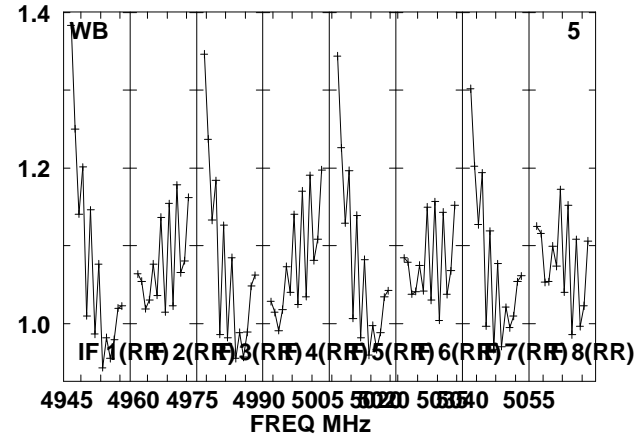
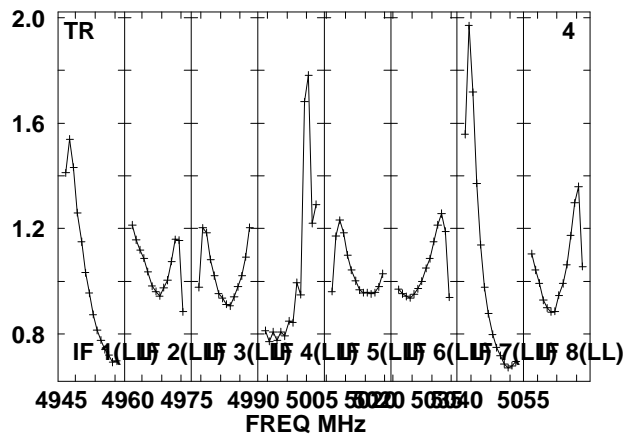
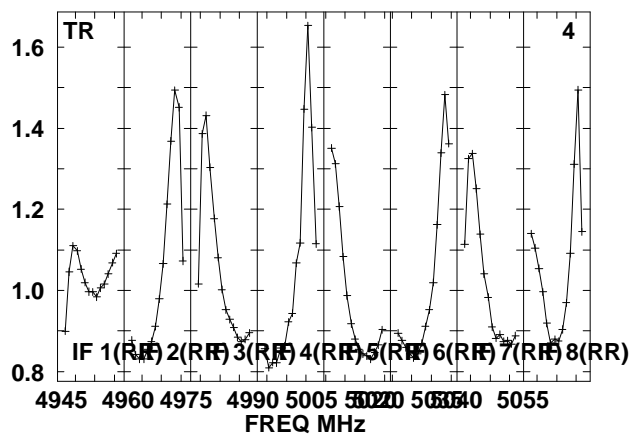
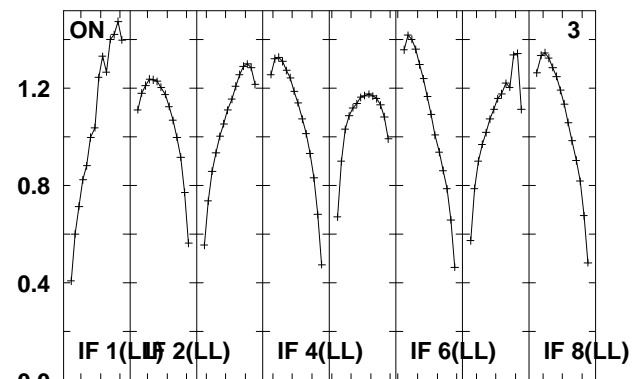
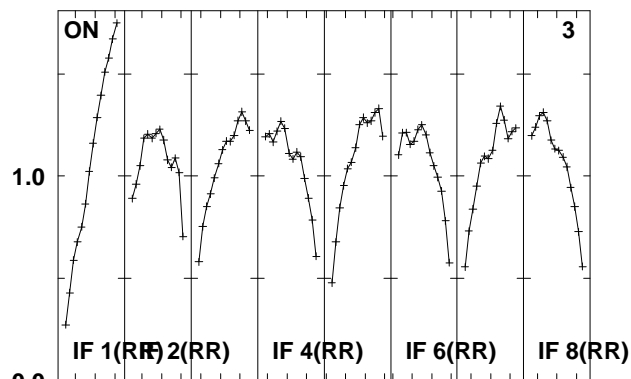
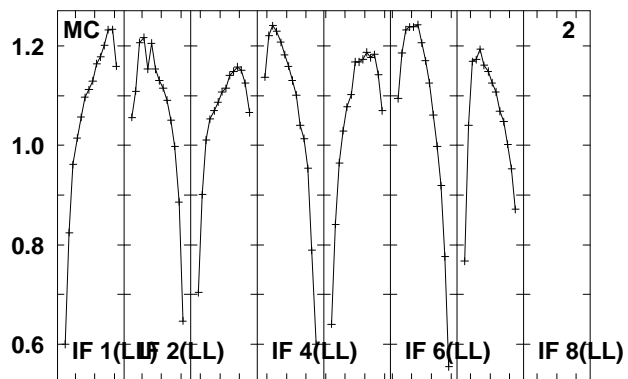
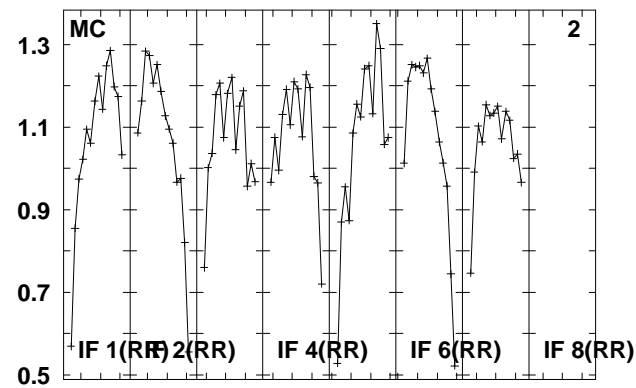
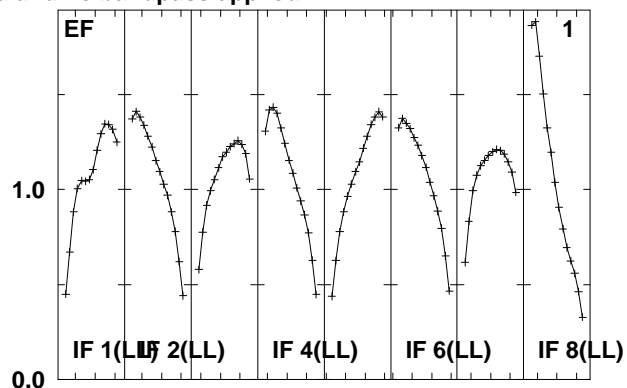
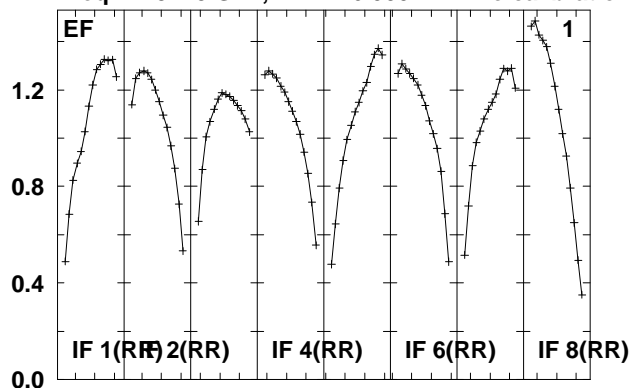

Lower frame: Real Jy
Total-power spectrum Antenna: *
Timerange: 00/19:07:26 to 00/19:18:14

Plot file version 193 created 08-JUL-2010 13:11:23

B1309+48 EM079.UVDATA.1

Freq = 4.9415 GHz, Bw = 16.000 MH No calibration applied and no bandpass applied

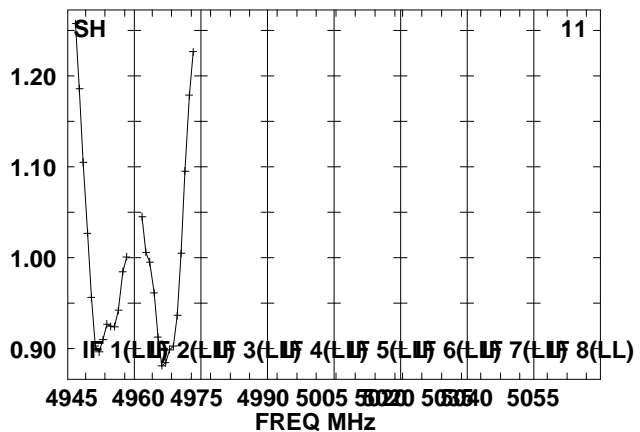
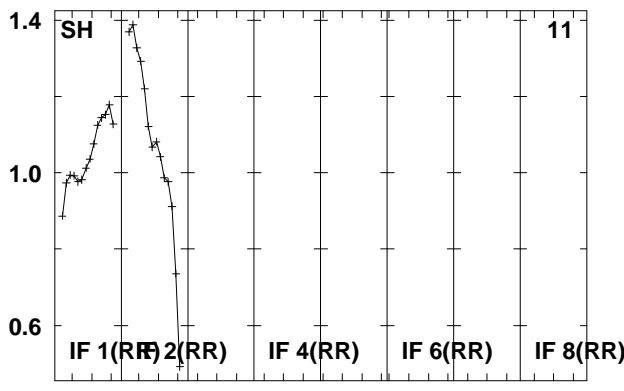
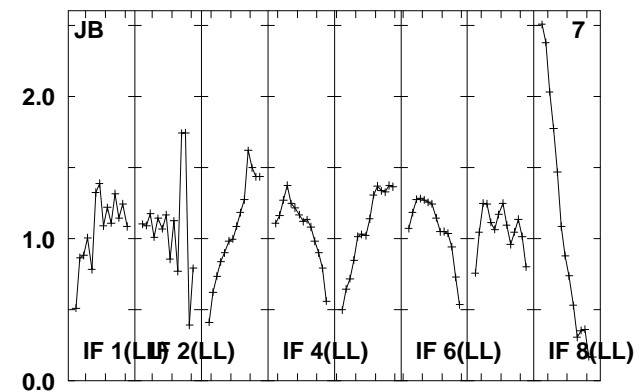
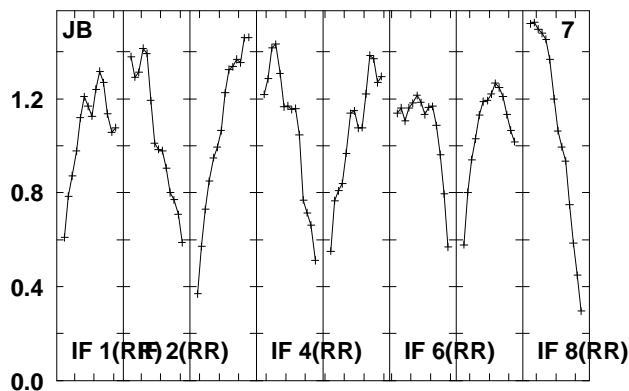
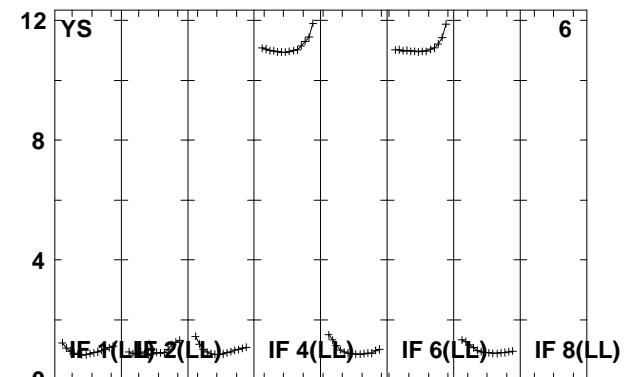
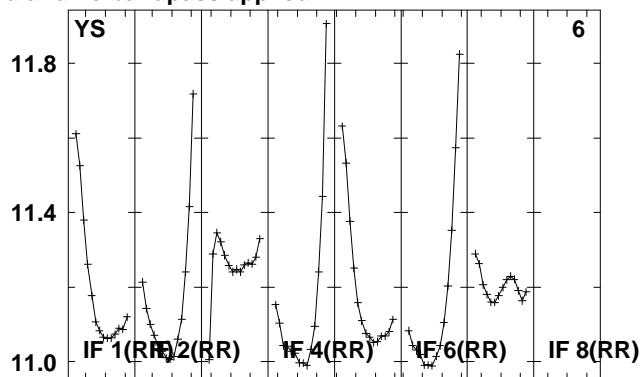
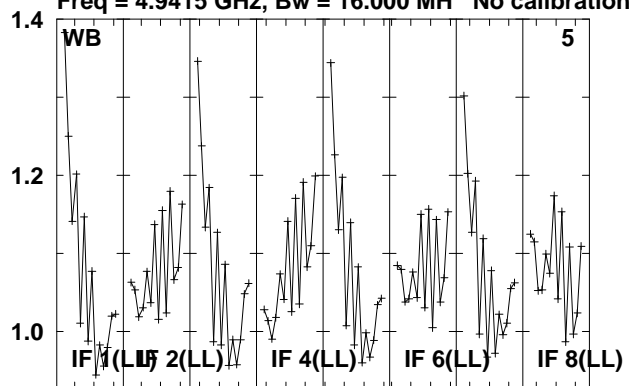

Lower frame: Real Jy

Total-power spectrum Antenna: *

Timerange: 00/19:07:26 to 00/19:18:14

Plot file version 194 created 08-JUL-2010 13:11:24

J1312+48 EM079.UVDATA.1

Freq = 4.9415 GHz, Bw = 16.000 MH No calibration applied and no bandpass applied

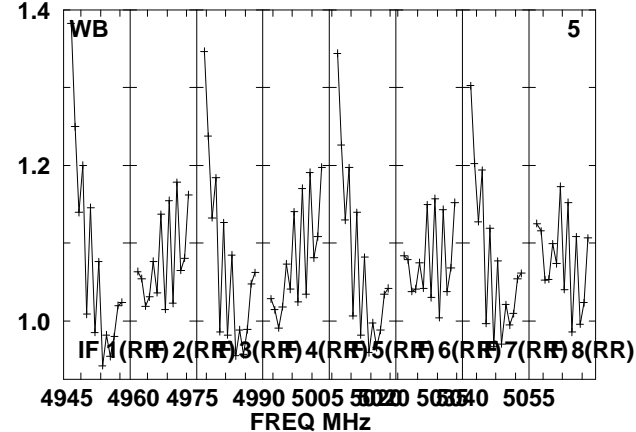
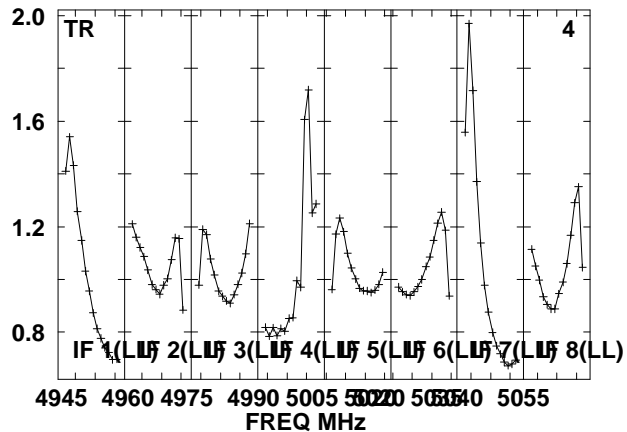
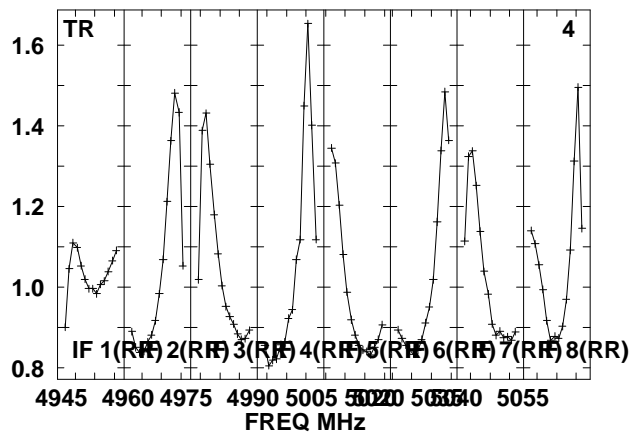
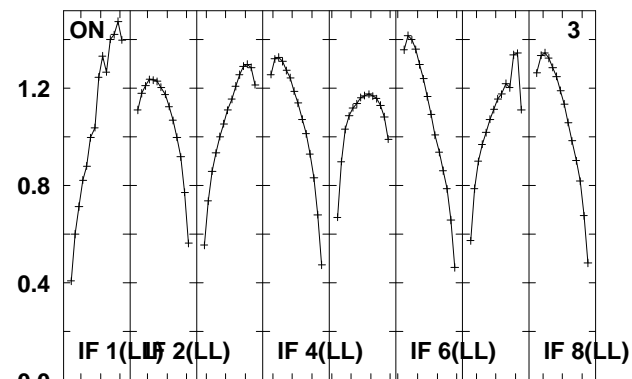
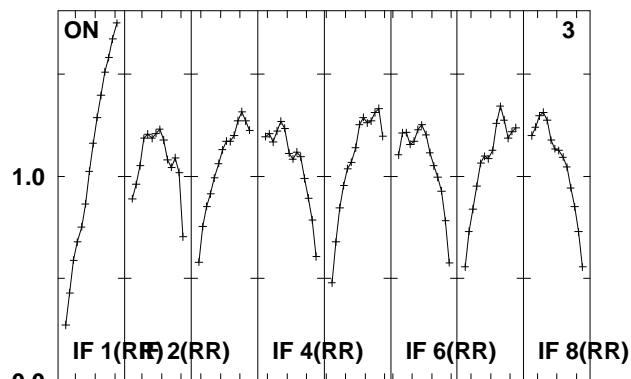
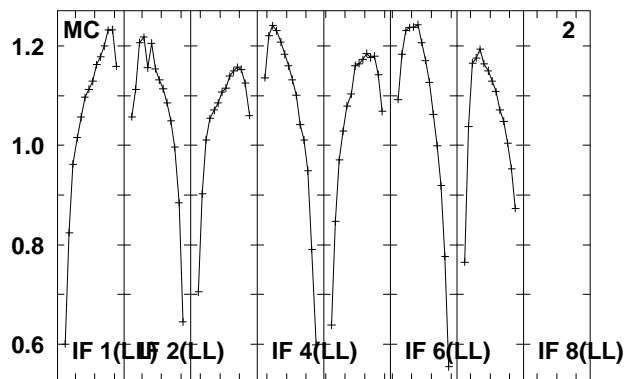
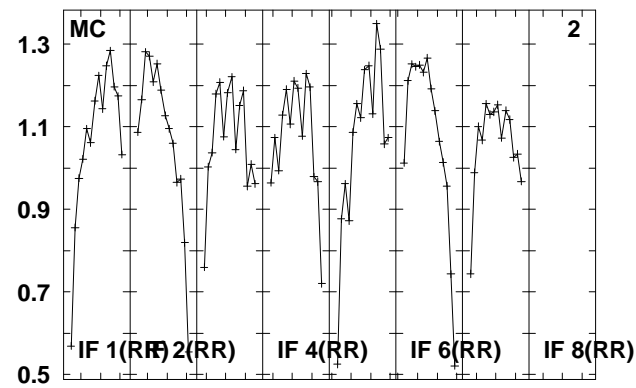
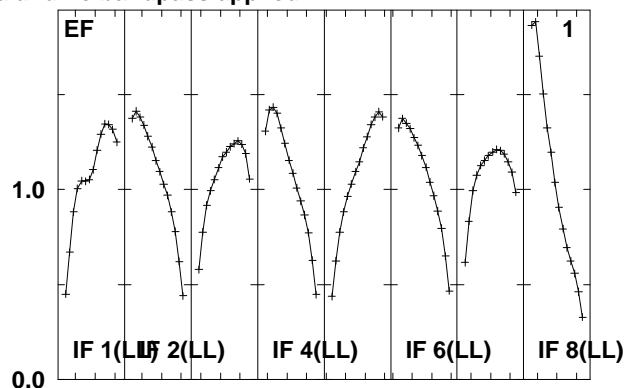
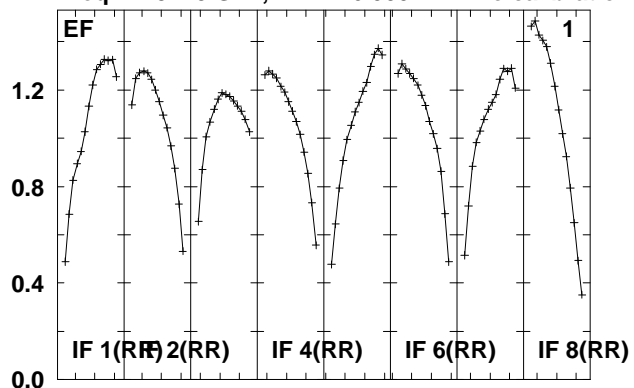

Lower frame: Real Jy

Total-power spectrum Antenna: *

Timerange: 00/19:18:16 to 00/19:20:14

Plot file version 195 created 08-JUL-2010 13:11:25

J1312+48 EM079.UVDATA.1

Freq = 4.9415 GHz, Bw = 16.000 MH No calibration applied and no bandpass applied

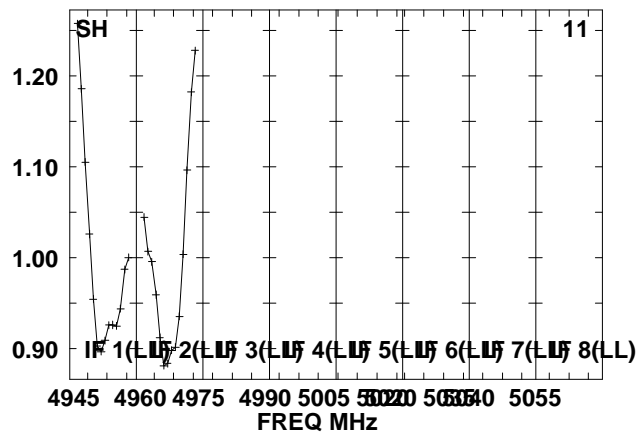
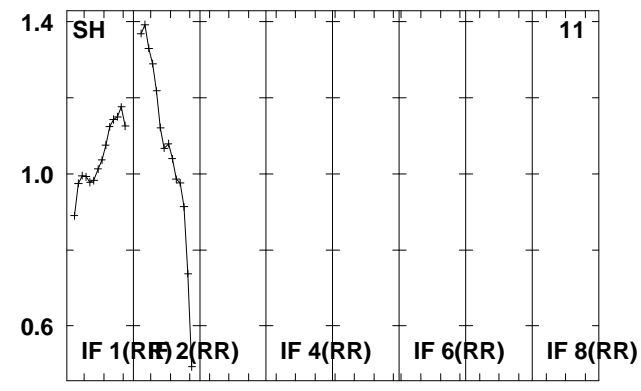
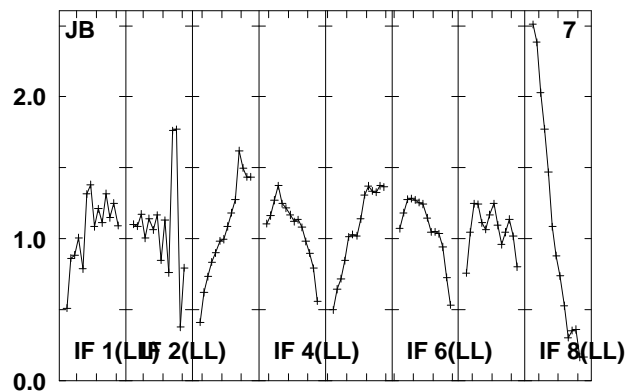
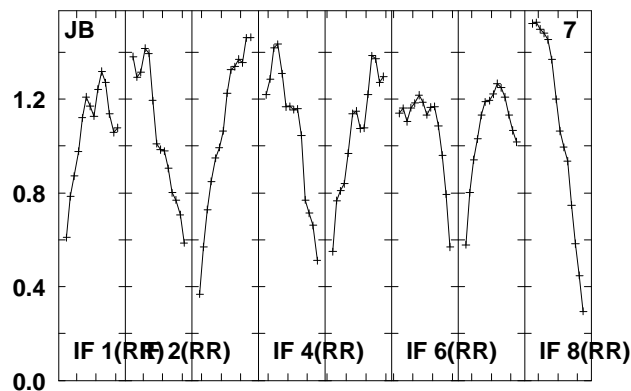
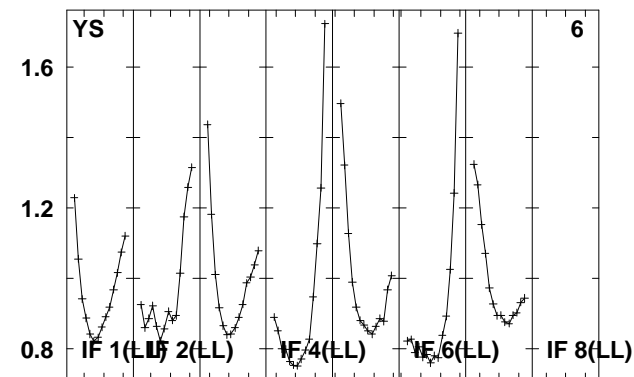
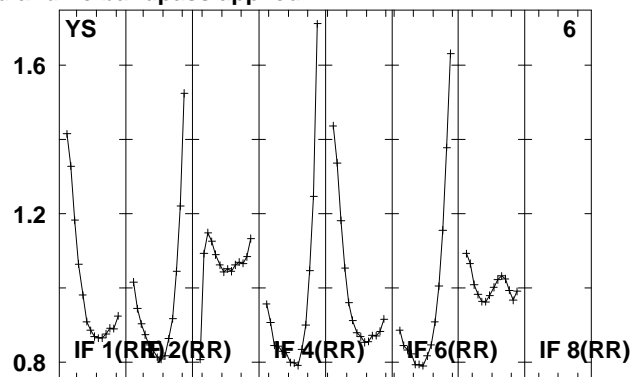
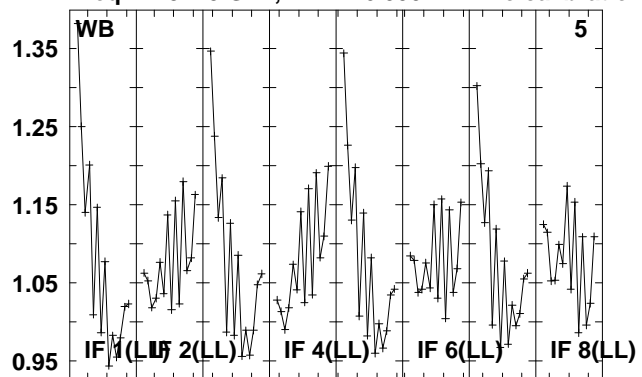

4945 4960 4975 4990 5005 5020 5035 5050 5055
FREQ MHz

Lower frame: Real Jy

Total-power spectrum Antenna: *

Timerange: 00/19:18:16 to 00/19:20:14

Plot file version 196 created 08-JUL-2010 13:11:25

B1309+48 EM079.UVDATA.1

Freq = 4.9415 GHz, Bw = 16.000 MH No calibration applied and no bandpass applied

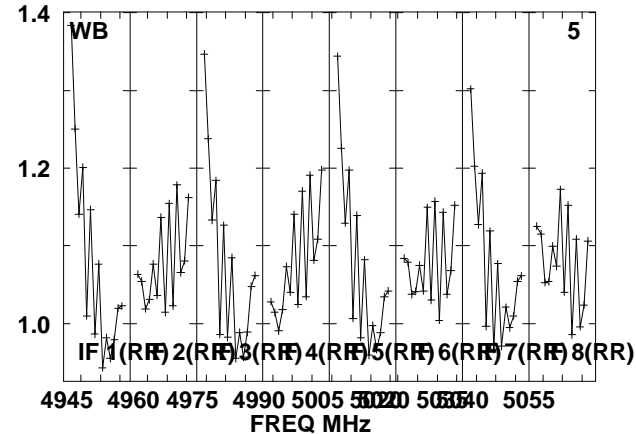
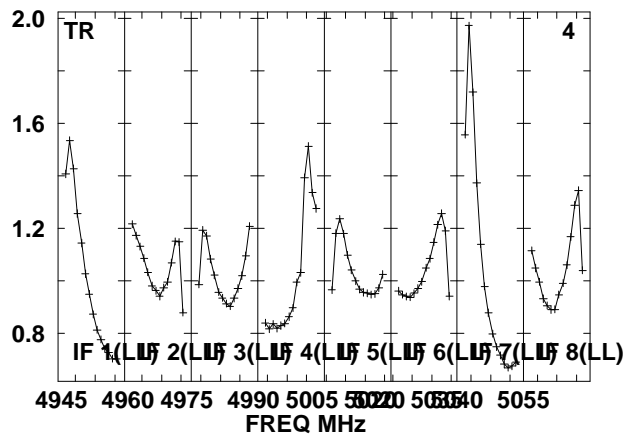
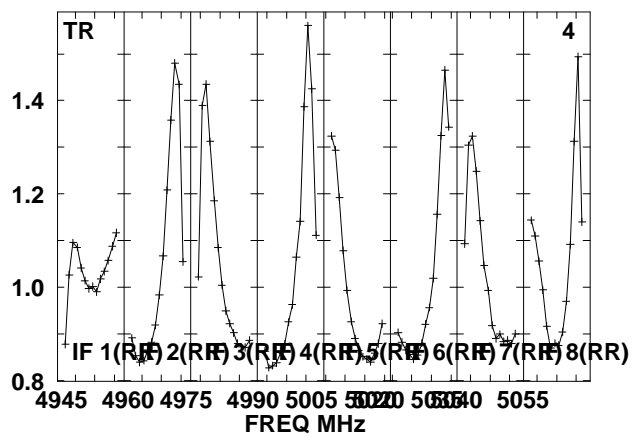
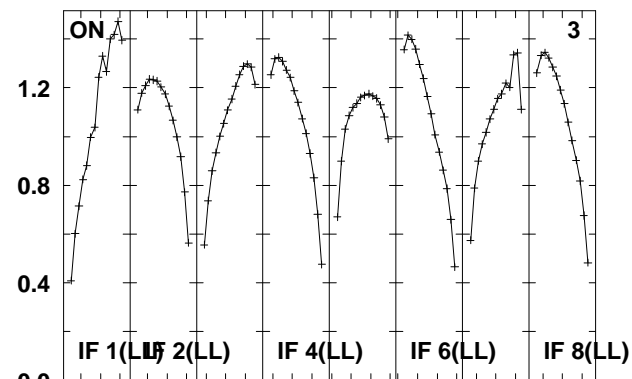
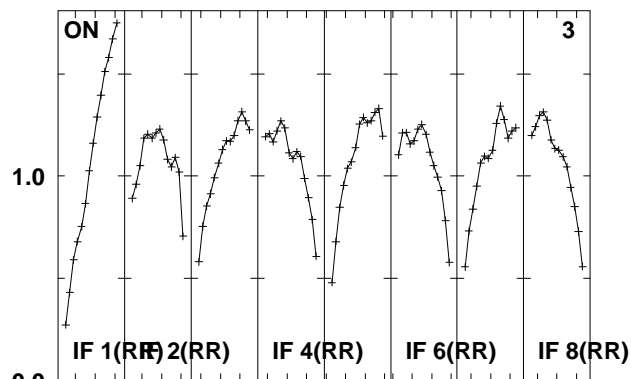
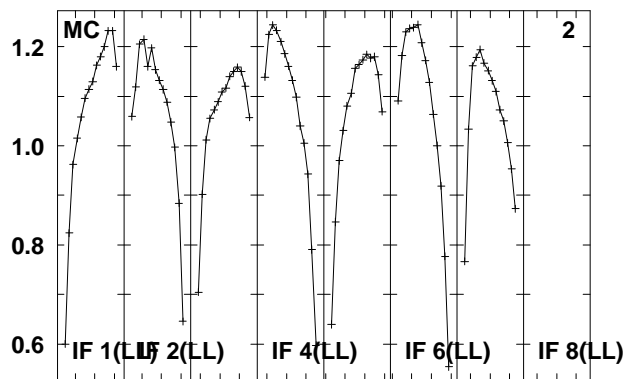
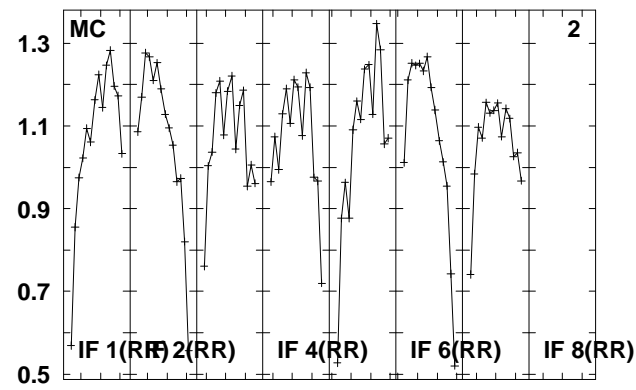
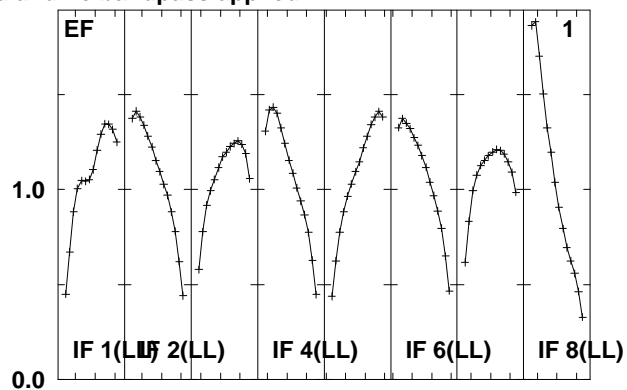
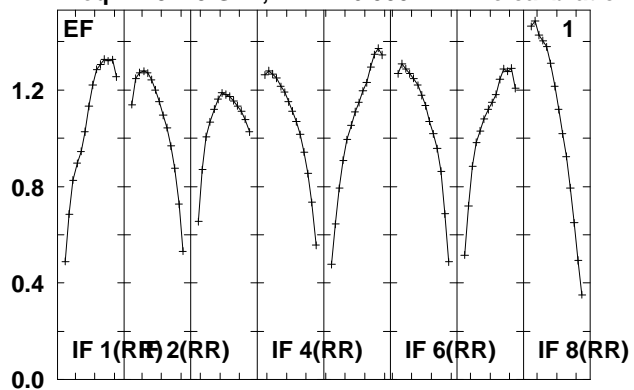

Lower frame: Real Jy
Total-power spectrum Antenna: *
Timerange: 00/19:20:16 to 00/19:31:04

Plot file version 197 created 08-JUL-2010 13:11:27

B1309+48 EM079.UVDATA.1

Freq = 4.9415 GHz, Bw = 16.000 MH No calibration applied and no bandpass applied

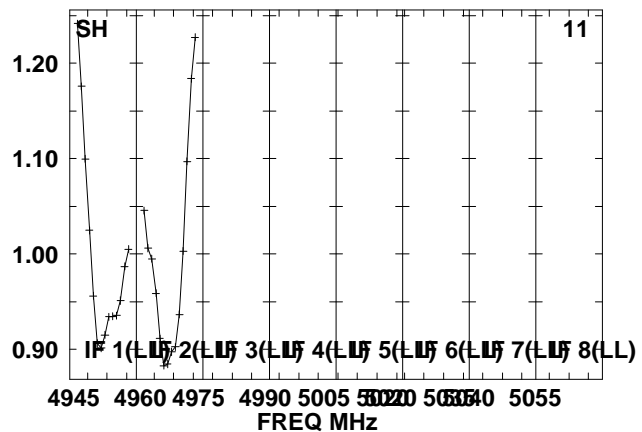
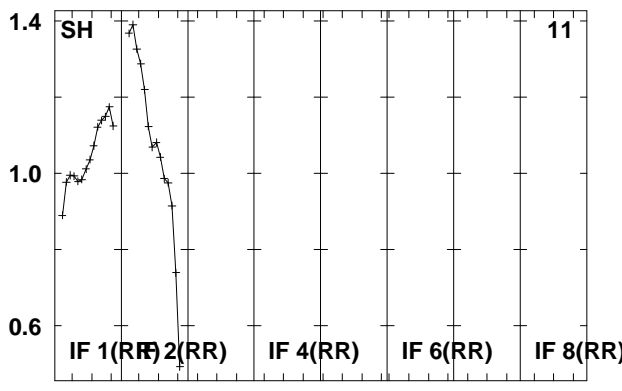
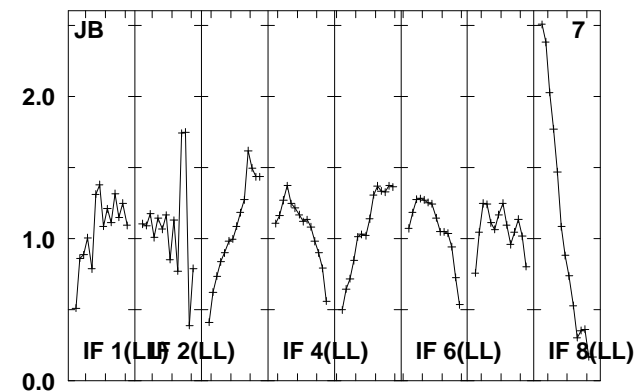
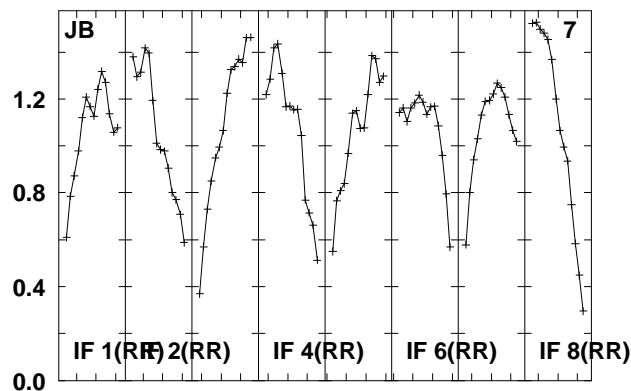
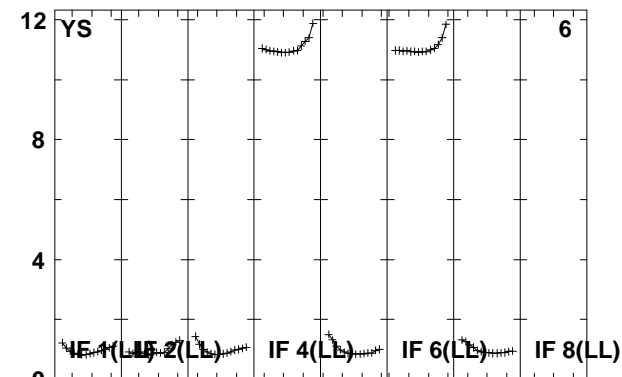
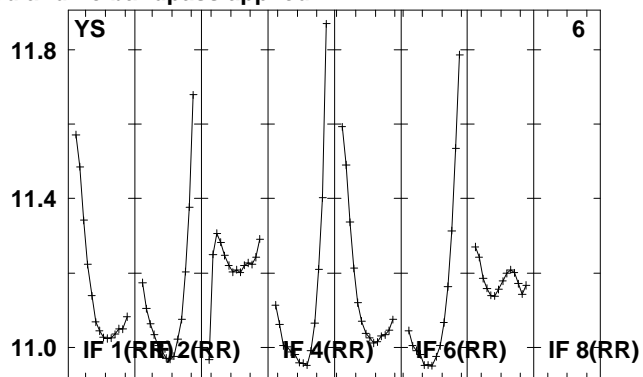
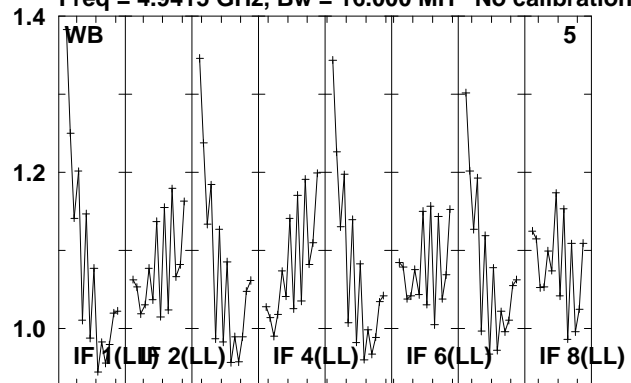

Lower frame: Real Jy

Total-power spectrum Antenna: *

Timerange: 00/19:20:16 to 00/19:31:04

Plot file version 198 created 08-JUL-2010 13:11:28

J1312+48 EM079.UVDATA.1

Freq = 4.9415 GHz, Bw = 16.000 MH No calibration applied and no bandpass applied

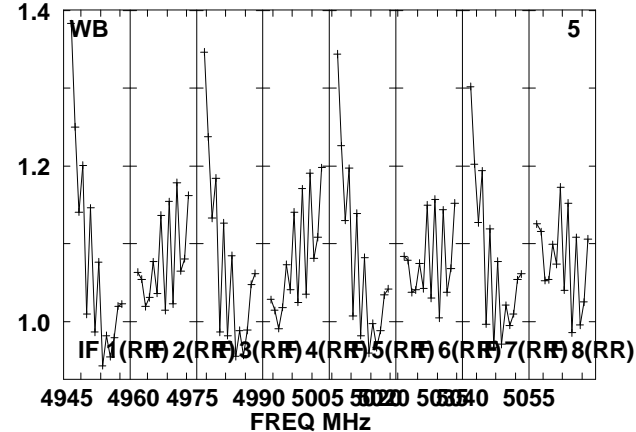
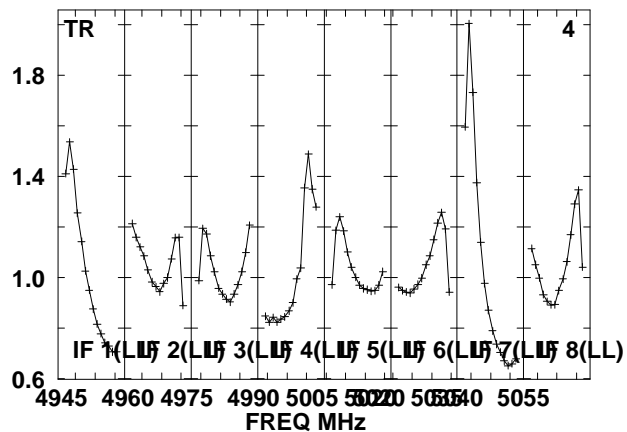
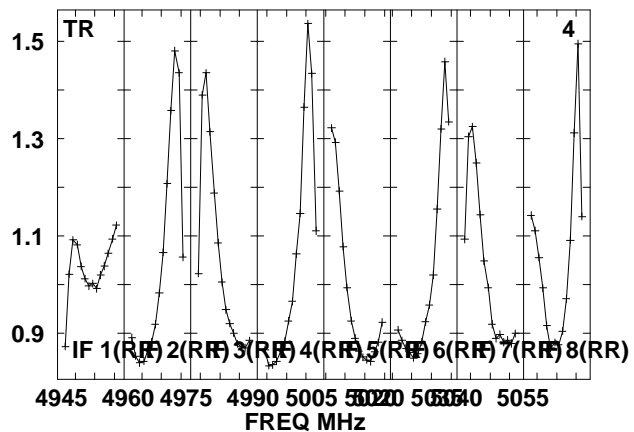
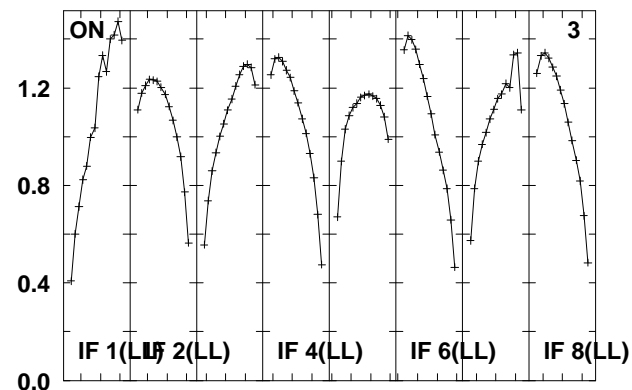
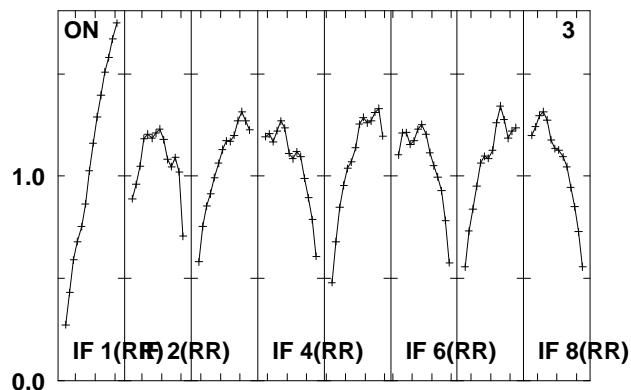
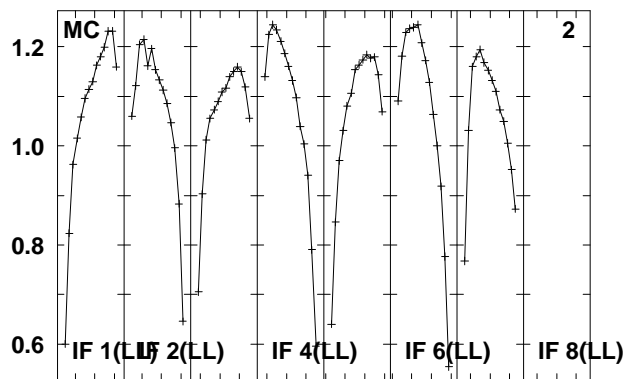
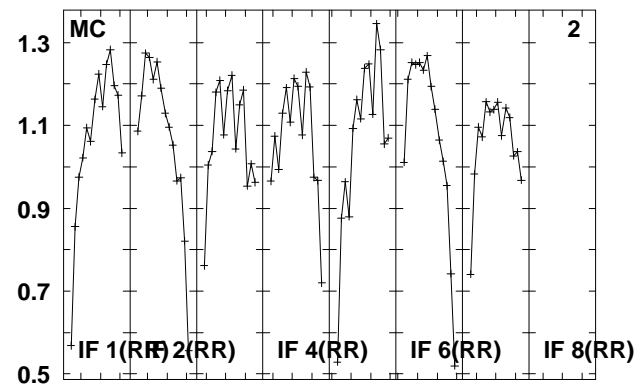
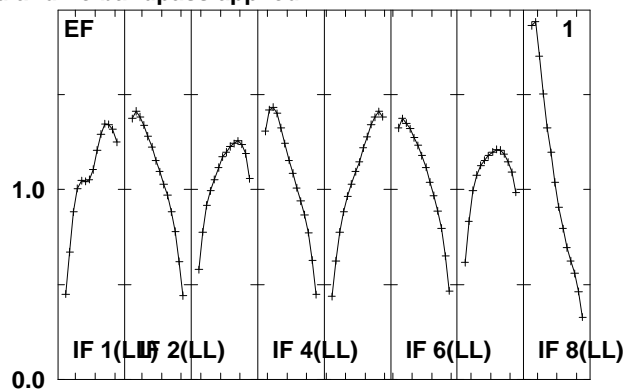
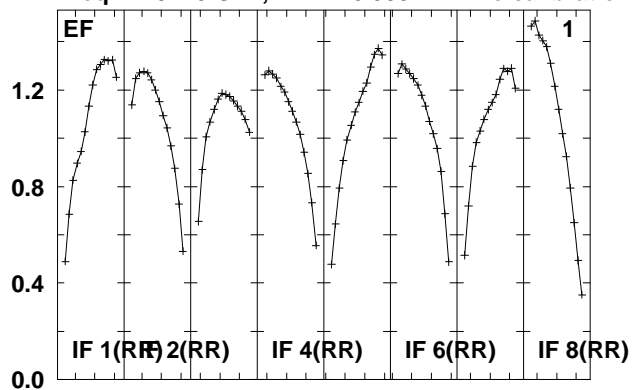

Lower frame: Real Jy
Total-power spectrum Antenna: *
Timerange: 00/19:31:06 to 00/19:33:04

Plot file version 199 created 08-JUL-2010 13:11:29

J1312+48 EM079.UVDATA.1

Freq = 4.9415 GHz, Bw = 16.000 MH No calibration applied and no bandpass applied

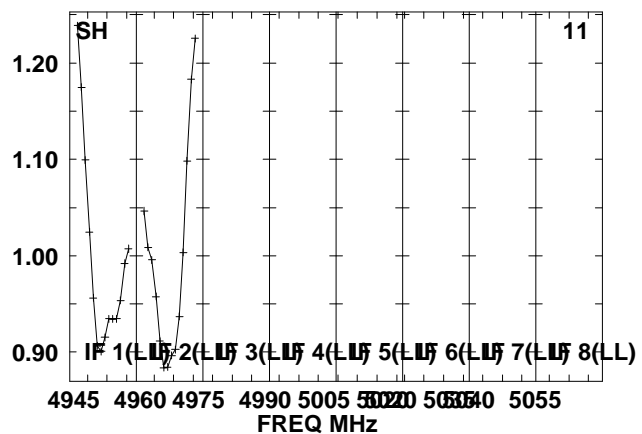
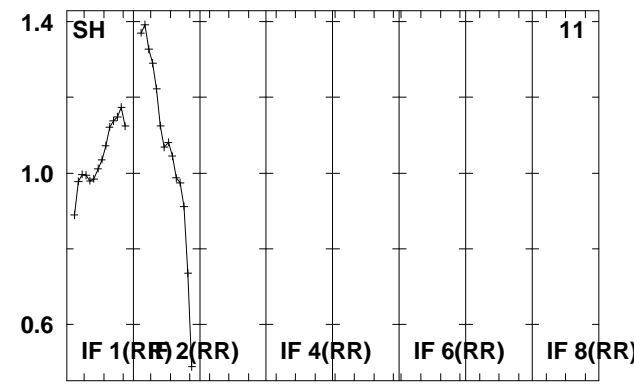
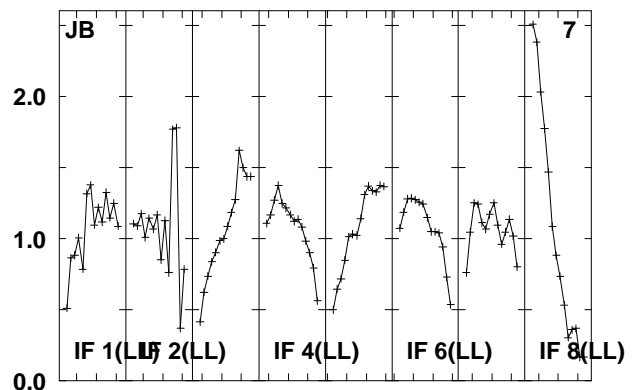
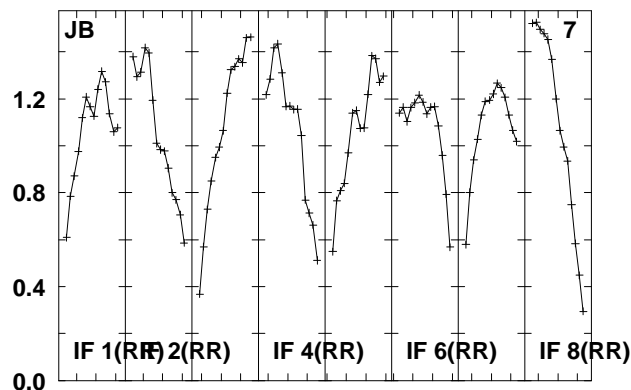
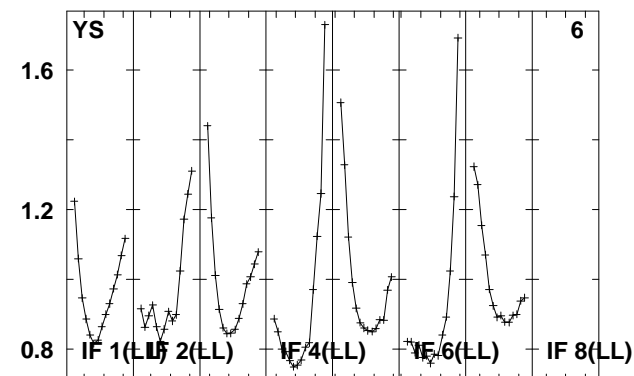
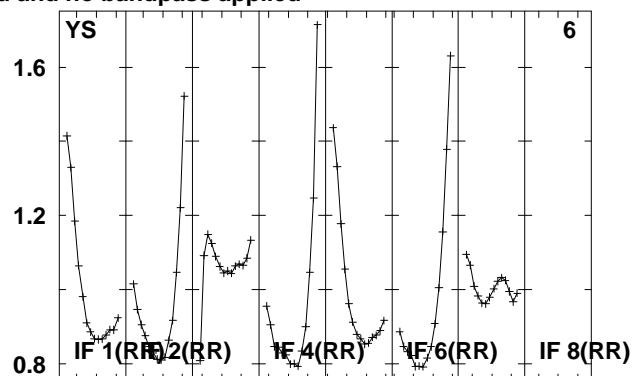
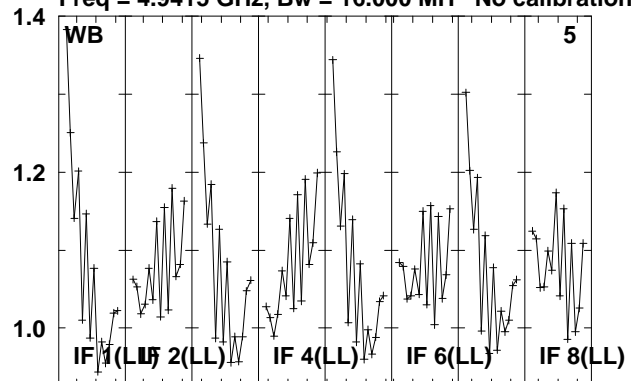

Lower frame: Real Jy

Total-power spectrum Antenna: *

Timerange: 00/19:31:06 to 00/19:33:04

Plot file version 200 created 08-JUL-2010 13:11:30

B1309+48 EM079.UVDATA.1

Freq = 4.9415 GHz, Bw = 16.000 MH No calibration applied and no bandpass applied

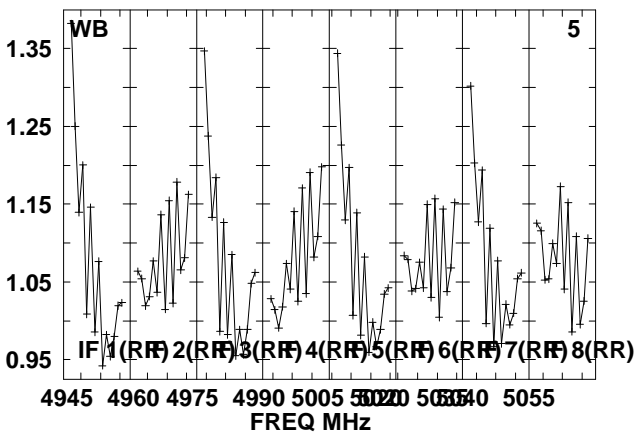
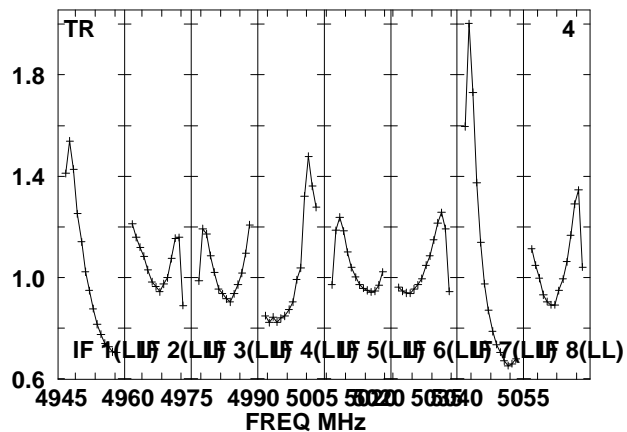
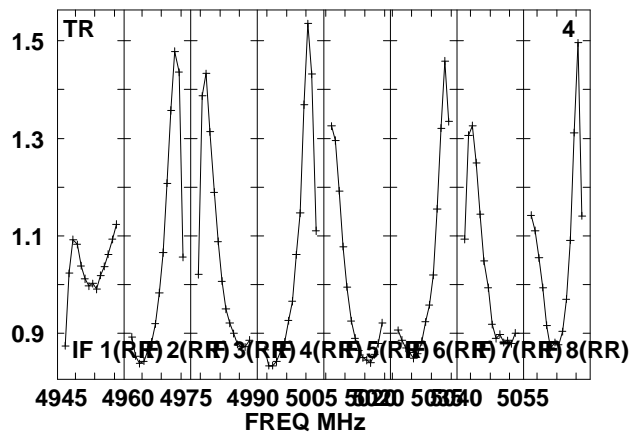
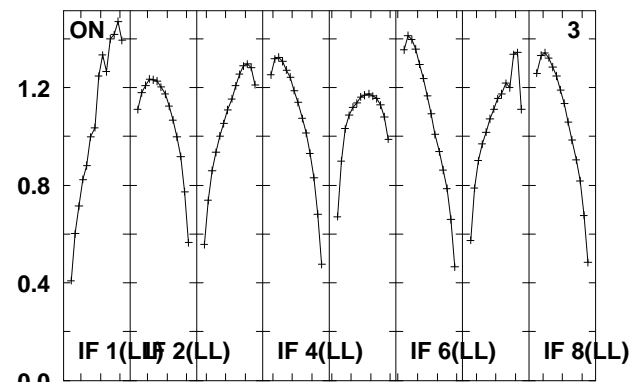
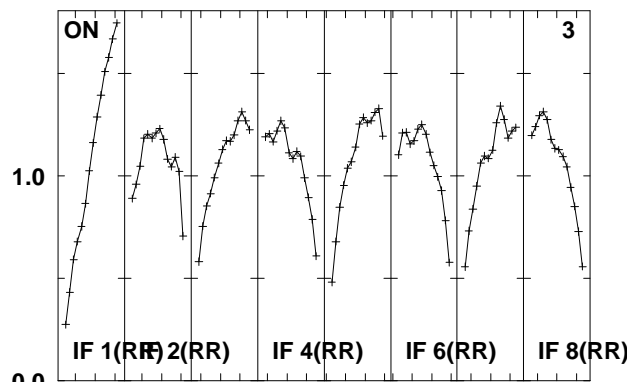
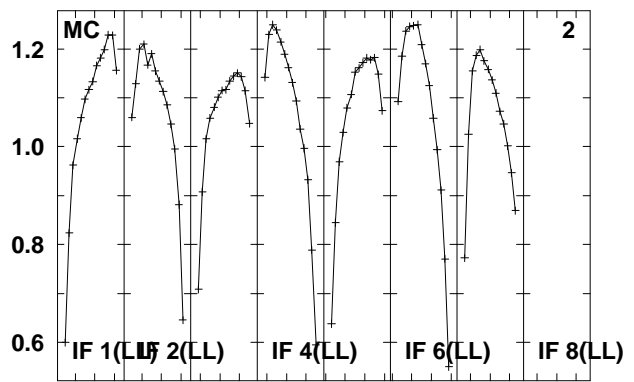
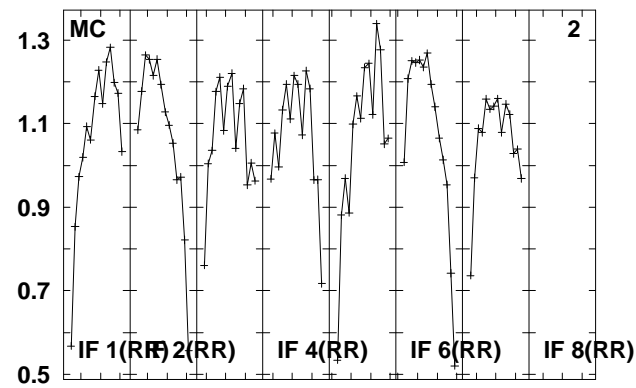
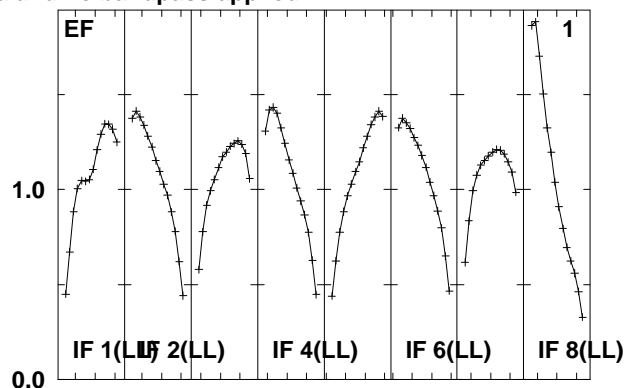
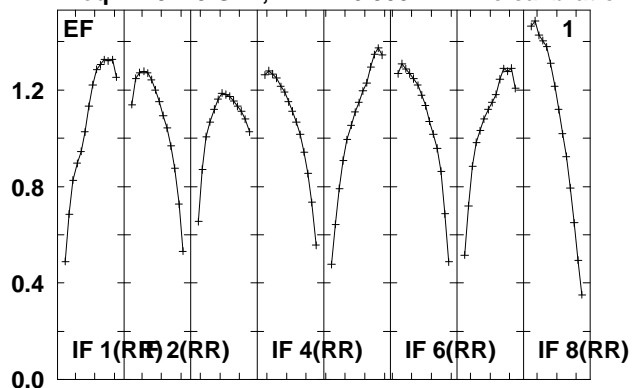

Lower frame: Real Jy
Total-power spectrum Antenna: *
Timerange: 00/19:33:06 to 00/19:43:54

Plot file version 201 created 08-JUL-2010 13:11:31

B1309+48 EM079.UVDATA.1

Freq = 4.9415 GHz, Bw = 16.000 MH No calibration applied and no bandpass applied

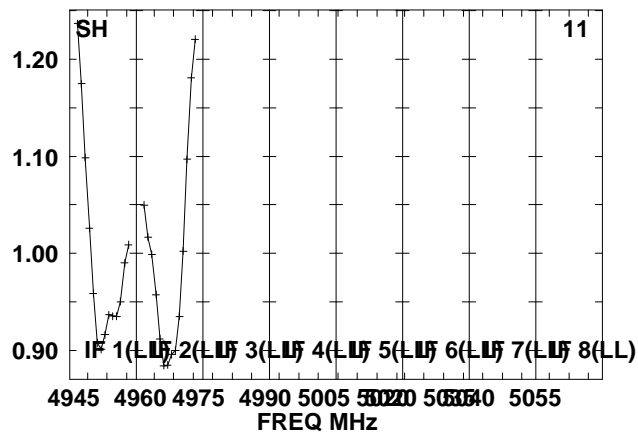
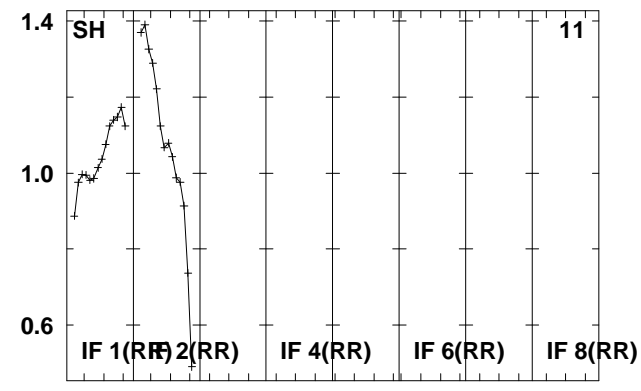
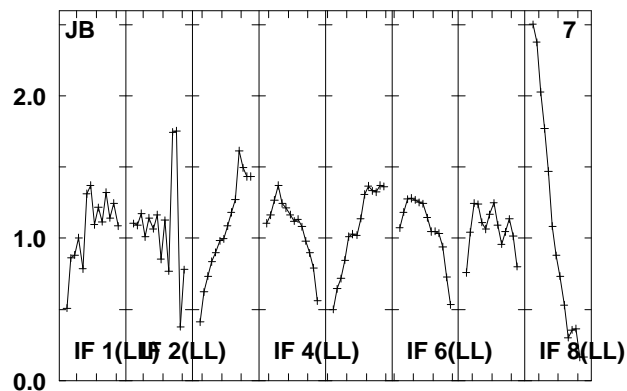
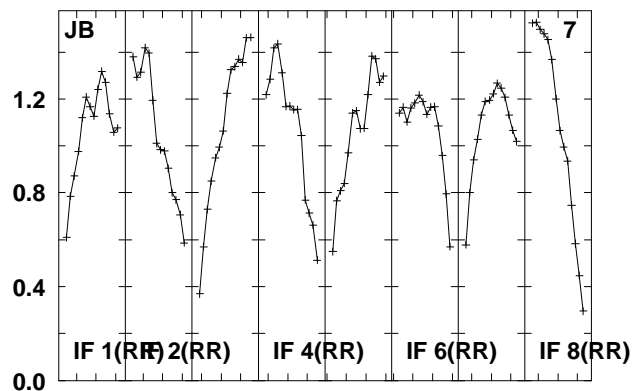
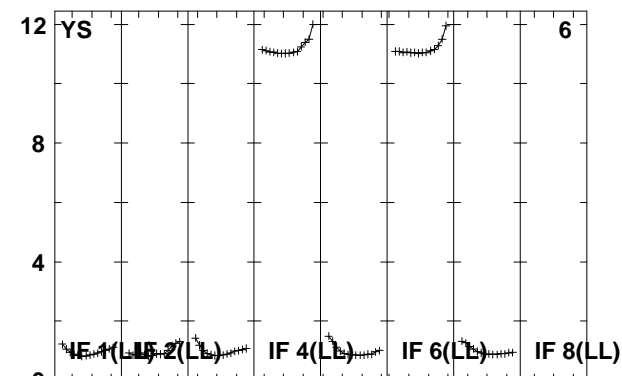
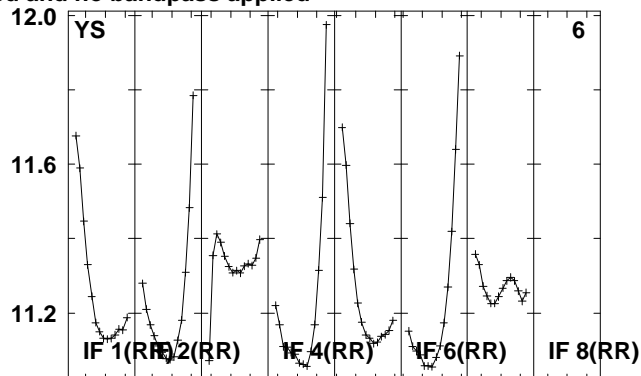
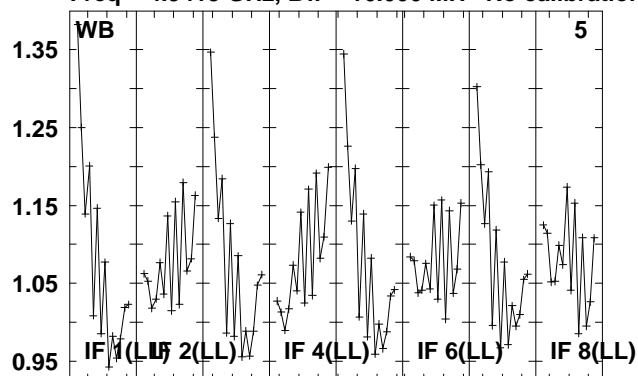

Lower frame: Real Jy

Total-power spectrum Antenna: *

Timerange: 00/19:33:06 to 00/19:43:54

Plot file version 202 created 08-JUL-2010 13:11:32

J1312+48 EM079.UVDATA.1

Freq = 4.9415 GHz, Bw = 16.000 MH No calibration applied and no bandpass applied

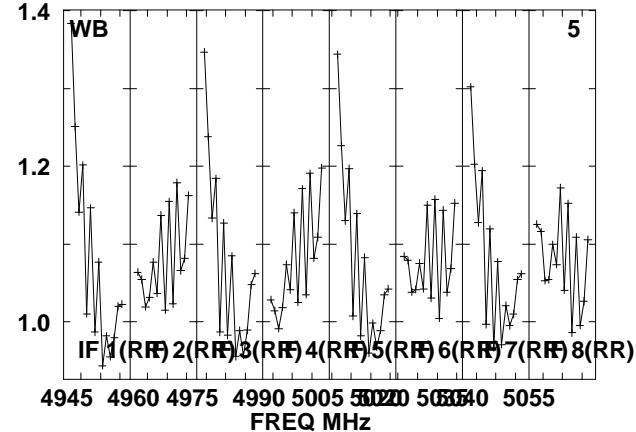
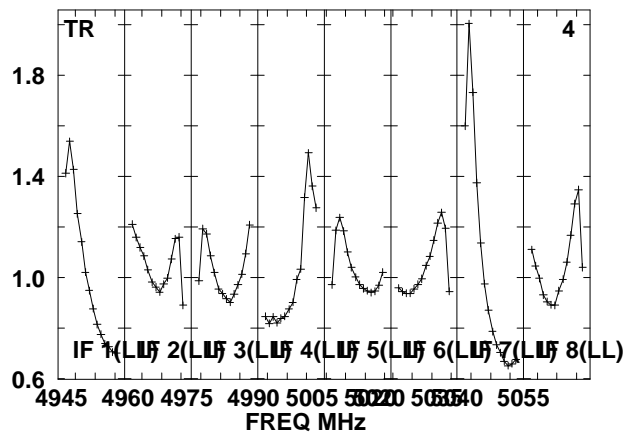
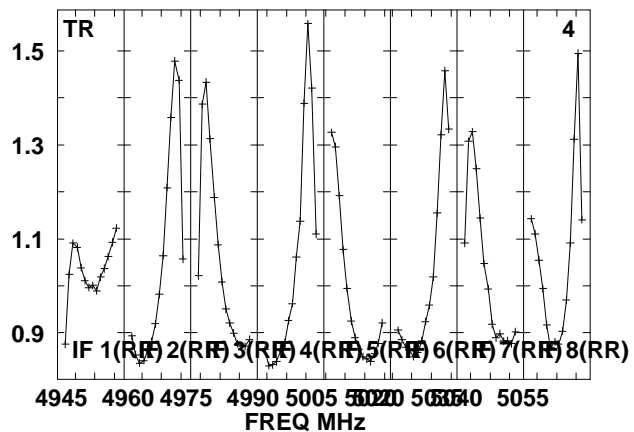
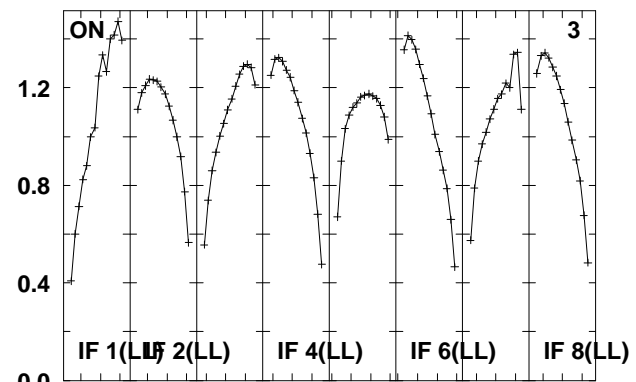
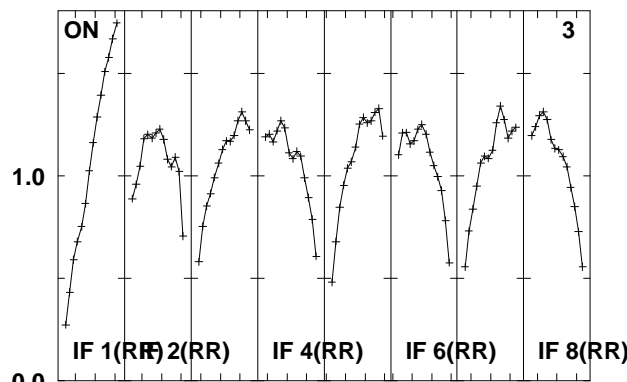
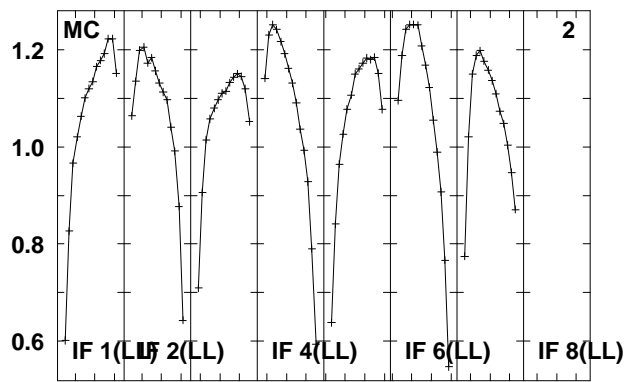
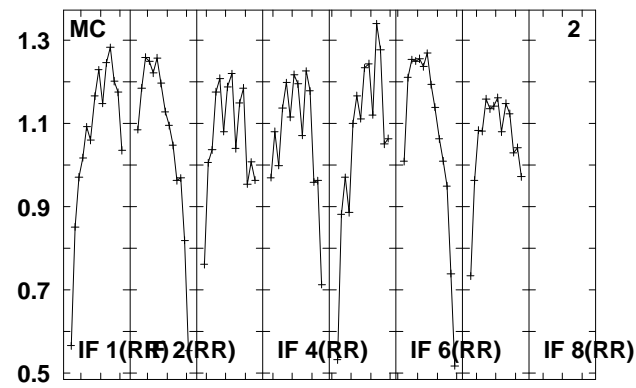
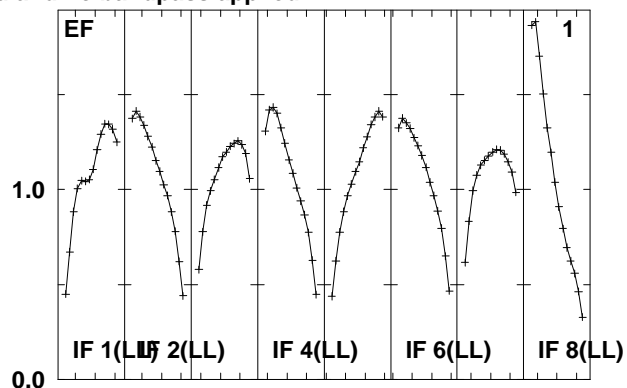
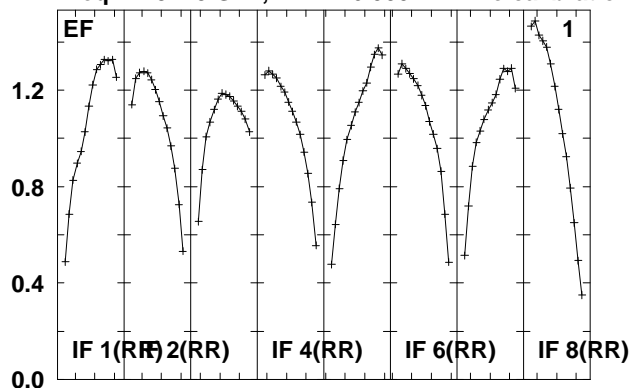

Lower frame: Real Jy
Total-power spectrum Antenna: *
Timerange: 00/19:43:56 to 00/19:45:54

Plot file version 203 created 08-JUL-2010 13:11:33

J1312+48 EM079.UVDATA.1

Freq = 4.9415 GHz, Bw = 16.000 MH No calibration applied and no bandpass applied

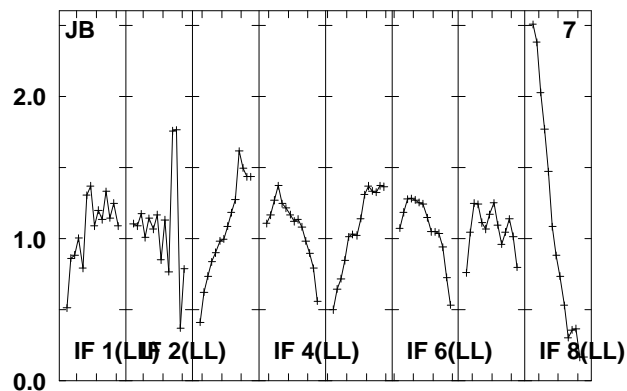
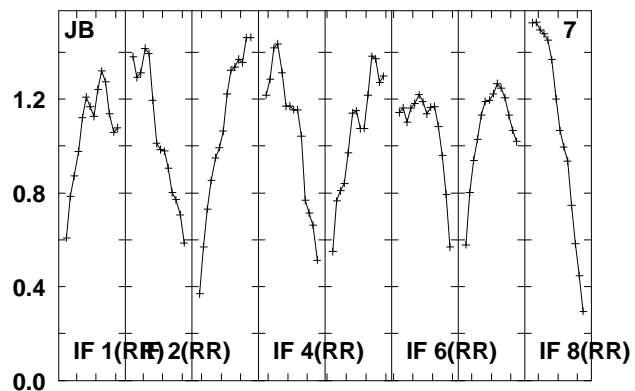
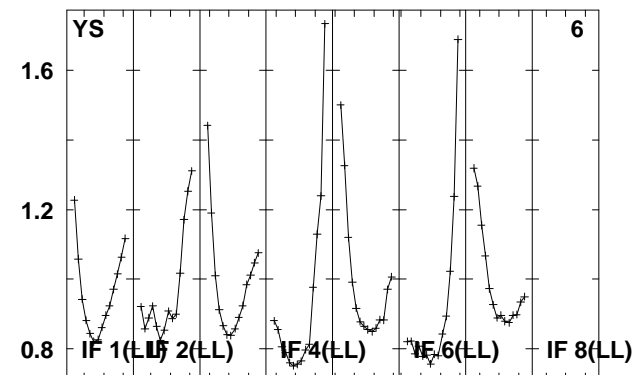
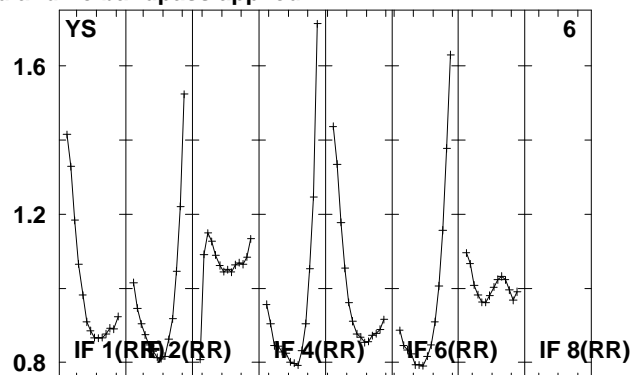
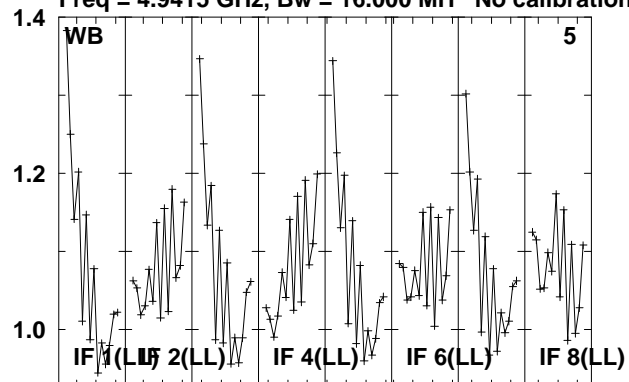

Lower frame: Real Jy
Total-power spectrum Antenna: *
Timerange: 00/19:43:56 to 00/19:45:54

Plot file version 204 created 08-JUL-2010 13:11:33

J1609+26 EM079.UVDATA.1

Freq = 4.9415 GHz, Bw = 16.000 MH No calibration applied and no bandpass applied

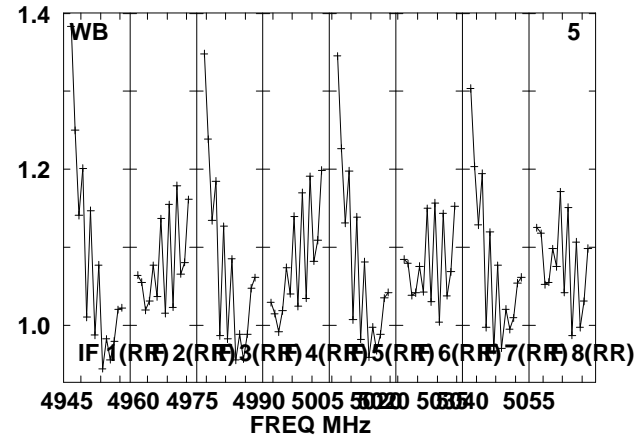
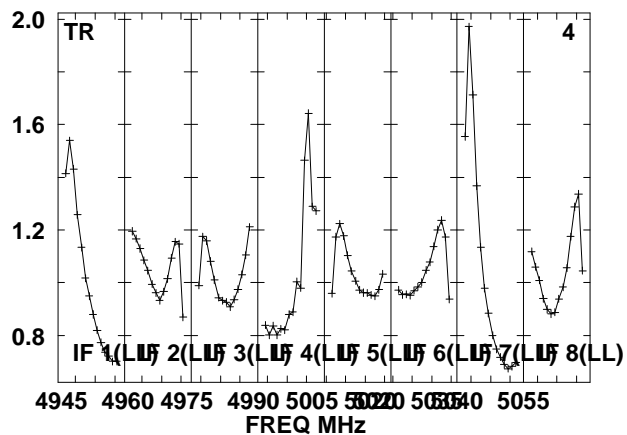
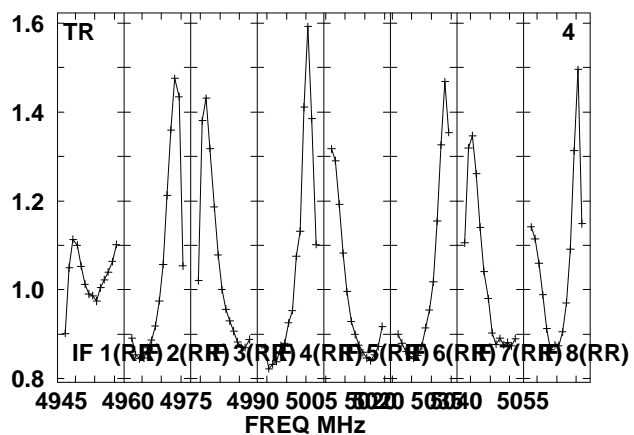
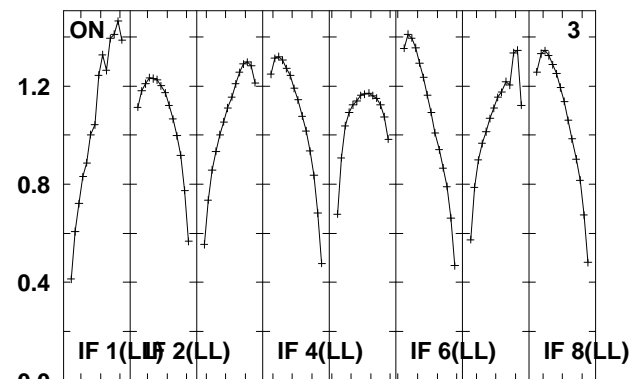
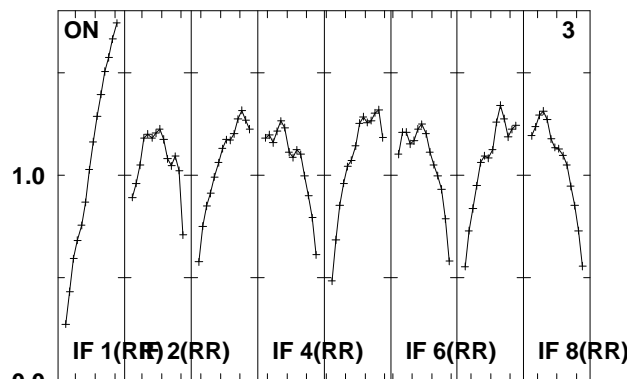
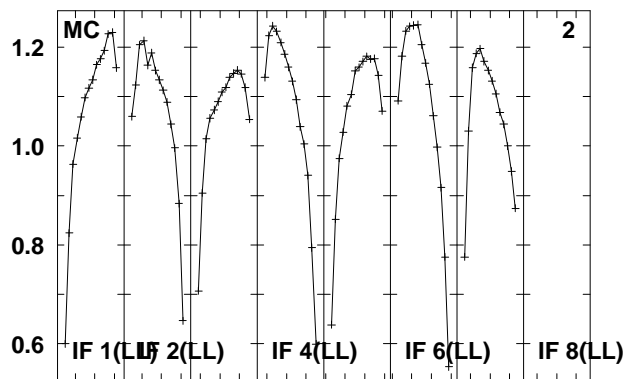
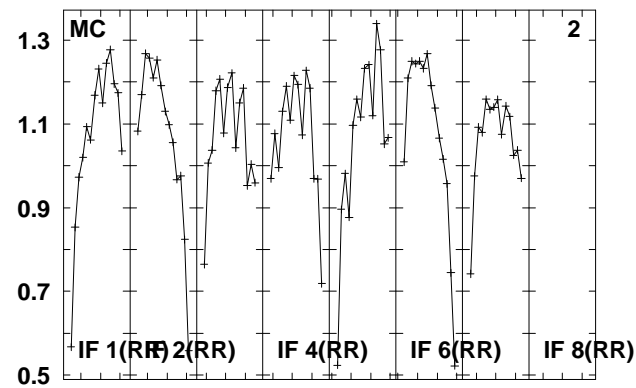
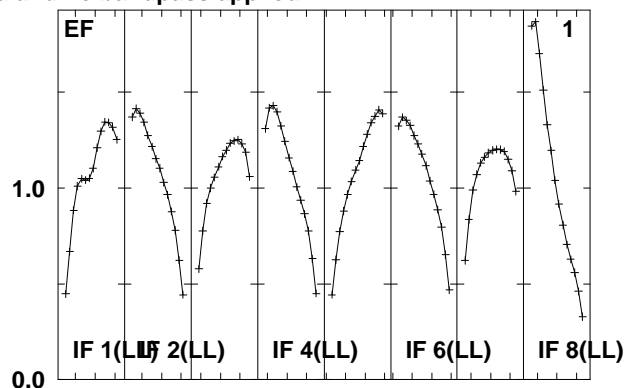
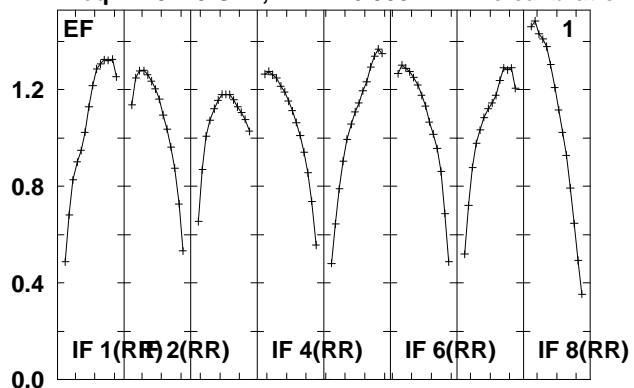

Lower frame: Real Jy
Total-power spectrum Antenna: *
Timerange: 00/19:45:56 to 00/19:54:34

Plot file version 205 created 08-JUL-2010 13:11:34

J1609+26 EM079.UVDATA.1

Freq = 4.9415 GHz, Bw = 16.000 MH No calibration applied and no bandpass applied

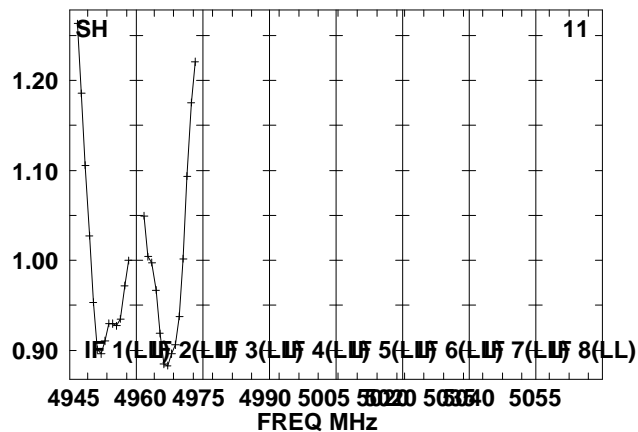
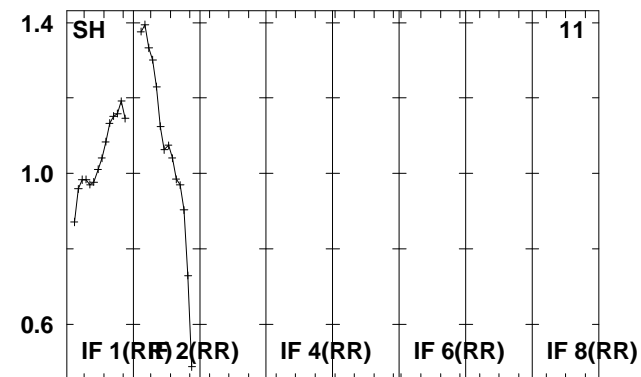
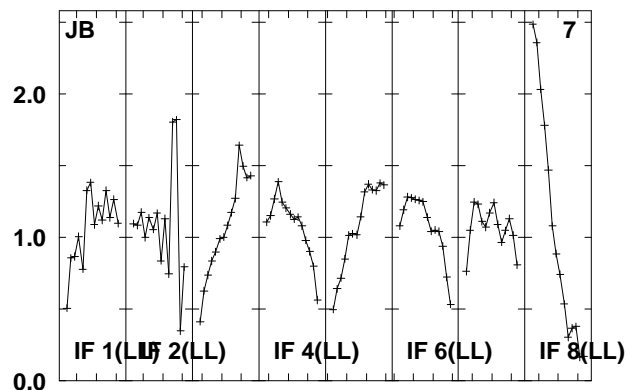
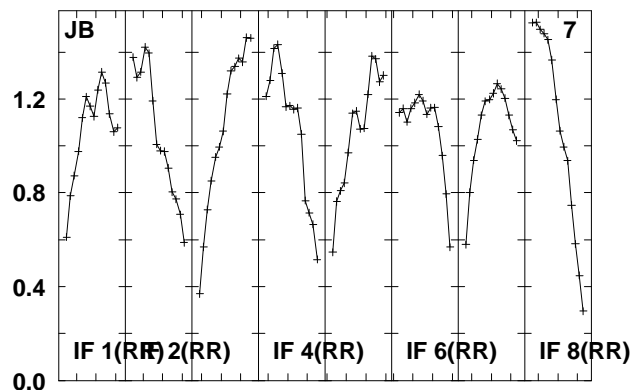
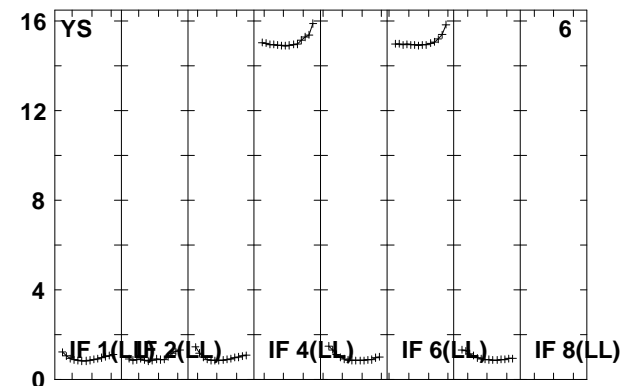
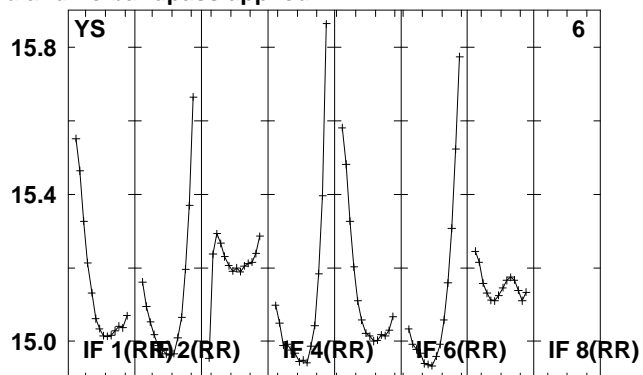
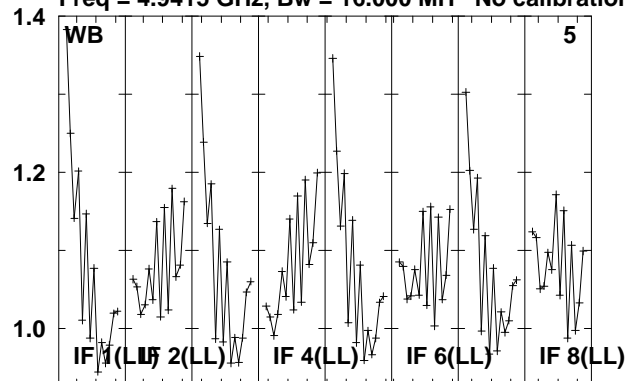

Lower frame: Real Jy

Total-power spectrum Antenna: *

Timerange: 00/19:45:56 to 00/19:54:34

Plot file version 206 created 08-JUL-2010 13:11:36

J1625+27 EM079.UVDATA.1

Freq = 4.9415 GHz, Bw = 16.000 MH No calibration applied and no bandpass applied

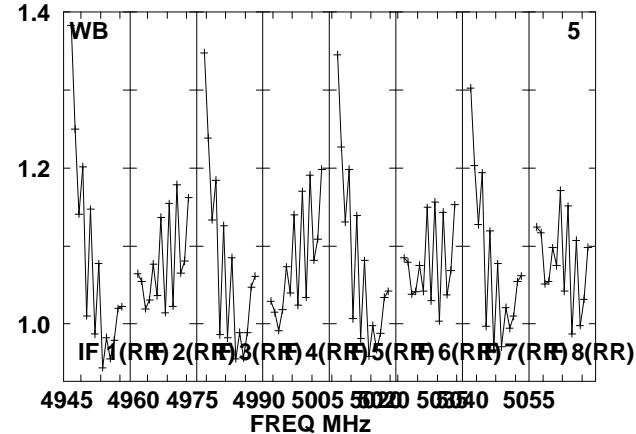
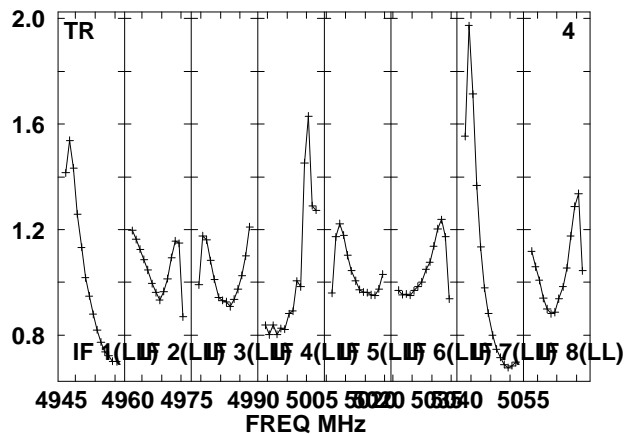
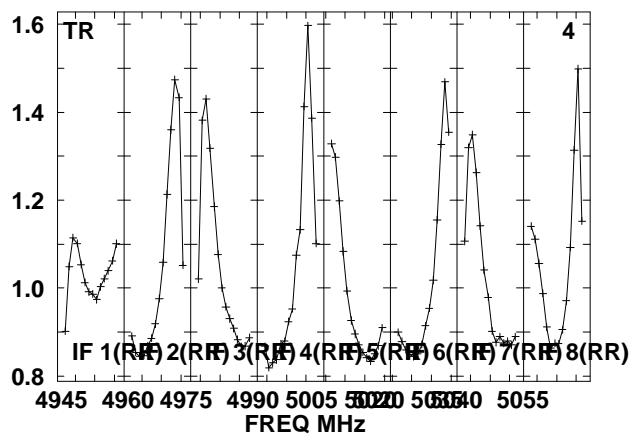
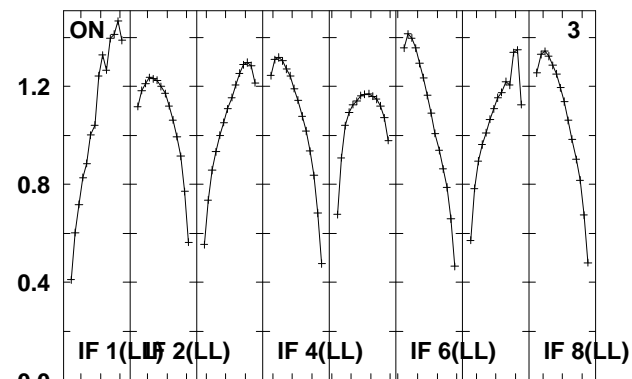
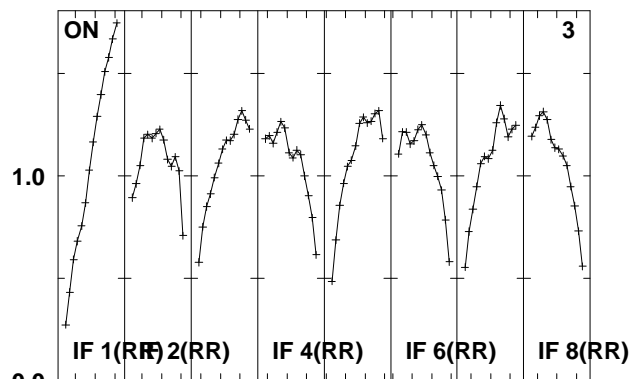
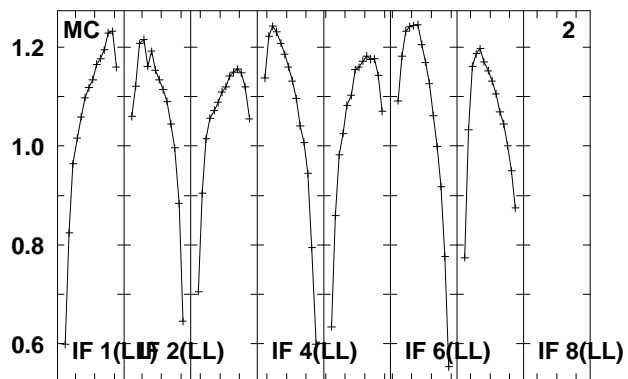
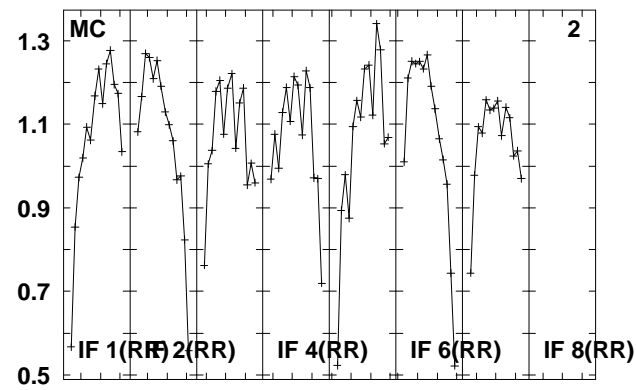
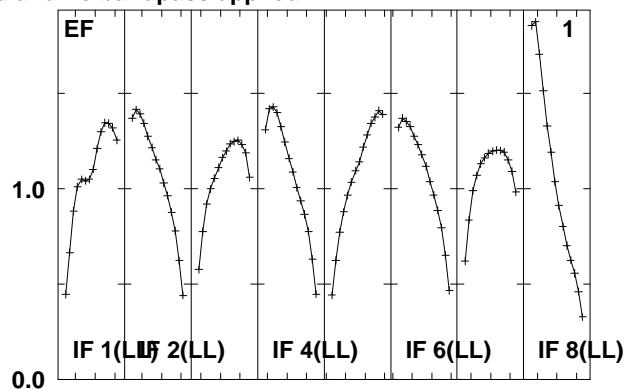
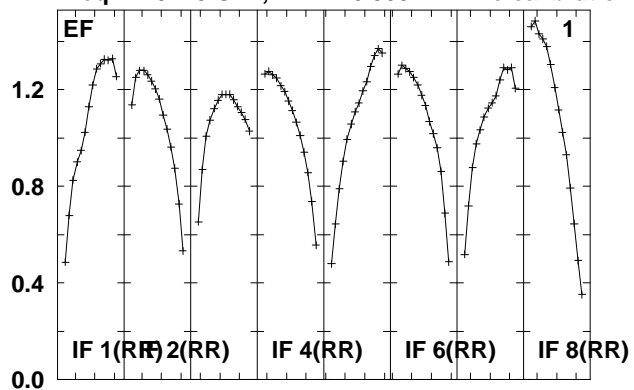

Lower frame: Real Jy
Total-power spectrum Antenna: *
Timerange: 00/19:54:36 to 00/20:05:34

Plot file version 207 created 08-JUL-2010 13:11:37

J1625+27 EM079.UVDATA.1

Freq = 4.9415 GHz, Bw = 16.000 MH No calibration applied and no bandpass applied

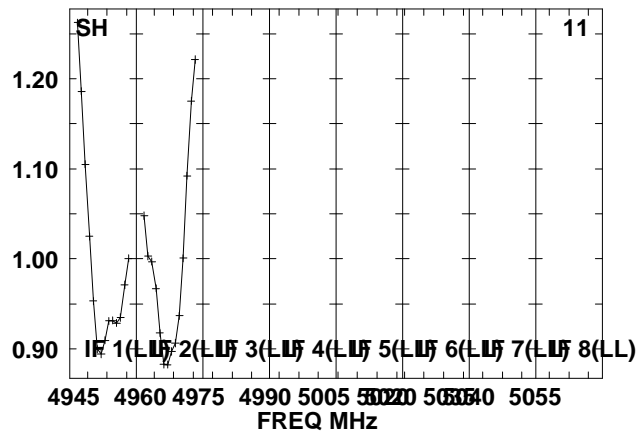
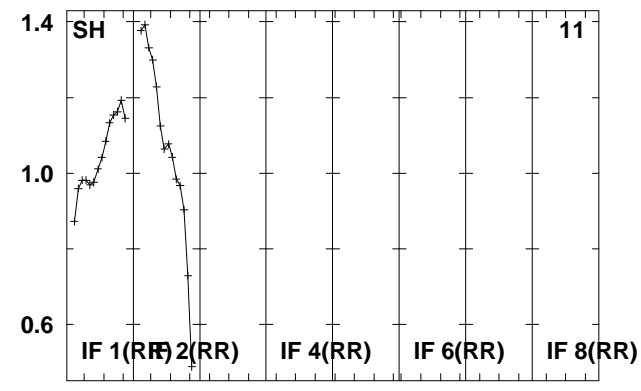
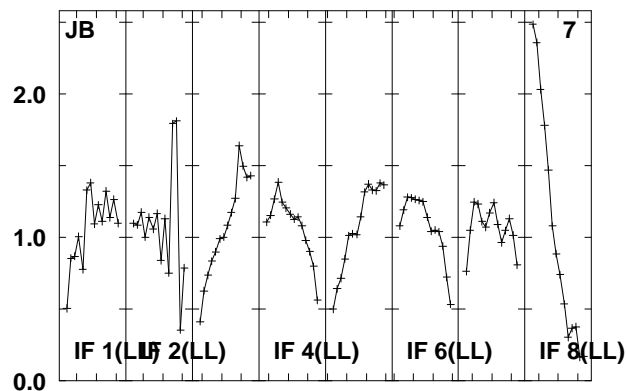
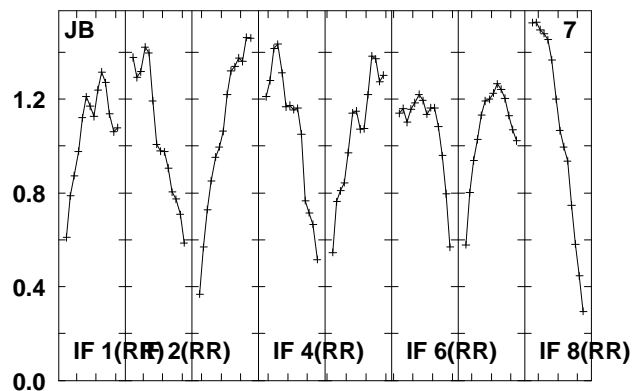
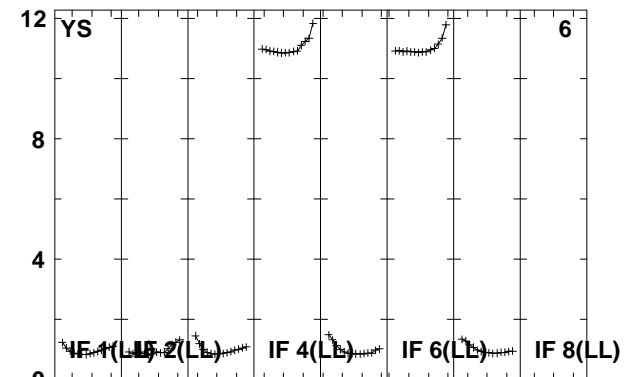
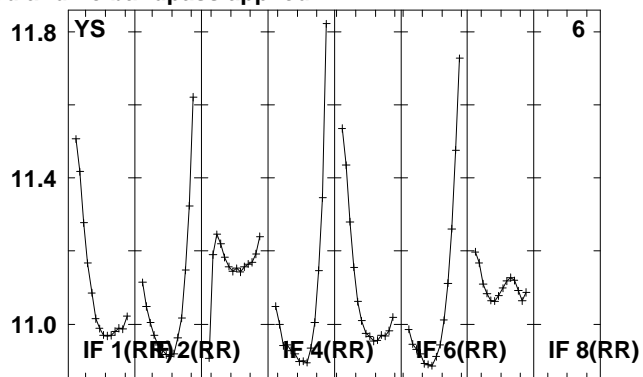
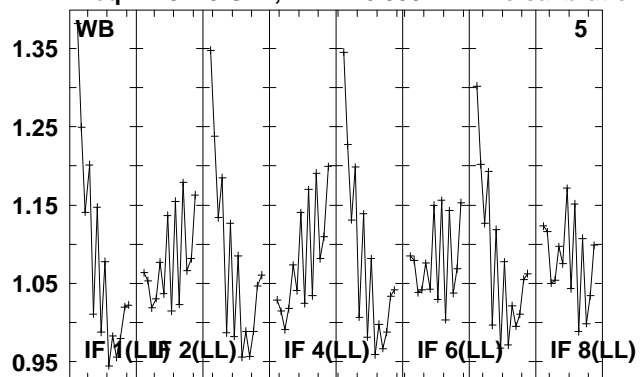

Lower frame: Real Jy

Total-power spectrum Antenna: *

Timerange: 00/19:54:36 to 00/20:05:34

Plot file version 208 created 08-JUL-2010 13:11:39

J1609+26 EM079.UVDATA.1

Freq = 4.9415 GHz, Bw = 16.000 MH No calibration applied and no bandpass applied

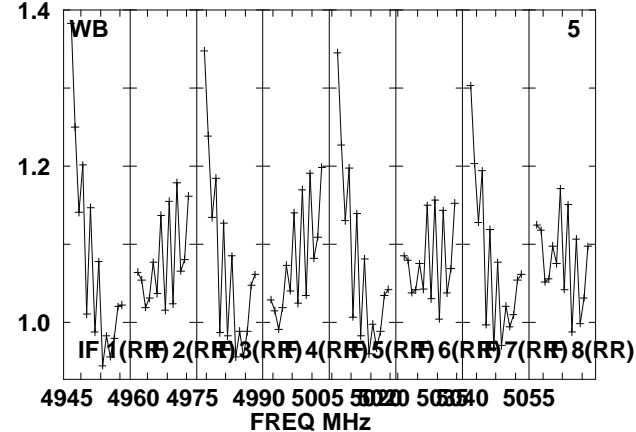
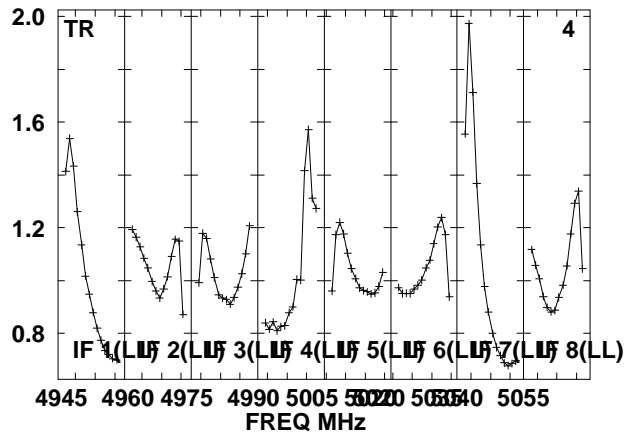
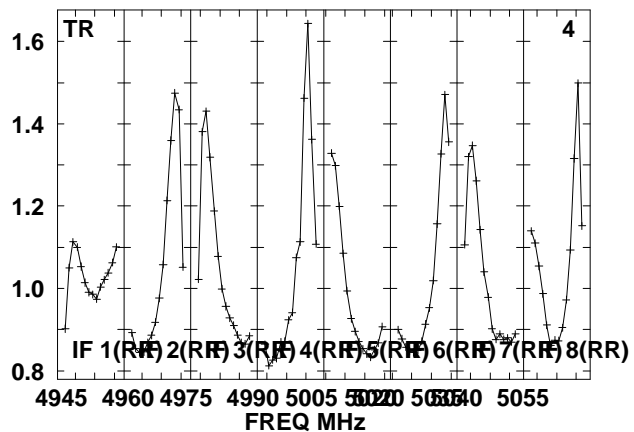
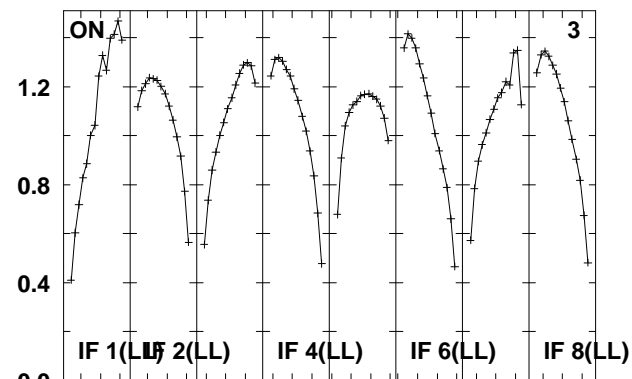
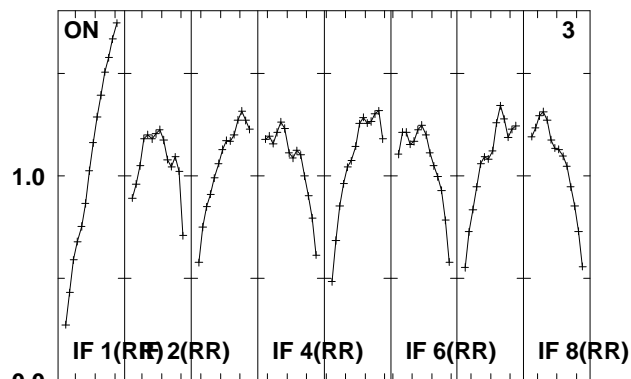
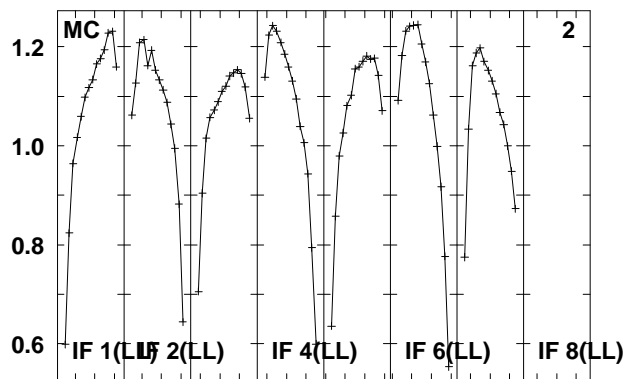
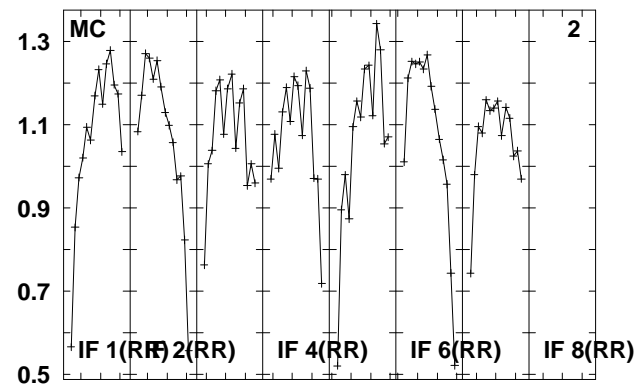
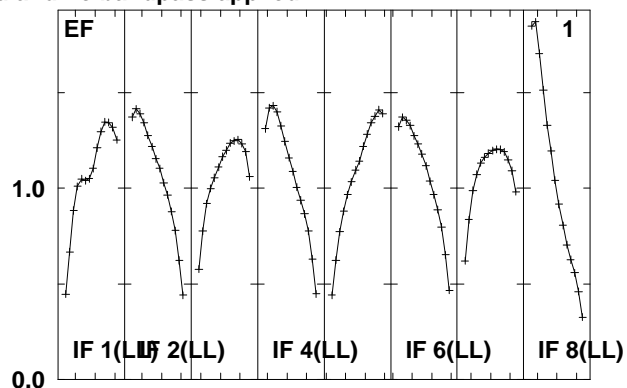
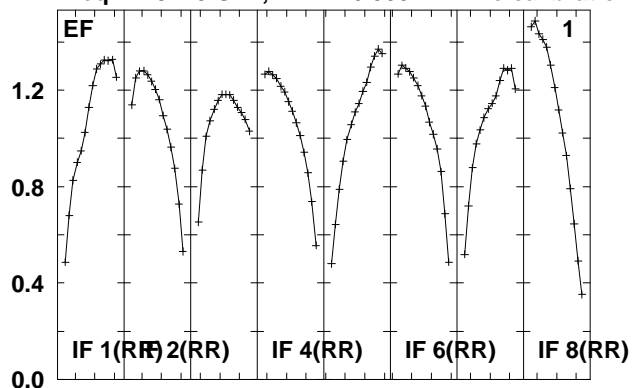

Lower frame: Real Jy

Total-power spectrum Antenna: *

Timerange: 00/20:05:36 to 00/20:07:34

Plot file version 209 created 08-JUL-2010 13:11:40

J1609+26 EM079.UVDATA.1

Freq = 4.9415 GHz, Bw = 16.000 MH No calibration applied and no bandpass applied

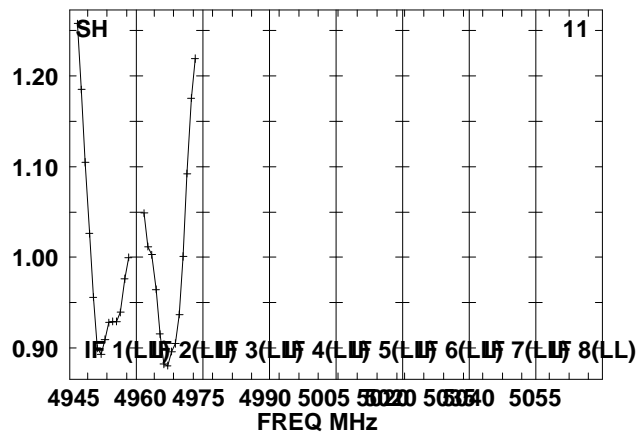
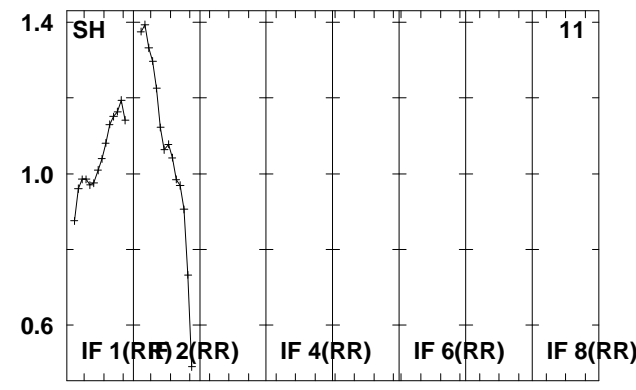
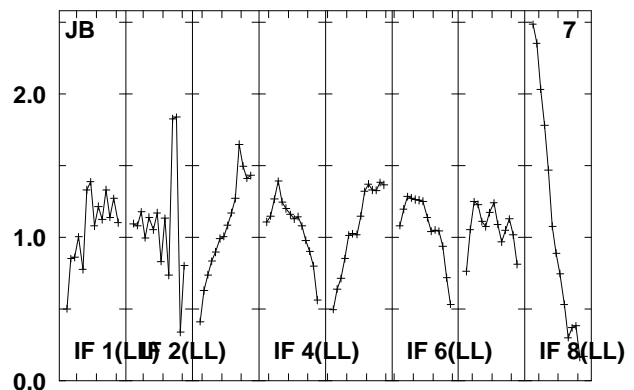
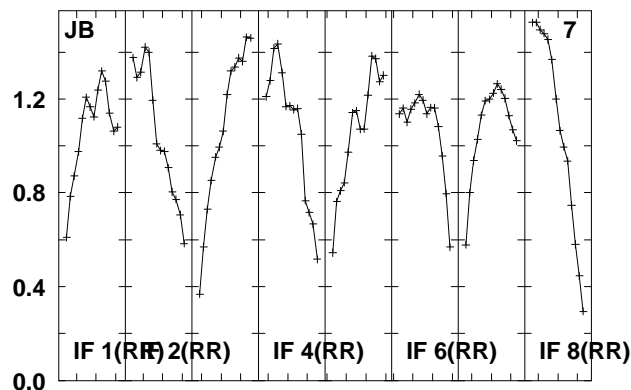
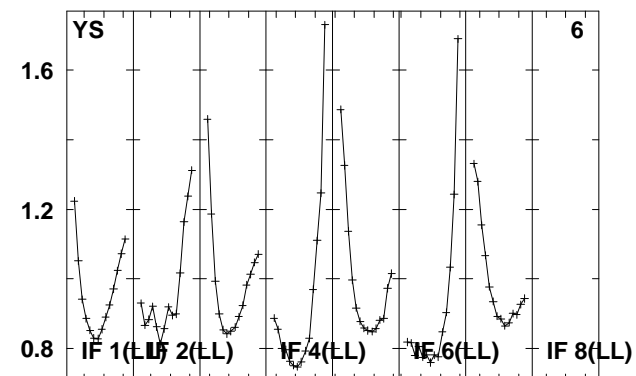
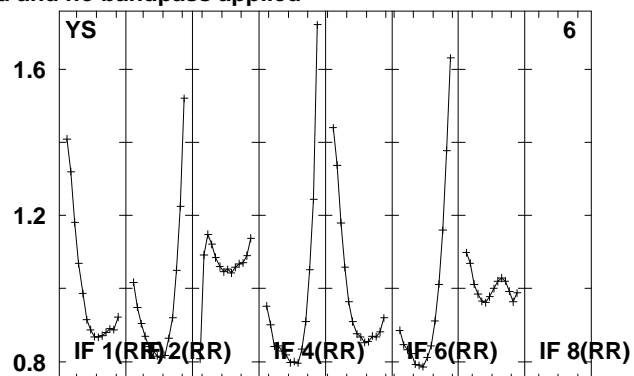
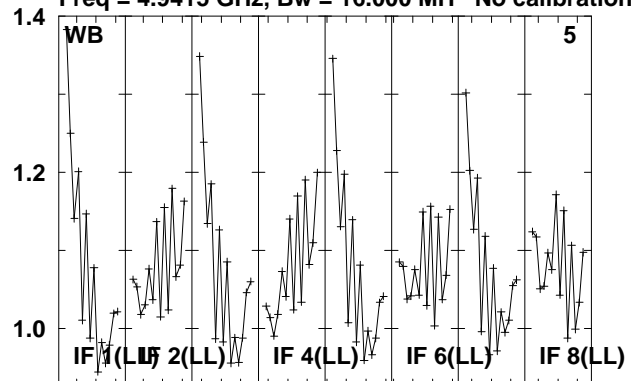

Lower frame: Real Jy

Total-power spectrum Antenna: *

Timerange: 00/20:05:36 to 00/20:07:34

Plot file version 210 created 08-JUL-2010 13:11:41

J1625+27 EM079.UVDATA.1

Freq = 4.9415 GHz, Bw = 16.000 MH No calibration applied and no bandpass applied

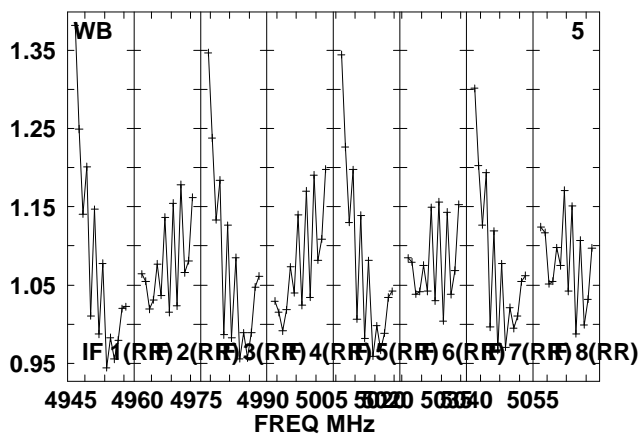
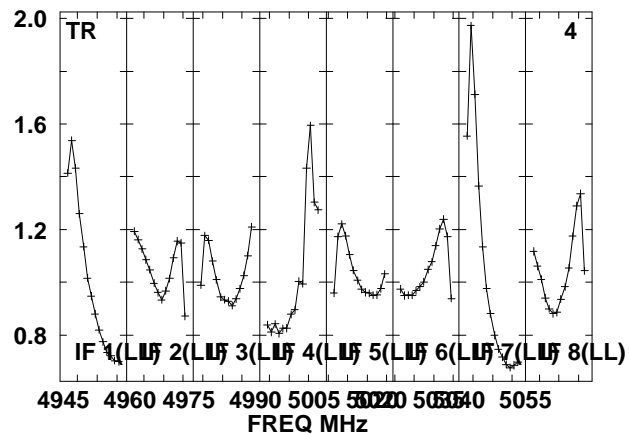
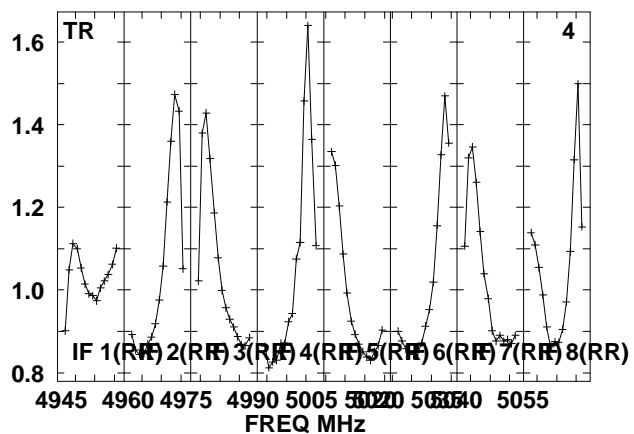
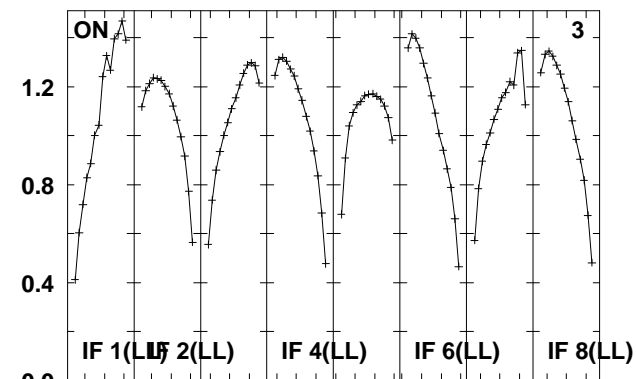
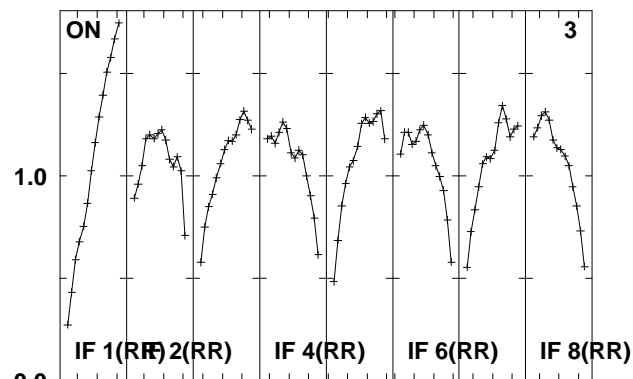
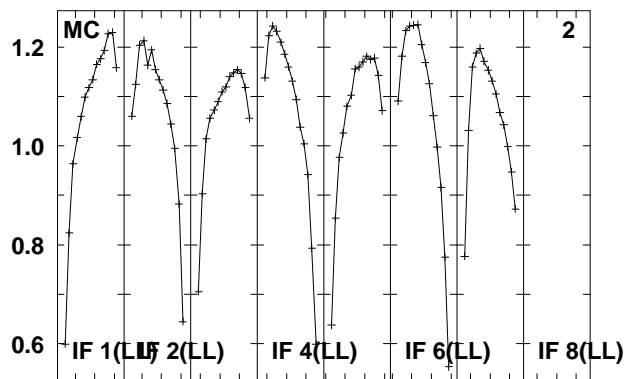
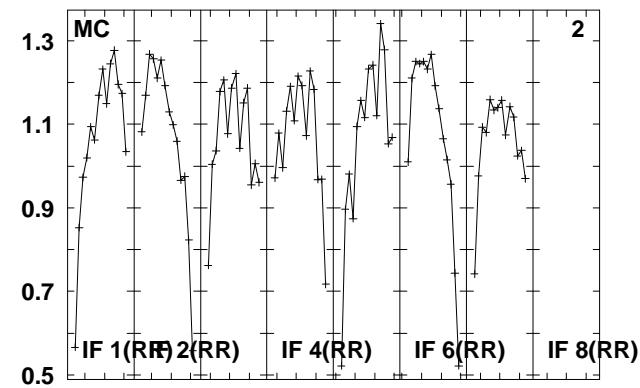
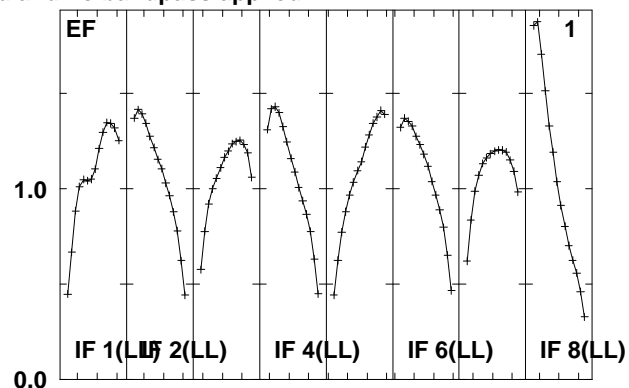
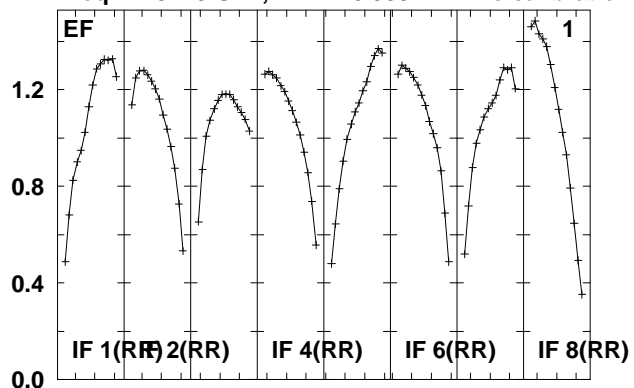

Lower frame: Real Jy
Total-power spectrum Antenna: *
Timerange: 00/20:07:36 to 00/20:18:34

Plot file version 211 created 08-JUL-2010 13:11:42

J1625+27 EM079.UVDATA.1

Freq = 4.9415 GHz, Bw = 16.000 MH No calibration applied and no bandpass applied

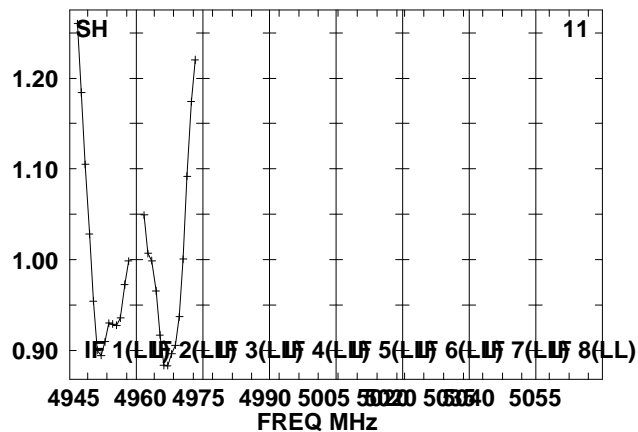
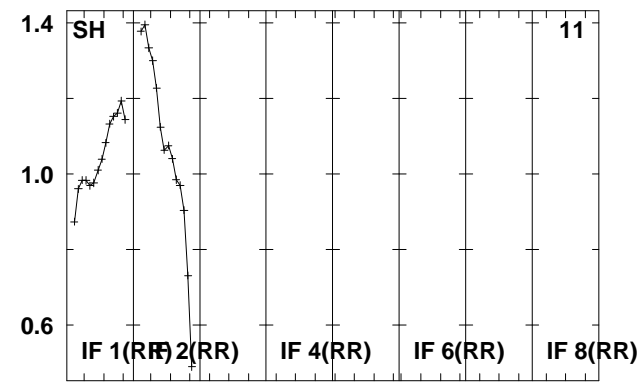
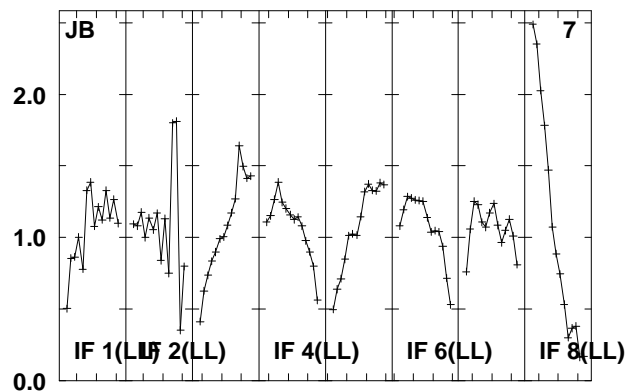
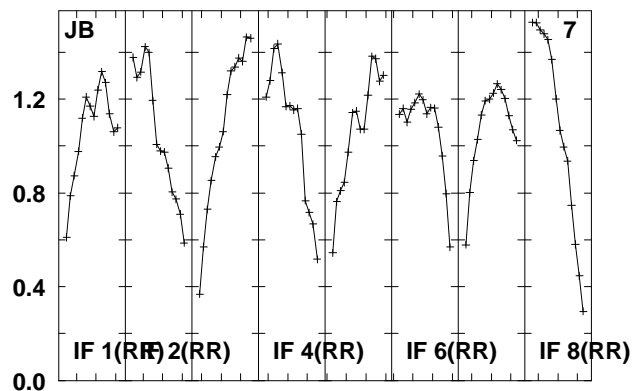
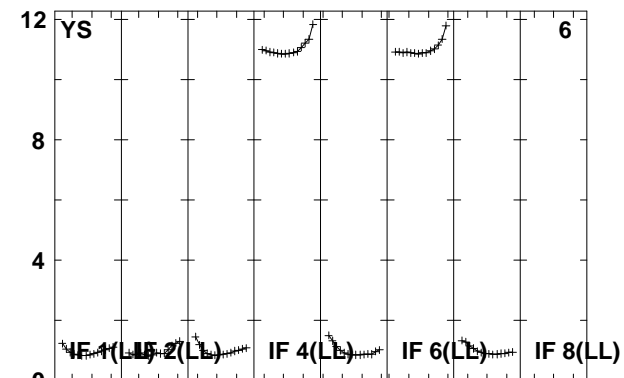
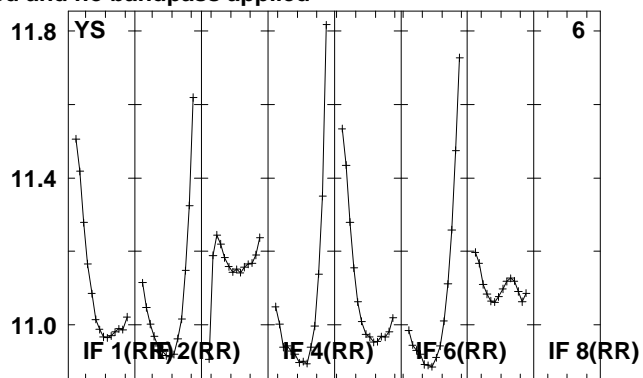
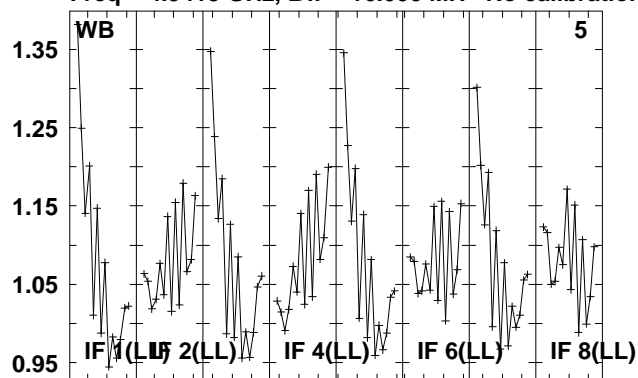

Lower frame: Real Jy

Total-power spectrum Antenna: *

Timerange: 00/20:07:36 to 00/20:18:34

Plot file version 212 created 08-JUL-2010 13:11:44

J1609+26 EM079.UVDATA.1

Freq = 4.9415 GHz, Bw = 16.000 MH No calibration applied and no bandpass applied

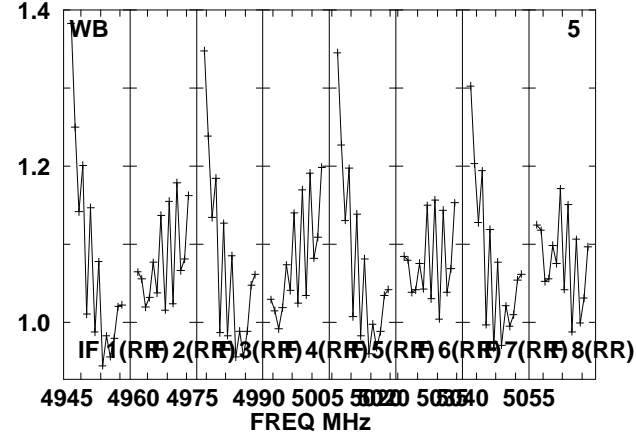
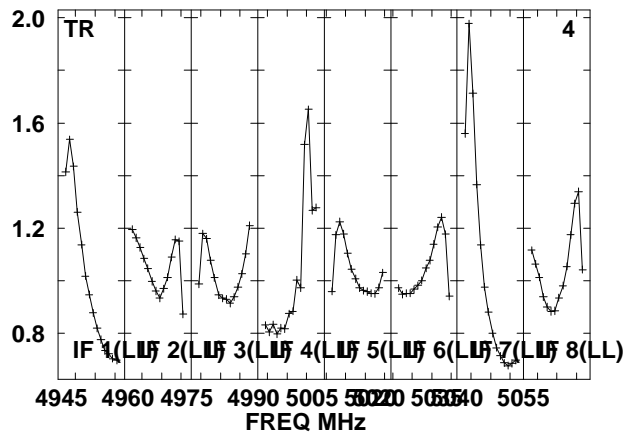
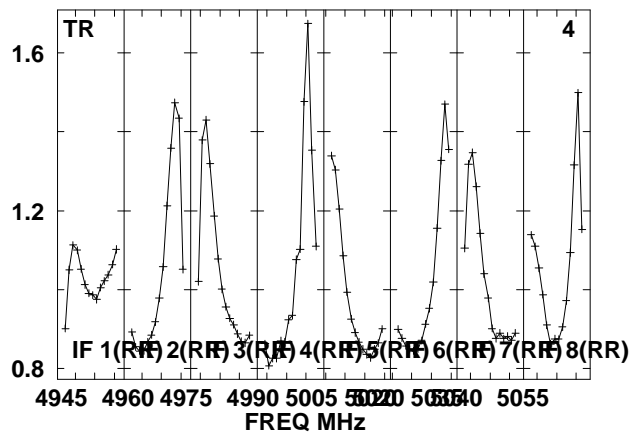
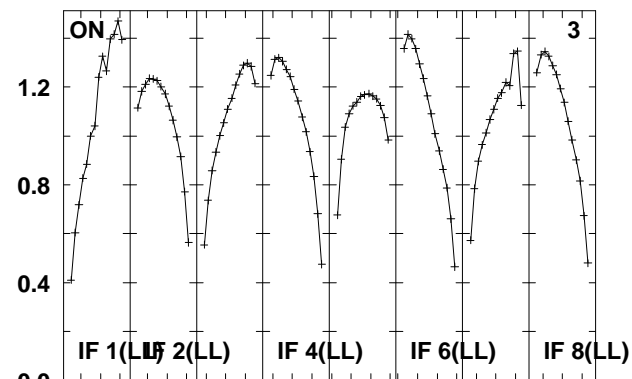
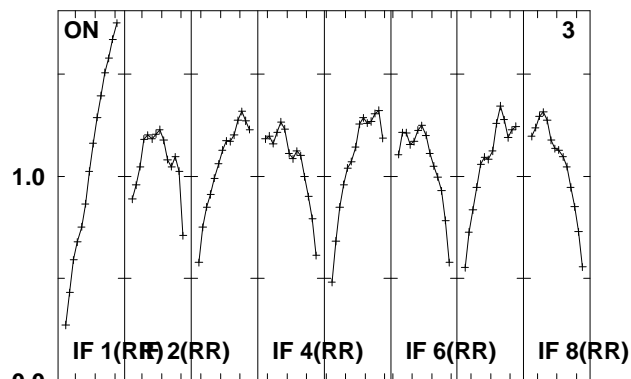
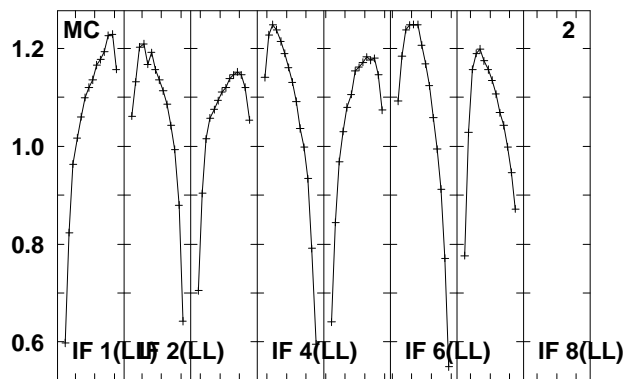
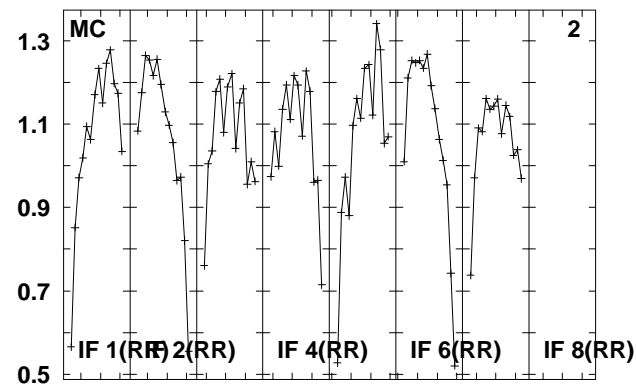
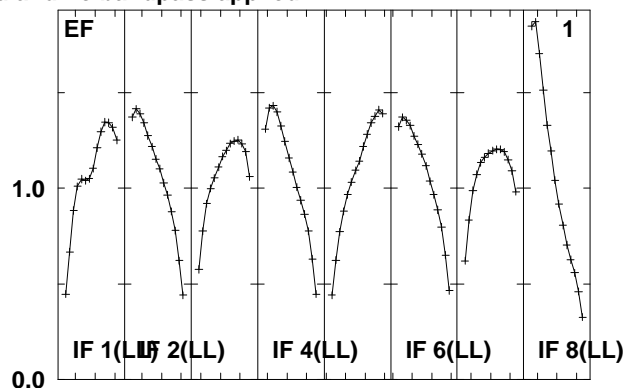
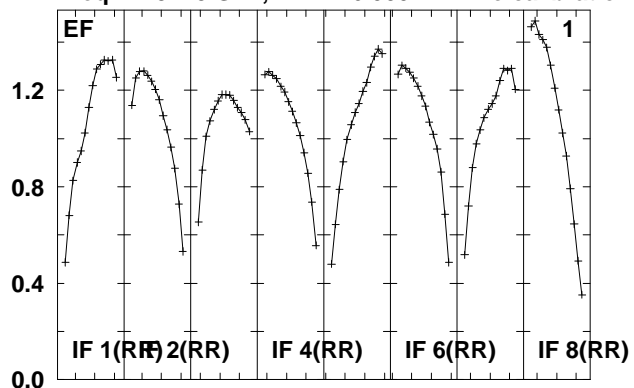

Lower frame: Real Jy
Total-power spectrum Antenna: *
Timerange: 00/20:18:36 to 00/20:20:34

Plot file version 213 created 08-JUL-2010 13:11:44

J1609+26 EM079.UVDATA.1

Freq = 4.9415 GHz, Bw = 16.000 MH No calibration applied and no bandpass applied

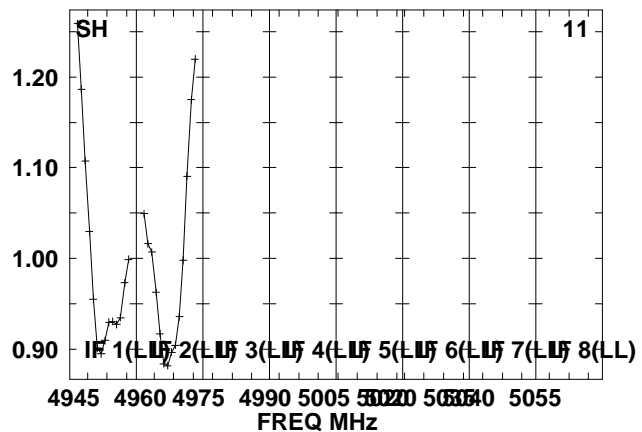
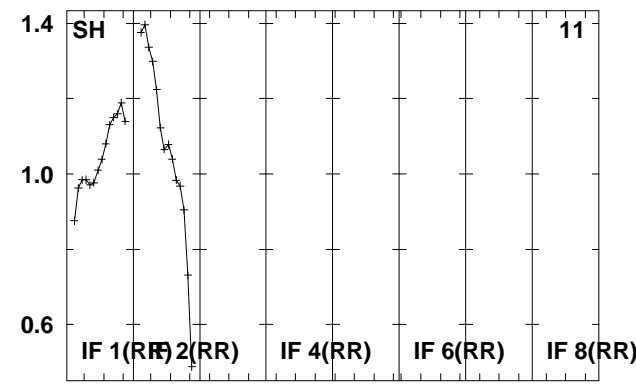
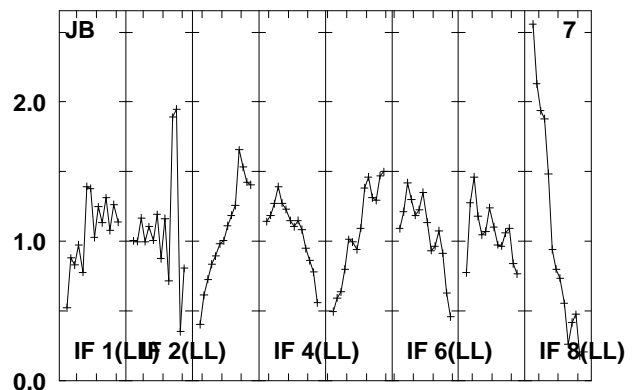
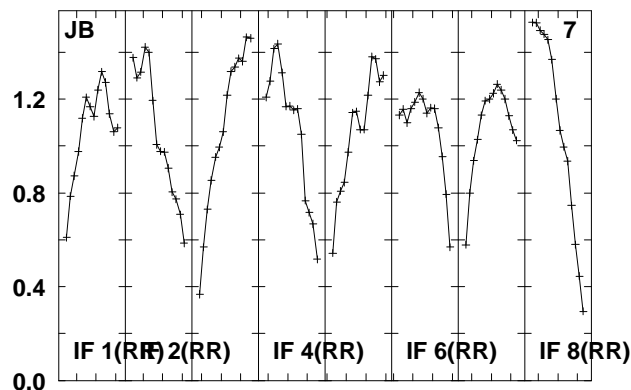
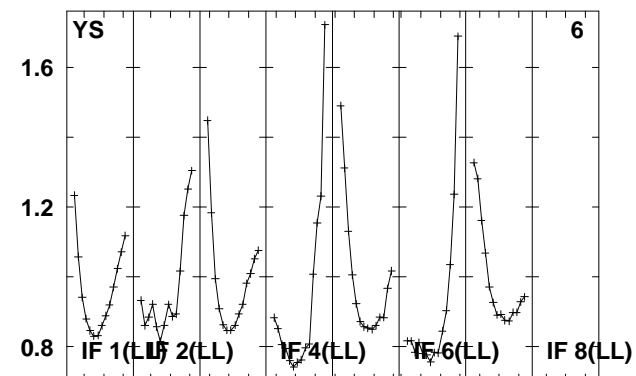
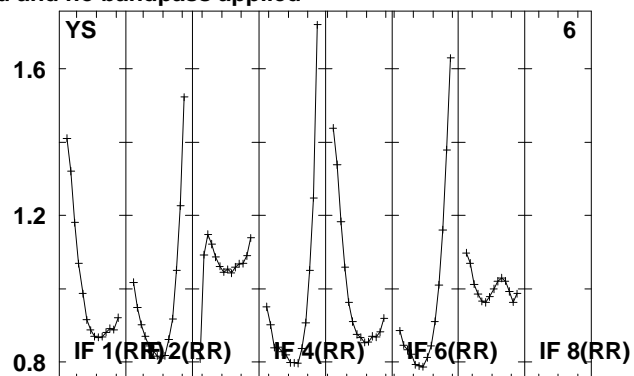
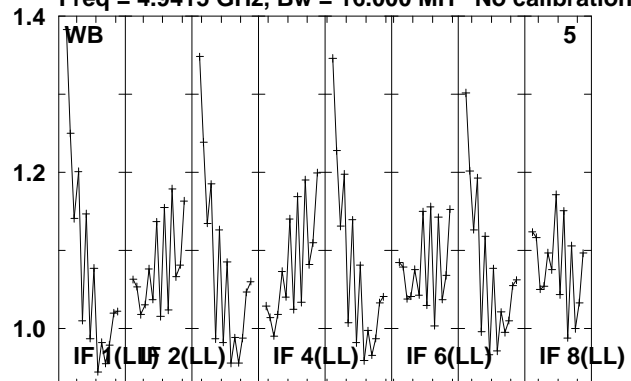

Lower frame: Real Jy

Total-power spectrum Antenna: *

Timerange: 00/20:18:36 to 00/20:20:34

Plot file version 214 created 08-JUL-2010 13:11:45

J1625+27 EM079.UVDATA.1

Freq = 4.9415 GHz, Bw = 16.000 MH No calibration applied and no bandpass applied

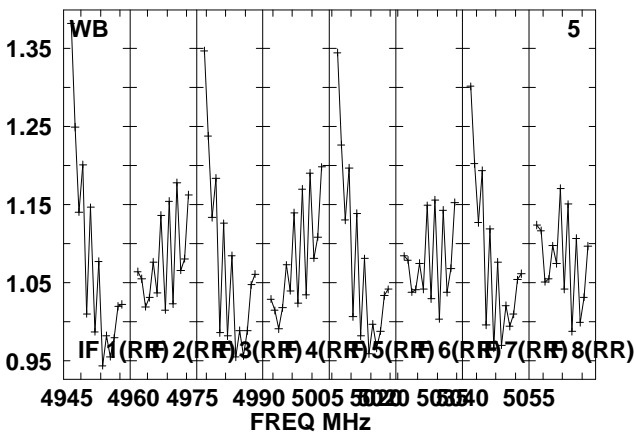
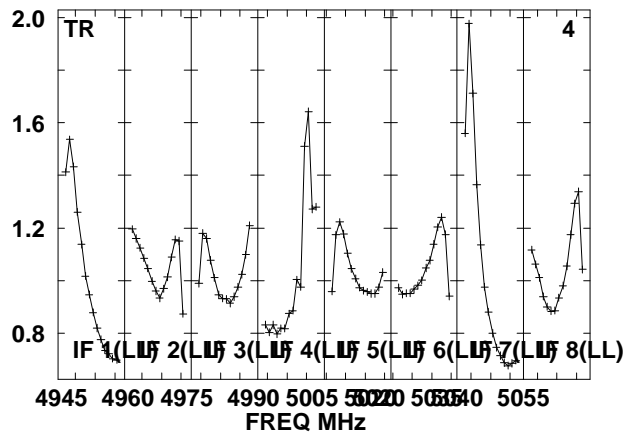
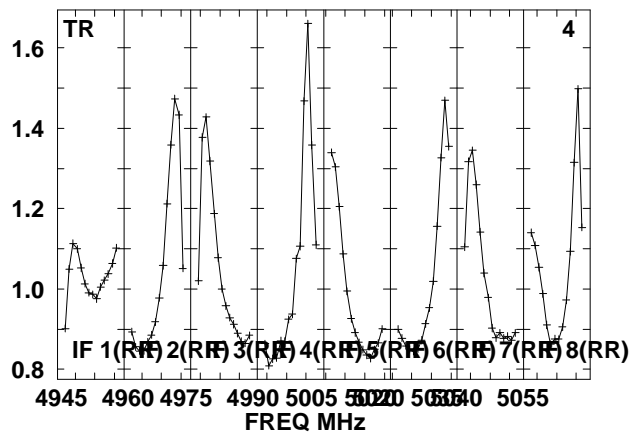
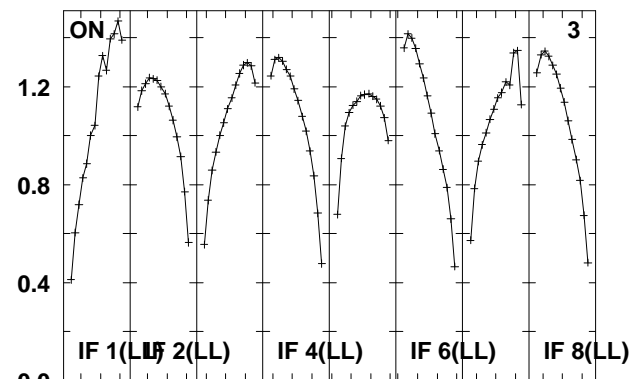
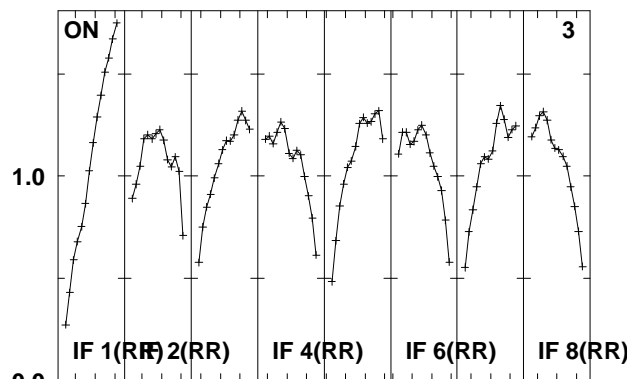
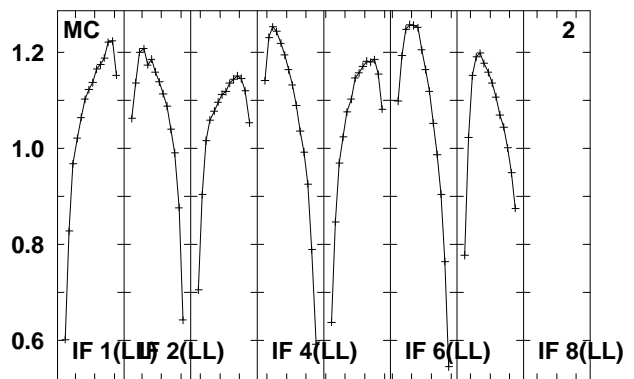
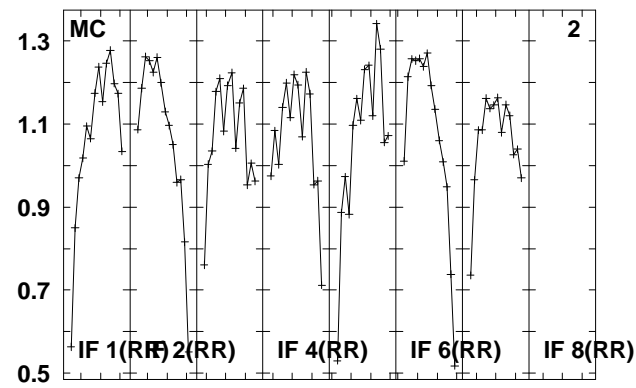
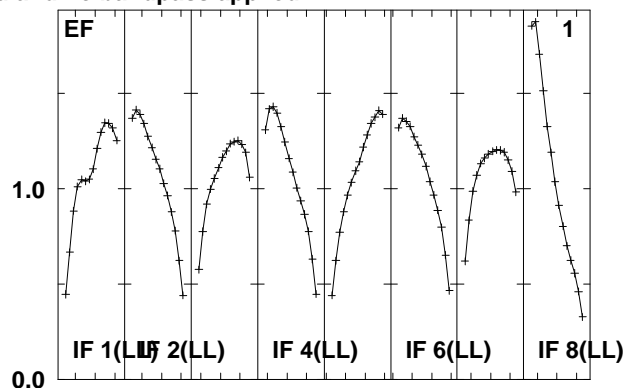
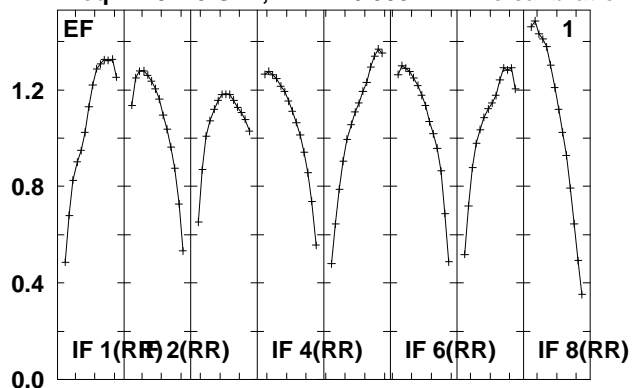

Lower frame: Real Jy
Total-power spectrum Antenna: *
Timerange: 00/20:20:36 to 00/20:31:34

Plot file version 215 created 08-JUL-2010 13:11:46

J1625+27 EM079.UVDATA.1

Freq = 4.9415 GHz, Bw = 16.000 MH No calibration applied and no bandpass applied

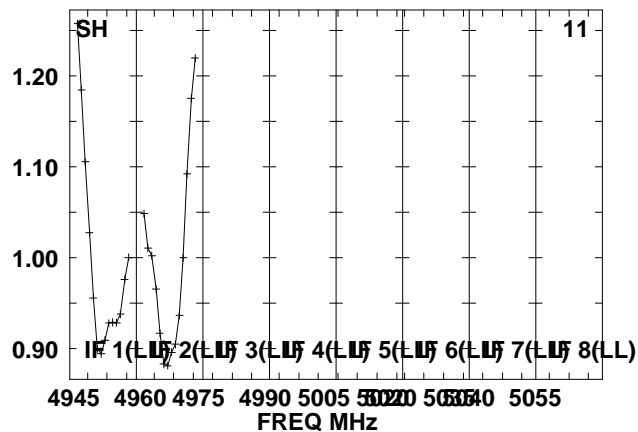
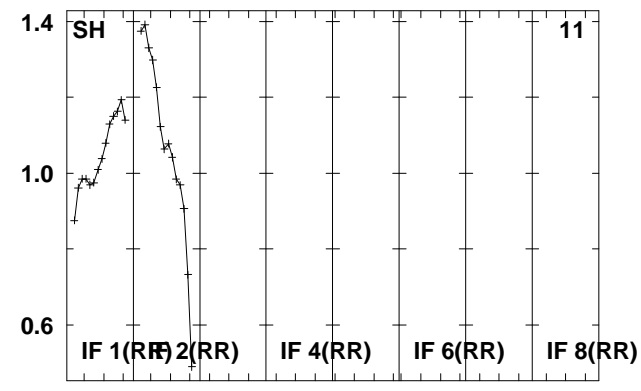
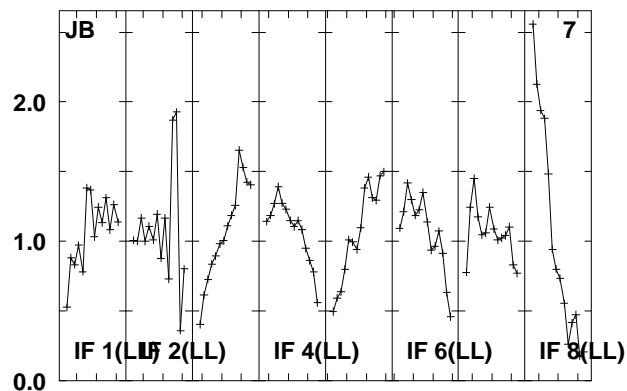
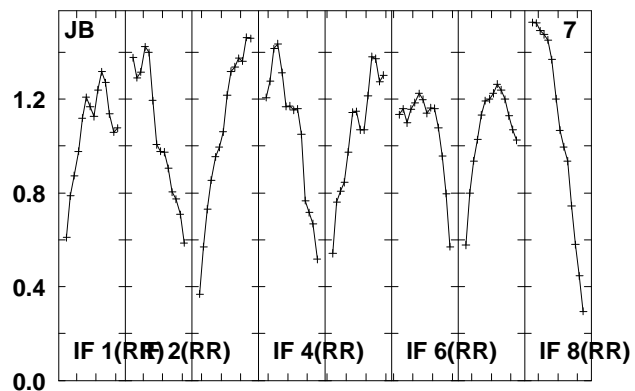
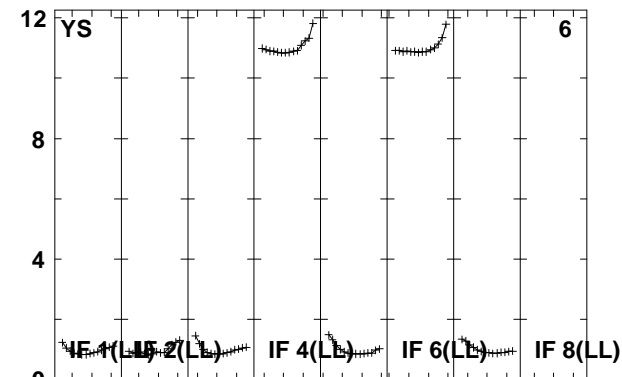
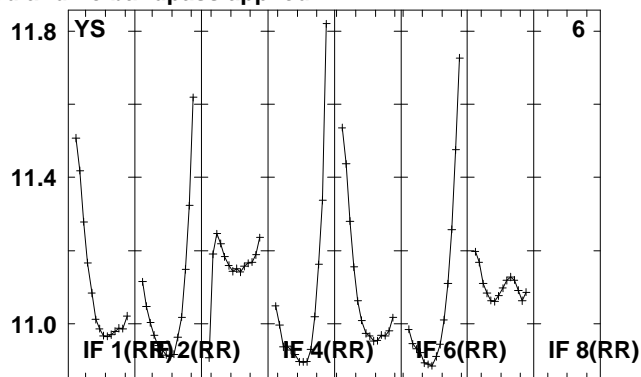
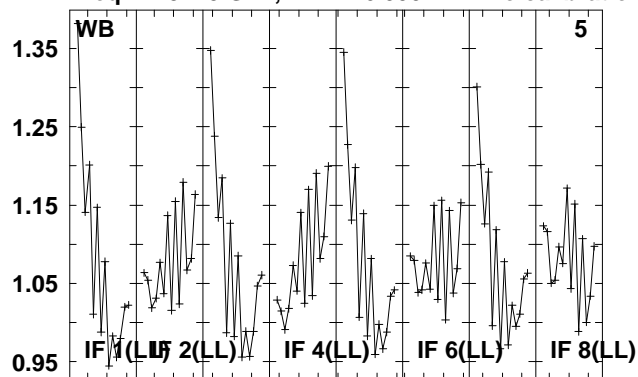

Lower frame: Real Jy

Total-power spectrum Antenna: *

Timerange: 00/20:20:36 to 00/20:31:34

Plot file version 216 created 08-JUL-2010 13:11:48

J1609+26 EM079.UVDATA.1

Freq = 4.9415 GHz, Bw = 16.000 MH No calibration applied and no bandpass applied

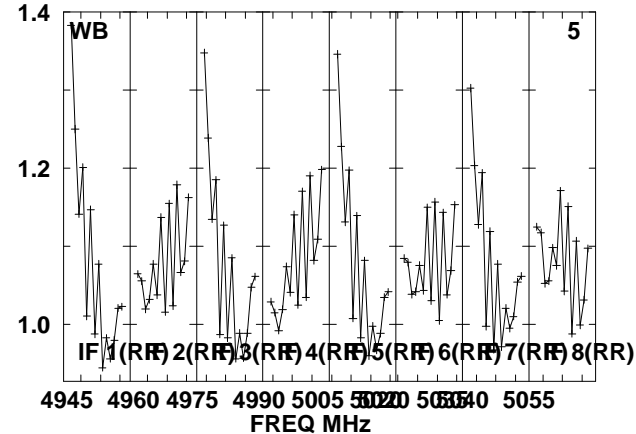
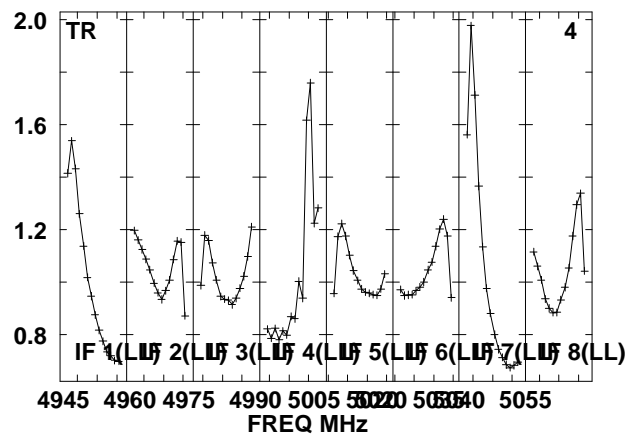
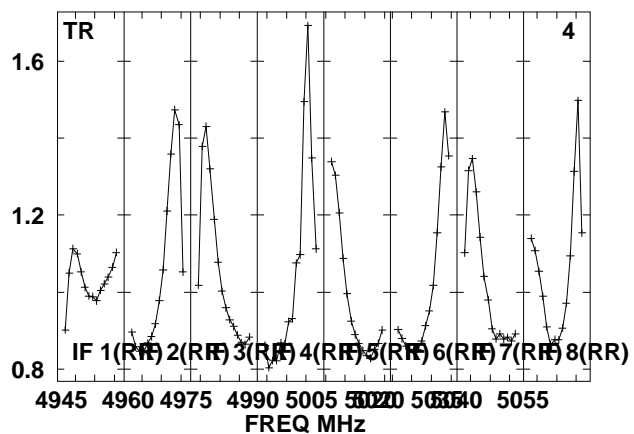
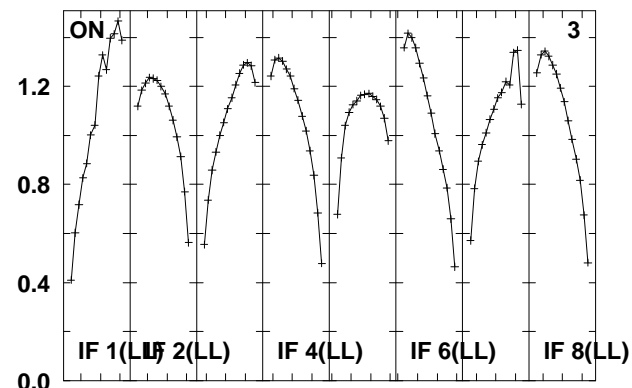
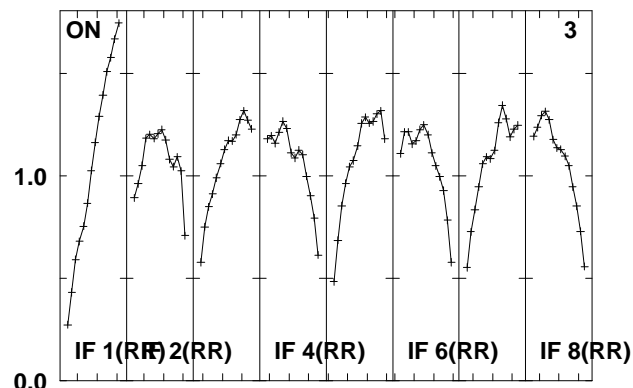
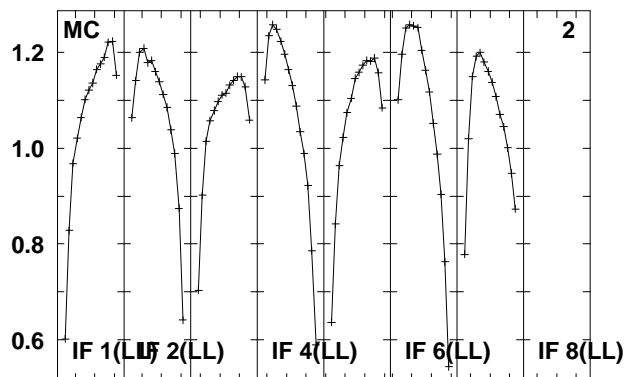
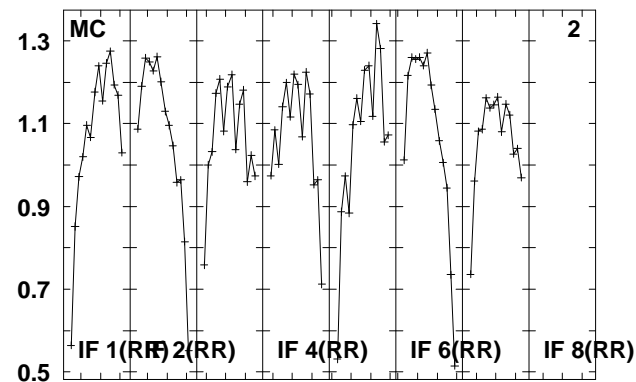
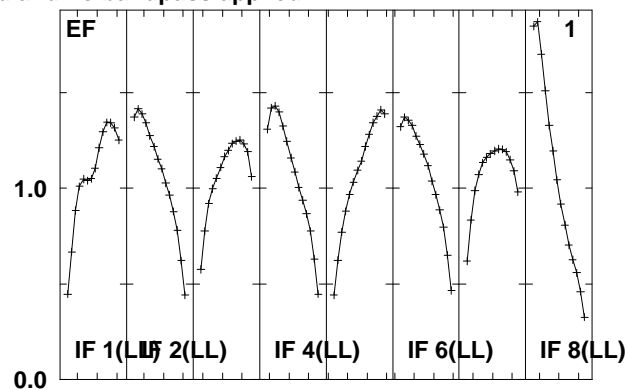
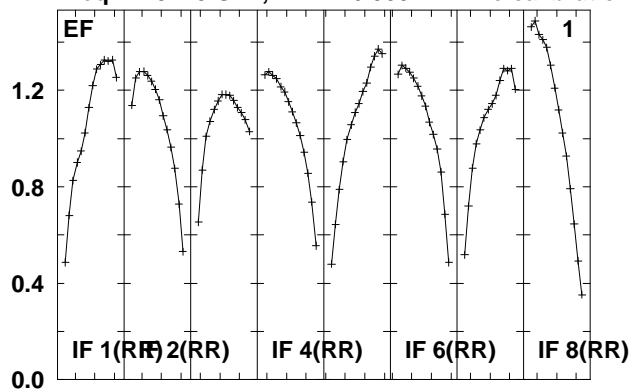

Lower frame: Real Jy
Total-power spectrum Antenna: *
Timerange: 00/20:31:36 to 00/20:33:34

Plot file version 217 created 08-JUL-2010 13:11:48

J1609+26 EM079.UVDATA.1

Freq = 4.9415 GHz, Bw = 16.000 MH No calibration applied and no bandpass applied

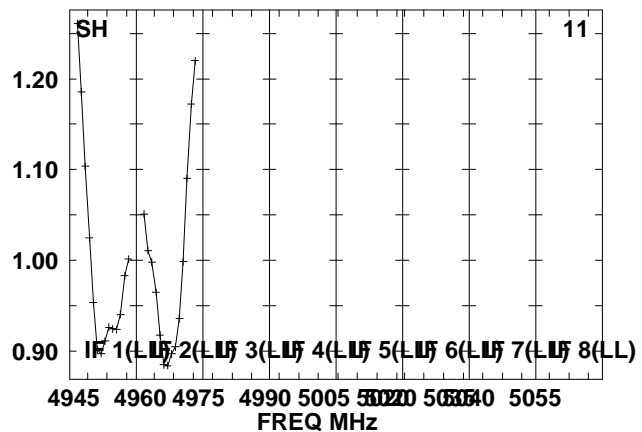
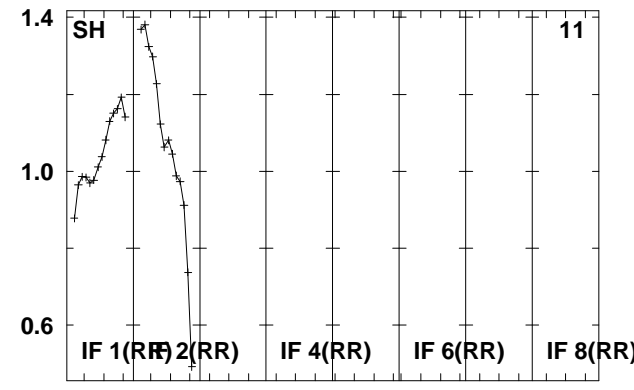
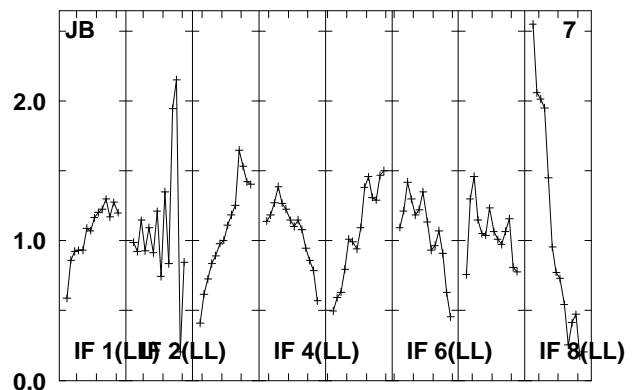
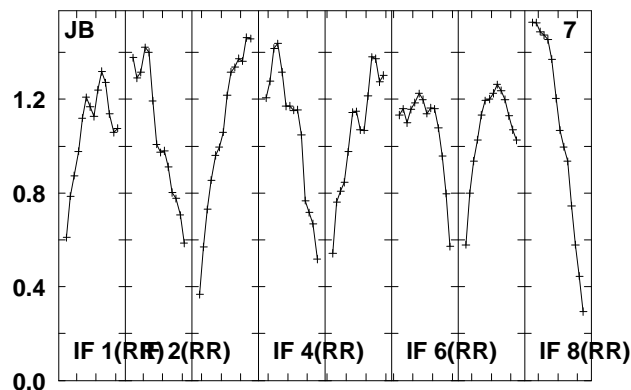
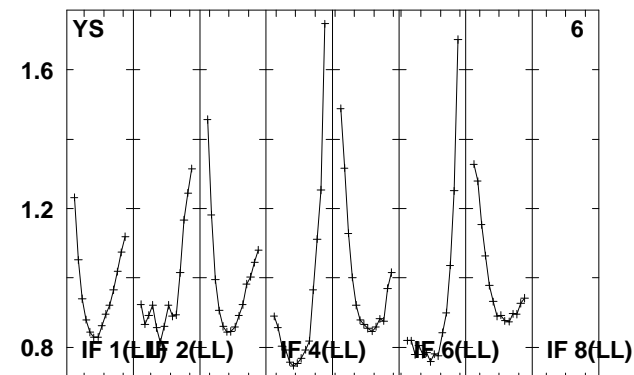
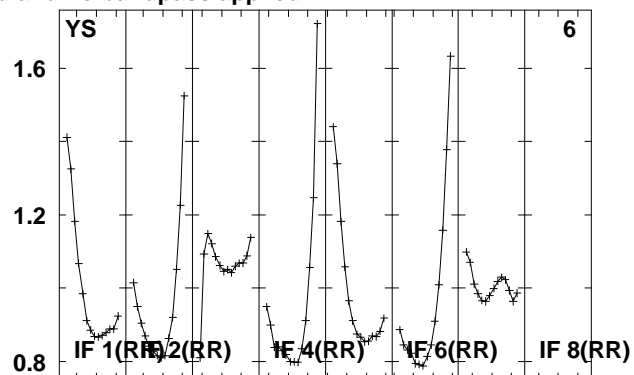
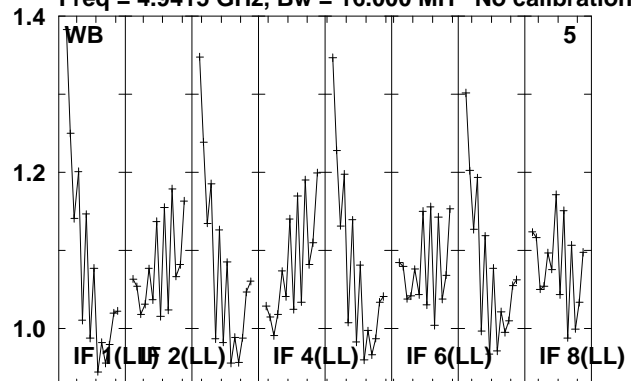

Lower frame: Real Jy

Total-power spectrum Antenna: *

Timerange: 00/20:31:36 to 00/20:33:34

Plot file version 218 created 08-JUL-2010 13:11:49

J1625+27 EM079.UVDATA.1

Freq = 4.9415 GHz, Bw = 16.000 MH No calibration applied and no bandpass applied

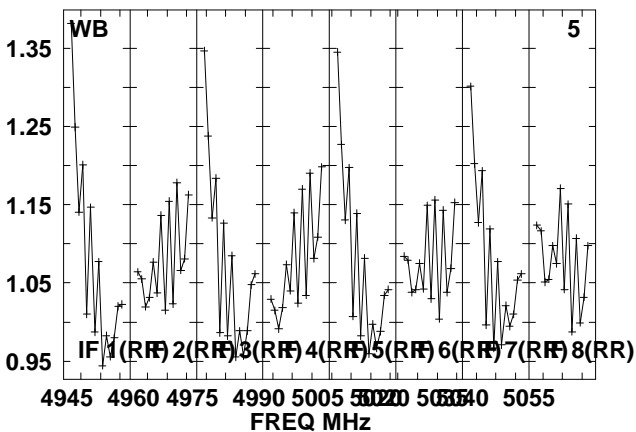
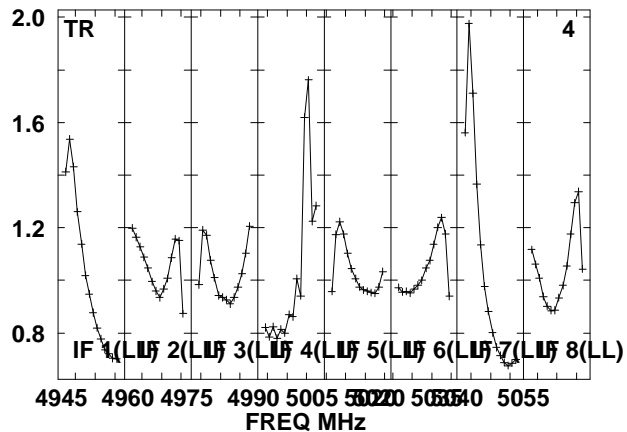
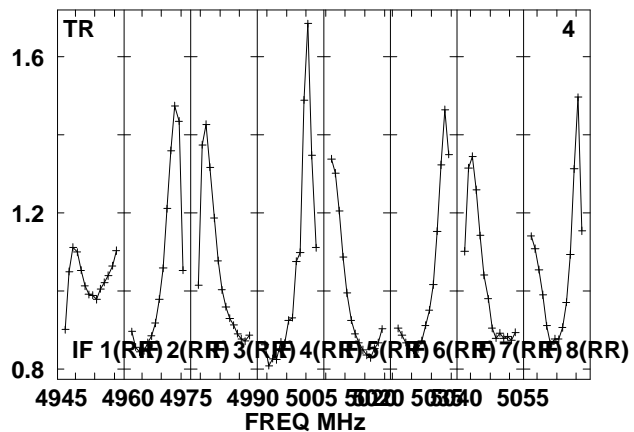
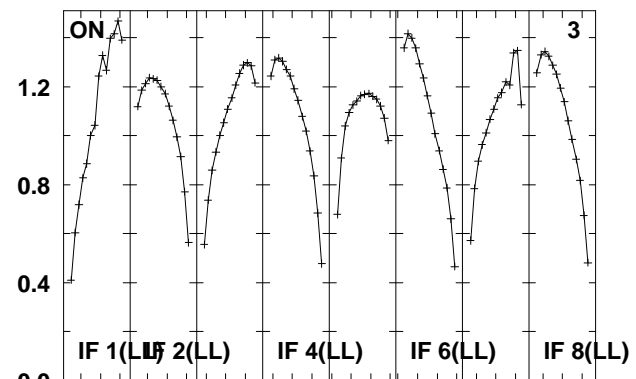
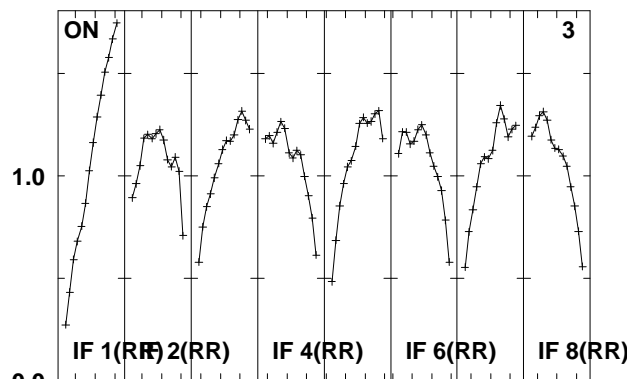
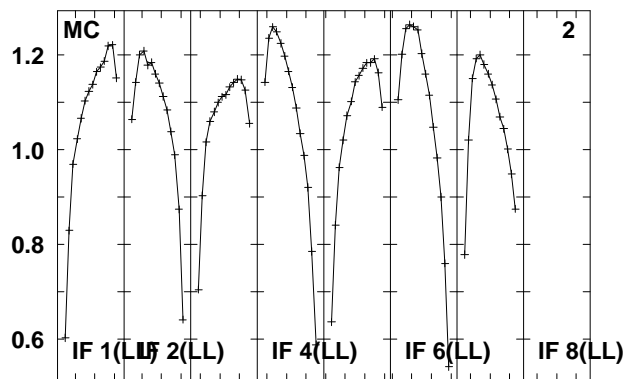
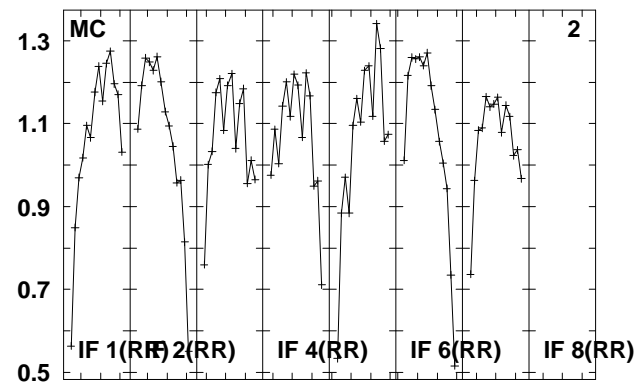
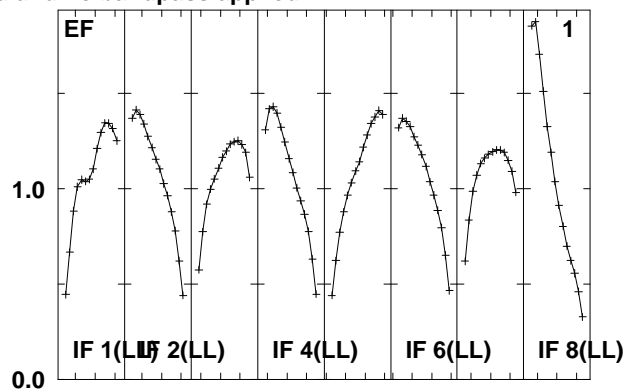
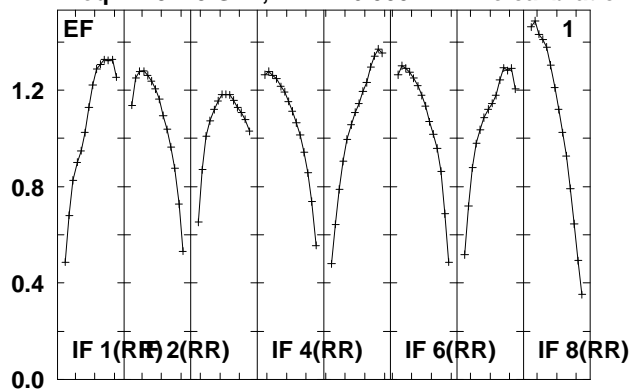

Lower frame: Real Jy
Total-power spectrum Antenna: *
Timerange: 00/20:33:36 to 00/20:44:34

Plot file version 219 created 08-JUL-2010 13:11:50

J1625+27 EM079.UVDATA.1

Freq = 4.9415 GHz, Bw = 16.000 MH No calibration applied and no bandpass applied

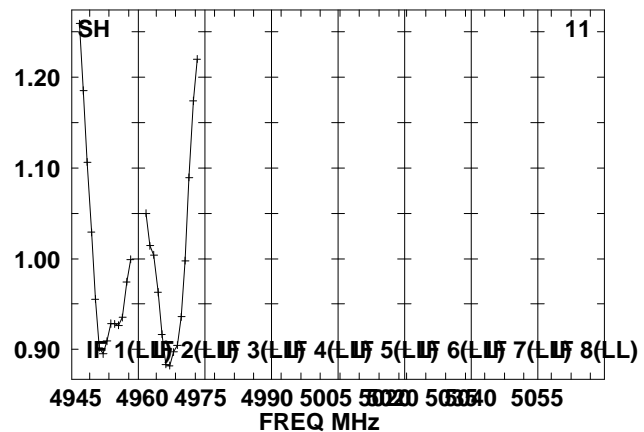
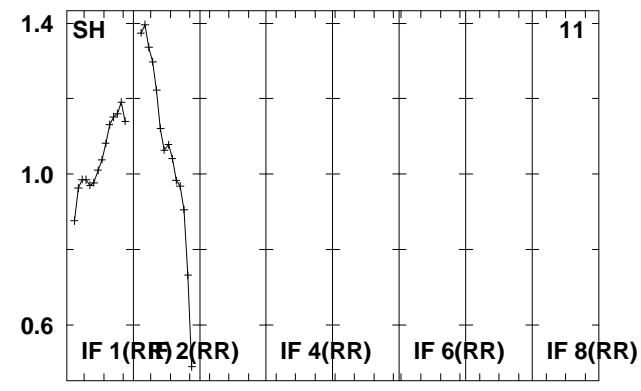
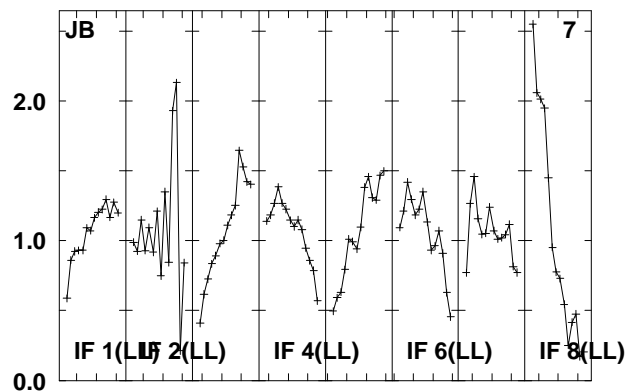
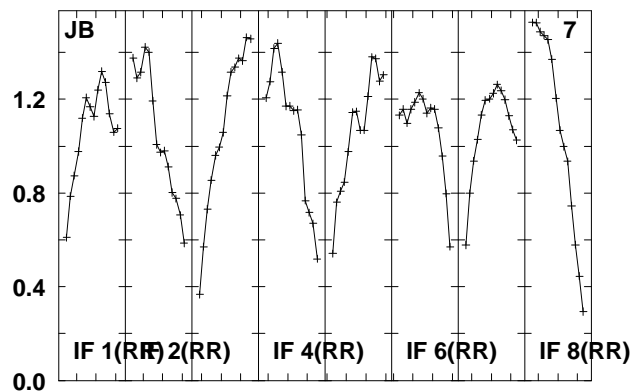
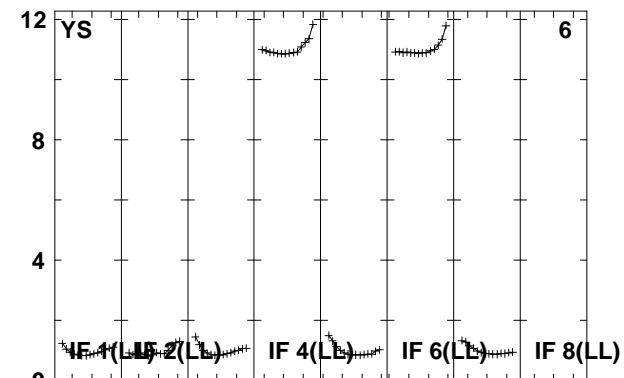
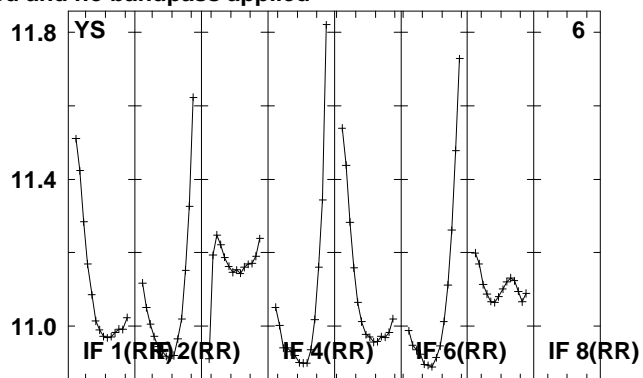
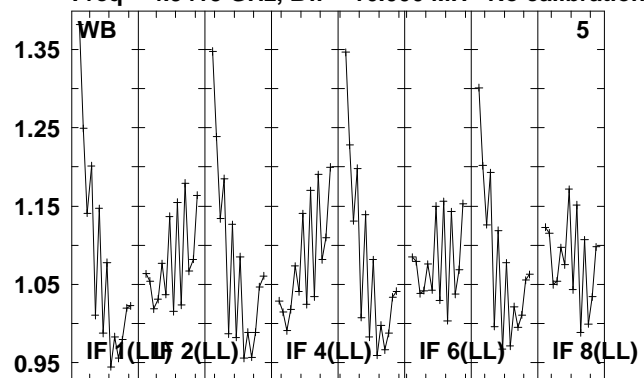

Lower frame: Real Jy

Total-power spectrum Antenna: *

Timerange: 00/20:33:36 to 00/20:44:34

Plot file version 220 created 08-JUL-2010 13:11:52

J1609+26 EM079.UVDATA.1

Freq = 4.9415 GHz, Bw = 16.000 MH No calibration applied and no bandpass applied

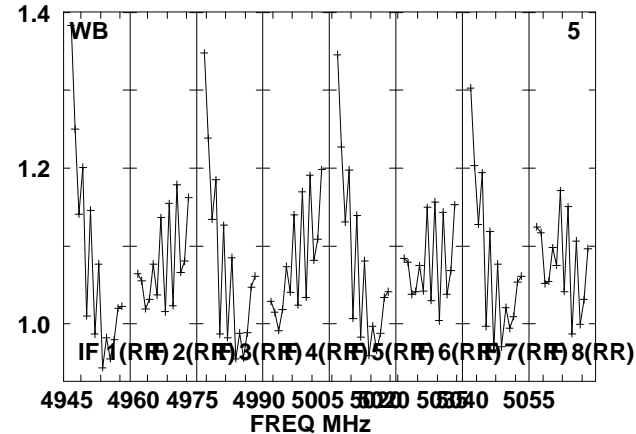
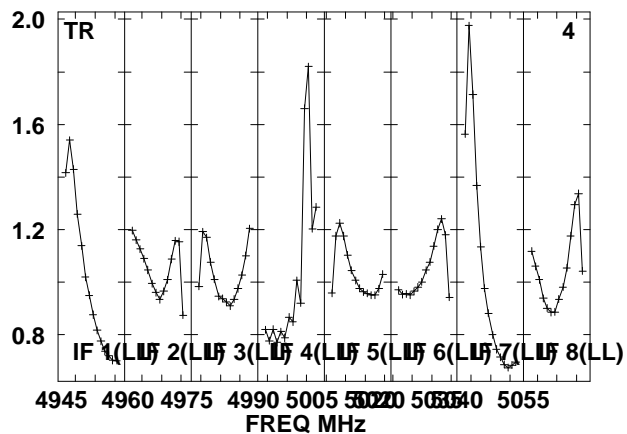
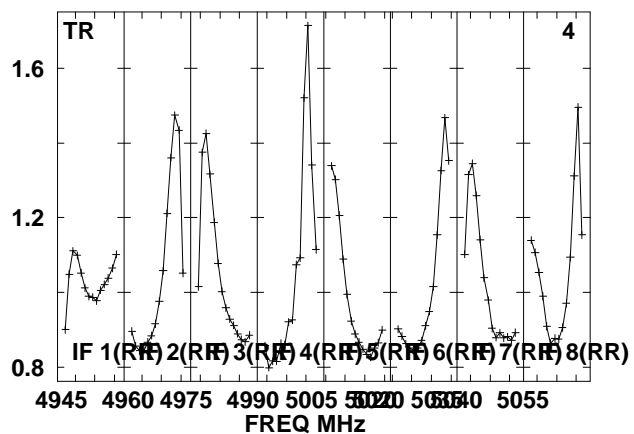
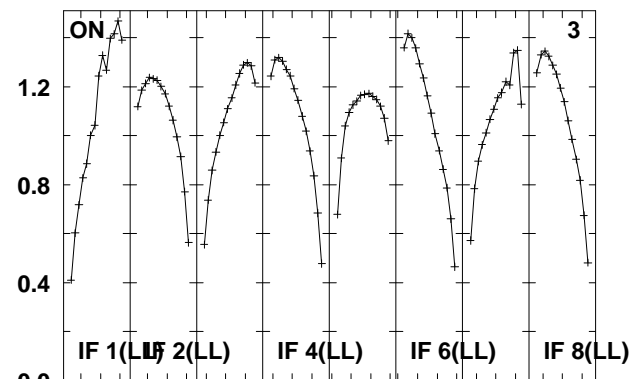
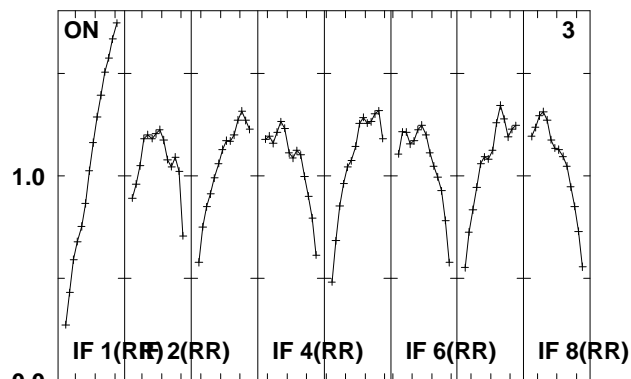
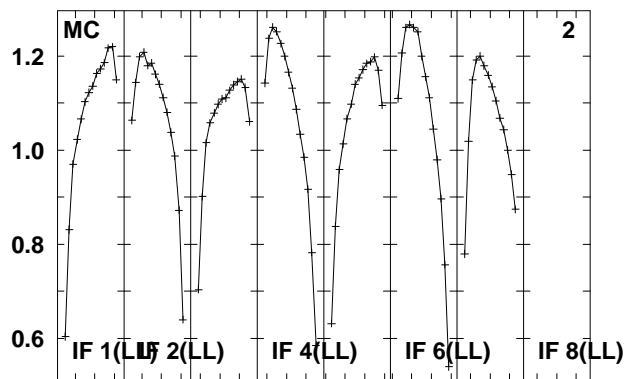
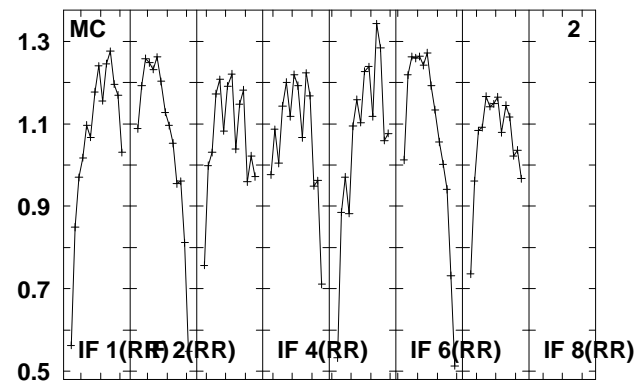
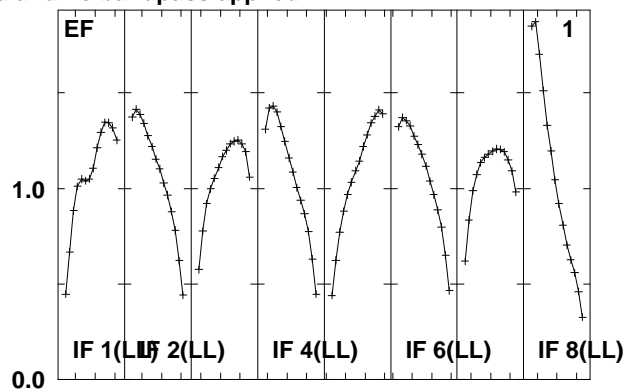
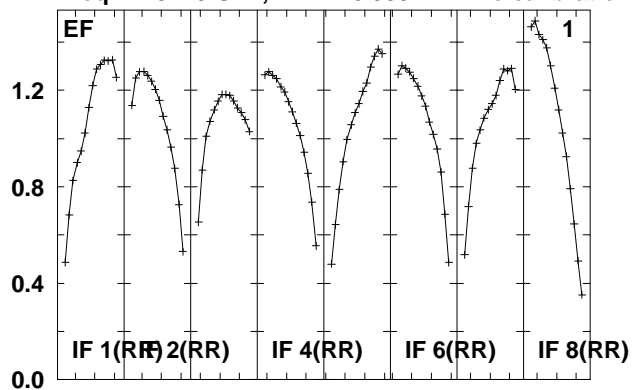

Lower frame: Real Jy
Total-power spectrum Antenna: *
Timerange: 00/20:44:36 to 00/20:46:34

Plot file version 221 created 08-JUL-2010 13:11:53

J1609+26 EM079.UVDATA.1

Freq = 4.9415 GHz, Bw = 16.000 MH No calibration applied and no bandpass applied

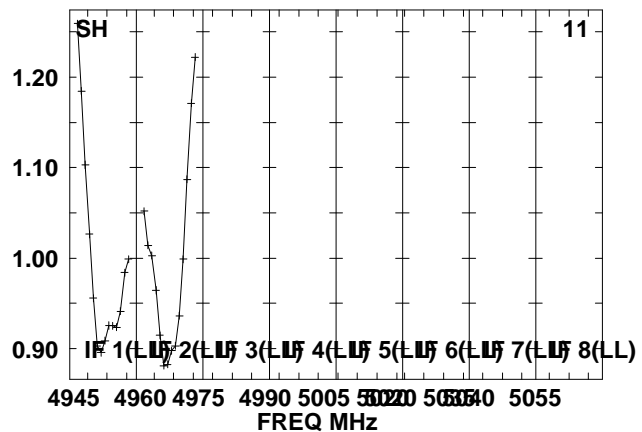
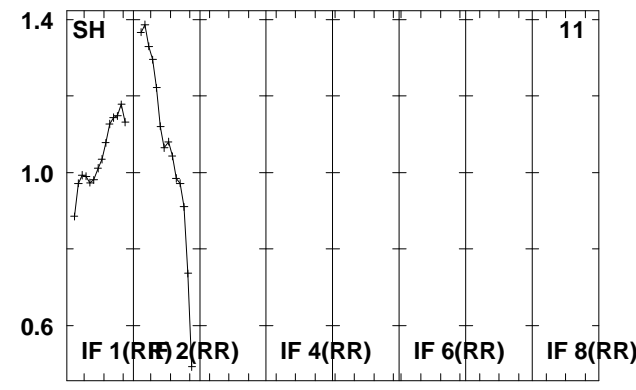
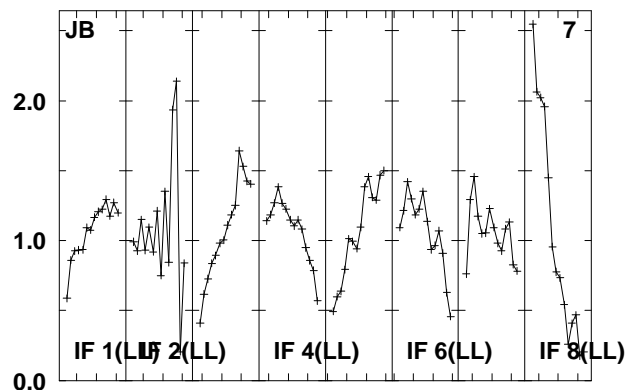
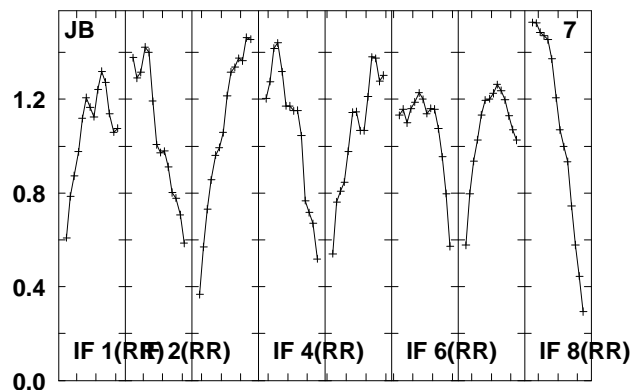
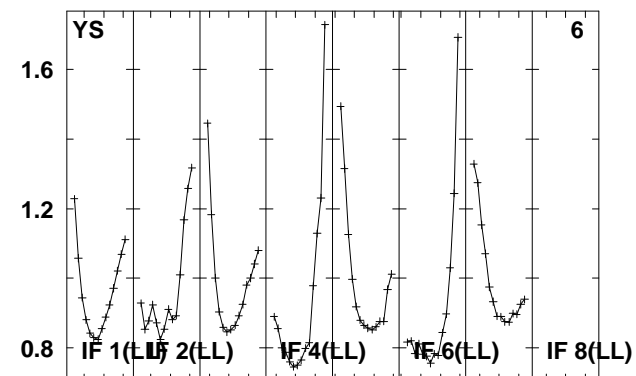
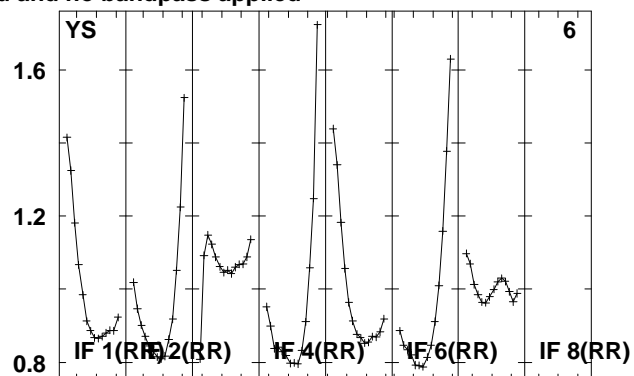
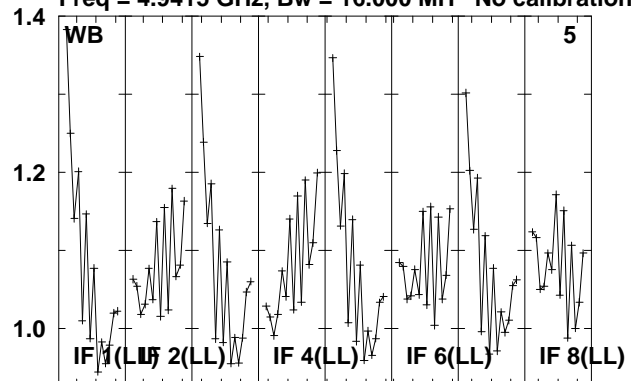

Lower frame: Real Jy

Total-power spectrum Antenna: *

Timerange: 00/20:44:36 to 00/20:46:34

Plot file version 222 created 08-JUL-2010 13:11:54

J1625+27 EM079.UVDATA.1

Freq = 4.9415 GHz, Bw = 16.000 MH No calibration applied and no bandpass applied

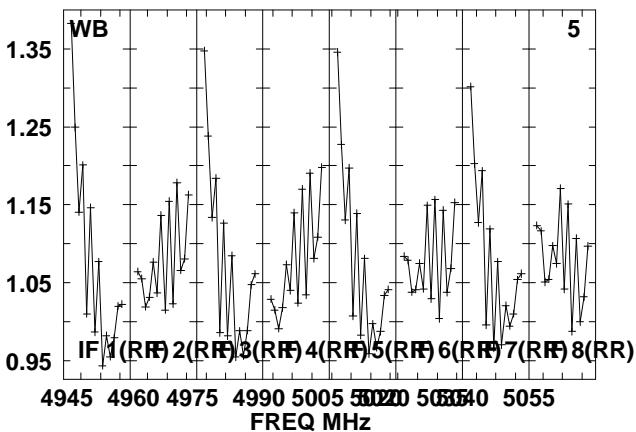
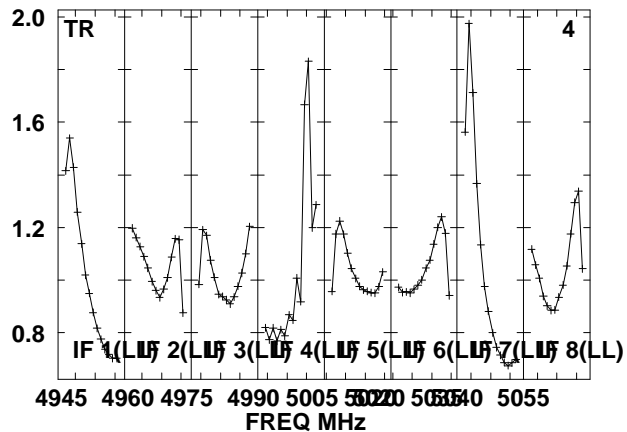
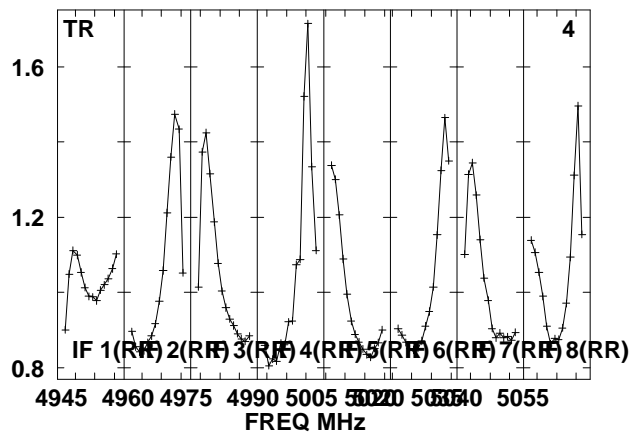
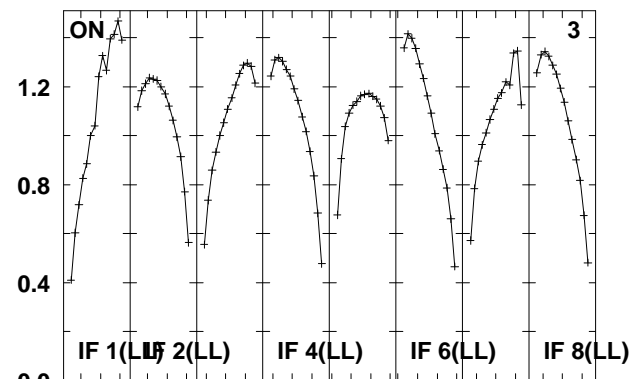
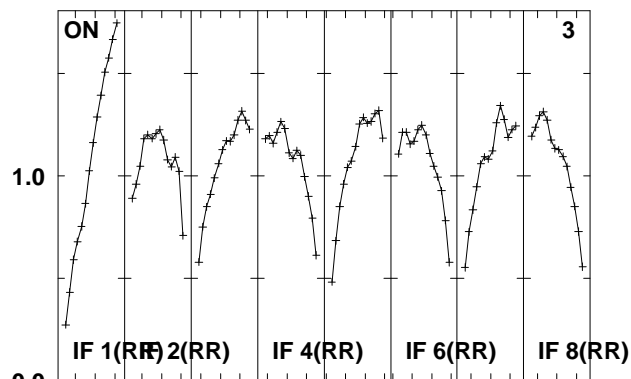
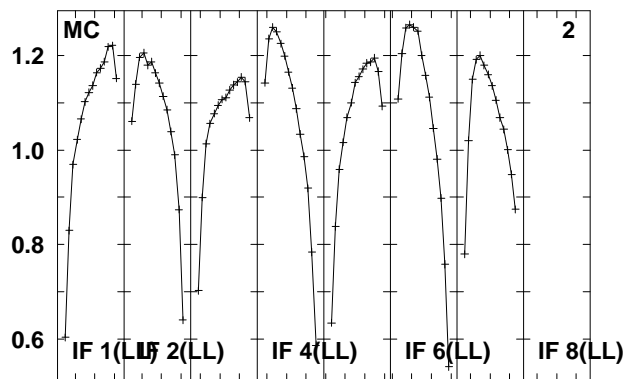
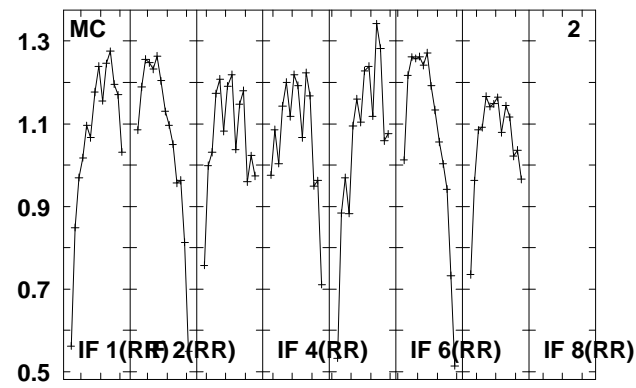
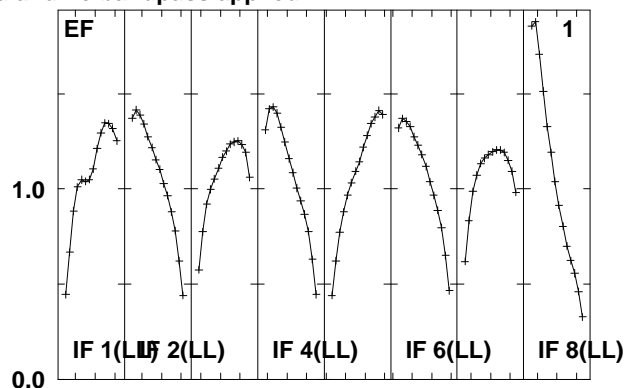
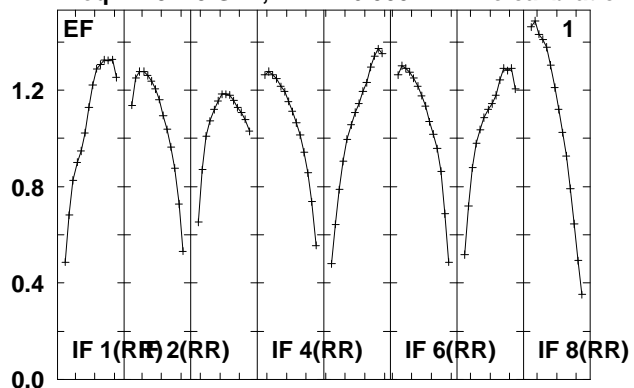

Lower frame: Real Jy
Total-power spectrum Antenna: *
Timerange: 00/20:46:36 to 00/20:57:34

Plot file version 223 created 08-JUL-2010 13:11:55

J1625+27 EM079.UVDATA.1

Freq = 4.9415 GHz, Bw = 16.000 MH No calibration applied and no bandpass applied

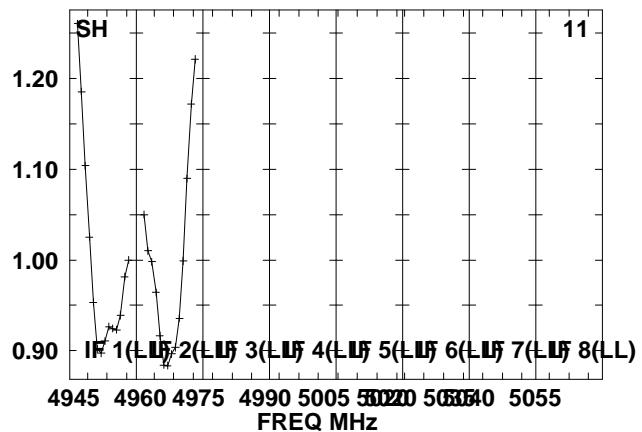
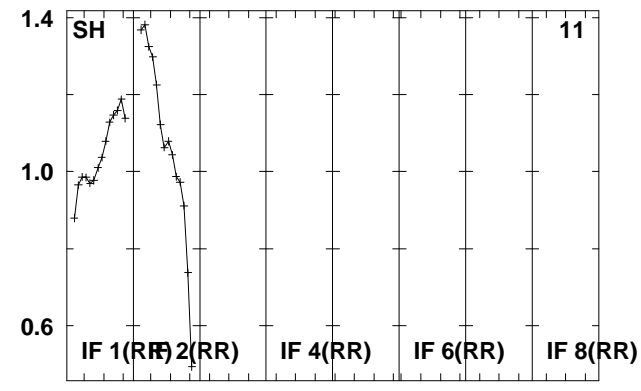
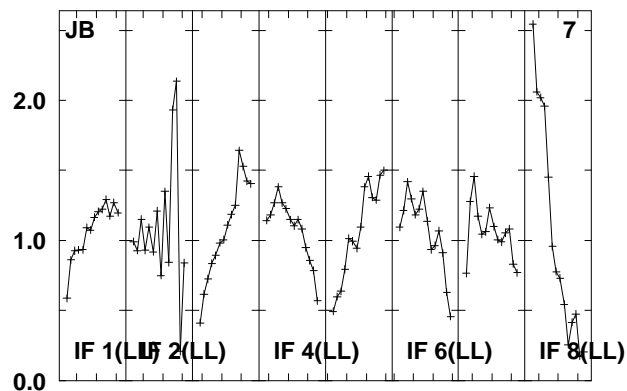
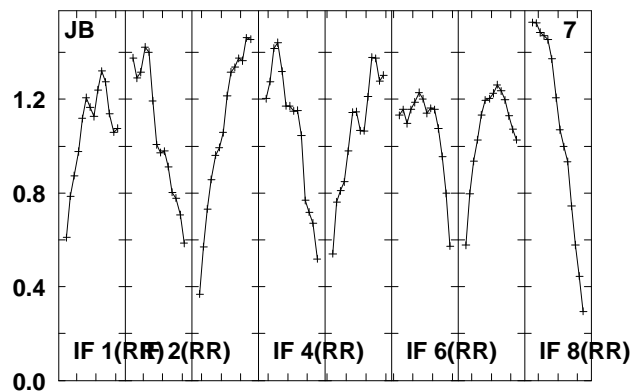
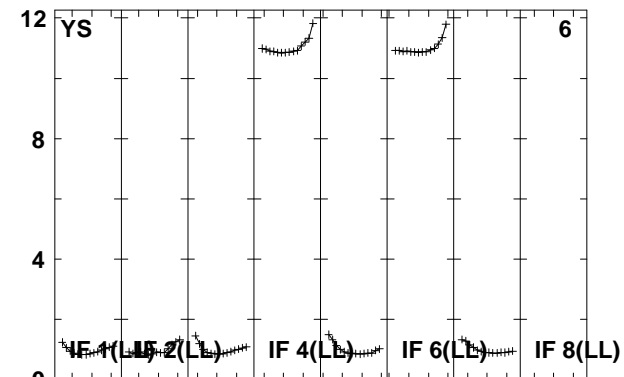
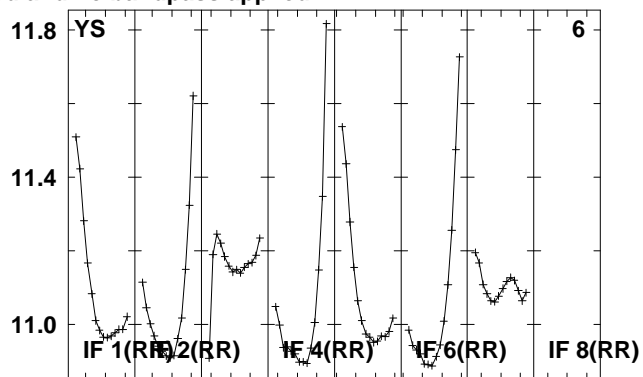
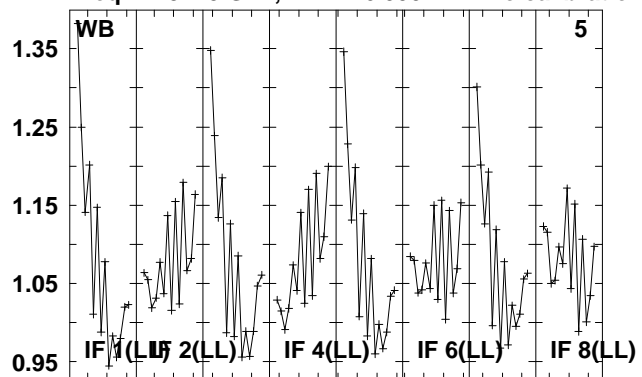

Lower frame: Real Jy

Total-power spectrum Antenna: *

Timerange: 00/20:46:36 to 00/20:57:34

Plot file version 224 created 08-JUL-2010 13:11:57

J1609+26 EM079.UVDATA.1

Freq = 4.9415 GHz, Bw = 16.000 MH No calibration applied and no bandpass applied

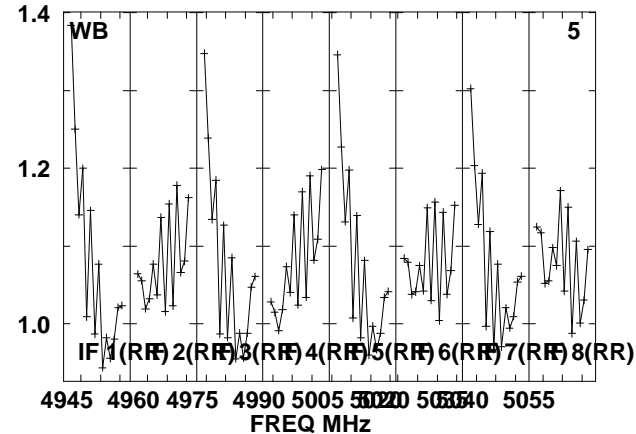
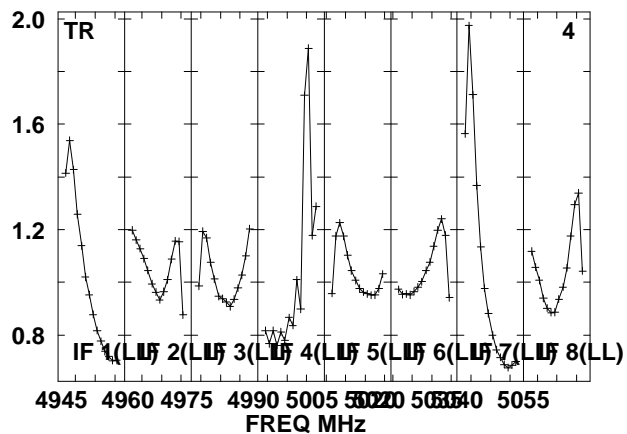
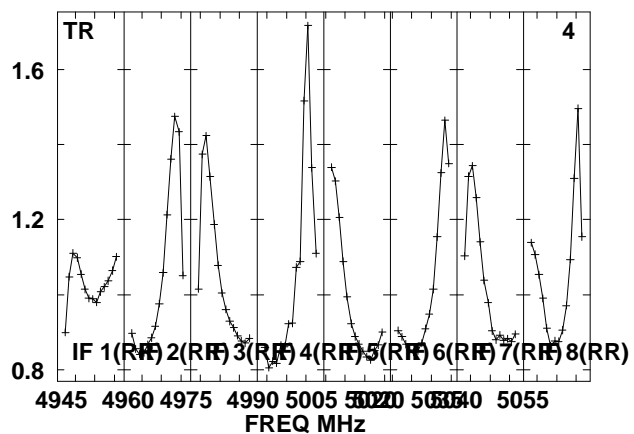
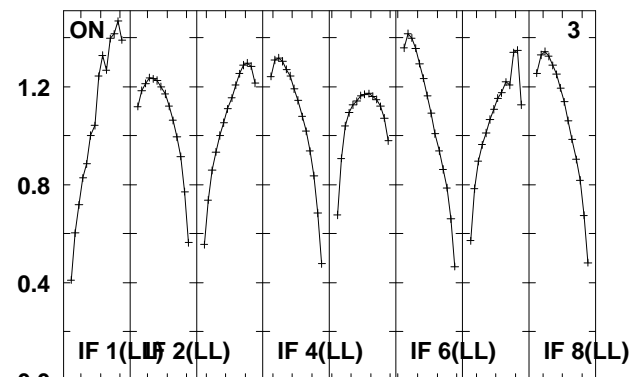
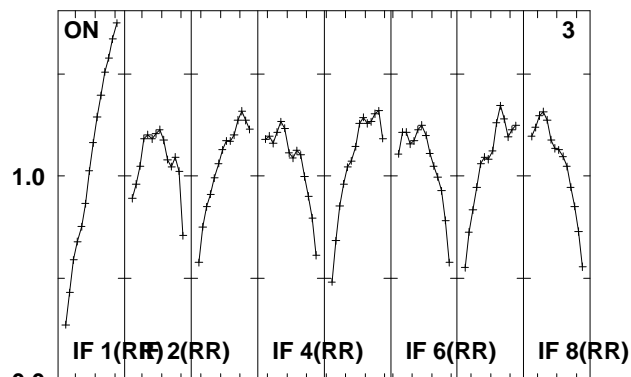
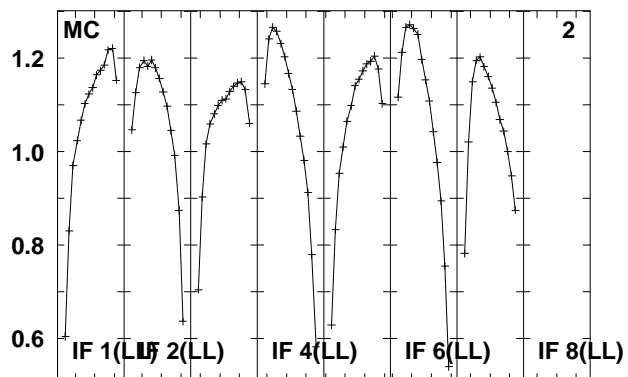
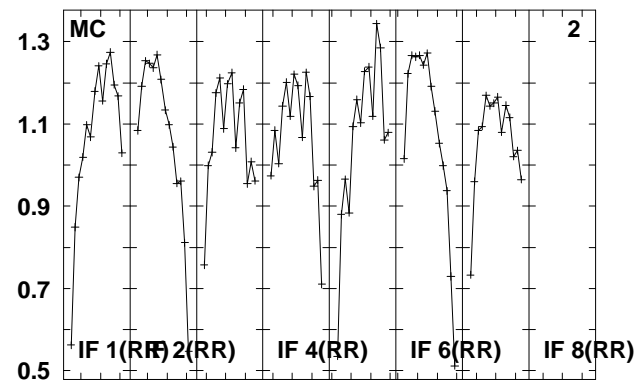
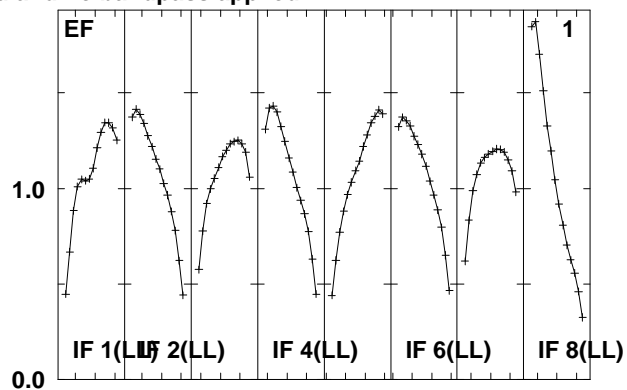
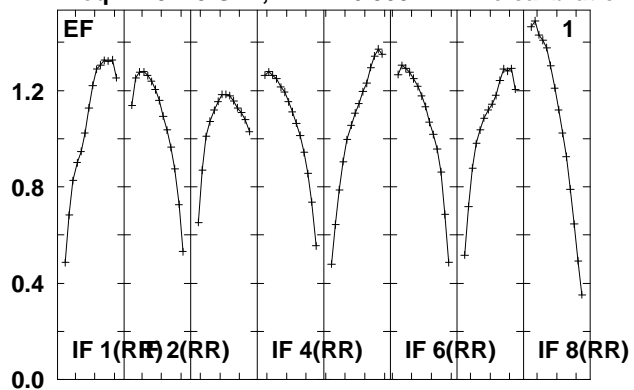

Lower frame: Real Jy
Total-power spectrum Antenna: *
Timerange: 00/20:57:36 to 00/20:59:34

Plot file version 225 created 08-JUL-2010 13:11:57

J1609+26 EM079.UVDATA.1

Freq = 4.9415 GHz, Bw = 16.000 MH No calibration applied and no bandpass applied

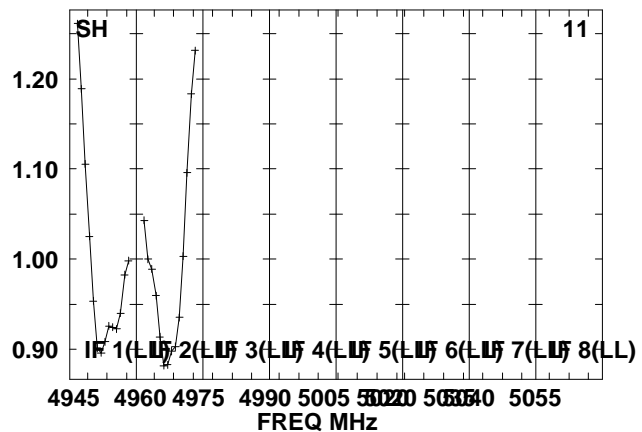
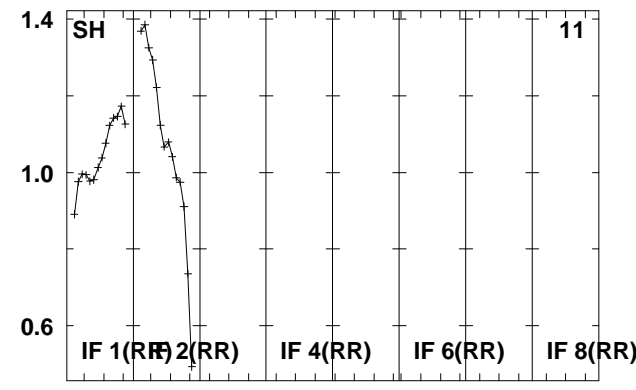
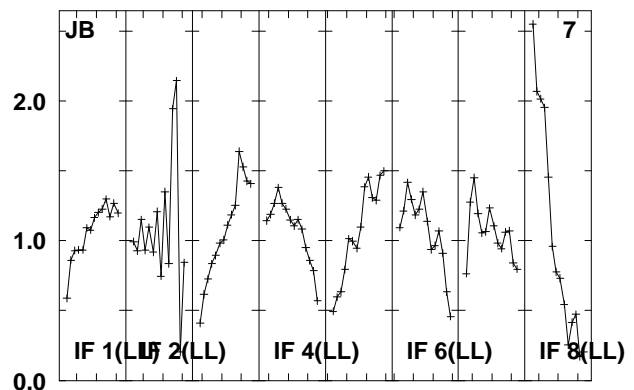
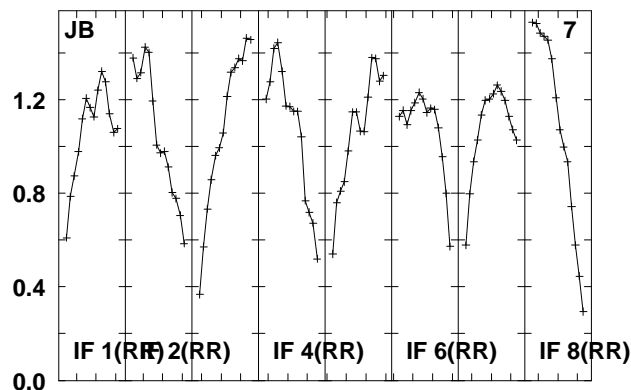
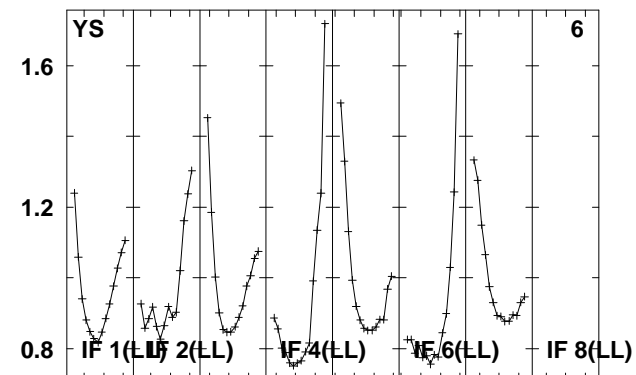
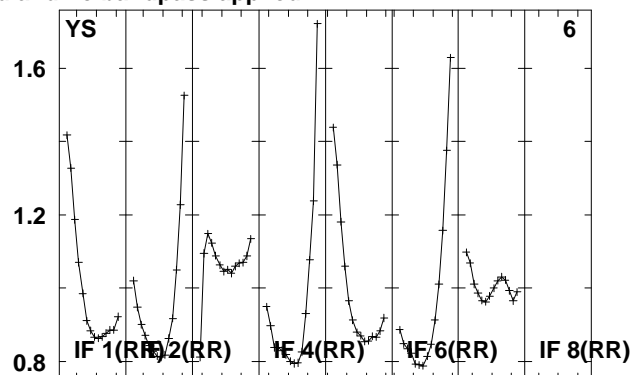
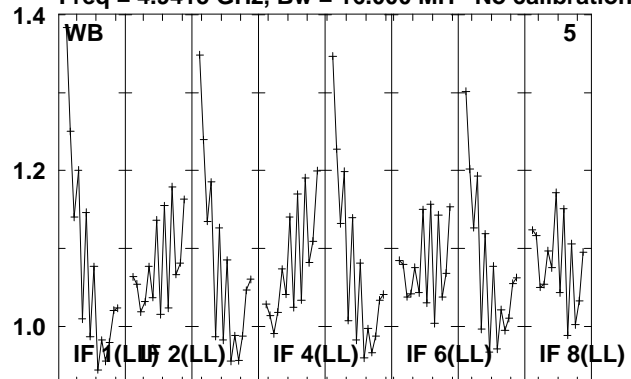

Lower frame: Real Jy

Total-power spectrum Antenna: *

Timerange: 00/20:57:36 to 00/20:59:34

Plot file version 226 created 08-JUL-2010 13:11:58

J1312+48 EM079.UVDATA.1

Freq = 4.9415 GHz, Bw = 16.000 MH No calibration applied and no bandpass applied

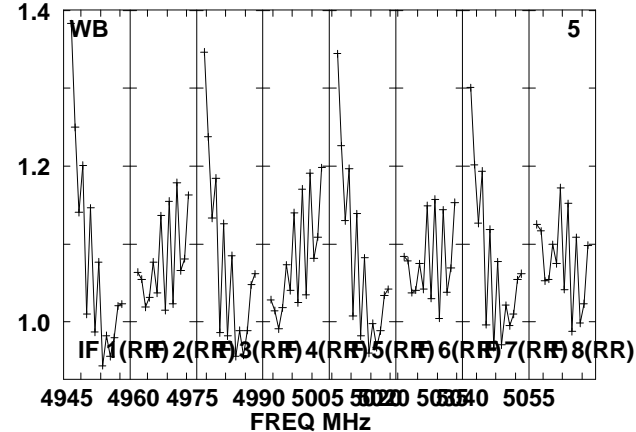
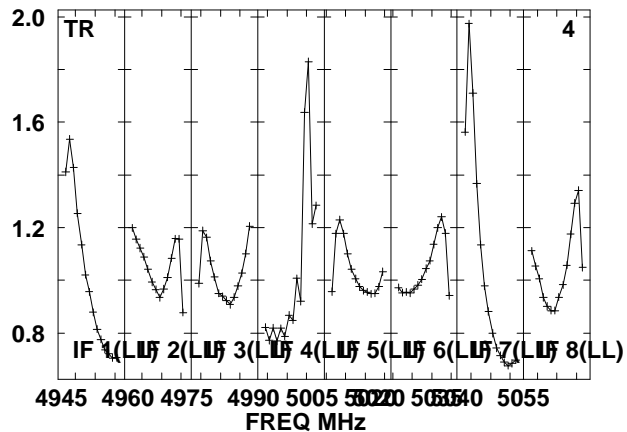
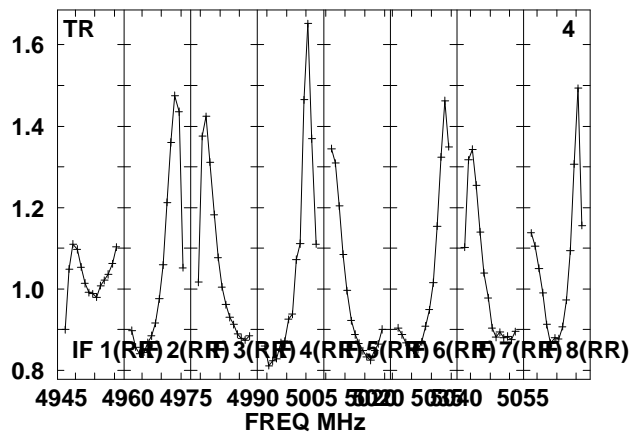
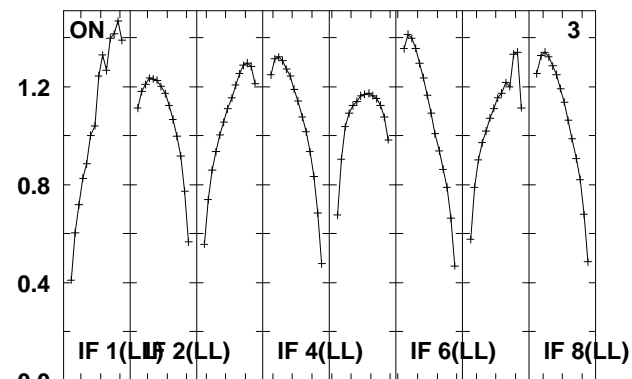
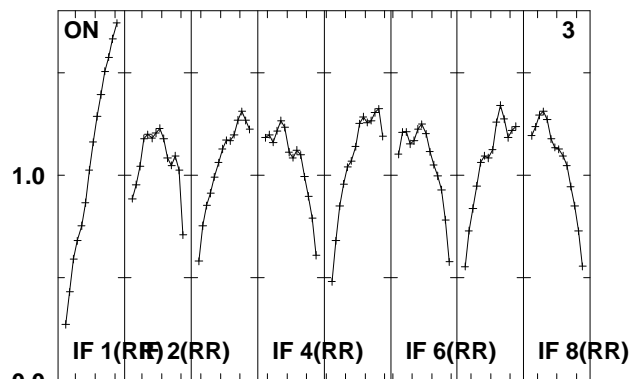
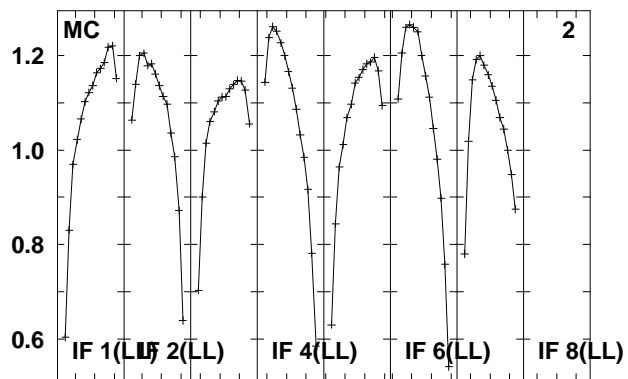
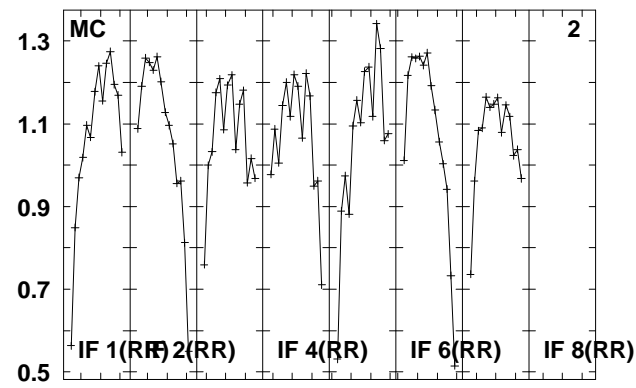
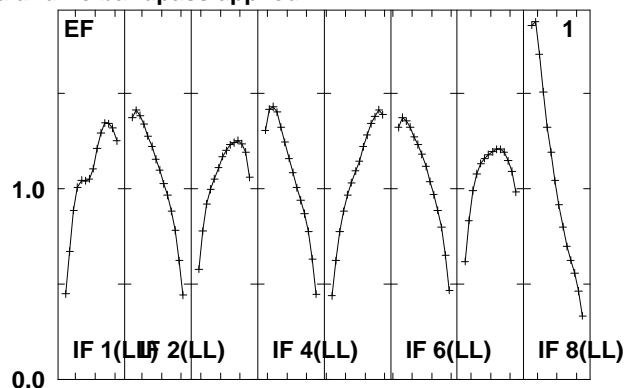
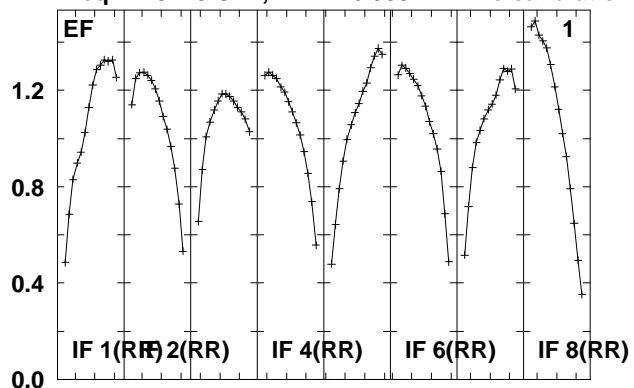

Lower frame: Real Jy
Total-power spectrum Antenna: *
Timerange: 00/20:59:36 to 00/21:08:14

Plot file version 227 created 08-JUL-2010 13:11:58

J1312+48 EM079.UVDATA.1

Freq = 4.9415 GHz, Bw = 16.000 MH No calibration applied and no bandpass applied

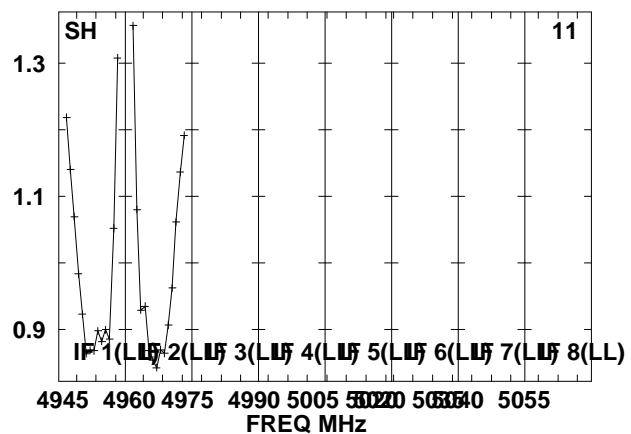
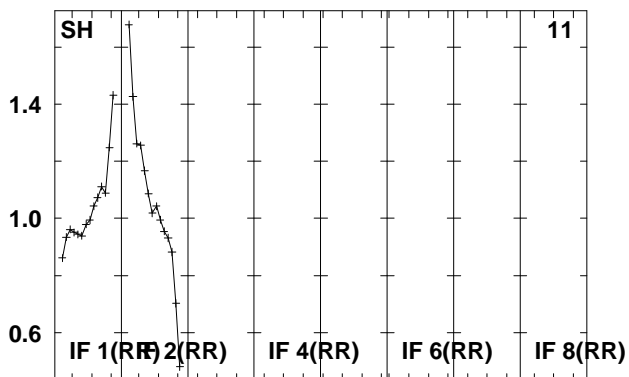
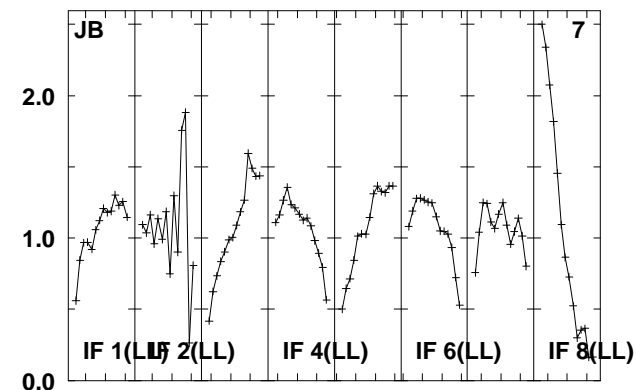
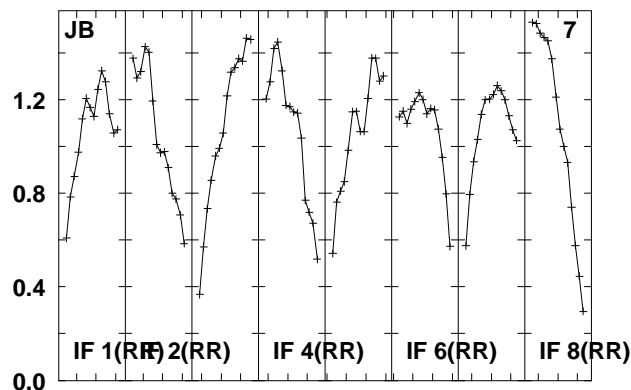
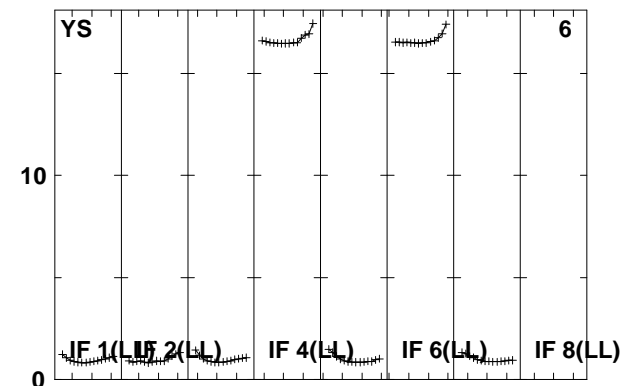
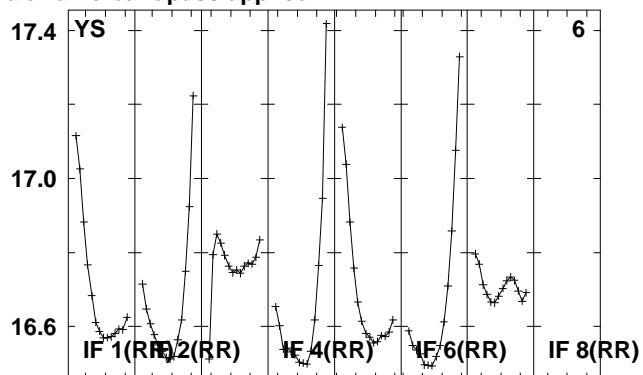
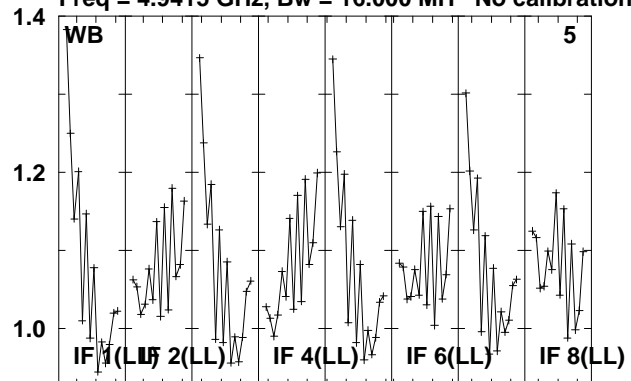

Lower frame: Real Jy

Total-power spectrum Antenna: *

Timerange: 00/20:59:36 to 00/21:08:14

Plot file version 228 created 08-JUL-2010 13:12:00

B1309+48 EM079.UVDATA.1

Freq = 4.9415 GHz, Bw = 16.000 MH No calibration applied and no bandpass applied

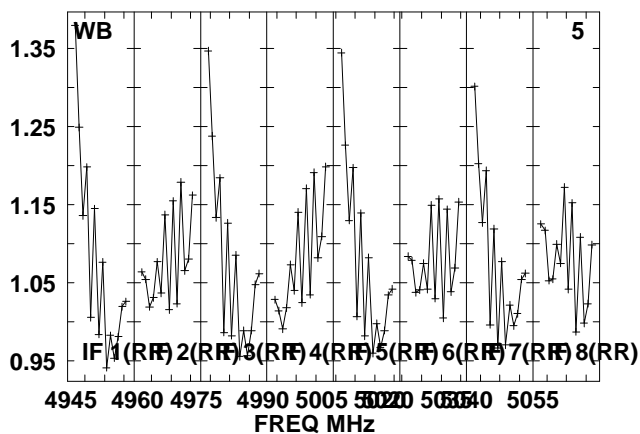
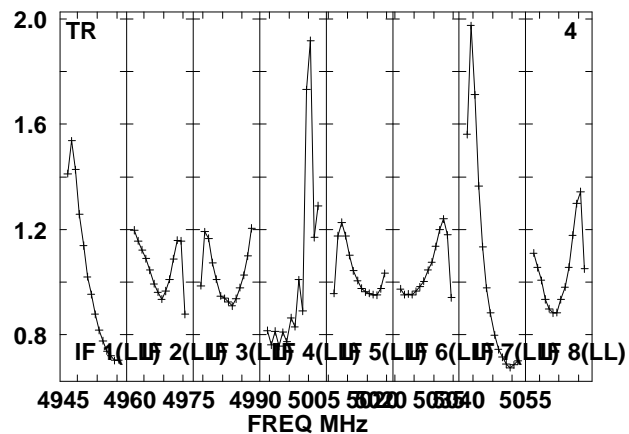
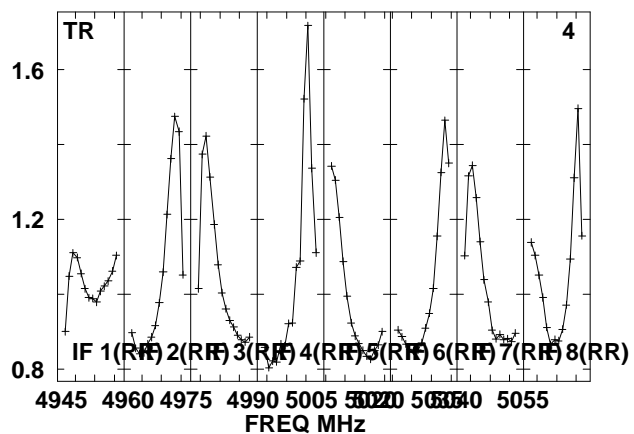
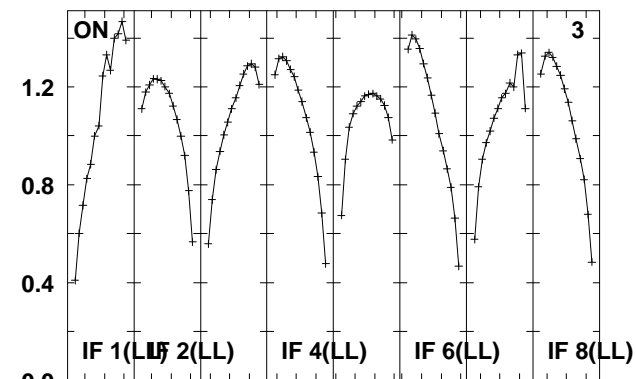
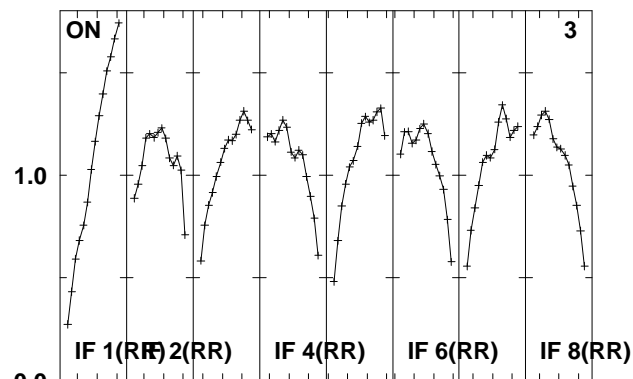
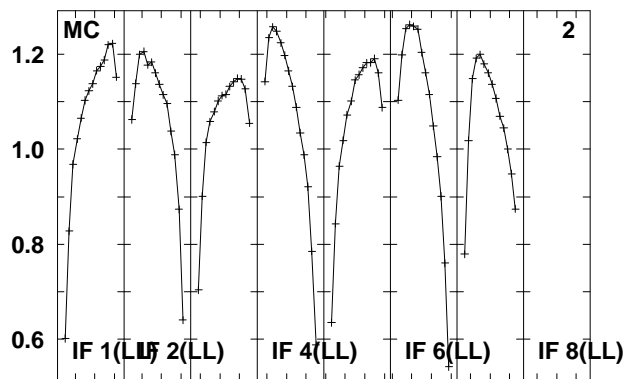
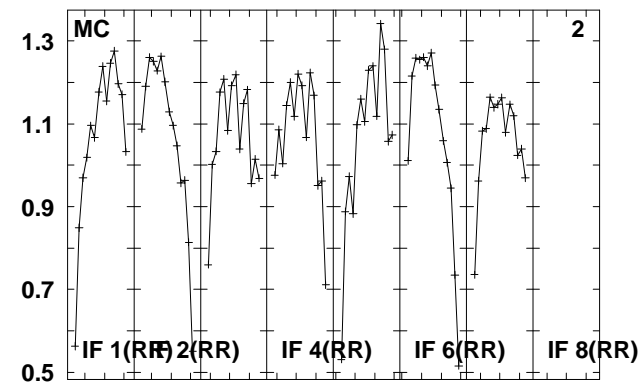
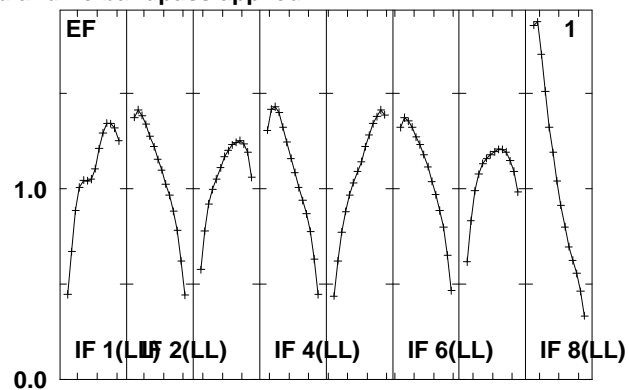
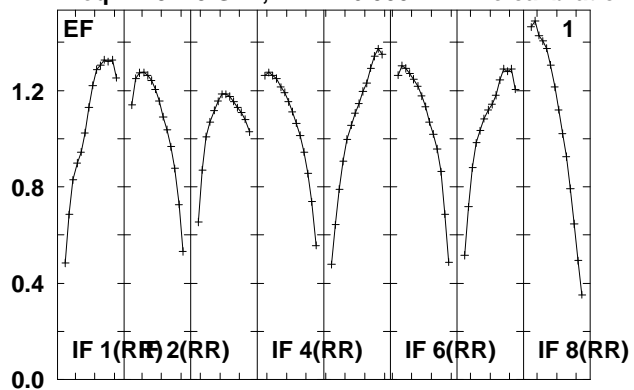

Lower frame: Real Jy
Total-power spectrum Antenna: *
Timerange: 00/21:08:16 to 00/21:18:58

Plot file version 229 created 08-JUL-2010 13:12:06

B1309+48 EM079.UVDATA.1

Freq = 4.9415 GHz, Bw = 16.000 MH No calibration applied and no bandpass applied

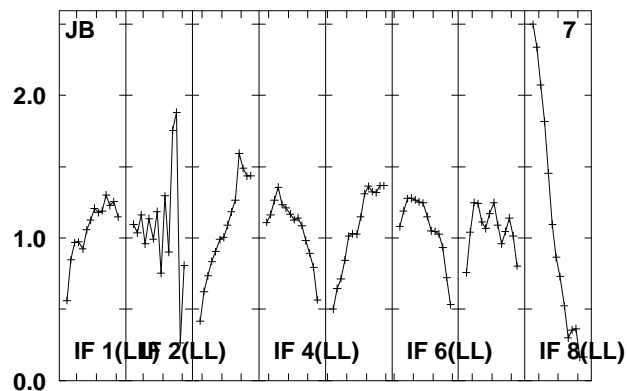
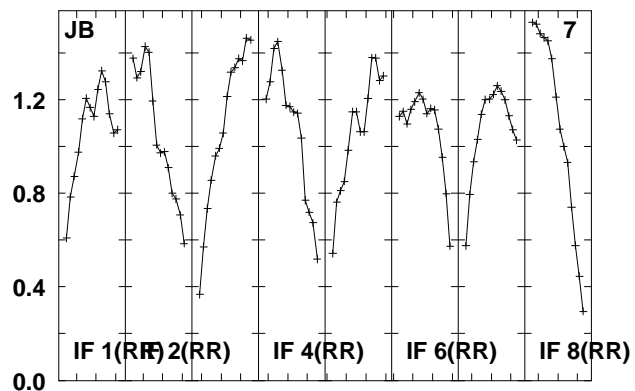
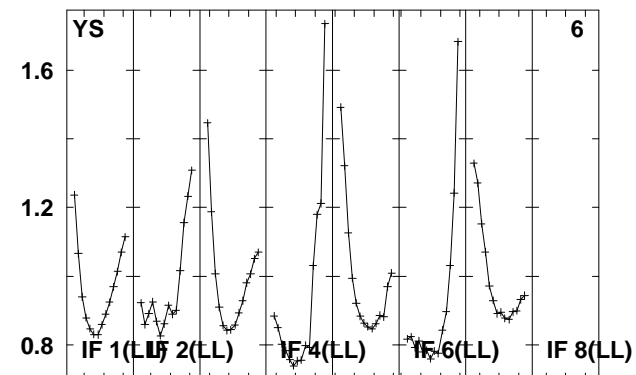
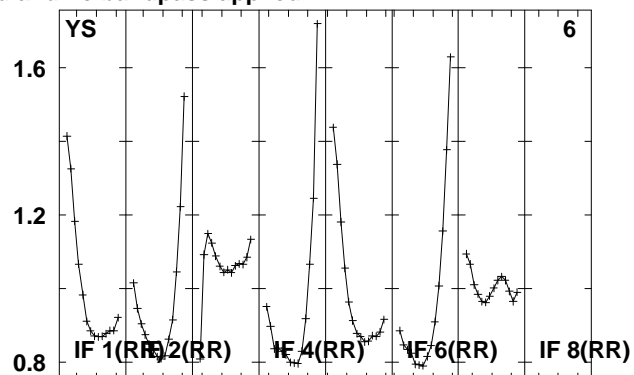
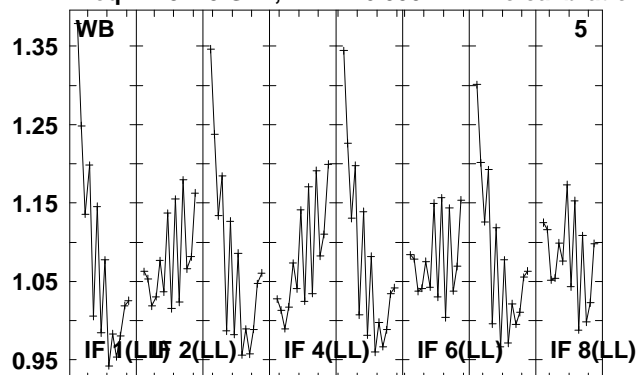

Lower frame: Real Jy
Total-power spectrum Antenna: *
Timerange: 00/21:08:16 to 00/21:18:58

Plot file version 230 created 08-JUL-2010 13:12:08

J1312+48 EM079.UVDATA.1

Freq = 4.9415 GHz, Bw = 16.000 MH No calibration applied and no bandpass applied

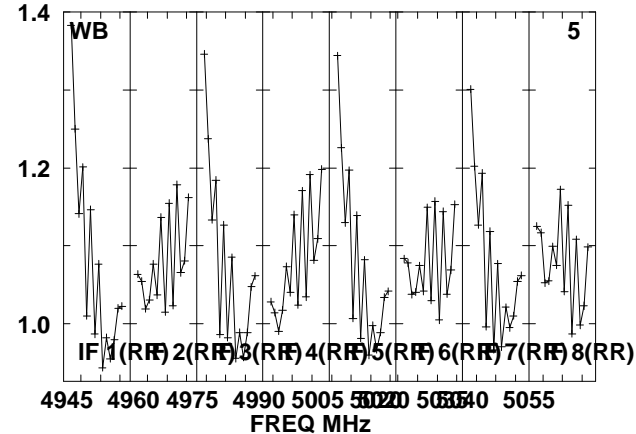
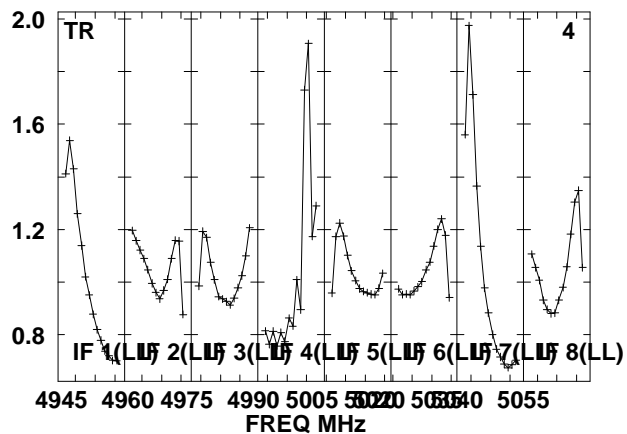
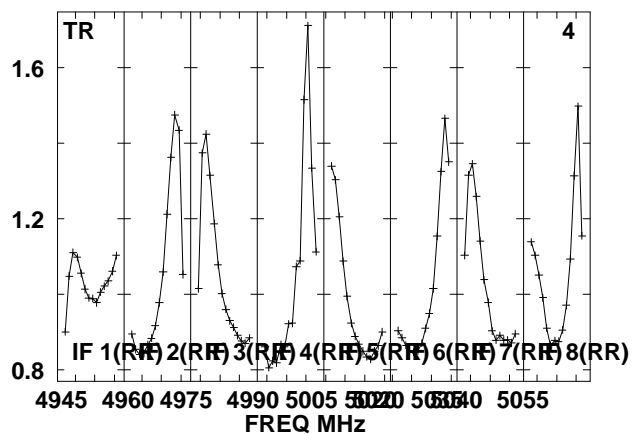
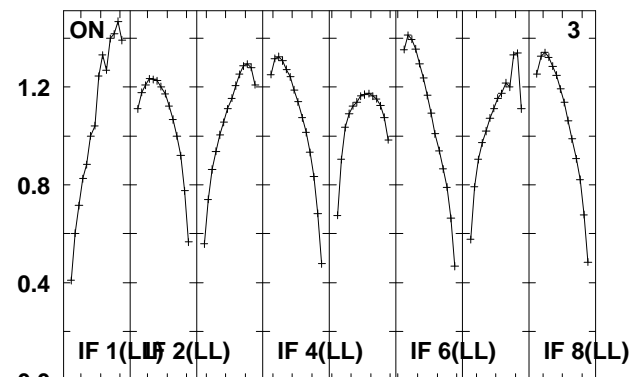
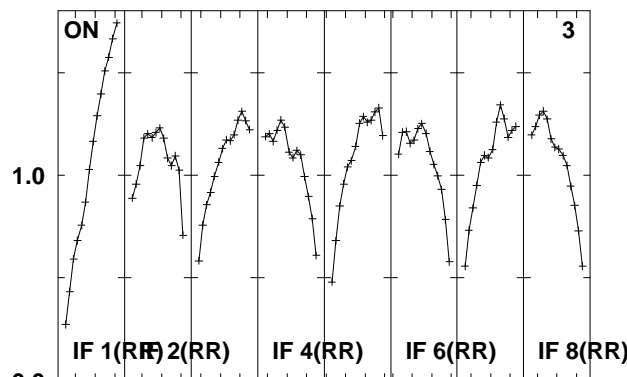
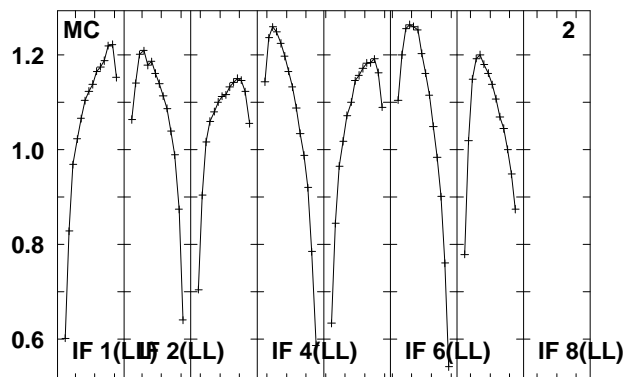
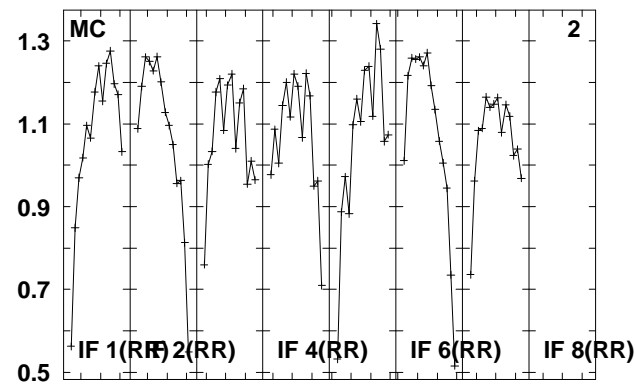
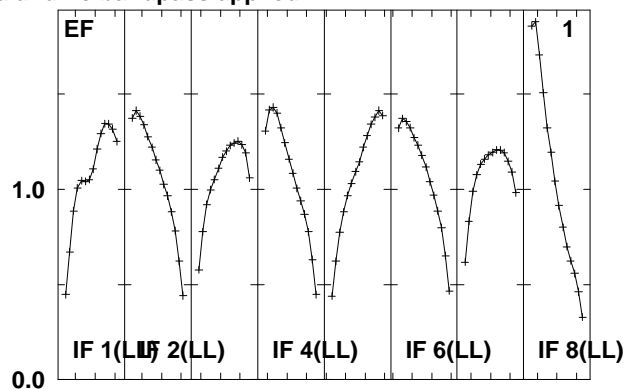
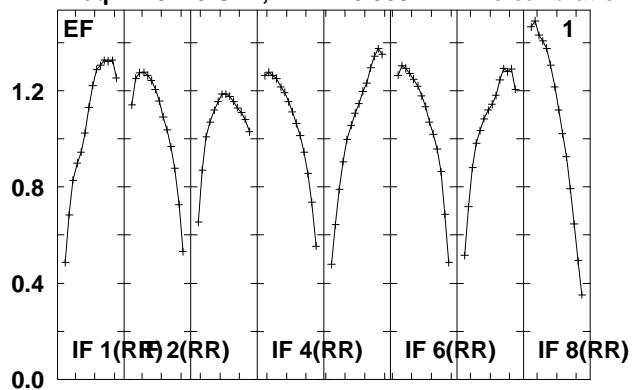

Lower frame: Real Jy
Total-power spectrum Antenna: *
Timerange: 00/21:19:00 to 00/21:20:58

Plot file version 231 created 08-JUL-2010 13:12:08

J1312+48 EM079.UVDATA.1

Freq = 4.9415 GHz, Bw = 16.000 MH No calibration applied and no bandpass applied

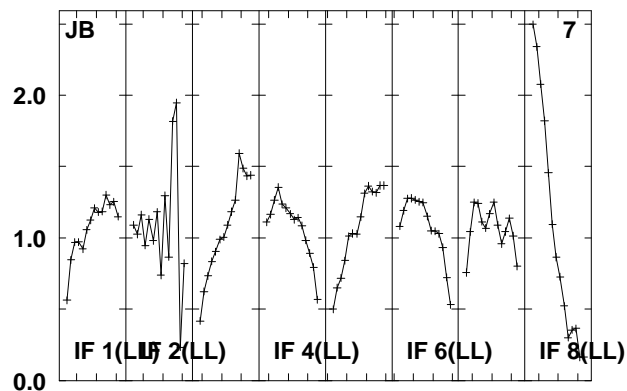
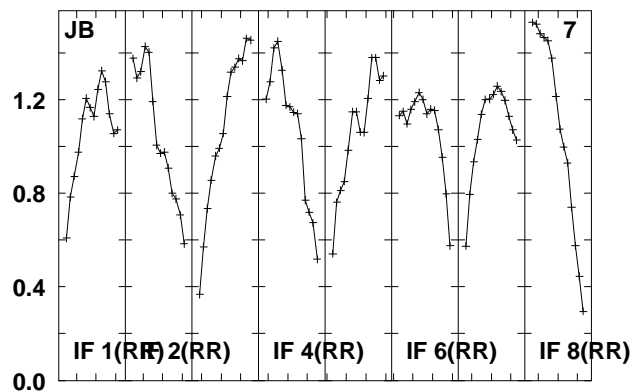
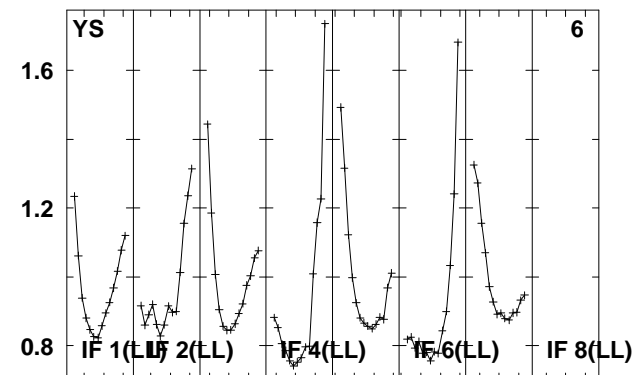
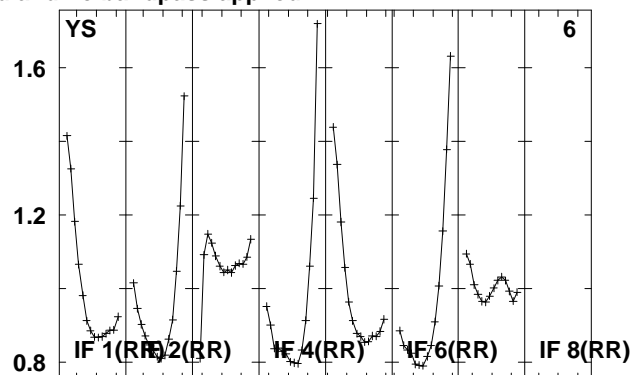
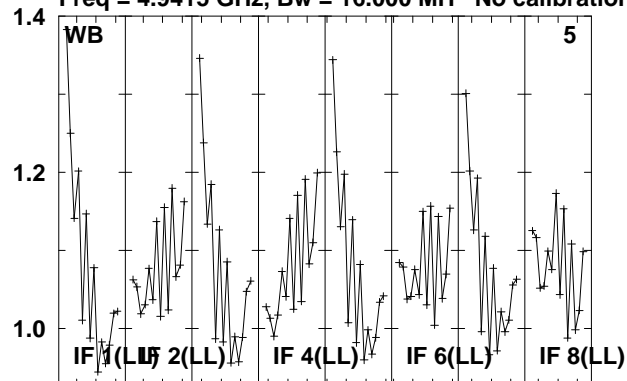

Lower frame: Real Jy
Total-power spectrum Antenna: *
Timerange: 00/21:19:00 to 00/21:20:58

Plot file version 232 created 08-JUL-2010 13:12:09

B1309+48 EM079.UVDATA.1

Freq = 4.9415 GHz, Bw = 16.000 MH No calibration applied and no bandpass applied

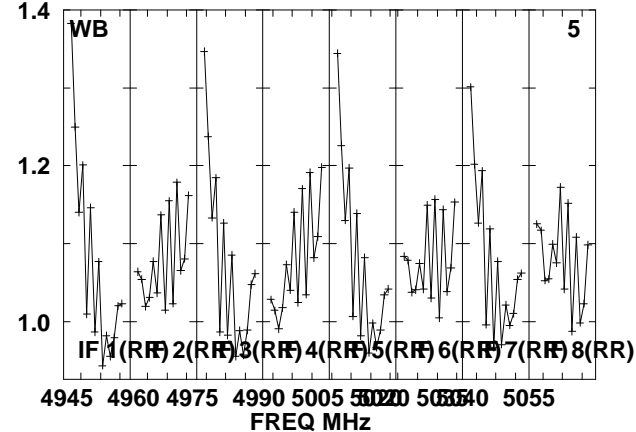
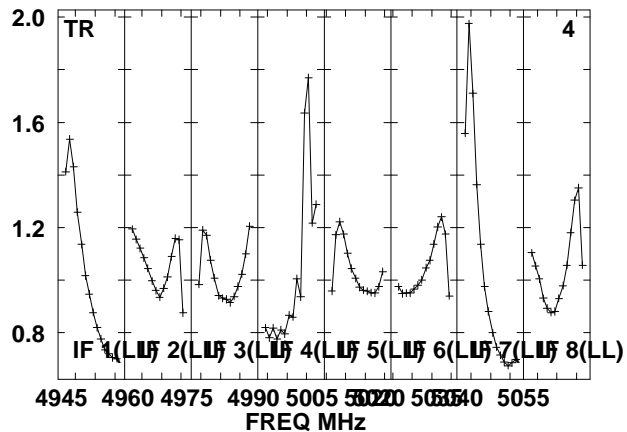
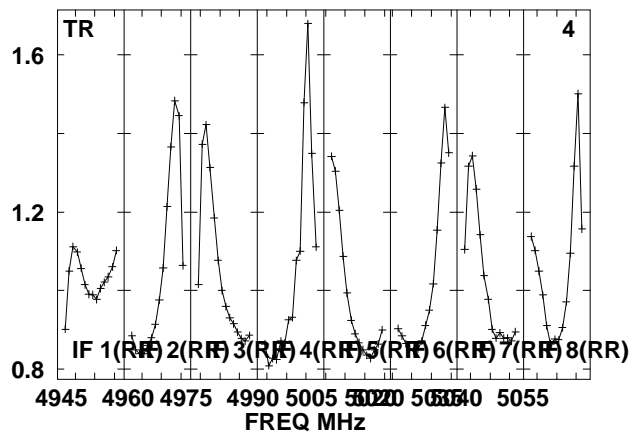
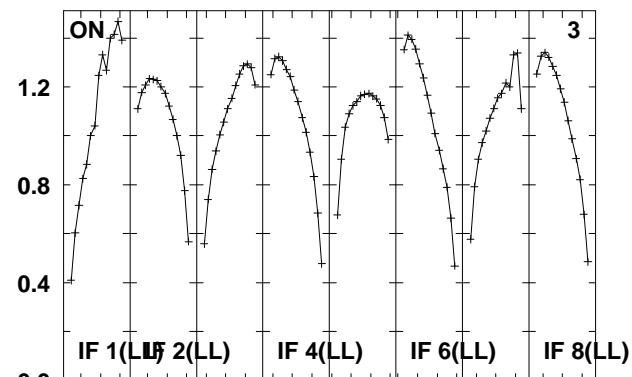
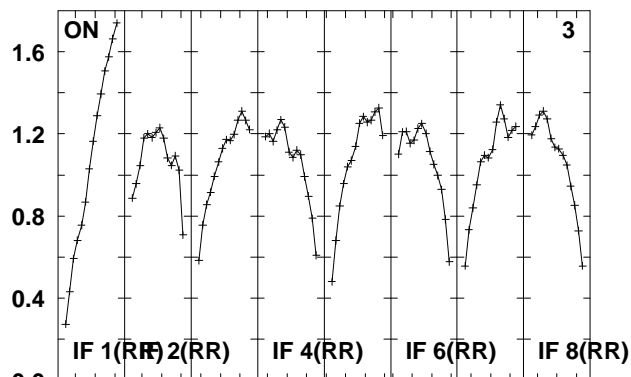
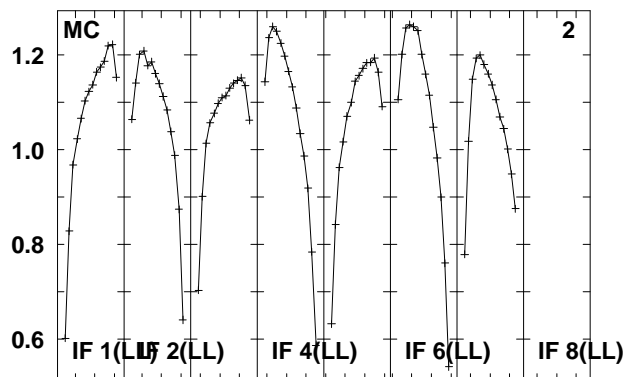
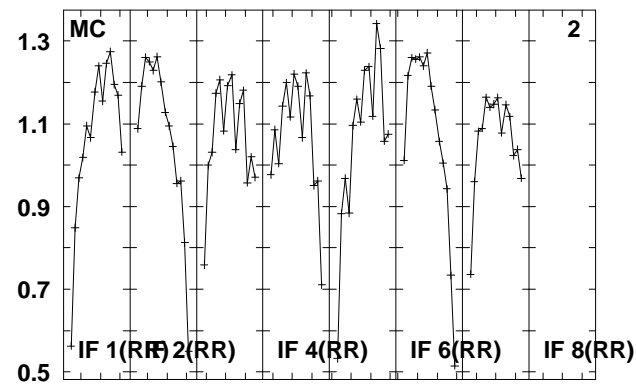
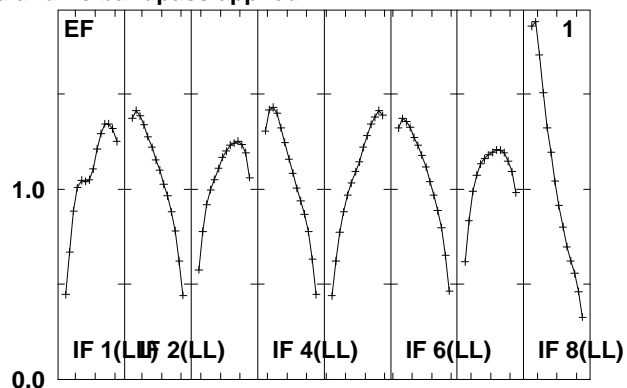
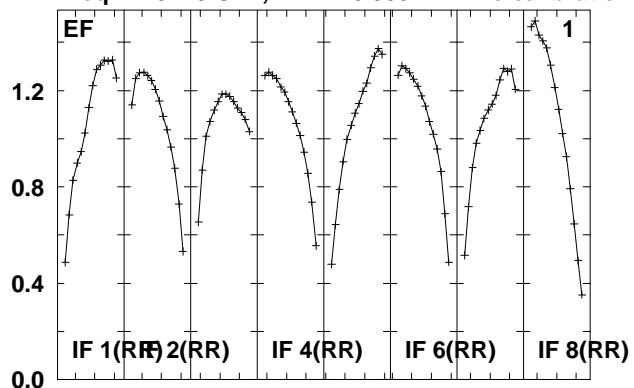

Lower frame: Real Jy
Total-power spectrum Antenna: *
Timerange: 00/21:21:00 to 00/21:31:44

Plot file version 233 created 08-JUL-2010 13:12:10

B1309+48 EM079.UVDATA.1

Freq = 4.9415 GHz, Bw = 16.000 MH No calibration applied and no bandpass applied

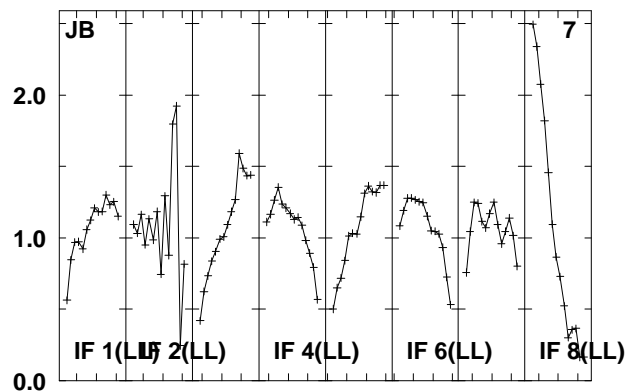
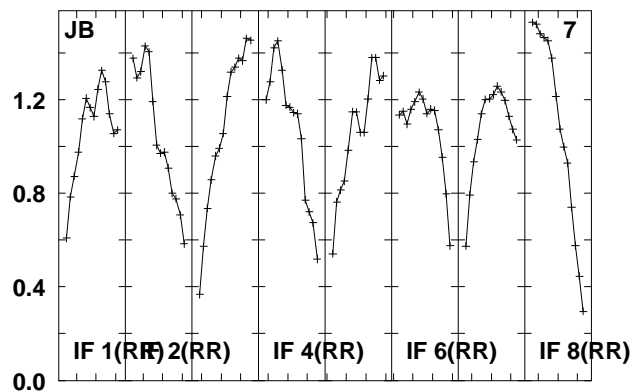
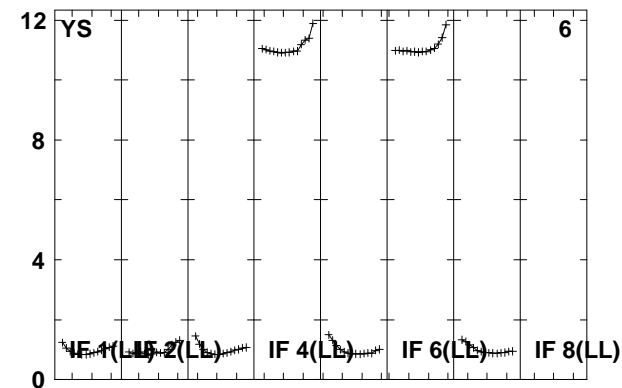
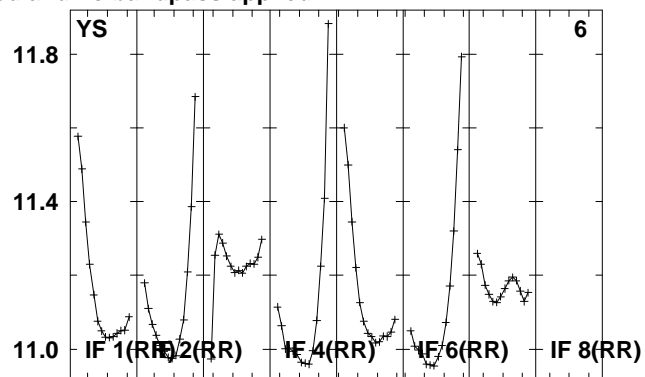
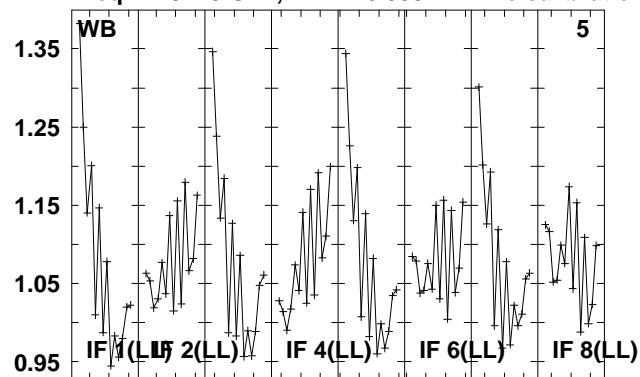

Lower frame: Real Jy
Total-power spectrum Antenna: *
Timerange: 00/21:21:00 to 00/21:31:44

Plot file version 234 created 08-JUL-2010 13:12:11

J1312+48 EM079.UVDATA.1

Freq = 4.9415 GHz, Bw = 16.000 MH No calibration applied and no bandpass applied

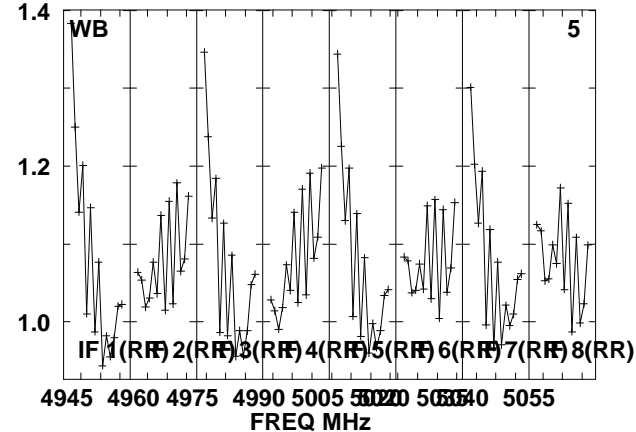
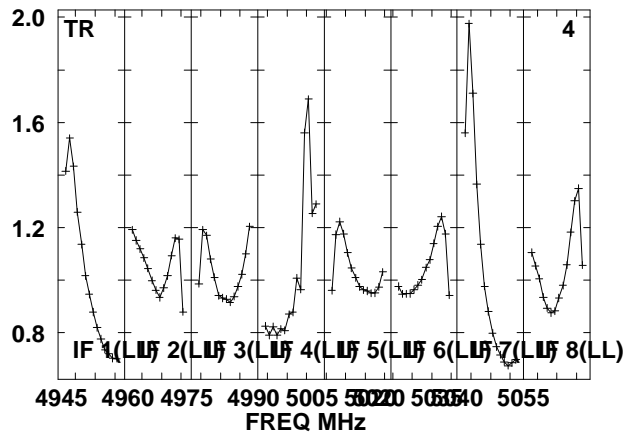
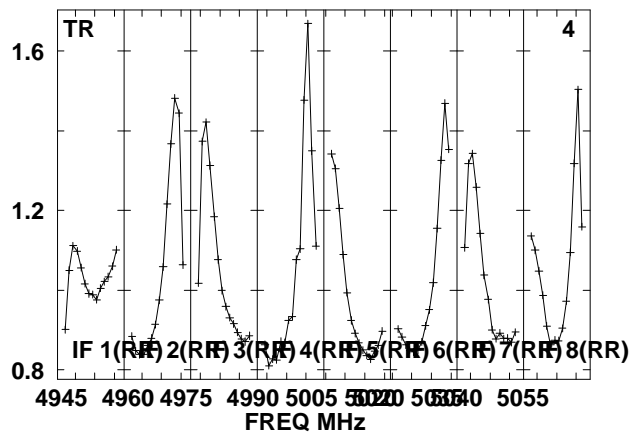
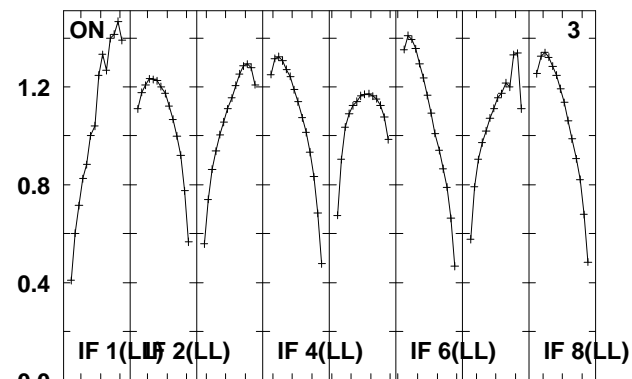
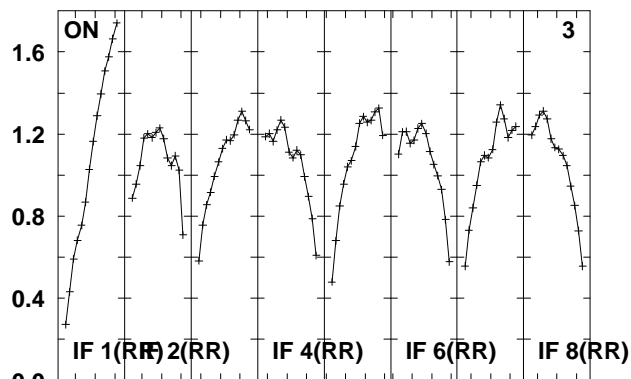
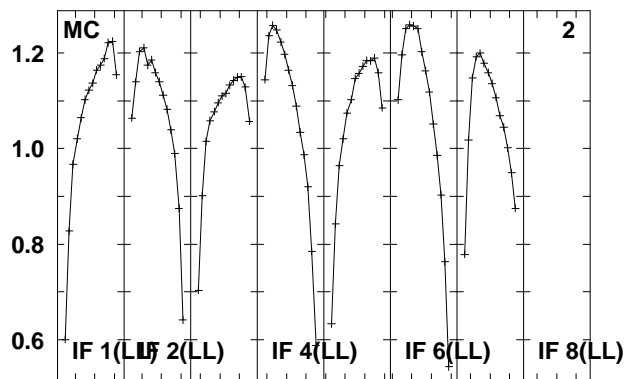
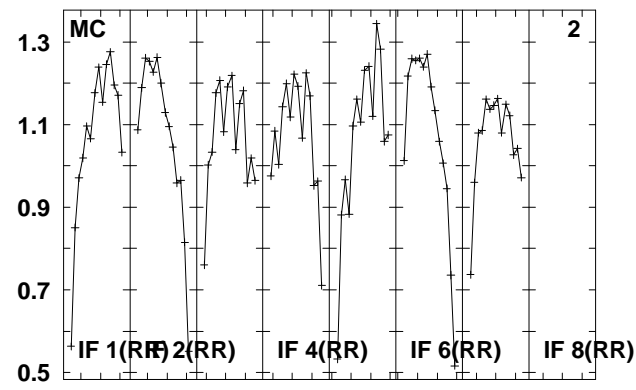
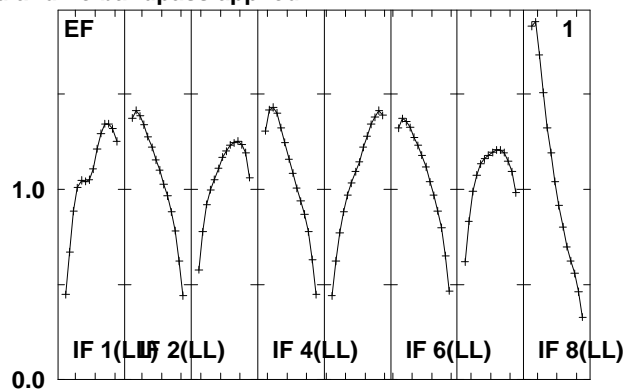
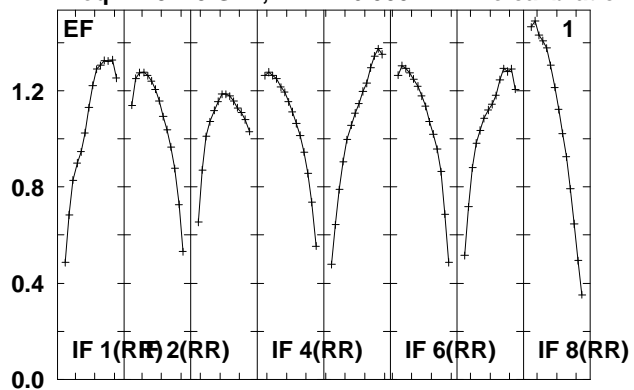

Lower frame: Real Jy
Total-power spectrum Antenna: *
Timerange: 00/21:31:46 to 00/21:33:44

Plot file version 235 created 08-JUL-2010 13:12:12

J1312+48 EM079.UVDATA.1

Freq = 4.9415 GHz, Bw = 16.000 MH No calibration applied and no bandpass applied

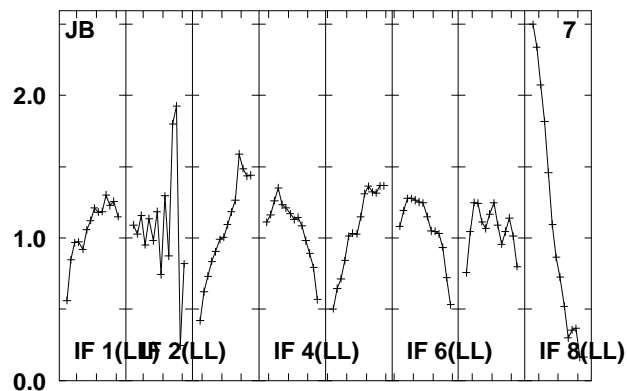
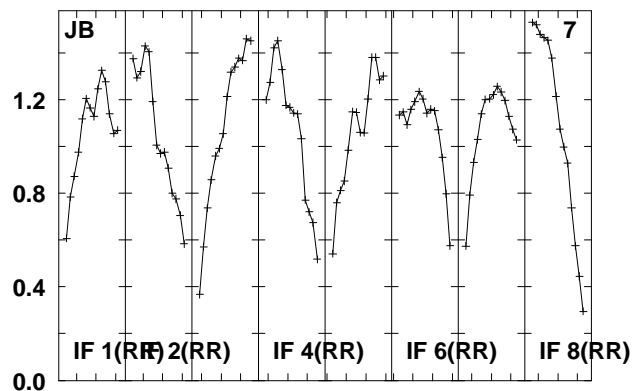
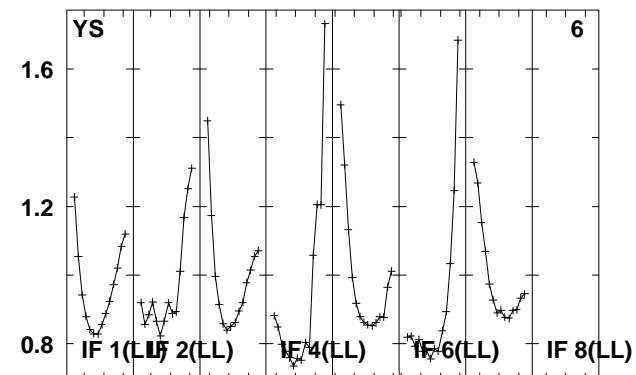
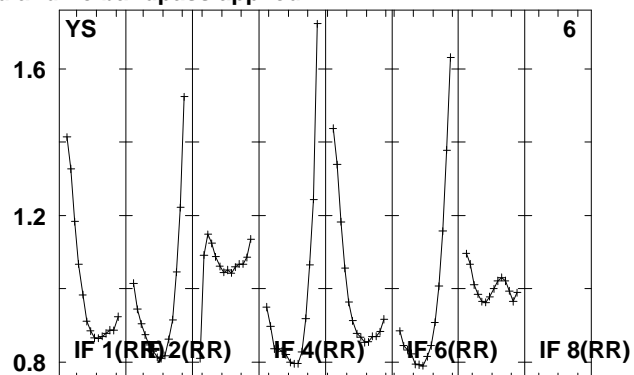
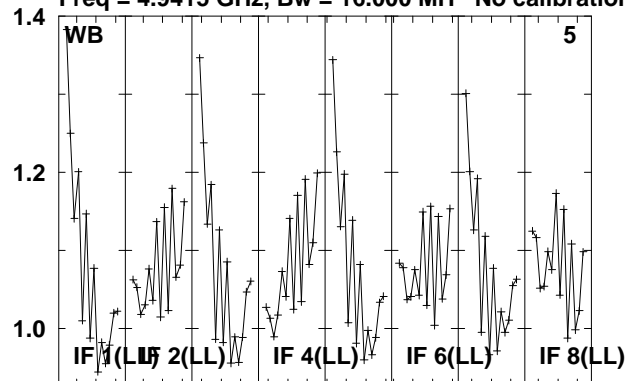

Lower frame: Real Jy
Total-power spectrum Antenna: *
Timerange: 00/21:31:46 to 00/21:33:44

Plot file version 236 created 08-JUL-2010 13:12:12

B1309+48 EM079.UVDATA.1

Freq = 4.9415 GHz, Bw = 16.000 MH No calibration applied and no bandpass applied

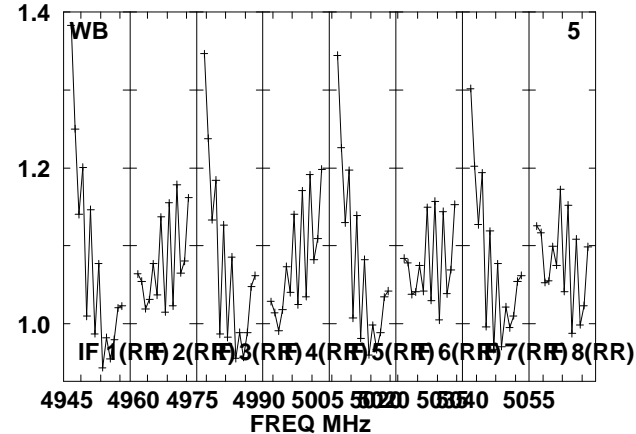
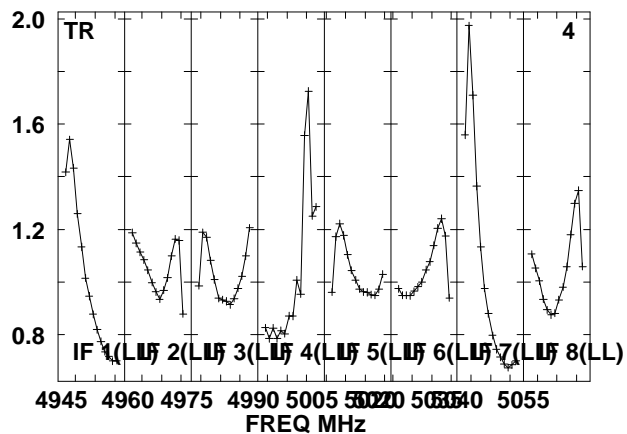
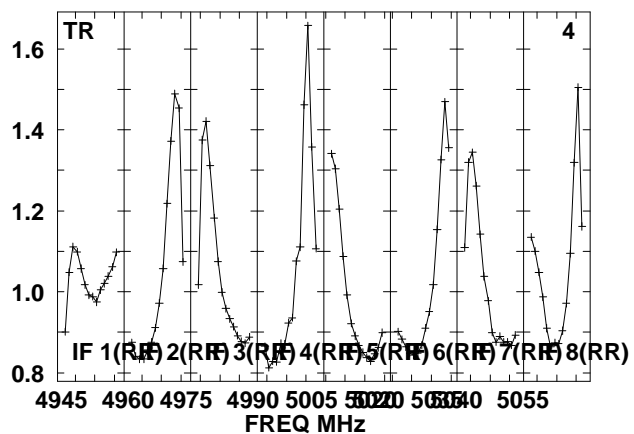
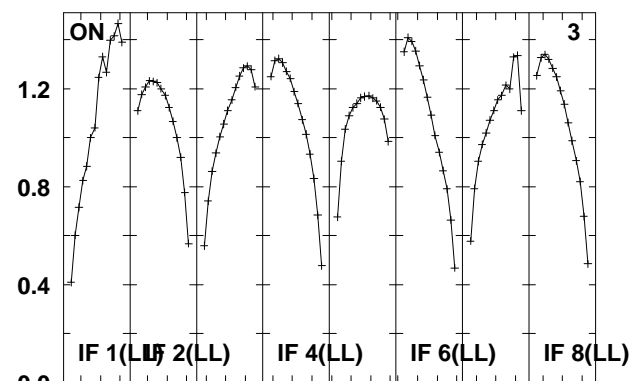
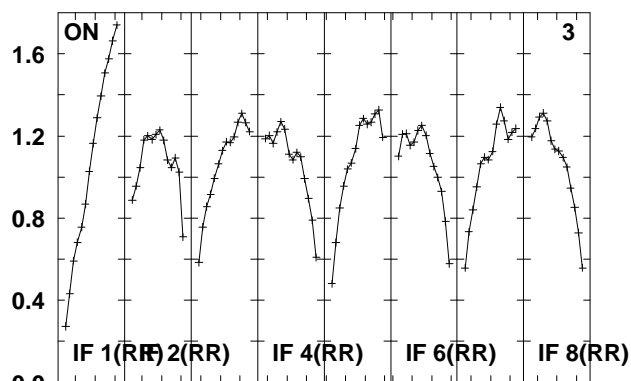
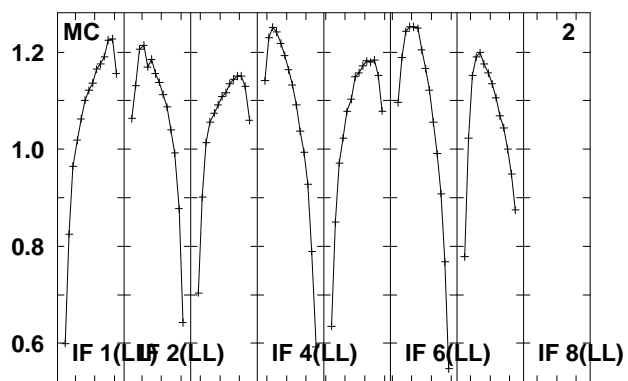
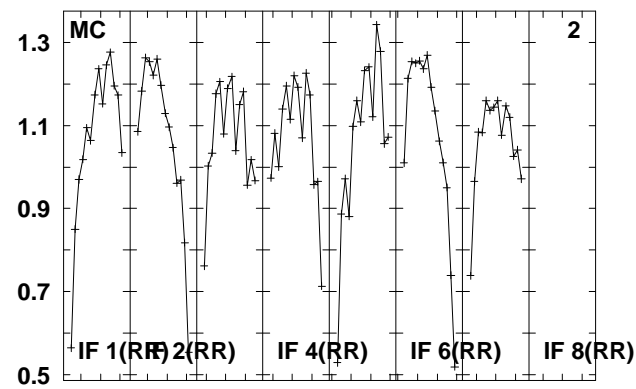
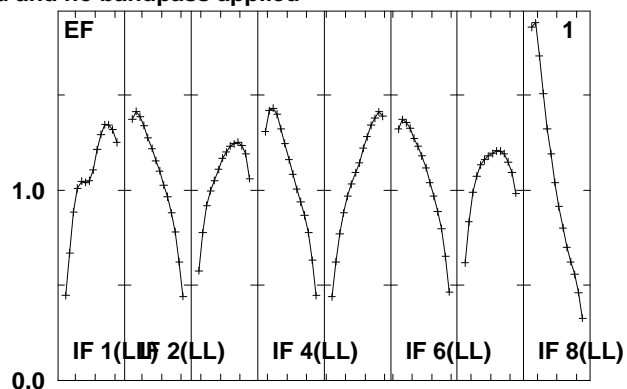
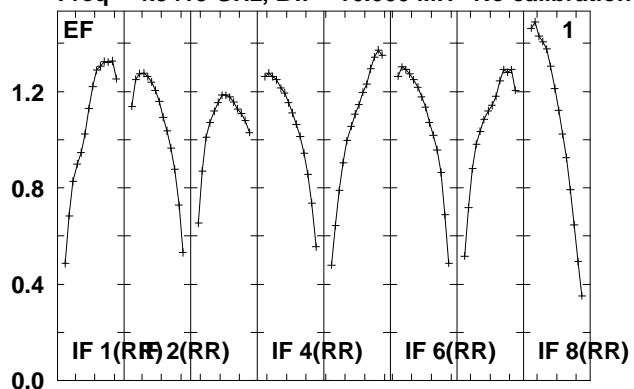

Lower frame: Real Jy
Total-power spectrum Antenna: *
Timerange: 00/21:33:46 to 00/21:44:28

Plot file version 237 created 08-JUL-2010 13:12:13

B1309+48 EM079.UVDATA.1

Freq = 4.9415 GHz, Bw = 16.000 MH No calibration applied and no bandpass applied

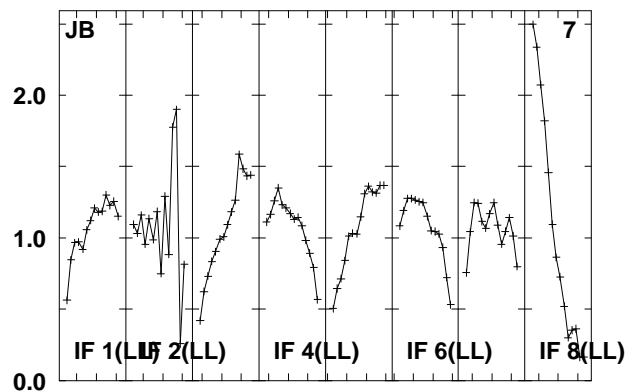
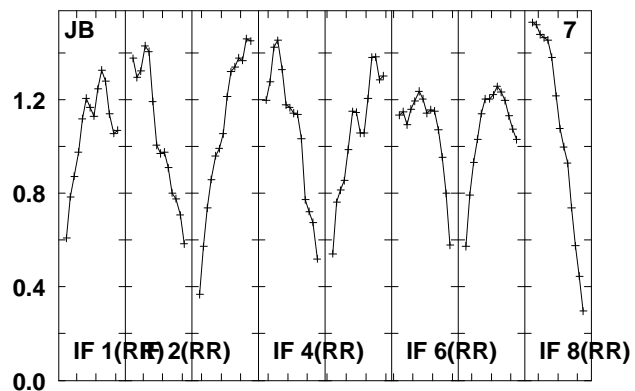
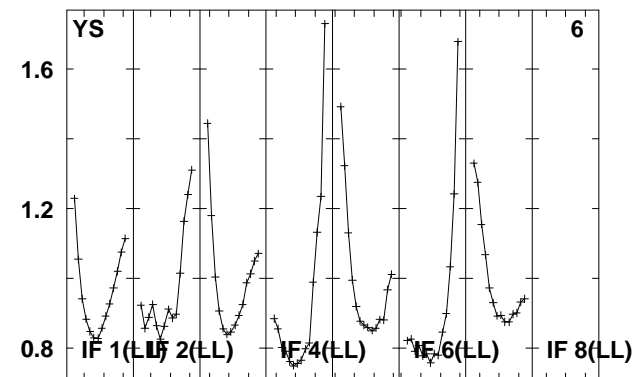
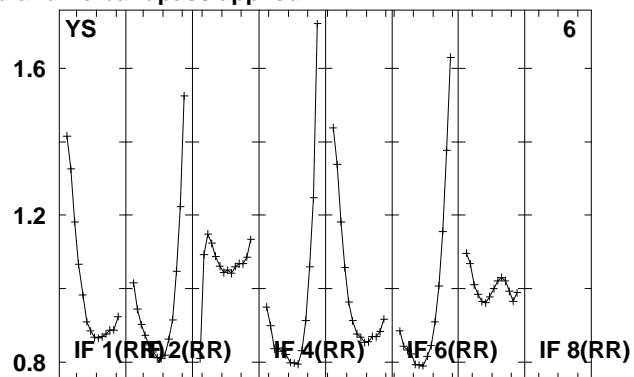
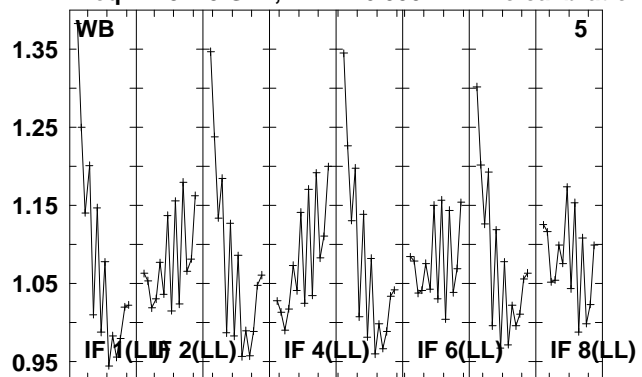

Lower frame: Real Jy
Total-power spectrum Antenna: *
Timerange: 00/21:33:46 to 00/21:44:28

Plot file version 238 created 08-JUL-2010 13:12:15

J1312+48 EM079.UVDATA.1

Freq = 4.9415 GHz, Bw = 16.000 MH No calibration applied and no bandpass applied

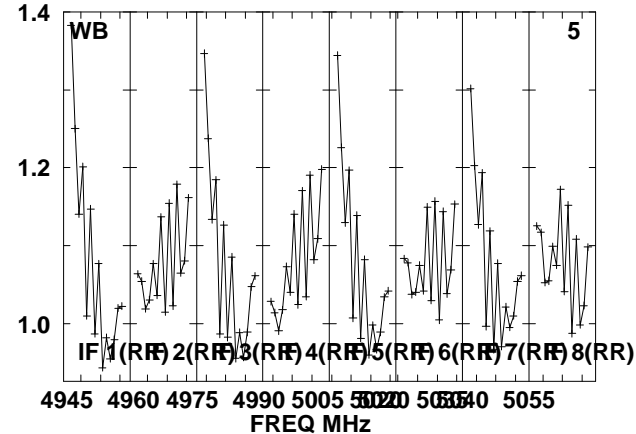
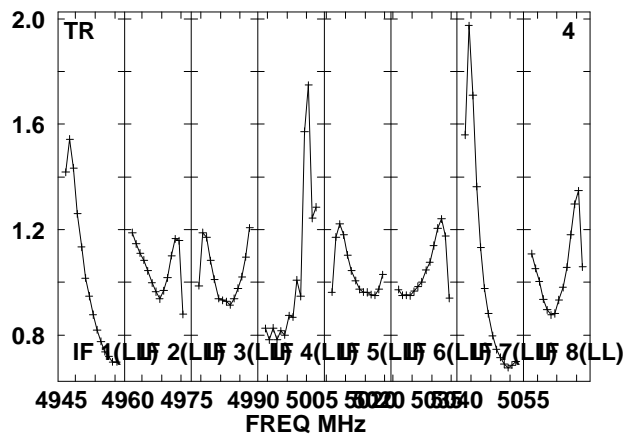
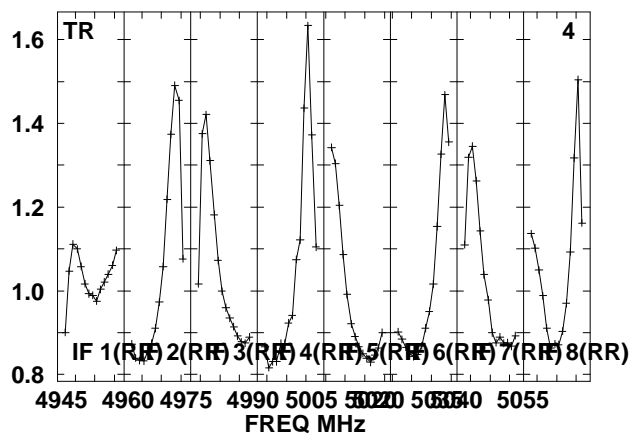
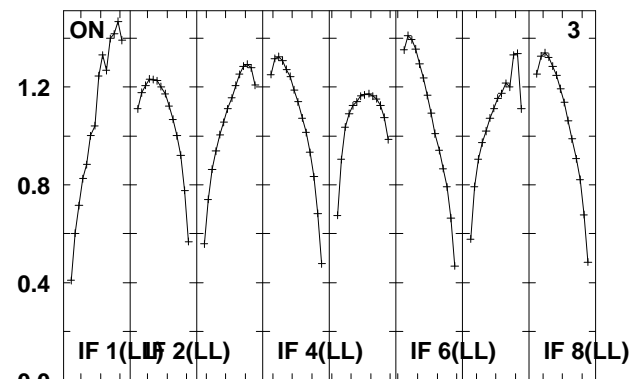
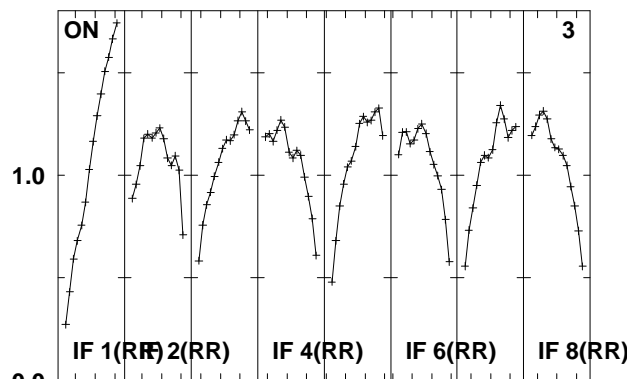
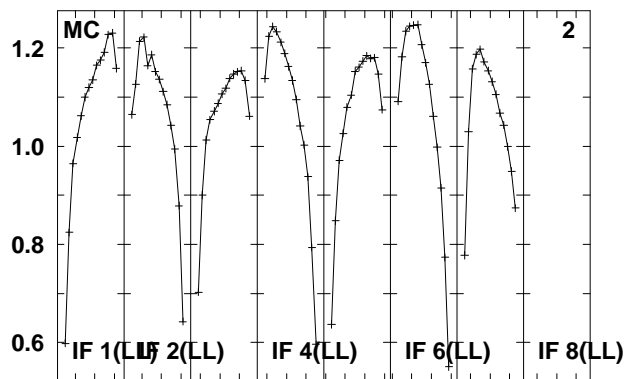
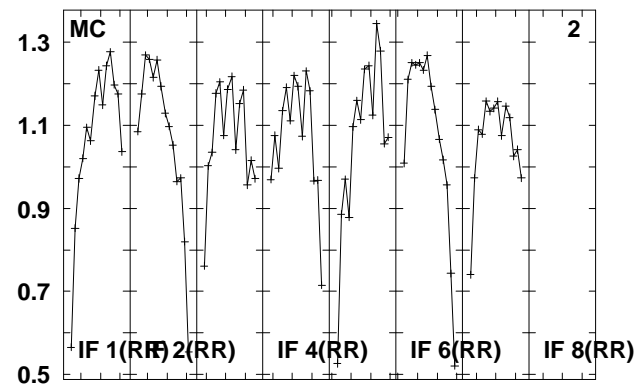
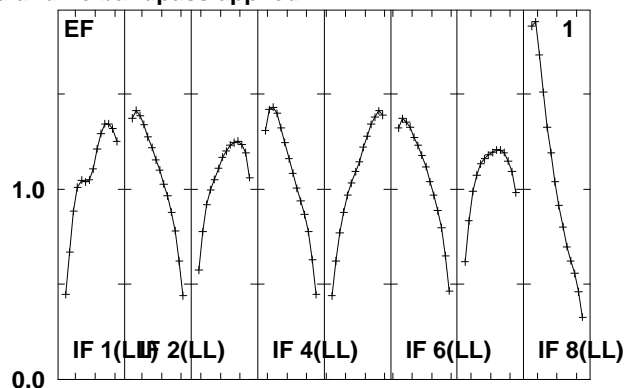
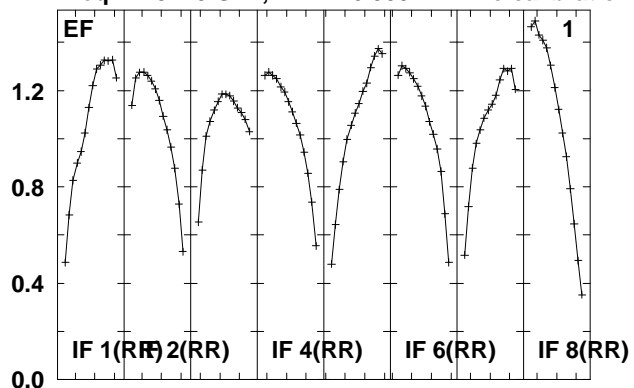

Lower frame: Real Jy
Total-power spectrum Antenna: *
Timerange: 00/21:44:30 to 00/21:46:28

Plot file version 239 created 08-JUL-2010 13:12:15

J1312+48 EM079.UVDATA.1

Freq = 4.9415 GHz, Bw = 16.000 MH No calibration applied and no bandpass applied

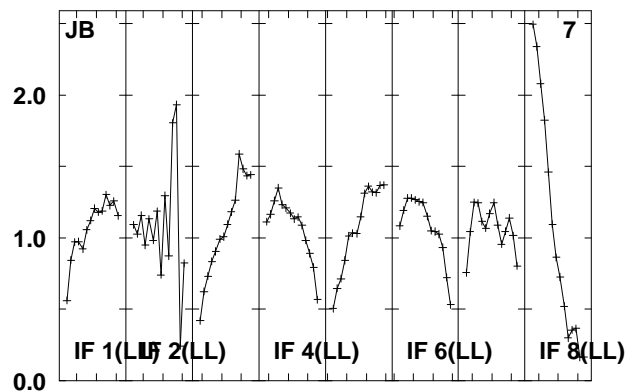
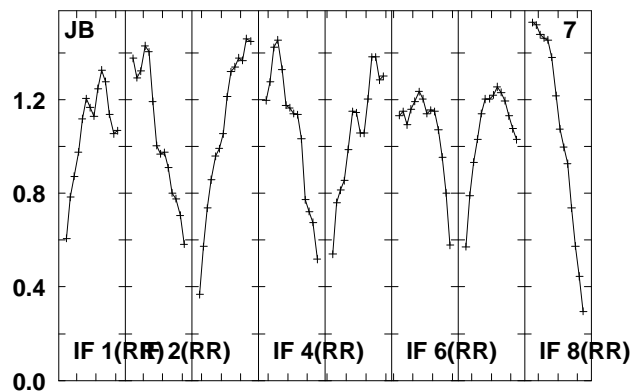
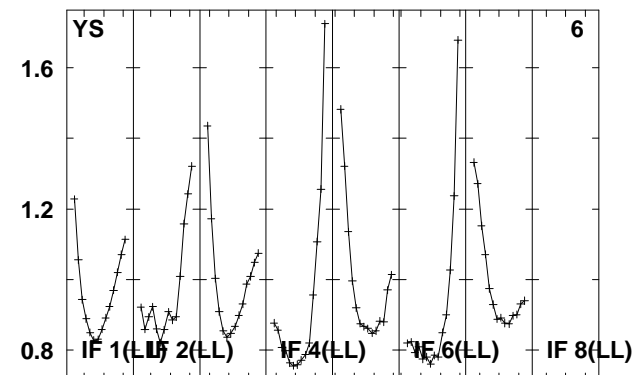
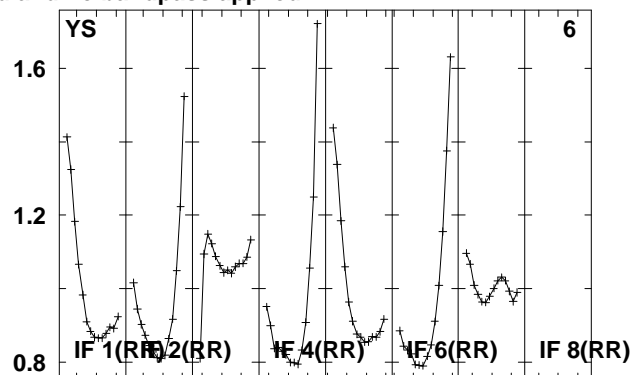
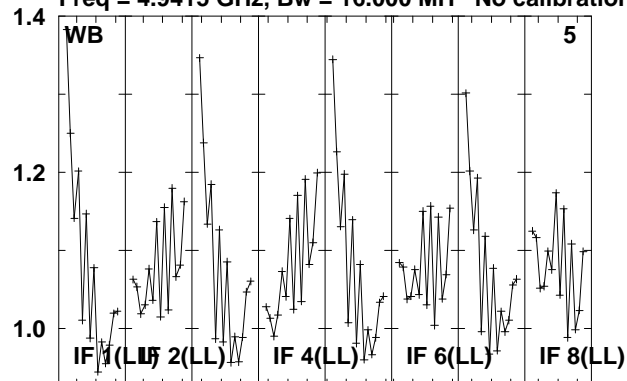

Lower frame: Real Jy
Total-power spectrum Antenna: *
Timerange: 00/21:44:30 to 00/21:46:28

Plot file version 240 created 08-JUL-2010 13:12:16

B1309+48 EM079.UVDATA.1

Freq = 4.9415 GHz, Bw = 16.000 MH No calibration applied and no bandpass applied

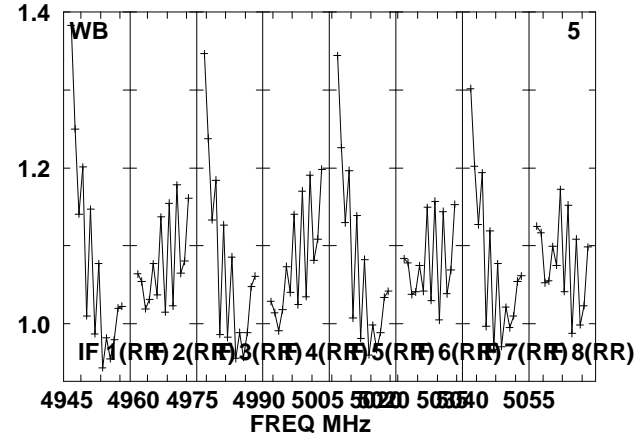
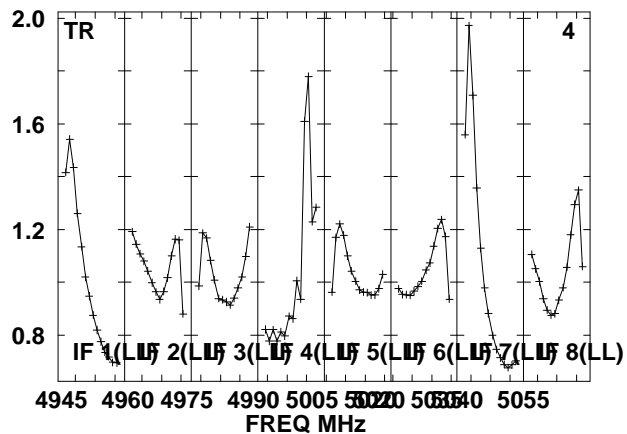
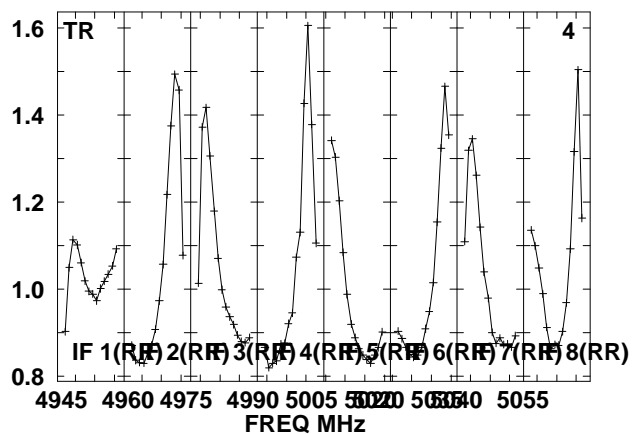
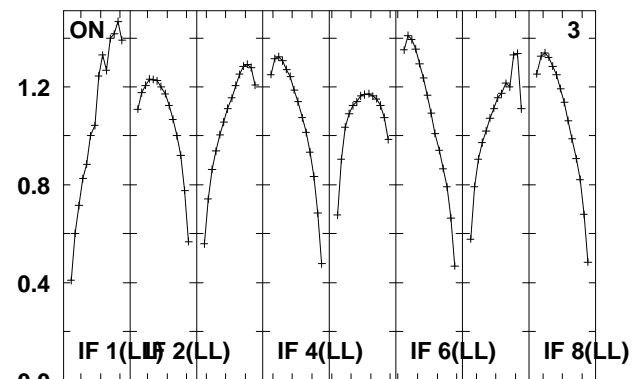
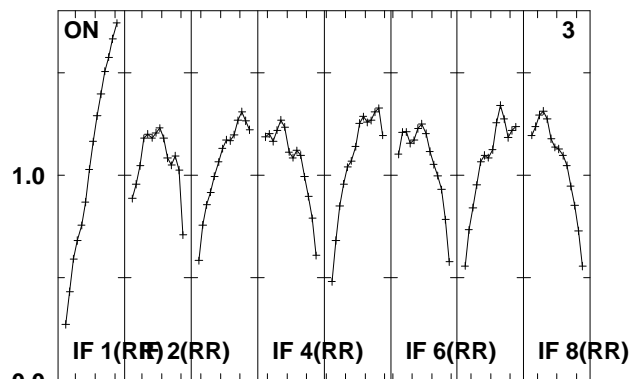
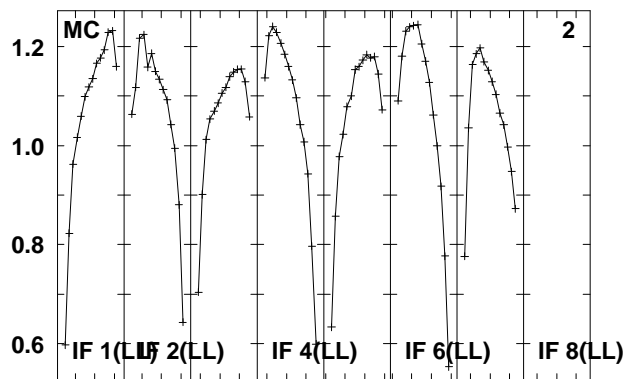
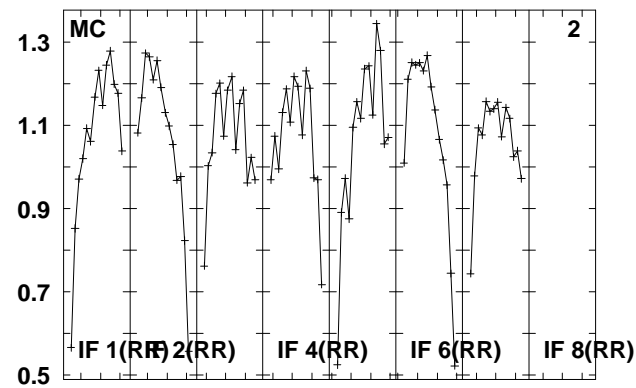
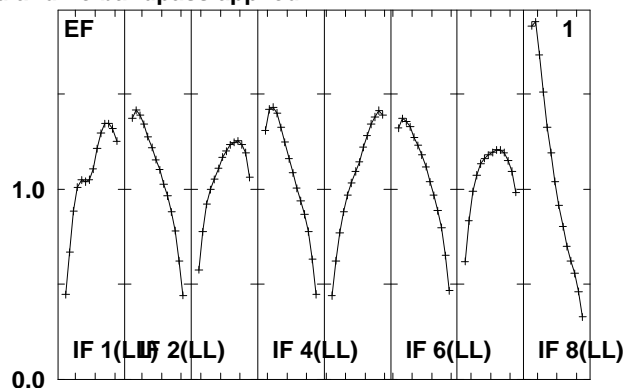
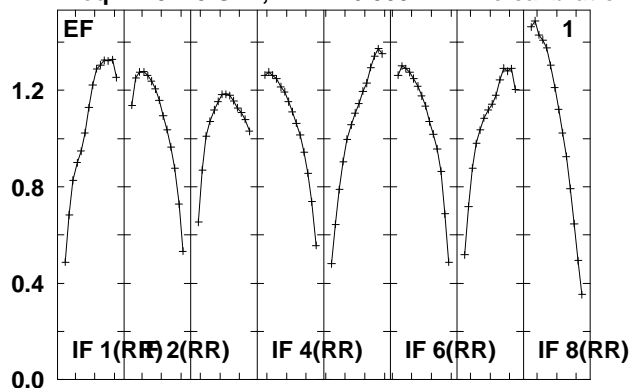

Lower frame: Real Jy

Total-power spectrum Antenna: *

Timerange: 00/21:46:30 to 00/21:57:14

Plot file version 241 created 08-JUL-2010 13:12:17

B1309+48 EM079.UVDATA.1

Freq = 4.9415 GHz, Bw = 16.000 MH No calibration applied and no bandpass applied

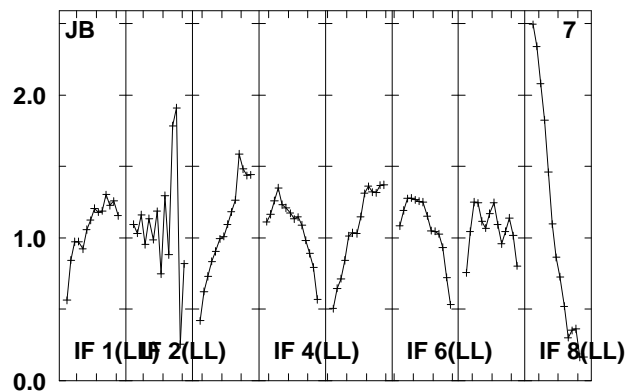
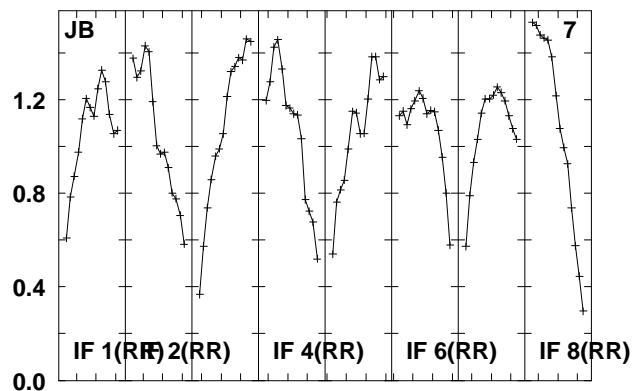
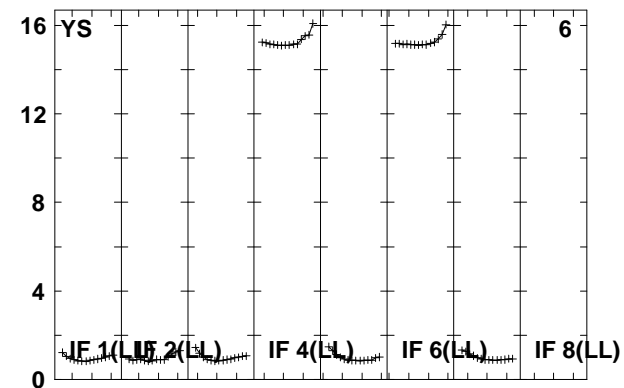
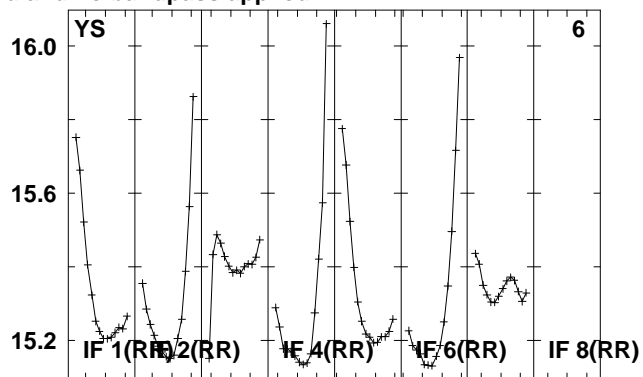
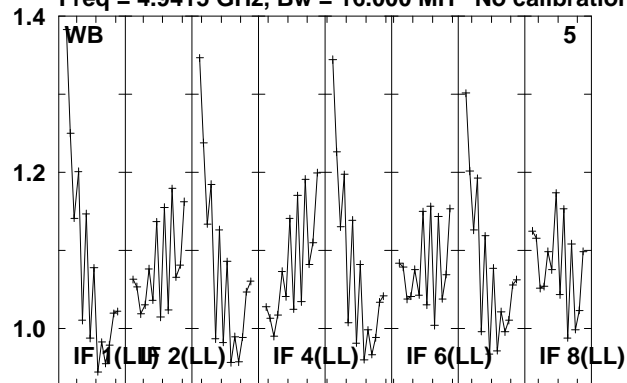

Lower frame: Real Jy
Total-power spectrum Antenna: *
Timerange: 00/21:46:30 to 00/21:57:14

Plot file version 242 created 08-JUL-2010 13:12:20

J1312+48 EM079.UVDATA.1

Freq = 4.9415 GHz, Bw = 16.000 MH No calibration applied and no bandpass applied

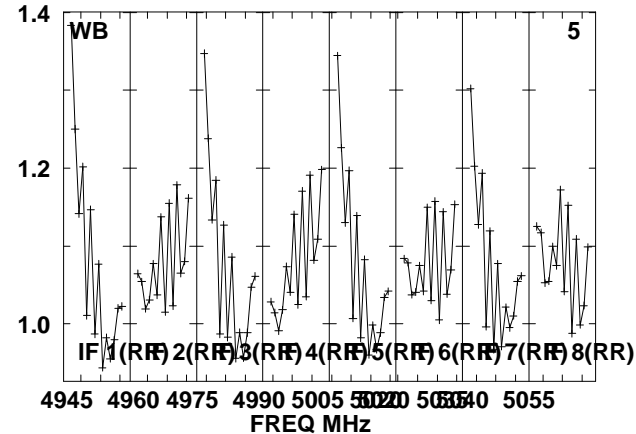
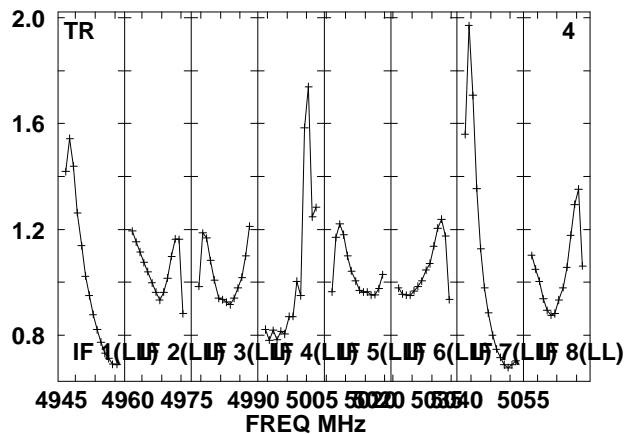
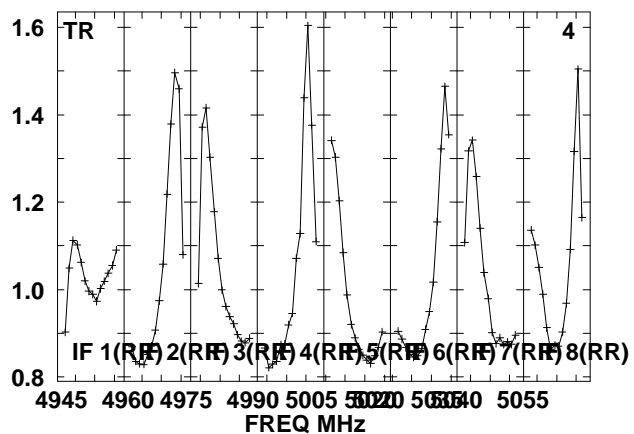
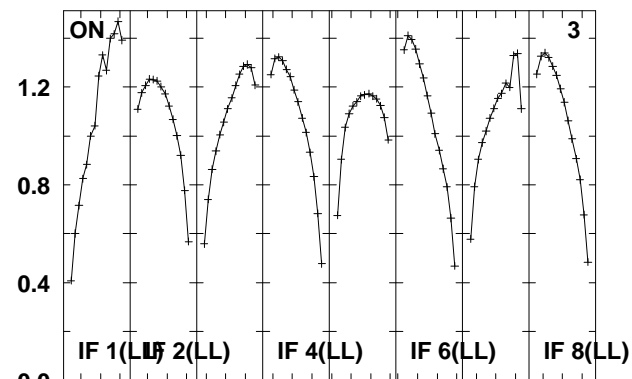
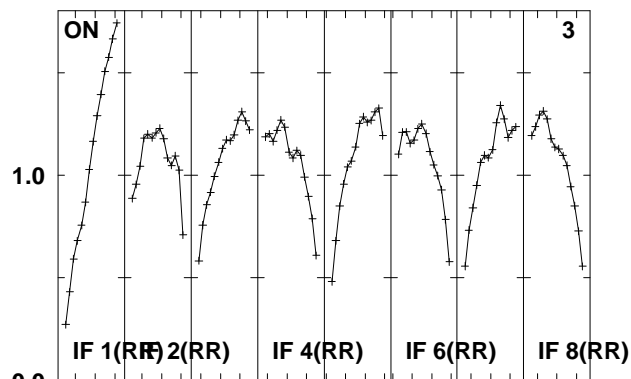
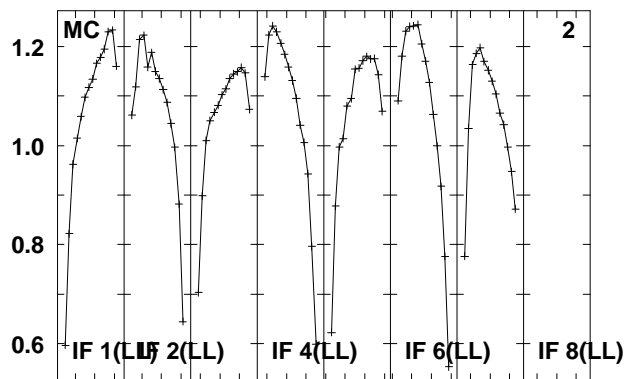
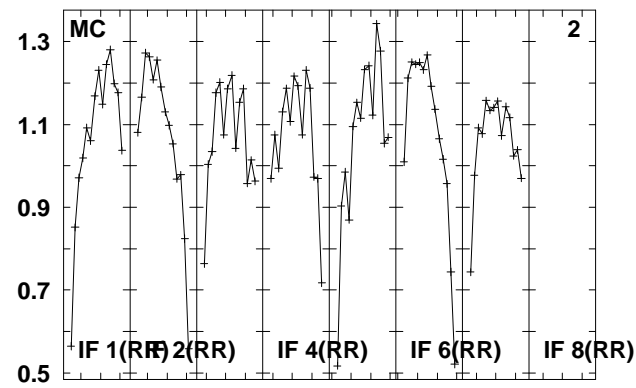
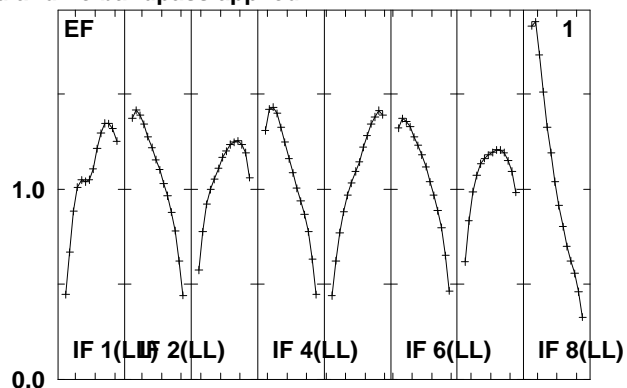
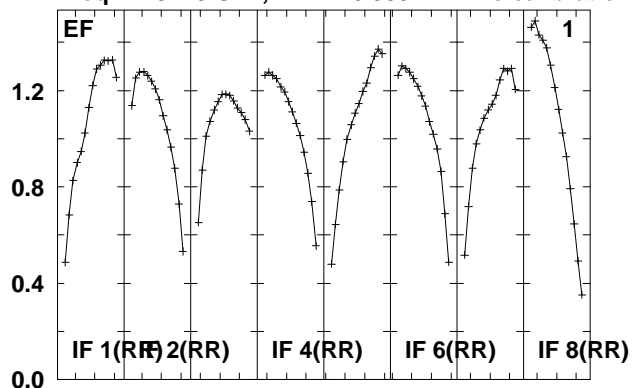

Lower frame: Real Jy

Total-power spectrum Antenna: *

Timerange: 00/21:57:16 to 00/21:59:14

Plot file version 243 created 08-JUL-2010 13:12:21

J1312+48 EM079.UVDATA.1

Freq = 4.9415 GHz, Bw = 16.000 MH No calibration applied and no bandpass applied

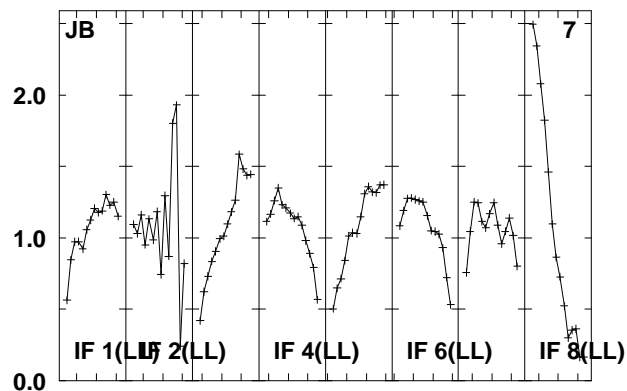
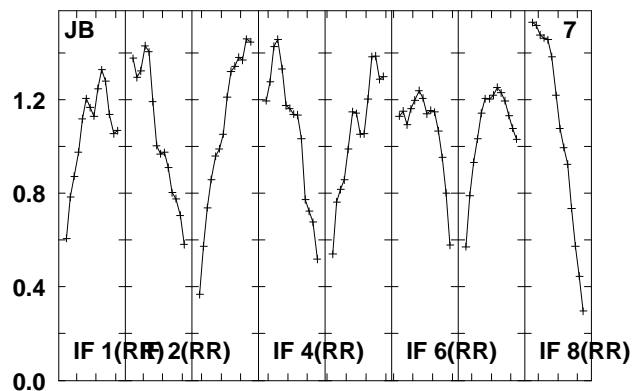
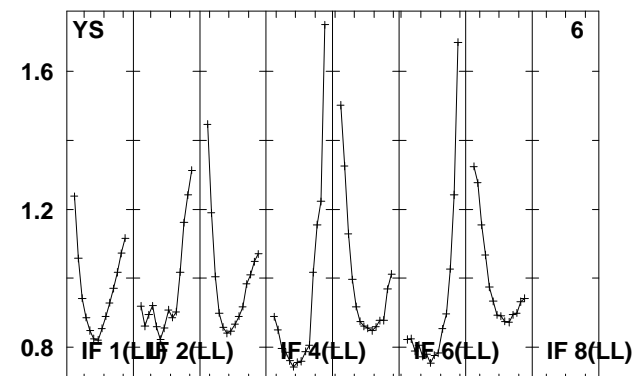
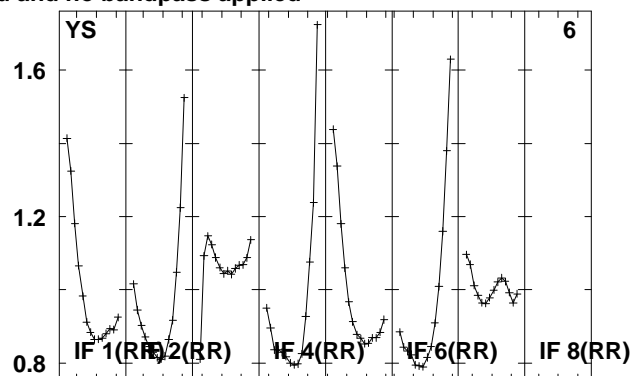
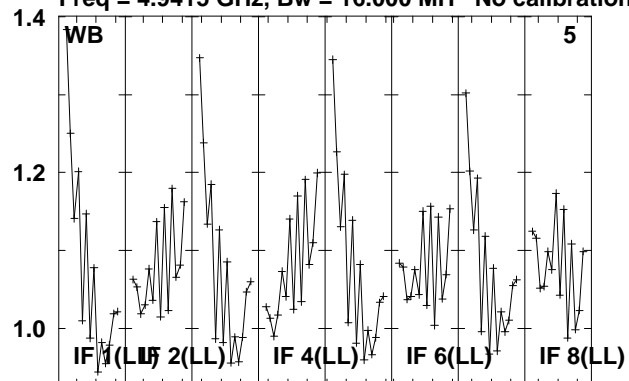

Lower frame: Real Jy
Total-power spectrum Antenna: *
Timerange: 00/21:57:16 to 00/21:59:14

Plot file version 244 created 08-JUL-2010 13:12:21

B1309+48 EM079.UVDATA.1

Freq = 4.9415 GHz, Bw = 16.000 MH No calibration applied and no bandpass applied

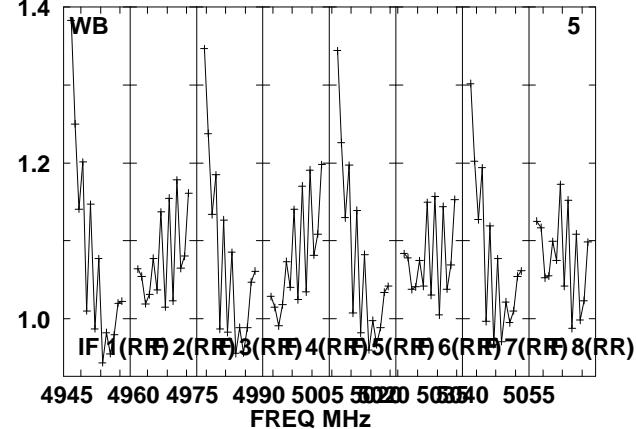
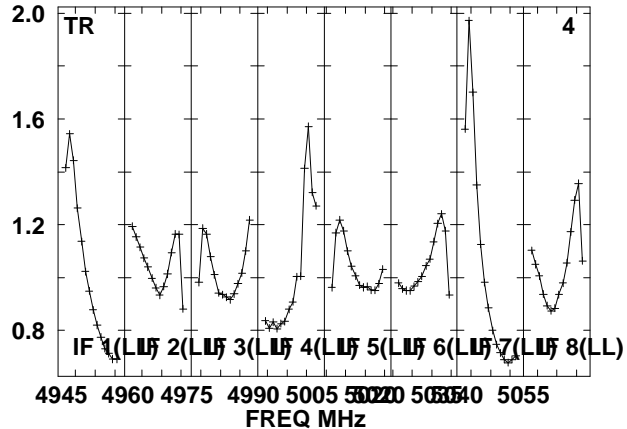
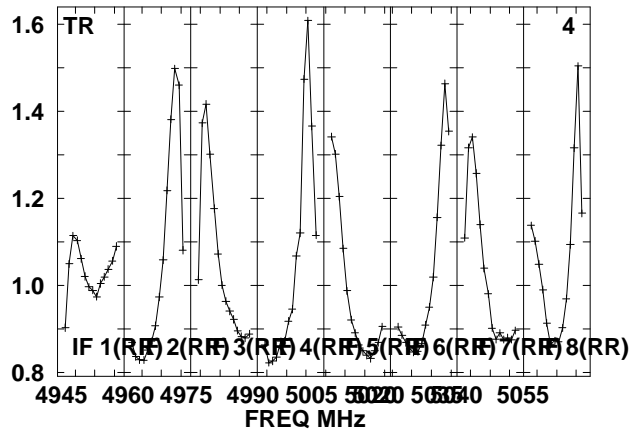
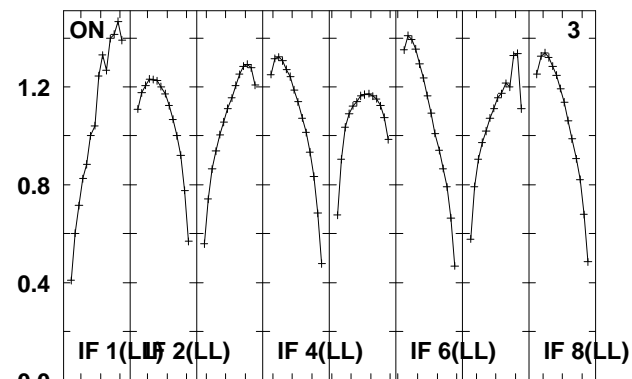
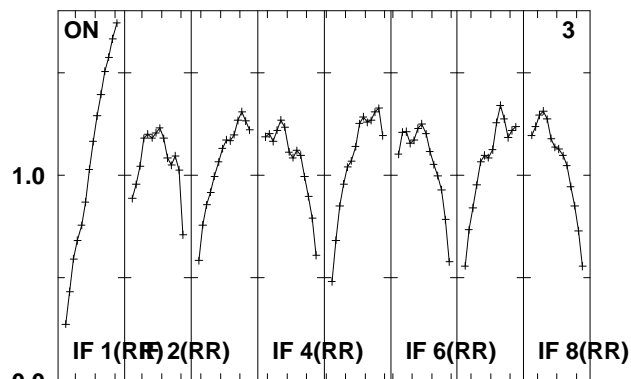
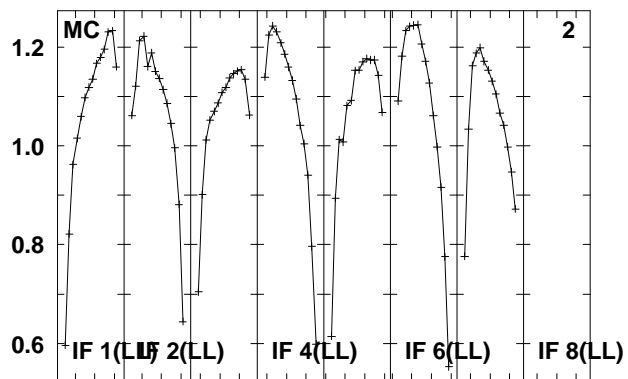
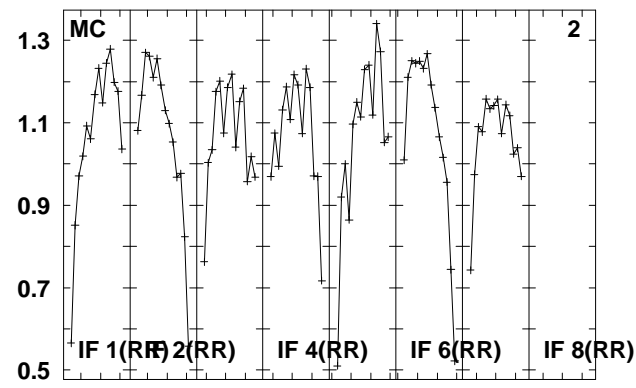
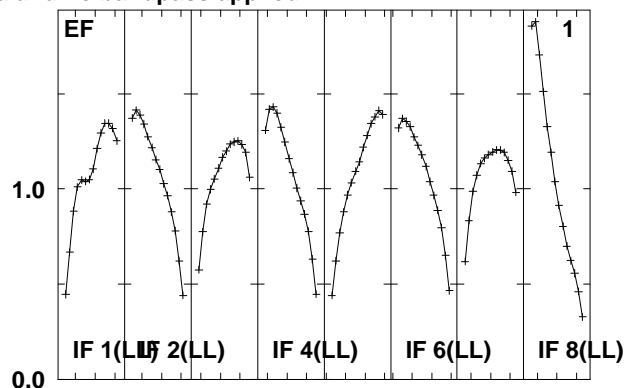
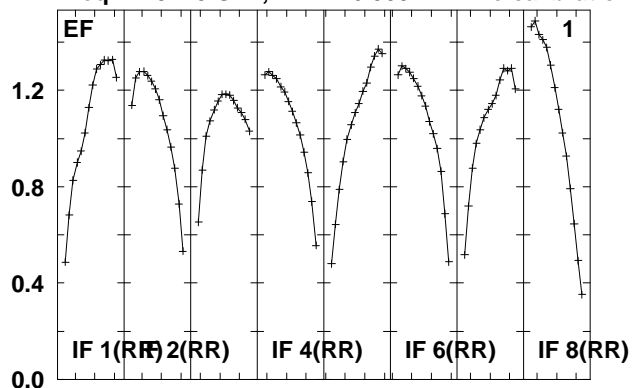

Lower frame: Real Jy
Total-power spectrum Antenna: *
Timerange: 00/21:59:16 to 00/22:09:58

Plot file version 245 created 08-JUL-2010 13:12:22

B1309+48 EM079.UVDATA.1

Freq = 4.9415 GHz, Bw = 16.000 MH No calibration applied and no bandpass applied

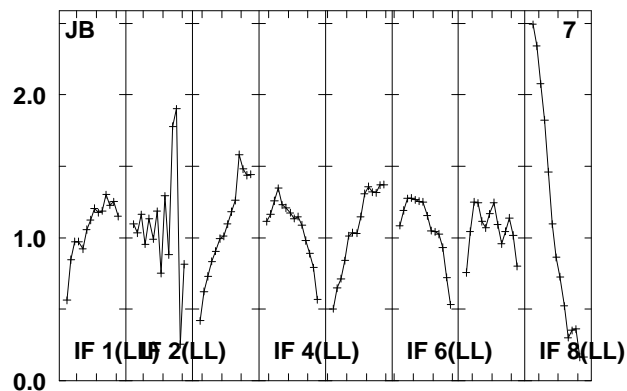
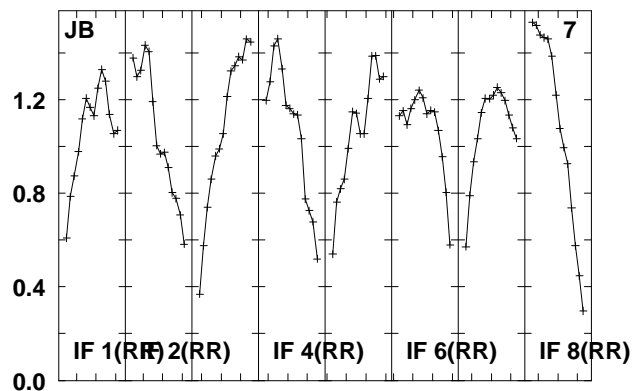
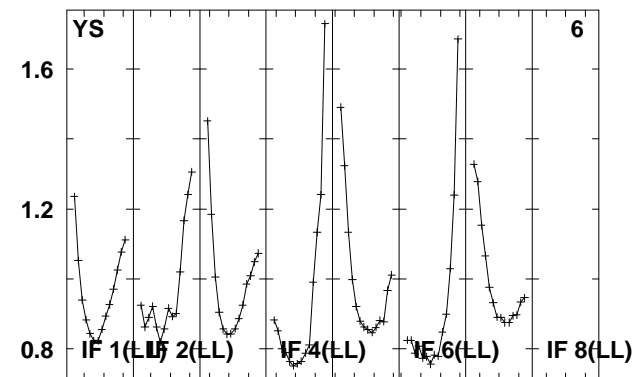
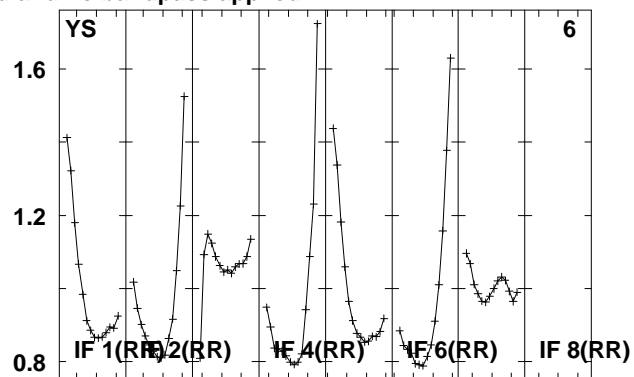
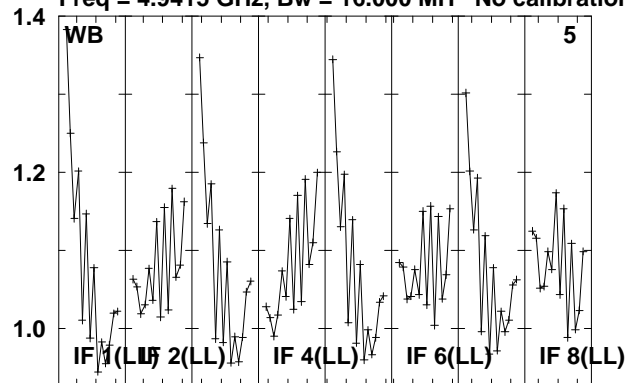

Lower frame: Real Jy
Total-power spectrum Antenna: *
Timerange: 00/21:59:16 to 00/22:09:58

Plot file version 246 created 08-JUL-2010 13:12:24

J1312+48 EM079.UVDATA.1

Freq = 4.9415 GHz, Bw = 16.000 MH No calibration applied and no bandpass applied

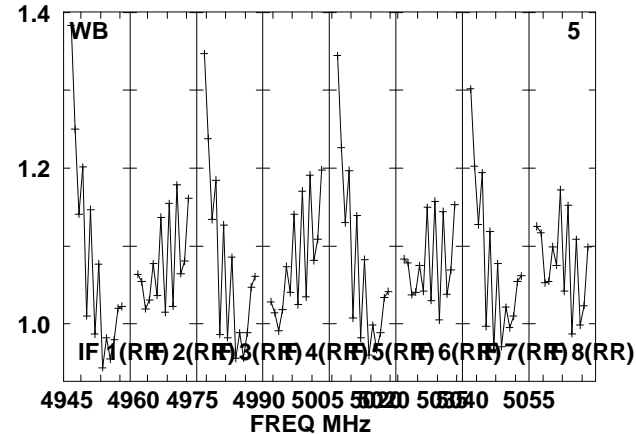
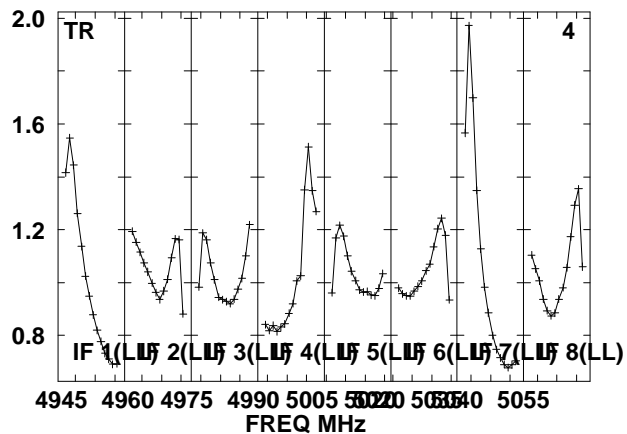
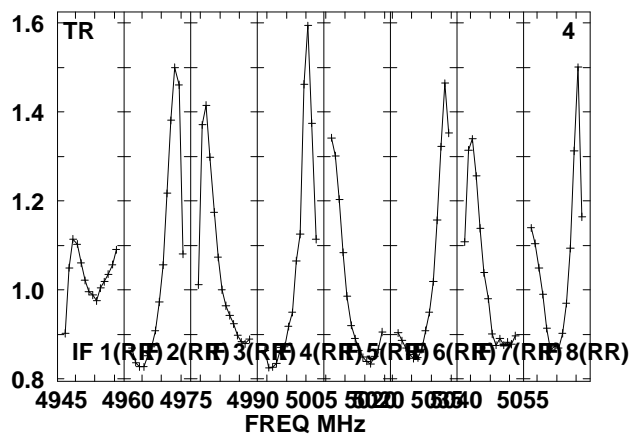
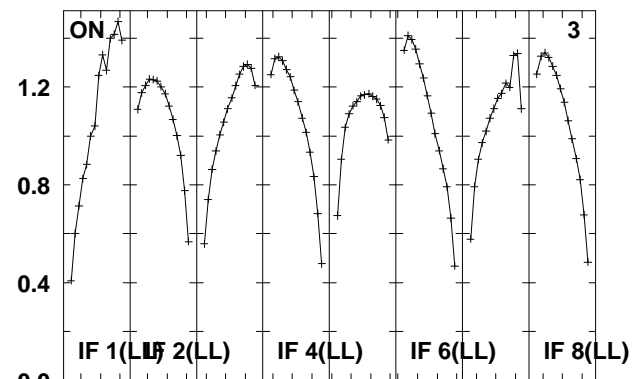
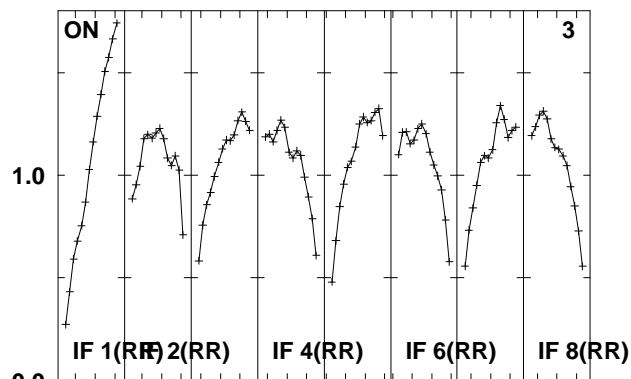
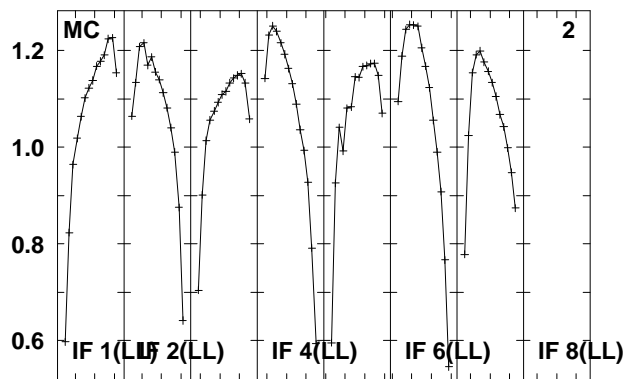
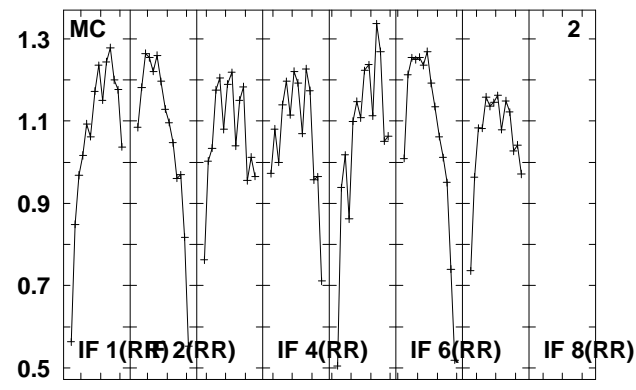
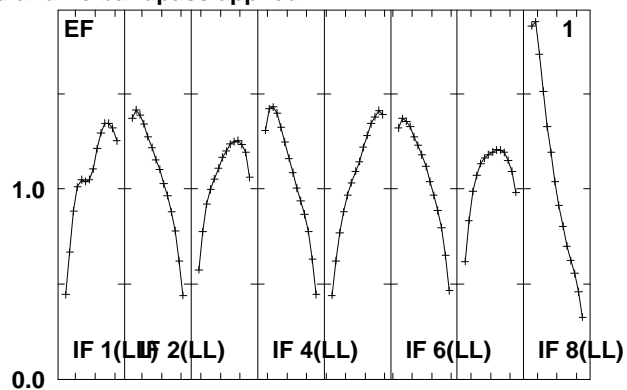
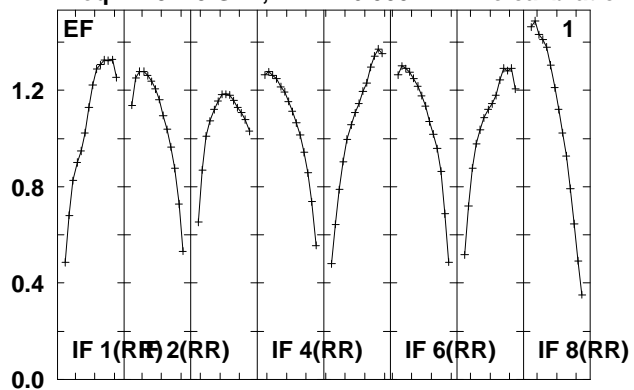

Lower frame: Real Jy
Total-power spectrum Antenna: *
Timerange: 00/22:10:00 to 00/22:11:58

Plot file version 247 created 08-JUL-2010 13:12:24

J1312+48 EM079.UVDATA.1

Freq = 4.9415 GHz, Bw = 16.000 MH No calibration applied and no bandpass applied

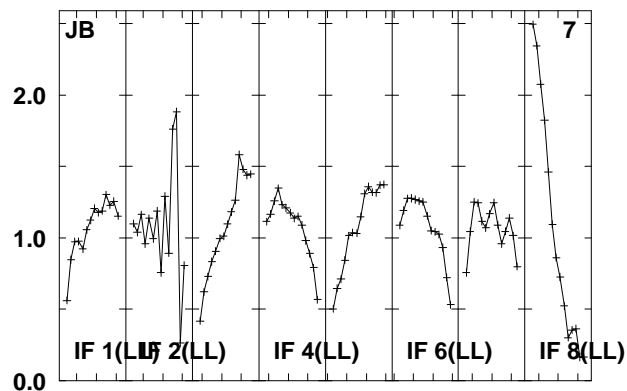
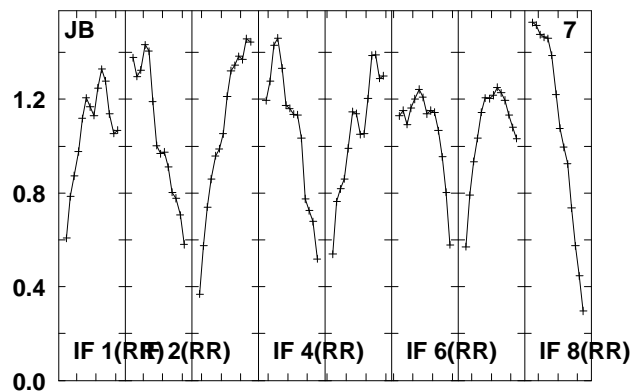
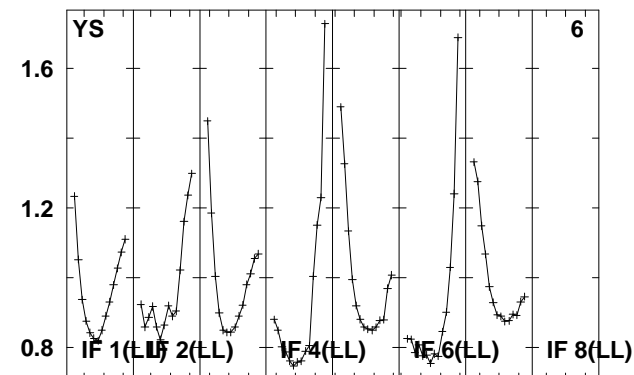
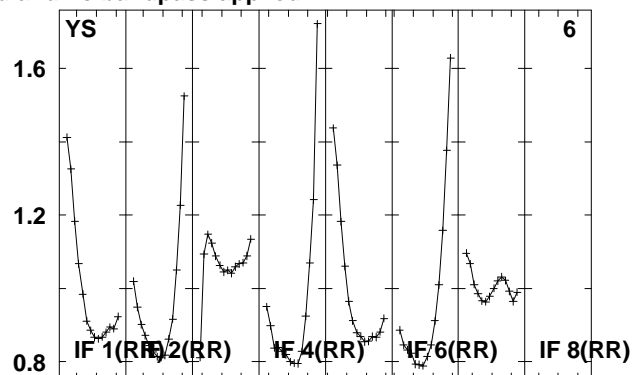
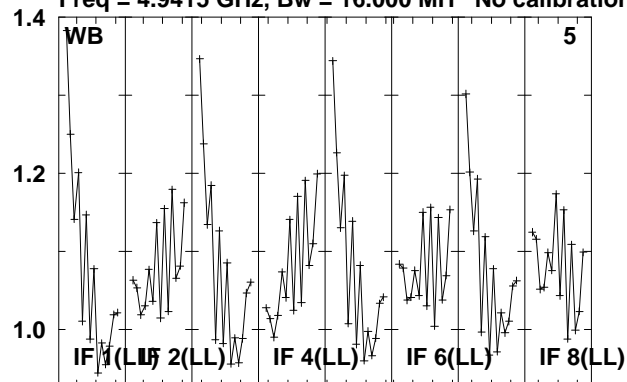

Lower frame: Real Jy
Total-power spectrum Antenna: *
Timerange: 00/22:10:00 to 00/22:11:58

Plot file version 248 created 08-JUL-2010 13:12:25

B1309+48 EM079.UVDATA.1

Freq = 4.9415 GHz, Bw = 16.000 MH No calibration applied and no bandpass applied

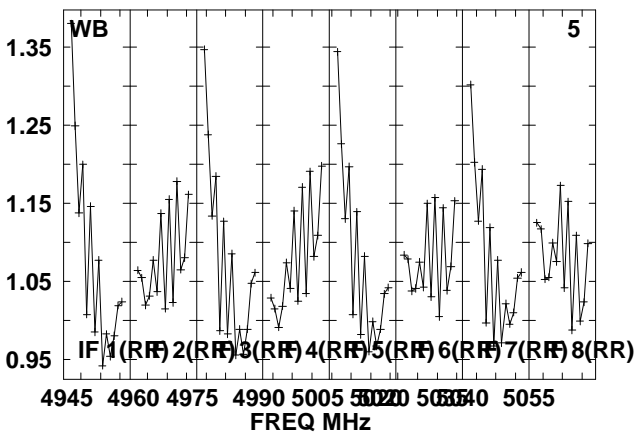
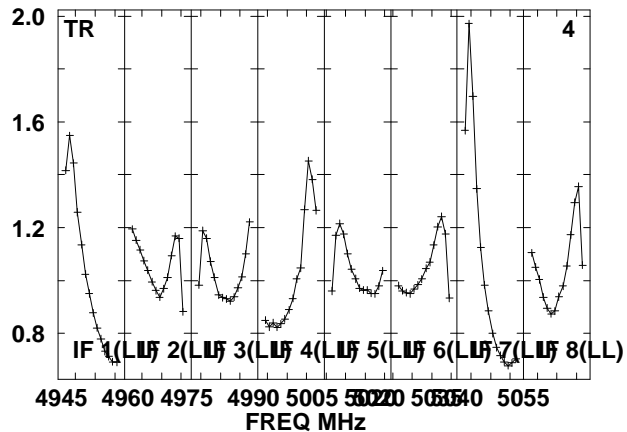
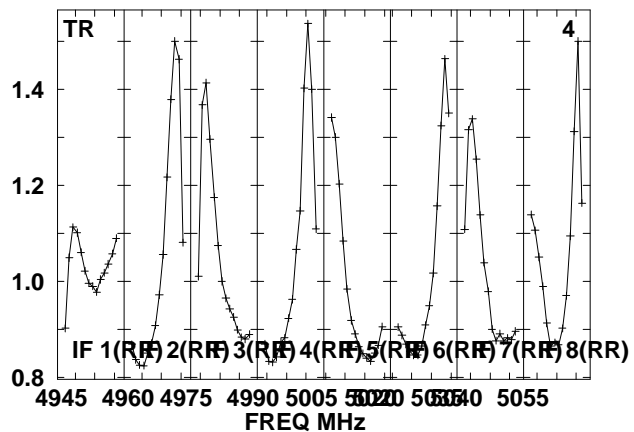
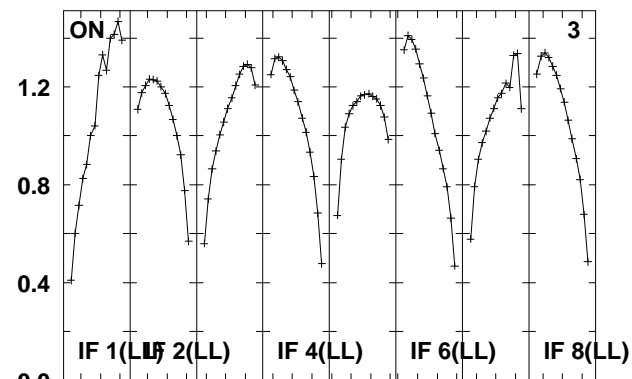
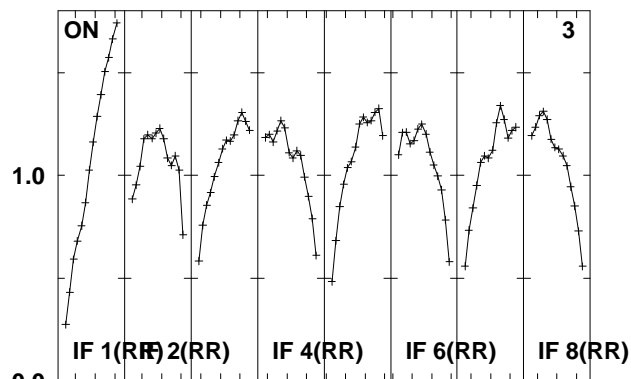
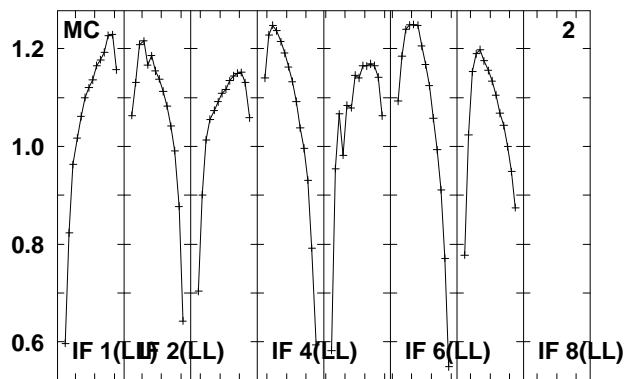
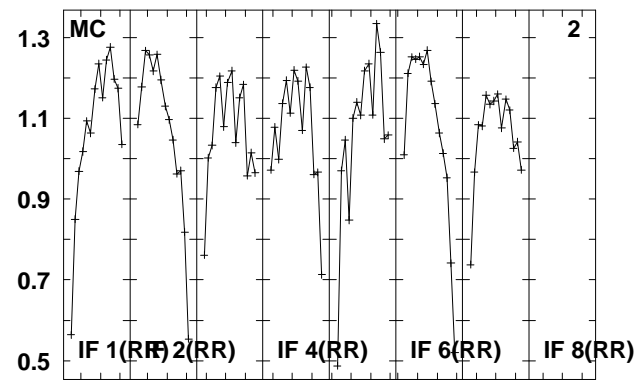
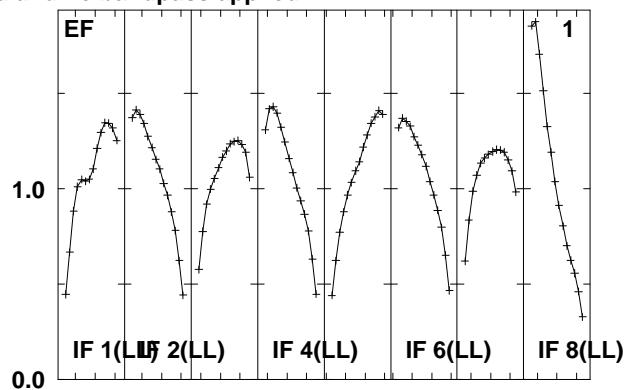
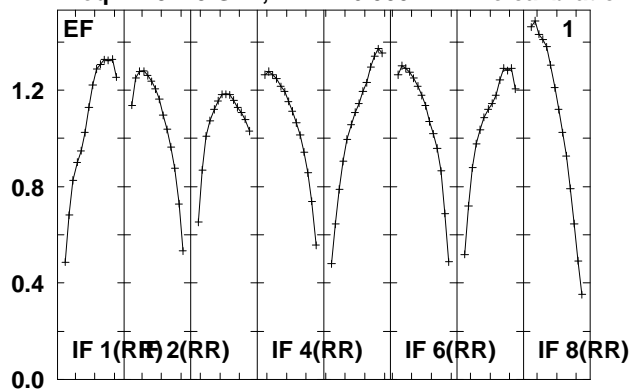

Lower frame: Real Jy
Total-power spectrum Antenna: *
Timerange: 00/22:12:00 to 00/22:22:44

Plot file version 249 created 08-JUL-2010 13:12:26

B1309+48 EM079.UVDATA.1

Freq = 4.9415 GHz, Bw = 16.000 MH No calibration applied and no bandpass applied

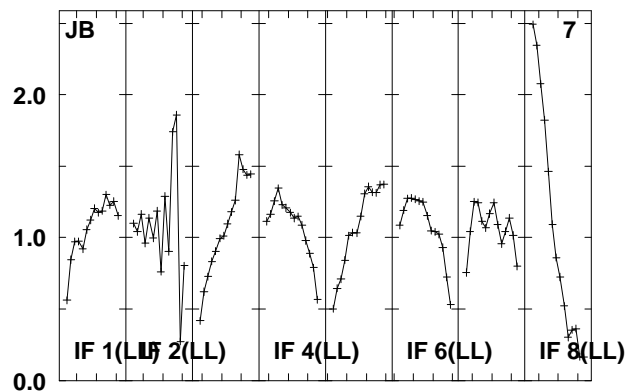
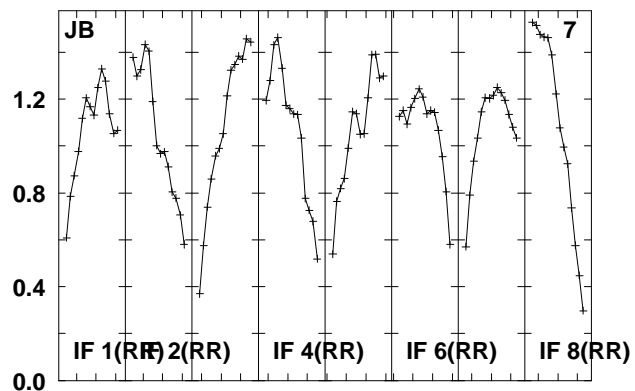
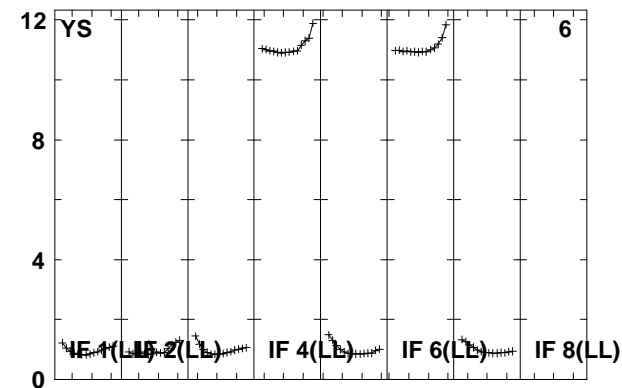
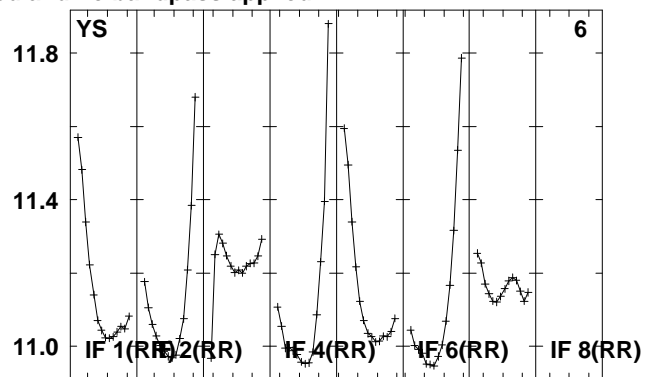
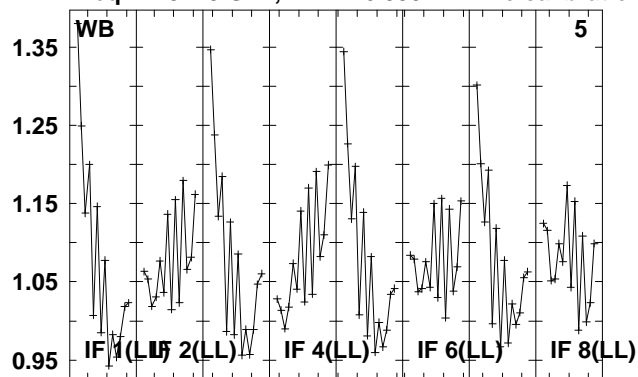

Lower frame: Real Jy
Total-power spectrum Antenna: *
Timerange: 00/22:12:00 to 00/22:22:44

Plot file version 250 created 08-JUL-2010 13:12:28

J1312+48 EM079.UVDATA.1

Freq = 4.9415 GHz, Bw = 16.000 MH No calibration applied and no bandpass applied

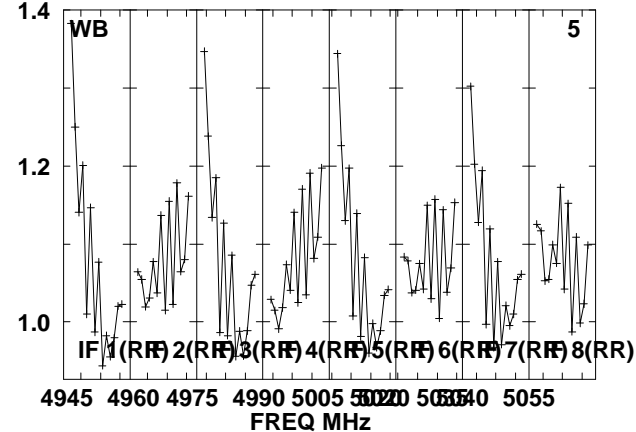
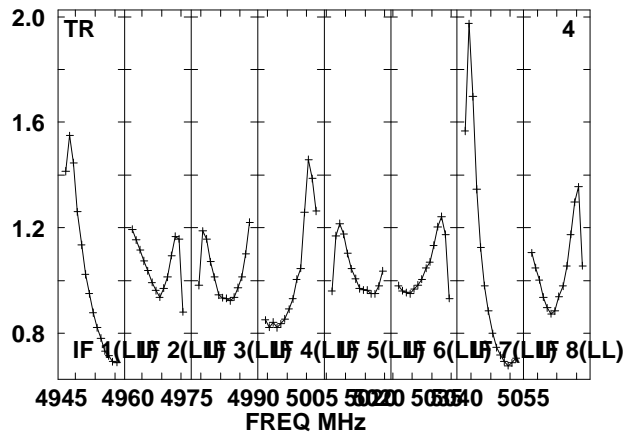
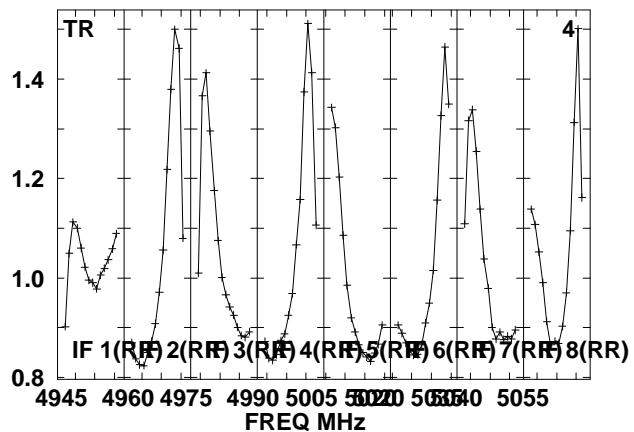
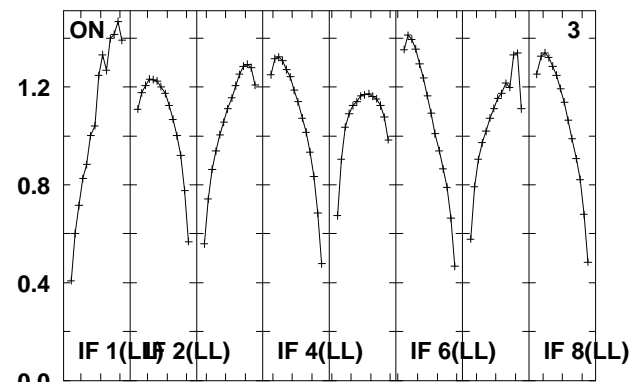
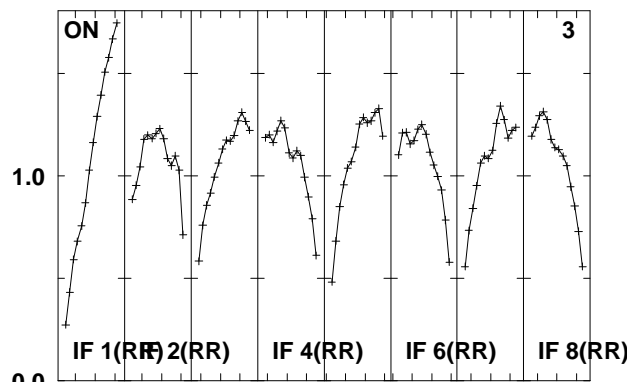
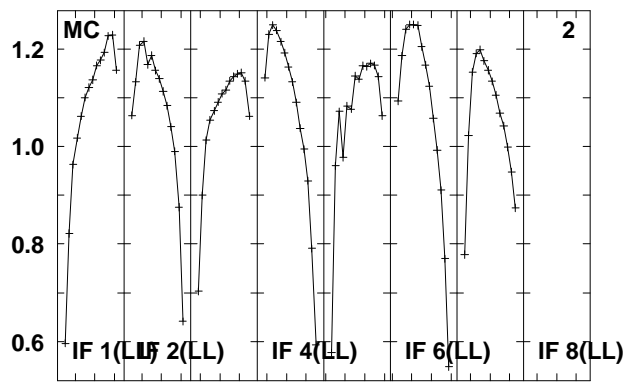
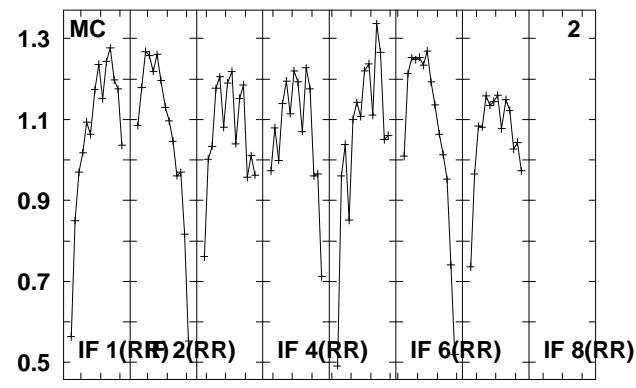
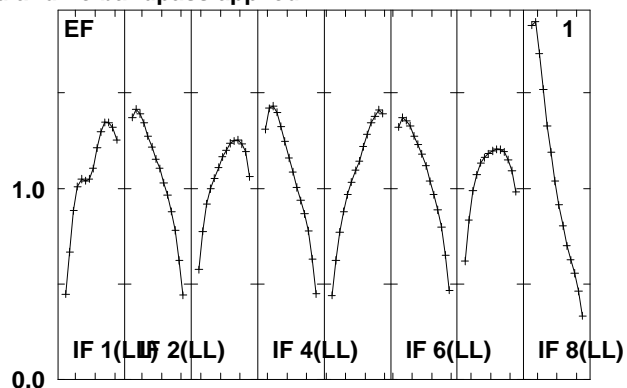
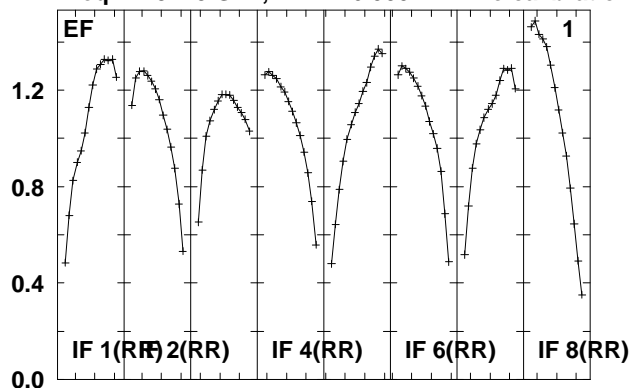

Lower frame: Real Jy
Total-power spectrum Antenna: *
Timerange: 00/22:22:46 to 00/22:24:44

Plot file version 251 created 08-JUL-2010 13:12:28

J1312+48 EM079.UVDATA.1

Freq = 4.9415 GHz, Bw = 16.000 MH No calibration applied and no bandpass applied

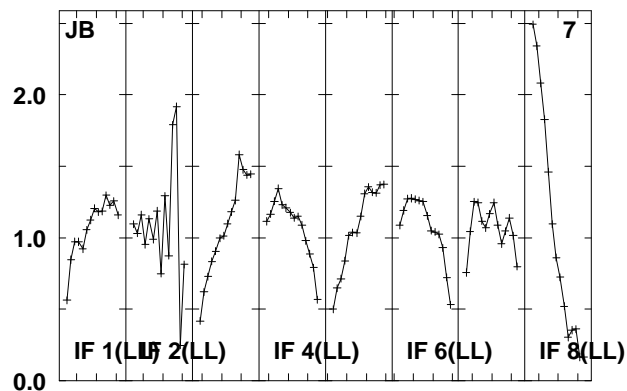
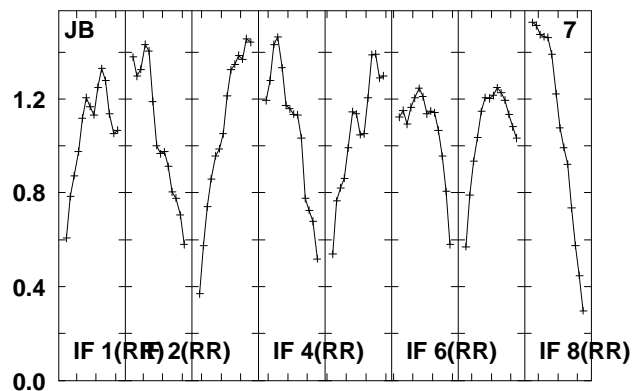
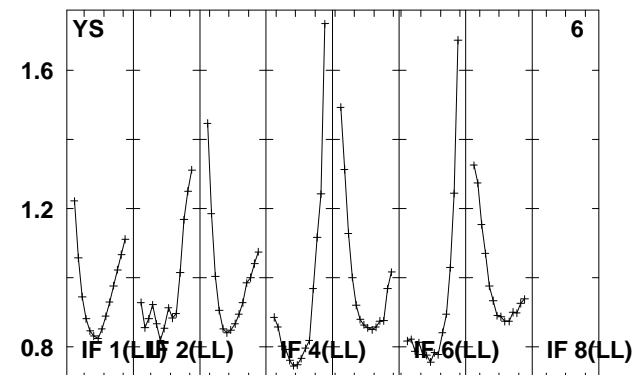
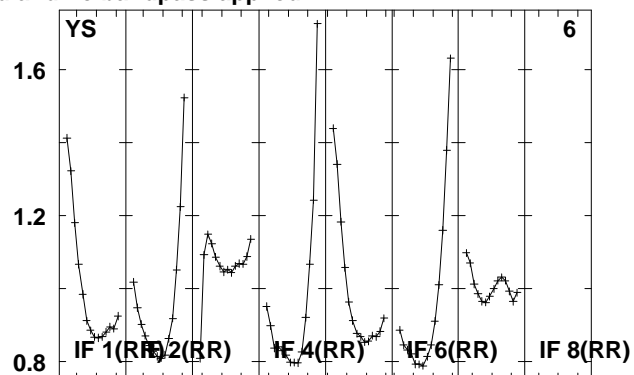
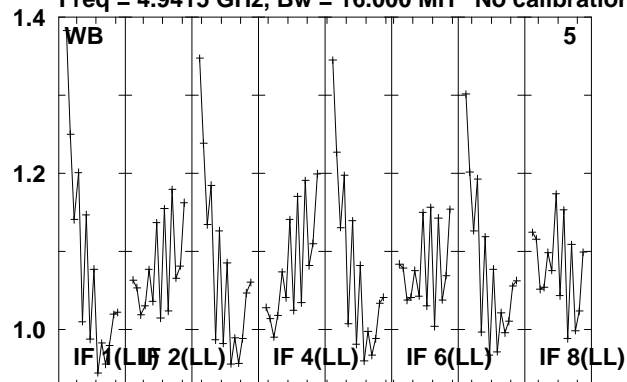

Lower frame: Real Jy
Total-power spectrum Antenna: *
Timerange: 00/22:22:46 to 00/22:24:44

Plot file version 252 created 08-JUL-2010 13:12:29

B1309+48 EM079.UVDATA.1

Freq = 4.9415 GHz, Bw = 16.000 MH No calibration applied and no bandpass applied

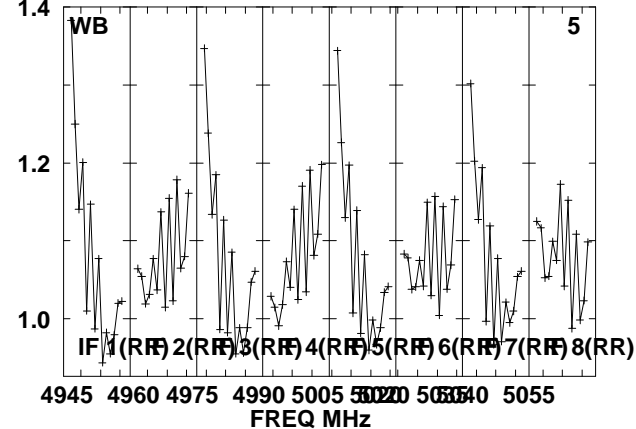
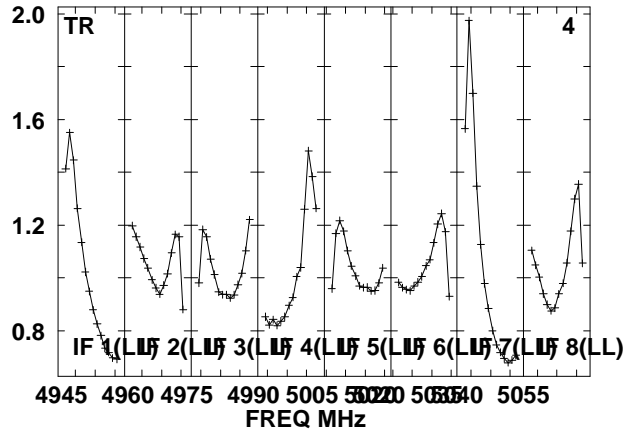
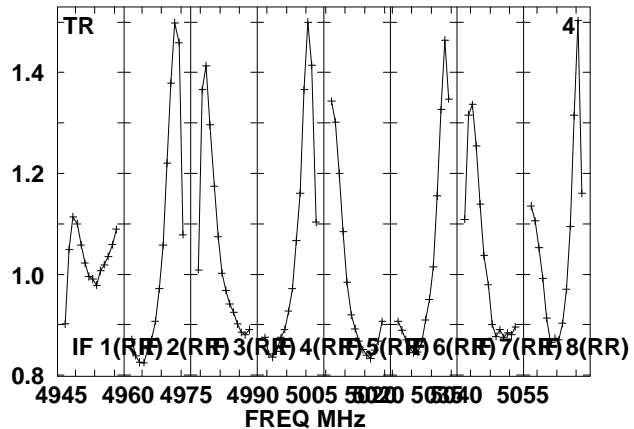
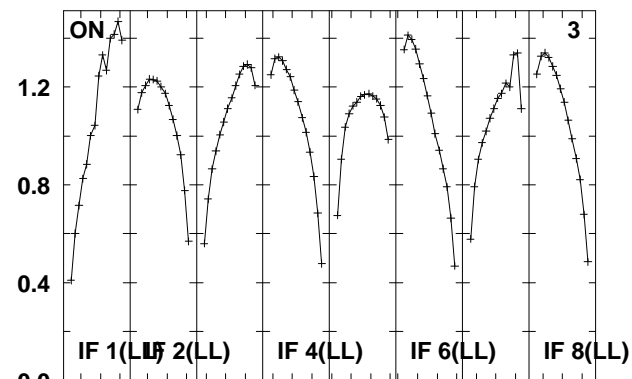
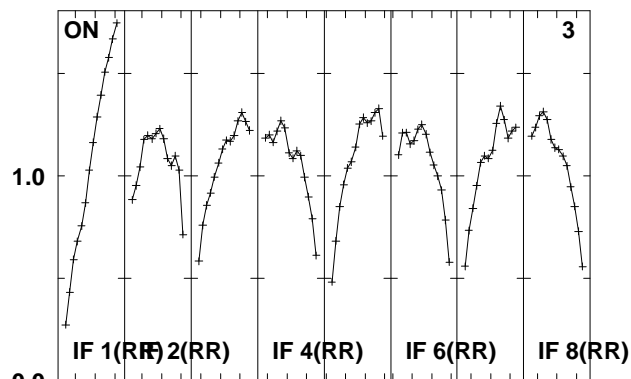
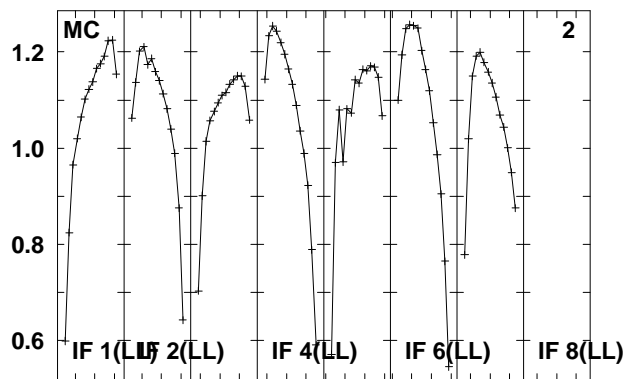
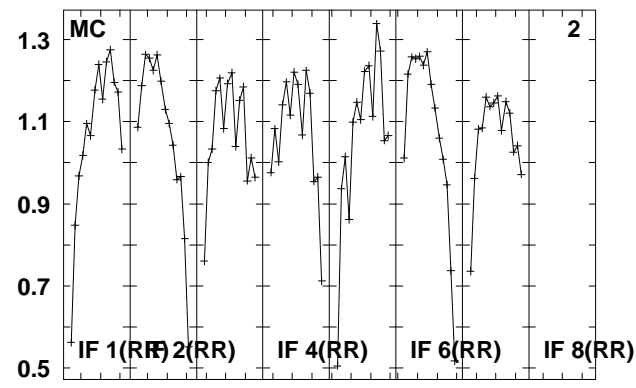
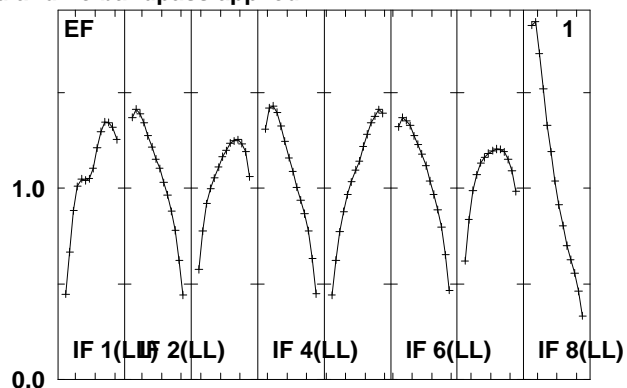
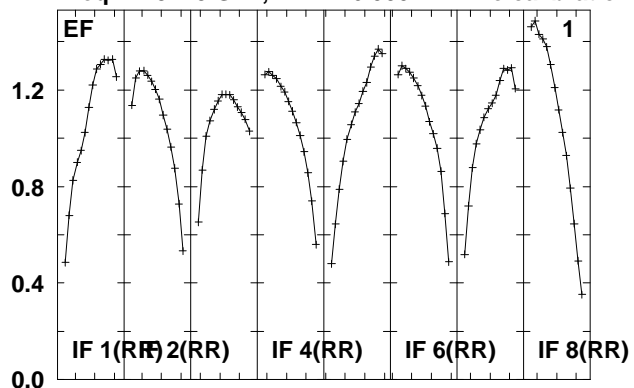

Lower frame: Real Jy
Total-power spectrum Antenna: *
Timerange: 00/22:24:46 to 00/22:35:28

Plot file version 253 created 08-JUL-2010 13:12:30

B1309+48 EM079.UVDATA.1

Freq = 4.9415 GHz, Bw = 16.000 MH No calibration applied and no bandpass applied

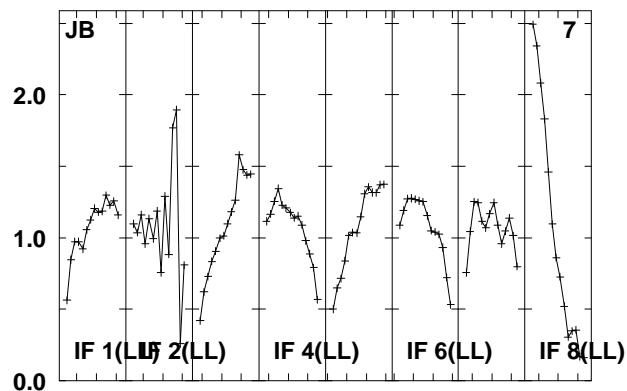
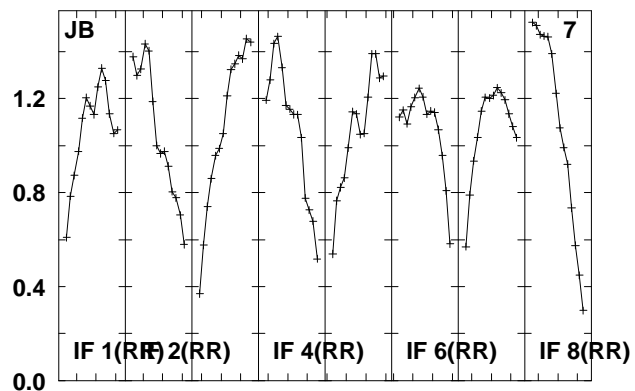
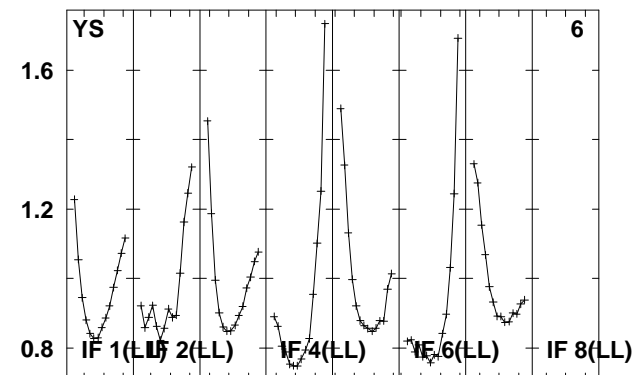
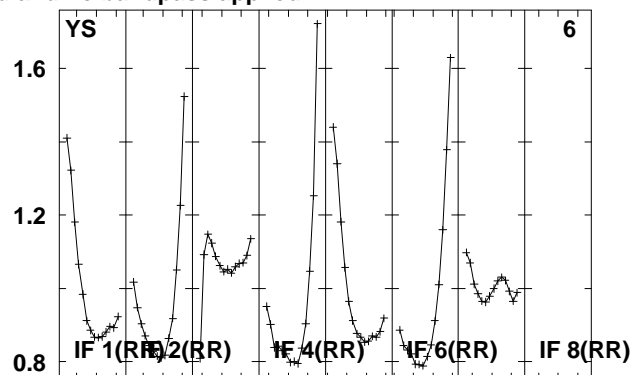
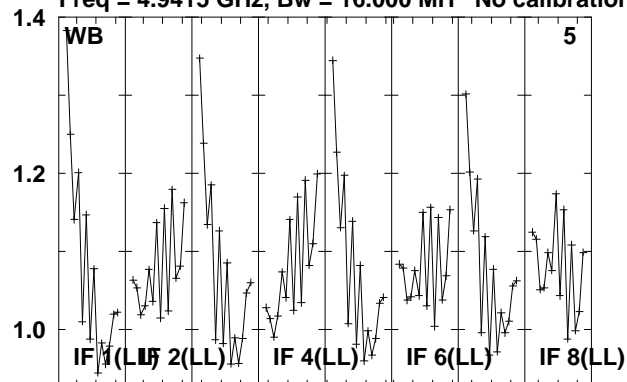

Lower frame: Real Jy
Total-power spectrum Antenna: *
Timerange: 00/22:24:46 to 00/22:35:28

Plot file version 254 created 08-JUL-2010 13:12:31

J1312+48 EM079.UVDATA.1

Freq = 4.9415 GHz, Bw = 16.000 MH No calibration applied and no bandpass applied

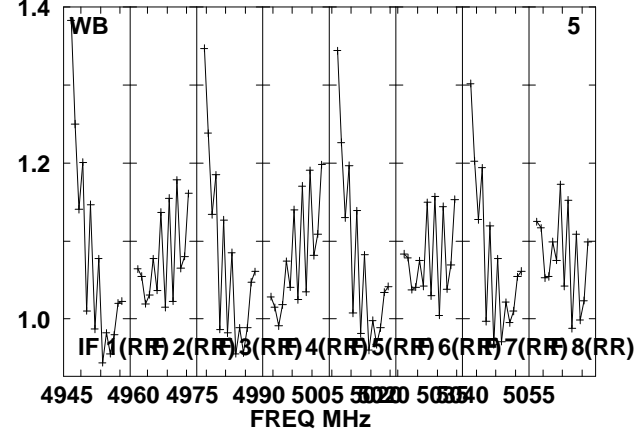
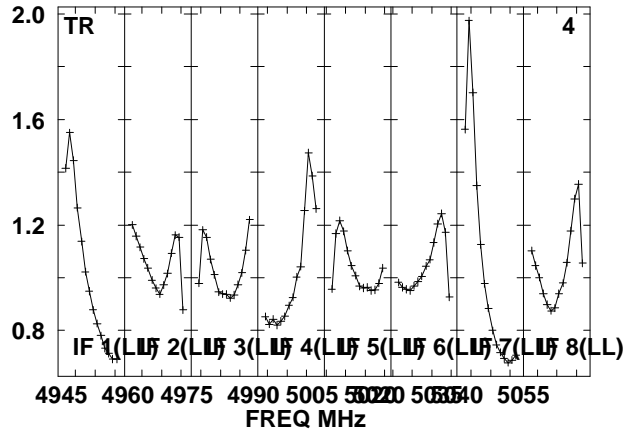
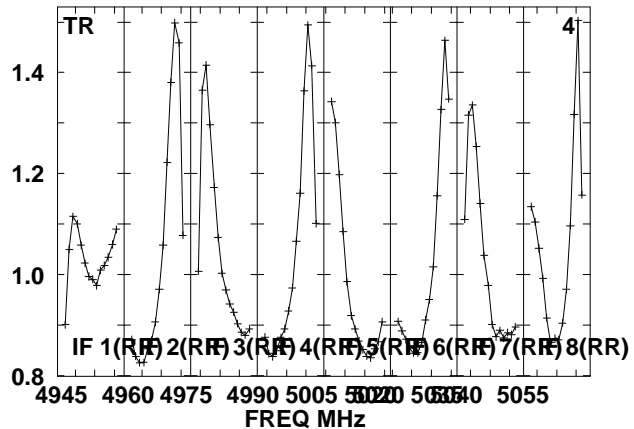
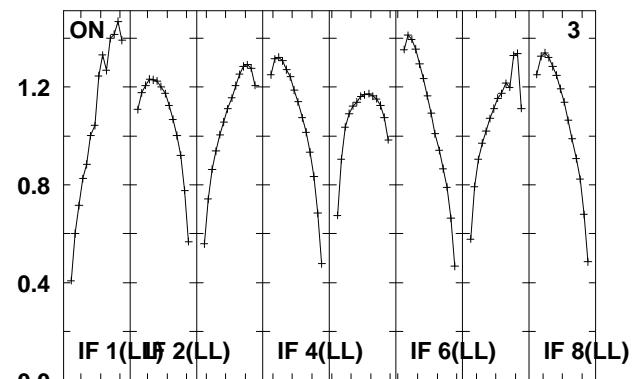
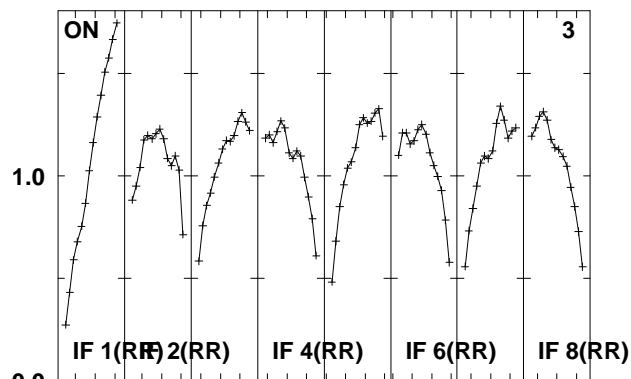
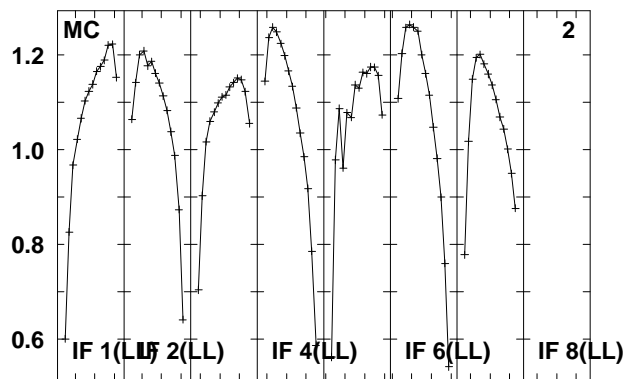
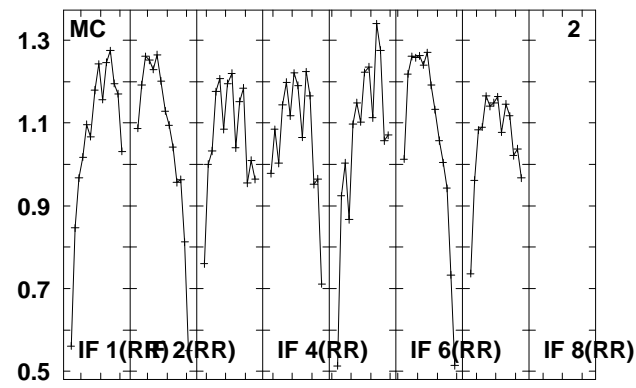
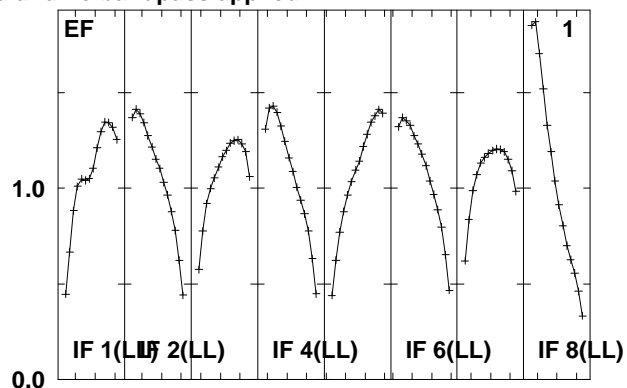
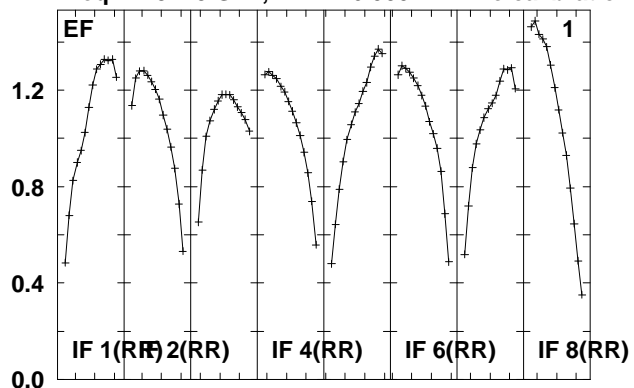

Lower frame: Real Jy
Total-power spectrum Antenna: *
Timerange: 00/22:35:30 to 00/22:37:28

Plot file version 255 created 08-JUL-2010 13:12:31

J1312+48 EM079.UVDATA.1

Freq = 4.9415 GHz, Bw = 16.000 MH No calibration applied and no bandpass applied

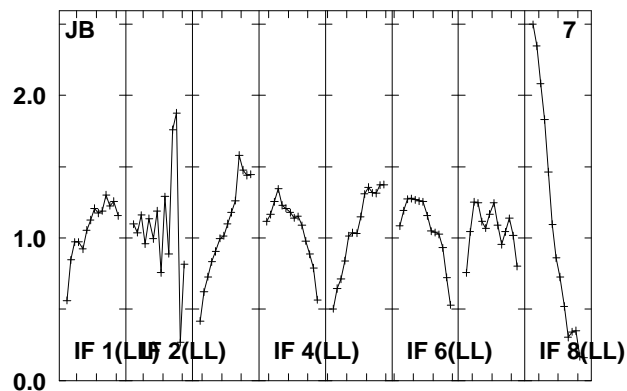
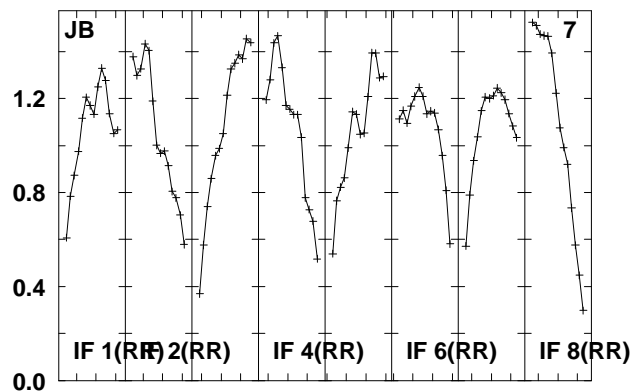
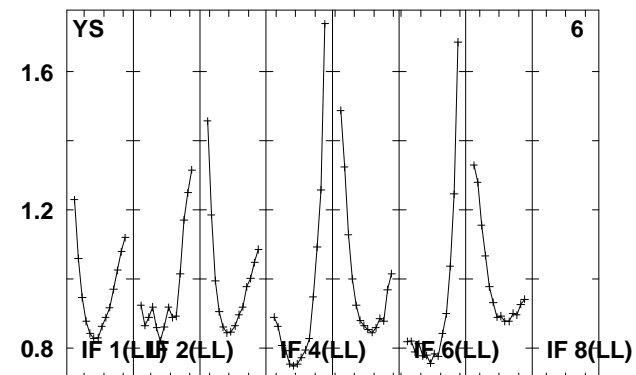
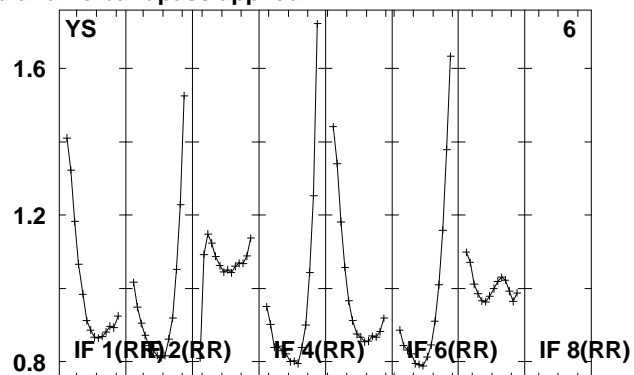
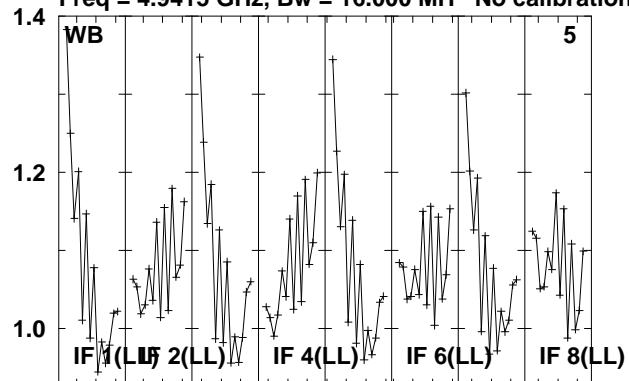

Lower frame: Real Jy
Total-power spectrum Antenna: *
Timerange: 00/22:35:30 to 00/22:37:28

Plot file version 256 created 08-JUL-2010 13:12:32

B1309+48 EM079.UVDATA.1

Freq = 4.9415 GHz, Bw = 16.000 MH No calibration applied and no bandpass applied

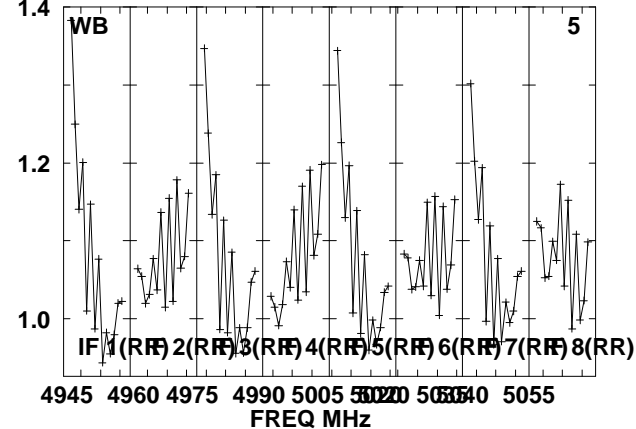
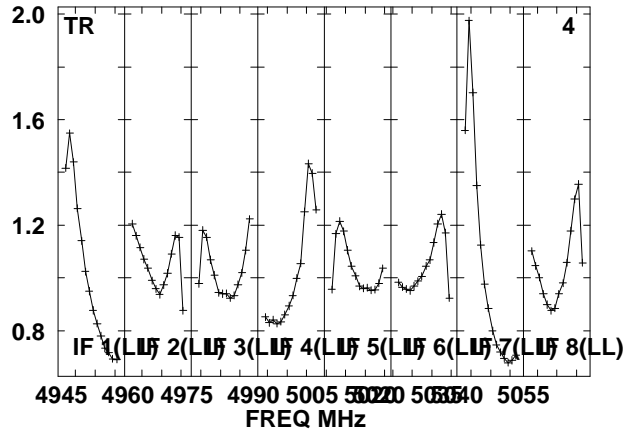
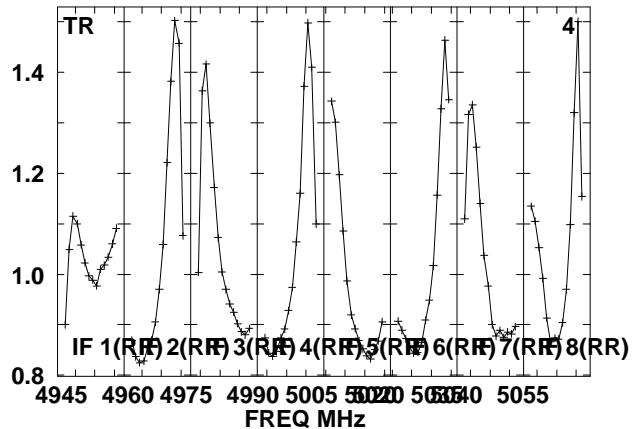
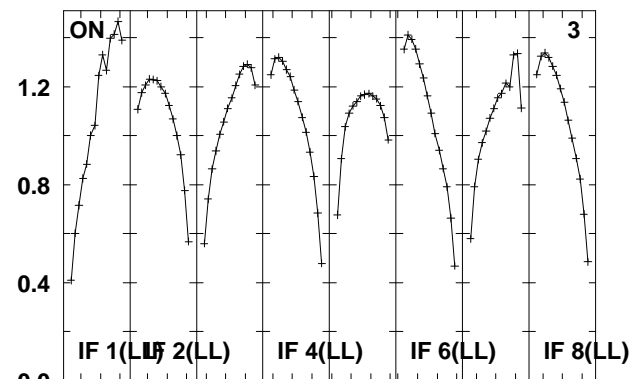
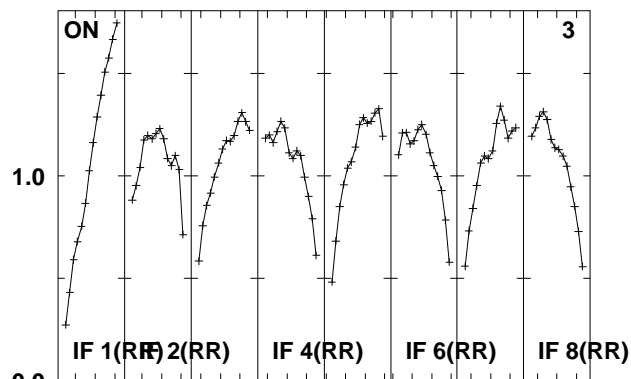
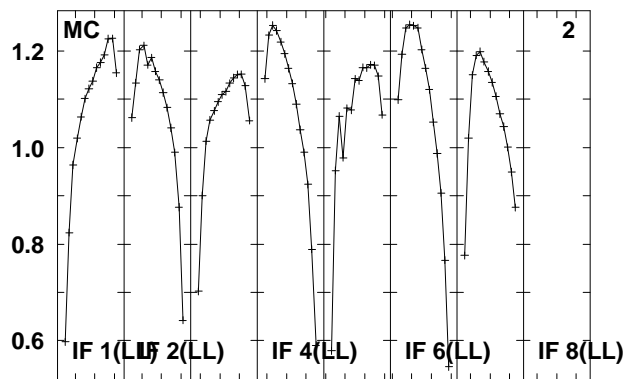
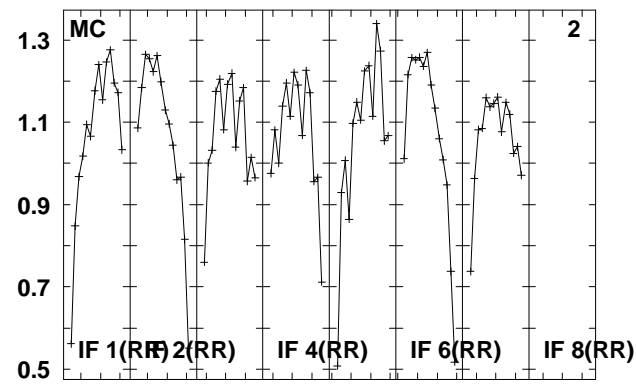
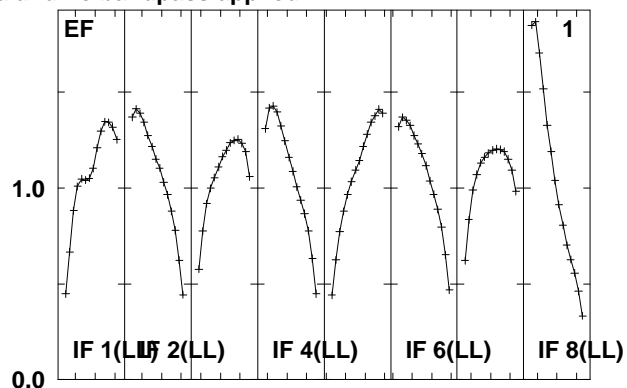
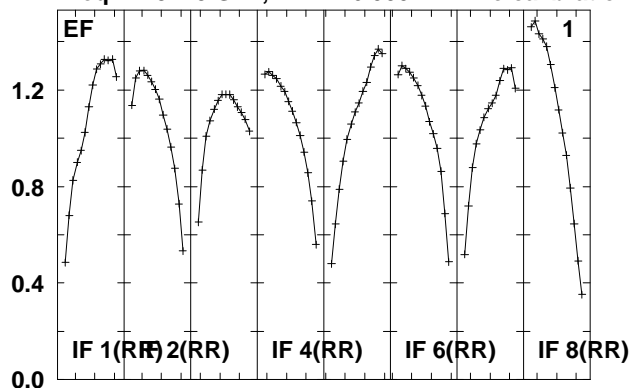

Lower frame: Real Jy
Total-power spectrum Antenna: *
Timerange: 00/22:37:30 to 00/22:48:14

Plot file version 257 created 08-JUL-2010 13:12:33

B1309+48 EM079.UVDATA.1

Freq = 4.9415 GHz, Bw = 16.000 MH No calibration applied and no bandpass applied

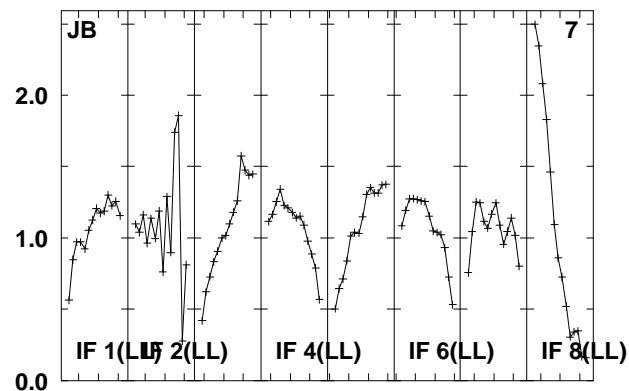
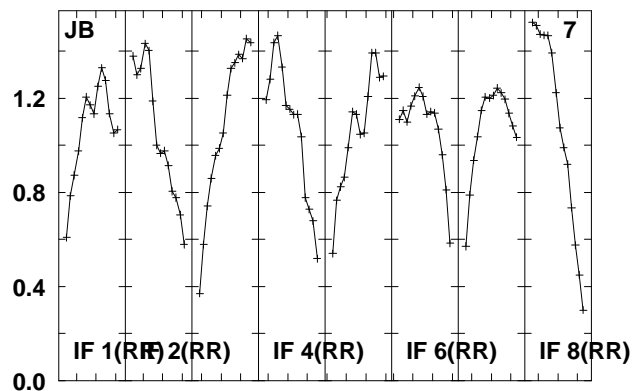
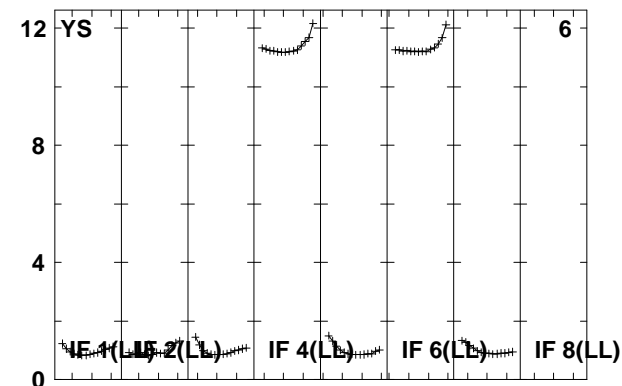
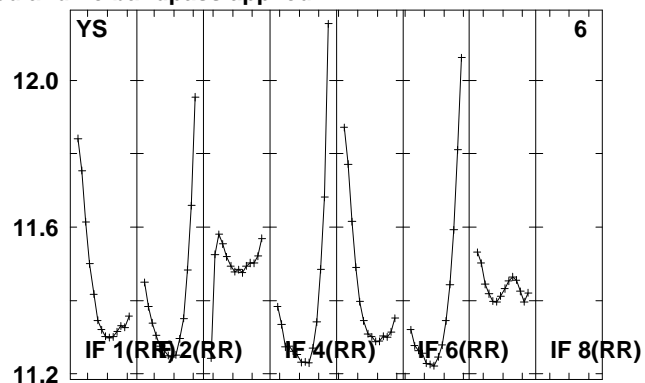
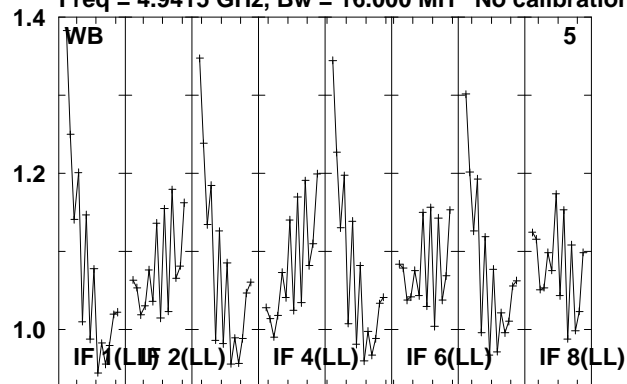

Lower frame: Real Jy
Total-power spectrum Antenna: *
Timerange: 00/22:37:30 to 00/22:48:14

Plot file version 258 created 08-JUL-2010 13:12:35

J1312+48 EM079.UVDATA.1

Freq = 4.9415 GHz, Bw = 16.000 MH No calibration applied and no bandpass applied

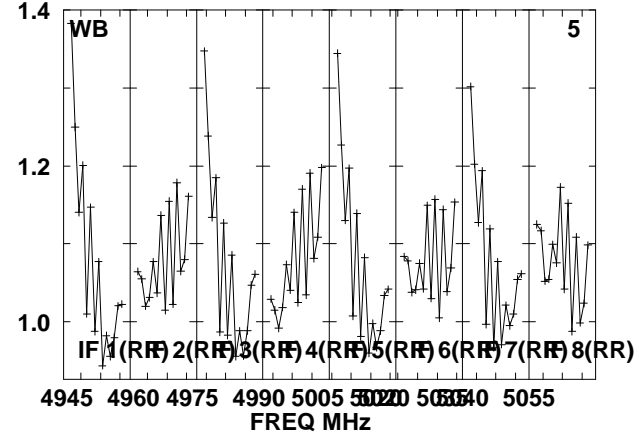
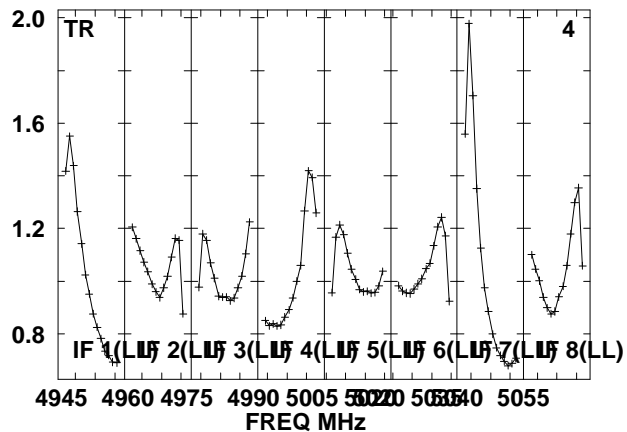
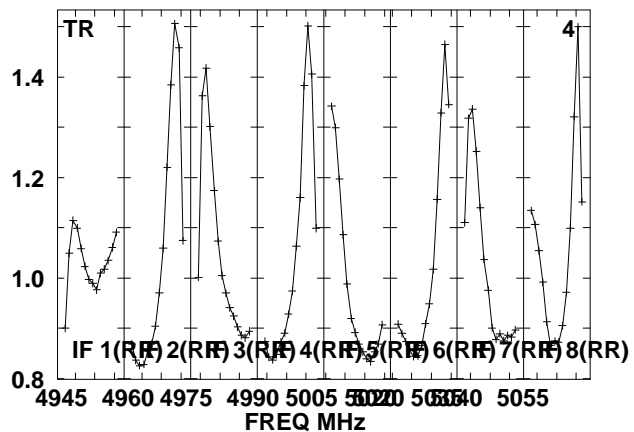
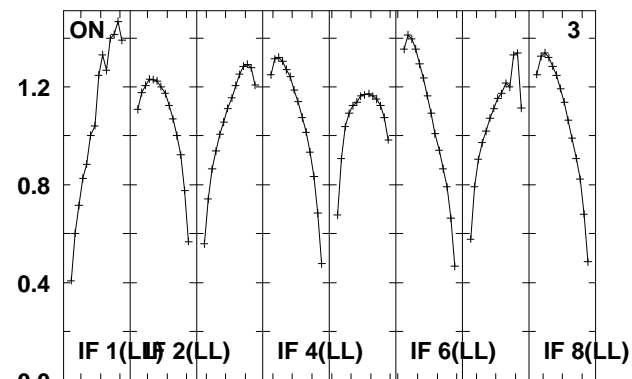
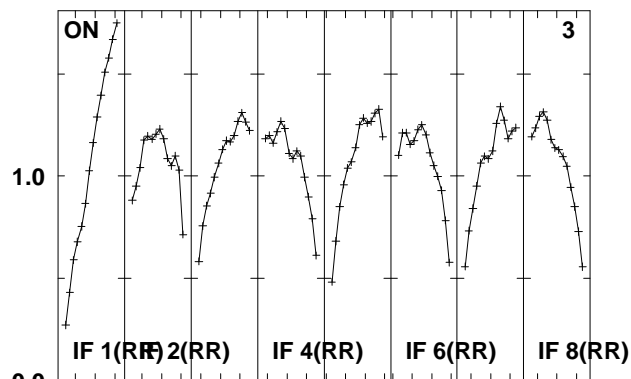
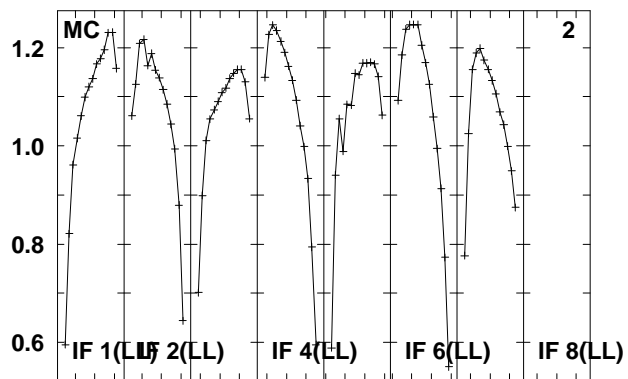
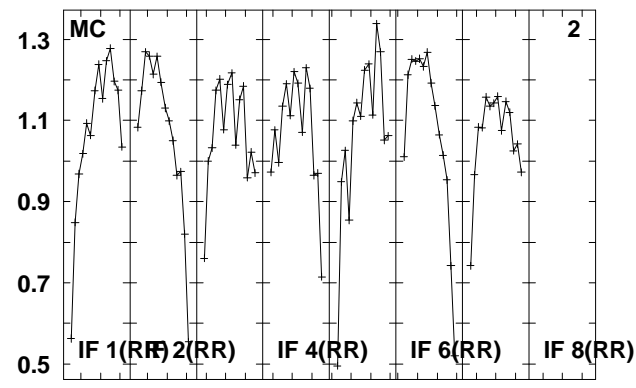
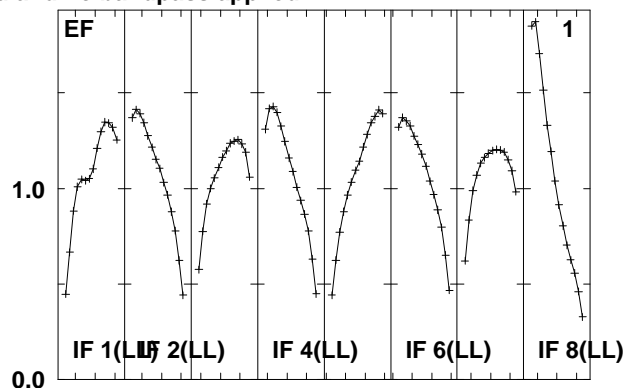
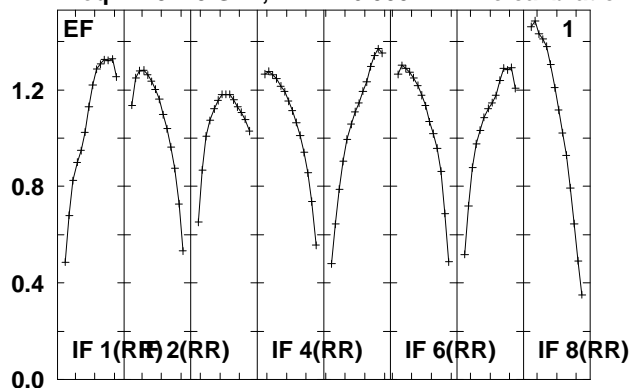

Lower frame: Real Jy
Total-power spectrum Antenna: *
Timerange: 00/22:48:16 to 00/22:50:14

Plot file version 259 created 08-JUL-2010 13:12:35

J1312+48 EM079.UVDATA.1

Freq = 4.9415 GHz, Bw = 16.000 MH No calibration applied and no bandpass applied

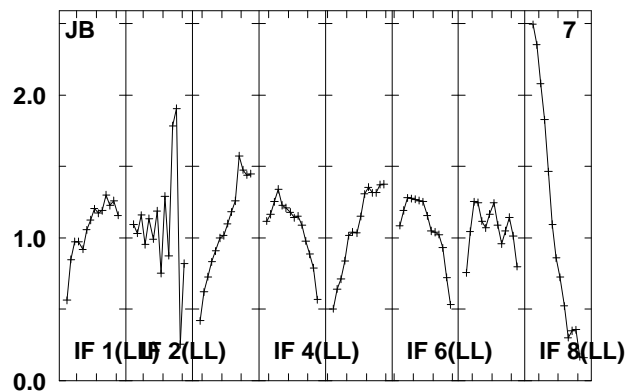
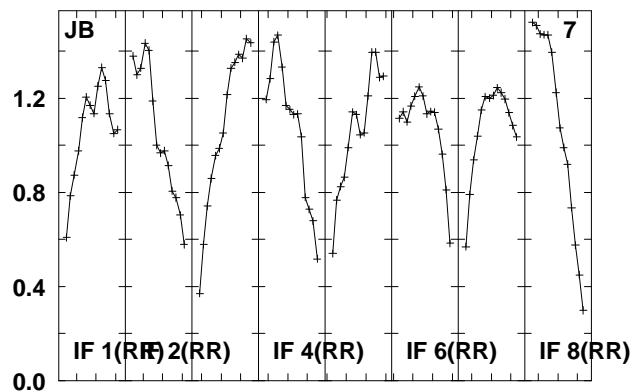
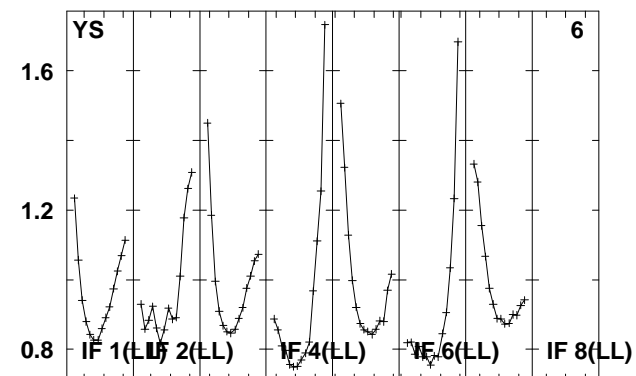
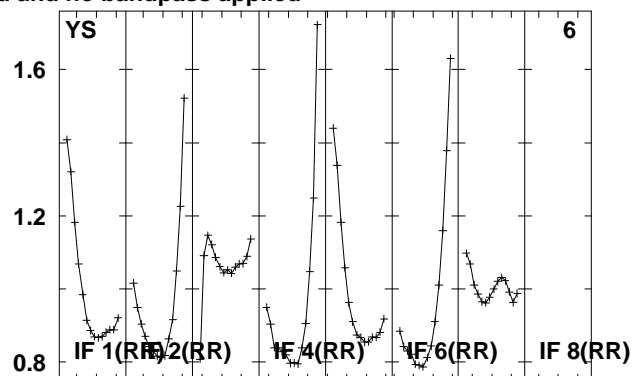
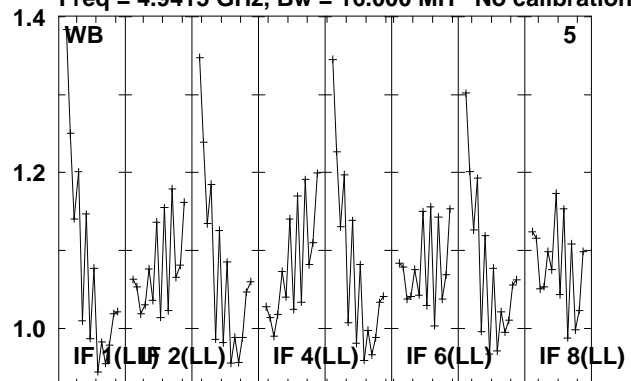

Lower frame: Real Jy
Total-power spectrum Antenna: *
Timerange: 00/22:48:16 to 00/22:50:14

Plot file version 260 created 08-JUL-2010 13:12:36

B1309+48 EM079.UVDATA.1

Freq = 4.9415 GHz, Bw = 16.000 MH No calibration applied and no bandpass applied

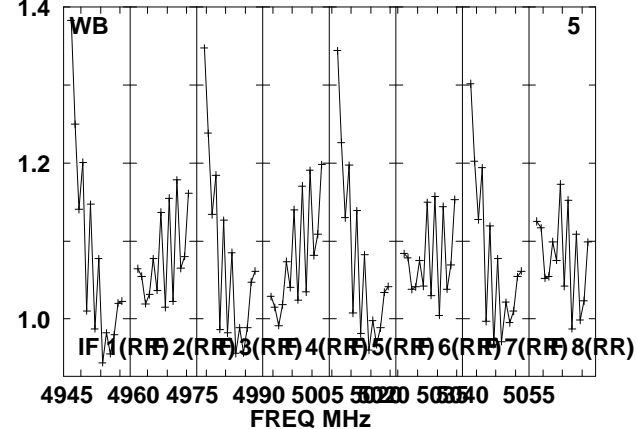
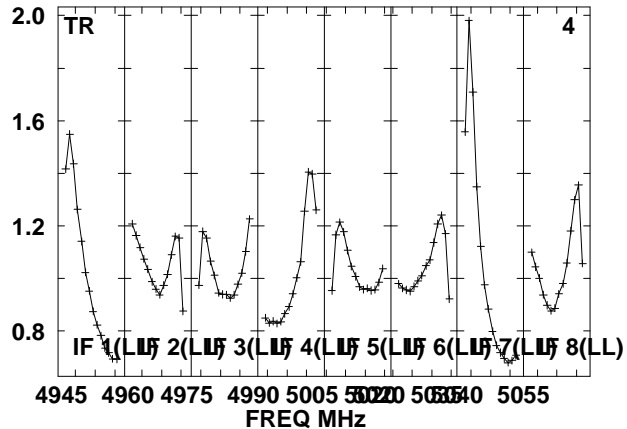
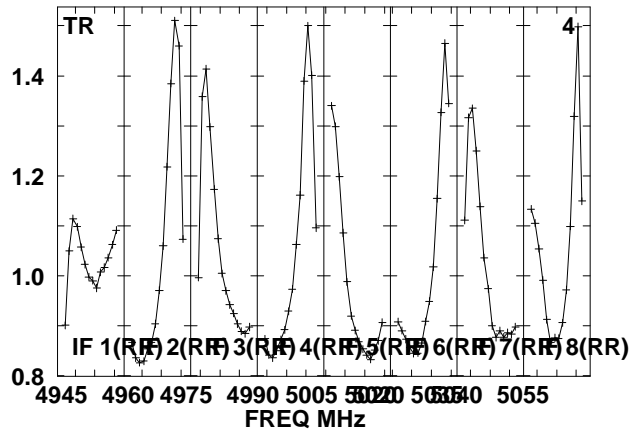
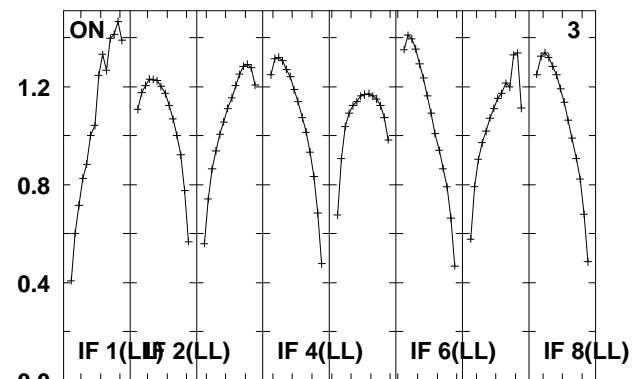
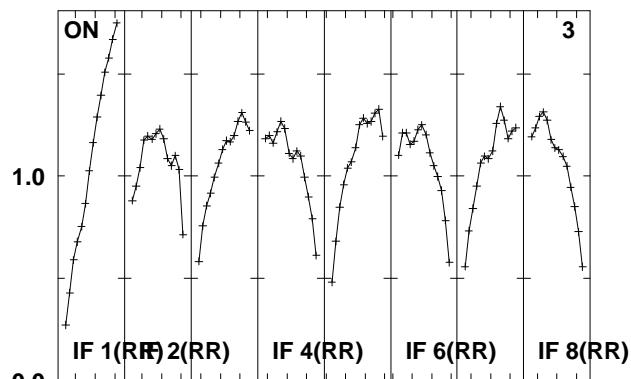
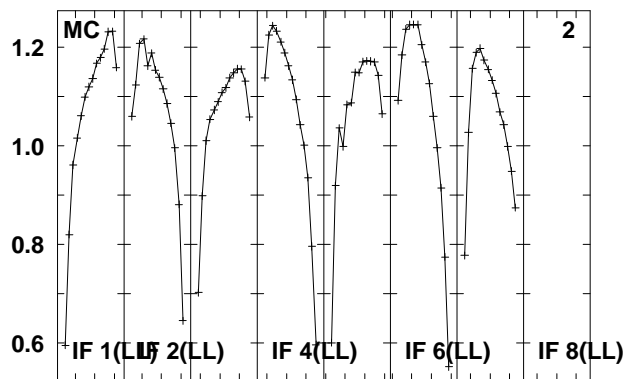
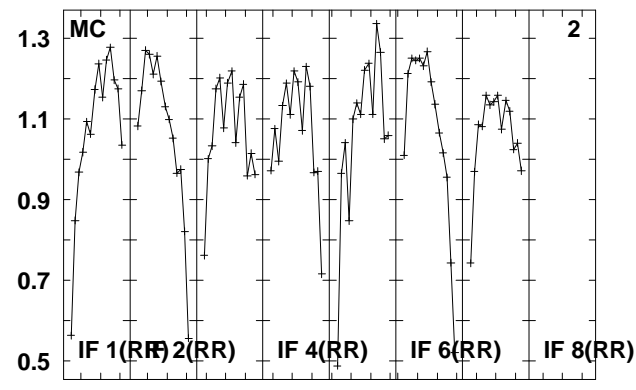
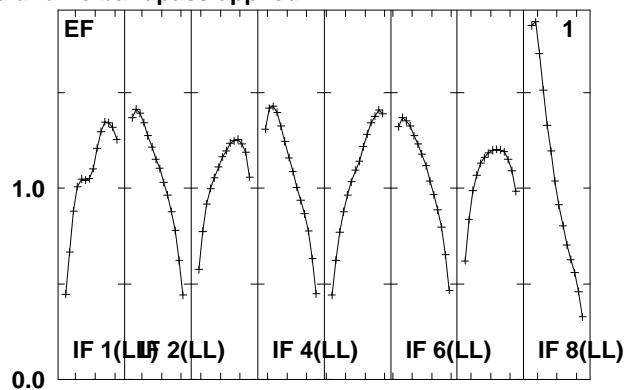
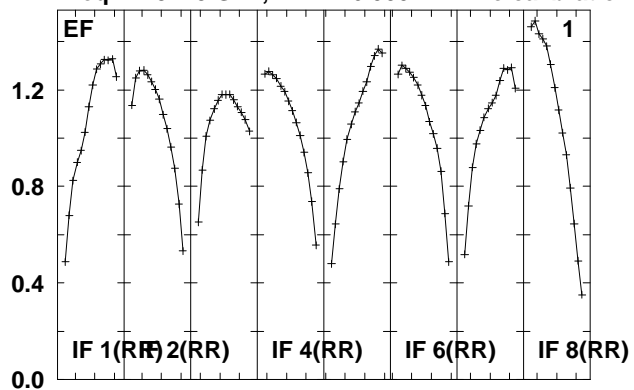

Lower frame: Real Jy
Total-power spectrum Antenna: *
Timerange: 00/22:50:16 to 00/23:00:58

Plot file version 261 created 08-JUL-2010 13:12:37

B1309+48 EM079.UVDATA.1

Freq = 4.9415 GHz, Bw = 16.000 MH No calibration applied and no bandpass applied

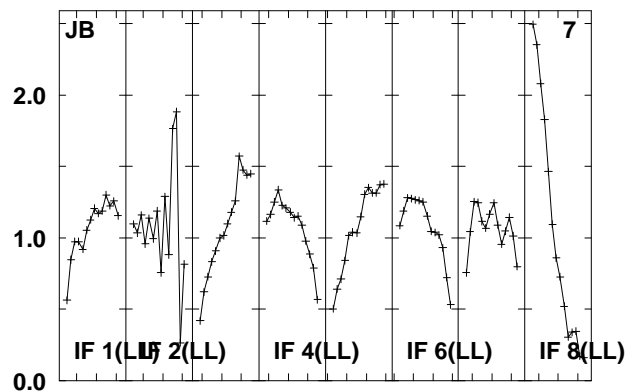
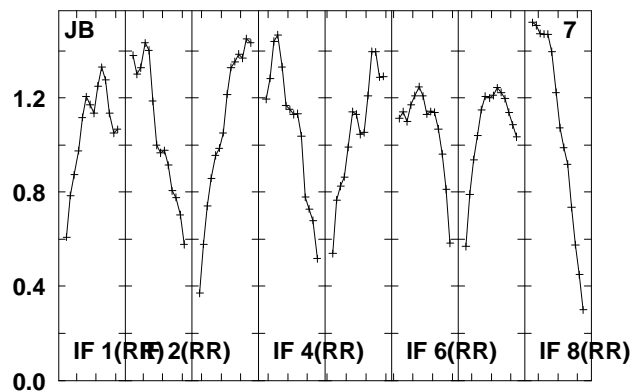
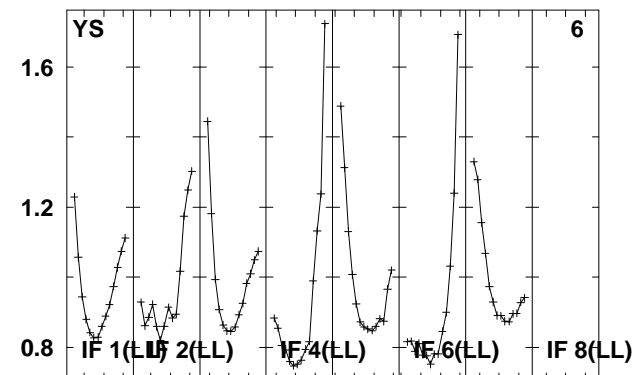
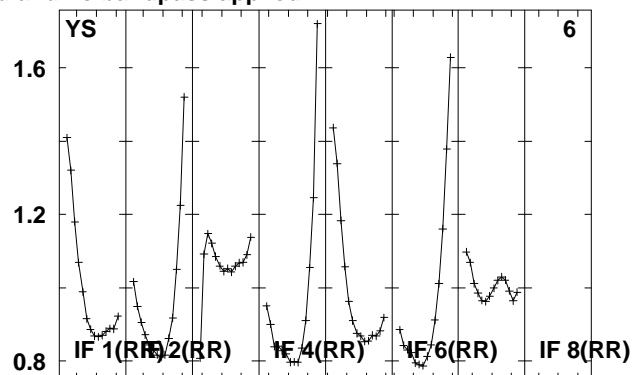
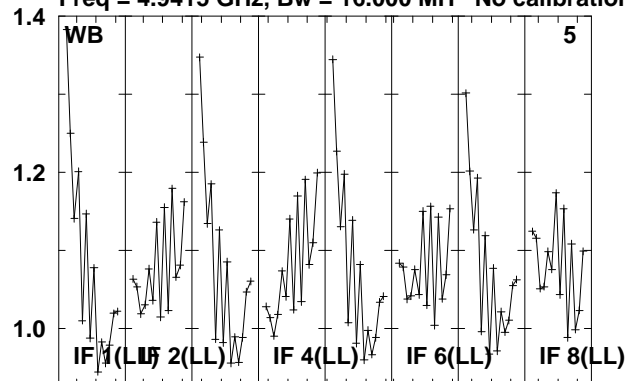

Lower frame: Real Jy
Total-power spectrum Antenna: *
Timerange: 00/22:50:16 to 00/23:00:58

Plot file version 262 created 08-JUL-2010 13:12:38

J1312+48 EM079.UVDATA.1

Freq = 4.9415 GHz, Bw = 16.000 MH No calibration applied and no bandpass applied

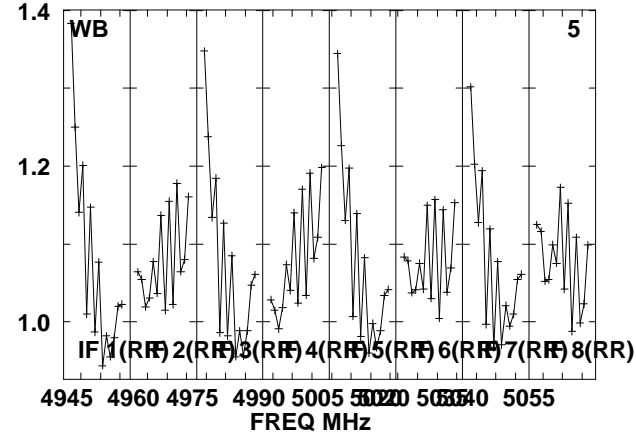
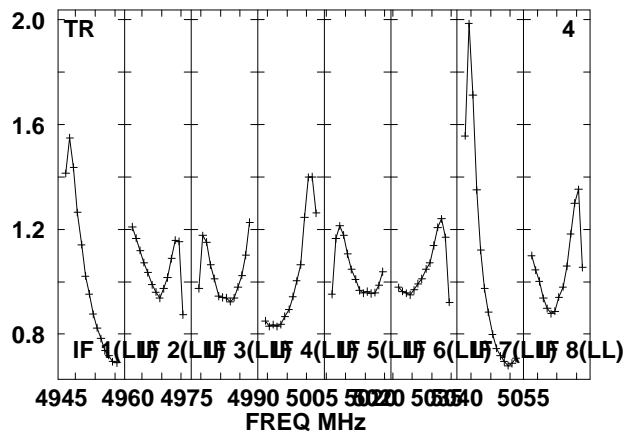
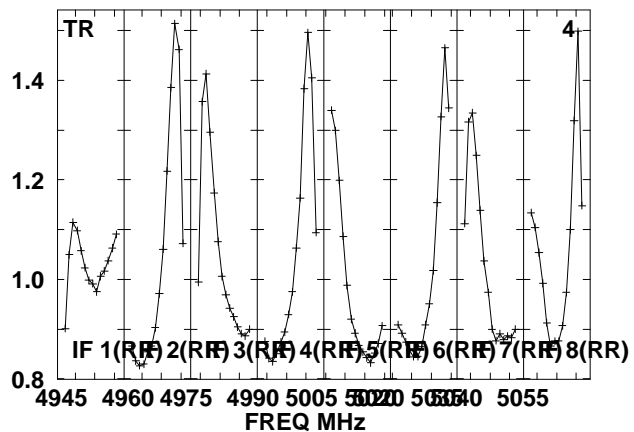
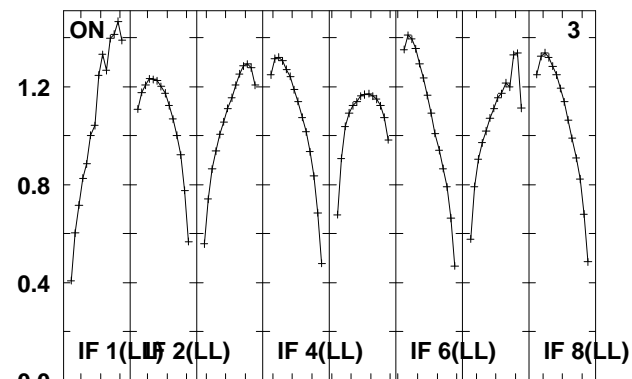
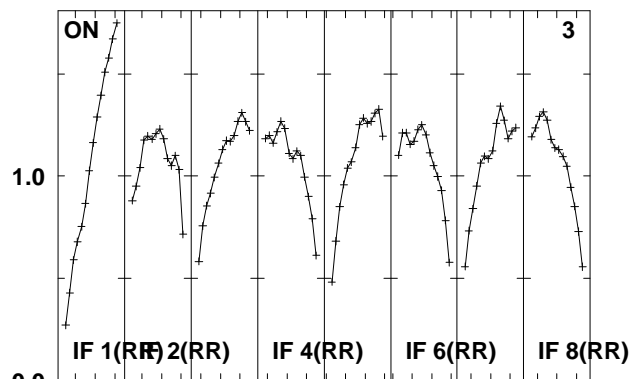
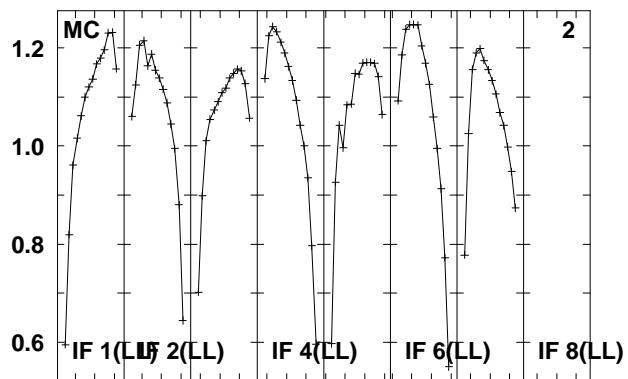
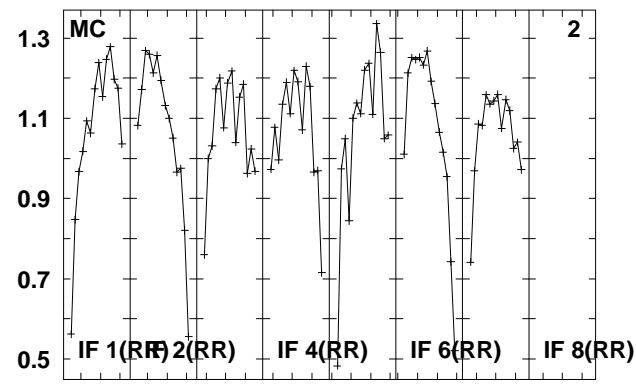
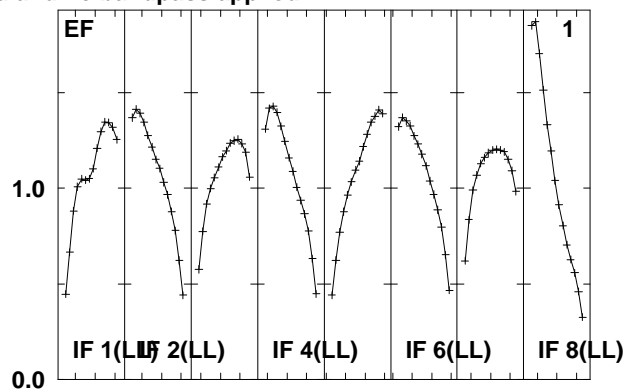
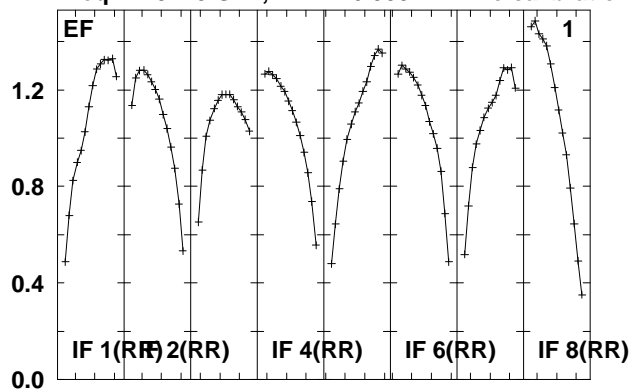

Lower frame: Real Jy
Total-power spectrum Antenna: *
Timerange: 00/23:01:00 to 00/23:02:58

Plot file version 263 created 08-JUL-2010 13:12:38

J1312+48 EM079.UVDATA.1

Freq = 4.9415 GHz, Bw = 16.000 MH No calibration applied and no bandpass applied

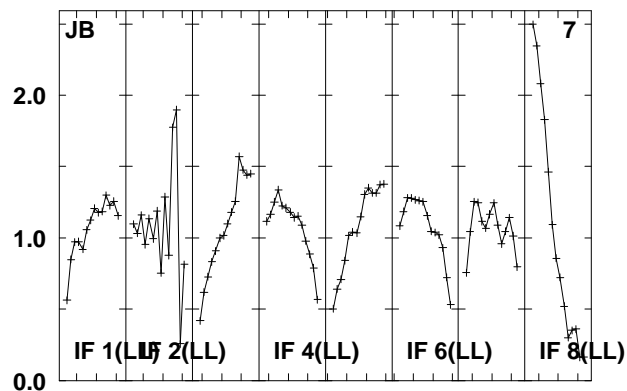
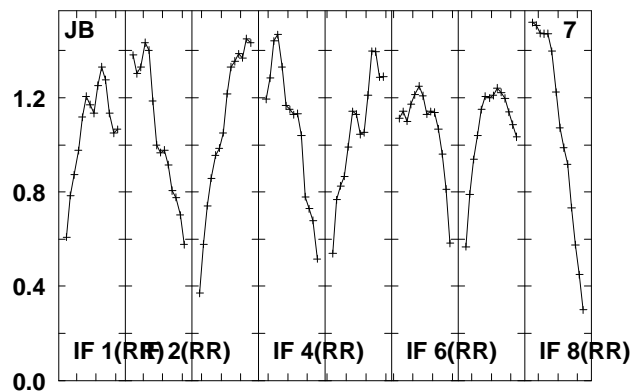
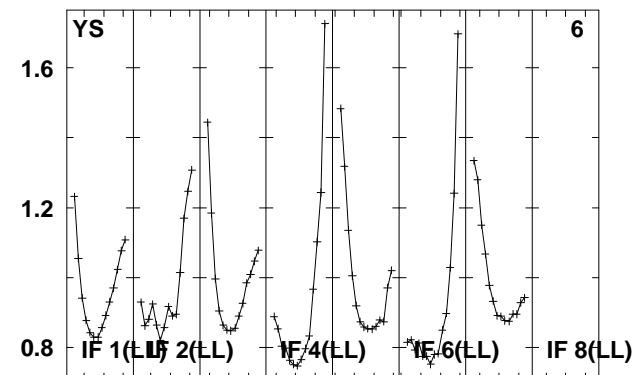
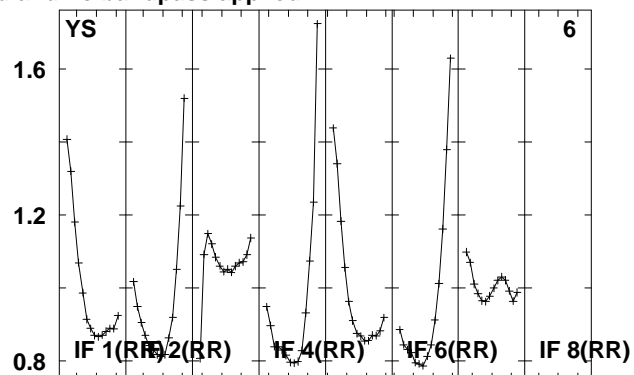
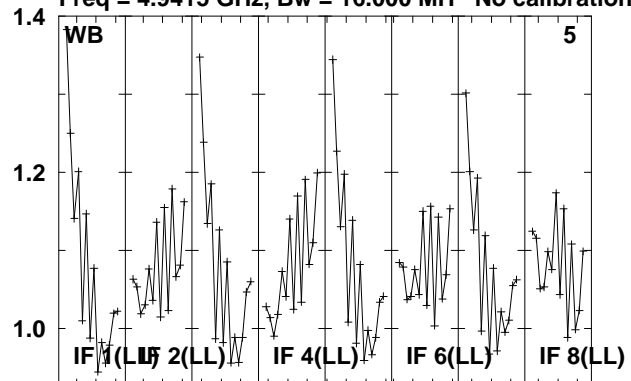

Lower frame: Real Jy
Total-power spectrum Antenna: *
Timerange: 00/23:01:00 to 00/23:02:58

Plot file version 264 created 08-JUL-2010 13:12:39

B1309+48 EM079.UVDATA.1

Freq = 4.9415 GHz, Bw = 16.000 MH No calibration applied and no bandpass applied

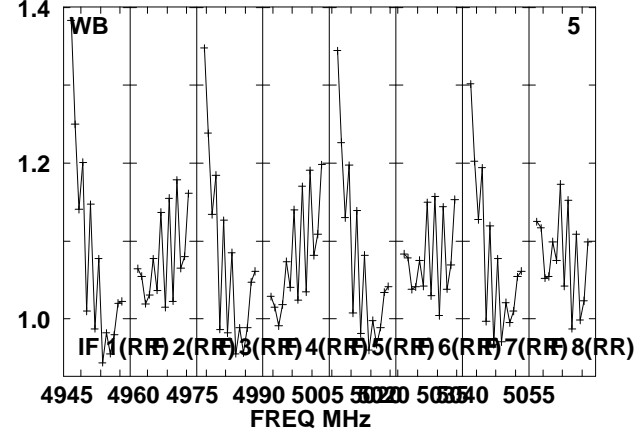
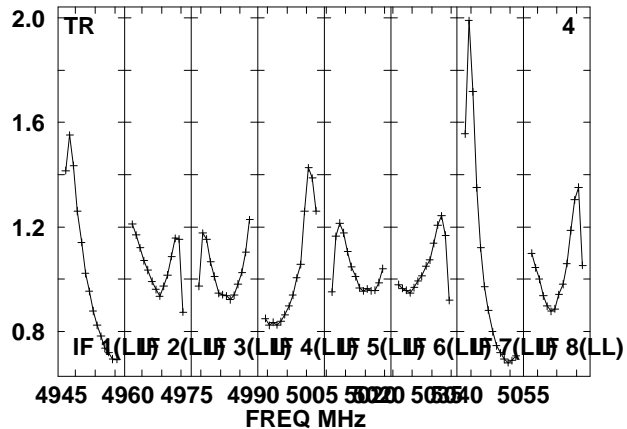
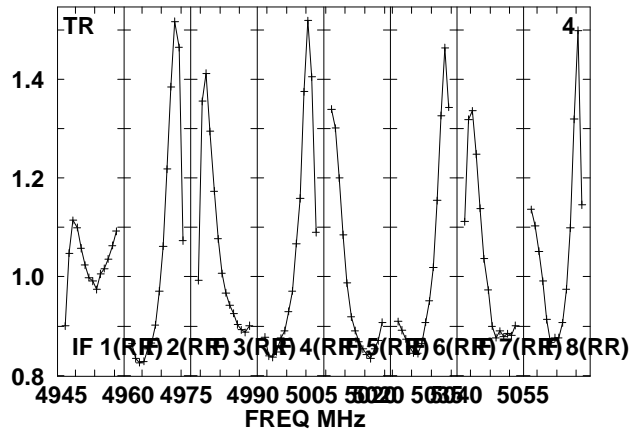
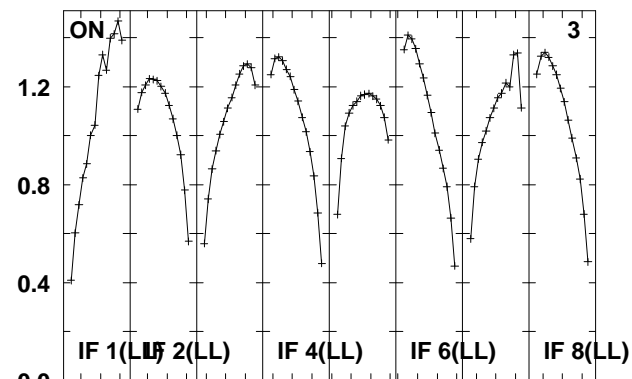
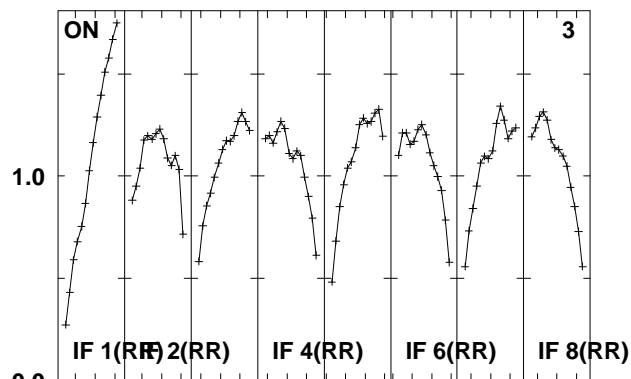
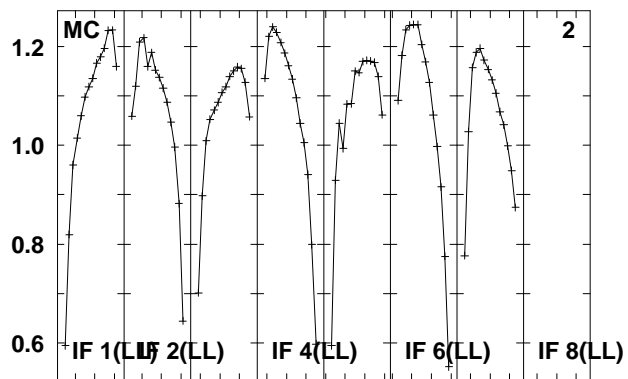
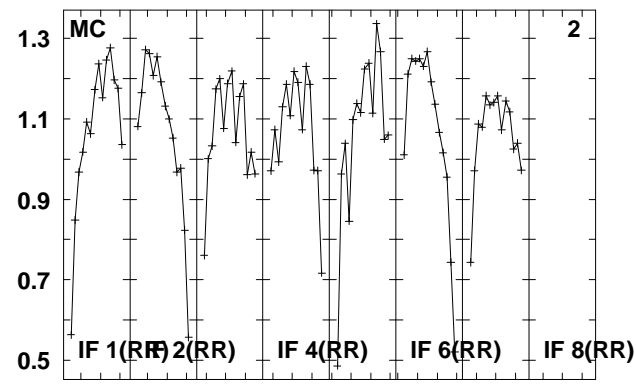
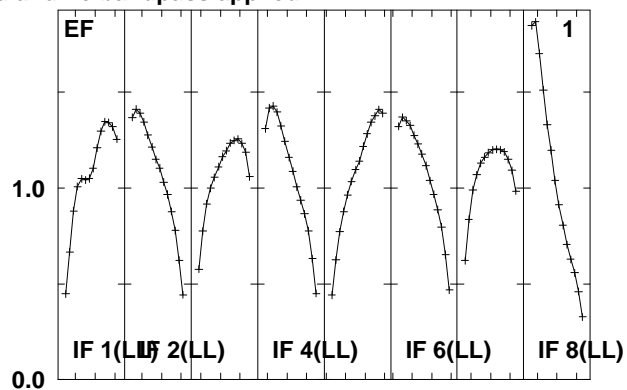
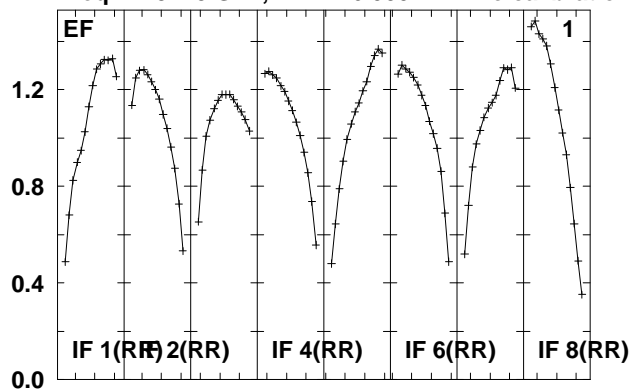

Lower frame: Real Jy
Total-power spectrum Antenna: *
Timerange: 00/23:03:00 to 00/23:13:44

Plot file version 265 created 08-JUL-2010 13:12:40

B1309+48 EM079.UVDATA.1

Freq = 4.9415 GHz, Bw = 16.000 MH No calibration applied and no bandpass applied

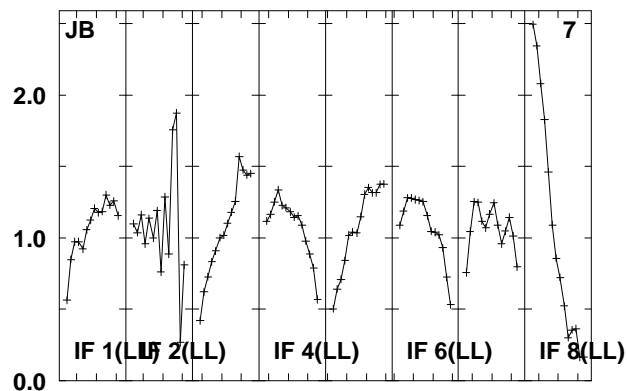
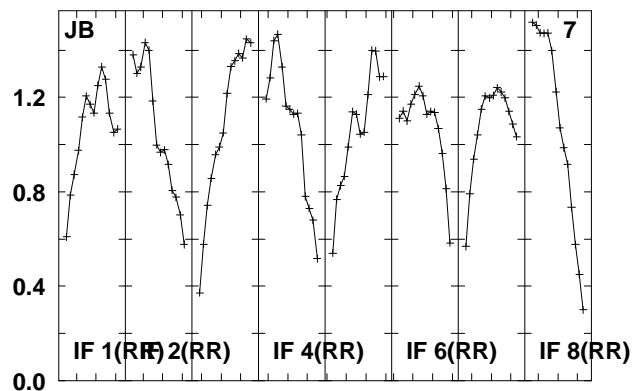
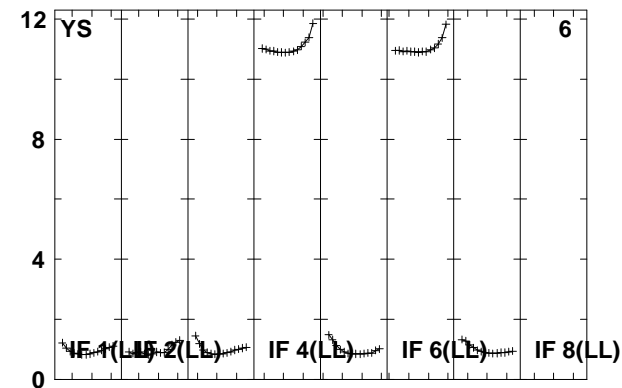
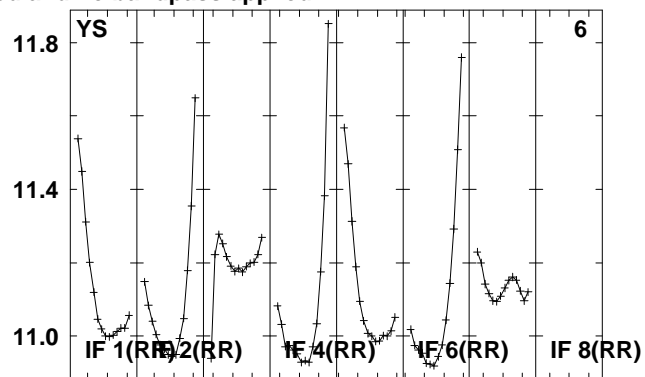
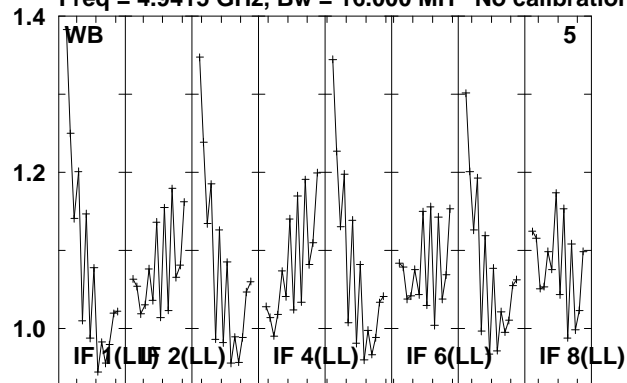

Lower frame: Real Jy
Total-power spectrum Antenna: *
Timerange: 00/23:03:00 to 00/23:13:44

Plot file version 266 created 08-JUL-2010 13:12:42

J1312+48 EM079.UVDATA.1

Freq = 4.9415 GHz, Bw = 16.000 MH No calibration applied and no bandpass applied

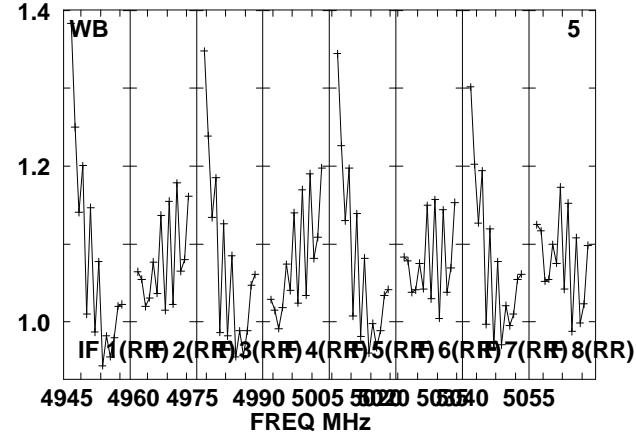
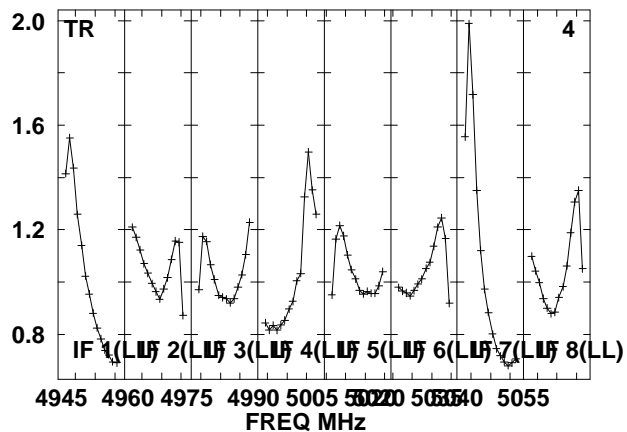
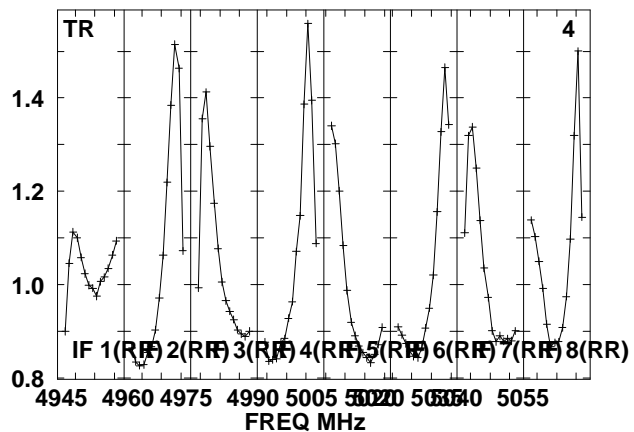
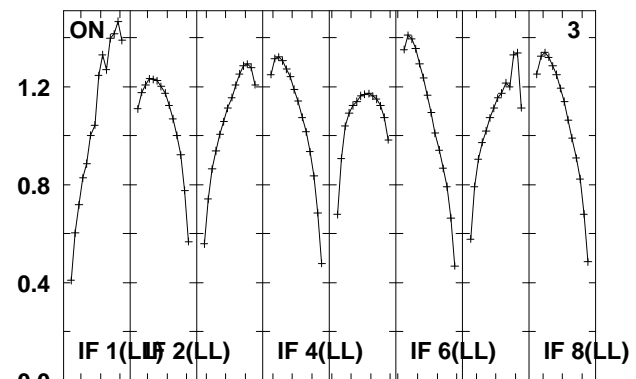
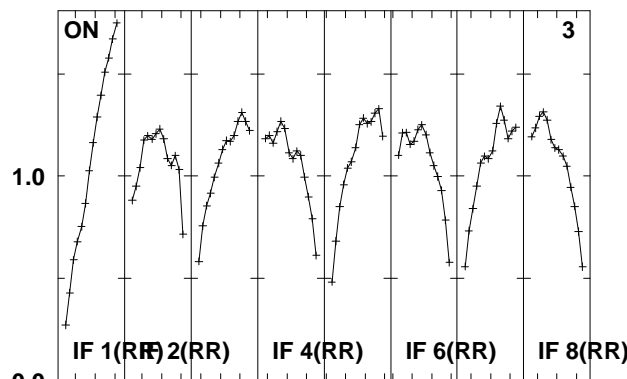
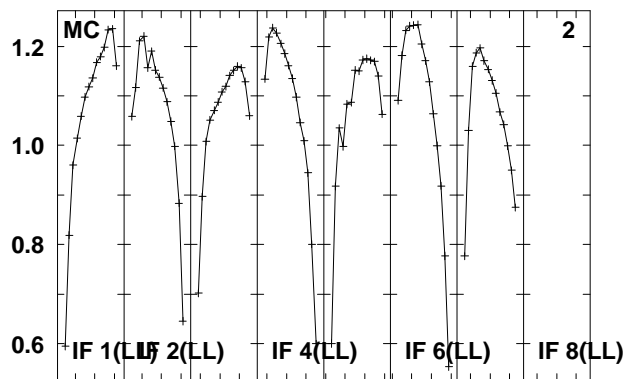
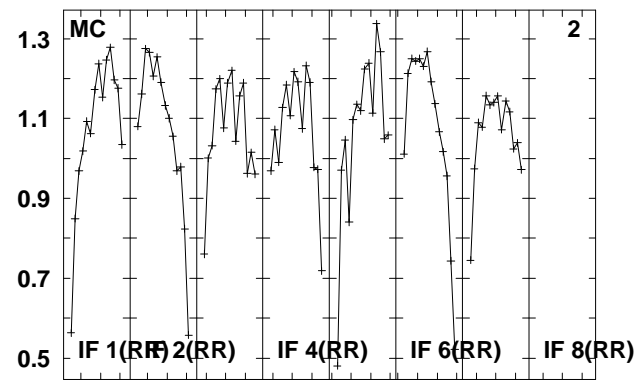
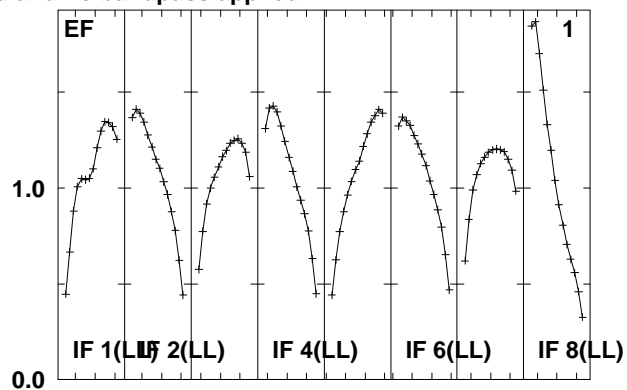
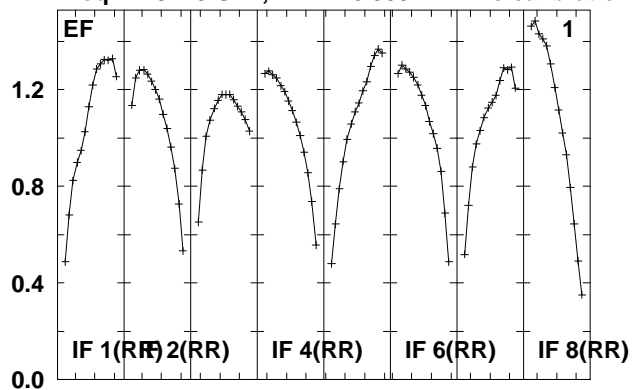

Lower frame: Real Jy
Total-power spectrum Antenna: *
Timerange: 00/23:13:46 to 00/23:15:44

Plot file version 267 created 08-JUL-2010 13:12:42

J1312+48 EM079.UVDATA.1

Freq = 4.9415 GHz, Bw = 16.000 MH No calibration applied and no bandpass applied

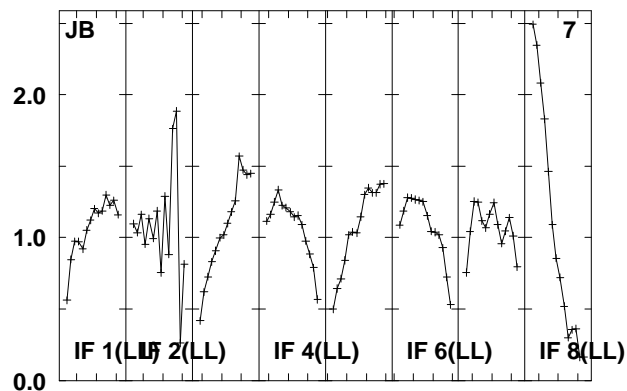
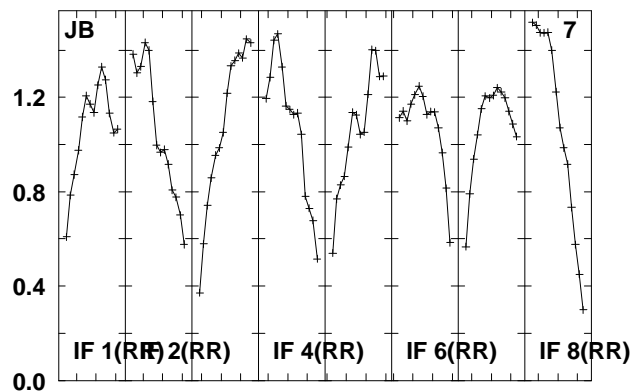
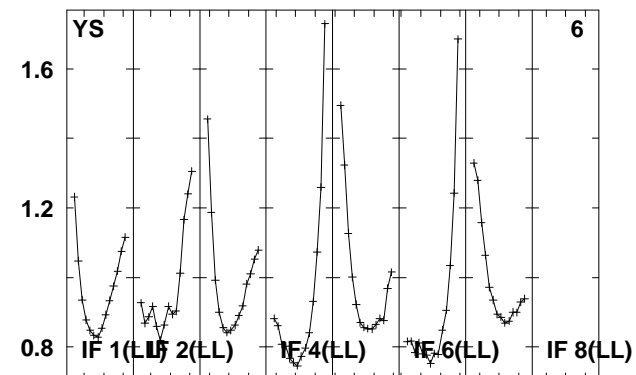
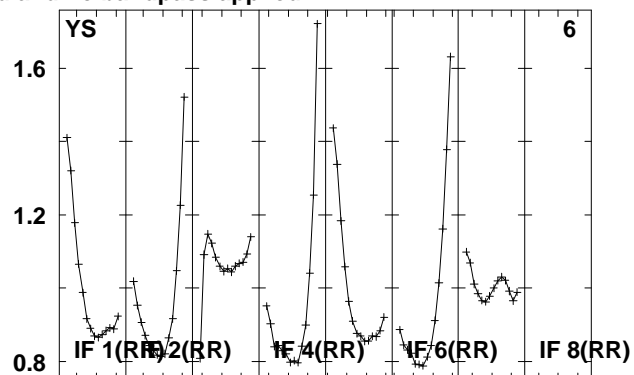
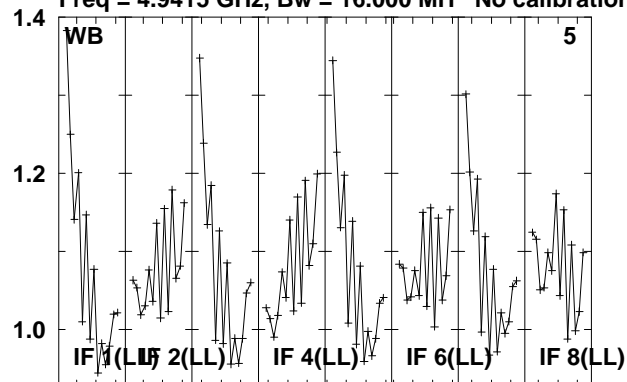

Lower frame: Real Jy
Total-power spectrum Antenna: *
Timerange: 00/23:13:46 to 00/23:15:44

Plot file version 268 created 08-JUL-2010 13:12:42

J1521+04 EM079.UVDATA.1

Freq = 4.9415 GHz, Bw = 16.000 MH No calibration applied and no bandpass applied

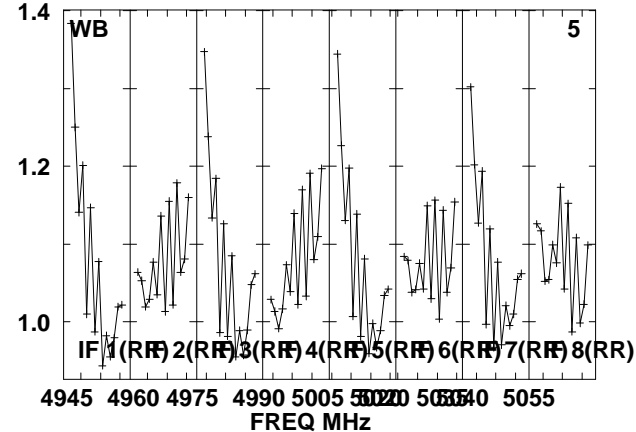
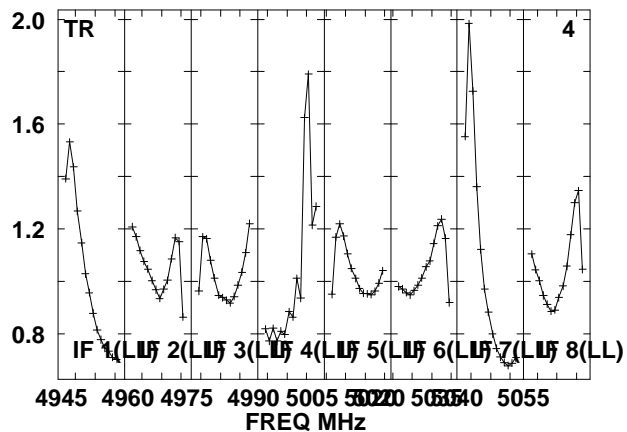
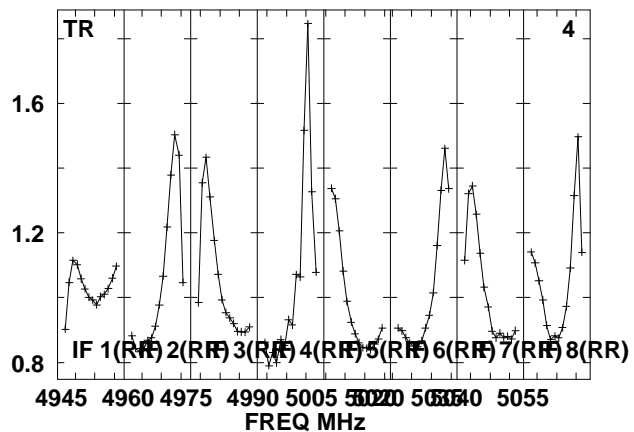
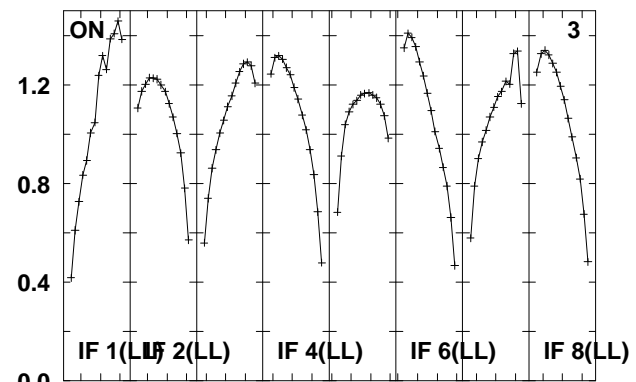
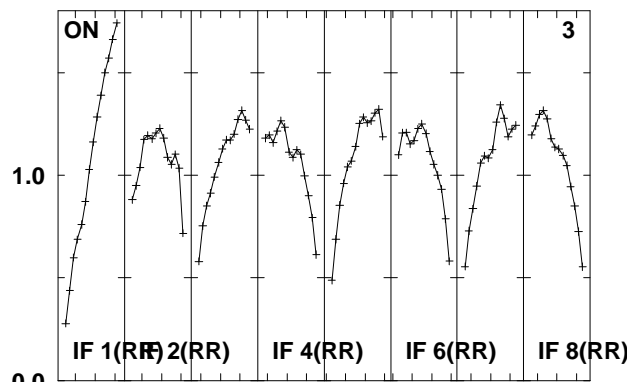
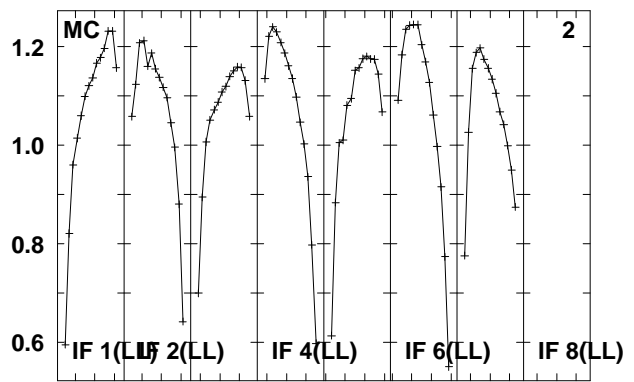
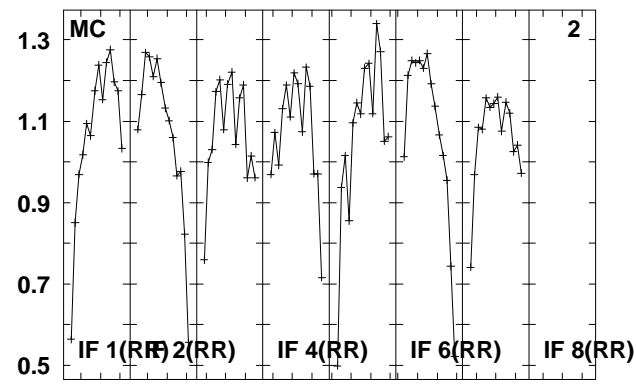
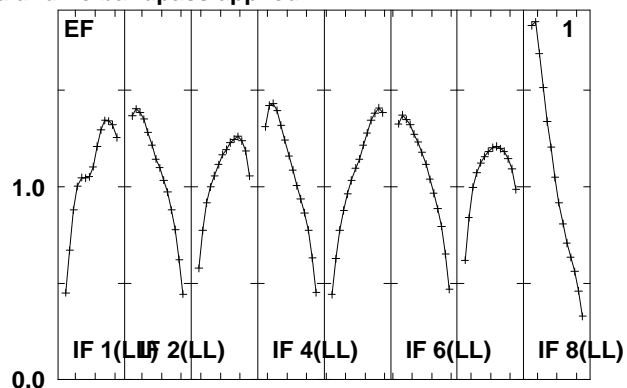
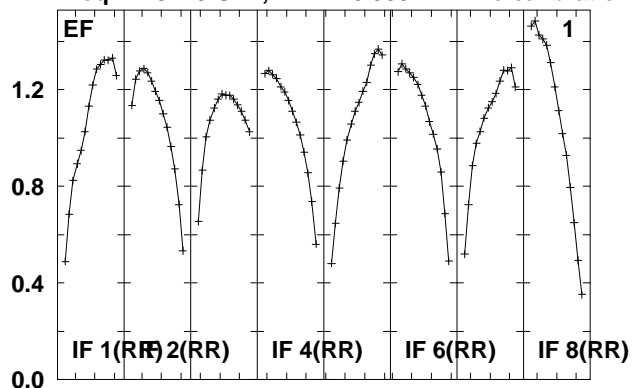

Lower frame: Real Jy
Total-power spectrum Antenna: *
Timerange: 00/23:15:46 to 00/23:22:24

Plot file version 269 created 08-JUL-2010 13:12:43

J1521+04 EM079.UVDATA.1

Freq = 4.9415 GHz, Bw = 16.000 MH No calibration applied and no bandpass applied

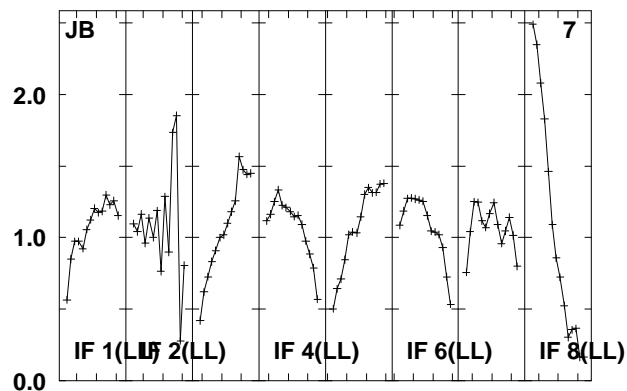
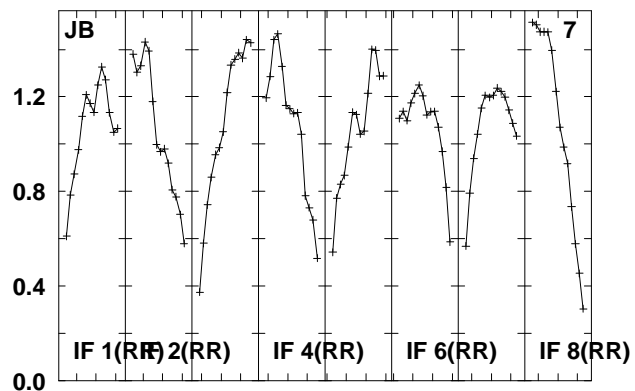
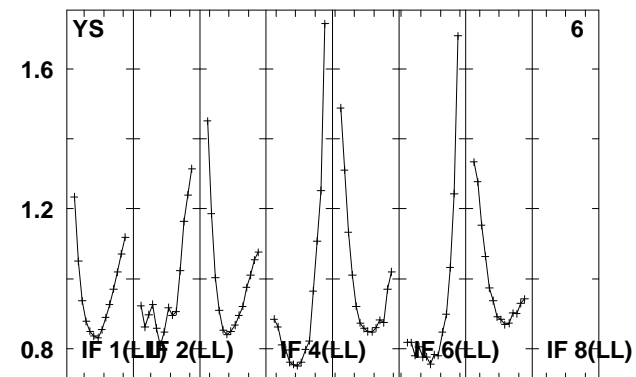
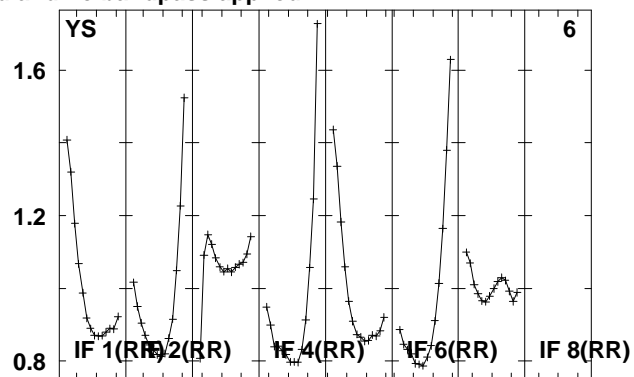
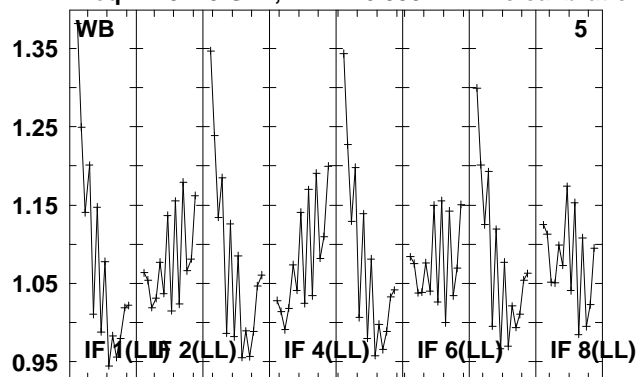

Lower frame: Real Jy
Total-power spectrum Antenna: *
Timerange: 00/23:15:46 to 00/23:22:24

Plot file version 270 created 08-JUL-2010 13:12:44

J1525+05 EM079.UVDATA.1

Freq = 4.9415 GHz, Bw = 16.000 MH No calibration applied and no bandpass applied

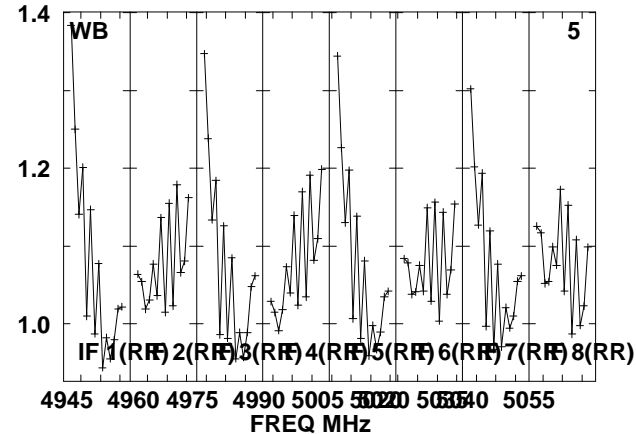
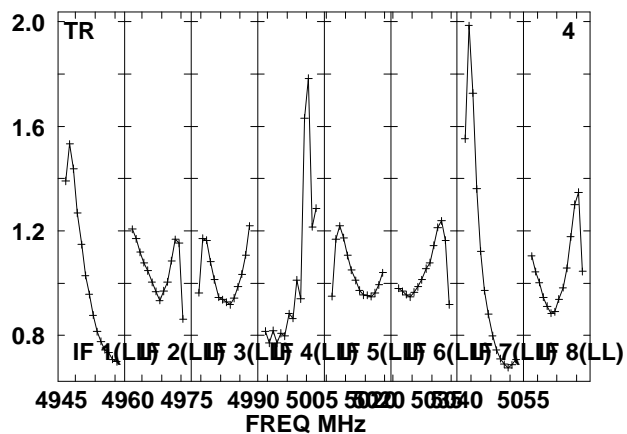
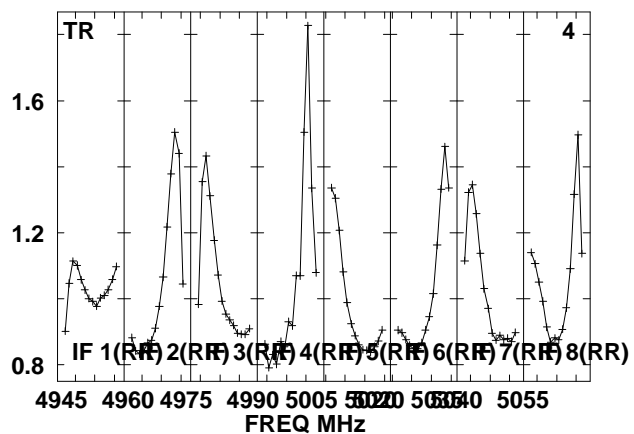
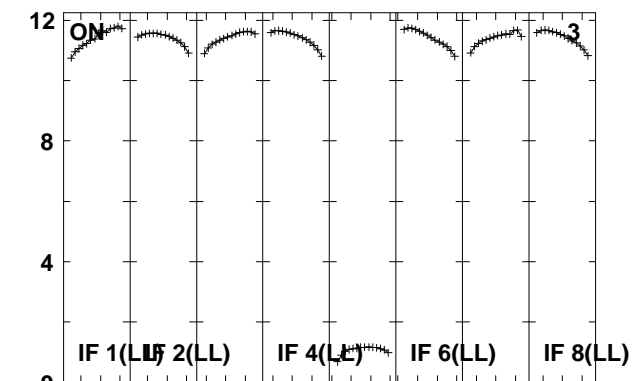
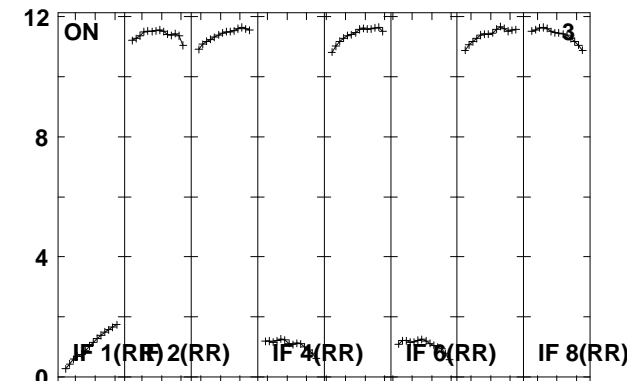
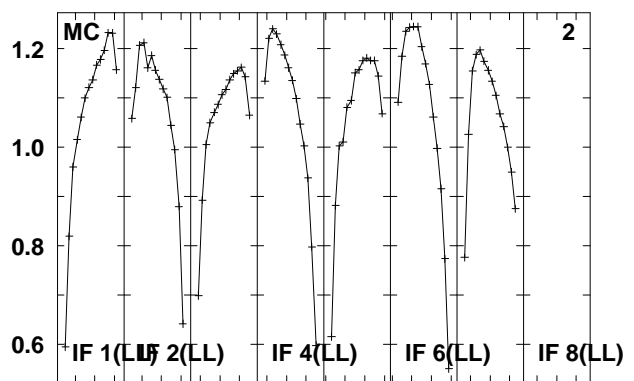
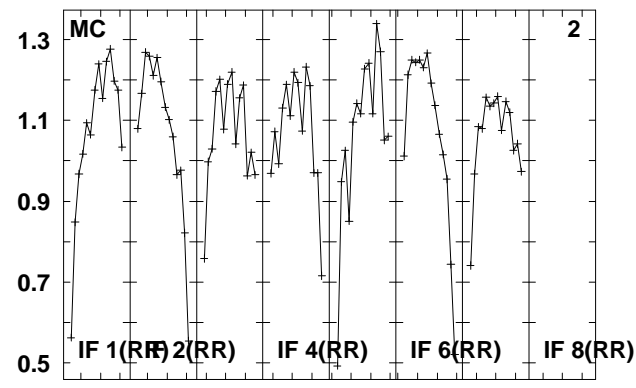
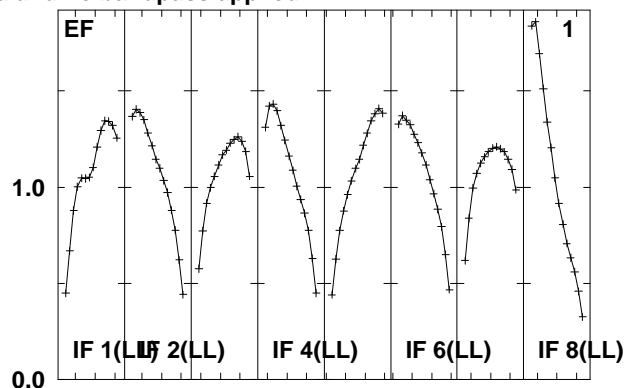
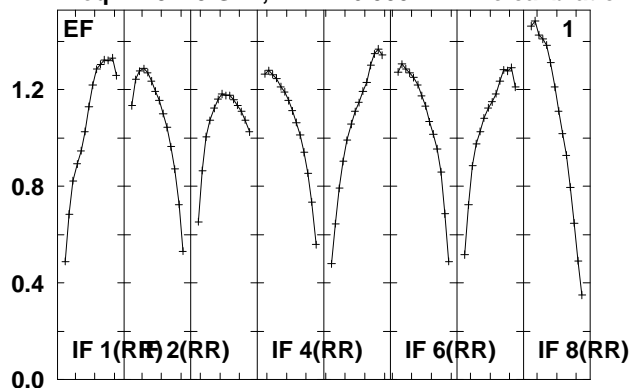

Lower frame: Real Jy
Total-power spectrum Antenna: *
Timerange: 00/23:22:26 to 00/23:33:08

Plot file version 271 created 08-JUL-2010 13:12:45

J1525+05 EM079.UVDATA.1

Freq = 4.9415 GHz, Bw = 16.000 MH No calibration applied and no bandpass applied

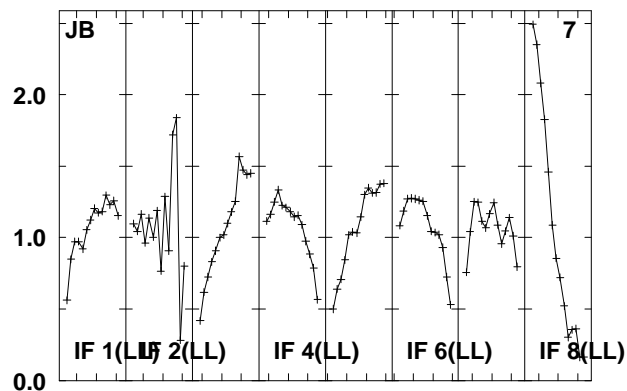
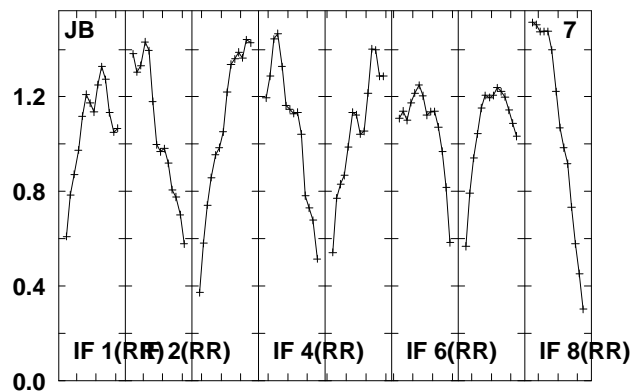
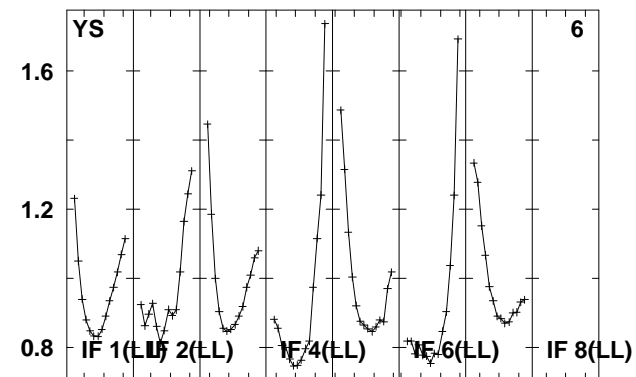
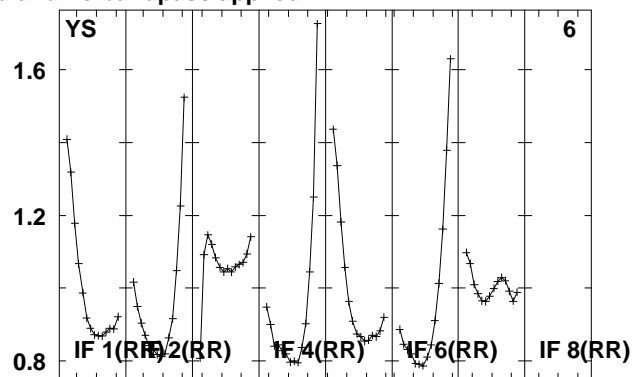
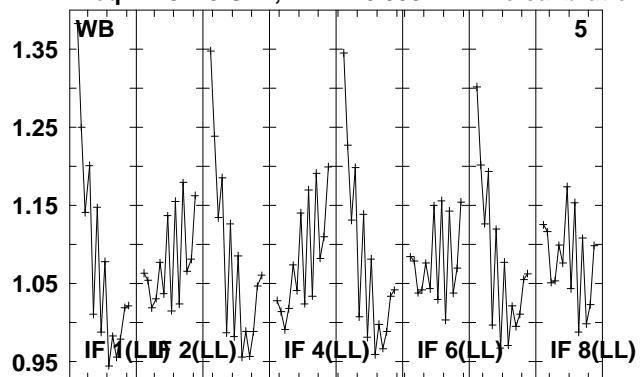

Lower frame: Real Jy
Total-power spectrum Antenna: *
Timerange: 00/23:22:26 to 00/23:33:08

Plot file version 272 created 08-JUL-2010 13:12:47

J1521+04 EM079.UVDATA.1

Freq = 4.9415 GHz, Bw = 16.000 MH No calibration applied and no bandpass applied

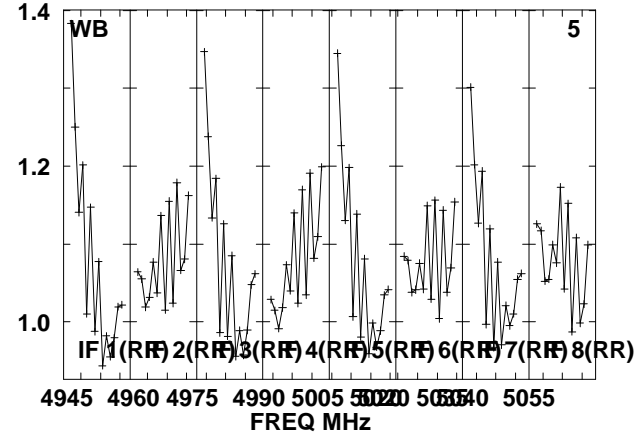
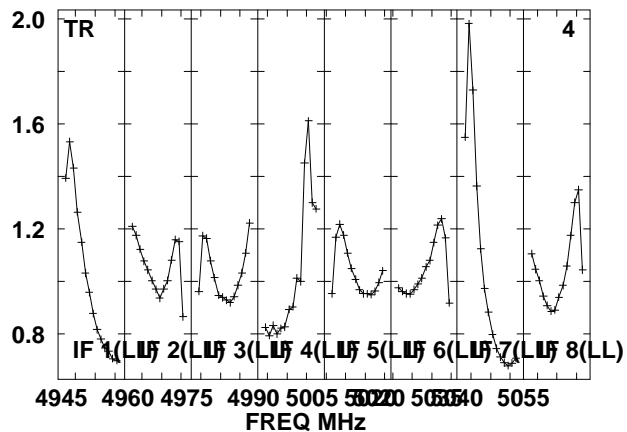
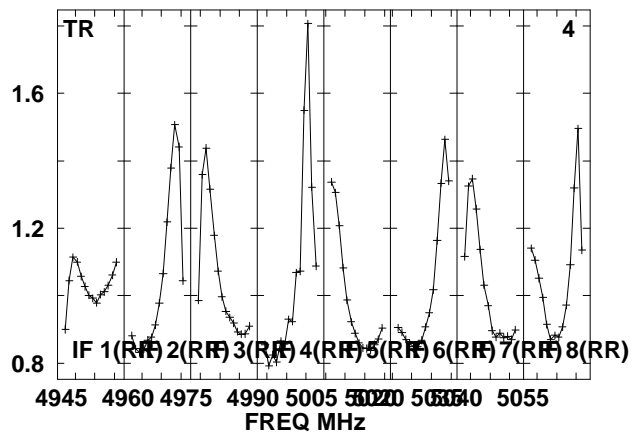
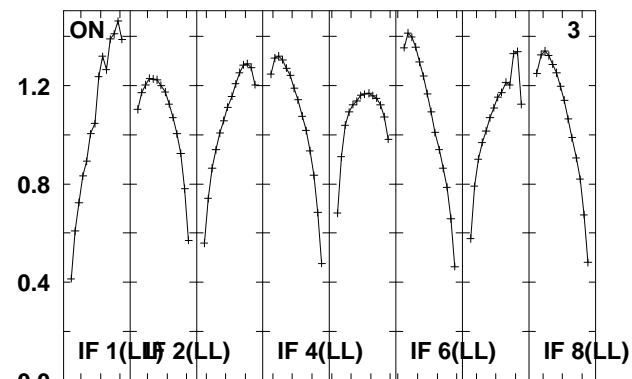
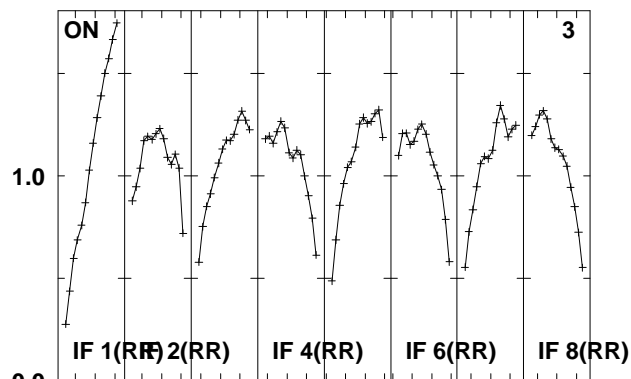
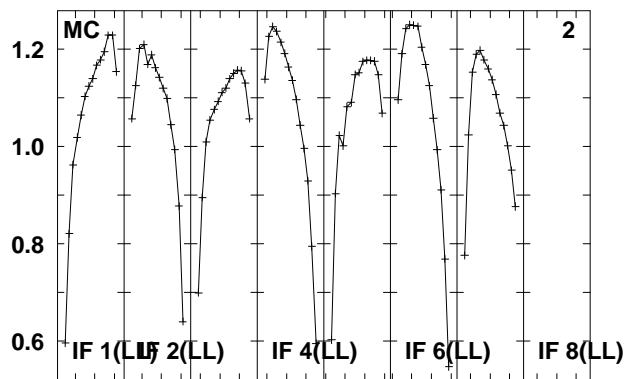
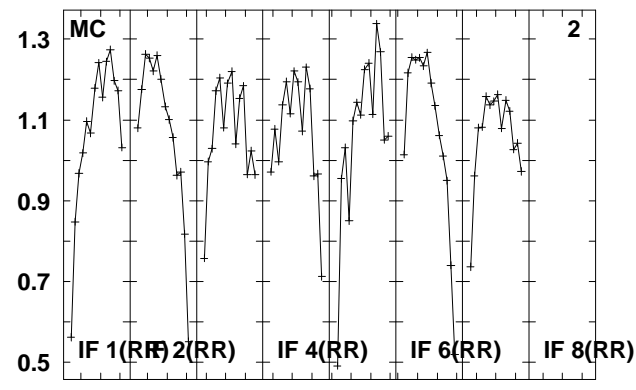
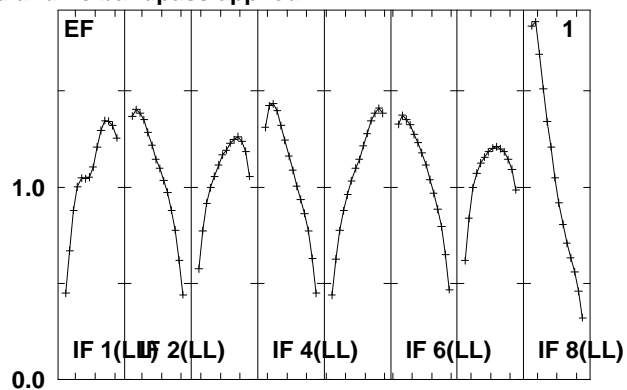
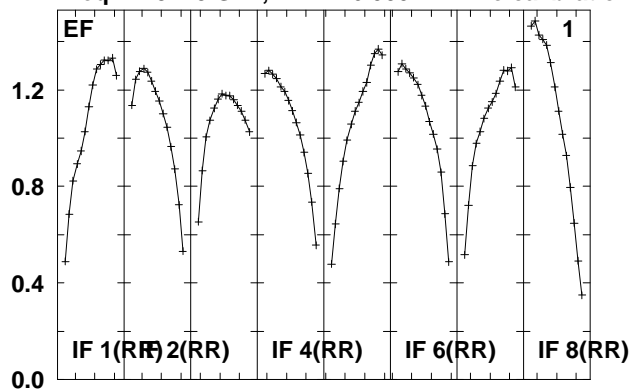

Lower frame: Real Jy
Total-power spectrum Antenna: *
Timerange: 00/23:33:10 to 00/23:35:08

Plot file version 273 created 08-JUL-2010 13:12:47

J1521+04 EM079.UVDATA.1

Freq = 4.9415 GHz, Bw = 16.000 MH No calibration applied and no bandpass applied

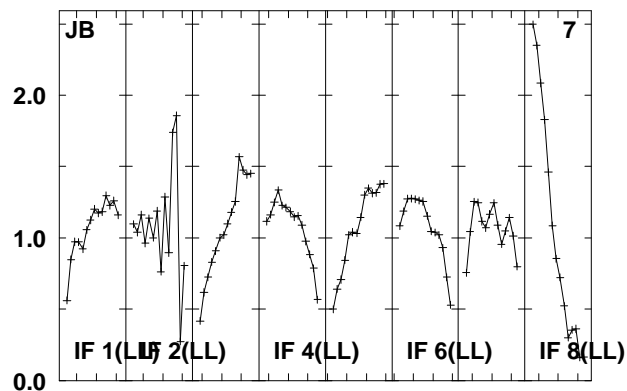
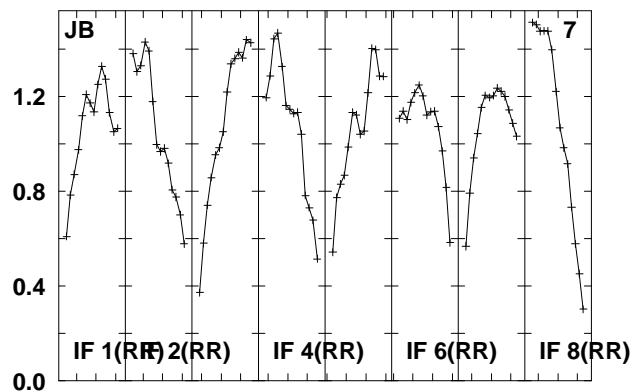
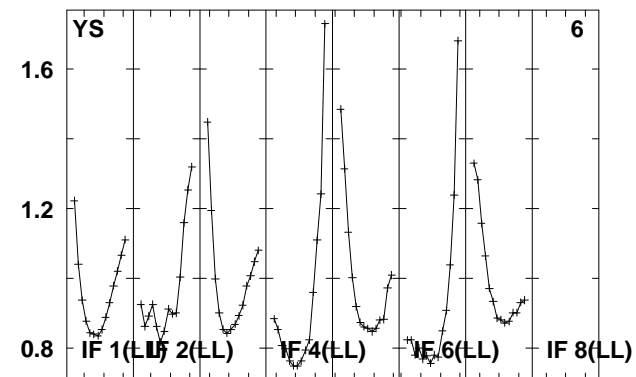
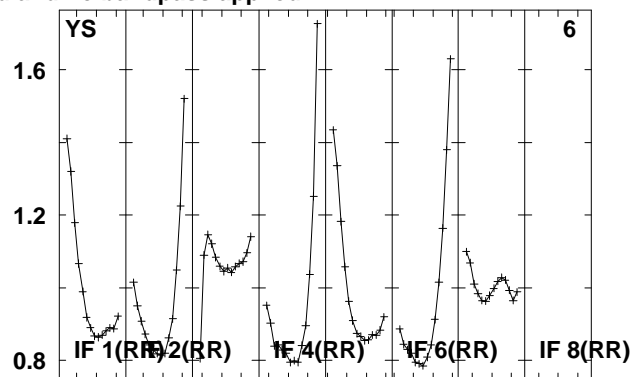
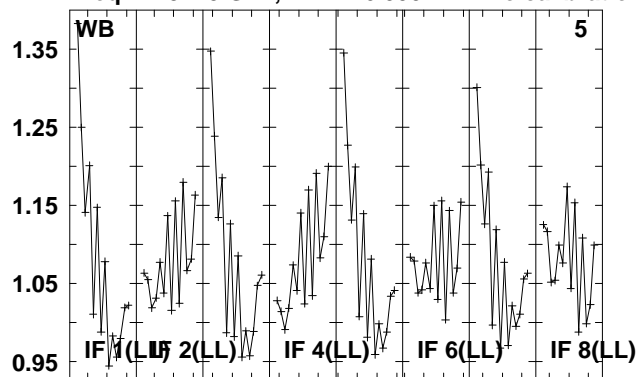

Lower frame: Real Jy
Total-power spectrum Antenna: *
Timerange: 00/23:33:10 to 00/23:35:08

Plot file version 274 created 08-JUL-2010 13:12:48

J1525+05 EM079.UVDATA.1

Freq = 4.9415 GHz, Bw = 16.000 MH No calibration applied and no bandpass applied

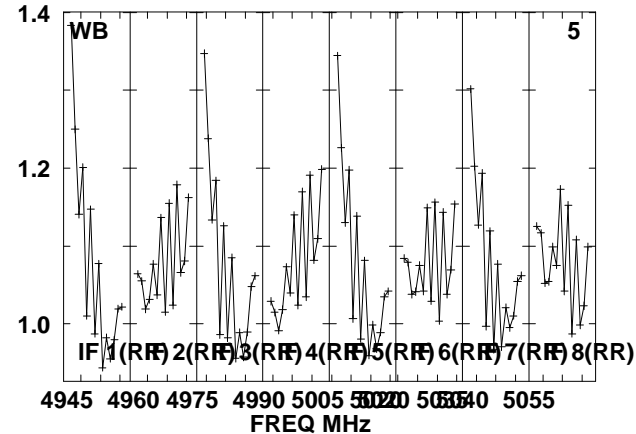
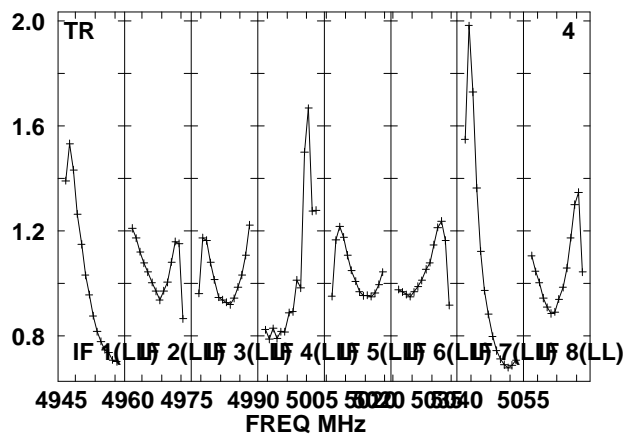
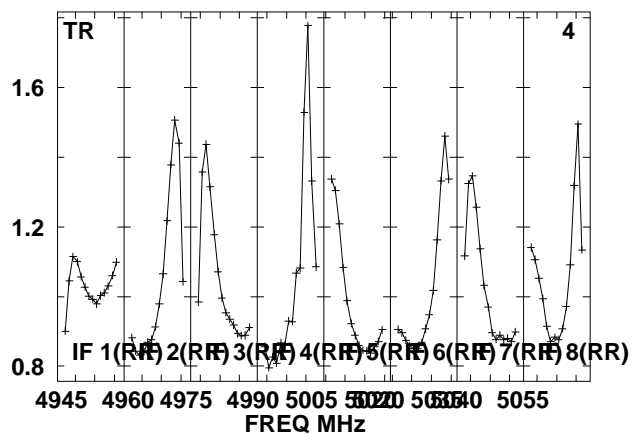
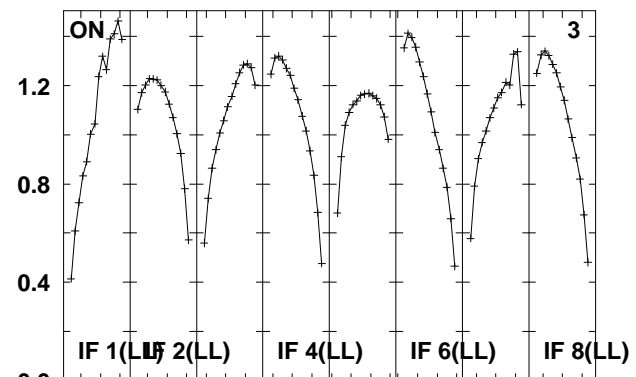
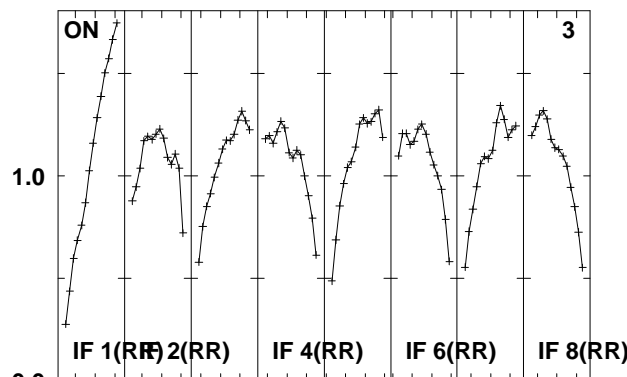
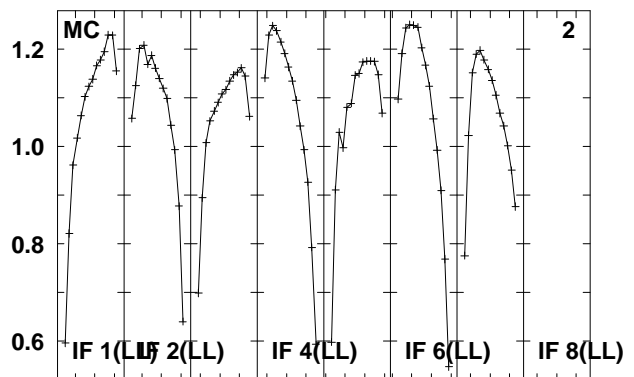
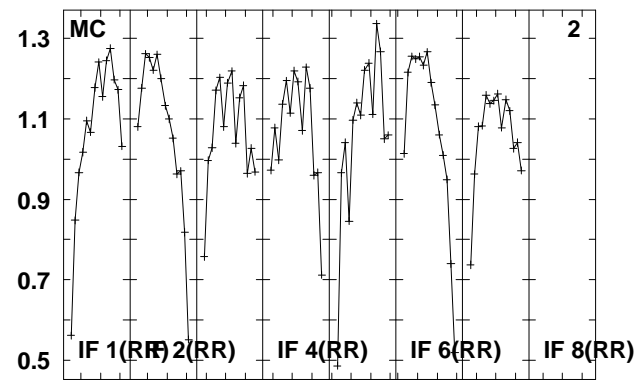
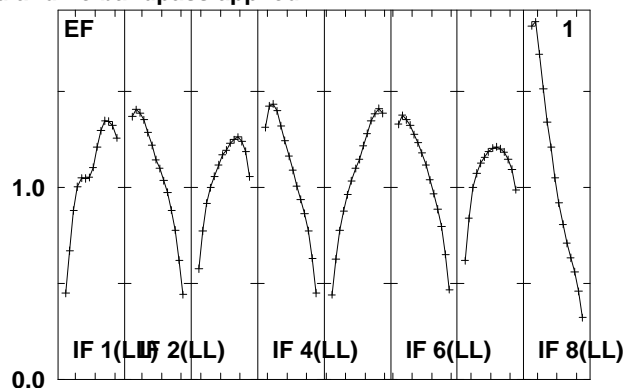
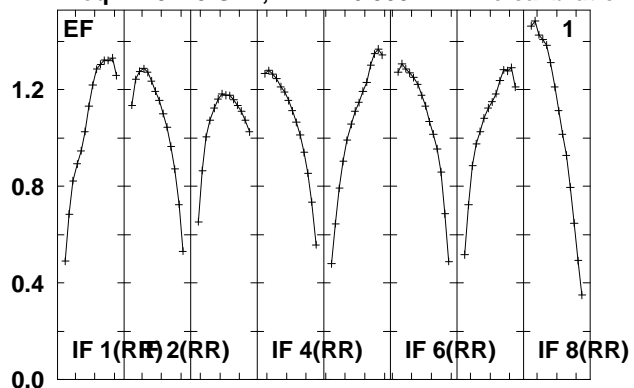

Lower frame: Real Jy
Total-power spectrum Antenna: *
Timerange: 00/23:35:10 to 00/23:45:54

Plot file version 275 created 08-JUL-2010 13:12:49

J1525+05 EM079.UVDATA.1

Freq = 4.9415 GHz, Bw = 16.000 MH No calibration applied and no bandpass applied

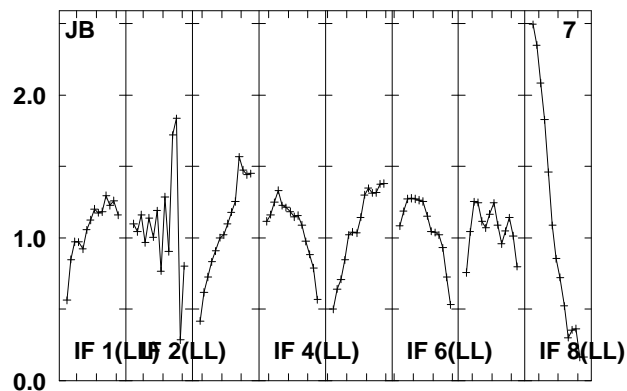
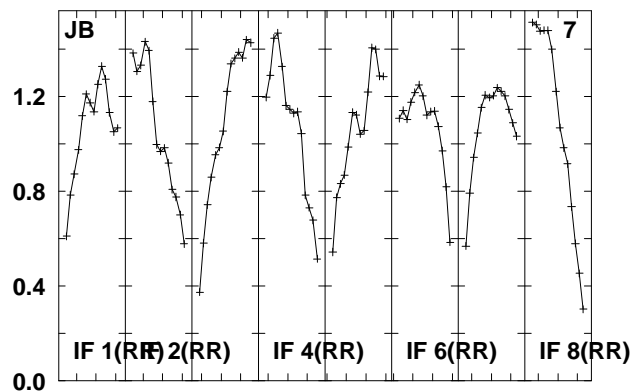
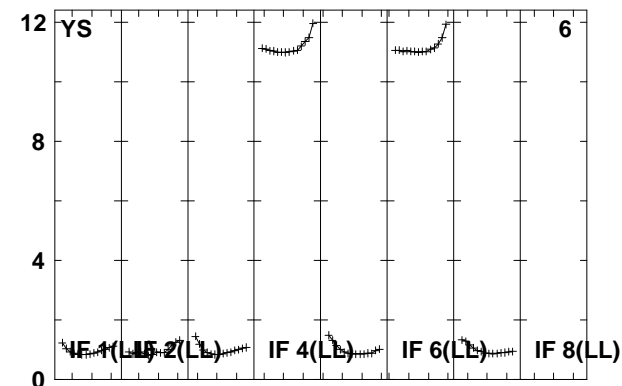
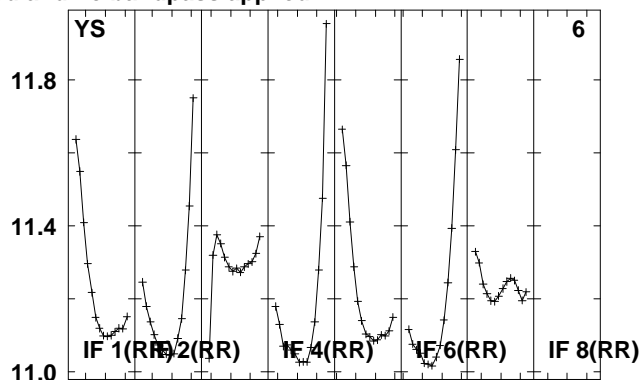
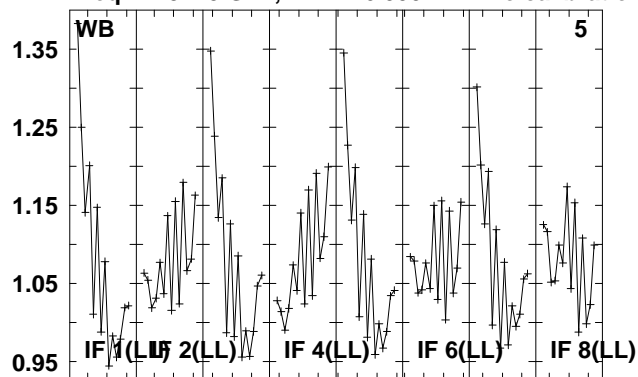

Lower frame: Real Jy
Total-power spectrum Antenna: *
Timerange: 00/23:35:10 to 00/23:45:54

Plot file version 276 created 08-JUL-2010 13:12:56

J1521+04 EM079.UVDATA.1

Freq = 4.9415 GHz, Bw = 16.000 MH No calibration applied and no bandpass applied

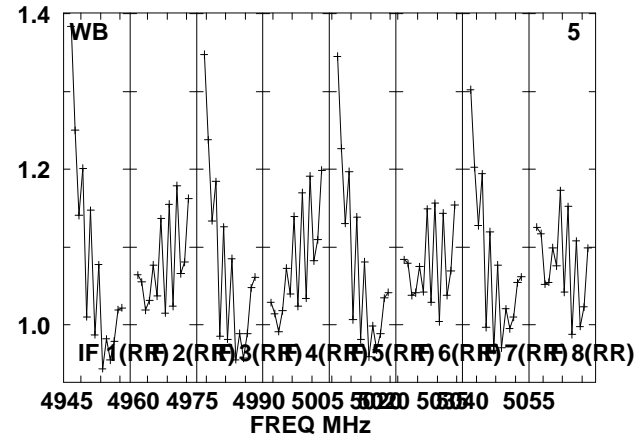
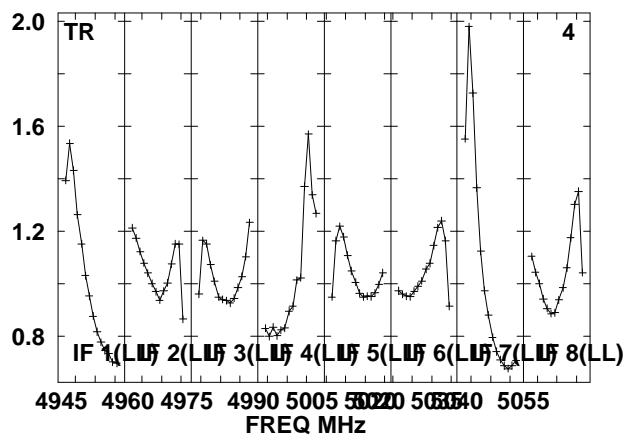
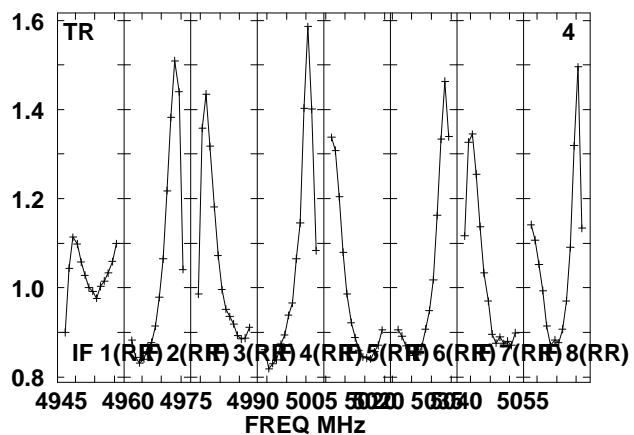
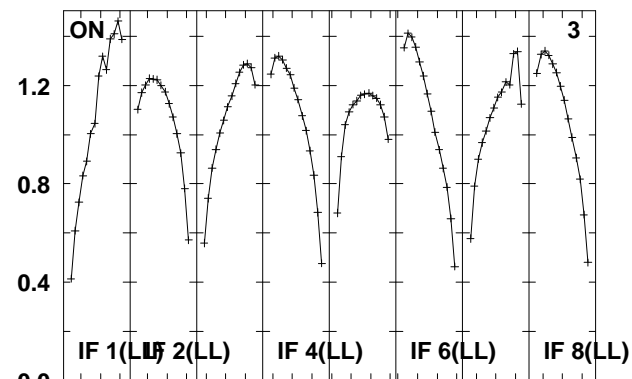
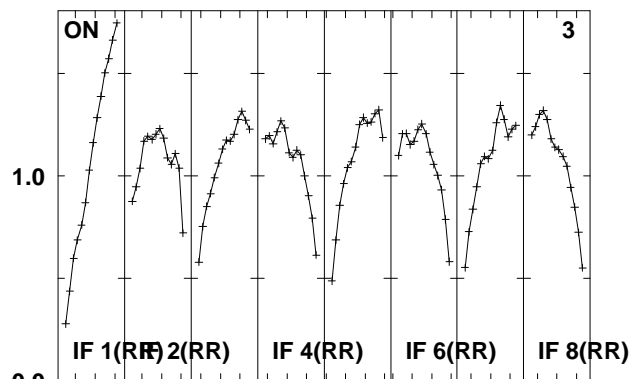
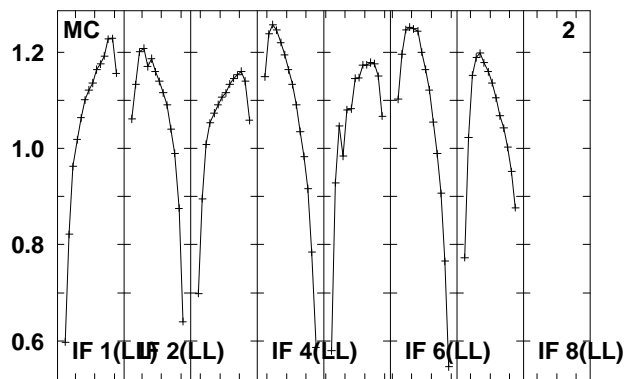
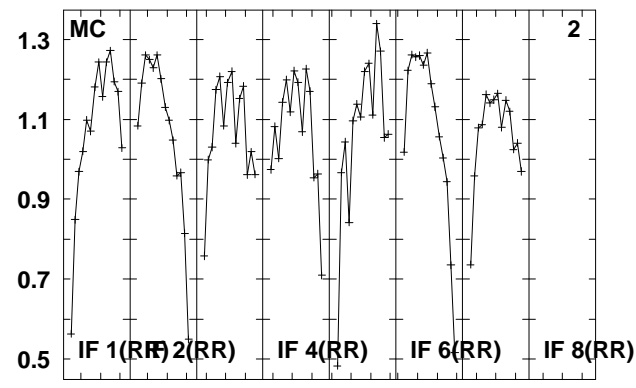
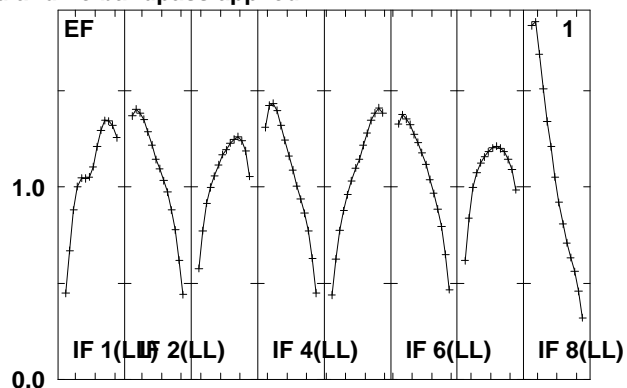
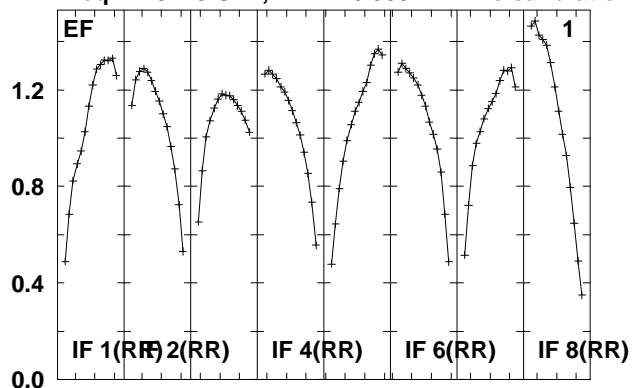

Lower frame: Real Jy
Total-power spectrum Antenna: *
Timerange: 00/23:45:56 to 00/23:47:54

Plot file version 277 created 08-JUL-2010 13:12:56

J1521+04 EM079.UVDATA.1

Freq = 4.9415 GHz, Bw = 16.000 MH No calibration applied and no bandpass applied

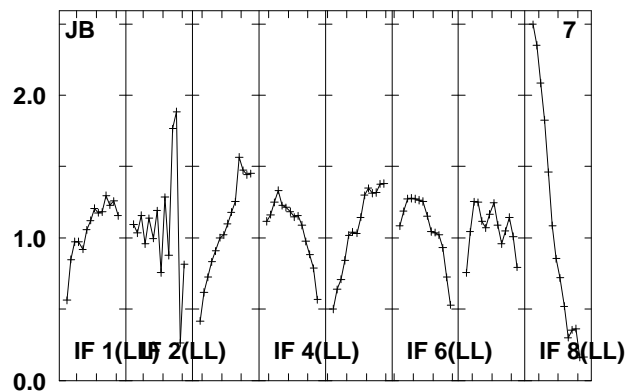
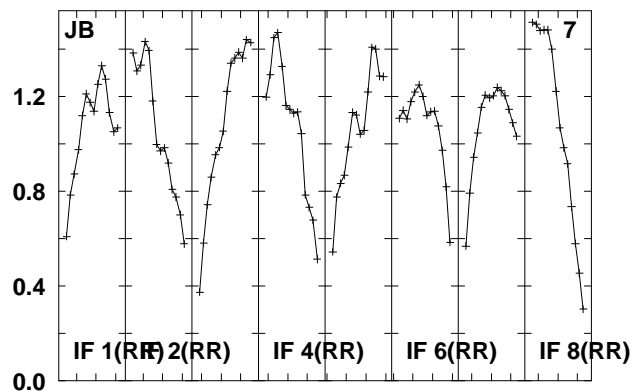
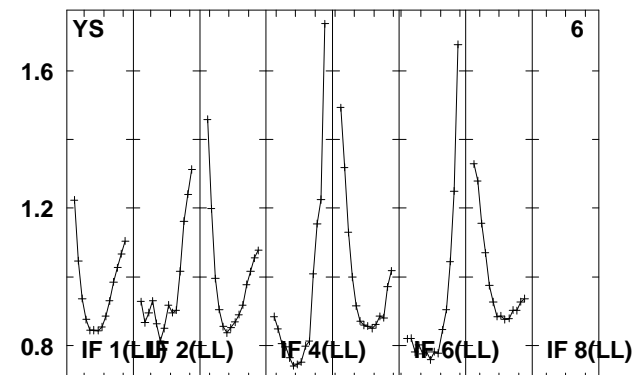
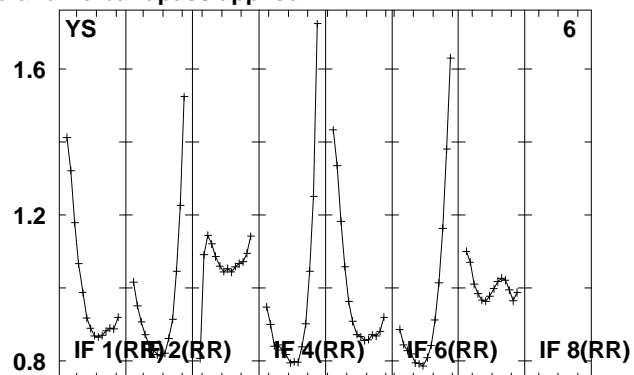
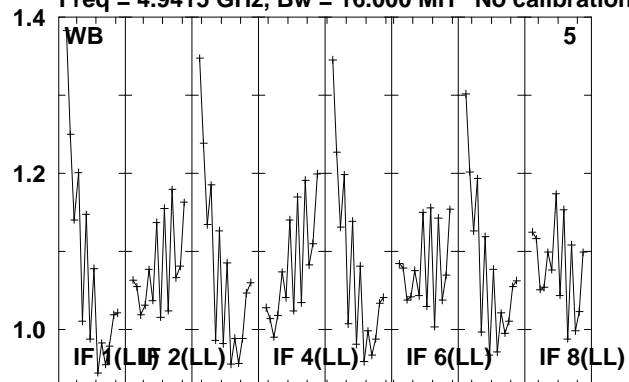

Lower frame: Real Jy
Total-power spectrum Antenna: *
Timerange: 00/23:45:56 to 00/23:47:54

Plot file version 278 created 08-JUL-2010 13:12:57

J1525+05 EM079.UVDATA.1

Freq = 4.9415 GHz, Bw = 16.000 MH No calibration applied and no bandpass applied

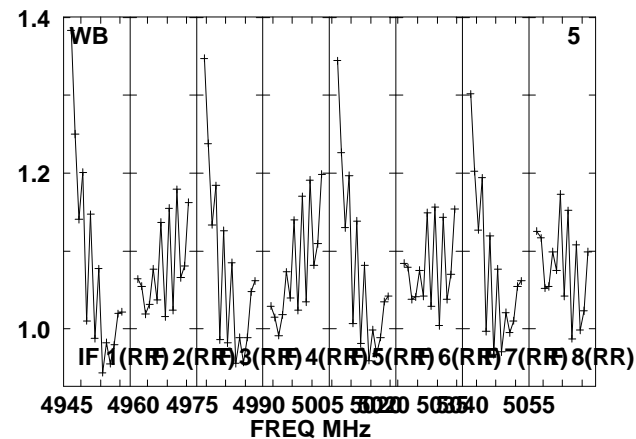
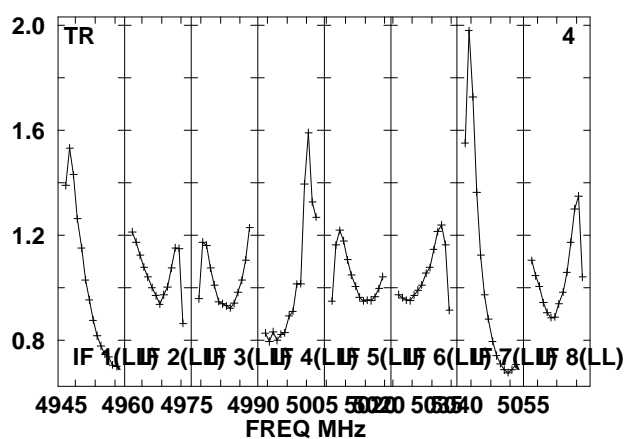
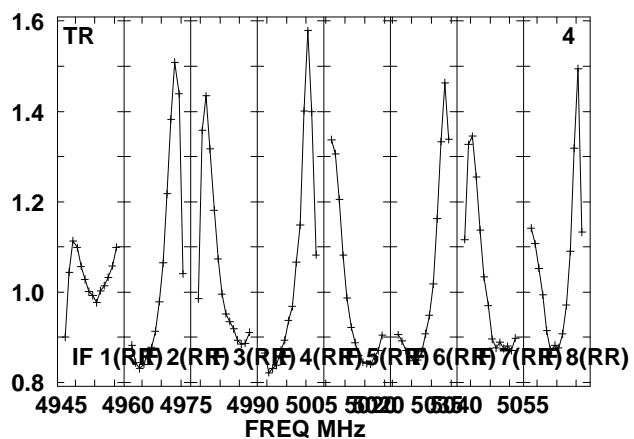
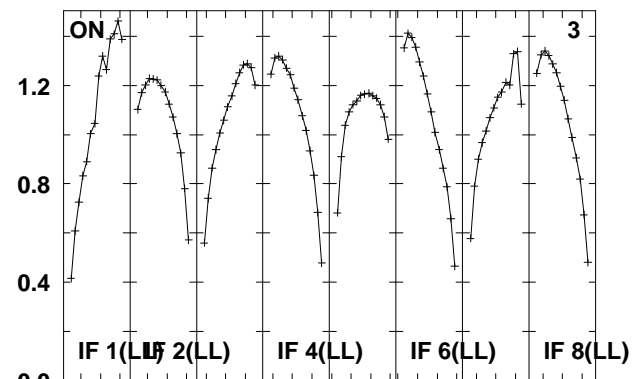
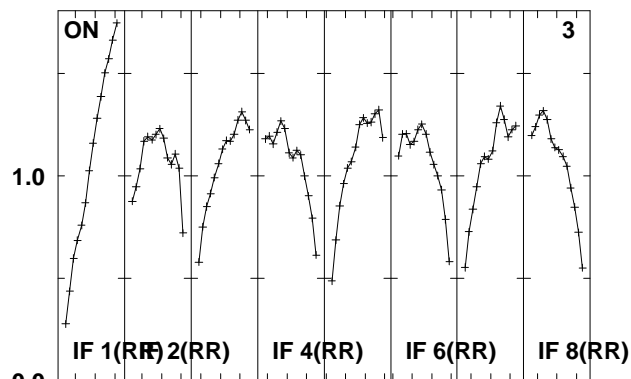
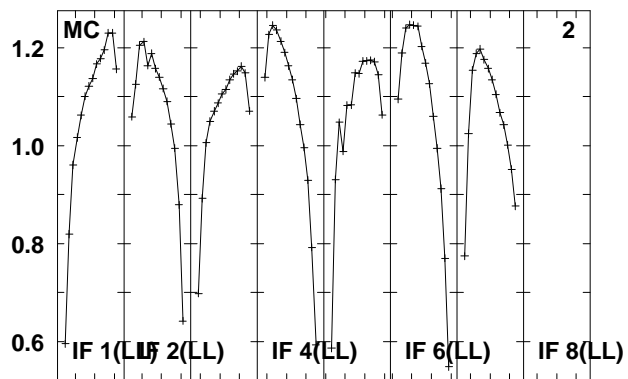
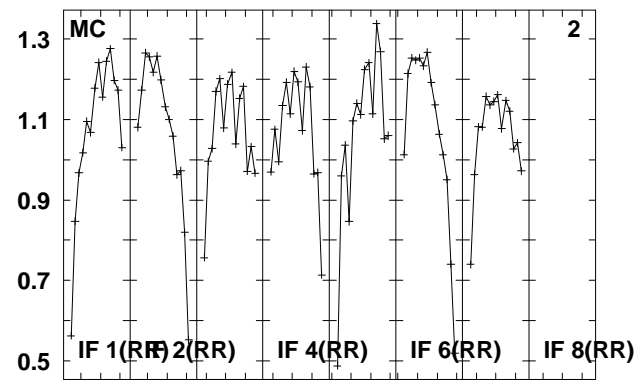
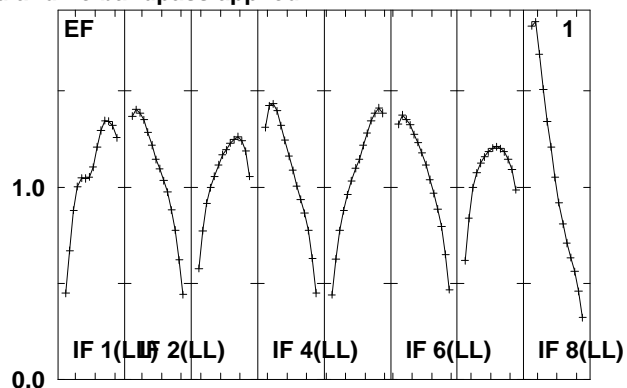
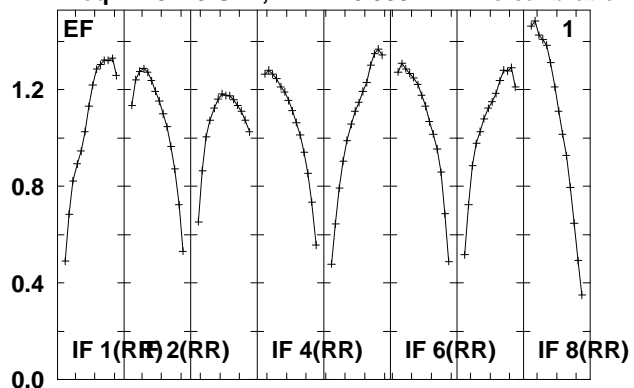

Lower frame: Real Jy
Total-power spectrum Antenna: *
Timerange: 00/23:47:56 to 00/23:58:38

Plot file version 279 created 08-JUL-2010 13:12:58

J1525+05 EM079.UVDATA.1

Freq = 4.9415 GHz, Bw = 16.000 MH No calibration applied and no bandpass applied

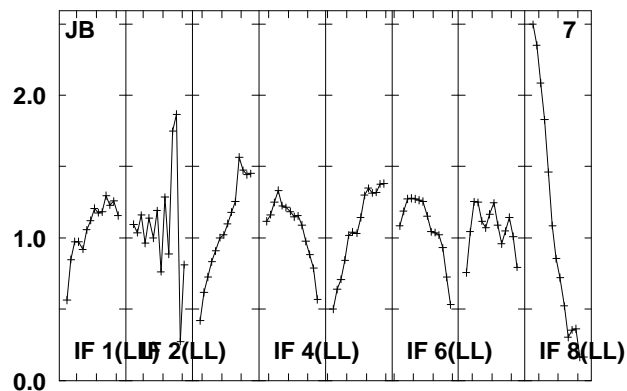
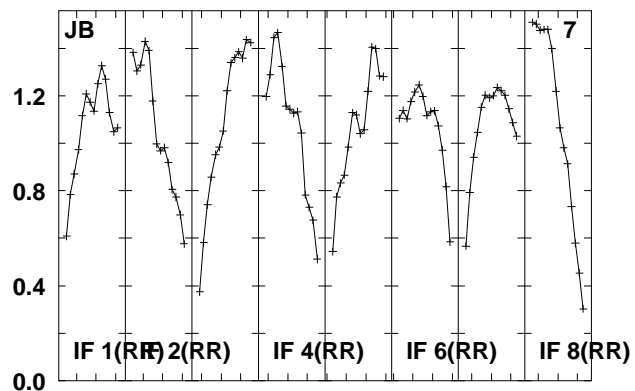
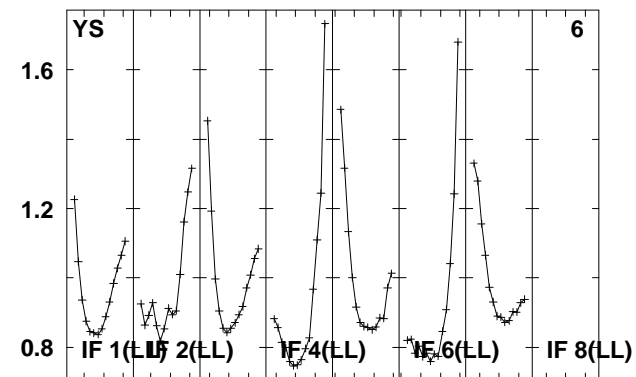
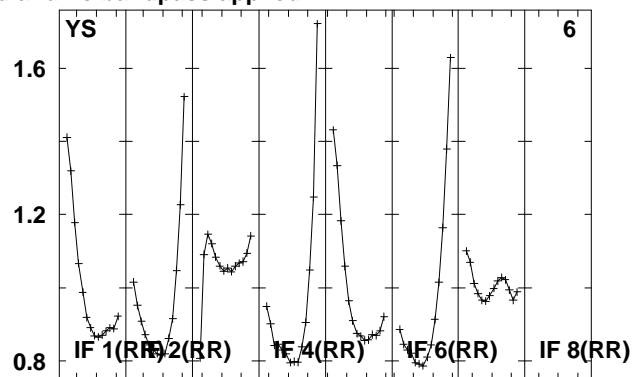
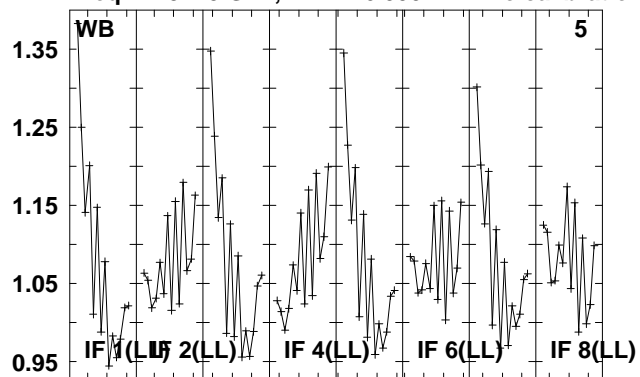

Lower frame: Real Jy
Total-power spectrum Antenna: *
Timerange: 00/23:47:56 to 00/23:58:38

Plot file version 280 created 08-JUL-2010 13:13:00

J1521+04 EM079.UVDATA.1

Freq = 4.9415 GHz, Bw = 16.000 MH No calibration applied and no bandpass applied

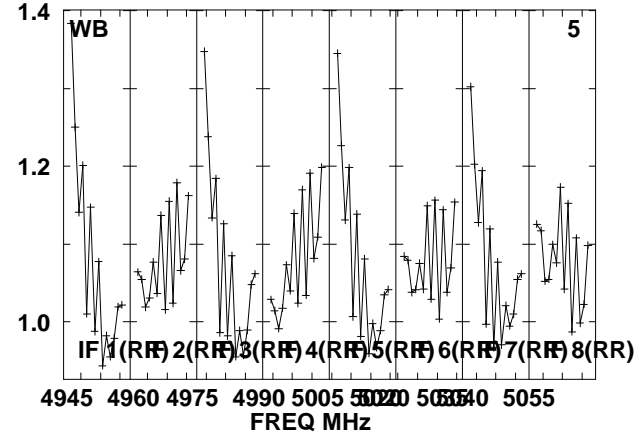
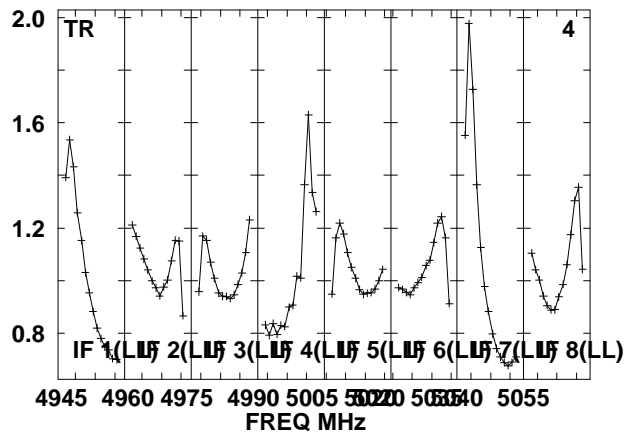
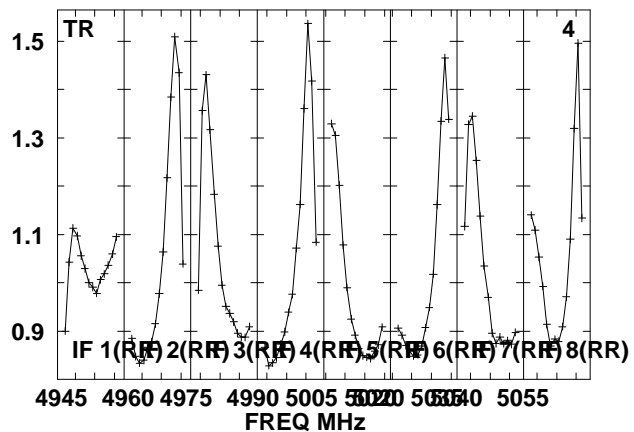
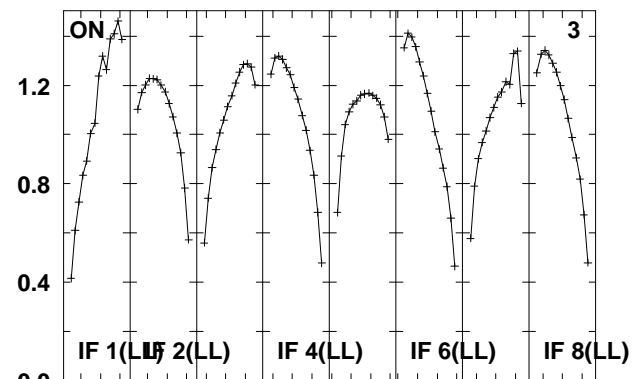
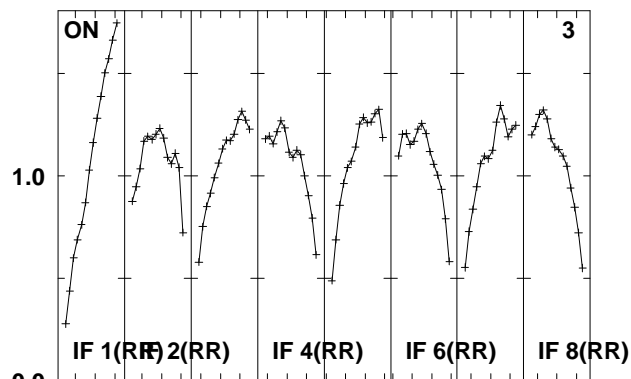
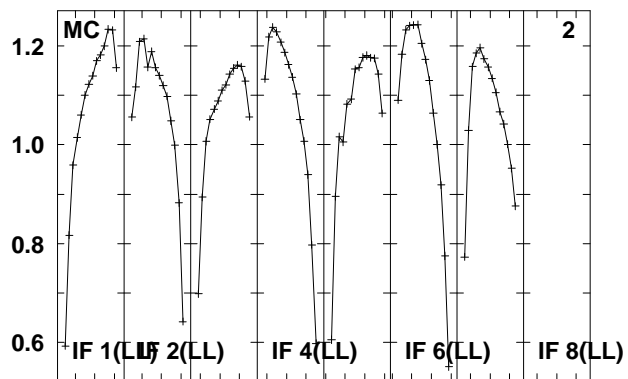
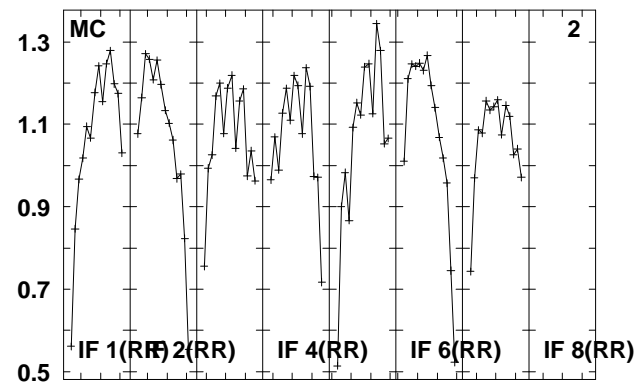
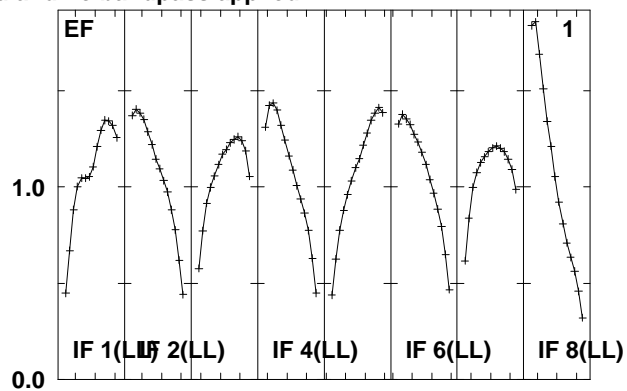
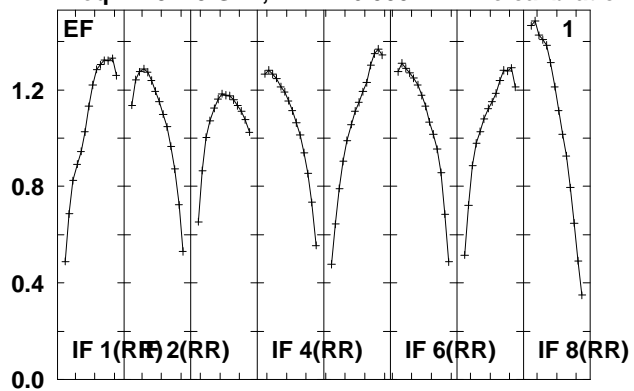

Lower frame: Real Jy
Total-power spectrum Antenna: *
Timerange: 00/23:58:40 to 01/00:00:38

Plot file version 281 created 08-JUL-2010 13:13:00

J1521+04 EM079.UVDATA.1

Freq = 4.9415 GHz, Bw = 16.000 MH No calibration applied and no bandpass applied

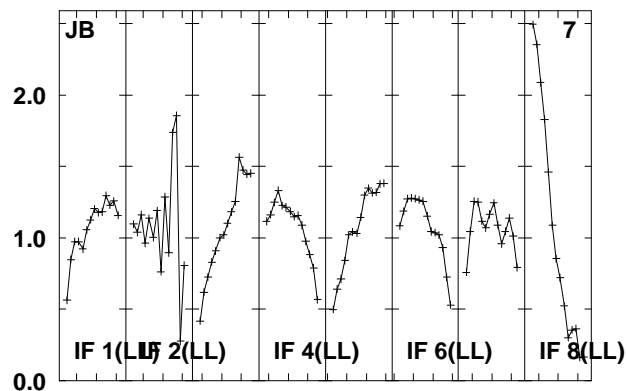
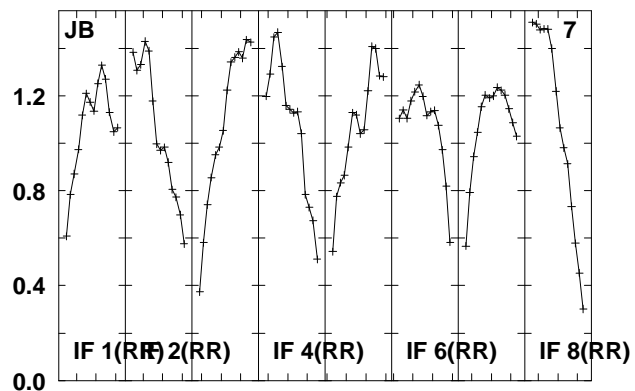
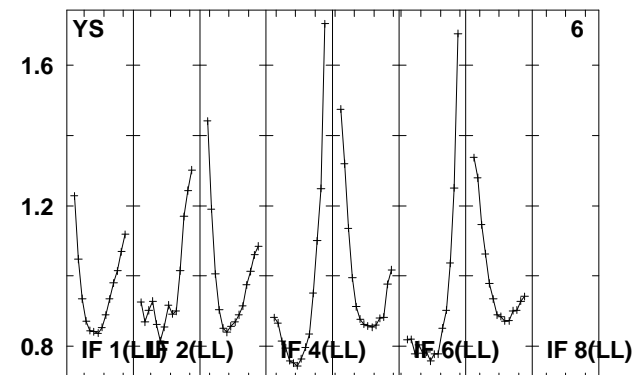
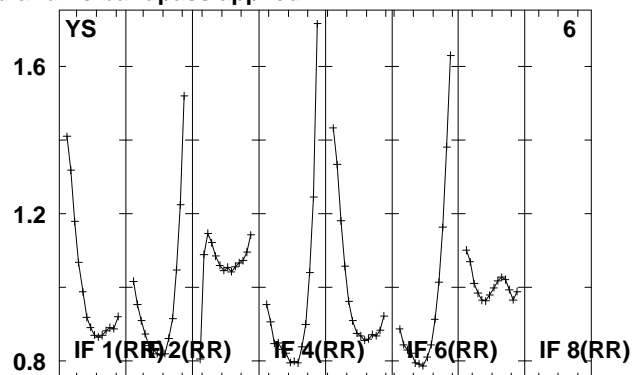
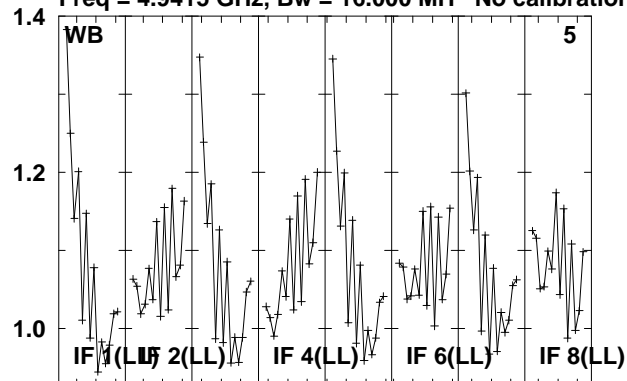

Lower frame: Real Jy
Total-power spectrum Antenna: *
Timerange: 00/23:58:40 to 01/00:00:38

Plot file version 282 created 08-JUL-2010 13:13:01

J1525+05 EM079.UVDATA.1

Freq = 4.9415 GHz, Bw = 16.000 MH No calibration applied and no bandpass applied

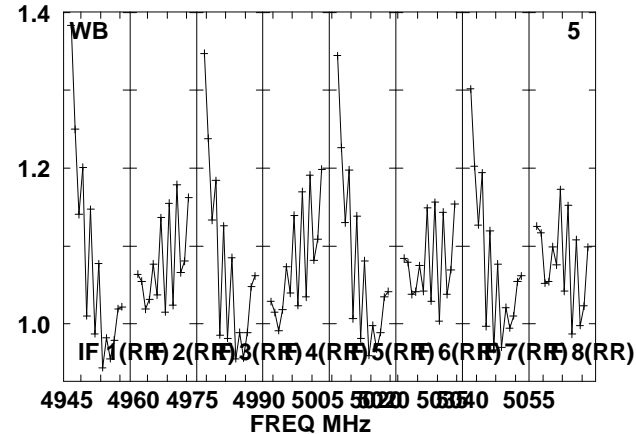
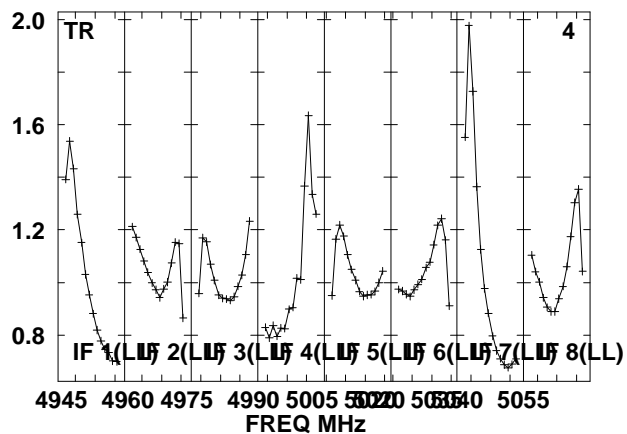
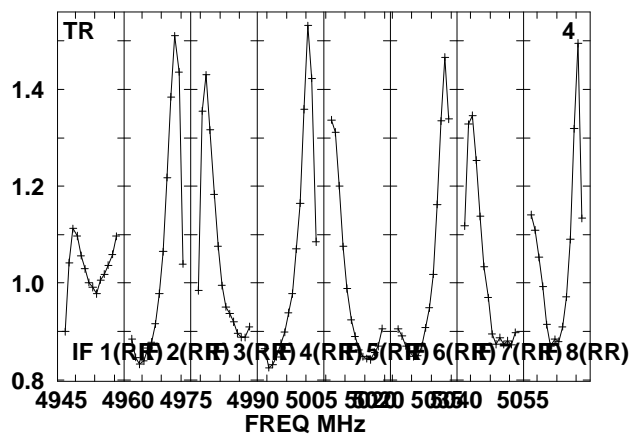
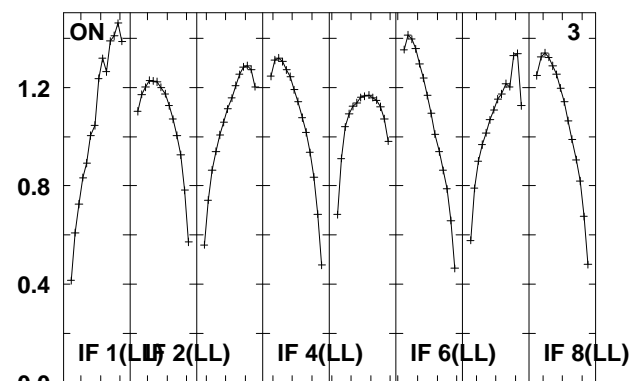
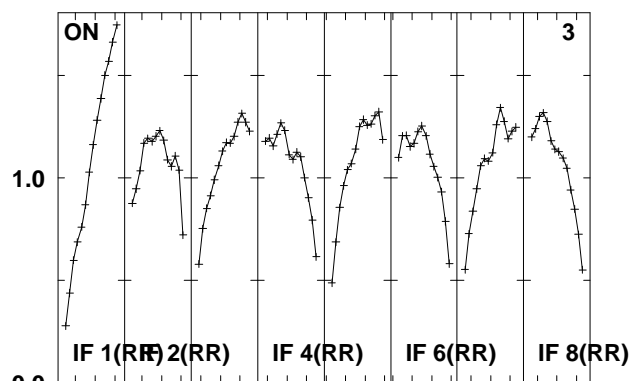
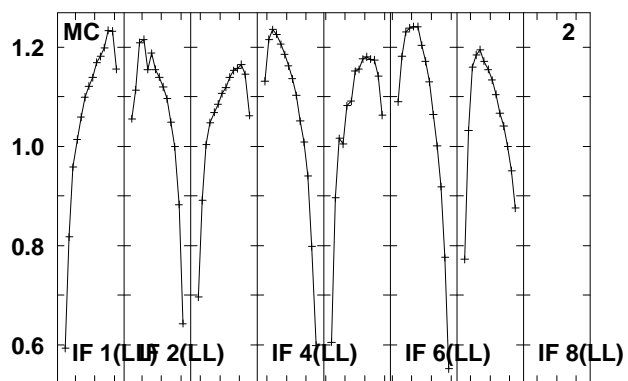
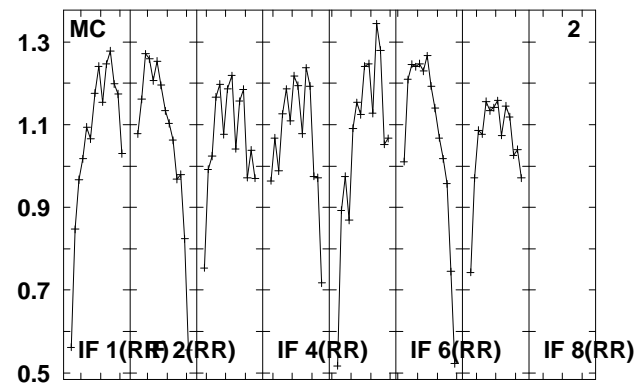
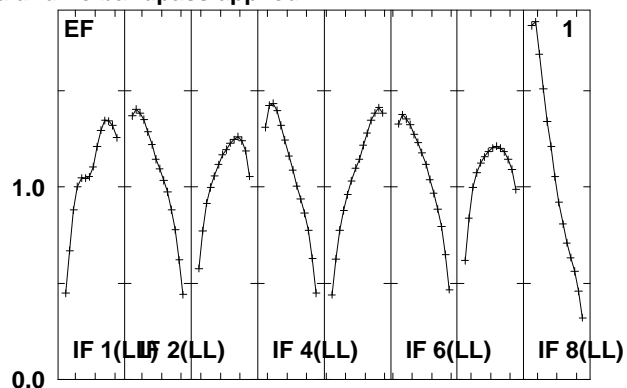
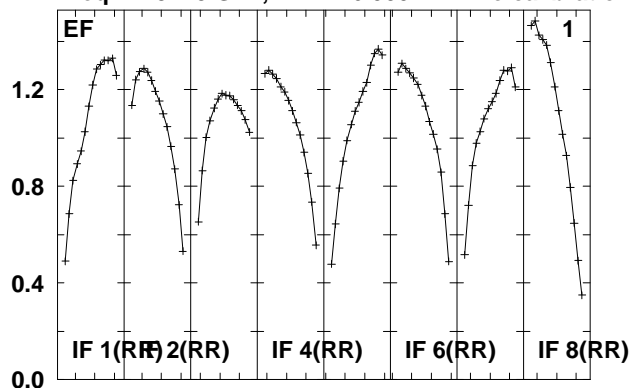

Lower frame: Real Jy
Total-power spectrum Antenna: *
Timerange: 01/00:00:40 to 01/00:11:24

Plot file version 283 created 08-JUL-2010 13:13:02

J1525+05 EM079.UVDATA.1

Freq = 4.9415 GHz, Bw = 16.000 MH No calibration applied and no bandpass applied

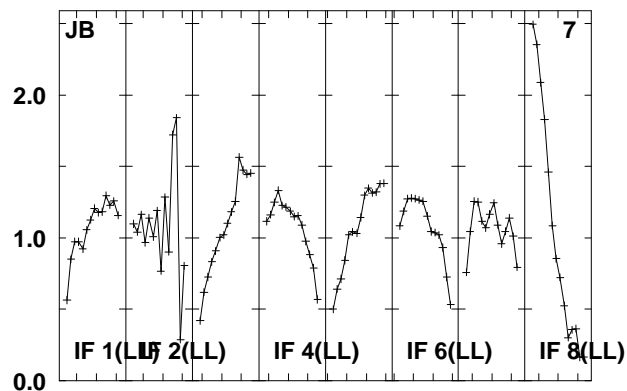
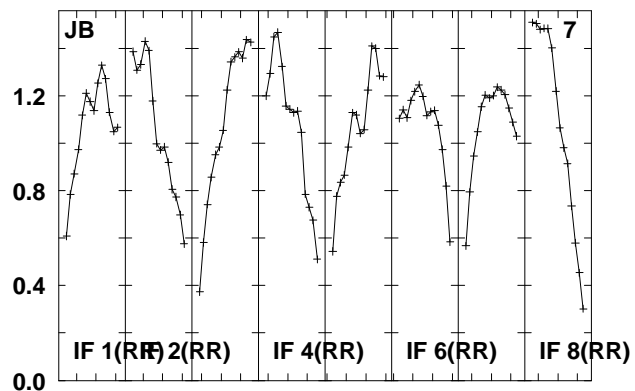
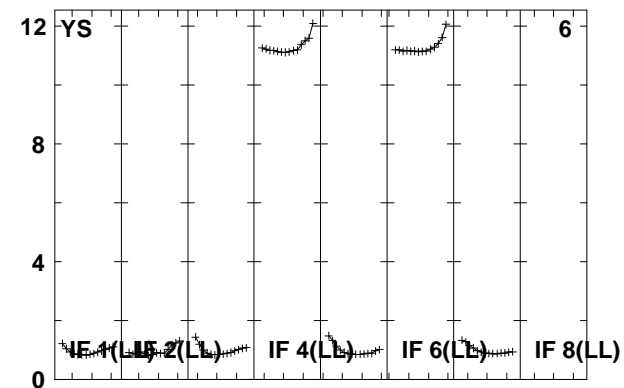
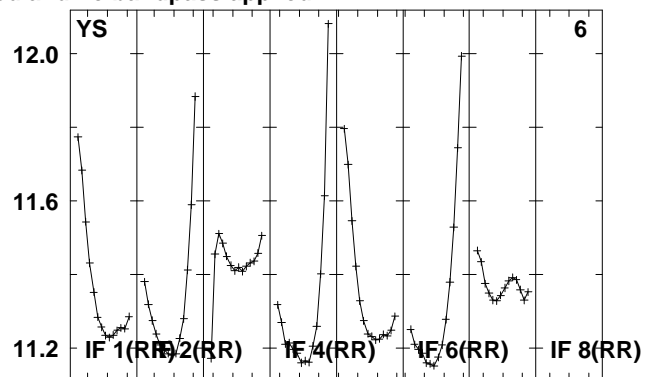
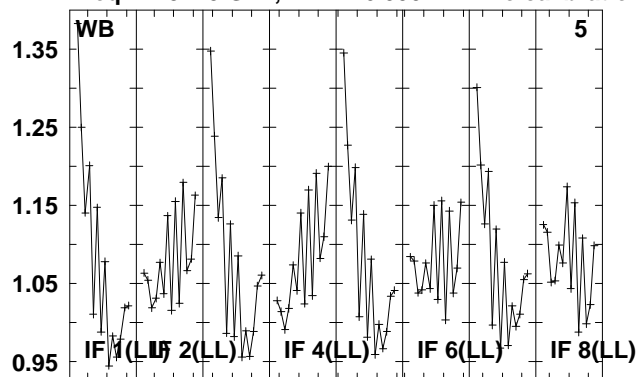

Lower frame: Real Jy
Total-power spectrum Antenna: *
Timerange: 01/00:00:40 to 01/00:11:24

Plot file version 284 created 08-JUL-2010 13:13:04

J1521+04 EM079.UVDATA.1

Freq = 4.9415 GHz, Bw = 16.000 MH No calibration applied and no bandpass applied

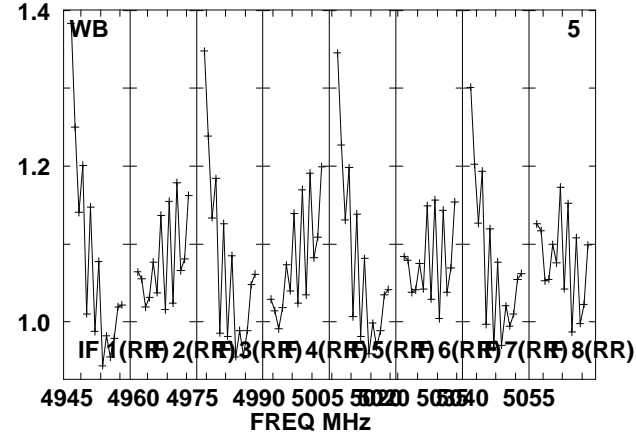
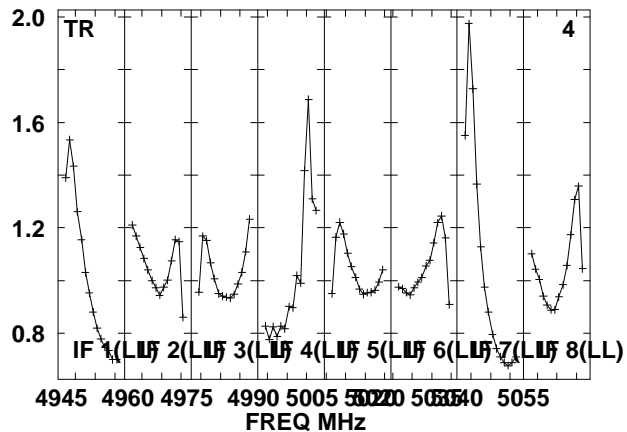
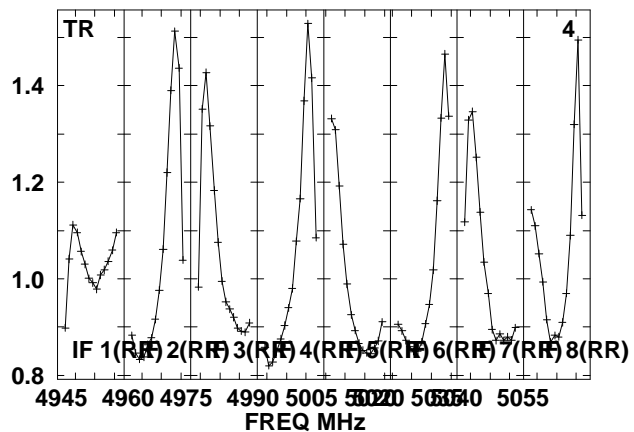
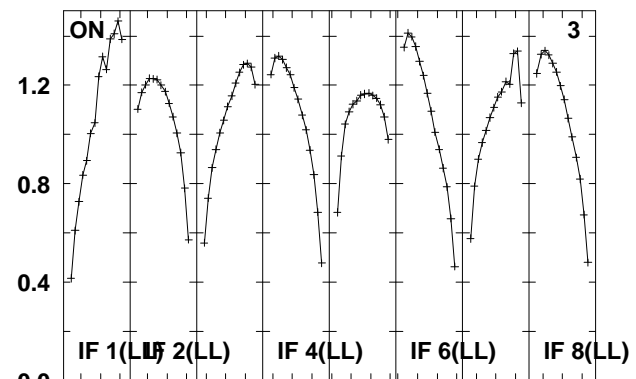
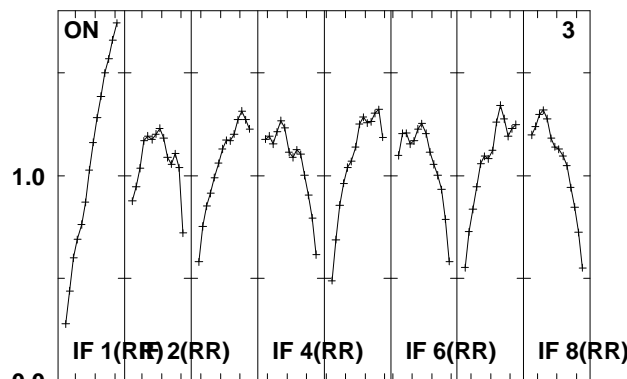
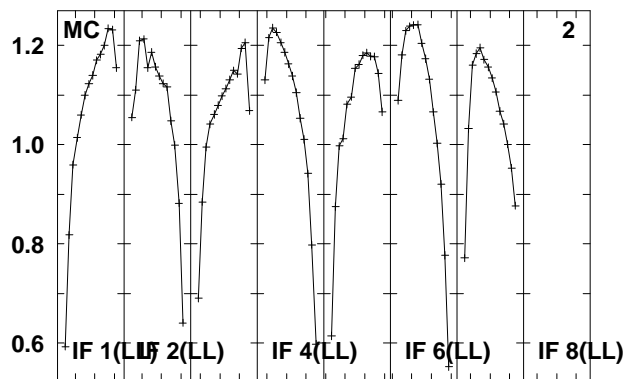
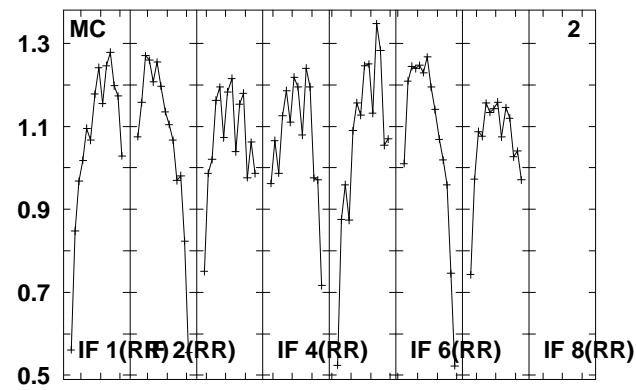
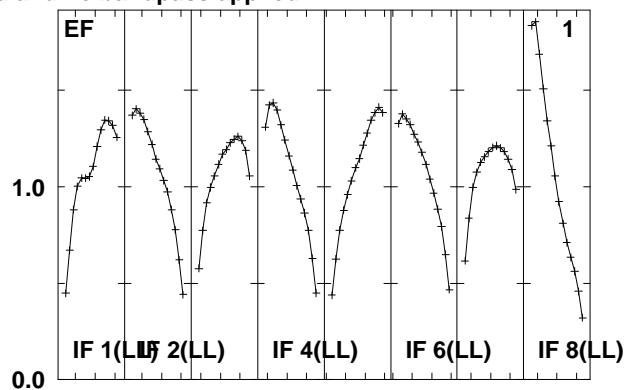
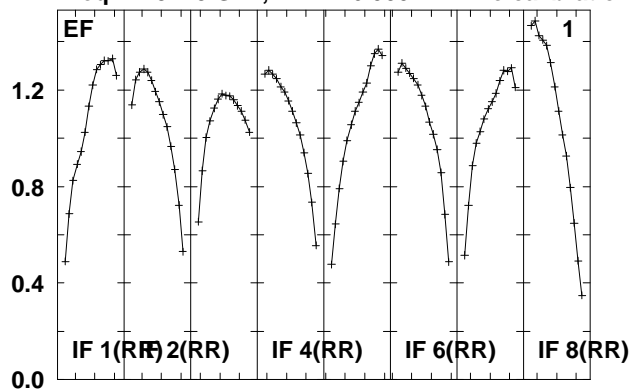

Lower frame: Real Jy
Total-power spectrum Antenna: *
Timerange: 01/00:11:26 to 01/00:13:24

Plot file version 285 created 08-JUL-2010 13:13:04

J1521+04 EM079.UVDATA.1

Freq = 4.9415 GHz, Bw = 16.000 MH No calibration applied and no bandpass applied

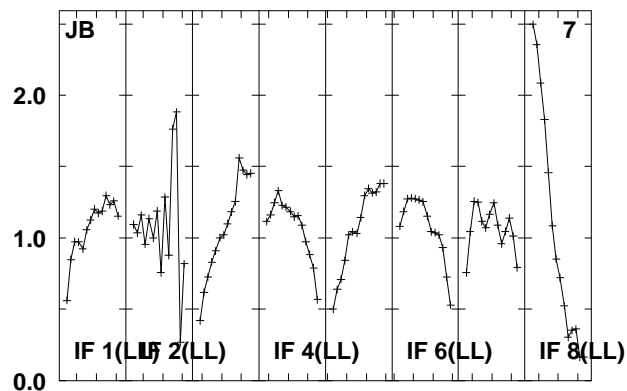
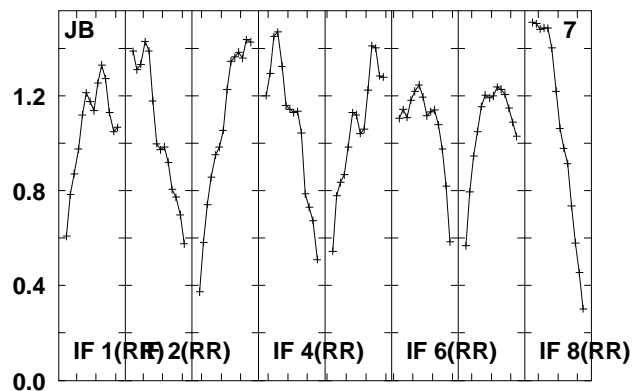
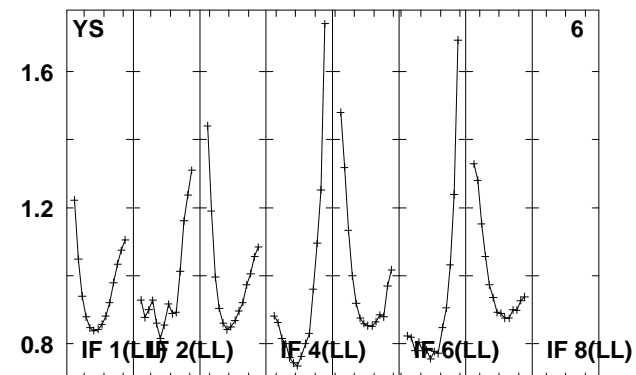
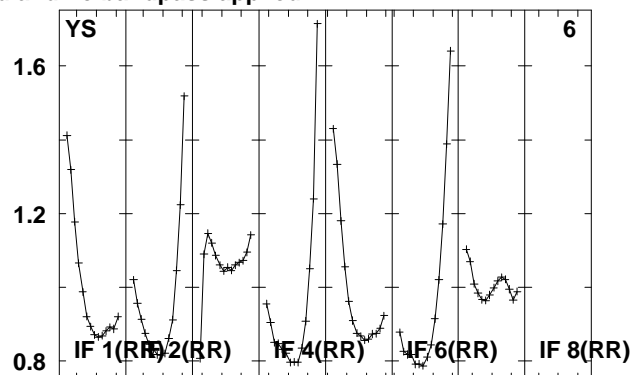
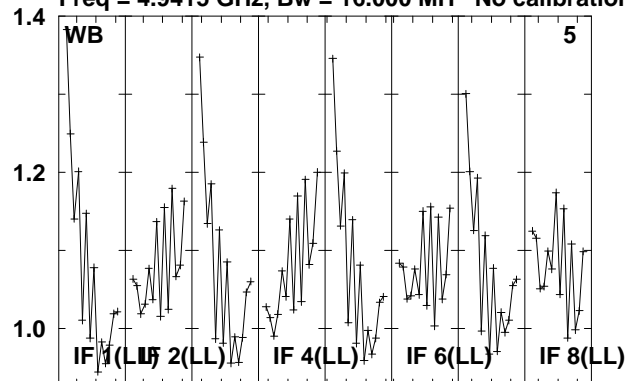

Lower frame: Real Jy
Total-power spectrum Antenna: *
Timerange: 01/00:11:26 to 01/00:13:24

Plot file version 286 created 08-JUL-2010 13:13:05

J1525+05 EM079.UVDATA.1

Freq = 4.9415 GHz, Bw = 16.000 MH No calibration applied and no bandpass applied

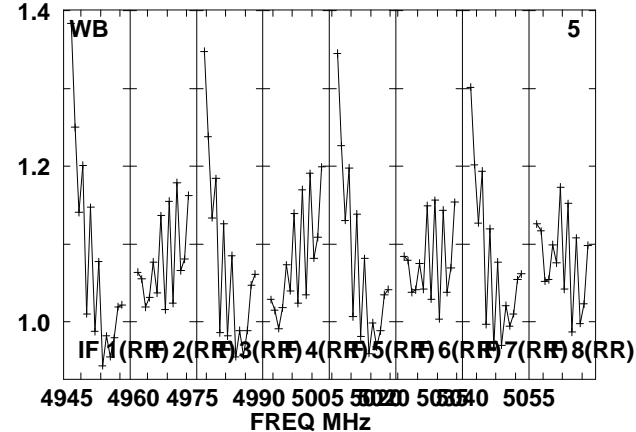
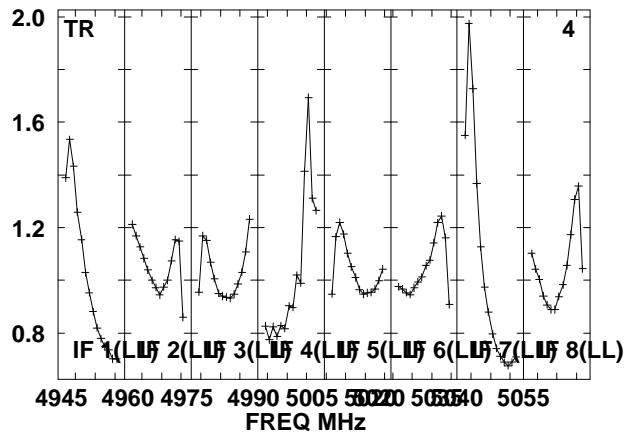
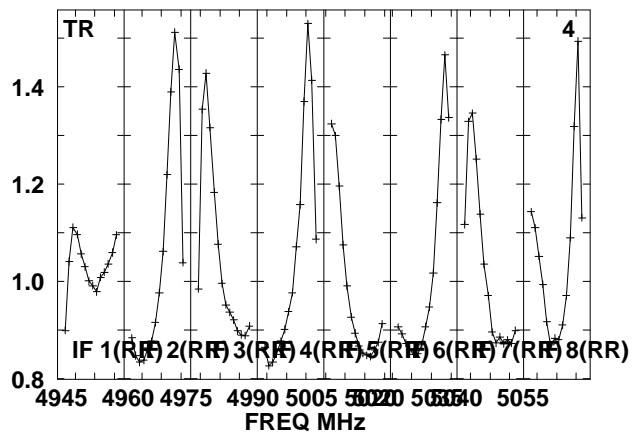
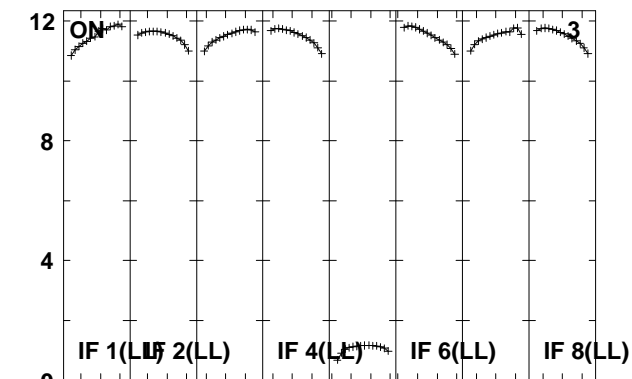
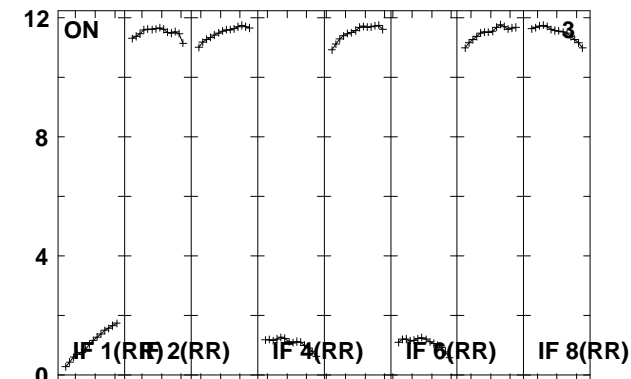
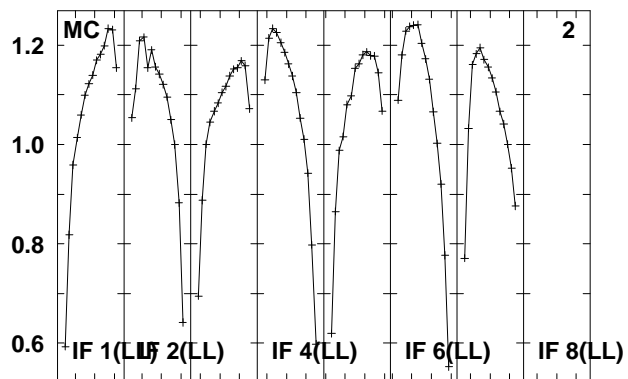
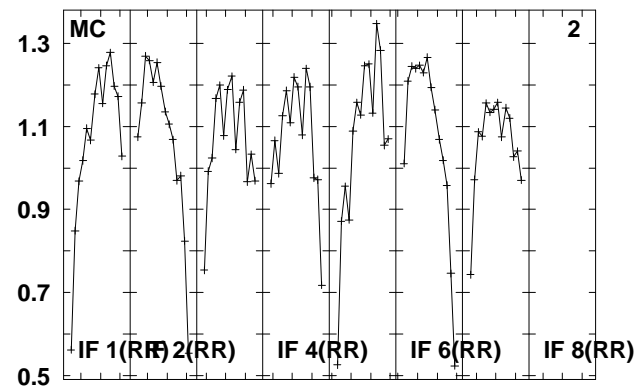
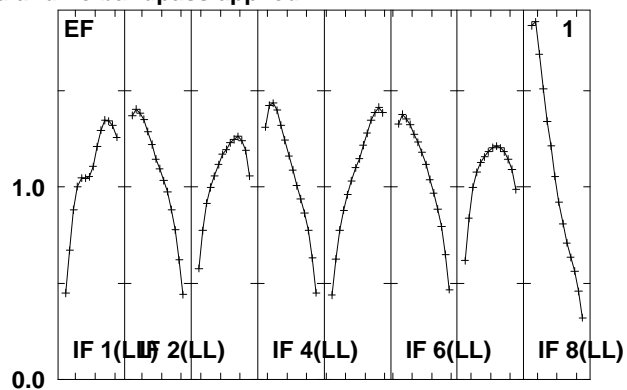
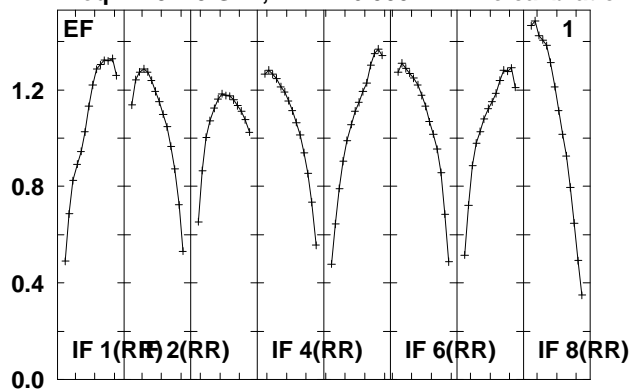

Lower frame: Real Jy
Total-power spectrum Antenna: *
Timerange: 01/00:13:26 to 01/00:24:08

Plot file version 287 created 08-JUL-2010 13:13:06

J1525+05 EM079.UVDATA.1

Freq = 4.9415 GHz, Bw = 16.000 MH No calibration applied and no bandpass applied

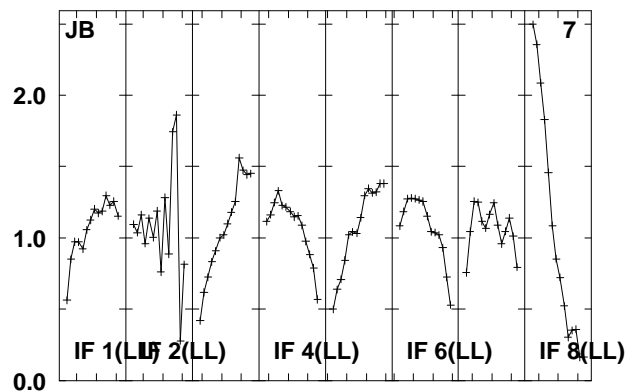
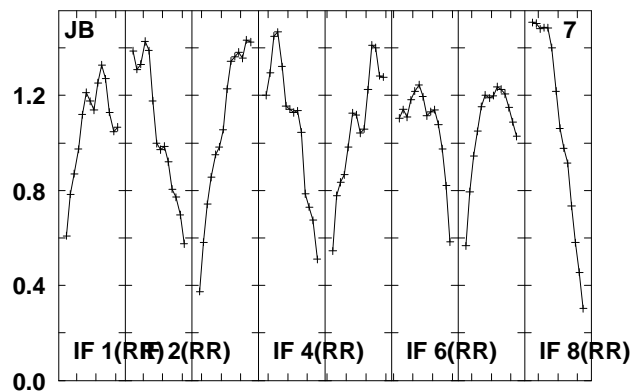
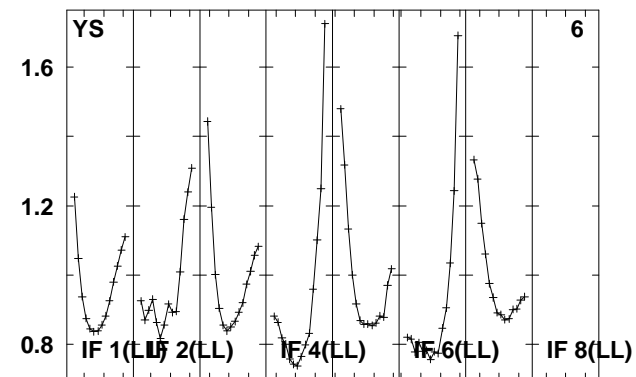
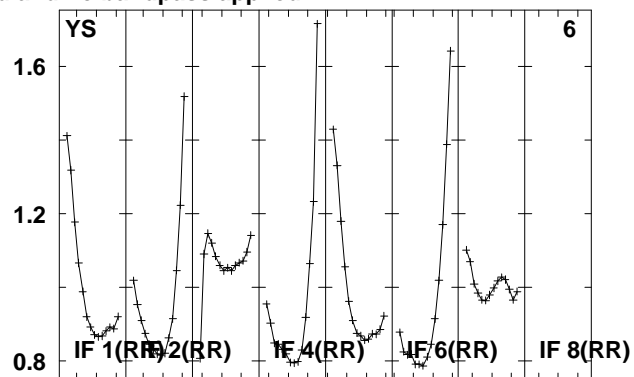
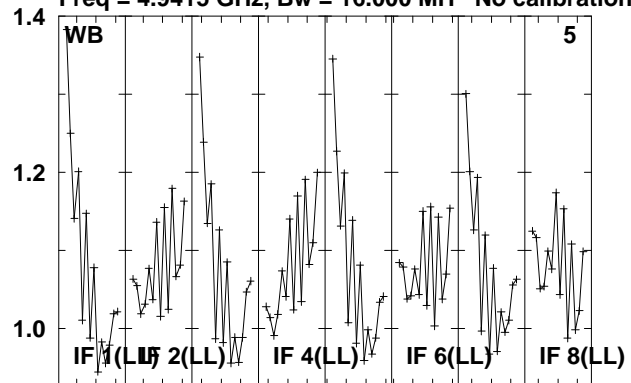

Lower frame: Real Jy
Total-power spectrum Antenna: *
Timerange: 01/00:13:26 to 01/00:24:08

Plot file version 288 created 08-JUL-2010 13:13:07

J1521+04 EM079.UVDATA.1

Freq = 4.9415 GHz, Bw = 16.000 MH No calibration applied and no bandpass applied

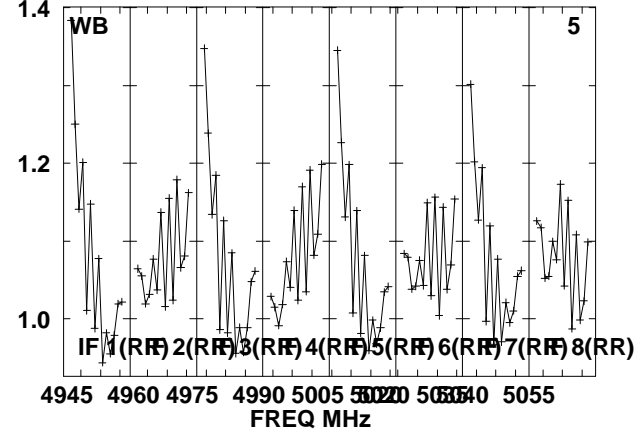
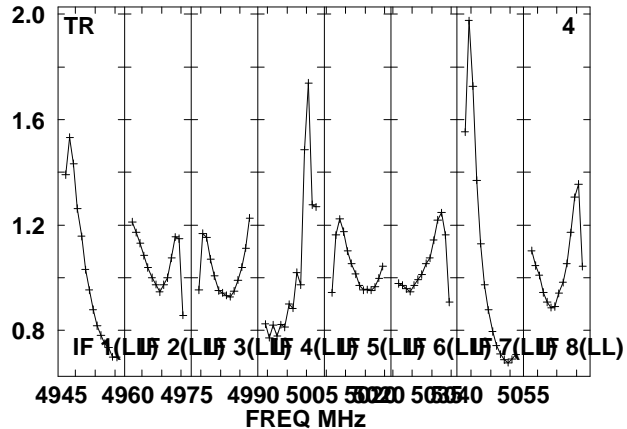
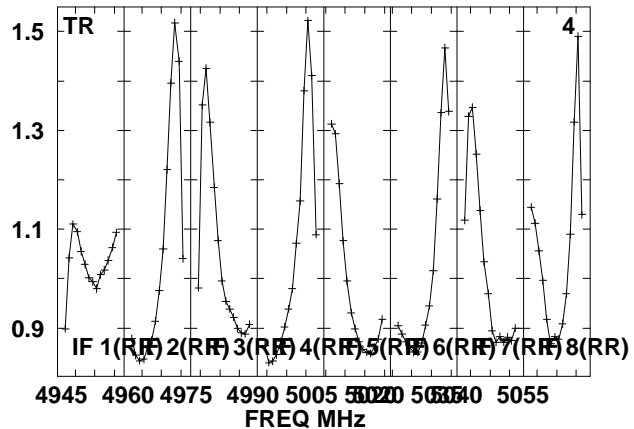
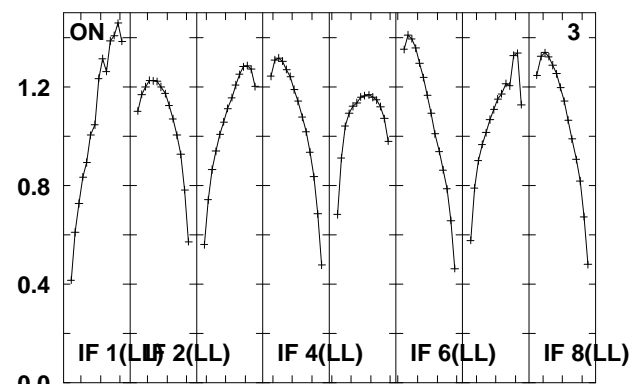
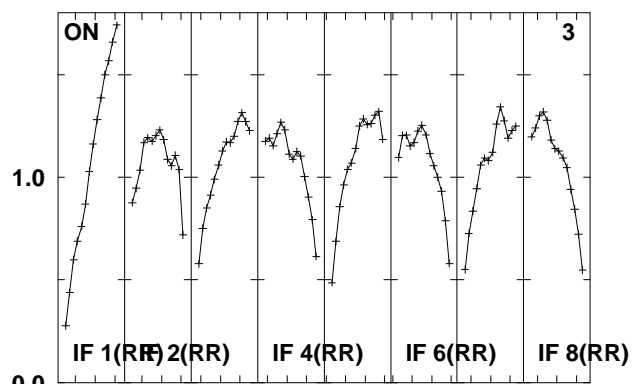
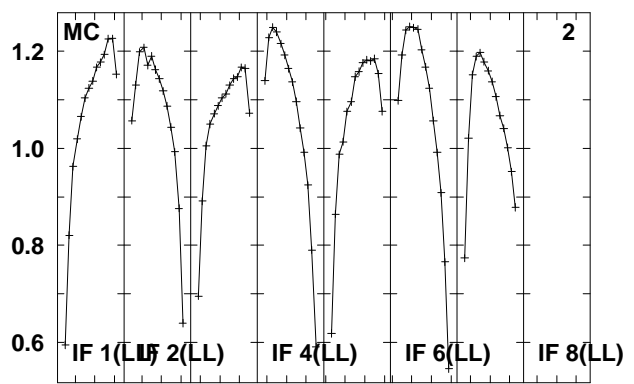
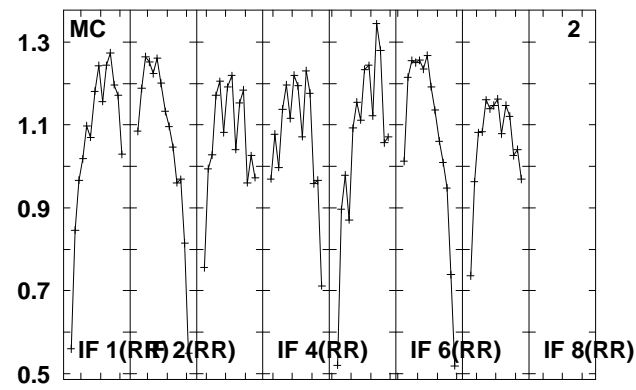
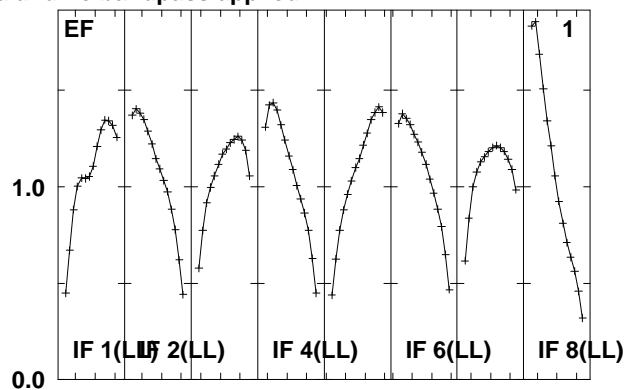
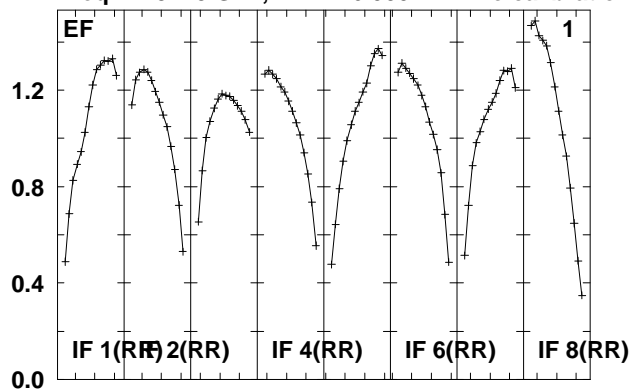

Lower frame: Real Jy
Total-power spectrum Antenna: *
Timerange: 01/00:24:10 to 01/00:26:08

Plot file version 289 created 08-JUL-2010 13:13:08

J1521+04 EM079.UVDATA.1

Freq = 4.9415 GHz, Bw = 16.000 MH No calibration applied and no bandpass applied

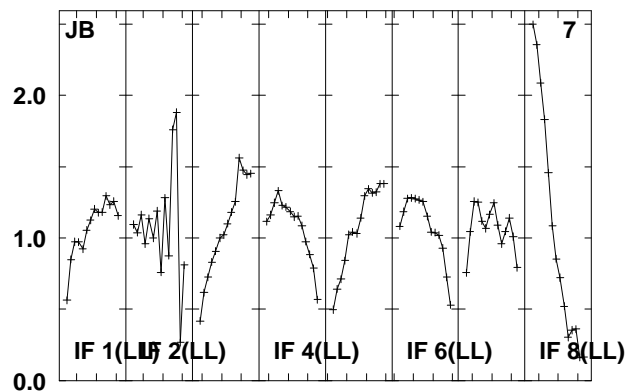
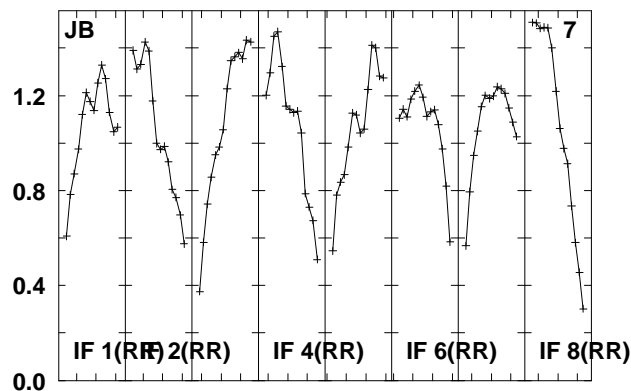
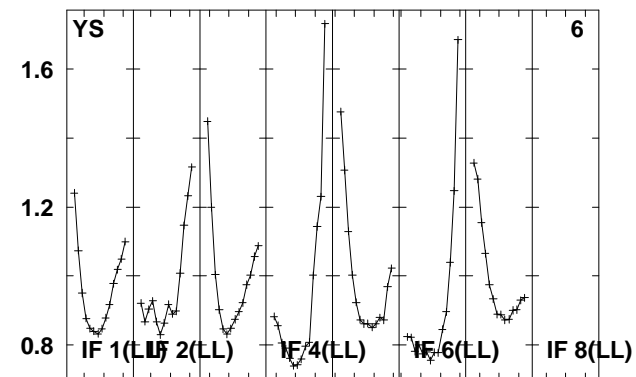
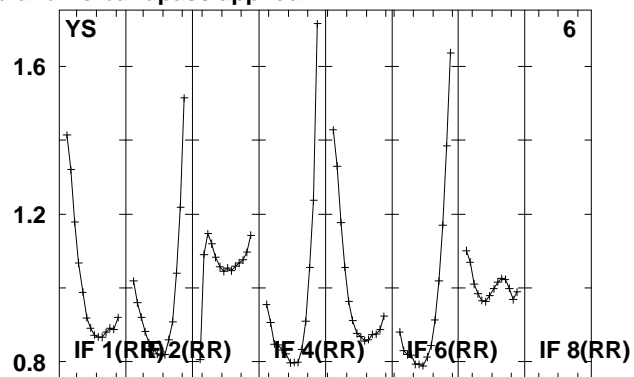
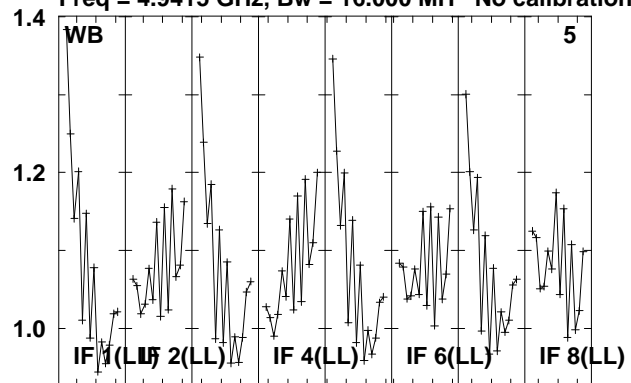

Lower frame: Real Jy
Total-power spectrum Antenna: *
Timerange: 01/00:24:10 to 01/00:26:08

Plot file version 290 created 08-JUL-2010 13:13:08

J1525+05 EM079.UVDATA.1

Freq = 4.9415 GHz, Bw = 16.000 MH No calibration applied and no bandpass applied

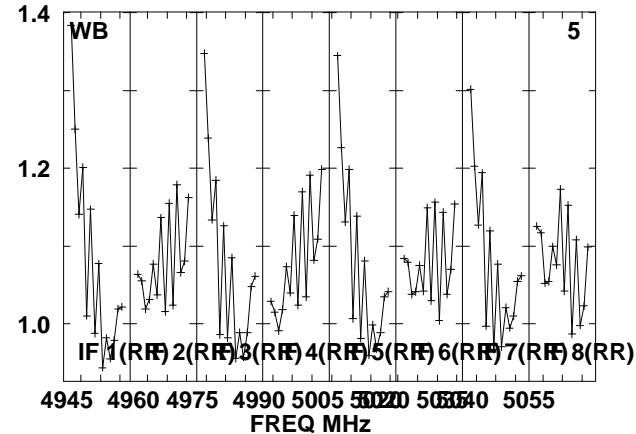
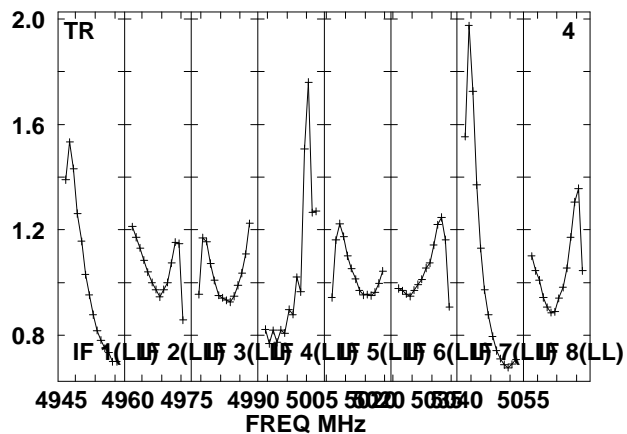
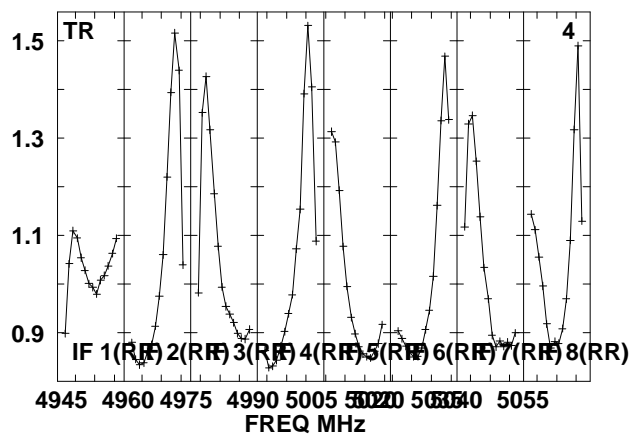
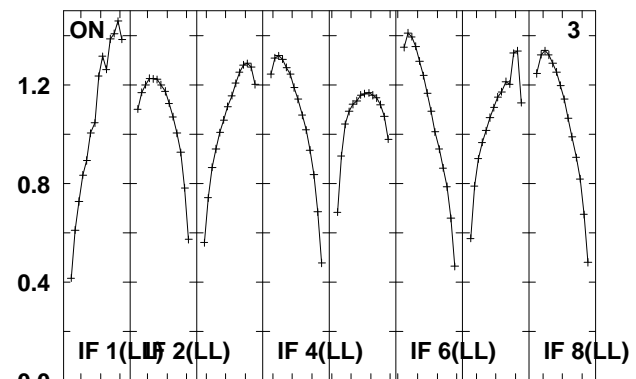
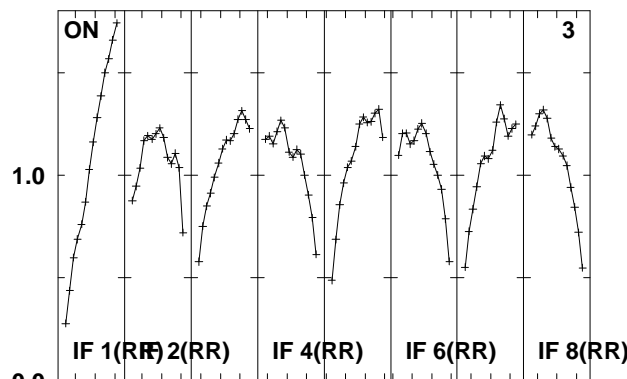
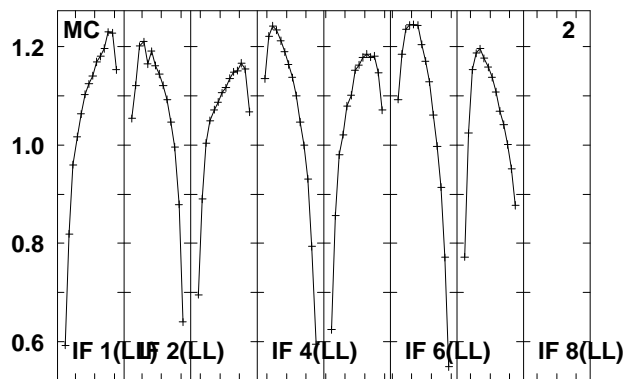
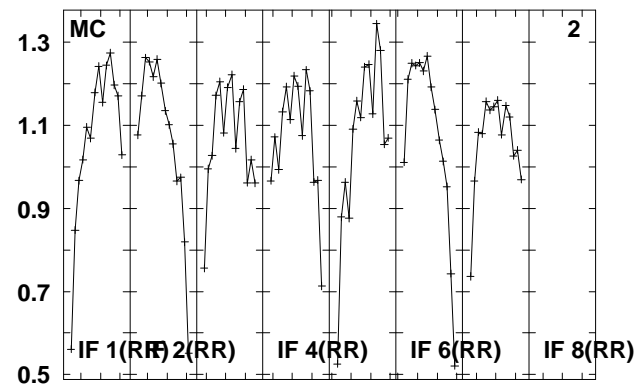
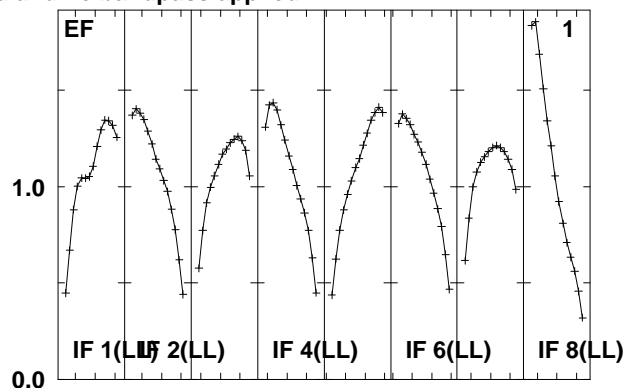
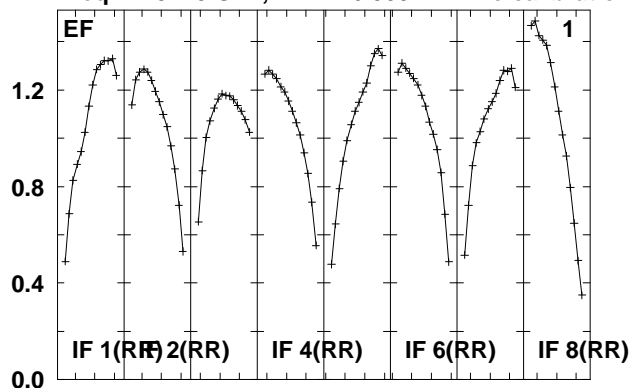

Lower frame: Real Jy
Total-power spectrum Antenna: *
Timerange: 01/00:26:10 to 01/00:36:54

Plot file version 291 created 08-JUL-2010 13:13:09

J1525+05 EM079.UVDATA.1

Freq = 4.9415 GHz, Bw = 16.000 MH No calibration applied and no bandpass applied

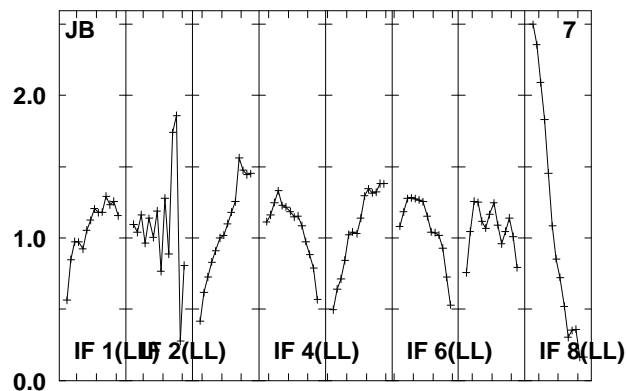
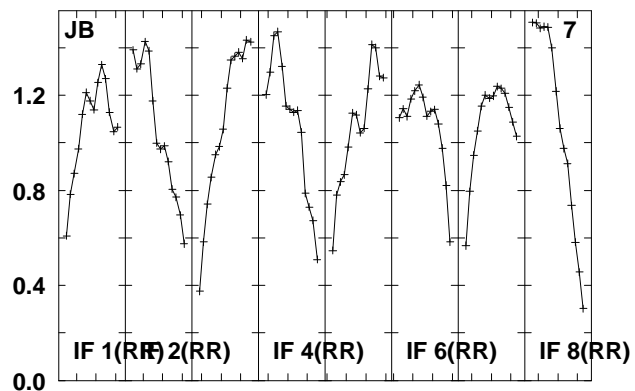
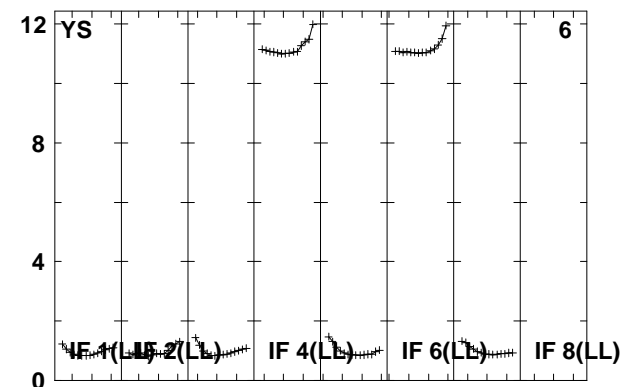
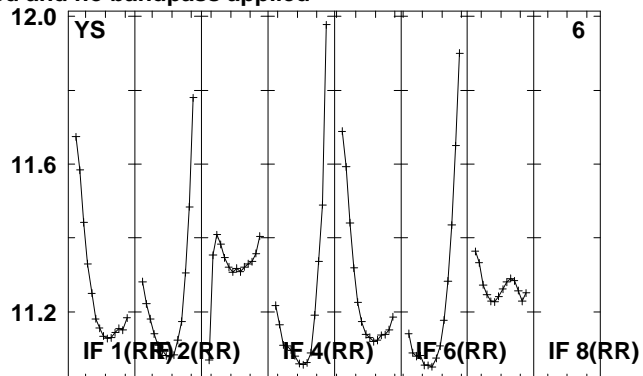
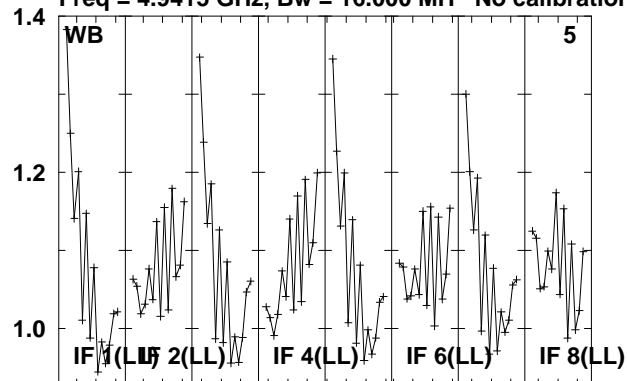

Lower frame: Real Jy
Total-power spectrum Antenna: *
Timerange: 01/00:26:10 to 01/00:36:54

Plot file version 292 created 08-JUL-2010 13:13:11

J1521+04 EM079.UVDATA.1

Freq = 4.9415 GHz, Bw = 16.000 MH No calibration applied and no bandpass applied

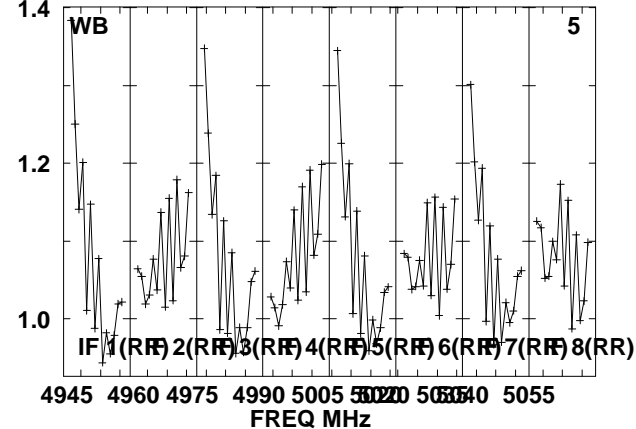
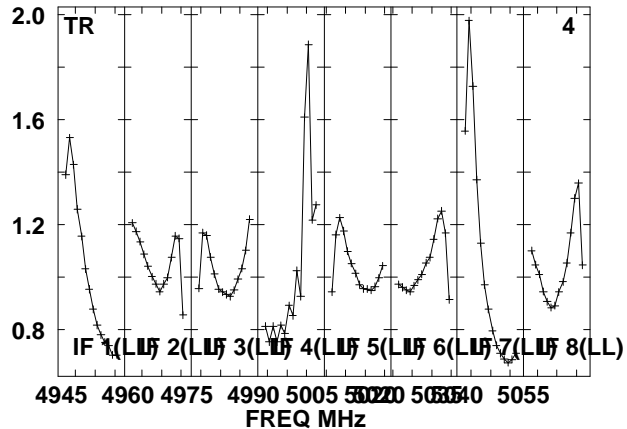
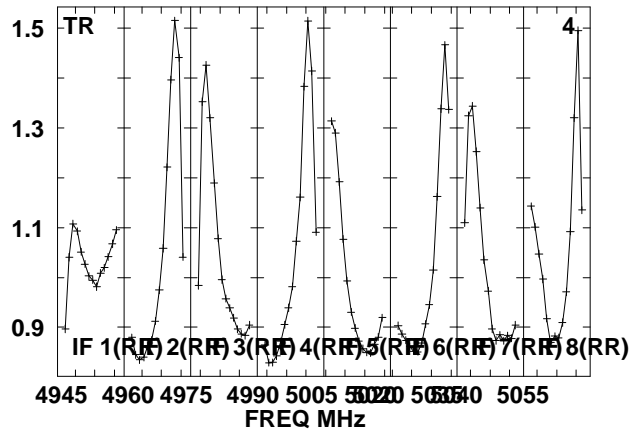
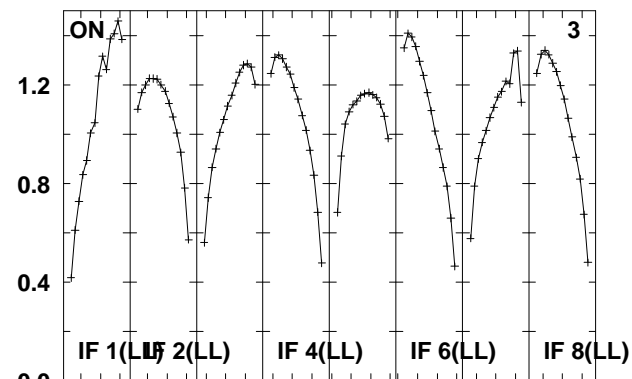
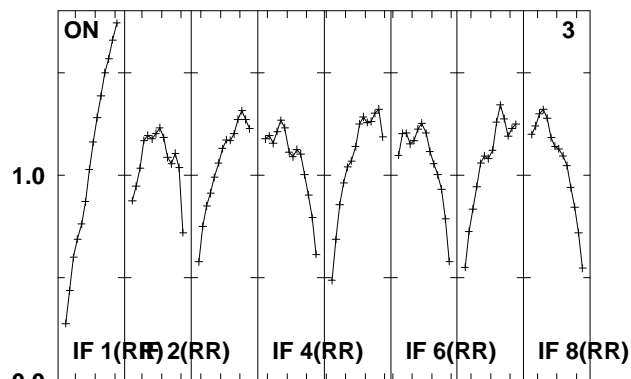
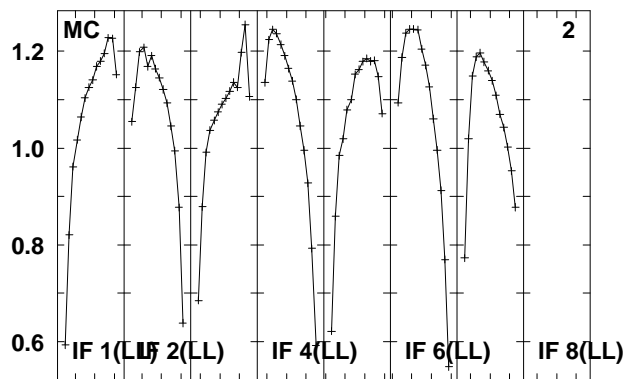
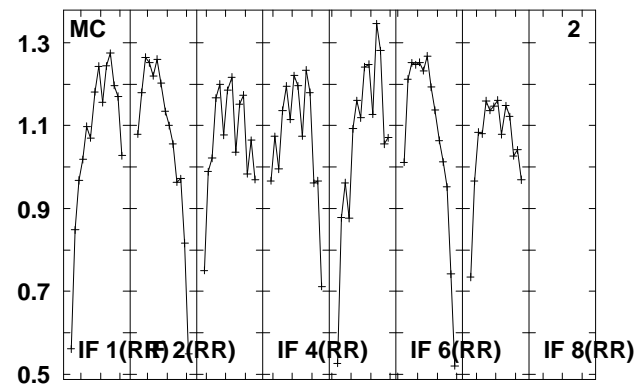
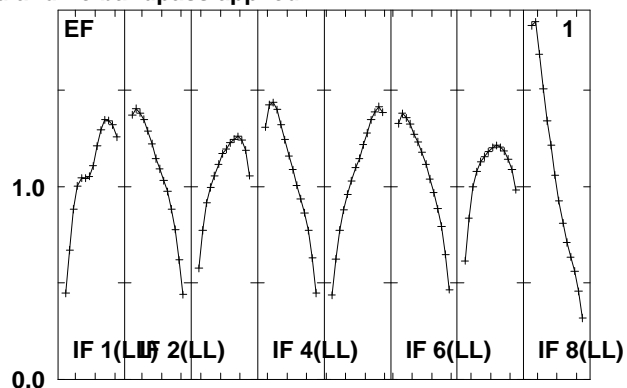
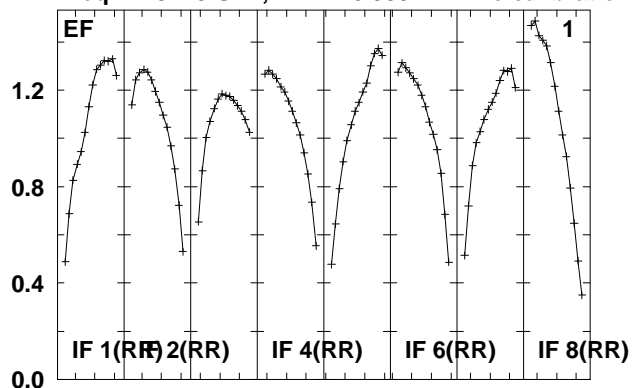

Lower frame: Real Jy
Total-power spectrum Antenna: *
Timerange: 01/00:36:56 to 01/00:38:54

Plot file version 293 created 08-JUL-2010 13:13:11

J1521+04 EM079.UVDATA.1

Freq = 4.9415 GHz, Bw = 16.000 MH No calibration applied and no bandpass applied

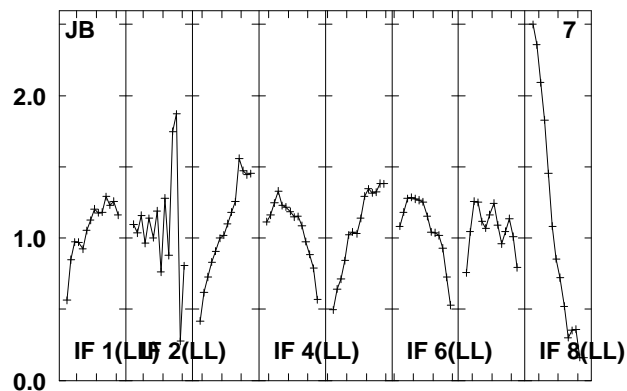
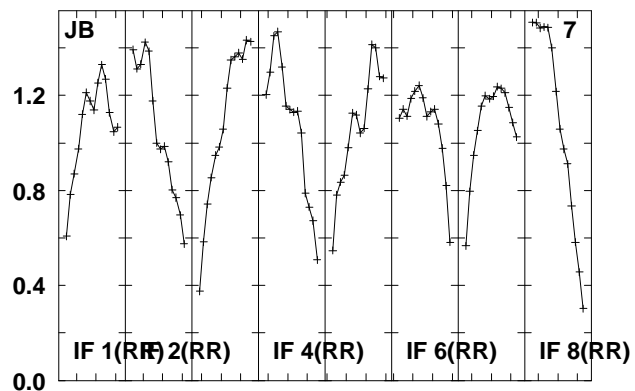
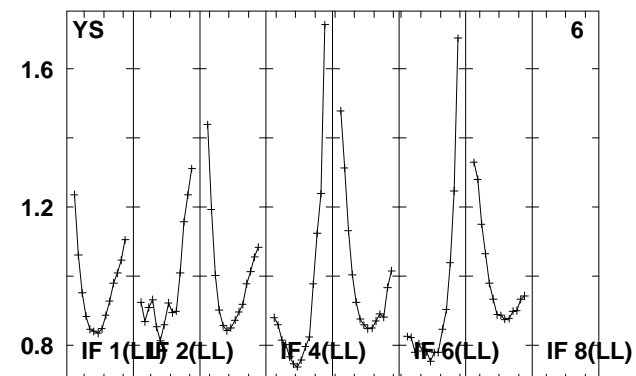
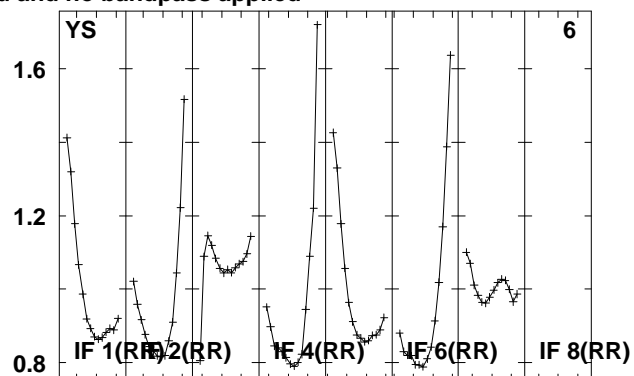
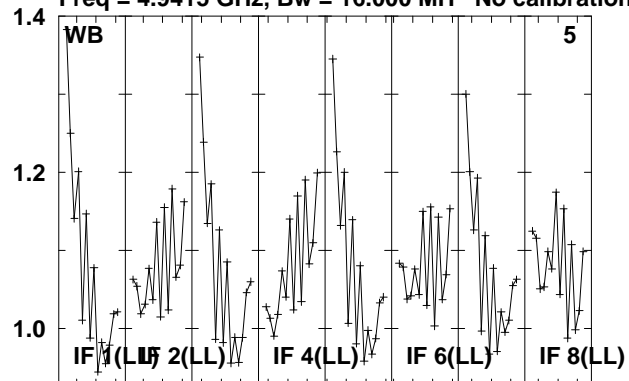

Lower frame: Real Jy
Total-power spectrum Antenna: *
Timerange: 01/00:36:56 to 01/00:38:54

Plot file version 294 created 08-JUL-2010 13:13:12

J1525+05 EM079.UVDATA.1

Freq = 4.9415 GHz, Bw = 16.000 MH No calibration applied and no bandpass applied

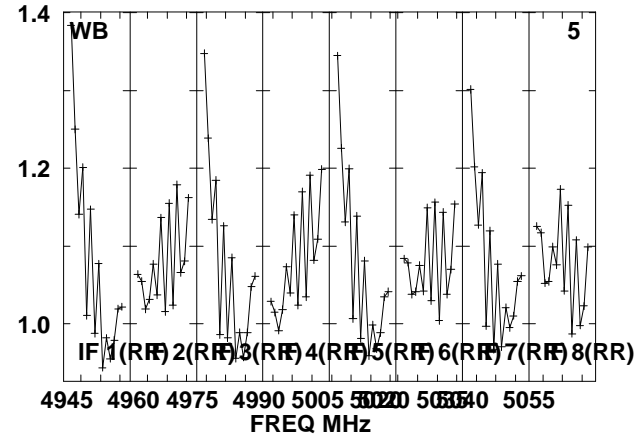
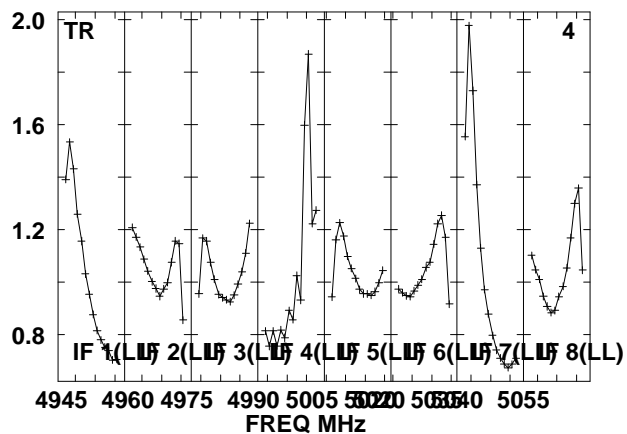
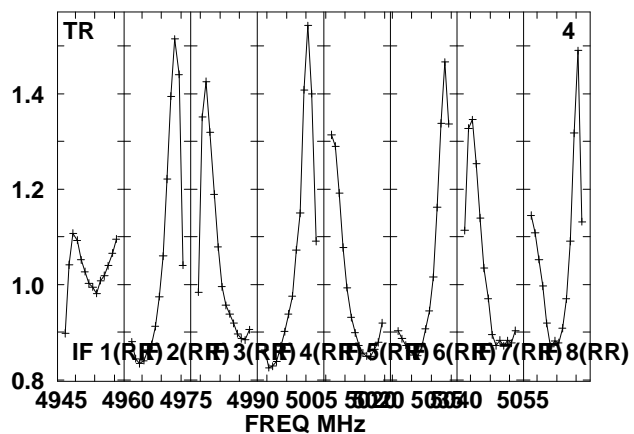
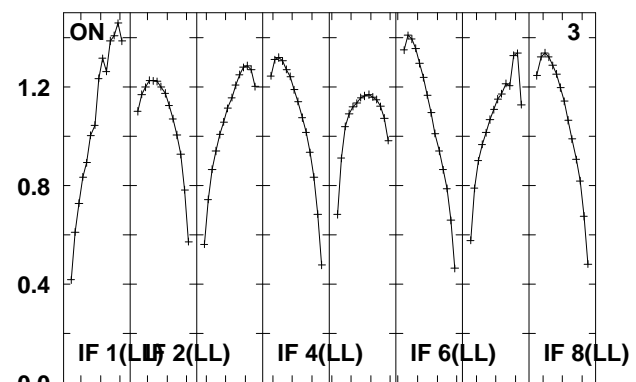
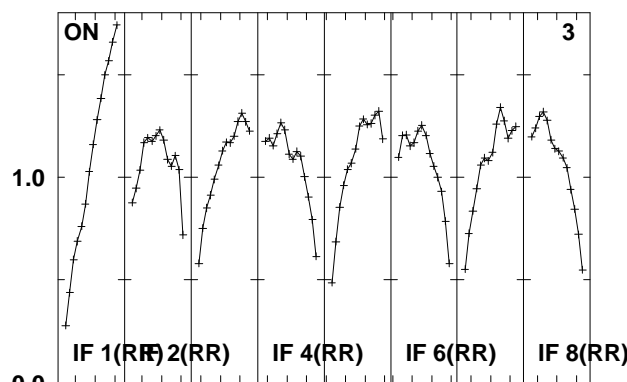
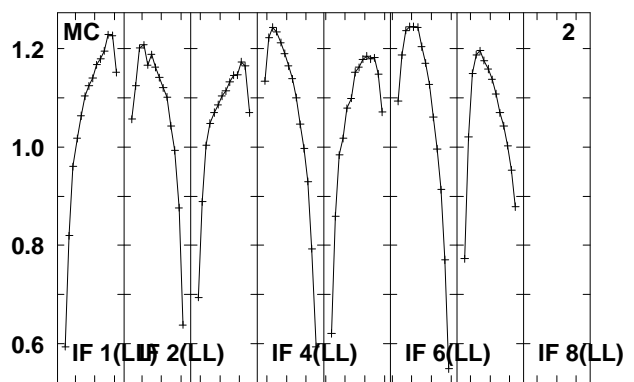
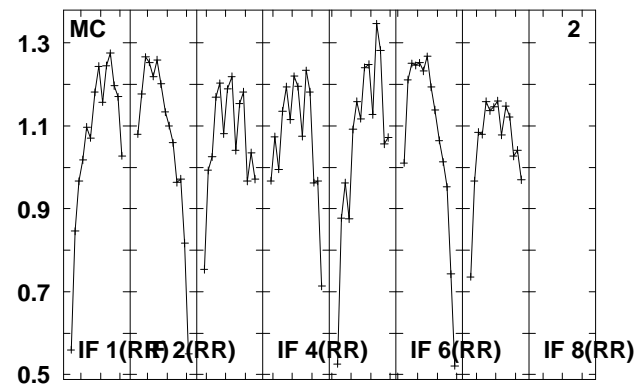
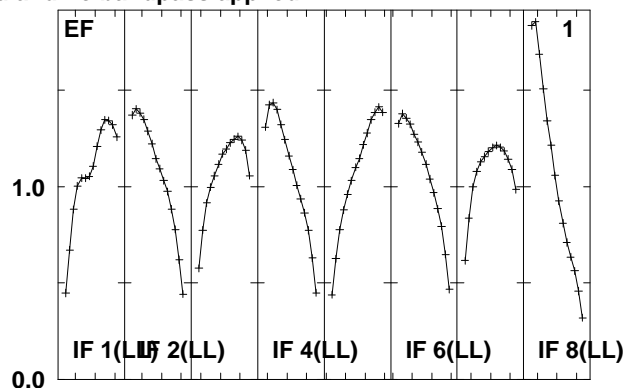
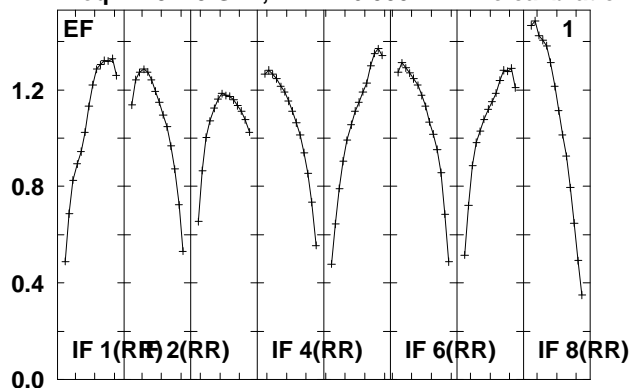

Lower frame: Real Jy
Total-power spectrum Antenna: *
Timerange: 01/00:38:56 to 01/00:49:38

Plot file version 295 created 08-JUL-2010 13:13:13

J1525+05 EM079.UVDATA.1

Freq = 4.9415 GHz, Bw = 16.000 MH No calibration applied and no bandpass applied

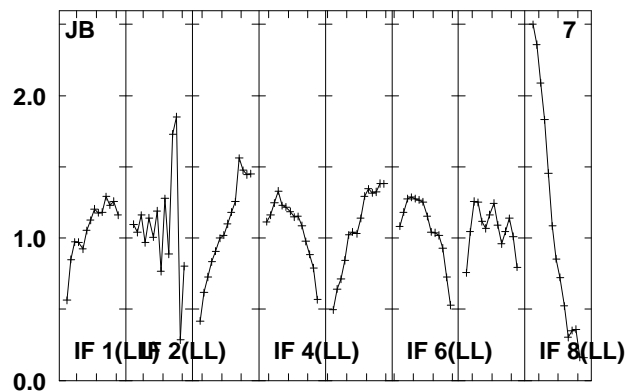
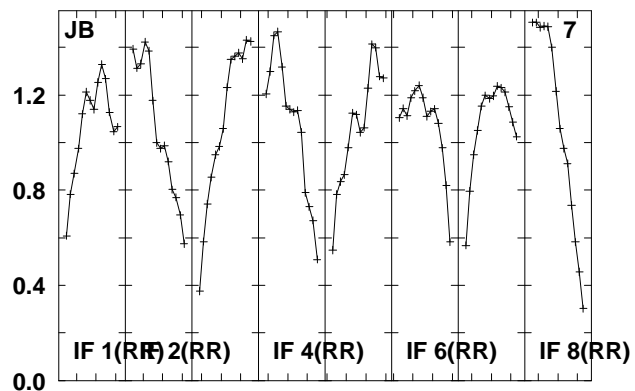
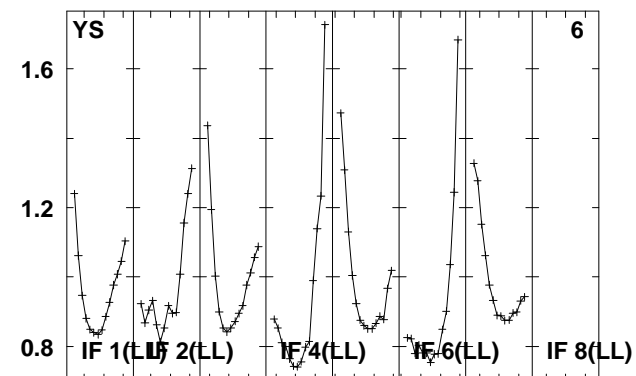
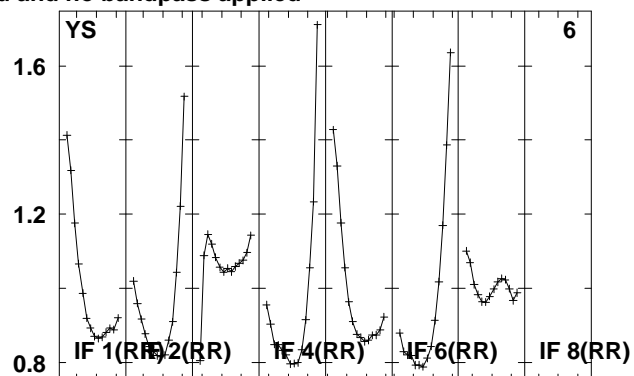
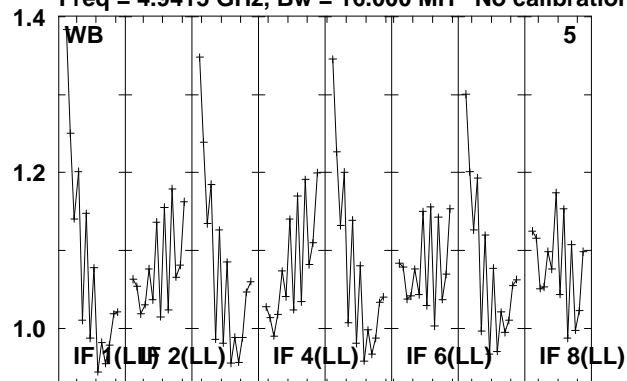

Lower frame: Real Jy
Total-power spectrum Antenna: *
Timerange: 01/00:38:56 to 01/00:49:38

Plot file version 296 created 08-JUL-2010 13:13:14

J1521+04 EM079.UVDATA.1

Freq = 4.9415 GHz, Bw = 16.000 MH No calibration applied and no bandpass applied

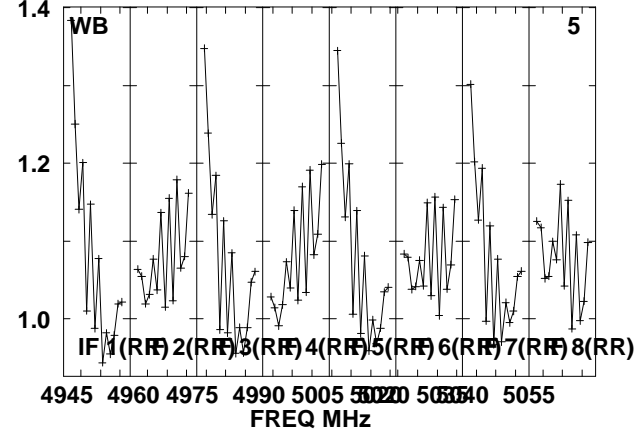
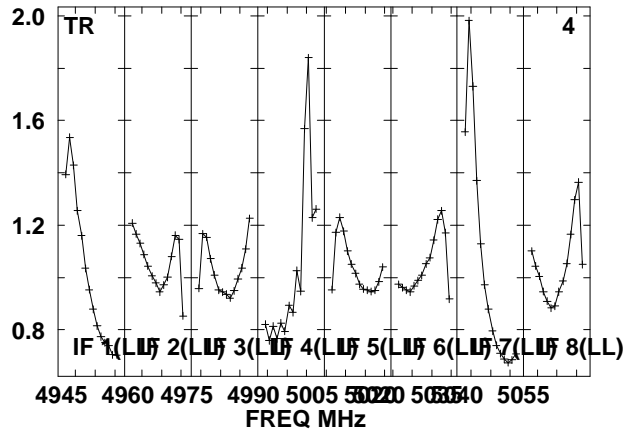
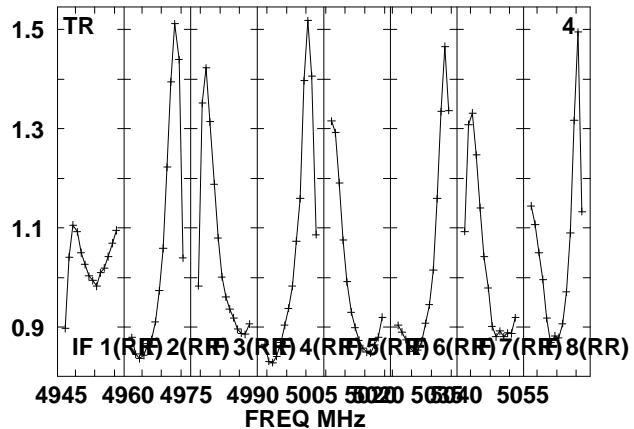
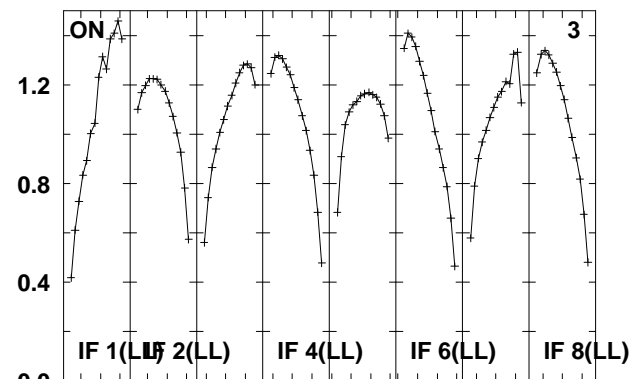
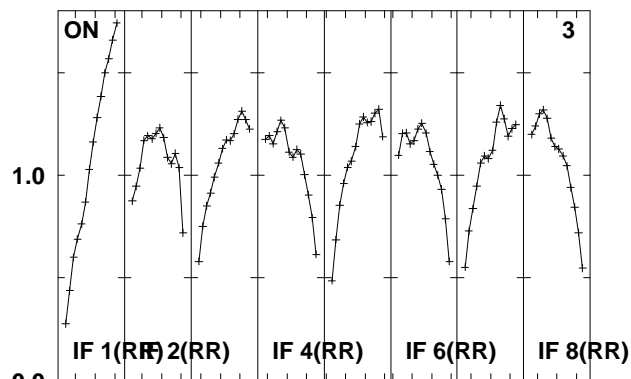
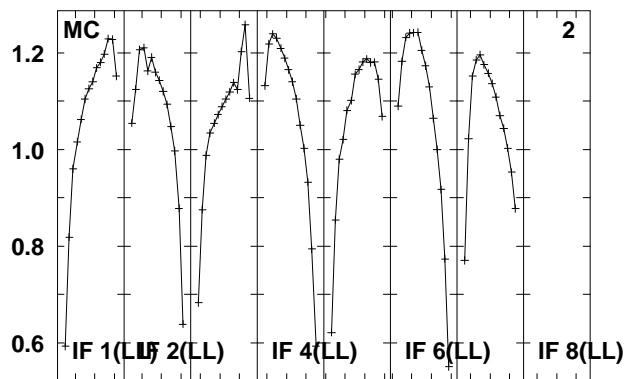
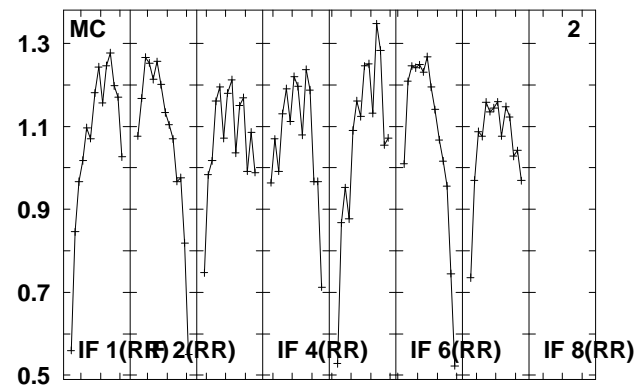
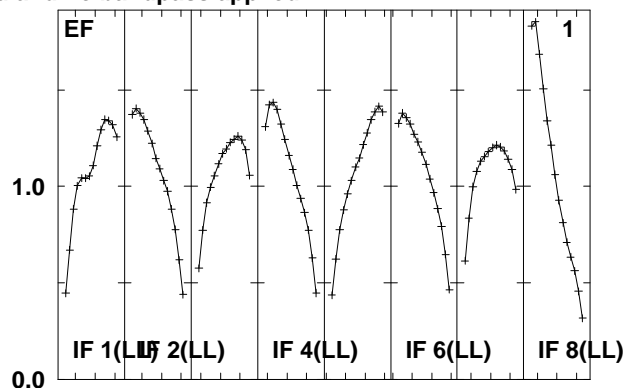
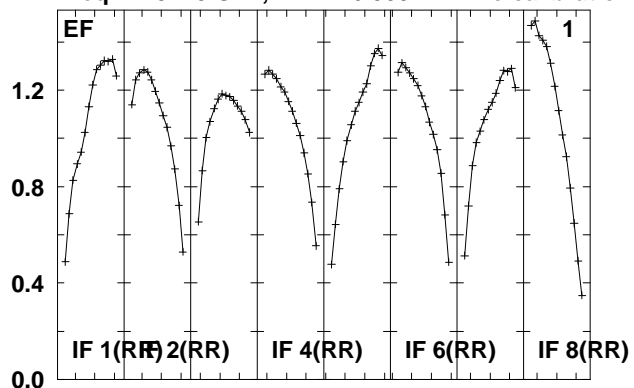

Lower frame: Real Jy
Total-power spectrum Antenna: *
Timerange: 01/00:49:40 to 01/00:51:38

Plot file version 297 created 08-JUL-2010 13:13:15

J1521+04 EM079.UVDATA.1

Freq = 4.9415 GHz, Bw = 16.000 MH No calibration applied and no bandpass applied

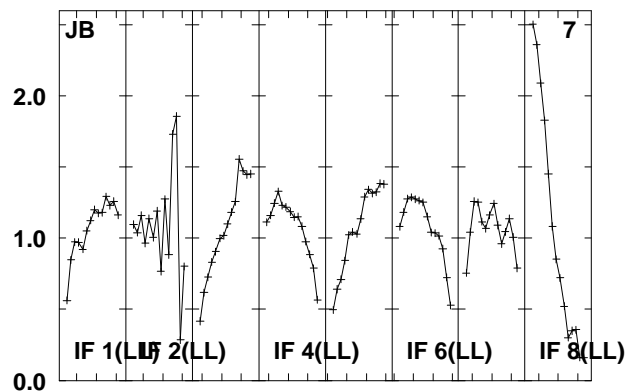
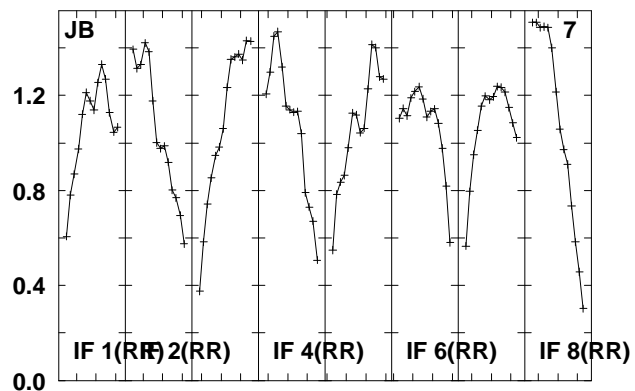
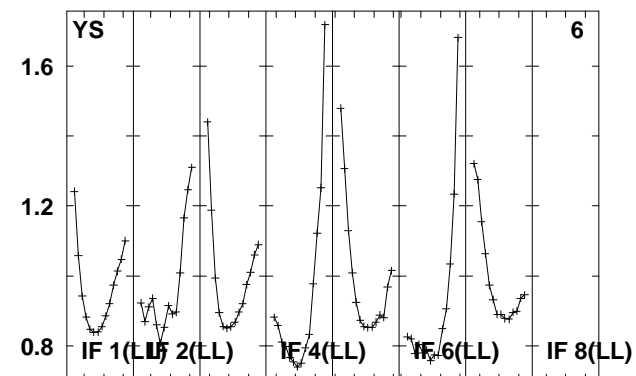
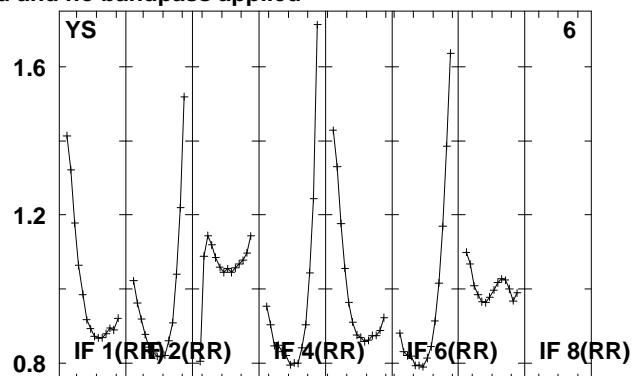
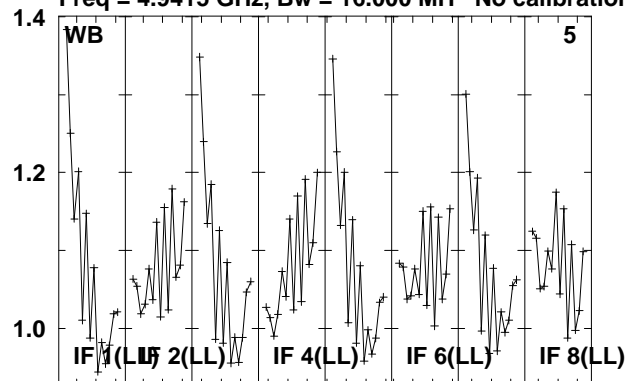

Lower frame: Real Jy
Total-power spectrum Antenna: *
Timerange: 01/00:49:40 to 01/00:51:38

Plot file version 298 created 08-JUL-2010 13:13:15

J1525+05 EM079.UVDATA.1

Freq = 4.9415 GHz, Bw = 16.000 MH No calibration applied and no bandpass applied

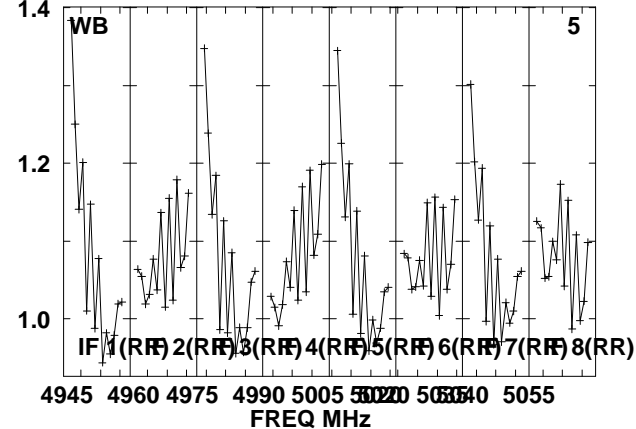
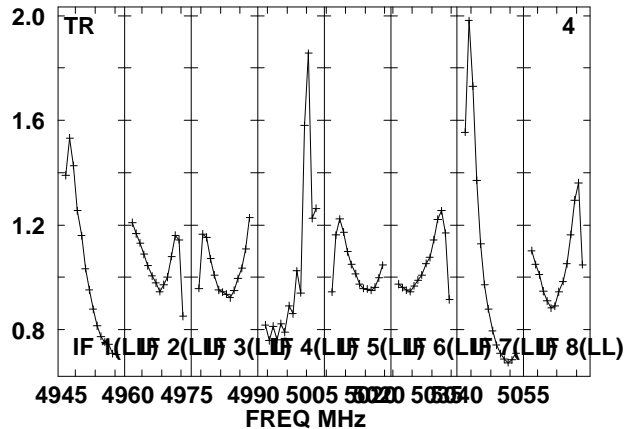
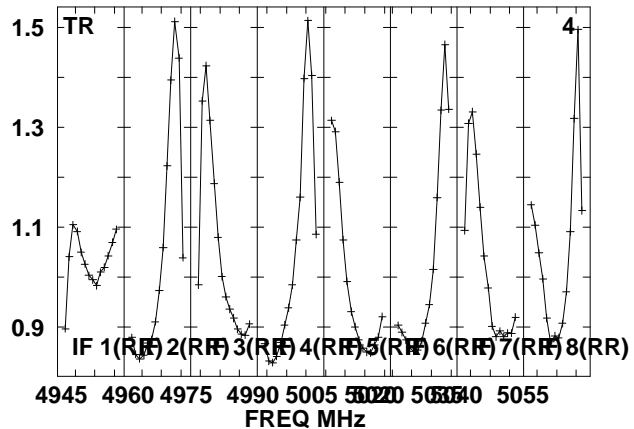
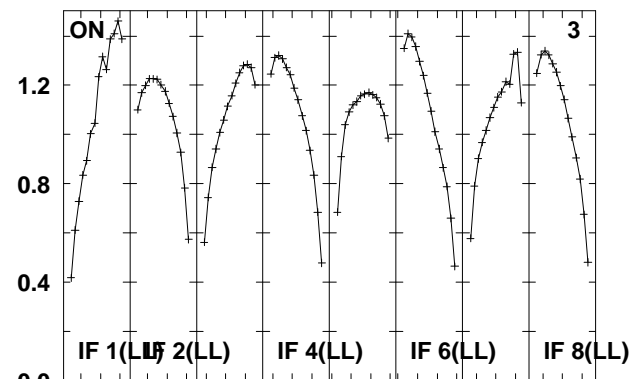
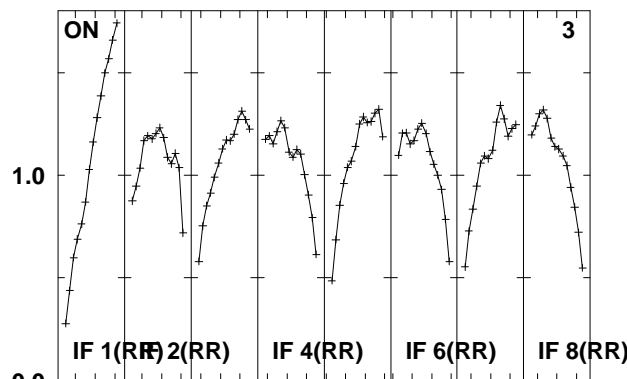
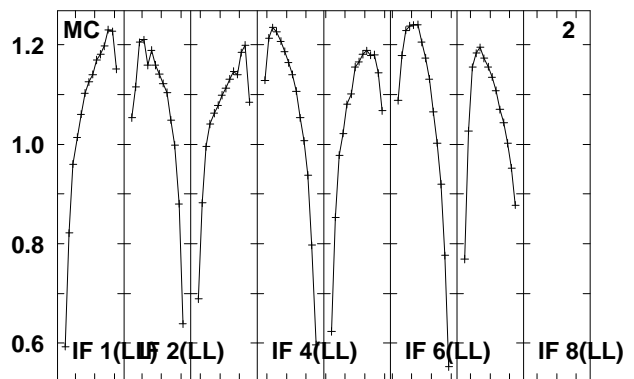
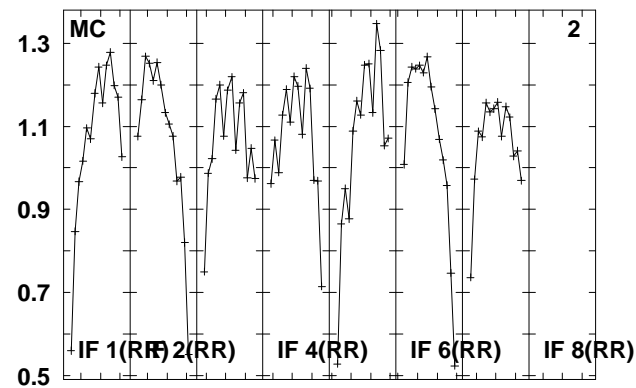
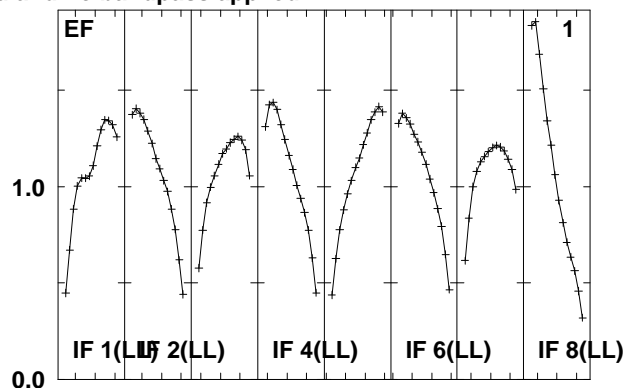
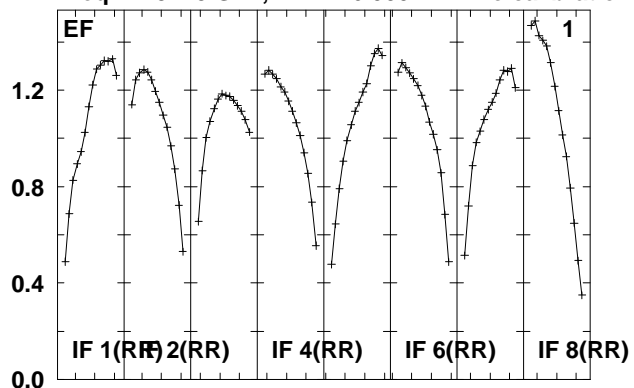

Lower frame: Real Jy
Total-power spectrum Antenna: *
Timerange: 01/00:51:40 to 01/01:02:24

Plot file version 299 created 08-JUL-2010 13:13:16

J1525+05 EM079.UVDATA.1

Freq = 4.9415 GHz, Bw = 16.000 MH No calibration applied and no bandpass applied

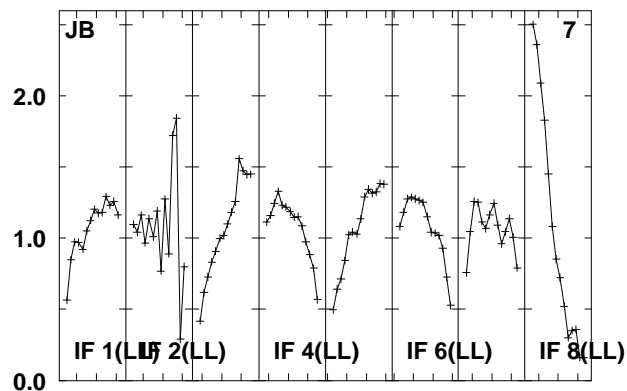
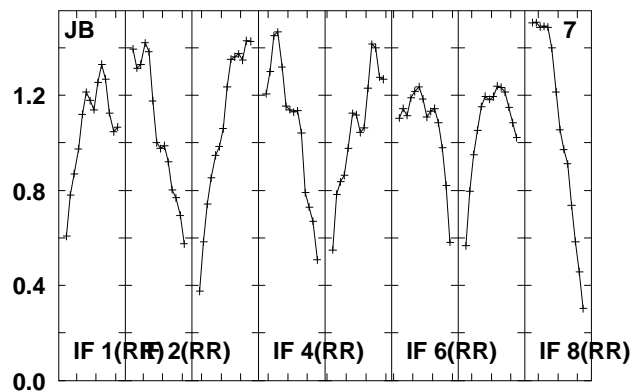
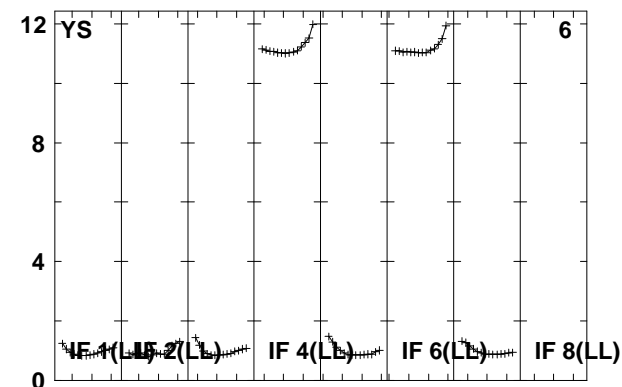
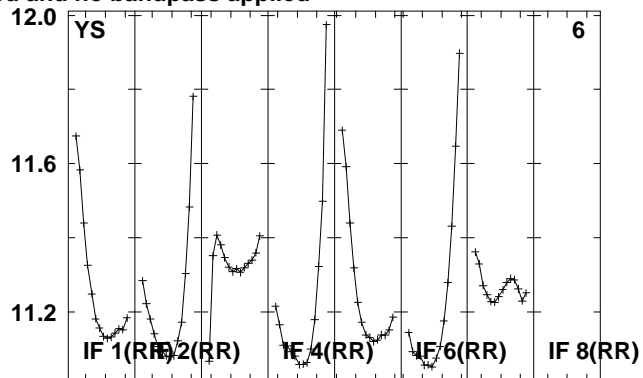
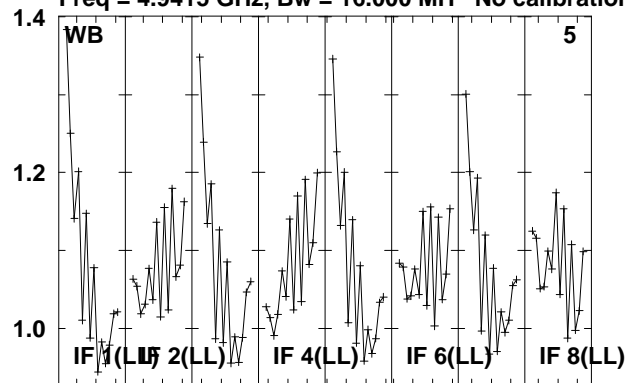

Lower frame: Real Jy
Total-power spectrum Antenna: *
Timerange: 01/00:51:40 to 01/01:02:24

Plot file version 300 created 08-JUL-2010 13:13:18

J1521+04 EM079.UVDATA.1

Freq = 4.9415 GHz, Bw = 16.000 MH No calibration applied and no bandpass applied

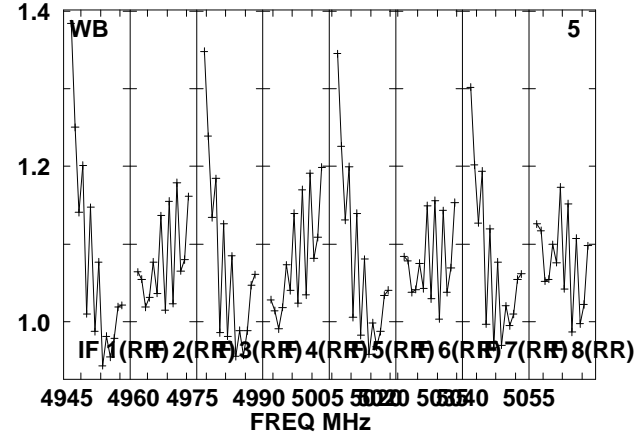
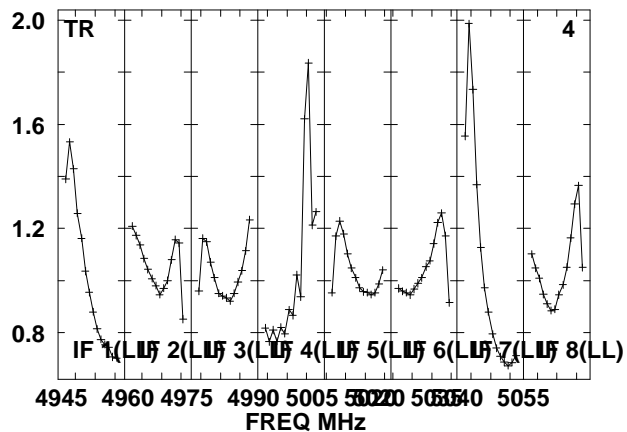
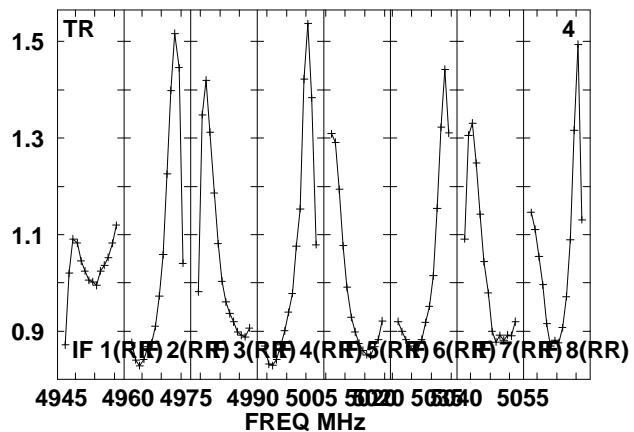
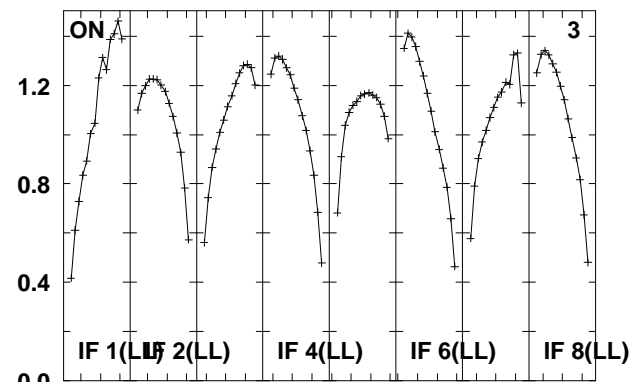
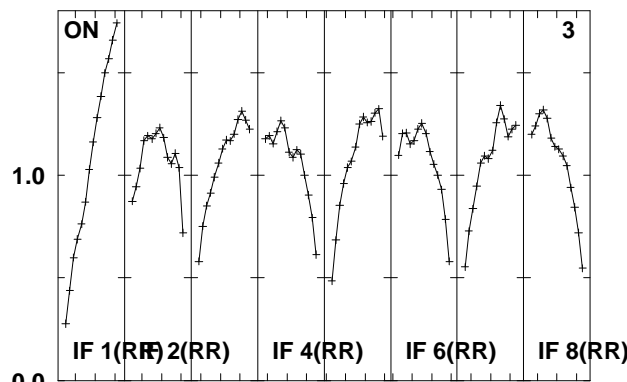
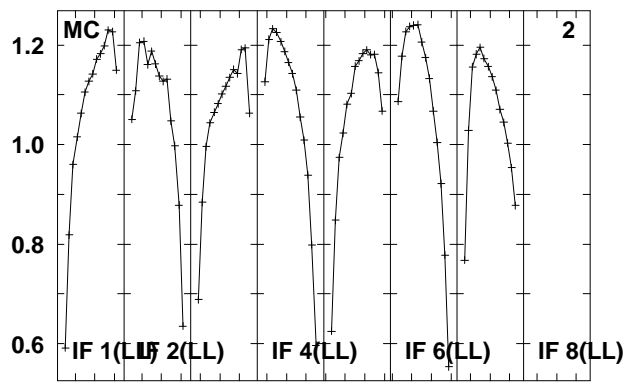
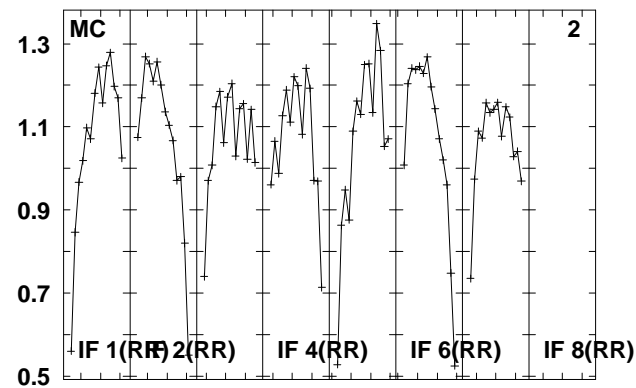
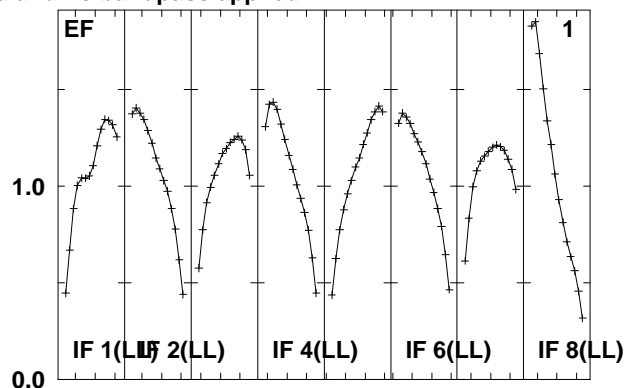
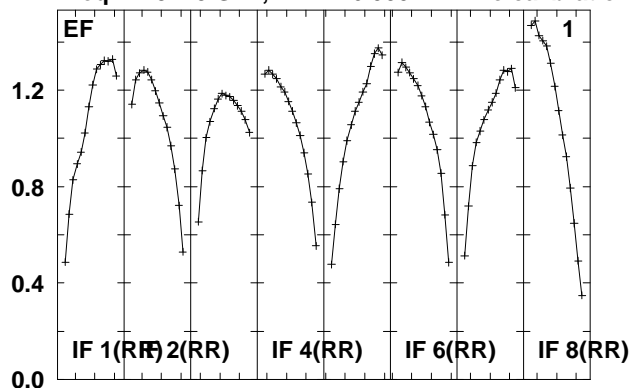

Lower frame: Real Jy
Total-power spectrum Antenna: *
Timerange: 01/01:02:26 to 01/01:04:24

Plot file version 301 created 08-JUL-2010 13:13:19

J1521+04 EM079.UVDATA.1

Freq = 4.9415 GHz, Bw = 16.000 MH No calibration applied and no bandpass applied

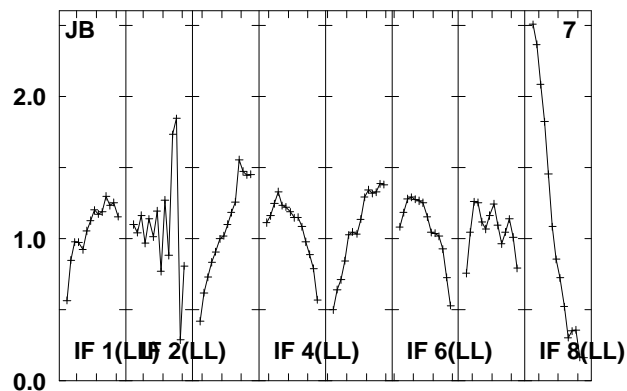
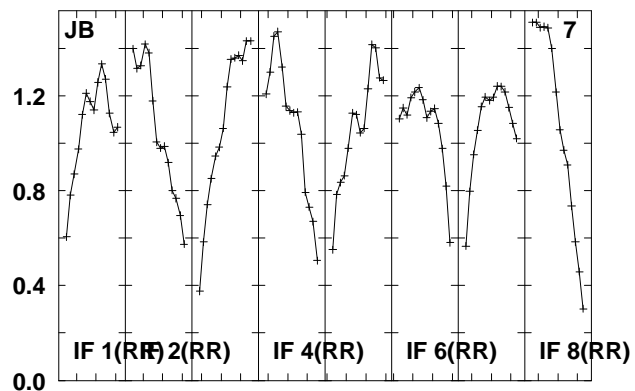
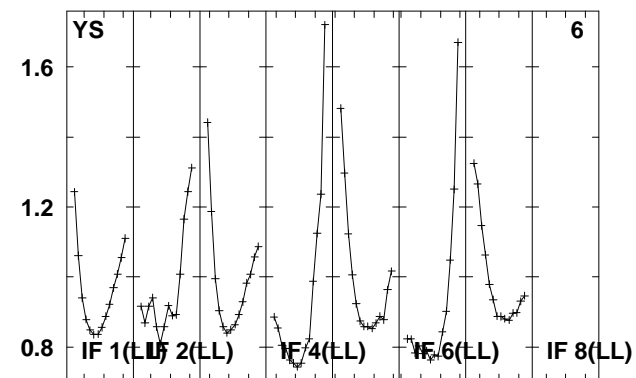
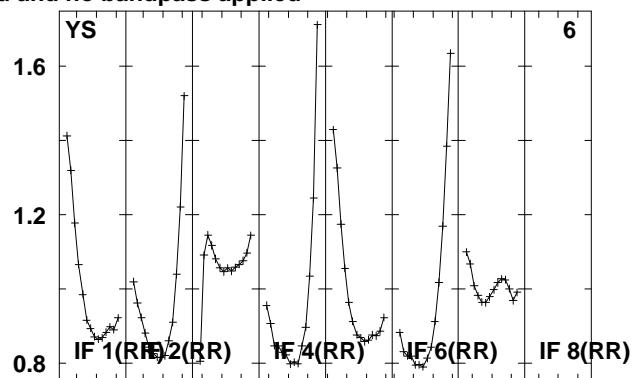
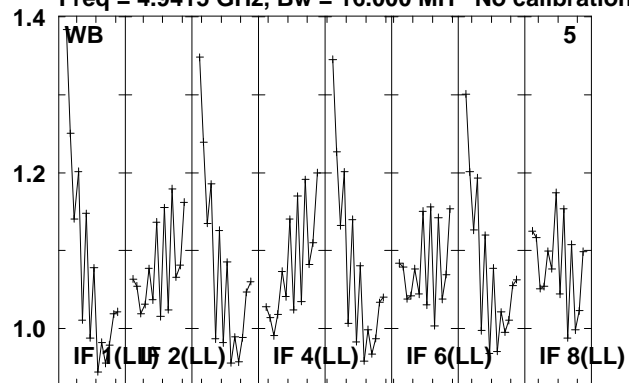

Lower frame: Real Jy
Total-power spectrum Antenna: *
Timerange: 01/01:02:26 to 01/01:04:24

Plot file version 302 created 08-JUL-2010 13:13:19
 J1525+05 EM079.UVDATA.1
 Freq = 4.9415 GHz, Bw = 16.000 MH No calibration applied and no bandpass applied

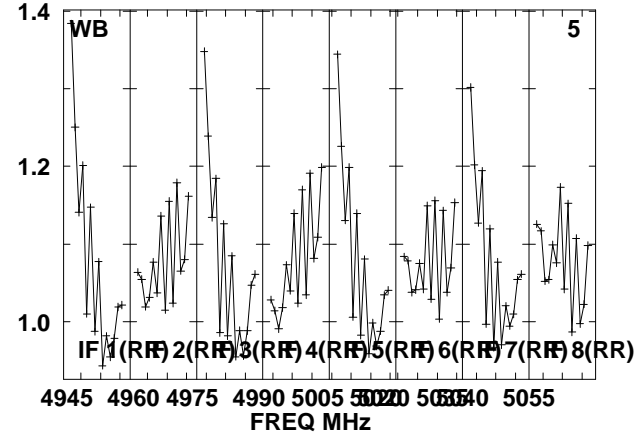
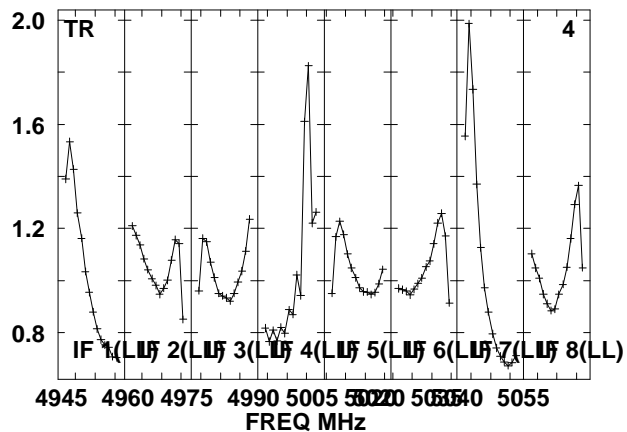
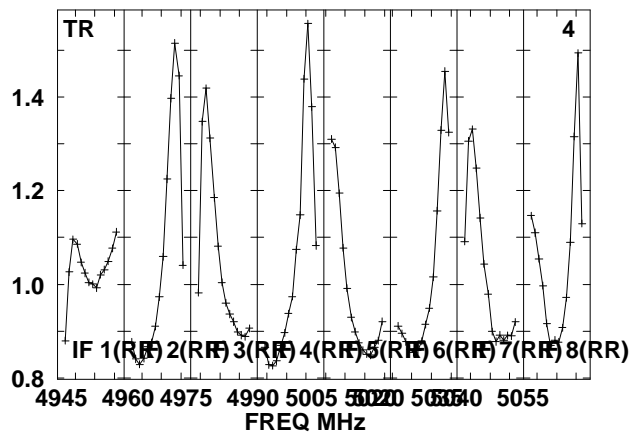
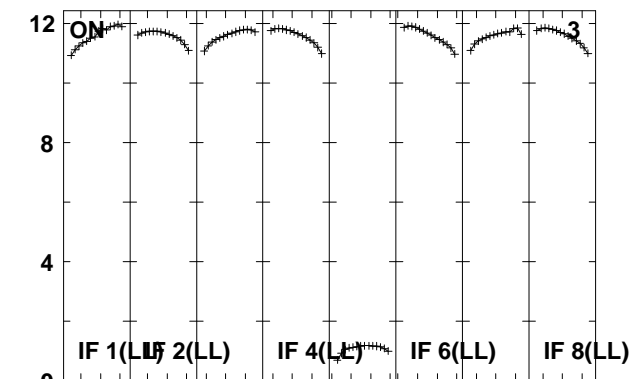
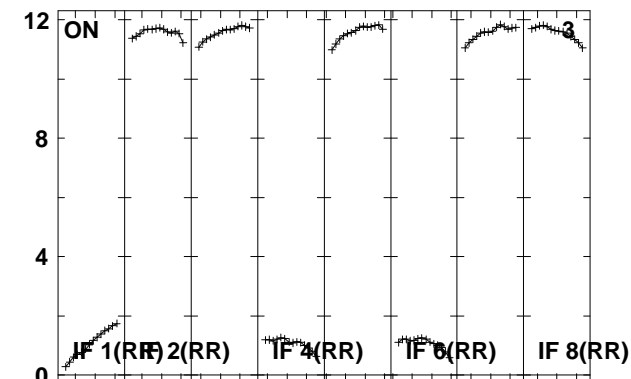
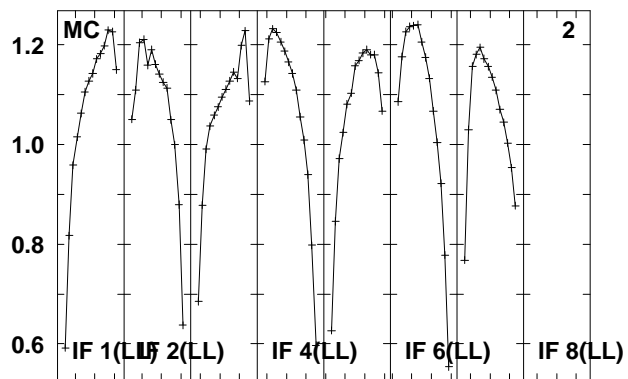
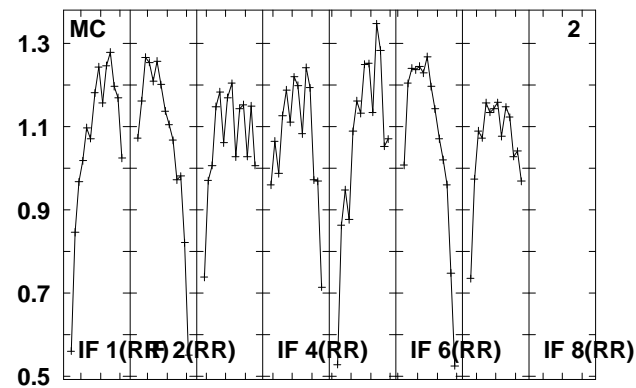
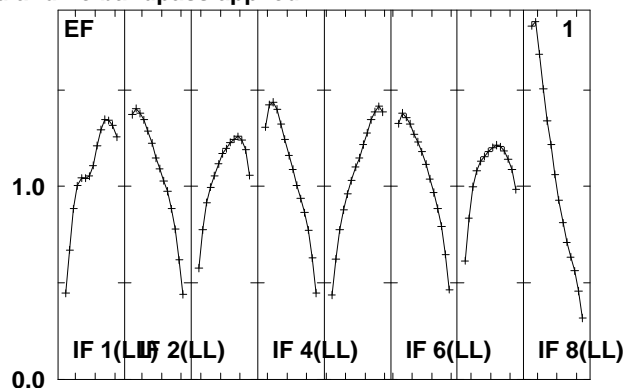
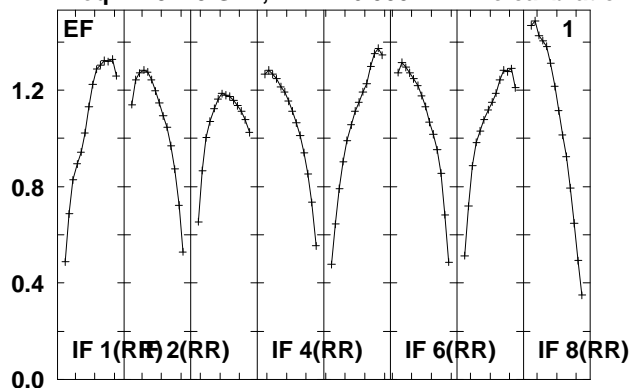

Lower frame: Real Jy
 Total-power spectrum Antenna: *
 Timerange: 01/01:04:26 to 01/01:15:08

Plot file version 303 created 08-JUL-2010 13:13:20

J1525+05 EM079.UVDATA.1

Freq = 4.9415 GHz, Bw = 16.000 MH No calibration applied and no bandpass applied

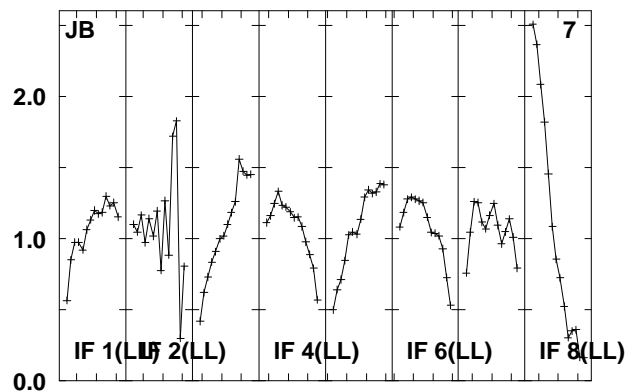
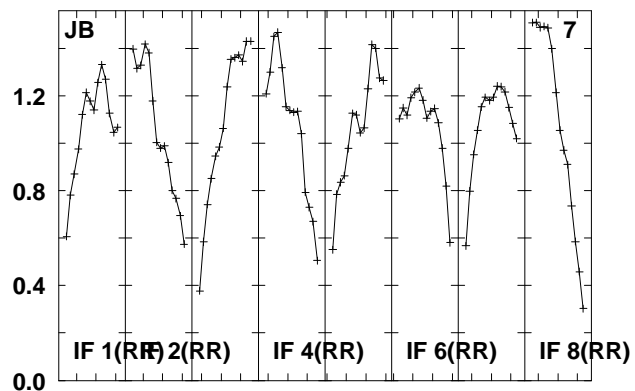
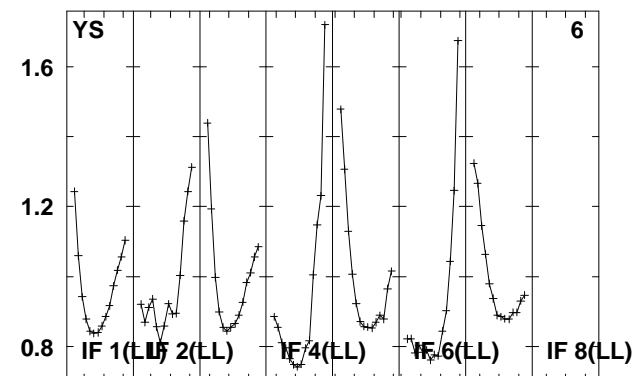
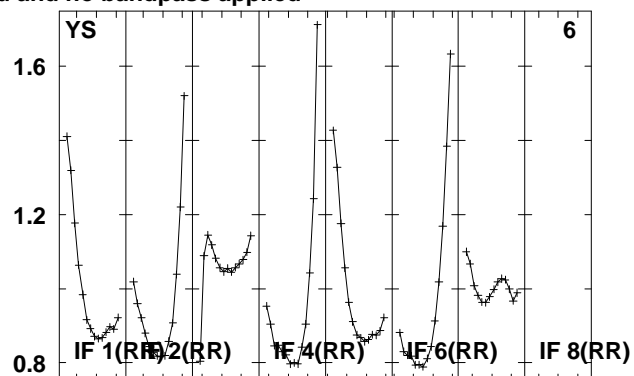
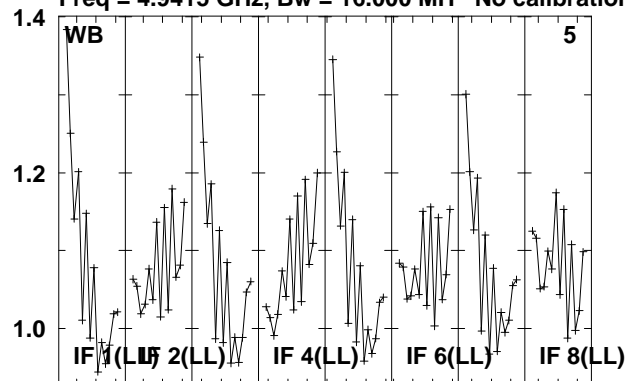

Lower frame: Real Jy
Total-power spectrum Antenna: *
Timerange: 01/01:04:26 to 01/01:15:08

Plot file version 304 created 08-JUL-2010 13:13:22

J1521+04 EM079.UVDATA.1

Freq = 4.9415 GHz, Bw = 16.000 MH No calibration applied and no bandpass applied

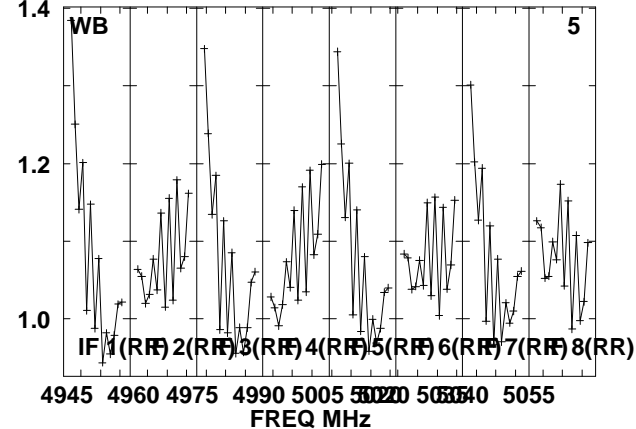
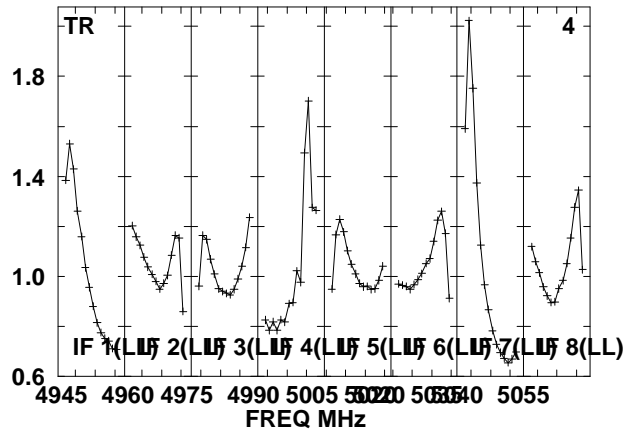
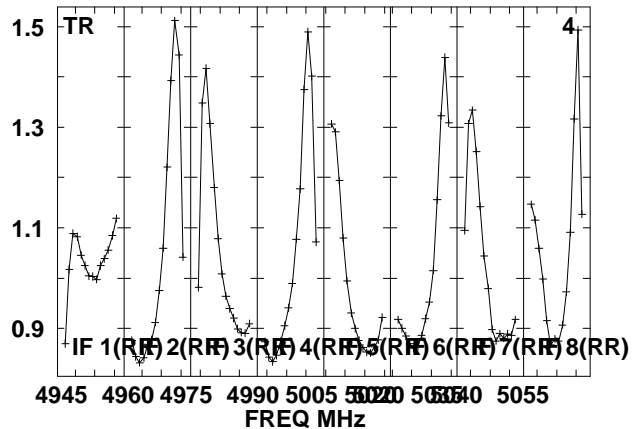
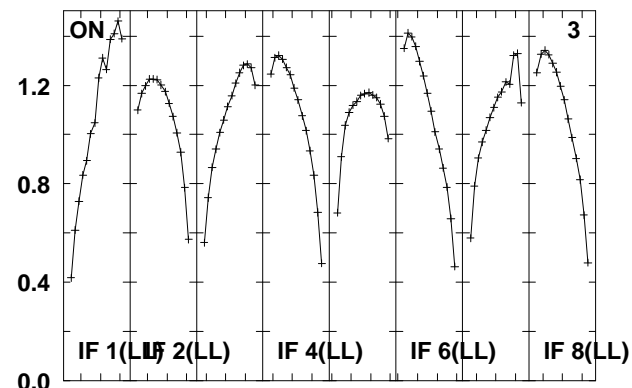
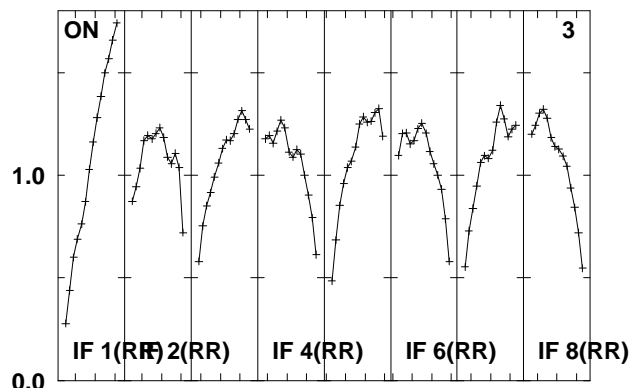
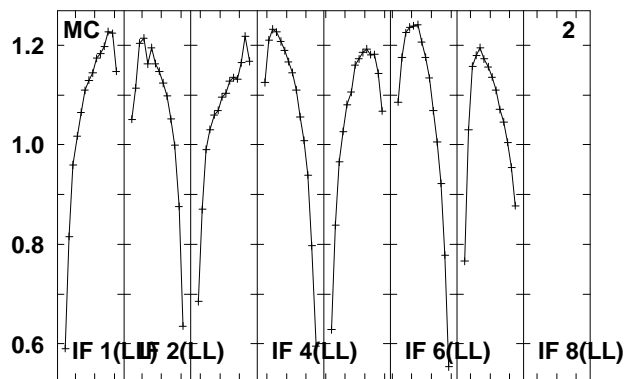
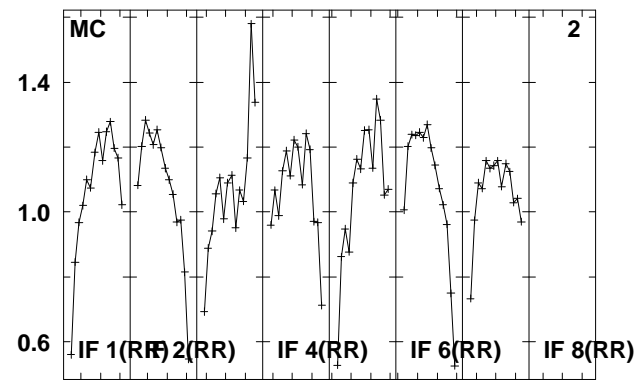
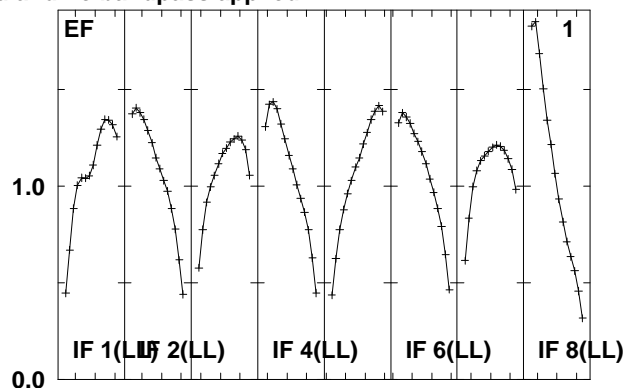
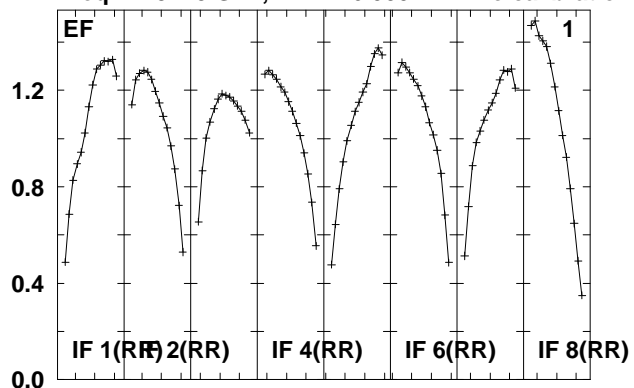

Lower frame: Real Jy
Total-power spectrum Antenna: *
Timerange: 01/01:15:10 to 01/01:17:08

Plot file version 305 created 08-JUL-2010 13:13:22

J1521+04 EM079.UVDATA.1

Freq = 4.9415 GHz, Bw = 16.000 MH No calibration applied and no bandpass applied

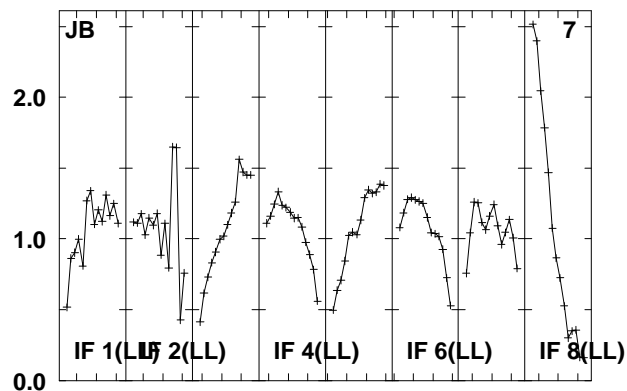
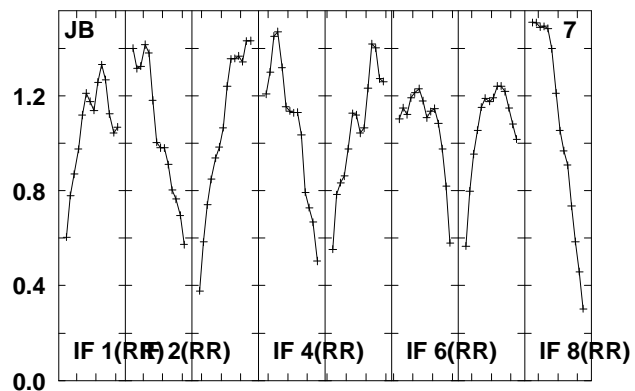
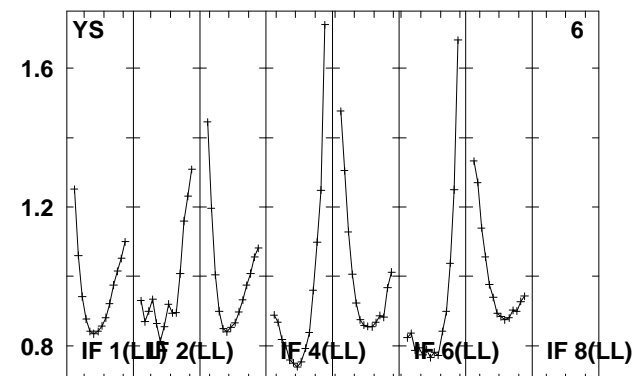
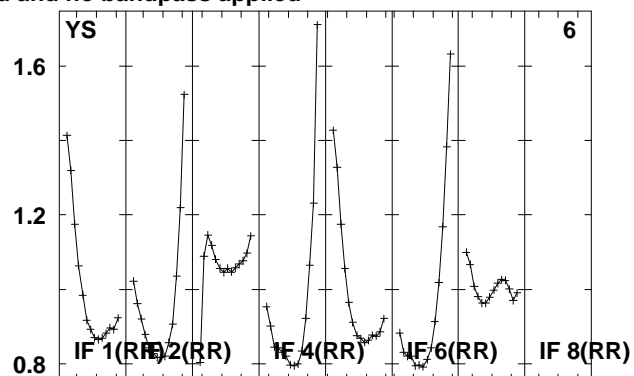
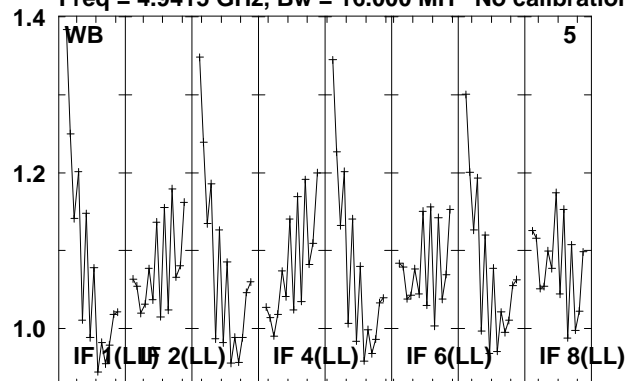

Lower frame: Real Jy
Total-power spectrum Antenna: *
Timerange: 01/01:15:10 to 01/01:17:08

Plot file version 306 created 08-JUL-2010 13:13:23

J1525+05 EM079.UVDATA.1

Freq = 4.9415 GHz, Bw = 16.000 MH No calibration applied and no bandpass applied

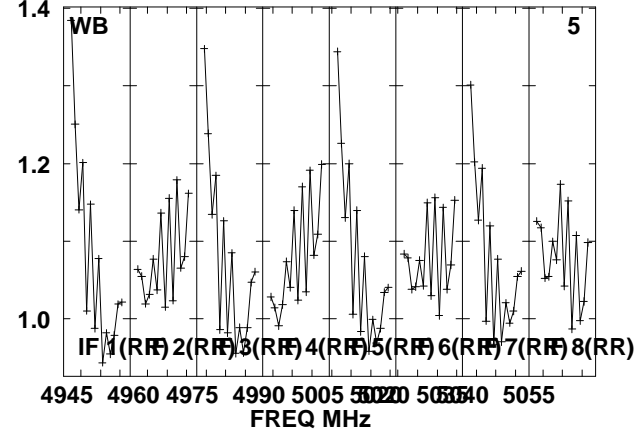
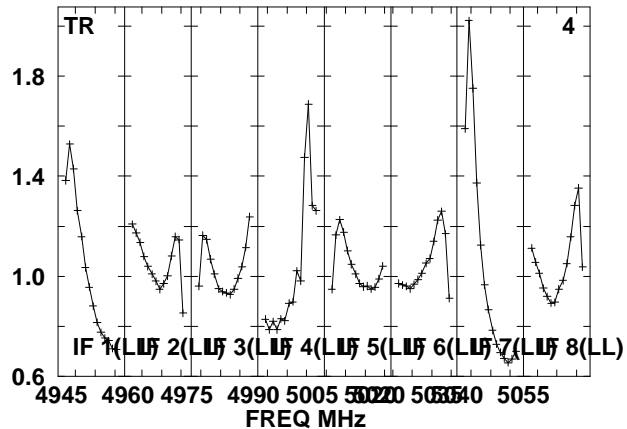
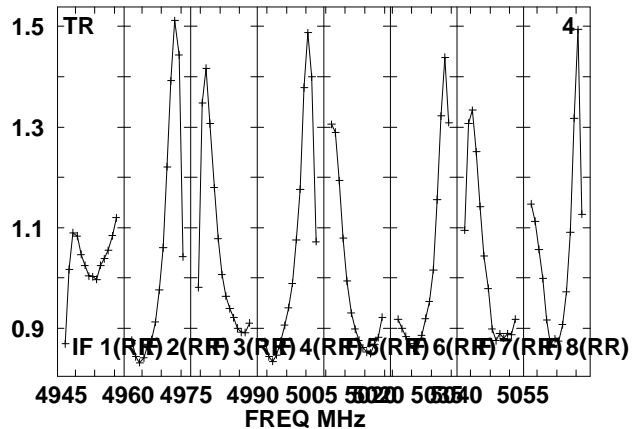
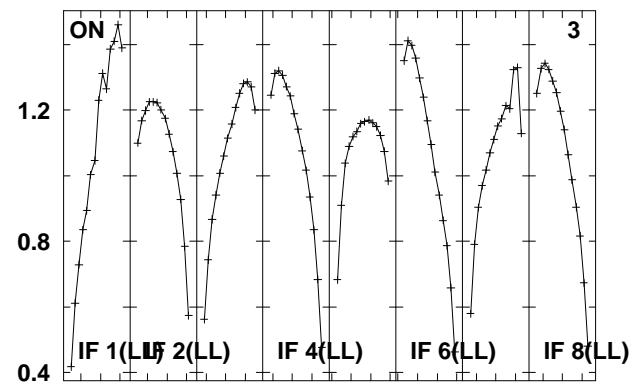
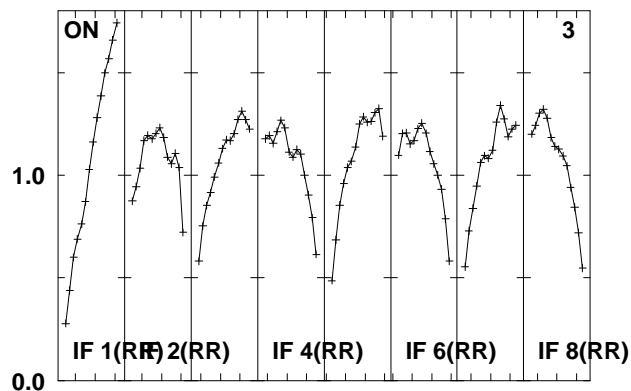
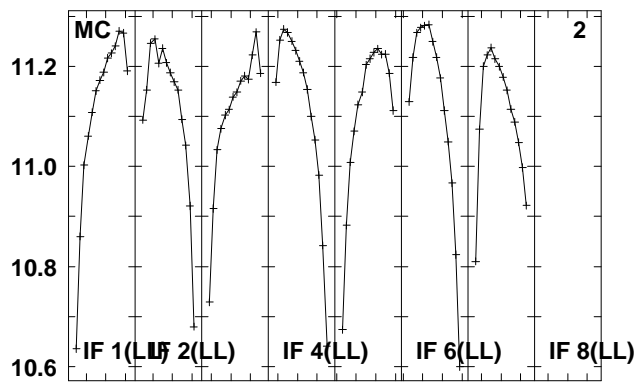
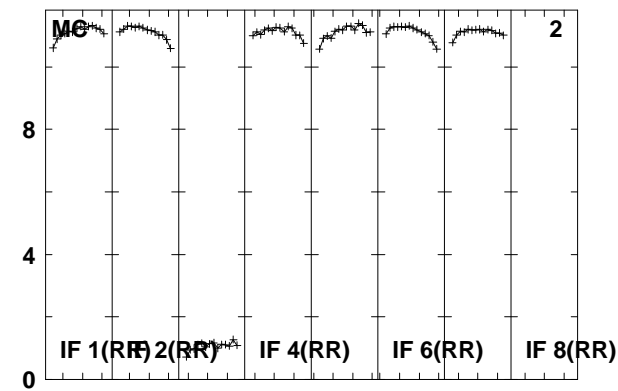
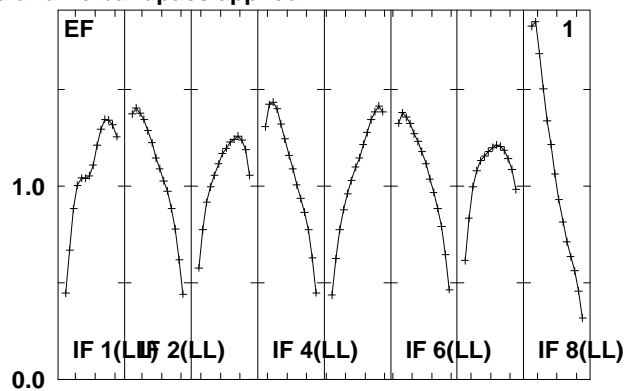
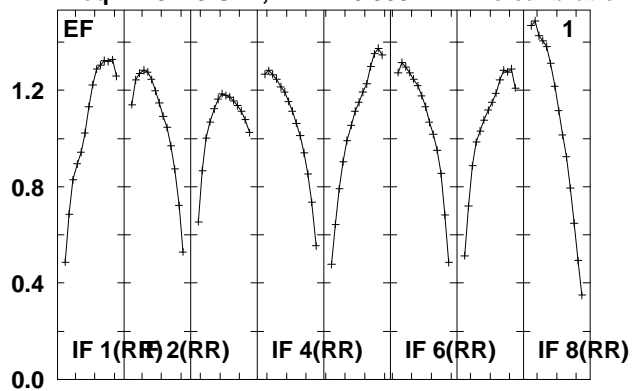

Lower frame: Real Jy
Total-power spectrum Antenna: *
Timerange: 01/01:17:10 to 01/01:27:54

Plot file version 307 created 08-JUL-2010 13:13:24

J1525+05 EM079.UVDATA.1

Freq = 4.9415 GHz, Bw = 16.000 MH No calibration applied and no bandpass applied

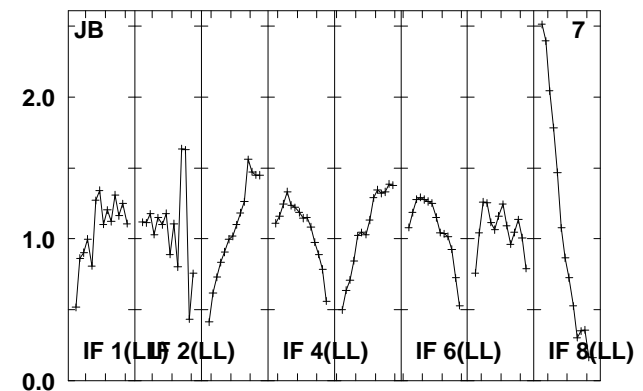
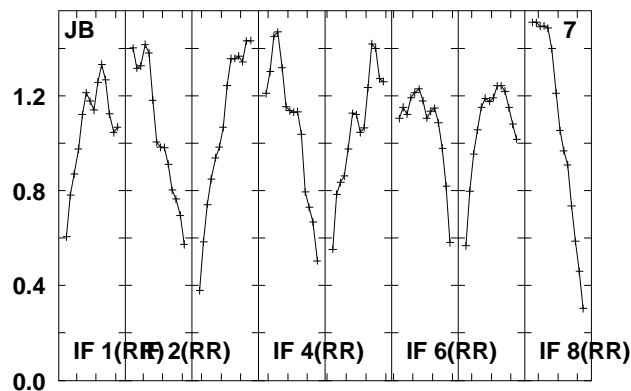
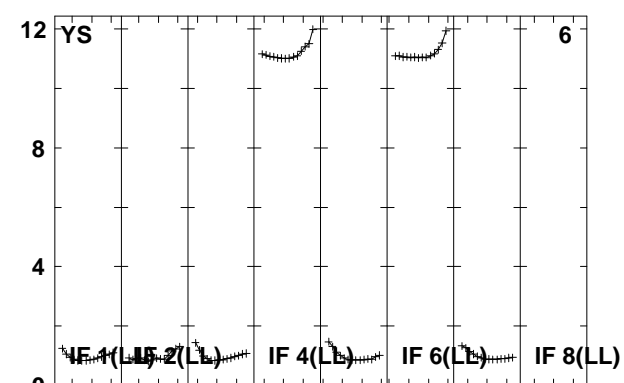
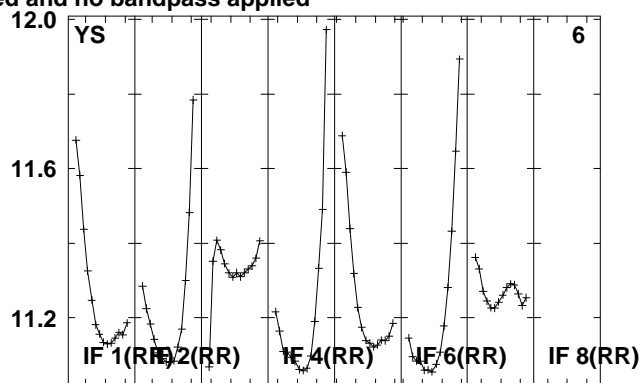
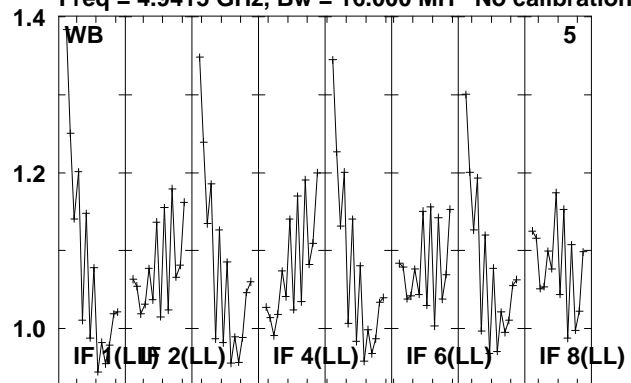

Lower frame: Real Jy
Total-power spectrum Antenna: *
Timerange: 01/01:17:10 to 01/01:27:54

Plot file version 308 created 08-JUL-2010 13:13:26

J1521+04 EM079.UVDATA.1

Freq = 4.9415 GHz, Bw = 16.000 MH No calibration applied and no bandpass applied

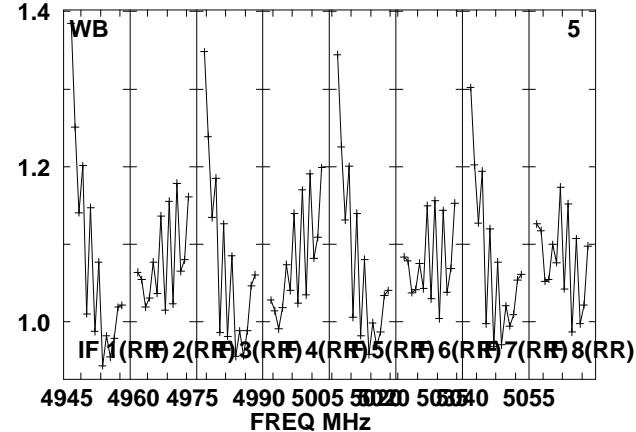
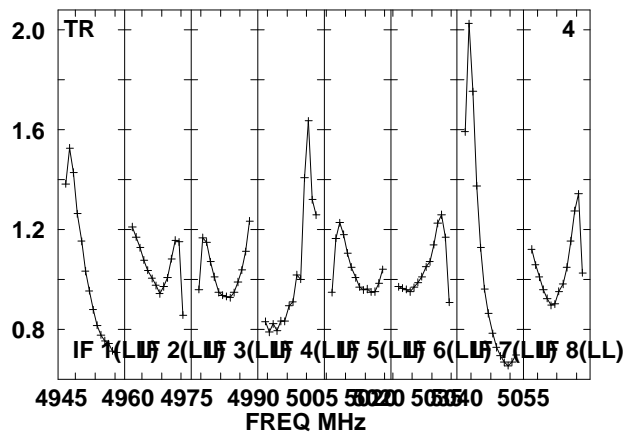
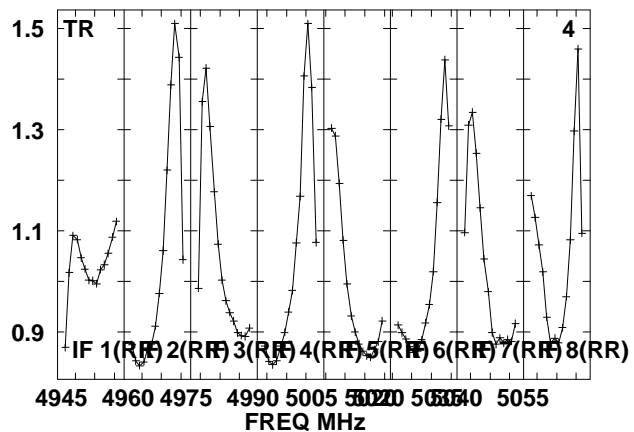
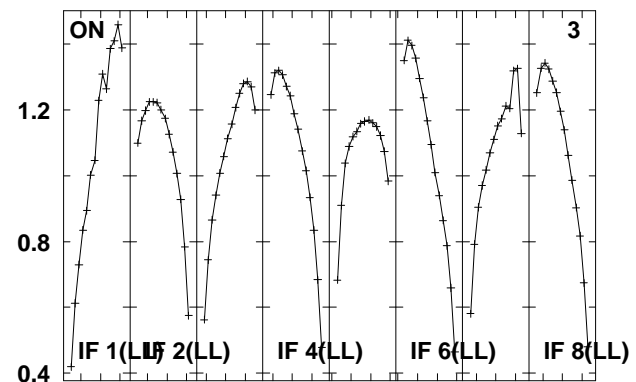
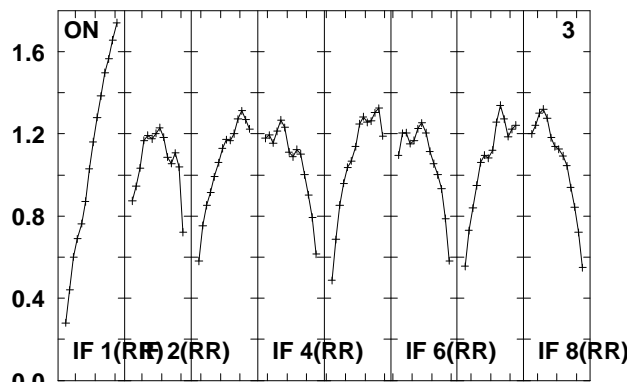
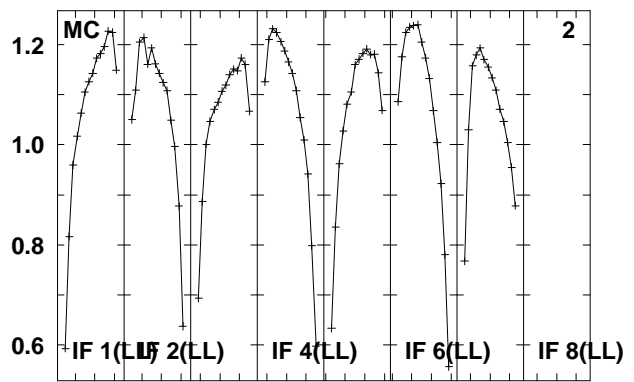
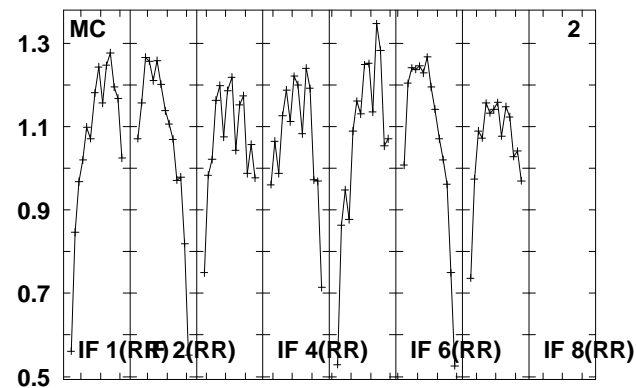
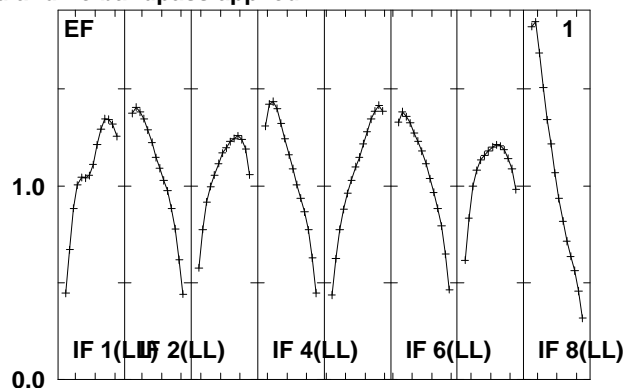
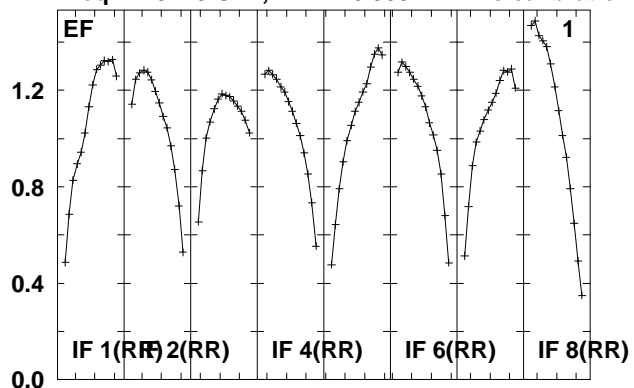

Lower frame: Real Jy
Total-power spectrum Antenna: *
Timerange: 01/01:27:56 to 01/01:31:54

Plot file version 309 created 08-JUL-2010 13:13:26

J1521+04 EM079.UVDATA.1

Freq = 4.9415 GHz, Bw = 16.000 MH No calibration applied and no bandpass applied

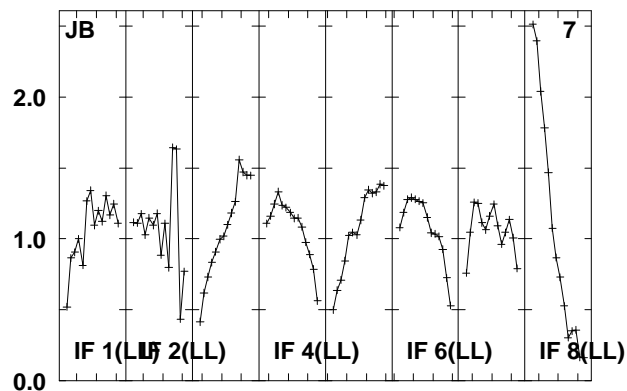
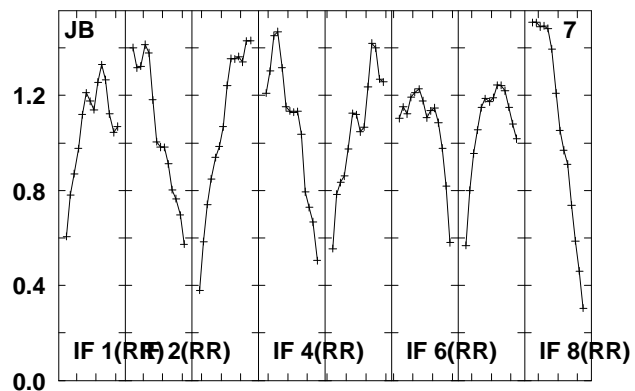
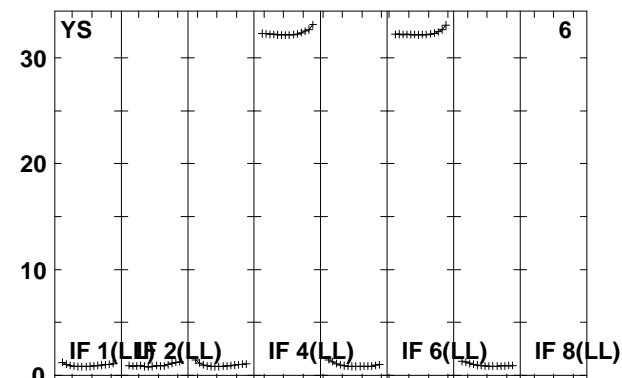
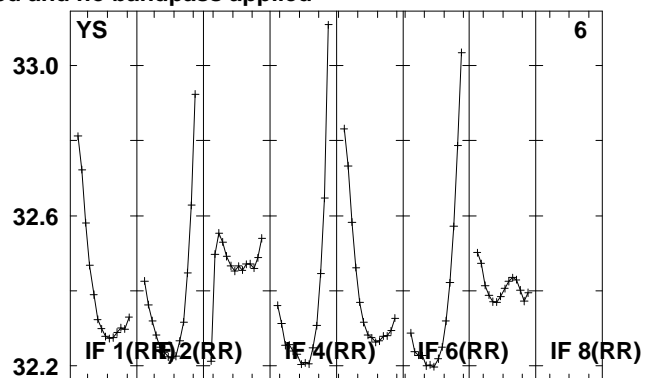
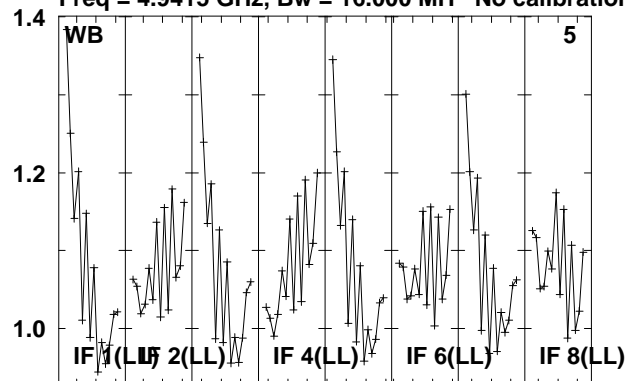

Lower frame: Real Jy
Total-power spectrum Antenna: *
Timerange: 01/01:27:56 to 01/01:31:54

Plot file version 310 created 08-JUL-2010 13:13:27

J1609+26 EM079.UVDATA.1

Freq = 4.9415 GHz, Bw = 16.000 MH No calibration applied and no bandpass applied

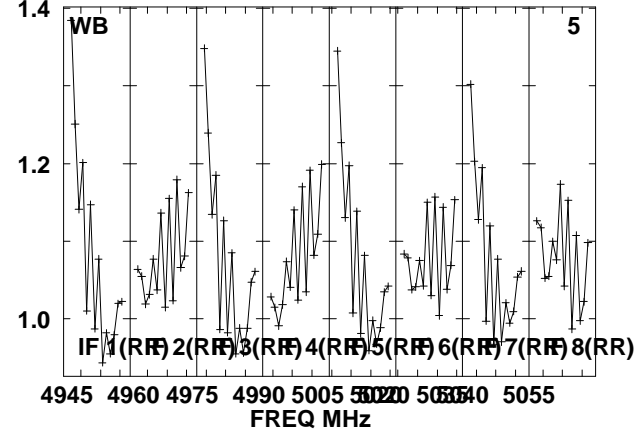
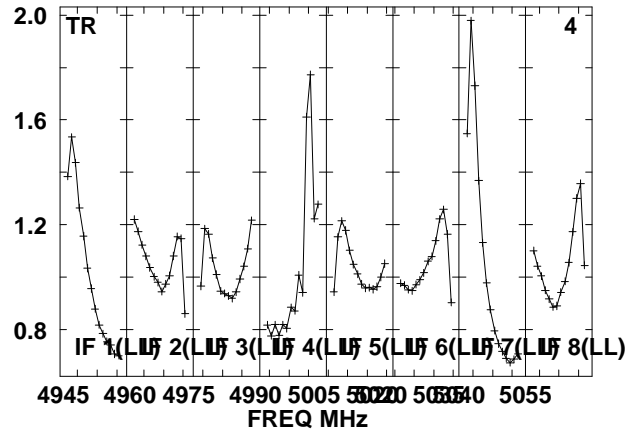
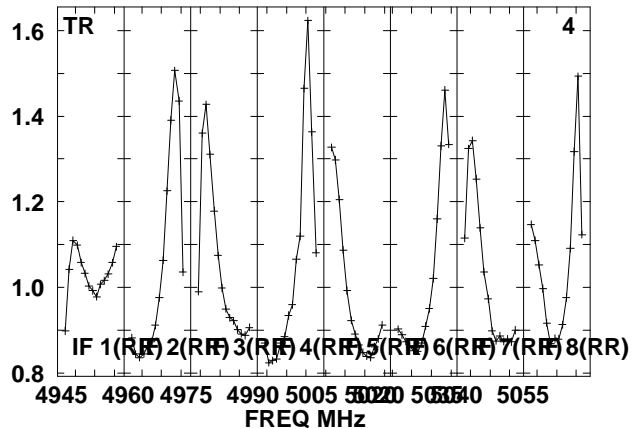
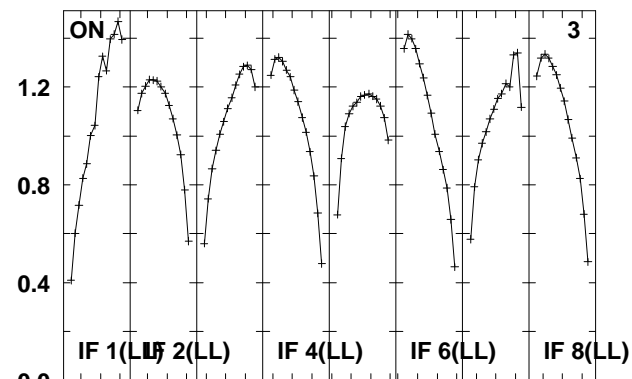
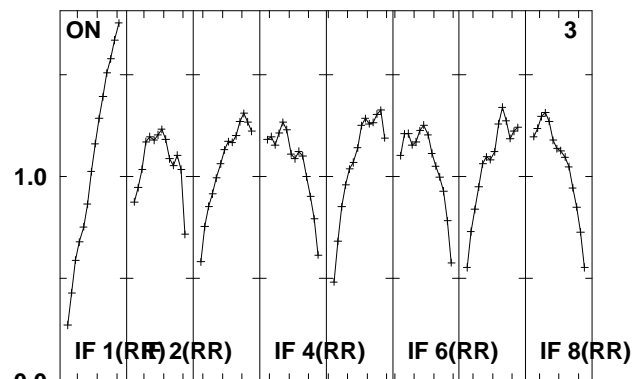
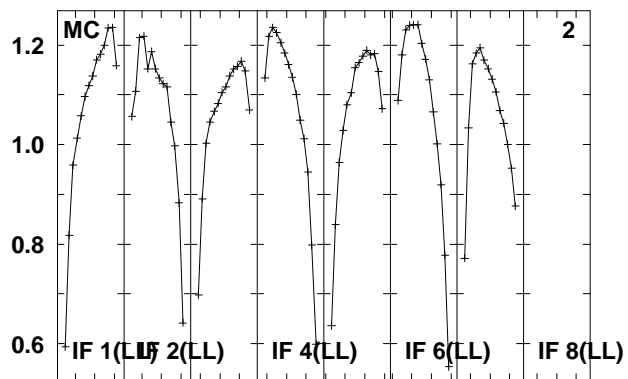
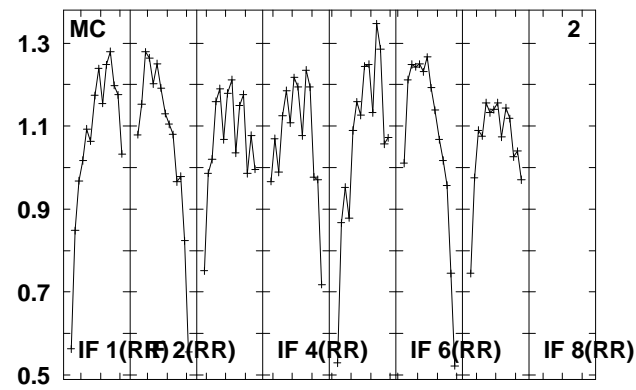
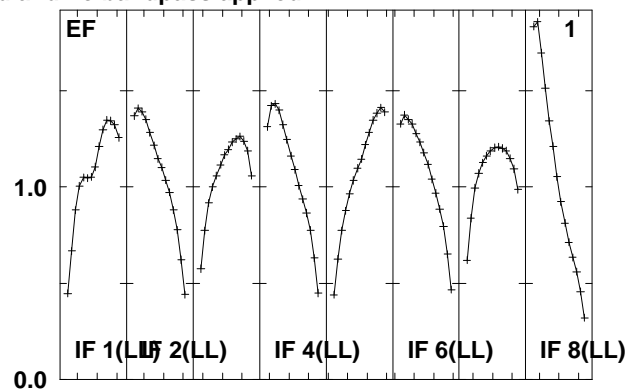
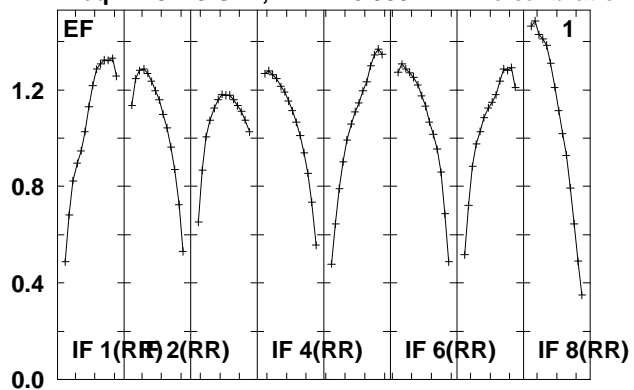

Lower frame: Real Jy

Total-power spectrum Antenna: *

Timerange: 01/01:31:56 to 01/01:33:54

Plot file version 311 created 08-JUL-2010 13:13:27

J1609+26 EM079.UVDATA.1

Freq = 4.9415 GHz, Bw = 16.000 MH No calibration applied and no bandpass applied

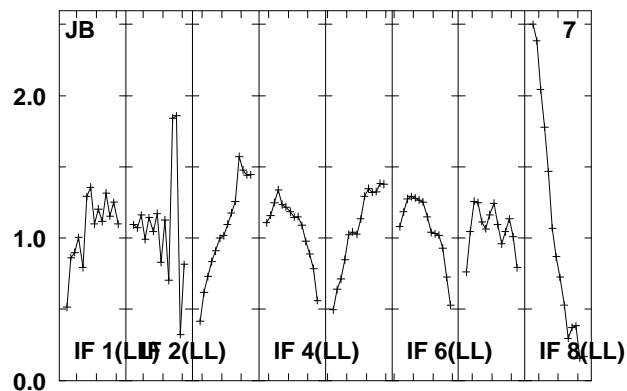
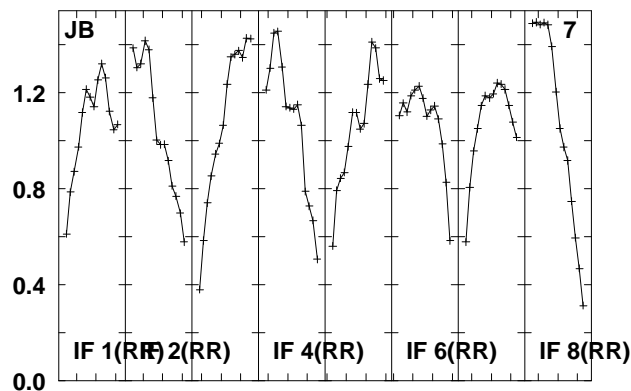
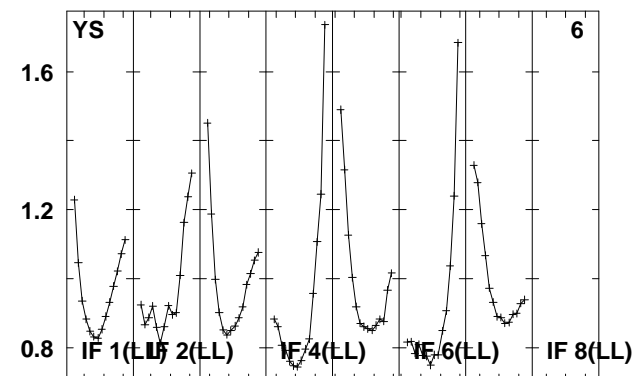
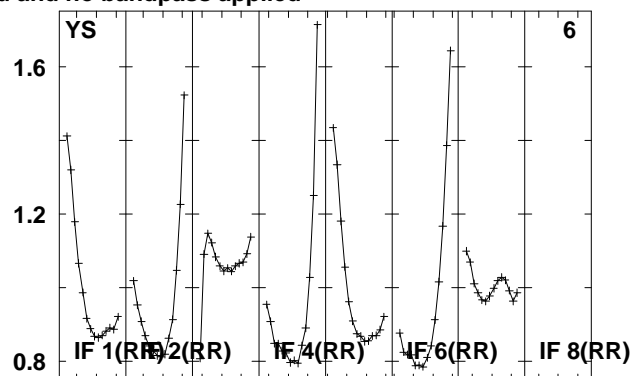
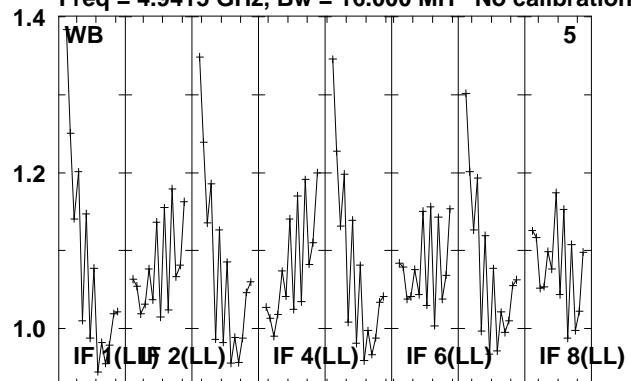

Lower frame: Real Jy
Total-power spectrum Antenna: *
Timerange: 01/01:31:56 to 01/01:33:54

Plot file version 312 created 08-JUL-2010 13:13:27

J1625+27 EM079.UVDATA.1

Freq = 4.9415 GHz, Bw = 16.000 MH No calibration applied and no bandpass applied

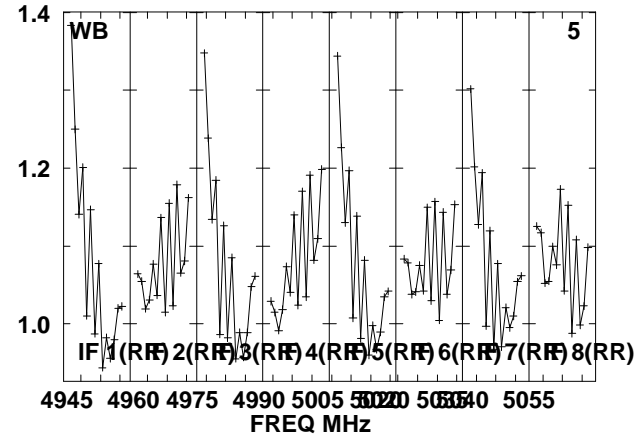
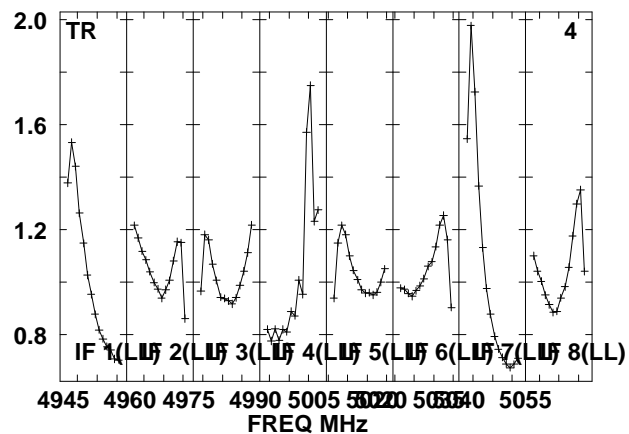
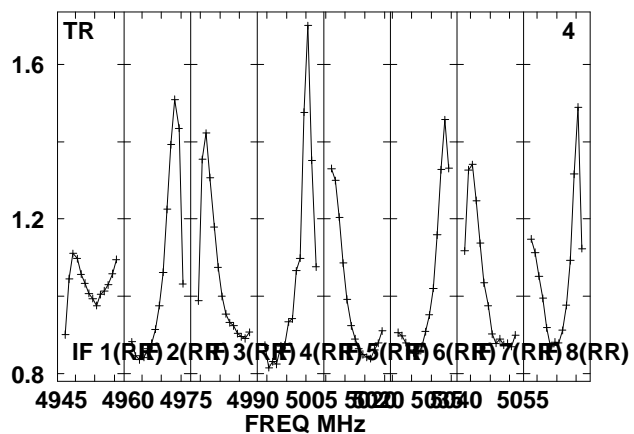
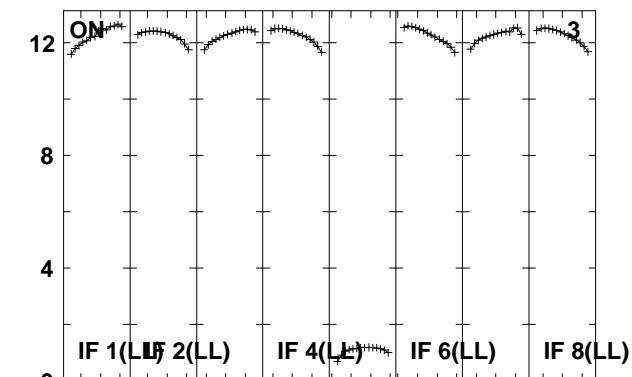
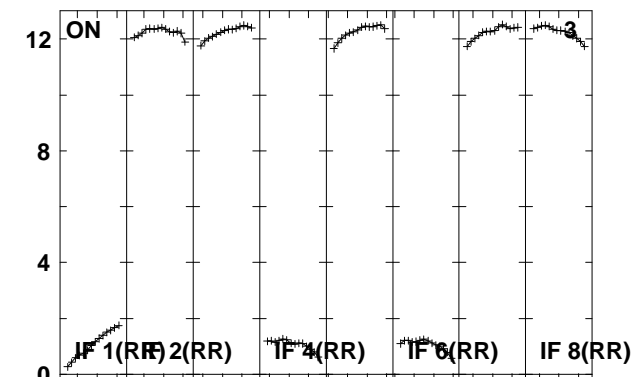
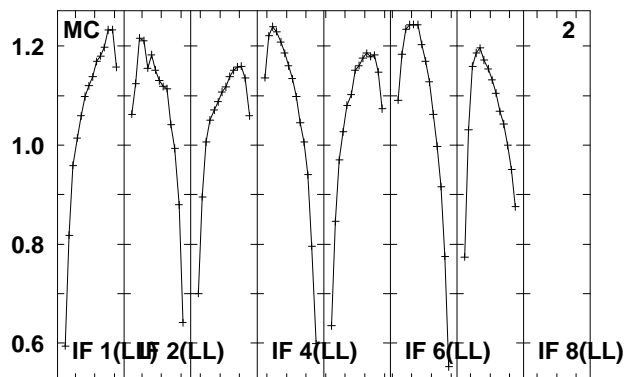
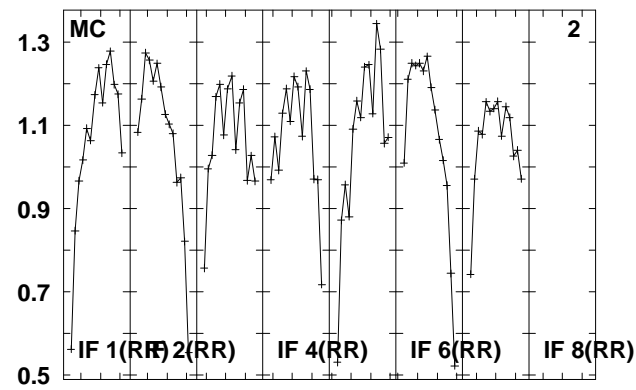
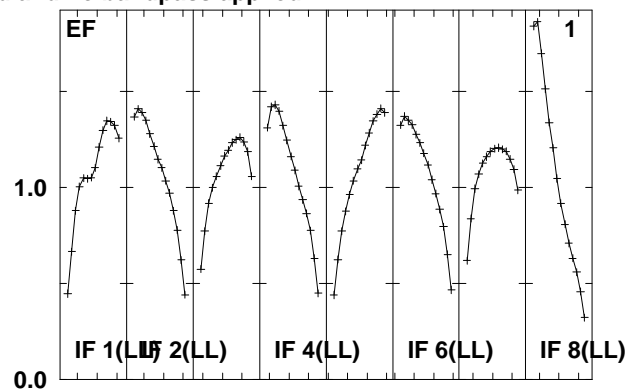
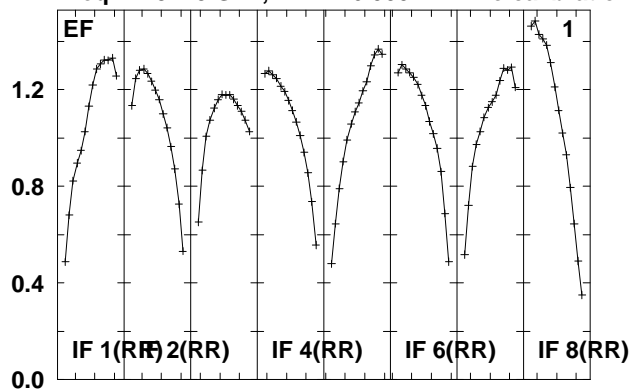

Lower frame: Real Jy
Total-power spectrum Antenna: *
Timerange: 01/01:33:56 to 01/01:44:38

Plot file version 313 created 08-JUL-2010 13:13:29

J1625+27 EM079.UVDATA.1

Freq = 4.9415 GHz, Bw = 16.000 MH No calibration applied and no bandpass applied

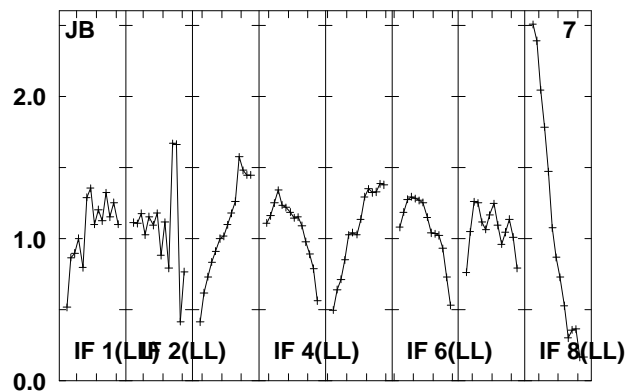
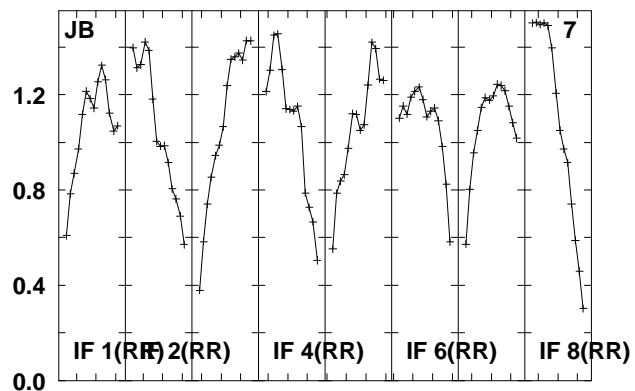
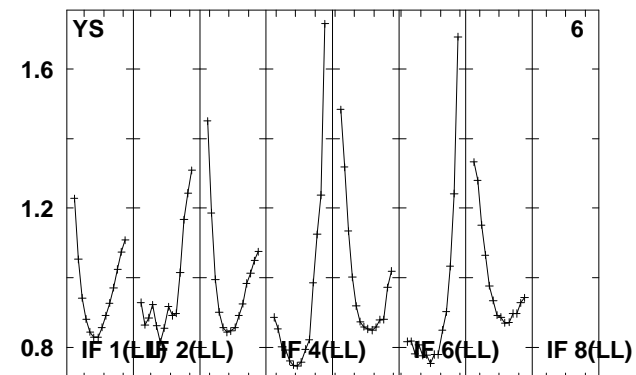
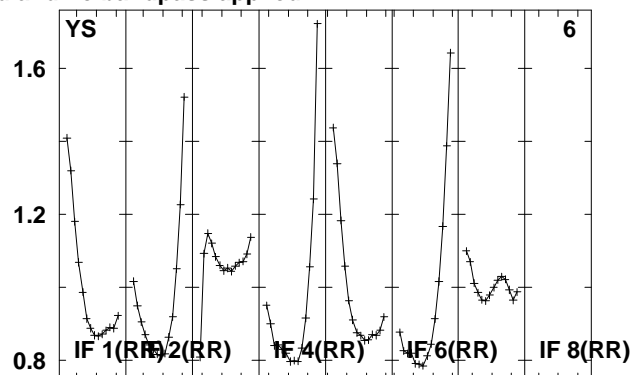
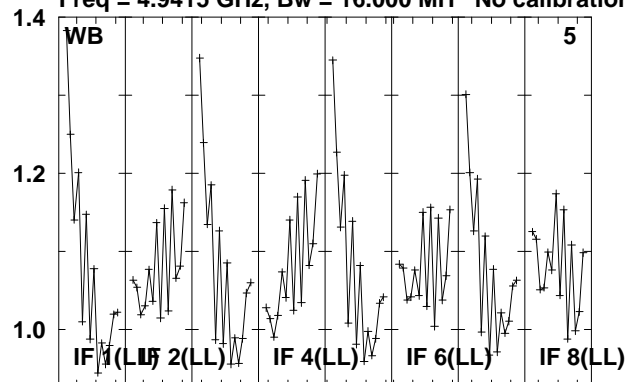

Lower frame: Real Jy
Total-power spectrum Antenna: *
Timerange: 01/01:33:56 to 01/01:44:38

Plot file version 314 created 08-JUL-2010 13:13:30

J1609+26 EM079.UVDATA.1

Freq = 4.9415 GHz, Bw = 16.000 MH No calibration applied and no bandpass applied

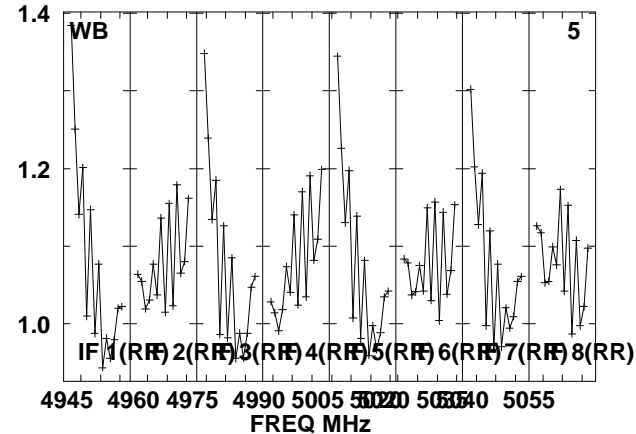
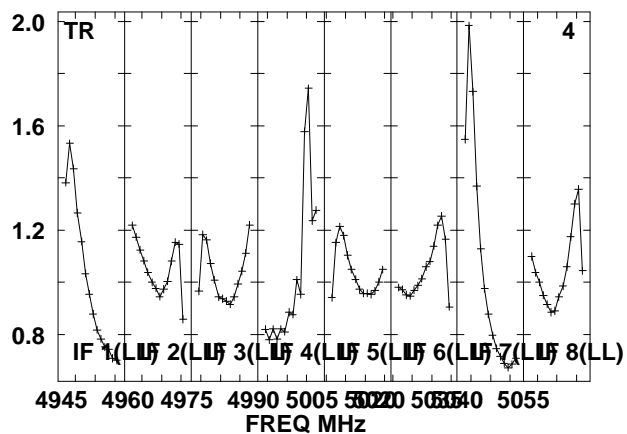
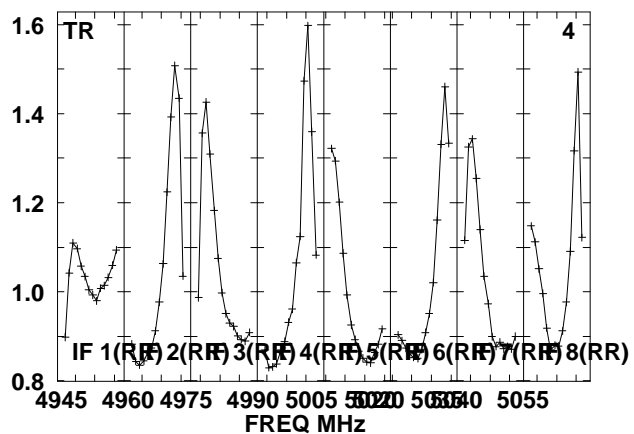
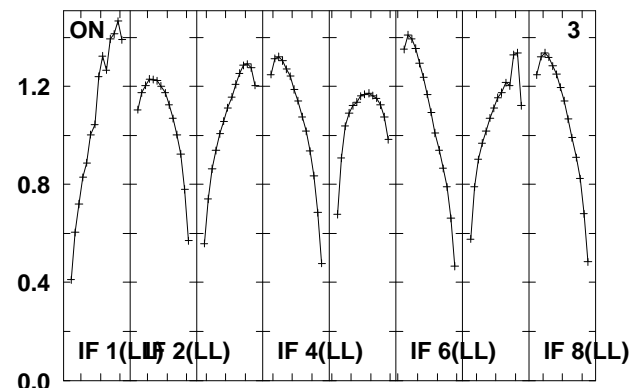
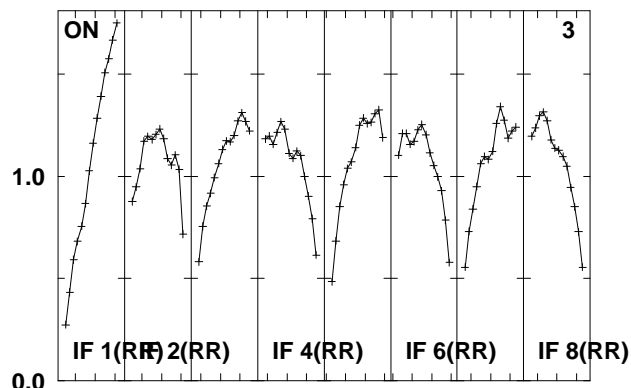
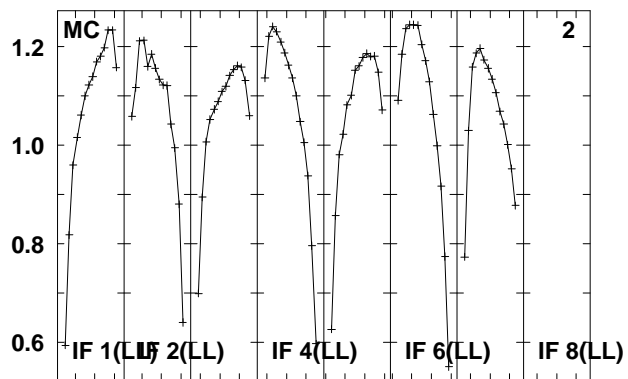
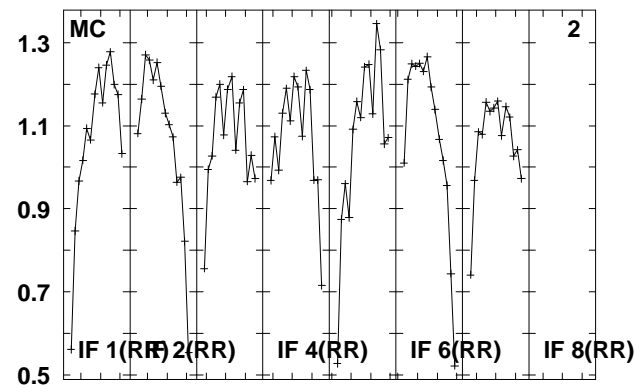
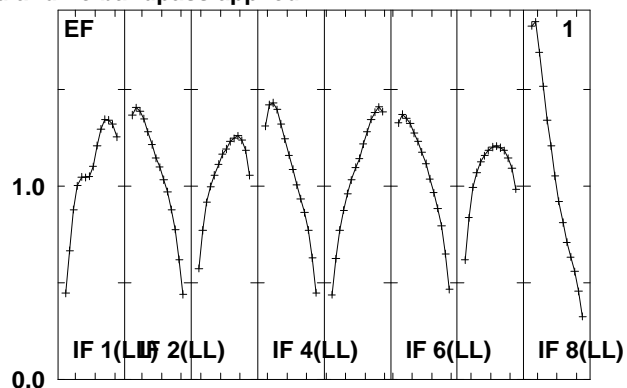
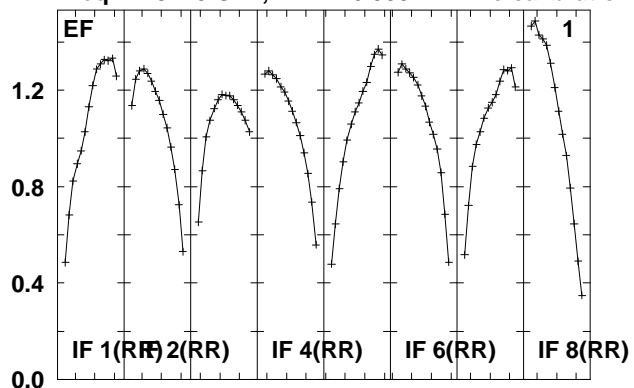

Lower frame: Real Jy
Total-power spectrum Antenna: *
Timerange: 01/01:44:40 to 01/01:46:38

Plot file version 315 created 08-JUL-2010 13:13:30

J1609+26 EM079.UVDATA.1

Freq = 4.9415 GHz, Bw = 16.000 MH No calibration applied and no bandpass applied

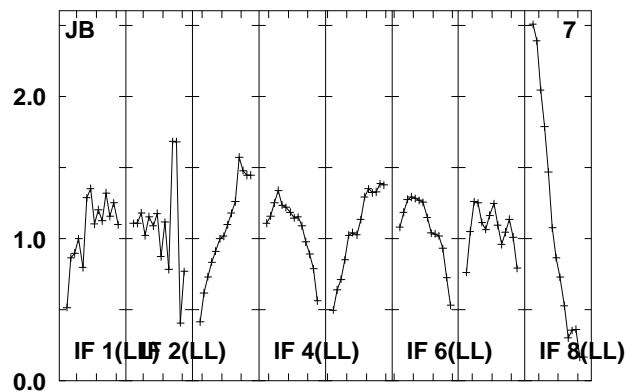
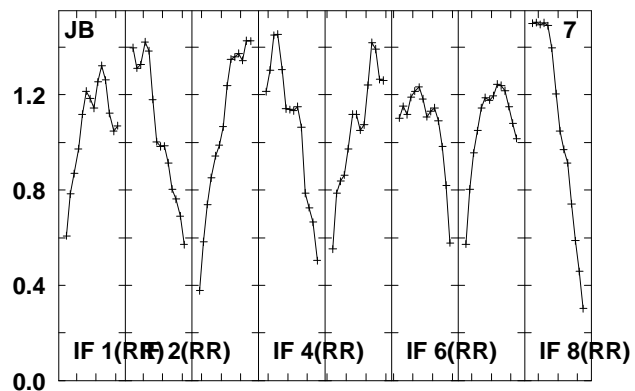
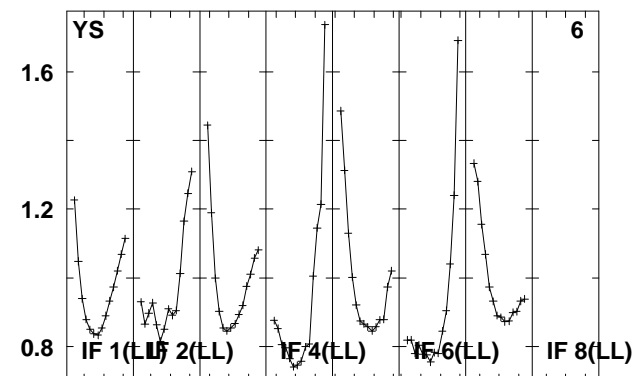
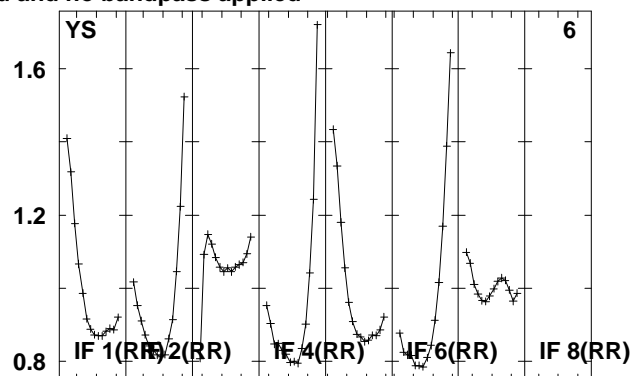
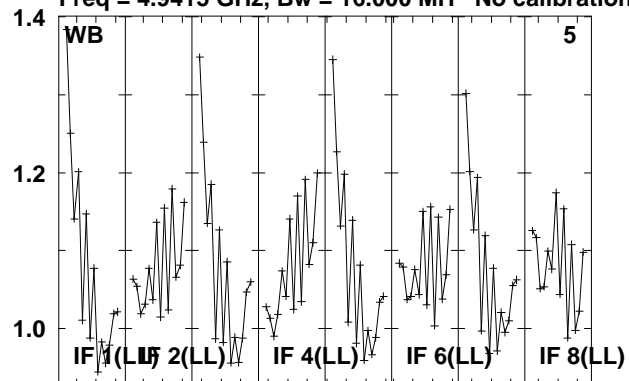

Lower frame: Real Jy
Total-power spectrum Antenna: *
Timerange: 01/01:44:40 to 01/01:46:38

Plot file version 316 created 08-JUL-2010 13:13:31

J1625+27 EM079.UVDATA.1

Freq = 4.9415 GHz, Bw = 16.000 MH No calibration applied and no bandpass applied

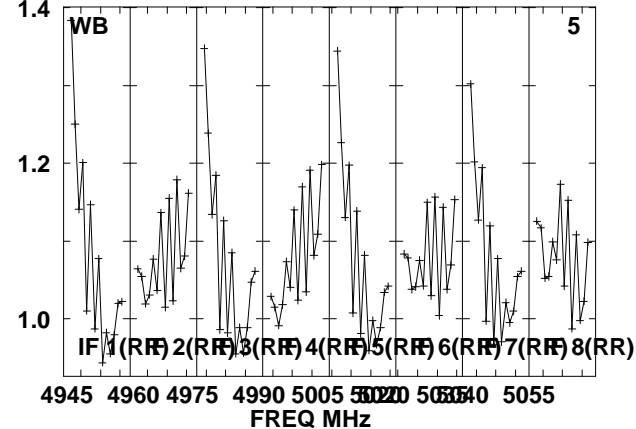
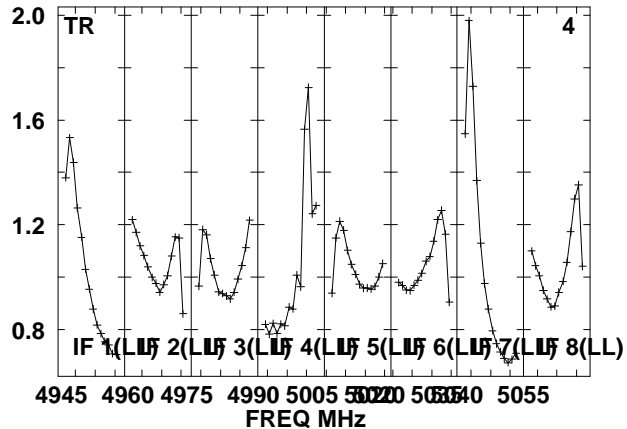
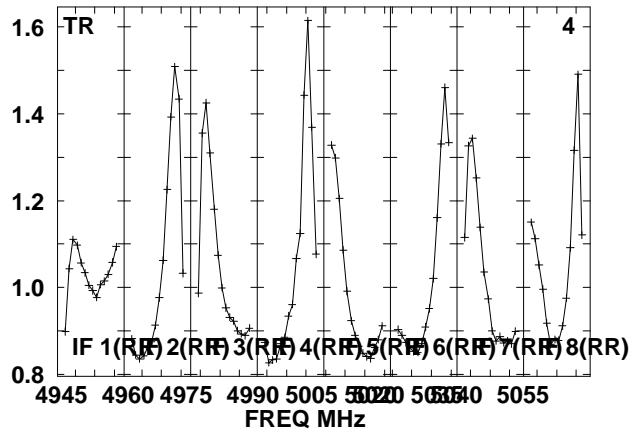
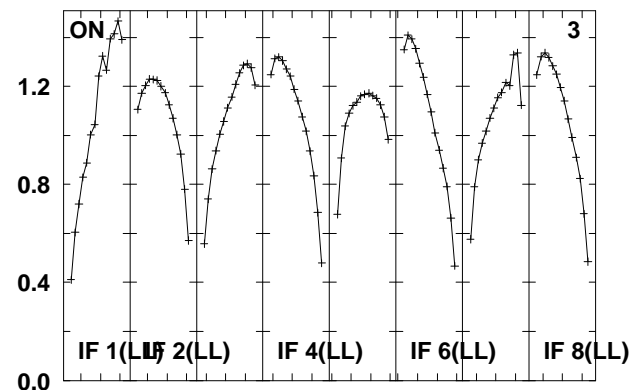
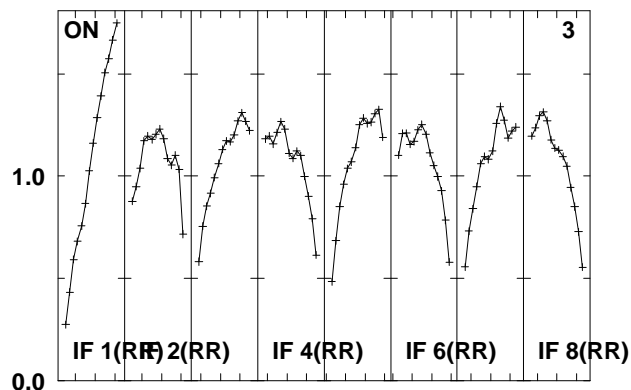
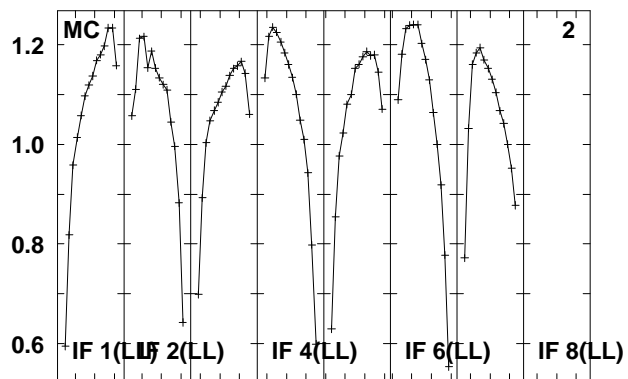
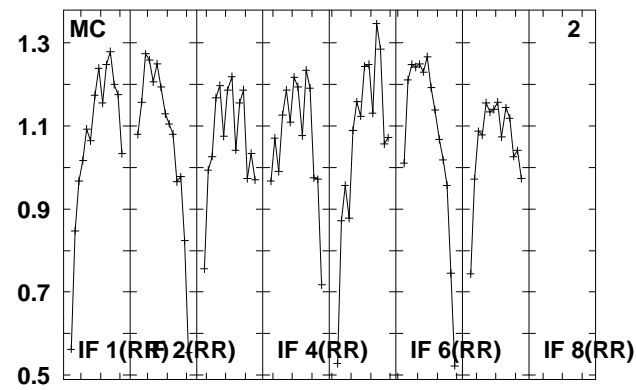
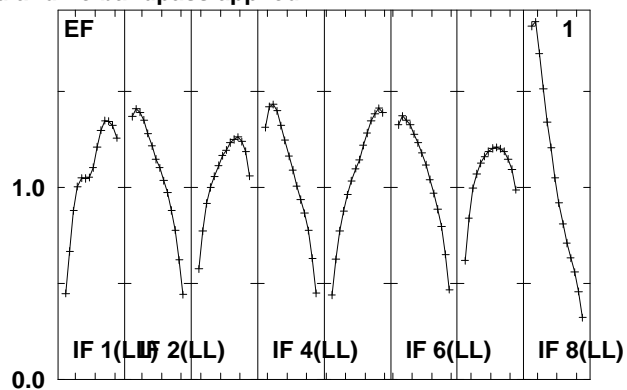
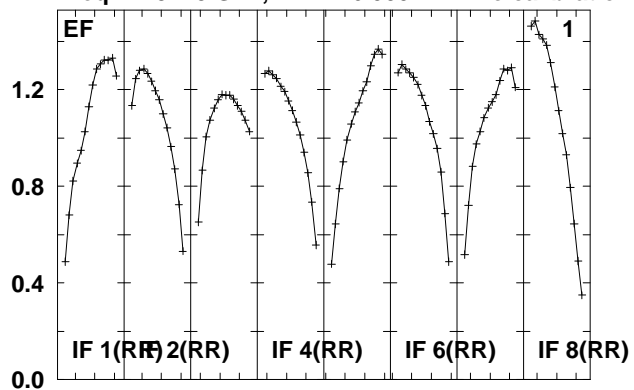

Lower frame: Real Jy
Total-power spectrum Antenna: *
Timerange: 01/01:46:40 to 01/01:57:24

Plot file version 317 created 08-JUL-2010 13:13:32

J1625+27 EM079.UVDATA.1

Freq = 4.9415 GHz, Bw = 16.000 MH No calibration applied and no bandpass applied

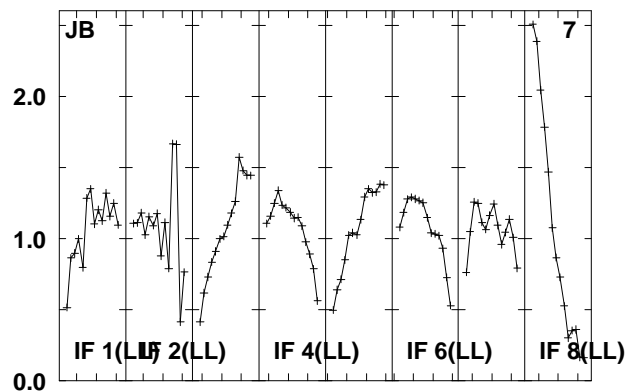
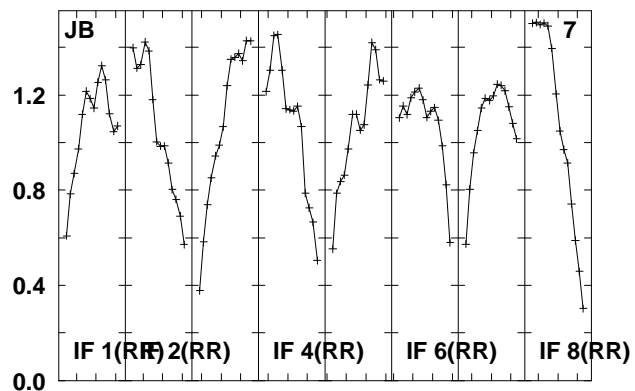
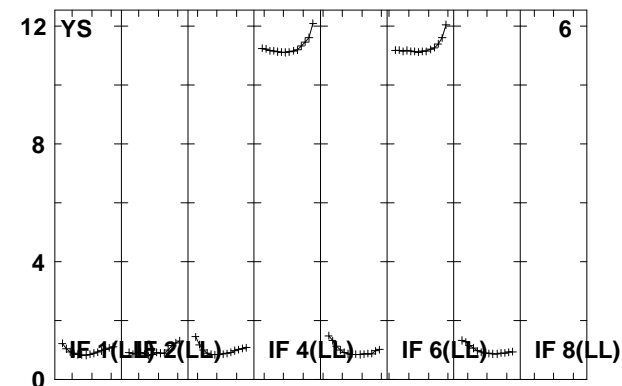
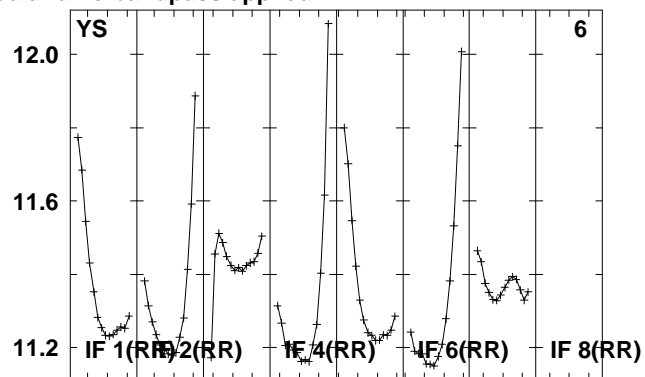
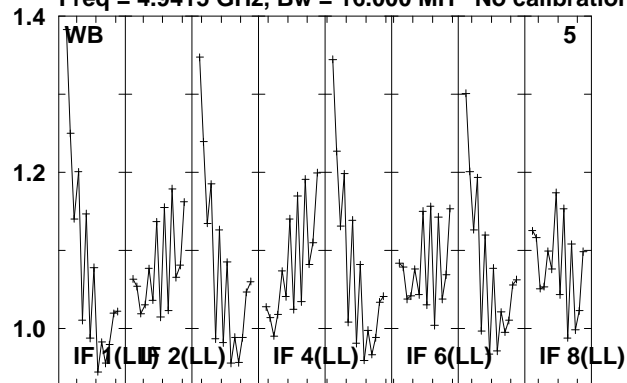

Lower frame: Real Jy
Total-power spectrum Antenna: *
Timerange: 01/01:46:40 to 01/01:57:24

Plot file version 318 created 08-JUL-2010 13:13:34

J1609+26 EM079.UVDATA.1

Freq = 4.9415 GHz, Bw = 16.000 MH No calibration applied and no bandpass applied

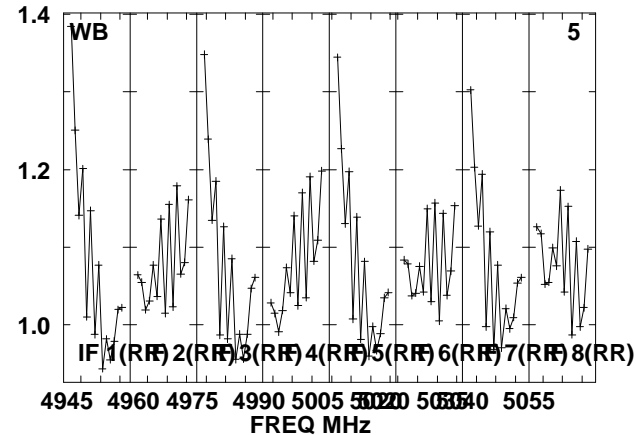
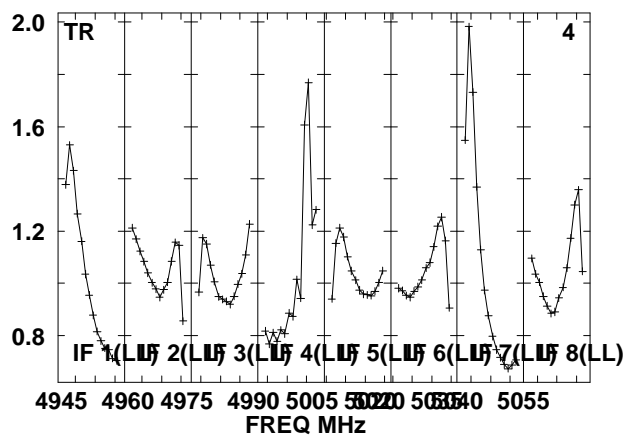
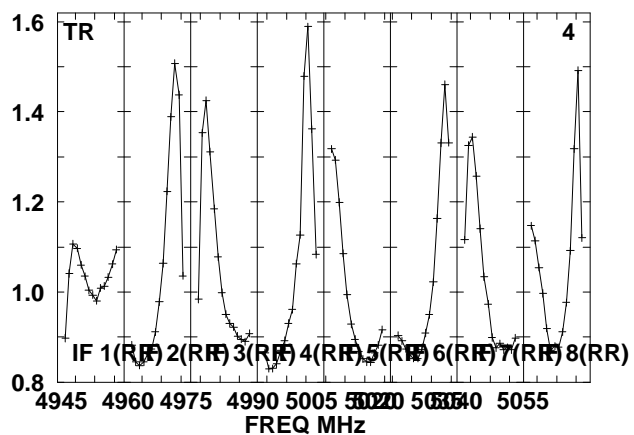
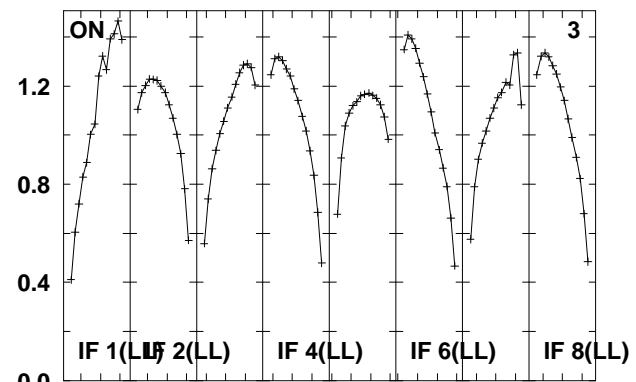
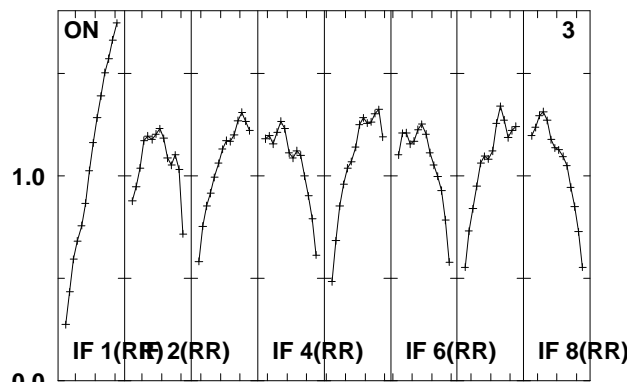
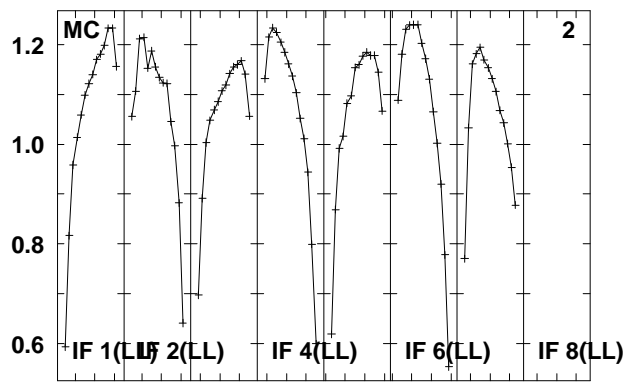
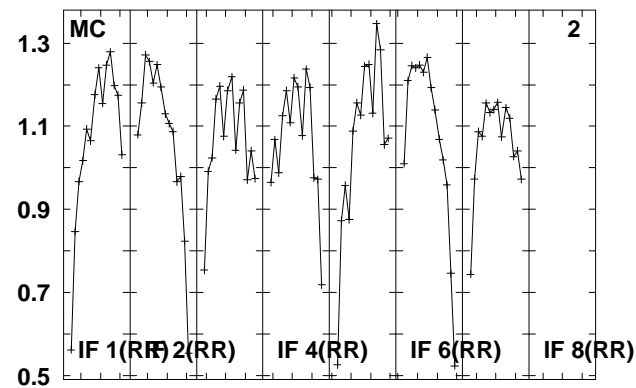
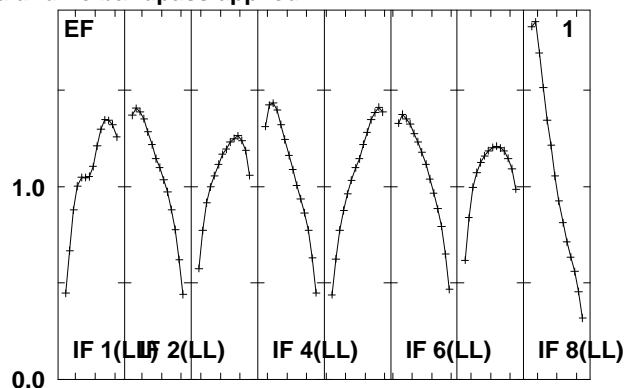
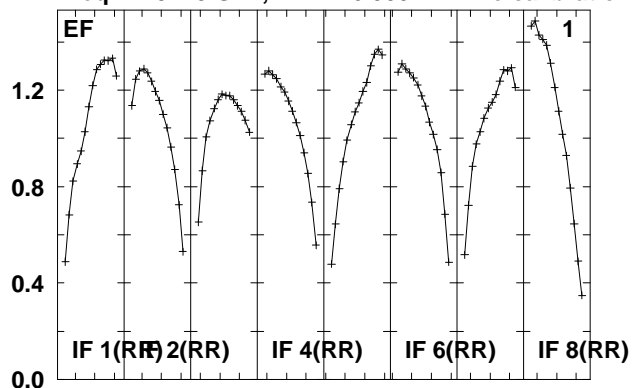

Lower frame: Real Jy
Total-power spectrum Antenna: *
Timerange: 01/01:57:26 to 01/01:59:24

Plot file version 319 created 08-JUL-2010 13:13:34

J1609+26 EM079.UVDATA.1

Freq = 4.9415 GHz, Bw = 16.000 MH No calibration applied and no bandpass applied

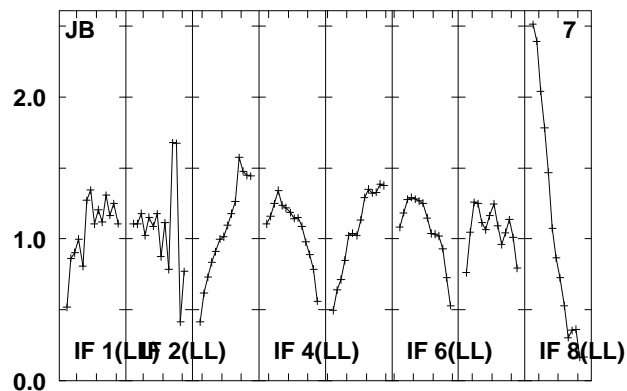
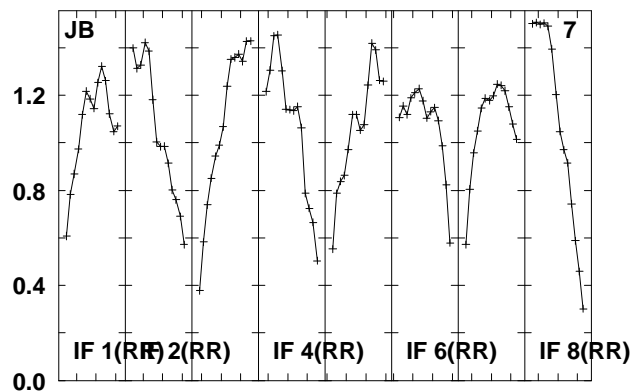
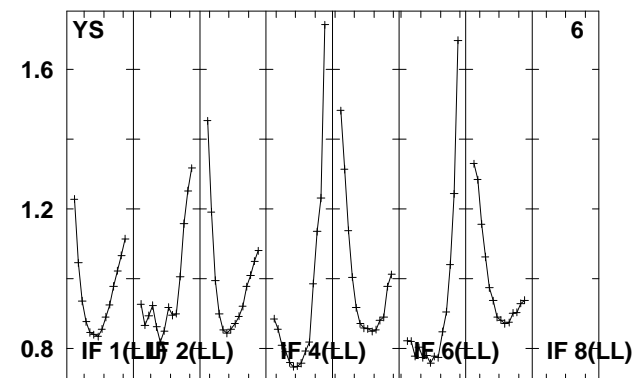
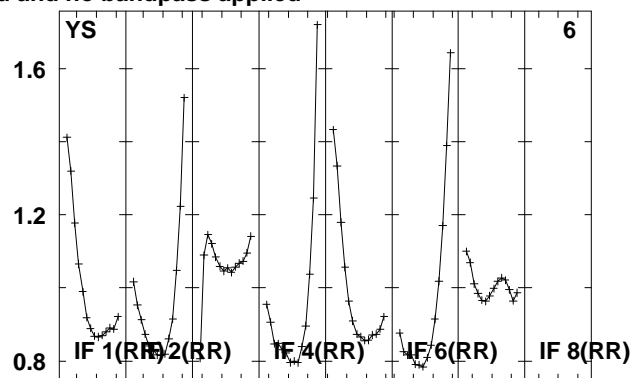
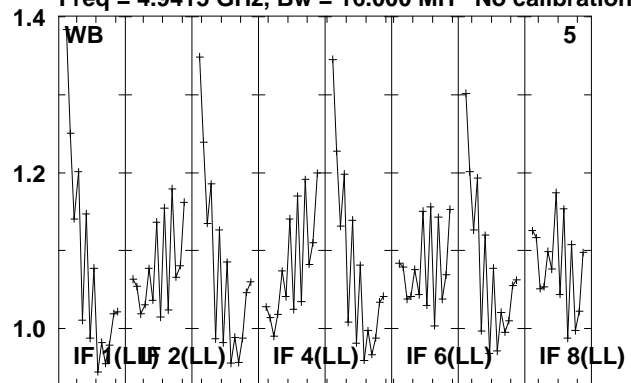

Lower frame: Real Jy
Total-power spectrum Antenna: *
Timerange: 01/01:57:26 to 01/01:59:24

Plot file version 320 created 08-JUL-2010 13:13:35

J1625+27 EM079.UVDATA.1

Freq = 4.9415 GHz, Bw = 16.000 MH No calibration applied and no bandpass applied

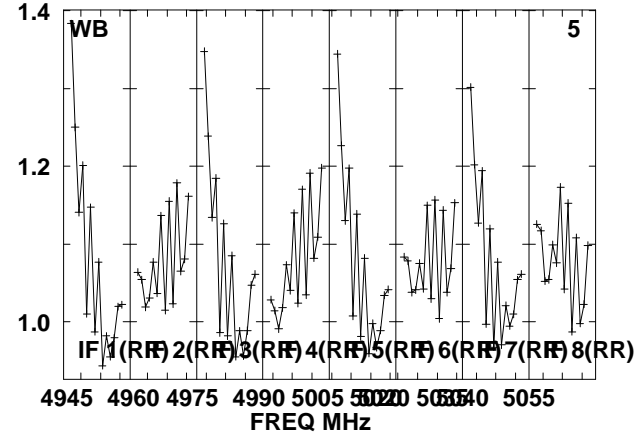
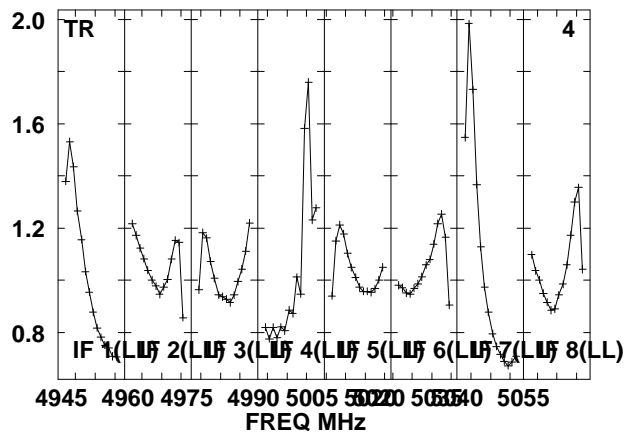
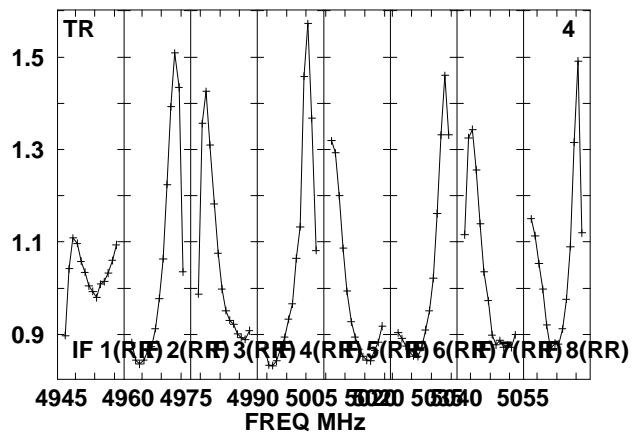
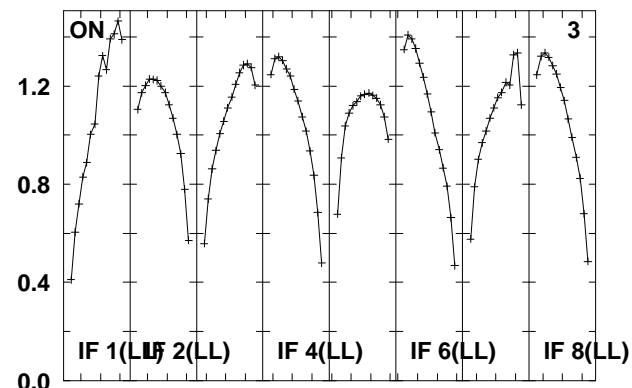
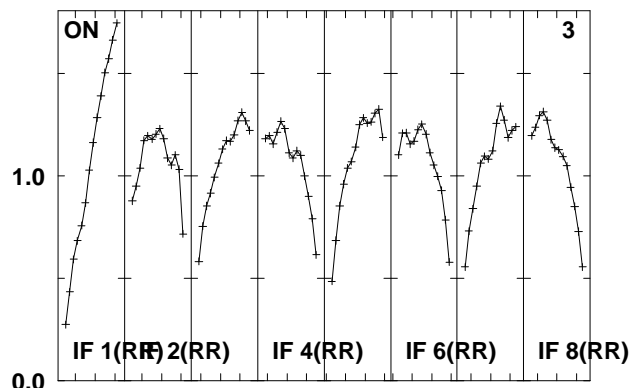
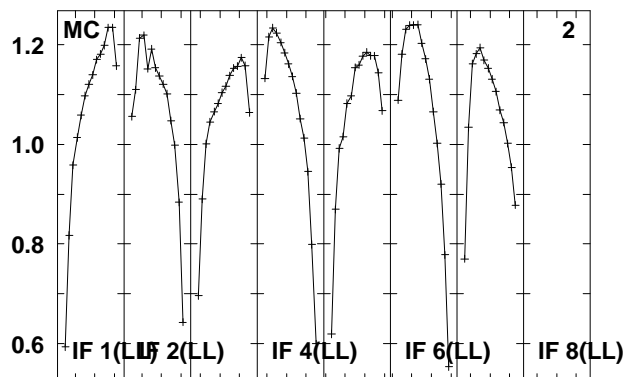
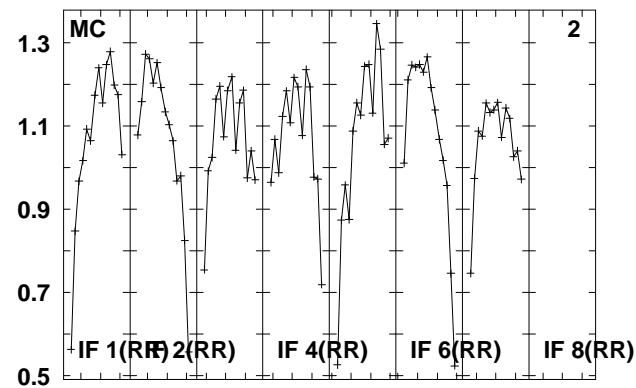
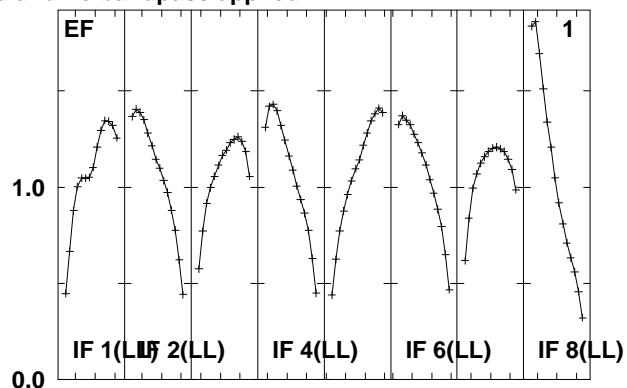
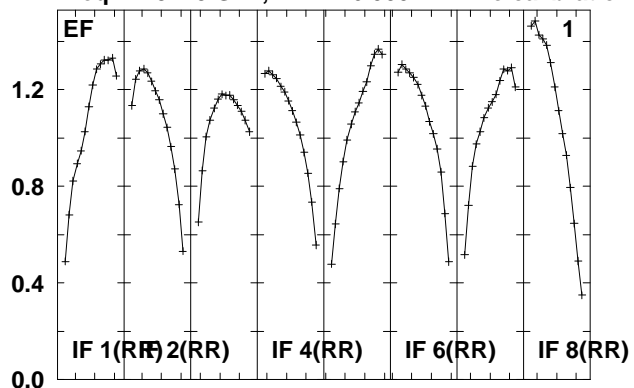

Lower frame: Real Jy
Total-power spectrum Antenna: *
Timerange: 01/01:59:26 to 01/02:10:08

Plot file version 321 created 08-JUL-2010 13:13:36

J1625+27 EM079.UVDATA.1

Freq = 4.9415 GHz, Bw = 16.000 MH No calibration applied and no bandpass applied

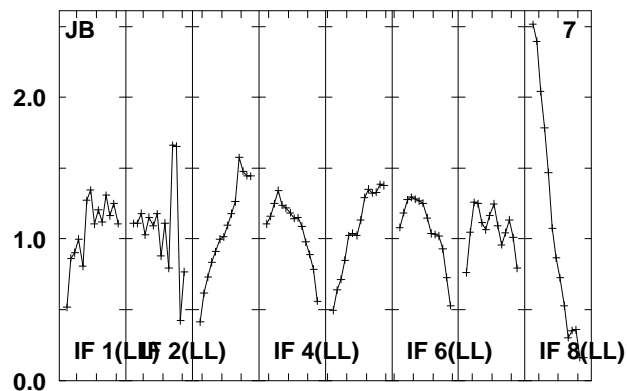
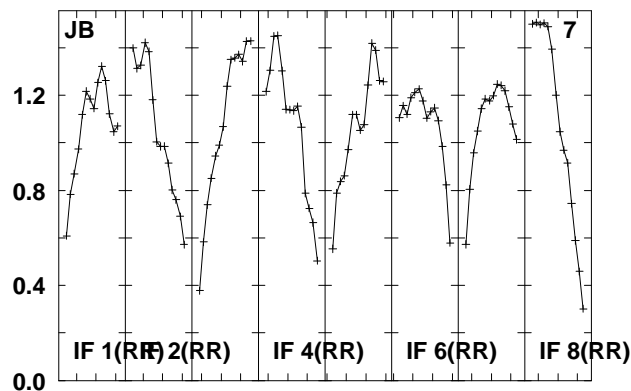
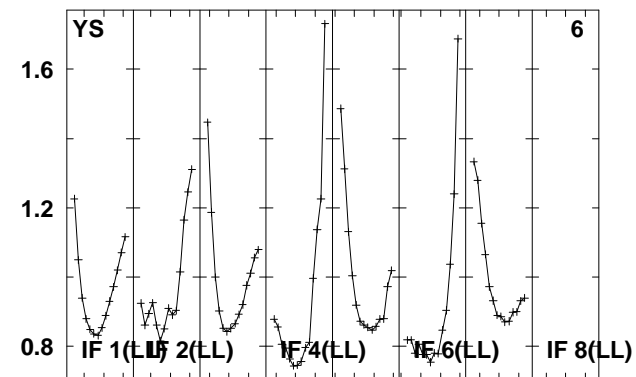
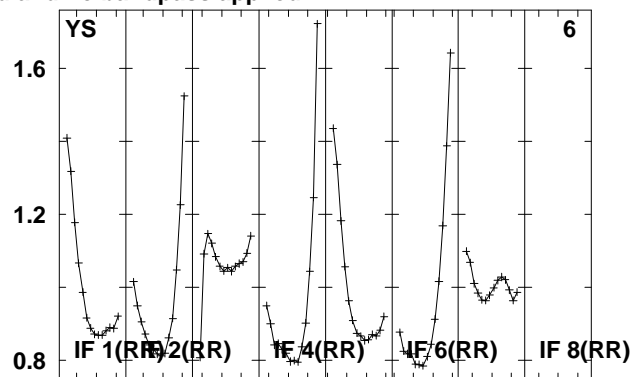
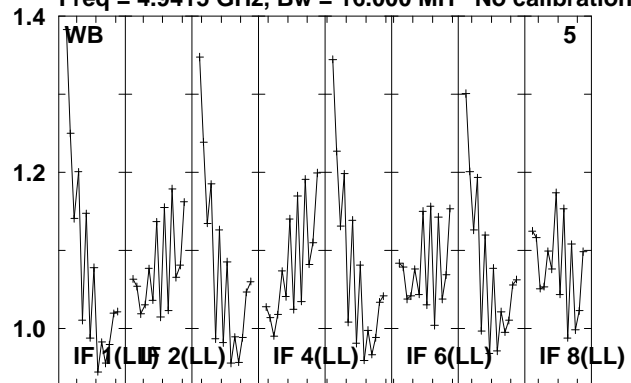

Lower frame: Real Jy
Total-power spectrum Antenna: *
Timerange: 01/01:59:26 to 01/02:10:08

Plot file version 322 created 08-JUL-2010 13:13:37

J1609+26 EM079.UVDATA.1

Freq = 4.9415 GHz, Bw = 16.000 MH No calibration applied and no bandpass applied

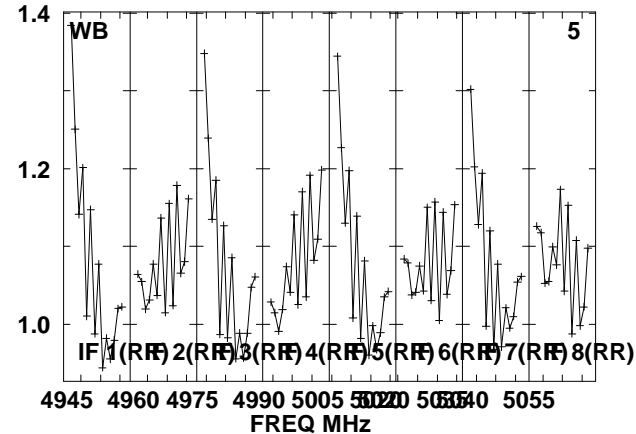
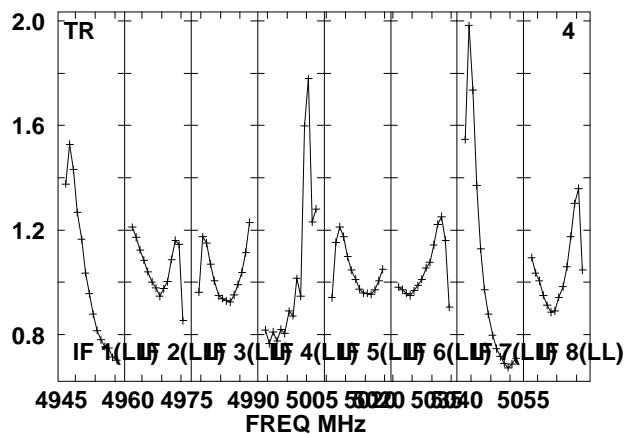
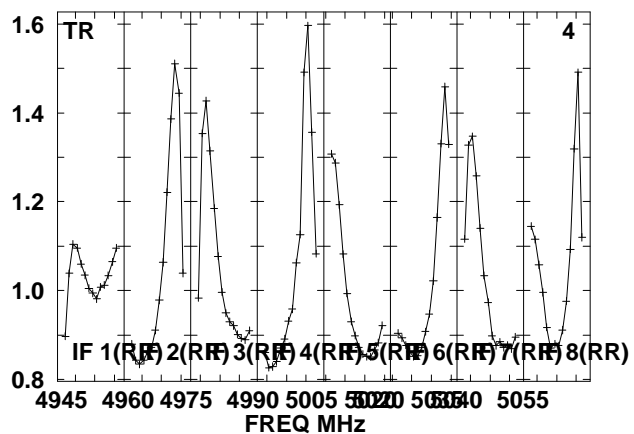
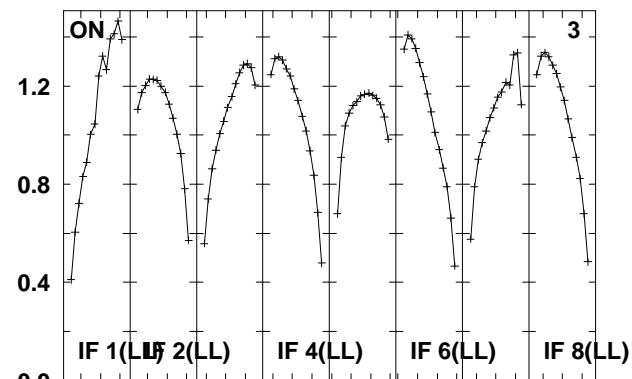
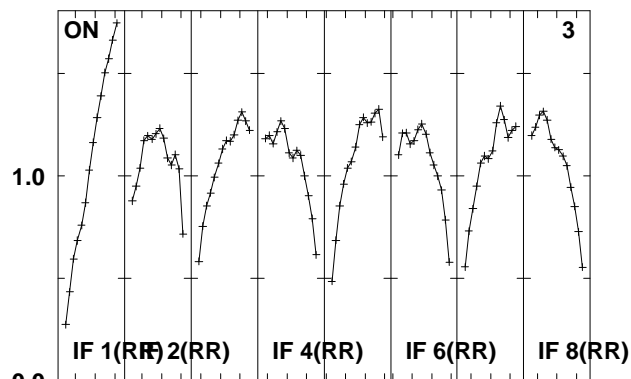
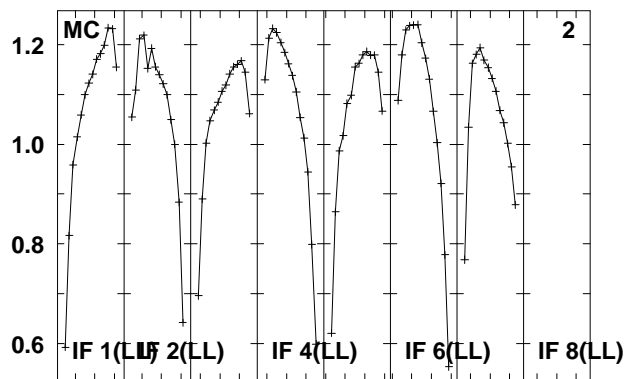
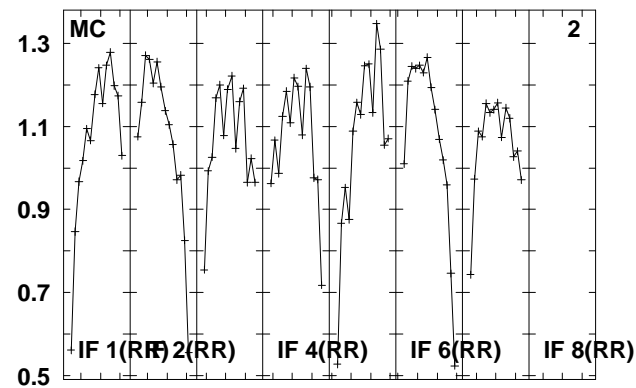
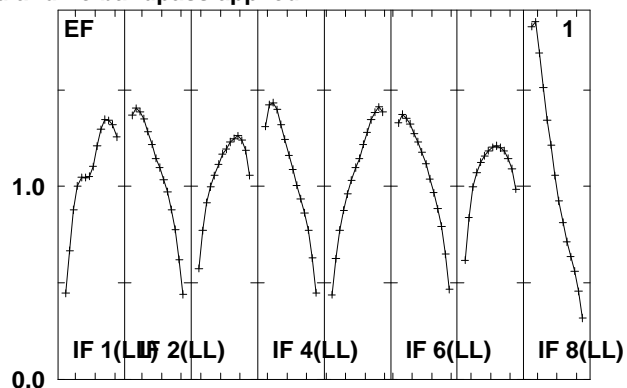
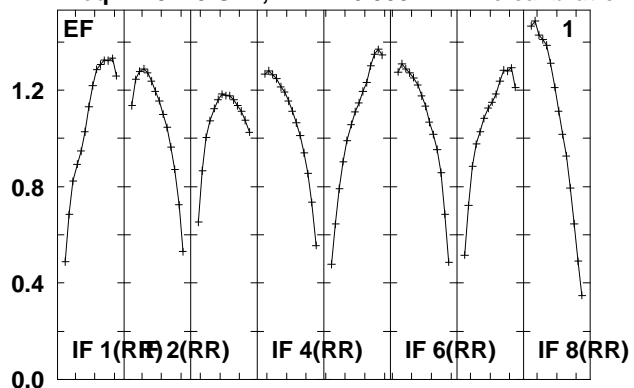

Lower frame: Real Jy
Total-power spectrum Antenna: *
Timerange: 01/02:10:10 to 01/02:12:08

Plot file version 323 created 08-JUL-2010 13:13:38

J1609+26 EM079.UVDATA.1

Freq = 4.9415 GHz, Bw = 16.000 MH No calibration applied and no bandpass applied

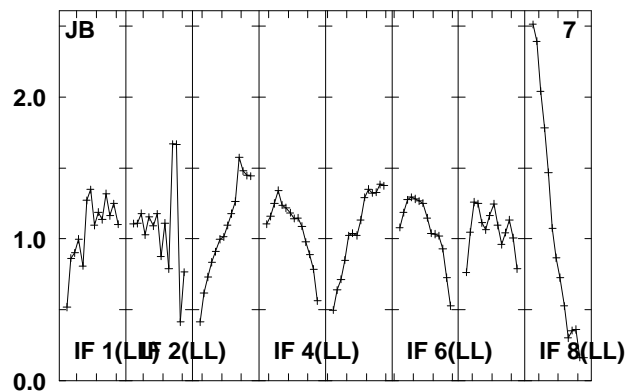
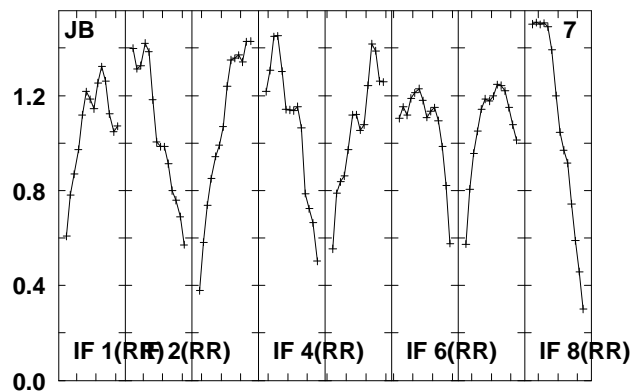
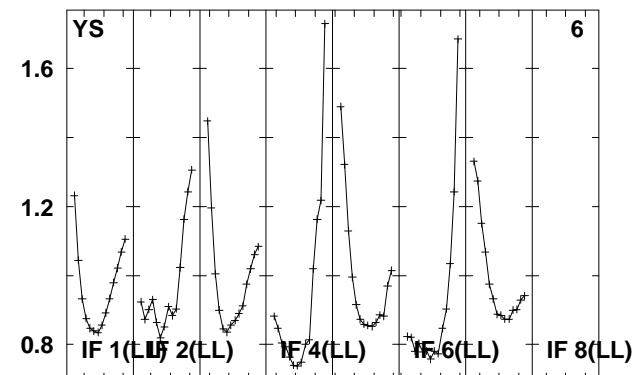
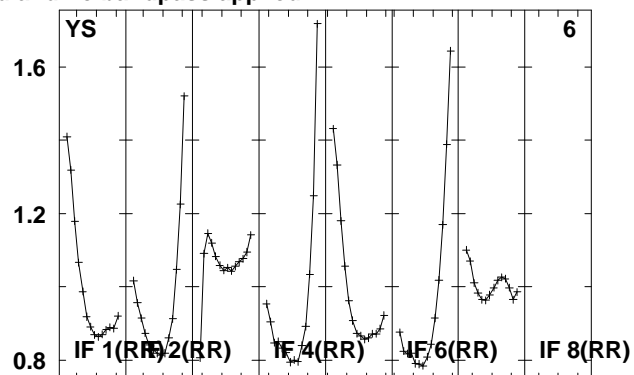
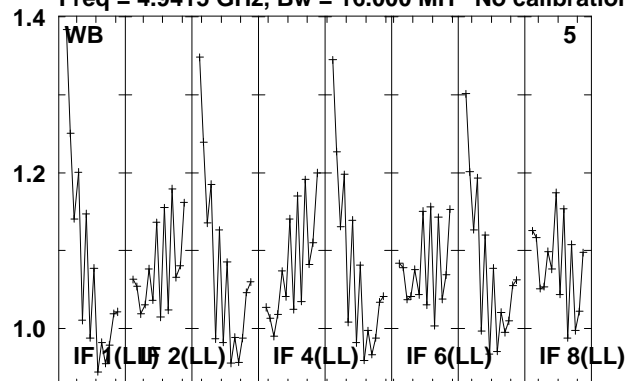

Lower frame: Real Jy
Total-power spectrum Antenna: *
Timerange: 01/02:10:10 to 01/02:12:08

Plot file version 324 created 08-JUL-2010 13:13:38

J1625+27 EM079.UVDATA.1

Freq = 4.9415 GHz, Bw = 16.000 MH No calibration applied and no bandpass applied

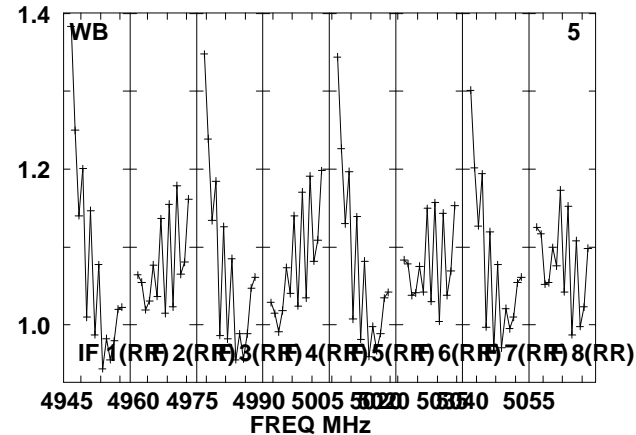
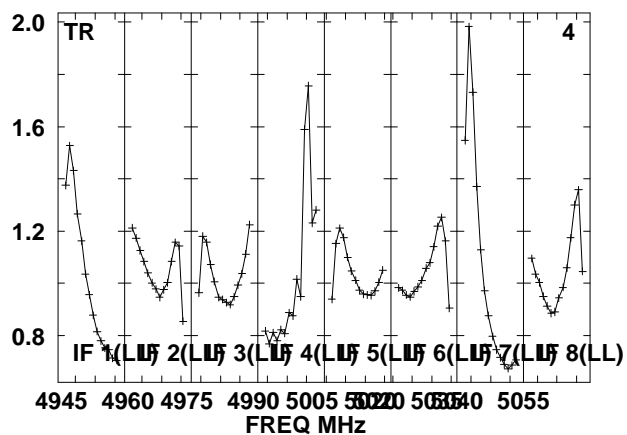
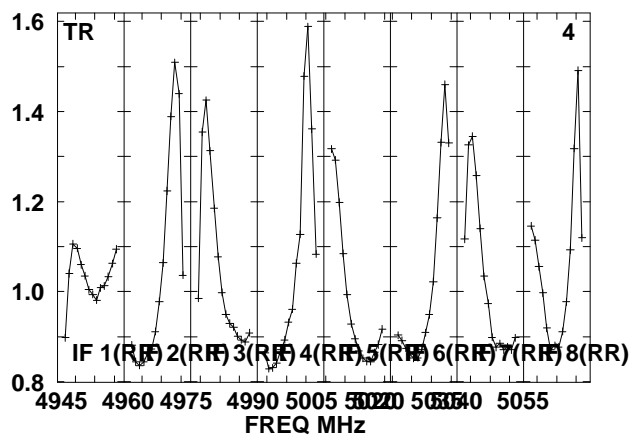
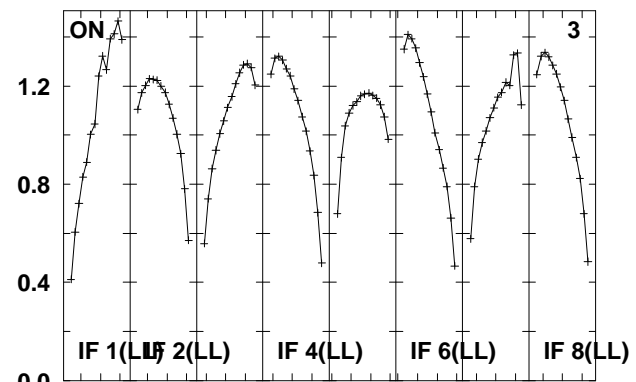
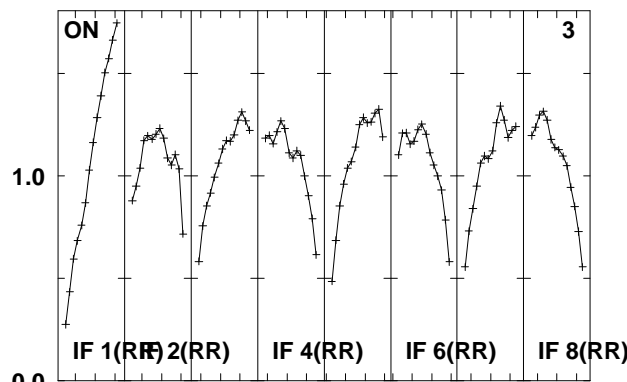
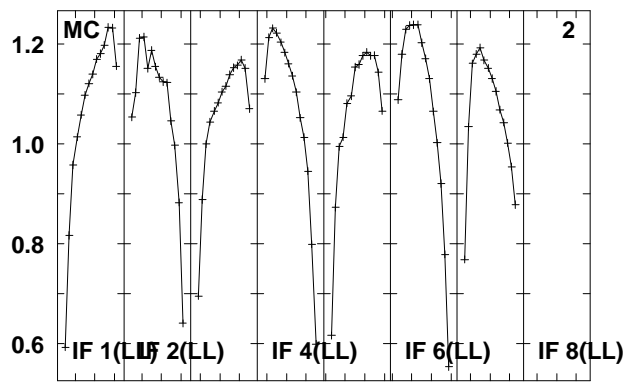
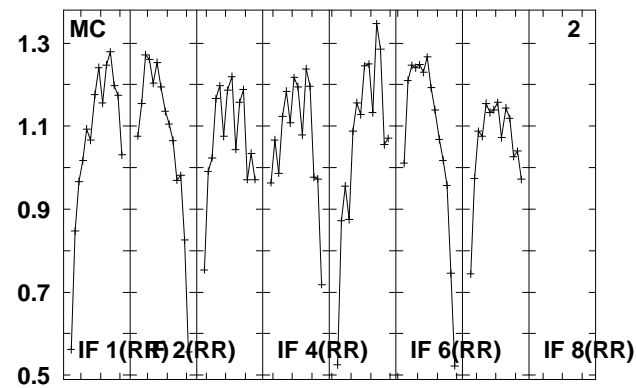
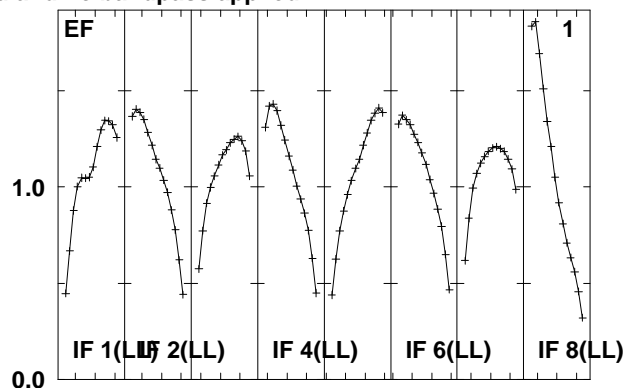
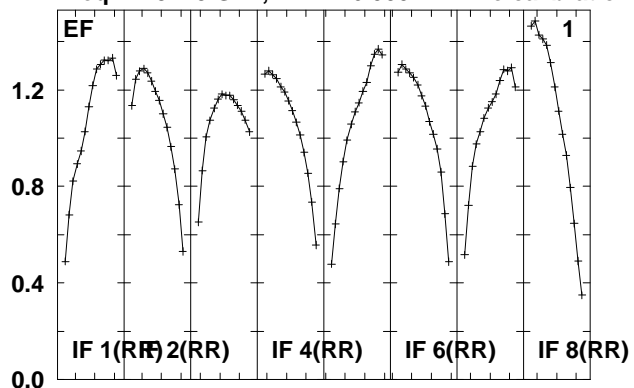

Lower frame: Real Jy
Total-power spectrum Antenna: *
Timerange: 01/02:12:10 to 01/02:22:54

Plot file version 325 created 08-JUL-2010 13:13:39

J1625+27 EM079.UVDATA.1

Freq = 4.9415 GHz, Bw = 16.000 MH No calibration applied and no bandpass applied

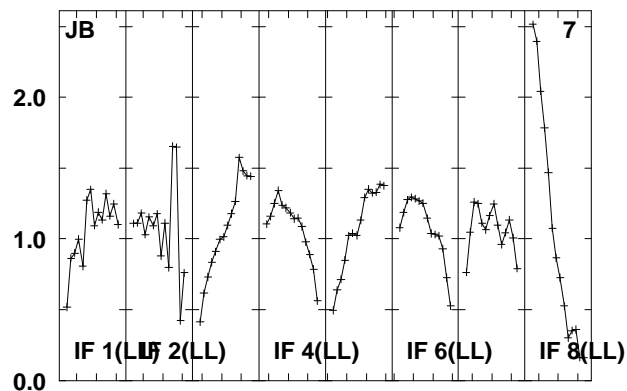
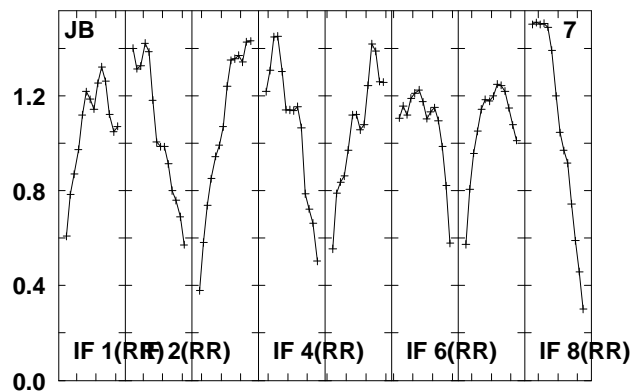
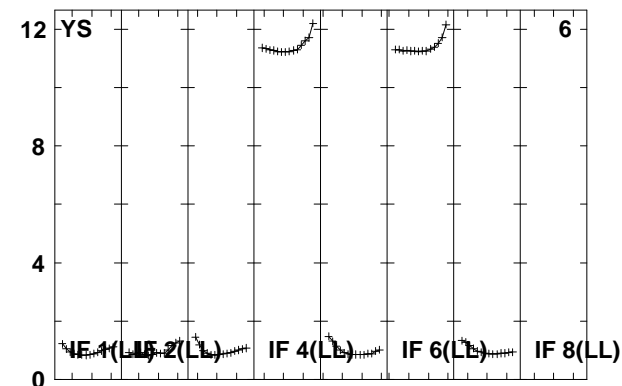
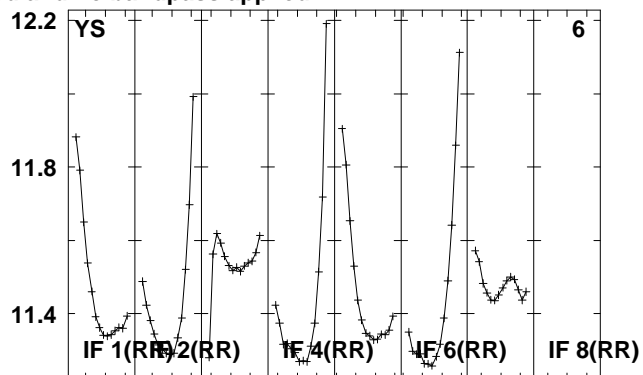
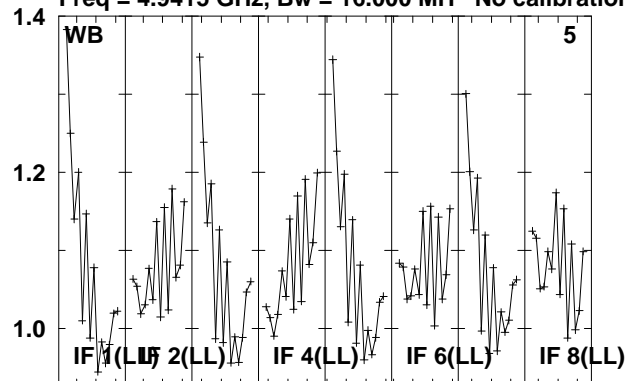

Lower frame: Real Jy
Total-power spectrum Antenna: *
Timerange: 01/02:12:10 to 01/02:22:54

Plot file version 326 created 08-JUL-2010 13:13:41

J1609+26 EM079.UVDATA.1

Freq = 4.9415 GHz, Bw = 16.000 MH No calibration applied and no bandpass applied

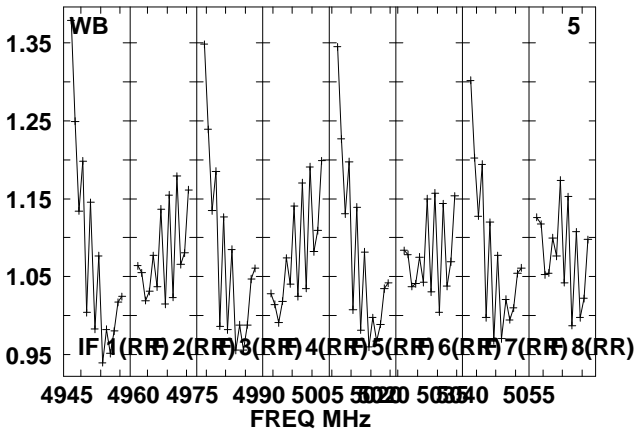
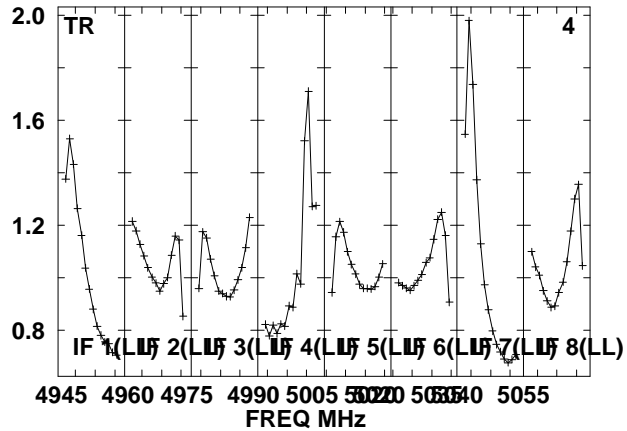
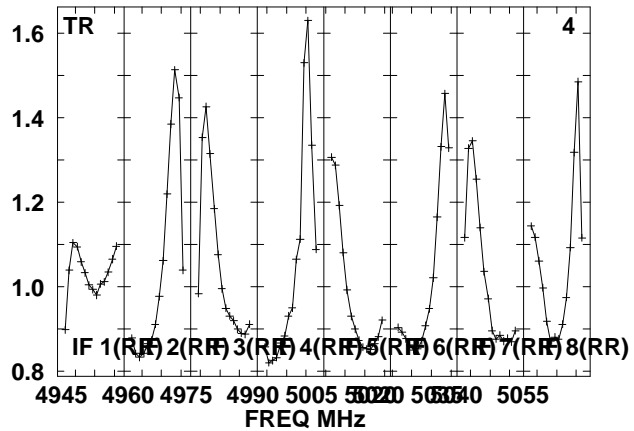
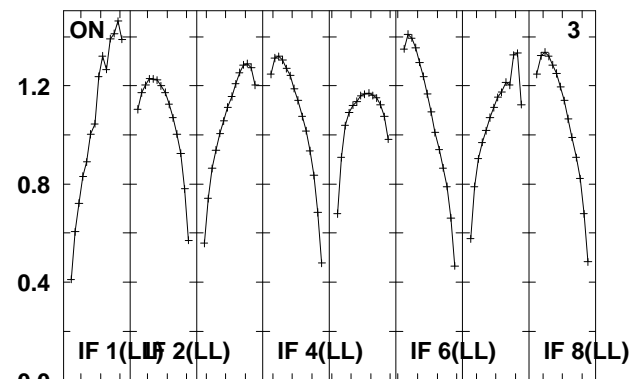
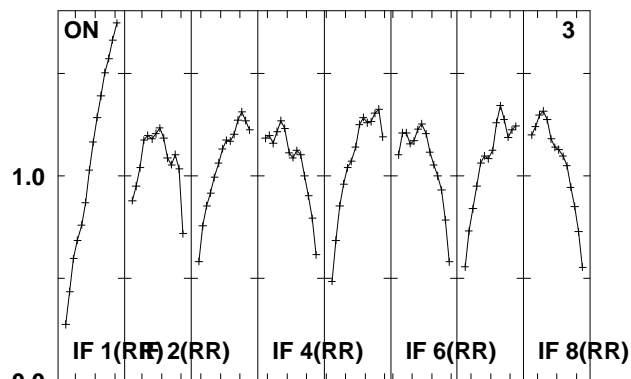
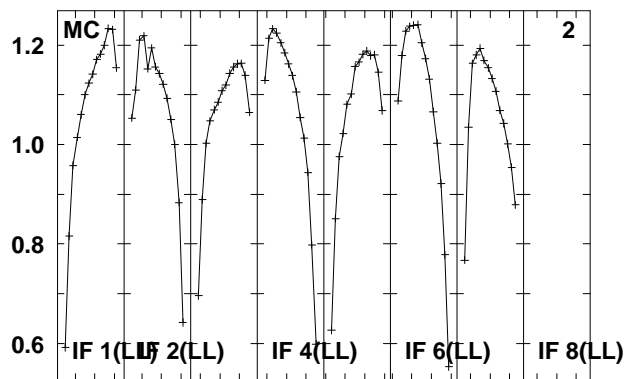
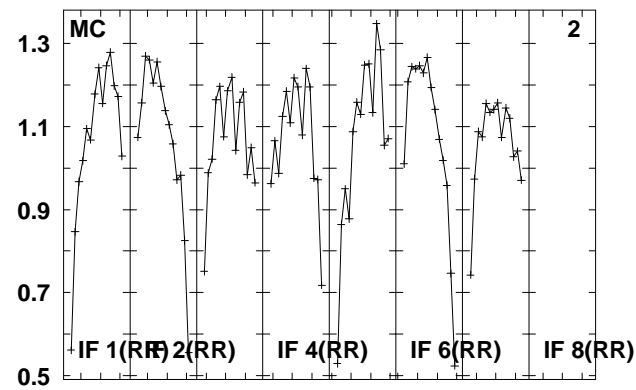
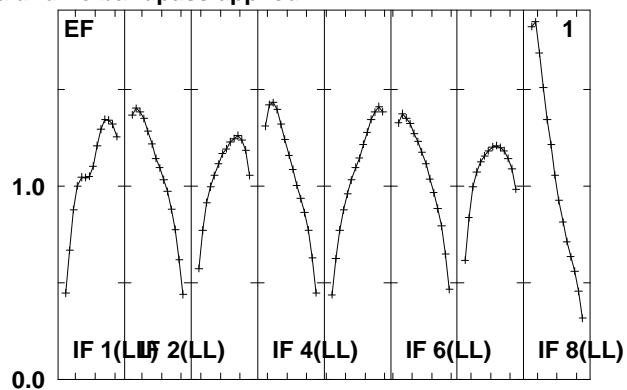
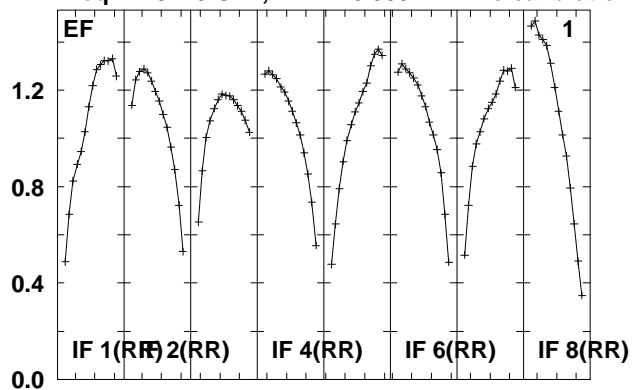

Lower frame: Real Jy
Total-power spectrum Antenna: *
Timerange: 01/02:22:56 to 01/02:24:54

Plot file version 327 created 08-JUL-2010 13:13:41

J1609+26 EM079.UVDATA.1

Freq = 4.9415 GHz, Bw = 16.000 MH No calibration applied and no bandpass applied

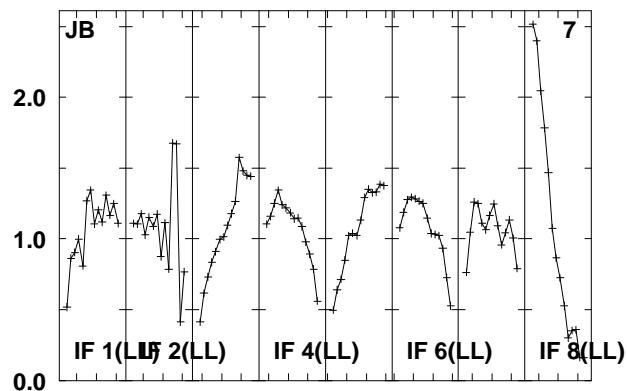
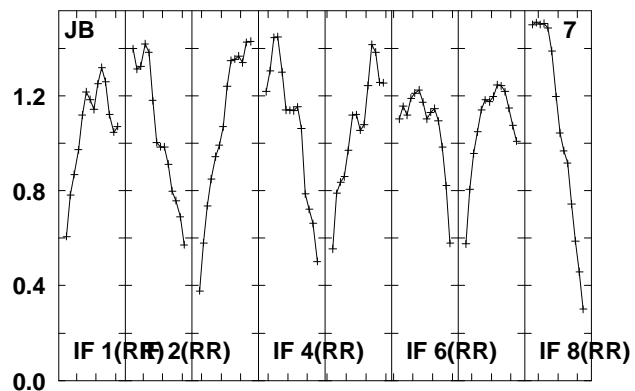
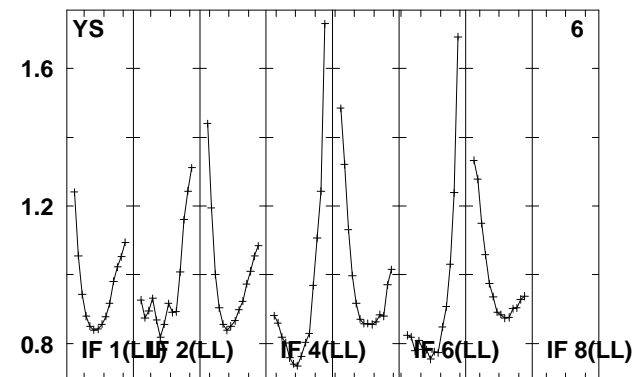
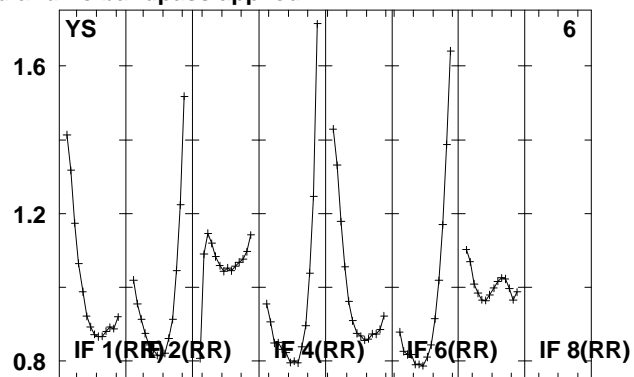
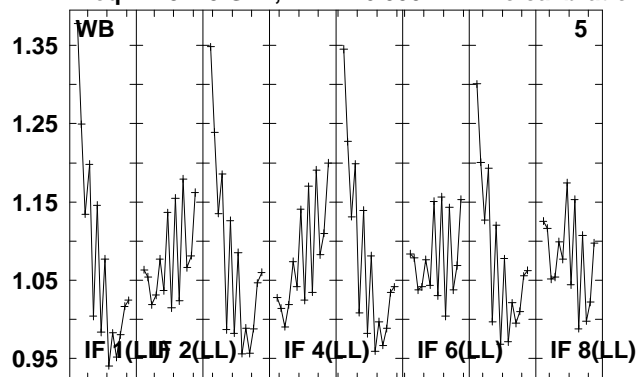

Lower frame: Real Jy
Total-power spectrum Antenna: *
Timerange: 01/02:22:56 to 01/02:24:54

Plot file version 328 created 08-JUL-2010 13:13:42

J1625+27 EM079.UVDATA.1

Freq = 4.9415 GHz, Bw = 16.000 MH No calibration applied and no bandpass applied

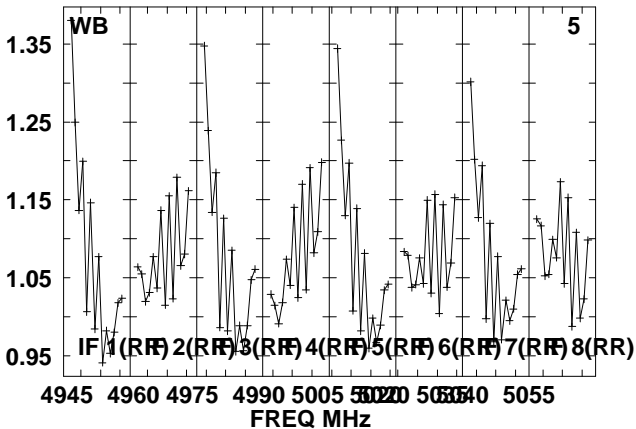
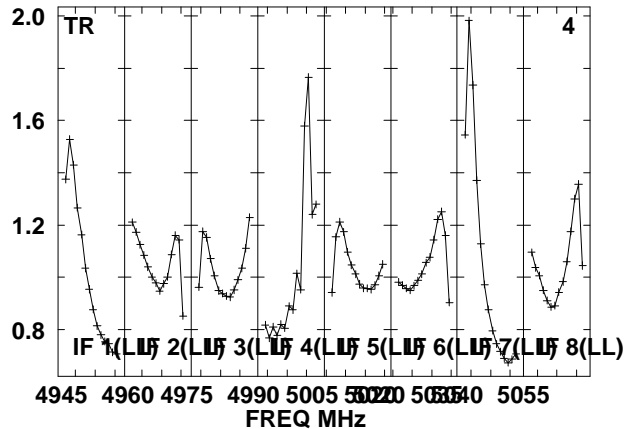
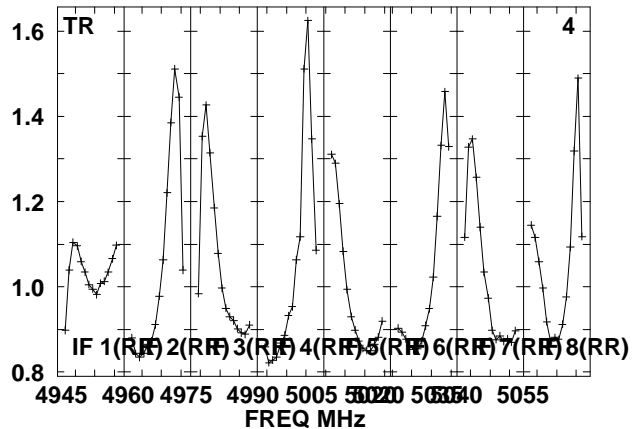
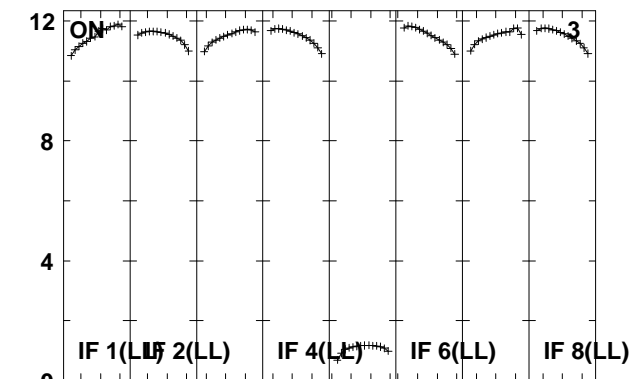
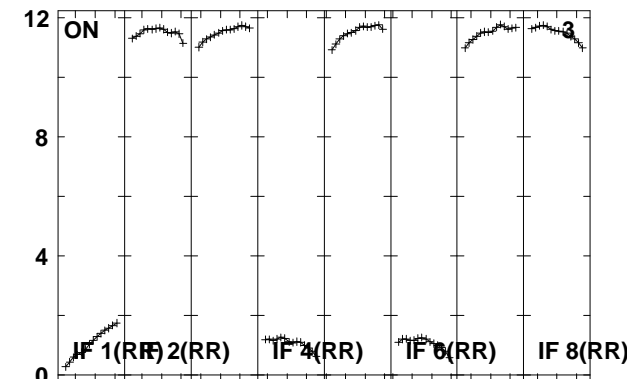
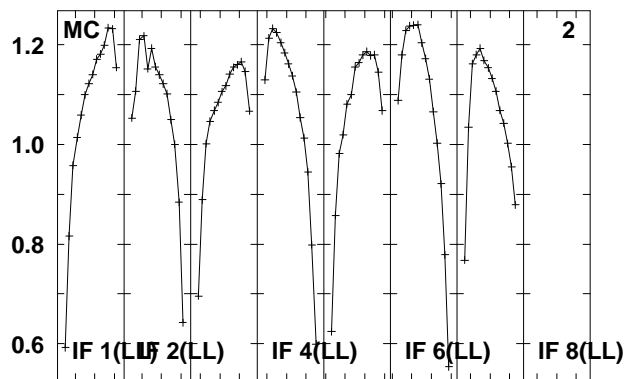
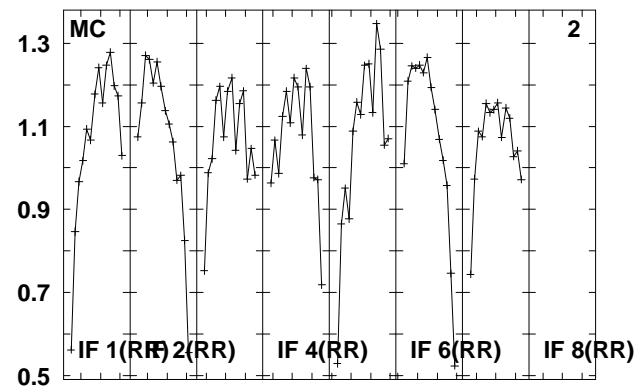
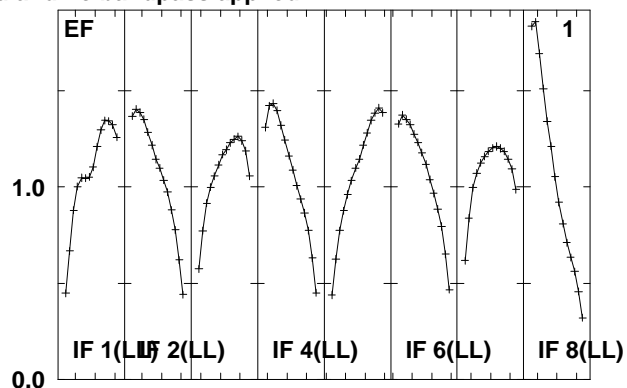
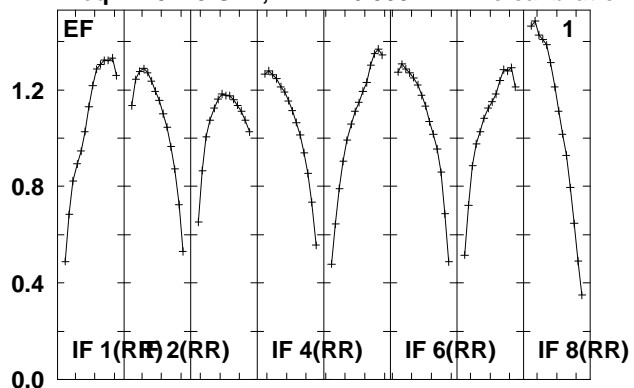

Lower frame: Real Jy
Total-power spectrum Antenna: *
Timerange: 01/02:24:56 to 01/02:35:38

Plot file version 329 created 08-JUL-2010 13:13:46

J1625+27 EM079.UVDATA.1

Freq = 4.9415 GHz, Bw = 16.000 MH No calibration applied and no bandpass applied

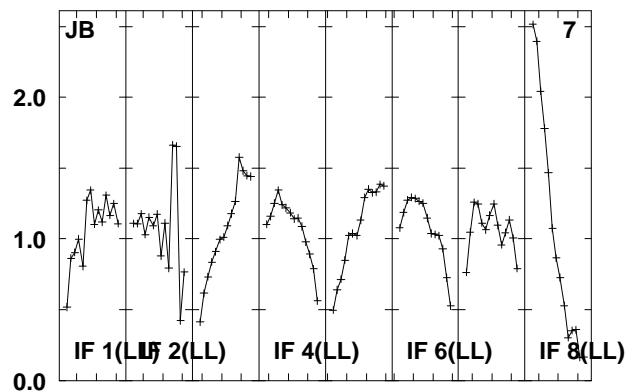
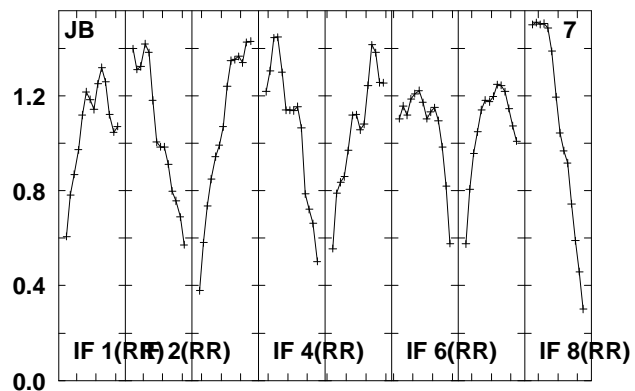
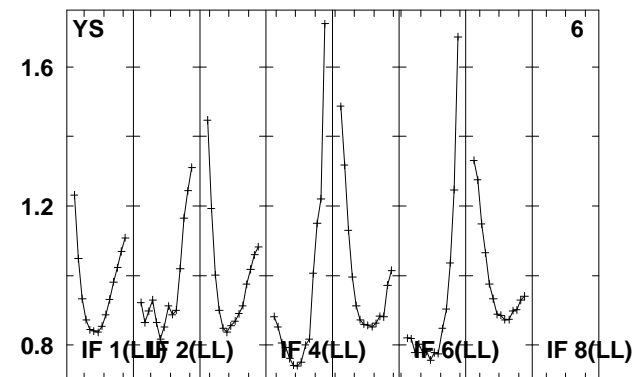
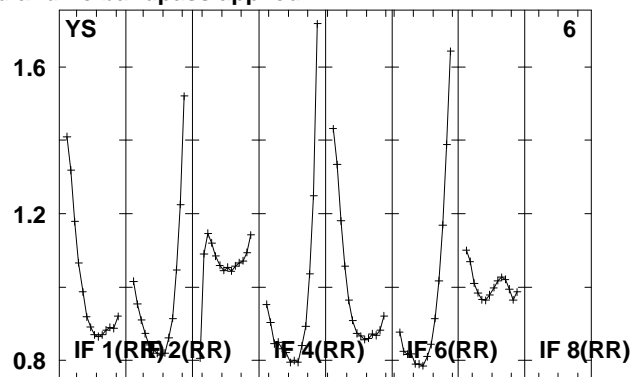
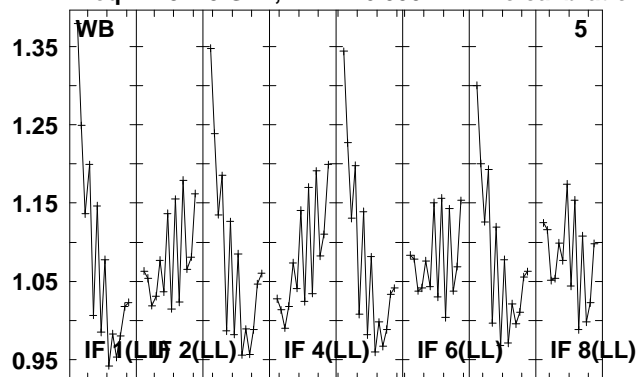

Lower frame: Real Jy
Total-power spectrum Antenna: *
Timerange: 01/02:24:56 to 01/02:35:38

Plot file version 330 created 08-JUL-2010 13:13:50

J1609+26 EM079.UVDATA.1

Freq = 4.9415 GHz, Bw = 16.000 MH No calibration applied and no bandpass applied

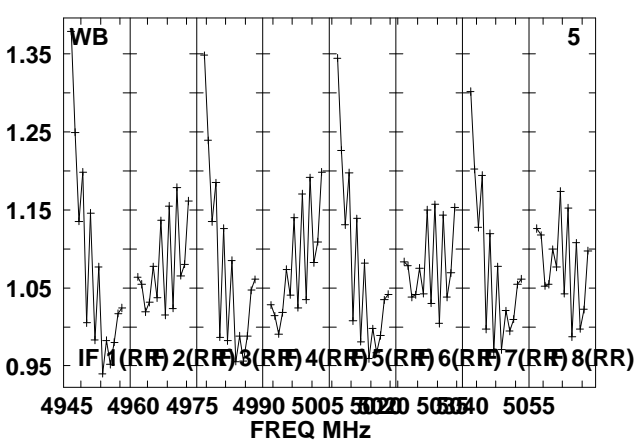
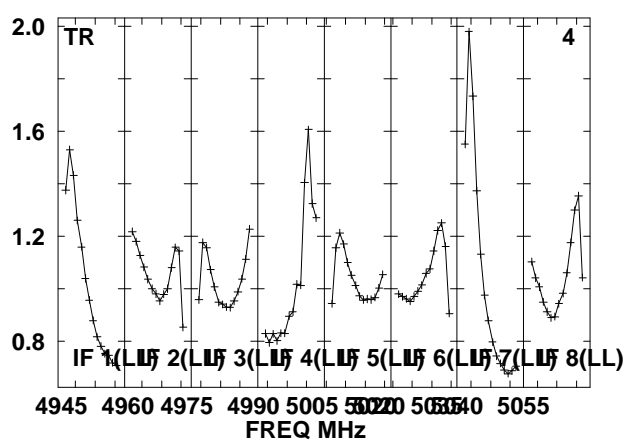
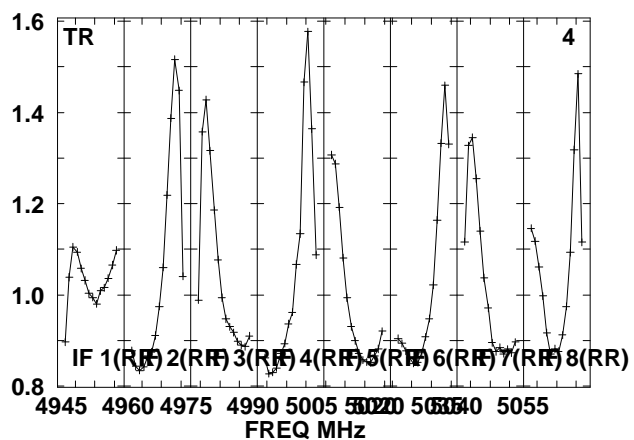
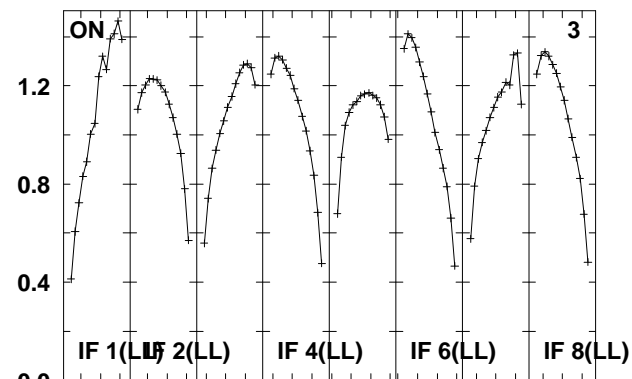
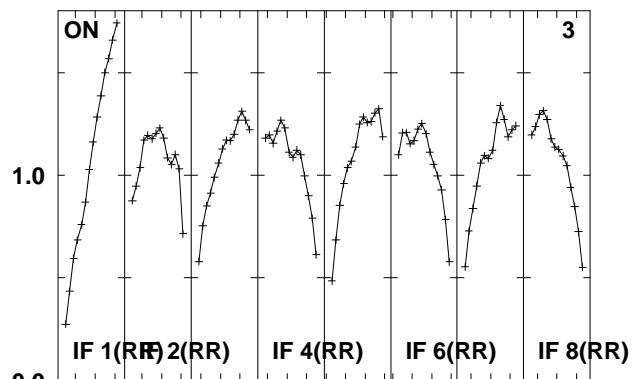
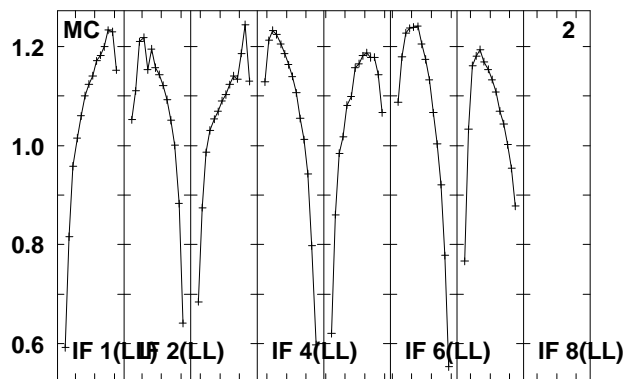
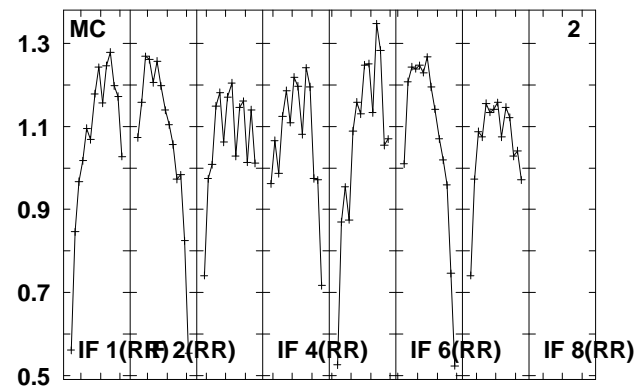
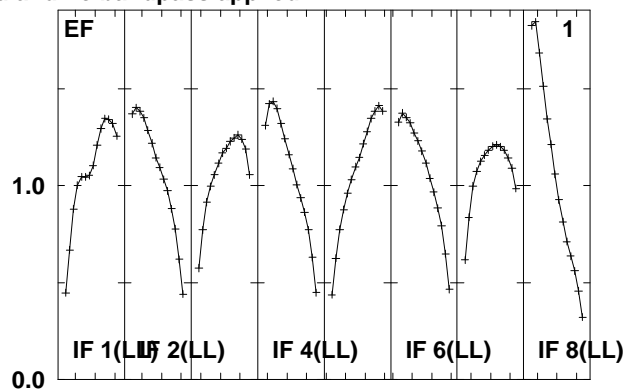
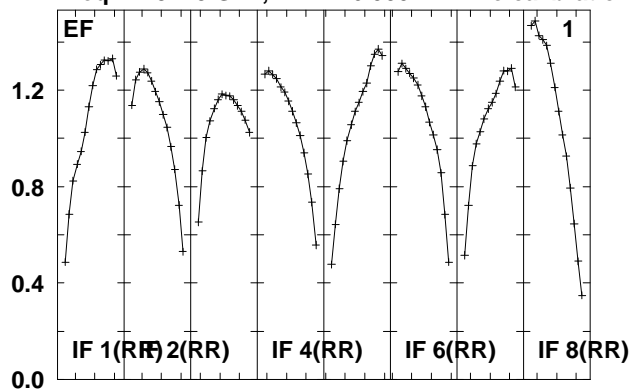

Lower frame: Real Jy
Total-power spectrum Antenna: *
Timerange: 01/02:35:40 to 01/02:37:38

Plot file version 331 created 08-JUL-2010 13:13:50

J1609+26 EM079.UVDATA.1

Freq = 4.9415 GHz, Bw = 16.000 MH No calibration applied and no bandpass applied

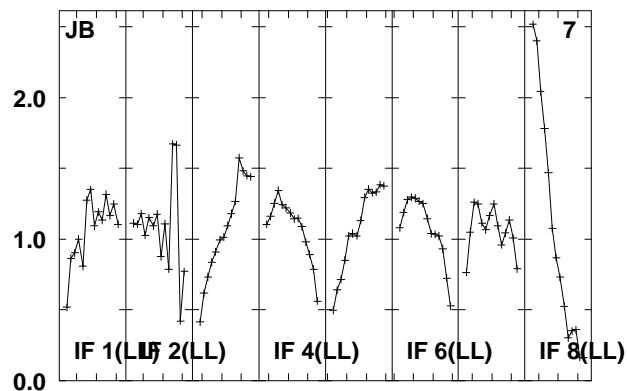
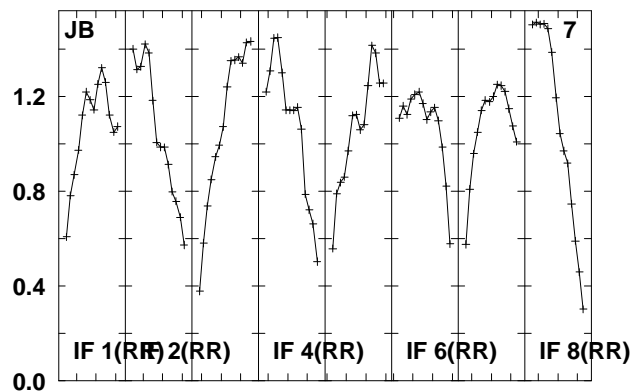
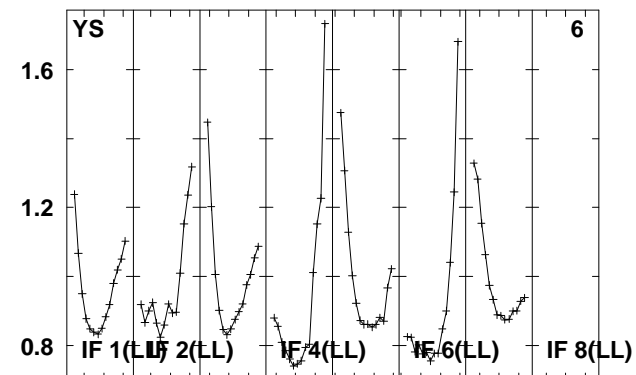
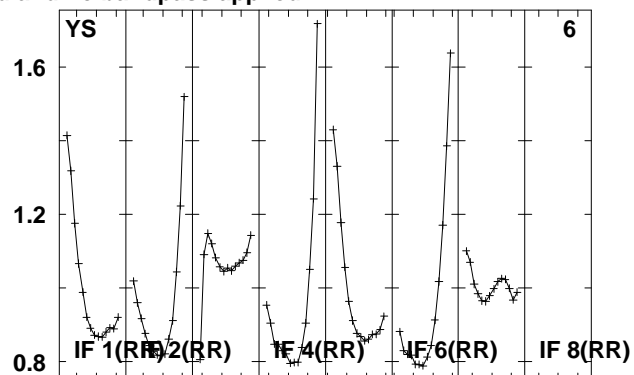
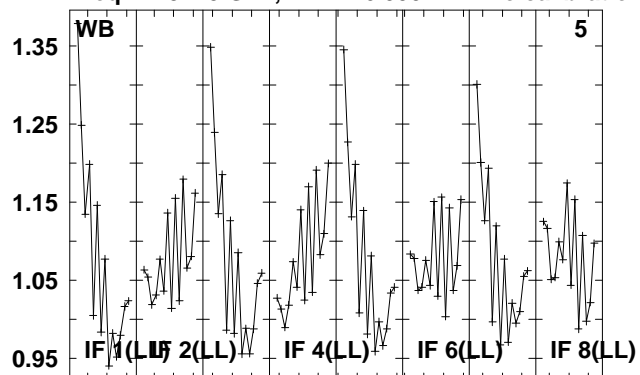

Lower frame: Real Jy
Total-power spectrum Antenna: *
Timerange: 01/02:35:40 to 01/02:37:38

Plot file version 332 created 08-JUL-2010 13:13:51

J1625+27 EM079.UVDATA.1

Freq = 4.9415 GHz, Bw = 16.000 MH No calibration applied and no bandpass applied

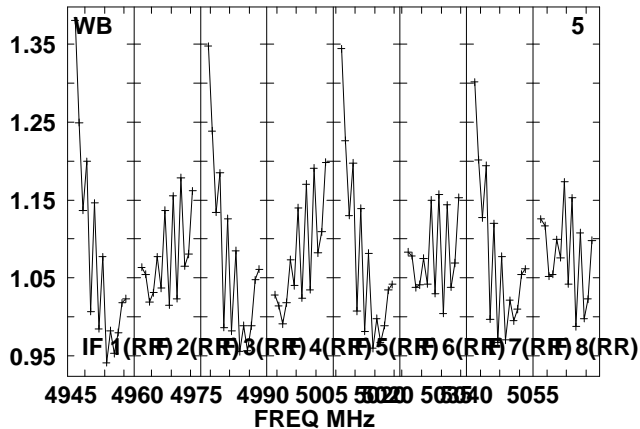
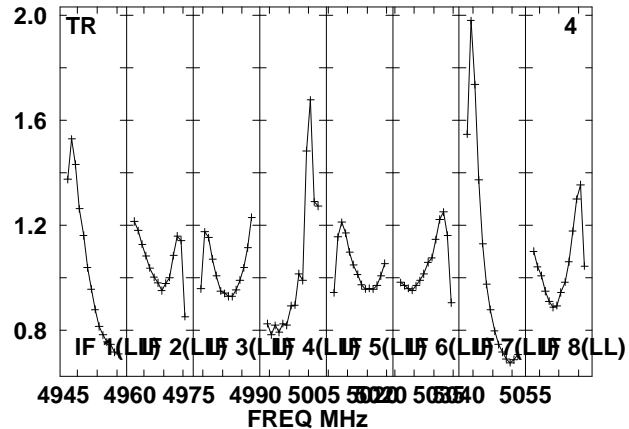
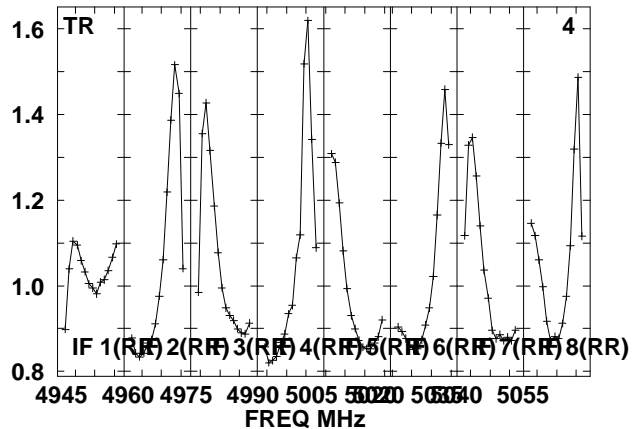
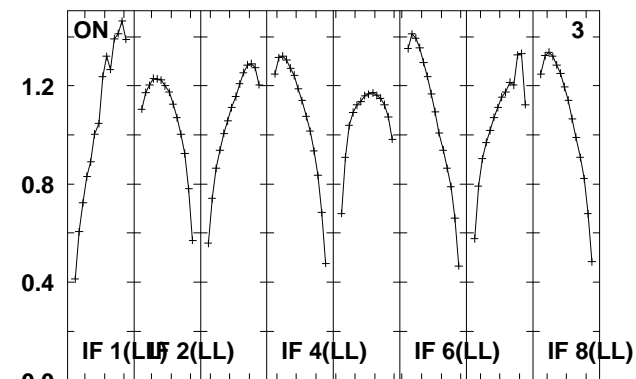
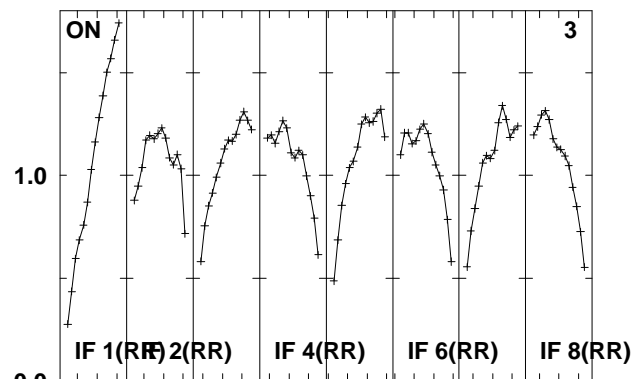
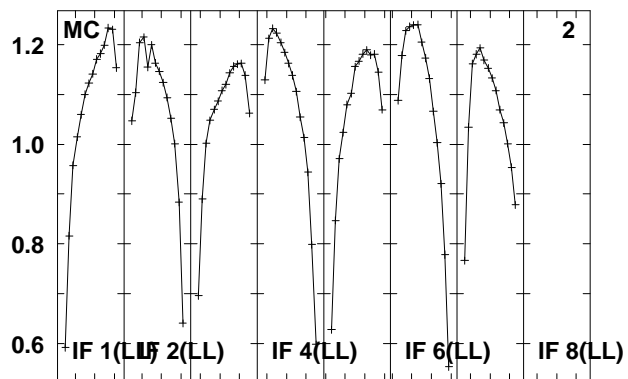
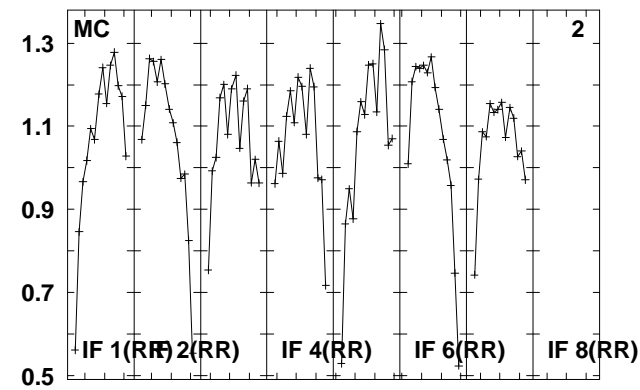
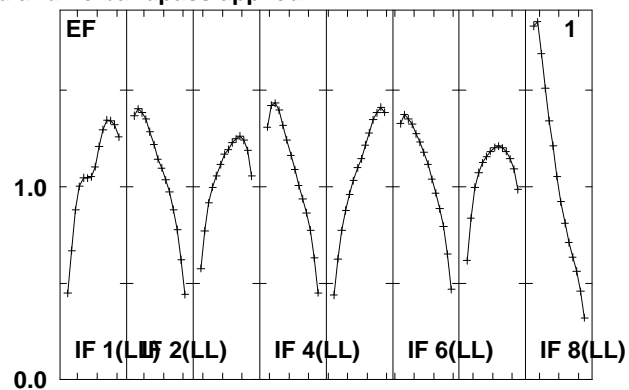
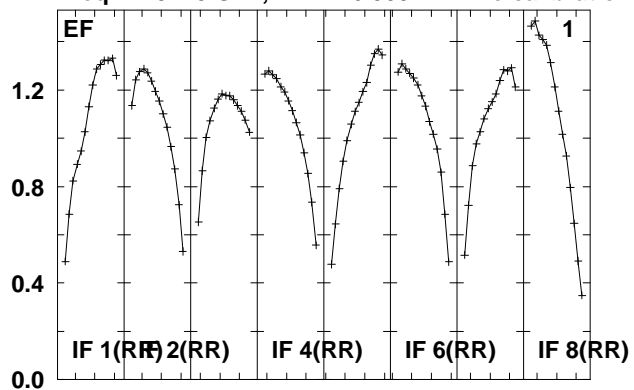

Lower frame: Real Jy
Total-power spectrum Antenna: *
Timerange: 01/02:37:40 to 01/02:48:24

Plot file version 333 created 08-JUL-2010 13:13:52

J1625+27 EM079.UVDATA.1

Freq = 4.9415 GHz, Bw = 16.000 MH No calibration applied and no bandpass applied

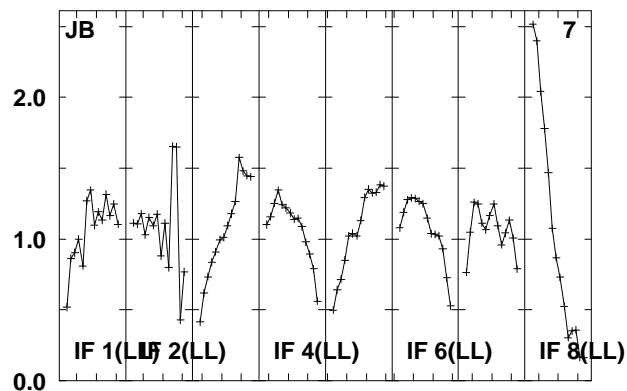
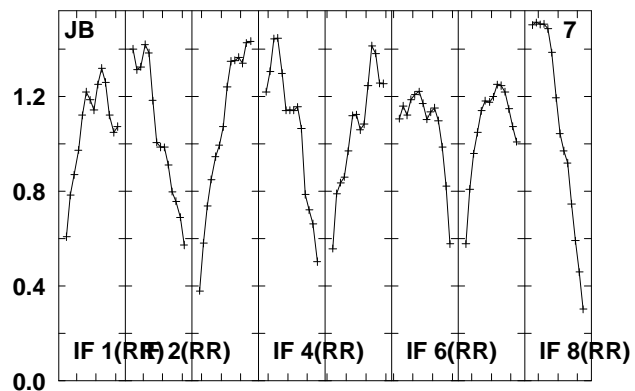
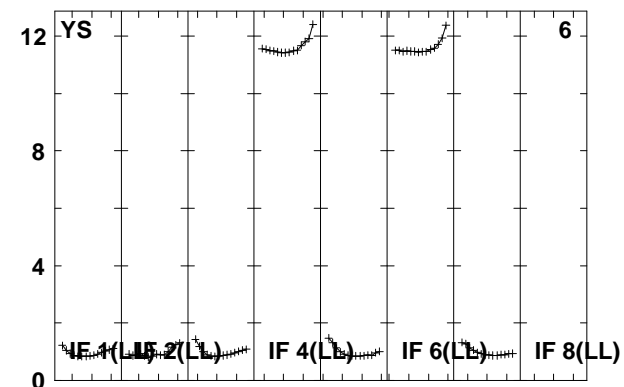
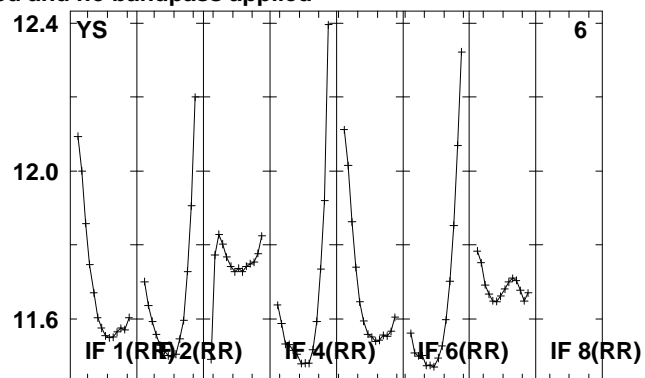
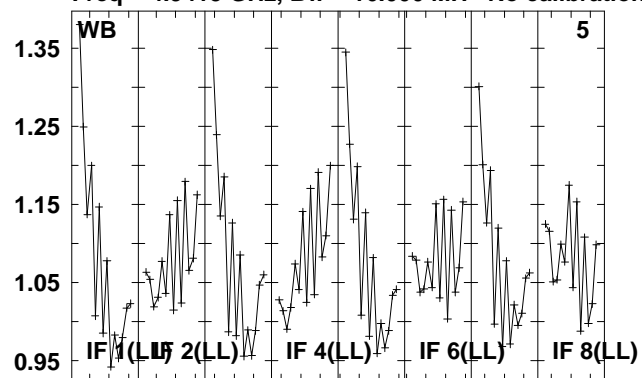

Lower frame: Real Jy
Total-power spectrum Antenna: *
Timerange: 01/02:37:40 to 01/02:48:24

Plot file version 334 created 08-JUL-2010 13:13:53

J1609+26 EM079.UVDATA.1

Freq = 4.9415 GHz, Bw = 16.000 MH No calibration applied and no bandpass applied

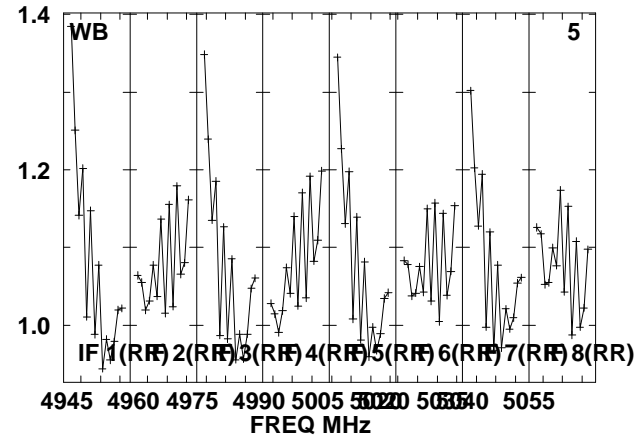
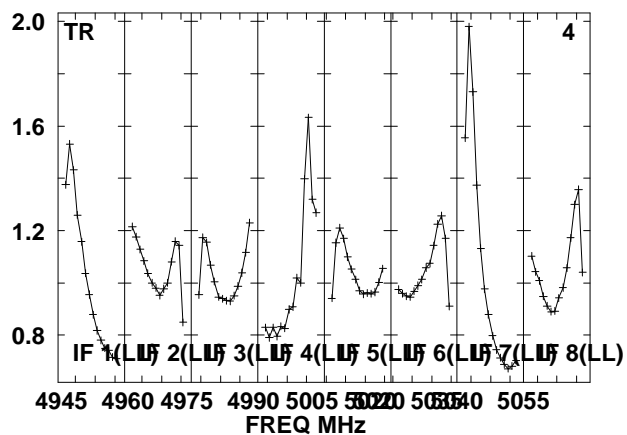
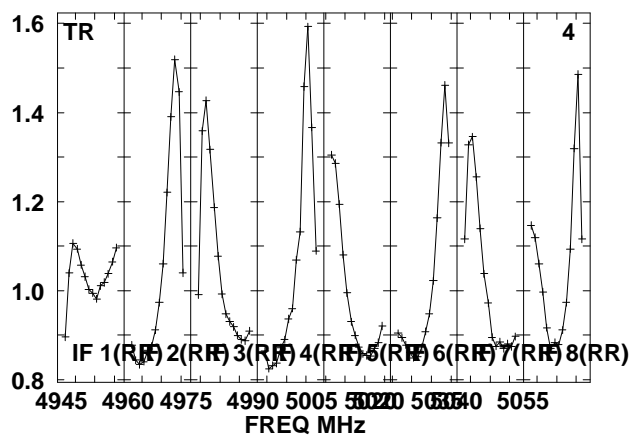
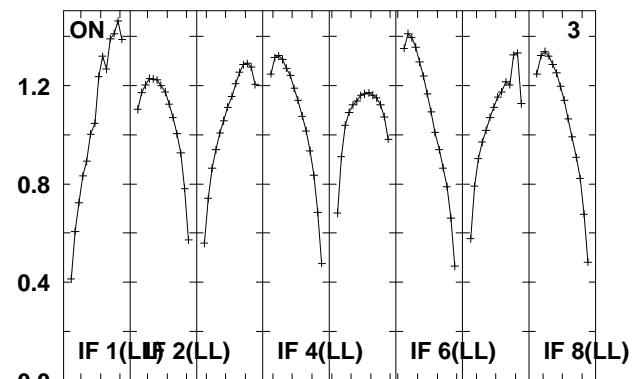
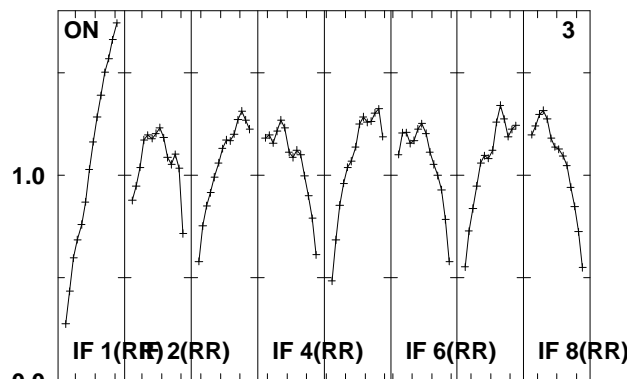
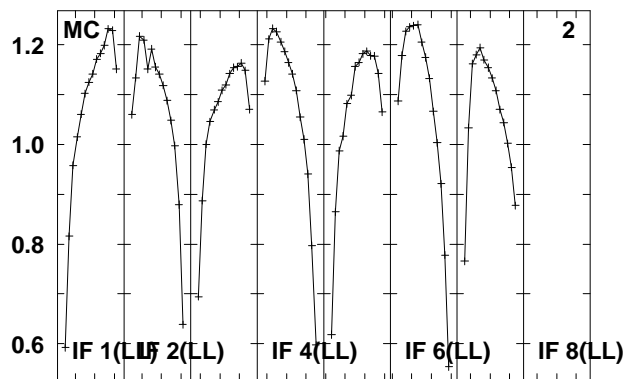
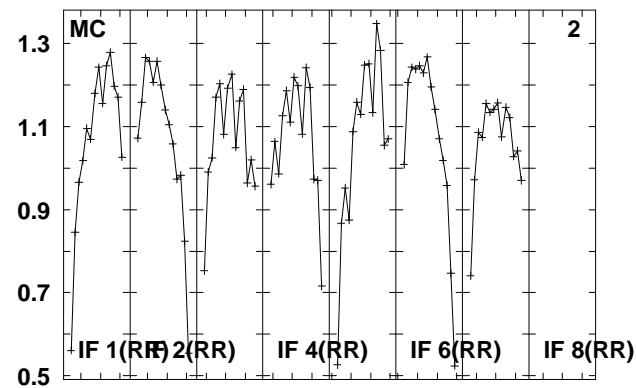
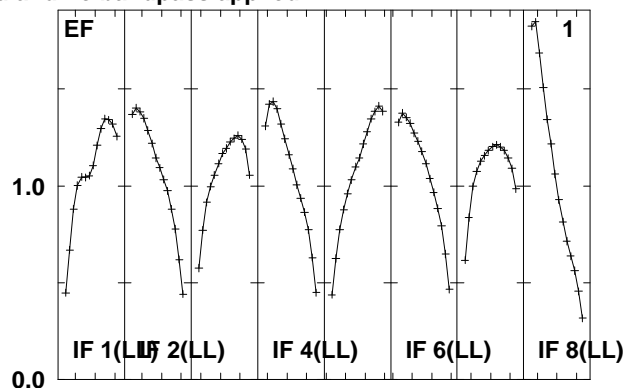
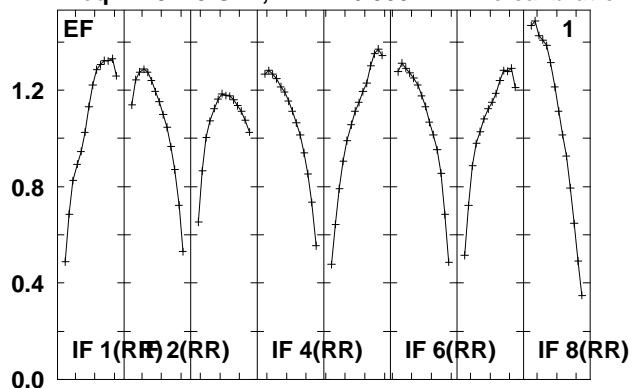

Lower frame: Real Jy
Total-power spectrum Antenna: *
Timerange: 01/02:48:26 to 01/02:50:24

Plot file version 335 created 08-JUL-2010 13:13:53

J1609+26 EM079.UVDATA.1

Freq = 4.9415 GHz, Bw = 16.000 MH No calibration applied and no bandpass applied

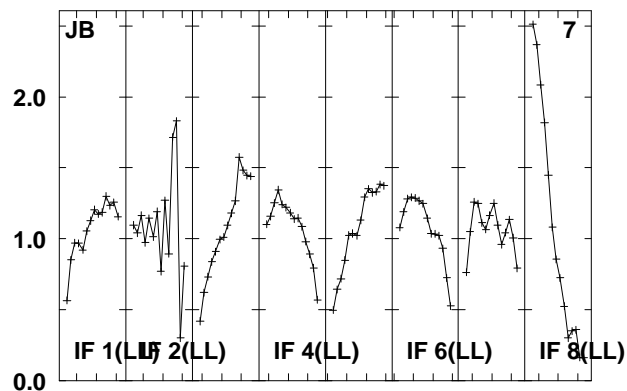
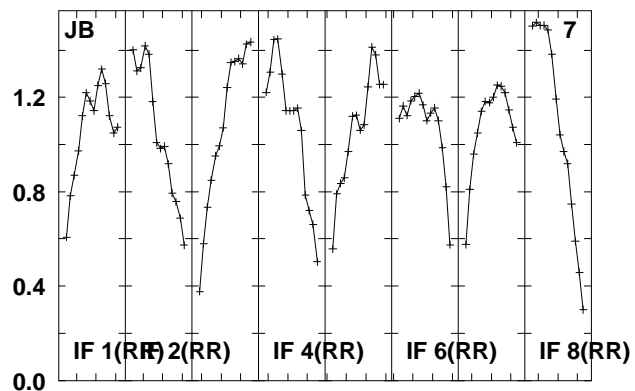
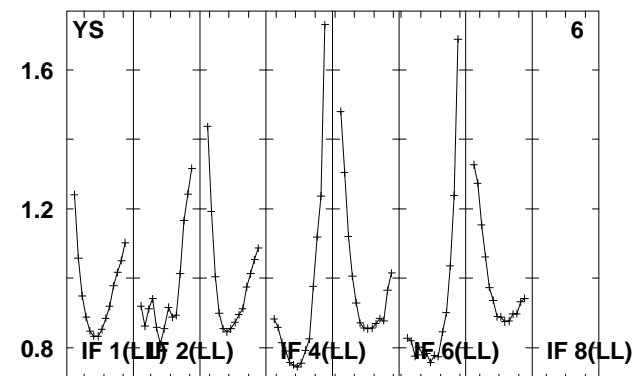
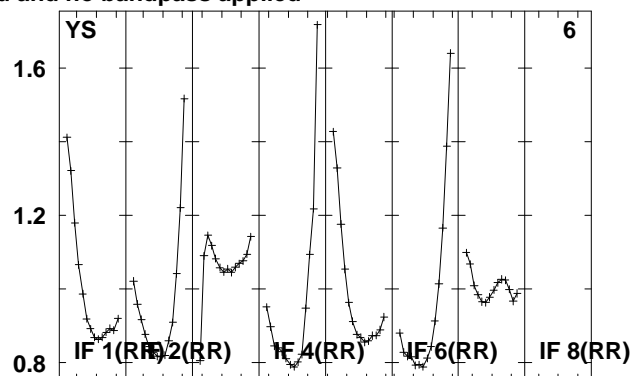
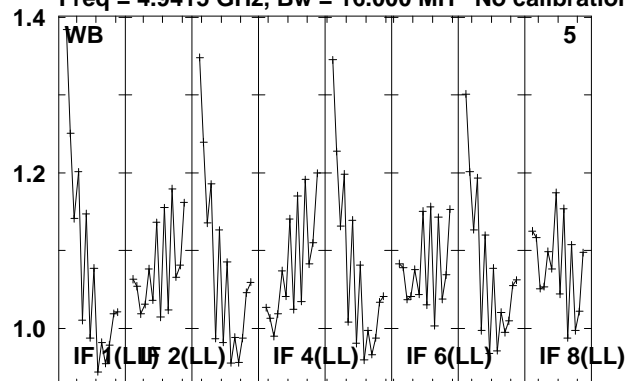

Lower frame: Real Jy
Total-power spectrum Antenna: *
Timerange: 01/02:48:26 to 01/02:50:24

Plot file version 336 created 08-JUL-2010 13:13:54

J1625+27 EM079.UVDATA.1

Freq = 4.9415 GHz, Bw = 16.000 MH No calibration applied and no bandpass applied

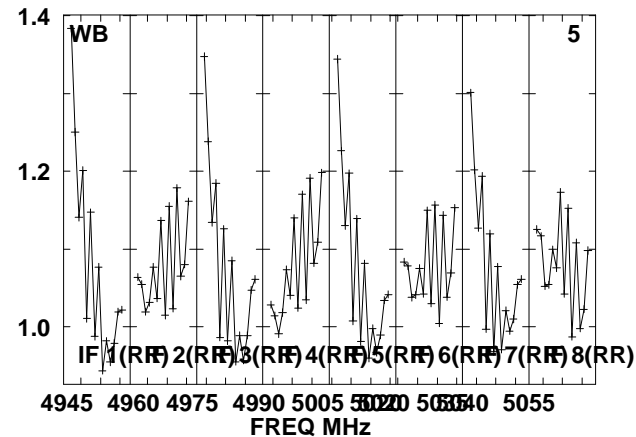
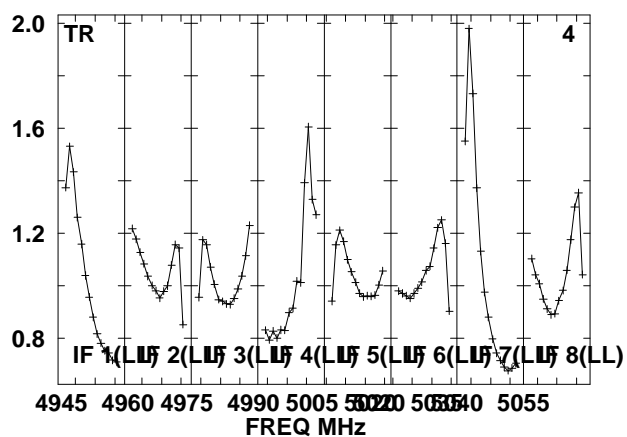
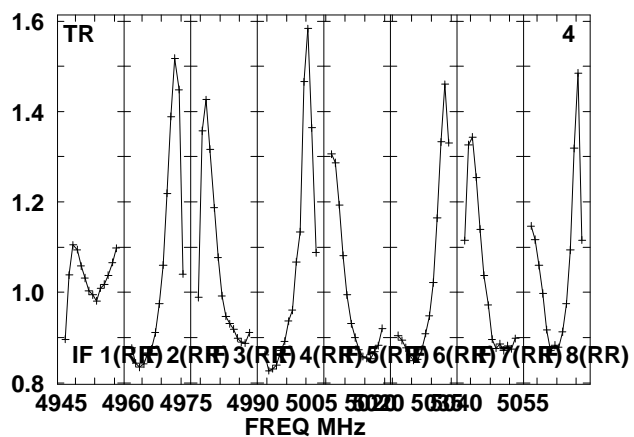
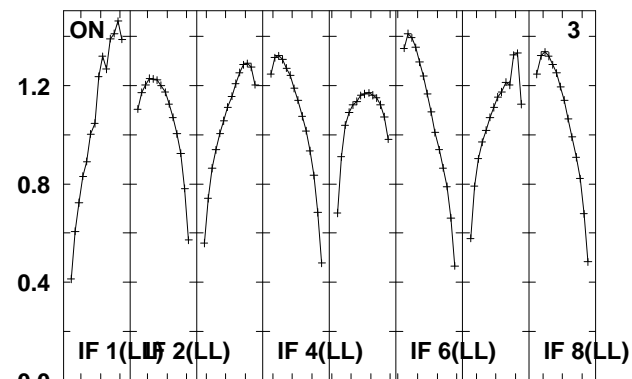
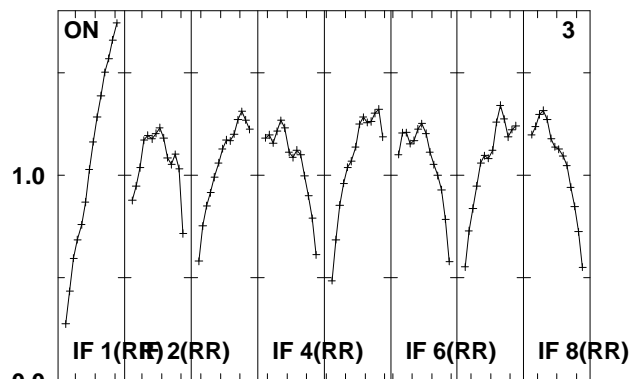
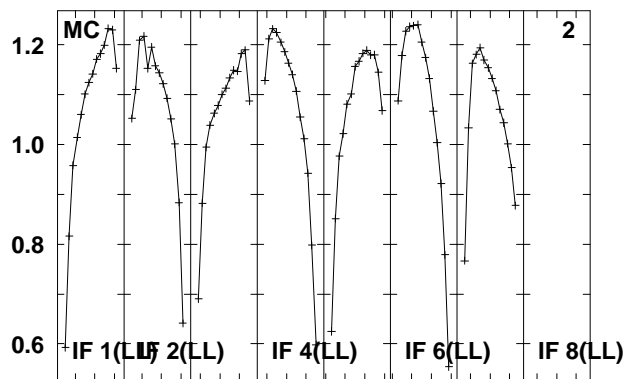
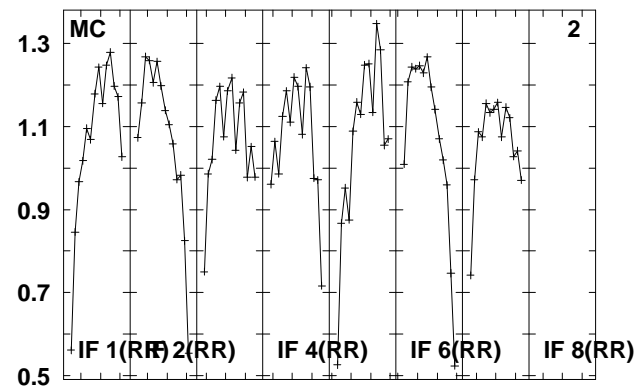
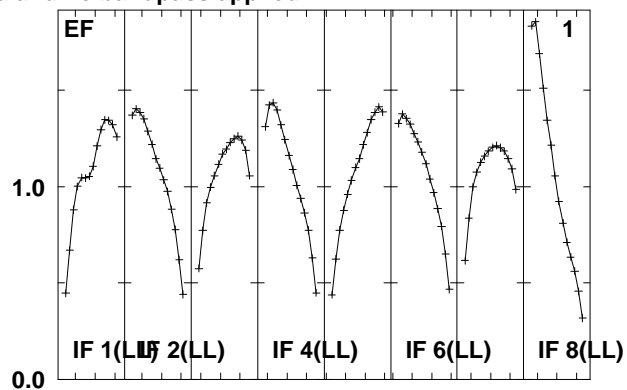
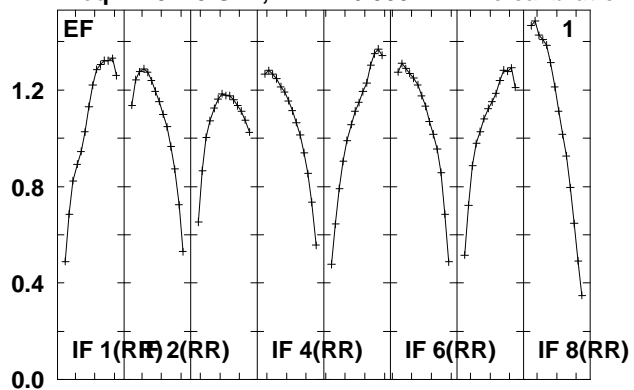

Lower frame: Real Jy
Total-power spectrum Antenna: *
Timerange: 01/02:50:26 to 01/03:01:08

Plot file version 337 created 08-JUL-2010 13:13:55

J1625+27 EM079.UVDATA.1

Freq = 4.9415 GHz, Bw = 16.000 MH No calibration applied and no bandpass applied

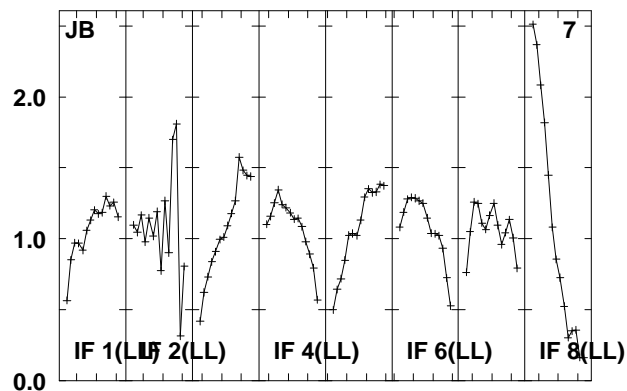
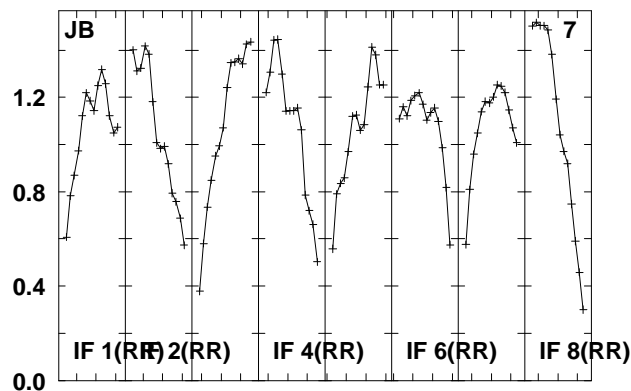
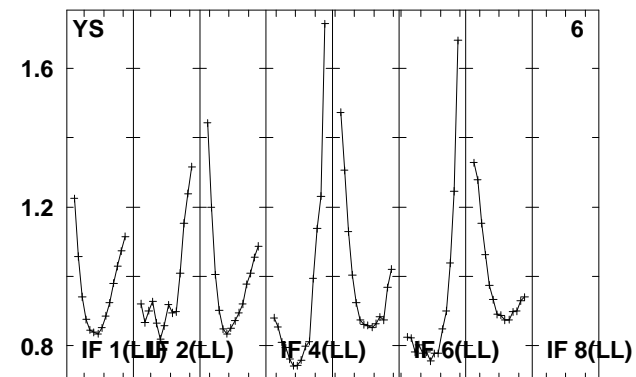
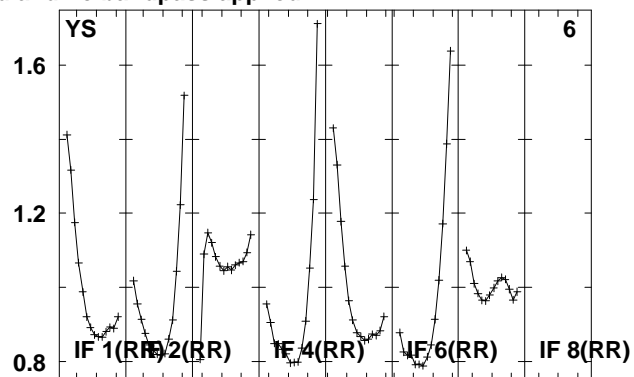
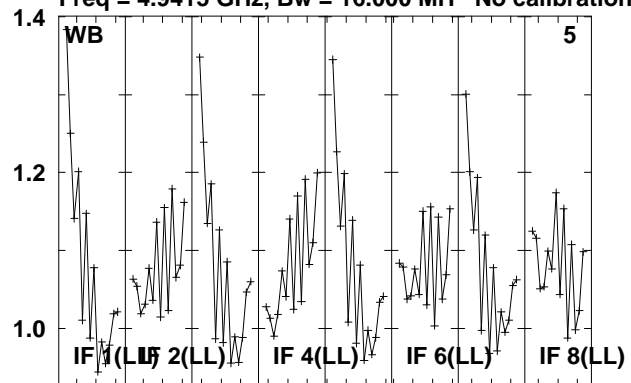

Lower frame: Real Jy
Total-power spectrum Antenna: *
Timerange: 01/02:50:26 to 01/03:01:08

Plot file version 338 created 08-JUL-2010 13:13:57

J1609+26 EM079.UVDATA.1

Freq = 4.9415 GHz, Bw = 16.000 MH No calibration applied and no bandpass applied

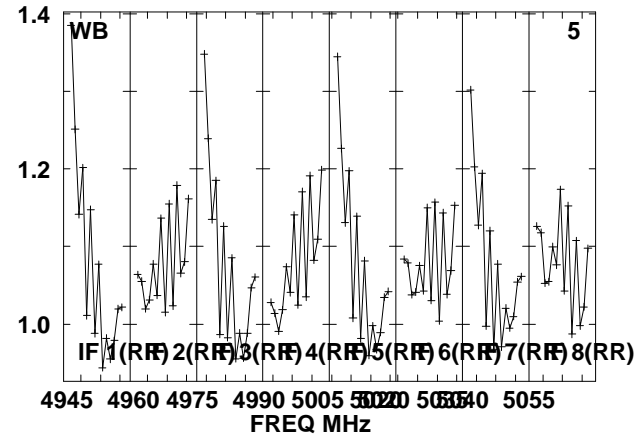
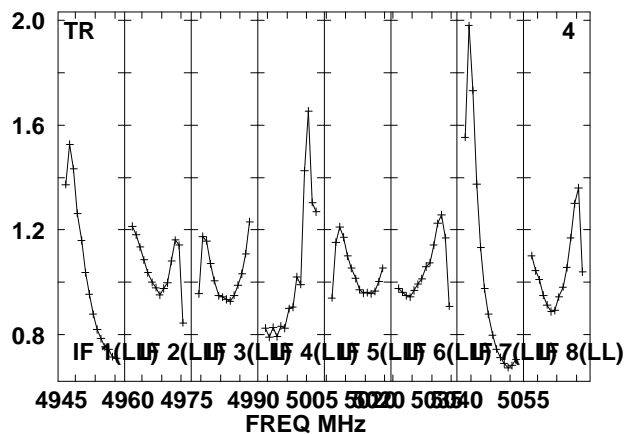
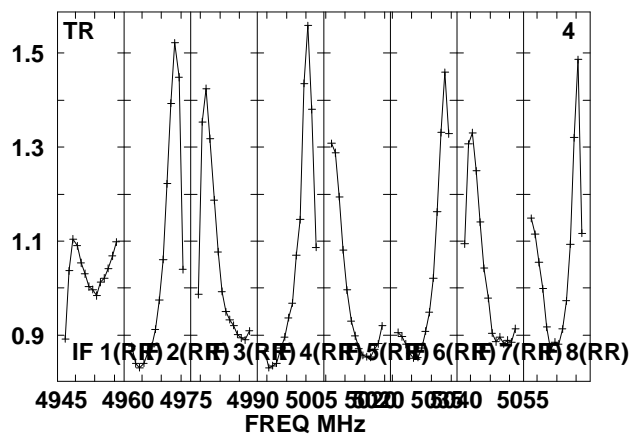
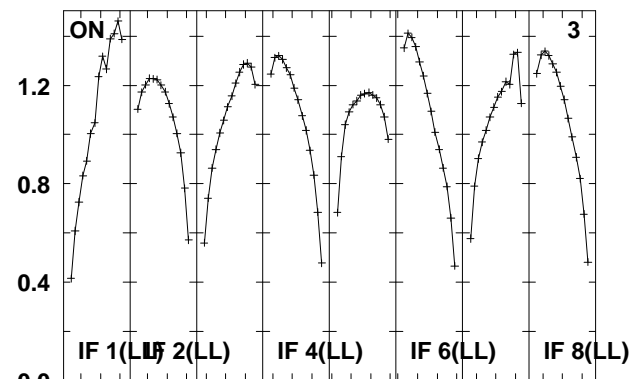
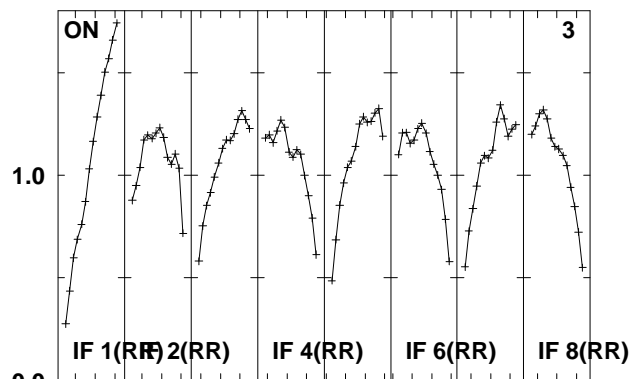
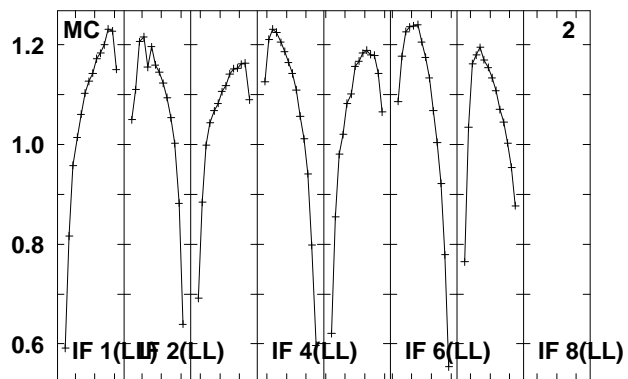
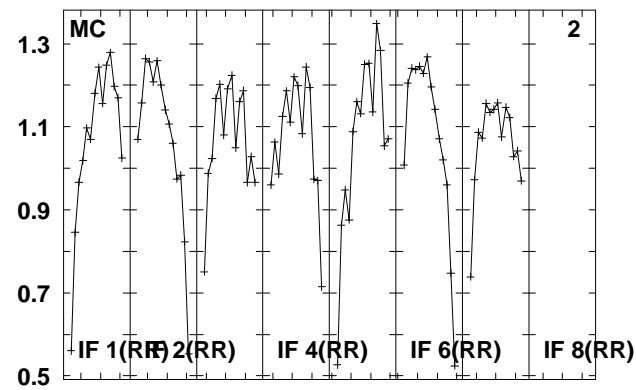
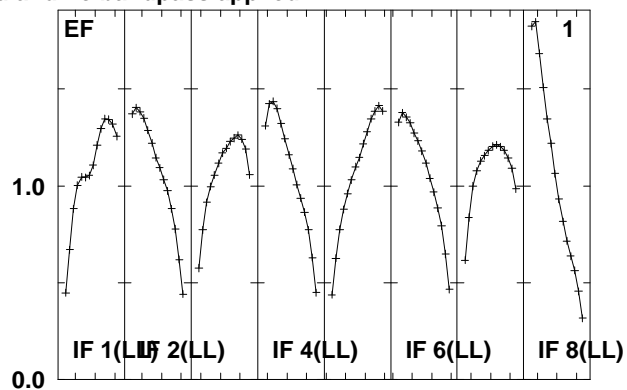
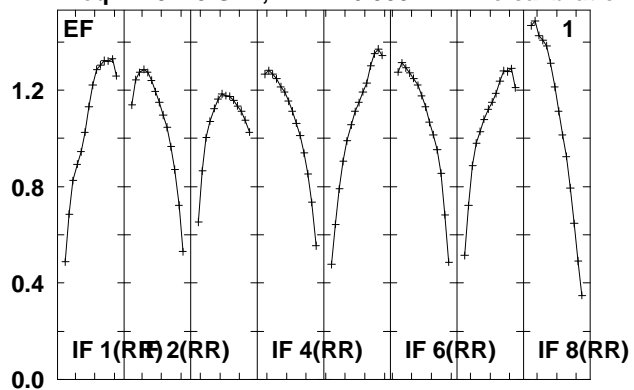

Lower frame: Real Jy
Total-power spectrum Antenna: *
Timerange: 01/03:01:10 to 01/03:03:08

Plot file version 339 created 08-JUL-2010 13:13:57

J1609+26 EM079.UVDATA.1

Freq = 4.9415 GHz, Bw = 16.000 MH No calibration applied and no bandpass applied

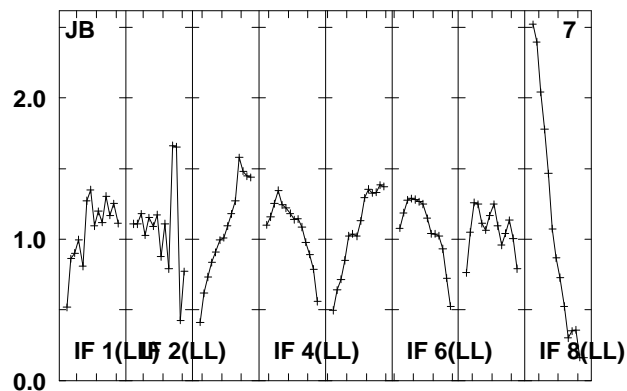
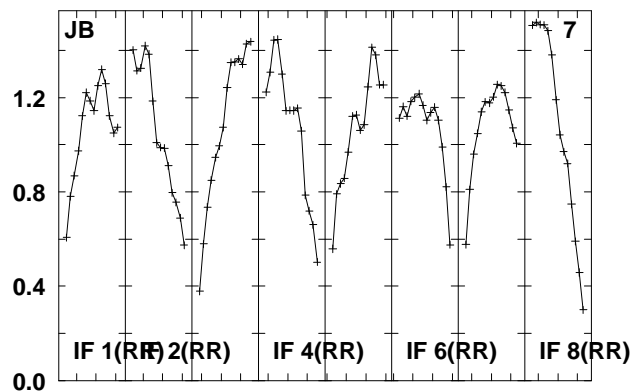
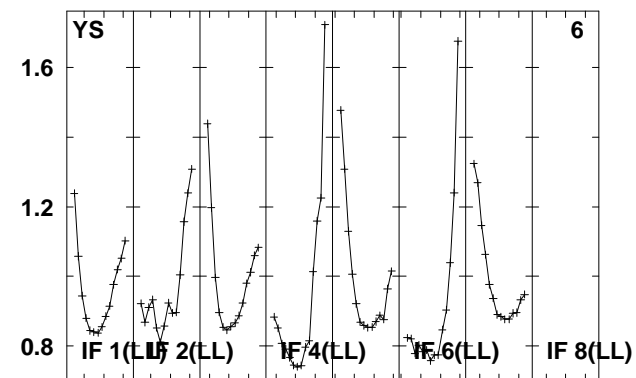
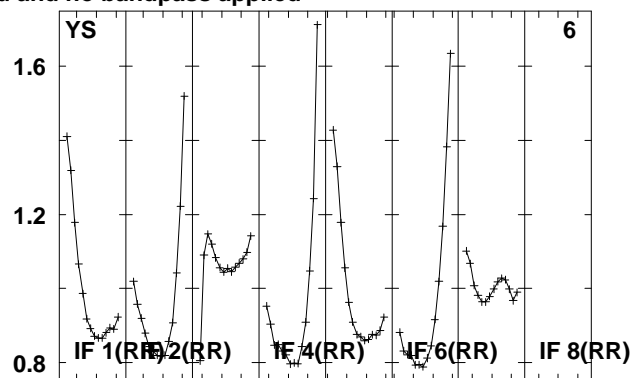
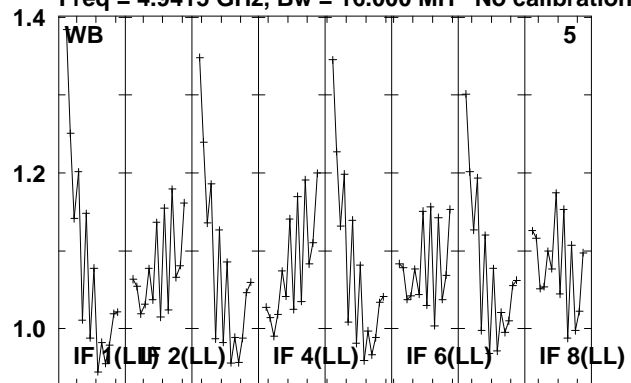

Lower frame: Real Jy
Total-power spectrum Antenna: *
Timerange: 01/03:01:10 to 01/03:03:08

Plot file version 340 created 08-JUL-2010 13:13:58

J1625+27 EM079.UVDATA.1

Freq = 4.9415 GHz, Bw = 16.000 MH No calibration applied and no bandpass applied

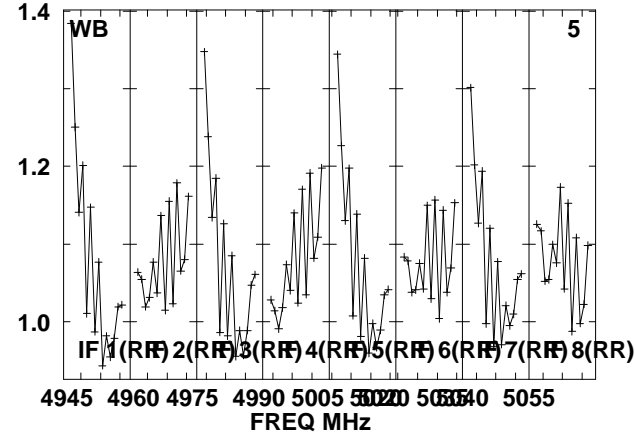
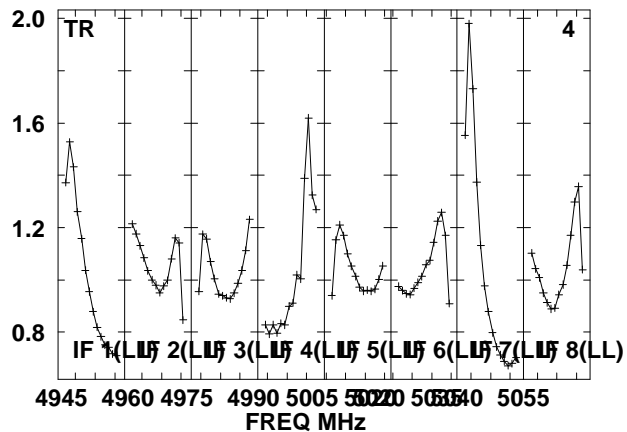
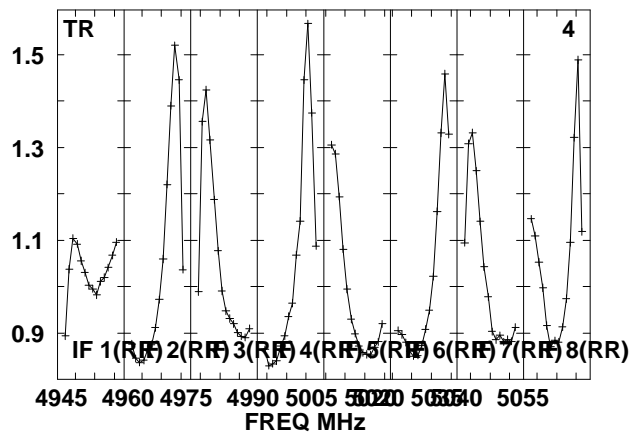
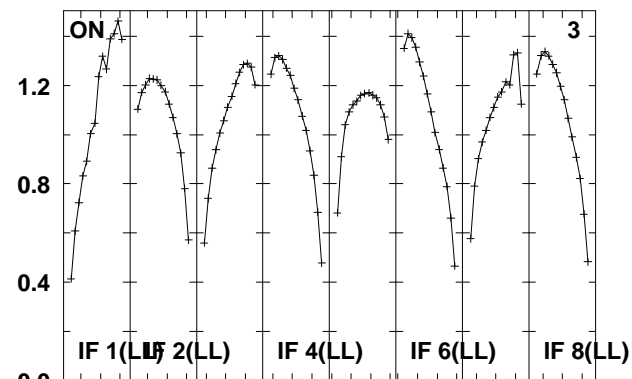
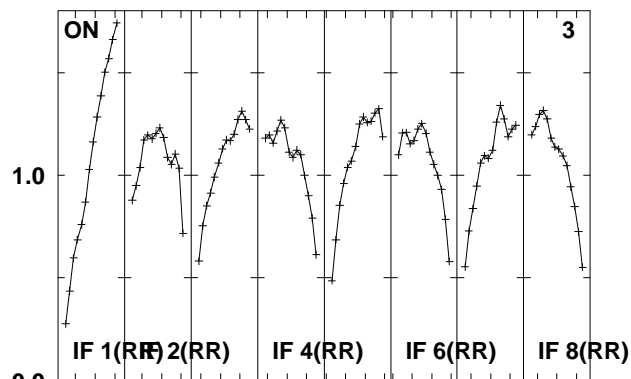
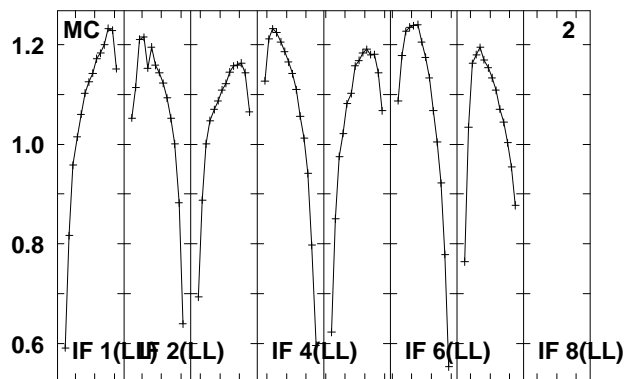
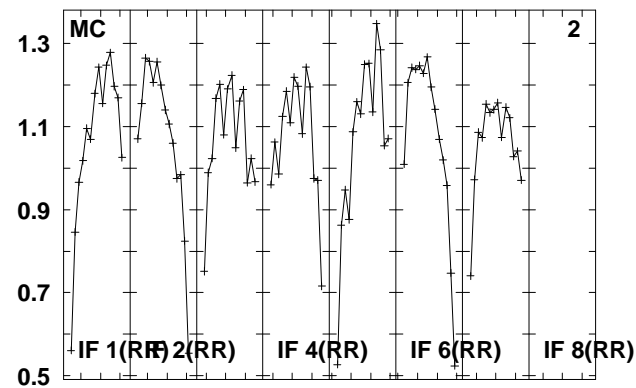
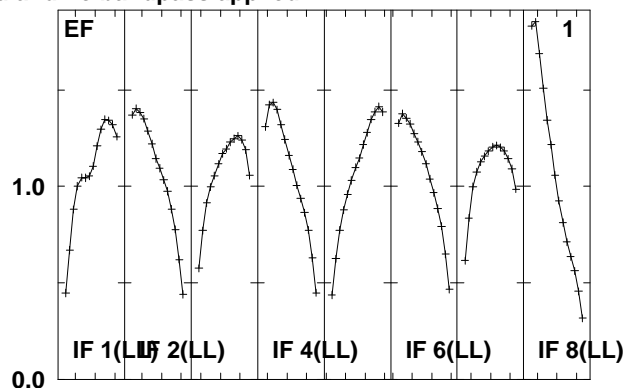
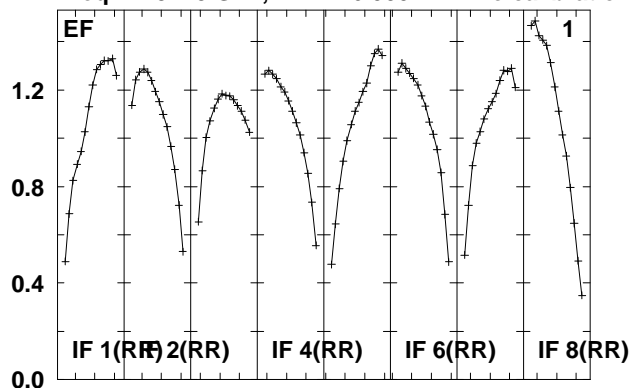

Lower frame: Real Jy
Total-power spectrum Antenna: *
Timerange: 01/03:03:10 to 01/03:13:54

Plot file version 341 created 08-JUL-2010 13:13:59

J1625+27 EM079.UVDATA.1

Freq = 4.9415 GHz, Bw = 16.000 MH No calibration applied and no bandpass applied

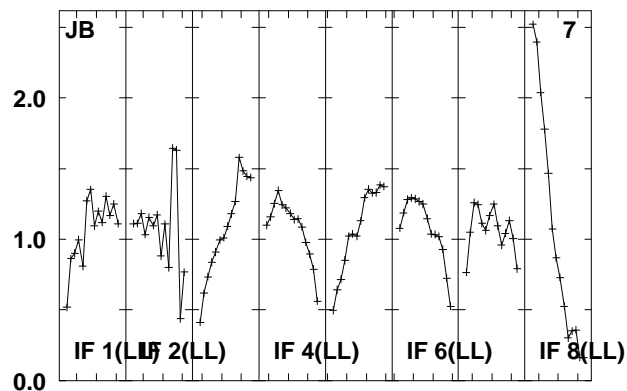
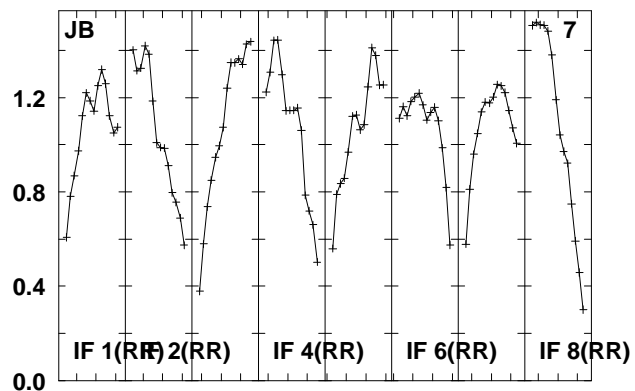
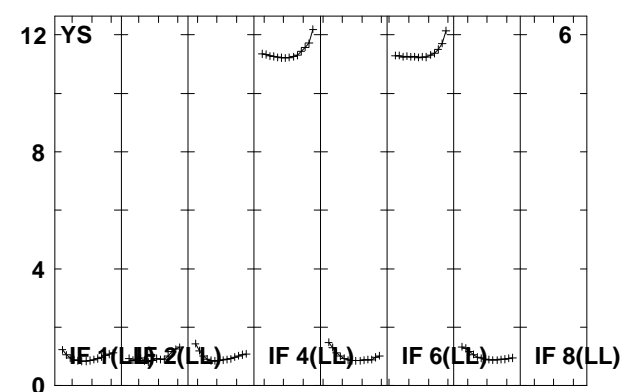
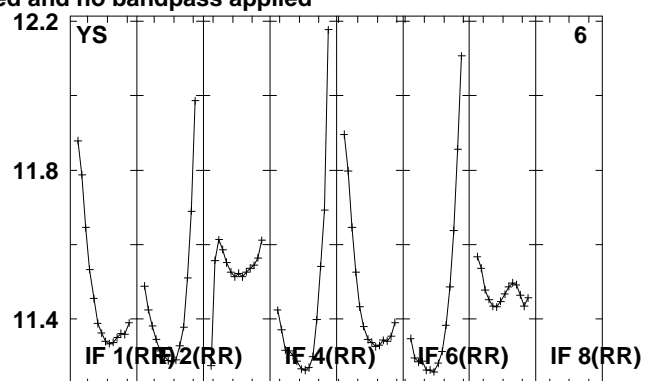
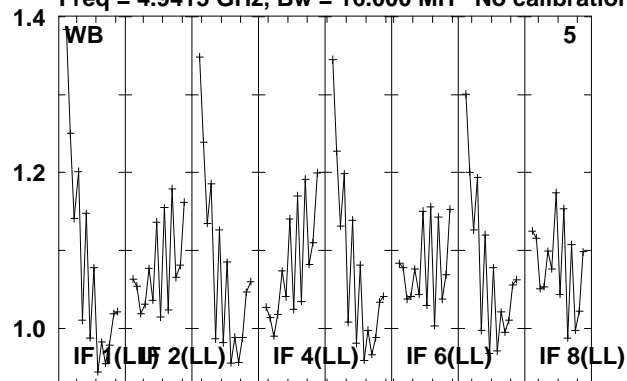

Lower frame: Real Jy
Total-power spectrum Antenna: *
Timerange: 01/03:03:10 to 01/03:13:54

Plot file version 342 created 08-JUL-2010 13:14:00

J1609+26 EM079.UVDATA.1

Freq = 4.9415 GHz, Bw = 16.000 MH No calibration applied and no bandpass applied

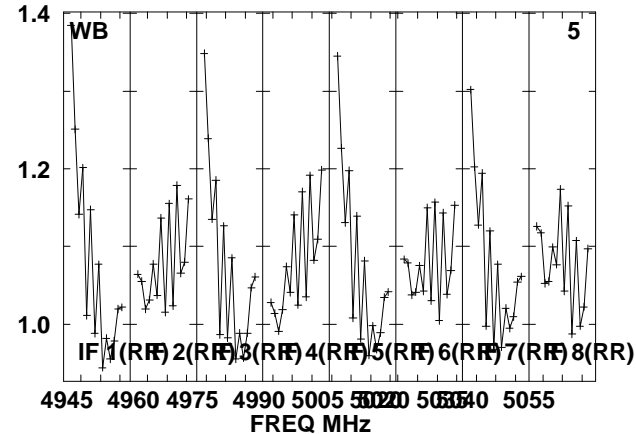
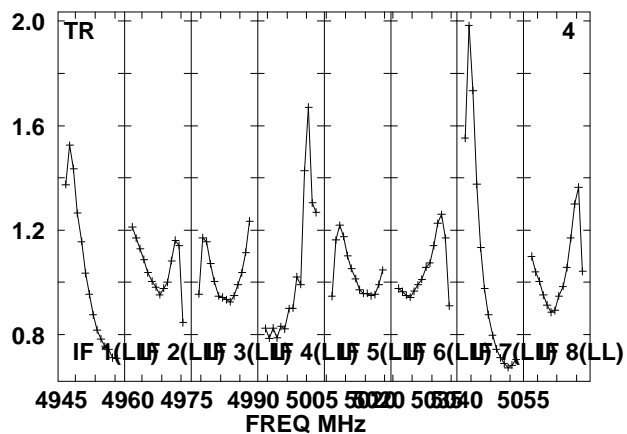
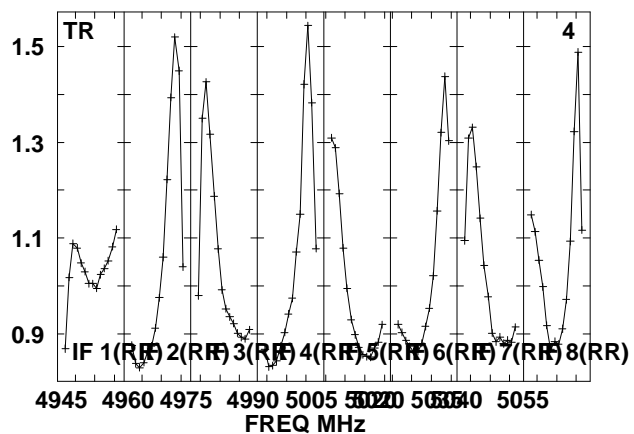
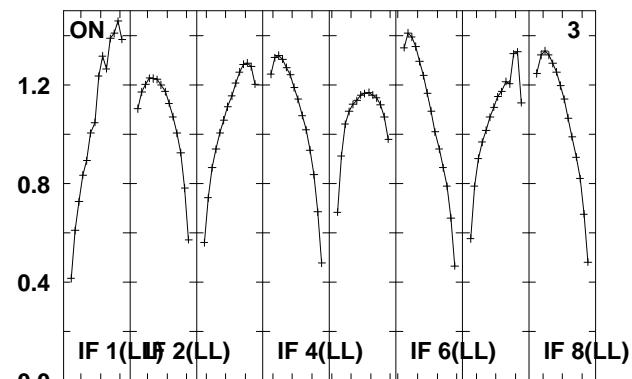
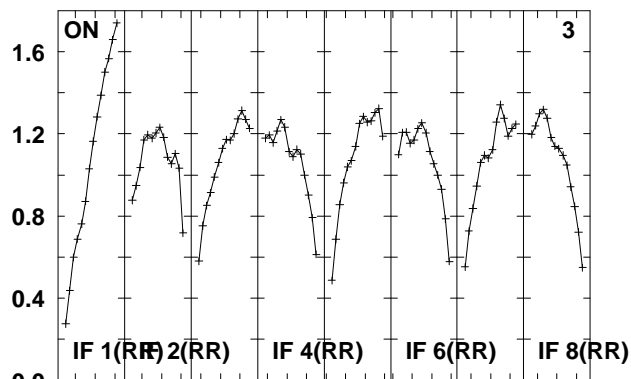
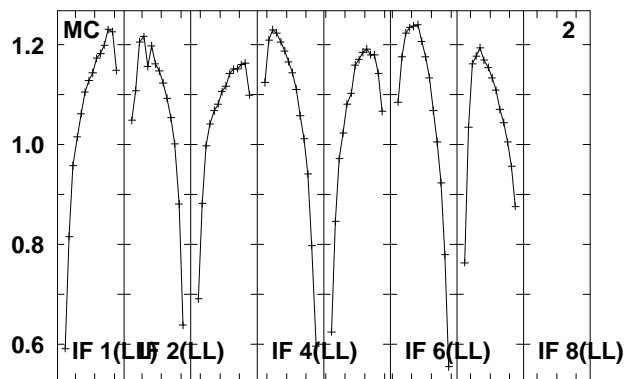
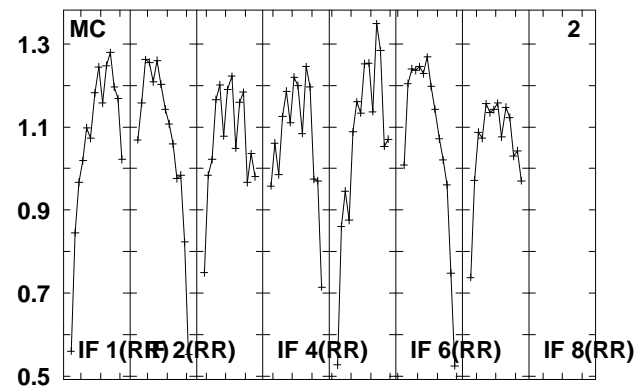
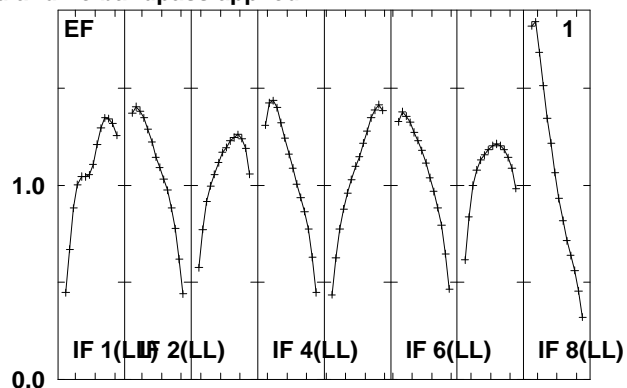
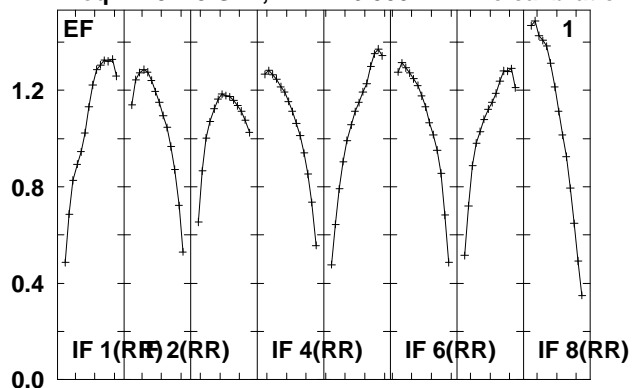

Lower frame: Real Jy
Total-power spectrum Antenna: *
Timerange: 01/03:13:56 to 01/03:15:54

Plot file version 343 created 08-JUL-2010 13:14:01

J1609+26 EM079.UVDATA.1

Freq = 4.9415 GHz, Bw = 16.000 MH No calibration applied and no bandpass applied

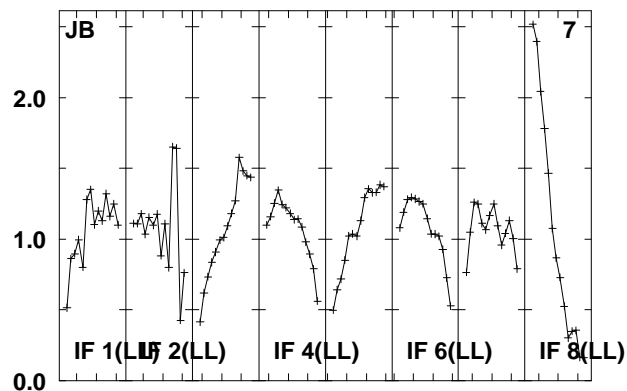
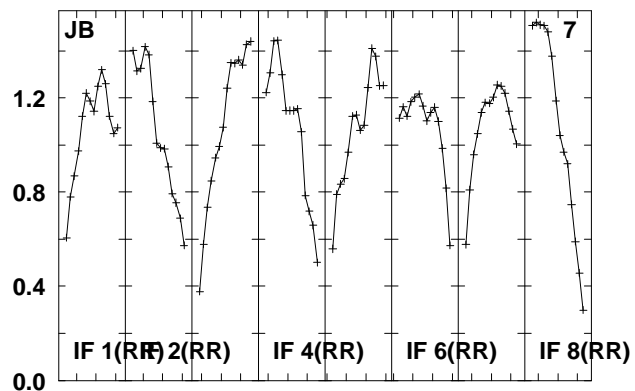
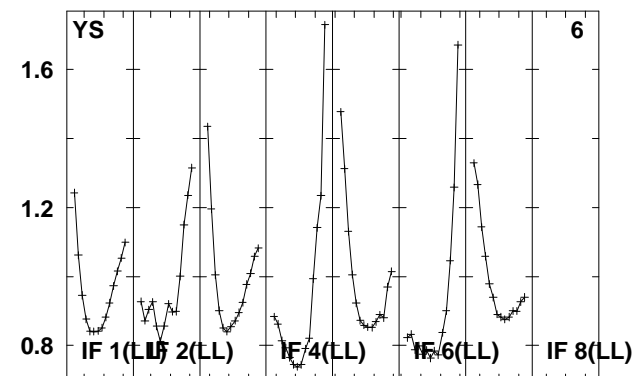
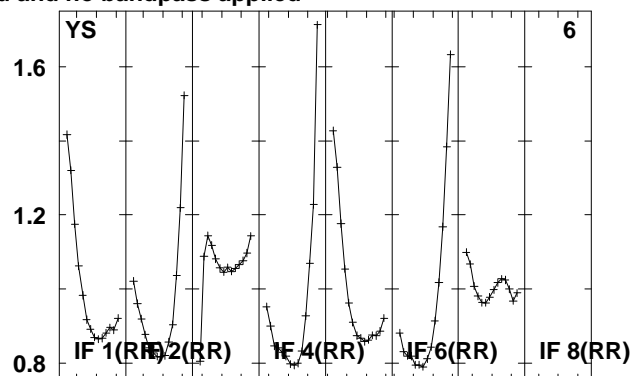
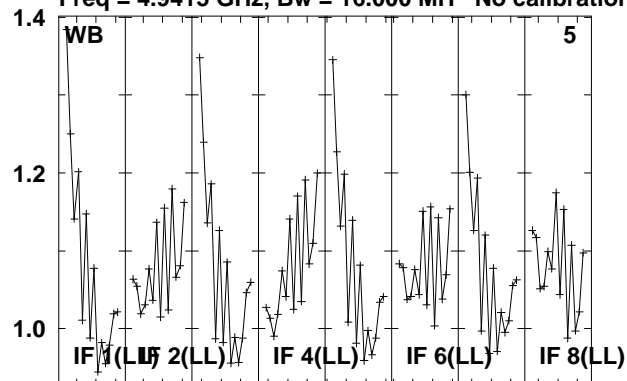

Lower frame: Real Jy
Total-power spectrum Antenna: *
Timerange: 01/03:13:56 to 01/03:15:54

Plot file version 344 created 08-JUL-2010 13:14:01

J1625+27 EM079.UVDATA.1

Freq = 4.9415 GHz, Bw = 16.000 MH No calibration applied and no bandpass applied

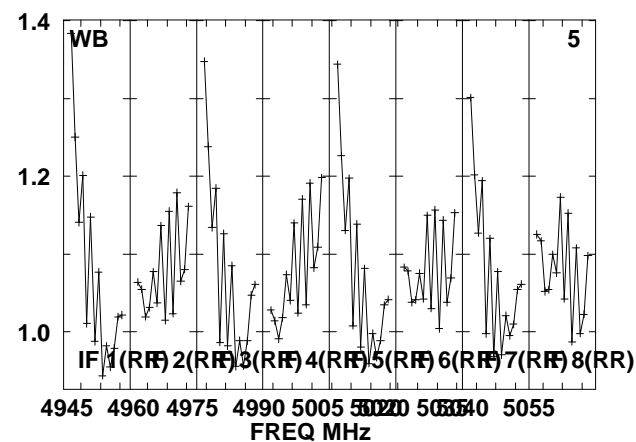
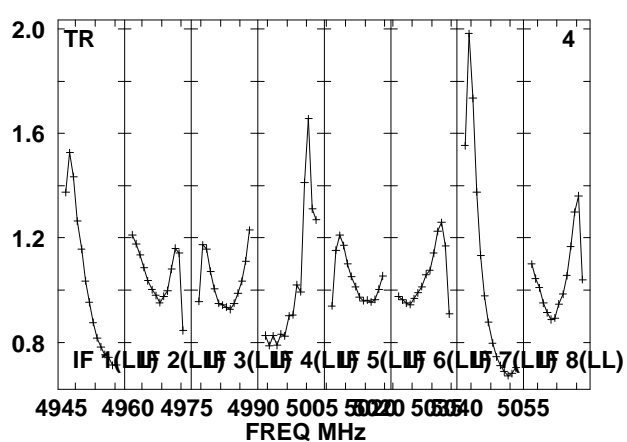
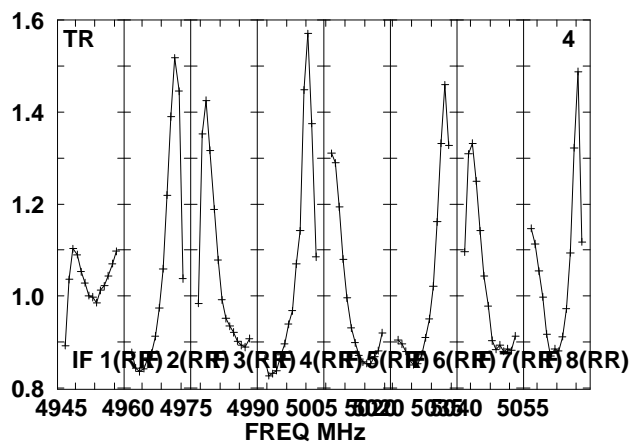
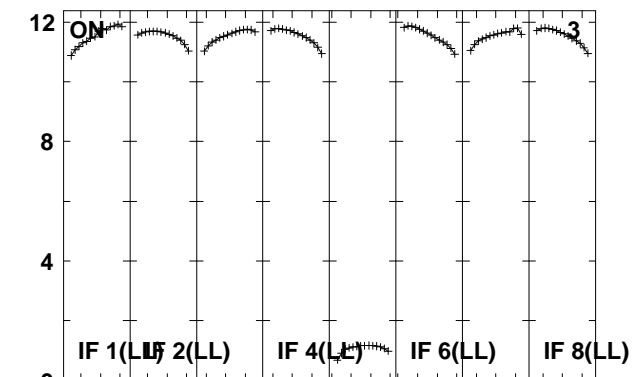
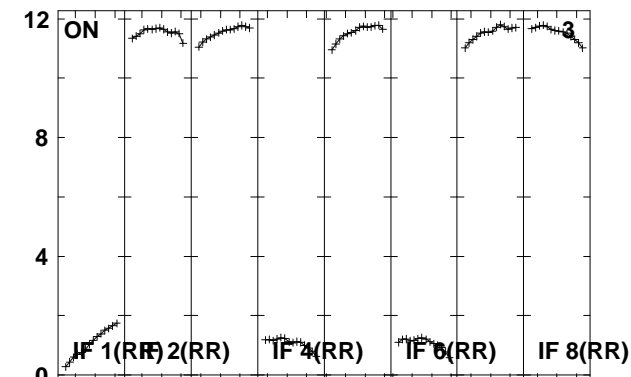
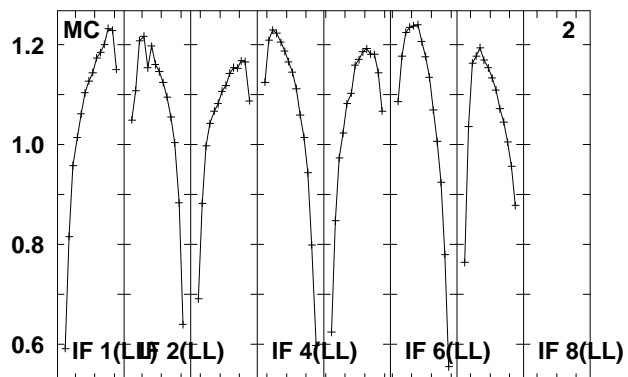
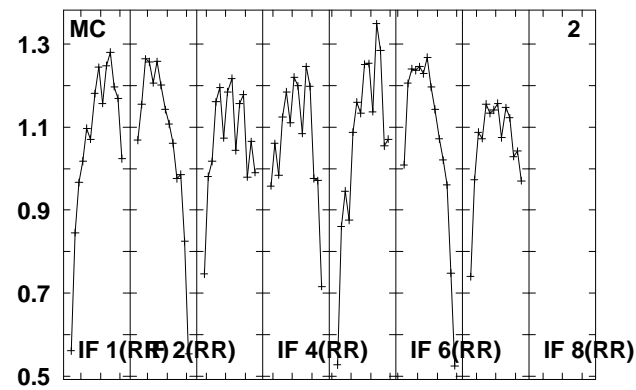
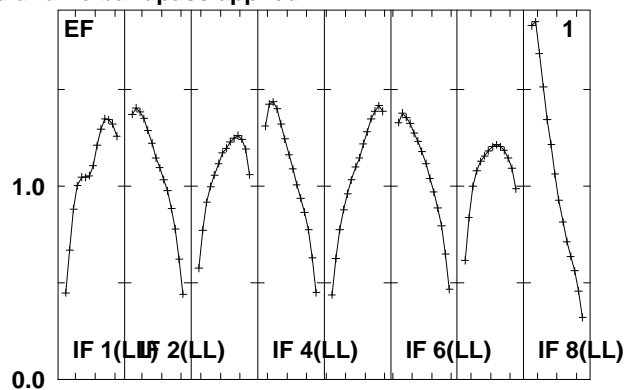
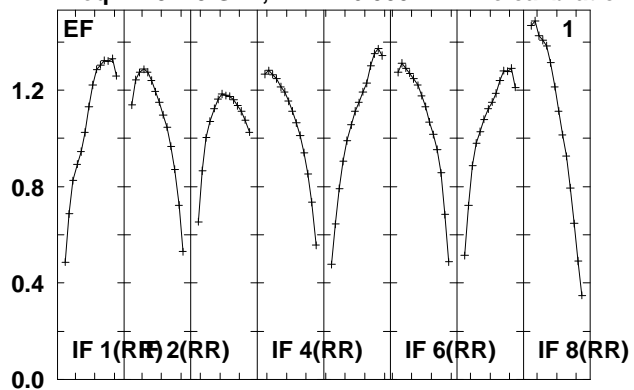

Lower frame: Real Jy
Total-power spectrum Antenna: *
Timerange: 01/03:15:56 to 01/03:26:38

Plot file version 345 created 08-JUL-2010 13:14:02

J1625+27 EM079.UVDATA.1

Freq = 4.9415 GHz, Bw = 16.000 MH No calibration applied and no bandpass applied

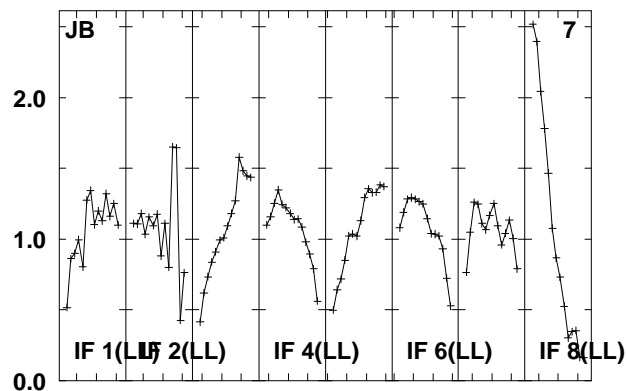
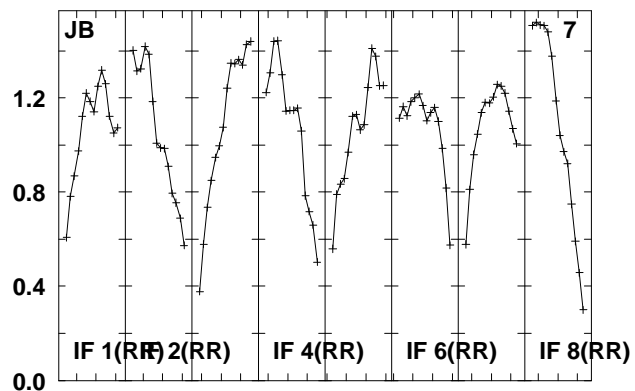
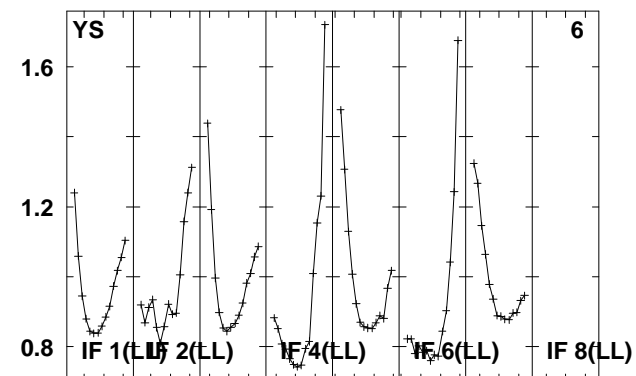
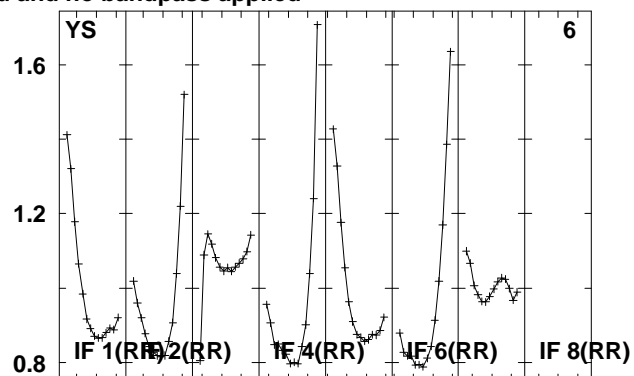
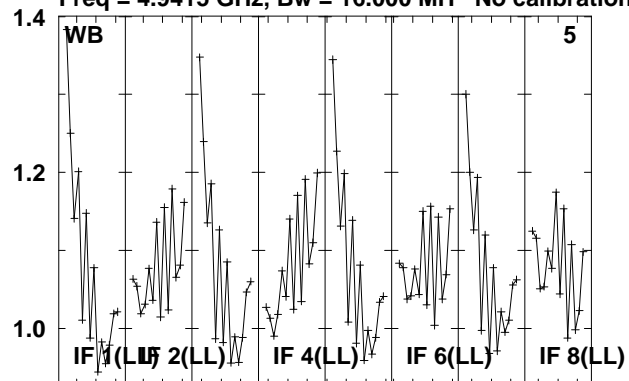

Lower frame: Real Jy
Total-power spectrum Antenna: *
Timerange: 01/03:15:56 to 01/03:26:38

Plot file version 346 created 08-JUL-2010 13:14:04

J1609+26 EM079.UVDATA.1

Freq = 4.9415 GHz, Bw = 16.000 MH No calibration applied and no bandpass applied

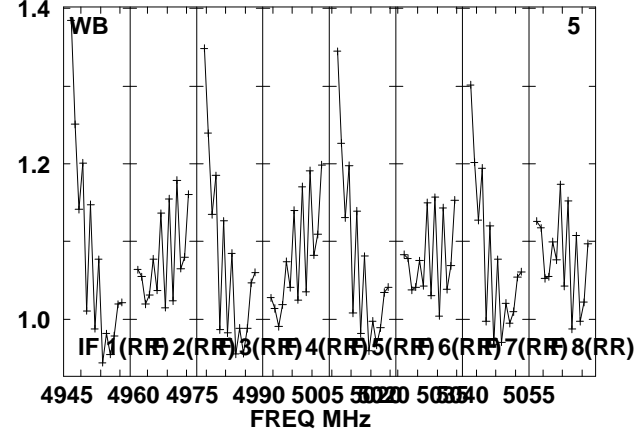
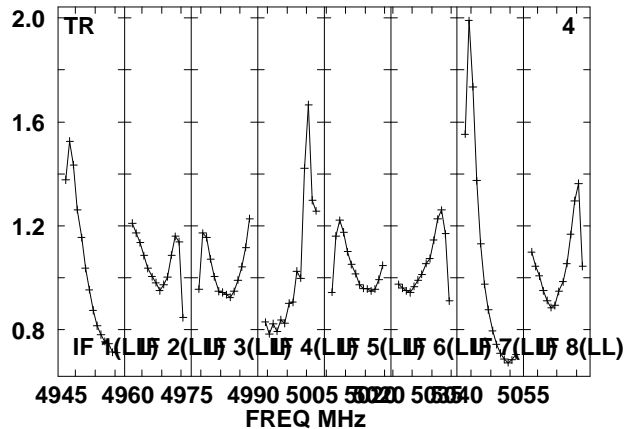
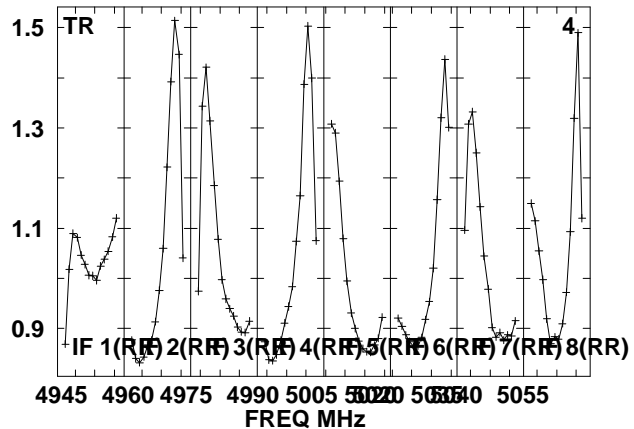
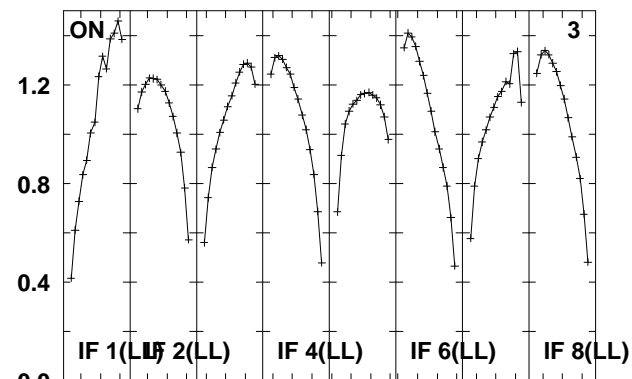
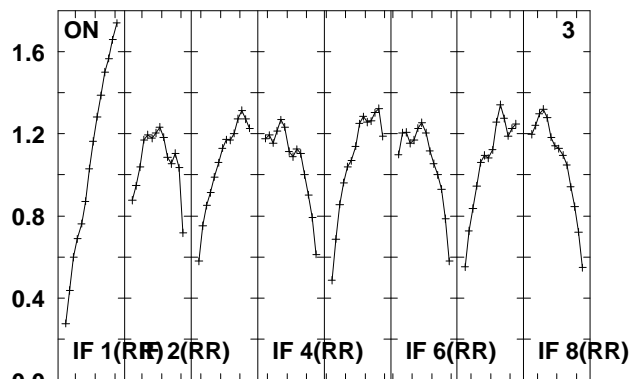
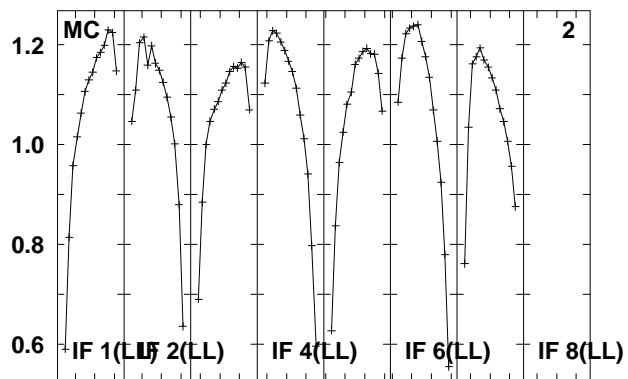
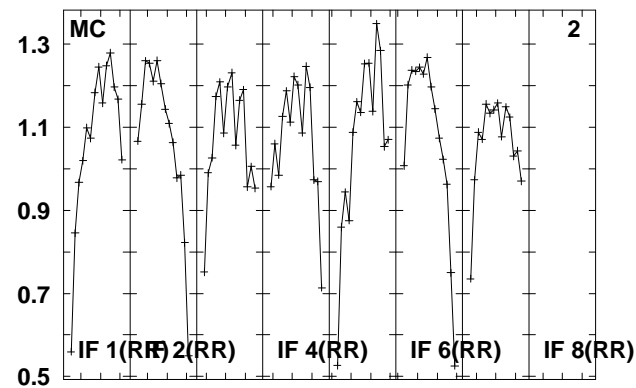
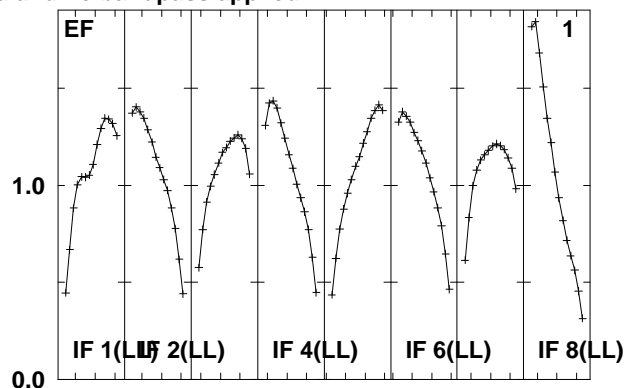
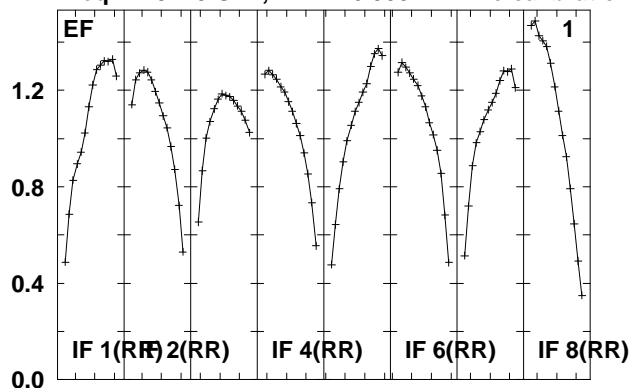

Lower frame: Real Jy
Total-power spectrum Antenna: *
Timerange: 01/03:26:40 to 01/03:28:36

Plot file version 347 created 08-JUL-2010 13:14:04

J1609+26 EM079.UVDATA.1

Freq = 4.9415 GHz, Bw = 16.000 MH No calibration applied and no bandpass applied

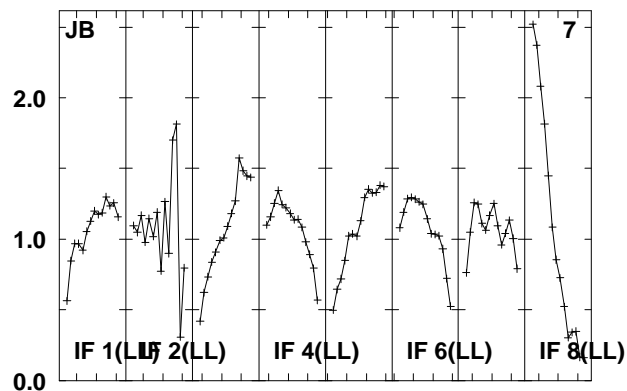
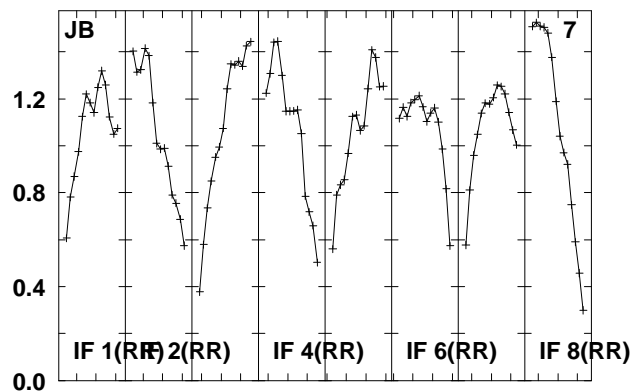
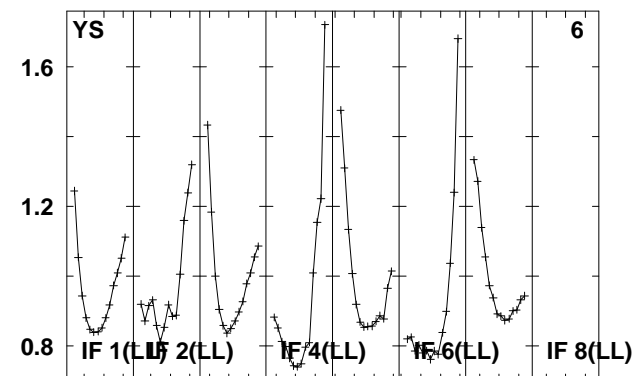
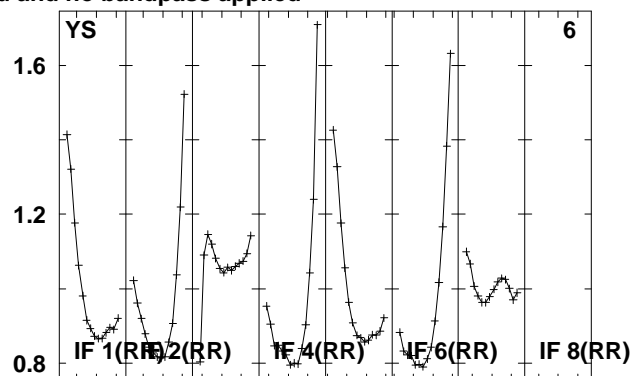
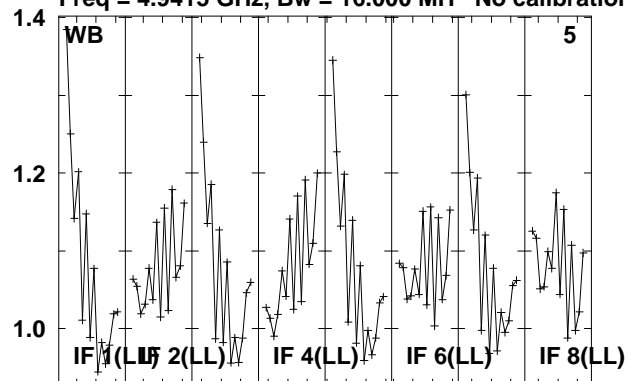

Lower frame: Real Jy
Total-power spectrum Antenna: *
Timerange: 01/03:26:40 to 01/03:28:36