

Plot file version 1 created 11-AUG-2014 17:05:28

3C345 EM110 2.UVDATA.1

Freq = 1.5950 GHz, Bw = 16.000 MH No calibration applied and no bandpass applied

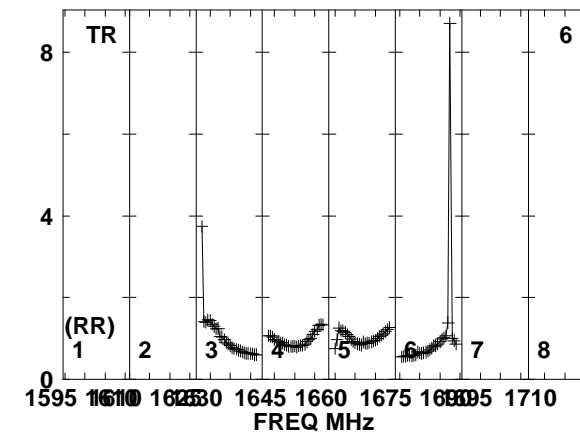
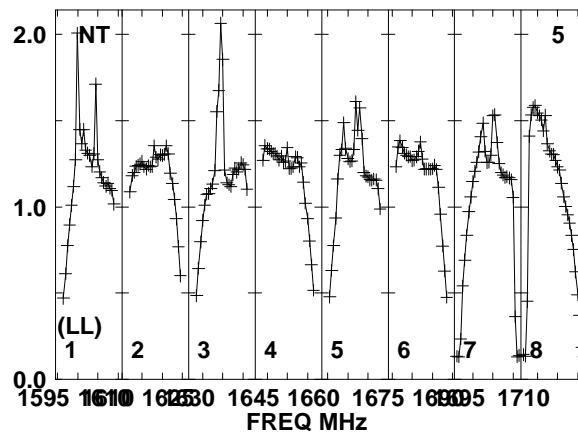
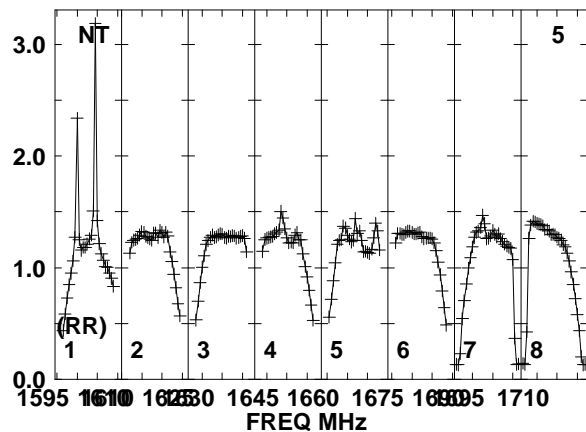
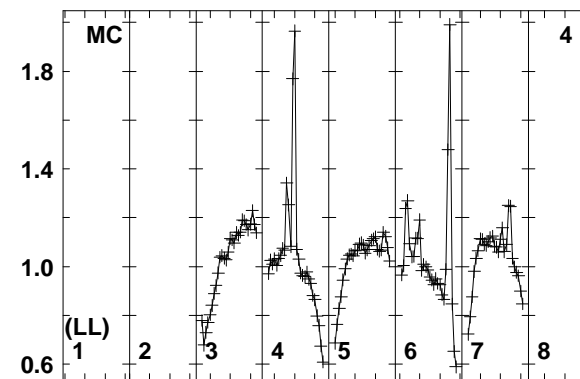
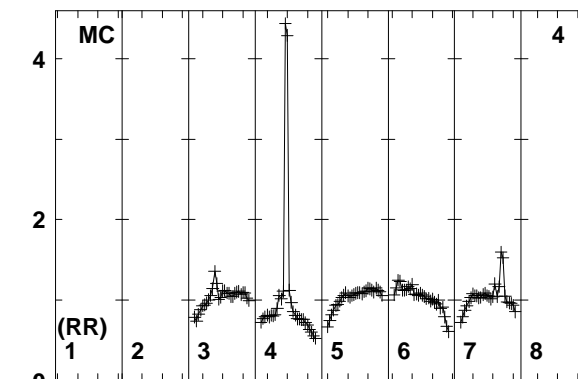
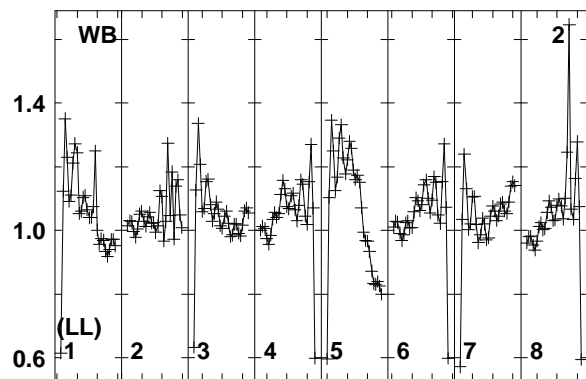
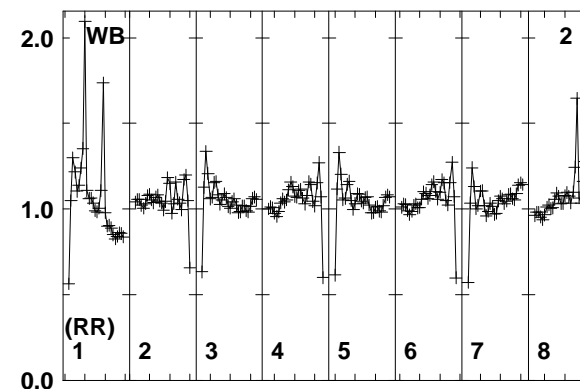
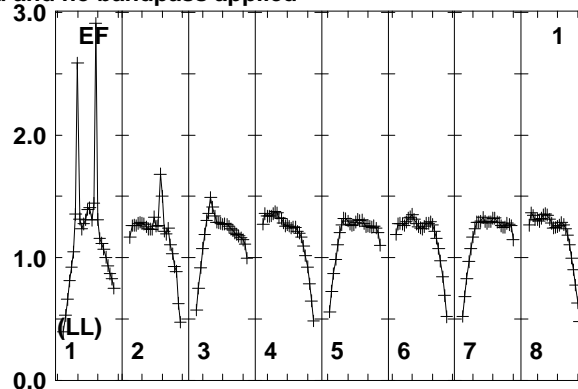
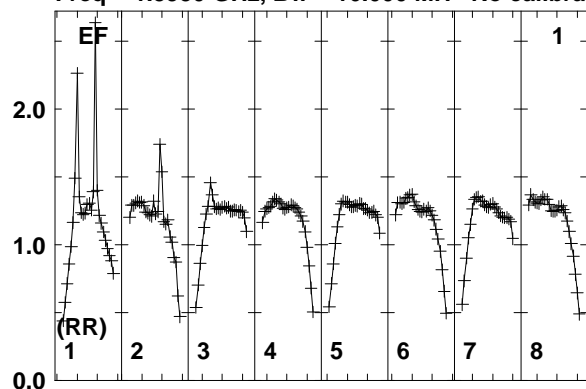

Lower frame: Real Jy
Total-power spectrum Antenna: EF (01)
Timerange: 00/02:30:01 to 00/02:34:49

Plot file version 2 created 11-AUG-2014 17:05:28

3C345 EM110 2.UVDATA.1

Freq = 1.5950 GHz, Bw = 16.000 MH No calibration applied and no bandpass applied

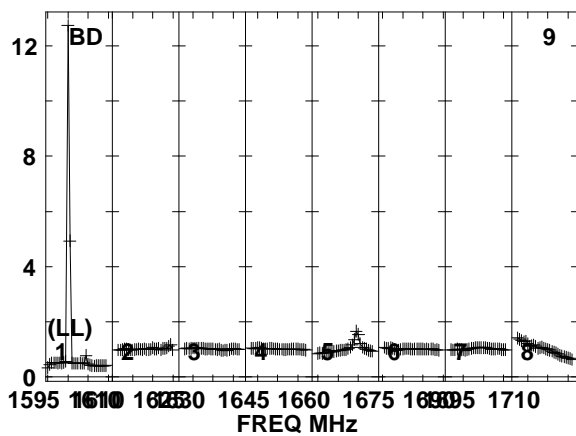
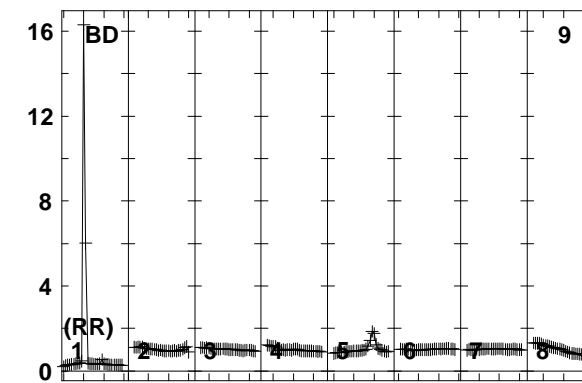
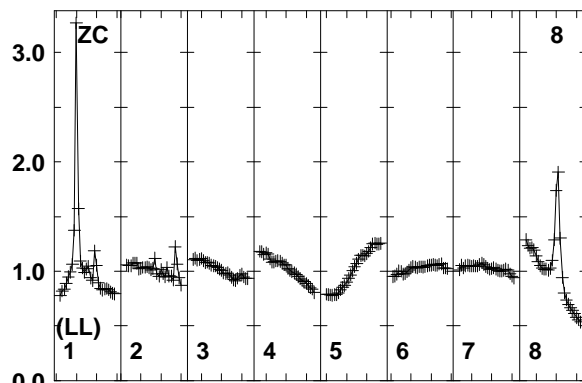
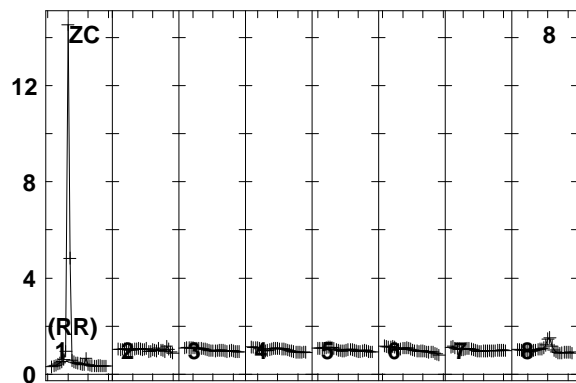
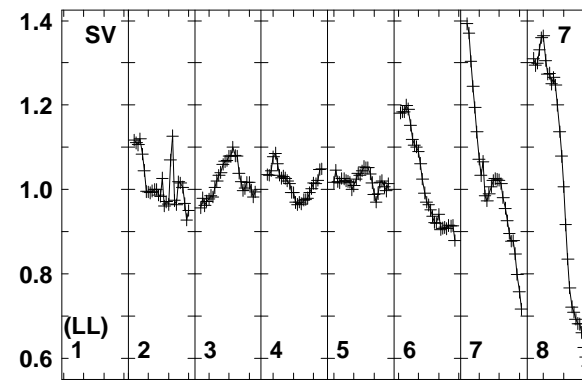
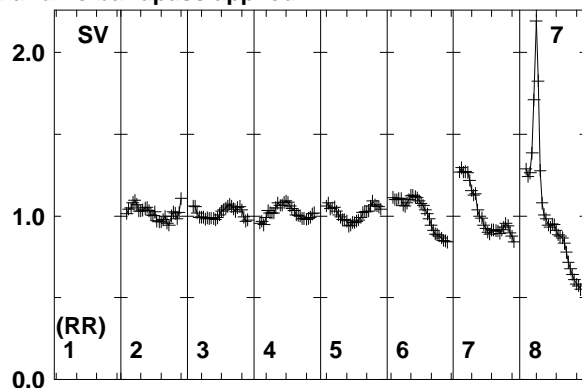
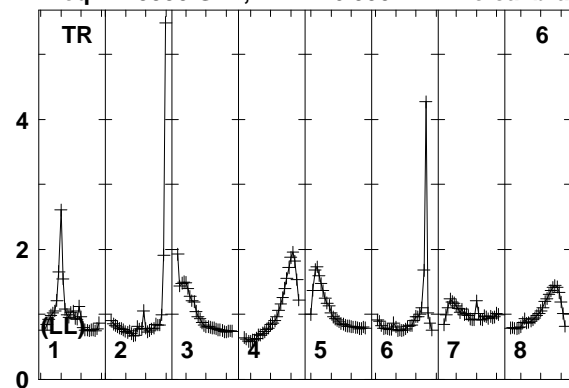

Lower frame: Real Jy
Total-power spectrum Antenna: TR (06)
Timerange: 00/02:30:01 to 00/02:34:49

Plot file version 3 created 11-AUG-2014 17:05:28

J2015+3710 EM110 2.UVDATA.1

Freq = 1.5950 GHz, Bw = 16.000 MH No calibration applied and no bandpass applied

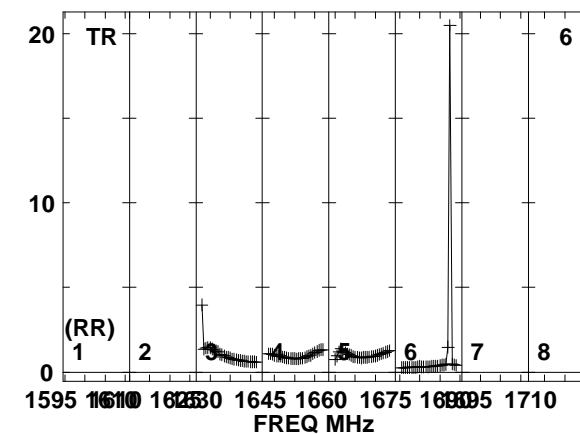
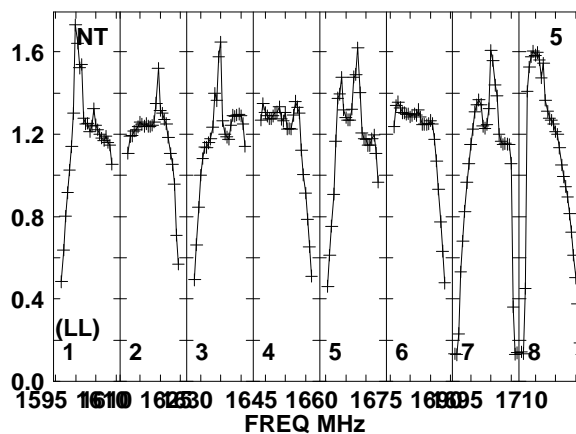
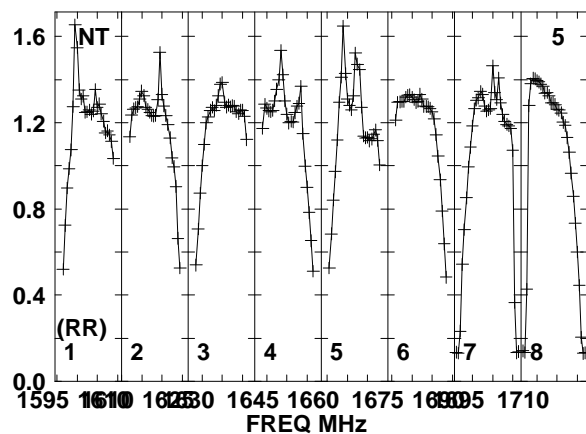
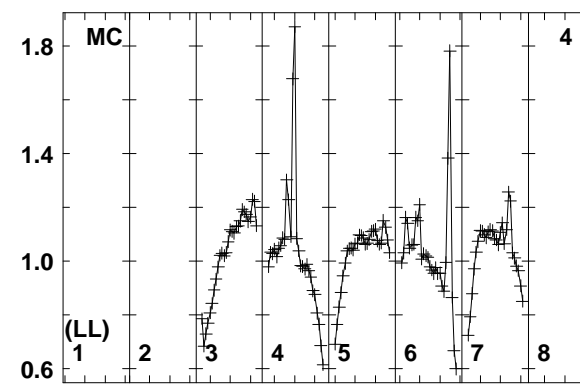
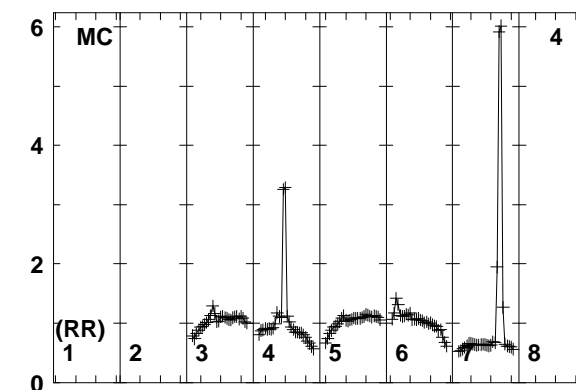
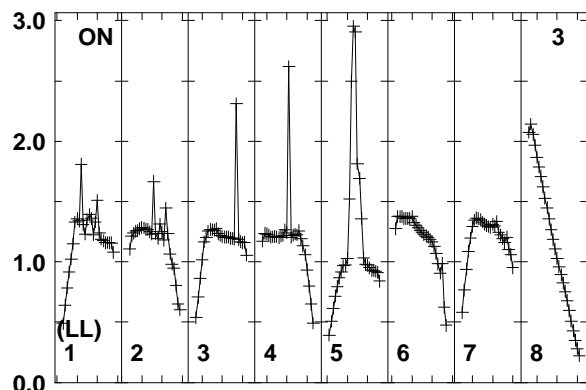
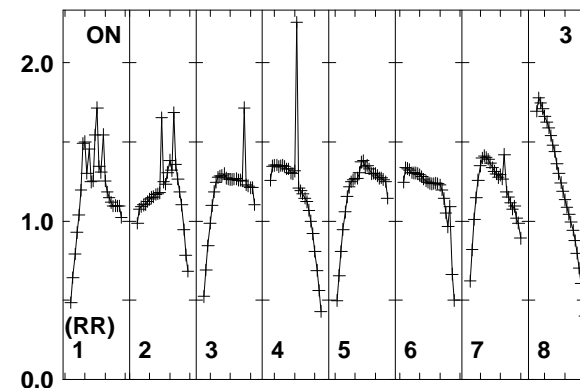
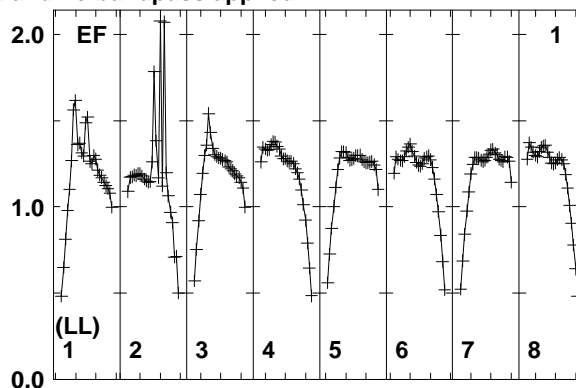
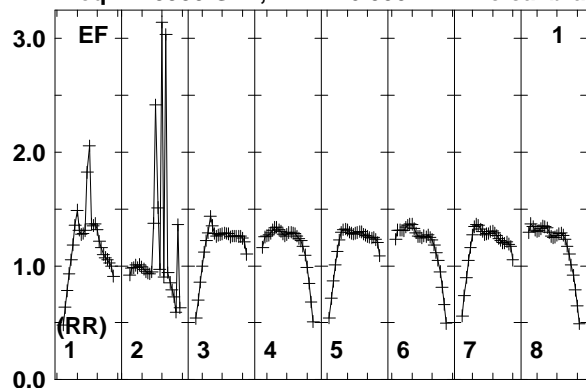

Lower frame: Real Jy
Total-power spectrum Antenna: EF (01)
Timerange: 00/02:37:51 to 00/02:39:49

Plot file version 4 created 11-AUG-2014 17:05:28

J2015+3710 EM110 2.UVDATA.1

Freq = 1.5950 GHz, Bw = 16.000 MH No calibration applied and no bandpass applied

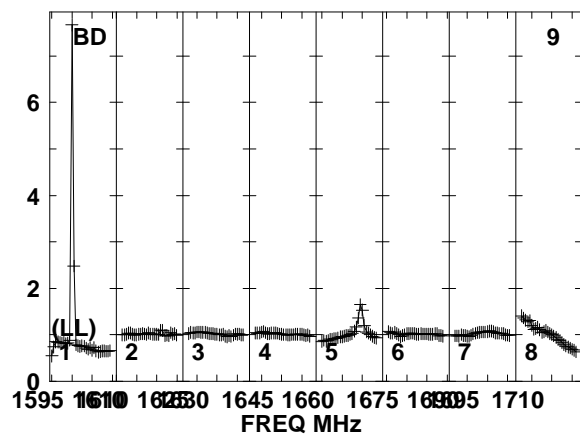
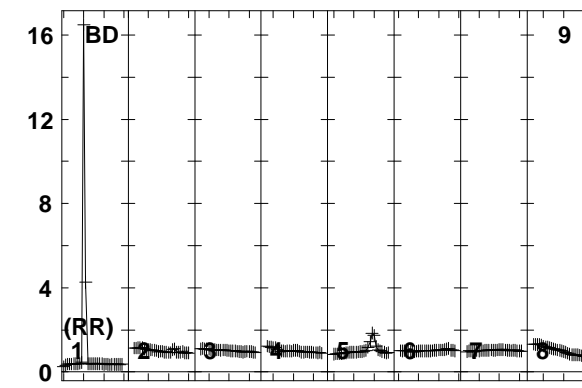
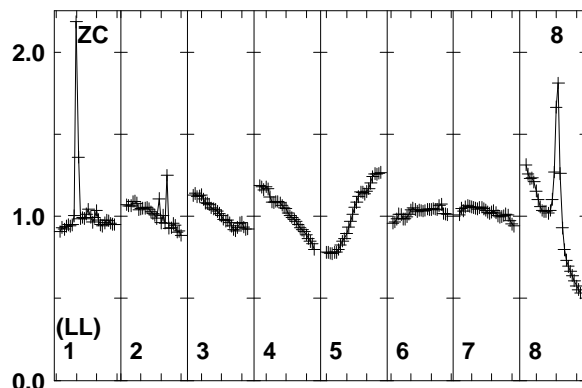
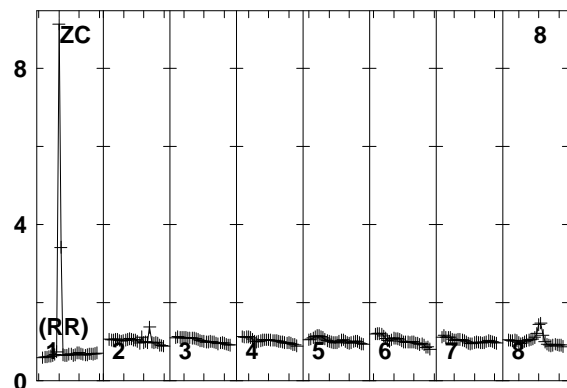
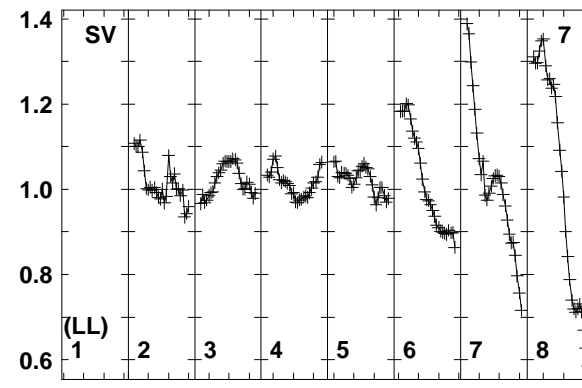
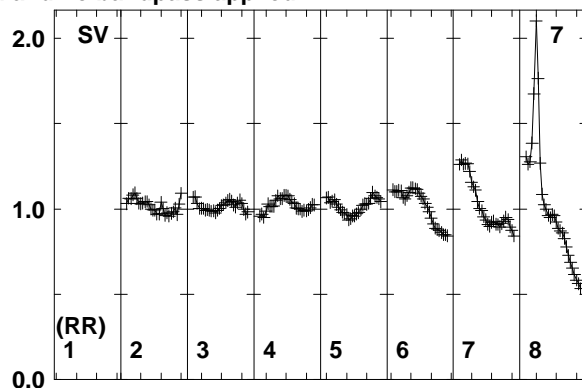
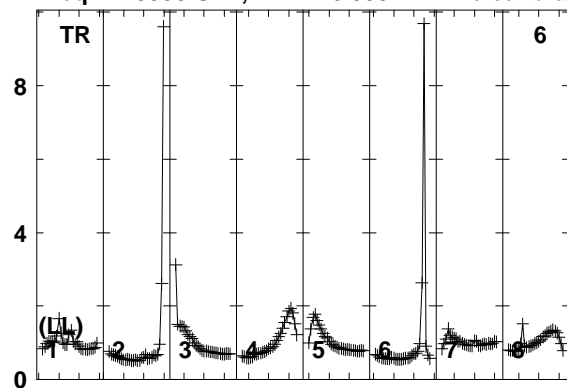

Lower frame: Real Jy
Total-power spectrum Antenna: TR (06)
Timerange: 00/02:37:51 to 00/02:39:49

Plot file version 5 created 11-AUG-2014 17:05:29

J2032+4127 EM110 2.UVDATA.1

Freq = 1.5950 GHz, Bw = 16.000 MH No calibration applied and no bandpass applied

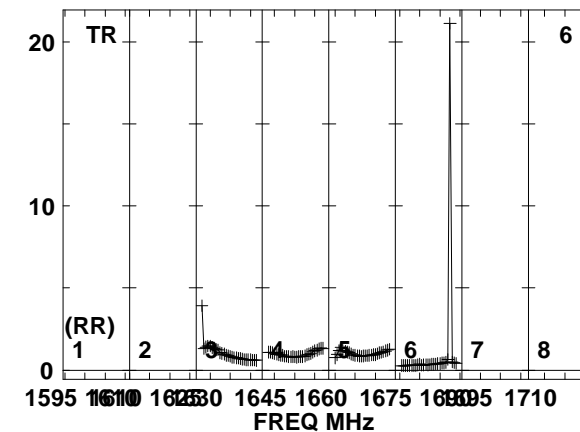
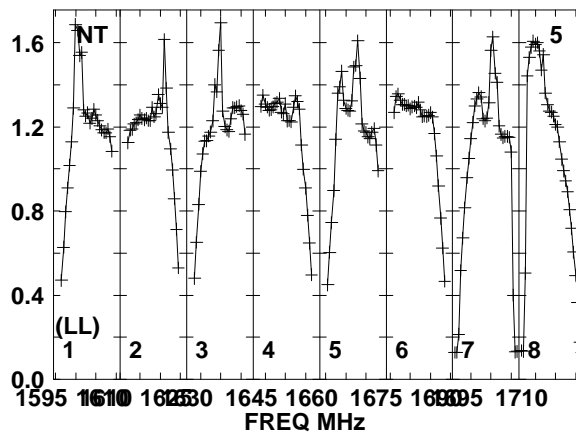
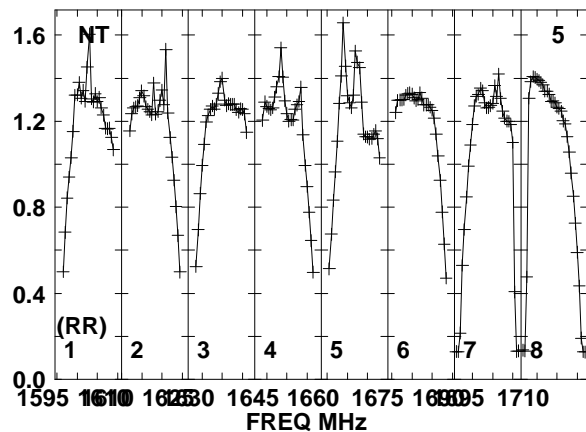
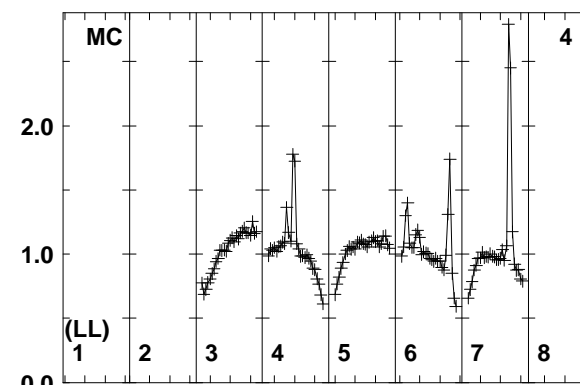
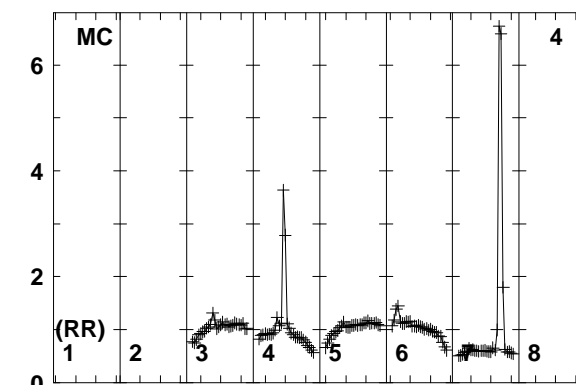
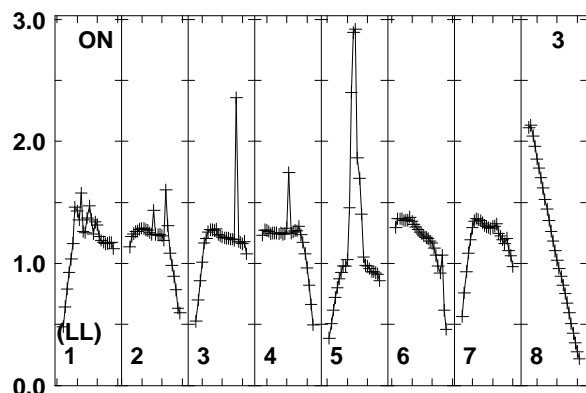
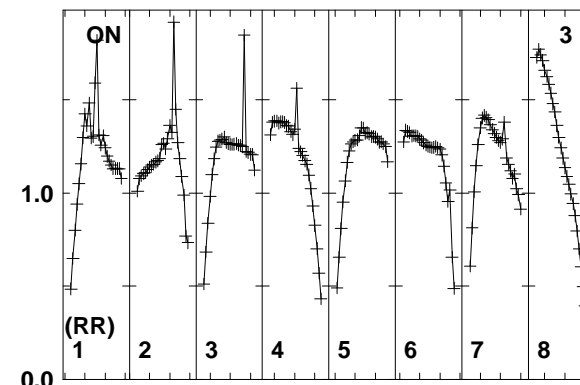
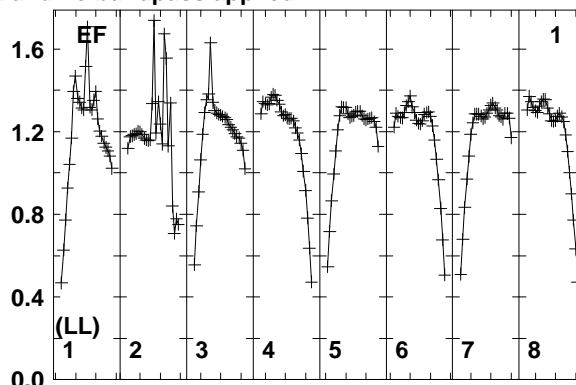
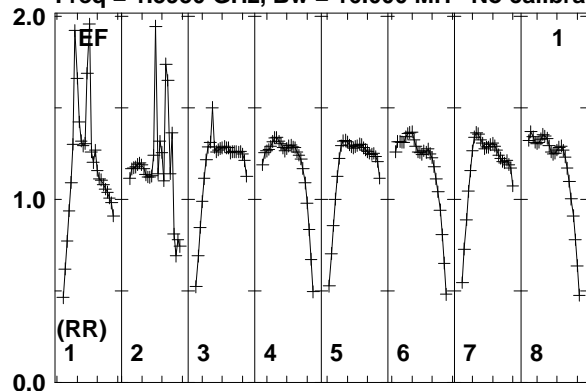

Lower frame: Real Jy
Total-power spectrum Antenna: EF (01)
Timerange: 00/02:40:01 to 00/02:43:49

Plot file version 6 created 11-AUG-2014 17:05:29

J2032+4127 EM110 2.UVDATA.1

Freq = 1.5950 GHz, Bw = 16.000 MH No calibration applied and no bandpass applied

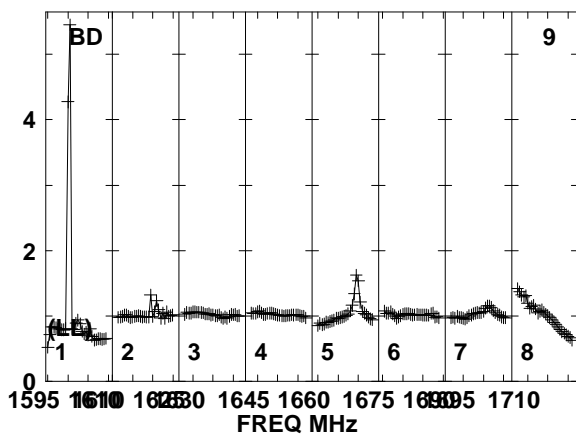
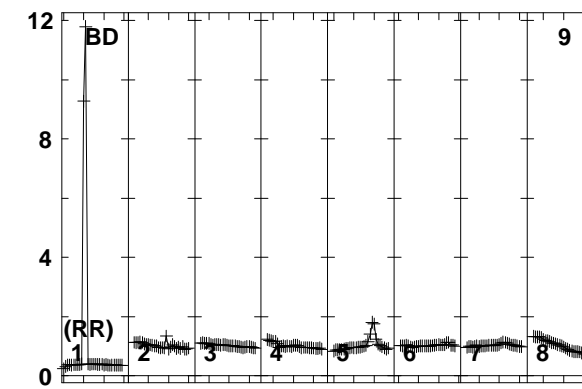
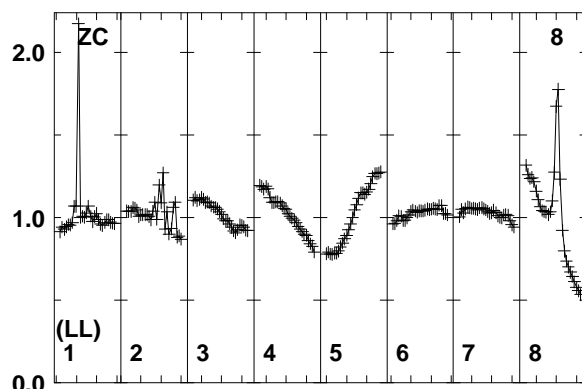
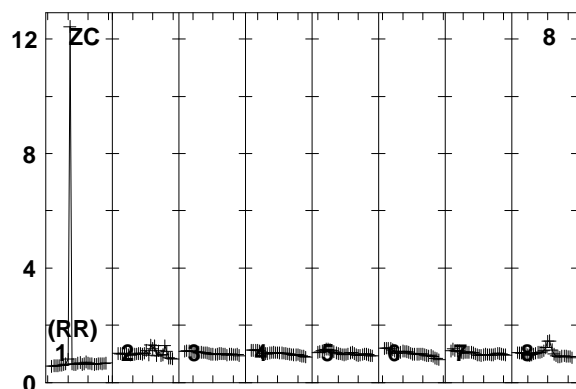
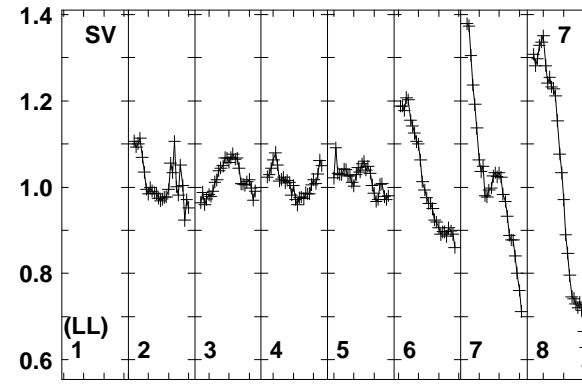
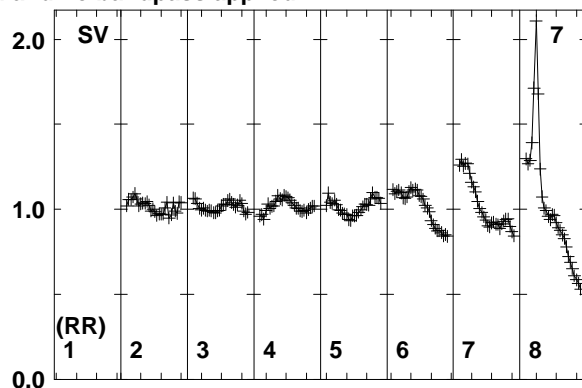
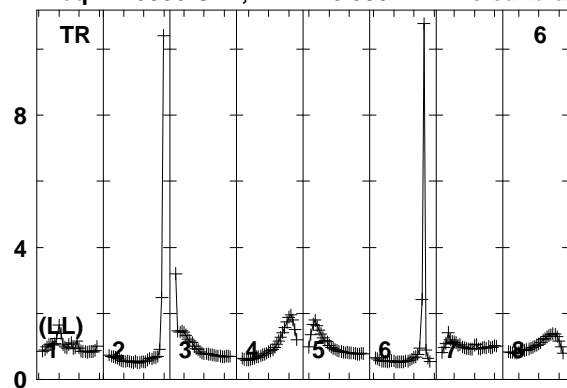

Lower frame: Real Jy
Total-power spectrum Antenna: TR (06)
Timerange: 00/02:40:01 to 00/02:43:49

Plot file version 7 created 11-AUG-2014 17:05:29

J2015+3710 EM110 2.UVDATA.1

Freq = 1.5950 GHz, Bw = 16.000 MH No calibration applied and no bandpass applied

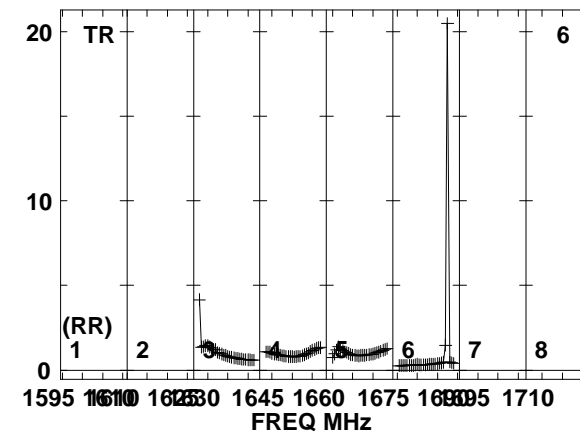
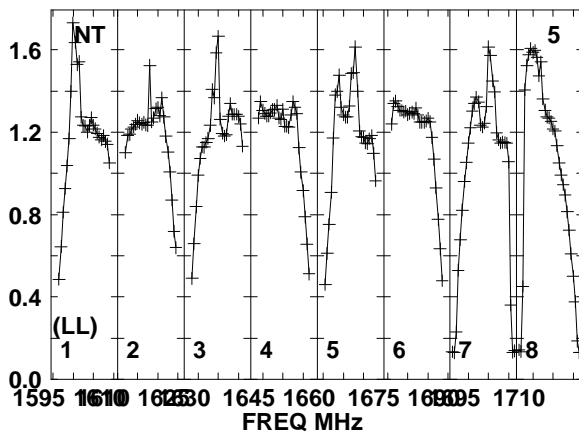
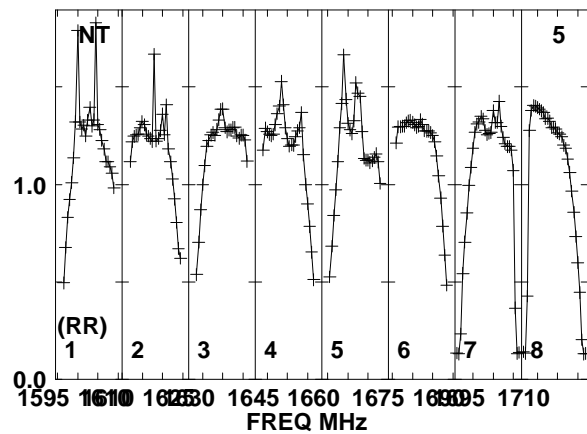
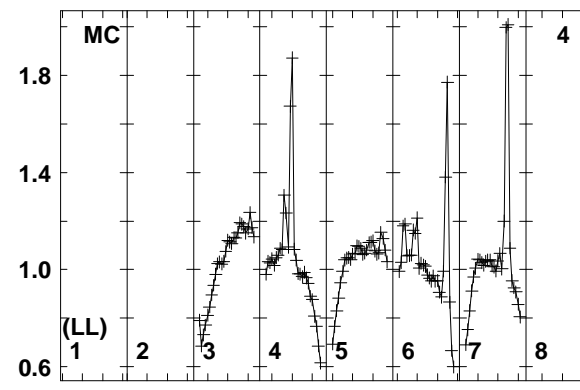
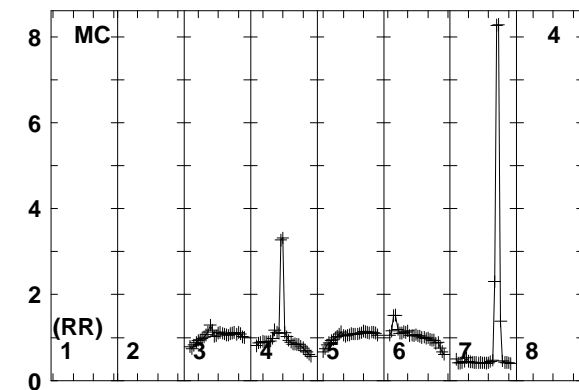
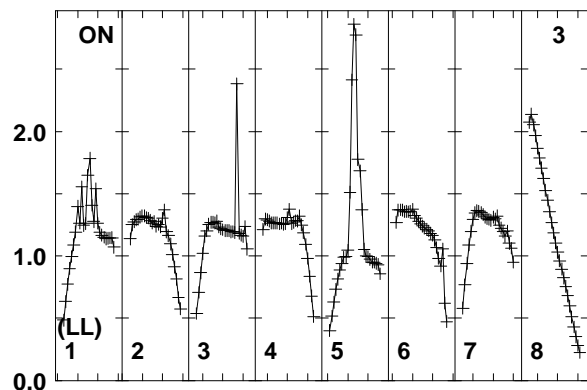
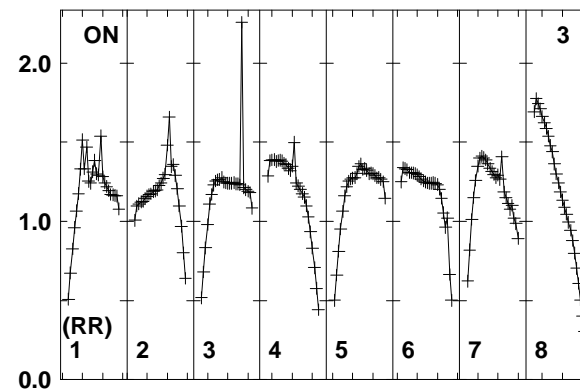
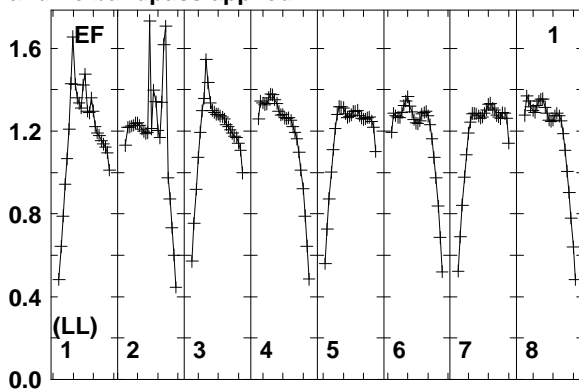
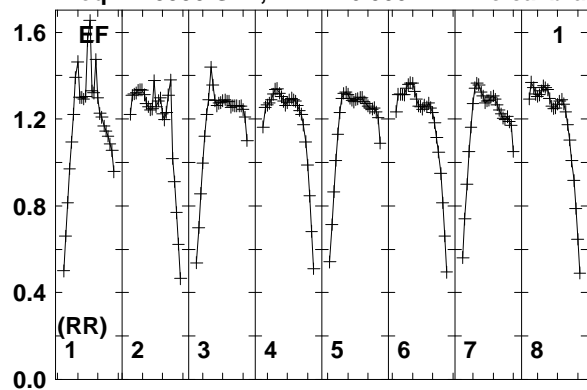

Lower frame: Real Jy
Total-power spectrum Antenna: EF (01)
Timerange: 00/02:44:01 to 00/02:45:49

Plot file version 8 created 11-AUG-2014 17:05:29

J2015+3710 EM110 2.UVDATA.1

Freq = 1.5950 GHz, Bw = 16.000 MH No calibration applied and no bandpass applied

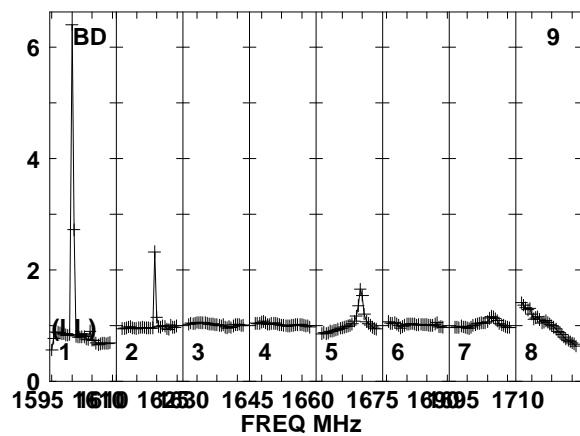
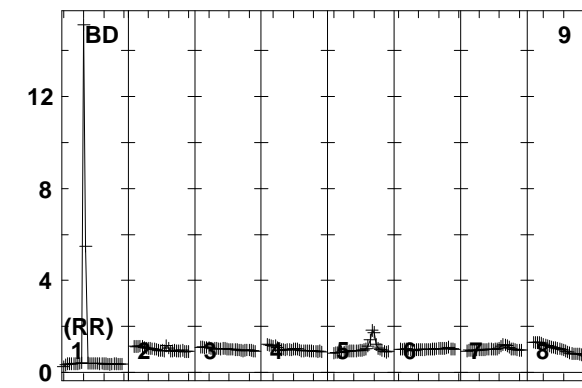
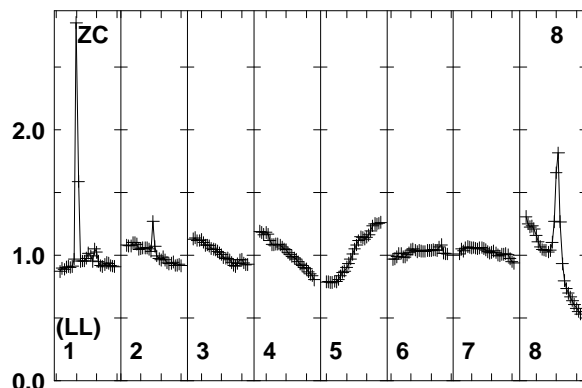
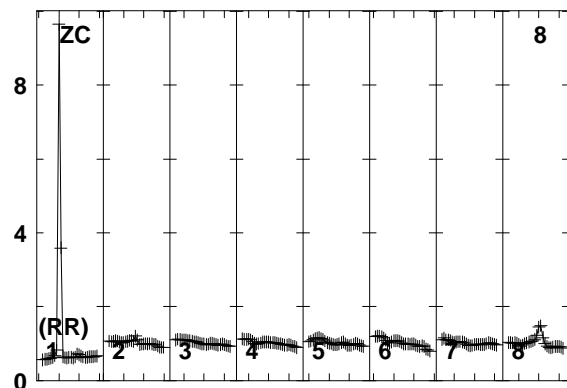
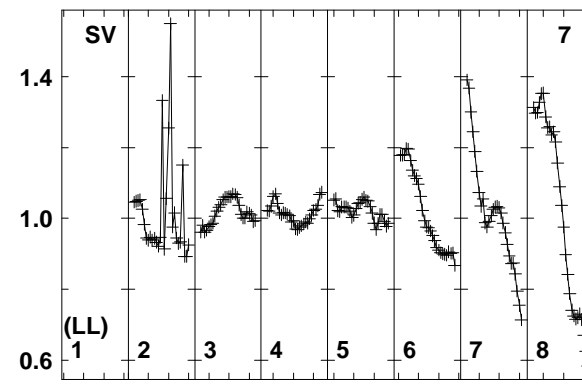
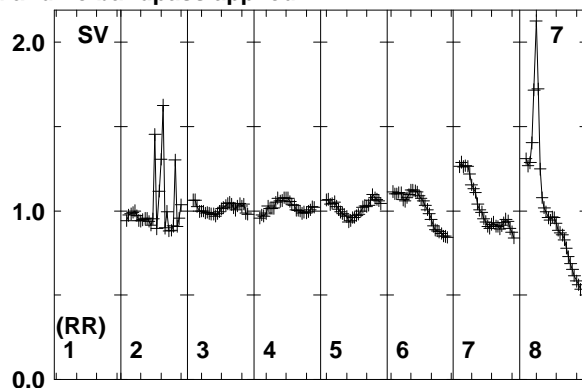
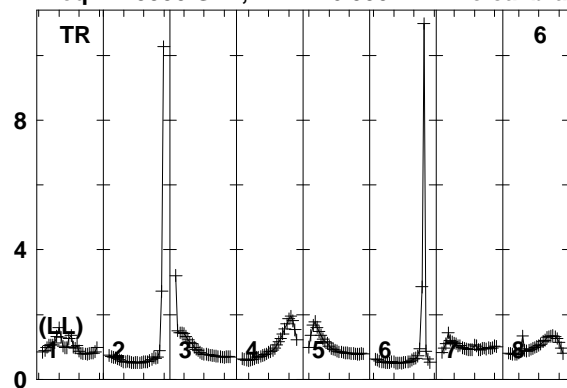

Lower frame: Real Jy
Total-power spectrum Antenna: TR (06)
Timerange: 00/02:44:01 to 00/02:45:49

Plot file version 9 created 11-AUG-2014 17:05:29

J2032+4127 EM110 2.UVDATA.1

Freq = 1.5950 GHz, Bw = 16.000 MH No calibration applied and no bandpass applied

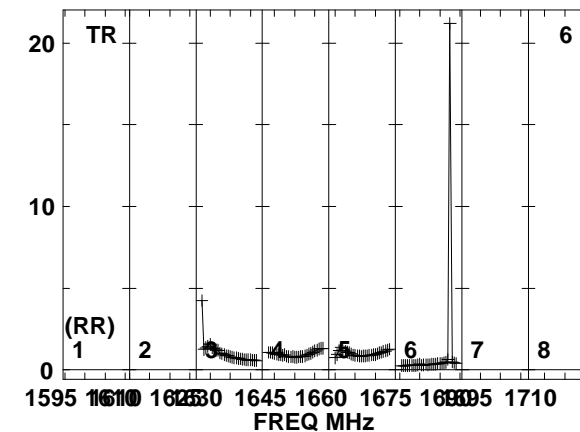
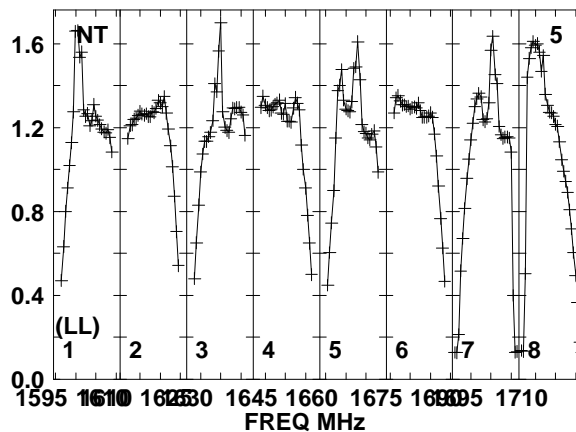
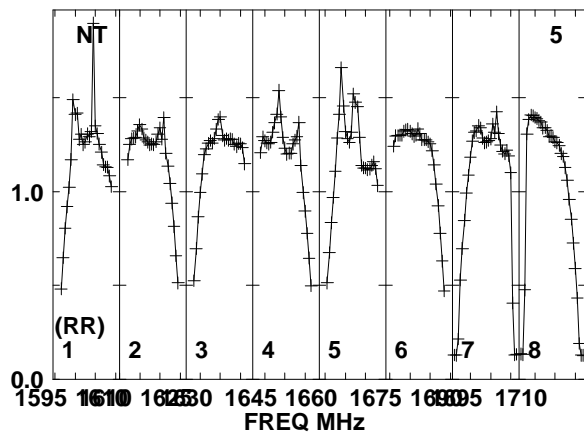
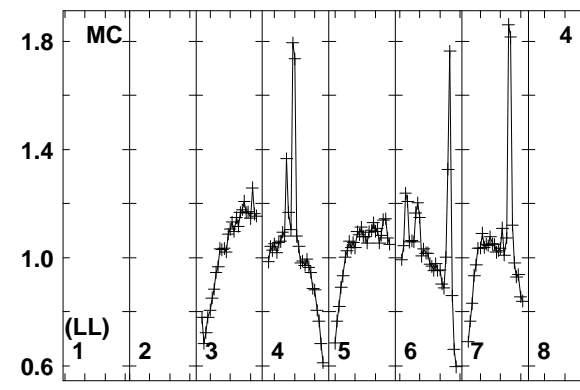
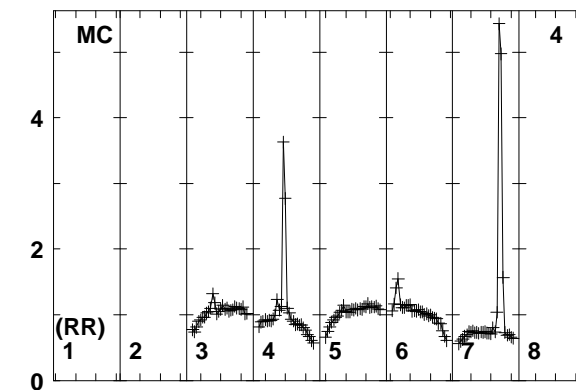
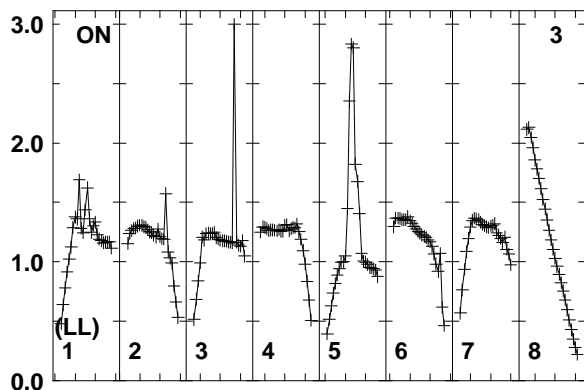
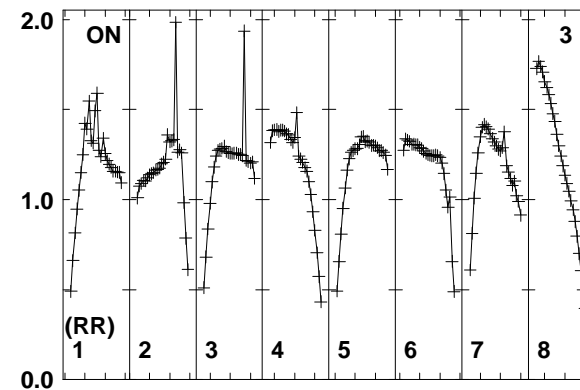
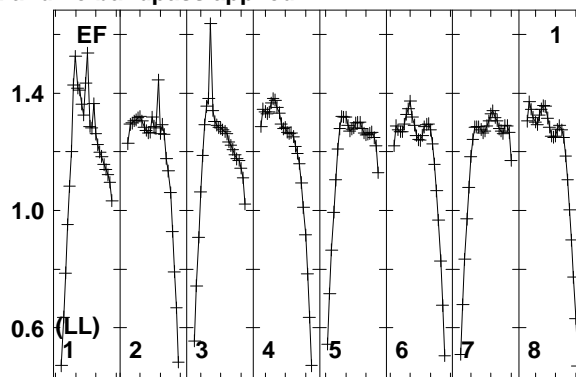
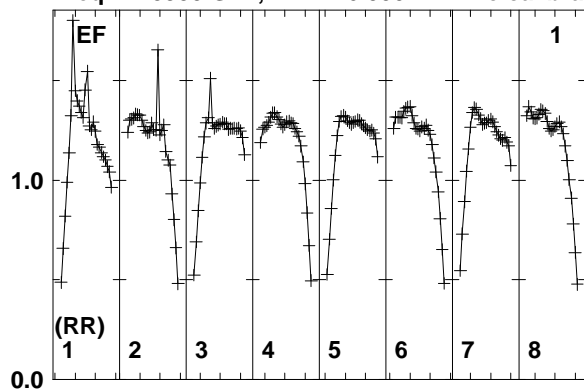

Lower frame: Real Jy
Total-power spectrum Antenna: EF (01)
Timerange: 00/02:46:01 to 00/02:49:49

Plot file version 10 created 11-AUG-2014 17:05:29

J2032+4127 EM110 2.UVDATA.1

Freq = 1.5950 GHz, Bw = 16.000 MH No calibration applied and no bandpass applied

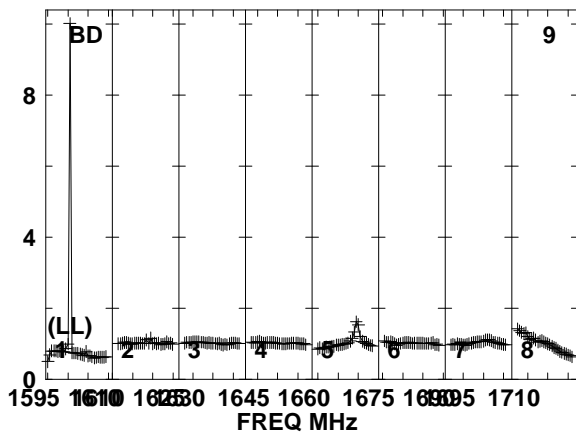
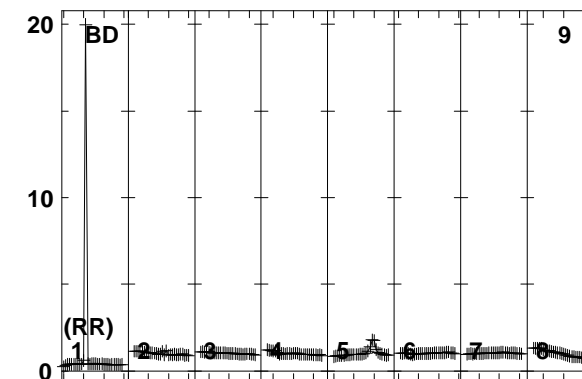
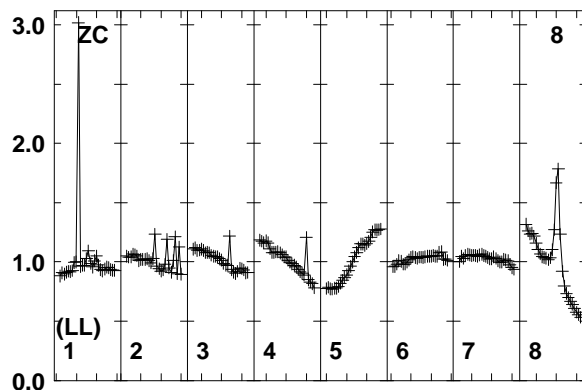
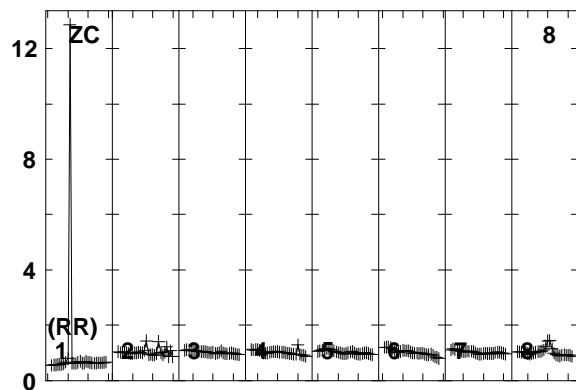
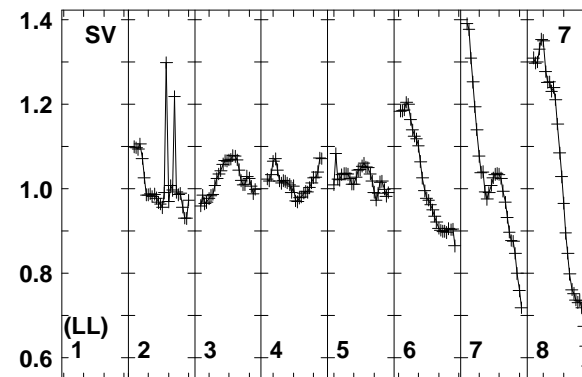
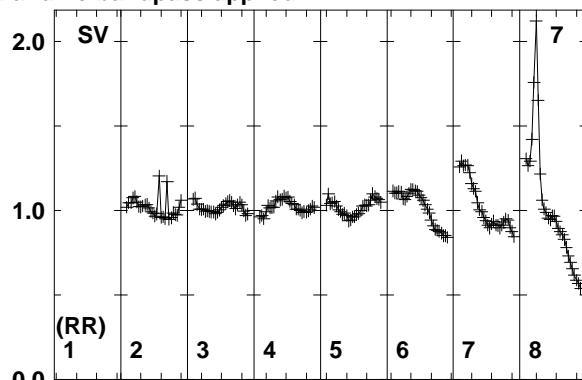
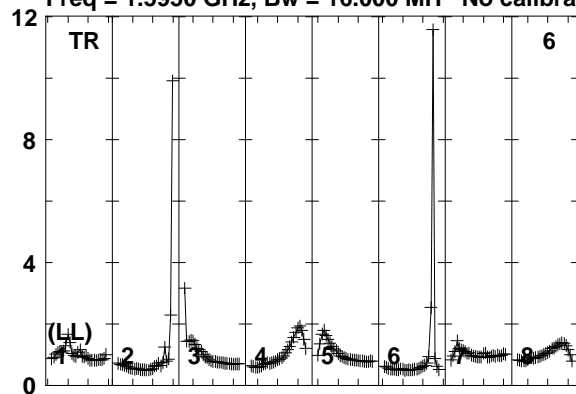

1595 1610 1625 1640 1655 1670 1685 1700 1710
FREQ MHz

Lower frame: Real Jy
Total-power spectrum Antenna: TR (06)
Timerange: 00/02:46:01 to 00/02:49:49

Plot file version 11 created 11-AUG-2014 17:05:29

J2015+3710 EM110 2.UVDATA.1

Freq = 1.5950 GHz, Bw = 16.000 MH No calibration applied and no bandpass applied

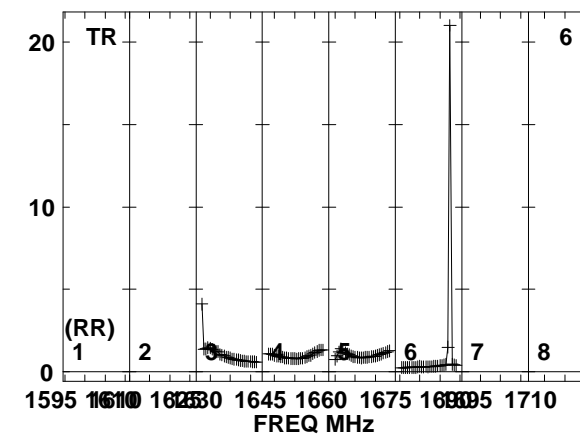
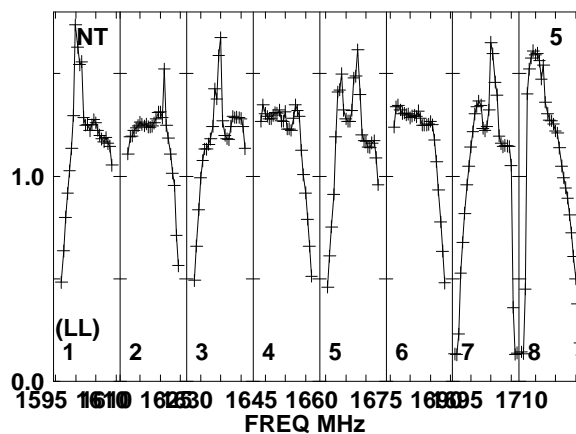
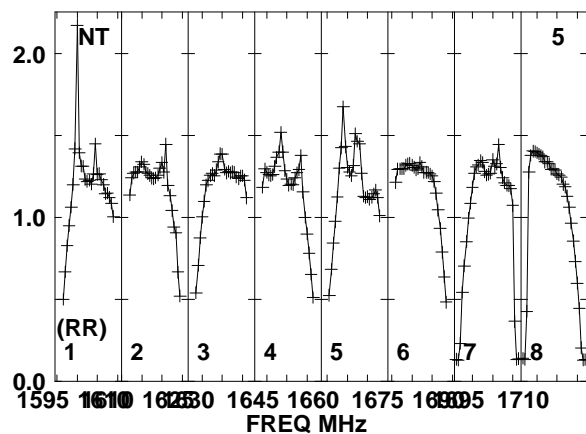
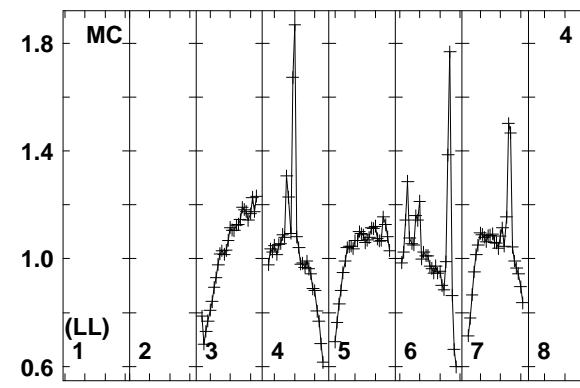
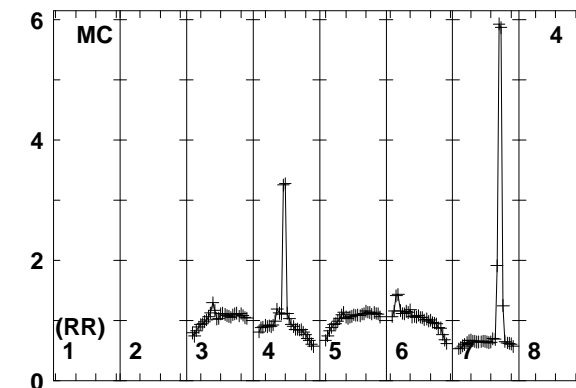
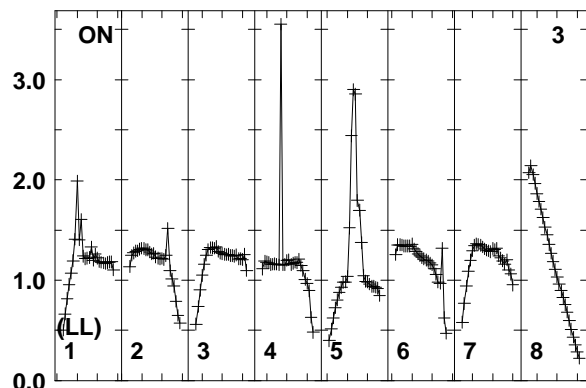
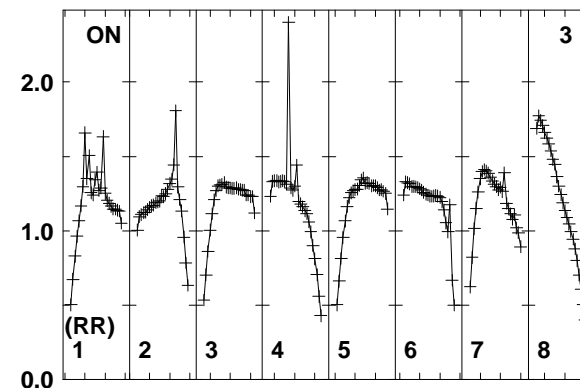
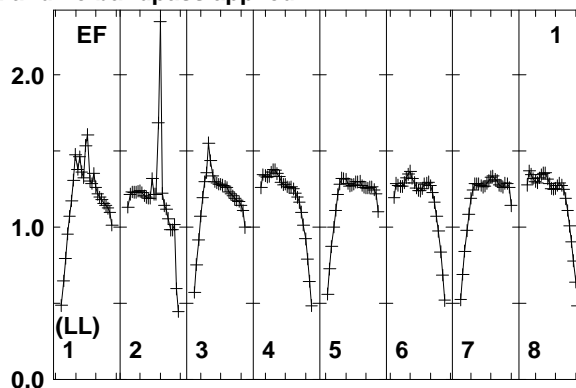
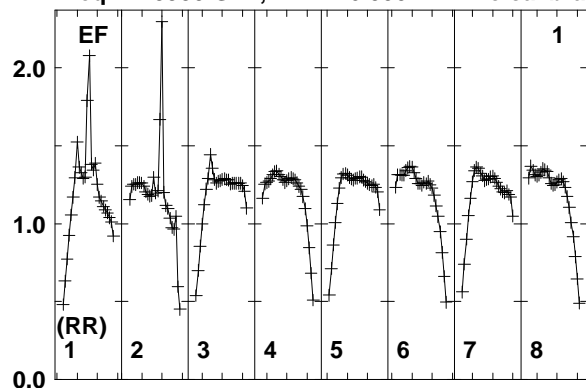

Lower frame: Real Jy
Total-power spectrum Antenna: EF (01)
Timerange: 00/02:50:51 to 00/02:52:49

Plot file version 12 created 11-AUG-2014 17:05:29

J2015+3710 EM110 2.UVDATA.1

Freq = 1.5950 GHz, Bw = 16.000 MH No calibration applied and no bandpass applied

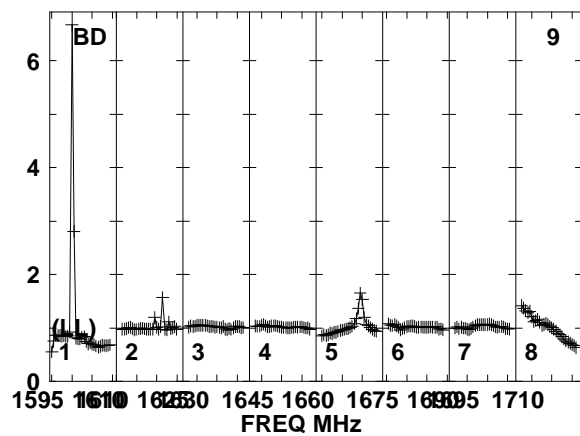
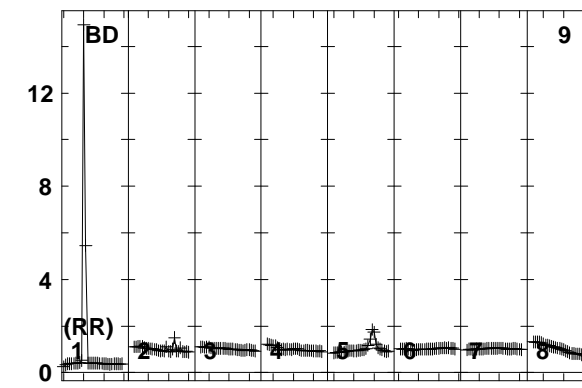
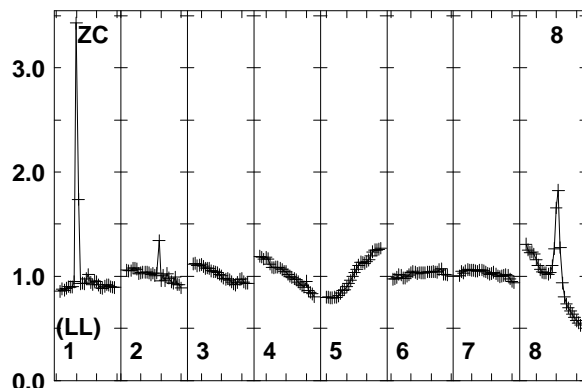
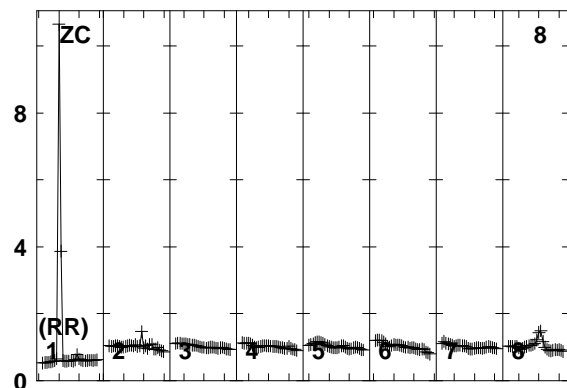
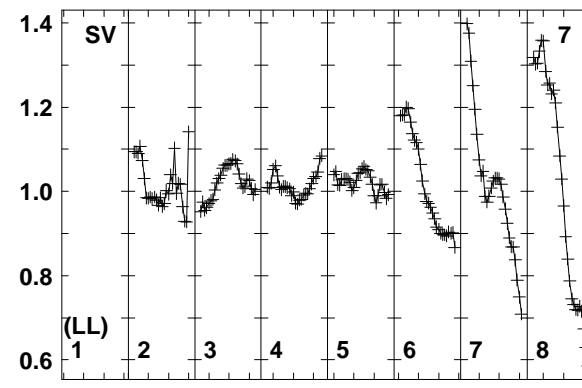
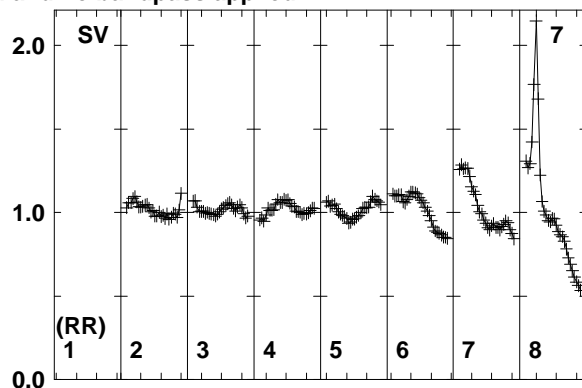
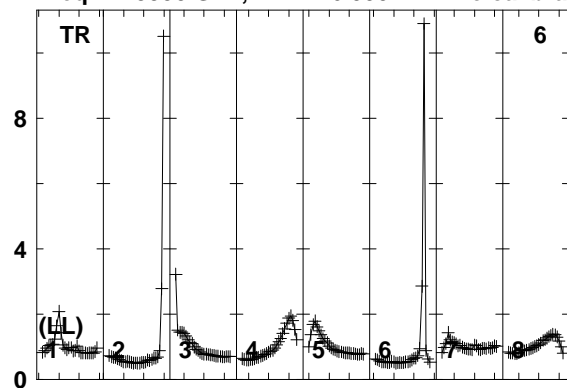

1595 1610 1625 1640 1655 1670 1685 1700 1710
FREQ MHz

Lower frame: Real Jy
Total-power spectrum Antenna: TR (06)
Timerange: 00/02:50:51 to 00/02:52:49

Plot file version 13 created 11-AUG-2014 17:05:29

J2032+4127 EM110 2.UVDATA.1

Freq = 1.5950 GHz, Bw = 16.000 MH No calibration applied and no bandpass applied

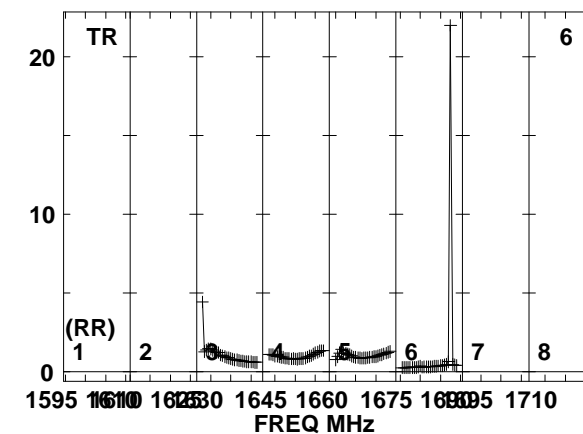
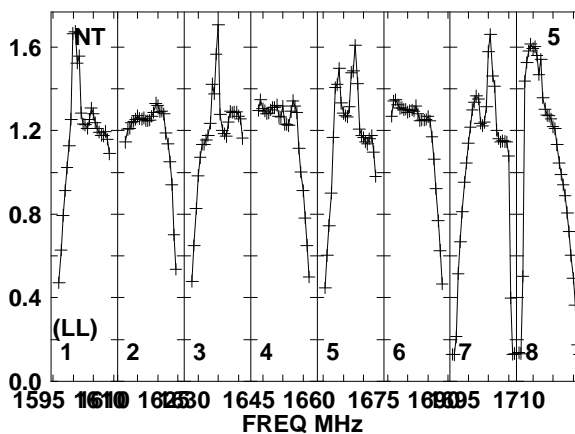
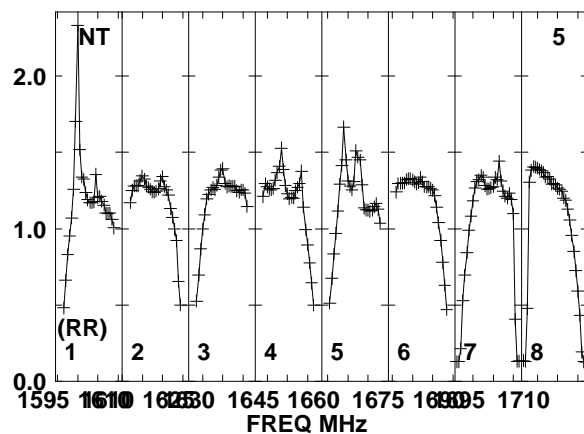
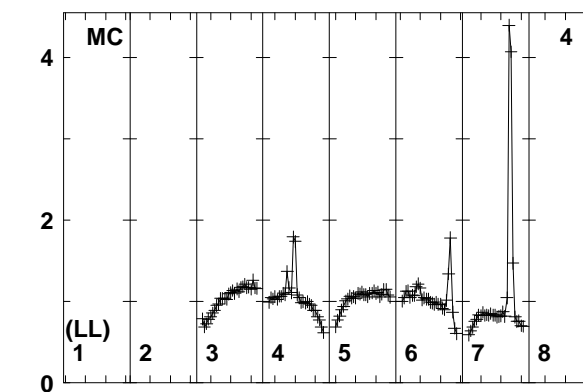
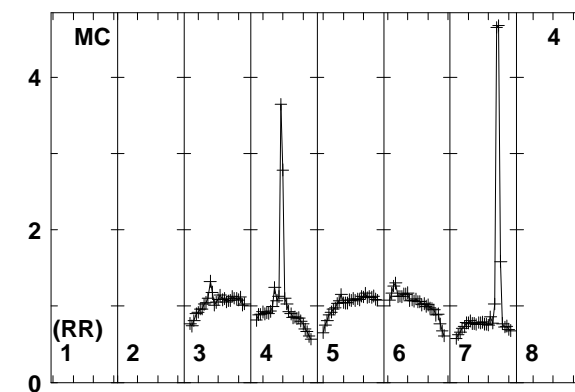
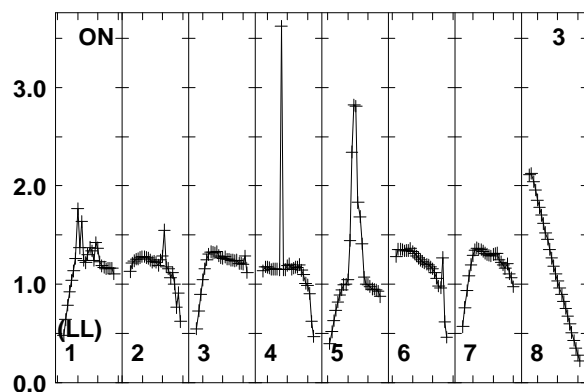
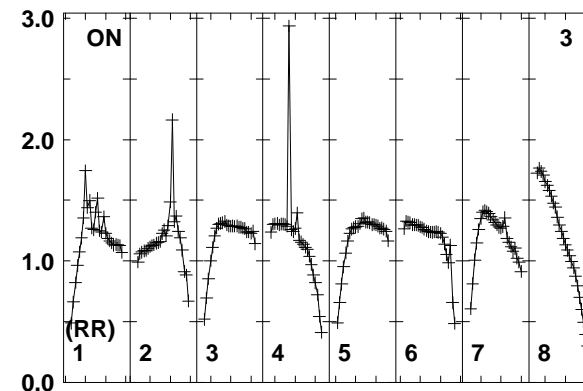
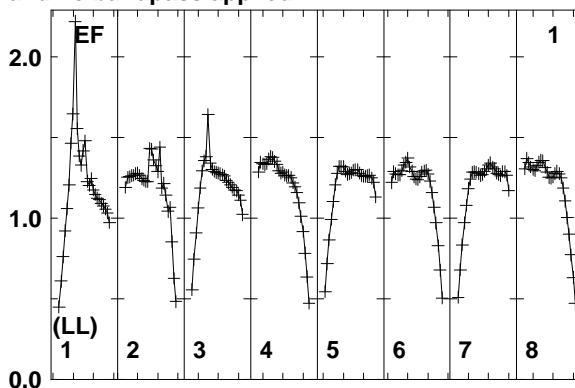
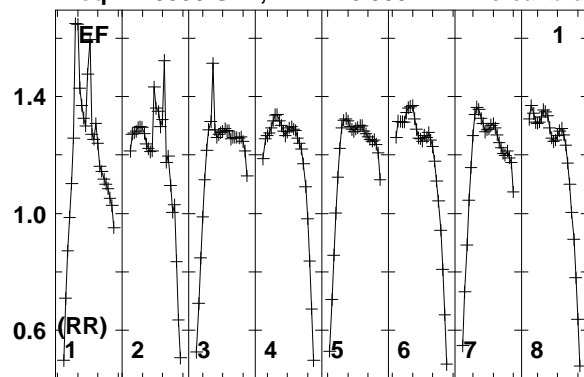

Lower frame: Real Jy
Total-power spectrum Antenna: EF (01)
Timerange: 00/02:53:01 to 00/02:56:49

Plot file version 14 created 11-AUG-2014 17:05:29

J2032+4127 EM110 2.UVDATA.1

Freq = 1.5950 GHz, Bw = 16.000 MH No calibration applied and no bandpass applied

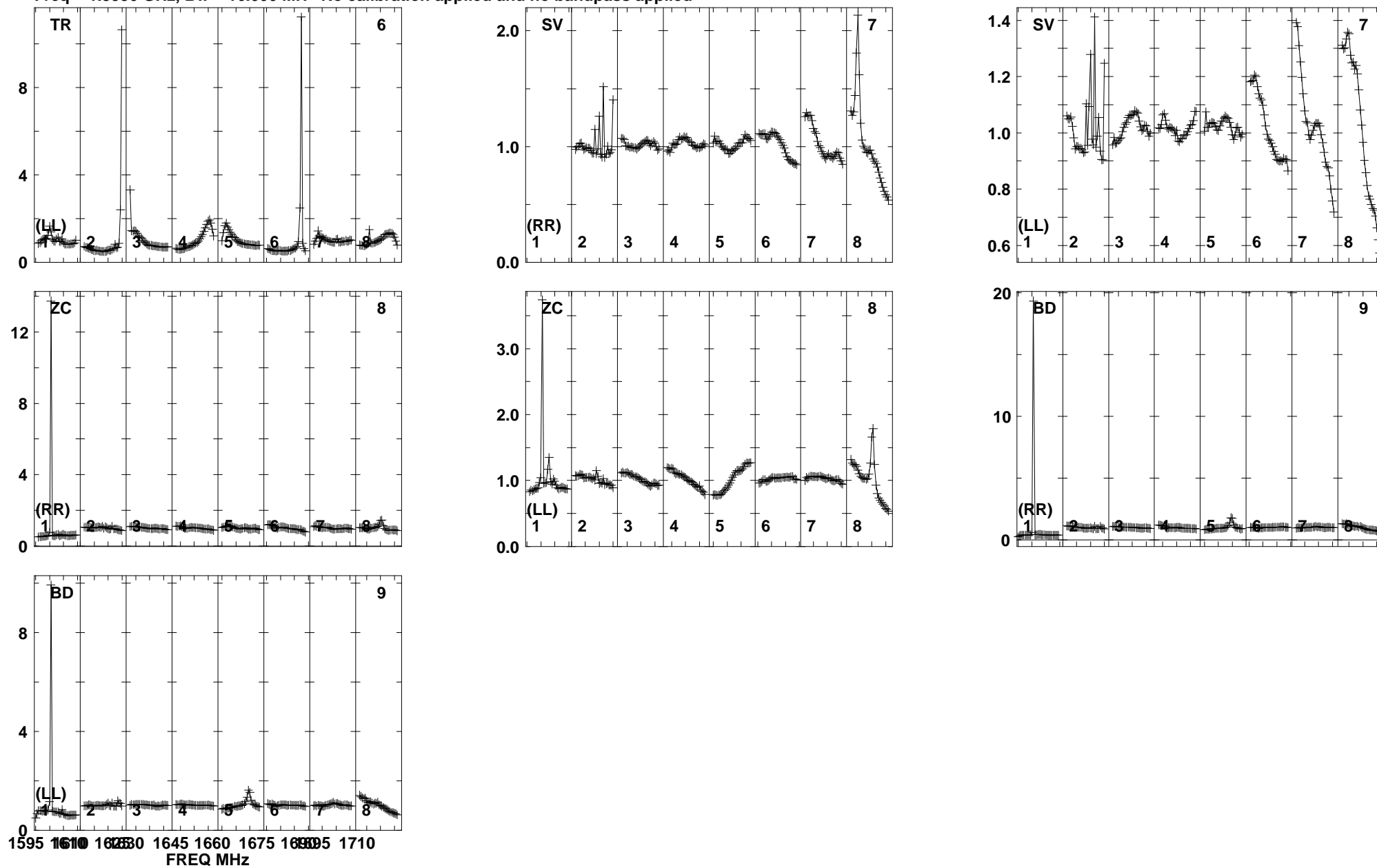

Lower frame: Real Jy
Total-power spectrum Antenna: TR (06)
Timerange: 00/02:53:01 to 00/02:56:49

Plot file version 15 created 11-AUG-2014 17:05:29

J2015+3710 EM110 2.UVDATA.1

Freq = 1.5950 GHz, Bw = 16.000 MH No calibration applied and no bandpass applied

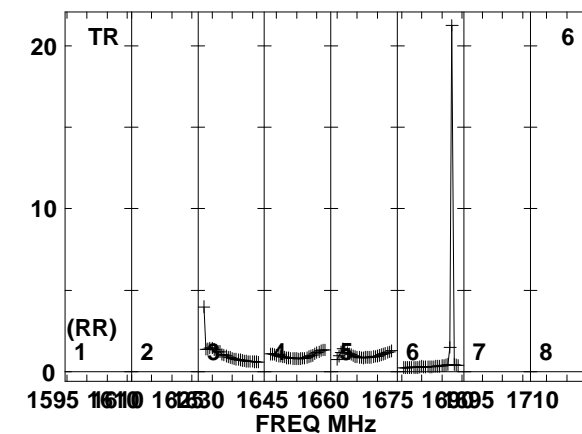
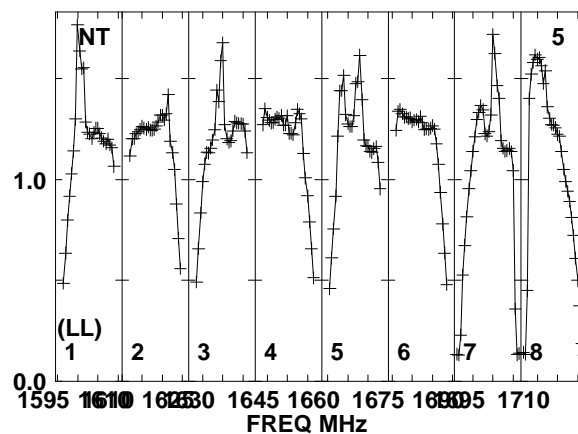
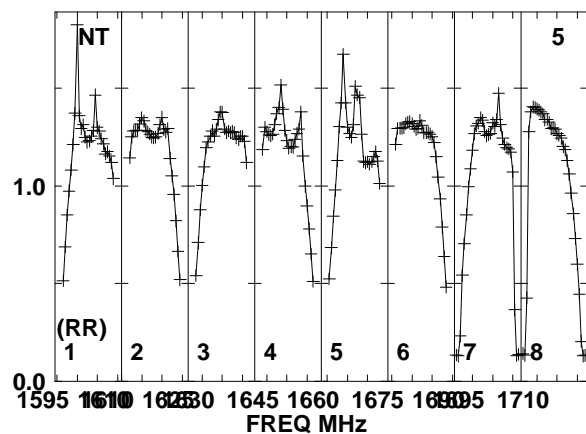
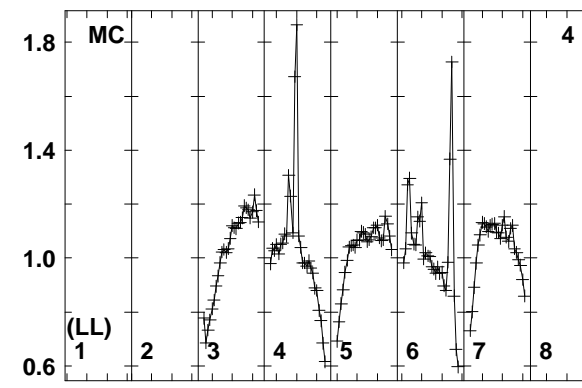
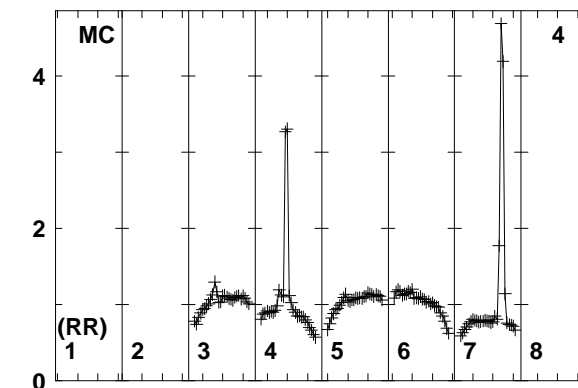
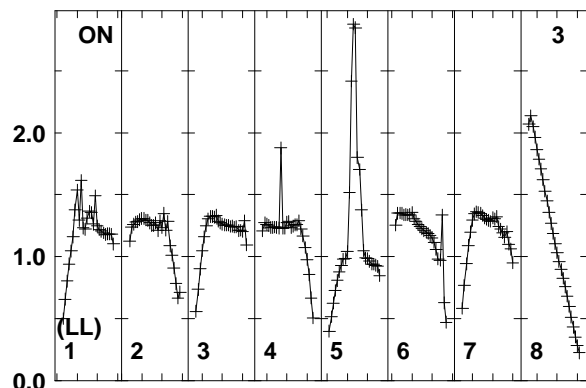
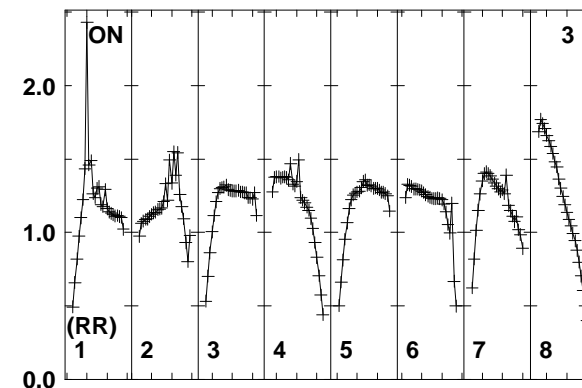
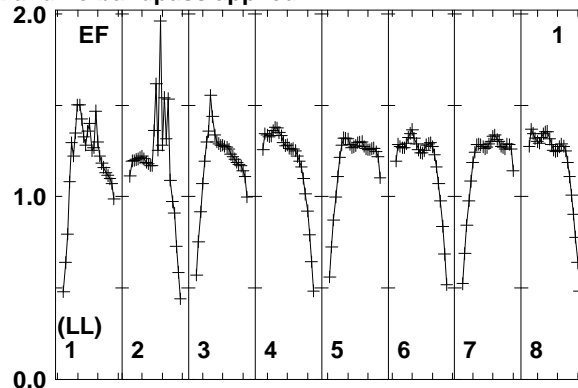
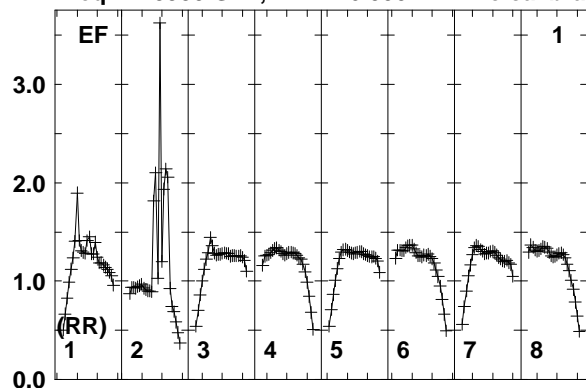

Lower frame: Real Jy
Total-power spectrum Antenna: EF (01)
Timerange: 00/02:57:01 to 00/02:58:49

Plot file version 16 created 11-AUG-2014 17:05:29

J2015+3710 EM110 2.UVDATA.1

Freq = 1.5950 GHz, Bw = 16.000 MH No calibration applied and no bandpass applied

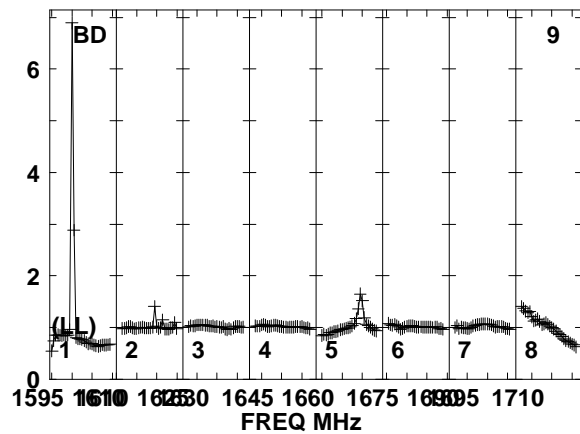
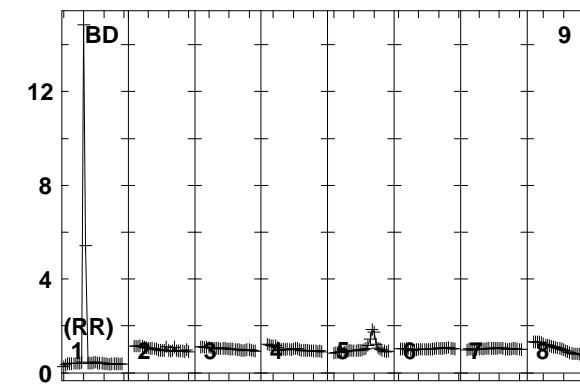
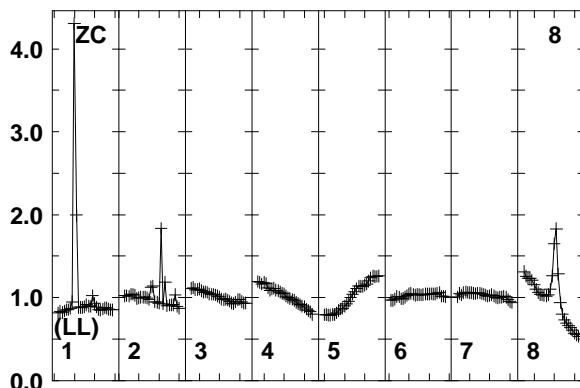
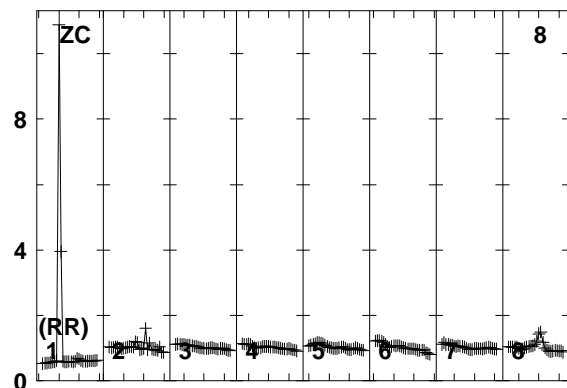
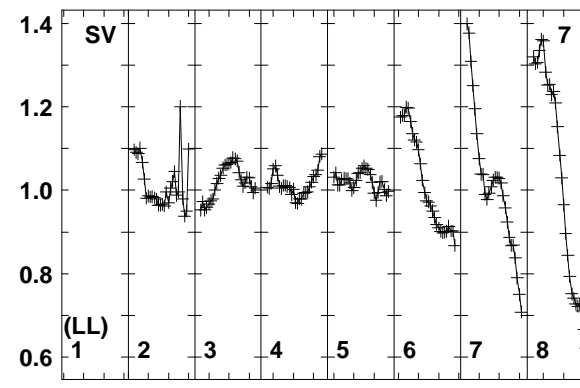
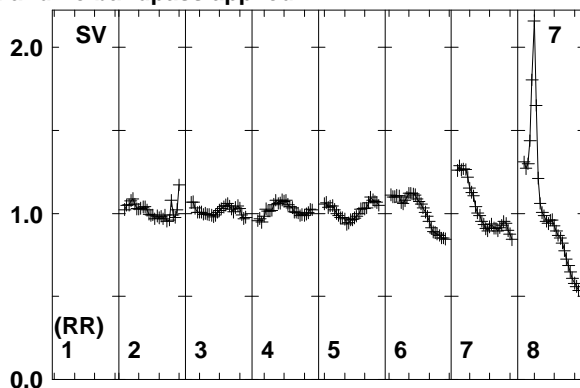
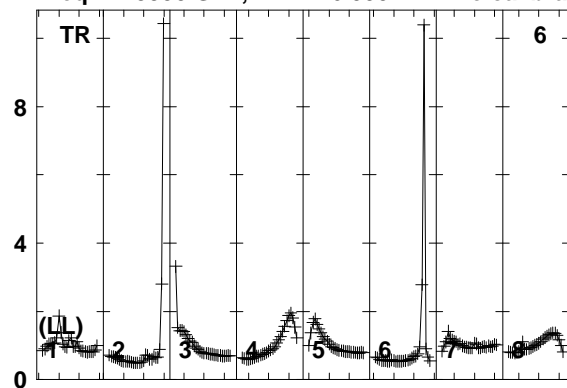

Lower frame: Real Jy
Total-power spectrum Antenna: TR (06)
Timerange: 00/02:57:01 to 00/02:58:49

Plot file version 17 created 11-AUG-2014 17:05:29

J2032+4127 EM110 2.UVDATA.1

Freq = 1.5950 GHz, Bw = 16.000 MH No calibration applied and no bandpass applied

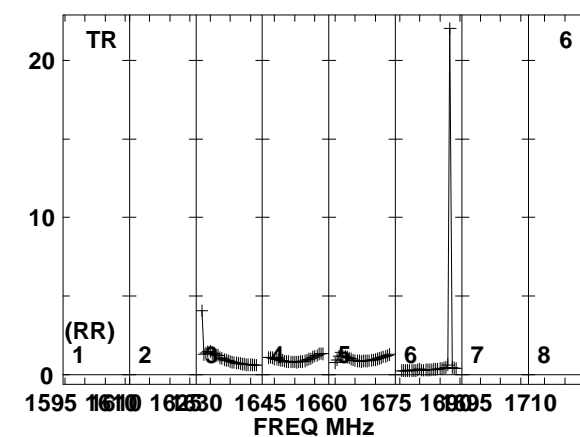
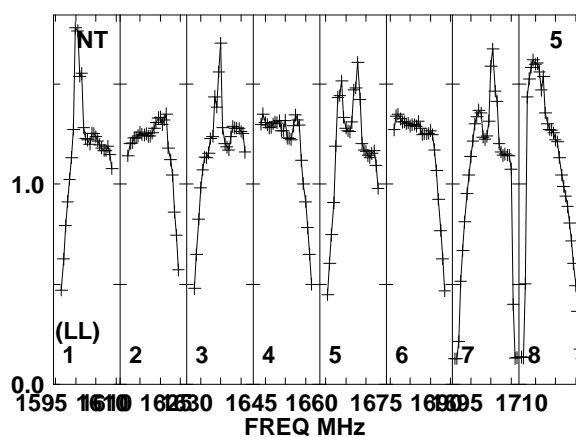
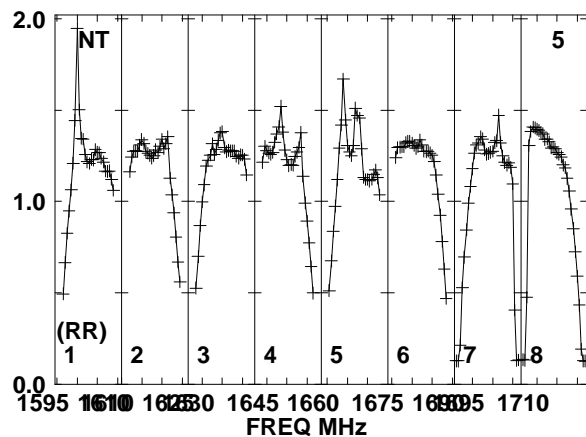
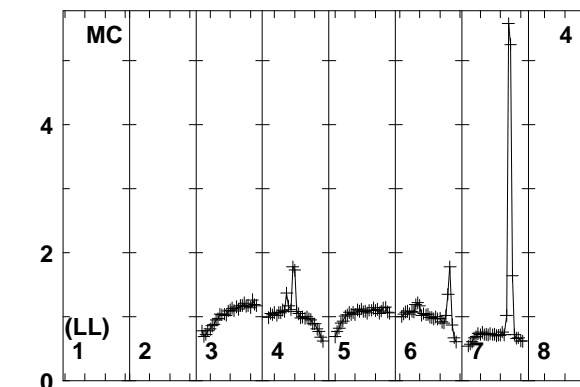
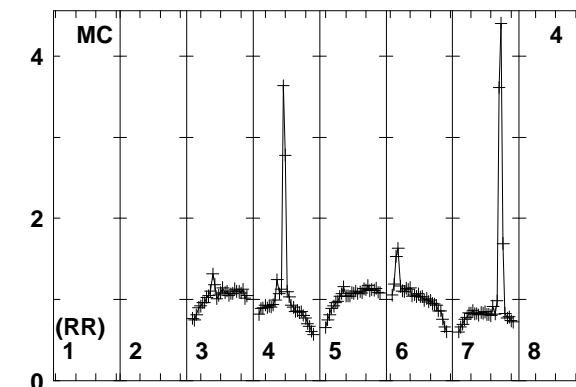
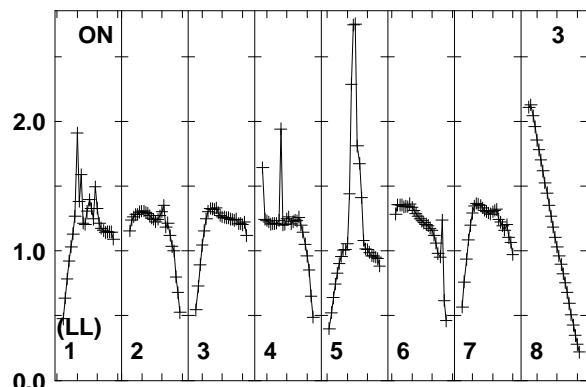
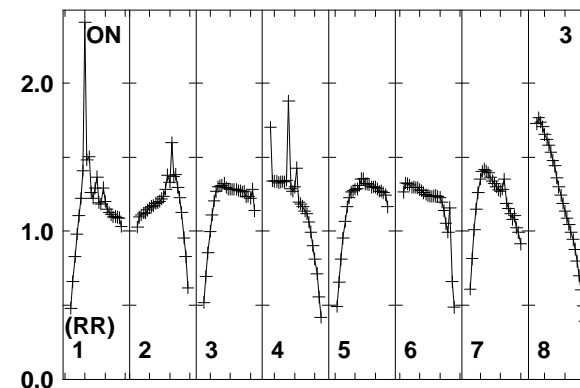
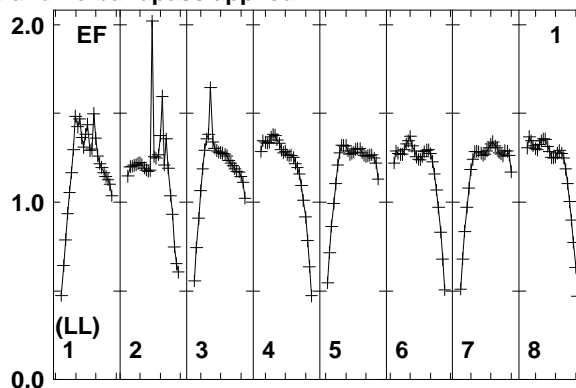
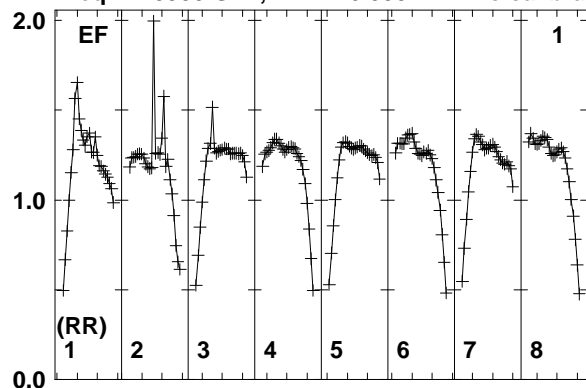

Lower frame: Real Jy
Total-power spectrum Antenna: EF (01)
Timerange: 00/02:59:01 to 00/03:02:49

Plot file version 18 created 11-AUG-2014 17:05:29

J2032+4127 EM110 2.UVDATA.1

Freq = 1.5950 GHz, Bw = 16.000 MH No calibration applied and no bandpass applied

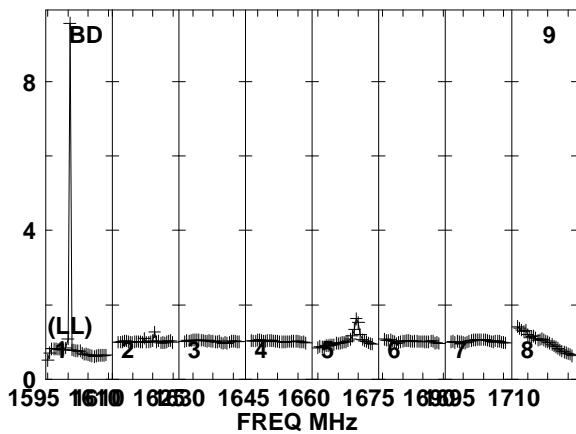
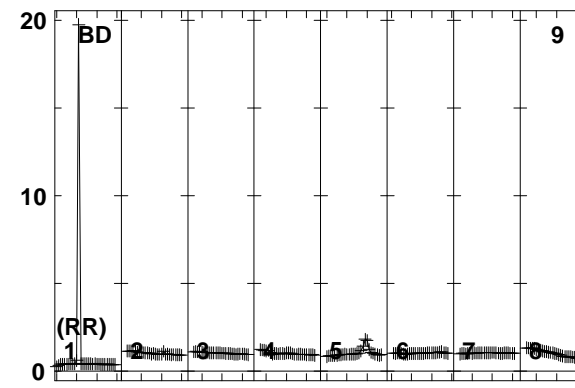
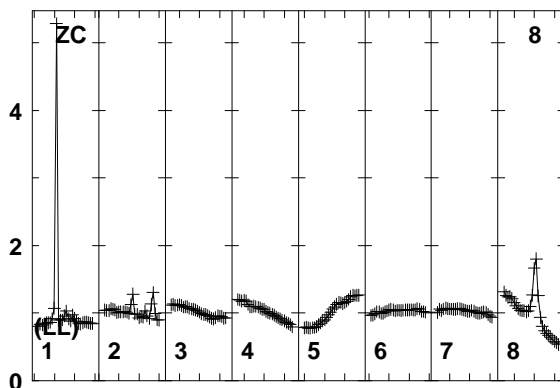
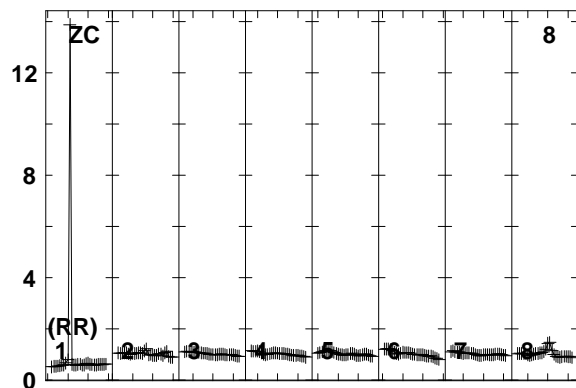
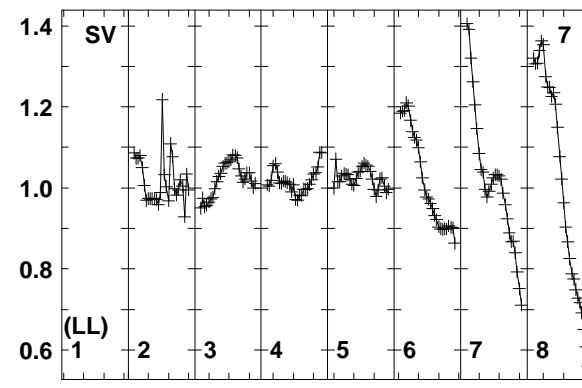
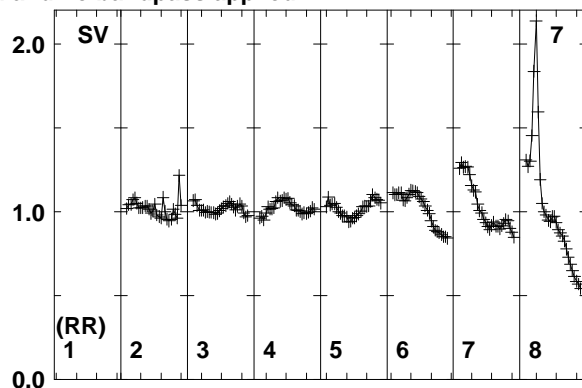
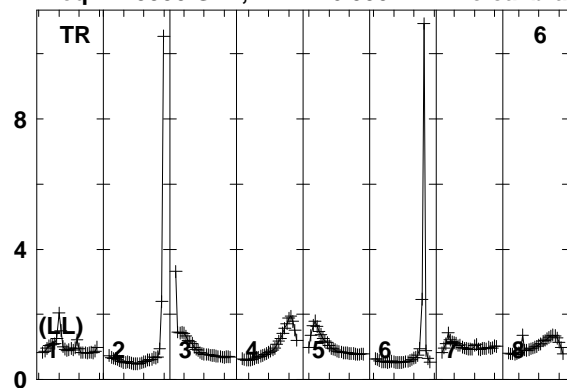

Lower frame: Real Jy
Total-power spectrum Antenna: TR (06)
Timerange: 00/02:59:01 to 00/03:02:49

Plot file version 19 created 11-AUG-2014 17:05:29

J2015+3710 EM110 2.UVDATA.1

Freq = 1.5950 GHz, Bw = 16.000 MH No calibration applied and no bandpass applied

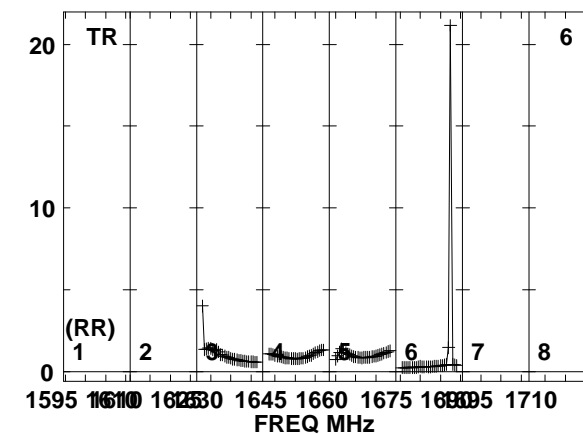
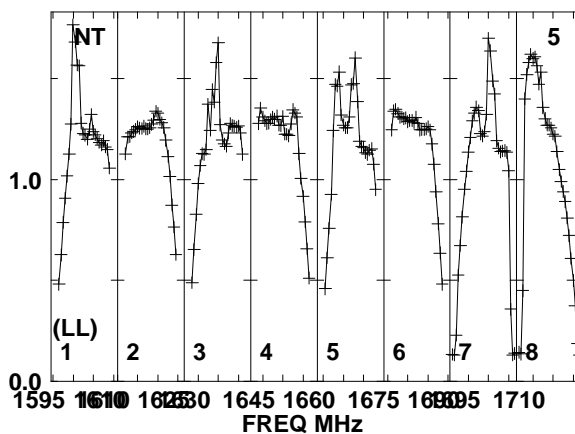
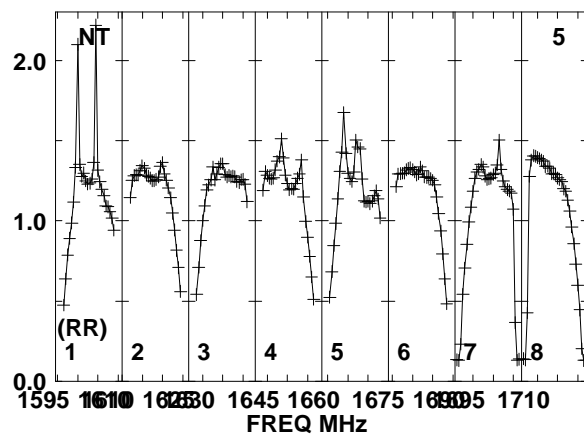
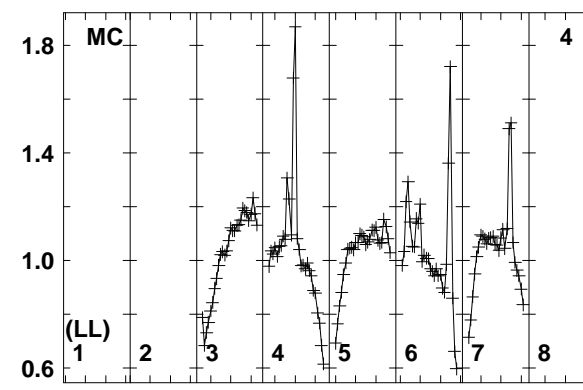
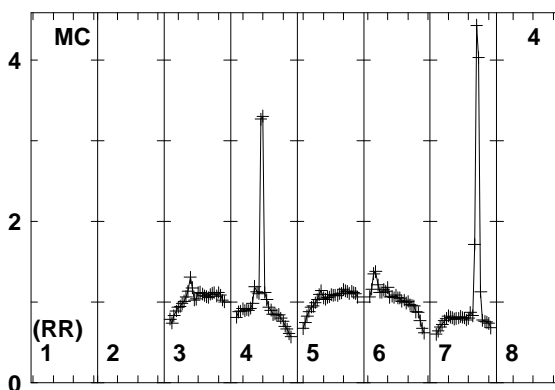
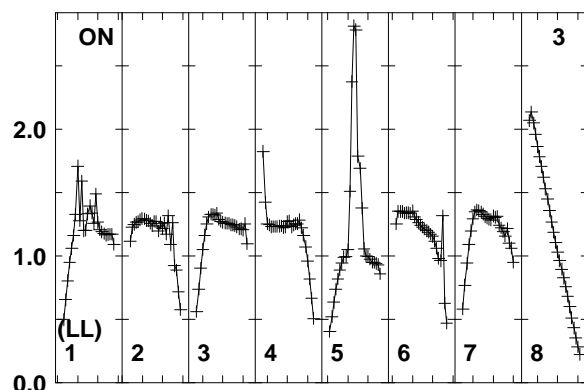
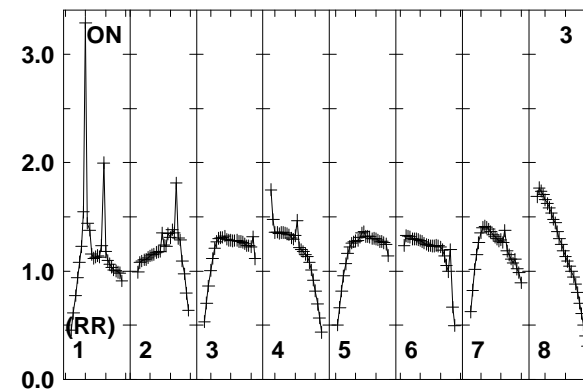
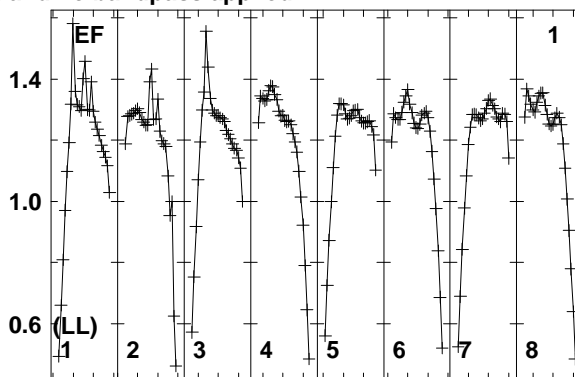
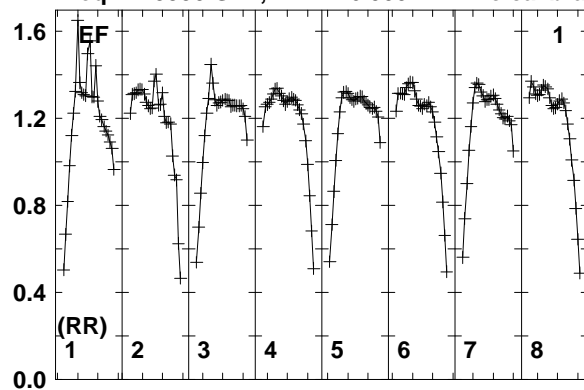

Lower frame: Real Jy
Total-power spectrum Antenna: EF (01)
Timerange: 00/03:03:51 to 00/03:05:49

Plot file version 20 created 11-AUG-2014 17:05:29

J2015+3710 EM110 2.UVDATA.1

Freq = 1.5950 GHz, Bw = 16.000 MH No calibration applied and no bandpass applied

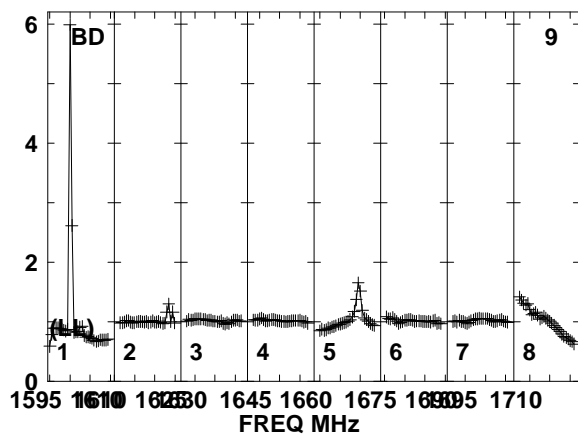
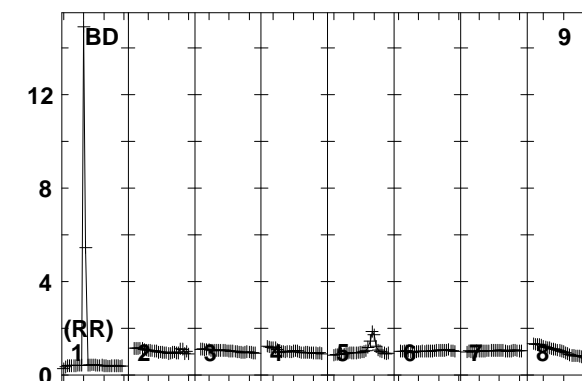
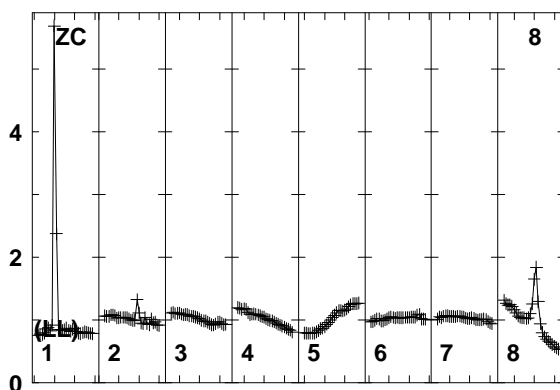
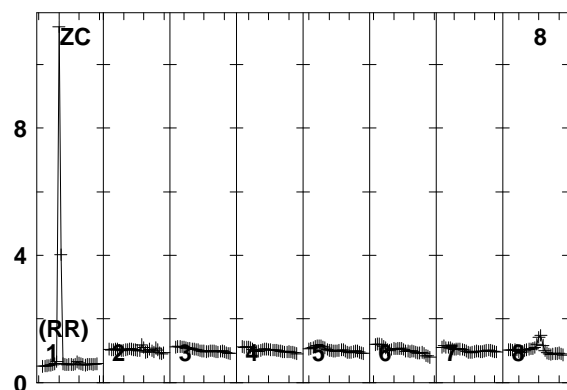
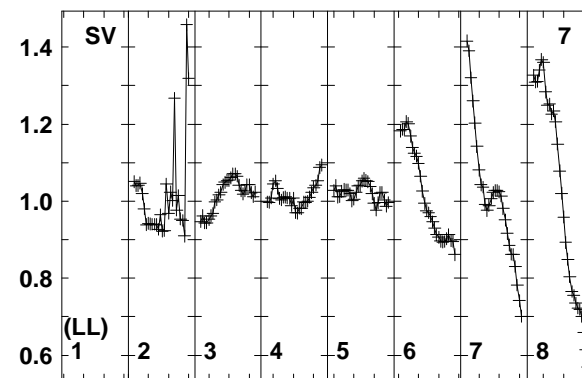
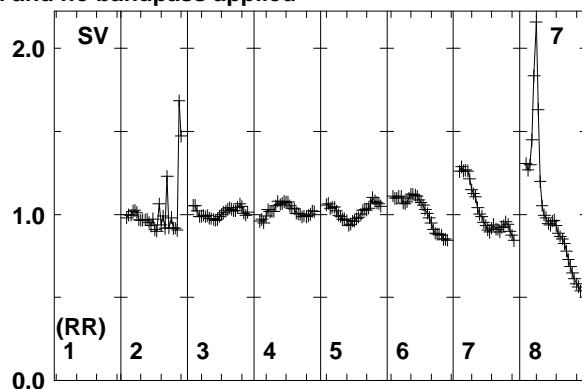
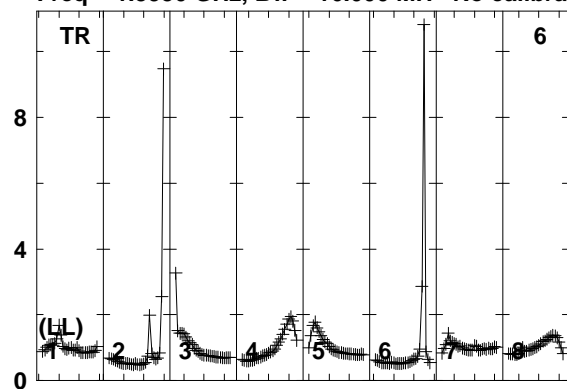

Lower frame: Real Jy
Total-power spectrum Antenna: TR (06)
Timerange: 00/03:03:51 to 00/03:05:49

Plot file version 21 created 11-AUG-2014 17:05:29

J2032+4127 EM110 2.UVDATA.1

Freq = 1.5950 GHz, Bw = 16.000 MH No calibration applied and no bandpass applied

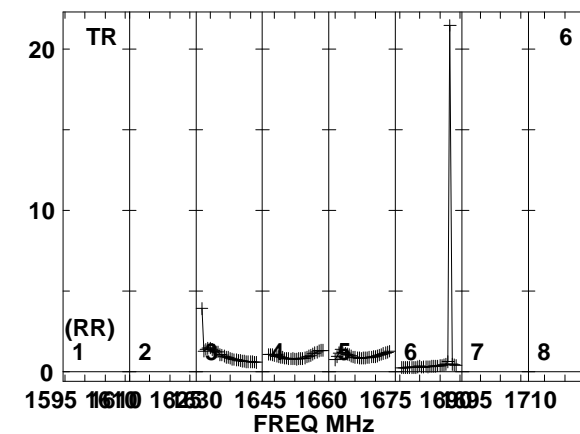
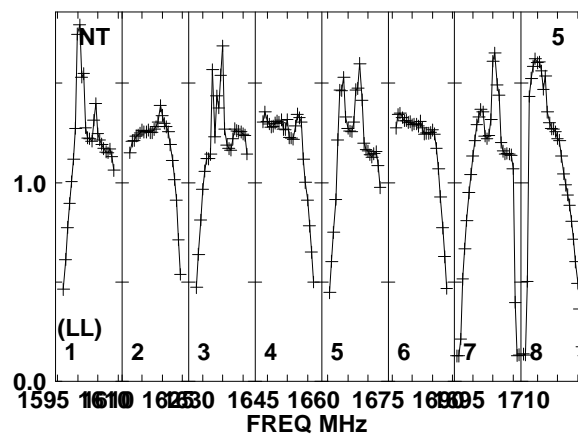
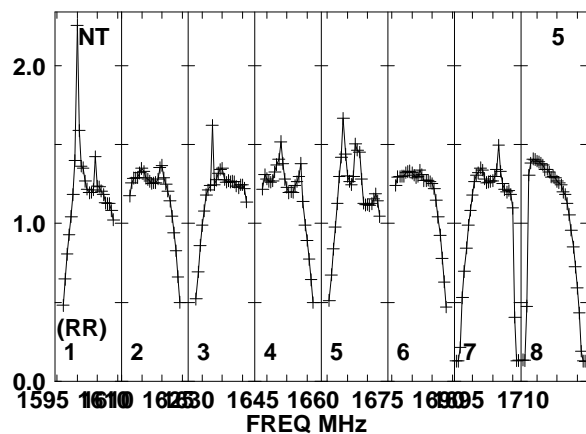
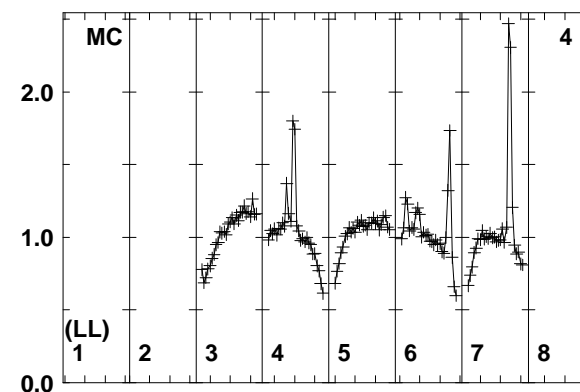
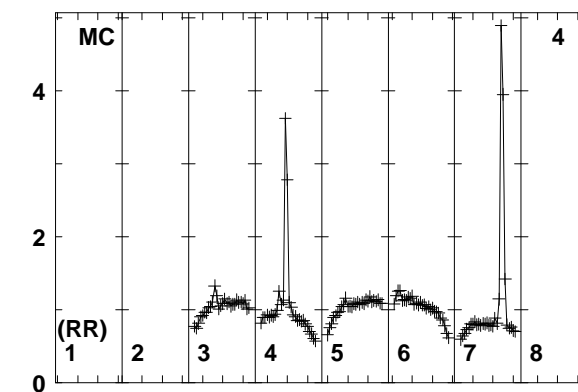
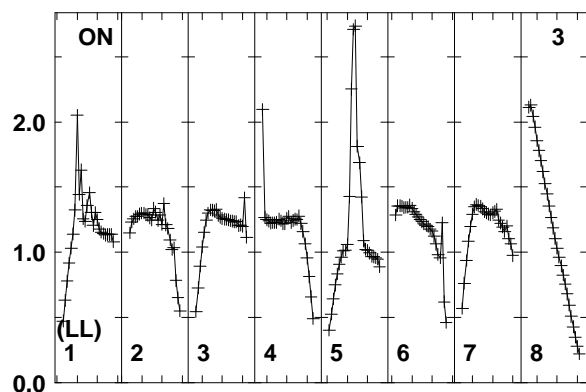
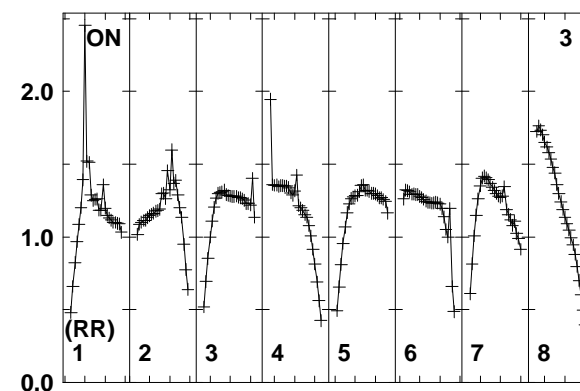
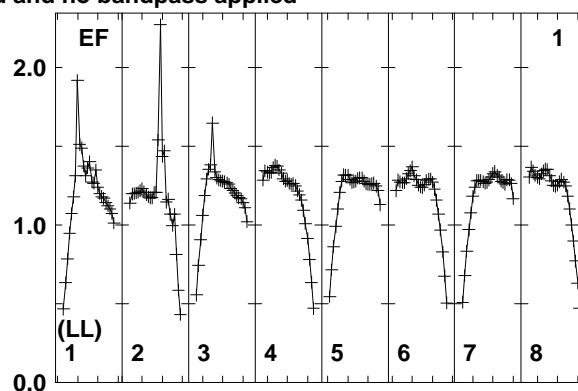
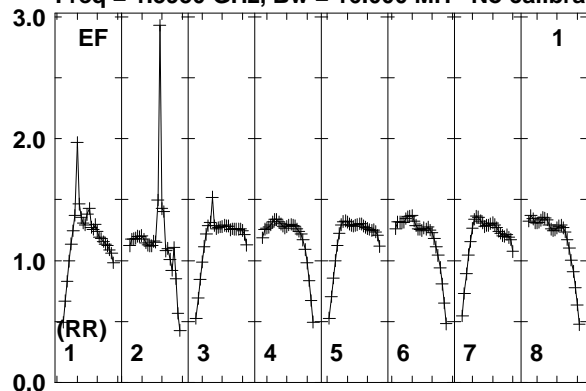

Lower frame: Real Jy
Total-power spectrum Antenna: EF (01)
Timerange: 00/03:06:01 to 00/03:09:49

Plot file version 22 created 11-AUG-2014 17:05:29

J2032+4127 EM110 2.UVDATA.1

Freq = 1.5950 GHz, Bw = 16.000 MH No calibration applied and no bandpass applied

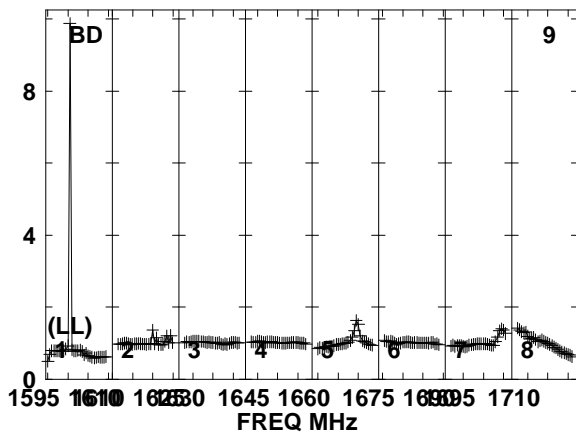
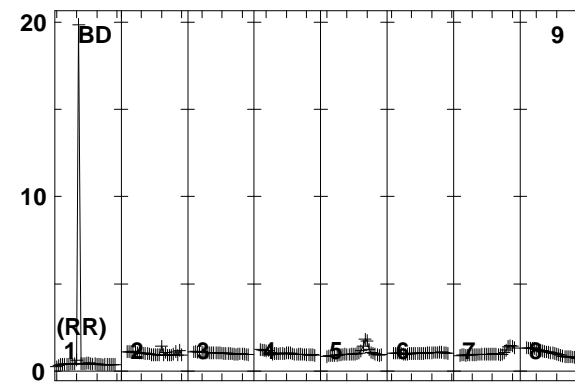
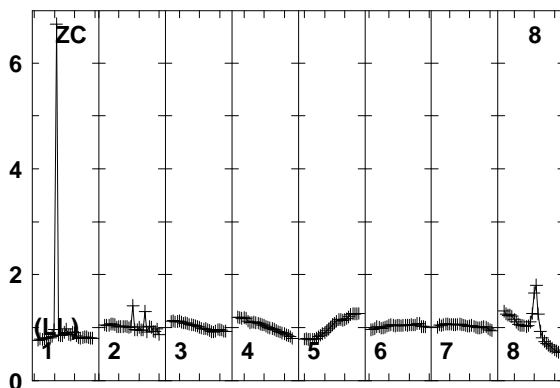
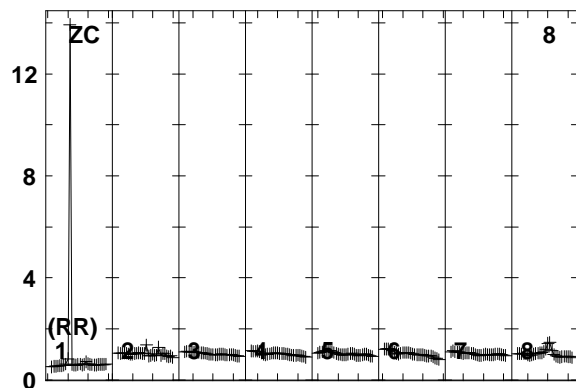
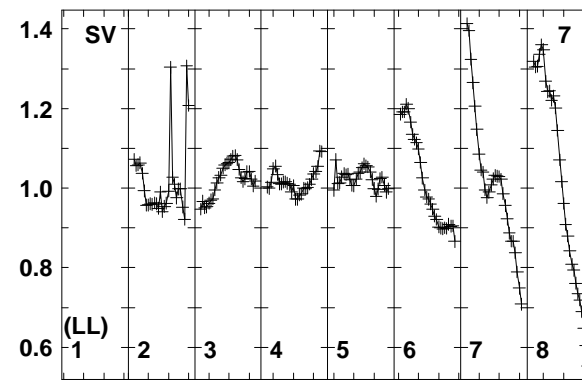
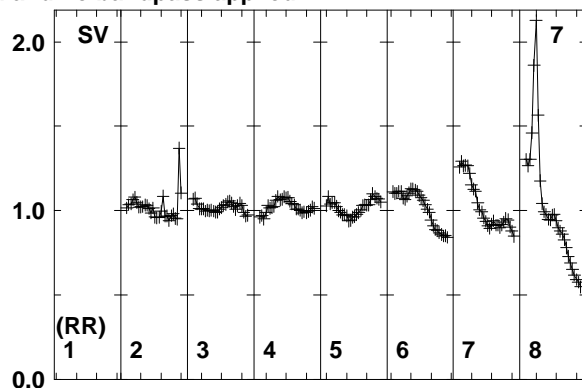
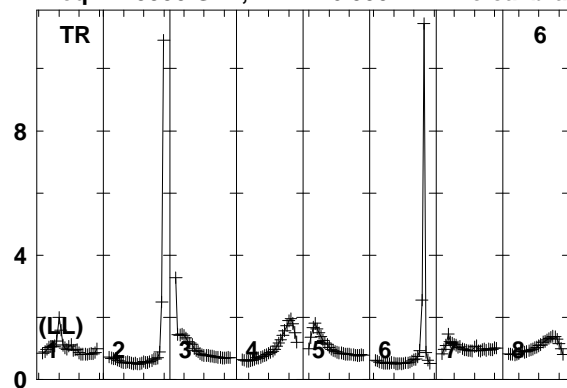

1595 1610 1625 1640 1655 1670 1685 1700 1710
FREQ MHz

Lower frame: Real Jy
Total-power spectrum Antenna: TR (06)
Timerange: 00/03:06:01 to 00/03:09:49

Plot file version 23 created 11-AUG-2014 17:05:29

J2015+3710 EM110 2.UVDATA.1

Freq = 1.5950 GHz, Bw = 16.000 MH No calibration applied and no bandpass applied

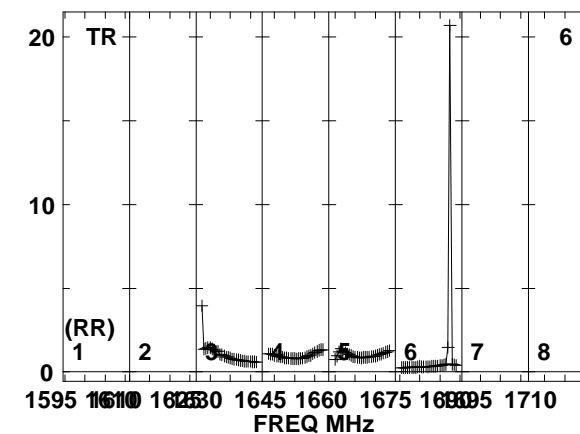
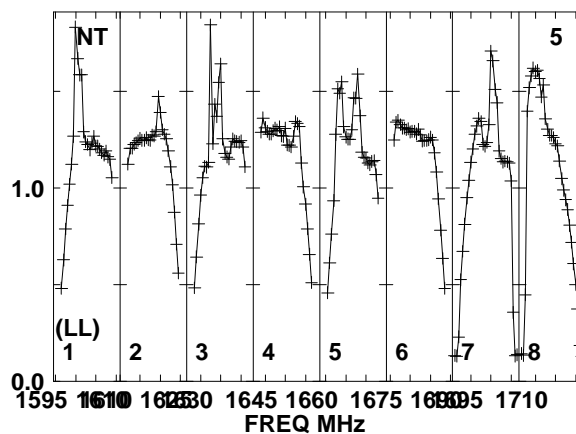
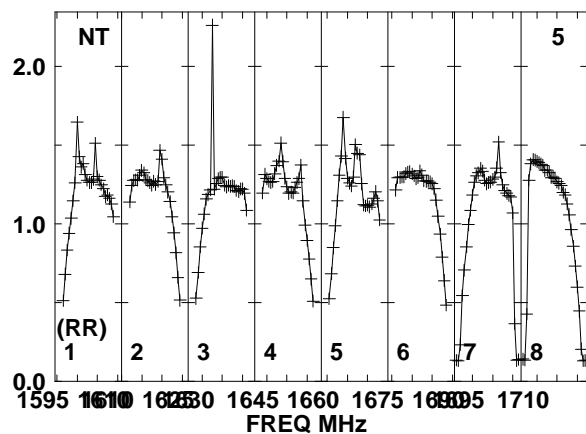
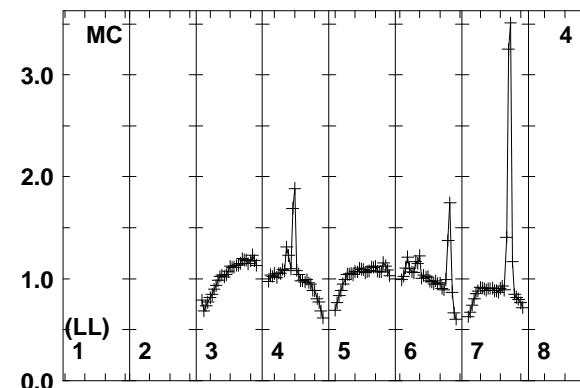
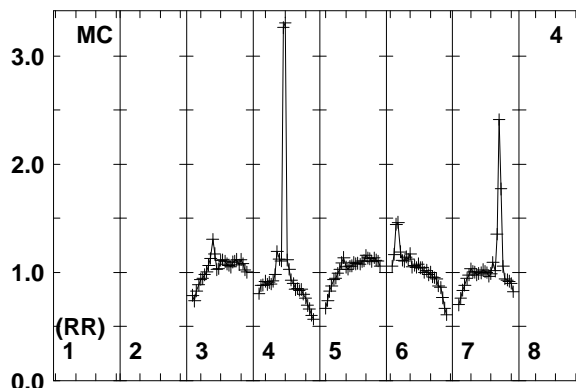
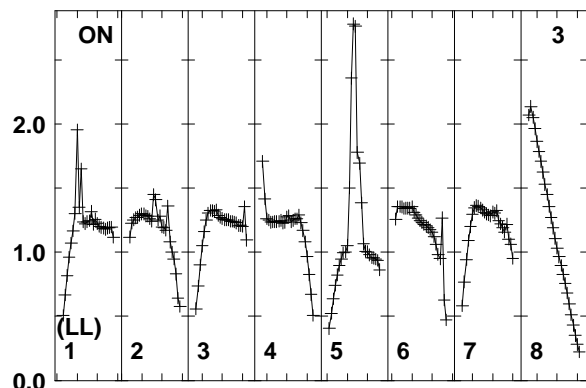
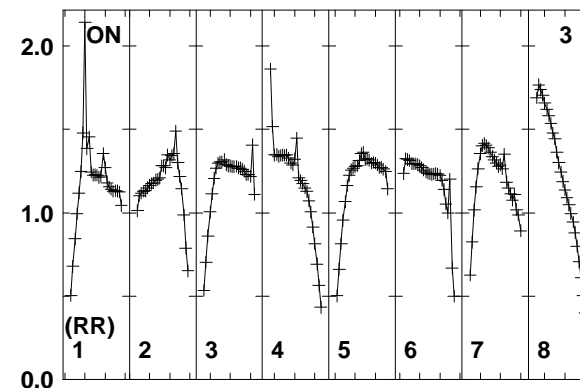
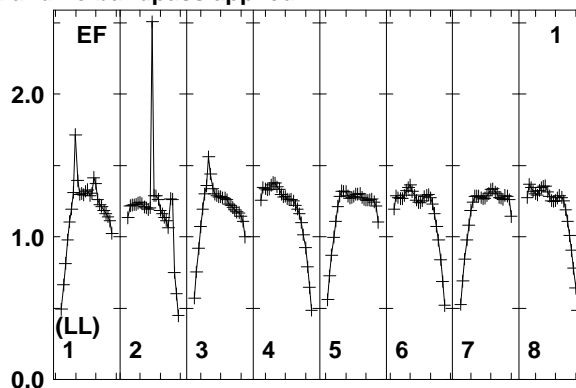
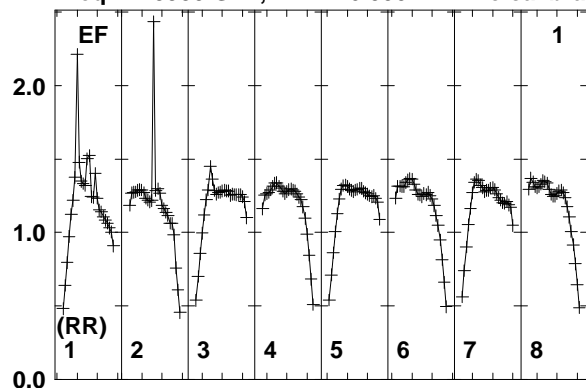

Lower frame: Real Jy
Total-power spectrum Antenna: EF (01)
Timerange: 00/03:10:01 to 00/03:11:49

Plot file version 24 created 11-AUG-2014 17:05:29

J2015+3710 EM110 2.UVDATA.1

Freq = 1.5950 GHz, Bw = 16.000 MH No calibration applied and no bandpass applied

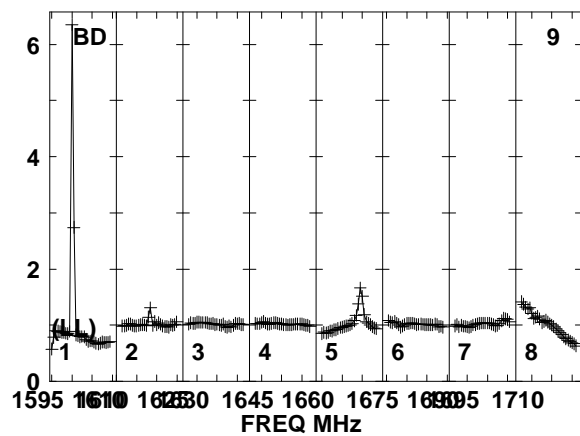
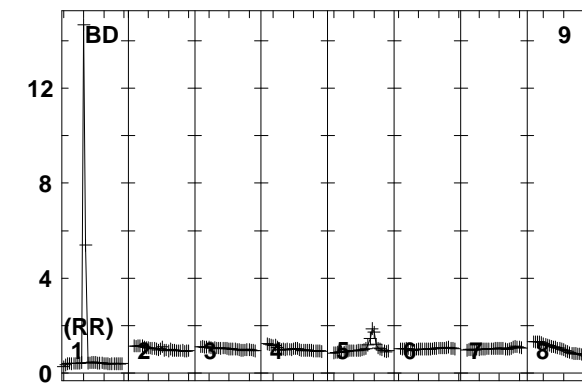
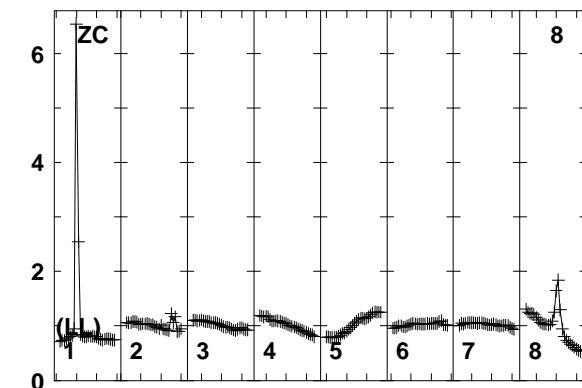
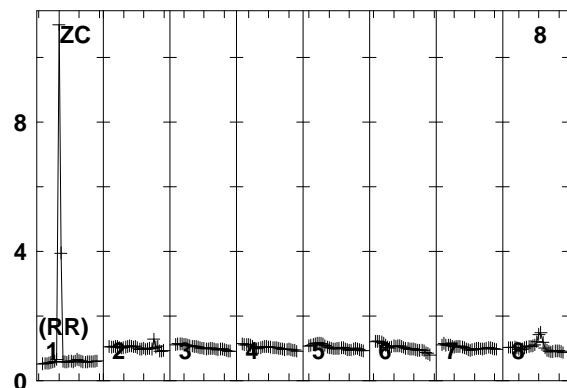
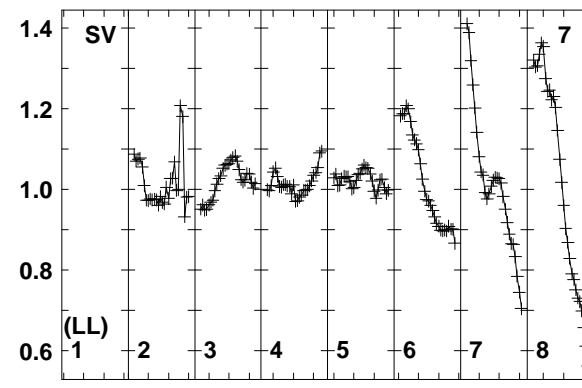
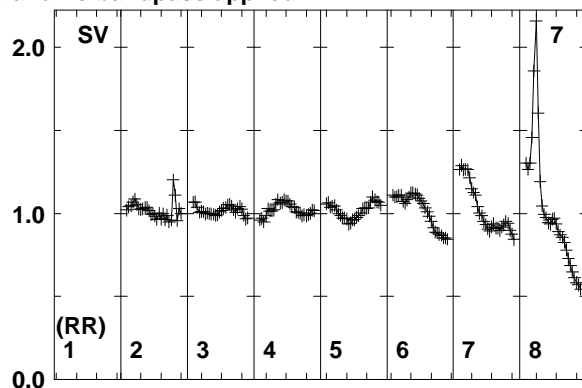
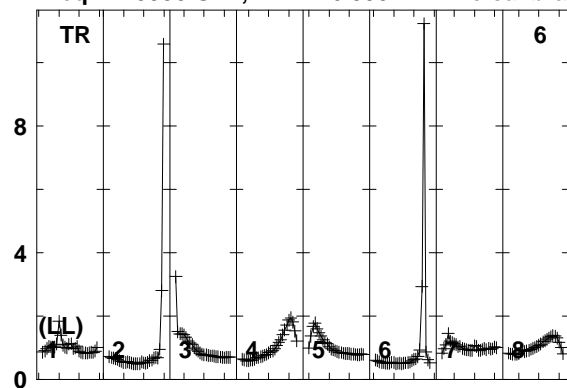

Lower frame: Real Jy
Total-power spectrum Antenna: TR (06)
Timerange: 00/03:10:01 to 00/03:11:49

Plot file version 25 created 11-AUG-2014 17:05:29

J2007+4029 EM110 2.UVDATA.1

Freq = 1.5950 GHz, Bw = 16.000 MH No calibration applied and no bandpass applied

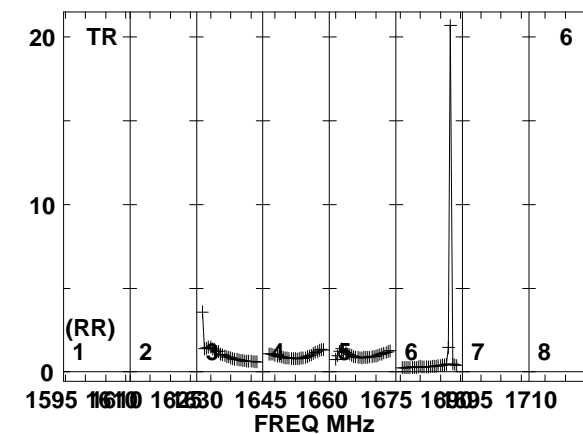
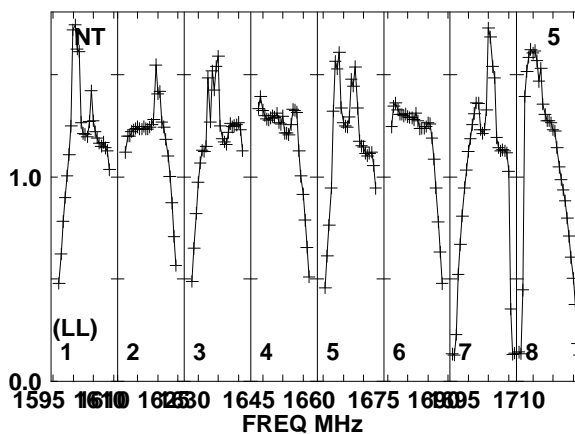
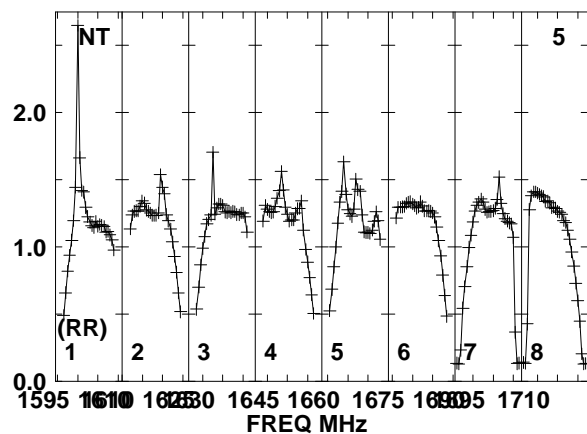
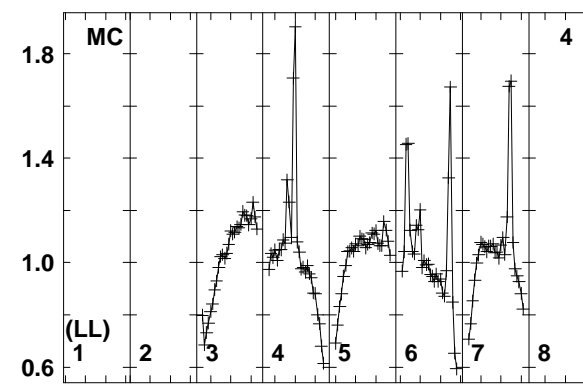
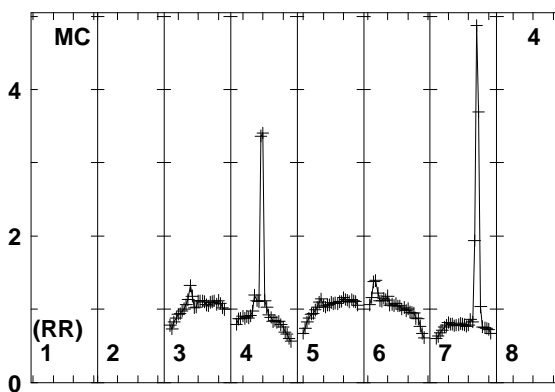
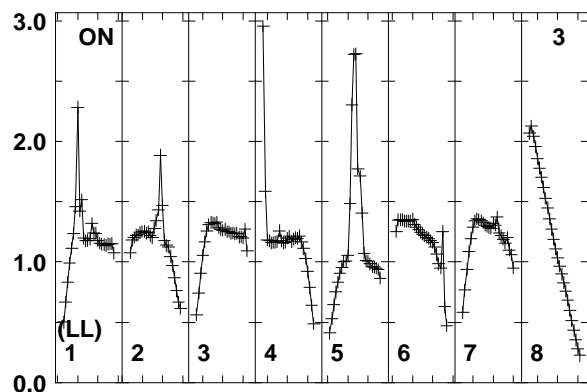
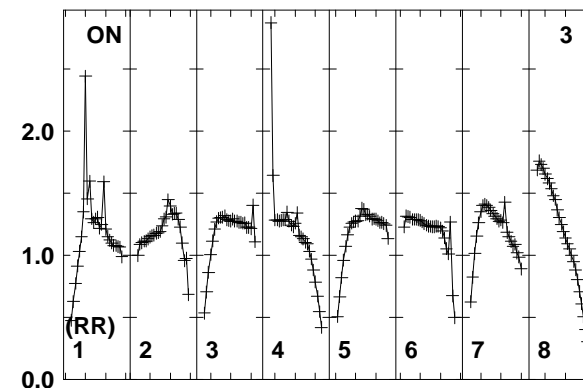
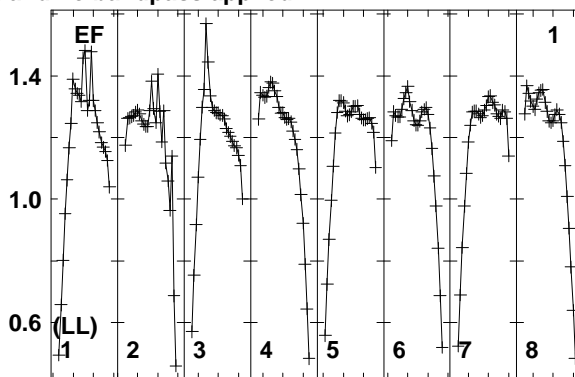
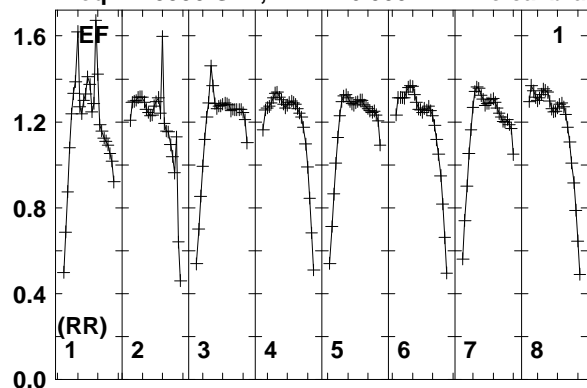

Lower frame: Real Jy
Total-power spectrum Antenna: EF (01)
Timerange: 00/03:11:59 to 00/03:12:49

Plot file version 26 created 11-AUG-2014 17:05:30

J2007+4029 EM110 2.UVDATA.1

Freq = 1.5950 GHz, Bw = 16.000 MH No calibration applied and no bandpass applied

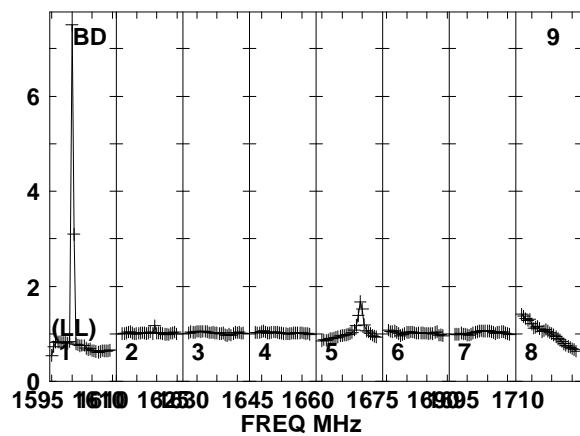
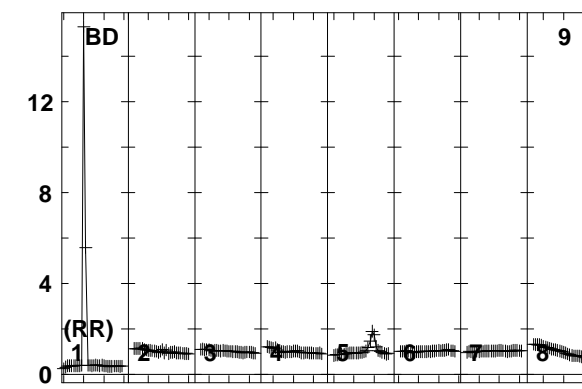
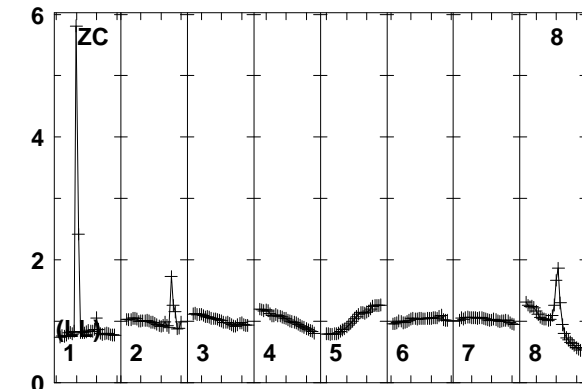
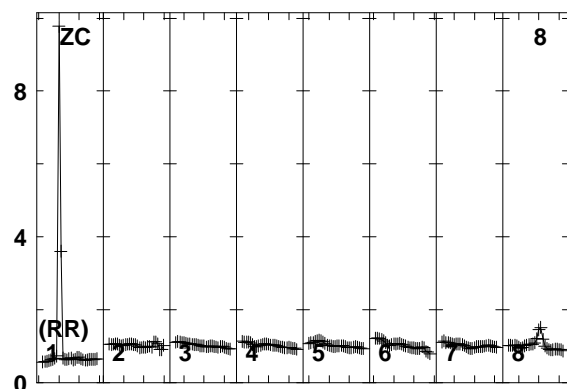
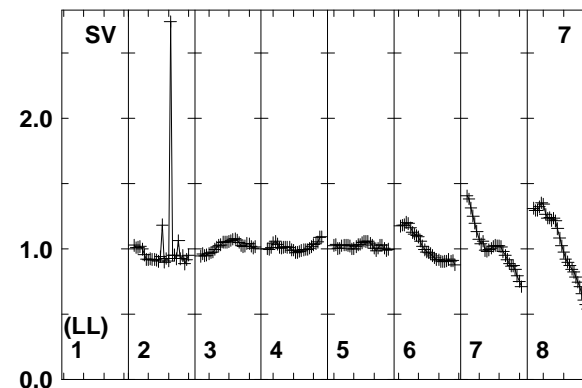
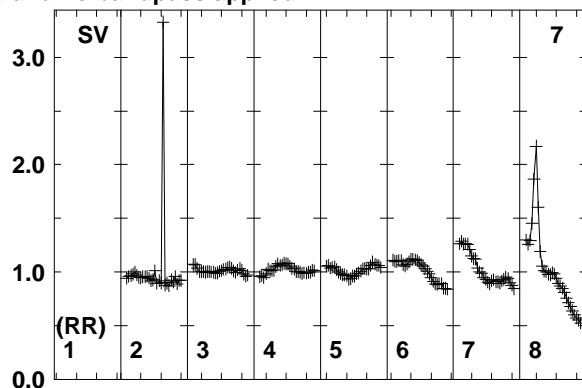
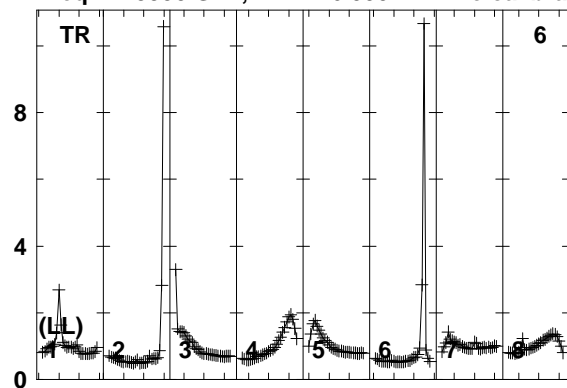

Lower frame: Real Jy
Total-power spectrum Antenna: TR (06)
Timerange: 00/03:11:59 to 00/03:12:49

Plot file version 27 created 11-AUG-2014 17:05:30

J2015+3710 EM110 2.UVDATA.1

Freq = 1.5950 GHz, Bw = 16.000 MH No calibration applied and no bandpass applied

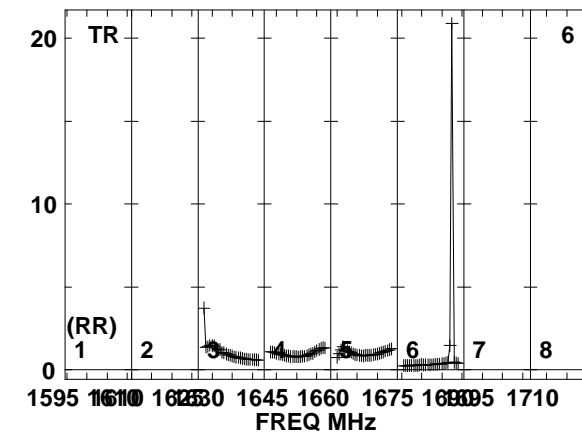
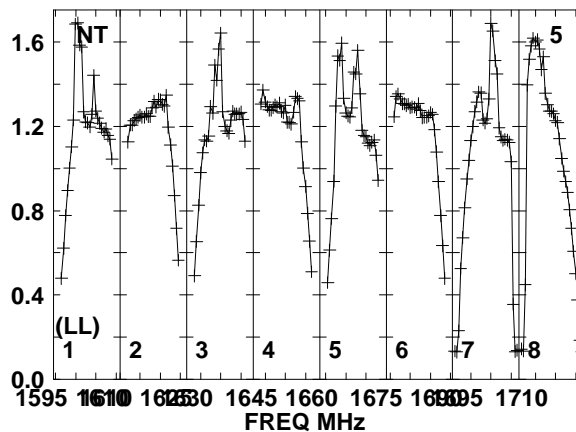
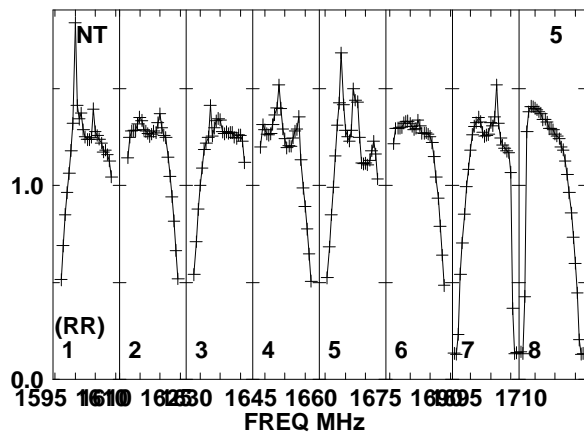
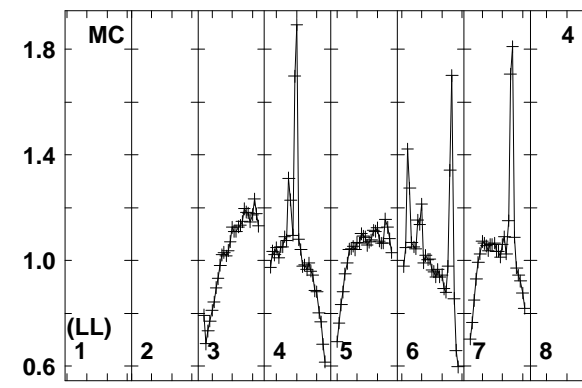
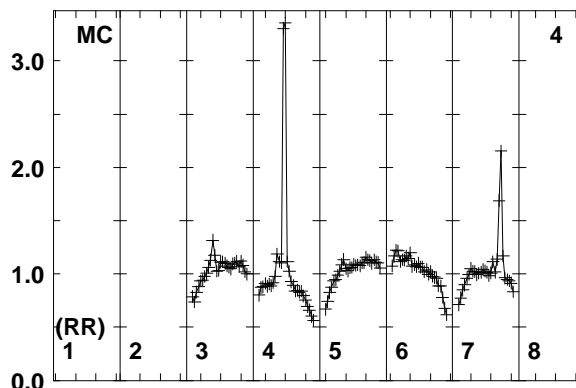
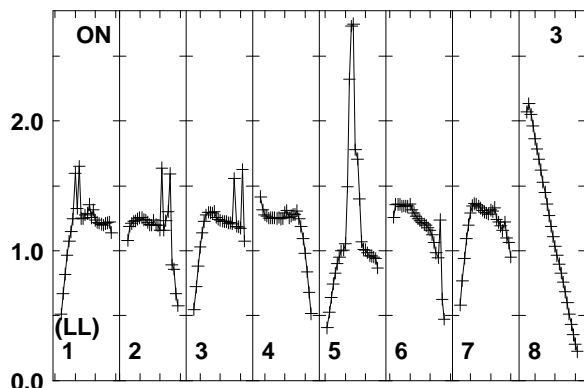
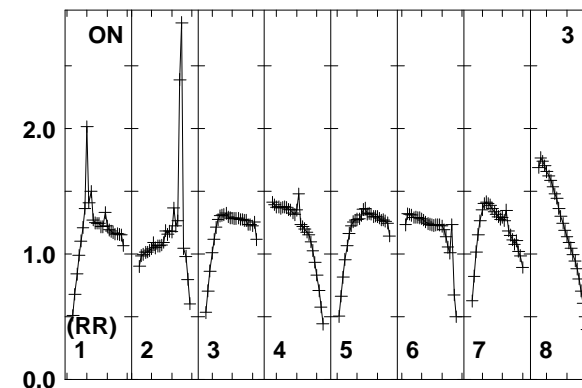
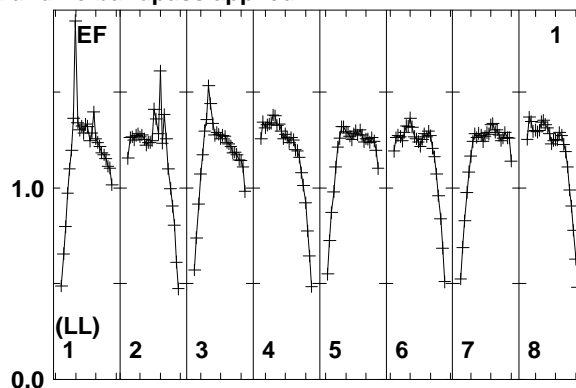
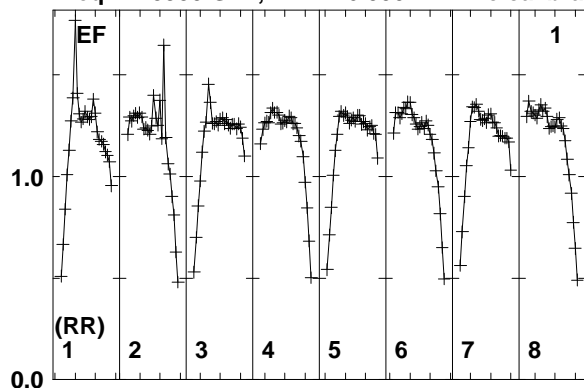

Lower frame: Real Jy
Total-power spectrum Antenna: EF (01)
Timerange: 00/03:13:51 to 00/03:15:49

Plot file version 28 created 11-AUG-2014 17:05:30

J2015+3710 EM110 2.UVDATA.1

Freq = 1.5950 GHz, Bw = 16.000 MH No calibration applied and no bandpass applied

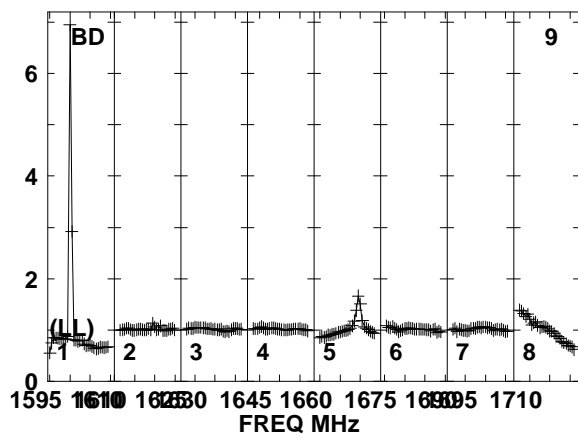
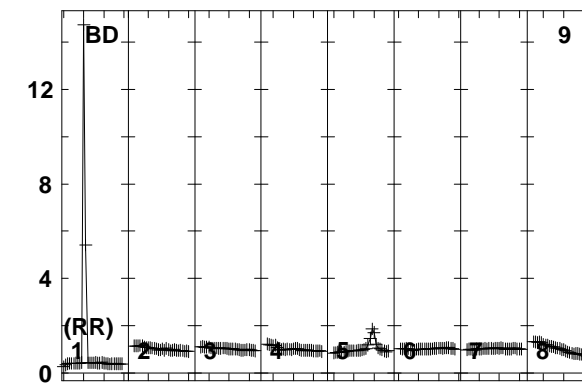
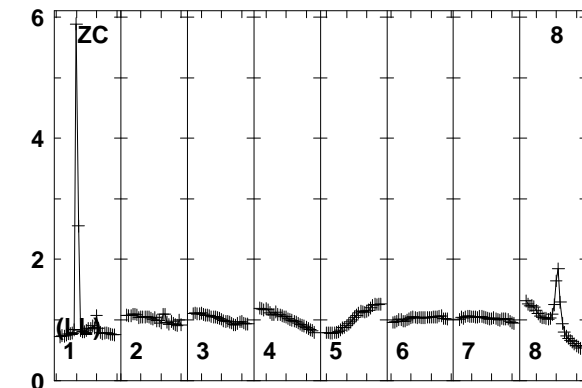
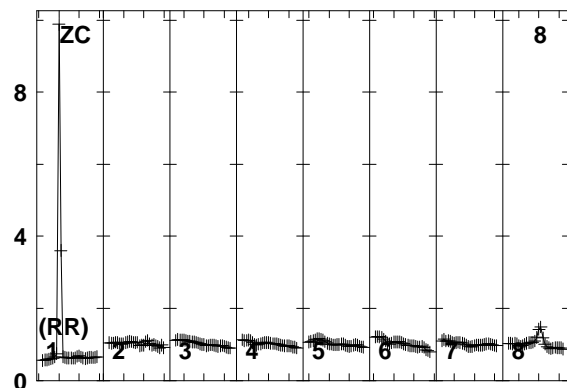
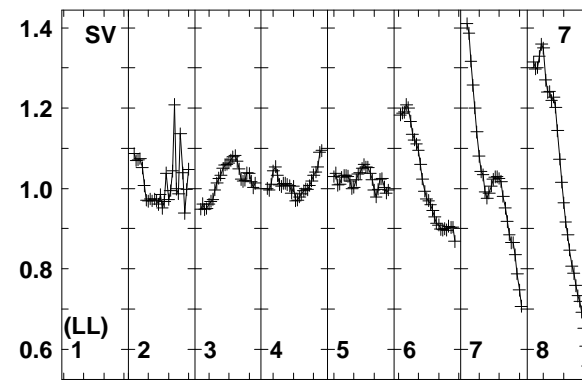
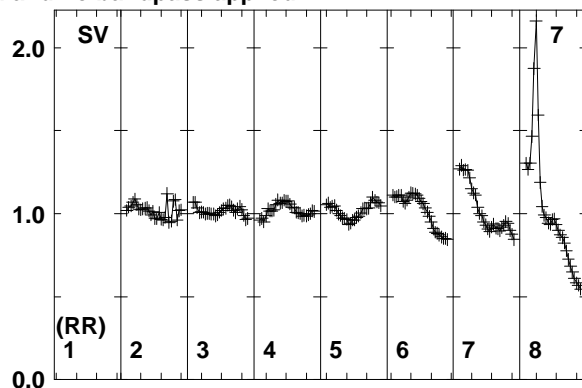
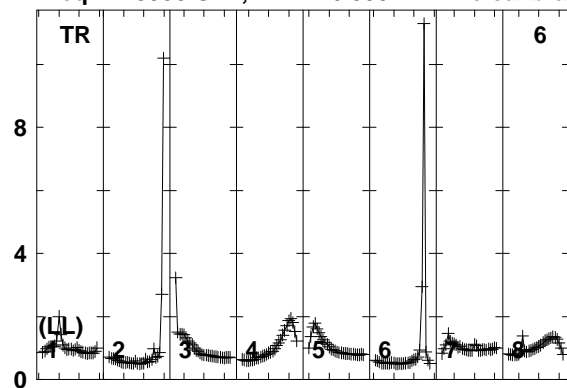

Lower frame: Real Jy
Total-power spectrum Antenna: TR (06)
Timerange: 00/03:13:51 to 00/03:15:49

Plot file version 29 created 11-AUG-2014 17:05:30

J2032+4127 EM110 2.UVDATA.1

Freq = 1.5950 GHz, Bw = 16.000 MH No calibration applied and no bandpass applied

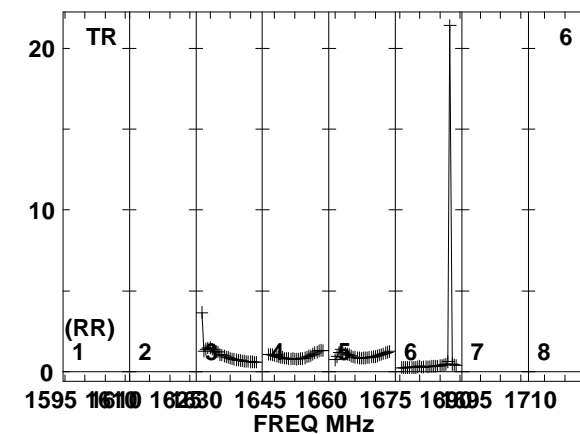
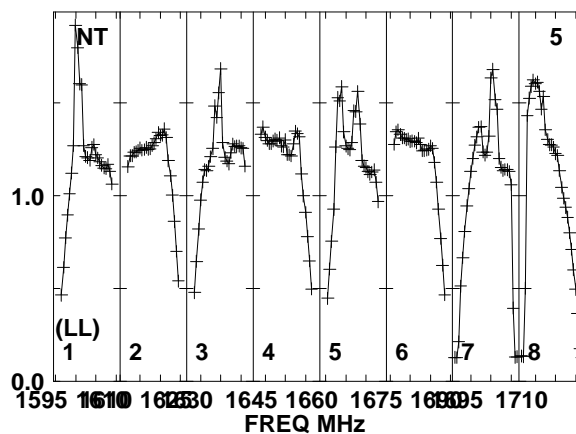
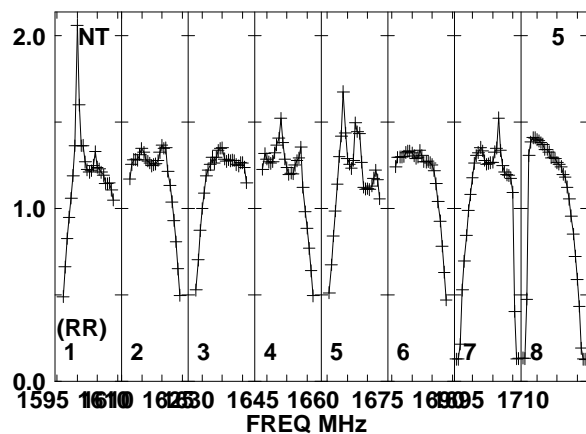
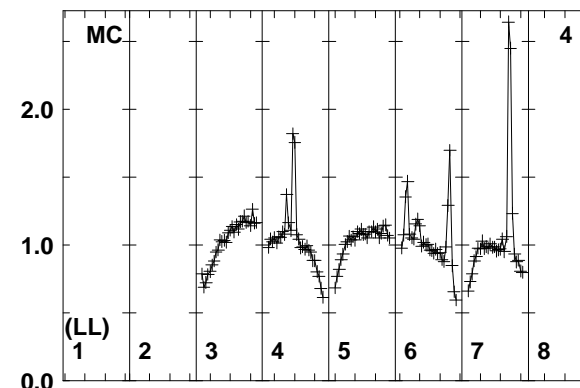
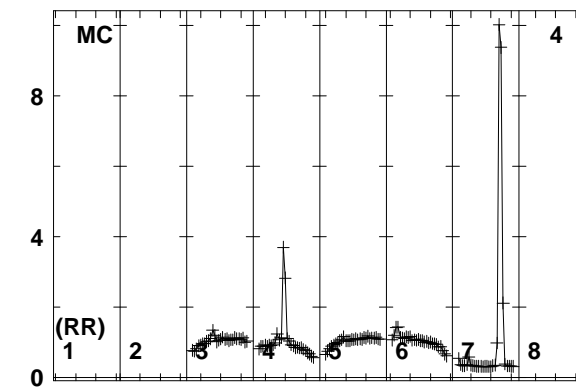
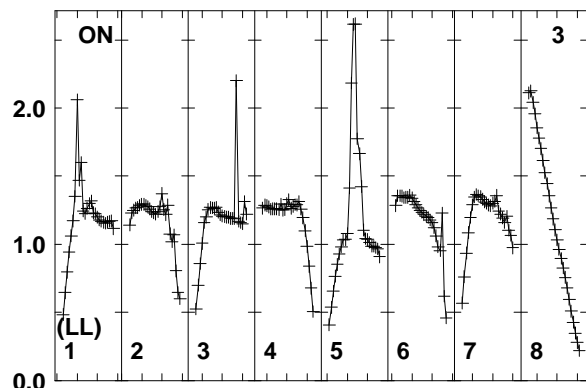
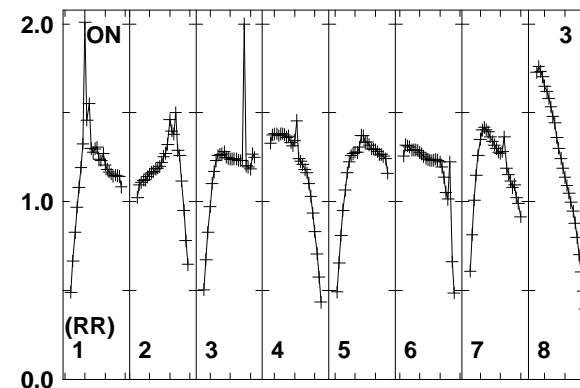
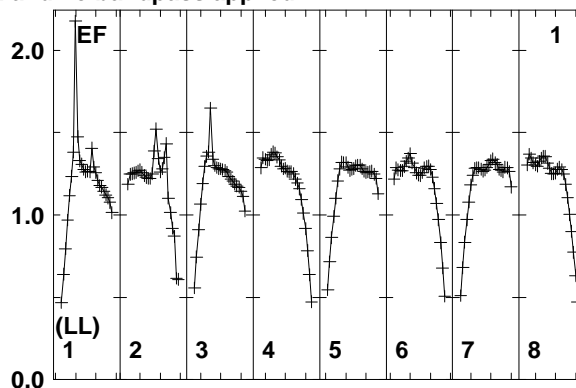
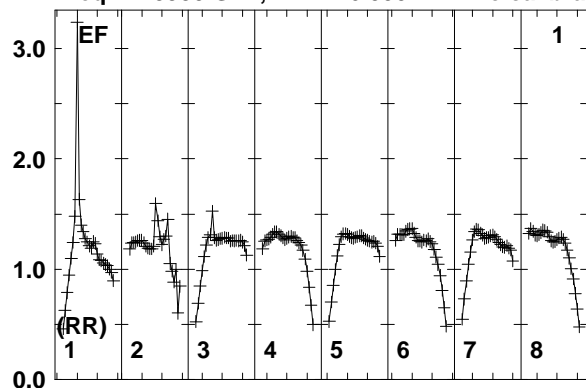

Lower frame: Real Jy
Total-power spectrum Antenna: EF (01)
Timerange: 00/03:16:01 to 00/03:19:49

Plot file version 30 created 11-AUG-2014 17:05:30

J2032+4127 EM110 2.UVDATA.1

Freq = 1.5950 GHz, Bw = 16.000 MH No calibration applied and no bandpass applied

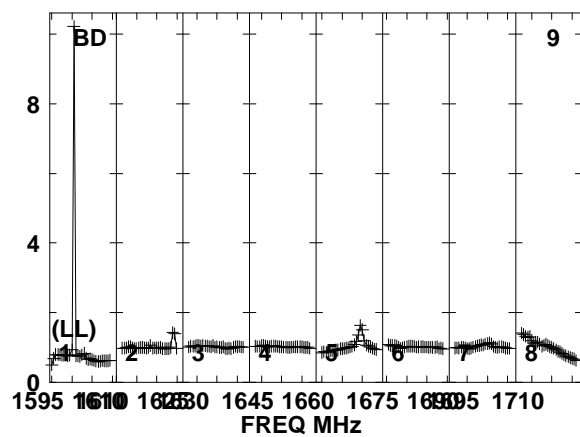
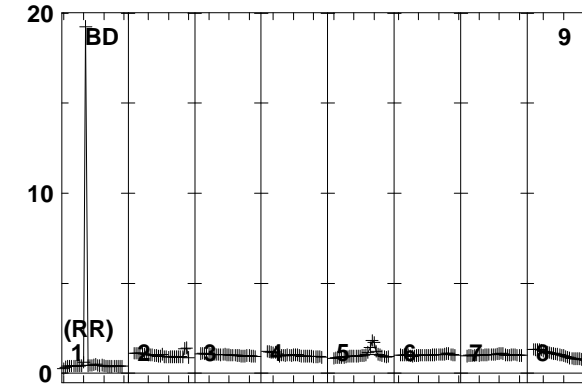
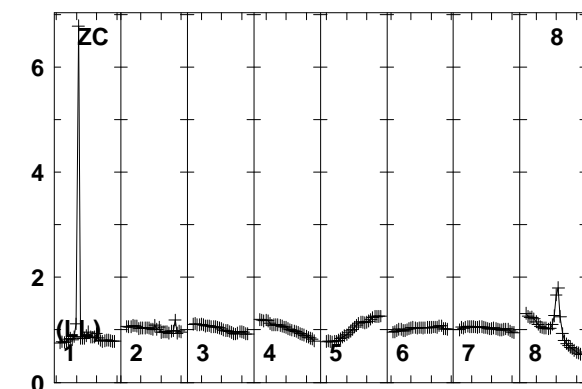
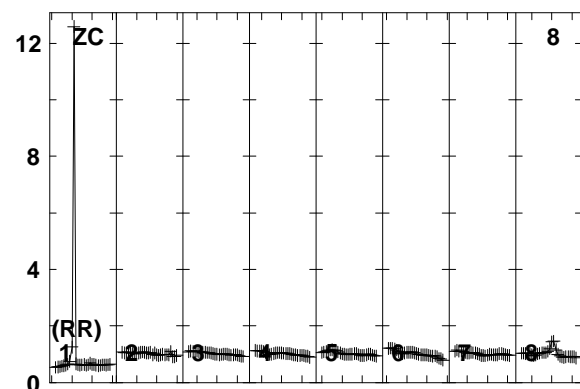
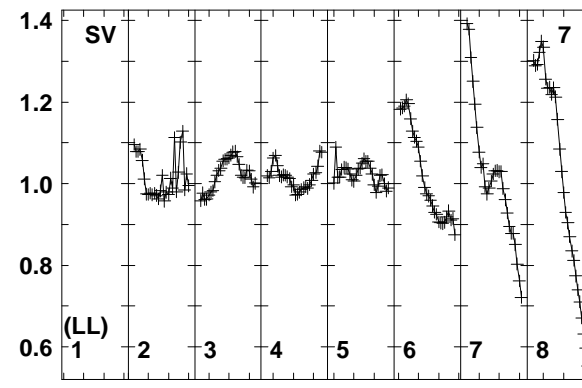
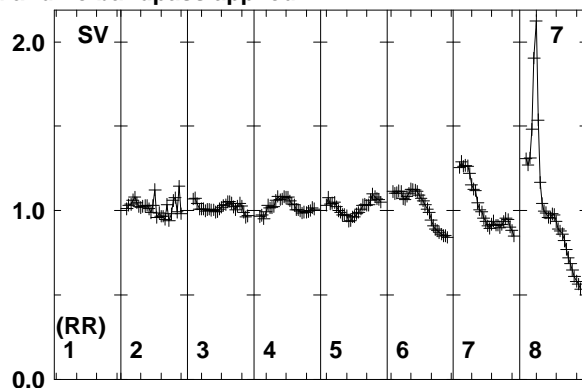
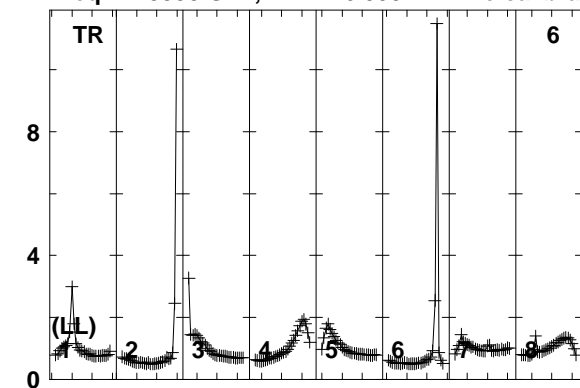

Lower frame: Real Jy
Total-power spectrum Antenna: TR (06)
Timerange: 00/03:16:01 to 00/03:19:49

Plot file version 31 created 11-AUG-2014 17:05:30

J2015+3710 EM110 2.UVDATA.1

Freq = 1.5950 GHz, Bw = 16.000 MH No calibration applied and no bandpass applied

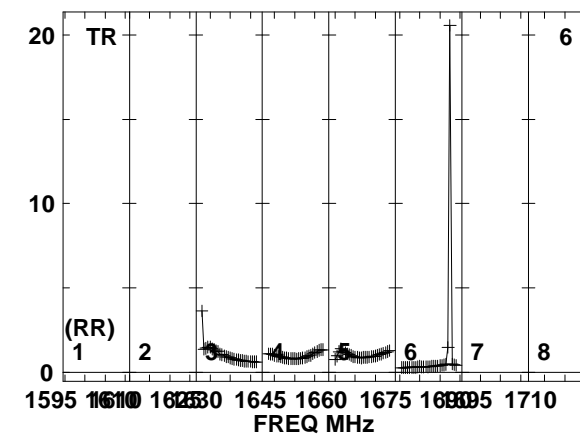
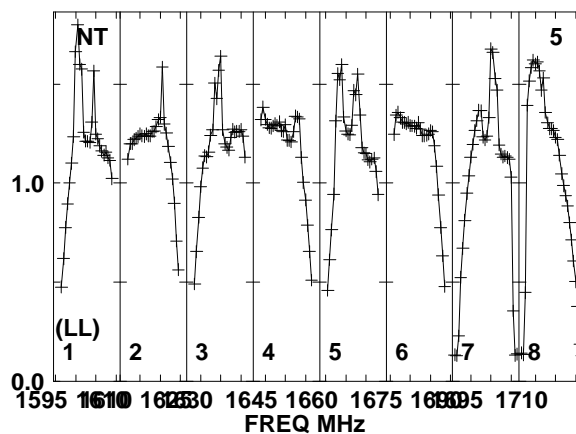
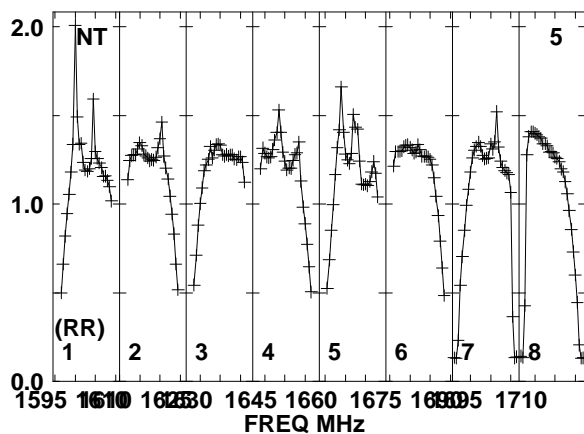
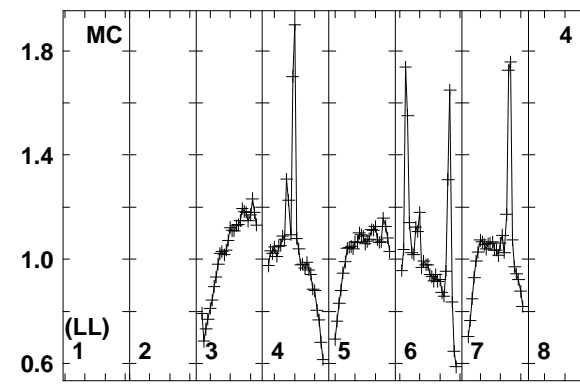
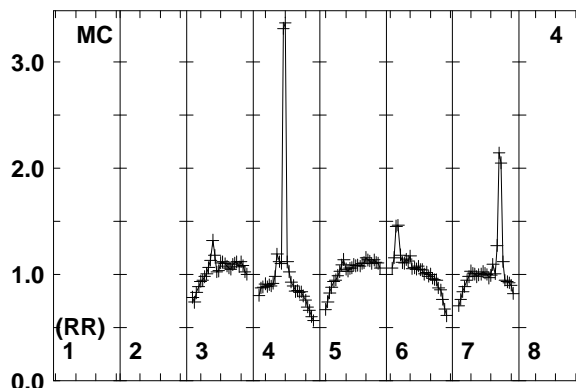
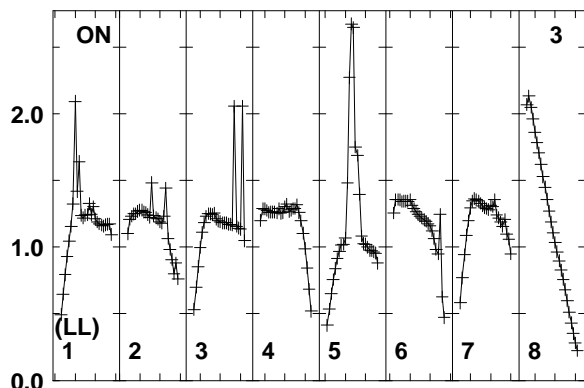
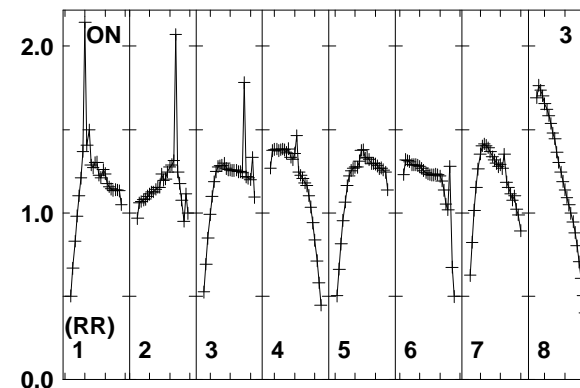
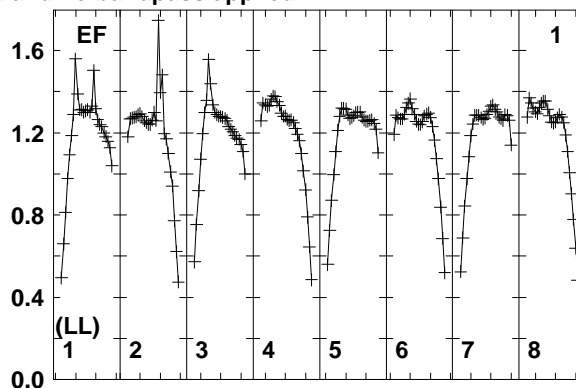
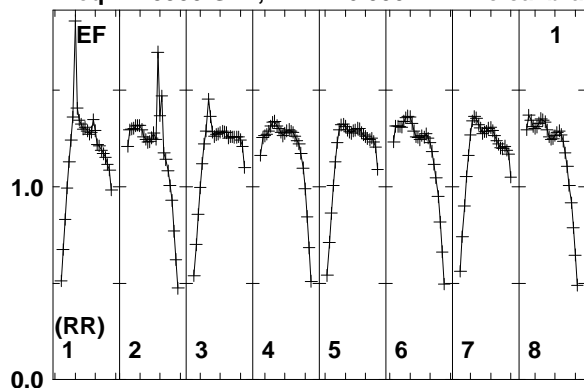

Lower frame: Real Jy
Total-power spectrum Antenna: EF (01)
Timerange: 00/03:20:01 to 00/03:21:49

Plot file version 32 created 11-AUG-2014 17:05:30

J2015+3710 EM110 2.UVDATA.1

Freq = 1.5950 GHz, Bw = 16.000 MH No calibration applied and no bandpass applied

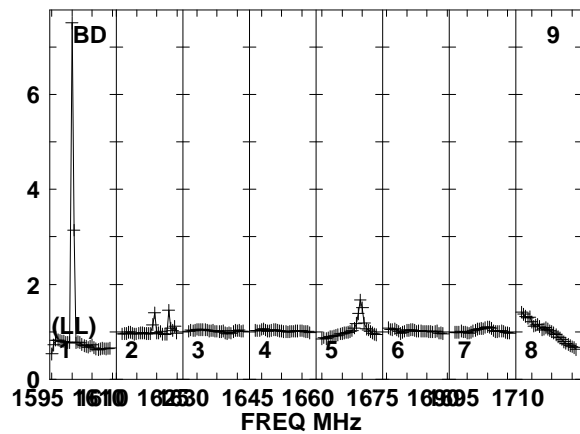
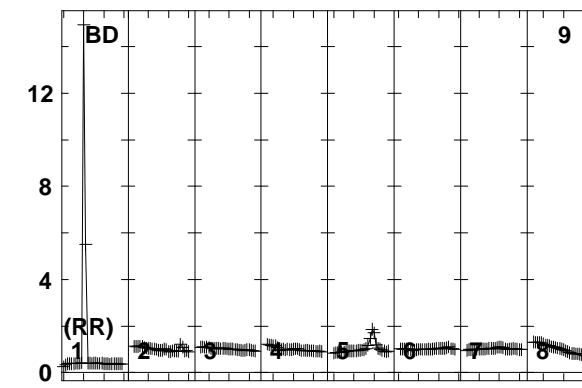
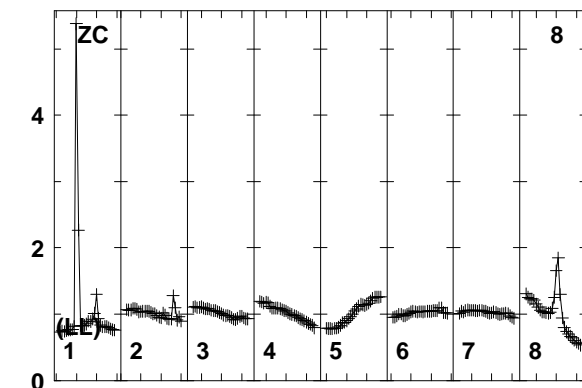
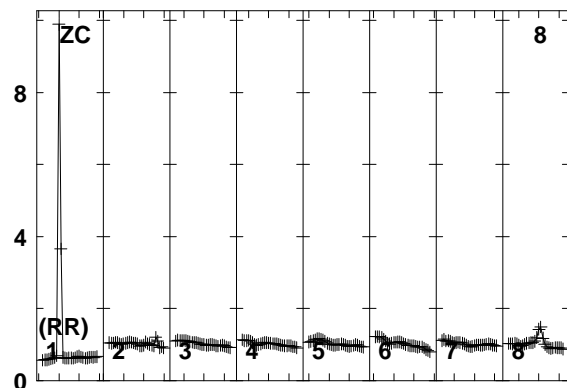
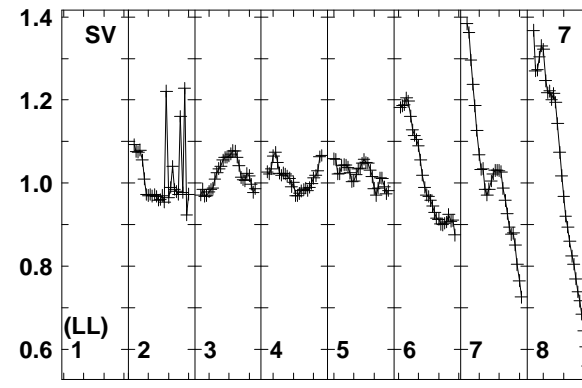
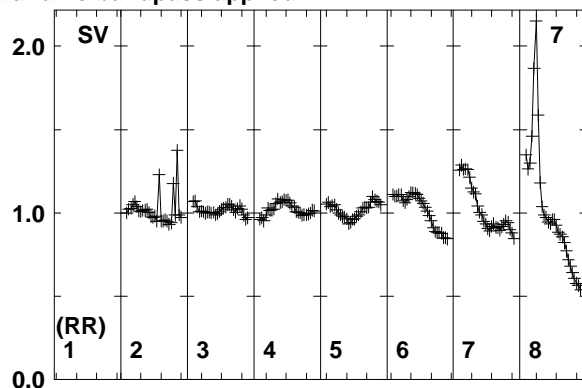
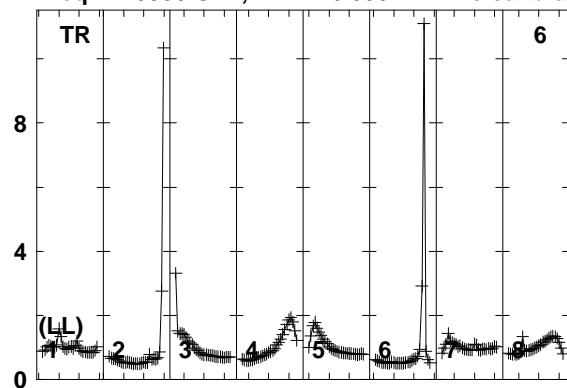

Lower frame: Real Jy
Total-power spectrum Antenna: TR (06)
Timerange: 00/03:20:01 to 00/03:21:49

Plot file version 33 created 11-AUG-2014 17:05:30

J2032+4127 EM110 2.UVDATA.1

Freq = 1.5950 GHz, Bw = 16.000 MH No calibration applied and no bandpass applied

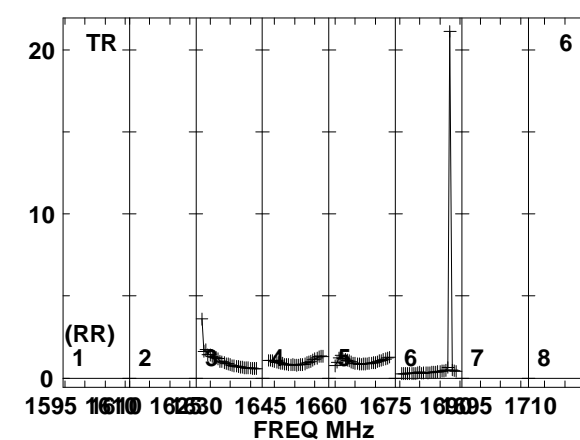
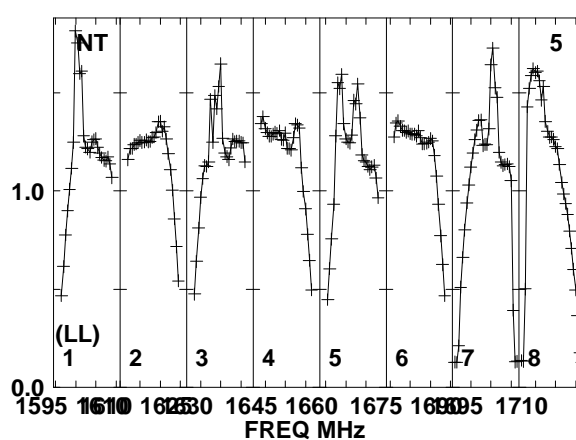
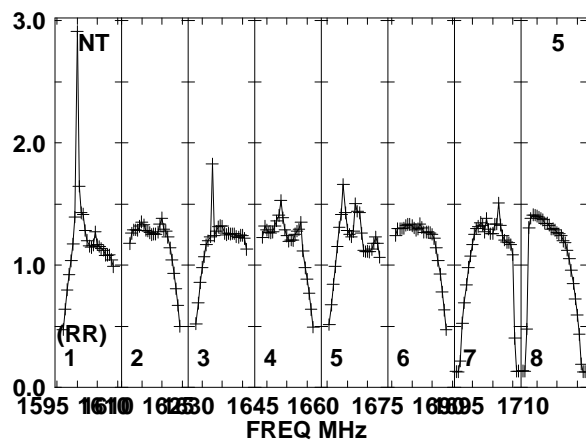
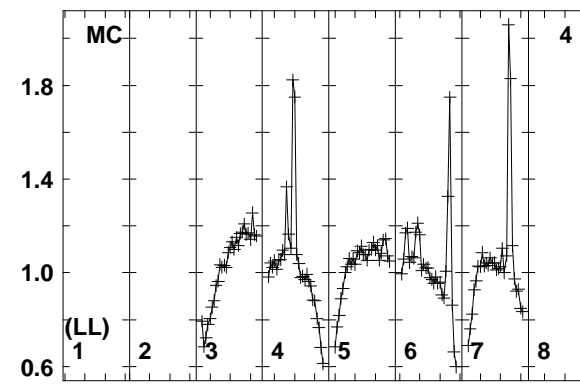
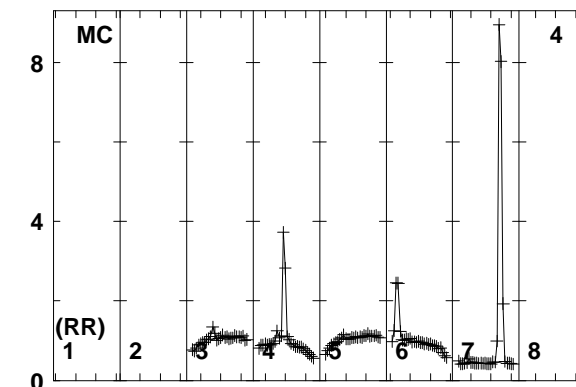
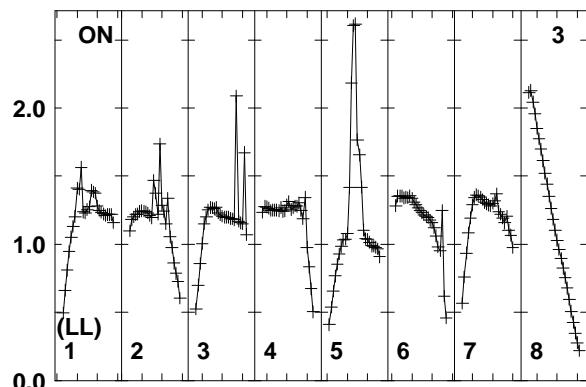
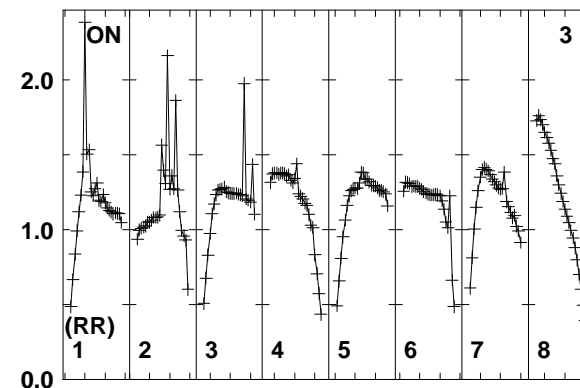
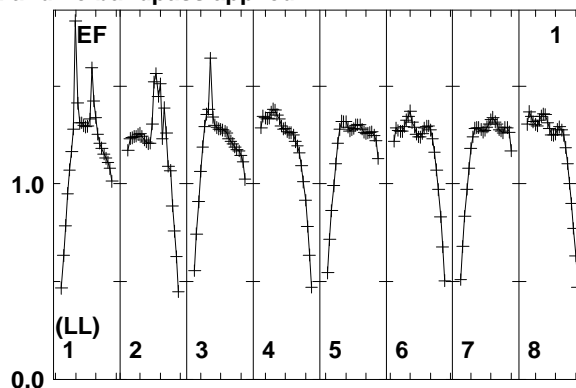
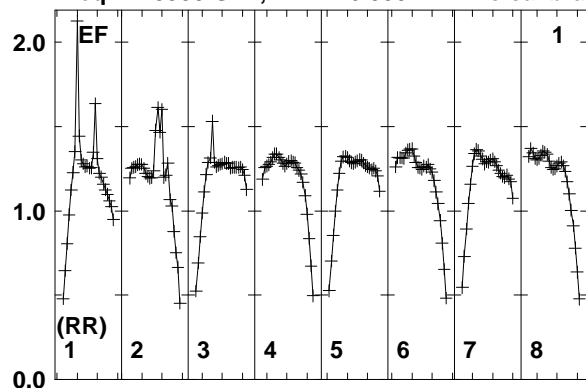

Lower frame: Real Jy
Total-power spectrum Antenna: EF (01)
Timerange: 00/03:22:01 to 00/03:25:49

Plot file version 34 created 11-AUG-2014 17:05:30

J2032+4127 EM110 2.UVDATA.1

Freq = 1.5950 GHz, Bw = 16.000 MH No calibration applied and no bandpass applied

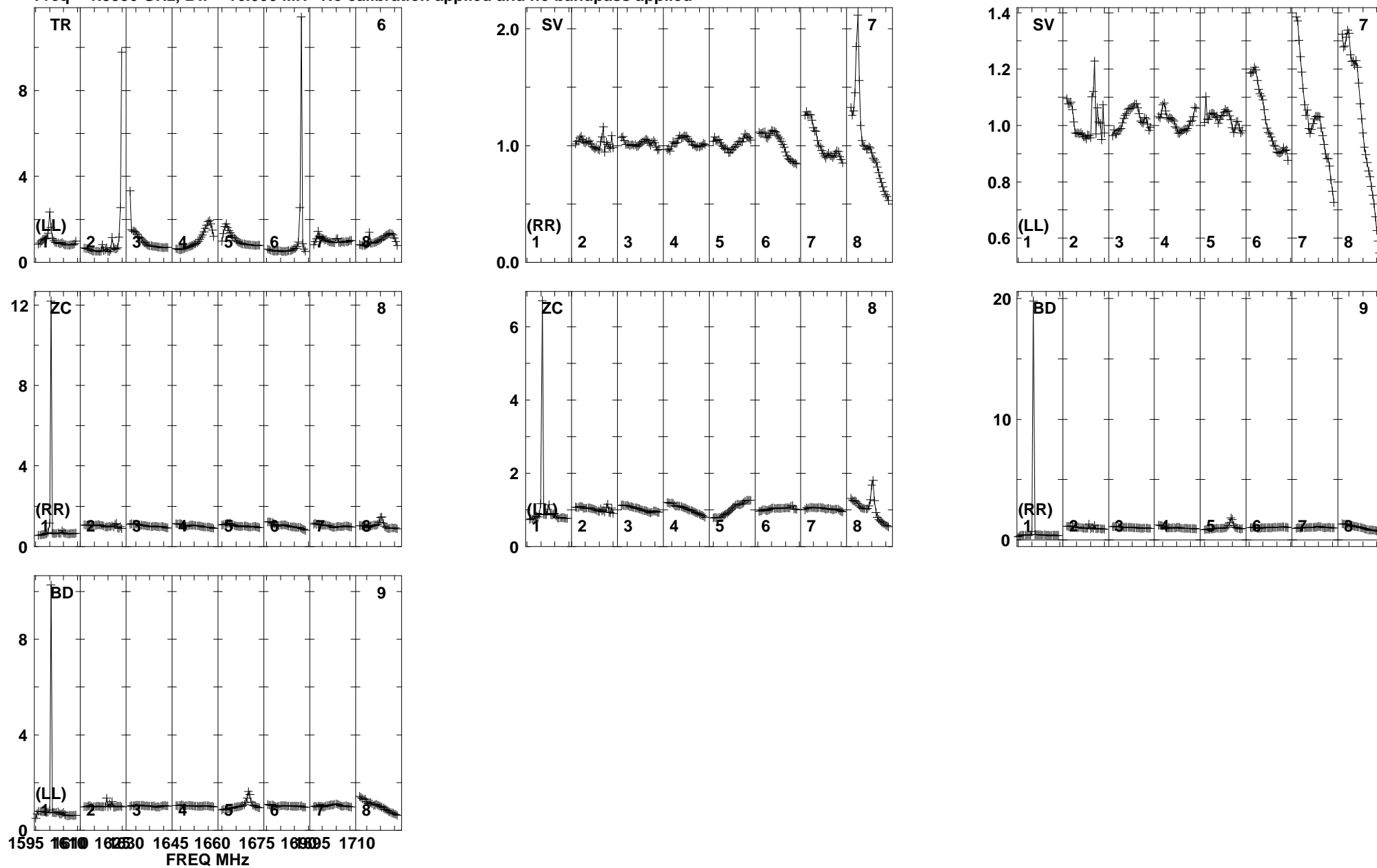

Lower frame: Real Jy
Total-power spectrum Antenna: TR (06)
Timerange: 00/03:22:01 to 00/03:25:49

Plot file version 35 created 11-AUG-2014 17:05:30

J2015+3710 EM110 2.UVDATA.1

Freq = 1.5950 GHz, Bw = 16.000 MH No calibration applied and no bandpass applied

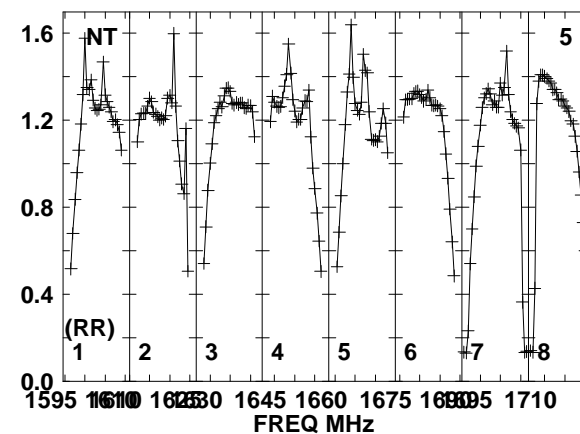
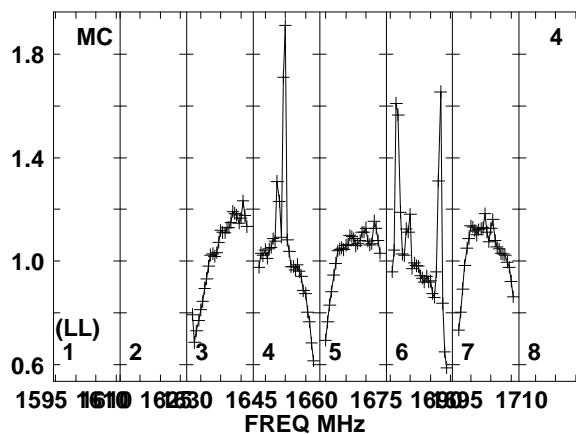
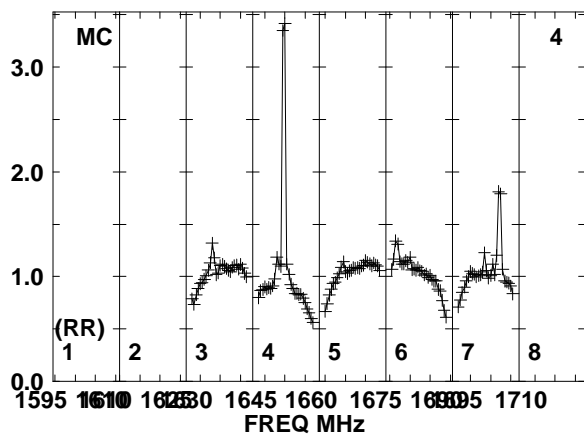
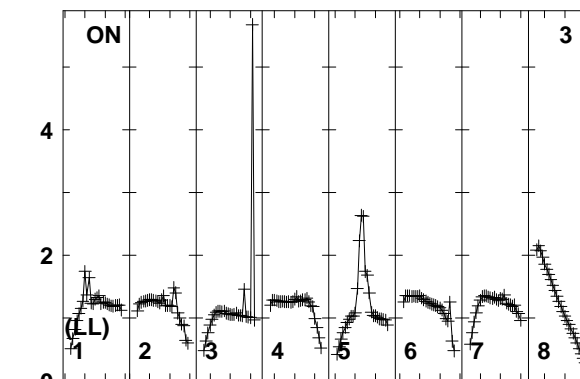
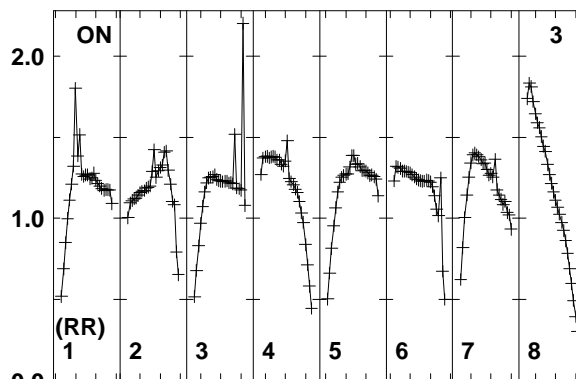
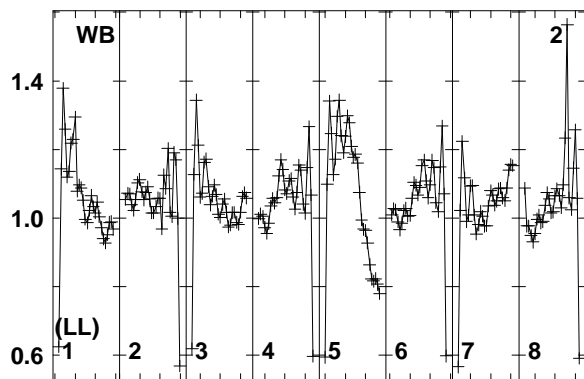
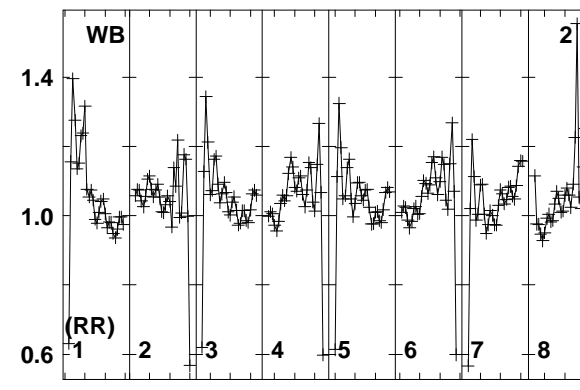
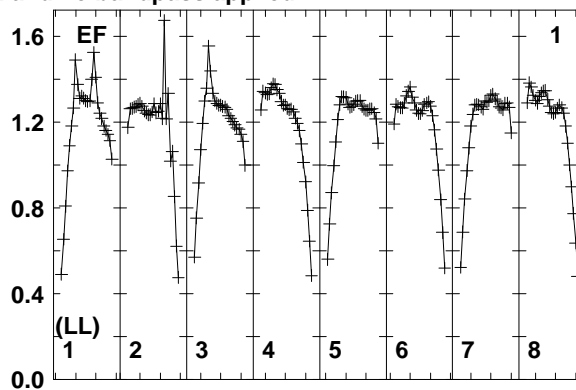
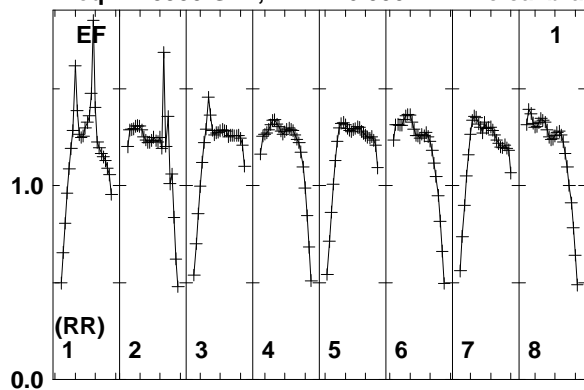

Lower frame: Real Jy
Total-power spectrum Antenna: EF (01)
Timerange: 00/03:26:51 to 00/03:28:49

Plot file version 36 created 11-AUG-2014 17:05:30

J2015+3710 EM110 2.UVDATA.1

Freq = 1.5950 GHz, Bw = 16.000 MH No calibration applied and no bandpass applied

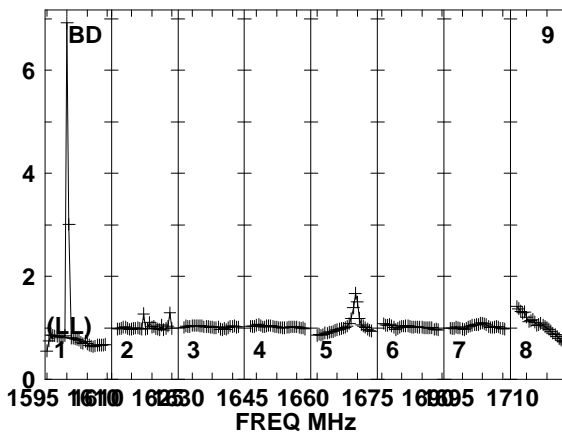
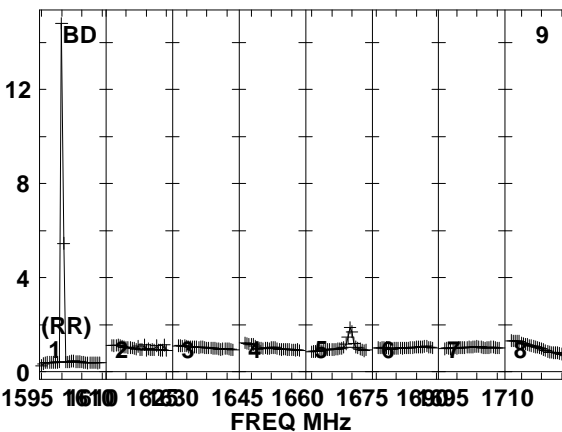
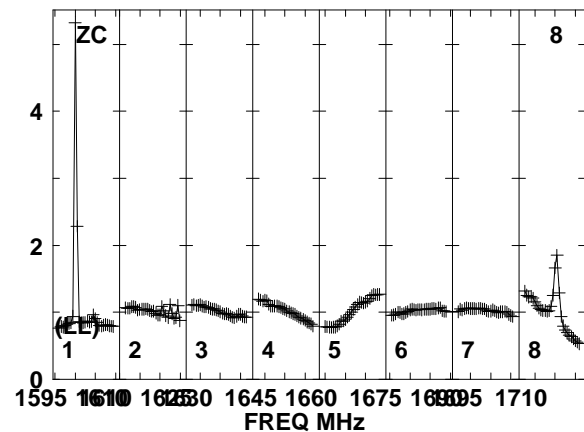
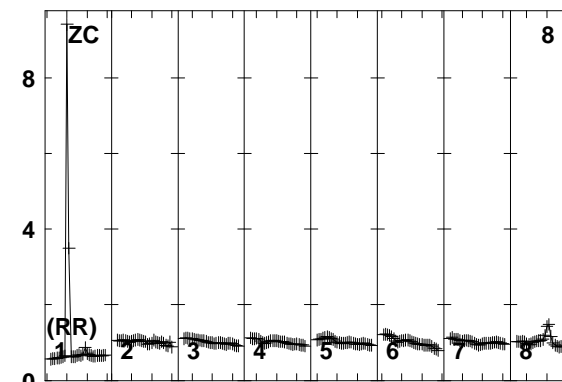
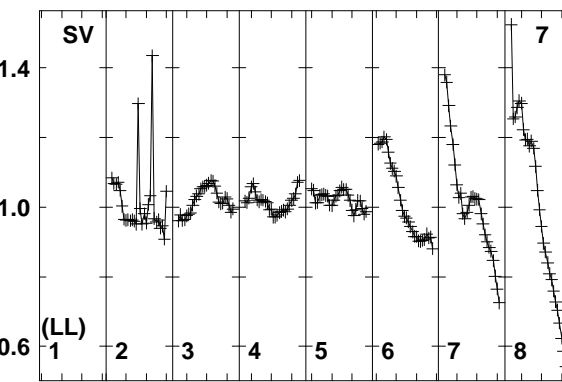
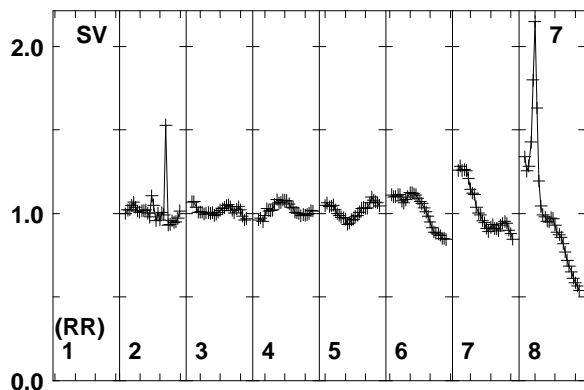
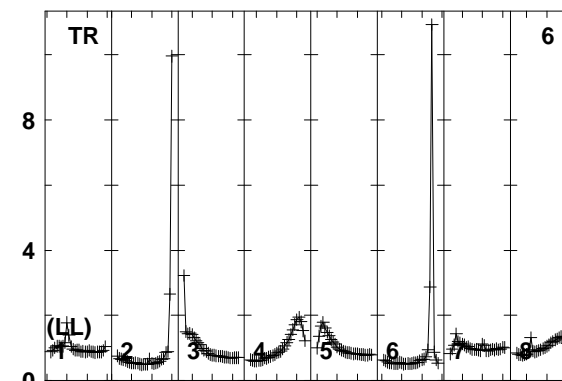
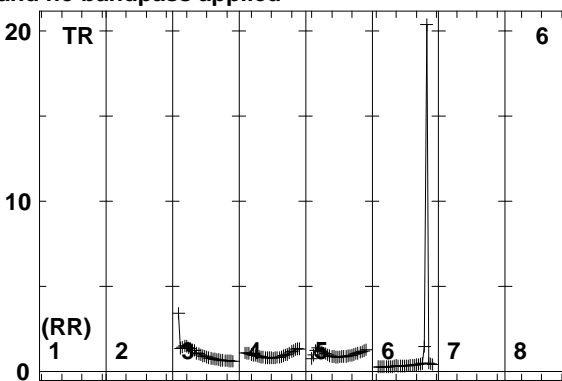
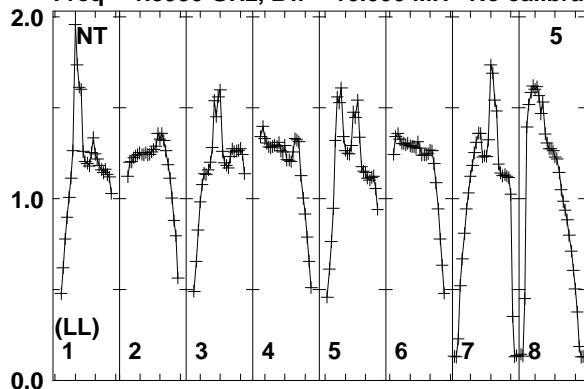

1595 1610 1625 1640 1655 1670 1685 1700 1710
FREQ MHz

1595 1610 1625 1640 1655 1670 1685 1700 1710
FREQ MHz

1595 1610 1625 1640 1655 1670 1685 1700 1710
FREQ MHz

Lower frame: Real Jy
Total-power spectrum Antenna: NT (05)
Timerange: 00/03:26:51 to 00/03:28:49

Plot file version 37 created 11-AUG-2014 17:05:30

J2032+4127 EM110 2.UVDATA.1

Freq = 1.5950 GHz, Bw = 16.000 MH No calibration applied and no bandpass applied

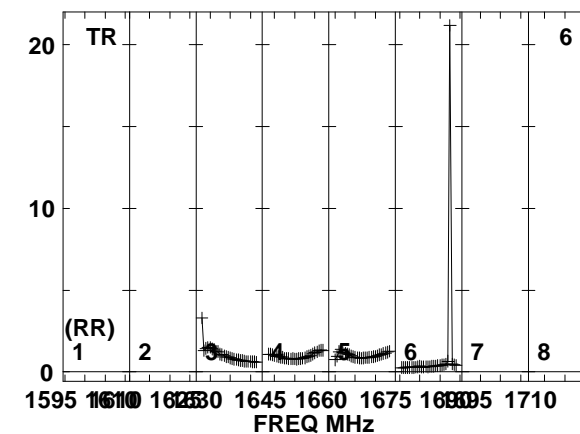
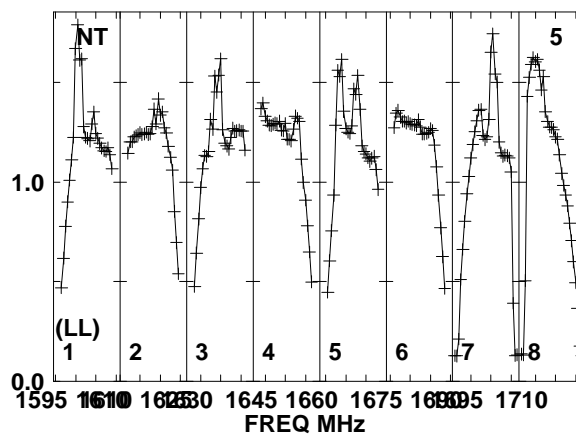
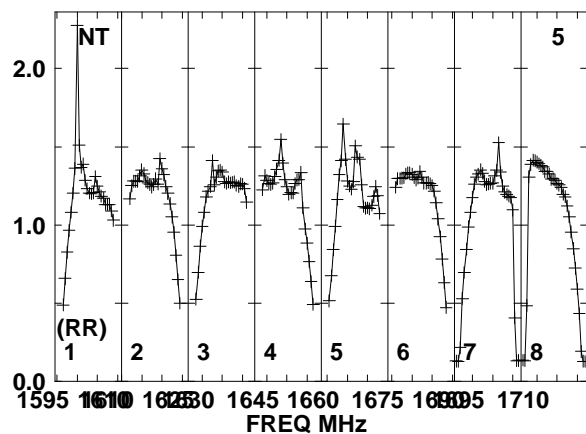
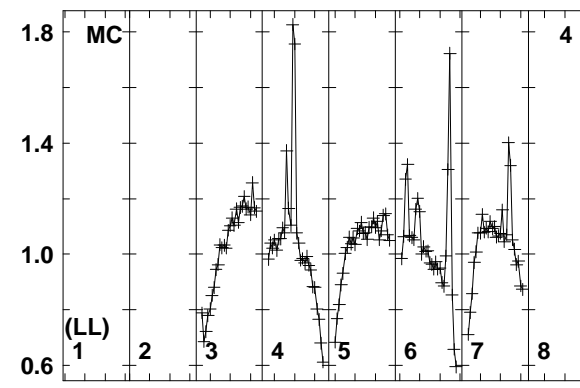
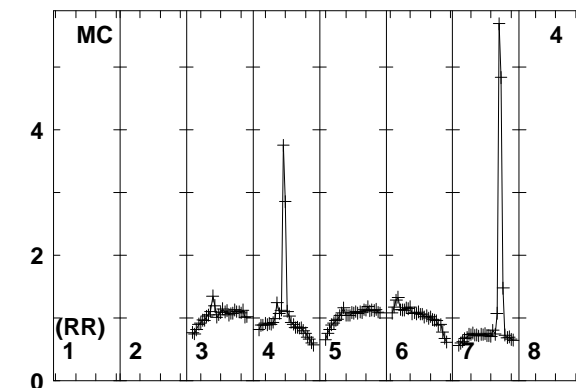
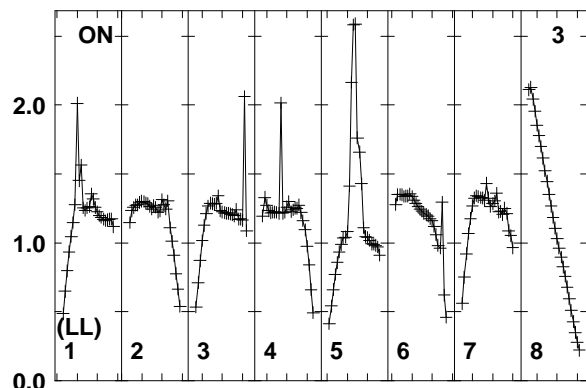
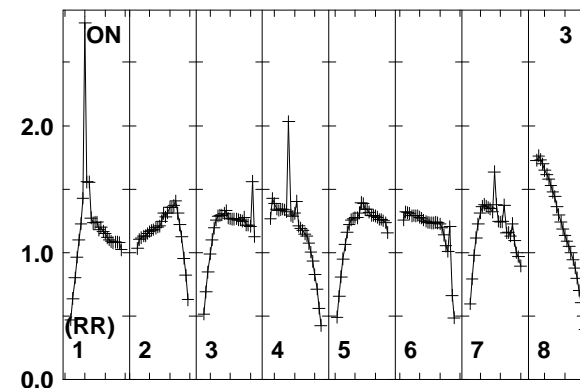
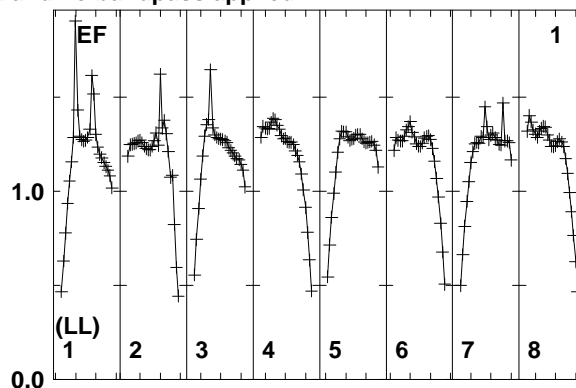
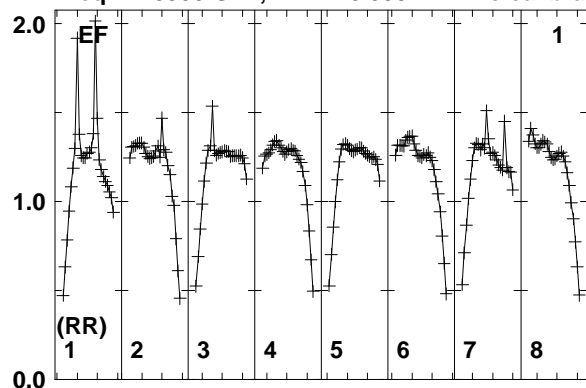

Lower frame: Real Jy
Total-power spectrum Antenna: EF (01)
Timerange: 00/03:29:01 to 00/03:32:49

Plot file version 38 created 11-AUG-2014 17:05:30

J2032+4127 EM110 2.UVDATA.1

Freq = 1.5950 GHz, Bw = 16.000 MH No calibration applied and no bandpass applied

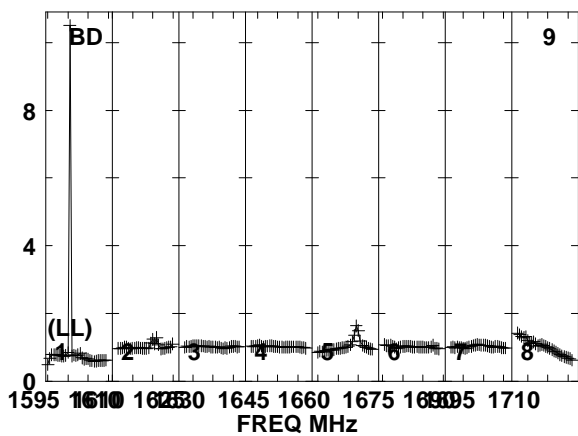
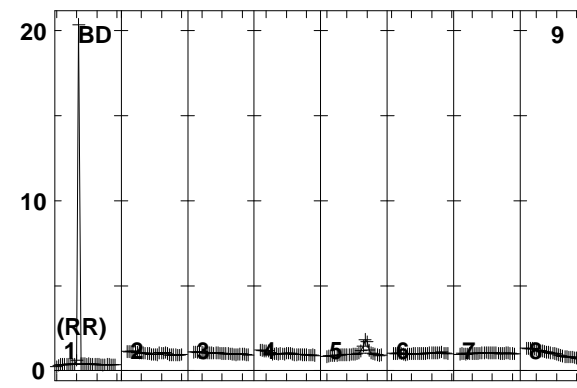
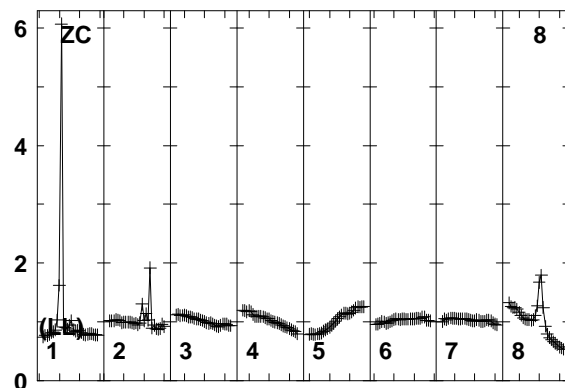
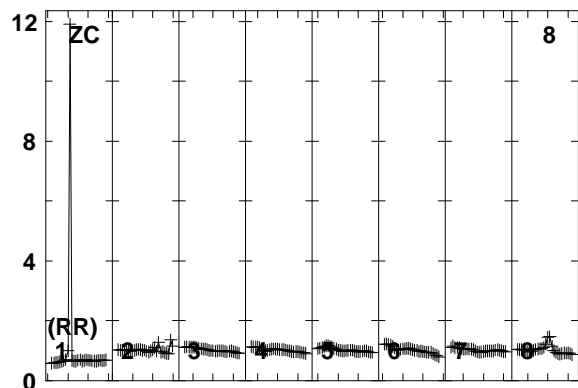
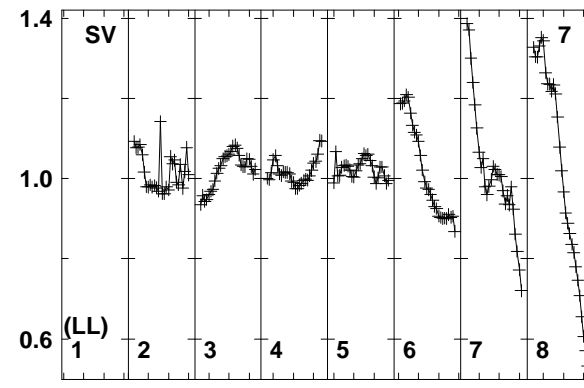
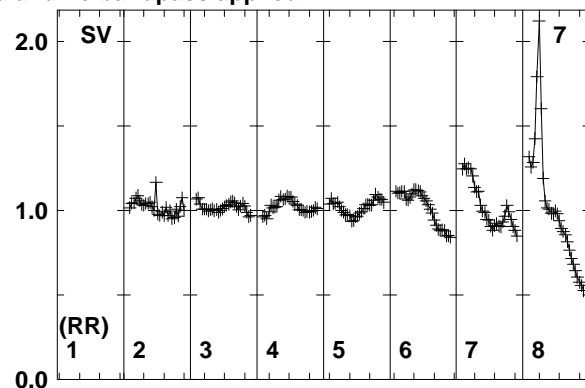
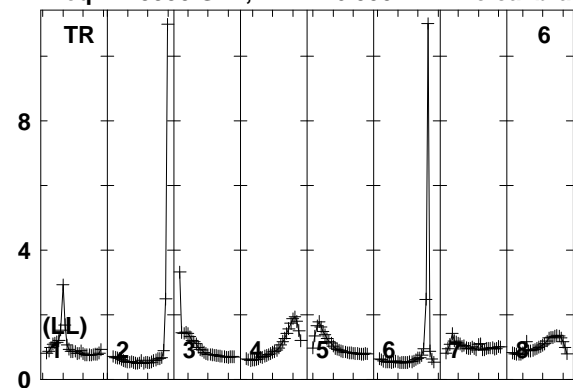

Lower frame: Real Jy

Total-power spectrum Antenna: TR (06)

Timerange: 00/03:29:01 to 00/03:32:49

Plot file version 39 created 11-AUG-2014 17:05:30

J2015+3710 EM110 2.UVDATA.1

Freq = 1.5950 GHz, Bw = 16.000 MH No calibration applied and no bandpass applied

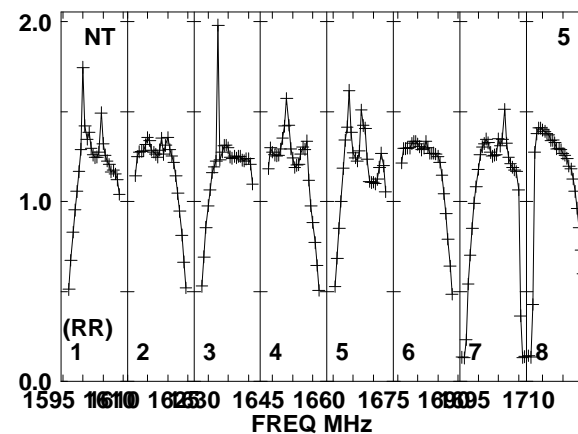
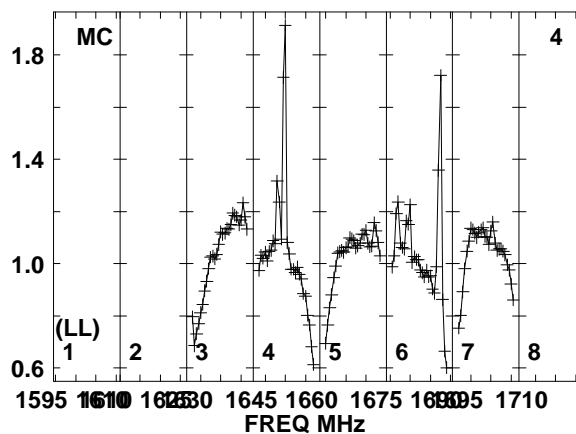
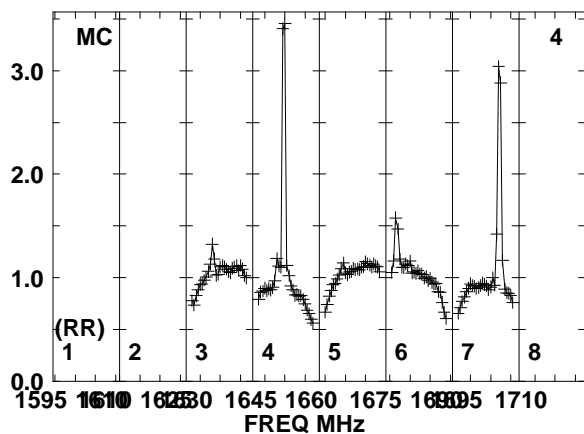
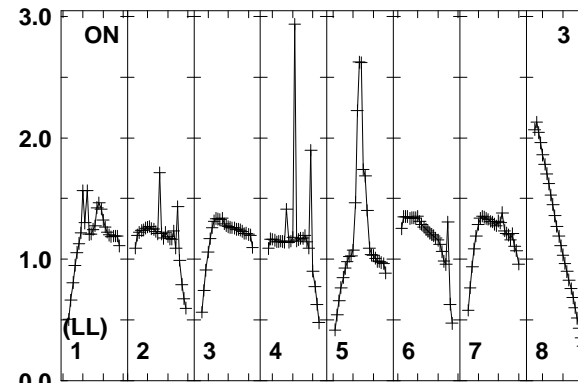
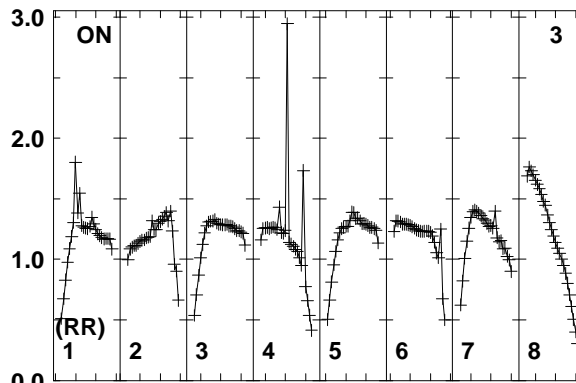
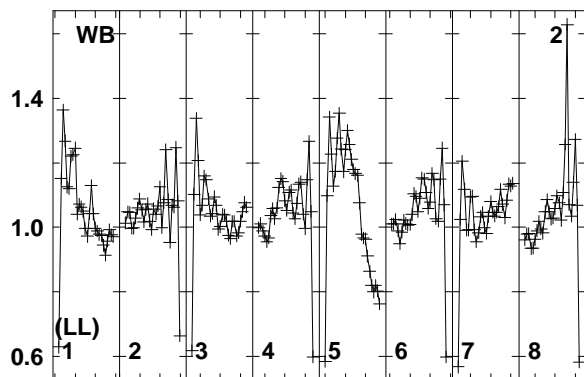
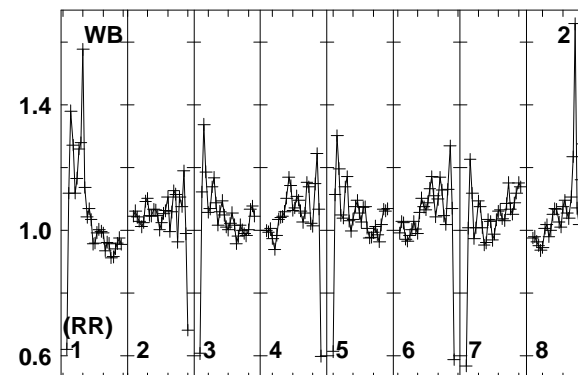
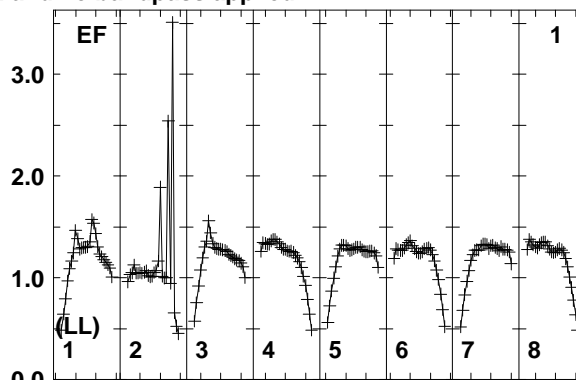
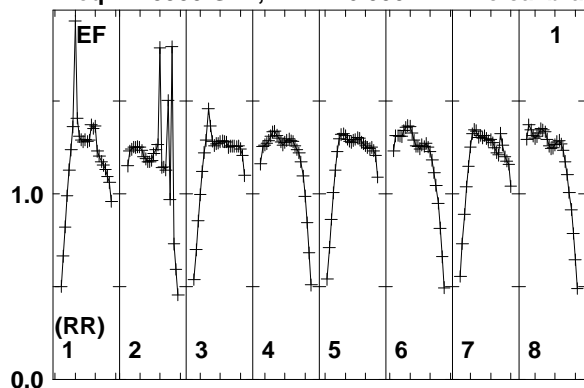

Lower frame: Real Jy
Total-power spectrum Antenna: EF (01)
Timerange: 00/03:33:51 to 00/03:35:49

Plot file version 40 created 11-AUG-2014 17:05:30

J2015+3710 EM110 2.UVDATA.1

Freq = 1.5950 GHz, Bw = 16.000 MH No calibration applied and no bandpass applied

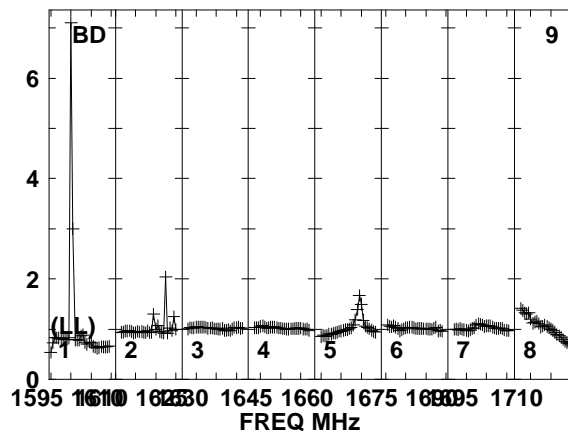
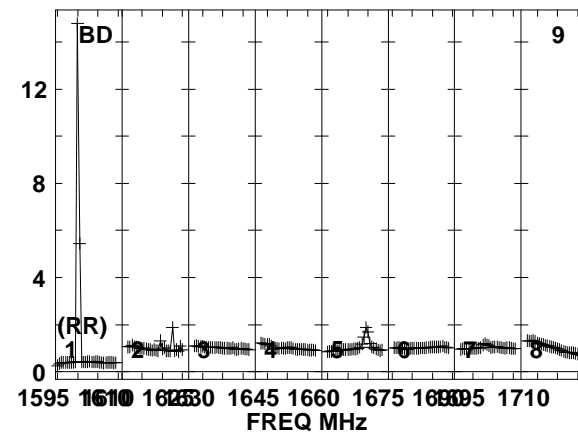
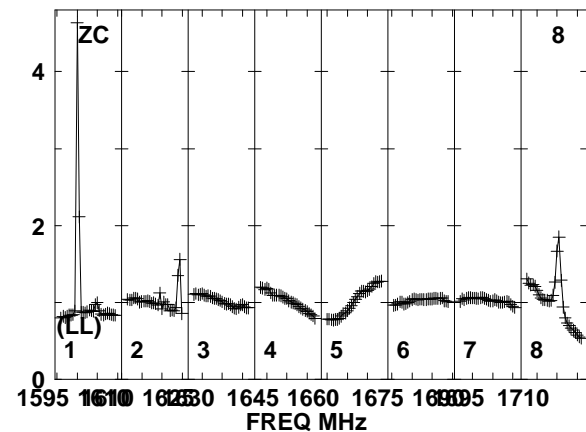
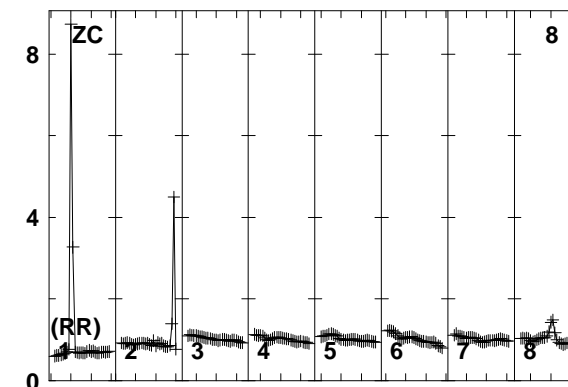
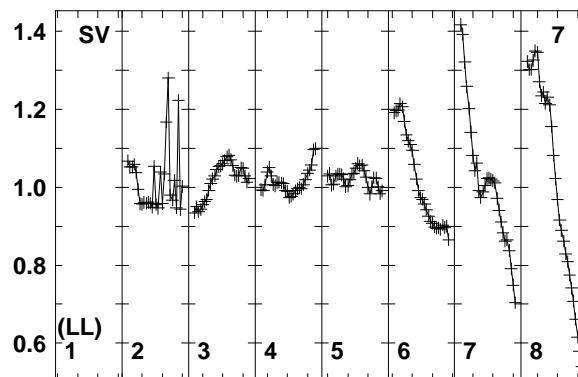
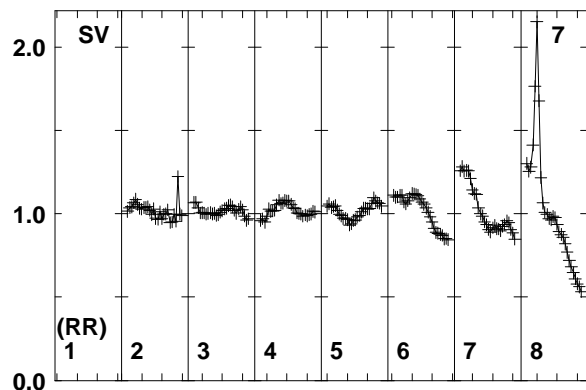
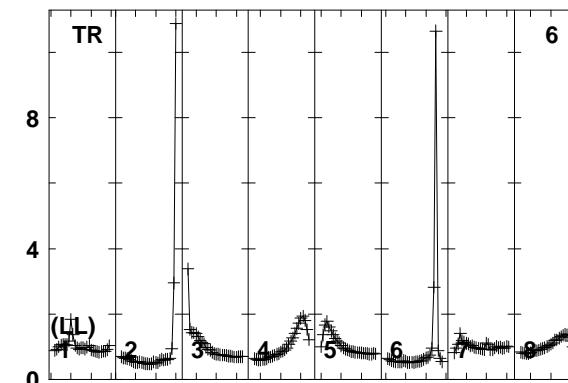
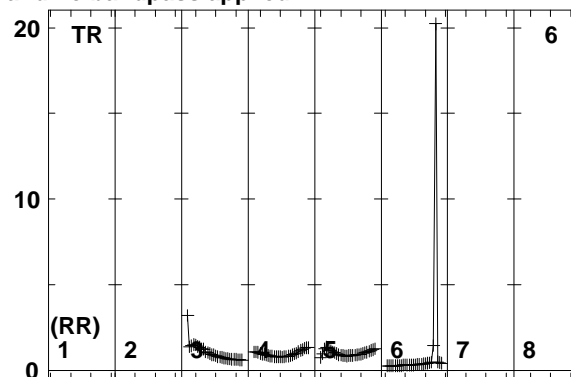
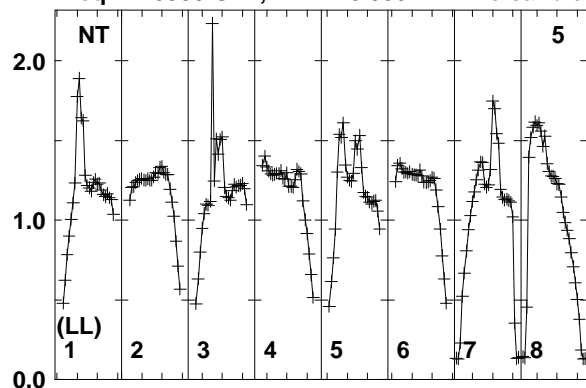

1595 1610 1625 1640 1655 1670 1685 1700 1710
FREQ MHz
Lower frame: Real Jy
Total-power spectrum Antenna: NT (05)
Timerange: 00/03:33:51 to 00/03:35:49

Plot file version 41 created 11-AUG-2014 17:05:30

J2032+4127 EM110 2.UVDATA.1

Freq = 1.5950 GHz, Bw = 16.000 MH No calibration applied and no bandpass applied

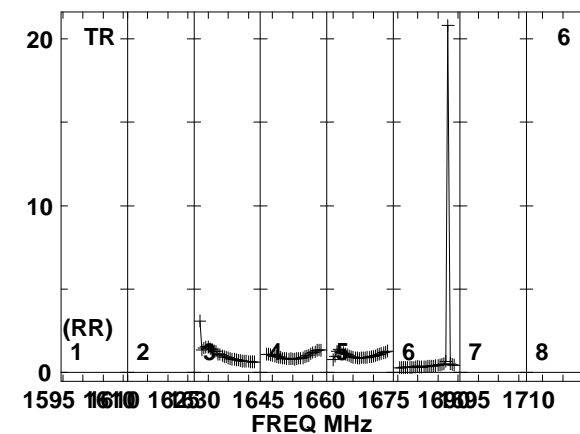
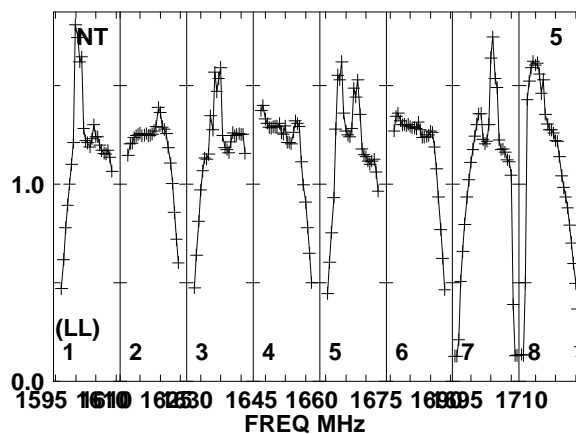
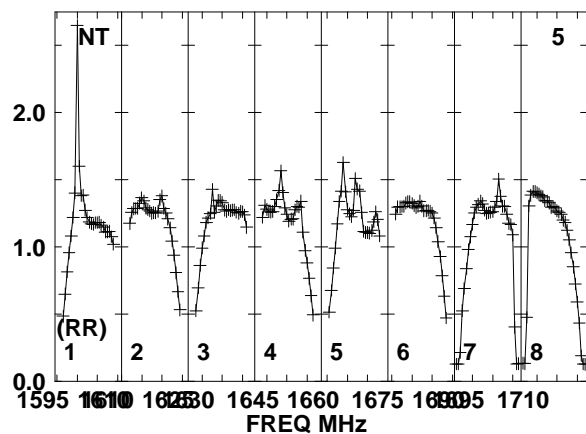
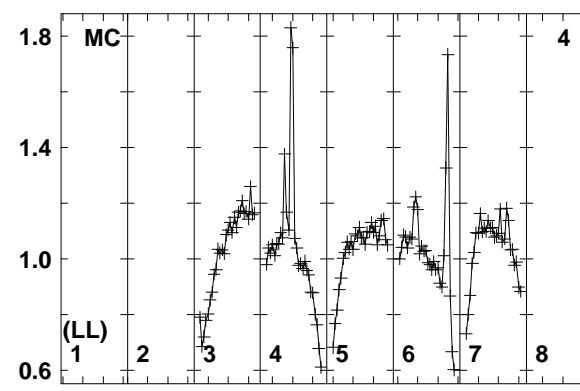
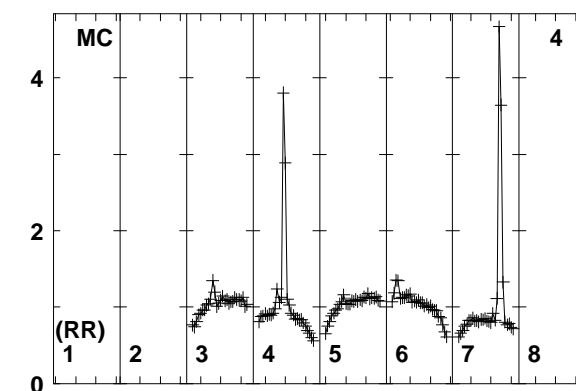
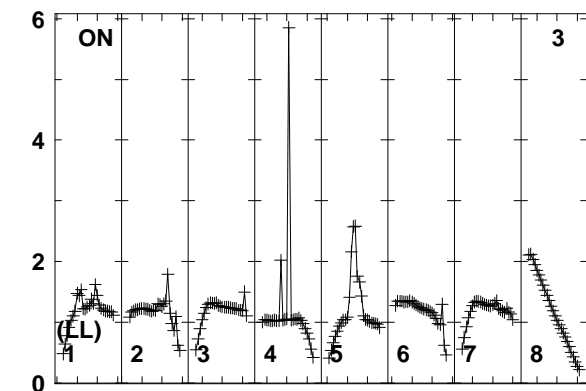
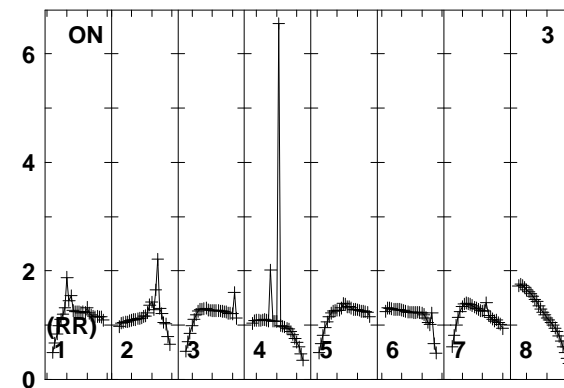
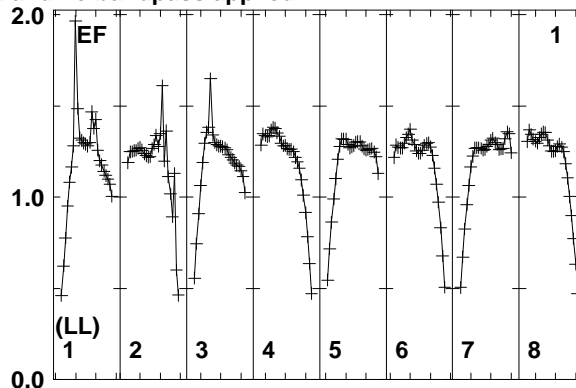
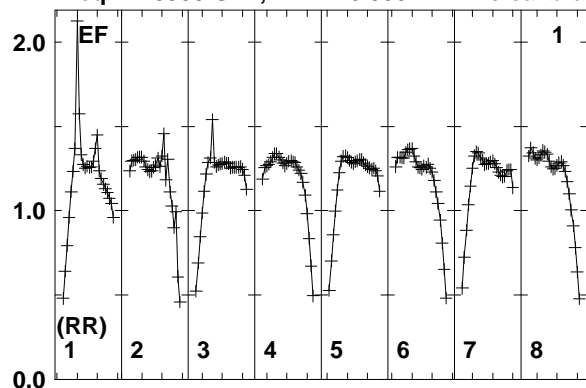

Lower frame: Real Jy
Total-power spectrum Antenna: EF (01)
Timerange: 00/03:36:01 to 00/03:39:49

Plot file version 42 created 11-AUG-2014 17:05:30

J2032+4127 EM110 2.UVDATA.1

Freq = 1.5950 GHz, Bw = 16.000 MH No calibration applied and no bandpass applied

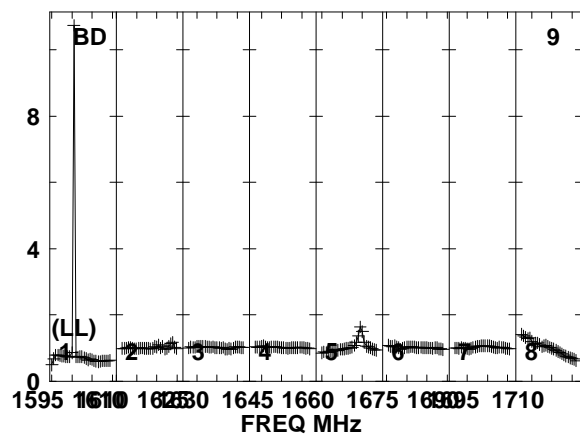
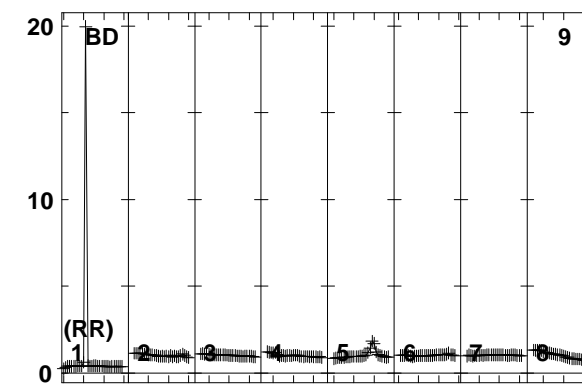
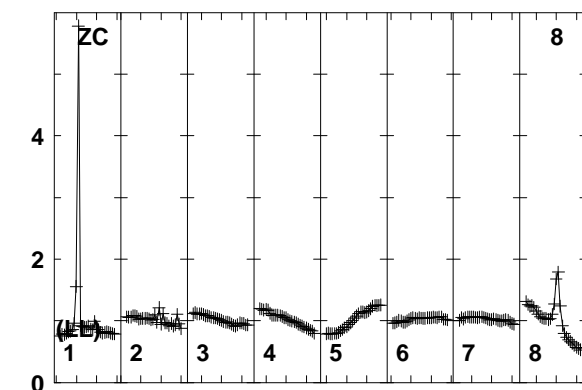
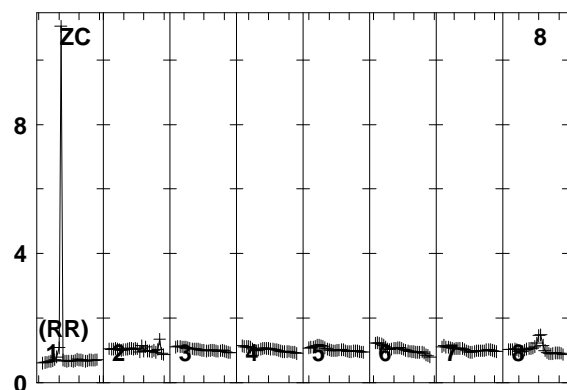
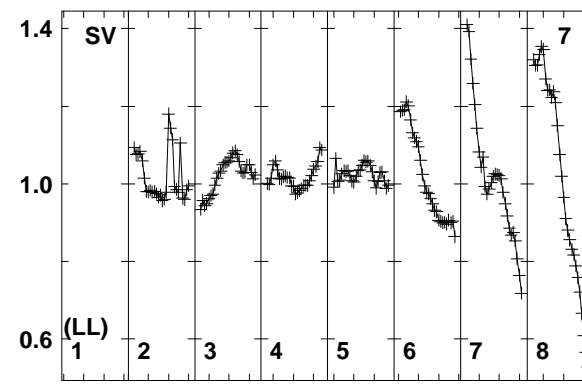
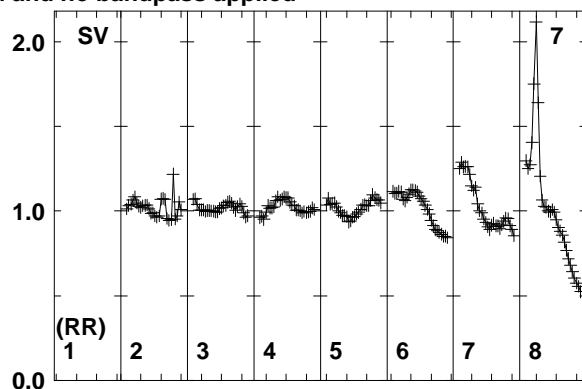
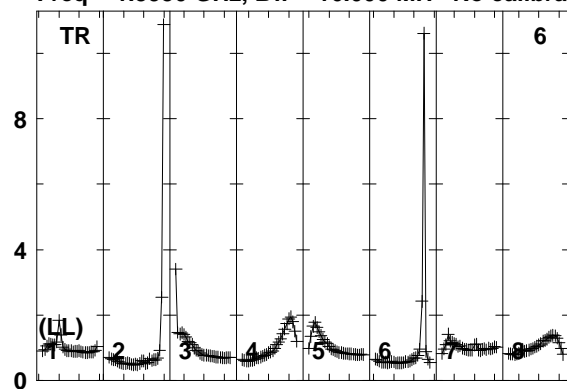

Lower frame: Real Jy
Total-power spectrum Antenna: TR (06)
Timerange: 00/03:36:01 to 00/03:39:49

Plot file version 43 created 11-AUG-2014 17:05:30

J2015+3710 EM110 2.UVDATA.1

Freq = 1.5950 GHz, Bw = 16.000 MH No calibration applied and no bandpass applied

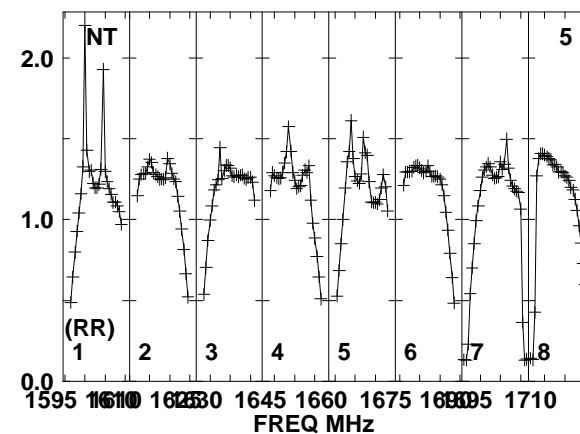
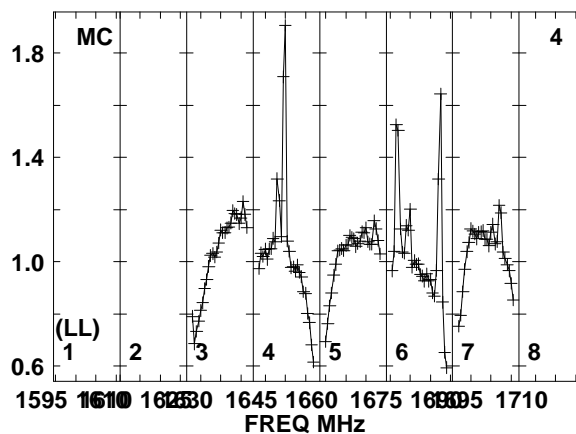
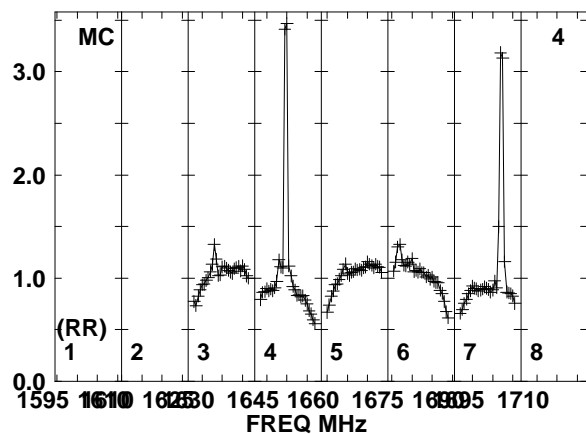
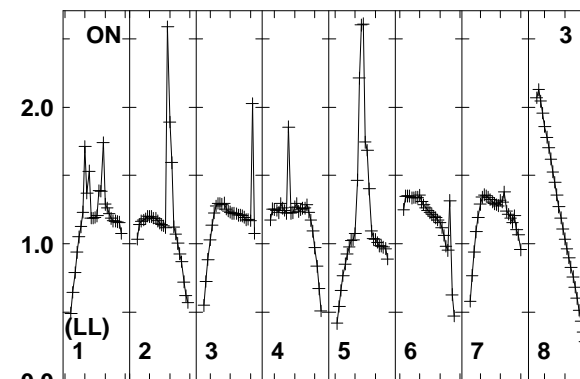
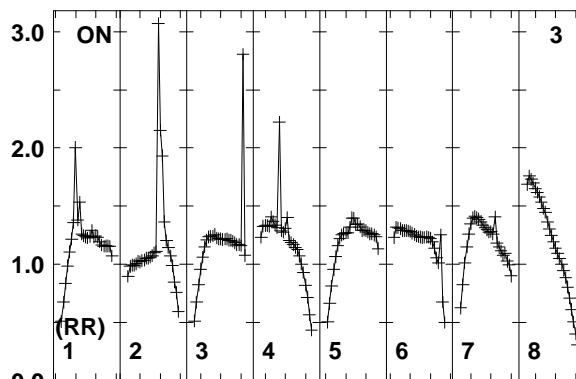
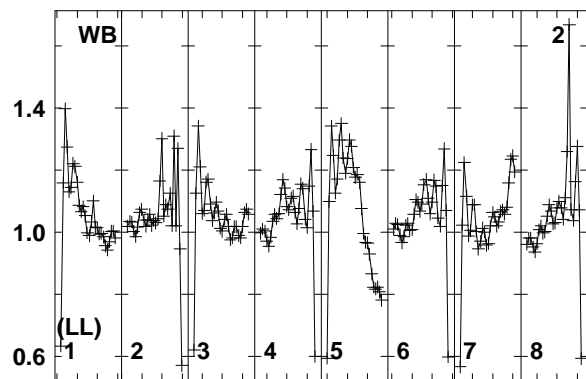
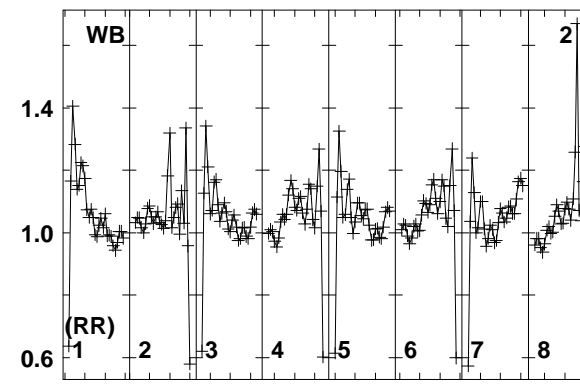
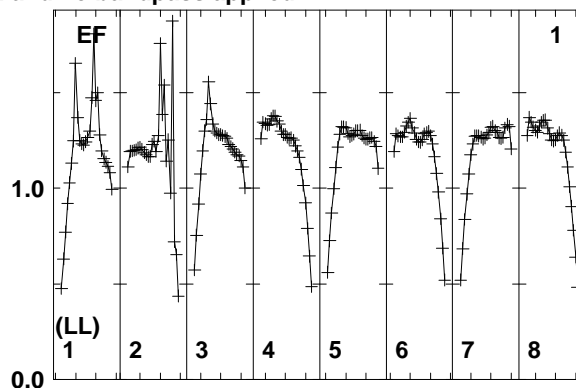
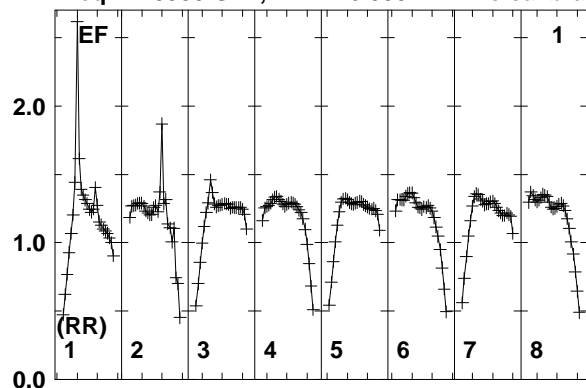

Lower frame: Real Jy
Total-power spectrum Antenna: EF (01)
Timerange: 00/03:39:53 to 00/03:41:49

Plot file version 44 created 11-AUG-2014 17:05:30

J2015+3710 EM110 2.UVDATA.1

Freq = 1.5950 GHz, Bw = 16.000 MH No calibration applied and no bandpass applied

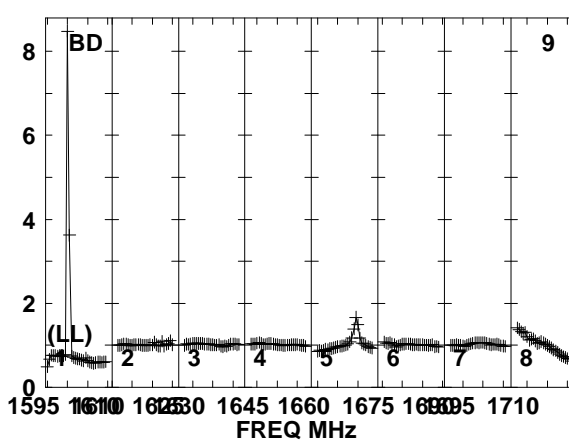
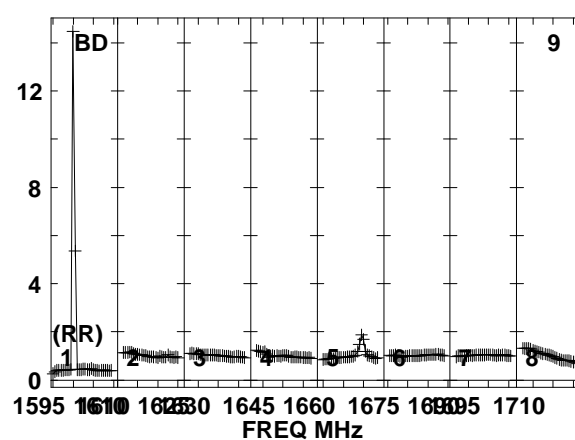
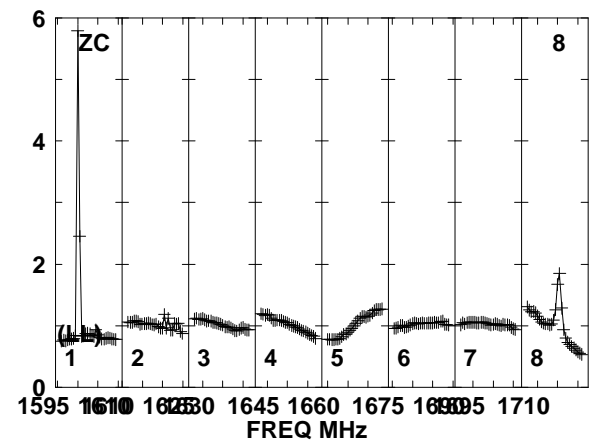
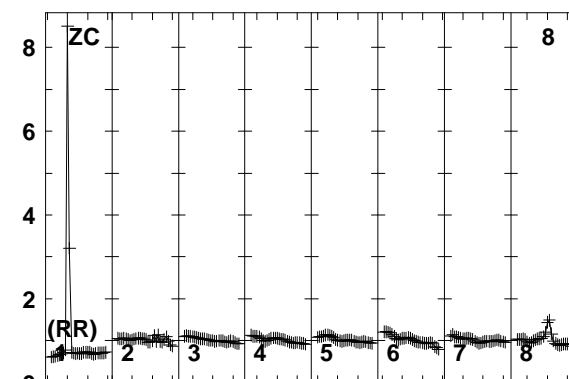
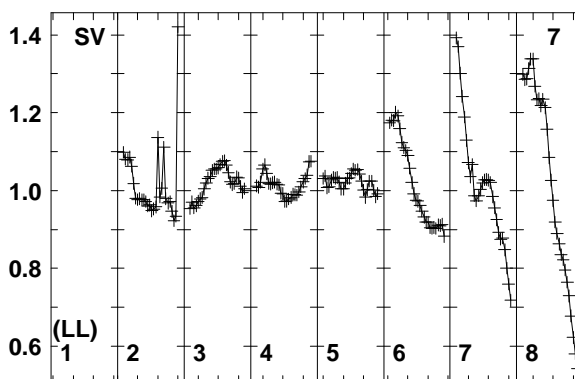
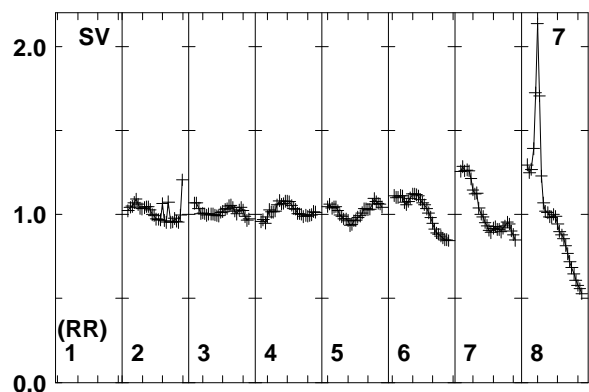
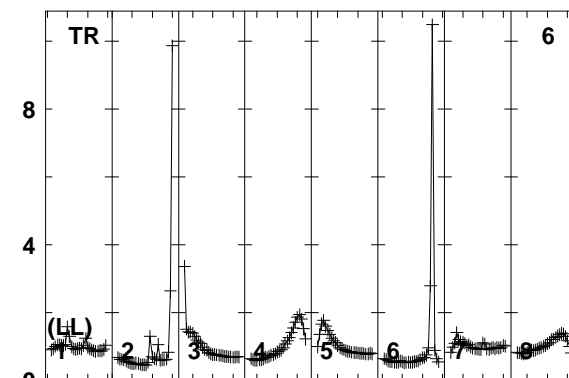
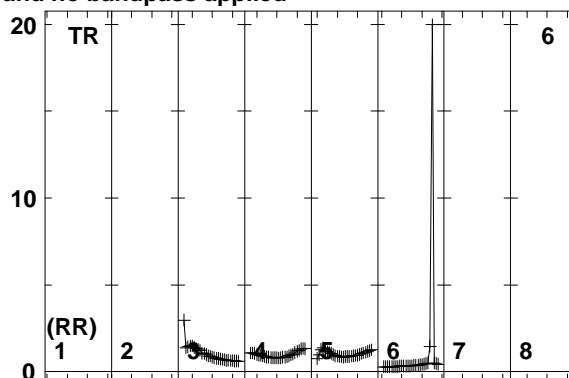
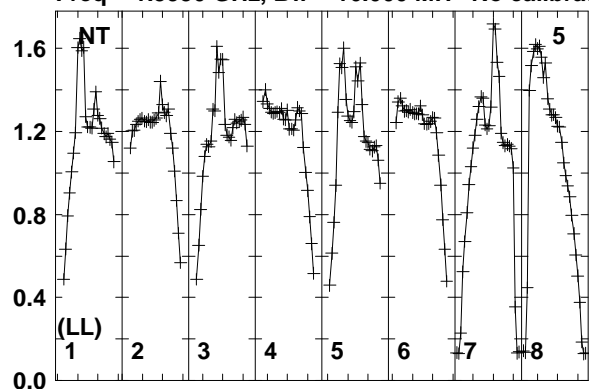

Lower frame: Real Jy
Total-power spectrum Antenna: NT (05)
Timerange: 00/03:39:53 to 00/03:41:49

Plot file version 45 created 11-AUG-2014 17:05:30

J2032+4127 EM110 2.UVDATA.1

Freq = 1.5950 GHz, Bw = 16.000 MH No calibration applied and no bandpass applied

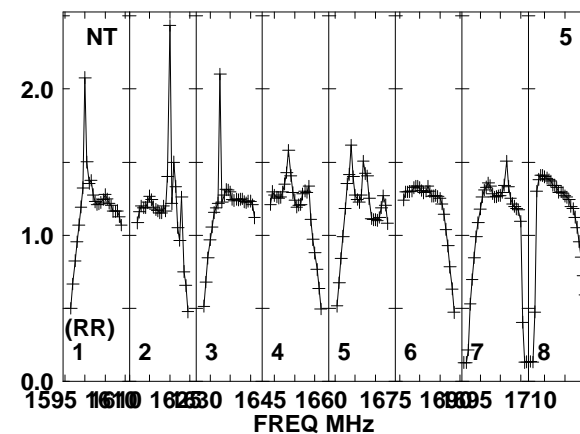
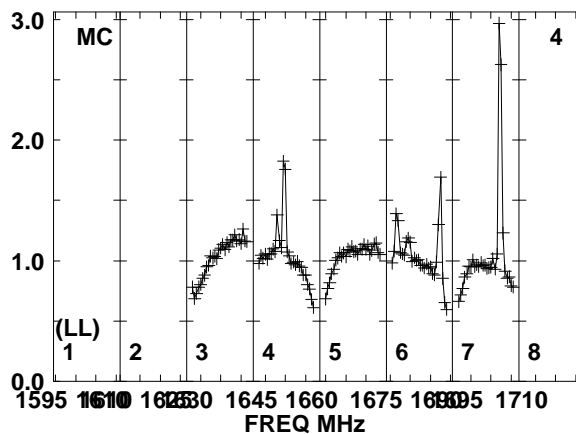
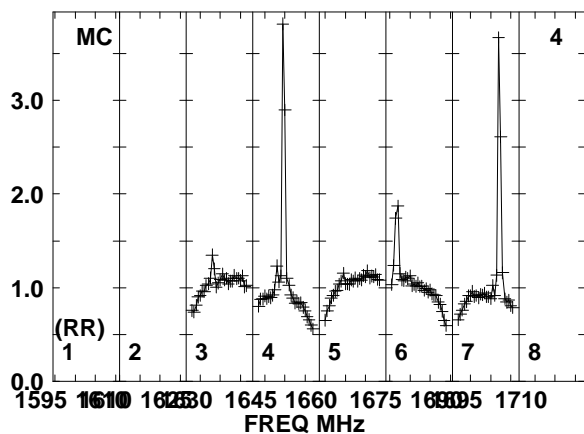
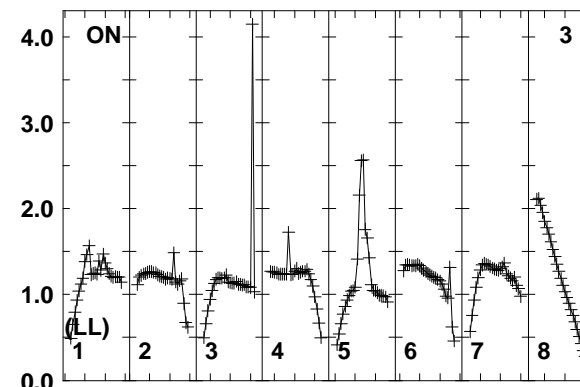
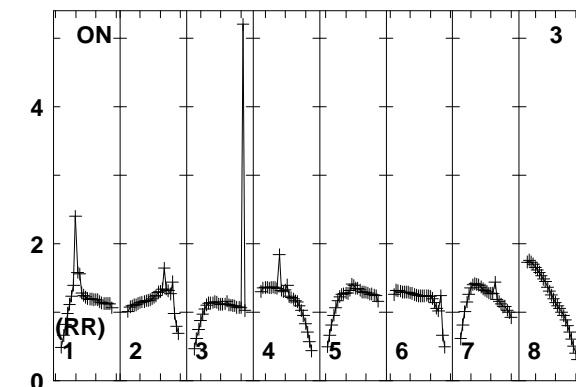
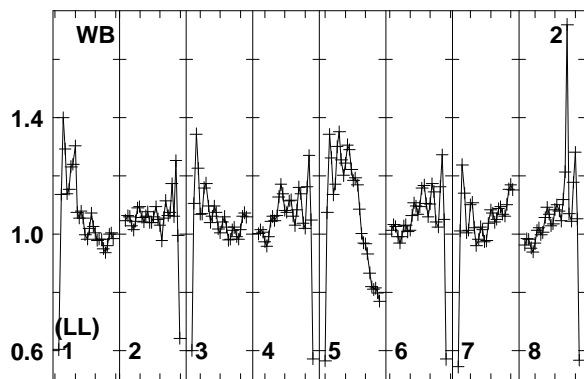
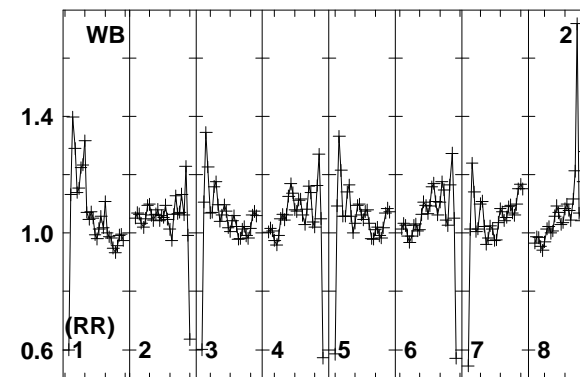
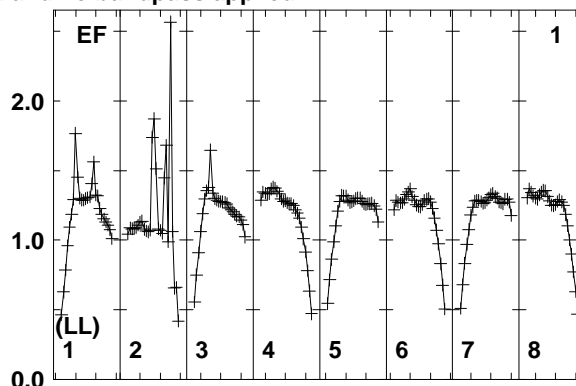
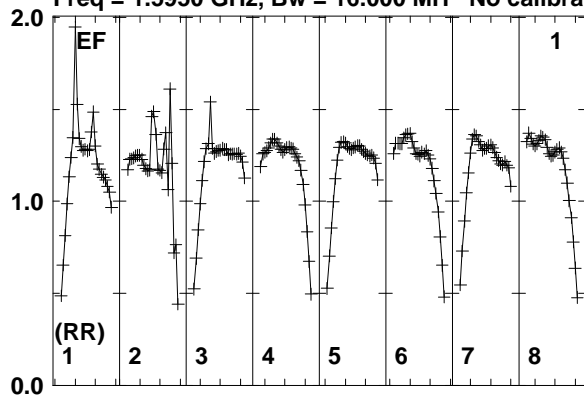

Lower frame: Real Jy
Total-power spectrum Antenna: EF (01)
Timerange: 00/03:42:01 to 00/03:45:49

Plot file version 46 created 11-AUG-2014 17:05:30

J2032+4127 EM110 2.UVDATA.1

Freq = 1.5950 GHz, Bw = 16.000 MH No calibration applied and no bandpass applied

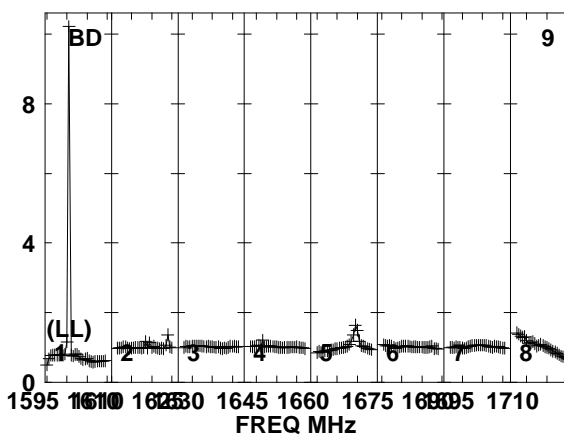
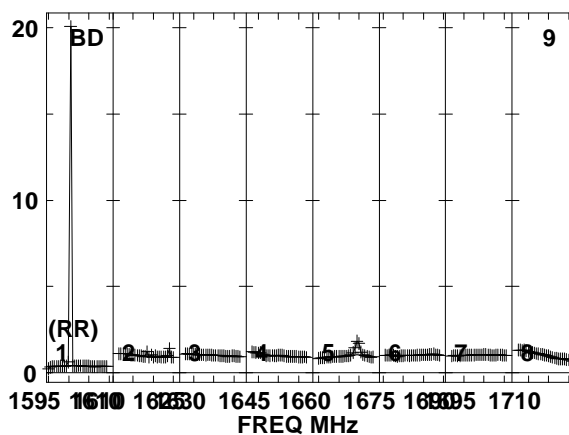
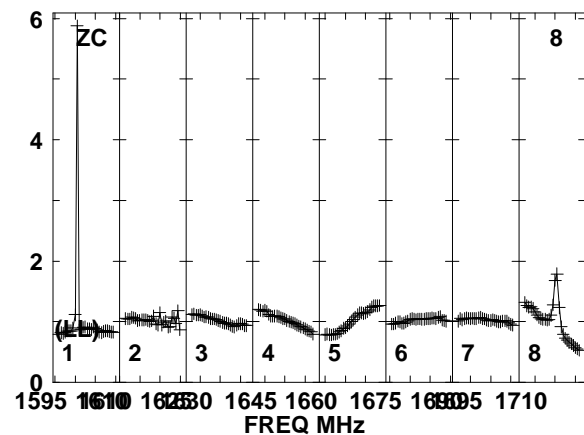
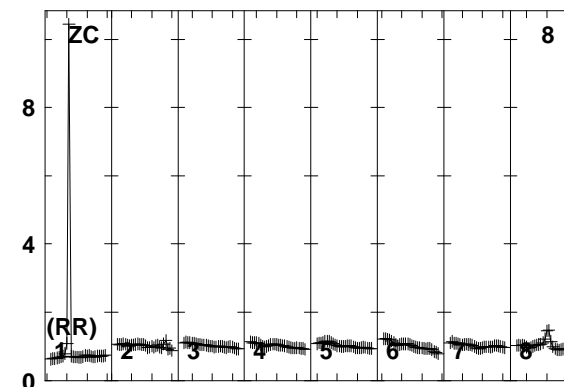
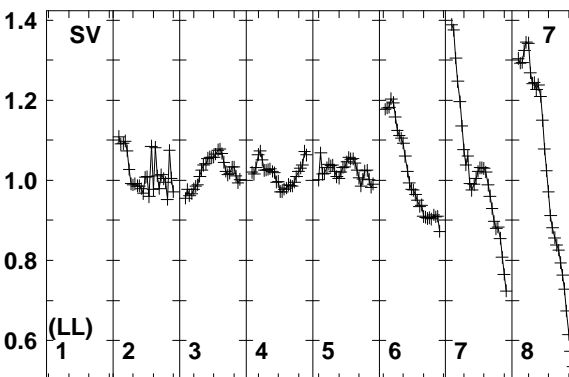
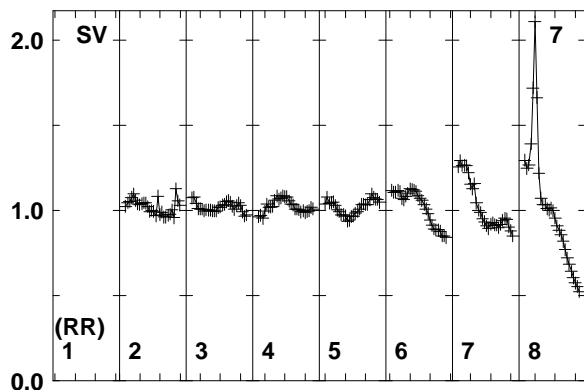
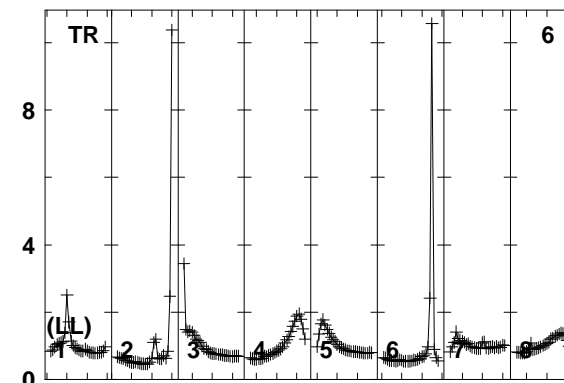
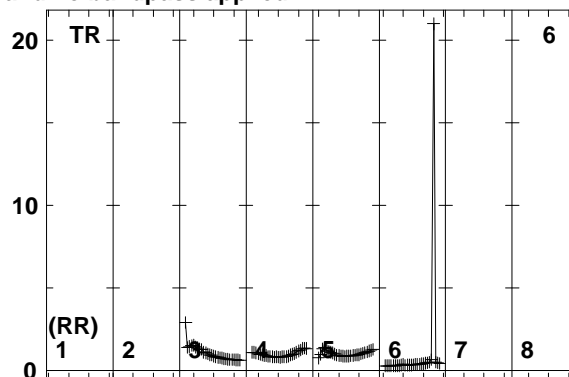
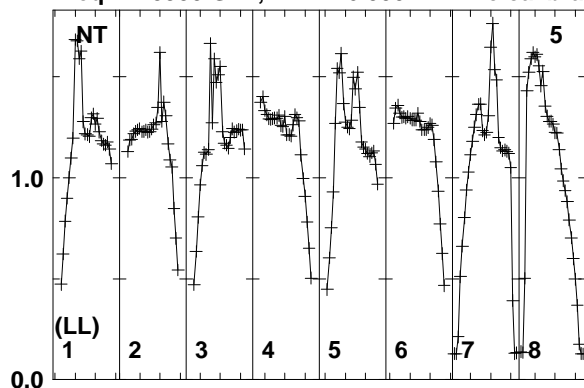

Lower frame: Real Jy
Total-power spectrum Antenna: NT (05)
Timerange: 00/03:42:01 to 00/03:45:49

Plot file version 47 created 11-AUG-2014 17:05:30

J2015+3710 EM110 2.UVDATA.1

Freq = 1.5950 GHz, Bw = 16.000 MH No calibration applied and no bandpass applied

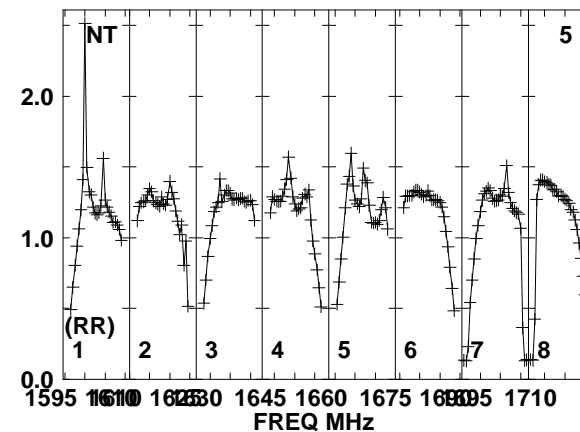
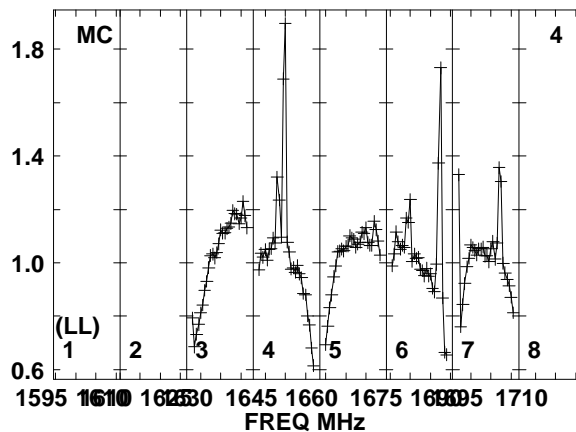
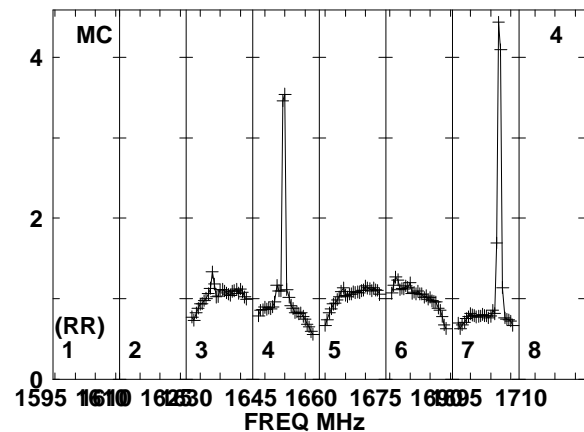
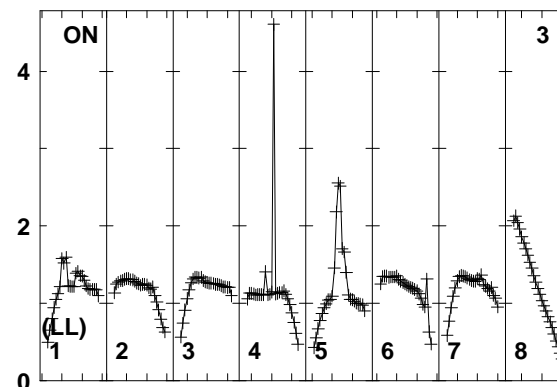
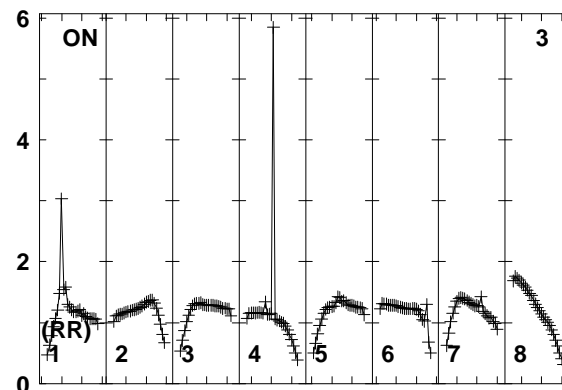
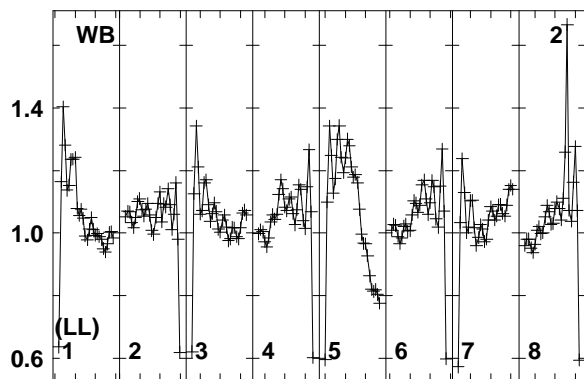
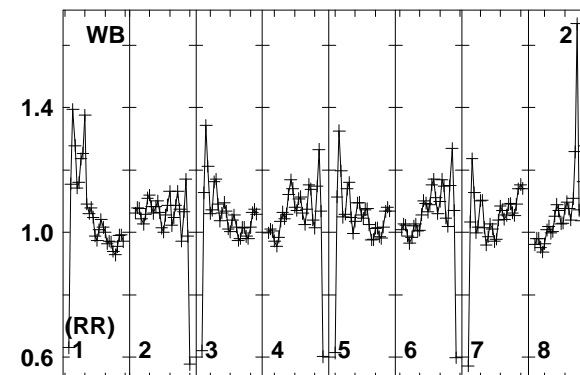
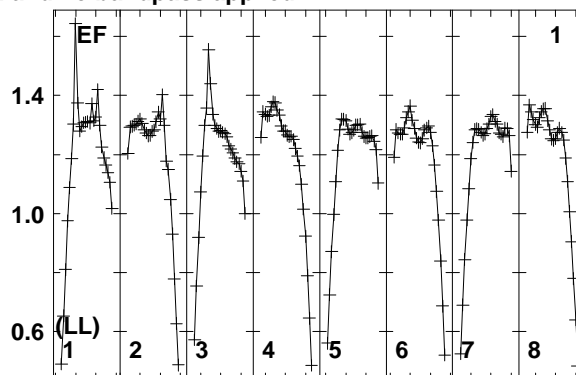
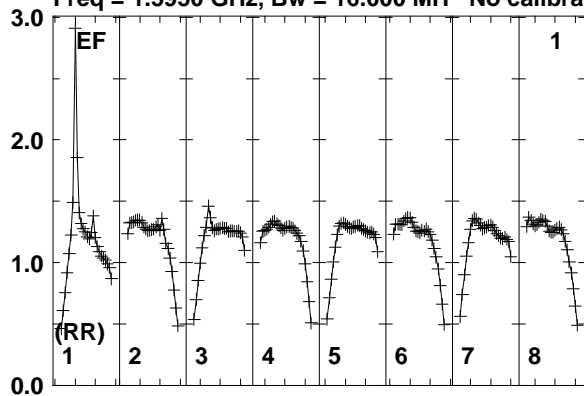

Lower frame: Real Jy
Total-power spectrum Antenna: EF (01)
Timerange: 00/03:46:51 to 00/03:48:49

Plot file version 48 created 11-AUG-2014 17:05:31

J2015+3710 EM110 2.UVDATA.1

Freq = 1.5950 GHz, Bw = 16.000 MH No calibration applied and no bandpass applied

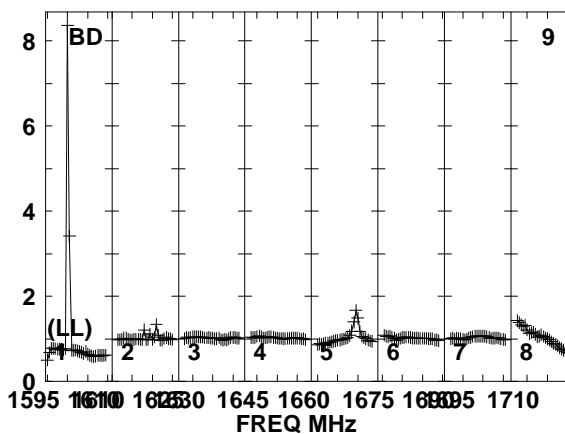
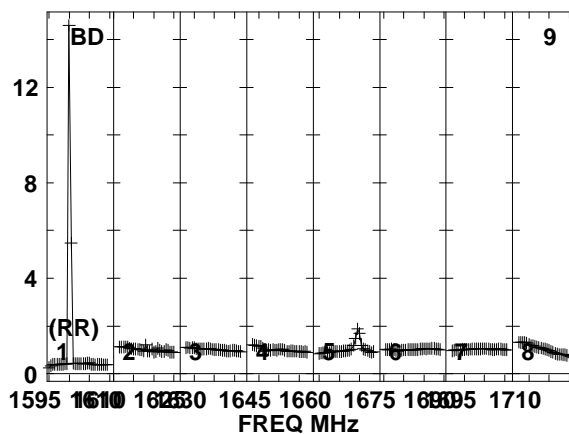
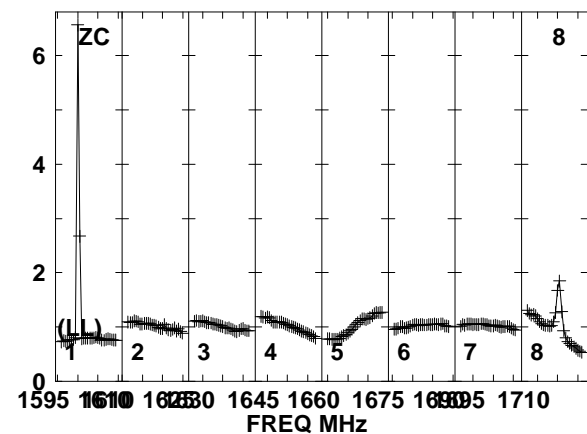
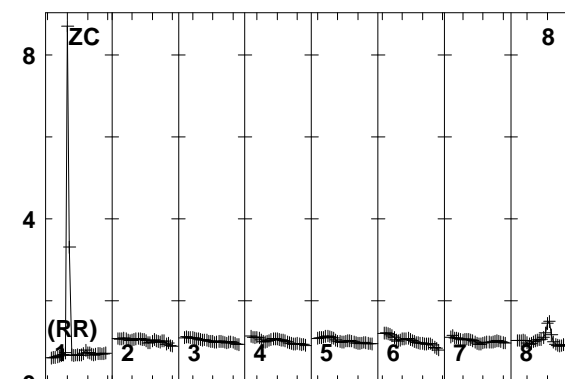
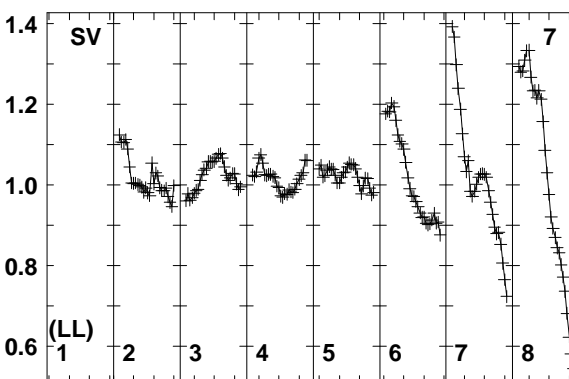
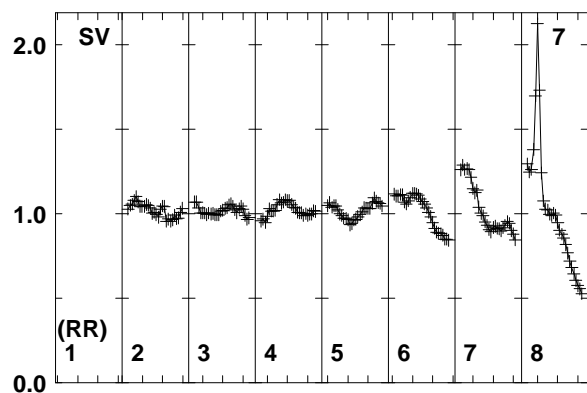
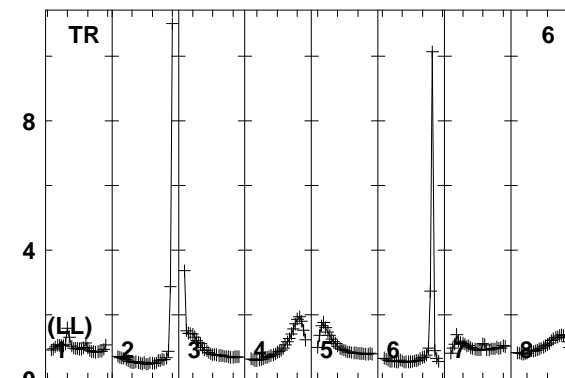
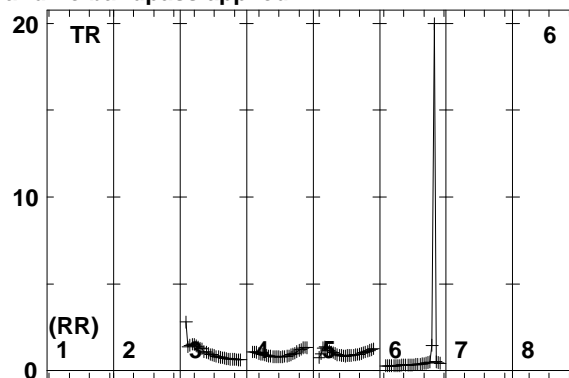
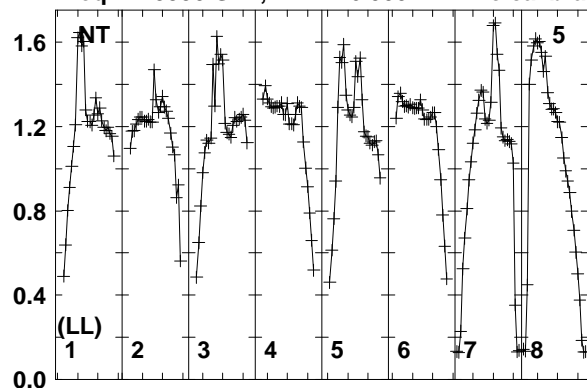

Lower frame: Real Jy
Total-power spectrum Antenna: NT (05)
Timerange: 00/03:46:51 to 00/03:48:49

Plot file version 49 created 11-AUG-2014 17:05:31

J2032+4127 EM110 2.UVDATA.1

Freq = 1.5950 GHz, Bw = 16.000 MH No calibration applied and no bandpass applied

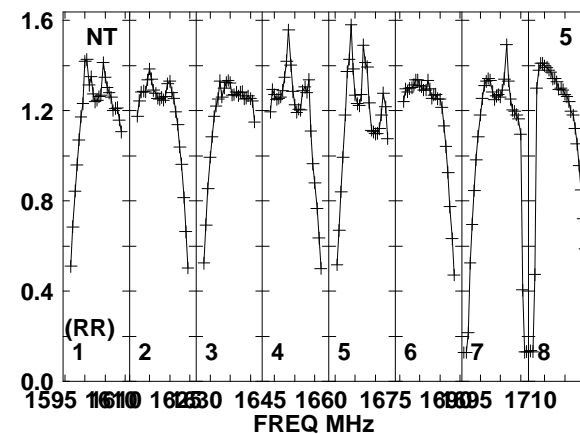
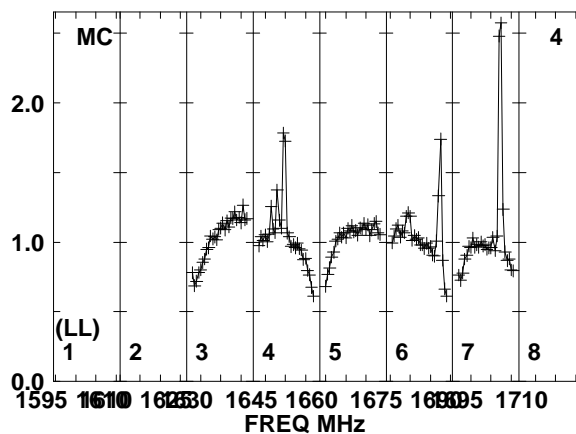
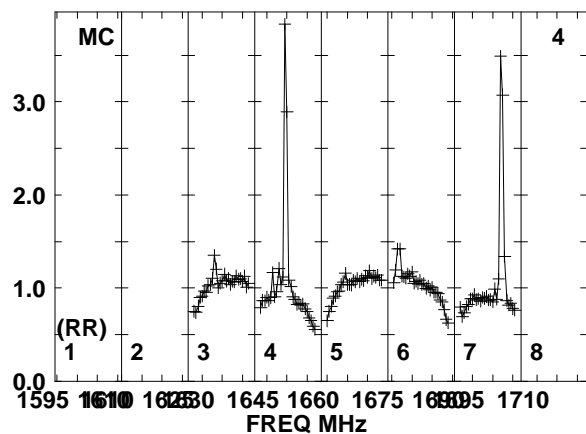
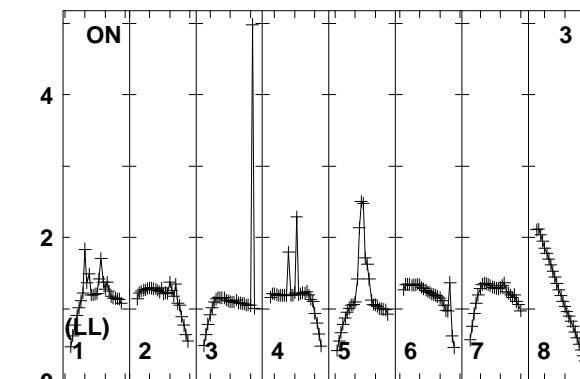
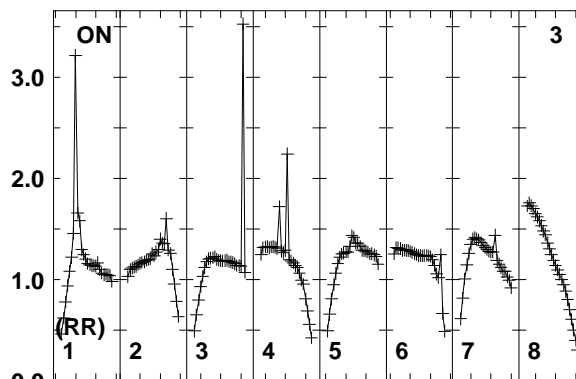
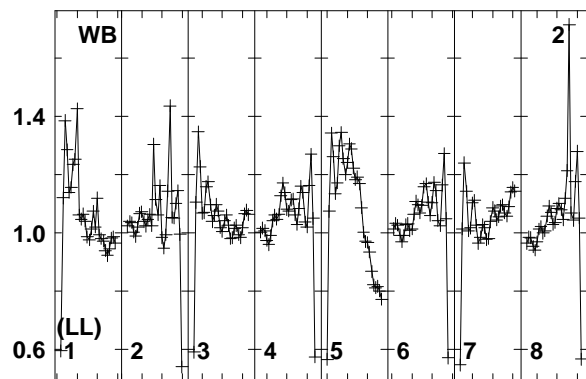
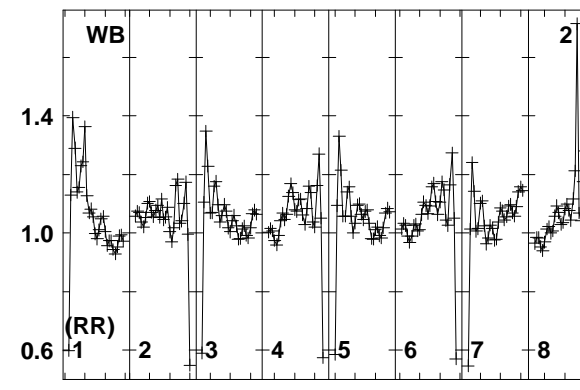
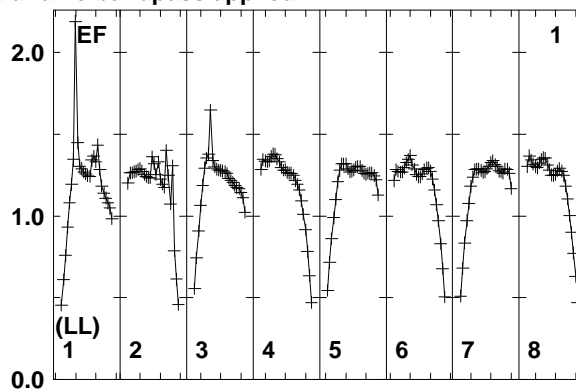
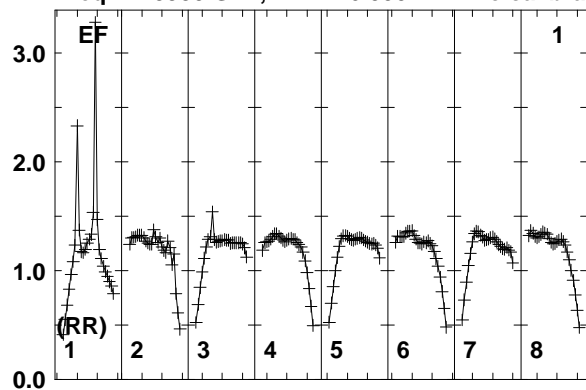

Lower frame: Real Jy
Total-power spectrum Antenna: EF (01)
Timerange: 00/03:49:01 to 00/03:52:49

Plot file version 50 created 11-AUG-2014 17:05:31

J2032+4127 EM110 2.UVDATA.1

Freq = 1.5950 GHz, Bw = 16.000 MH No calibration applied and no bandpass applied

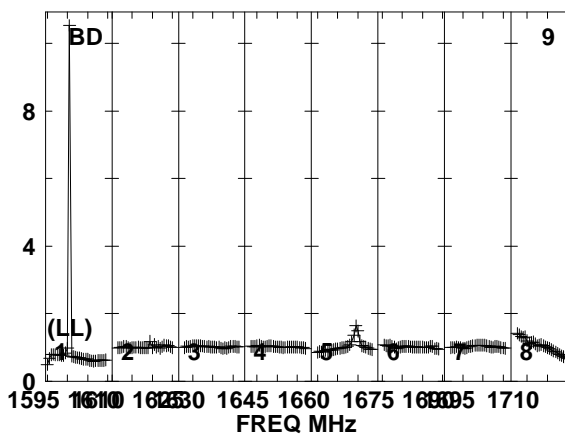
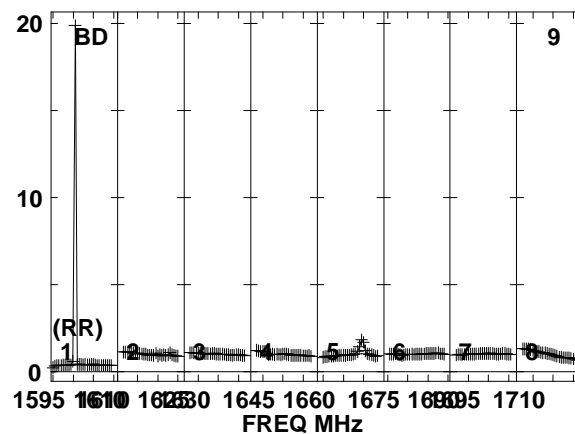
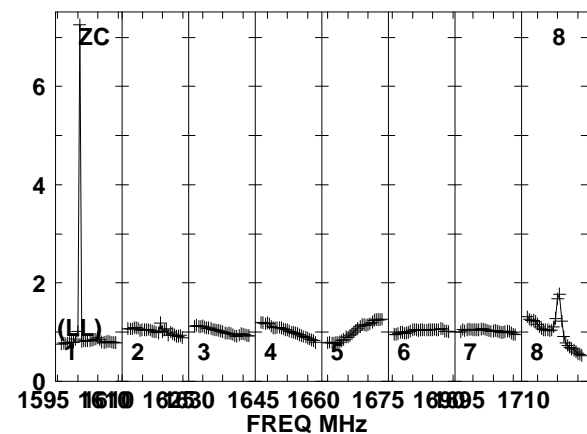
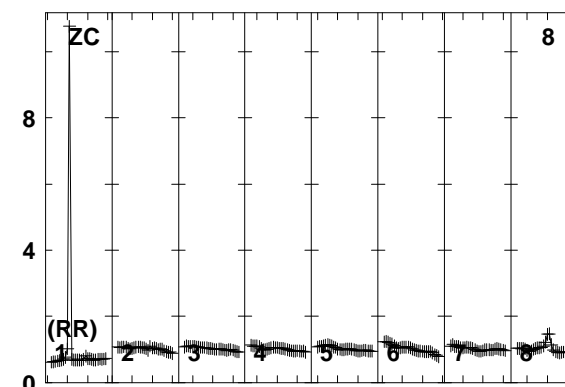
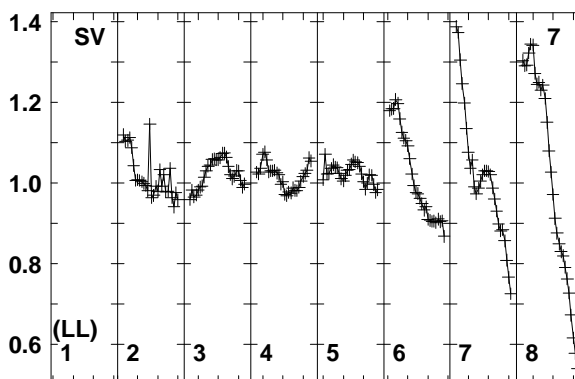
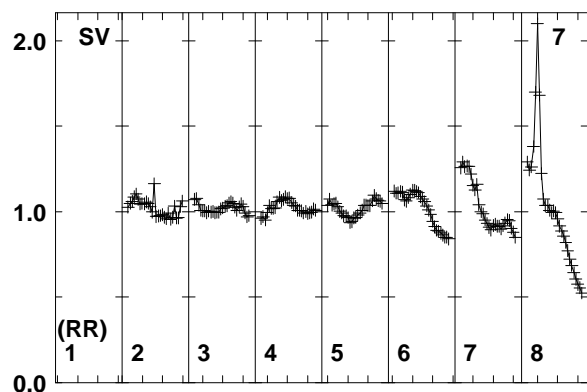
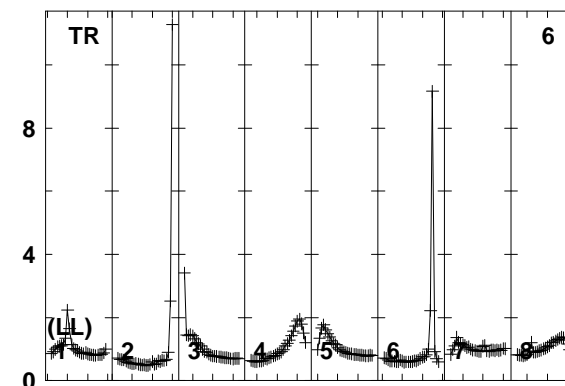
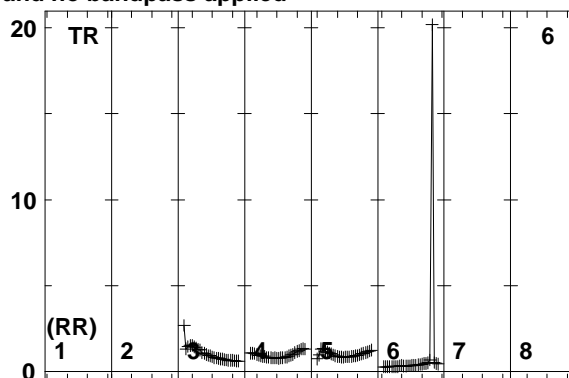
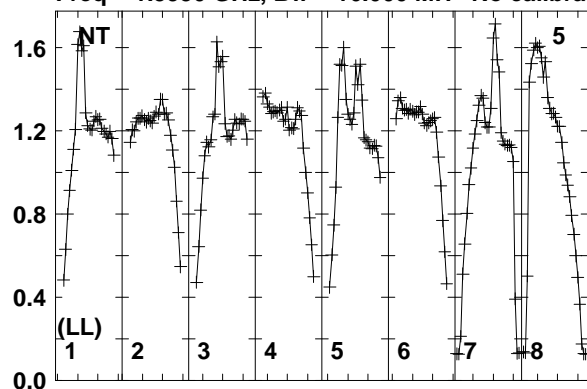

Lower frame: Real Jy
Total-power spectrum Antenna: NT (05)
Timerange: 00/03:49:01 to 00/03:52:49

Plot file version 51 created 11-AUG-2014 17:05:31

J2015+3710 EM110 2.UVDATA.1

Freq = 1.5950 GHz, Bw = 16.000 MH No calibration applied and no bandpass applied

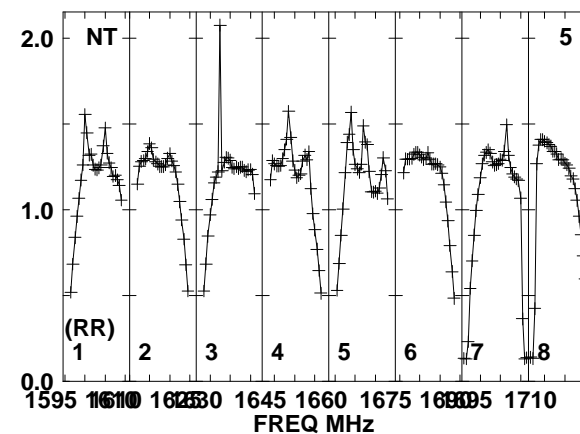
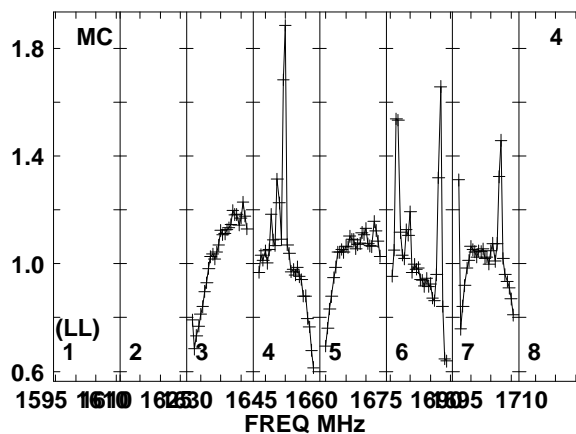
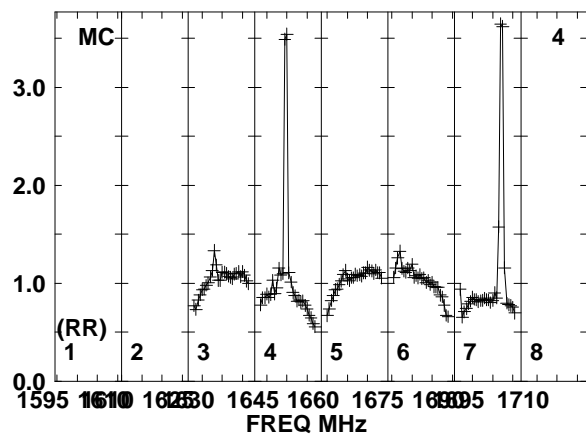
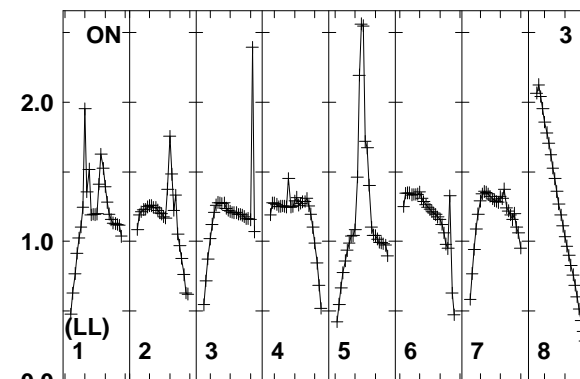
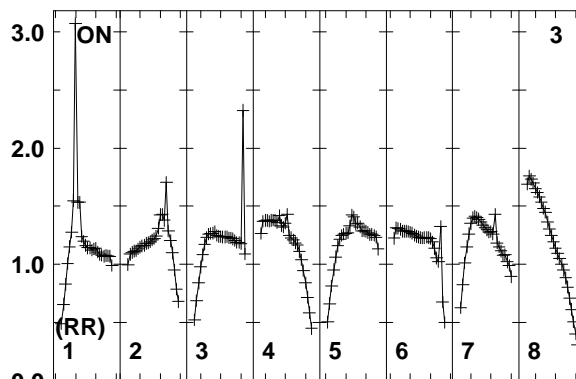
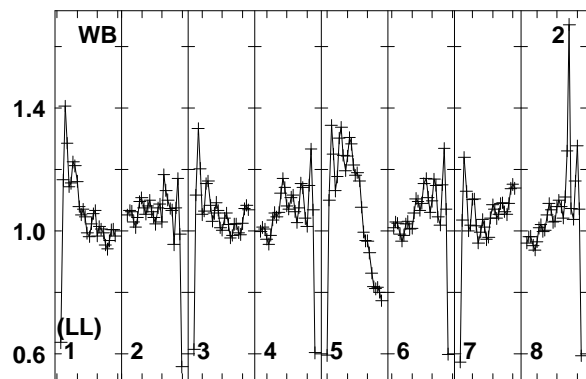
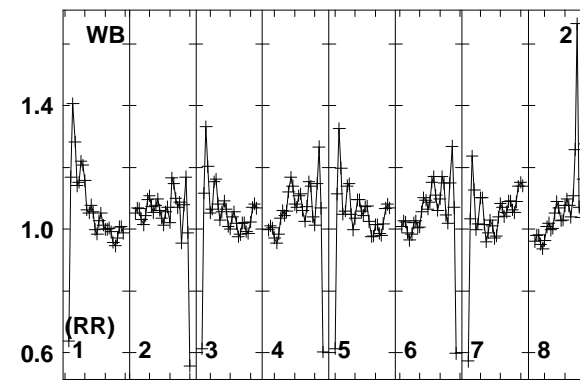
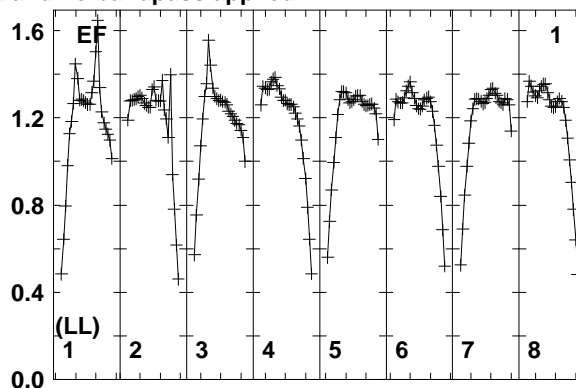
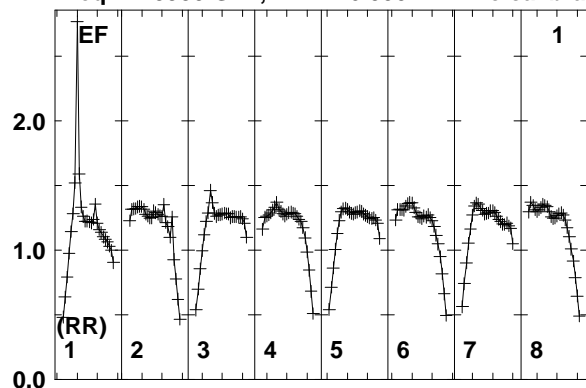

Lower frame: Real Jy
Total-power spectrum Antenna: EF (01)
Timerange: 00/03:53:02 to 00/03:54:48

Plot file version 52 created 11-AUG-2014 17:05:31

J2015+3710 EM110 2.UVDATA.1

Freq = 1.5950 GHz, Bw = 16.000 MH No calibration applied and no bandpass applied

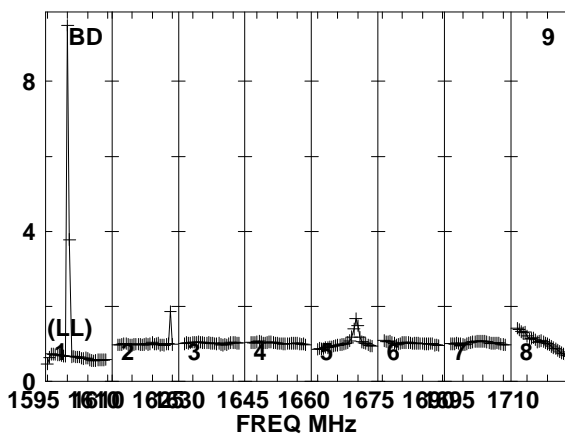
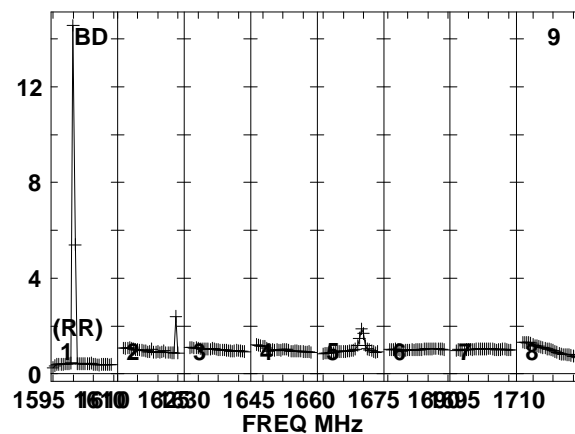
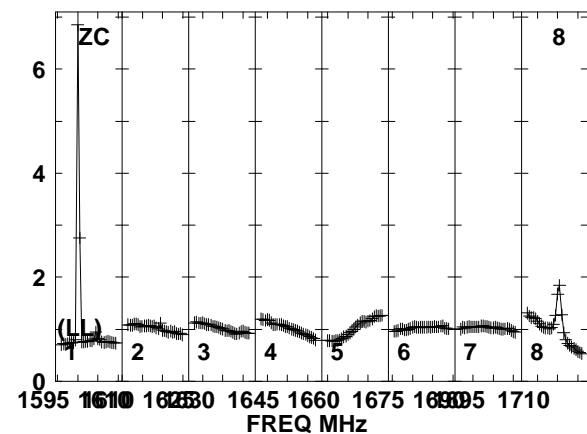
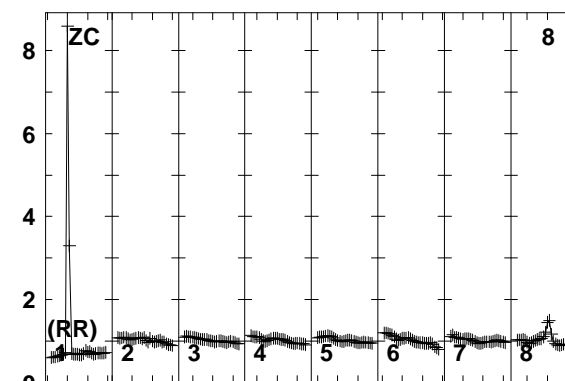
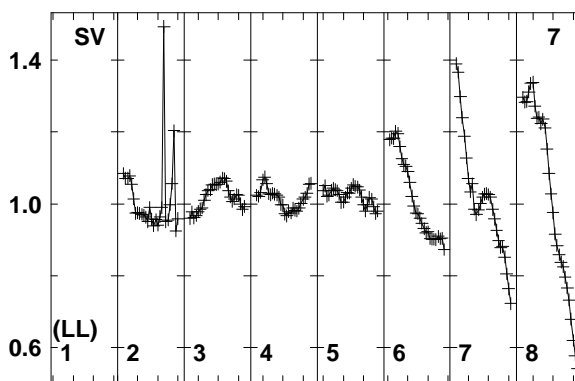
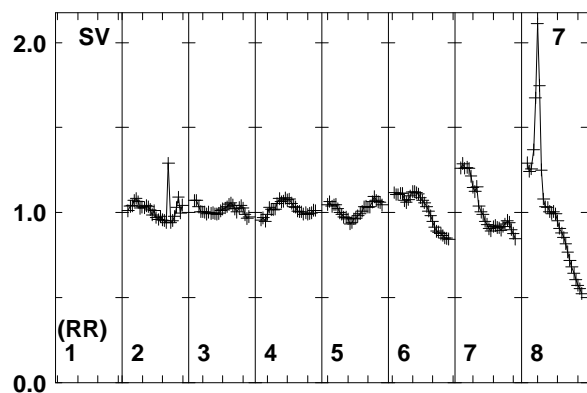
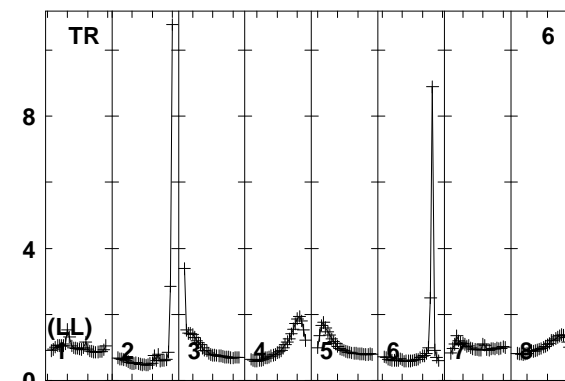
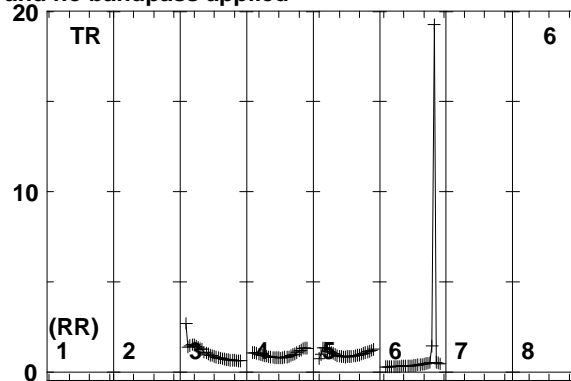
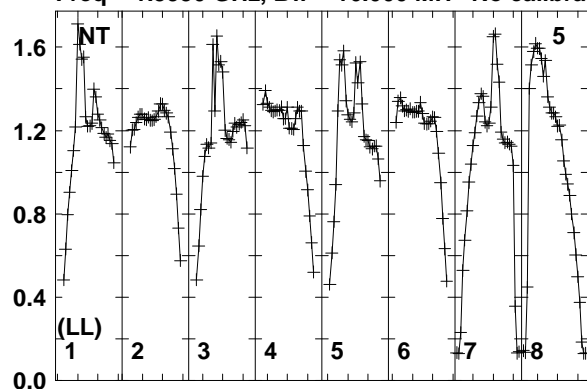

Lower frame: Real Jy
Total-power spectrum Antenna: NT (05)
Timerange: 00/03:53:02 to 00/03:54:48

Plot file version 53 created 11-AUG-2014 17:05:31

J2032+4127 EM110 2.UVDATA.1

Freq = 1.5950 GHz, Bw = 16.000 MH No calibration applied and no bandpass applied

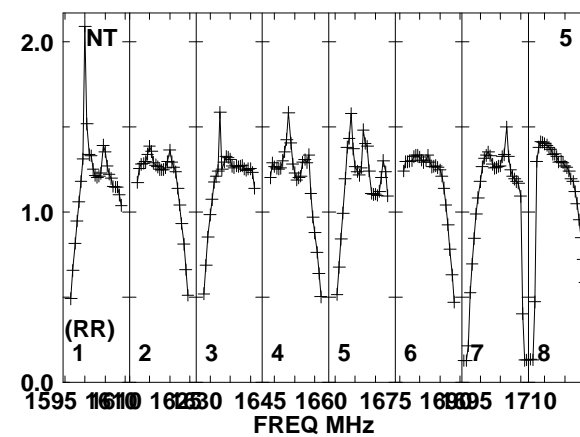
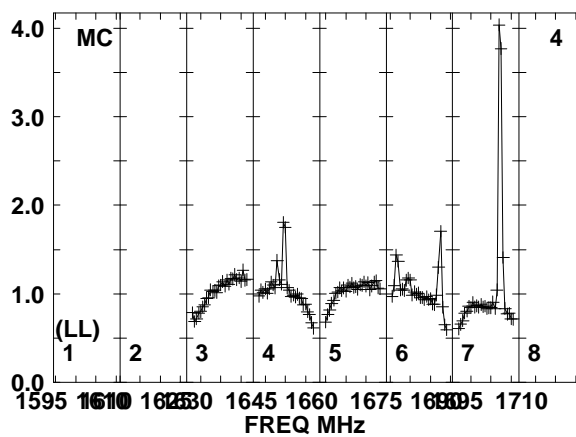
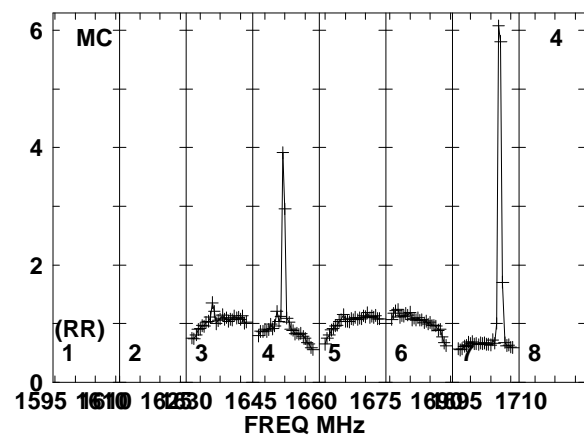
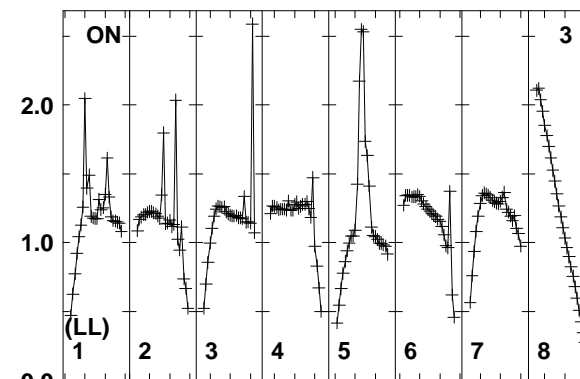
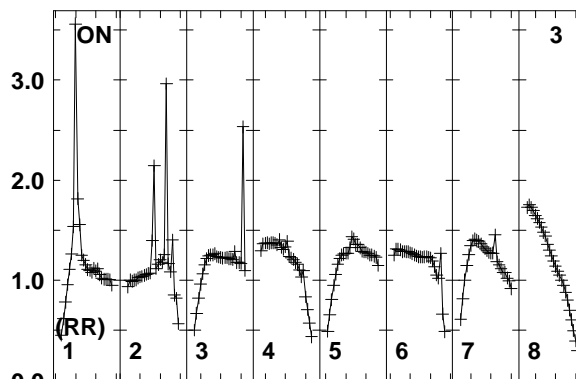
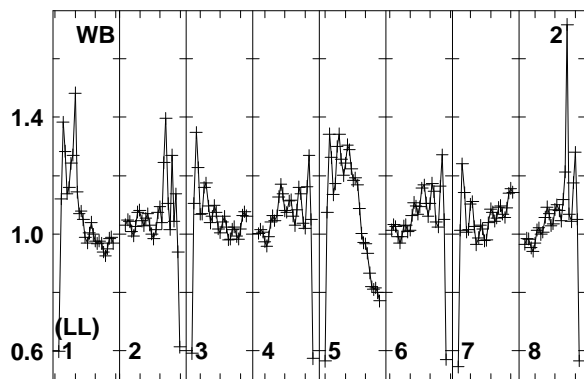
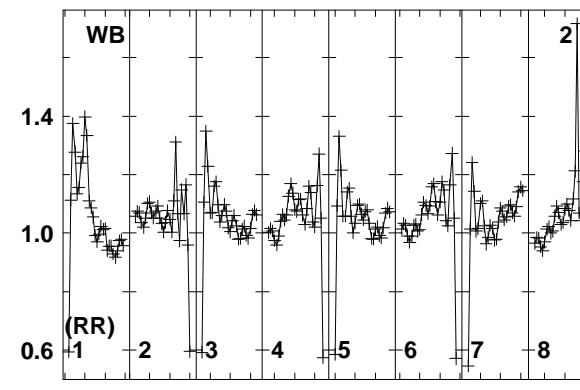
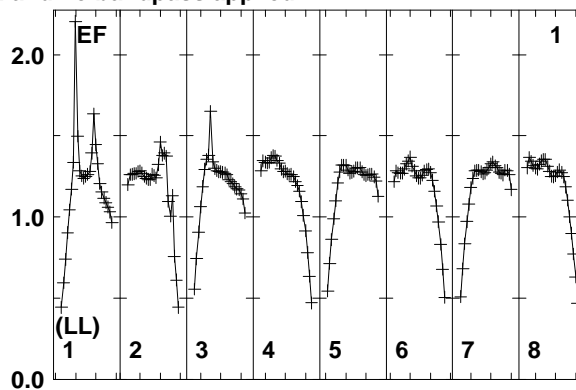
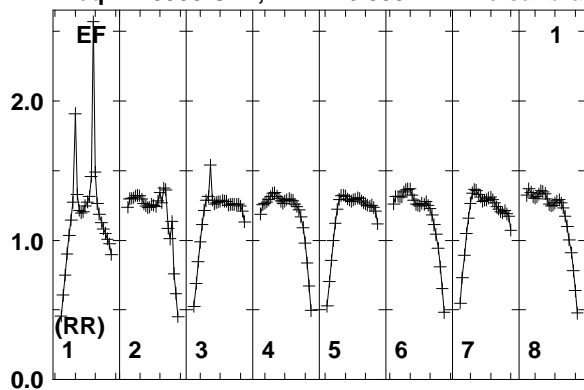

Lower frame: Real Jy
Total-power spectrum Antenna: EF (01)
Timerange: 00/03:54:51 to 00/03:58:49

Plot file version 54 created 11-AUG-2014 17:05:31

J2032+4127 EM110 2.UVDATA.1

Freq = 1.5950 GHz, Bw = 16.000 MH No calibration applied and no bandpass applied

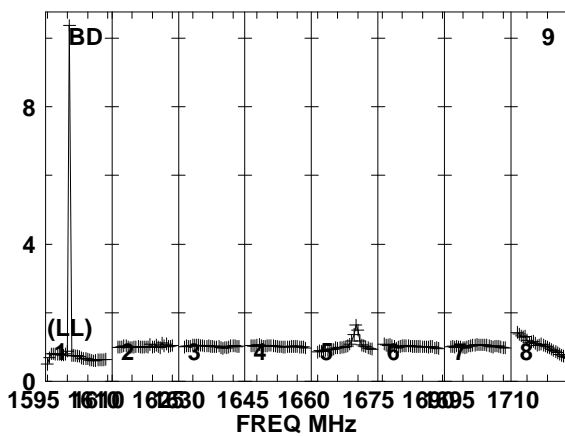
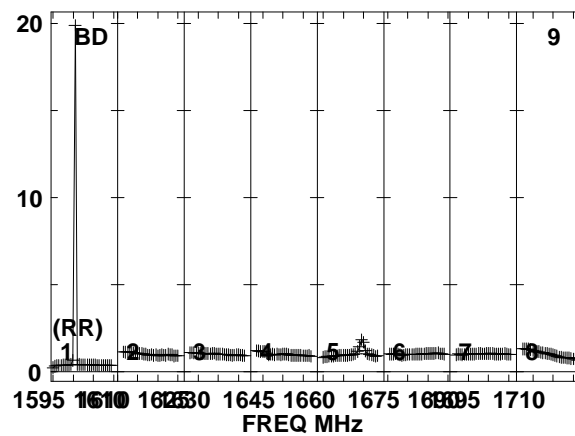
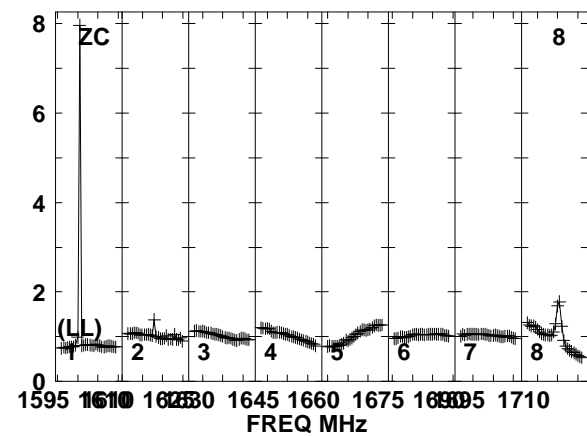
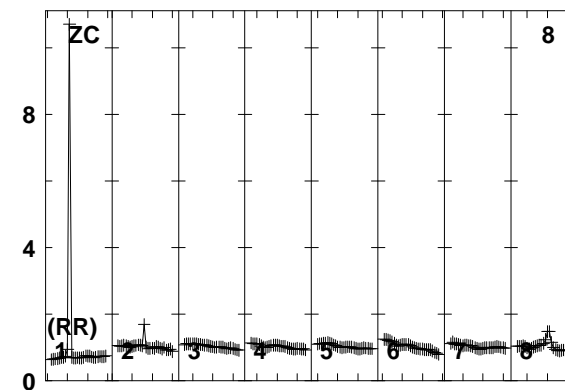
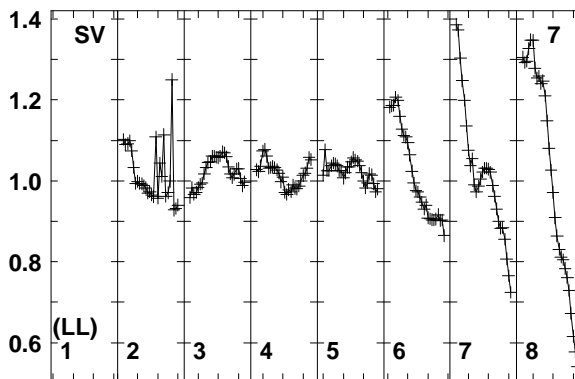
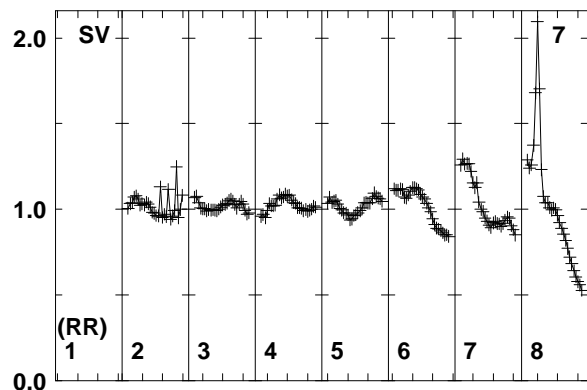
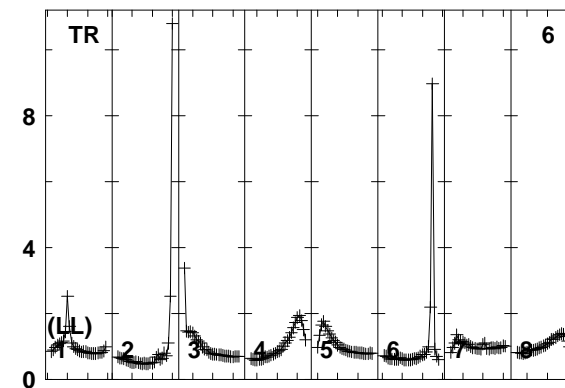
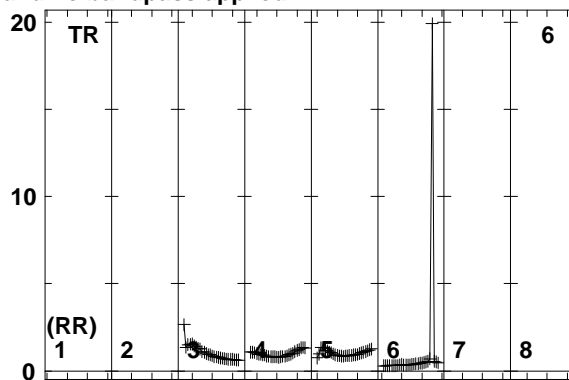
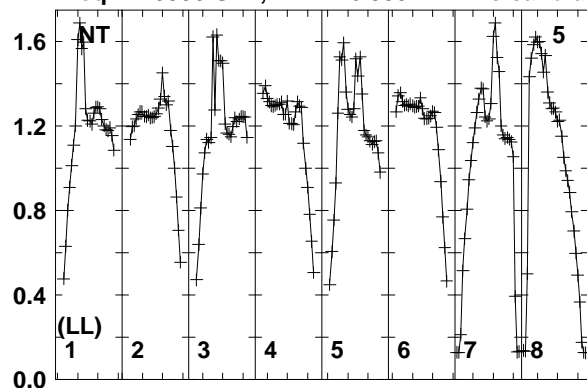

Lower frame: Real Jy
Total-power spectrum Antenna: NT (05)
Timerange: 00/03:54:51 to 00/03:58:49

Plot file version 55 created 11-AUG-2014 17:05:31

J2032+4127 EM110 2.UVDATA.1

Freq = 1.5950 GHz, Bw = 16.000 MH No calibration applied and no bandpass applied

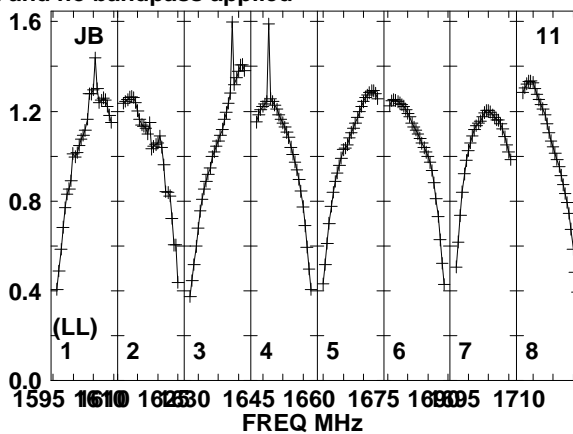
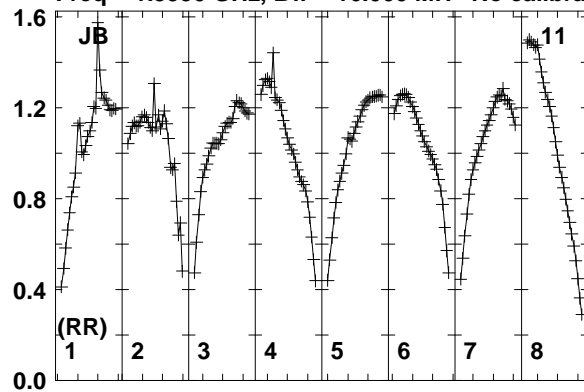

Lower frame: Real Jy
Total-power spectrum Antenna: JB (11)
Timerange: 00/03:54:51 to 00/03:58:49

Plot file version 56 created 11-AUG-2014 17:05:31

J2015+3710 EM110 2.UVDATA.1

Freq = 1.5950 GHz, Bw = 16.000 MH No calibration applied and no bandpass applied

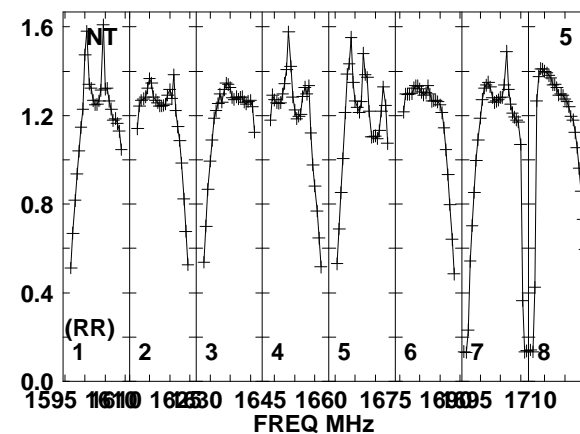
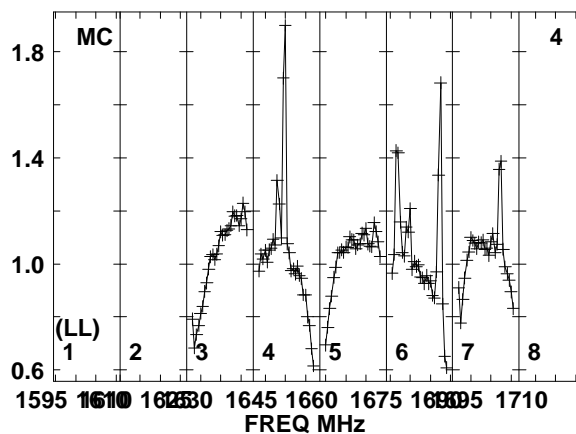
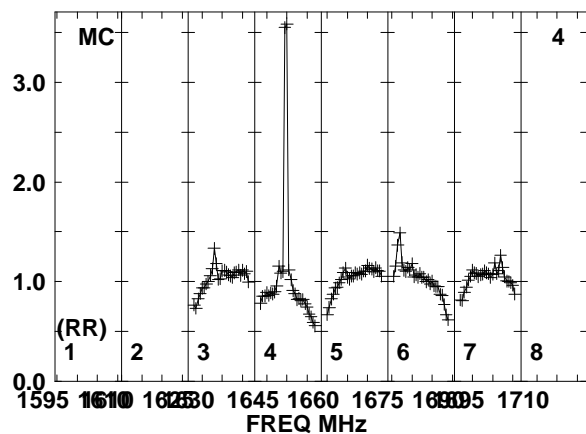
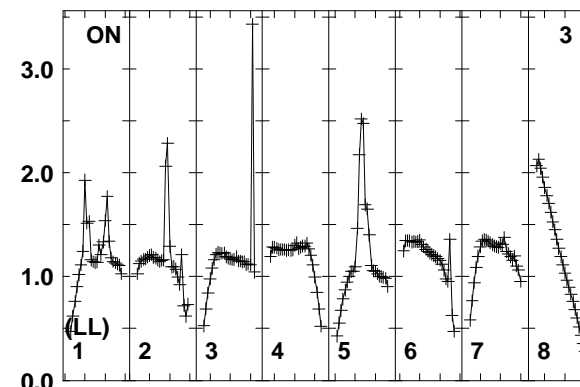
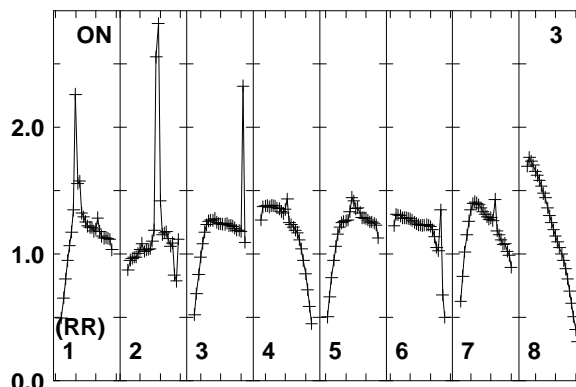
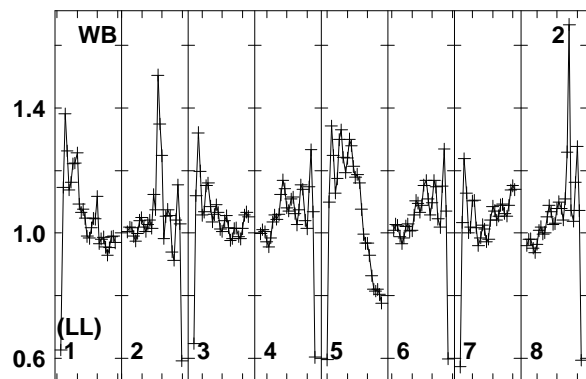
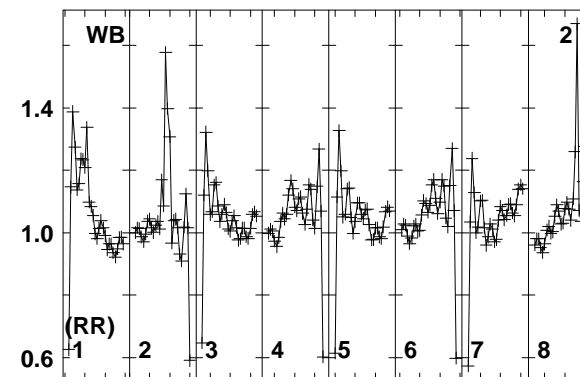
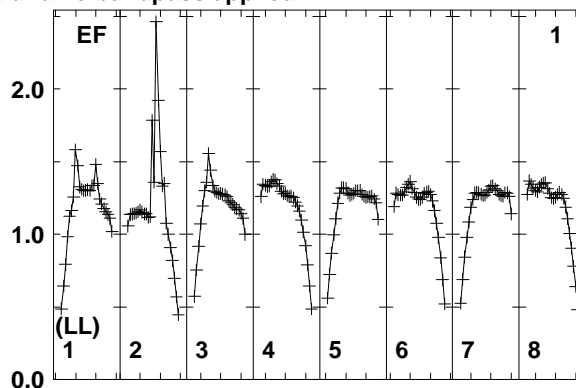
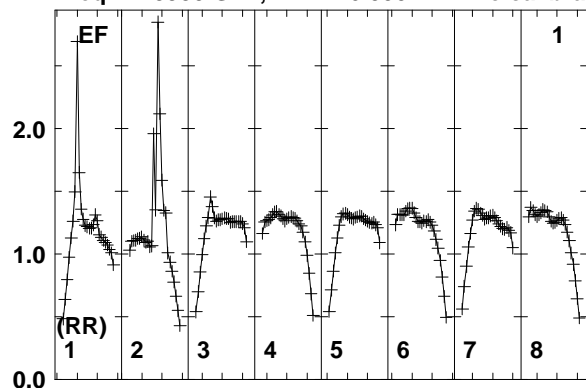

Lower frame: Real Jy
Total-power spectrum Antenna: EF (01)
Timerange: 00/03:59:51 to 00/04:01:49

Plot file version 57 created 11-AUG-2014 17:05:31

J2015+3710 EM110 2.UVDATA.1

Freq = 1.5950 GHz, Bw = 16.000 MH No calibration applied and no bandpass applied

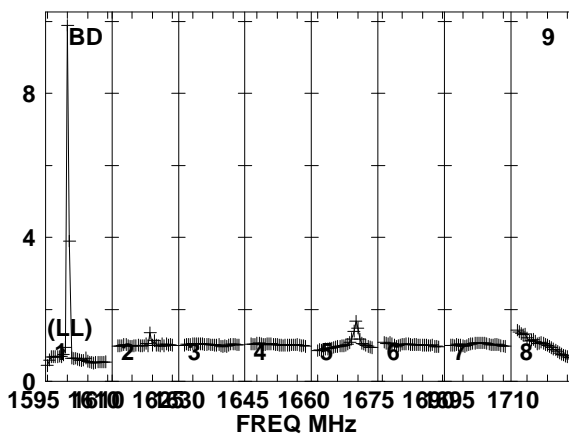
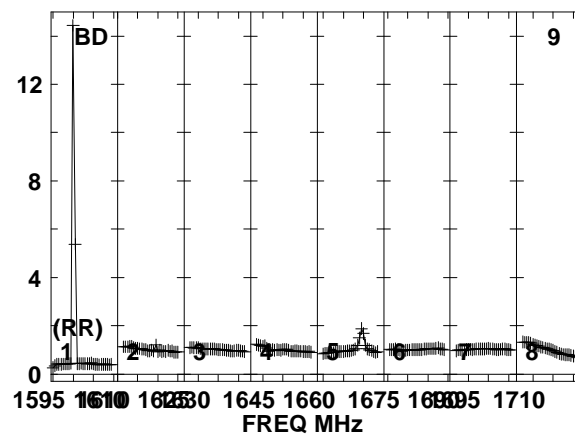
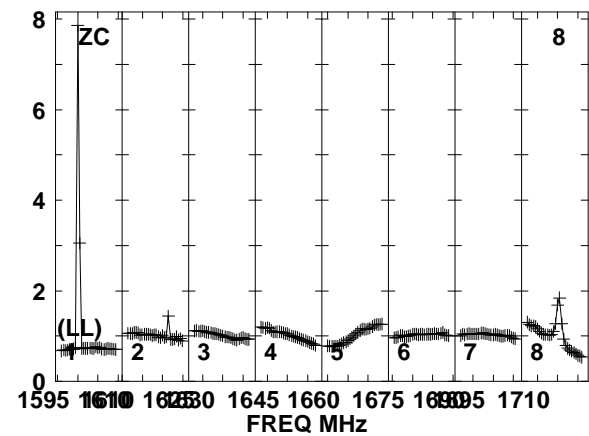
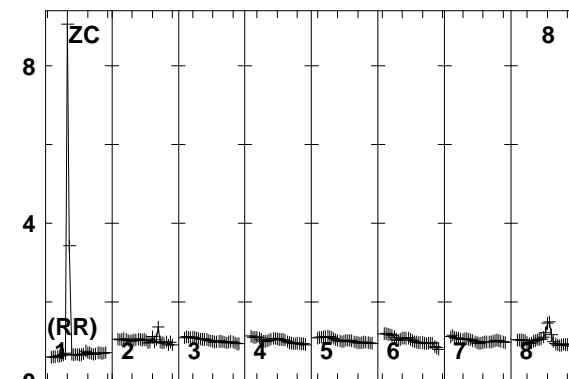
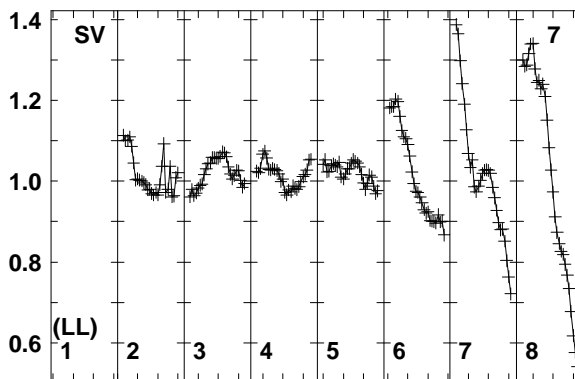
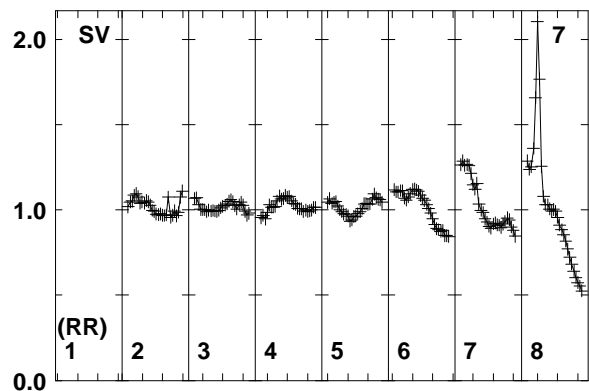
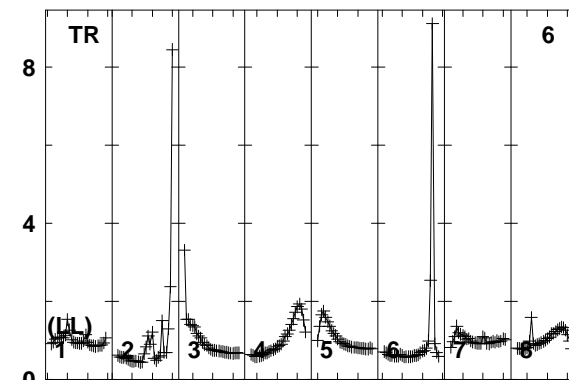
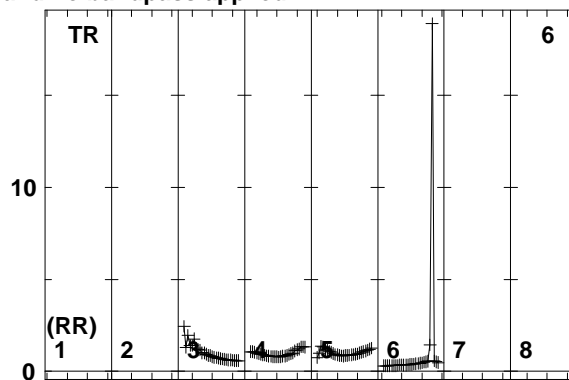
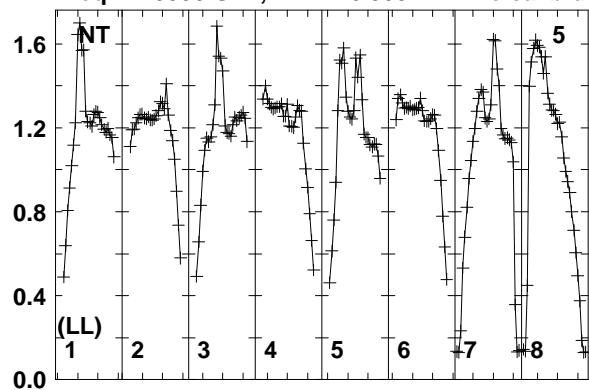

Lower frame: Real Jy
Total-power spectrum Antenna: NT (05)
Timerange: 00/03:59:51 to 00/04:01:49

Plot file version 58 created 11-AUG-2014 17:05:31

J2015+3710 EM110 2.UVDATA.1

Freq = 1.5950 GHz, Bw = 16.000 MH No calibration applied and no bandpass applied

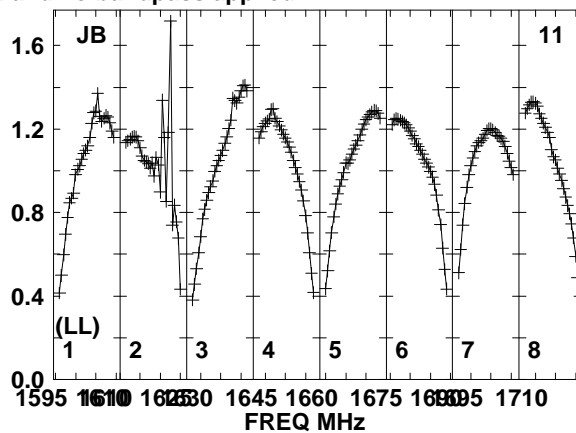
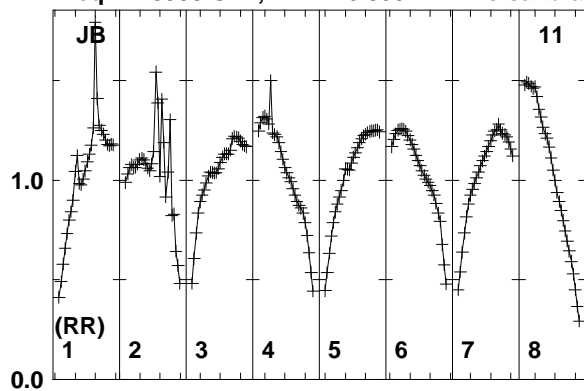

Lower frame: Real Jy
Total-power spectrum Antenna: JB (11)
Timerange: 00/03:59:51 to 00/04:01:49

Plot file version 59 created 11-AUG-2014 17:05:31

J2032+4127 EM110 2.UVDATA.1

Freq = 1.5950 GHz, Bw = 16.000 MH No calibration applied and no bandpass applied

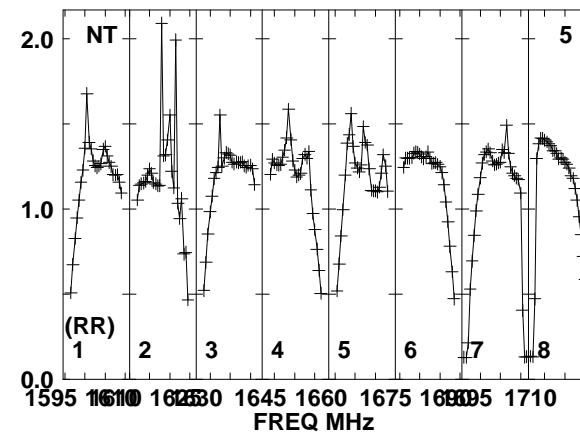
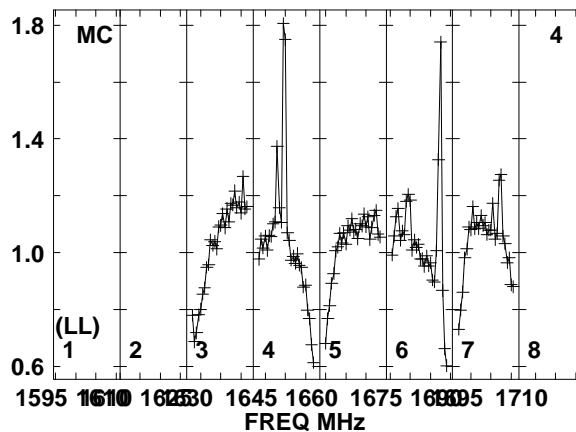
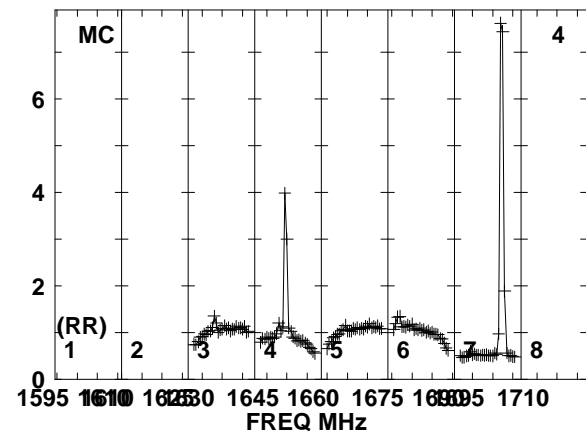
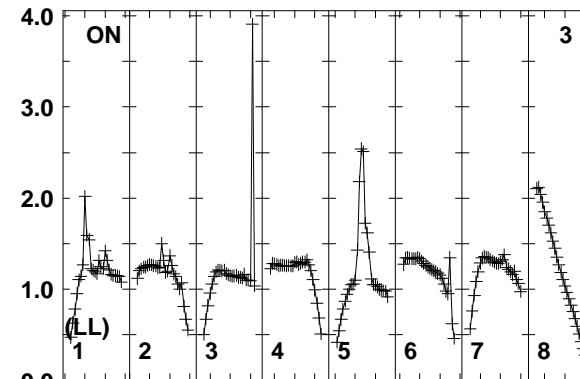
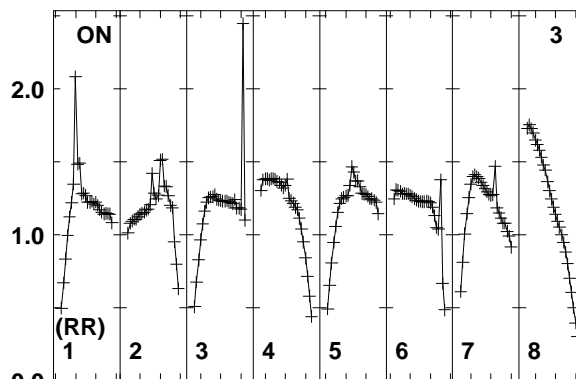
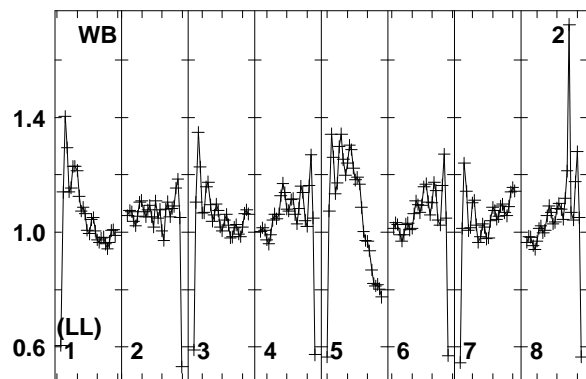
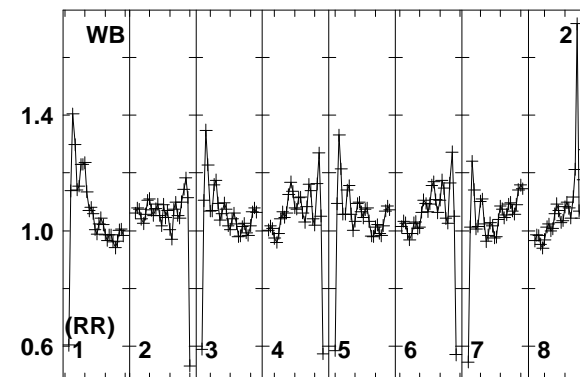
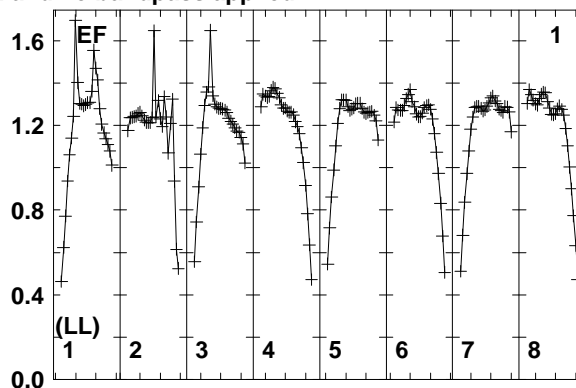
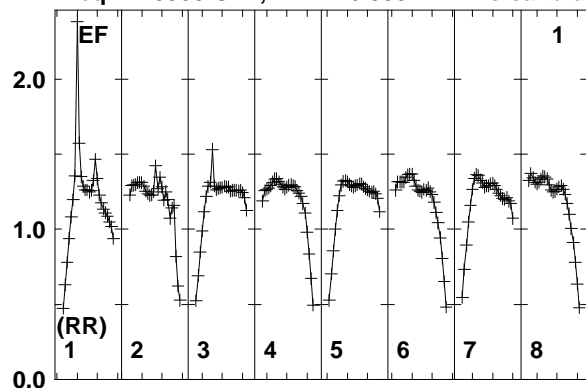

Lower frame: Real Jy
Total-power spectrum Antenna: EF (01)
Timerange: 00/04:02:02 to 00/04:05:48

Plot file version 60 created 11-AUG-2014 17:05:31

J2032+4127 EM110 2.UVDATA.1

Freq = 1.5950 GHz, Bw = 16.000 MH No calibration applied and no bandpass applied

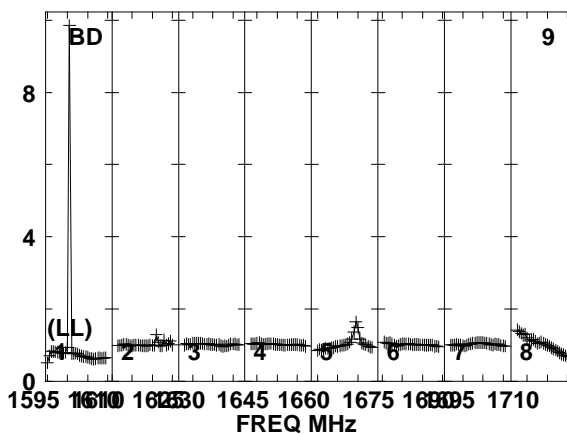
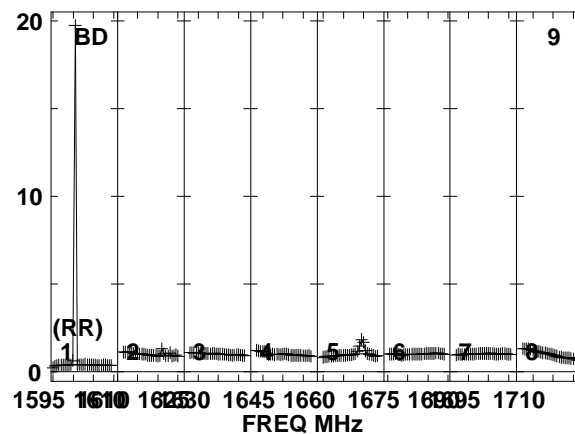
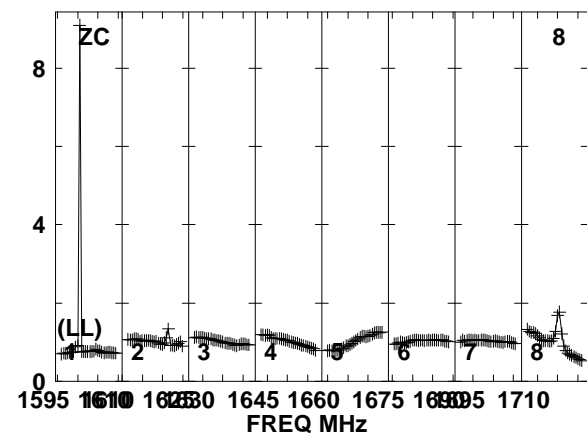
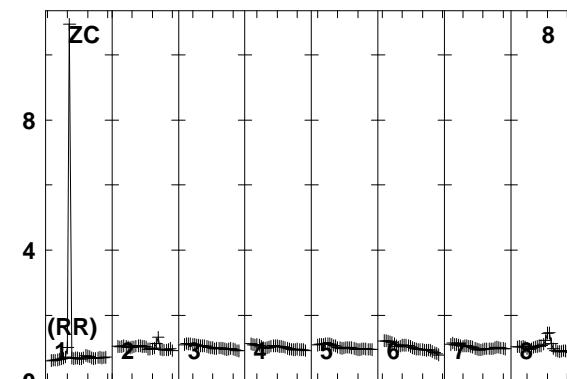
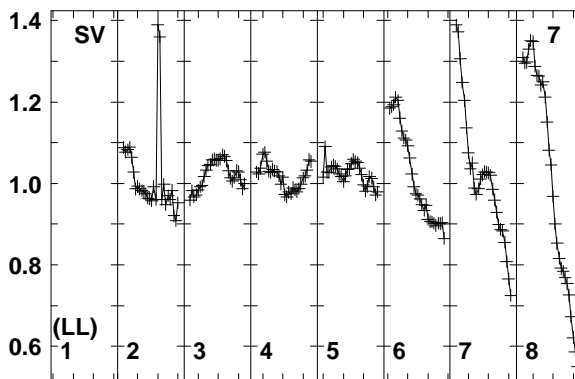
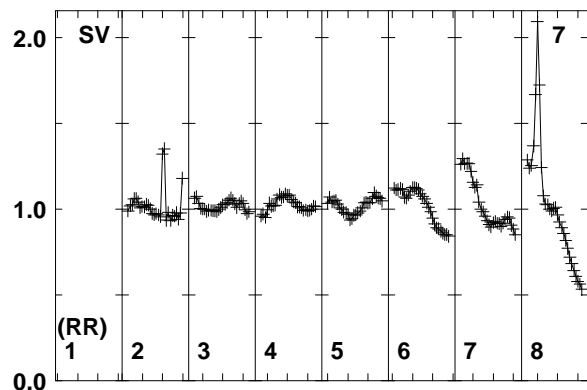
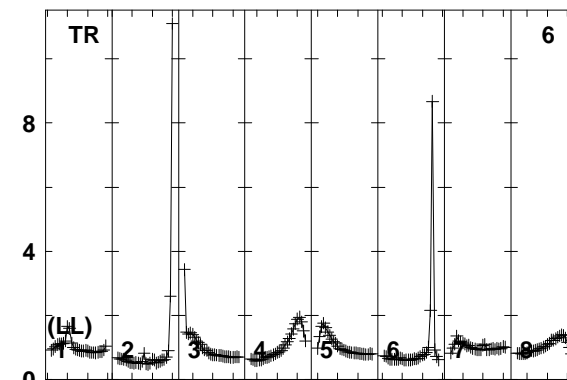
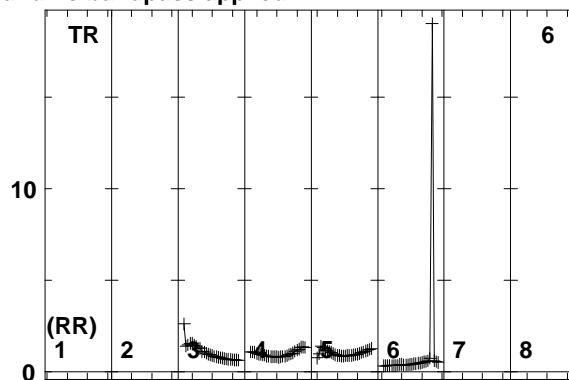
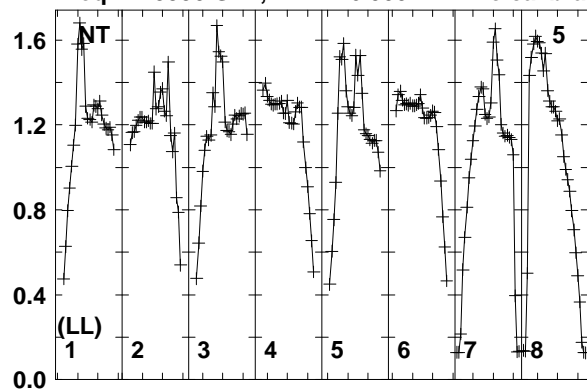

Lower frame: Real Jy
Total-power spectrum Antenna: NT (05)
Timerange: 00/04:02:02 to 00/04:05:48

Plot file version 61 created 11-AUG-2014 17:05:31

J2032+4127 EM110 2.UVDATA.1

Freq = 1.5950 GHz, Bw = 16.000 MH No calibration applied and no bandpass applied

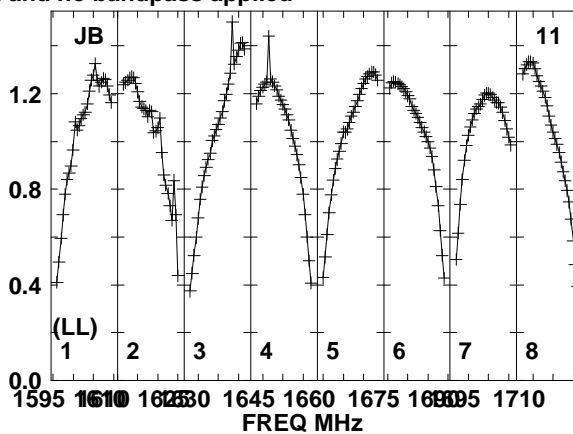
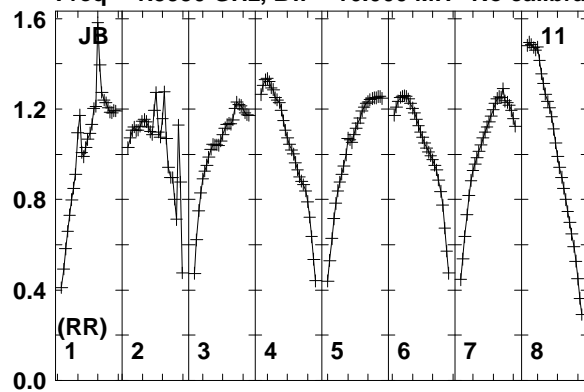

Lower frame: Real Jy
Total-power spectrum Antenna: JB (11)
Timerange: 00/04:02:02 to 00/04:05:48

Plot file version 62 created 11-AUG-2014 17:05:31

J2015+3710 EM110 2.UVDATA.1

Freq = 1.5950 GHz, Bw = 16.000 MH No calibration applied and no bandpass applied

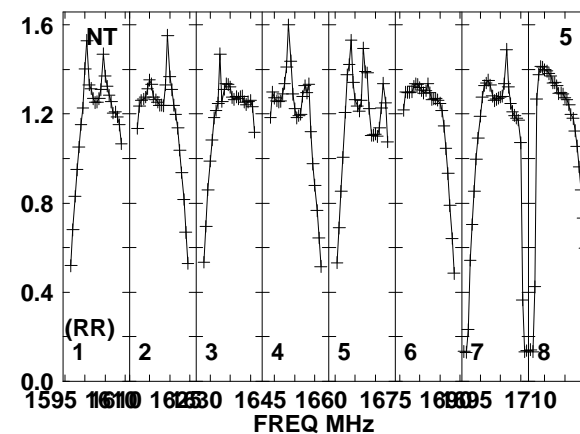
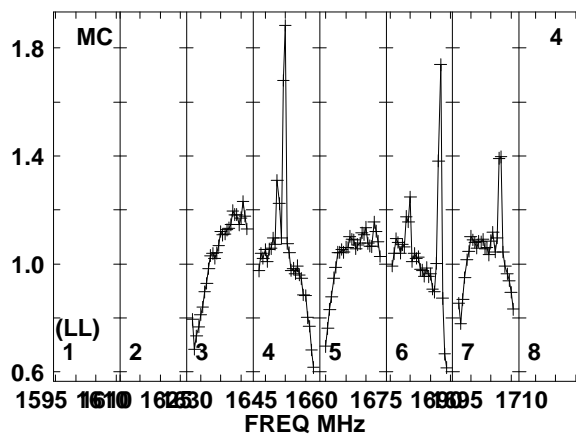
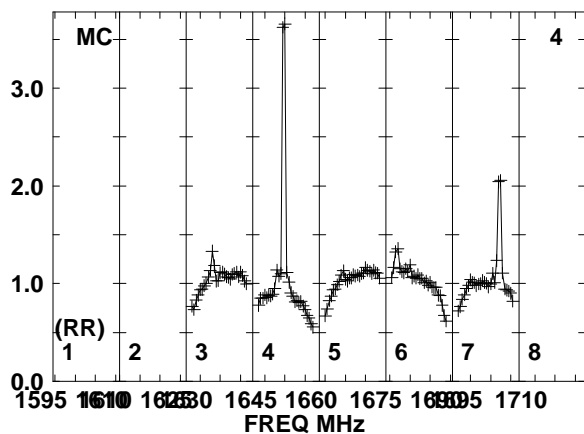
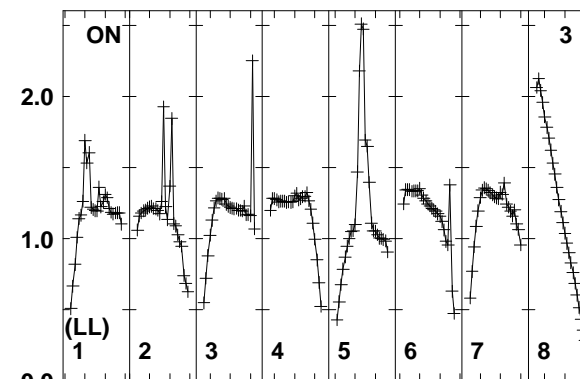
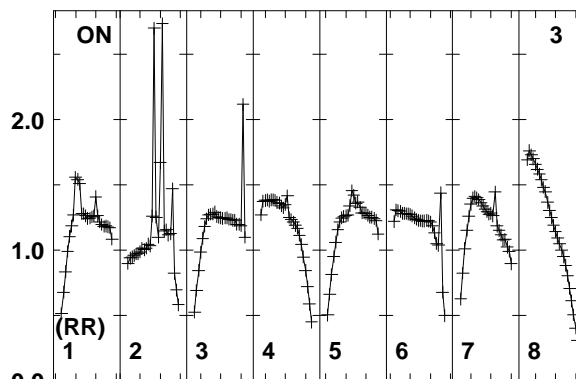
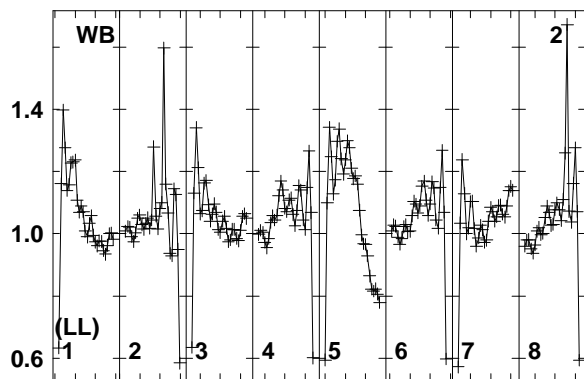
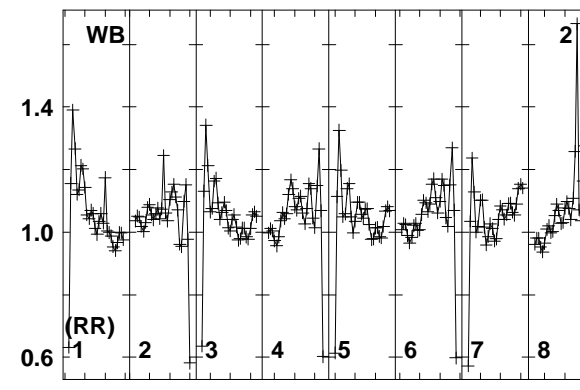
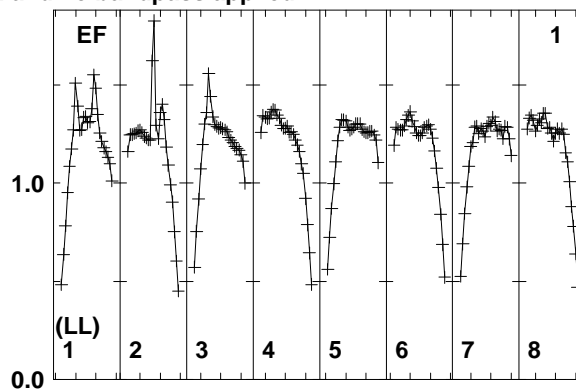
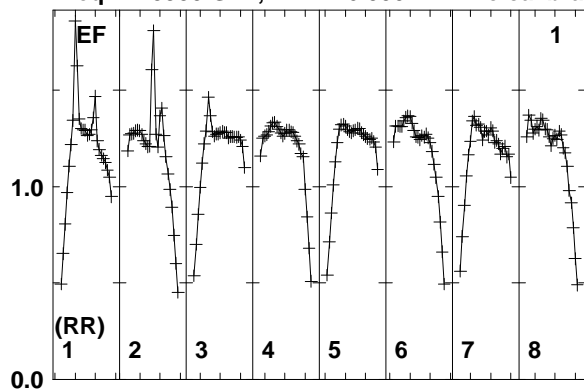

Lower frame: Real Jy
Total-power spectrum Antenna: EF (01)
Timerange: 00/04:06:02 to 00/04:07:48

Plot file version 63 created 11-AUG-2014 17:05:31

J2015+3710 EM110 2.UVDATA.1

Freq = 1.5950 GHz, Bw = 16.000 MH No calibration applied and no bandpass applied

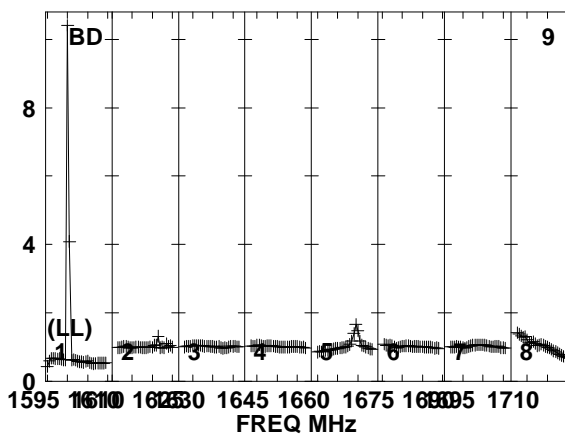
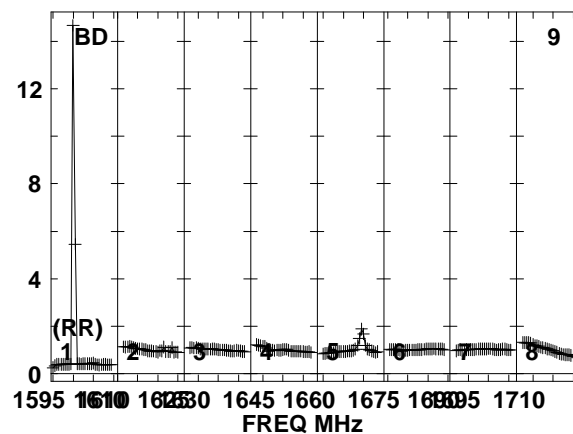
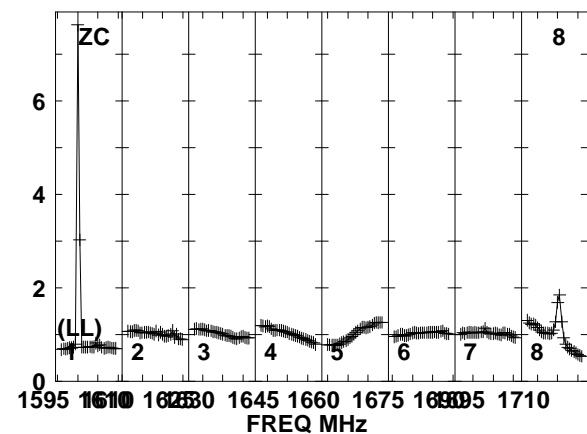
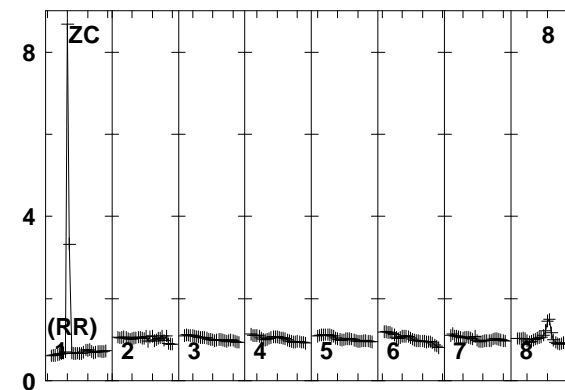
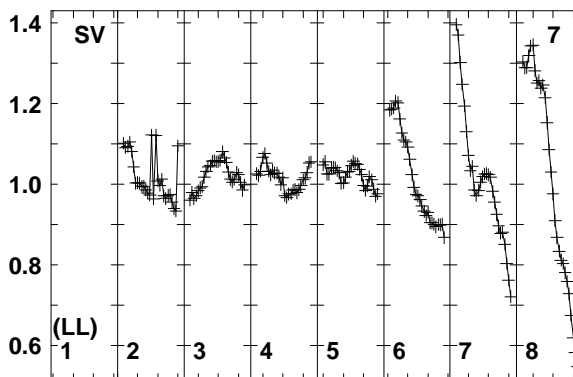
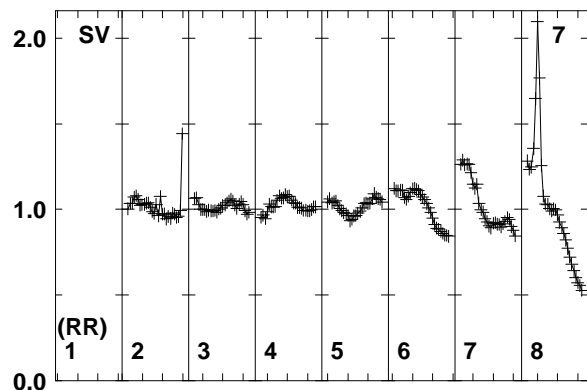
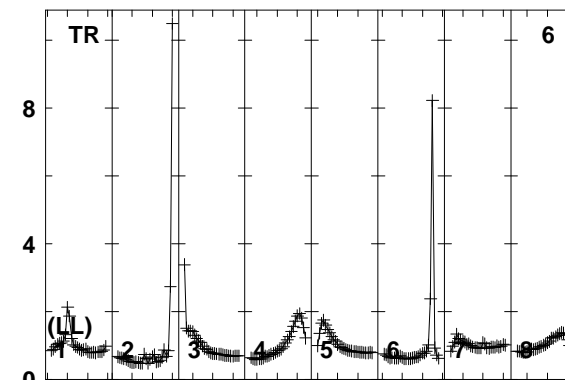
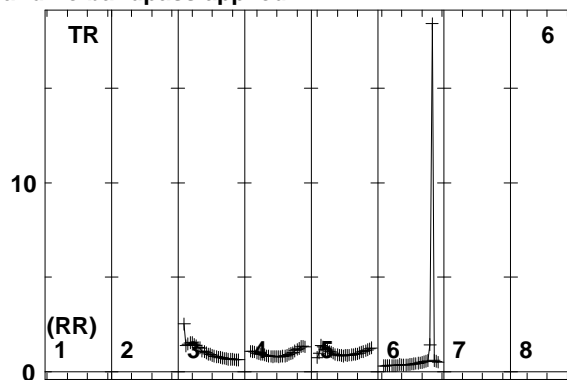
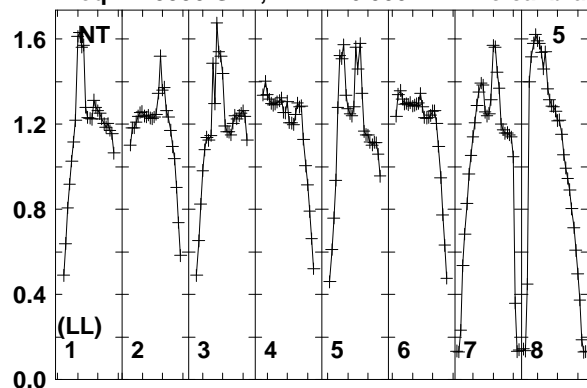

Lower frame: Real Jy
Total-power spectrum Antenna: NT (05)
Timerange: 00/04:06:02 to 00/04:07:48

Plot file version 64 created 11-AUG-2014 17:05:31

J2015+3710 EM110 2.UVDATA.1

Freq = 1.5950 GHz, Bw = 16.000 MH No calibration applied and no bandpass applied

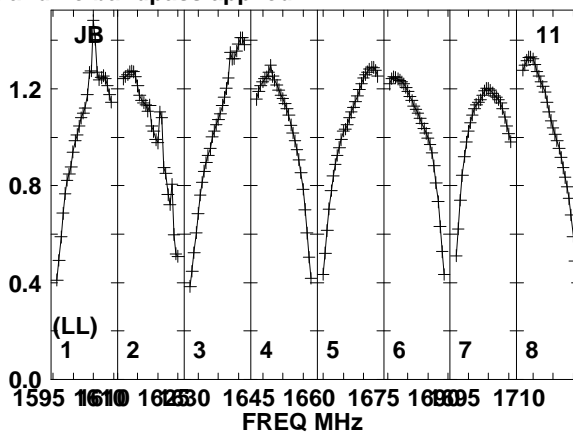
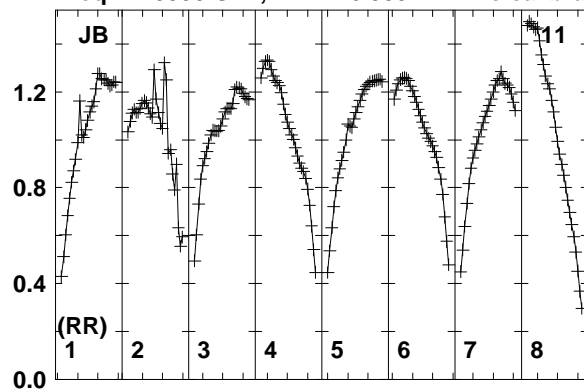

Lower frame: Real Jy
Total-power spectrum Antenna: JB (11)
Timerange: 00/04:06:02 to 00/04:07:48

Plot file version 65 created 11-AUG-2014 17:05:31

J2007+4029 EM110 2.UVDATA.1

Freq = 1.5950 GHz, Bw = 16.000 MH No calibration applied and no bandpass applied

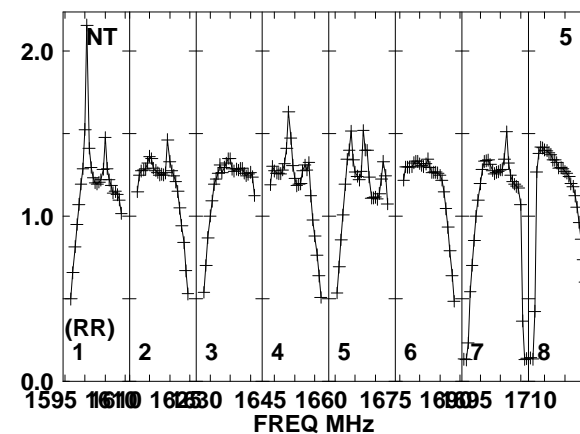
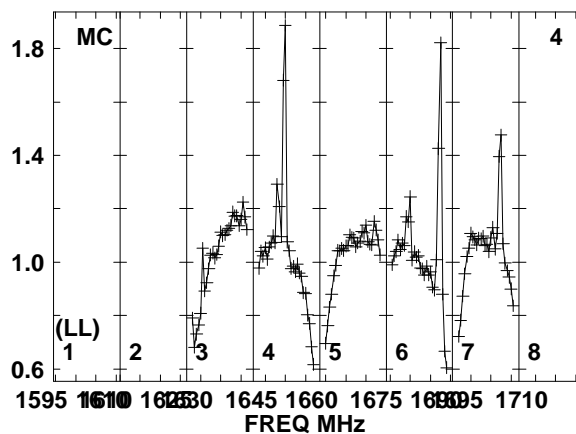
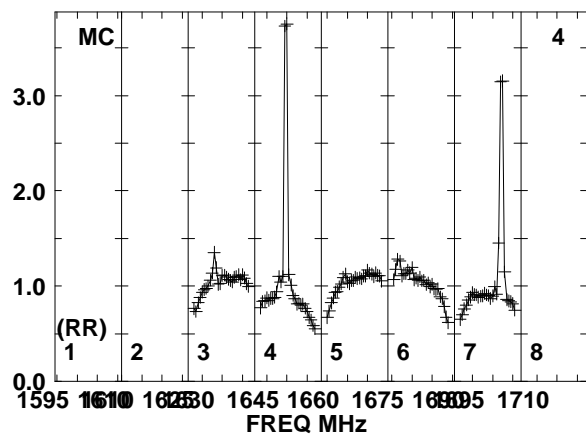
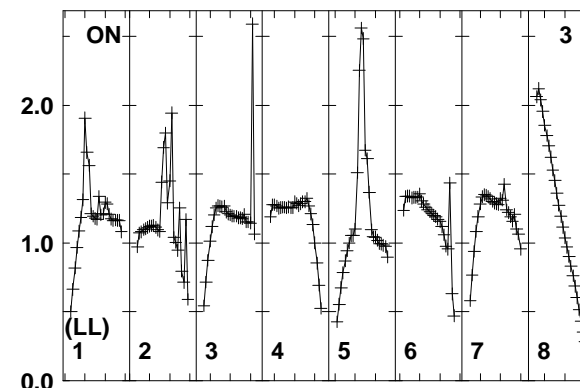
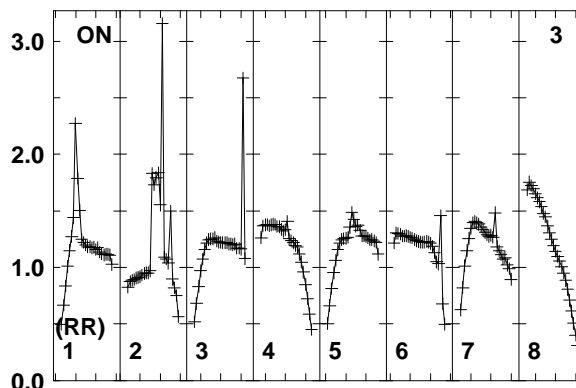
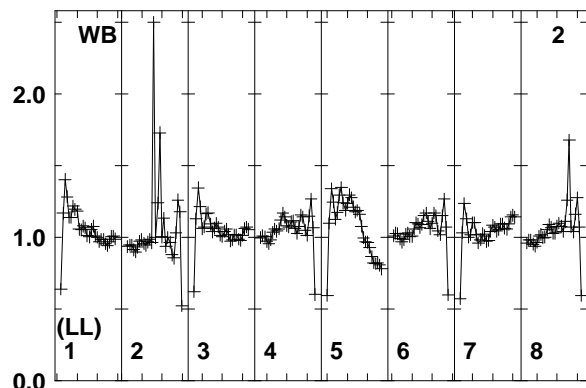
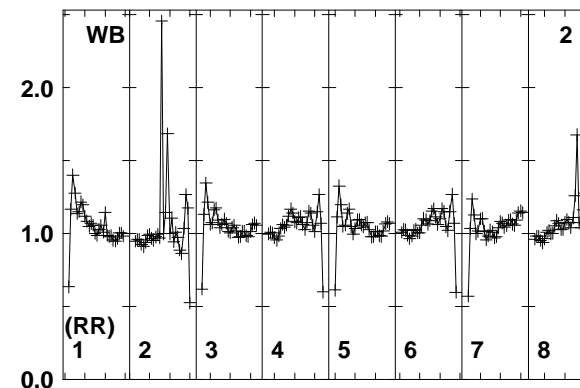
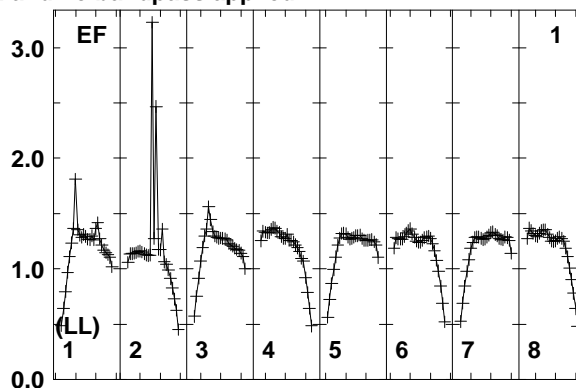
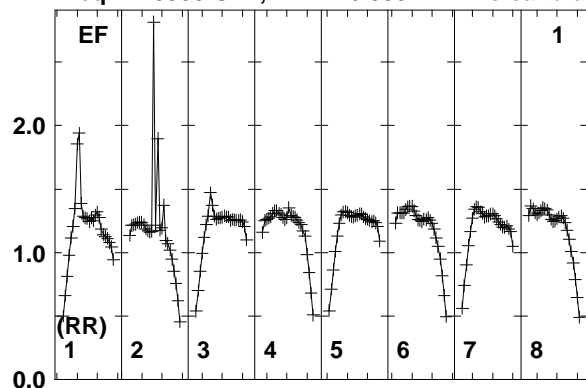

Lower frame: Real Jy
Total-power spectrum Antenna: EF (01)
Timerange: 00/04:07:58 to 00/04:08:48

Plot file version 66 created 11-AUG-2014 17:05:31

J2007+4029 EM110 2.UVDATA.1

Freq = 1.5950 GHz, Bw = 16.000 MH No calibration applied and no bandpass applied

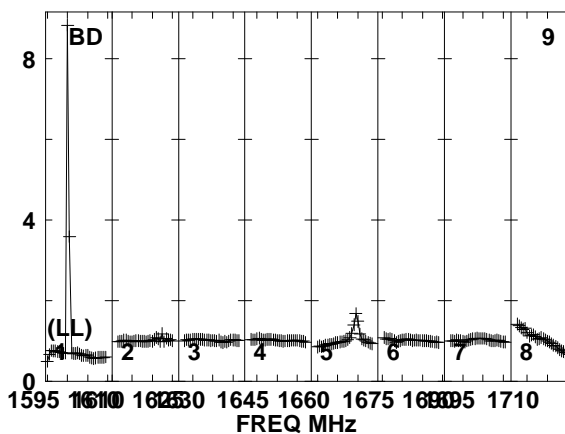
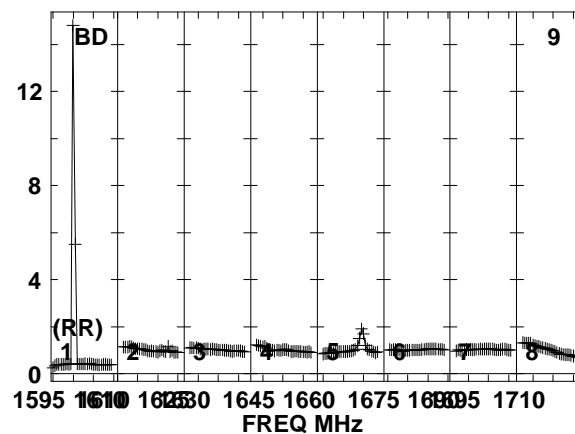
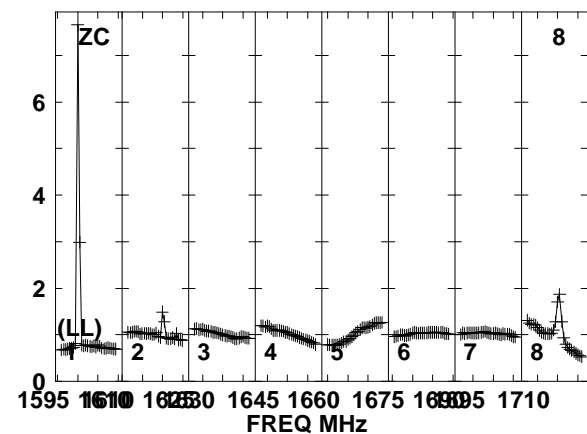
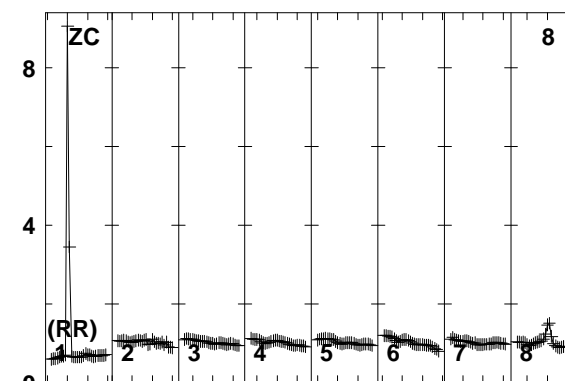
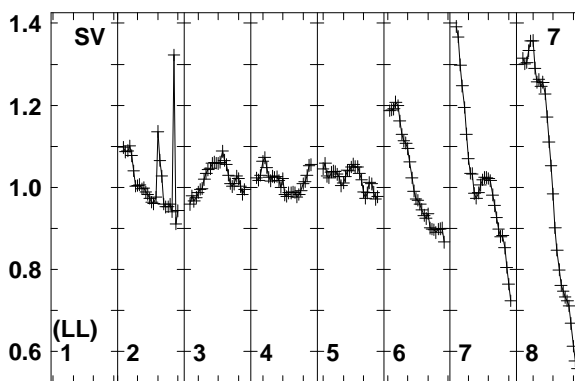
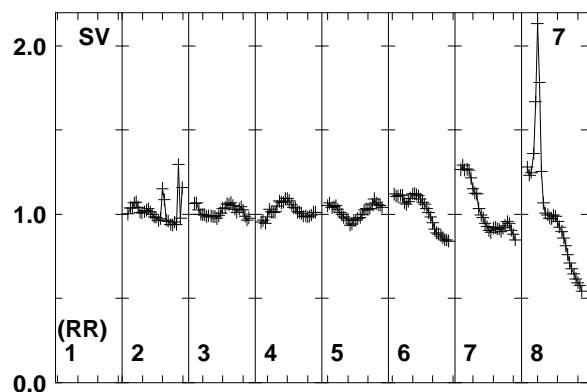
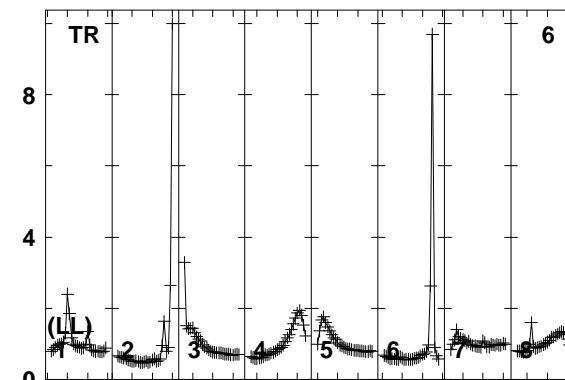
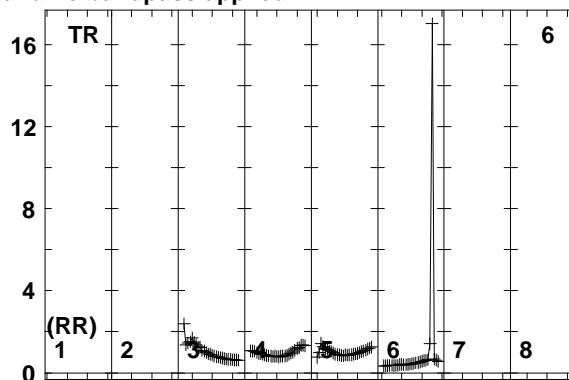
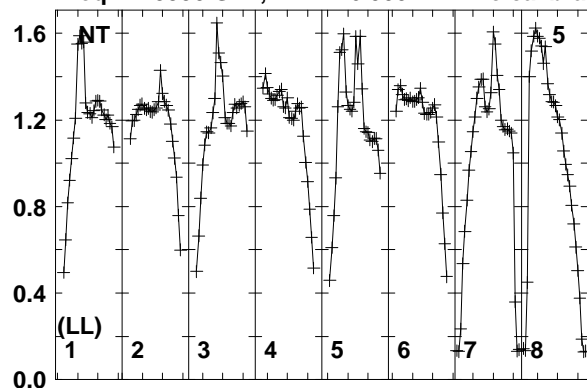

1595 1610 1625 1640 1655 1670 1685 1700 1715
FREQ MHz
Lower frame: Real Jy
Total-power spectrum Antenna: NT (05)
Timerange: 00/04:07:58 to 00/04:08:48

Plot file version 67 created 11-AUG-2014 17:05:31

J2007+4029 EM110 2.UVDATA.1

Freq = 1.5950 GHz, Bw = 16.000 MH No calibration applied and no bandpass applied

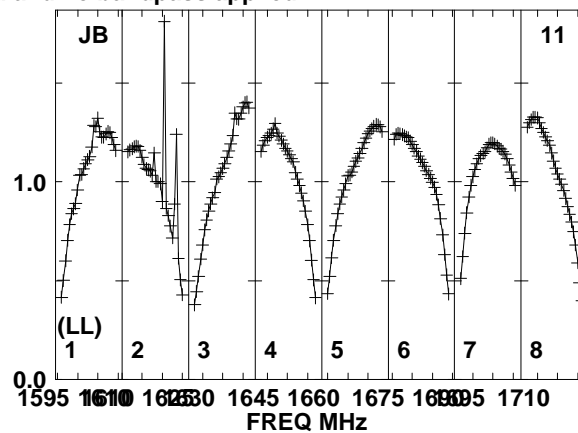
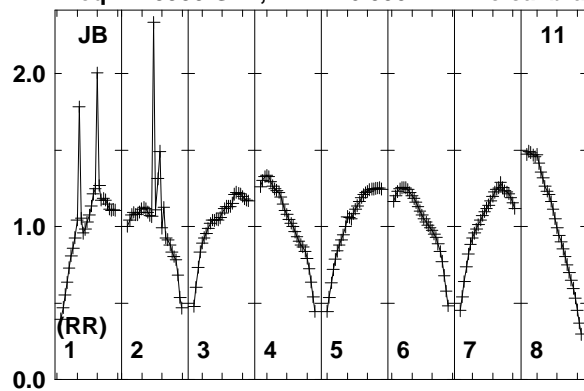

Lower frame: Real Jy
Total-power spectrum Antenna: JB (11)
Timerange: 00/04:07:58 to 00/04:08:48

Plot file version 68 created 11-AUG-2014 17:05:31

J2015+3710 EM110 2.UVDATA.1

Freq = 1.5950 GHz, Bw = 16.000 MH No calibration applied and no bandpass applied

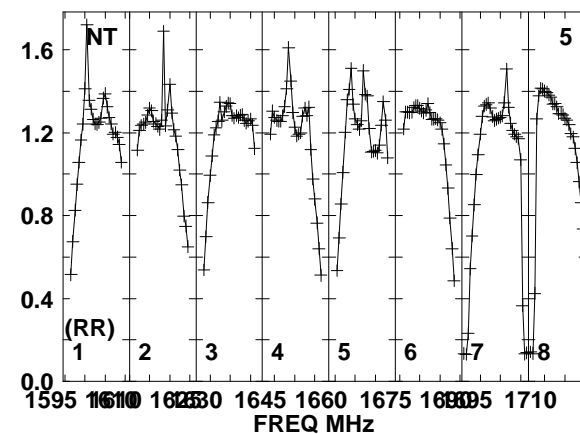
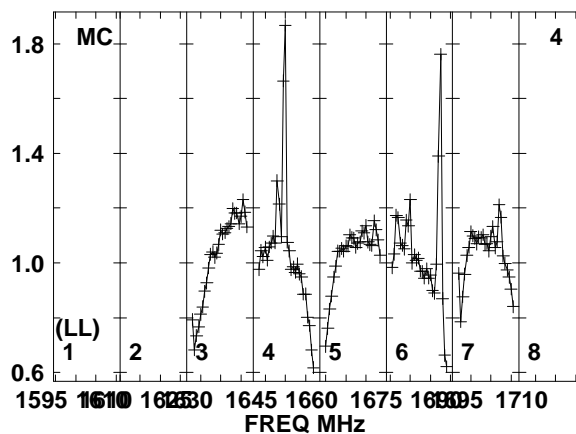
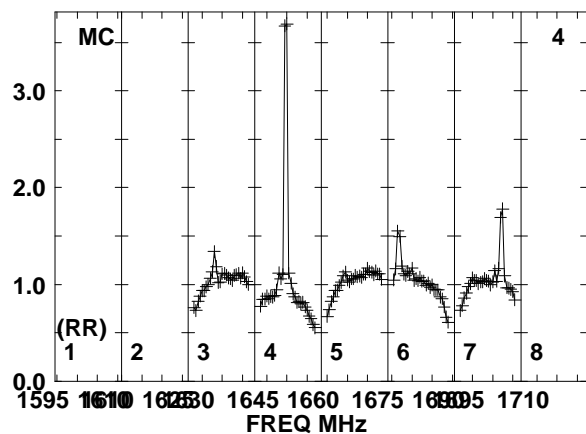
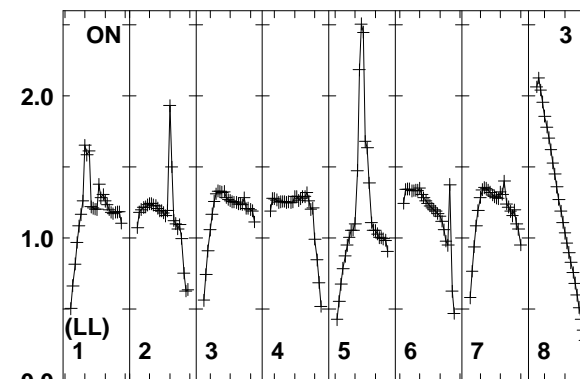
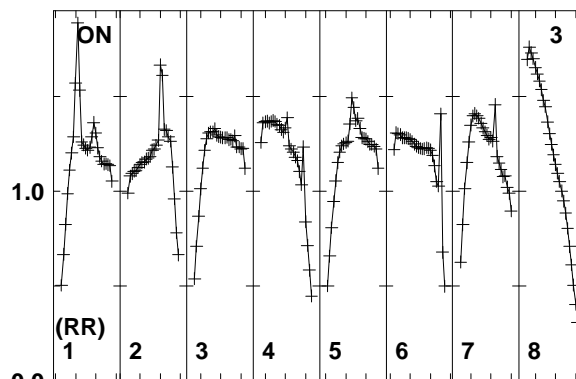
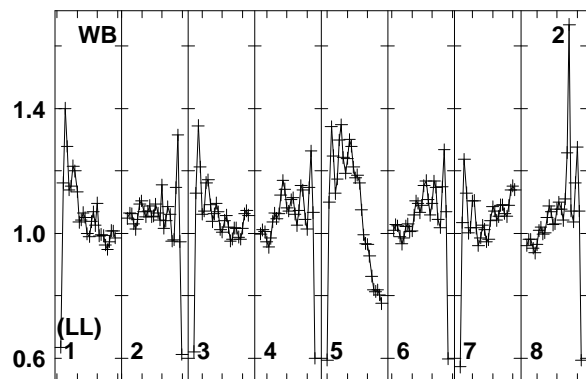
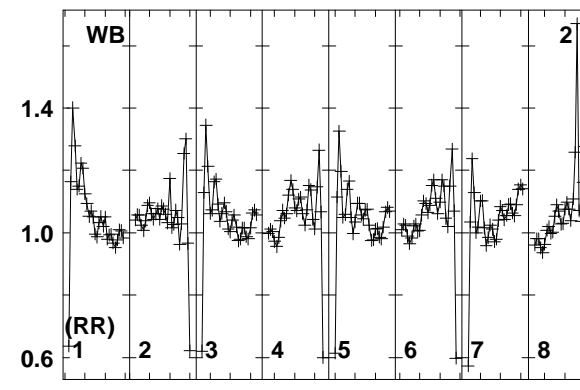
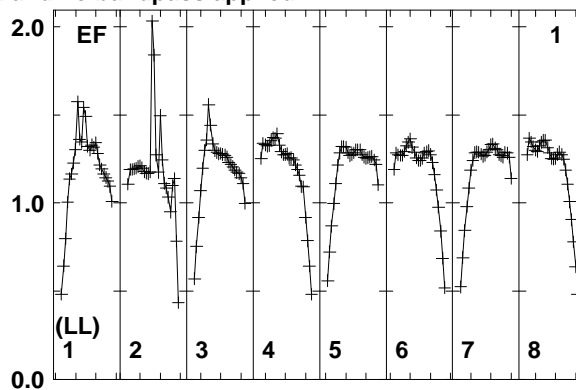
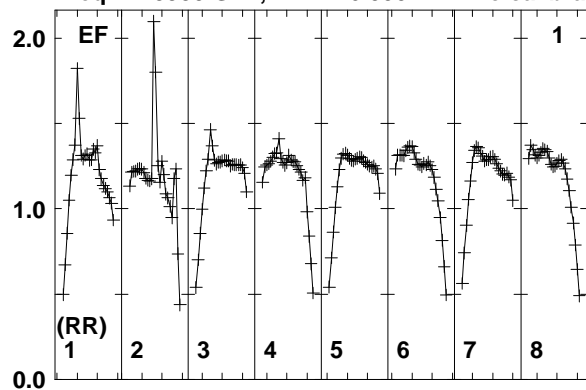

Lower frame: Real Jy
Total-power spectrum Antenna: EF (01)
Timerange: 00/04:09:51 to 00/04:11:49

Plot file version 69 created 11-AUG-2014 17:05:31

J2015+3710 EM110 2.UVDATA.1

Freq = 1.5950 GHz, Bw = 16.000 MH No calibration applied and no bandpass applied

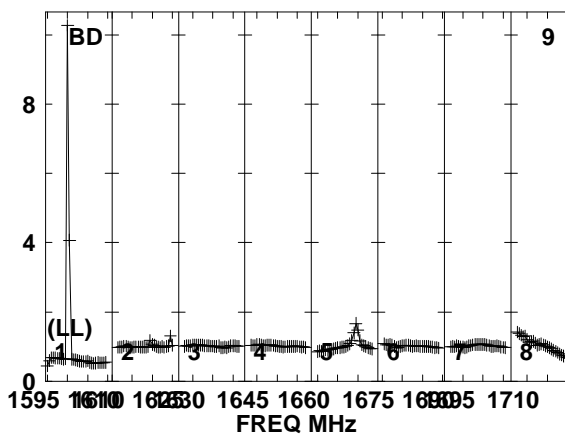
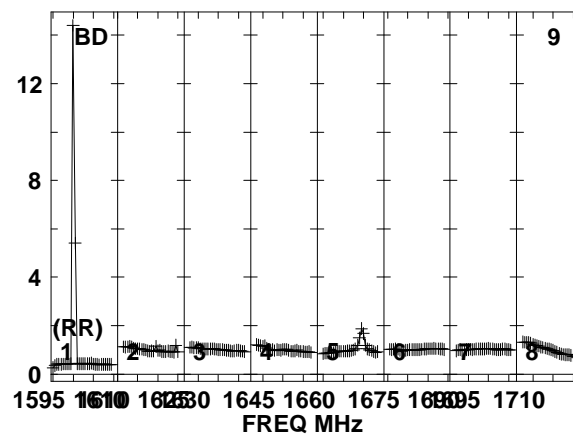
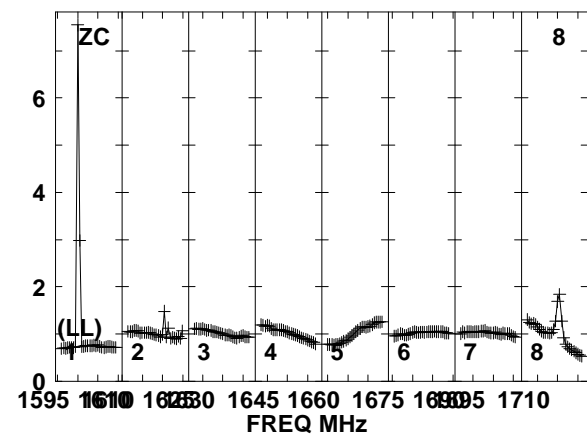
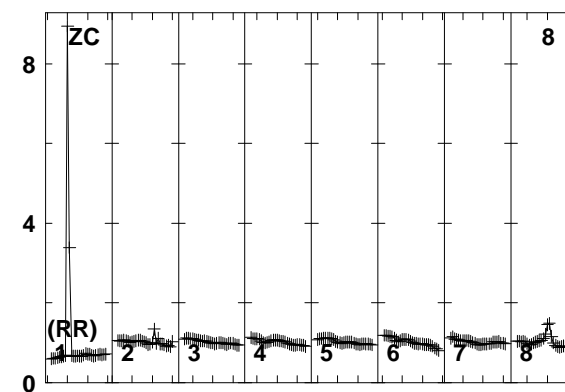
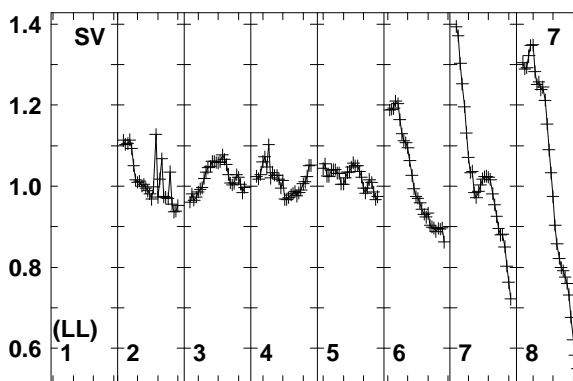
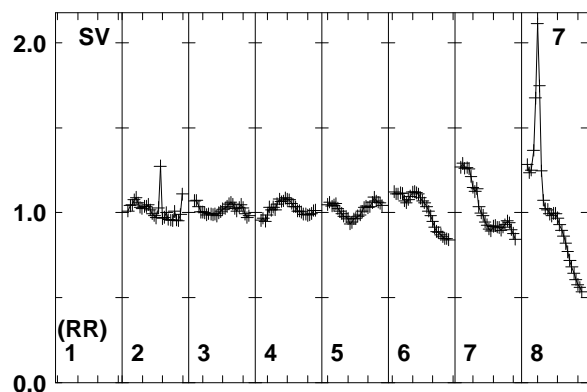
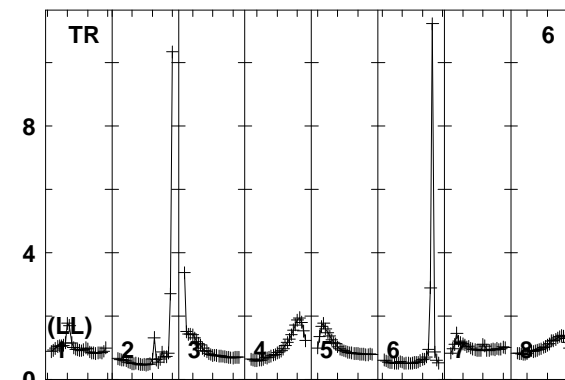
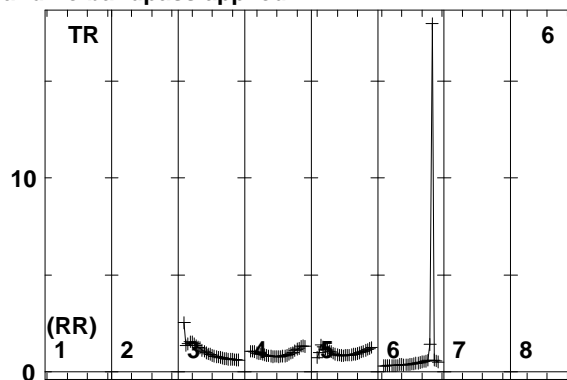
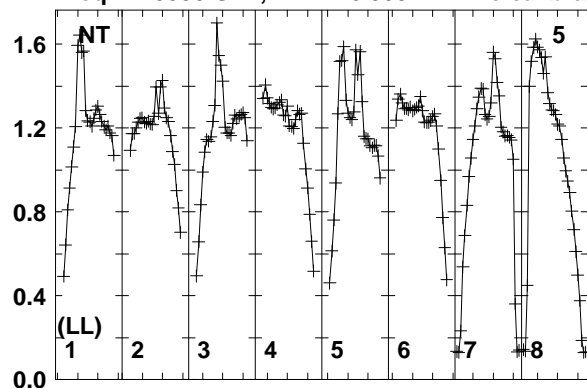

Lower frame: Real Jy
Total-power spectrum Antenna: NT (05)
Timerange: 00/04:09:51 to 00/04:11:49

Plot file version 70 created 11-AUG-2014 17:05:31

J2032+4127 EM110 2.UVDATA.1

Freq = 1.5950 GHz, Bw = 16.000 MH No calibration applied and no bandpass applied

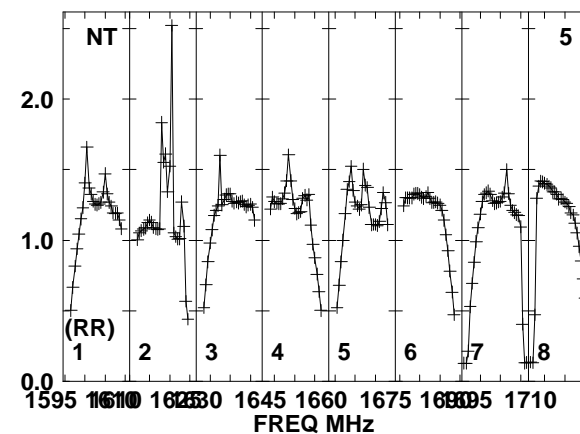
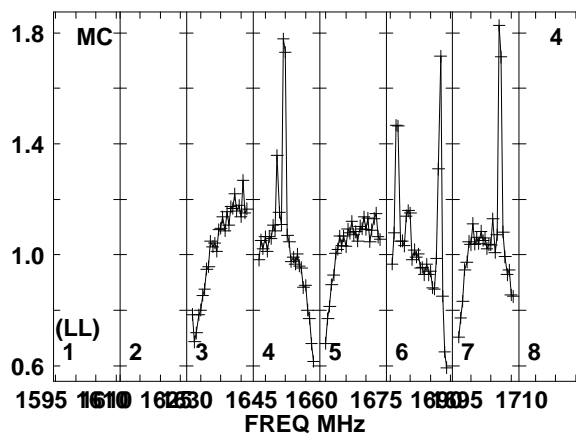
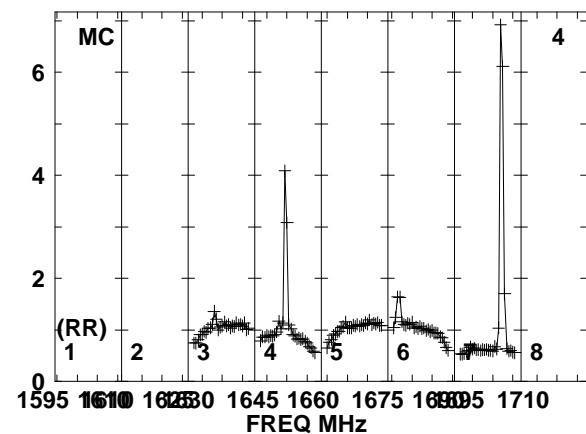
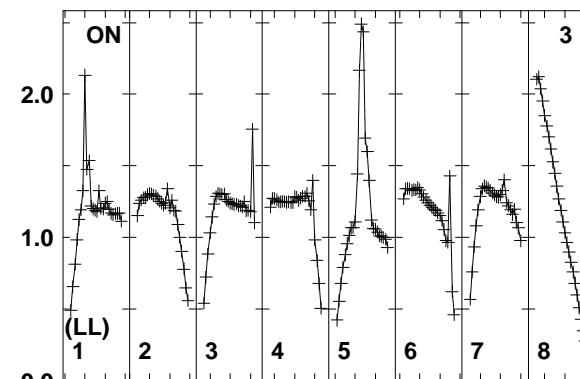
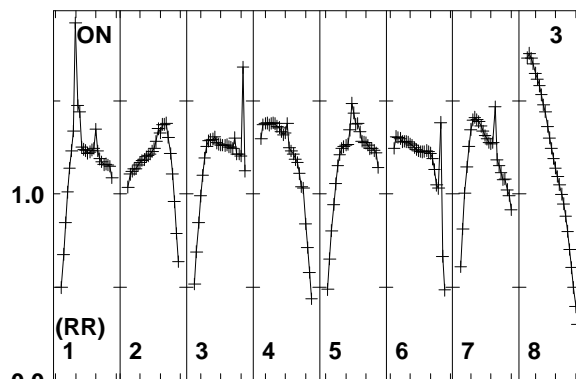
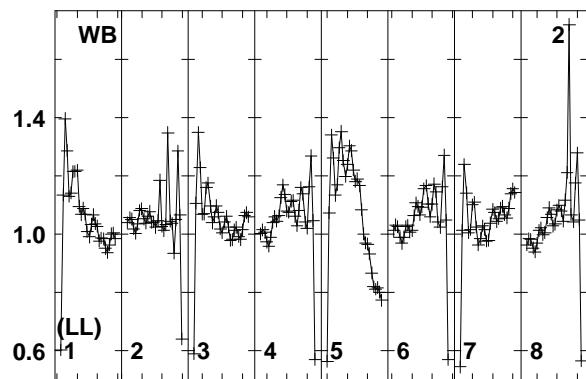
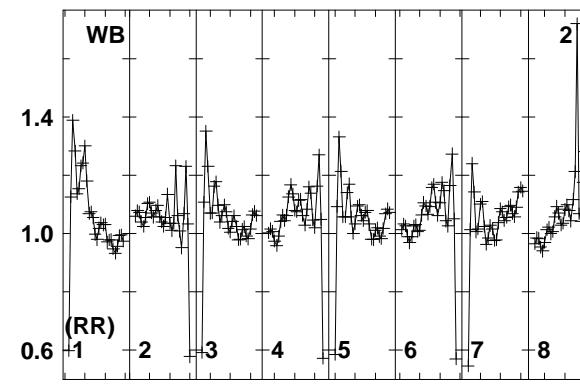
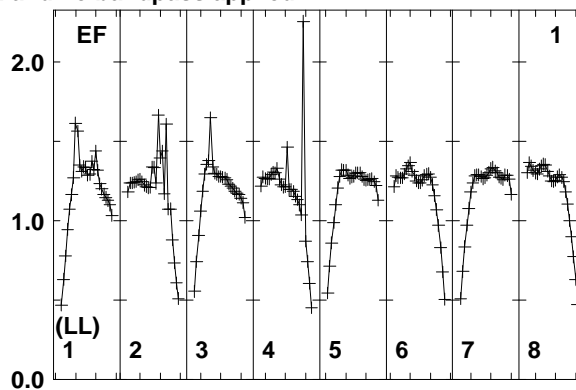
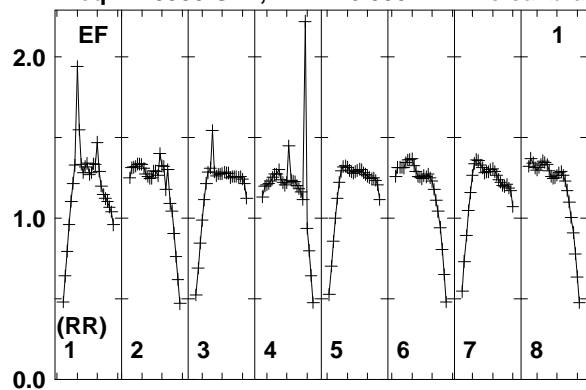

Lower frame: Real Jy
Total-power spectrum Antenna: EF (01)
Timerange: 00/04:11:51 to 00/04:15:49

Plot file version 71 created 11-AUG-2014 17:05:31

J2032+4127 EM110 2.UVDATA.1

Freq = 1.5950 GHz, Bw = 16.000 MH No calibration applied and no bandpass applied

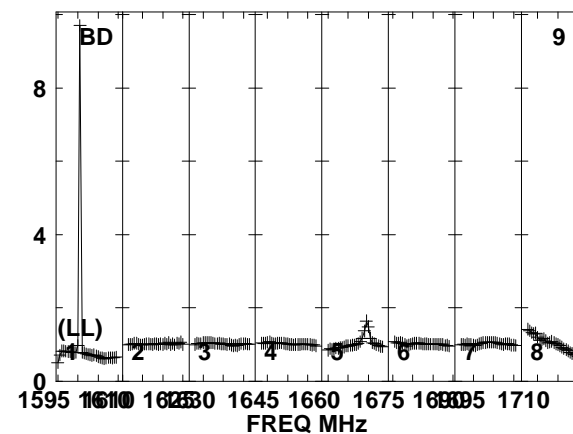
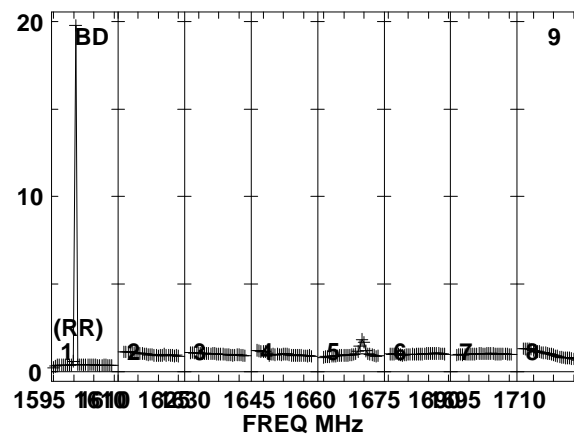
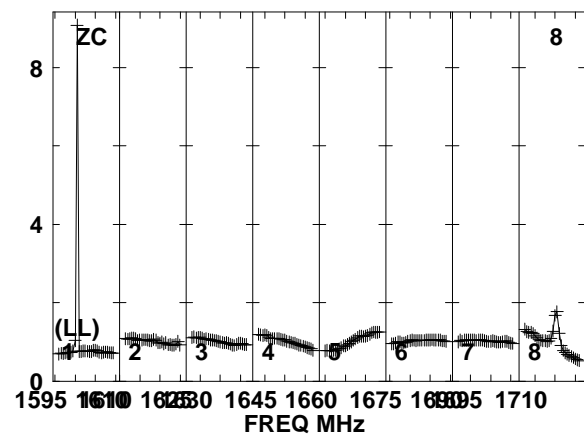
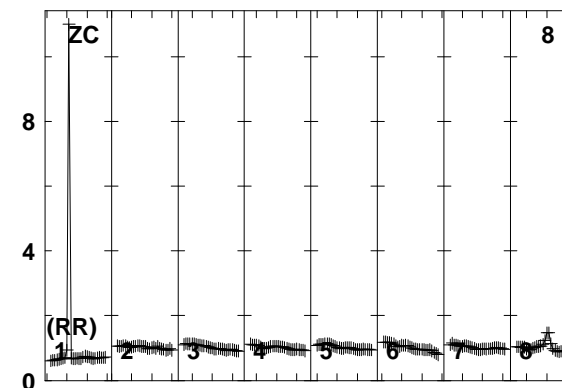
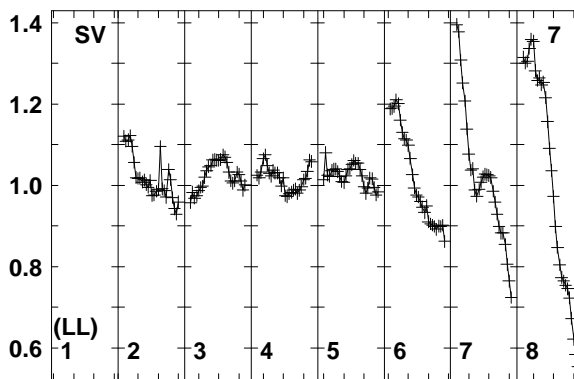
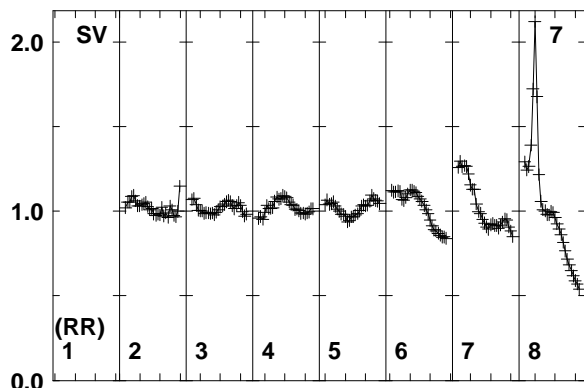
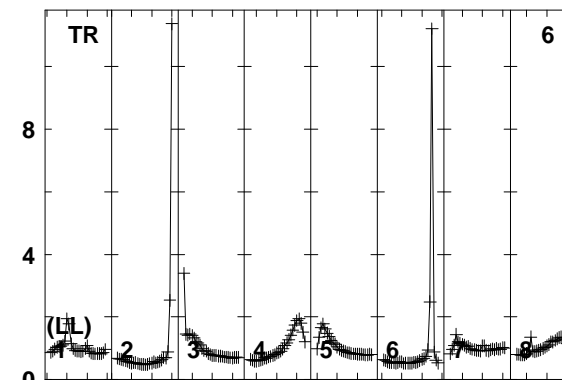
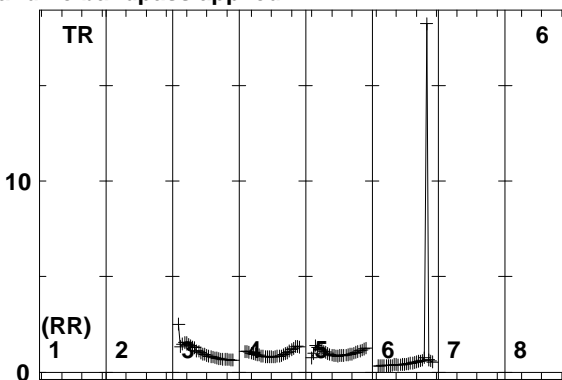
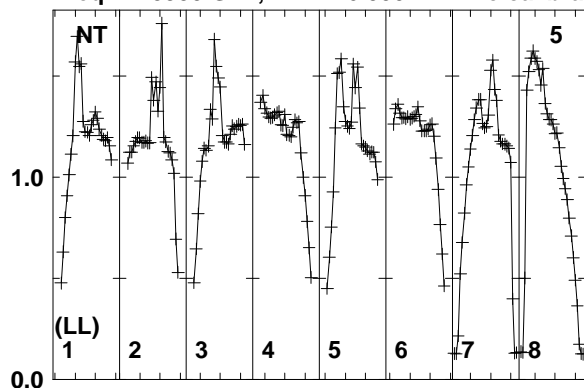

Lower frame: Real Jy
Total-power spectrum Antenna: NT (05)
Timerange: 00/04:11:51 to 00/04:15:49

Plot file version 72 created 11-AUG-2014 17:05:31

J2032+4127 EM110 2.UVDATA.1

Freq = 1.5950 GHz, Bw = 16.000 MH No calibration applied and no bandpass applied

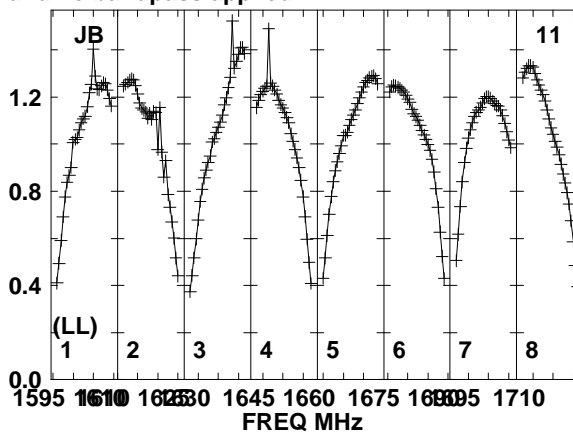
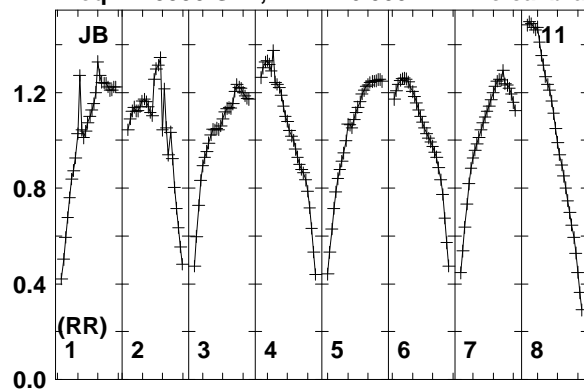

Lower frame: Real Jy
Total-power spectrum Antenna: JB (11)
Timerange: 00/04:11:51 to 00/04:15:49

Plot file version 73 created 11-AUG-2014 17:05:31

J2015+3710 EM110 2.UVDATA.1

Freq = 1.5950 GHz, Bw = 16.000 MH No calibration applied and no bandpass applied

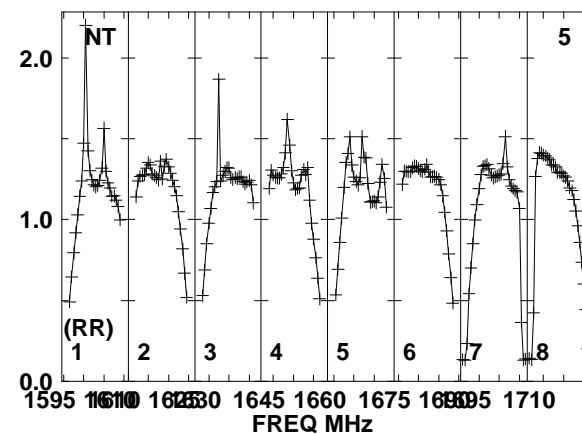
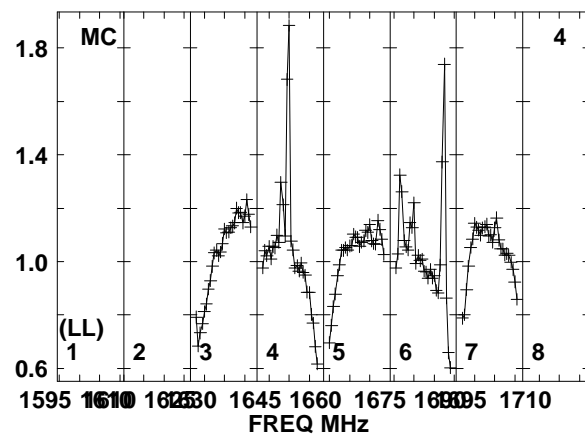
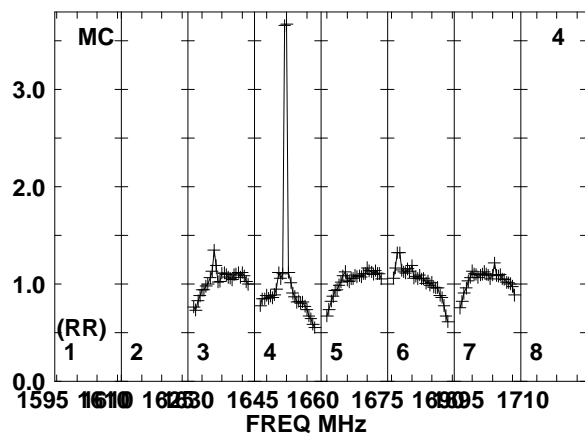
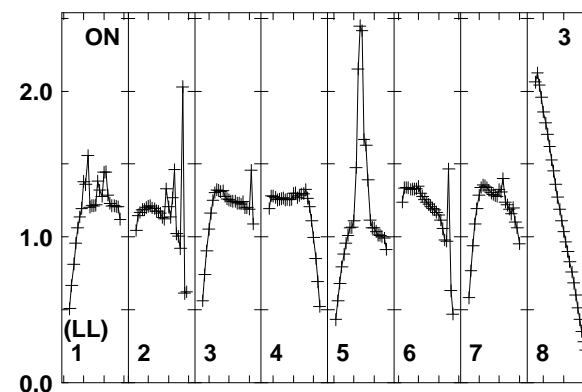
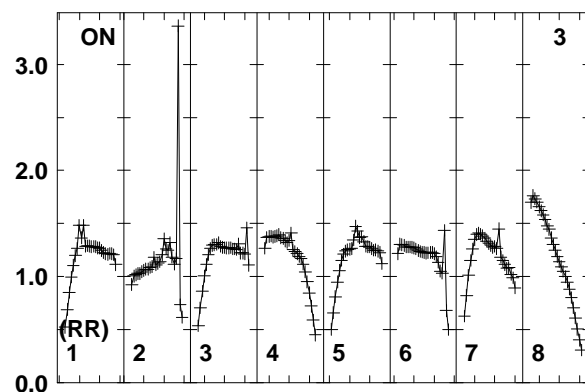
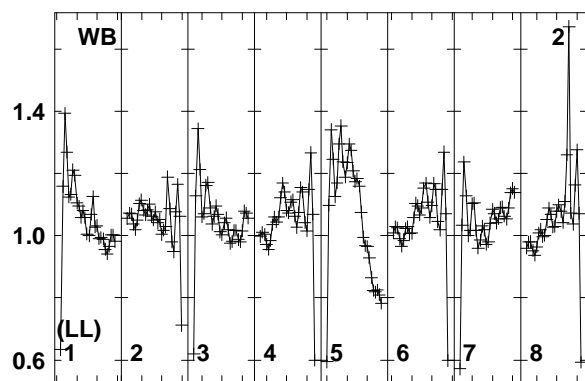
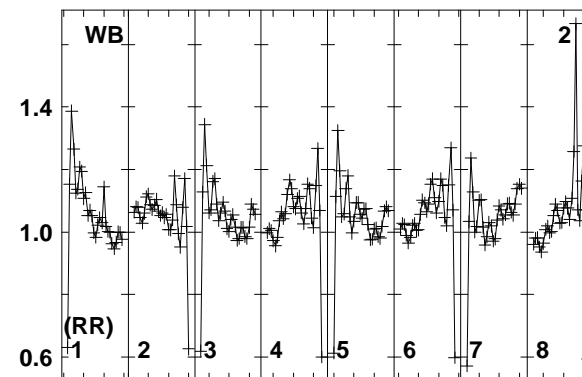
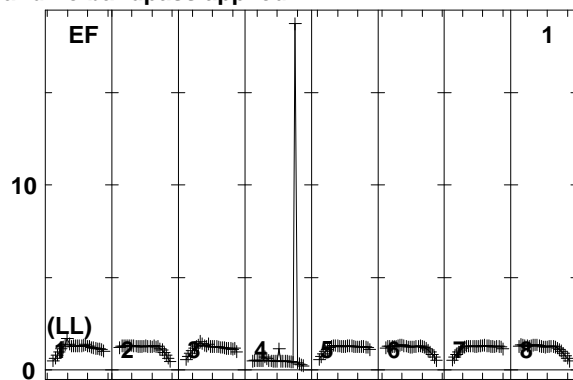
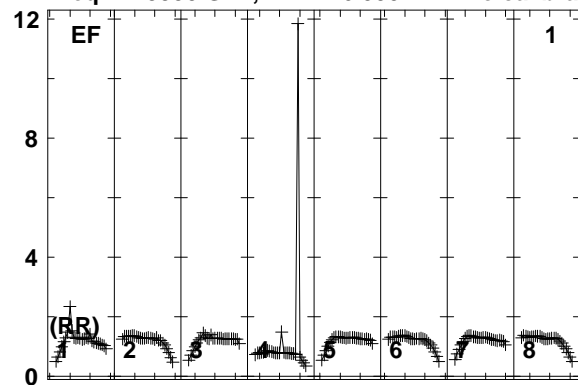

Lower frame: Real Jy
Total-power spectrum Antenna: EF (01)
Timerange: 00/04:16:02 to 00/04:17:48

Plot file version 74 created 11-AUG-2014 17:05:32

J2015+3710 EM110 2.UVDATA.1

Freq = 1.5950 GHz, Bw = 16.000 MH No calibration applied and no bandpass applied

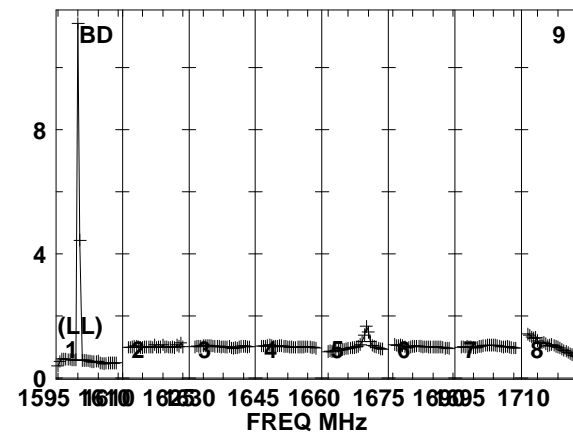
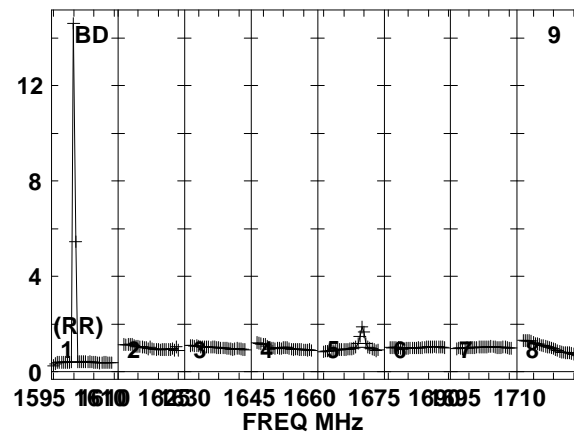
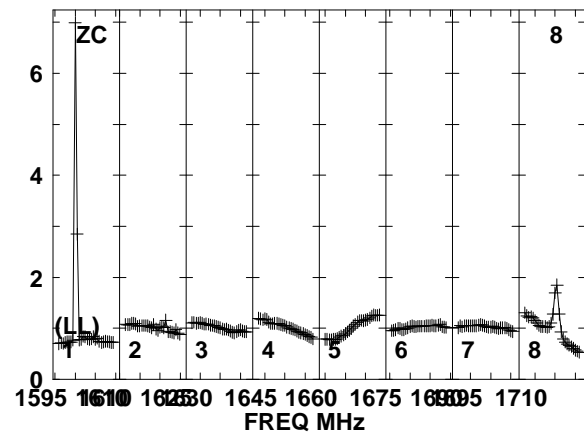
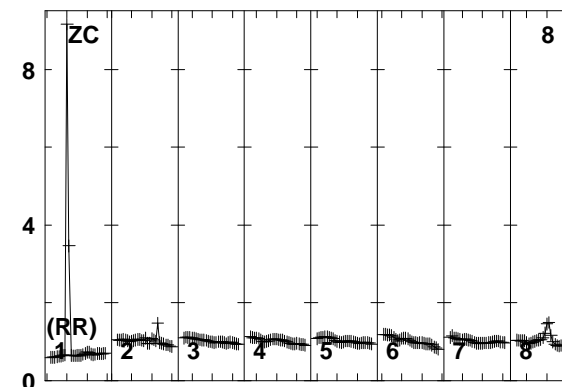
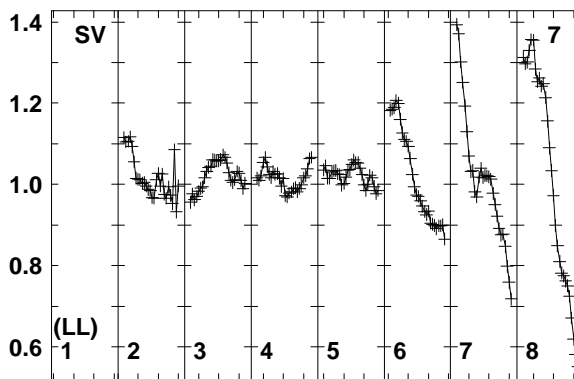
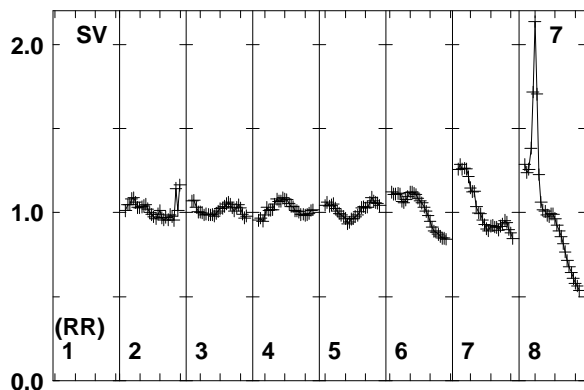
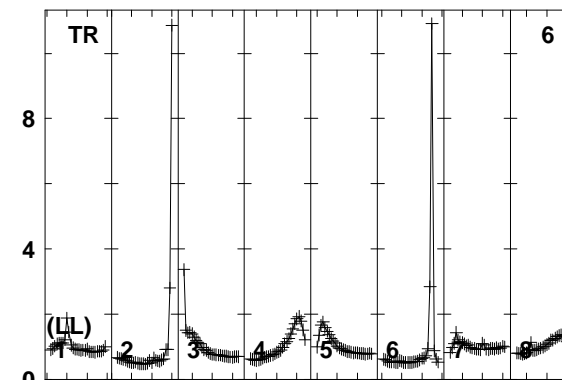
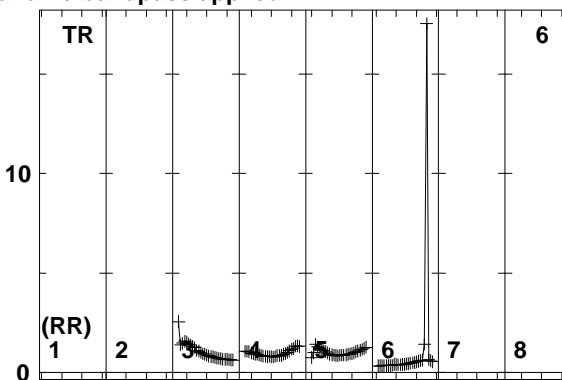
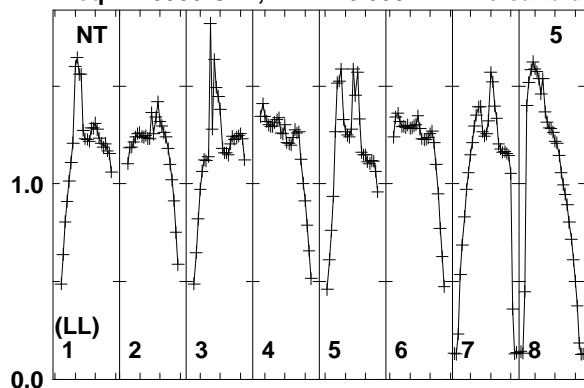

Lower frame: Real Jy
Total-power spectrum Antenna: NT (05)
Timerange: 00/04:16:02 to 00/04:17:48

Plot file version 75 created 11-AUG-2014 17:05:32

J2015+3710 EM110 2.UVDATA.1

Freq = 1.5950 GHz, Bw = 16.000 MH No calibration applied and no bandpass applied

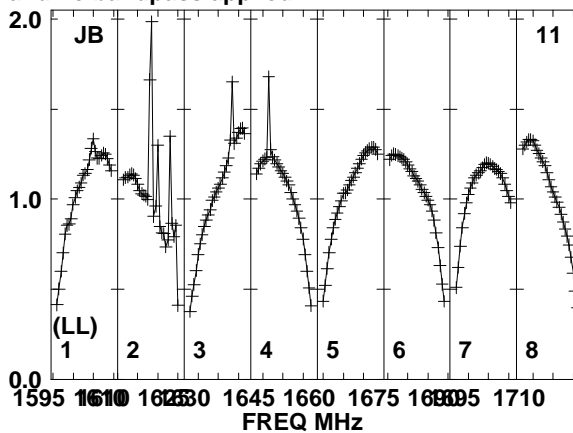
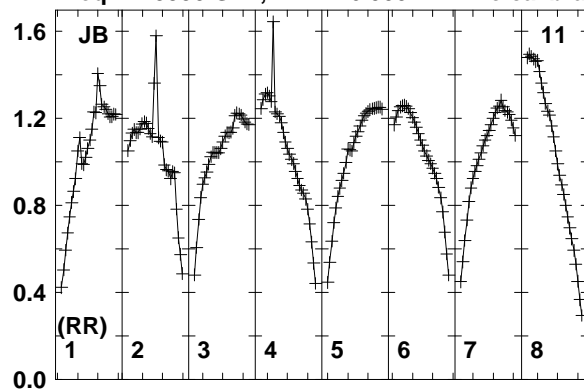

Lower frame: Real Jy
Total-power spectrum Antenna: JB (11)
Timerange: 00/04:16:02 to 00/04:17:48

Plot file version 76 created 11-AUG-2014 17:05:32

J2032+4127 EM110 2.UVDATA.1

Freq = 1.5950 GHz, Bw = 16.000 MH No calibration applied and no bandpass applied

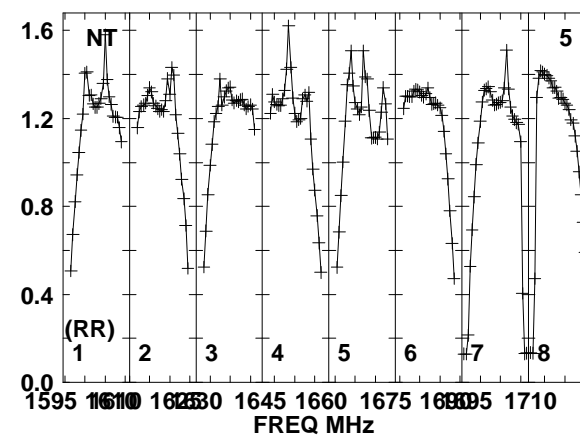
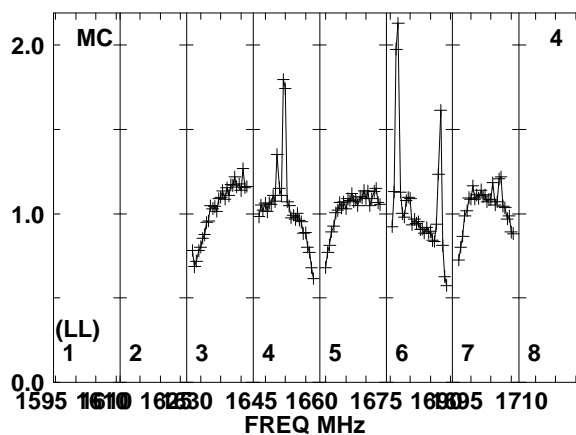
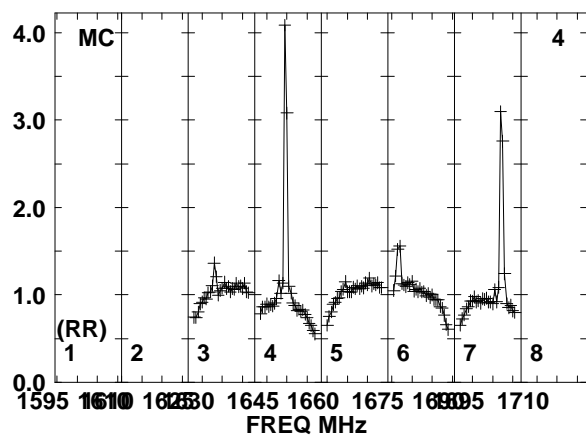
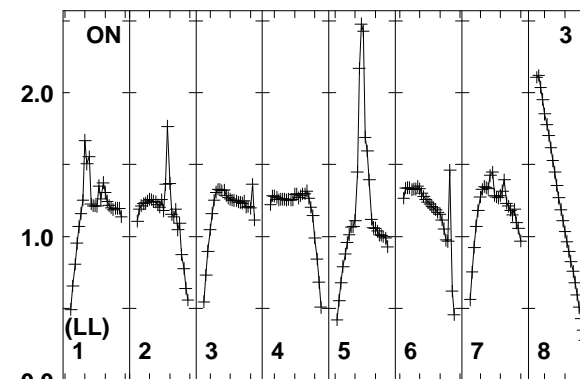
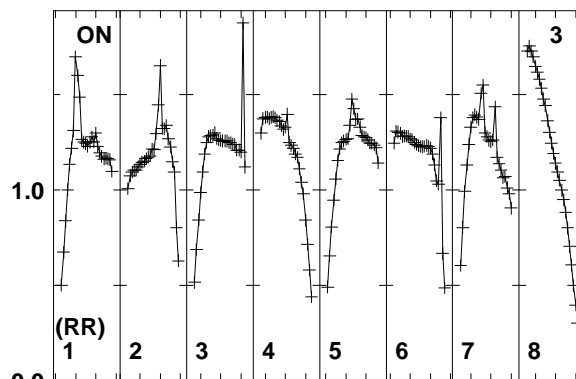
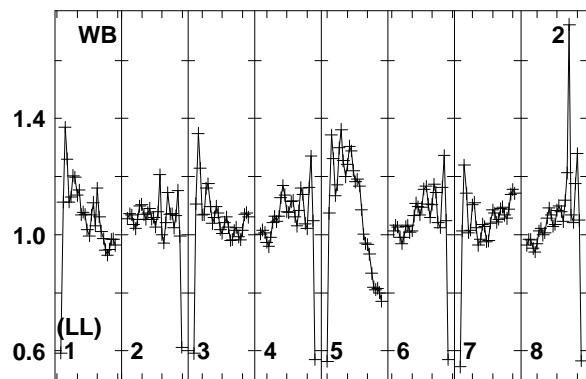
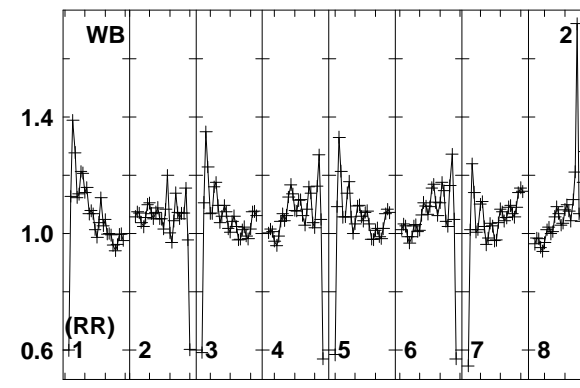
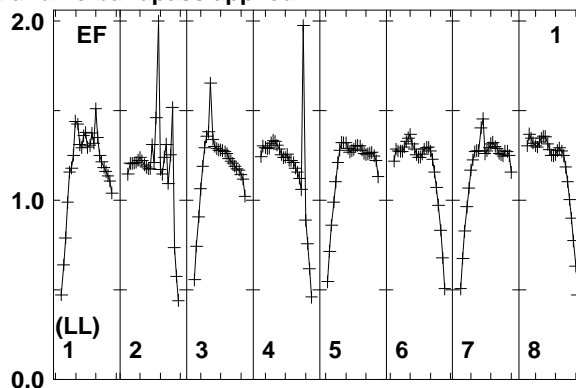
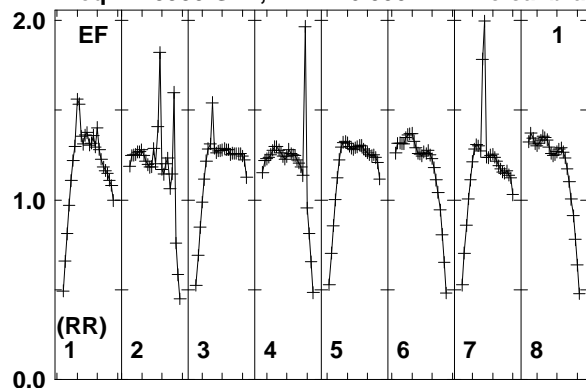

Lower frame: Real Jy
Total-power spectrum Antenna: EF (01)
Timerange: 00/04:18:02 to 00/04:21:48

Plot file version 77 created 11-AUG-2014 17:05:32

J2032+4127 EM110 2.UVDATA.1

Freq = 1.5950 GHz, Bw = 16.000 MH No calibration applied and no bandpass applied

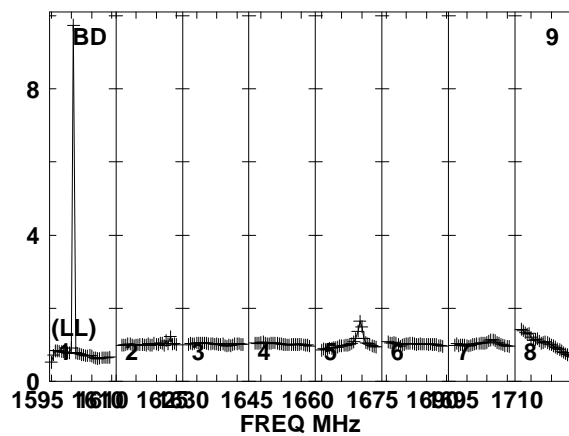
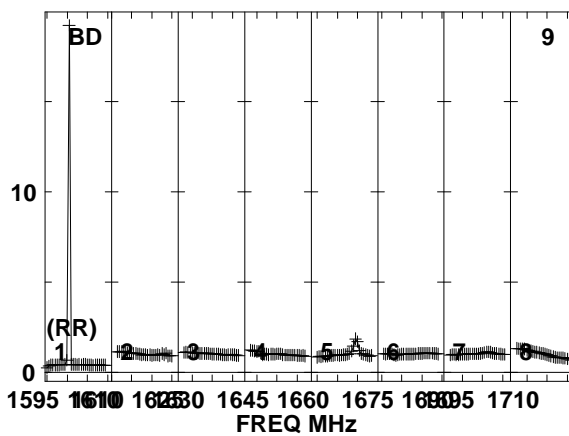
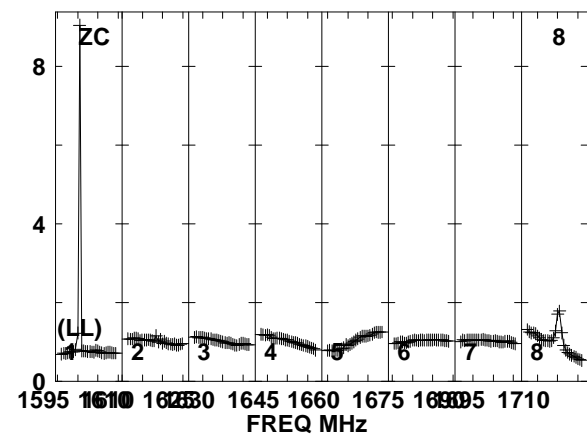
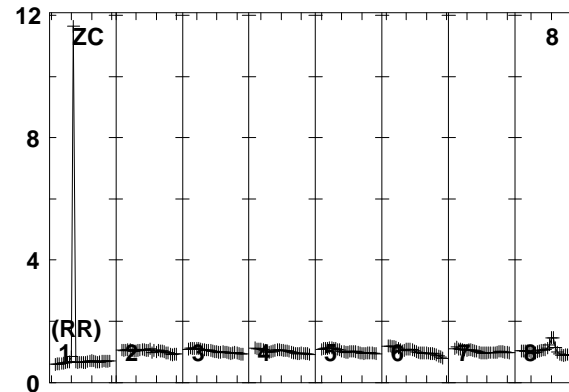
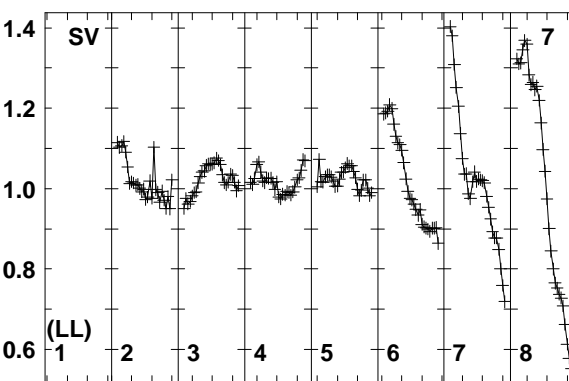
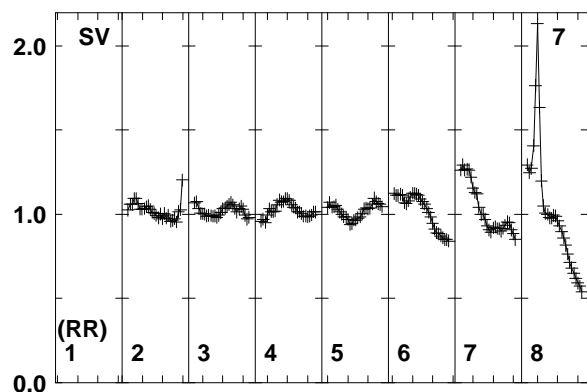
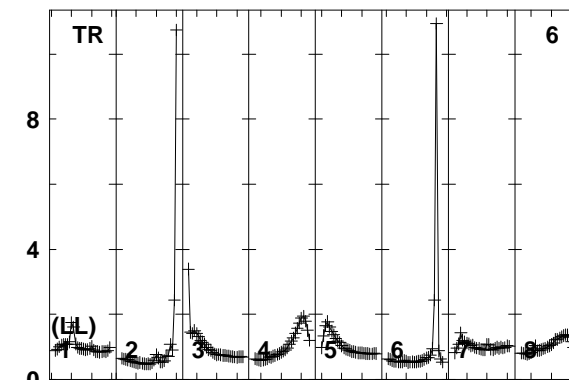
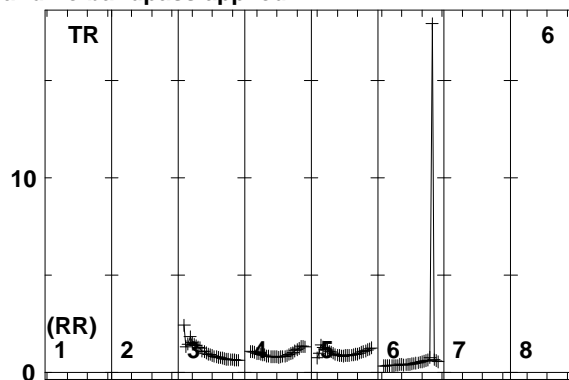
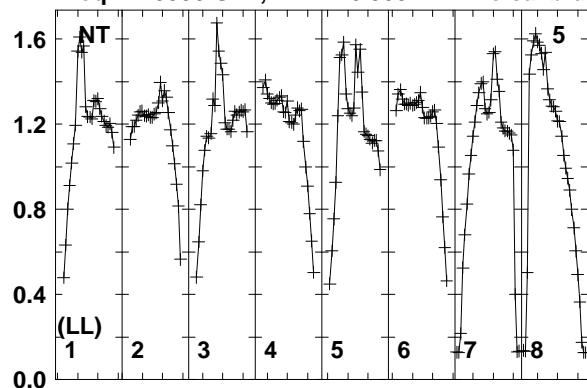

Lower frame: Real Jy
Total-power spectrum Antenna: NT (05)
Timerange: 00/04:18:02 to 00/04:21:48

Plot file version 78 created 11-AUG-2014 17:05:32

J2032+4127 EM110 2.UVDATA.1

Freq = 1.5950 GHz, Bw = 16.000 MH No calibration applied and no bandpass applied

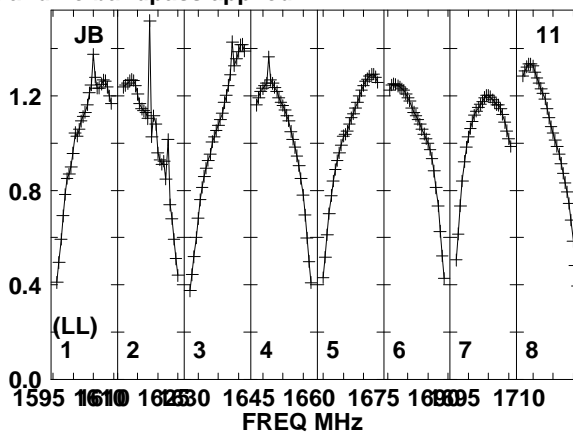
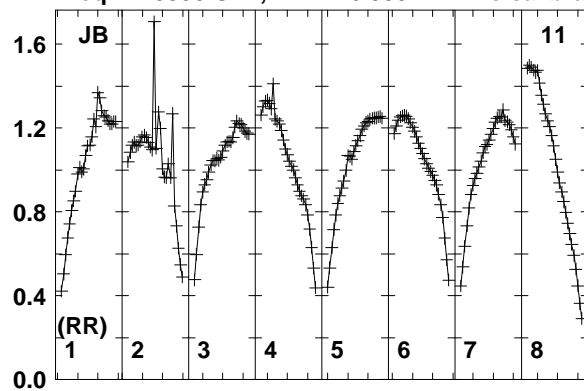

Lower frame: Real Jy
Total-power spectrum Antenna: JB (11)
Timerange: 00/04:18:02 to 00/04:21:48

Plot file version 79 created 11-AUG-2014 17:05:32

J2015+3710 EM110 2.UVDATA.1

Freq = 1.5950 GHz, Bw = 16.000 MH No calibration applied and no bandpass applied

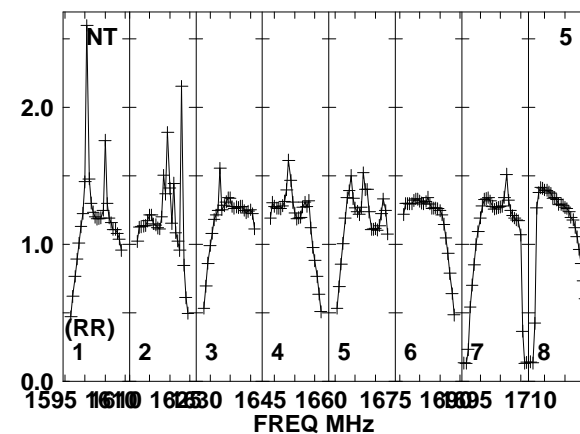
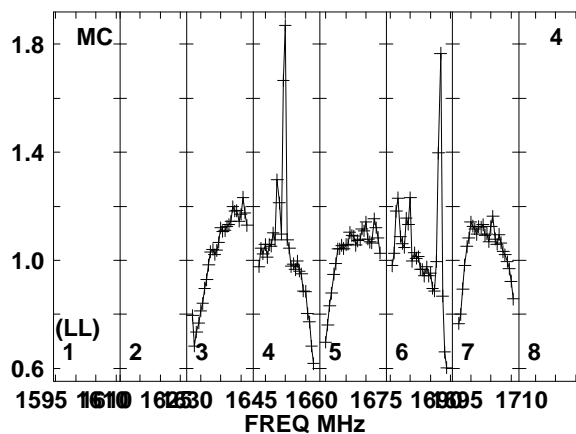
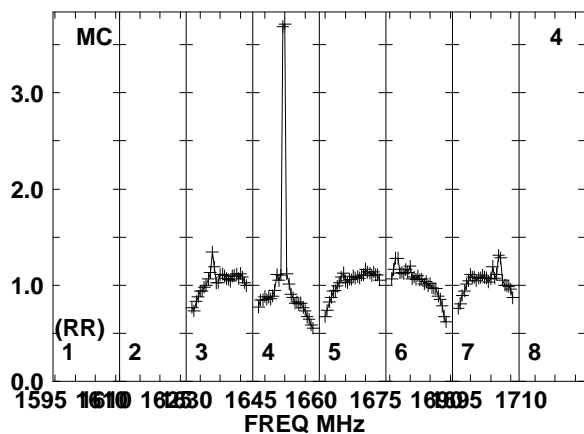
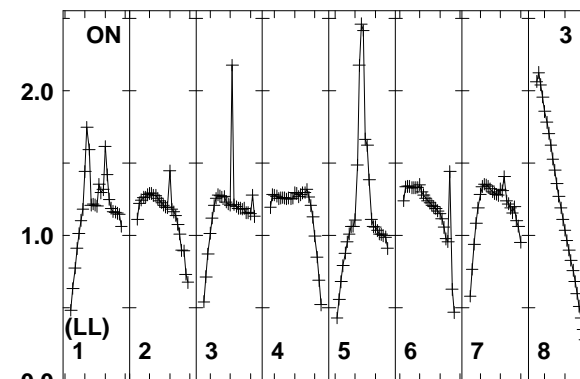
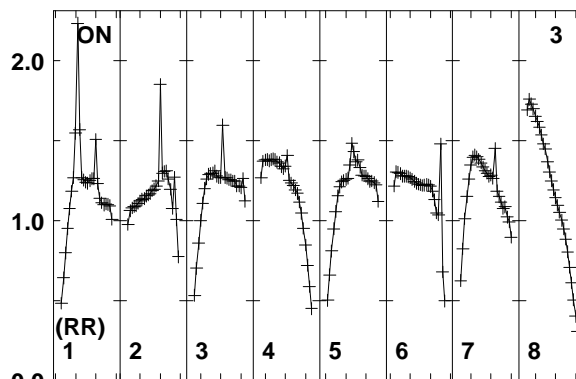
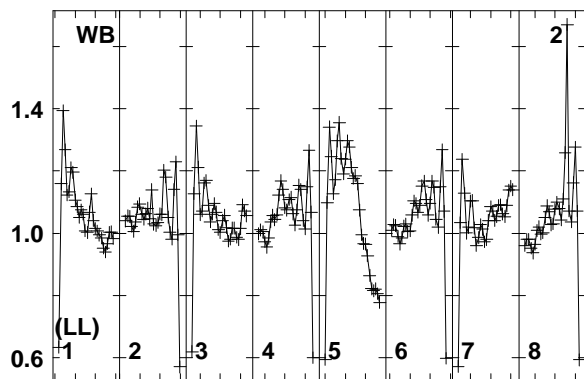
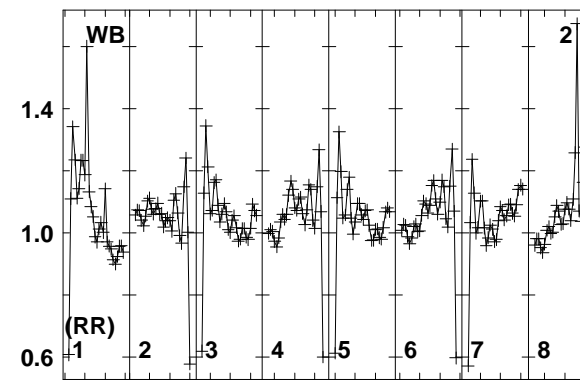
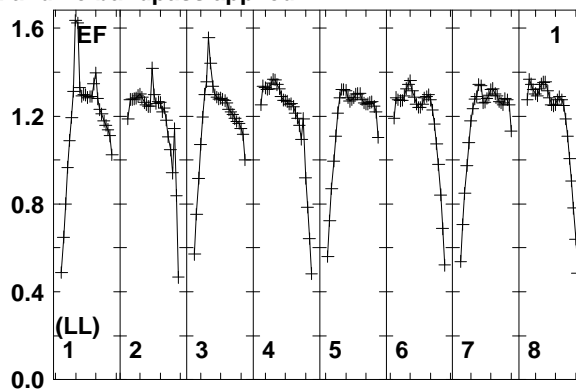
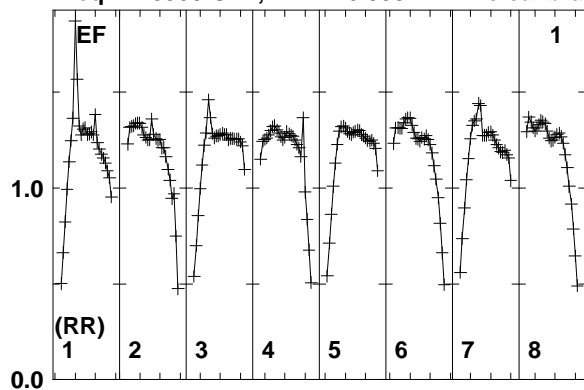

Lower frame: Real Jy
Total-power spectrum Antenna: EF (01)
Timerange: 00/04:22:51 to 00/04:24:49

Plot file version 80 created 11-AUG-2014 17:05:32

J2015+3710 EM110 2.UVDATA.1

Freq = 1.5950 GHz, Bw = 16.000 MH No calibration applied and no bandpass applied

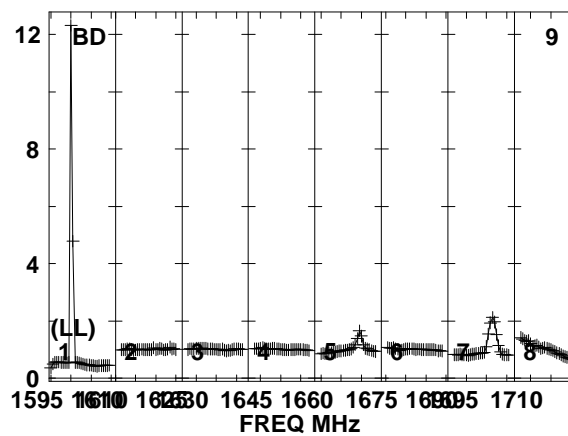
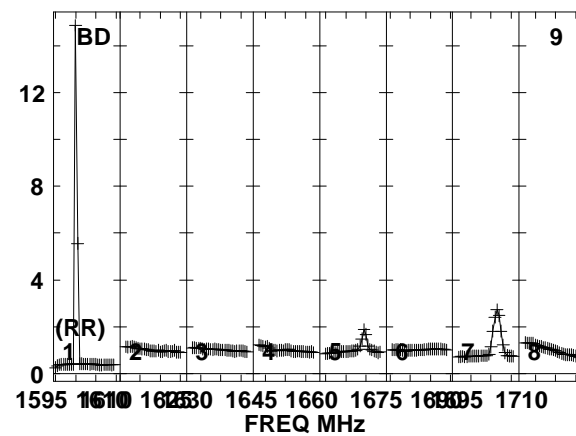
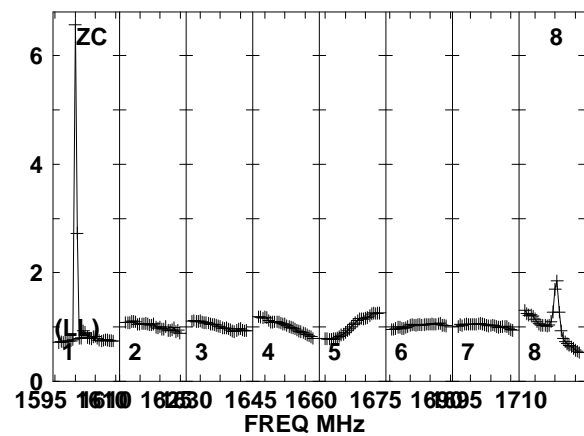
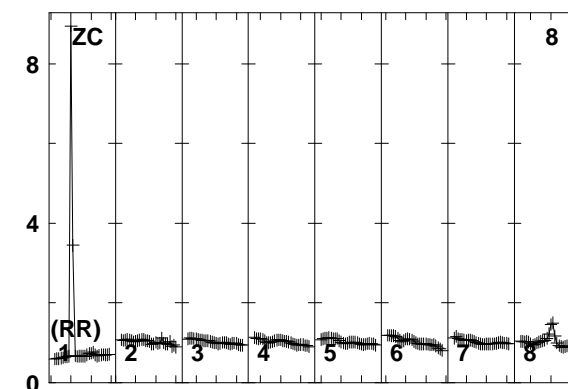
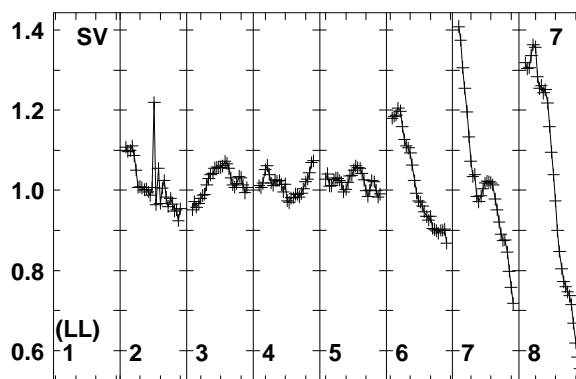
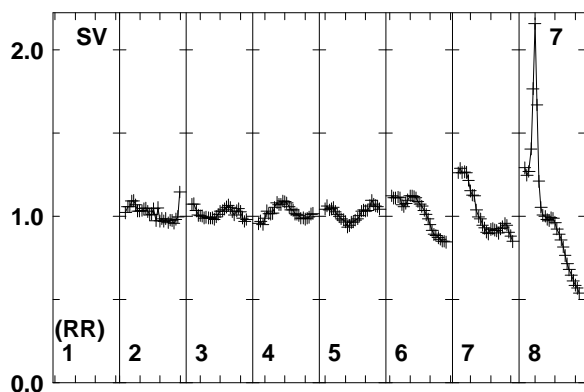
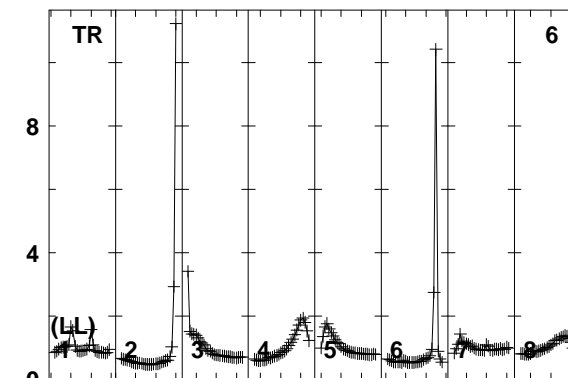
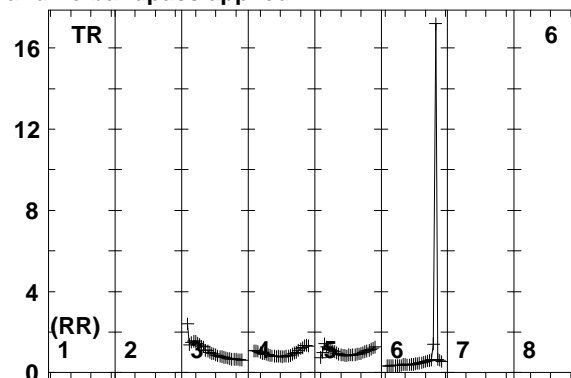
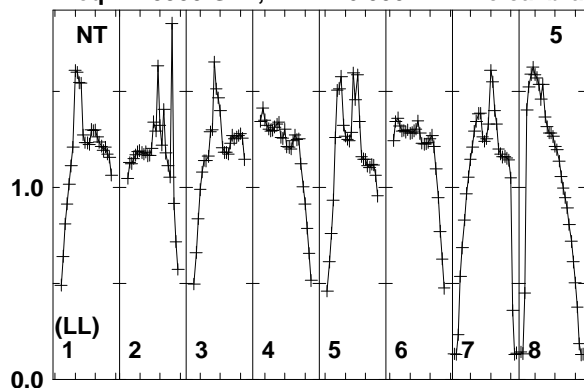

Lower frame: Real Jy
Total-power spectrum Antenna: NT (05)
Timerange: 00/04:22:51 to 00/04:24:49

Plot file version 81 created 11-AUG-2014 17:05:32

J2032+4127 EM110 2.UVDATA.1

Freq = 1.5950 GHz, Bw = 16.000 MH No calibration applied and no bandpass applied

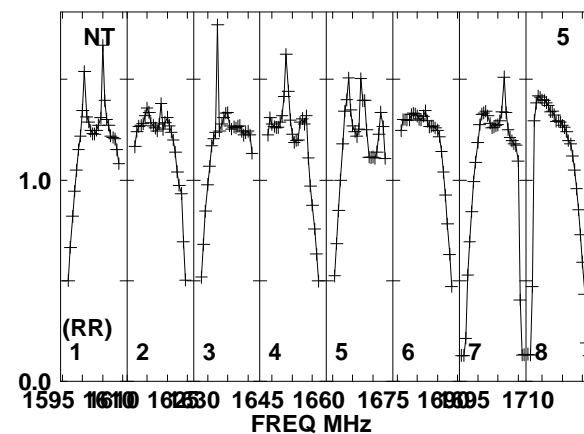
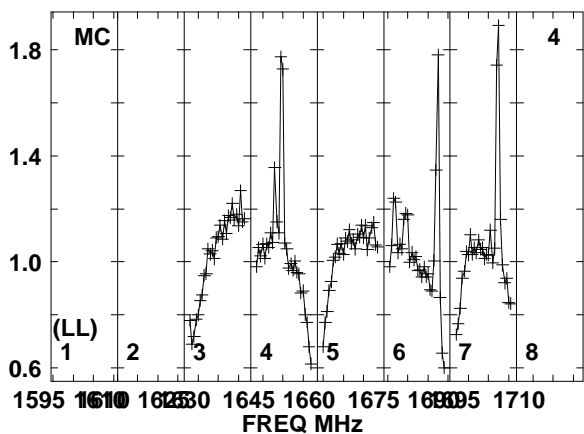
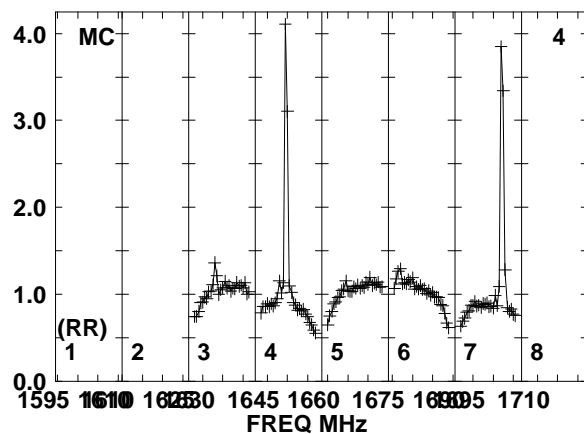
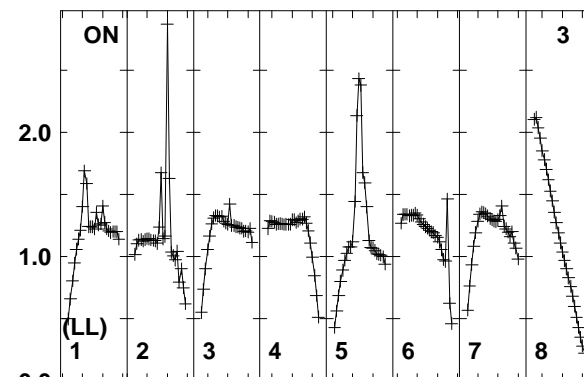
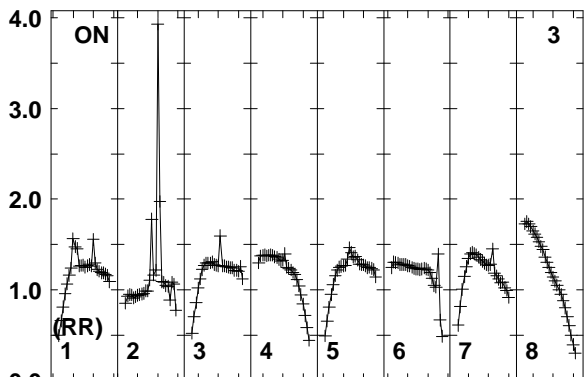
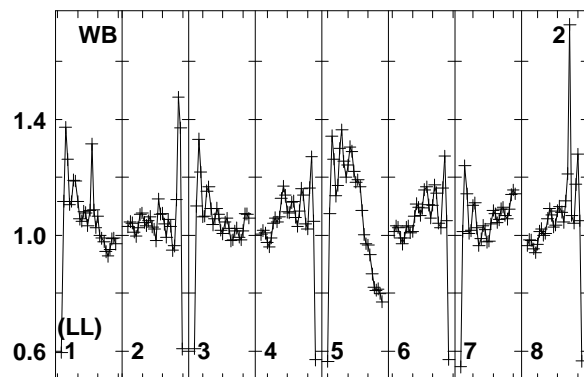
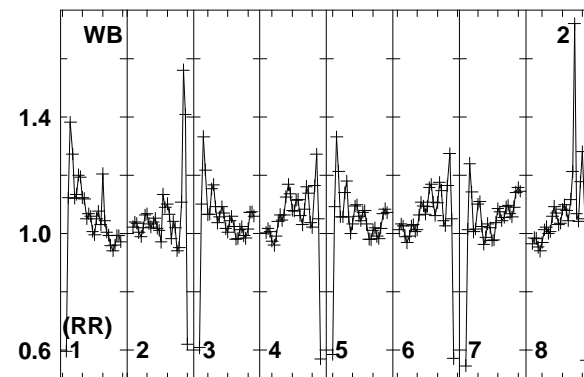
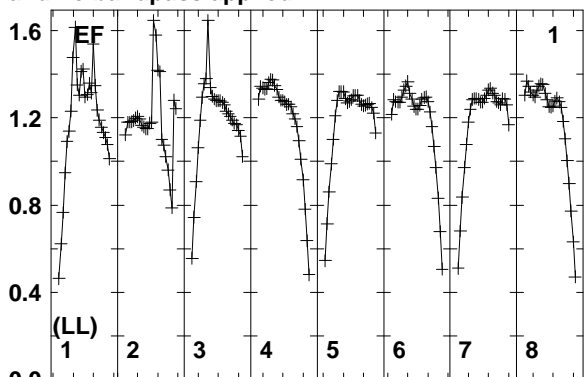
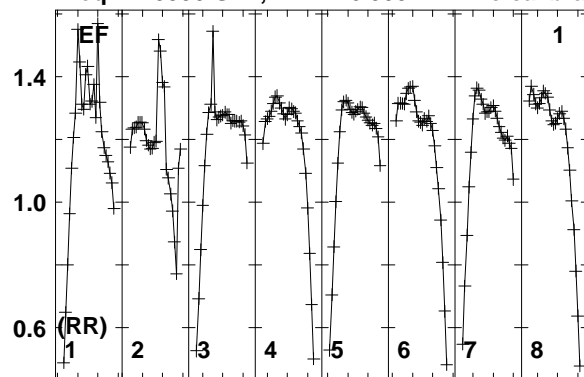

Lower frame: Real Jy
Total-power spectrum Antenna: EF (01)
Timerange: 00/04:24:51 to 00/04:28:49

Plot file version 82 created 11-AUG-2014 17:05:32

J2032+4127 EM110 2.UVDATA.1

Freq = 1.5950 GHz, Bw = 16.000 MH No calibration applied and no bandpass applied

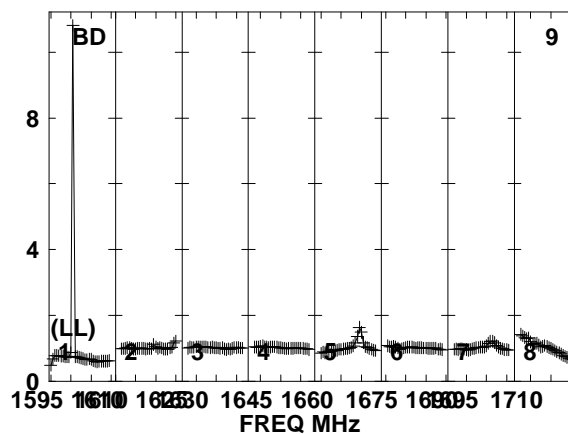
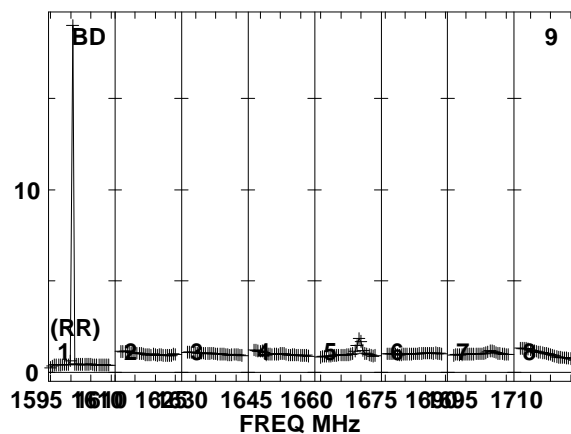
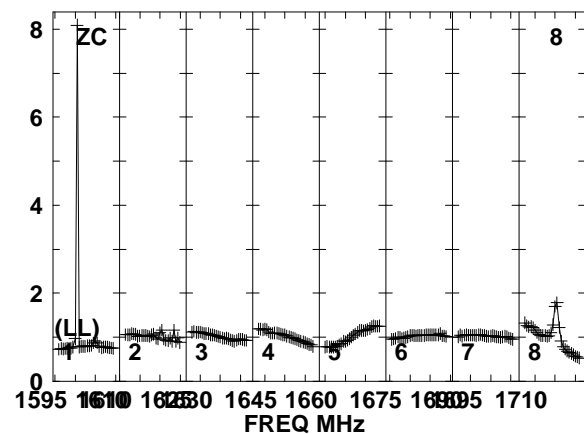
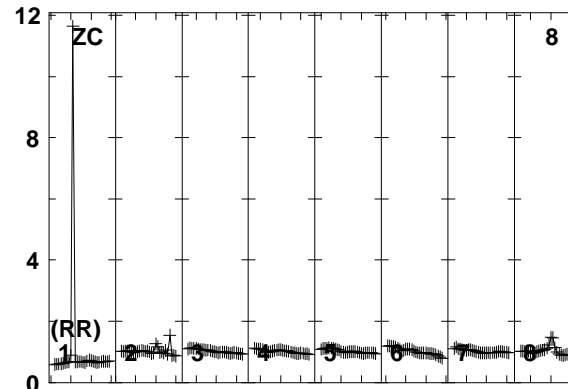
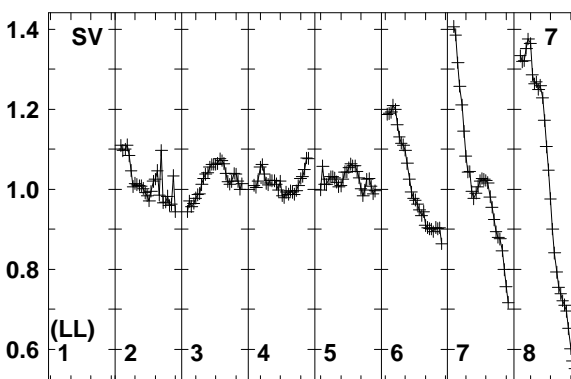
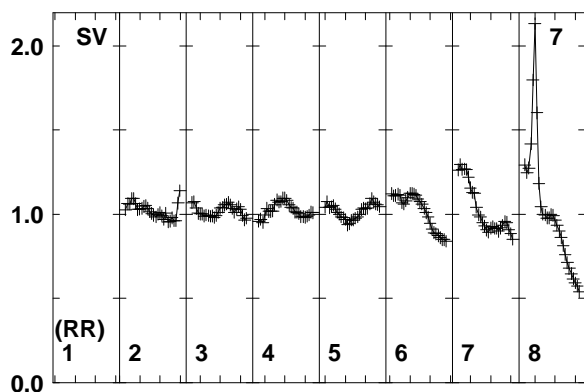
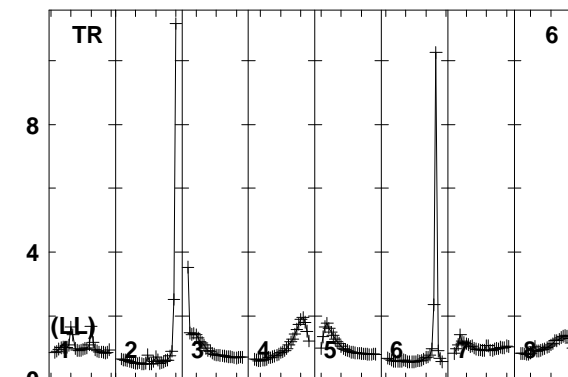
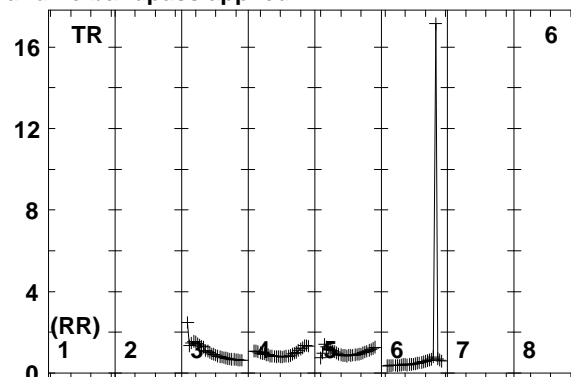
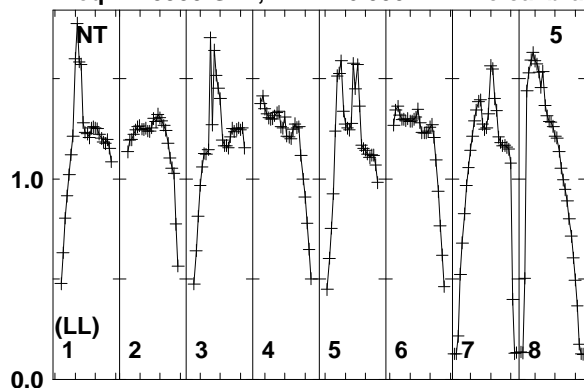

Lower frame: Real Jy
Total-power spectrum Antenna: NT (05)
Timerange: 00/04:24:51 to 00/04:28:49

Plot file version 83 created 11-AUG-2014 17:05:32

J2032+4127 EM110 2.UVDATA.1

Freq = 1.5950 GHz, Bw = 16.000 MH No calibration applied and no bandpass applied

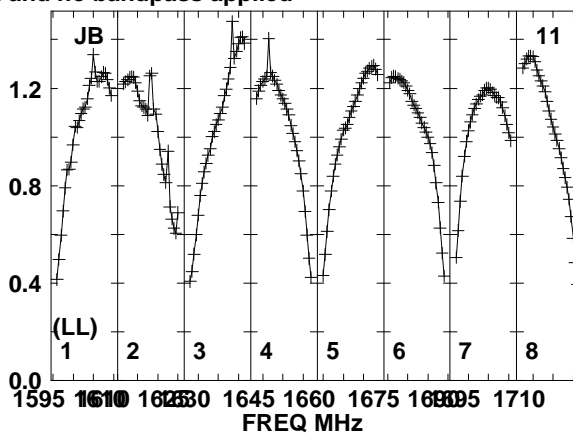
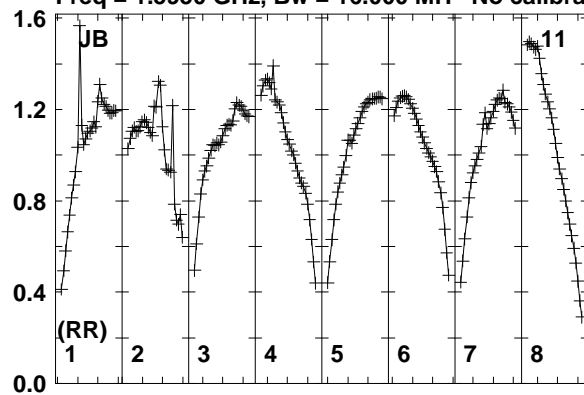

Lower frame: Real Jy
Total-power spectrum Antenna: JB (11)
Timerange: 00/04:24:51 to 00/04:28:49

Plot file version 84 created 11-AUG-2014 17:05:32

J2015+3710 EM110 2.UVDATA.1

Freq = 1.5950 GHz, Bw = 16.000 MH No calibration applied and no bandpass applied

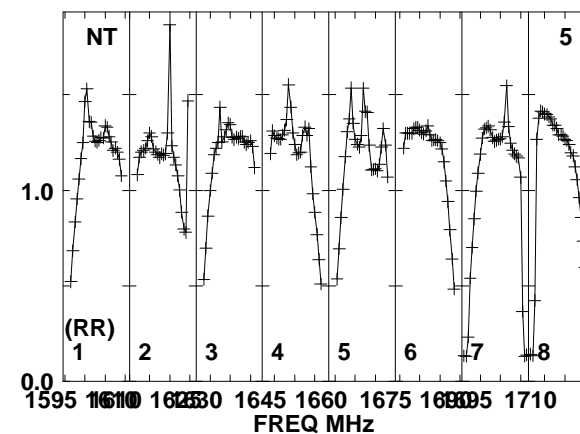
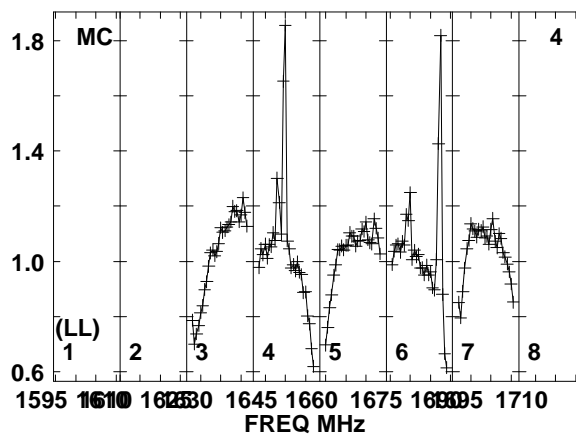
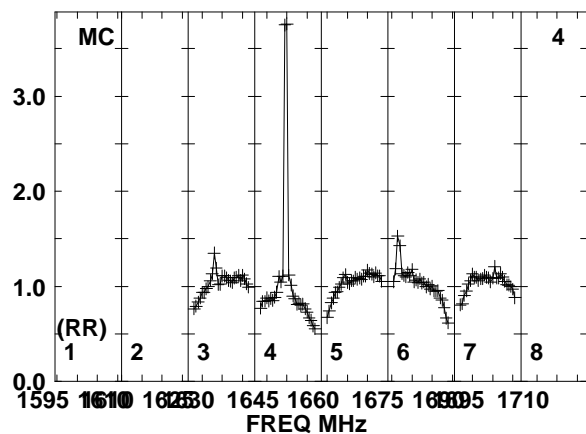
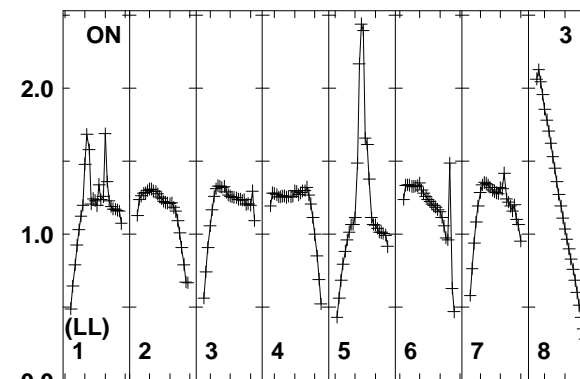
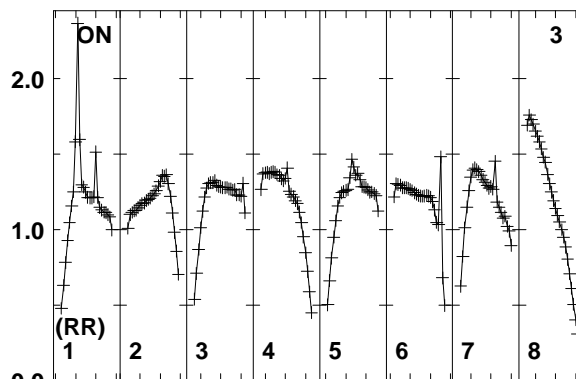
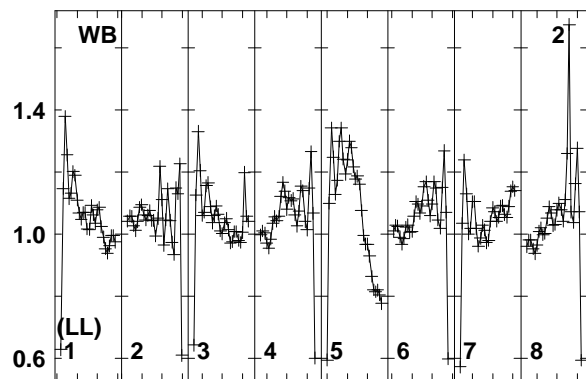
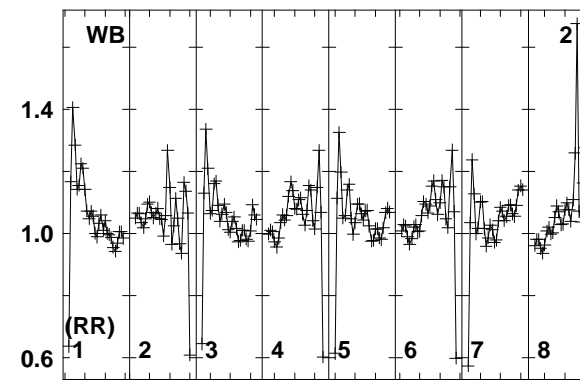
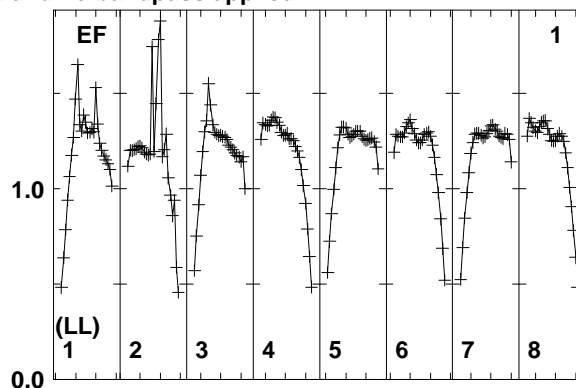
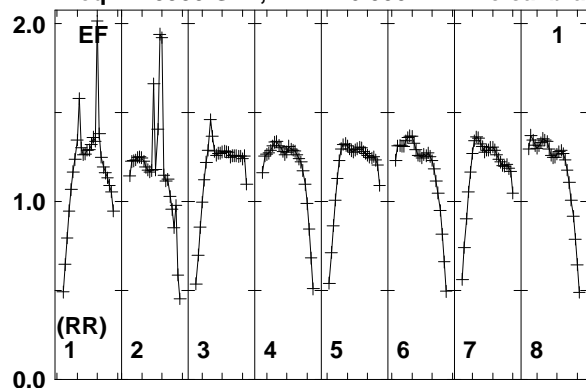

Lower frame: Real Jy
Total-power spectrum Antenna: EF (01)
Timerange: 00/04:29:51 to 00/04:31:49

Plot file version 85 created 11-AUG-2014 17:05:32

J2015+3710 EM110 2.UVDATA.1

Freq = 1.5950 GHz, Bw = 16.000 MH No calibration applied and no bandpass applied

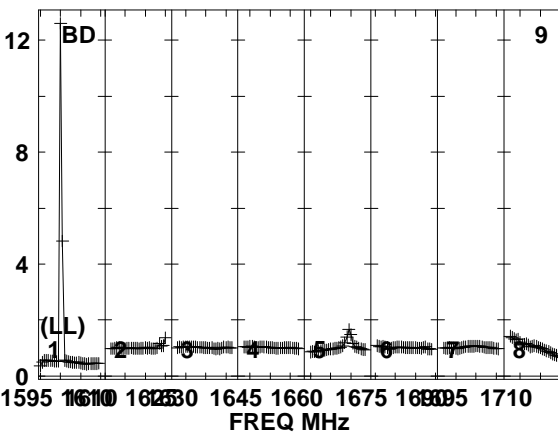
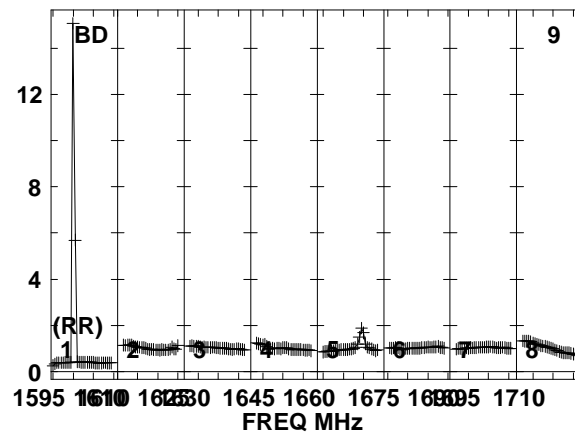
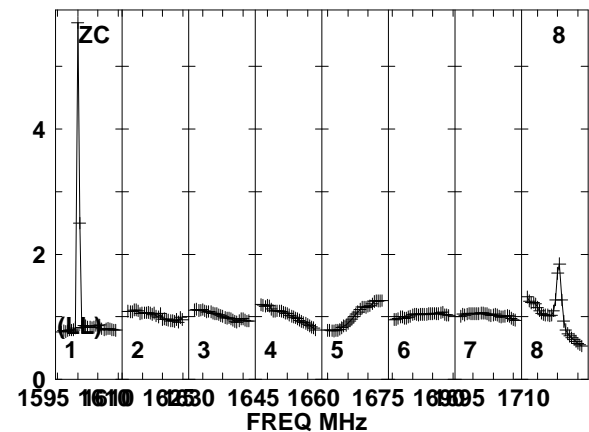
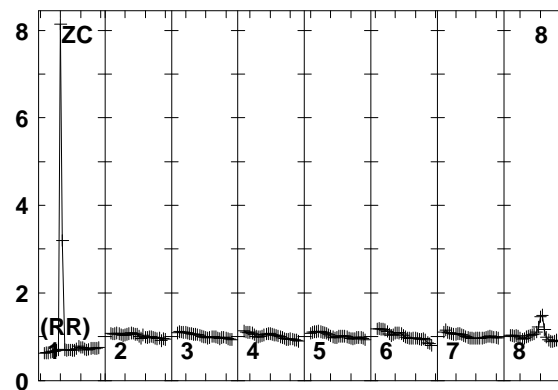
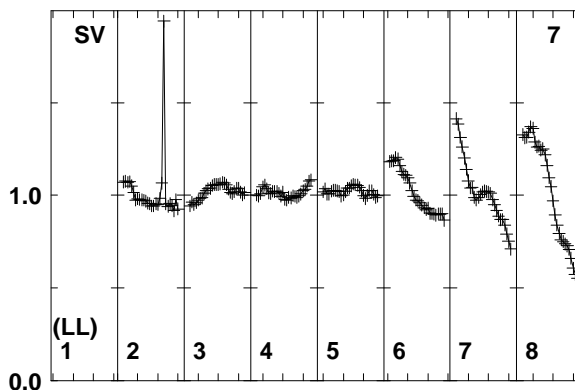
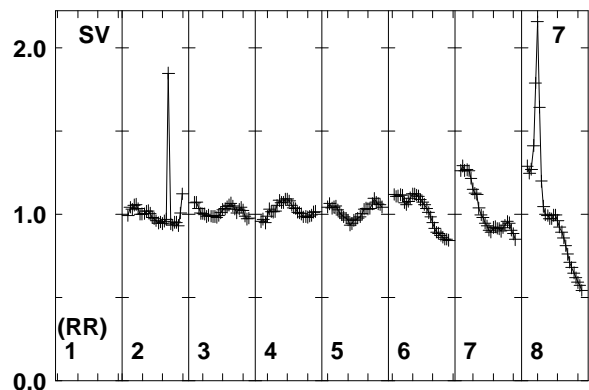
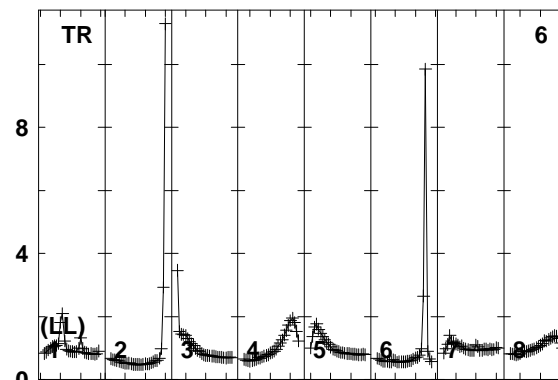
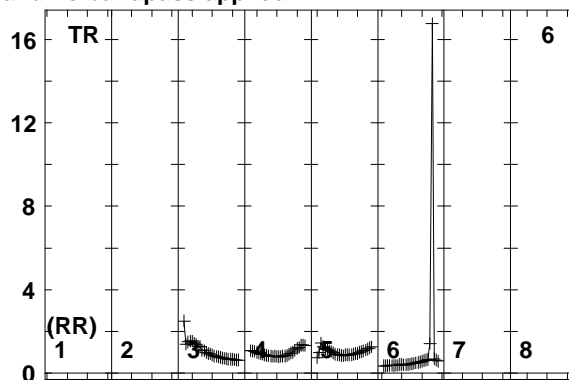
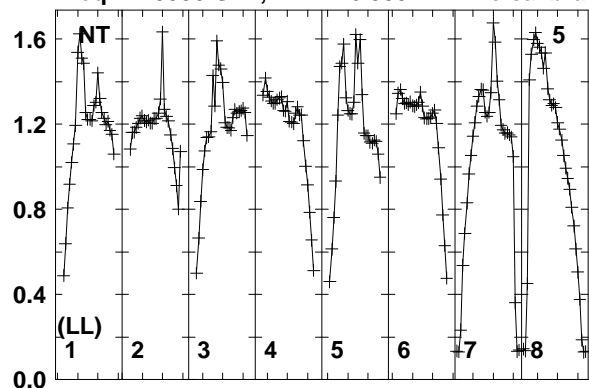

1595 1610 1625 1640 1655 1670 1685 1700 1715
FREQ MHz
Lower frame: Real Jy
Total-power spectrum Antenna: NT (05)
Timerange: 00/04:29:51 to 00/04:31:49

Plot file version 86 created 11-AUG-2014 17:05:32

J2015+3710 EM110 2.UVDATA.1

Freq = 1.5950 GHz, Bw = 16.000 MH No calibration applied and no bandpass applied

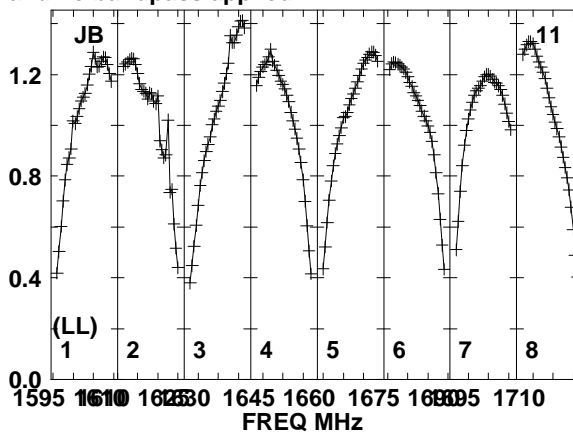
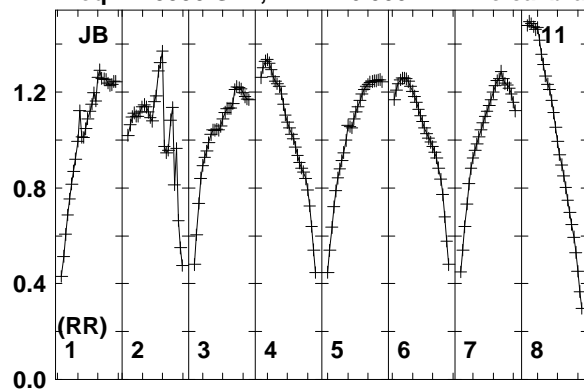

Lower frame: Real Jy
Total-power spectrum Antenna: JB (11)
Timerange: 00/04:29:51 to 00/04:31:49

Plot file version 87 created 11-AUG-2014 17:05:32

J2032+4127 EM110 2.UVDATA.1

Freq = 1.5950 GHz, Bw = 16.000 MH No calibration applied and no bandpass applied

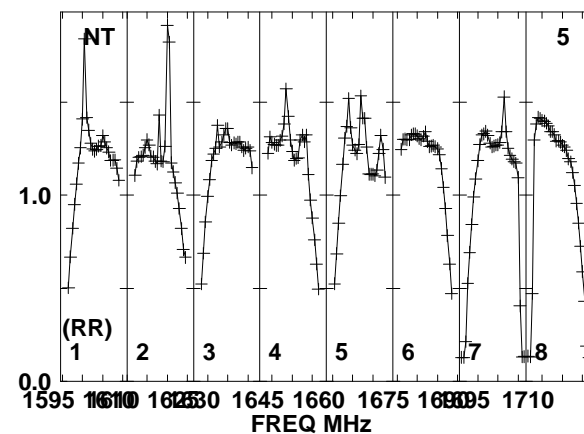
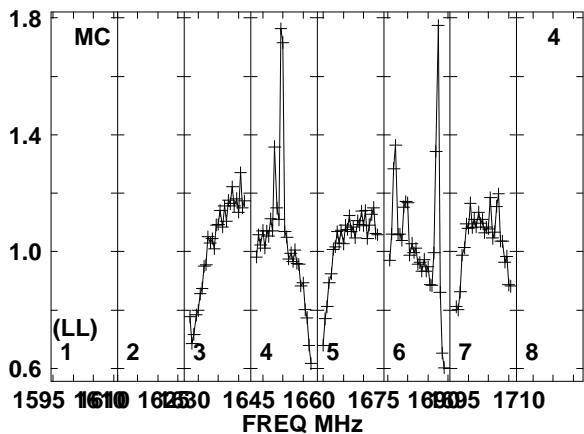
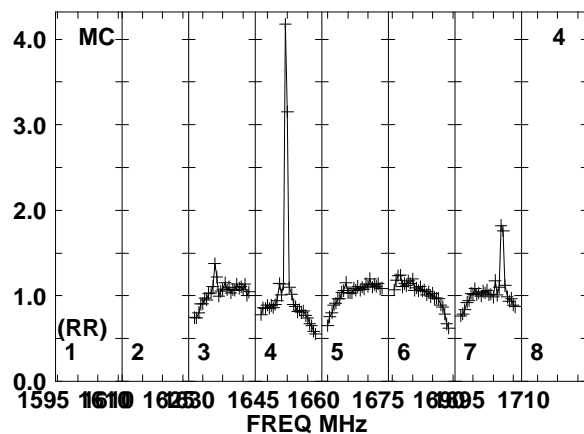
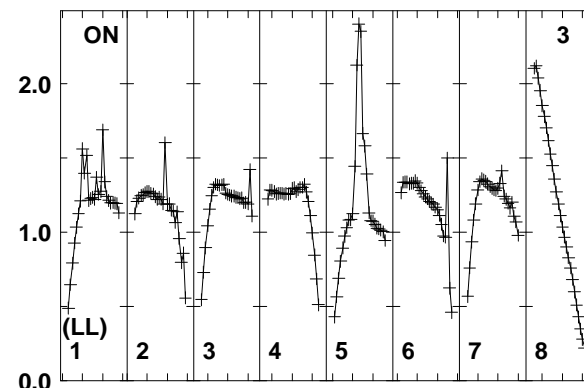
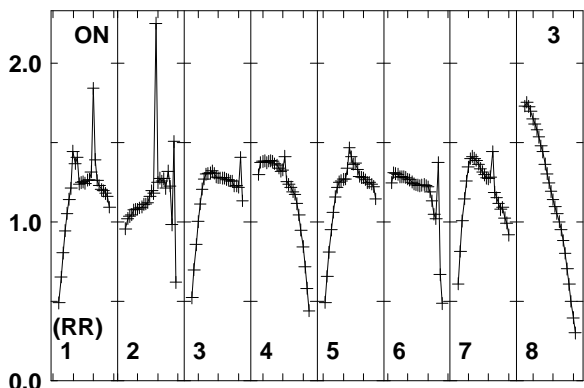
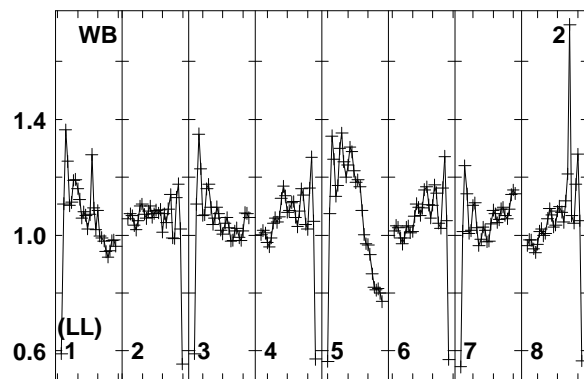
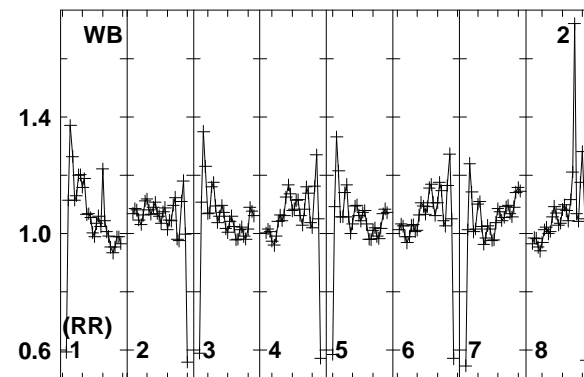
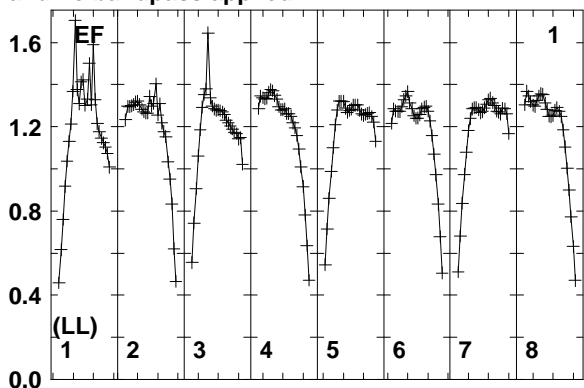
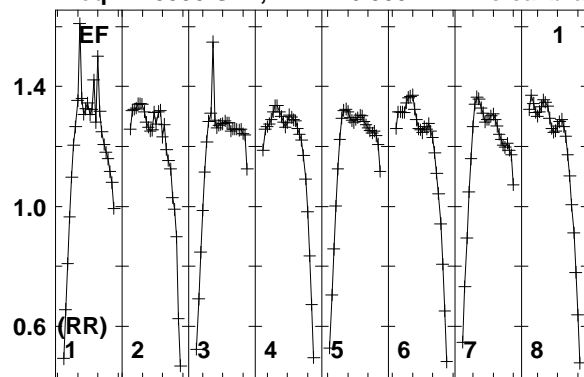

Lower frame: Real Jy
Total-power spectrum Antenna: EF (01)
Timerange: 00/04:32:02 to 00/04:35:48

Plot file version 88 created 11-AUG-2014 17:05:32

J2032+4127 EM110 2.UVDATA.1

Freq = 1.5950 GHz, Bw = 16.000 MH No calibration applied and no bandpass applied

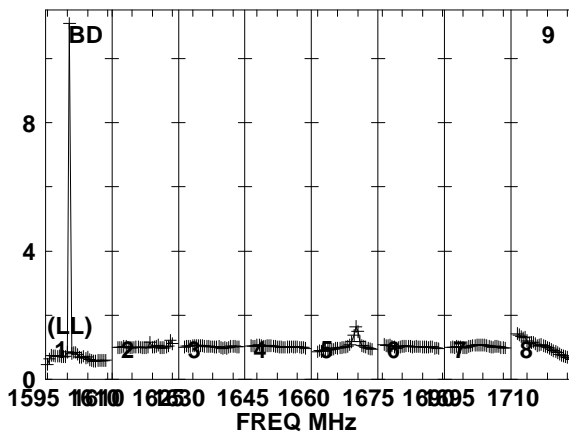
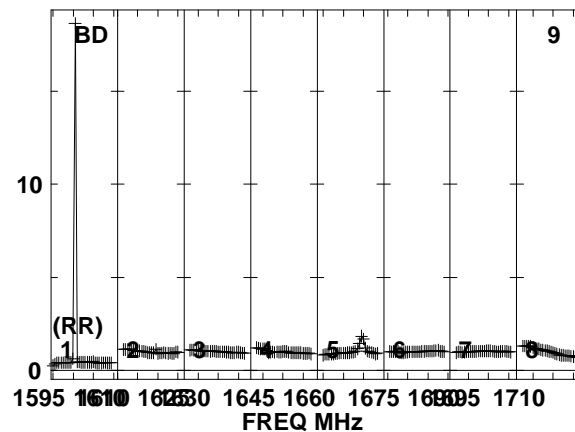
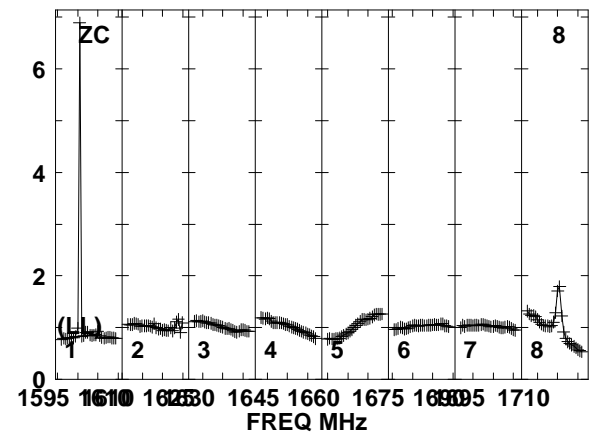
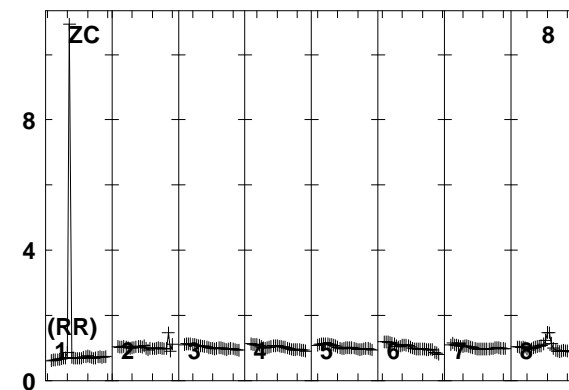
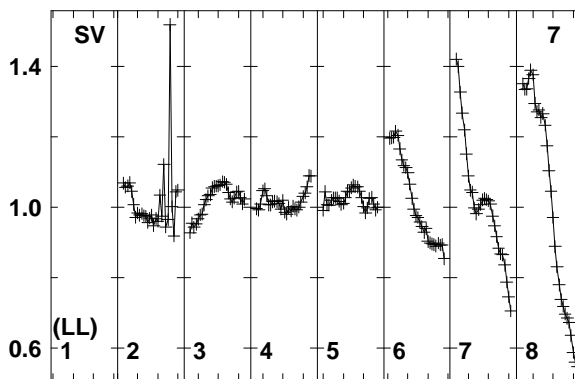
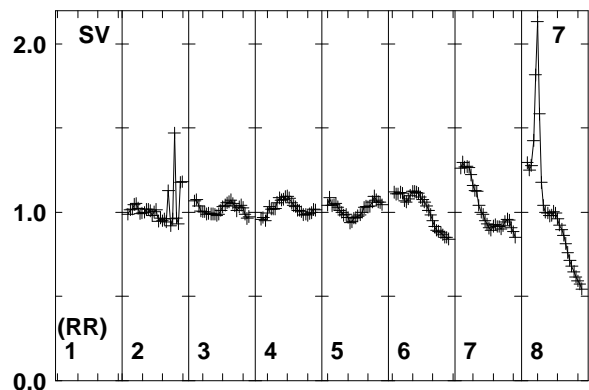
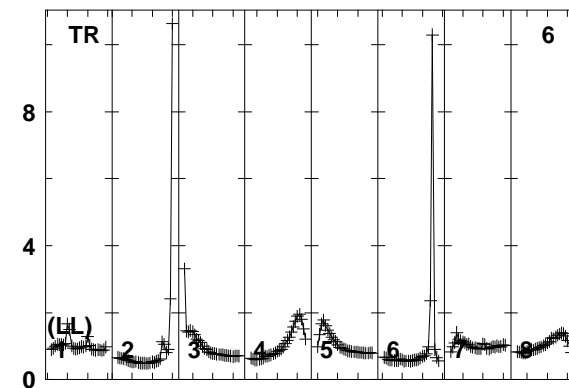
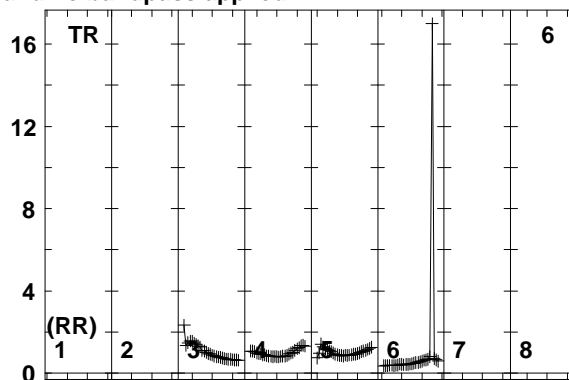
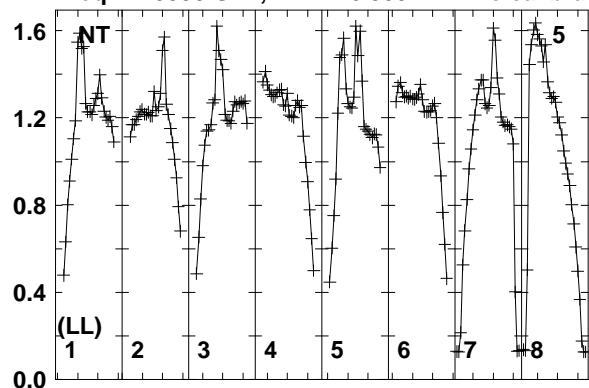

1595 1610 1625 1640 1655 1670 1685 1700 1715
FREQ MHz
Lower frame: Real Jy
Total-power spectrum Antenna: NT (05)
Timerange: 00/04:32:02 to 00/04:35:48

Plot file version 89 created 11-AUG-2014 17:05:32

J2032+4127 EM110 2.UVDATA.1

Freq = 1.5950 GHz, Bw = 16.000 MH No calibration applied and no bandpass applied

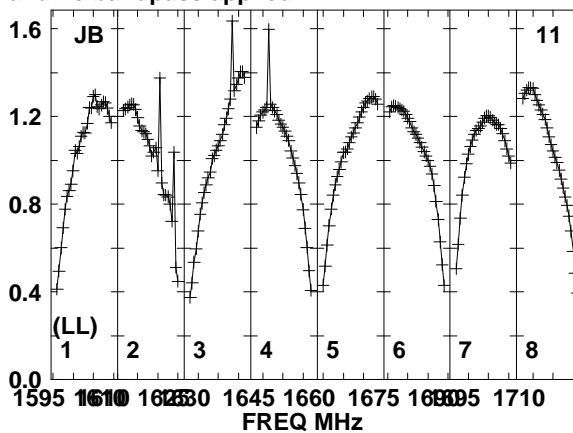
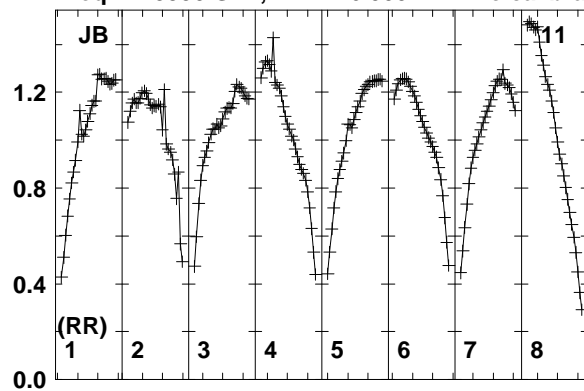

Lower frame: Real Jy
Total-power spectrum Antenna: JB (11)
Timerange: 00/04:32:02 to 00/04:35:48

Plot file version 90 created 11-AUG-2014 17:05:32

J2015+3710 EM110 2.UVDATA.1

Freq = 1.5950 GHz, Bw = 16.000 MH No calibration applied and no bandpass applied

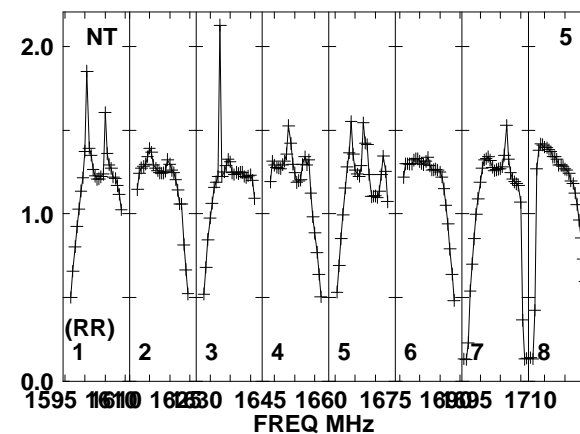
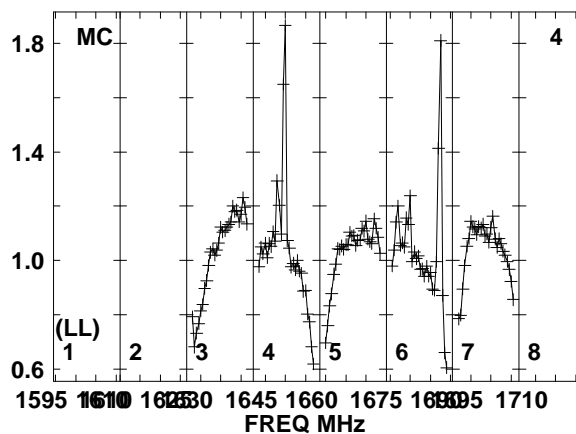
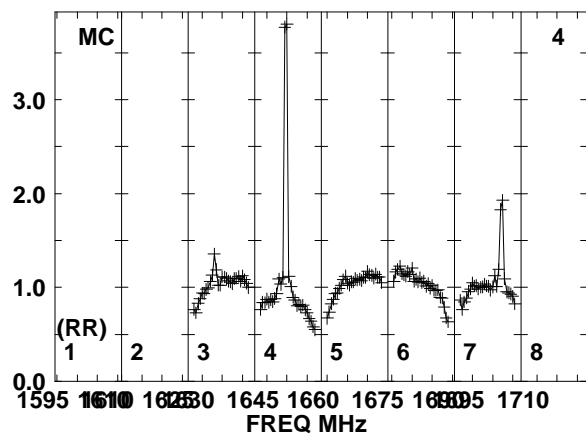
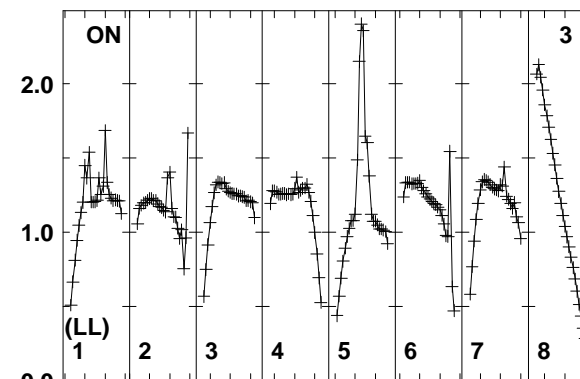
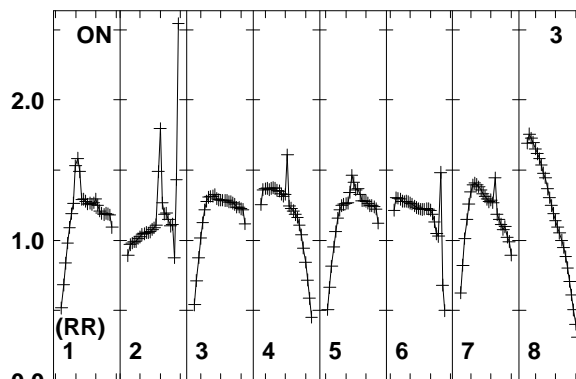
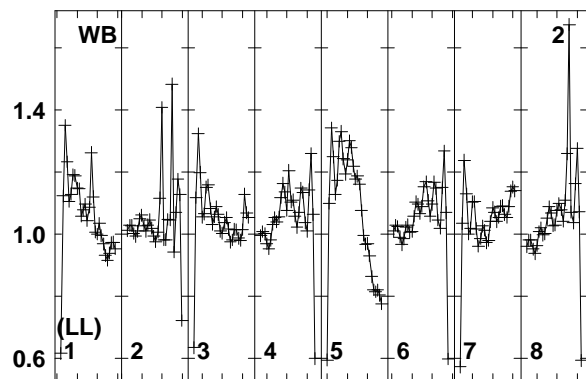
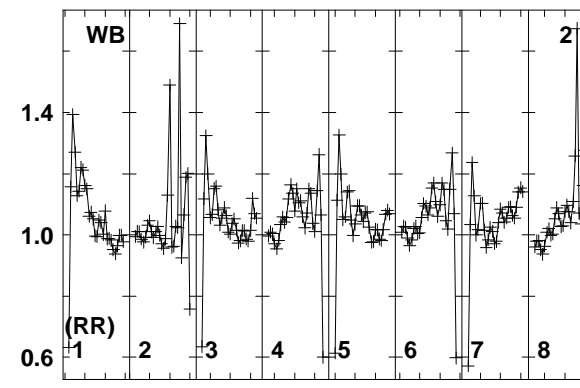
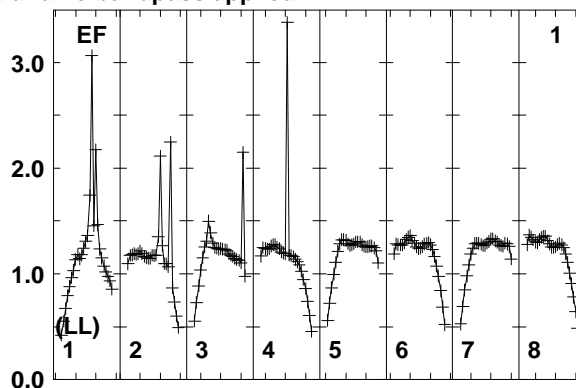
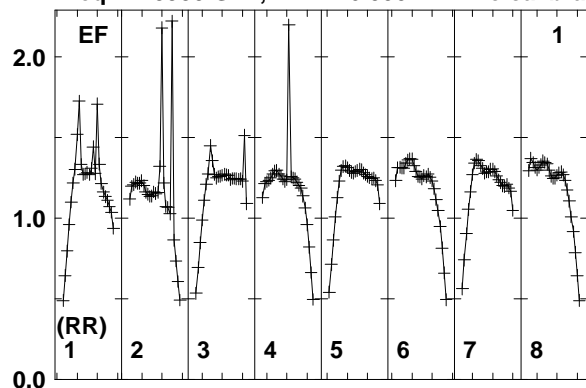

Lower frame: Real Jy
Total-power spectrum Antenna: EF (01)
Timerange: 00/04:36:02 to 00/04:37:48

Plot file version 91 created 11-AUG-2014 17:05:32

J2015+3710 EM110 2.UVDATA.1

Freq = 1.5950 GHz, Bw = 16.000 MH No calibration applied and no bandpass applied

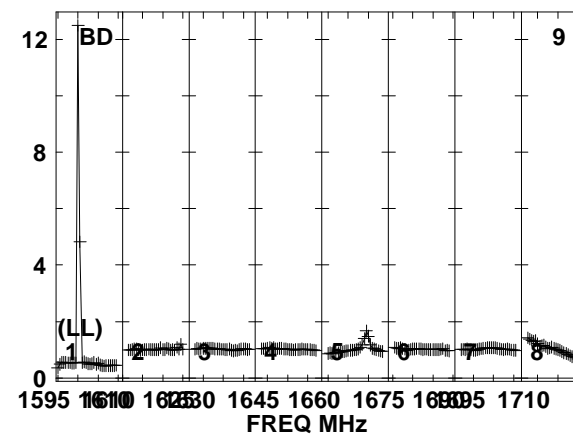
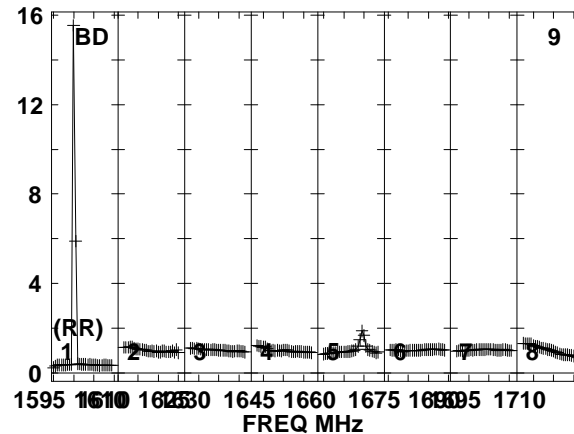
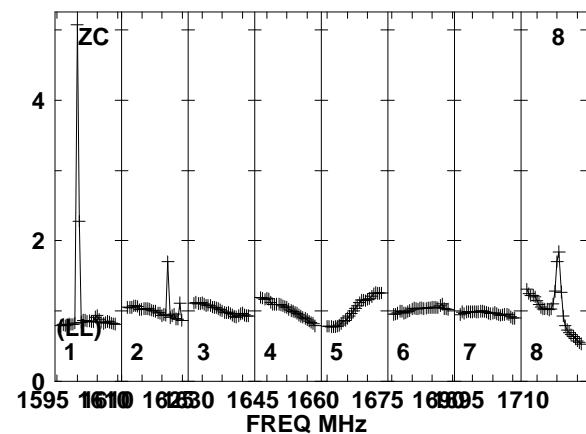
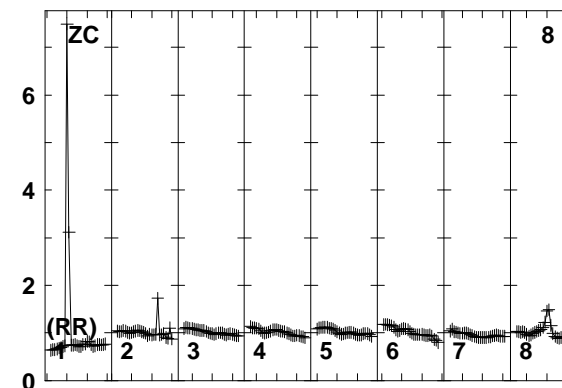
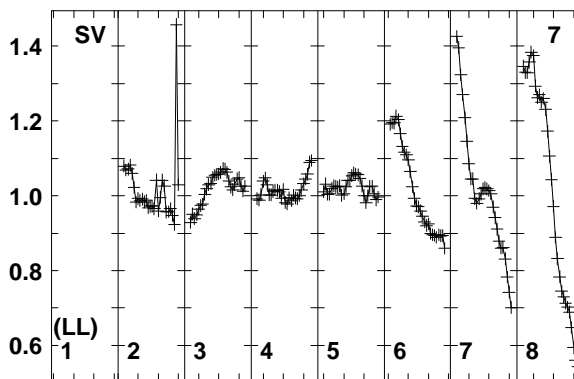
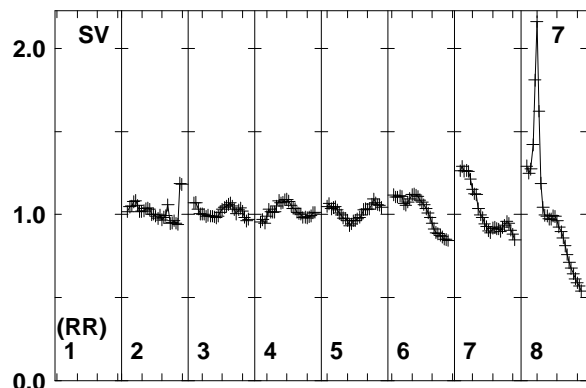
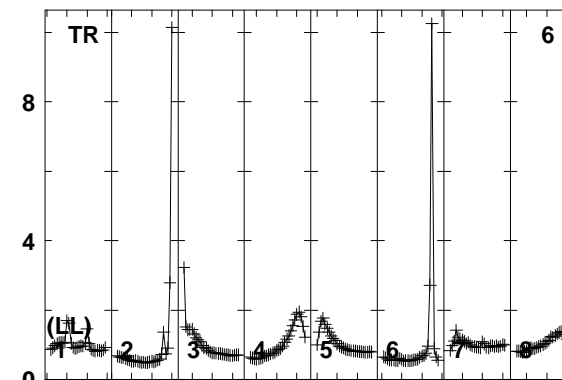
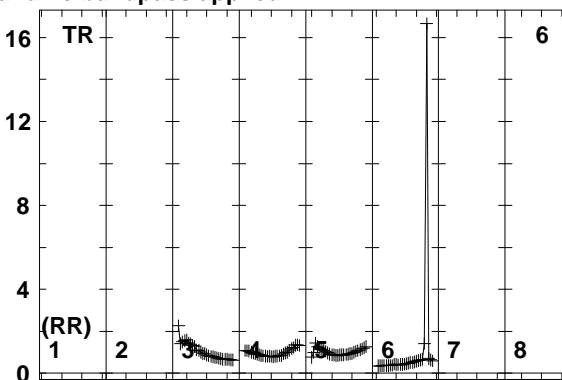
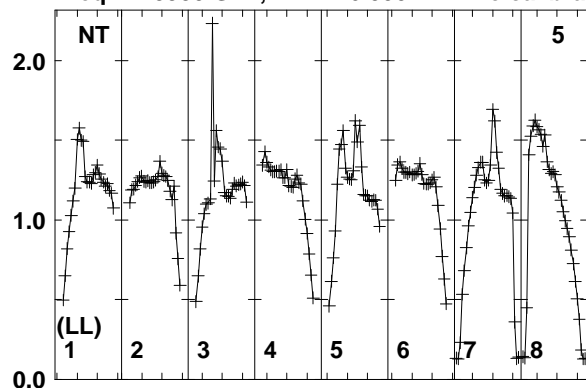

1595 1610 1625 1645 1660 1675 1695 1710
FREQ MHz
Lower frame: Real Jy
Total-power spectrum Antenna: NT (05)
Timerange: 00/04:36:02 to 00/04:37:48

Plot file version 92 created 11-AUG-2014 17:05:32

J2032+4127 EM110 2.UVDATA.1

Freq = 1.5950 GHz, Bw = 16.000 MH No calibration applied and no bandpass applied

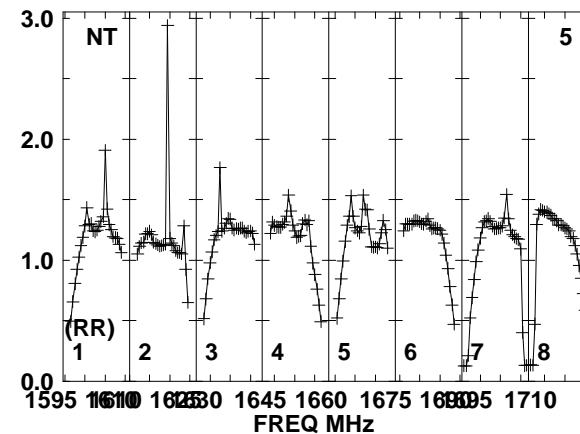
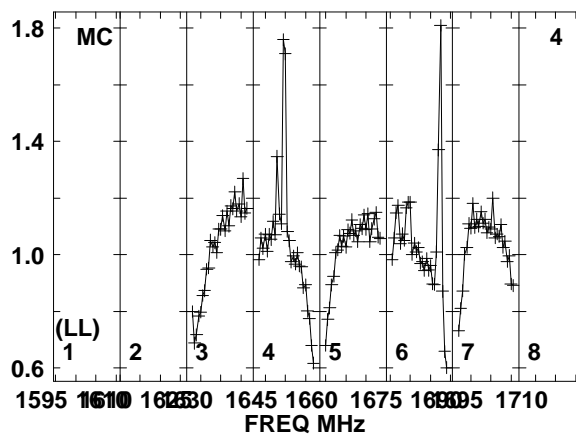
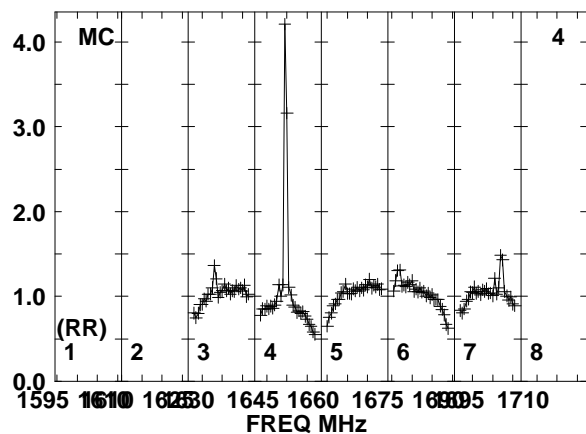
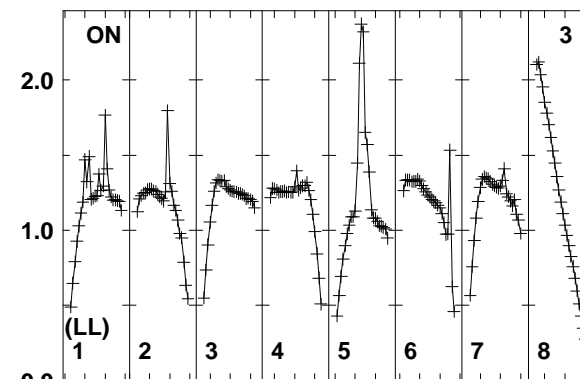
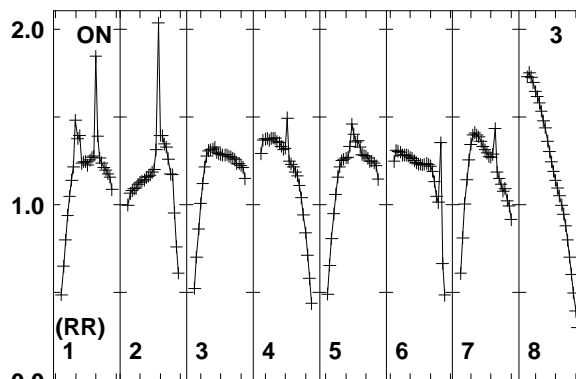
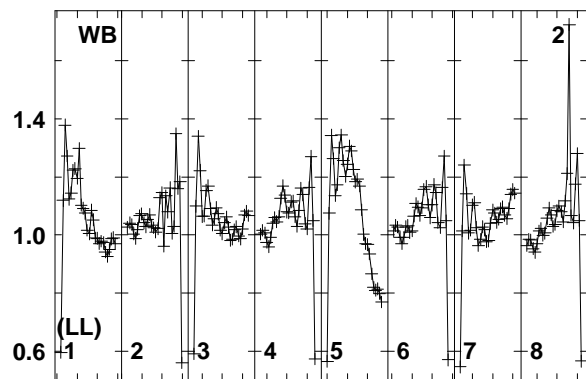
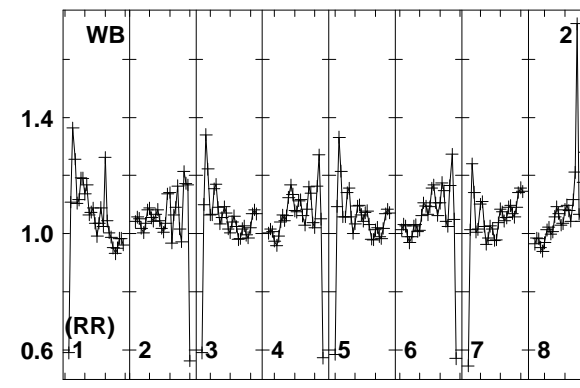
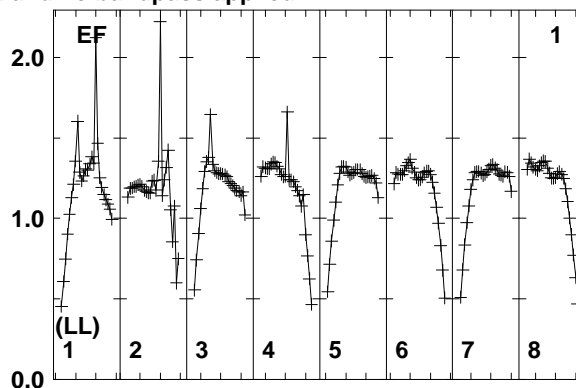
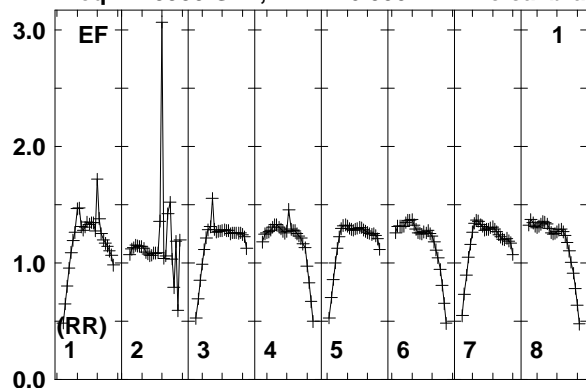

Lower frame: Real Jy
Total-power spectrum Antenna: EF (01)
Timerange: 00/04:37:51 to 00/04:41:49

Plot file version 93 created 11-AUG-2014 17:05:32

J2032+4127 EM110 2.UVDATA.1

Freq = 1.5950 GHz, Bw = 16.000 MH No calibration applied and no bandpass applied

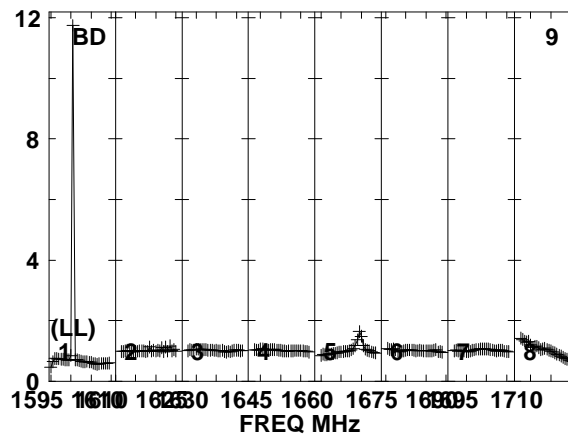
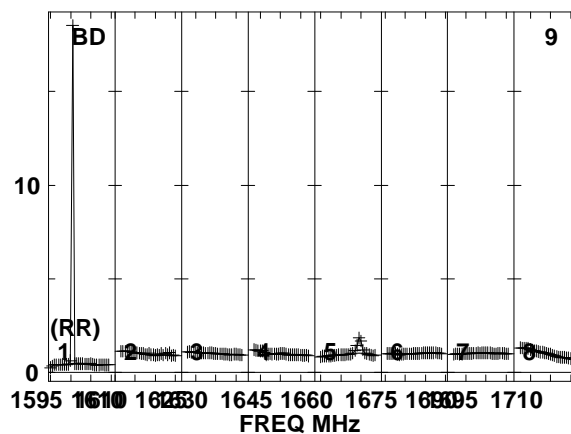
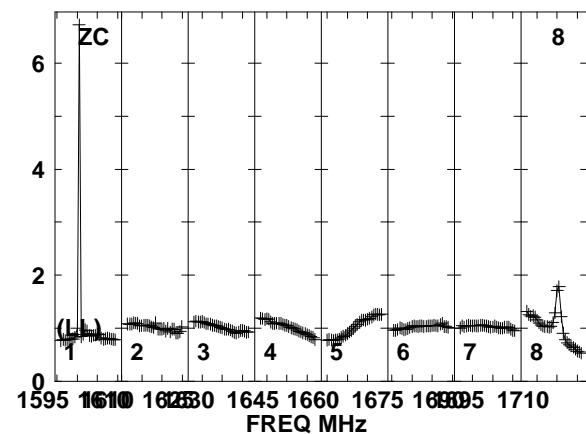
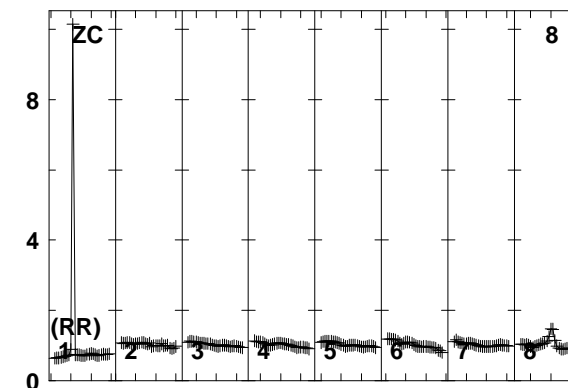
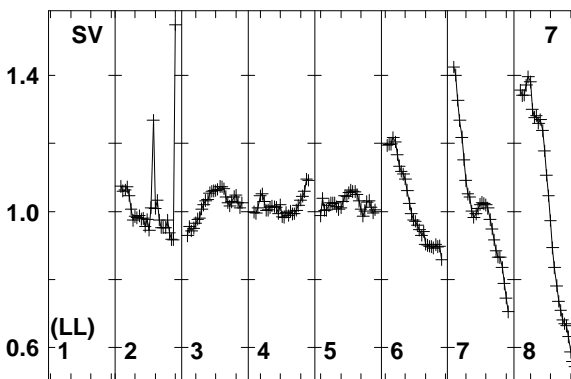
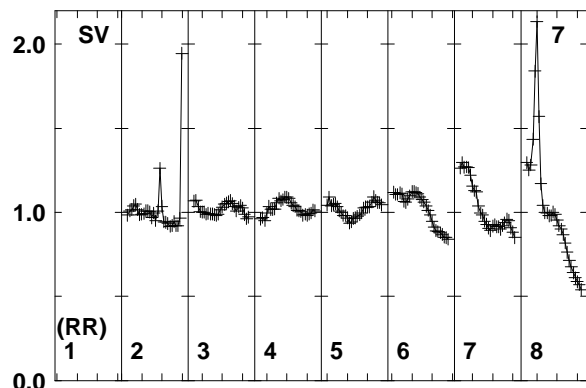
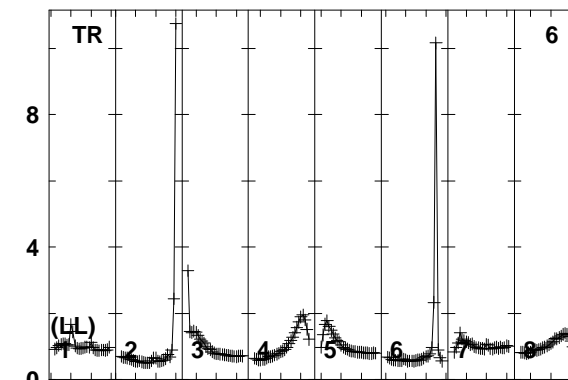
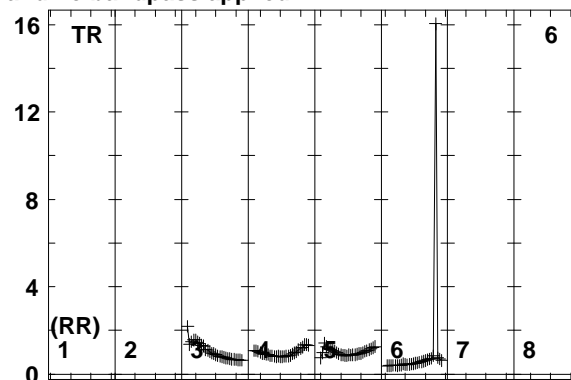
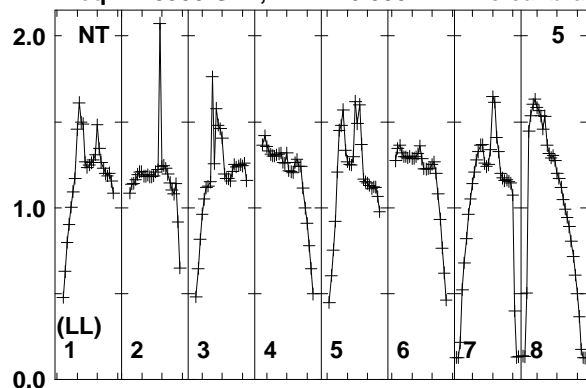

Lower frame: Real Jy
Total-power spectrum Antenna: NT (05)
Timerange: 00/04:37:51 to 00/04:41:49

Plot file version 94 created 11-AUG-2014 17:05:32

J2032+4127 EM110 2.UVDATA.1

Freq = 1.5950 GHz, Bw = 16.000 MH No calibration applied and no bandpass applied

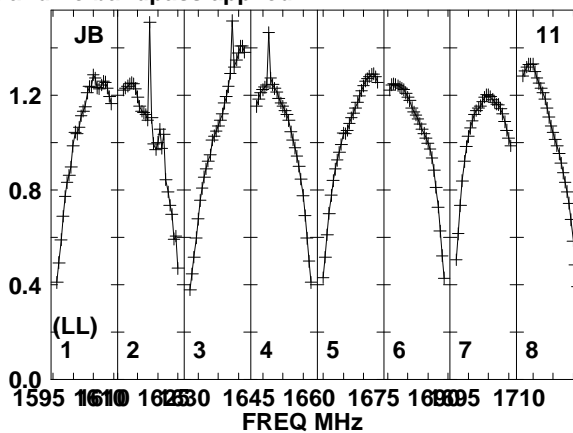
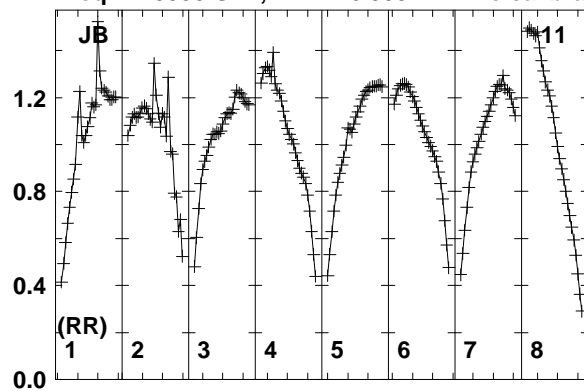

Lower frame: Real Jy
Total-power spectrum Antenna: JB (11)
Timerange: 00/04:37:51 to 00/04:41:49

Plot file version 95 created 11-AUG-2014 17:05:32

J2015+3710 EM110 2.UVDATA.1

Freq = 1.5950 GHz, Bw = 16.000 MH No calibration applied and no bandpass applied

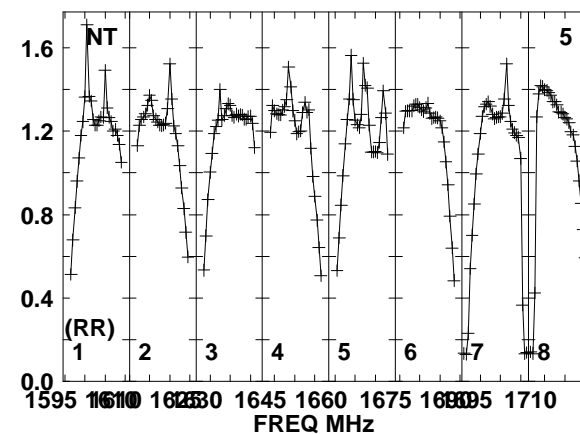
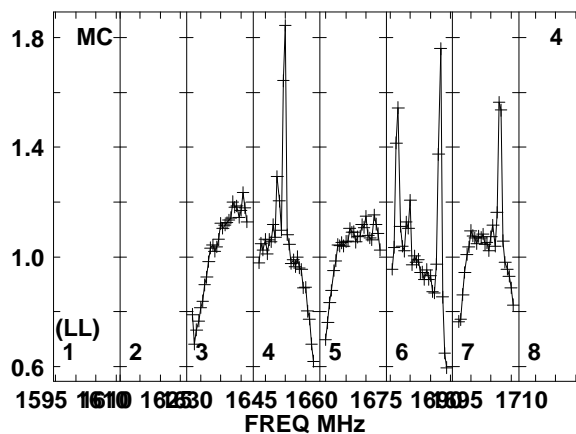
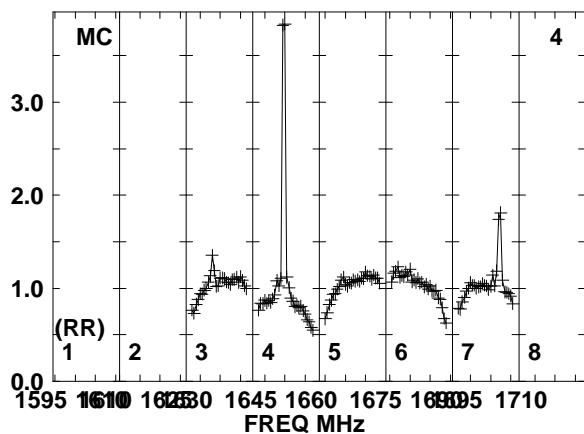
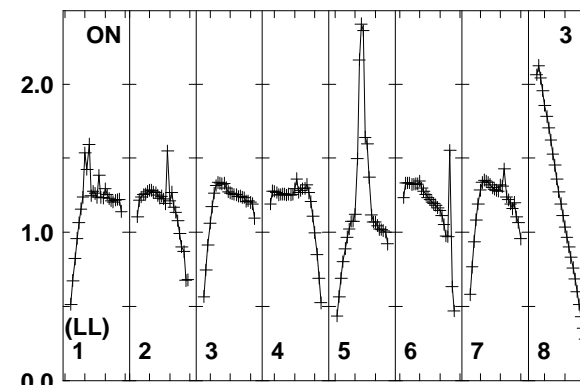
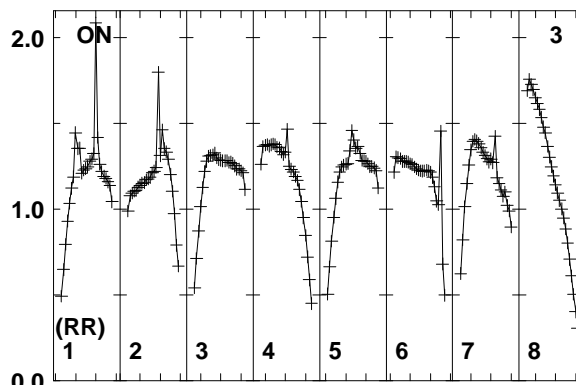
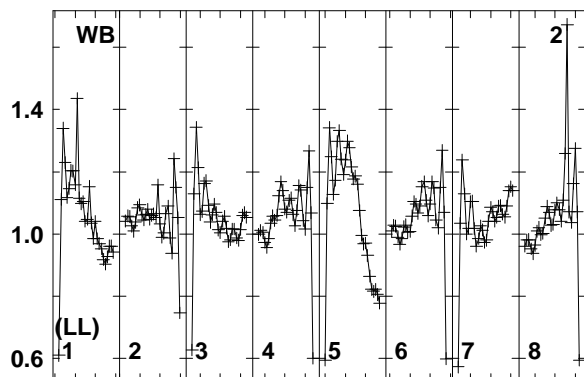
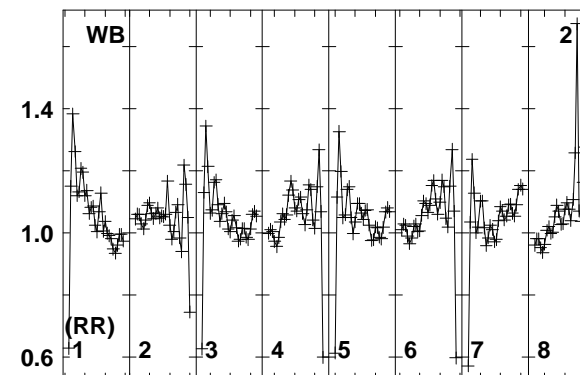
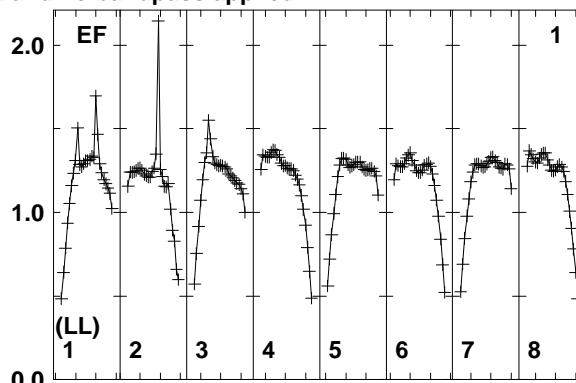
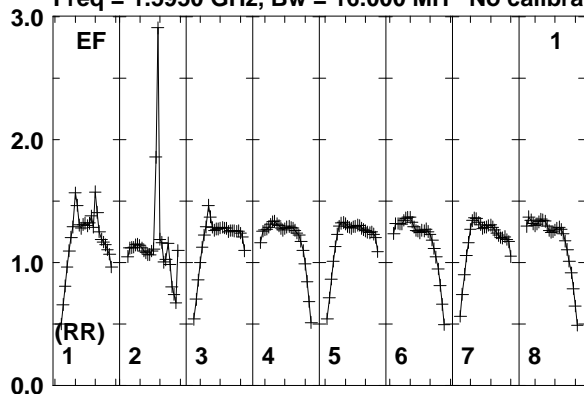

Lower frame: Real Jy
Total-power spectrum Antenna: EF (01)
Timerange: 00/04:42:51 to 00/04:44:49

Plot file version 96 created 11-AUG-2014 17:05:32

J2015+3710 EM110 2.UVDATA.1

Freq = 1.5950 GHz, Bw = 16.000 MH No calibration applied and no bandpass applied

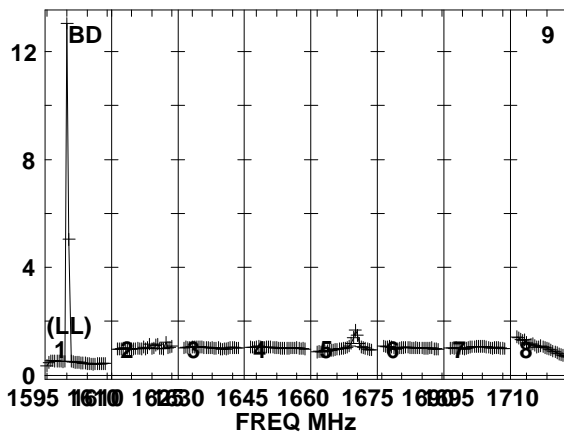
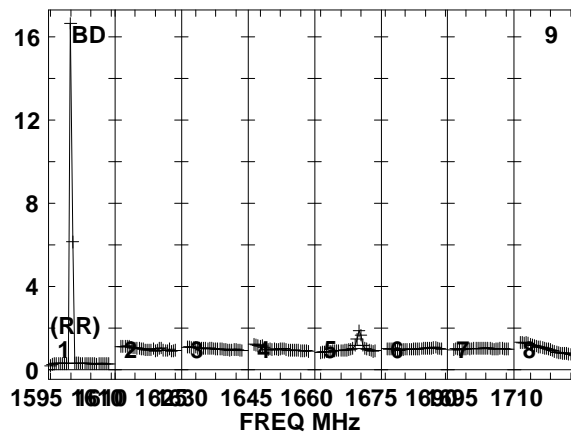
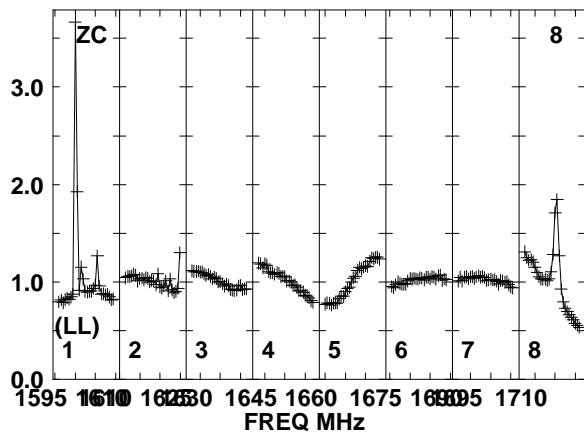
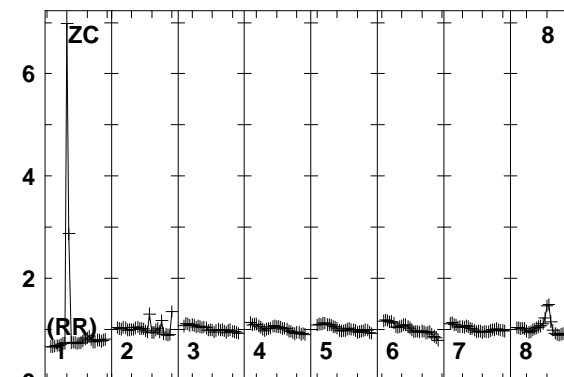
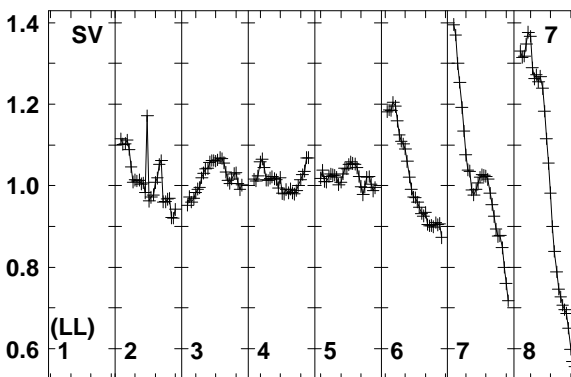
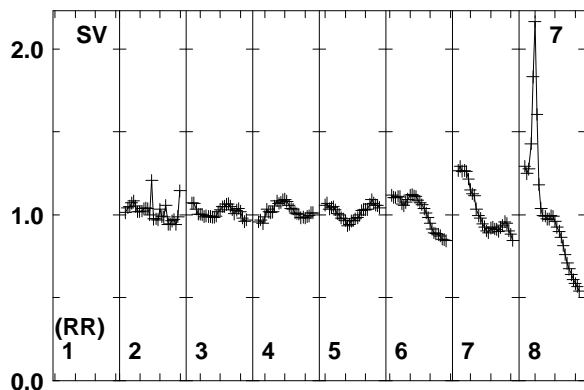
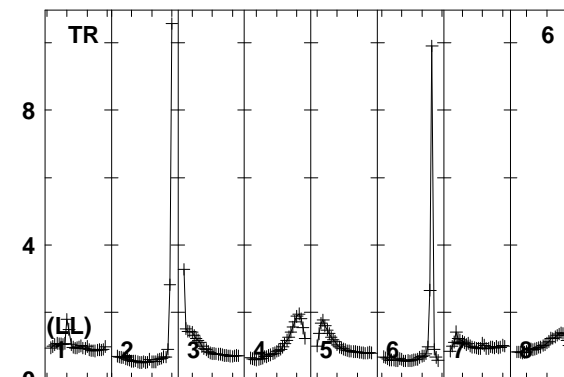
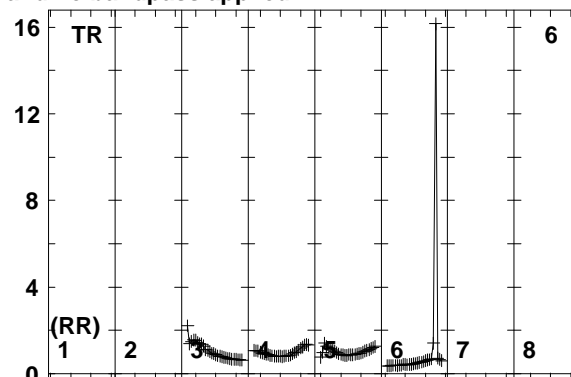
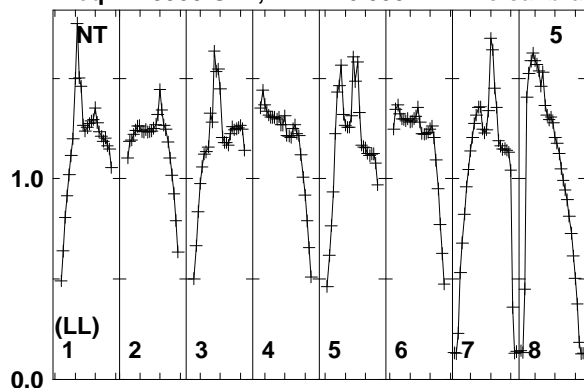

Lower frame: Real Jy
Total-power spectrum Antenna: NT (05)
Timerange: 00/04:42:51 to 00/04:44:49

Plot file version 97 created 11-AUG-2014 17:05:32

J2015+3710 EM110 2.UVDATA.1

Freq = 1.5950 GHz, Bw = 16.000 MH No calibration applied and no bandpass applied

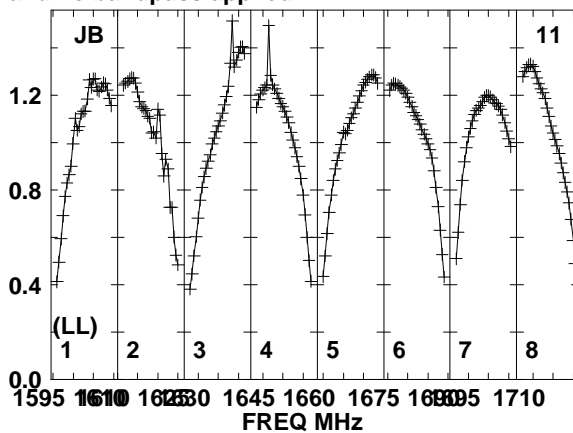
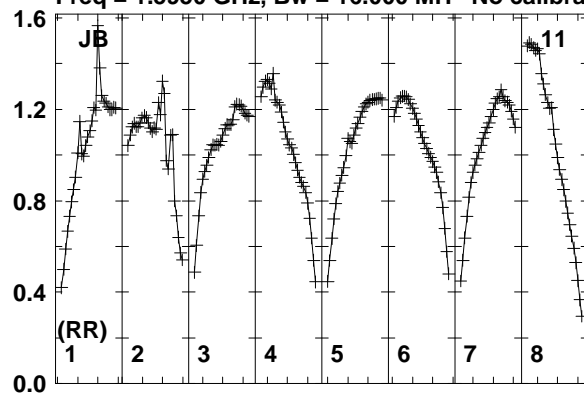

Lower frame: Real Jy
Total-power spectrum Antenna: JB (11)
Timerange: 00/04:42:51 to 00/04:44:49

Plot file version 98 created 11-AUG-2014 17:05:32

J2032+4127 EM110 2.UVDATA.1

Freq = 1.5950 GHz, Bw = 16.000 MH No calibration applied and no bandpass applied

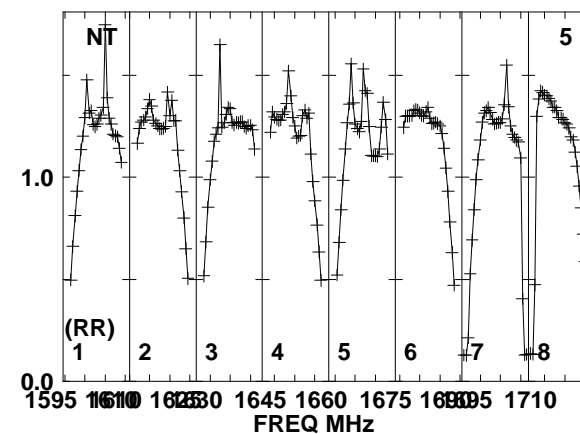
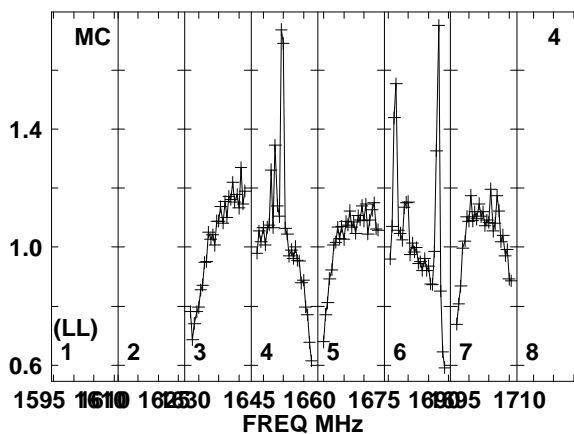
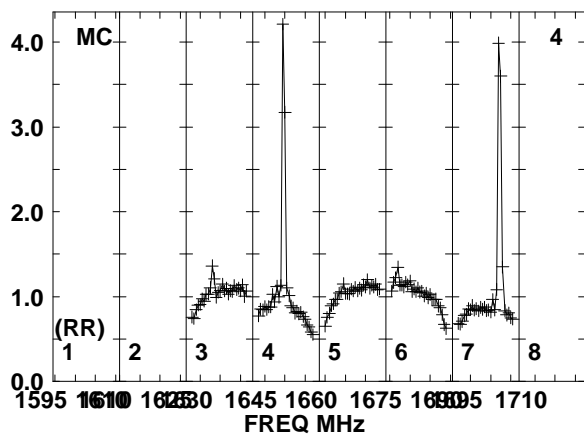
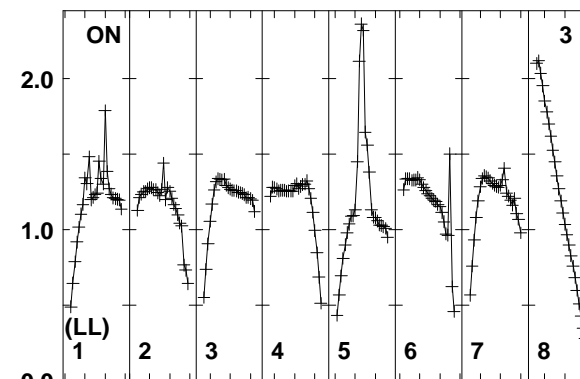
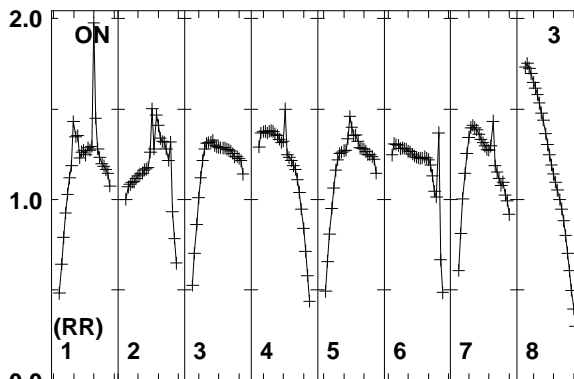
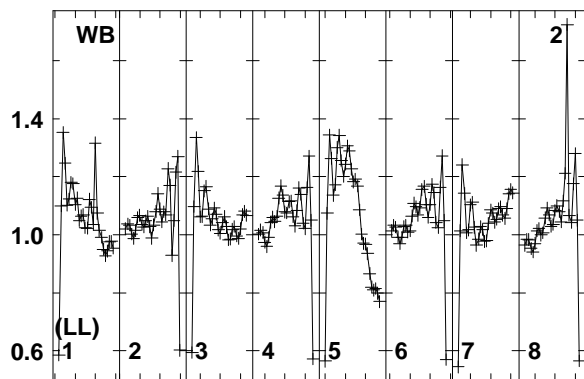
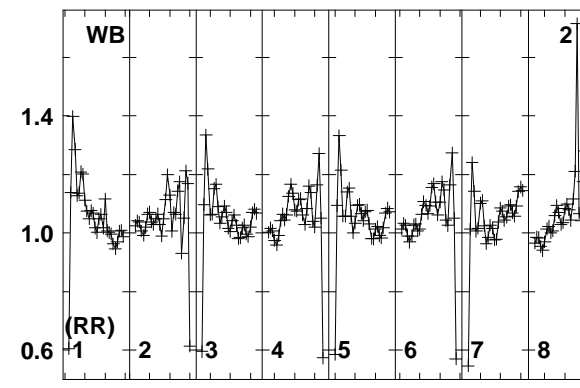
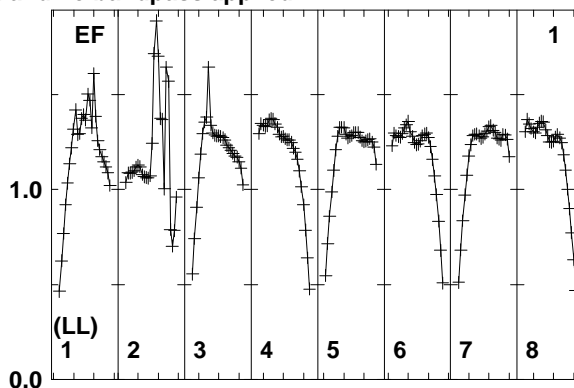
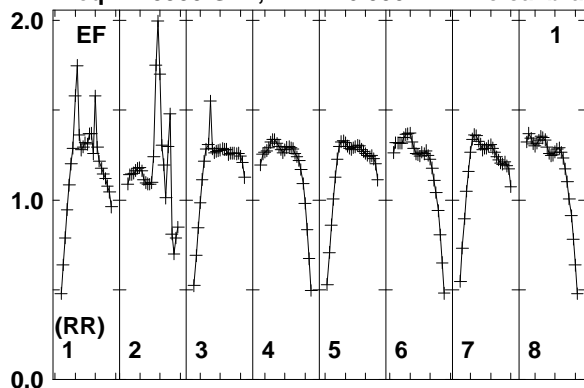

Lower frame: Real Jy
Total-power spectrum Antenna: EF (01)
Timerange: 00/04:45:02 to 00/04:48:48

Plot file version 99 created 11-AUG-2014 17:05:32

J2032+4127 EM110 2.UVDATA.1

Freq = 1.5950 GHz, Bw = 16.000 MH No calibration applied and no bandpass applied

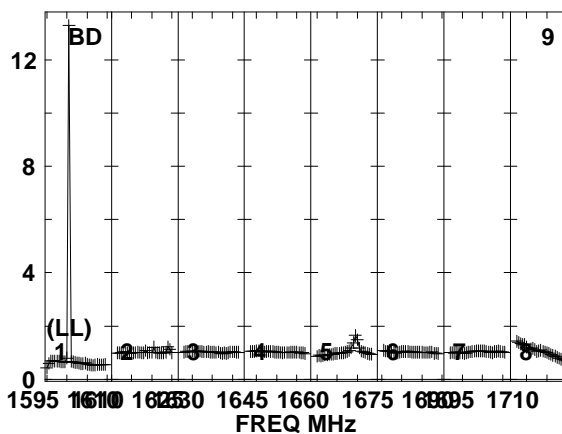
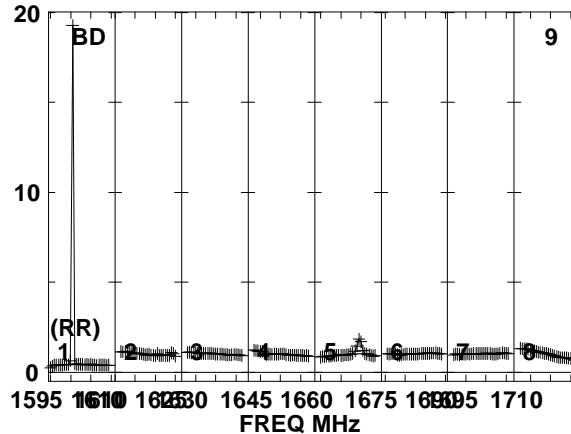
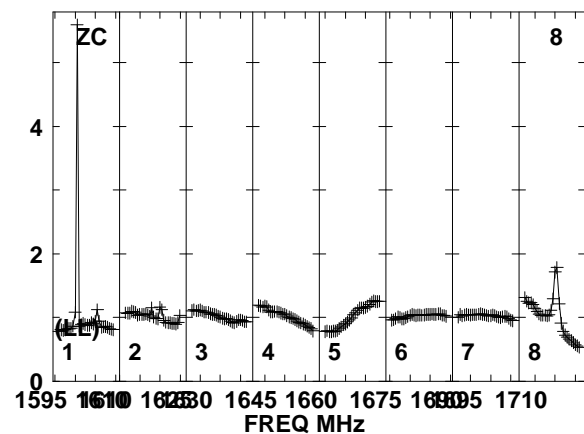
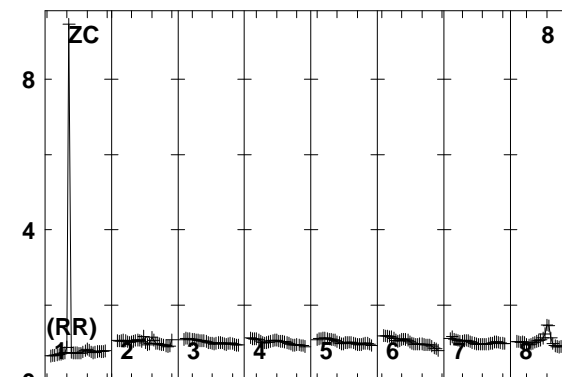
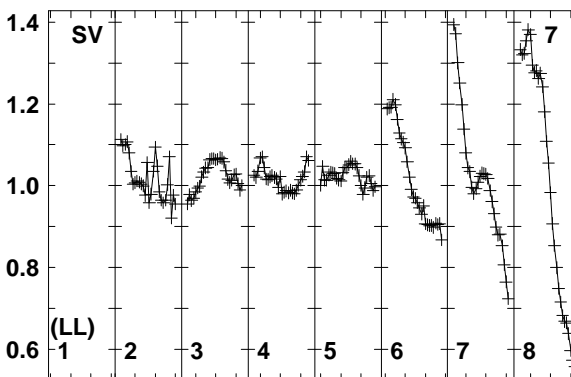
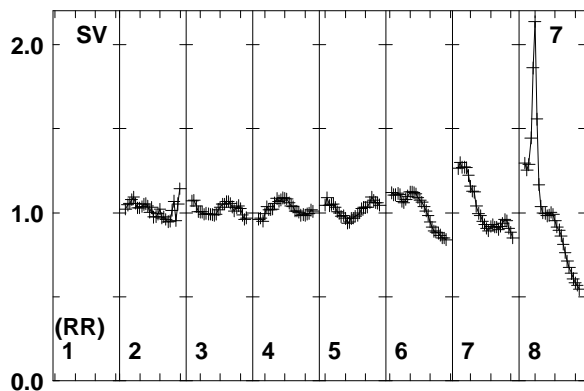
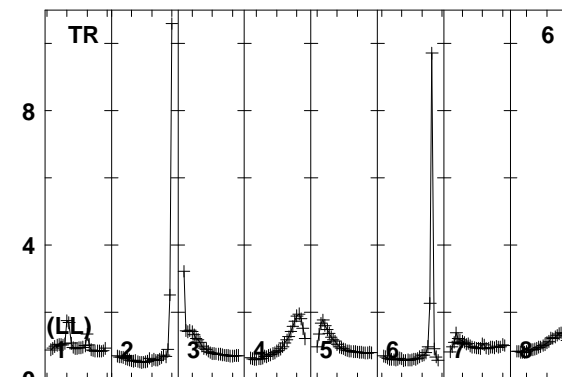
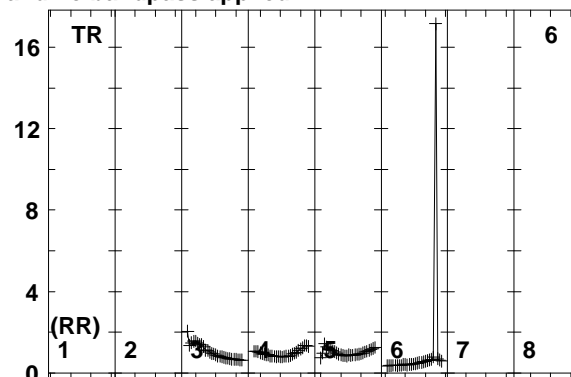
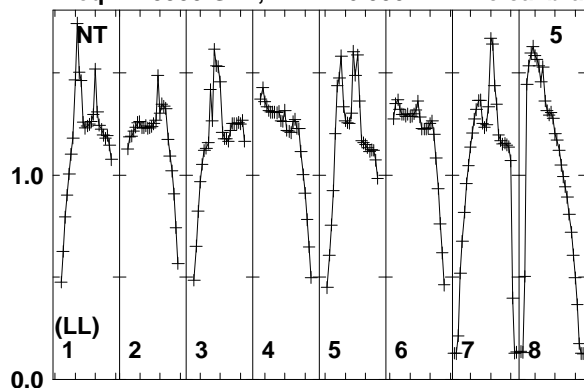

Lower frame: Real Jy
Total-power spectrum Antenna: NT (05)
Timerange: 00/04:45:02 to 00/04:48:48

Plot file version 100 created 11-AUG-2014 17:05:33

J2032+4127 EM110 2.UVDATA.1

Freq = 1.5950 GHz, Bw = 16.000 MH No calibration applied and no bandpass applied

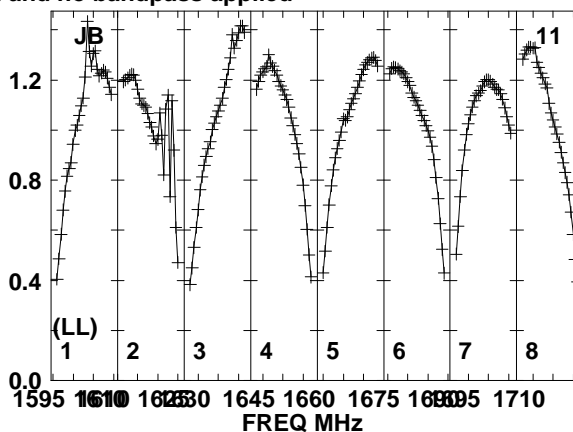
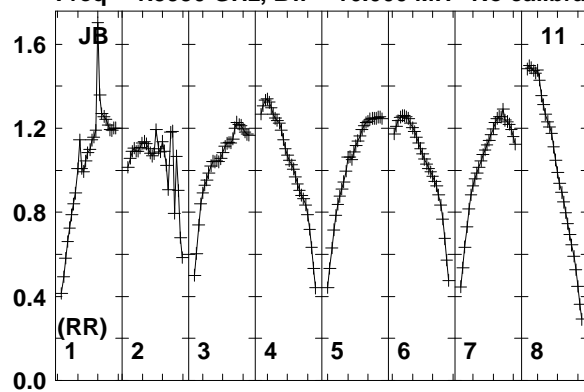

Lower frame: Real Jy
Total-power spectrum Antenna: JB (11)
Timerange: 00/04:45:02 to 00/04:48:48

Plot file version 101 created 11-AUG-2014 17:05:33

J2015+3710 EM110 2.UVDATA.1

Freq = 1.5950 GHz, Bw = 16.000 MH No calibration applied and no bandpass applied

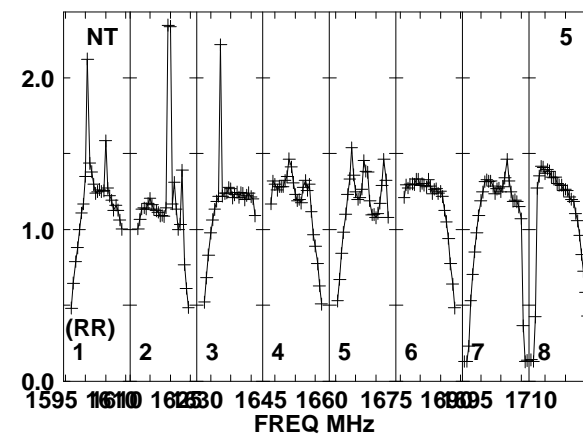
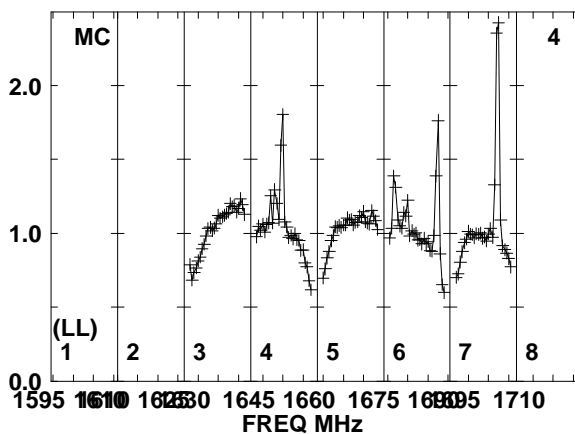
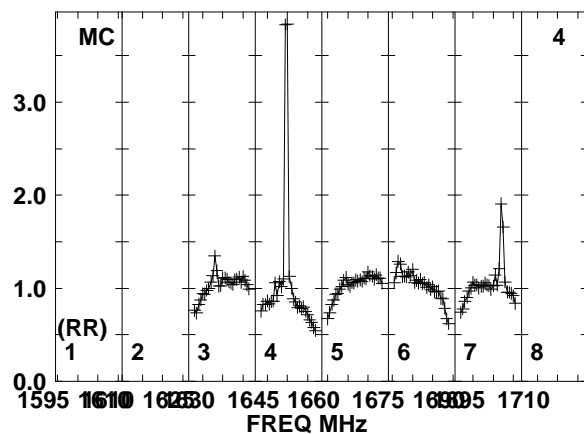
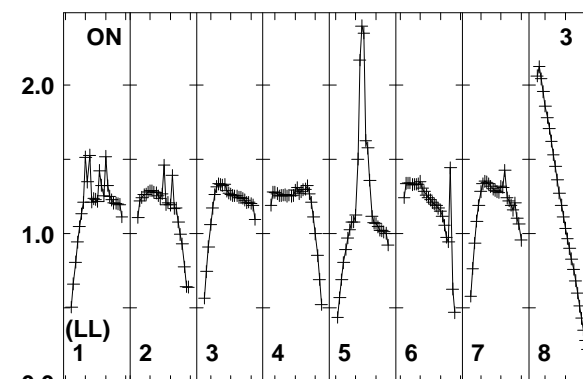
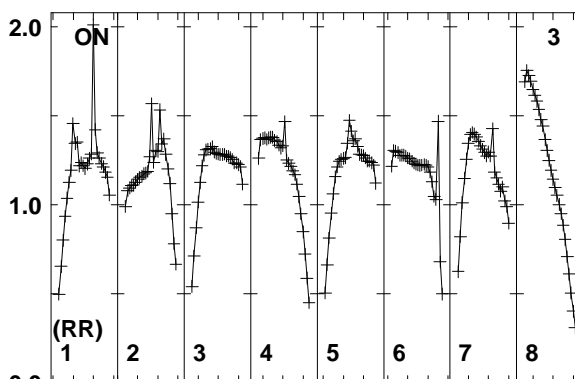
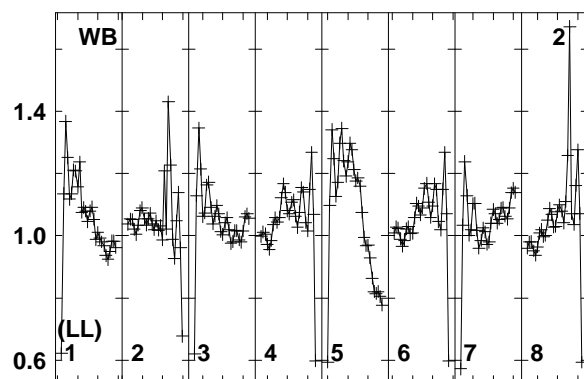
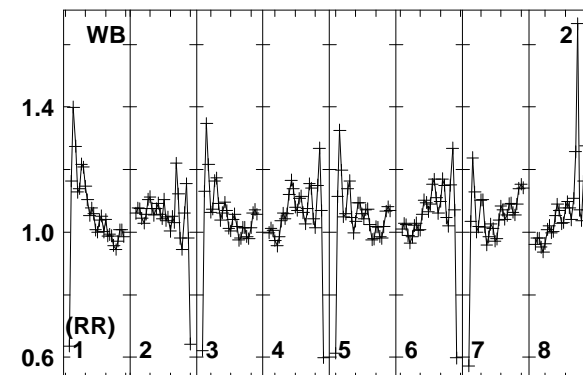
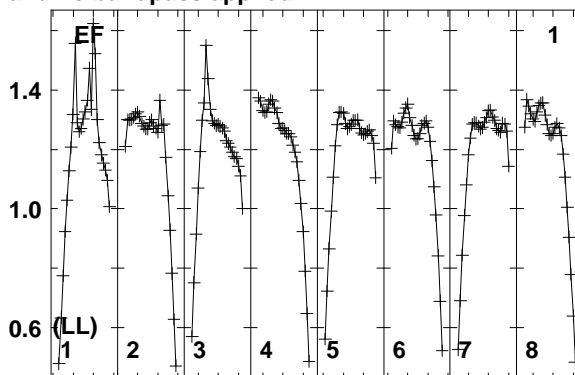
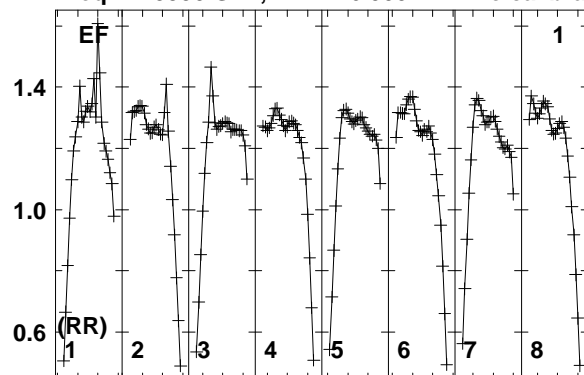

Lower frame: Real Jy
Total-power spectrum Antenna: EF (01)
Timerange: 00/04:49:02 to 00/04:50:48

Plot file version 102 created 11-AUG-2014 17:05:33

J2015+3710 EM110 2.UVDATA.1

Freq = 1.5950 GHz, Bw = 16.000 MH No calibration applied and no bandpass applied

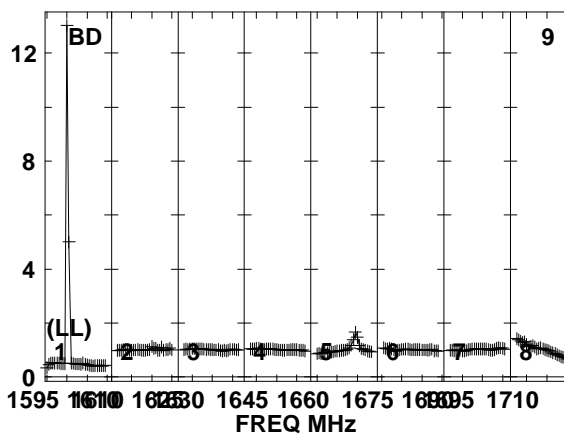
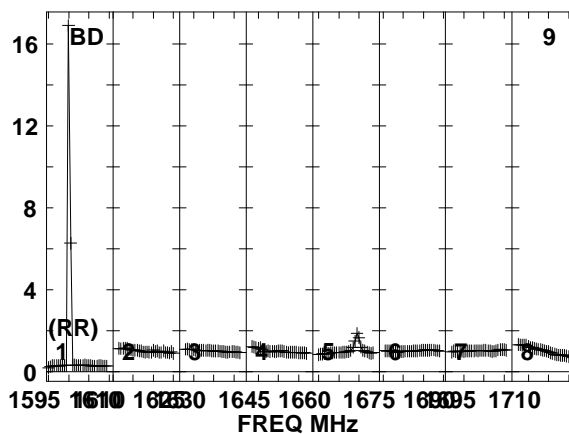
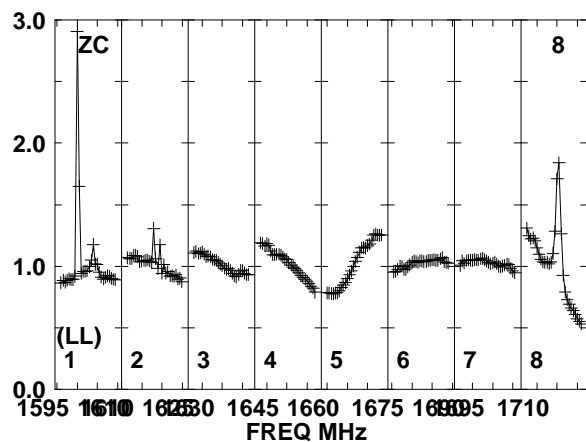
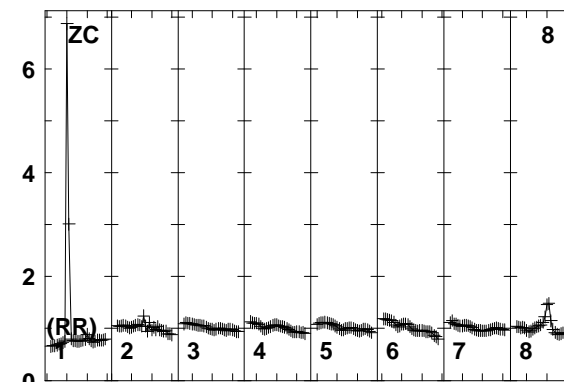
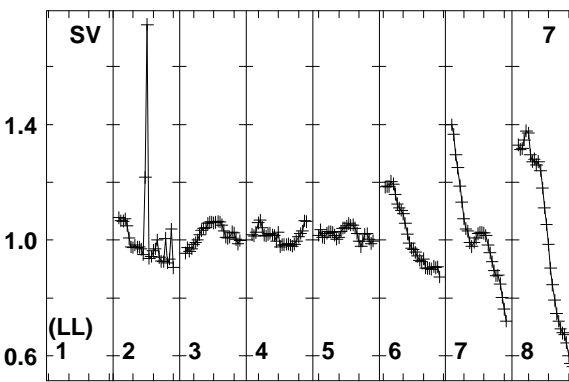
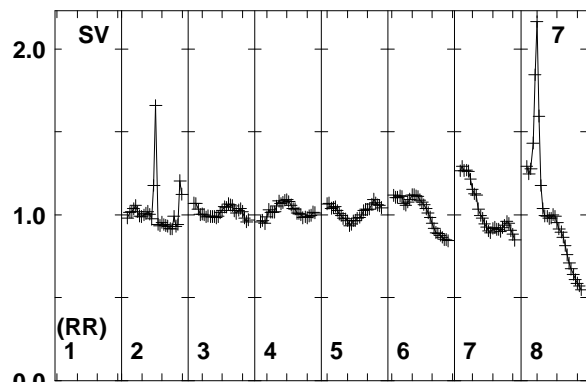
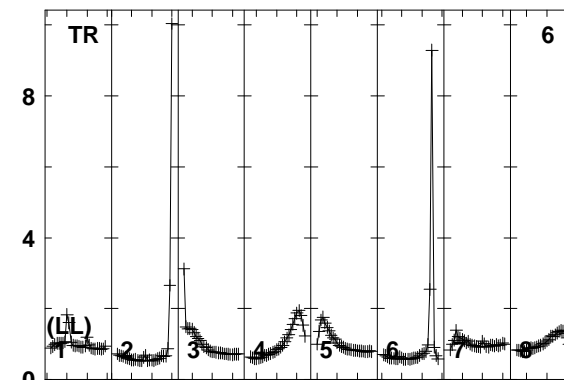
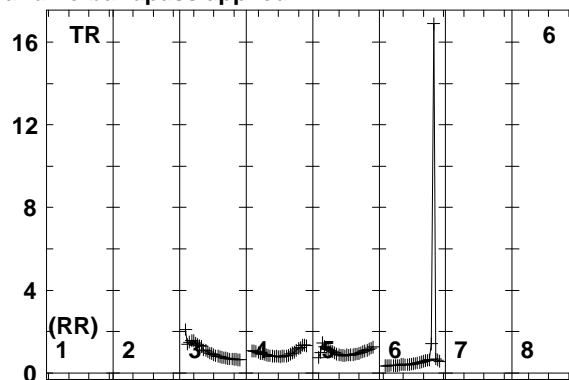
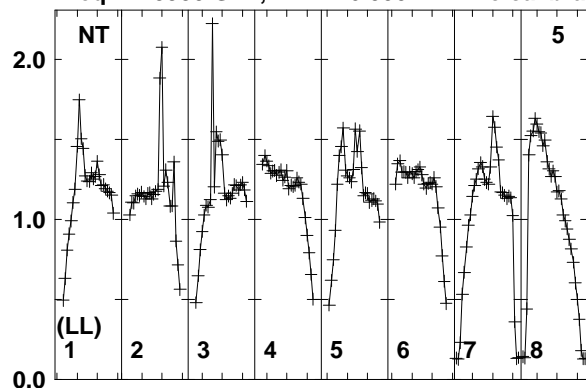

Lower frame: Real Jy
Total-power spectrum Antenna: NT (05)
Timerange: 00/04:49:02 to 00/04:50:48

Plot file version 103 created 11-AUG-2014 17:05:33

J2032+4127 EM110 2.UVDATA.1

Freq = 1.5950 GHz, Bw = 16.000 MH No calibration applied and no bandpass applied

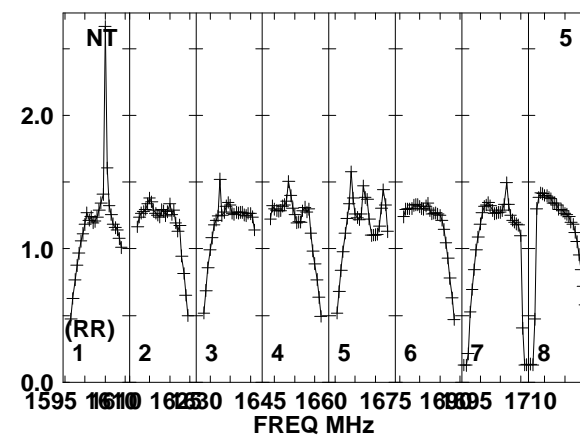
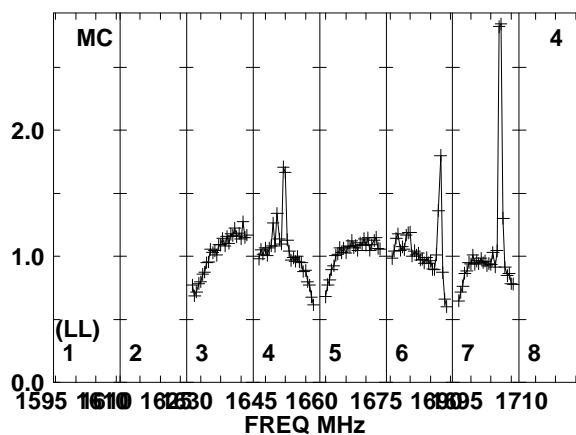
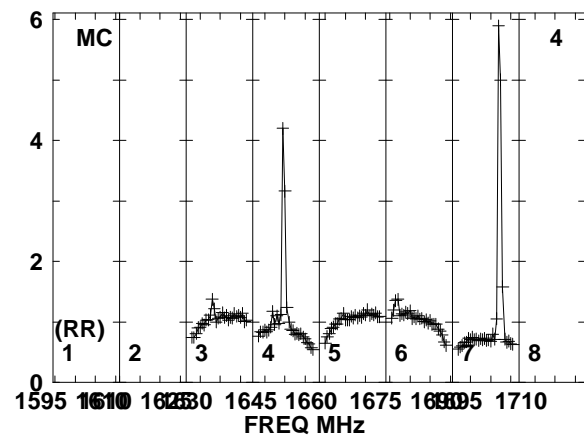
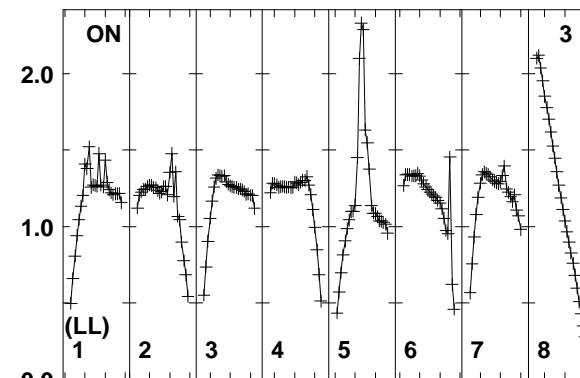
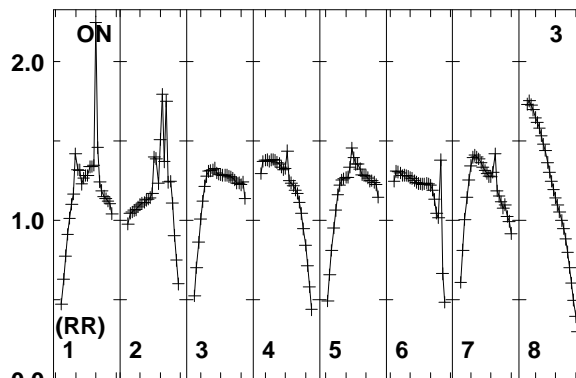
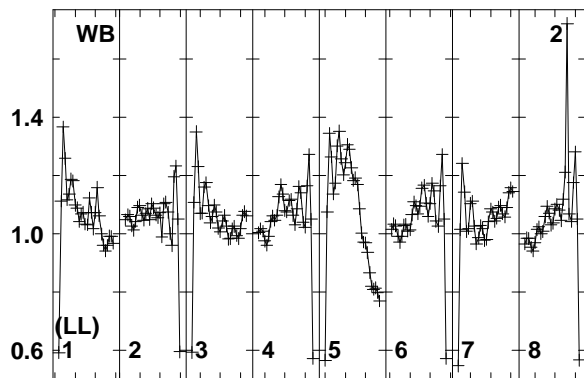
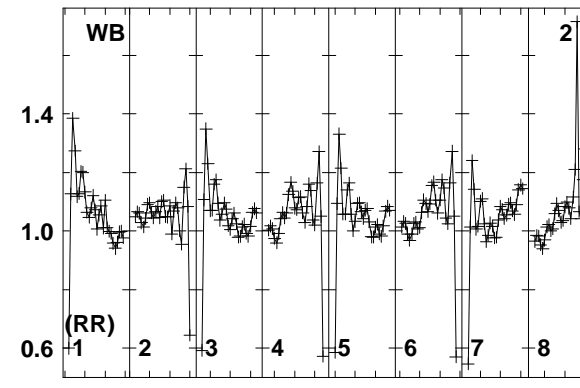
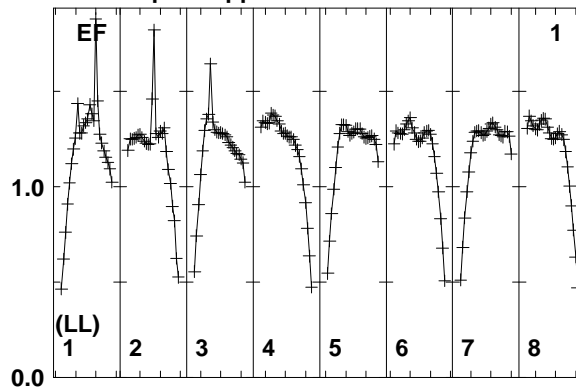
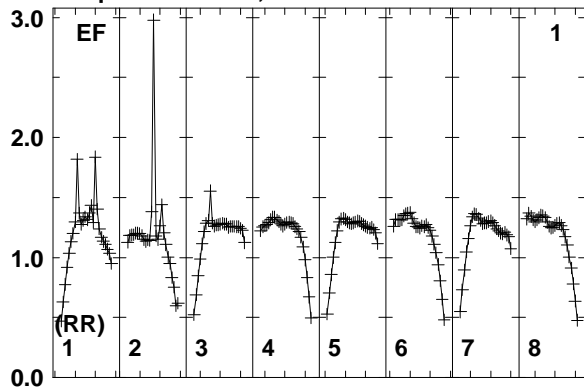

Lower frame: Real Jy
Total-power spectrum Antenna: EF (01)
Timerange: 00/04:50:51 to 00/04:54:49

Plot file version 104 created 11-AUG-2014 17:05:33

J2032+4127 EM110 2.UVDATA.1

Freq = 1.5950 GHz, Bw = 16.000 MH No calibration applied and no bandpass applied

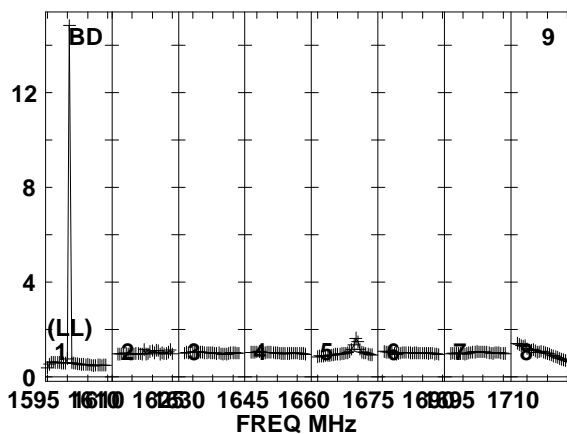
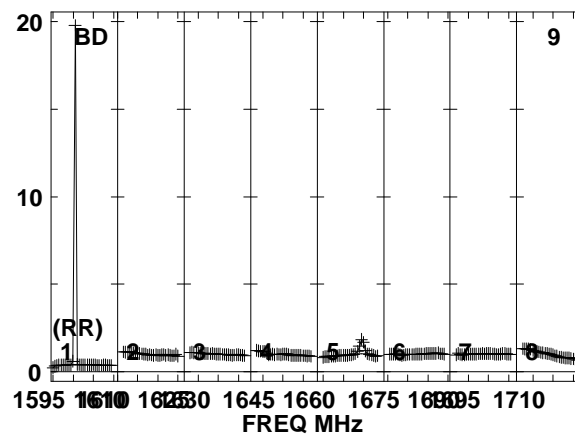
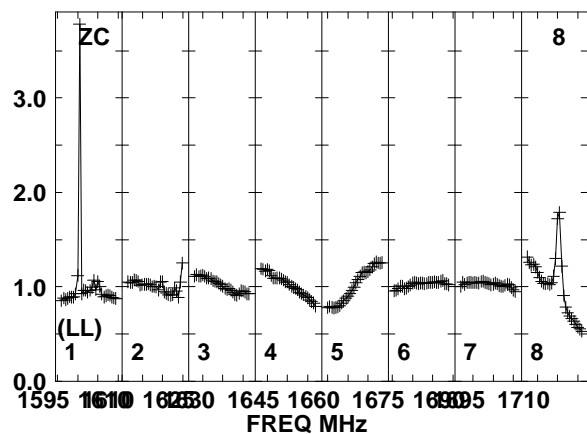
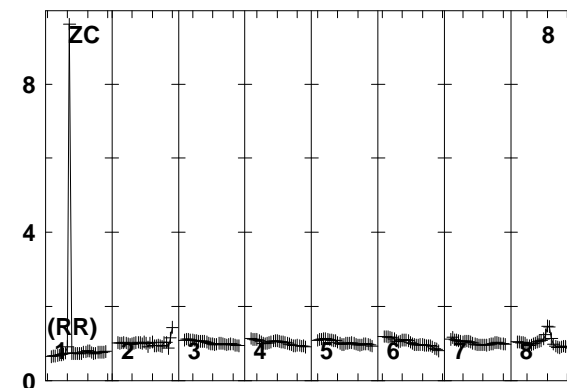
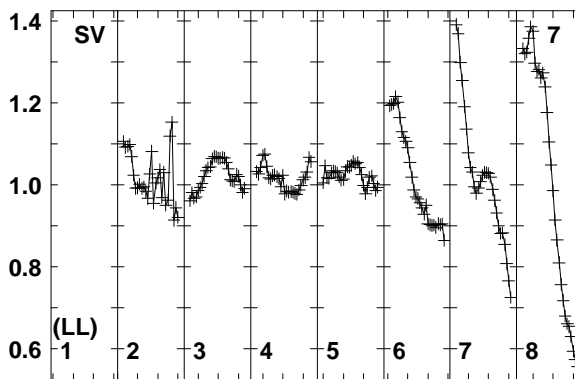
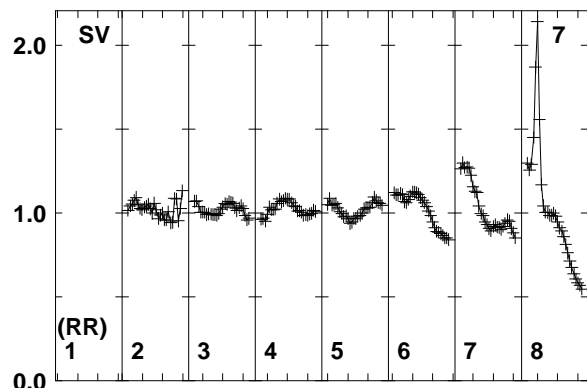
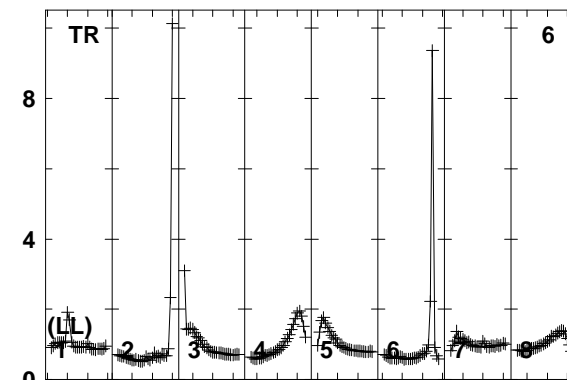
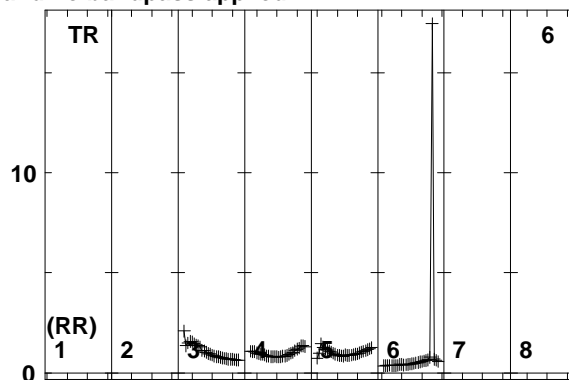
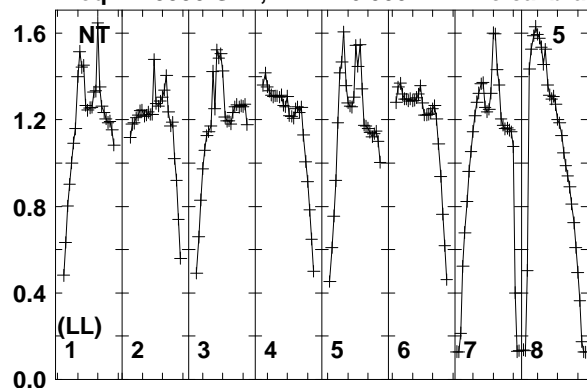

Lower frame: Real Jy
Total-power spectrum Antenna: NT (05)
Timerange: 00/04:50:51 to 00/04:54:49

Plot file version 105 created 11-AUG-2014 17:05:33

J2032+4127 EM110 2.UVDATA.1

Freq = 1.5950 GHz, Bw = 16.000 MH No calibration applied and no bandpass applied

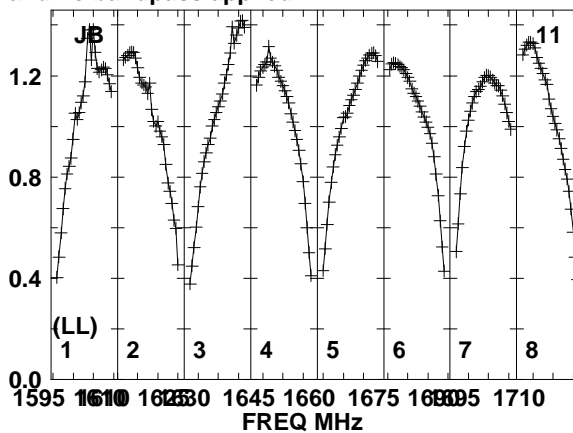
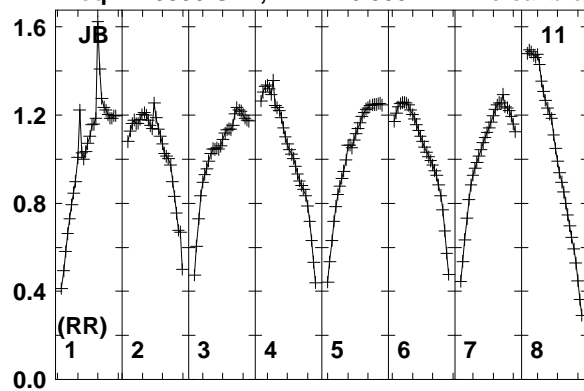

Lower frame: Real Jy
Total-power spectrum Antenna: JB (11)
Timerange: 00/04:50:51 to 00/04:54:49

Plot file version 106 created 11-AUG-2014 17:05:33

J2015+3710 EM110 2.UVDATA.1

Freq = 1.5950 GHz, Bw = 16.000 MH No calibration applied and no bandpass applied

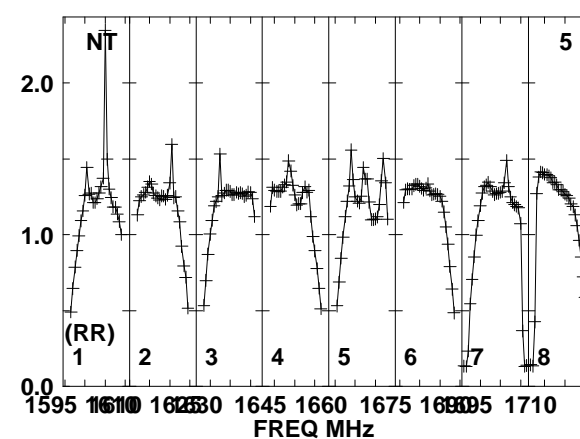
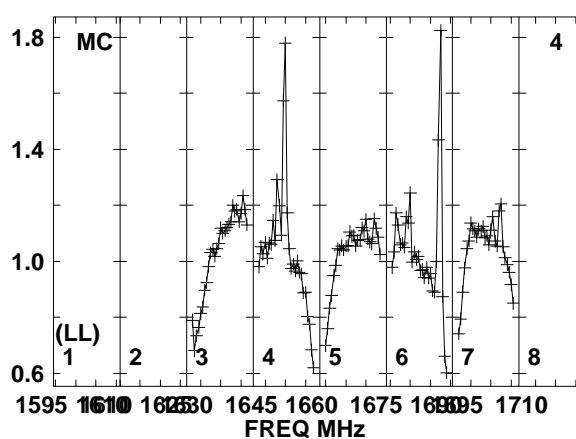
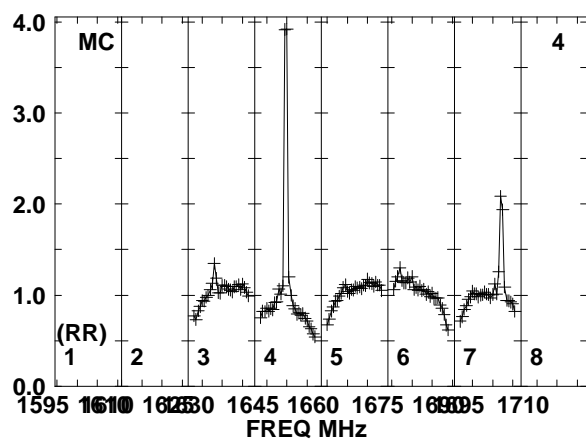
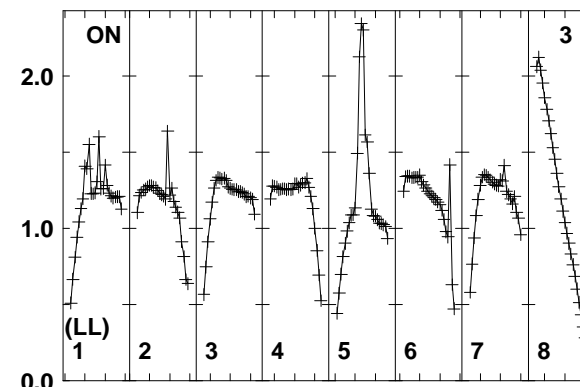
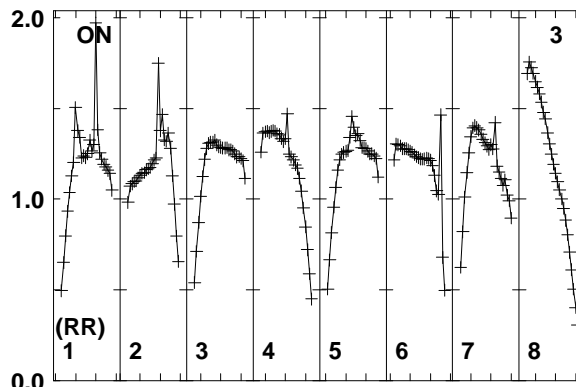
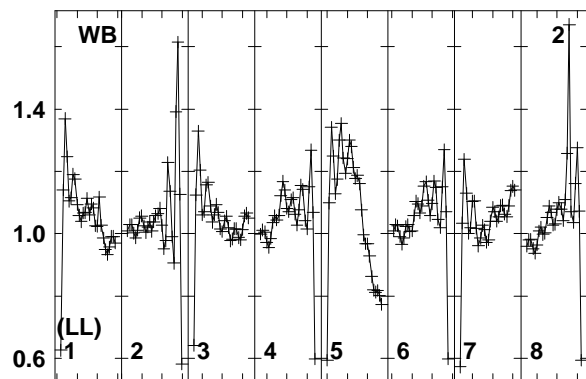
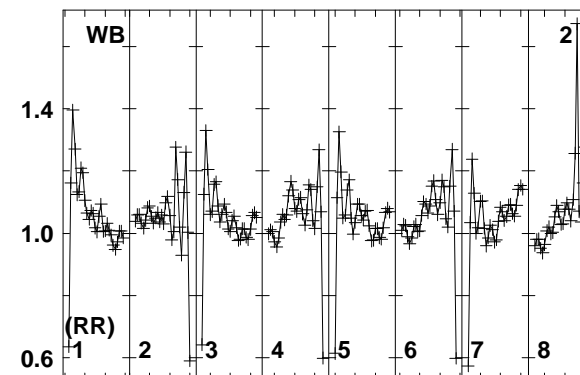
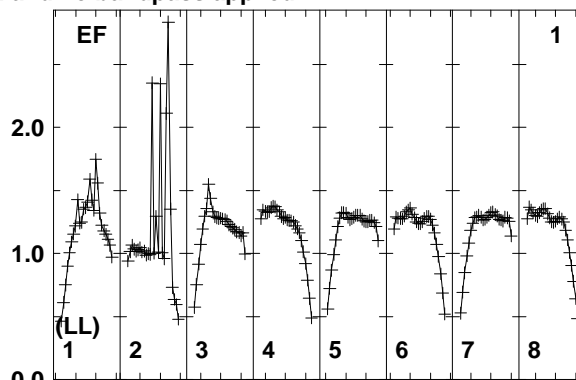
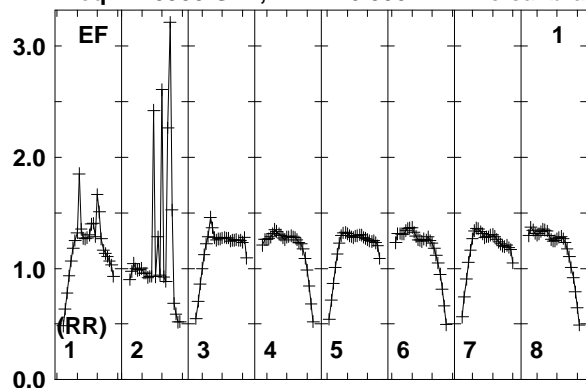

Lower frame: Real Jy
Total-power spectrum Antenna: EF (01)
Timerange: 00/04:55:51 to 00/04:57:49

Plot file version 107 created 11-AUG-2014 17:05:33

J2015+3710 EM110 2.UVDATA.1

Freq = 1.5950 GHz, Bw = 16.000 MH No calibration applied and no bandpass applied

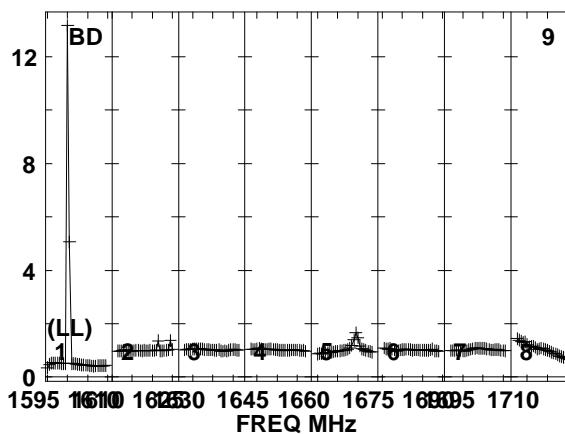
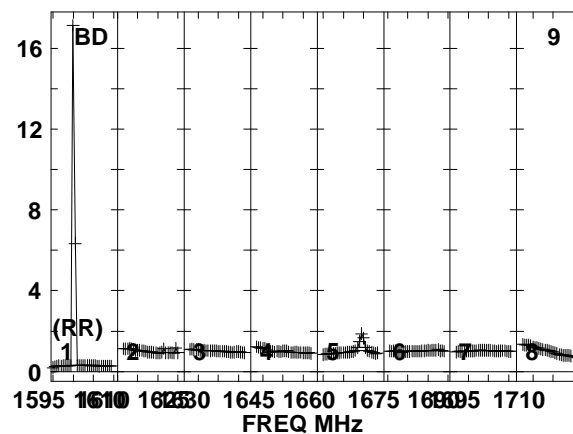
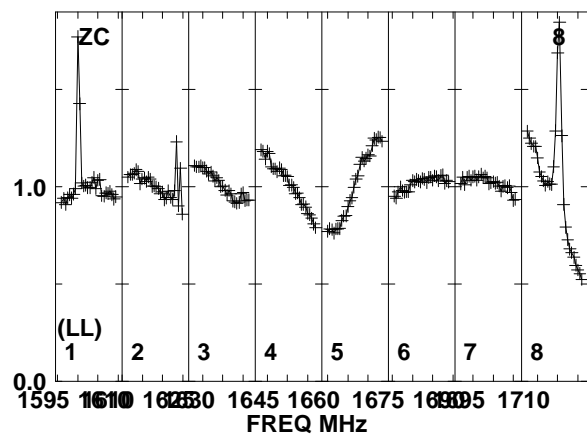
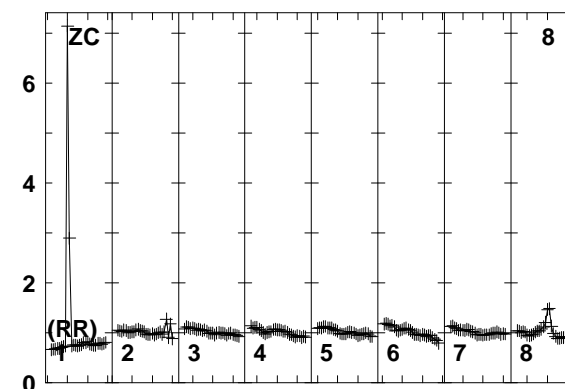
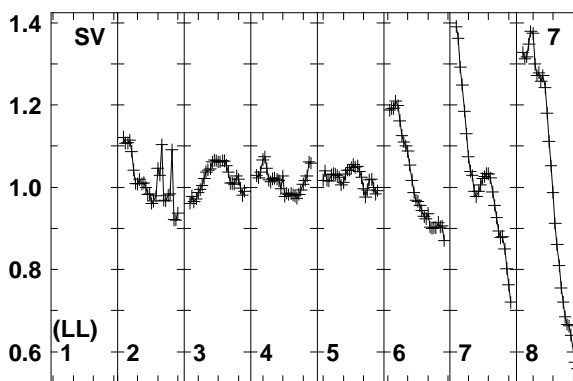
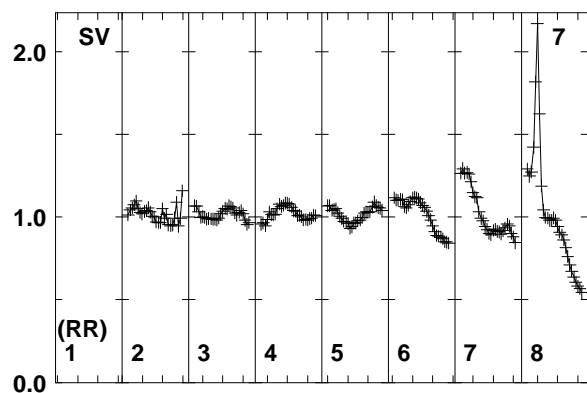
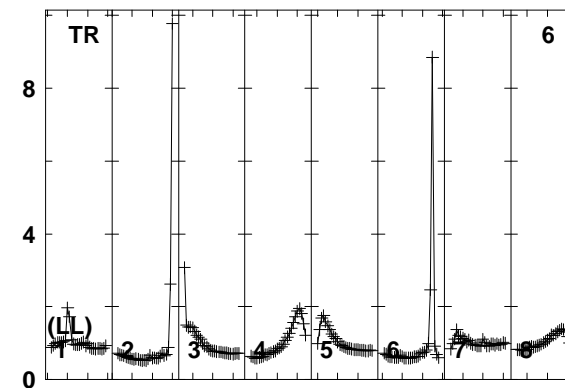
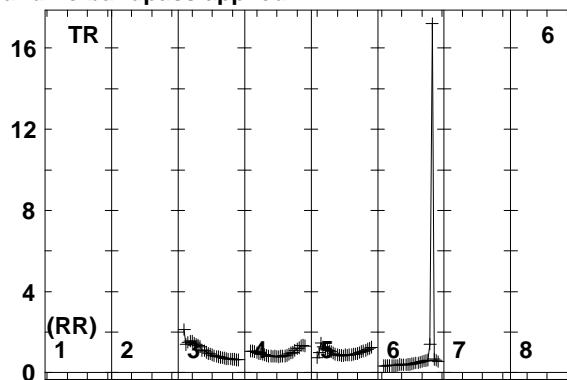
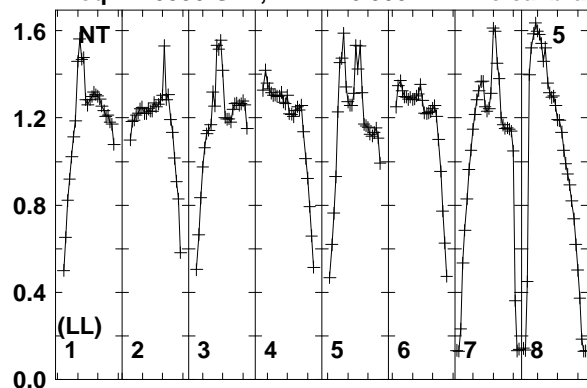

Lower frame: Real Jy
Total-power spectrum Antenna: NT (05)
Timerange: 00/04:55:51 to 00/04:57:49

Plot file version 108 created 11-AUG-2014 17:05:33

J2015+3710 EM110 2.UVDATA.1

Freq = 1.5950 GHz, Bw = 16.000 MH No calibration applied and no bandpass applied

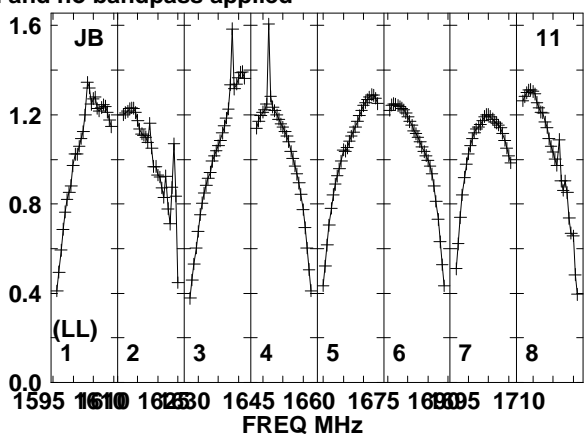
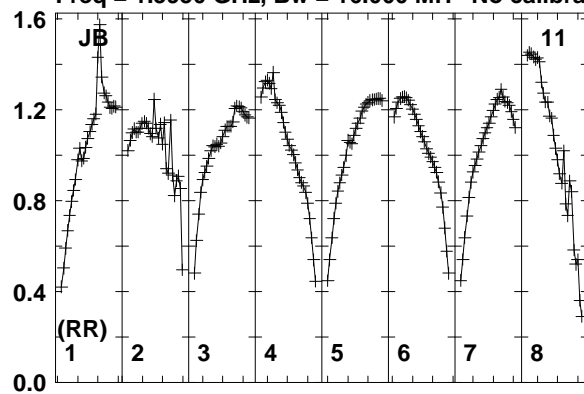

Lower frame: Real Jy
Total-power spectrum Antenna: JB (11)
Timerange: 00/04:55:51 to 00/04:57:49

Plot file version 109 created 11-AUG-2014 17:05:33

J2032+4127 EM110 2.UVDATA.1

Freq = 1.5950 GHz, Bw = 16.000 MH No calibration applied and no bandpass applied

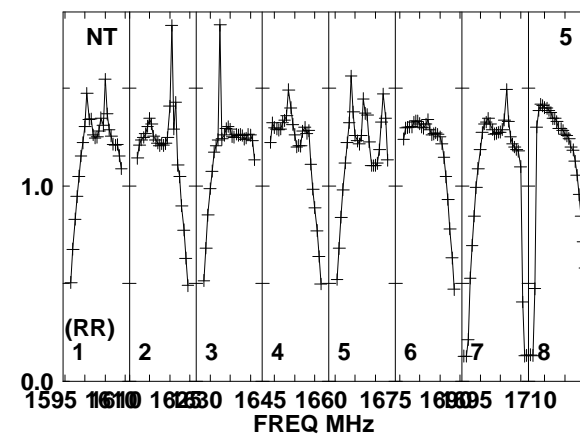
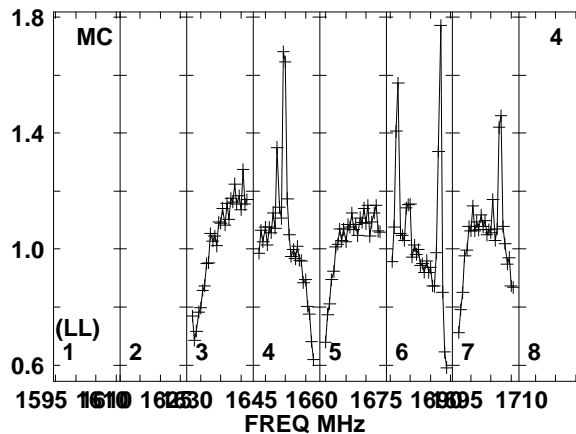
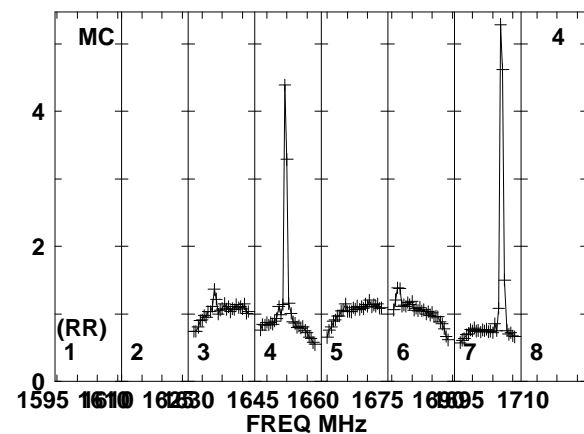
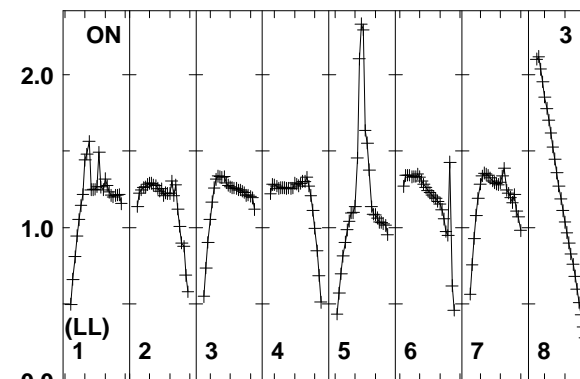
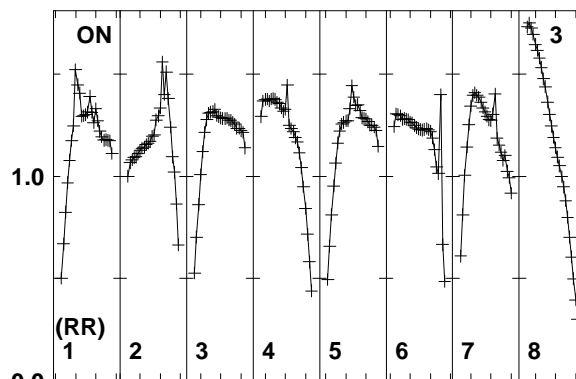
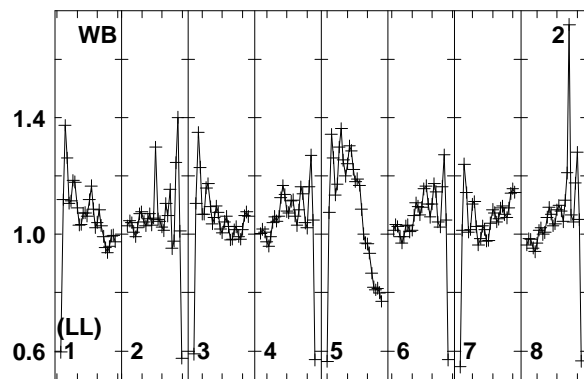
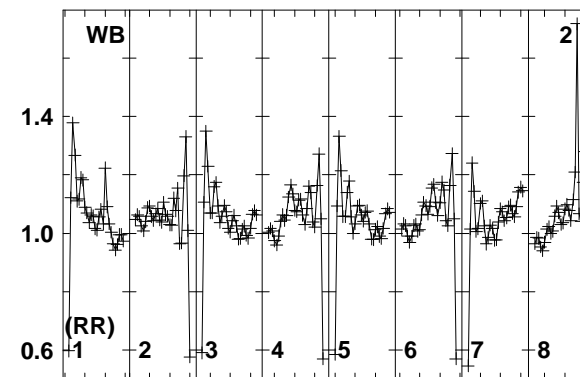
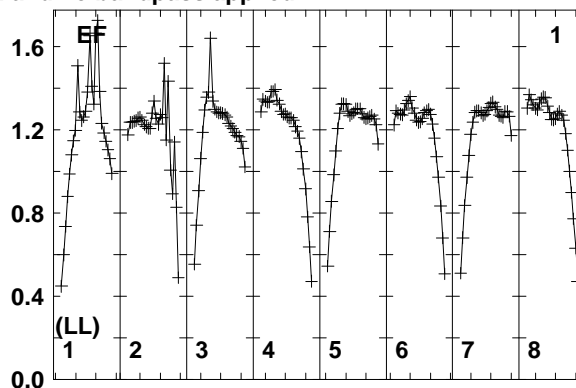
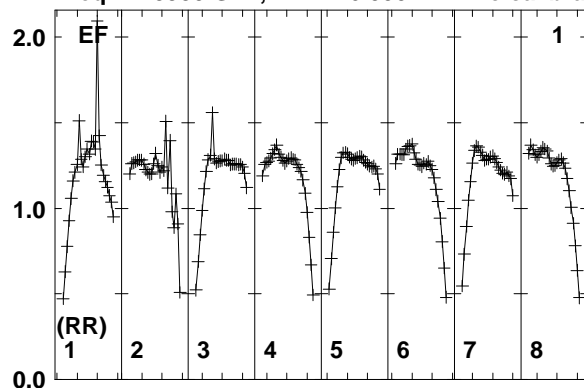

Lower frame: Real Jy
Total-power spectrum Antenna: EF (01)
Timerange: 00/04:58:03 to 00/05:01:49

Plot file version 110 created 11-AUG-2014 17:05:33

J2032+4127 EM110 2.UVDATA.1

Freq = 1.5950 GHz, Bw = 16.000 MH No calibration applied and no bandpass applied

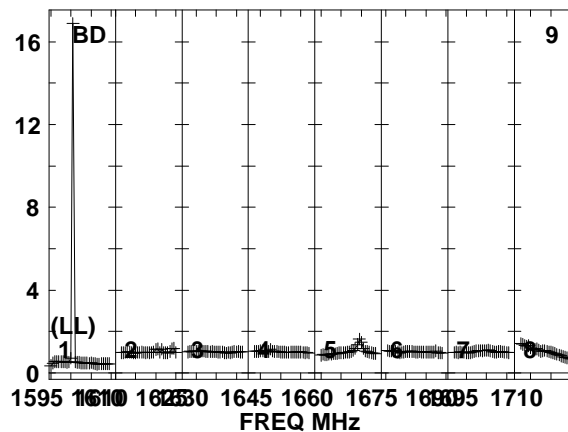
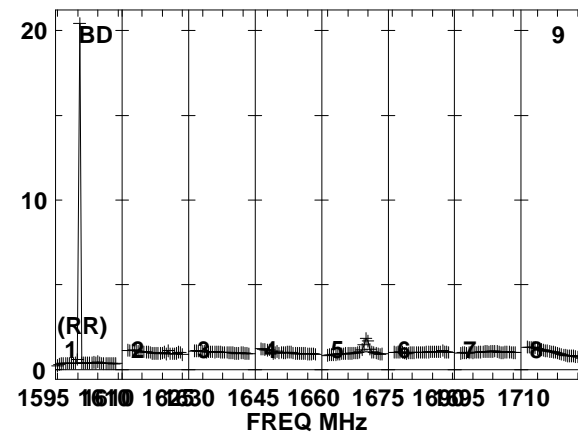
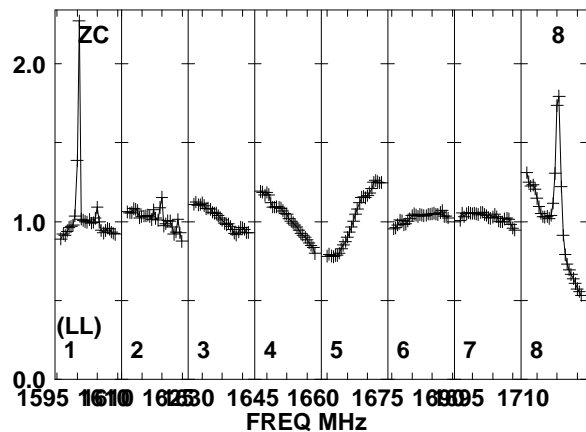
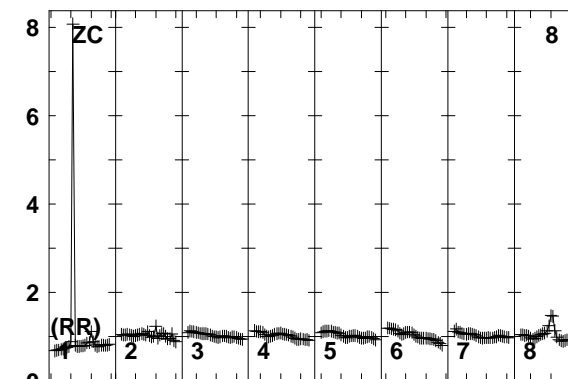
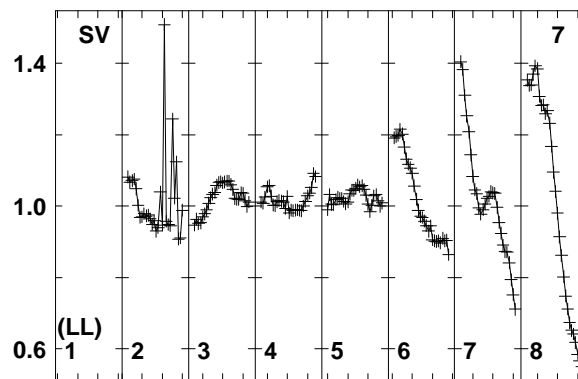
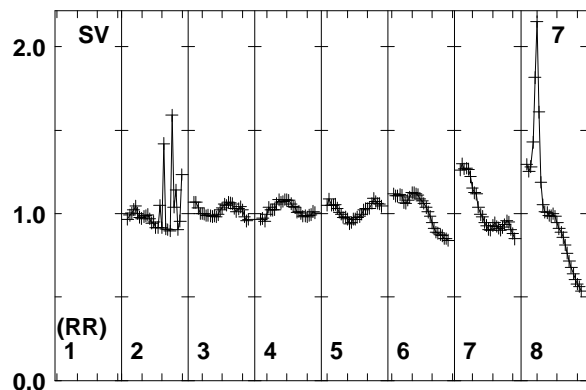
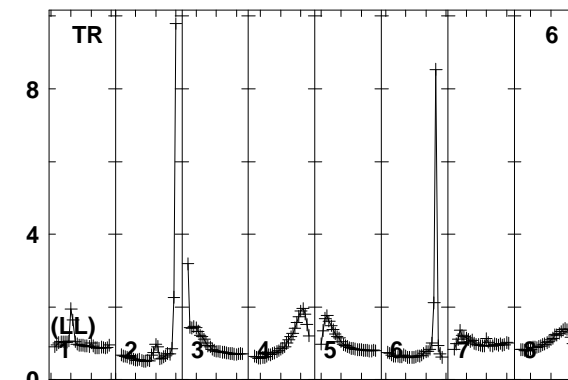
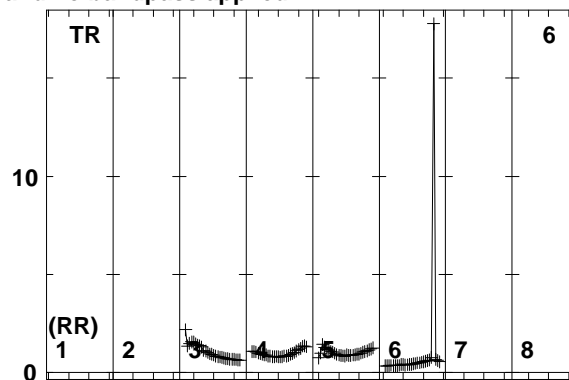
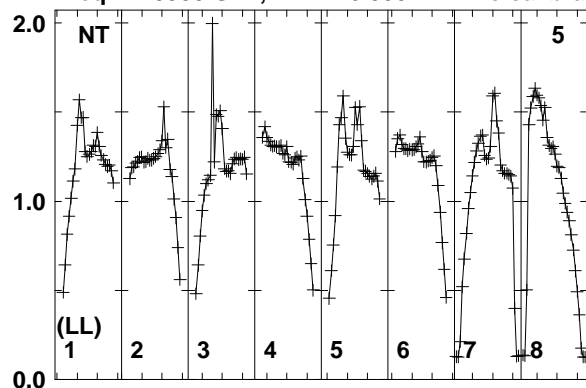

Lower frame: Real Jy
Total-power spectrum Antenna: NT (05)
Timerange: 00/04:58:03 to 00/05:01:49

Plot file version 111 created 11-AUG-2014 17:05:33

J2032+4127 EM110 2.UVDATA.1

Freq = 1.5950 GHz, Bw = 16.000 MH No calibration applied and no bandpass applied

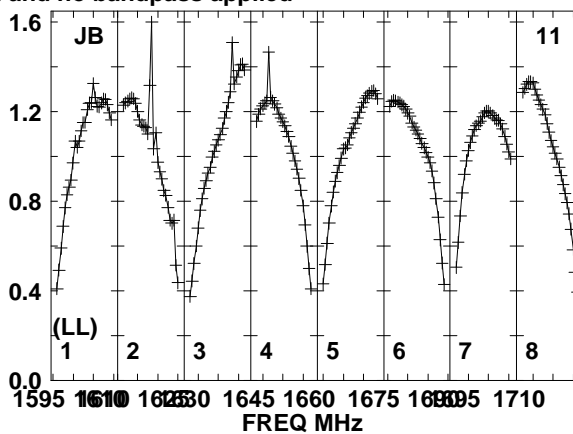
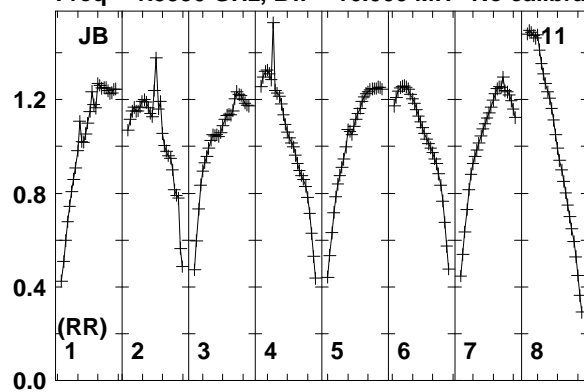

Lower frame: Real Jy
Total-power spectrum Antenna: JB (11)
Timerange: 00/04:58:03 to 00/05:01:49

Plot file version 112 created 11-AUG-2014 17:05:33

J2015+3710 EM110 2.UVDATA.1

Freq = 1.5950 GHz, Bw = 16.000 MH No calibration applied and no bandpass applied

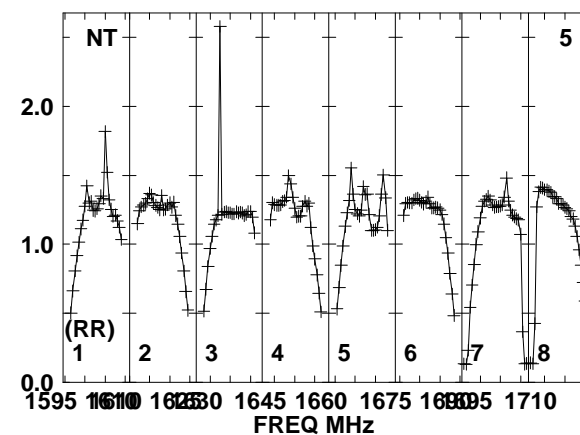
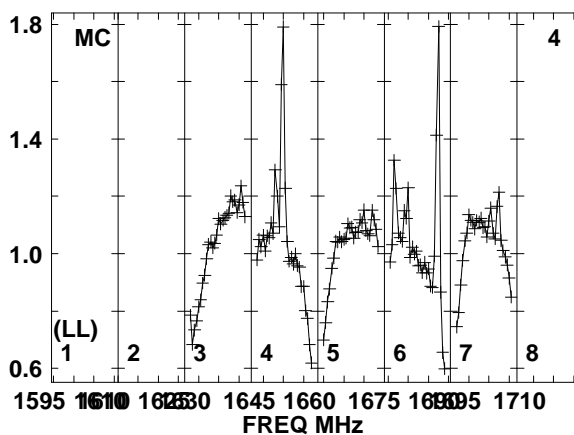
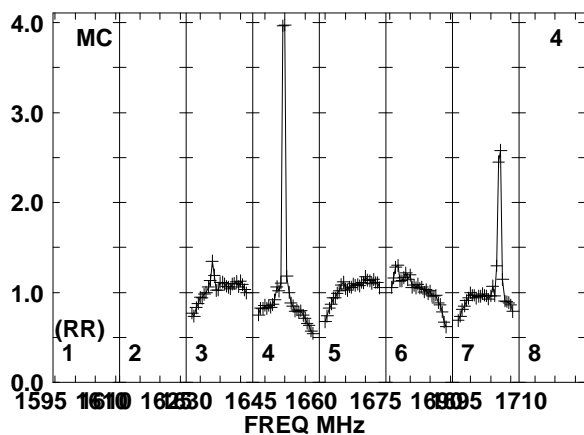
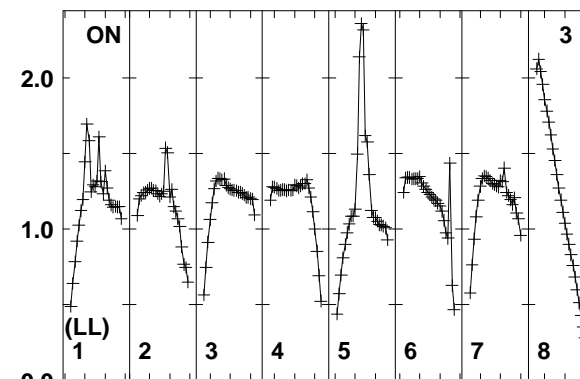
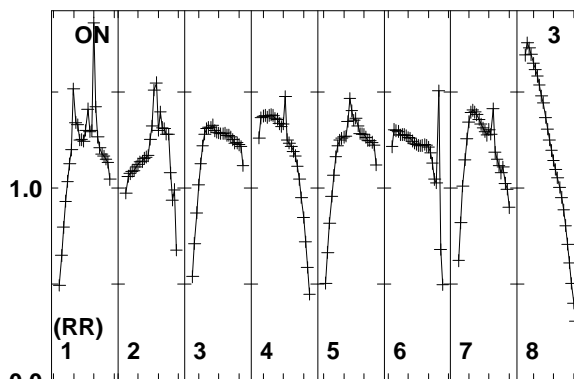
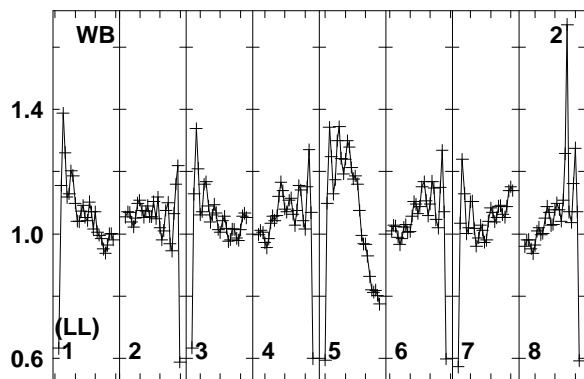
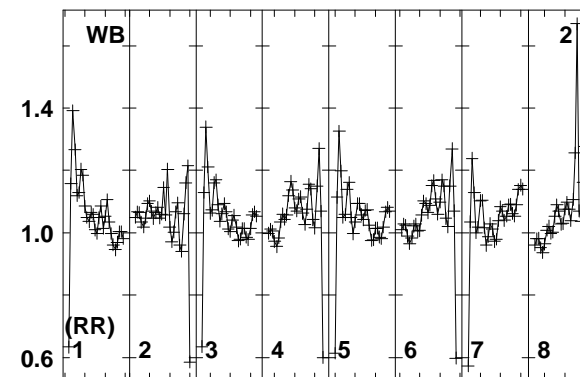
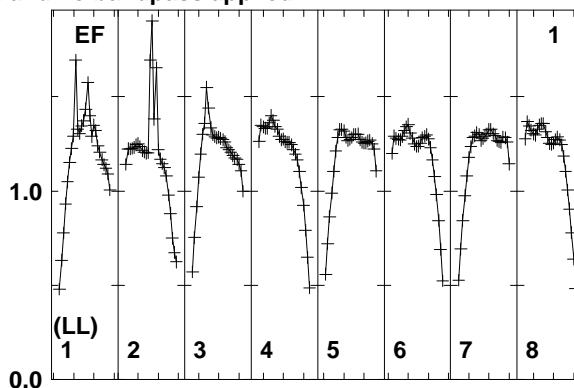
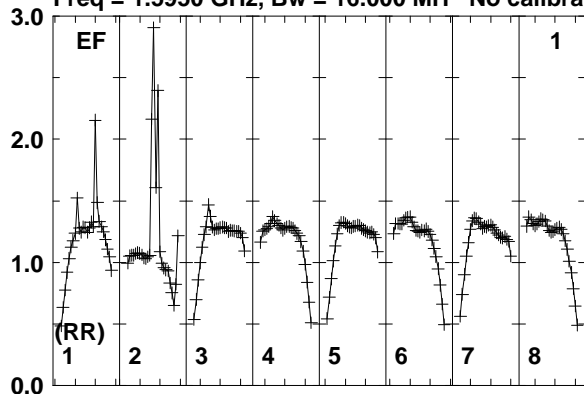

Lower frame: Real Jy
Total-power spectrum Antenna: EF (01)
Timerange: 00/05:02:03 to 00/05:03:49

Plot file version 113 created 11-AUG-2014 17:05:33

J2015+3710 EM110 2.UVDATA.1

Freq = 1.5950 GHz, Bw = 16.000 MH No calibration applied and no bandpass applied

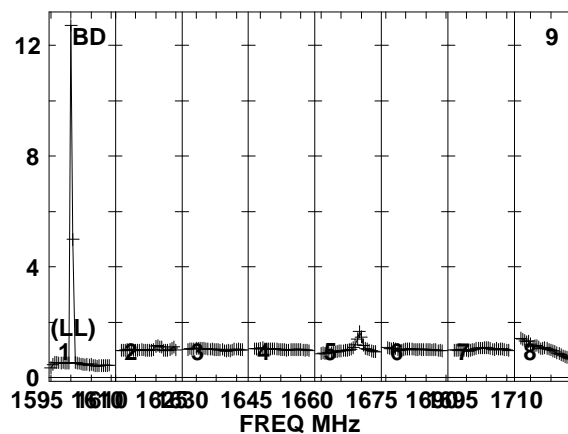
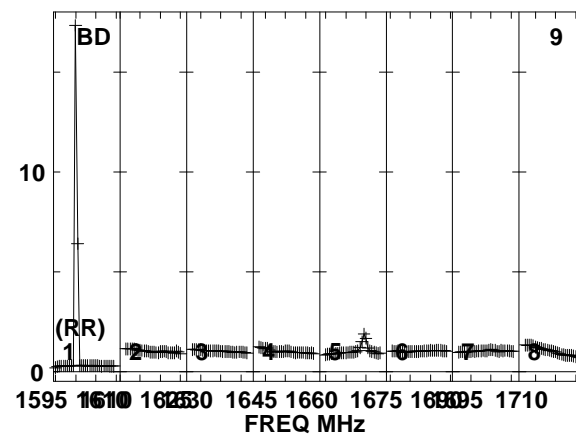
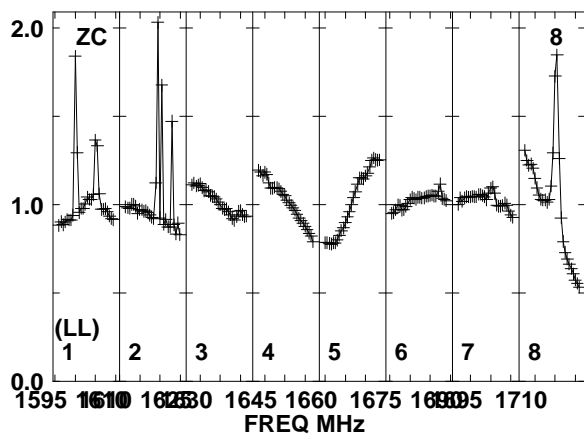
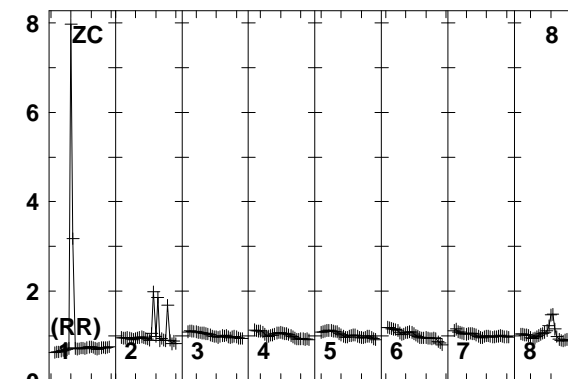
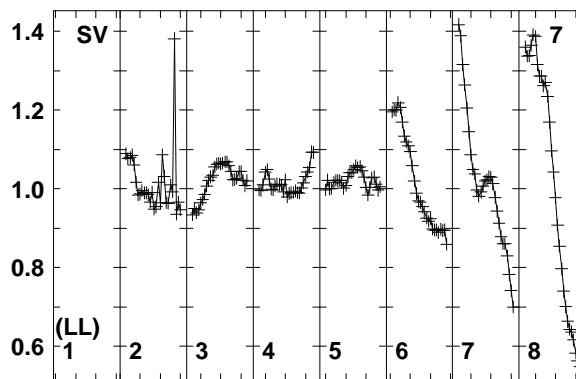
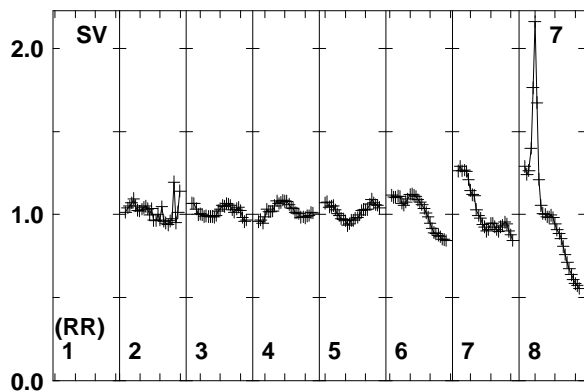
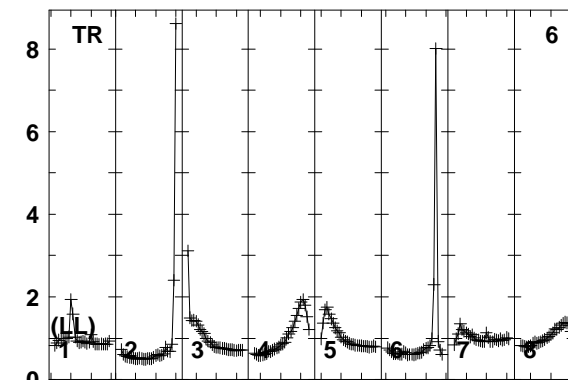
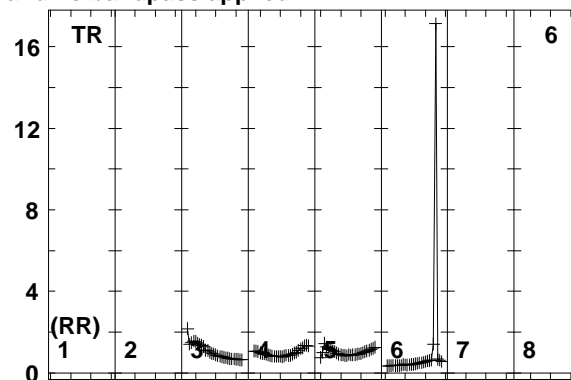
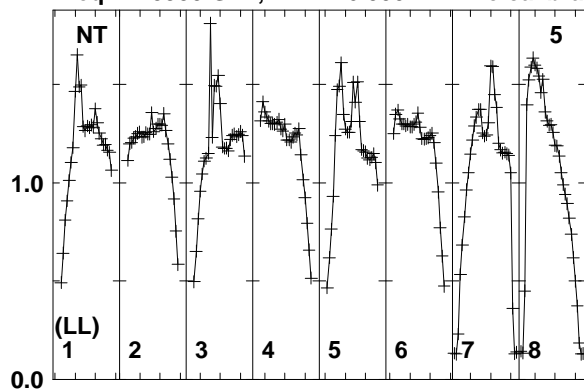

Lower frame: Real Jy
Total-power spectrum Antenna: NT (05)
Timerange: 00/05:02:03 to 00/05:03:49

Plot file version 114 created 11-AUG-2014 17:05:33

J2015+3710 EM110 2.UVDATA.1

Freq = 1.5950 GHz, Bw = 16.000 MH No calibration applied and no bandpass applied

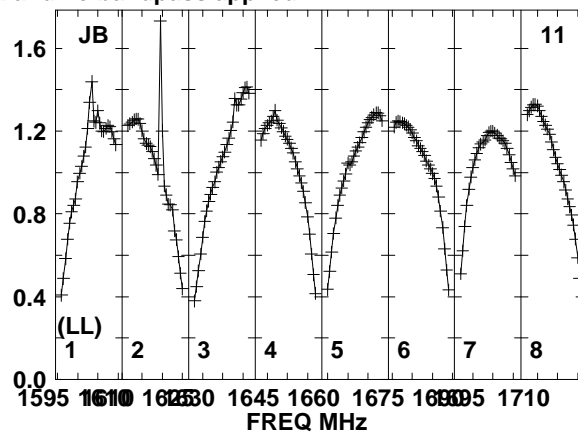
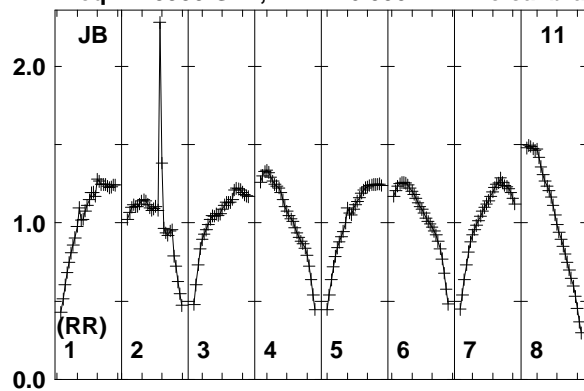

Lower frame: Real Jy
Total-power spectrum Antenna: JB (11)
Timerange: 00/05:02:03 to 00/05:03:49

Plot file version 115 created 11-AUG-2014 17:05:33

J2007+4029 EM110 2.UVDATA.1

Freq = 1.5950 GHz, Bw = 16.000 MH No calibration applied and no bandpass applied

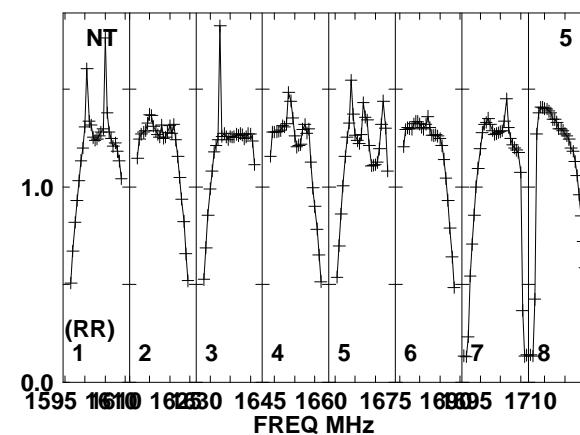
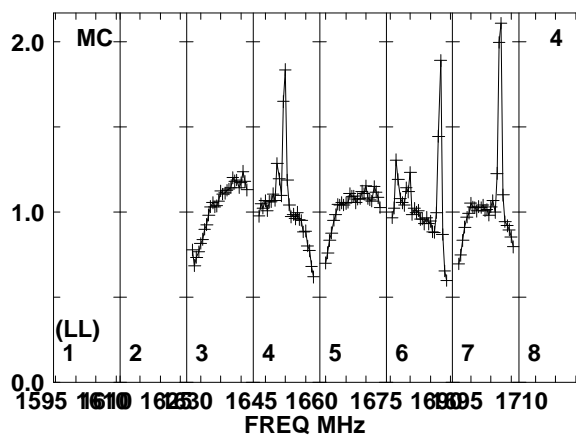
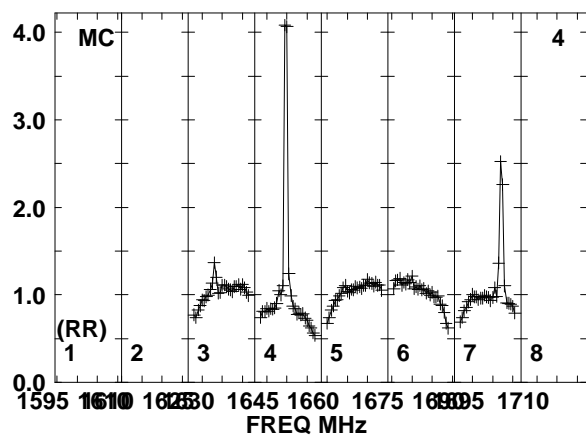
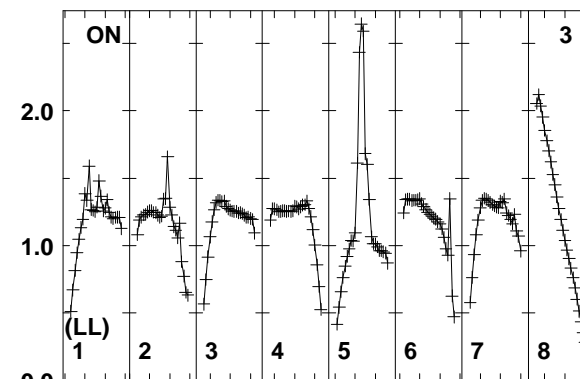
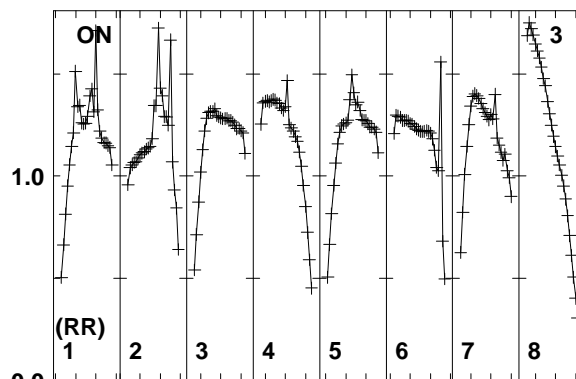
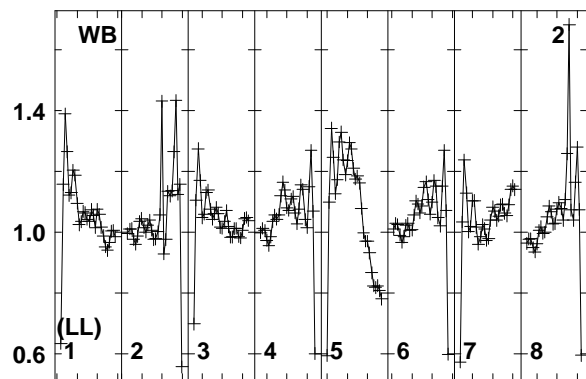
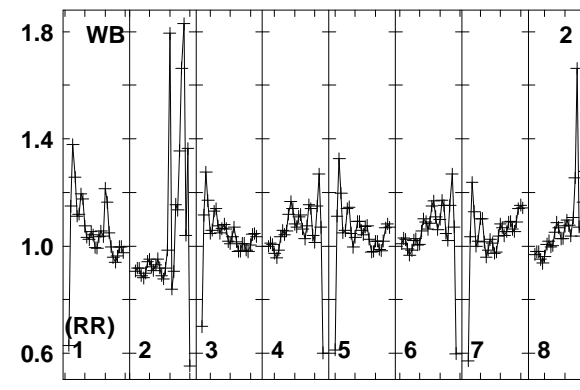
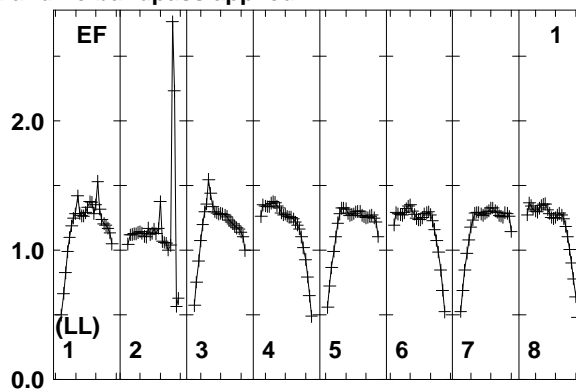
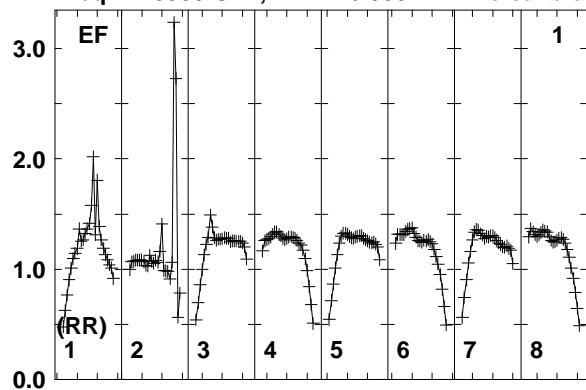

Lower frame: Real Jy
Total-power spectrum Antenna: EF (01)
Timerange: 00/05:03:59 to 00/05:04:49

Plot file version 116 created 11-AUG-2014 17:05:33

J2007+4029 EM110 2.UVDATA.1

Freq = 1.5950 GHz, Bw = 16.000 MH No calibration applied and no bandpass applied

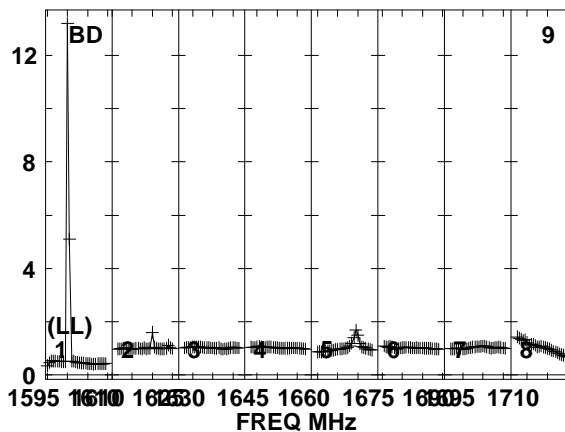
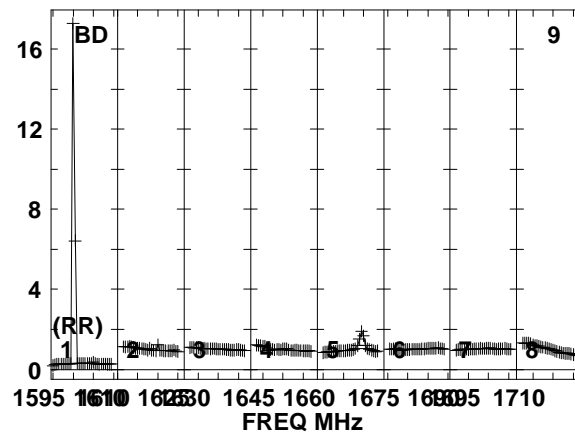
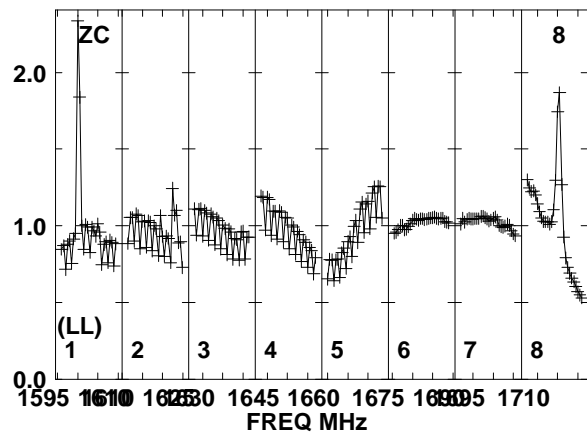
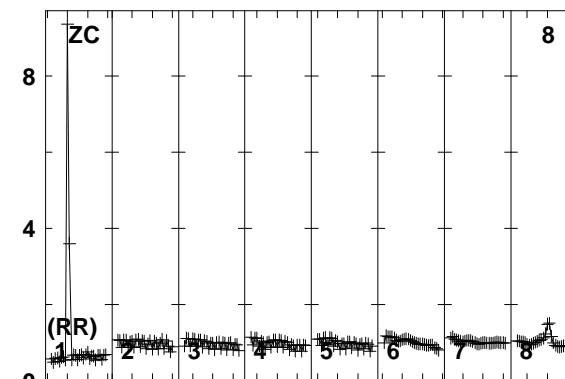
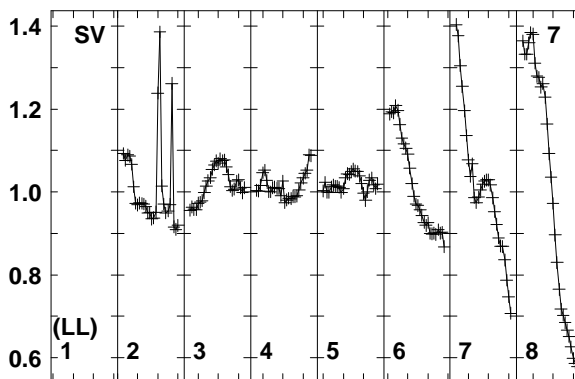
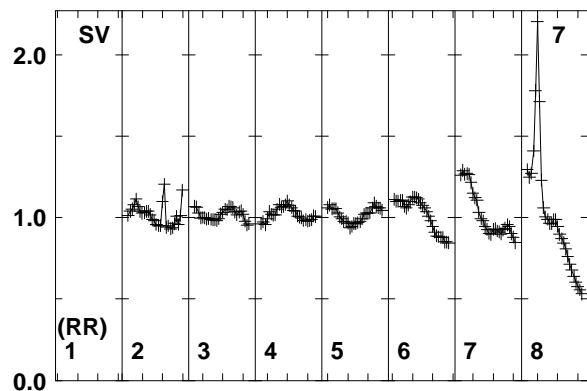
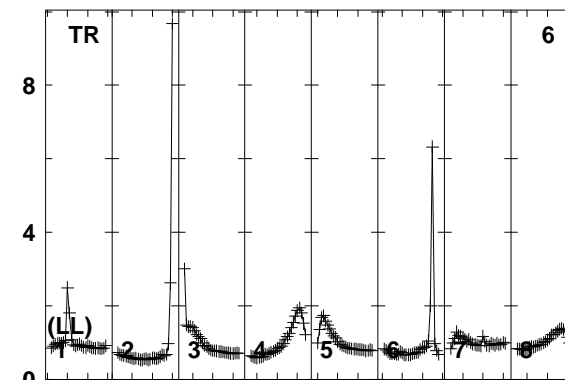
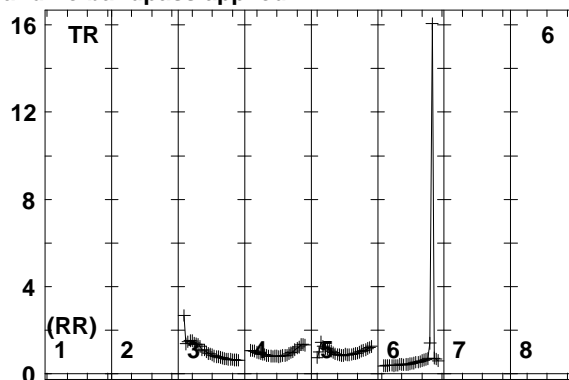
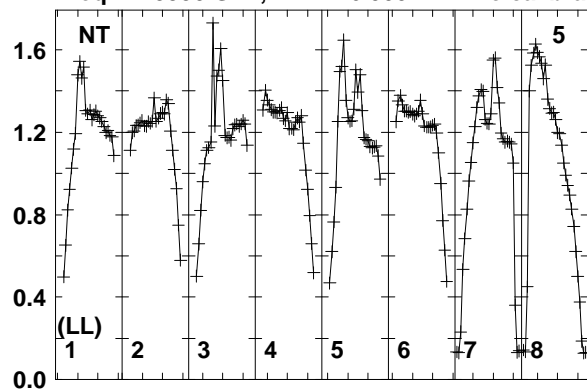

Lower frame: Real Jy
Total-power spectrum Antenna: NT (05)
Timerange: 00/05:03:59 to 00/05:04:49

Plot file version 117 created 11-AUG-2014 17:05:33

J2007+4029 EM110 2.UVDATA.1

Freq = 1.5950 GHz, Bw = 16.000 MH No calibration applied and no bandpass applied

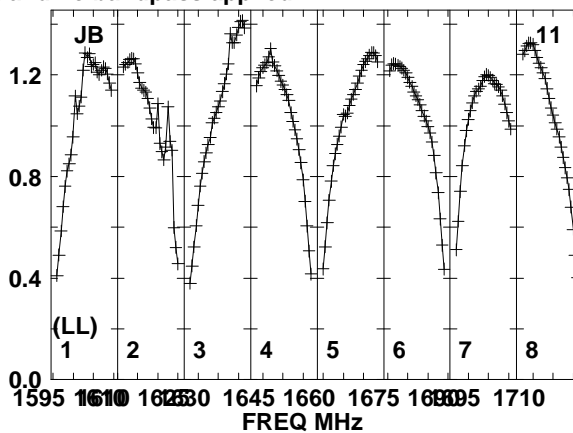
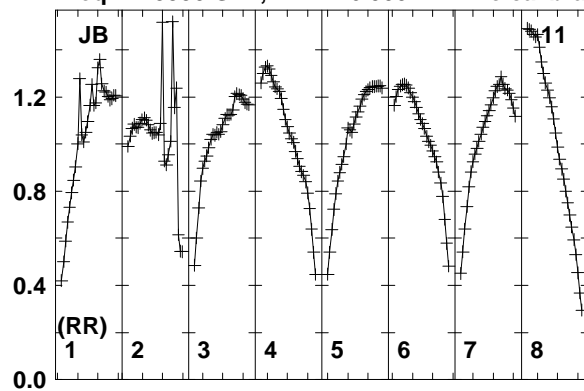

Lower frame: Real Jy
Total-power spectrum Antenna: JB (11)
Timerange: 00/05:03:59 to 00/05:04:49

Plot file version 118 created 11-AUG-2014 17:05:33

J2015+3710 EM110 2.UVDATA.1

Freq = 1.5950 GHz, Bw = 16.000 MH No calibration applied and no bandpass applied

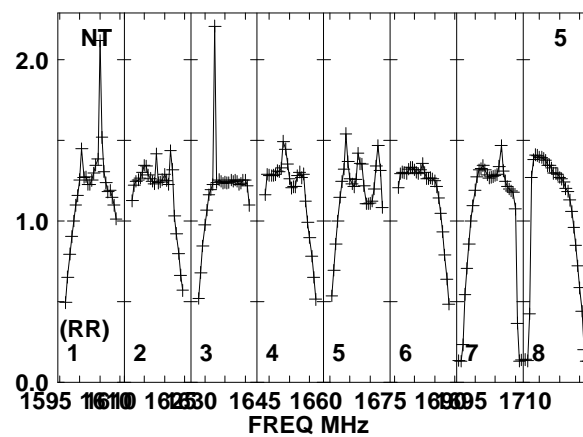
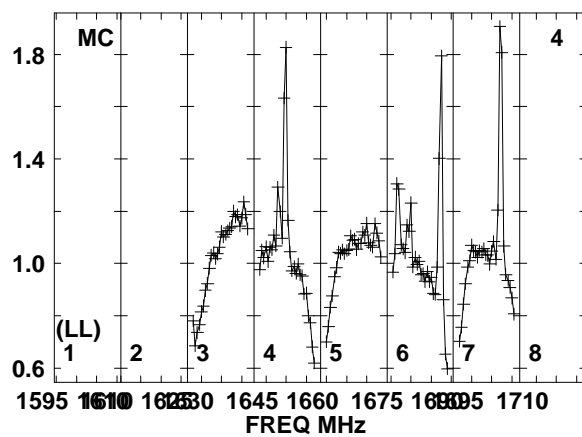
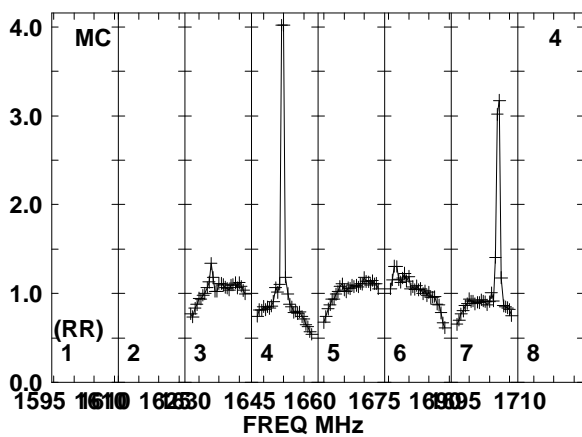
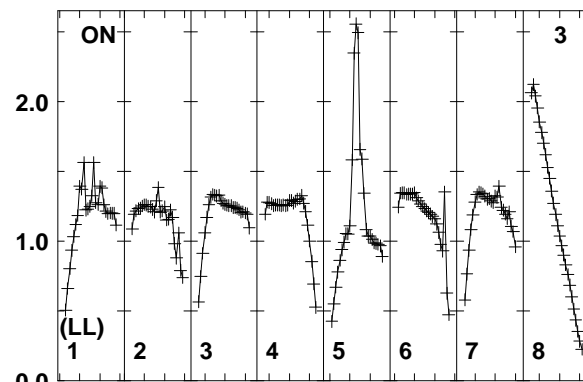
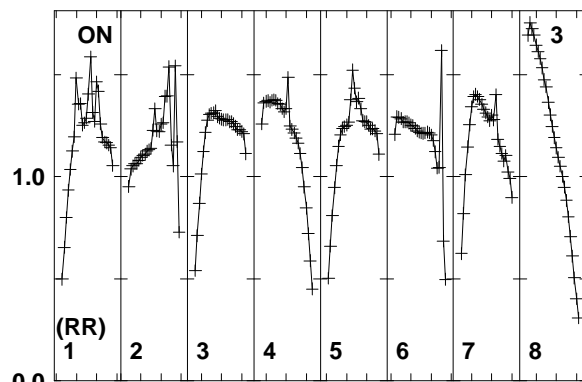
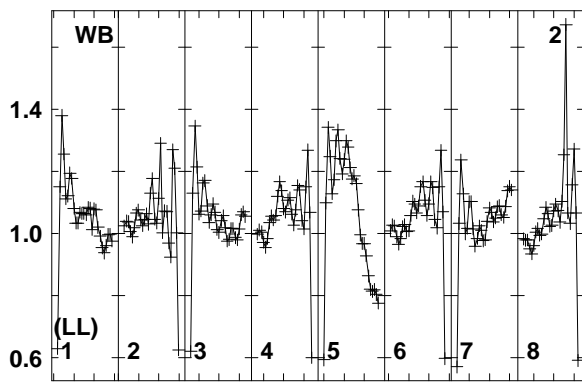
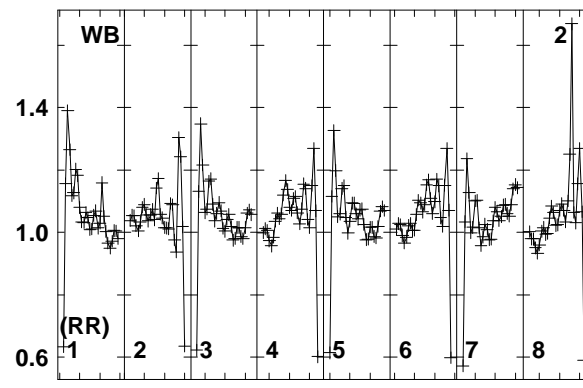
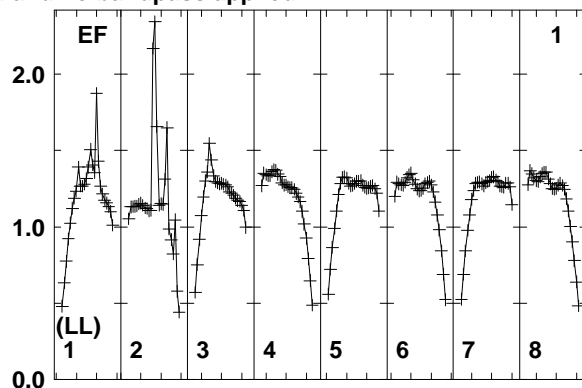
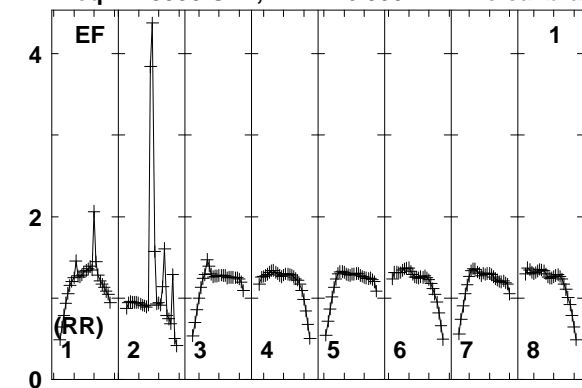

Lower frame: Real Jy
Total-power spectrum Antenna: EF (01)
Timerange: 00/05:05:51 to 00/05:07:49

Plot file version 119 created 11-AUG-2014 17:05:33

J2015+3710 EM110 2.UVDATA.1

Freq = 1.5950 GHz, Bw = 16.000 MH No calibration applied and no bandpass applied

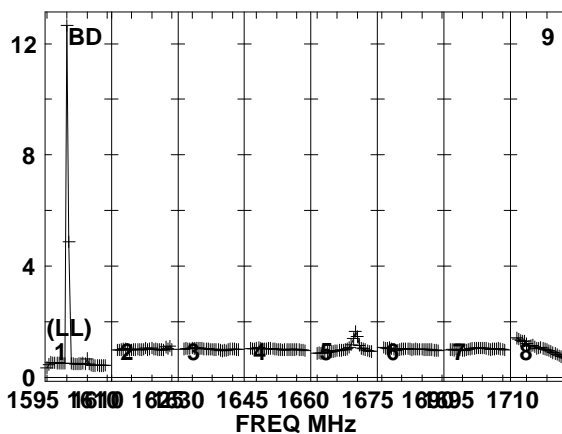
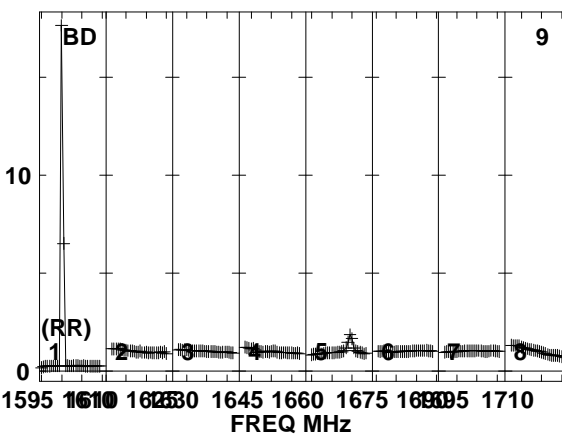
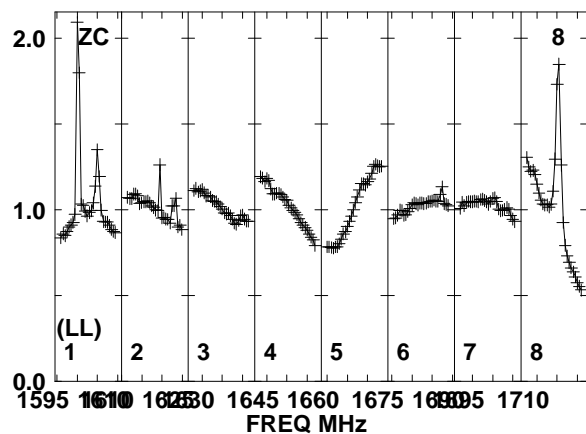
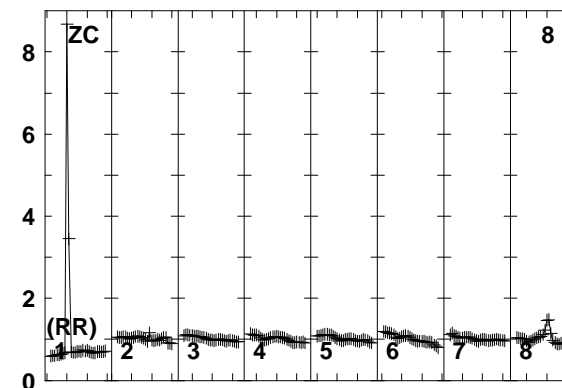
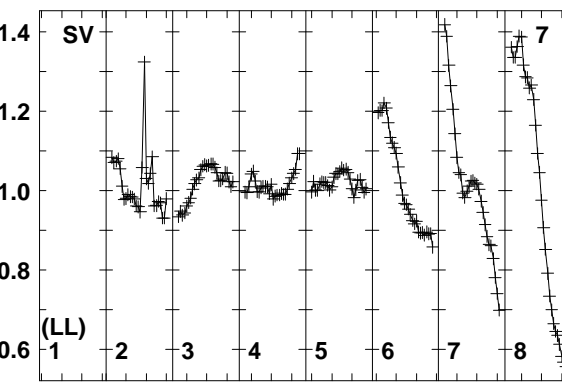
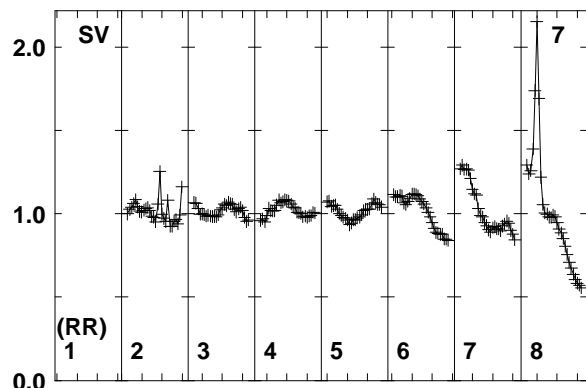
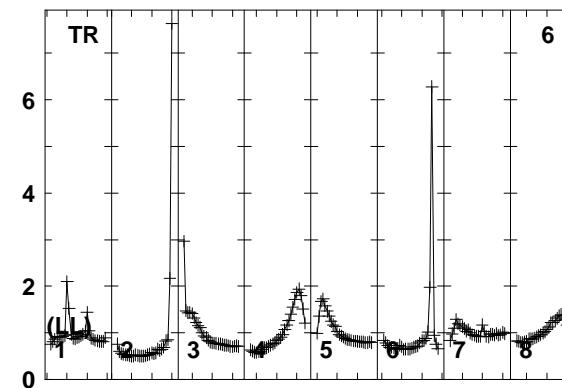
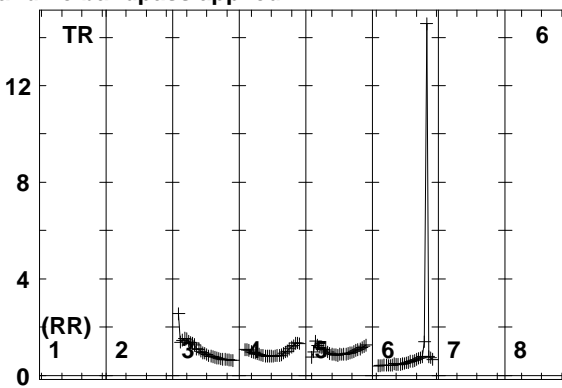
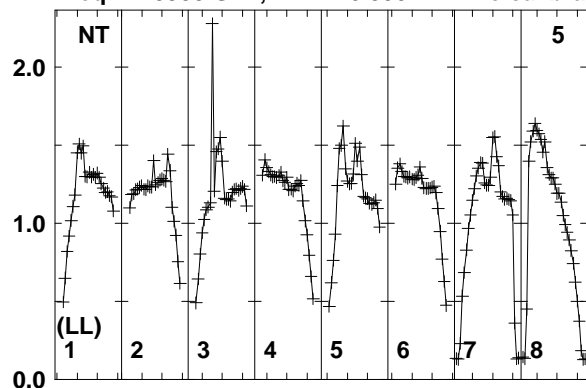

Lower frame: Real Jy
Total-power spectrum Antenna: NT (05)
Timerange: 00/05:05:51 to 00/05:07:49

Plot file version 120 created 11-AUG-2014 17:05:33

J2032+4127 EM110 2.UVDATA.1

Freq = 1.5950 GHz, Bw = 16.000 MH No calibration applied and no bandpass applied

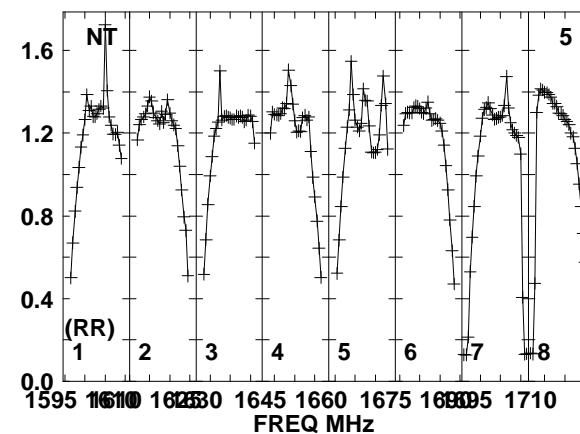
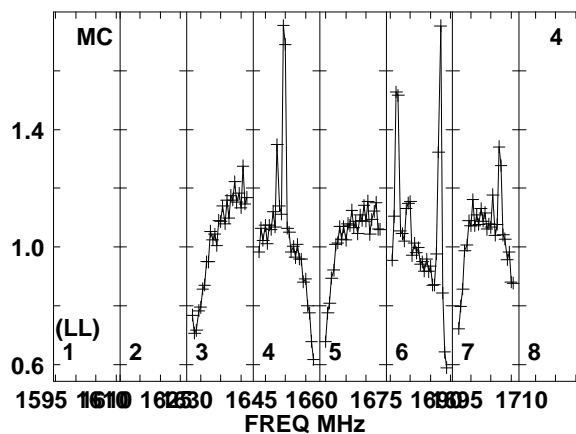
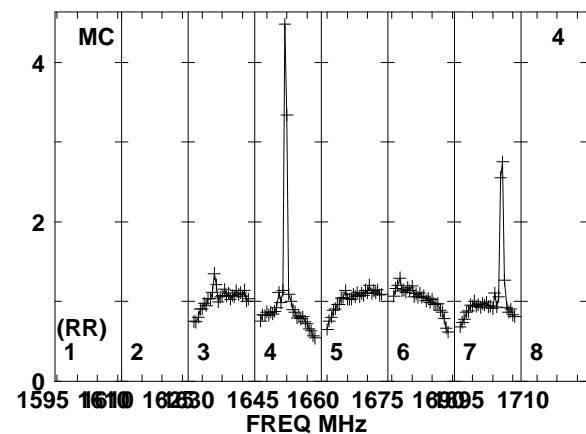
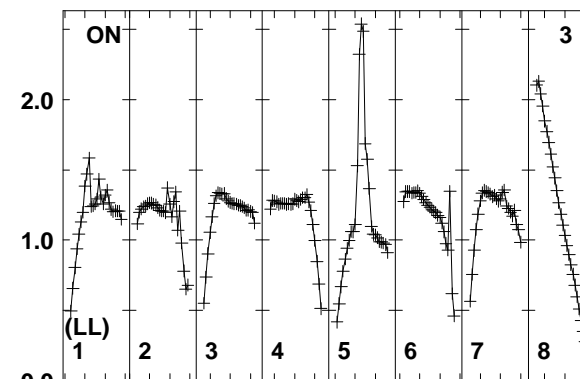
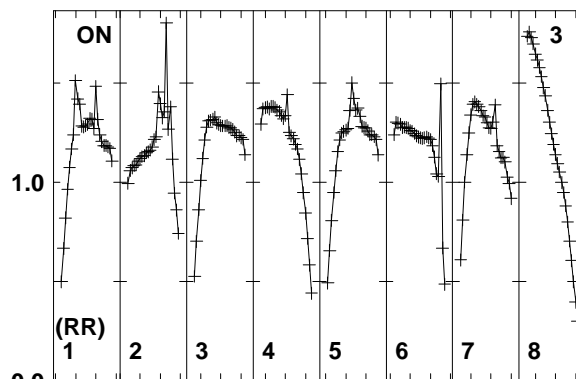
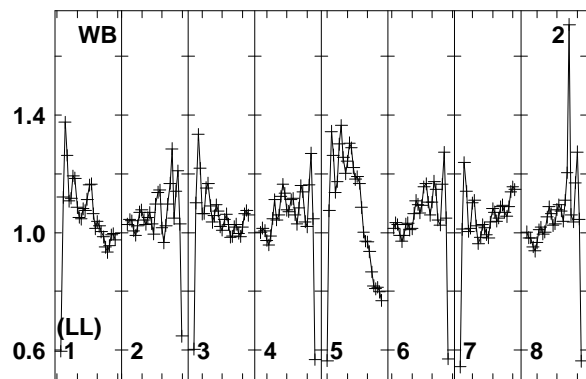
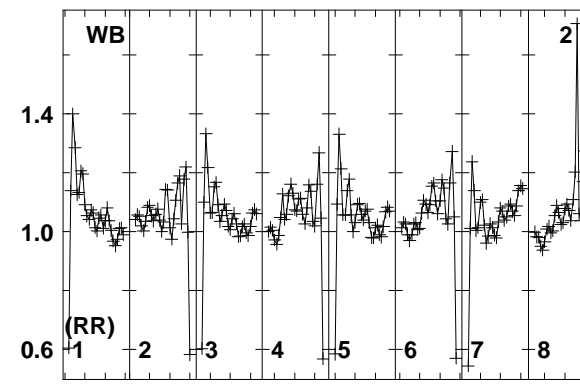
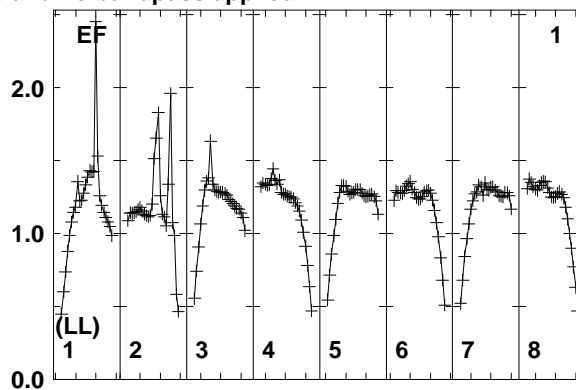
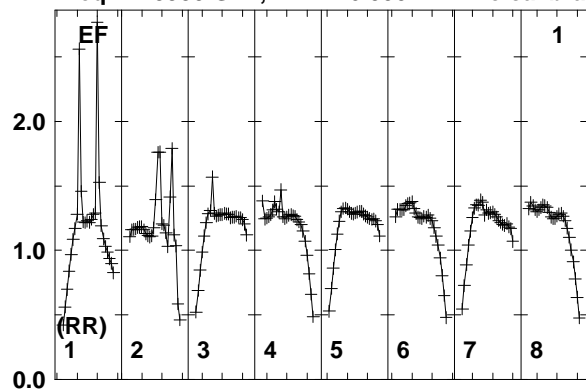

Lower frame: Real Jy
Total-power spectrum Antenna: EF (01)
Timerange: 00/05:07:51 to 00/05:11:49

Plot file version 121 created 11-AUG-2014 17:05:33

J2032+4127 EM110 2.UVDATA.1

Freq = 1.5950 GHz, Bw = 16.000 MH No calibration applied and no bandpass applied

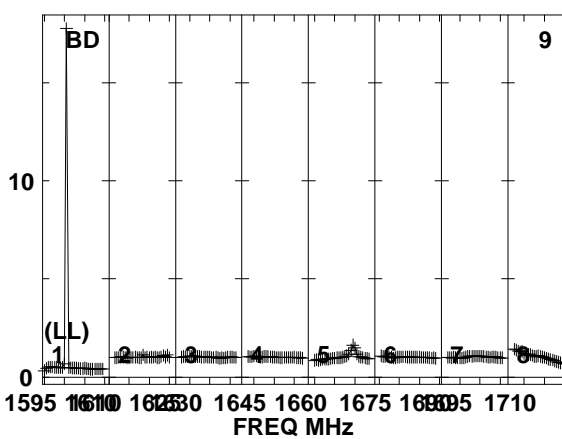
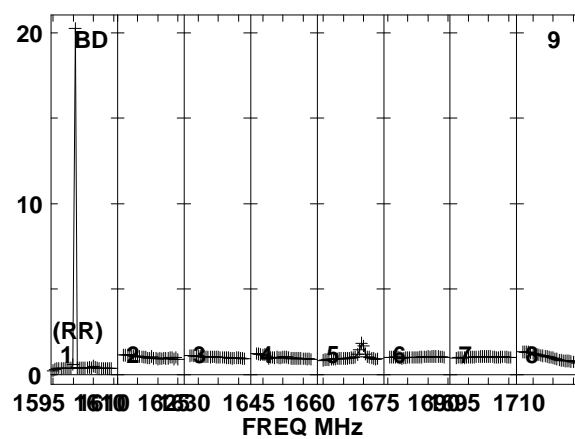
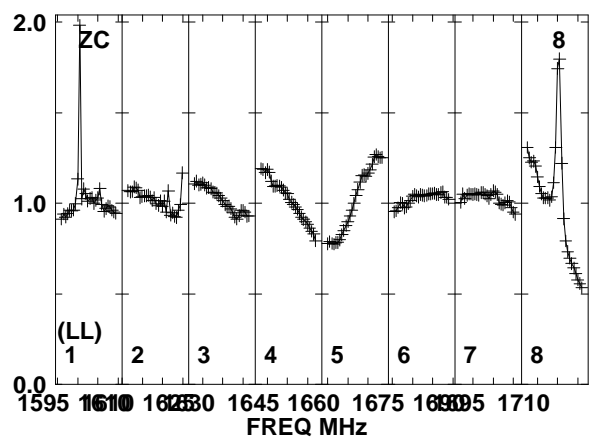
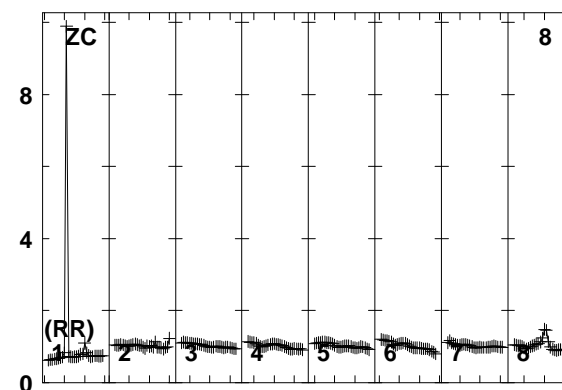
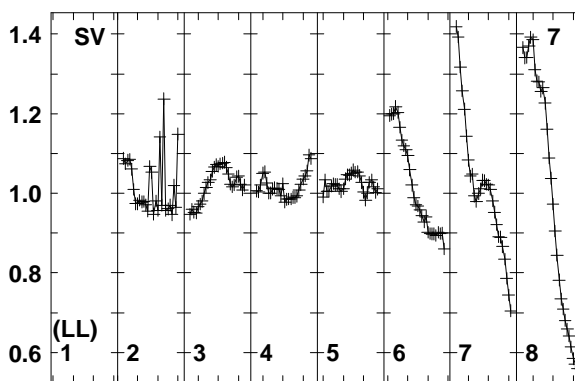
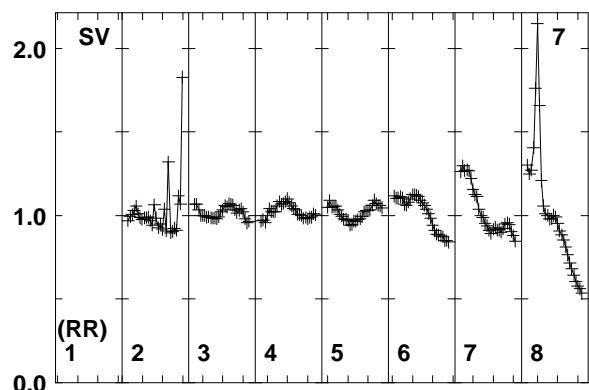
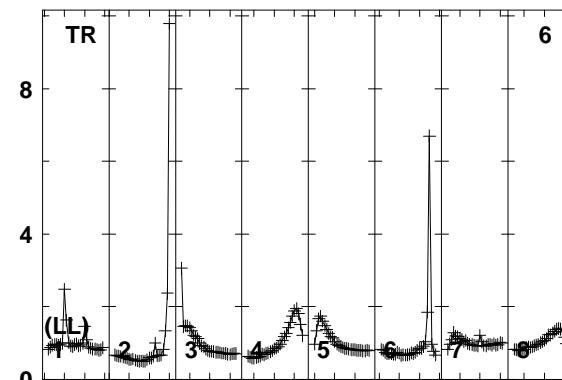
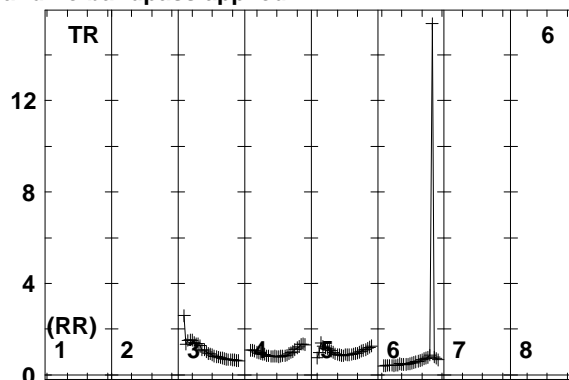
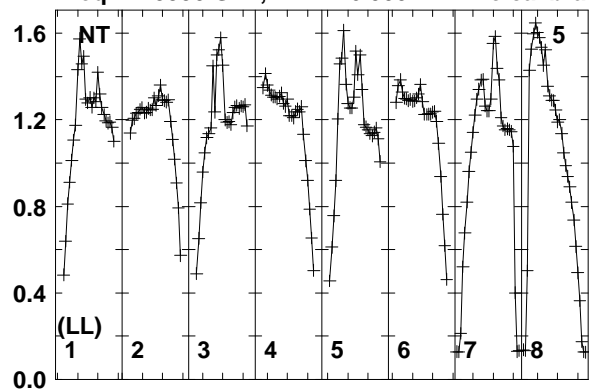

Lower frame: Real Jy
Total-power spectrum Antenna: NT (05)
Timerange: 00/05:07:51 to 00/05:11:49

Plot file version 122 created 11-AUG-2014 17:05:33

J2032+4127 EM110 2.UVDATA.1

Freq = 1.5950 GHz, Bw = 16.000 MH No calibration applied and no bandpass applied

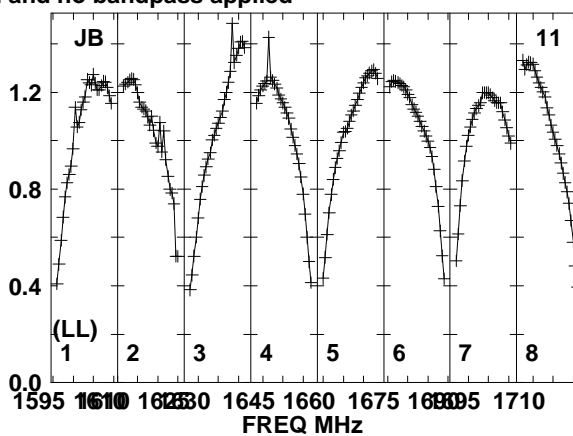
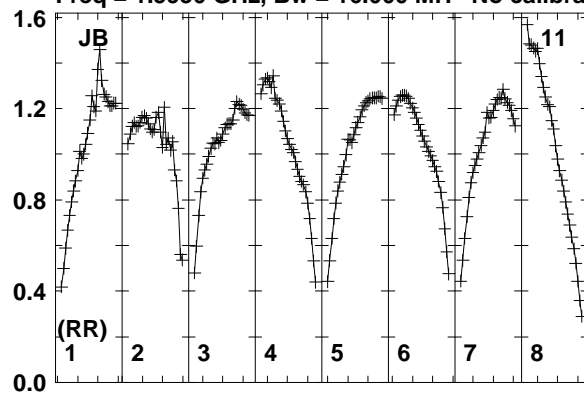

Lower frame: Real Jy
Total-power spectrum Antenna: JB (11)
Timerange: 00/05:07:51 to 00/05:11:49

Plot file version 123 created 11-AUG-2014 17:05:33

J2015+3710 EM110 2.UVDATA.1

Freq = 1.5950 GHz, Bw = 16.000 MH No calibration applied and no bandpass applied

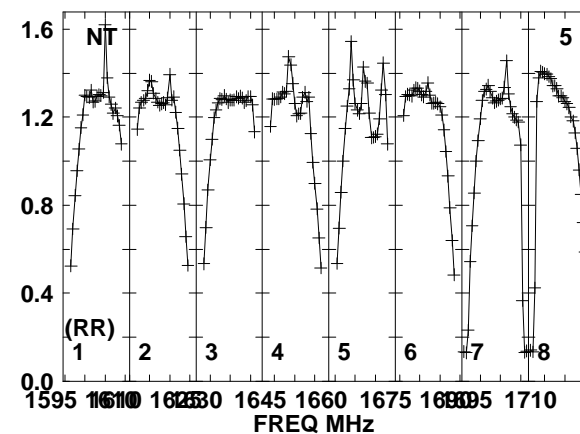
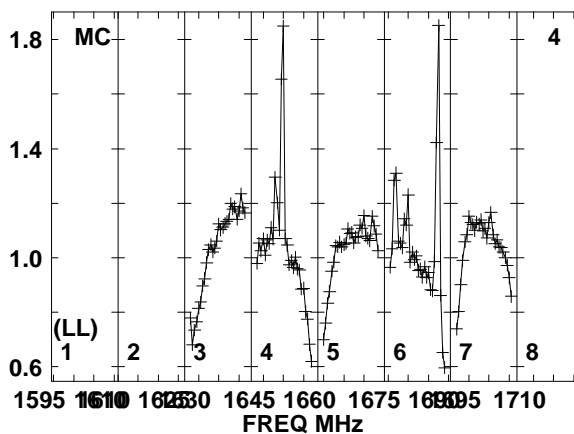
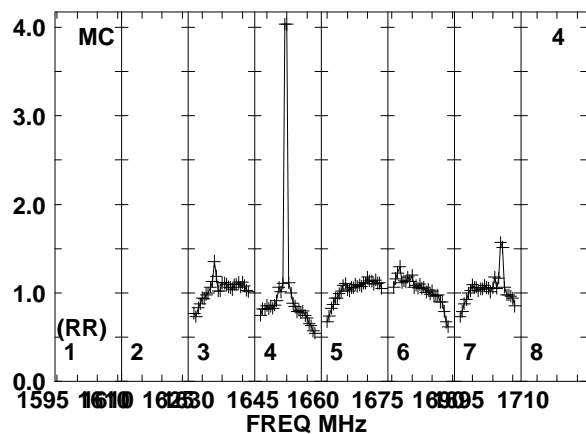
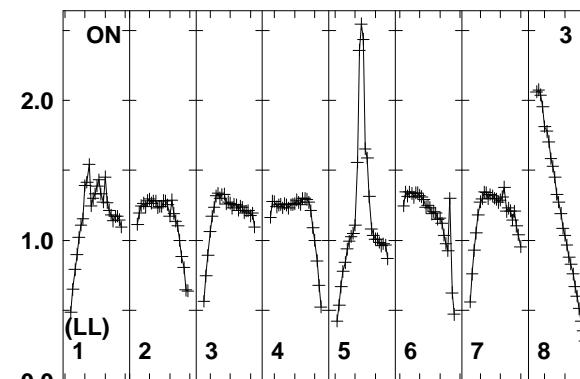
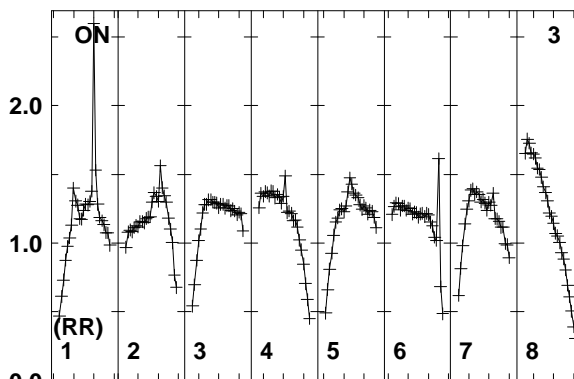
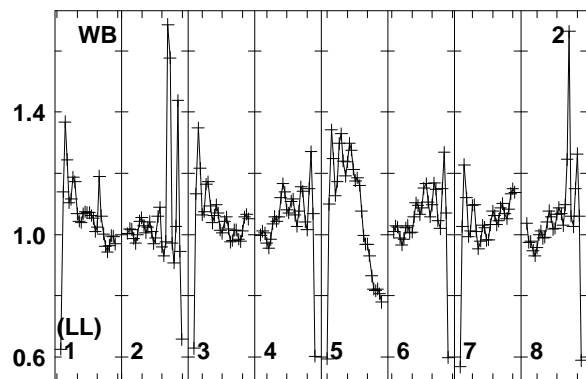
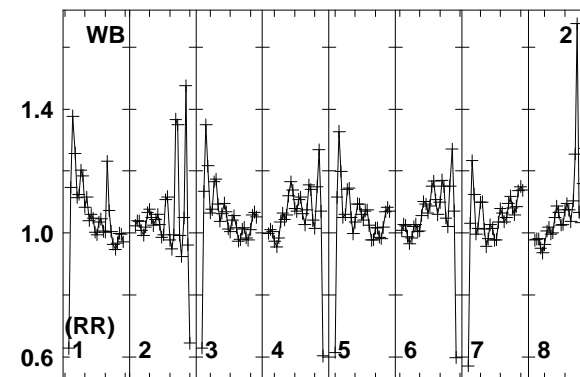
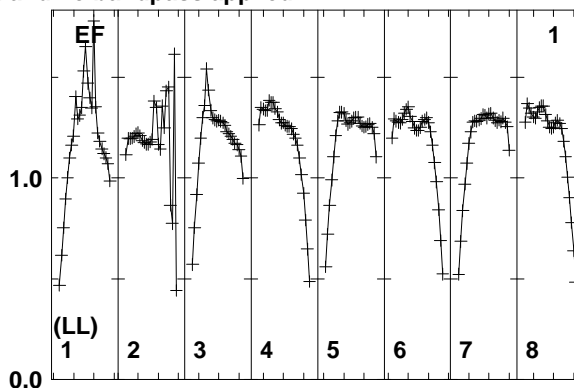
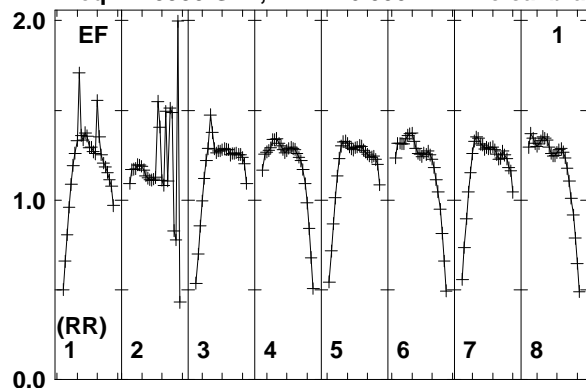

Lower frame: Real Jy
Total-power spectrum Antenna: EF (01)
Timerange: 00/05:12:03 to 00/05:13:49

Plot file version 124 created 11-AUG-2014 17:05:33

J2015+3710 EM110 2.UVDATA.1

Freq = 1.5950 GHz, Bw = 16.000 MH No calibration applied and no bandpass applied

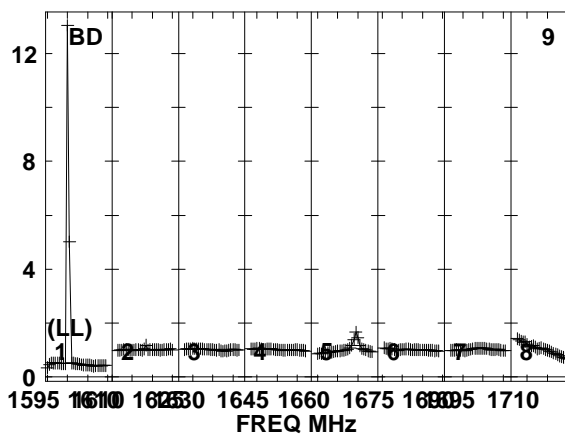
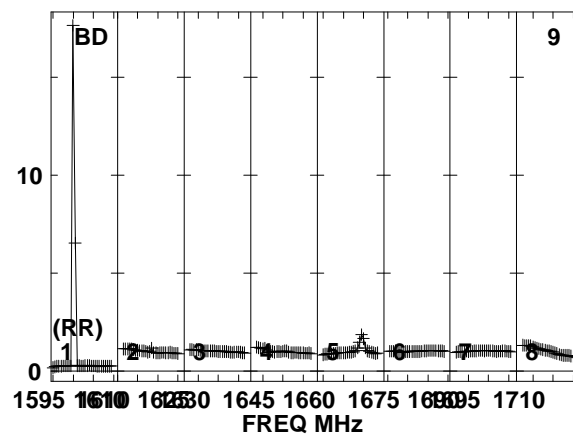
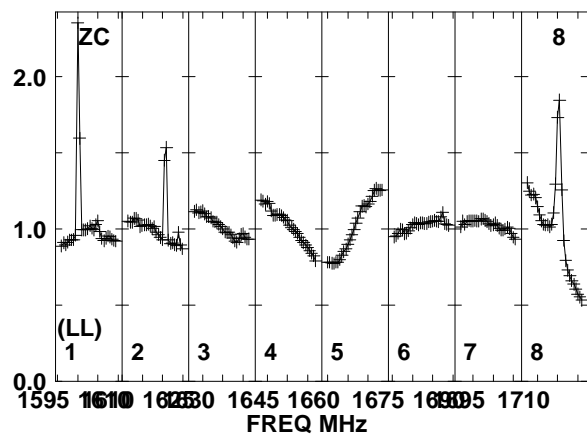
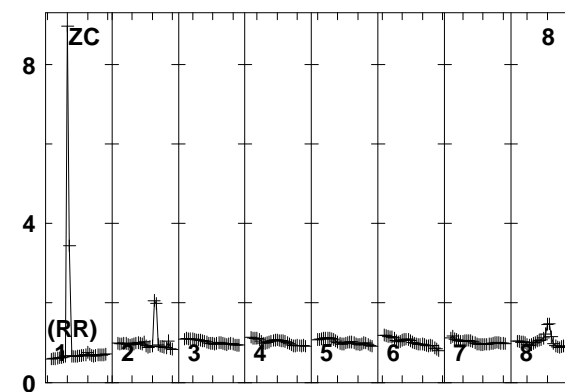
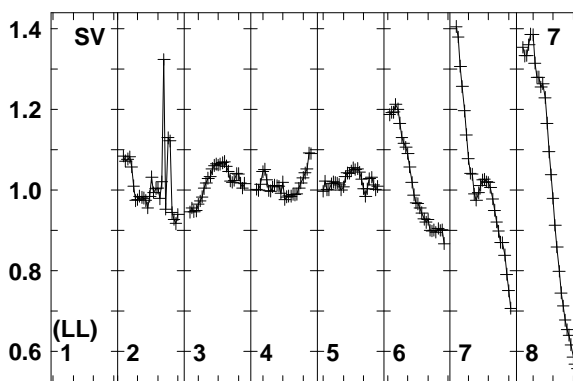
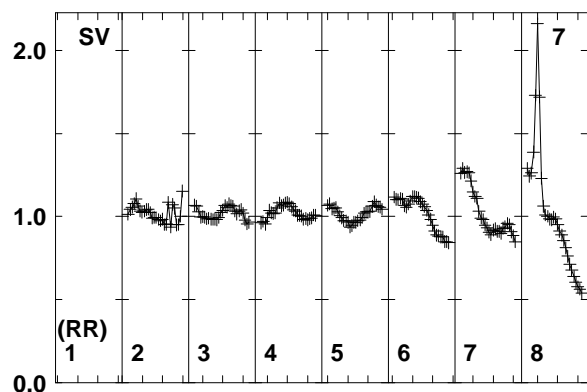
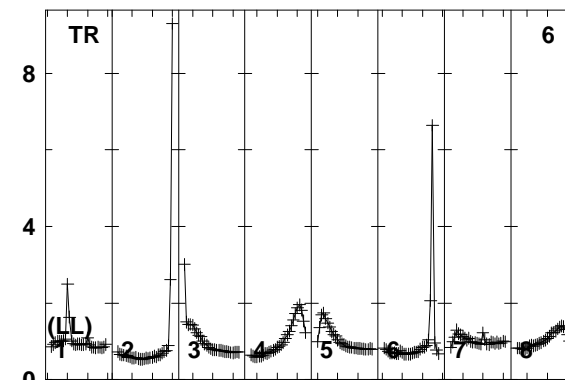
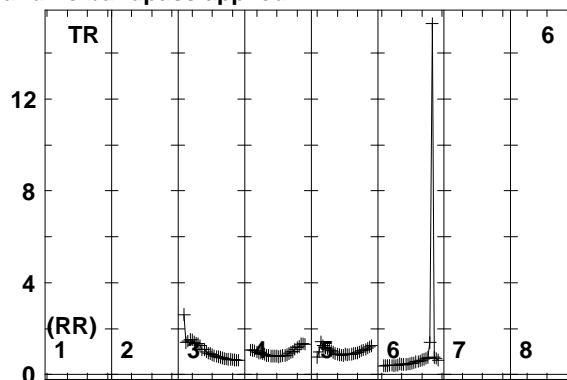
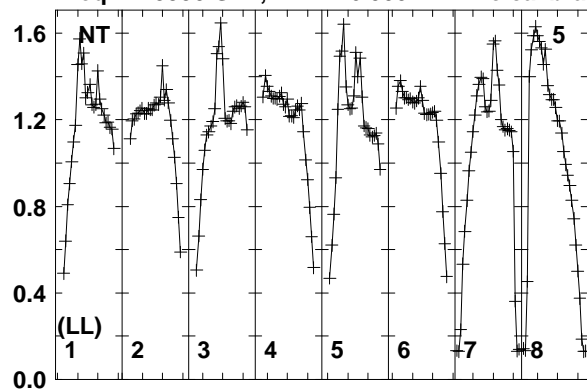

Lower frame: Real Jy
Total-power spectrum Antenna: NT (05)
Timerange: 00/05:12:03 to 00/05:13:49

Plot file version 125 created 11-AUG-2014 17:05:34

J2015+3710 EM110 2.UVDATA.1

Freq = 1.5950 GHz, Bw = 16.000 MH No calibration applied and no bandpass applied

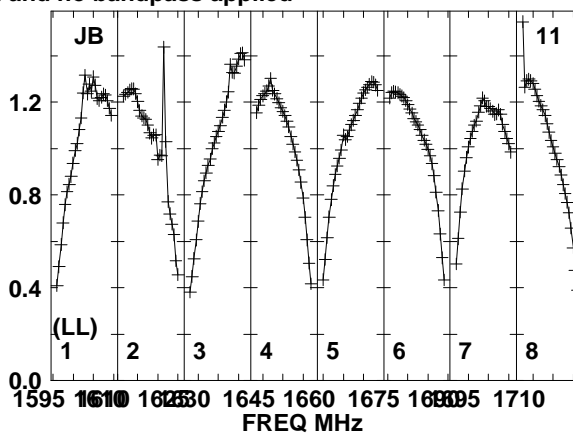
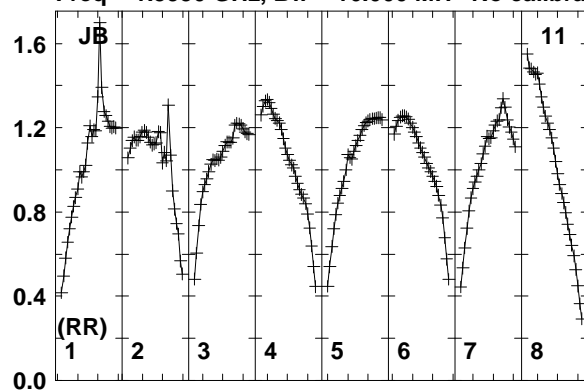

Lower frame: Real Jy
Total-power spectrum Antenna: JB (11)
Timerange: 00/05:12:03 to 00/05:13:49

Plot file version 126 created 11-AUG-2014 17:05:34

J2032+4127 EM110 2.UVDATA.1

Freq = 1.5950 GHz, Bw = 16.000 MH No calibration applied and no bandpass applied

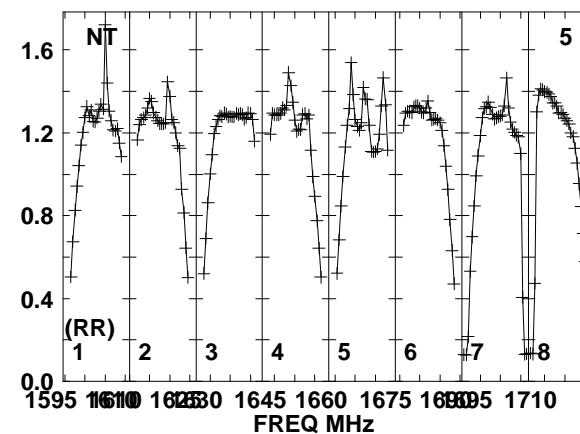
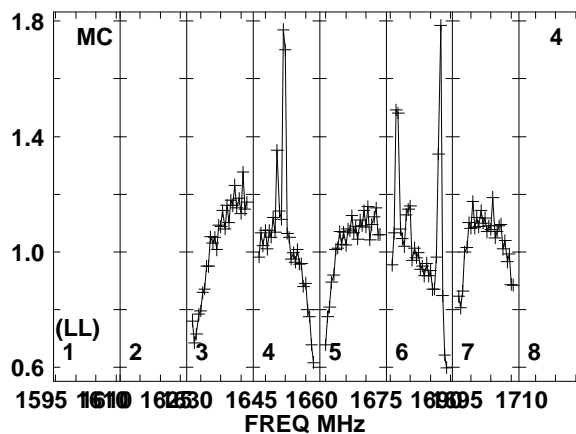
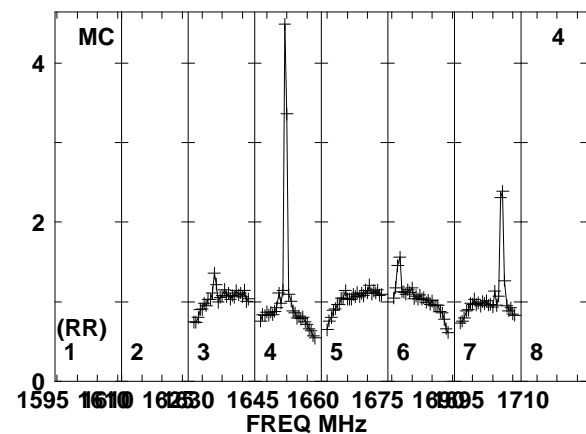
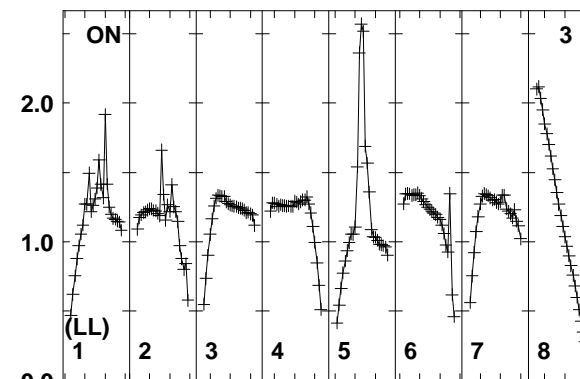
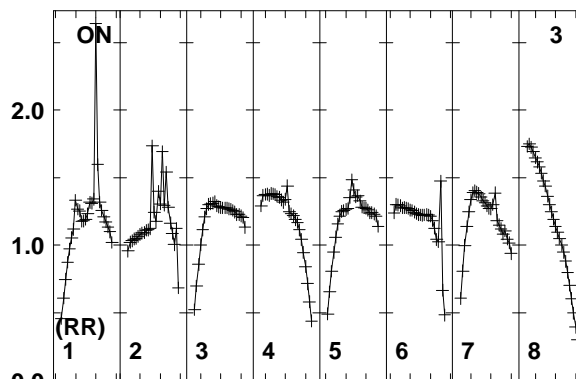
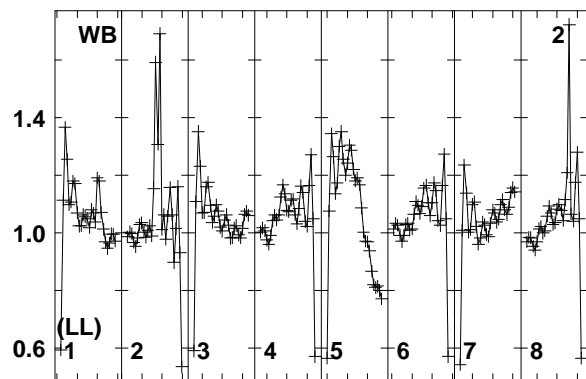
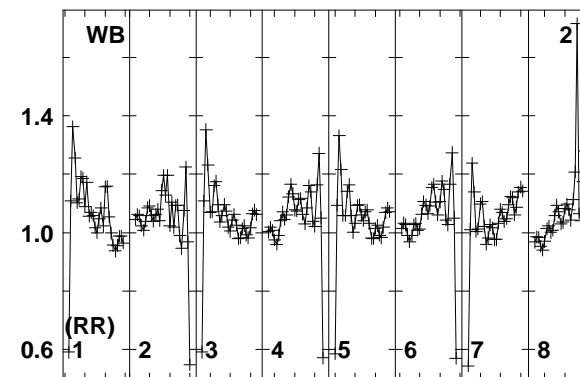
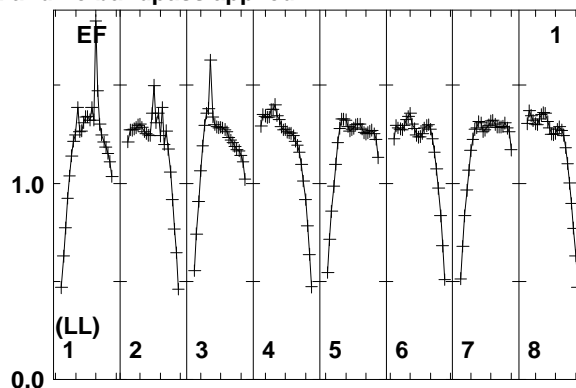
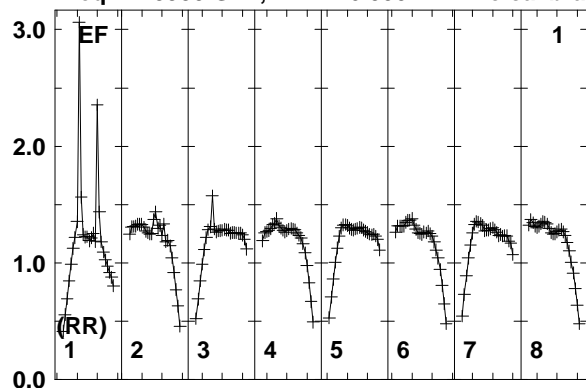

Lower frame: Real Jy
Total-power spectrum Antenna: EF (01)
Timerange: 00/05:14:03 to 00/05:17:49

Plot file version 127 created 11-AUG-2014 17:05:34

J2032+4127 EM110 2.UVDATA.1

Freq = 1.5950 GHz, Bw = 16.000 MH No calibration applied and no bandpass applied

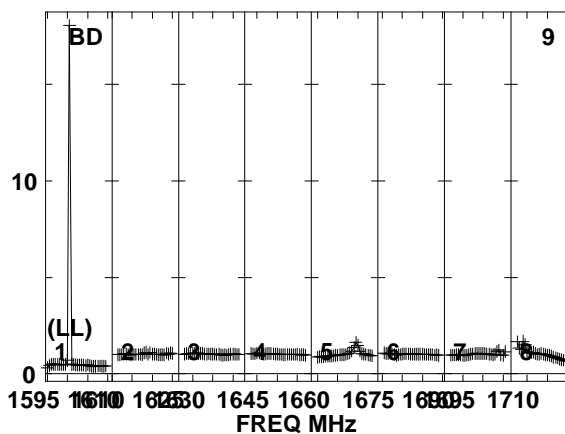
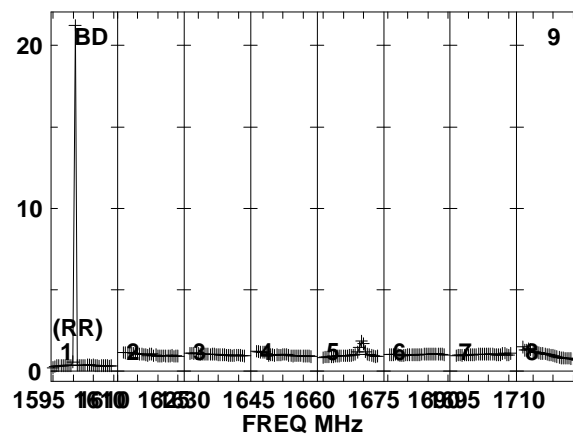
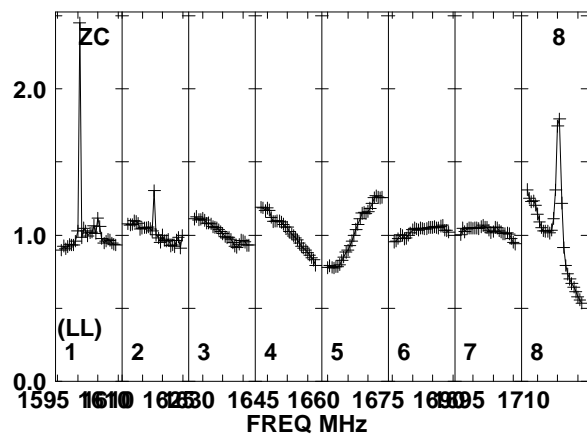
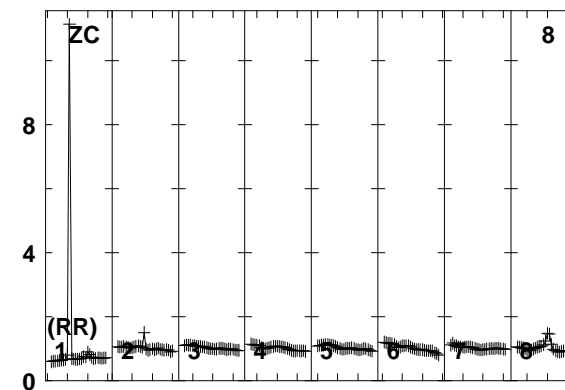
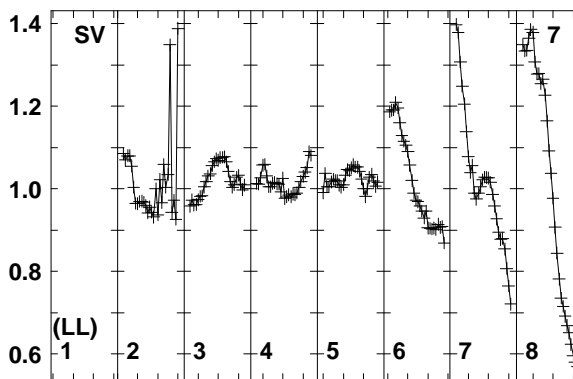
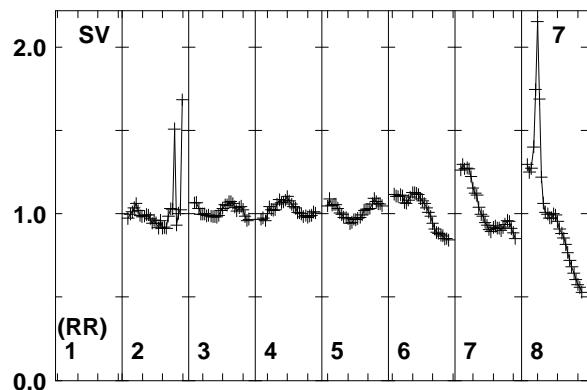
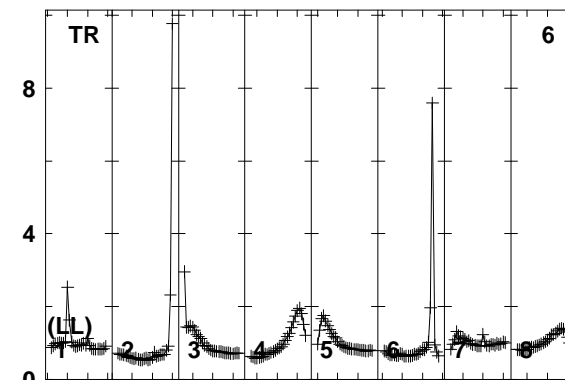
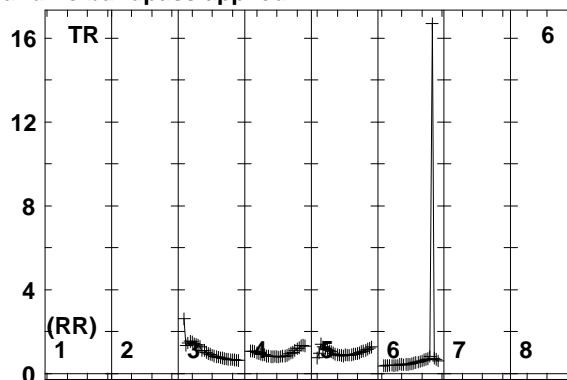
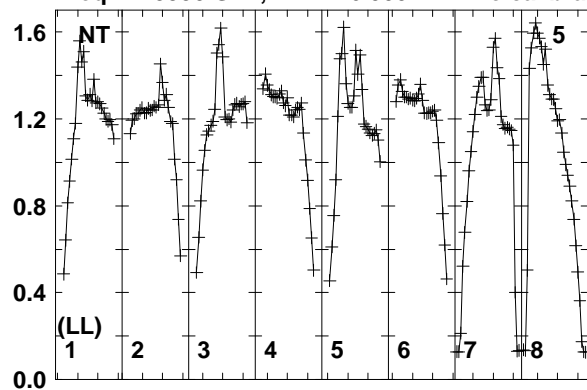

Lower frame: Real Jy
Total-power spectrum Antenna: NT (05)
Timerange: 00/05:14:03 to 00/05:17:49

Plot file version 128 created 11-AUG-2014 17:05:34

J2032+4127 EM110 2.UVDATA.1

Freq = 1.5950 GHz, Bw = 16.000 MH No calibration applied and no bandpass applied

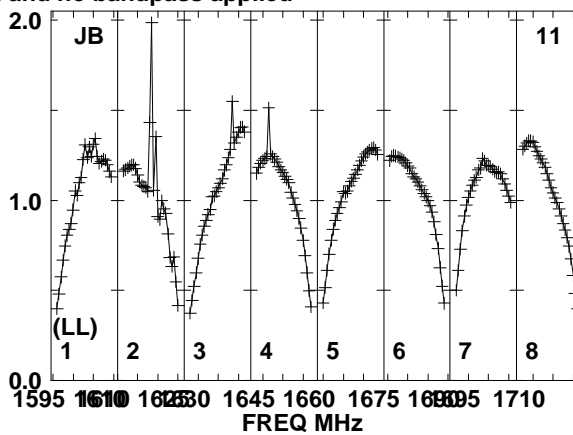
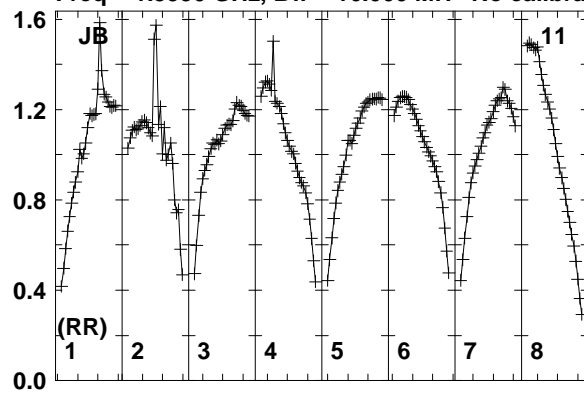

Lower frame: Real Jy
Total-power spectrum Antenna: JB (11)
Timerange: 00/05:14:03 to 00/05:17:49

Plot file version 129 created 11-AUG-2014 17:05:34

J2015+3710 EM110 2.UVDATA.1

Freq = 1.5950 GHz, Bw = 16.000 MH No calibration applied and no bandpass applied

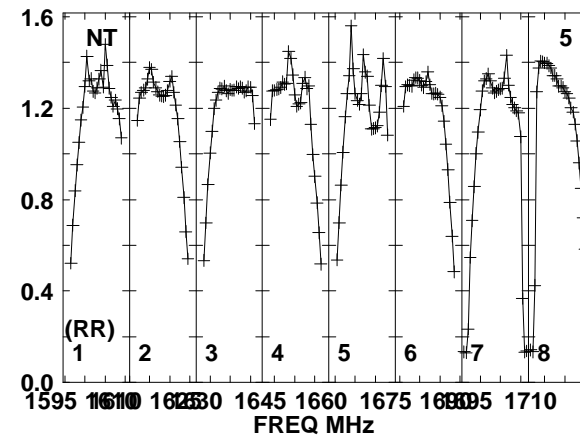
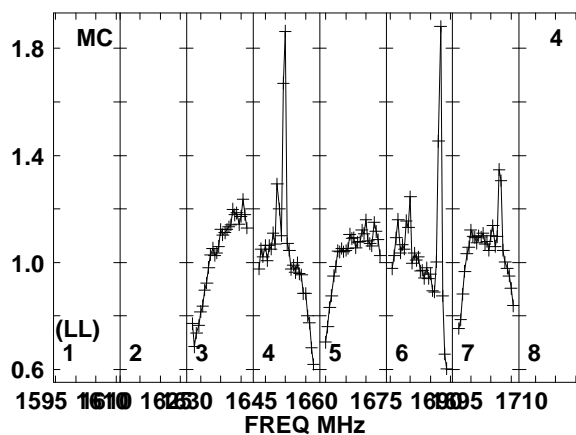
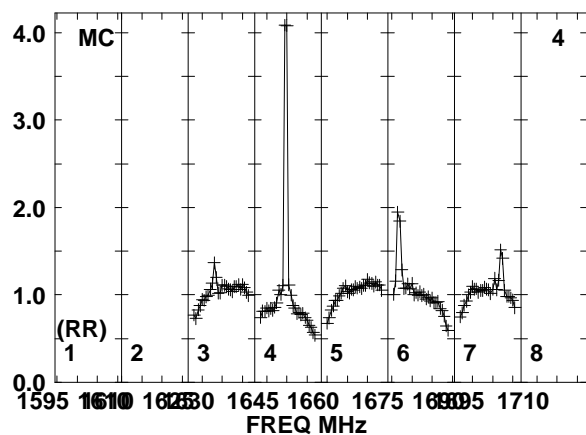
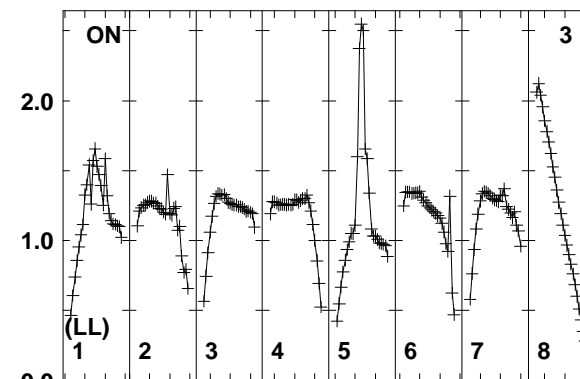
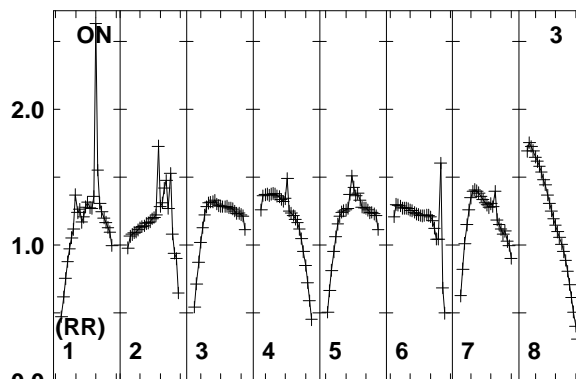
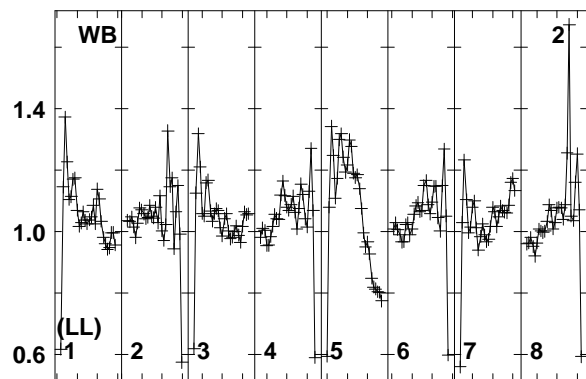
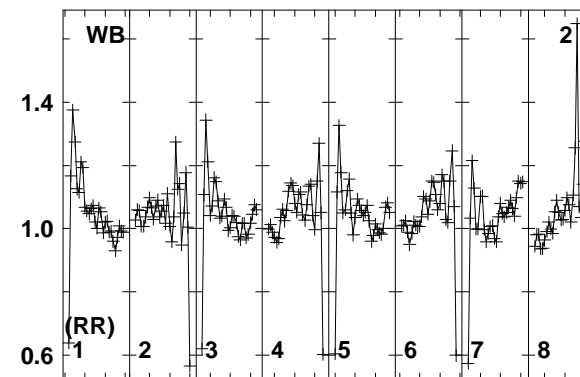
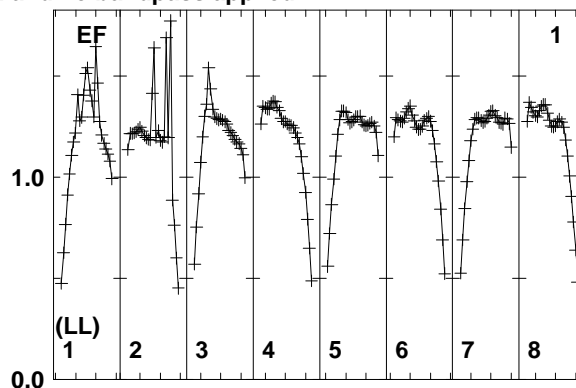
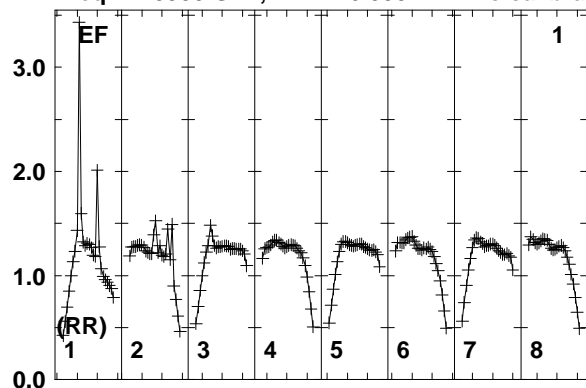

Lower frame: Real Jy
Total-power spectrum Antenna: EF (01)
Timerange: 00/05:18:51 to 00/05:20:49

Plot file version 130 created 11-AUG-2014 17:05:34

J2015+3710 EM110 2.UVDATA.1

Freq = 1.5950 GHz, Bw = 16.000 MH No calibration applied and no bandpass applied

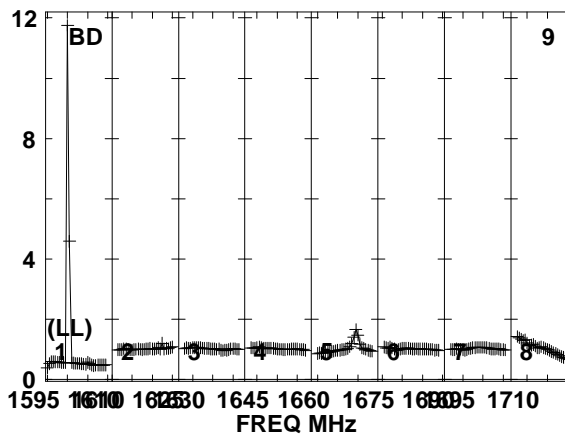
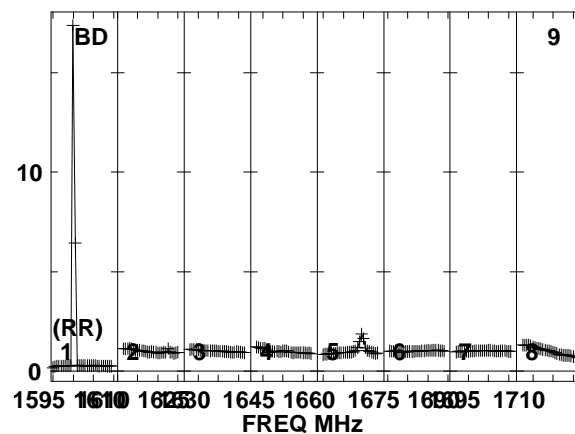
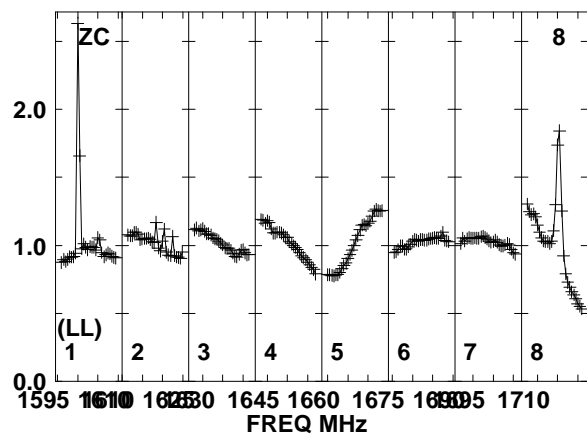
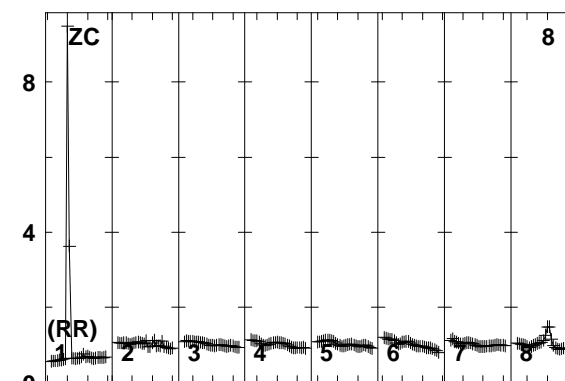
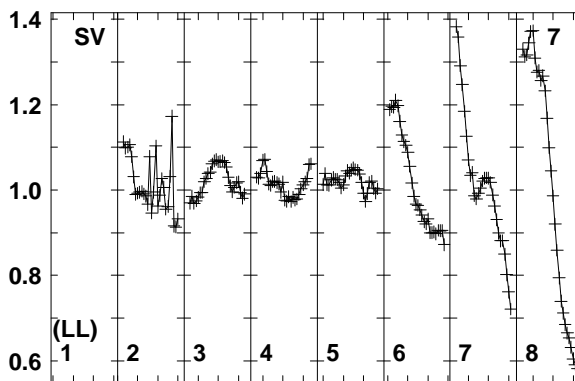
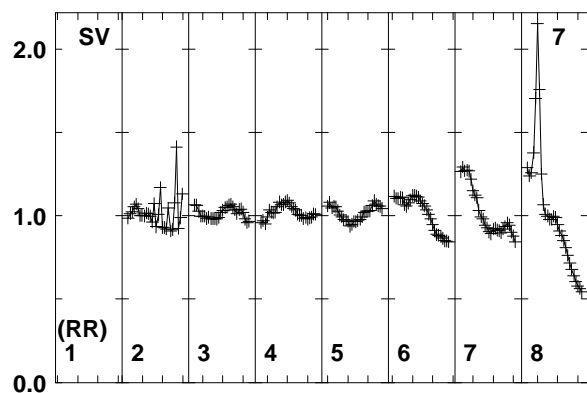
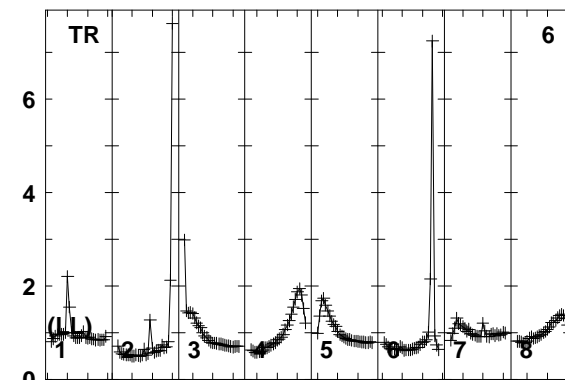
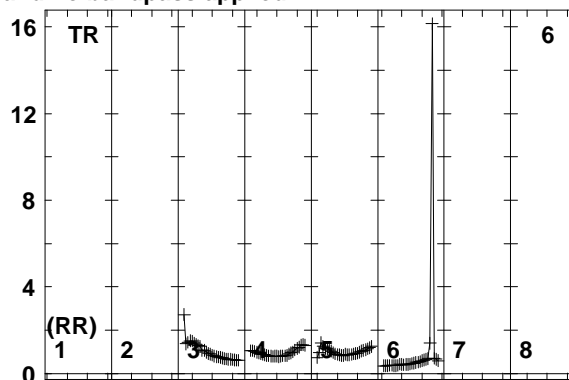
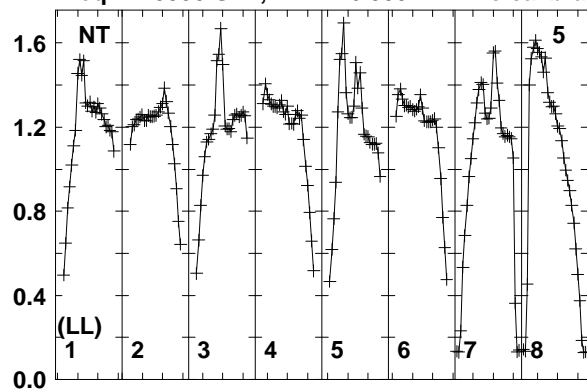

Lower frame: Real Jy
Total-power spectrum Antenna: NT (05)
Timerange: 00/05:18:51 to 00/05:20:49

Plot file version 131 created 11-AUG-2014 17:05:34

J2032+4127 EM110 2.UVDATA.1

Freq = 1.5950 GHz, Bw = 16.000 MH No calibration applied and no bandpass applied

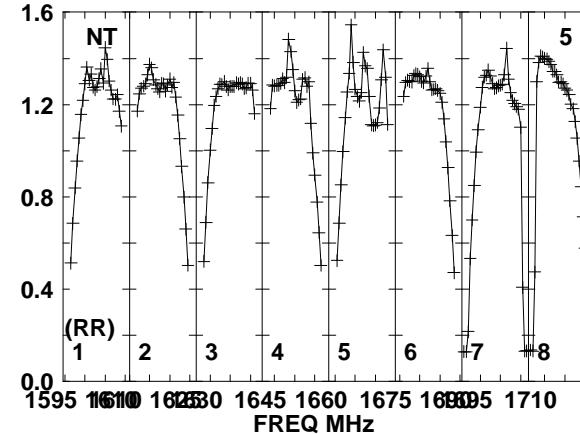
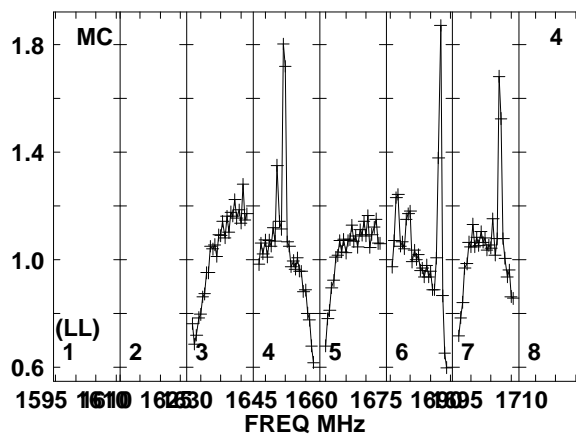
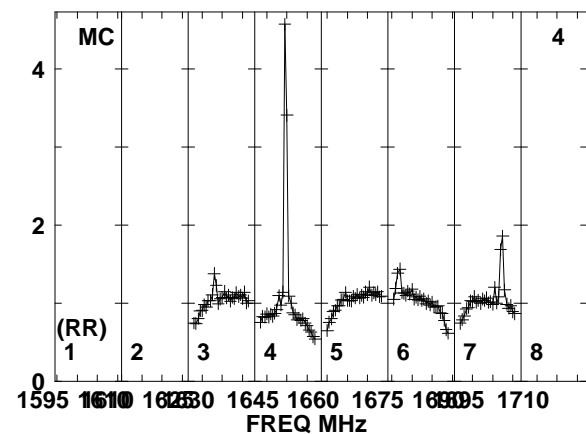
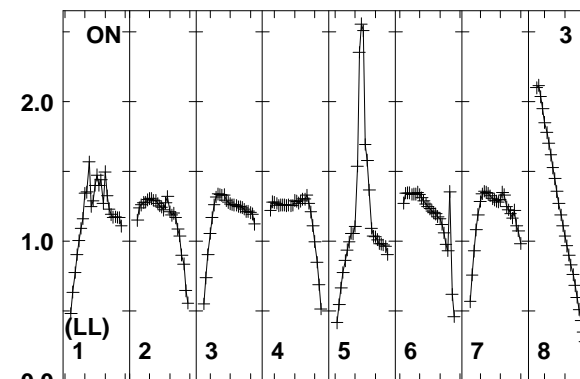
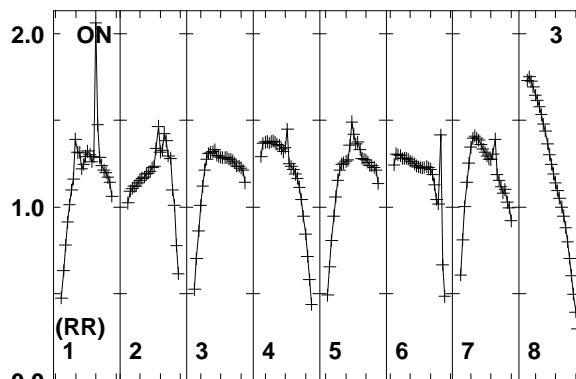
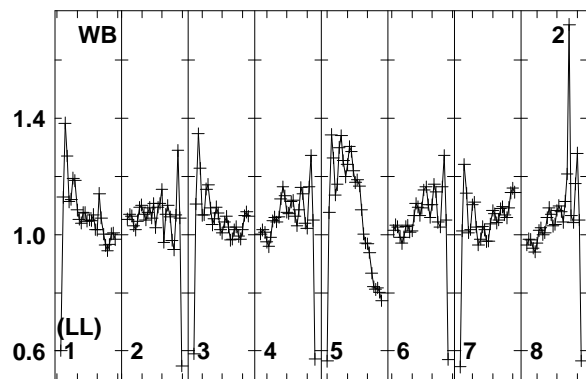
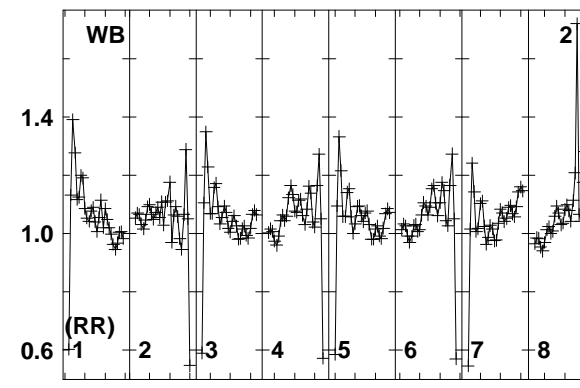
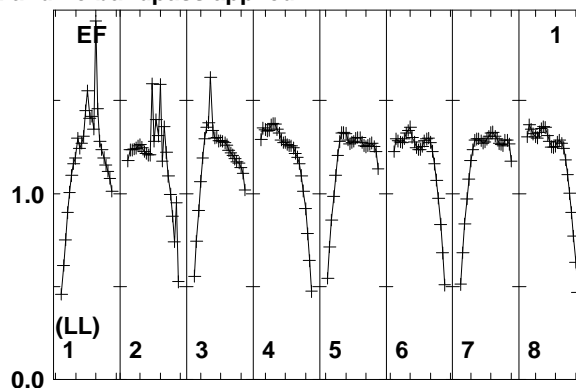
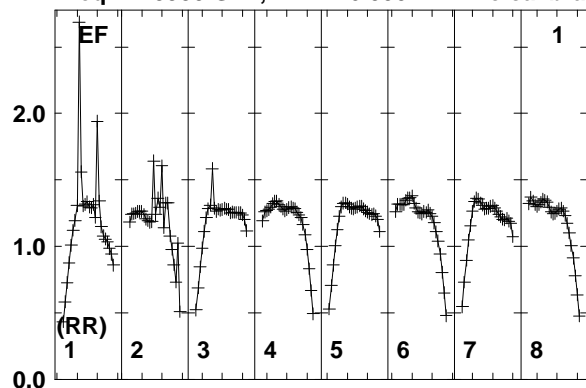

Lower frame: Real Jy
Total-power spectrum Antenna: EF (01)
Timerange: 00/05:20:51 to 00/05:24:49

Plot file version 132 created 11-AUG-2014 17:05:34

J2032+4127 EM110 2.UVDATA.1

Freq = 1.5950 GHz, Bw = 16.000 MH No calibration applied and no bandpass applied

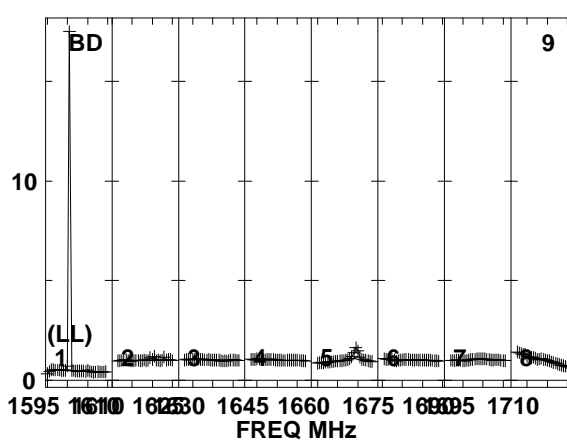
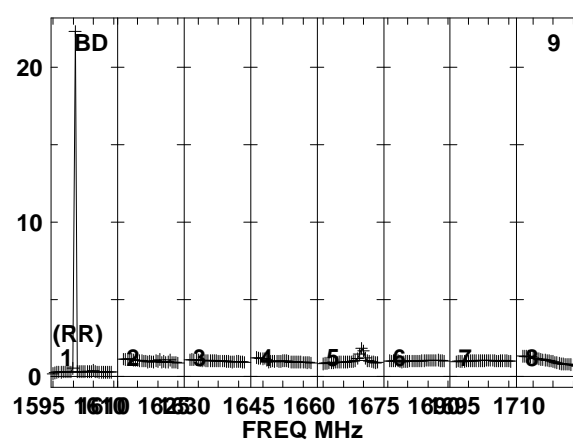
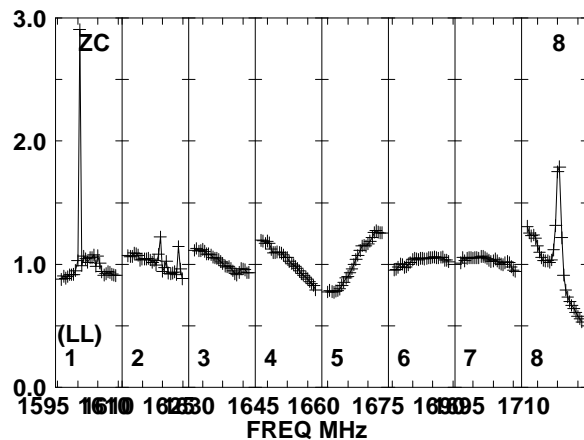
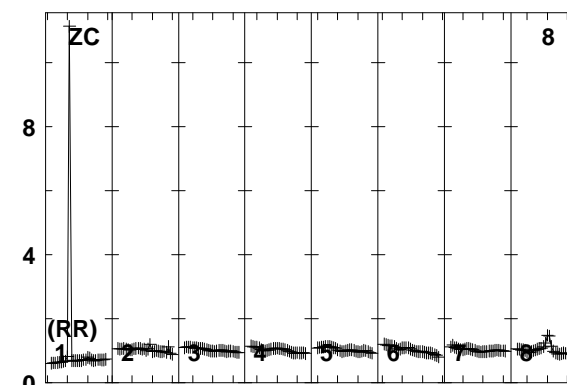
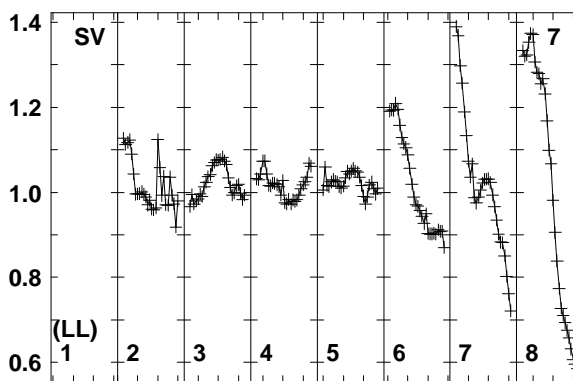
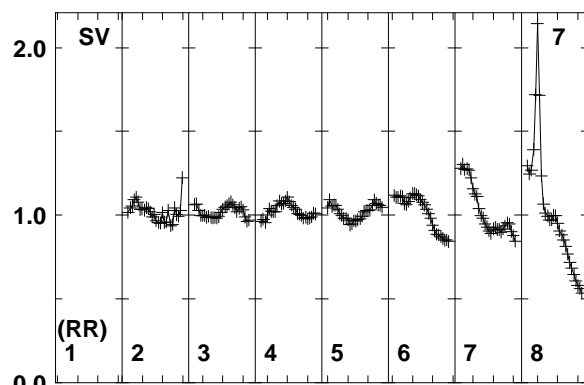
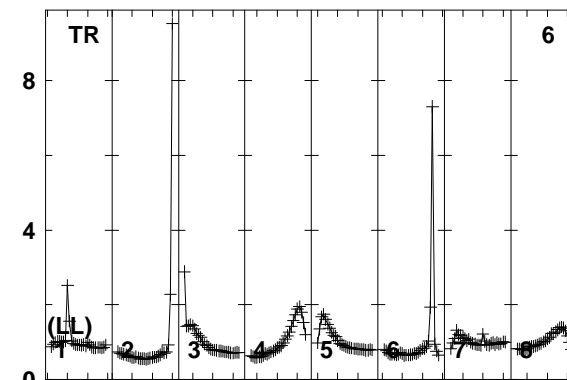
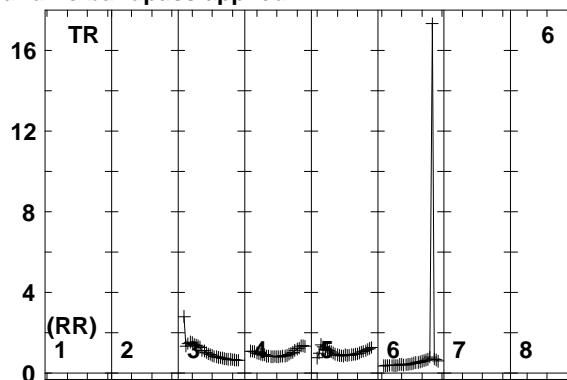
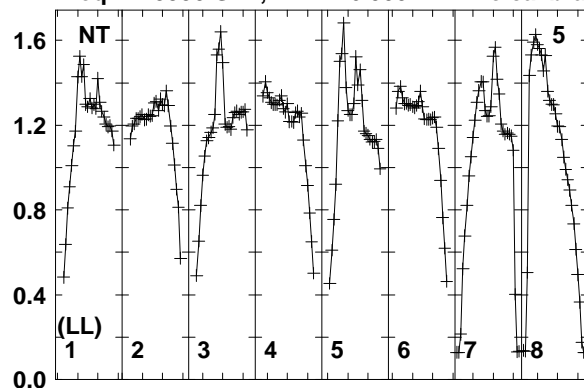

Lower frame: Real Jy
Total-power spectrum Antenna: NT (05)
Timerange: 00/05:20:51 to 00/05:24:49

Plot file version 133 created 11-AUG-2014 17:05:34

J2032+4127 EM110 2.UVDATA.1

Freq = 1.5950 GHz, Bw = 16.000 MH No calibration applied and no bandpass applied

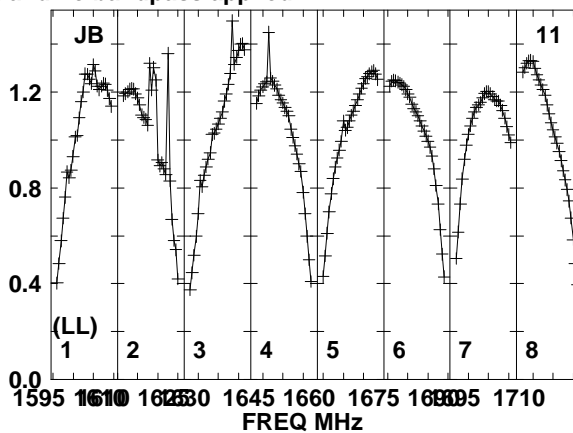
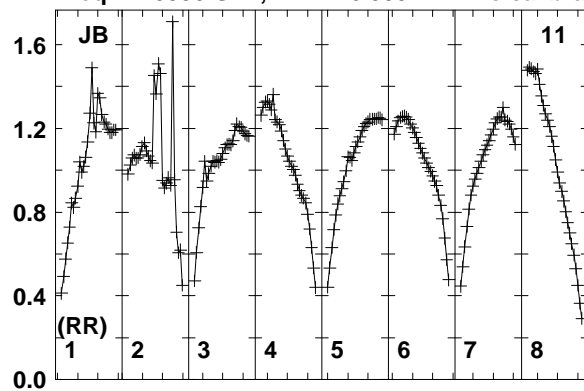

Lower frame: Real Jy
Total-power spectrum Antenna: JB (11)
Timerange: 00/05:20:51 to 00/05:24:49

Plot file version 134 created 11-AUG-2014 17:05:34

J2015+3710 EM110 2.UVDATA.1

Freq = 1.5950 GHz, Bw = 16.000 MH No calibration applied and no bandpass applied

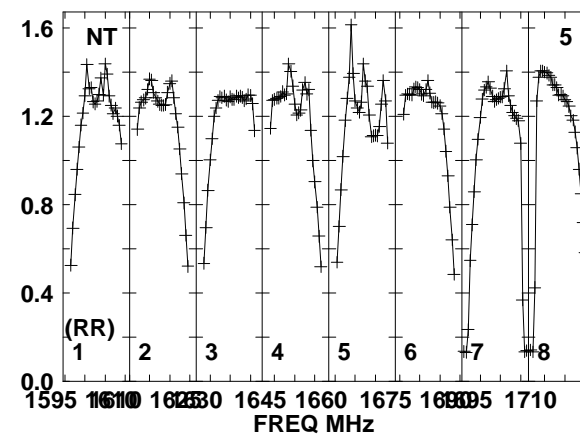
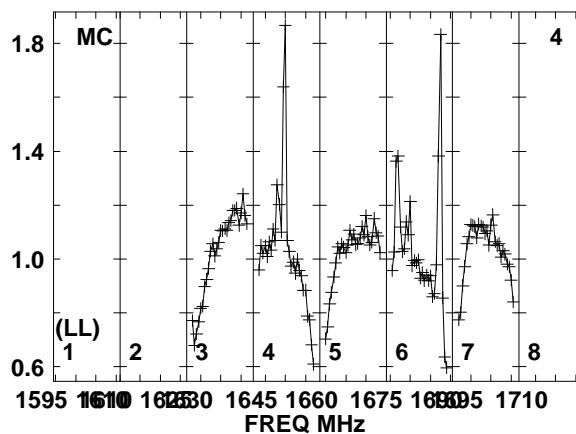
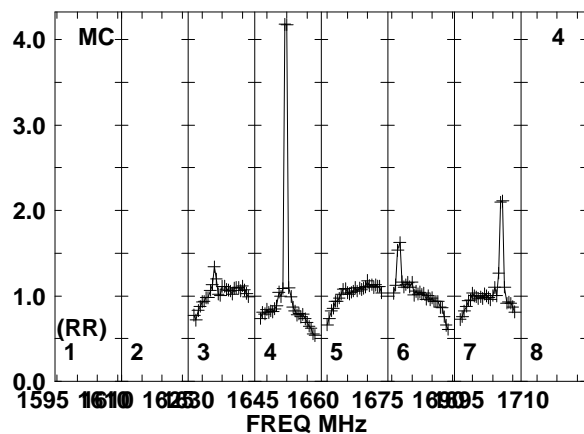
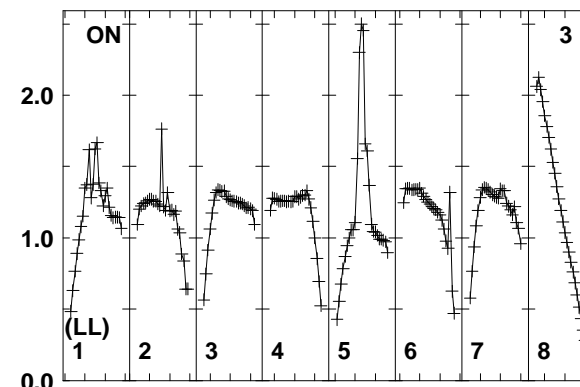
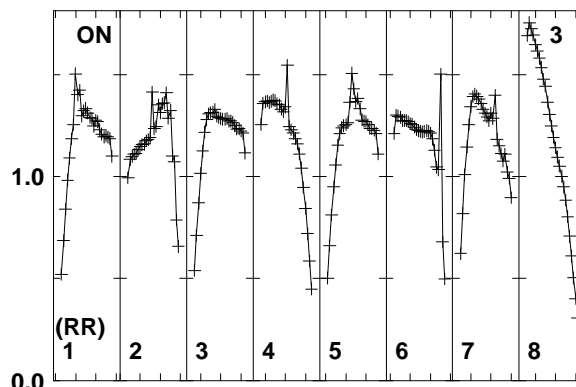
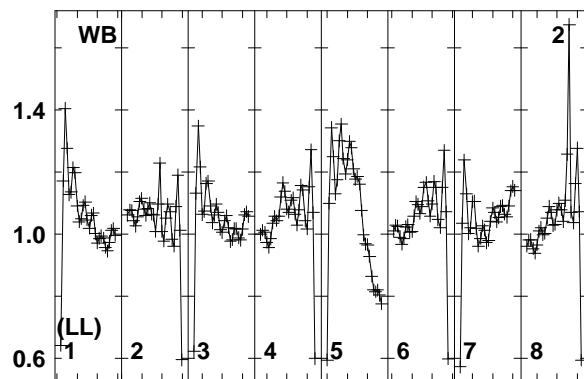
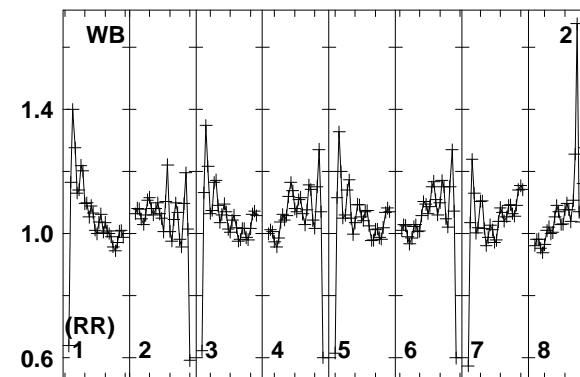
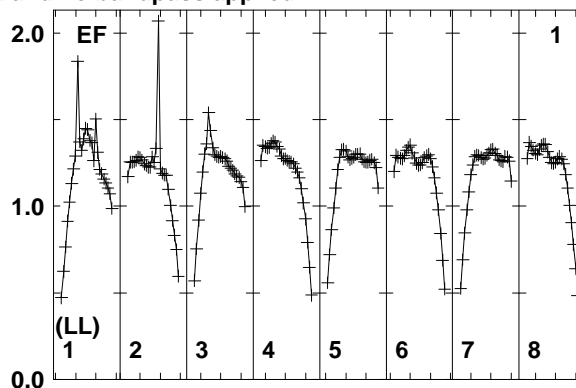
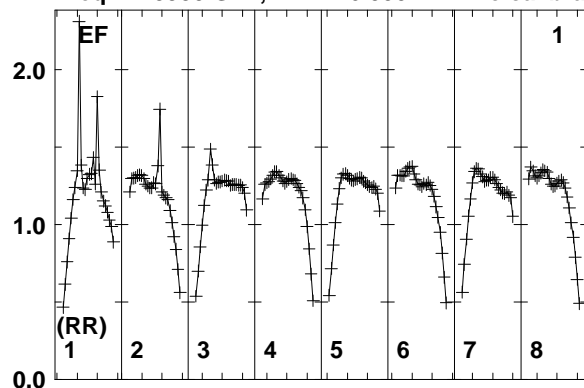

Lower frame: Real Jy
Total-power spectrum Antenna: EF (01)
Timerange: 00/05:25:51 to 00/05:27:49

Plot file version 135 created 11-AUG-2014 17:05:34

J2015+3710 EM110 2.UVDATA.1

Freq = 1.5950 GHz, Bw = 16.000 MH No calibration applied and no bandpass applied

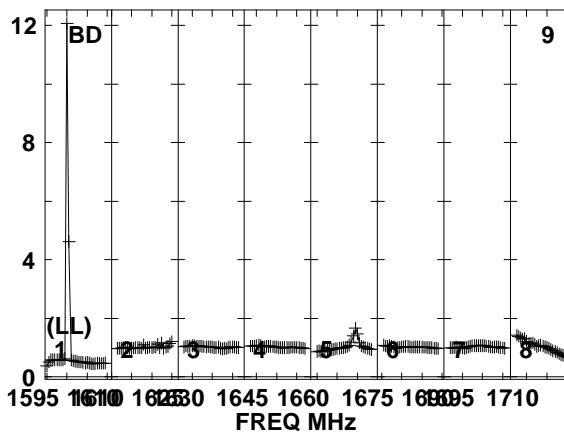
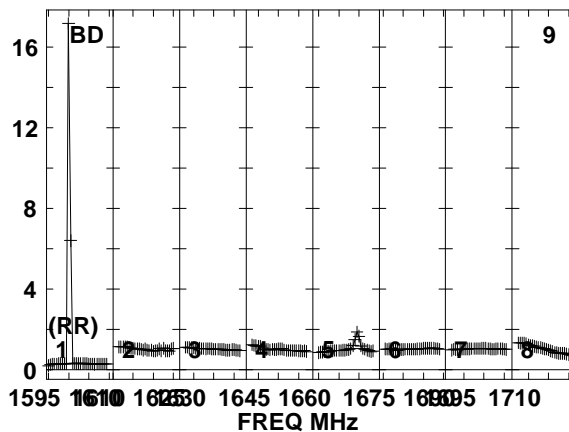
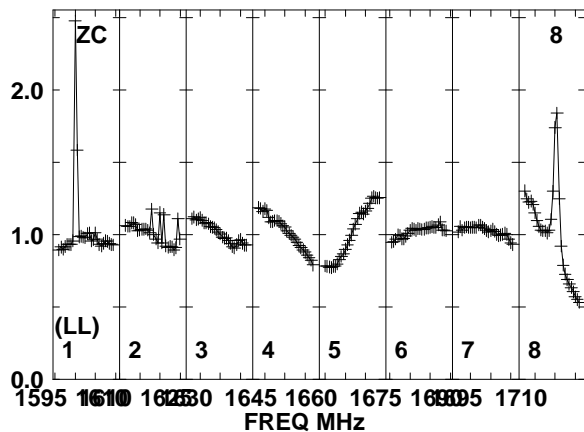
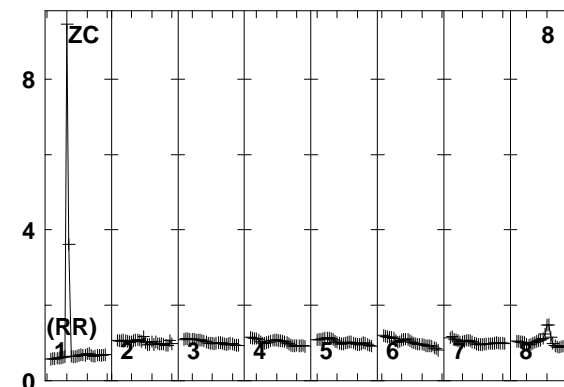
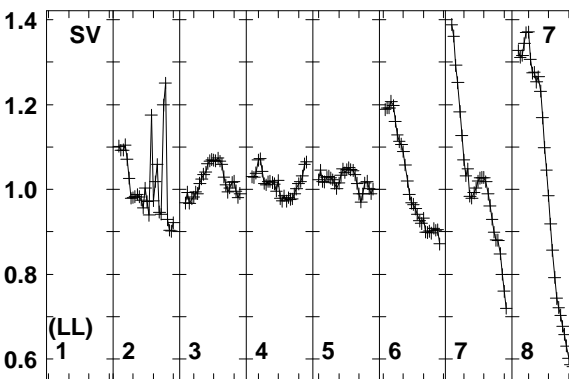
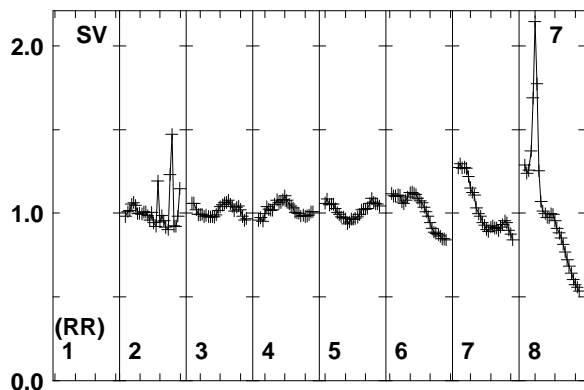
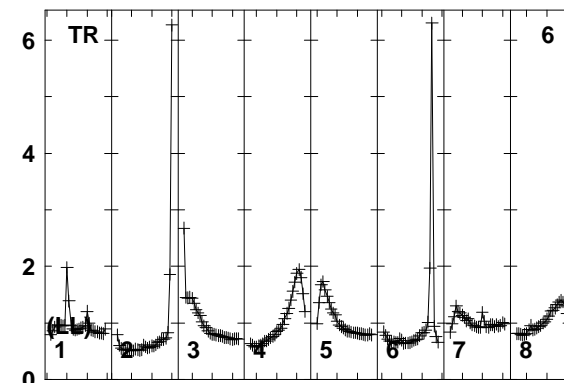
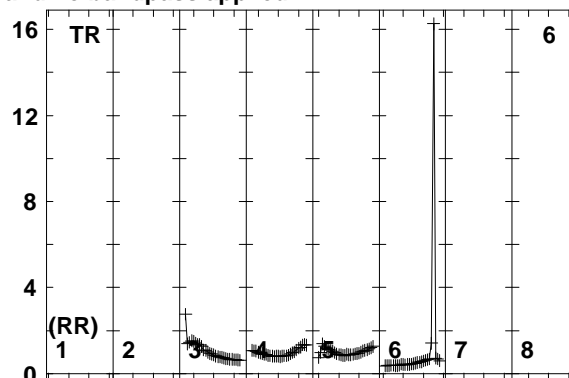
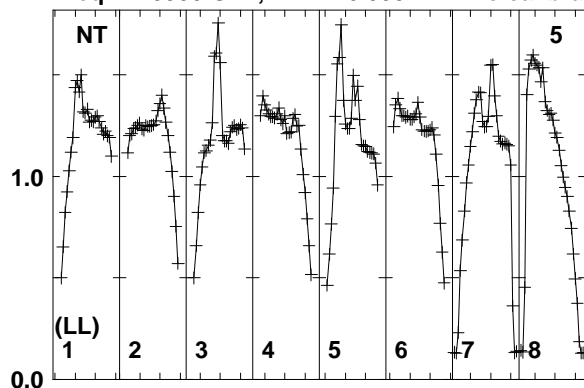

Lower frame: Real Jy
Total-power spectrum Antenna: NT (05)
Timerange: 00/05:25:51 to 00/05:27:49

Plot file version 136 created 11-AUG-2014 17:05:34

J2015+3710 EM110 2.UVDATA.1

Freq = 1.5950 GHz, Bw = 16.000 MH No calibration applied and no bandpass applied

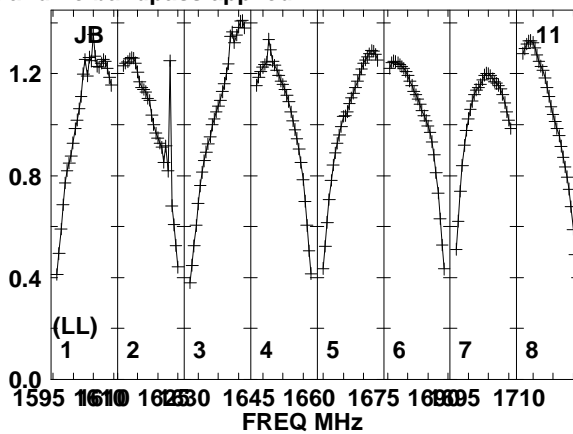
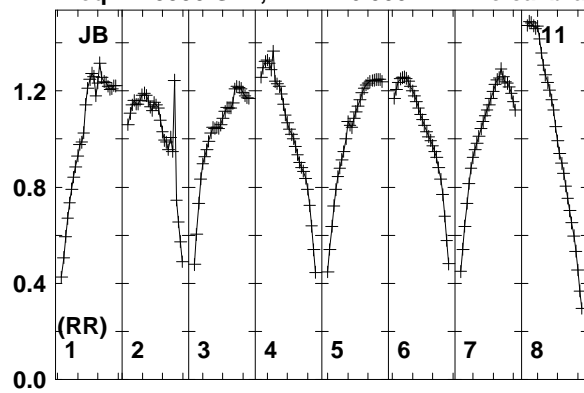

Lower frame: Real Jy
Total-power spectrum Antenna: JB (11)
Timerange: 00/05:25:51 to 00/05:27:49

Plot file version 137 created 11-AUG-2014 17:05:34

J2032+4127 EM110 2.UVDATA.1

Freq = 1.5950 GHz, Bw = 16.000 MH No calibration applied and no bandpass applied

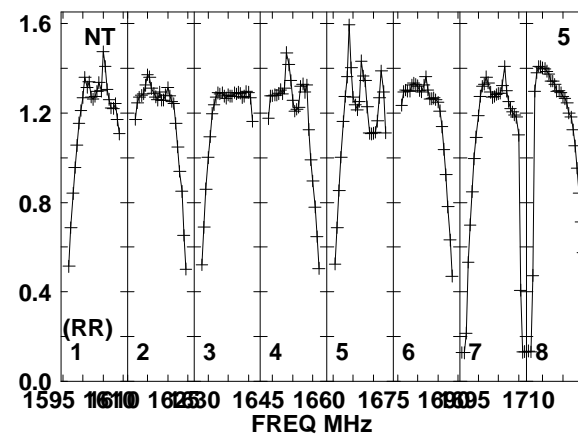
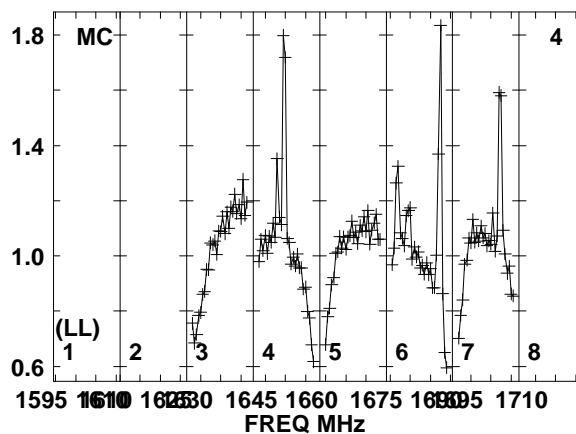
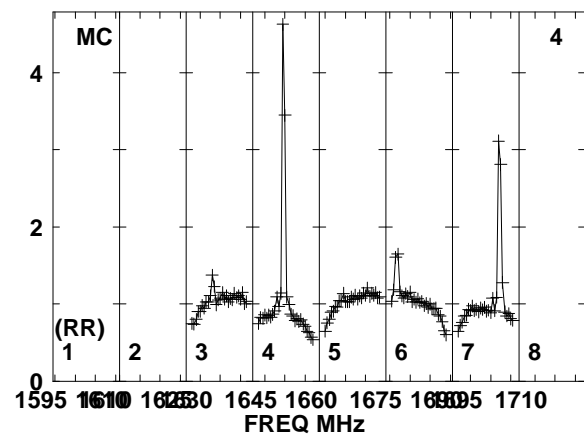
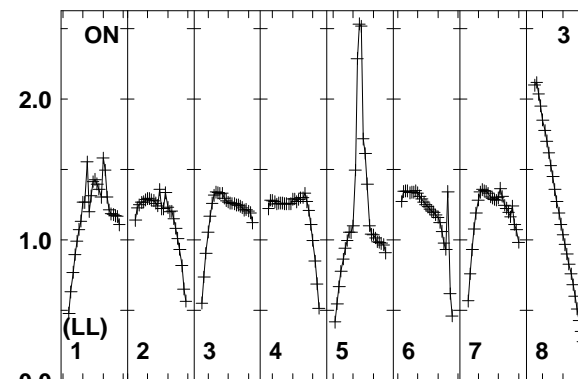
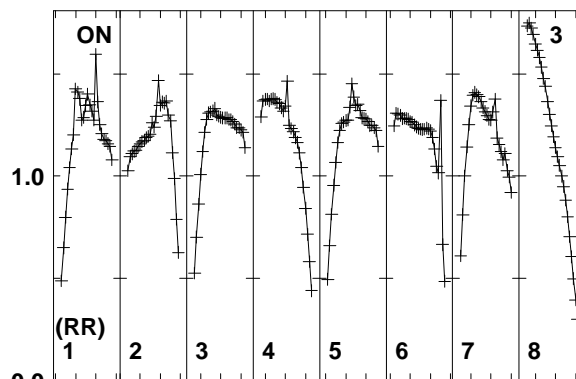
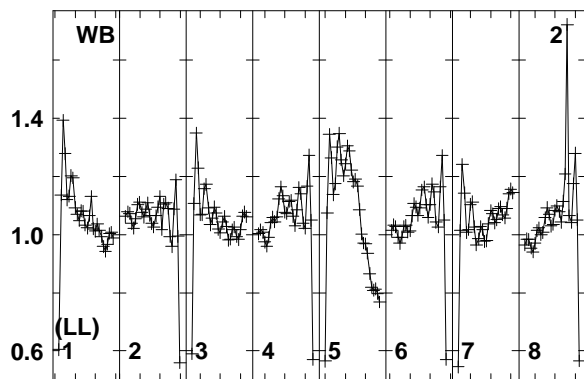
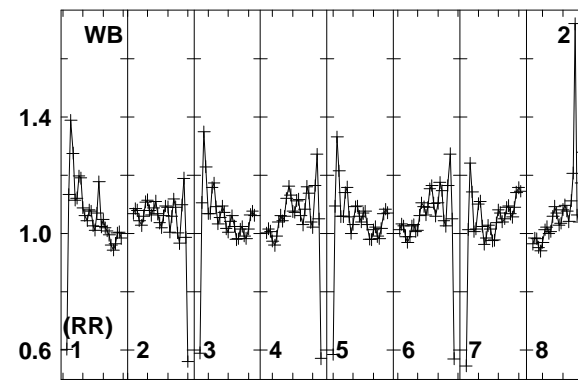
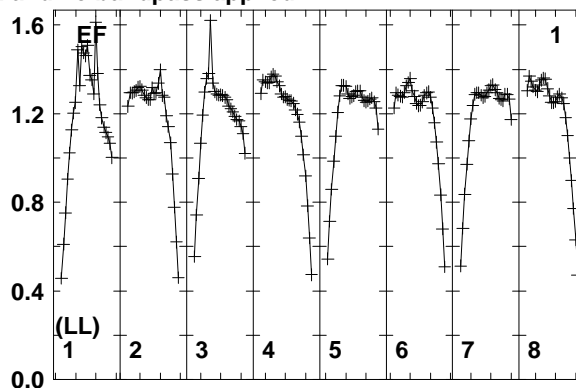
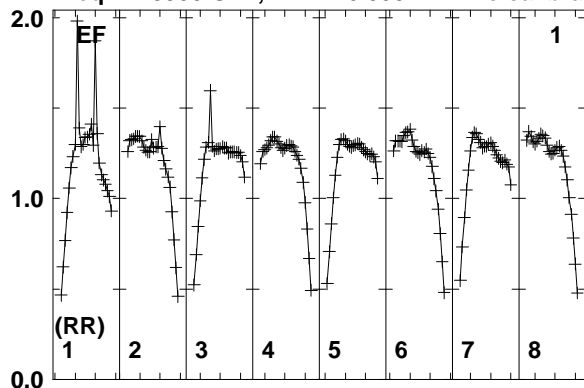

Lower frame: Real Jy
Total-power spectrum Antenna: EF (01)
Timerange: 00/05:28:03 to 00/05:31:49

Plot file version 138 created 11-AUG-2014 17:05:34

J2032+4127 EM110 2.UVDATA.1

Freq = 1.5950 GHz, Bw = 16.000 MH No calibration applied and no bandpass applied

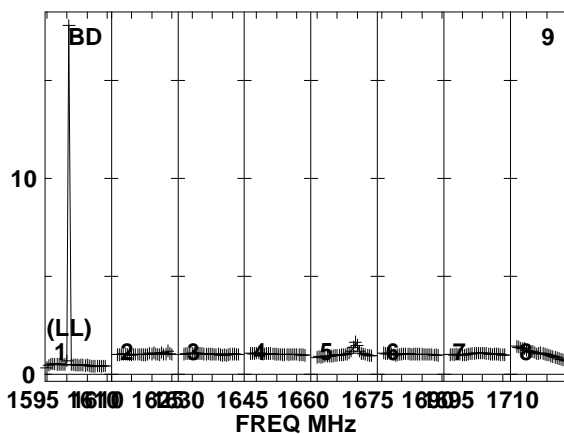
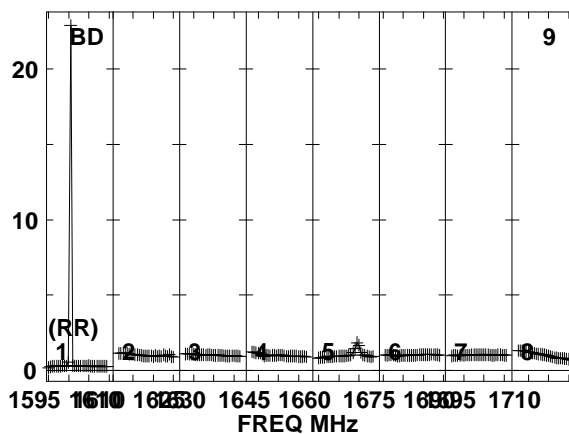
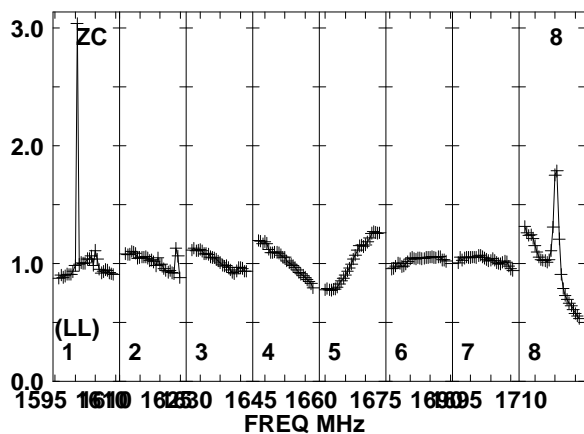
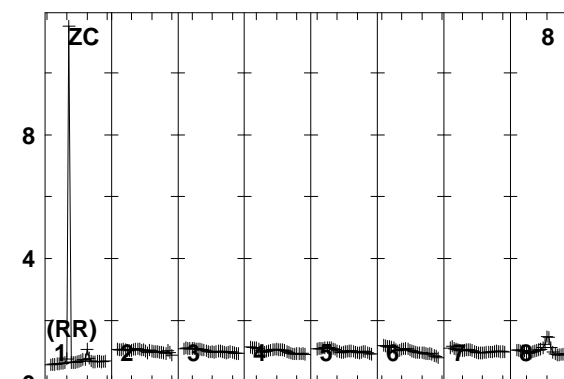
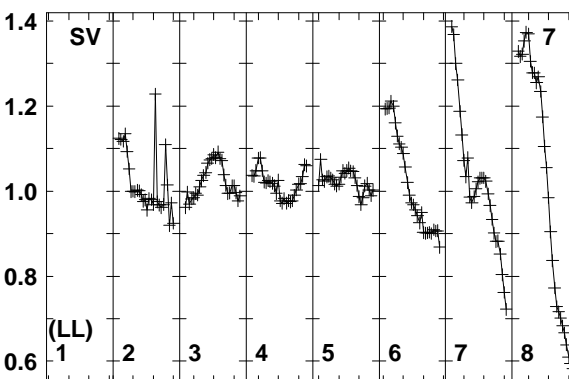
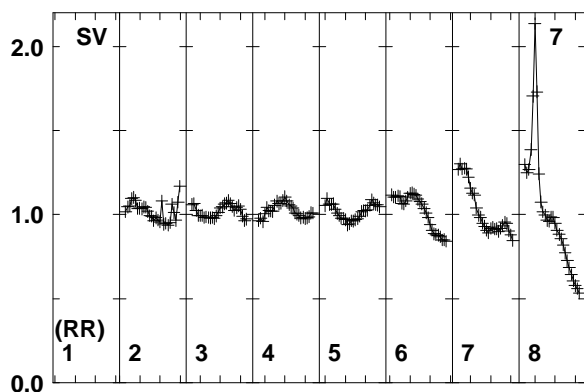
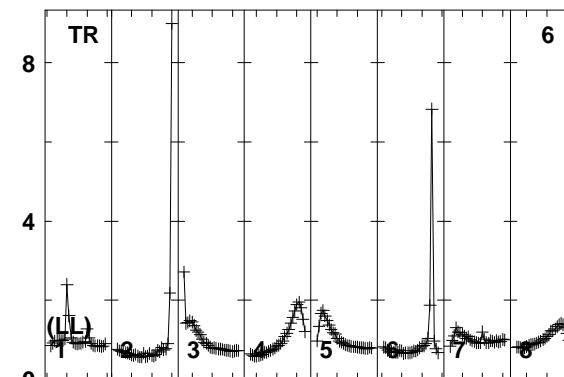
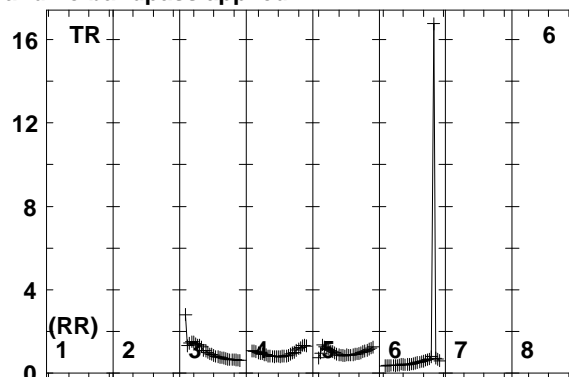
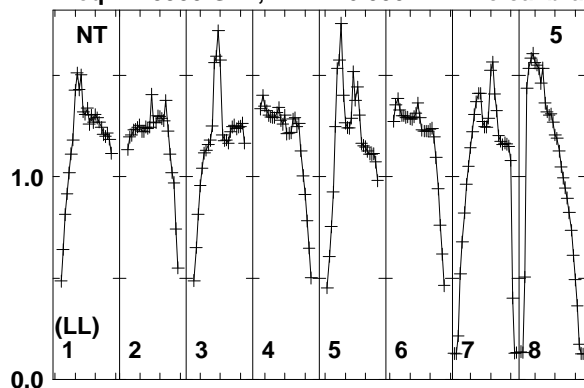

Lower frame: Real Jy
Total-power spectrum Antenna: NT (05)
Timerange: 00/05:28:03 to 00/05:31:49

Plot file version 139 created 11-AUG-2014 17:05:34

J2032+4127 EM110 2.UVDATA.1

Freq = 1.5950 GHz, Bw = 16.000 MH No calibration applied and no bandpass applied

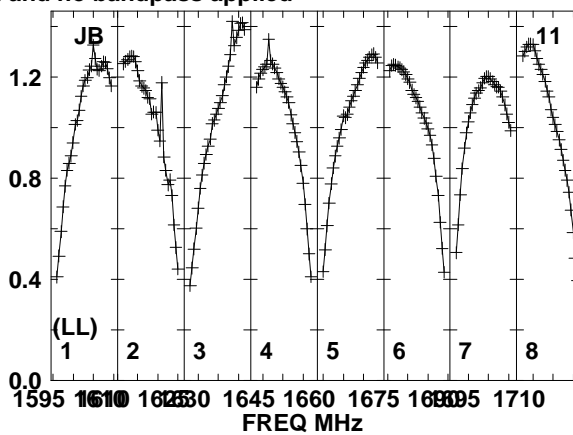
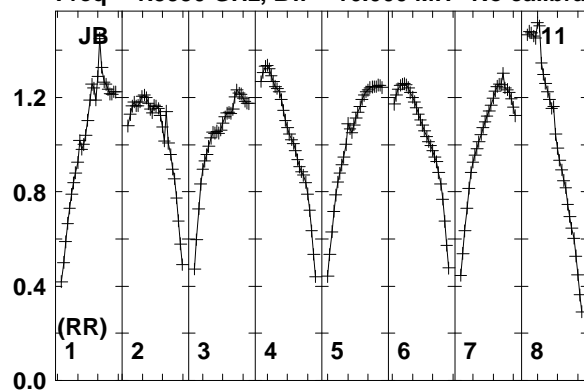

Lower frame: Real Jy
Total-power spectrum Antenna: JB (11)
Timerange: 00/05:28:03 to 00/05:31:49

Plot file version 140 created 11-AUG-2014 17:05:34

J2015+3710 EM110 2.UVDATA.1

Freq = 1.5950 GHz, Bw = 16.000 MH No calibration applied and no bandpass applied

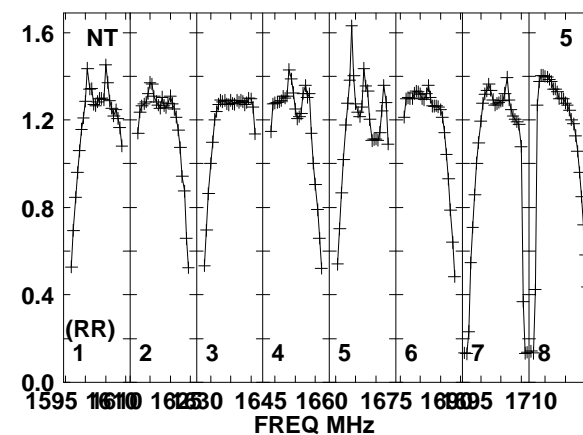
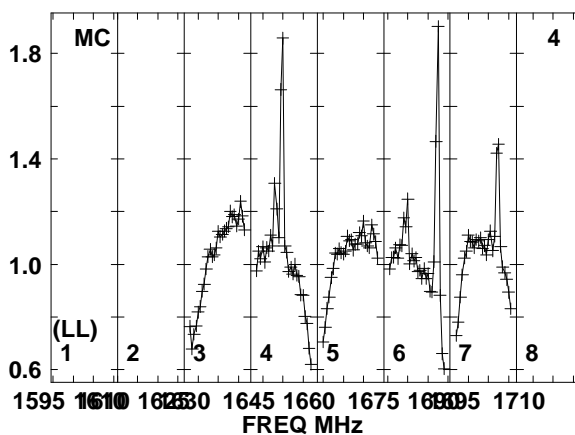
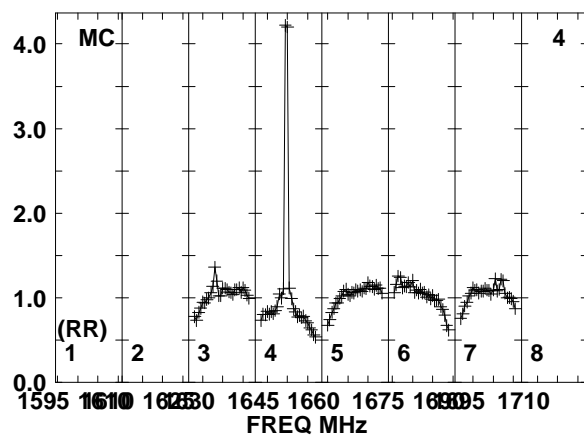
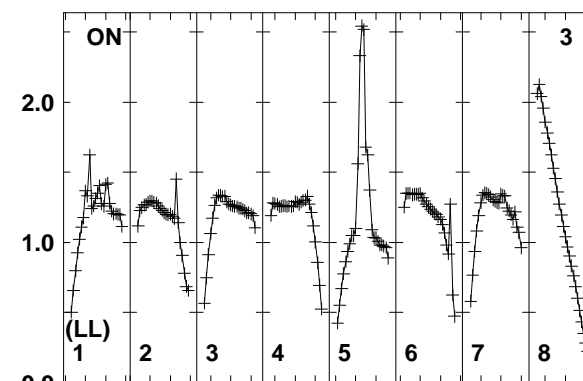
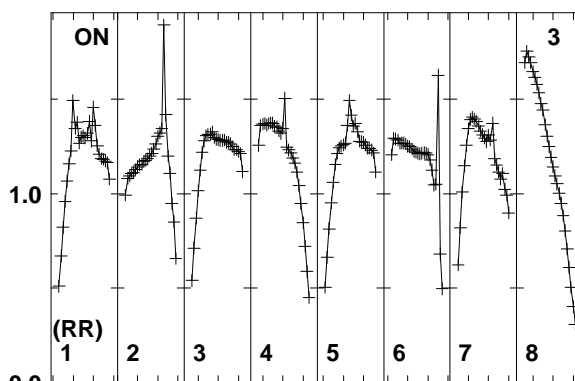
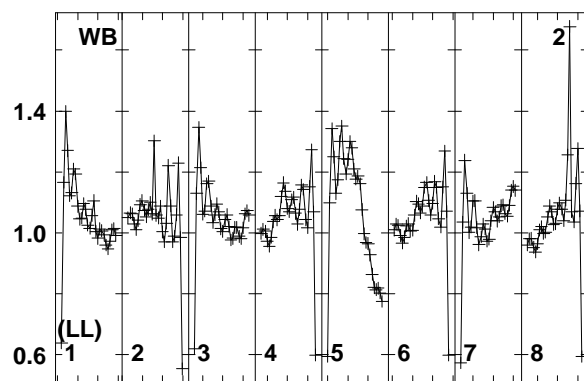
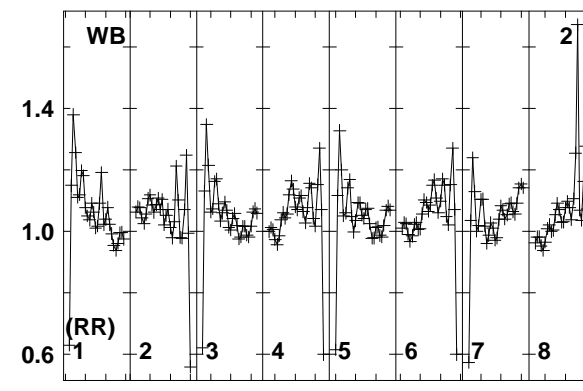
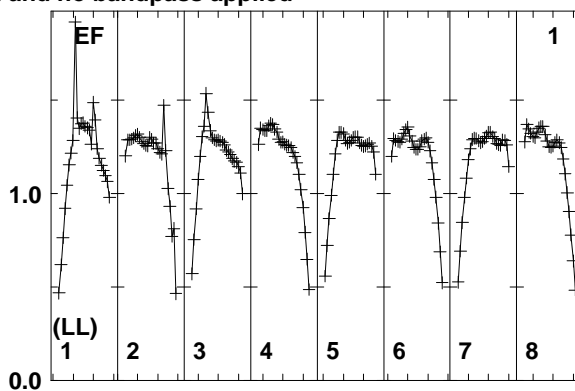
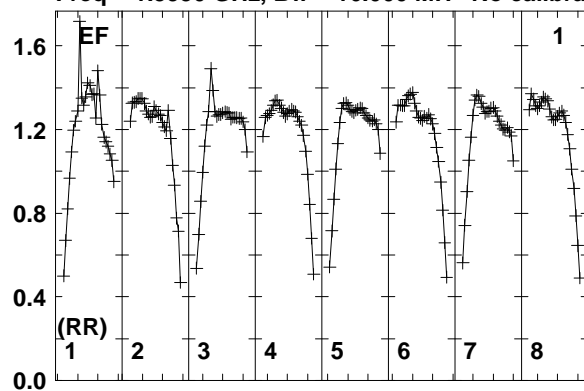

Lower frame: Real Jy
Total-power spectrum Antenna: EF (01)
Timerange: 00/05:32:04 to 00/05:33:48

Plot file version 141 created 11-AUG-2014 17:05:34

J2015+3710 EM110 2.UVDATA.1

Freq = 1.5950 GHz, Bw = 16.000 MH No calibration applied and no bandpass applied

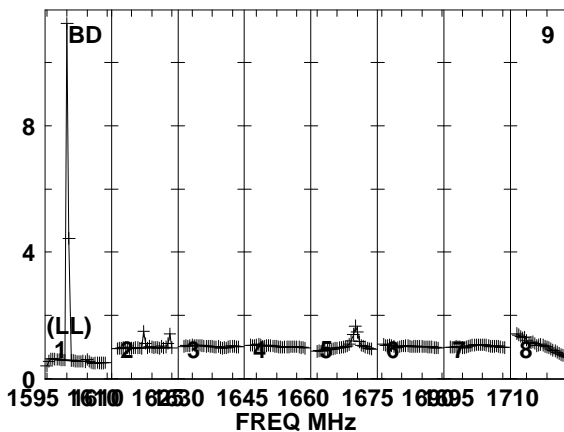
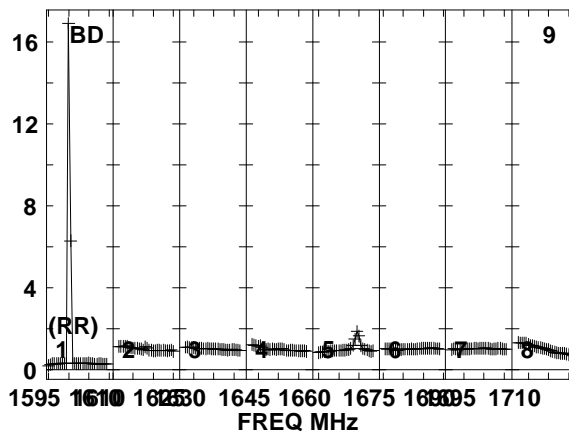
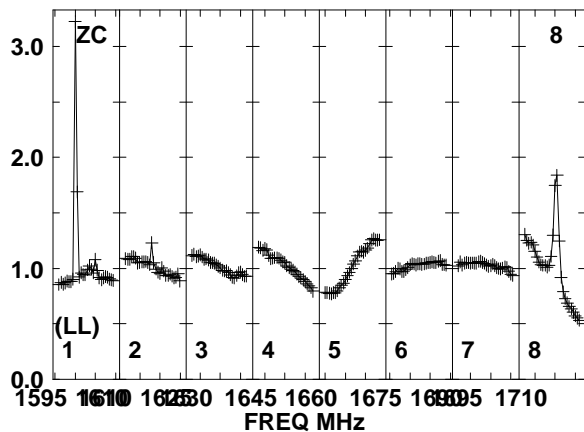
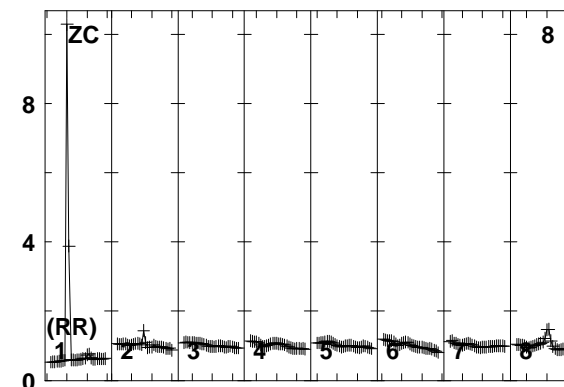
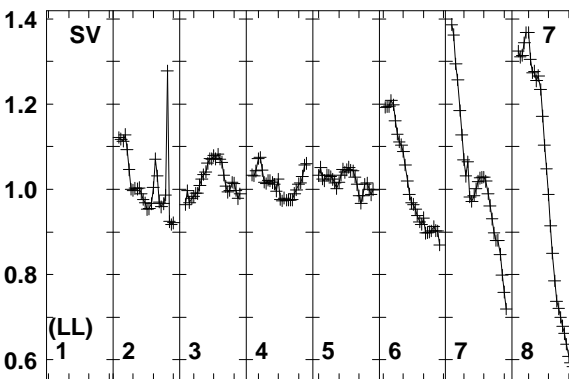
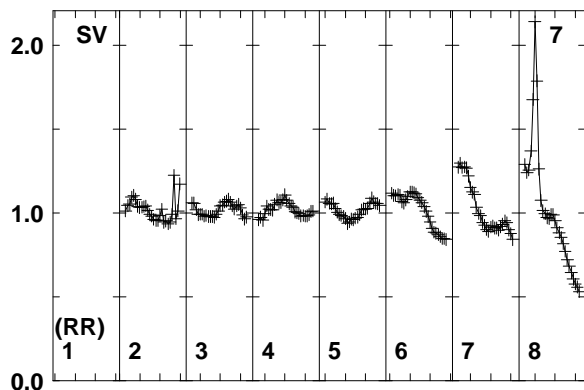
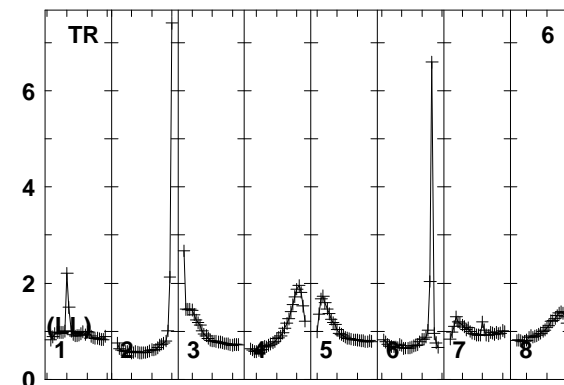
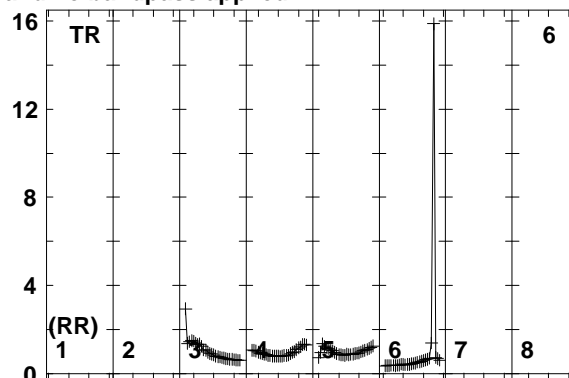
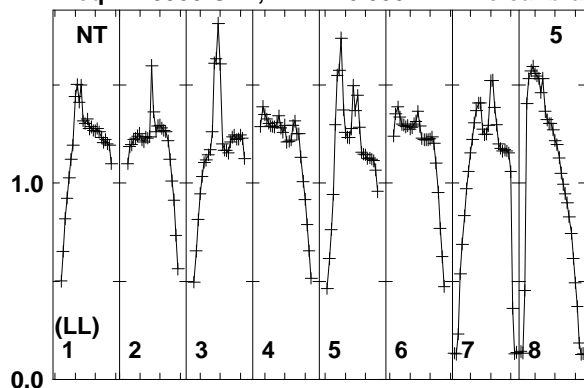

Lower frame: Real Jy
Total-power spectrum Antenna: NT (05)
Timerange: 00/05:32:04 to 00/05:33:48

Plot file version 142 created 11-AUG-2014 17:05:34

J2032+4127 EM110 2.UVDATA.1

Freq = 1.5950 GHz, Bw = 16.000 MH No calibration applied and no bandpass applied

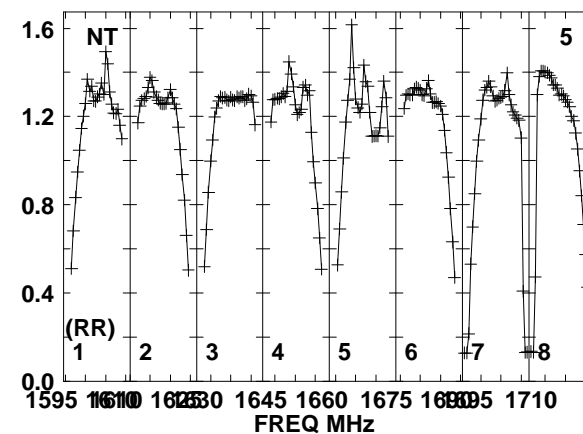
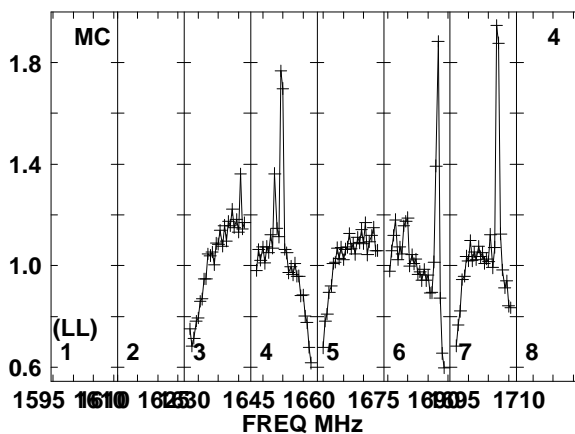
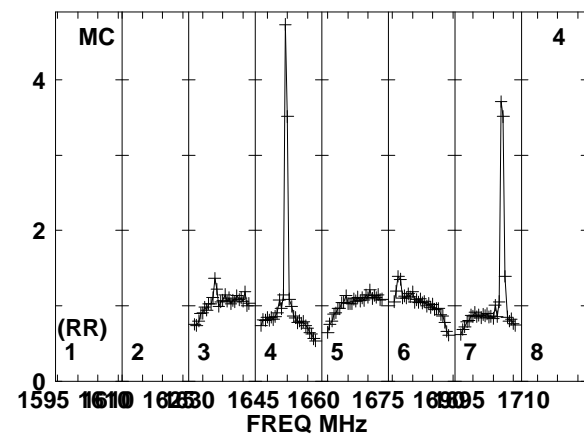
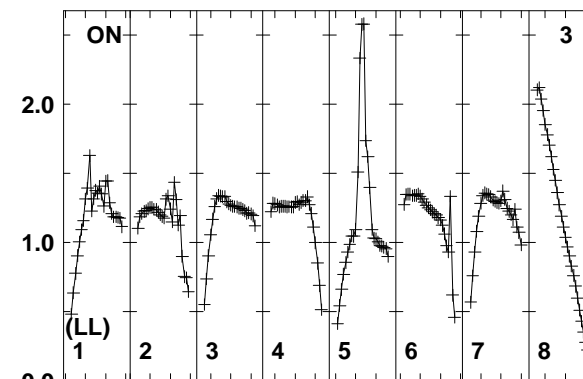
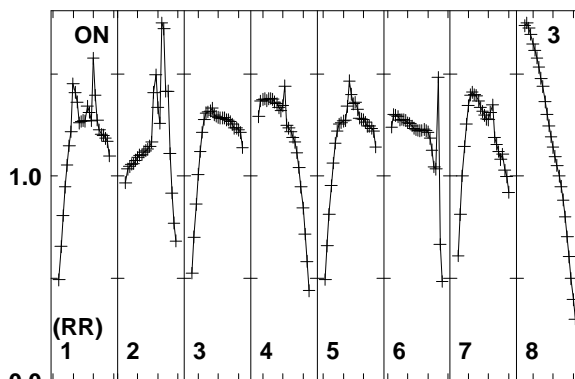
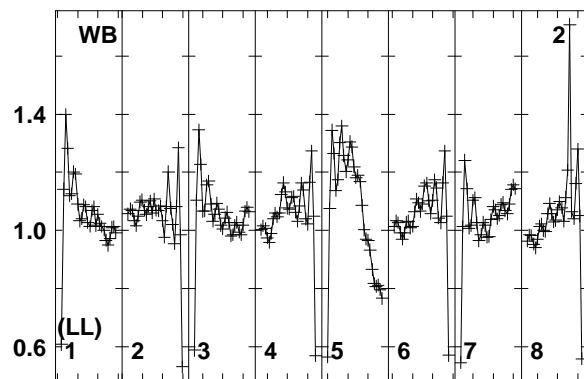
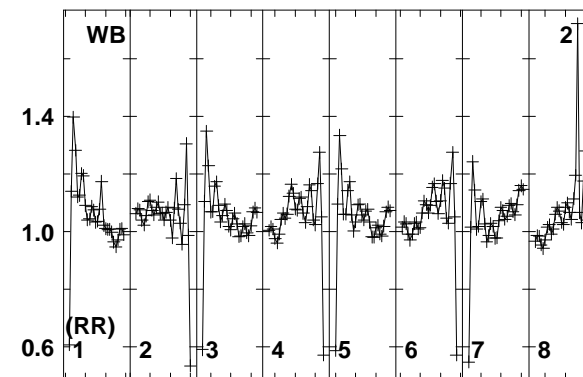
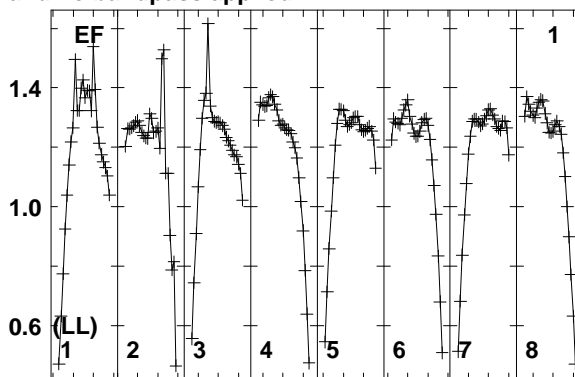
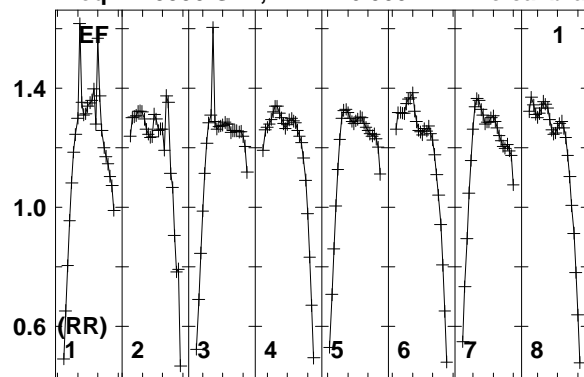

Lower frame: Real Jy
Total-power spectrum Antenna: EF (01)
Timerange: 00/05:33:51 to 00/05:37:49

Plot file version 143 created 11-AUG-2014 17:05:34

J2032+4127 EM110 2.UVDATA.1

Freq = 1.5950 GHz, Bw = 16.000 MH No calibration applied and no bandpass applied

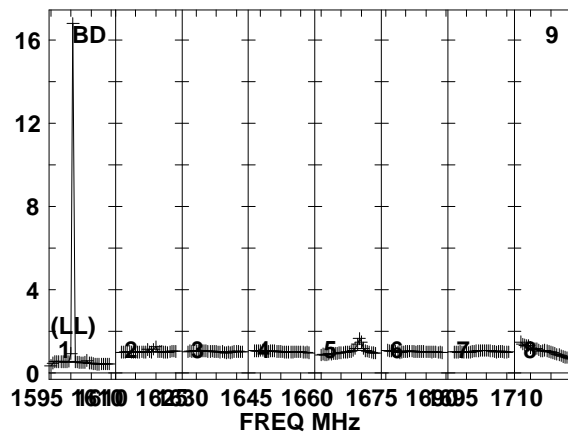
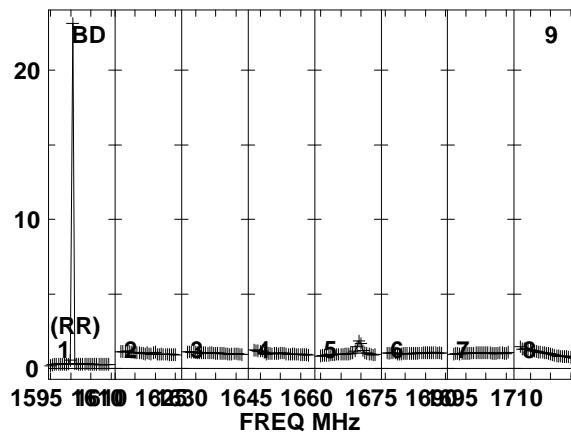
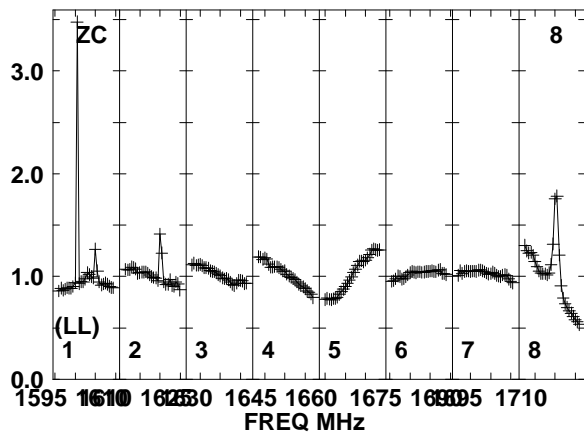
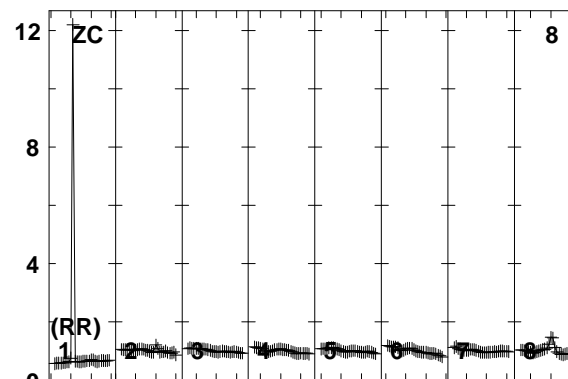
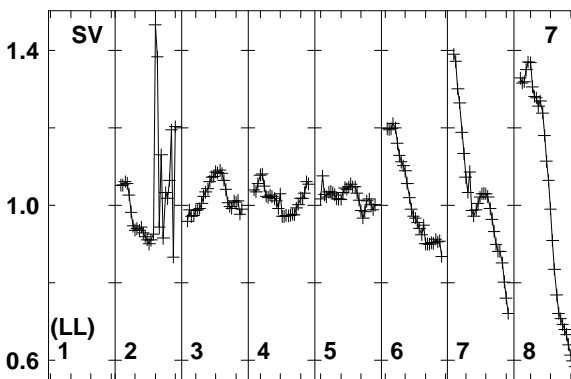
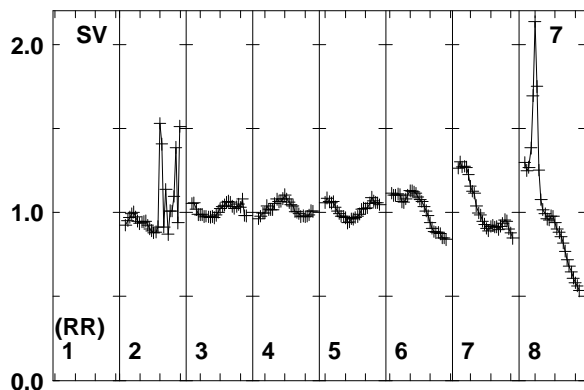
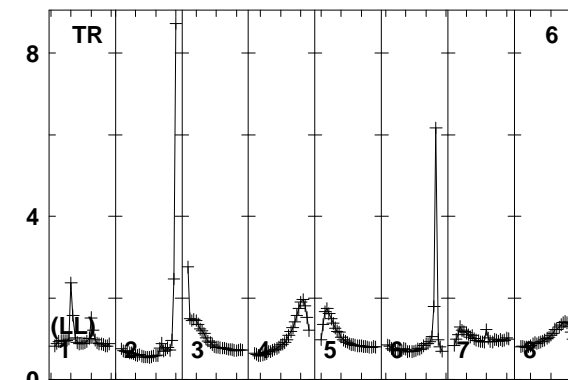
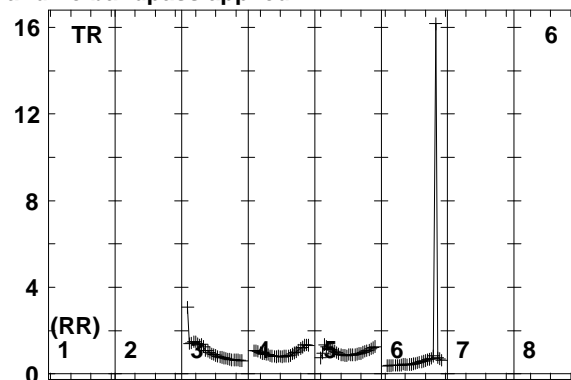
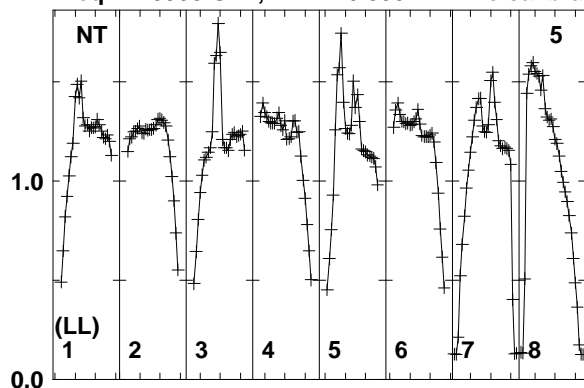

Lower frame: Real Jy
Total-power spectrum Antenna: NT (05)
Timerange: 00/05:33:51 to 00/05:37:49

Plot file version 144 created 11-AUG-2014 17:05:34

J2032+4127 EM110 2.UVDATA.1

Freq = 1.5950 GHz, Bw = 16.000 MH No calibration applied and no bandpass applied

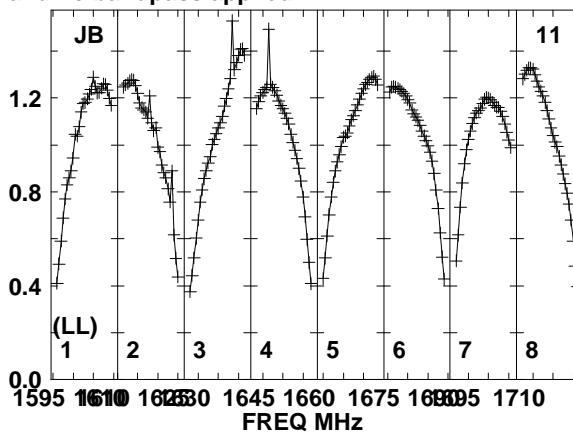
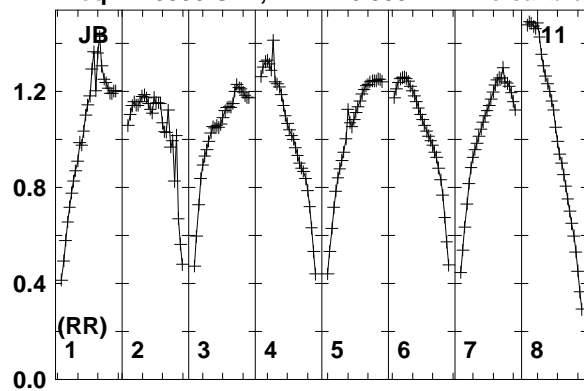

Lower frame: Real Jy
Total-power spectrum Antenna: JB (11)
Timerange: 00/05:33:51 to 00/05:37:49

Plot file version 145 created 11-AUG-2014 17:05:34

J2015+3710 EM110 2.UVDATA.1

Freq = 1.5950 GHz, Bw = 16.000 MH No calibration applied and no bandpass applied

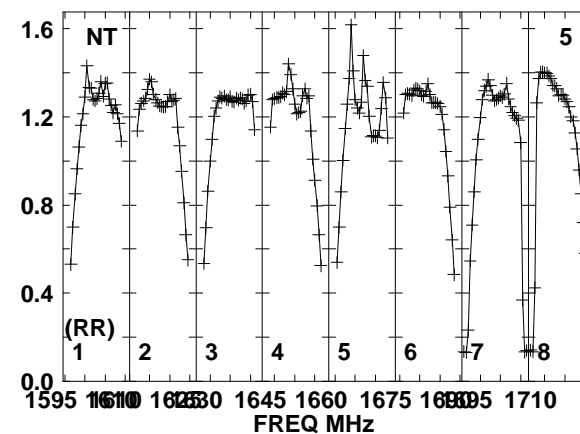
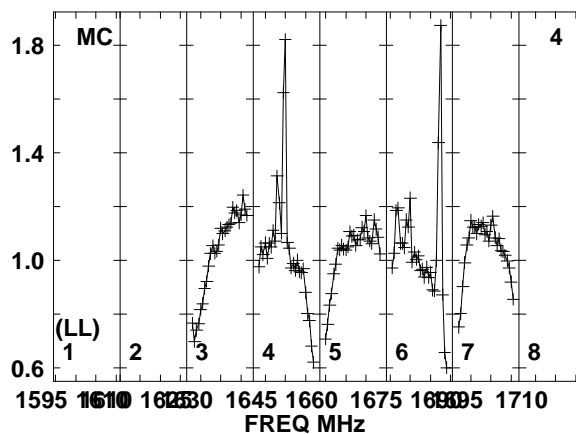
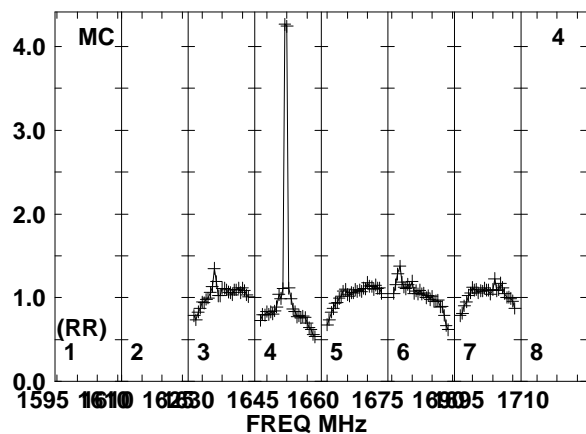
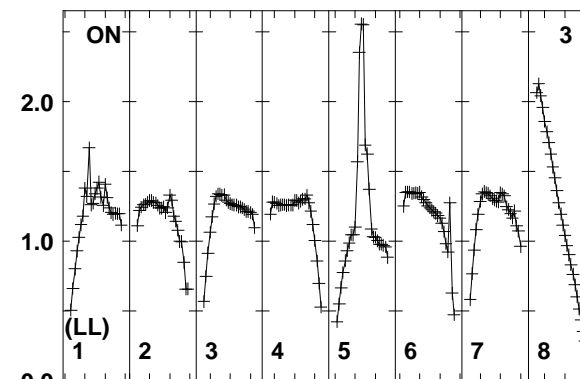
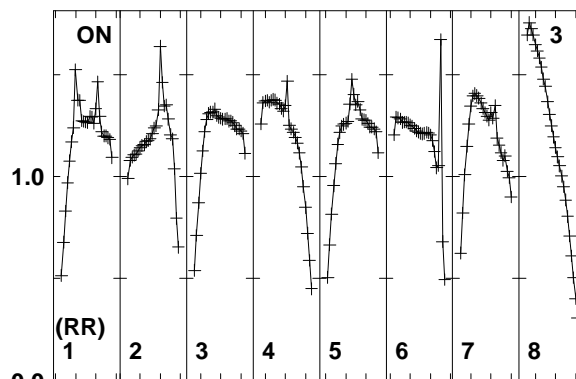
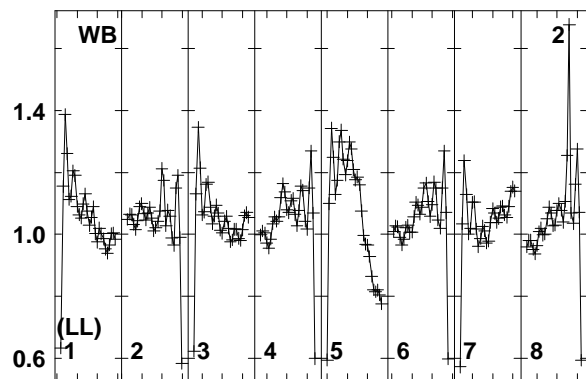
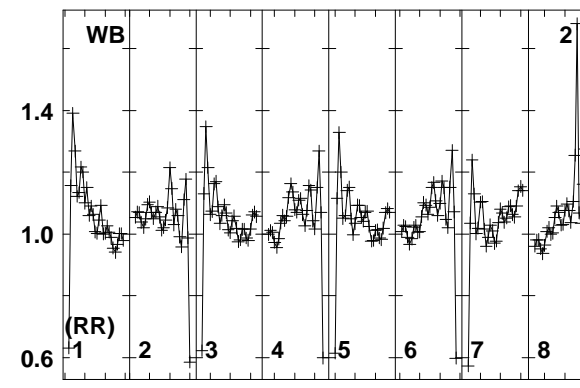
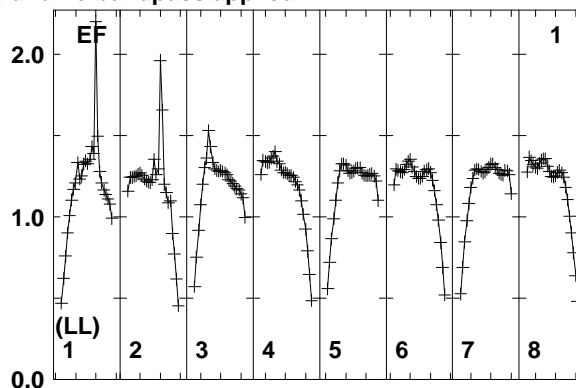
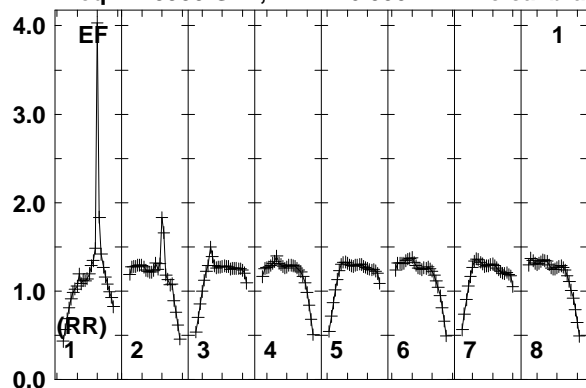

Lower frame: Real Jy
Total-power spectrum Antenna: EF (01)
Timerange: 00/05:38:51 to 00/05:40:49

Plot file version 146 created 11-AUG-2014 17:05:34

J2015+3710 EM110 2.UVDATA.1

Freq = 1.5950 GHz, Bw = 16.000 MH No calibration applied and no bandpass applied

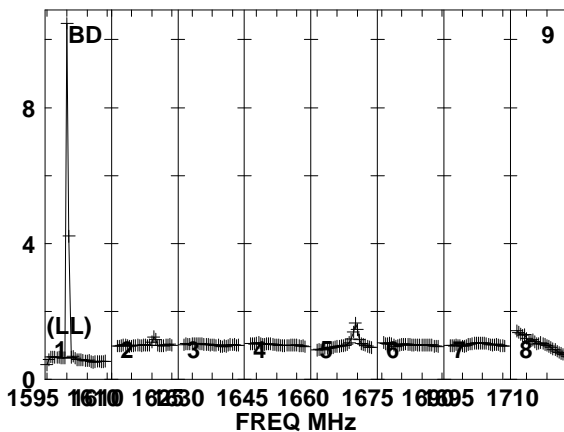
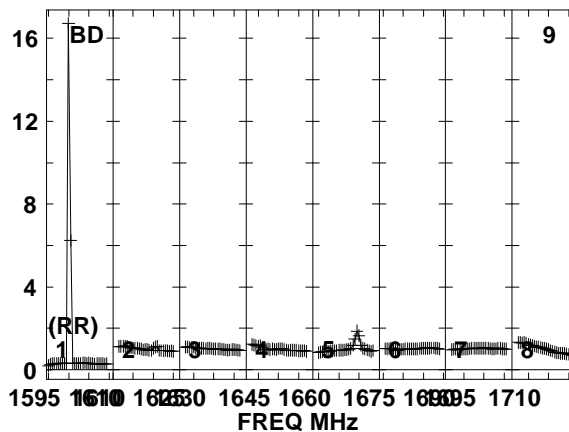
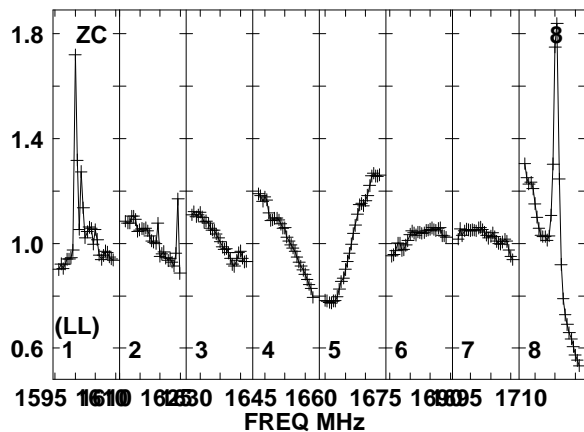
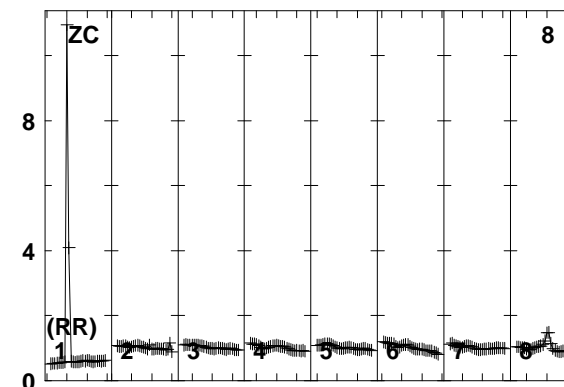
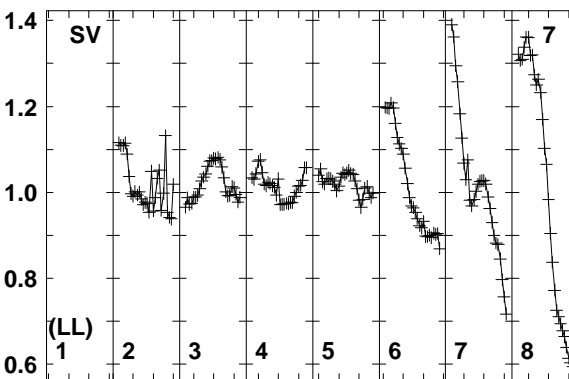
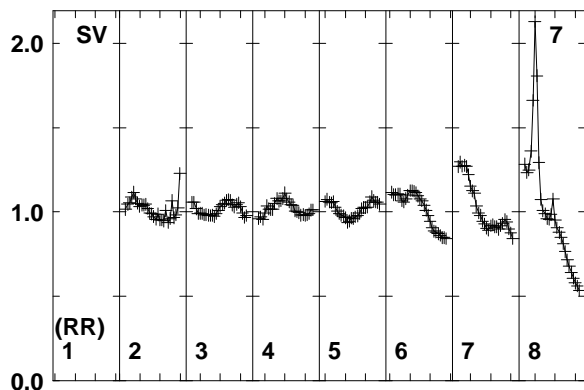
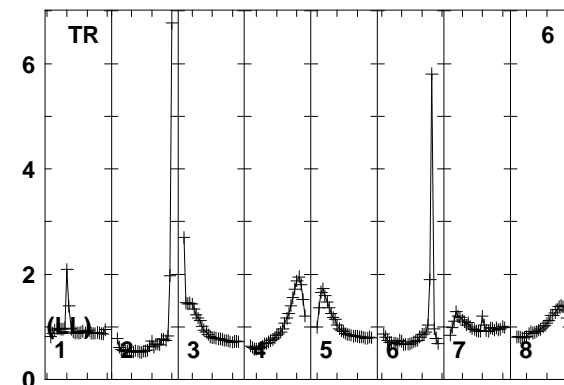
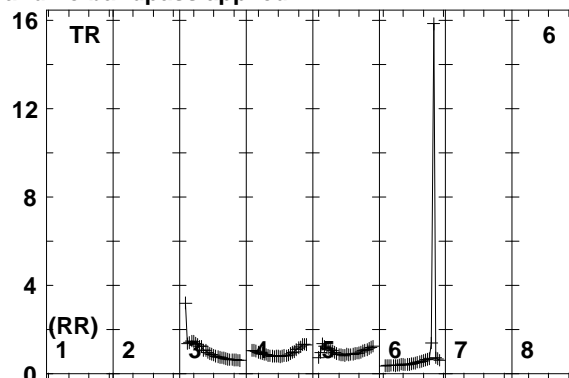
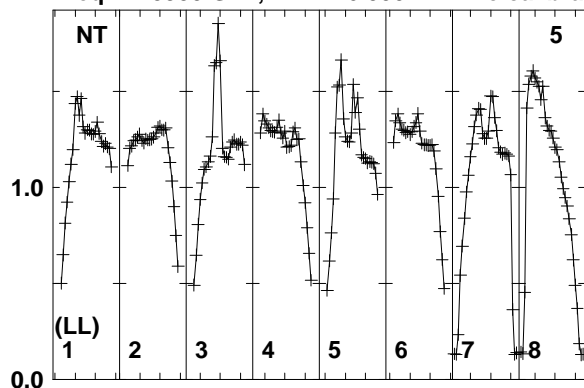

Lower frame: Real Jy
Total-power spectrum Antenna: NT (05)
Timerange: 00/05:38:51 to 00/05:40:49

Plot file version 147 created 11-AUG-2014 17:05:35

J2015+3710 EM110 2.UVDATA.1

Freq = 1.5950 GHz, Bw = 16.000 MH No calibration applied and no bandpass applied

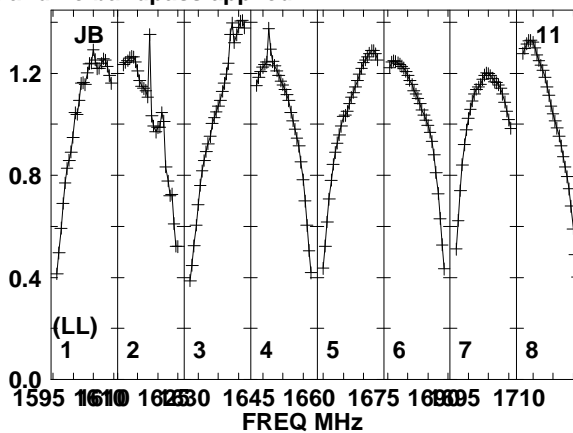
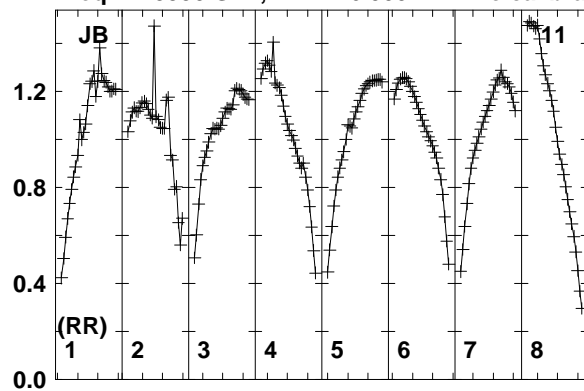

Lower frame: Real Jy
Total-power spectrum Antenna: JB (11)
Timerange: 00/05:38:51 to 00/05:40:49

Plot file version 148 created 11-AUG-2014 17:05:35

J2032+4127 EM110 2.UVDATA.1

Freq = 1.5950 GHz, Bw = 16.000 MH No calibration applied and no bandpass applied

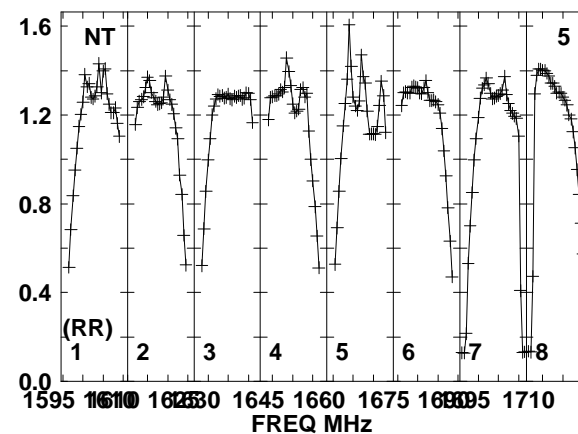
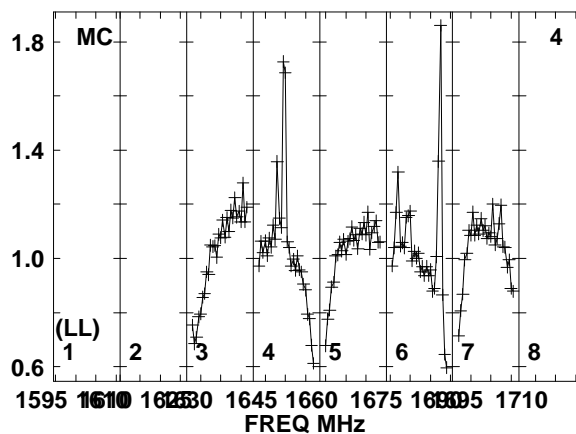
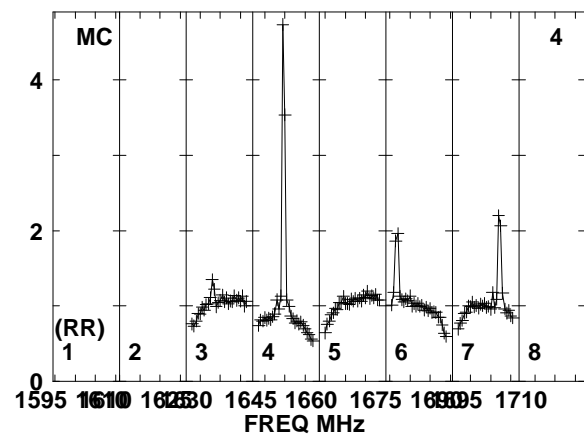
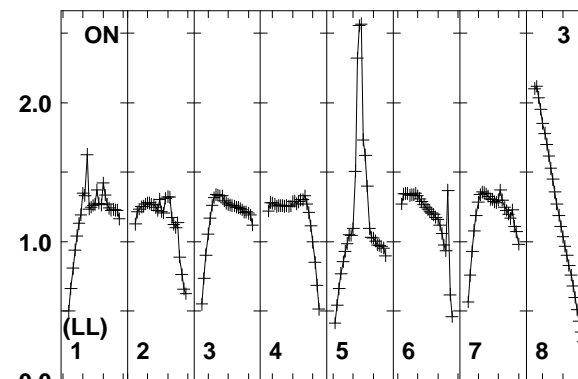
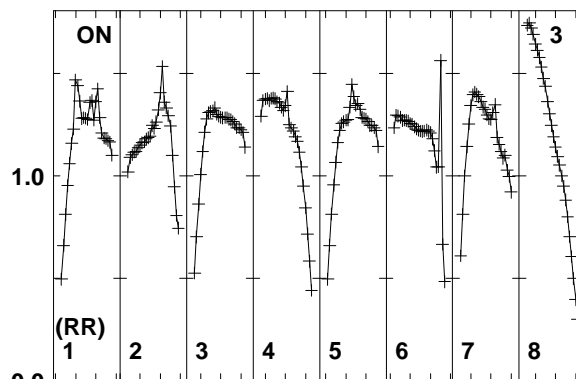
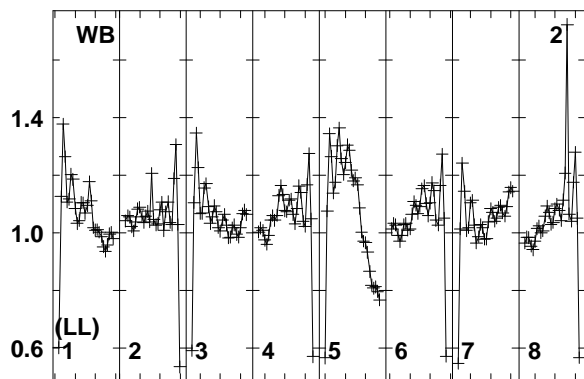
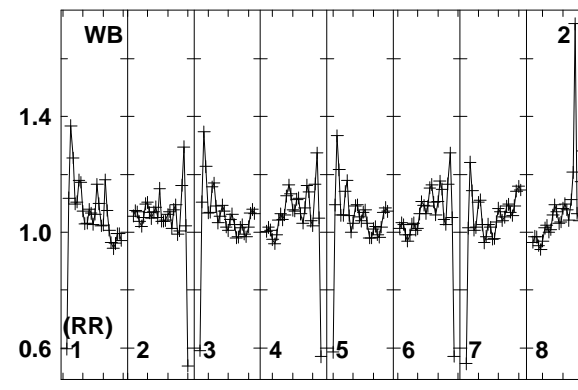
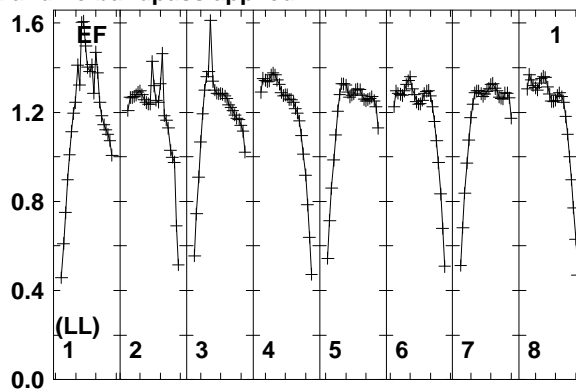
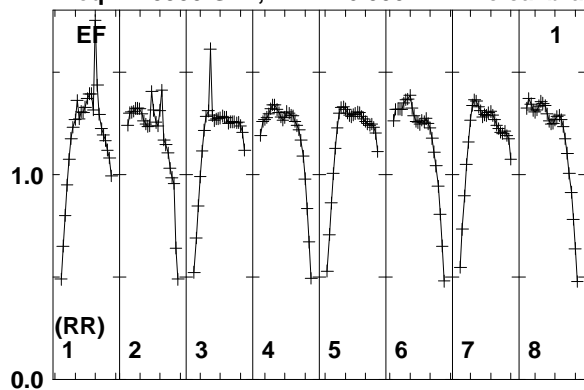

Lower frame: Real Jy
Total-power spectrum Antenna: EF (01)
Timerange: 00/05:41:04 to 00/05:44:48

Plot file version 149 created 11-AUG-2014 17:05:35

J2032+4127 EM110 2.UVDATA.1

Freq = 1.5950 GHz, Bw = 16.000 MH No calibration applied and no bandpass applied

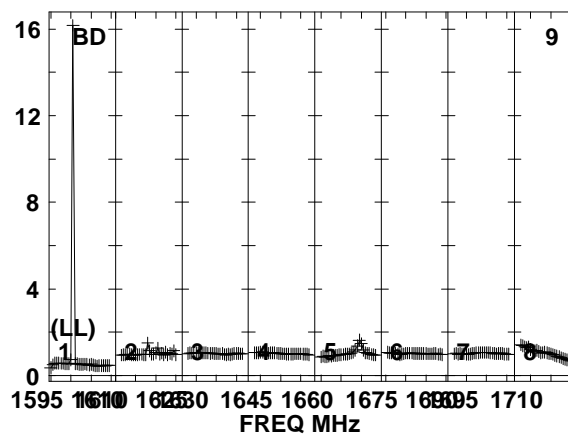
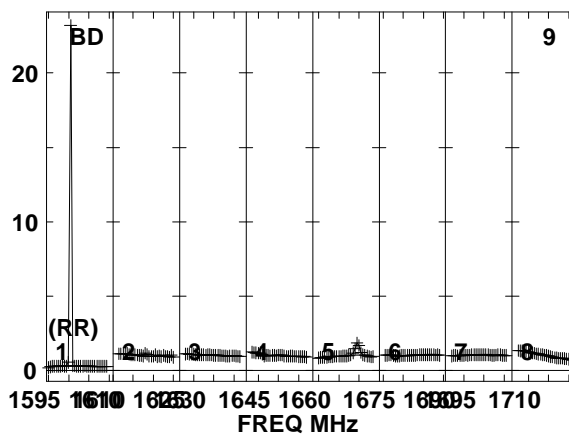
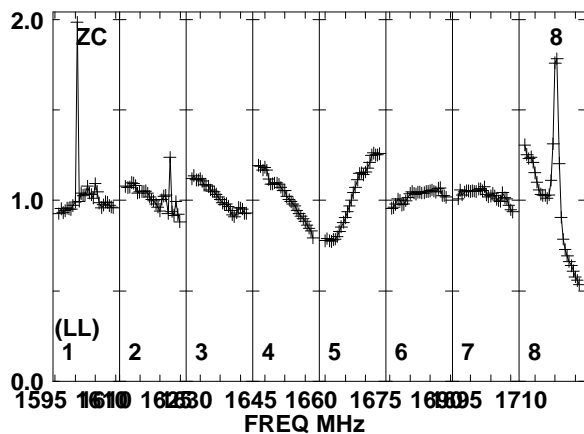
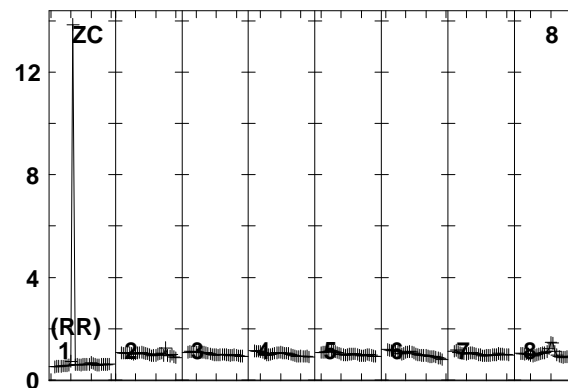
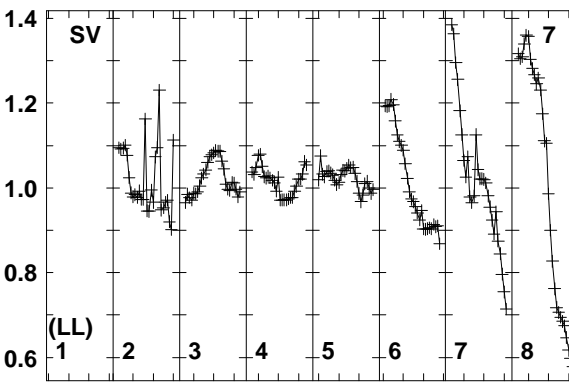
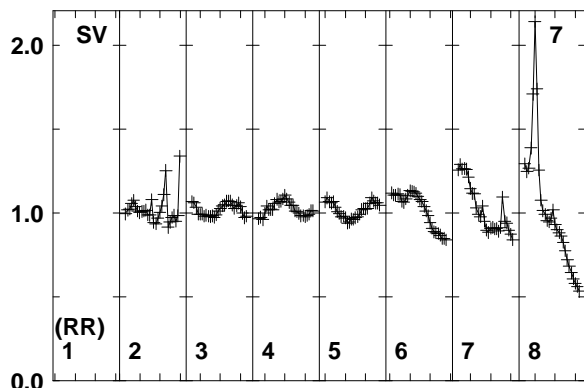
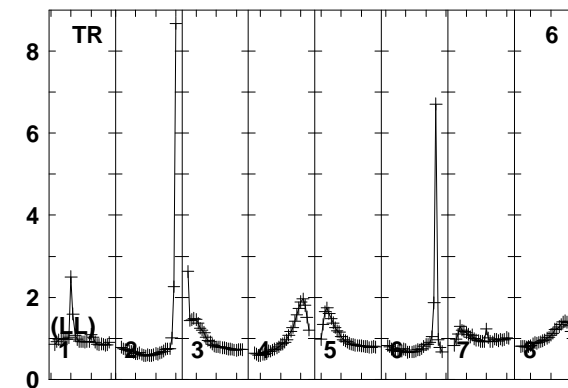
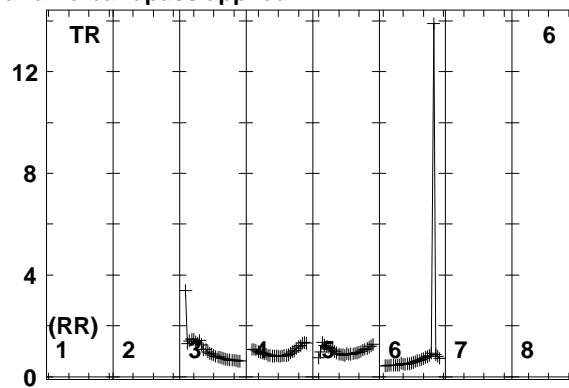
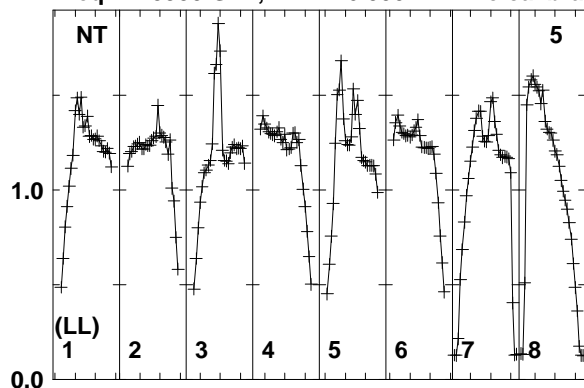

Lower frame: Real Jy
Total-power spectrum Antenna: NT (05)
Timerange: 00/05:41:04 to 00/05:44:48

Plot file version 150 created 11-AUG-2014 17:05:35

J2032+4127 EM110 2.UVDATA.1

Freq = 1.5950 GHz, Bw = 16.000 MH No calibration applied and no bandpass applied

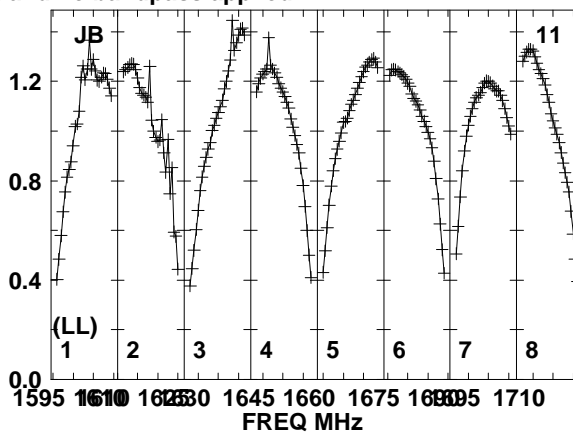
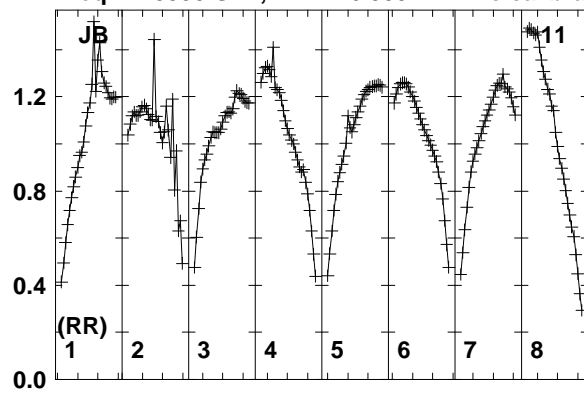

Lower frame: Real Jy
Total-power spectrum Antenna: JB (11)
Timerange: 00/05:41:04 to 00/05:44:48

Plot file version 151 created 11-AUG-2014 17:05:35

J2015+3710 EM110 2.UVDATA.1

Freq = 1.5950 GHz, Bw = 16.000 MH No calibration applied and no bandpass applied

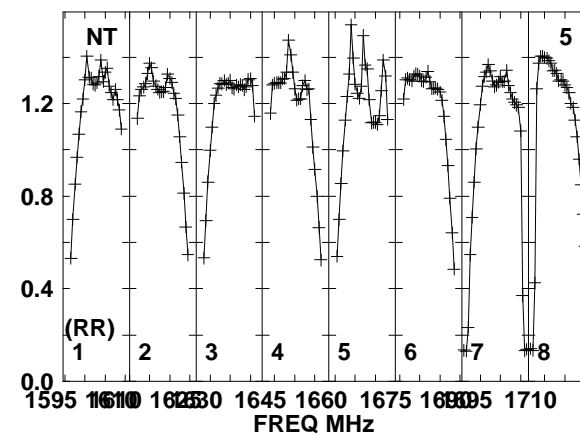
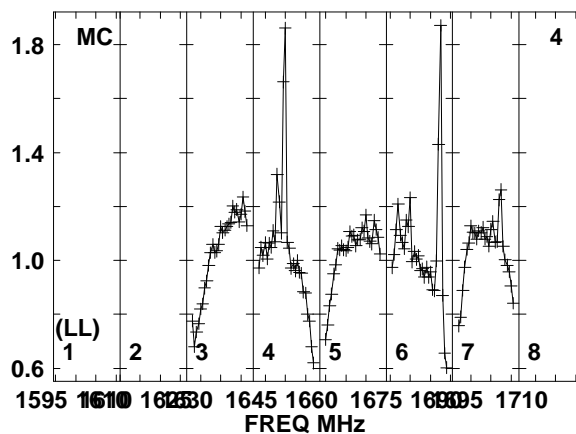
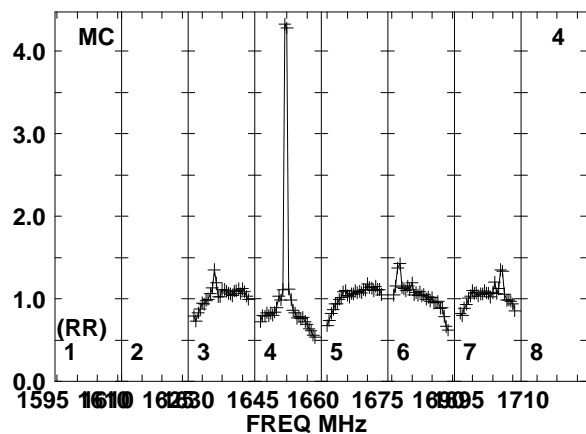
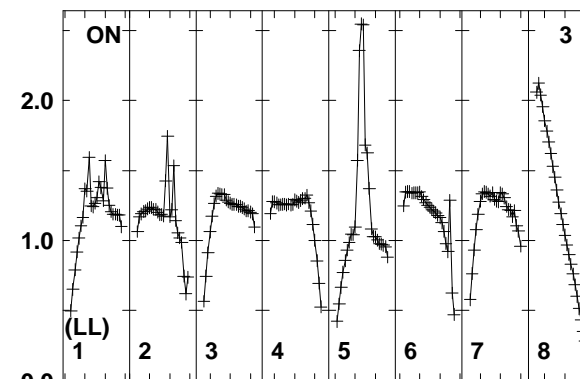
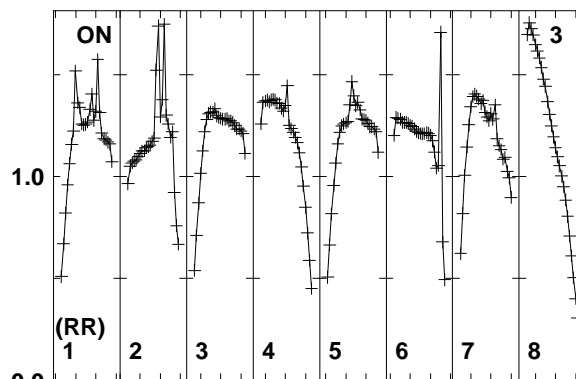
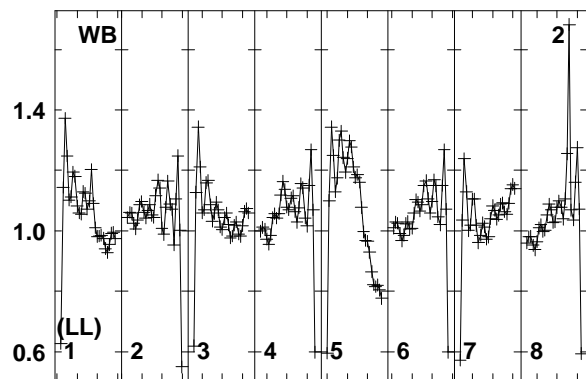
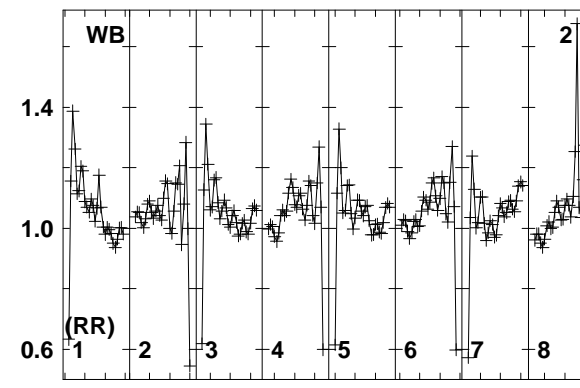
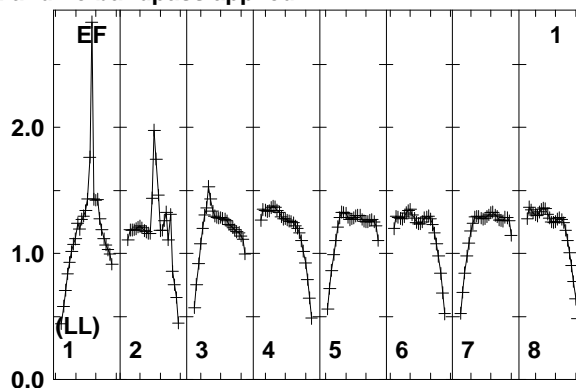
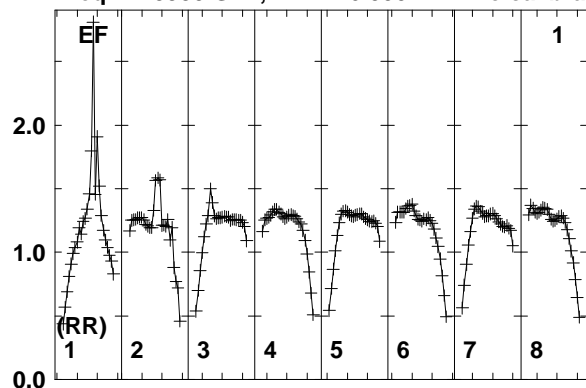

Lower frame: Real Jy
Total-power spectrum Antenna: EF (01)
Timerange: 00/05:45:04 to 00/05:46:48

Plot file version 152 created 11-AUG-2014 17:05:35

J2015+3710 EM110 2.UVDATA.1

Freq = 1.5950 GHz, Bw = 16.000 MH No calibration applied and no bandpass applied

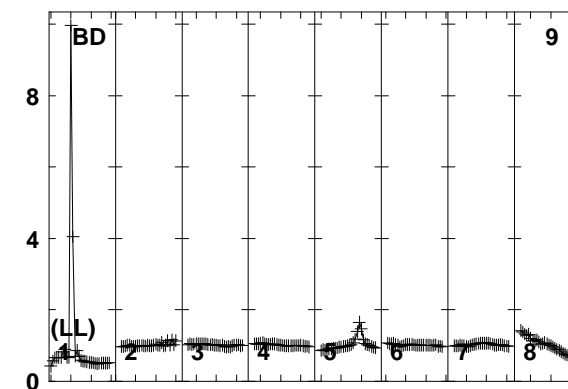
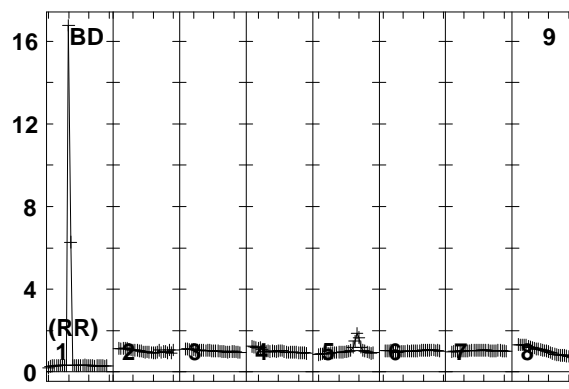
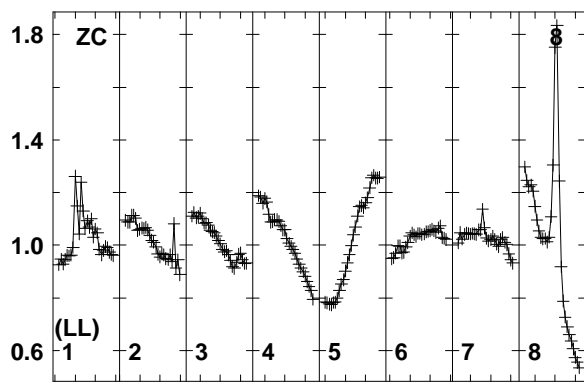
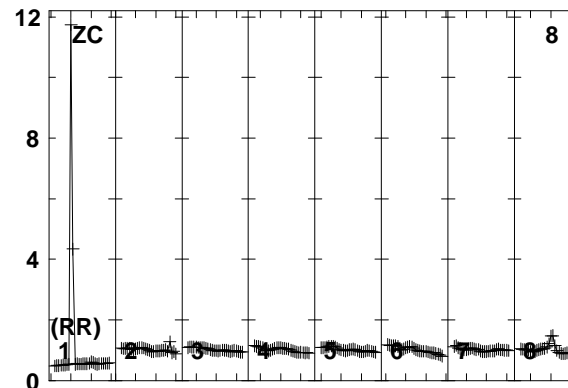
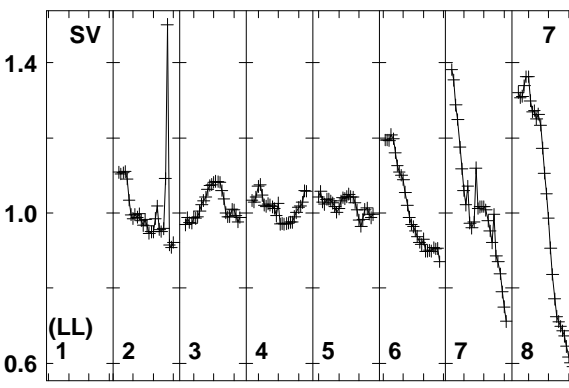
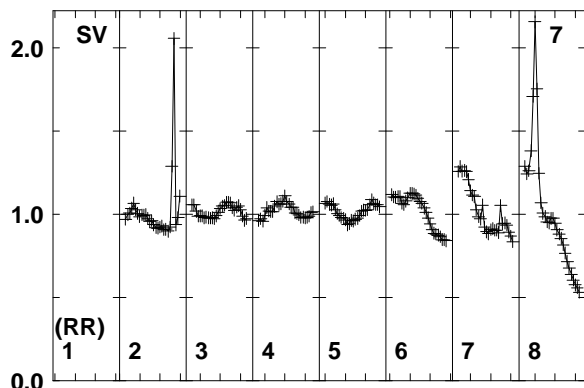
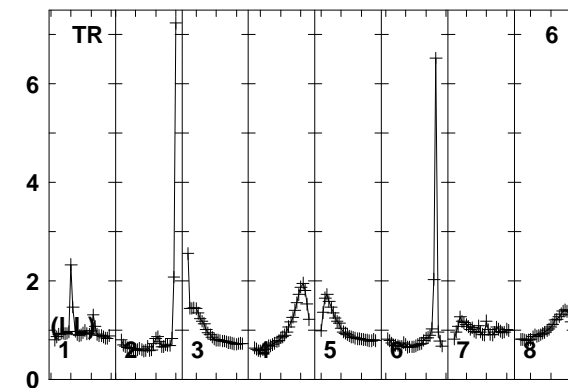
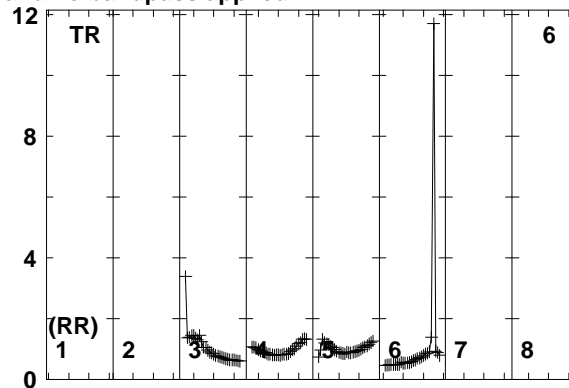
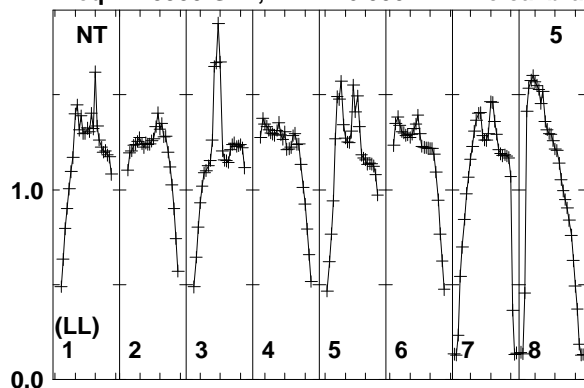

1595 1610 1625 1640 1655 1670 1685 1700 1710
FREQ MHz

1595 1610 1625 1640 1655 1670 1685 1700 1710
FREQ MHz

1595 1610 1625 1640 1655 1670 1685 1700 1710
FREQ MHz

Lower frame: Real Jy
Total-power spectrum Antenna: NT (05)
Timerange: 00/05:45:04 to 00/05:46:48

Plot file version 153 created 11-AUG-2014 17:05:35

J2032+4127 EM110 2.UVDATA.1

Freq = 1.5950 GHz, Bw = 16.000 MH No calibration applied and no bandpass applied

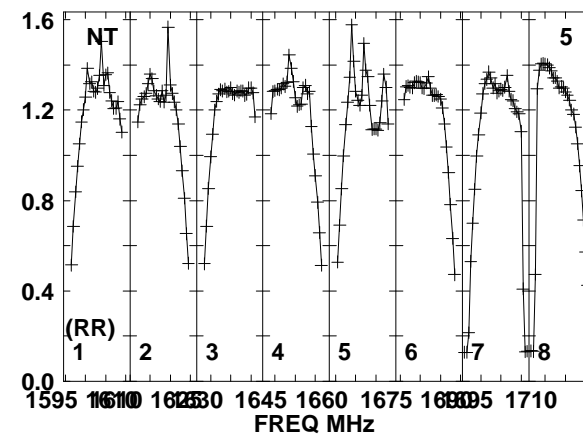
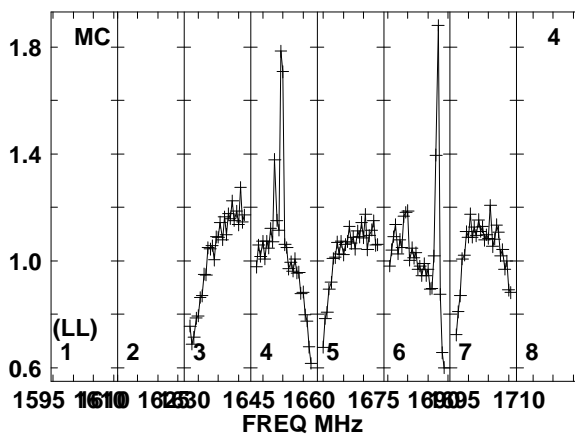
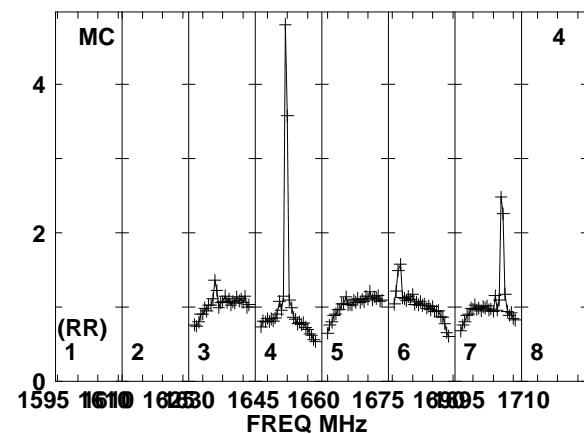
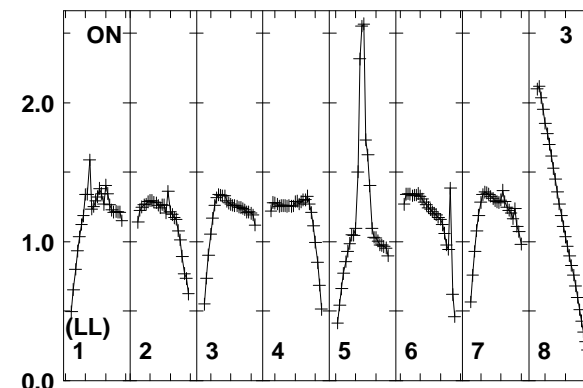
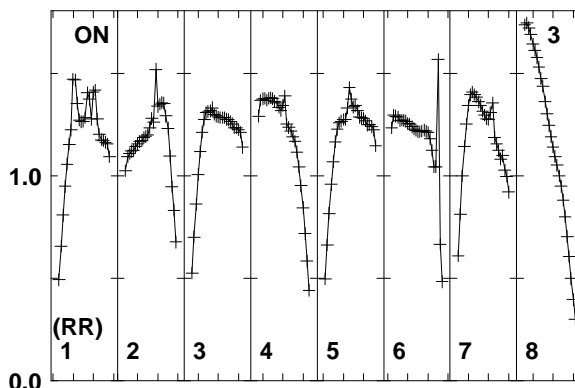
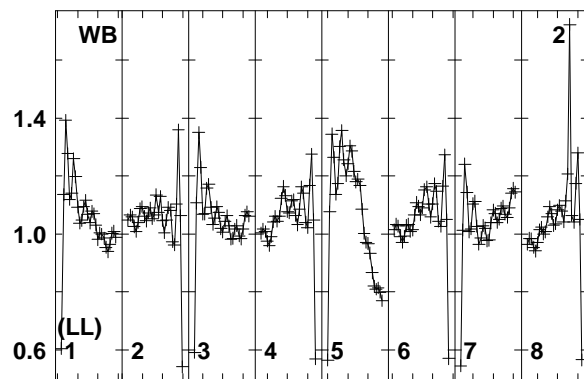
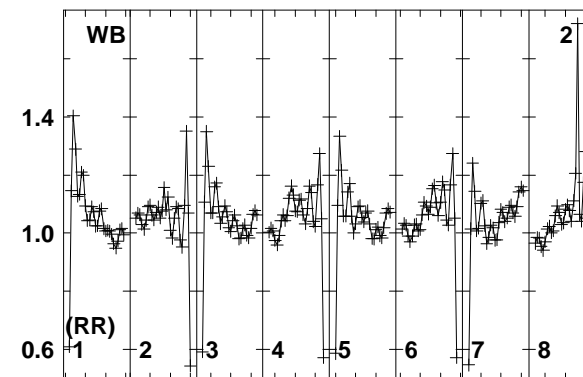
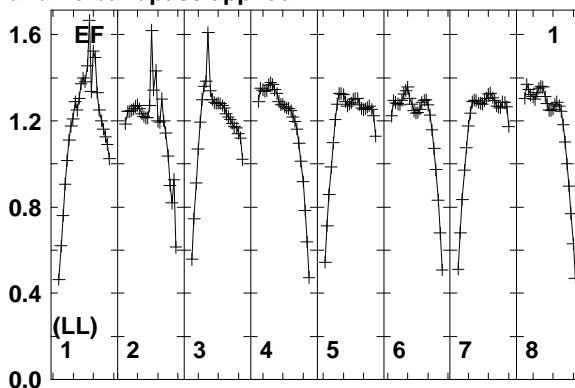
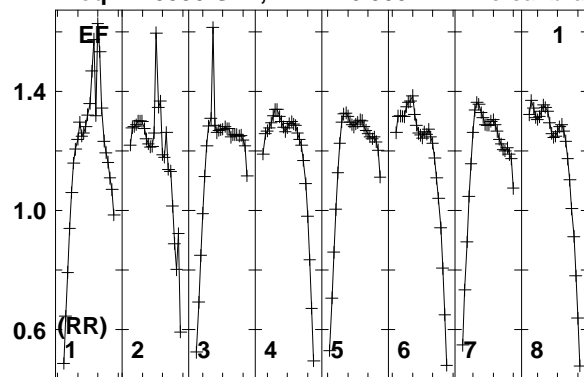

Lower frame: Real Jy
Total-power spectrum Antenna: EF (01)
Timerange: 00/05:46:51 to 00/05:50:49

Plot file version 154 created 11-AUG-2014 17:05:35

J2032+4127 EM110 2.UVDATA.1

Freq = 1.5950 GHz, Bw = 16.000 MH No calibration applied and no bandpass applied

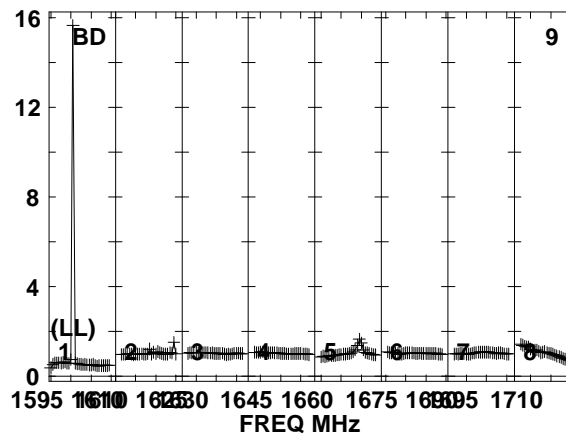
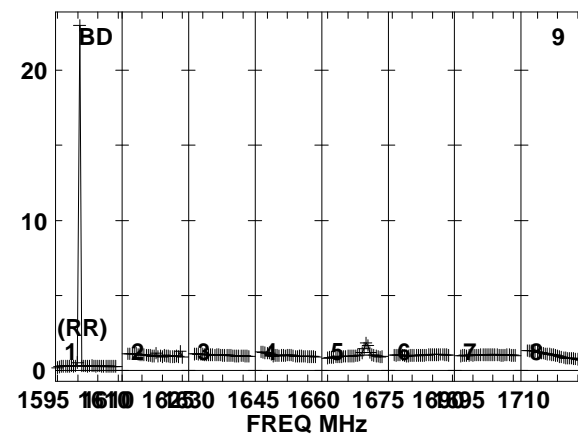
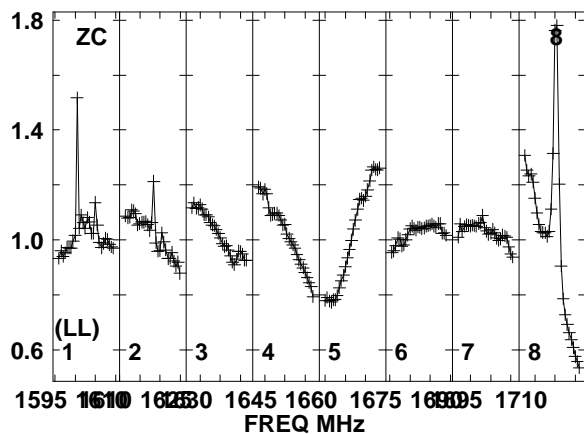
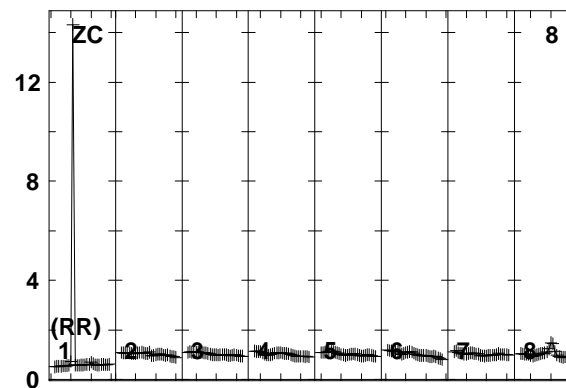
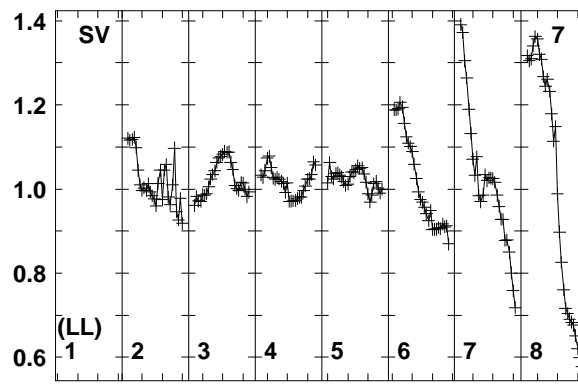
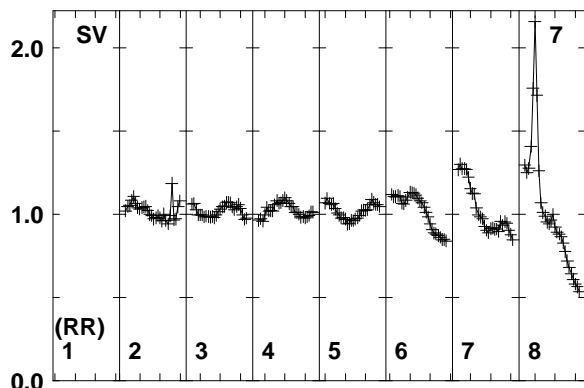
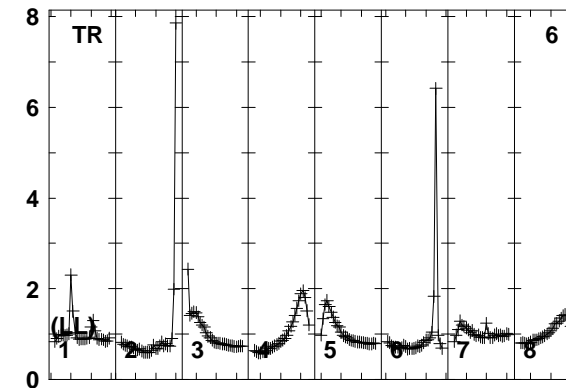
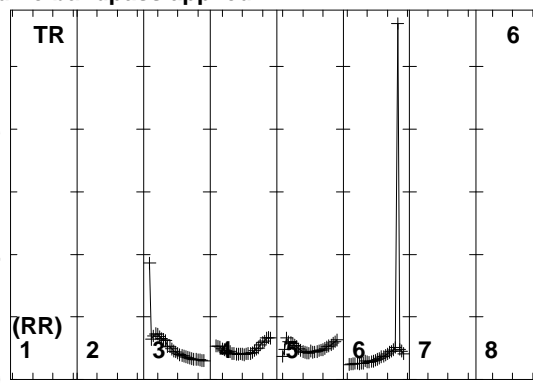
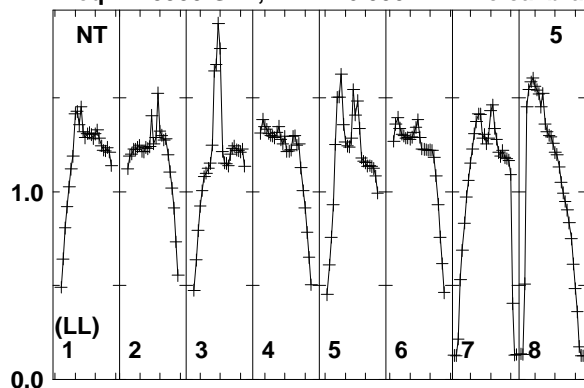

Lower frame: Real Jy
Total-power spectrum Antenna: NT (05)
Timerange: 00/05:46:51 to 00/05:50:49

Plot file version 155 created 11-AUG-2014 17:05:35

J2032+4127 EM110 2.UVDATA.1

Freq = 1.5950 GHz, Bw = 16.000 MH No calibration applied and no bandpass applied

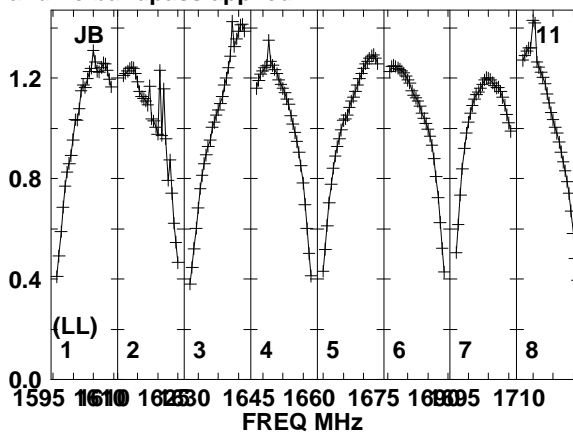
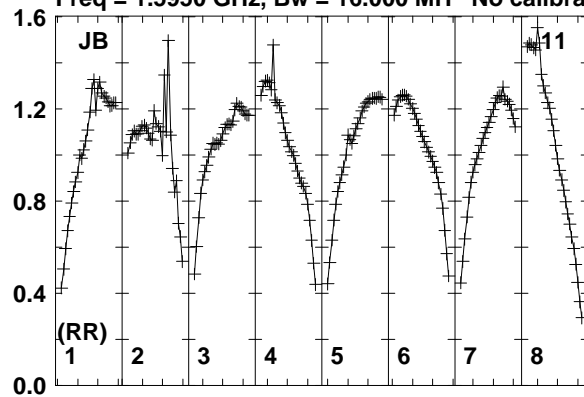

Lower frame: Real Jy
Total-power spectrum Antenna: JB (11)
Timerange: 00/05:46:51 to 00/05:50:49

Plot file version 156 created 11-AUG-2014 17:05:35

J2015+3710 EM110 2.UVDATA.1

Freq = 1.5950 GHz, Bw = 16.000 MH No calibration applied and no bandpass applied

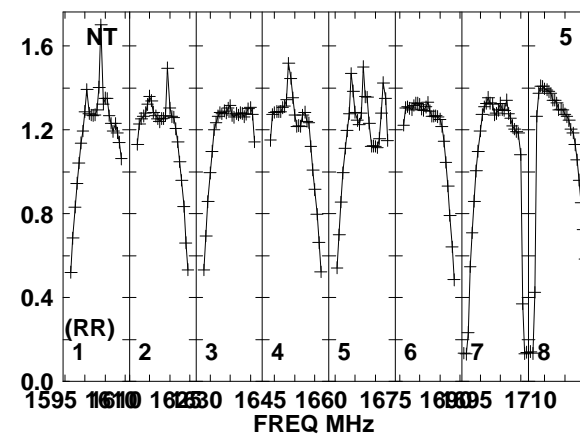
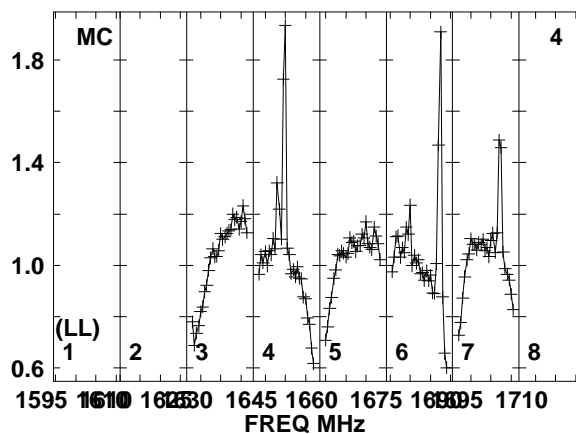
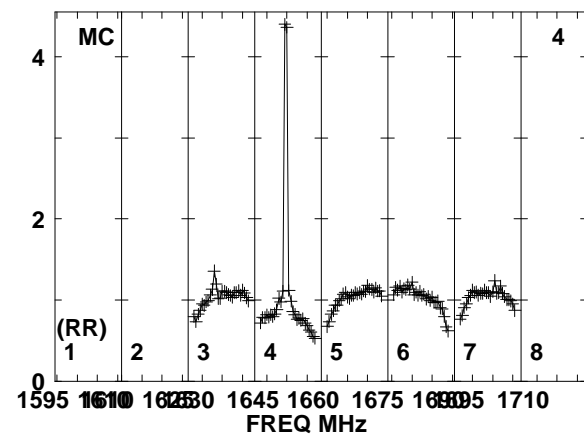
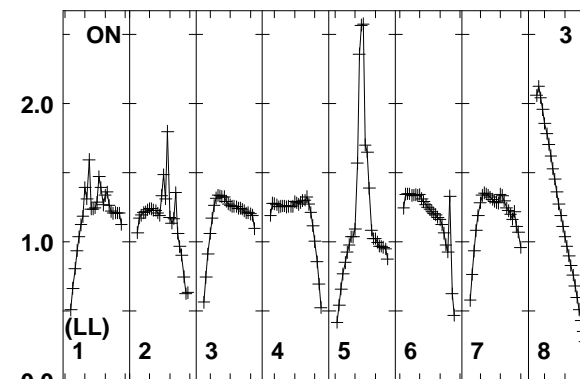
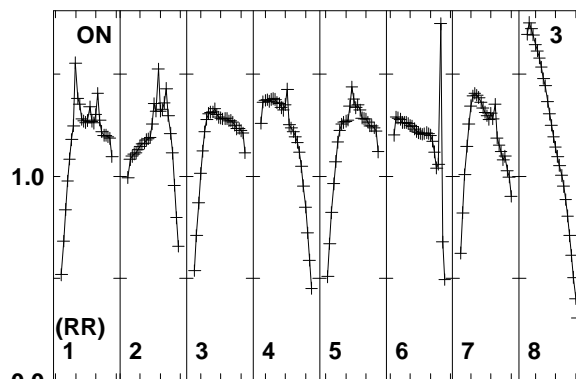
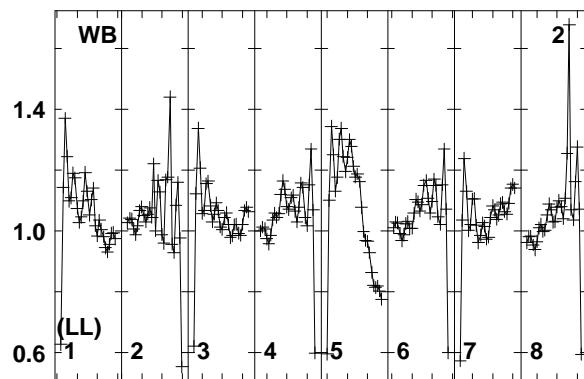
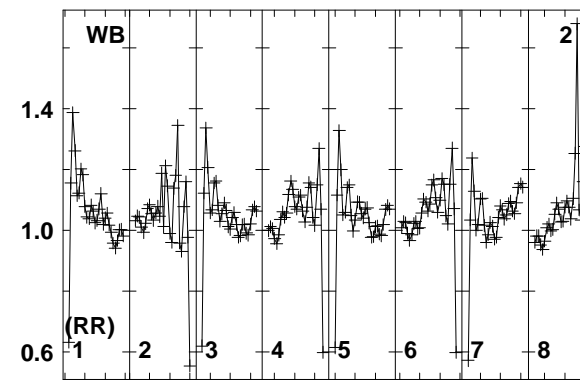
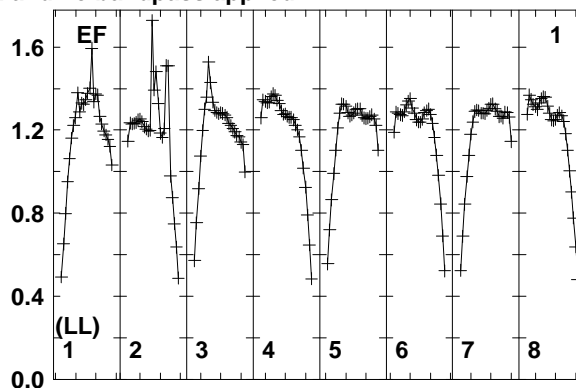
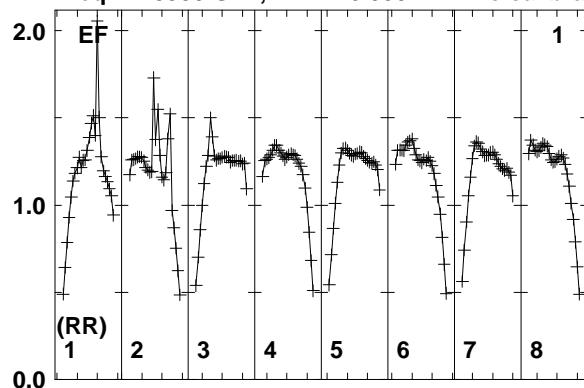

Lower frame: Real Jy
Total-power spectrum Antenna: EF (01)
Timerange: 00/05:51:51 to 00/05:53:49

Plot file version 157 created 11-AUG-2014 17:05:35

J2015+3710 EM110 2.UVDATA.1

Freq = 1.5950 GHz, Bw = 16.000 MH No calibration applied and no bandpass applied

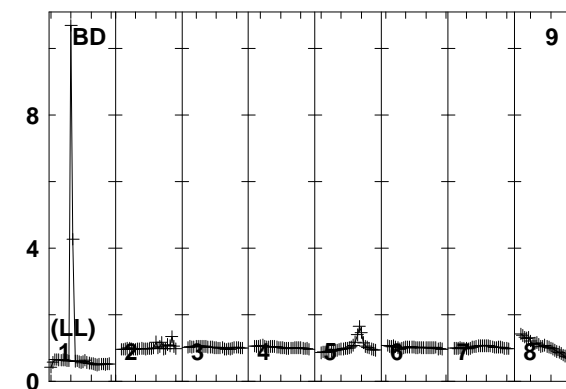
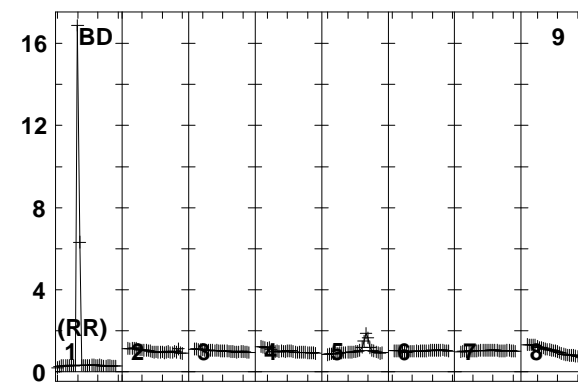
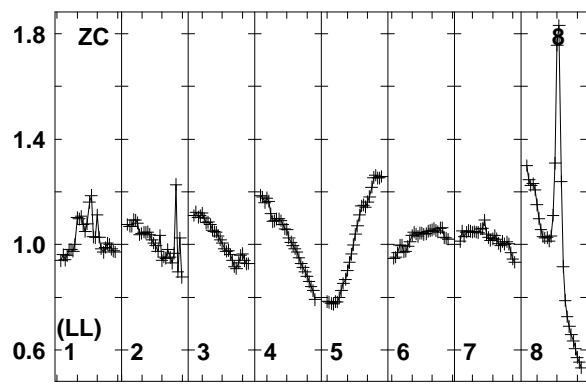
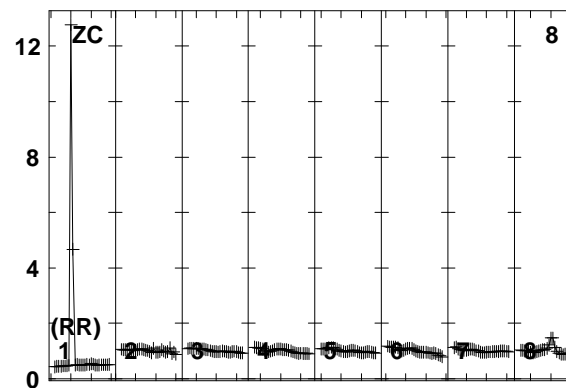
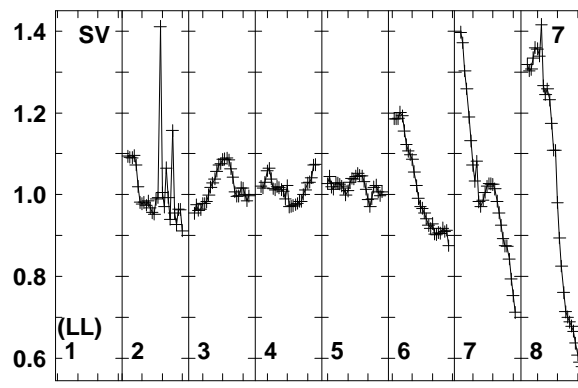
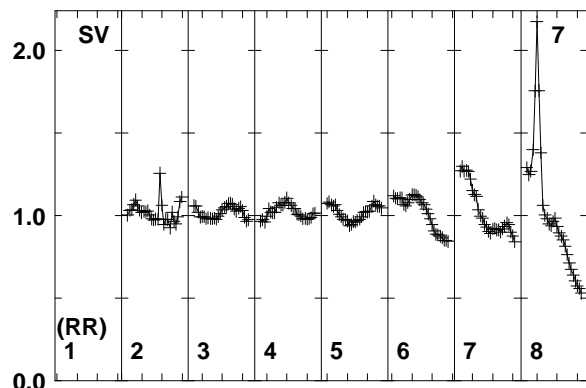
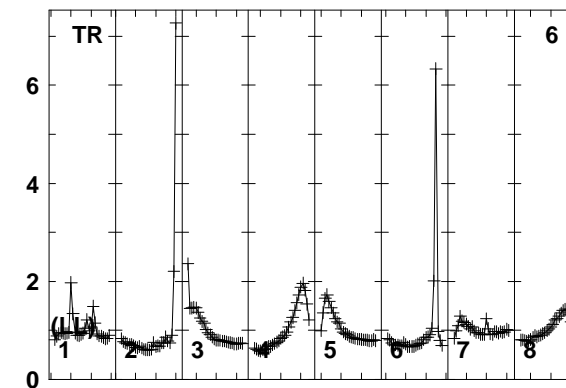
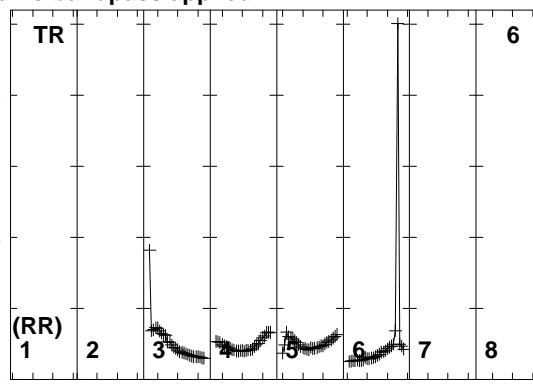
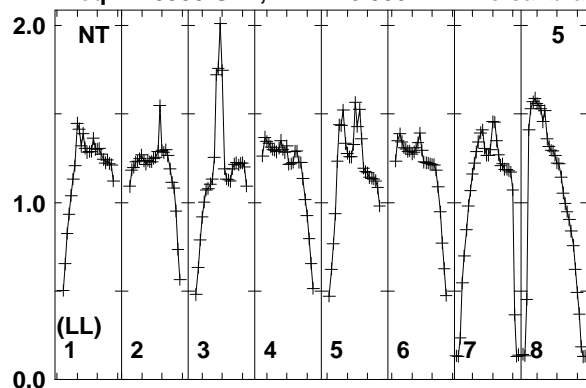

1595 1610 1625 1640 1655 1670 1685 1700 1710
FREQ MHz

1595 1610 1625 1640 1655 1670 1685 1700 1710
FREQ MHz

1595 1610 1625 1640 1655 1670 1685 1700 1710
FREQ MHz

Lower frame: Real Jy
Total-power spectrum Antenna: NT (05)
Timerange: 00/05:51:51 to 00/05:53:49

Plot file version 158 created 11-AUG-2014 17:05:35

J2015+3710 EM110 2.UVDATA.1

Freq = 1.5950 GHz, Bw = 16.000 MH No calibration applied and no bandpass applied

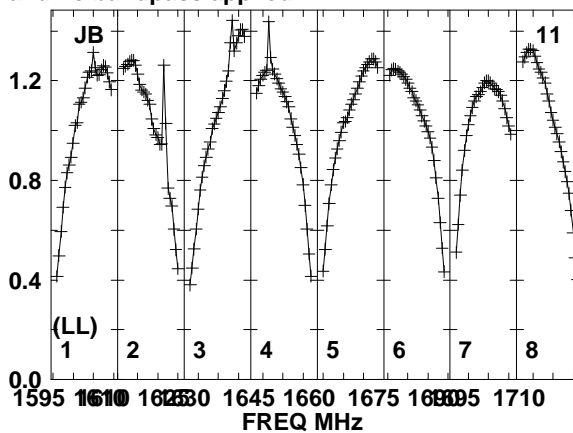
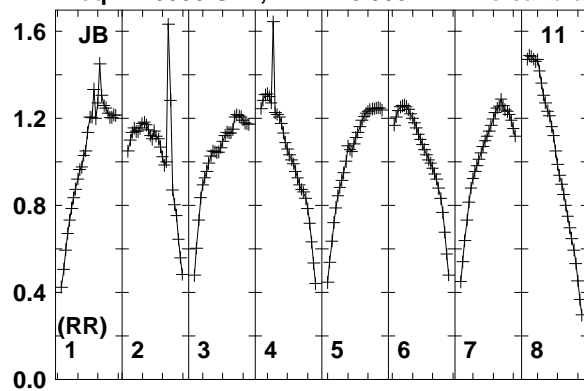

Lower frame: Real Jy
Total-power spectrum Antenna: JB (11)
Timerange: 00/05:51:51 to 00/05:53:49

Plot file version 159 created 11-AUG-2014 17:05:35

J2032+4127 EM110 2.UVDATA.1

Freq = 1.5950 GHz, Bw = 16.000 MH No calibration applied and no bandpass applied

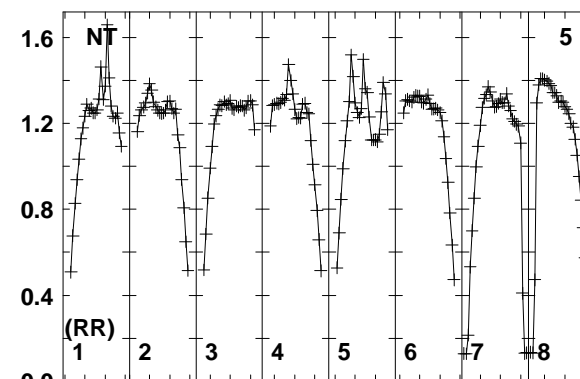
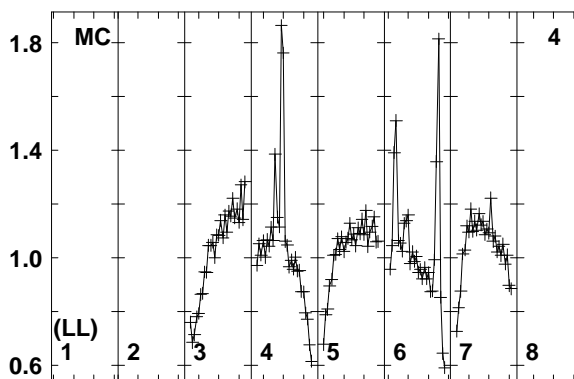
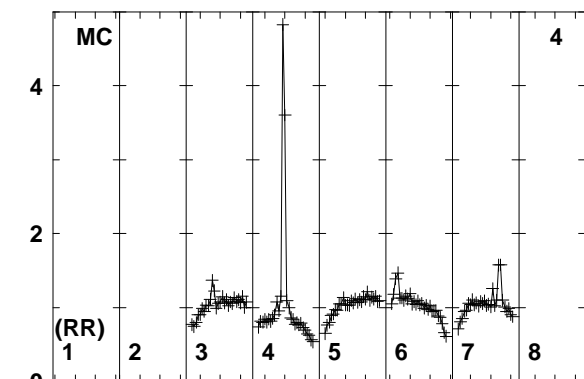
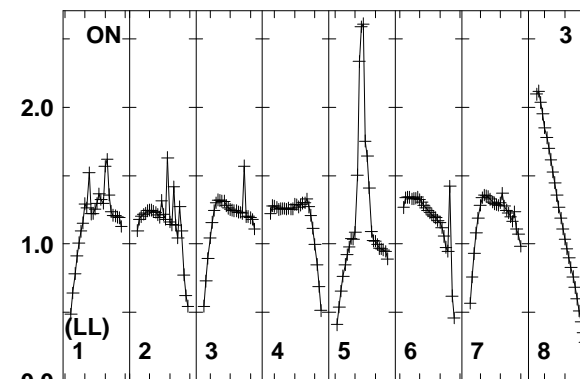
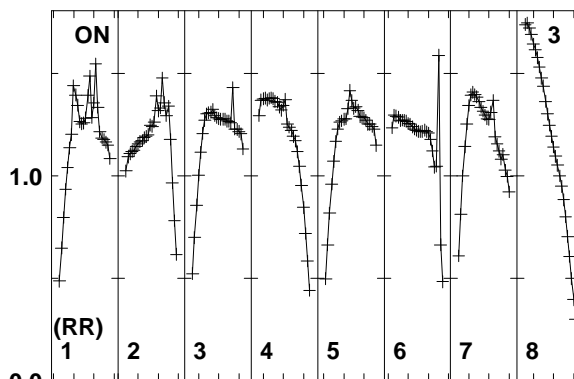
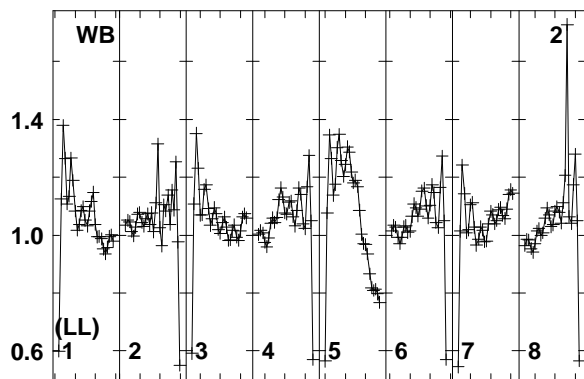
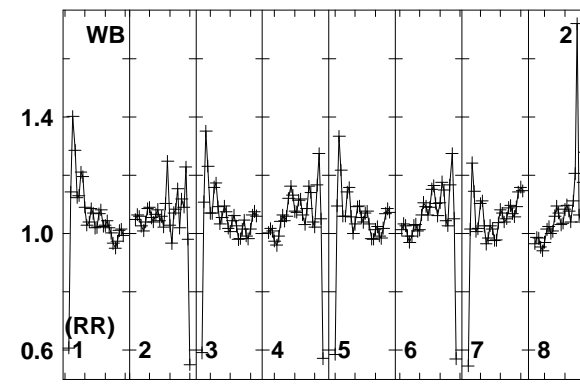
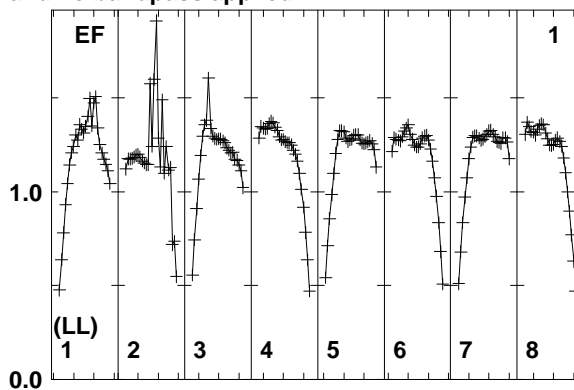
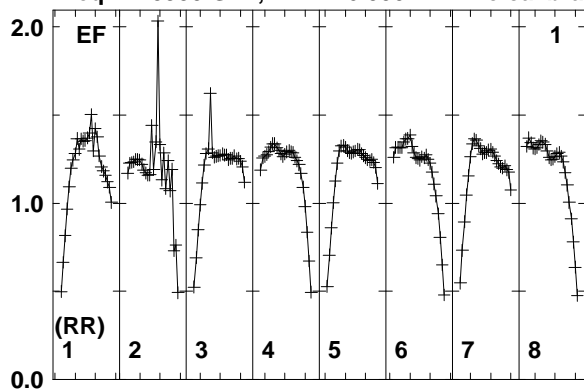

1595 1610 1625 1640 1655 1670 1685 1700 1710
FREQ MHz

1595 1610 1625 1640 1655 1670 1685 1700 1710
FREQ MHz

1595 1610 1625 1640 1655 1670 1685 1700 1710
FREQ MHz

Lower frame: Real Jy
Total-power spectrum Antenna: EF (01)
Timerange: 00/05:54:04 to 00/05:57:48

Plot file version 160 created 11-AUG-2014 17:05:35

J2032+4127 EM110 2.UVDATA.1

Freq = 1.5950 GHz, Bw = 16.000 MH No calibration applied and no bandpass applied

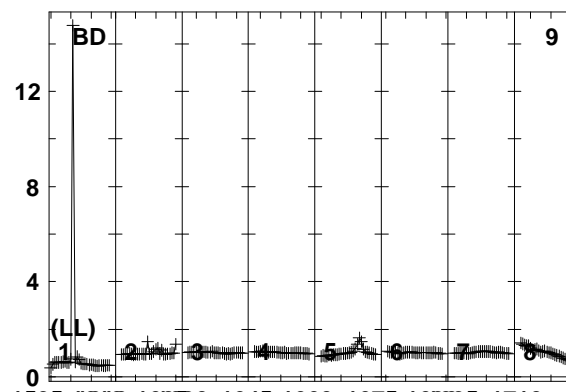
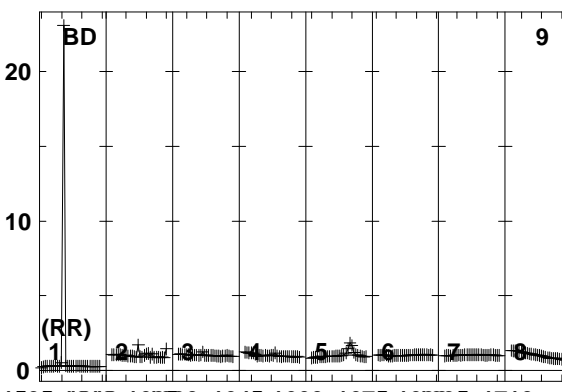
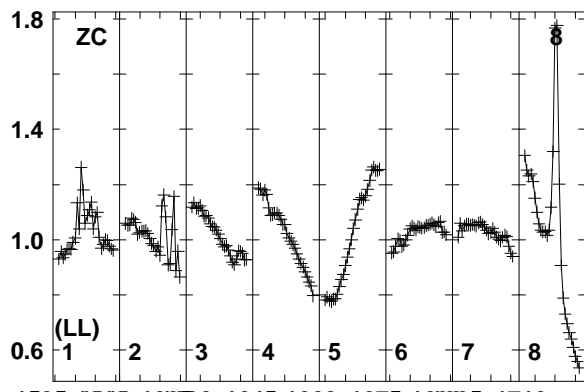
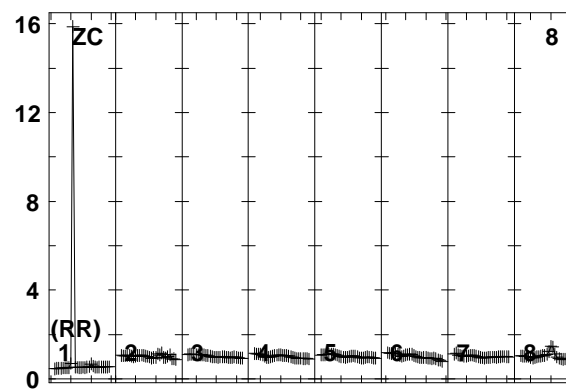
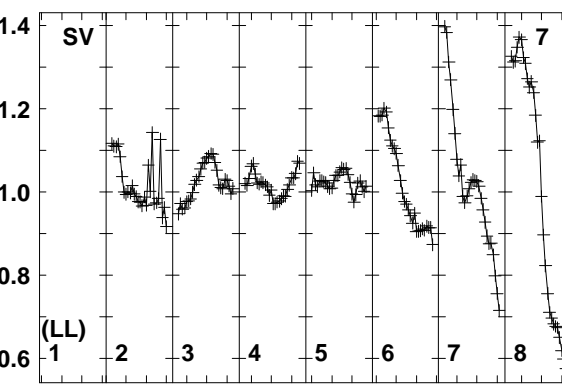
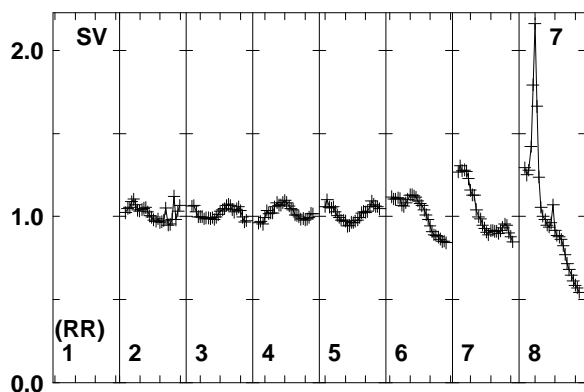
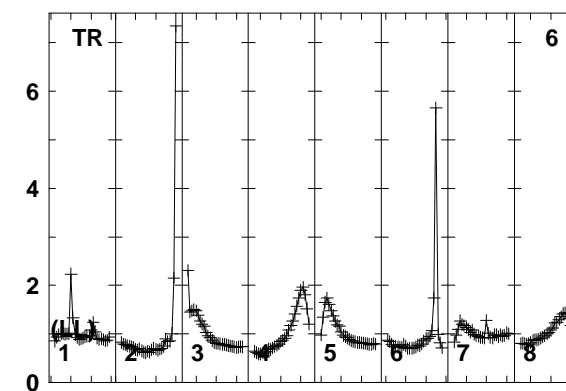
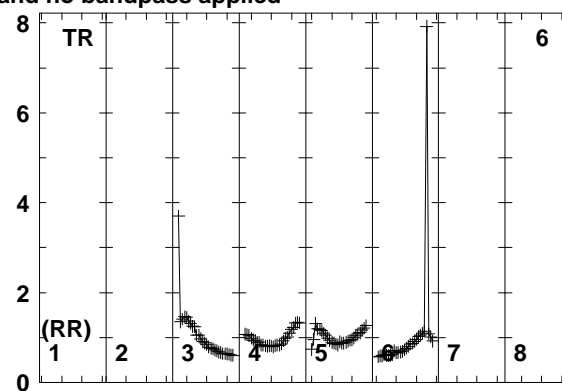
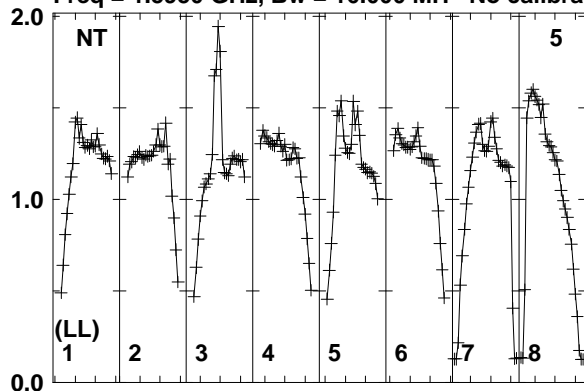

1595 1610 1625 1640 1655 1670 1685 1700 1710
FREQ MHz

1595 1610 1625 1640 1655 1670 1685 1700 1710
FREQ MHz

1595 1610 1625 1640 1655 1670 1685 1700 1710
FREQ MHz

Lower frame: Real Jy
Total-power spectrum Antenna: NT (05)
Timerange: 00/05:54:04 to 00/05:57:48

Plot file version 161 created 11-AUG-2014 17:05:35

J2032+4127 EM110 2.UVDATA.1

Freq = 1.5950 GHz, Bw = 16.000 MH No calibration applied and no bandpass applied

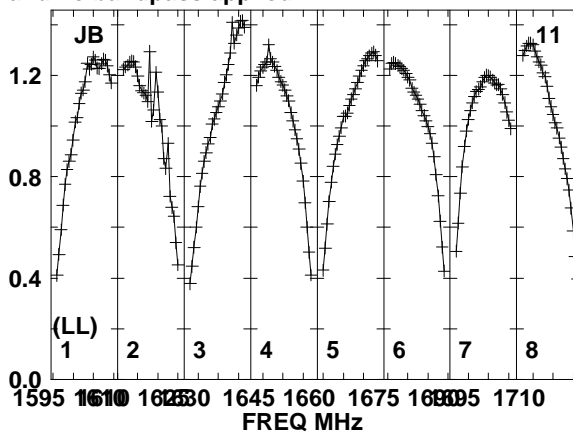
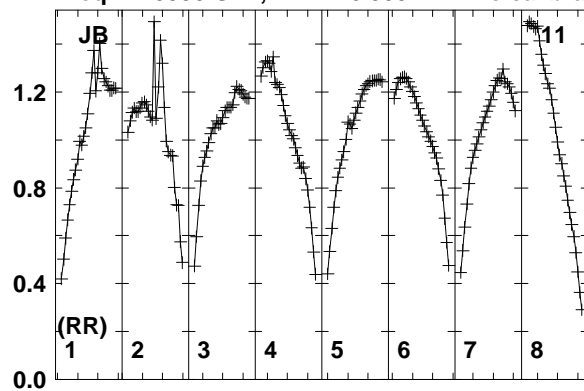

Lower frame: Real Jy
Total-power spectrum Antenna: JB (11)
Timerange: 00/05:54:04 to 00/05:57:48

Plot file version 162 created 11-AUG-2014 17:05:35

J2015+3710 EM110 2.UVDATA.1

Freq = 1.5950 GHz, Bw = 16.000 MH No calibration applied and no bandpass applied

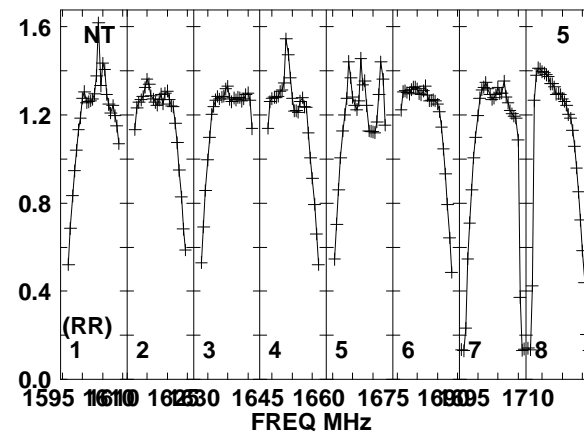
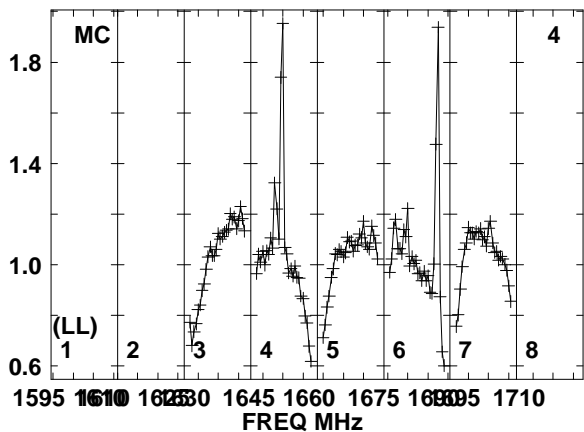
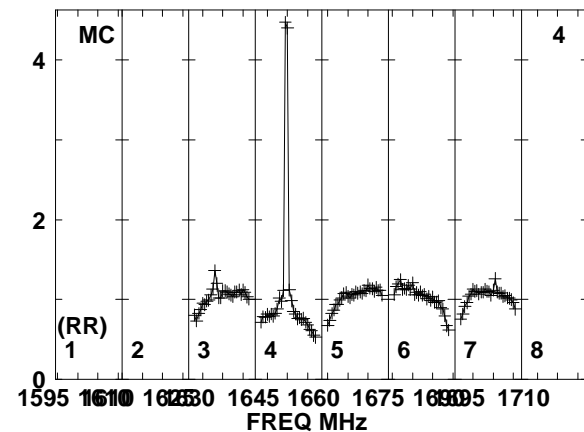
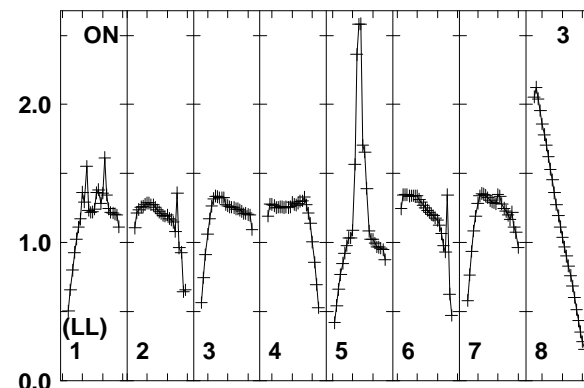
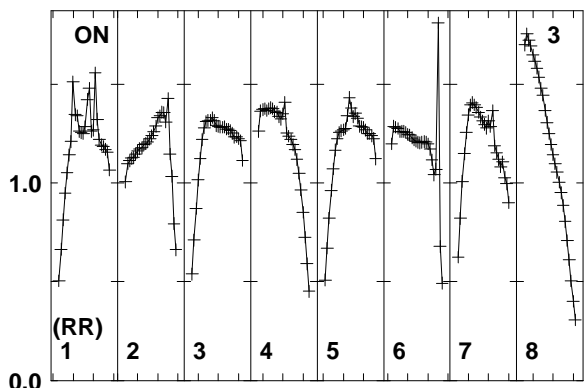
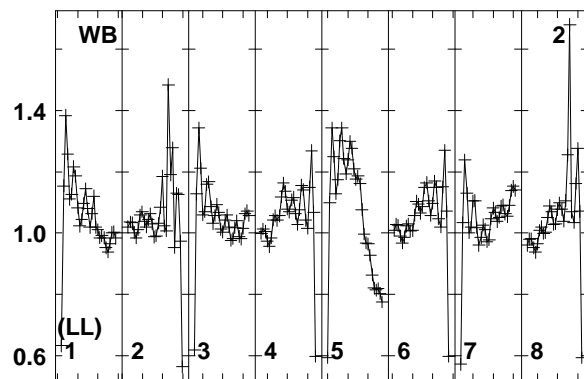
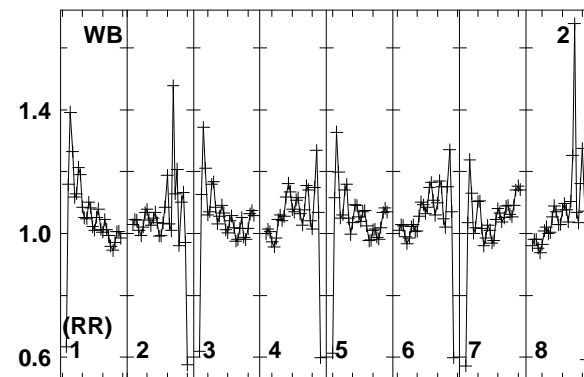
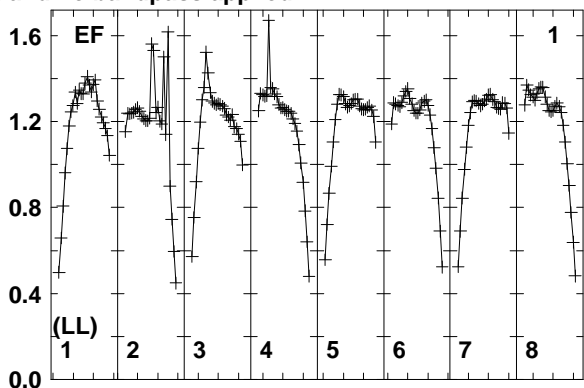
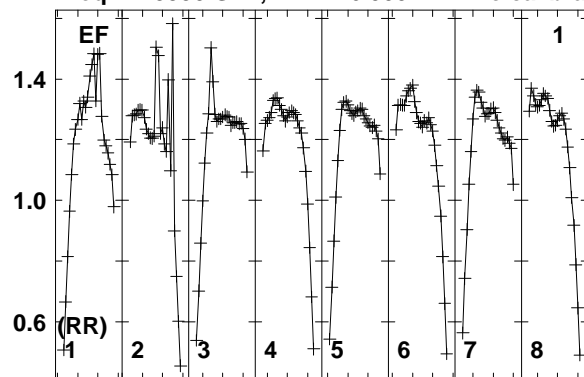

1595 1610 1625 1640 1655 1670 1685 1700 1710
FREQ MHz
Lower frame: Real Jy
Total-power spectrum Antenna: EF (01)
Timerange: 00/05:58:05 to 00/05:59:49

Plot file version 163 created 11-AUG-2014 17:05:35

J2015+3710 EM110 2.UVDATA.1

Freq = 1.5950 GHz, Bw = 16.000 MH No calibration applied and no bandpass applied

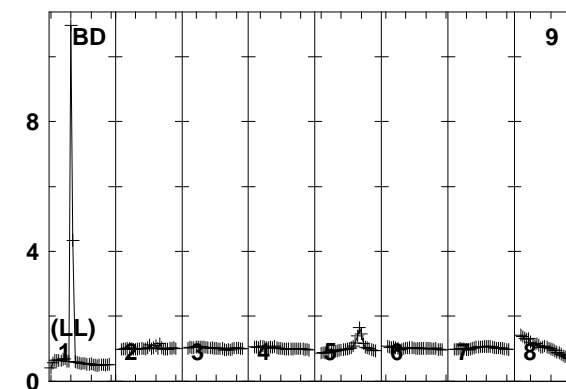
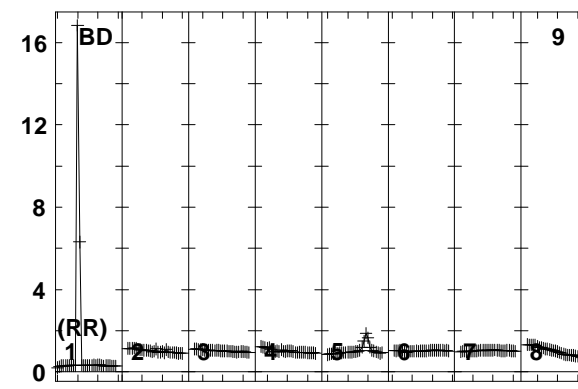
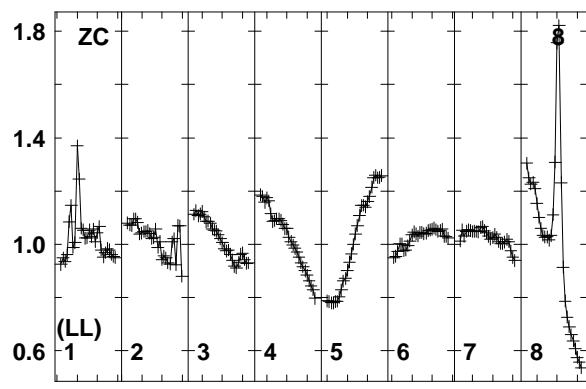
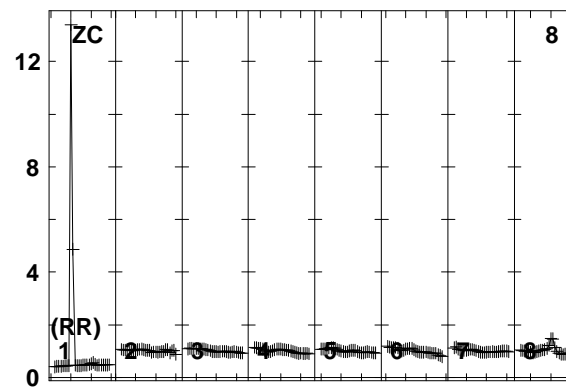
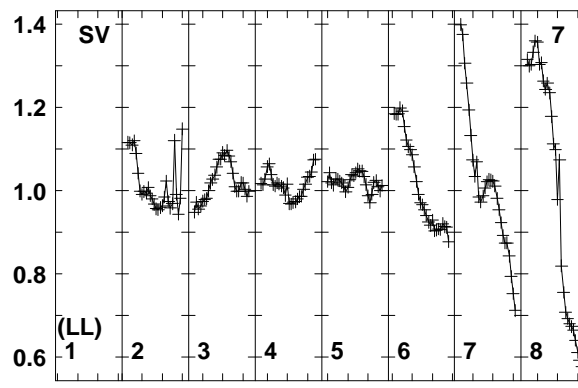
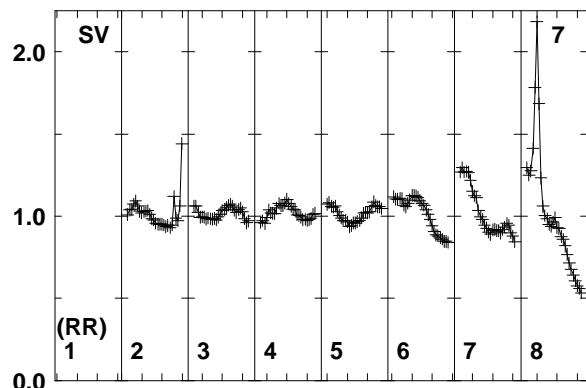
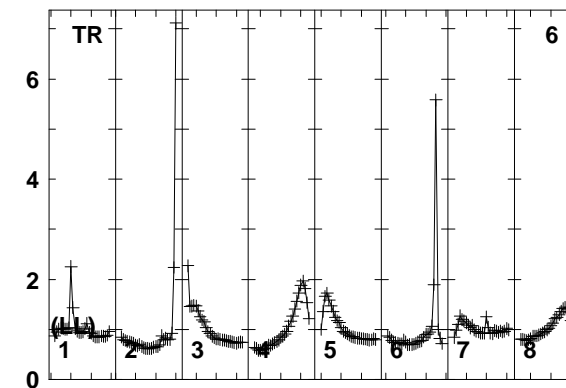
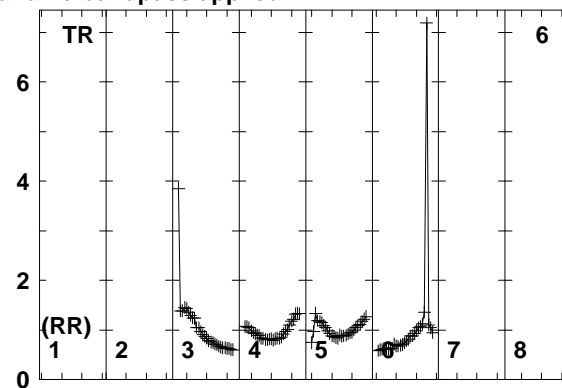
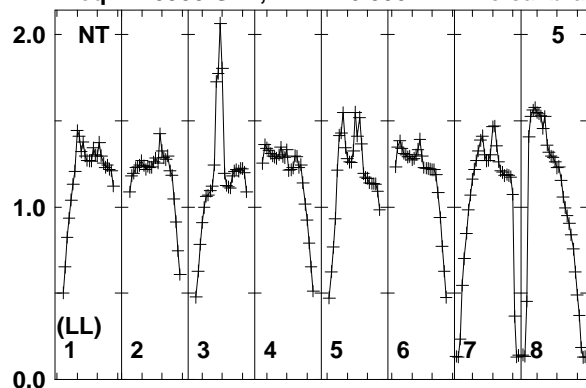

1595 1610 1625 1640 1655 1670 1685 1700 1710
FREQ MHz

1595 1610 1625 1640 1655 1670 1685 1700 1710
FREQ MHz

1595 1610 1625 1640 1655 1670 1685 1700 1710
FREQ MHz

Lower frame: Real Jy
Total-power spectrum Antenna: NT (05)
Timerange: 00/05:58:05 to 00/05:59:49

Plot file version 164 created 11-AUG-2014 17:05:35

J2015+3710 EM110 2.UVDATA.1

Freq = 1.5950 GHz, Bw = 16.000 MH No calibration applied and no bandpass applied

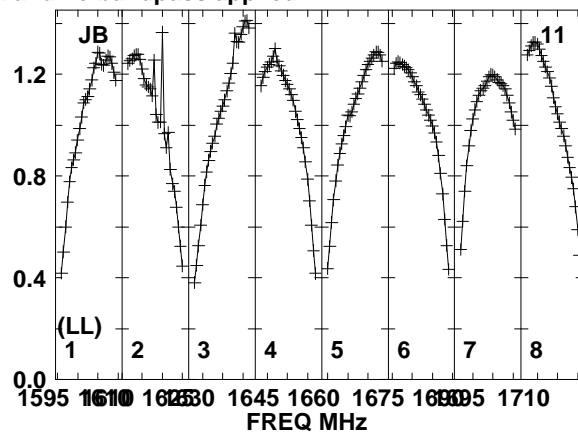
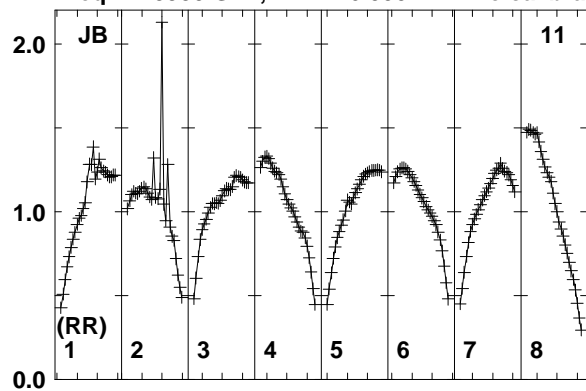

Lower frame: Real Jy
Total-power spectrum Antenna: JB (11)
Timerange: 00/05:58:05 to 00/05:59:49

Plot file version 165 created 11-AUG-2014 17:05:35

J2007+4029 EM110 2.UVDATA.1

Freq = 1.5950 GHz, Bw = 16.000 MH No calibration applied and no bandpass applied

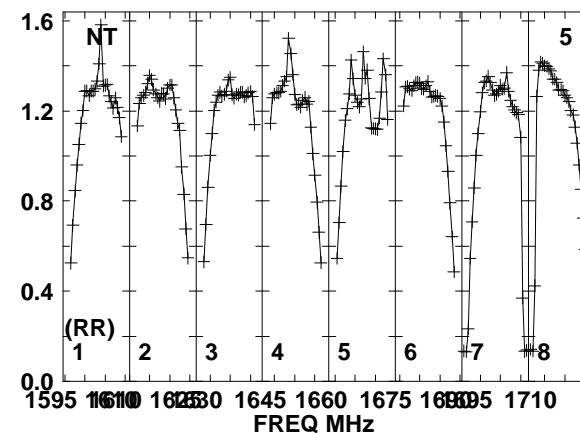
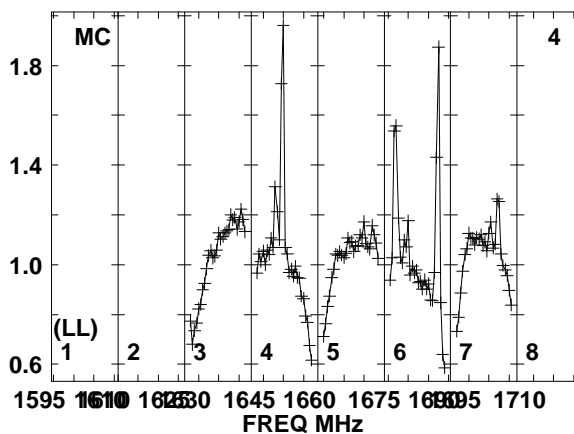
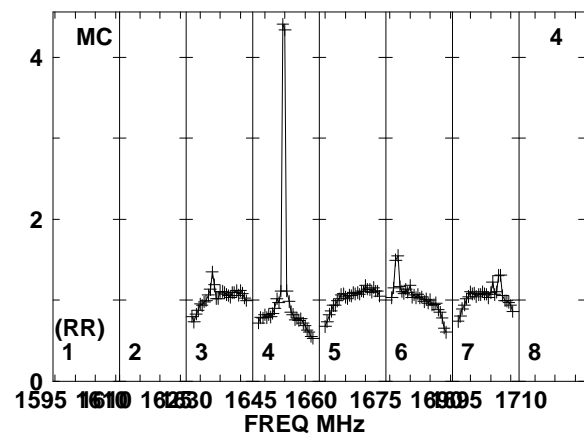
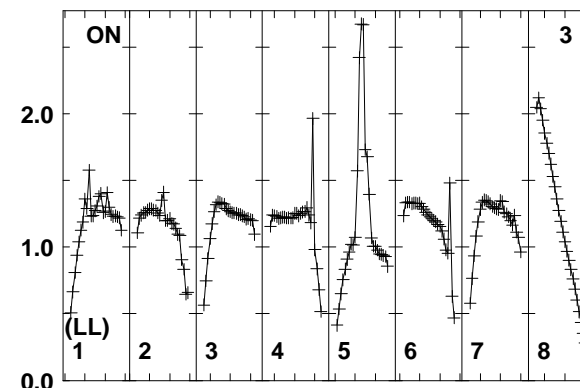
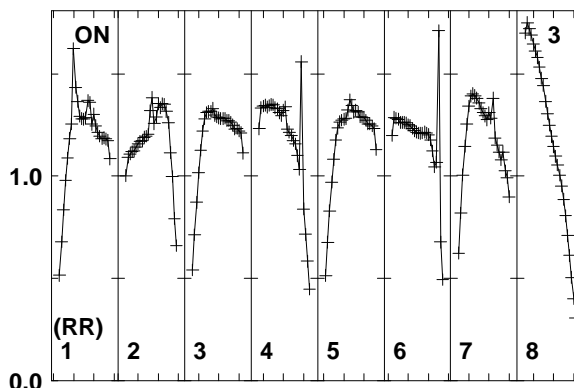
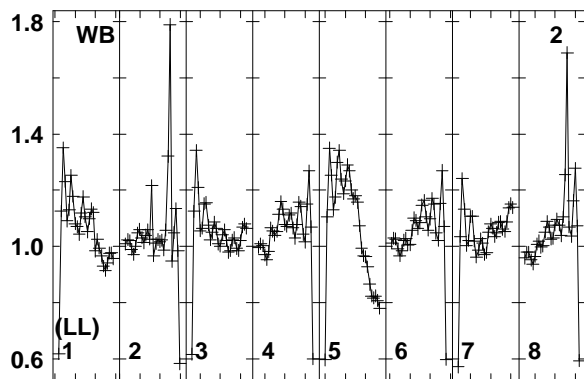
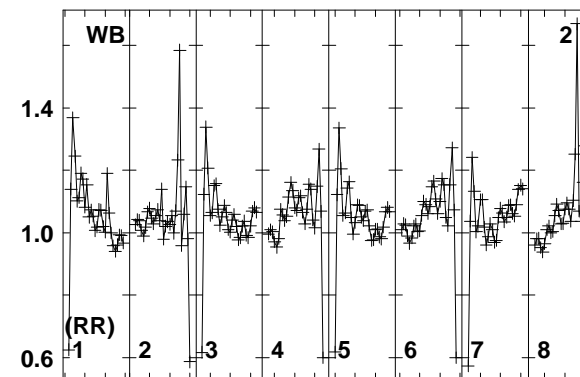
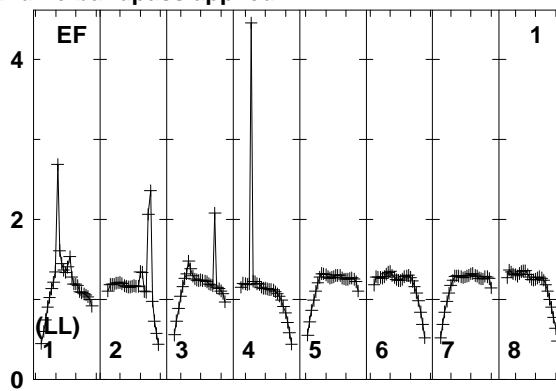
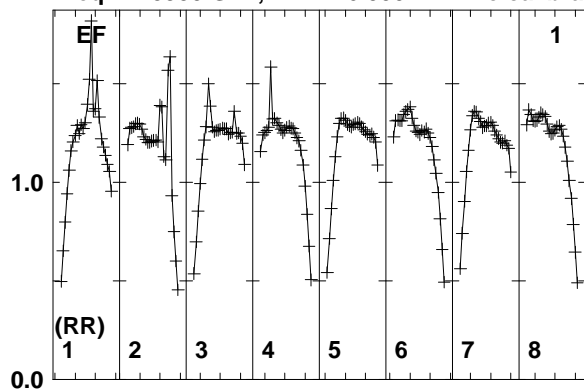

Lower frame: Real Jy
Total-power spectrum Antenna: EF (01)
Timerange: 00/06:00:01 to 00/06:00:49

Plot file version 166 created 11-AUG-2014 17:05:35

J2007+4029 EM110 2.UVDATA.1

Freq = 1.5950 GHz, Bw = 16.000 MH No calibration applied and no bandpass applied

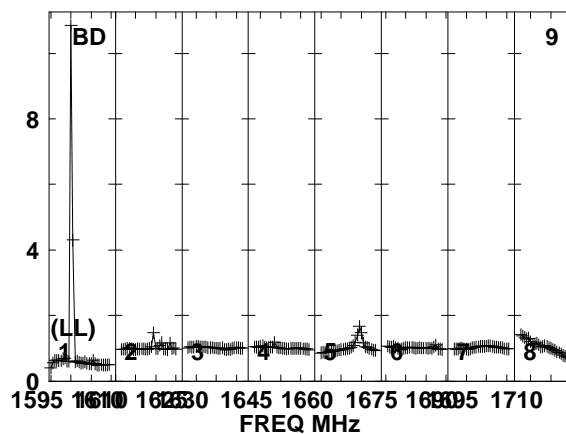
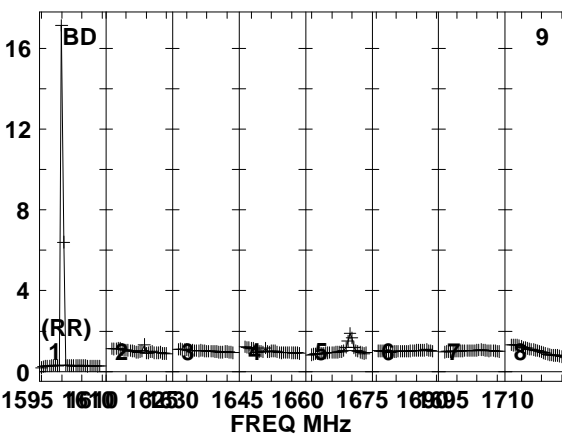
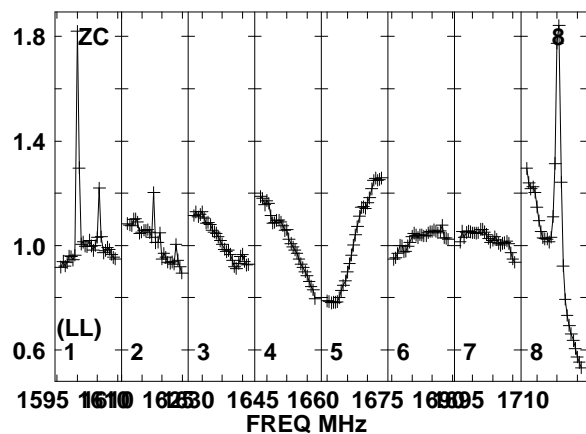
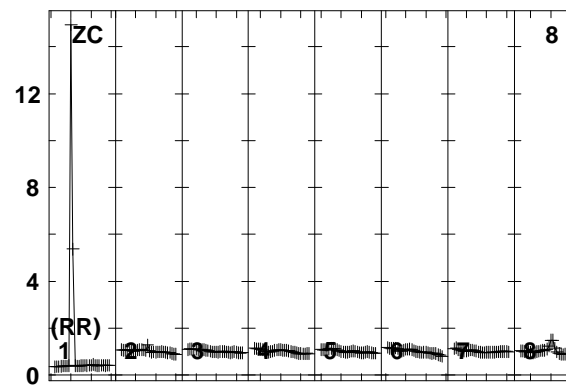
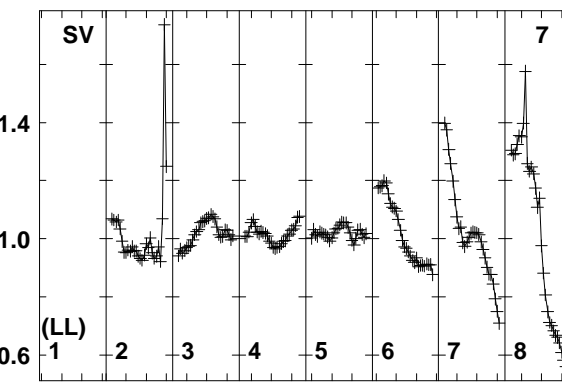
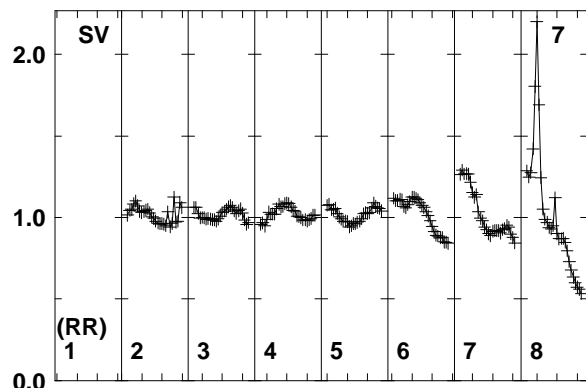
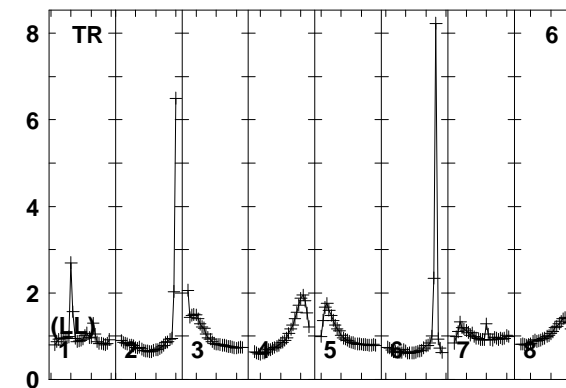
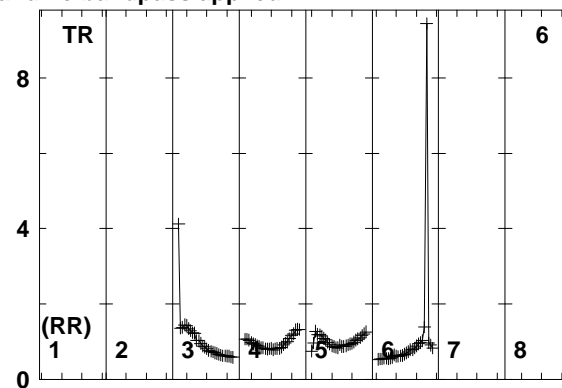
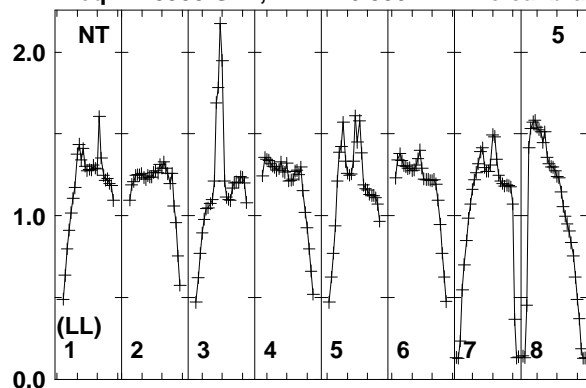

Lower frame: Real Jy
Total-power spectrum Antenna: NT (05)
Timerange: 00/06:00:01 to 00/06:00:49

Plot file version 167 created 11-AUG-2014 17:05:35

J2007+4029 EM110 2.UVDATA.1

Freq = 1.5950 GHz, Bw = 16.000 MH No calibration applied and no bandpass applied

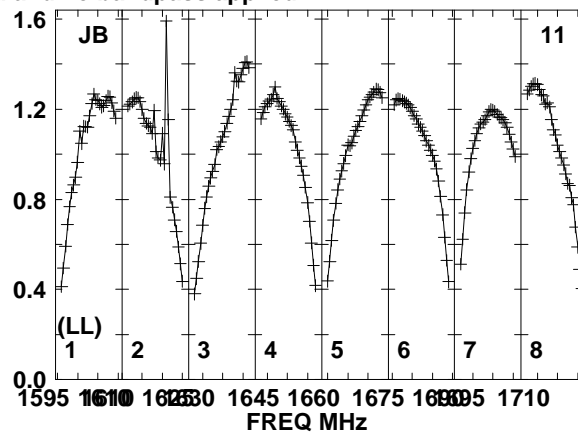
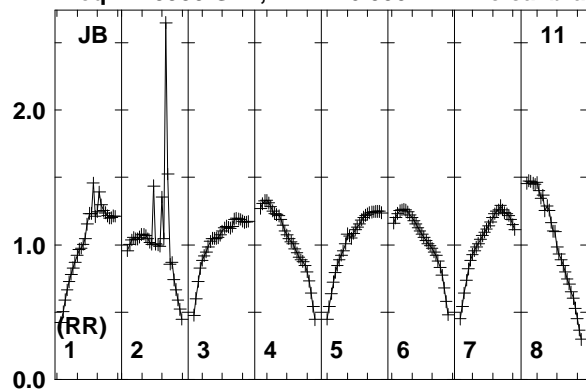

Lower frame: Real Jy
Total-power spectrum Antenna: JB (11)
Timerange: 00/06:00:01 to 00/06:00:49

Plot file version 168 created 11-AUG-2014 17:05:35

J2015+3710 EM110 2.UVDATA.1

Freq = 1.5950 GHz, Bw = 16.000 MH No calibration applied and no bandpass applied

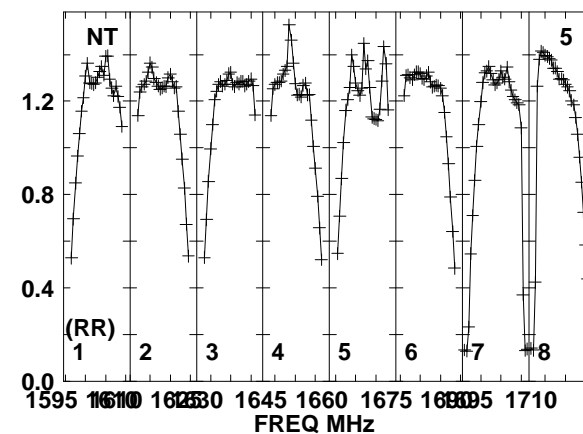
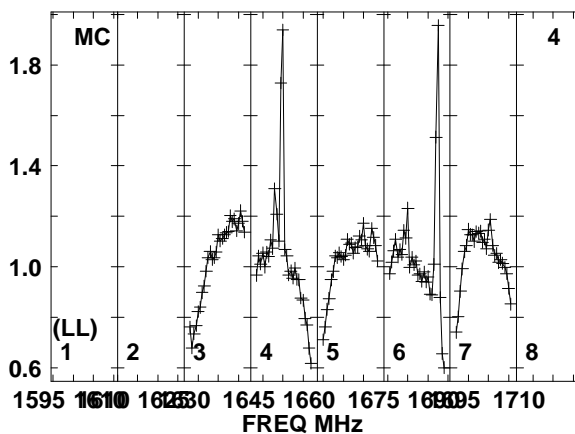
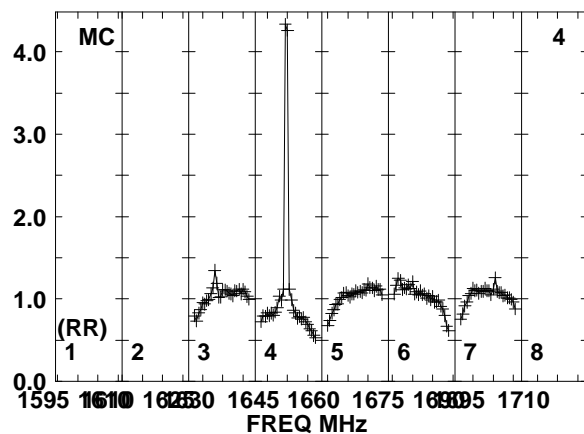
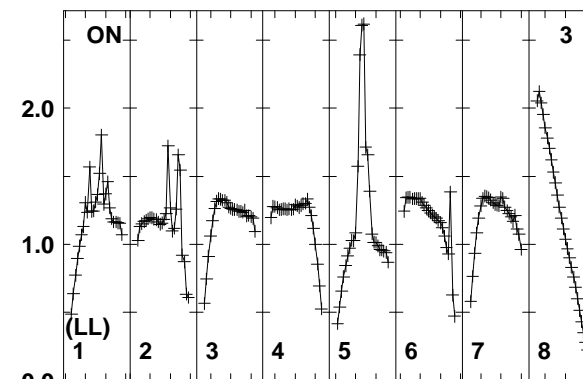
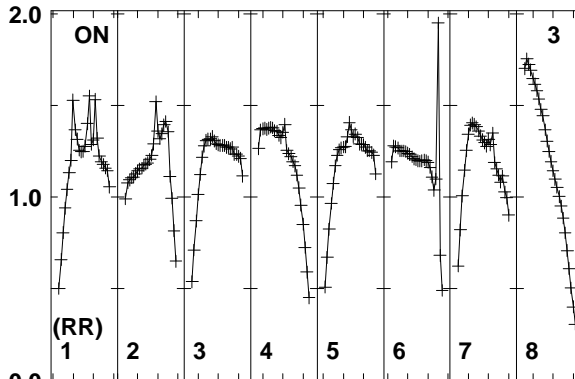
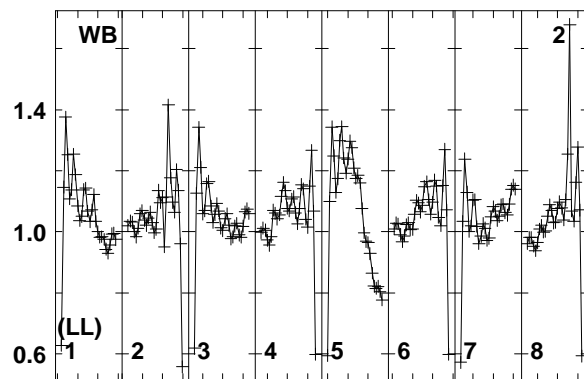
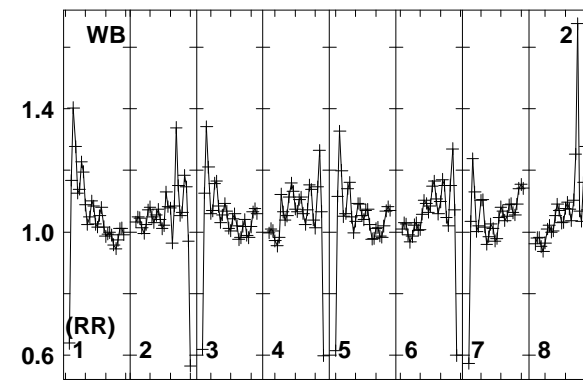
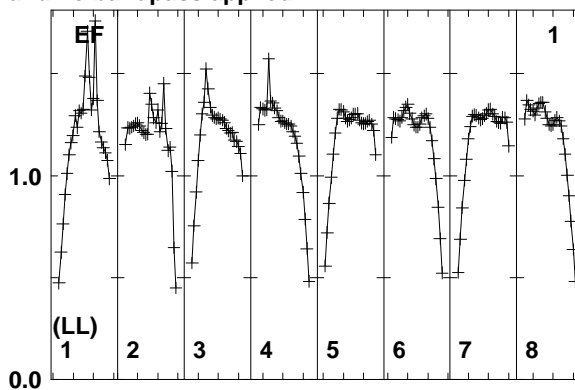
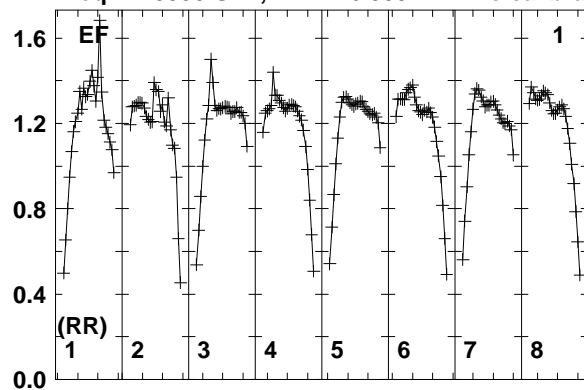

Lower frame: Real Jy
Total-power spectrum Antenna: EF (01)
Timerange: 00/06:01:51 to 00/06:03:49

Plot file version 169 created 11-AUG-2014 17:05:35

J2015+3710 EM110 2.UVDATA.1

Freq = 1.5950 GHz, Bw = 16.000 MH No calibration applied and no bandpass applied

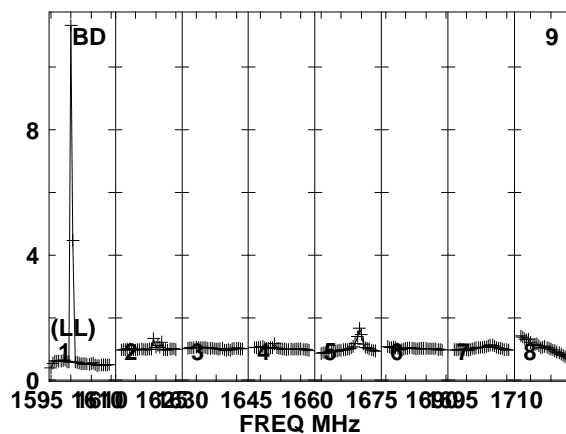
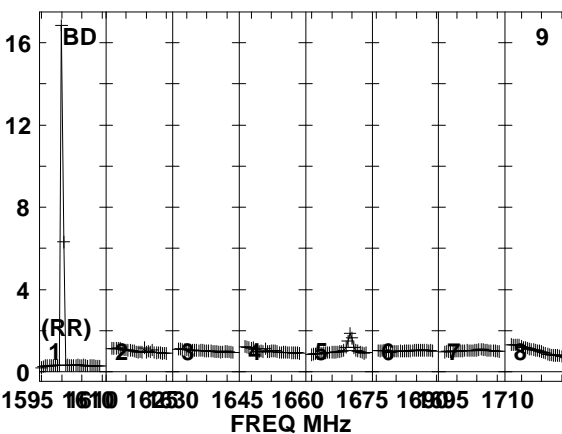
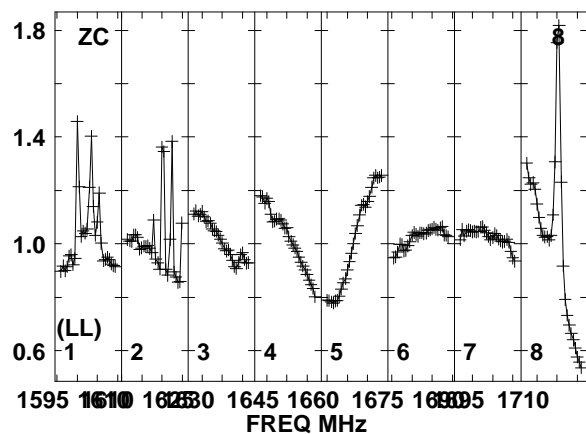
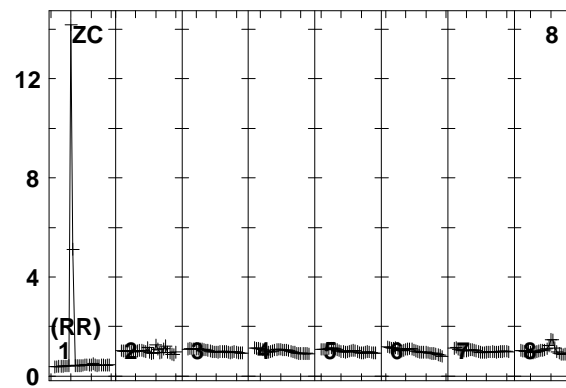
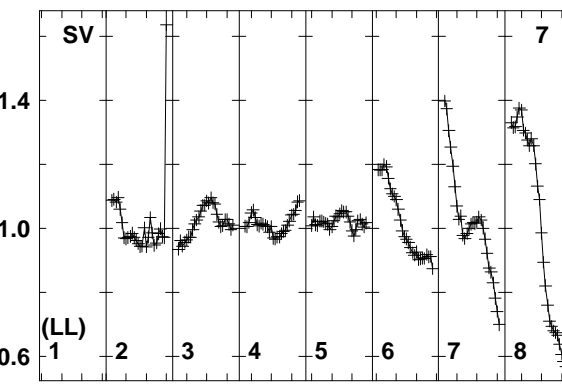
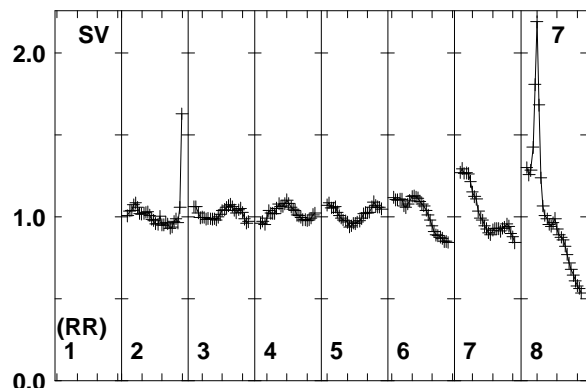
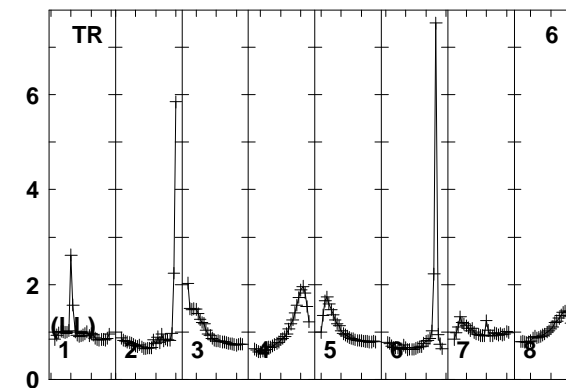
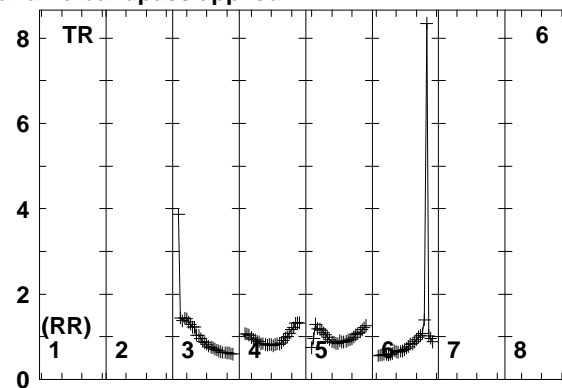
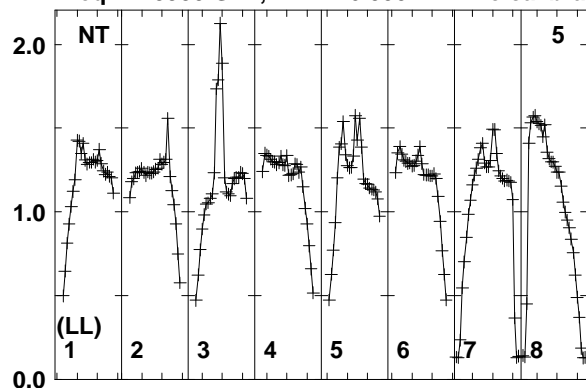

Lower frame: Real Jy
Total-power spectrum Antenna: NT (05)
Timerange: 00/06:01:51 to 00/06:03:49

Plot file version 170 created 11-AUG-2014 17:05:35
 J2032+4127 EM110 2.UVDATA.1
 Freq = 1.5950 GHz, Bw = 16.000 MH No calibration applied and no bandpass applied

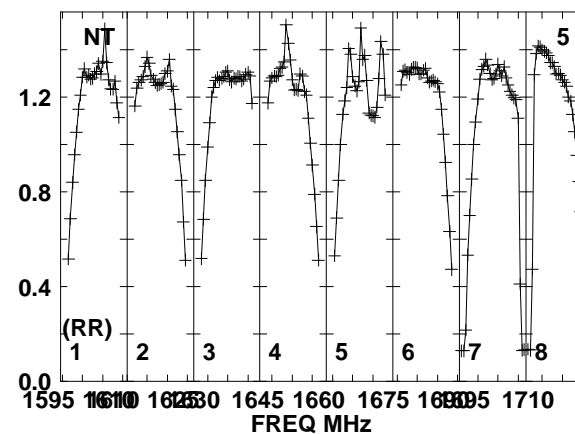
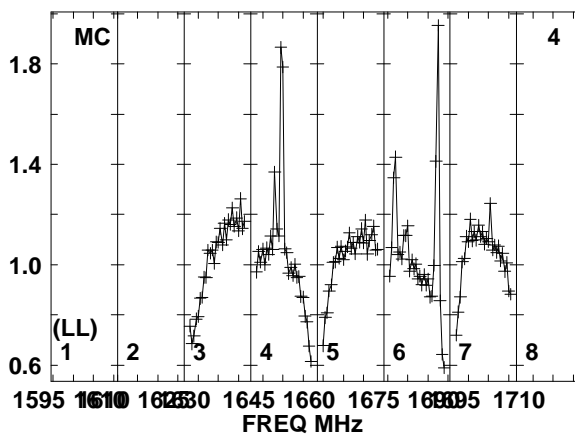
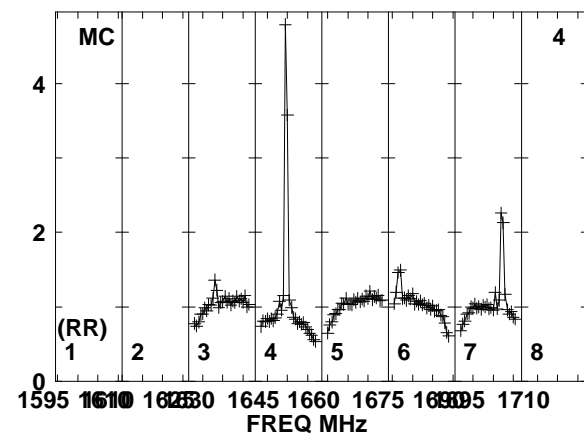
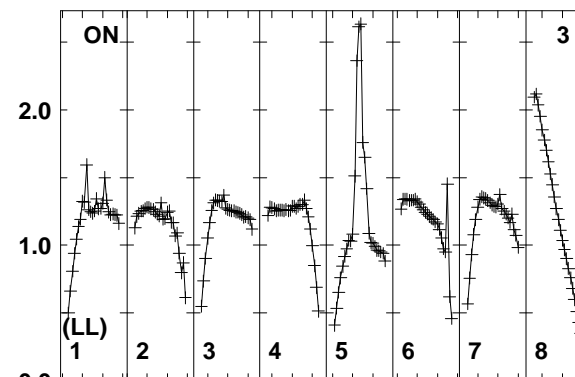
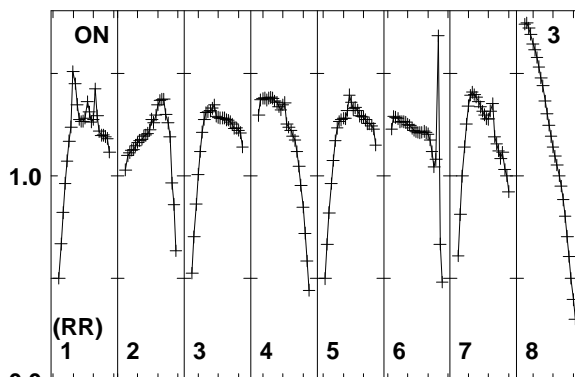
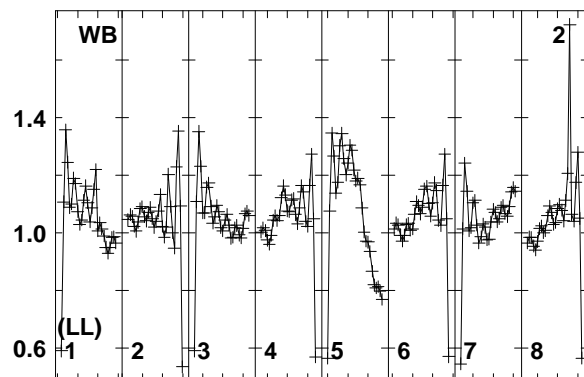
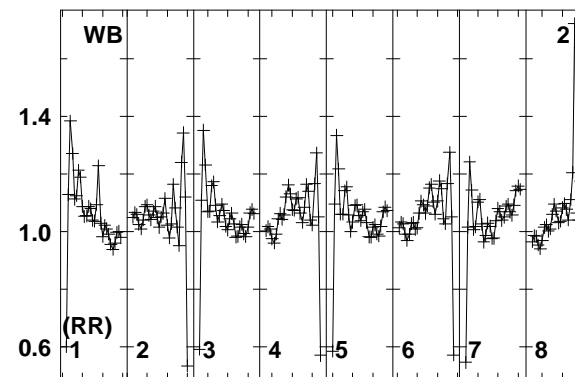
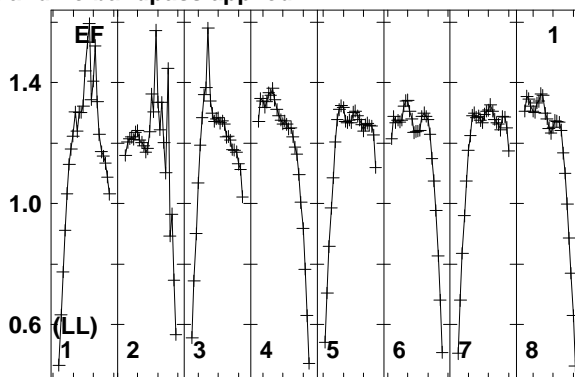
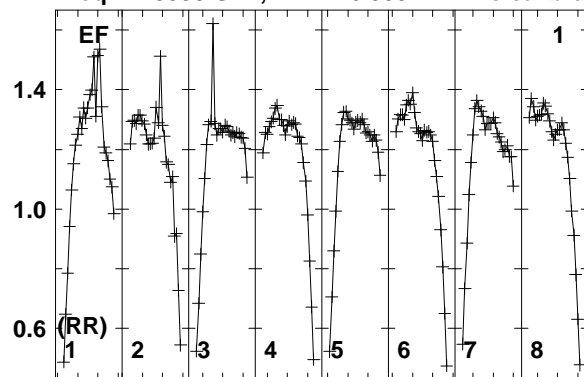

Lower frame: Real Jy
 Total-power spectrum Antenna: EF (01)
 Timerange: 00/06:03:51 to 00/06:07:49

Plot file version 171 created 11-AUG-2014 17:05:35

J2032+4127 EM110 2.UVDATA.1

Freq = 1.5950 GHz, Bw = 16.000 MH No calibration applied and no bandpass applied

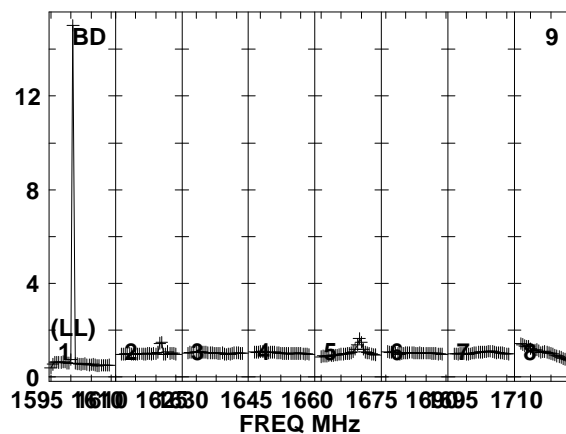
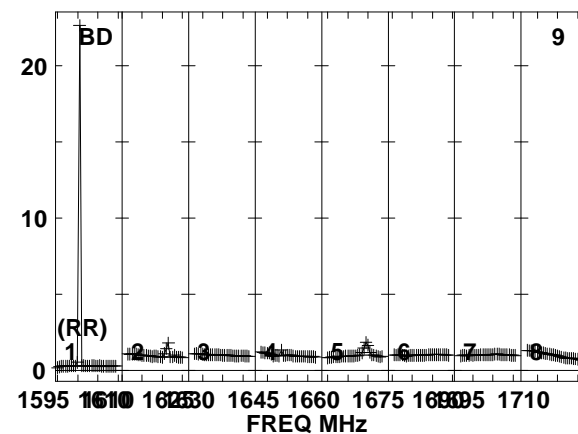
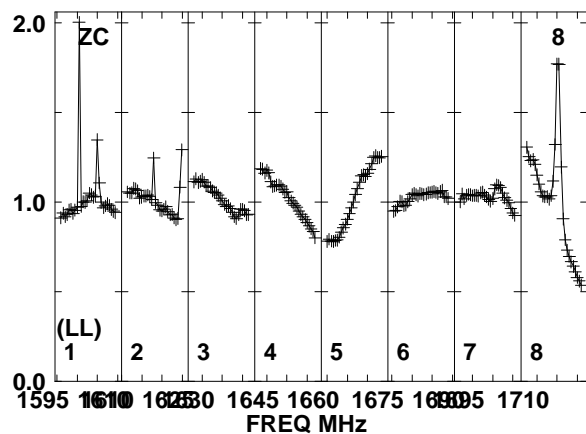
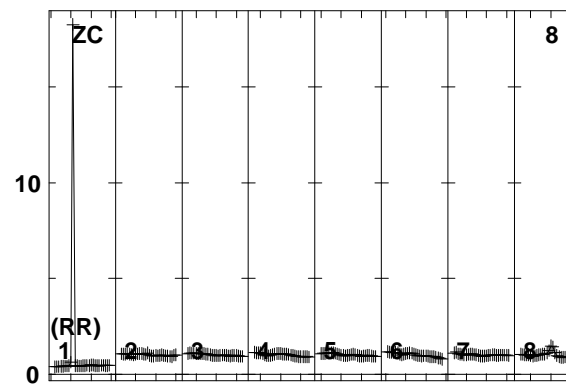
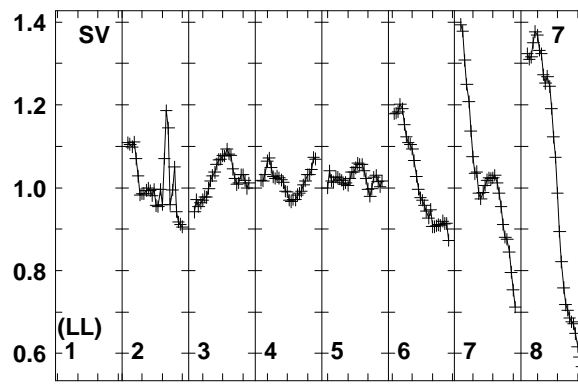
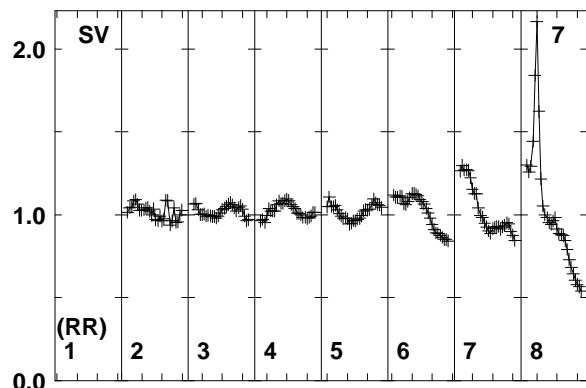
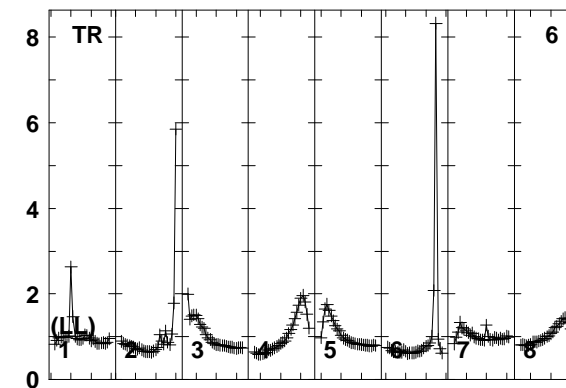
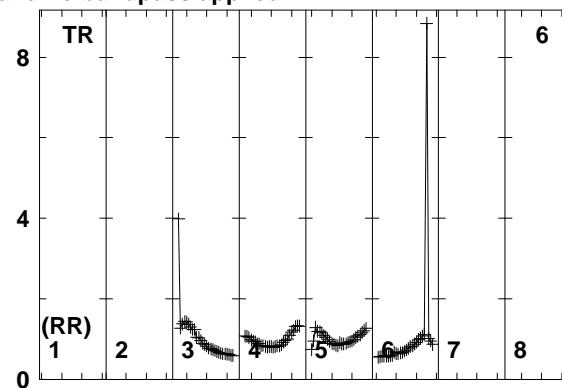
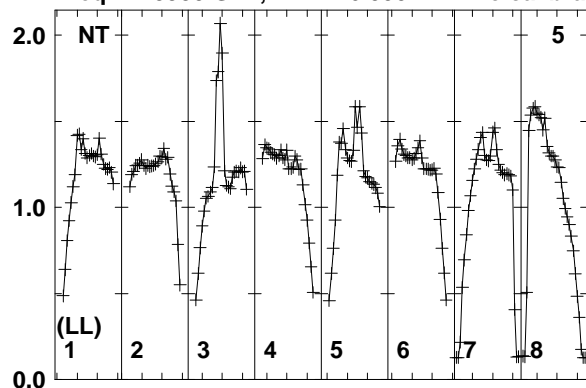

Lower frame: Real Jy
Total-power spectrum Antenna: NT (05)
Timerange: 00/06:03:51 to 00/06:07:49

Plot file version 172 created 11-AUG-2014 17:05:35

J2032+4127 EM110 2.UVDATA.1

Freq = 1.5950 GHz, Bw = 16.000 MH No calibration applied and no bandpass applied

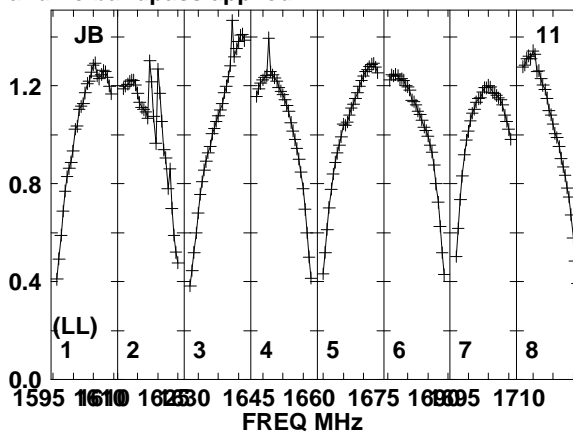
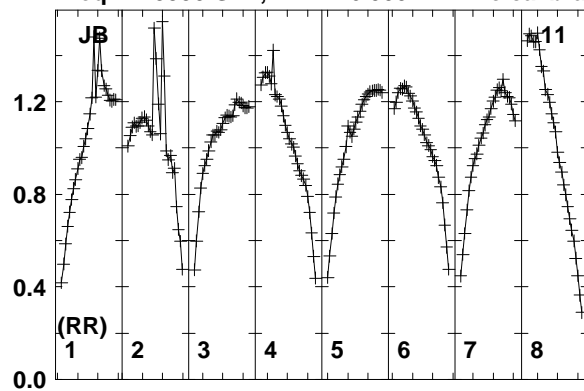

Lower frame: Real Jy
Total-power spectrum Antenna: JB (11)
Timerange: 00/06:03:51 to 00/06:07:49

Plot file version 173 created 11-AUG-2014 17:05:35

J2015+3710 EM110 2.UVDATA.1

Freq = 1.5950 GHz, Bw = 16.000 MH No calibration applied and no bandpass applied

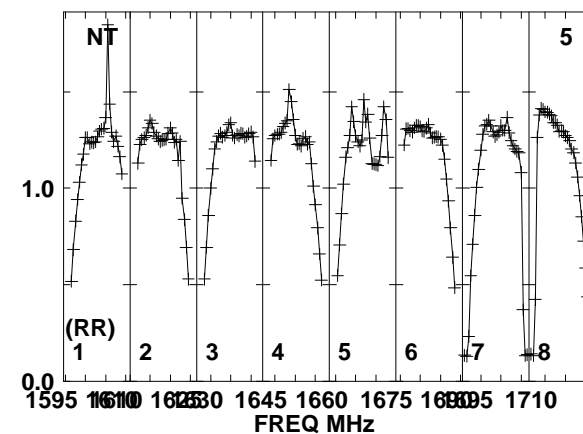
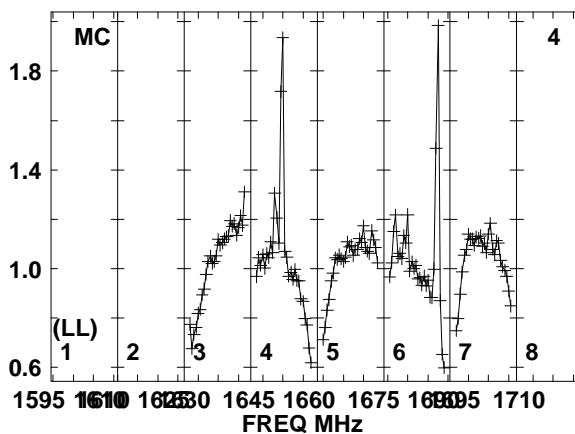
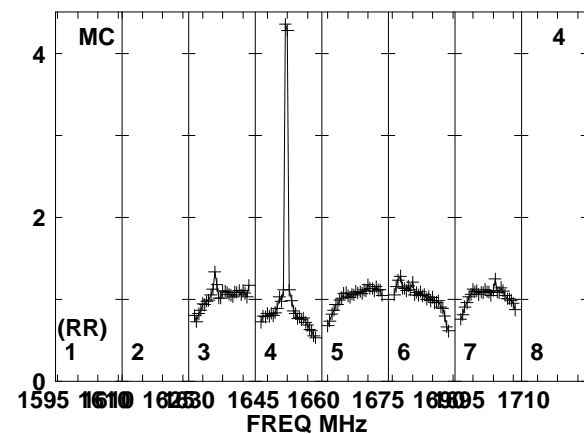
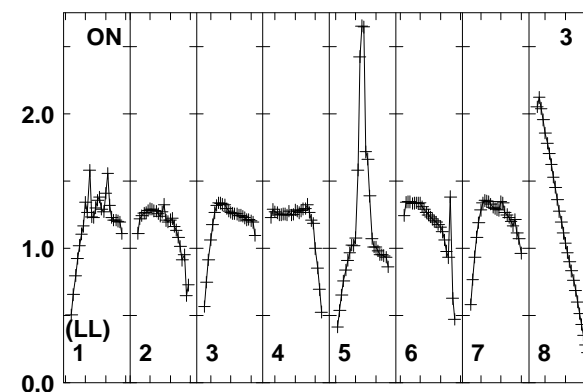
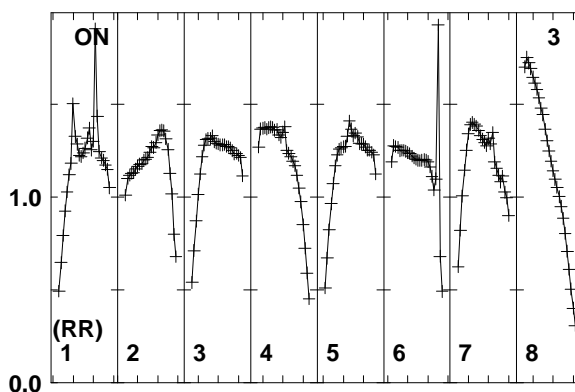
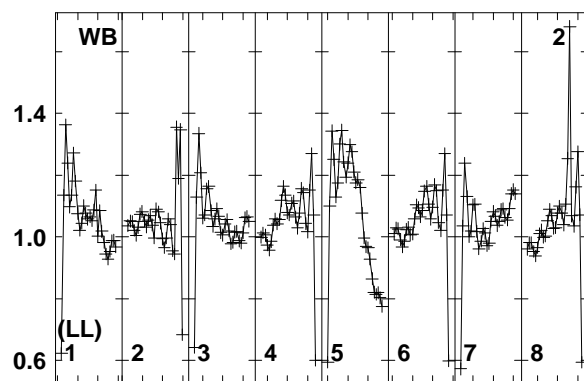
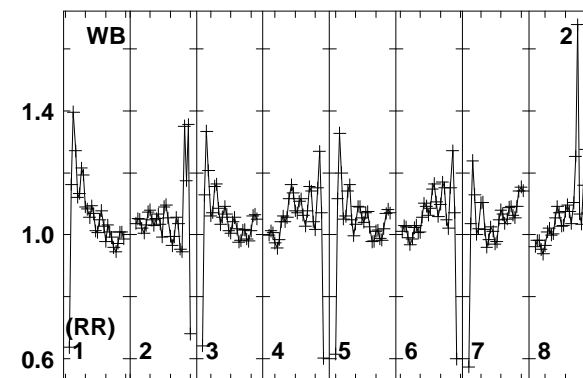
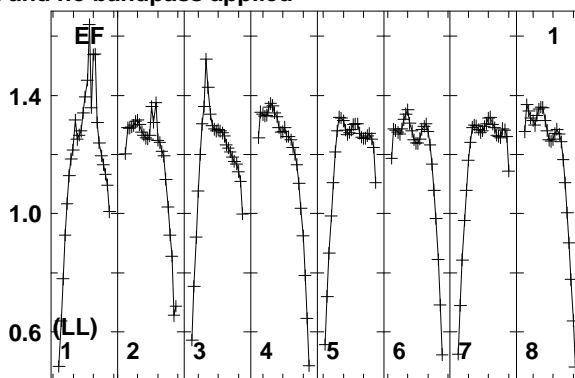
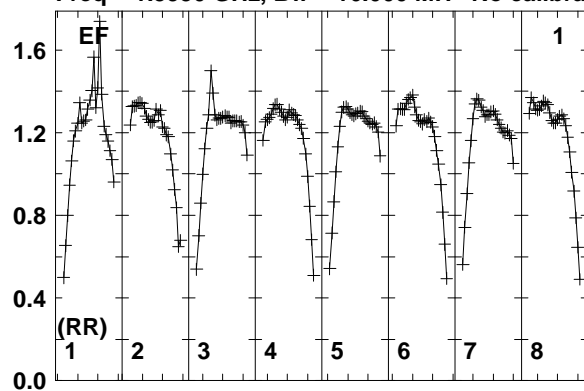

Lower frame: Real Jy
Total-power spectrum Antenna: EF (01)
Timerange: 00/06:08:05 to 00/06:09:49

Plot file version 174 created 11-AUG-2014 17:05:35

J2015+3710 EM110 2.UVDATA.1

Freq = 1.5950 GHz, Bw = 16.000 MH No calibration applied and no bandpass applied

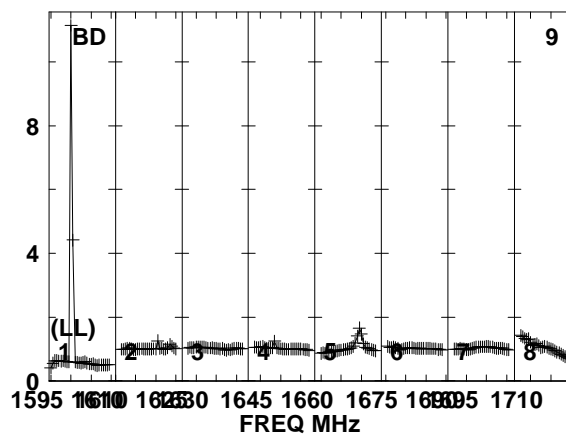
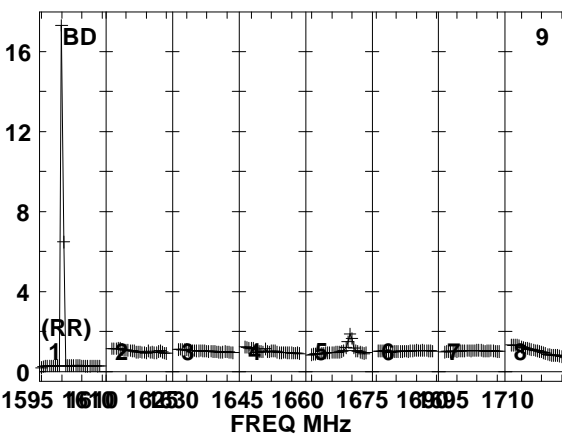
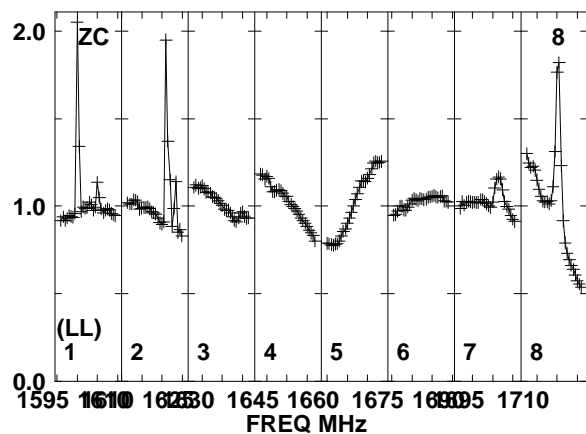
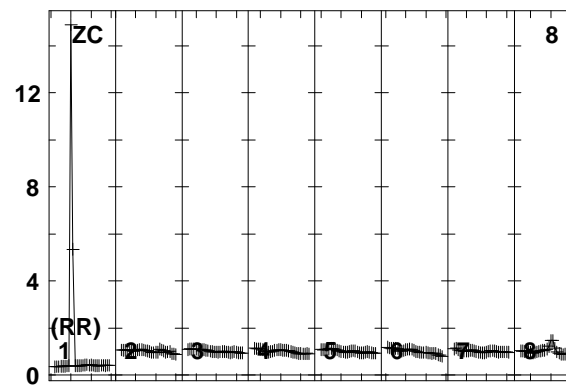
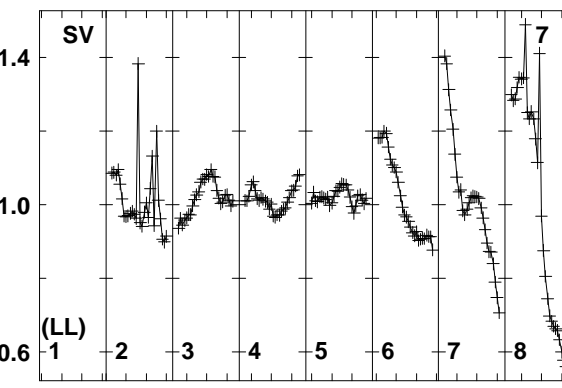
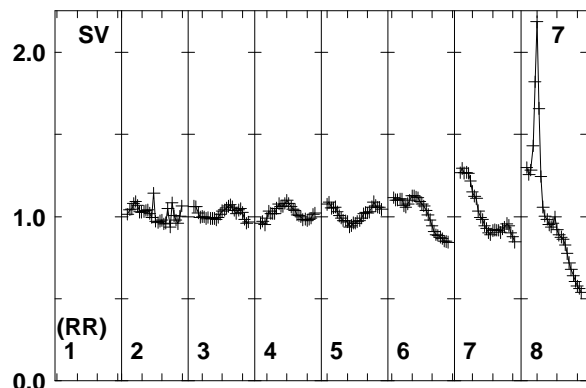
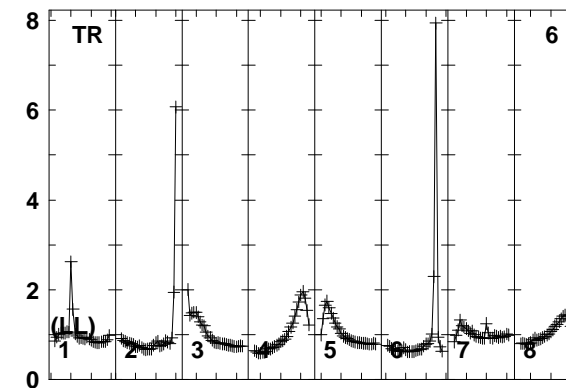
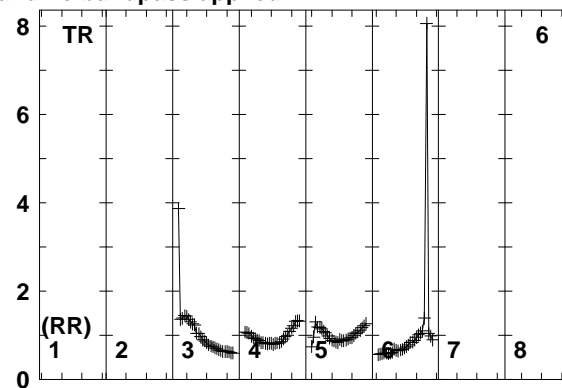
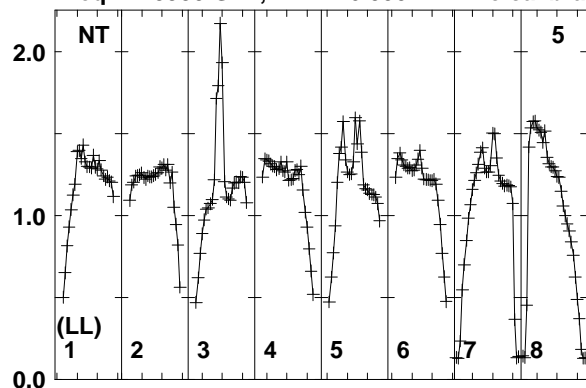

Lower frame: Real Jy
Total-power spectrum Antenna: NT (05)
Timerange: 00/06:08:05 to 00/06:09:49

Plot file version 175 created 11-AUG-2014 17:05:36

J2015+3710 EM110 2.UVDATA.1

Freq = 1.5950 GHz, Bw = 16.000 MH No calibration applied and no bandpass applied

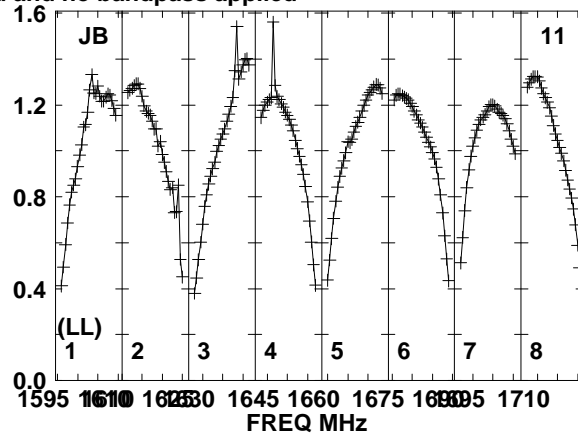
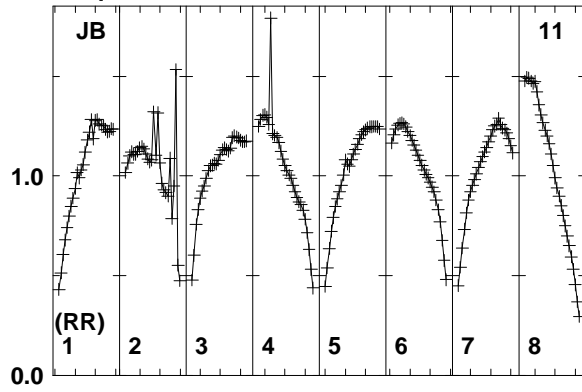

Lower frame: Real Jy
Total-power spectrum Antenna: JB (11)
Timerange: 00/06:08:05 to 00/06:09:49

Plot file version 176 created 11-AUG-2014 17:05:36

J2032+4127 EM110 2.UVDATA.1

Freq = 1.5950 GHz, Bw = 16.000 MH No calibration applied and no bandpass applied

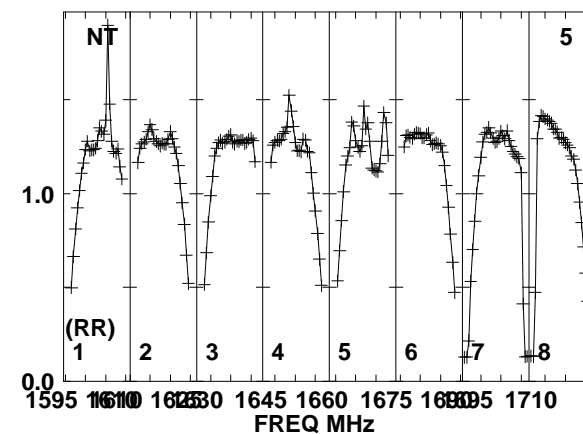
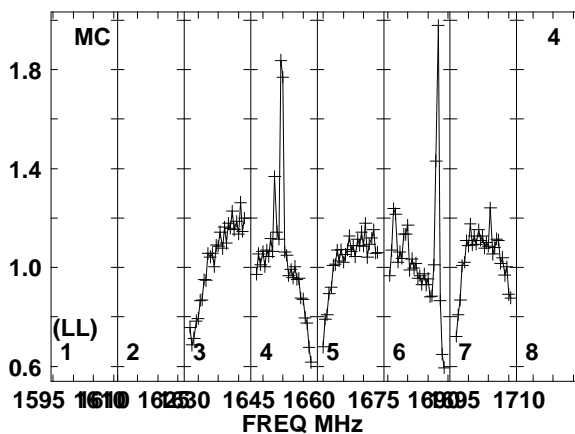
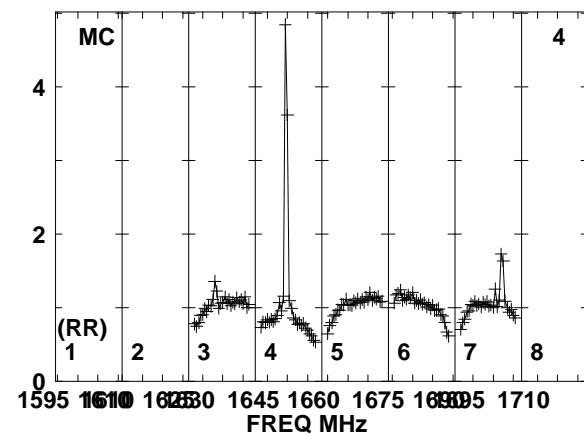
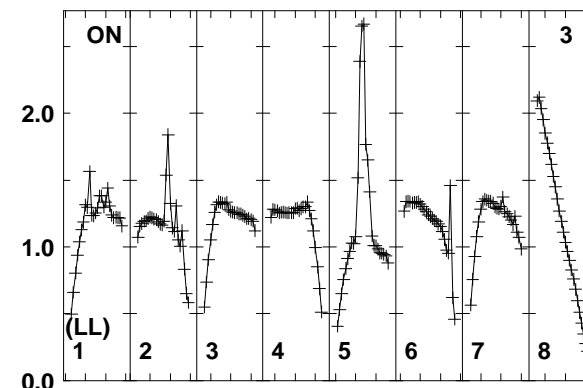
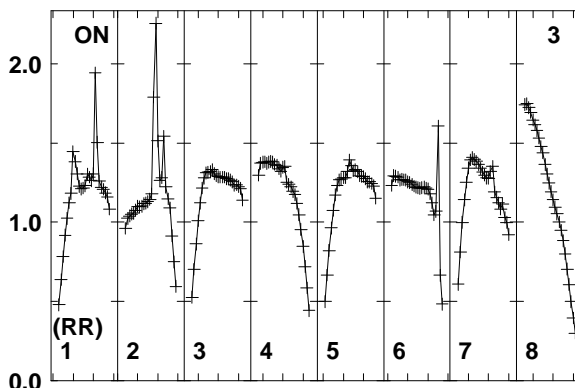
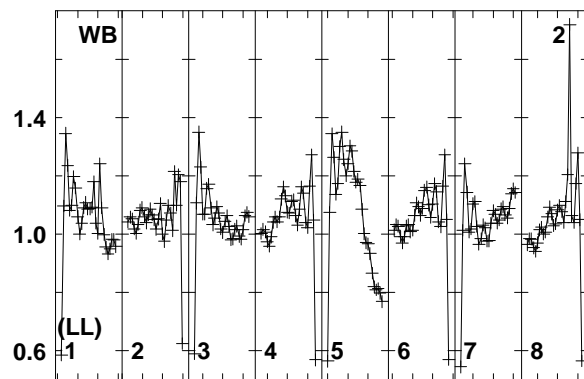
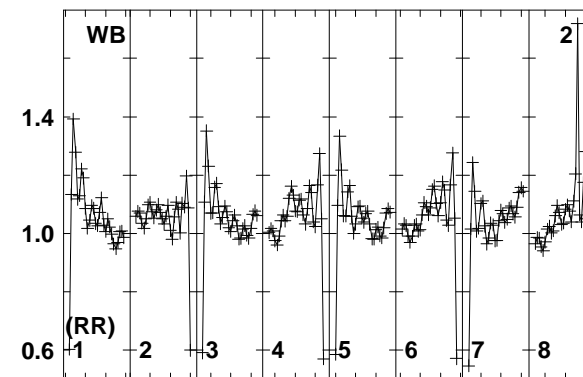
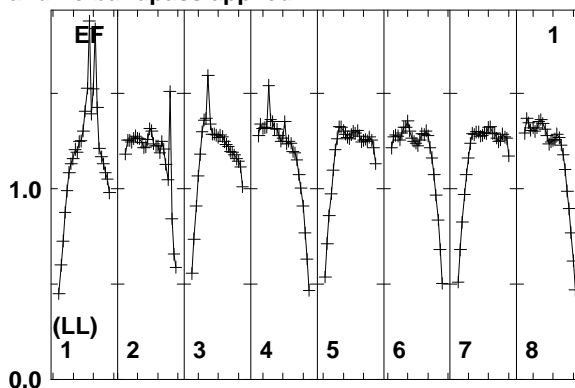
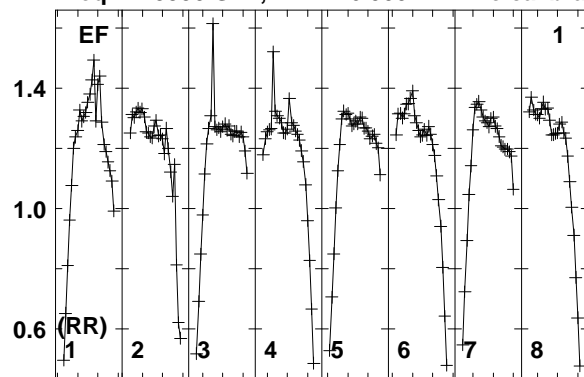

Lower frame: Real Jy
Total-power spectrum Antenna: EF (01)
Timerange: 00/06:10:05 to 00/06:13:49

Plot file version 177 created 11-AUG-2014 17:05:36

J2032+4127 EM110 2.UVDATA.1

Freq = 1.5950 GHz, Bw = 16.000 MH No calibration applied and no bandpass applied

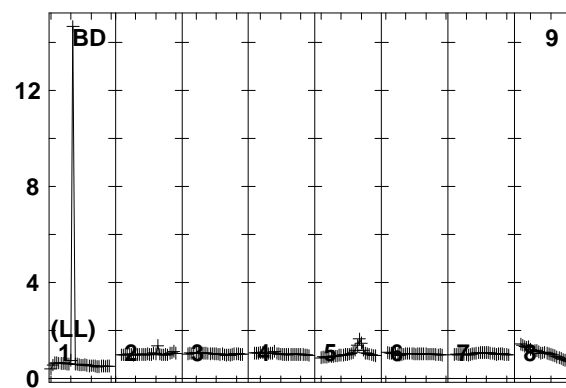
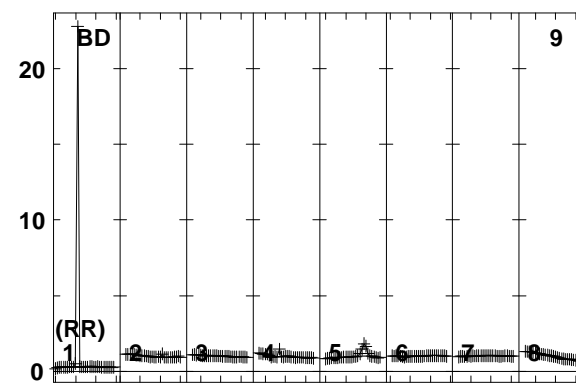
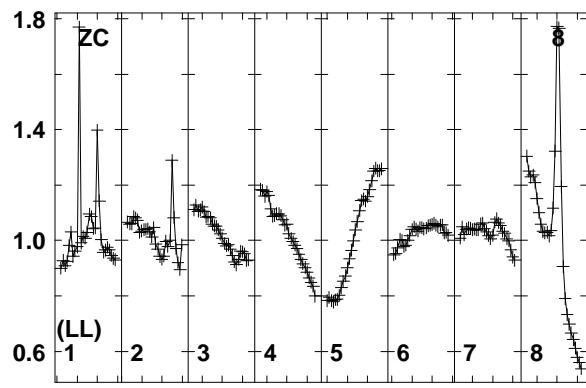
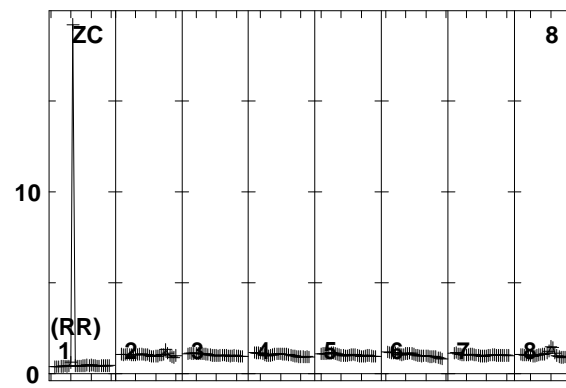
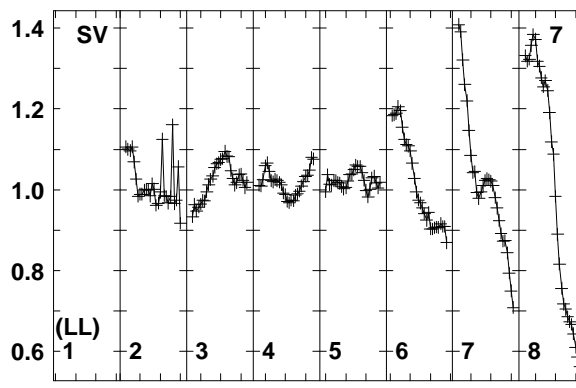
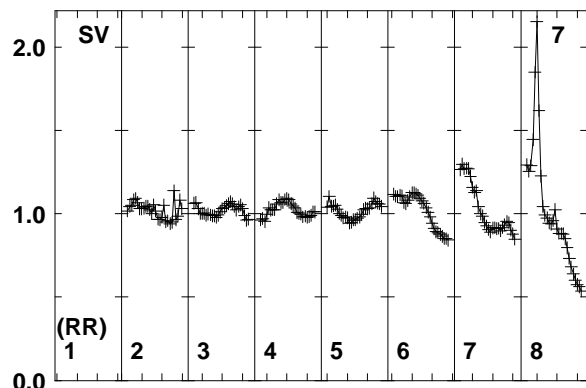
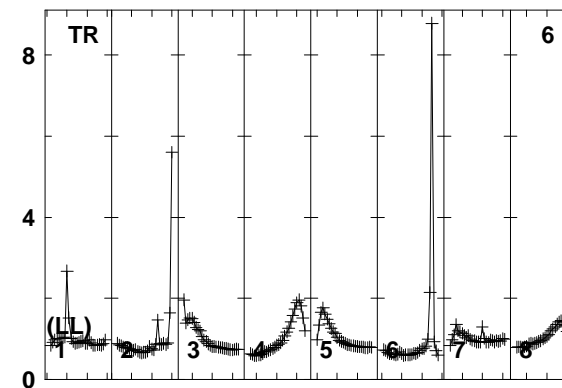
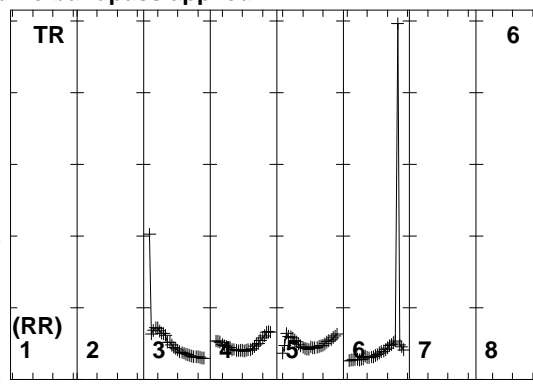
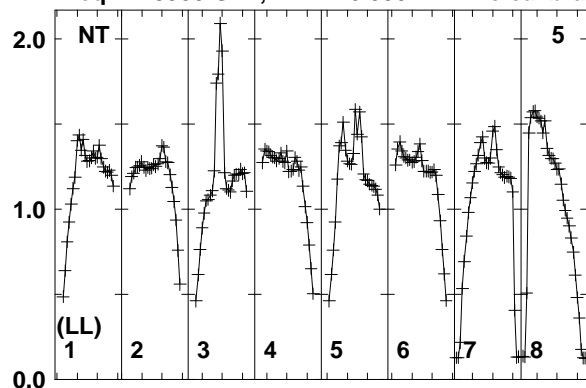

1595 1610 1625 1640 1655 1670 1685 1700 1710
FREQ MHz

1595 1610 1625 1640 1655 1670 1685 1700 1710
FREQ MHz

1595 1610 1625 1640 1655 1670 1685 1700 1710
FREQ MHz

Lower frame: Real Jy
Total-power spectrum Antenna: NT (05)
Timerange: 00/06:10:05 to 00/06:13:49

Plot file version 178 created 11-AUG-2014 17:05:36

J2032+4127 EM110 2.UVDATA.1

Freq = 1.5950 GHz, Bw = 16.000 MH No calibration applied and no bandpass applied

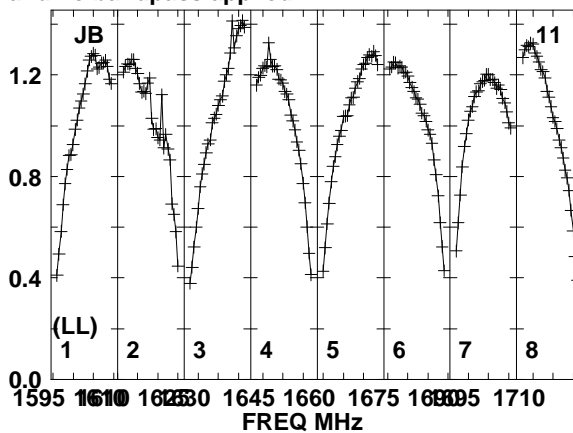
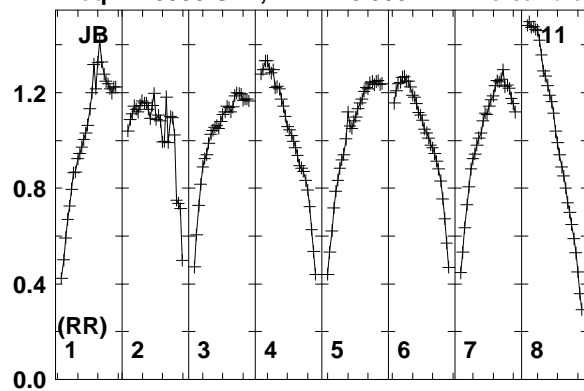

Lower frame: Real Jy
Total-power spectrum Antenna: JB (11)
Timerange: 00/06:10:05 to 00/06:13:49

Plot file version 179 created 11-AUG-2014 17:05:36

J2015+3710 EM110 2.UVDATA.1

Freq = 1.5950 GHz, Bw = 16.000 MH No calibration applied and no bandpass applied

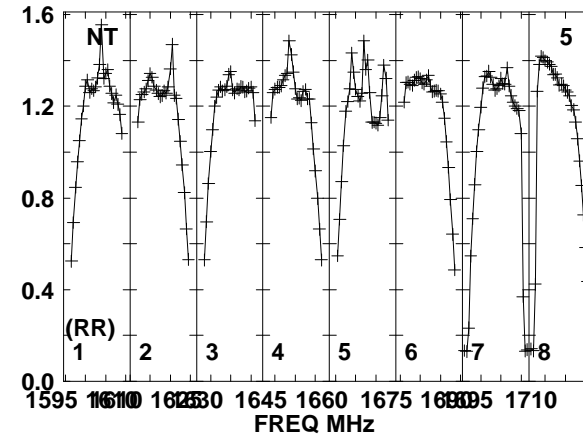
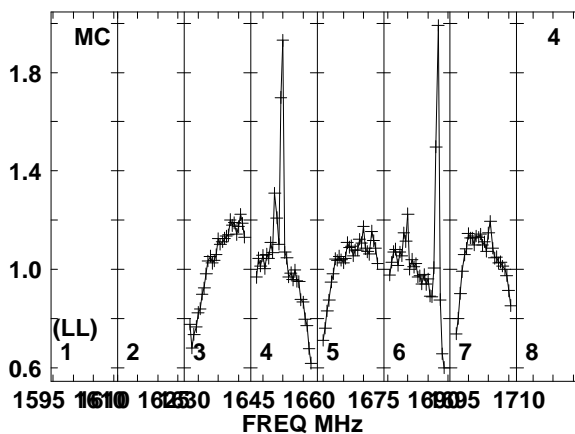
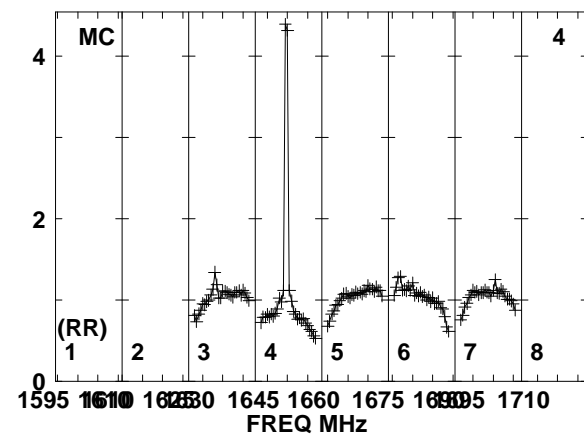
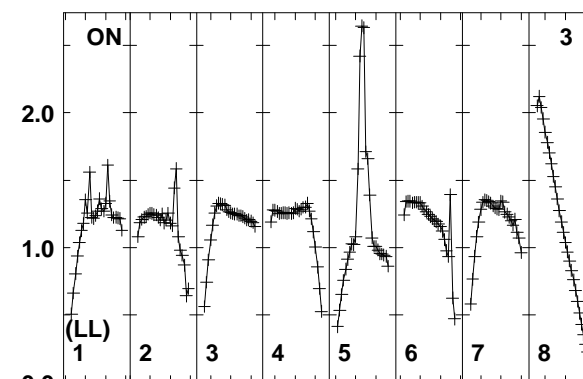
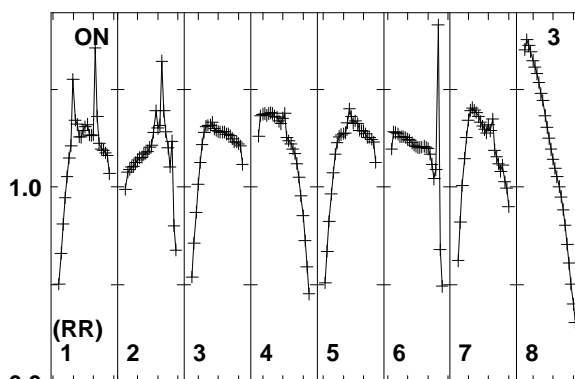
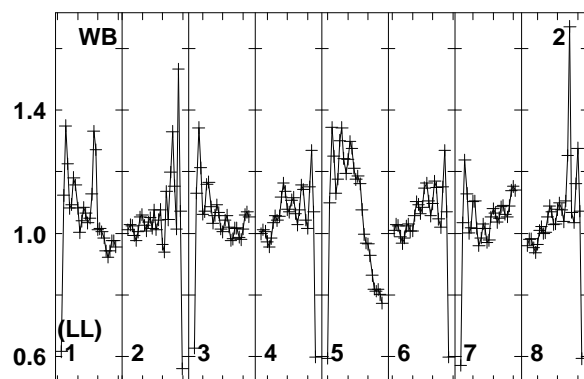
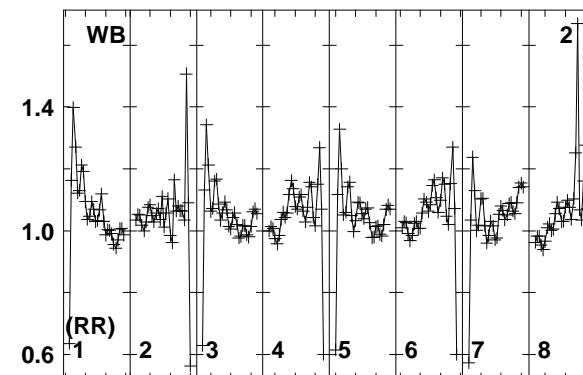
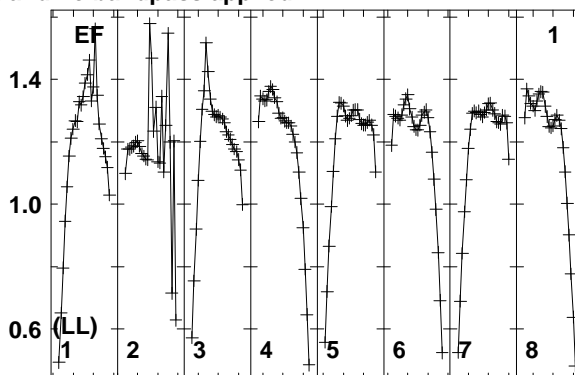
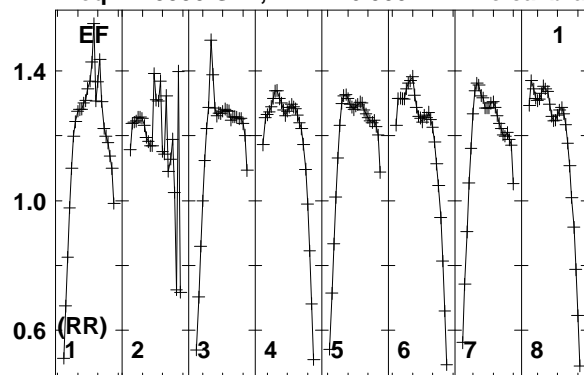

Lower frame: Real Jy
Total-power spectrum Antenna: EF (01)
Timerange: 00/06:14:51 to 00/06:16:49

Plot file version 180 created 11-AUG-2014 17:05:36

J2015+3710 EM110 2.UVDATA.1

Freq = 1.5950 GHz, Bw = 16.000 MH No calibration applied and no bandpass applied

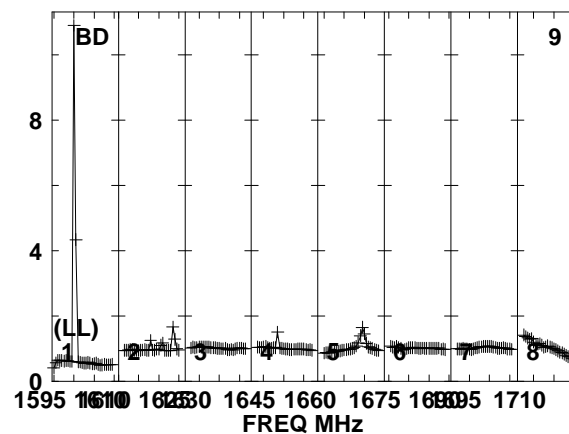
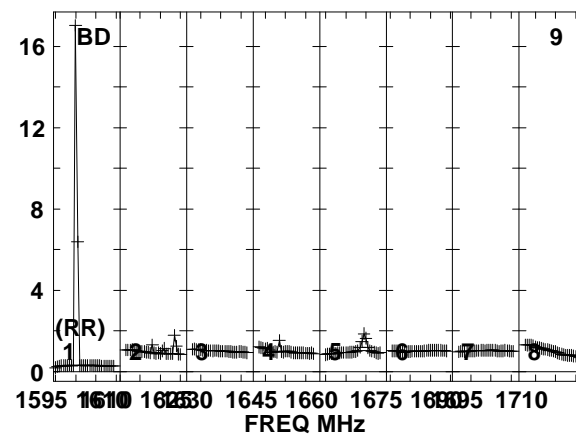
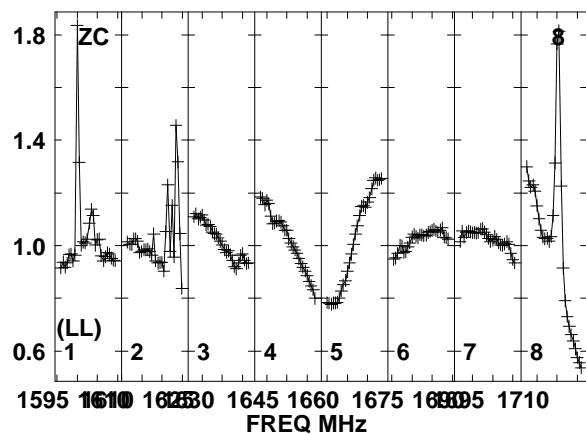
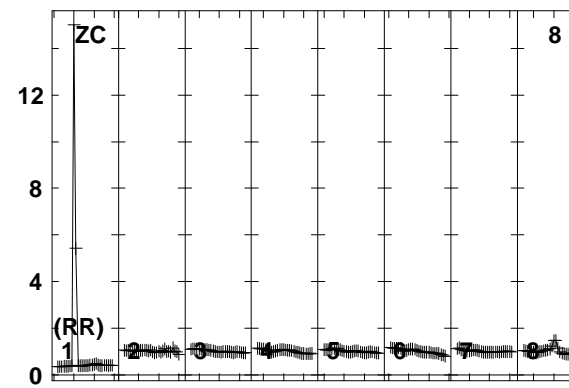
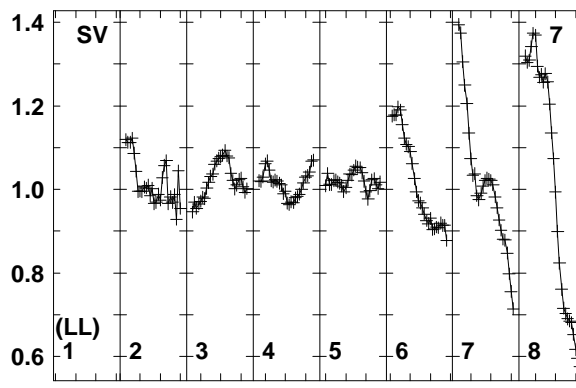
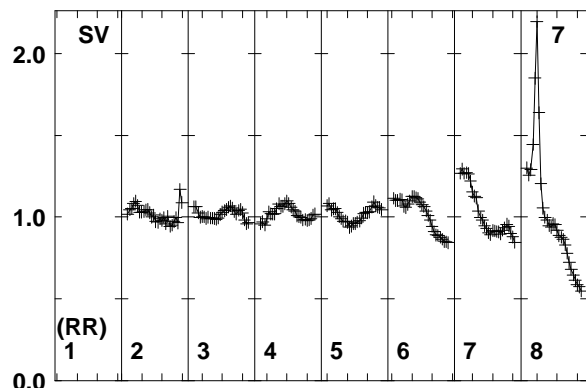
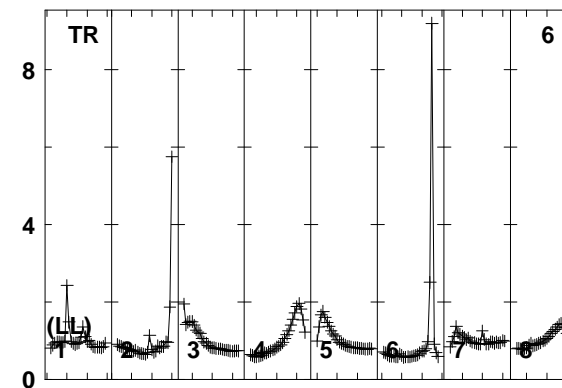
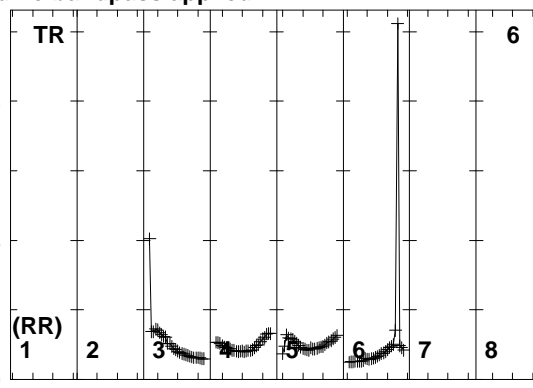
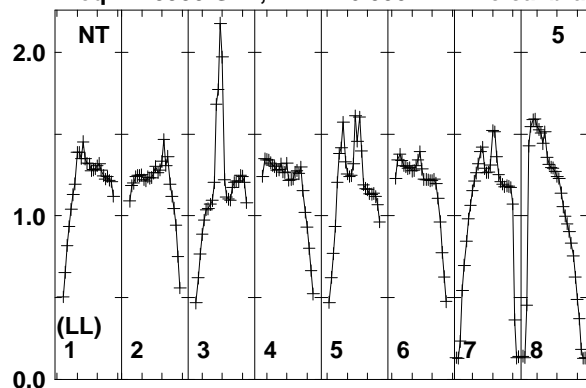

Lower frame: Real Jy
Total-power spectrum Antenna: NT (05)
Timerange: 00/06:14:51 to 00/06:16:49

Plot file version 181 created 11-AUG-2014 17:05:36

J2032+4127 EM110 2.UVDATA.1

Freq = 1.5950 GHz, Bw = 16.000 MH No calibration applied and no bandpass applied

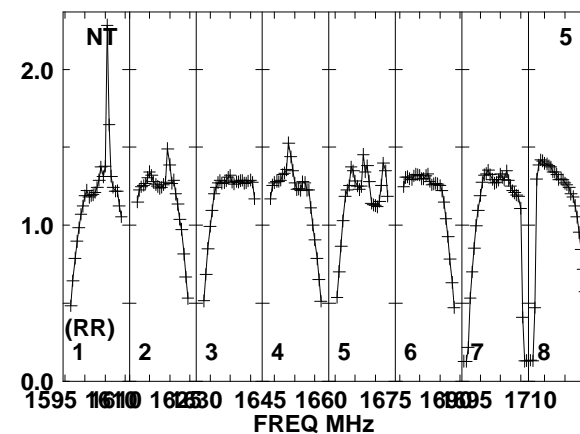
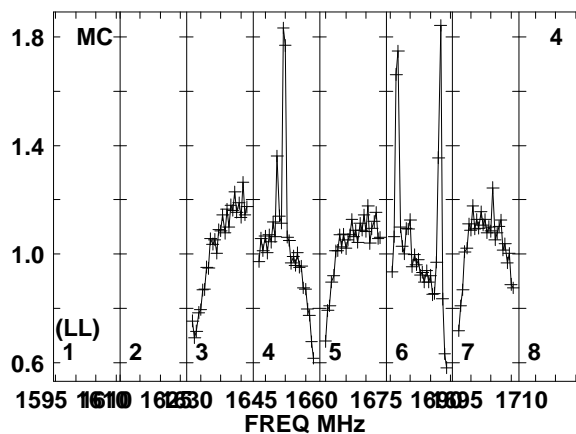
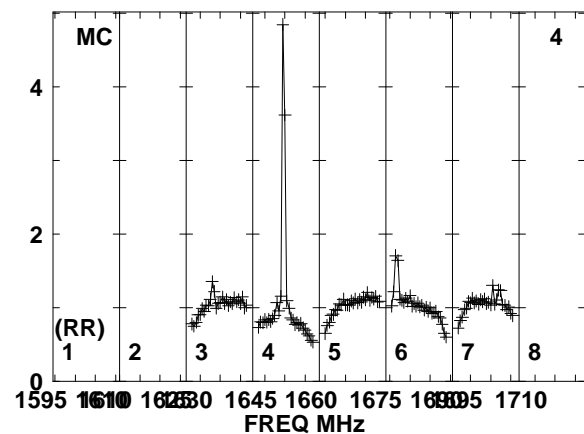
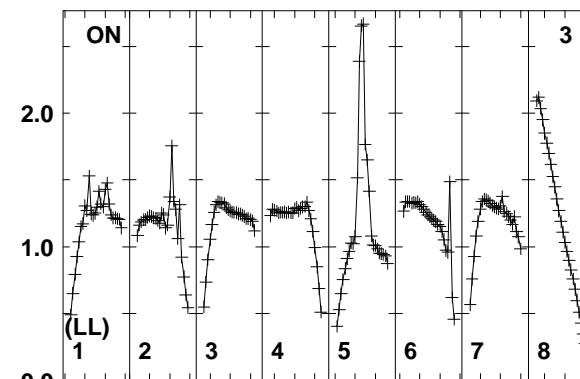
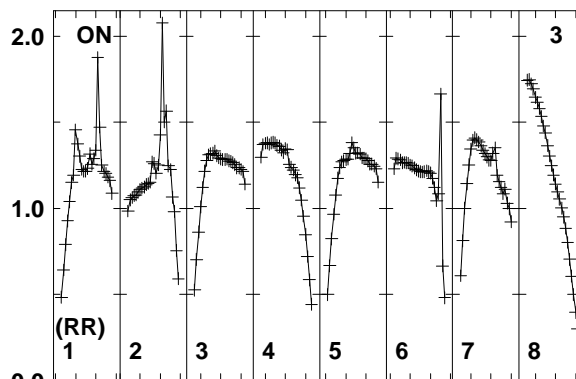
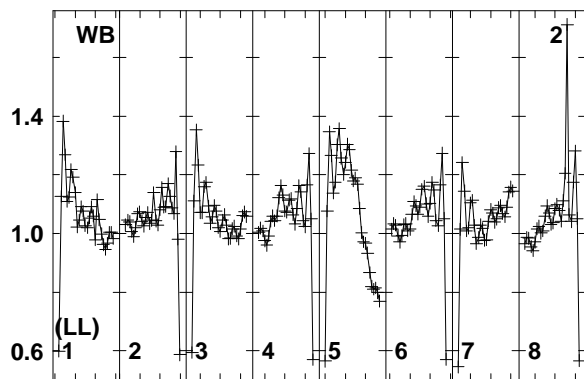
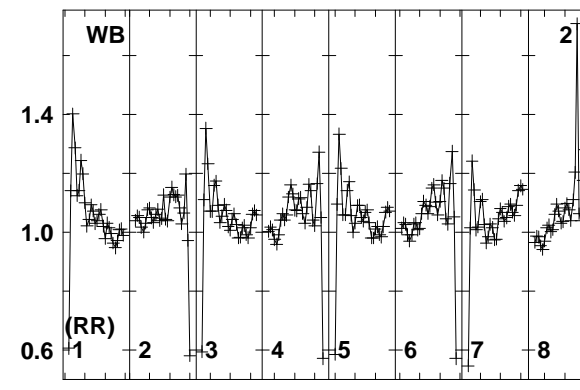
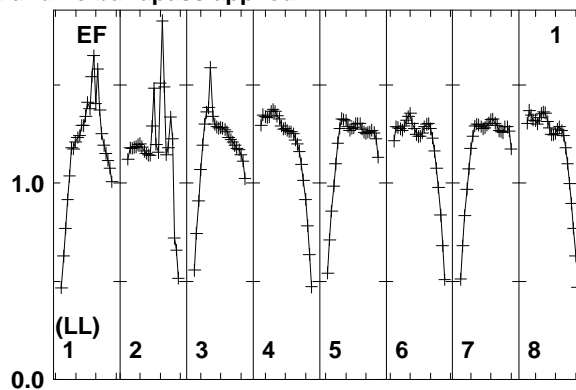
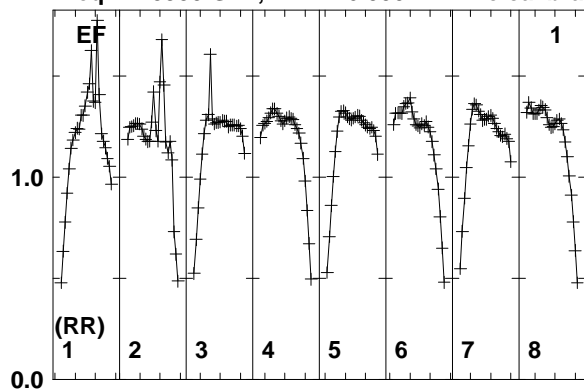

Lower frame: Real Jy
Total-power spectrum Antenna: EF (01)
Timerange: 00/06:16:51 to 00/06:20:49

Plot file version 182 created 11-AUG-2014 17:05:36

J2032+4127 EM110 2.UVDATA.1

Freq = 1.5950 GHz, Bw = 16.000 MH No calibration applied and no bandpass applied

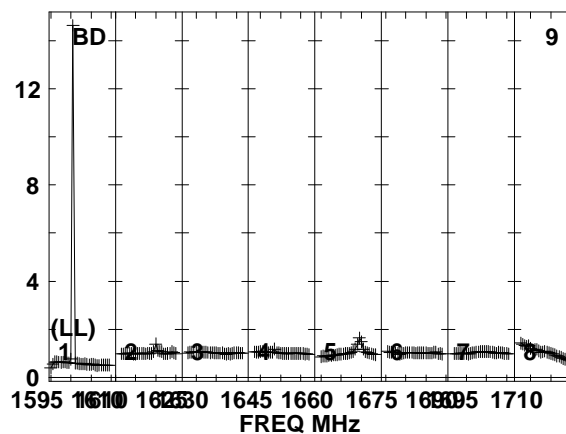
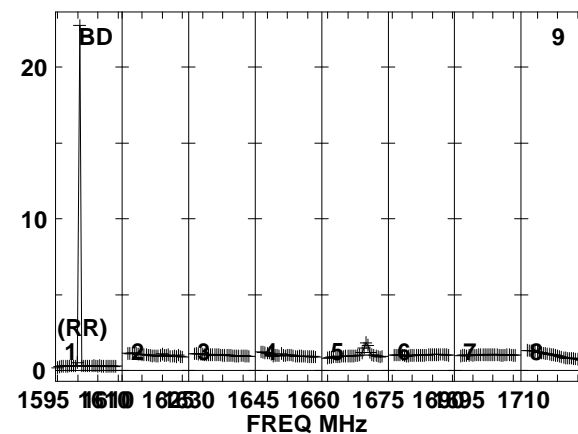
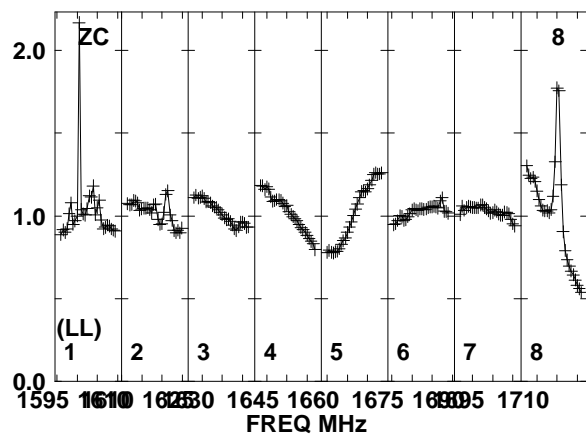
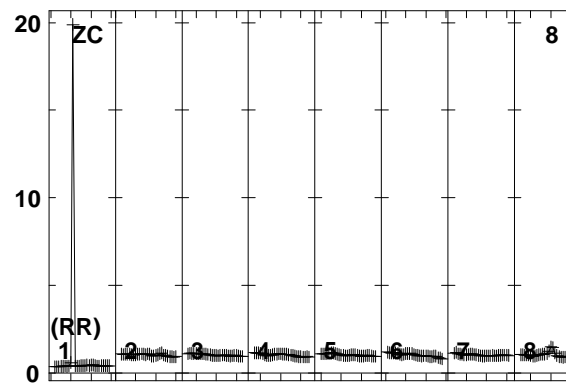
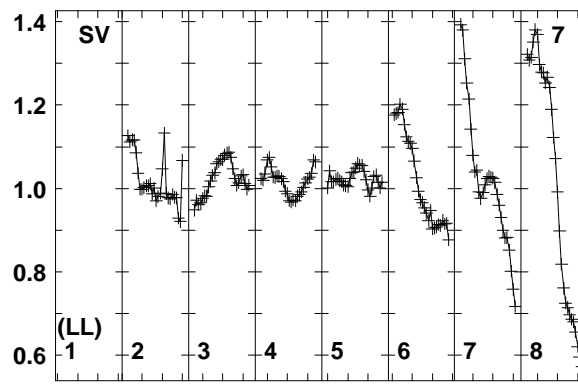
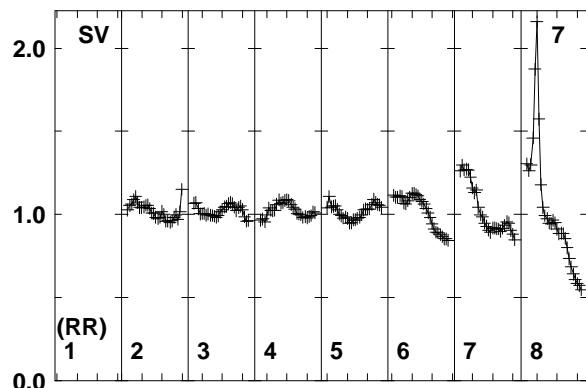
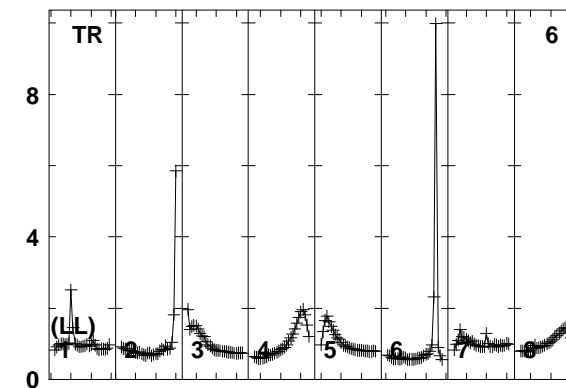
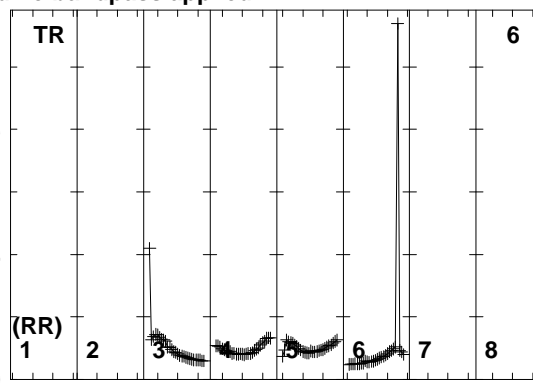
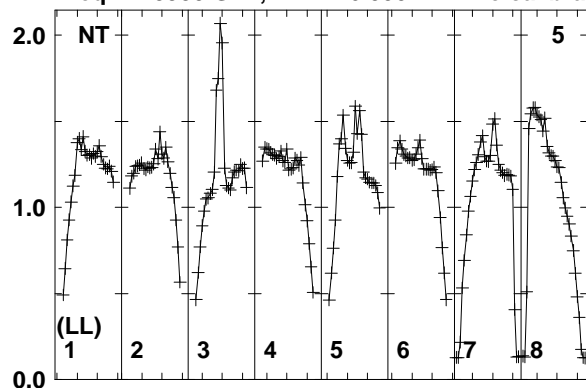

Lower frame: Real Jy
Total-power spectrum Antenna: NT (05)
Timerange: 00/06:16:51 to 00/06:20:49

Plot file version 183 created 11-AUG-2014 17:05:36

J2032+4127 EM110 2.UVDATA.1

Freq = 1.5950 GHz, Bw = 16.000 MH No calibration applied and no bandpass applied

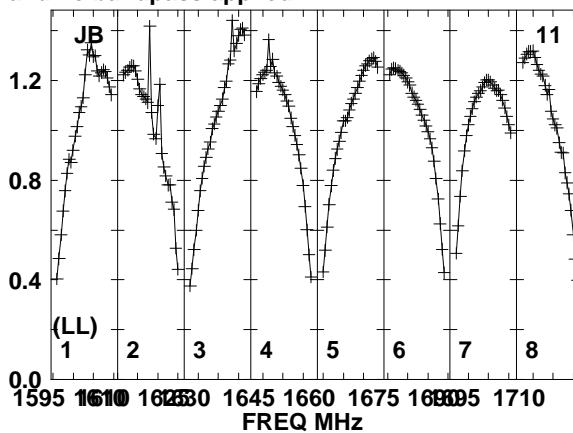
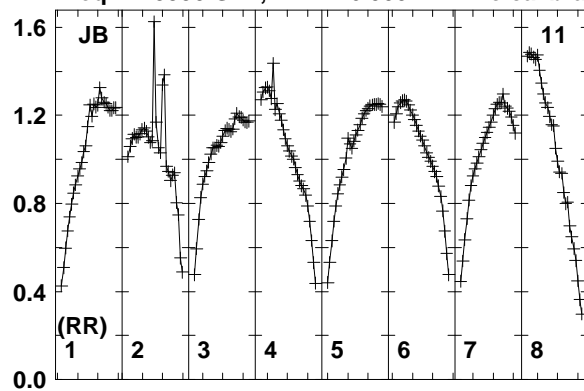

Lower frame: Real Jy
Total-power spectrum Antenna: JB (11)
Timerange: 00/06:16:51 to 00/06:20:49

Plot file version 184 created 11-AUG-2014 17:05:36

J2015+3710 EM110 2.UVDATA.1

Freq = 1.5950 GHz, Bw = 16.000 MH No calibration applied and no bandpass applied

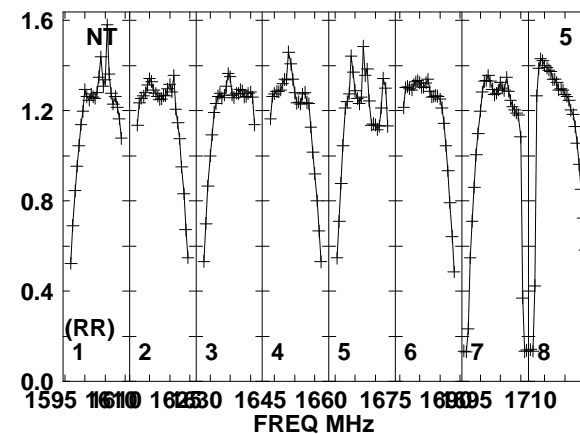
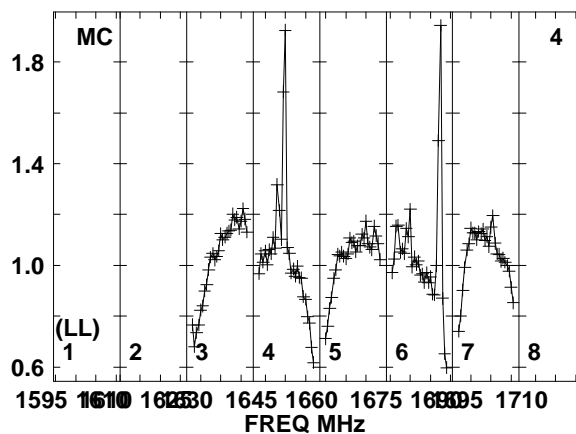
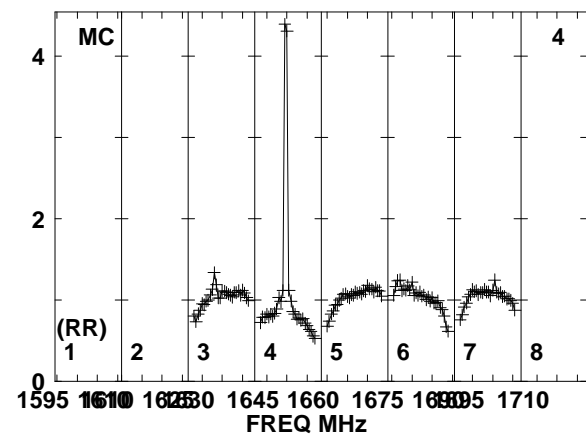
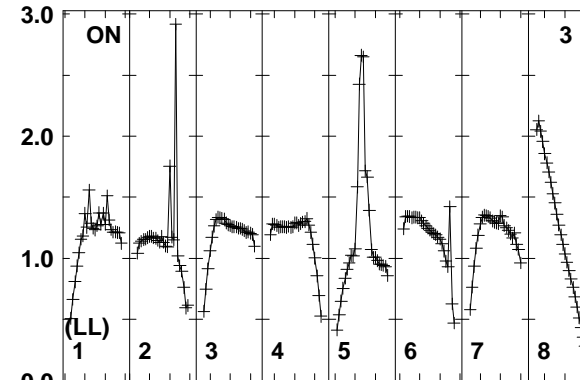
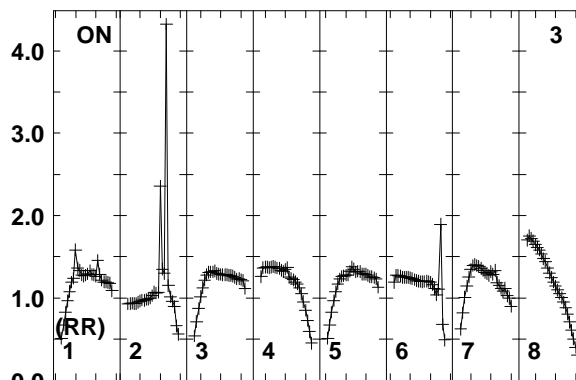
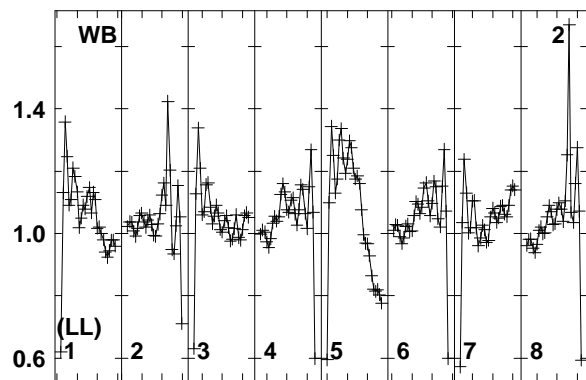
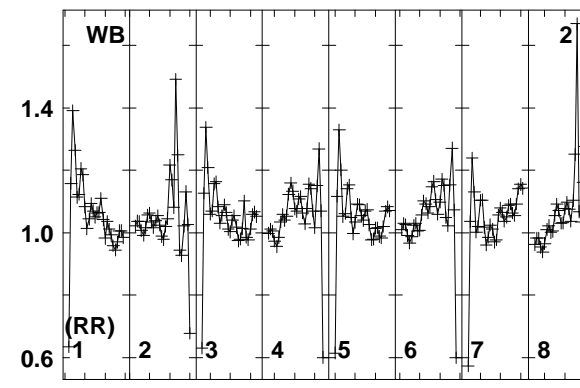
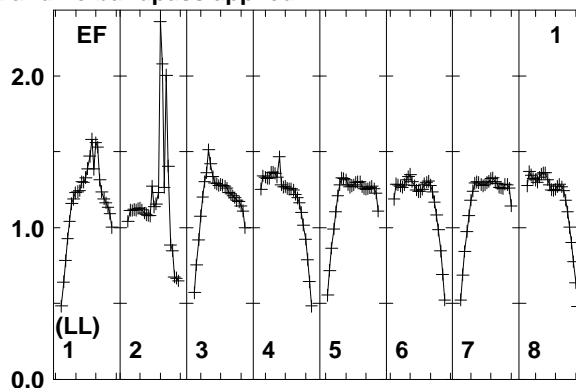
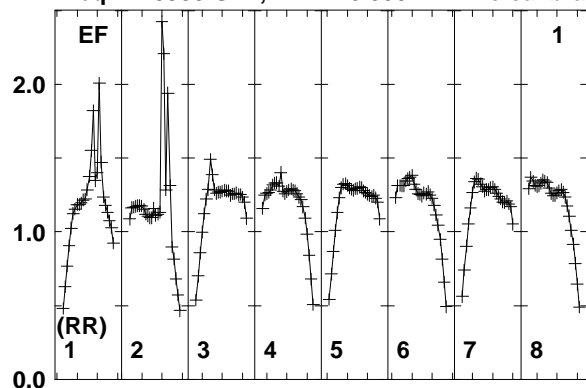

Lower frame: Real Jy
Total-power spectrum Antenna: EF (01)
Timerange: 00/06:21:51 to 00/06:23:49

Plot file version 185 created 11-AUG-2014 17:05:36

J2015+3710 EM110 2.UVDATA.1

Freq = 1.5950 GHz, Bw = 16.000 MH No calibration applied and no bandpass applied

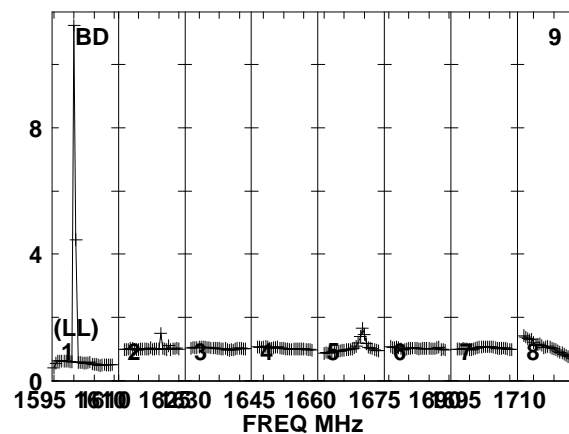
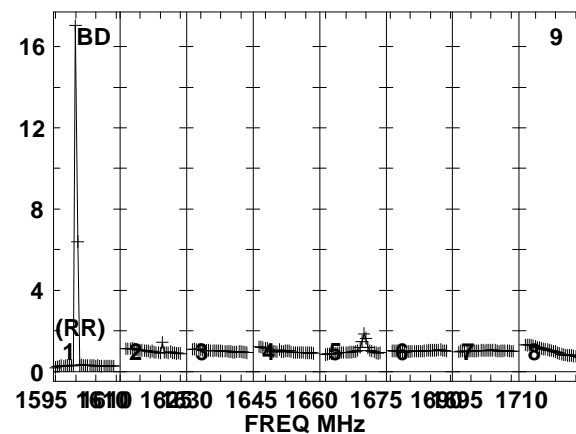
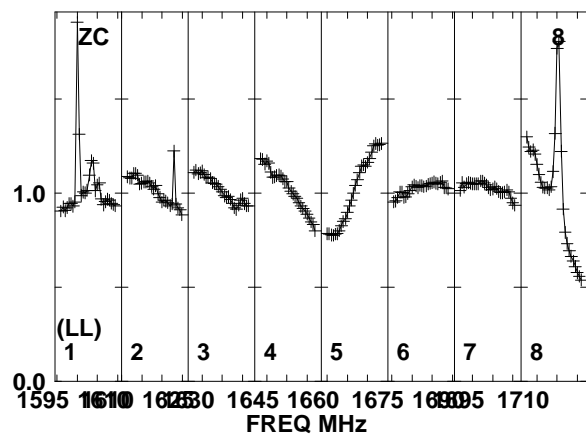
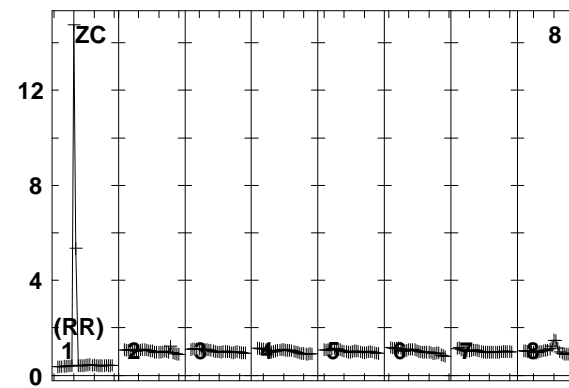
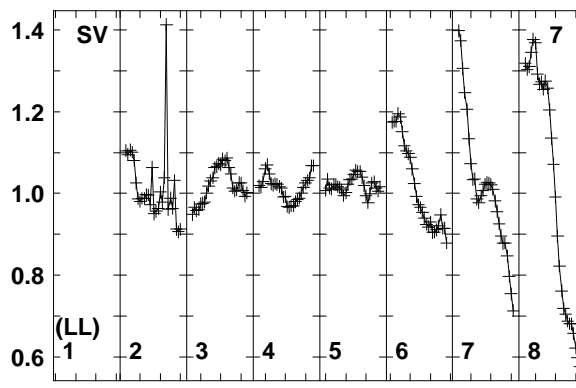
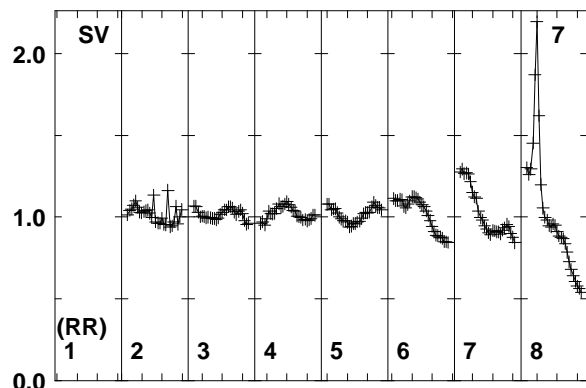
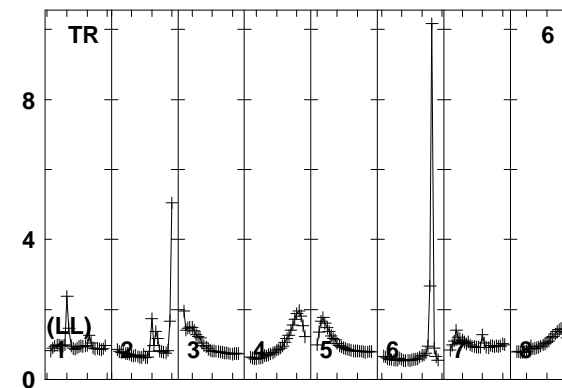
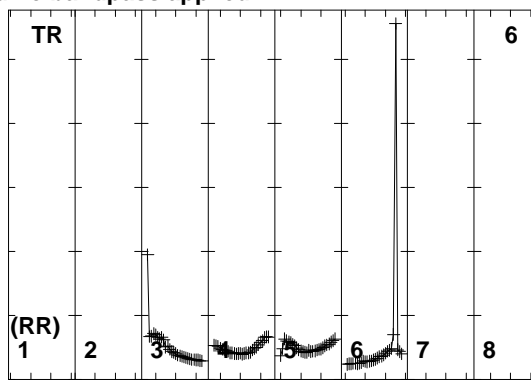
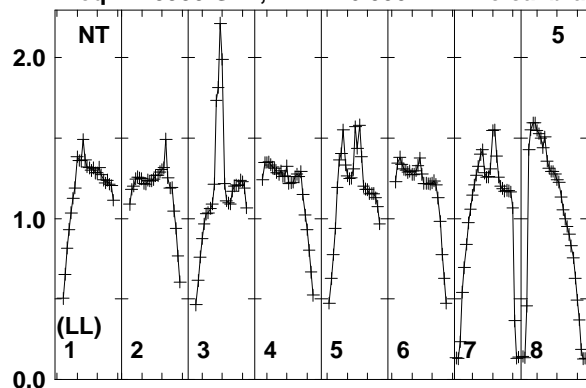

Lower frame: Real Jy
Total-power spectrum Antenna: NT (05)
Timerange: 00/06:21:51 to 00/06:23:49

Plot file version 186 created 11-AUG-2014 17:05:36

J2015+3710 EM110 2.UVDATA.1

Freq = 1.5950 GHz, Bw = 16.000 MH No calibration applied and no bandpass applied

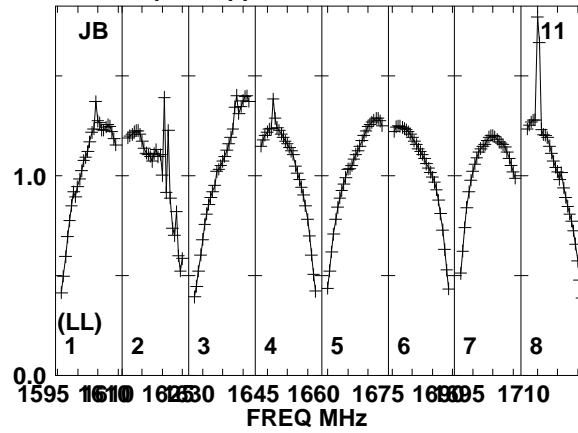
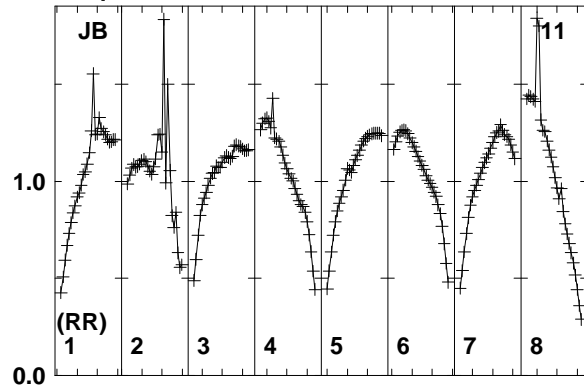

Lower frame: Real Jy
Total-power spectrum Antenna: JB (11)
Timerange: 00/06:21:51 to 00/06:23:49

Plot file version 187 created 11-AUG-2014 17:05:36

3C345 EM110 2.UVDATA.1

Freq = 1.5950 GHz, Bw = 16.000 MH No calibration applied and no bandpass applied

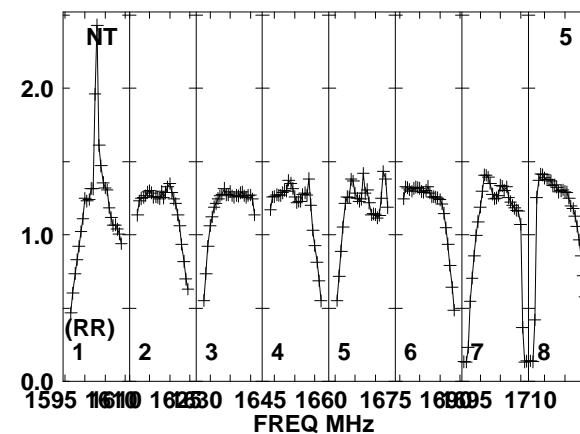
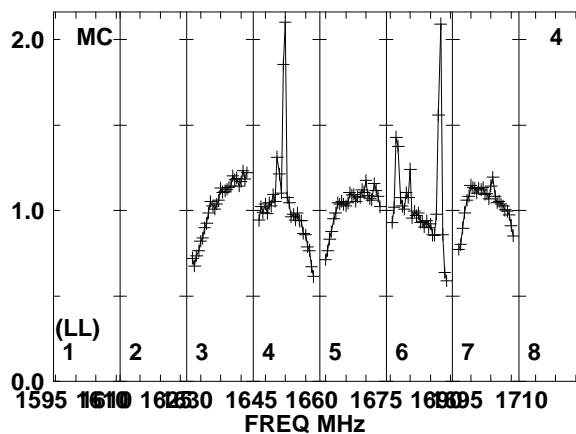
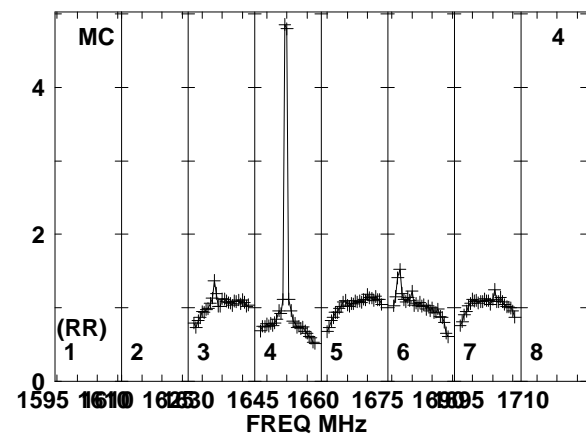
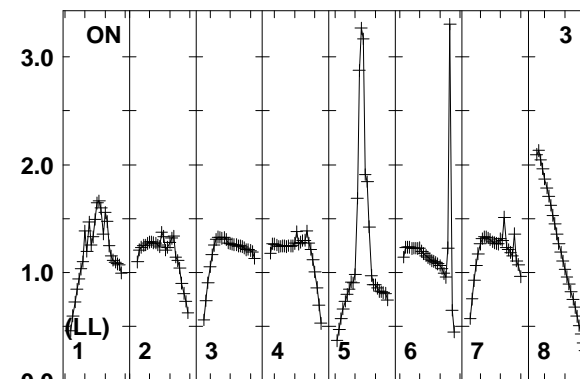
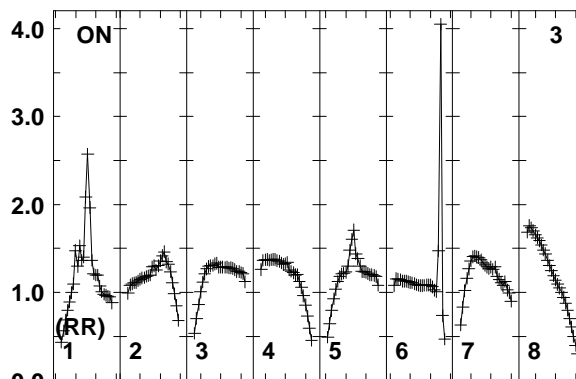
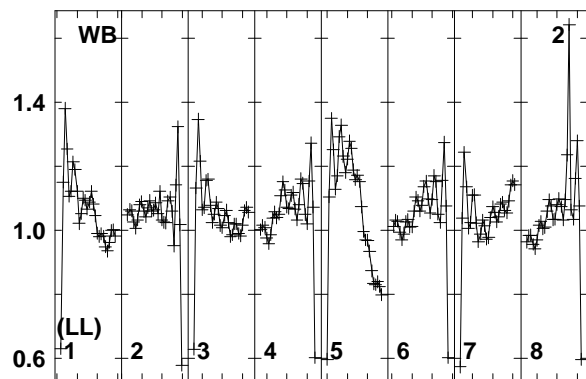
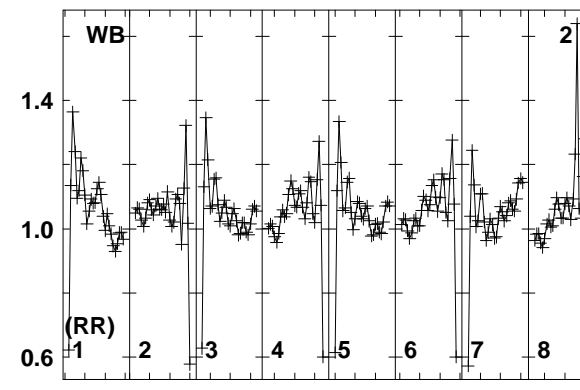
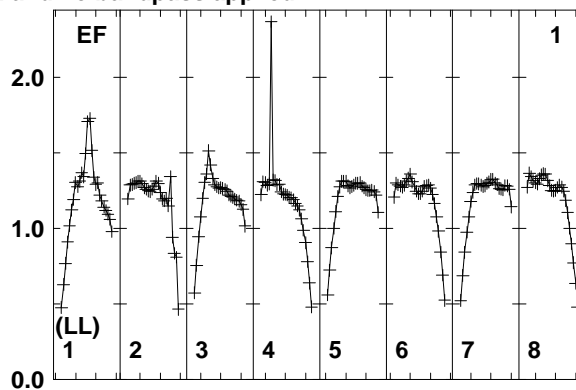
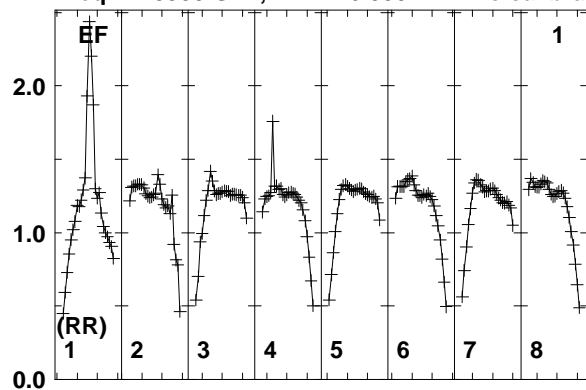

Lower frame: Real Jy
Total-power spectrum Antenna: EF (01)
Timerange: 00/06:26:53 to 00/06:31:49

Plot file version 188 created 11-AUG-2014 17:05:36

3C345 EM110 2.UVDATA.1

Freq = 1.5950 GHz, Bw = 16.000 MH No calibration applied and no bandpass applied

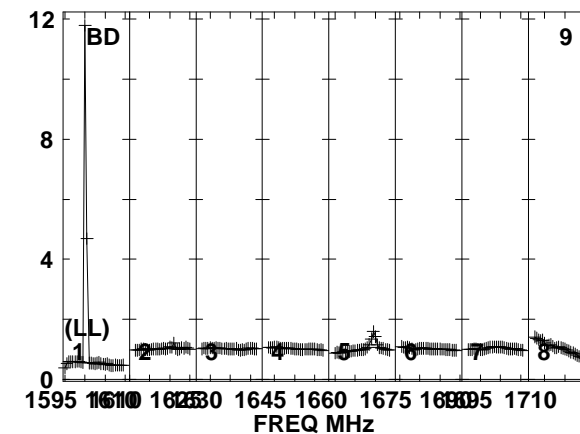
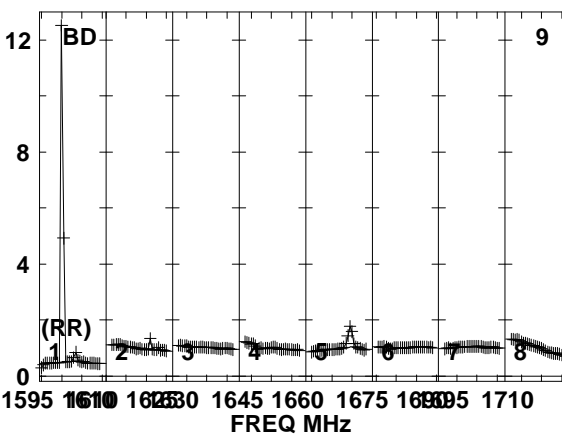
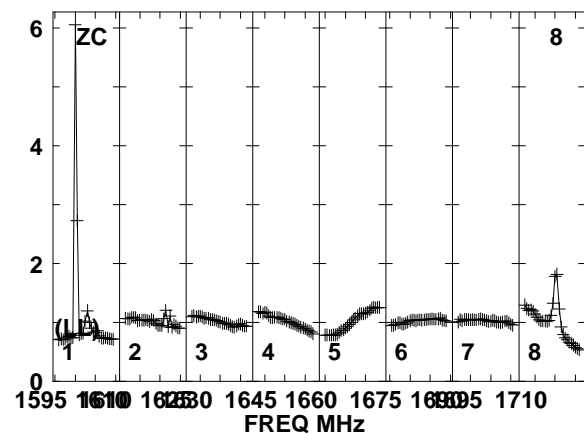
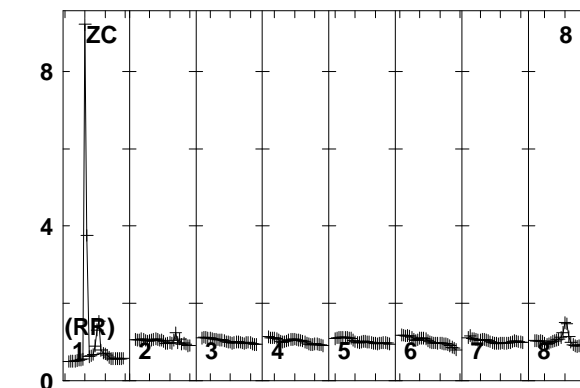
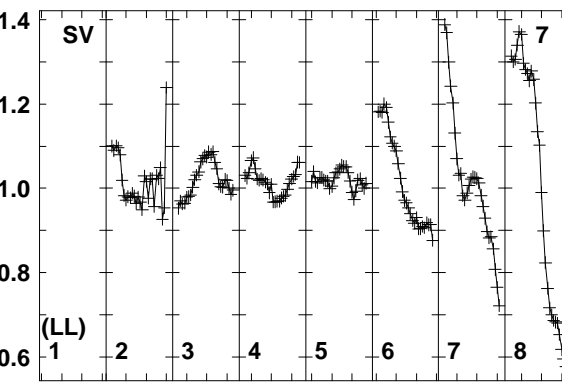
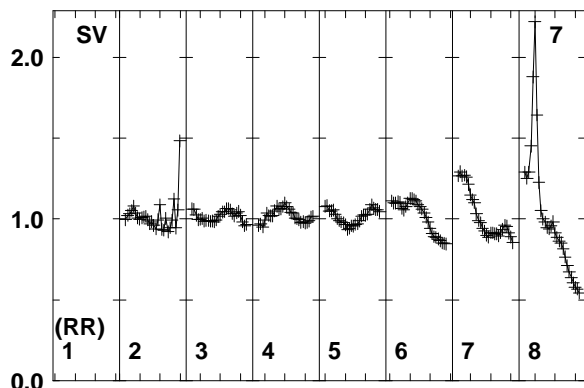
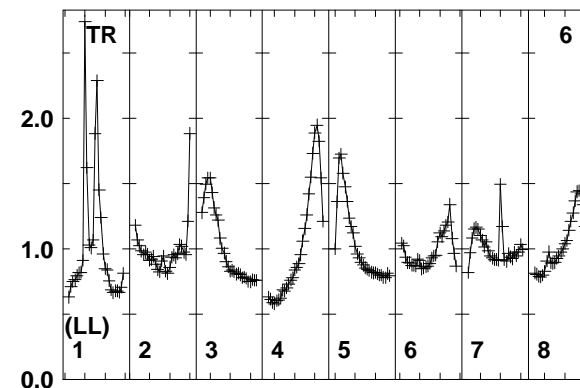
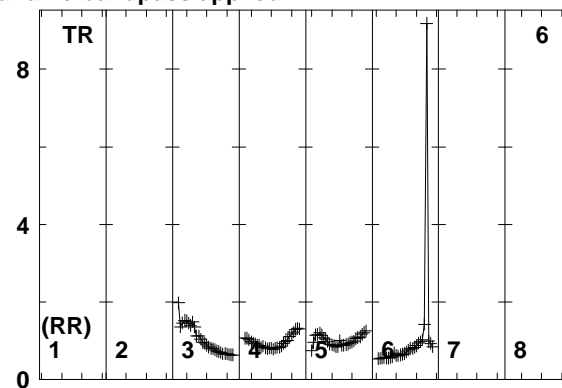
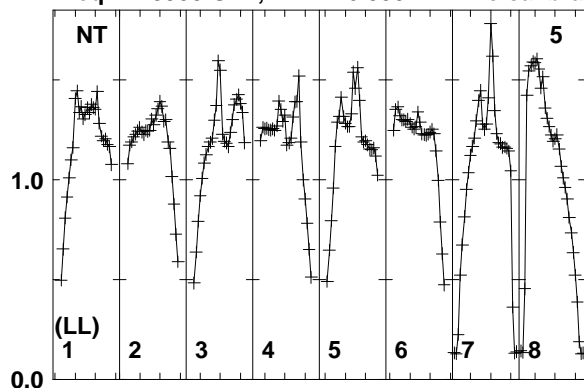

Lower frame: Real Jy
Total-power spectrum Antenna: NT (05)
Timerange: 00/06:26:53 to 00/06:31:49

Plot file version 189 created 11-AUG-2014 17:05:36

3C345 EM110 2.UVDATA.1

Freq = 1.5950 GHz, Bw = 16.000 MH No calibration applied and no bandpass applied

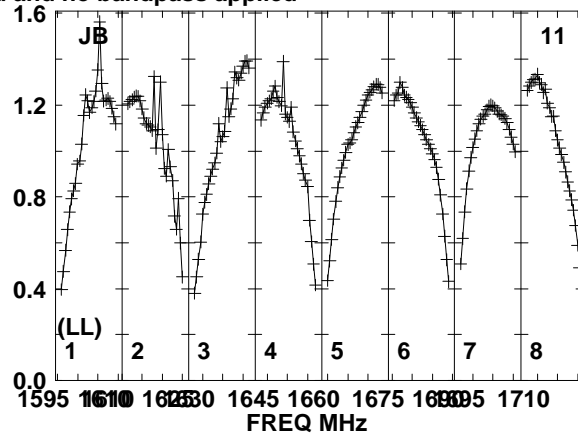
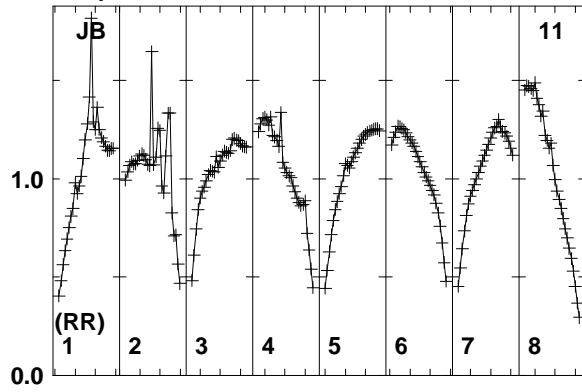

Lower frame: Real Jy
Total-power spectrum Antenna: JB (11)
Timerange: 00/06:26:53 to 00/06:31:49

Plot file version 190 created 11-AUG-2014 17:05:36

J2015+3710 EM110 2.UVDATA.1

Freq = 1.5950 GHz, Bw = 16.000 MH No calibration applied and no bandpass applied

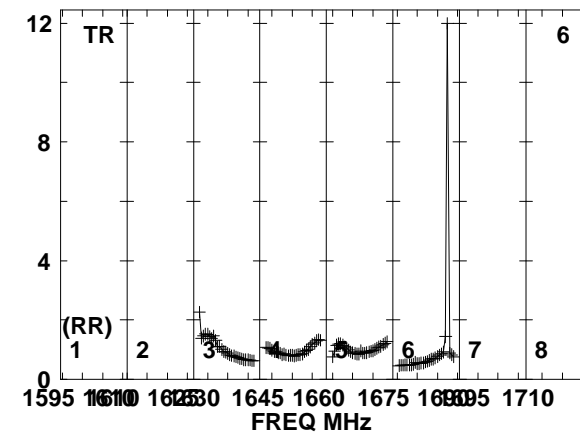
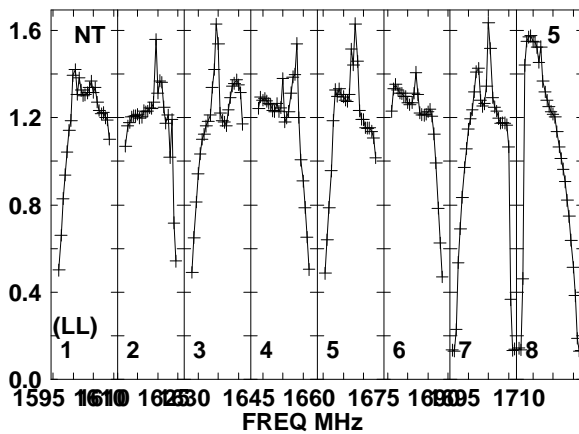
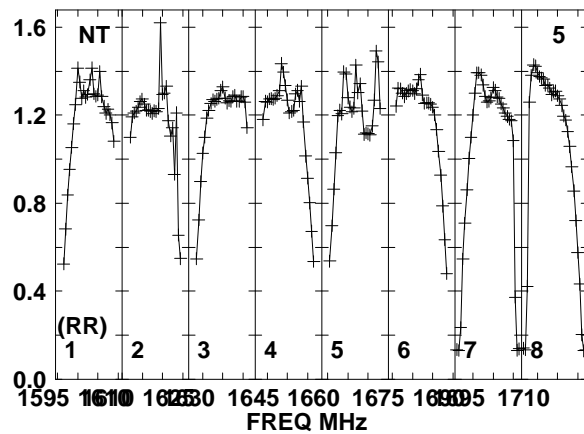
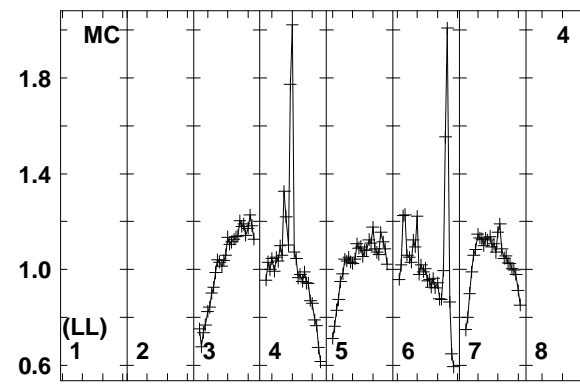
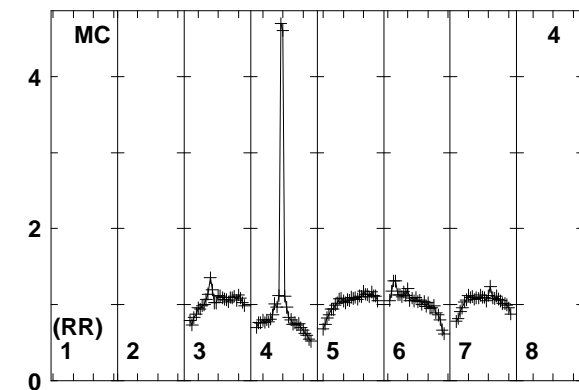
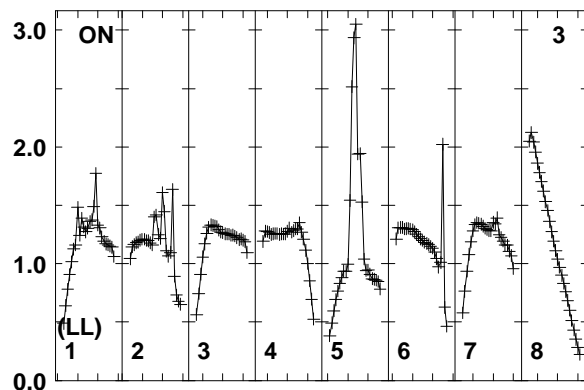
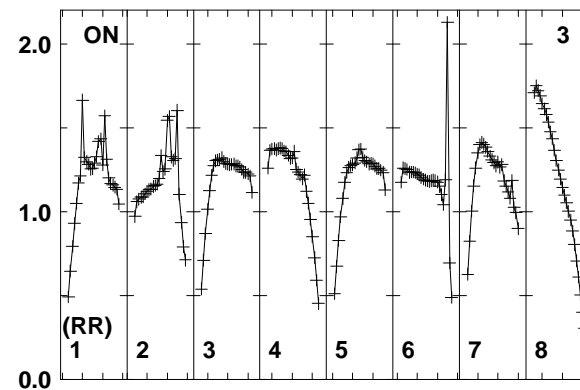
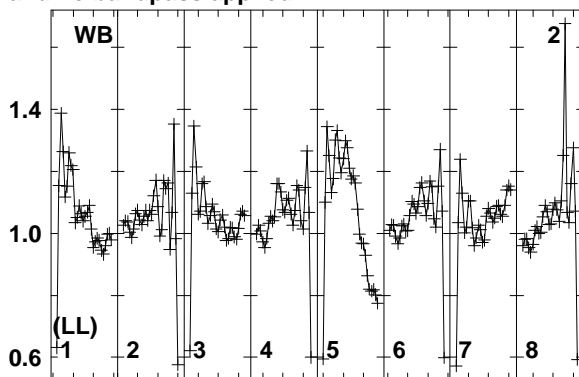
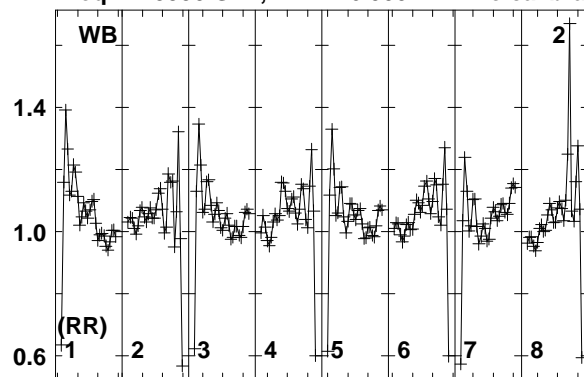

Lower frame: Real Jy
Total-power spectrum Antenna: WB (02)
Timerange: 00/06:34:53 to 00/06:36:49

Plot file version 191 created 11-AUG-2014 17:05:36

J2015+3710 EM110 2.UVDATA.1

Freq = 1.5950 GHz, Bw = 16.000 MH No calibration applied and no bandpass applied

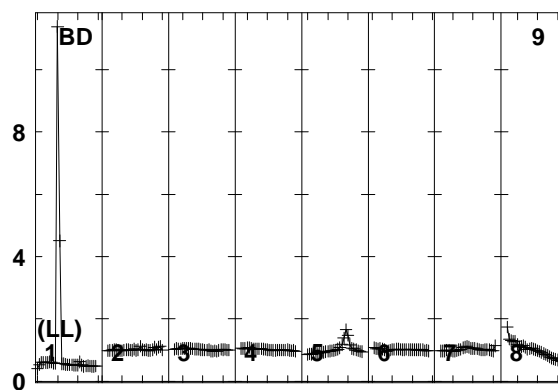
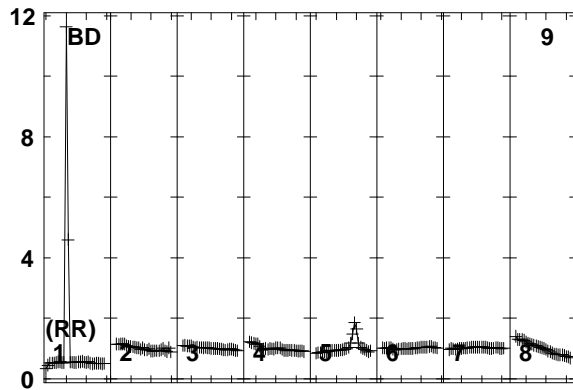
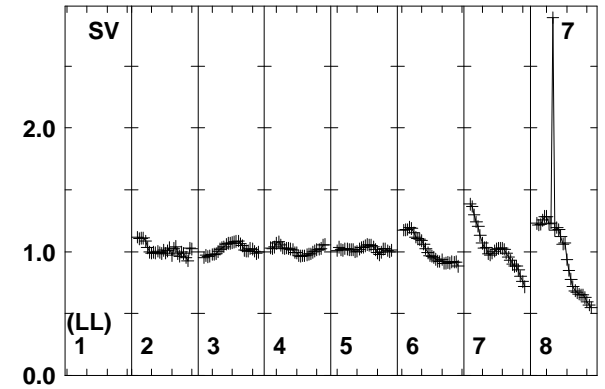
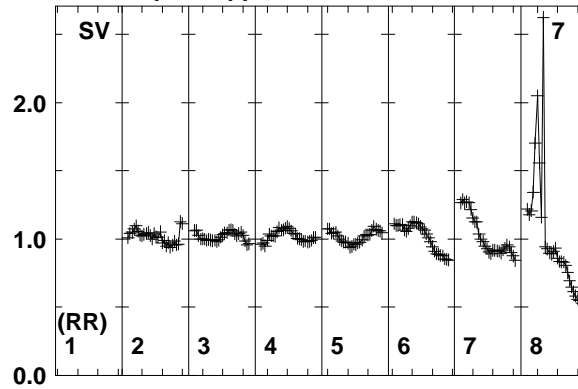
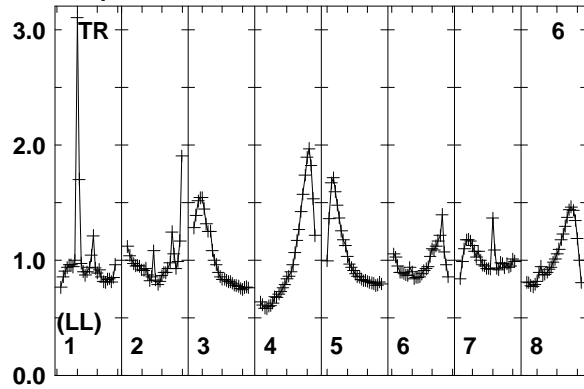

Lower frame: Real Jy
Total-power spectrum Antenna: TR (06)
Timerange: 00/06:34:53 to 00/06:36:49

Plot file version 192 created 11-AUG-2014 17:05:36

J2032+4127 EM110 2.UVDATA.1

Freq = 1.5950 GHz, Bw = 16.000 MH No calibration applied and no bandpass applied

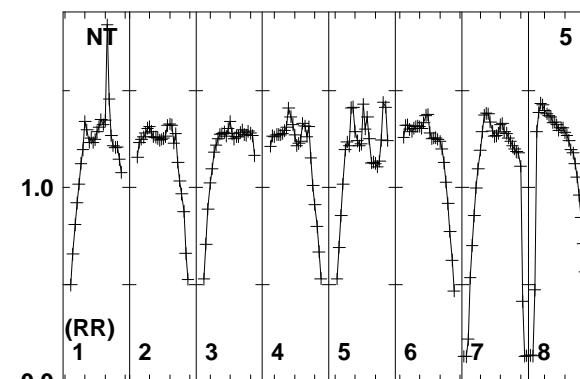
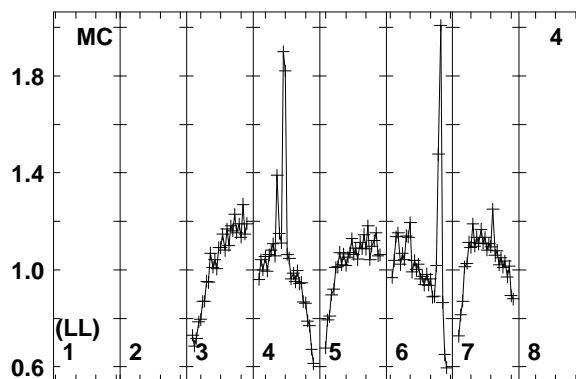
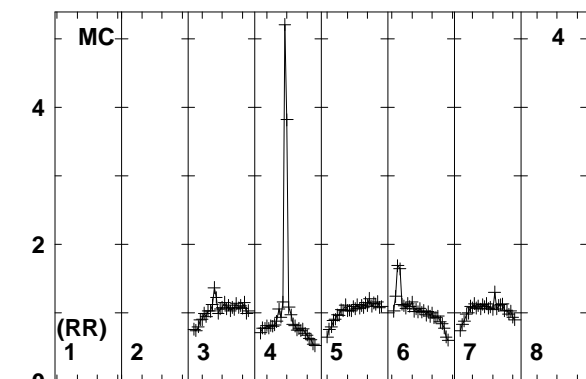
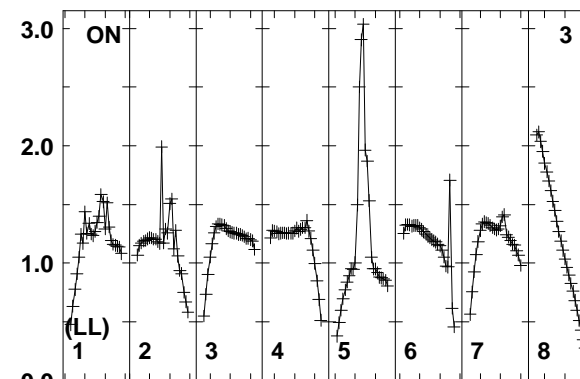
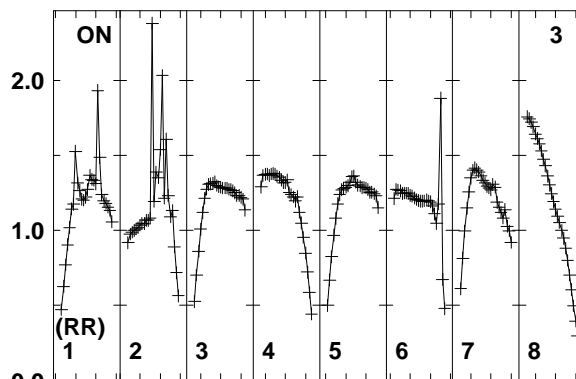
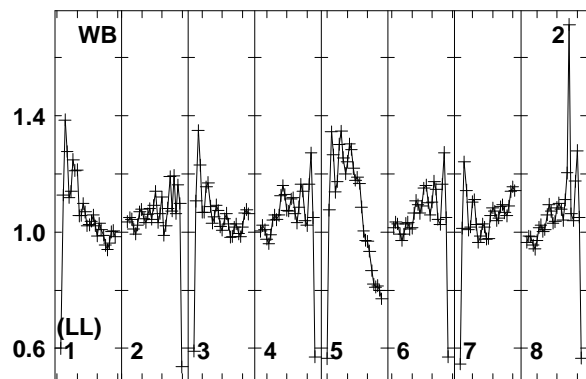
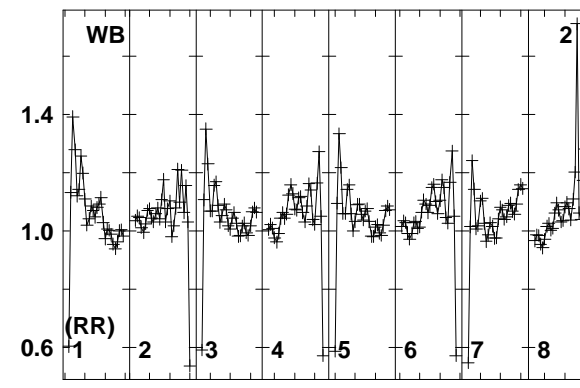
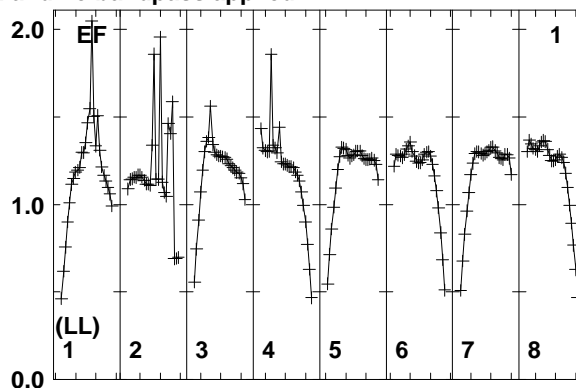
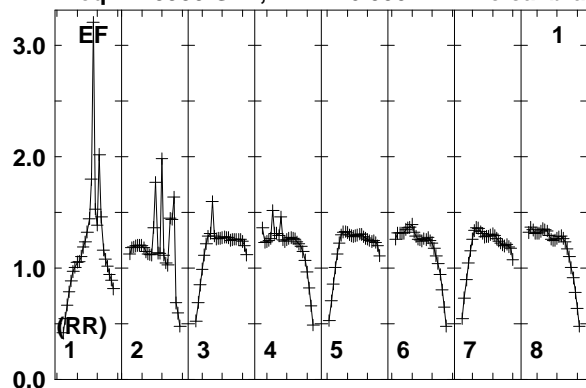

1595 1610 1625 1640 1655 1670 1685 1700 1710
FREQ MHz

1595 1610 1625 1640 1655 1670 1685 1700 1710
FREQ MHz

1595 1610 1625 1640 1655 1670 1685 1700 1710
FREQ MHz

Lower frame: Real Jy
Total-power spectrum Antenna: EF (01)
Timerange: 00/06:37:07 to 00/06:40:49

Plot file version 193 created 11-AUG-2014 17:05:36

J2032+4127 EM110 2.UVDATA.1

Freq = 1.5950 GHz, Bw = 16.000 MH No calibration applied and no bandpass applied

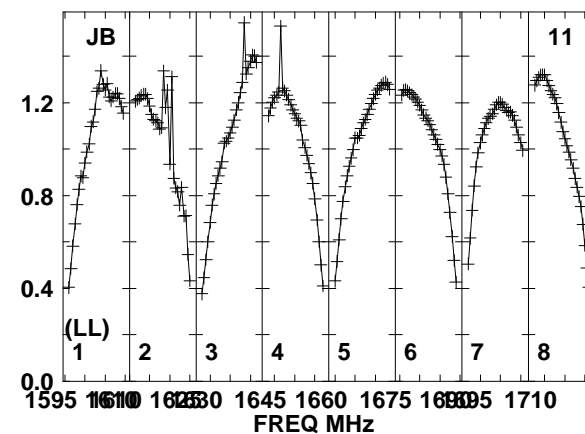
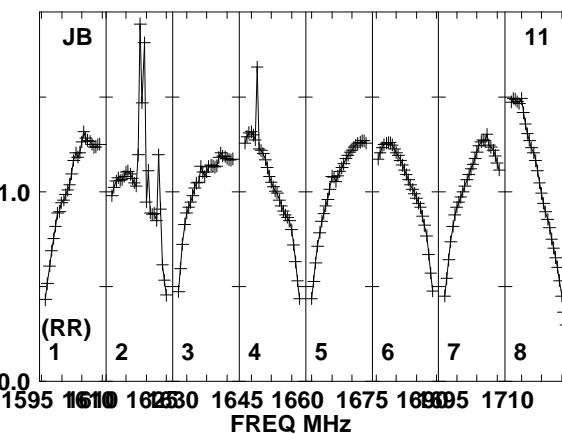
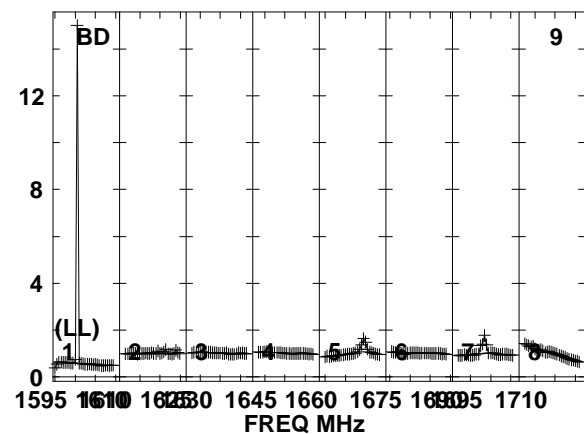
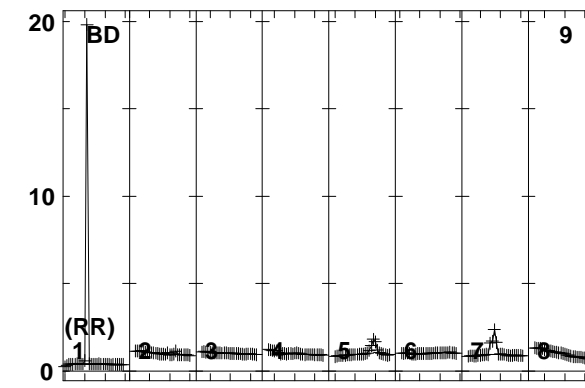
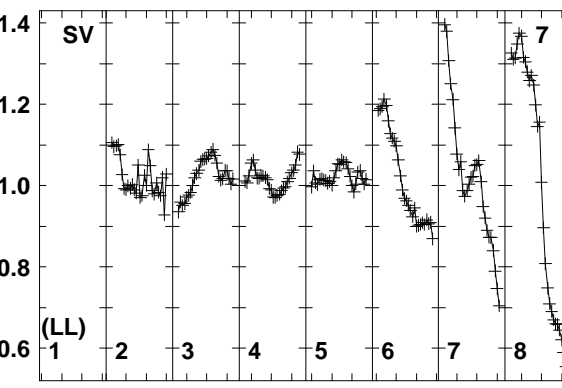
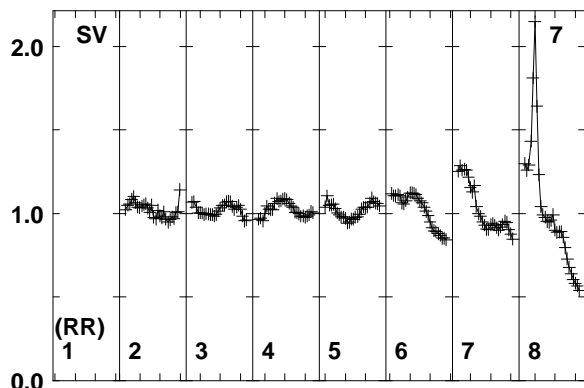
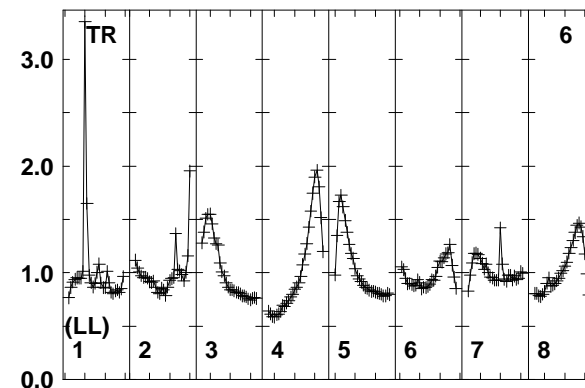
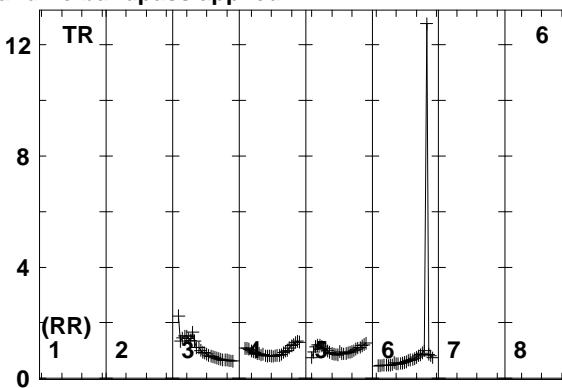
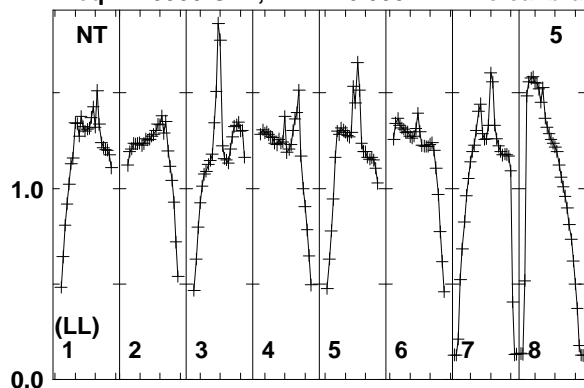

Lower frame: Real Jy
Total-power spectrum Antenna: NT (05)
Timerange: 00/06:37:07 to 00/06:40:49

Plot file version 194 created 11-AUG-2014 17:05:36

J2015+3710 EM110 2.UVDATA.1

Freq = 1.5950 GHz, Bw = 16.000 MH No calibration applied and no bandpass applied

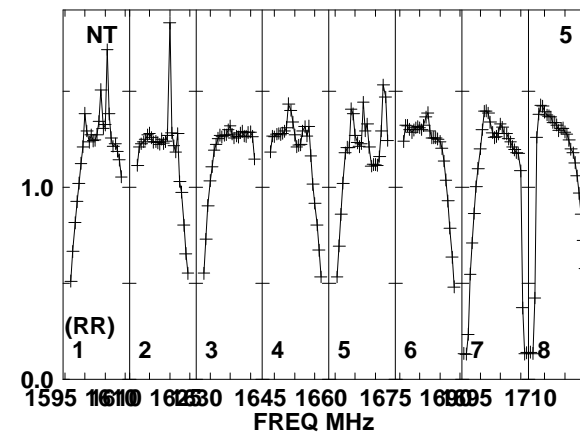
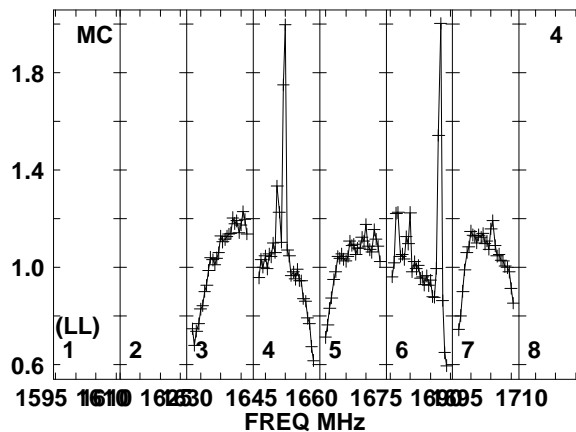
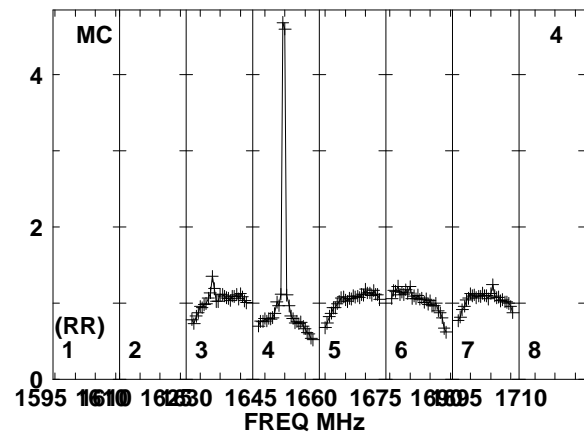
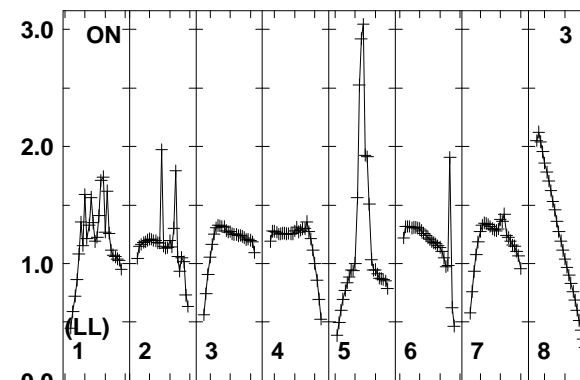
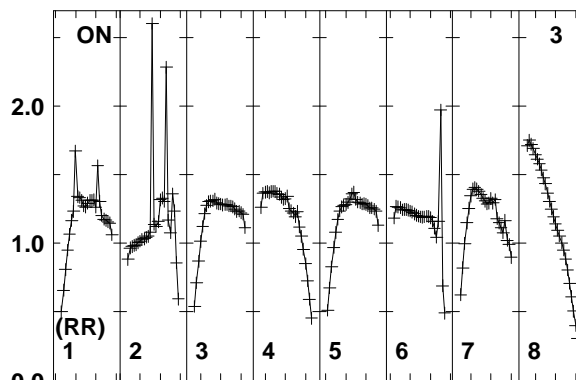
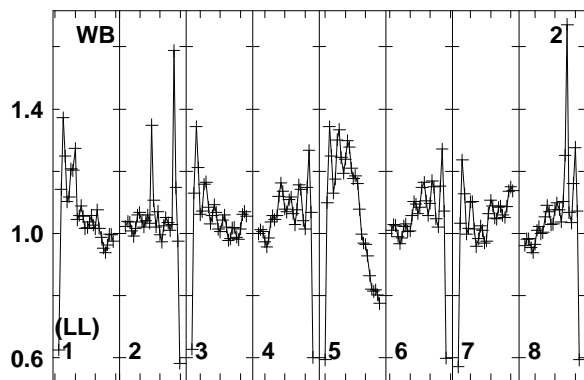
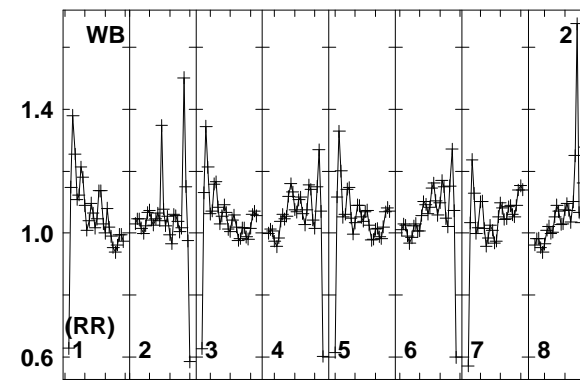
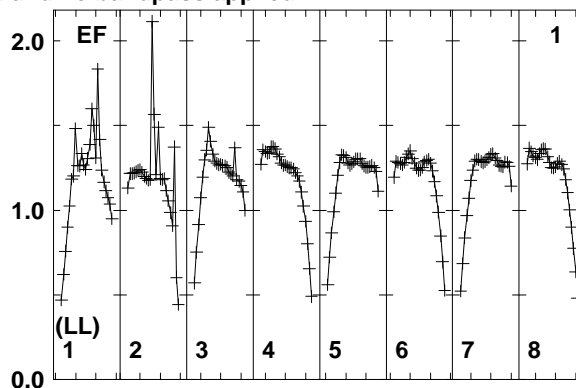
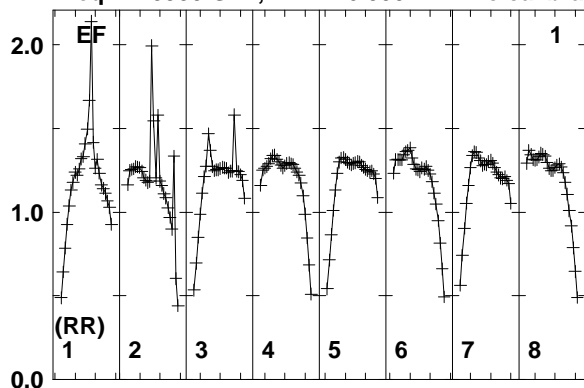

Lower frame: Real Jy
Total-power spectrum Antenna: EF (01)
Timerange: 00/06:41:07 to 00/06:42:49

Plot file version 195 created 11-AUG-2014 17:05:36

J2015+3710 EM110 2.UVDATA.1

Freq = 1.5950 GHz, Bw = 16.000 MH No calibration applied and no bandpass applied

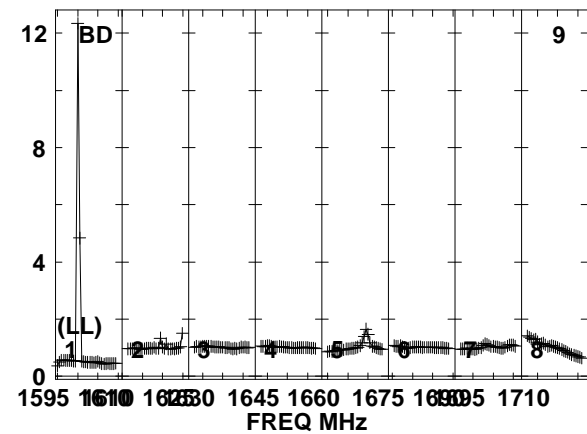
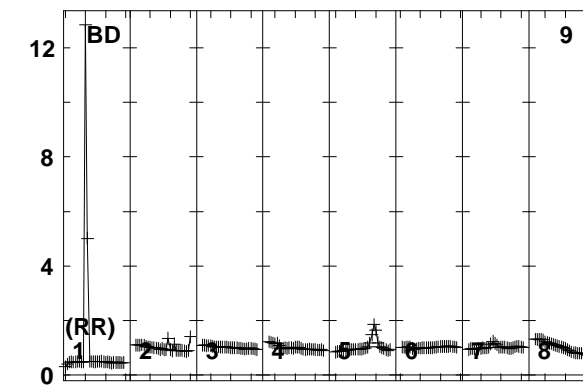
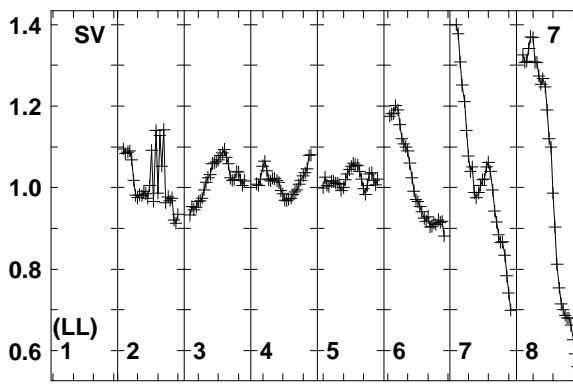
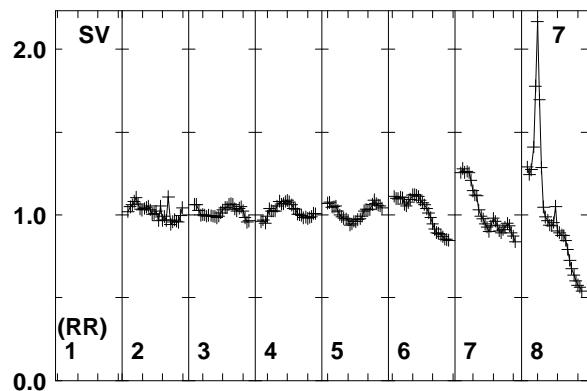
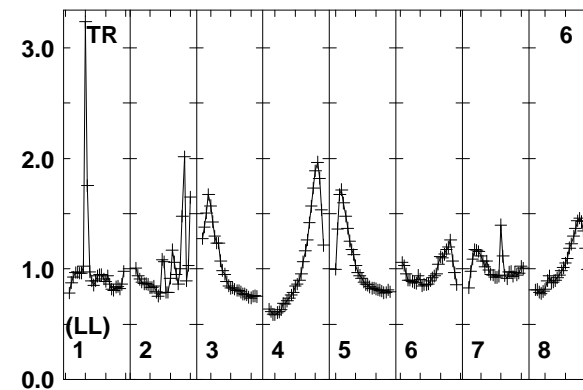
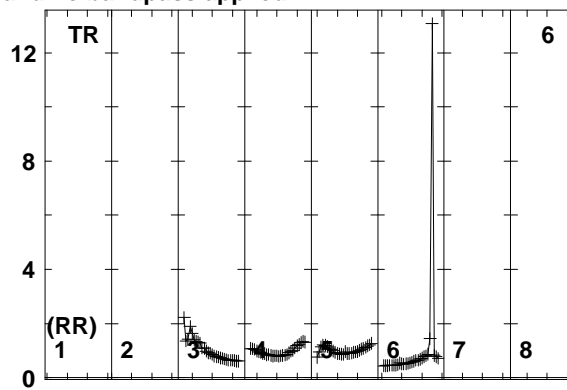
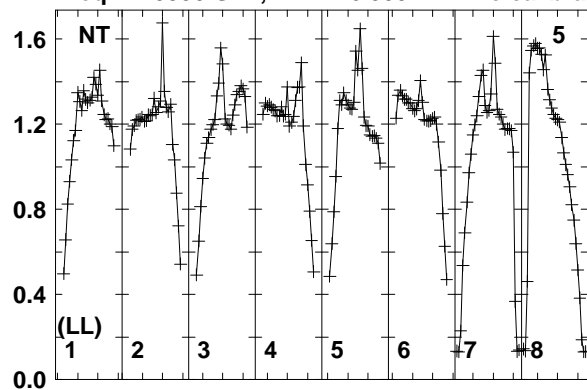

1595 1610 1625 1640 1655 1670 1685 1700 1710
FREQ MHz

Lower frame: Real Jy
Total-power spectrum Antenna: NT (05)
Timerange: 00/06:41:07 to 00/06:42:49

Plot file version 196 created 11-AUG-2014 17:05:36

J2032+4127 EM110 2.UVDATA.1

Freq = 1.5950 GHz, Bw = 16.000 MH No calibration applied and no bandpass applied

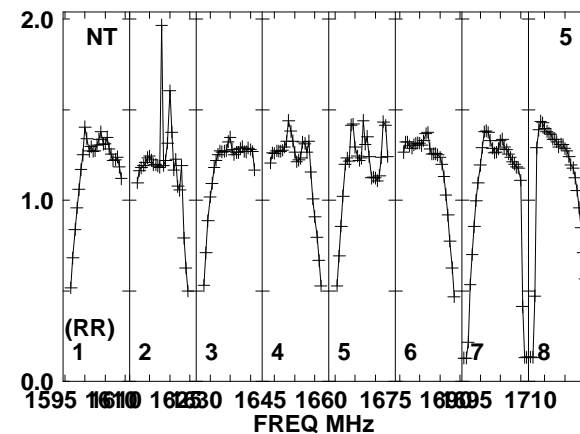
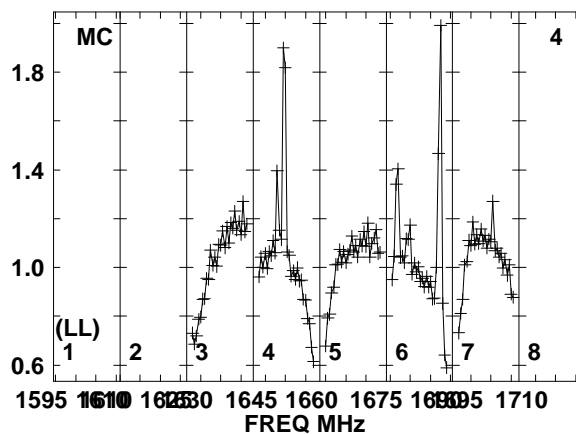
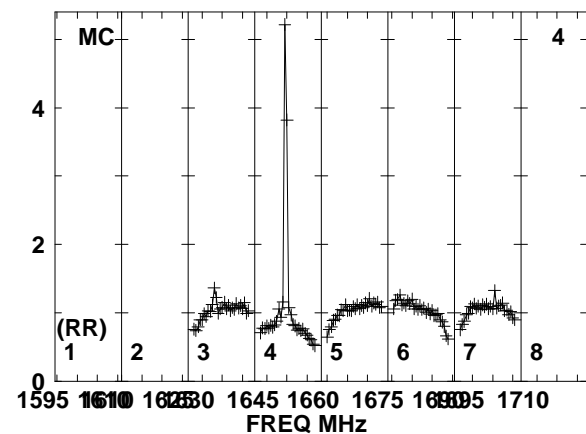
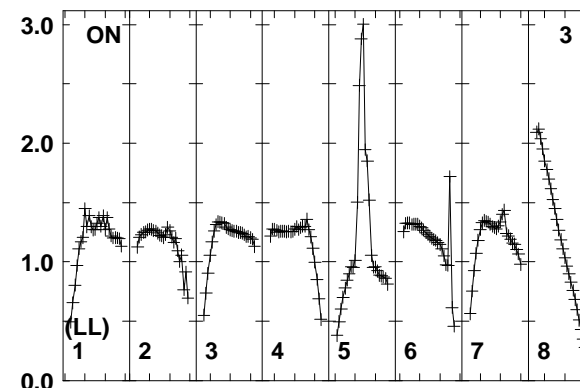
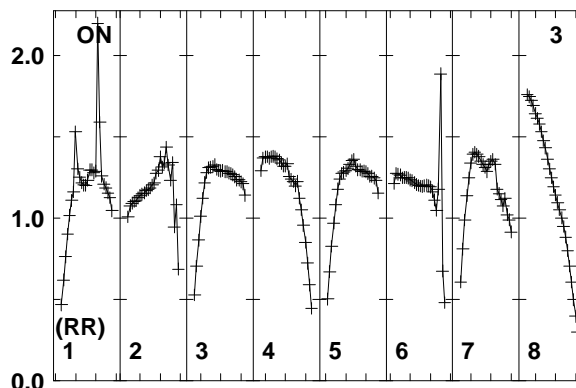
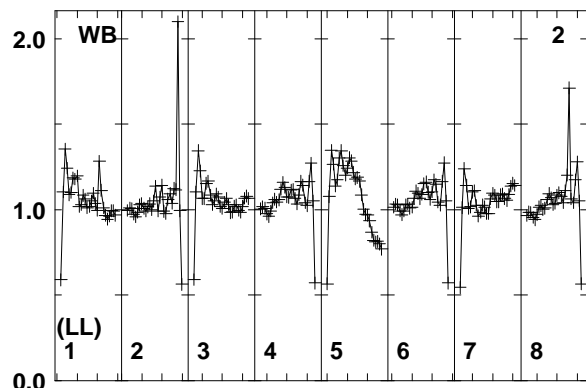
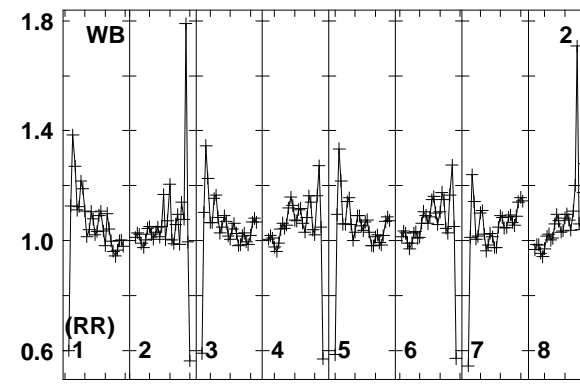
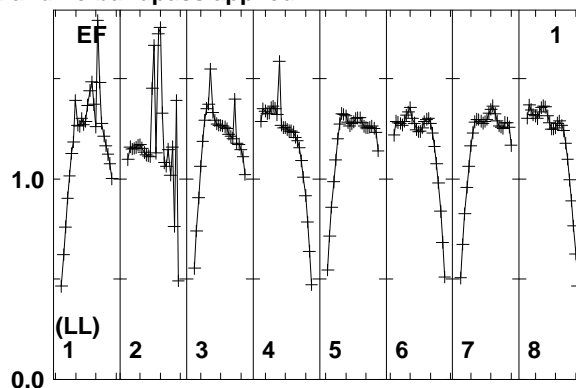
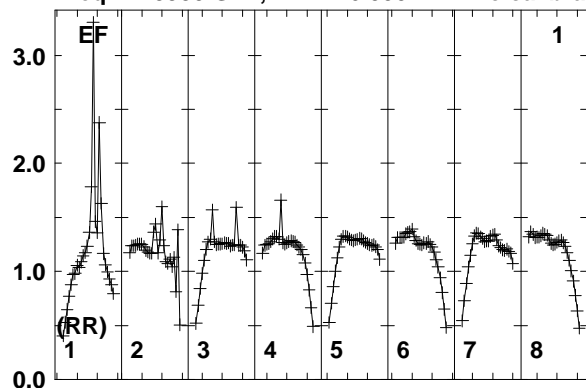

Lower frame: Real Jy
Total-power spectrum Antenna: EF (01)
Timerange: 00/06:42:51 to 00/06:46:49

Plot file version 197 created 11-AUG-2014 17:05:36

J2032+4127 EM110 2.UVDATA.1

Freq = 1.5950 GHz, Bw = 16.000 MH No calibration applied and no bandpass applied

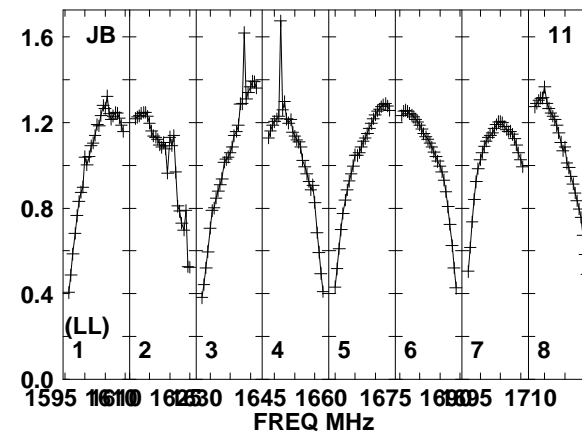
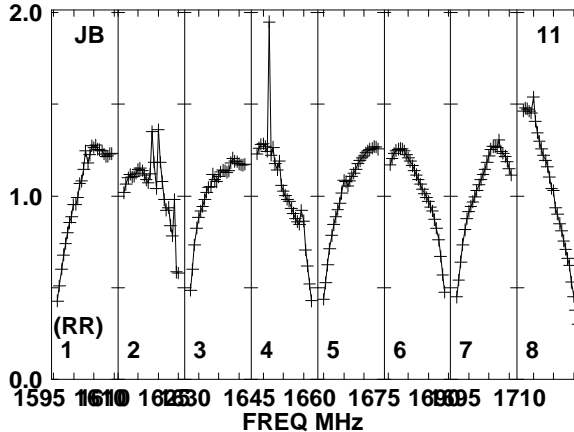
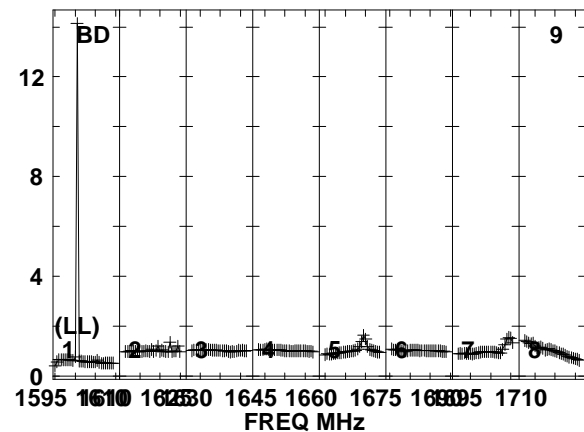
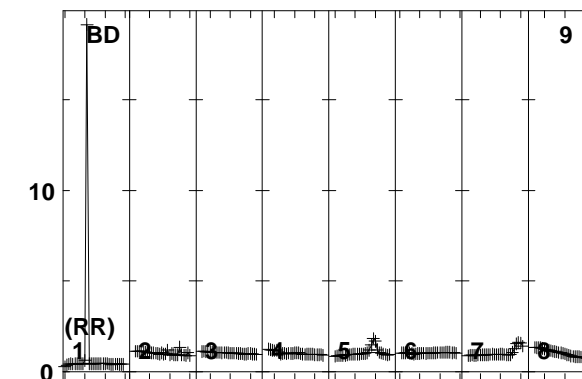
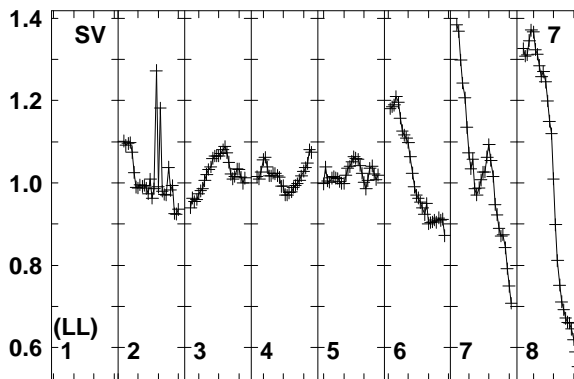
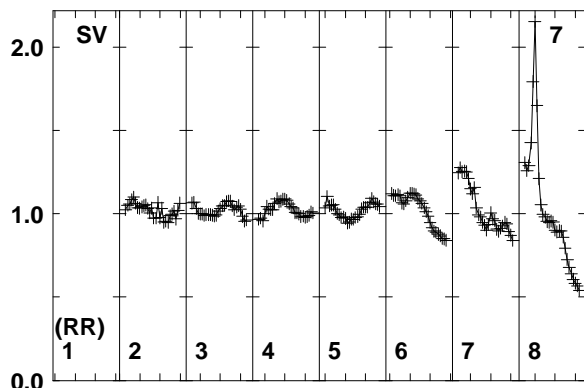
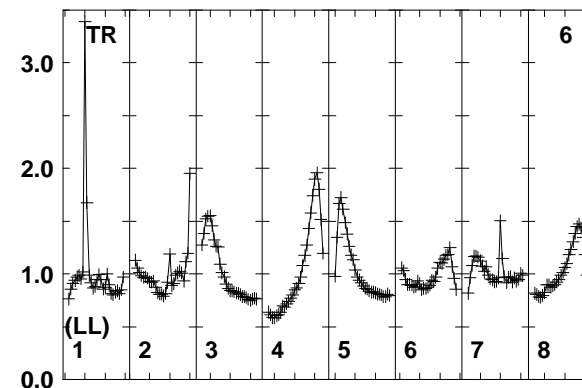
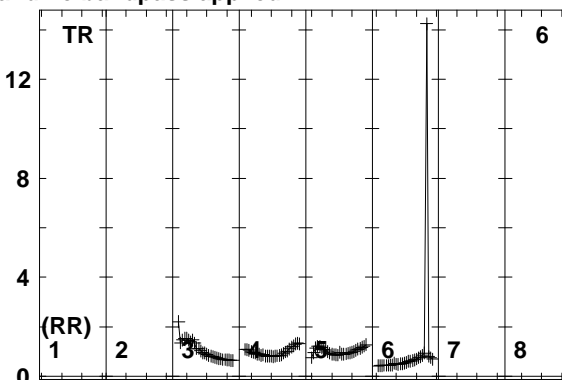
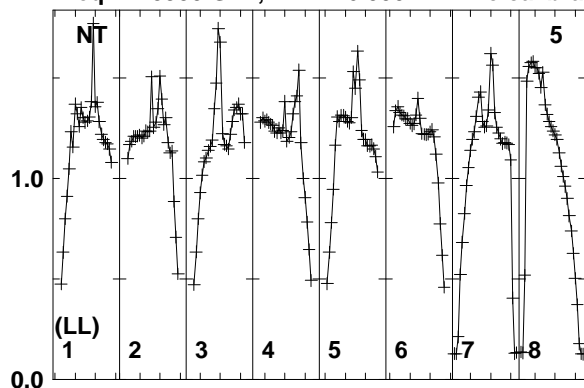

Lower frame: Real Jy
Total-power spectrum Antenna: NT (05)
Timerange: 00/06:42:51 to 00/06:46:49

Plot file version 198 created 11-AUG-2014 17:05:37

J2015+3710 EM110 2.UVDATA.1

Freq = 1.5950 GHz, Bw = 16.000 MH No calibration applied and no bandpass applied

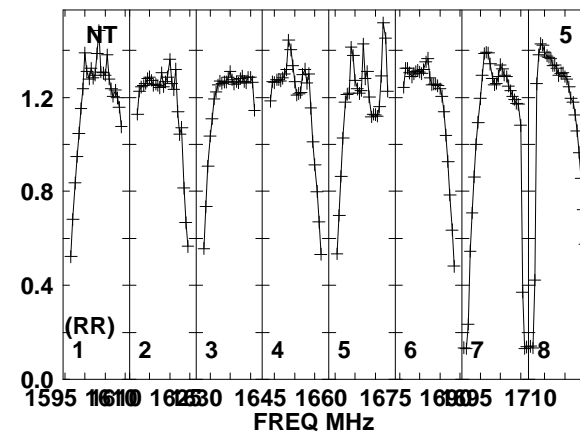
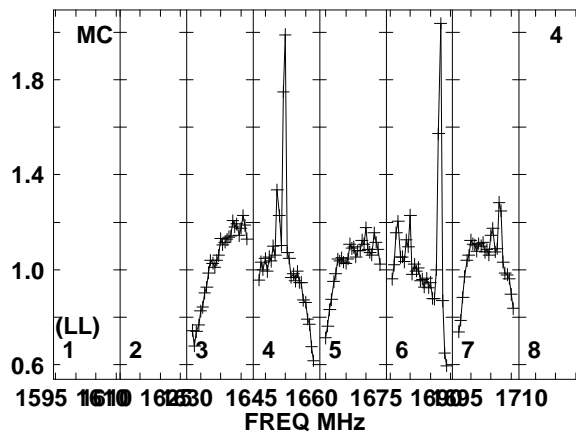
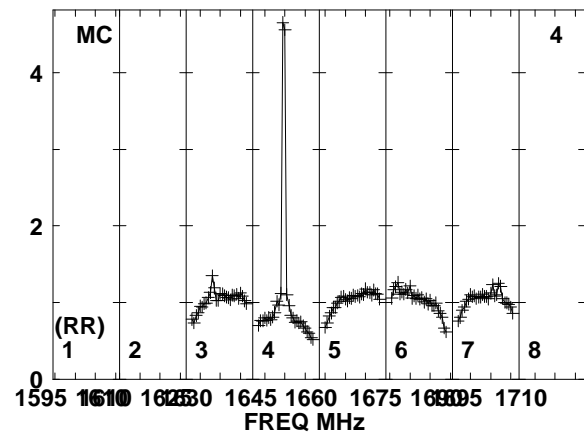
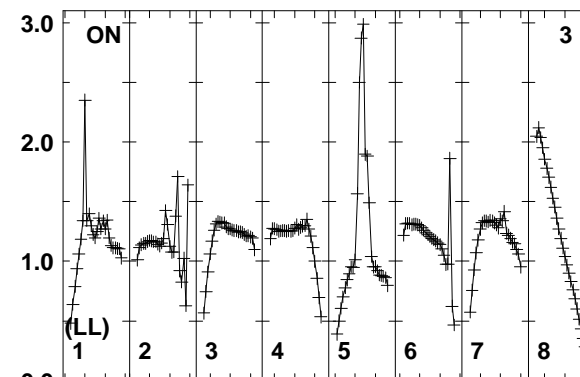
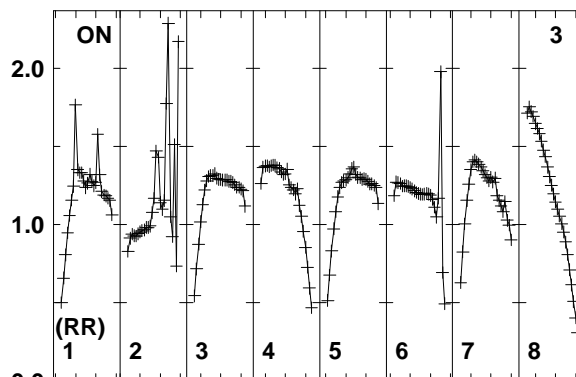
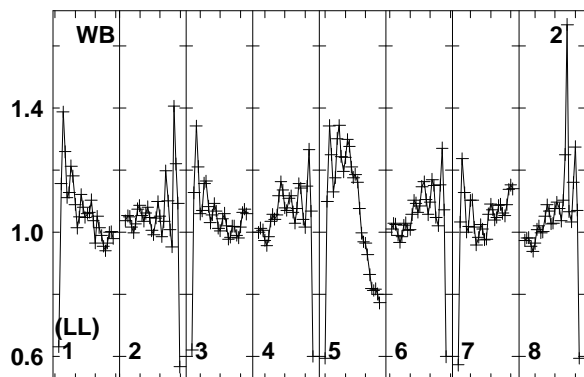
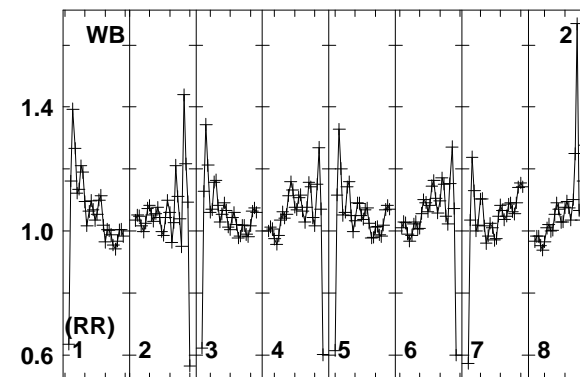
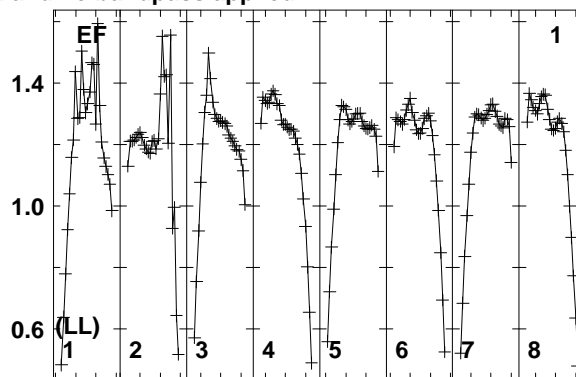
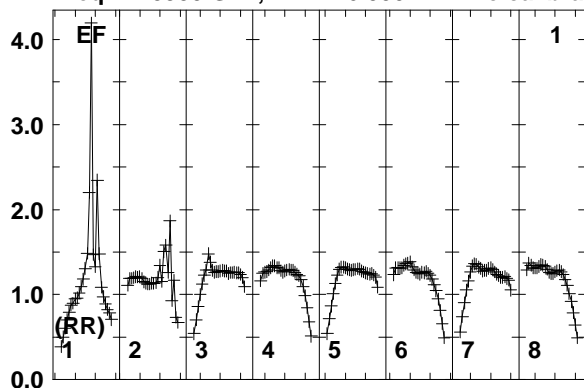

Lower frame: Real Jy
Total-power spectrum Antenna: EF (01)
Timerange: 00/06:47:51 to 00/06:49:49

Plot file version 199 created 11-AUG-2014 17:05:37

J2015+3710 EM110 2.UVDATA.1

Freq = 1.5950 GHz, Bw = 16.000 MH No calibration applied and no bandpass applied

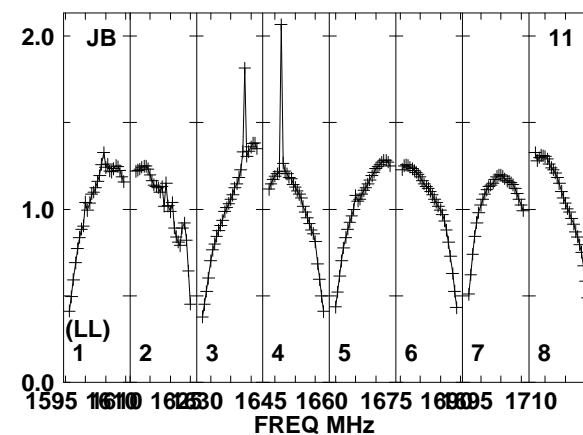
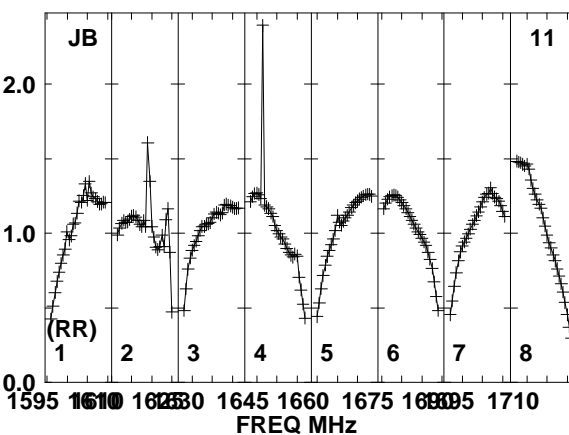
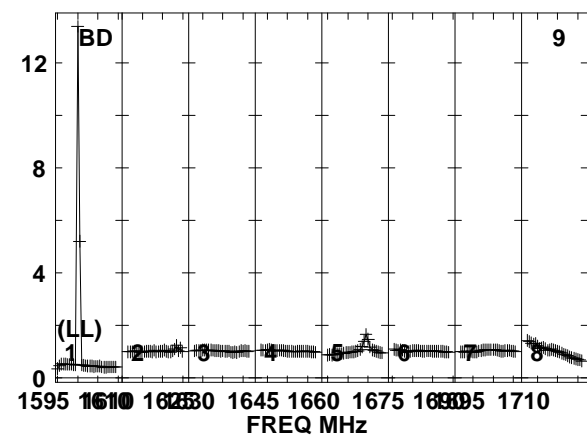
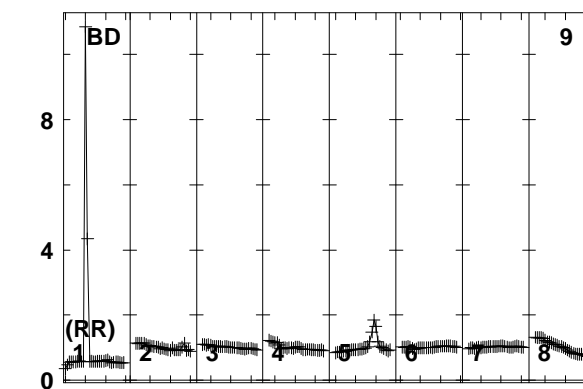
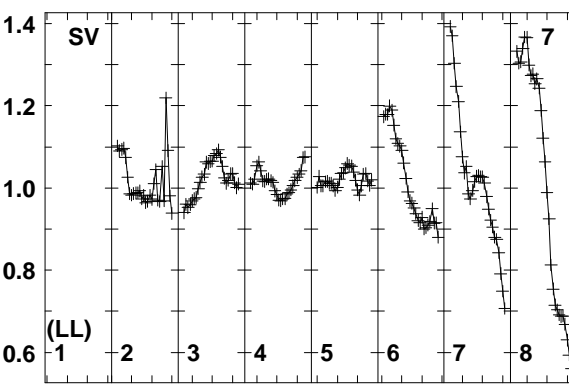
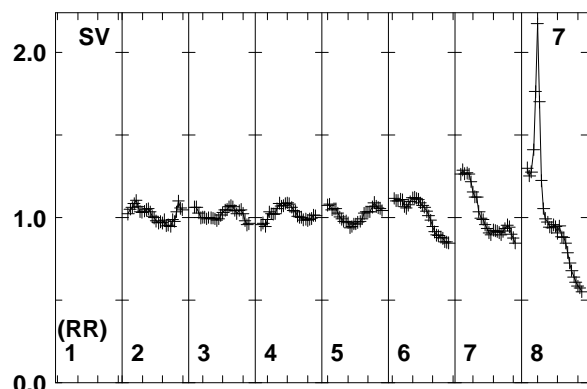
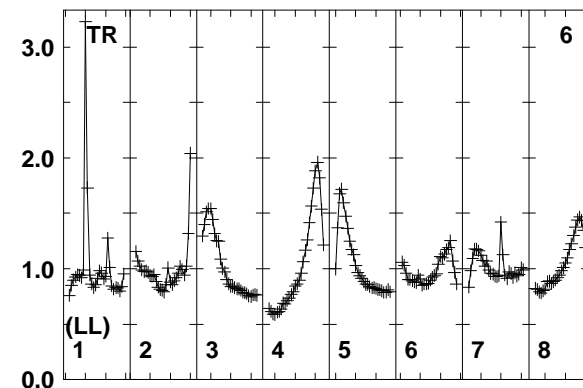
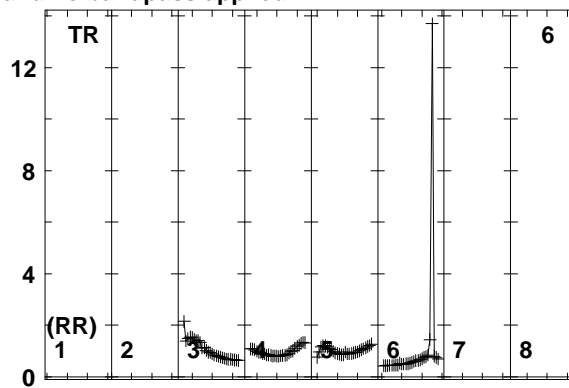
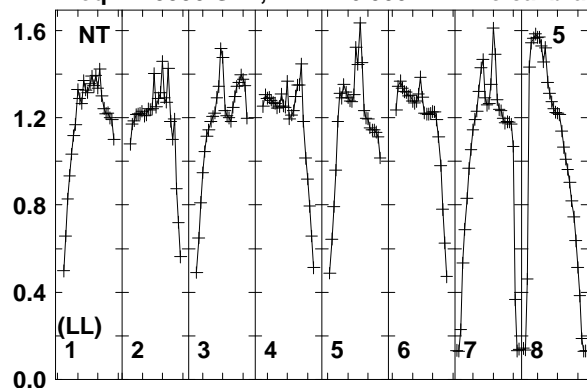

1595 1610 1625 1640 1655 1670 1685 1700 1710
FREQ MHz
Lower frame: Real Jy
Total-power spectrum Antenna: NT (05)
Timerange: 00/06:47:51 to 00/06:49:49

Plot file version 200 created 11-AUG-2014 17:05:37

J2032+4127 EM110 2.UVDATA.1

Freq = 1.5950 GHz, Bw = 16.000 MH No calibration applied and no bandpass applied

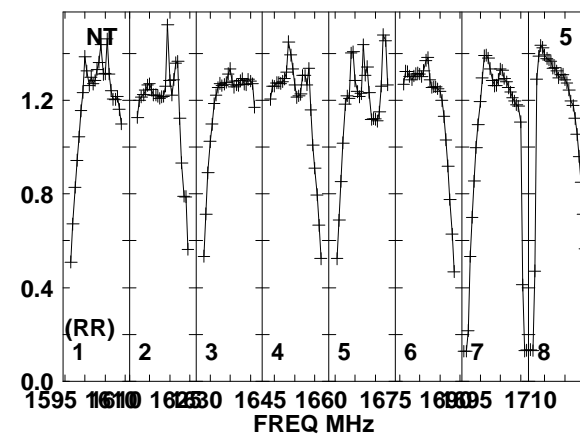
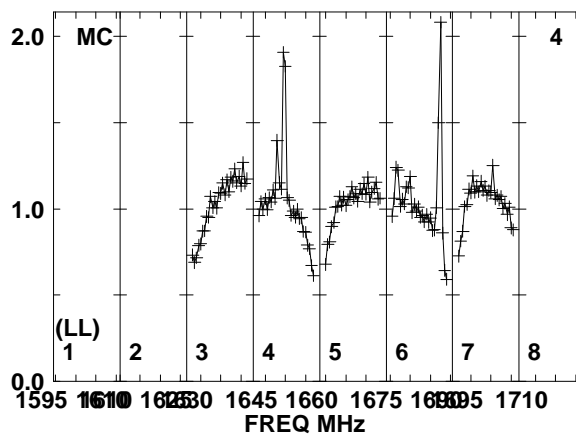
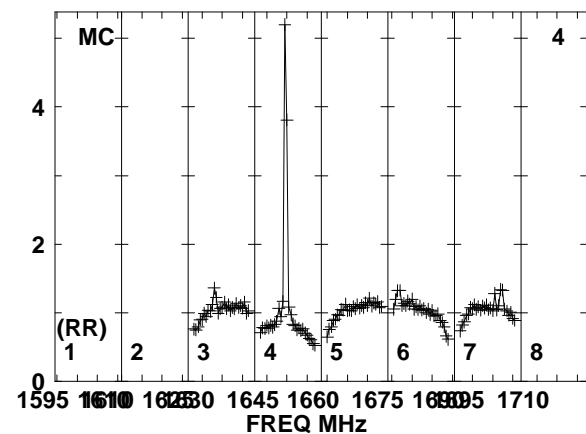
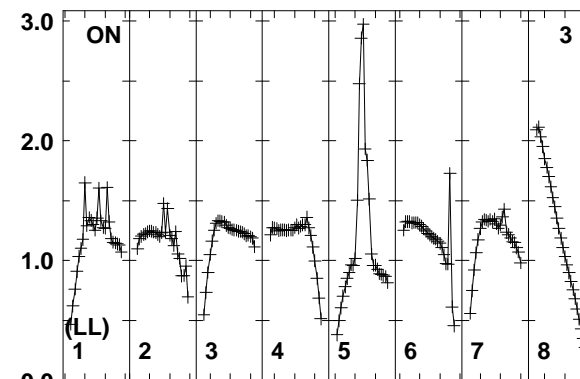
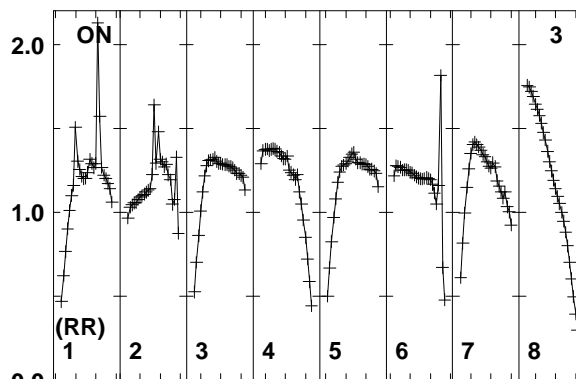
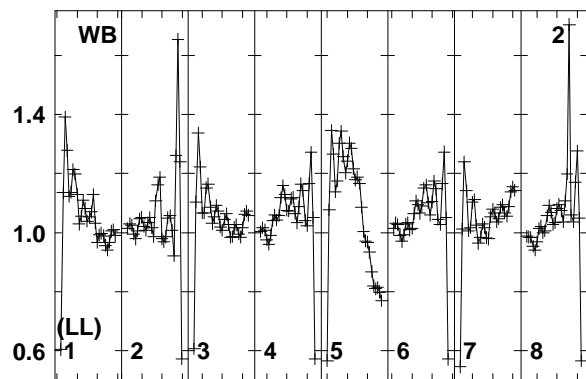
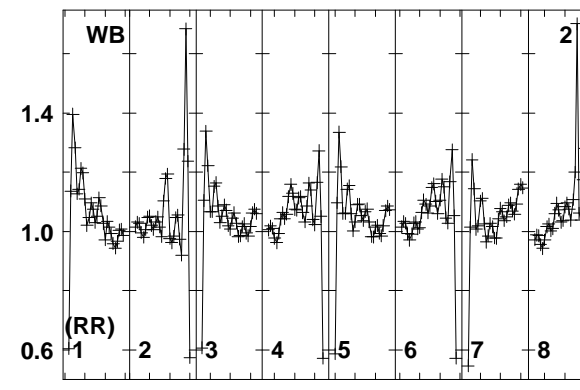
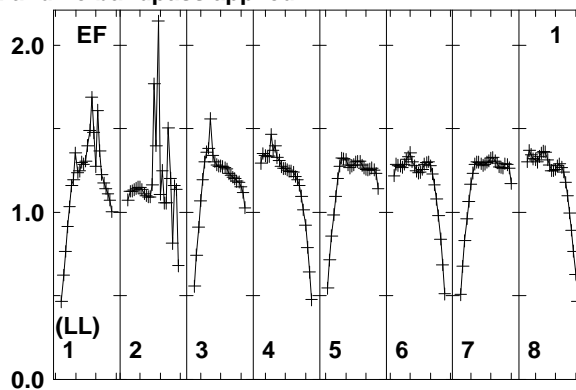
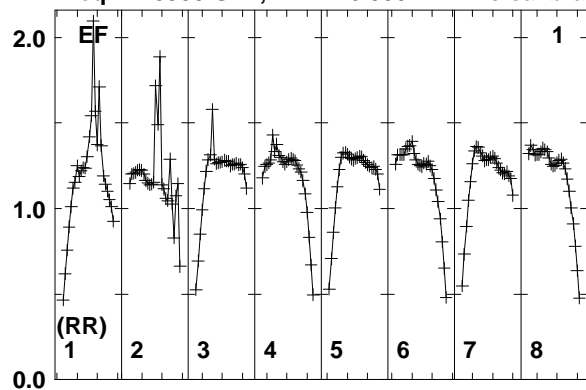

Lower frame: Real Jy
Total-power spectrum Antenna: EF (01)
Timerange: 00/06:50:08 to 00/06:53:48

Plot file version 201 created 11-AUG-2014 17:05:37

J2032+4127 EM110 2.UVDATA.1

Freq = 1.5950 GHz, Bw = 16.000 MH No calibration applied and no bandpass applied

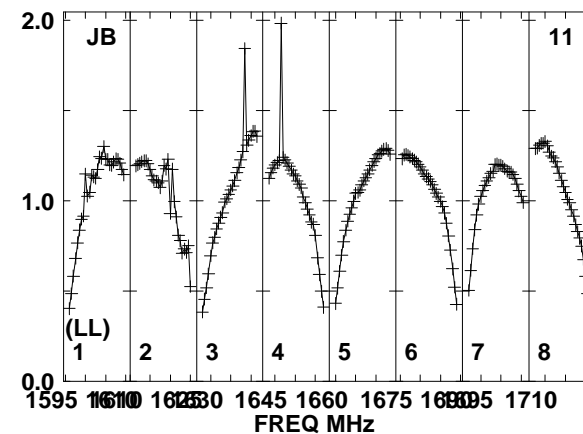
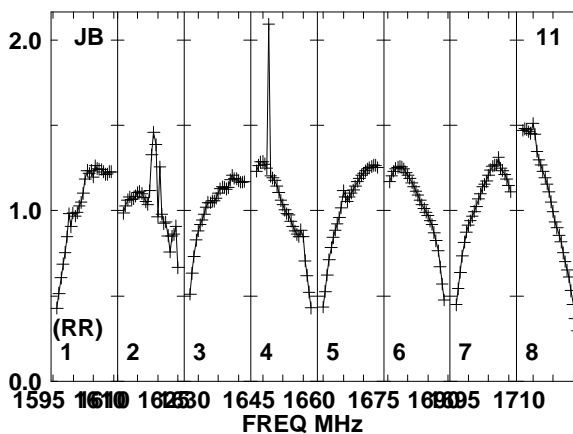
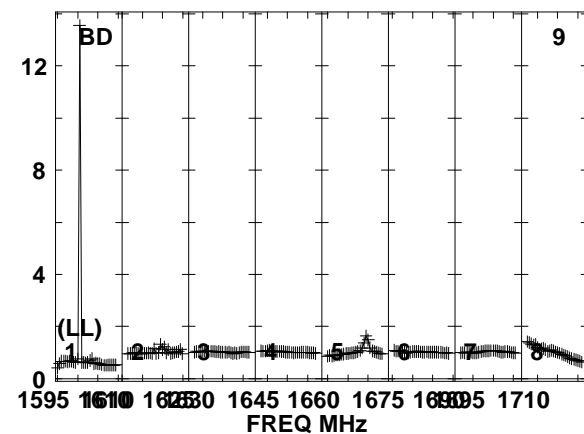
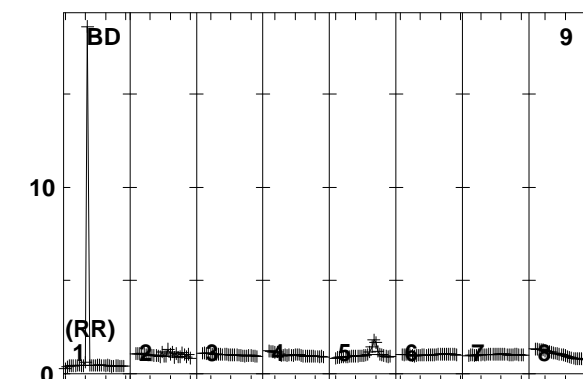
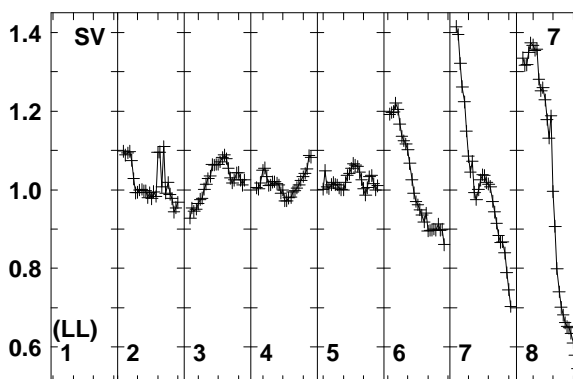
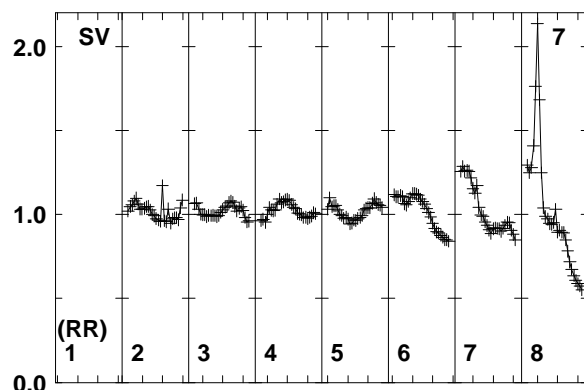
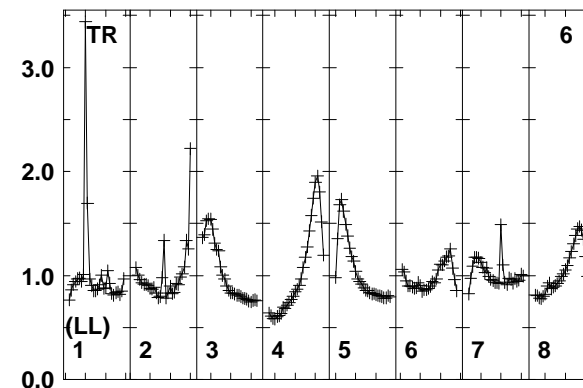
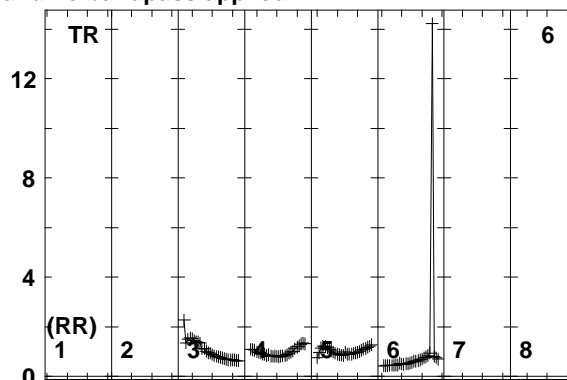
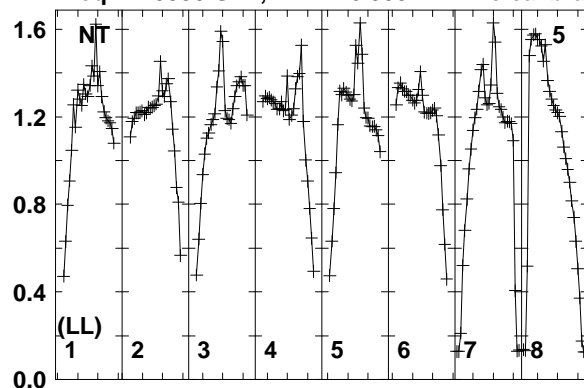

Lower frame: Real Jy
Total-power spectrum Antenna: NT (05)
Timerange: 00/06:50:08 to 00/06:53:48

Plot file version 202 created 11-AUG-2014 17:05:37

J2015+3710 EM110 2.UVDATA.1

Freq = 1.5950 GHz, Bw = 16.000 MH No calibration applied and no bandpass applied

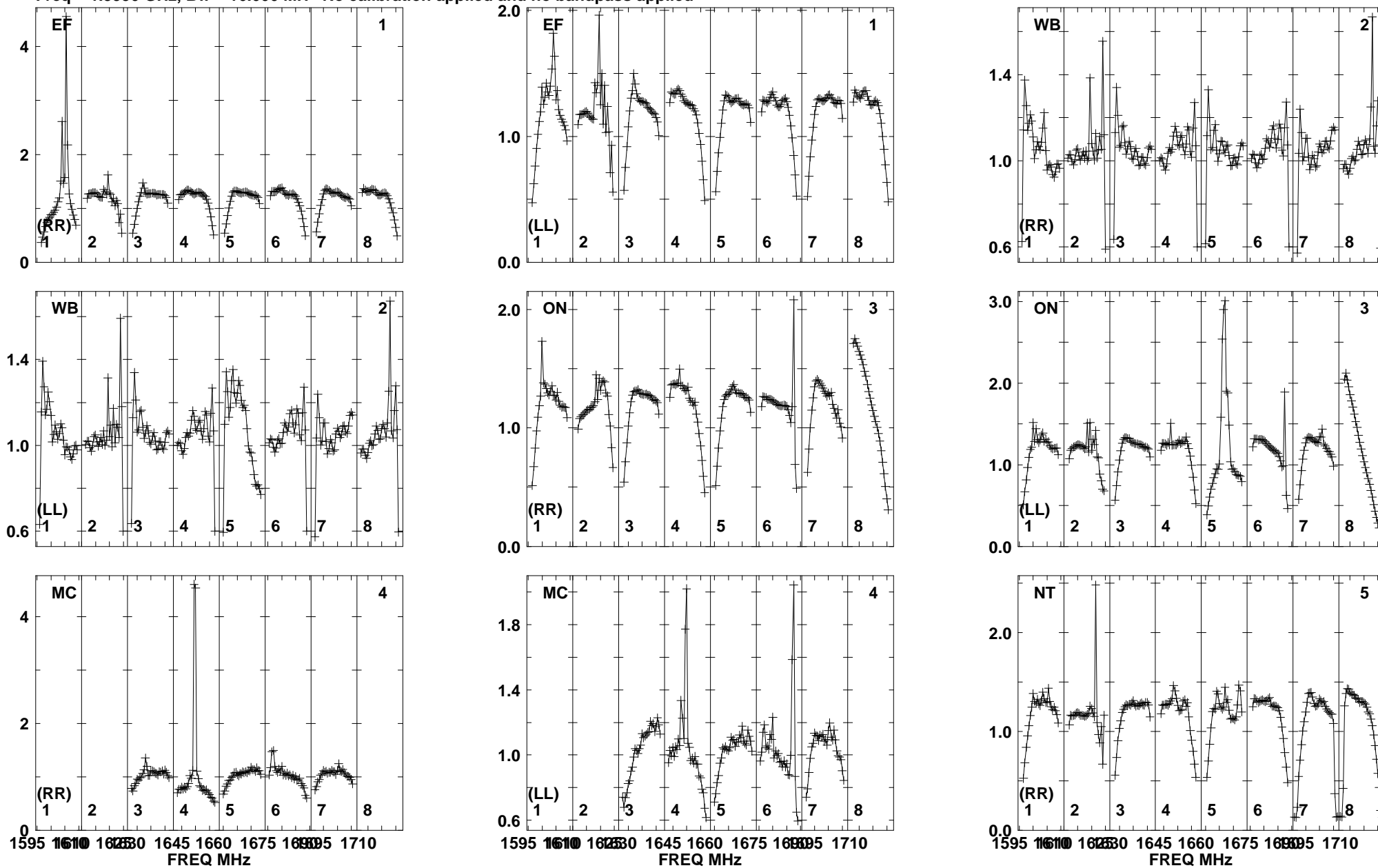

Lower frame: Real Jy
Total-power spectrum Antenna: EF (01)
Timerange: 00/06:54:08 to 00/06:55:48

Plot file version 203 created 11-AUG-2014 17:05:37

J2015+3710 EM110 2.UVDATA.1

Freq = 1.5950 GHz, Bw = 16.000 MH No calibration applied and no bandpass applied

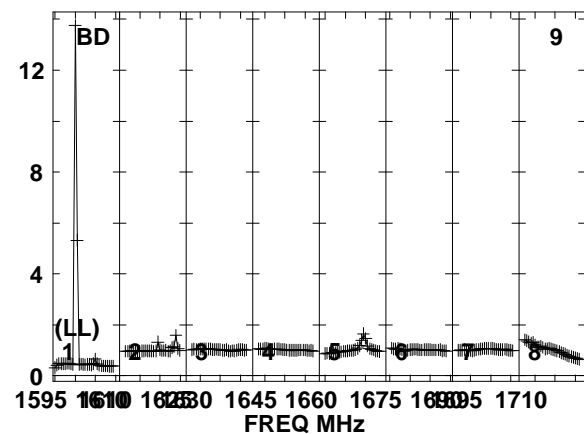
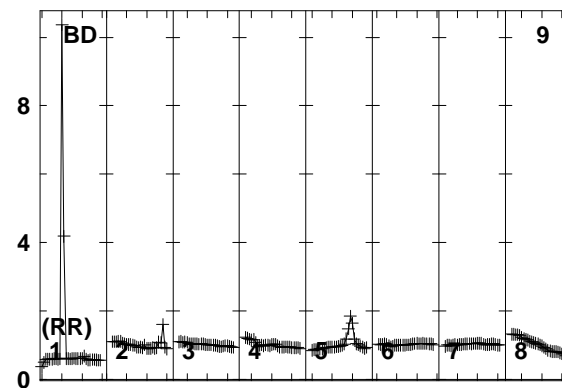
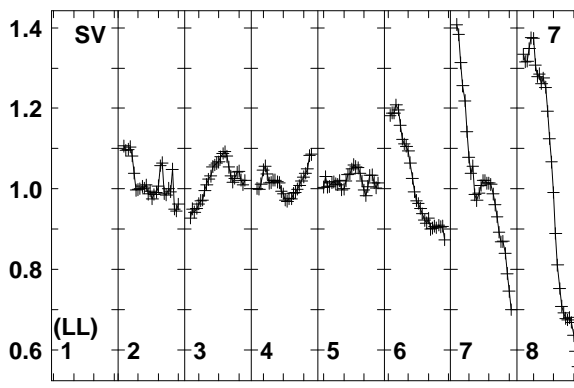
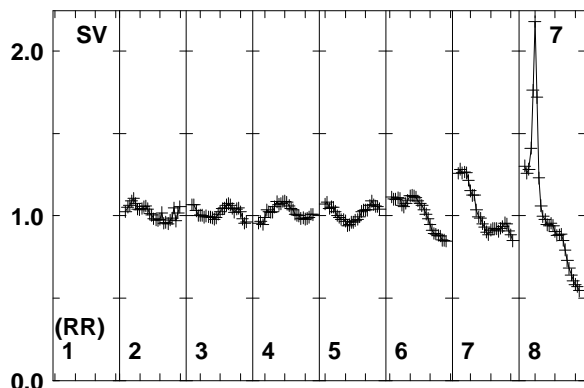
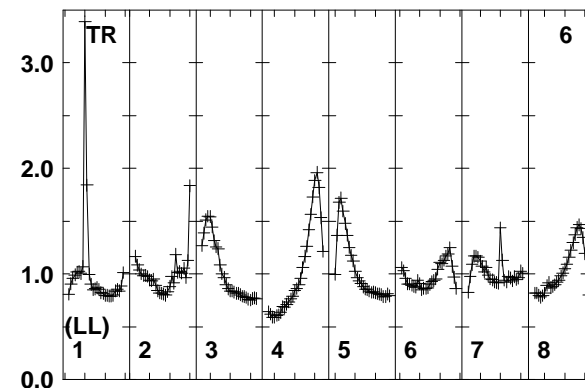
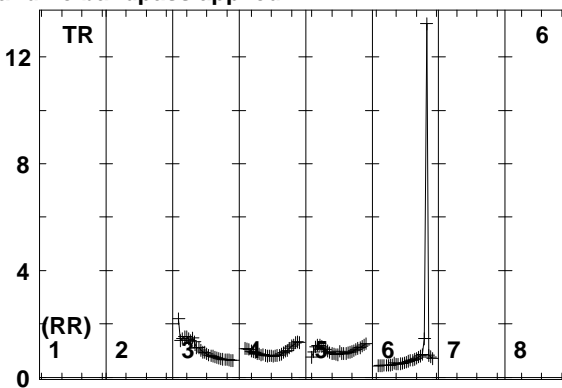
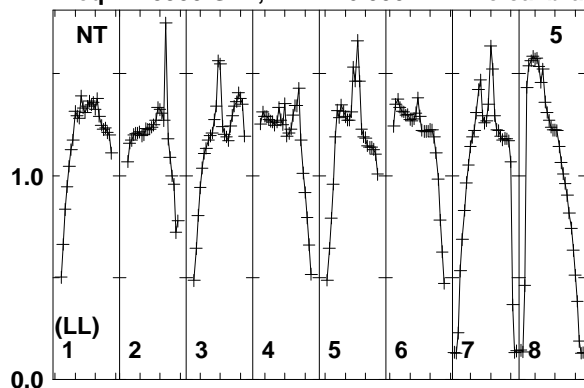

Lower frame: Real Jy
Total-power spectrum Antenna: NT (05)
Timerange: 00/06:54:08 to 00/06:55:48

Plot file version 204 created 11-AUG-2014 17:05:37

J2032+4127 EM110 2.UVDATA.1

Freq = 1.5950 GHz, Bw = 16.000 MH No calibration applied and no bandpass applied

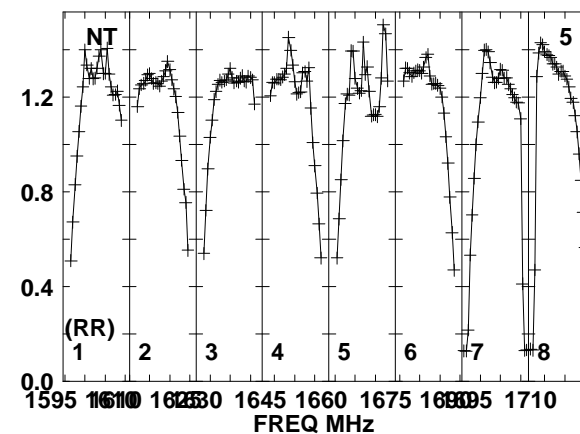
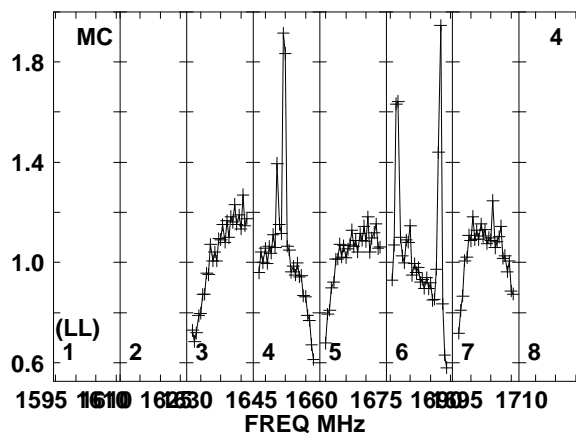
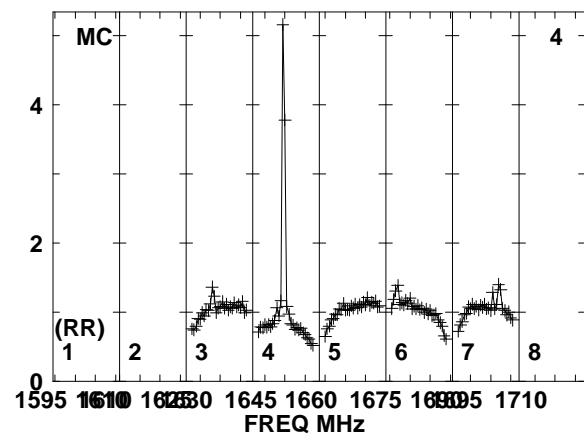
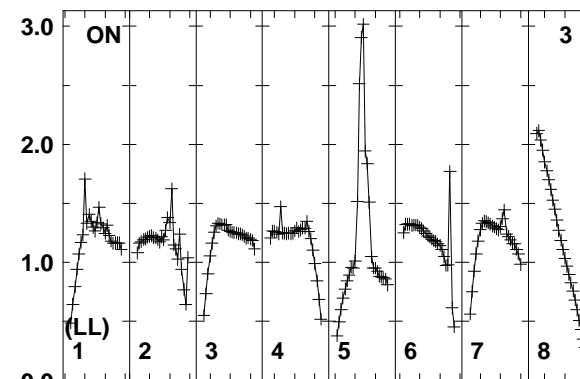
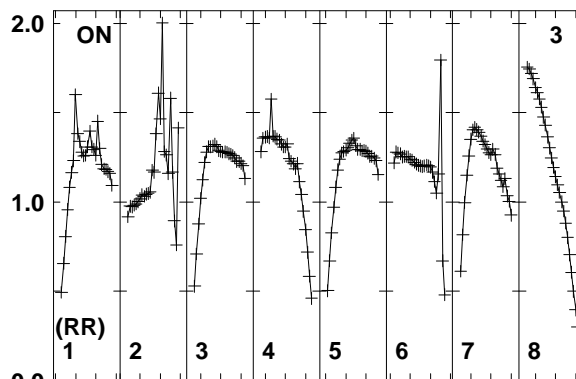
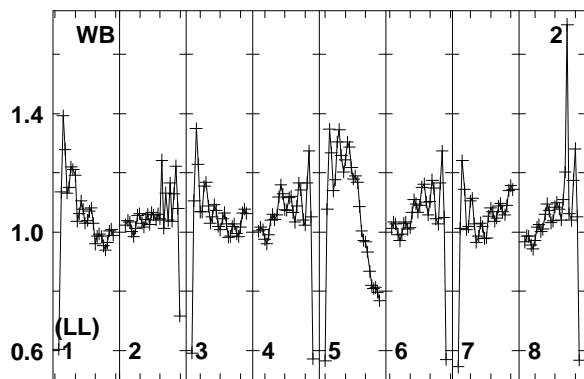
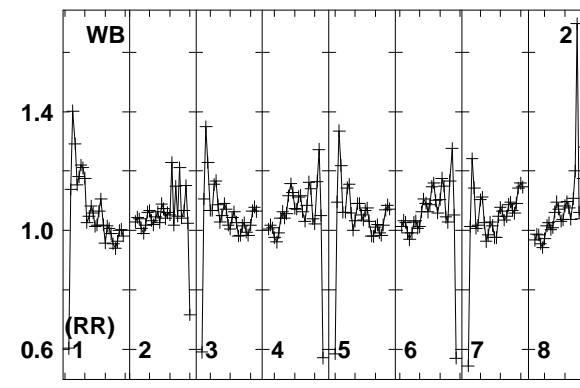
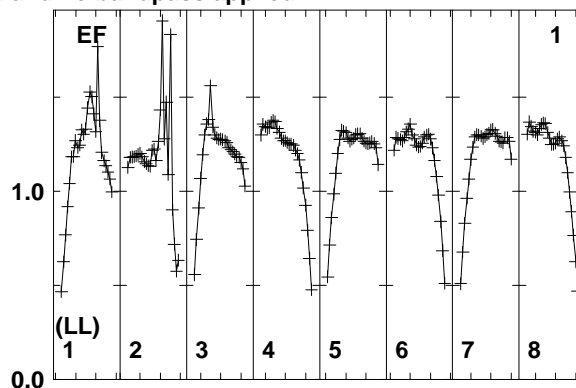
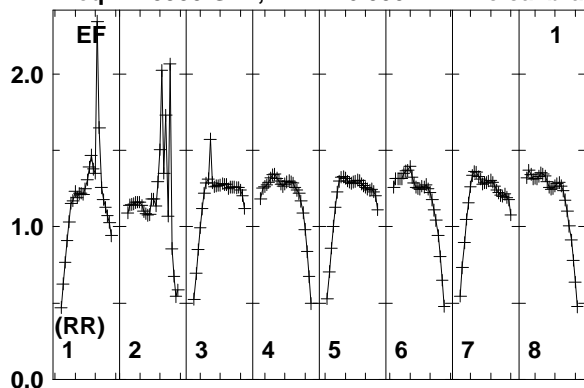

Lower frame: Real Jy
Total-power spectrum Antenna: EF (01)
Timerange: 00/06:55:51 to 00/06:59:49

Plot file version 205 created 11-AUG-2014 17:05:37

J2032+4127 EM110 2.UVDATA.1

Freq = 1.5950 GHz, Bw = 16.000 MH No calibration applied and no bandpass applied

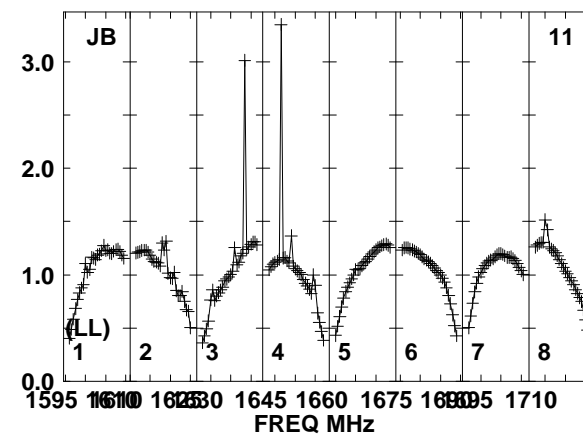
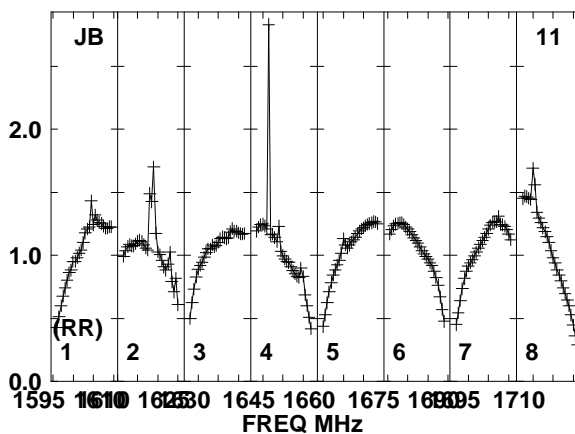
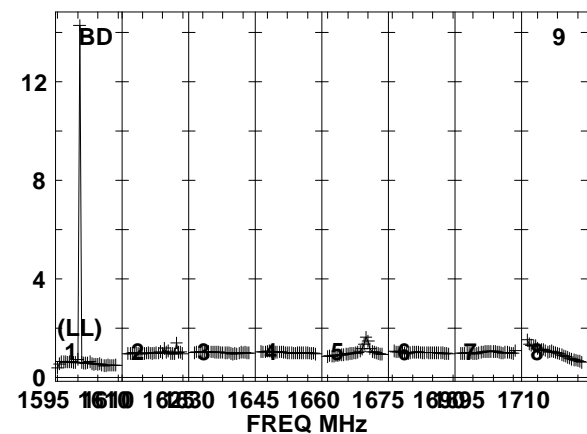
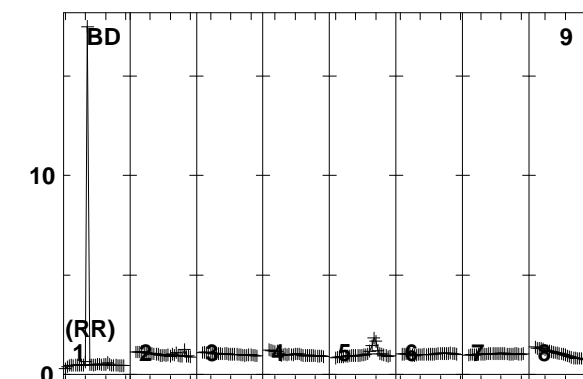
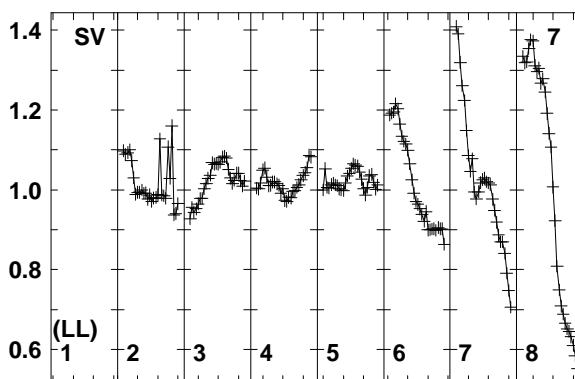
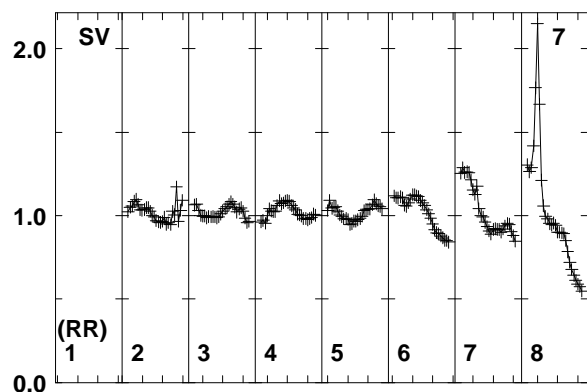
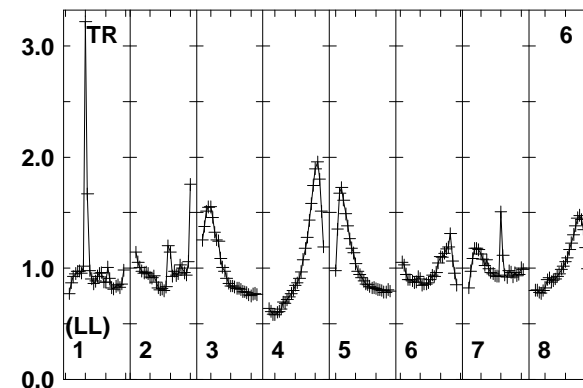
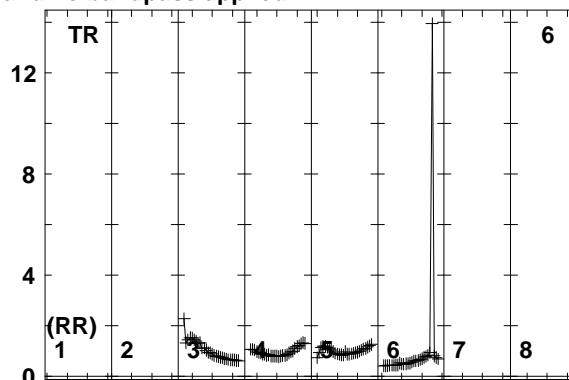
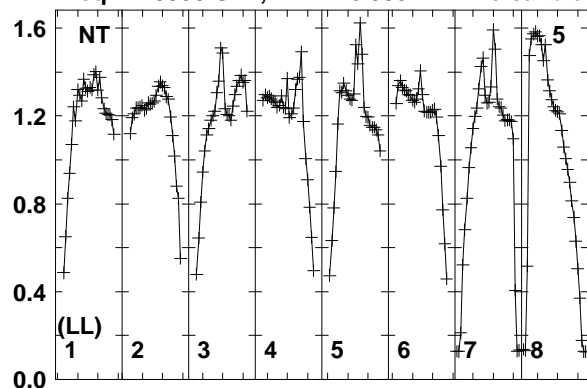

1595 1610 1625 1640 1655 1670 1685 1700 1710
FREQ MHz
Lower frame: Real Jy
Total-power spectrum Antenna: NT (05)
Timerange: 00/06:55:51 to 00/06:59:49

Plot file version 206 created 11-AUG-2014 17:05:37

J2015+3710 EM110 2.UVDATA.1

Freq = 1.5950 GHz, Bw = 16.000 MH No calibration applied and no bandpass applied

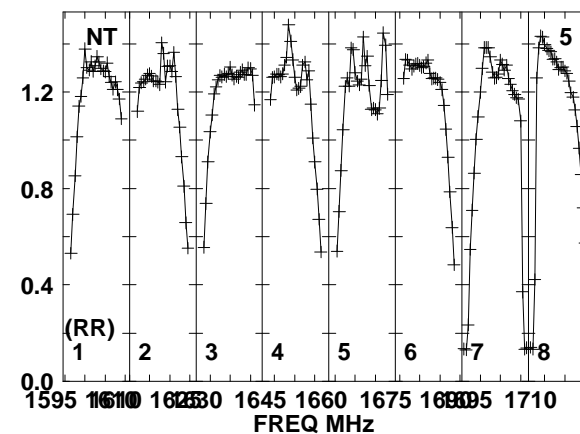
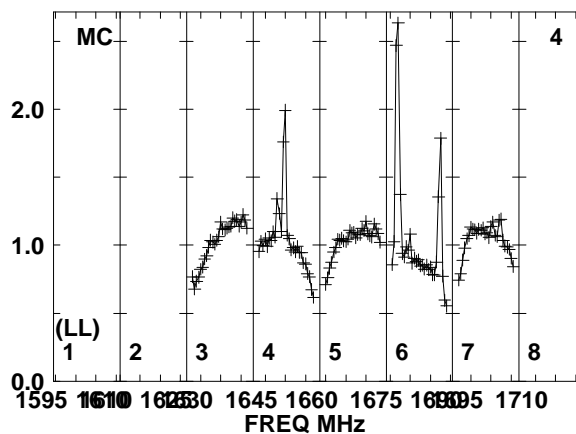
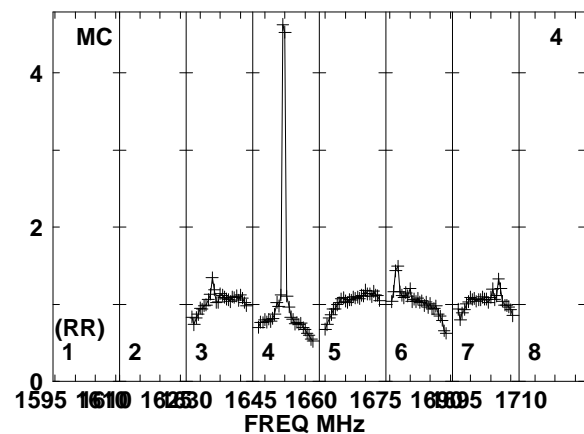
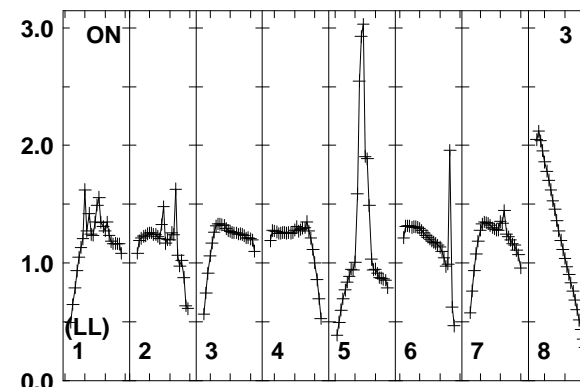
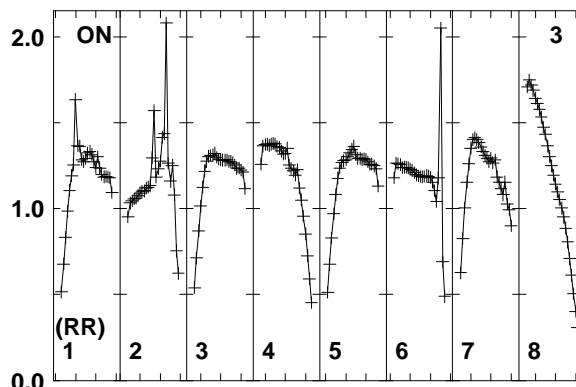
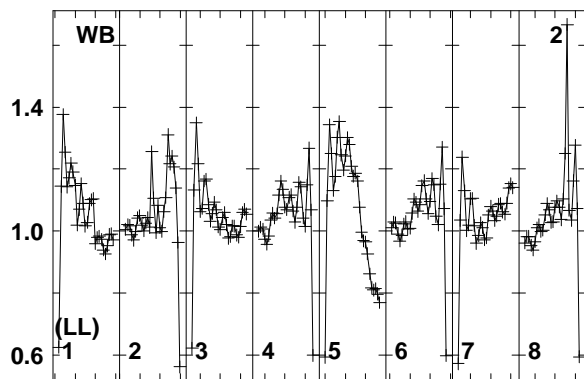
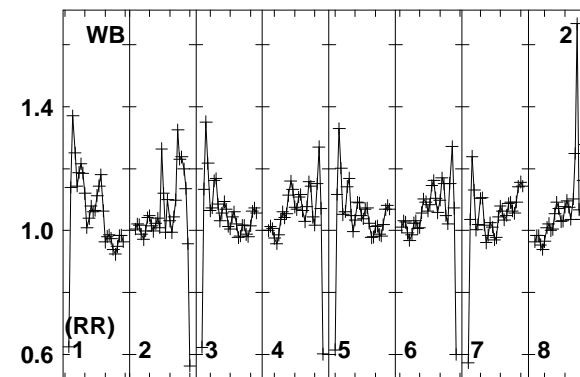
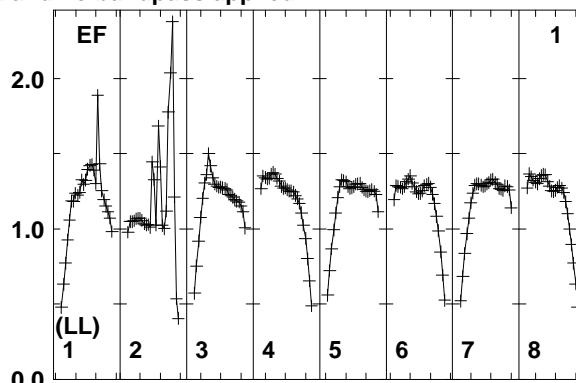
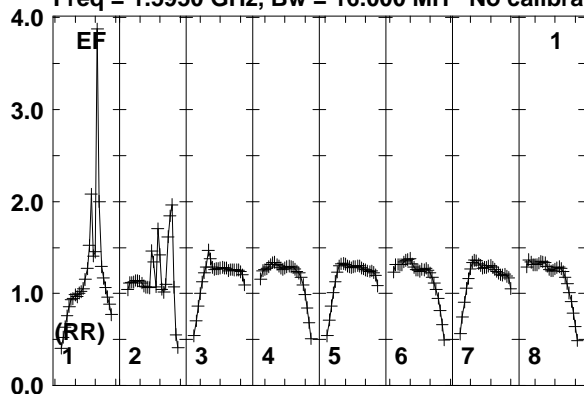

Lower frame: Real Jy
Total-power spectrum Antenna: EF (01)
Timerange: 00/07:00:51 to 00/07:02:49

Plot file version 207 created 11-AUG-2014 17:05:37

J2015+3710 EM110 2.UVDATA.1

Freq = 1.5950 GHz, Bw = 16.000 MH No calibration applied and no bandpass applied

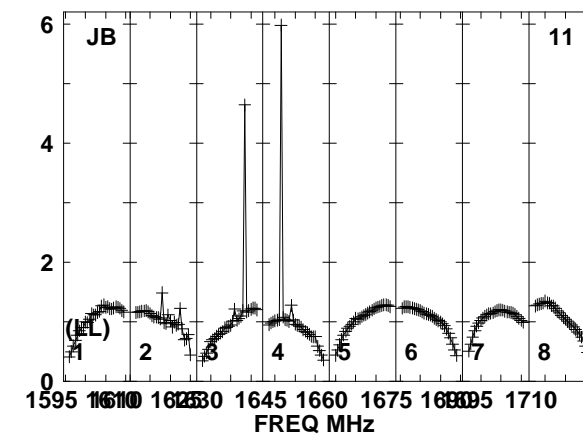
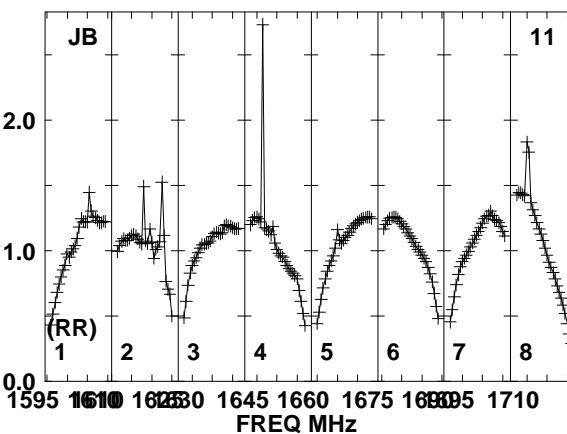
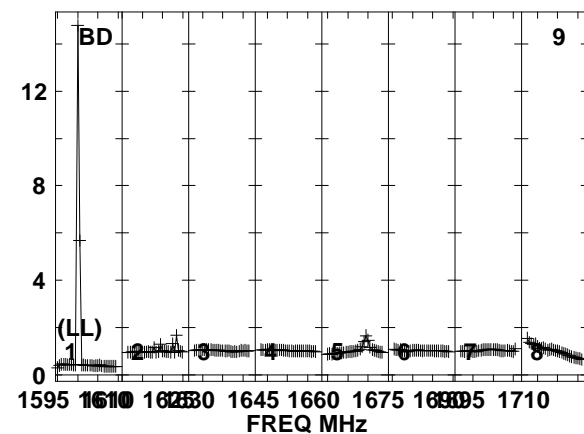
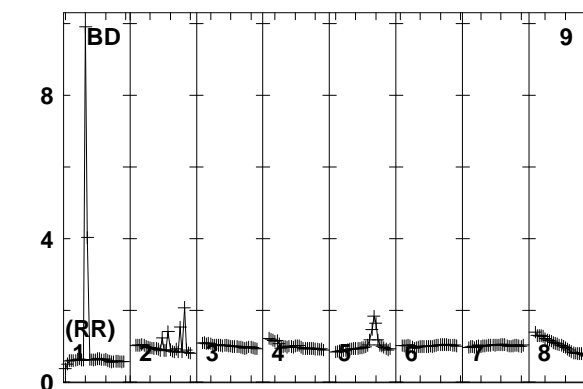
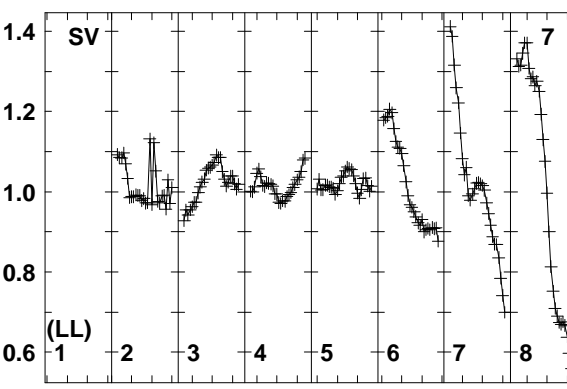
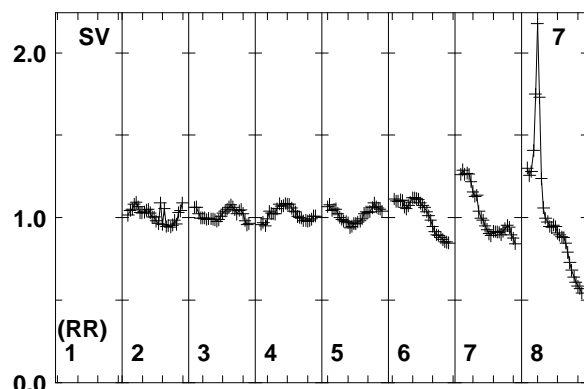
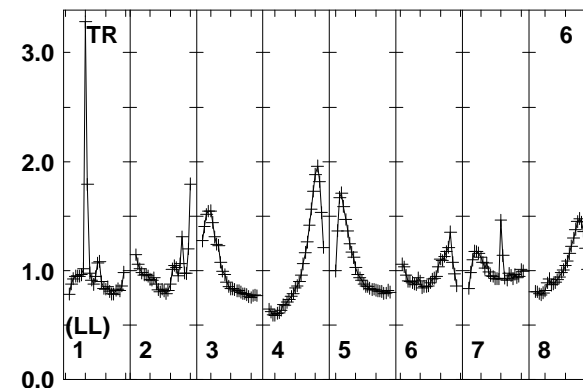
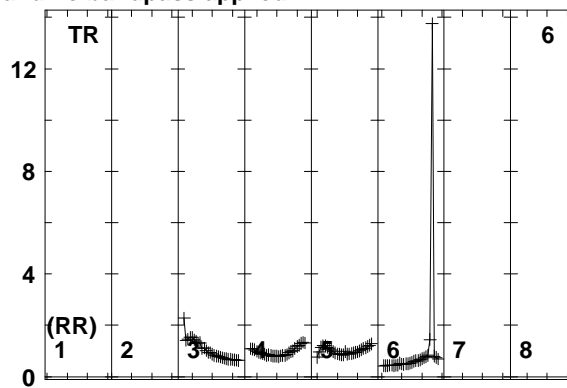
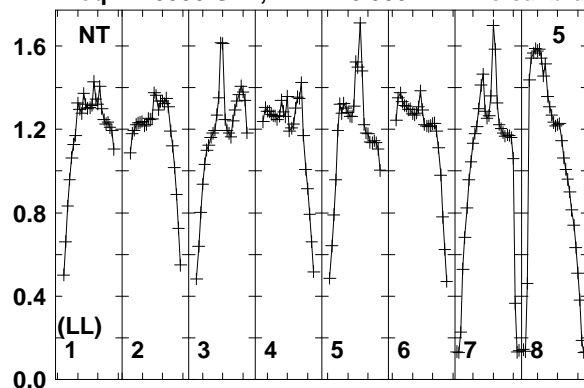

1595 1610 1625 1640 1655 1670 1685 1700 1710
FREQ MHz
Lower frame: Real Jy
Total-power spectrum Antenna: NT (05)
Timerange: 00/07:00:51 to 00/07:02:49

Plot file version 208 created 11-AUG-2014 17:05:37

J2032+4127 EM110 2.UVDATA.1

Freq = 1.5950 GHz, Bw = 16.000 MH No calibration applied and no bandpass applied

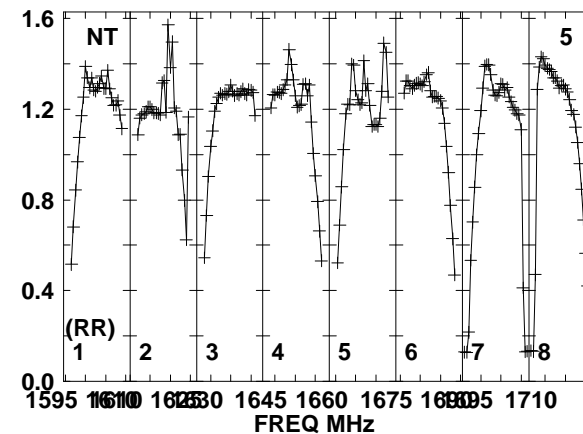
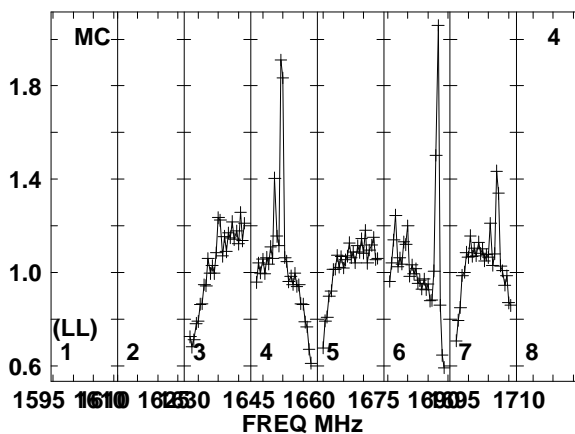
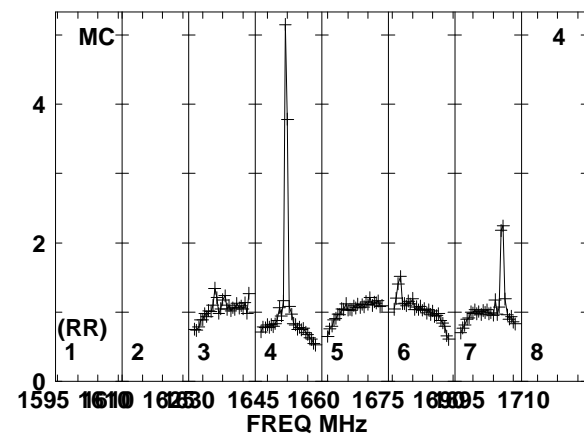
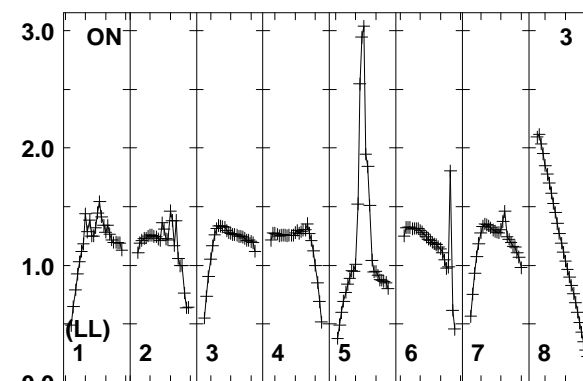
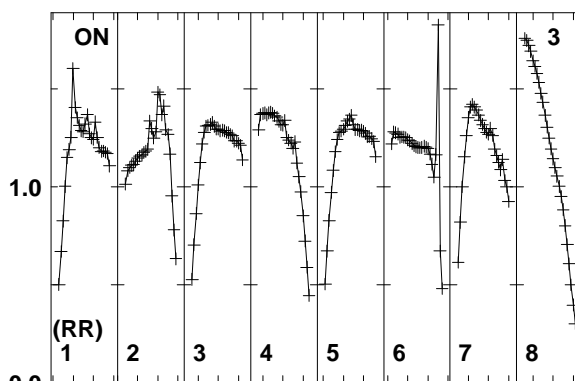
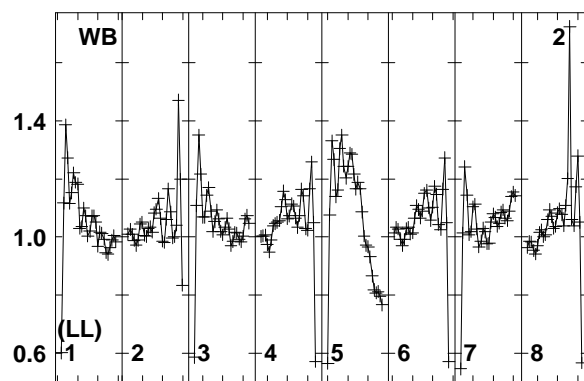
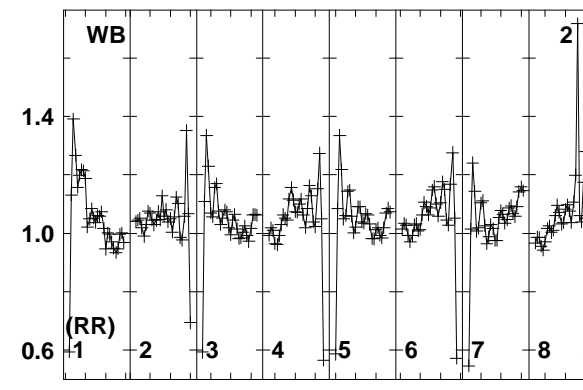
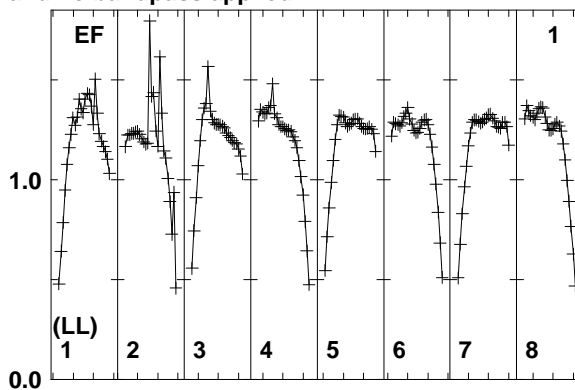
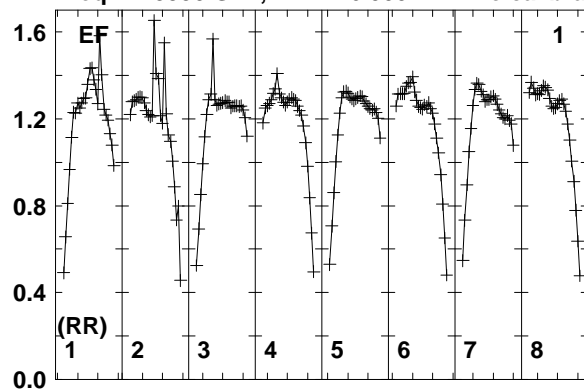

1595 1610 1625 1640 1655 1670 1685 1700 1710
FREQ MHz
Lower frame: Real Jy
Total-power spectrum Antenna: EF (01)
Timerange: 00/07:03:09 to 00/07:06:39

Plot file version 209 created 11-AUG-2014 17:05:37

J2032+4127 EM110 2.UVDATA.1

Freq = 1.5950 GHz, Bw = 16.000 MH No calibration applied and no bandpass applied

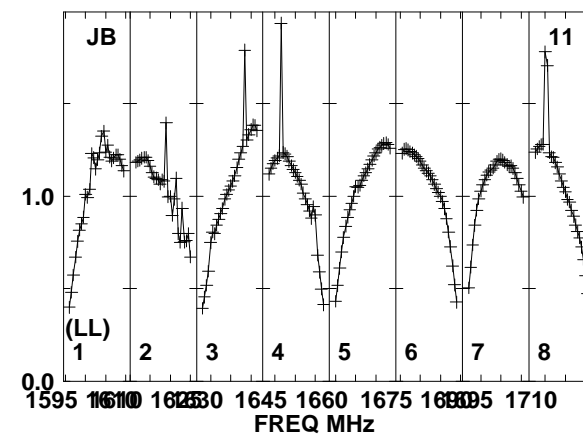
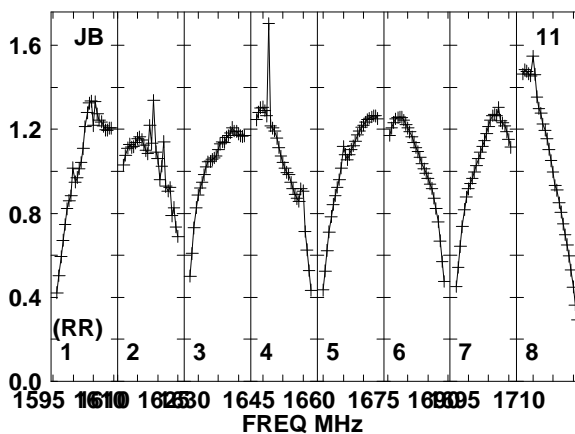
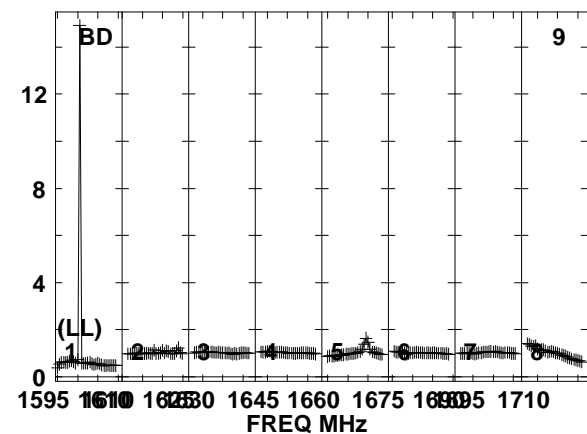
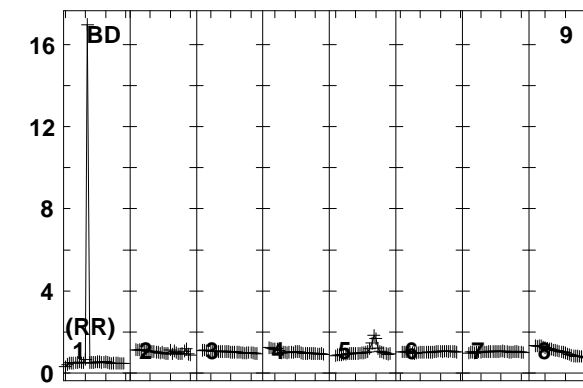
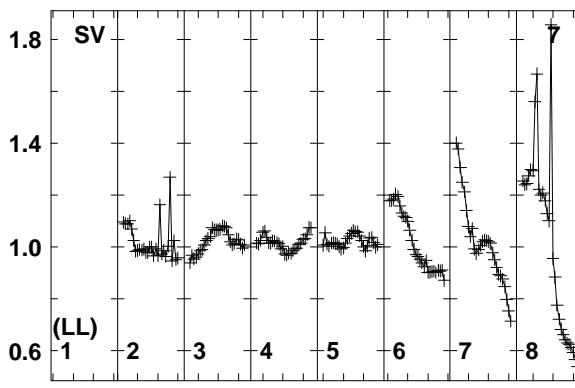
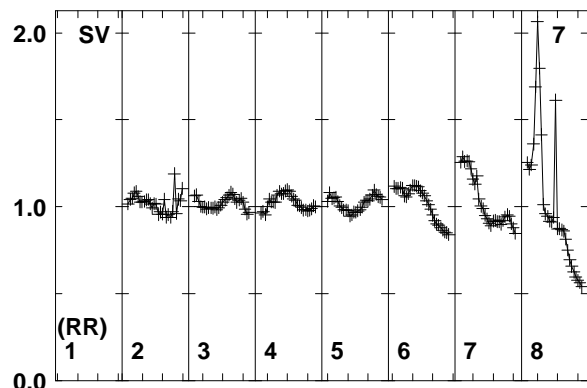
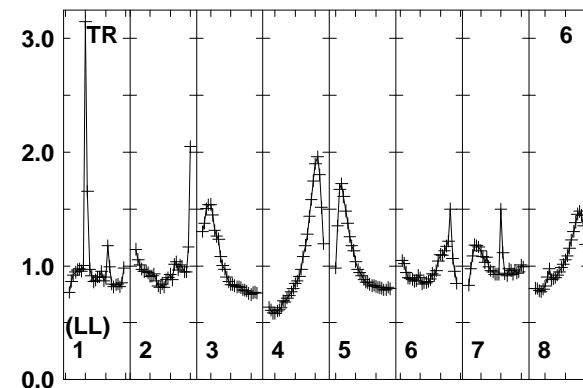
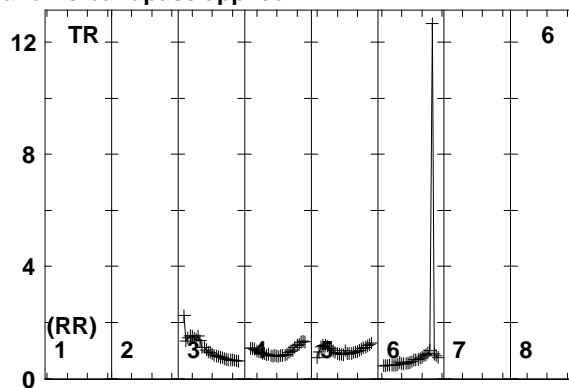
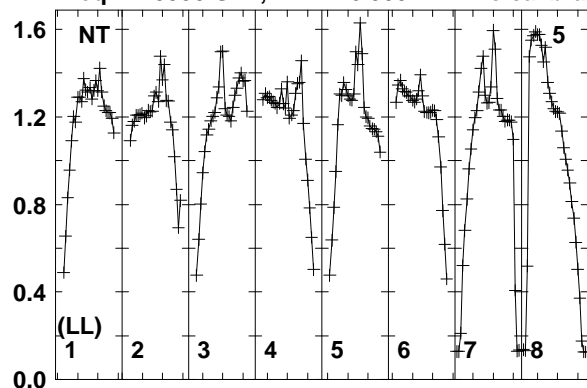

1595 1610 1625 1640 1655 1670 1685 1700 1715
FREQ MHz
Lower frame: Real Jy
Total-power spectrum Antenna: NT (05)
Timerange: 00/07:03:09 to 00/07:06:39

Plot file version 210 created 11-AUG-2014 17:05:37

J2015+3710 EM110 2.UVDATA.1

Freq = 1.5950 GHz, Bw = 16.000 MH No calibration applied and no bandpass applied

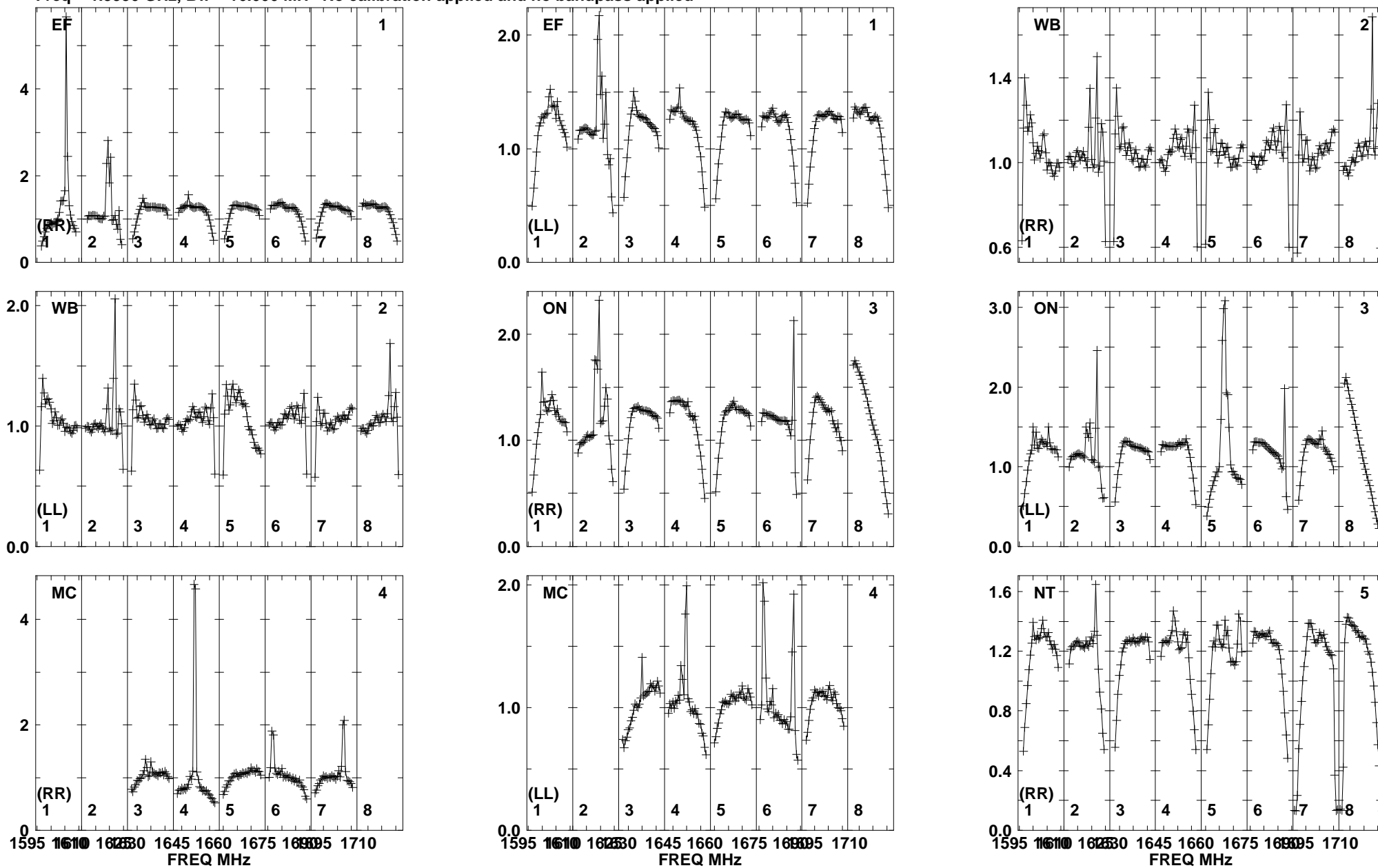

Lower frame: Real Jy
Total-power spectrum Antenna: EF (01)
Timerange: 00/07:06:59 to 00/07:08:39

Plot file version 211 created 11-AUG-2014 17:05:37

J2015+3710 EM110 2.UVDATA.1

Freq = 1.5950 GHz, Bw = 16.000 MH No calibration applied and no bandpass applied

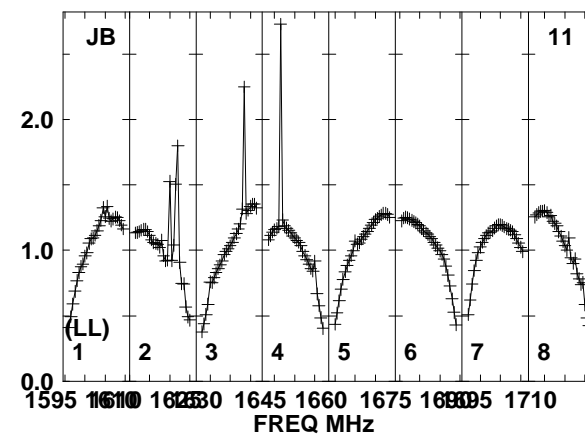
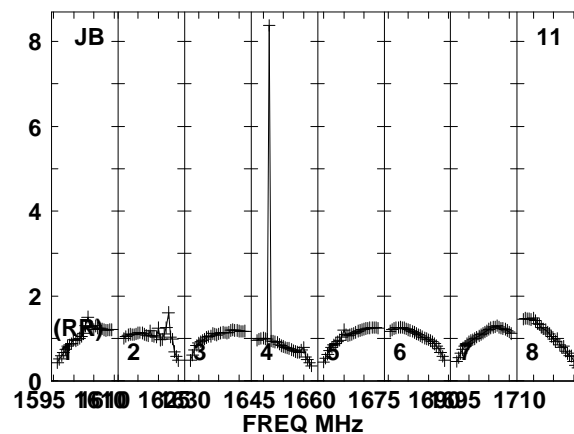
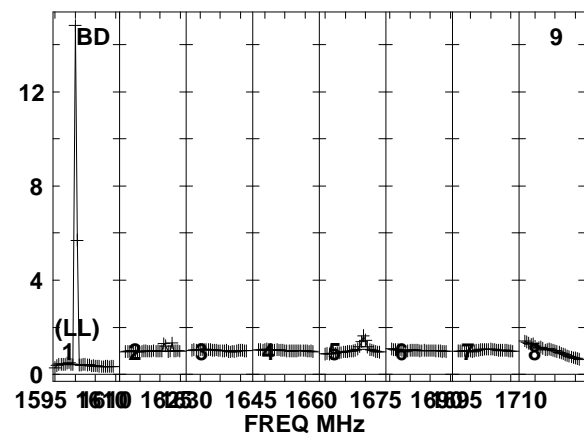
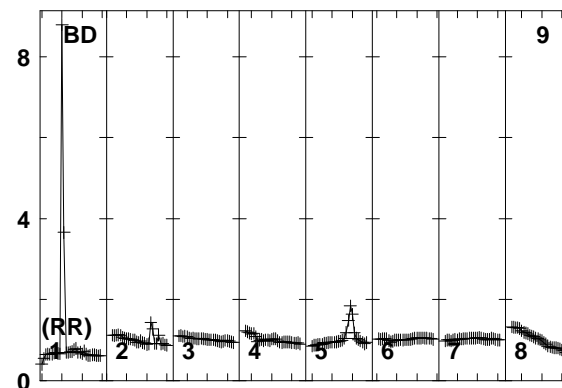
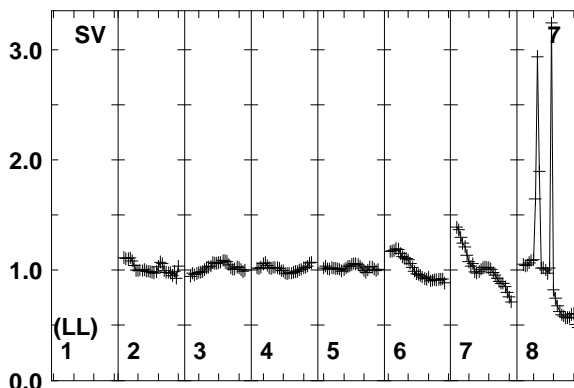
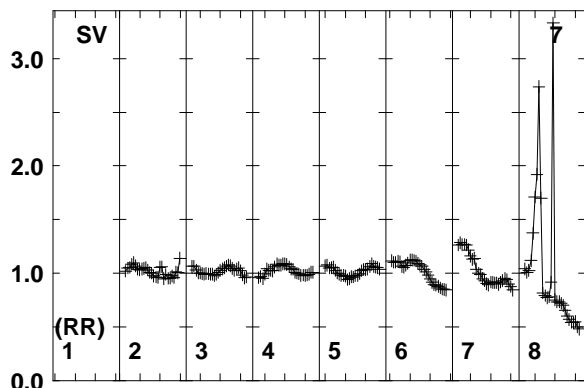
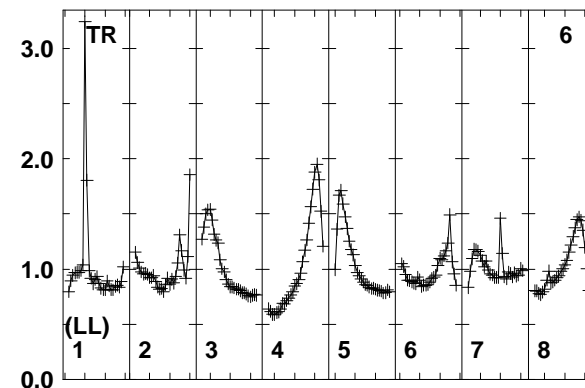
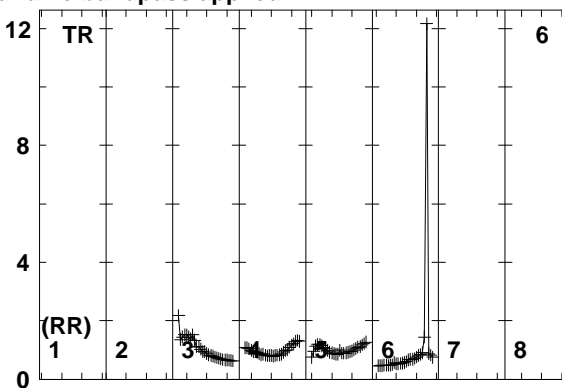
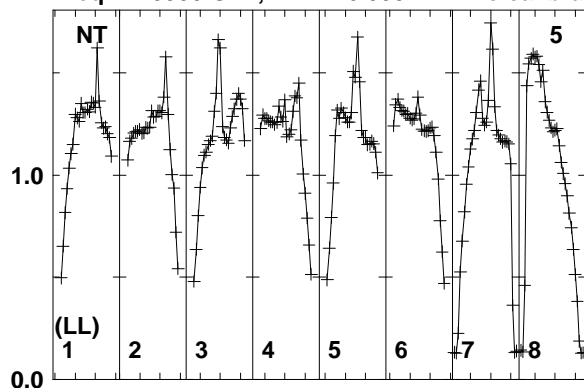

Lower frame: Real Jy
Total-power spectrum Antenna: NT (05)
Timerange: 00/07:06:59 to 00/07:08:39

Plot file version 212 created 11-AUG-2014 17:05:37

J2007+4029 EM110 2.UVDATA.1

Freq = 1.5950 GHz, Bw = 16.000 MH No calibration applied and no bandpass applied

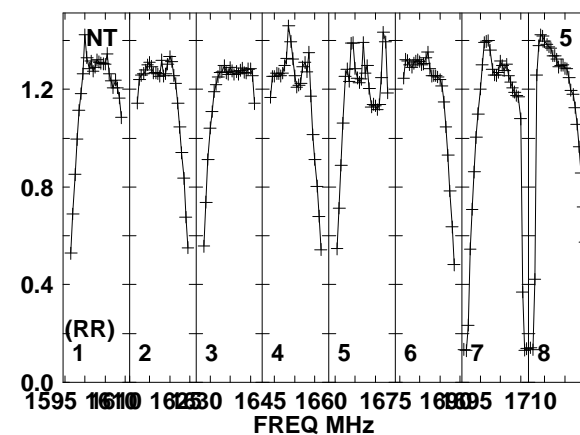
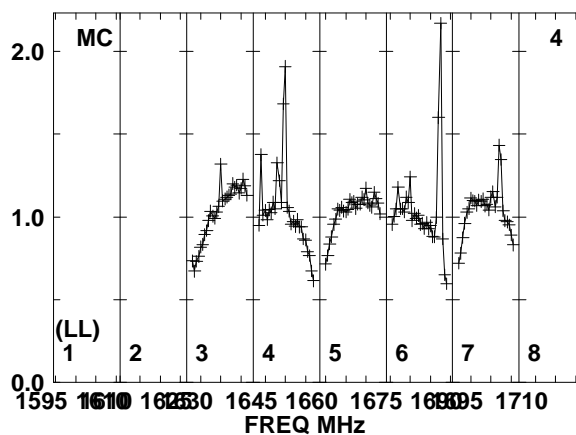
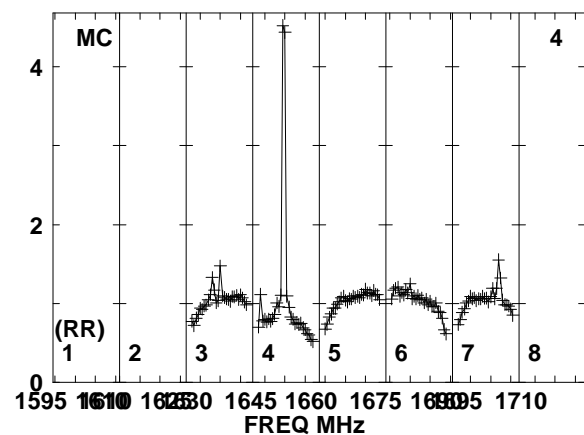
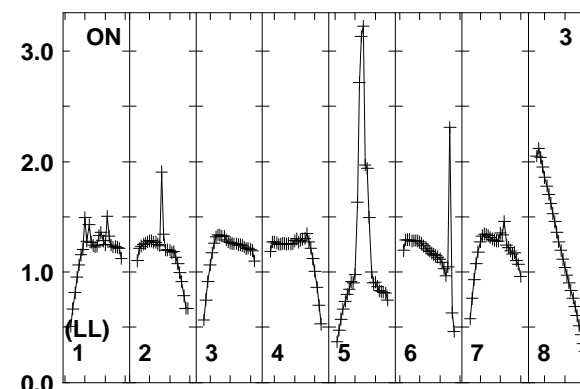
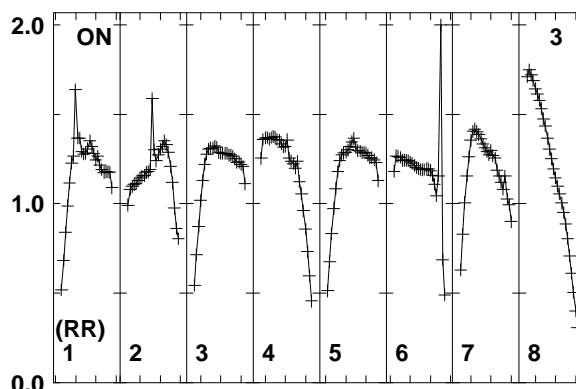
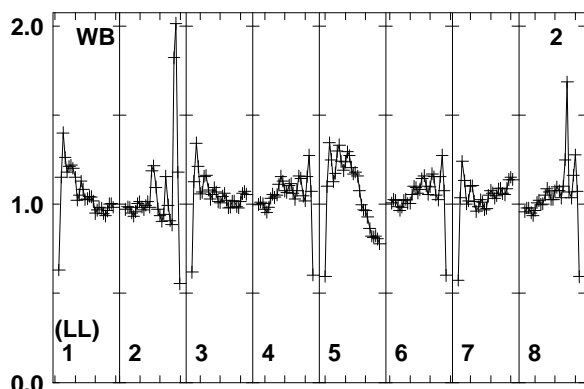
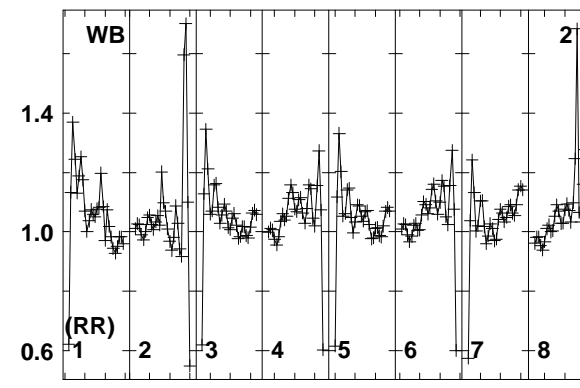
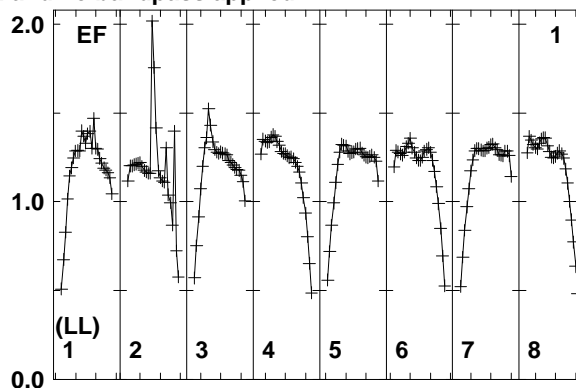
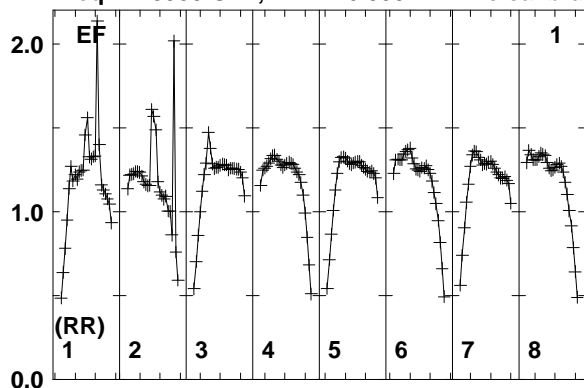

Lower frame: Real Jy
Total-power spectrum Antenna: EF (01)
Timerange: 00/07:08:54 to 00/07:09:38

Plot file version 213 created 11-AUG-2014 17:05:37

J2007+4029 EM110 2.UVDATA.1

Freq = 1.5950 GHz, Bw = 16.000 MH No calibration applied and no bandpass applied

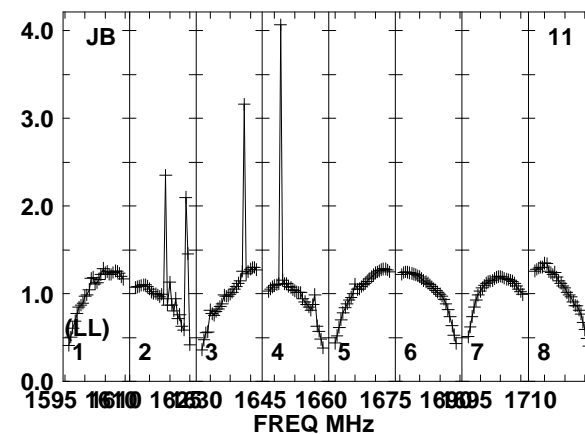
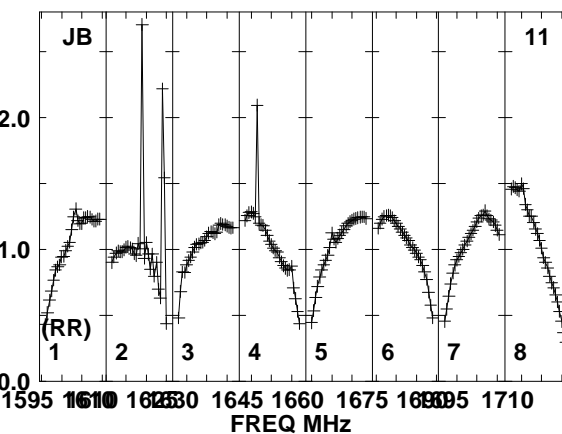
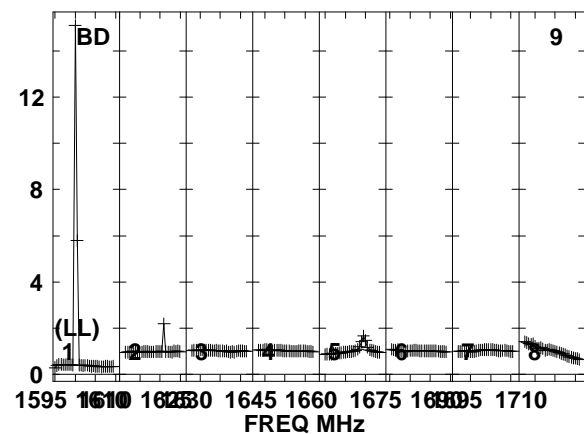
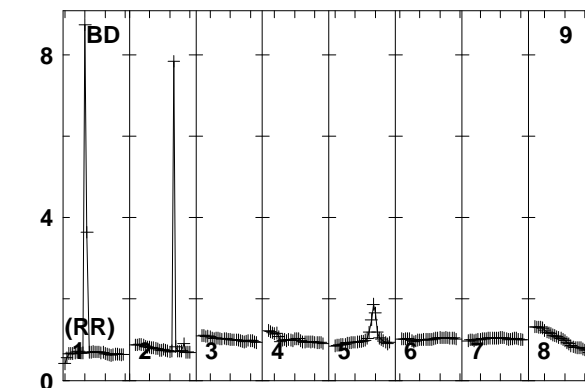
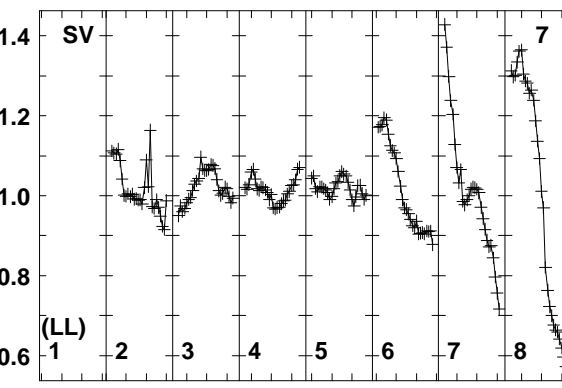
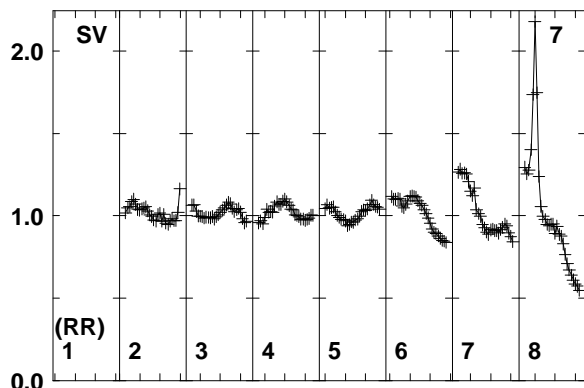
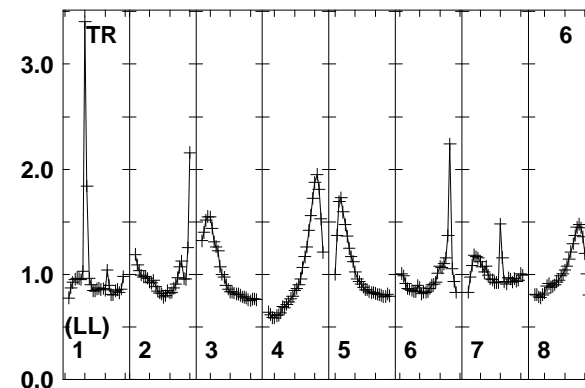
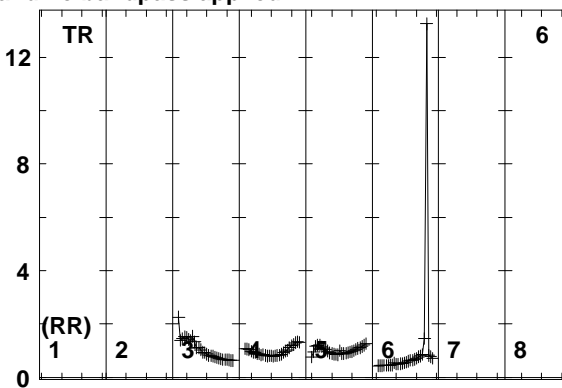
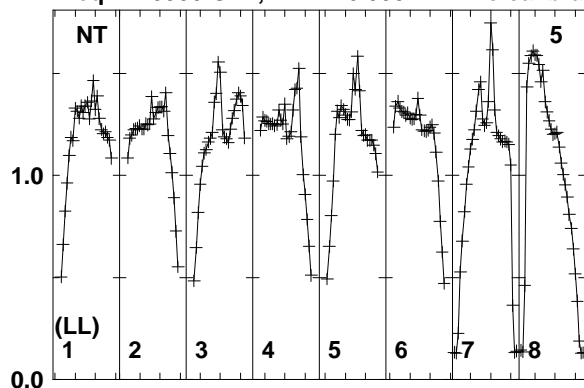

Lower frame: Real Jy
Total-power spectrum Antenna: NT (05)
Timerange: 00/07:08:54 to 00/07:09:38

Plot file version 214 created 11-AUG-2014 17:05:37

J2015+3710 EM110 2.UVDATA.1

Freq = 1.5950 GHz, Bw = 16.000 MH No calibration applied and no bandpass applied

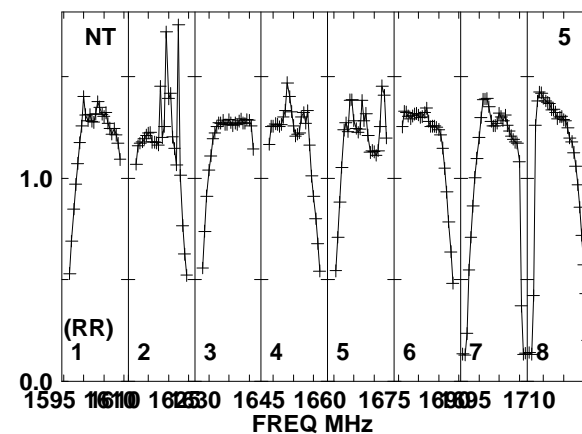
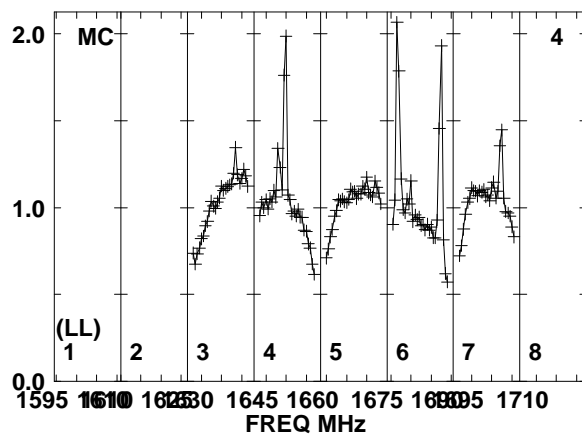
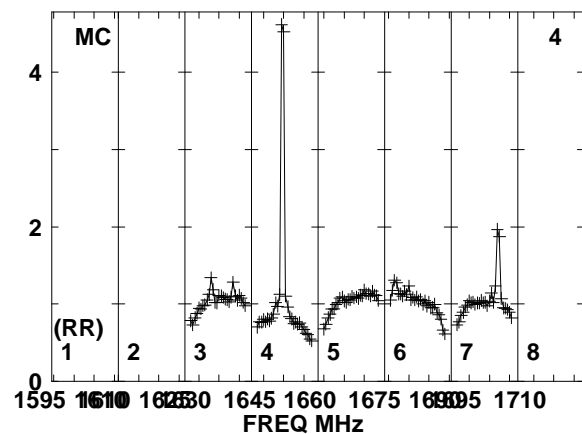
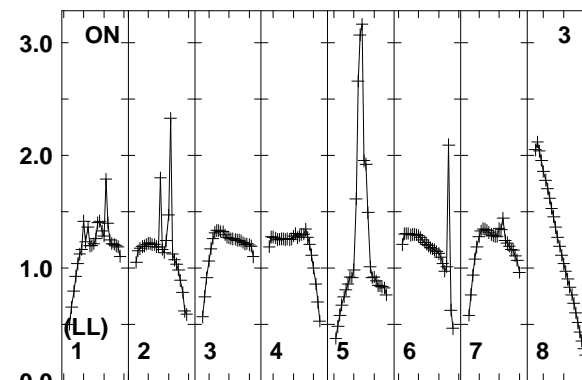
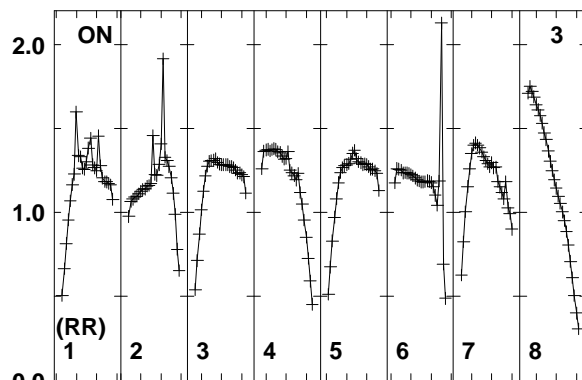
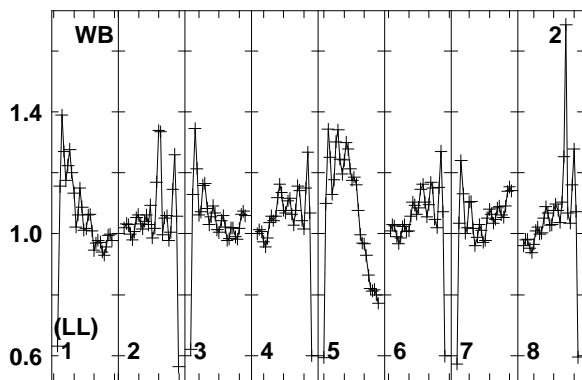
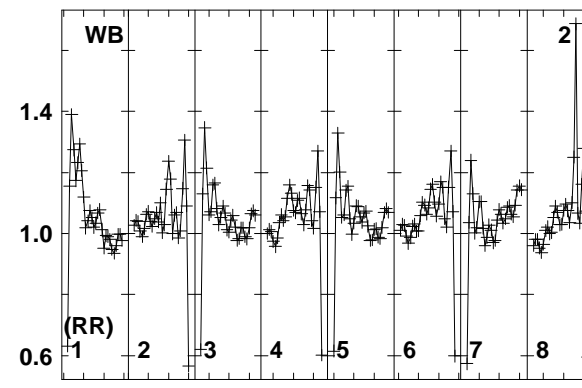
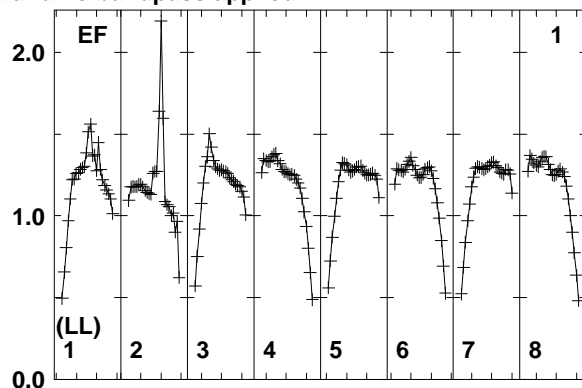
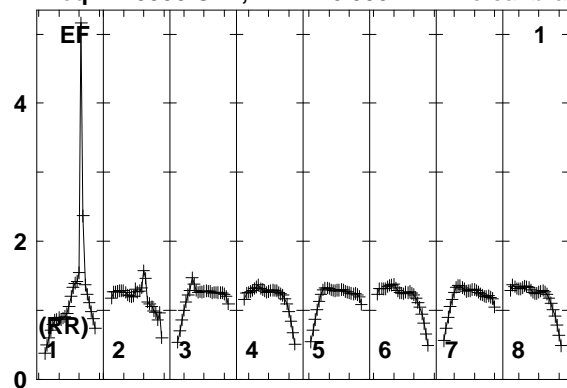

Lower frame: Real Jy
Total-power spectrum Antenna: EF (01)
Timerange: 00/07:10:41 to 00/07:12:39

Plot file version 215 created 11-AUG-2014 17:05:37

J2015+3710 EM110 2.UVDATA.1

Freq = 1.5950 GHz, Bw = 16.000 MH No calibration applied and no bandpass applied

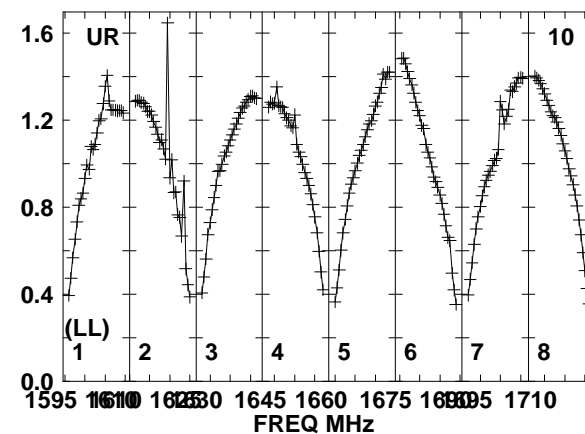
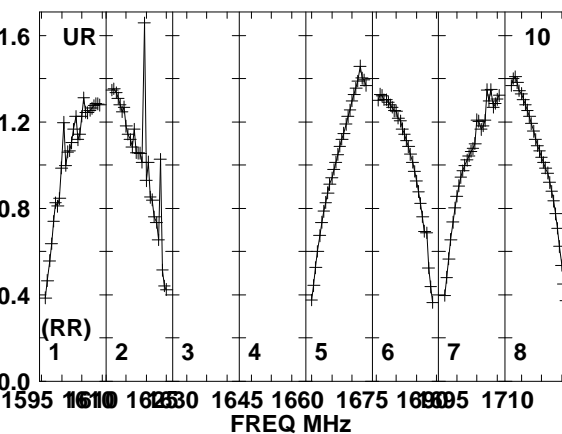
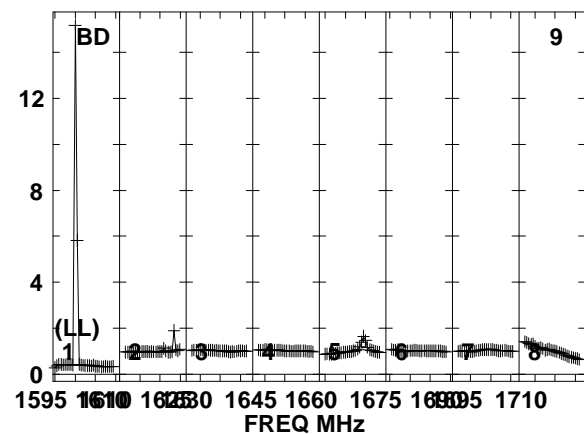
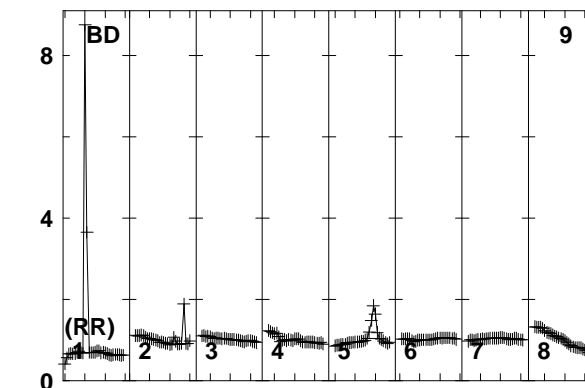
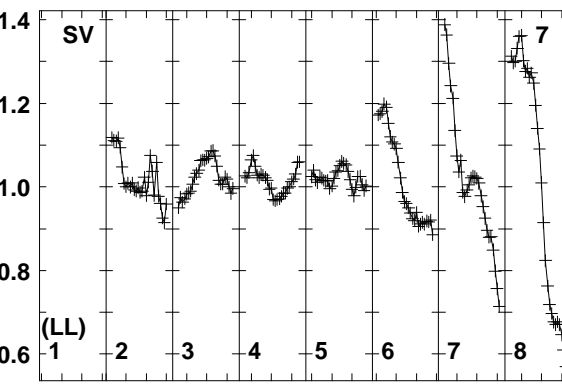
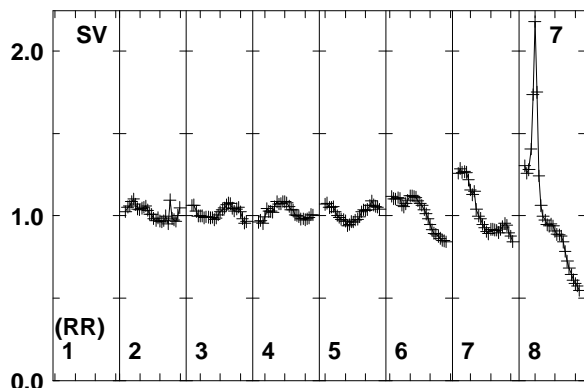
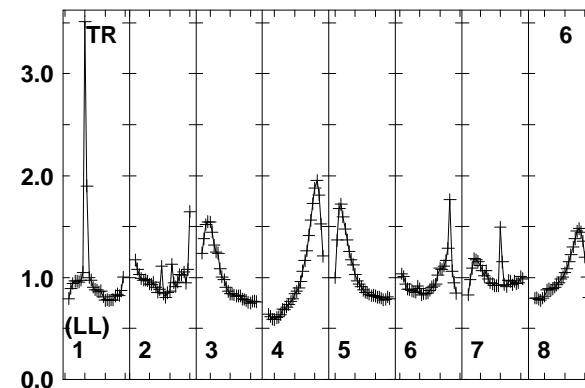
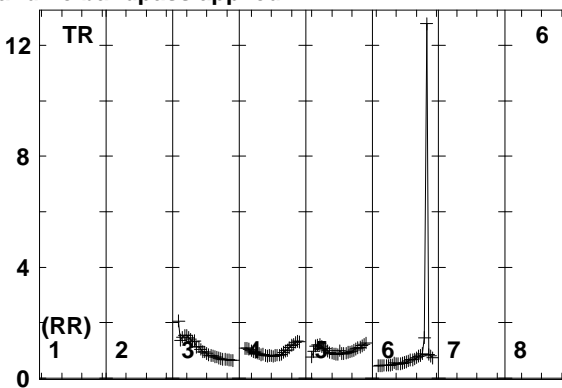
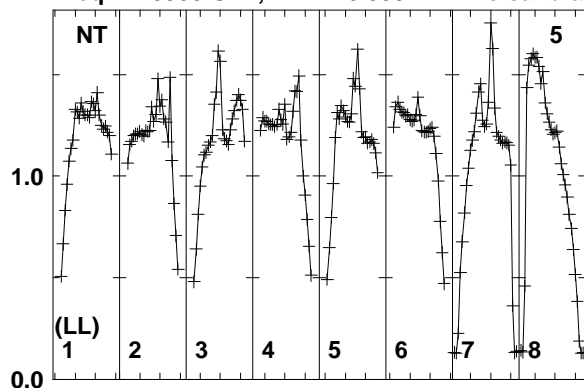

Lower frame: Real Jy
Total-power spectrum Antenna: NT (05)
Timerange: 00/07:10:41 to 00/07:12:39

Plot file version 216 created 11-AUG-2014 17:05:37

J2032+4127 EM110 2.UVDATA.1

Freq = 1.5950 GHz, Bw = 16.000 MH No calibration applied and no bandpass applied

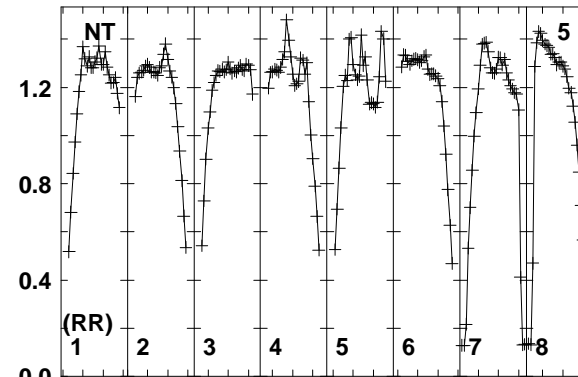
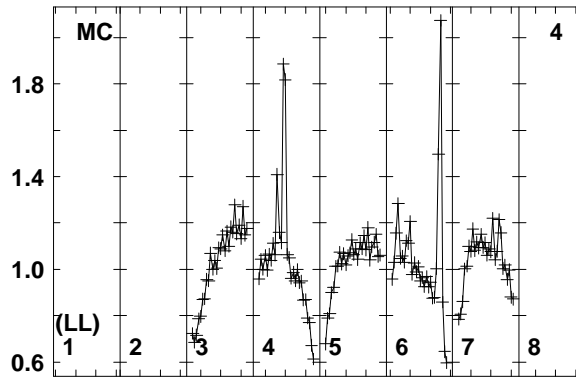
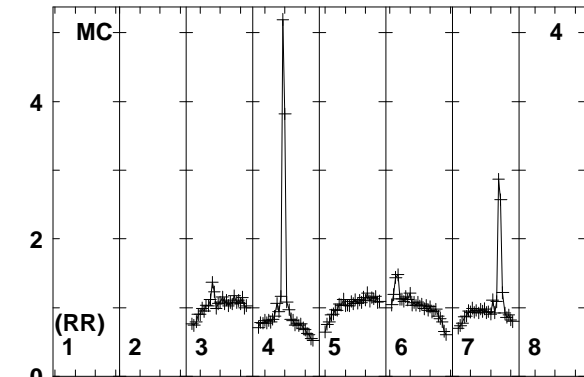
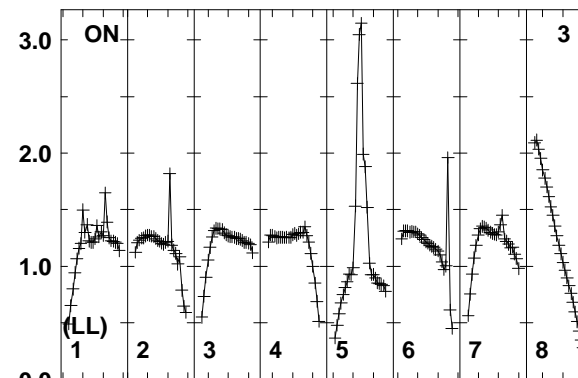
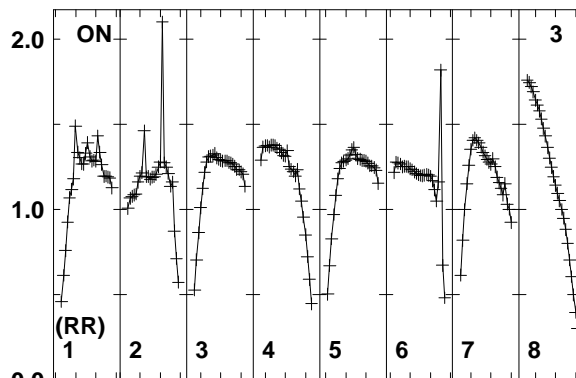
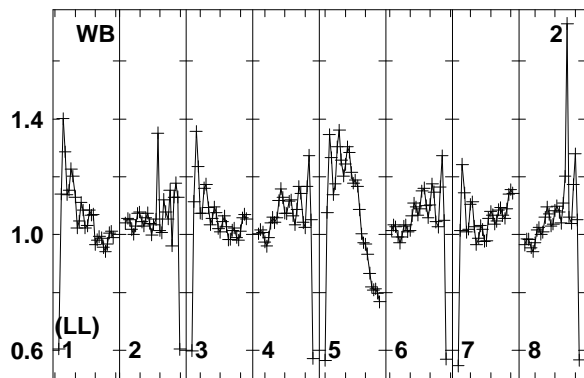
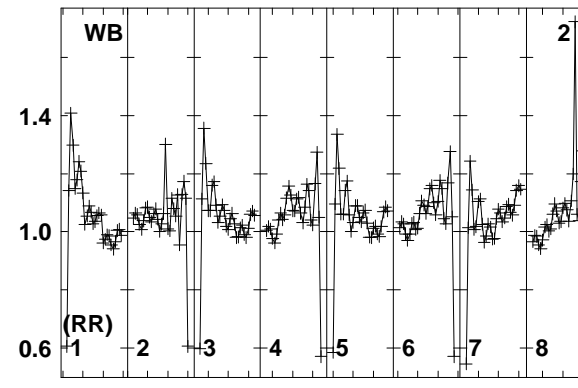
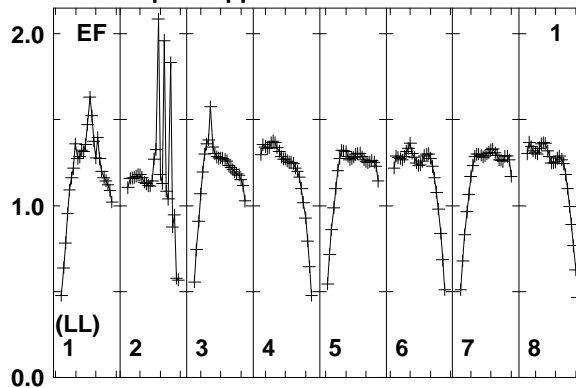
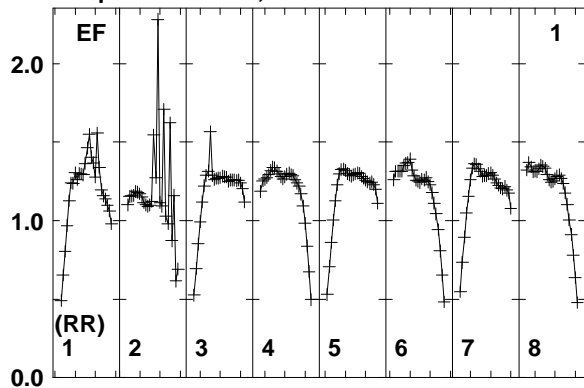

1595 1610 1625 1640 1655 1670 1685 1700 1715
FREQ MHz

Lower frame: Real Jy
Total-power spectrum Antenna: EF (01)
Timerange: 00/07:12:41 to 00/07:16:39

Plot file version 217 created 11-AUG-2014 17:05:37

J2032+4127 EM110 2.UVDATA.1

Freq = 1.5950 GHz, Bw = 16.000 MH No calibration applied and no bandpass applied

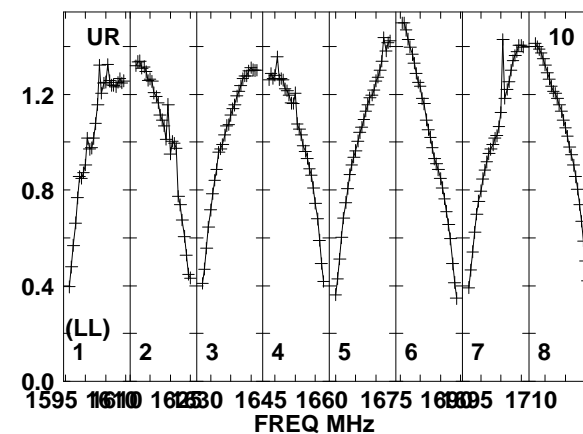
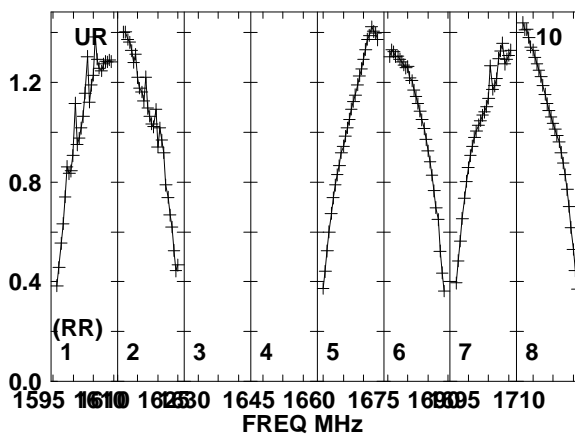
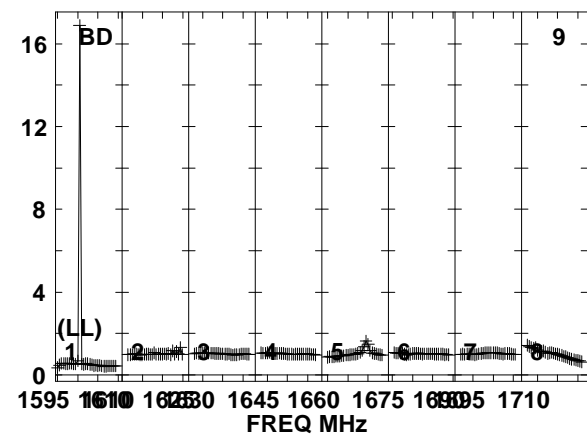
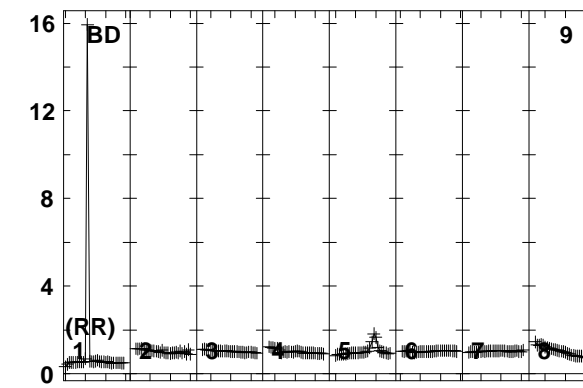
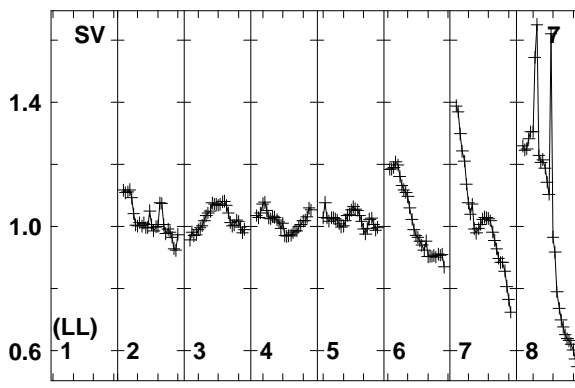
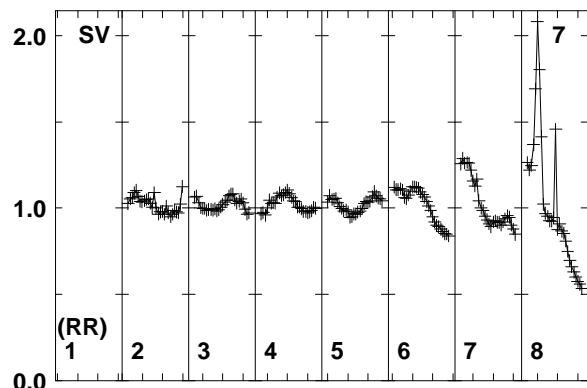
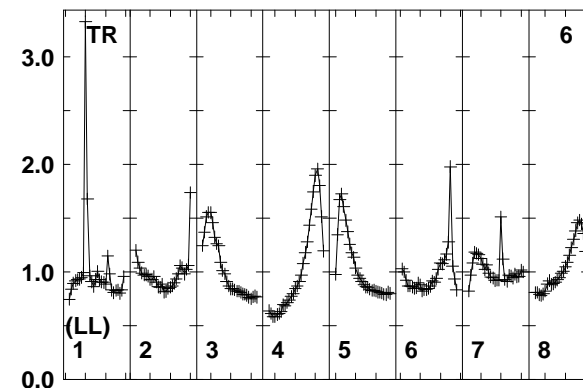
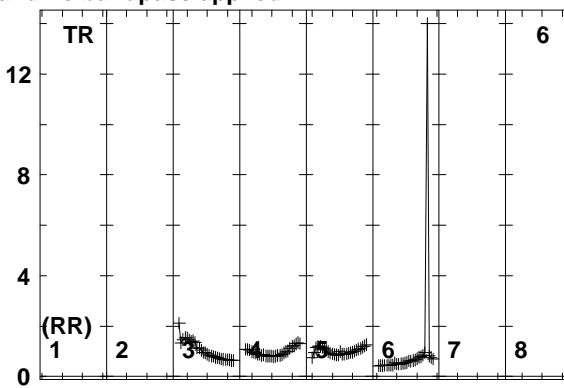
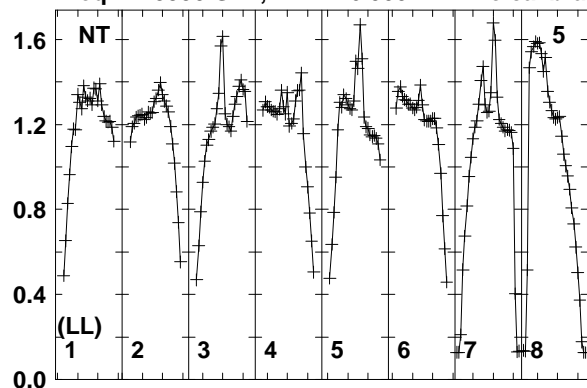

Lower frame: Real Jy
Total-power spectrum Antenna: NT (05)
Timerange: 00/07:12:41 to 00/07:16:39

Plot file version 218 created 11-AUG-2014 17:05:37

J2032+4127 EM110 2.UVDATA.1

Freq = 1.5950 GHz, Bw = 16.000 MH No calibration applied and no bandpass applied

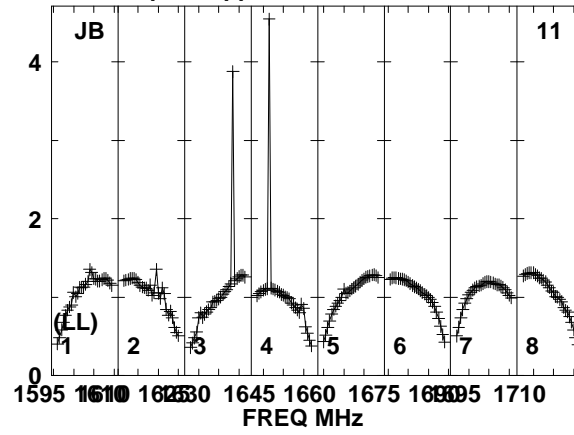
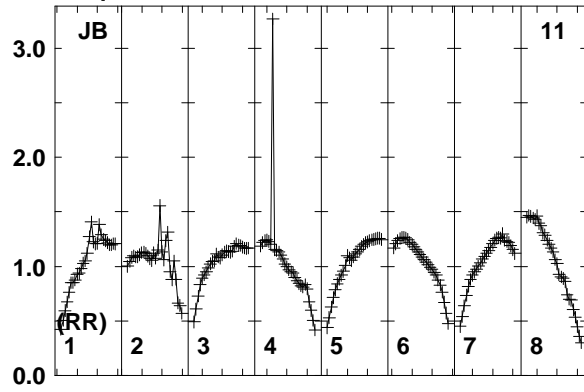

Lower frame: Real Jy
Total-power spectrum Antenna: JB (11)
Timerange: 00/07:12:41 to 00/07:16:39

Plot file version 219 created 11-AUG-2014 17:05:37

J2015+3710 EM110 2.UVDATA.1

Freq = 1.5950 GHz, Bw = 16.000 MH No calibration applied and no bandpass applied

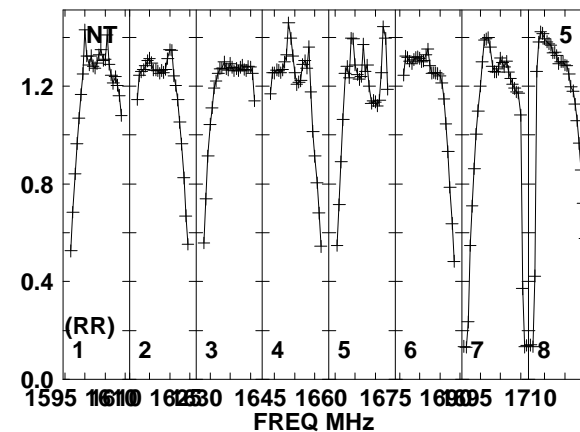
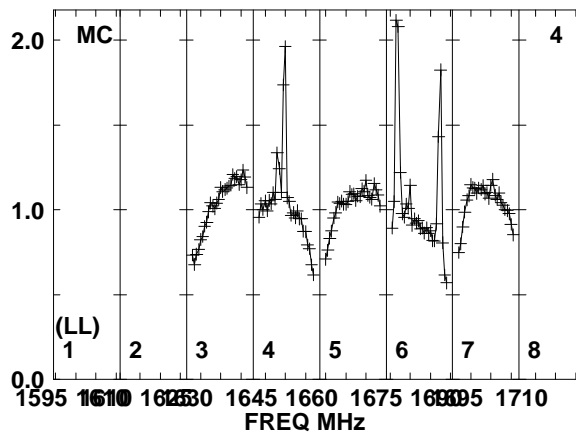
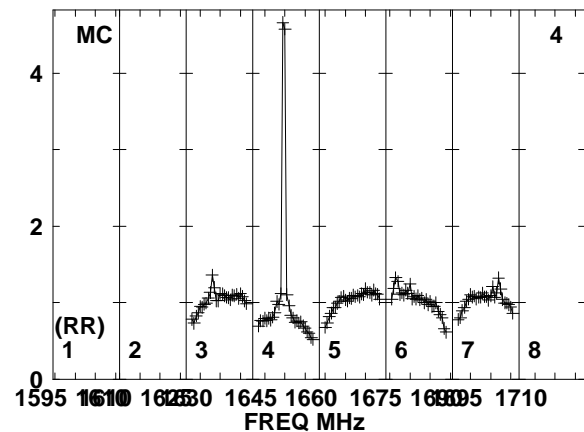
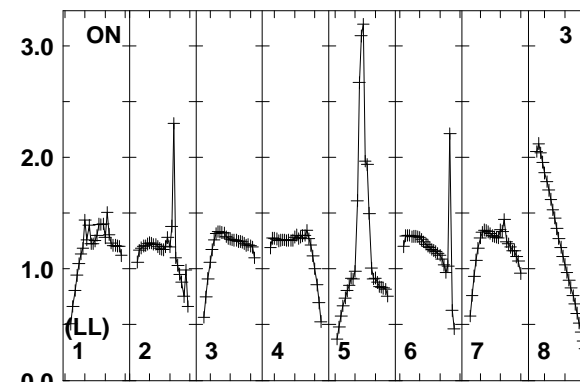
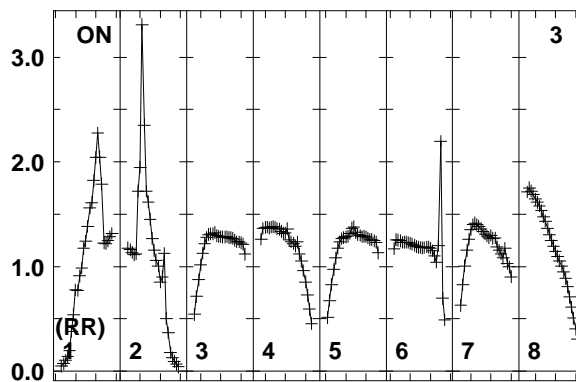
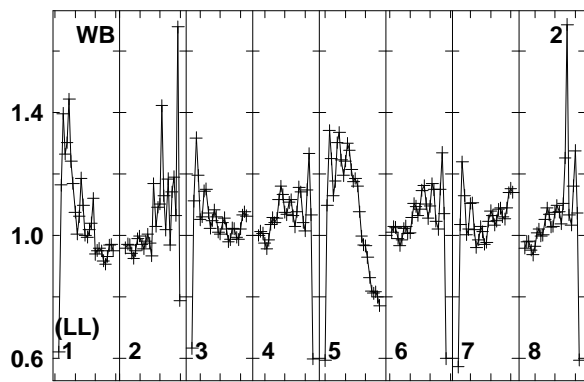
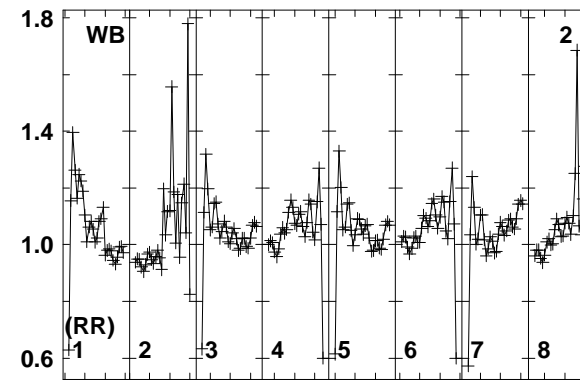
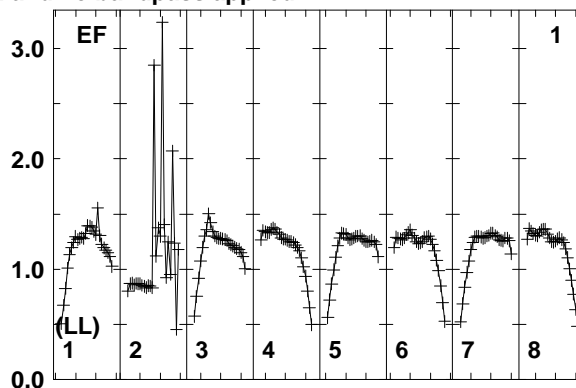
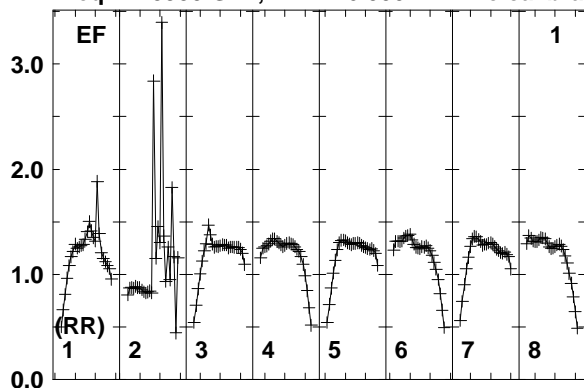

Lower frame: Real Jy
Total-power spectrum Antenna: EF (01)
Timerange: 00/07:16:53 to 00/07:18:39

Plot file version 220 created 11-AUG-2014 17:05:37

J2015+3710 EM110 2.UVDATA.1

Freq = 1.5950 GHz, Bw = 16.000 MH No calibration applied and no bandpass applied

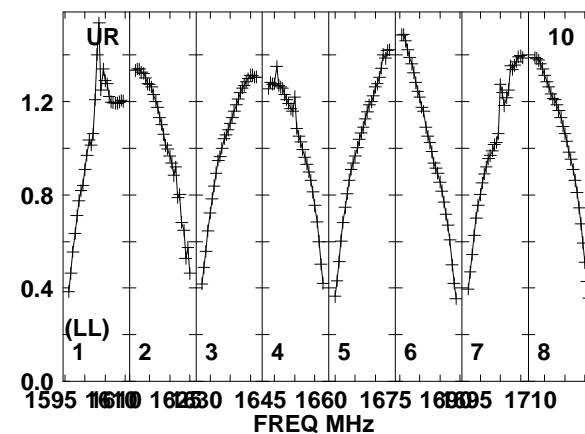
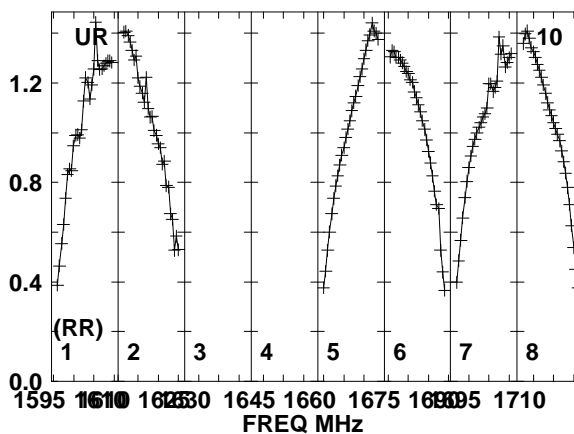
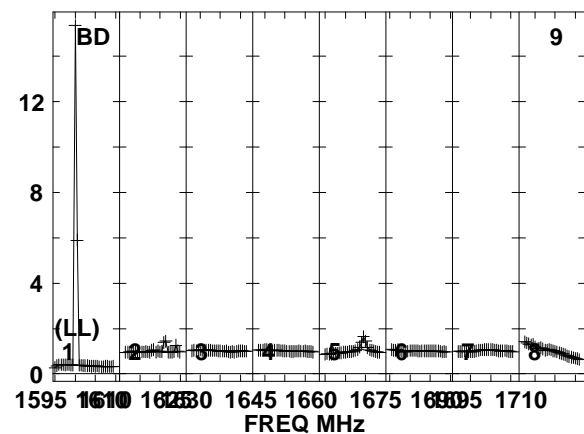
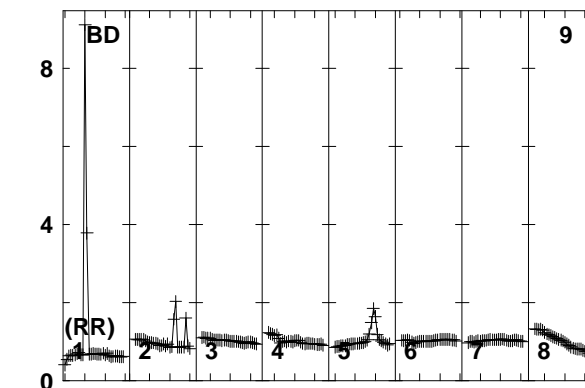
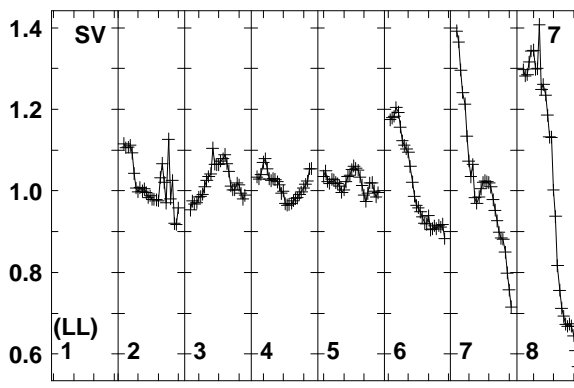
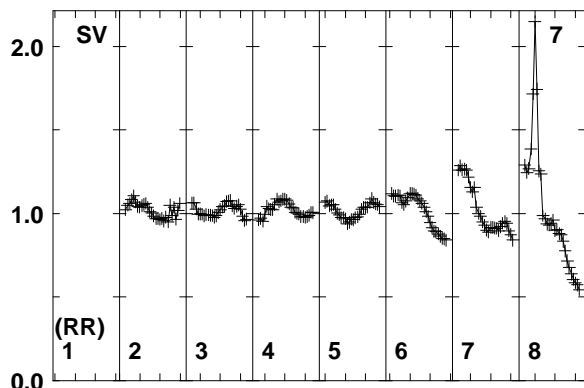
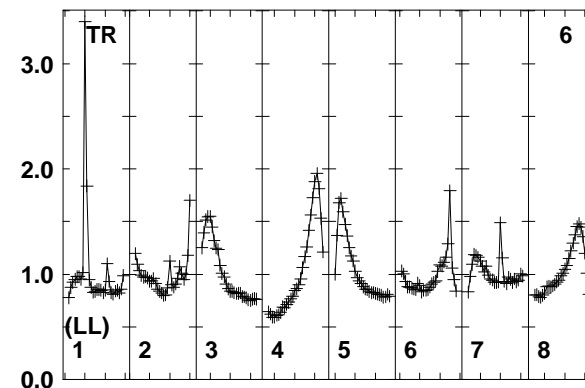
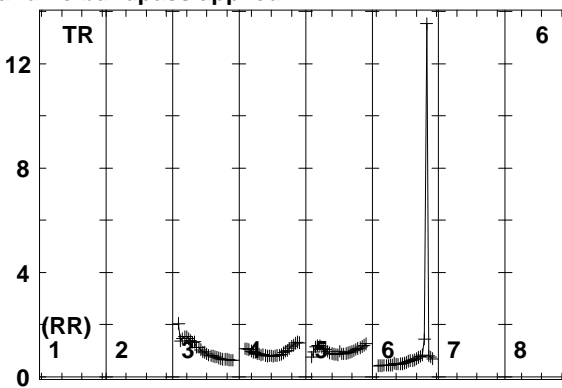
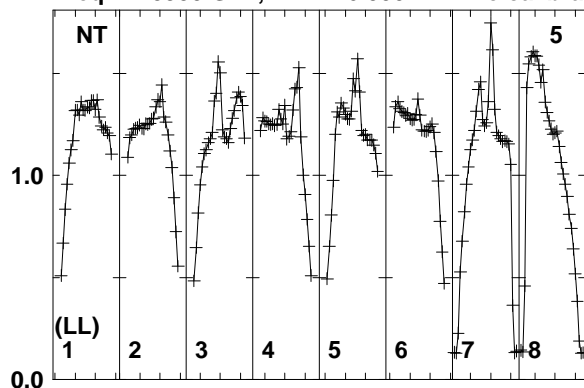

Lower frame: Real Jy
Total-power spectrum Antenna: NT (05)
Timerange: 00/07:16:53 to 00/07:18:39

Plot file version 221 created 11-AUG-2014 17:05:38

J2015+3710 EM110 2.UVDATA.1

Freq = 1.5950 GHz, Bw = 16.000 MH No calibration applied and no bandpass applied

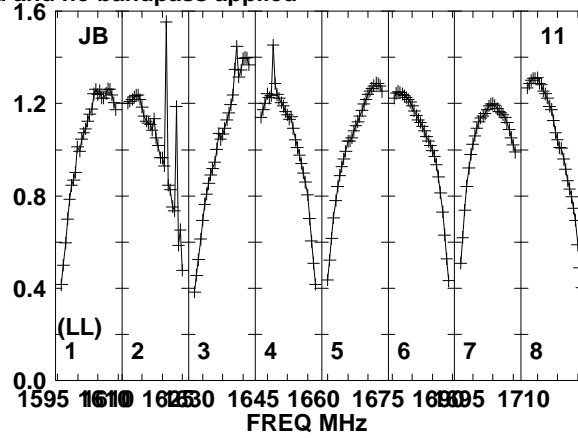
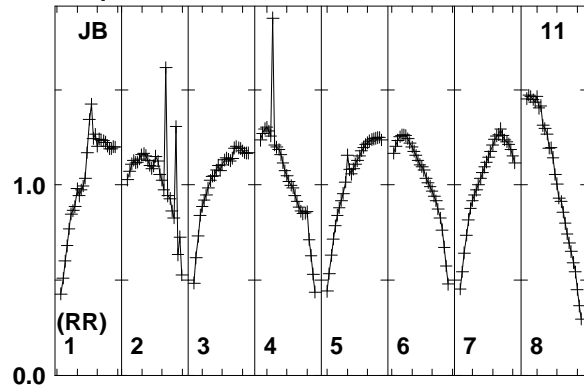

Lower frame: Real Jy
Total-power spectrum Antenna: JB (11)
Timerange: 00/07:16:53 to 00/07:18:39

Plot file version 222 created 11-AUG-2014 17:05:38

J2032+4127 EM110 2.UVDATA.1

Freq = 1.5950 GHz, Bw = 16.000 MH No calibration applied and no bandpass applied

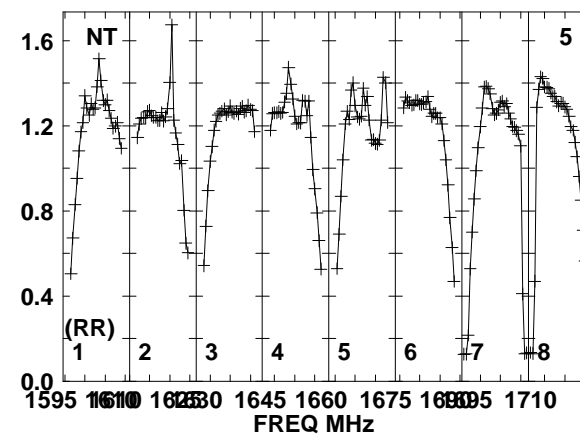
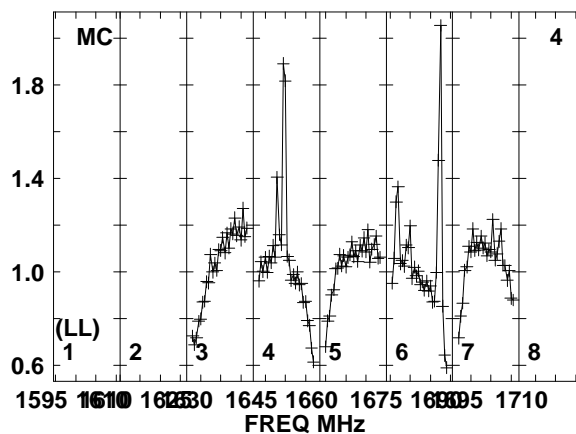
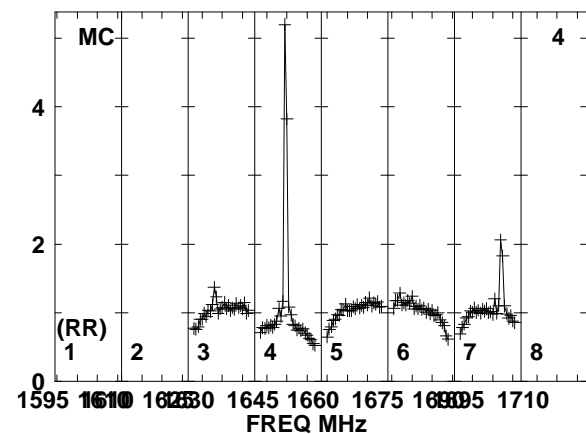
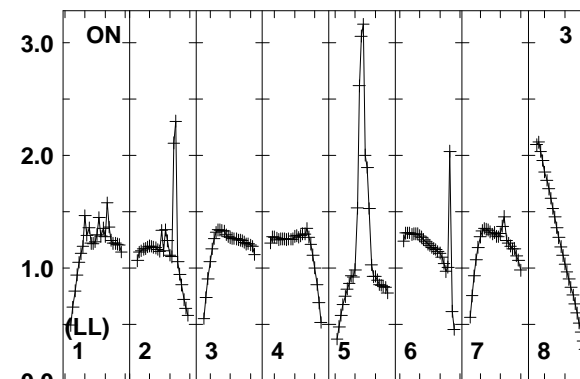
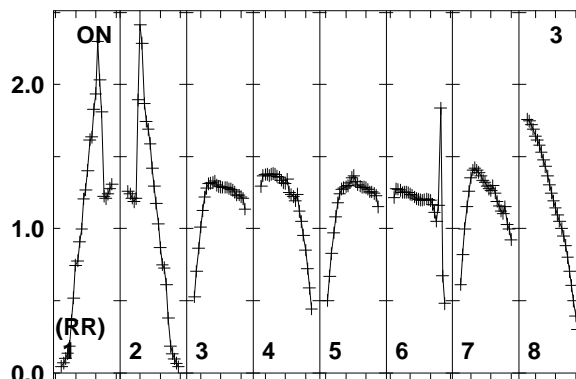
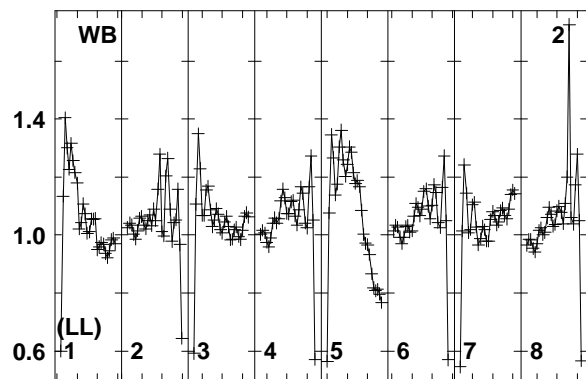
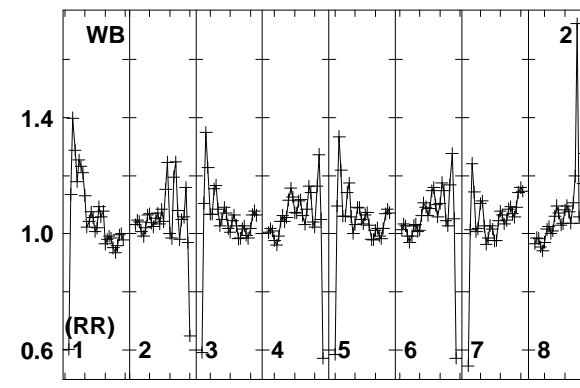
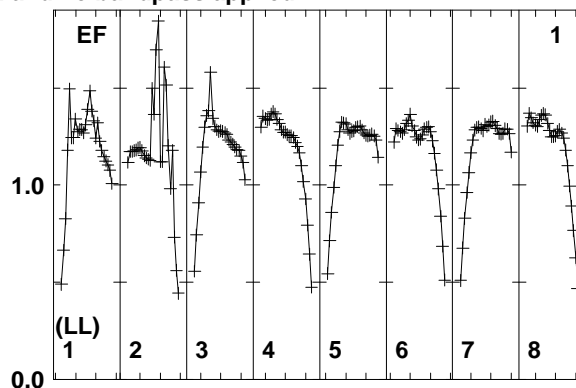
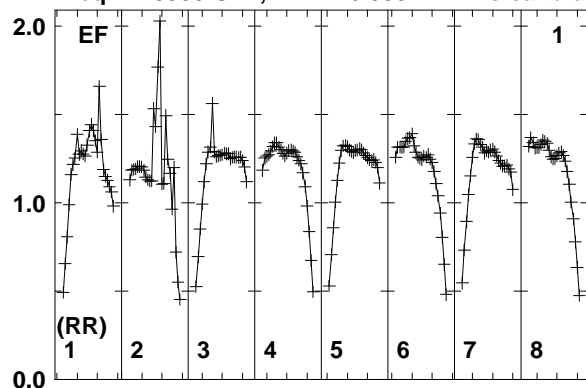

Lower frame: Real Jy
Total-power spectrum Antenna: EF (01)
Timerange: 00/07:18:53 to 00/07:22:39

Plot file version 223 created 11-AUG-2014 17:05:38

J2032+4127 EM110 2.UVDATA.1

Freq = 1.5950 GHz, Bw = 16.000 MH No calibration applied and no bandpass applied

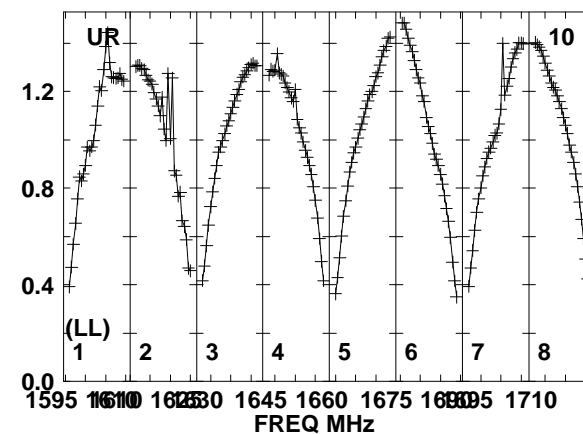
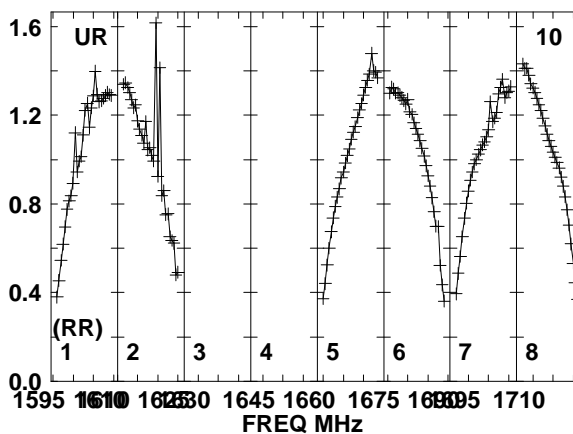
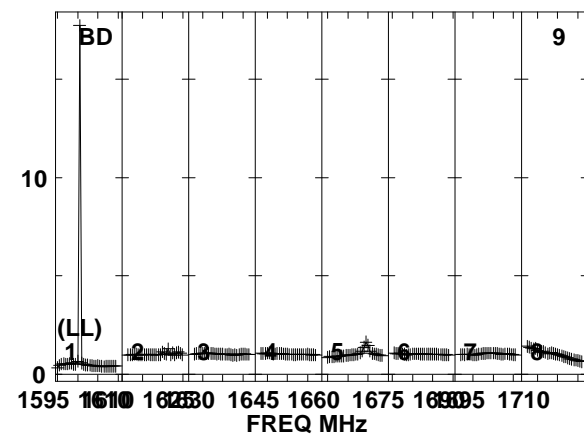
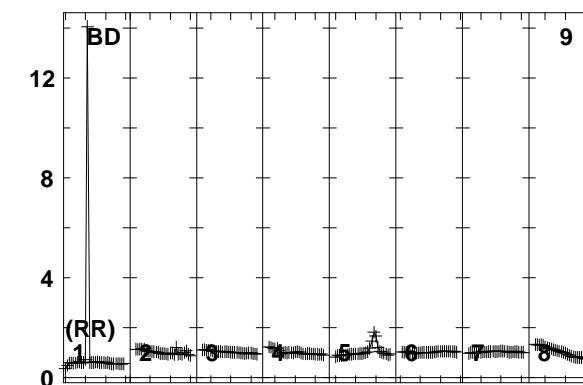
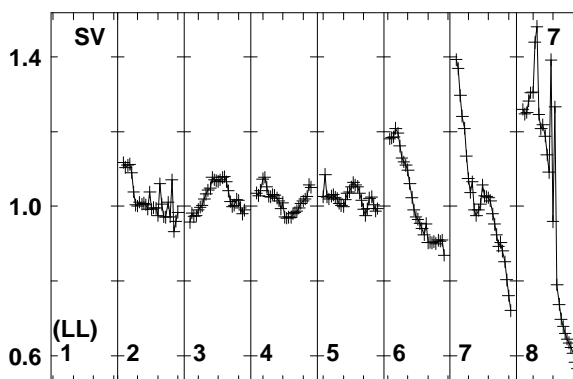
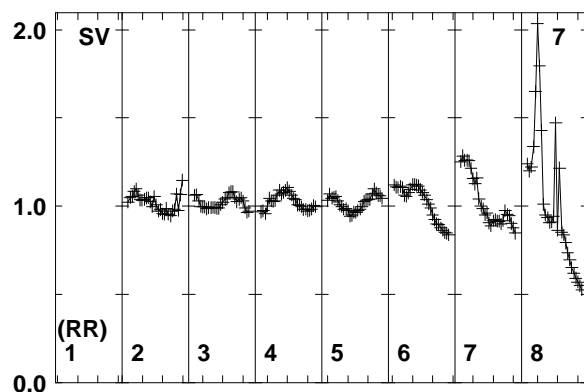
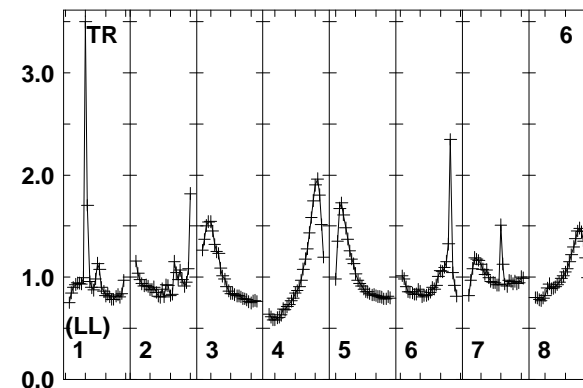
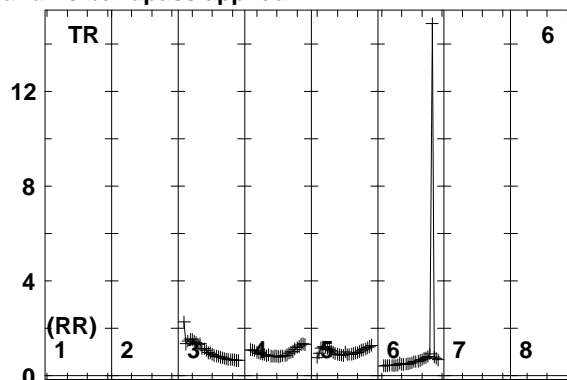
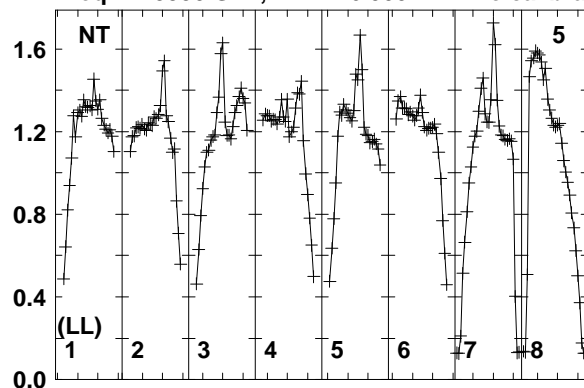

Lower frame: Real Jy
Total-power spectrum Antenna: NT (05)
Timerange: 00/07:18:53 to 00/07:22:39

Plot file version 224 created 11-AUG-2014 17:05:38

J2032+4127 EM110 2.UVDATA.1

Freq = 1.5950 GHz, Bw = 16.000 MH No calibration applied and no bandpass applied

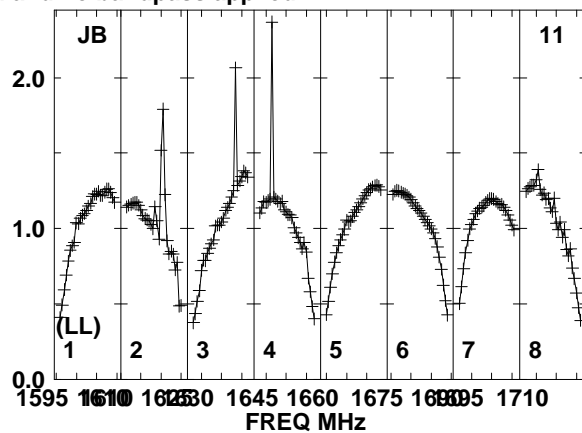
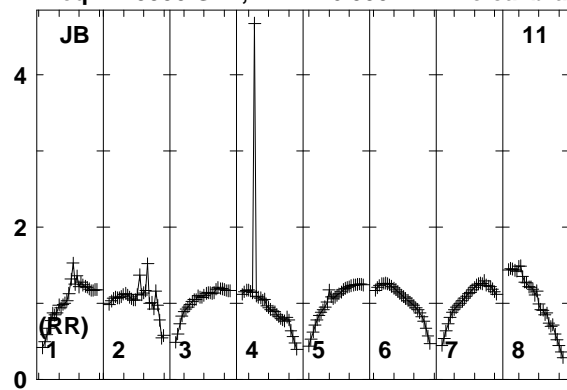

Lower frame: Real Jy
Total-power spectrum Antenna: JB (11)
Timerange: 00/07:18:53 to 00/07:22:39

Plot file version 225 created 11-AUG-2014 17:05:38

J2015+3710 EM110 2.UVDATA.1

Freq = 1.5950 GHz, Bw = 16.000 MH No calibration applied and no bandpass applied

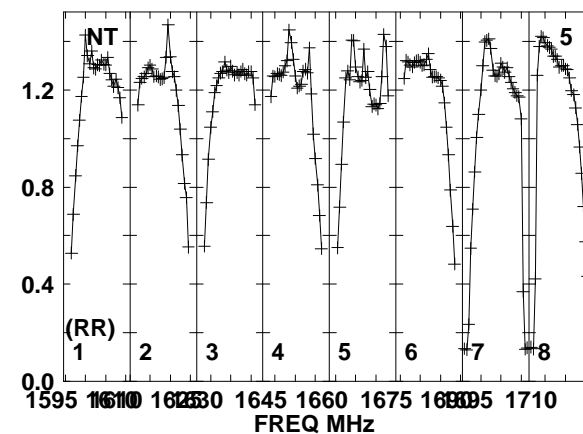
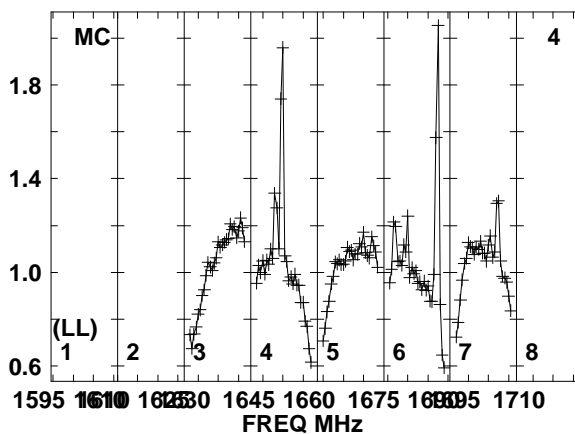
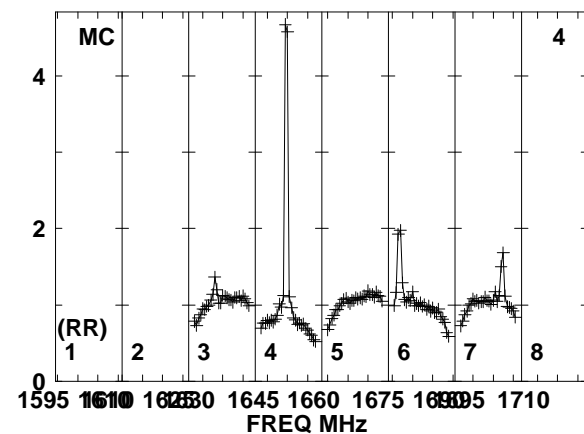
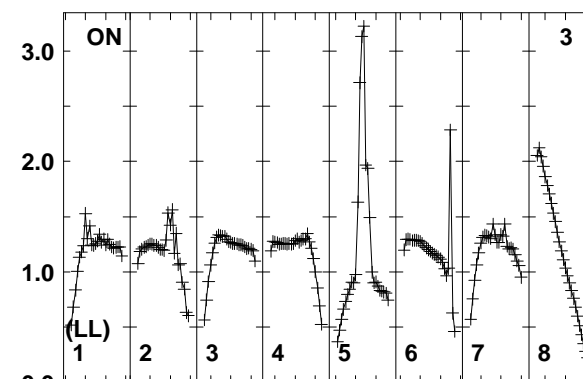
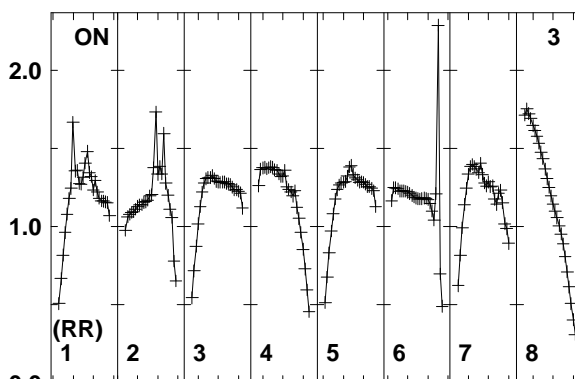
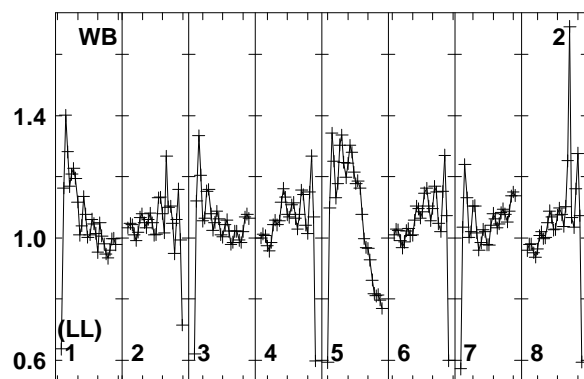
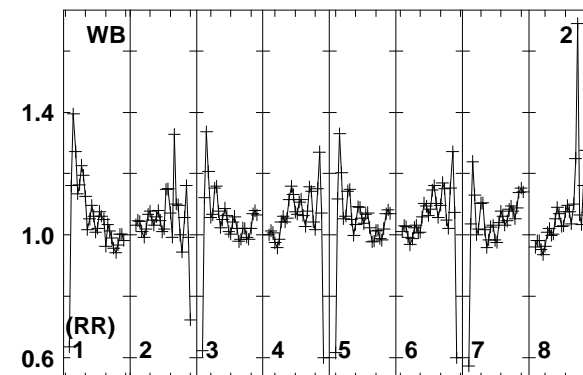
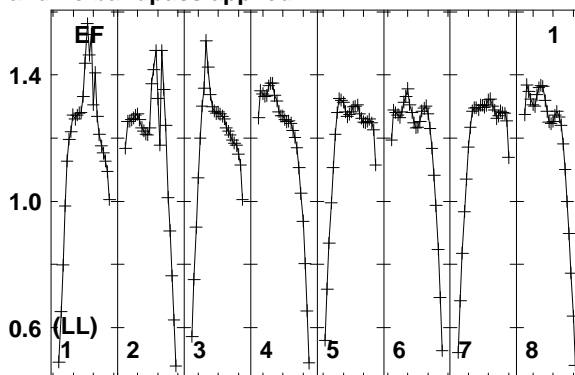
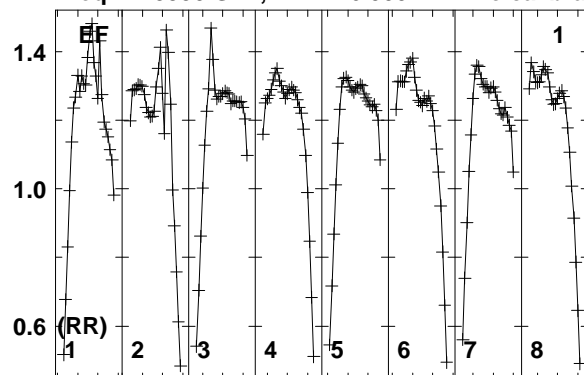

Lower frame: Real Jy
Total-power spectrum Antenna: EF (01)
Timerange: 00/07:23:41 to 00/07:25:39

Plot file version 226 created 11-AUG-2014 17:05:38

J2015+3710 EM110 2.UVDATA.1

Freq = 1.5950 GHz, Bw = 16.000 MH No calibration applied and no bandpass applied

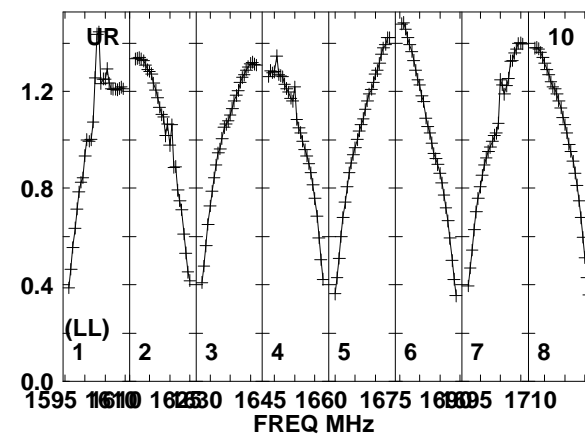
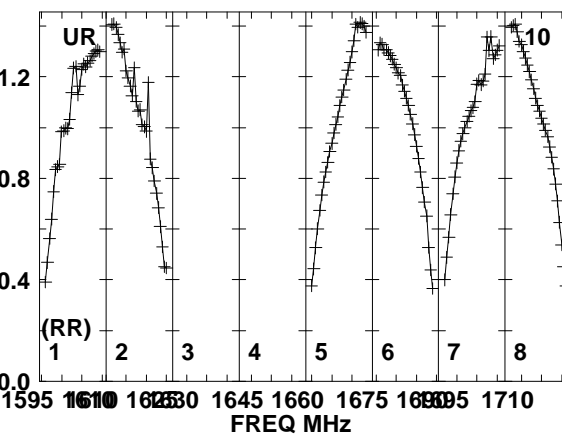
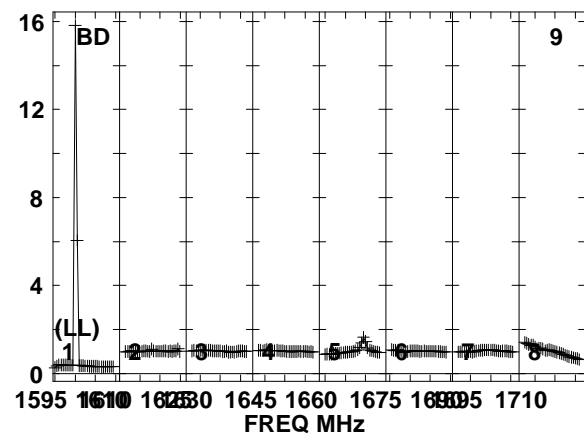
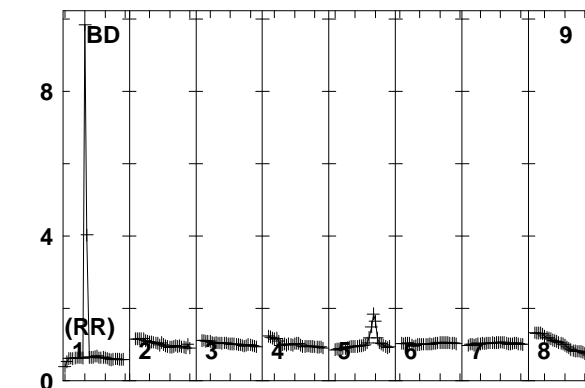
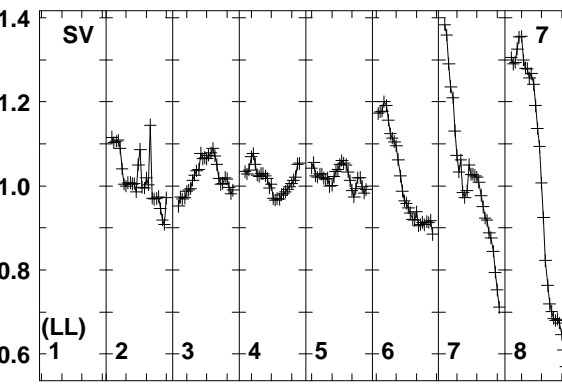
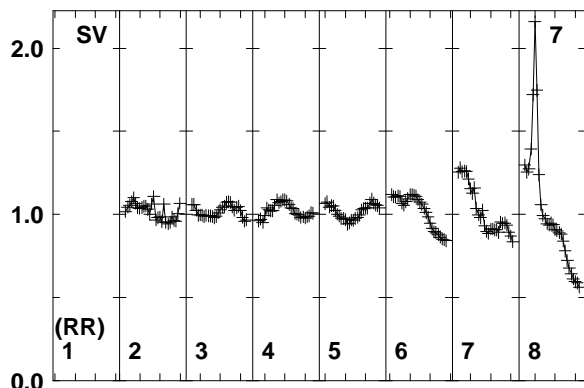
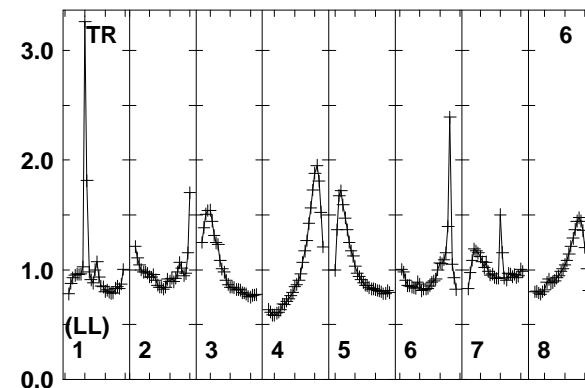
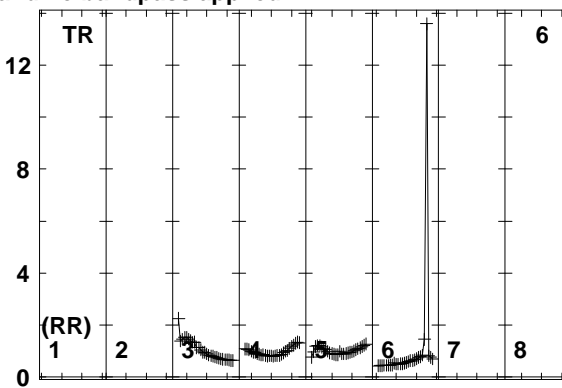
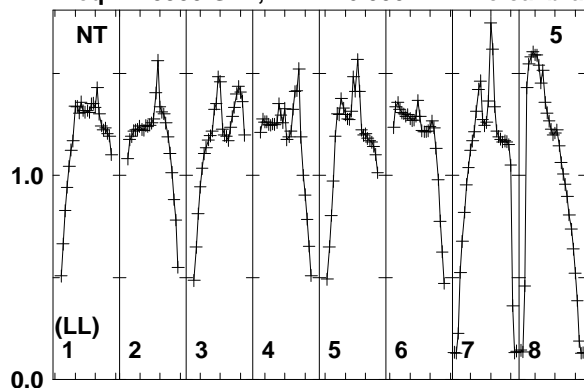

Lower frame: Real Jy
Total-power spectrum Antenna: NT (05)
Timerange: 00/07:23:41 to 00/07:25:39

Plot file version 227 created 11-AUG-2014 17:05:38

J2032+4127 EM110 2.UVDATA.1

Freq = 1.5950 GHz, Bw = 16.000 MH No calibration applied and no bandpass applied

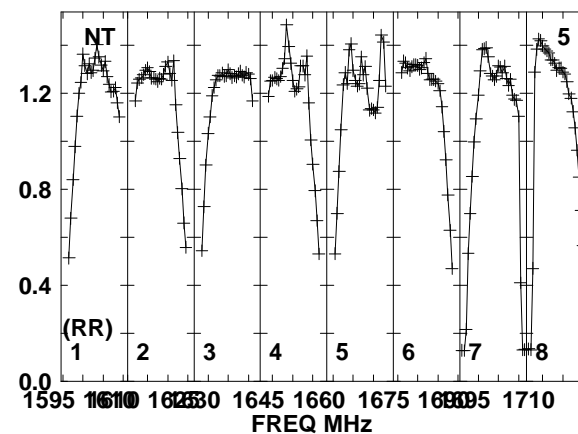
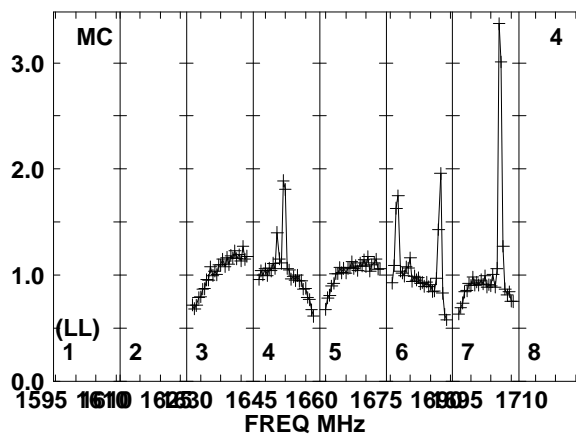
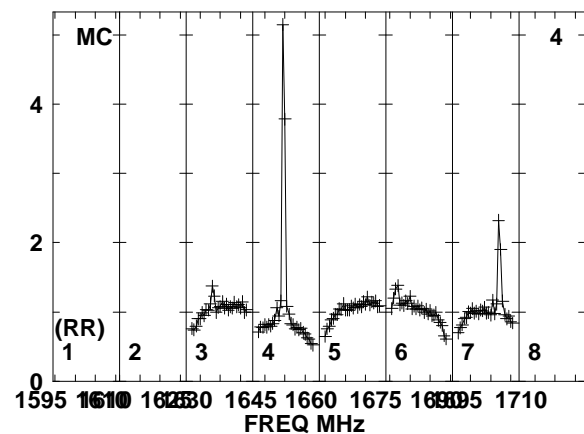
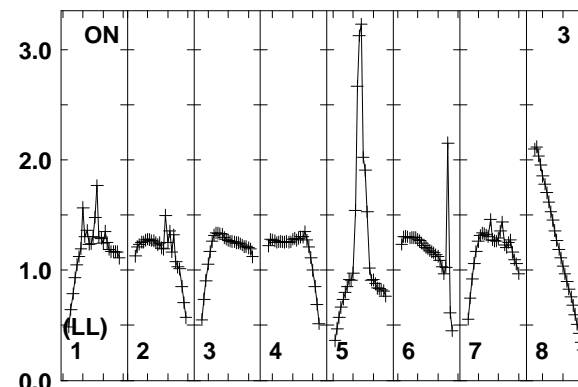
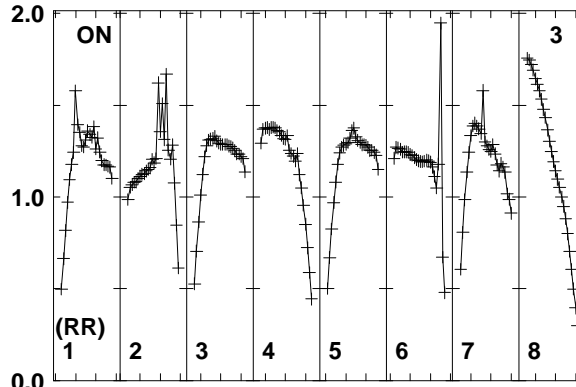
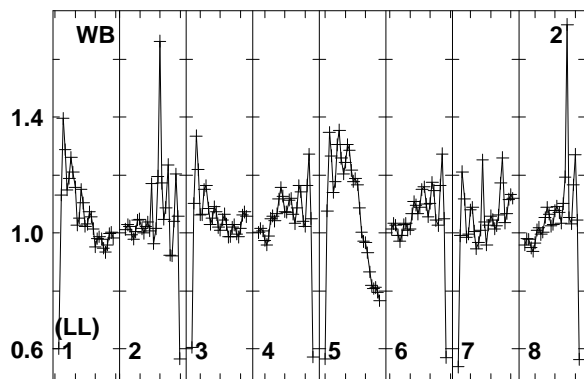
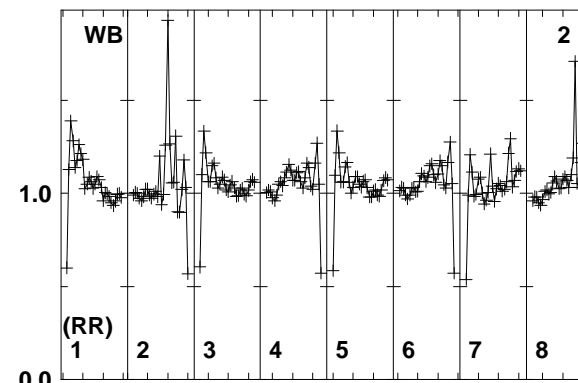
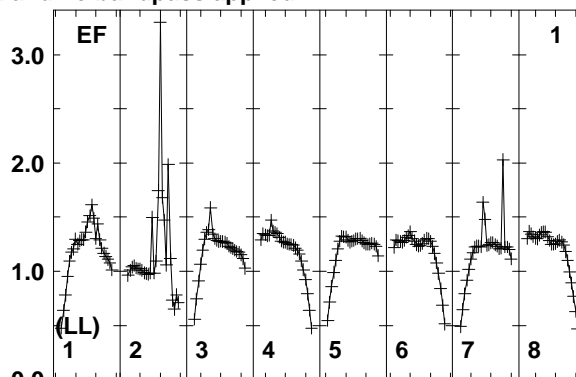
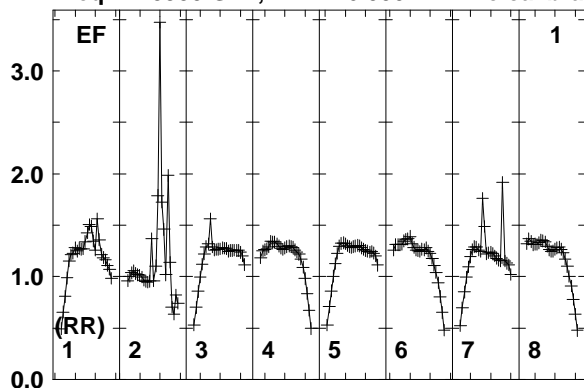

Lower frame: Real Jy
Total-power spectrum Antenna: EF (01)
Timerange: 00/07:25:41 to 00/07:29:39

Plot file version 228 created 11-AUG-2014 17:05:38

J2032+4127 EM110 2.UVDATA.1

Freq = 1.5950 GHz, Bw = 16.000 MH No calibration applied and no bandpass applied

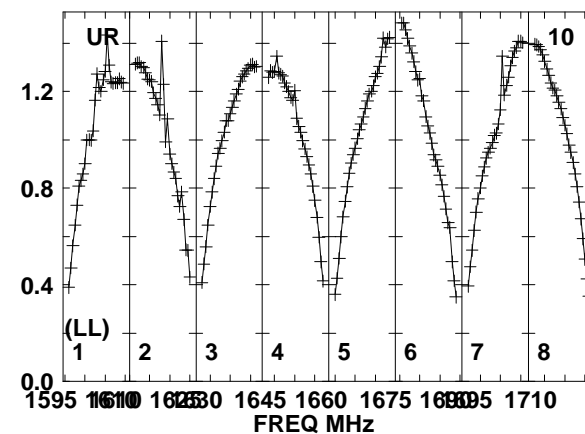
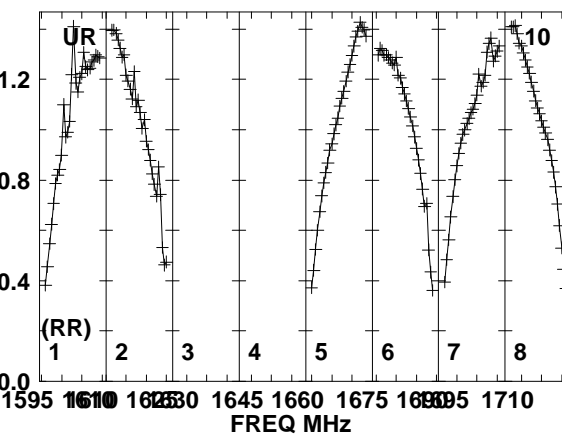
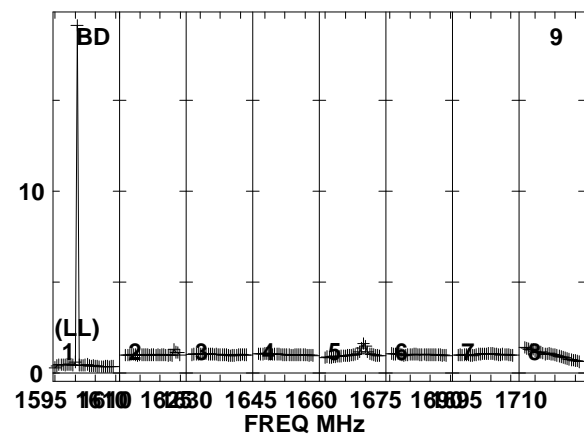
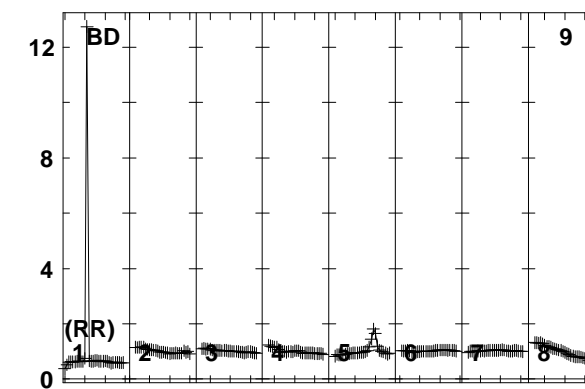
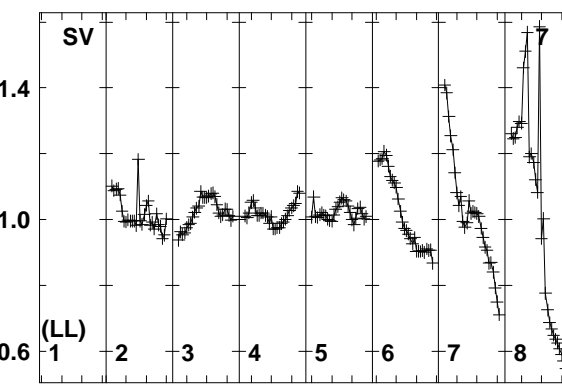
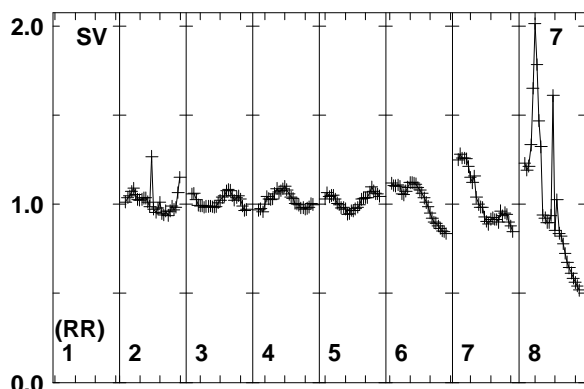
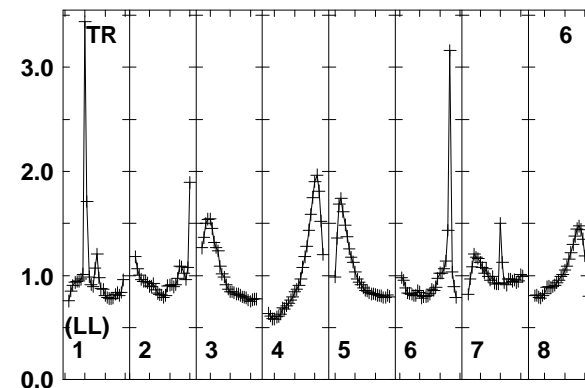
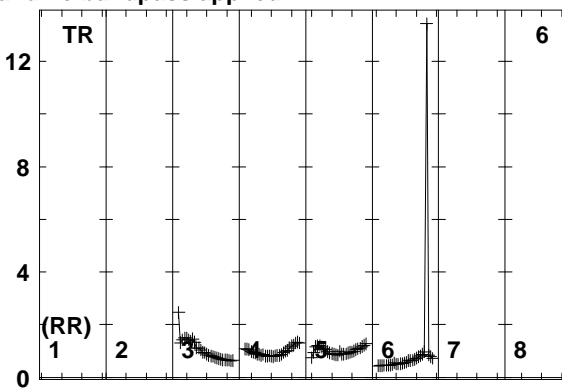
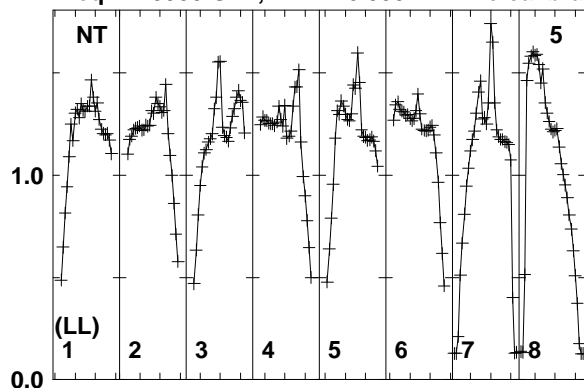

Lower frame: Real Jy
Total-power spectrum Antenna: NT (05)
Timerange: 00/07:25:41 to 00/07:29:39

Plot file version 229 created 11-AUG-2014 17:05:38

J2032+4127 EM110 2.UVDATA.1

Freq = 1.5950 GHz, Bw = 16.000 MH No calibration applied and no bandpass applied

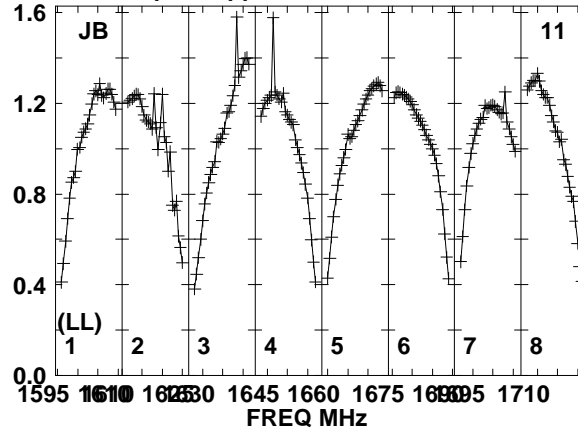
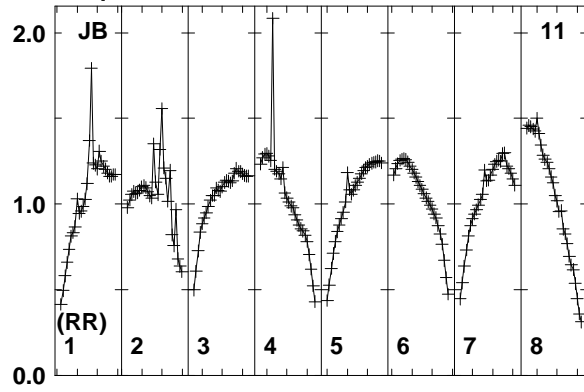

Lower frame: Real Jy
Total-power spectrum Antenna: JB (11)
Timerange: 00/07:25:41 to 00/07:29:39

Plot file version 230 created 11-AUG-2014 17:05:38

J2015+3710 EM110 2.UVDATA.1

Freq = 1.5950 GHz, Bw = 16.000 MH No calibration applied and no bandpass applied

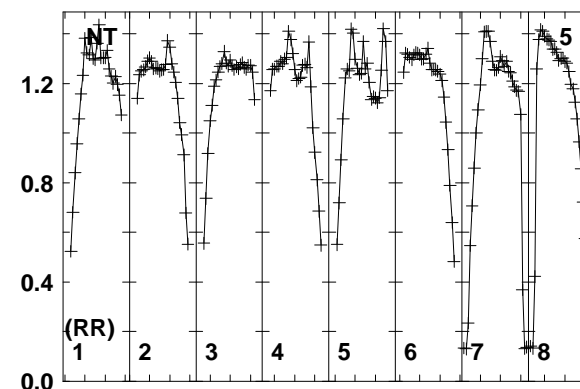
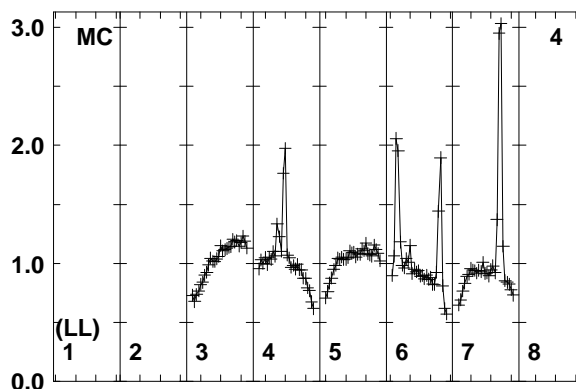
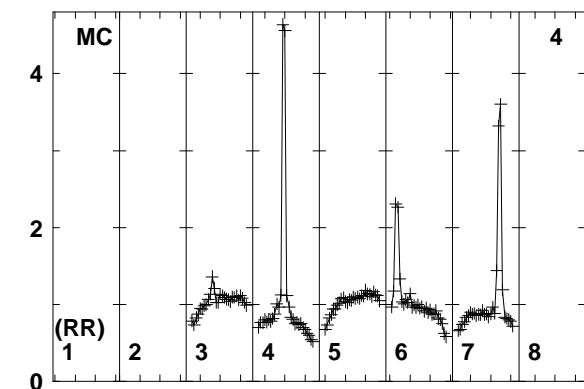
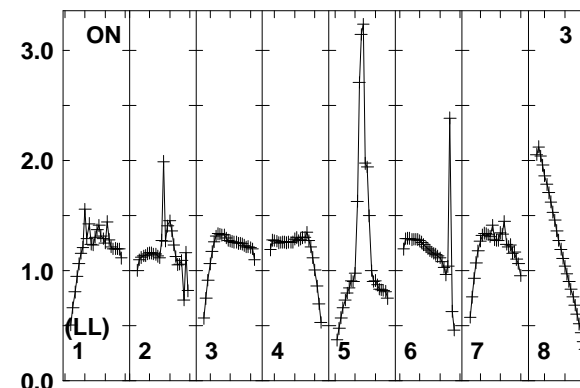
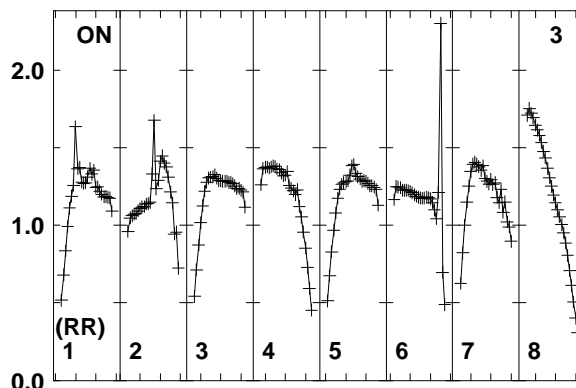
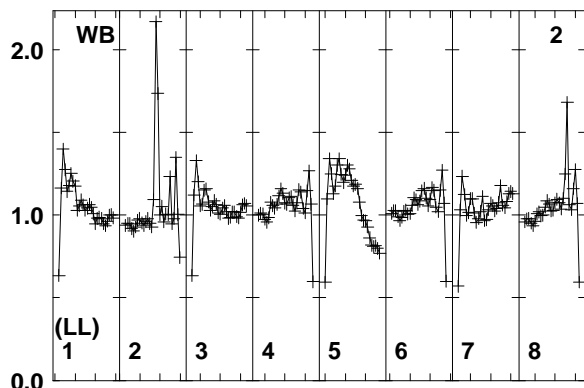
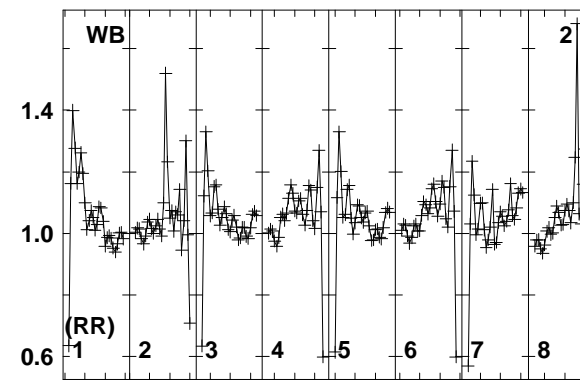
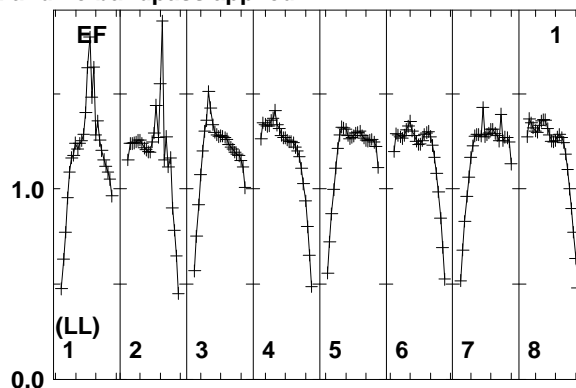
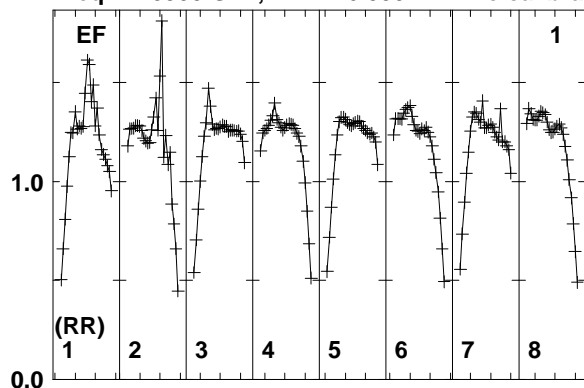

1595 1610 1625 1640 1655 1670 1685 1700 1710
FREQ MHz

1595 1610 1625 1640 1655 1670 1685 1700 1710
FREQ MHz

1595 1610 1625 1640 1655 1670 1685 1700 1710
FREQ MHz

Lower frame: Real Jy
Total-power spectrum Antenna: EF (01)
Timerange: 00/07:30:41 to 00/07:32:39

Plot file version 231 created 11-AUG-2014 17:05:38

J2015+3710 EM110 2.UVDATA.1

Freq = 1.5950 GHz, Bw = 16.000 MH No calibration applied and no bandpass applied

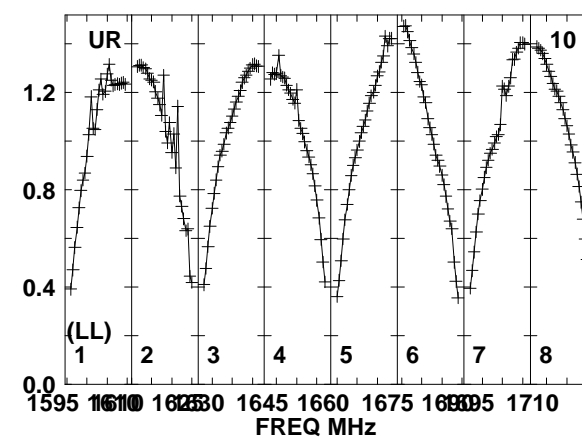
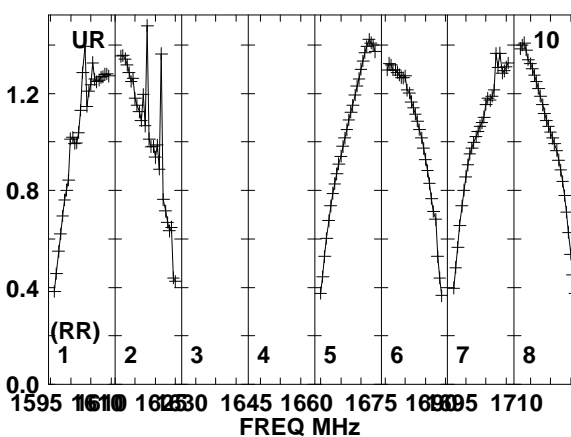
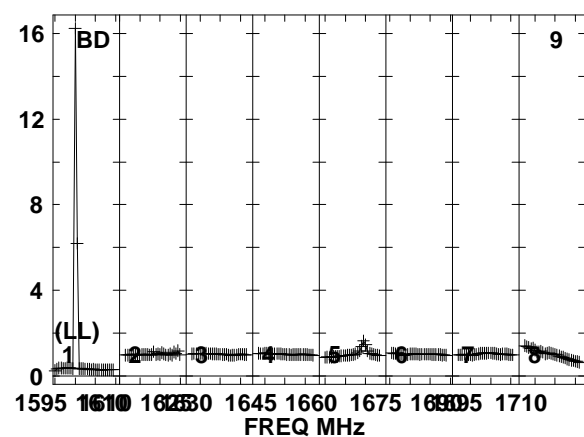
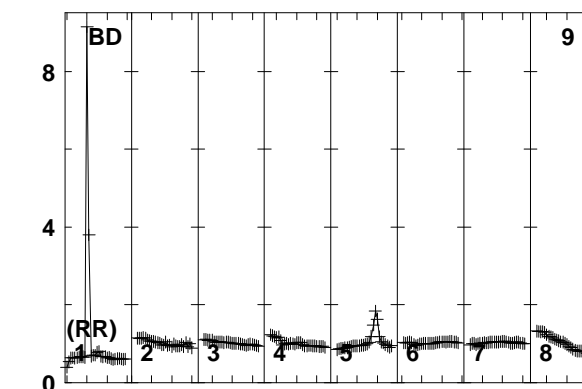
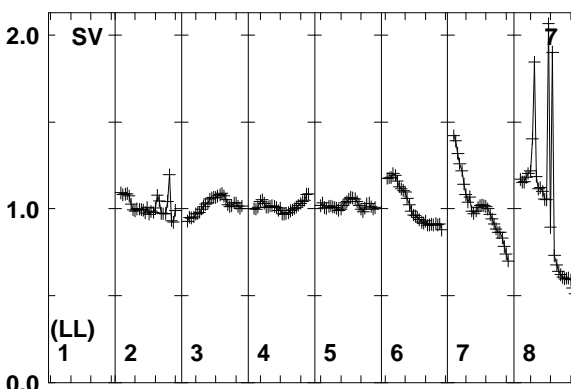
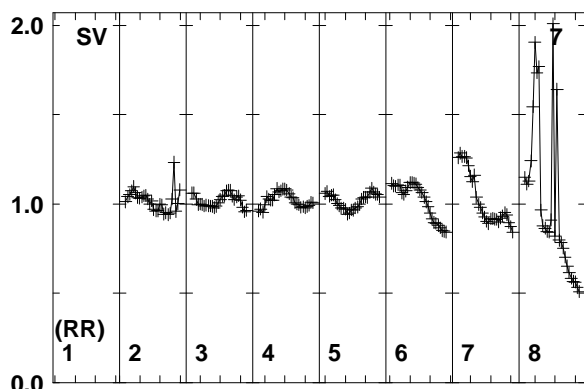
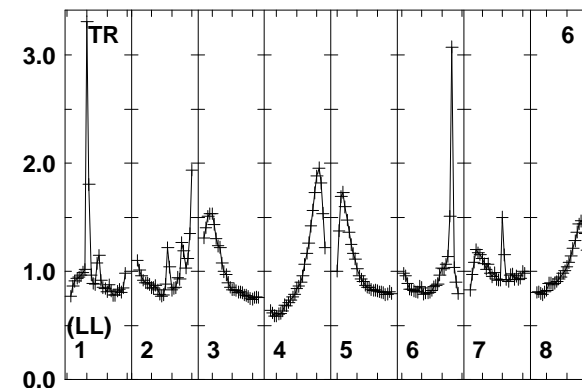
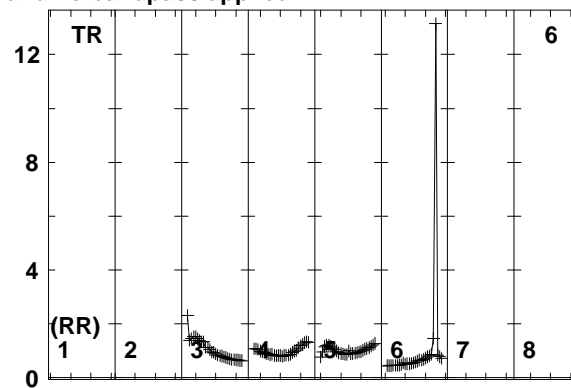
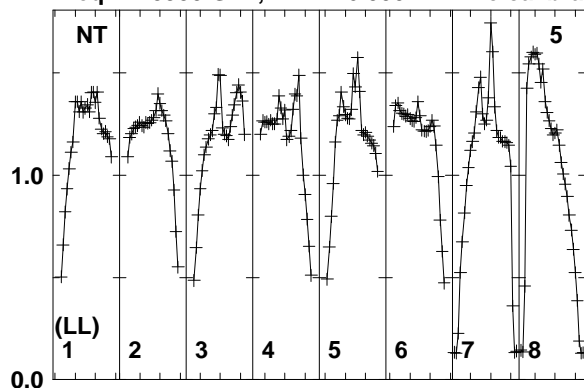

Lower frame: Real Jy
Total-power spectrum Antenna: NT (05)
Timerange: 00/07:30:41 to 00/07:32:39

Plot file version 232 created 11-AUG-2014 17:05:38

J2015+3710 EM110 2.UVDATA.1

Freq = 1.5950 GHz, Bw = 16.000 MH No calibration applied and no bandpass applied

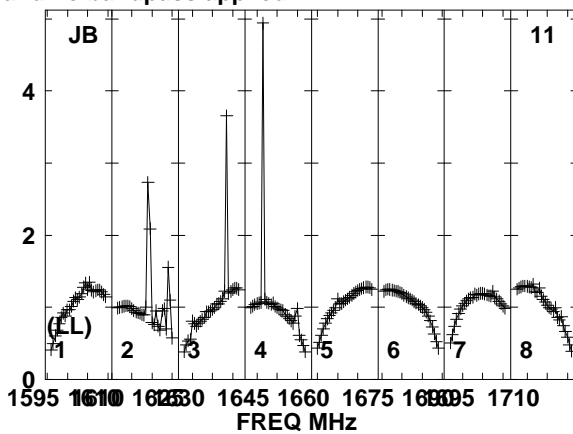
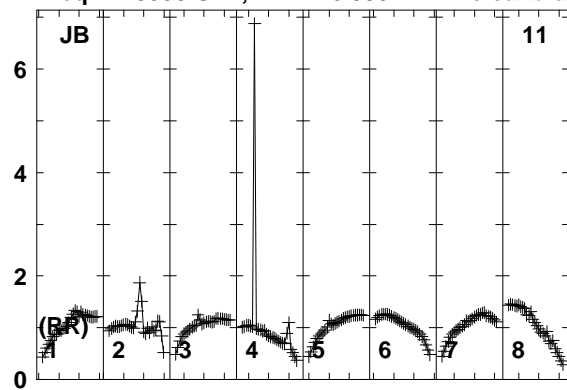

Lower frame: Real Jy
Total-power spectrum Antenna: JB (11)
Timerange: 00/07:30:41 to 00/07:32:39

Plot file version 233 created 11-AUG-2014 17:05:38

J2032+4127 EM110 2.UVDATA.1

Freq = 1.5950 GHz, Bw = 16.000 MH No calibration applied and no bandpass applied

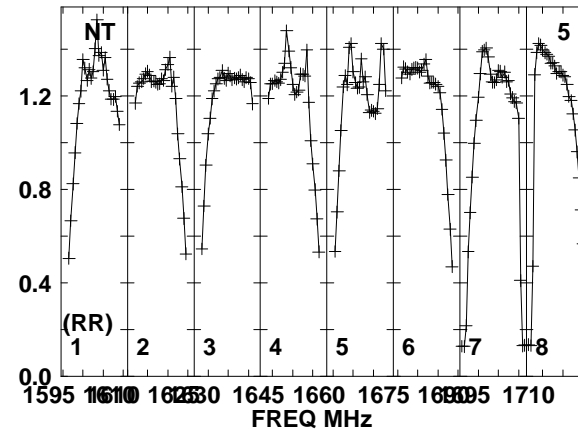
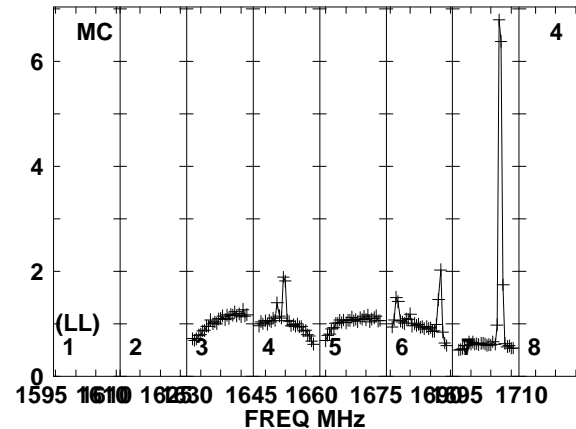
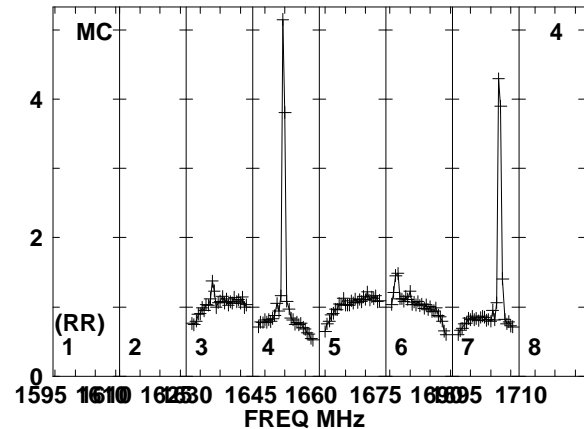
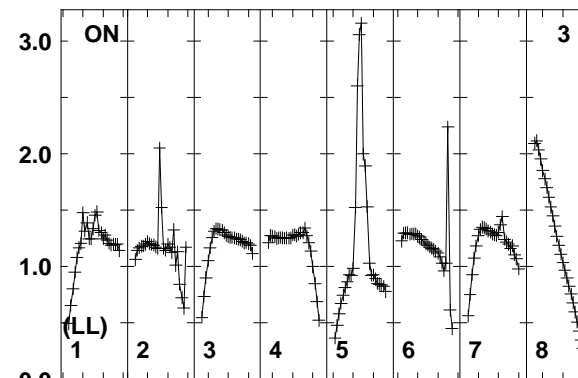
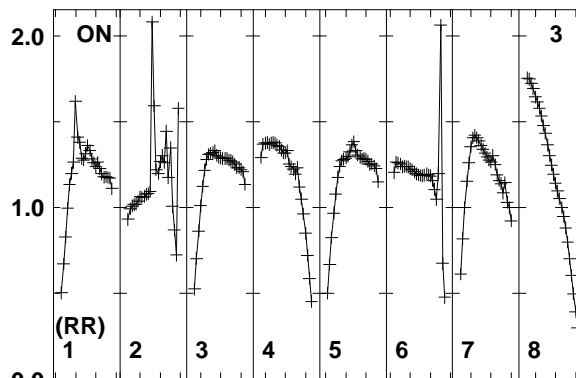
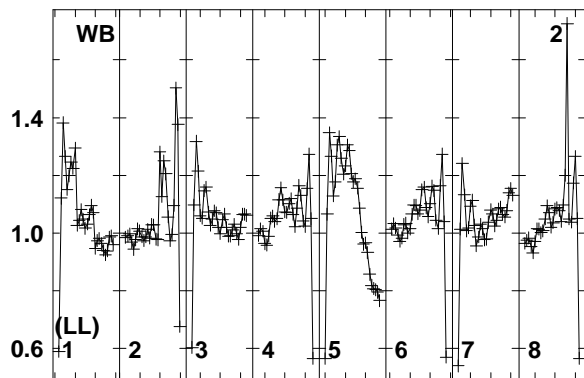
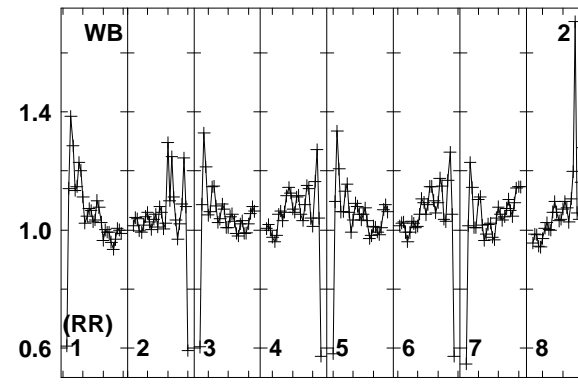
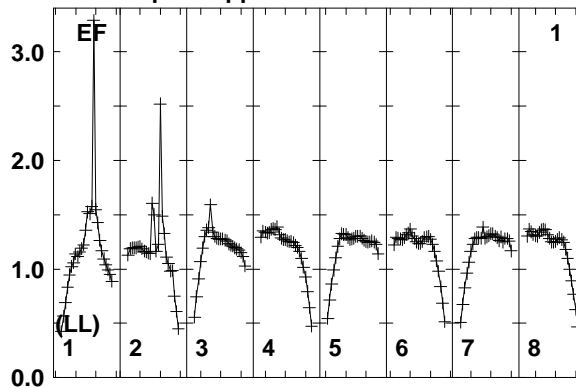
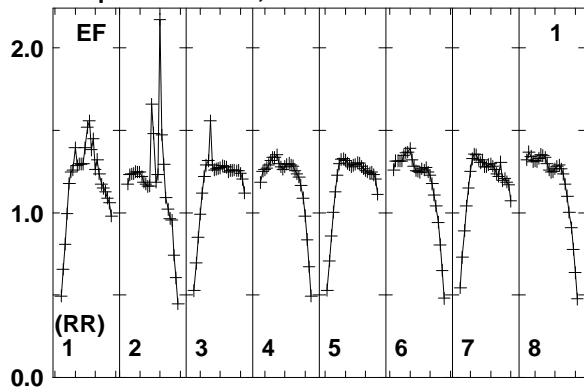

Lower frame: Real Jy
Total-power spectrum Antenna: EF (01)
Timerange: 00/07:32:53 to 00/07:36:39

Plot file version 234 created 11-AUG-2014 17:05:38

J2032+4127 EM110 2.UVDATA.1

Freq = 1.5950 GHz, Bw = 16.000 MH No calibration applied and no bandpass applied

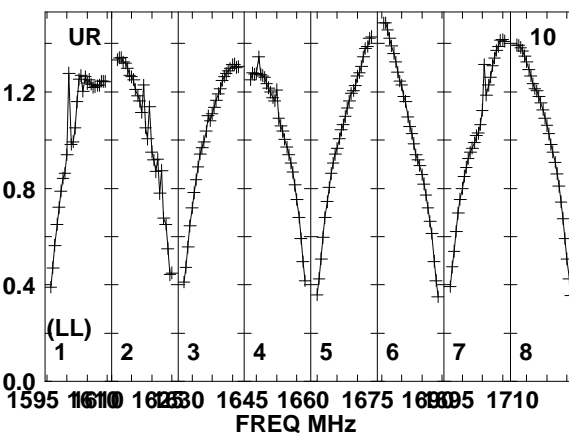
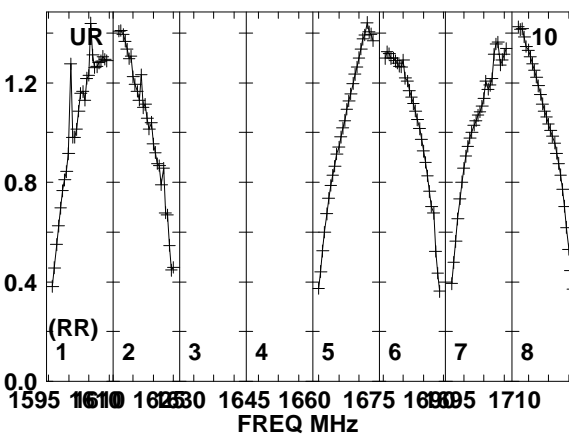
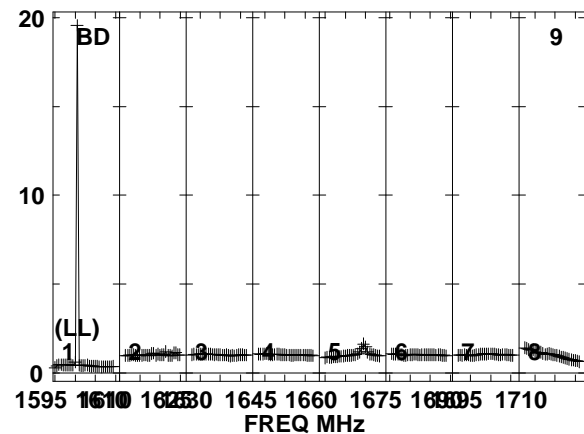
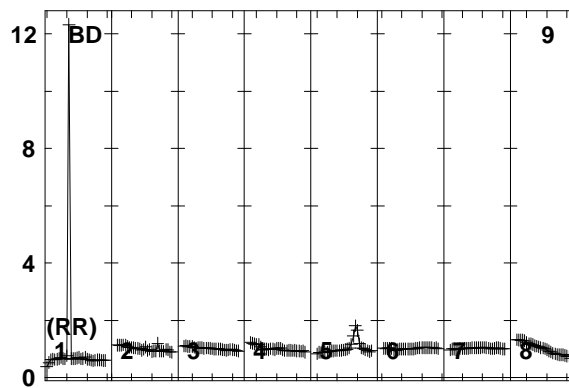
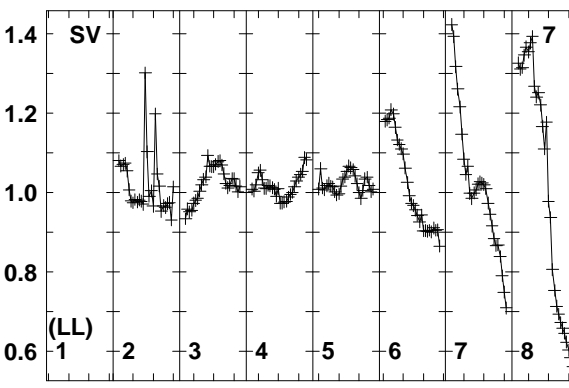
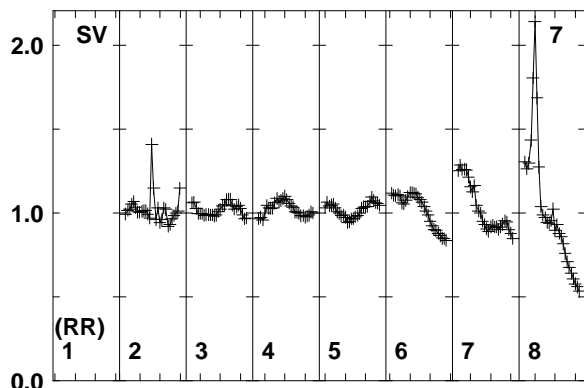
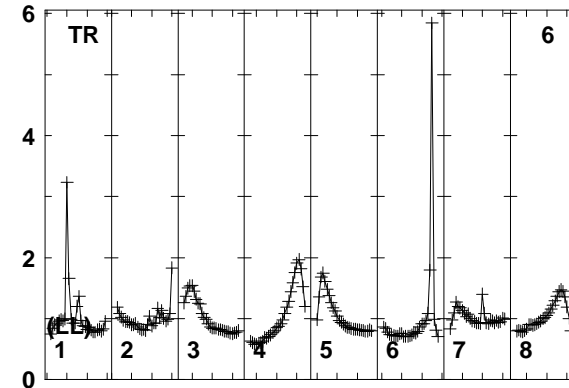
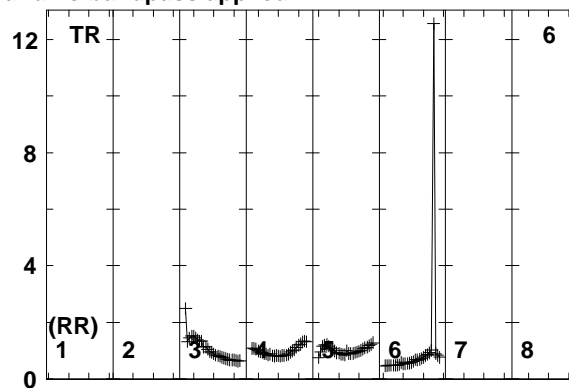
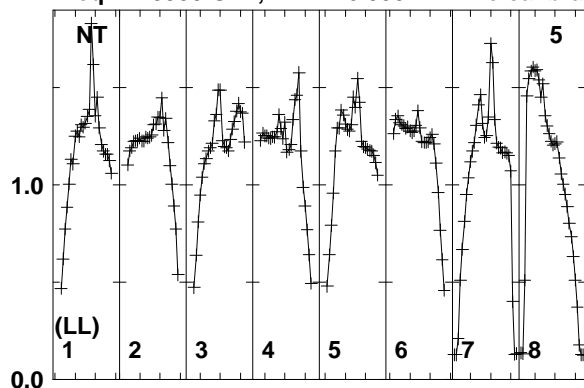

Lower frame: Real Jy
Total-power spectrum Antenna: NT (05)
Timerange: 00/07:32:53 to 00/07:36:39

Plot file version 235 created 11-AUG-2014 17:05:38

J2032+4127 EM110 2.UVDATA.1

Freq = 1.5950 GHz, Bw = 16.000 MH No calibration applied and no bandpass applied

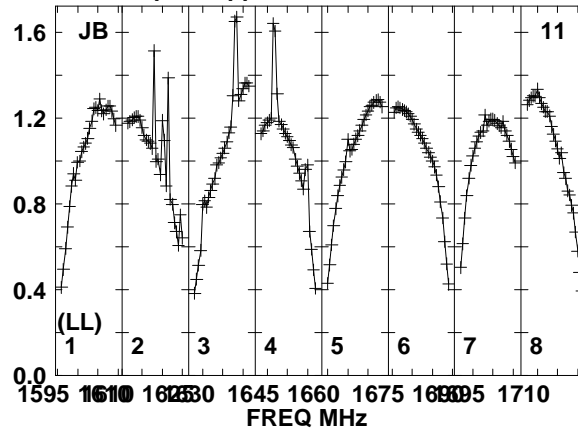
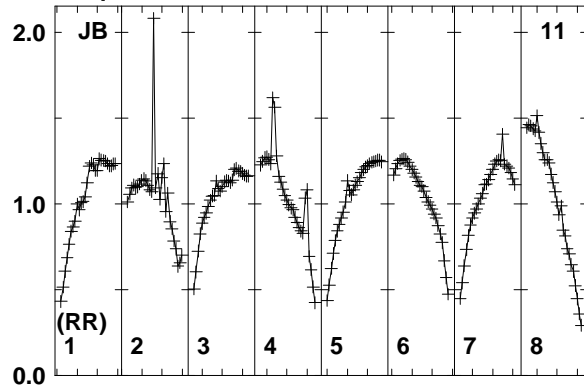

Lower frame: Real Jy
Total-power spectrum Antenna: JB (11)
Timerange: 00/07:32:53 to 00/07:36:39

Plot file version 236 created 11-AUG-2014 17:05:38

J2015+3710 EM110 2.UVDATA.1

Freq = 1.5950 GHz, Bw = 16.000 MH No calibration applied and no bandpass applied

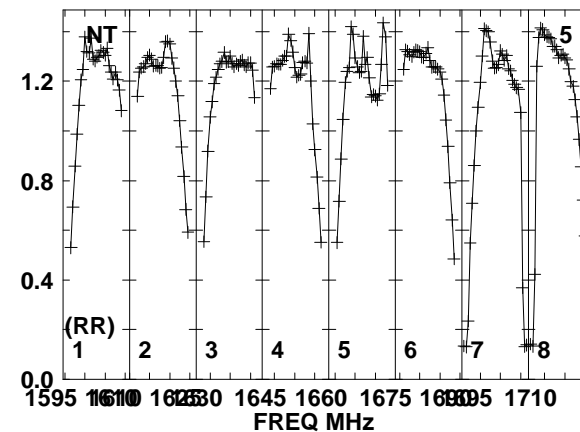
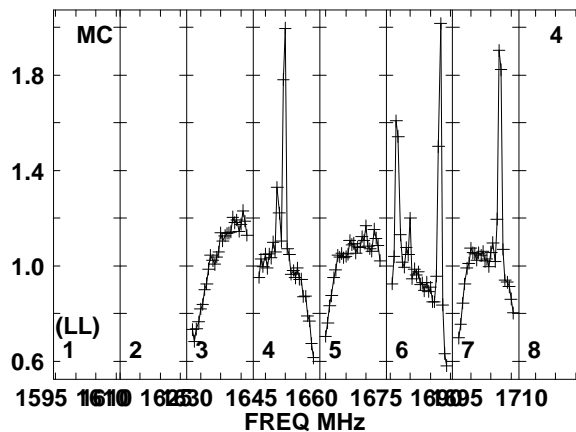
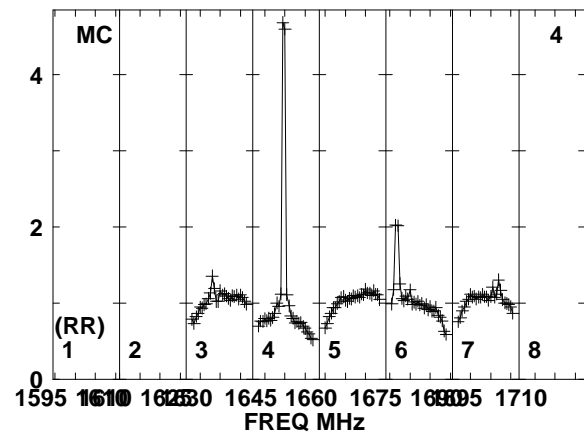
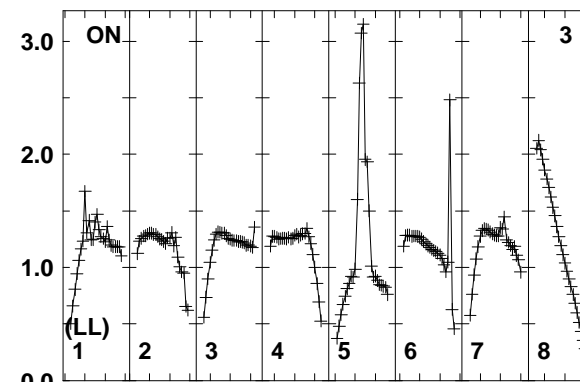
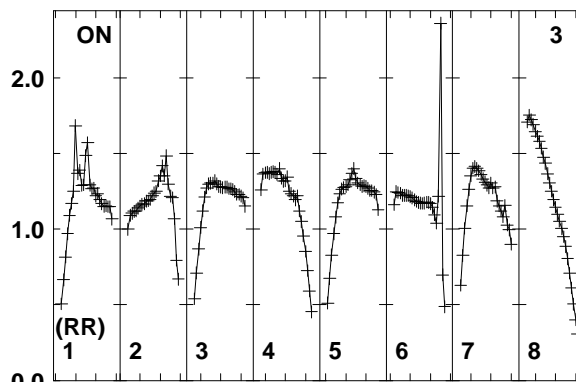
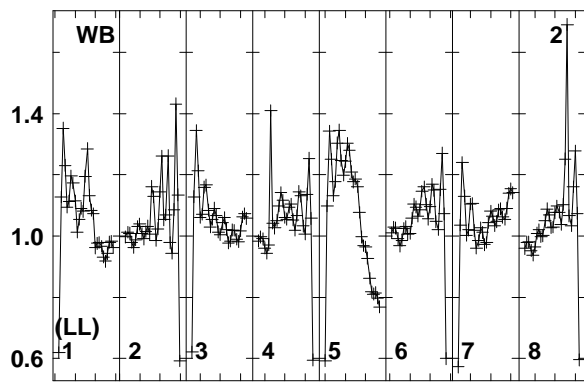
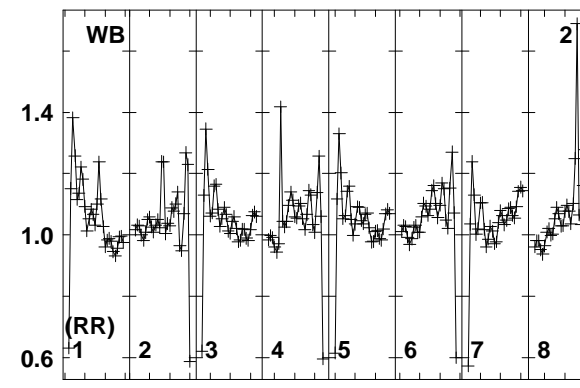
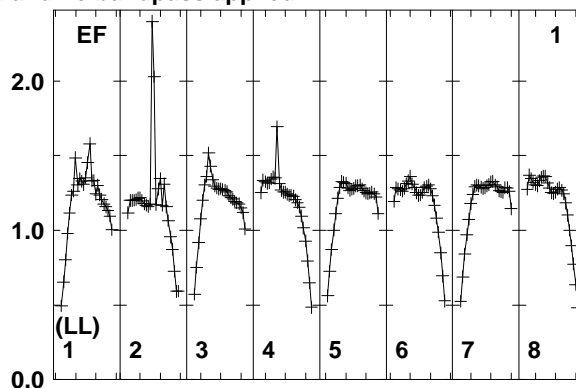
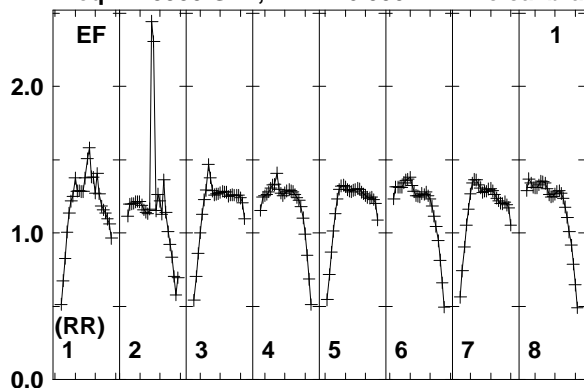

1595 1610 1625 1640 1655 1670 1685 1700 1710
FREQ MHz
Lower frame: Real Jy
Total-power spectrum Antenna: EF (01)
Timerange: 00/07:36:53 to 00/07:38:39

Plot file version 237 created 11-AUG-2014 17:05:38

J2015+3710 EM110 2.UVDATA.1

Freq = 1.5950 GHz, Bw = 16.000 MH No calibration applied and no bandpass applied

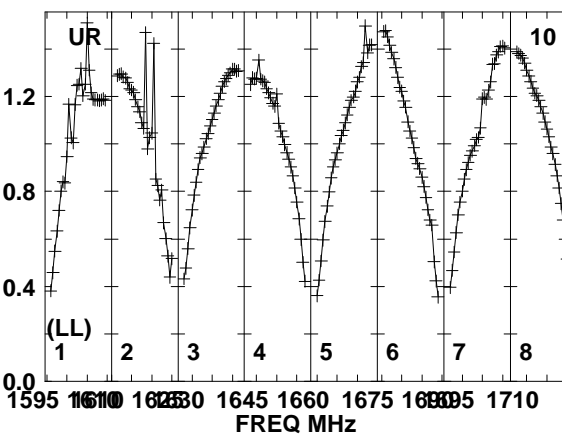
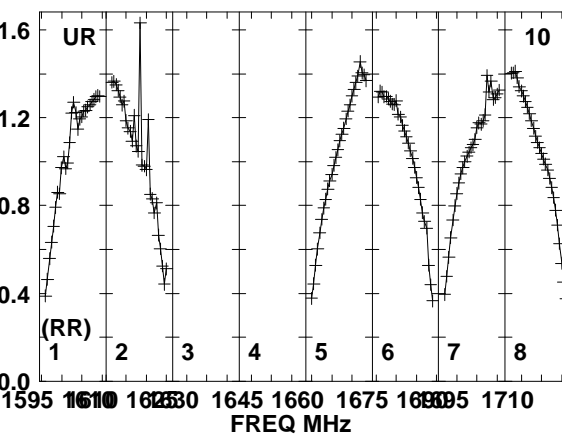
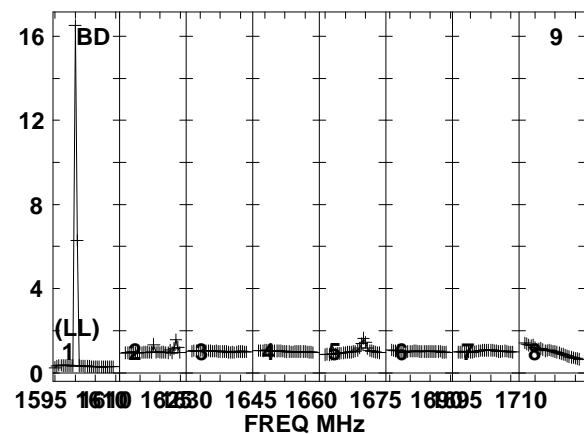
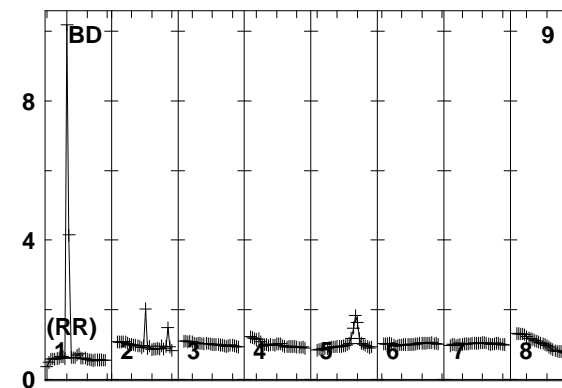
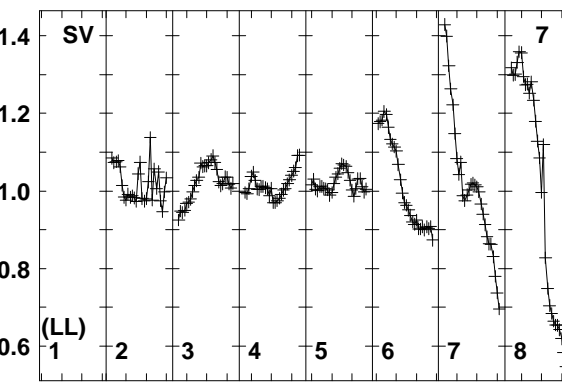
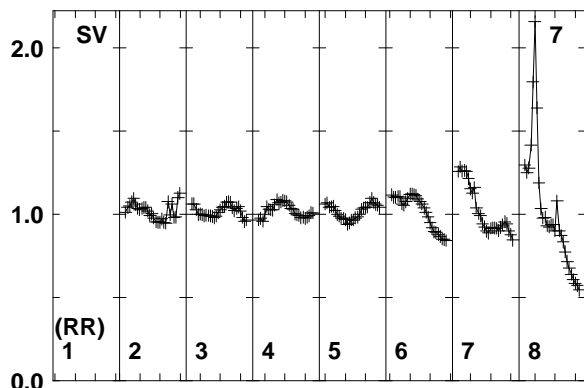
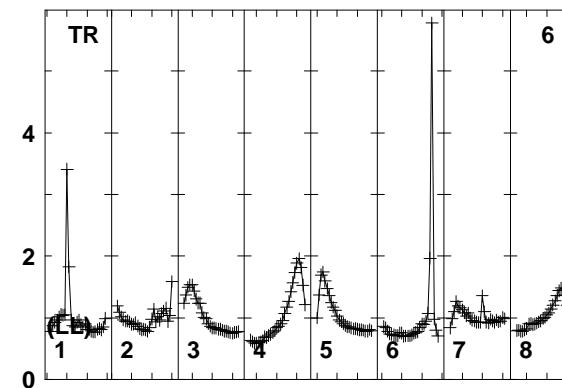
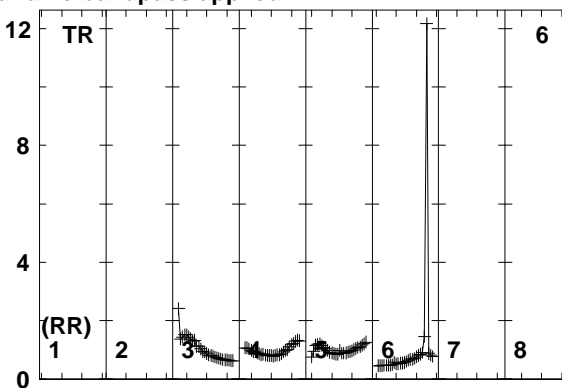
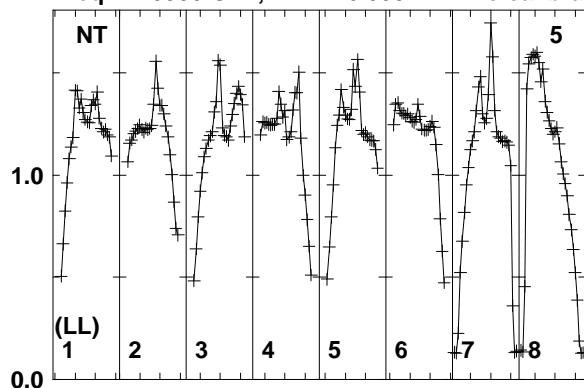

Lower frame: Real Jy
Total-power spectrum Antenna: NT (05)
Timerange: 00/07:36:53 to 00/07:38:39

Plot file version 238 created 11-AUG-2014 17:05:38

J2032+4127 EM110 2.UVDATA.1

Freq = 1.5950 GHz, Bw = 16.000 MH No calibration applied and no bandpass applied

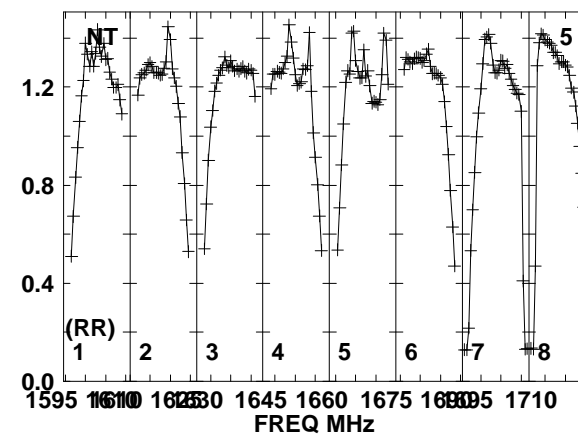
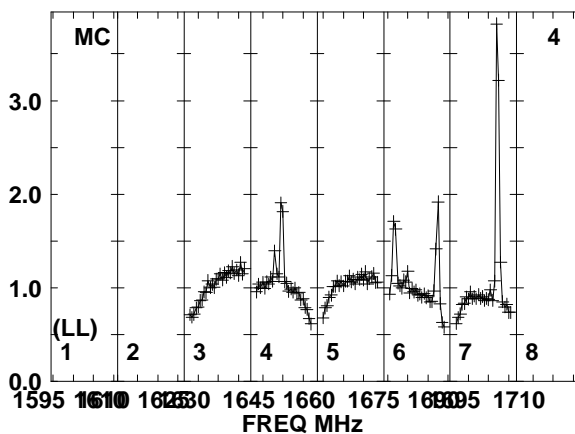
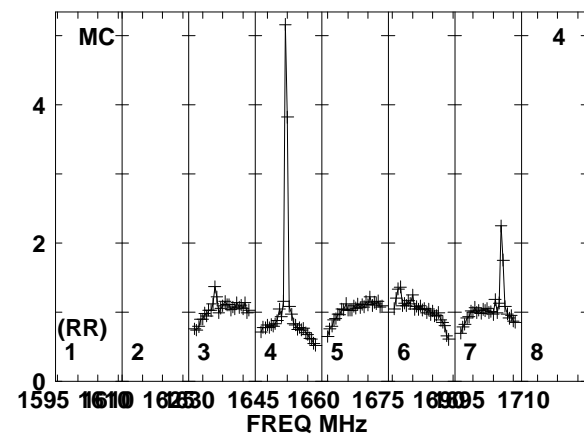
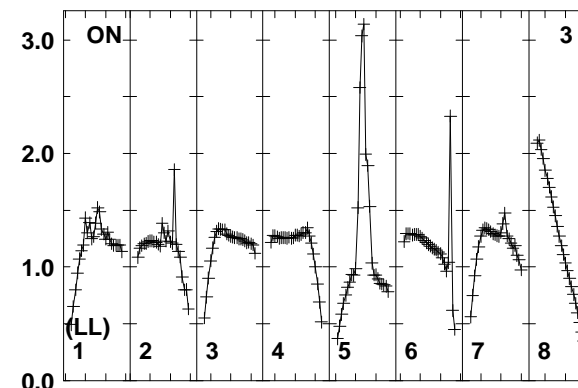
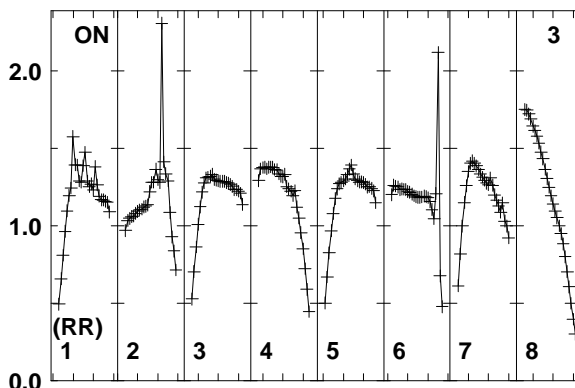
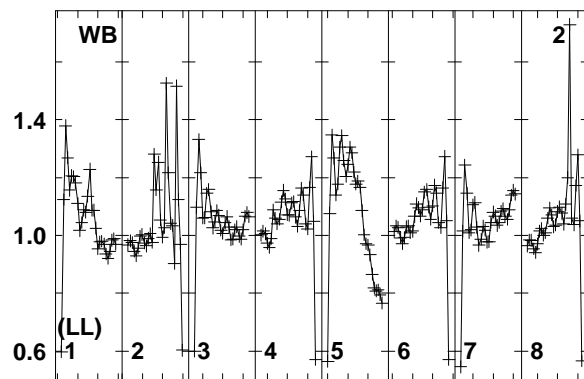
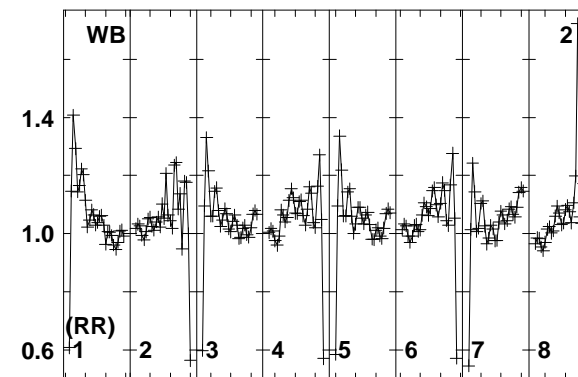
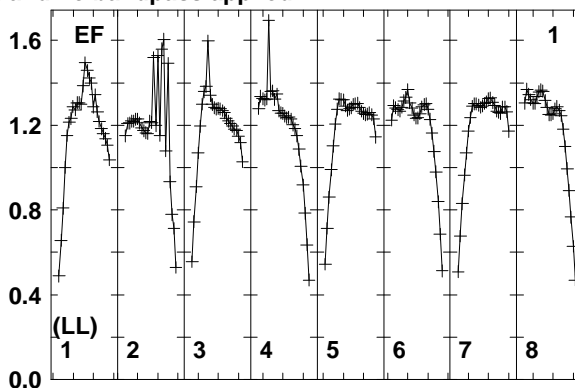
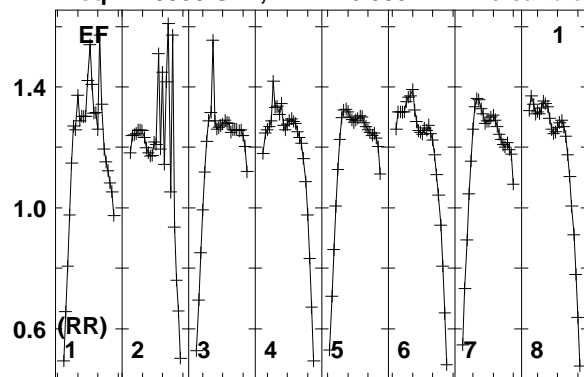

Lower frame: Real Jy
Total-power spectrum Antenna: EF (01)
Timerange: 00/07:38:41 to 00/07:42:39

Plot file version 239 created 11-AUG-2014 17:05:38

J2032+4127 EM110 2.UVDATA.1

Freq = 1.5950 GHz, Bw = 16.000 MH No calibration applied and no bandpass applied

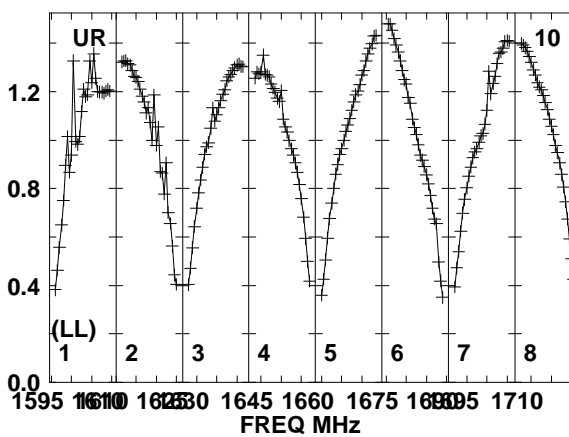
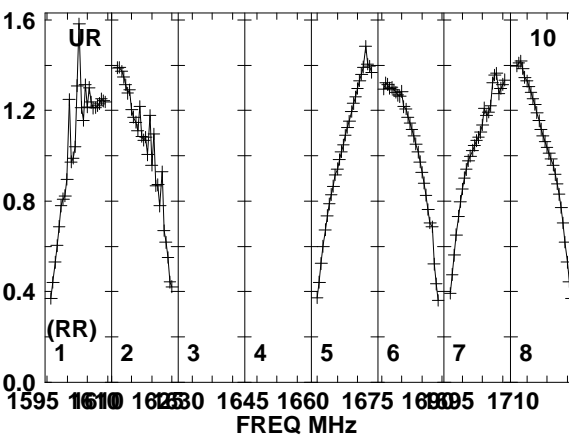
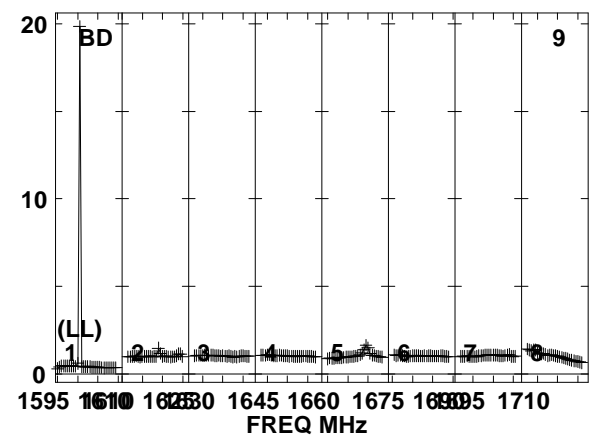
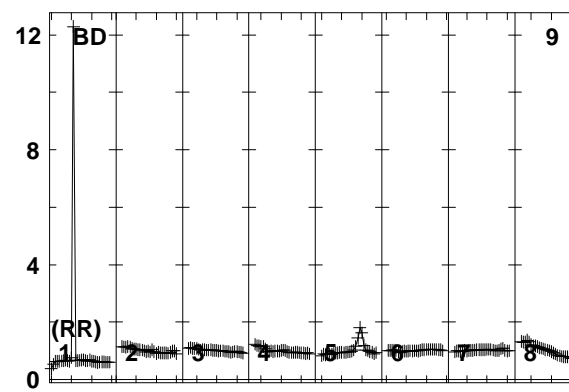
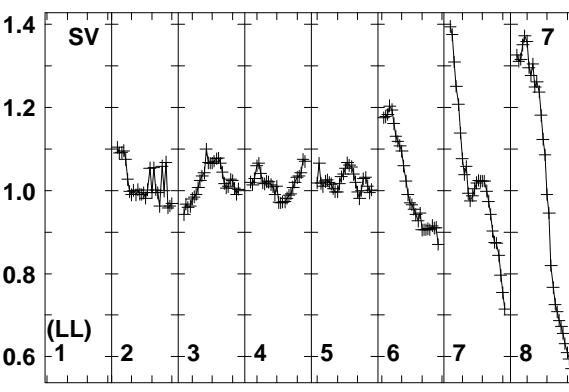
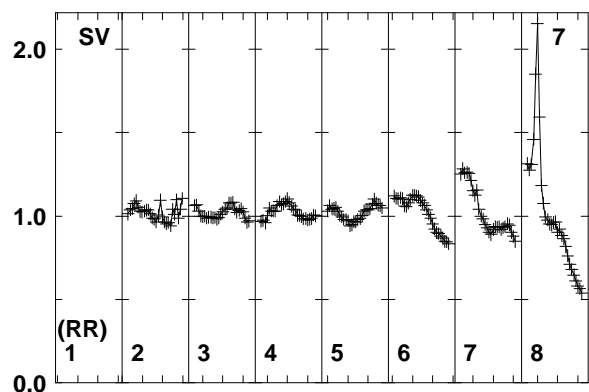
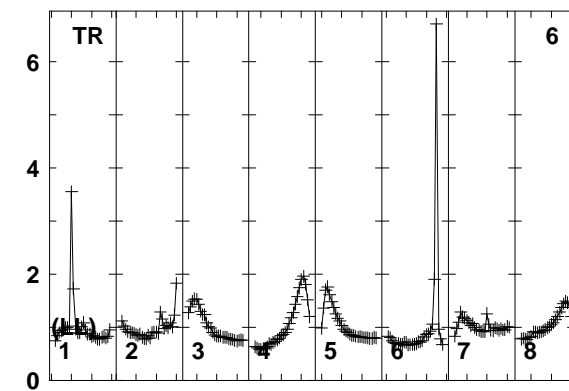
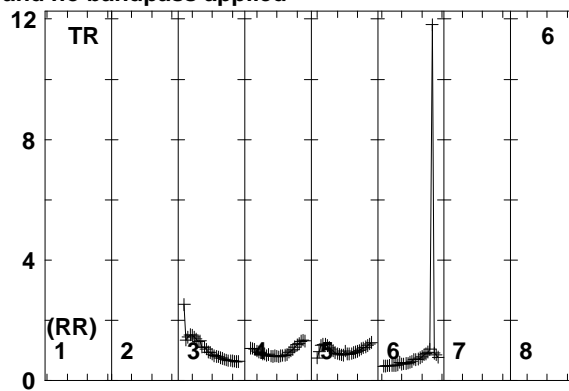
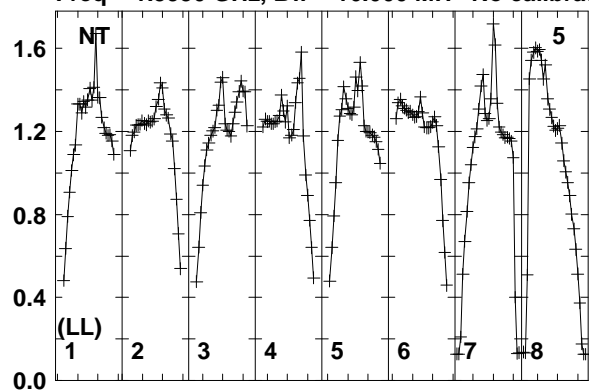

Lower frame: Real Jy
Total-power spectrum Antenna: NT (05)
Timerange: 00/07:38:41 to 00/07:42:39

Plot file version 240 created 11-AUG-2014 17:05:38

J2032+4127 EM110 2.UVDATA.1

Freq = 1.5950 GHz, Bw = 16.000 MH No calibration applied and no bandpass applied

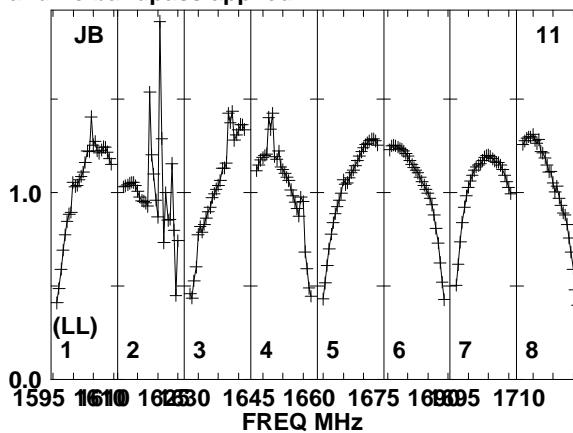
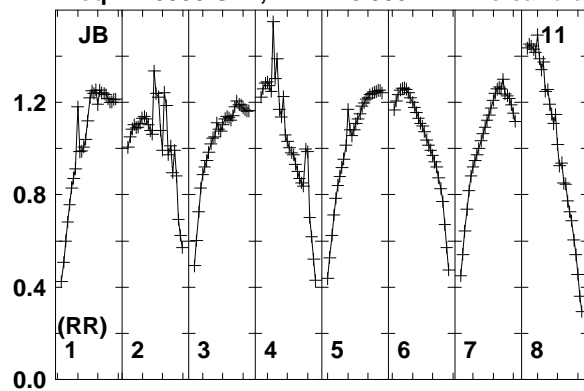

Lower frame: Real Jy
Total-power spectrum Antenna: JB (11)
Timerange: 00/07:38:41 to 00/07:42:39

Plot file version 241 created 11-AUG-2014 17:05:38

J2015+3710 EM110 2.UVDATA.1

Freq = 1.5950 GHz, Bw = 16.000 MH No calibration applied and no bandpass applied

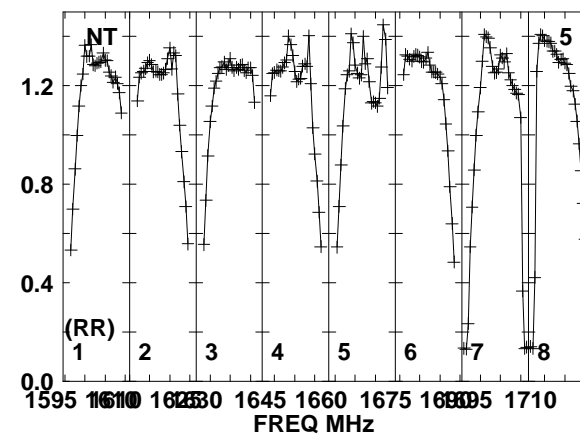
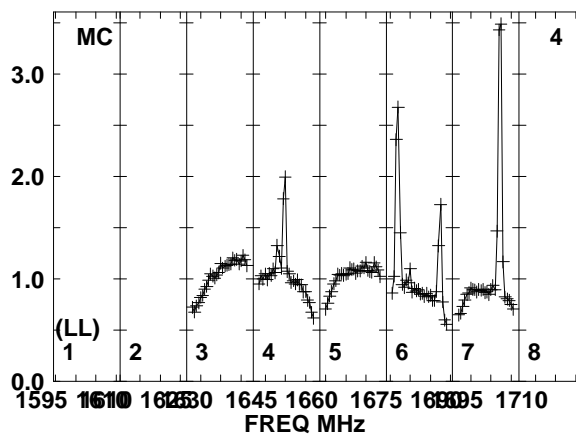
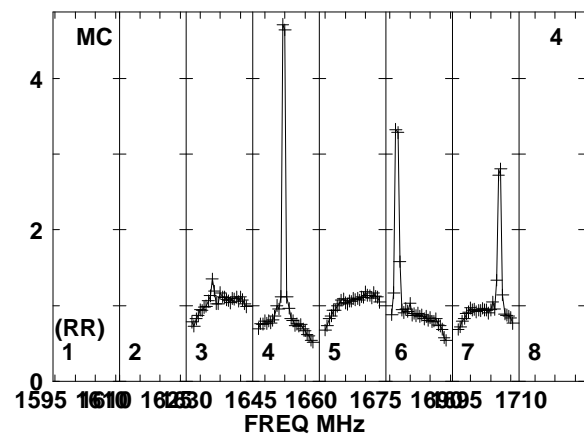
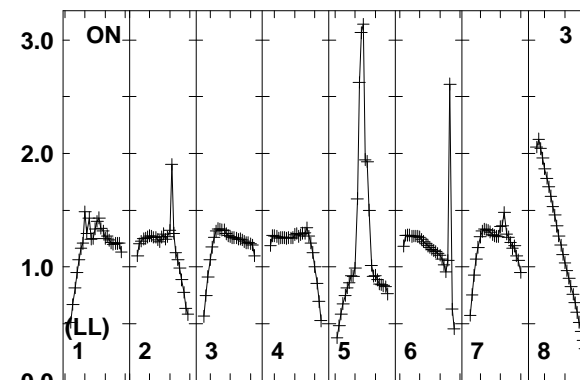
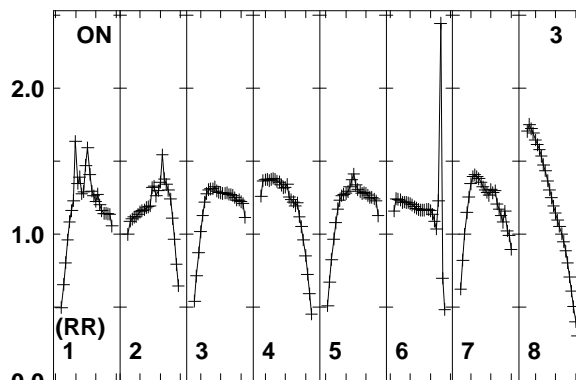
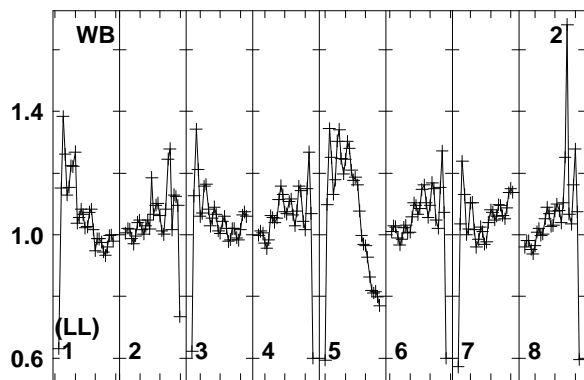
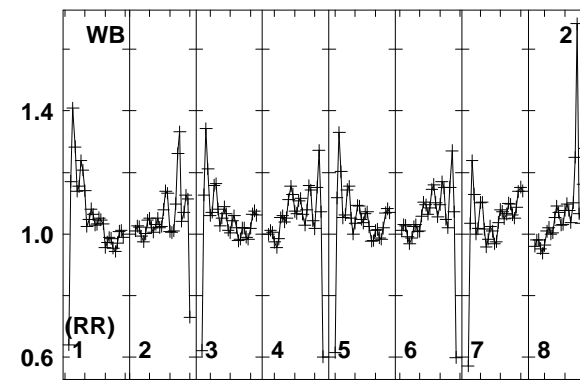
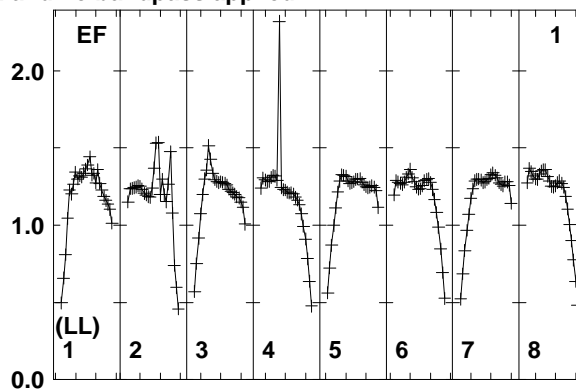
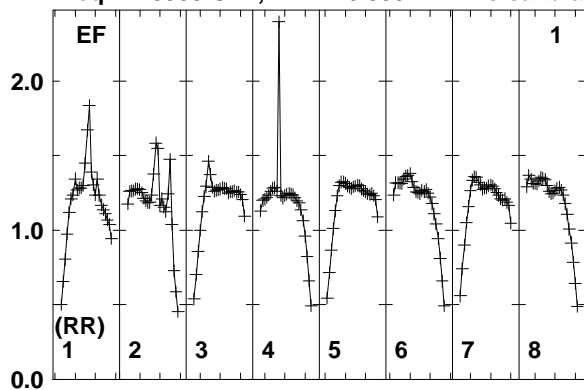

Lower frame: Real Jy
Total-power spectrum Antenna: EF (01)
Timerange: 00/07:43:41 to 00/07:45:39

Plot file version 242 created 11-AUG-2014 17:05:38

J2015+3710 EM110 2.UVDATA.1

Freq = 1.5950 GHz, Bw = 16.000 MH No calibration applied and no bandpass applied

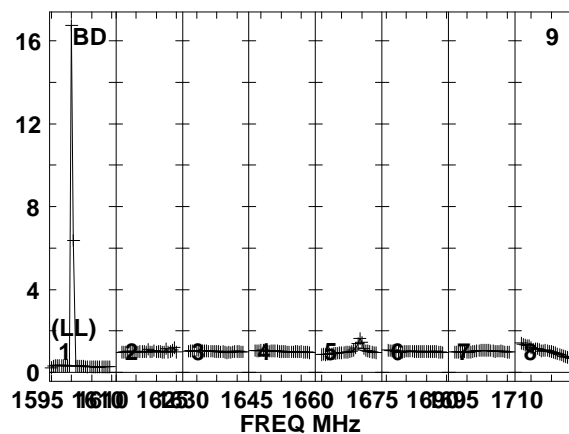
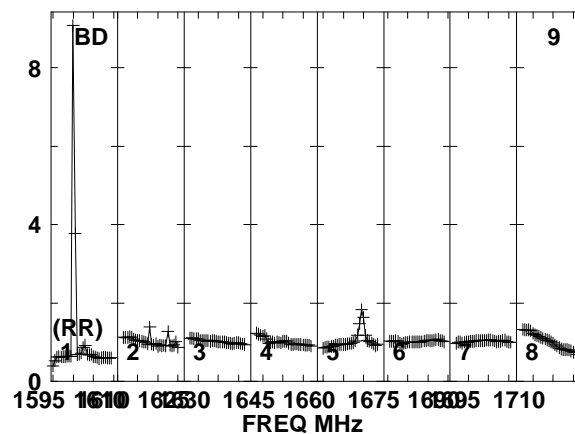
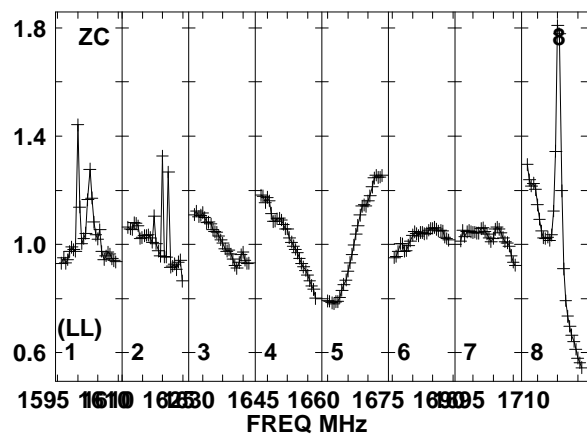
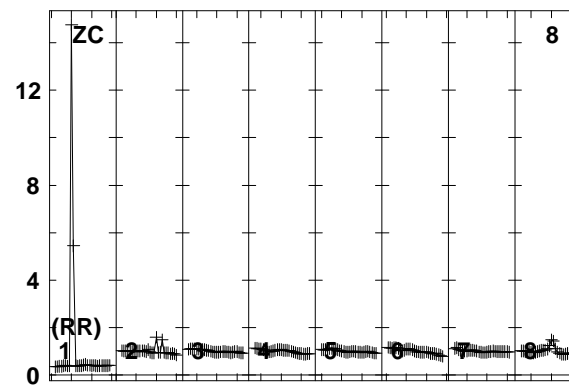
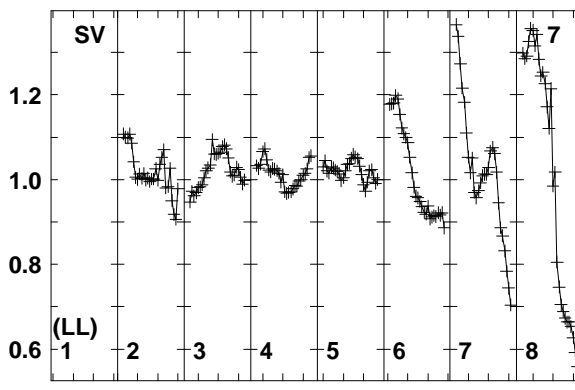
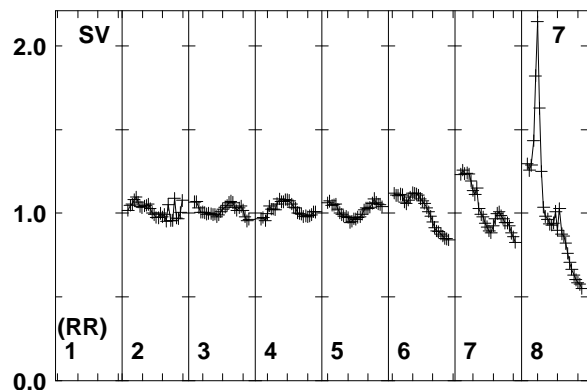
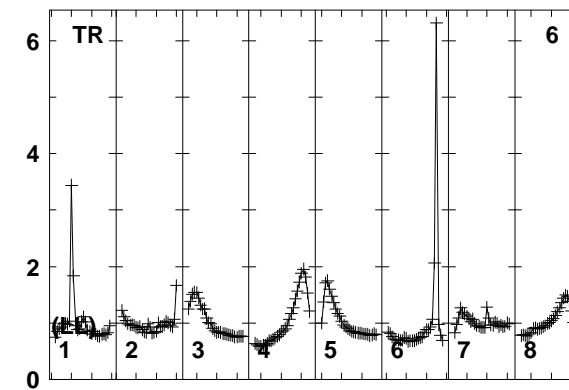
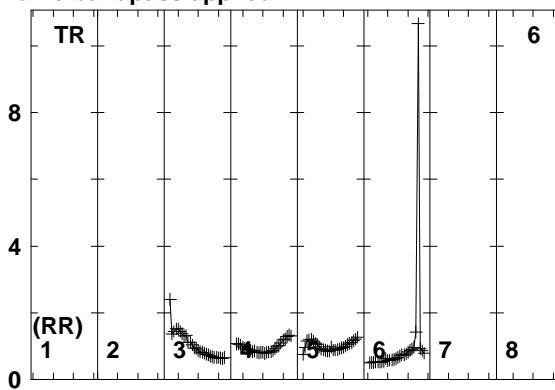
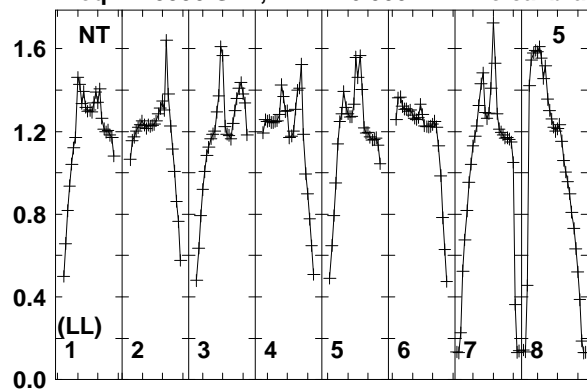

Lower frame: Real Jy
Total-power spectrum Antenna: NT (05)
Timerange: 00/07:43:41 to 00/07:45:39

Plot file version 243 created 11-AUG-2014 17:05:38

J2015+3710 EM110 2.UVDATA.1

Freq = 1.5950 GHz, Bw = 16.000 MH No calibration applied and no bandpass applied

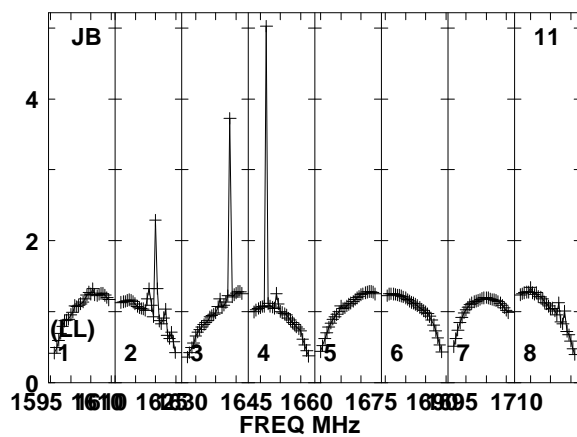
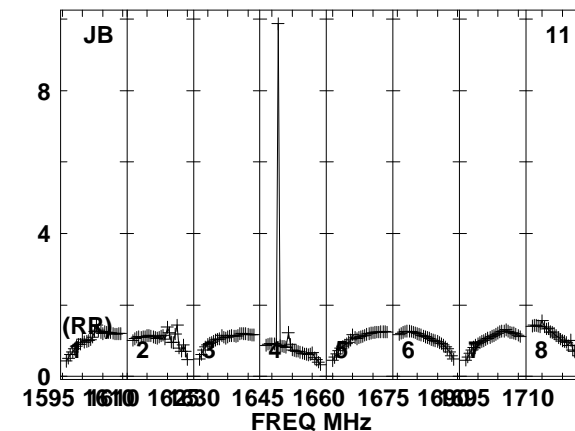
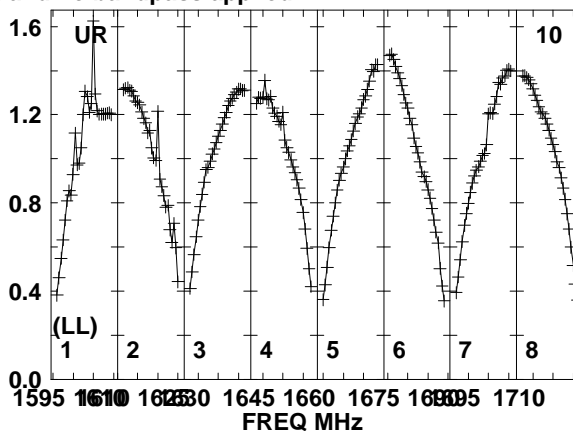
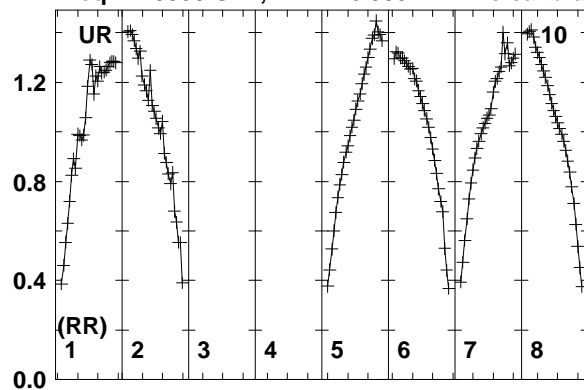

Lower frame: Real Jy
Total-power spectrum Antenna: UR (10)
Timerange: 00/07:43:41 to 00/07:45:39

Plot file version 244 created 11-AUG-2014 17:05:38

J2032+4127 EM110 2.UVDATA.1

Freq = 1.5950 GHz, Bw = 16.000 MH No calibration applied and no bandpass applied

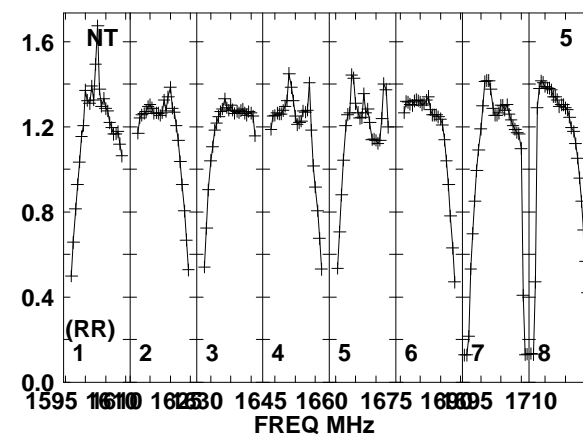
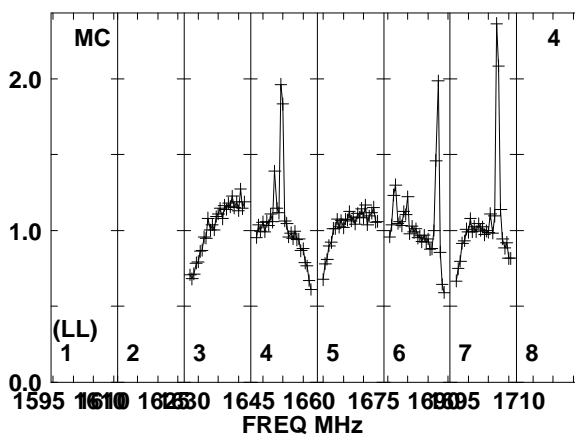
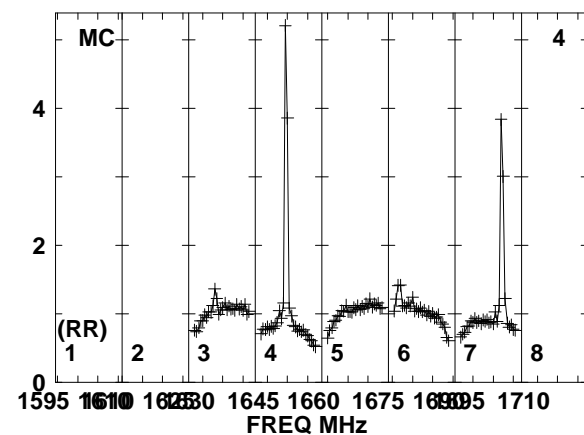
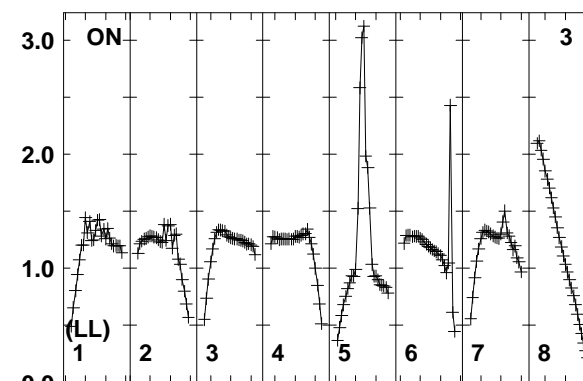
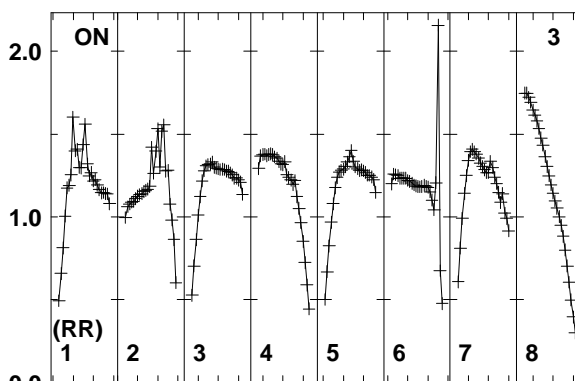
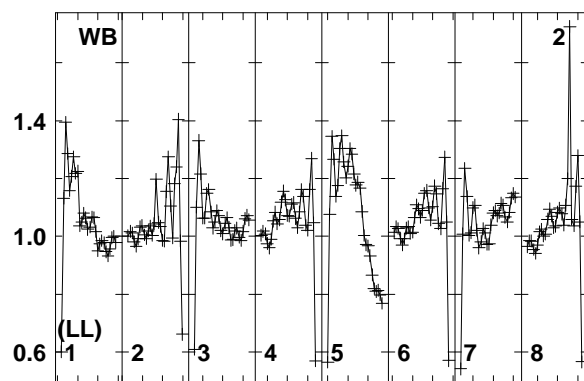
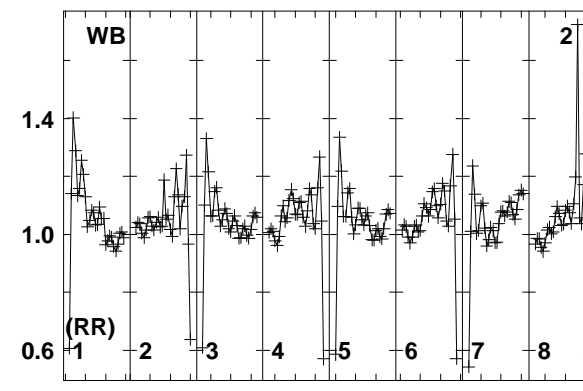
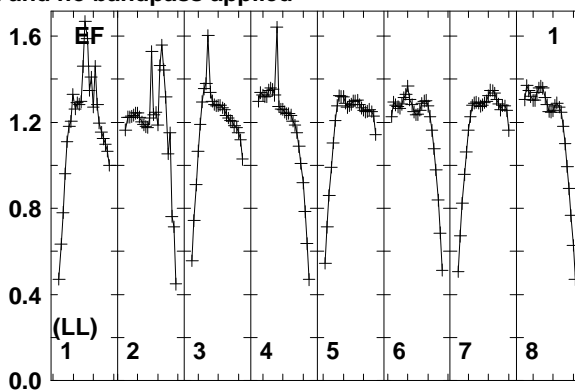
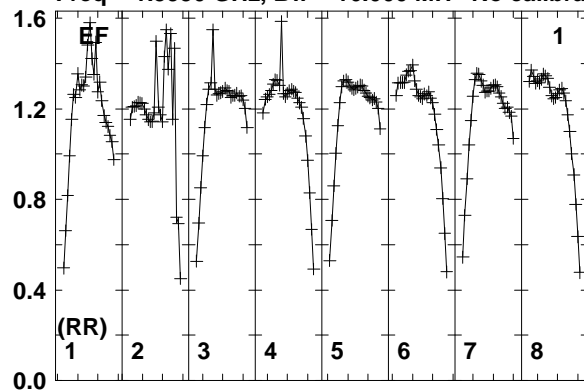

Lower frame: Real Jy
Total-power spectrum Antenna: EF (01)
Timerange: 00/07:45:53 to 00/07:49:39

Plot file version 245 created 11-AUG-2014 17:05:38

J2032+4127 EM110 2.UVDATA.1

Freq = 1.5950 GHz, Bw = 16.000 MH No calibration applied and no bandpass applied

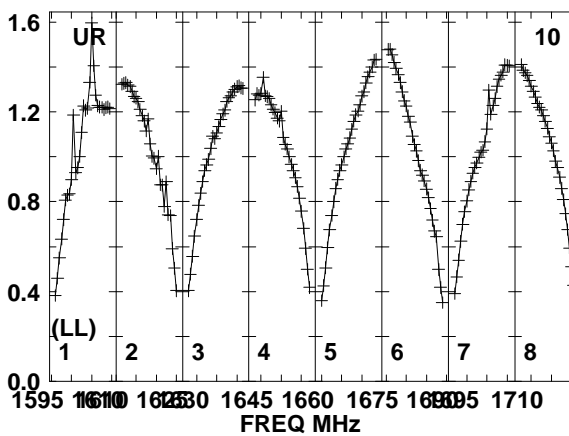
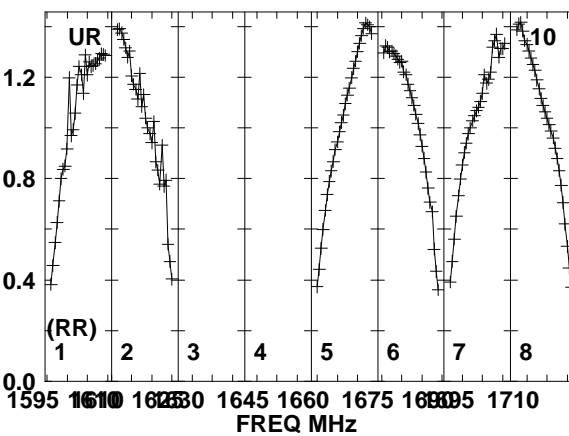
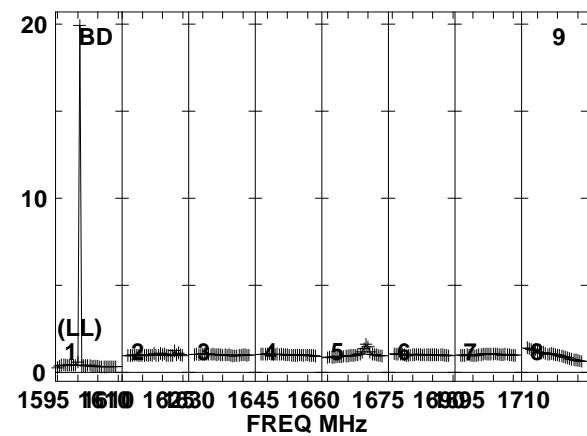
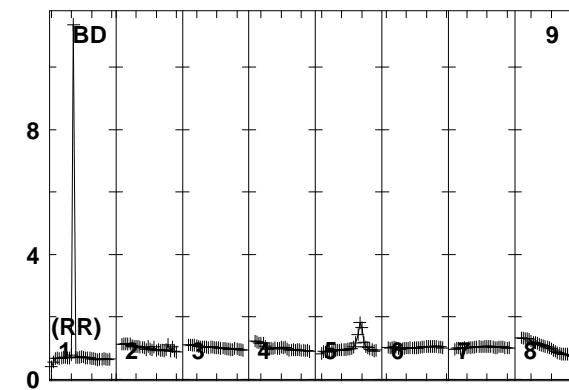
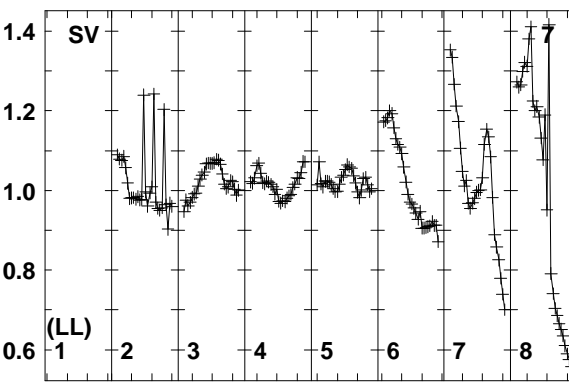
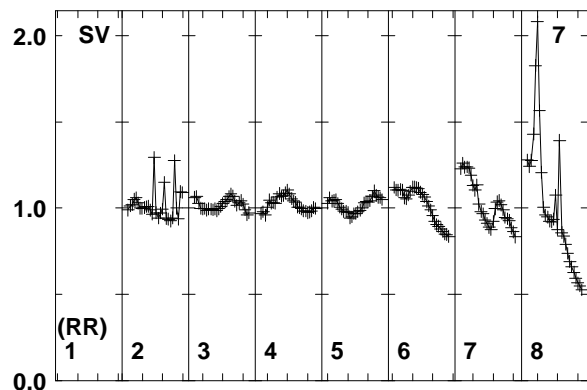
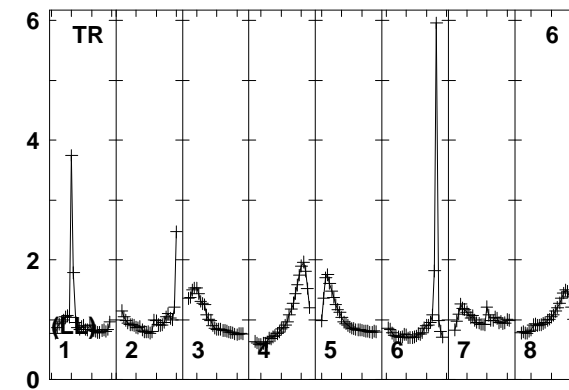
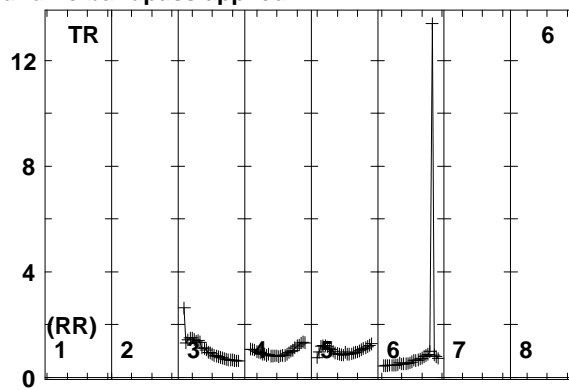
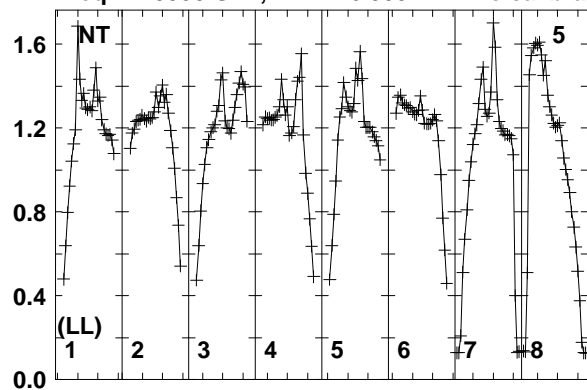

Lower frame: Real Jy
Total-power spectrum Antenna: NT (05)
Timerange: 00/07:45:53 to 00/07:49:39

Plot file version 246 created 11-AUG-2014 17:05:39

J2032+4127 EM110 2.UVDATA.1

Freq = 1.5950 GHz, Bw = 16.000 MH No calibration applied and no bandpass applied

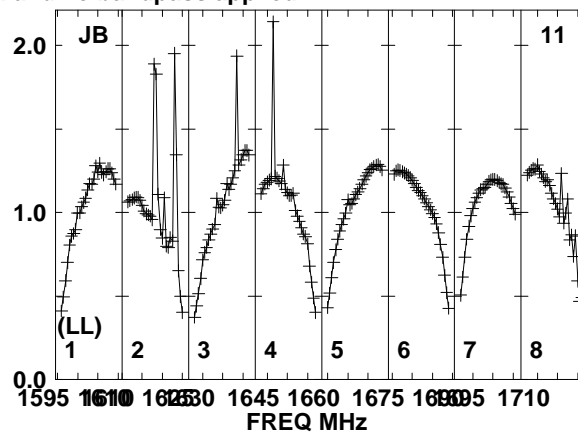
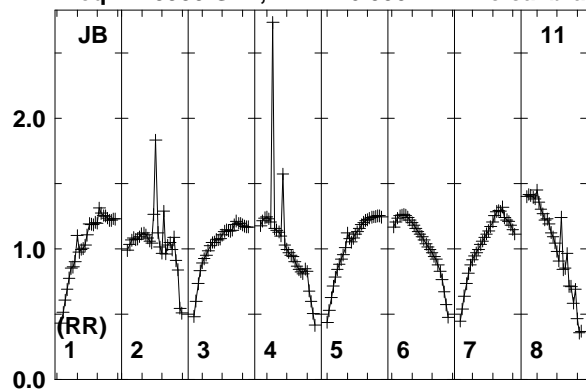

Lower frame: Real Jy
Total-power spectrum Antenna: JB (11)
Timerange: 00/07:45:53 to 00/07:49:39

Plot file version 247 created 11-AUG-2014 17:05:39

J2015+3710 EM110 2.UVDATA.1

Freq = 1.5950 GHz, Bw = 16.000 MH No calibration applied and no bandpass applied

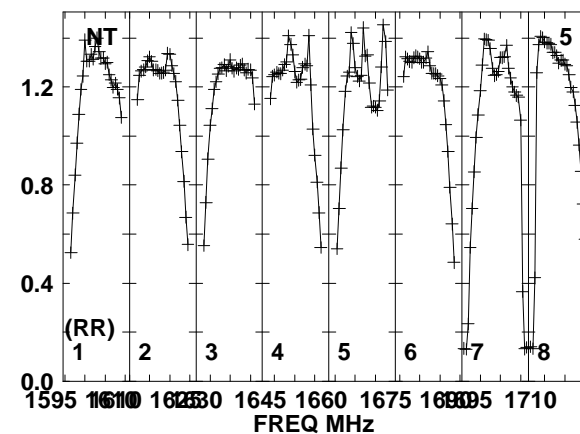
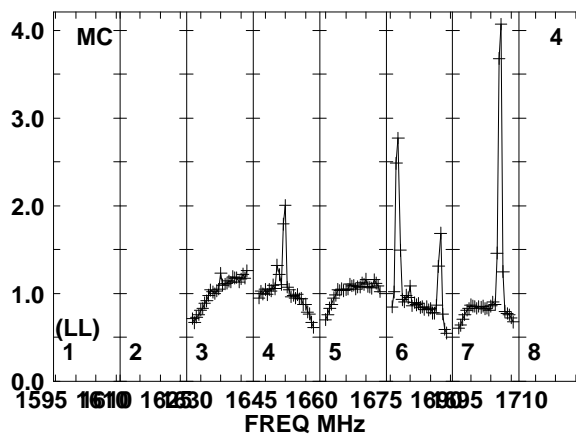
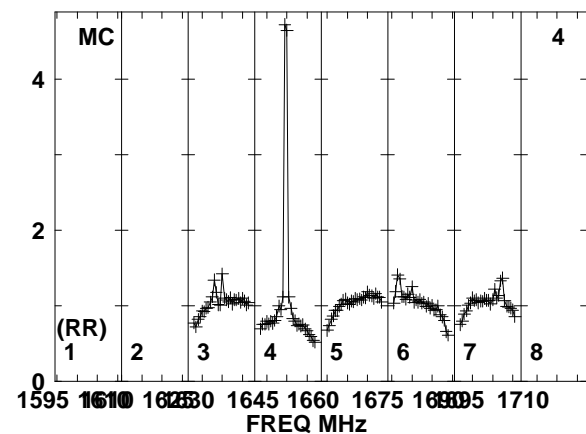
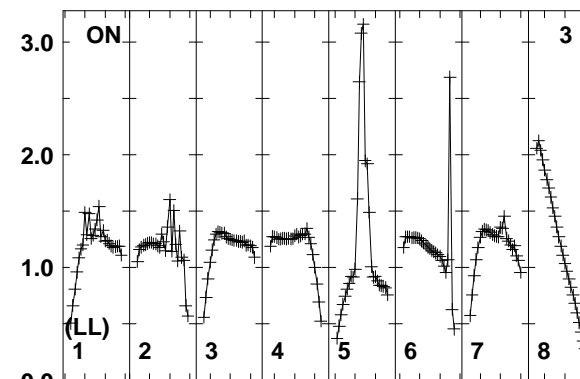
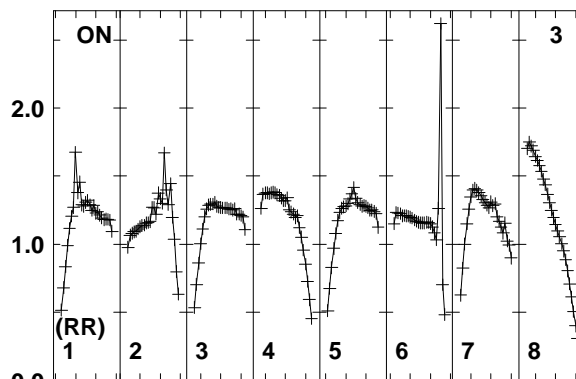
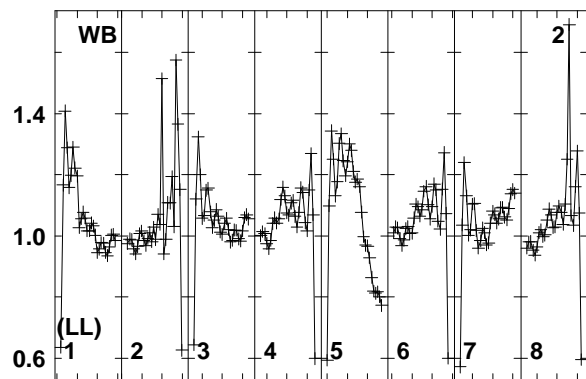
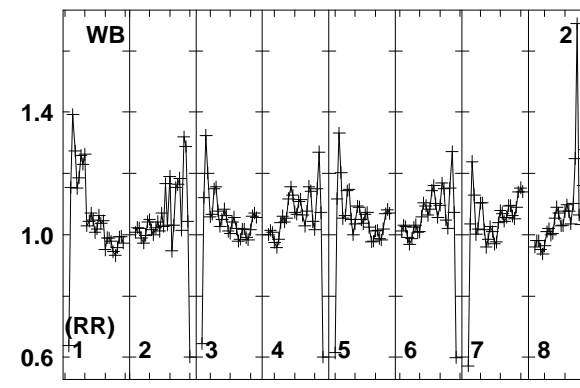
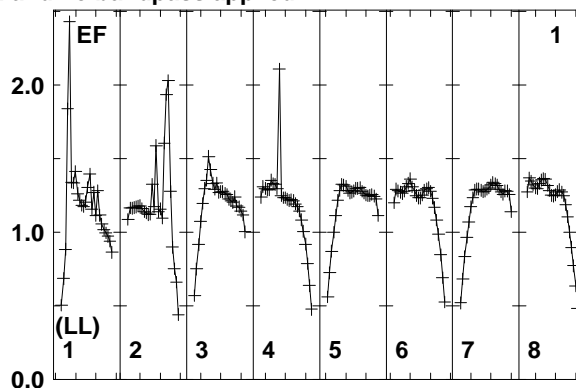
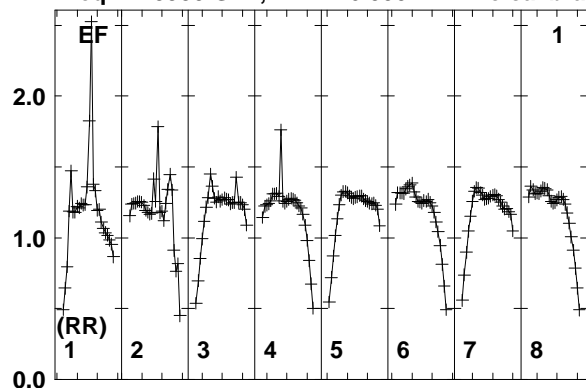

Lower frame: Real Jy
Total-power spectrum Antenna: EF (01)
Timerange: 00/07:49:43 to 00/07:51:39

Plot file version 248 created 11-AUG-2014 17:05:39

J2015+3710 EM110 2.UVDATA.1

Freq = 1.5950 GHz, Bw = 16.000 MH No calibration applied and no bandpass applied

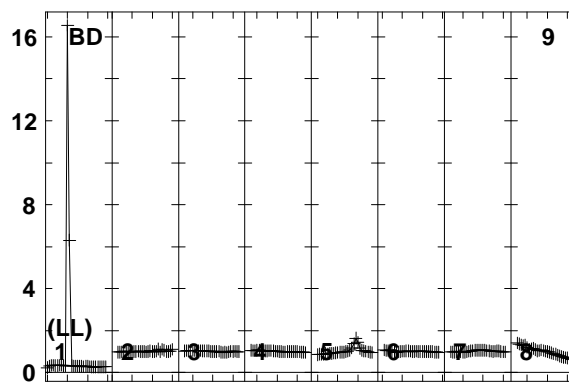
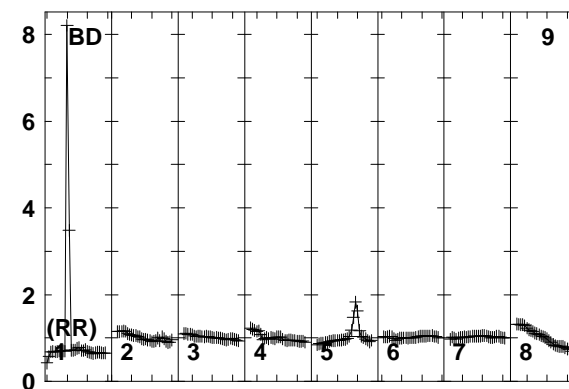
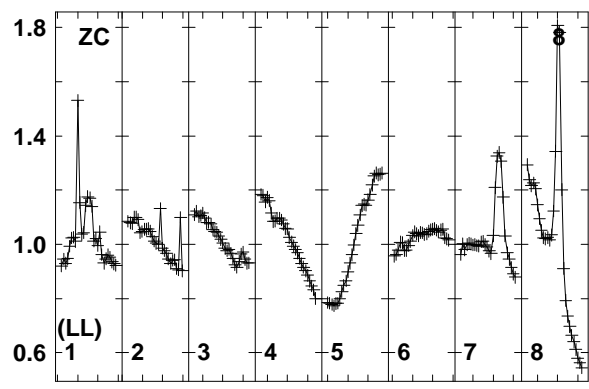
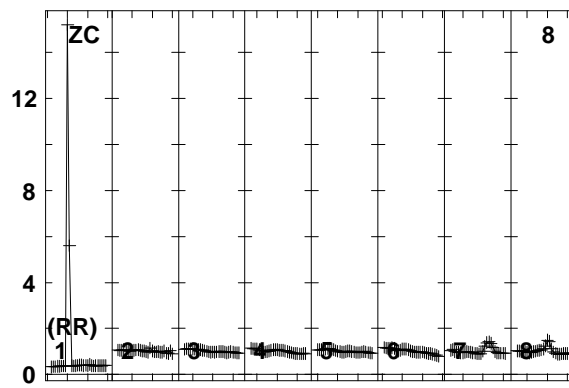
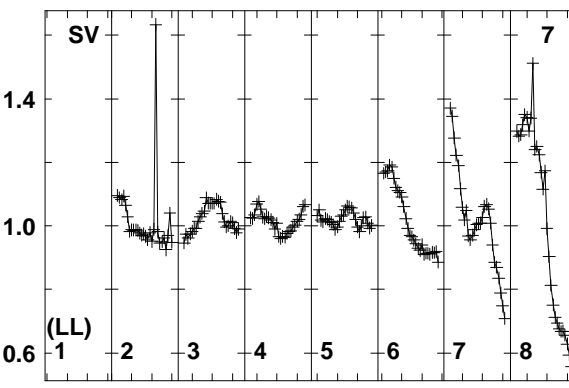
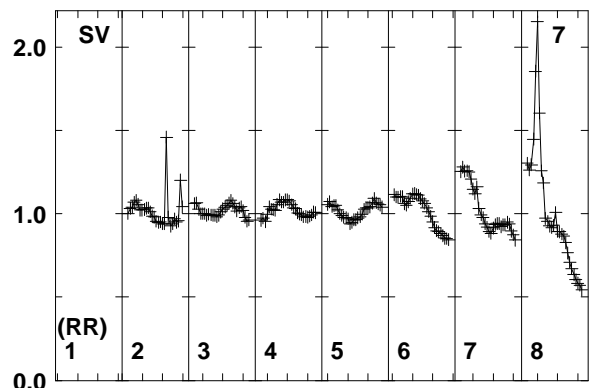
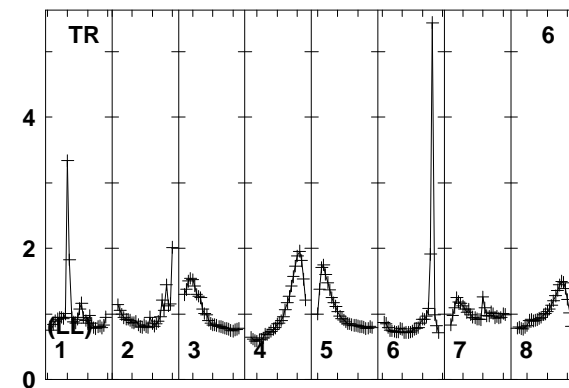
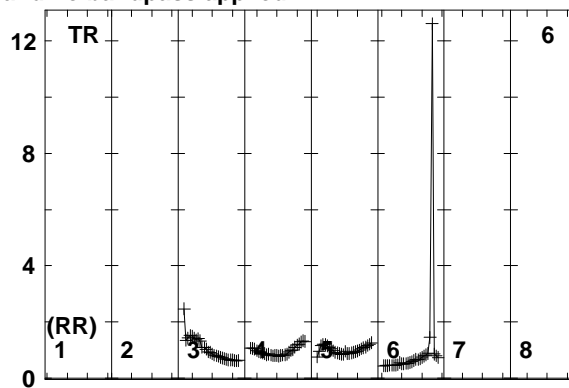
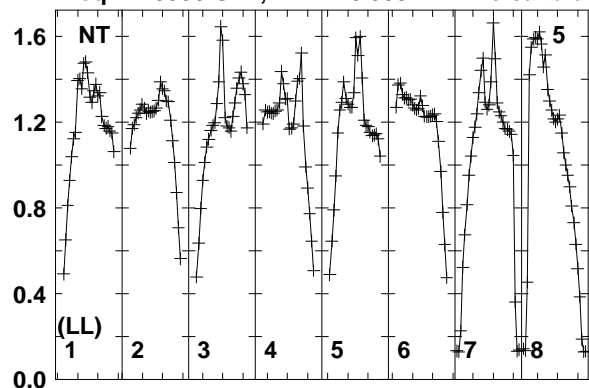

1595 1610 1625 1640 1655 1670 1685 1700 1715
FREQ MHz
Lower frame: Real Jy
Total-power spectrum Antenna: NT (05)
Timerange: 00/07:49:43 to 00/07:51:39

1595 1610 1625 1640 1655 1670 1685 1700 1715
FREQ MHz

1595 1610 1625 1640 1655 1670 1685 1700 1715
FREQ MHz

Plot file version 249 created 11-AUG-2014 17:05:39

J2015+3710 EM110 2.UVDATA.1

Freq = 1.5950 GHz, Bw = 16.000 MH No calibration applied and no bandpass applied

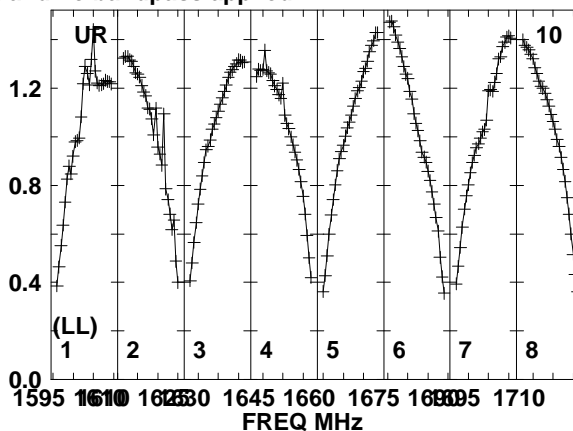
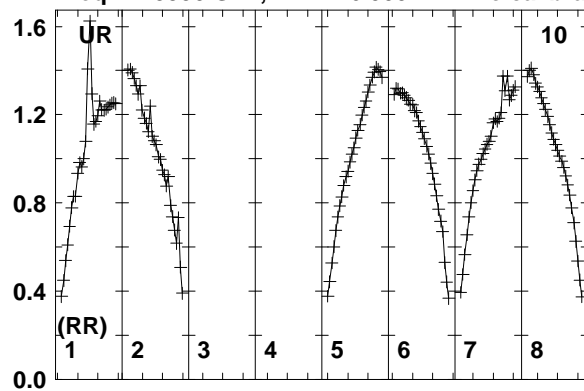

Lower frame: Real Jy
Total-power spectrum Antenna: UR (10)
Timerange: 00/07:49:43 to 00/07:51:39

Plot file version 250 created 11-AUG-2014 17:05:39

J2032+4127 EM110 2.UVDATA.1

Freq = 1.5950 GHz, Bw = 16.000 MH No calibration applied and no bandpass applied

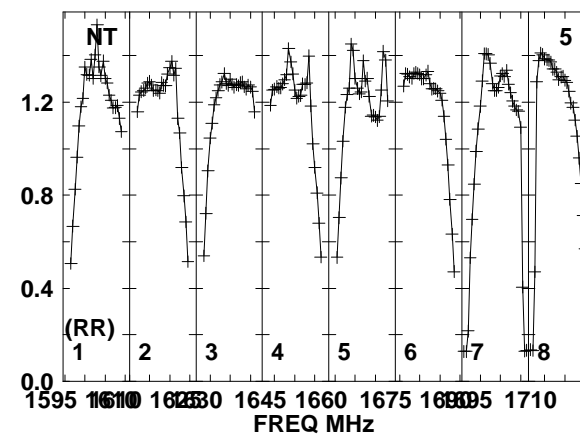
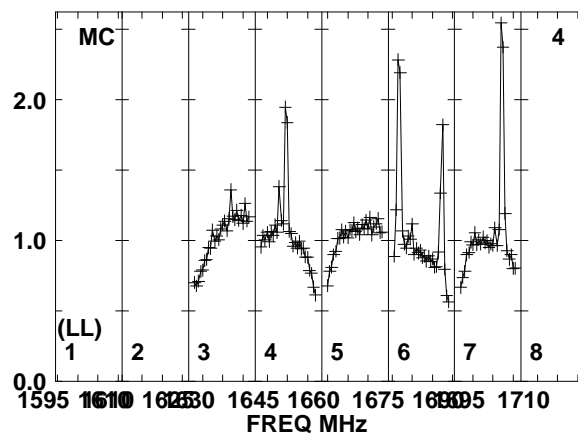
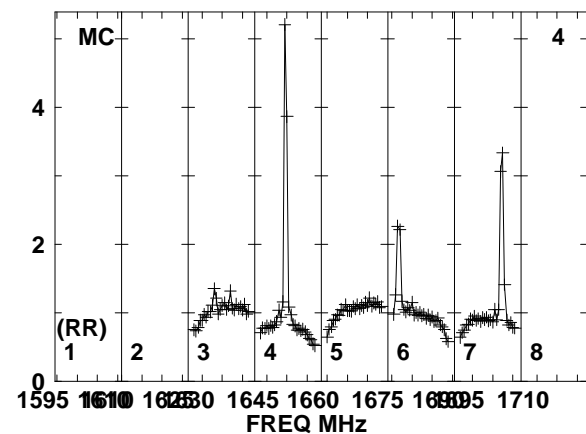
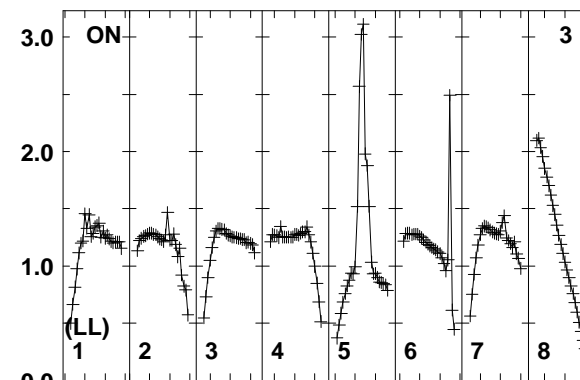
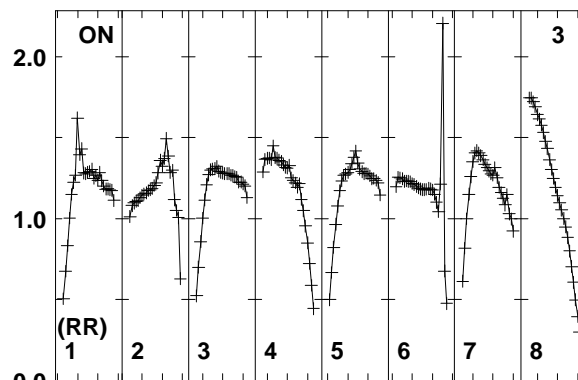
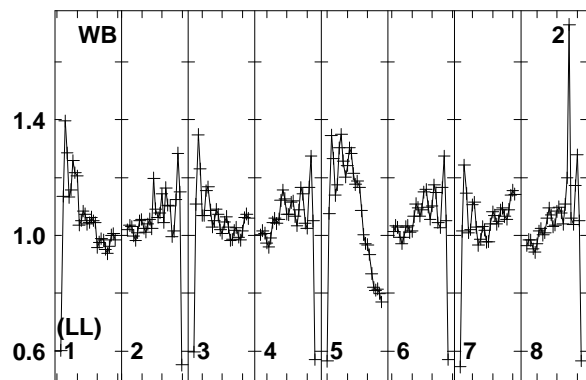
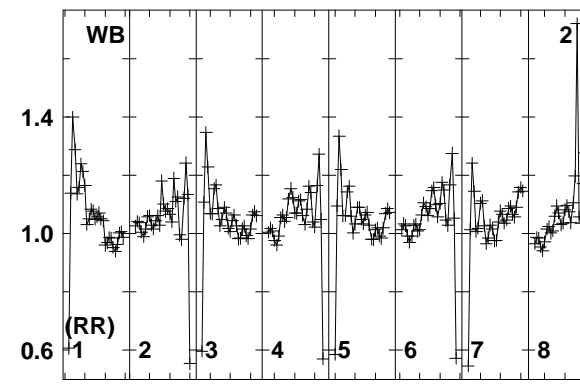
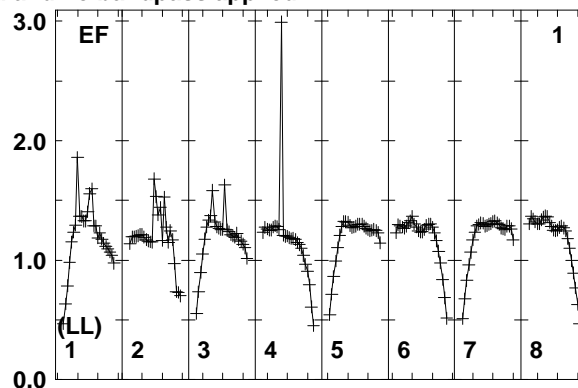
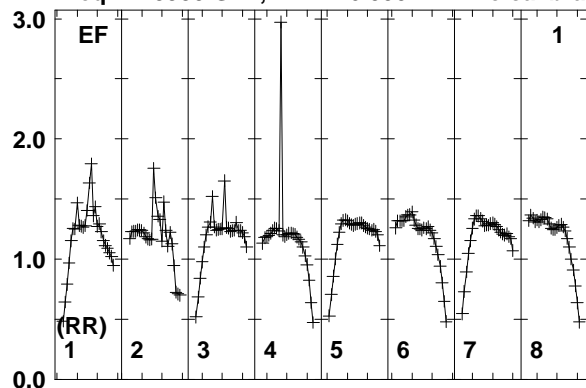

Lower frame: Real Jy
Total-power spectrum Antenna: EF (01)
Timerange: 00/07:51:41 to 00/07:55:39

Plot file version 251 created 11-AUG-2014 17:05:39

J2032+4127 EM110 2.UVDATA.1

Freq = 1.5950 GHz, Bw = 16.000 MH No calibration applied and no bandpass applied

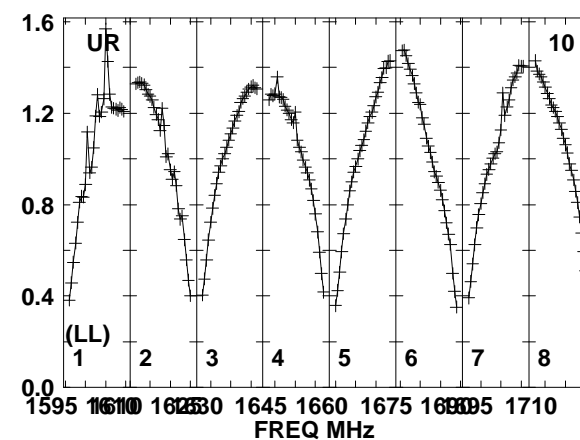
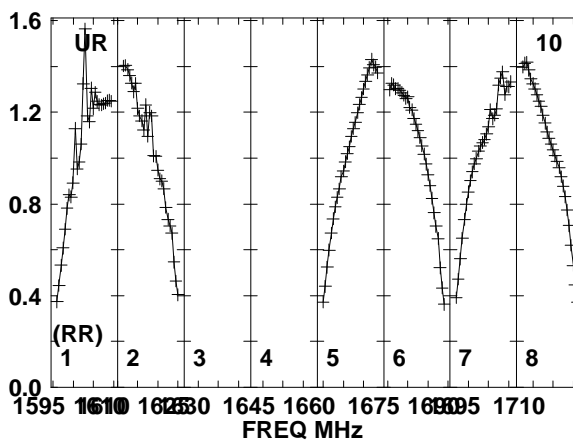
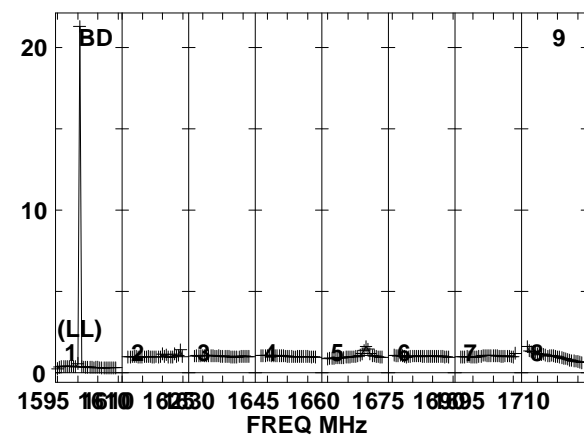
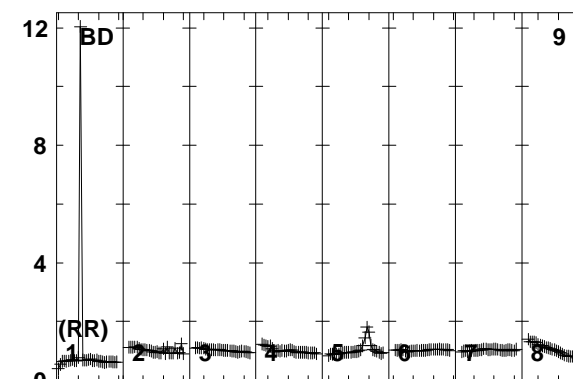
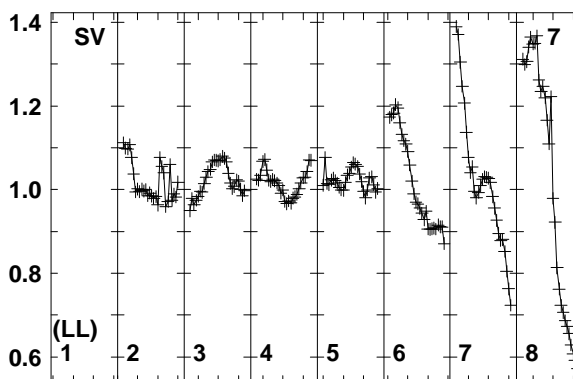
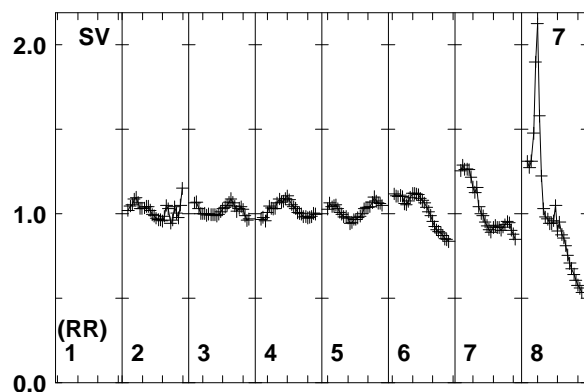
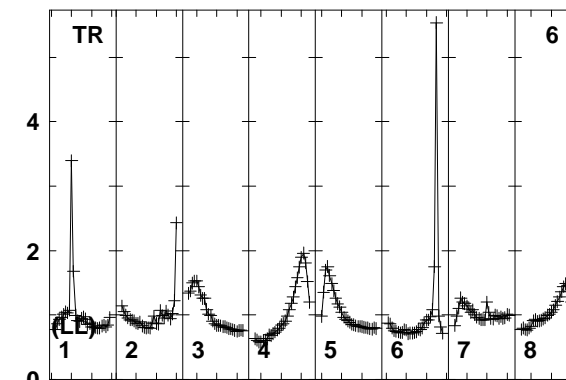
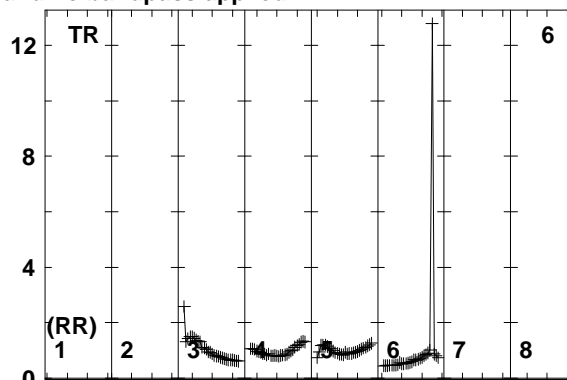
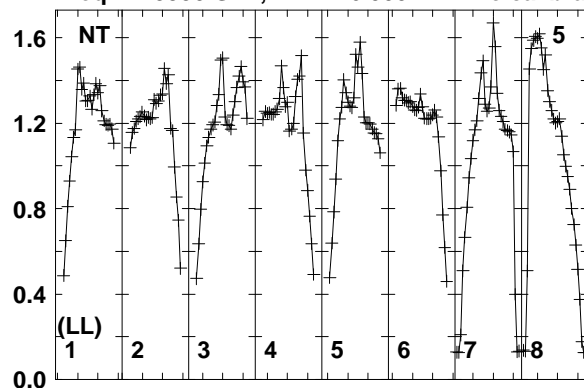

Lower frame: Real Jy
Total-power spectrum Antenna: NT (05)
Timerange: 00/07:51:41 to 00/07:55:39

Plot file version 252 created 11-AUG-2014 17:05:39

J2032+4127 EM110 2.UVDATA.1

Freq = 1.5950 GHz, Bw = 16.000 MH No calibration applied and no bandpass applied

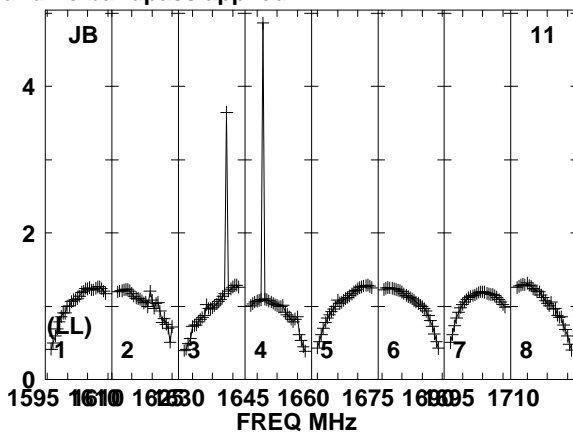
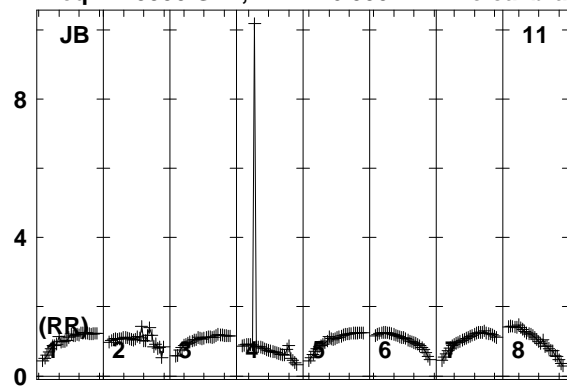

Lower frame: Real Jy
Total-power spectrum Antenna: JB (11)
Timerange: 00/07:51:41 to 00/07:55:39

Plot file version 253 created 11-AUG-2014 17:05:39

J2015+3710 EM110 2.UVDATA.1

Freq = 1.5950 GHz, Bw = 16.000 MH No calibration applied and no bandpass applied

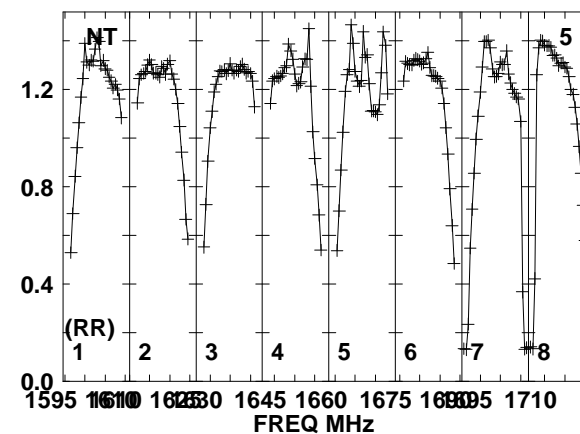
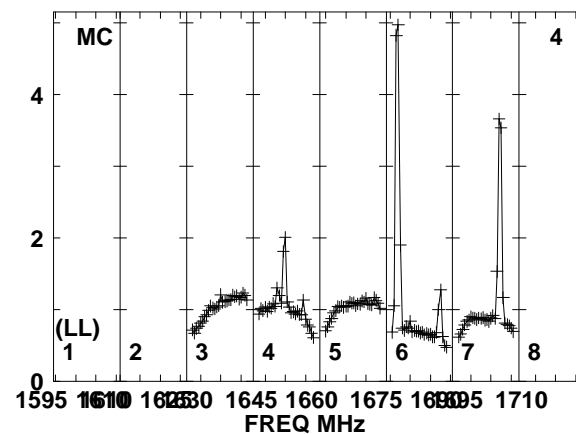
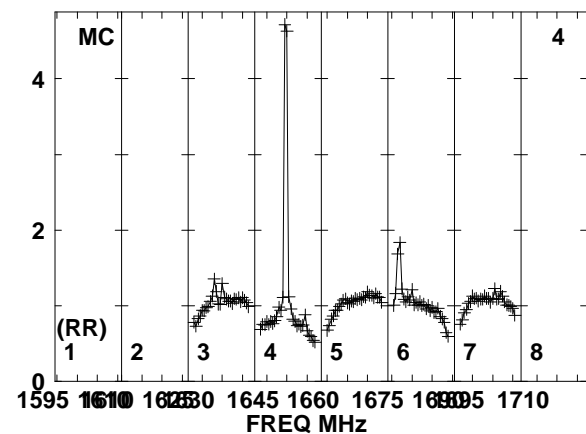
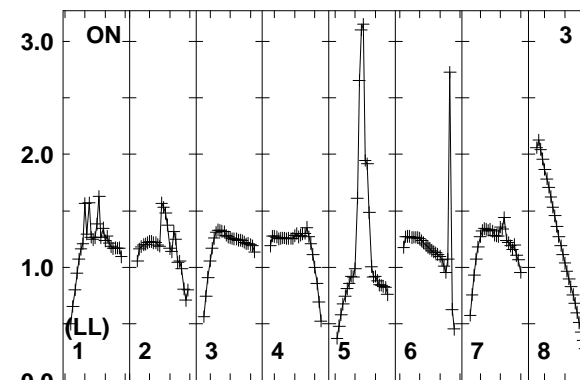
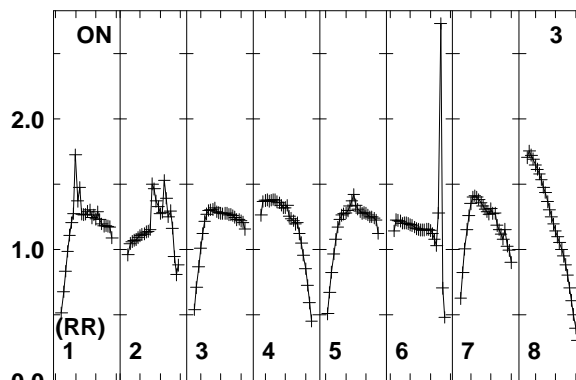
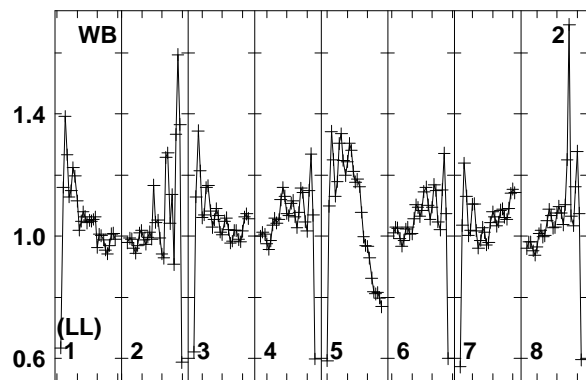
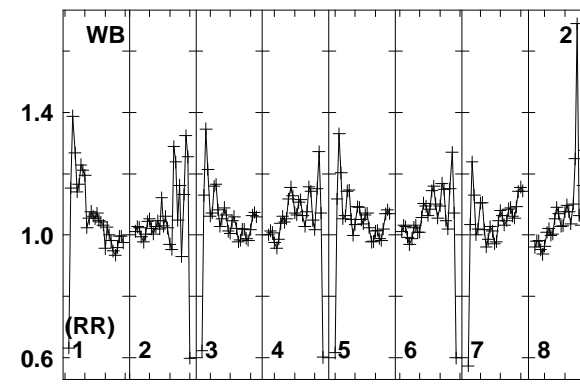
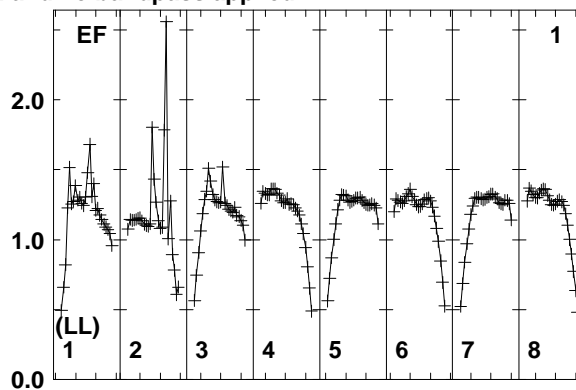
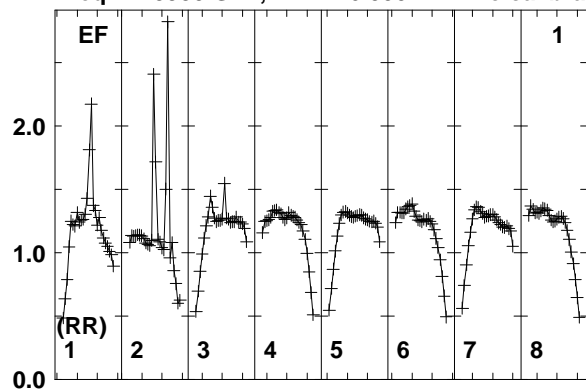

Lower frame: Real Jy
Total-power spectrum Antenna: EF (01)
Timerange: 00/07:56:41 to 00/07:58:39

Plot file version 254 created 11-AUG-2014 17:05:39

J2015+3710 EM110 2.UVDATA.1

Freq = 1.5950 GHz, Bw = 16.000 MH No calibration applied and no bandpass applied

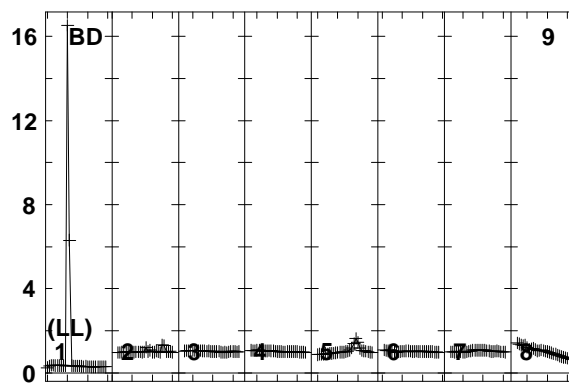
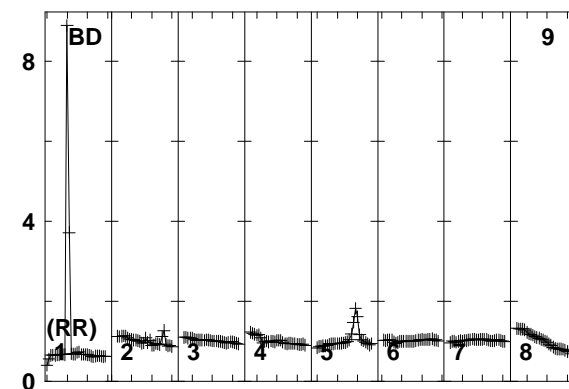
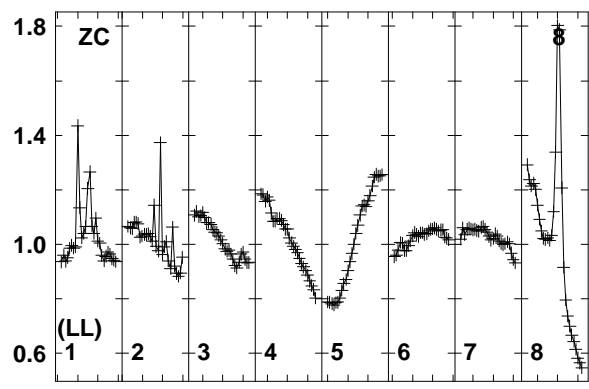
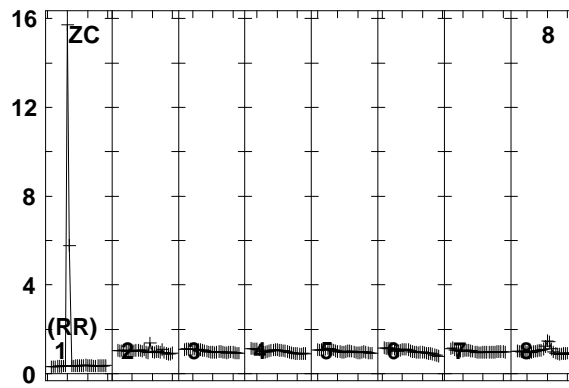
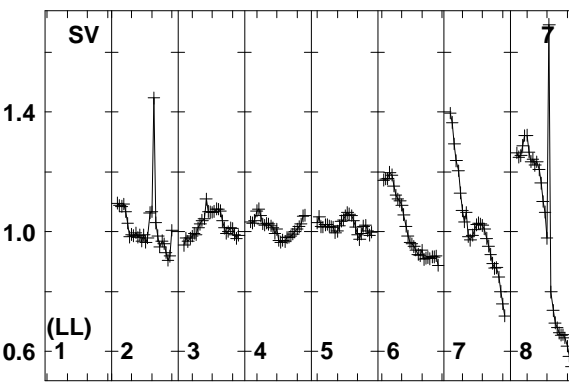
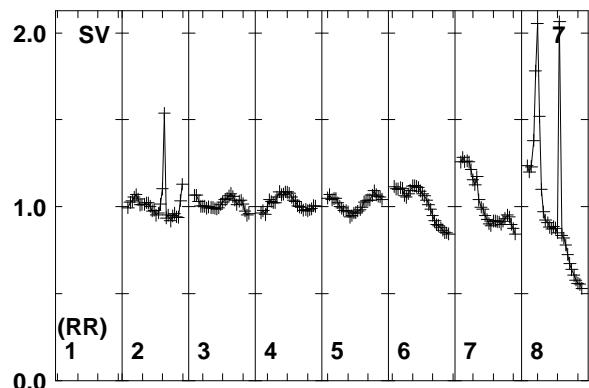
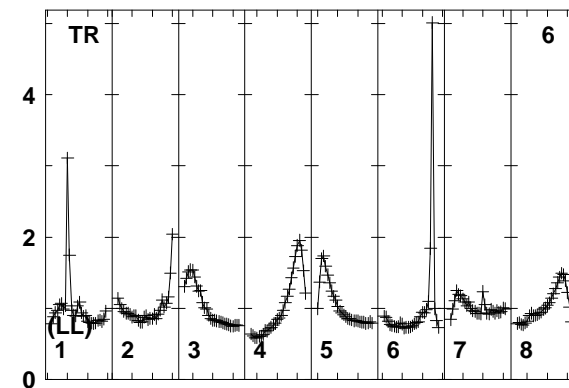
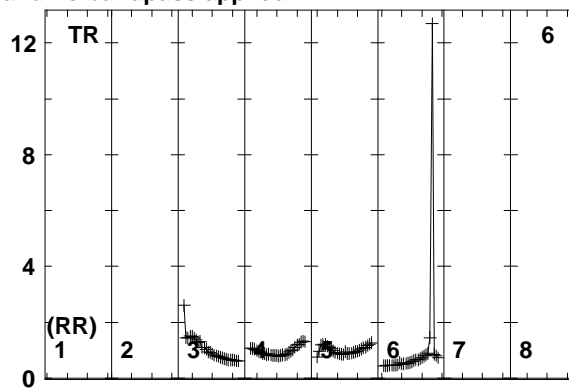
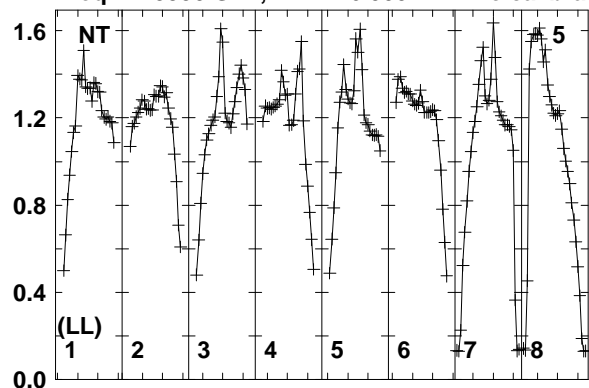

1595 1610 1625 1640 1655 1670 1685 1700 1715
FREQ MHz
Lower frame: Real Jy
Total-power spectrum Antenna: NT (05)
Timerange: 00/07:56:41 to 00/07:58:39

1595 1610 1625 1640 1655 1670 1685 1700 1715
FREQ MHz

1595 1610 1625 1640 1655 1670 1685 1700 1715
FREQ MHz

Plot file version 255 created 11-AUG-2014 17:05:39

J2015+3710 EM110 2.UVDATA.1

Freq = 1.5950 GHz, Bw = 16.000 MH No calibration applied and no bandpass applied

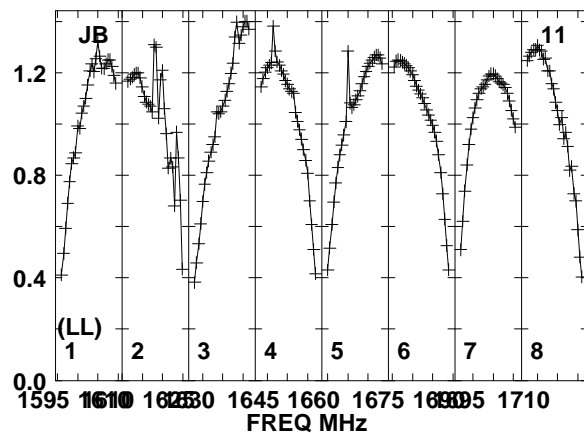
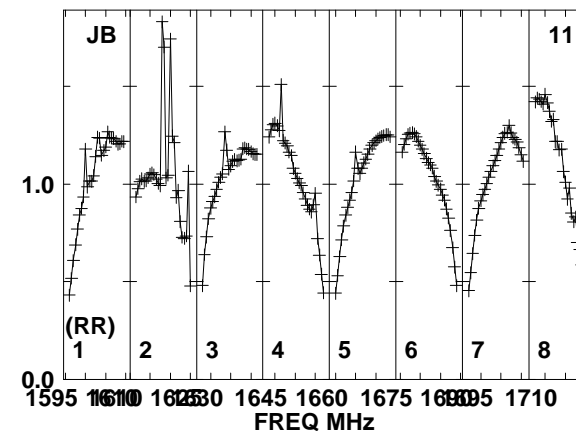
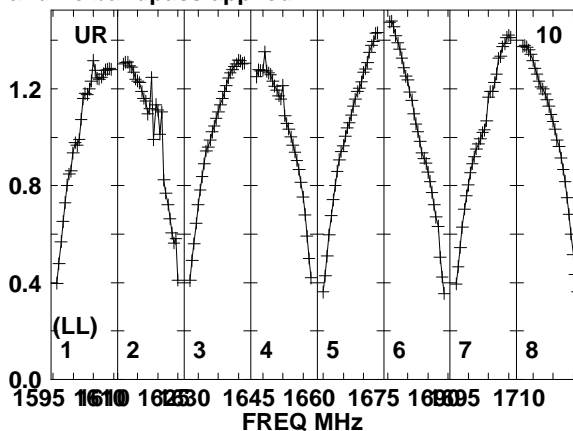
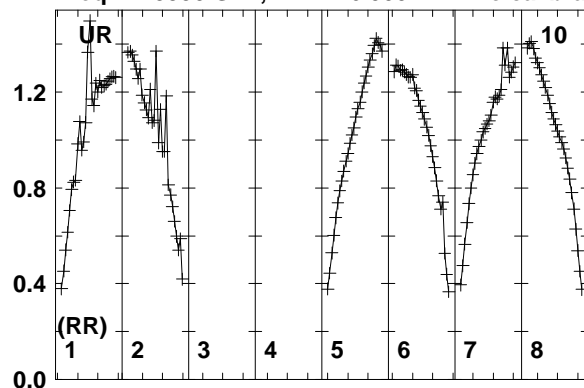

Lower frame: Real Jy
Total-power spectrum Antenna: UR (10)
Timerange: 00/07:56:41 to 00/07:58:39

Plot file version 256 created 11-AUG-2014 17:05:39

J2032+4127 EM110 2.UVDATA.1

Freq = 1.5950 GHz, Bw = 16.000 MH No calibration applied and no bandpass applied

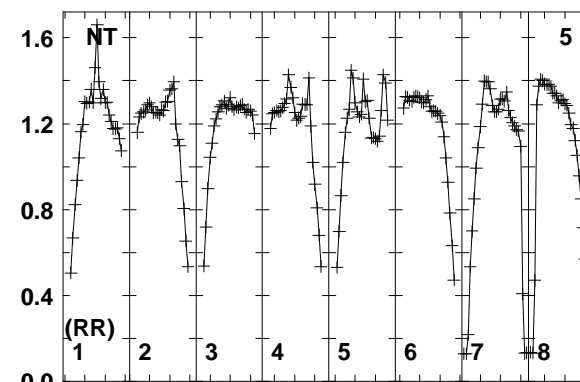
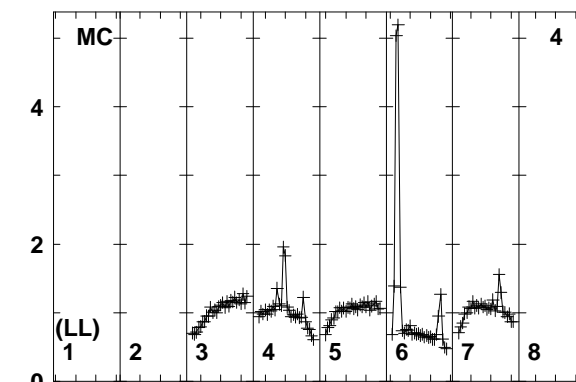
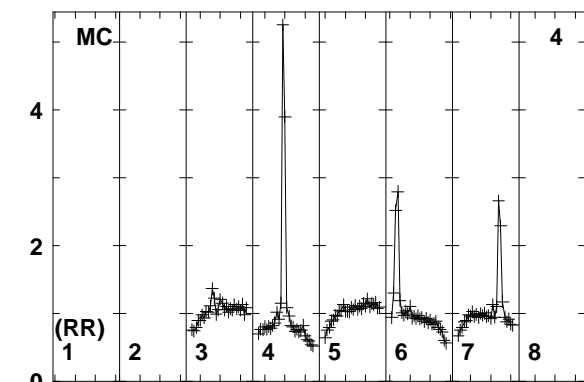
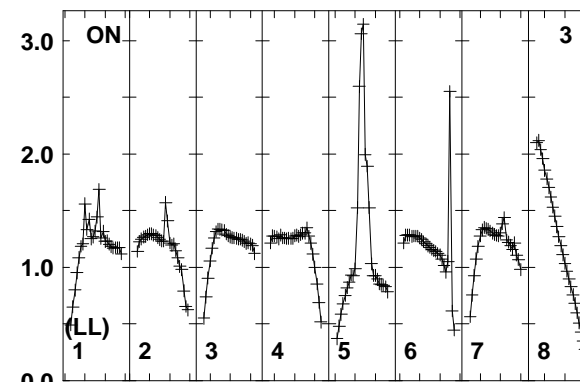
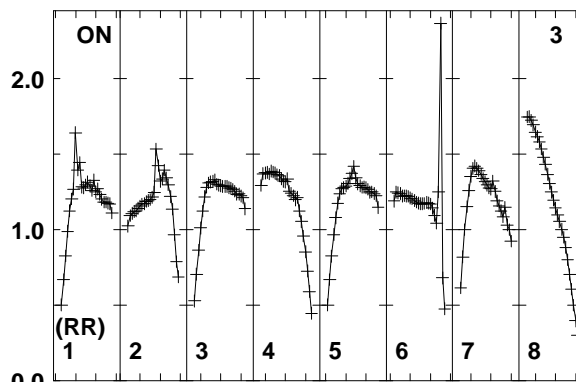
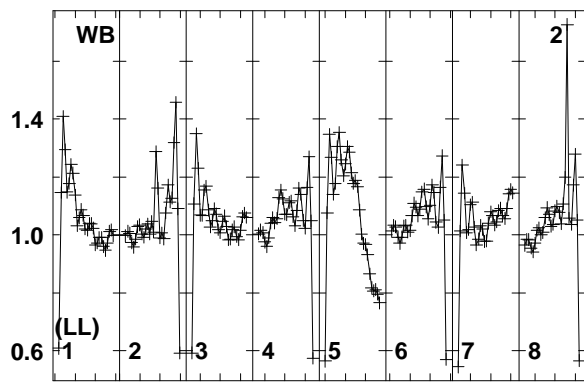
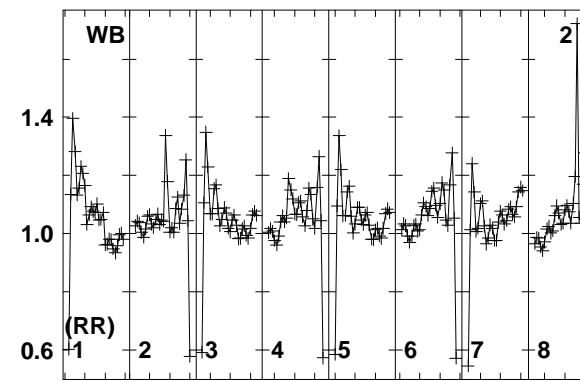
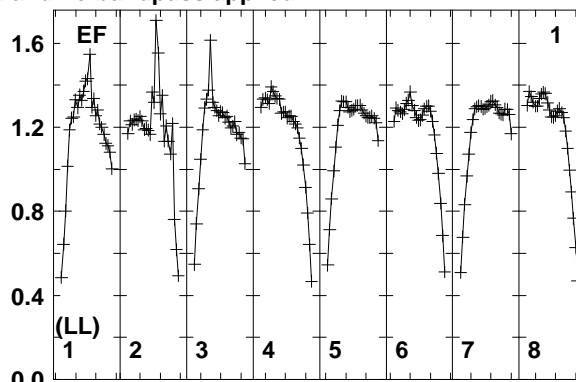
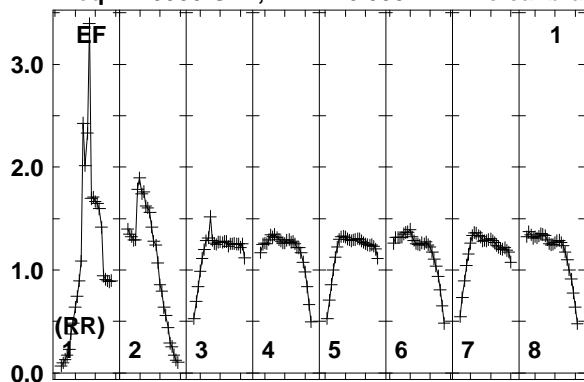

1595 1610 1625 1640 1655 1670 1685 1700 1710
FREQ MHz

Lower frame: Real Jy
Total-power spectrum Antenna: EF (01)
Timerange: 00/07:58:53 to 00/08:02:29

Plot file version 257 created 11-AUG-2014 17:05:39

J2032+4127 EM110 2.UVDATA.1

Freq = 1.5950 GHz, Bw = 16.000 MH No calibration applied and no bandpass applied

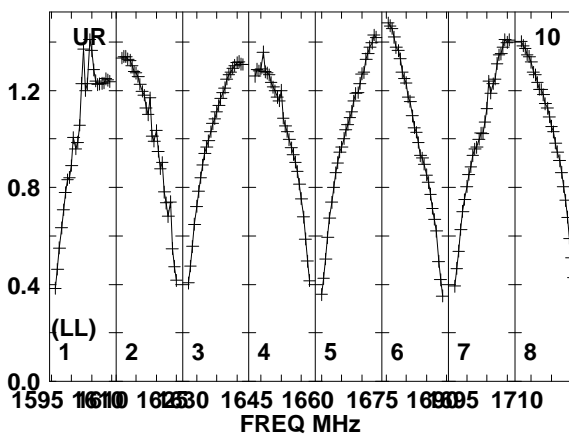
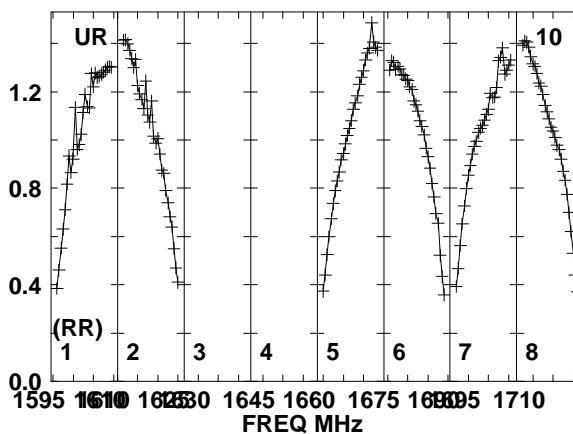
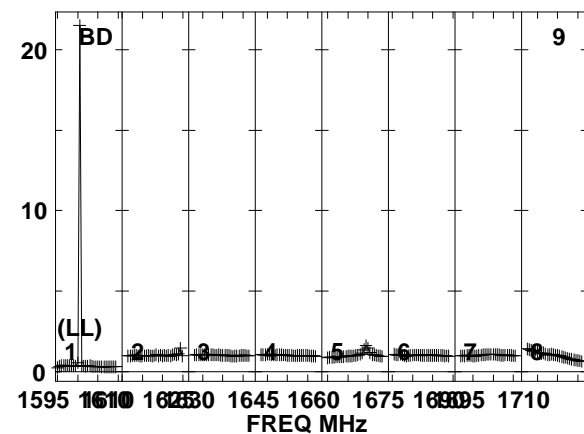
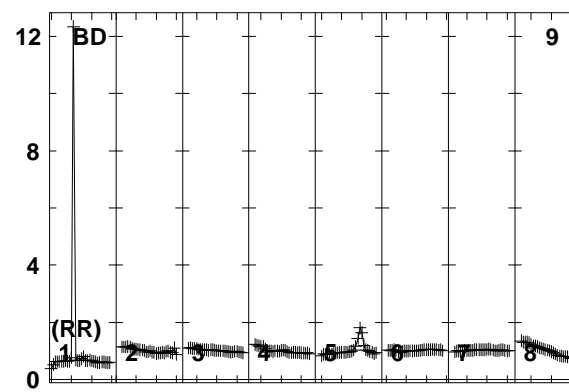
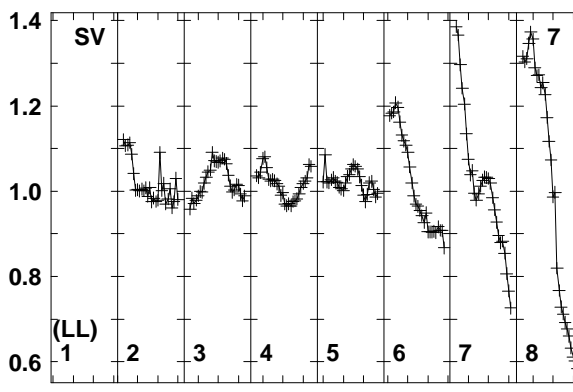
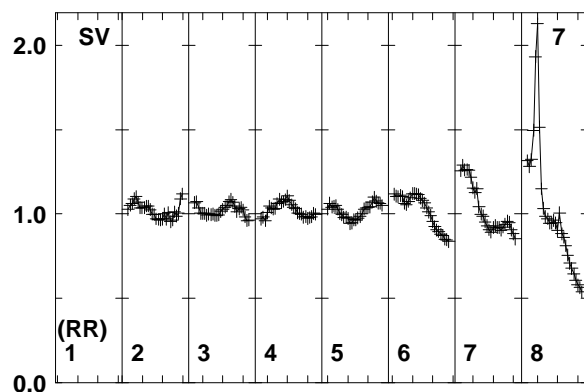
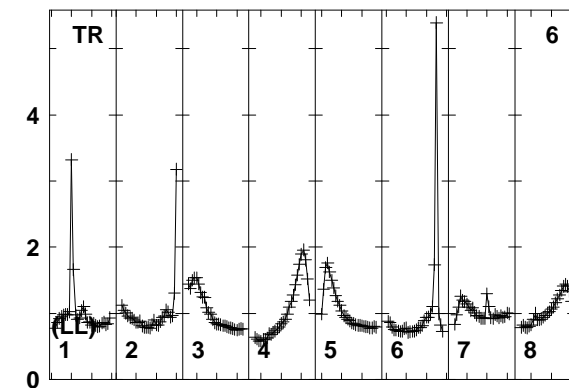
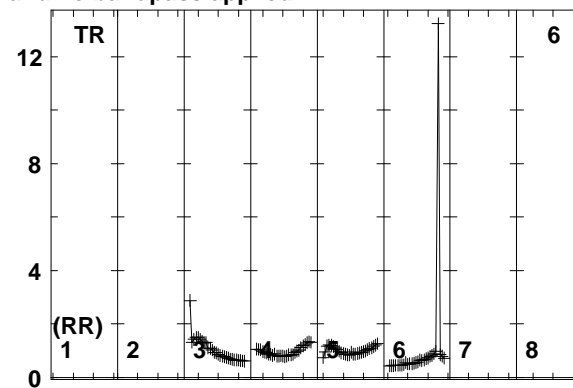
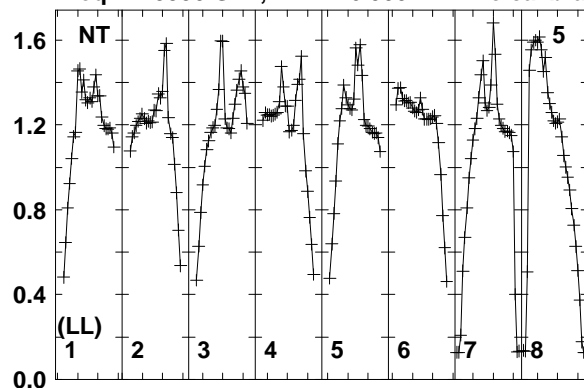

Lower frame: Real Jy
Total-power spectrum Antenna: NT (05)
Timerange: 00/07:58:53 to 00/08:02:29

Plot file version 258 created 11-AUG-2014 17:05:39

J2032+4127 EM110 2.UVDATA.1

Freq = 1.5950 GHz, Bw = 16.000 MH No calibration applied and no bandpass applied

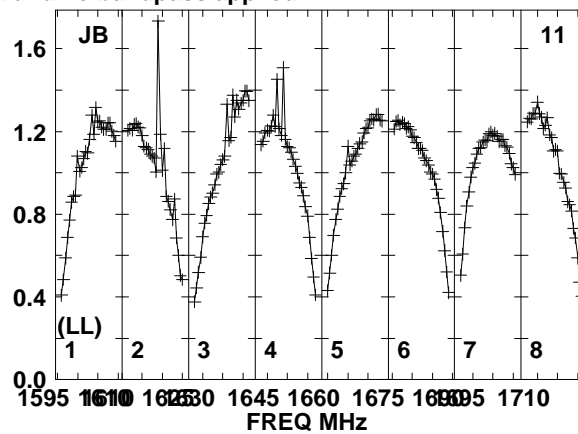
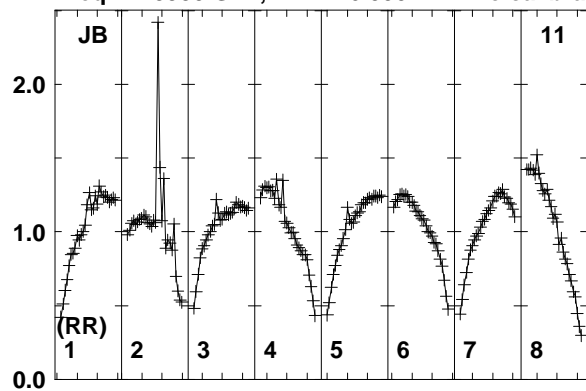

Lower frame: Real Jy
Total-power spectrum Antenna: JB (11)
Timerange: 00/07:58:53 to 00/08:02:29

Plot file version 259 created 11-AUG-2014 17:05:39

J2015+3710 EM110 2.UVDATA.1

Freq = 1.5950 GHz, Bw = 16.000 MH No calibration applied and no bandpass applied

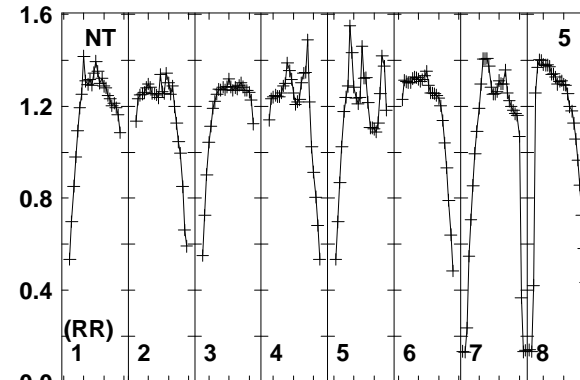
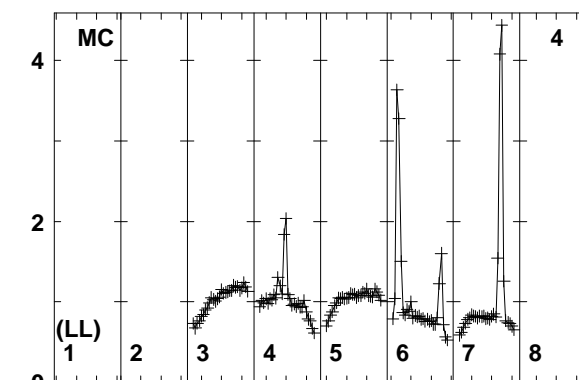
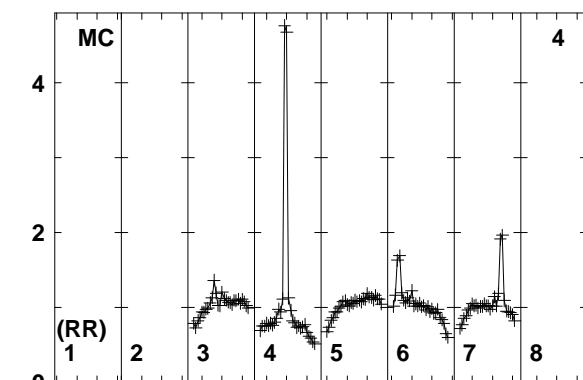
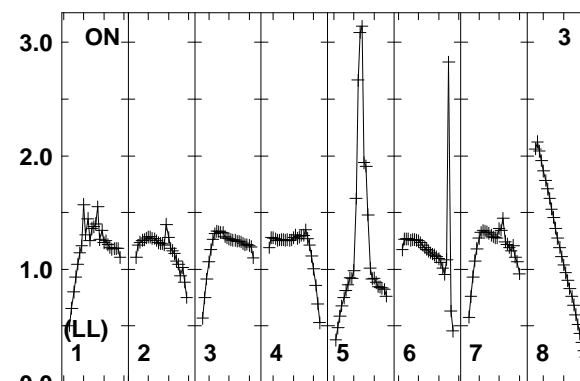
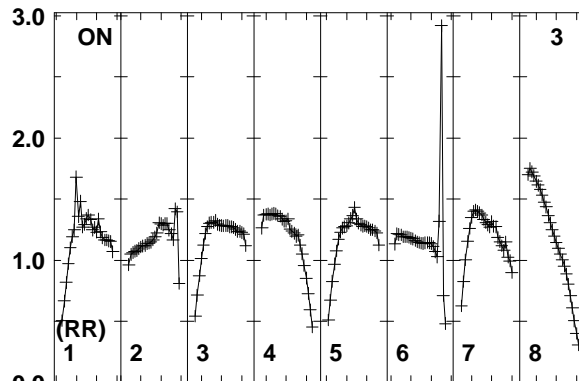
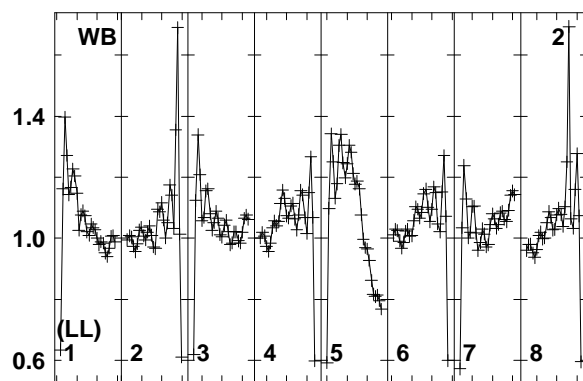
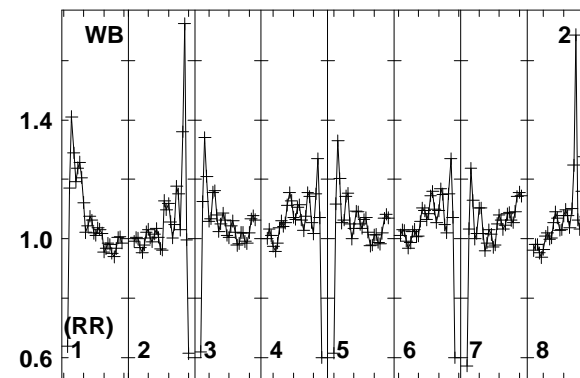
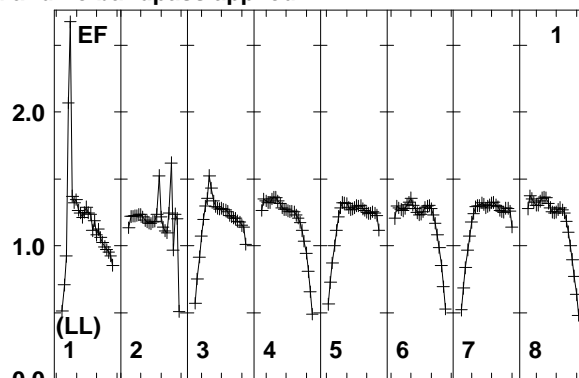
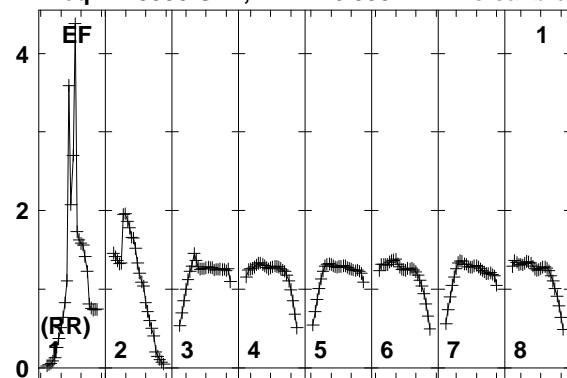

Lower frame: Real Jy
Total-power spectrum Antenna: EF (01)
Timerange: 00/08:02:33 to 00/08:04:29

Plot file version 260 created 11-AUG-2014 17:05:39

J2015+3710 EM110 2.UVDATA.1

Freq = 1.5950 GHz, Bw = 16.000 MH No calibration applied and no bandpass applied

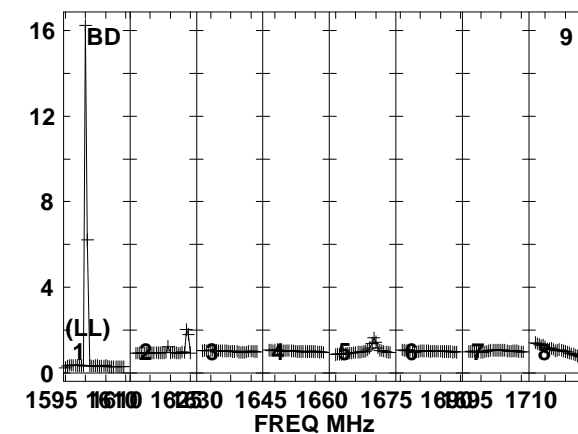
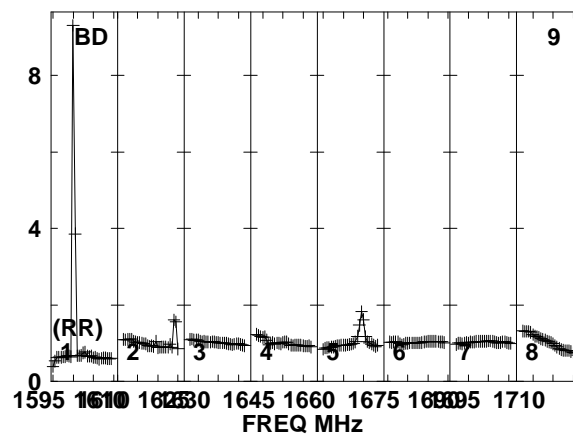
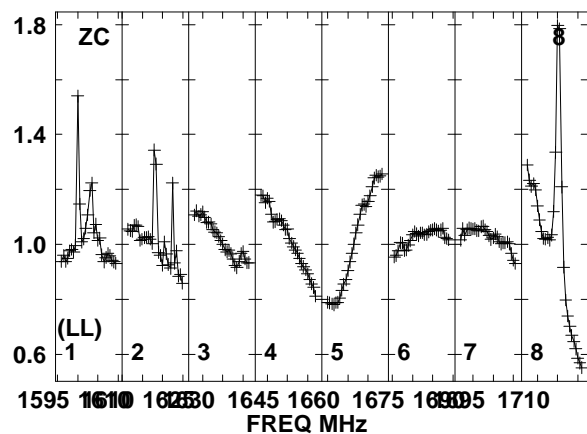
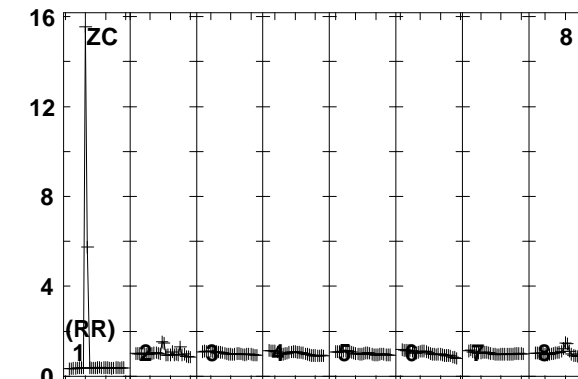
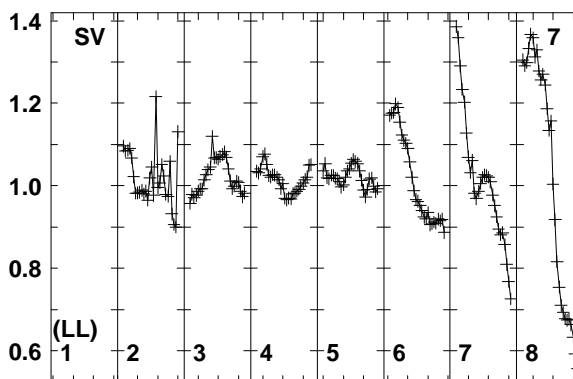
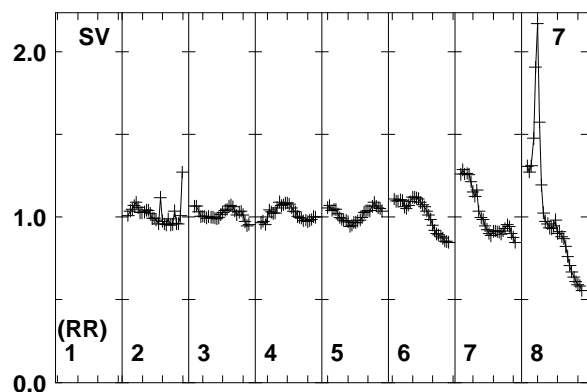
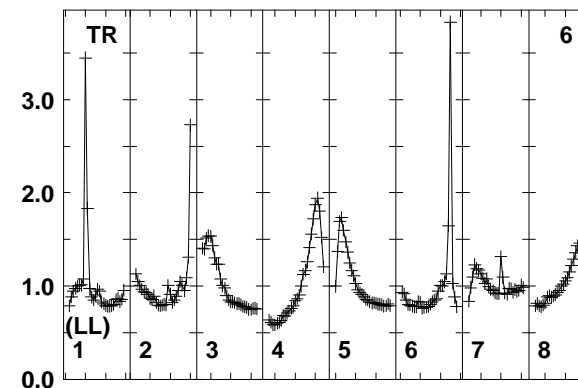
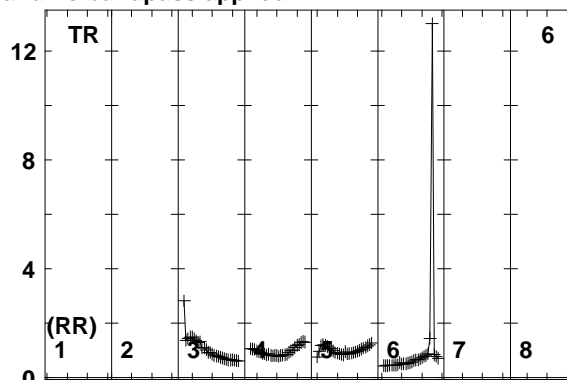
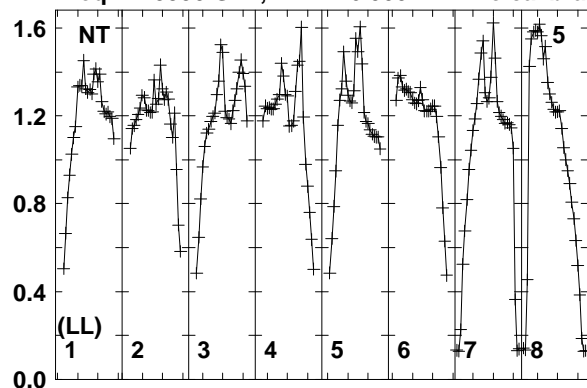

Lower frame: Real Jy
Total-power spectrum Antenna: NT (05)
Timerange: 00/08:02:33 to 00/08:04:29

Plot file version 261 created 11-AUG-2014 17:05:39

J2015+3710 EM110 2.UVDATA.1

Freq = 1.5950 GHz, Bw = 16.000 MH No calibration applied and no bandpass applied

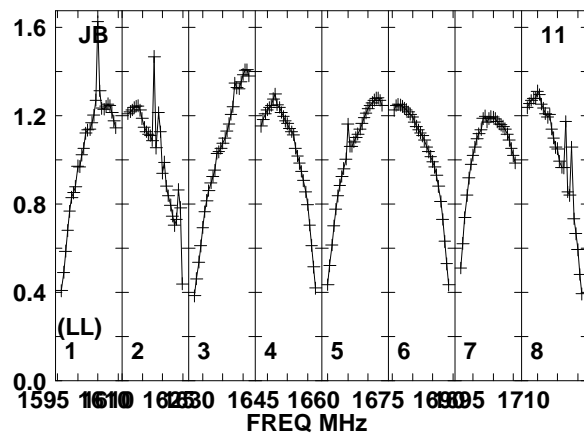
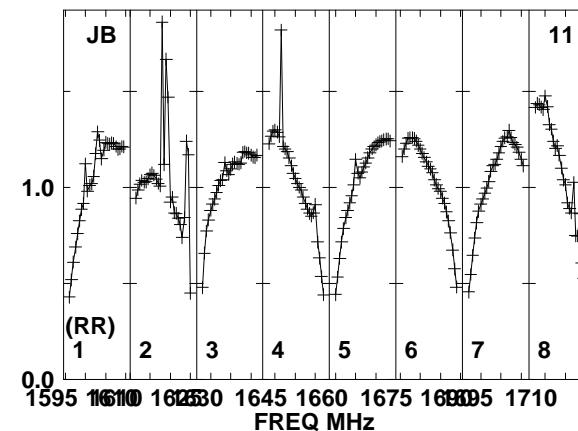
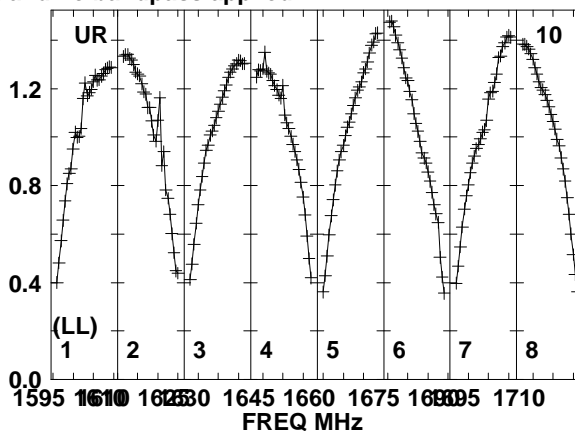
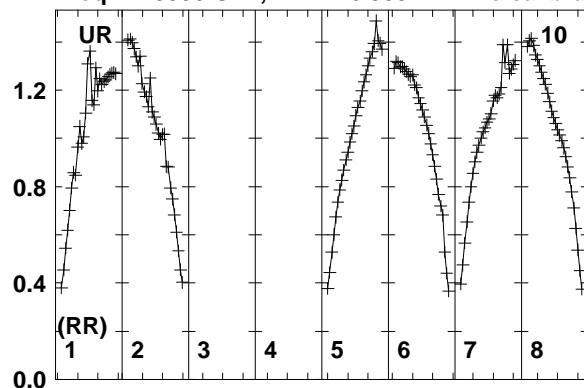

Lower frame: Real Jy
Total-power spectrum Antenna: UR (10)
Timerange: 00/08:02:33 to 00/08:04:29

Plot file version 262 created 11-AUG-2014 17:05:39

J2007+4029 EM110 2.UVDATA.1

Freq = 1.5950 GHz, Bw = 16.000 MH No calibration applied and no bandpass applied

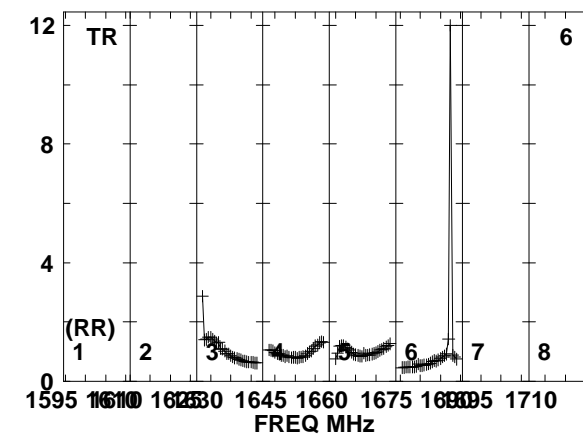
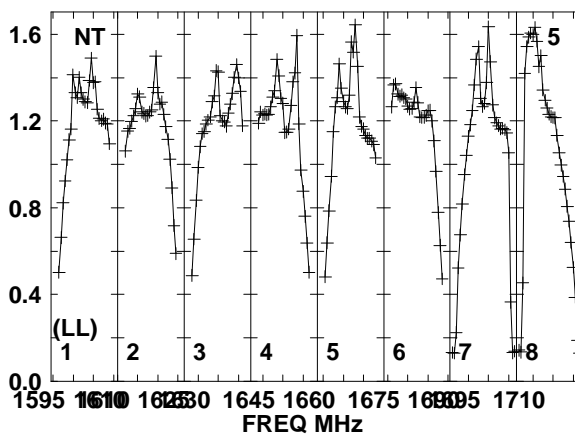
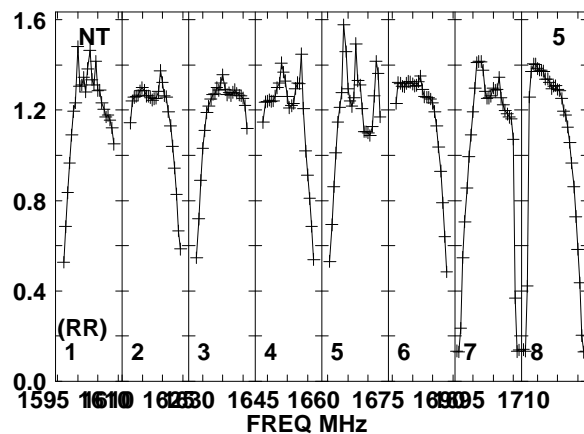
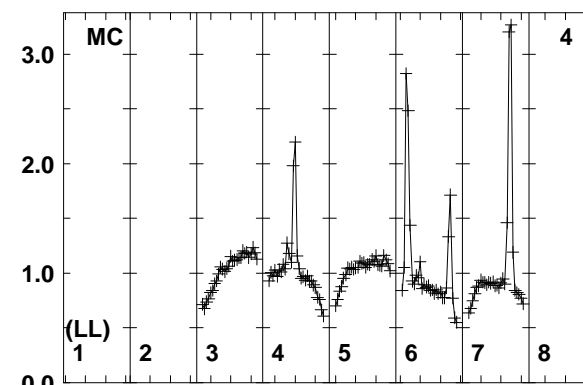
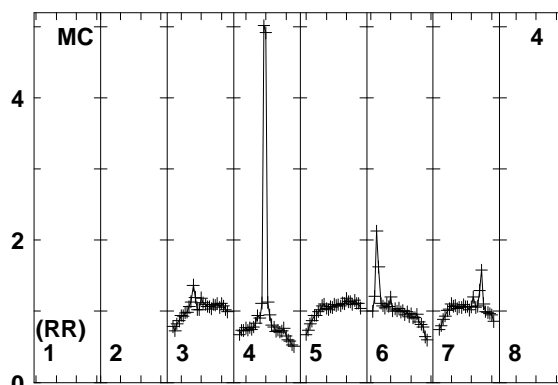
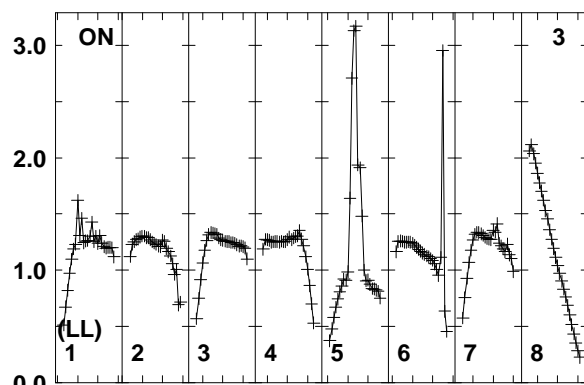
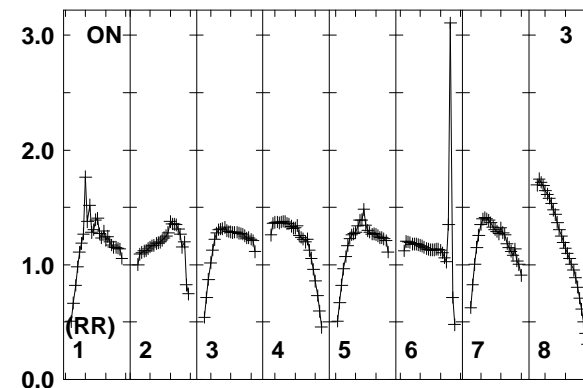
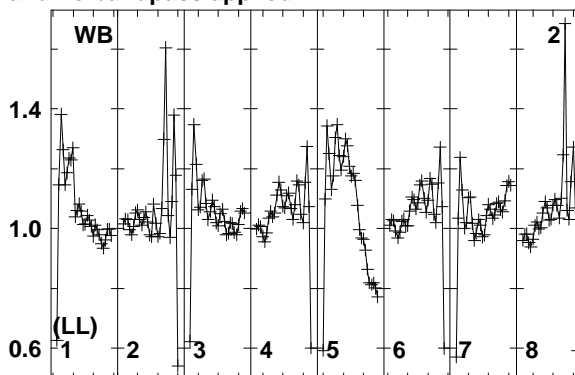
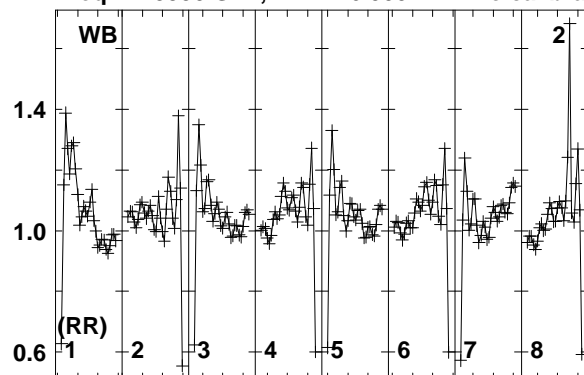

Lower frame: Real Jy
Total-power spectrum Antenna: WB (02)
Timerange: 00/08:04:40 to 00/08:05:28

Plot file version 263 created 11-AUG-2014 17:05:39

J2007+4029 EM110 2.UVDATA.1

Freq = 1.5950 GHz, Bw = 16.000 MH No calibration applied and no bandpass applied

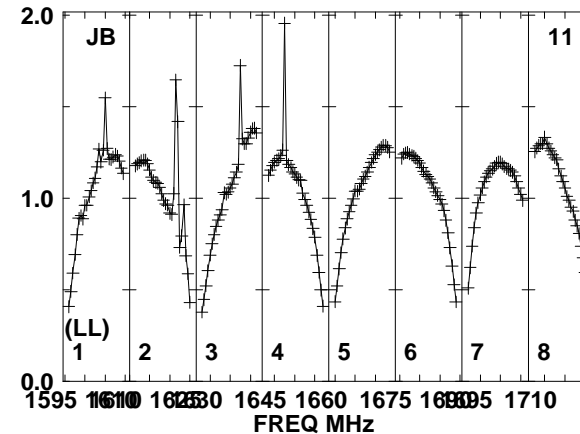
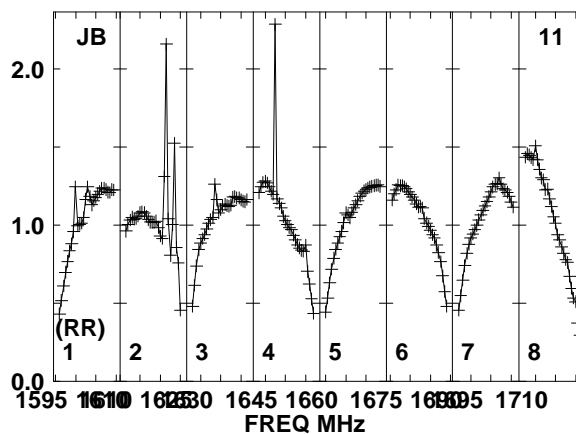
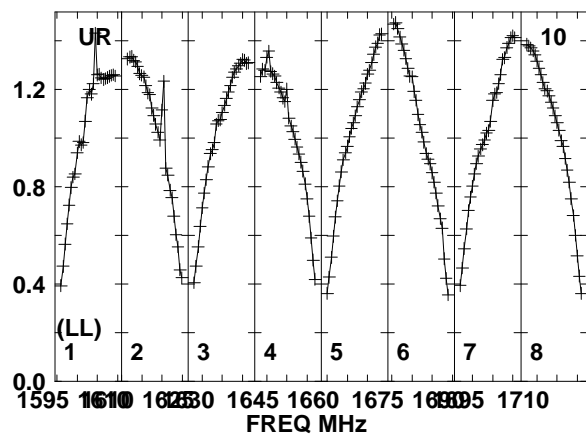
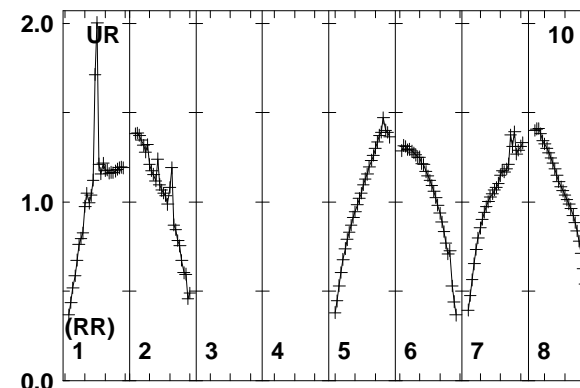
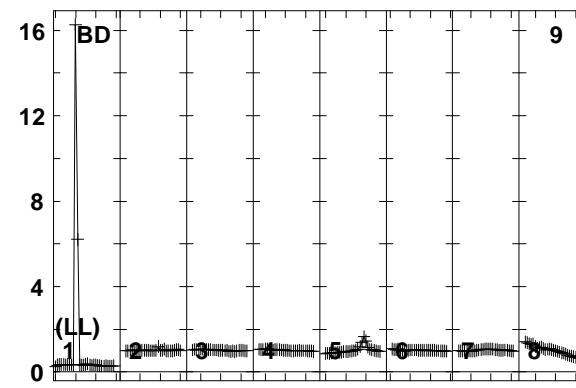
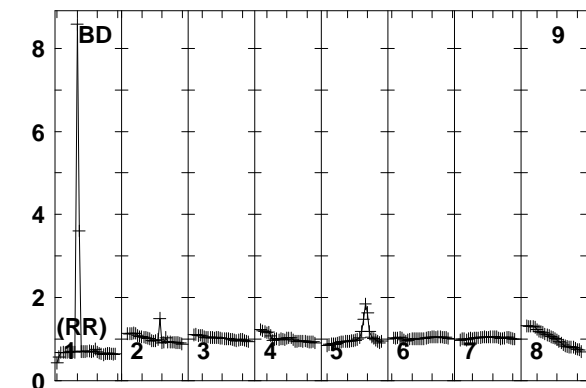
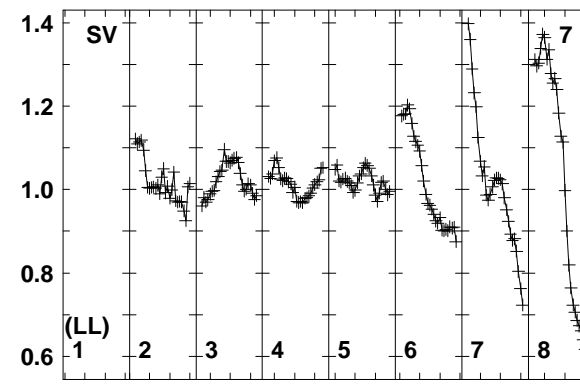
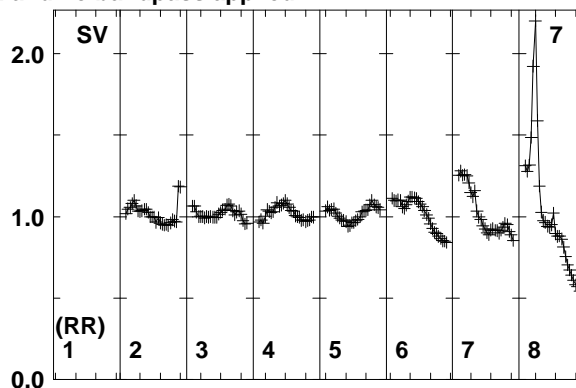
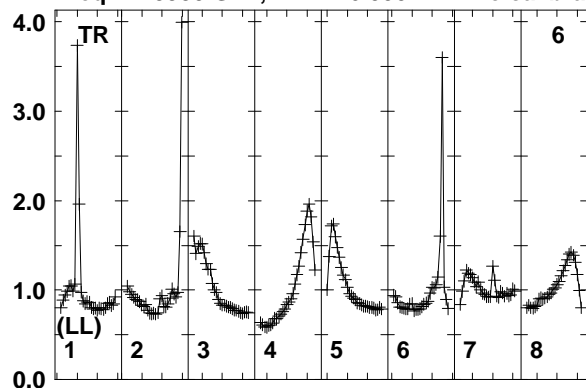

Lower frame: Real Jy
Total-power spectrum Antenna: TR (06)
Timerange: 00/08:04:40 to 00/08:05:28

Plot file version 264 created 11-AUG-2014 17:05:39

J2015+3710 EM110 2.UVDATA.1

Freq = 1.5950 GHz, Bw = 16.000 MH No calibration applied and no bandpass applied

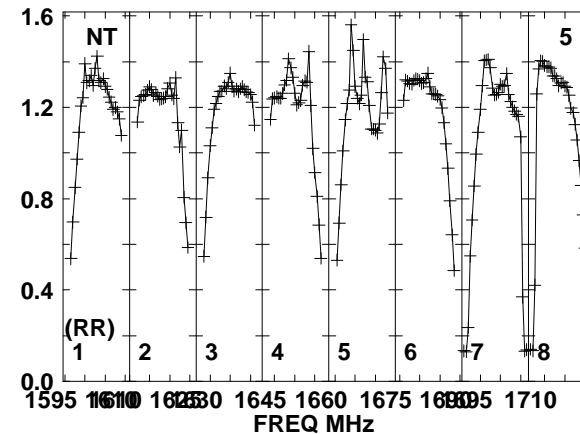
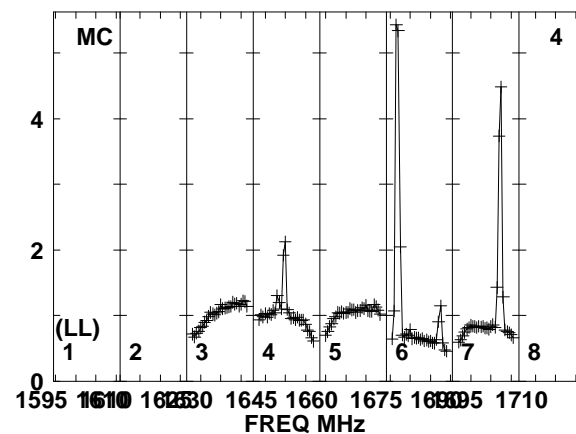
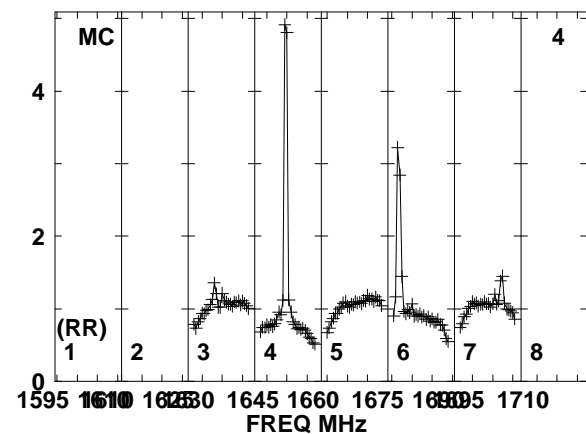
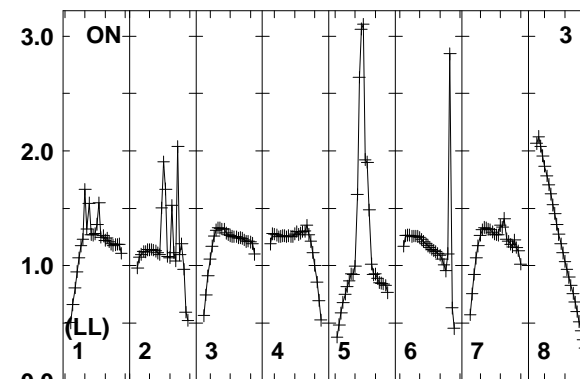
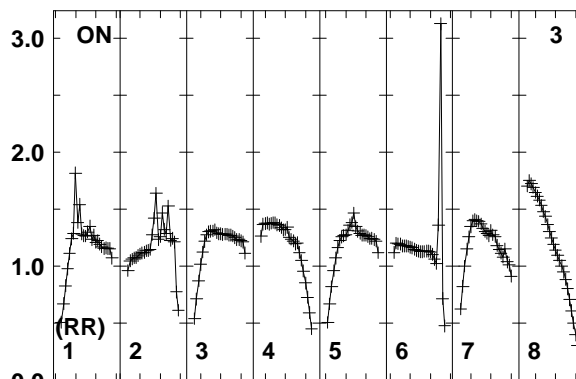
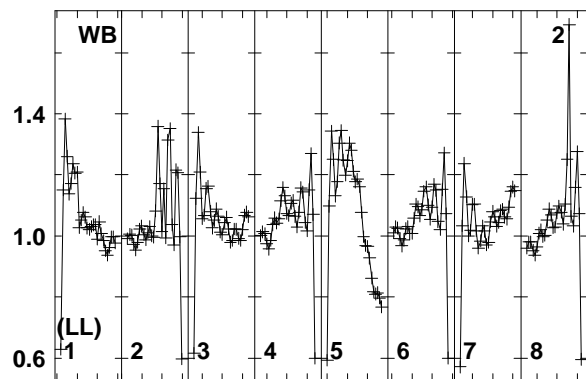
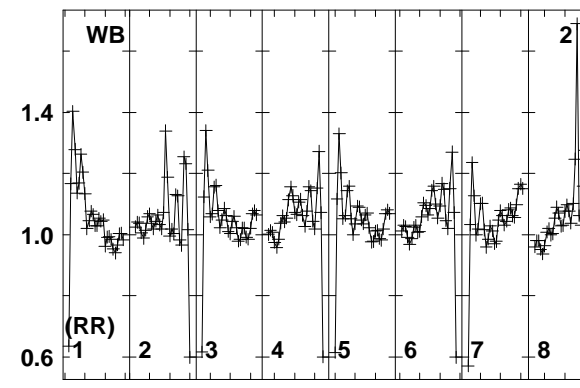
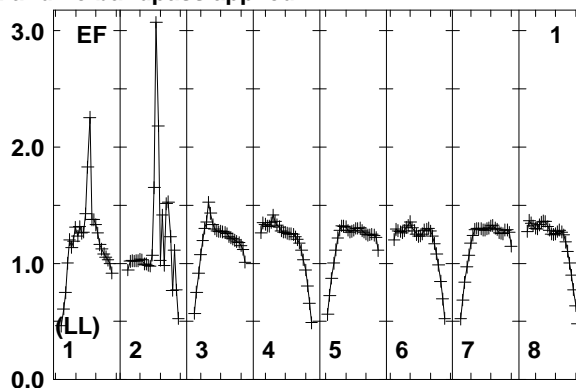
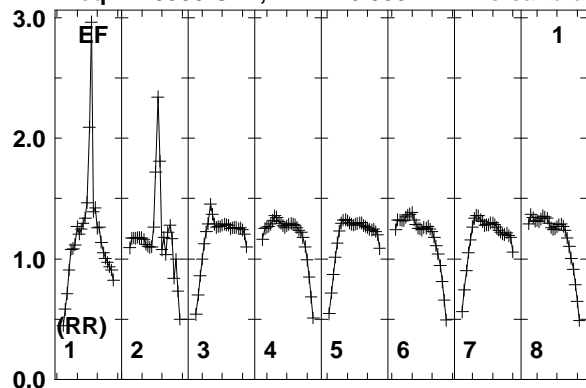

1595 1610 1625 1640 1655 1670 1685 1700 1715
FREQ MHz

1595 1610 1625 1640 1655 1670 1685 1700 1715
FREQ MHz

1595 1610 1625 1640 1655 1670 1685 1700 1715
FREQ MHz

Lower frame: Real Jy
Total-power spectrum Antenna: EF (01)
Timerange: 00/08:06:31 to 00/08:08:29

Plot file version 265 created 11-AUG-2014 17:05:39

J2015+3710 EM110 2.UVDATA.1

Freq = 1.5950 GHz, Bw = 16.000 MH No calibration applied and no bandpass applied

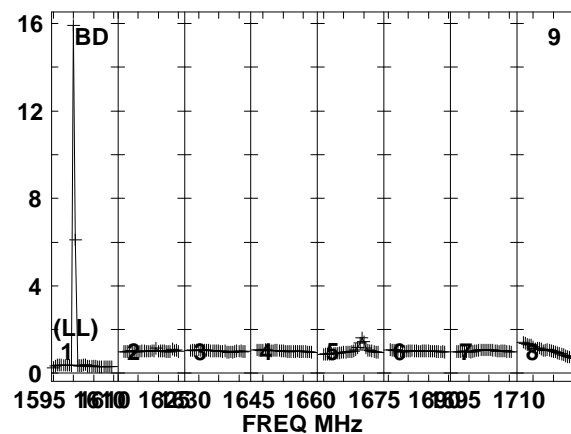
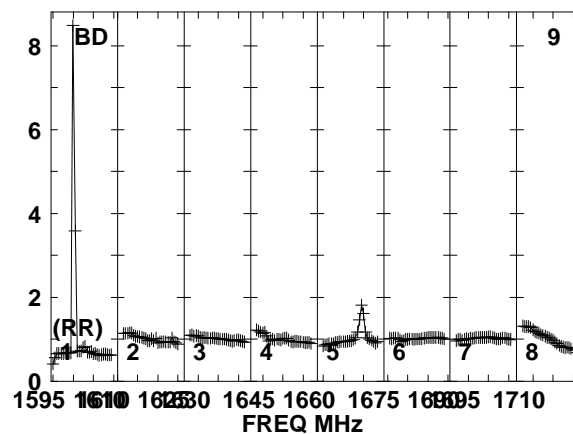
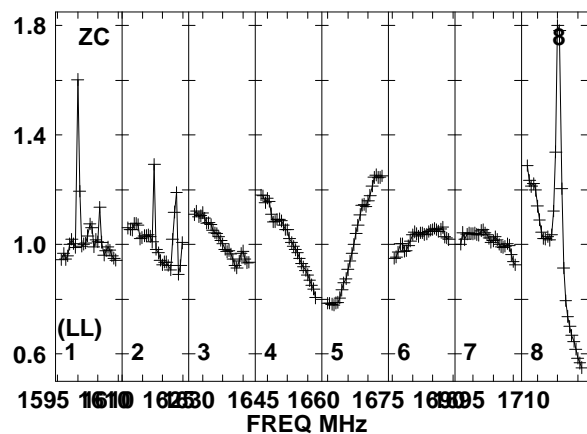
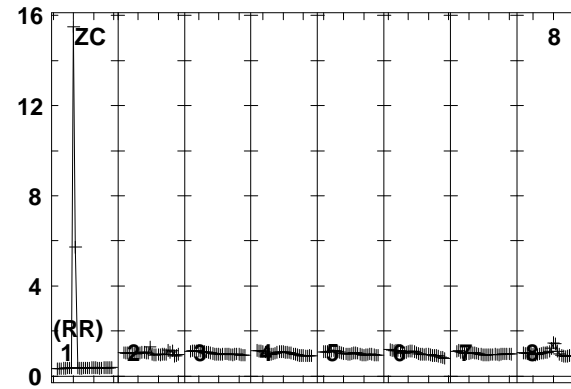
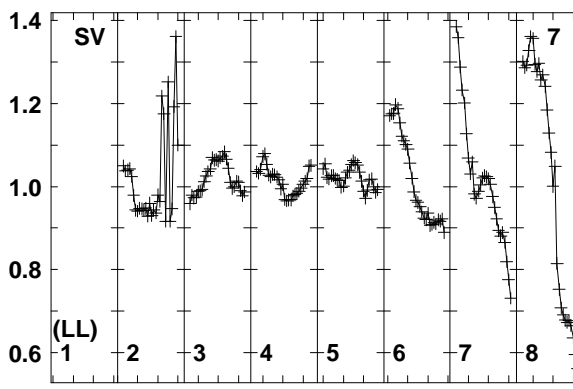
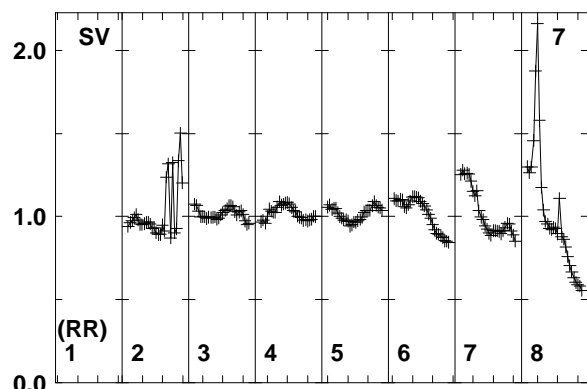
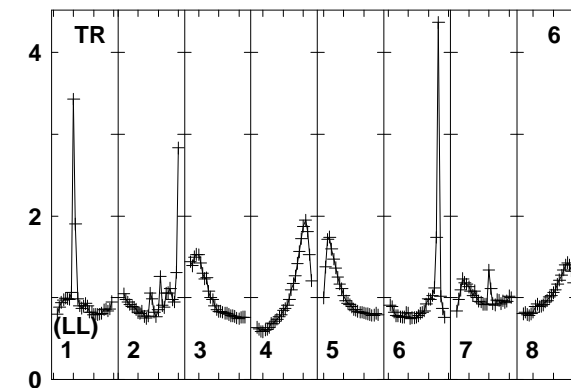
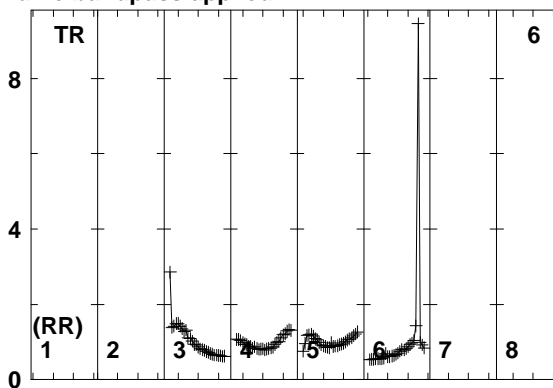
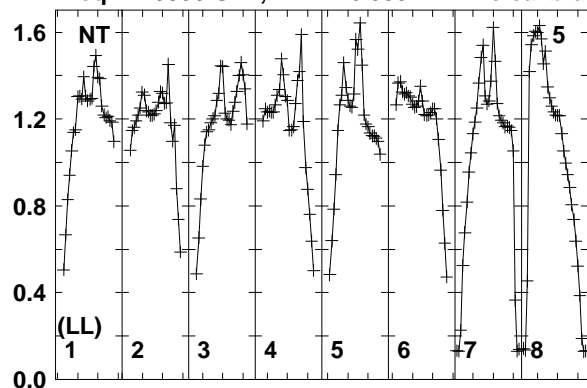

Lower frame: Real Jy
Total-power spectrum Antenna: NT (05)
Timerange: 00/08:06:31 to 00/08:08:29

Plot file version 266 created 11-AUG-2014 17:05:39

J2015+3710 EM110 2.UVDATA.1

Freq = 1.5950 GHz, Bw = 16.000 MH No calibration applied and no bandpass applied

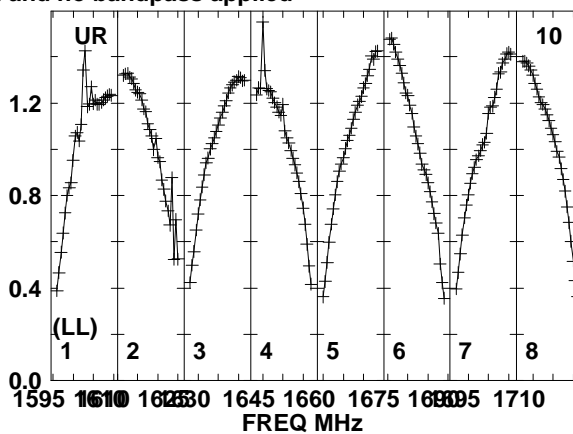
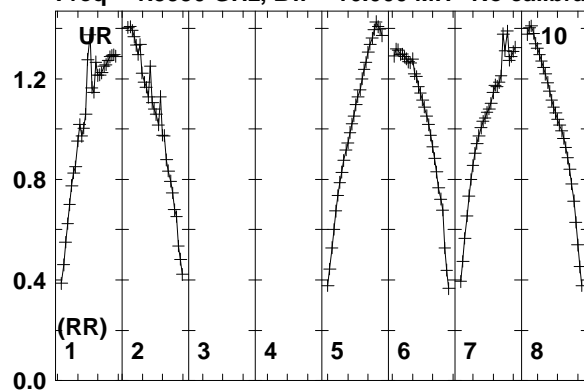

Lower frame: Real Jy
Total-power spectrum Antenna: UR (10)
Timerange: 00/08:06:31 to 00/08:08:29

Plot file version 267 created 11-AUG-2014 17:05:39

J2032+4127 EM110 2.UVDATA.1

Freq = 1.5950 GHz, Bw = 16.000 MH No calibration applied and no bandpass applied

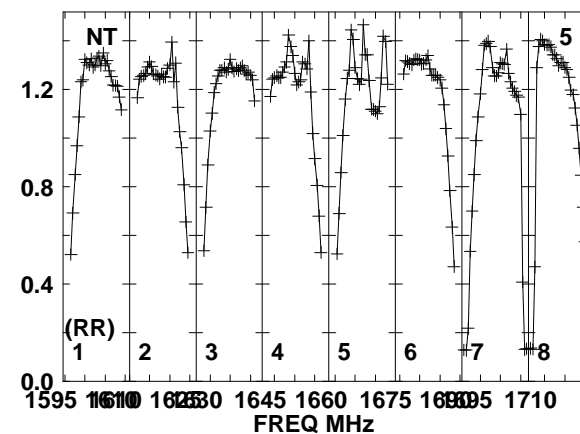
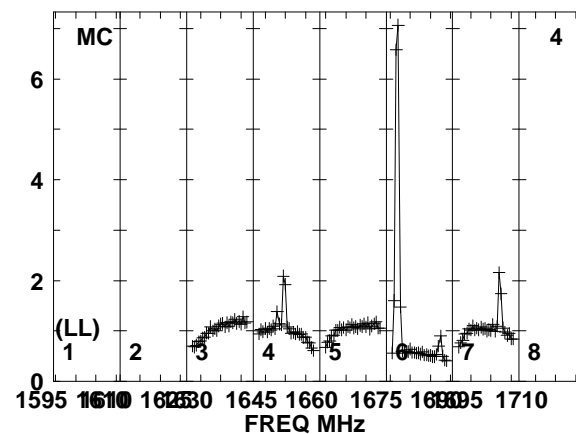
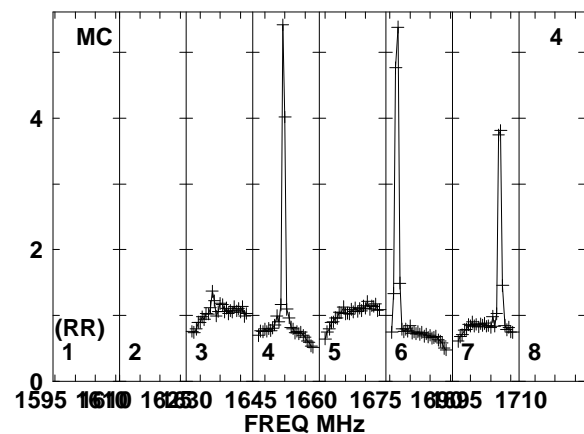
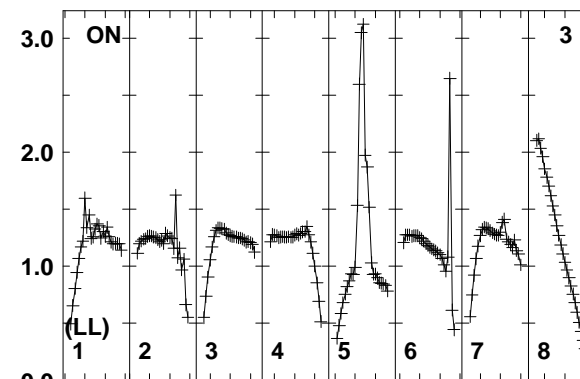
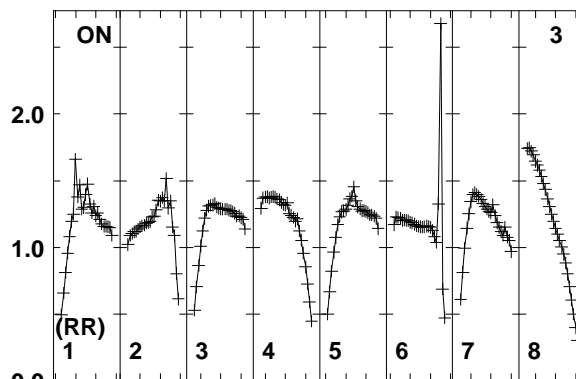
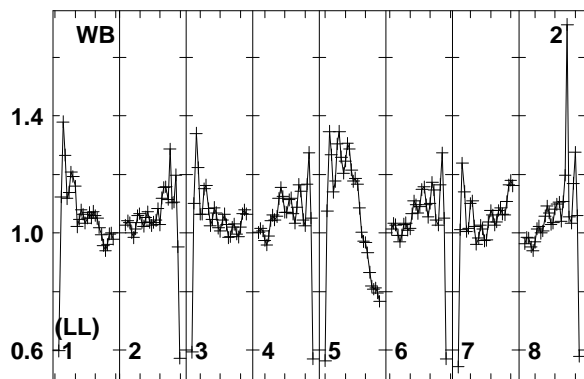
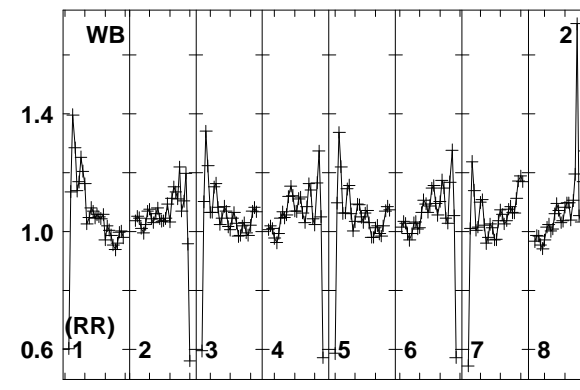
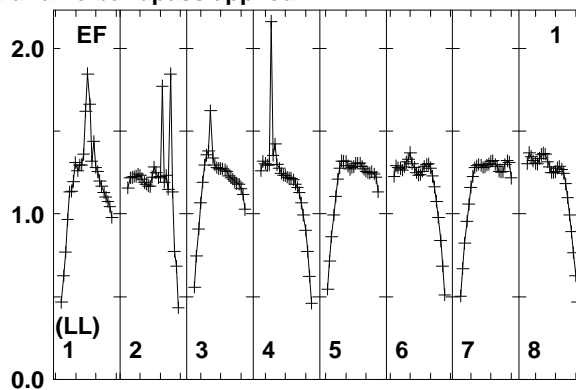
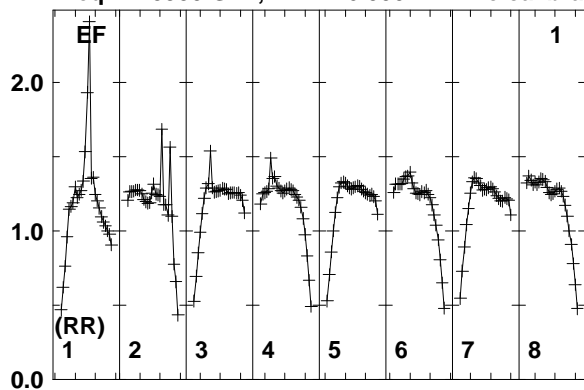

Lower frame: Real Jy
Total-power spectrum Antenna: EF (01)
Timerange: 00/08:08:31 to 00/08:12:29

Plot file version 268 created 11-AUG-2014 17:05:39

J2032+4127 EM110 2.UVDATA.1

Freq = 1.5950 GHz, Bw = 16.000 MH No calibration applied and no bandpass applied

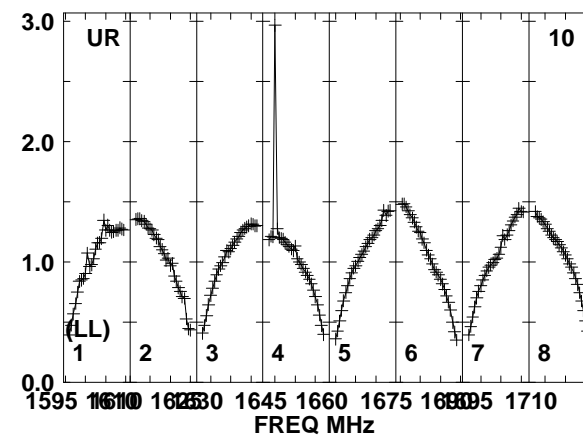
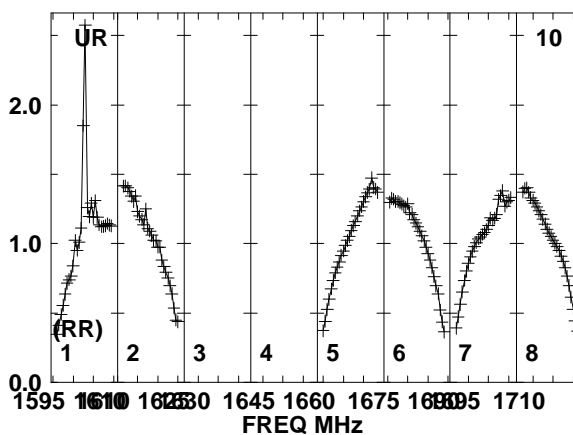
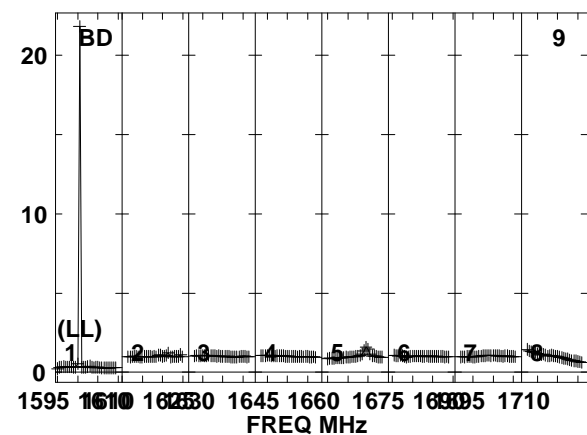
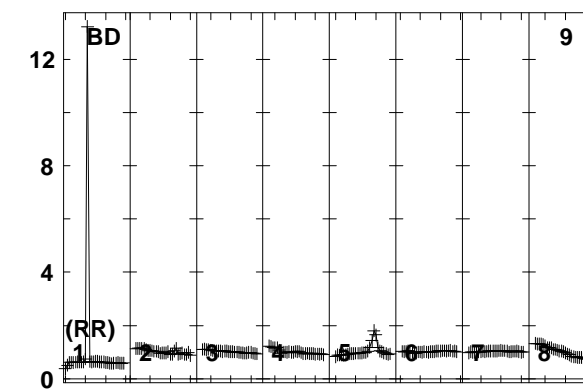
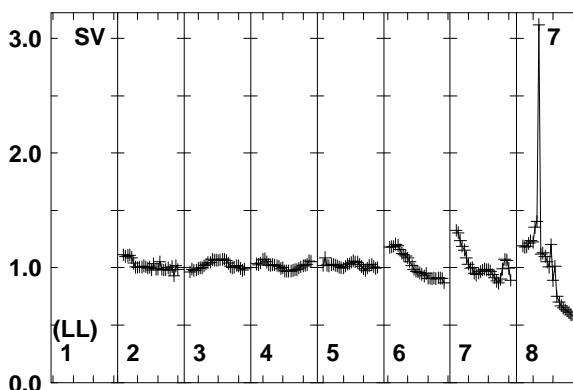
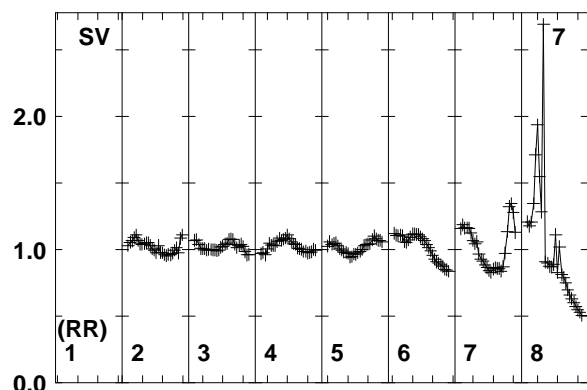
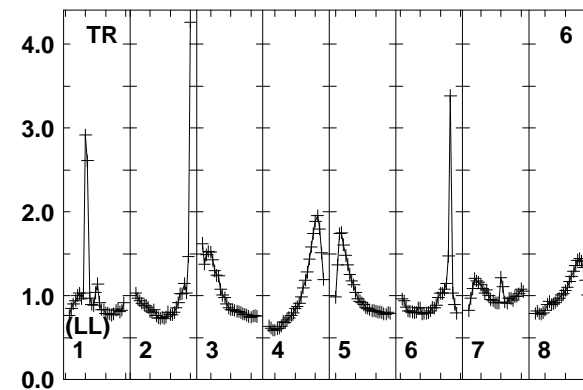
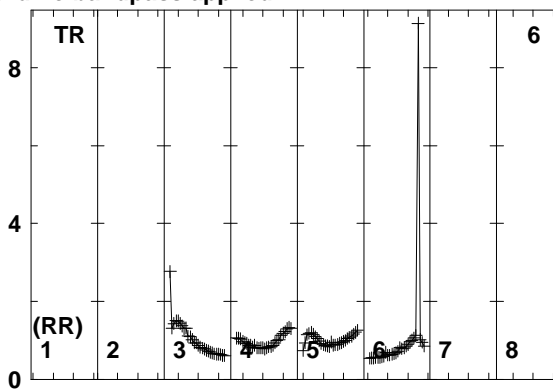
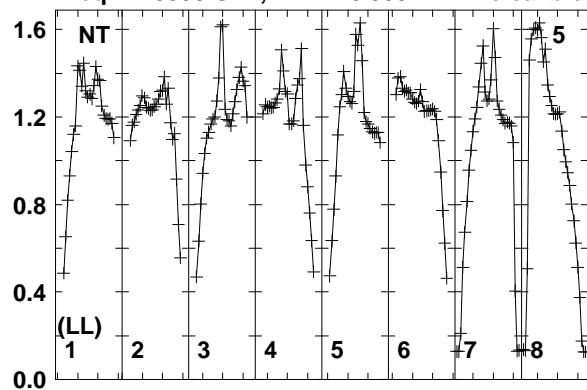

Lower frame: Real Jy
Total-power spectrum Antenna: NT (05)
Timerange: 00/08:08:31 to 00/08:12:29

Plot file version 269 created 11-AUG-2014 17:05:39

J2032+4127 EM110 2.UVDATA.1

Freq = 1.5950 GHz, Bw = 16.000 MH No calibration applied and no bandpass applied

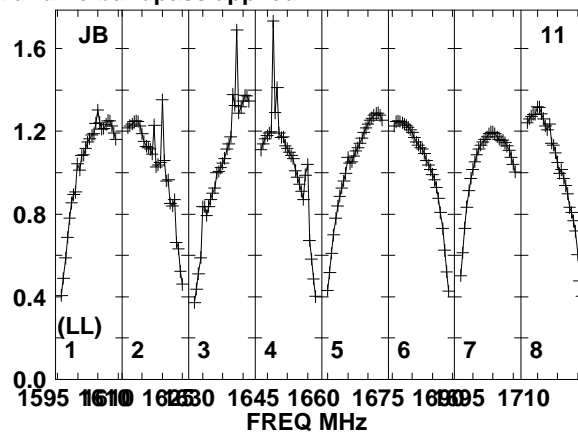
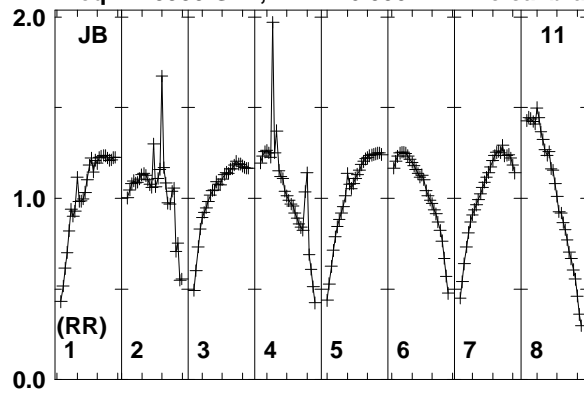

Lower frame: Real Jy
Total-power spectrum Antenna: JB (11)
Timerange: 00/08:08:31 to 00/08:12:29

Plot file version 270 created 11-AUG-2014 17:05:39

J2015+3710 EM110 2.UVDATA.1

Freq = 1.5950 GHz, Bw = 16.000 MH No calibration applied and no bandpass applied

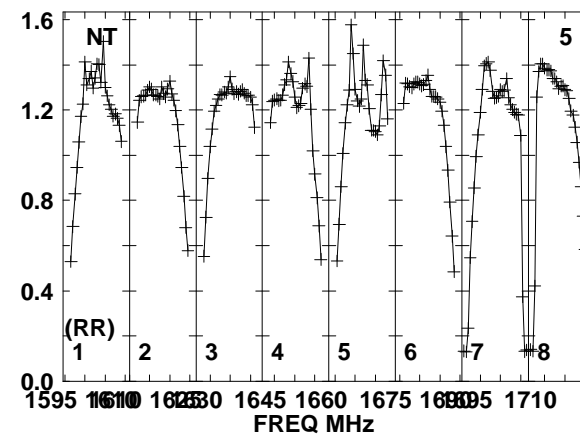
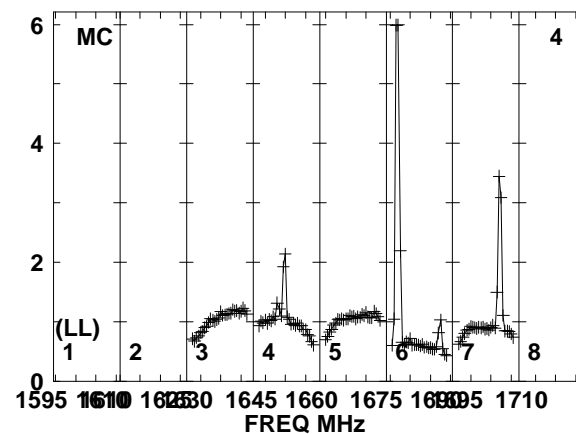
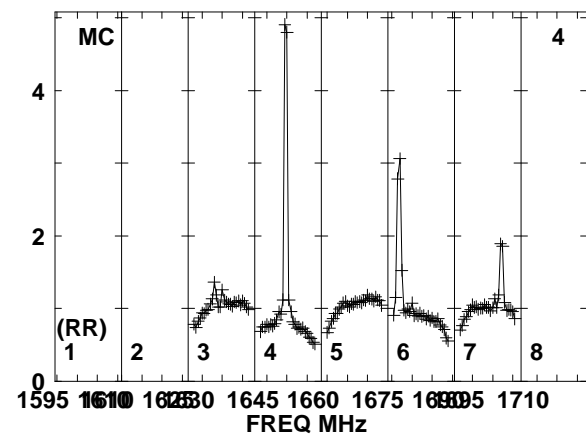
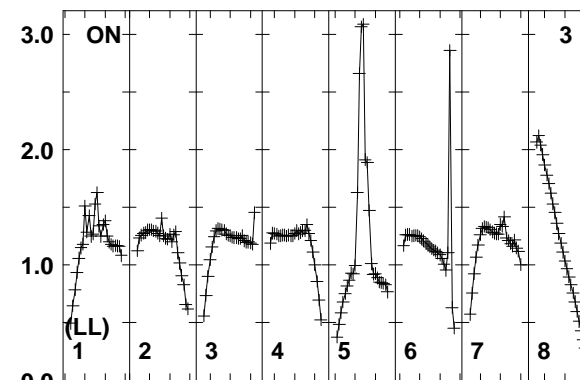
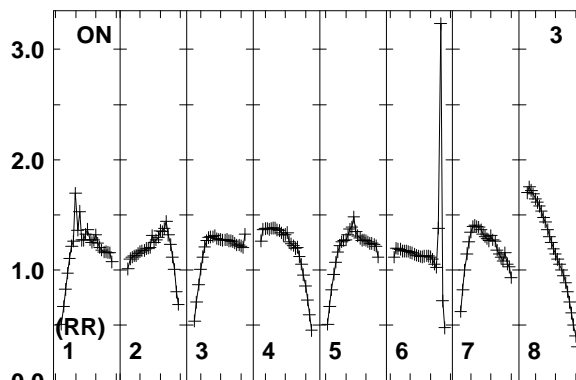
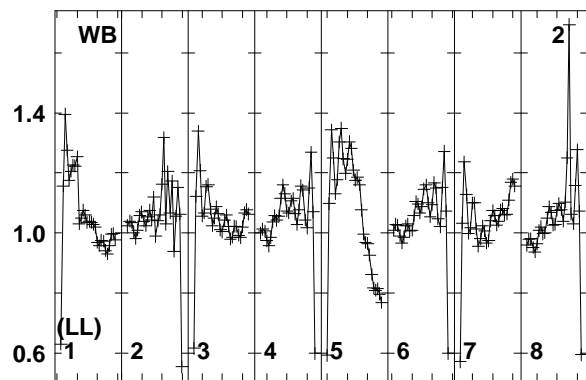
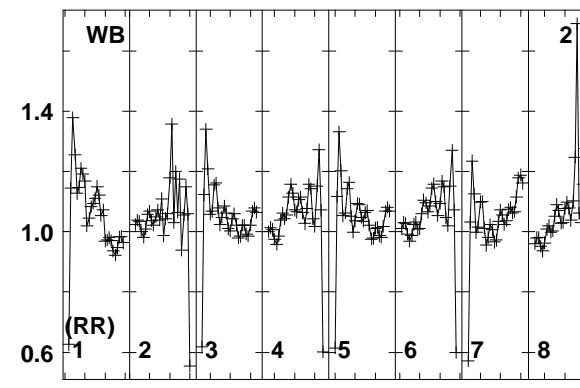
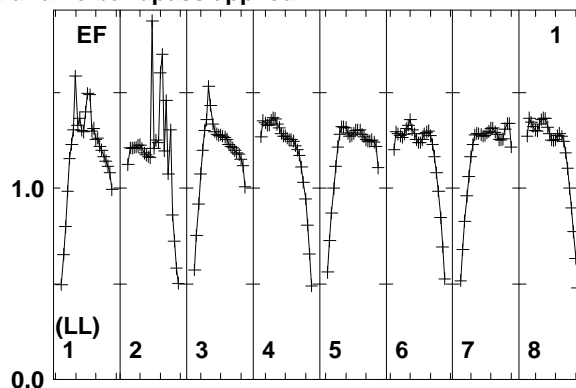
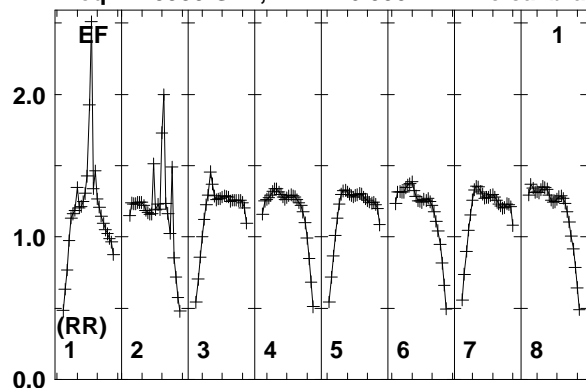

Lower frame: Real Jy
Total-power spectrum Antenna: EF (01)
Timerange: 00/08:12:33 to 00/08:14:29

Plot file version 271 created 11-AUG-2014 17:05:39

J2015+3710 EM110 2.UVDATA.1

Freq = 1.5950 GHz, Bw = 16.000 MH No calibration applied and no bandpass applied

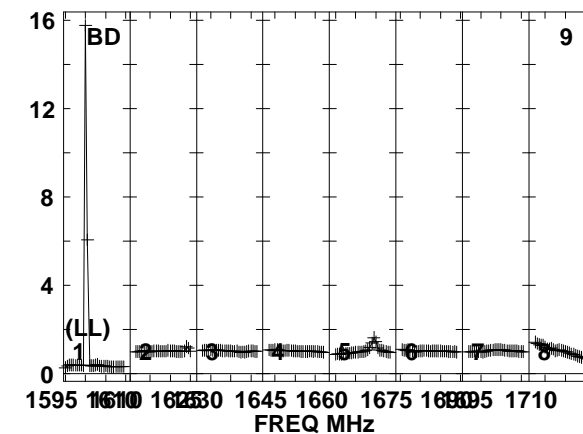
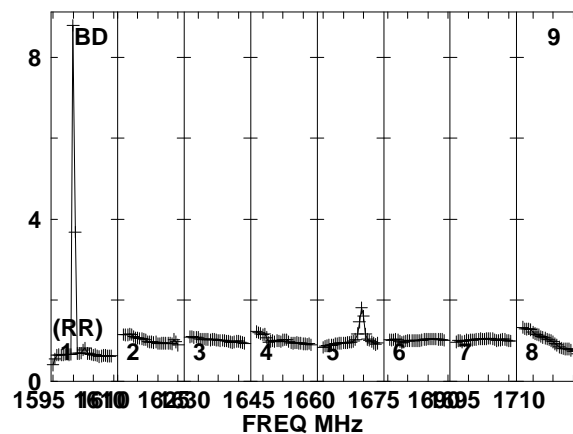
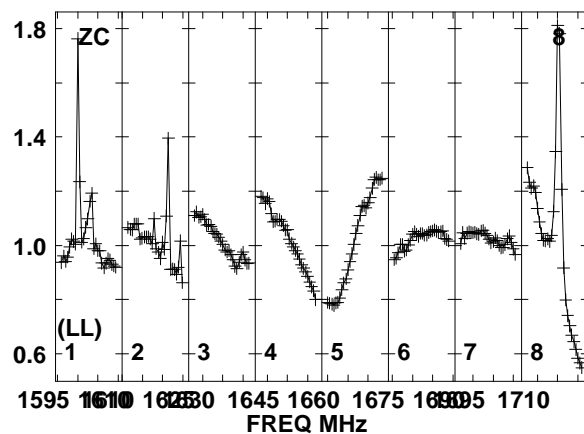
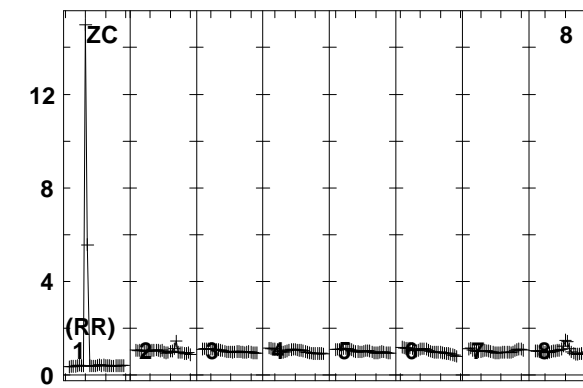
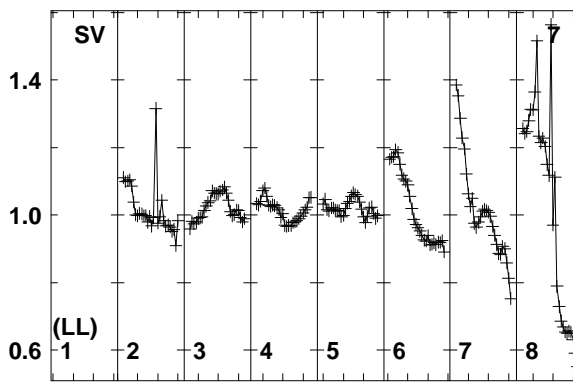
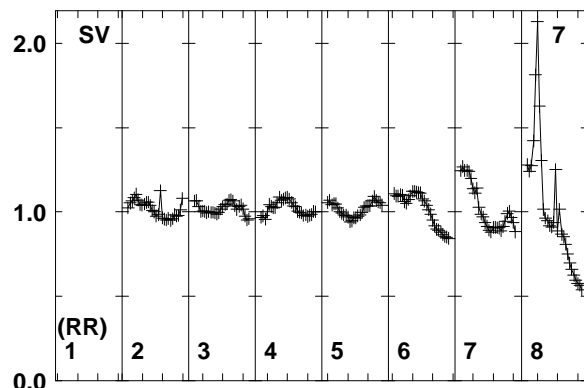
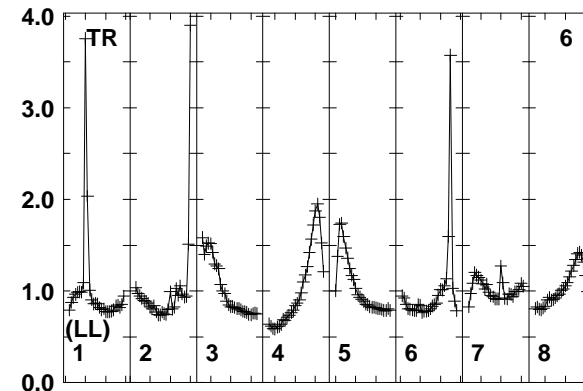
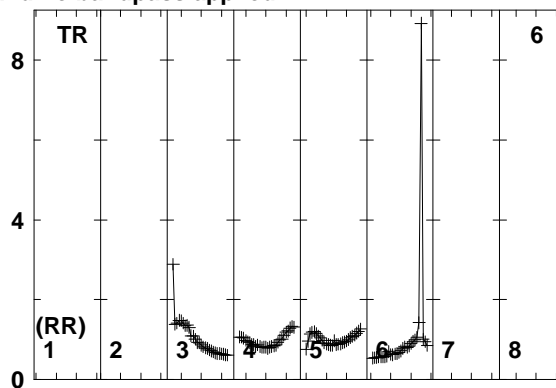
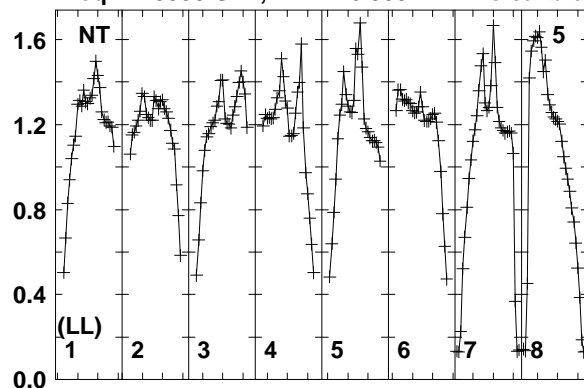

Lower frame: Real Jy
Total-power spectrum Antenna: NT (05)
Timerange: 00/08:12:33 to 00/08:14:29

Plot file version 272 created 11-AUG-2014 17:05:39

J2015+3710 EM110 2.UVDATA.1

Freq = 1.5950 GHz, Bw = 16.000 MH No calibration applied and no bandpass applied

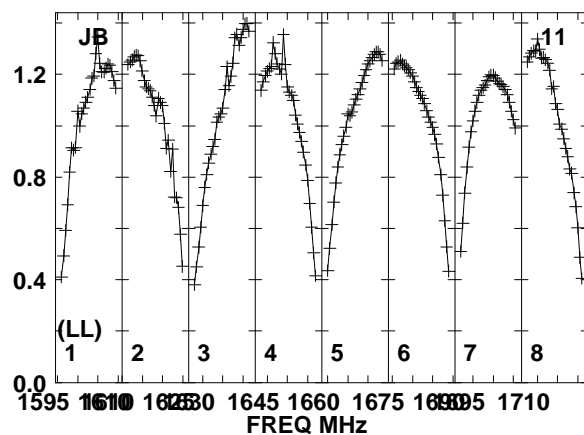
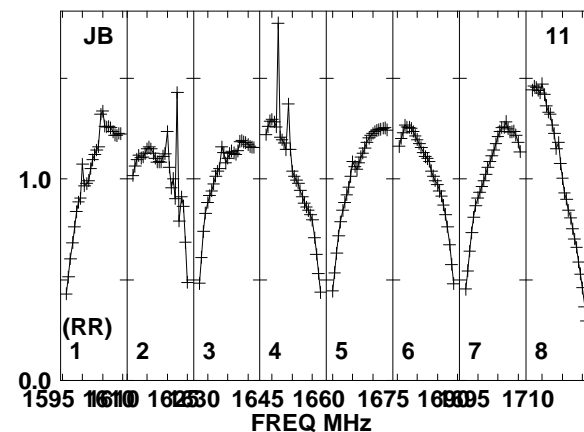
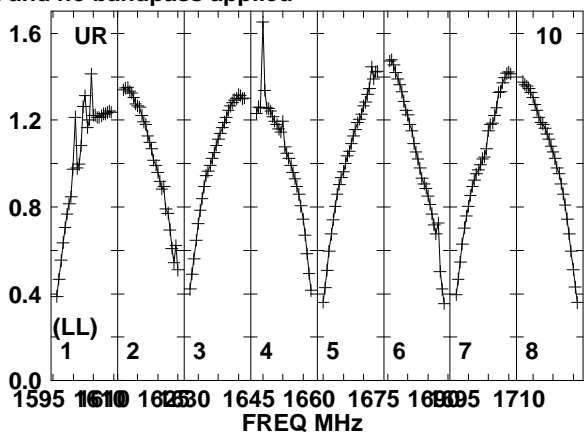
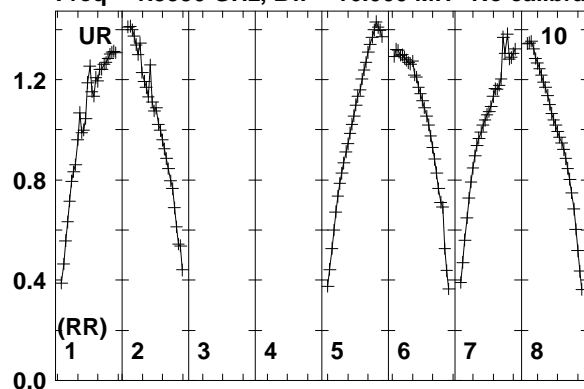

Lower frame: Real Jy
Total-power spectrum Antenna: UR (10)
Timerange: 00/08:12:33 to 00/08:14:29

Plot file version 273 created 11-AUG-2014 17:05:39

J2032+4127 EM110 2.UVDATA.1

Freq = 1.5950 GHz, Bw = 16.000 MH No calibration applied and no bandpass applied

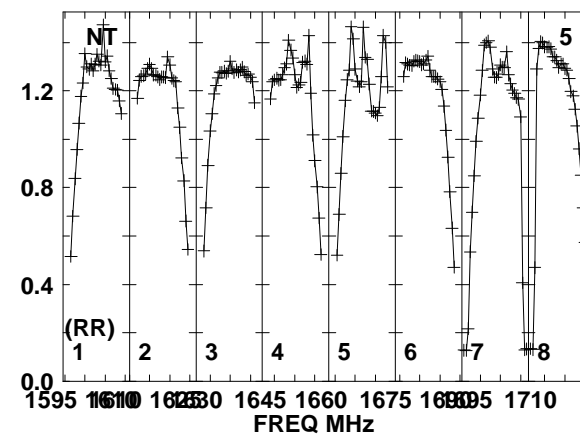
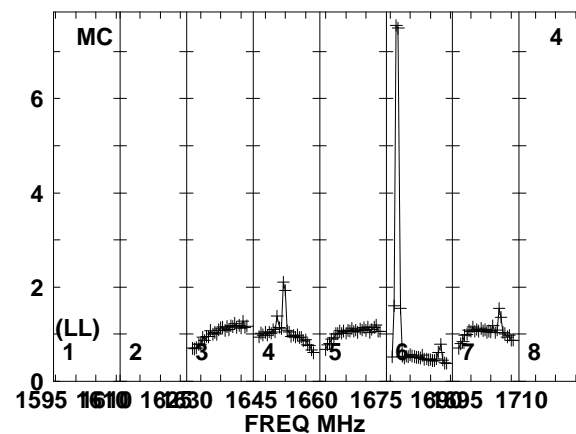
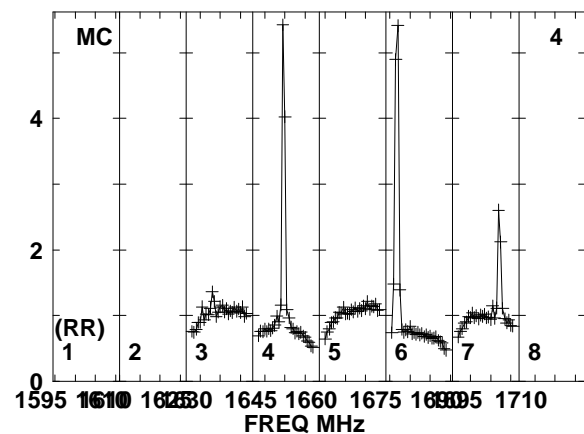
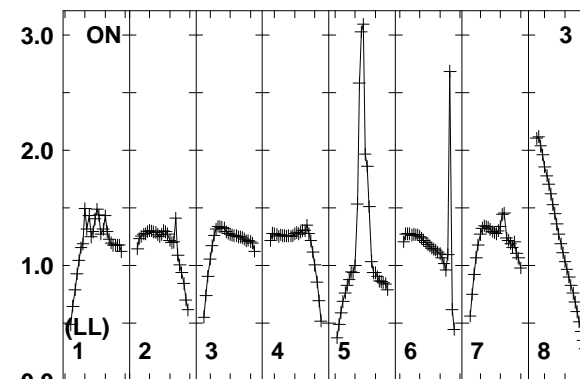
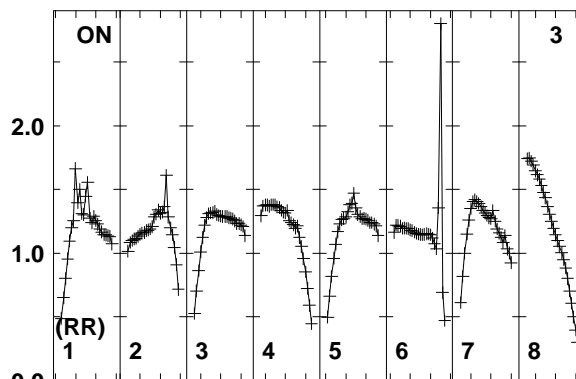
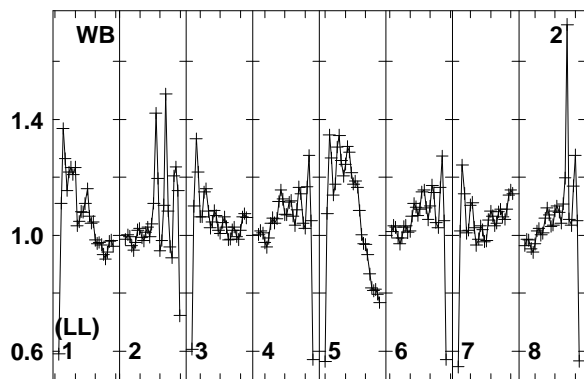
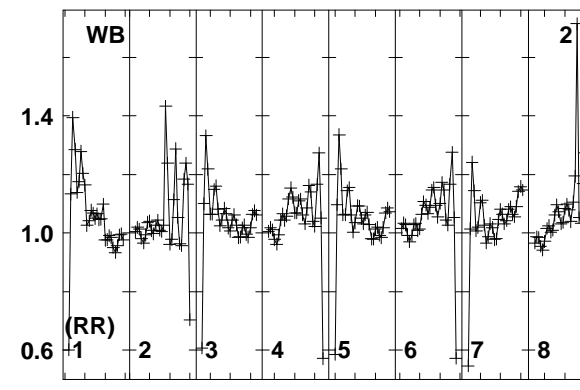
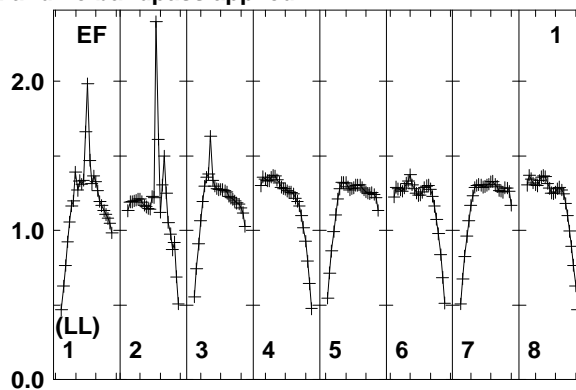
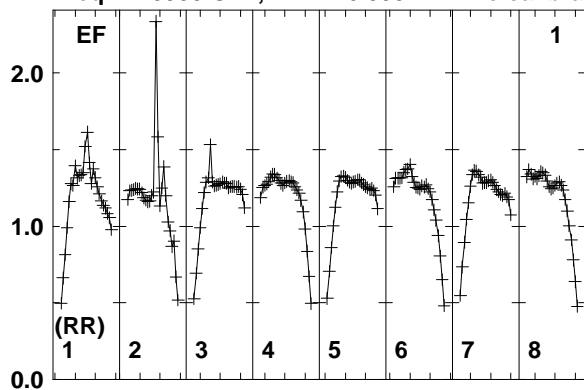

Lower frame: Real Jy
Total-power spectrum Antenna: EF (01)
Timerange: 00/08:14:43 to 00/08:18:29

Plot file version 274 created 11-AUG-2014 17:05:40

J2032+4127 EM110 2.UVDATA.1

Freq = 1.5950 GHz, Bw = 16.000 MH No calibration applied and no bandpass applied

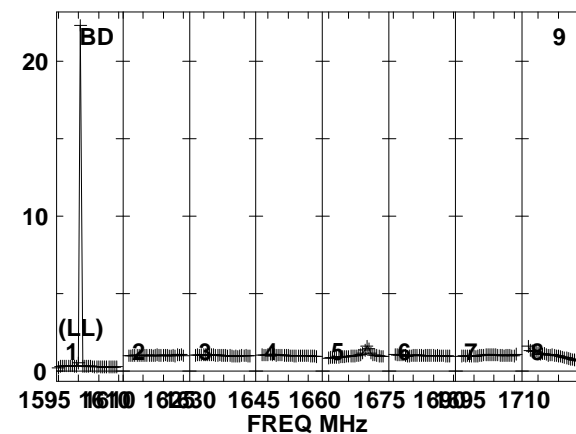
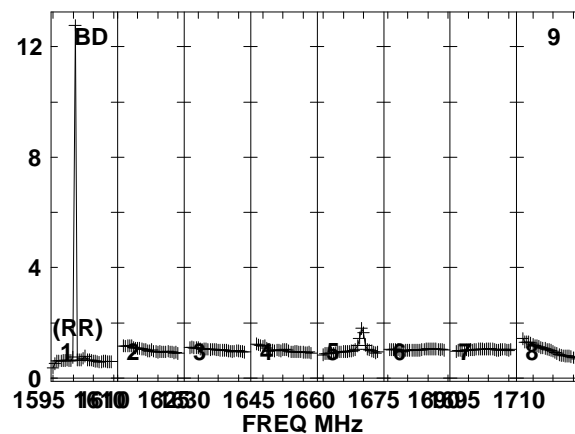
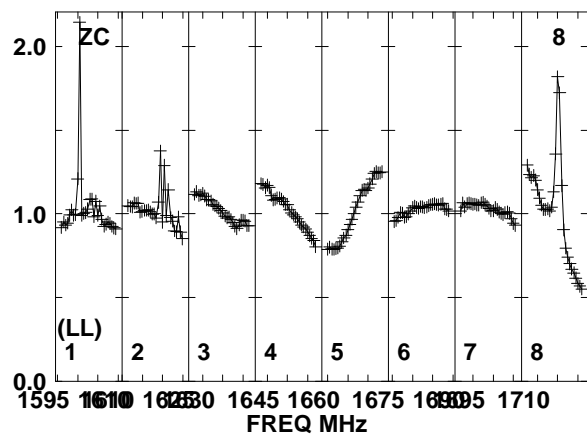
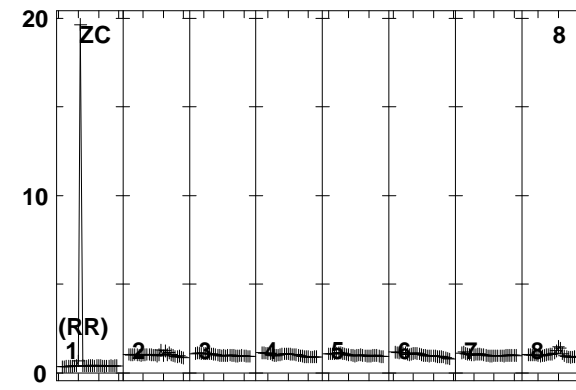
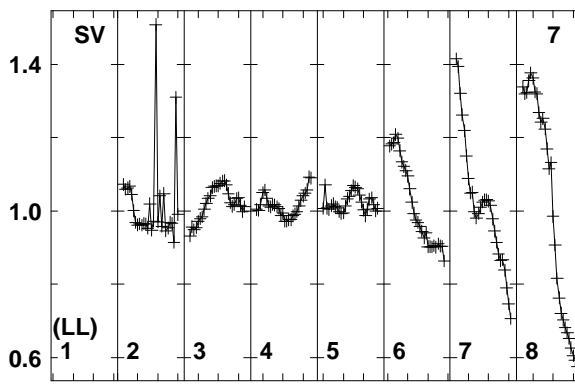
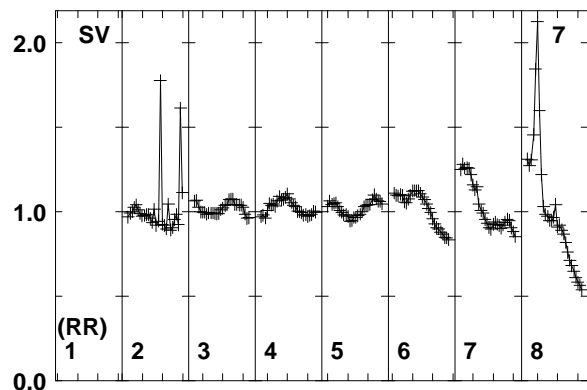
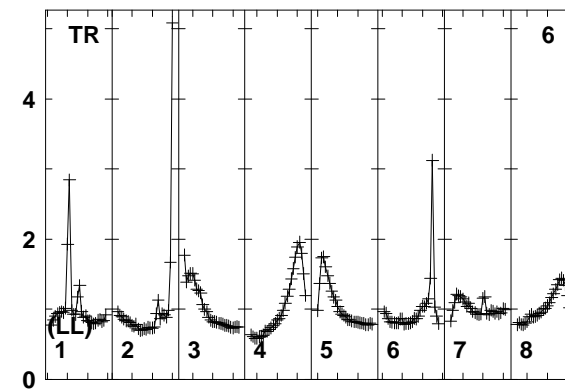
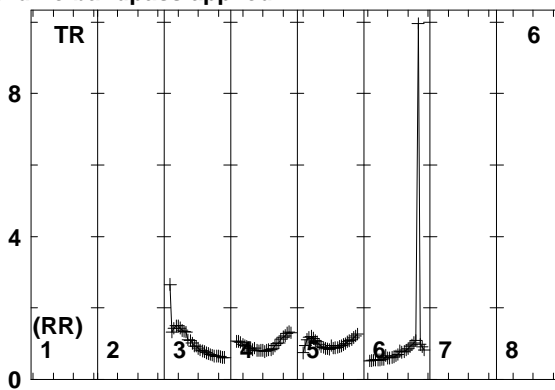
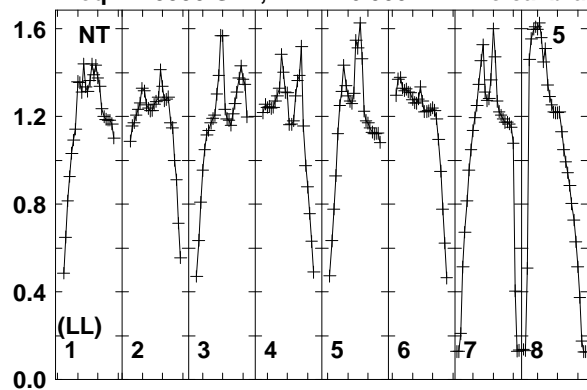

Lower frame: Real Jy
Total-power spectrum Antenna: NT (05)
Timerange: 00/08:14:43 to 00/08:18:29

Plot file version 275 created 11-AUG-2014 17:05:40

J2032+4127 EM110 2.UVDATA.1

Freq = 1.5950 GHz, Bw = 16.000 MH No calibration applied and no bandpass applied

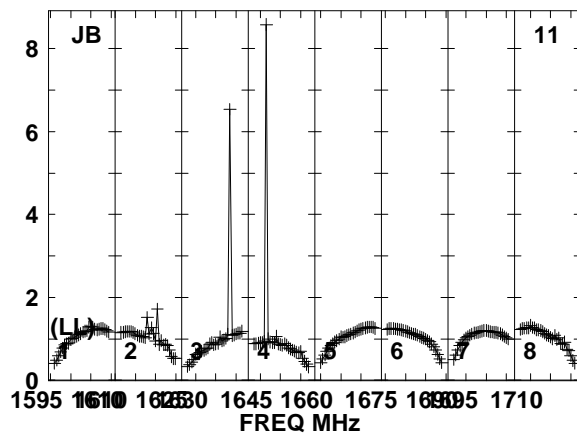
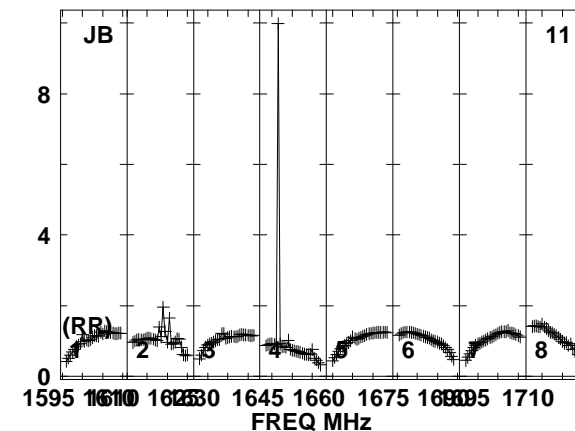
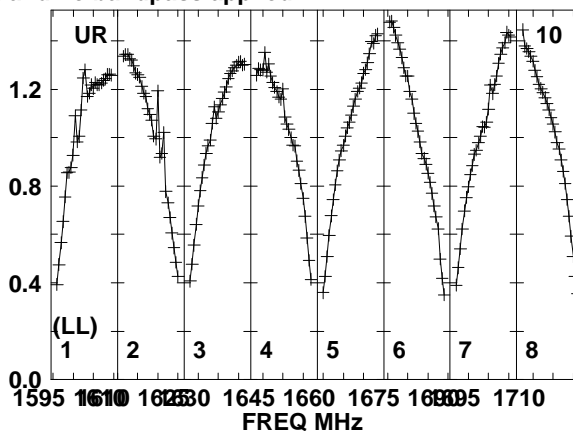
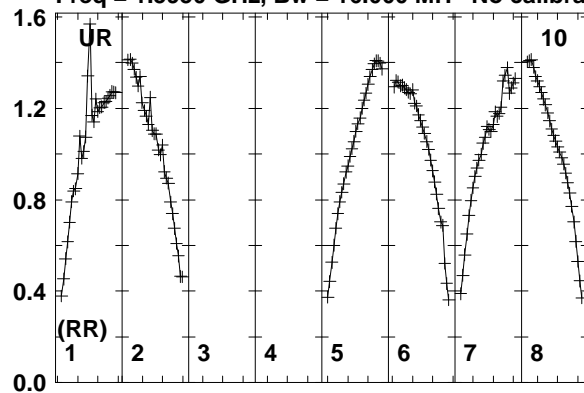

Lower frame: Real Jy
Total-power spectrum Antenna: UR (10)
Timerange: 00/08:14:43 to 00/08:18:29

Plot file version 276 created 11-AUG-2014 17:05:40

J2015+3710 EM110 2.UVDATA.1

Freq = 1.5950 GHz, Bw = 16.000 MH No calibration applied and no bandpass applied

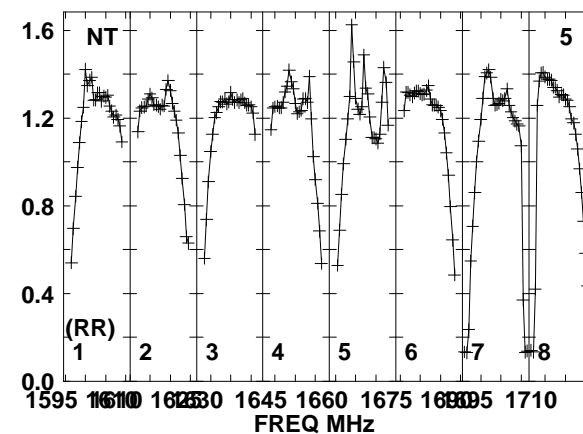
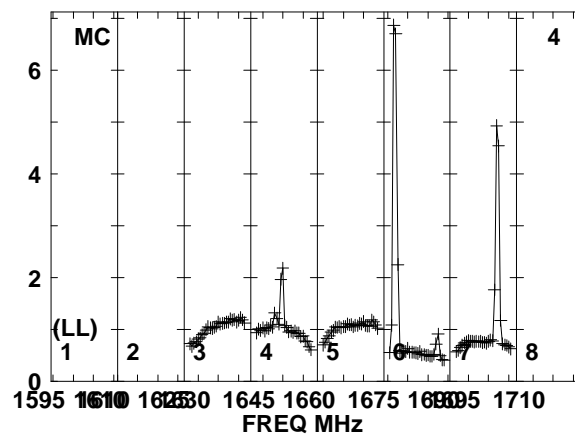
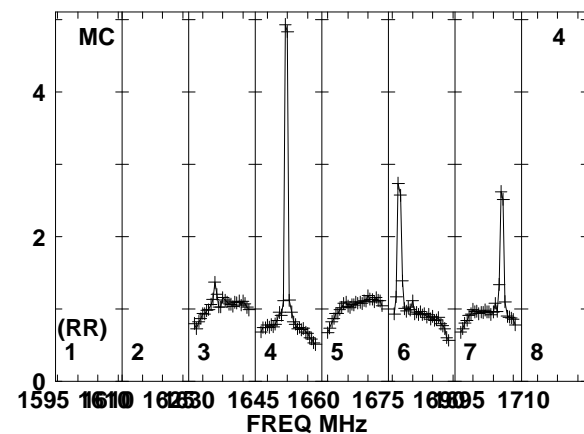
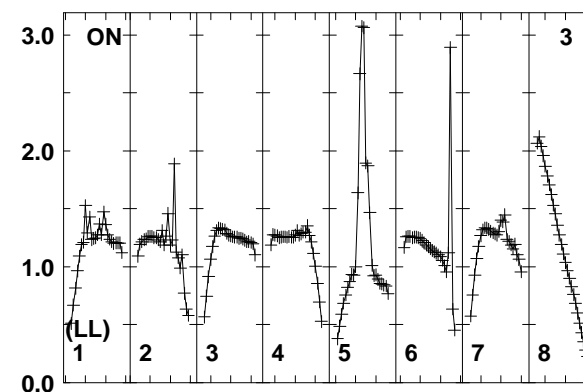
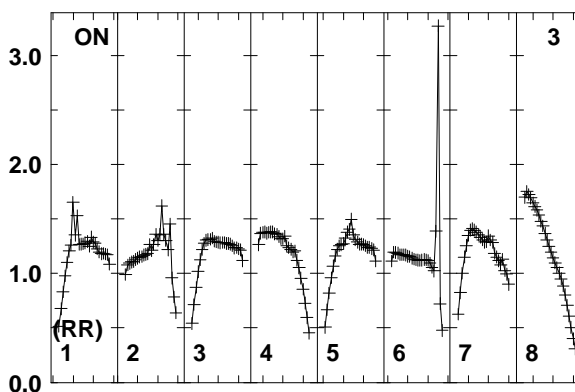
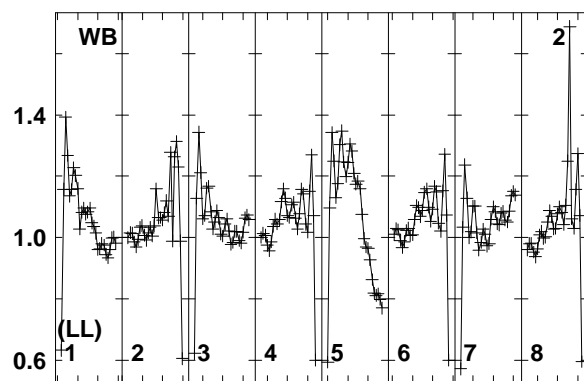
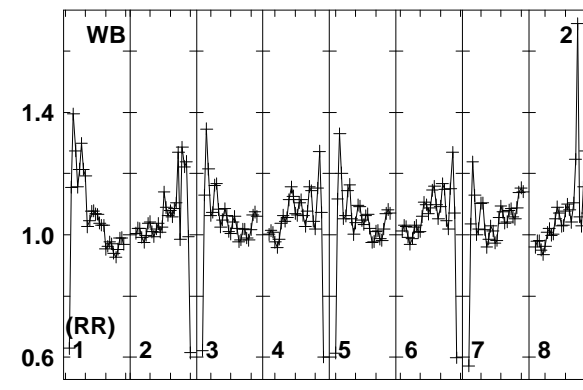
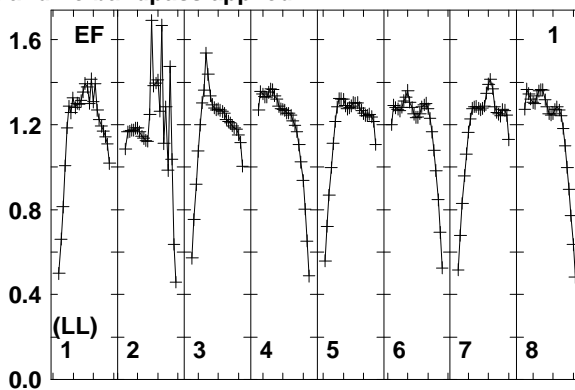
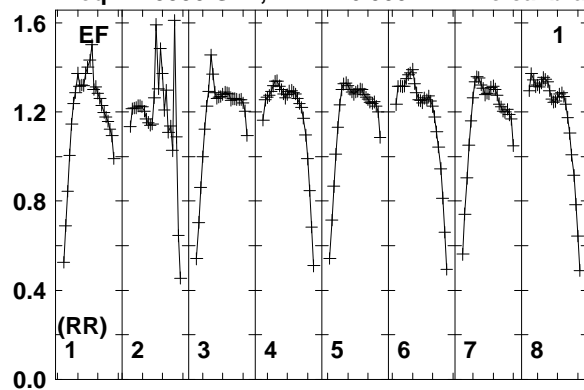

Lower frame: Real Jy
Total-power spectrum Antenna: EF (01)
Timerange: 00/08:19:31 to 00/08:21:29

Plot file version 277 created 11-AUG-2014 17:05:40

J2015+3710 EM110 2.UVDATA.1

Freq = 1.5950 GHz, Bw = 16.000 MH No calibration applied and no bandpass applied

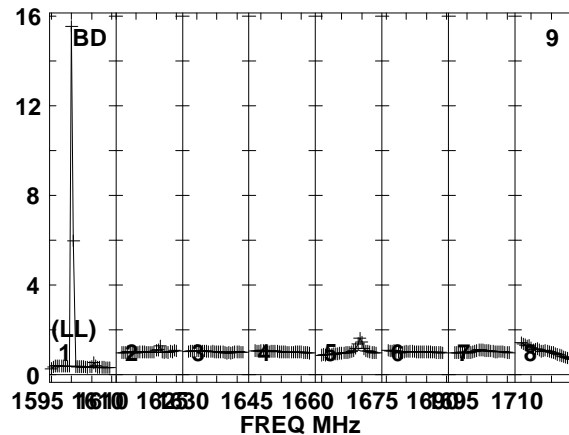
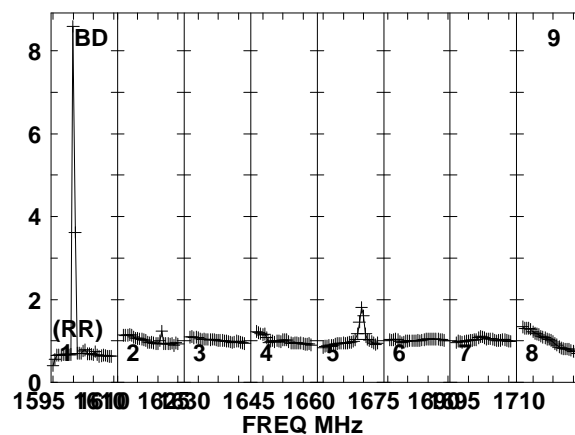
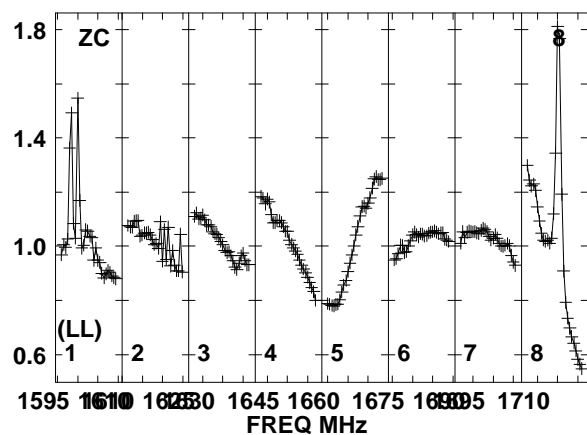
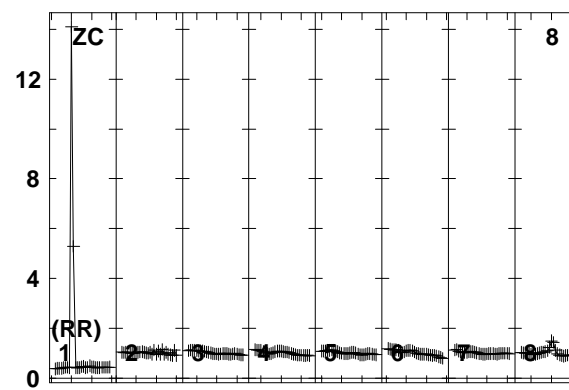
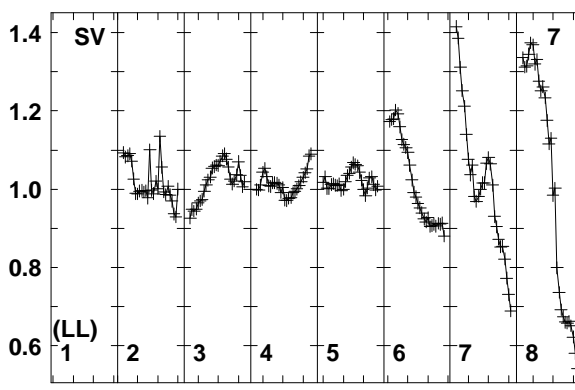
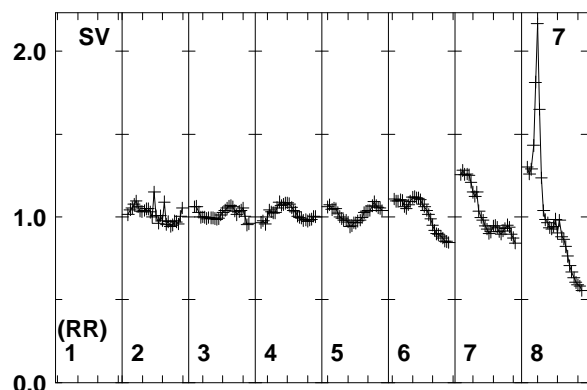
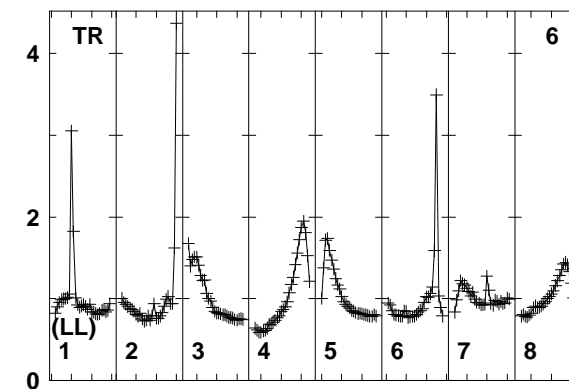
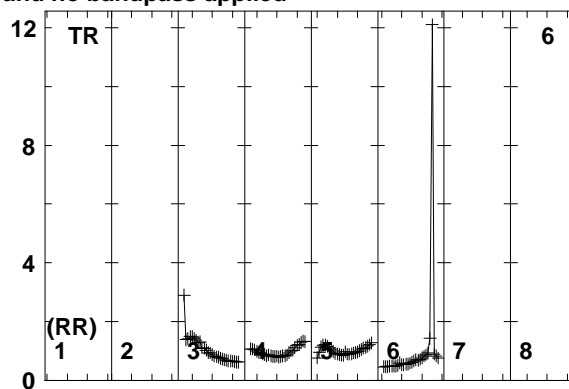
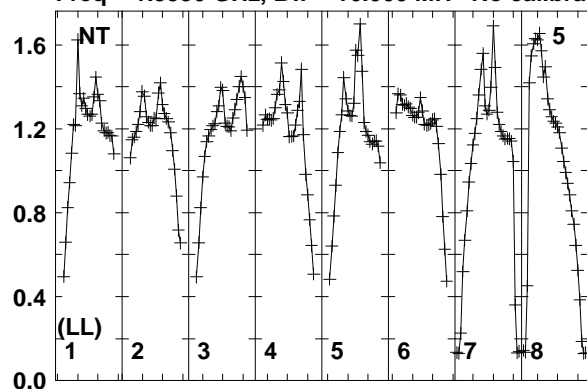

Lower frame: Real Jy
Total-power spectrum Antenna: NT (05)
Timerange: 00/08:19:31 to 00/08:21:29

Plot file version 278 created 11-AUG-2014 17:05:40

J2015+3710 EM110 2.UVDATA.1

Freq = 1.5950 GHz, Bw = 16.000 MH No calibration applied and no bandpass applied

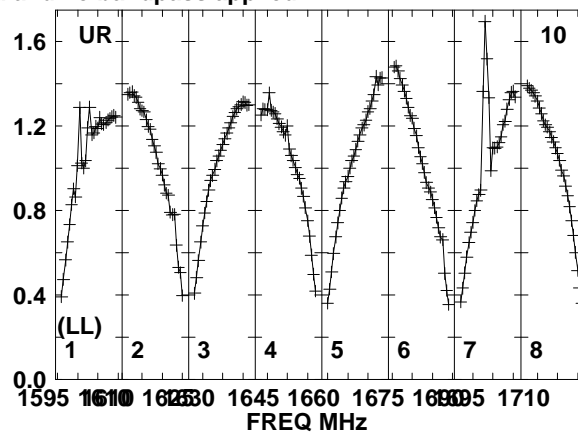
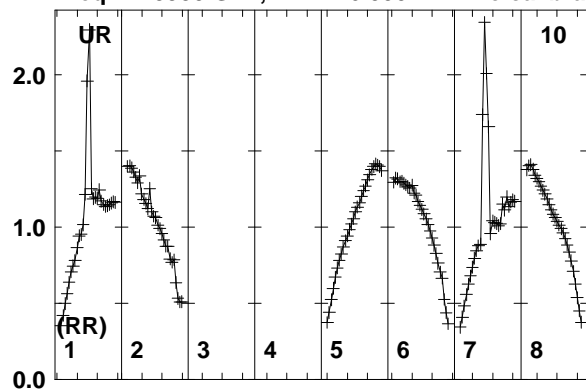

Lower frame: Real Jy
Total-power spectrum Antenna: UR (10)
Timerange: 00/08:19:31 to 00/08:21:29

Plot file version 279 created 11-AUG-2014 17:05:40

J2032+4127 EM110 2.UVDATA.1

Freq = 1.5950 GHz, Bw = 16.000 MH No calibration applied and no bandpass applied

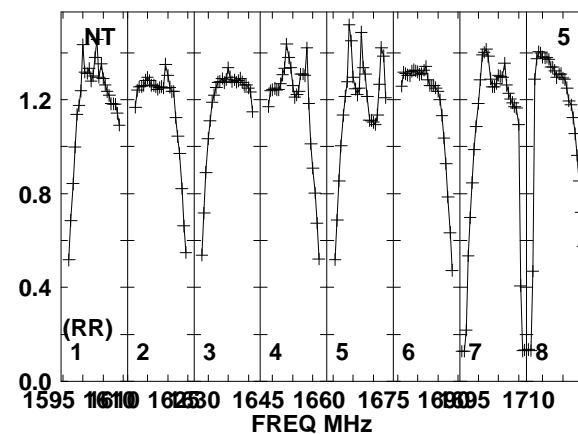
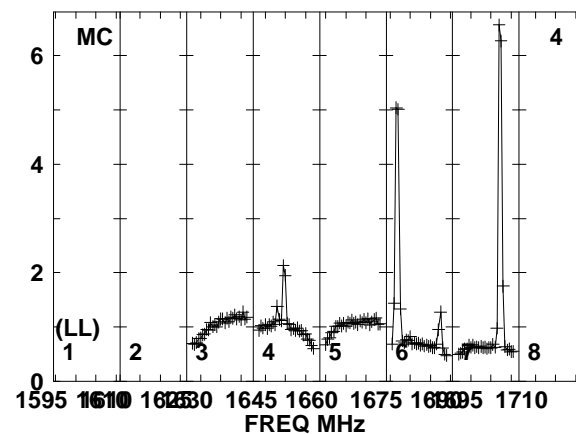
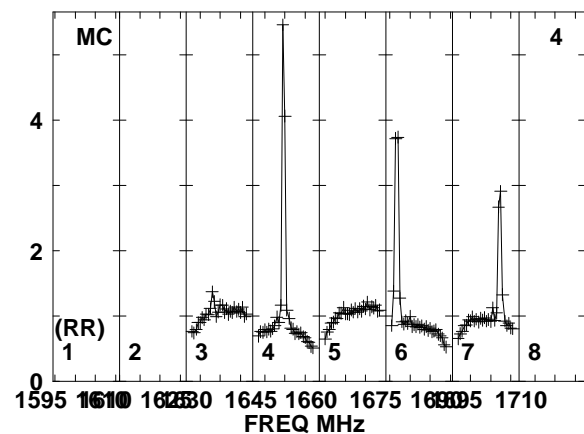
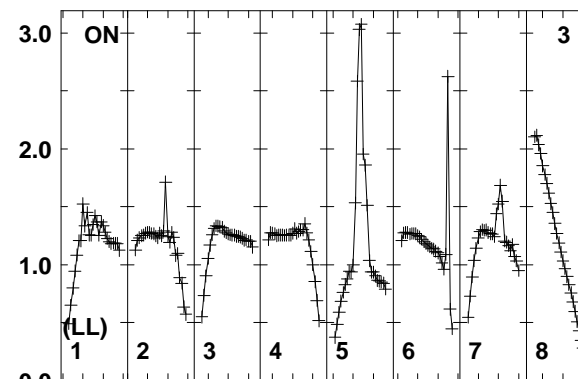
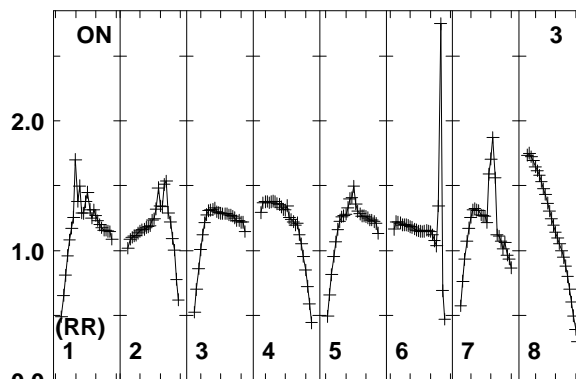
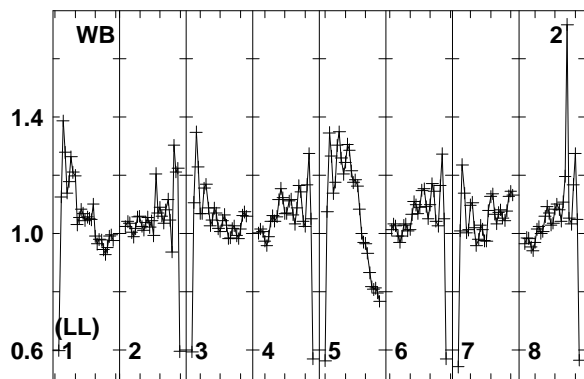
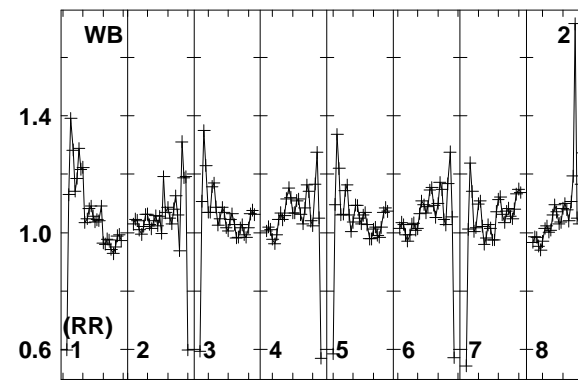
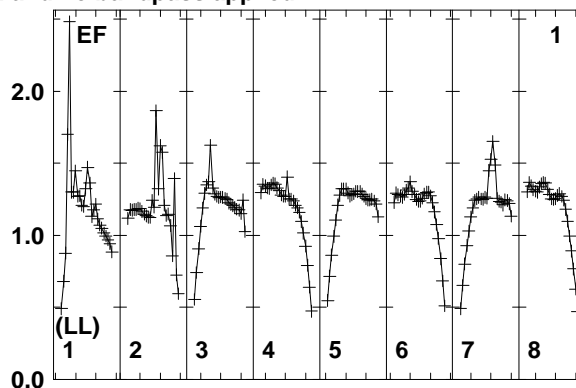
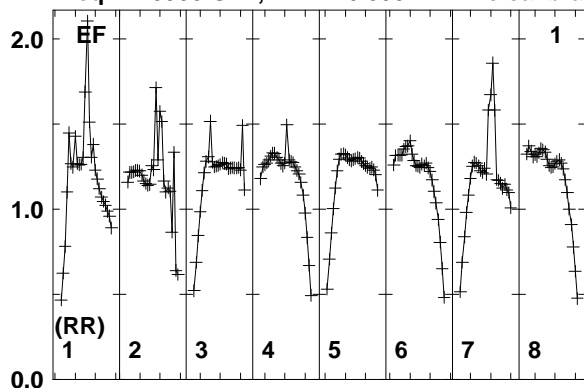

Lower frame: Real Jy
Total-power spectrum Antenna: EF (01)
Timerange: 00/08:21:31 to 00/08:25:29

Plot file version 280 created 11-AUG-2014 17:05:40

J2032+4127 EM110 2.UVDATA.1

Freq = 1.5950 GHz, Bw = 16.000 MH No calibration applied and no bandpass applied

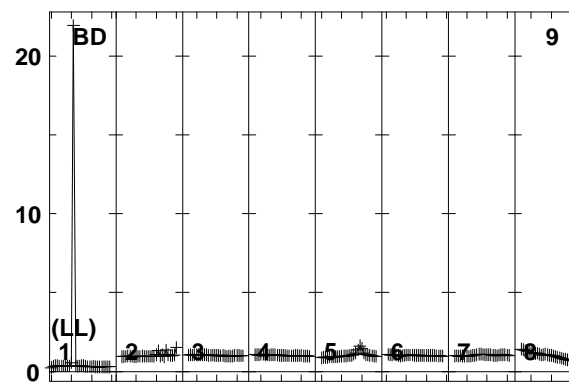
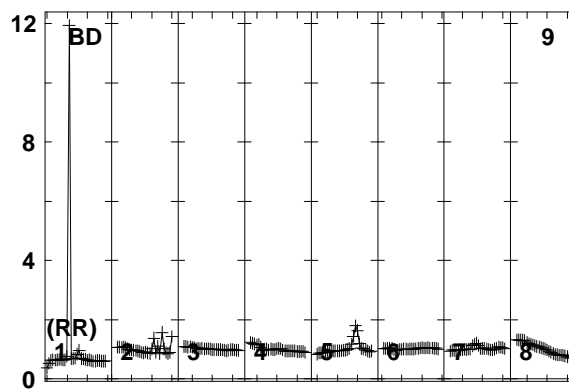
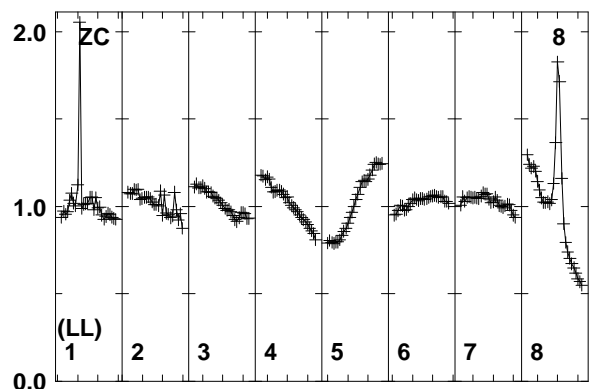
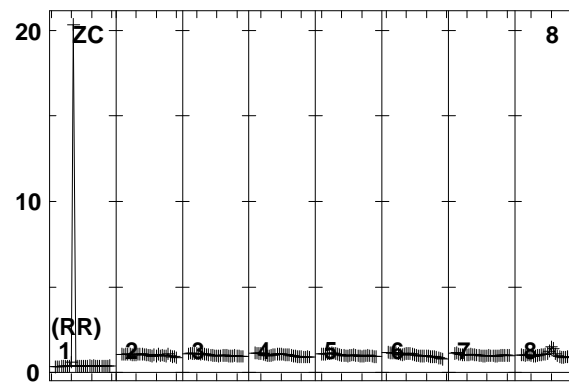
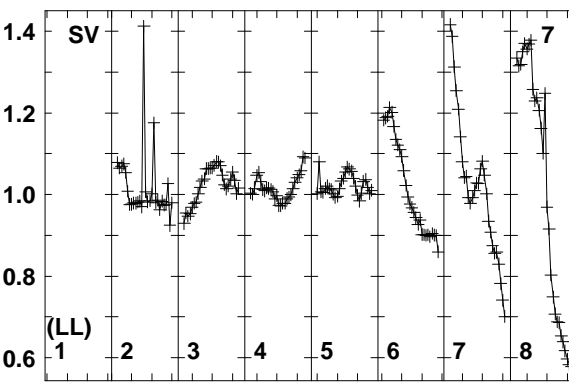
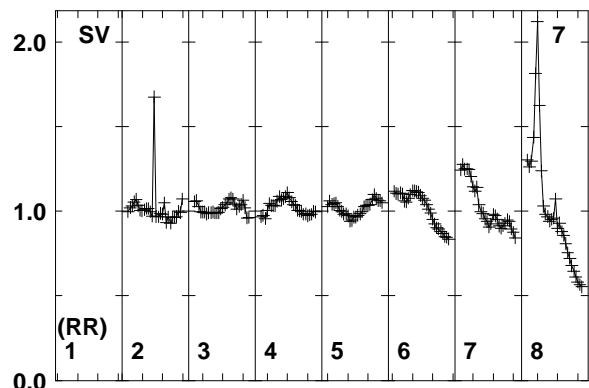
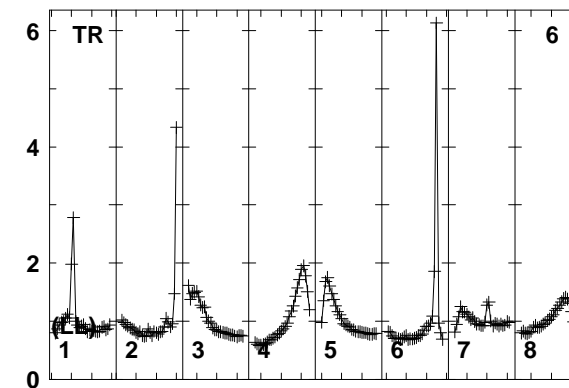
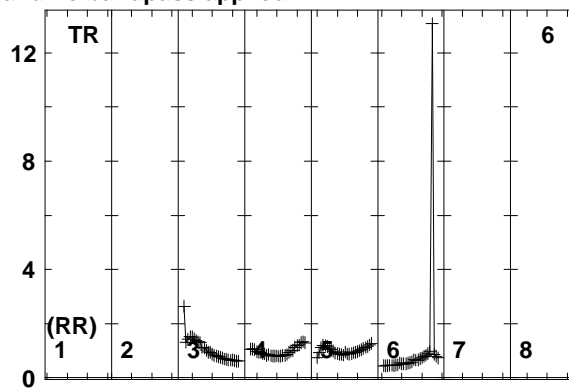
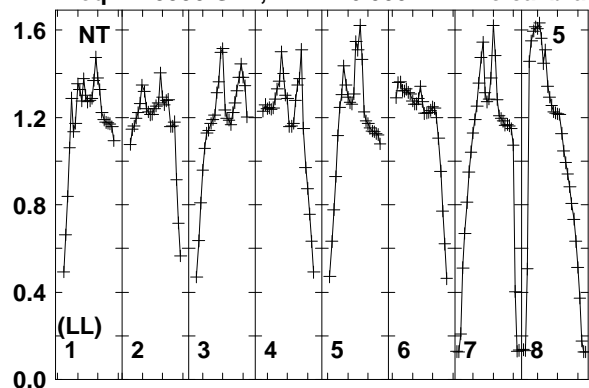

1595 1610 1625 1640 1655 1670 1685 1700 1710
FREQ MHz
Lower frame: Real Jy
Total-power spectrum Antenna: NT (05)
Timerange: 00/08:21:31 to 00/08:25:29

1595 1610 1625 1640 1655 1670 1685 1700 1710
FREQ MHz

1595 1610 1625 1640 1655 1670 1685 1700 1710
FREQ MHz

Plot file version 281 created 11-AUG-2014 17:05:40

J2032+4127 EM110 2.UVDATA.1

Freq = 1.5950 GHz, Bw = 16.000 MH No calibration applied and no bandpass applied

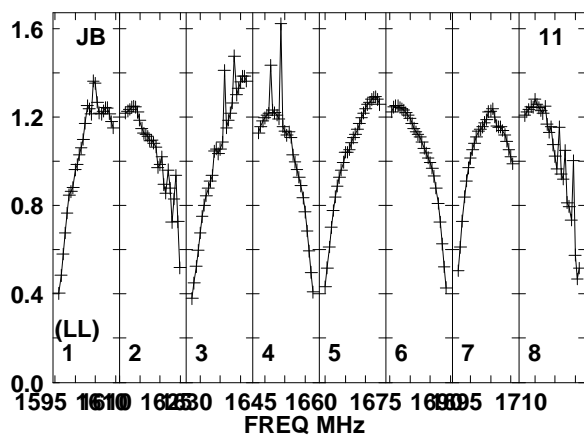
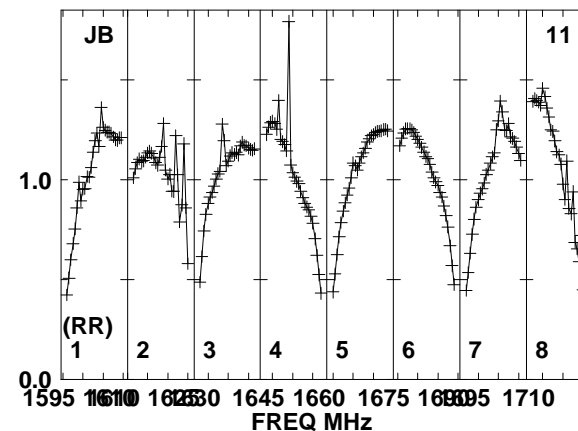
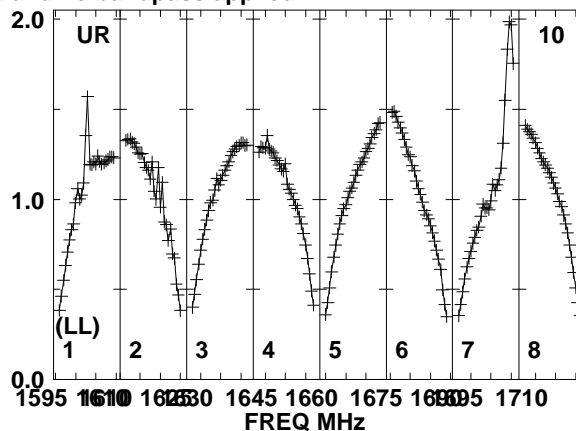
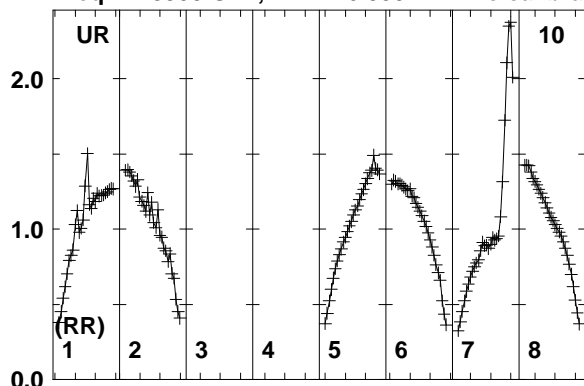

Lower frame: Real Jy
Total-power spectrum Antenna: UR (10)
Timerange: 00/08:21:31 to 00/08:25:29

Plot file version 282 created 11-AUG-2014 17:05:40

J2015+3710 EM110 2.UVDATA.1

Freq = 1.5950 GHz, Bw = 16.000 MH No calibration applied and no bandpass applied

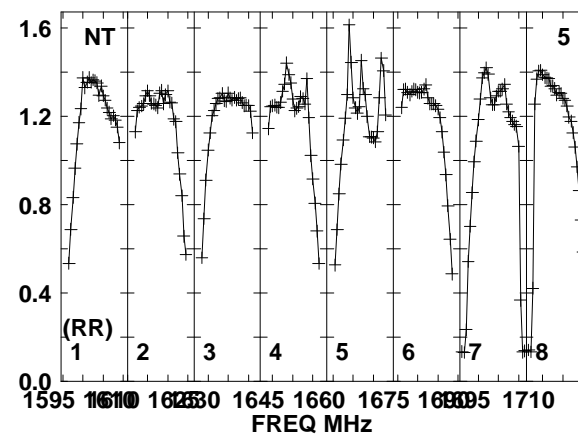
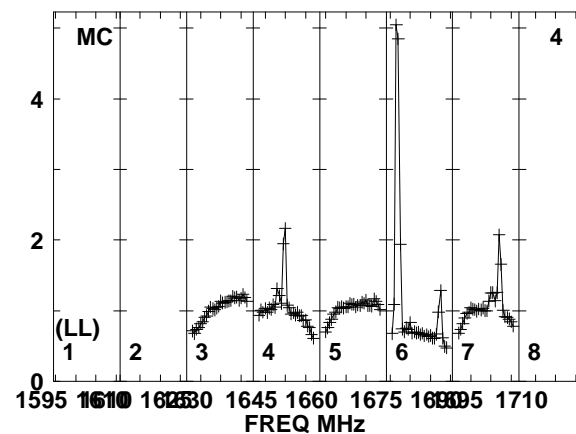
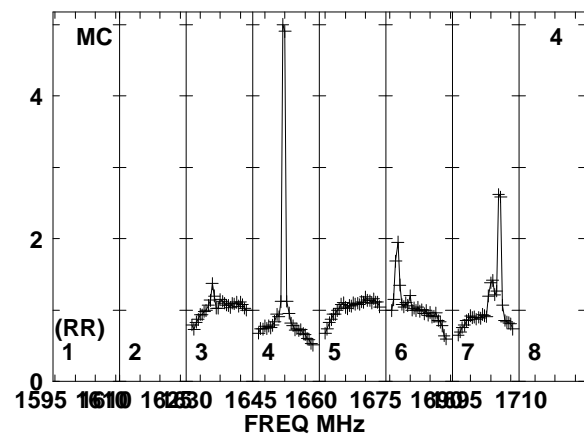
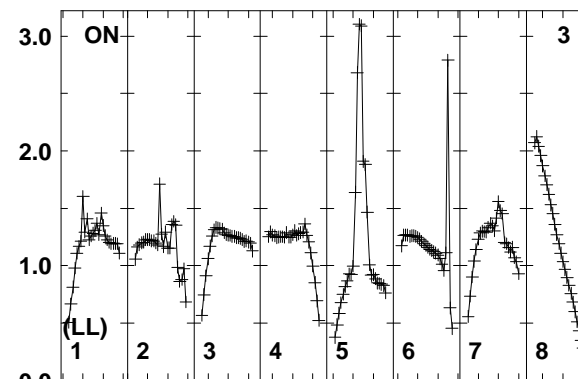
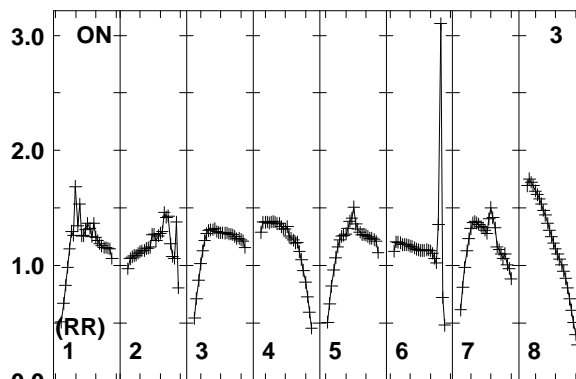
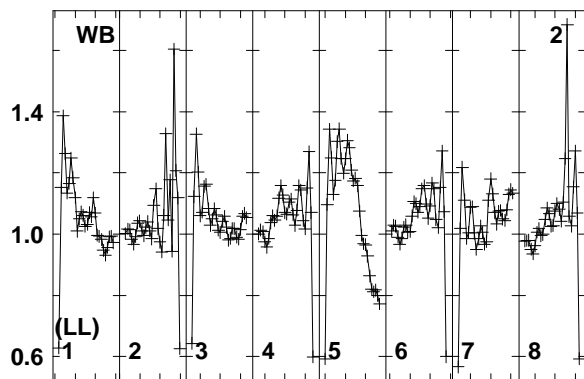
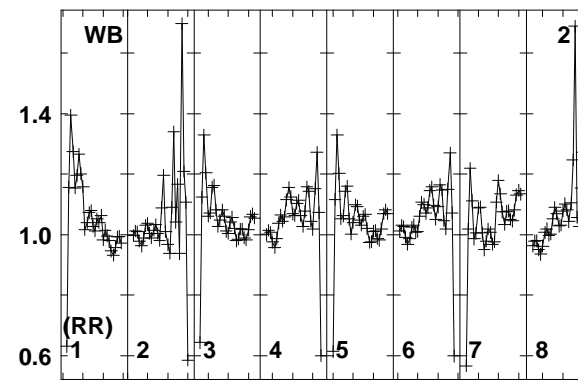
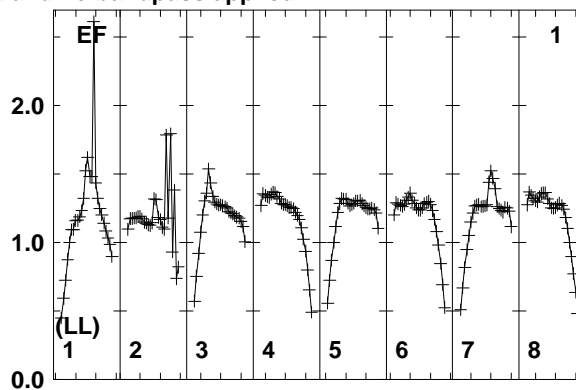
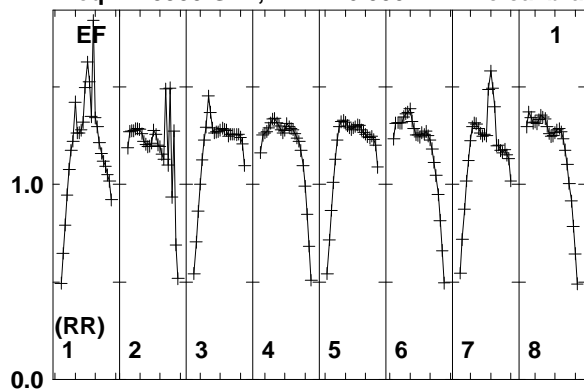

Lower frame: Real Jy
Total-power spectrum Antenna: EF (01)
Timerange: 00/08:26:31 to 00/08:28:29

Plot file version 283 created 11-AUG-2014 17:05:40

J2015+3710 EM110 2.UVDATA.1

Freq = 1.5950 GHz, Bw = 16.000 MH No calibration applied and no bandpass applied

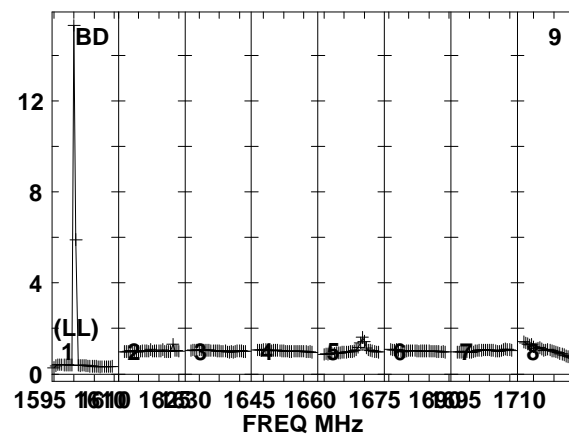
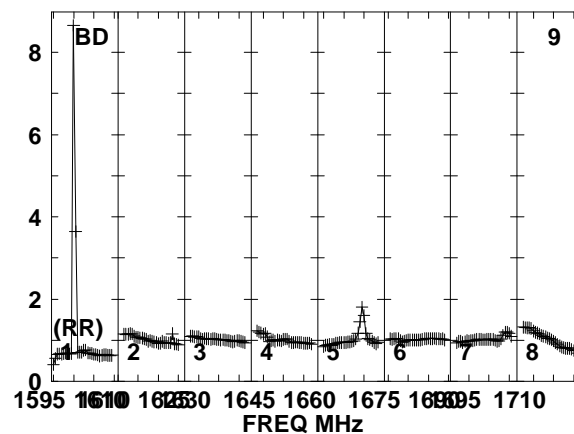
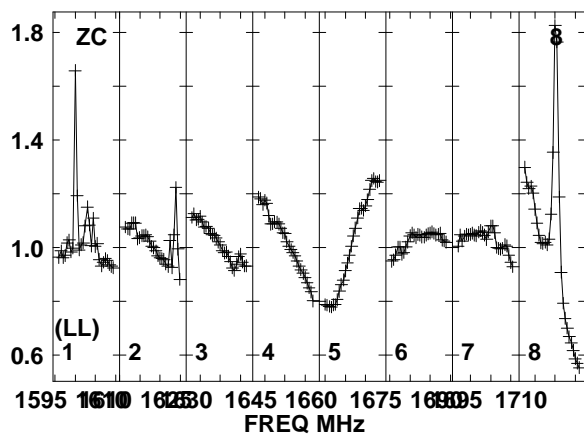
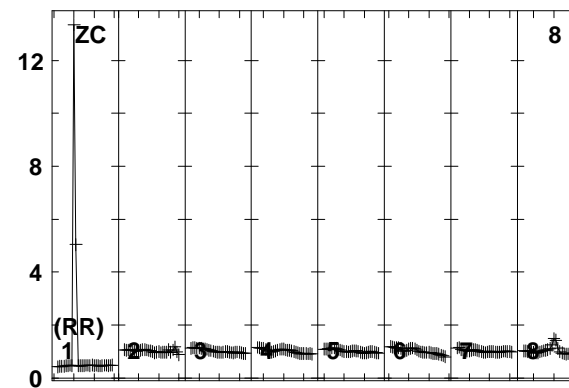
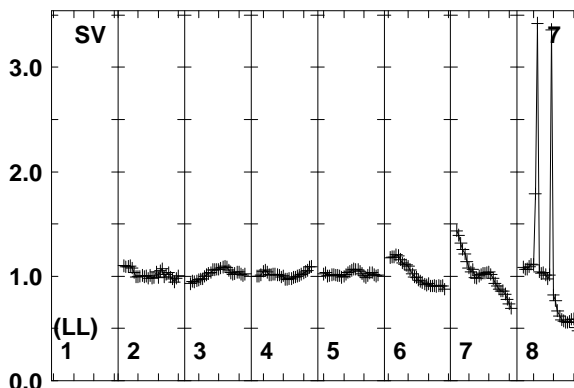
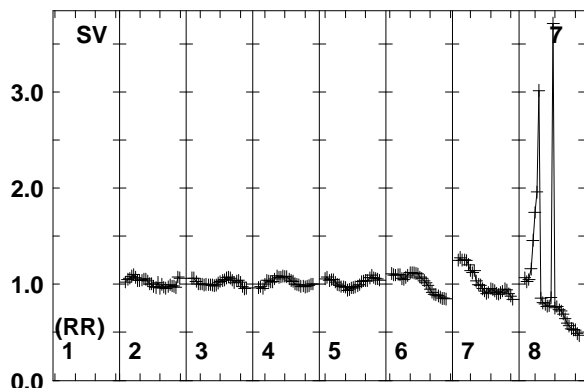
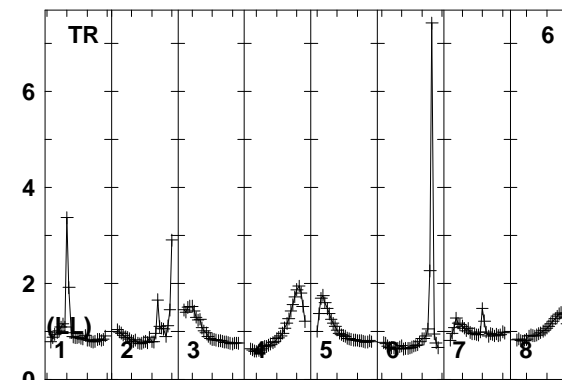
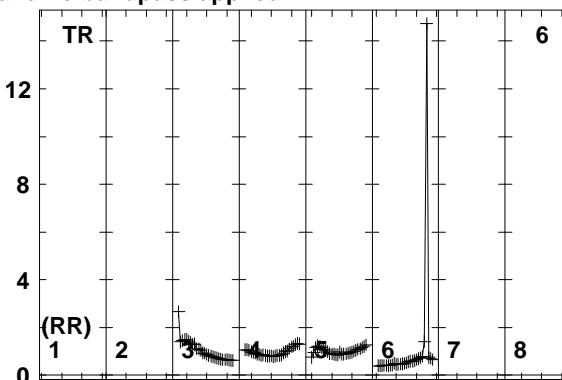
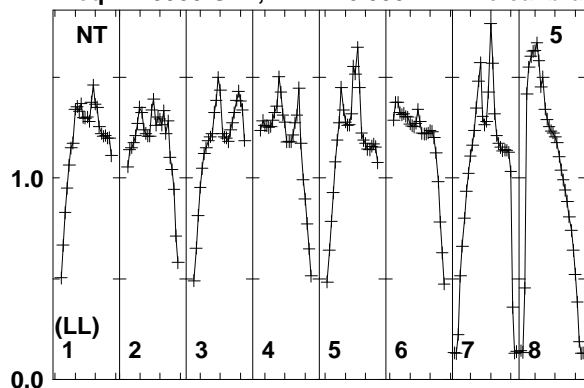

Lower frame: Real Jy
Total-power spectrum Antenna: NT (05)
Timerange: 00/08:26:31 to 00/08:28:29

Plot file version 284 created 11-AUG-2014 17:05:40

J2015+3710 EM110 2.UVDATA.1

Freq = 1.5950 GHz, Bw = 16.000 MH No calibration applied and no bandpass applied

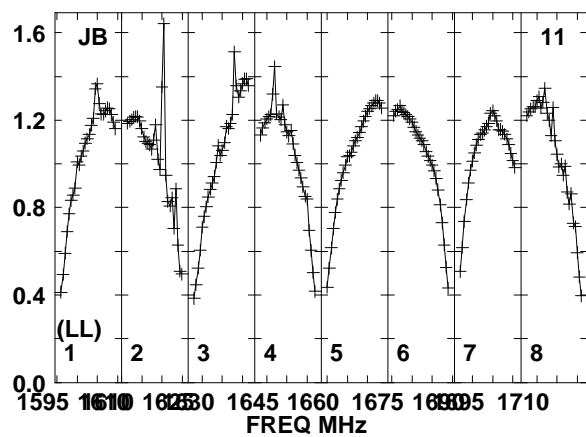
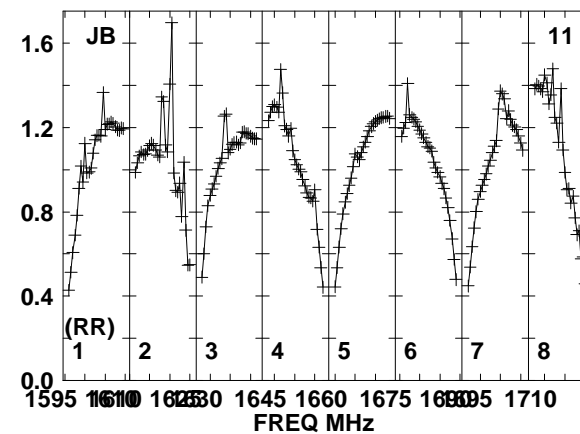
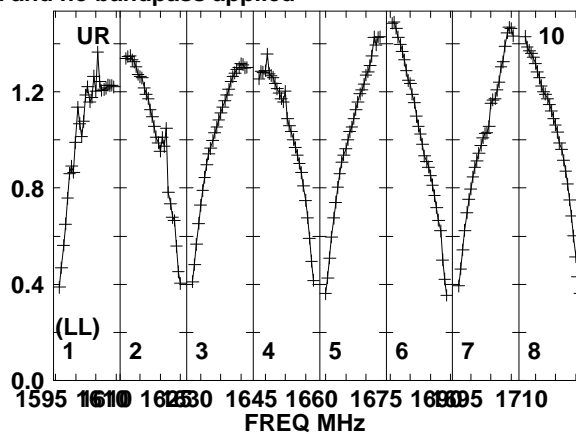
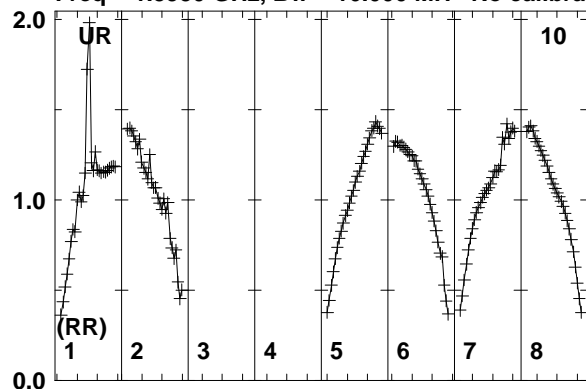

Lower frame: Real Jy
Total-power spectrum Antenna: UR (10)
Timerange: 00/08:26:31 to 00/08:28:29

Plot file version 285 created 11-AUG-2014 17:05:40

J2032+4127 EM110 2.UVDATA.1

Freq = 1.5950 GHz, Bw = 16.000 MH No calibration applied and no bandpass applied

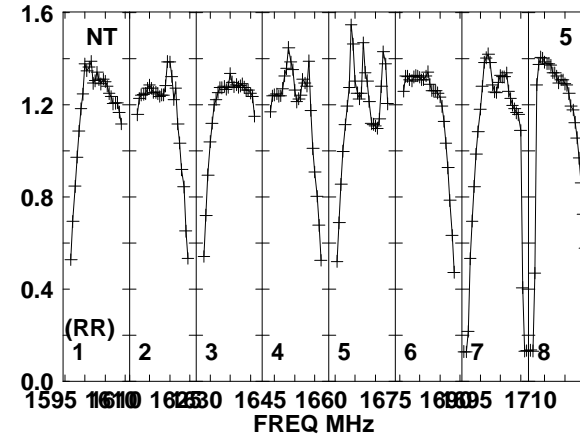
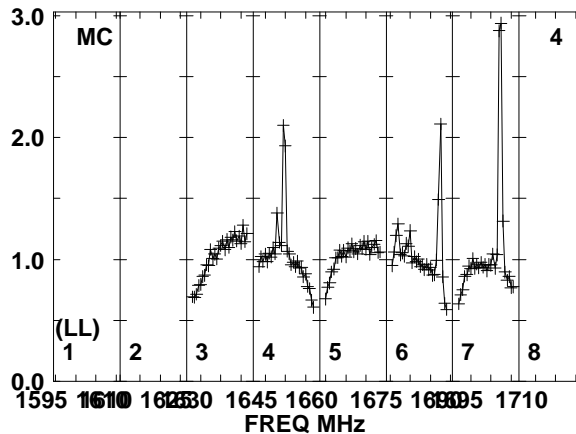
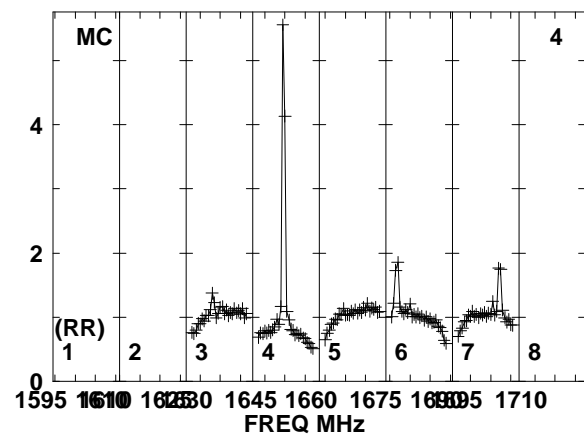
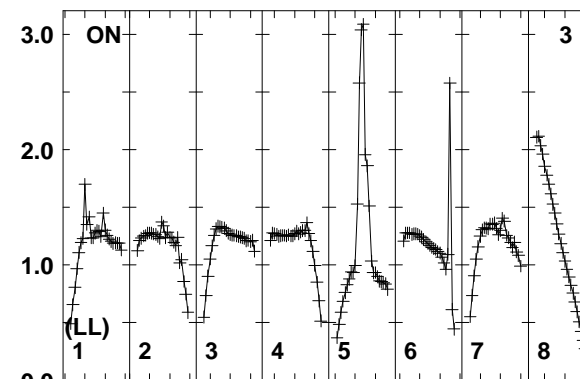
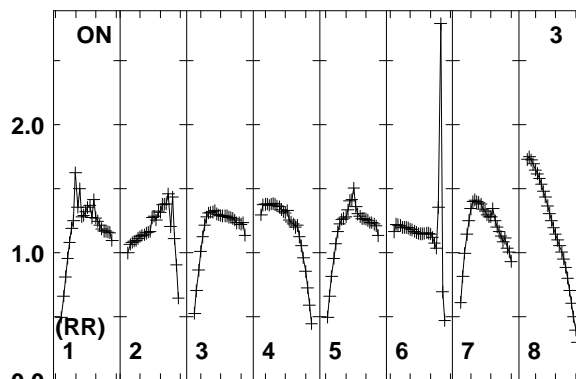
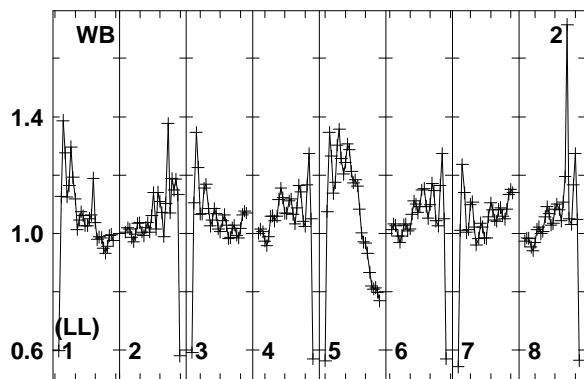
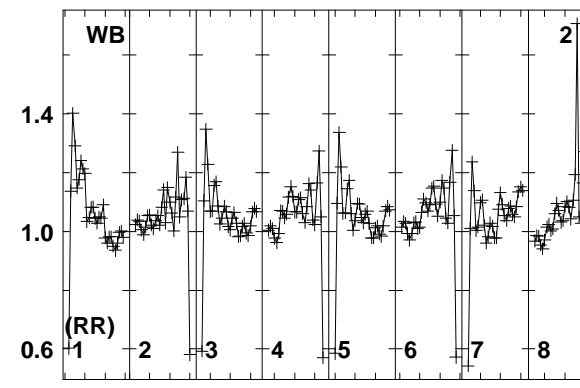
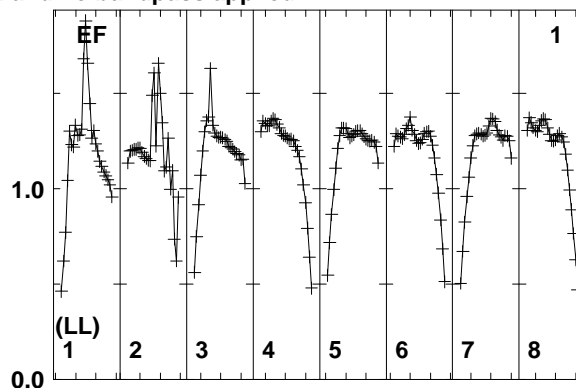
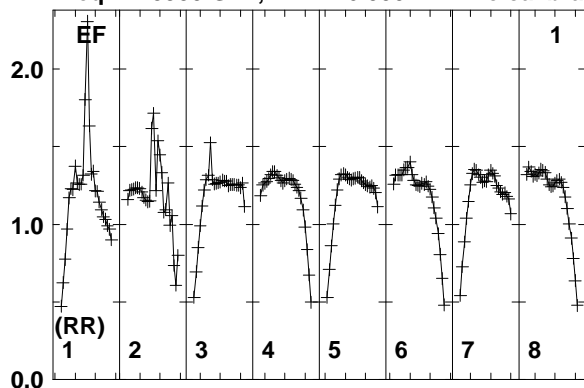

Lower frame: Real Jy
Total-power spectrum Antenna: EF (01)
Timerange: 00/08:28:44 to 00/08:32:28

Plot file version 286 created 11-AUG-2014 17:05:40

J2032+4127 EM110 2.UVDATA.1

Freq = 1.5950 GHz, Bw = 16.000 MH No calibration applied and no bandpass applied

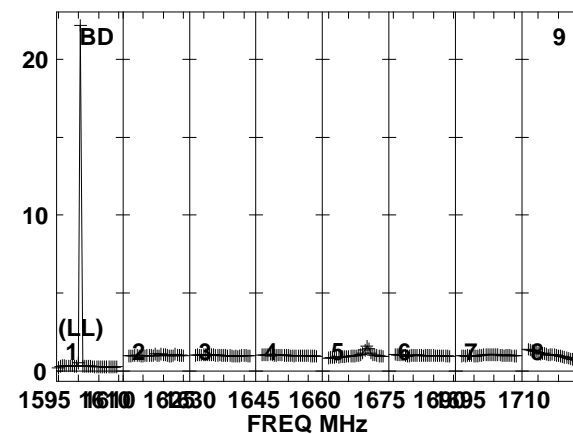
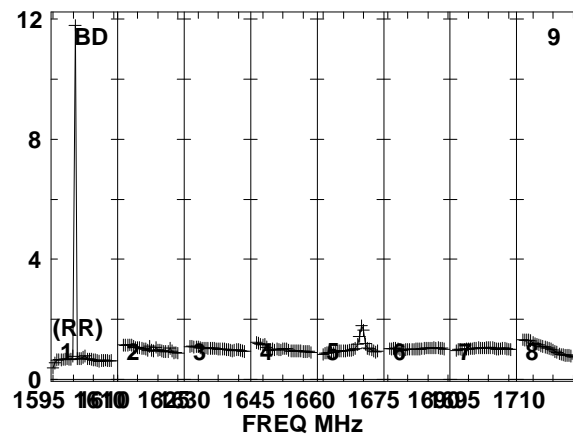
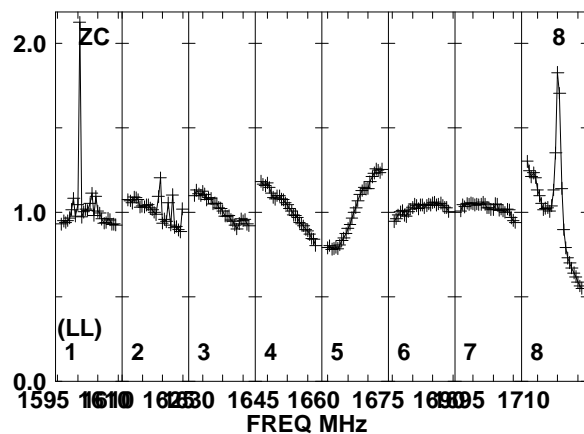
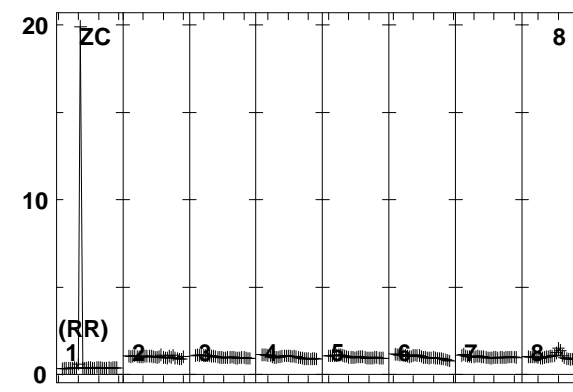
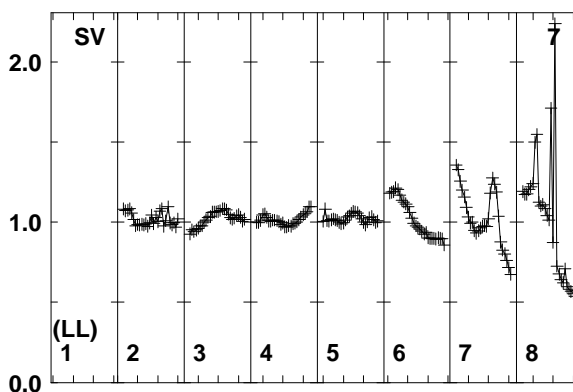
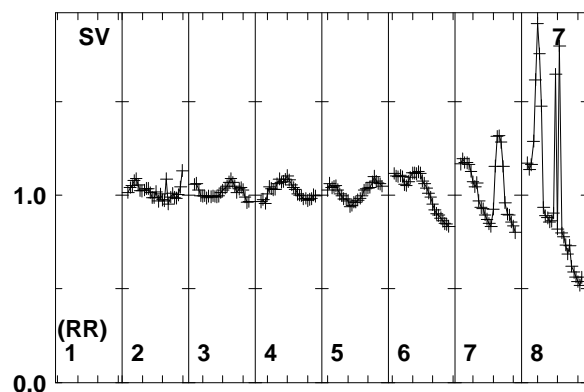
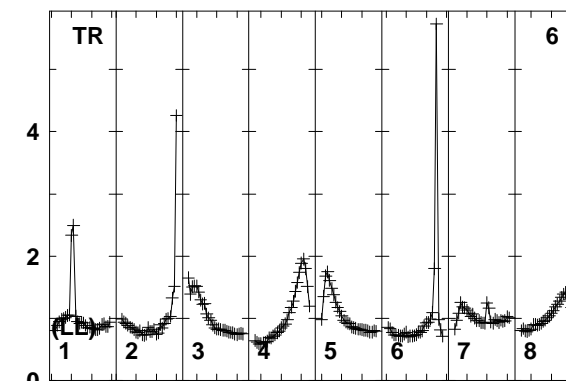
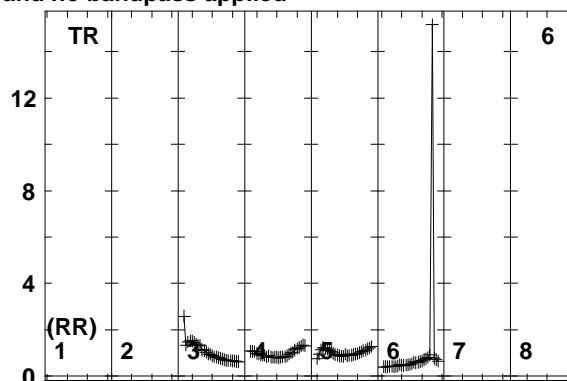
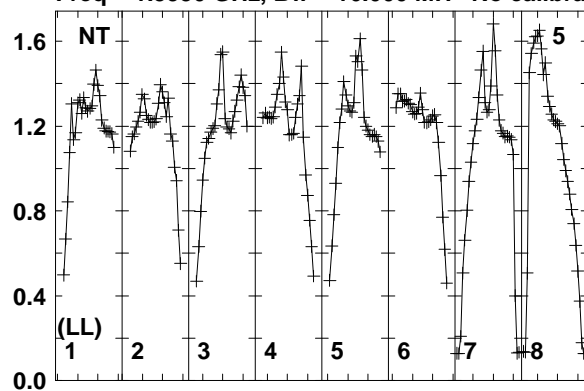

Lower frame: Real Jy
Total-power spectrum Antenna: NT (05)
Timerange: 00/08:28:44 to 00/08:32:28

Plot file version 287 created 11-AUG-2014 17:05:40

J2032+4127 EM110 2.UVDATA.1

Freq = 1.5950 GHz, Bw = 16.000 MH No calibration applied and no bandpass applied

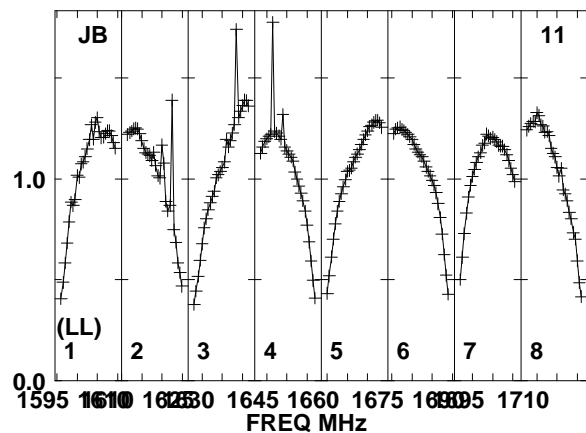
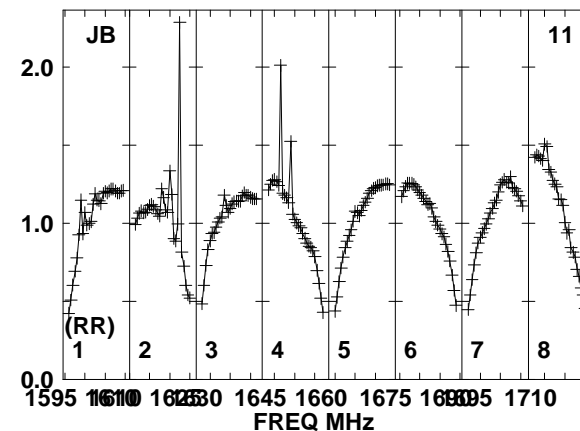
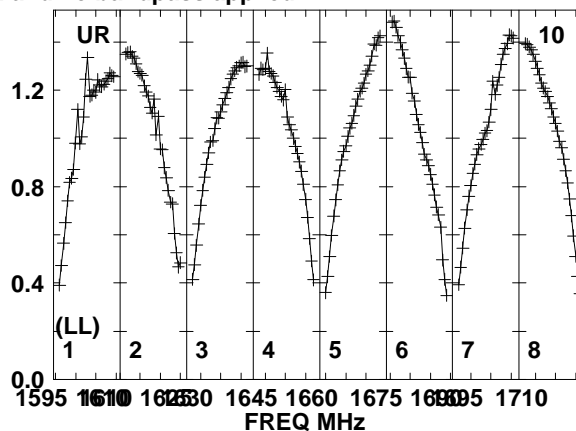
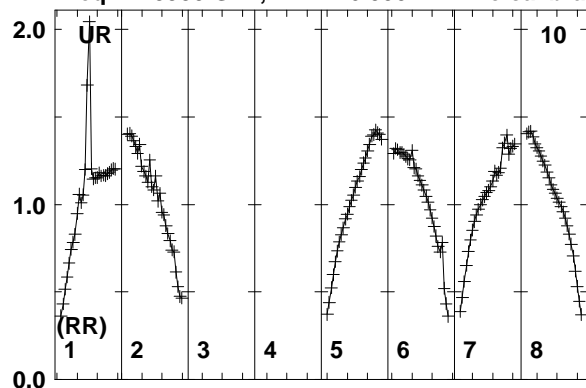

Lower frame: Real Jy
Total-power spectrum Antenna: UR (10)
Timerange: 00/08:28:44 to 00/08:32:28

Plot file version 288 created 11-AUG-2014 17:05:40

J2015+3710 EM110 2.UVDATA.1

Freq = 1.5950 GHz, Bw = 16.000 MH No calibration applied and no bandpass applied

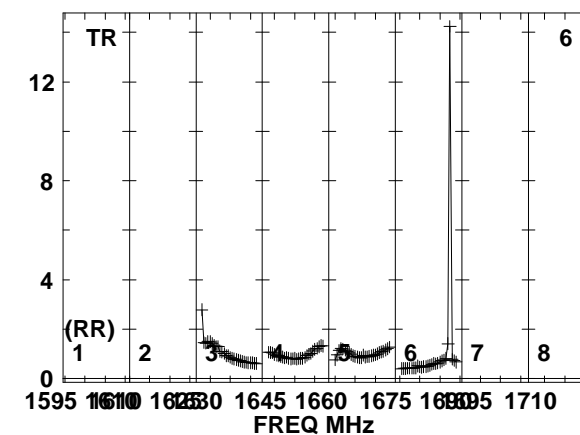
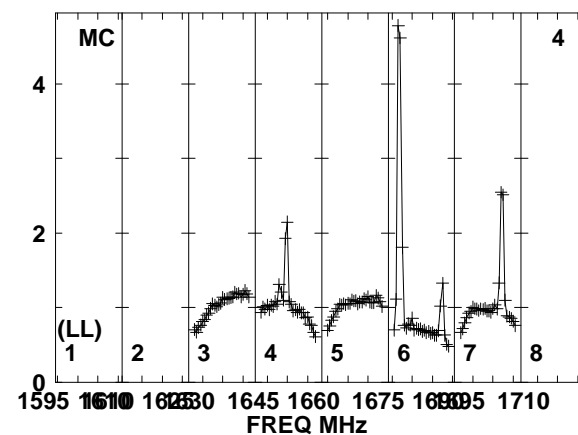
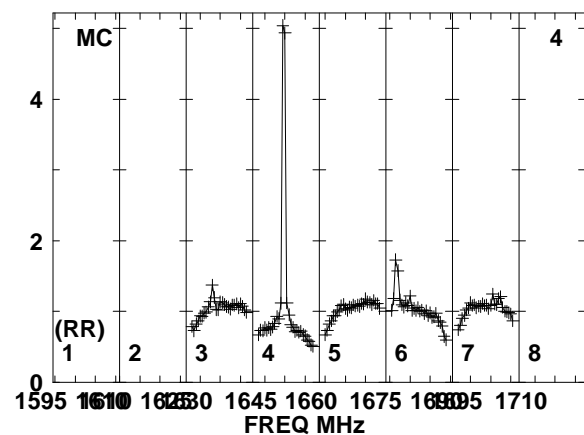
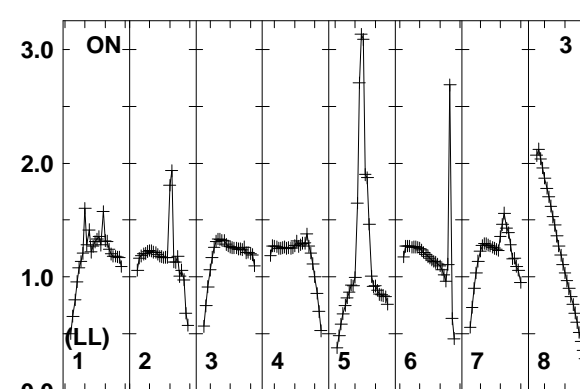
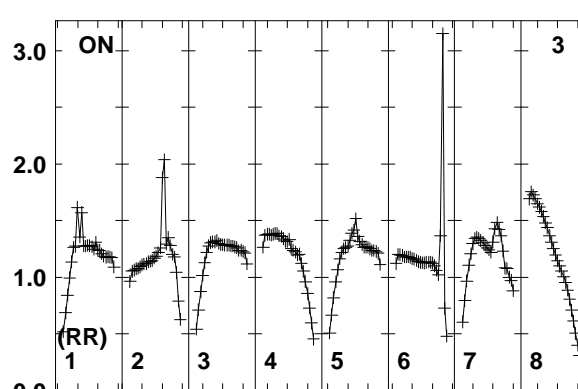
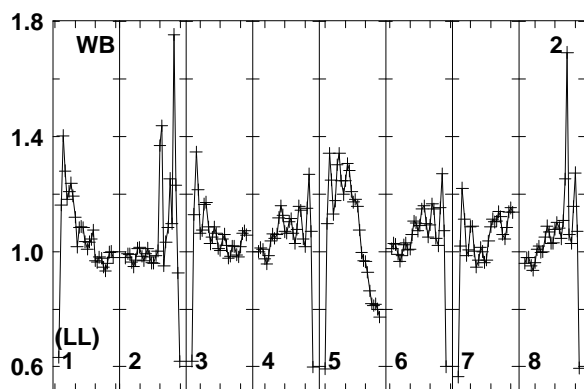
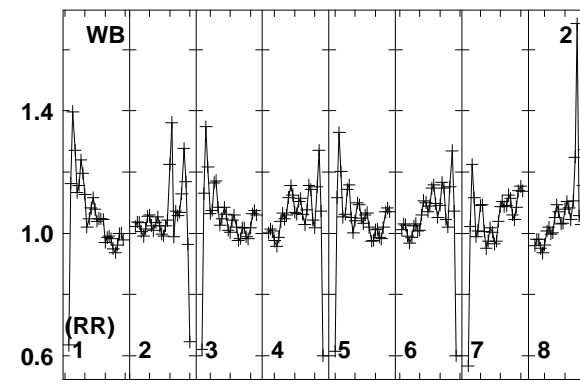
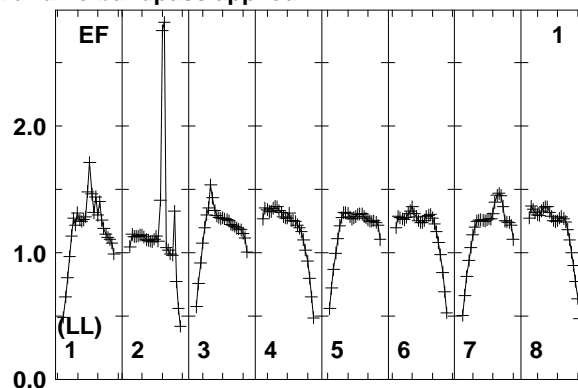
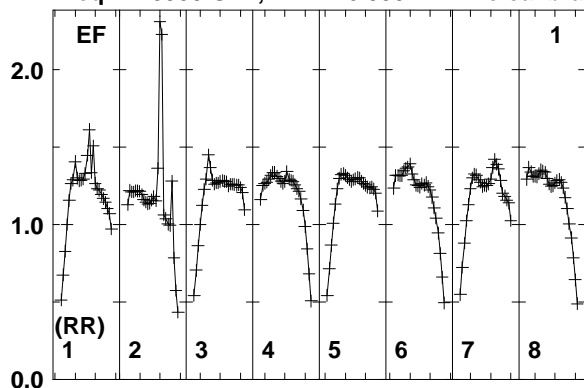

Lower frame: Real Jy
Total-power spectrum Antenna: EF (01)
Timerange: 00/08:32:44 to 00/08:34:28

Plot file version 289 created 11-AUG-2014 17:05:40

J2015+3710 EM110 2.UVDATA.1

Freq = 1.5950 GHz, Bw = 16.000 MH No calibration applied and no bandpass applied

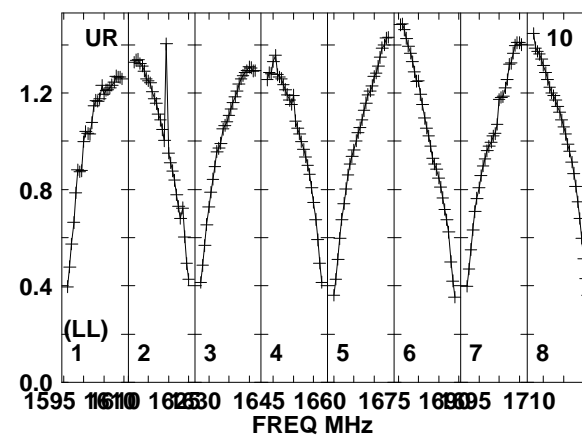
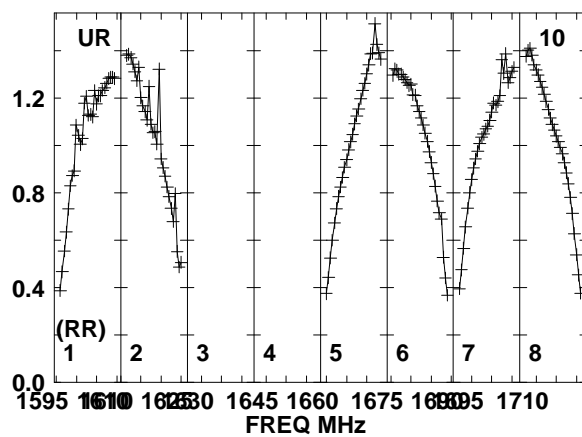
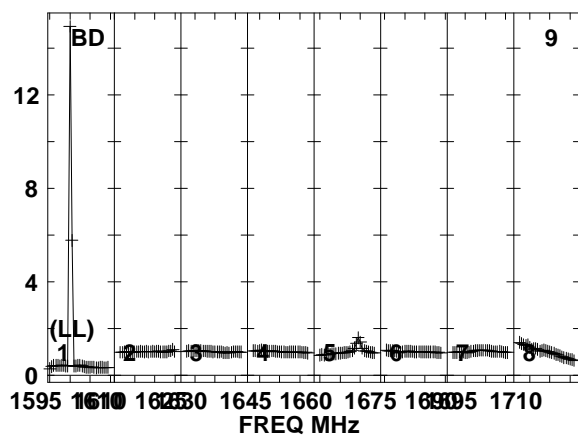
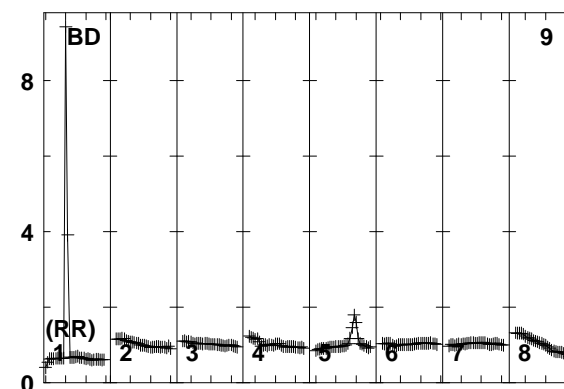
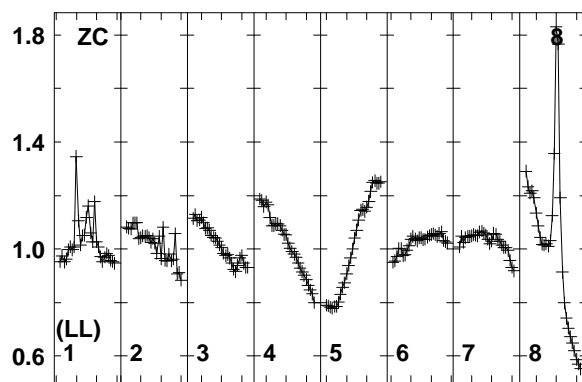
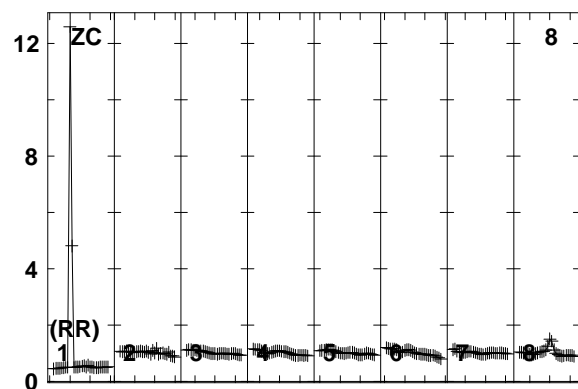
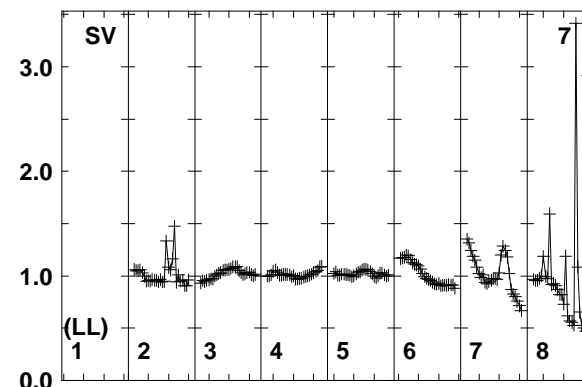
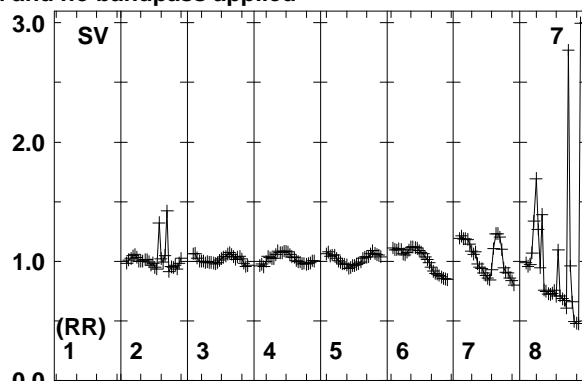
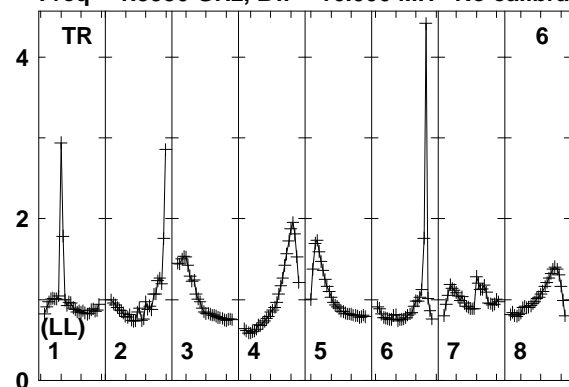

Lower frame: Real Jy
Total-power spectrum Antenna: TR (06)
Timerange: 00/08:32:44 to 00/08:34:28

Plot file version 290 created 11-AUG-2014 17:05:40

J2032+4127 EM110 2.UVDATA.1

Freq = 1.5950 GHz, Bw = 16.000 MH No calibration applied and no bandpass applied

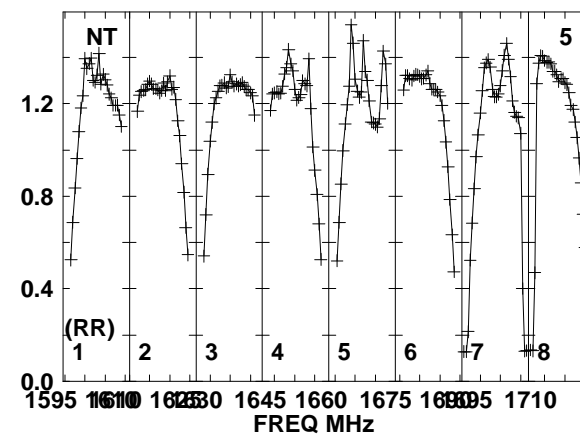
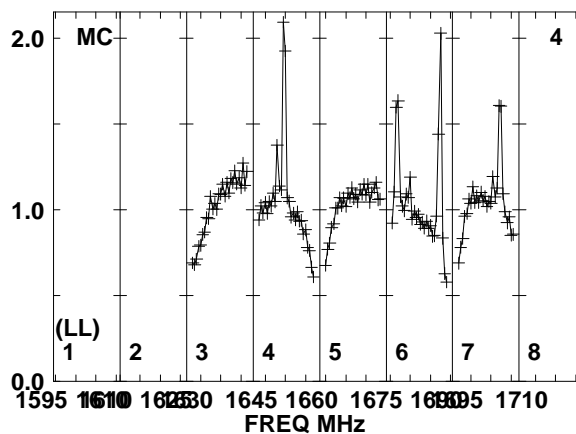
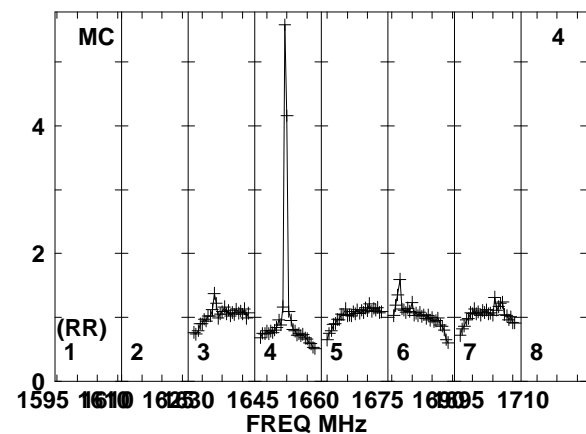
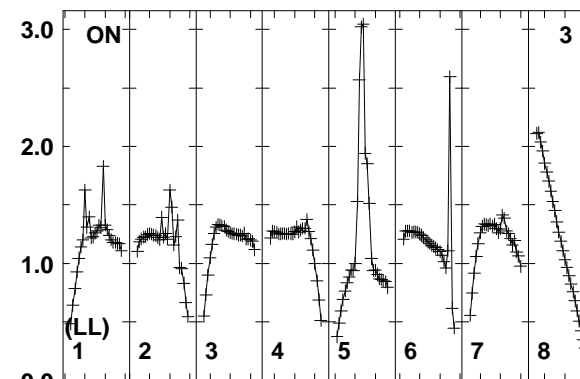
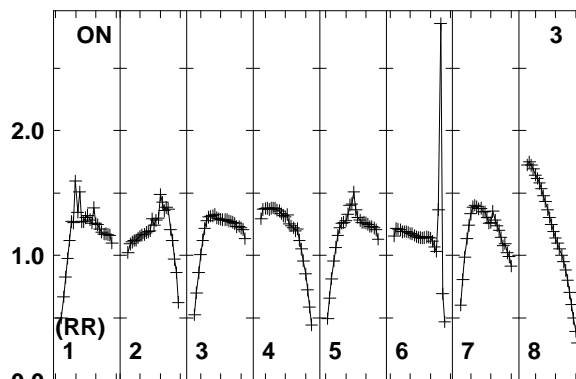
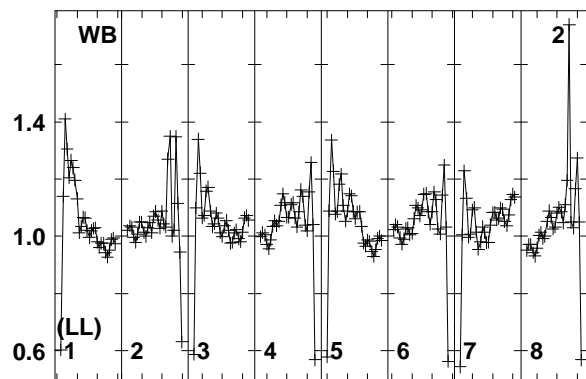
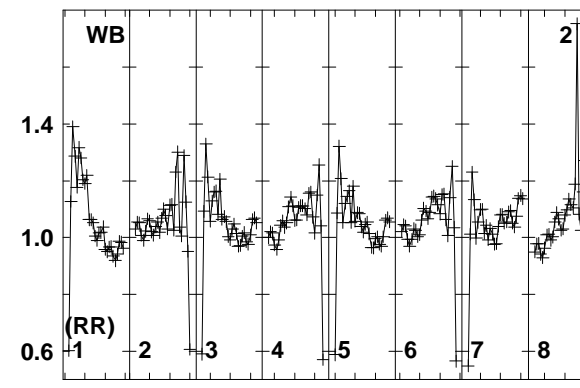
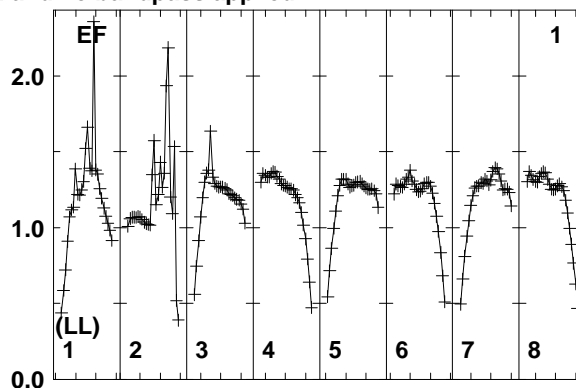
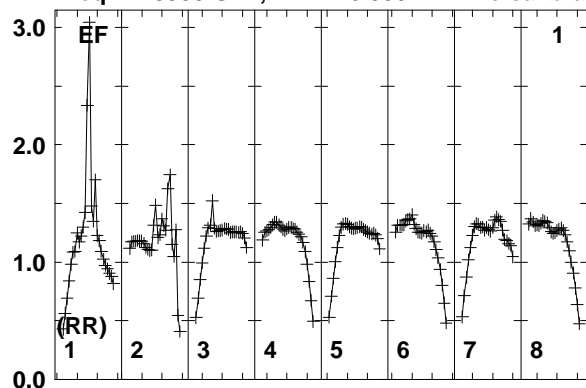

Lower frame: Real Jy
Total-power spectrum Antenna: EF (01)
Timerange: 00/08:34:31 to 00/08:38:29

Plot file version 291 created 11-AUG-2014 17:05:40

J2032+4127 EM110 2.UVDATA.1

Freq = 1.5950 GHz, Bw = 16.000 MH No calibration applied and no bandpass applied

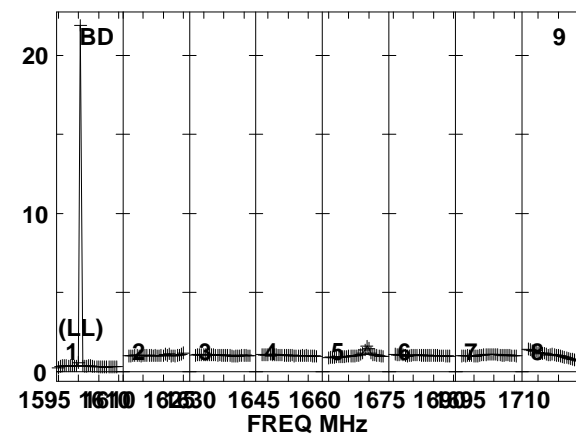
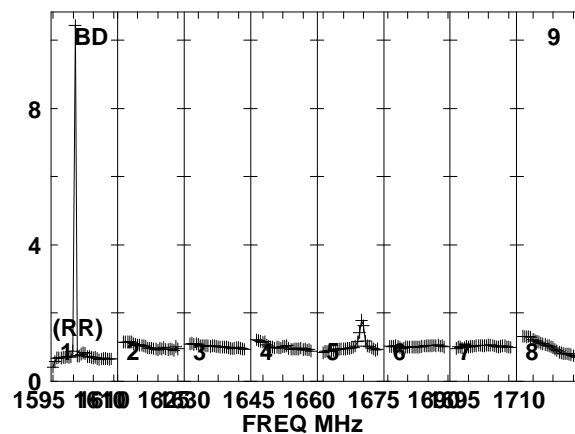
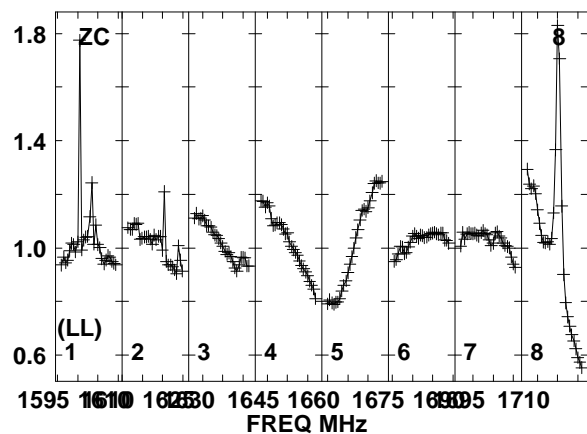
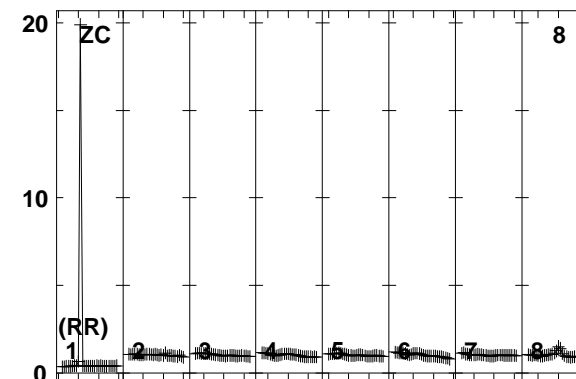
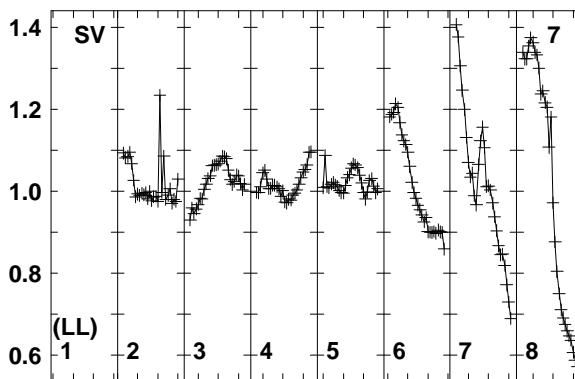
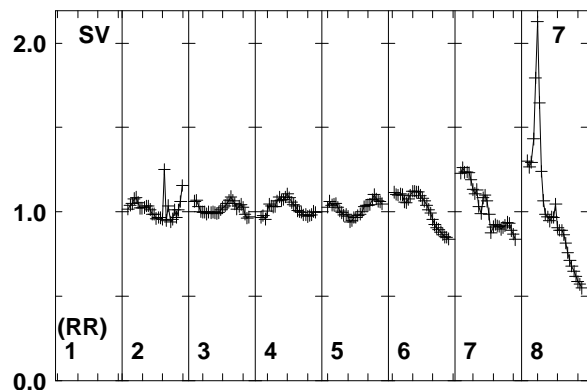
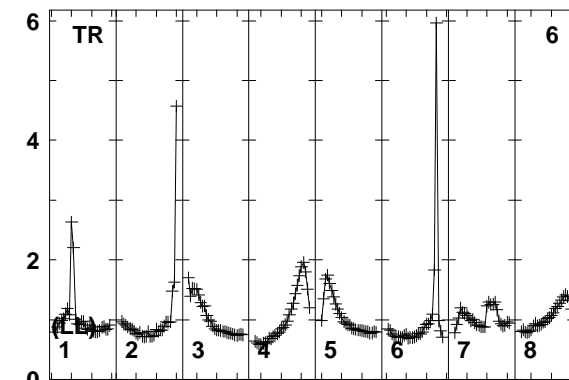
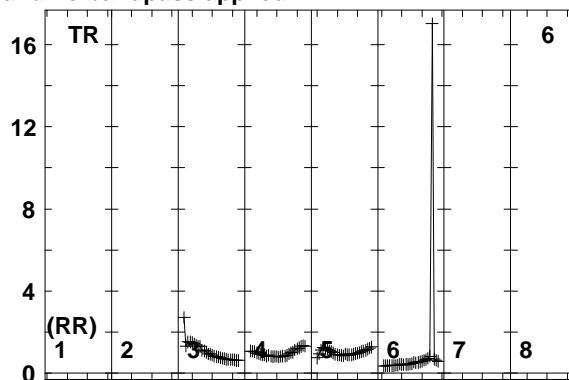
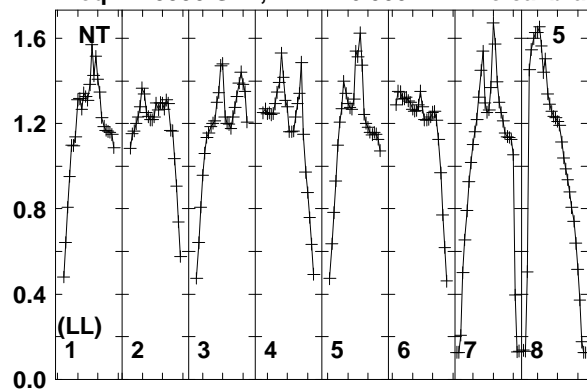

Lower frame: Real Jy
Total-power spectrum Antenna: NT (05)
Timerange: 00/08:34:31 to 00/08:38:29

Plot file version 292 created 11-AUG-2014 17:05:40

J2032+4127 EM110 2.UVDATA.1

Freq = 1.5950 GHz, Bw = 16.000 MH No calibration applied and no bandpass applied

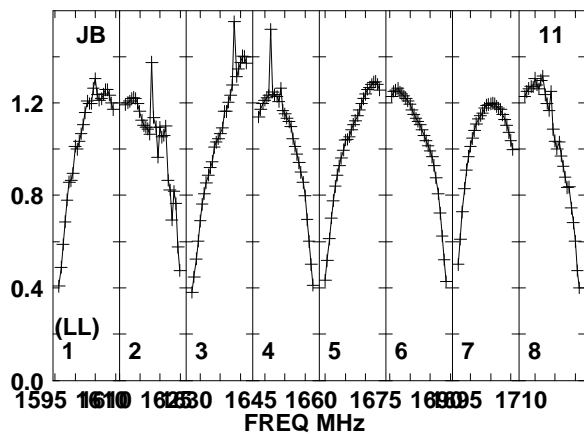
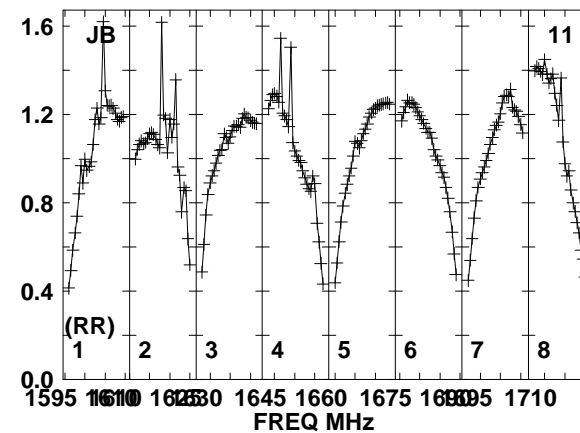
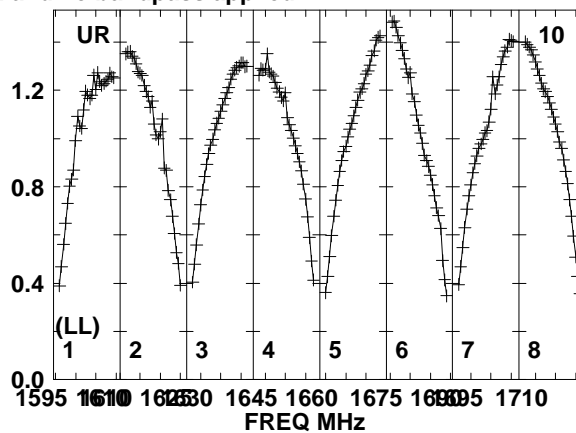
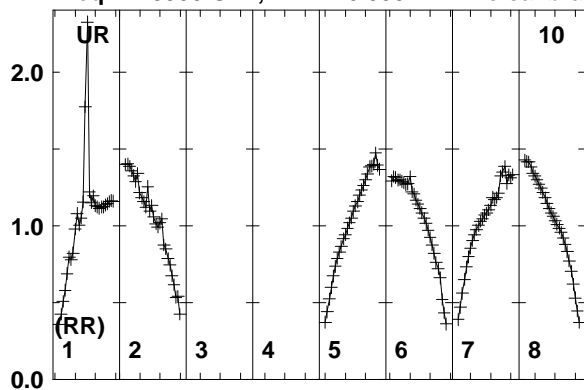

Lower frame: Real Jy
Total-power spectrum Antenna: UR (10)
Timerange: 00/08:34:31 to 00/08:38:29

Plot file version 293 created 11-AUG-2014 17:05:40

J2015+3710 EM110 2.UVDATA.1

Freq = 1.5950 GHz, Bw = 16.000 MH No calibration applied and no bandpass applied

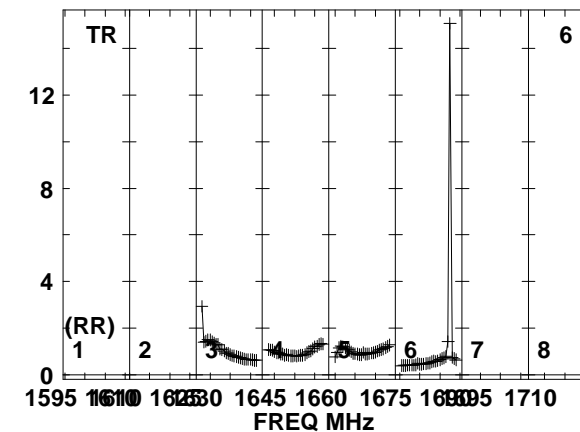
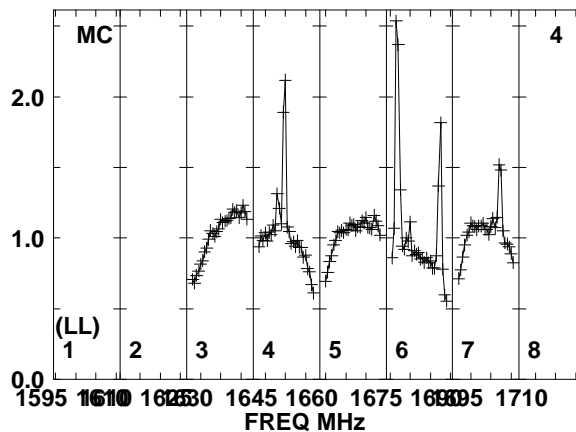
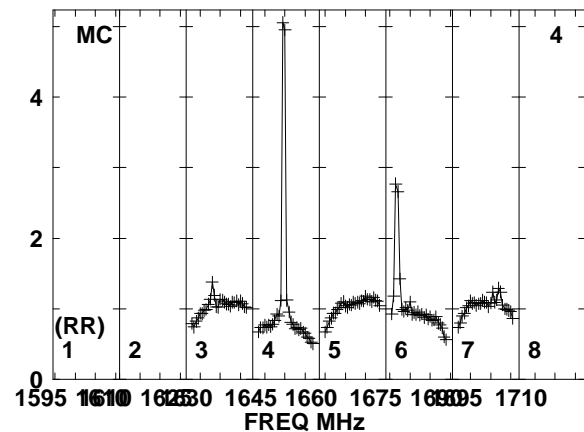
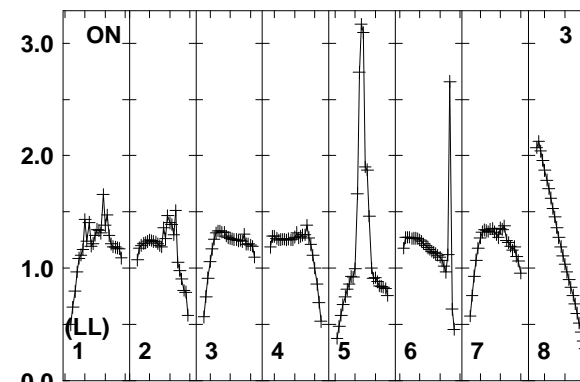
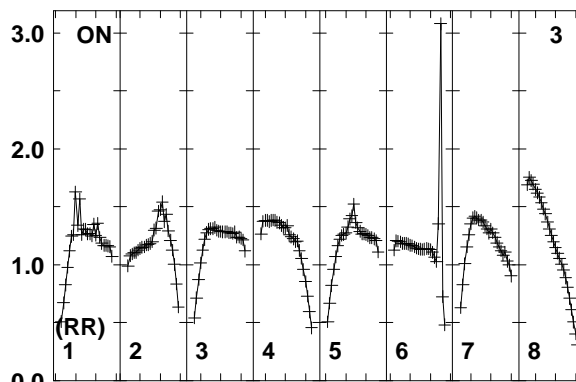
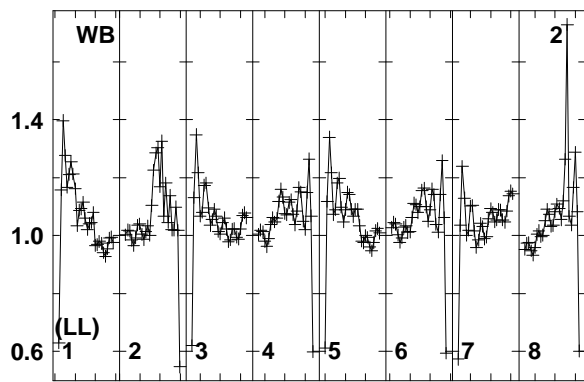
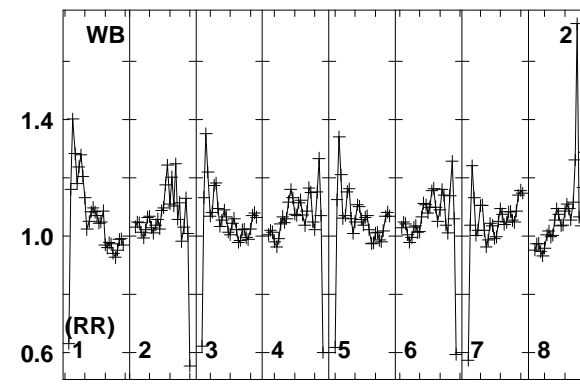
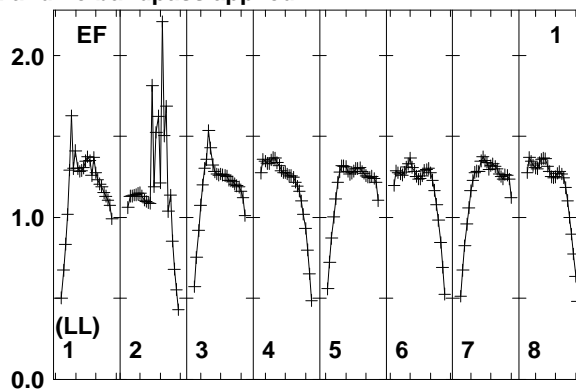
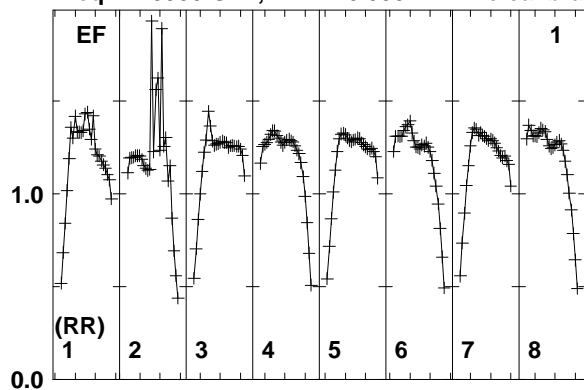

1595 1610 1625 1640 1655 1670 1685 1700 1710
FREQ MHz

1595 1610 1625 1640 1655 1670 1685 1700 1710
FREQ MHz

1595 1610 1625 1640 1655 1670 1685 1700 1710
FREQ MHz

Lower frame: Real Jy
Total-power spectrum Antenna: EF (01)
Timerange: 00/08:39:31 to 00/08:41:29

Plot file version 294 created 11-AUG-2014 17:05:40

J2015+3710 EM110 2.UVDATA.1

Freq = 1.5950 GHz, Bw = 16.000 MH No calibration applied and no bandpass applied

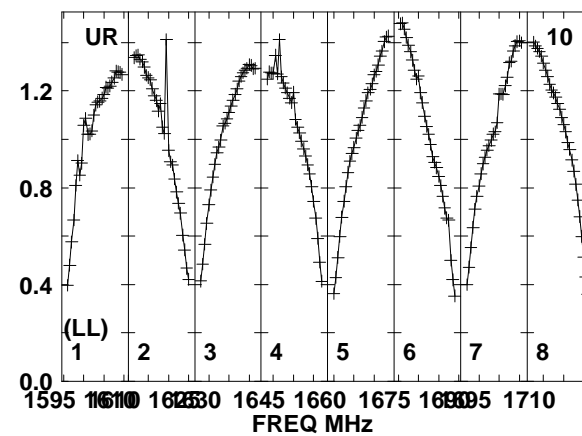
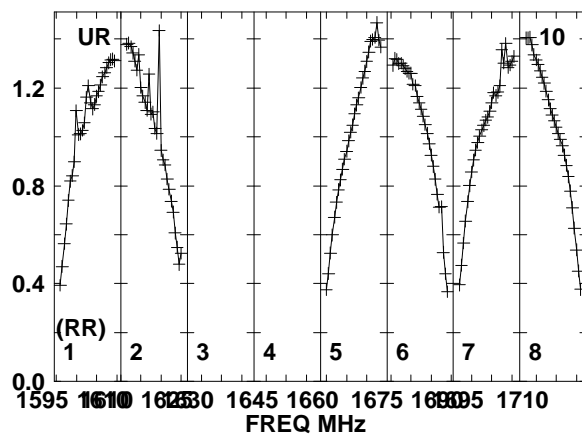
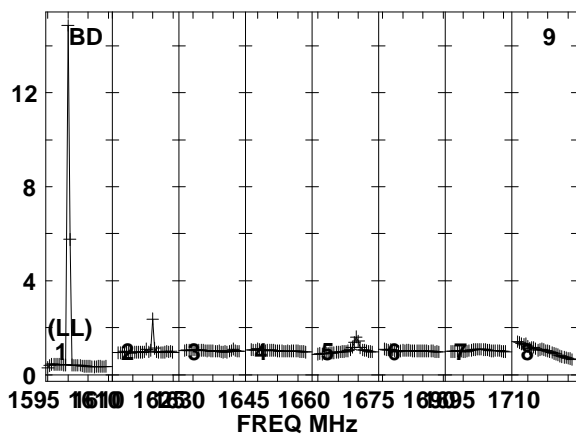
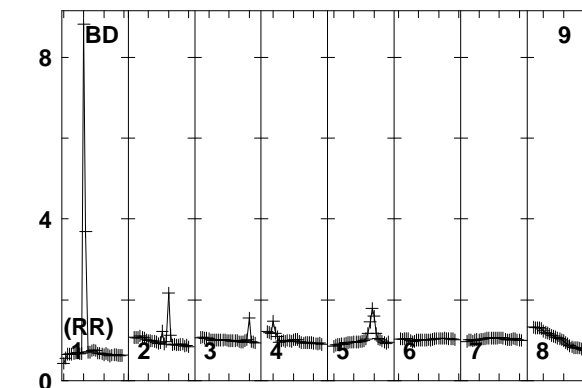
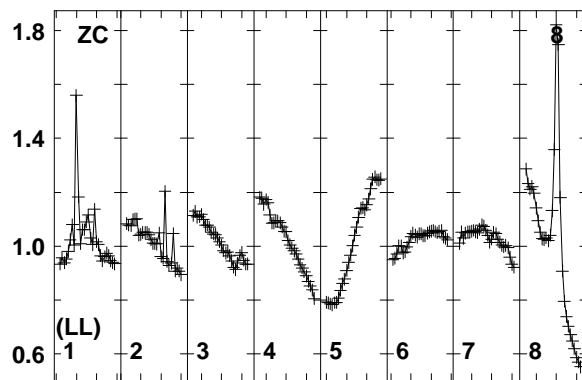
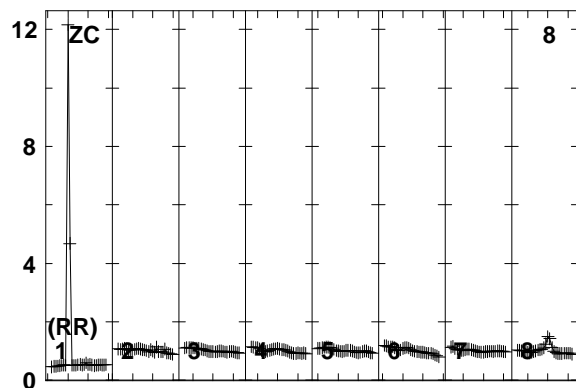
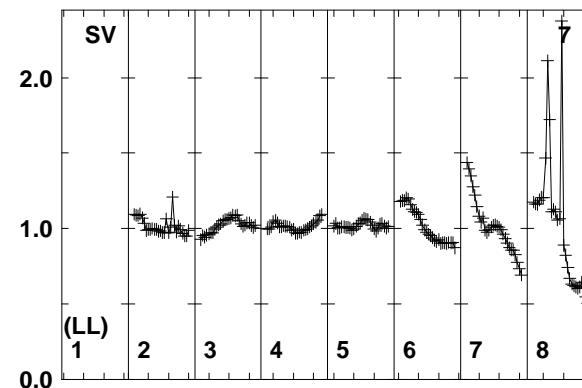
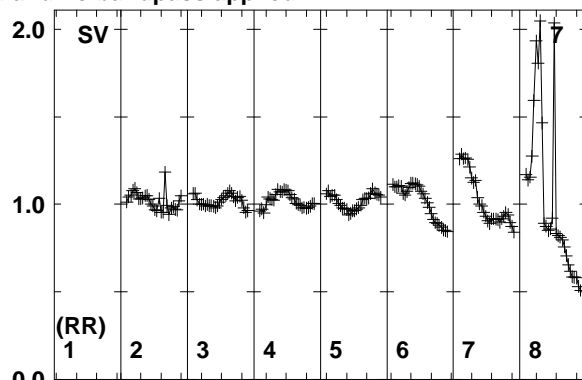
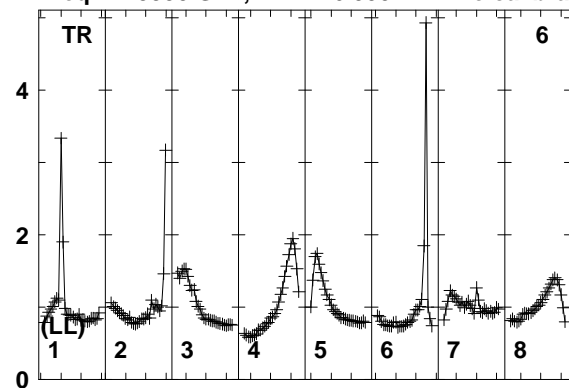

Lower frame: Real Jy
Total-power spectrum Antenna: TR (06)
Timerange: 00/08:39:31 to 00/08:41:29

Plot file version 295 created 11-AUG-2014 17:05:40

J2015+3710 EM110 2.UVDATA.1

Freq = 1.5950 GHz, Bw = 16.000 MH No calibration applied and no bandpass applied

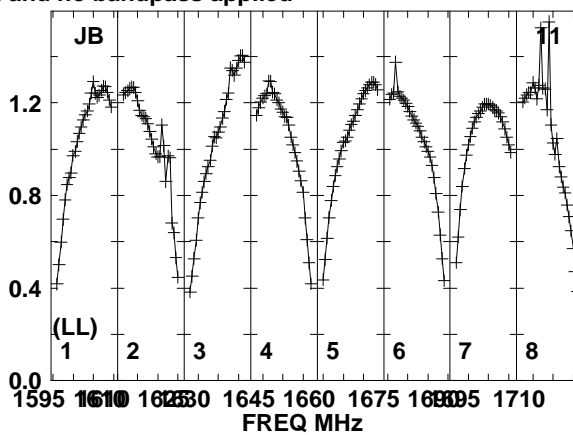
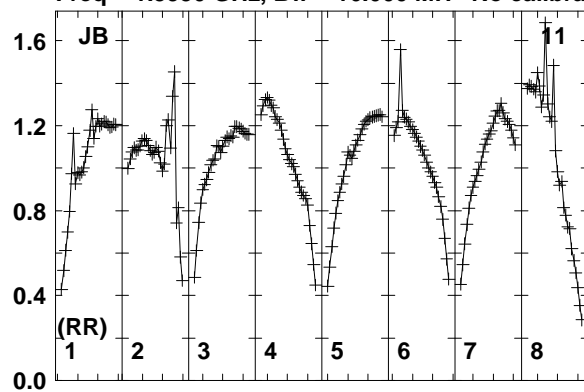

Lower frame: Real Jy
Total-power spectrum Antenna: JB (11)
Timerange: 00/08:39:31 to 00/08:41:29

Plot file version 296 created 11-AUG-2014 17:05:40

J2032+4127 EM110 2.UVDATA.1

Freq = 1.5950 GHz, Bw = 16.000 MH No calibration applied and no bandpass applied

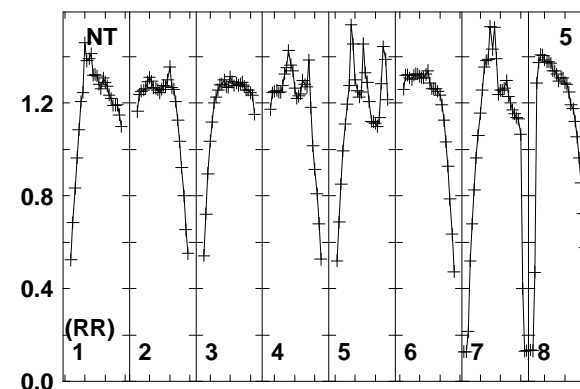
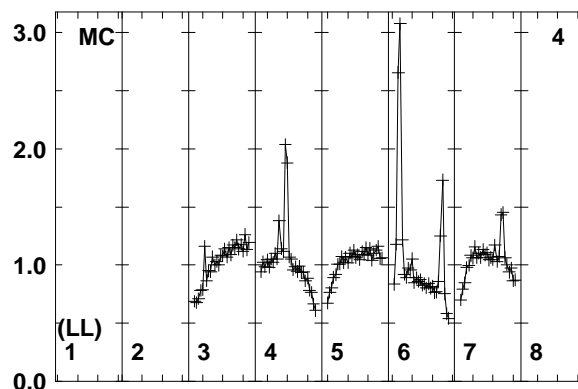
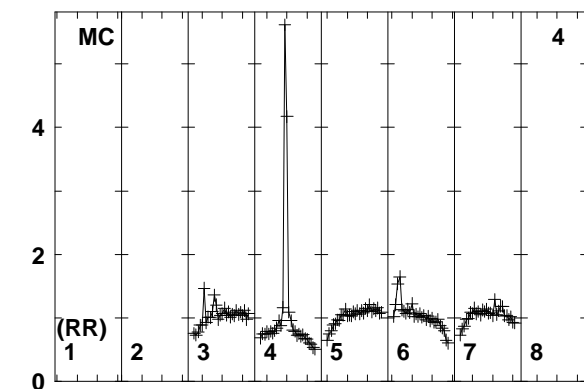
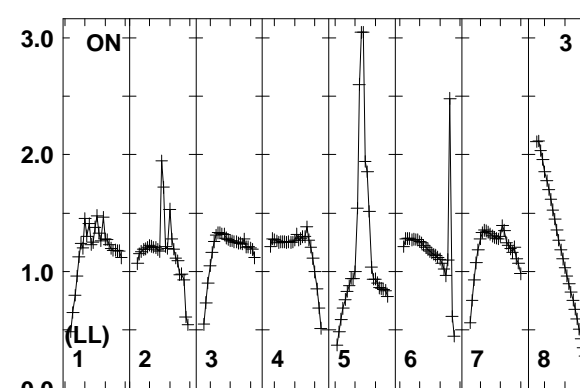
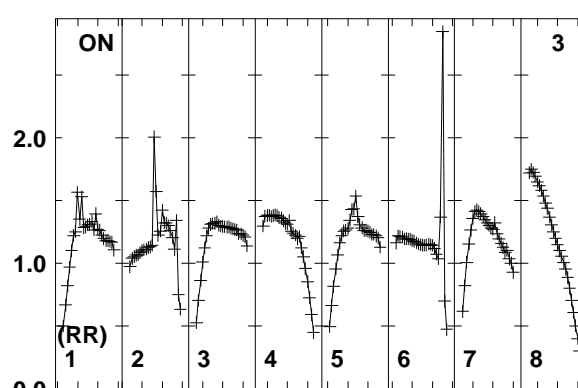
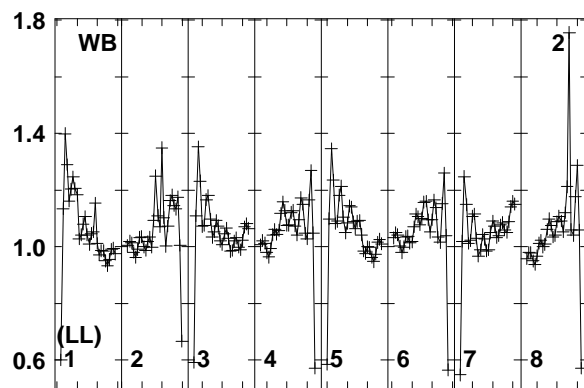
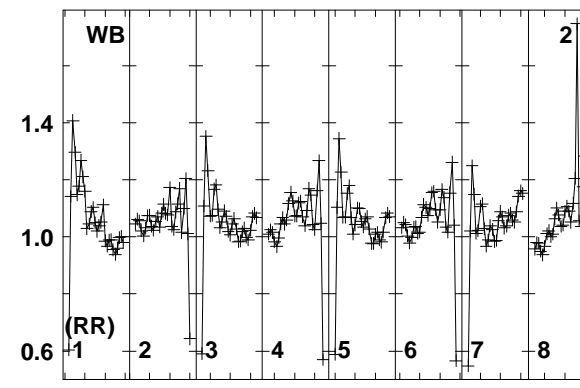
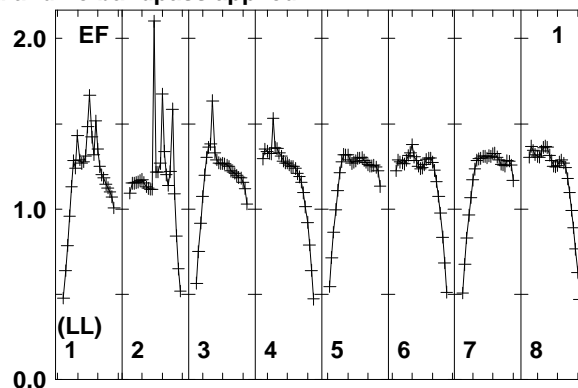
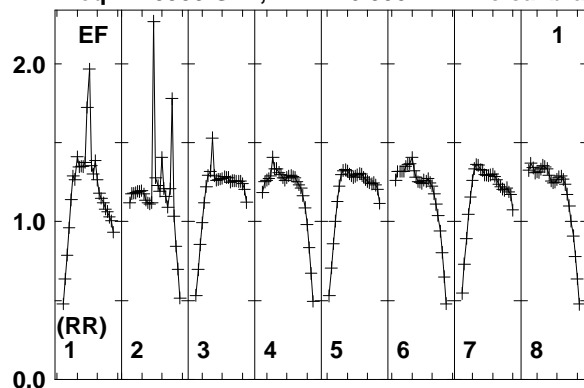

1595 1610 1625 1640 1655 1670 1685 1700 1710
FREQ MHz

1595 1610 1625 1640 1655 1670 1685 1700 1710
FREQ MHz

1595 1610 1625 1640 1655 1670 1685 1700 1710
FREQ MHz

Lower frame: Real Jy
Total-power spectrum Antenna: EF (01)
Timerange: 00/08:41:33 to 00/08:45:29

Plot file version 297 created 11-AUG-2014 17:05:40

J2032+4127 EM110 2.UVDATA.1

Freq = 1.5950 GHz, Bw = 16.000 MH No calibration applied and no bandpass applied

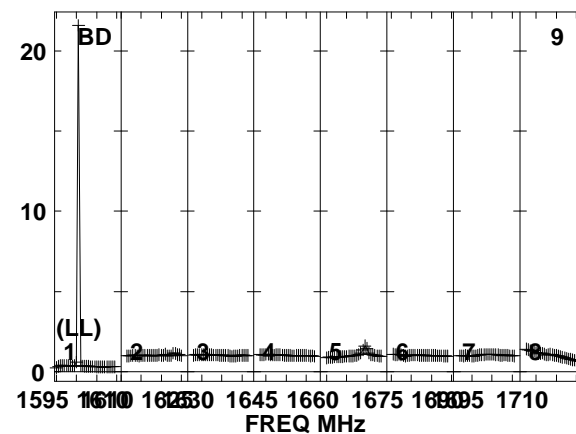
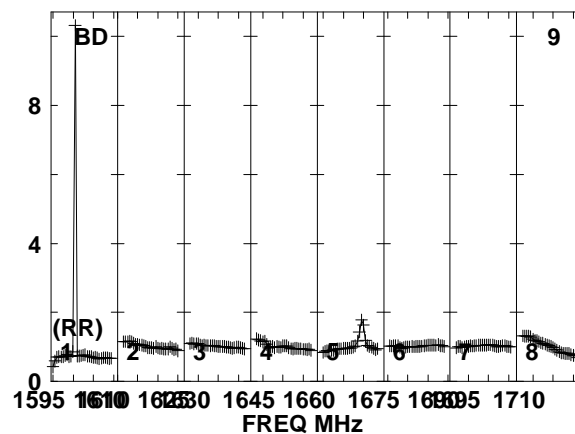
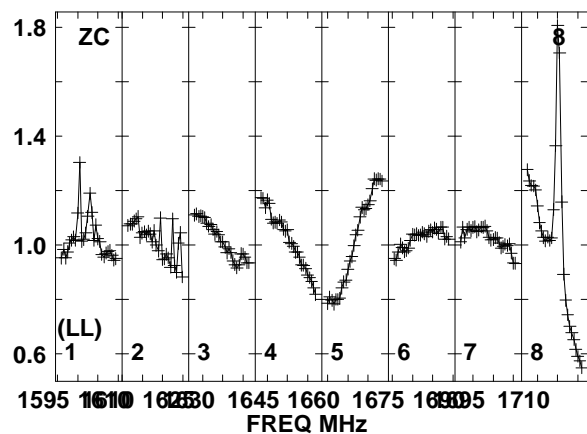
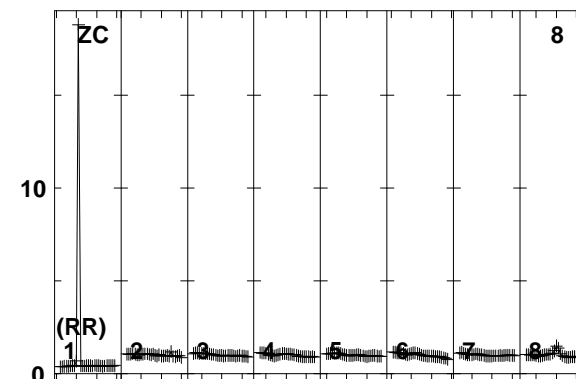
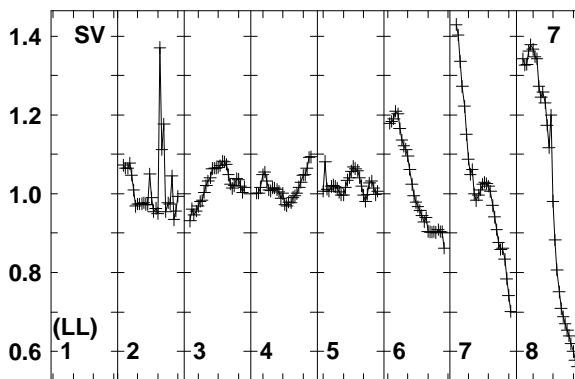
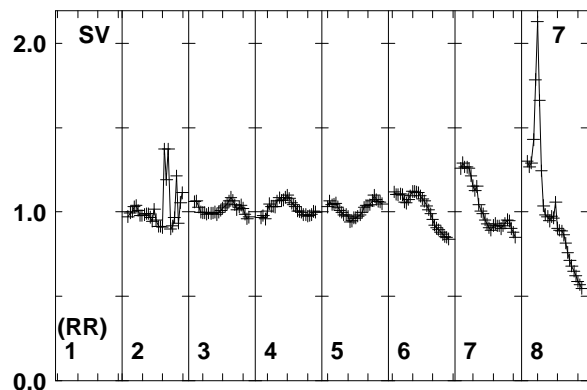
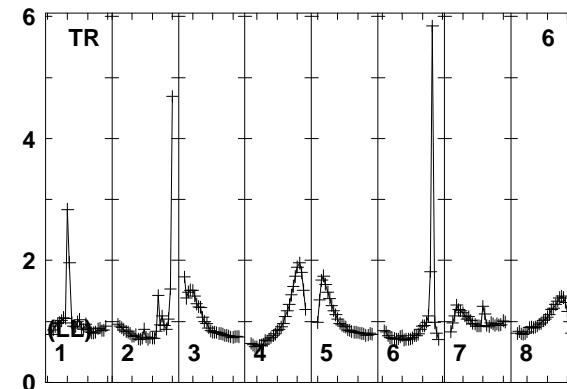
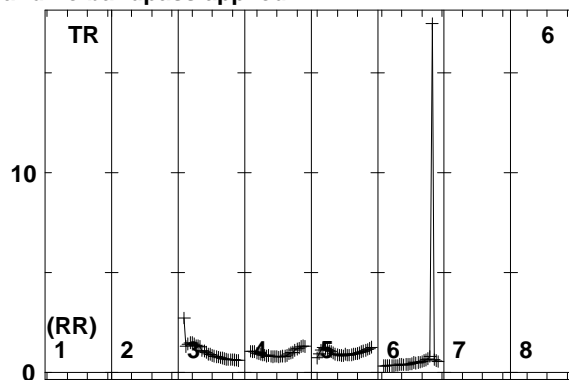
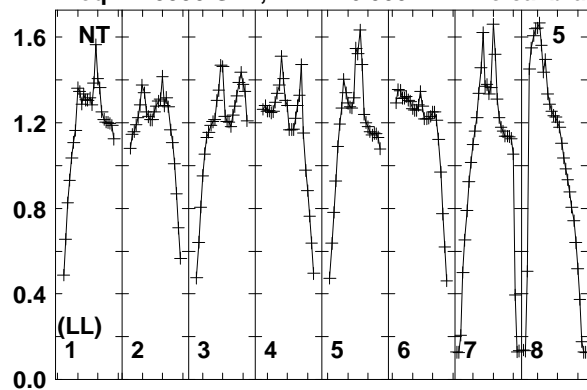

Lower frame: Real Jy
Total-power spectrum Antenna: NT (05)
Timerange: 00/08:41:33 to 00/08:45:29

Plot file version 298 created 11-AUG-2014 17:05:41

J2032+4127 EM110 2.UVDATA.1

Freq = 1.5950 GHz, Bw = 16.000 MH No calibration applied and no bandpass applied

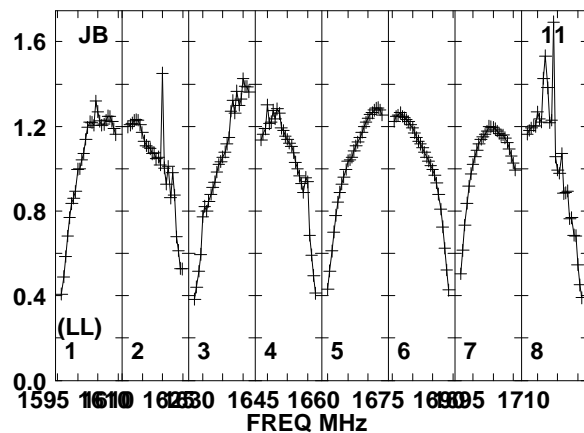
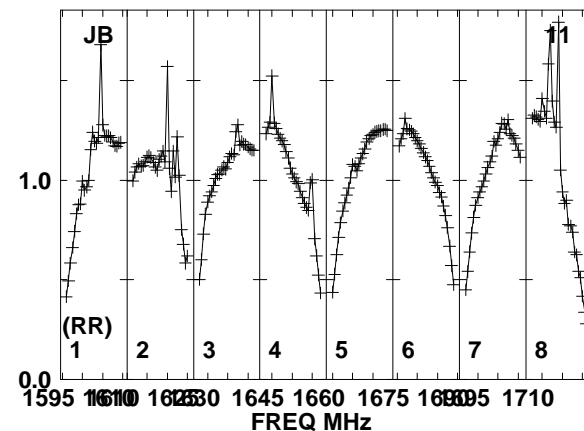
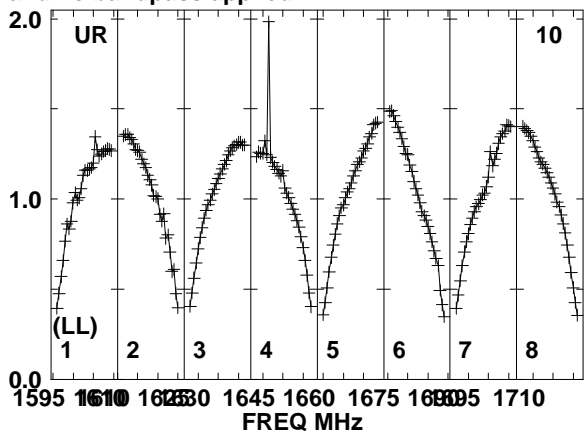
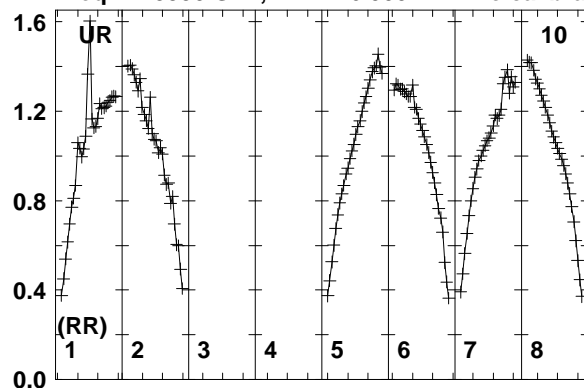

Lower frame: Real Jy
Total-power spectrum Antenna: UR (10)
Timerange: 00/08:41:33 to 00/08:45:29

Plot file version 299 created 11-AUG-2014 17:05:41

J2015+3710 EM110 2.UVDATA.1

Freq = 1.5950 GHz, Bw = 16.000 MH No calibration applied and no bandpass applied

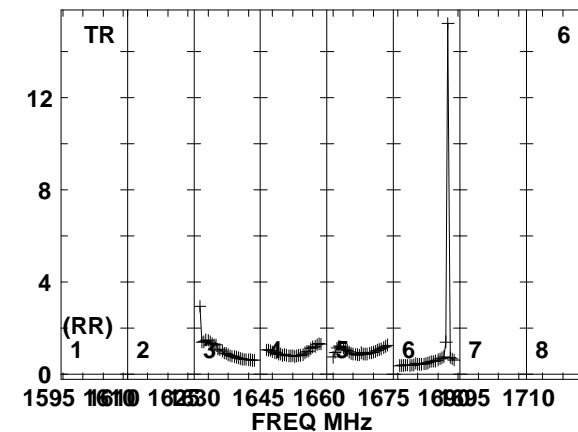
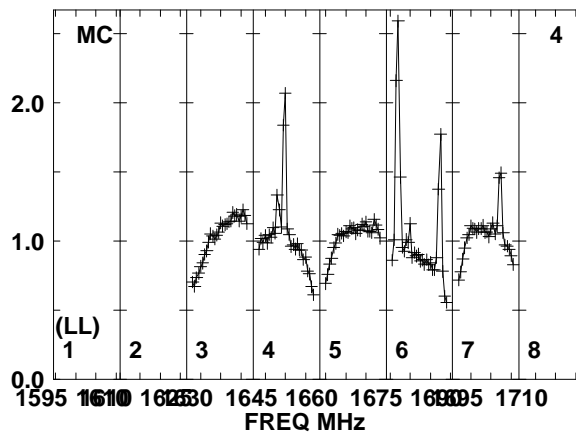
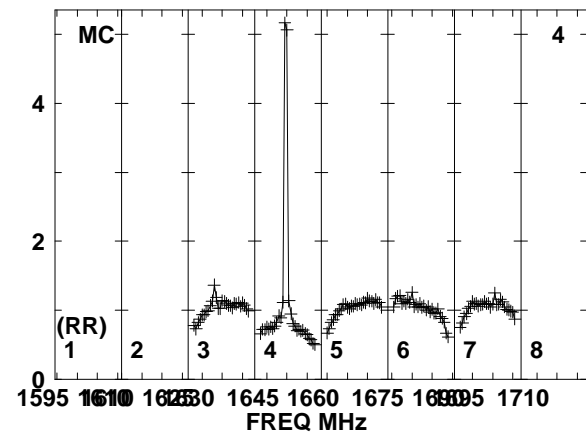
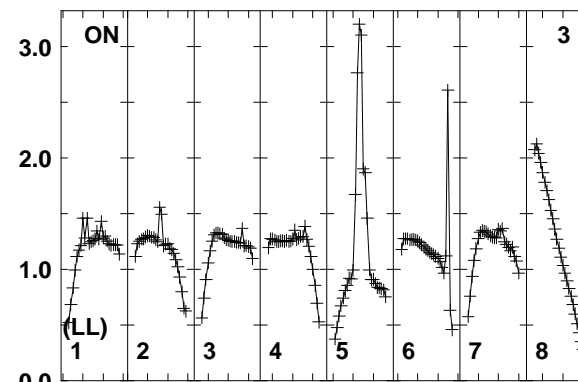
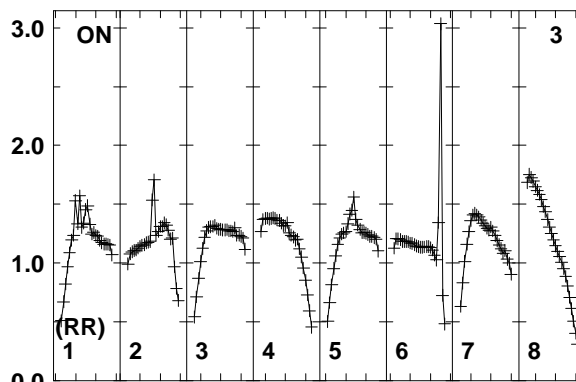
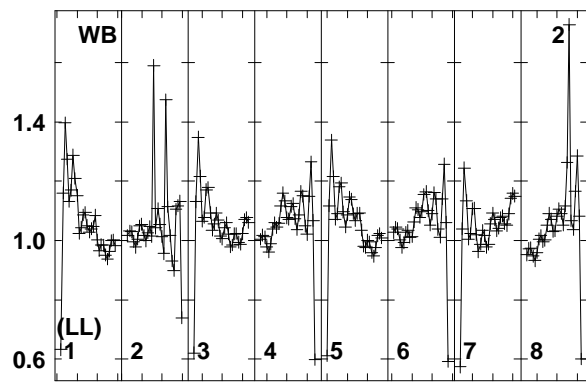
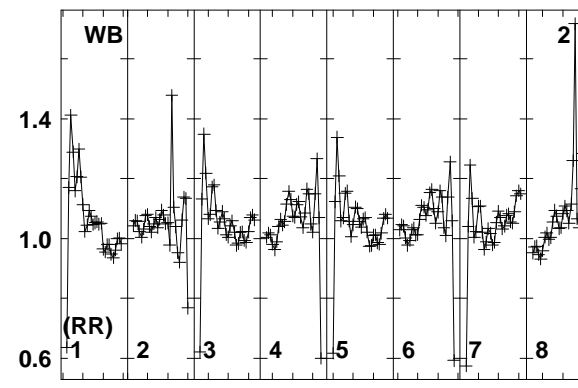
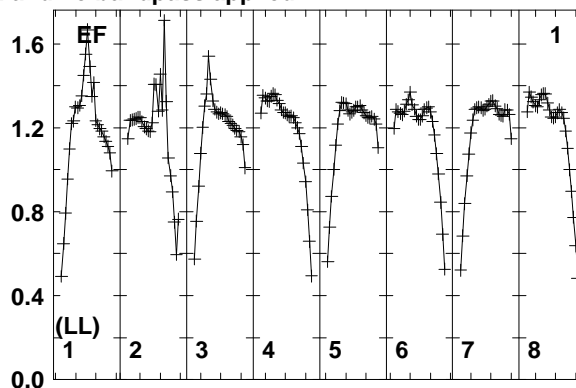
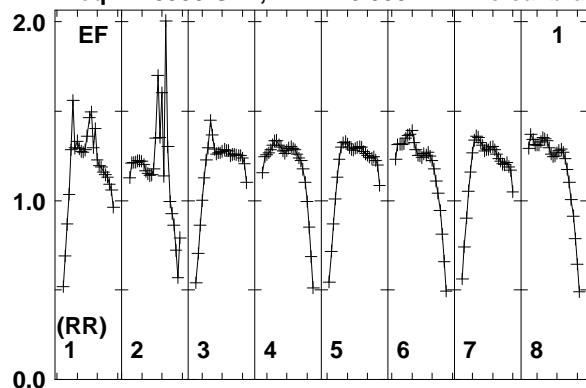

Lower frame: Real Jy
Total-power spectrum Antenna: EF (01)
Timerange: 00/08:45:44 to 00/08:47:28

Plot file version 300 created 11-AUG-2014 17:05:41

J2015+3710 EM110 2.UVDATA.1

Freq = 1.5950 GHz, Bw = 16.000 MH No calibration applied and no bandpass applied

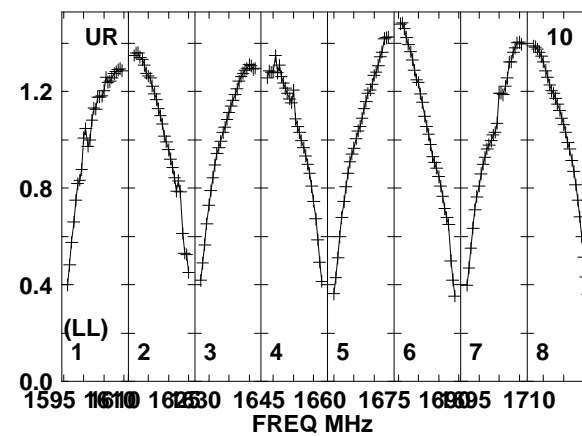
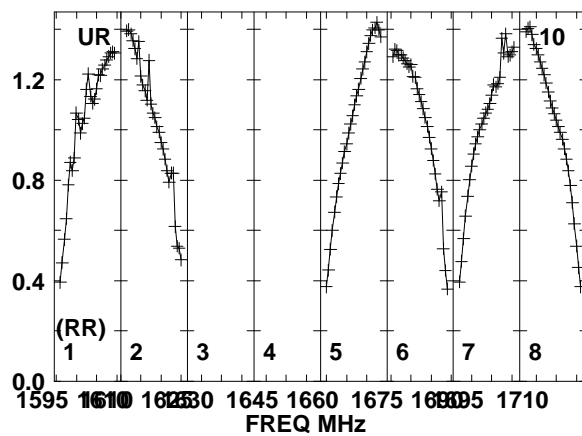
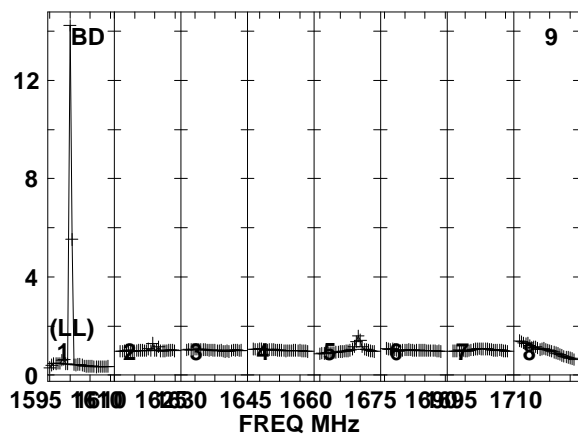
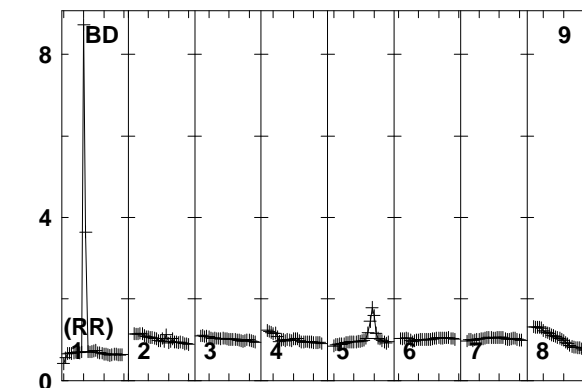
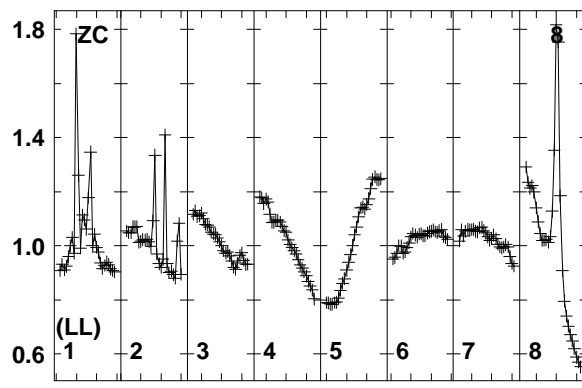
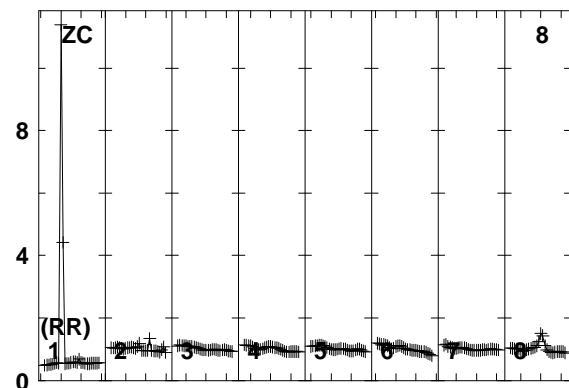
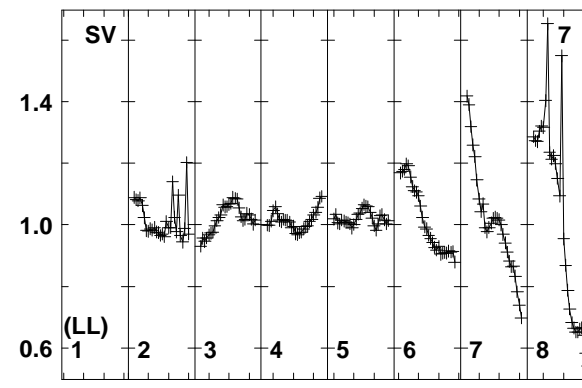
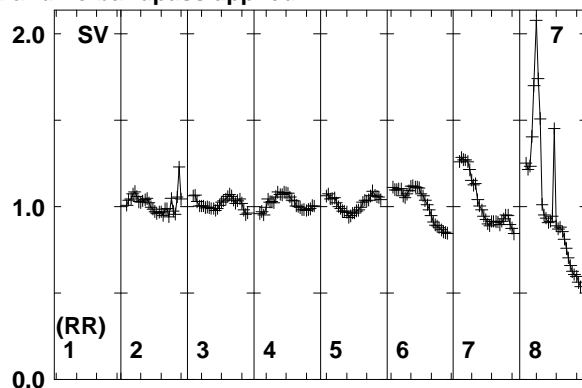
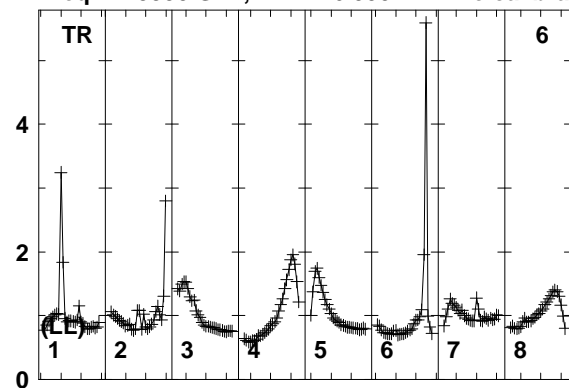

Lower frame: Real Jy
Total-power spectrum Antenna: TR (06)
Timerange: 00/08:45:44 to 00/08:47:28

Plot file version 301 created 11-AUG-2014 17:05:41

J2032+4127 EM110 2.UVDATA.1

Freq = 1.5950 GHz, Bw = 16.000 MH No calibration applied and no bandpass applied

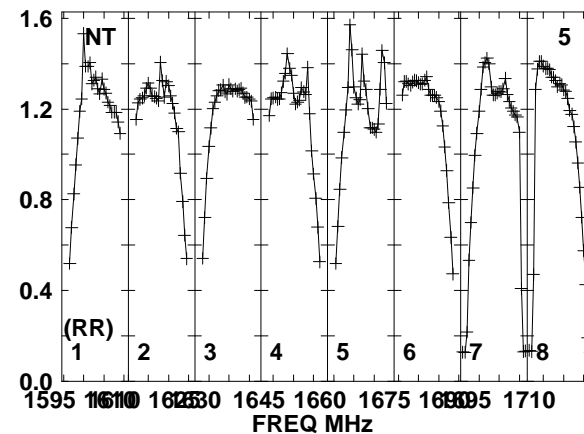
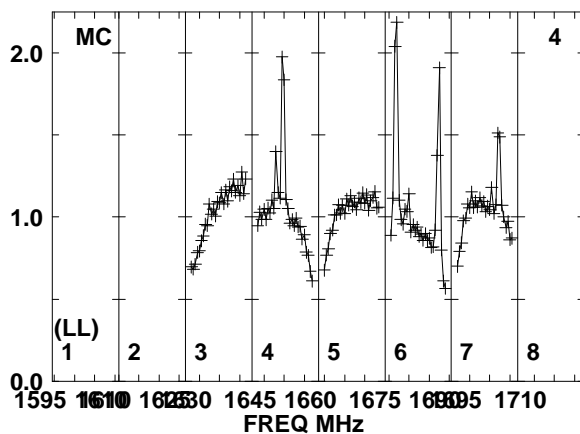
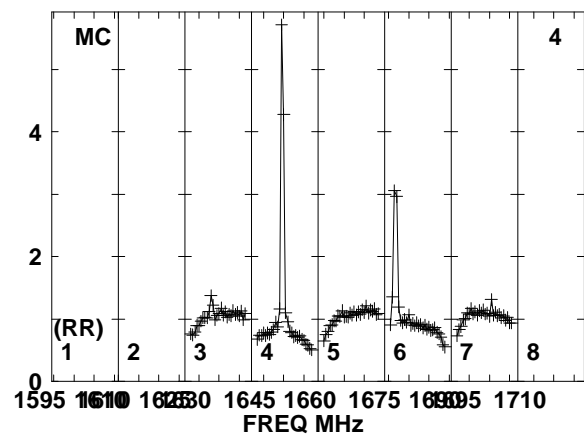
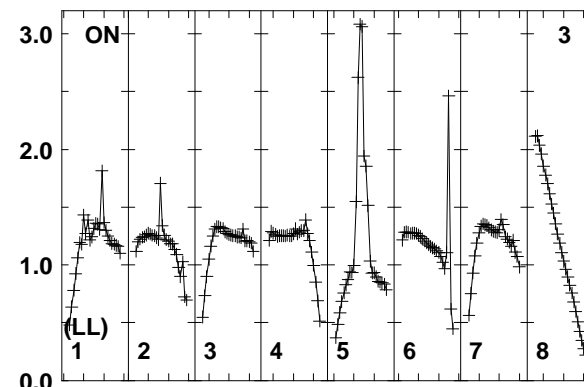
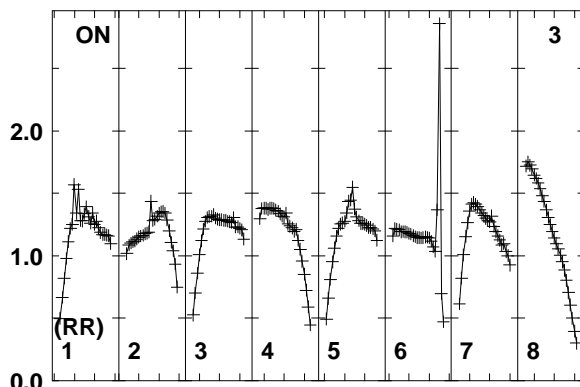
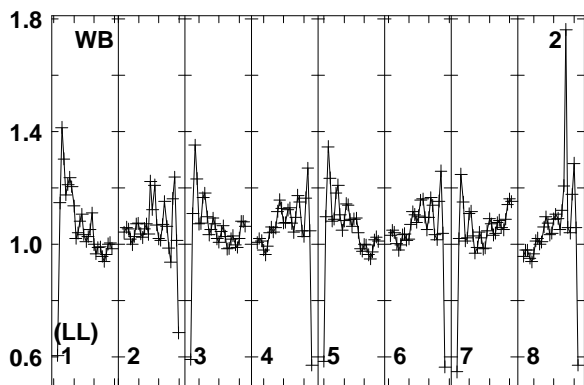
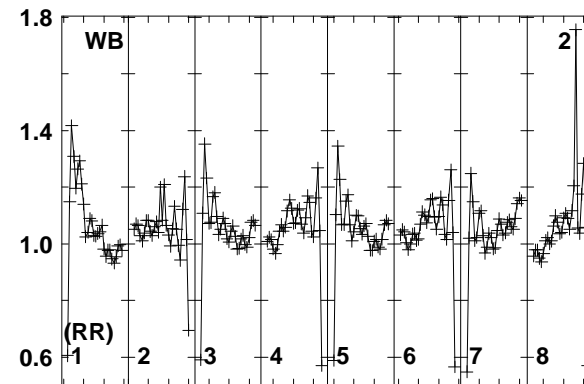
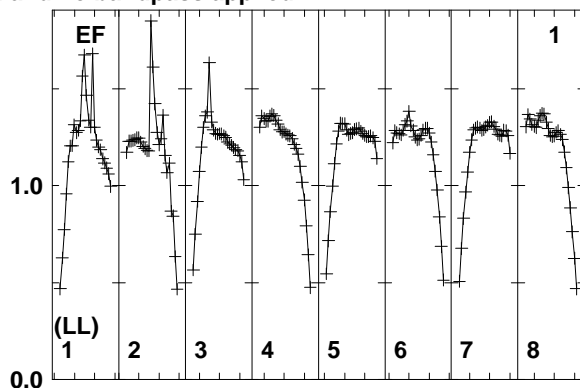
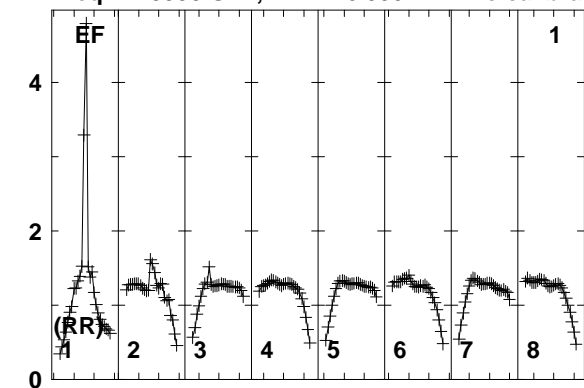

Lower frame: Real Jy
Total-power spectrum Antenna: EF (01)
Timerange: 00/08:47:31 to 00/08:51:29

Plot file version 302 created 11-AUG-2014 17:05:41

J2032+4127 EM110 2.UVDATA.1

Freq = 1.5950 GHz, Bw = 16.000 MH No calibration applied and no bandpass applied

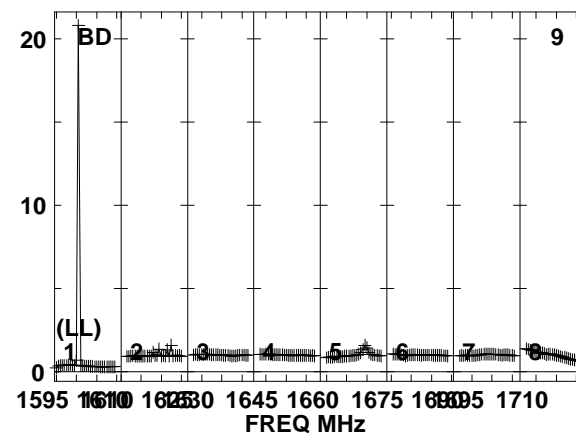
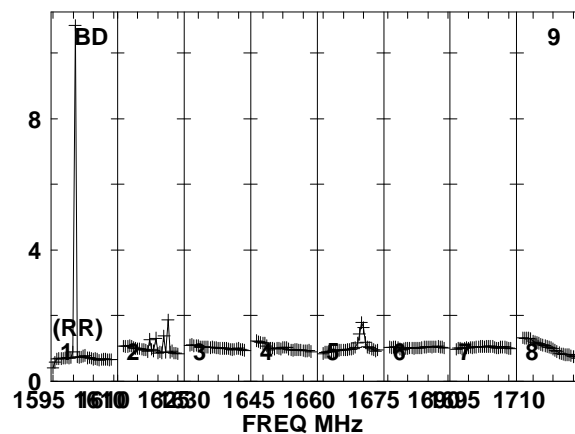
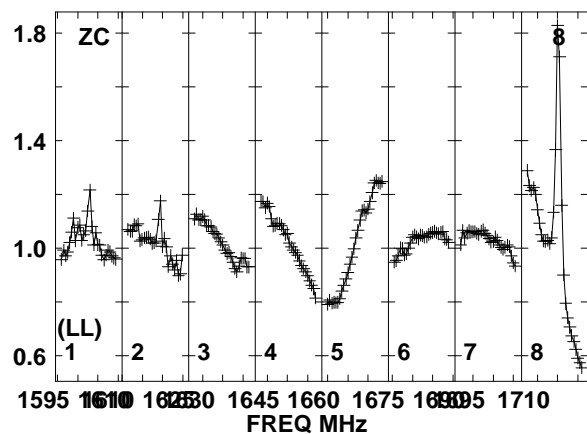
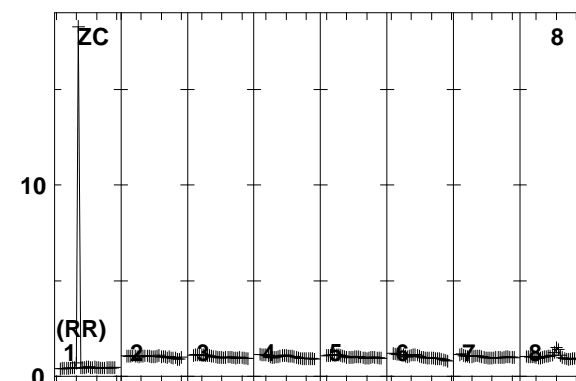
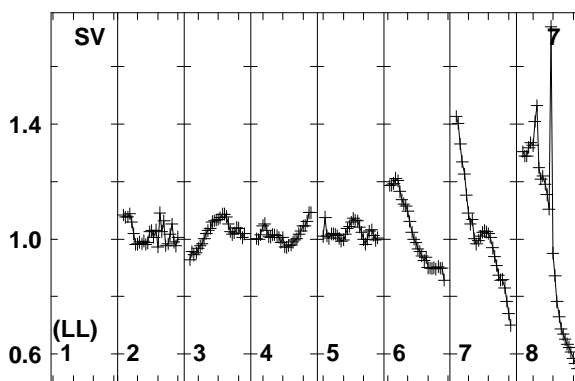
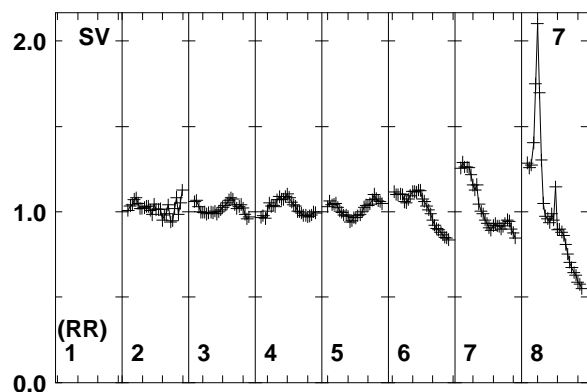
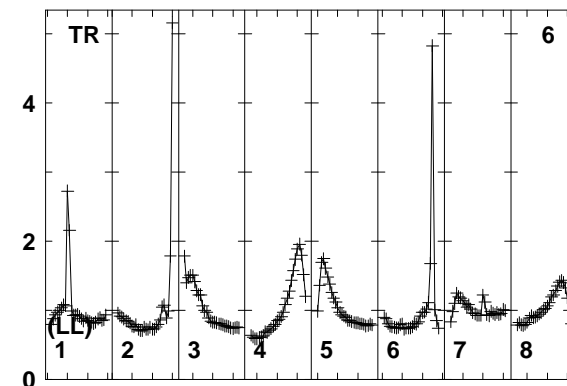
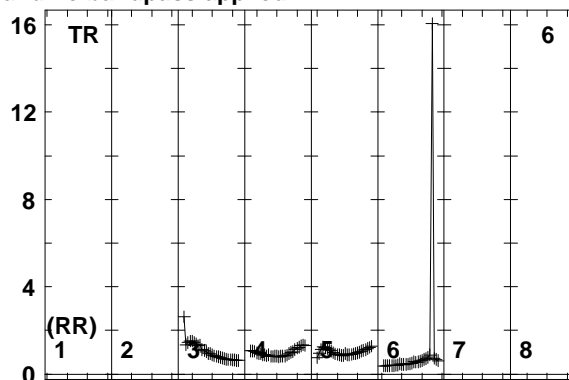
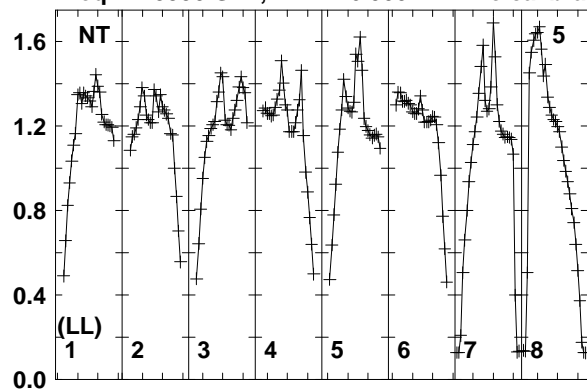

Lower frame: Real Jy
Total-power spectrum Antenna: NT (05)
Timerange: 00/08:47:31 to 00/08:51:29

Plot file version 303 created 11-AUG-2014 17:05:41

J2032+4127 EM110 2.UVDATA.1

Freq = 1.5950 GHz, Bw = 16.000 MH No calibration applied and no bandpass applied

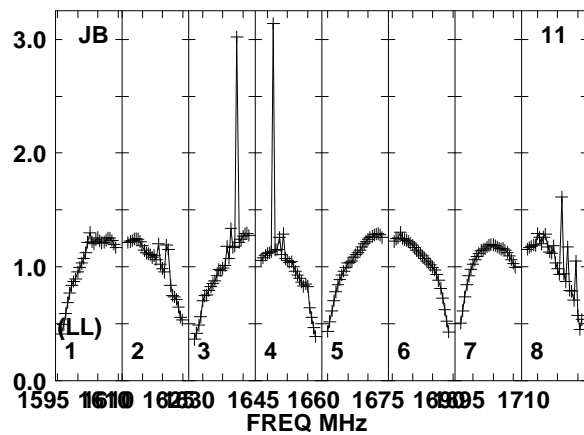
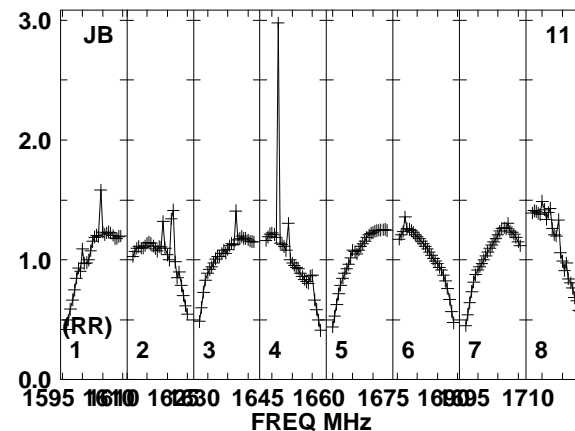
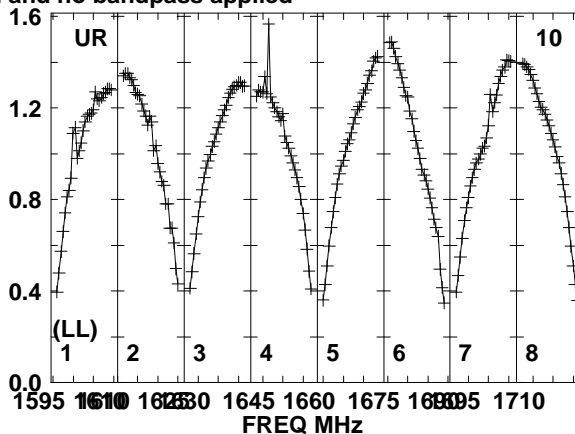
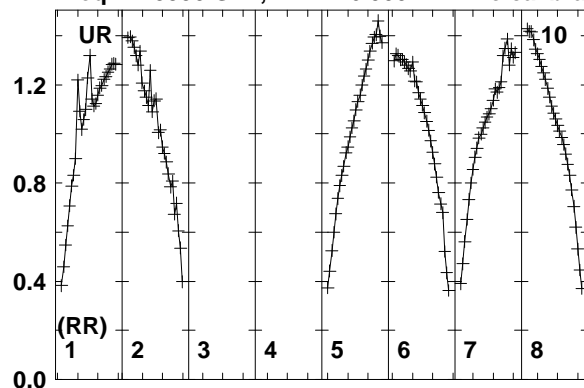

Lower frame: Real Jy
Total-power spectrum Antenna: UR (10)
Timerange: 00/08:47:31 to 00/08:51:29

Plot file version 304 created 11-AUG-2014 17:05:41

J2015+3710 EM110 2.UVDATA.1

Freq = 1.5950 GHz, Bw = 16.000 MH No calibration applied and no bandpass applied

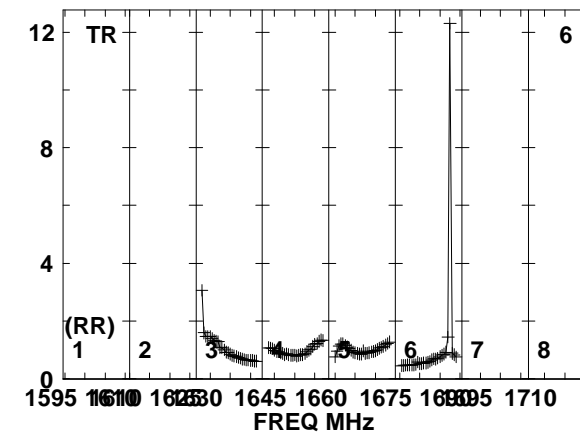
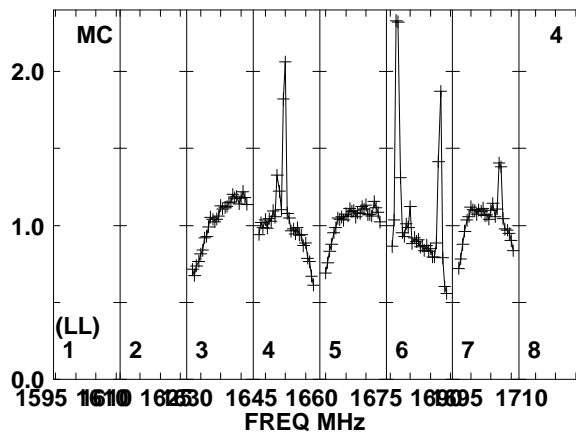
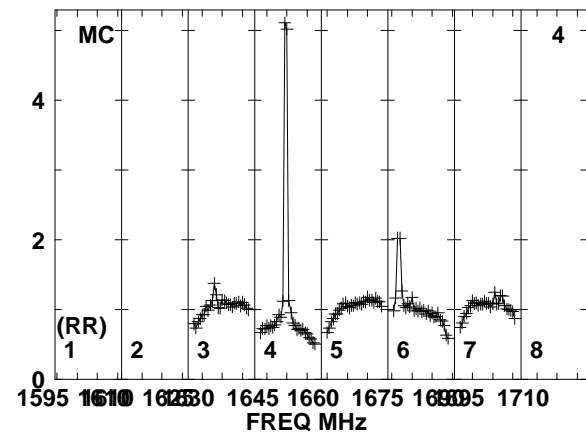
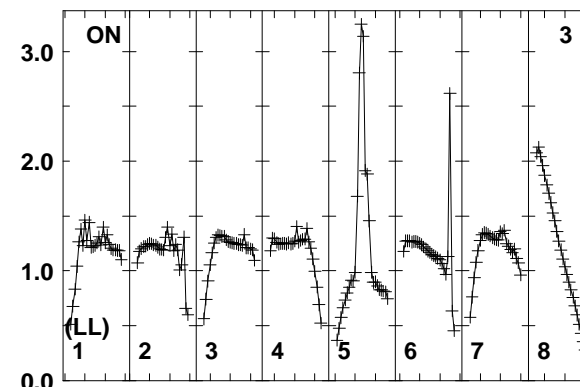
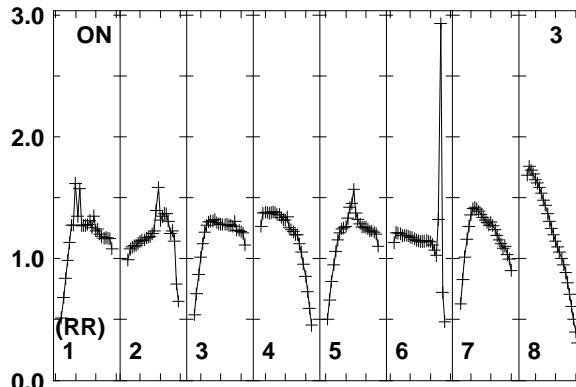
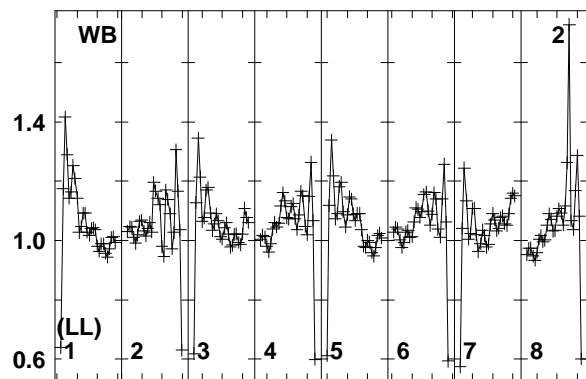
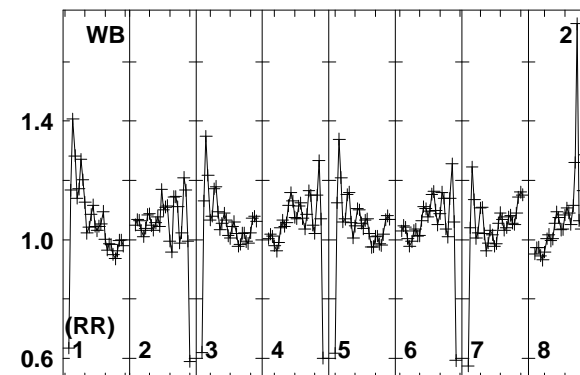
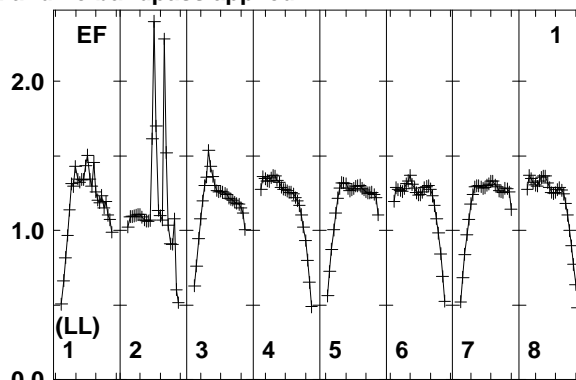
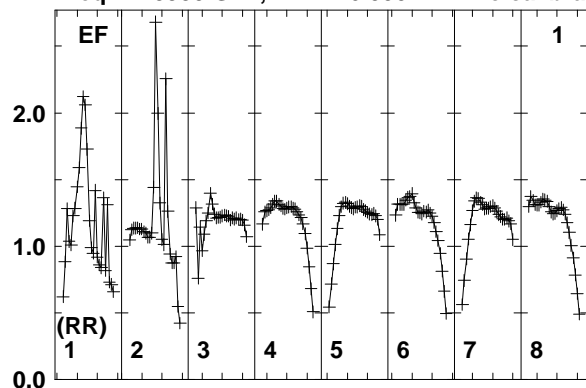

Lower frame: Real Jy
Total-power spectrum Antenna: EF (01)
Timerange: 00/08:52:33 to 00/08:54:29

Plot file version 305 created 11-AUG-2014 17:05:41

J2015+3710 EM110 2.UVDATA.1

Freq = 1.5950 GHz, Bw = 16.000 MH No calibration applied and no bandpass applied

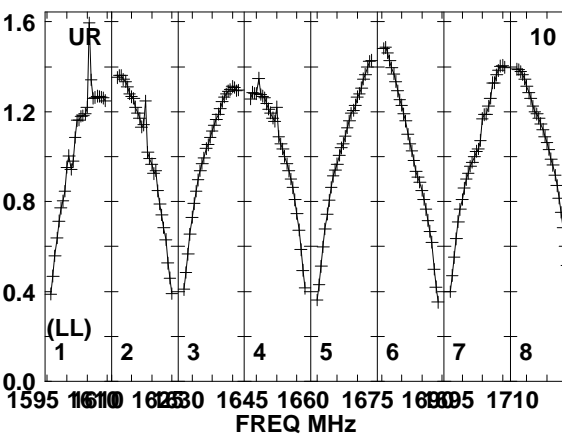
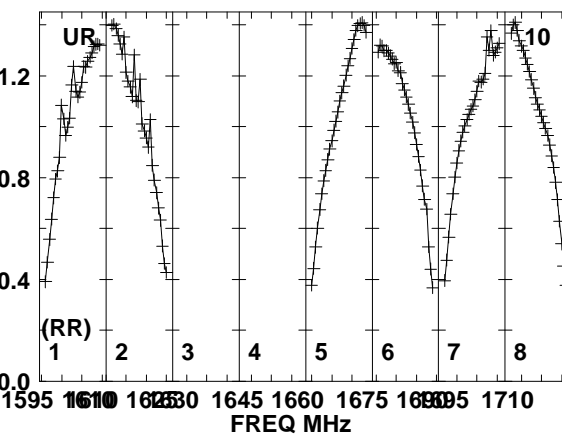
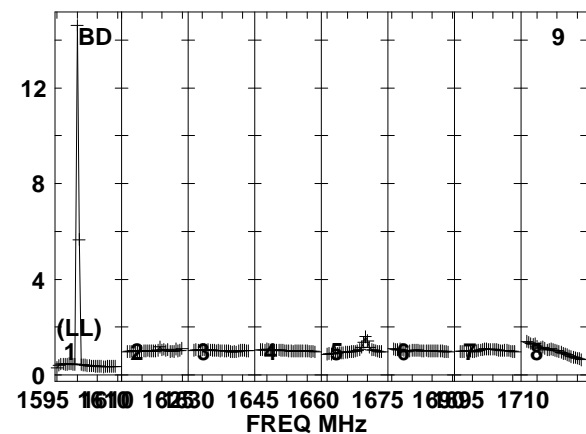
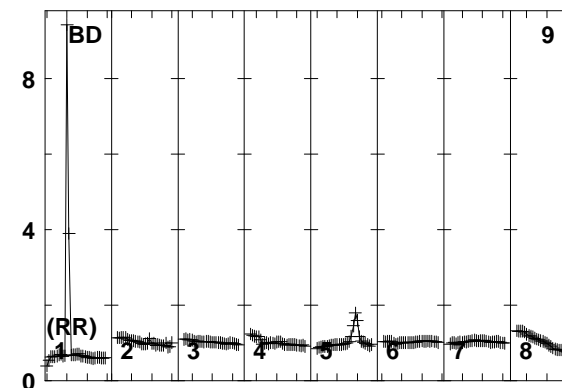
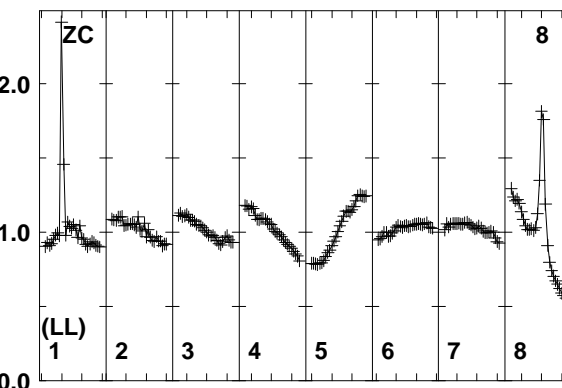
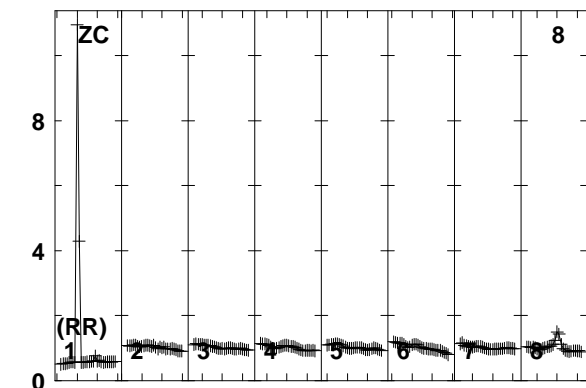
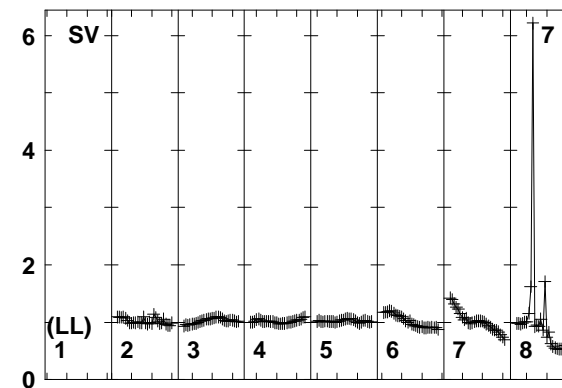
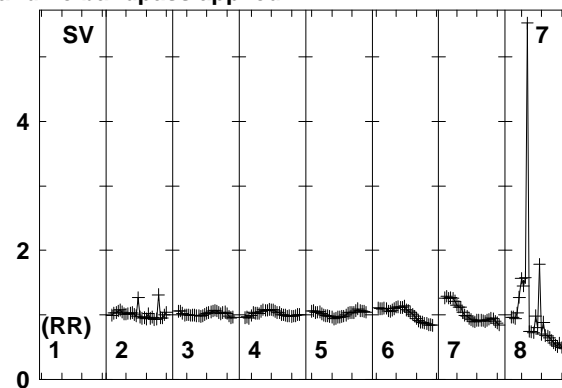
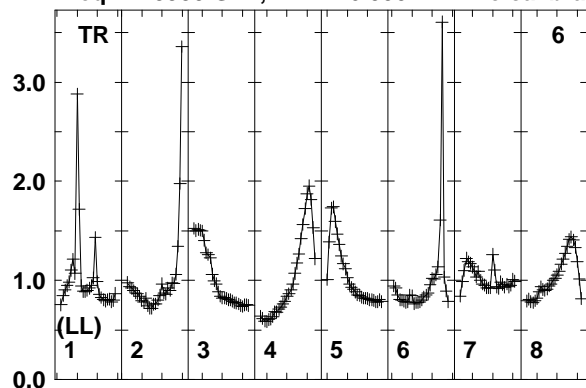

Lower frame: Real Jy
Total-power spectrum Antenna: TR (06)
Timerange: 00/08:52:33 to 00/08:54:29

Plot file version 306 created 11-AUG-2014 17:05:41

J2015+3710 EM110 2.UVDATA.1

Freq = 1.5950 GHz, Bw = 16.000 MH No calibration applied and no bandpass applied

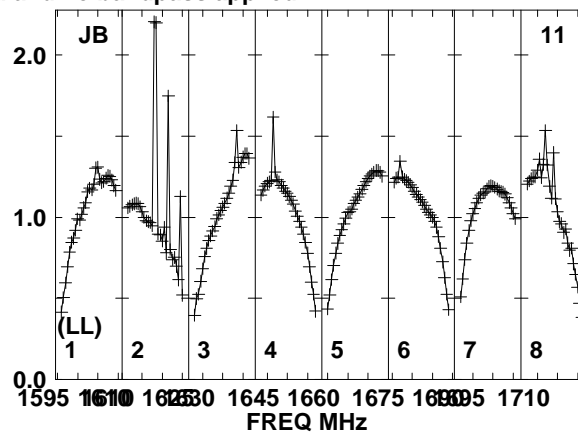
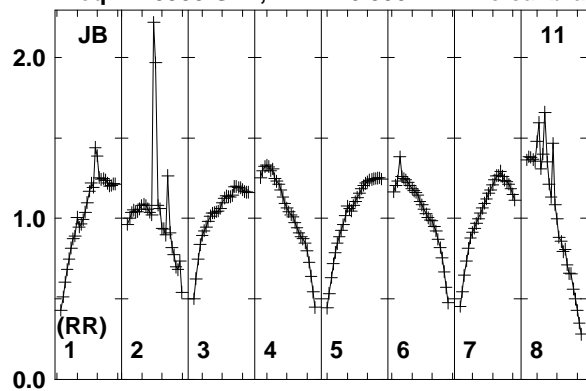

Lower frame: Real Jy
Total-power spectrum Antenna: JB (11)
Timerange: 00/08:52:33 to 00/08:54:29

Plot file version 307 created 11-AUG-2014 17:05:41

J2032+4127 EM110 2.UVDATA.1

Freq = 1.5950 GHz, Bw = 16.000 MH No calibration applied and no bandpass applied

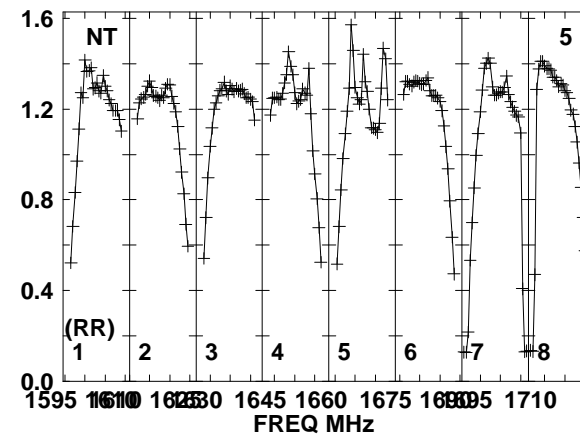
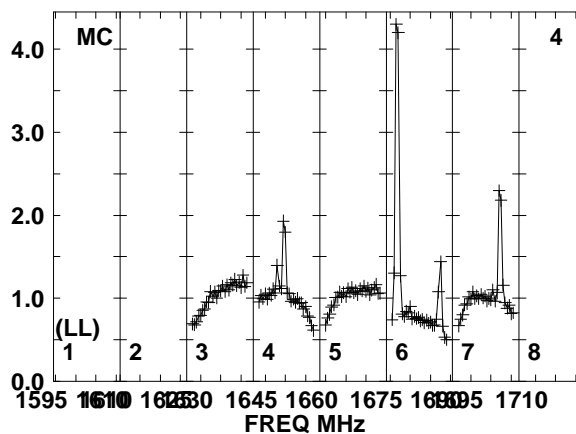
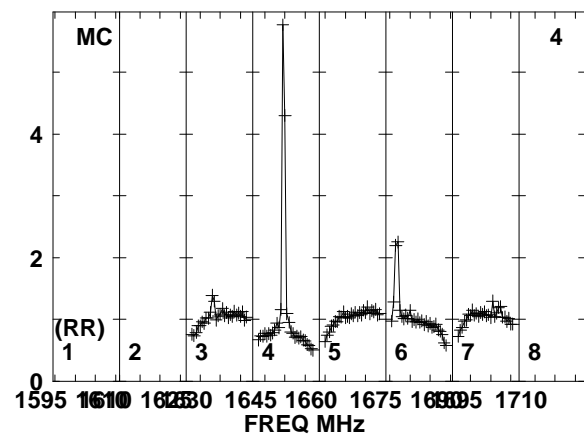
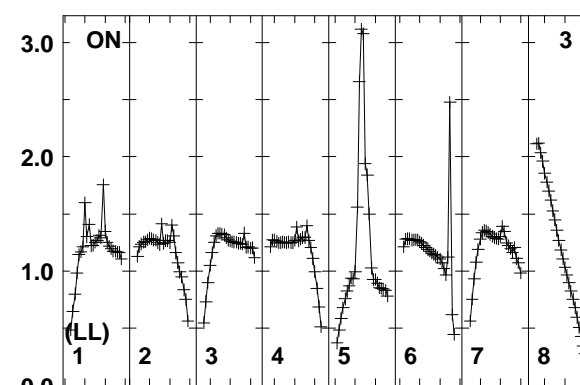
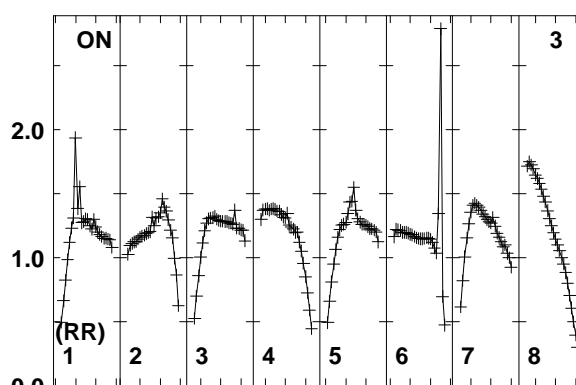
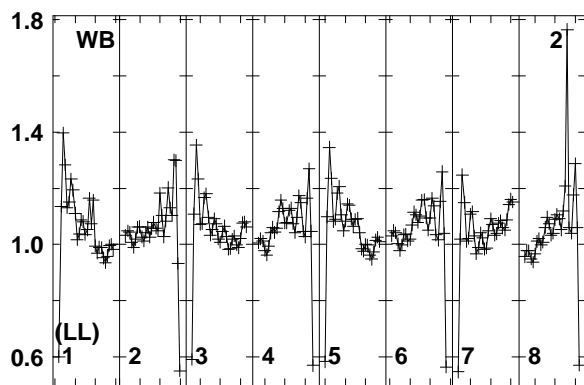
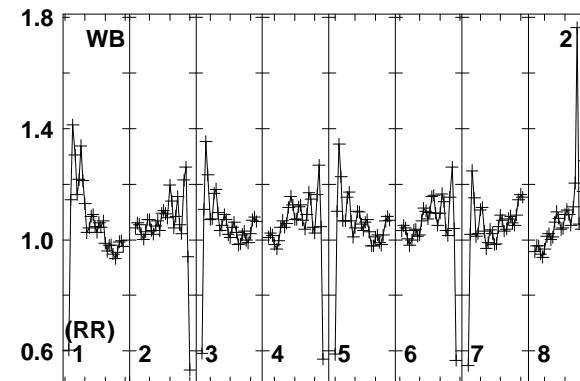
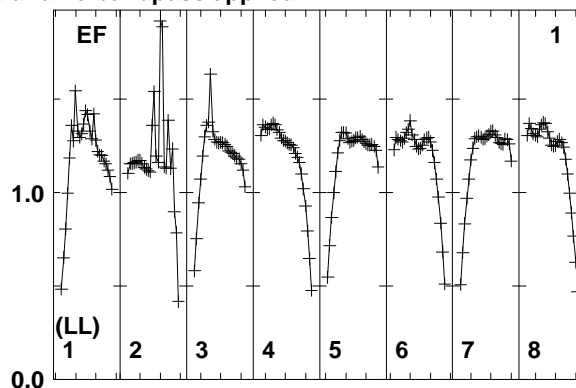
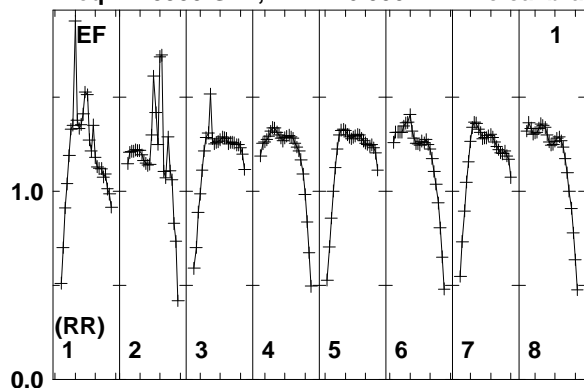

Lower frame: Real Jy
Total-power spectrum Antenna: EF (01)
Timerange: 00/08:54:33 to 00/08:58:19

Plot file version 308 created 11-AUG-2014 17:05:41

J2032+4127 EM110 2.UVDATA.1

Freq = 1.5950 GHz, Bw = 16.000 MH No calibration applied and no bandpass applied

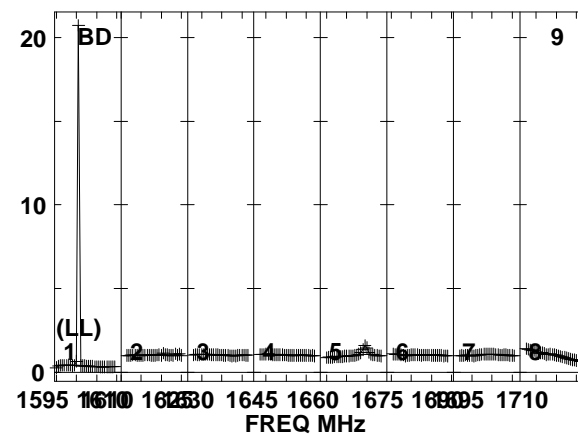
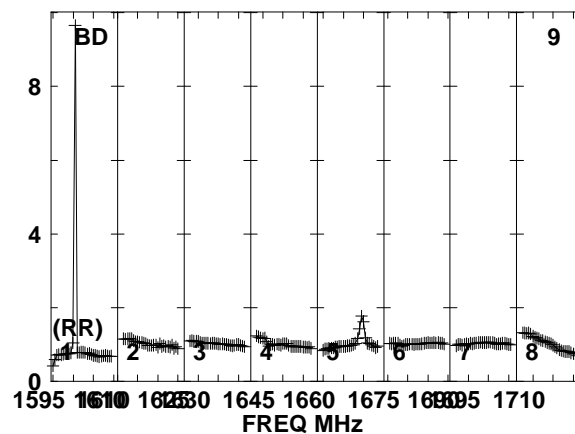
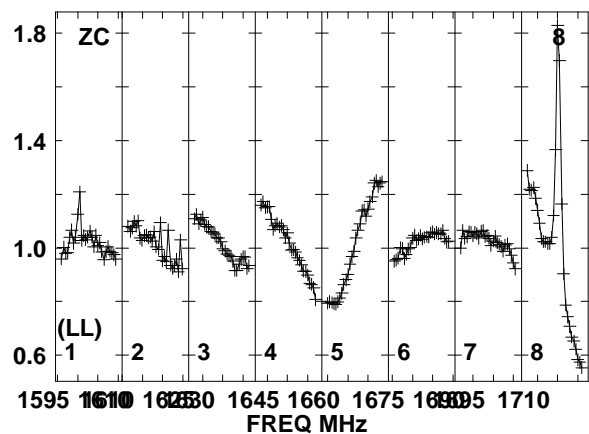
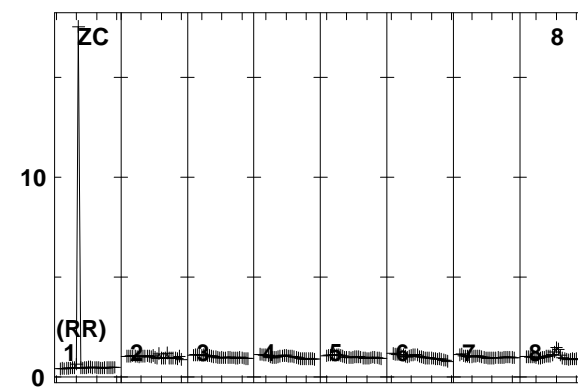
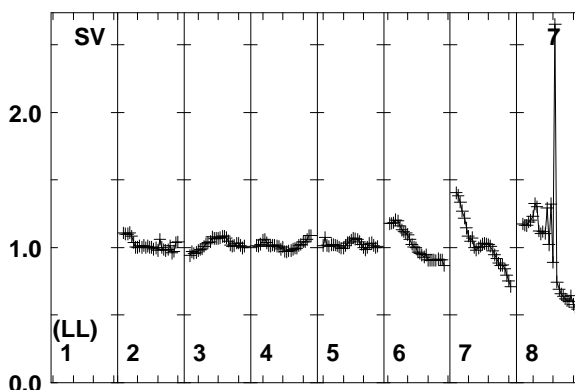
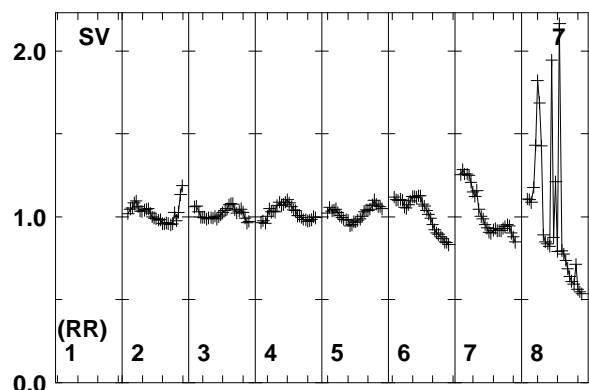
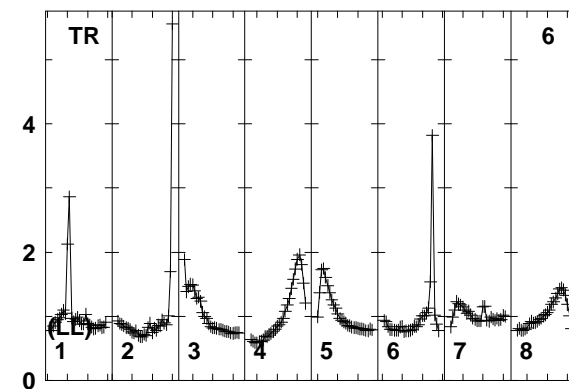
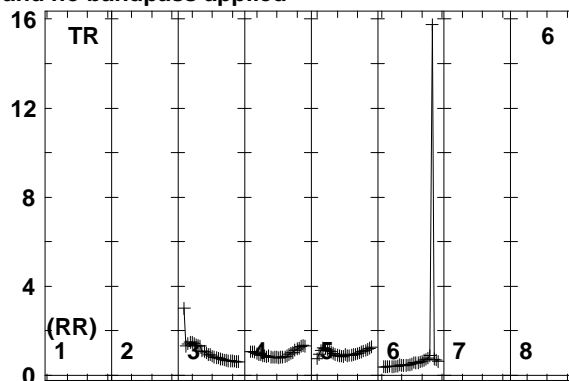
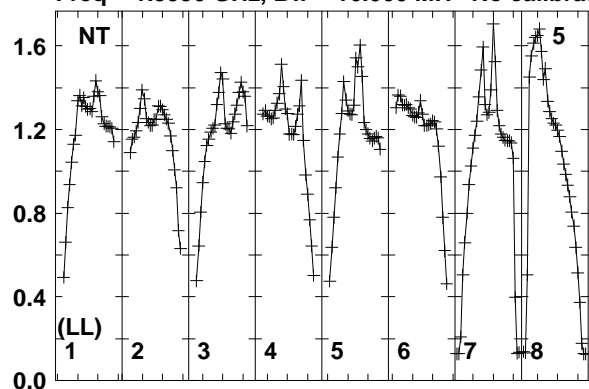

Lower frame: Real Jy
Total-power spectrum Antenna: NT (05)
Timerange: 00/08:54:33 to 00/08:58:19

Plot file version 309 created 11-AUG-2014 17:05:41

J2032+4127 EM110 2.UVDATA.1

Freq = 1.5950 GHz, Bw = 16.000 MH No calibration applied and no bandpass applied

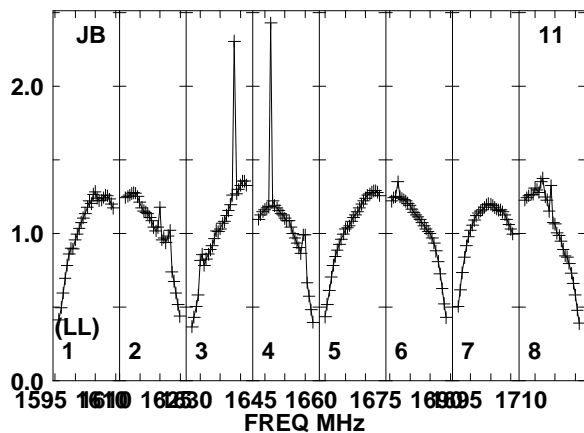
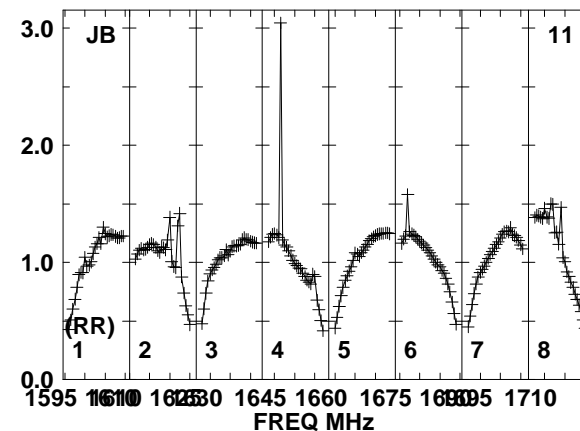
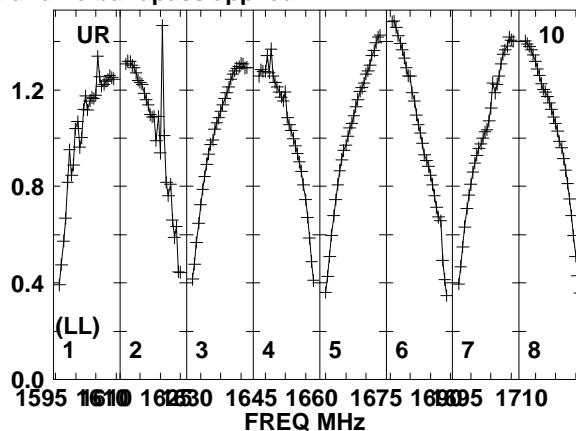
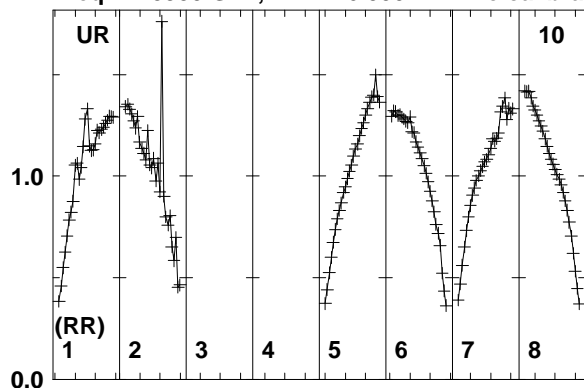

Lower frame: Real Jy
Total-power spectrum Antenna: UR (10)
Timerange: 00/08:54:33 to 00/08:58:19

Plot file version 310 created 11-AUG-2014 17:05:41

J2015+3710 EM110 2.UVDATA.1

Freq = 1.5950 GHz, Bw = 16.000 MH No calibration applied and no bandpass applied

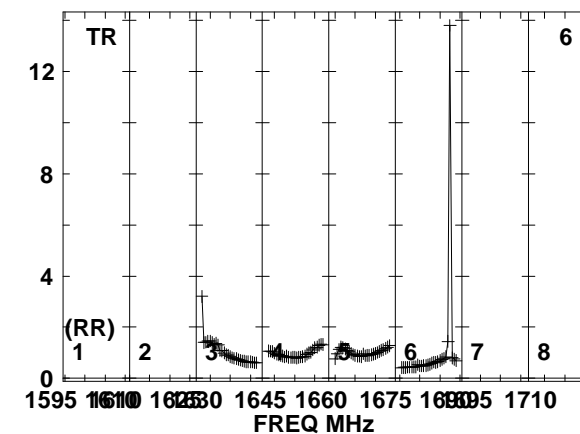
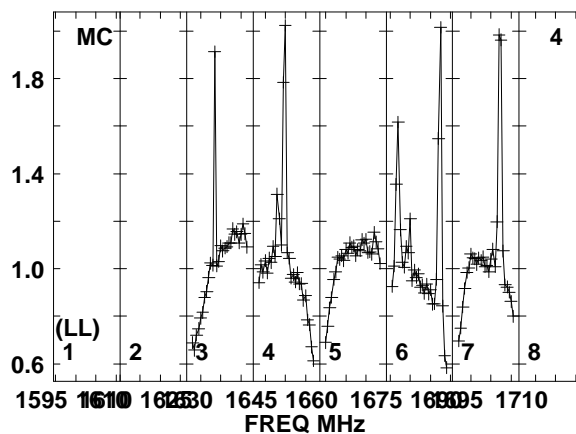
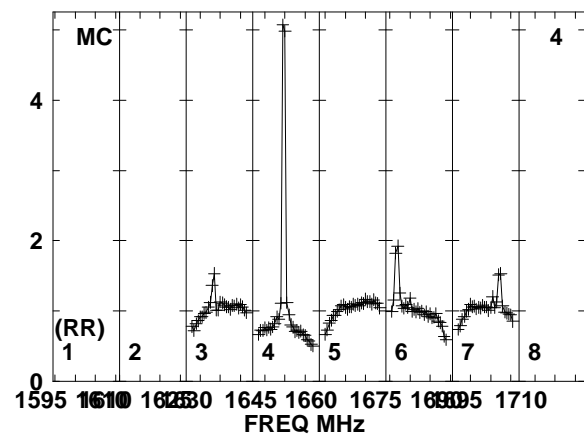
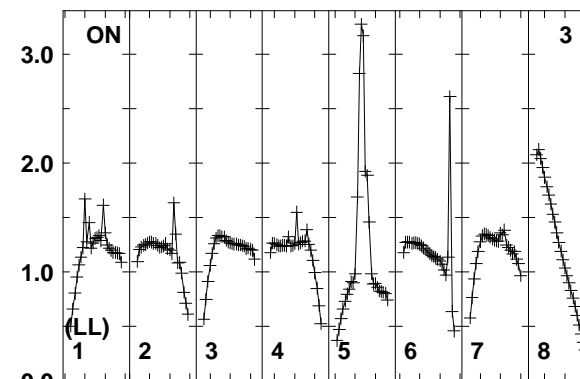
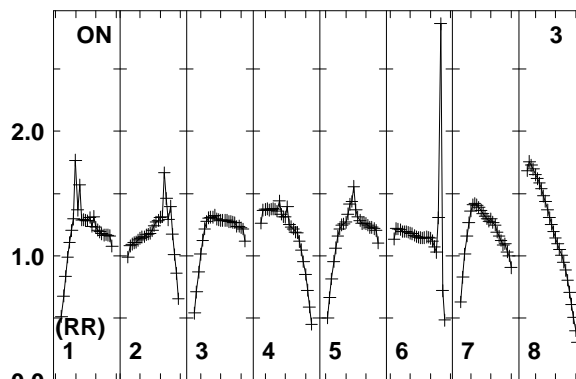
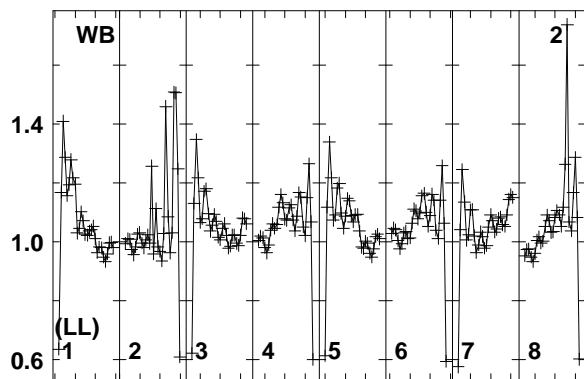
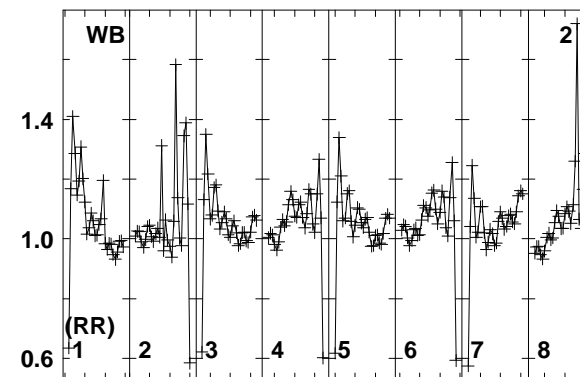
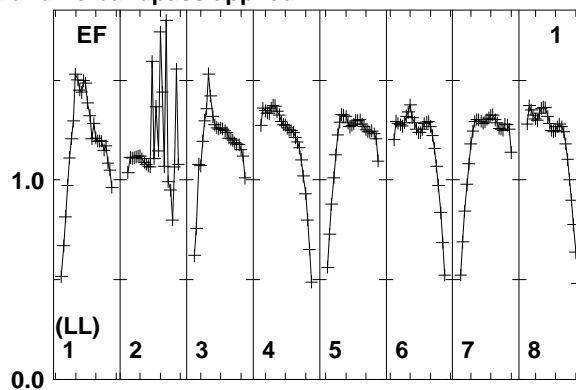
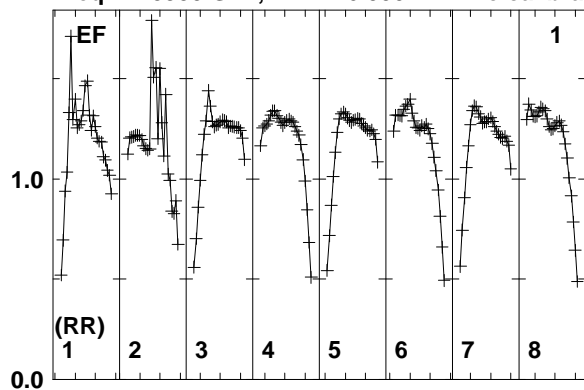

Lower frame: Real Jy
Total-power spectrum Antenna: EF (01)
Timerange: 00/08:58:34 to 00/09:00:18

Plot file version 311 created 11-AUG-2014 17:05:41

J2015+3710 EM110 2.UVDATA.1

Freq = 1.5950 GHz, Bw = 16.000 MH No calibration applied and no bandpass applied

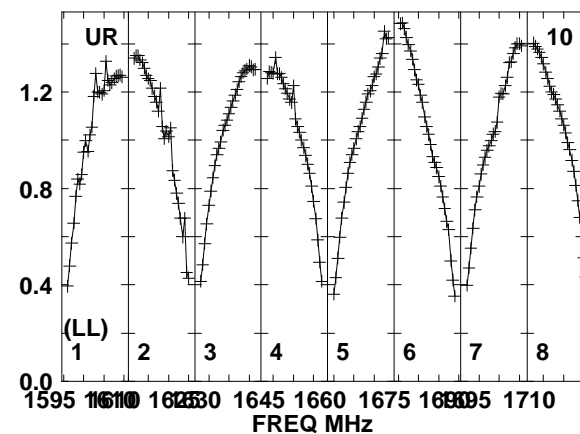
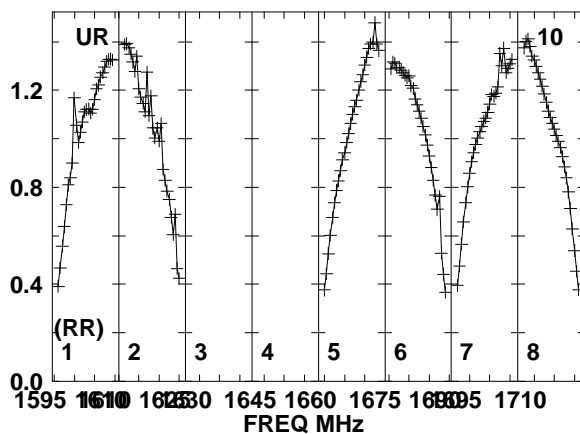
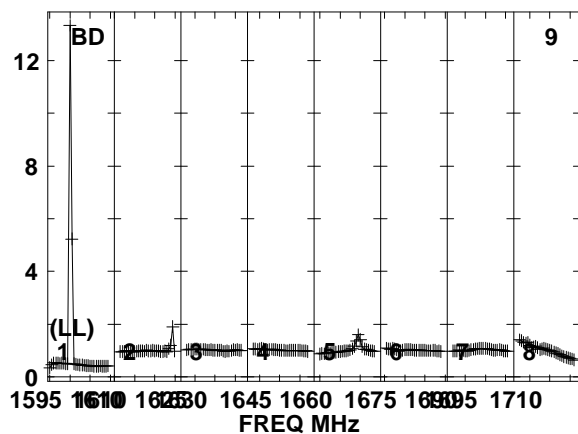
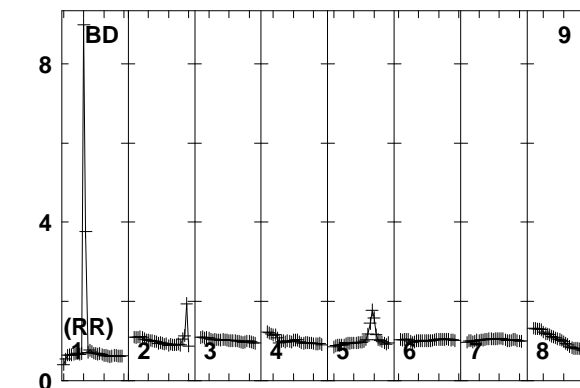
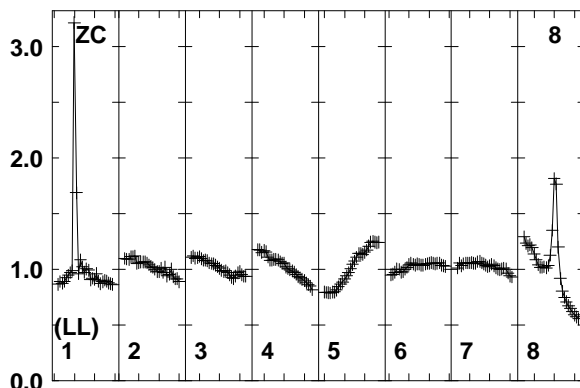
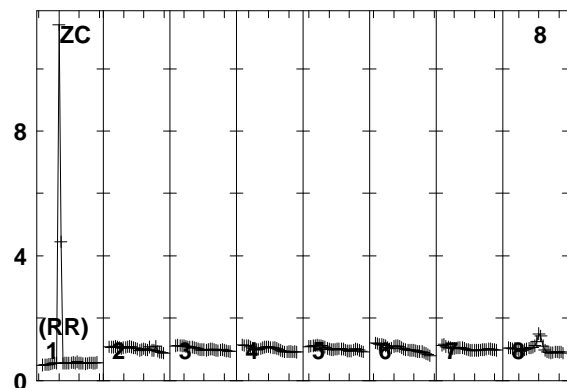
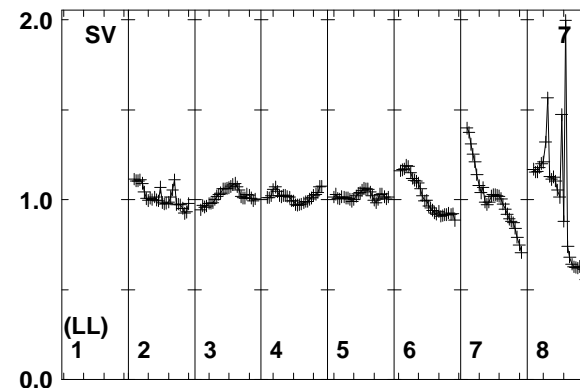
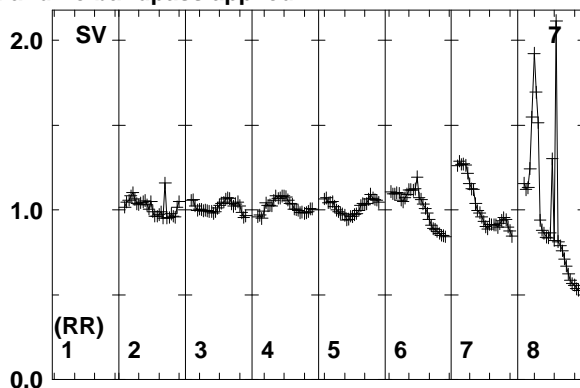
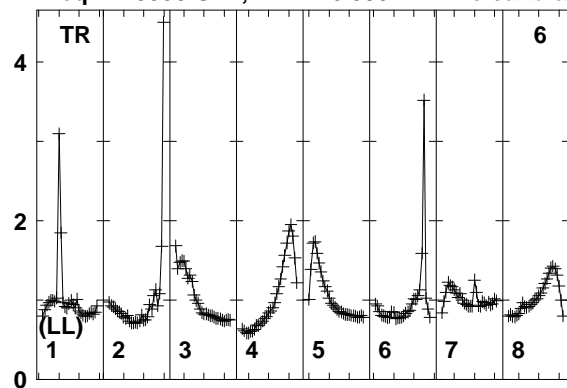

Lower frame: Real Jy
Total-power spectrum Antenna: TR (06)
Timerange: 00/08:58:34 to 00/09:00:18

Plot file version 312 created 11-AUG-2014 17:05:41

J2015+3710 EM110 2.UVDATA.1

Freq = 1.5950 GHz, Bw = 16.000 MH No calibration applied and no bandpass applied

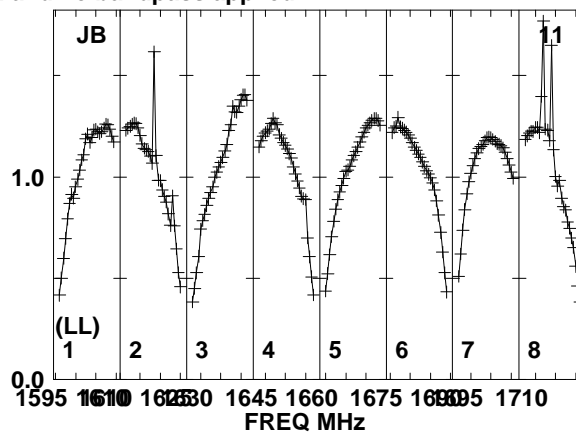
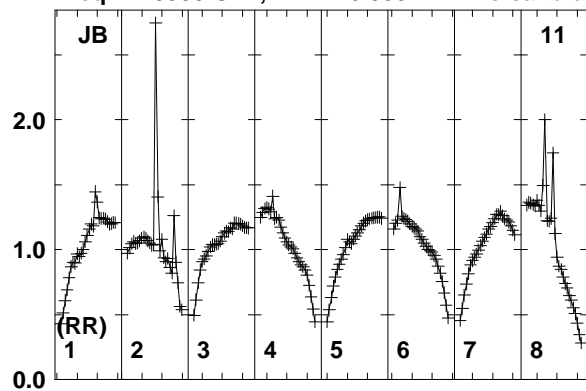

Lower frame: Real Jy
Total-power spectrum Antenna: JB (11)
Timerange: 00/08:58:34 to 00/09:00:18

Plot file version 313 created 11-AUG-2014 17:05:41

J2007+4029 EM110 2.UVDATA.1

Freq = 1.5950 GHz, Bw = 16.000 MH No calibration applied and no bandpass applied

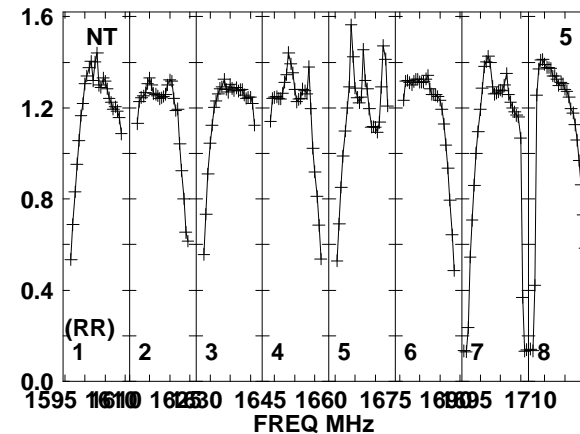
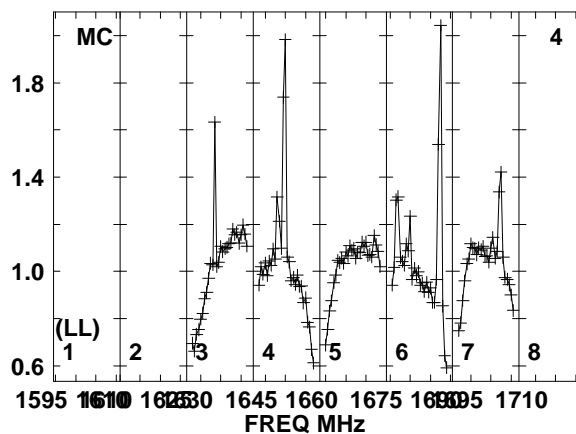
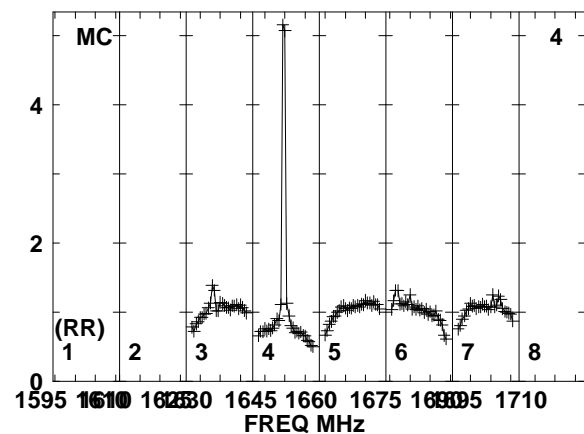
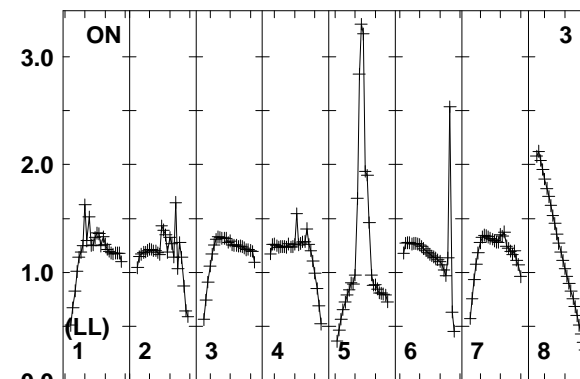
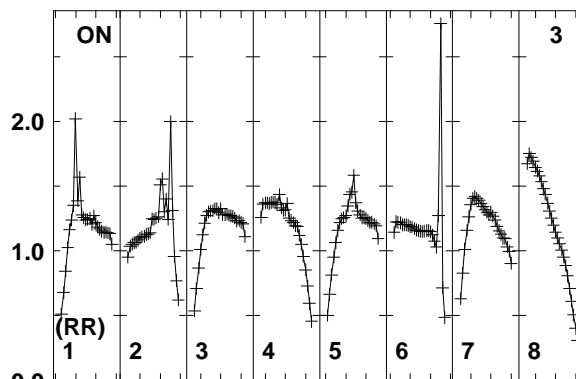
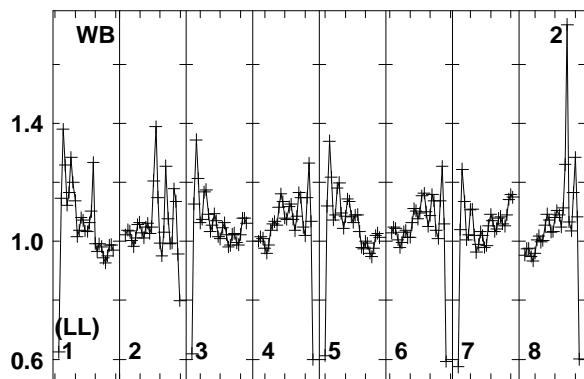
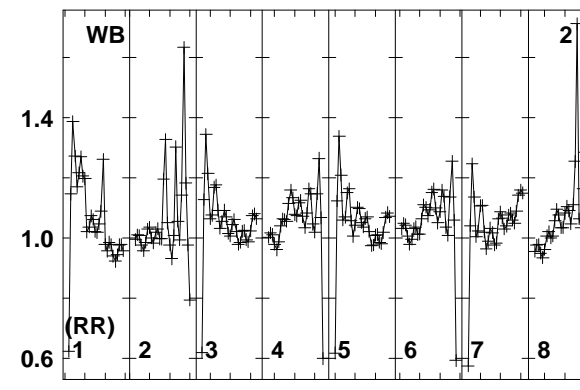
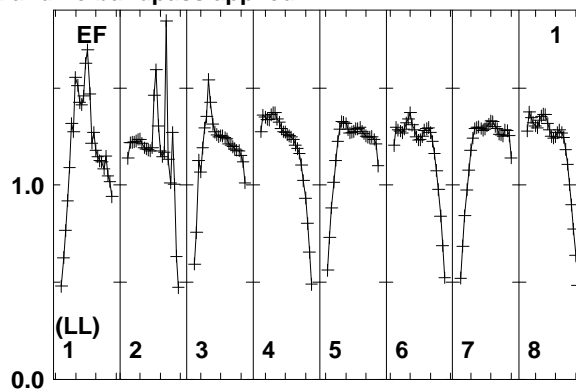
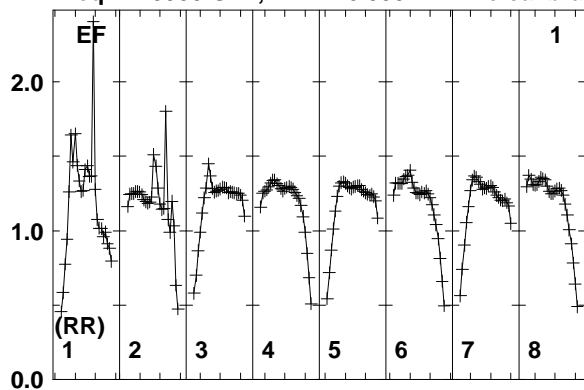

1595 1610 1625 1640 1655 1670 1685 1700 1710
FREQ MHz

Lower frame: Real Jy
Total-power spectrum Antenna: EF (01)
Timerange: 00/09:00:23 to 00/09:01:19

Plot file version 314 created 11-AUG-2014 17:05:41

J2007+4029 EM110 2.UVDATA.1

Freq = 1.5950 GHz, Bw = 16.000 MH No calibration applied and no bandpass applied

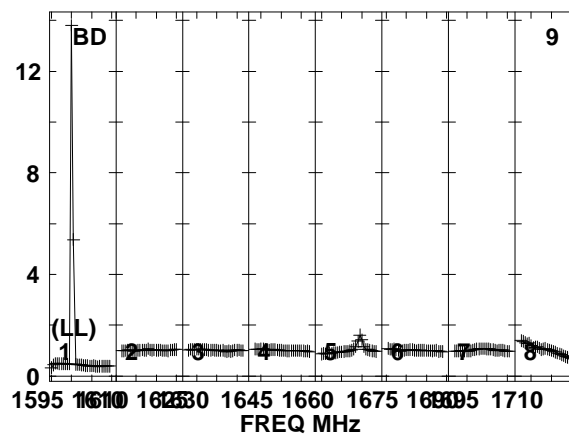
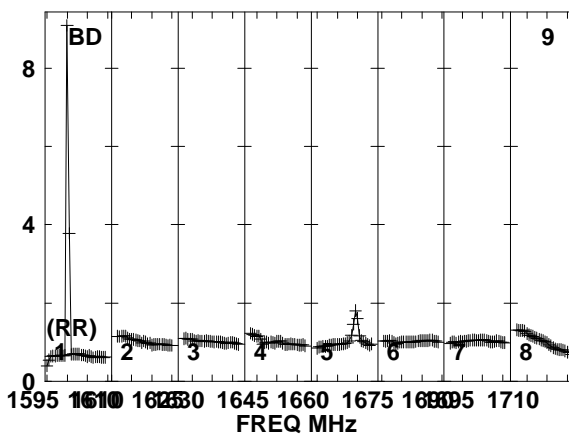
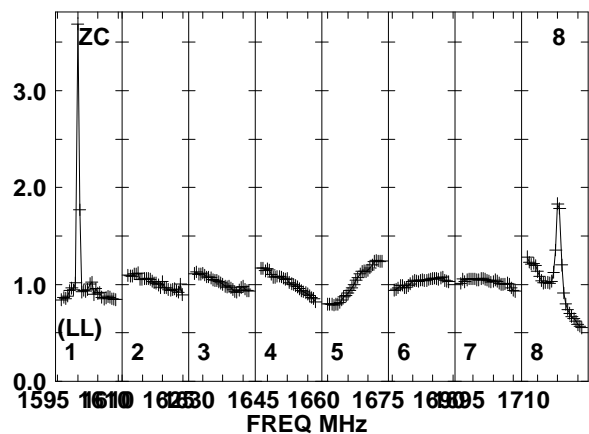
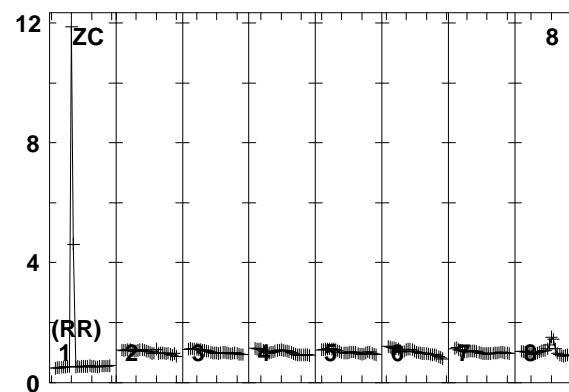
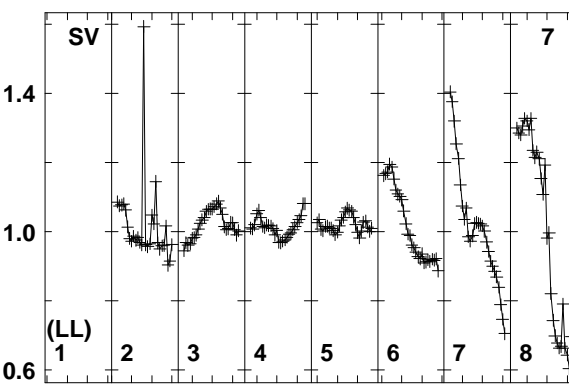
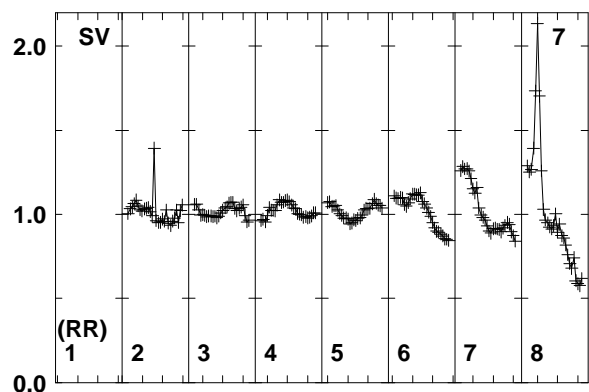
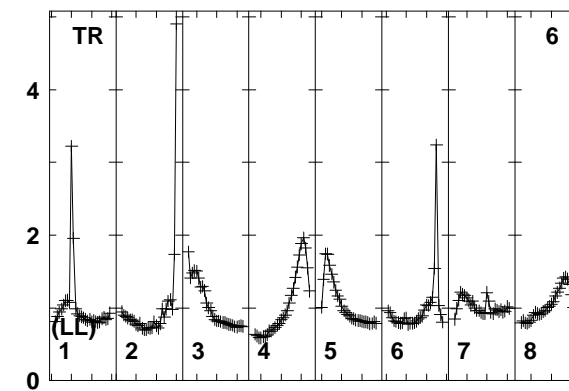
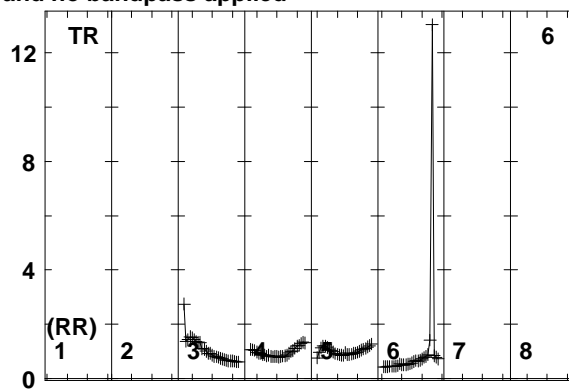
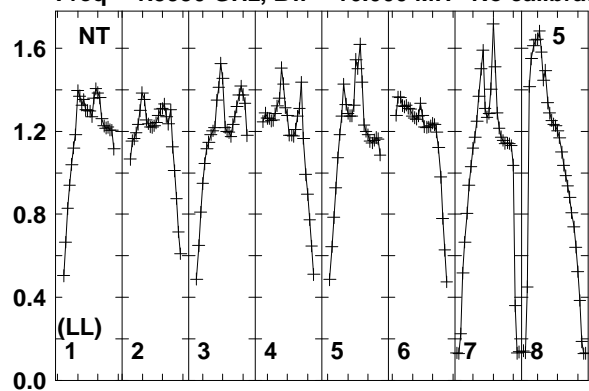

Lower frame: Real Jy
Total-power spectrum Antenna: NT (05)
Timerange: 00/09:00:23 to 00/09:01:19

Plot file version 315 created 11-AUG-2014 17:05:41

J2007+4029 EM110 2.UVDATA.1

Freq = 1.5950 GHz, Bw = 16.000 MH No calibration applied and no bandpass applied

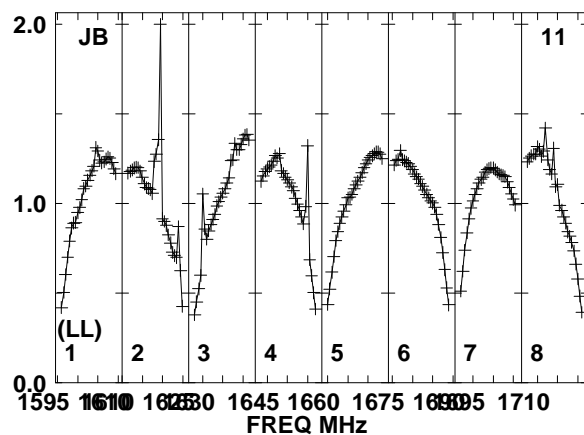
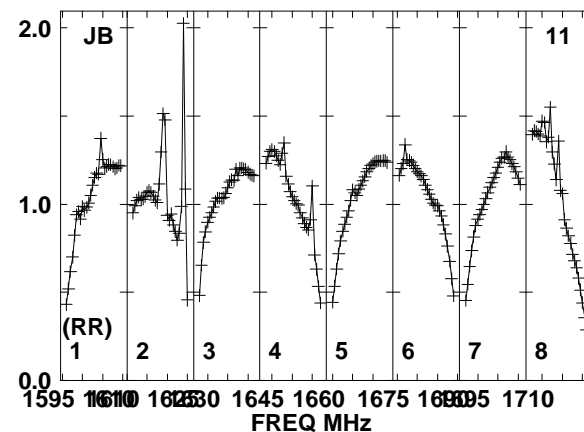
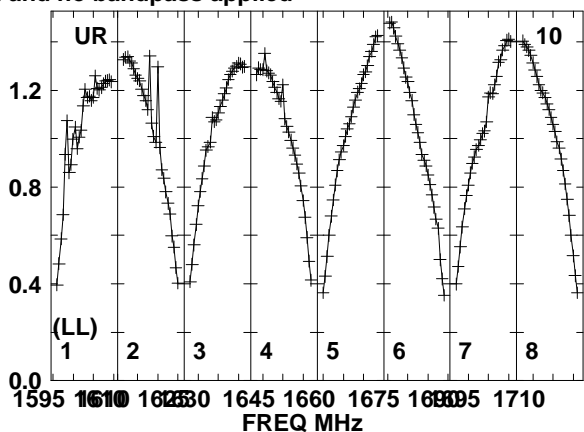
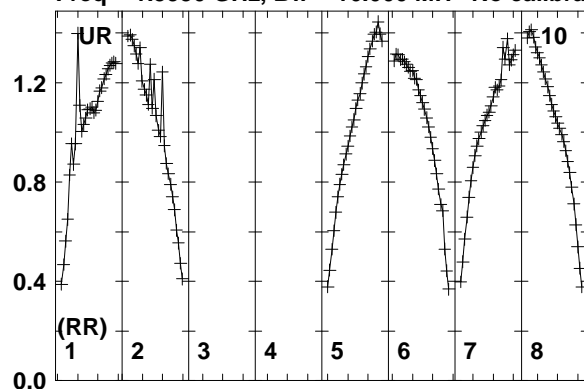

Lower frame: Real Jy
Total-power spectrum Antenna: UR (10)
Timerange: 00/09:00:23 to 00/09:01:19

Plot file version 316 created 11-AUG-2014 17:05:41

J2015+3710 EM110 2.UVDATA.1

Freq = 1.5950 GHz, Bw = 16.000 MH No calibration applied and no bandpass applied

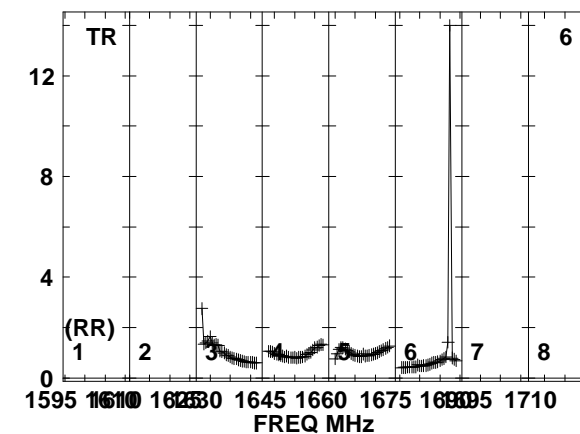
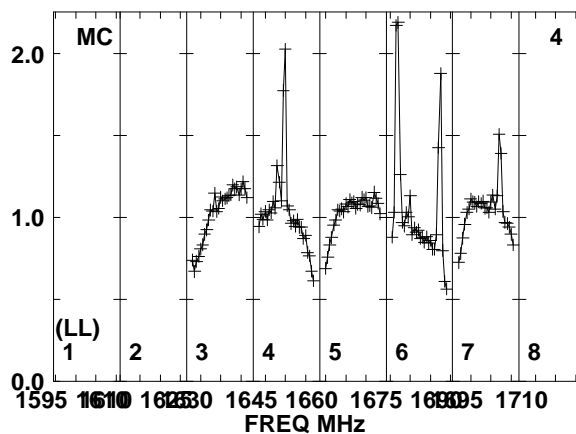
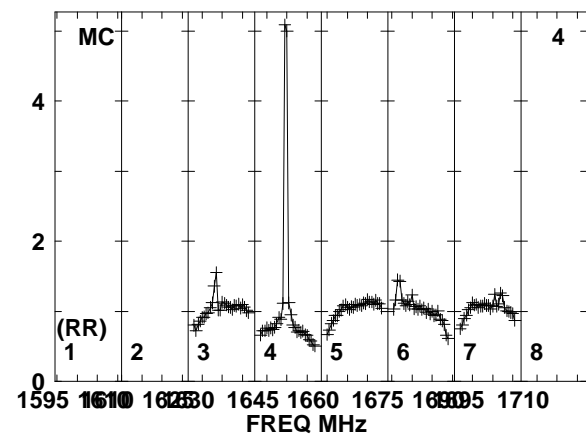
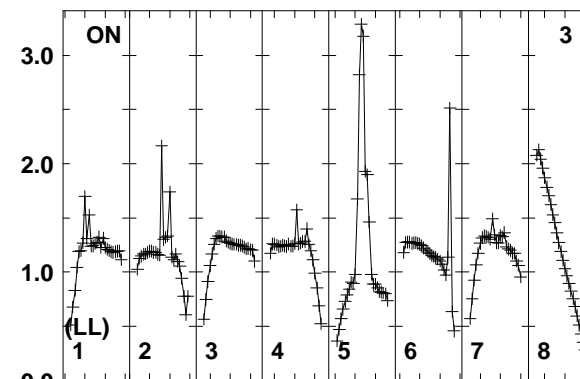
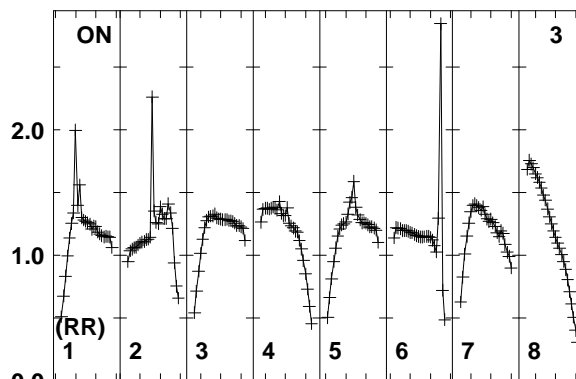
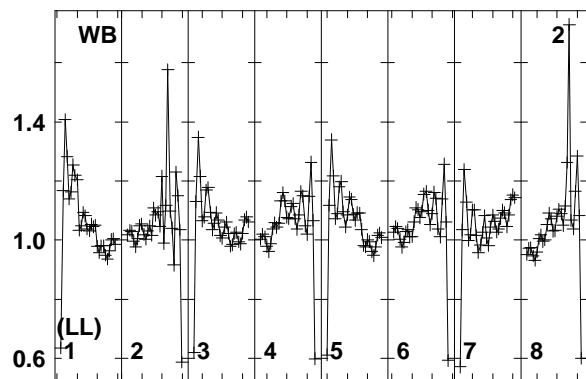
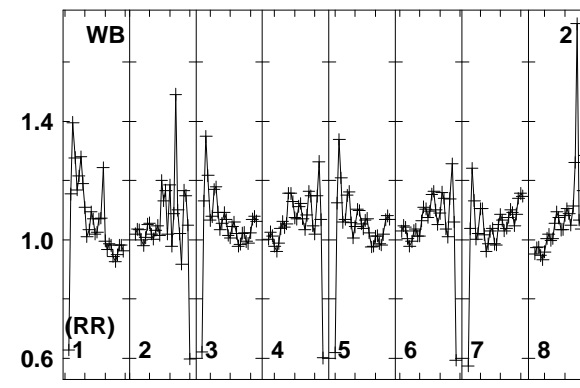
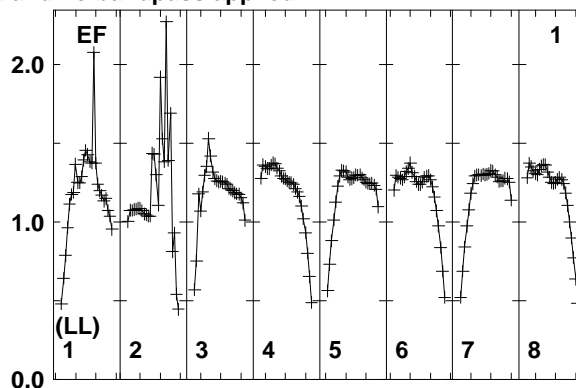
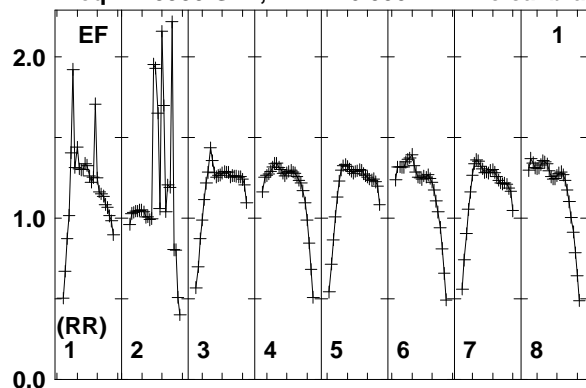

1595 1610 1625 1640 1655 1670 1685 1700 1710
FREQ MHz
Lower frame: Real Jy
Total-power spectrum Antenna: EF (01)
Timerange: 00/09:02:21 to 00/09:04:19

Plot file version 317 created 11-AUG-2014 17:05:41

J2015+3710 EM110 2.UVDATA.1

Freq = 1.5950 GHz, Bw = 16.000 MH No calibration applied and no bandpass applied

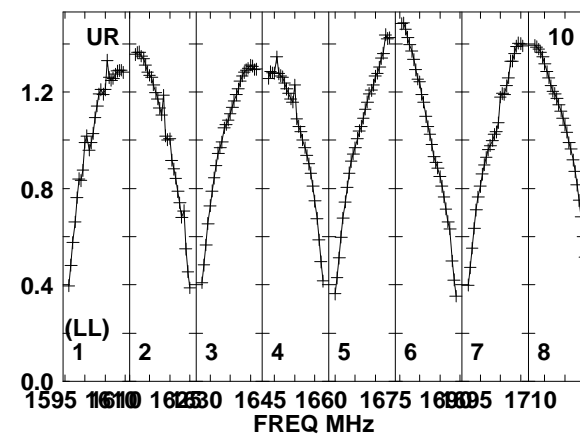
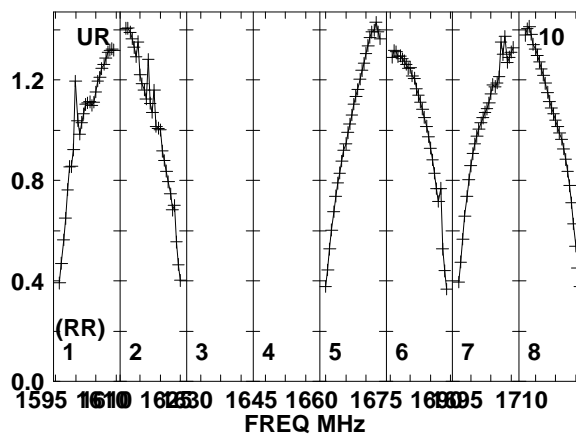
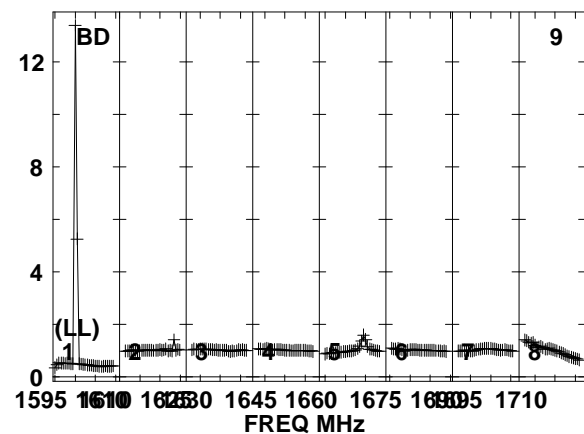
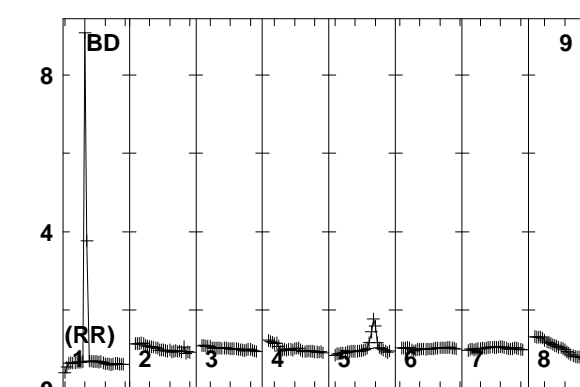
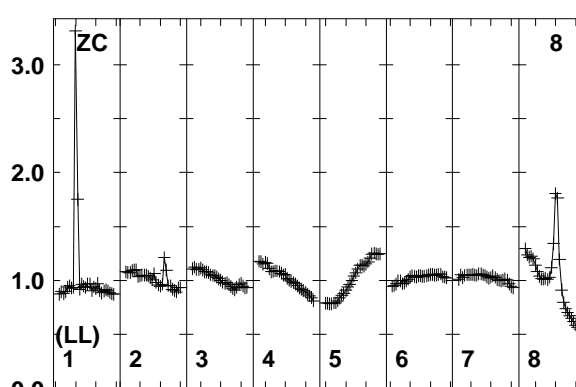
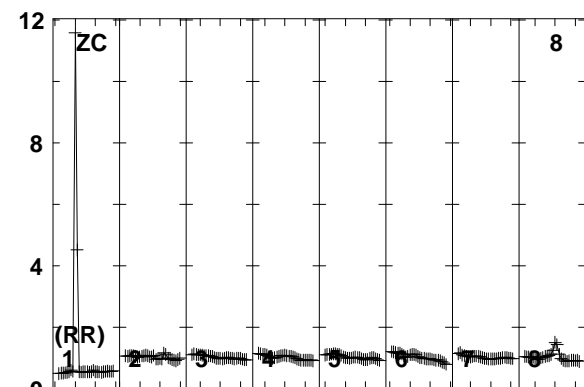
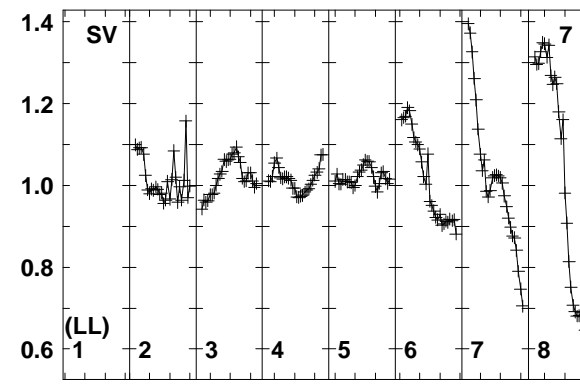
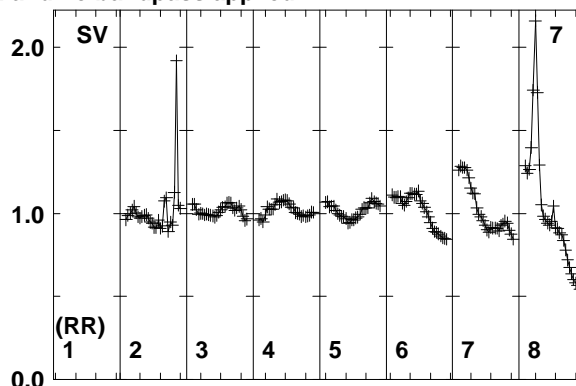
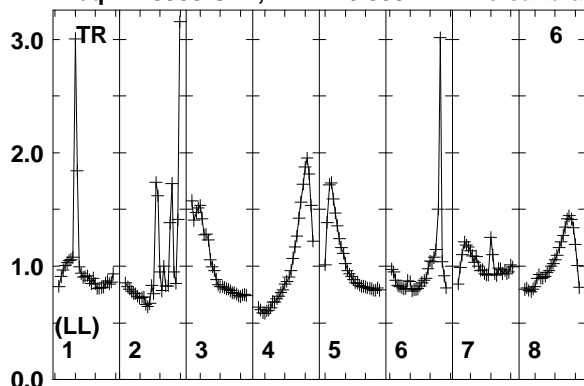

Lower frame: Real Jy
Total-power spectrum Antenna: TR (06)
Timerange: 00/09:02:21 to 00/09:04:19

Plot file version 318 created 11-AUG-2014 17:05:41

J2032+4127 EM110 2.UVDATA.1

Freq = 1.5950 GHz, Bw = 16.000 MH No calibration applied and no bandpass applied

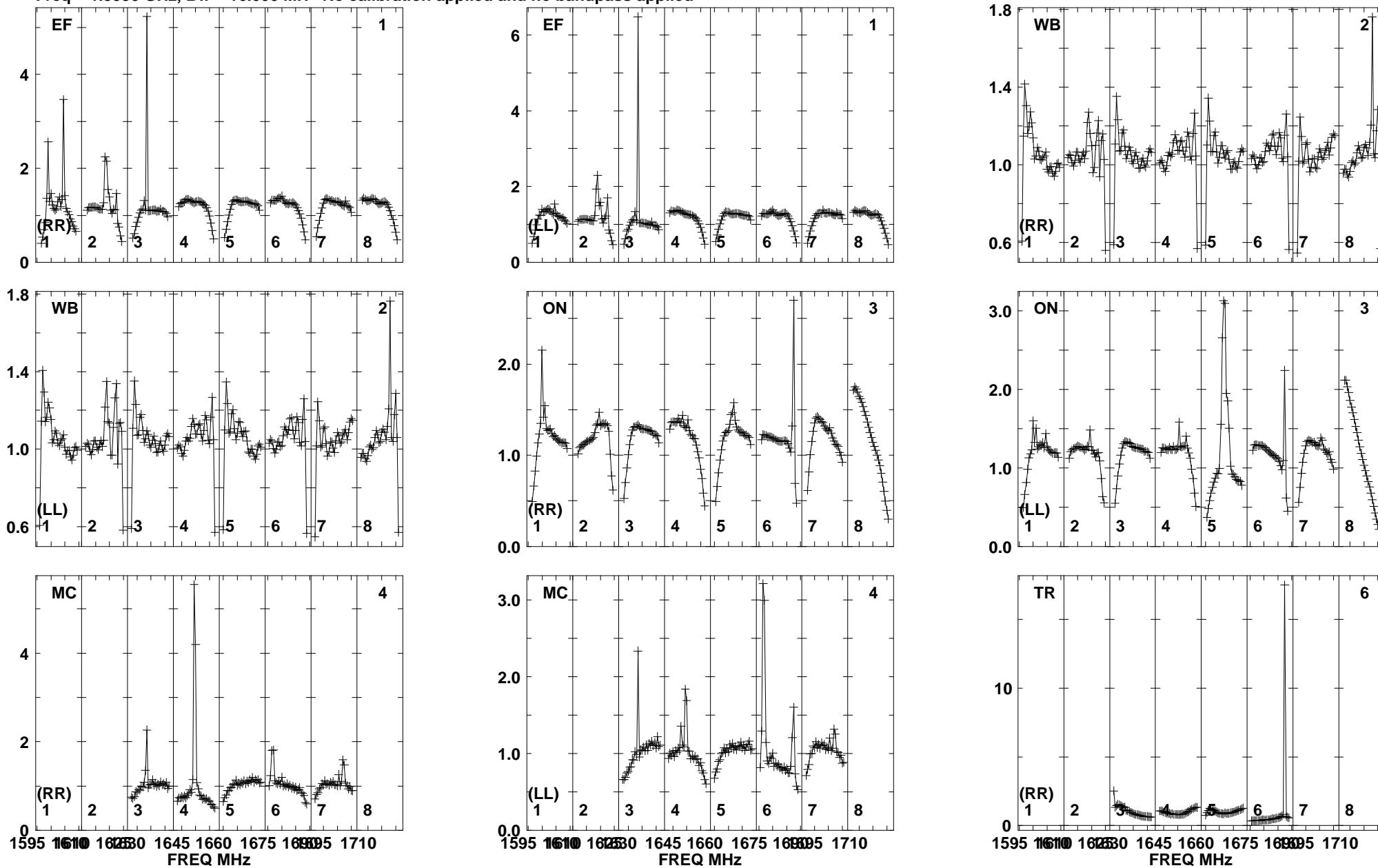

Lower frame: Real Jy
Total-power spectrum Antenna: EF (01)
Timerange: 00/09:04:21 to 00/09:08:19

Plot file version 319 created 11-AUG-2014 17:05:41

J2032+4127 EM110 2.UVDATA.1

Freq = 1.5950 GHz, Bw = 16.000 MH No calibration applied and no bandpass applied

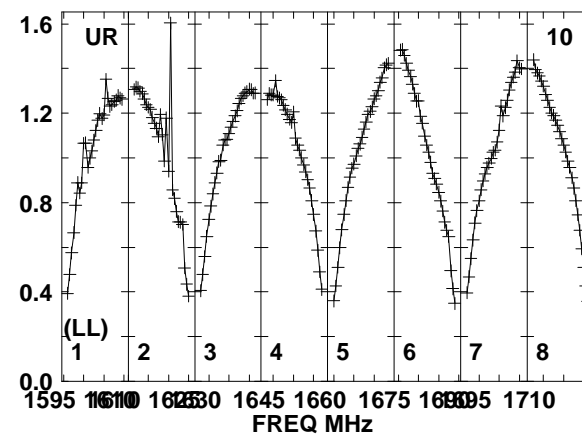
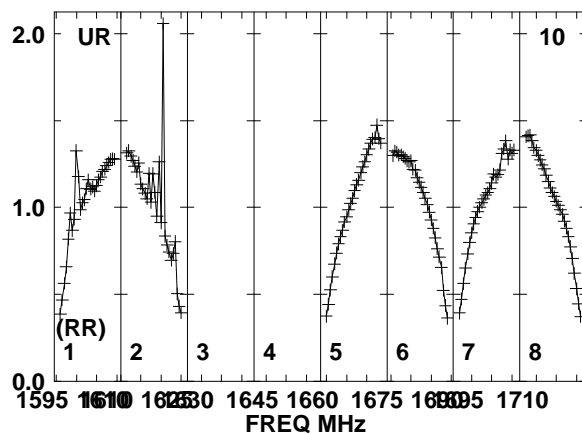
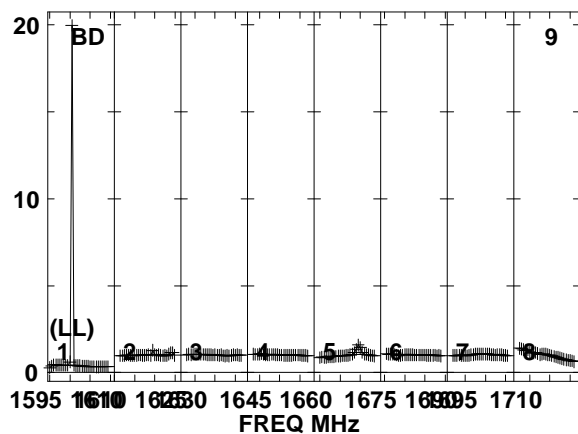
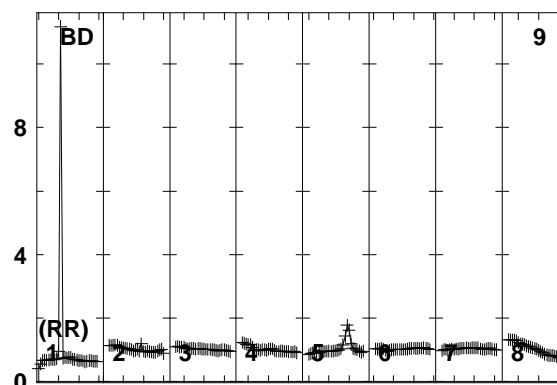
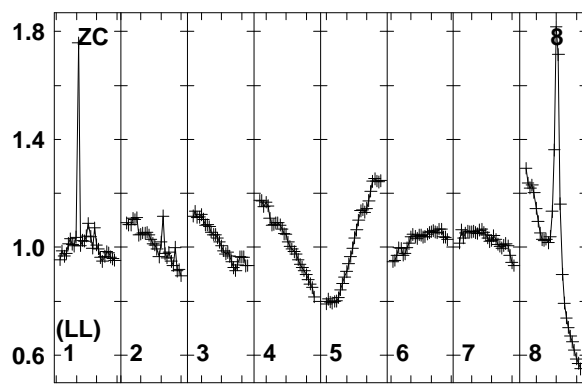
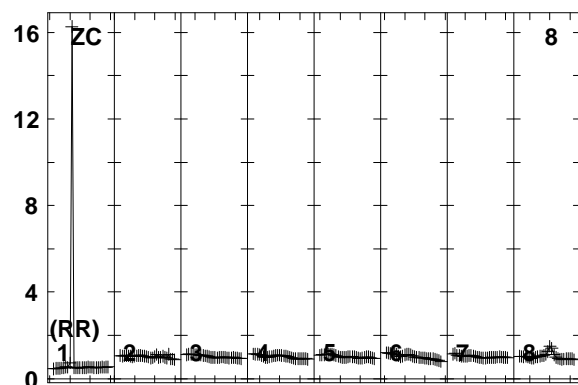
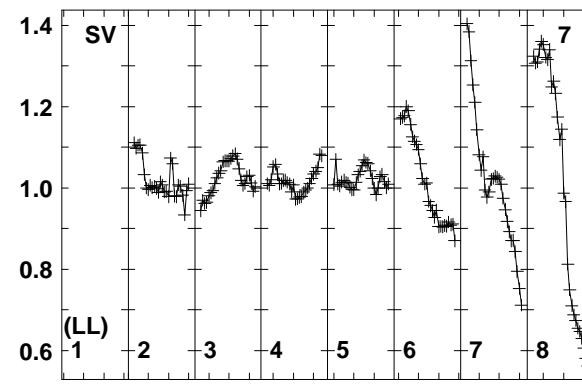
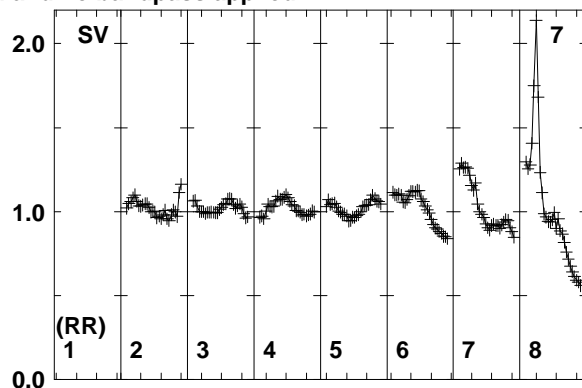
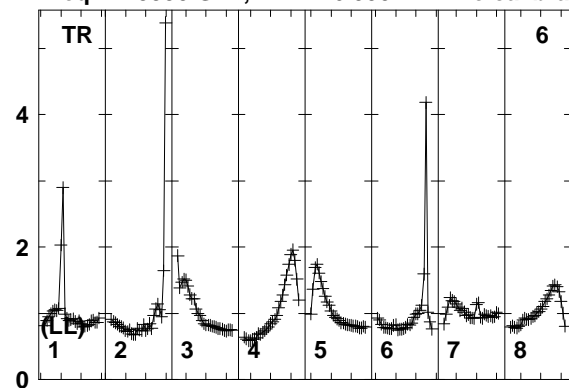

Lower frame: Real Jy
Total-power spectrum Antenna: TR (06)
Timerange: 00/09:04:21 to 00/09:08:19

Plot file version 320 created 11-AUG-2014 17:05:41

J2032+4127 EM110 2.UVDATA.1

Freq = 1.5950 GHz, Bw = 16.000 MH No calibration applied and no bandpass applied

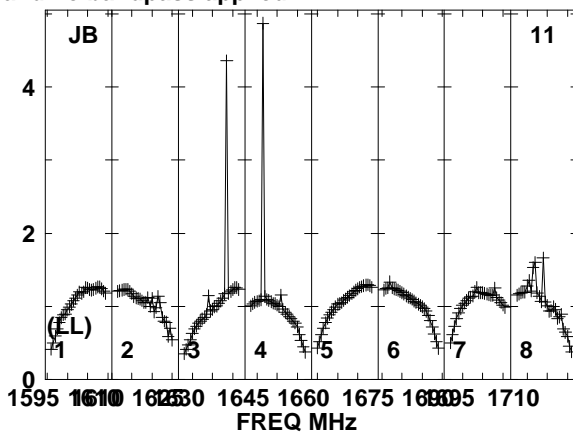
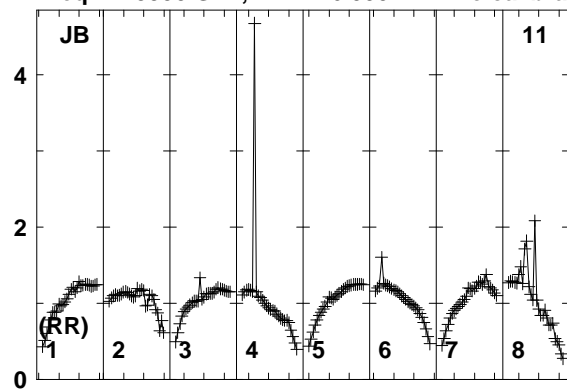

Lower frame: Real Jy
Total-power spectrum Antenna: JB (11)
Timerange: 00/09:04:21 to 00/09:08:19

Plot file version 321 created 11-AUG-2014 17:05:41

J2015+3710 EM110 2.UVDATA.1

Freq = 1.5950 GHz, Bw = 16.000 MH No calibration applied and no bandpass applied

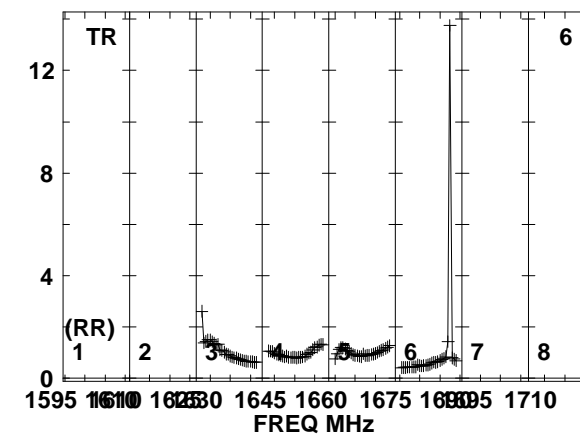
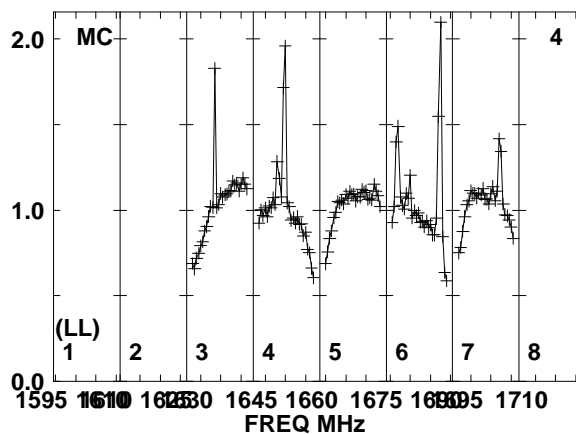
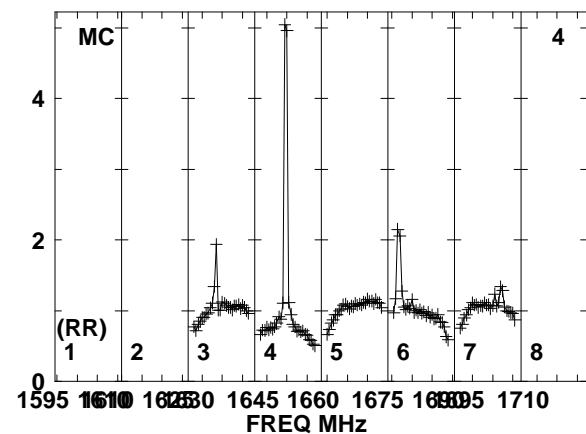
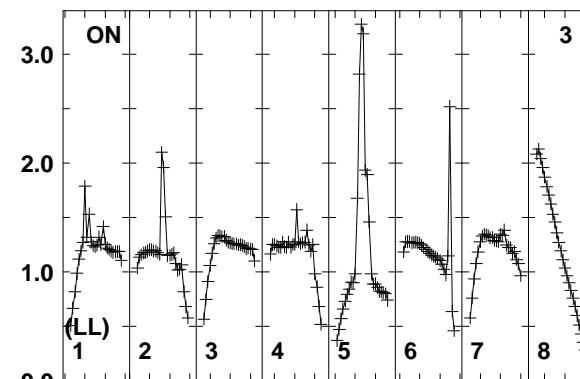
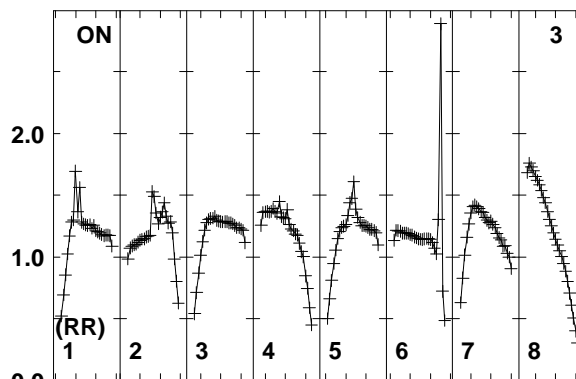
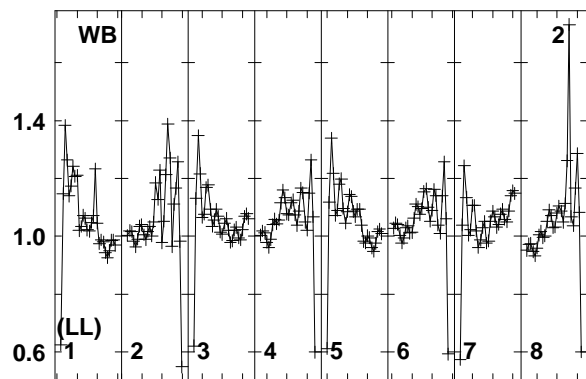
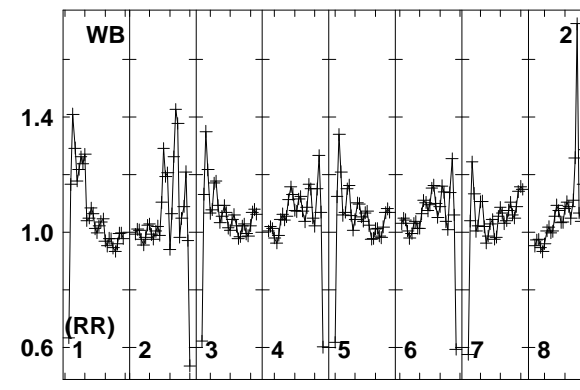
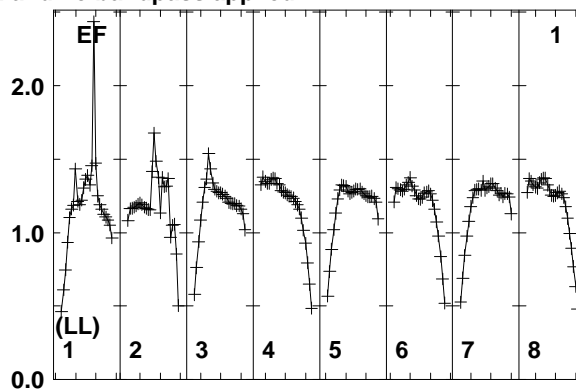
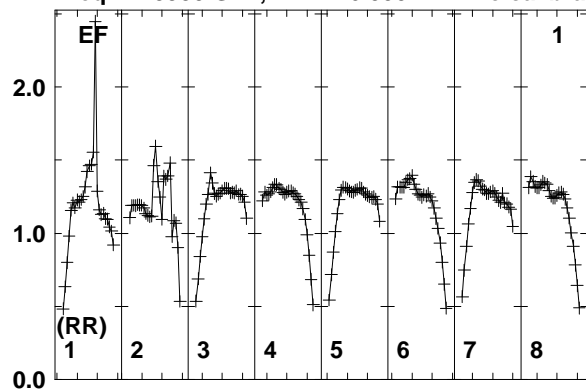

Lower frame: Real Jy
Total-power spectrum Antenna: EF (01)
Timerange: 00/09:08:34 to 00/09:10:18

Plot file version 322 created 11-AUG-2014 17:05:41

J2015+3710 EM110 2.UVDATA.1

Freq = 1.5950 GHz, Bw = 16.000 MH No calibration applied and no bandpass applied

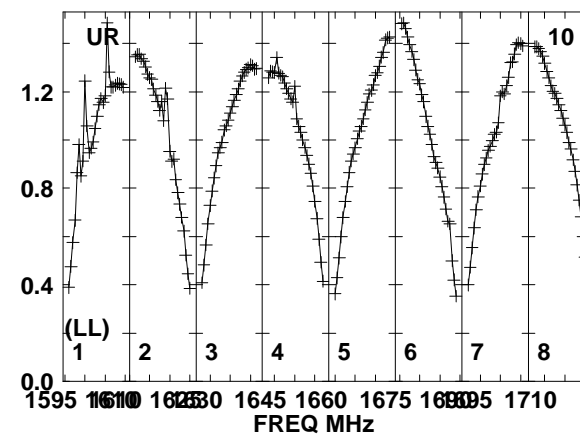
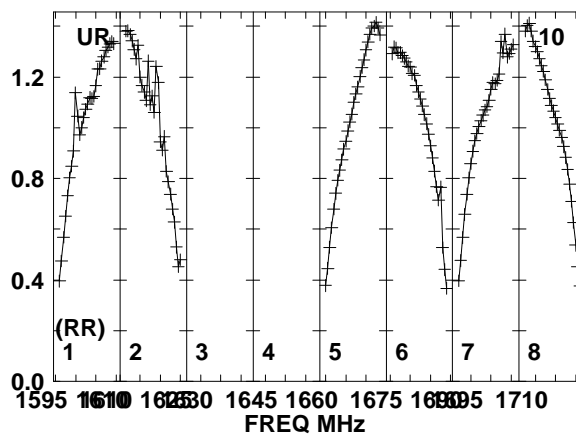
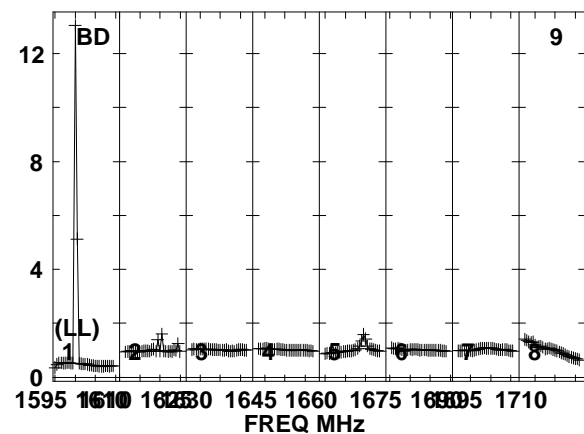
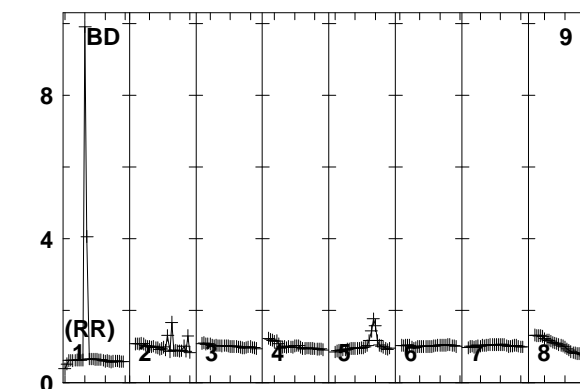
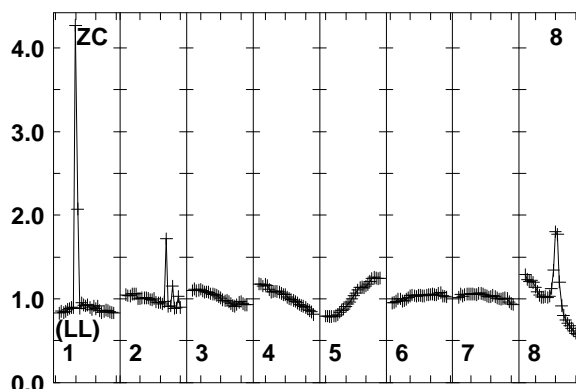
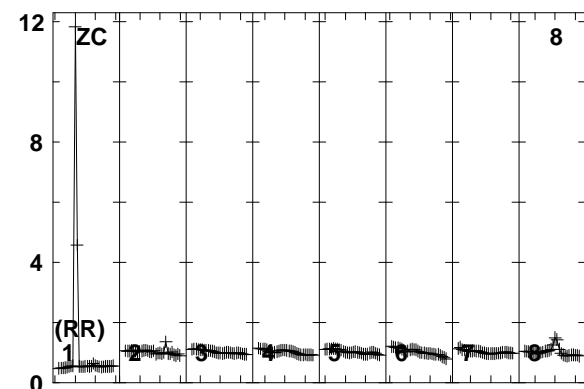
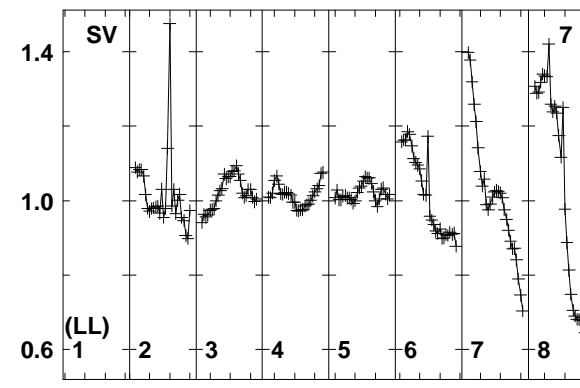
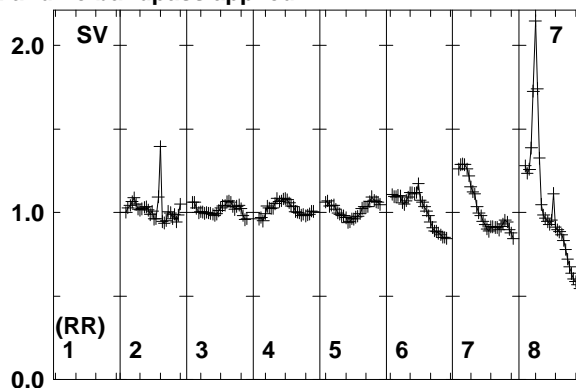
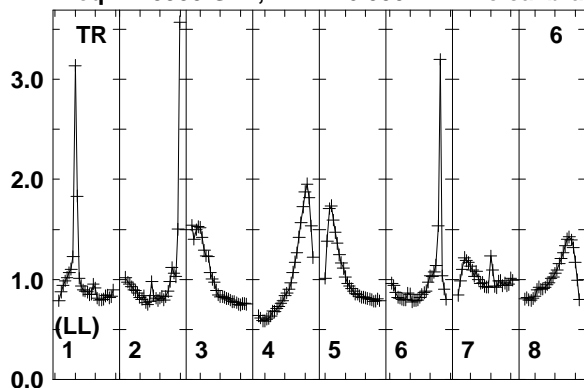

1595 1610 1625 1645 1660 1675 1690 1710
FREQ MHz

1595 1610 1625 1645 1660 1675 1690 1710
FREQ MHz

1595 1610 1625 1645 1660 1675 1690 1710
FREQ MHz

Lower frame: Real Jy
Total-power spectrum Antenna: TR (06)
Timerange: 00/09:08:34 to 00/09:10:18

Plot file version 323 created 11-AUG-2014 17:05:41

J2015+3710 EM110 2.UVDATA.1

Freq = 1.5950 GHz, Bw = 16.000 MH No calibration applied and no bandpass applied

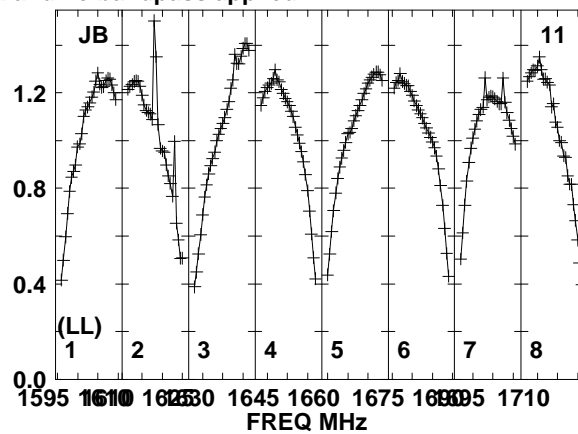
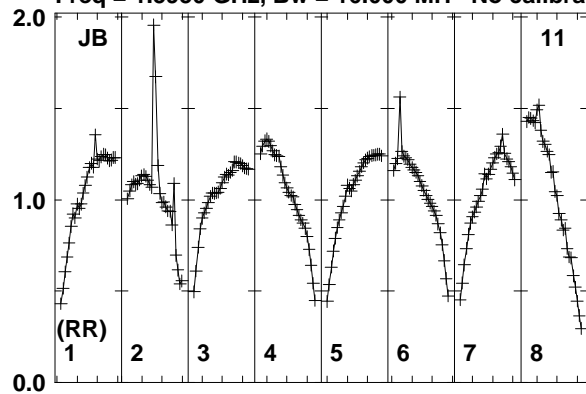

Lower frame: Real Jy
Total-power spectrum Antenna: JB (11)
Timerange: 00/09:08:34 to 00/09:10:18

Plot file version 324 created 11-AUG-2014 17:05:41

J2032+4127 EM110 2.UVDATA.1

Freq = 1.5950 GHz, Bw = 16.000 MH No calibration applied and no bandpass applied

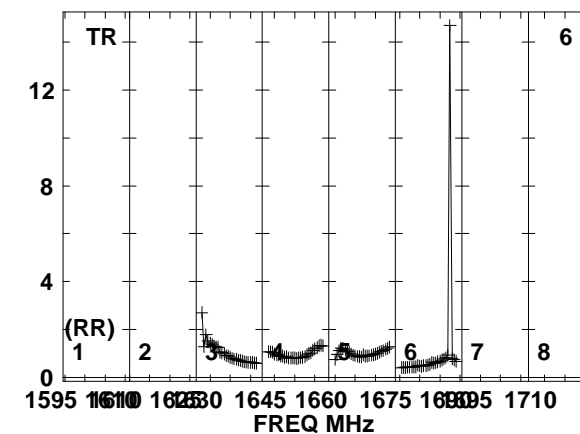
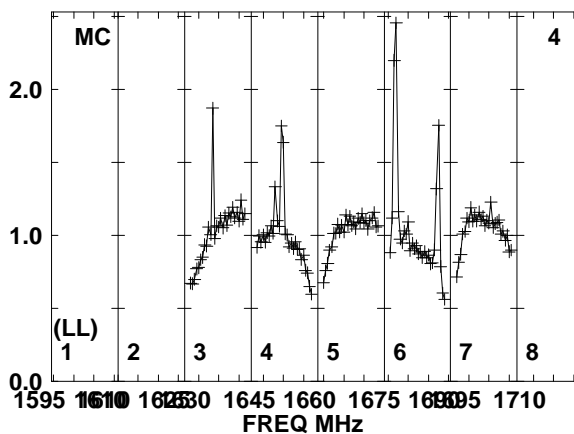
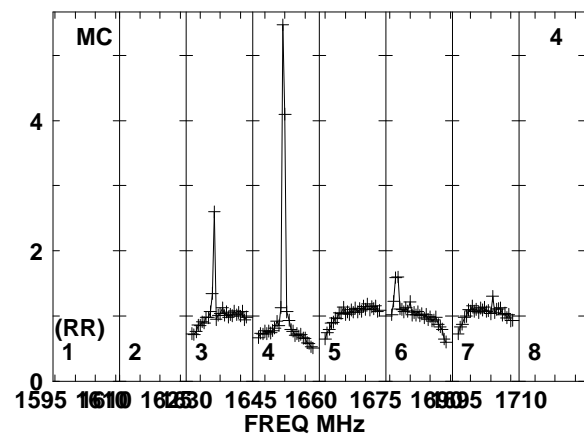
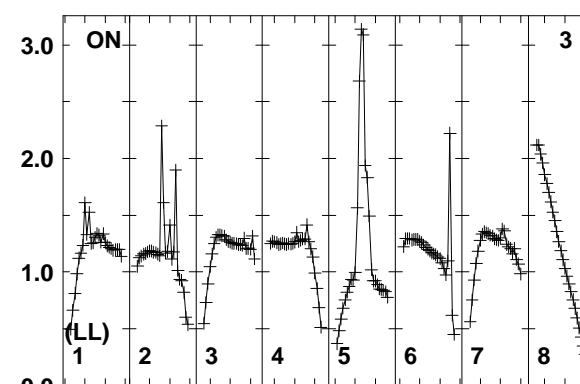
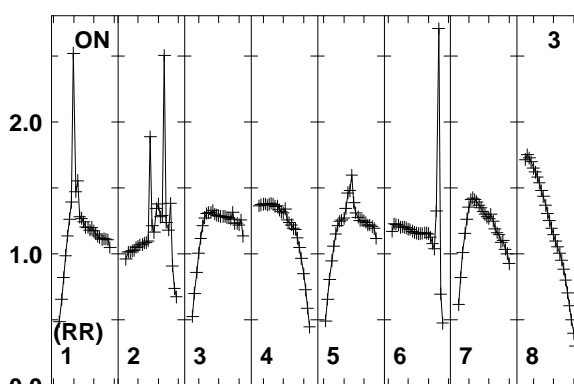
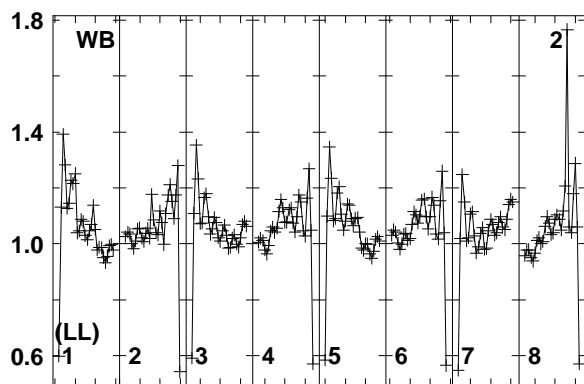
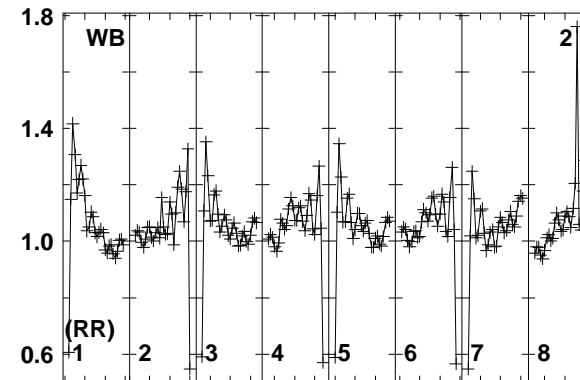
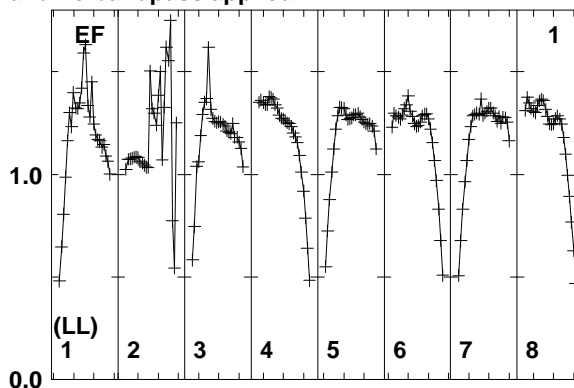
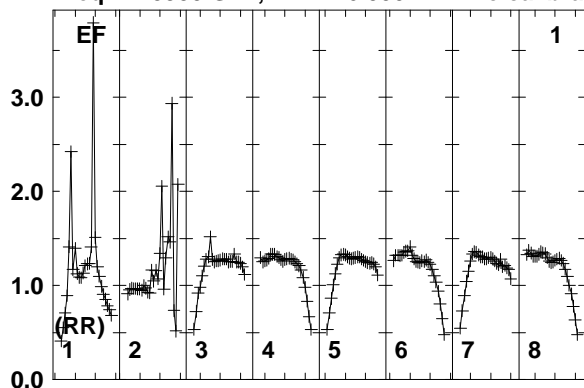

Lower frame: Real Jy
Total-power spectrum Antenna: EF (01)
Timerange: 00/09:10:34 to 00/09:14:18

Plot file version 325 created 11-AUG-2014 17:05:42

J2032+4127 EM110 2.UVDATA.1

Freq = 1.5950 GHz, Bw = 16.000 MH No calibration applied and no bandpass applied

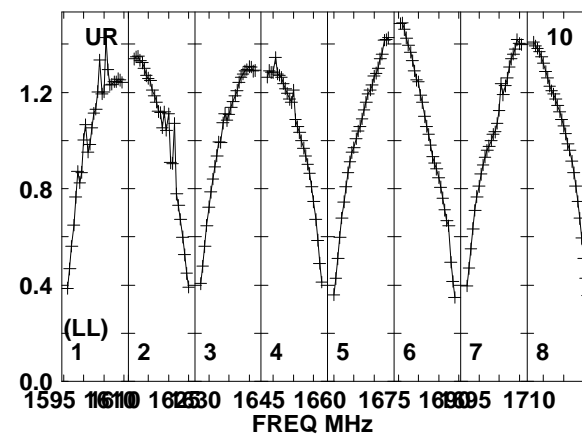
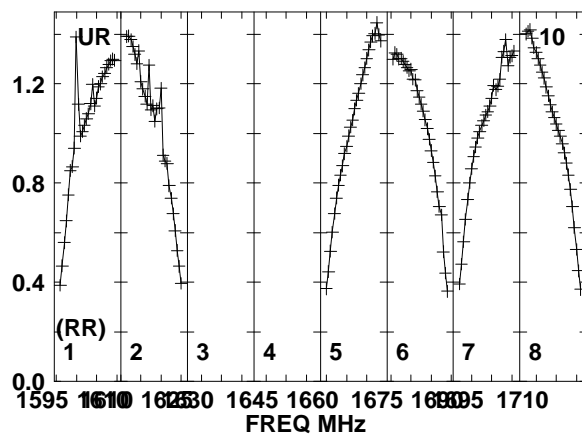
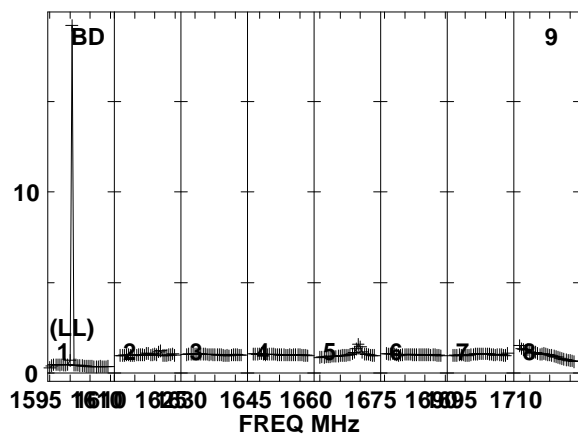
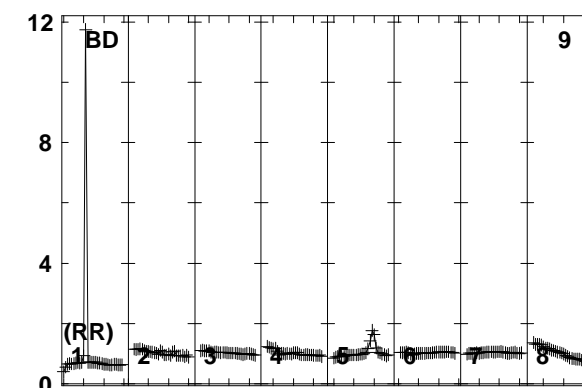
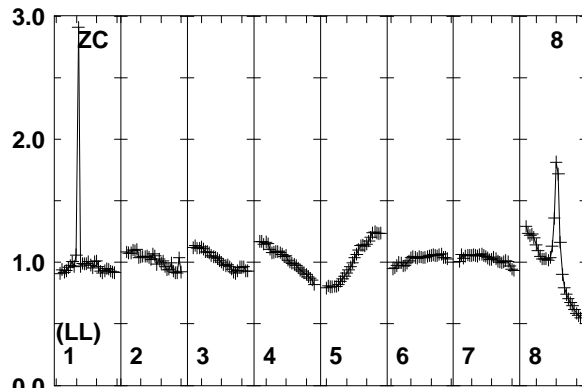
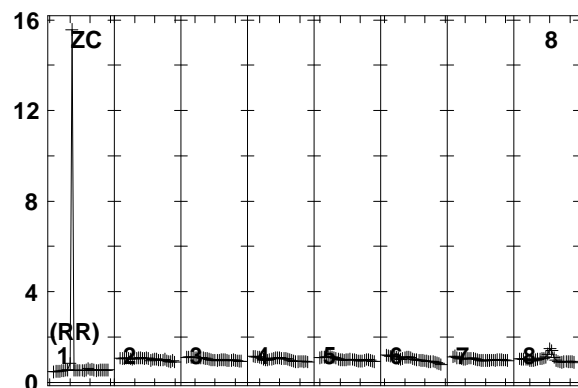
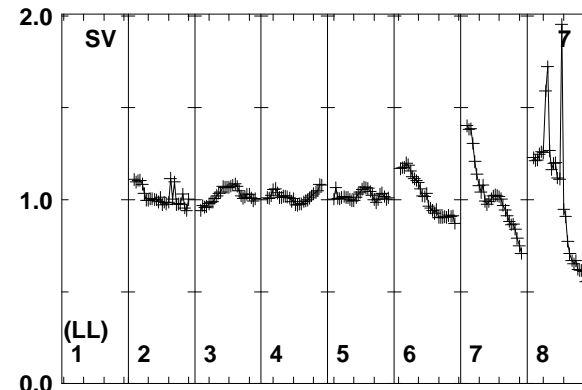
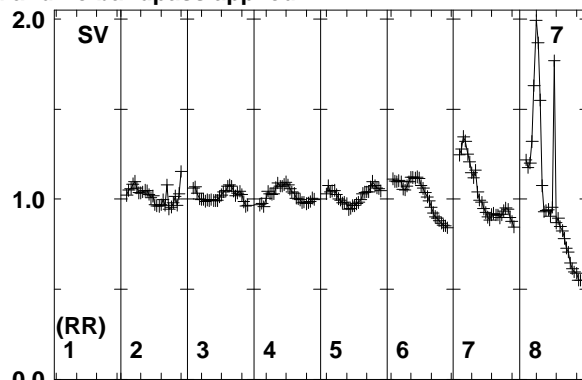
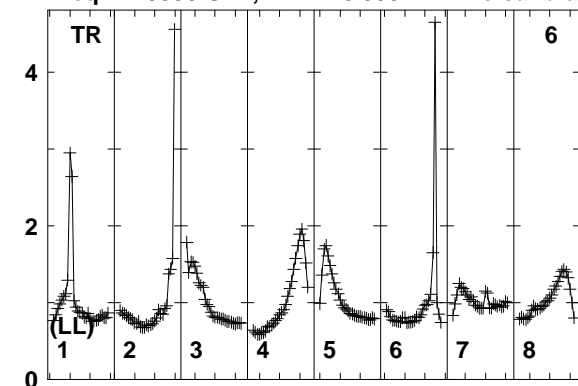

Lower frame: Real Jy
Total-power spectrum Antenna: TR (06)
Timerange: 00/09:10:34 to 00/09:14:18

Plot file version 326 created 11-AUG-2014 17:05:42

J2032+4127 EM110 2.UVDATA.1

Freq = 1.5950 GHz, Bw = 16.000 MH No calibration applied and no bandpass applied

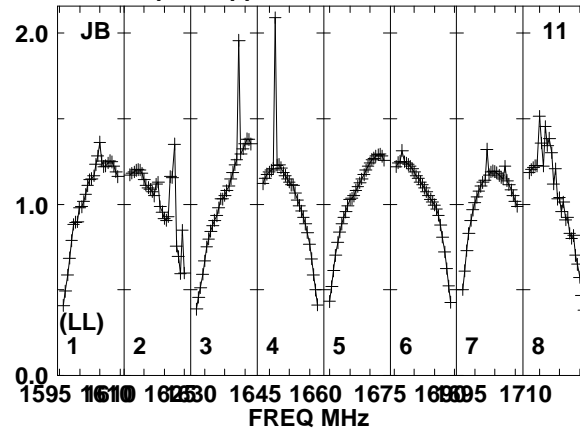
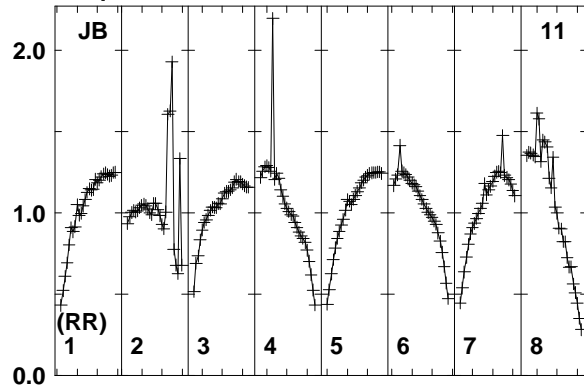

Lower frame: Real Jy
Total-power spectrum Antenna: JB (11)
Timerange: 00/09:10:34 to 00/09:14:18

Plot file version 327 created 11-AUG-2014 17:05:42

J2015+3710 EM110 2.UVDATA.1

Freq = 1.5950 GHz, Bw = 16.000 MH No calibration applied and no bandpass applied

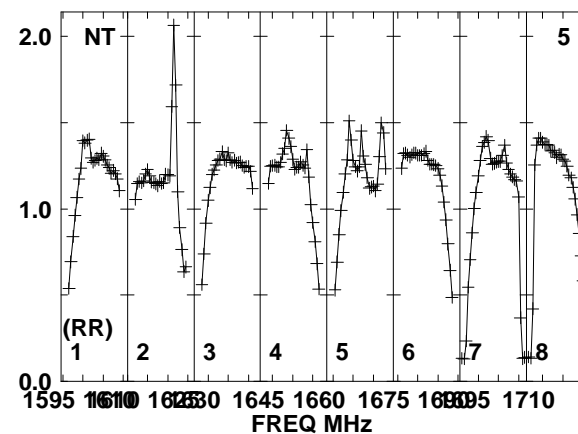
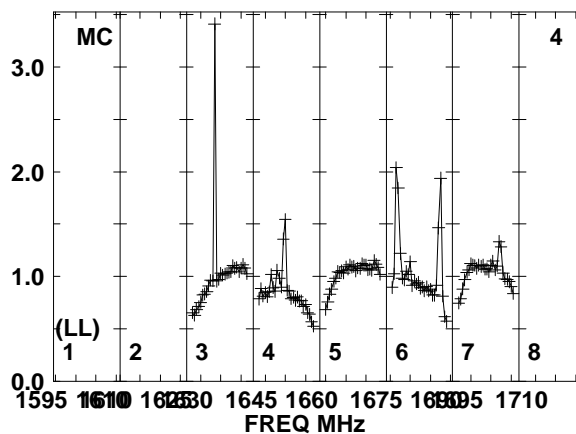
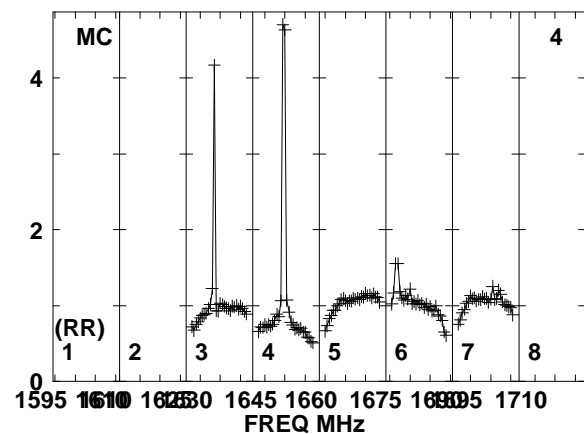
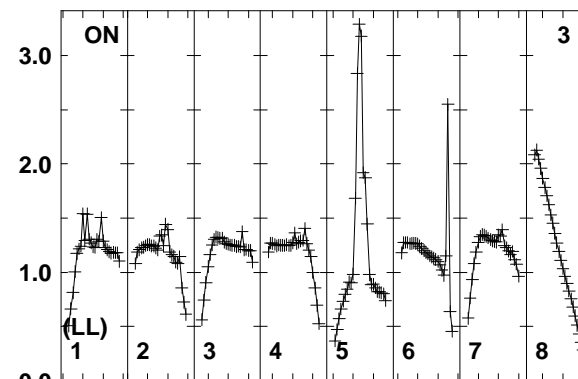
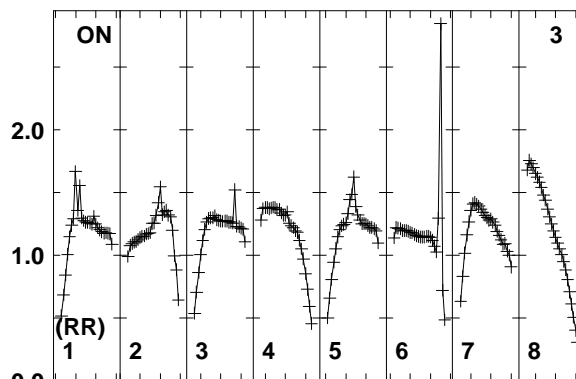
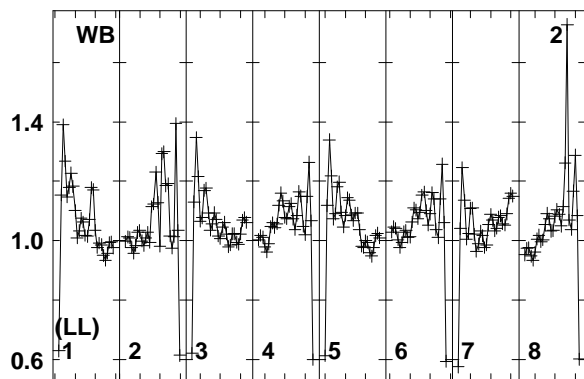
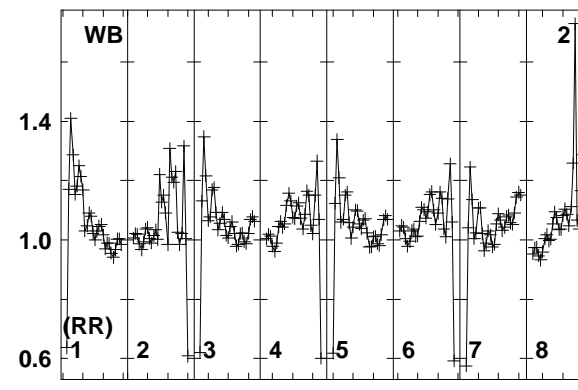
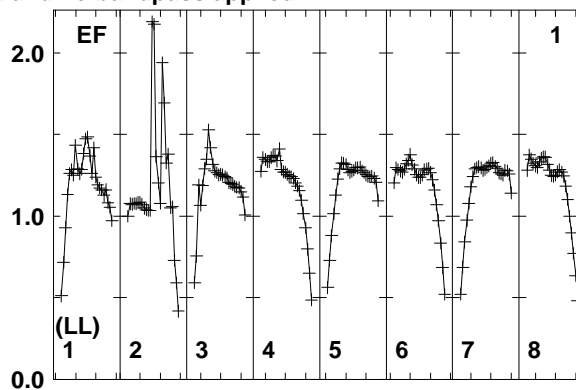
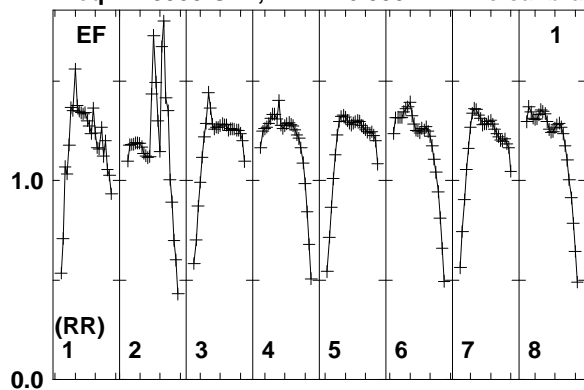

Lower frame: Real Jy
Total-power spectrum Antenna: EF (01)
Timerange: 00/09:15:21 to 00/09:17:19

Plot file version 328 created 11-AUG-2014 17:05:42

J2015+3710 EM110 2.UVDATA.1

Freq = 1.5950 GHz, Bw = 16.000 MH No calibration applied and no bandpass applied

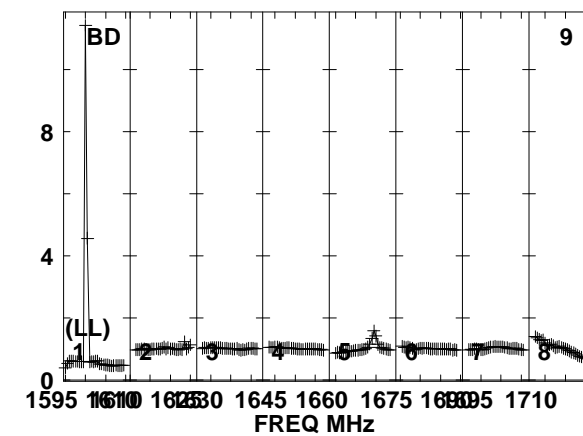
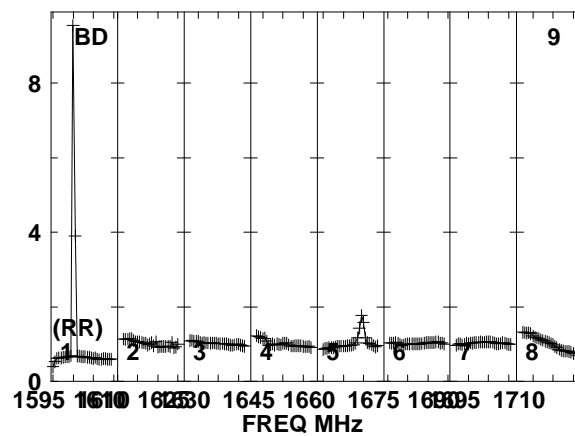
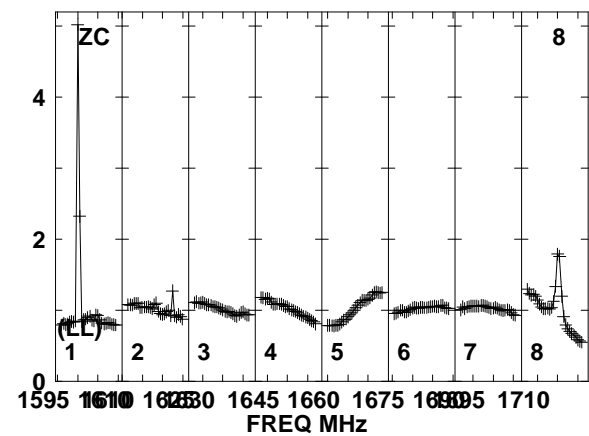
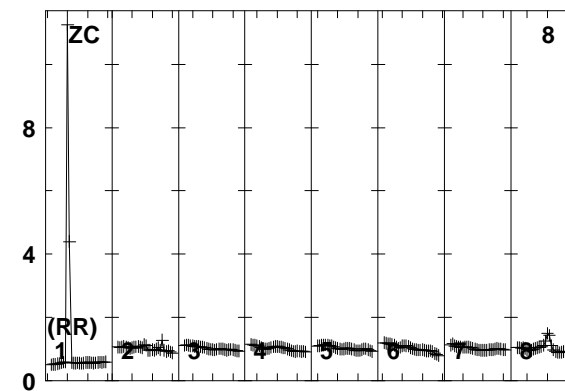
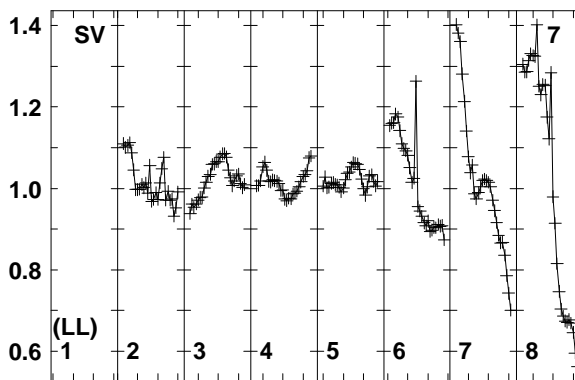
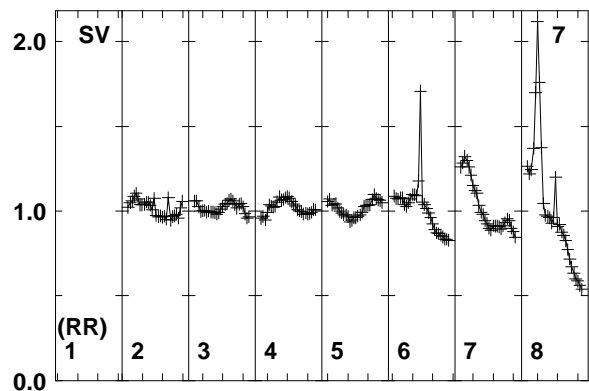
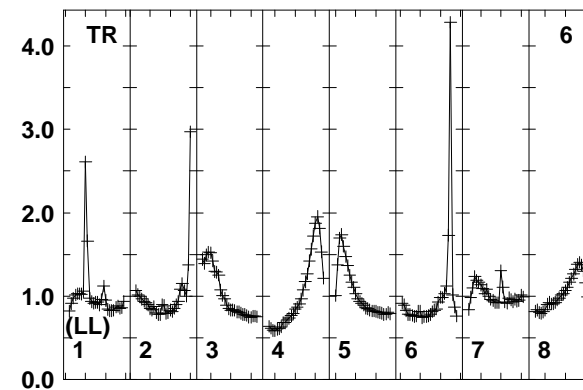
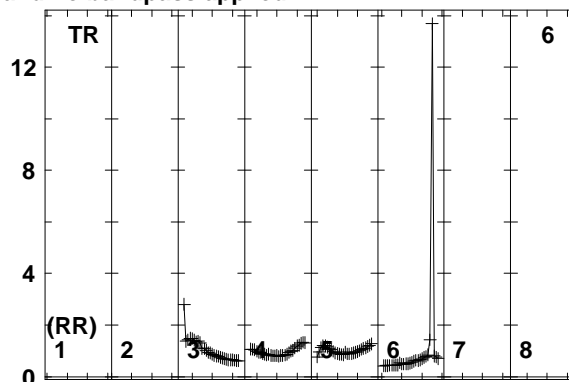
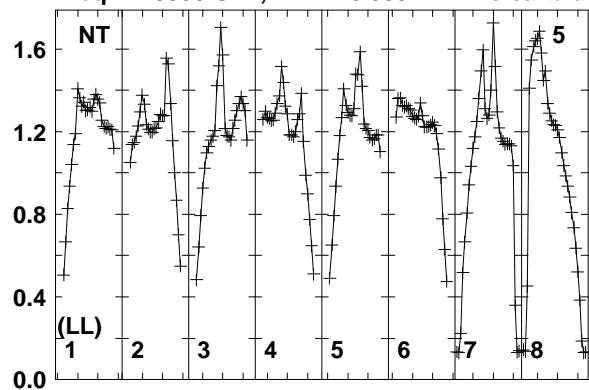

Lower frame: Real Jy
Total-power spectrum Antenna: NT (05)
Timerange: 00/09:15:21 to 00/09:17:19

Plot file version 329 created 11-AUG-2014 17:05:42

J2015+3710 EM110 2.UVDATA.1

Freq = 1.5950 GHz, Bw = 16.000 MH No calibration applied and no bandpass applied

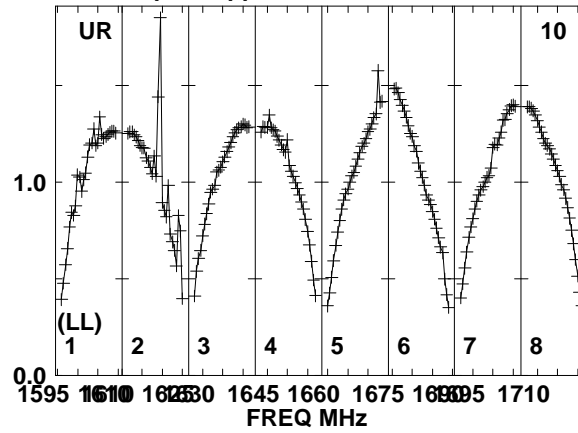
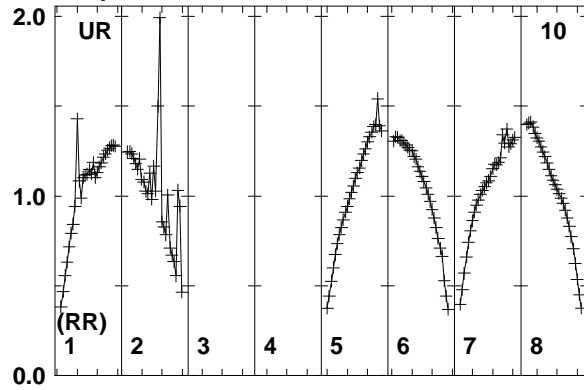

Lower frame: Real Jy
Total-power spectrum Antenna: UR (10)
Timerange: 00/09:15:21 to 00/09:17:19

Plot file version 330 created 11-AUG-2014 17:05:42

J2032+4127 EM110 2.UVDATA.1

Freq = 1.5950 GHz, Bw = 16.000 MH No calibration applied and no bandpass applied

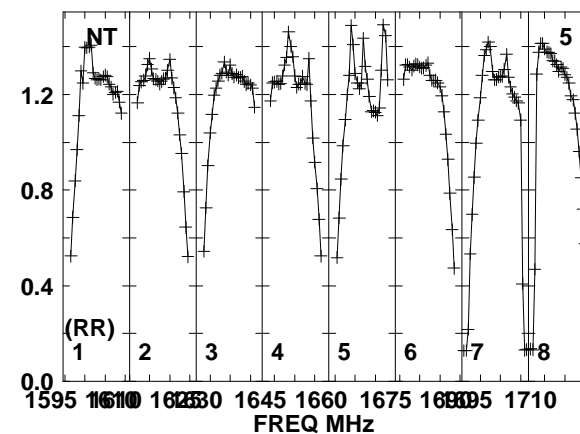
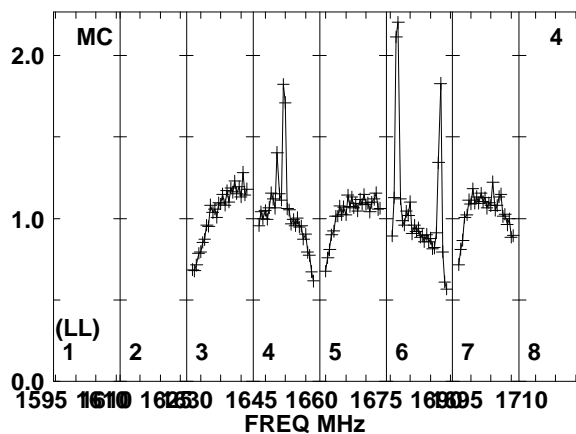
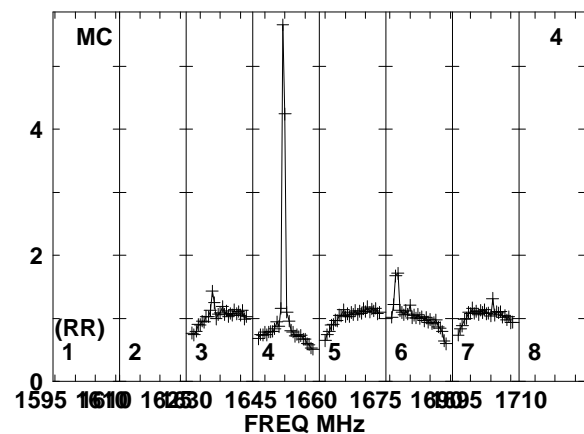
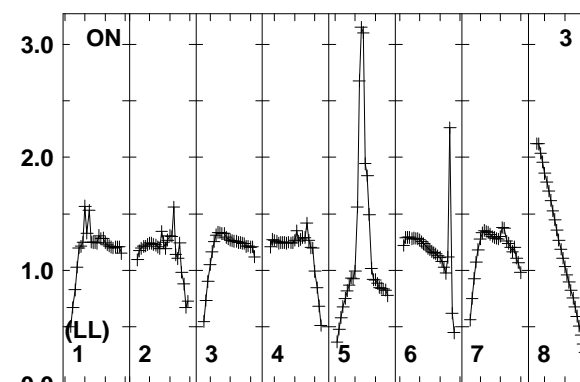
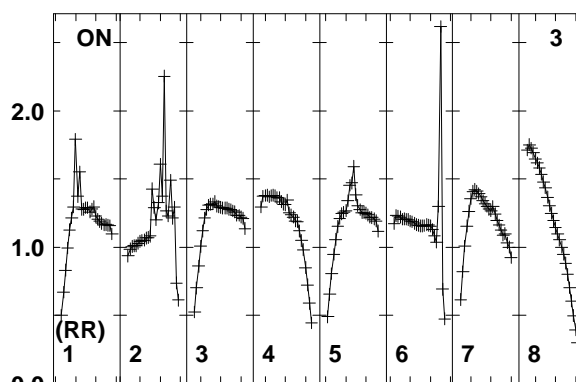
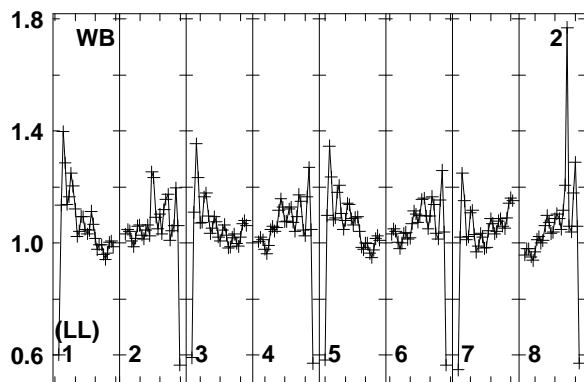
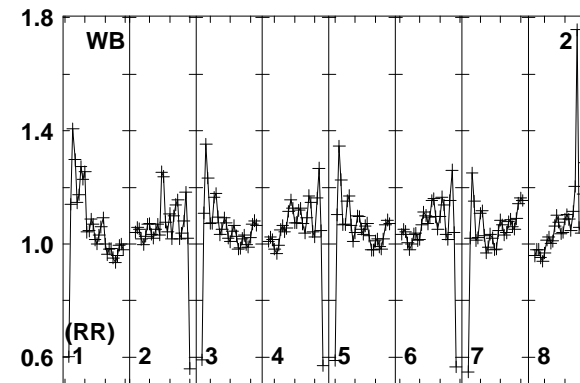
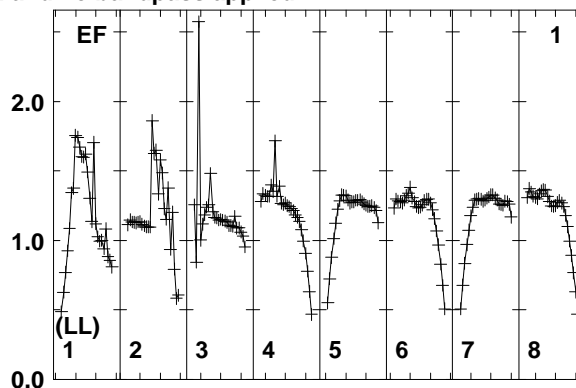
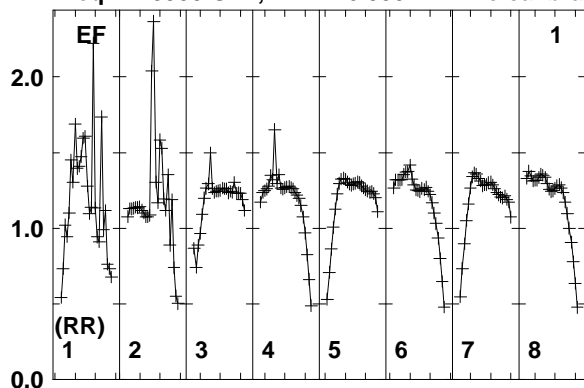

Lower frame: Real Jy
Total-power spectrum Antenna: EF (01)
Timerange: 00/09:17:21 to 00/09:21:19

Plot file version 331 created 11-AUG-2014 17:05:42

J2032+4127 EM110 2.UVDATA.1

Freq = 1.5950 GHz, Bw = 16.000 MH No calibration applied and no bandpass applied

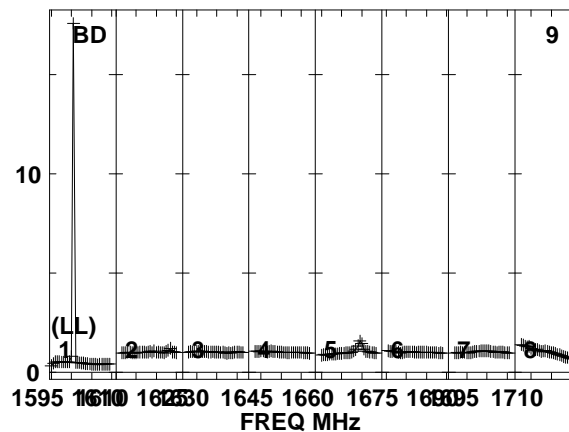
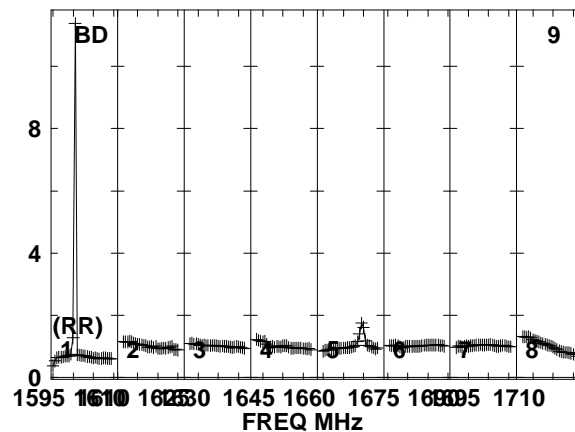
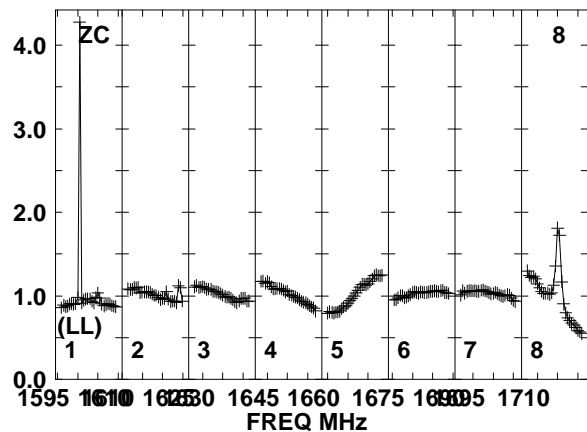
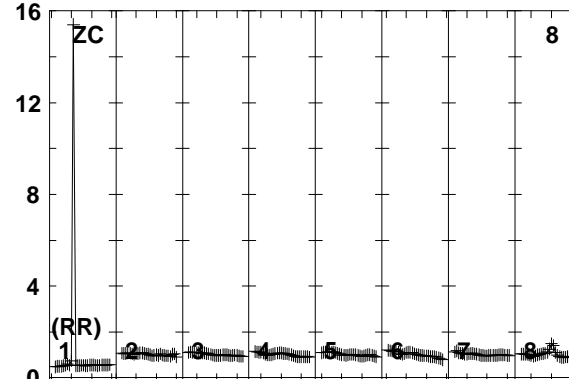
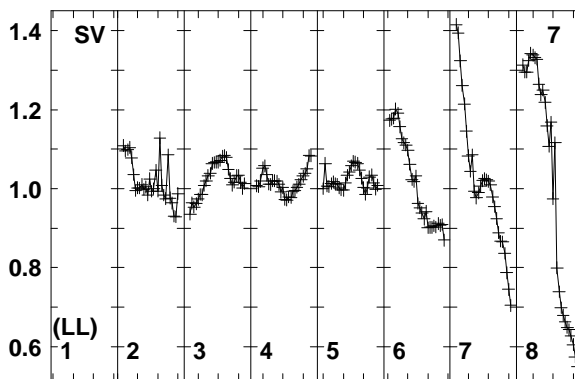
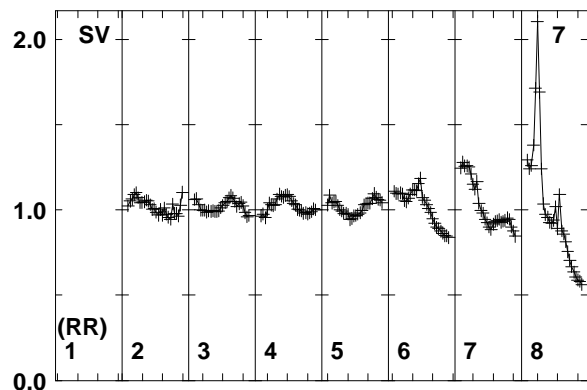
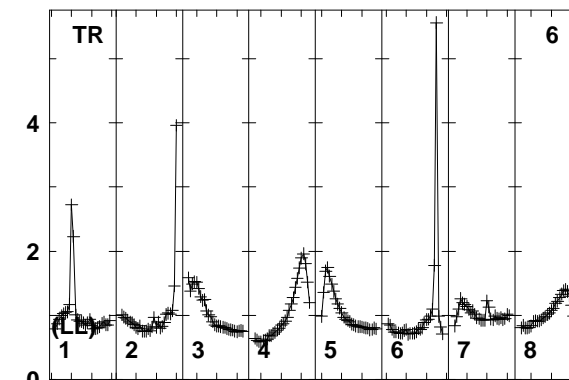
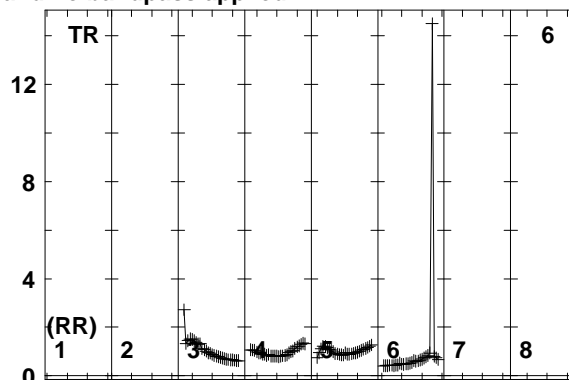
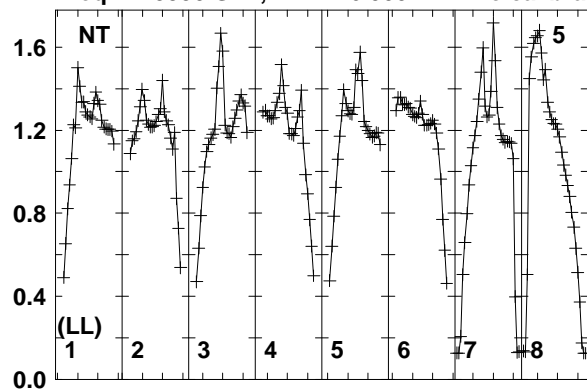

Lower frame: Real Jy
Total-power spectrum Antenna: NT (05)
Timerange: 00/09:17:21 to 00/09:21:19

Plot file version 332 created 11-AUG-2014 17:05:42

J2032+4127 EM110 2.UVDATA.1

Freq = 1.5950 GHz, Bw = 16.000 MH No calibration applied and no bandpass applied

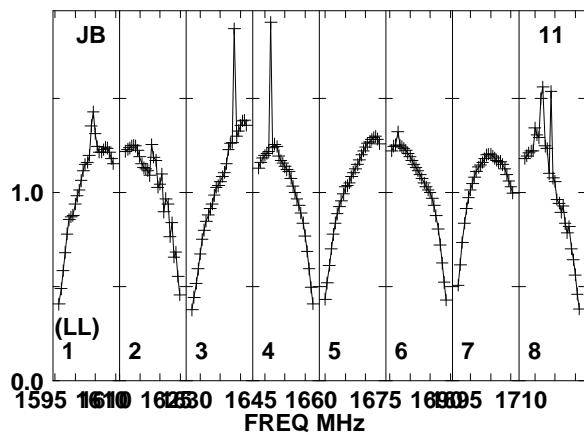
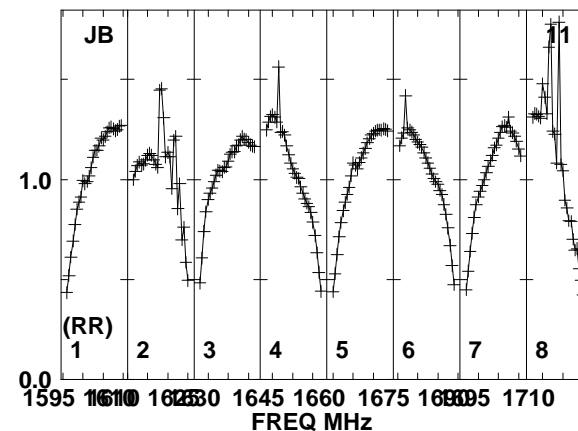
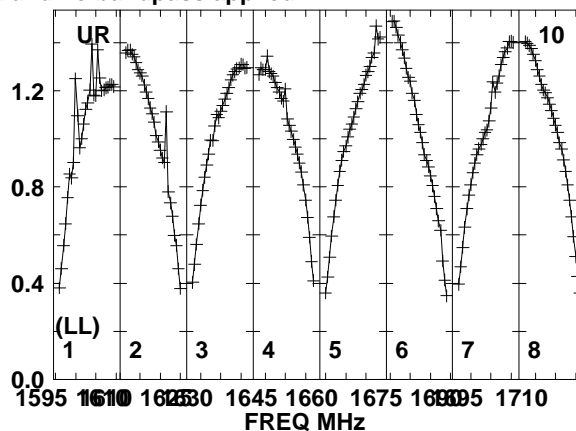
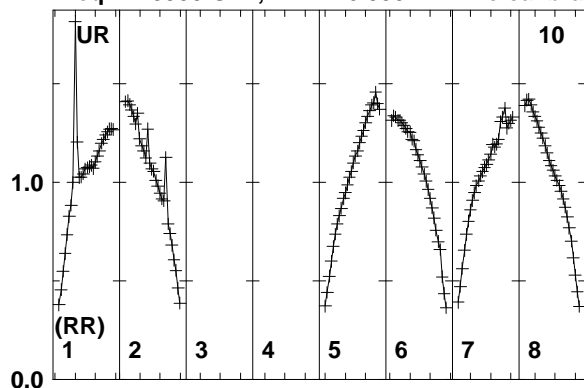

Lower frame: Real Jy
Total-power spectrum Antenna: UR (10)
Timerange: 00/09:17:21 to 00/09:21:19

Plot file version 333 created 11-AUG-2014 17:05:42

J2015+3710 EM110 2.UVDATA.1

Freq = 1.5950 GHz, Bw = 16.000 MH No calibration applied and no bandpass applied

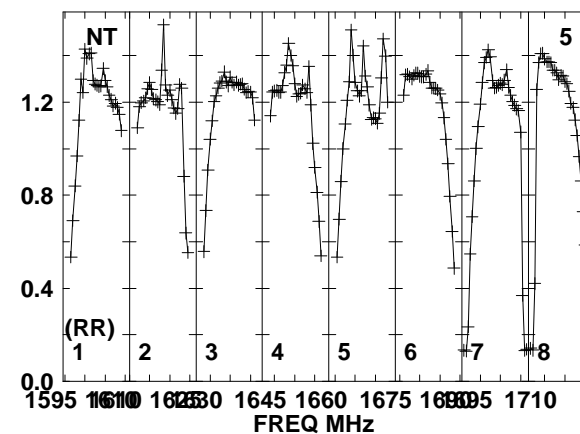
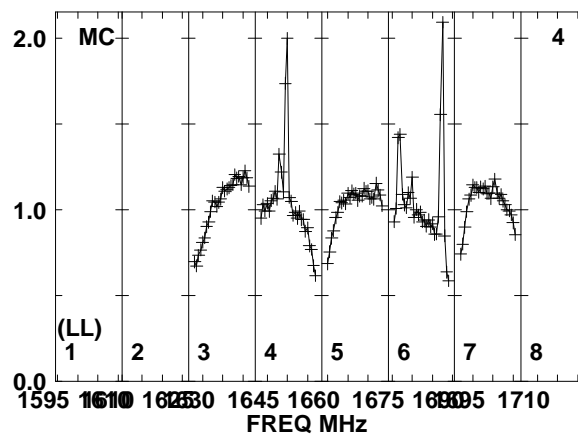
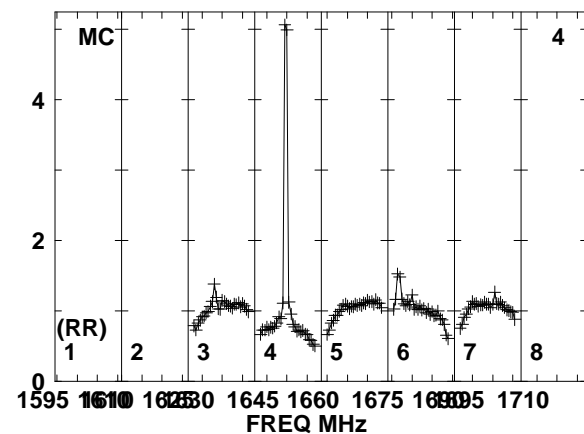
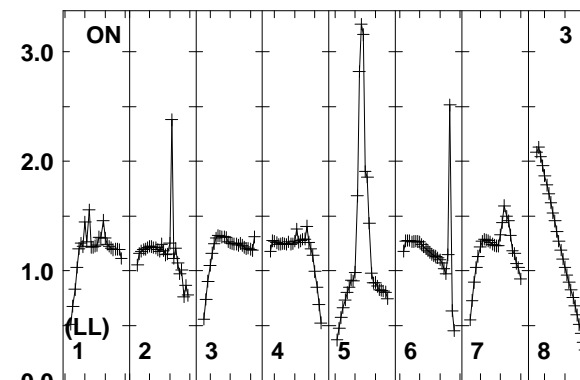
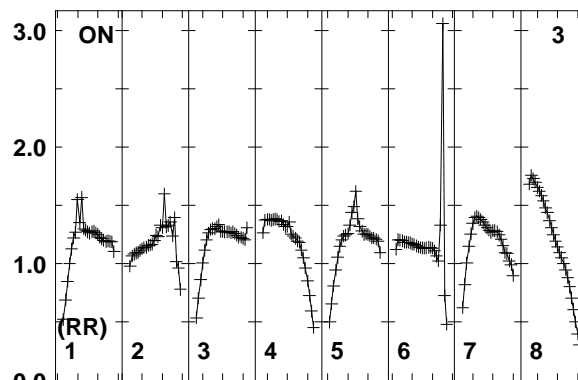
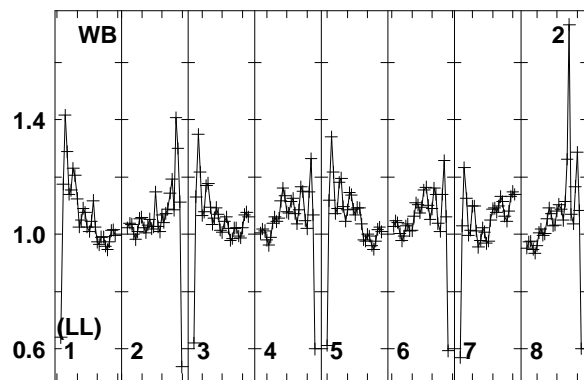
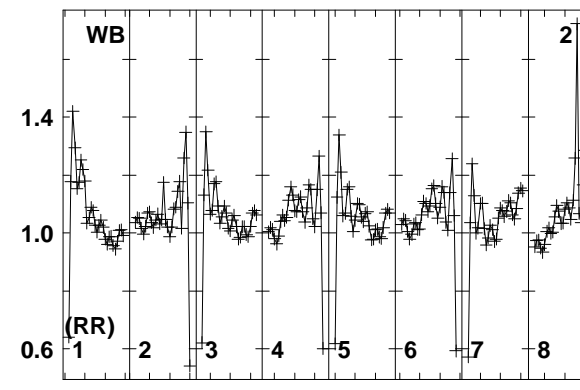
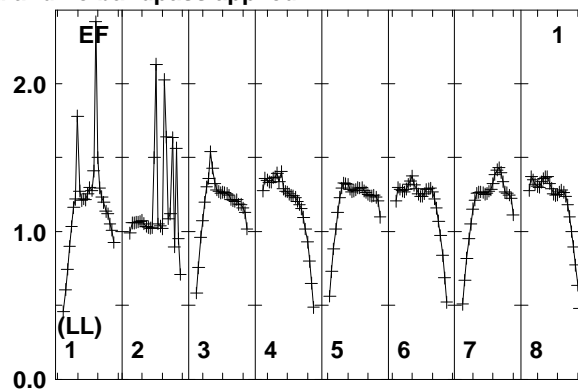
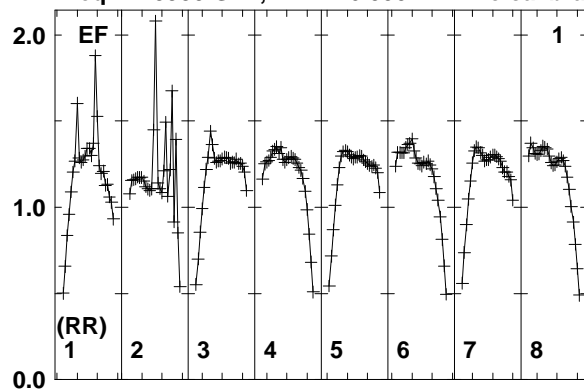

Lower frame: Real Jy
Total-power spectrum Antenna: EF (01)
Timerange: 00/09:22:21 to 00/09:24:19

Plot file version 334 created 11-AUG-2014 17:05:42

J2015+3710 EM110 2.UVDATA.1

Freq = 1.5950 GHz, Bw = 16.000 MH No calibration applied and no bandpass applied

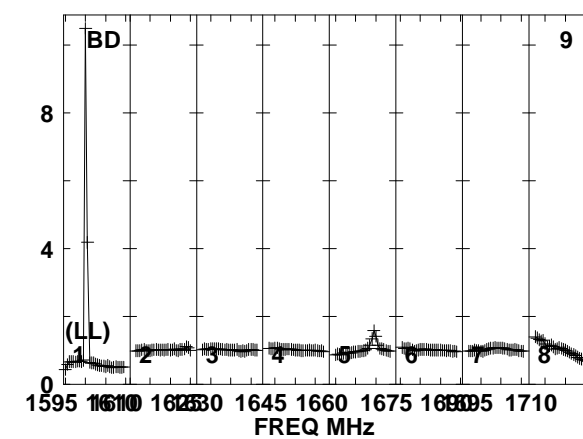
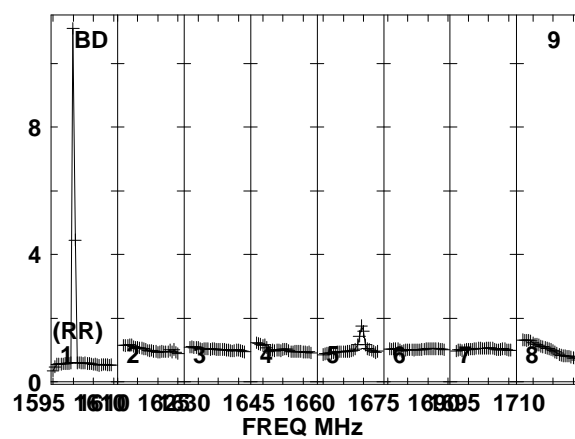
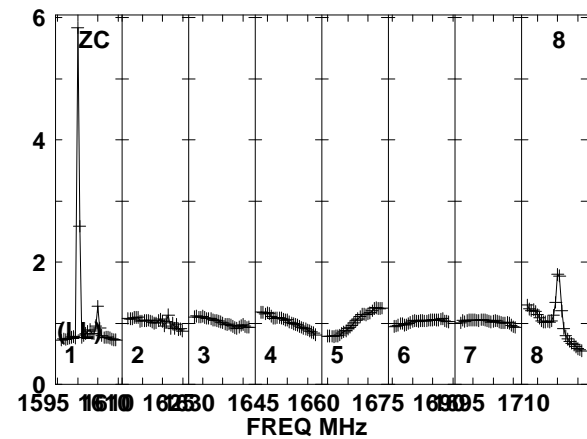
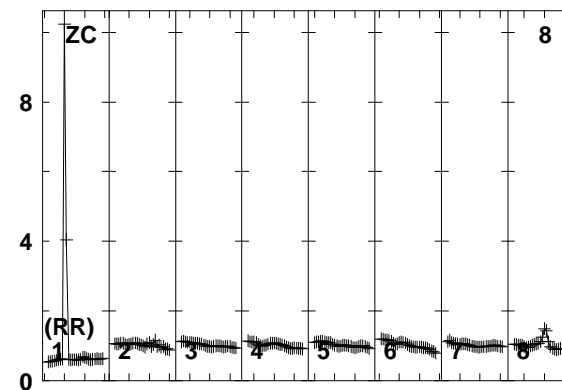
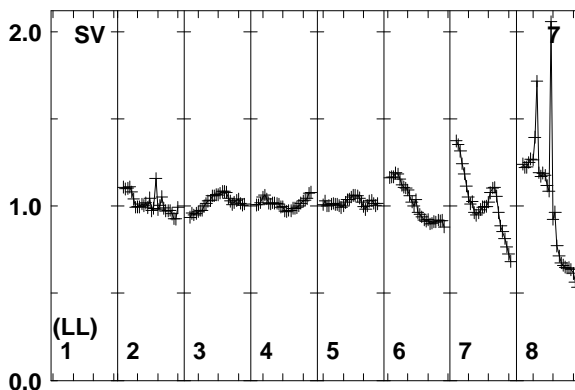
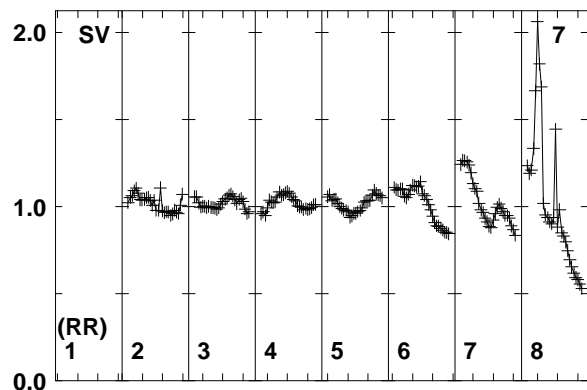
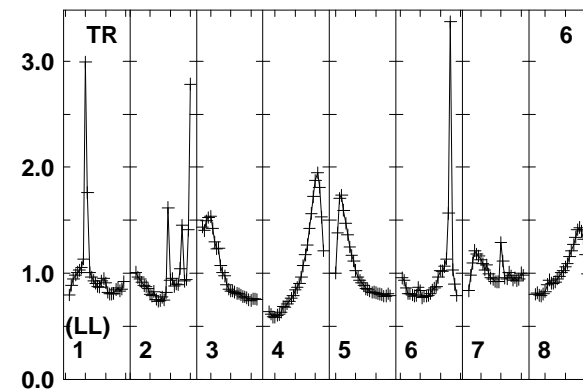
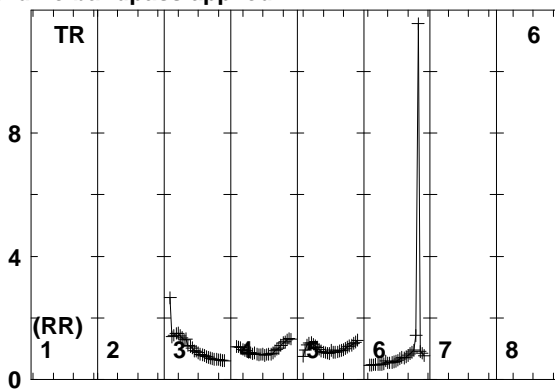
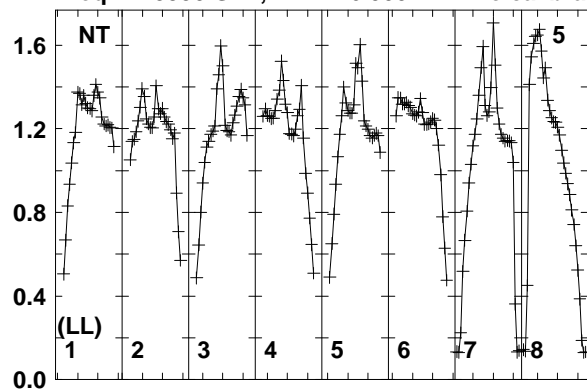

Lower frame: Real Jy
Total-power spectrum Antenna: NT (05)
Timerange: 00/09:22:21 to 00/09:24:19

Plot file version 335 created 11-AUG-2014 17:05:42

J2015+3710 EM110 2.UVDATA.1

Freq = 1.5950 GHz, Bw = 16.000 MH No calibration applied and no bandpass applied

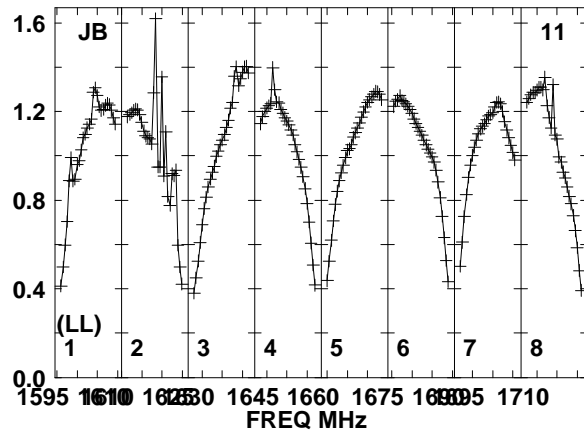
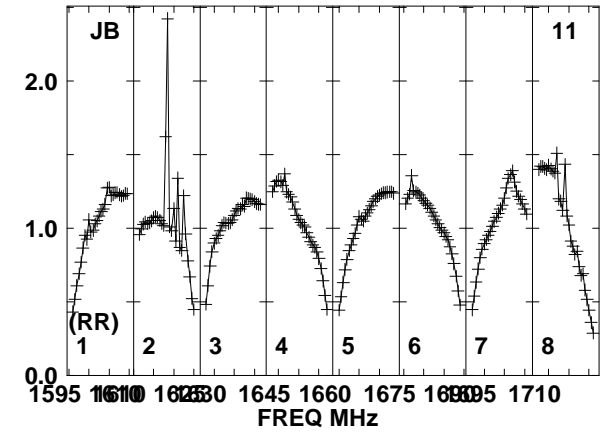
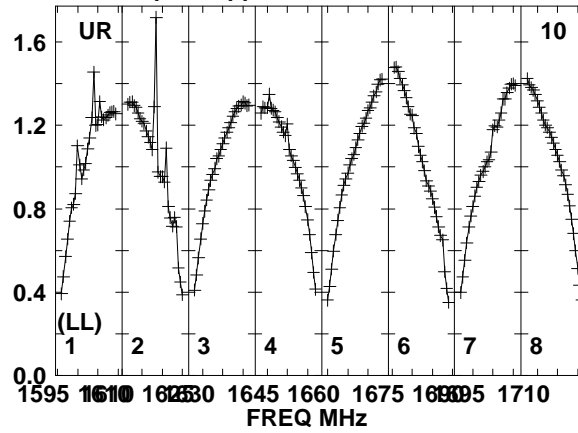
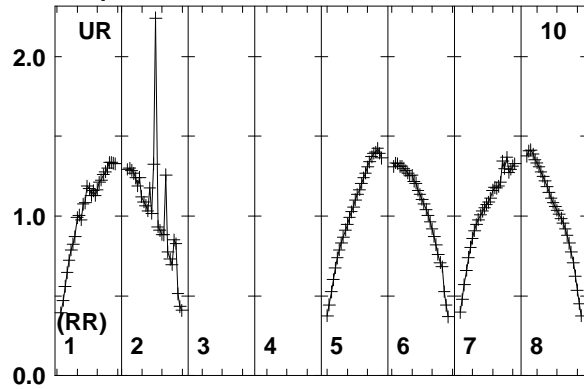

Lower frame: Real Jy
Total-power spectrum Antenna: UR (10)
Timerange: 00/09:22:21 to 00/09:24:19

Plot file version 336 created 11-AUG-2014 17:05:42

J2253+1608 EM110 2.UVDATA.1

Freq = 1.5950 GHz, Bw = 16.000 MH No calibration applied and no bandpass applied

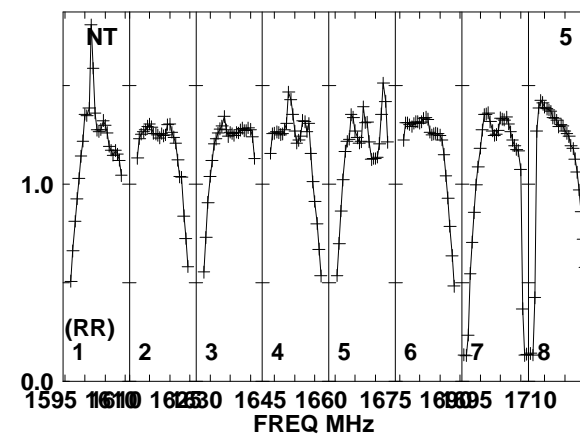
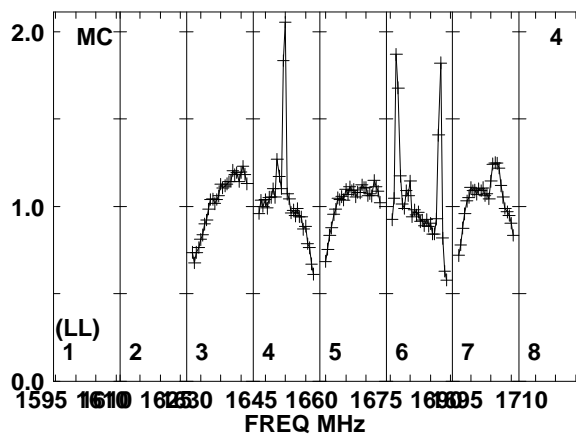
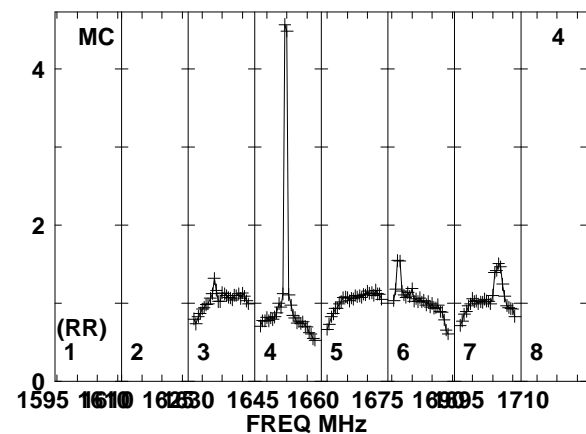
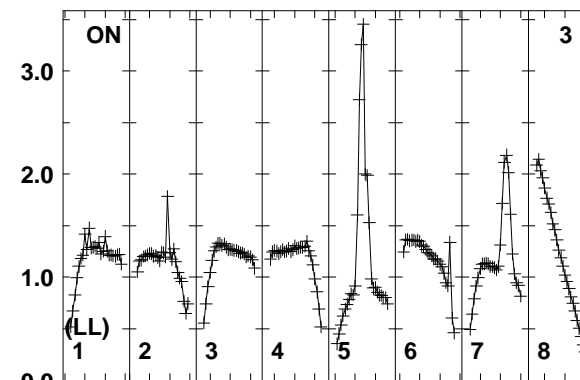
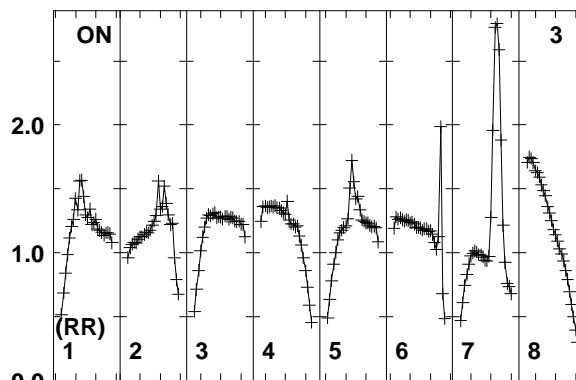
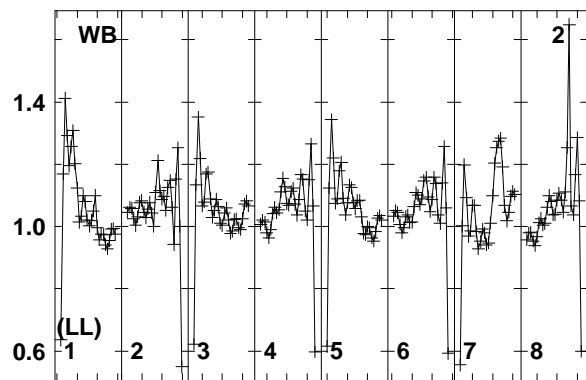
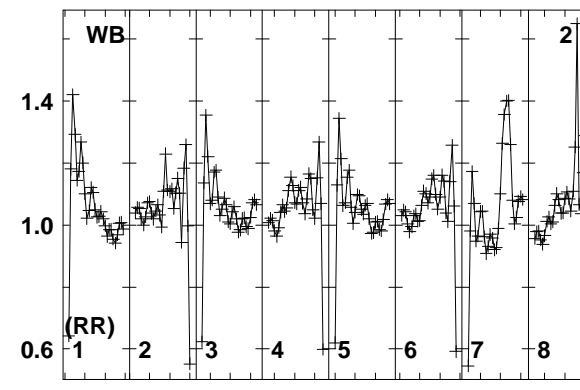
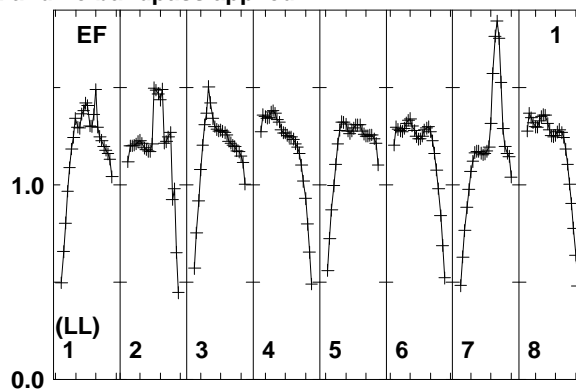
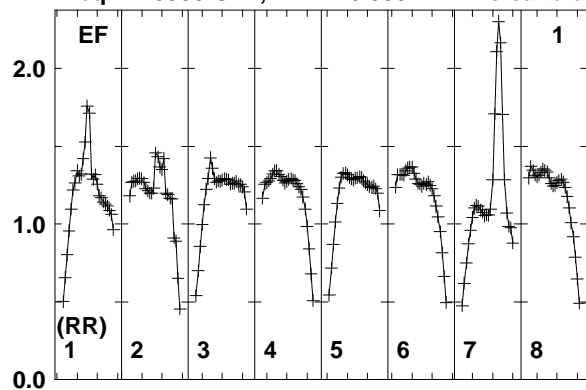

Lower frame: Real Jy
Total-power spectrum Antenna: EF (01)
Timerange: 00/09:26:21 to 00/09:31:19

Plot file version 337 created 11-AUG-2014 17:05:42

J2253+1608 EM110 2.UVDATA.1

Freq = 1.5950 GHz, Bw = 16.000 MH No calibration applied and no bandpass applied

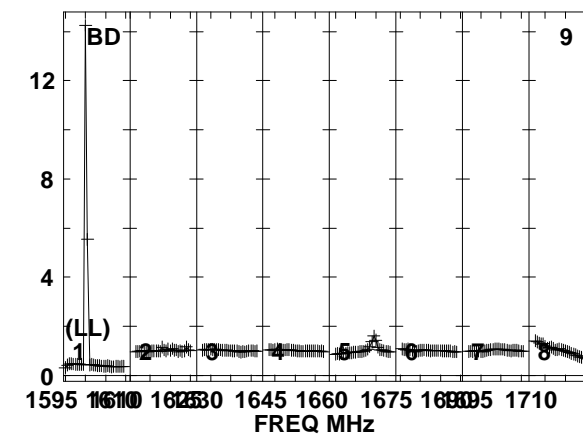
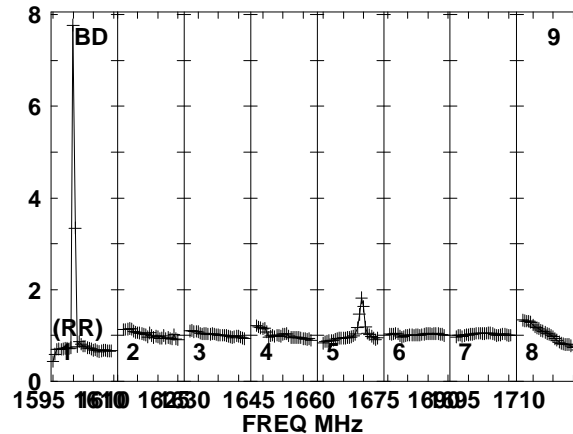
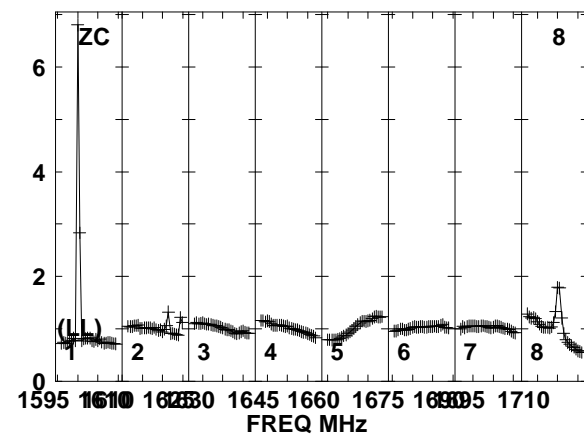
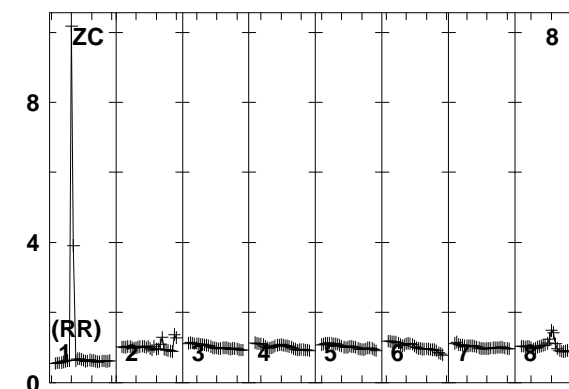
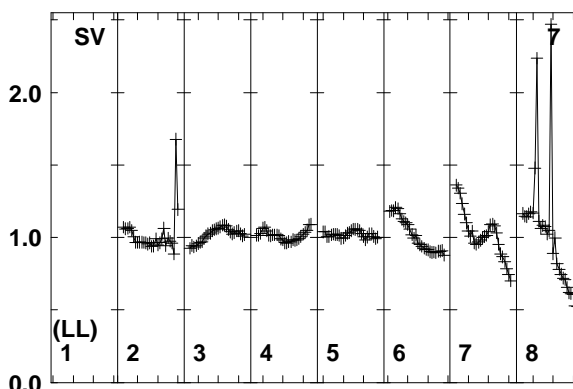
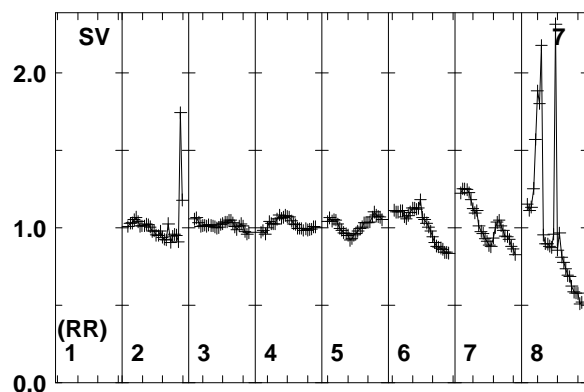
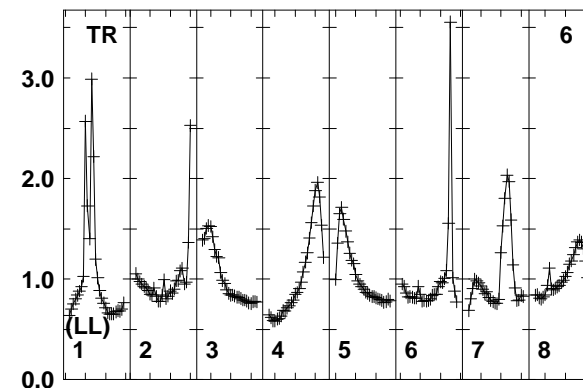
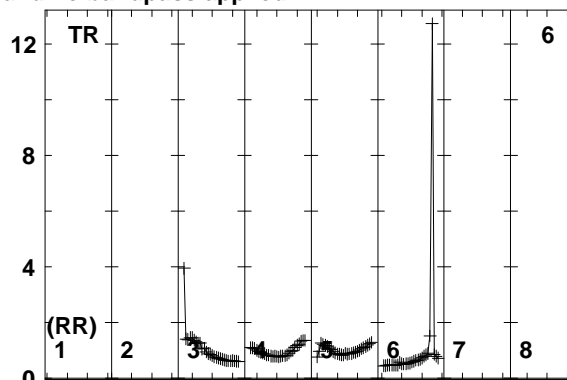
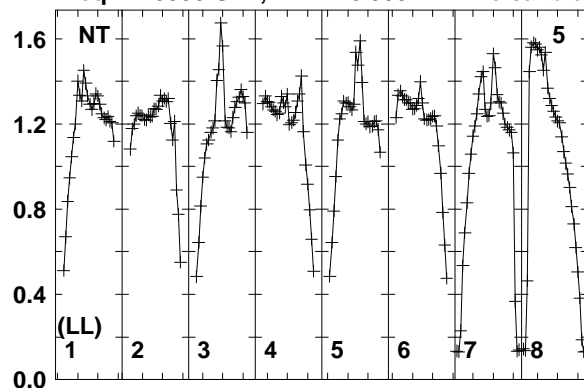

Lower frame: Real Jy
Total-power spectrum Antenna: NT (05)
Timerange: 00/09:26:21 to 00/09:31:19

Plot file version 338 created 11-AUG-2014 17:05:42

J2253+1608 EM110 2.UVDATA.1

Freq = 1.5950 GHz, Bw = 16.000 MH No calibration applied and no bandpass applied

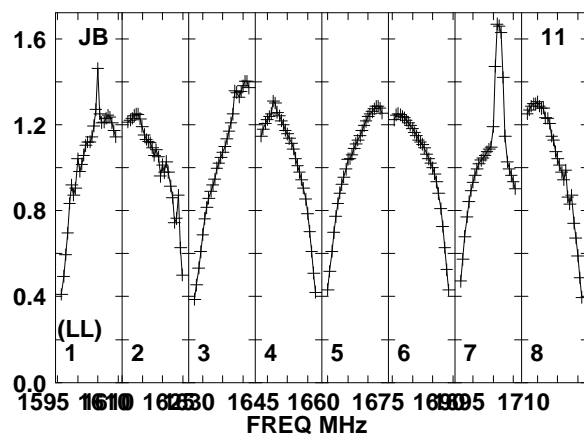
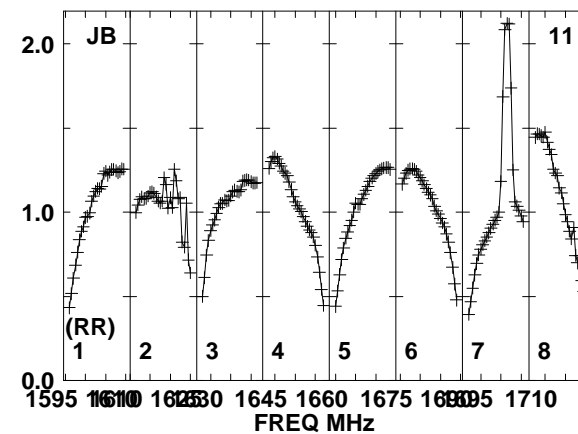
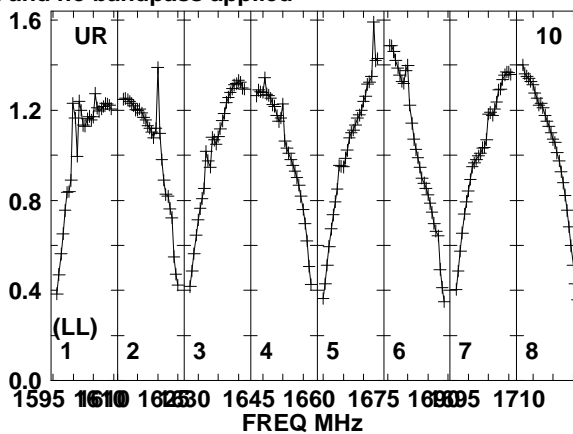
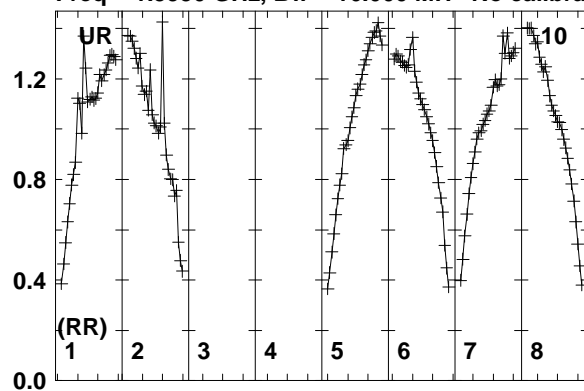

Lower frame: Real Jy
Total-power spectrum Antenna: UR (10)
Timerange: 00/09:26:21 to 00/09:31:19

Plot file version 339 created 11-AUG-2014 17:05:42

J2015+3710 EM110 2.UVDATA.1

Freq = 1.5950 GHz, Bw = 16.000 MH No calibration applied and no bandpass applied

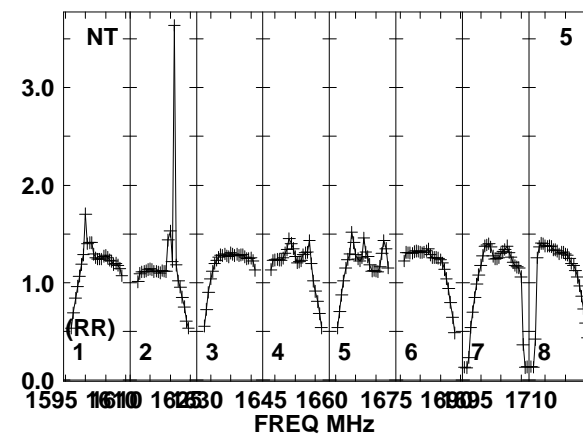
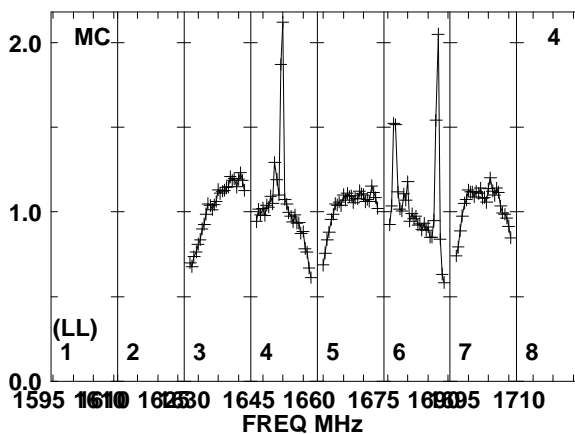
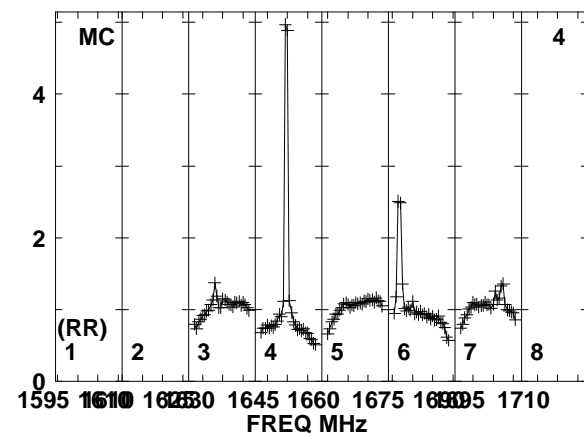
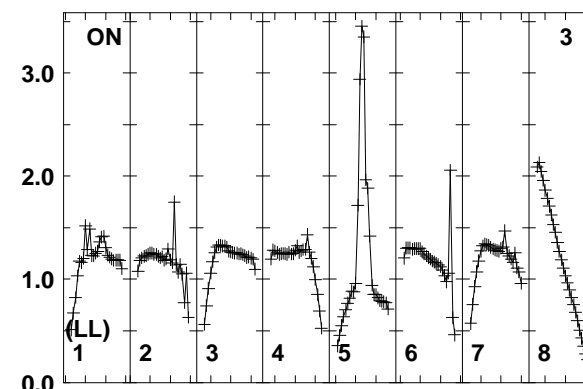
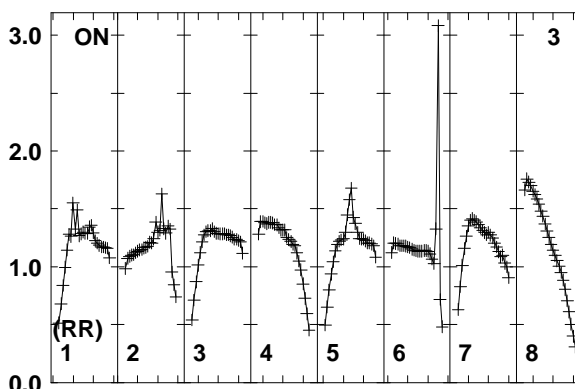
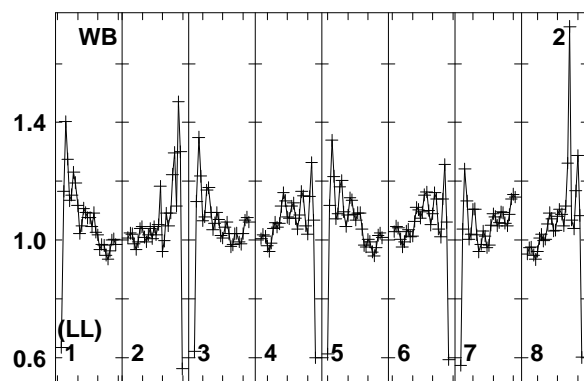
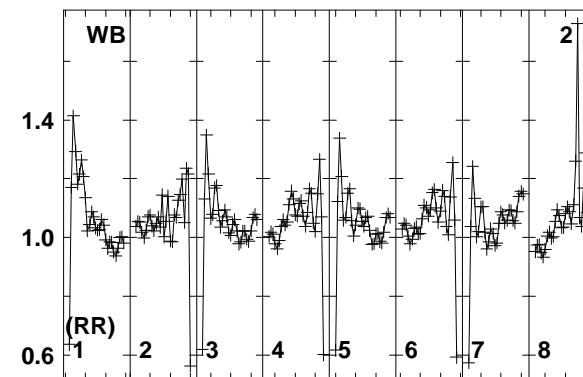
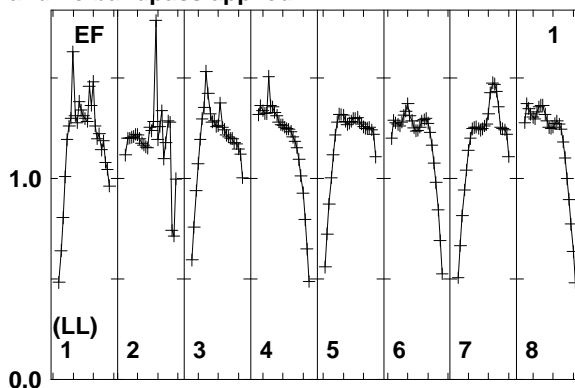
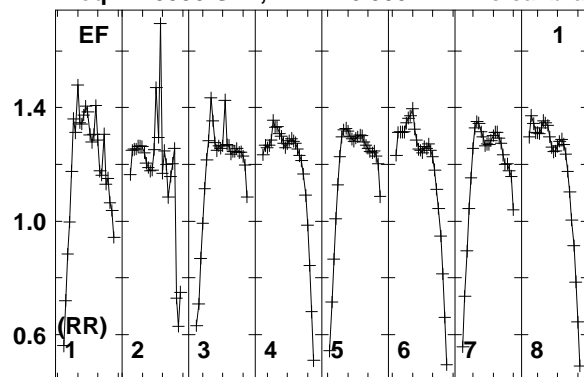

Lower frame: Real Jy
Total-power spectrum Antenna: EF (01)
Timerange: 00/09:34:11 to 00/09:36:09

Plot file version 340 created 11-AUG-2014 17:05:42

J2015+3710 EM110 2.UVDATA.1

Freq = 1.5950 GHz, Bw = 16.000 MH No calibration applied and no bandpass applied

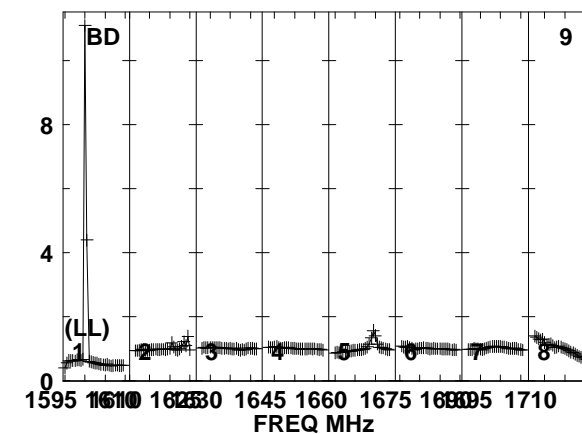
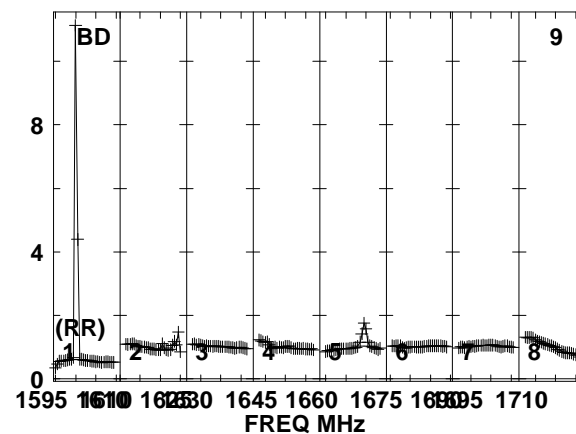
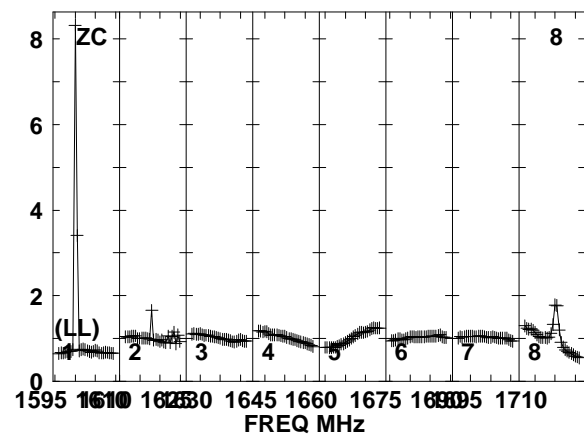
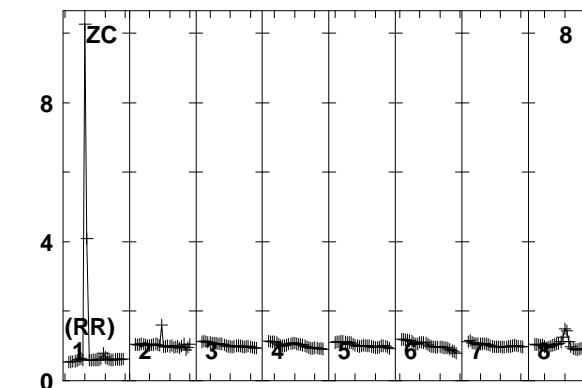
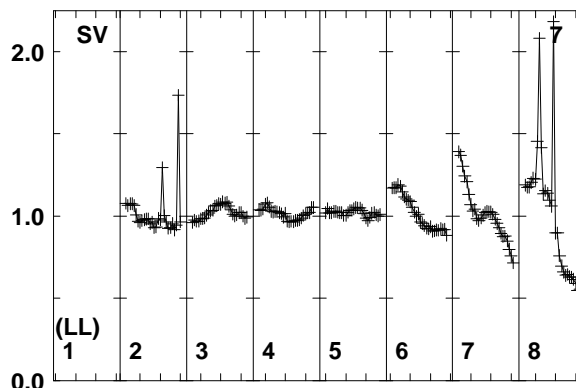
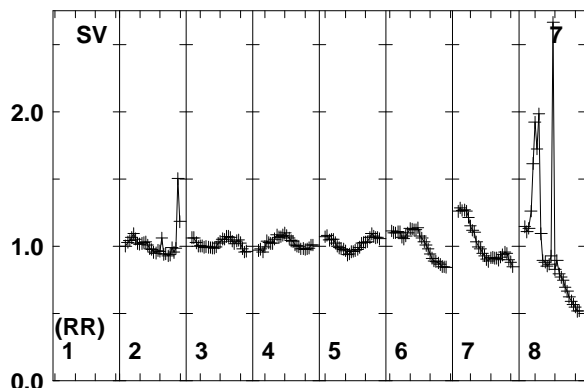
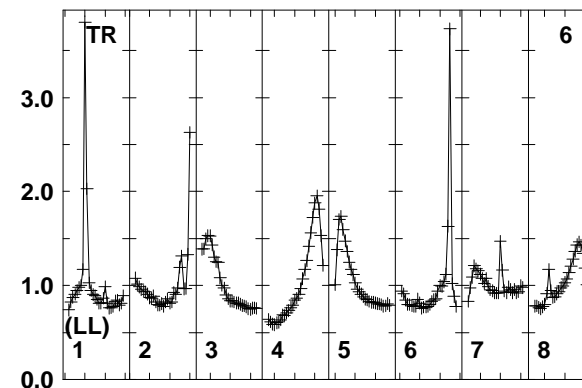
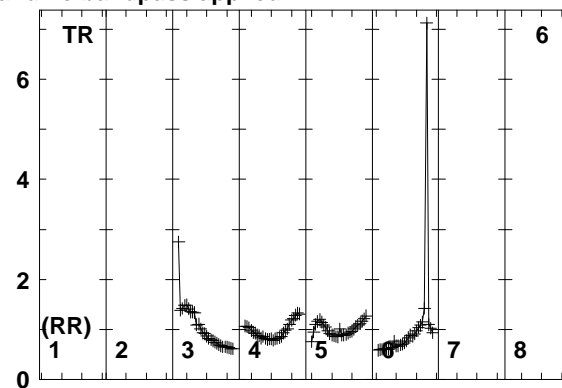
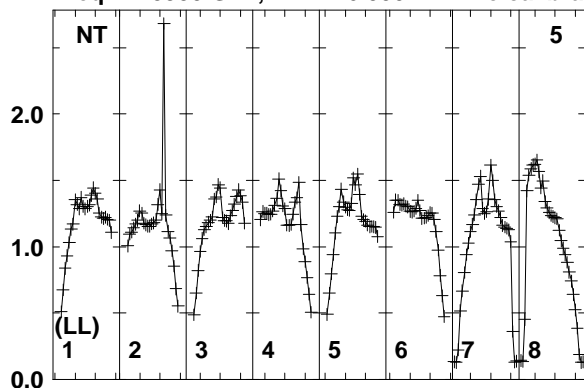

Lower frame: Real Jy
Total-power spectrum Antenna: NT (05)
Timerange: 00/09:34:11 to 00/09:36:09

Plot file version 341 created 11-AUG-2014 17:05:42

J2015+3710 EM110 2.UVDATA.1

Freq = 1.5950 GHz, Bw = 16.000 MH No calibration applied and no bandpass applied

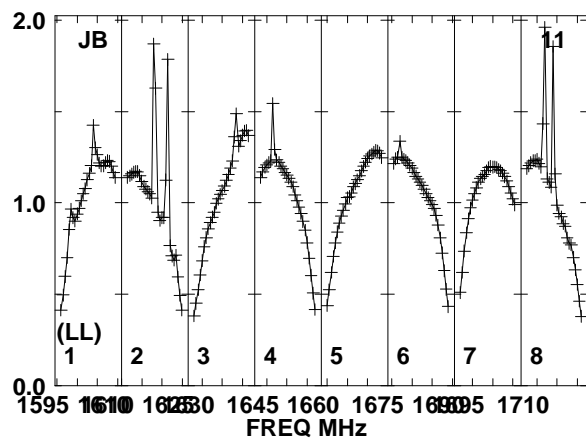
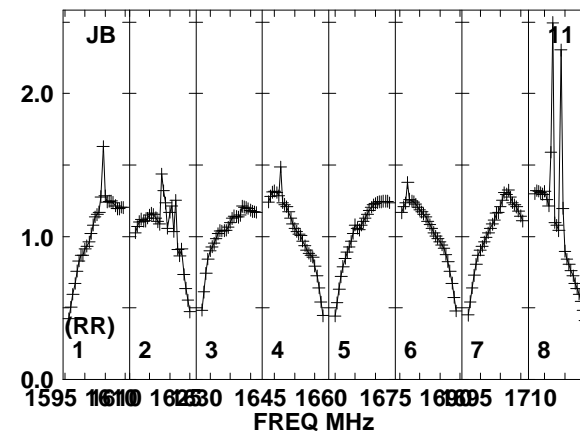
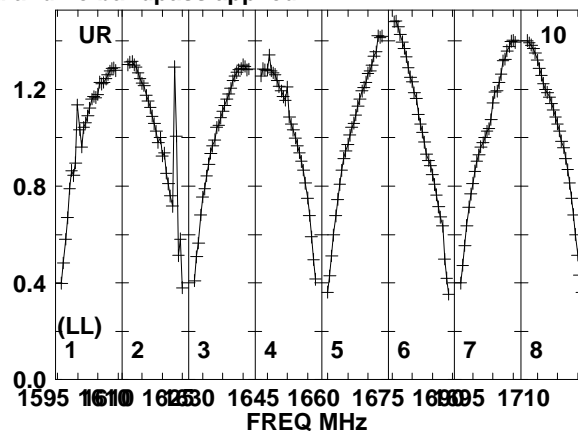
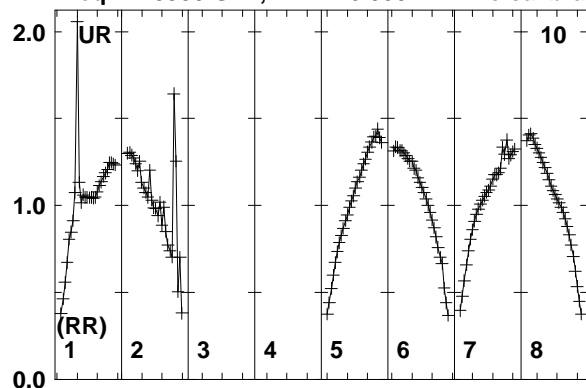

Lower frame: Real Jy
Total-power spectrum Antenna: UR (10)
Timerange: 00/09:34:11 to 00/09:36:09

Plot file version 342 created 11-AUG-2014 17:05:43

J2032+4127 EM110 2.UVDATA.1

Freq = 1.5950 GHz, Bw = 16.000 MH No calibration applied and no bandpass applied

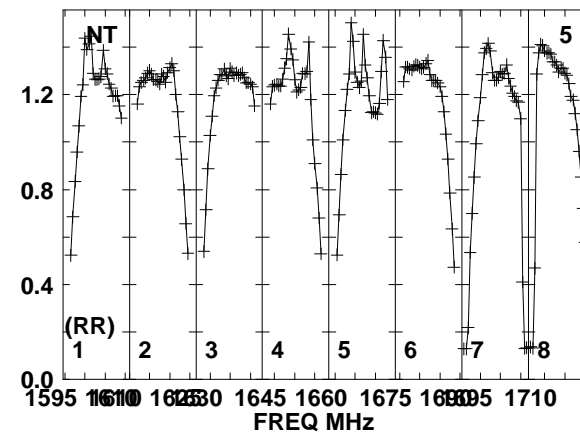
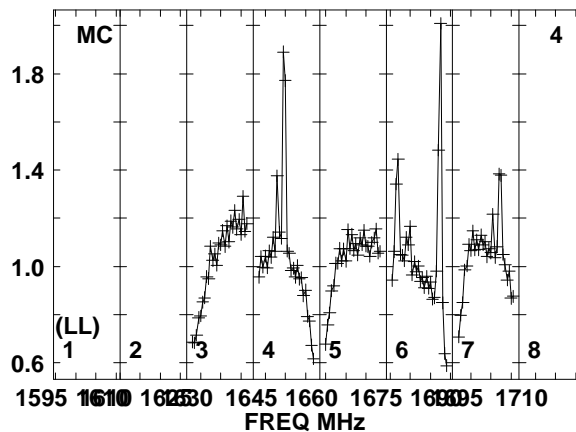
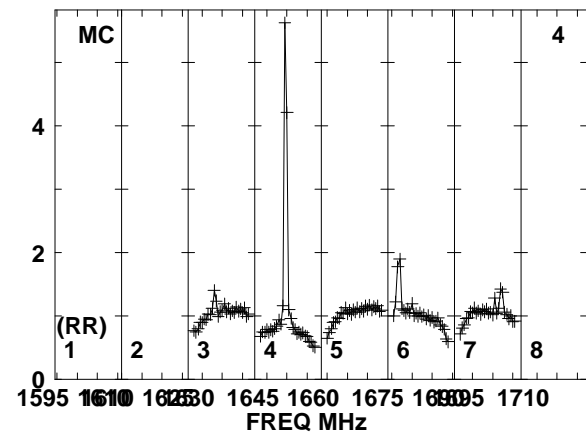
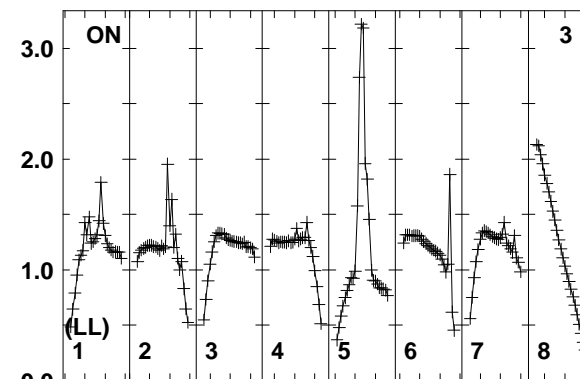
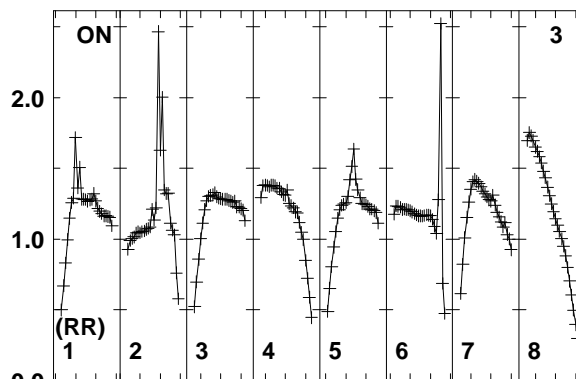
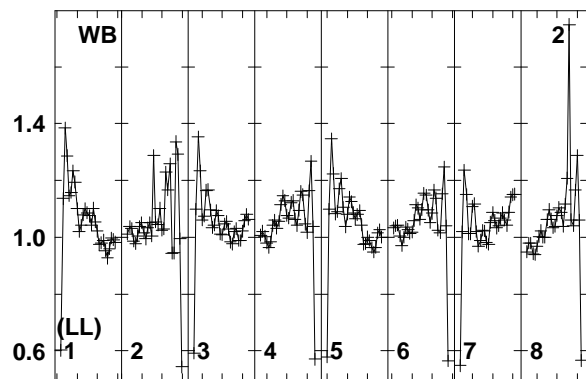
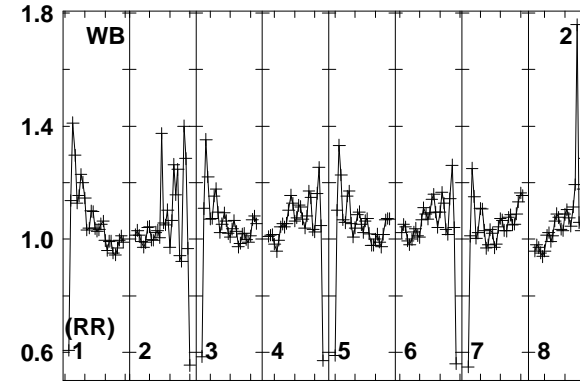
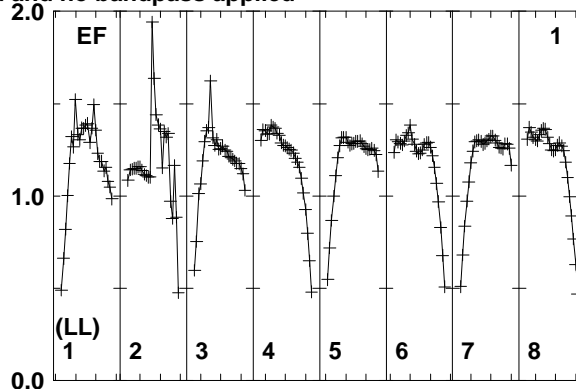
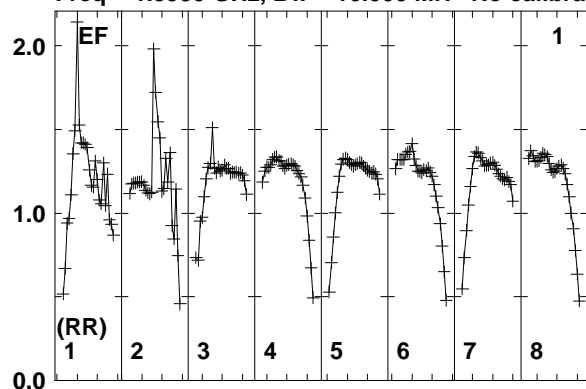

Lower frame: Real Jy
Total-power spectrum Antenna: EF (01)
Timerange: 00/09:36:24 to 00/09:40:08

Plot file version 343 created 11-AUG-2014 17:05:43

J2032+4127 EM110 2.UVDATA.1

Freq = 1.5950 GHz, Bw = 16.000 MH No calibration applied and no bandpass applied

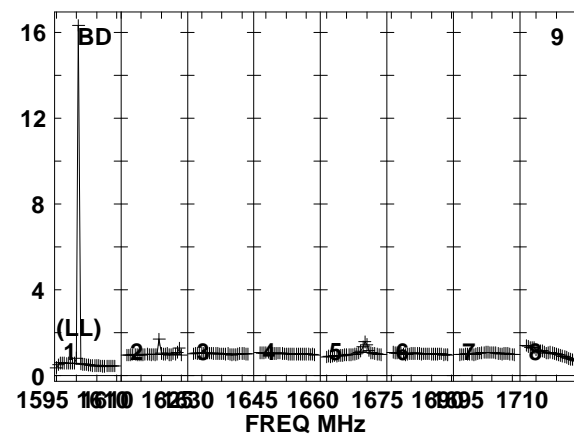
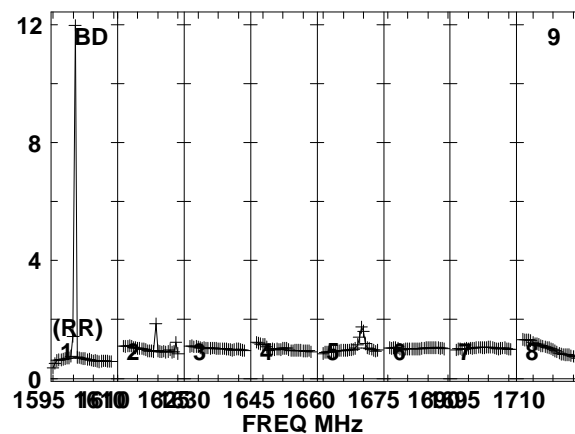
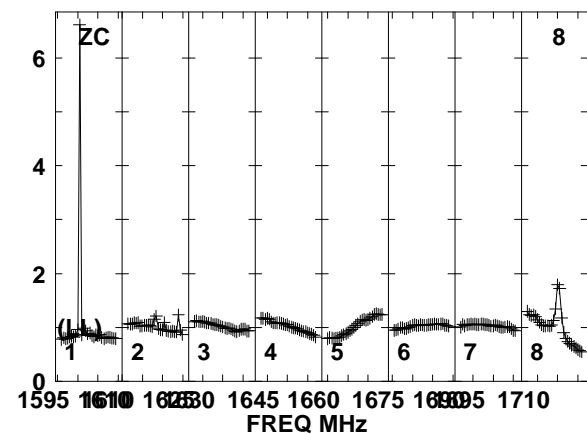
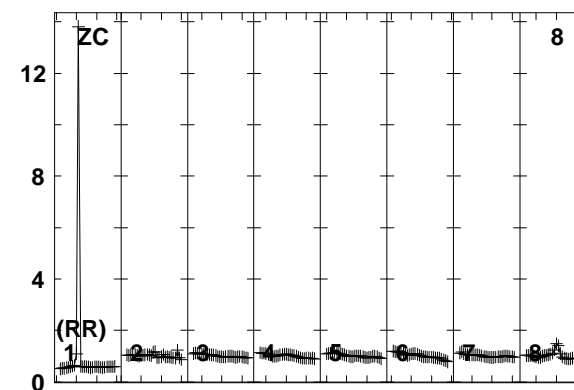
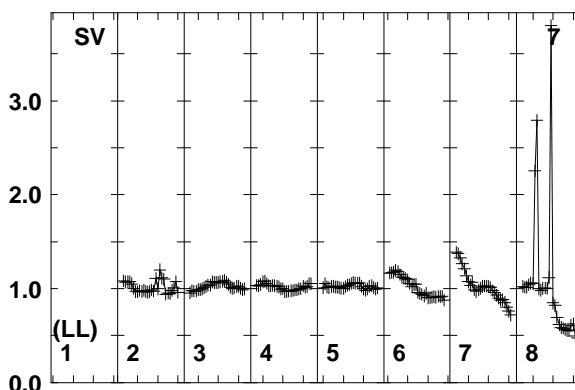
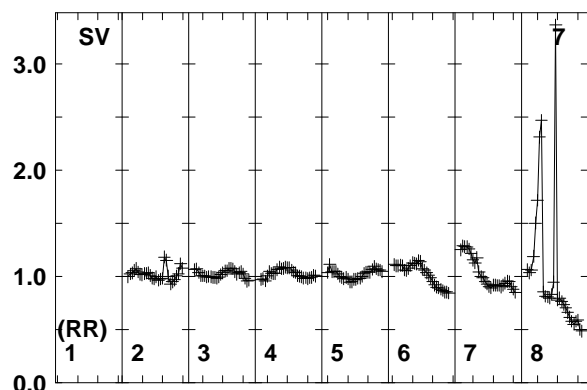
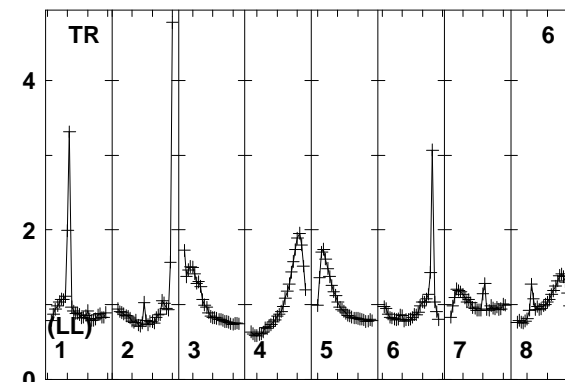
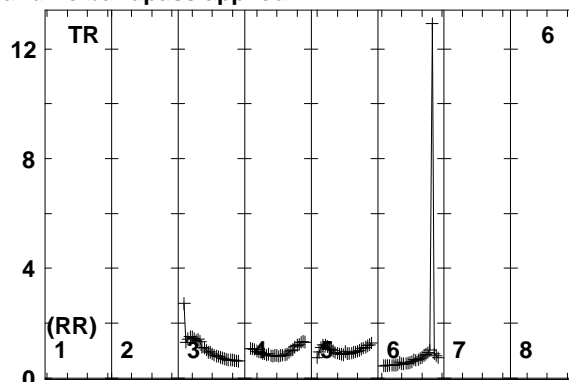
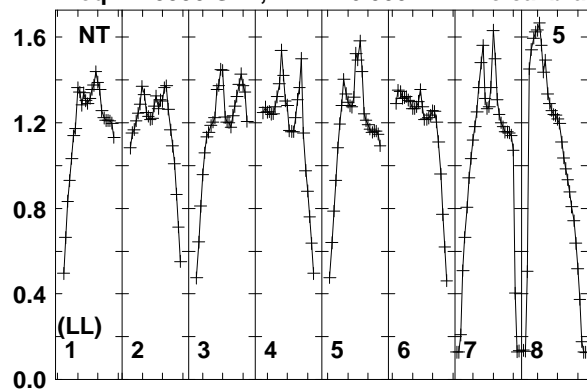

Lower frame: Real Jy
Total-power spectrum Antenna: NT (05)
Timerange: 00/09:36:24 to 00/09:40:08

Plot file version 344 created 11-AUG-2014 17:05:43

J2032+4127 EM110 2.UVDATA.1

Freq = 1.5950 GHz, Bw = 16.000 MH No calibration applied and no bandpass applied

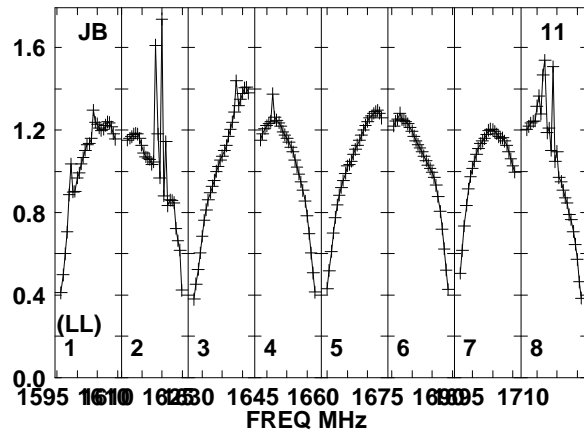
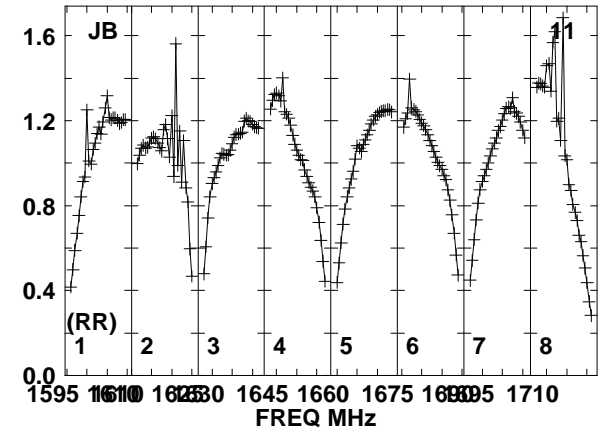
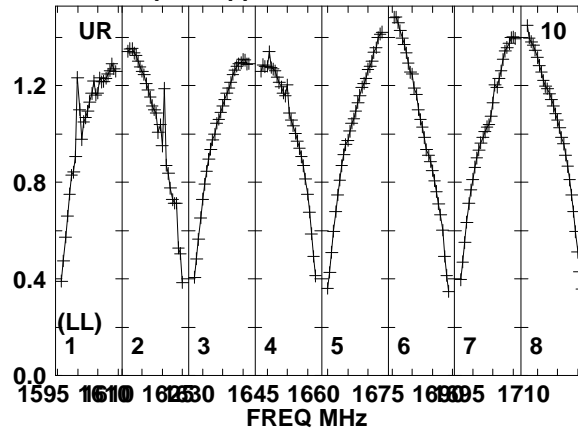
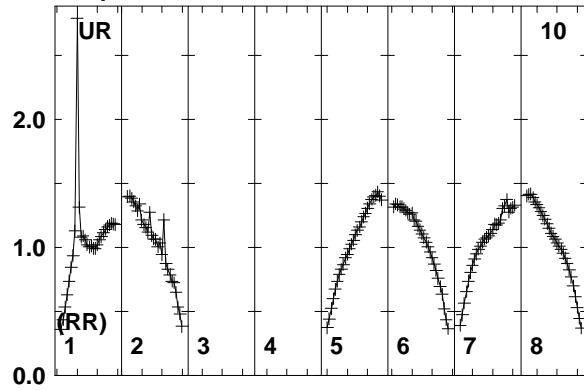

Lower frame: Real Jy
Total-power spectrum Antenna: UR (10)
Timerange: 00/09:36:24 to 00/09:40:08

Plot file version 345 created 11-AUG-2014 17:05:43

J2015+3710 EM110 2.UVDATA.1

Freq = 1.5950 GHz, Bw = 16.000 MH No calibration applied and no bandpass applied

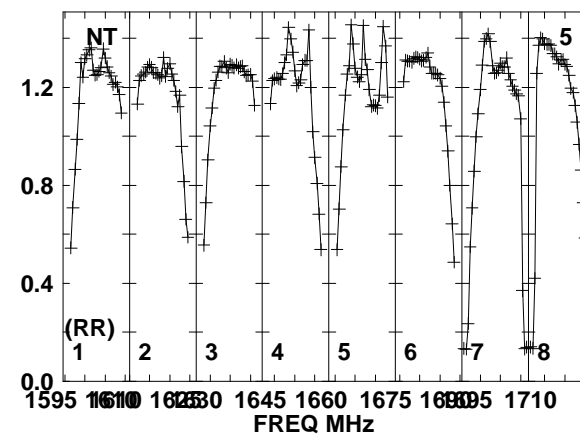
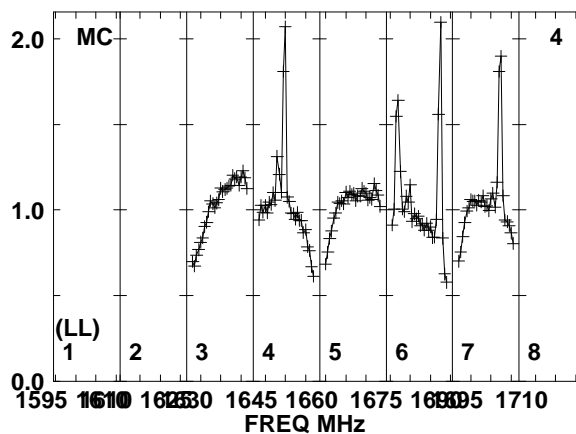
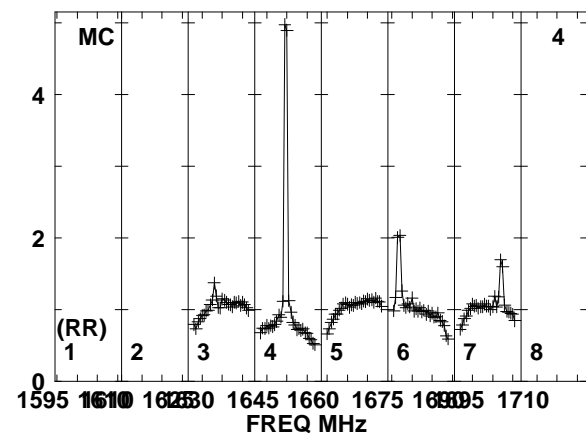
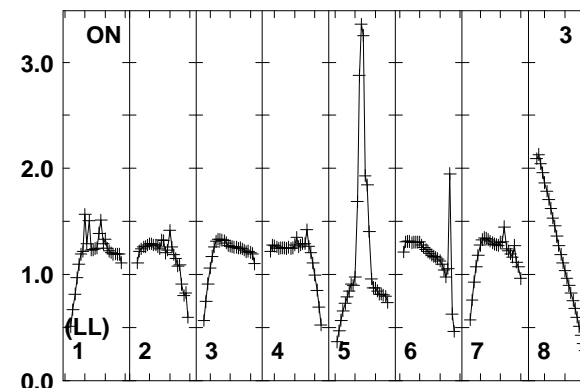
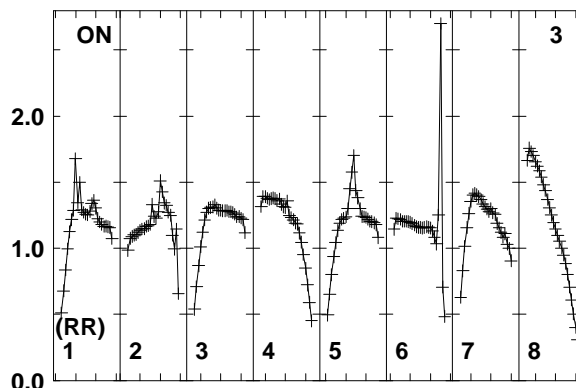
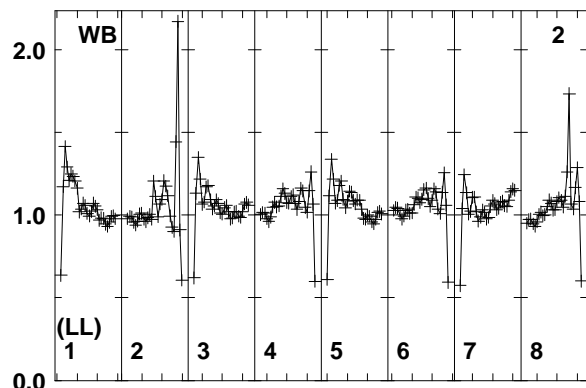
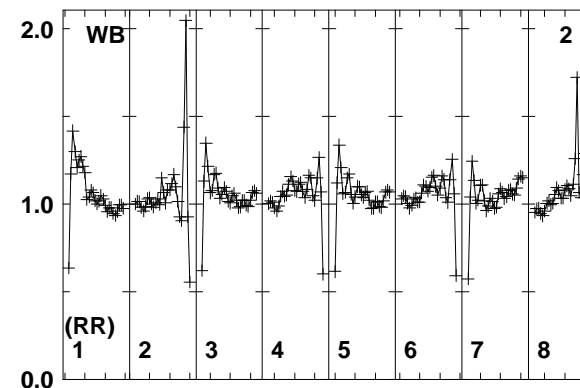
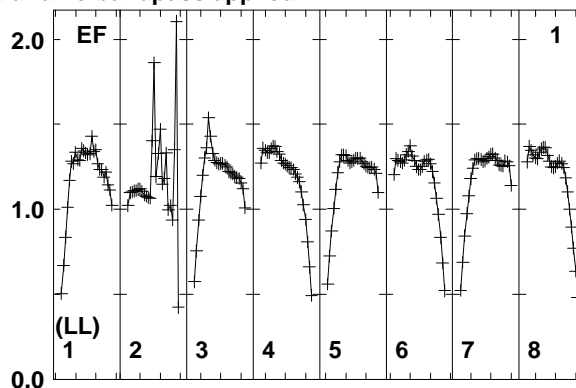
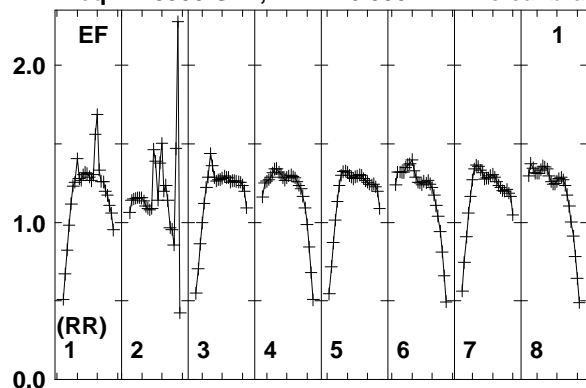

Lower frame: Real Jy
Total-power spectrum Antenna: EF (01)
Timerange: 00/09:40:24 to 00/09:42:08

Plot file version 346 created 11-AUG-2014 17:05:43

J2015+3710 EM110 2.UVDATA.1

Freq = 1.5950 GHz, Bw = 16.000 MH No calibration applied and no bandpass applied

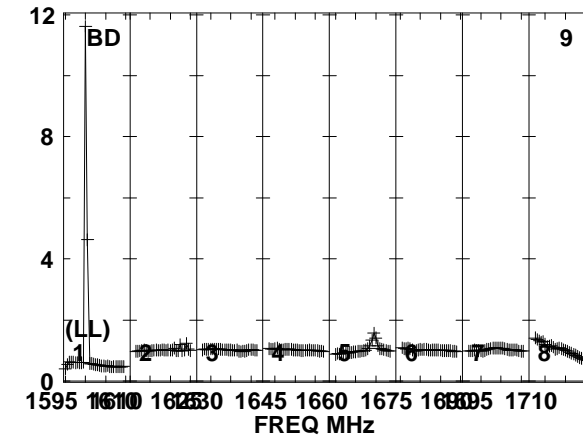
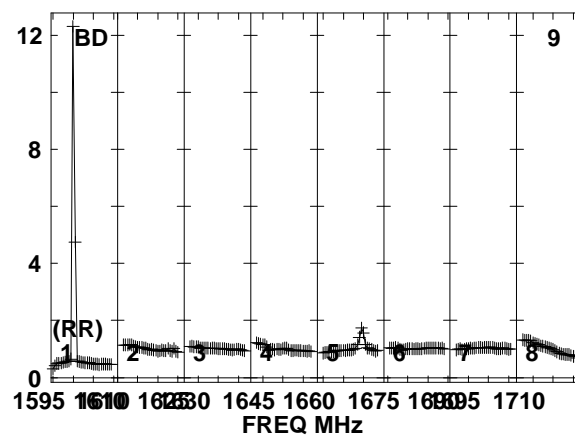
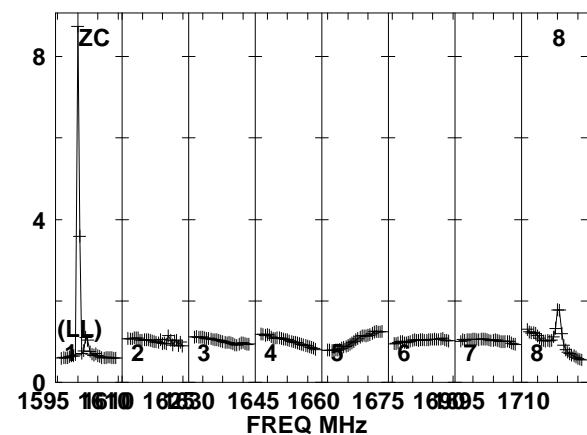
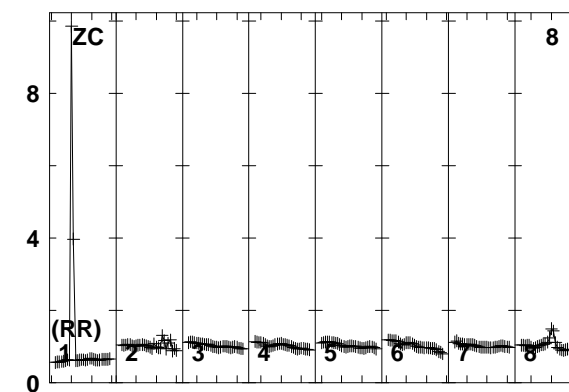
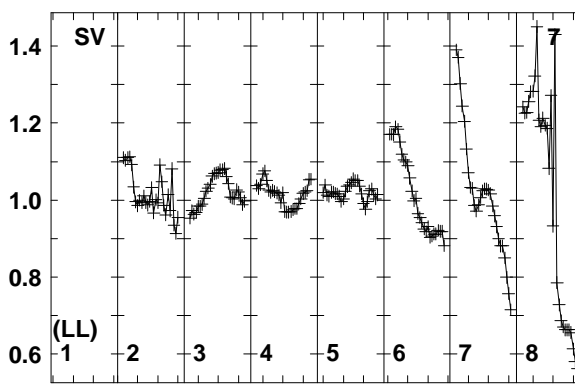
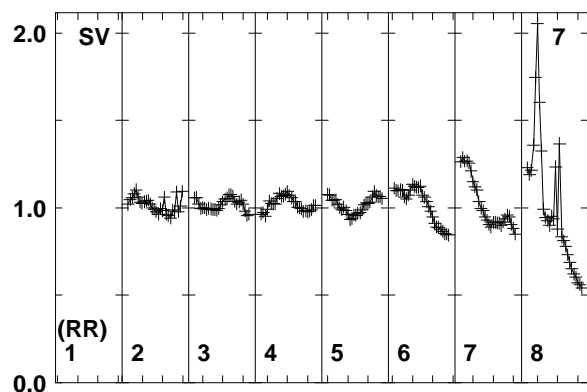
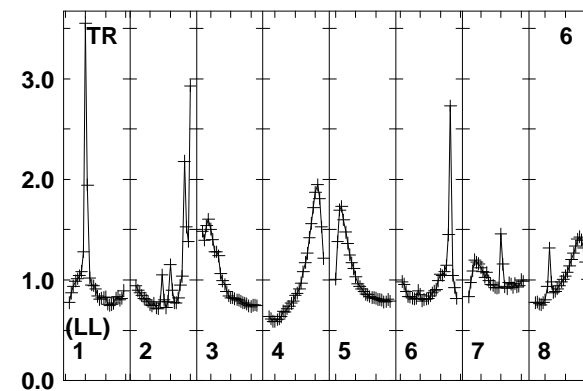
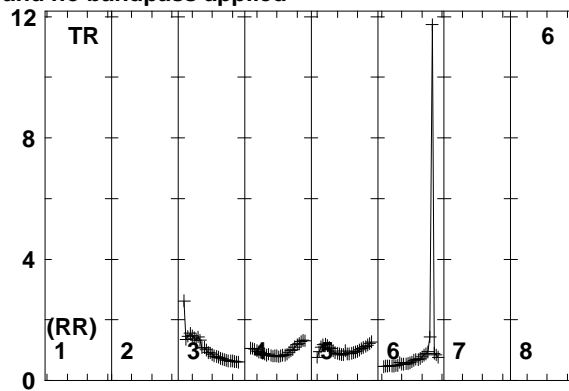
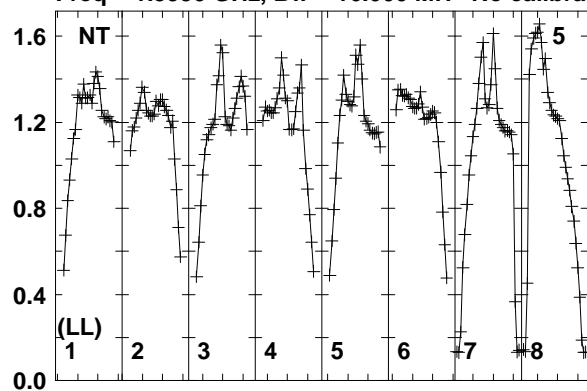

Lower frame: Real Jy
Total-power spectrum Antenna: NT (05)
Timerange: 00/09:40:24 to 00/09:42:08

Plot file version 347 created 11-AUG-2014 17:05:43

J2015+3710 EM110 2.UVDATA.1

Freq = 1.5950 GHz, Bw = 16.000 MH No calibration applied and no bandpass applied

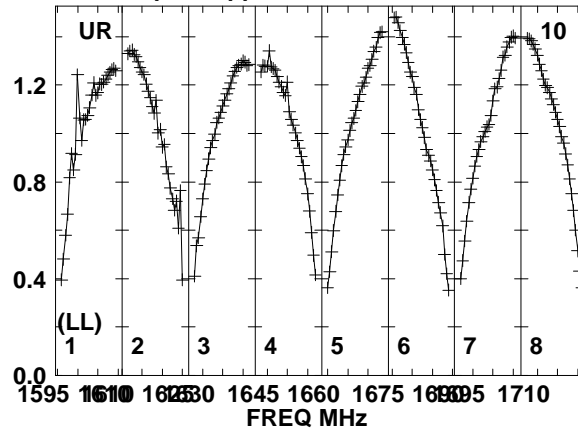
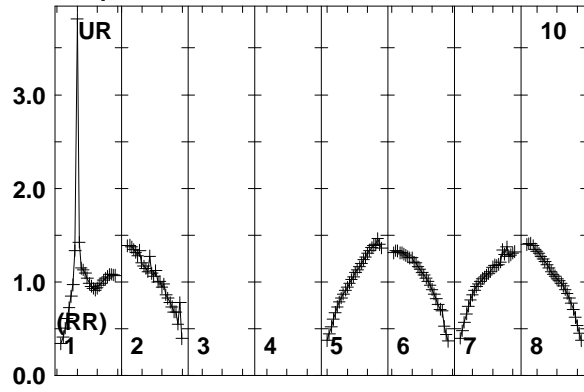

Lower frame: Real Jy
Total-power spectrum Antenna: UR (10)
Timerange: 00/09:40:24 to 00/09:42:08

Plot file version 348 created 11-AUG-2014 17:05:43

J2032+4127 EM110 2.UVDATA.1

Freq = 1.5950 GHz, Bw = 16.000 MH No calibration applied and no bandpass applied

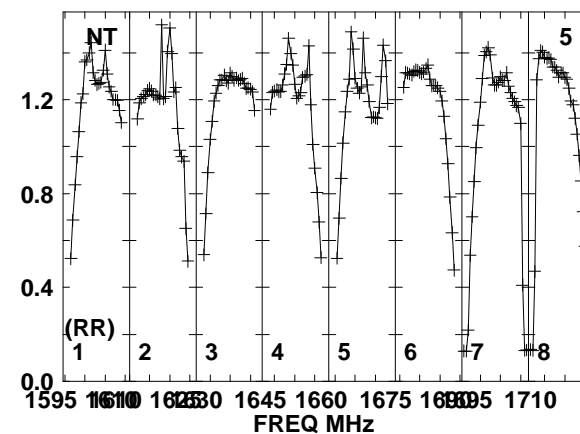
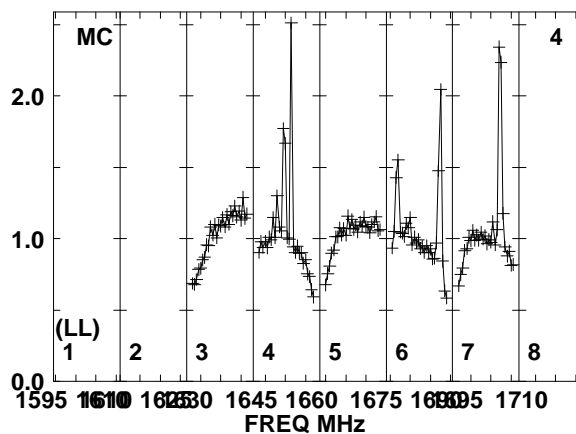
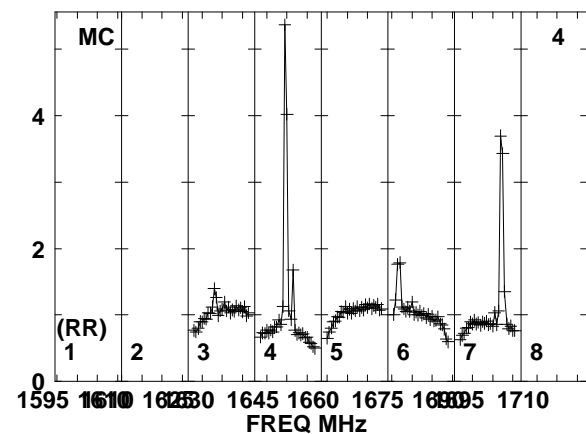
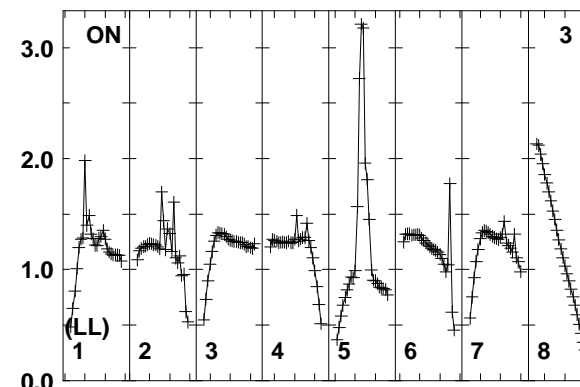
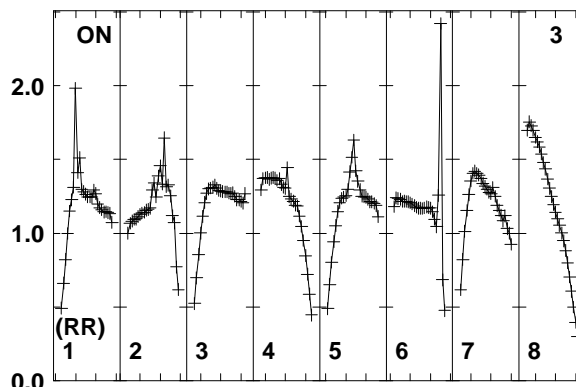
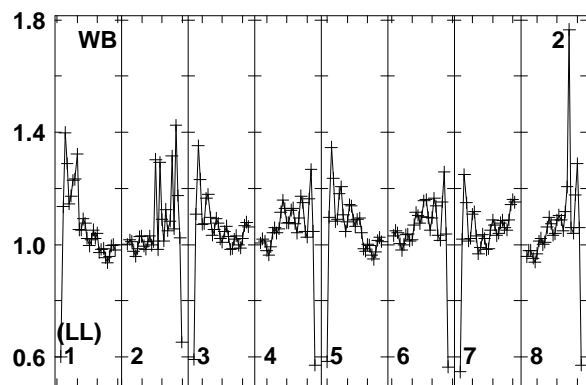
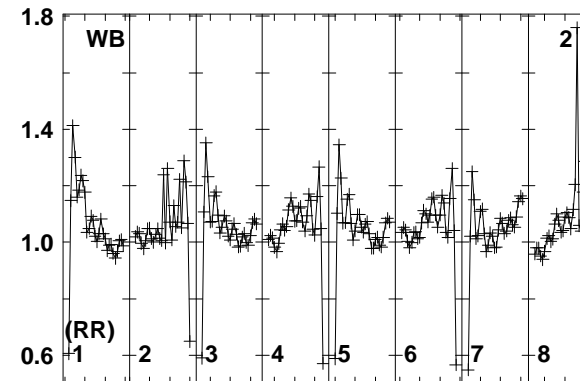
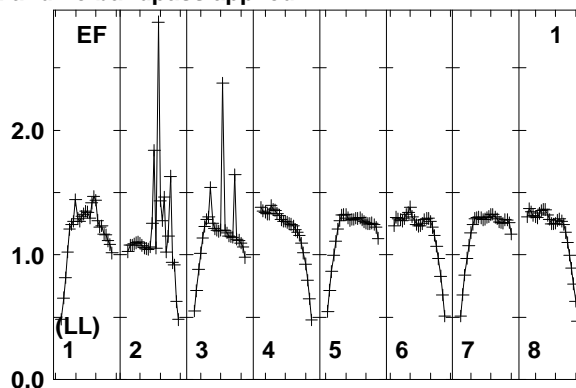
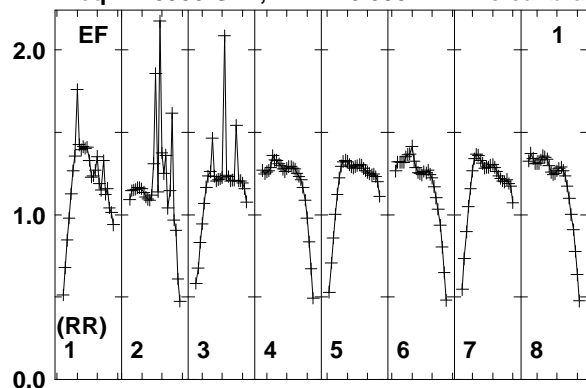

Lower frame: Real Jy
Total-power spectrum Antenna: EF (01)
Timerange: 00/09:42:11 to 00/09:46:09

Plot file version 349 created 11-AUG-2014 17:05:43

J2032+4127 EM110 2.UVDATA.1

Freq = 1.5950 GHz, Bw = 16.000 MH No calibration applied and no bandpass applied

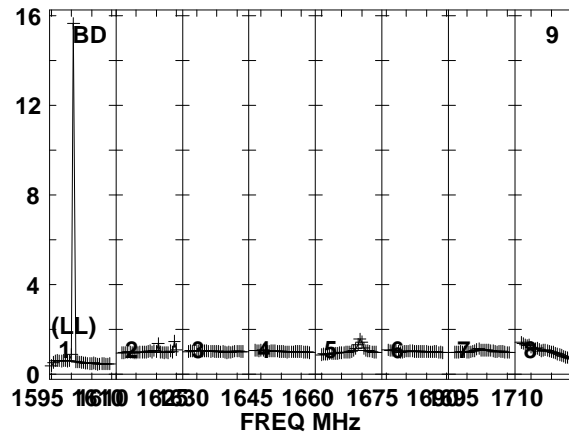
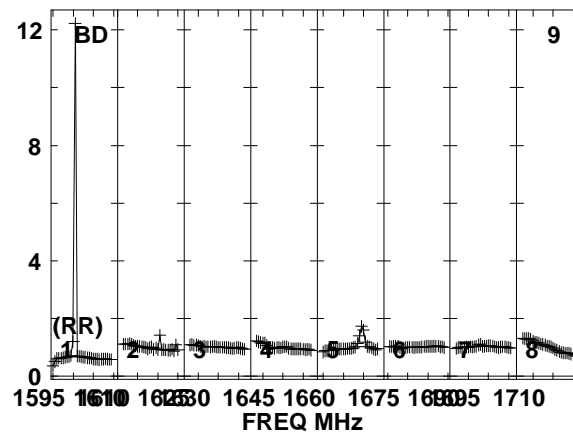
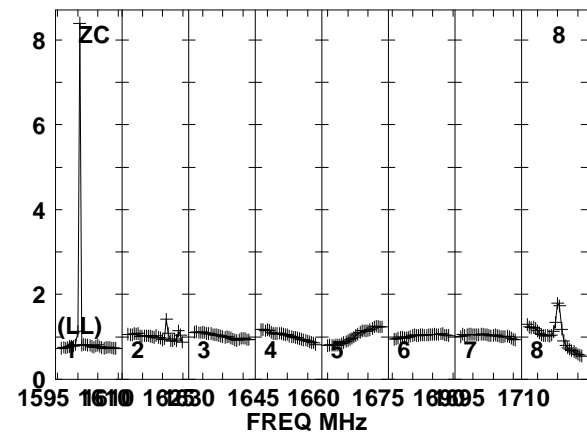
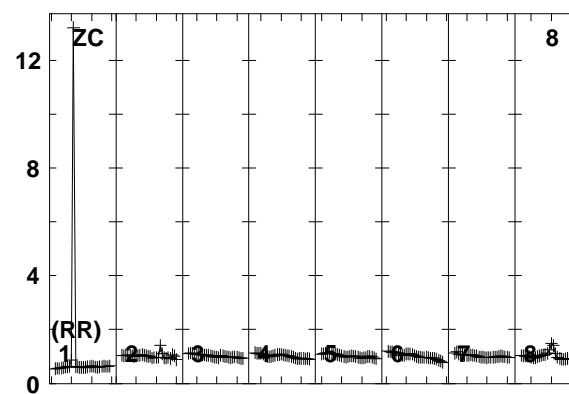
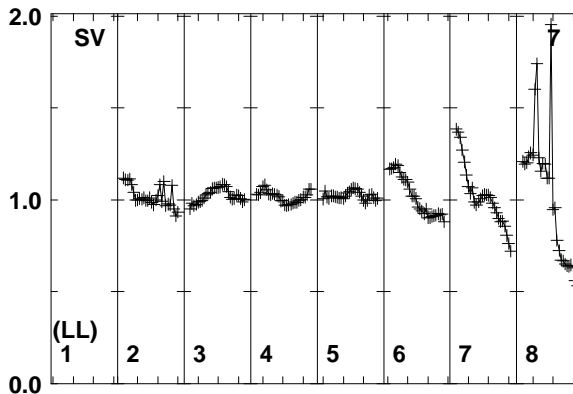
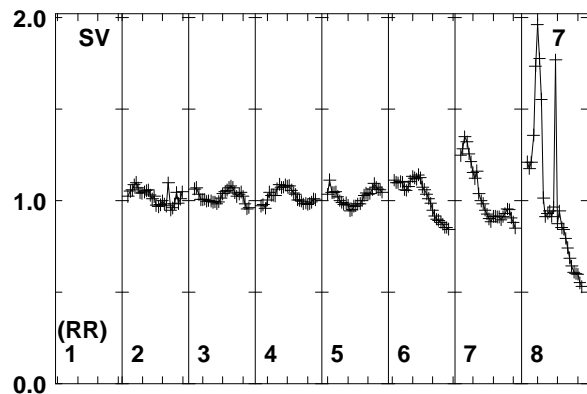
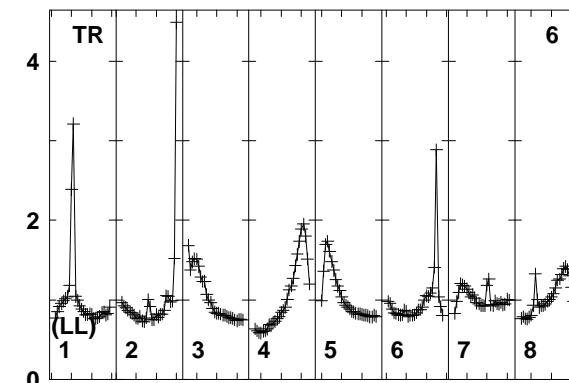
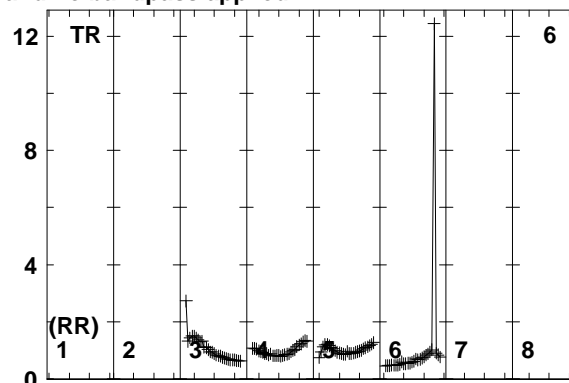
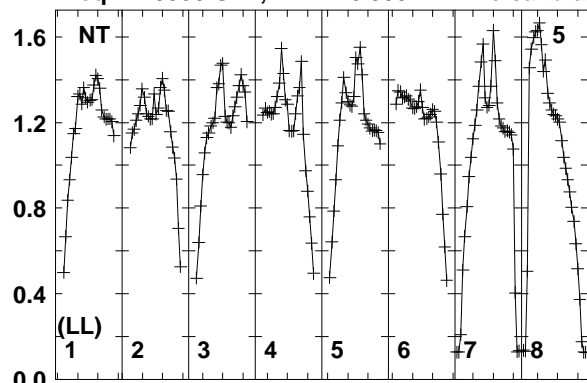

Lower frame: Real Jy
Total-power spectrum Antenna: NT (05)
Timerange: 00/09:42:11 to 00/09:46:09

Plot file version 350 created 11-AUG-2014 17:05:43

J2032+4127 EM110 2.UVDATA.1

Freq = 1.5950 GHz, Bw = 16.000 MH No calibration applied and no bandpass applied

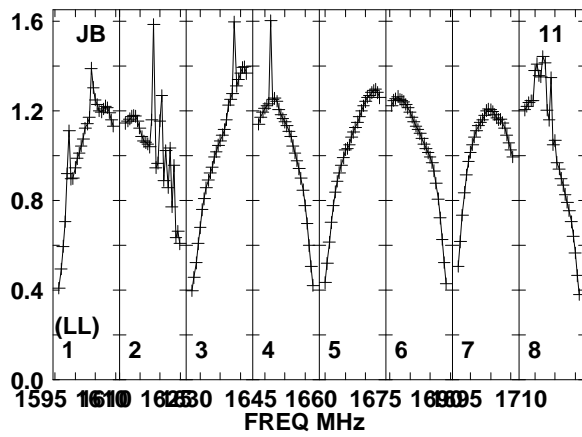
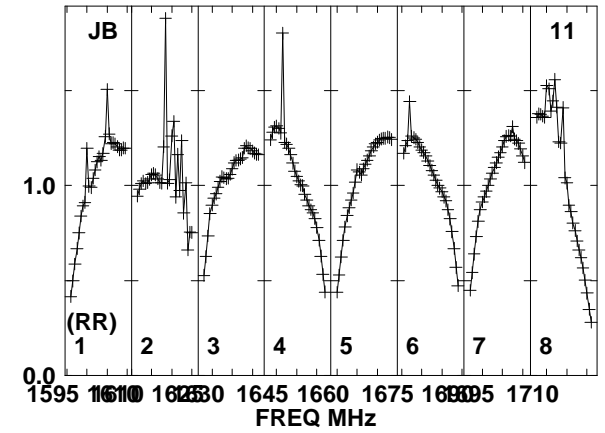
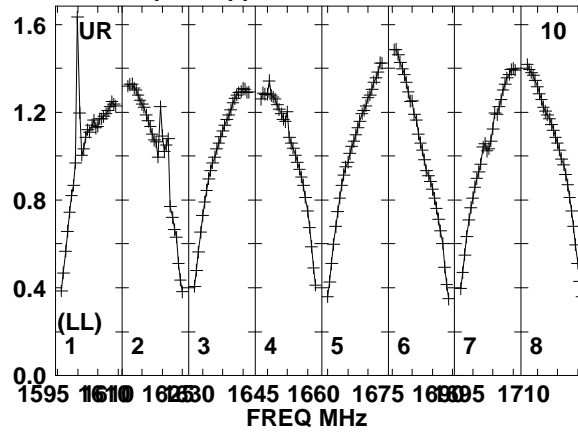
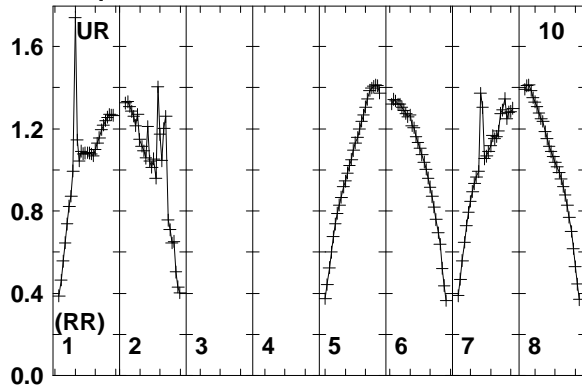

Lower frame: Real Jy
Total-power spectrum Antenna: UR (10)
Timerange: 00/09:42:11 to 00/09:46:09

Plot file version 351 created 11-AUG-2014 17:05:43

J2015+3710 EM110 2.UVDATA.1

Freq = 1.5950 GHz, Bw = 16.000 MH No calibration applied and no bandpass applied

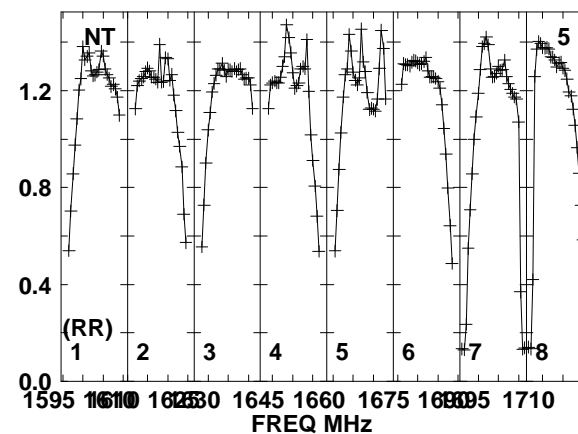
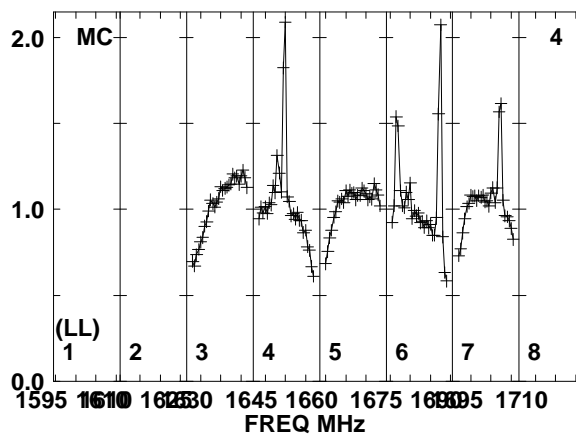
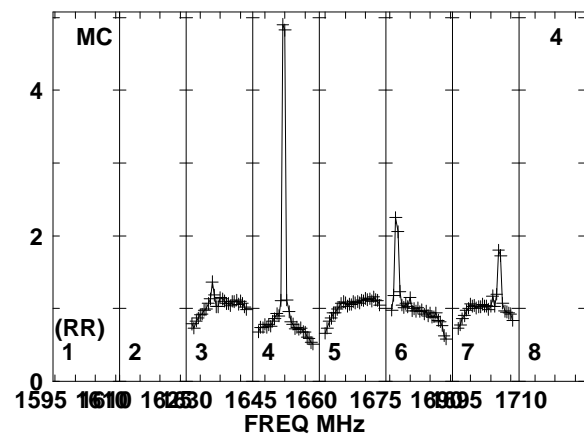
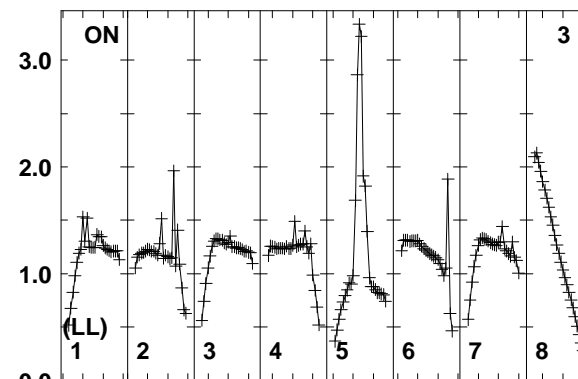
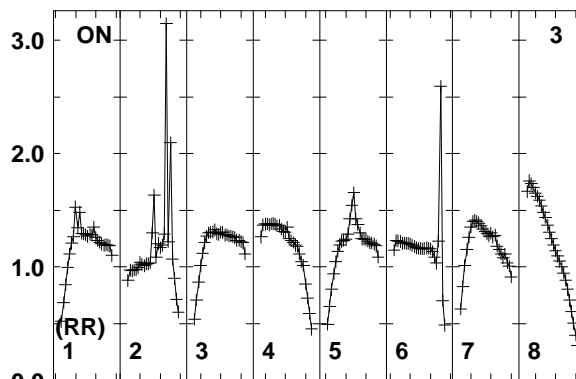
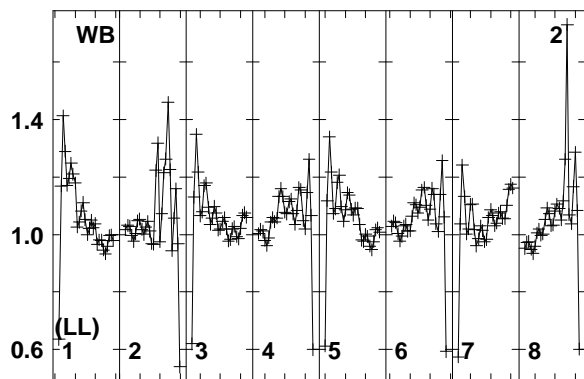
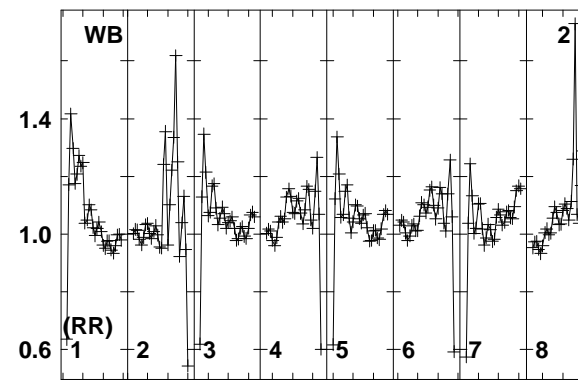
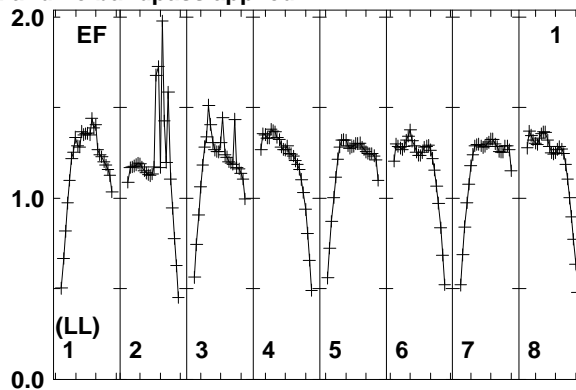
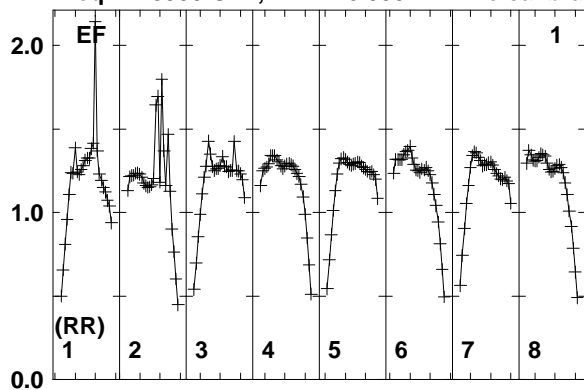

Lower frame: Real Jy
Total-power spectrum Antenna: EF (01)
Timerange: 00/09:47:11 to 00/09:49:09

Plot file version 352 created 11-AUG-2014 17:05:43

J2015+3710 EM110 2.UVDATA.1

Freq = 1.5950 GHz, Bw = 16.000 MH No calibration applied and no bandpass applied

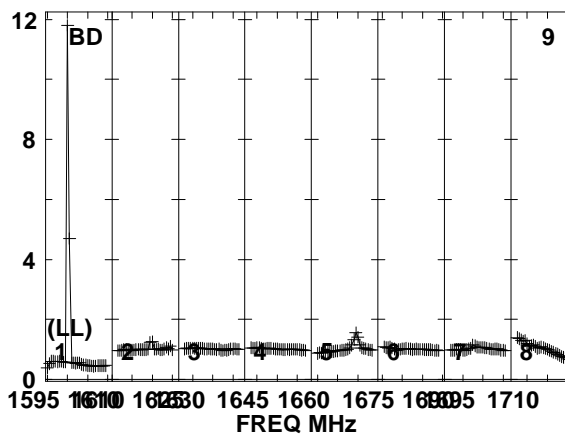
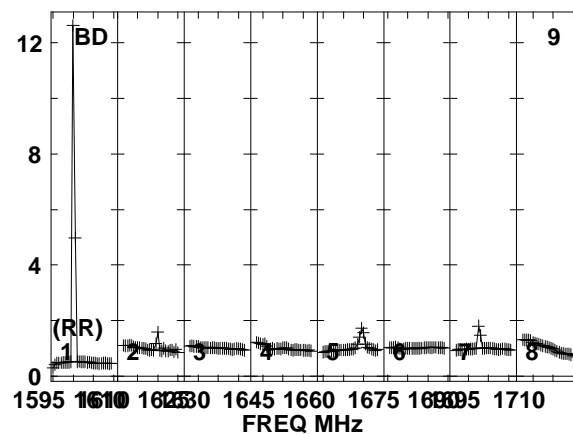
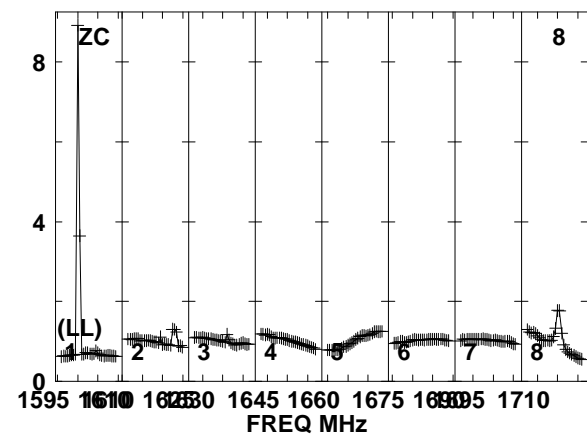
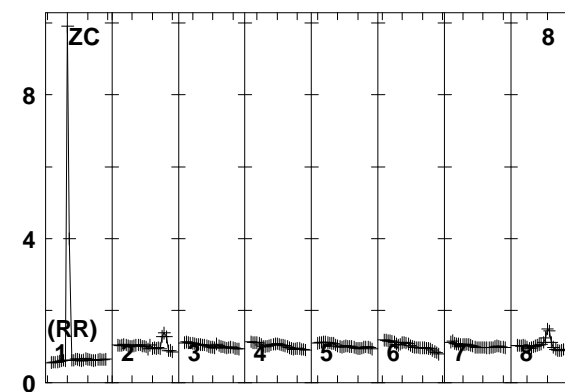
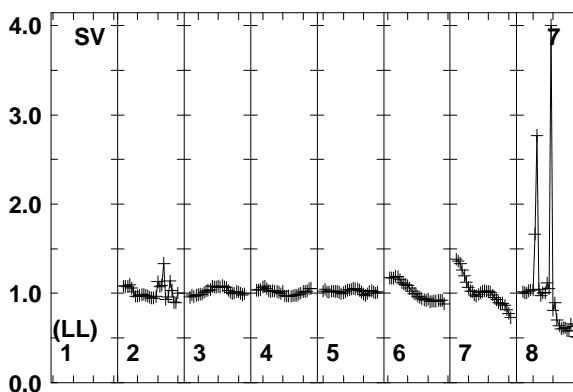
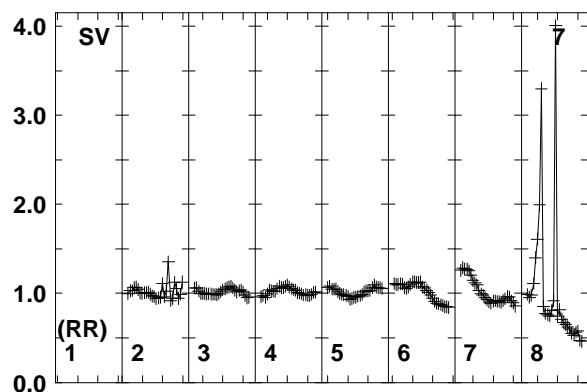
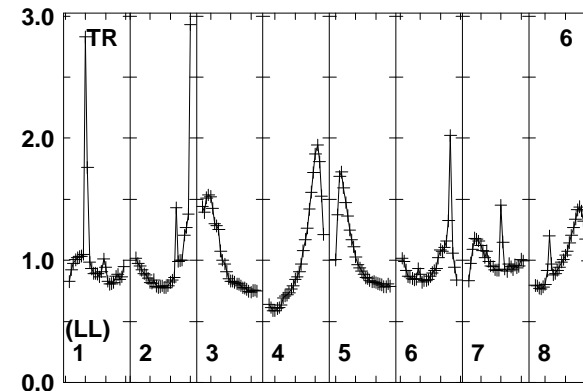
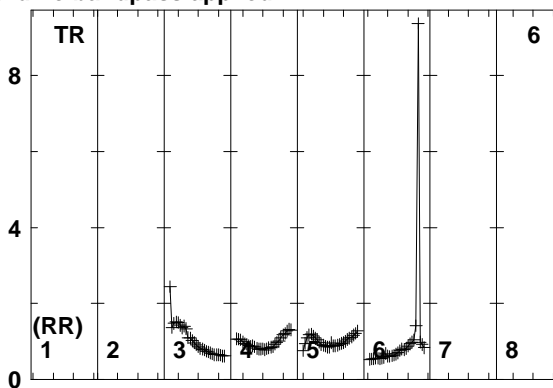
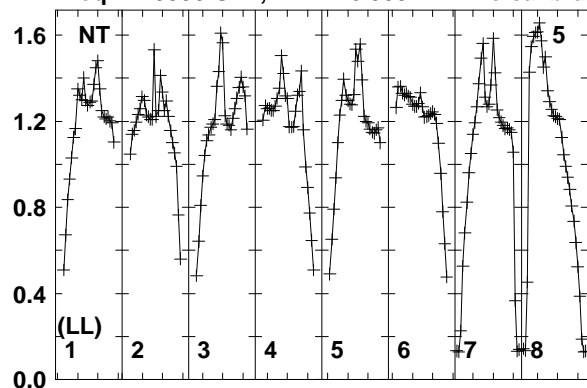

Lower frame: Real Jy
Total-power spectrum Antenna: NT (05)
Timerange: 00/09:47:11 to 00/09:49:09

Plot file version 353 created 11-AUG-2014 17:05:43

J2015+3710 EM110 2.UVDATA.1

Freq = 1.5950 GHz, Bw = 16.000 MH No calibration applied and no bandpass applied

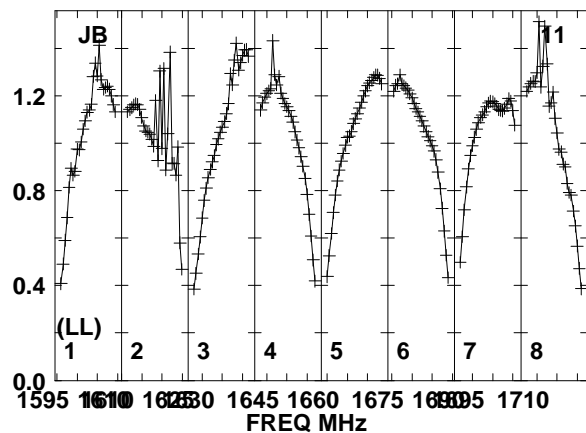
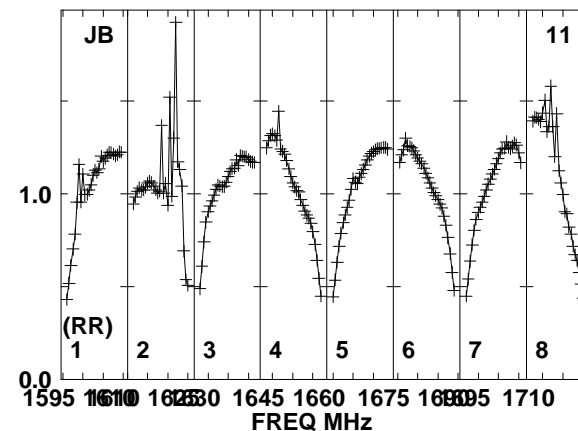
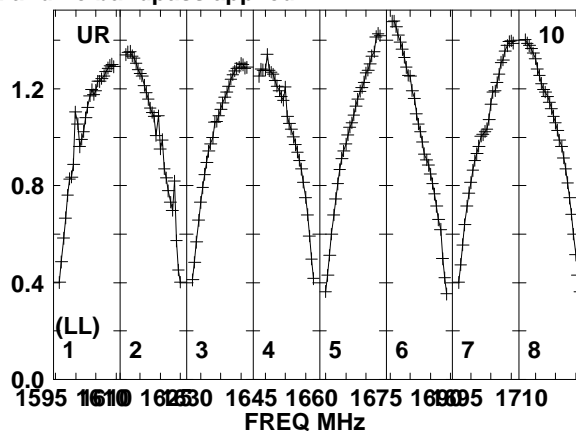
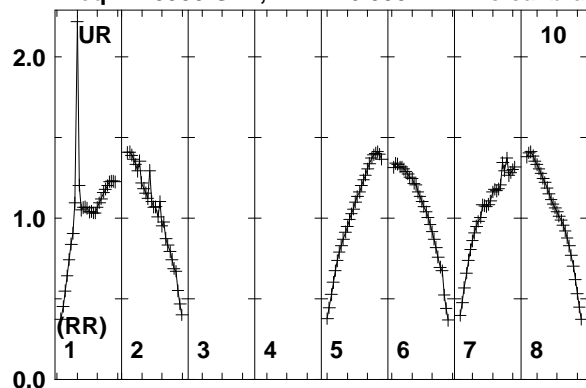

Lower frame: Real Jy
Total-power spectrum Antenna: UR (10)
Timerange: 00/09:47:11 to 00/09:49:09

Plot file version 354 created 11-AUG-2014 17:05:43

J2032+4127 EM110 2.UVDATA.1

Freq = 1.5950 GHz, Bw = 16.000 MH No calibration applied and no bandpass applied

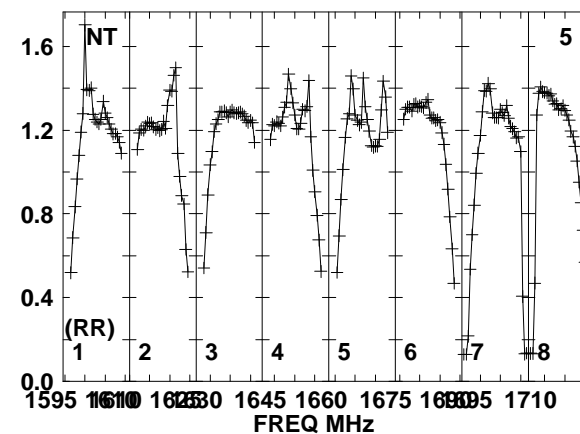
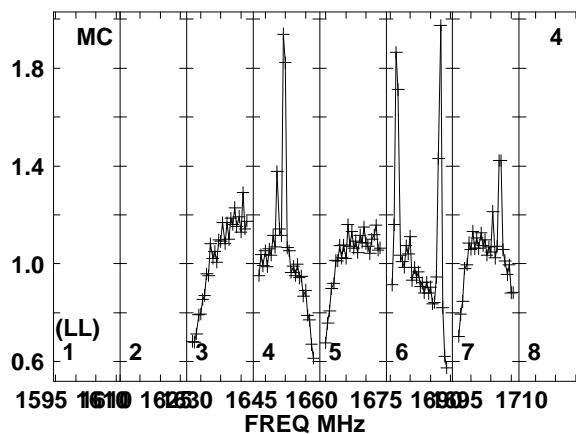
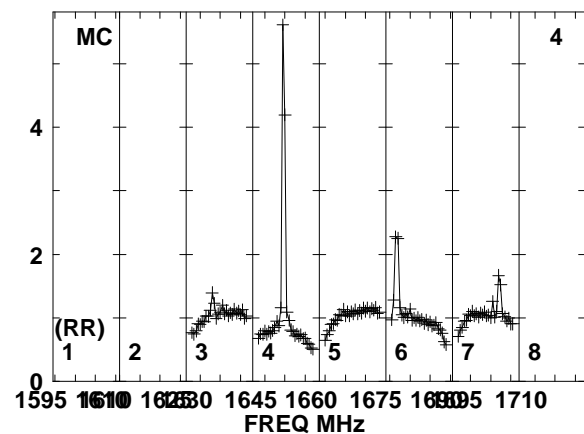
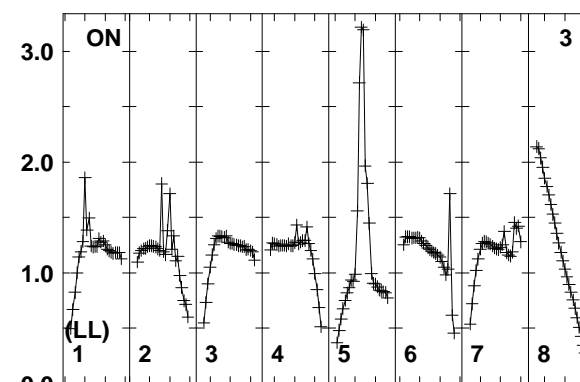
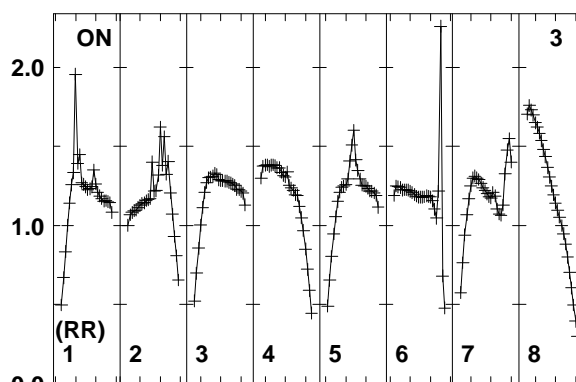
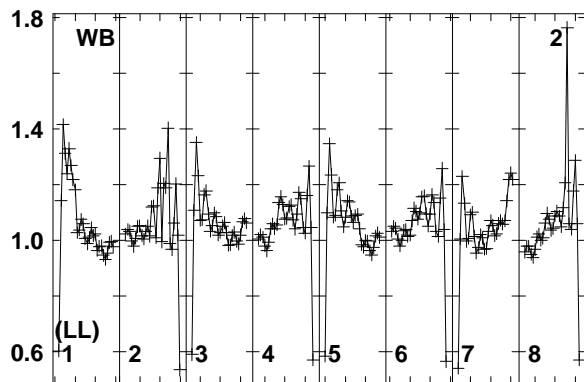
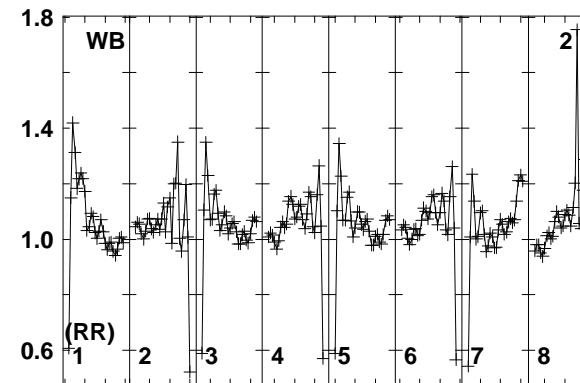
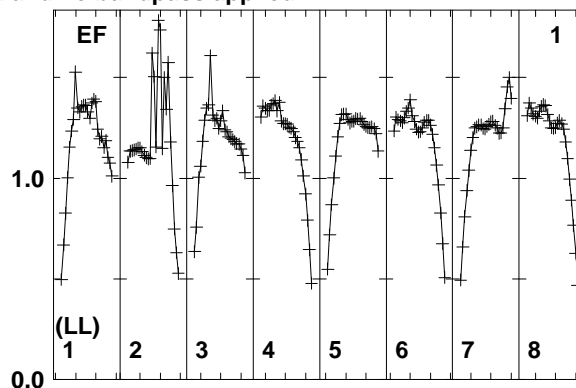
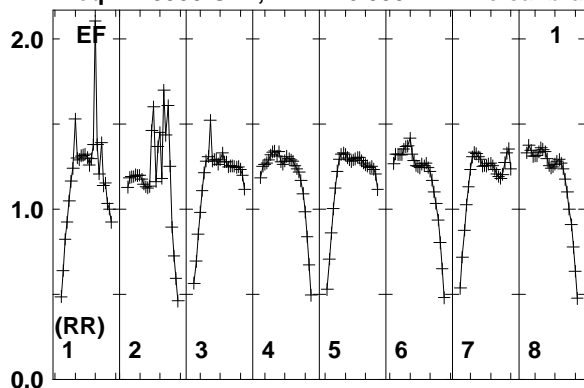

Lower frame: Real Jy
Total-power spectrum Antenna: EF (01)
Timerange: 00/09:49:24 to 00/09:53:08

Plot file version 355 created 11-AUG-2014 17:05:43

J2032+4127 EM110 2.UVDATA.1

Freq = 1.5950 GHz, Bw = 16.000 MH No calibration applied and no bandpass applied

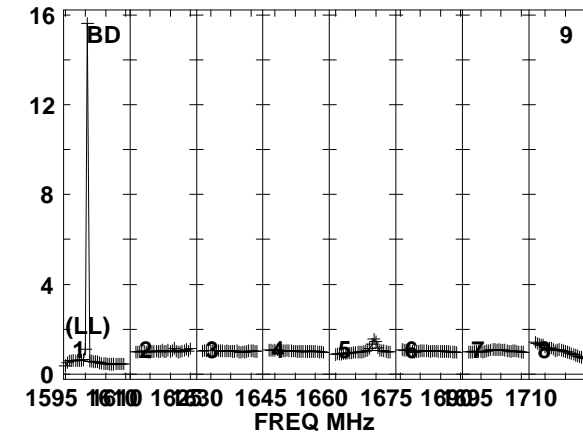
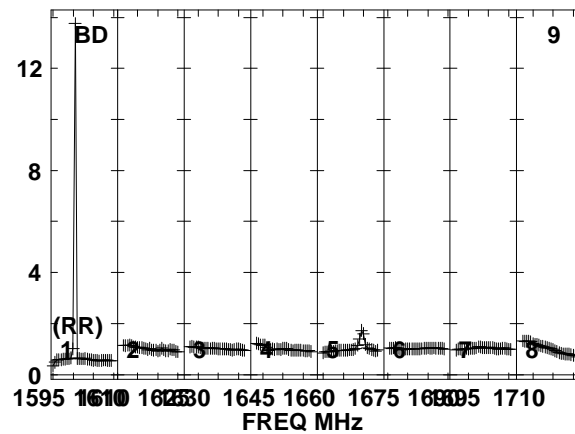
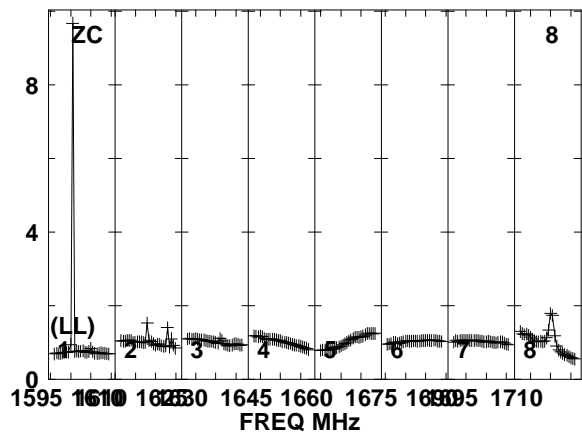
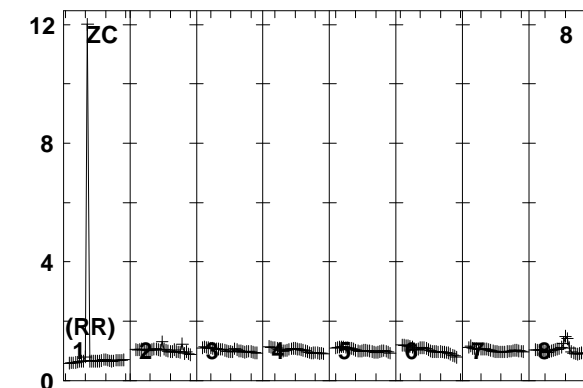
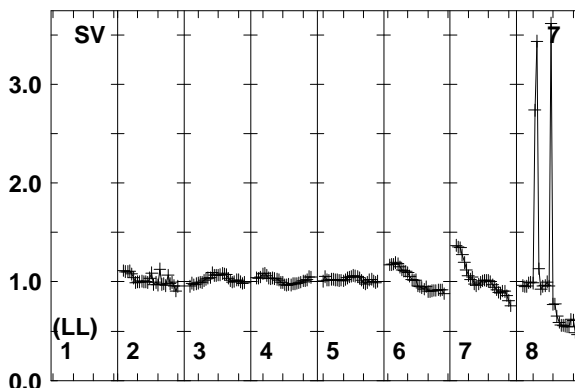
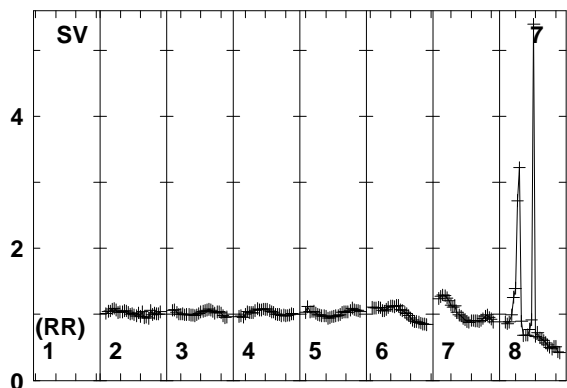
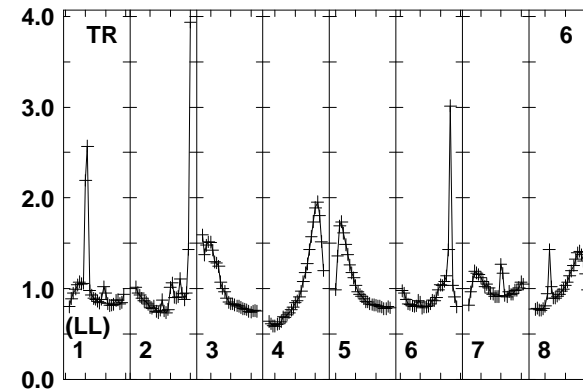
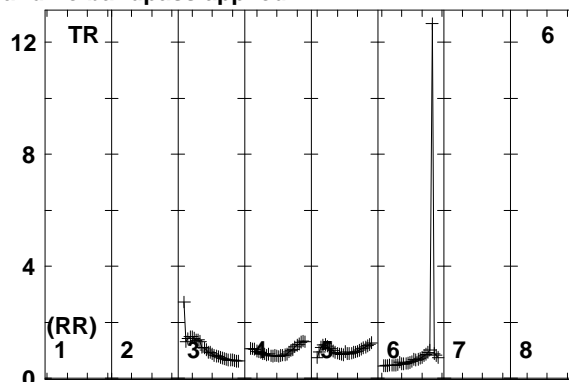
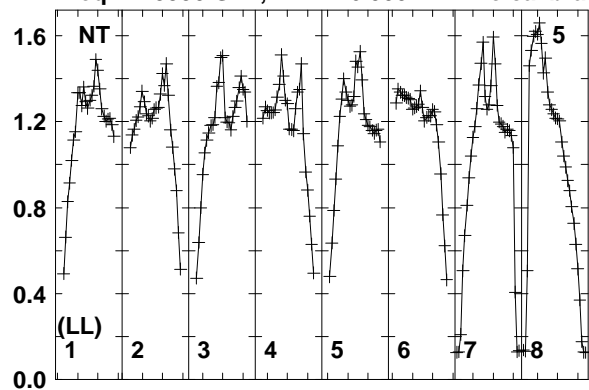

Lower frame: Real Jy
Total-power spectrum Antenna: NT (05)
Timerange: 00/09:49:24 to 00/09:53:08

Plot file version 356 created 11-AUG-2014 17:05:43

J2032+4127 EM110 2.UVDATA.1

Freq = 1.5950 GHz, Bw = 16.000 MH No calibration applied and no bandpass applied

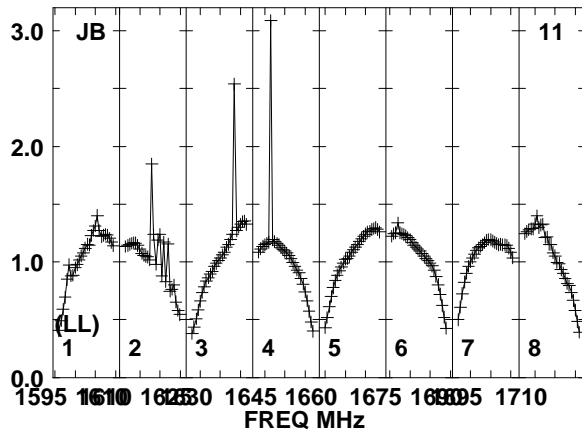
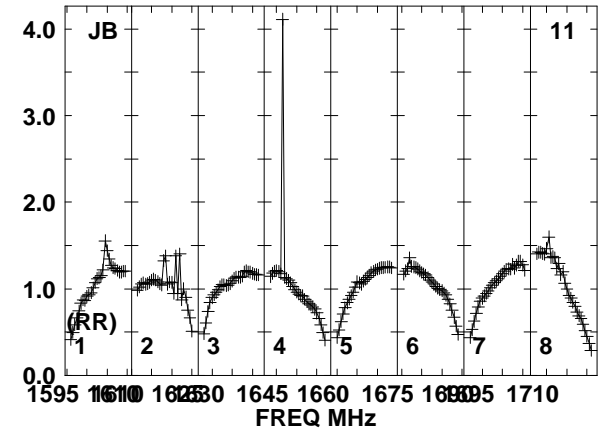
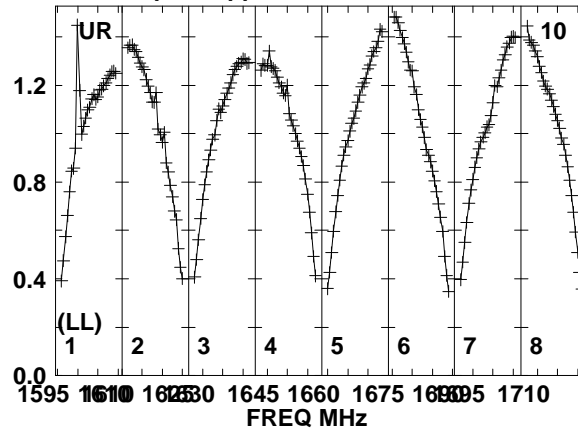
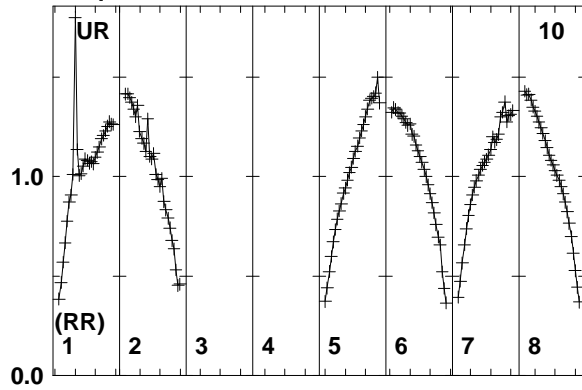

Lower frame: Real Jy
Total-power spectrum Antenna: UR (10)
Timerange: 00/09:49:24 to 00/09:53:08

Plot file version 357 created 11-AUG-2014 17:05:43

J2015+3710 EM110 2.UVDATA.1

Freq = 1.5950 GHz, Bw = 16.000 MH No calibration applied and no bandpass applied

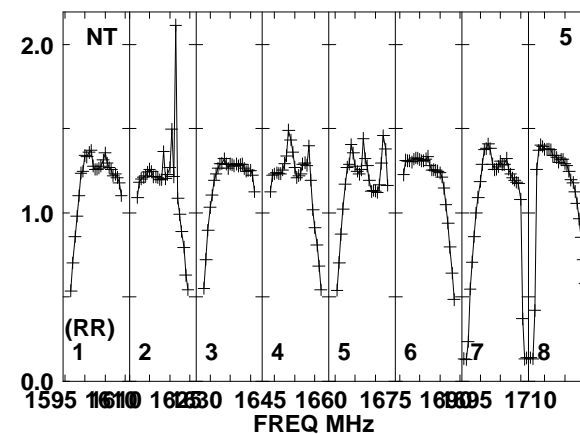
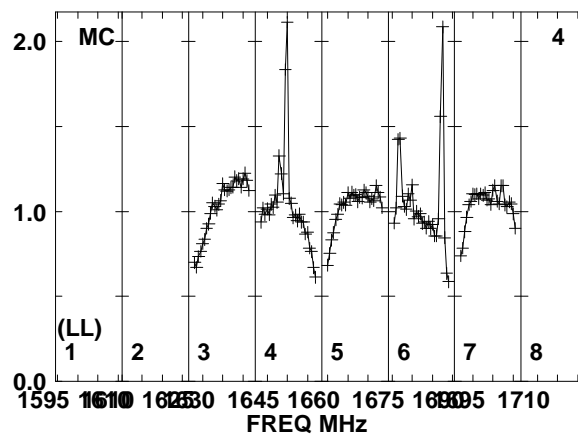
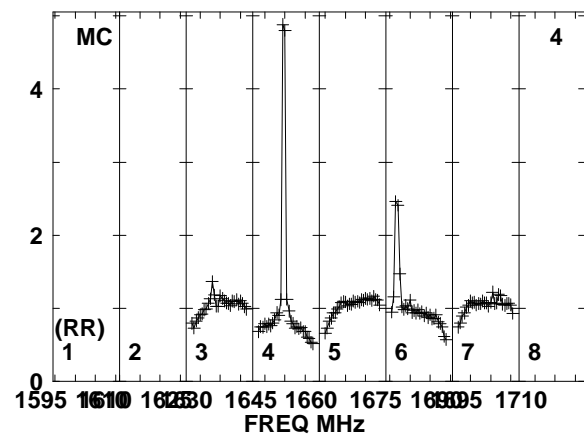
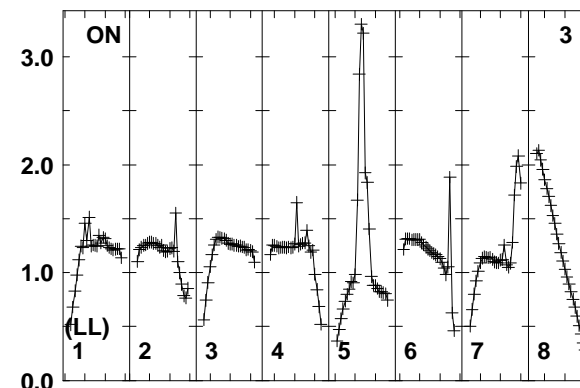
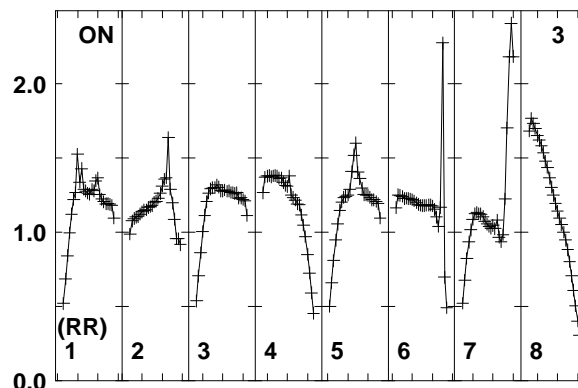
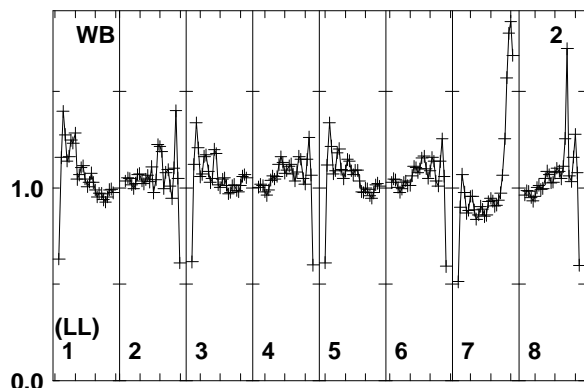
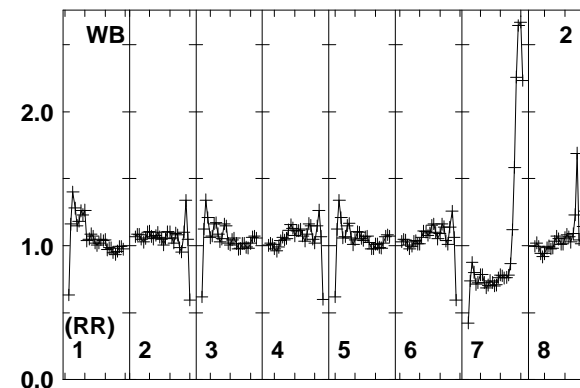
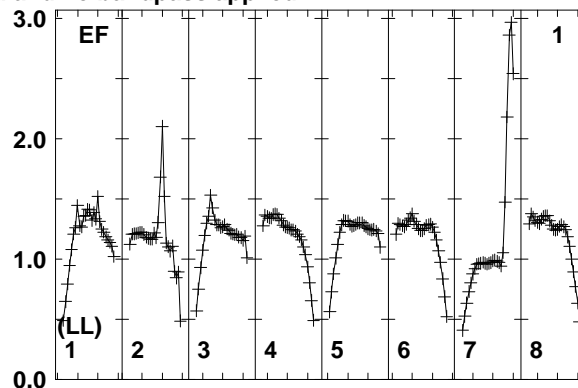
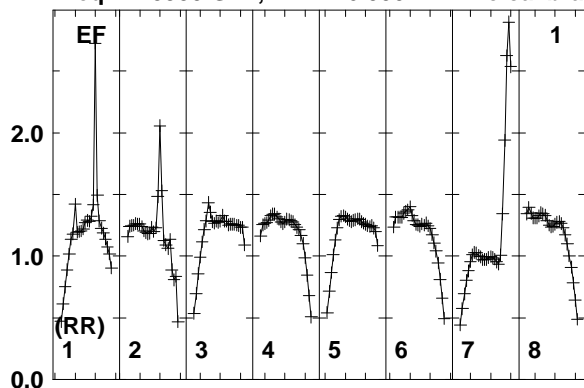

Lower frame: Real Jy
Total-power spectrum Antenna: EF (01)
Timerange: 00/09:53:24 to 00/09:55:08

Plot file version 358 created 11-AUG-2014 17:05:43

J2015+3710 EM110 2.UVDATA.1

Freq = 1.5950 GHz, Bw = 16.000 MH No calibration applied and no bandpass applied

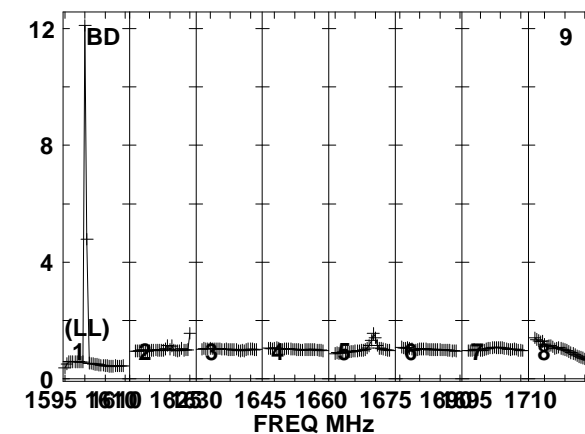
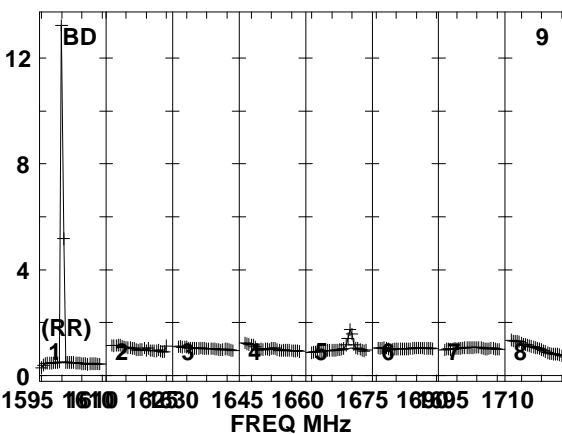
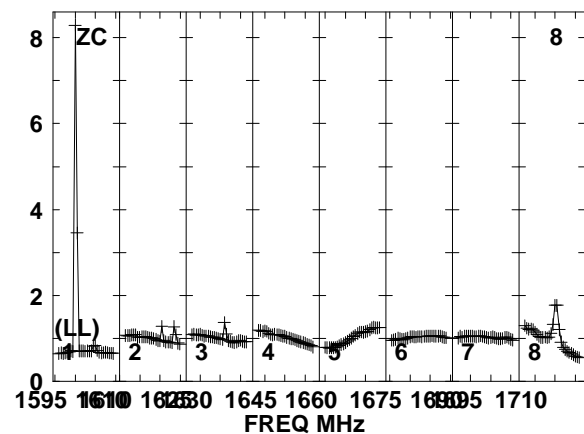
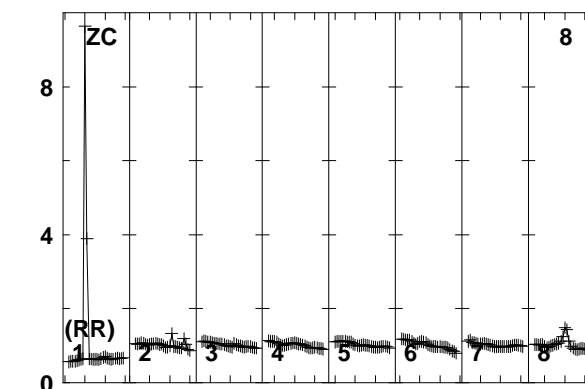
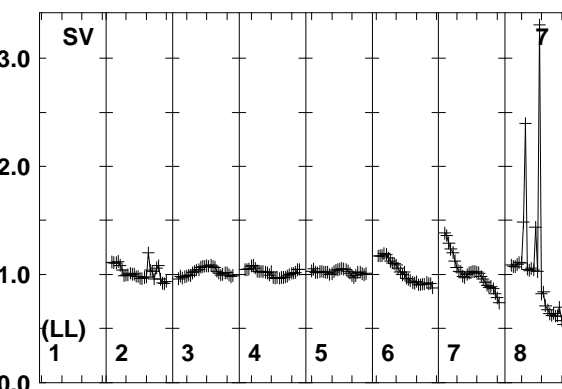
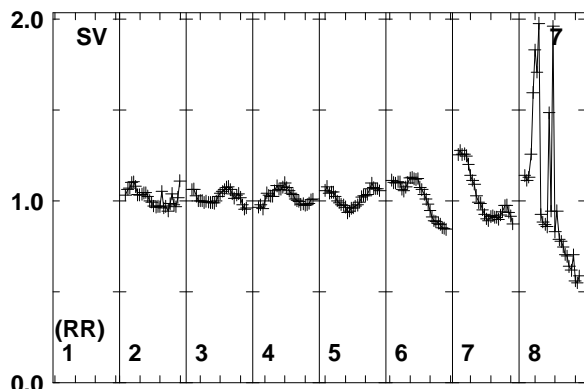
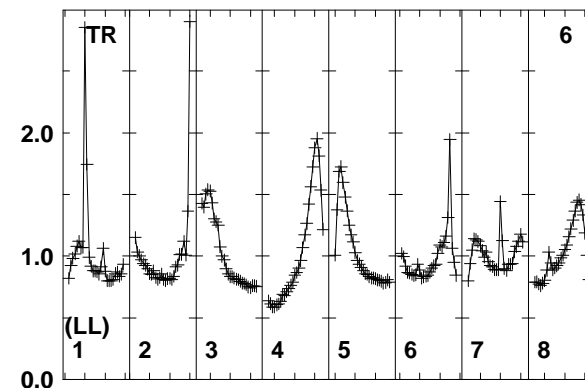
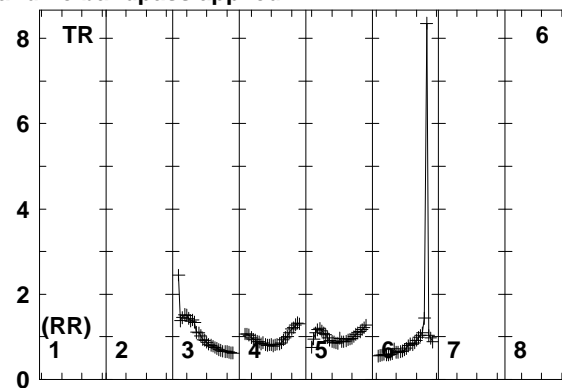
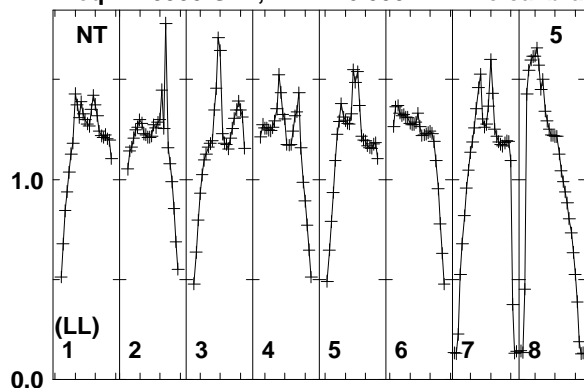

1595 1610 1625 1640 1645 1660 1675 1690 1710
FREQ MHz
Lower frame: Real Jy
Total-power spectrum Antenna: NT (05)
Timerange: 00/09:53:24 to 00/09:55:08

Plot file version 359 created 11-AUG-2014 17:05:43

J2015+3710 EM110 2.UVDATA.1

Freq = 1.5950 GHz, Bw = 16.000 MH No calibration applied and no bandpass applied

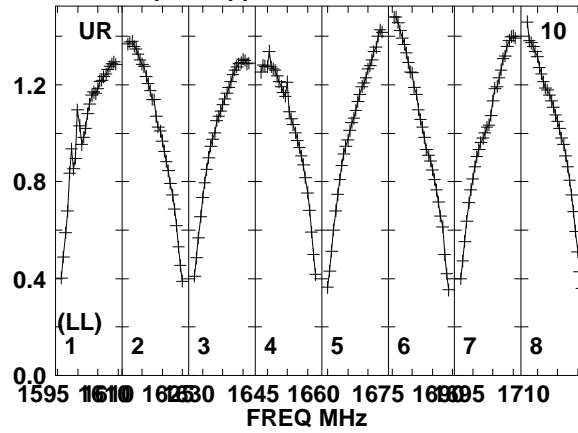
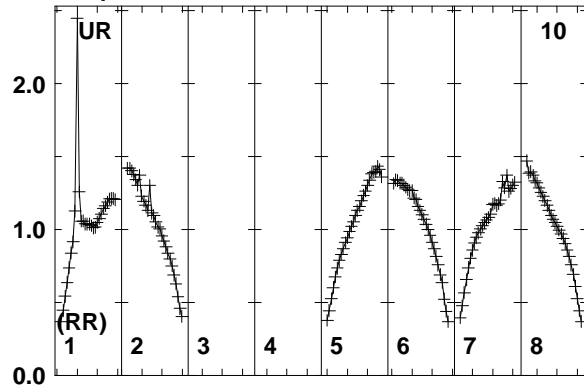

Lower frame: Real Jy
Total-power spectrum Antenna: UR (10)
Timerange: 00/09:53:24 to 00/09:55:08

Plot file version 360 created 11-AUG-2014 17:05:43

J2032+4127 EM110 2.UVDATA.1

Freq = 1.5950 GHz, Bw = 16.000 MH No calibration applied and no bandpass applied

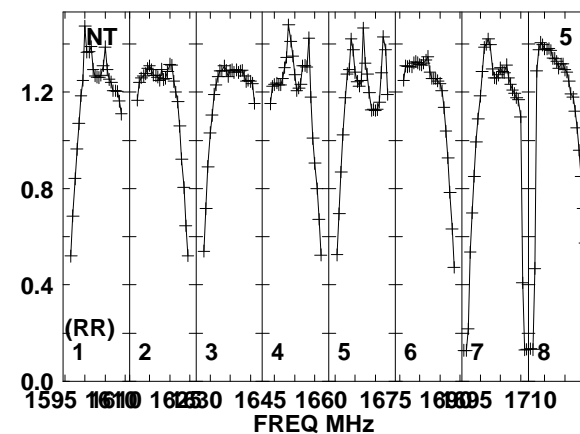
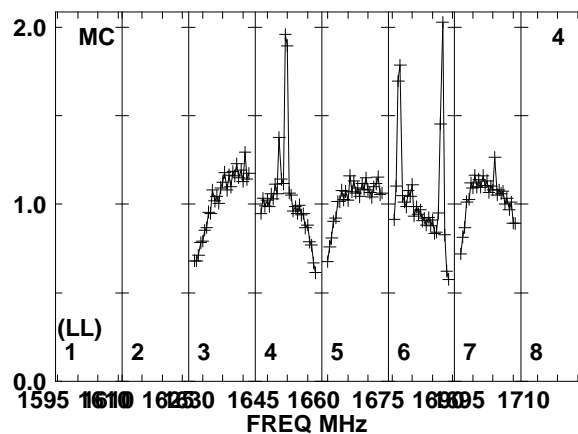
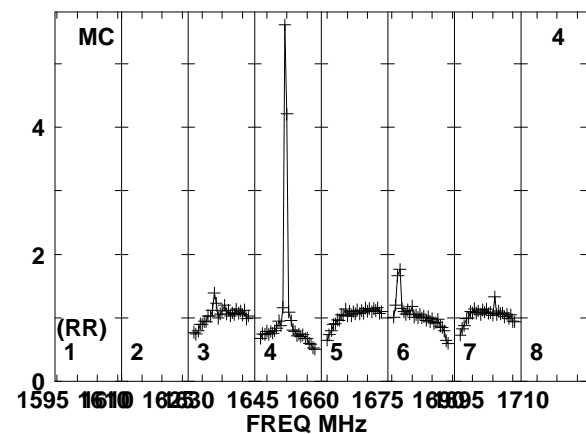
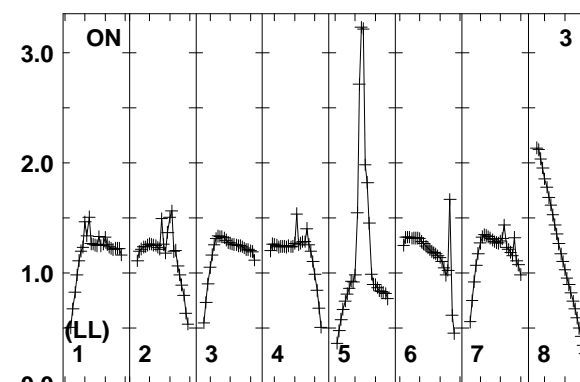
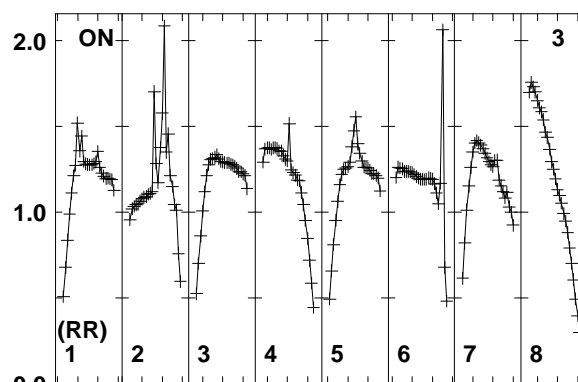
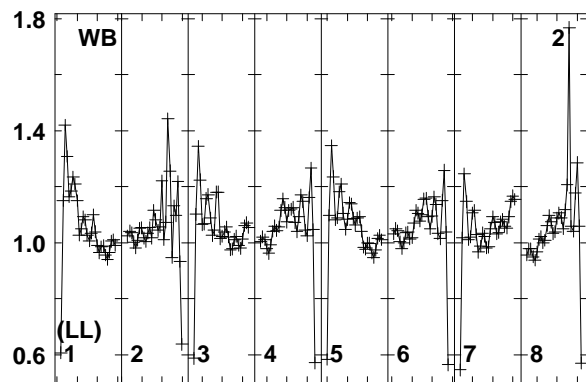
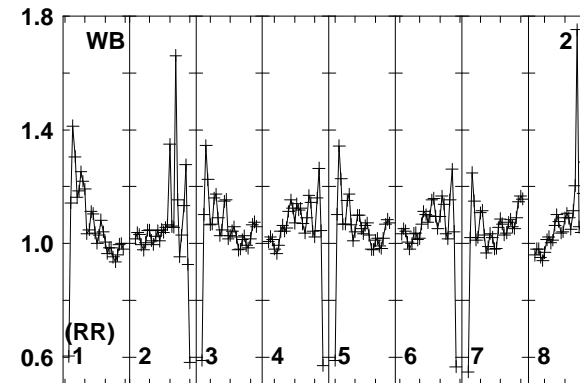
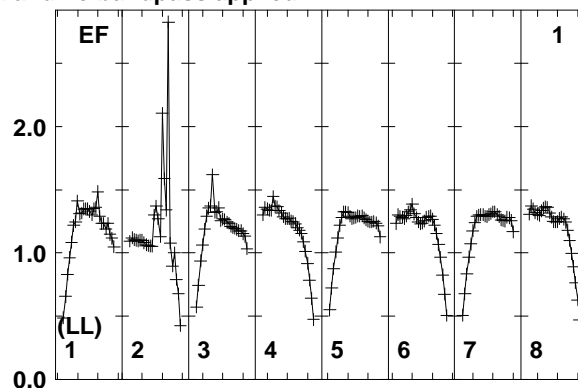
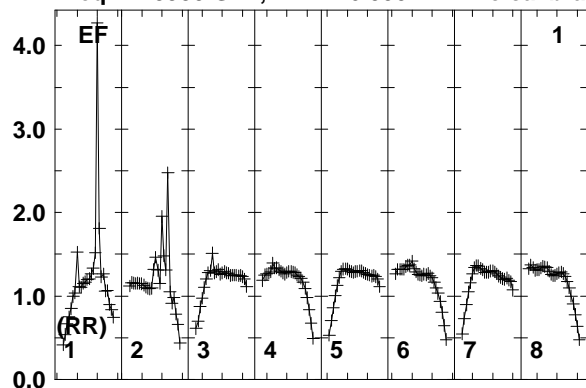

Lower frame: Real Jy
Total-power spectrum Antenna: EF (01)
Timerange: 00/09:55:11 to 00/09:59:09

Plot file version 361 created 11-AUG-2014 17:05:43

J2032+4127 EM110 2.UVDATA.1

Freq = 1.5950 GHz, Bw = 16.000 MH No calibration applied and no bandpass applied

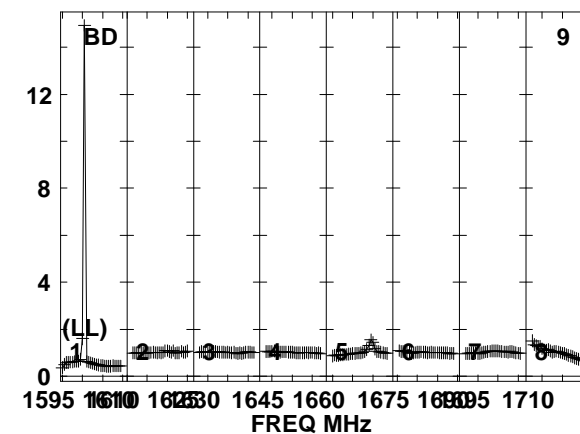
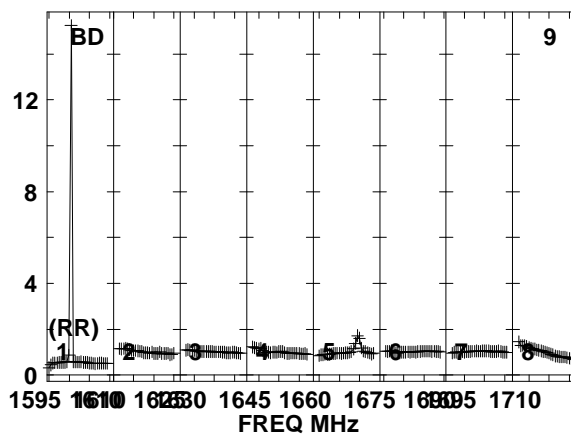
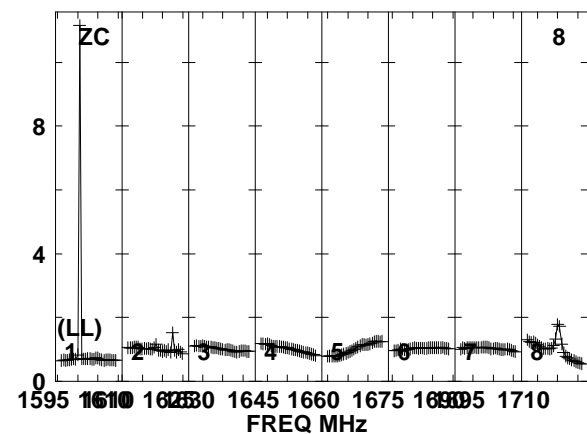
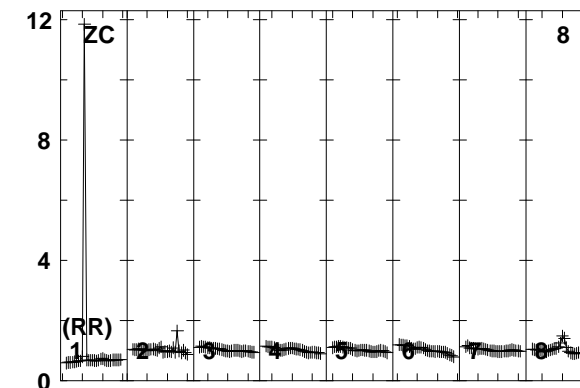
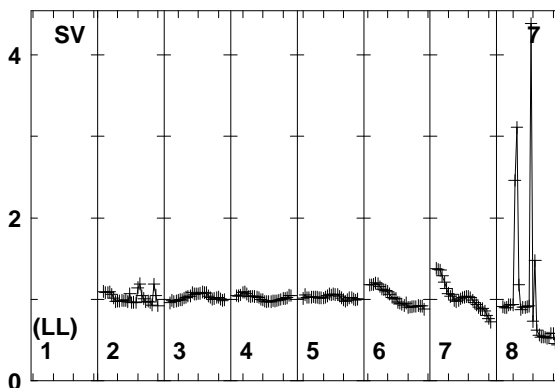
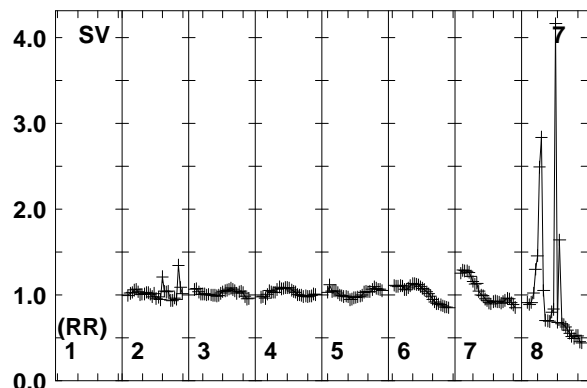
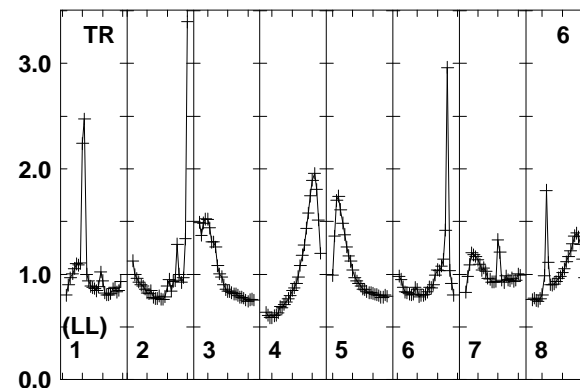
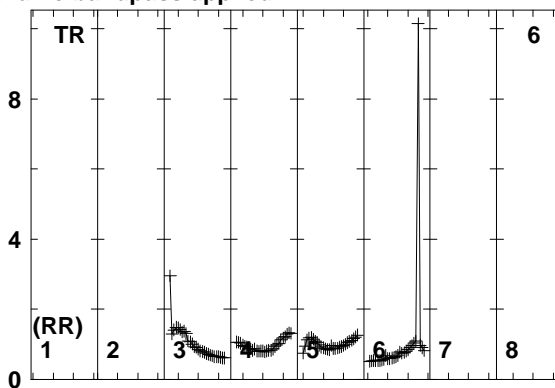
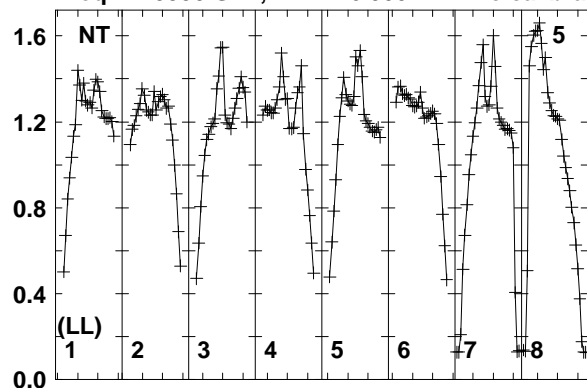

Lower frame: Real Jy
Total-power spectrum Antenna: NT (05)
Timerange: 00/09:55:11 to 00/09:59:09

Plot file version 362 created 11-AUG-2014 17:05:43

J2032+4127 EM110 2.UVDATA.1

Freq = 1.5950 GHz, Bw = 16.000 MH No calibration applied and no bandpass applied

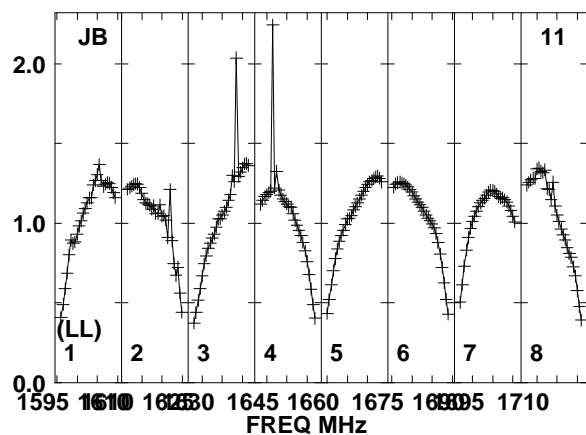
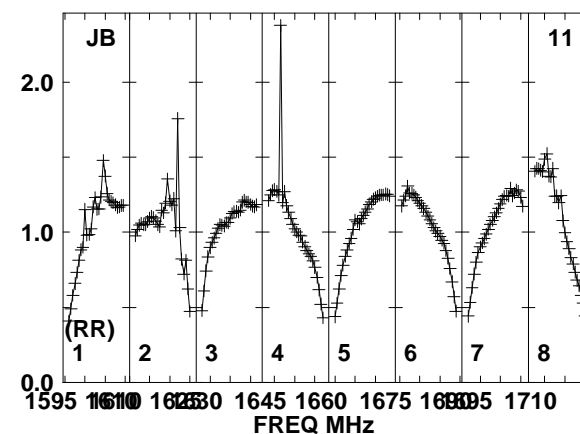
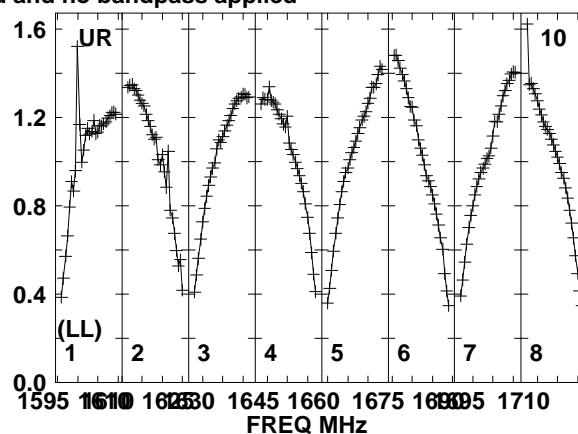
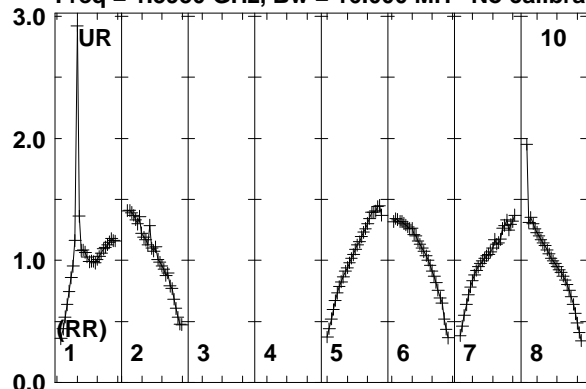

Lower frame: Real Jy
Total-power spectrum Antenna: UR (10)
Timerange: 00/09:55:11 to 00/09:59:09

Plot file version 363 created 11-AUG-2014 17:05:43

J2015+3710 EM110 2.UVDATA.1

Freq = 1.5950 GHz, Bw = 16.000 MH No calibration applied and no bandpass applied

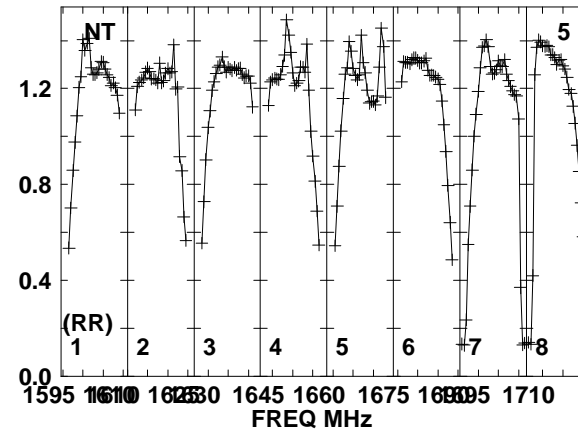
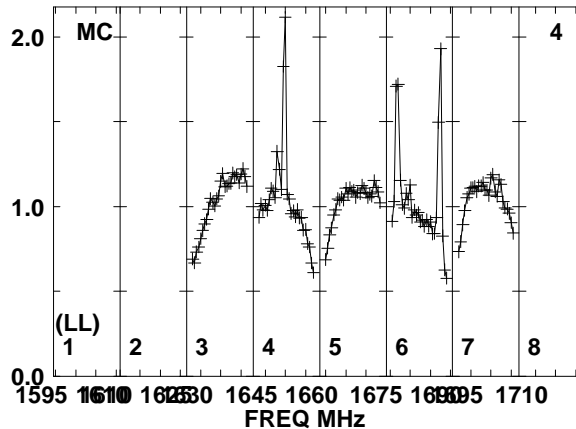
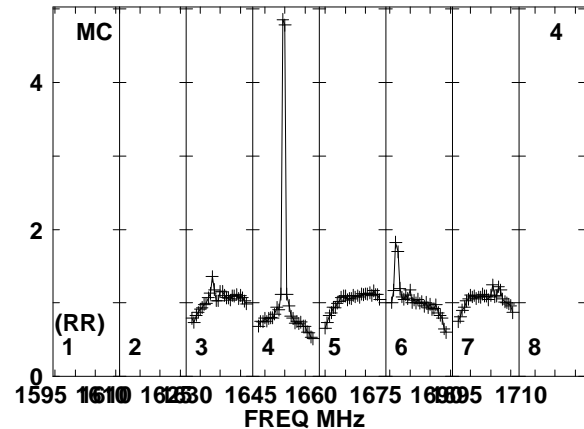
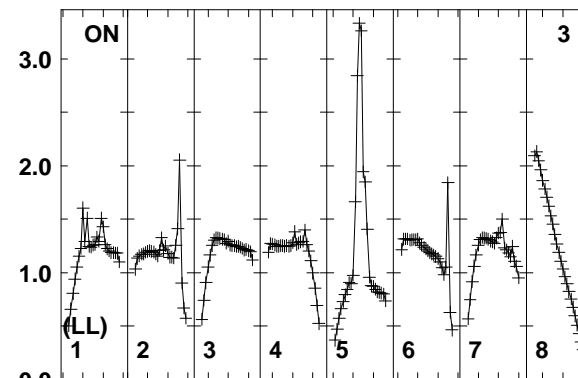
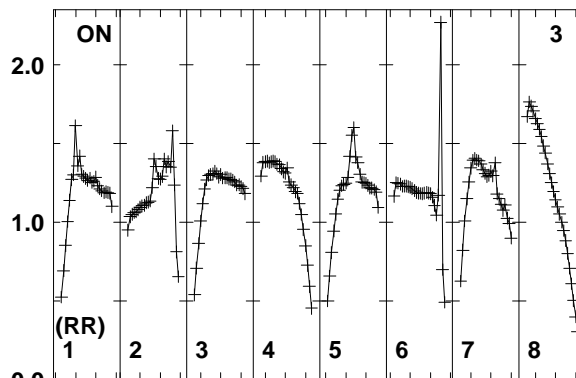
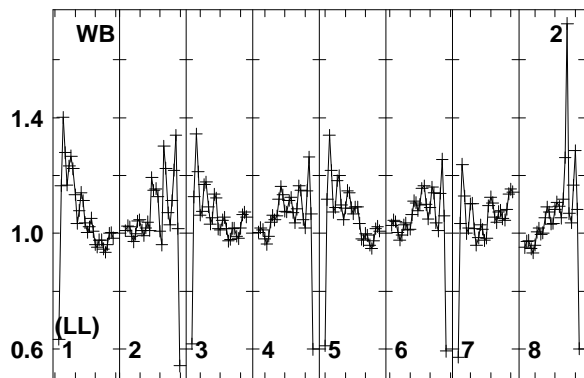
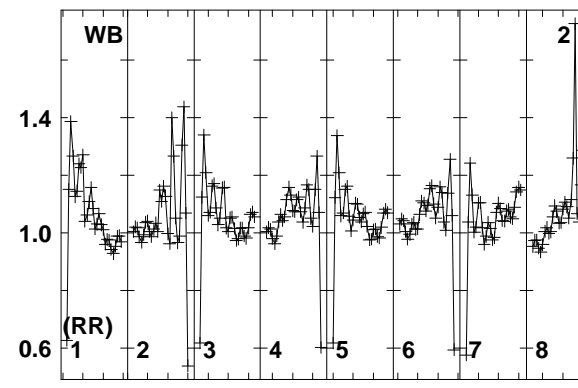
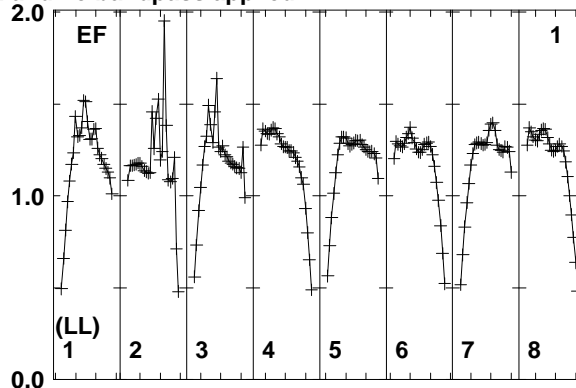
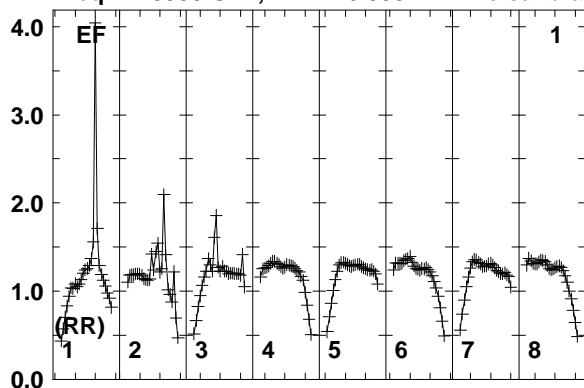

1595 1610 1625 1640 1655 1670 1685 1700 1710
FREQ MHz
Lower frame: Real Jy
Total-power spectrum Antenna: EF (01)
Timerange: 00/10:00:11 to 00/10:02:09

Plot file version 364 created 11-AUG-2014 17:05:43

J2015+3710 EM110 2.UVDATA.1

Freq = 1.5950 GHz, Bw = 16.000 MH No calibration applied and no bandpass applied

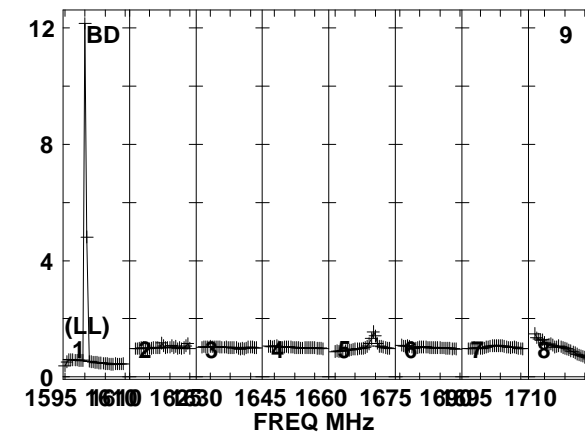
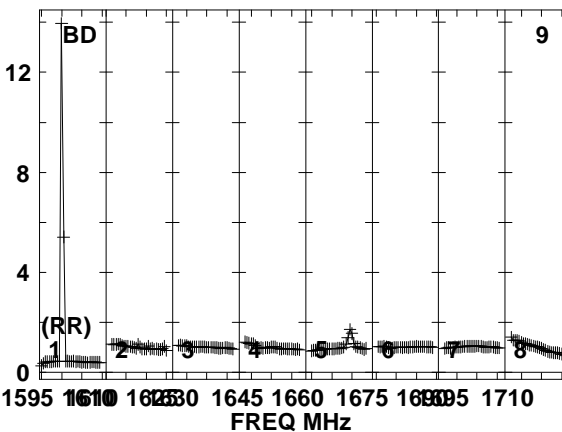
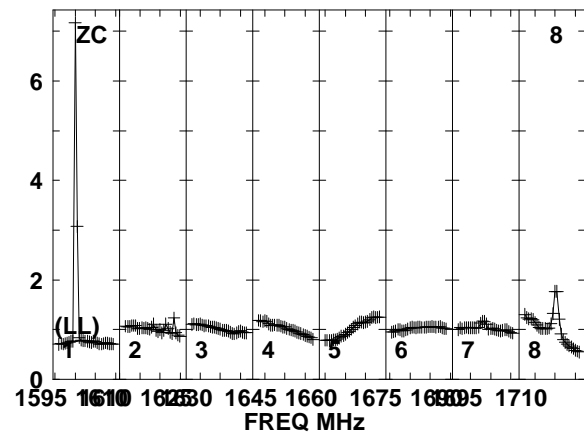
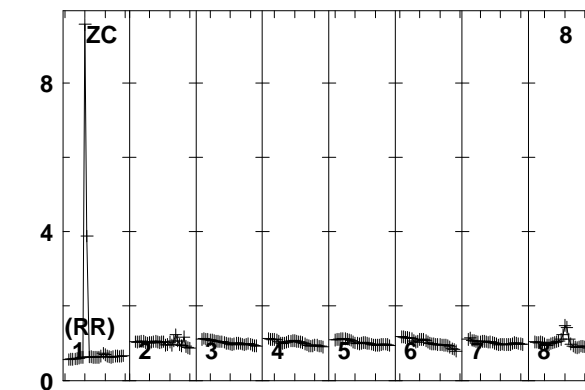
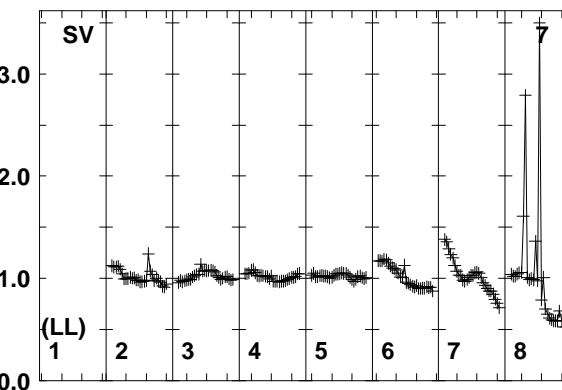
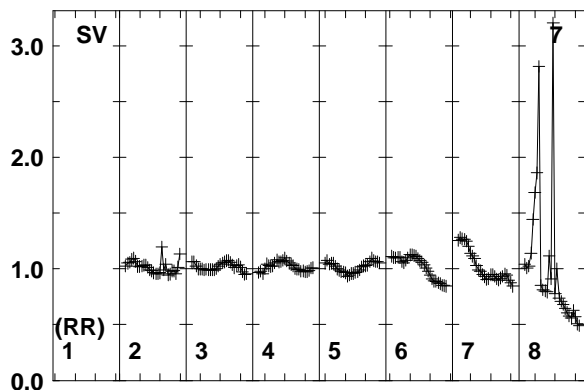
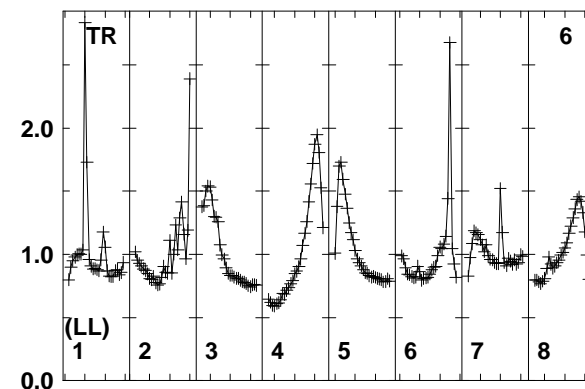
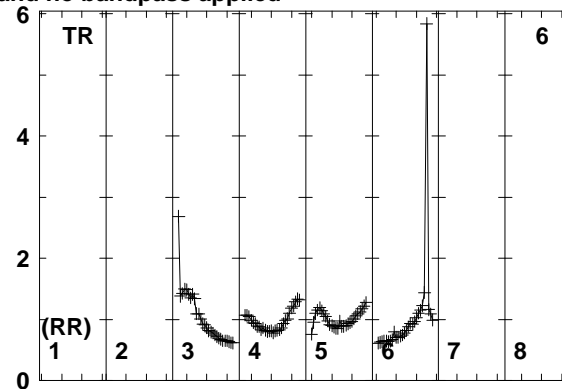
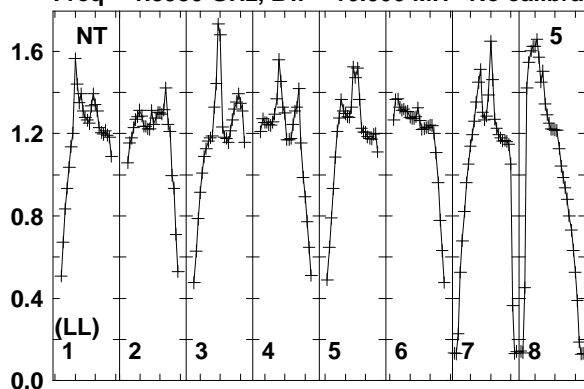

1595 1610 1625 1645 1660 1675 1695 1710
FREQ MHz

1595 1610 1625 1645 1660 1675 1695 1710
FREQ MHz

1595 1610 1625 1645 1660 1675 1695 1710
FREQ MHz

Lower frame: Real Jy
Total-power spectrum Antenna: NT (05)
Timerange: 00/10:00:11 to 00/10:02:09

Plot file version 365 created 11-AUG-2014 17:05:44

J2015+3710 EM110 2.UVDATA.1

Freq = 1.5950 GHz, Bw = 16.000 MH No calibration applied and no bandpass applied

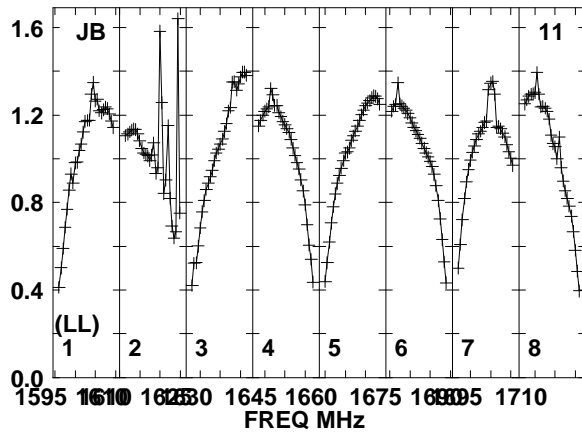
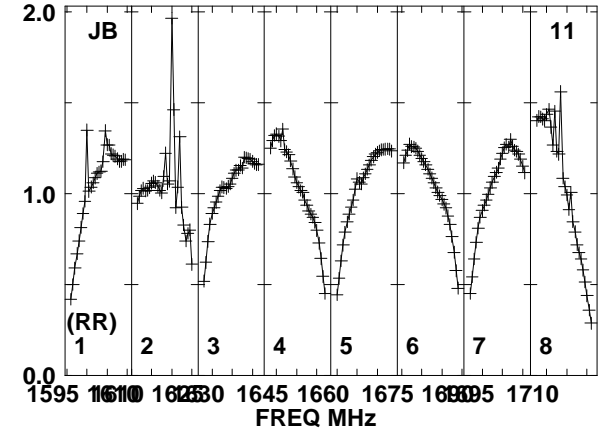
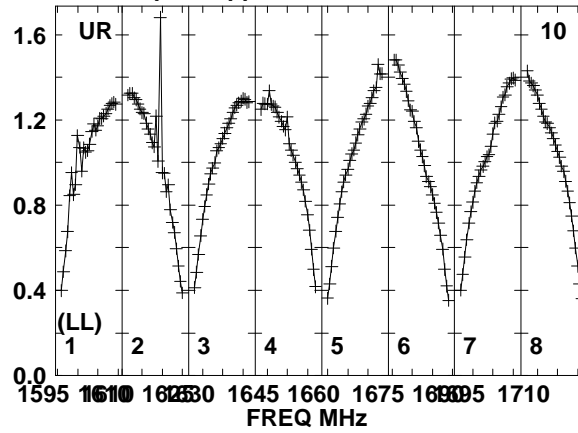
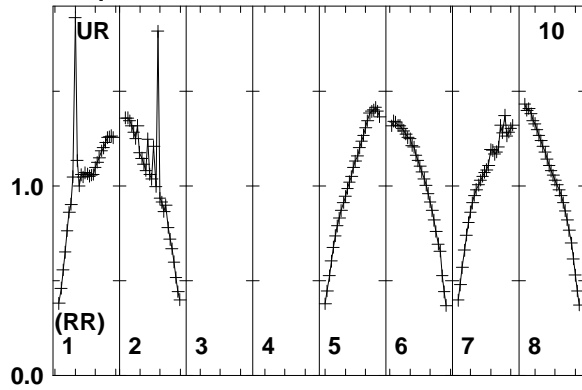

Lower frame: Real Jy
Total-power spectrum Antenna: UR (10)
Timerange: 00/10:00:11 to 00/10:02:09

Plot file version 366 created 11-AUG-2014 17:05:44

J2032+4127 EM110 2.UVDATA.1

Freq = 1.5950 GHz, Bw = 16.000 MH No calibration applied and no bandpass applied

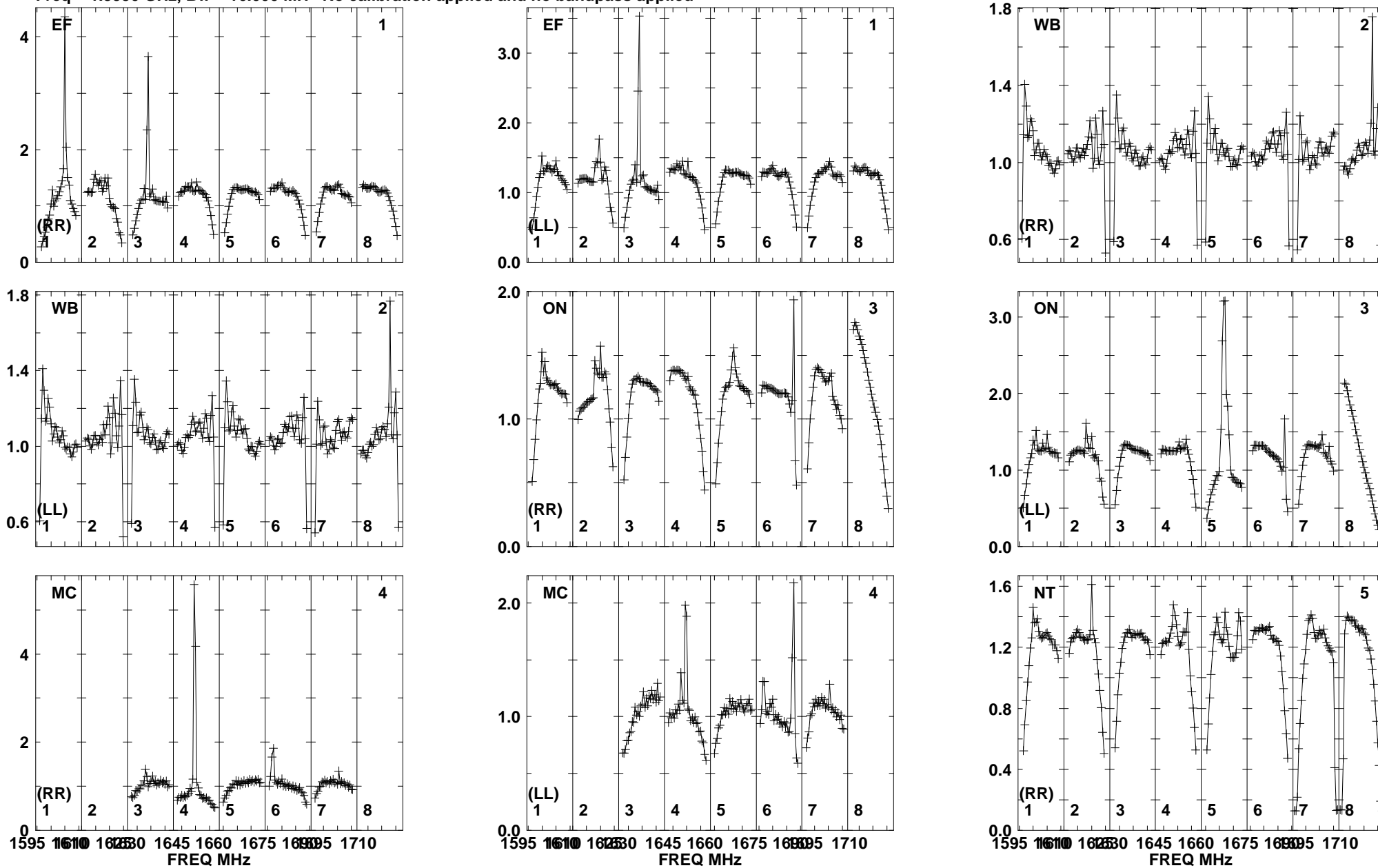

Lower frame: Real Jy
Total-power spectrum Antenna: EF (01)
Timerange: 00/10:02:24 to 00/10:06:08

Plot file version 367 created 11-AUG-2014 17:05:44

J2032+4127 EM110 2.UVDATA.1

Freq = 1.5950 GHz, Bw = 16.000 MH No calibration applied and no bandpass applied

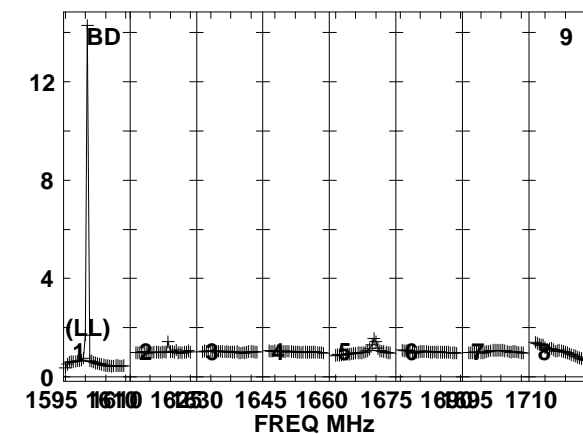
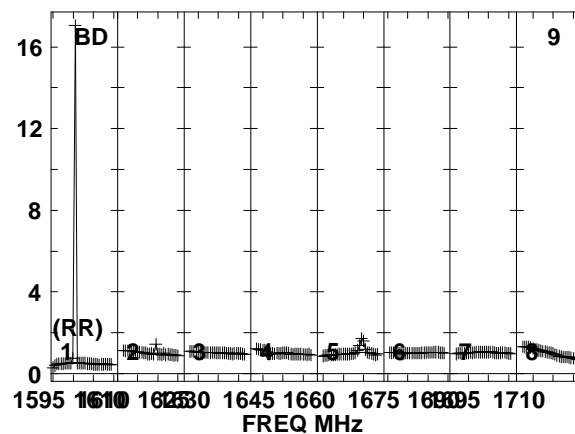
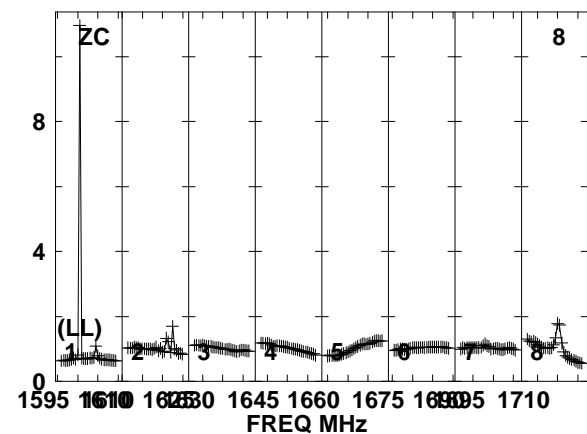
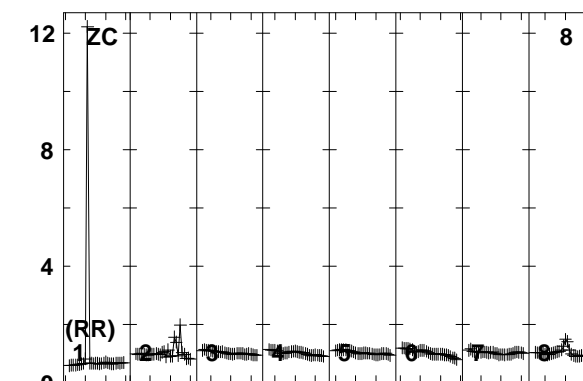
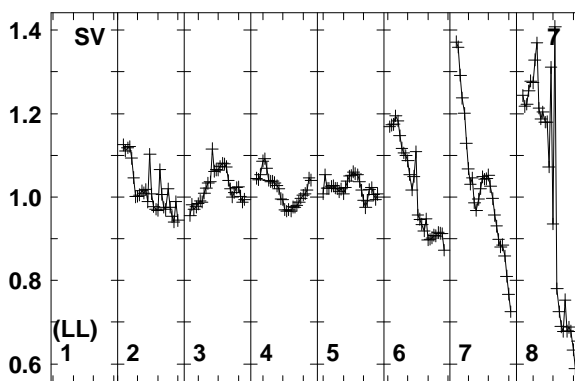
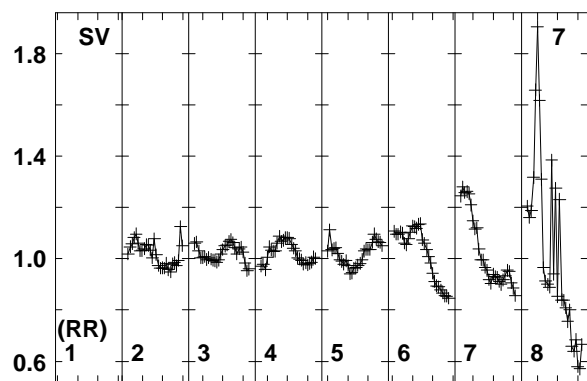
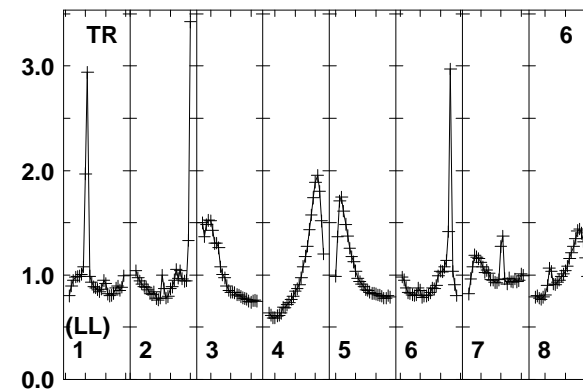
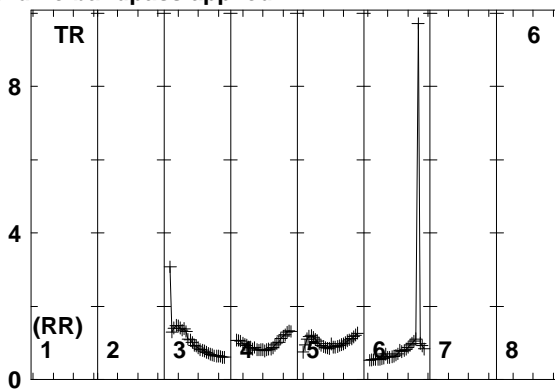
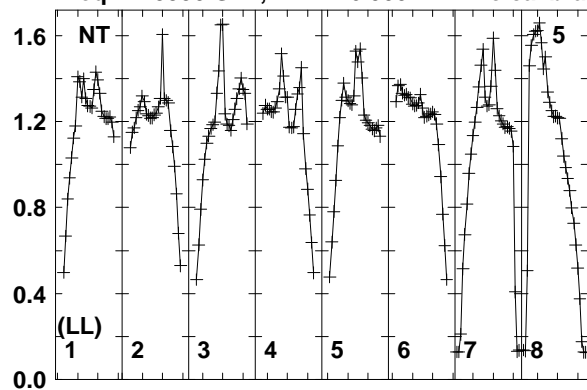

1595 1610 1625 1640 1655 1670 1685 1700 1715
FREQ MHz
Lower frame: Real Jy
Total-power spectrum Antenna: NT (05)
Timerange: 00/10:02:24 to 00/10:06:08

Plot file version 368 created 11-AUG-2014 17:05:44

J2032+4127 EM110 2.UVDATA.1

Freq = 1.5950 GHz, Bw = 16.000 MH No calibration applied and no bandpass applied

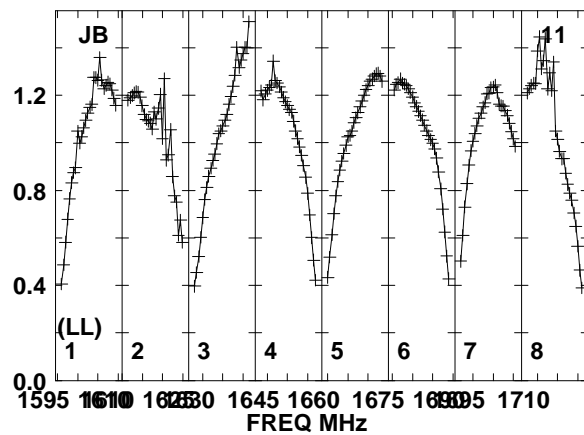
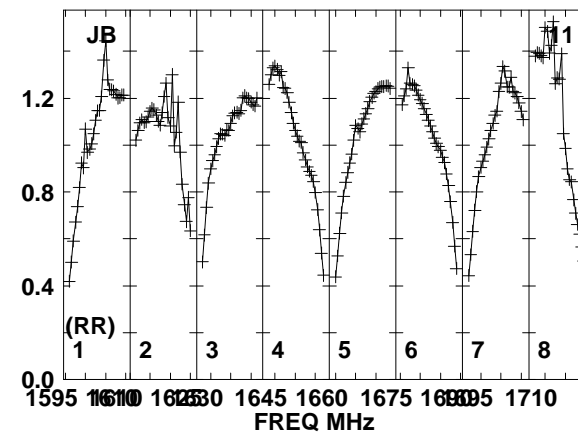
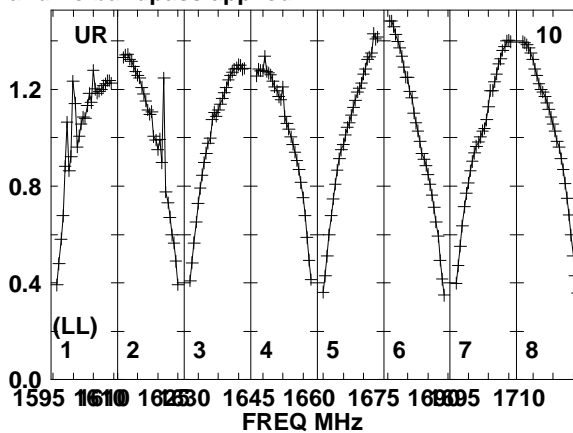
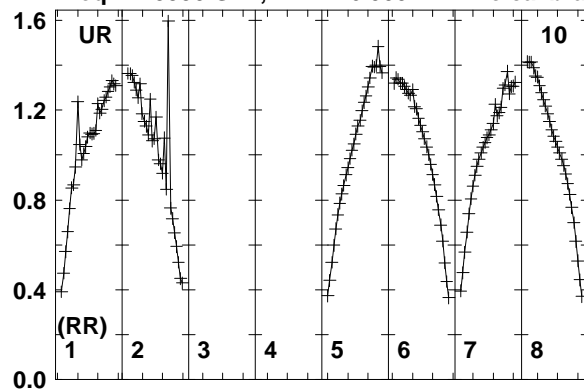

Lower frame: Real Jy
Total-power spectrum Antenna: UR (10)
Timerange: 00/10:02:24 to 00/10:06:08

Plot file version 369 created 11-AUG-2014 17:05:44

J2015+3710 EM110 2.UVDATA.1

Freq = 1.5950 GHz, Bw = 16.000 MH No calibration applied and no bandpass applied

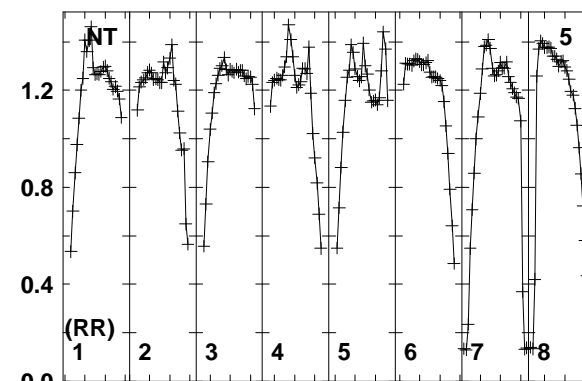
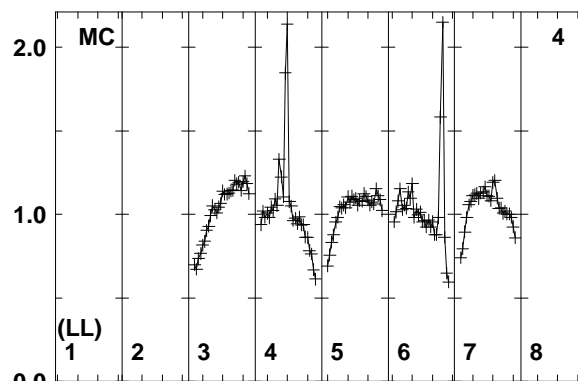
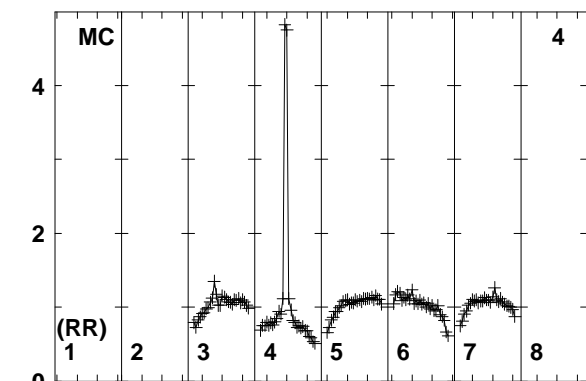
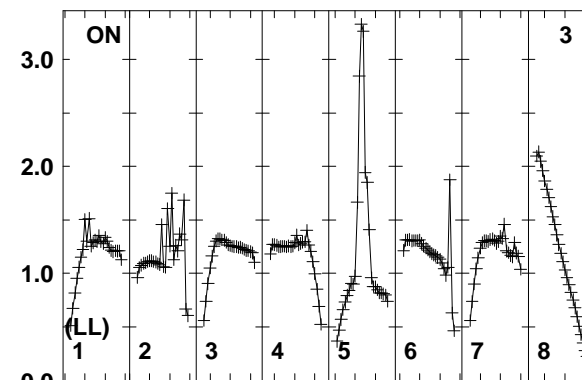
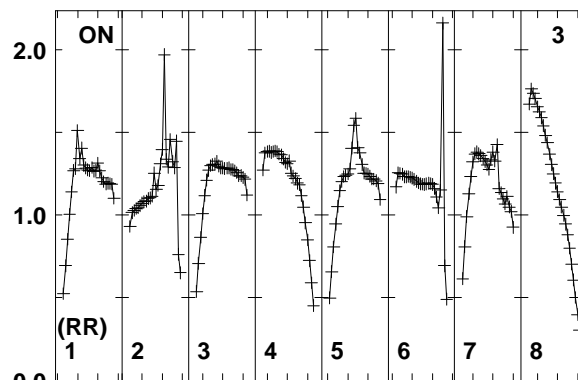
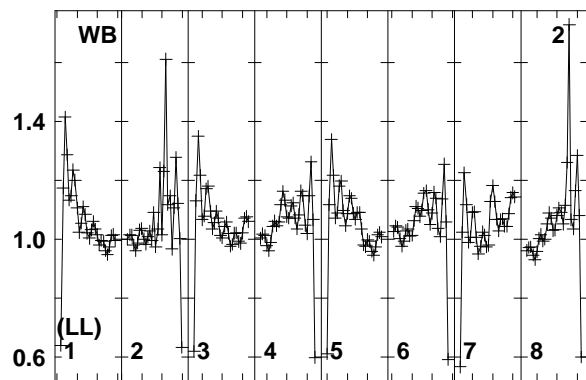
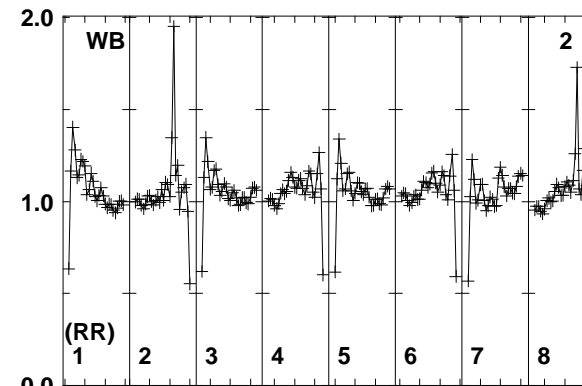
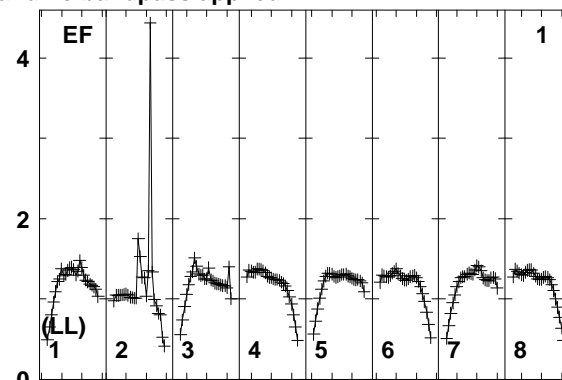
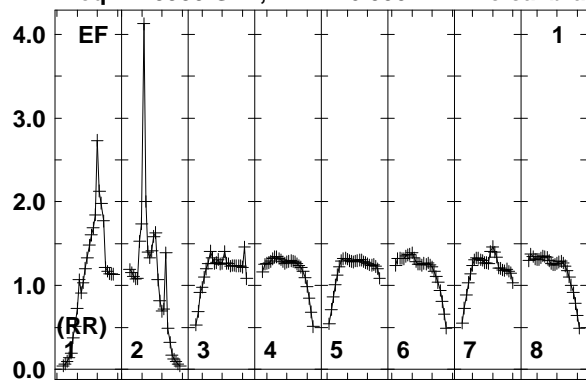

1595 1610 1625 1640 1655 1670 1685 1700 1710
FREQ MHz

Lower frame: Real Jy
Total-power spectrum Antenna: EF (01)
Timerange: 00/10:06:24 to 00/10:08:08

Plot file version 370 created 11-AUG-2014 17:05:44

J2015+3710 EM110 2.UVDATA.1

Freq = 1.5950 GHz, Bw = 16.000 MH No calibration applied and no bandpass applied

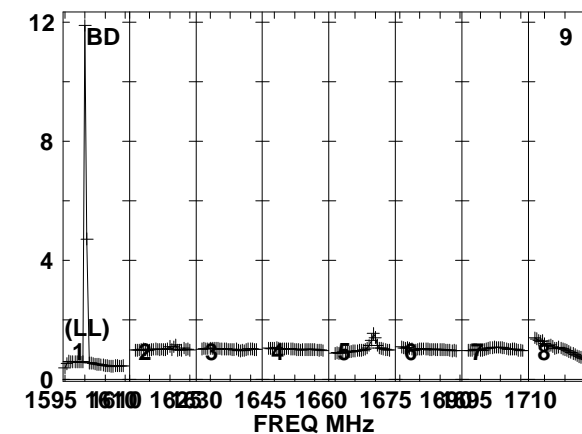
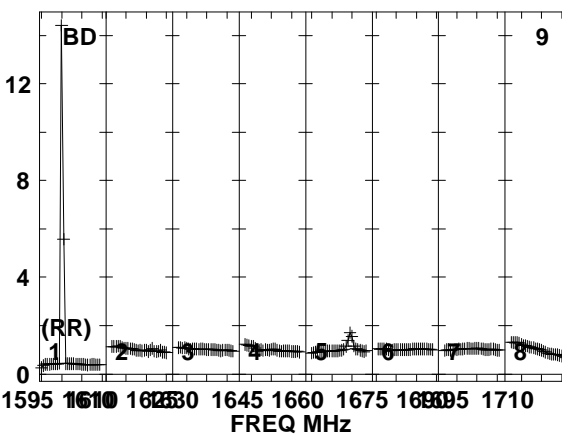
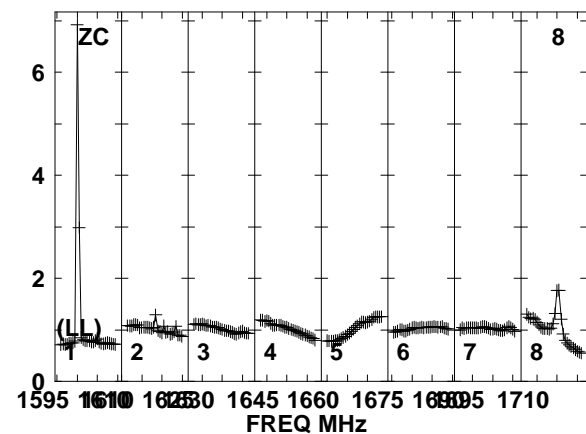
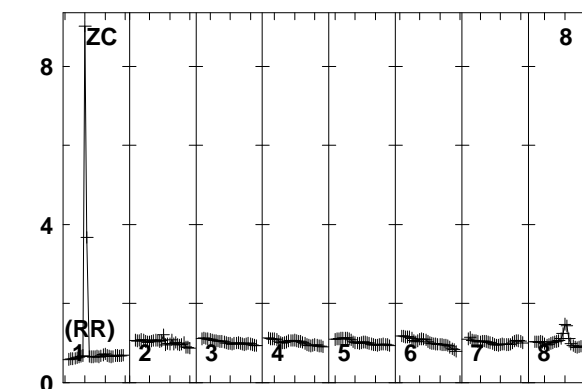
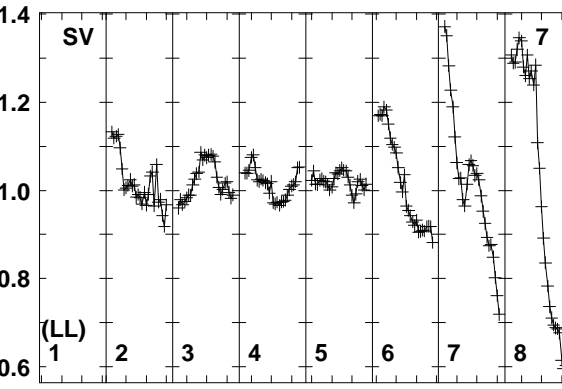
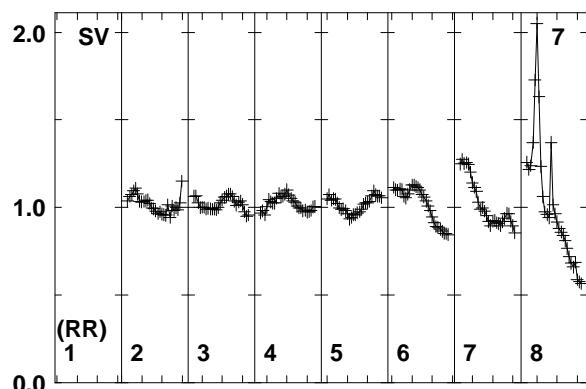
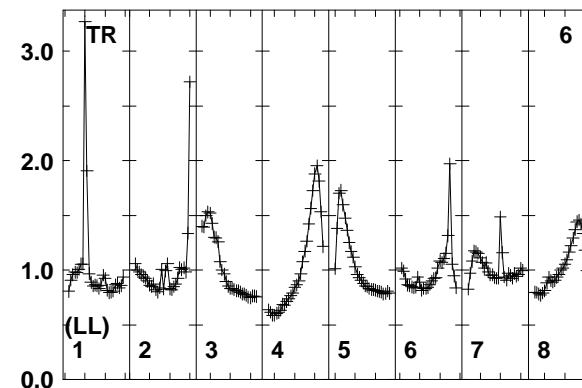
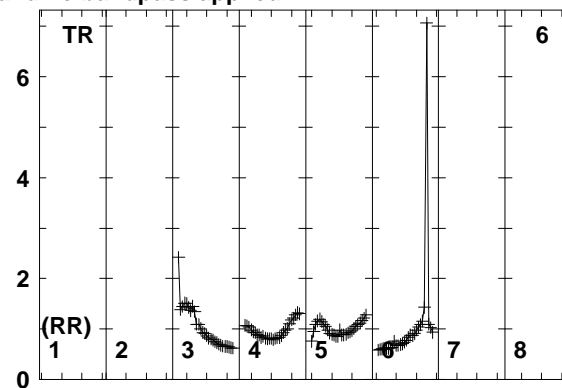
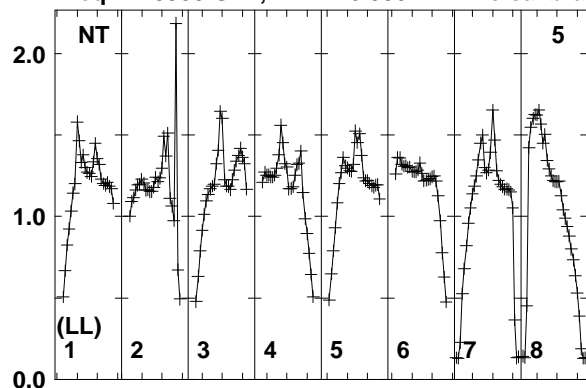

1595 1610 1625 1645 1660 1675 1690 1710
FREQ MHz

1595 1610 1625 1645 1660 1675 1690 1710
FREQ MHz

1595 1610 1625 1645 1660 1675 1690 1710
FREQ MHz

Lower frame: Real Jy
Total-power spectrum Antenna: NT (05)
Timerange: 00/10:06:24 to 00/10:08:08

Plot file version 371 created 11-AUG-2014 17:05:44

J2015+3710 EM110 2.UVDATA.1

Freq = 1.5950 GHz, Bw = 16.000 MH No calibration applied and no bandpass applied

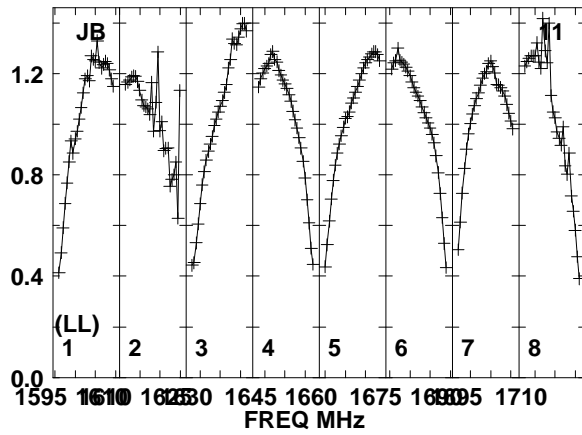
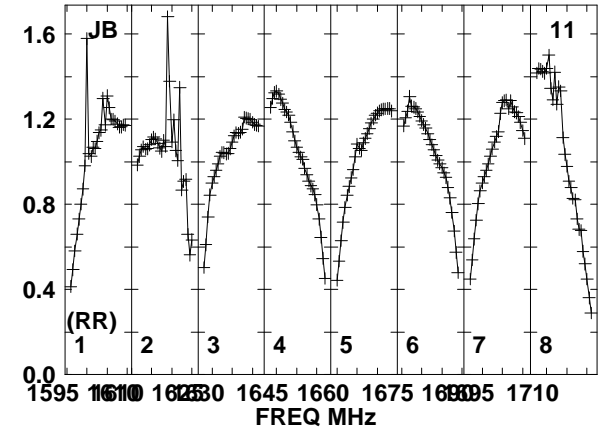
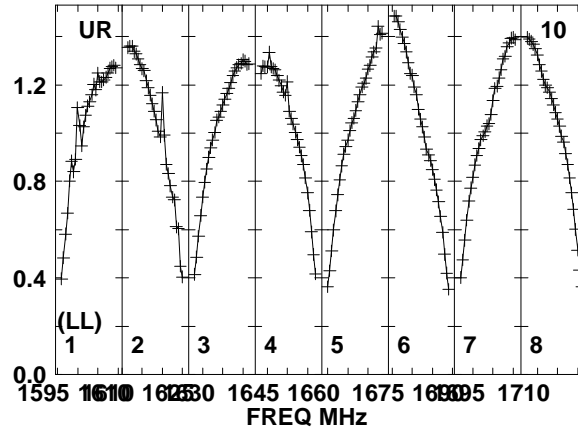
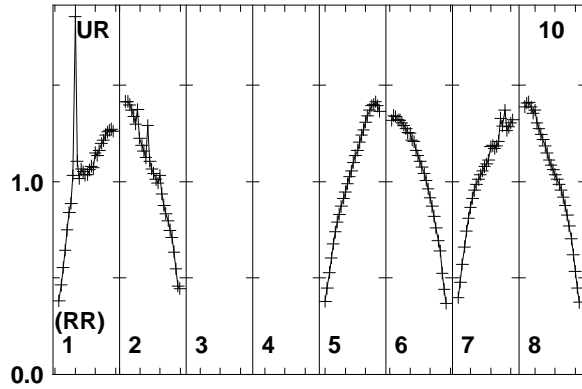

Lower frame: Real Jy
Total-power spectrum Antenna: UR (10)
Timerange: 00/10:06:24 to 00/10:08:08

Plot file version 372 created 11-AUG-2014 17:05:44

J2007+4029 EM110 2.UVDATA.1

Freq = 1.5950 GHz, Bw = 16.000 MH No calibration applied and no bandpass applied

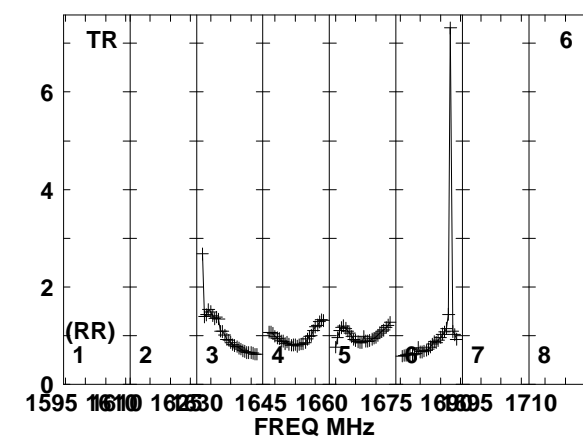
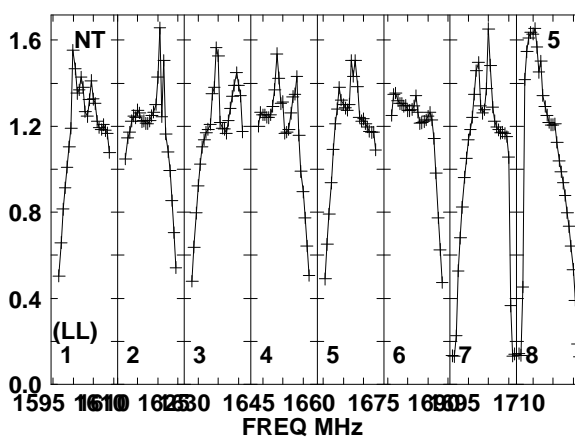
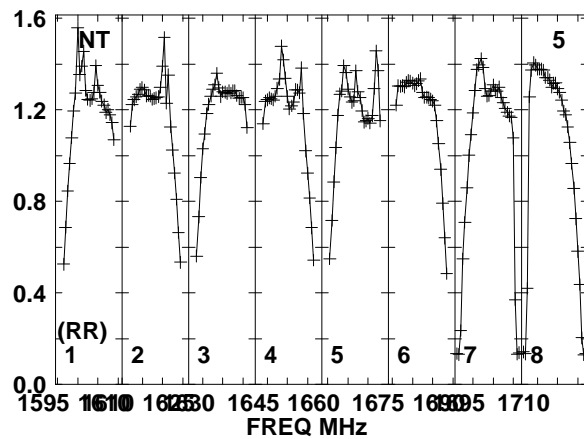
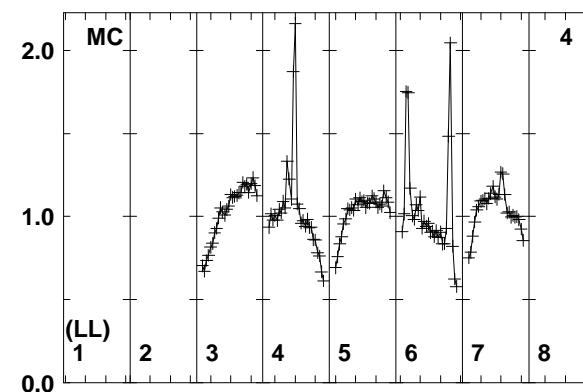
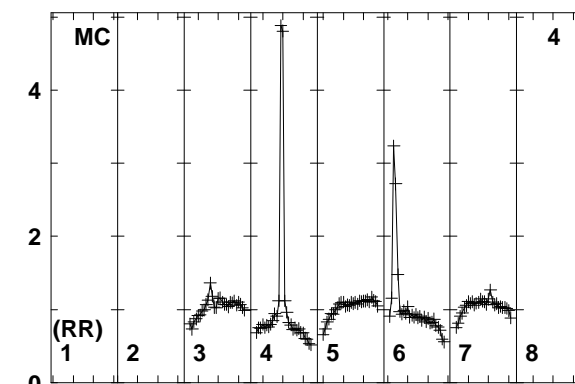
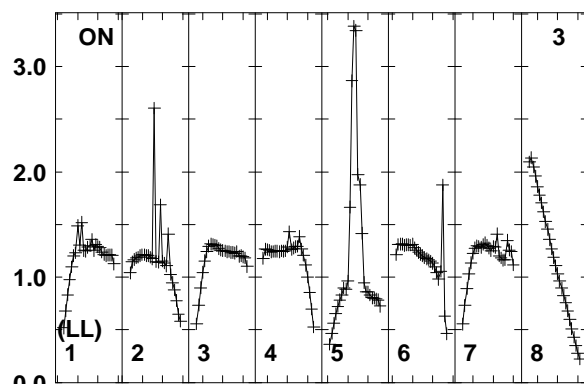
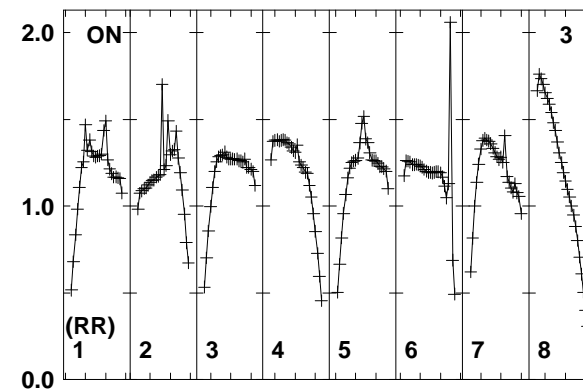
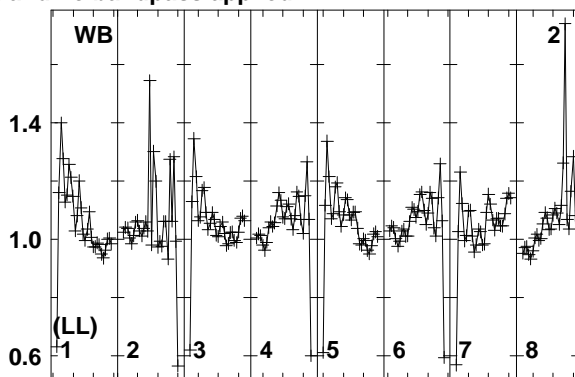
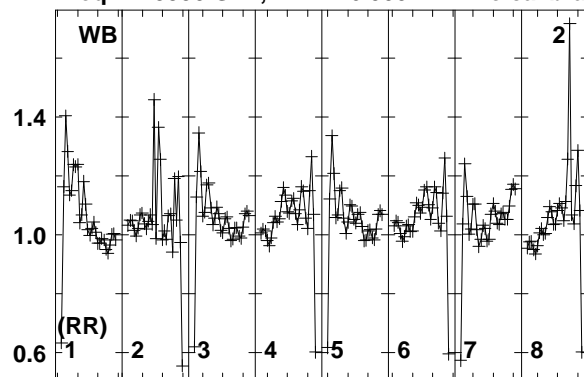

Lower frame: Real Jy
Total-power spectrum Antenna: WB (02)
Timerange: 00/10/08:19 to 00/10/09:09

Plot file version 373 created 11-AUG-2014 17:05:44

J2007+4029 EM110 2.UVDATA.1

Freq = 1.5950 GHz, Bw = 16.000 MH No calibration applied and no bandpass applied

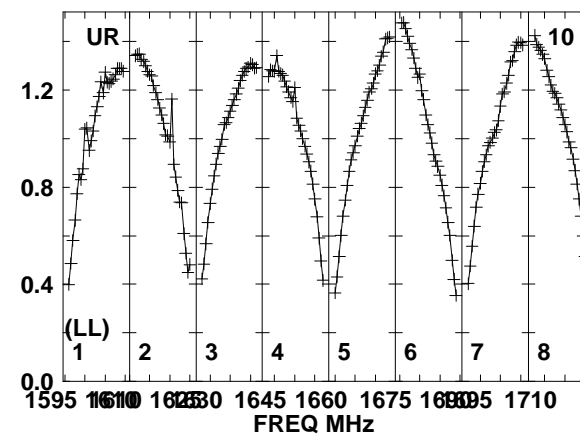
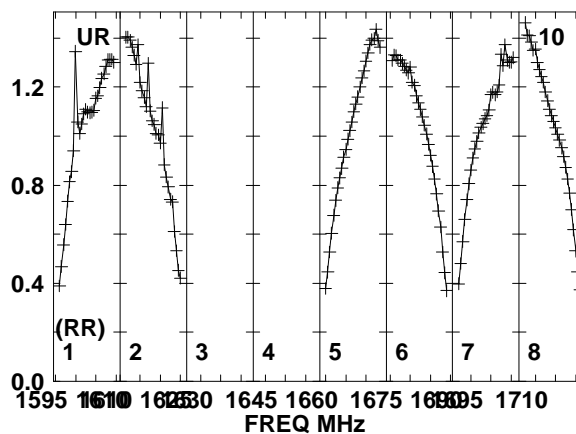
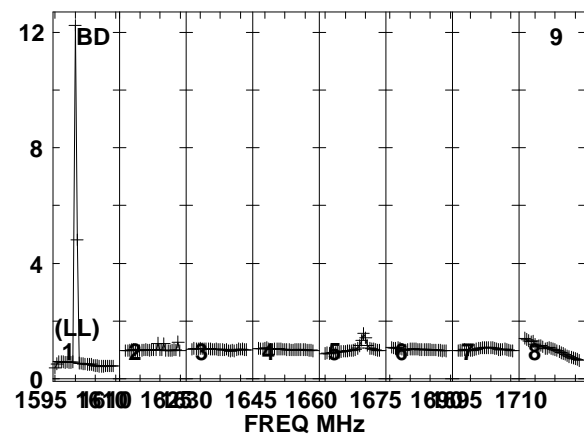
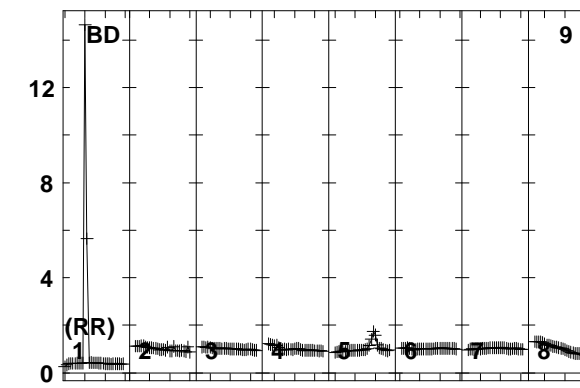
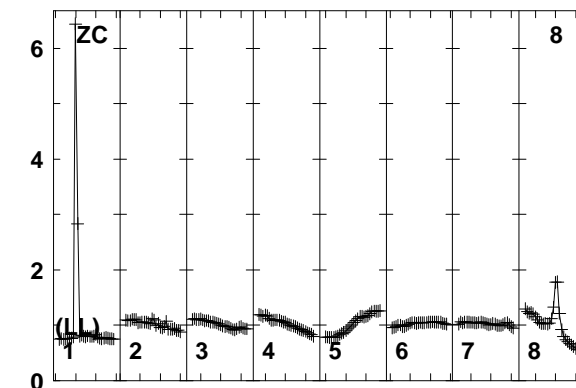
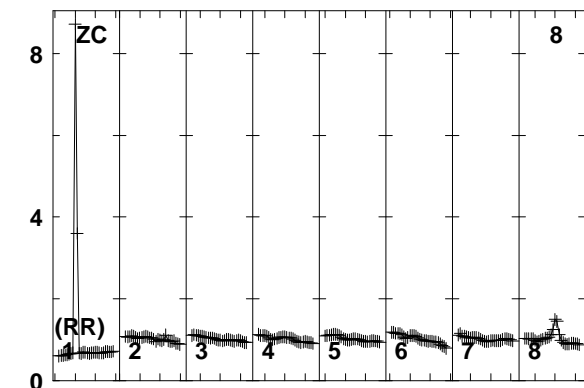
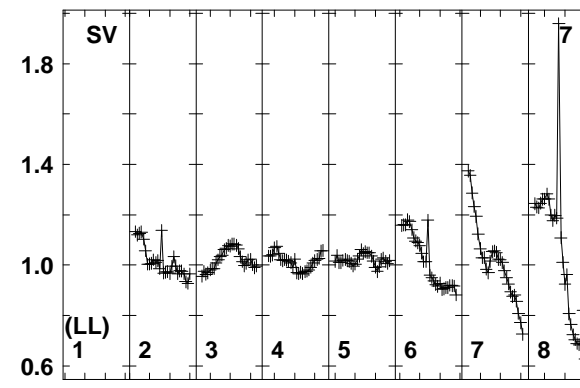
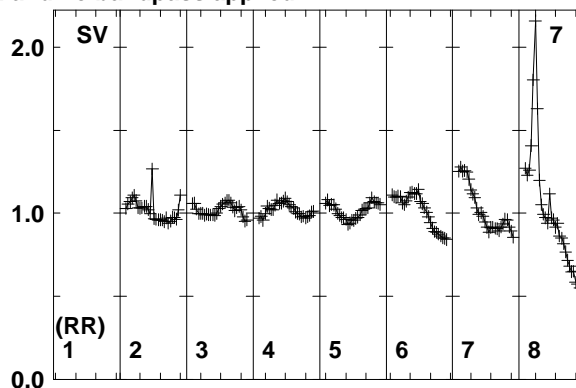
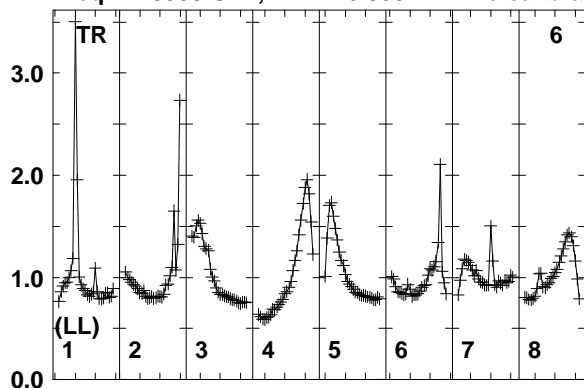

1595 1610 1625 1645 1660 1675 1695 1710
FREQ MHz

1595 1610 1625 1645 1660 1675 1695 1710
FREQ MHz

1595 1610 1625 1645 1660 1675 1695 1710
FREQ MHz

Lower frame: Real Jy
Total-power spectrum Antenna: TR (06)
Timerange: 00/10:08:19 to 00/10:09:09

Plot file version 374 created 11-AUG-2014 17:05:44

J2015+3710 EM110 2.UVDATA.1

Freq = 1.5950 GHz, Bw = 16.000 MH No calibration applied and no bandpass applied

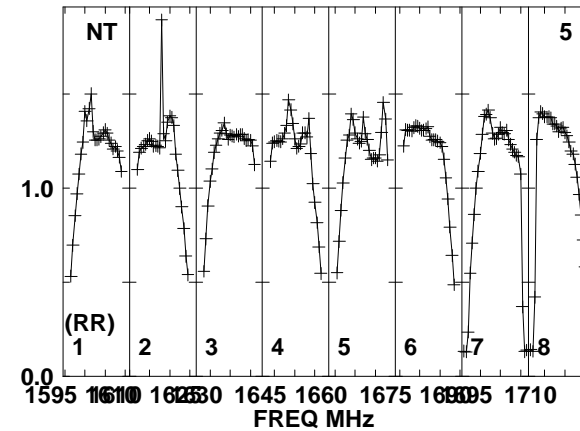
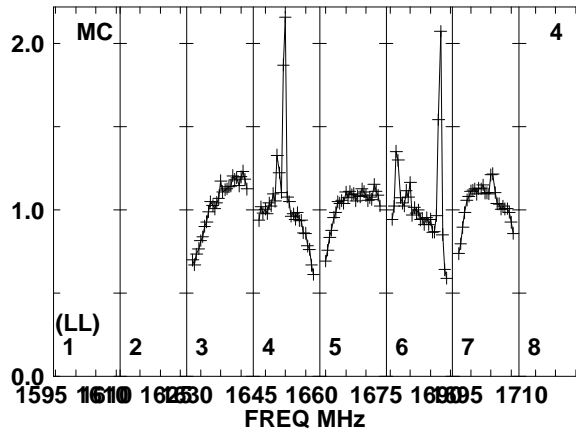
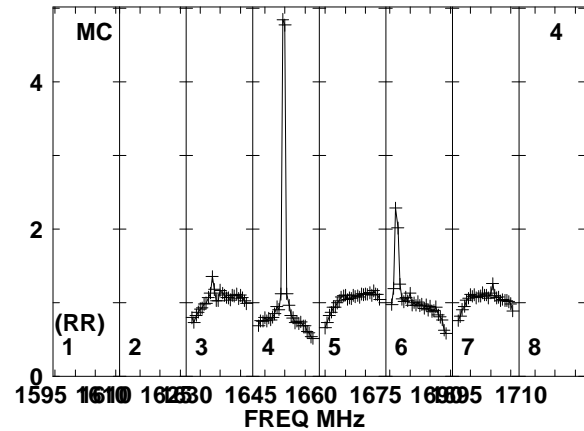
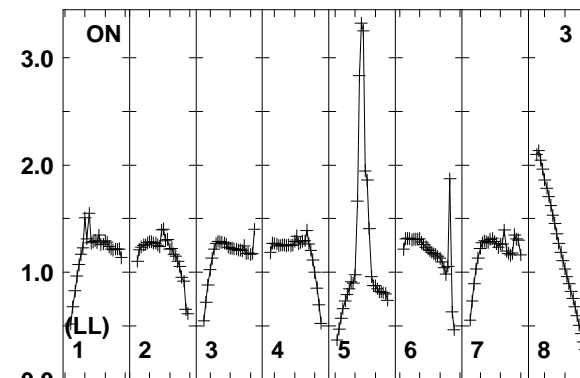
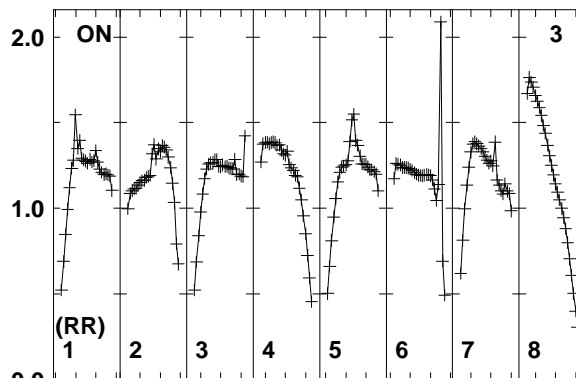
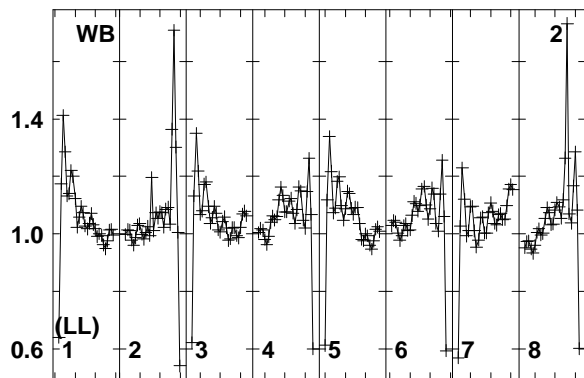
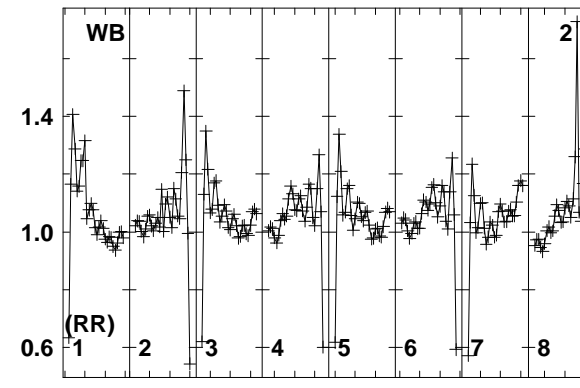
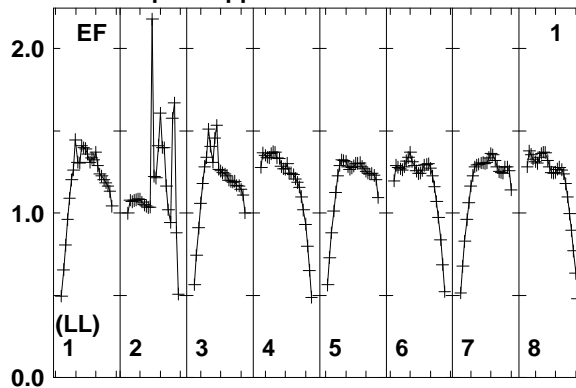
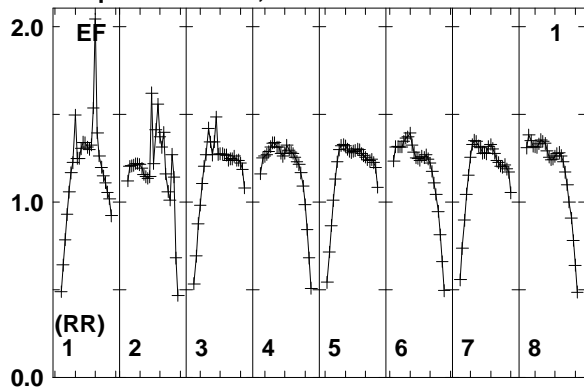

Lower frame: Real Jy
Total-power spectrum Antenna: EF (01)
Timerange: 00/10:10:11 to 00/10:12:09

Plot file version 375 created 11-AUG-2014 17:05:44

J2015+3710 EM110 2.UVDATA.1

Freq = 1.5950 GHz, Bw = 16.000 MH No calibration applied and no bandpass applied

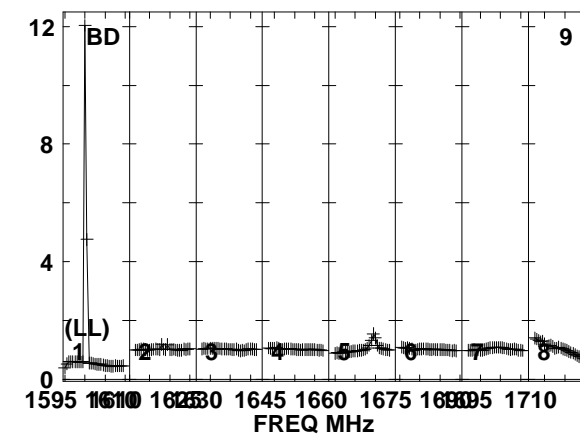
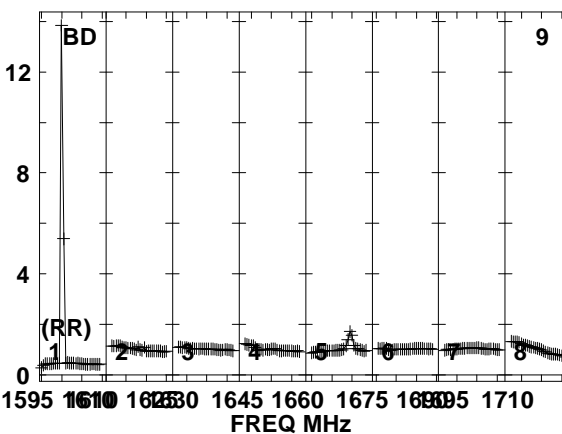
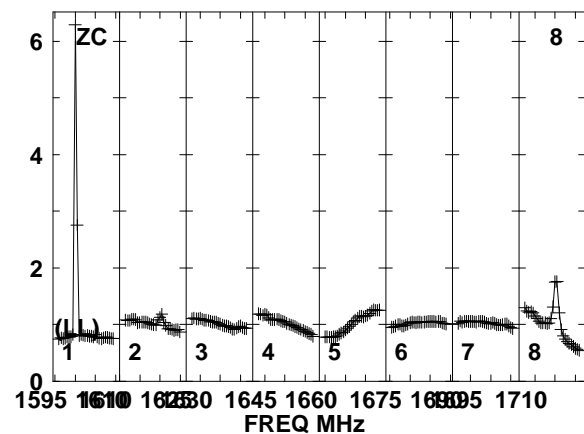
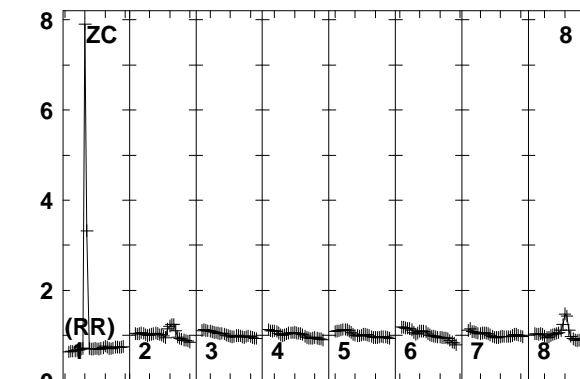
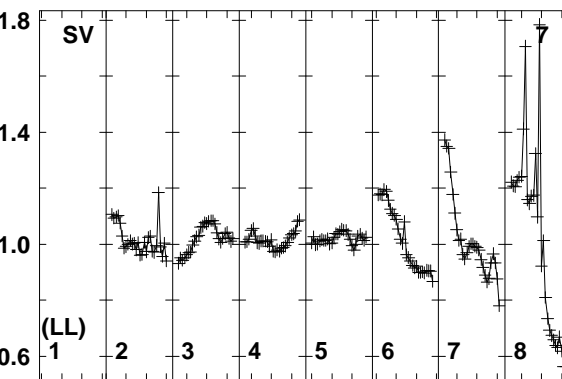
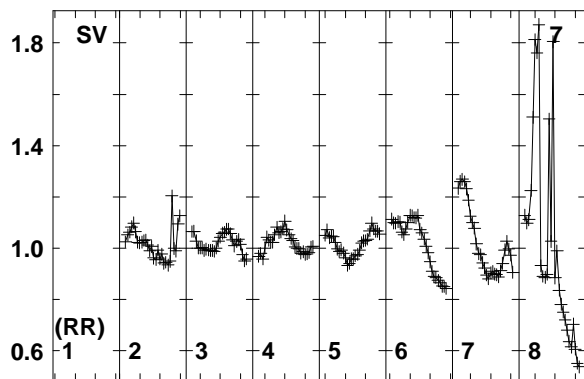
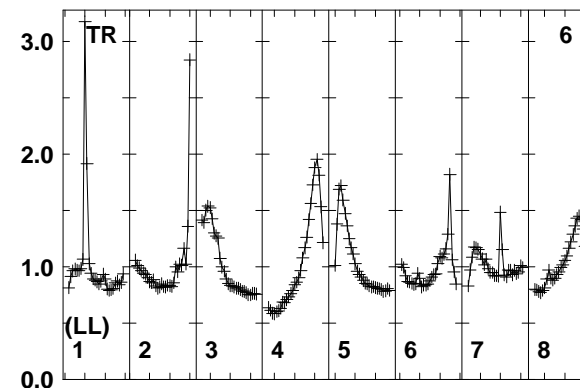
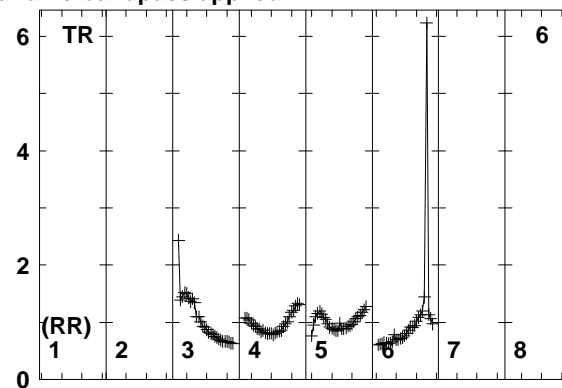
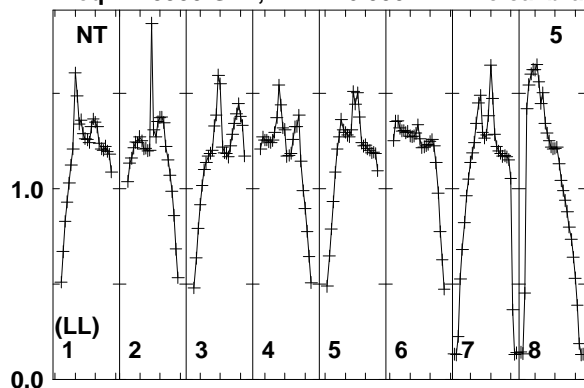

Lower frame: Real Jy
Total-power spectrum Antenna: NT (05)
Timerange: 00/10:10:11 to 00/10:12:09

Plot file version 376 created 11-AUG-2014 17:05:44

J2015+3710 EM110 2.UVDATA.1

Freq = 1.5950 GHz, Bw = 16.000 MH No calibration applied and no bandpass applied

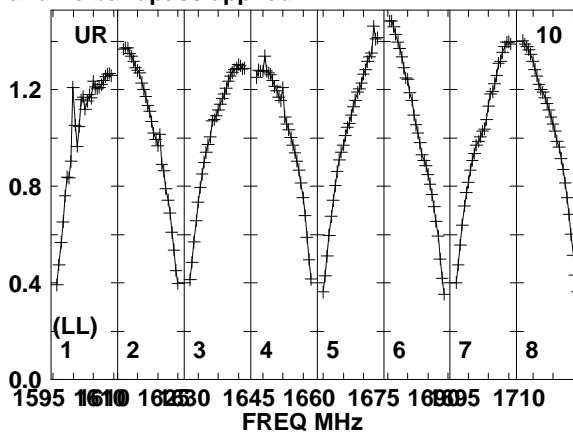
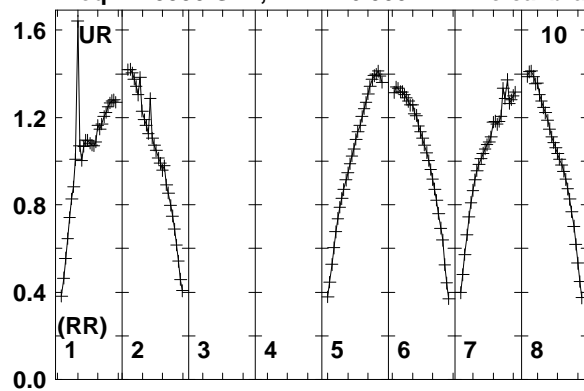

Lower frame: Real Jy
Total-power spectrum Antenna: UR (10)
Timerange: 00/10:10:11 to 00/10:12:09

Plot file version 377 created 11-AUG-2014 17:05:44

J2032+4127 EM110 2.UVDATA.1

Freq = 1.5950 GHz, Bw = 16.000 MH No calibration applied and no bandpass applied

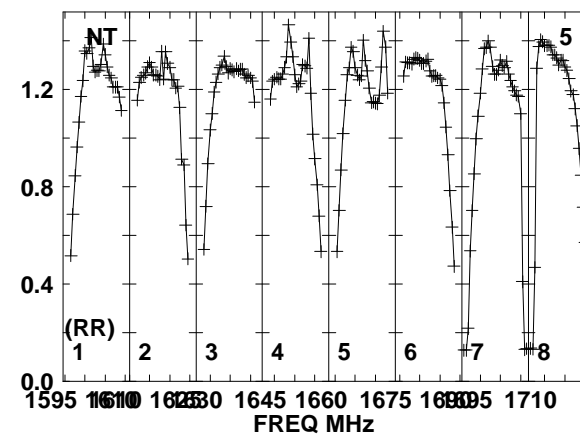
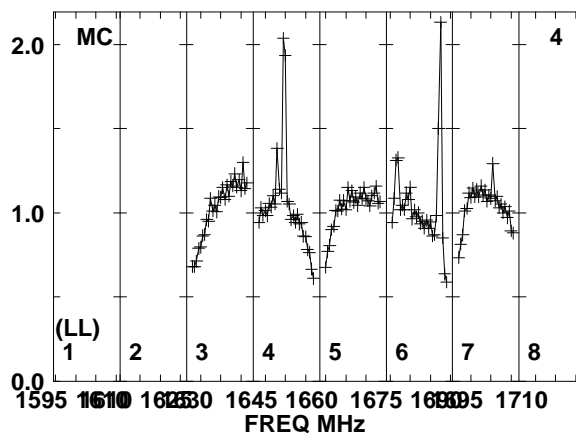
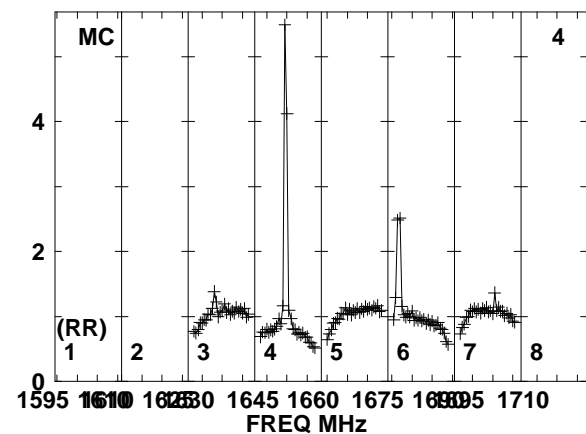
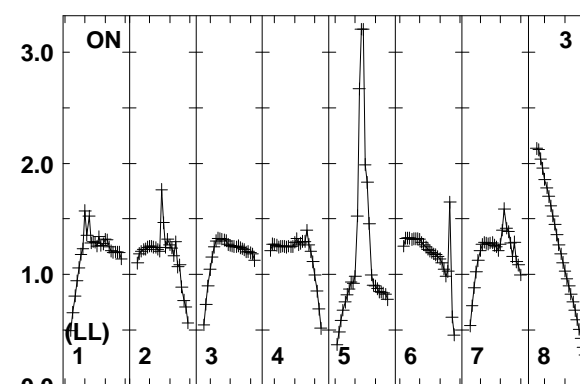
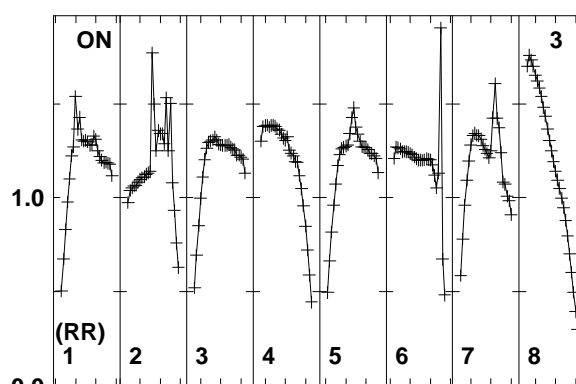
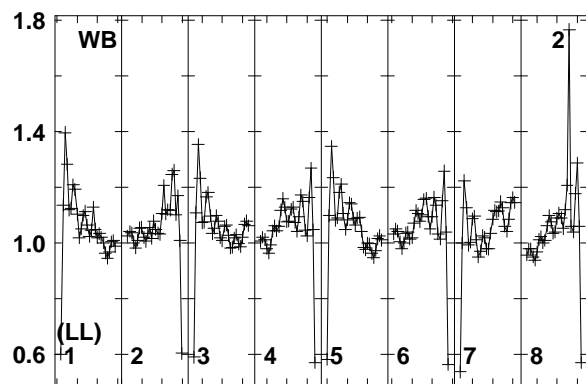
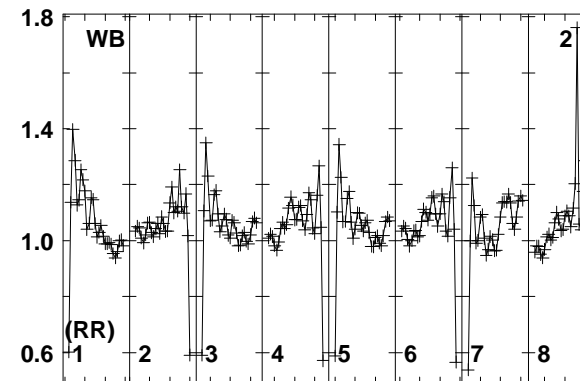
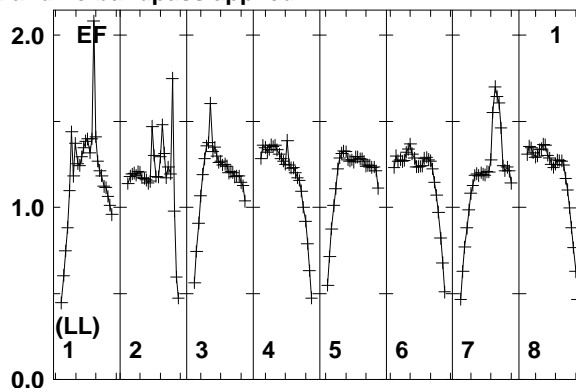
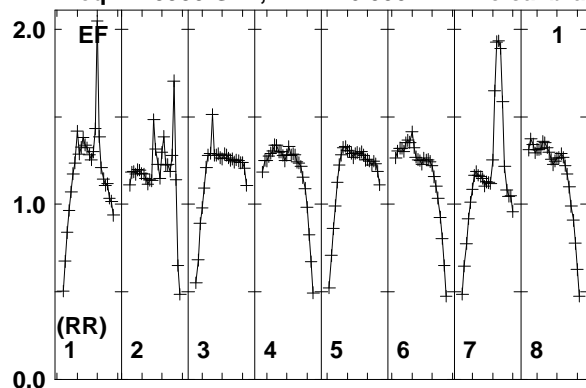

Lower frame: Real Jy
Total-power spectrum Antenna: EF (01)
Timerange: 00/10:12:11 to 00/10:16:09

Plot file version 378 created 11-AUG-2014 17:05:44

J2032+4127 EM110 2.UVDATA.1

Freq = 1.5950 GHz, Bw = 16.000 MH No calibration applied and no bandpass applied

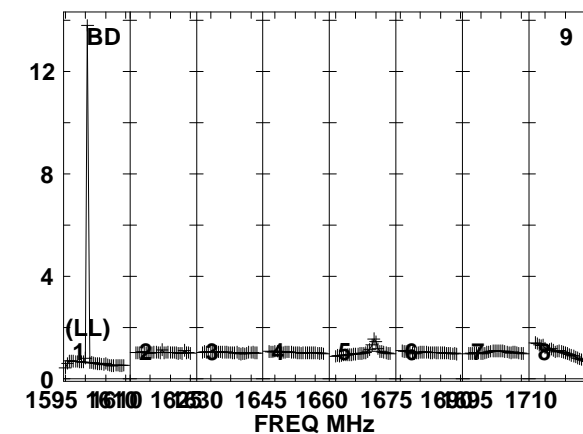
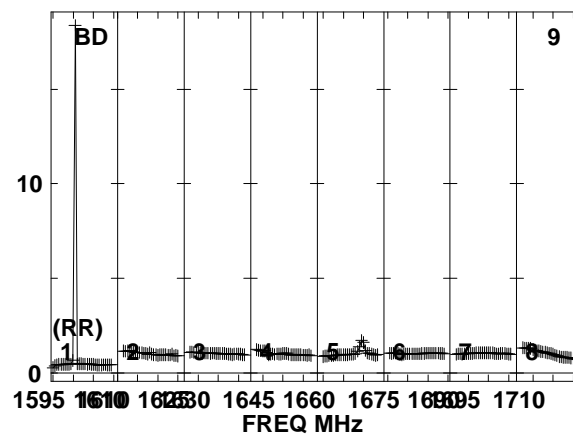
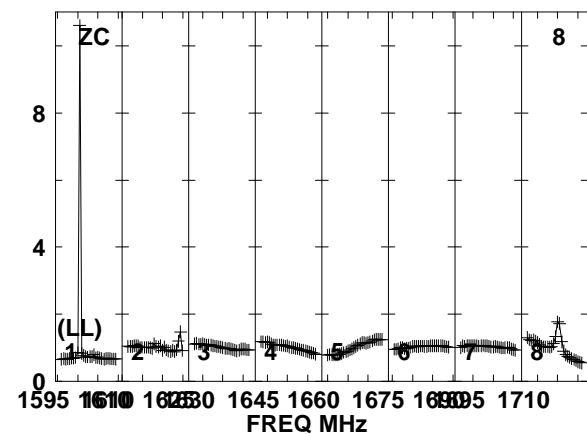
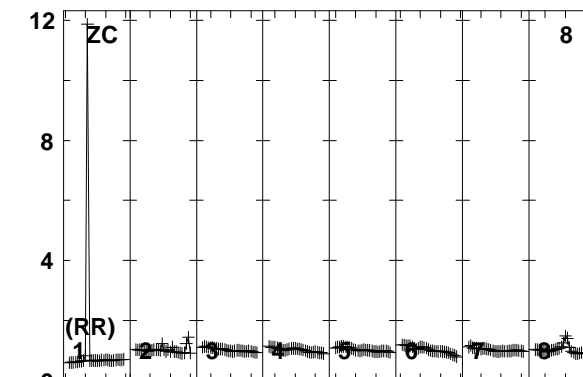
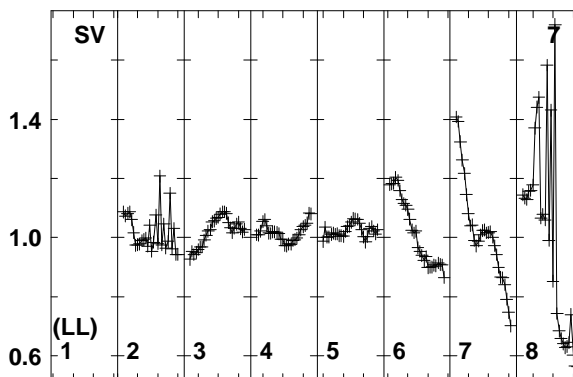
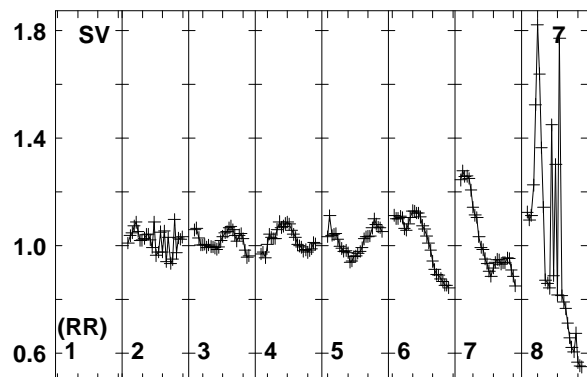
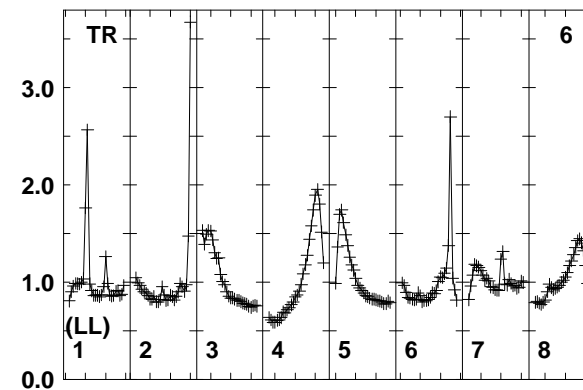
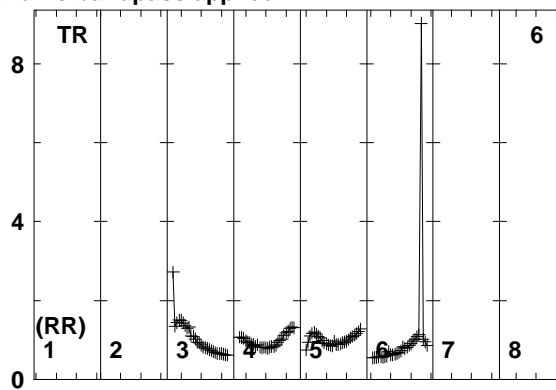
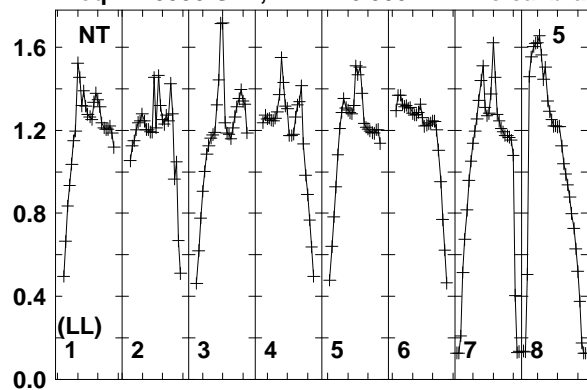

1595 1610 1625 1640 1655 1670 1685 1700 1710
FREQ MHz
Lower frame: Real Jy
Total-power spectrum Antenna: NT (05)
Timerange: 00/10:12:11 to 00/10:16:09

Plot file version 379 created 11-AUG-2014 17:05:44

J2032+4127 EM110 2.UVDATA.1

Freq = 1.5950 GHz, Bw = 16.000 MH No calibration applied and no bandpass applied

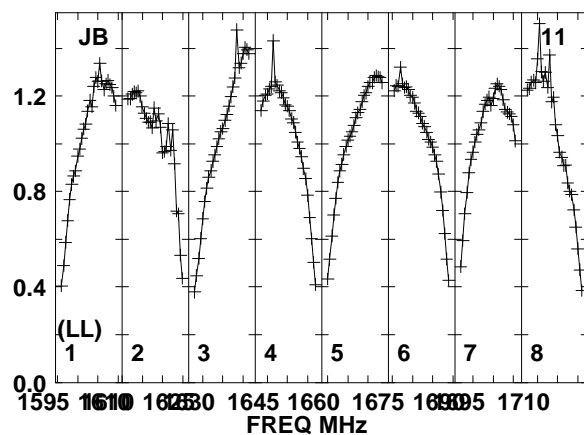
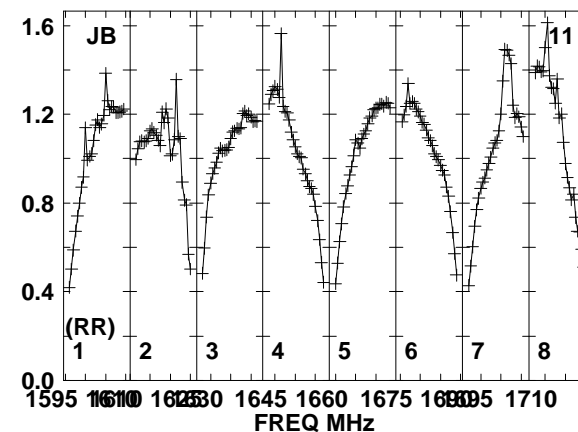
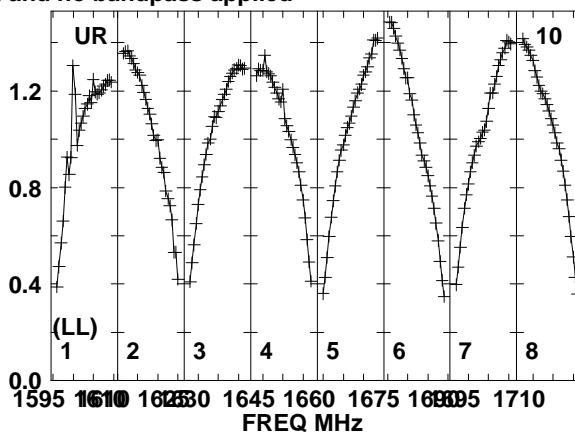
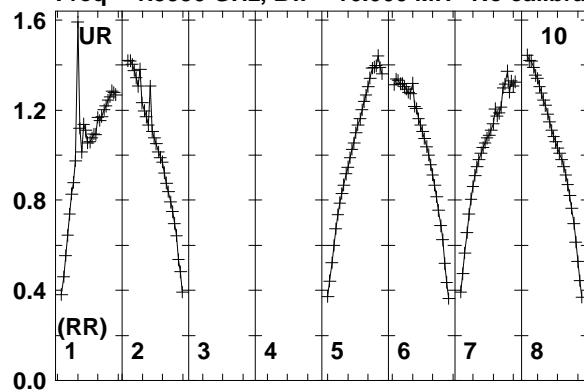

Lower frame: Real Jy
Total-power spectrum Antenna: UR (10)
Timerange: 00/10:12:11 to 00/10:16:09

Plot file version 380 created 11-AUG-2014 17:05:44

J2015+3710 EM110 2.UVDATA.1

Freq = 1.5950 GHz, Bw = 16.000 MH No calibration applied and no bandpass applied

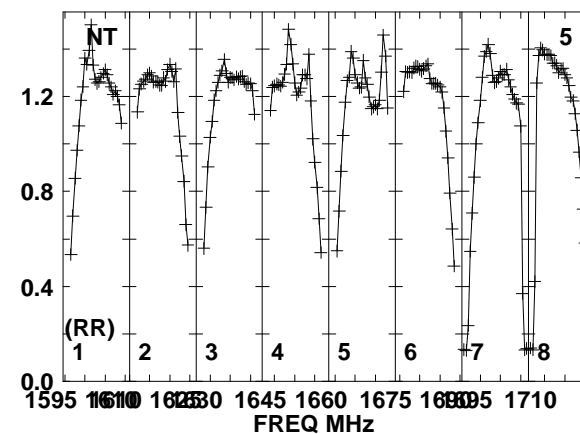
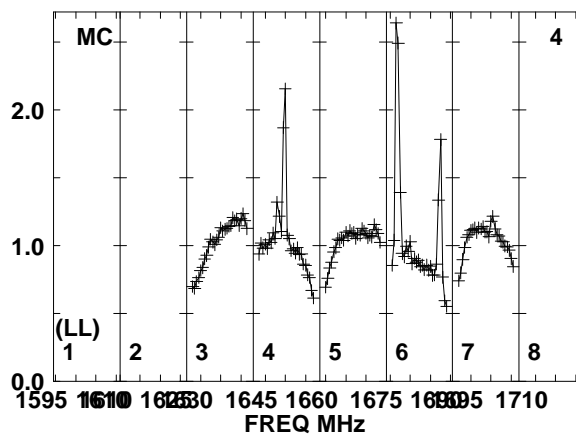
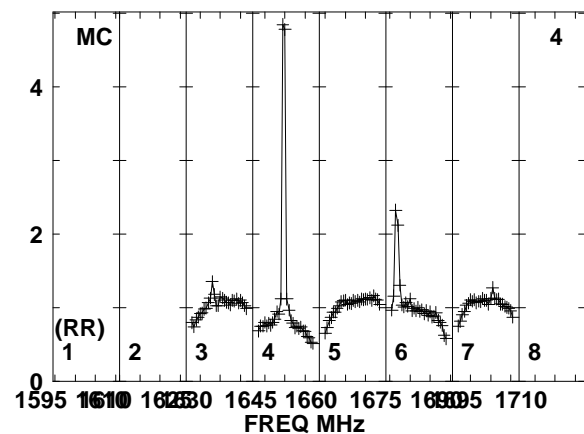
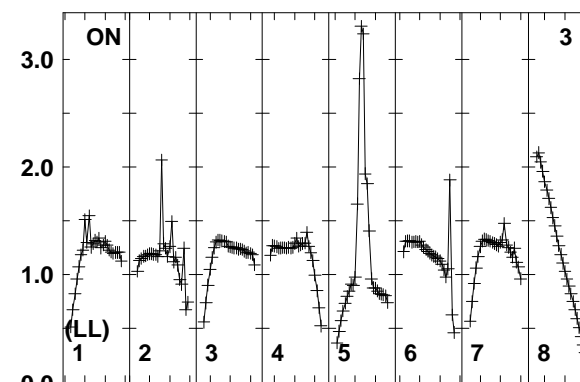
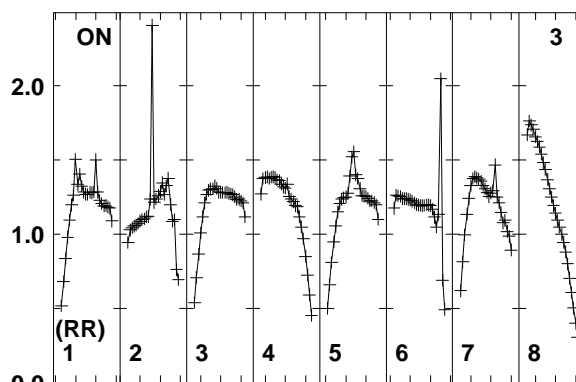
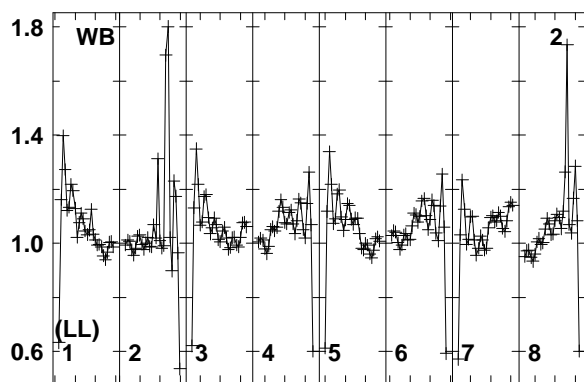
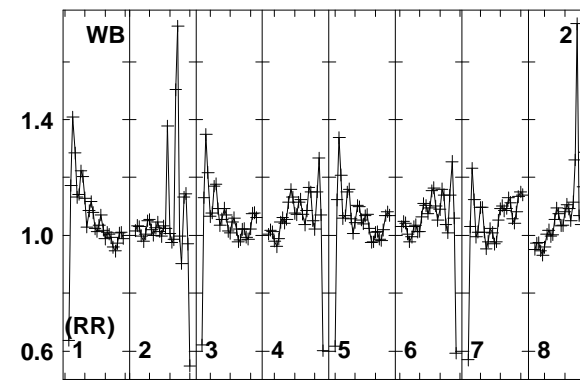
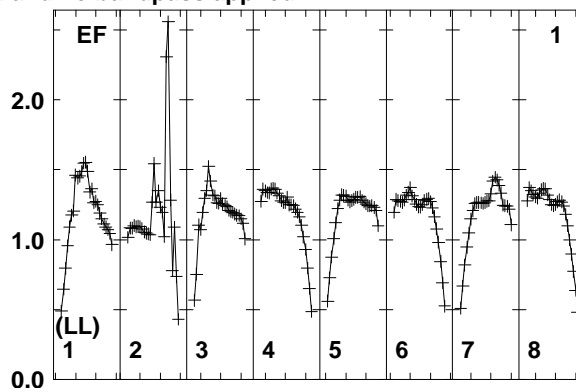
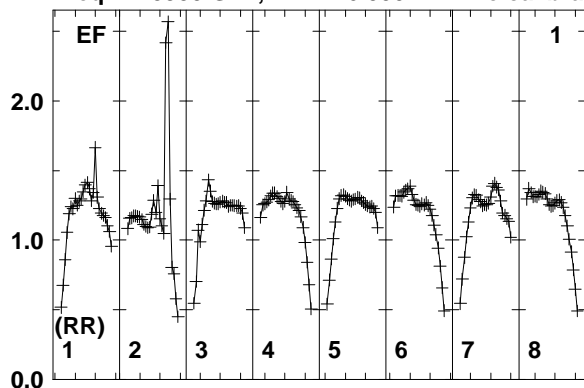

Lower frame: Real Jy
Total-power spectrum Antenna: EF (01)
Timerange: 00/10:16:24 to 00/10:18:08

Plot file version 381 created 11-AUG-2014 17:05:44

J2015+3710 EM110 2.UVDATA.1

Freq = 1.5950 GHz, Bw = 16.000 MH No calibration applied and no bandpass applied

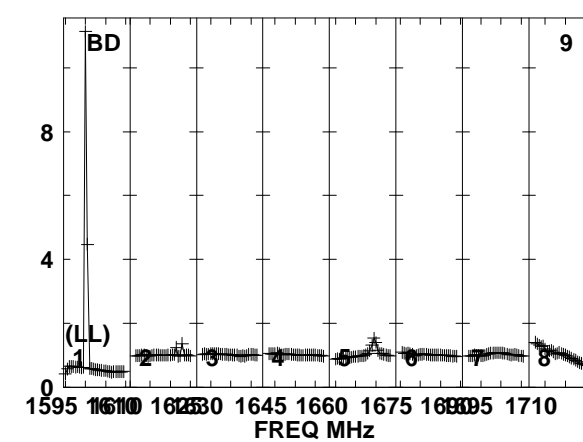
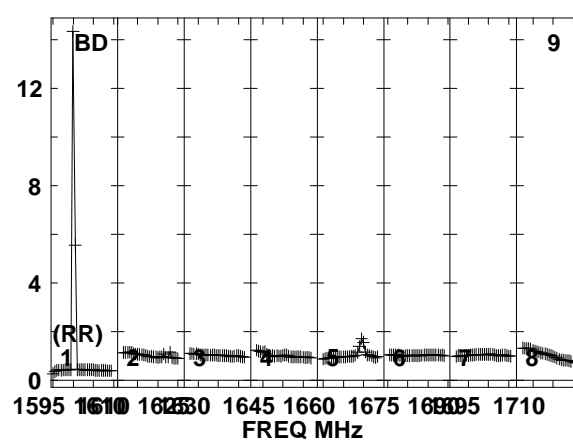
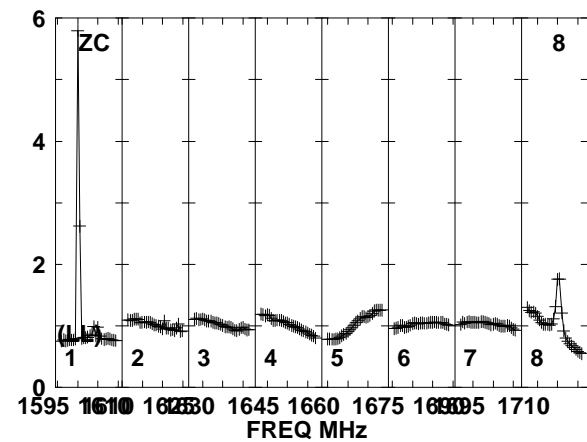
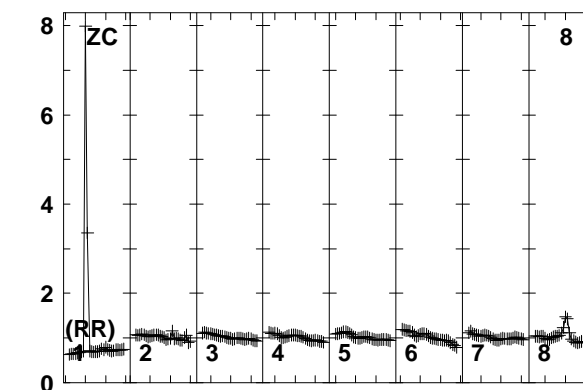
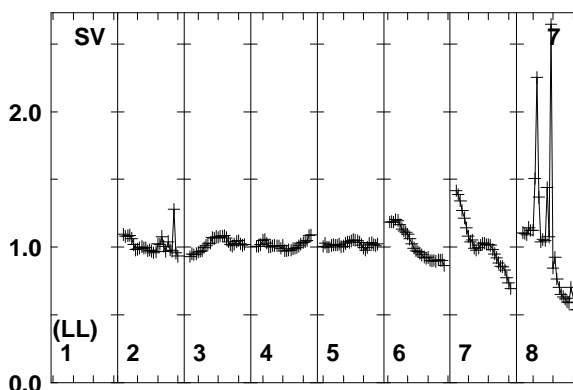
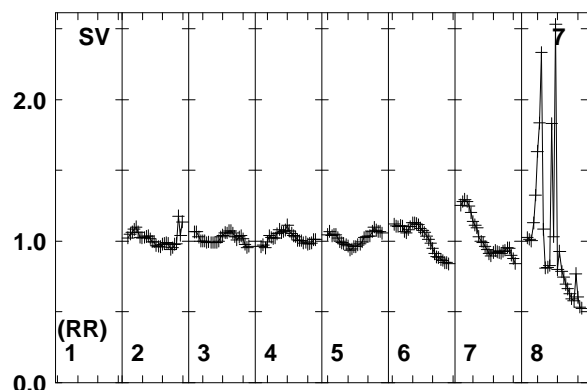
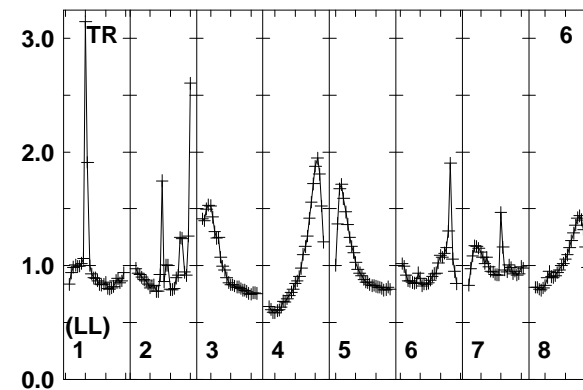
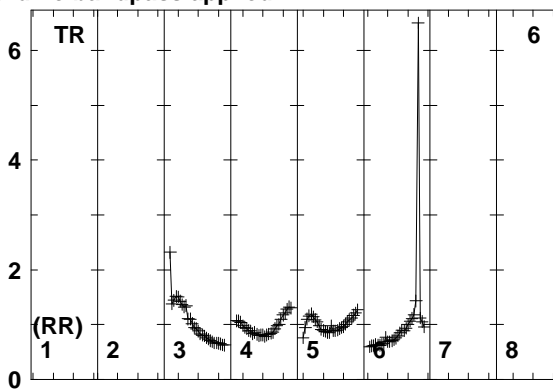
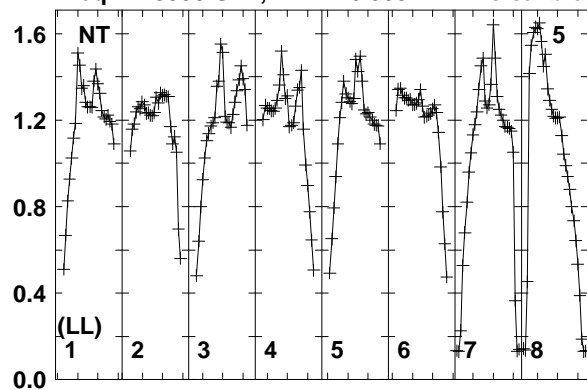

Lower frame: Real Jy
Total-power spectrum Antenna: NT (05)
Timerange: 00/10:16:24 to 00/10:18:08

Plot file version 382 created 11-AUG-2014 17:05:44

J2015+3710 EM110 2.UVDATA.1

Freq = 1.5950 GHz, Bw = 16.000 MH No calibration applied and no bandpass applied

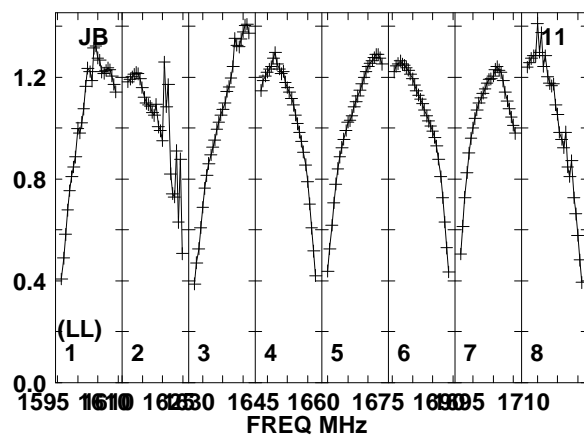
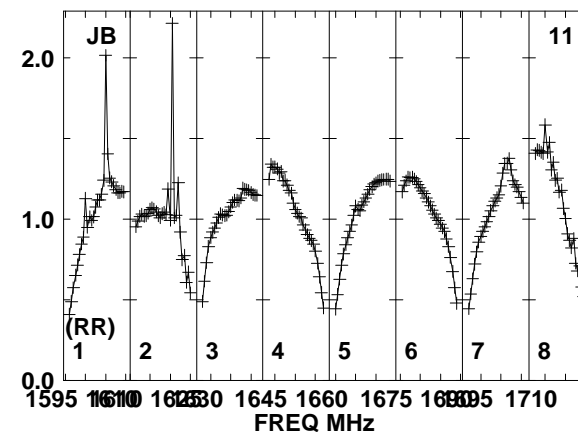
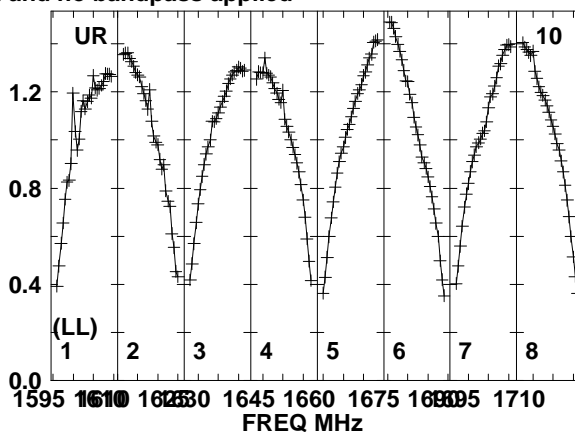
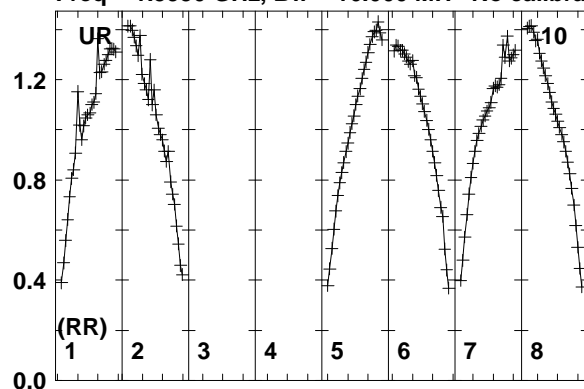

Lower frame: Real Jy
Total-power spectrum Antenna: UR (10)
Timerange: 00/10:16:24 to 00/10:18:08

Plot file version 383 created 11-AUG-2014 17:05:44

J2032+4127 EM110 2.UVDATA.1

Freq = 1.5950 GHz, Bw = 16.000 MH No calibration applied and no bandpass applied

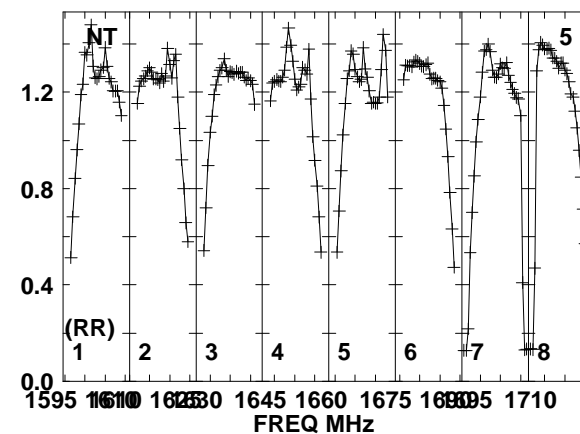
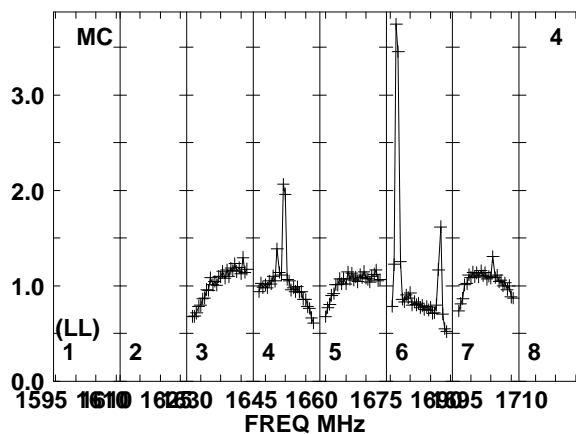
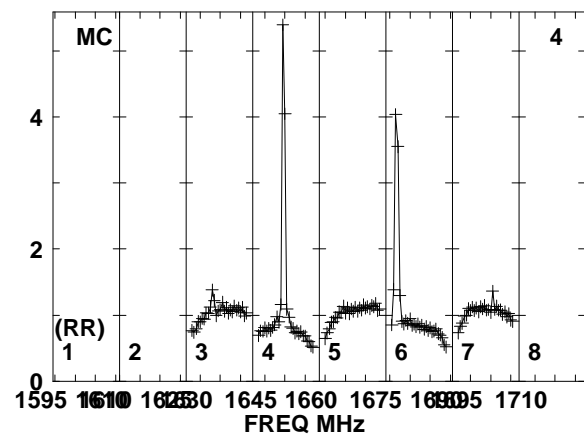
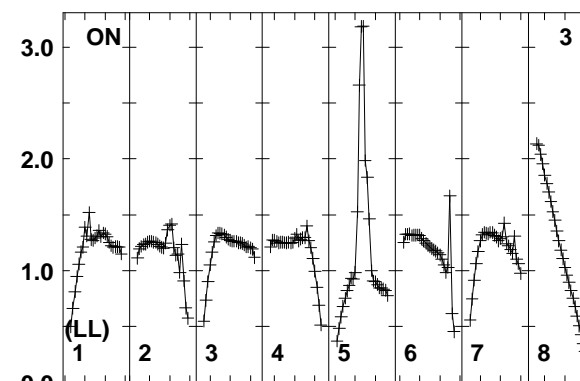
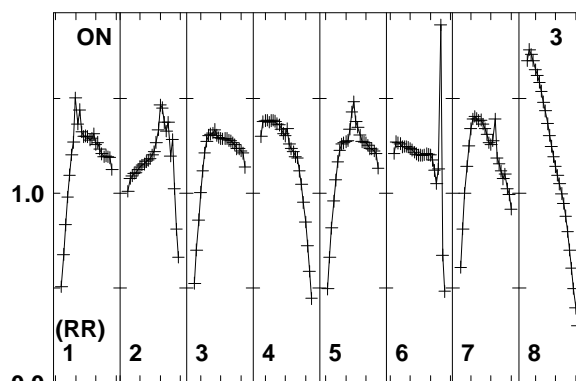
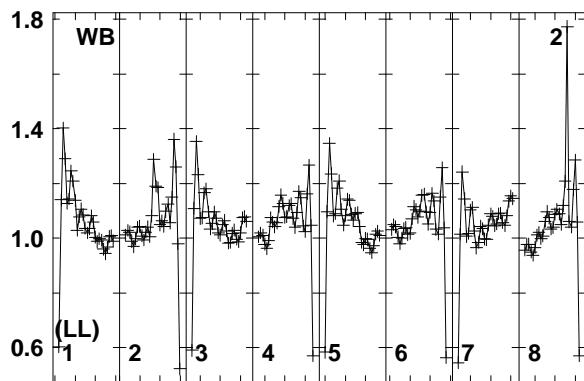
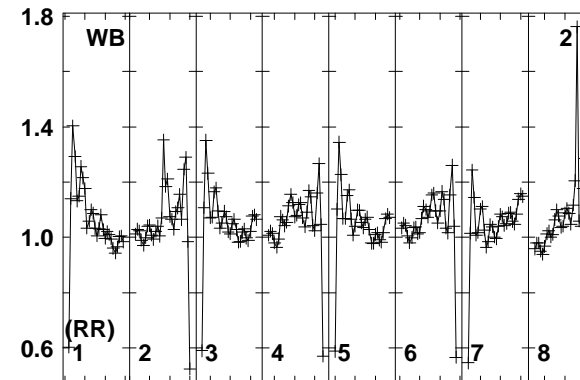
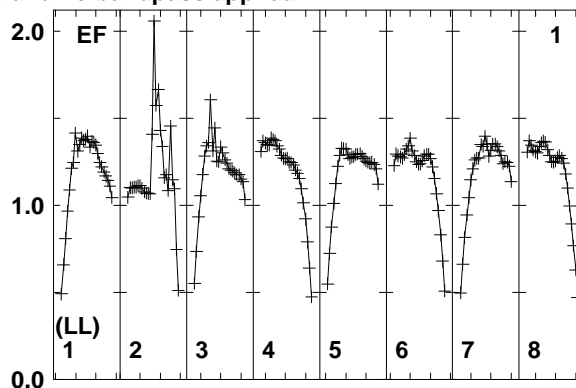
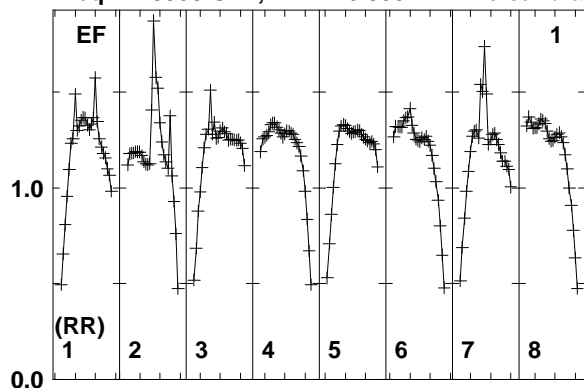

Lower frame: Real Jy
Total-power spectrum Antenna: EF (01)
Timerange: 00/10:18:24 to 00/10:22:08

Plot file version 384 created 11-AUG-2014 17:05:44

J2032+4127 EM110 2.UVDATA.1

Freq = 1.5950 GHz, Bw = 16.000 MH No calibration applied and no bandpass applied

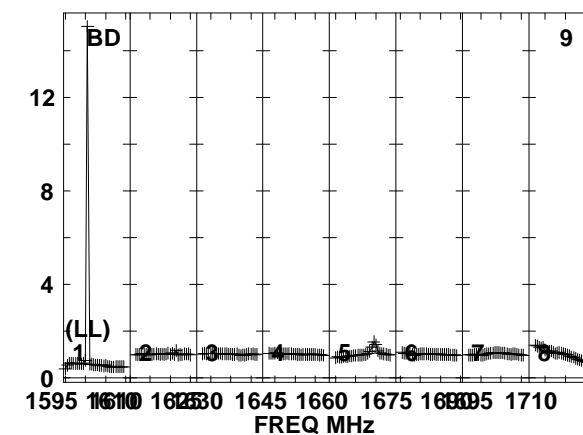
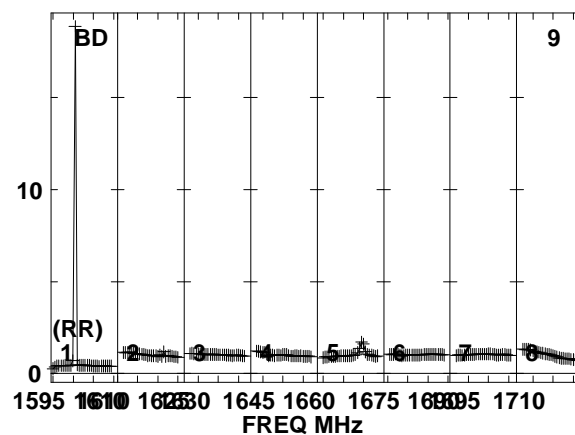
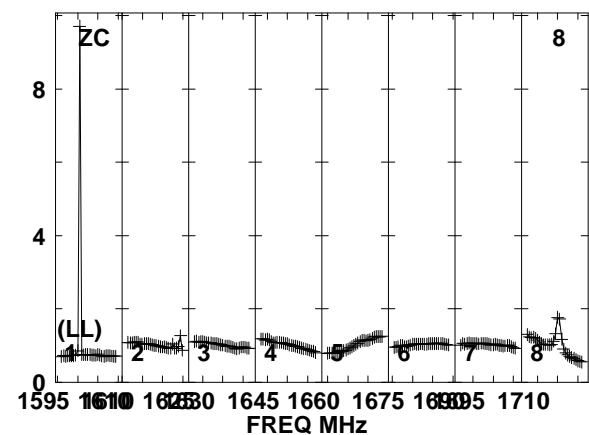
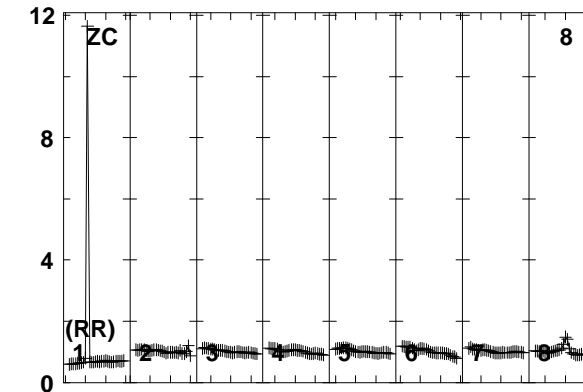
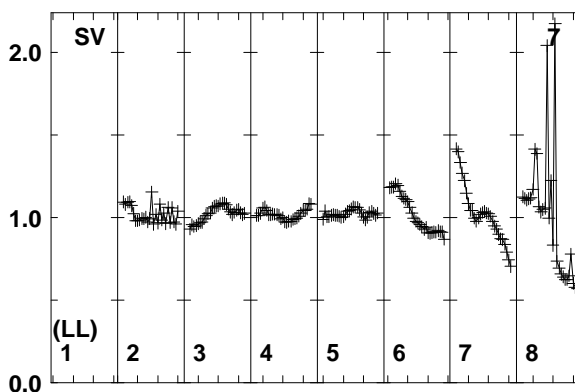
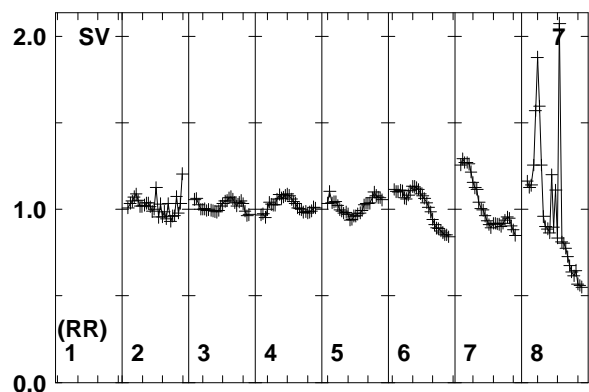
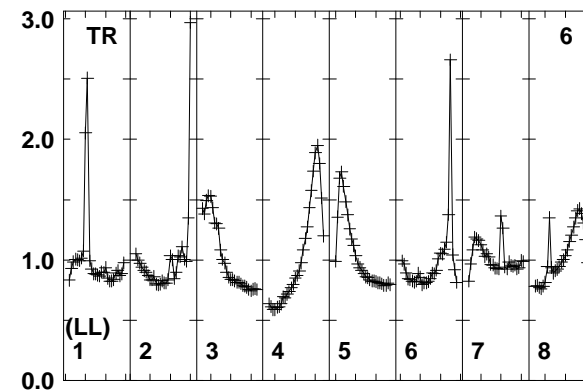
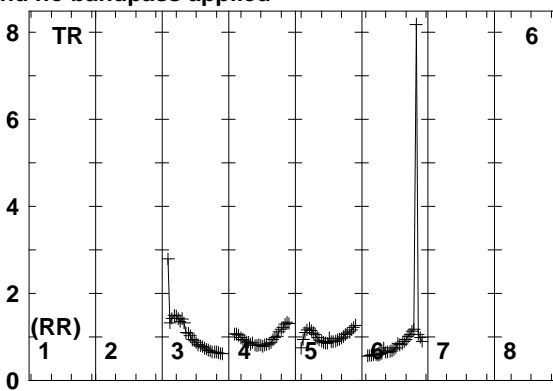
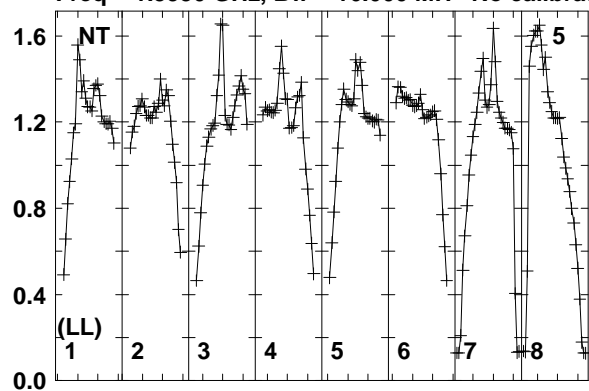

Lower frame: Real Jy
Total-power spectrum Antenna: NT (05)
Timerange: 00/10:18:24 to 00/10:22:08

Plot file version 385 created 11-AUG-2014 17:05:44

J2032+4127 EM110 2.UVDATA.1

Freq = 1.5950 GHz, Bw = 16.000 MH No calibration applied and no bandpass applied

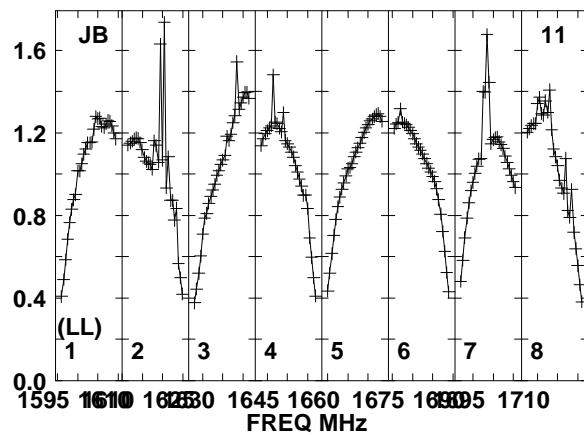
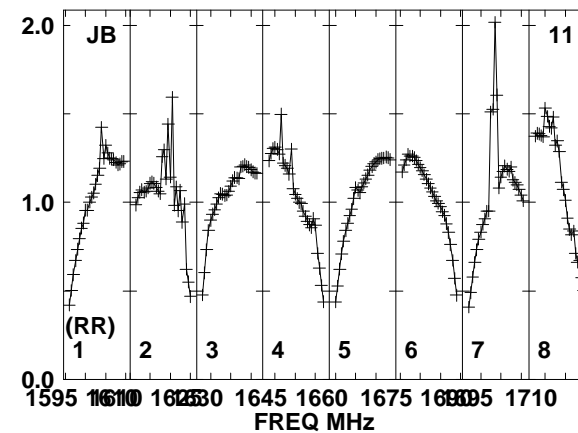
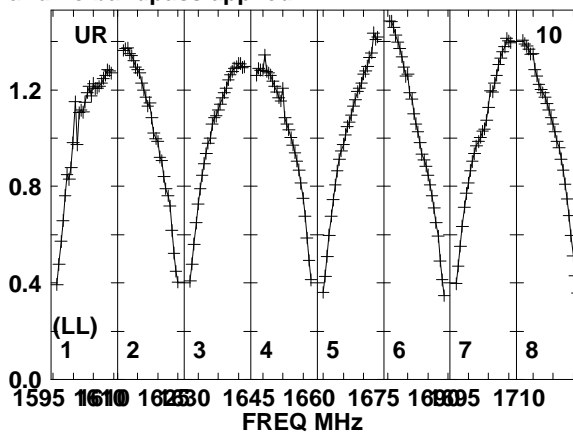
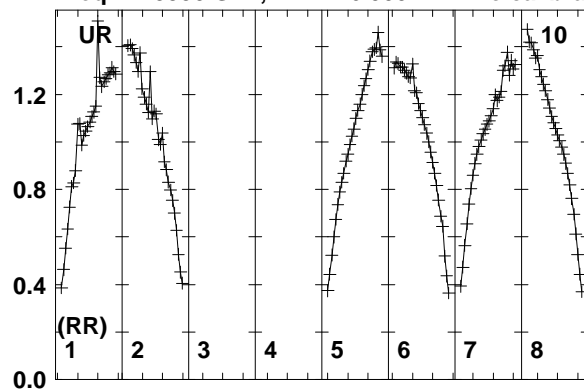

Lower frame: Real Jy
Total-power spectrum Antenna: UR (10)
Timerange: 00/10:18:24 to 00/10:22:08

Plot file version 386 created 11-AUG-2014 17:05:44

J2015+3710 EM110 2.UVDATA.1

Freq = 1.5950 GHz, Bw = 16.000 MH No calibration applied and no bandpass applied

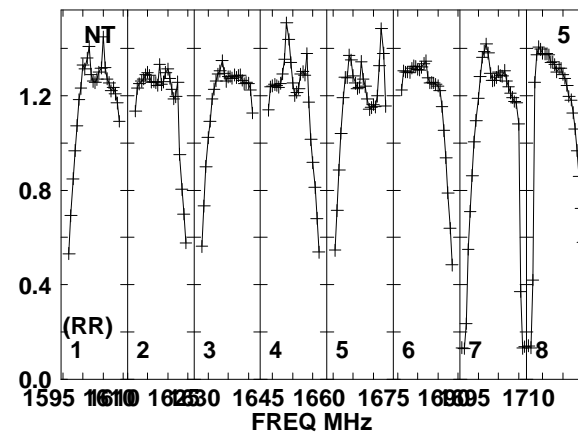
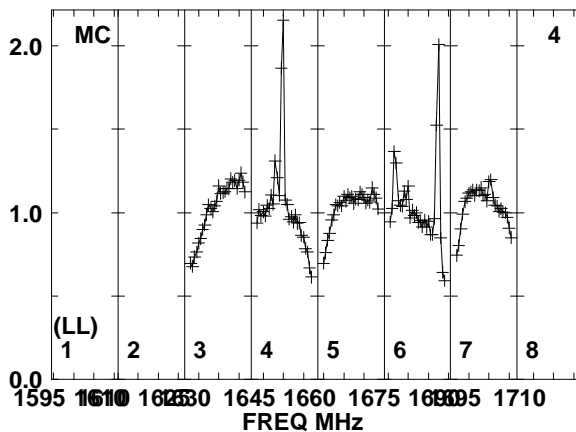
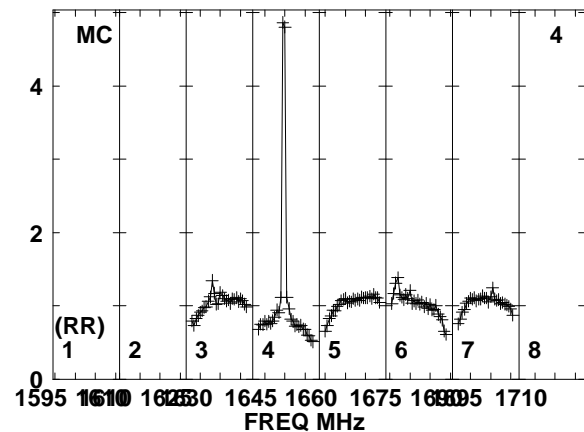
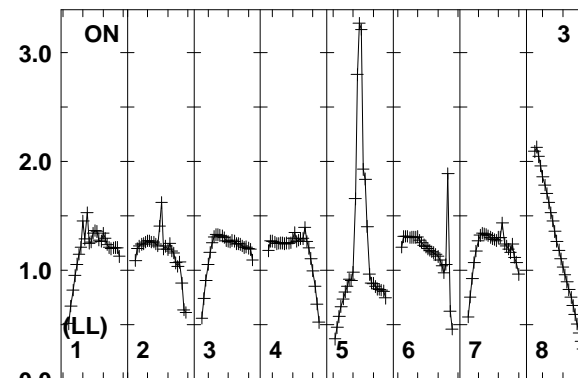
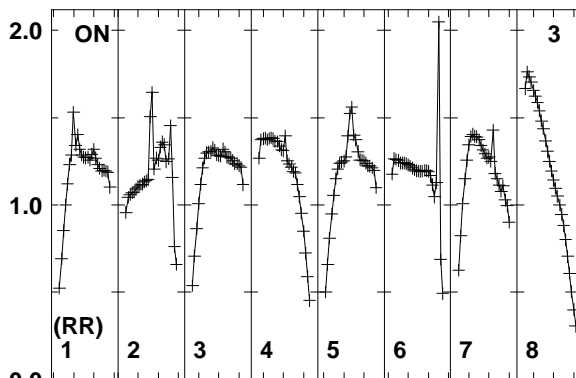
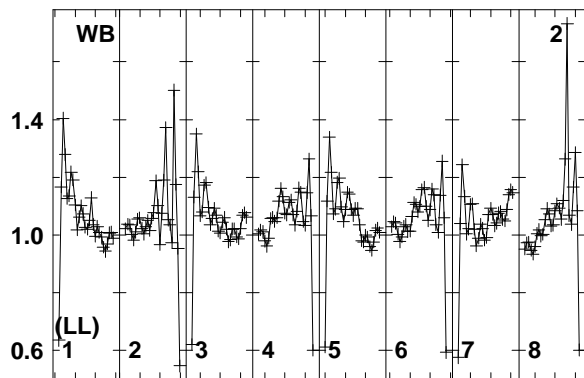
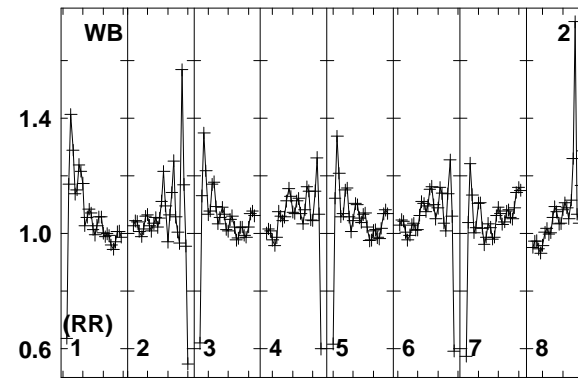
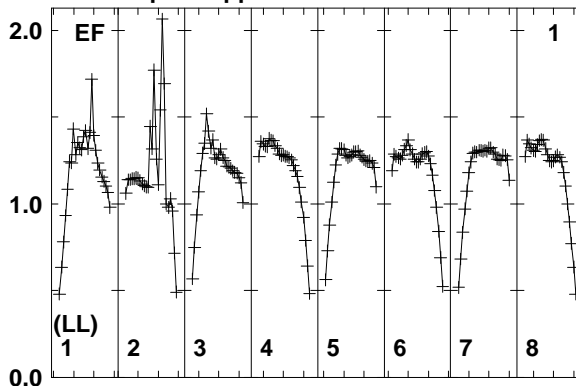
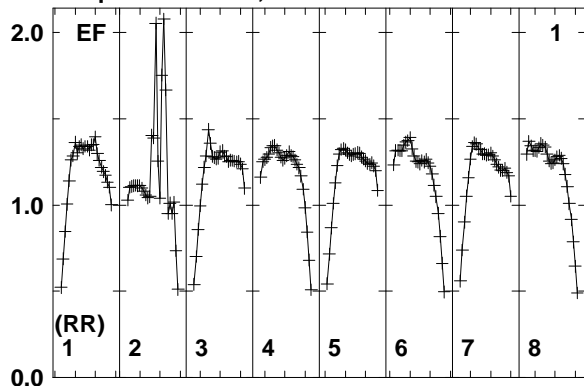

Lower frame: Real Jy
Total-power spectrum Antenna: EF (01)
Timerange: 00/10:23:11 to 00/10:25:09

Plot file version 387 created 11-AUG-2014 17:05:44

J2015+3710 EM110 2.UVDATA.1

Freq = 1.5950 GHz, Bw = 16.000 MH No calibration applied and no bandpass applied

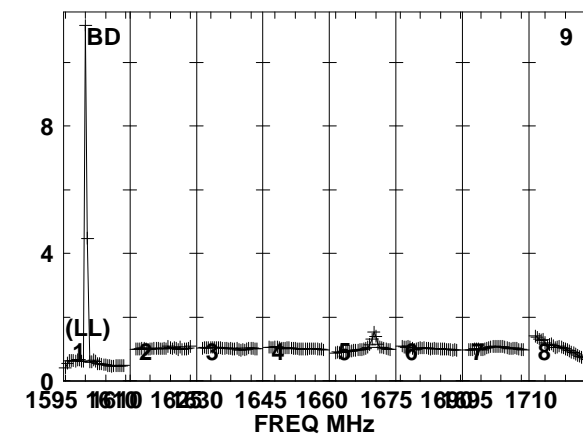
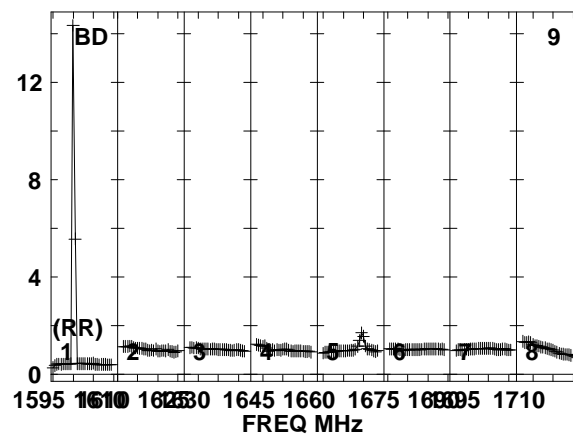
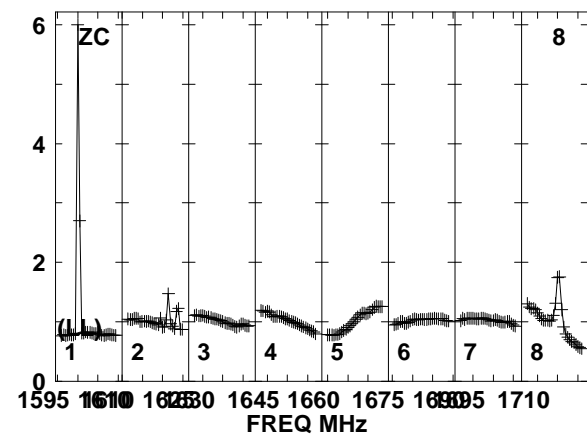
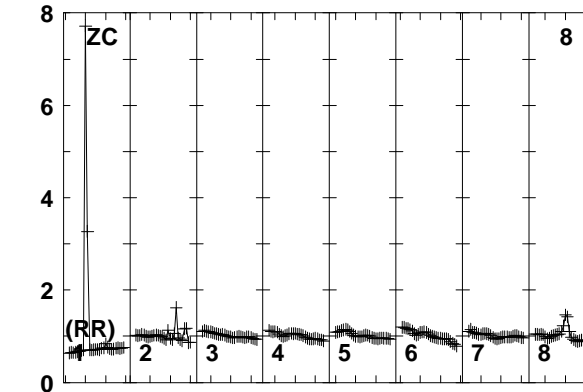
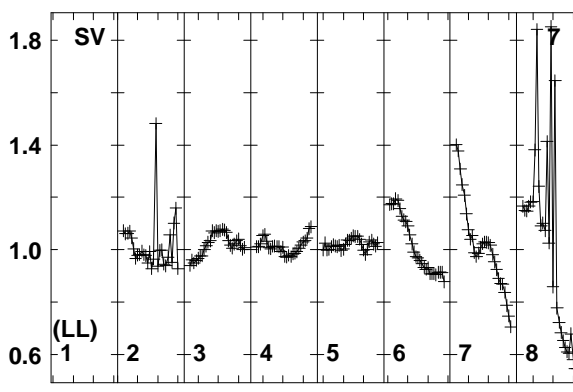
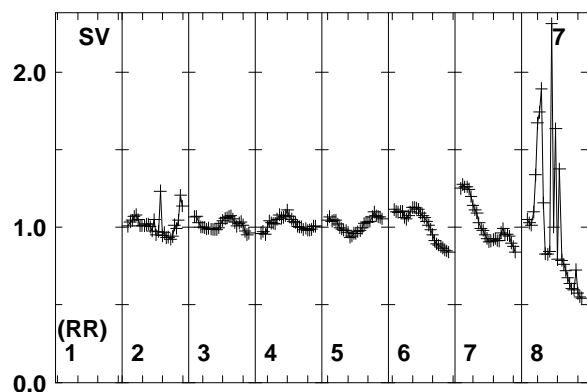
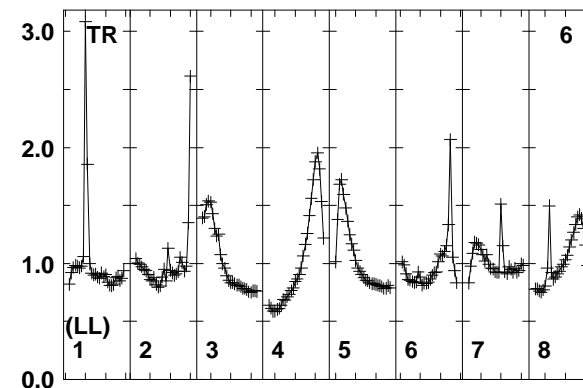
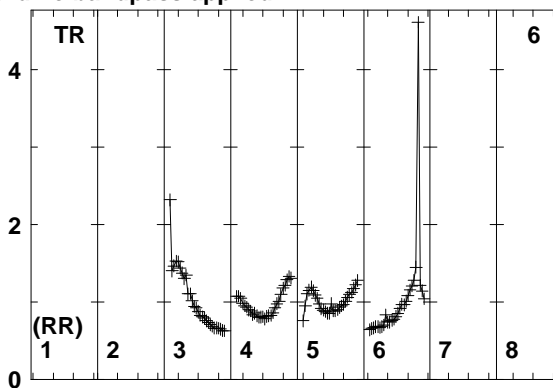
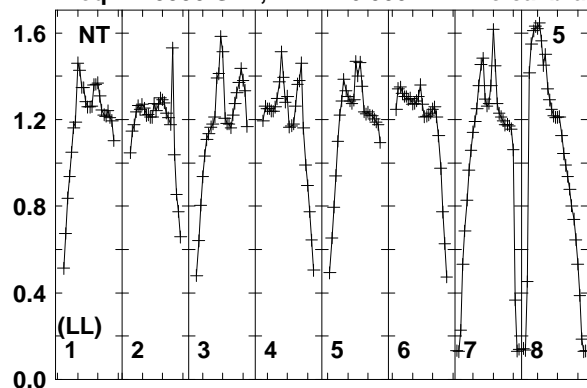

1595 1610 1625 1640 1655 1670 1685 1700 1710
FREQ MHz
Lower frame: Real Jy
Total-power spectrum Antenna: NT (05)
Timerange: 00/10/23:11 to 00/10/25:09

Plot file version 388 created 11-AUG-2014 17:05:45

J2015+3710 EM110 2.UVDATA.1

Freq = 1.5950 GHz, Bw = 16.000 MH No calibration applied and no bandpass applied

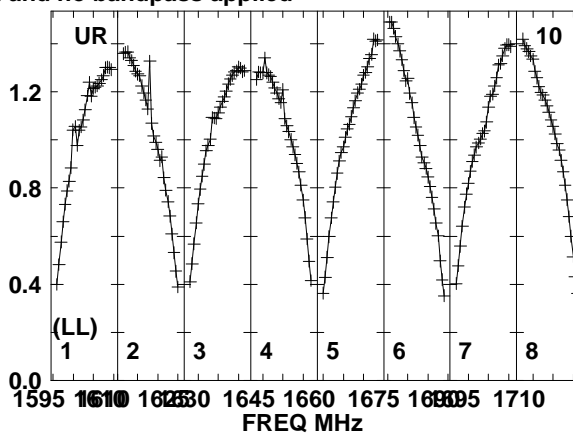
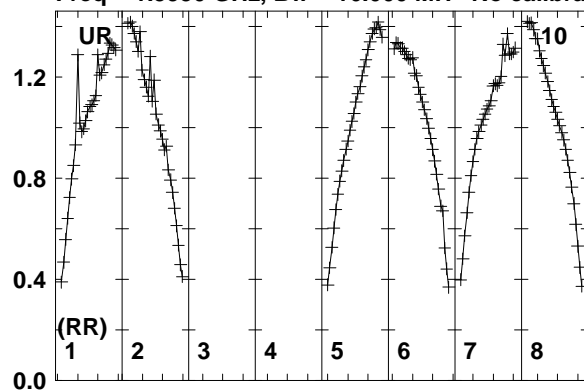

Lower frame: Real Jy
Total-power spectrum Antenna: UR (10)
Timerange: 00/10:23:11 to 00/10:25:09

Plot file version 389 created 11-AUG-2014 17:05:45

J2032+4127 EM110 2.UVDATA.1

Freq = 1.5950 GHz, Bw = 16.000 MH No calibration applied and no bandpass applied

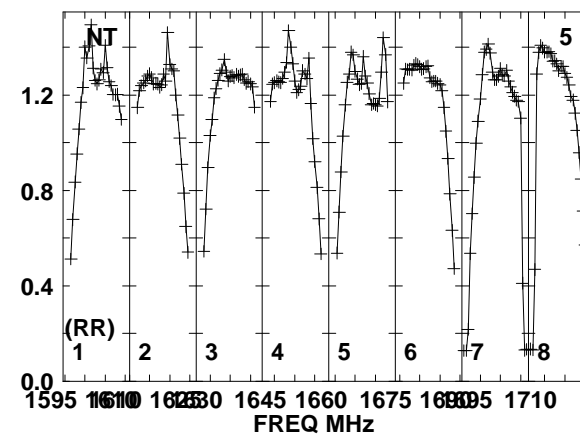
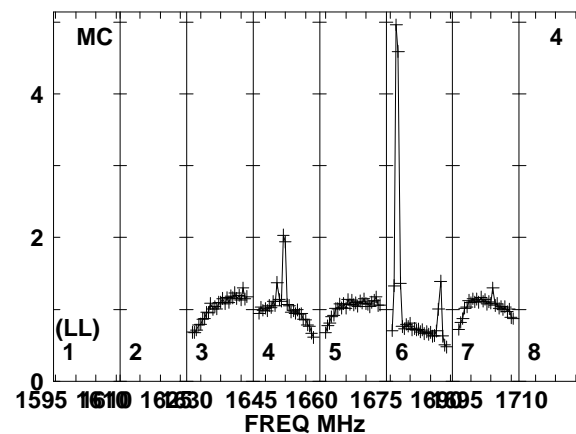
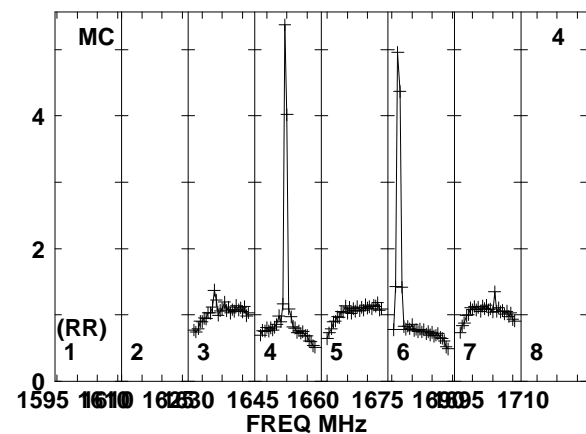
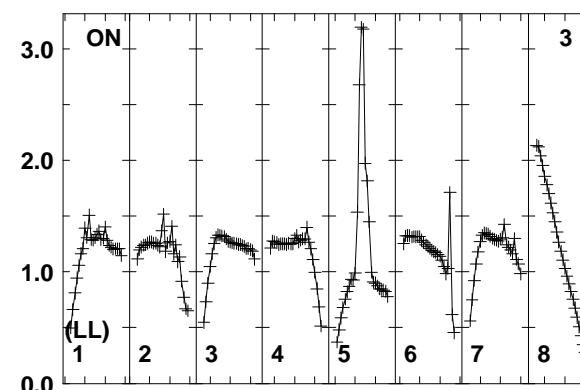
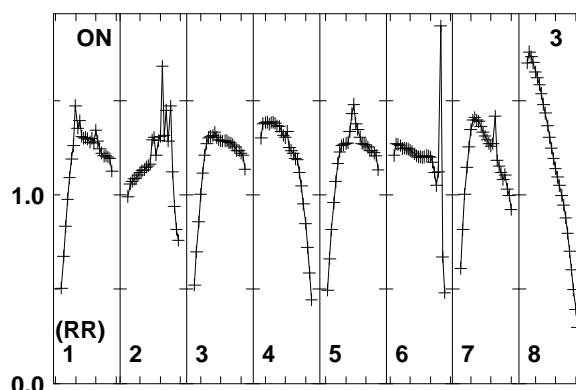
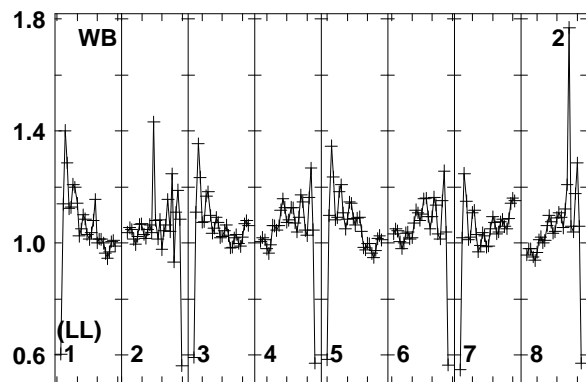
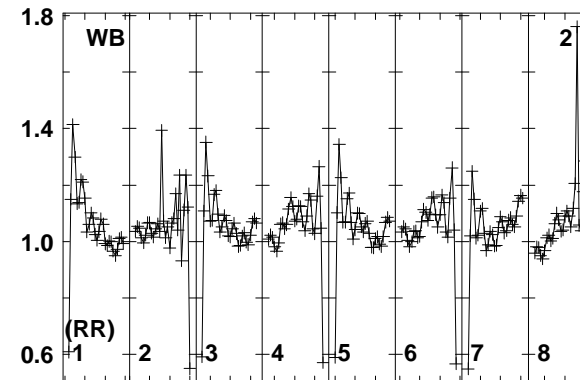
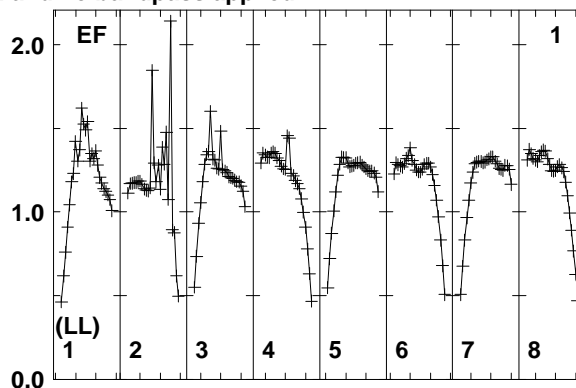
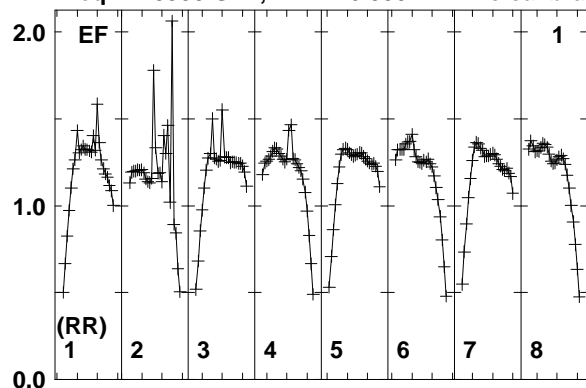

Lower frame: Real Jy
Total-power spectrum Antenna: EF (01)
Timerange: 00/10:25:11 to 00/10:29:09

Plot file version 390 created 11-AUG-2014 17:05:45

J2032+4127 EM110 2.UVDATA.1

Freq = 1.5950 GHz, Bw = 16.000 MH No calibration applied and no bandpass applied

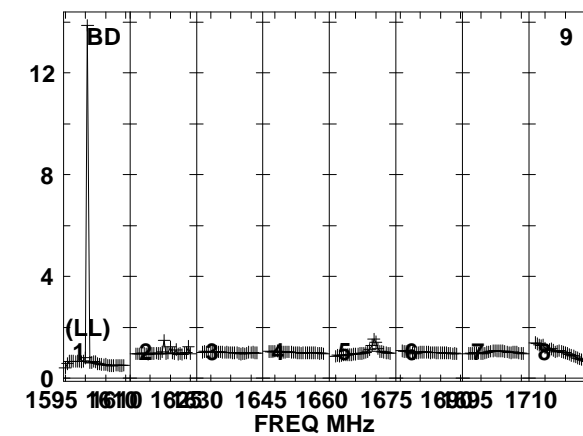
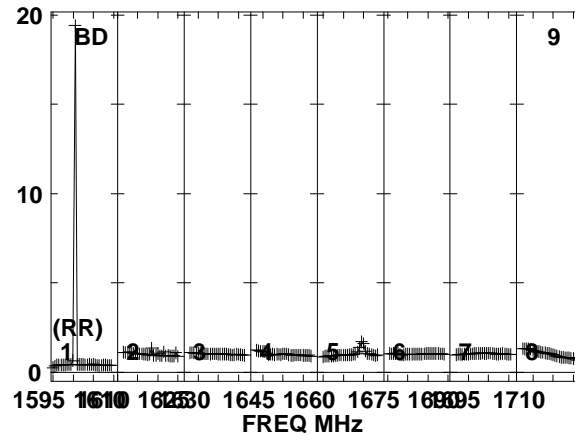
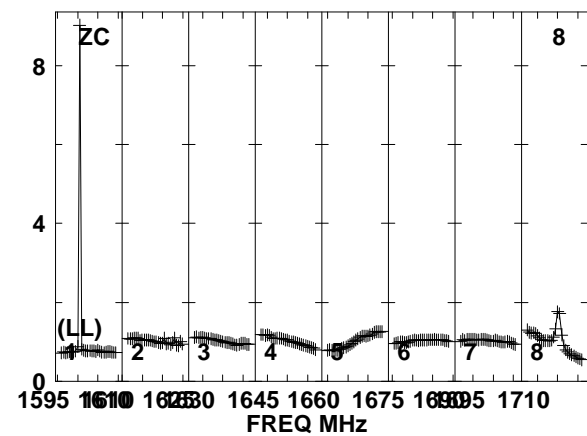
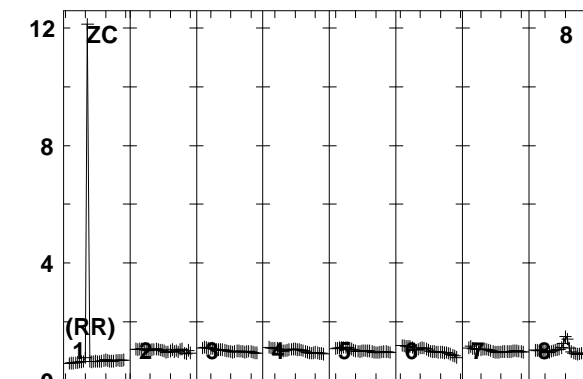
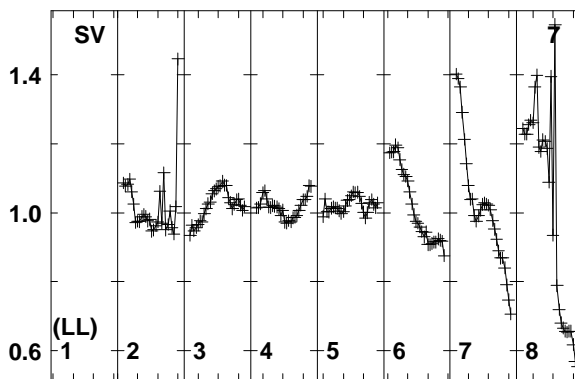
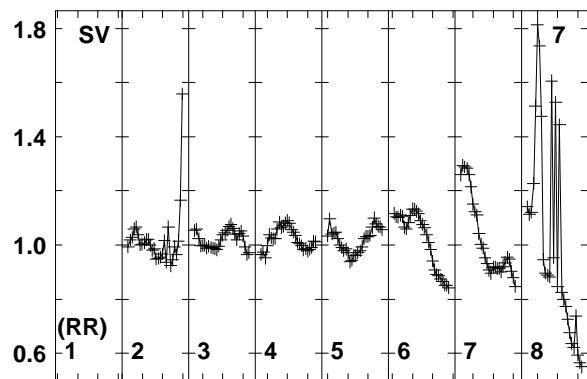
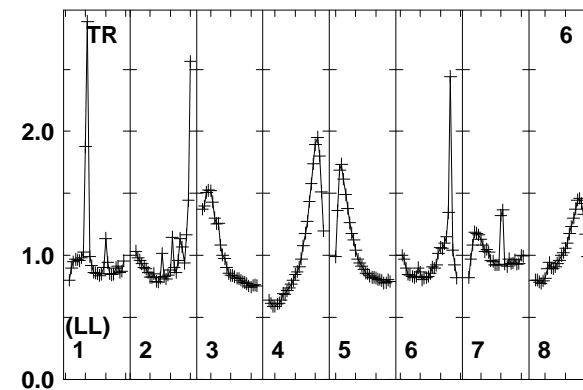
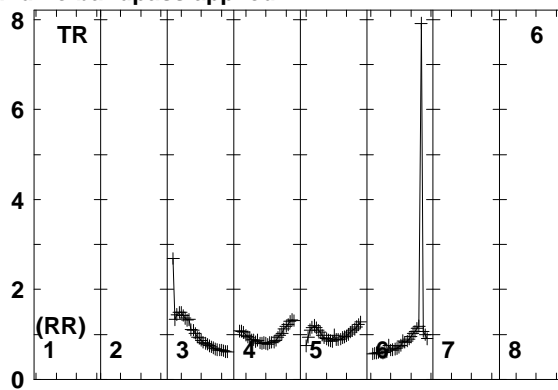
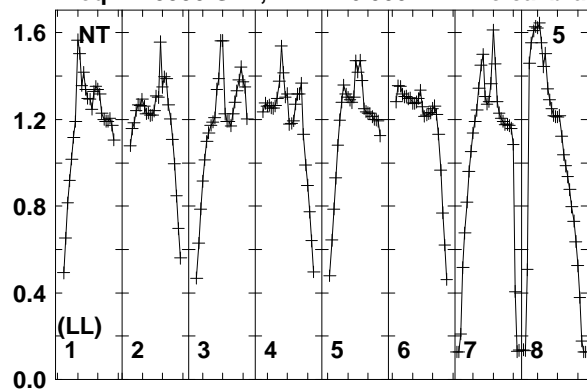

1595 1610 1625 1640 1655 1670 1685 1700 1710
FREQ MHz
Lower frame: Real Jy
Total-power spectrum Antenna: NT (05)
Timerange: 00/10:25:11 to 00/10:29:09

Plot file version 391 created 11-AUG-2014 17:05:45

J2032+4127 EM110 2.UVDATA.1

Freq = 1.5950 GHz, Bw = 16.000 MH No calibration applied and no bandpass applied

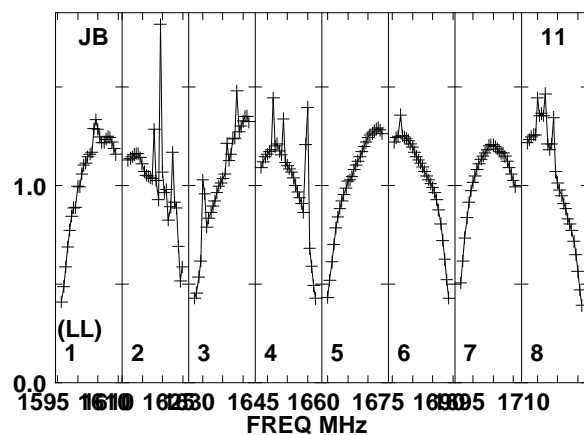
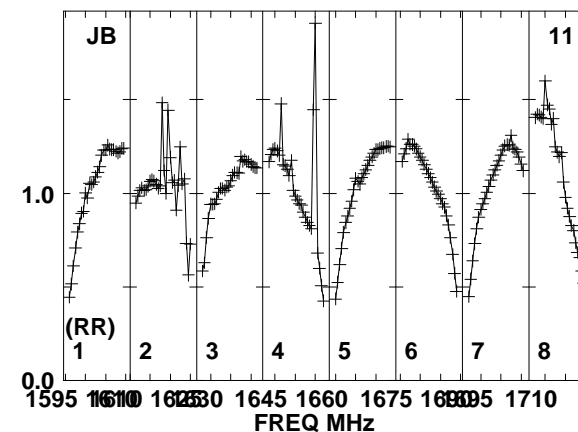
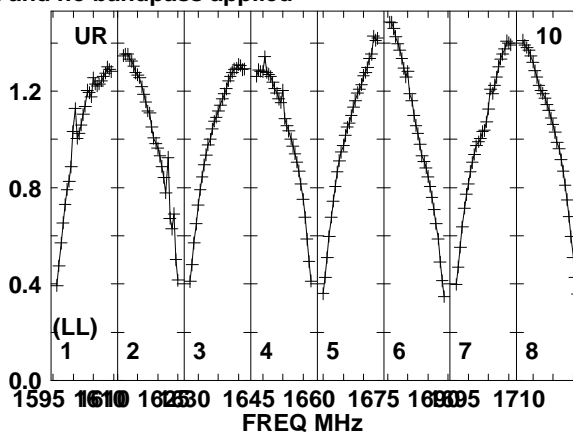
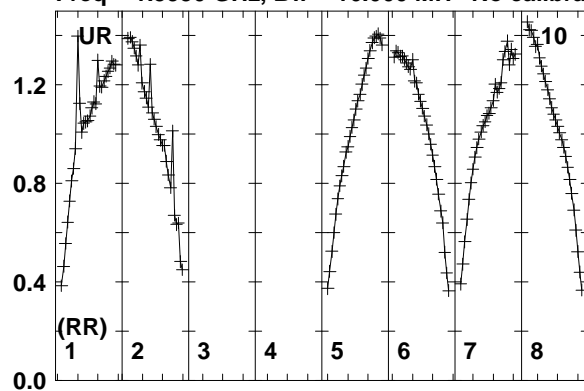

Lower frame: Real Jy
Total-power spectrum Antenna: UR (10)
Timerange: 00/10:25:11 to 00/10:29:09

Plot file version 392 created 11-AUG-2014 17:05:45

J2015+3710 EM110 2.UVDATA.1

Freq = 1.5950 GHz, Bw = 16.000 MH No calibration applied and no bandpass applied

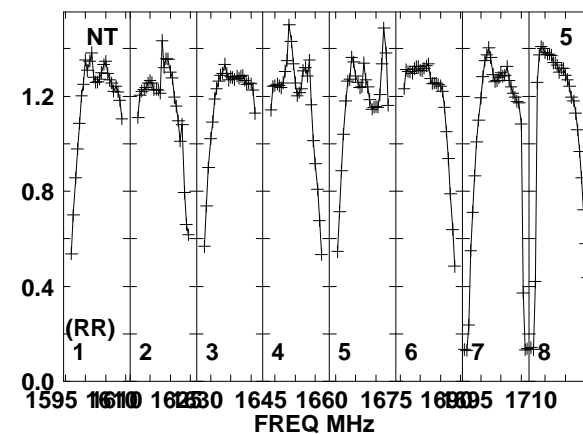
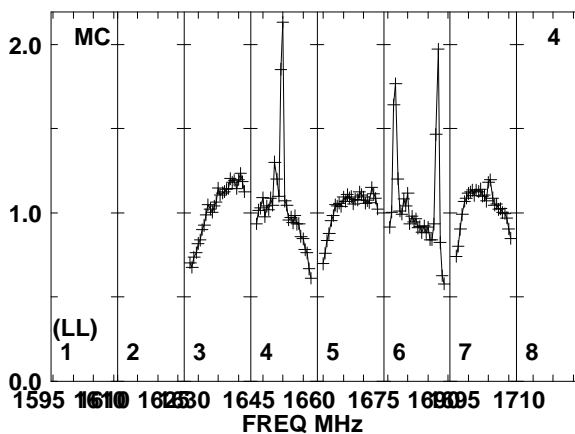
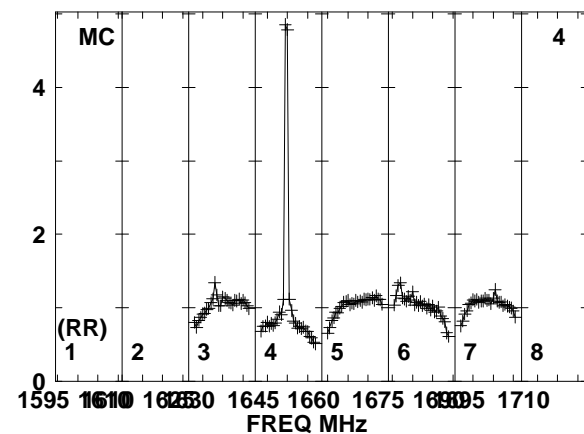
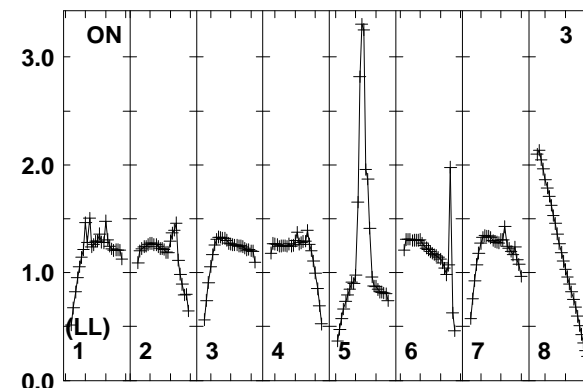
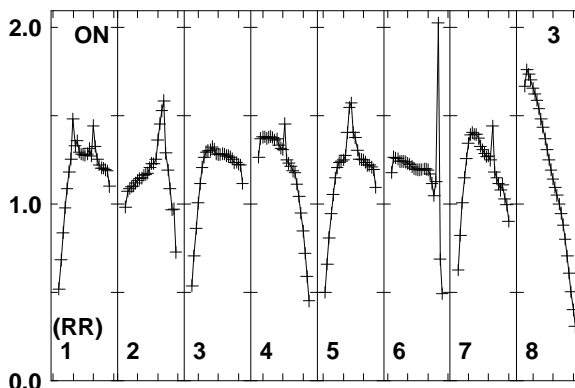
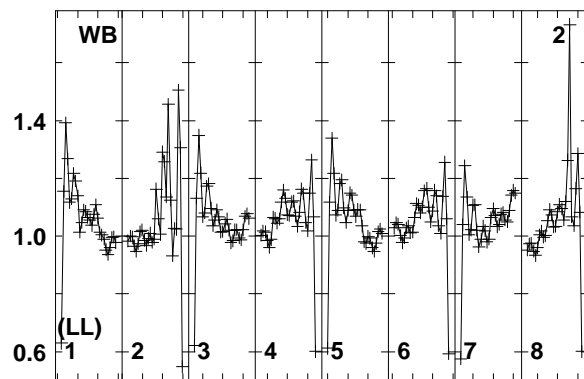
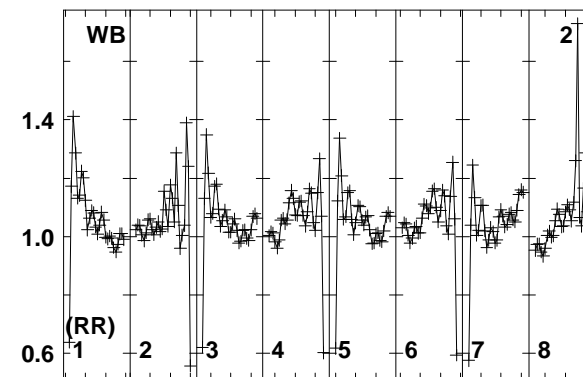
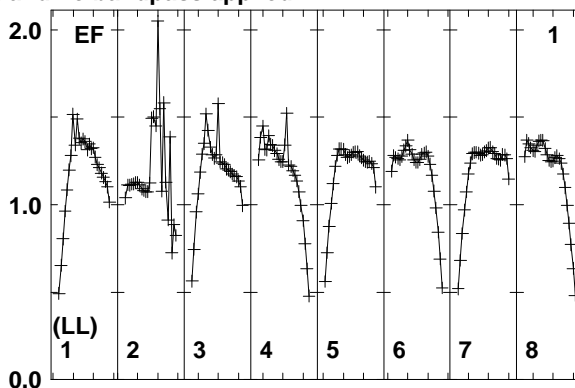
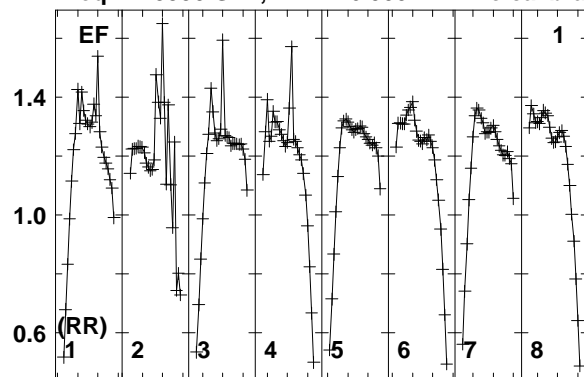

Lower frame: Real Jy
Total-power spectrum Antenna: EF (01)
Timerange: 00/10/30:11 to 00/10/32:09

Plot file version 393 created 11-AUG-2014 17:05:45

J2015+3710 EM110 2.UVDATA.1

Freq = 1.5950 GHz, Bw = 16.000 MH No calibration applied and no bandpass applied

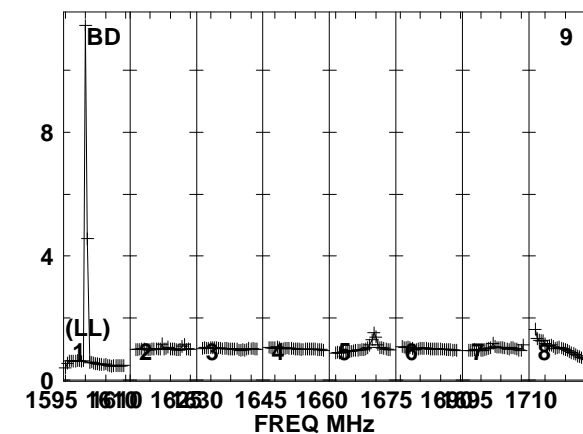
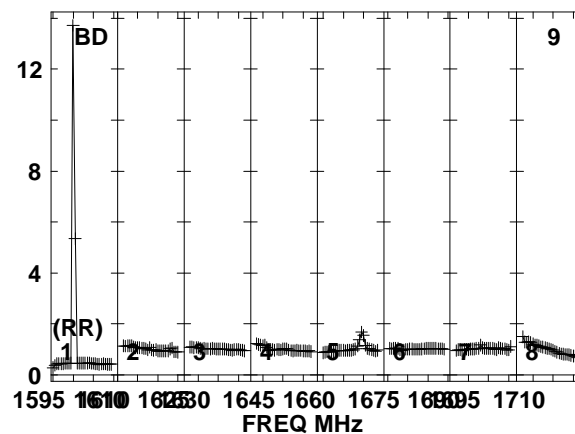
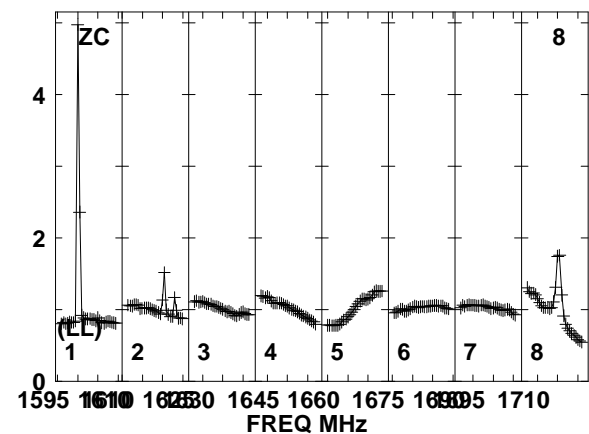
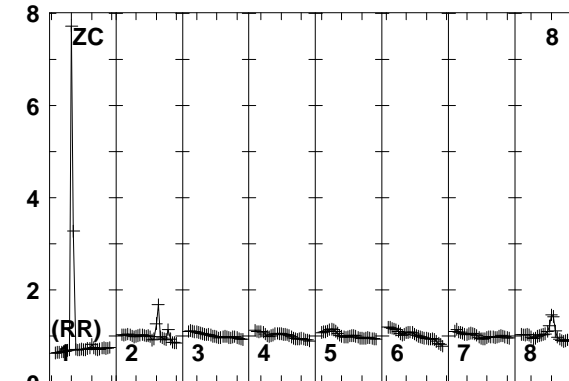
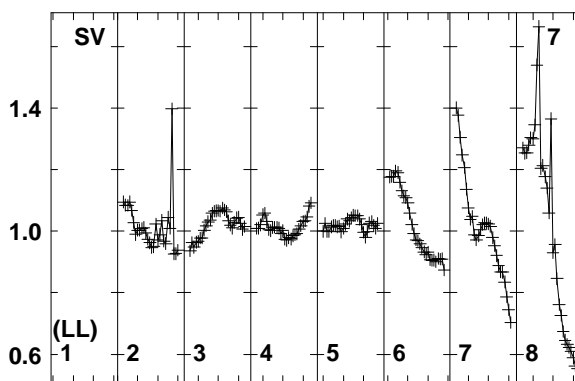
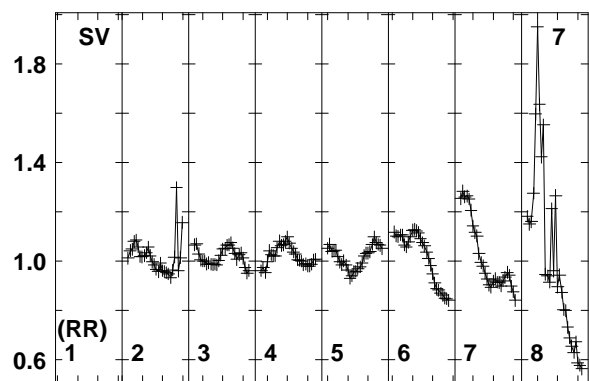
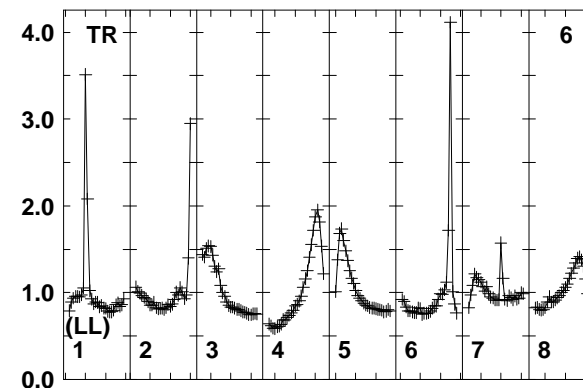
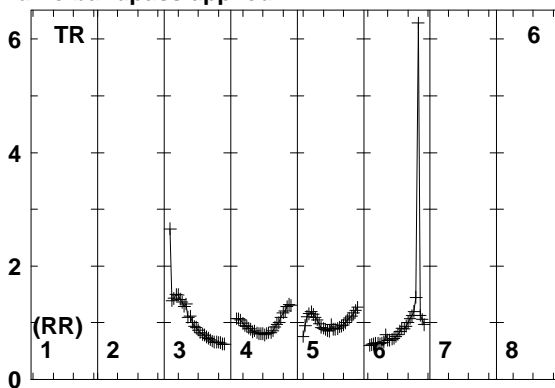
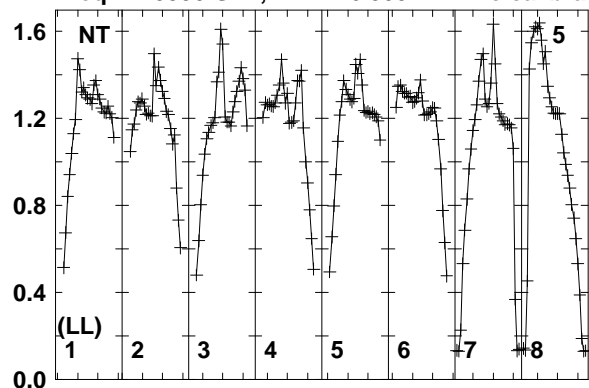

Lower frame: Real Jy
Total-power spectrum Antenna: NT (05)
Timerange: 00/10:30:11 to 00/10:32:09

Plot file version 394 created 11-AUG-2014 17:05:45

J2015+3710 EM110 2.UVDATA.1

Freq = 1.5950 GHz, Bw = 16.000 MH No calibration applied and no bandpass applied

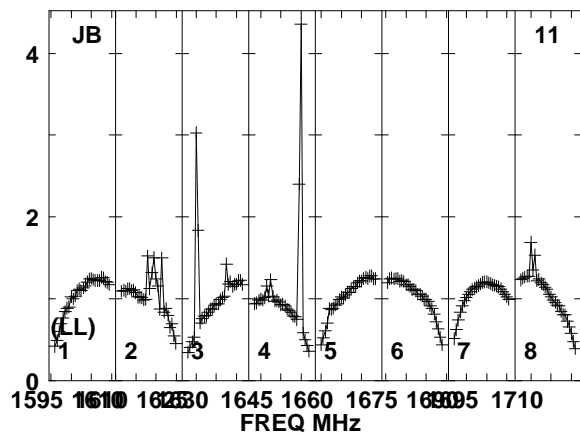
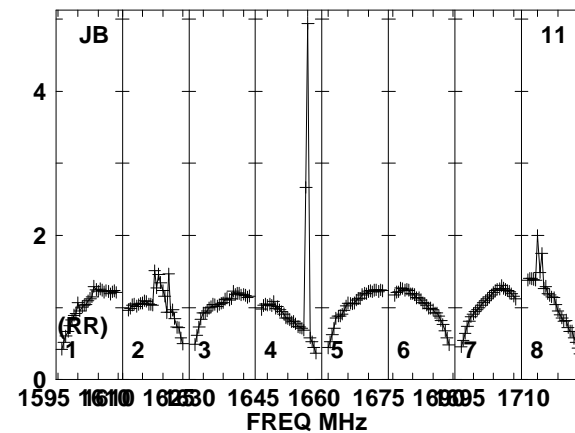
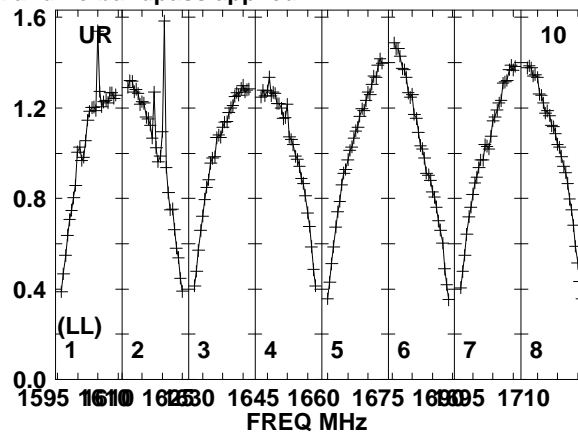
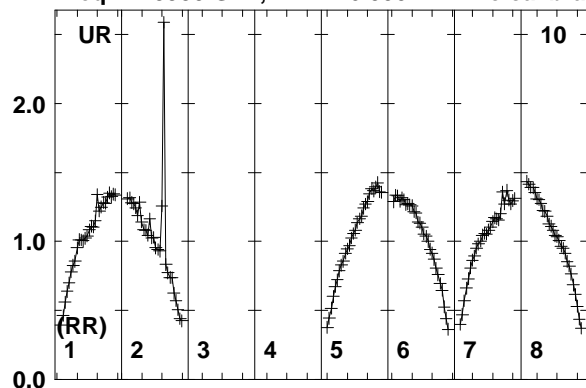

Lower frame: Real Jy
Total-power spectrum Antenna: UR (10)
Timerange: 00/10:30:11 to 00/10:32:09

Plot file version 395 created 11-AUG-2014 17:05:45

J2032+4127 EM110 2.UVDATA.1

Freq = 1.5950 GHz, Bw = 16.000 MH No calibration applied and no bandpass applied

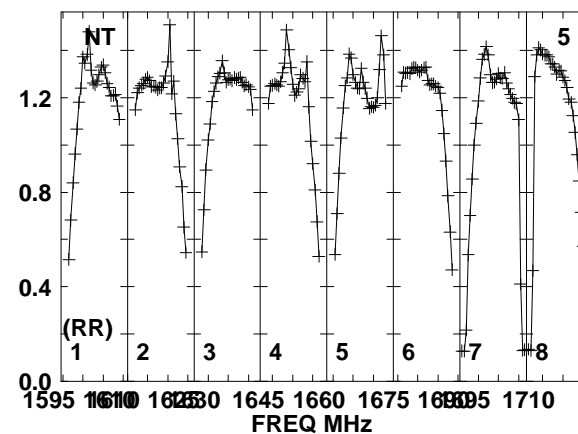
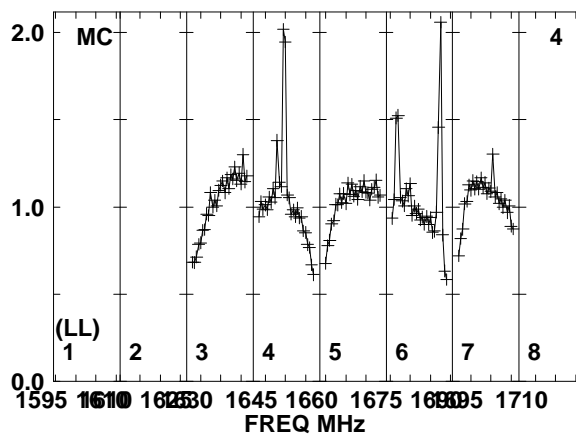
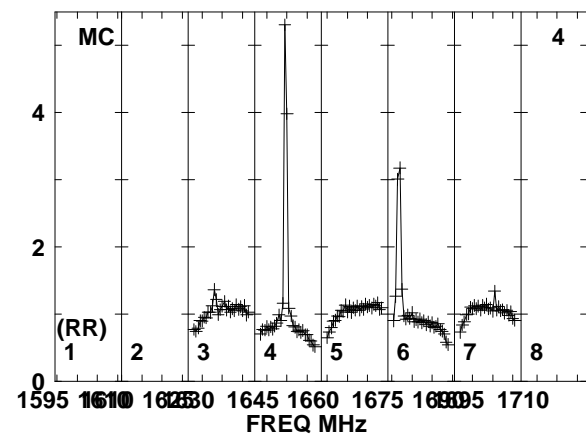
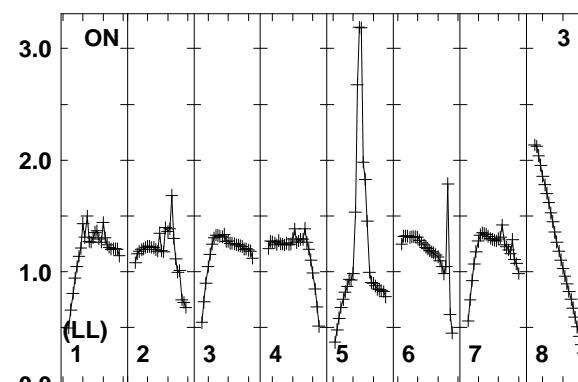
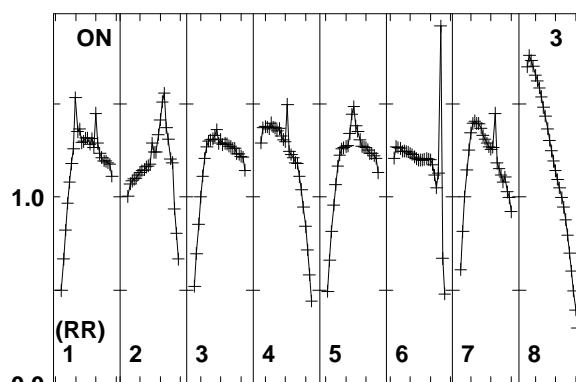
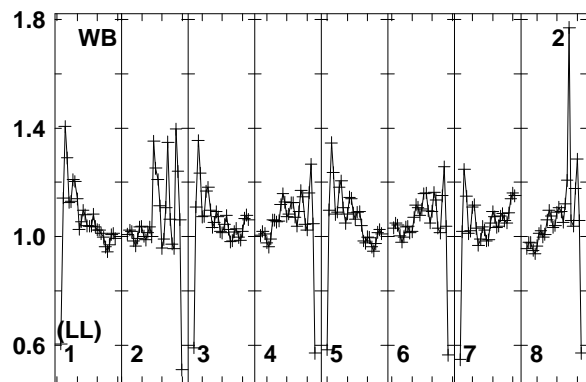
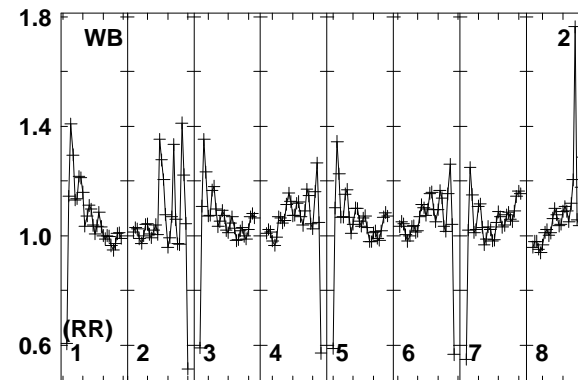
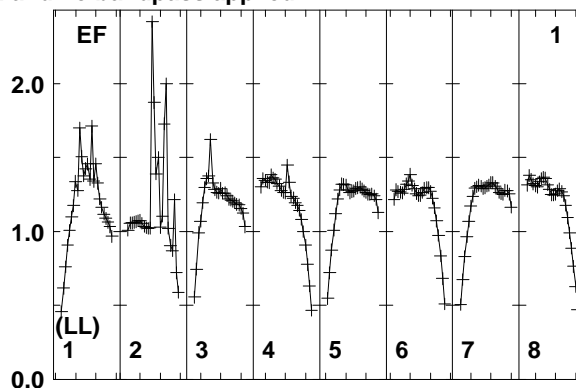
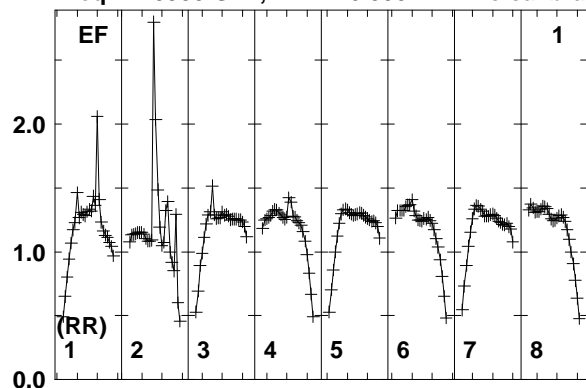

Lower frame: Real Jy
Total-power spectrum Antenna: EF (01)
Timerange: 00/10:32:24 to 00/10:36:08

Plot file version 396 created 11-AUG-2014 17:05:45

J2032+4127 EM110 2.UVDATA.1

Freq = 1.5950 GHz, Bw = 16.000 MH No calibration applied and no bandpass applied

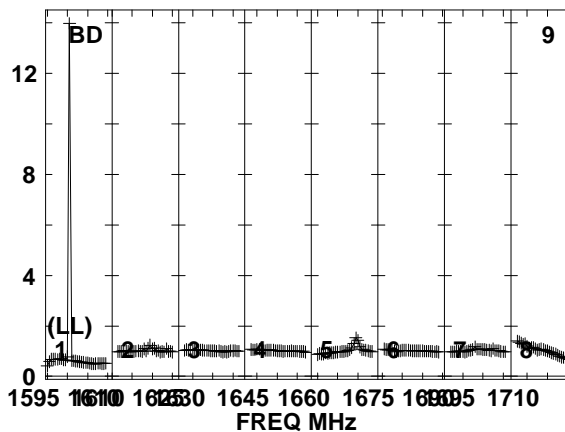
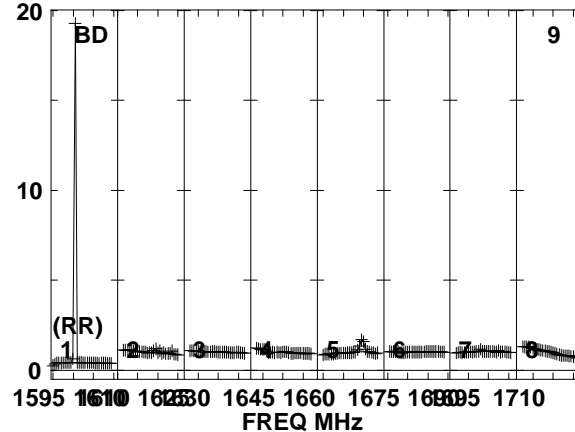
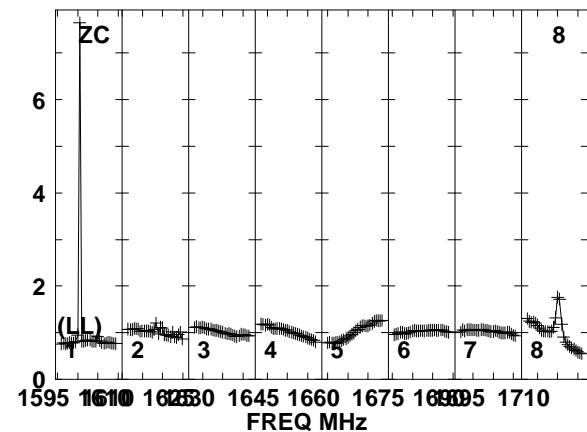
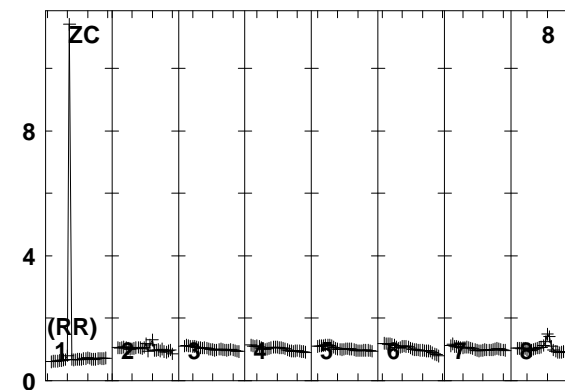
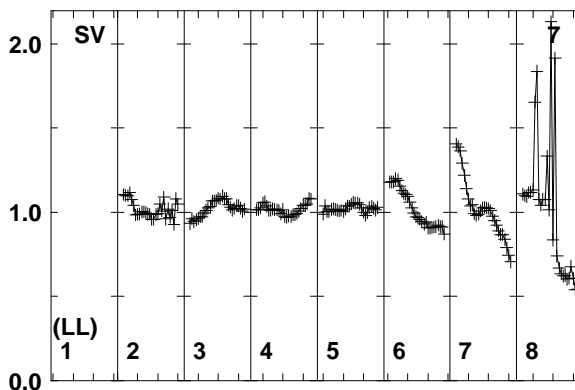
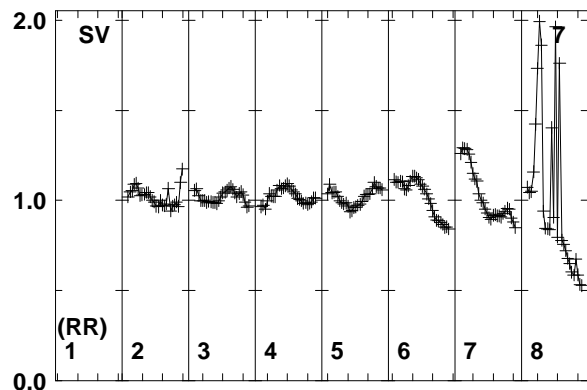
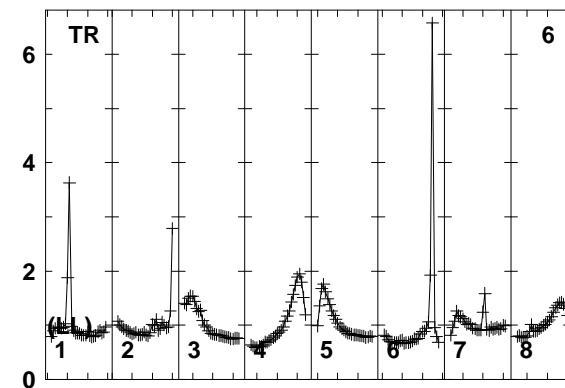
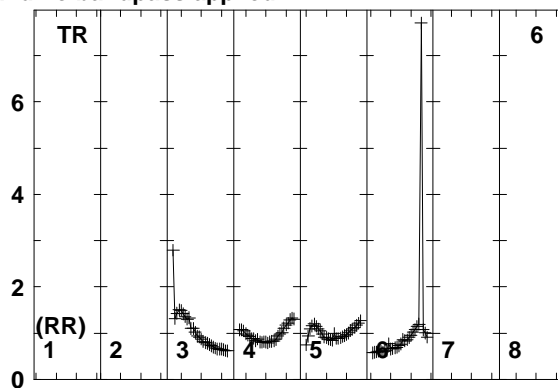
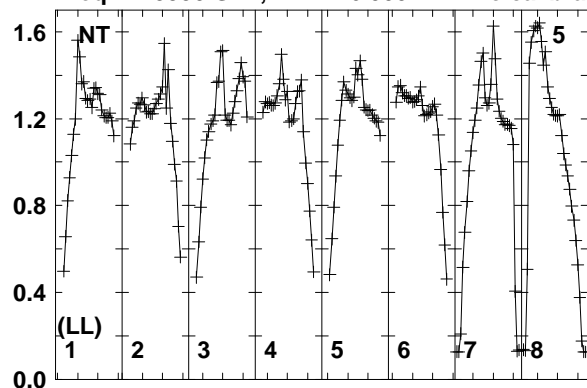

Lower frame: Real Jy
Total-power spectrum Antenna: NT (05)
Timerange: 00/10:32:24 to 00/10:36:08

Plot file version 397 created 11-AUG-2014 17:05:45

J2032+4127 EM110 2.UVDATA.1

Freq = 1.5950 GHz, Bw = 16.000 MH No calibration applied and no bandpass applied

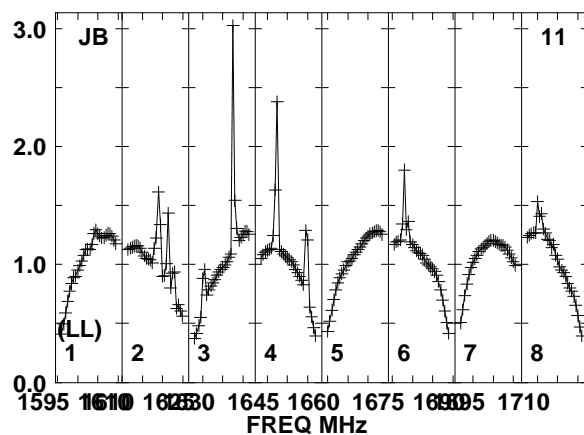
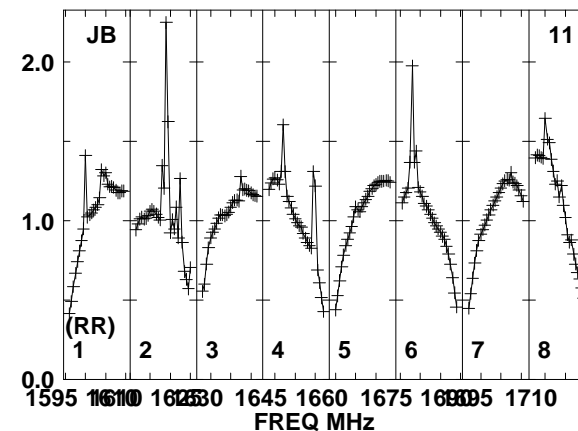
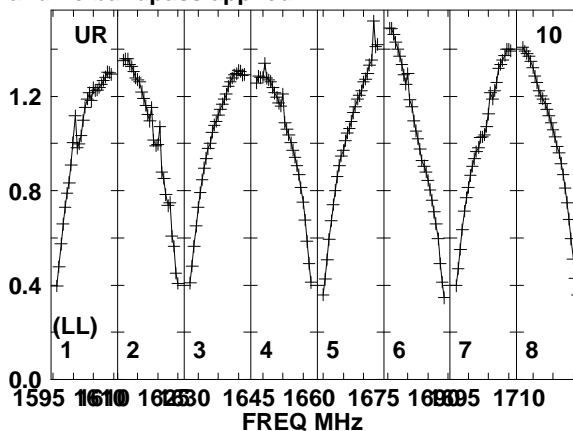
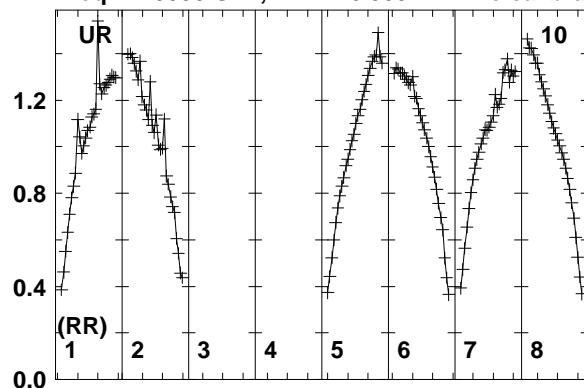

Lower frame: Real Jy
Total-power spectrum Antenna: UR (10)
Timerange: 00/10:32:24 to 00/10:36:08

Plot file version 398 created 11-AUG-2014 17:05:45

J2015+3710 EM110 2.UVDATA.1

Freq = 1.5950 GHz, Bw = 16.000 MH No calibration applied and no bandpass applied

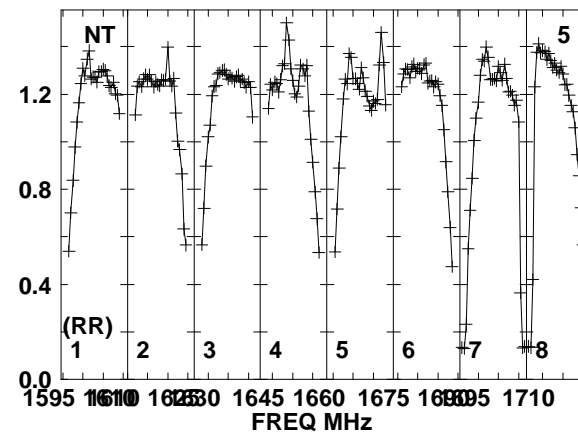
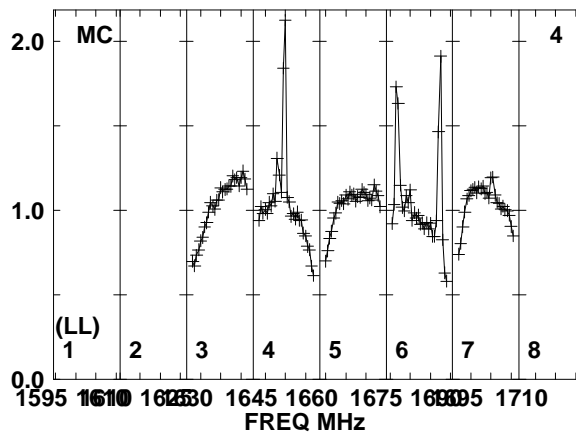
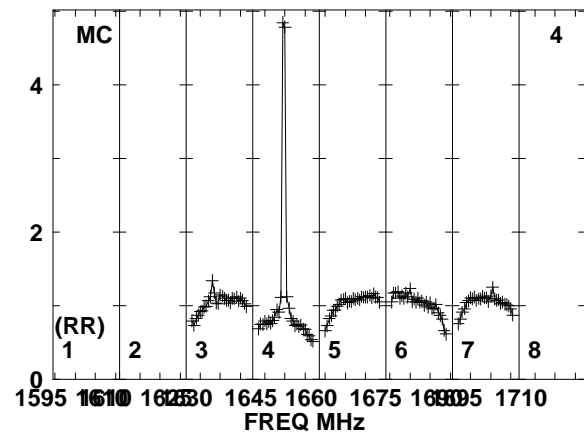
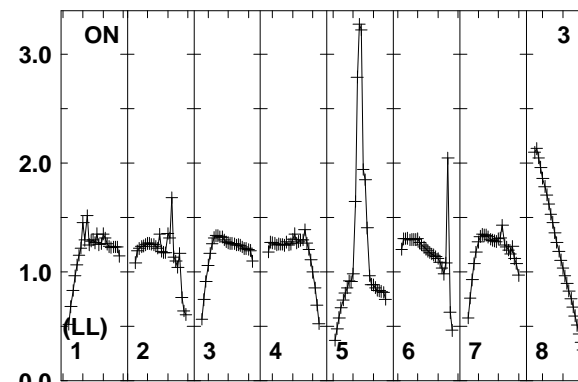
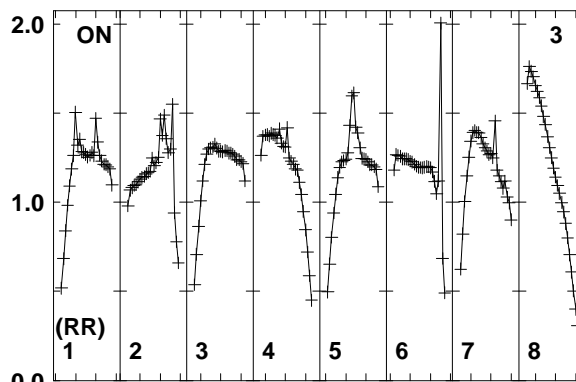
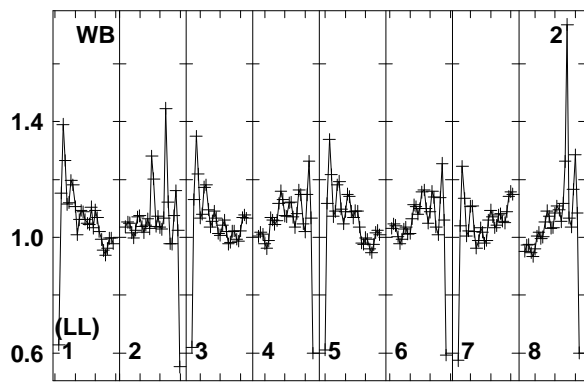
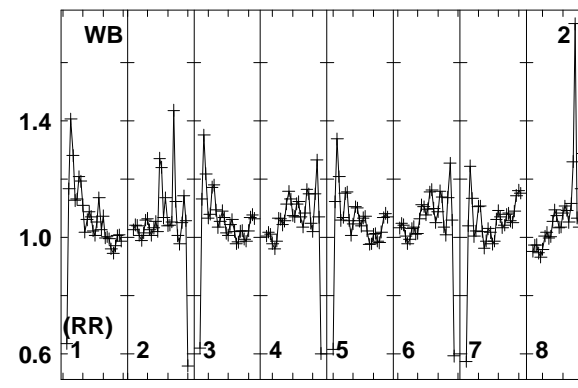
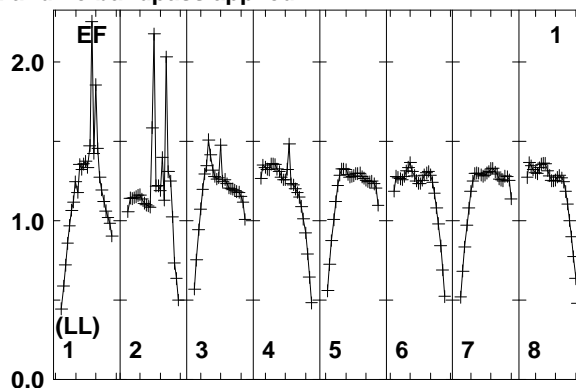
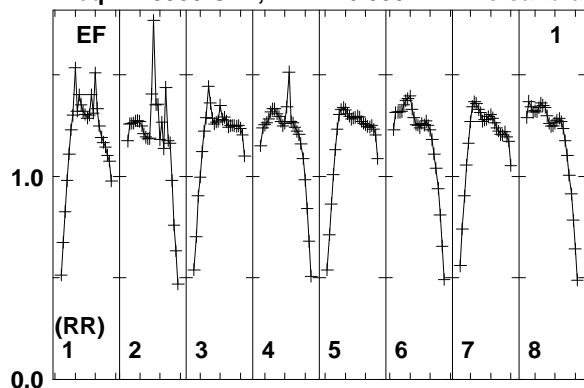

Lower frame: Real Jy
Total-power spectrum Antenna: EF (01)
Timerange: 00/10:36:24 to 00/10:38:08

Plot file version 399 created 11-AUG-2014 17:05:45

J2015+3710 EM110 2.UVDATA.1

Freq = 1.5950 GHz, Bw = 16.000 MH No calibration applied and no bandpass applied

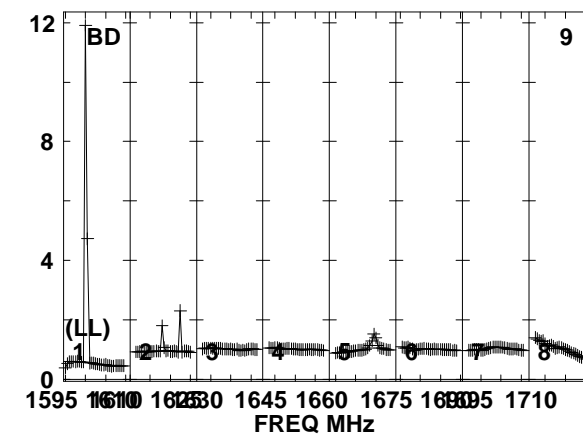
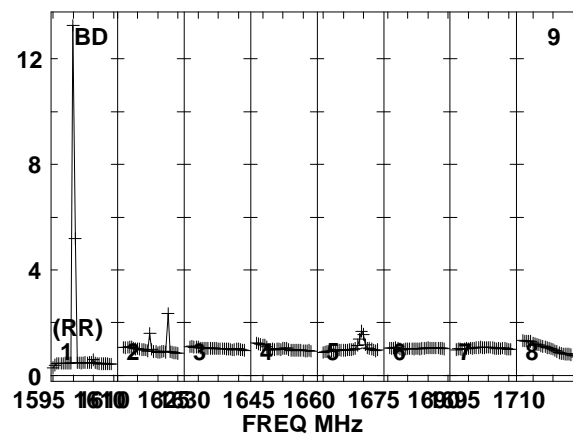
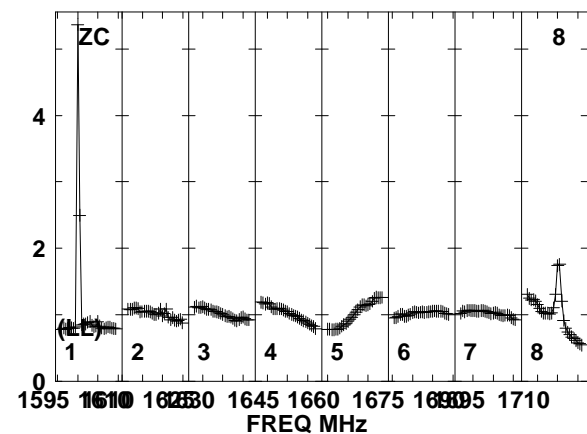
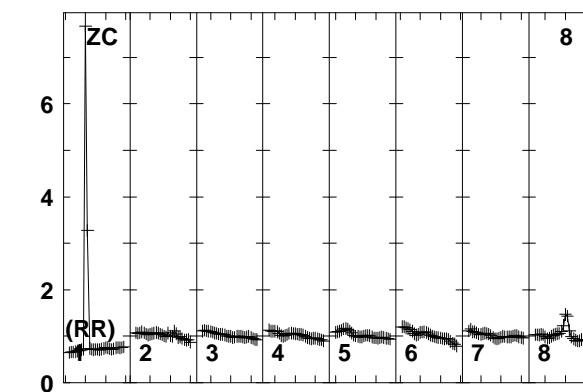
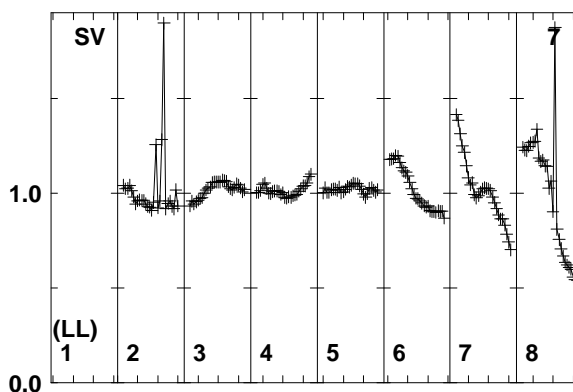
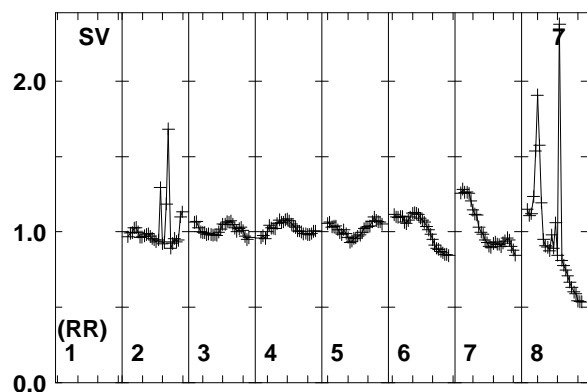
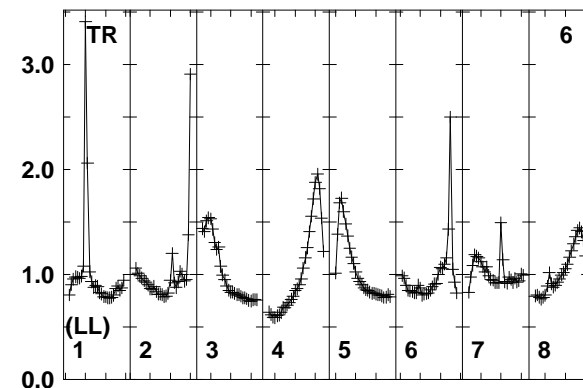
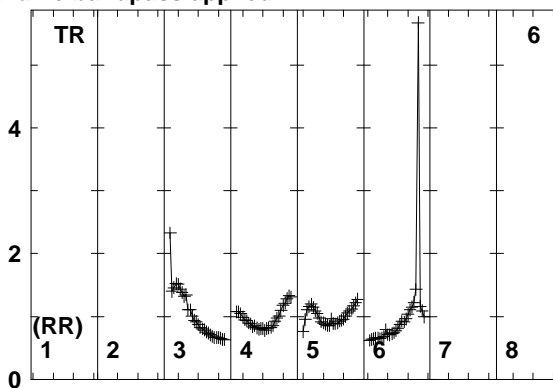
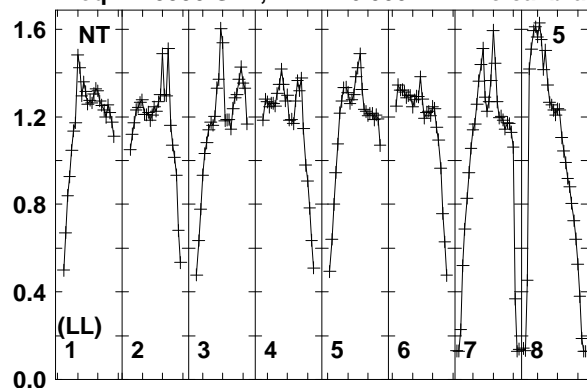

1595 1610 1625 1640 1655 1670 1685 1700 1715
FREQ MHz

1595 1610 1625 1640 1655 1670 1685 1700 1715
FREQ MHz

1595 1610 1625 1640 1655 1670 1685 1700 1715
FREQ MHz

Lower frame: Real Jy
Total-power spectrum Antenna: NT (05)
Timerange: 00/10:36:24 to 00/10:38:08

Plot file version 400 created 11-AUG-2014 17:05:45

J2015+3710 EM110 2.UVDATA.1

Freq = 1.5950 GHz, Bw = 16.000 MH No calibration applied and no bandpass applied

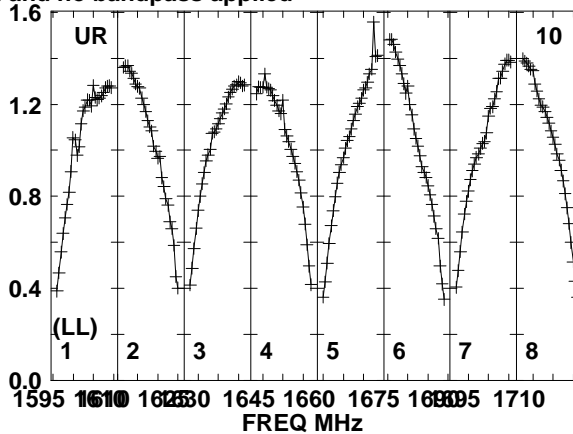
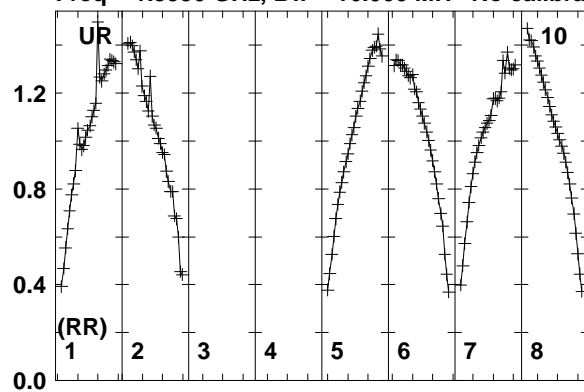

Lower frame: Real Jy
Total-power spectrum Antenna: UR (10)
Timerange: 00/10:36:24 to 00/10:38:08

Plot file version 401 created 11-AUG-2014 17:05:45

J2032+4127 EM110 2.UVDATA.1

Freq = 1.5950 GHz, Bw = 16.000 MH No calibration applied and no bandpass applied

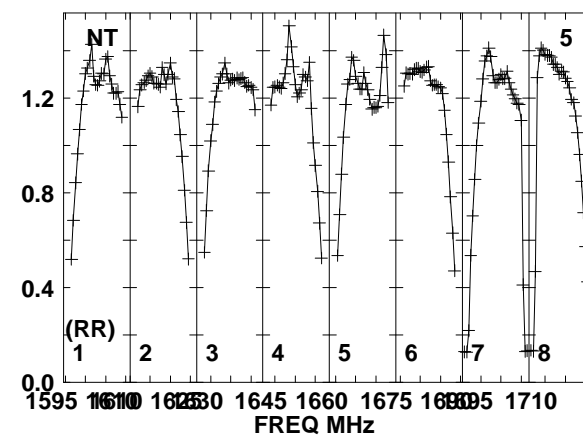
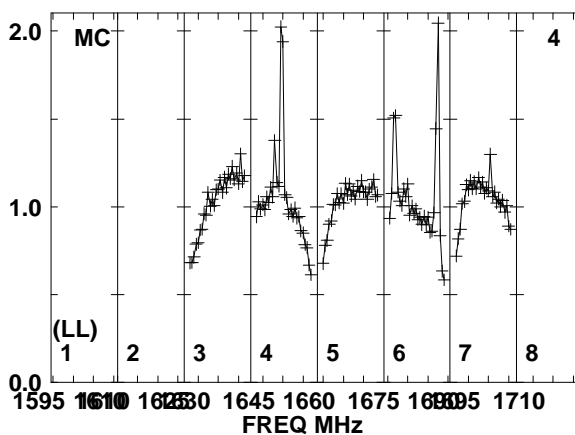
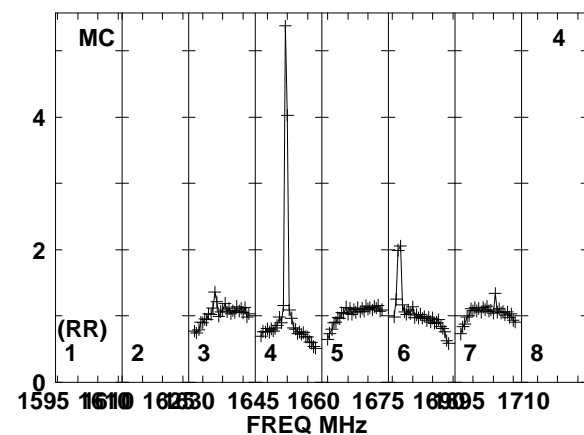
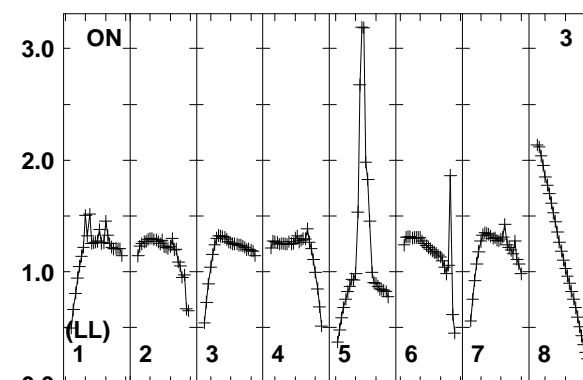
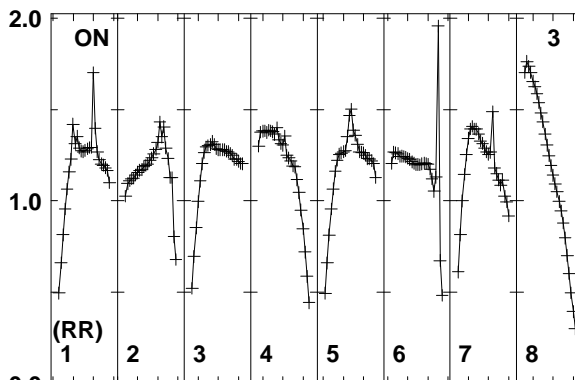
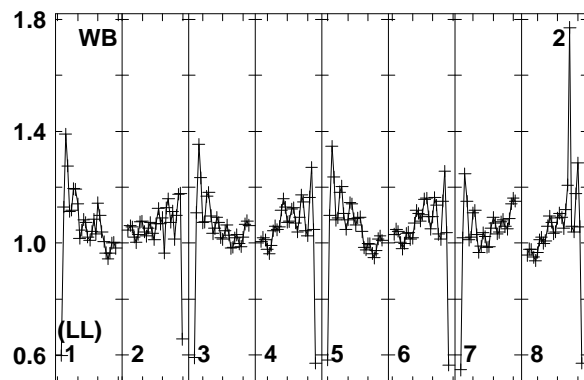
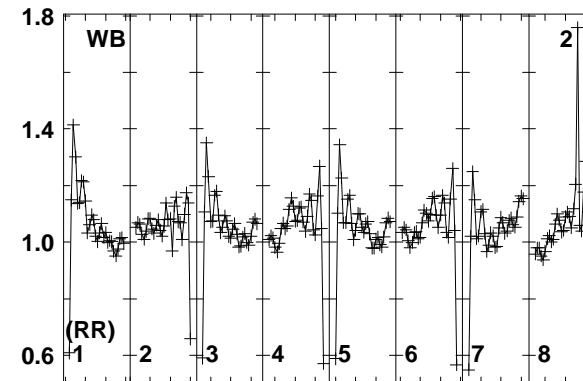
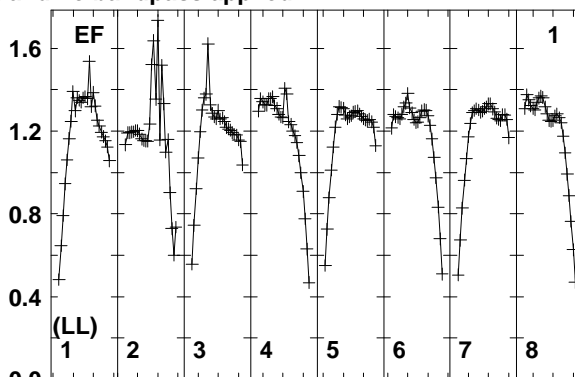
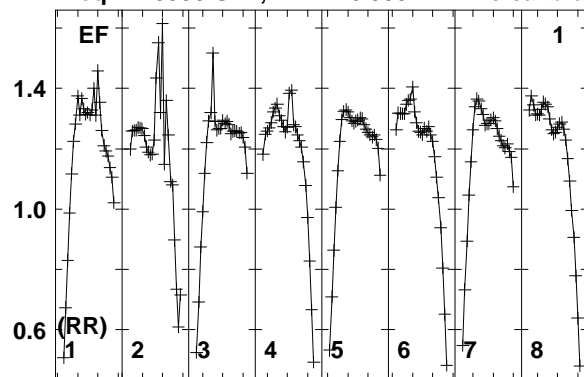

Lower frame: Real Jy
Total-power spectrum Antenna: EF (01)
Timerange: 00/10:38:11 to 00/10:42:09

Plot file version 402 created 11-AUG-2014 17:05:45

J2032+4127 EM110 2.UVDATA.1

Freq = 1.5950 GHz, Bw = 16.000 MH No calibration applied and no bandpass applied

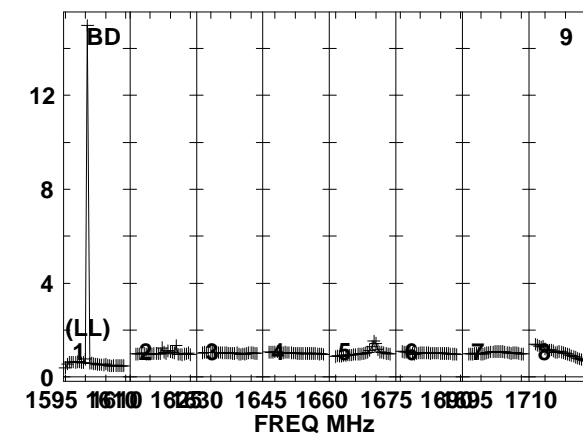
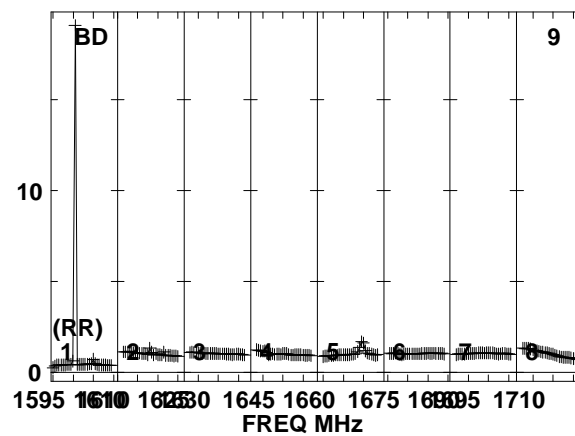
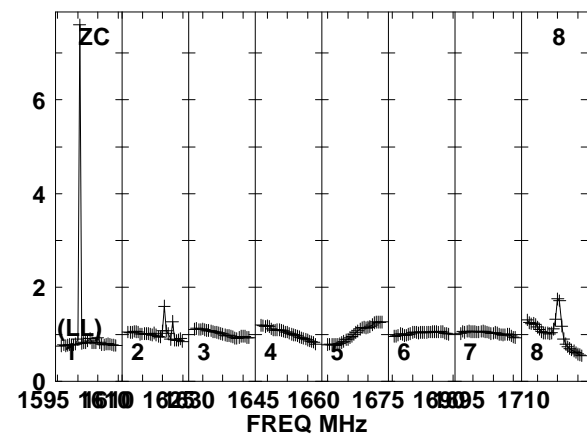
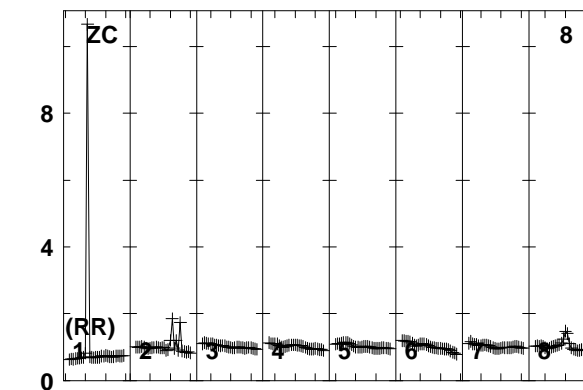
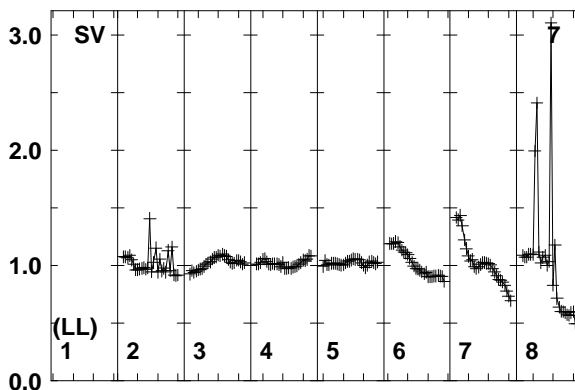
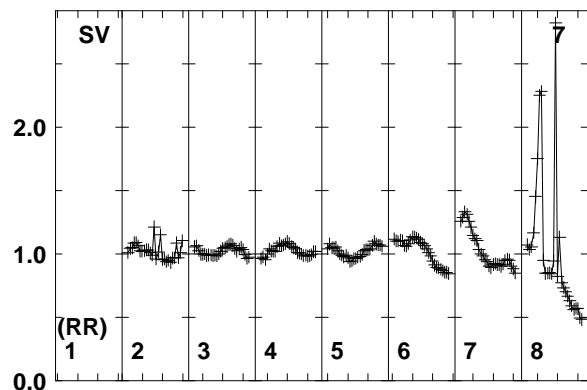
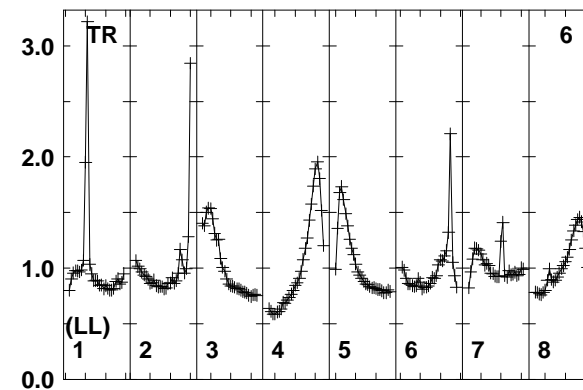
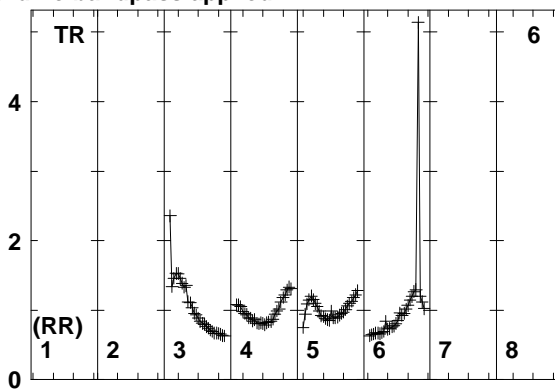
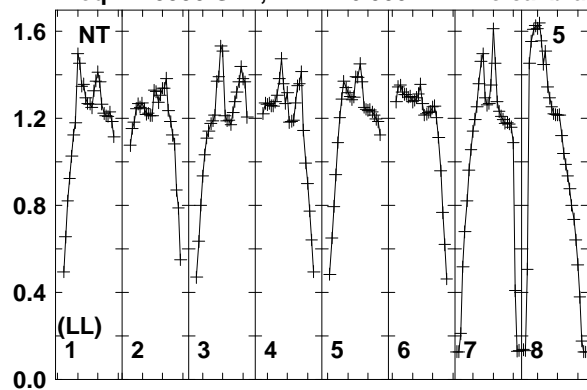

1595 1610 1625 1640 1655 1670 1685 1700 1715
FREQ MHz
Lower frame: Real Jy
Total-power spectrum Antenna: NT (05)
Timerange: 00/10:38:11 to 00/10:42:09

Plot file version 403 created 11-AUG-2014 17:05:45

J2032+4127 EM110 2.UVDATA.1

Freq = 1.5950 GHz, Bw = 16.000 MH No calibration applied and no bandpass applied

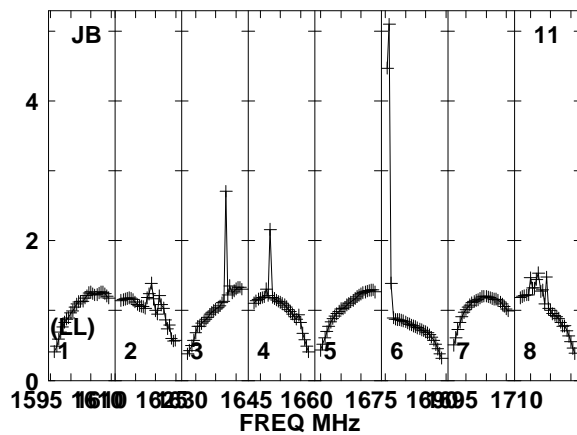
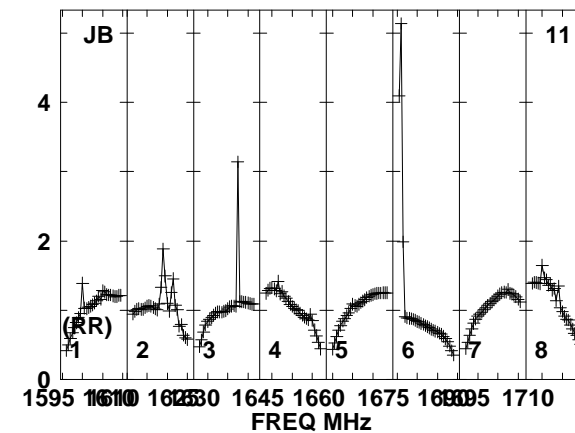
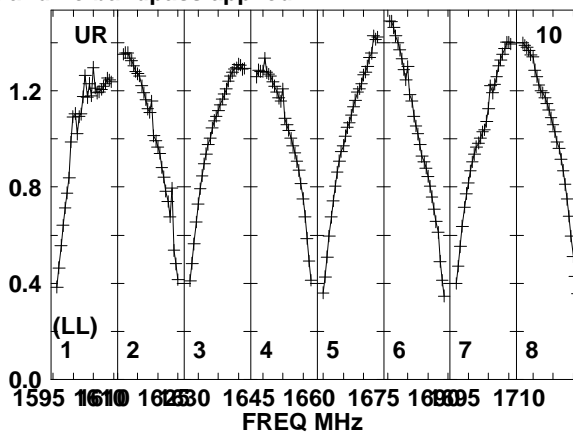
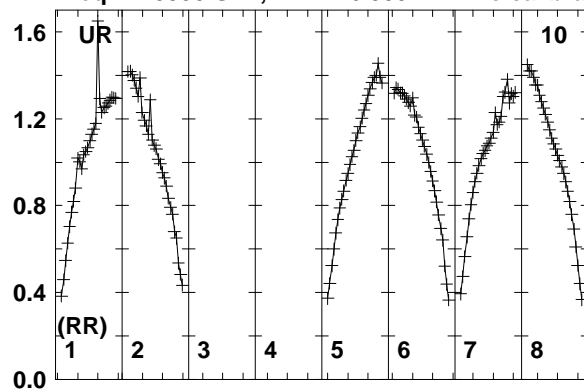

Lower frame: Real Jy
Total-power spectrum Antenna: UR (10)
Timerange: 00/10:38:11 to 00/10:42:09

Plot file version 404 created 11-AUG-2014 17:05:45

J2015+3710 EM110 2.UVDATA.1

Freq = 1.5950 GHz, Bw = 16.000 MH No calibration applied and no bandpass applied

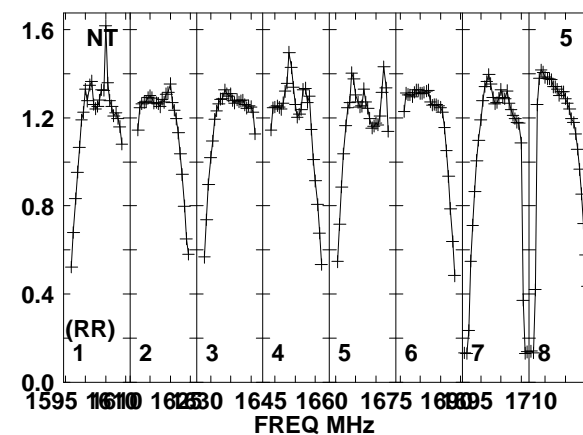
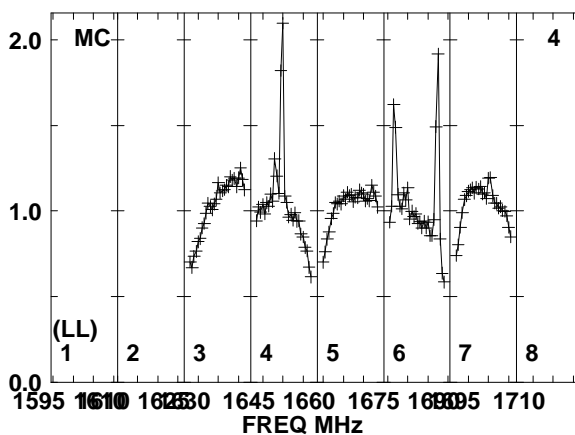
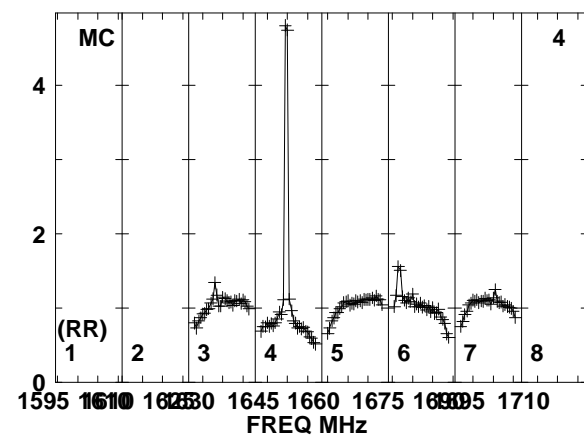
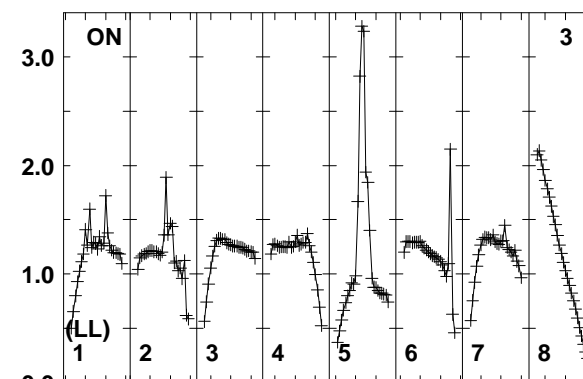
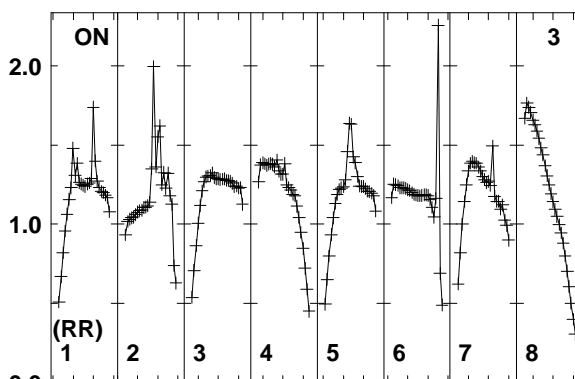
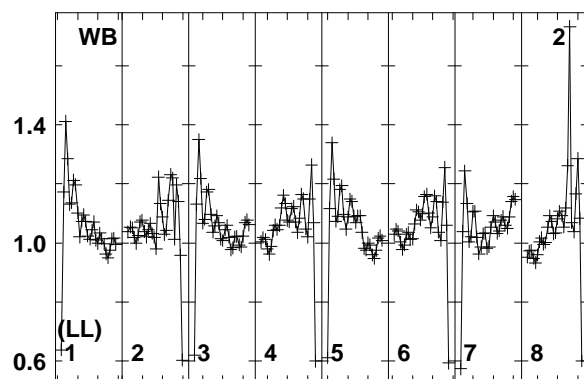
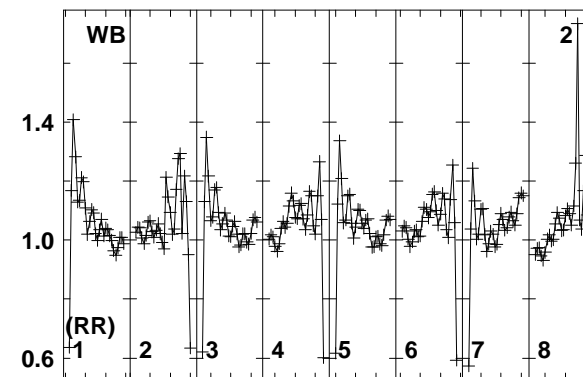
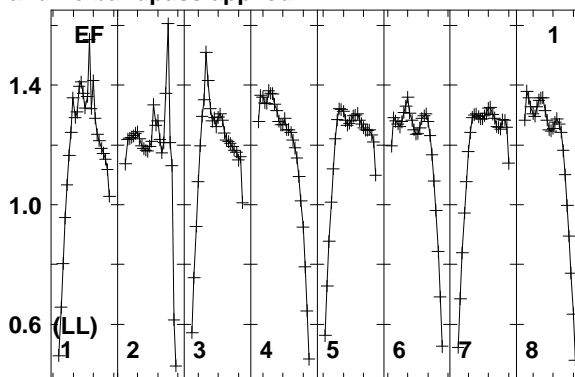
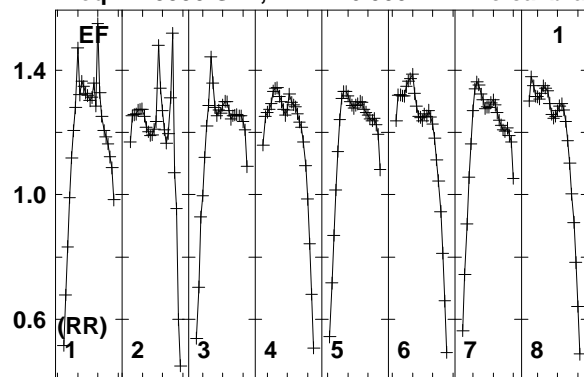

Lower frame: Real Jy
Total-power spectrum Antenna: EF (01)
Timerange: 00/10:43:11 to 00/10:45:09

Plot file version 405 created 11-AUG-2014 17:05:45

J2015+3710 EM110 2.UVDATA.1

Freq = 1.5950 GHz, Bw = 16.000 MH No calibration applied and no bandpass applied

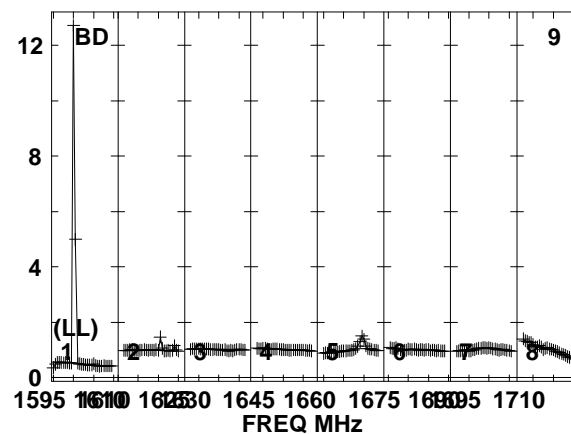
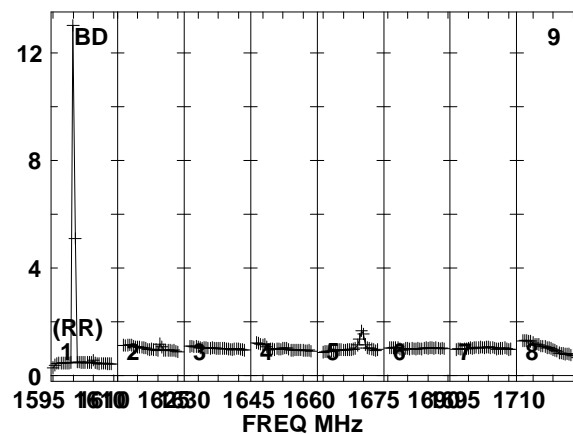
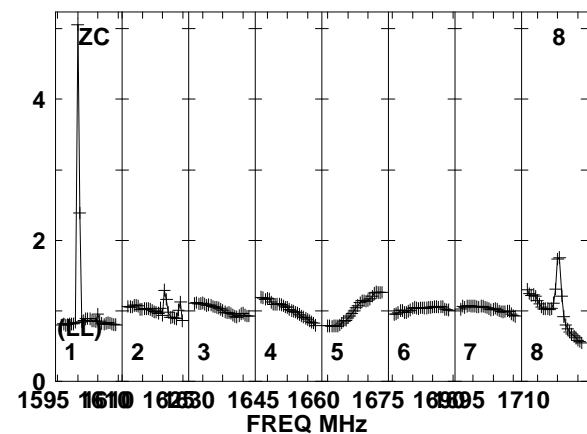
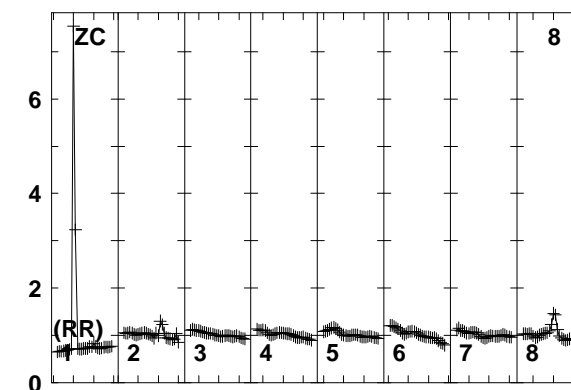
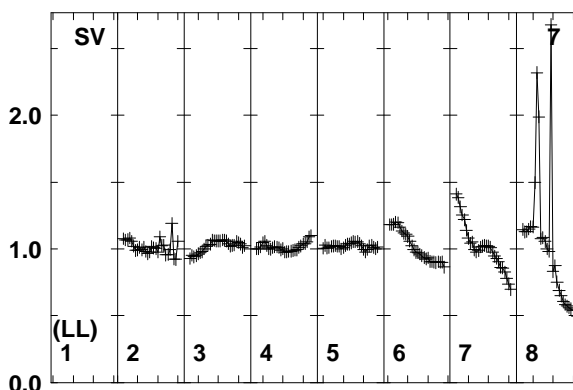
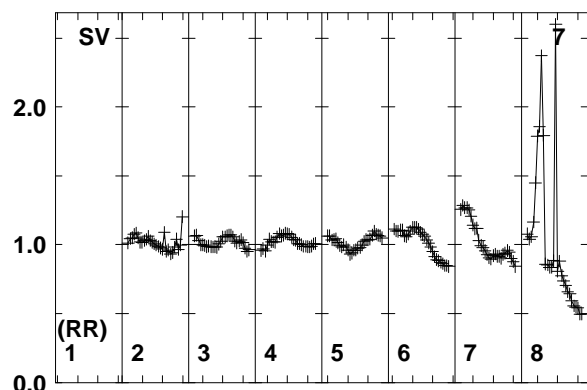
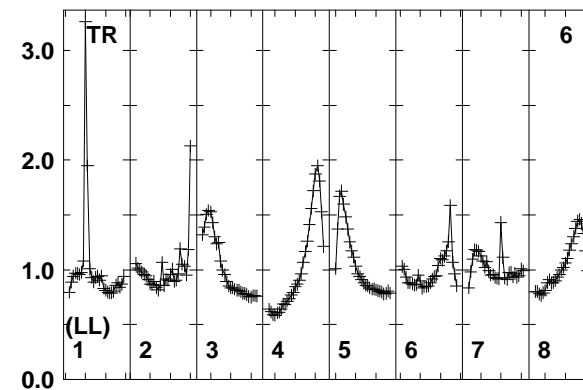
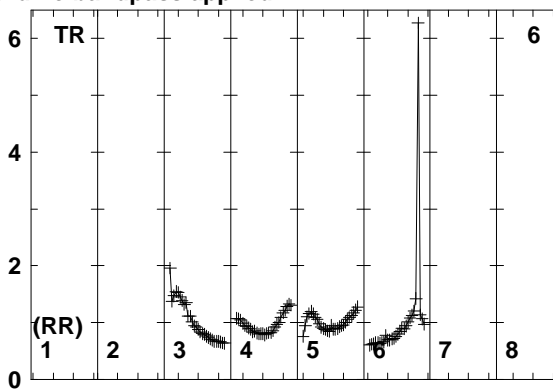
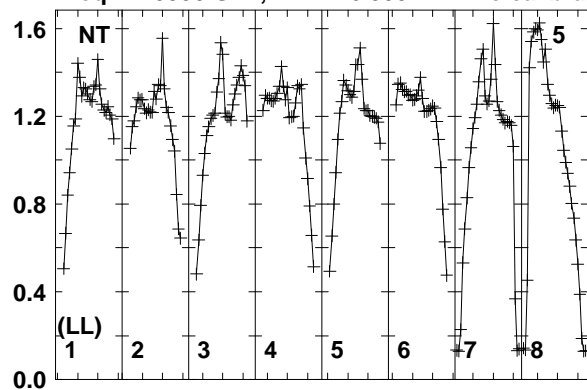

Lower frame: Real Jy
Total-power spectrum Antenna: NT (05)
Timerange: 00/10:43:11 to 00/10:45:09

Plot file version 406 created 11-AUG-2014 17:05:45

J2015+3710 EM110 2.UVDATA.1

Freq = 1.5950 GHz, Bw = 16.000 MH No calibration applied and no bandpass applied

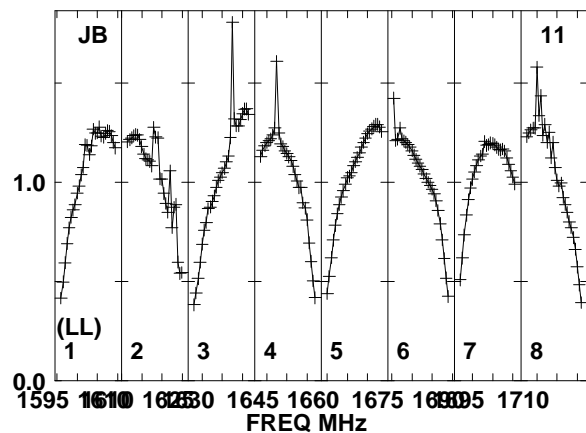
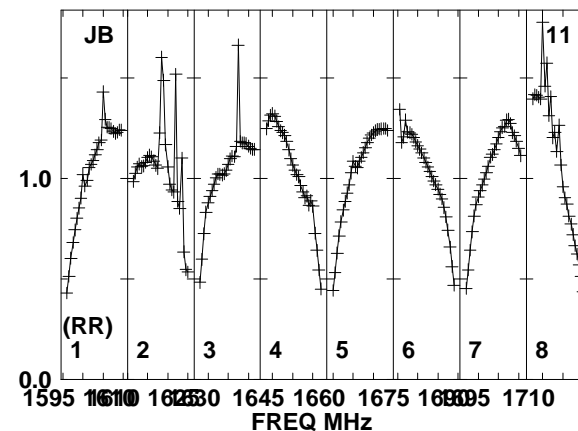
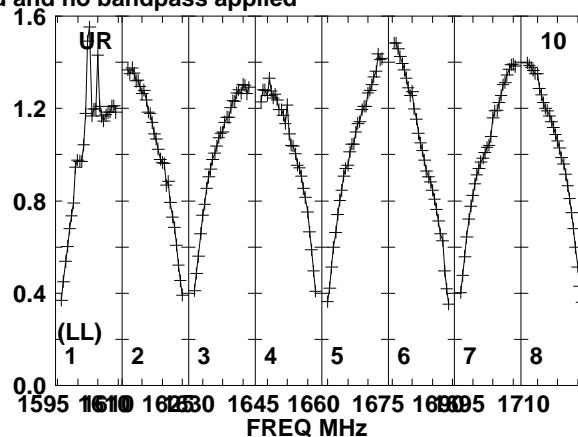
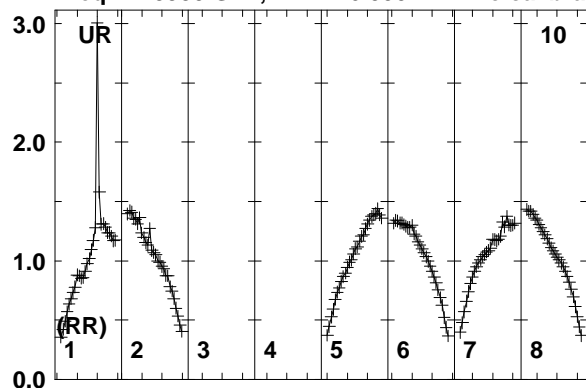

Lower frame: Real Jy
Total-power spectrum Antenna: UR (10)
Timerange: 00/10:43:11 to 00/10:45:09

Plot file version 407 created 11-AUG-2014 17:05:45

J2032+4127 EM110 2.UVDATA.1

Freq = 1.5950 GHz, Bw = 16.000 MH No calibration applied and no bandpass applied

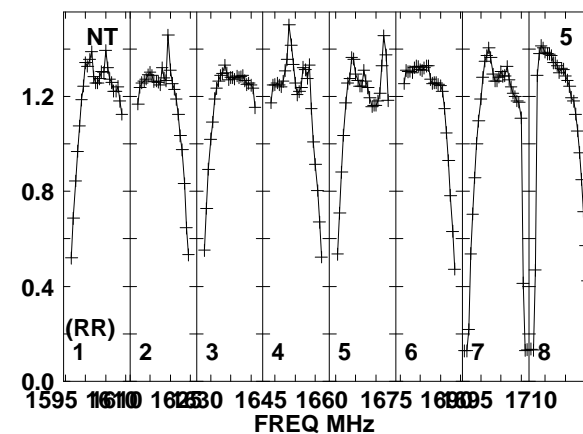
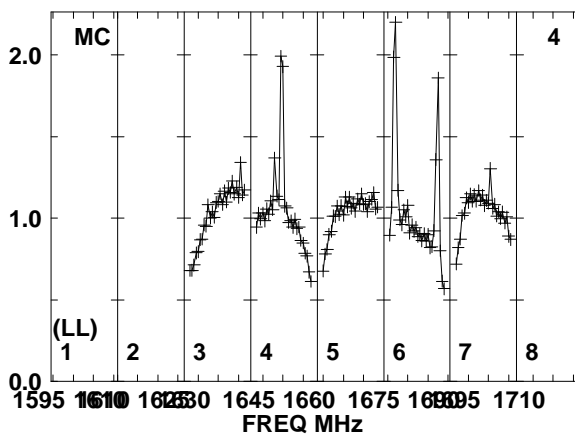
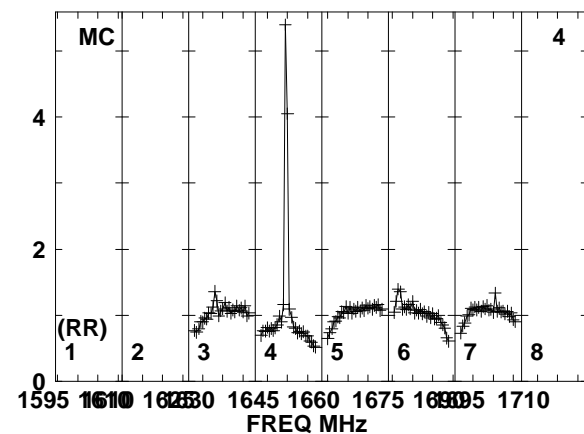
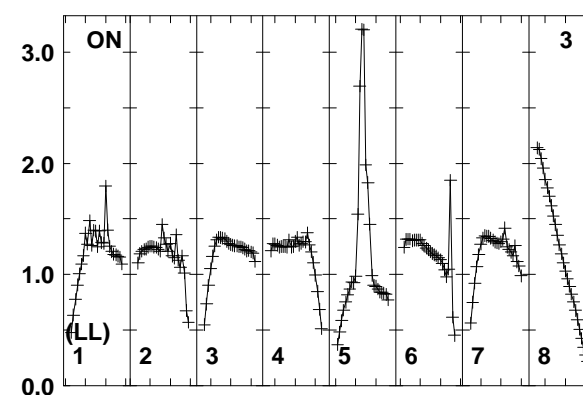
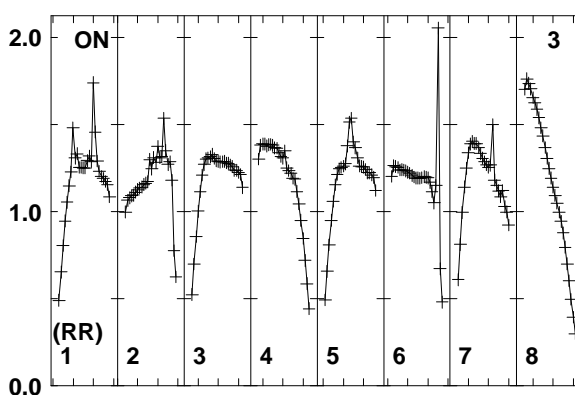
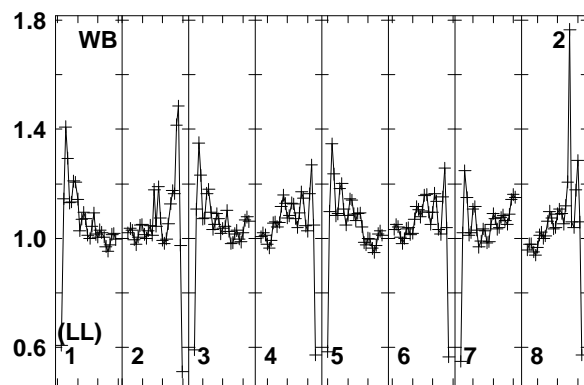
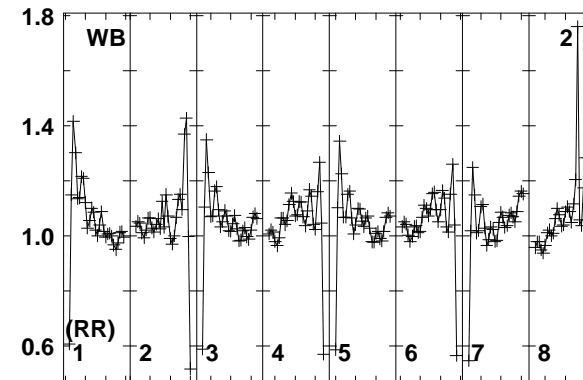
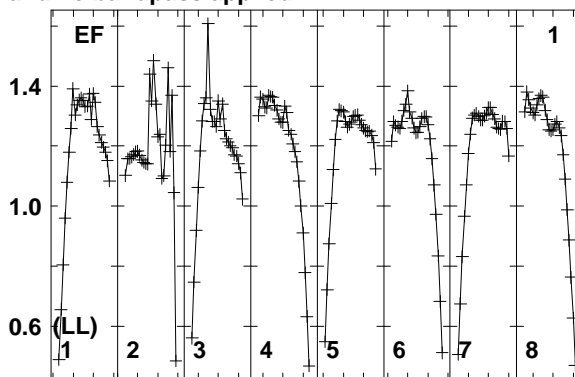
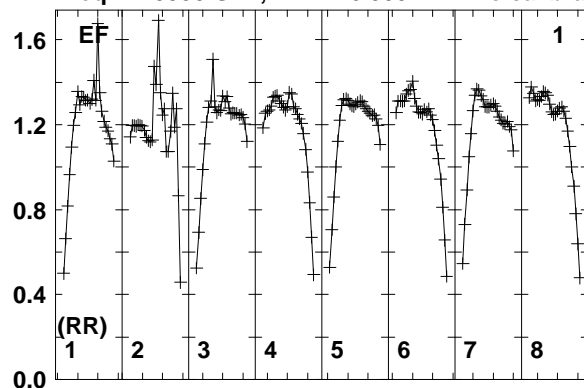

Lower frame: Real Jy
Total-power spectrum Antenna: EF (01)
Timerange: 00/10:45:24 to 00/10:49:08

Plot file version 408 created 11-AUG-2014 17:05:45

J2032+4127 EM110 2.UVDATA.1

Freq = 1.5950 GHz, Bw = 16.000 MH No calibration applied and no bandpass applied

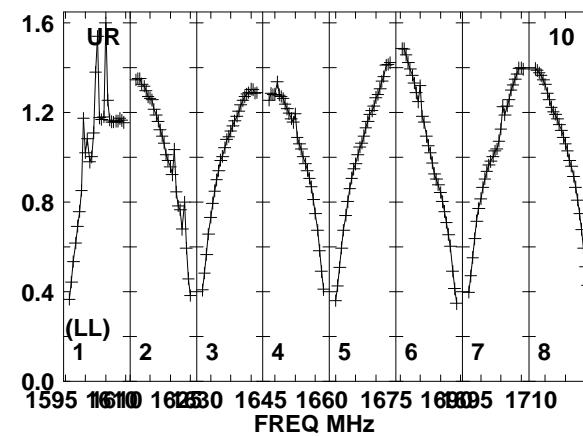
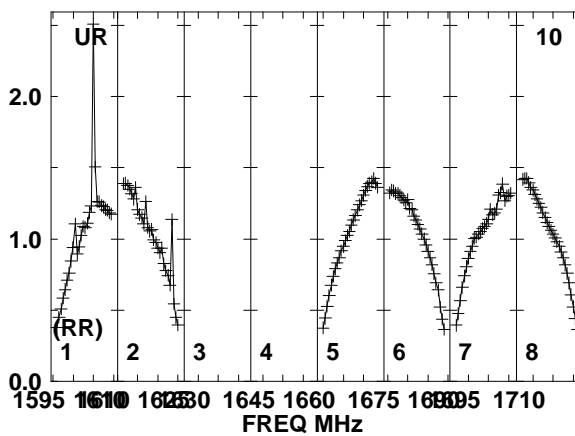
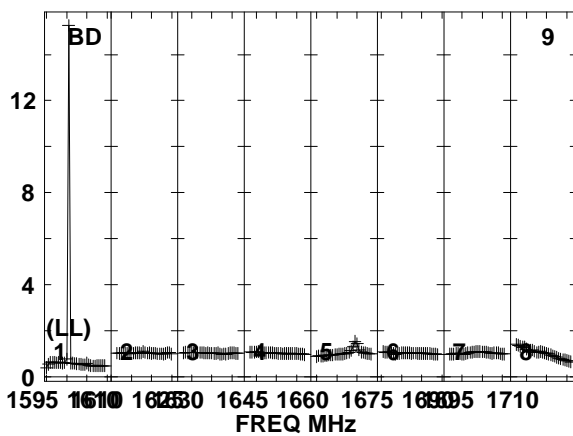
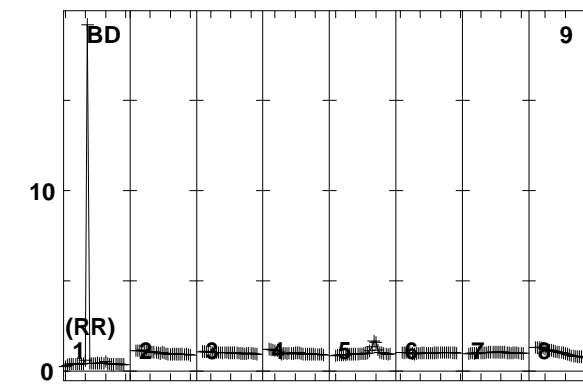
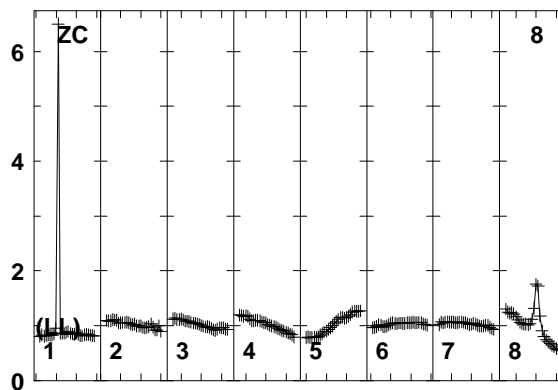
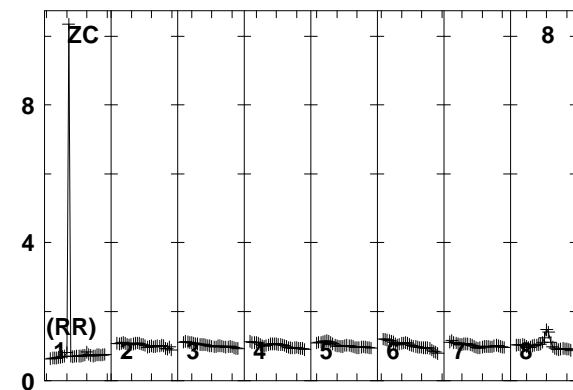
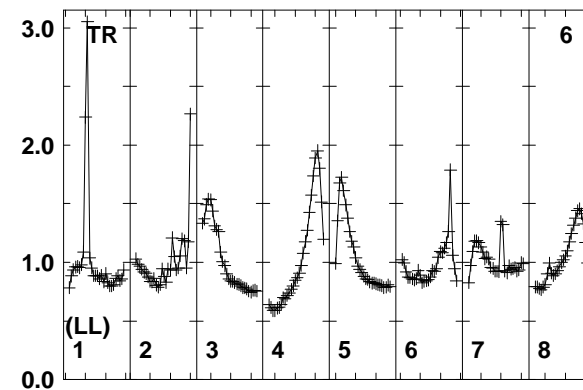
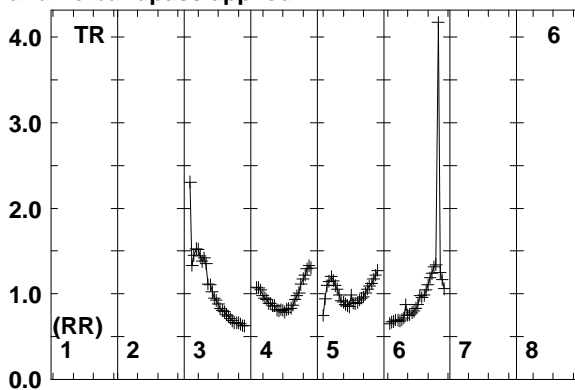
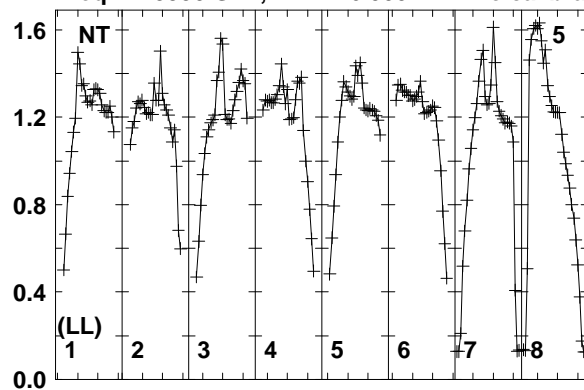

Lower frame: Real Jy
Total-power spectrum Antenna: NT (05)
Timerange: 00/10:45:24 to 00/10:49:08

Plot file version 409 created 11-AUG-2014 17:05:46

J2032+4127 EM110 2.UVDATA.1

Freq = 1.5950 GHz, Bw = 16.000 MH No calibration applied and no bandpass applied

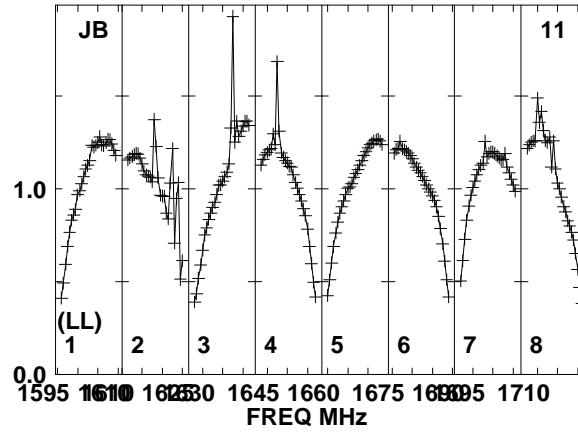
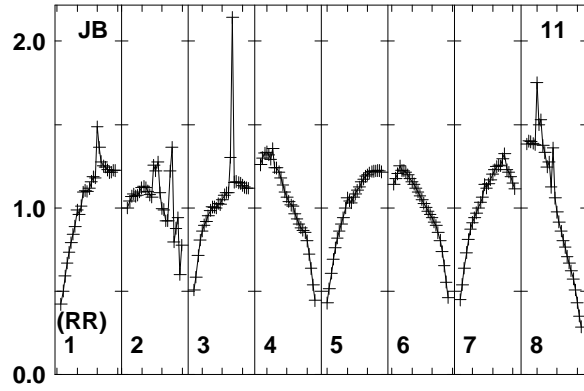

Lower frame: Real Jy
Total-power spectrum Antenna: JB (11)
Timerange: 00/10:45:24 to 00/10:49:08

Plot file version 410 created 11-AUG-2014 17:05:46

J2015+3710 EM110 2.UVDATA.1

Freq = 1.5950 GHz, Bw = 16.000 MH No calibration applied and no bandpass applied

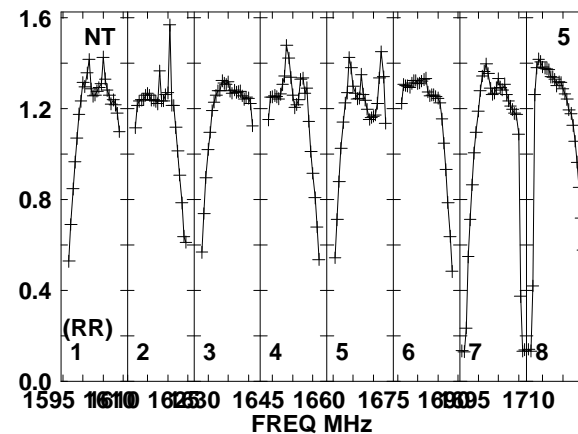
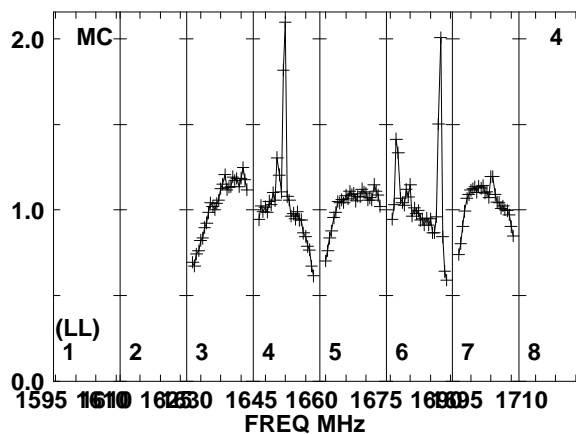
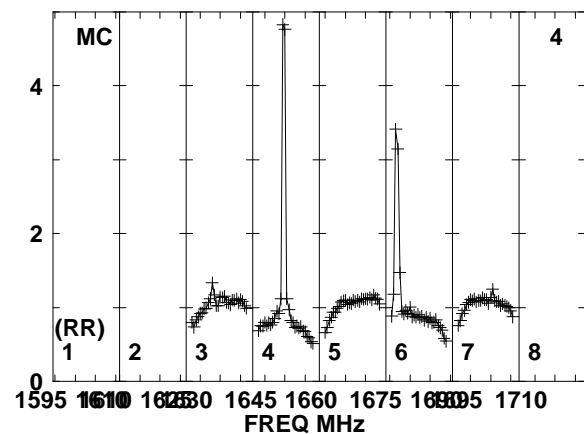
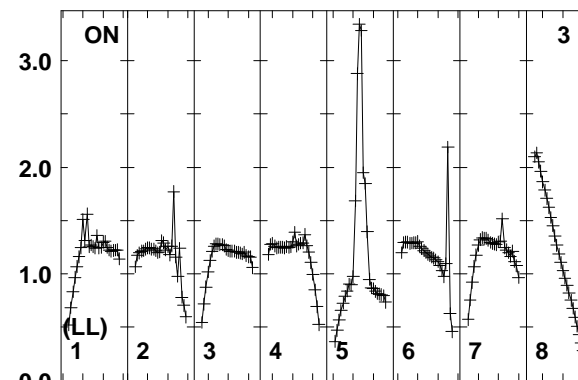
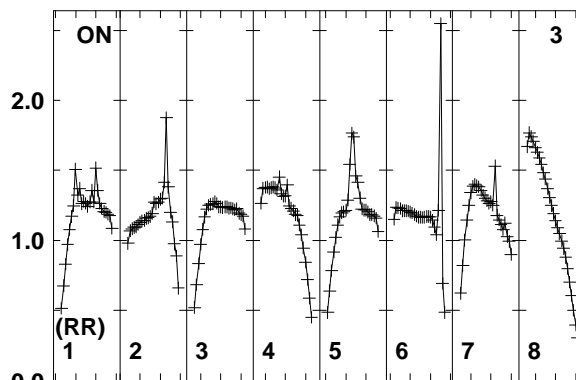
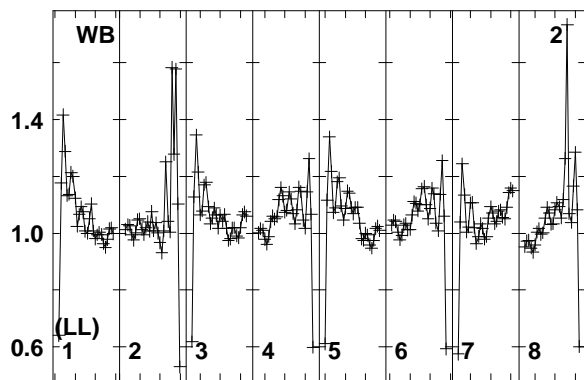
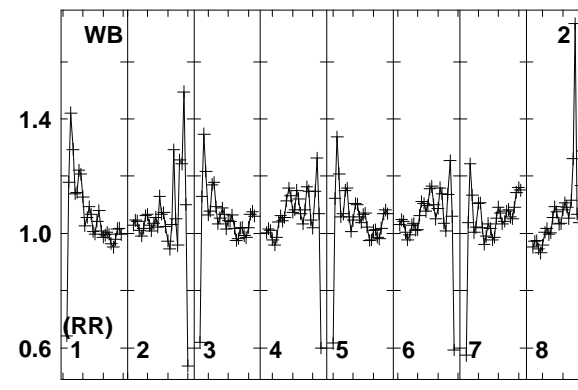
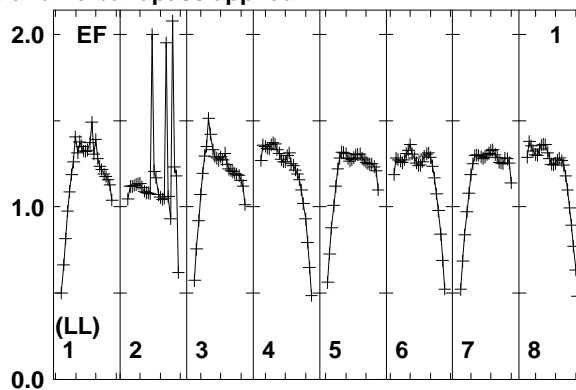
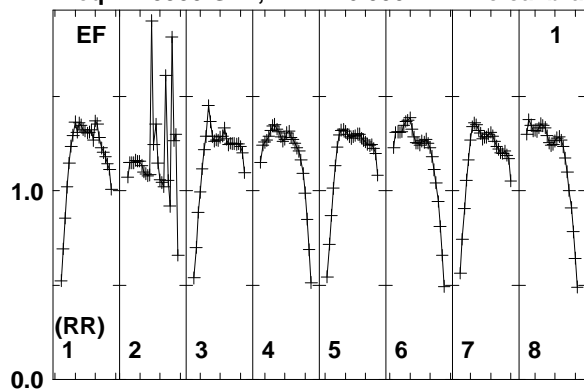

Lower frame: Real Jy
Total-power spectrum Antenna: EF (01)
Timerange: 00/10:49:25 to 00/10:51:09

Plot file version 411 created 11-AUG-2014 17:05:46

J2015+3710 EM110 2.UVDATA.1

Freq = 1.5950 GHz, Bw = 16.000 MH No calibration applied and no bandpass applied

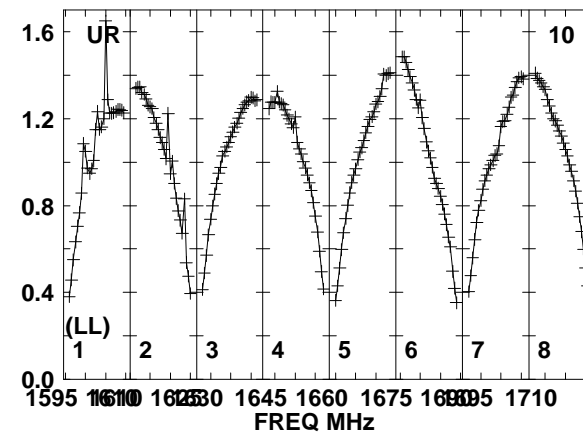
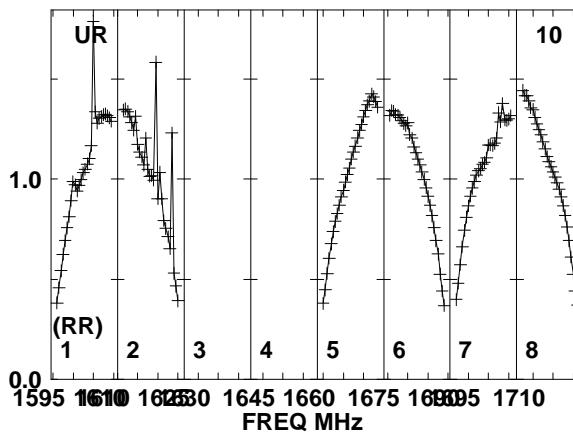
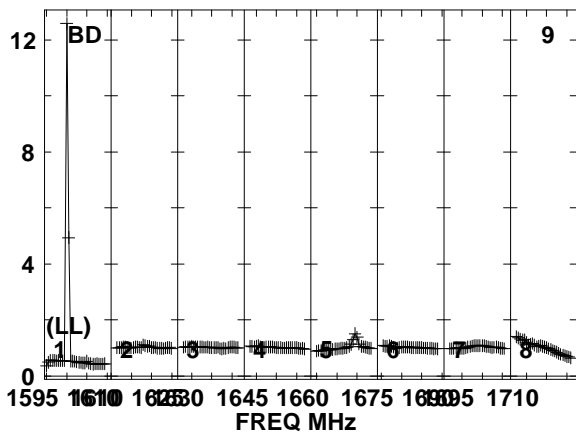
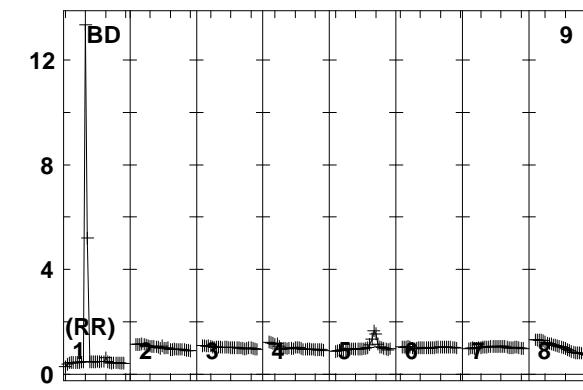
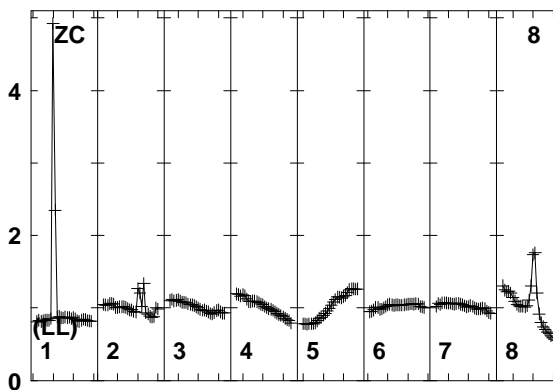
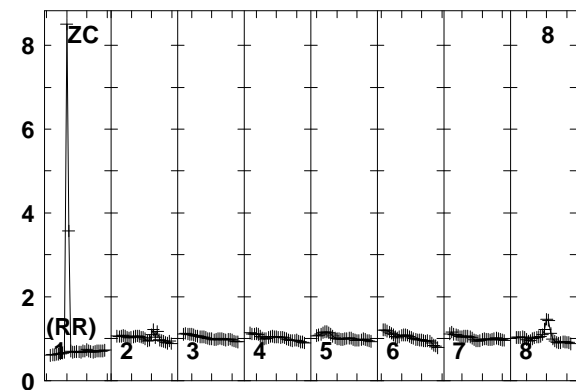
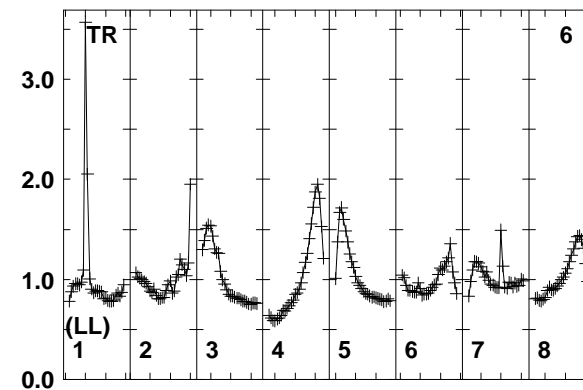
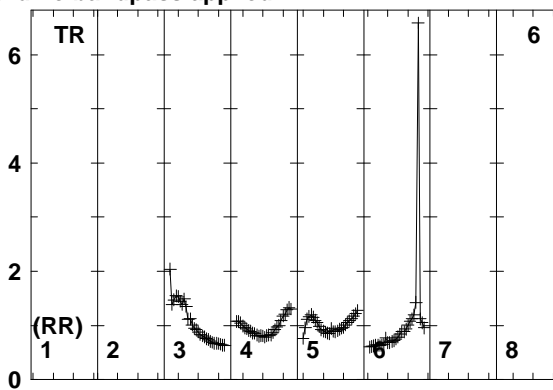
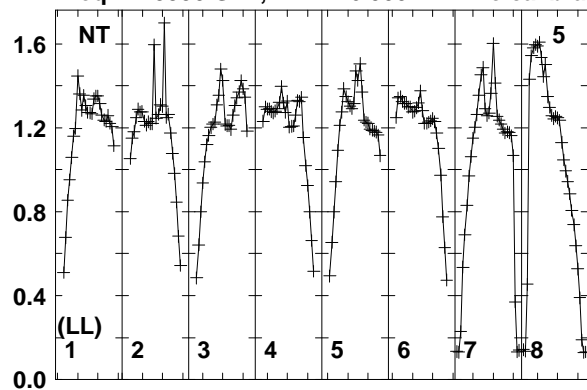

Lower frame: Real Jy
Total-power spectrum Antenna: NT (05)
Timerange: 00/10:49:25 to 00/10:51:09

Plot file version 412 created 11-AUG-2014 17:05:46

J2032+4127 EM110 2.UVDATA.1

Freq = 1.5950 GHz, Bw = 16.000 MH No calibration applied and no bandpass applied

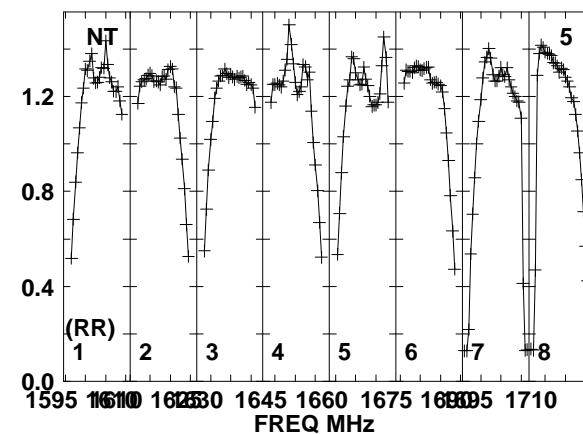
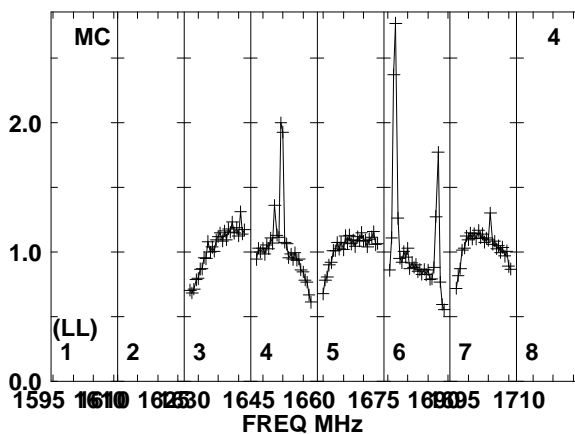
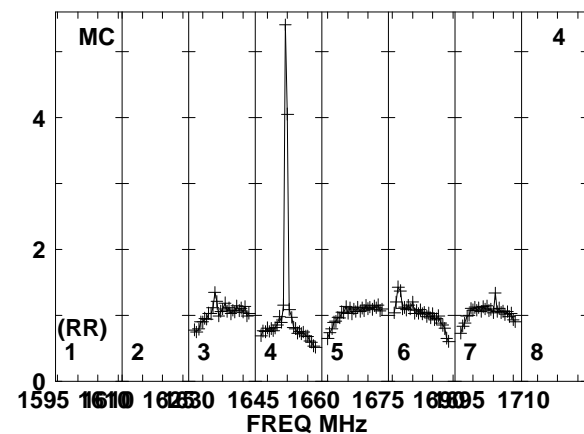
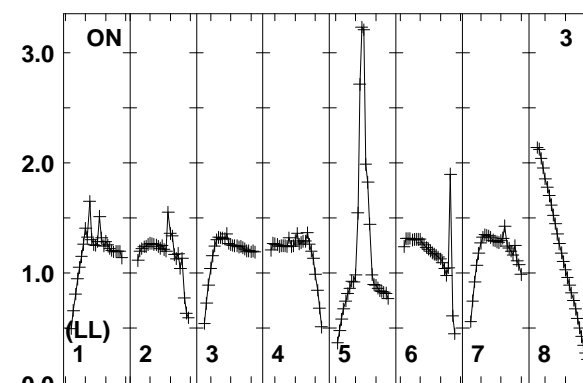
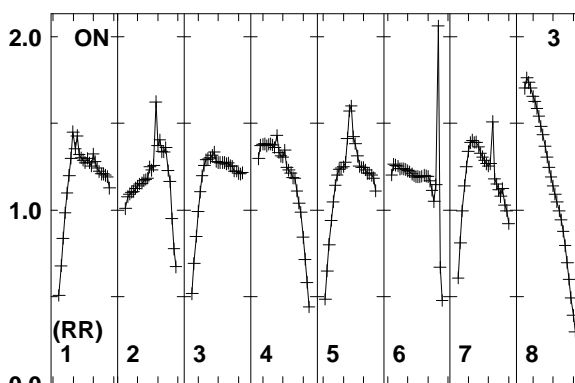
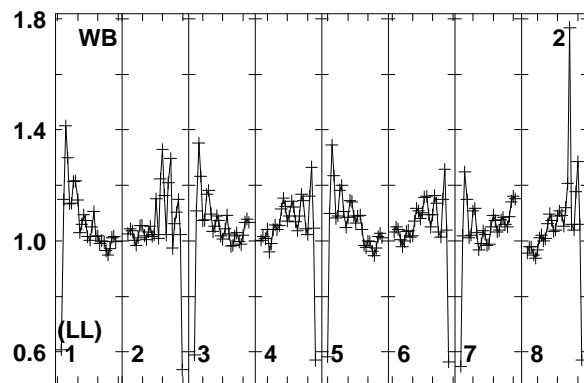
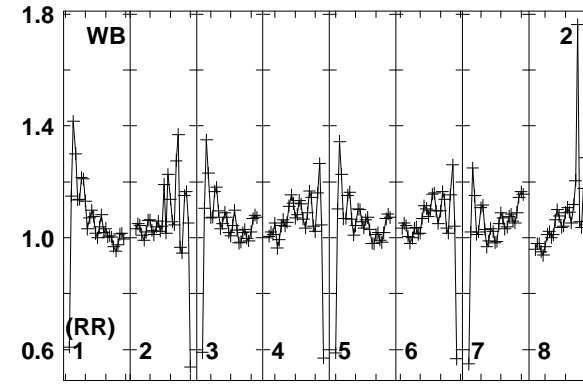
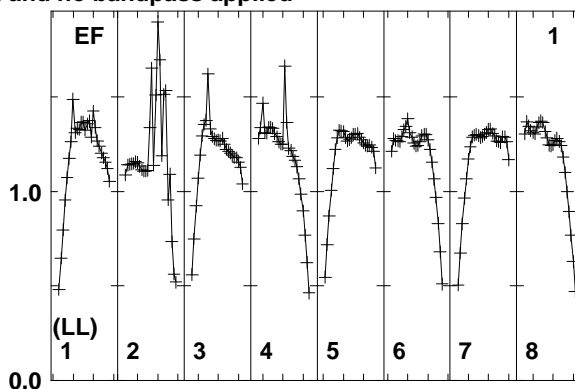
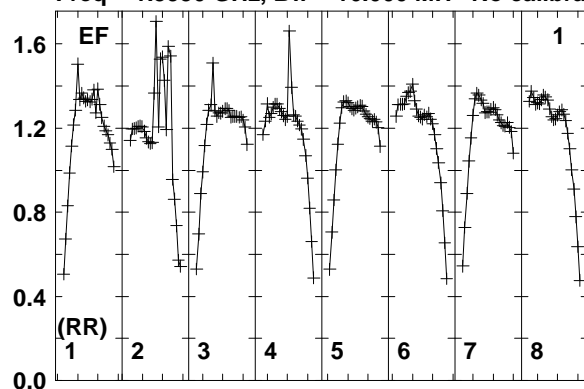

Lower frame: Real Jy
Total-power spectrum Antenna: EF (01)
Timerange: 00/10:51:11 to 00/10:55:09

Plot file version 413 created 11-AUG-2014 17:05:46

J2032+4127 EM110 2.UVDATA.1

Freq = 1.5950 GHz, Bw = 16.000 MH No calibration applied and no bandpass applied

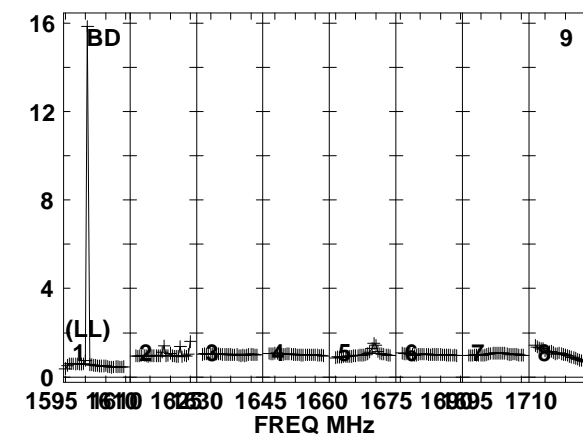
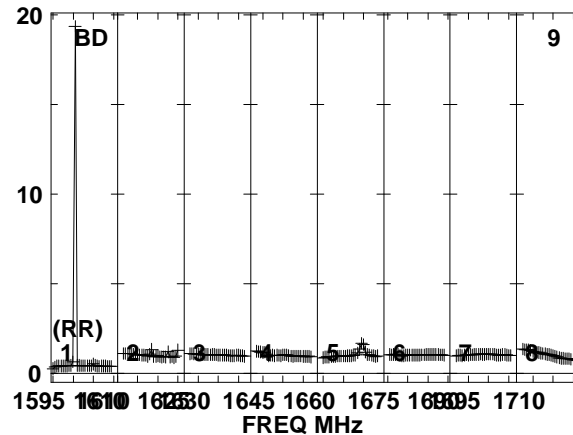
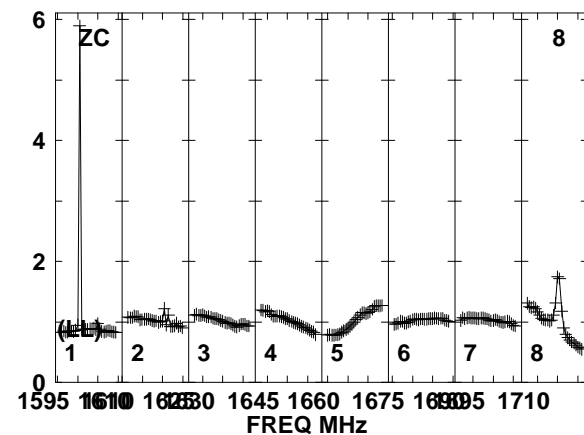
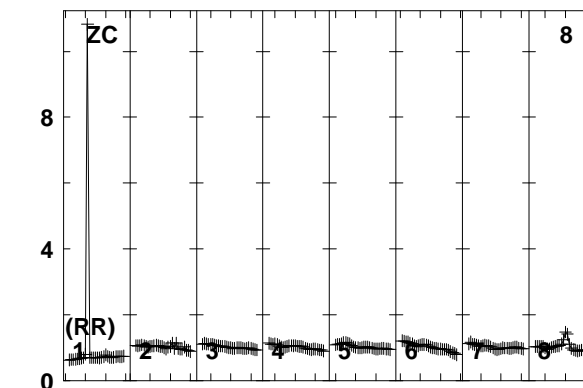
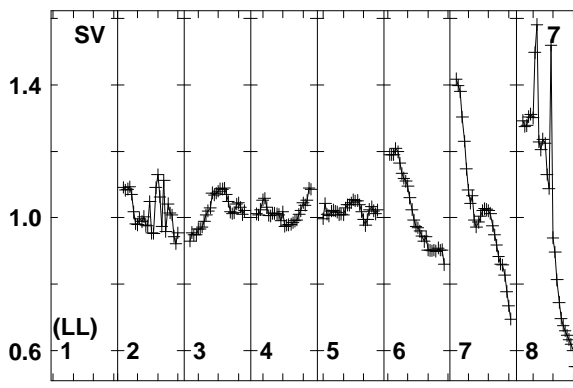
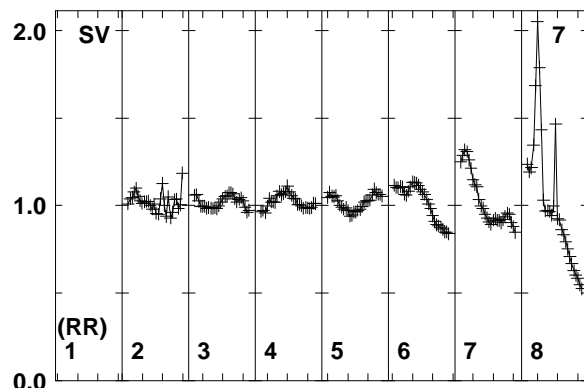
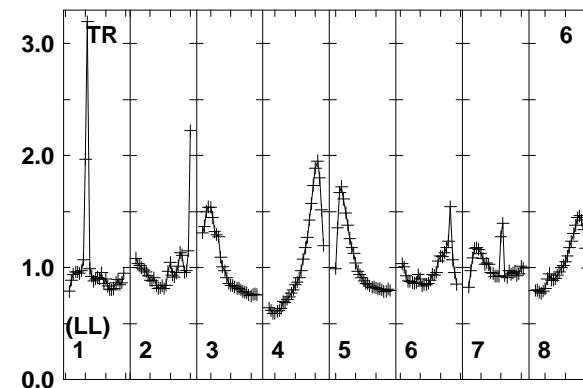
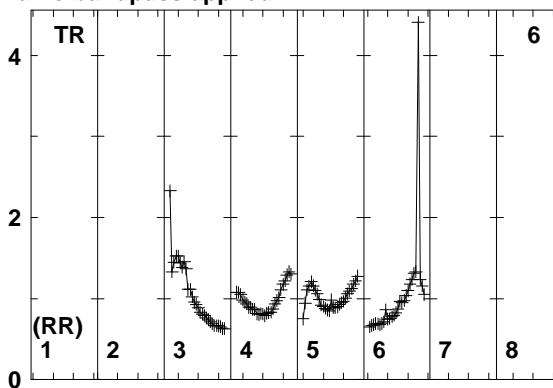
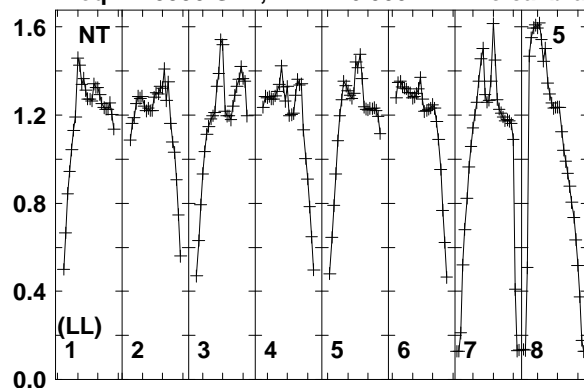

Lower frame: Real Jy
Total-power spectrum Antenna: NT (05)
Timerange: 00/10:51:11 to 00/10:55:09

Plot file version 414 created 11-AUG-2014 17:05:46

J2032+4127 EM110 2.UVDATA.1

Freq = 1.5950 GHz, Bw = 16.000 MH No calibration applied and no bandpass applied

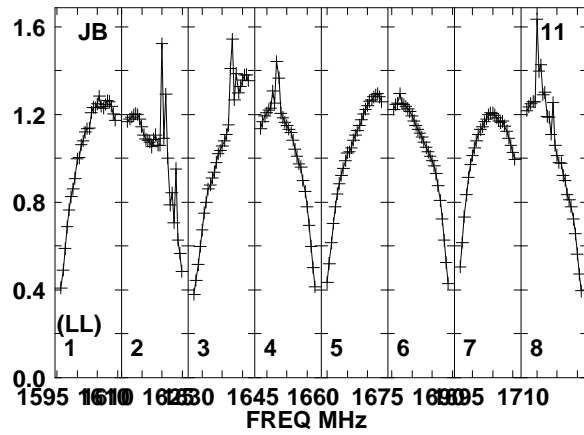
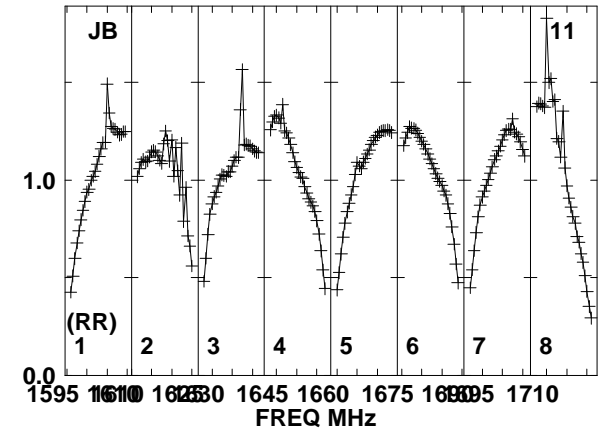
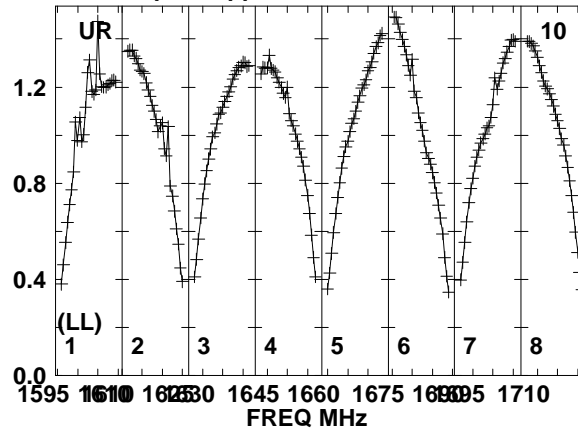
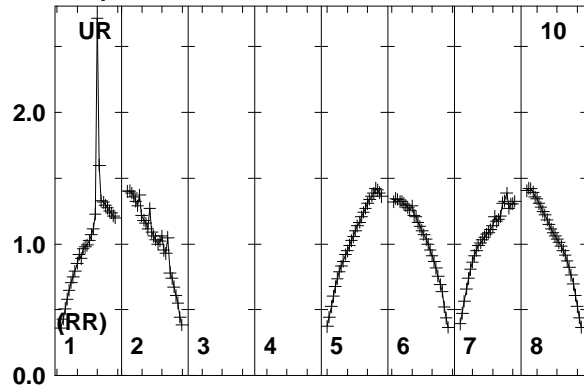

Lower frame: Real Jy
Total-power spectrum Antenna: UR (10)
Timerange: 00/10:51:11 to 00/10:55:09

Plot file version 415 created 11-AUG-2014 17:05:46

J2015+3710 EM110 2.UVDATA.1

Freq = 1.5950 GHz, Bw = 16.000 MH No calibration applied and no bandpass applied

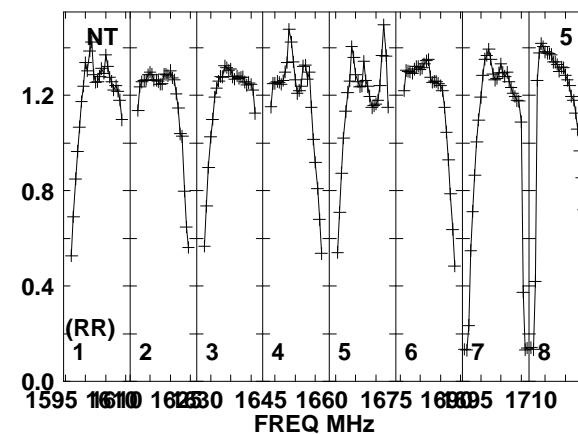
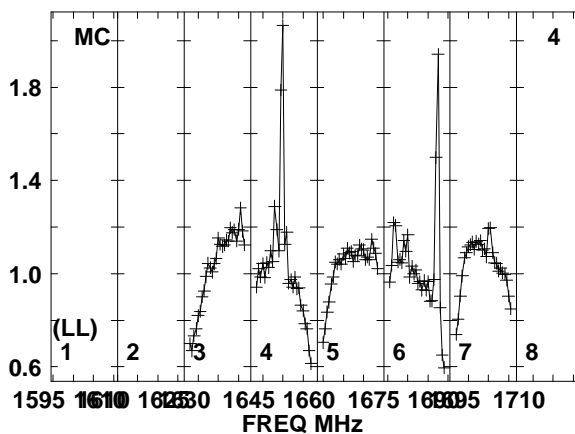
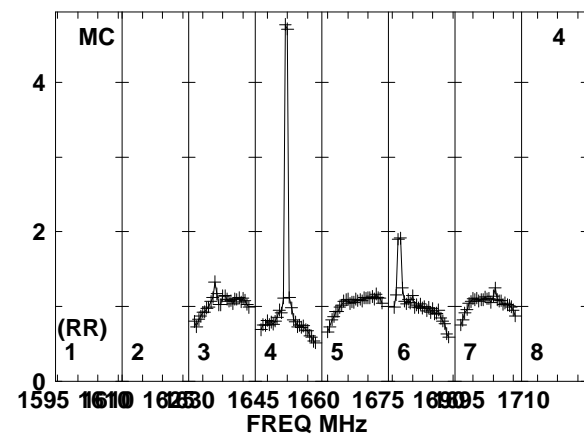
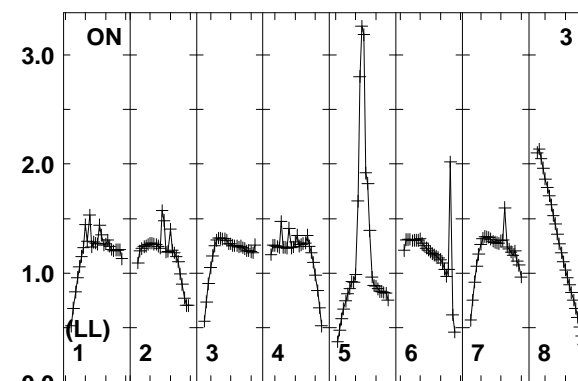
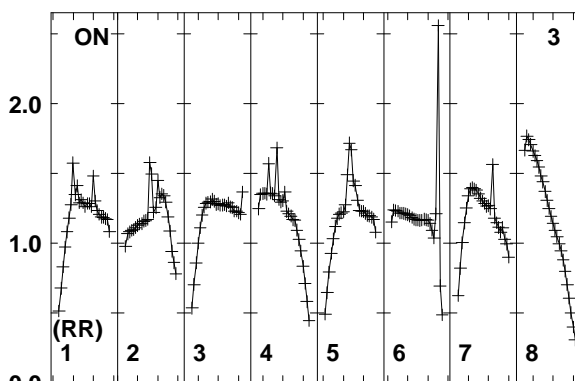
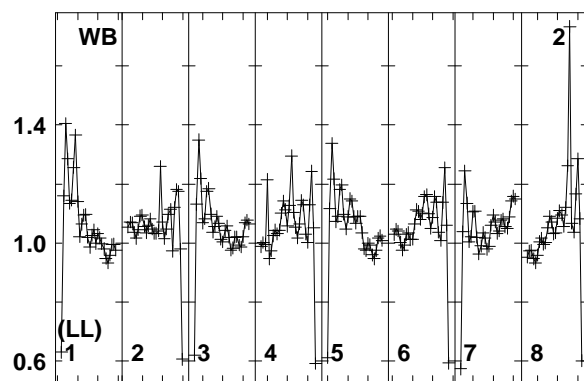
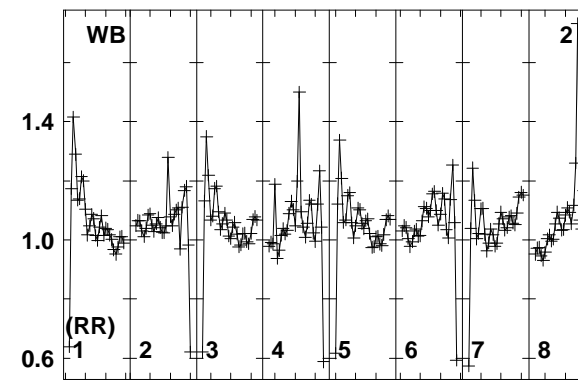
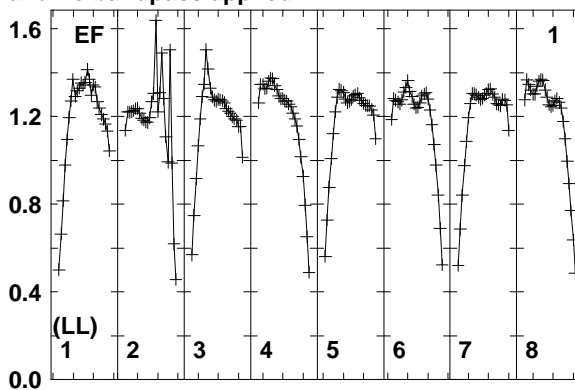
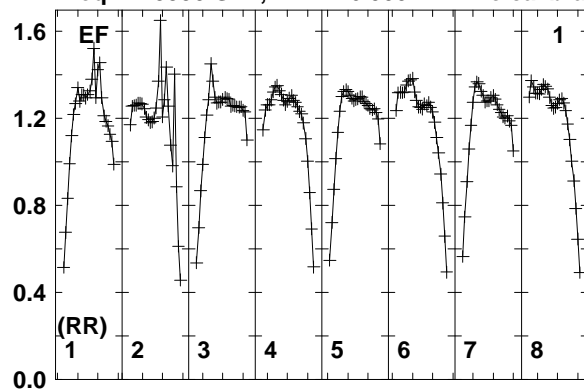

Lower frame: Real Jy
Total-power spectrum Antenna: EF (01)
Timerange: 00/10:56:11 to 00/10:58:09

Plot file version 416 created 11-AUG-2014 17:05:46

J2015+3710 EM110 2.UVDATA.1

Freq = 1.5950 GHz, Bw = 16.000 MH No calibration applied and no bandpass applied

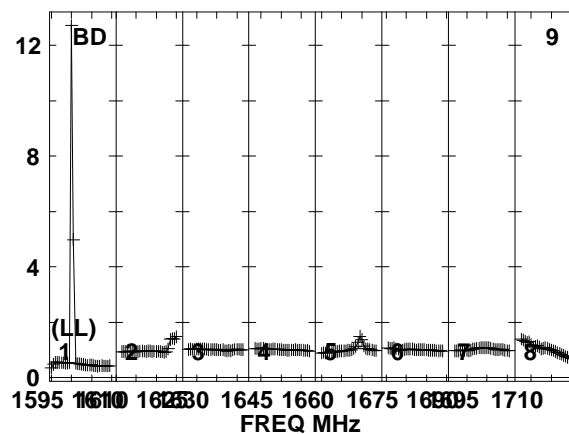
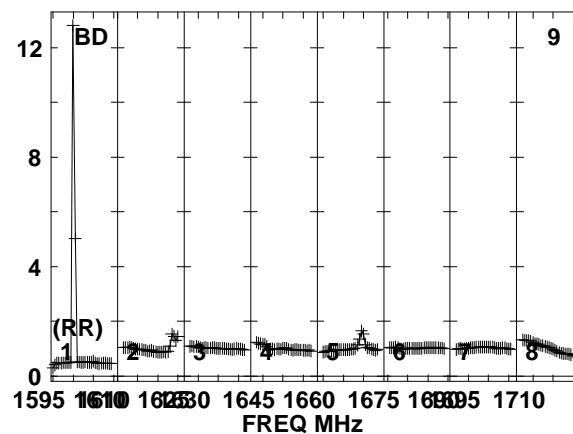
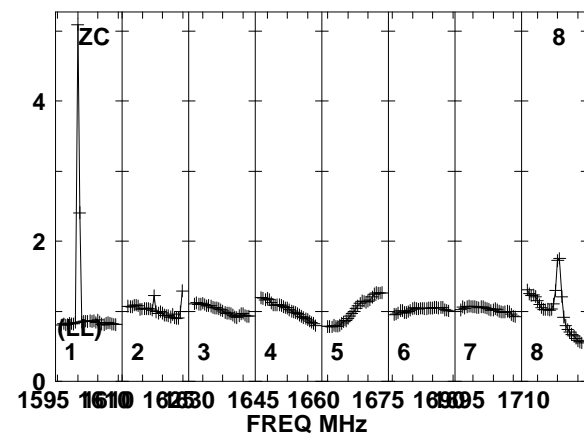
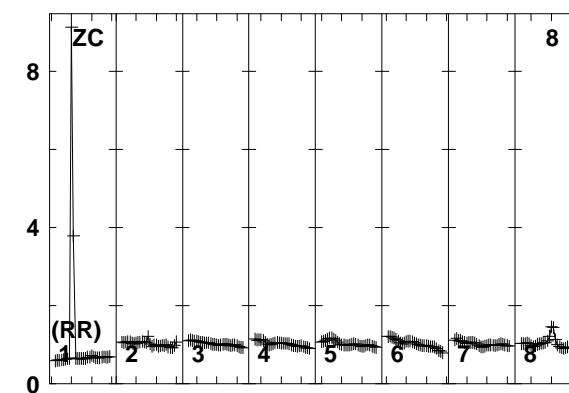
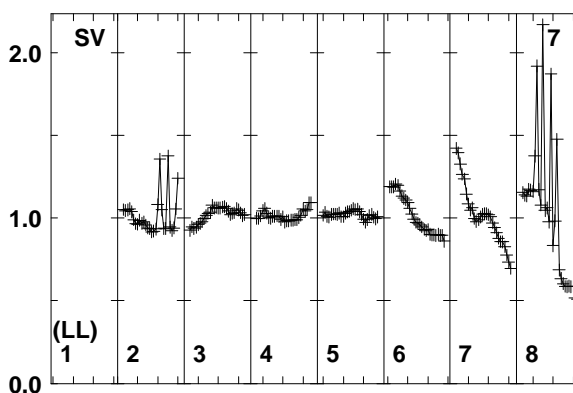
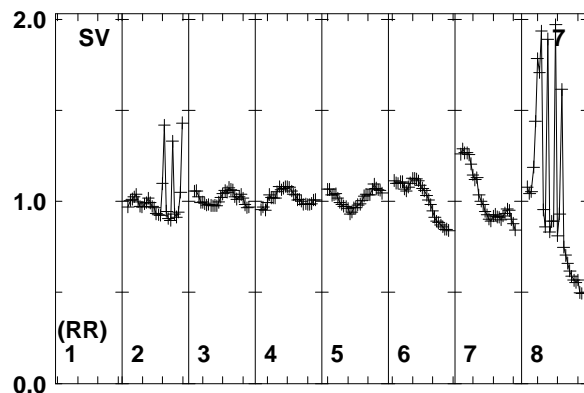
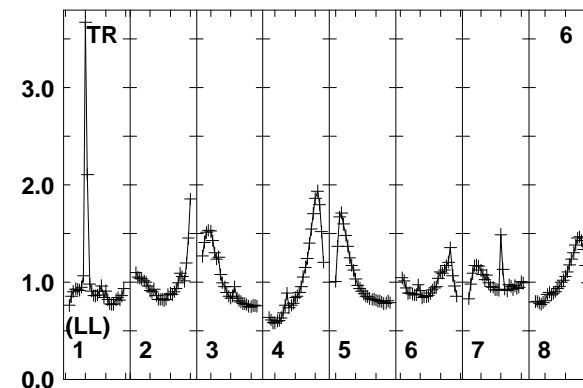
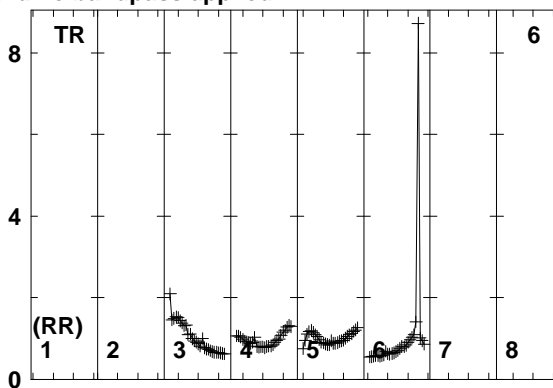
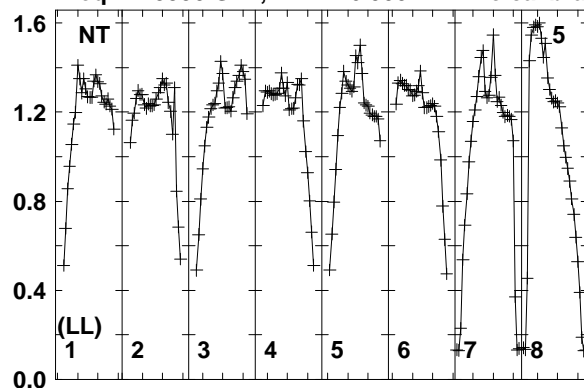

Lower frame: Real Jy
Total-power spectrum Antenna: NT (05)
Timerange: 00/10:56:11 to 00/10:58:09

Plot file version 417 created 11-AUG-2014 17:05:46

J2015+3710 EM110 2.UVDATA.1

Freq = 1.5950 GHz, Bw = 16.000 MH No calibration applied and no bandpass applied

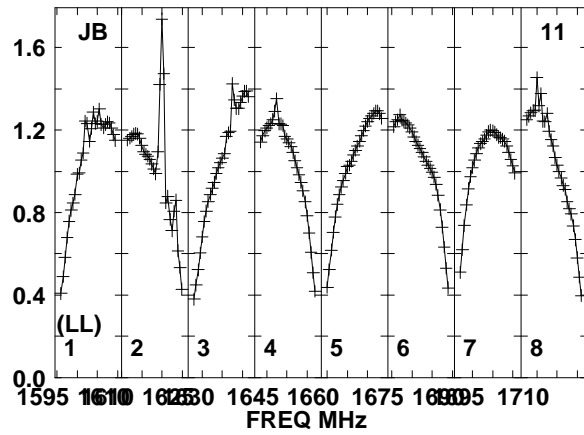
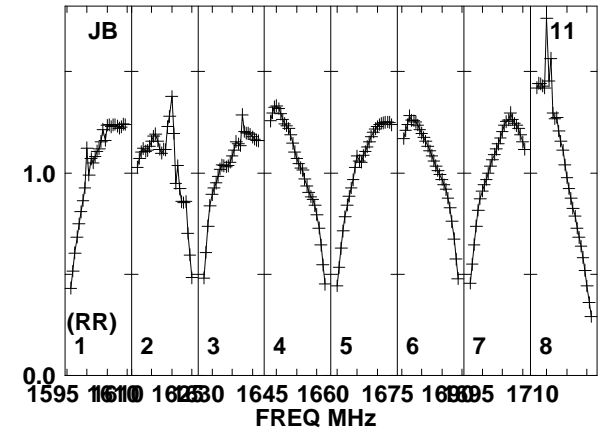
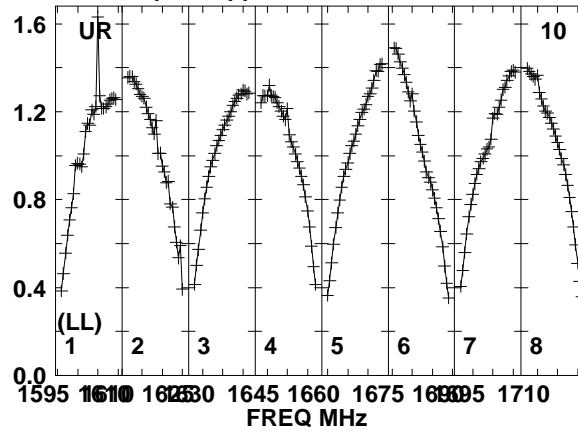
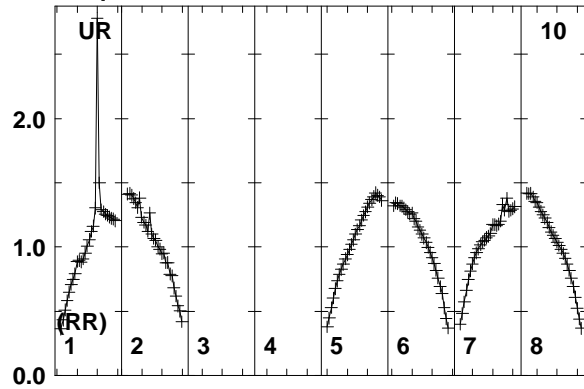

Lower frame: Real Jy
Total-power spectrum Antenna: UR (10)
Timerange: 00/10:56:11 to 00/10:58:09

Plot file version 418 created 11-AUG-2014 17:05:46

J2032+4127 EM110 2.UVDATA.1

Freq = 1.5950 GHz, Bw = 16.000 MH No calibration applied and no bandpass applied

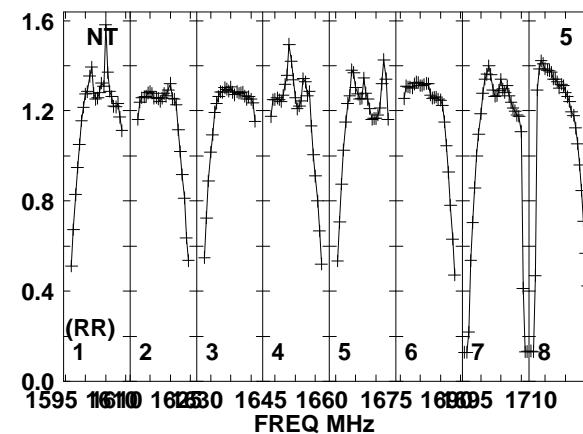
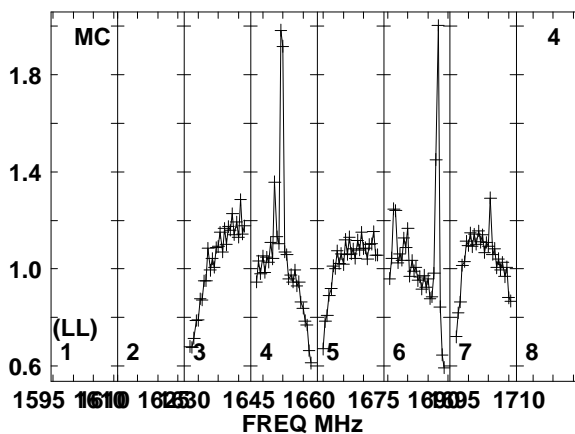
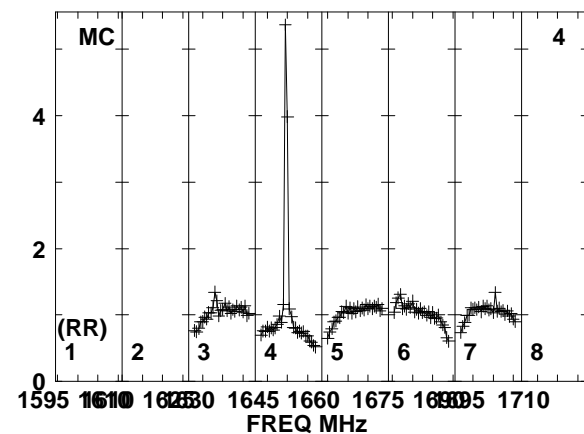
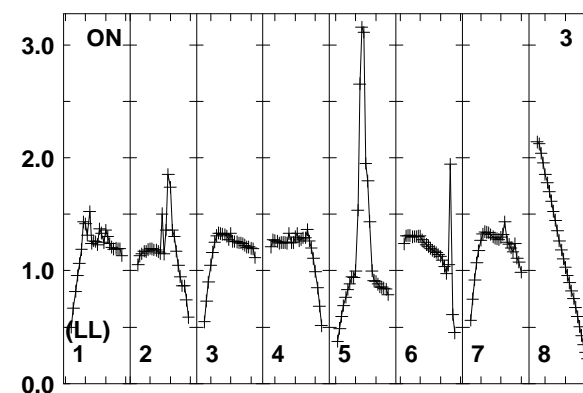
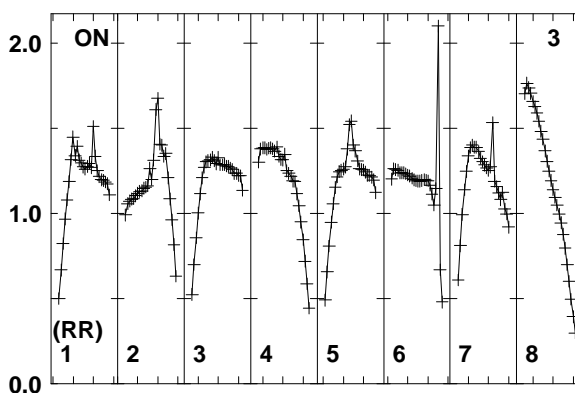
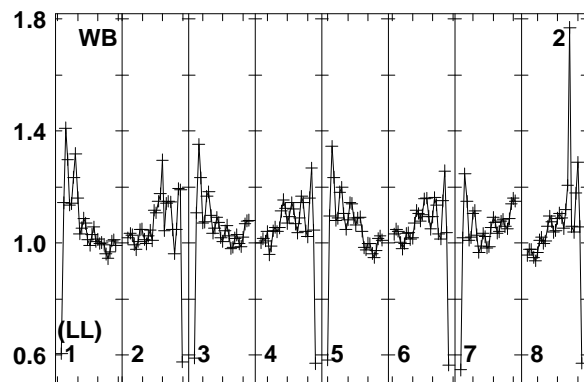
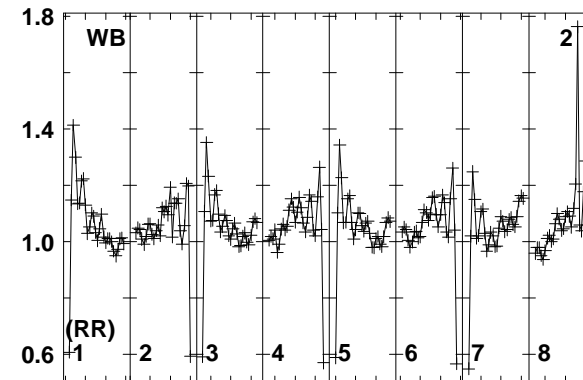
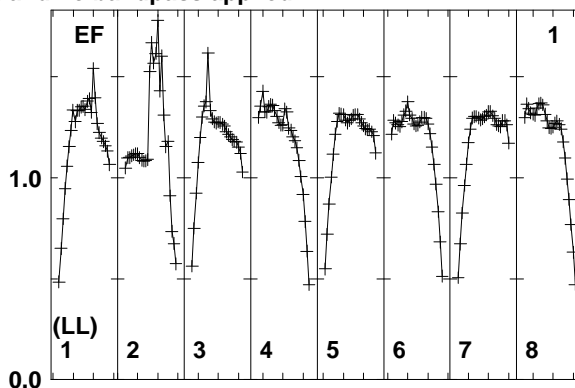
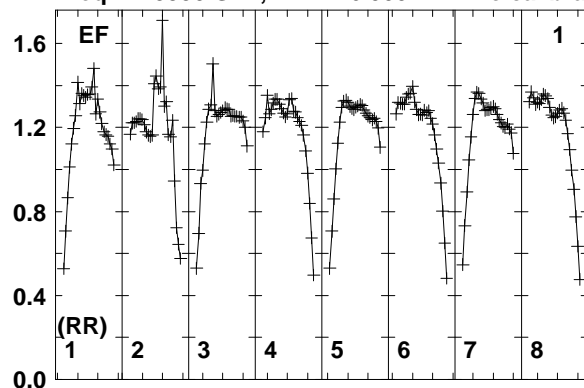

Lower frame: Real Jy
Total-power spectrum Antenna: EF (01)
Timerange: 00/10:58:24 to 00/11:02:08

Plot file version 419 created 11-AUG-2014 17:05:46

J2032+4127 EM110 2.UVDATA.1

Freq = 1.5950 GHz, Bw = 16.000 MH No calibration applied and no bandpass applied

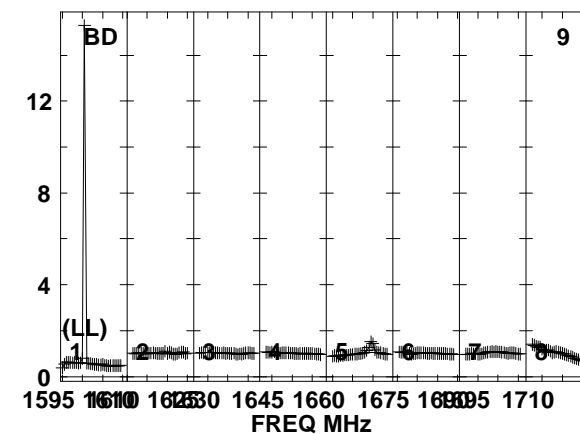
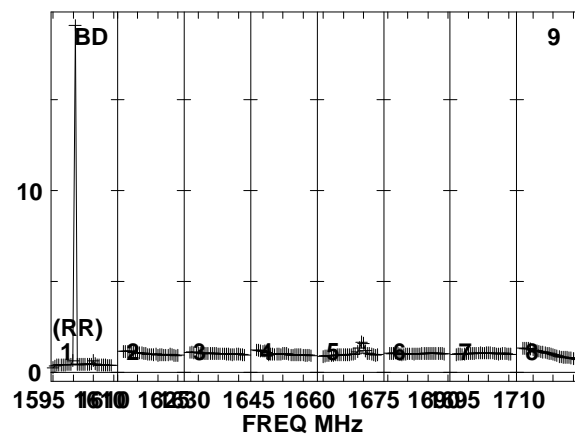
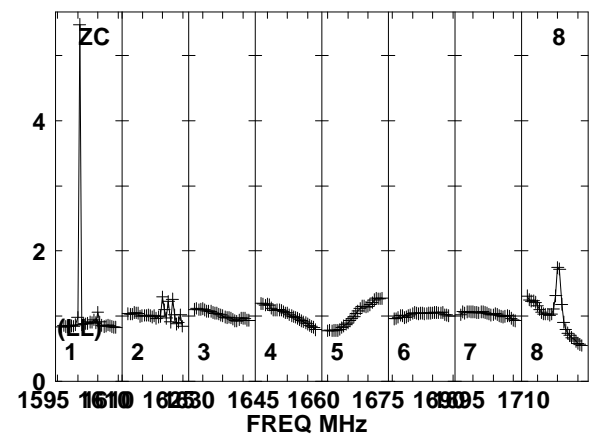
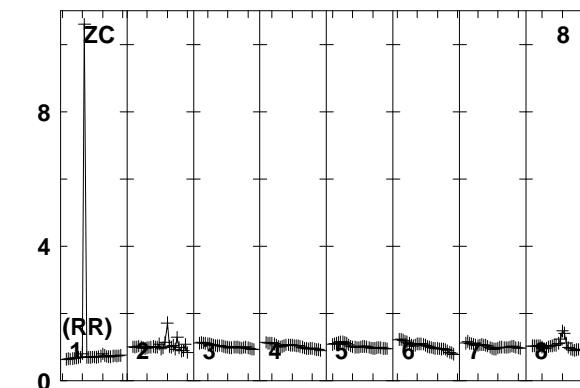
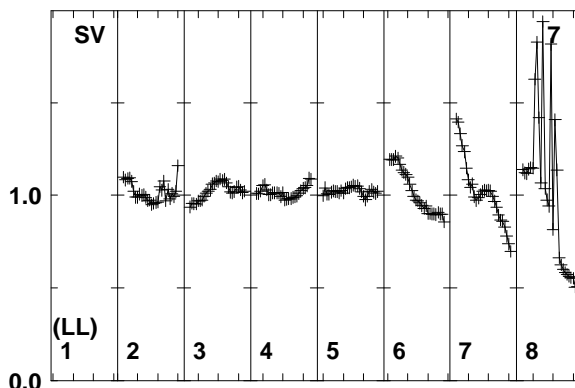
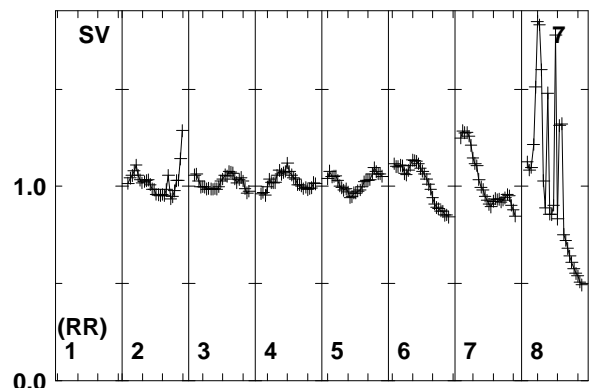
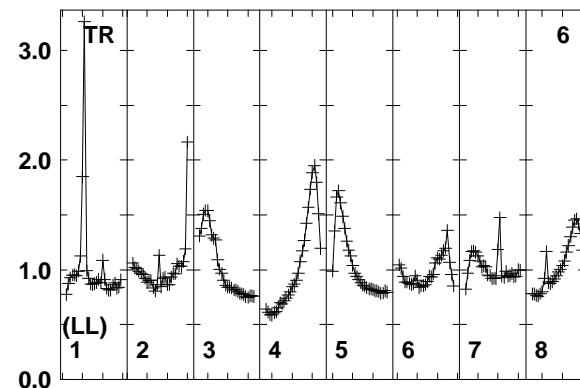
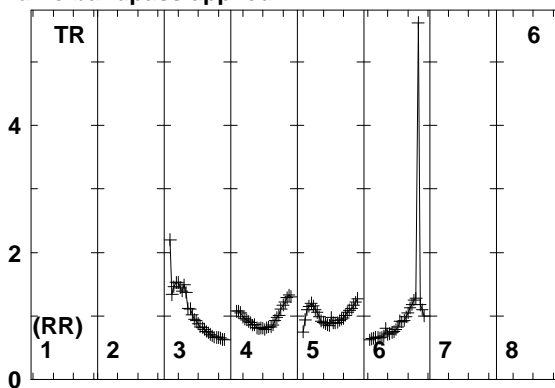
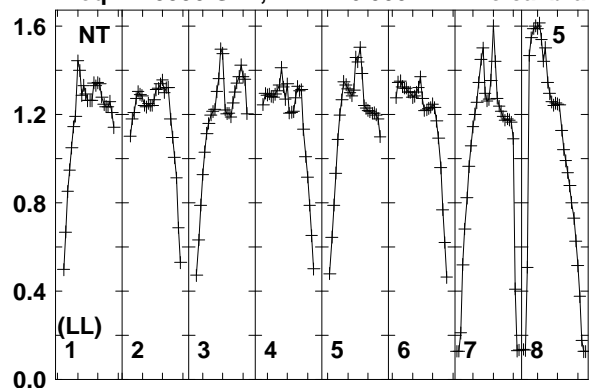

Lower frame: Real Jy
Total-power spectrum Antenna: NT (05)
Timerange: 00/10:58:24 to 00/11:02:08

Plot file version 420 created 11-AUG-2014 17:05:46

J2032+4127 EM110 2.UVDATA.1

Freq = 1.5950 GHz, Bw = 16.000 MH No calibration applied and no bandpass applied

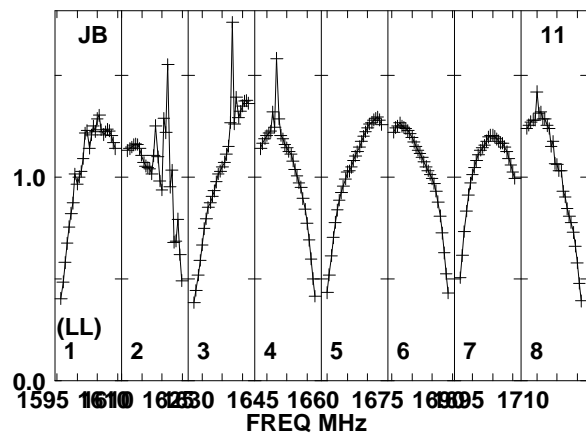
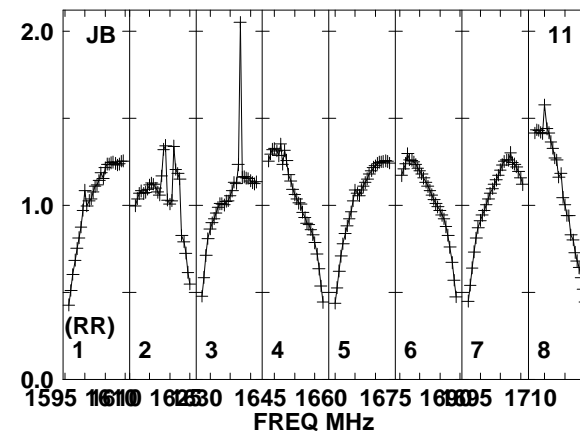
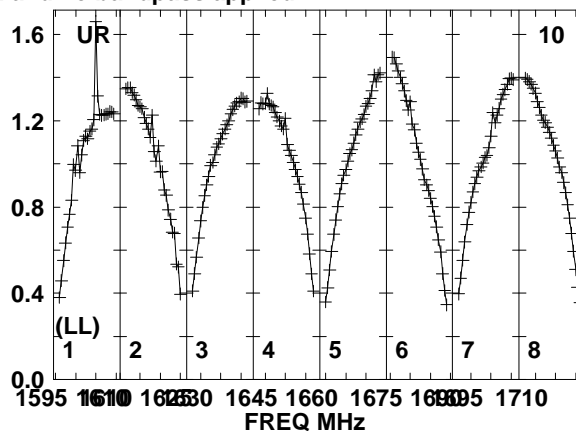
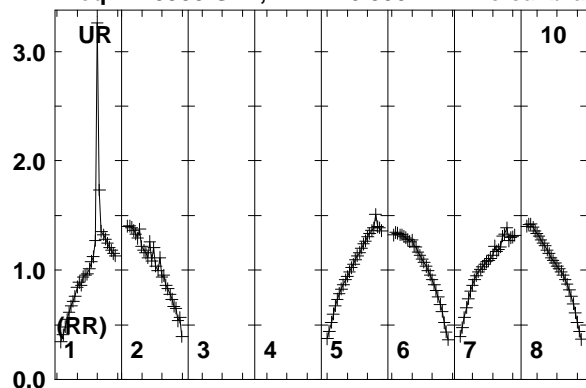

Lower frame: Real Jy
Total-power spectrum Antenna: UR (10)
Timerange: 00/10:58:24 to 00/11:02:08

Plot file version 421 created 11-AUG-2014 17:05:46

J2015+3710 EM110 2.UVDATA.1

Freq = 1.5950 GHz, Bw = 16.000 MH No calibration applied and no bandpass applied

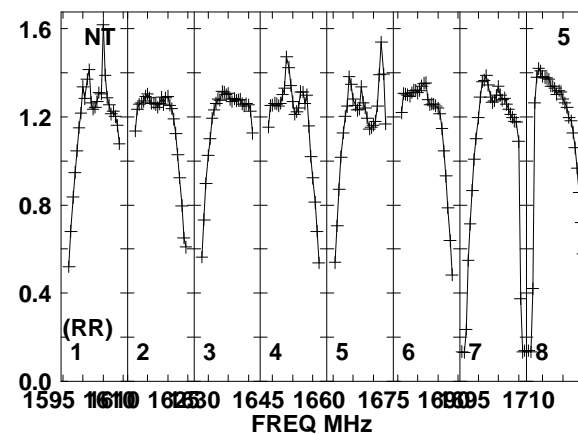
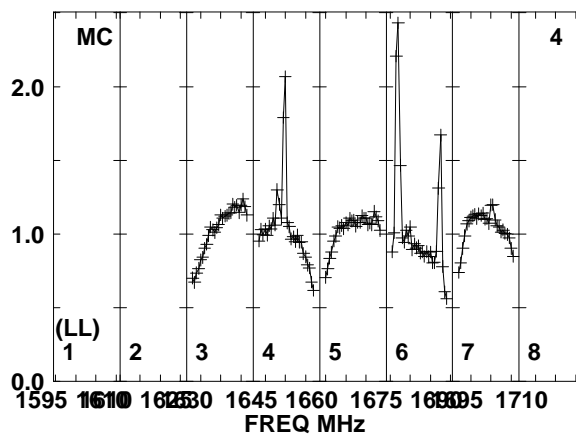
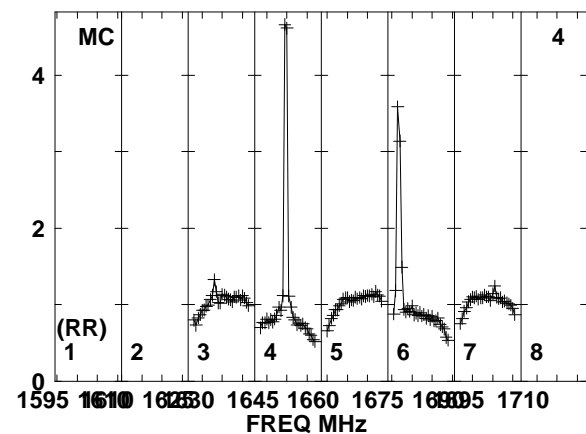
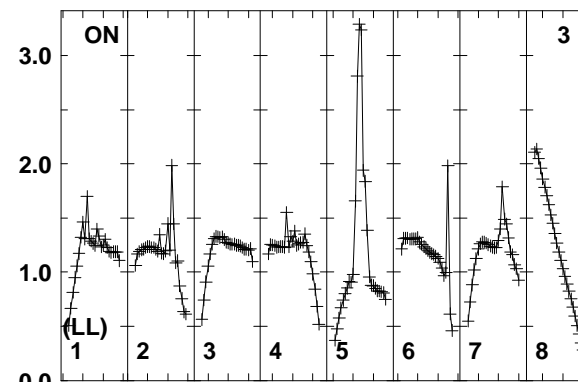
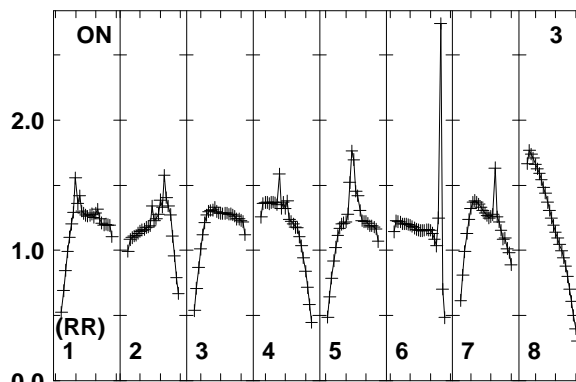
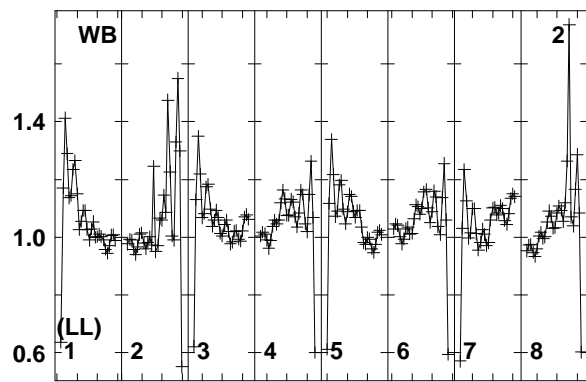
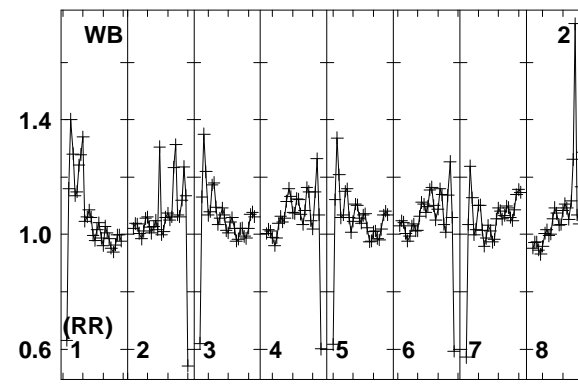
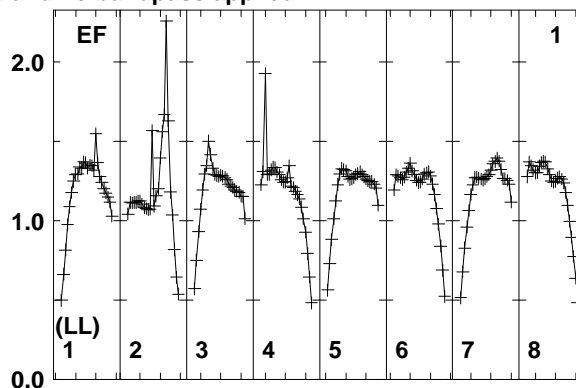
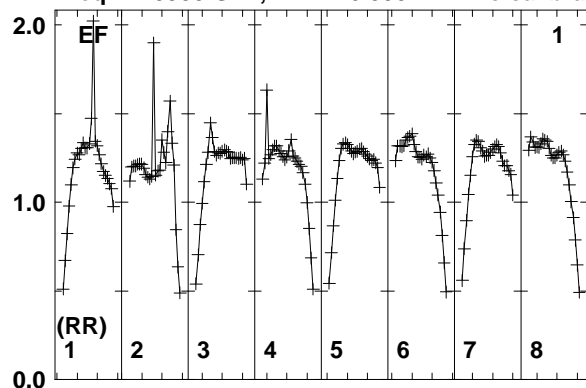

1595 1610 1625 1640 1655 1670 1685 1700 1710
FREQ MHz
Lower frame: Real Jy
Total-power spectrum Antenna: EF (01)
Timerange: 00/11:02:25 to 00/11:04:09

Plot file version 422 created 11-AUG-2014 17:05:46

J2015+3710 EM110 2.UVDATA.1

Freq = 1.5950 GHz, Bw = 16.000 MH No calibration applied and no bandpass applied

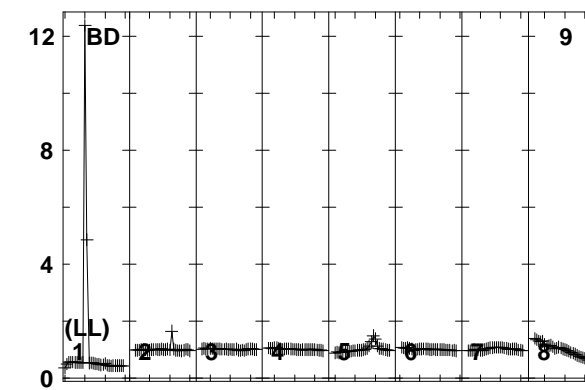
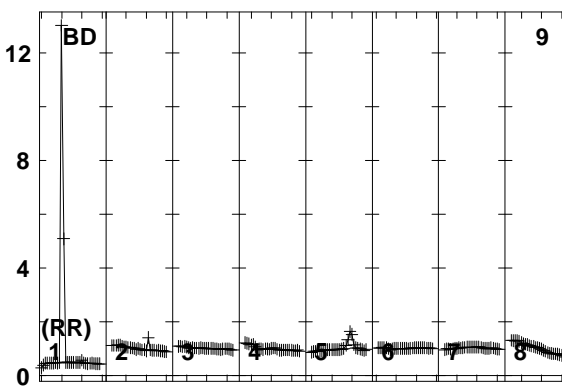
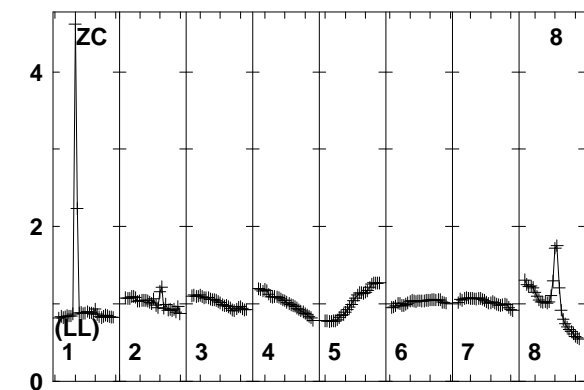
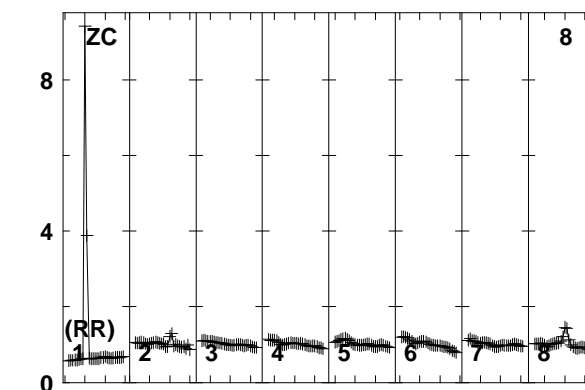
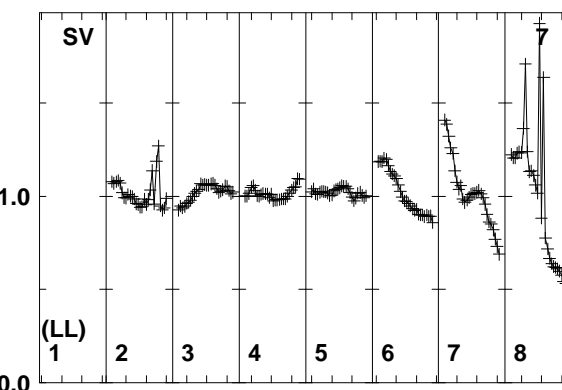
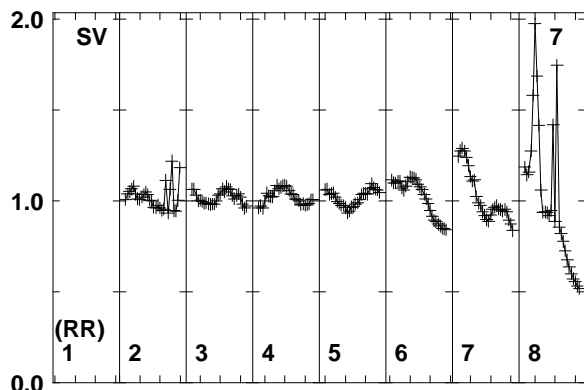
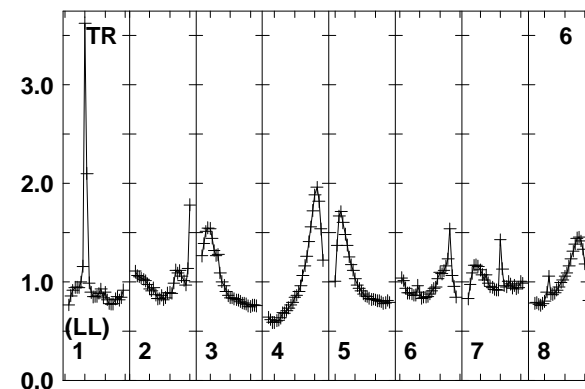
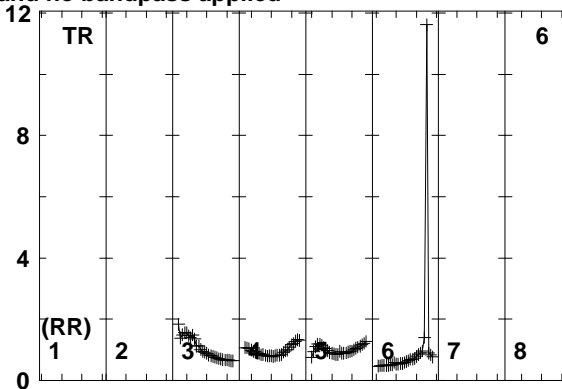
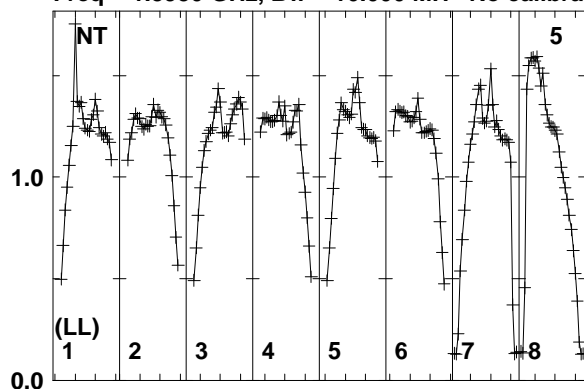

1595 1610 1625 1640 1645 1660 1675 1690 1710
FREQ MHz

1595 1610 1625 1640 1645 1660 1675 1690 1710
FREQ MHz

1595 1610 1625 1640 1645 1660 1675 1690 1710
FREQ MHz

Lower frame: Real Jy
Total-power spectrum Antenna: NT (05)
Timerange: 00/11:02:25 to 00/11:04:09

Plot file version 423 created 11-AUG-2014 17:05:46

J2015+3710 EM110 2.UVDATA.1

Freq = 1.5950 GHz, Bw = 16.000 MH No calibration applied and no bandpass applied

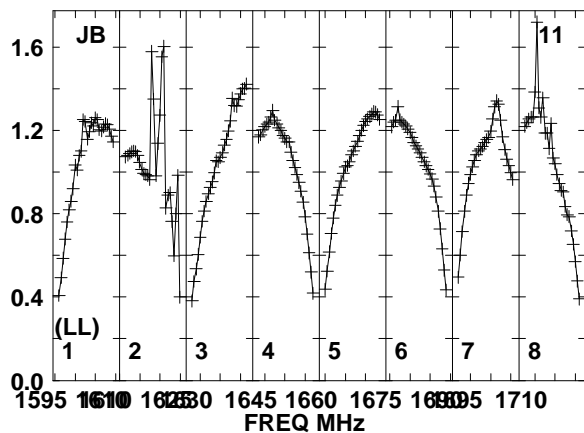
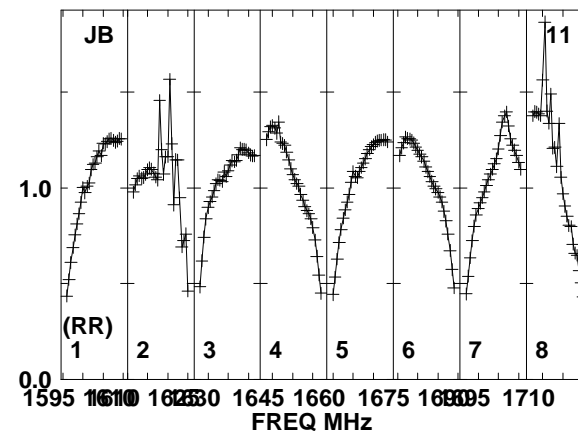
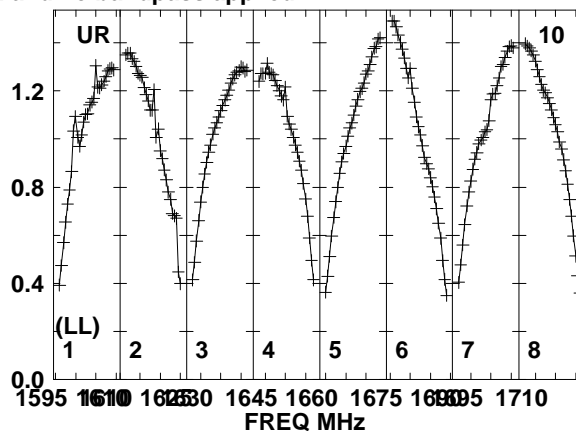
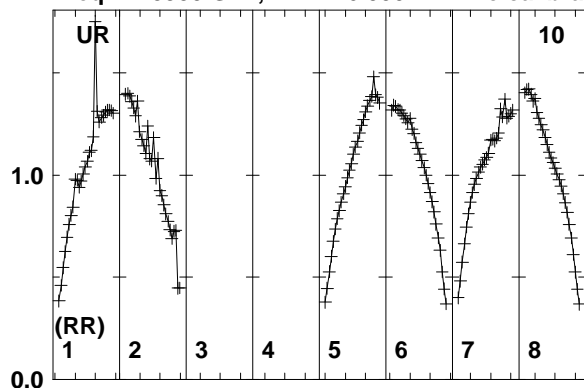

Lower frame: Real Jy
Total-power spectrum Antenna: UR (10)
Timerange: 00/11:02:25 to 00/11:04:09

Plot file version 424 created 11-AUG-2014 17:05:46

J2007+4029 EM110 2.UVDATA.1

Freq = 1.5950 GHz, Bw = 16.000 MH No calibration applied and no bandpass applied

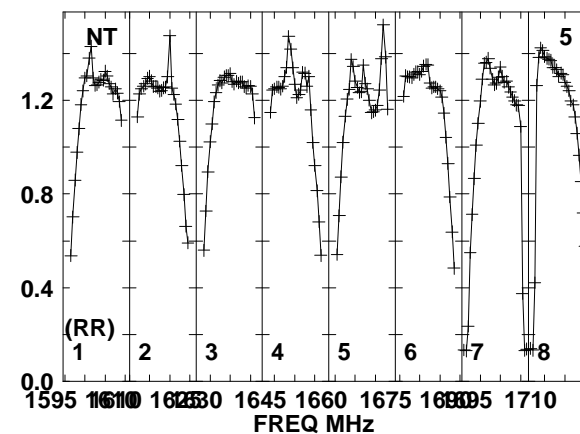
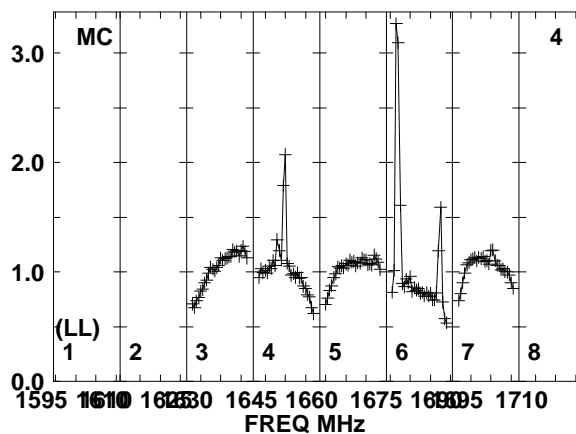
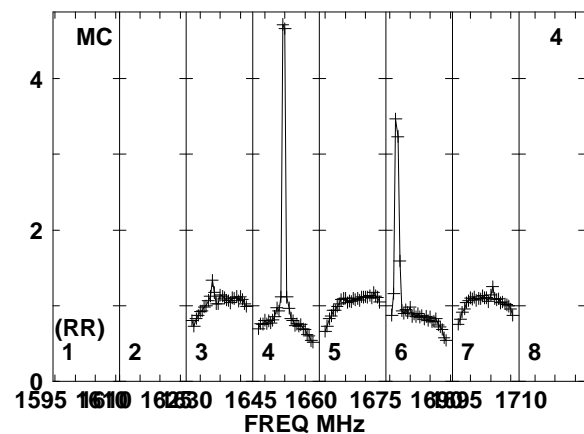
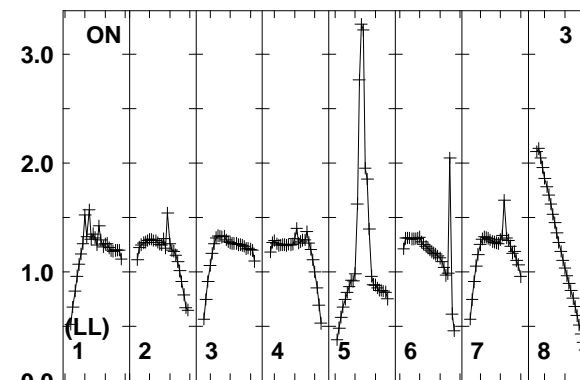
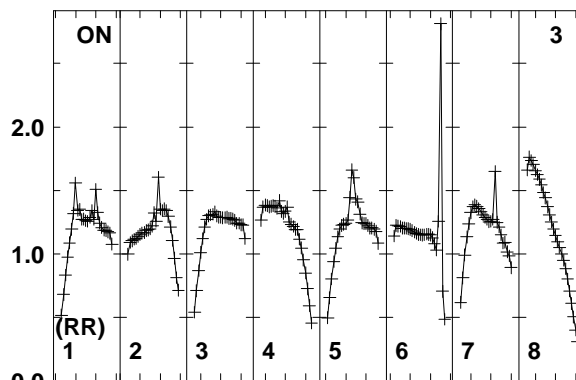
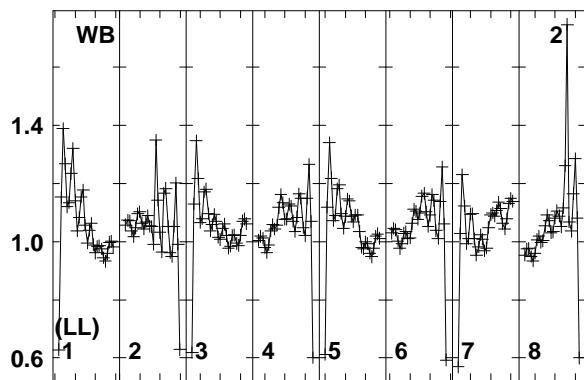
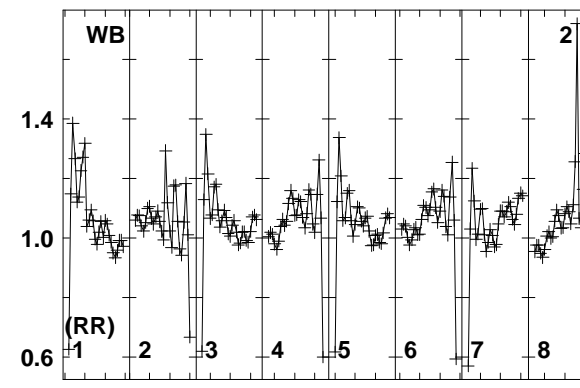
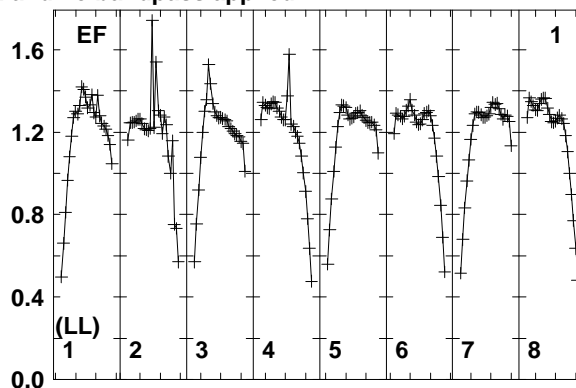
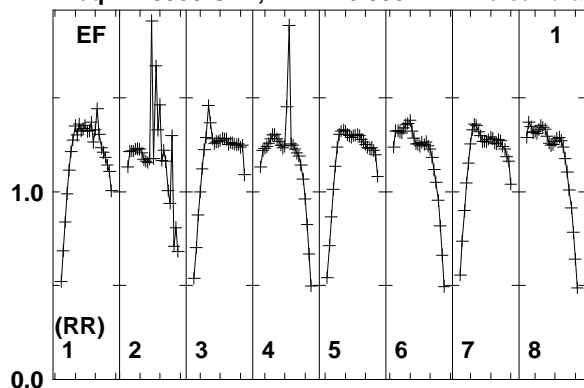

Lower frame: Real Jy
Total-power spectrum Antenna: EF (01)
Timerange: 00/11:04:19 to 00/11:05:09

Plot file version 425 created 11-AUG-2014 17:05:46

J2007+4029 EM110 2.UVDATA.1

Freq = 1.5950 GHz, Bw = 16.000 MH No calibration applied and no bandpass applied

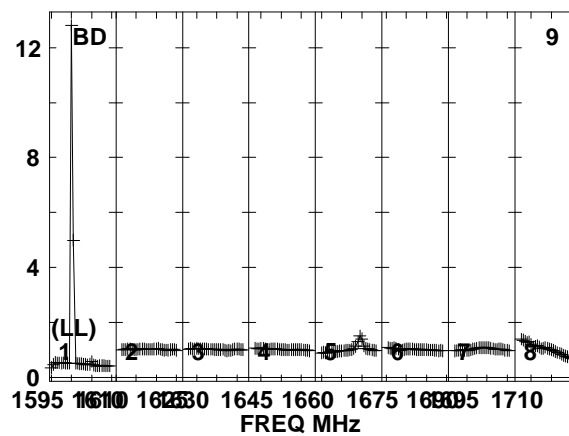
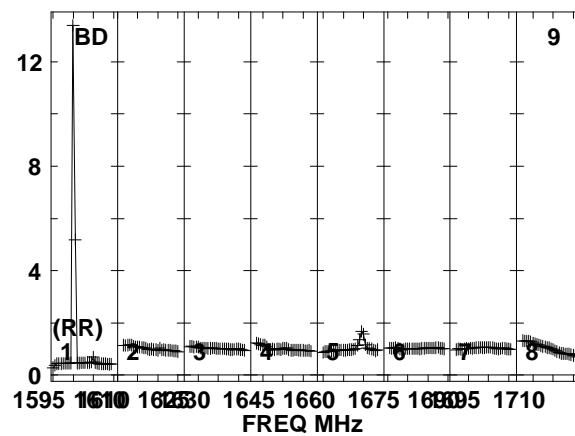
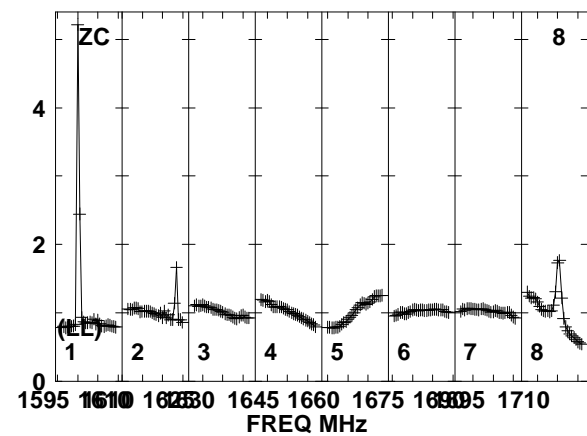
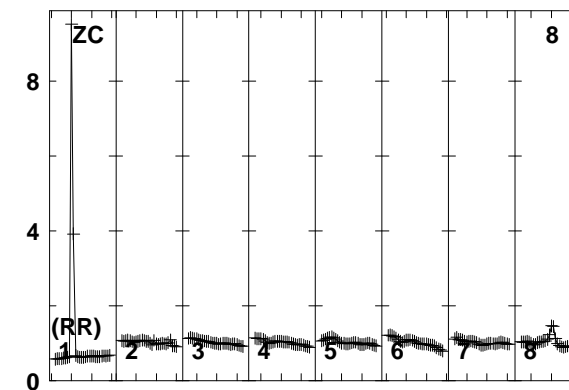
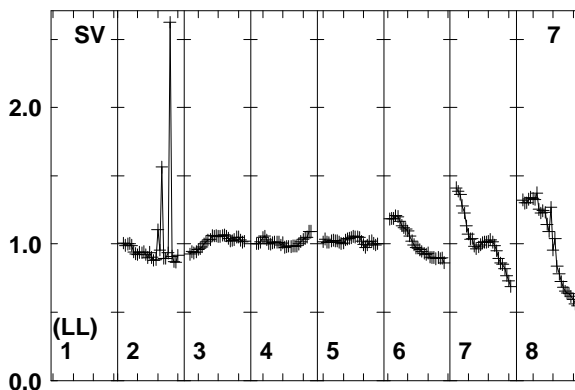
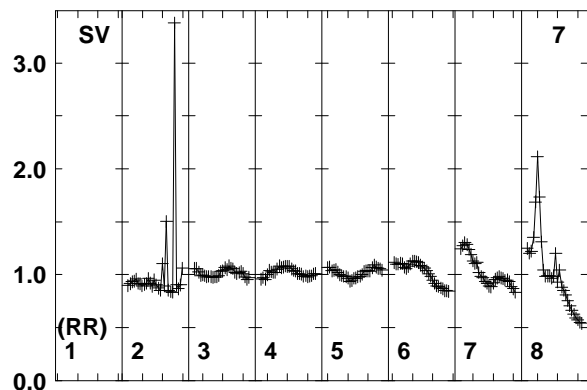
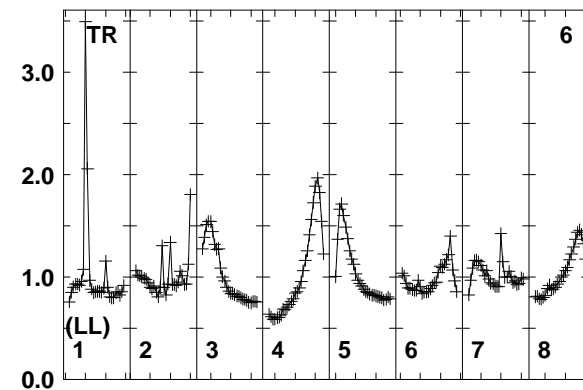
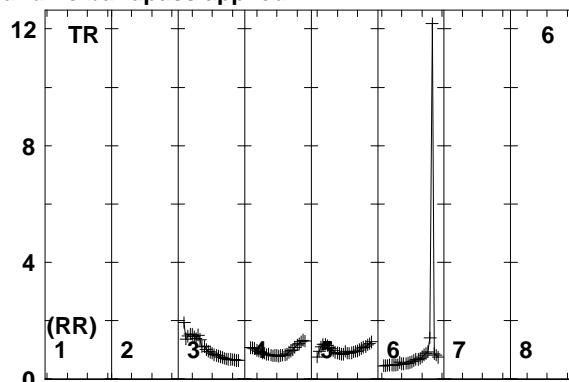
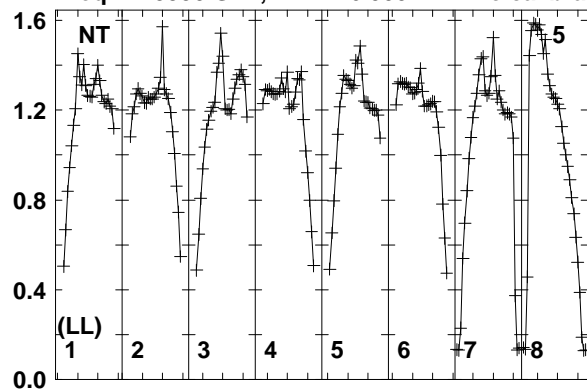

Lower frame: Real Jy
Total-power spectrum Antenna: NT (05)
Timerange: 00/11:04:19 to 00/11:05:09

Plot file version 426 created 11-AUG-2014 17:05:46

J2007+4029 EM110 2.UVDATA.1

Freq = 1.5950 GHz, Bw = 16.000 MH No calibration applied and no bandpass applied

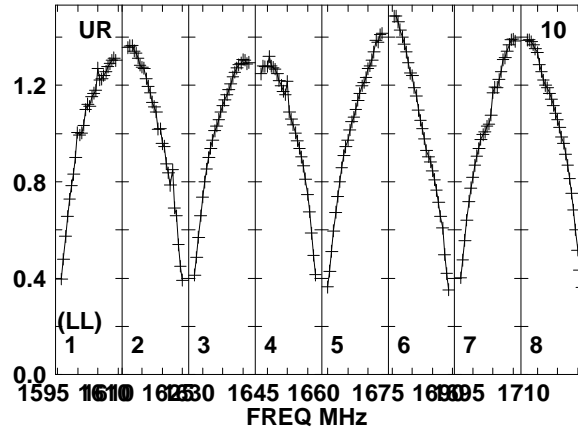
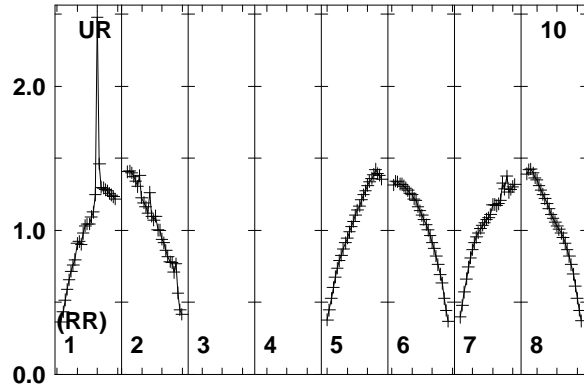

Lower frame: Real Jy
Total-power spectrum Antenna: UR (10)
Timerange: 00/11:04:19 to 00/11:05:09

Plot file version 427 created 11-AUG-2014 17:05:46

J2015+3710 EM110 2.UVDATA.1

Freq = 1.5950 GHz, Bw = 16.000 MH No calibration applied and no bandpass applied

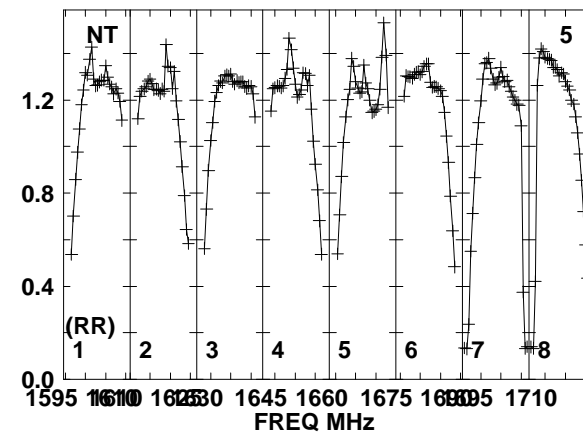
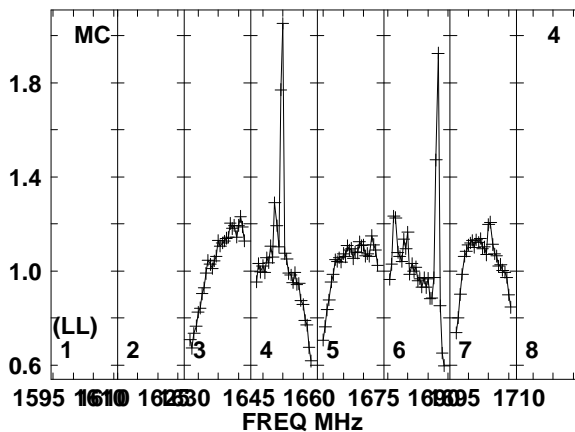
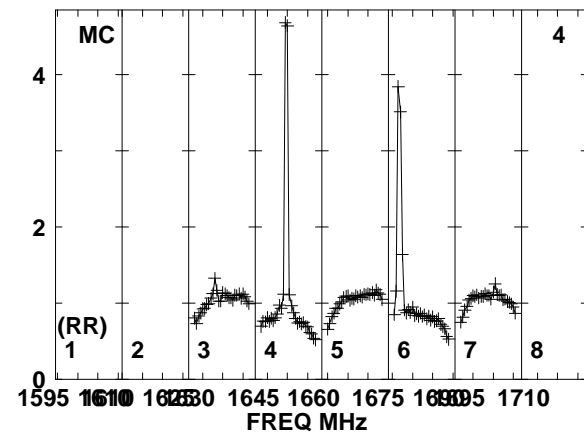
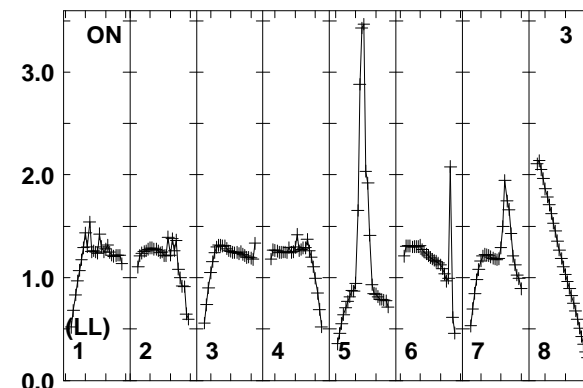
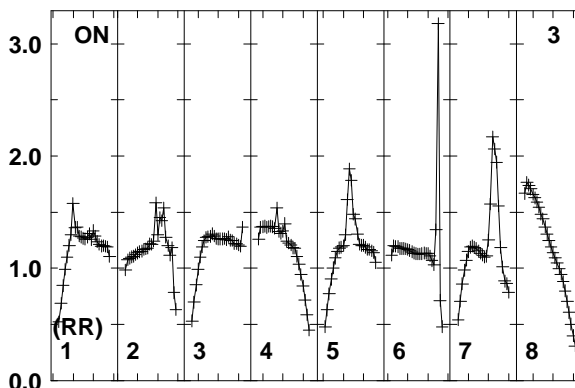
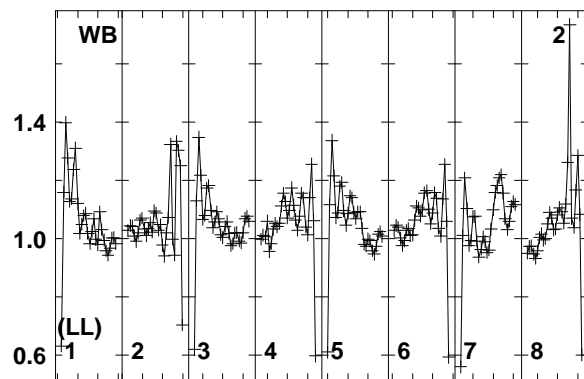
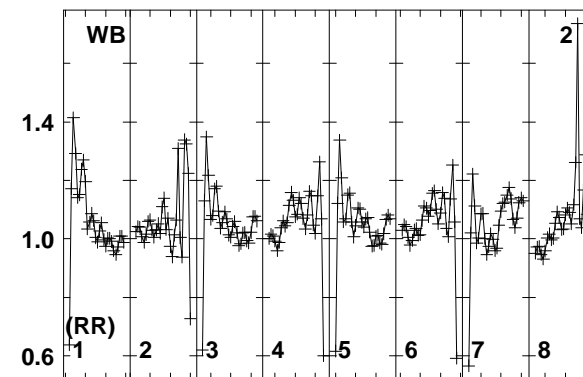
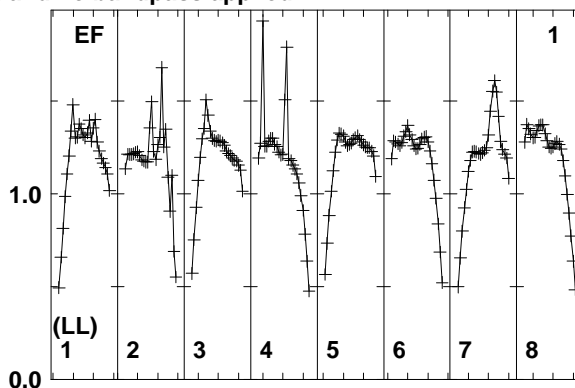
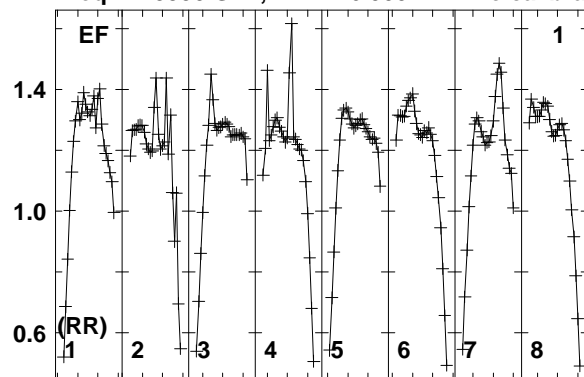

1595 1610 1625 1640 1655 1670 1685 1700 1710
FREQ MHz
Lower frame: Real Jy
Total-power spectrum Antenna: EF (01)
Timerange: 00/11:06:11 to 00/11:08:09

Plot file version 428 created 11-AUG-2014 17:05:46

J2015+3710 EM110 2.UVDATA.1

Freq = 1.5950 GHz, Bw = 16.000 MH No calibration applied and no bandpass applied

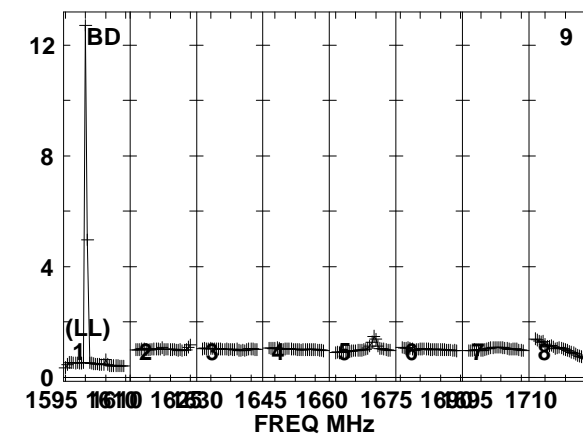
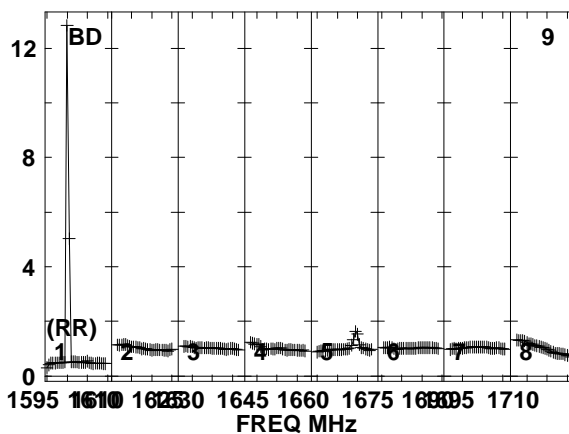
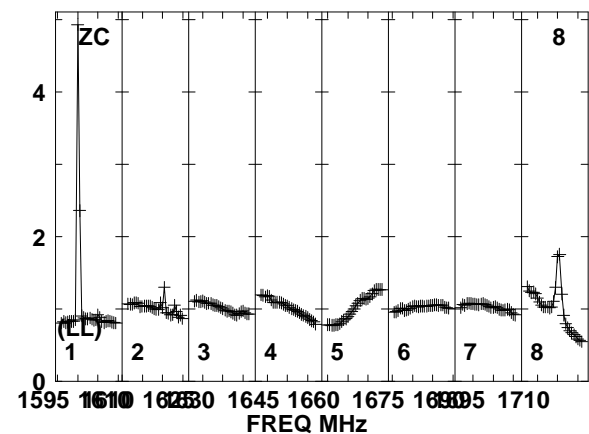
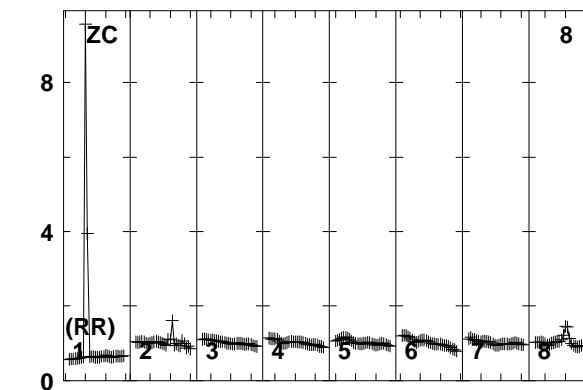
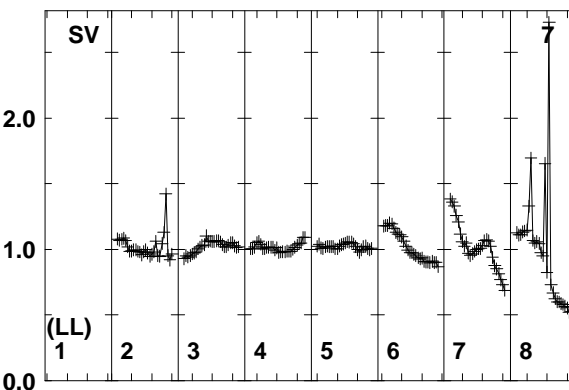
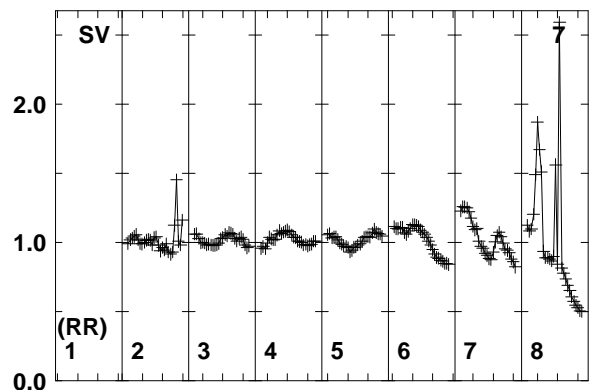
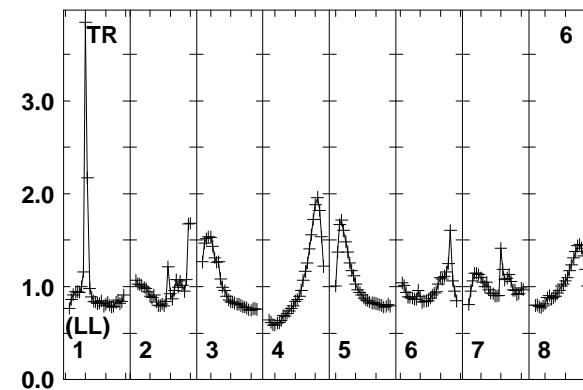
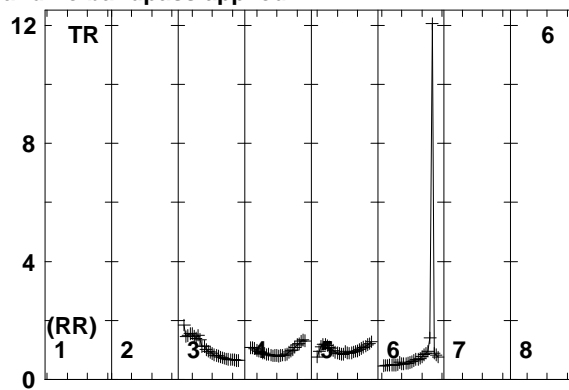
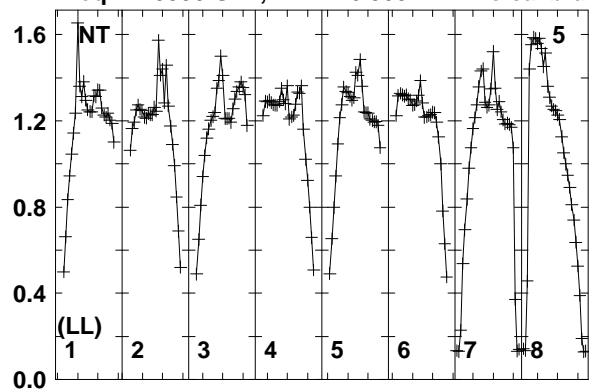

Lower frame: Real Jy
Total-power spectrum Antenna: NT (05)
Timerange: 00/11:06:11 to 00/11:08:09

Plot file version 429 created 11-AUG-2014 17:05:46

J2015+3710 EM110 2.UVDATA.1

Freq = 1.5950 GHz, Bw = 16.000 MH No calibration applied and no bandpass applied

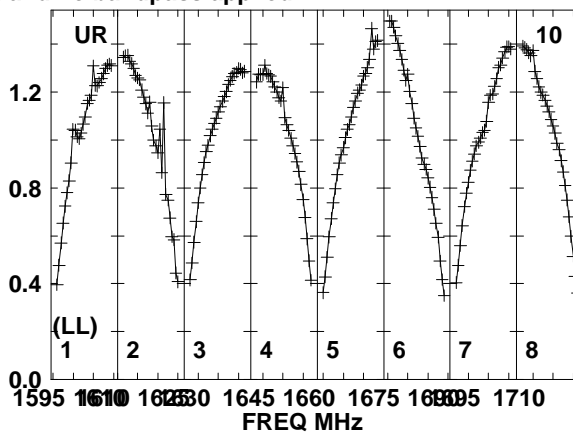
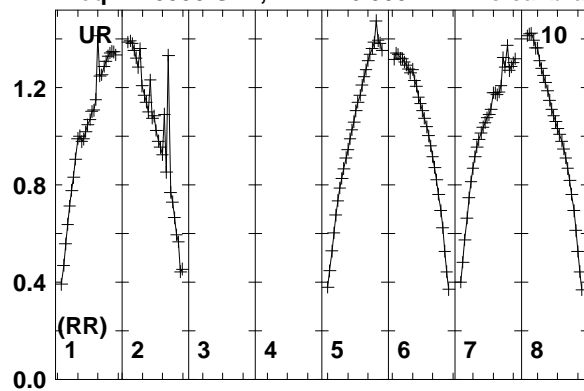

Lower frame: Real Jy
Total-power spectrum Antenna: UR (10)
Timerange: 00/11:06:11 to 00/11:08:09

Plot file version 430 created 11-AUG-2014 17:05:46

J2032+4127 EM110 2.UVDATA.1

Freq = 1.5950 GHz, Bw = 16.000 MH No calibration applied and no bandpass applied

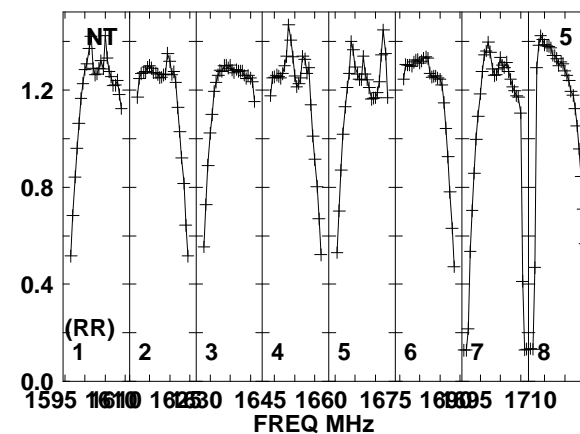
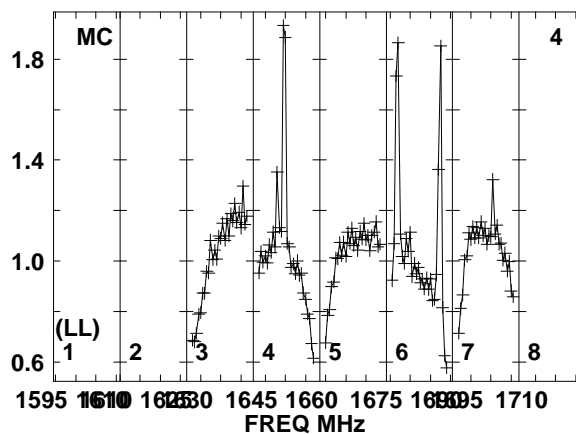
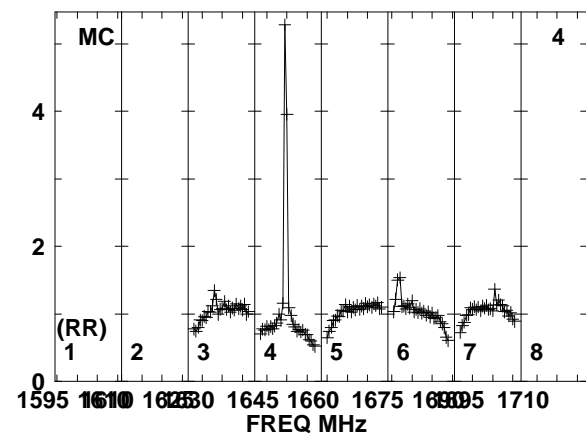
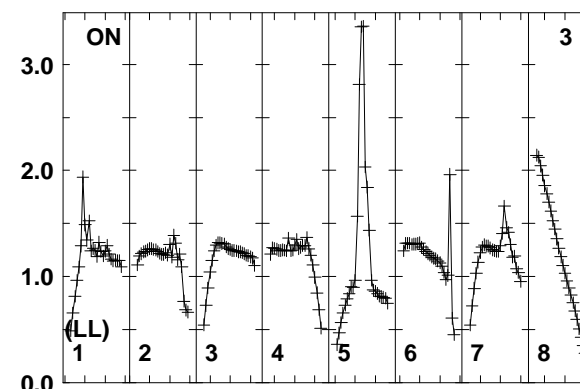
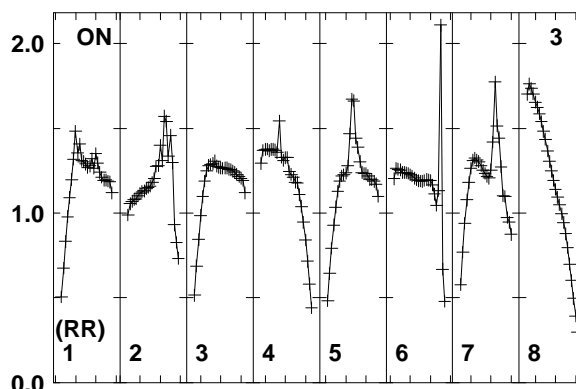
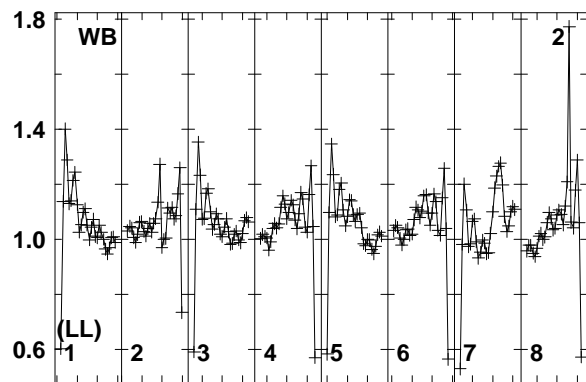
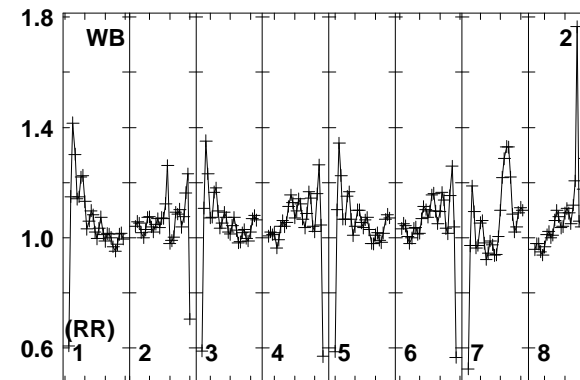
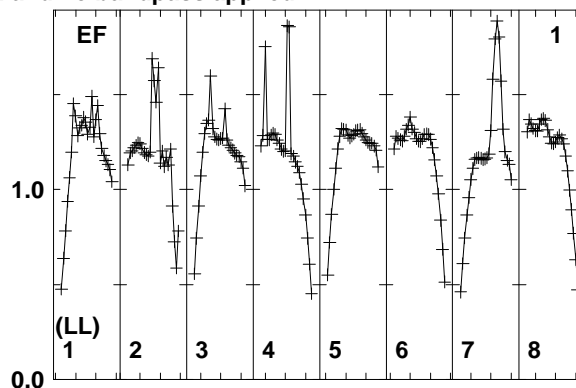
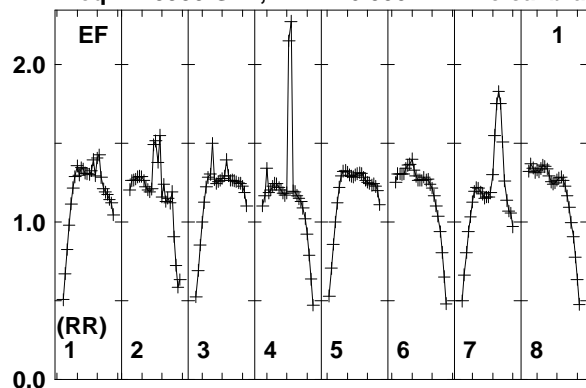

Lower frame: Real Jy
Total-power spectrum Antenna: EF (01)
Timerange: 00/11:08:11 to 00/11:12:09

Plot file version 431 created 11-AUG-2014 17:05:46

J2032+4127 EM110 2.UVDATA.1

Freq = 1.5950 GHz, Bw = 16.000 MH No calibration applied and no bandpass applied

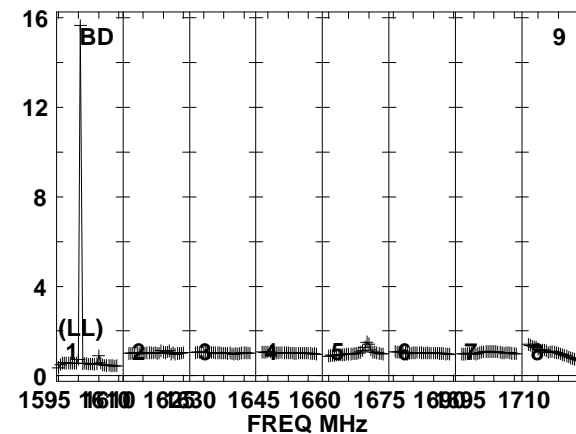
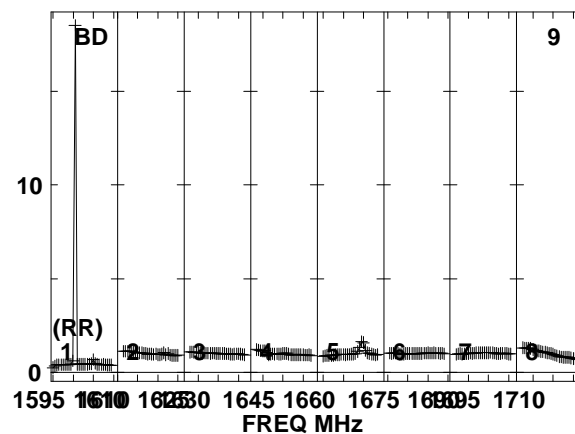
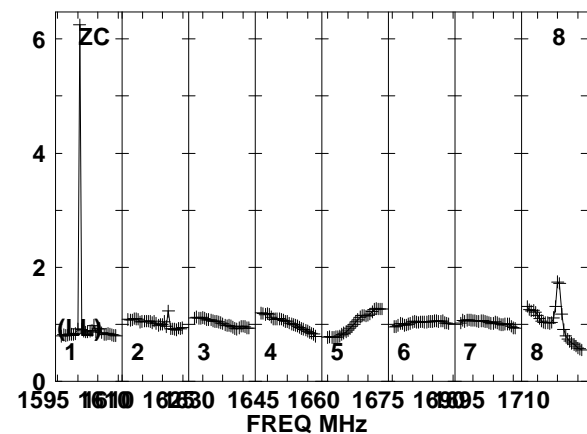
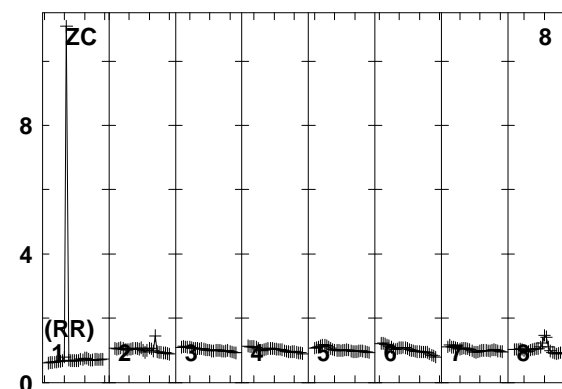
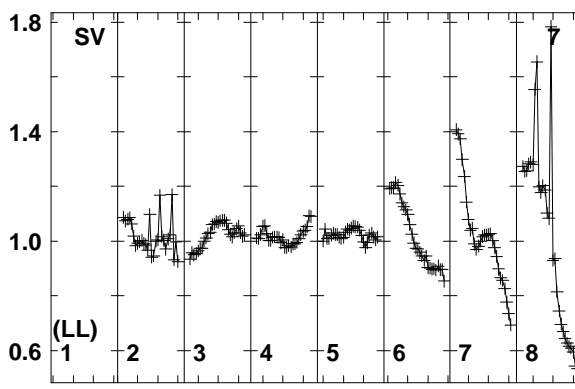
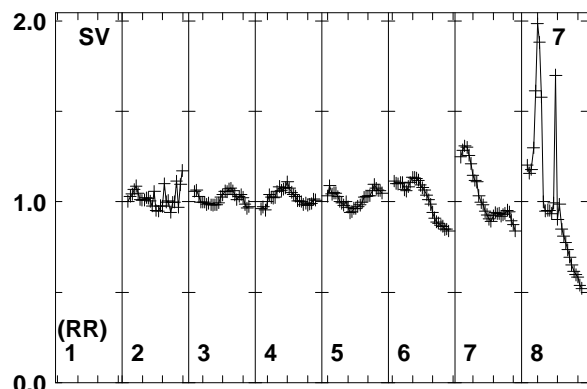
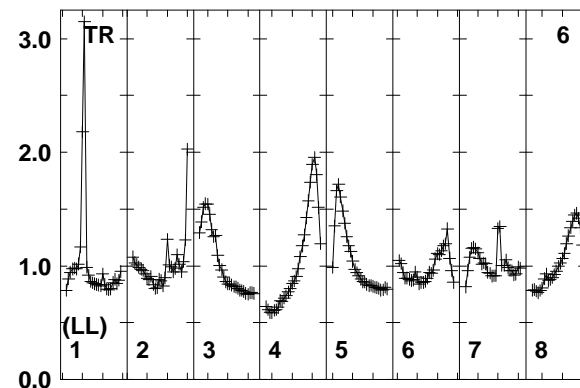
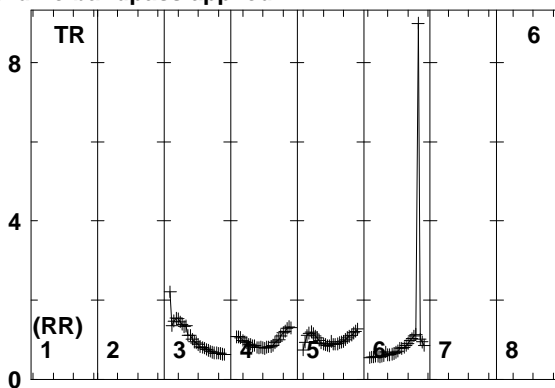
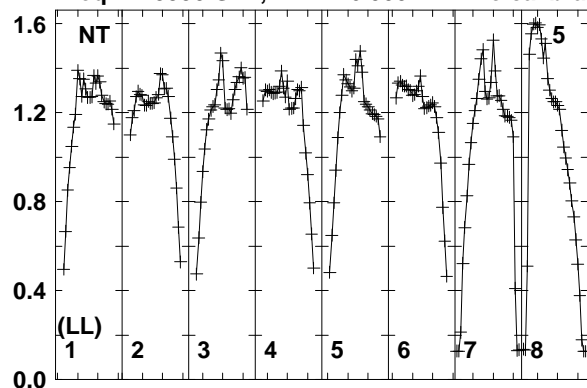

1595 1610 1625 1645 1660 1675 1690 1710
FREQ MHz
Lower frame: Real Jy
Total-power spectrum Antenna: NT (05)
Timerange: 00/11:08:11 to 00/11:12:09

Plot file version 432 created 11-AUG-2014 17:05:46

J2032+4127 EM110 2.UVDATA.1

Freq = 1.5950 GHz, Bw = 16.000 MH No calibration applied and no bandpass applied

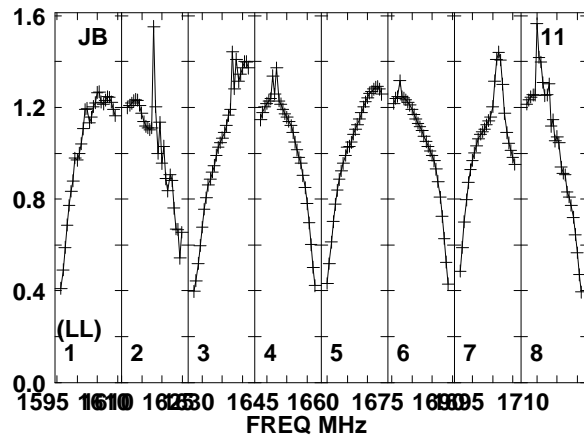
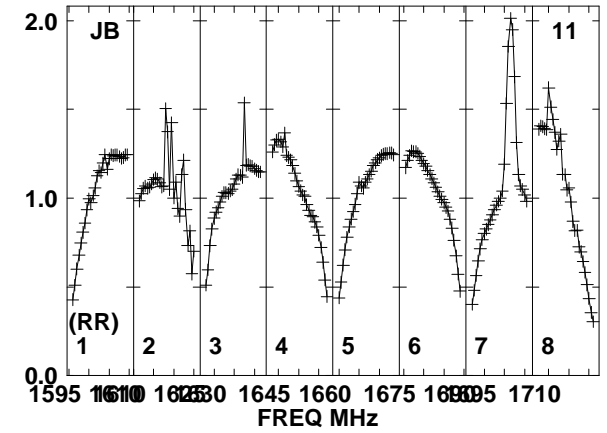
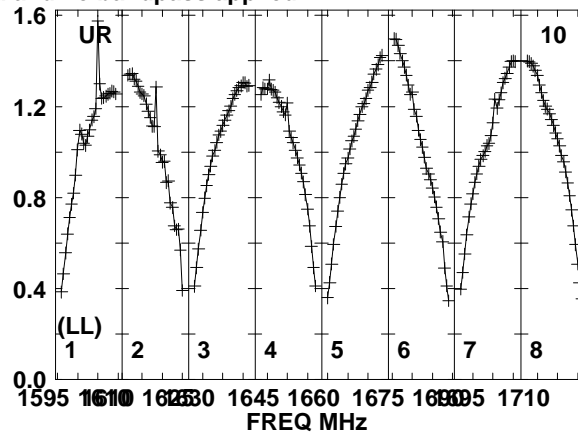
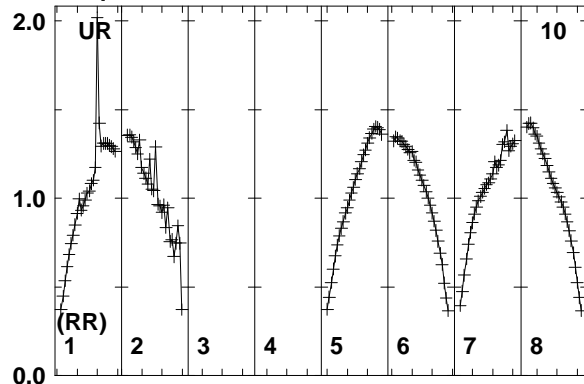

Lower frame: Real Jy
Total-power spectrum Antenna: UR (10)
Timerange: 00/11:08:11 to 00/11:12:09

Plot file version 433 created 11-AUG-2014 17:05:47

J2015+3710 EM110 2.UVDATA.1

Freq = 1.5950 GHz, Bw = 16.000 MH No calibration applied and no bandpass applied

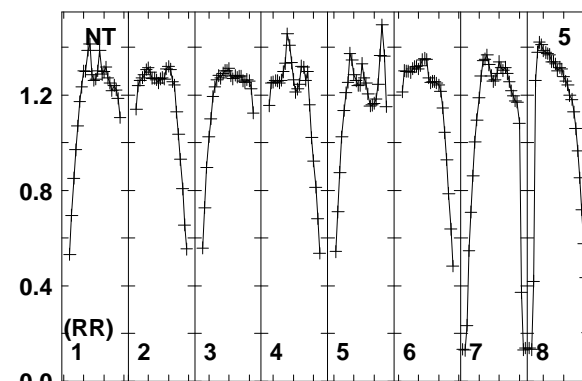
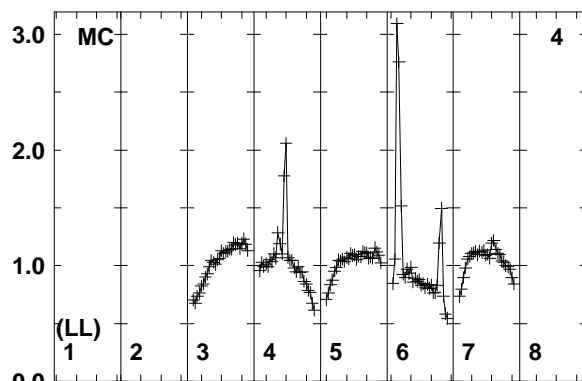
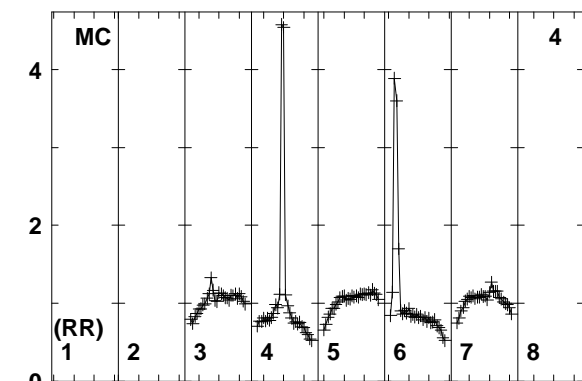
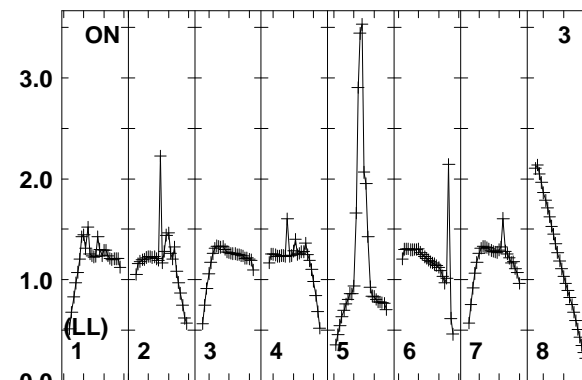
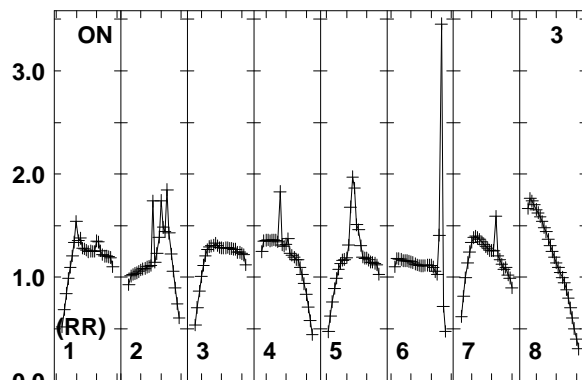
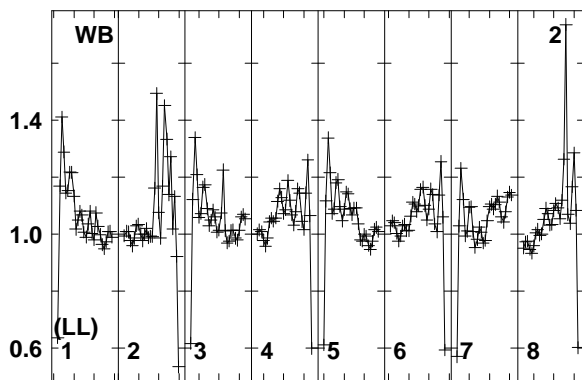
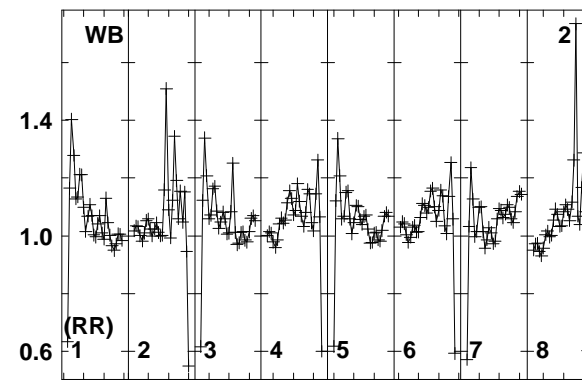
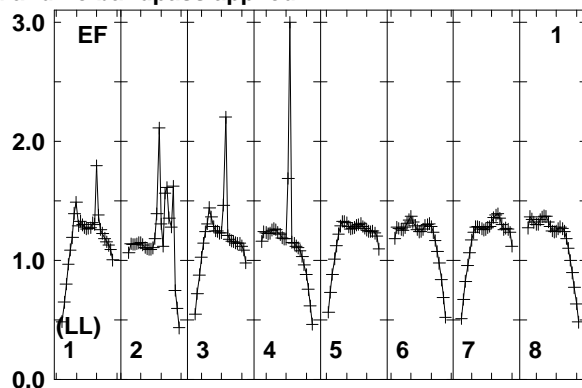
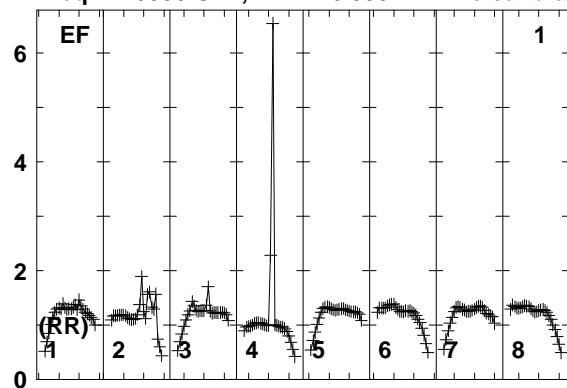

1595 1610 1625 1640 1655 1670 1685 1700 1710
FREQ MHz

1595 1610 1625 1640 1655 1670 1685 1700 1710
FREQ MHz

1595 1610 1625 1640 1655 1670 1685 1700 1710
FREQ MHz

Lower frame: Real Jy
Total-power spectrum Antenna: EF (01)
Timerange: 00/11:12:25 to 00/11:14:09

Plot file version 434 created 11-AUG-2014 17:05:47

J2015+3710 EM110 2.UVDATA.1

Freq = 1.5950 GHz, Bw = 16.000 MH No calibration applied and no bandpass applied

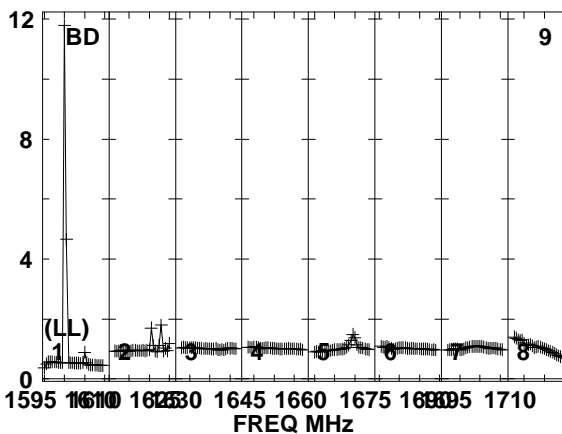
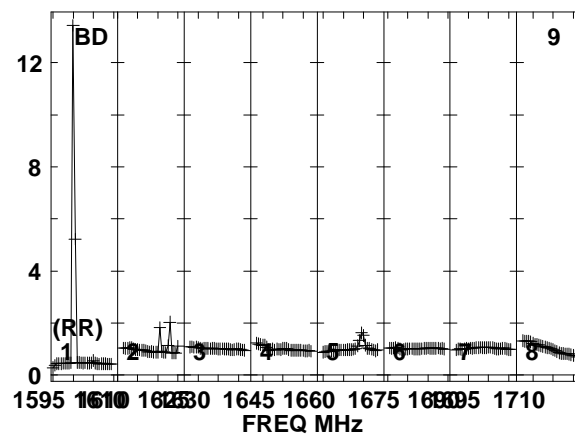
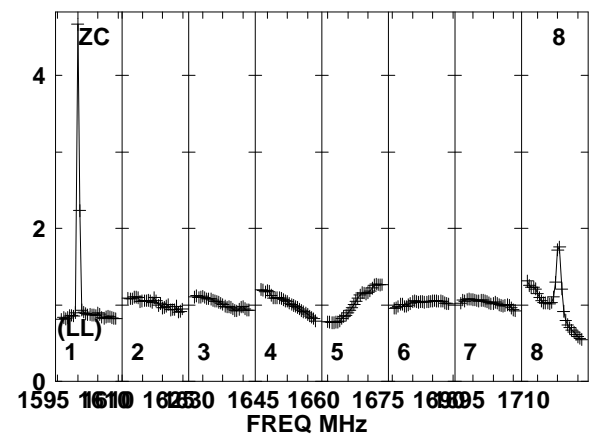
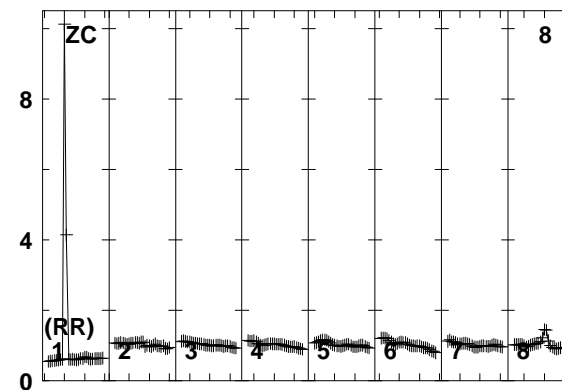
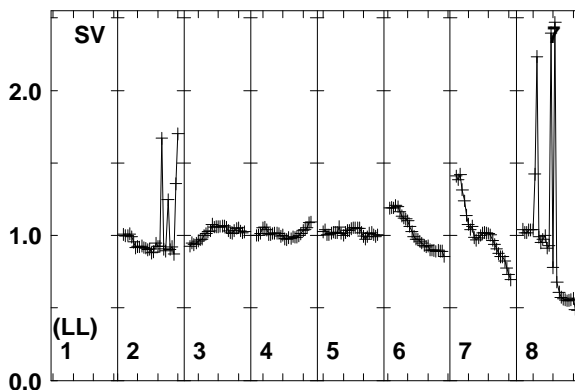
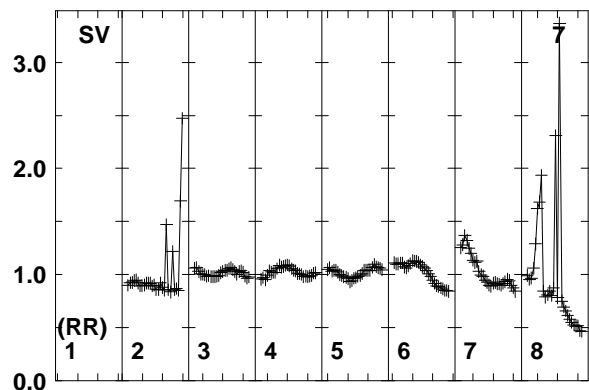
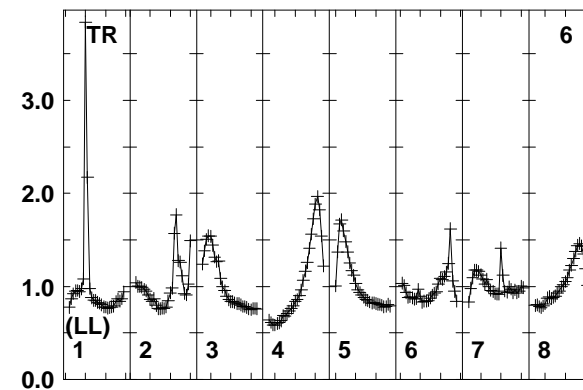
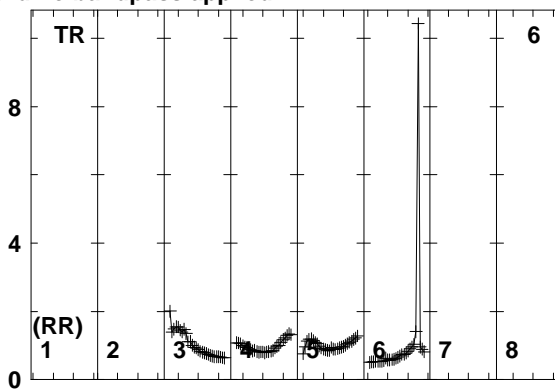
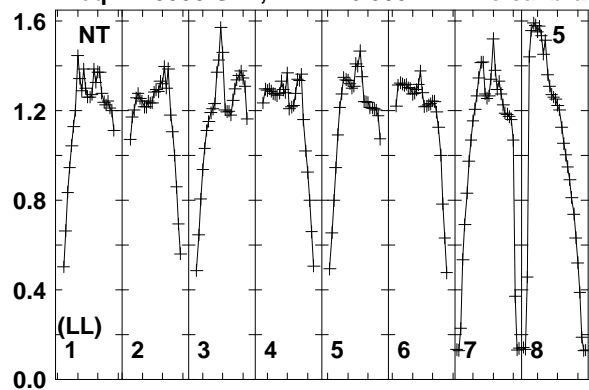

Lower frame: Real Jy
Total-power spectrum Antenna: NT (05)
Timerange: 00/11:12:25 to 00/11:14:09

Plot file version 435 created 11-AUG-2014 17:05:47

J2015+3710 EM110 2.UVDATA.1

Freq = 1.5950 GHz, Bw = 16.000 MH No calibration applied and no bandpass applied

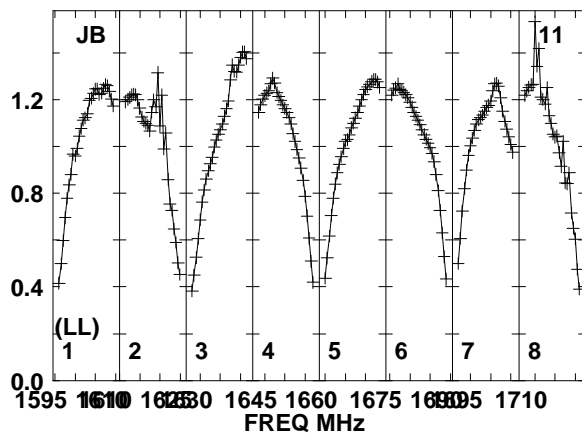
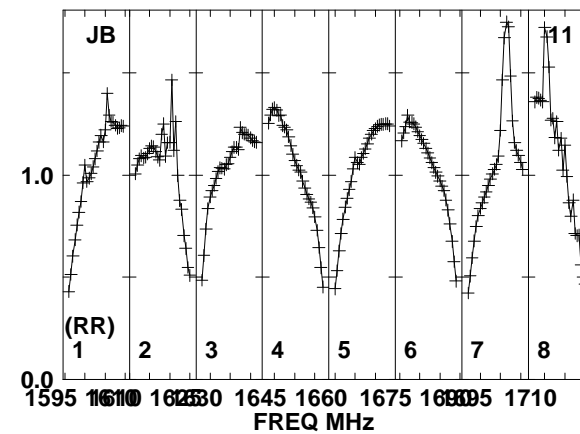
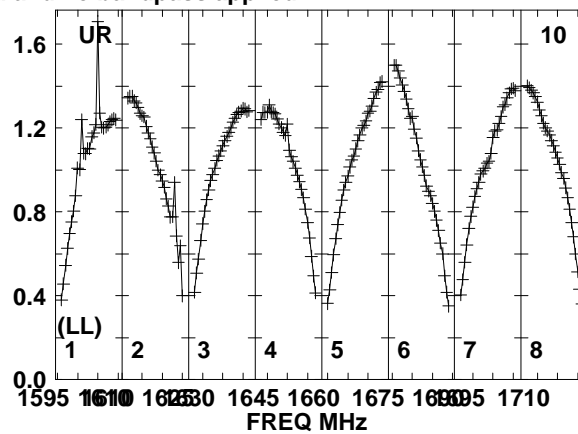
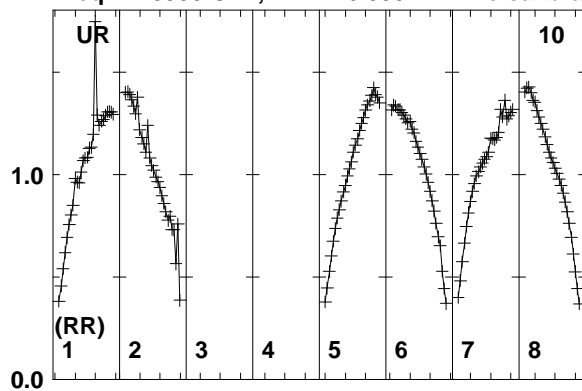

Lower frame: Real Jy
Total-power spectrum Antenna: UR (10)
Timerange: 00/11:12:25 to 00/11:14:09

Plot file version 436 created 11-AUG-2014 17:05:47

J2032+4127 EM110 2.UVDATA.1

Freq = 1.5950 GHz, Bw = 16.000 MH No calibration applied and no bandpass applied

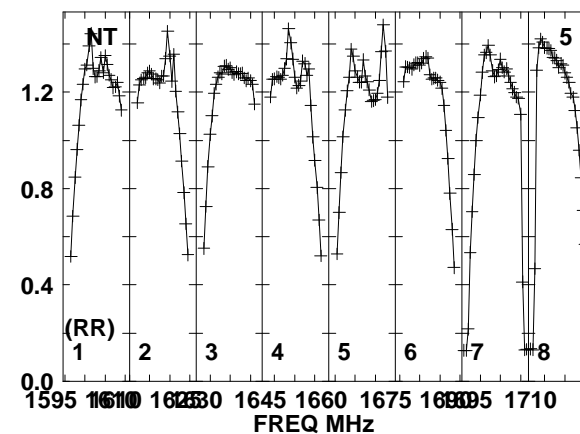
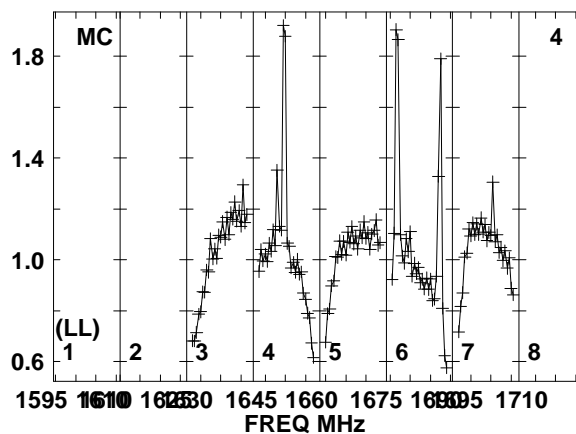
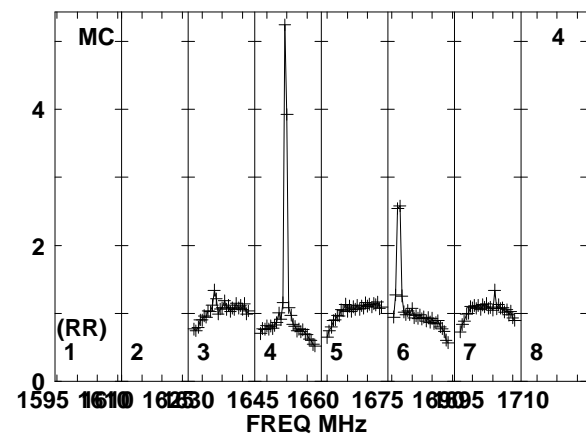
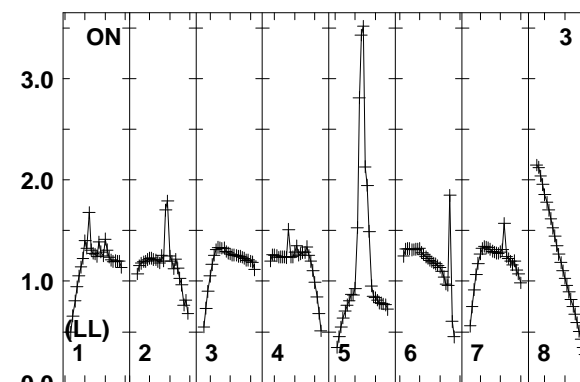
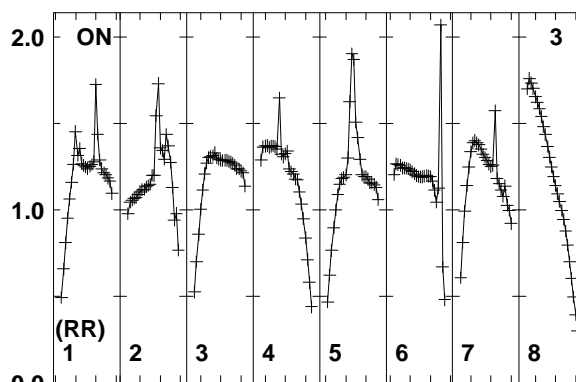
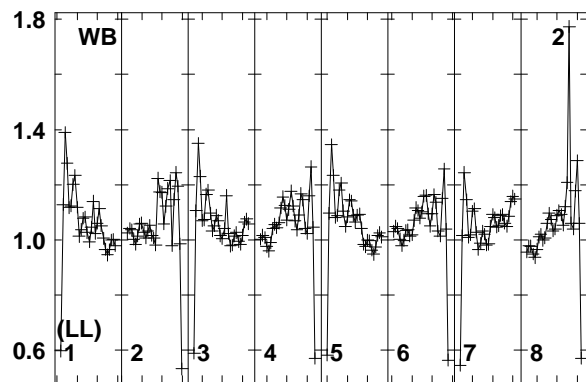
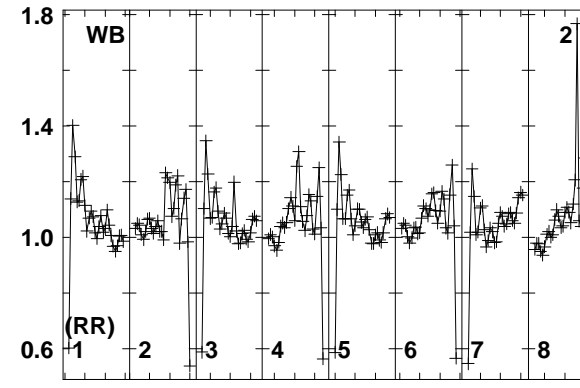
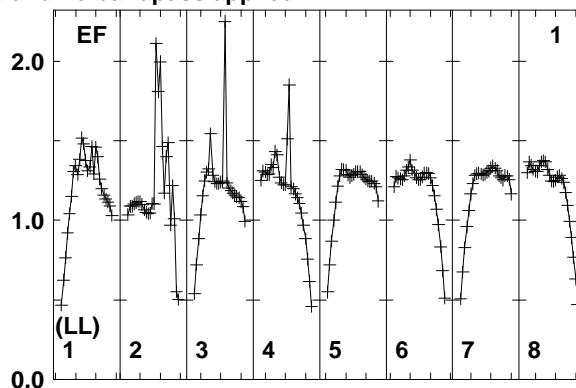
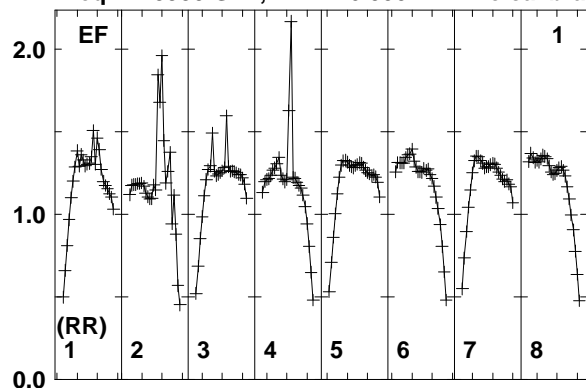

Lower frame: Real Jy
Total-power spectrum Antenna: EF (01)
Timerange: 00/11:14:25 to 00/11:18:09

Plot file version 437 created 11-AUG-2014 17:05:47

J2032+4127 EM110 2.UVDATA.1

Freq = 1.5950 GHz, Bw = 16.000 MH No calibration applied and no bandpass applied

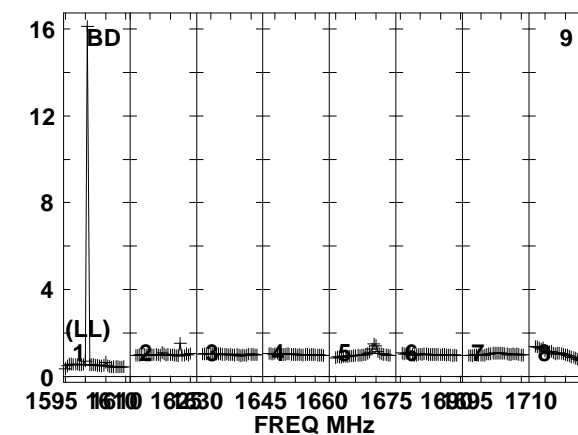
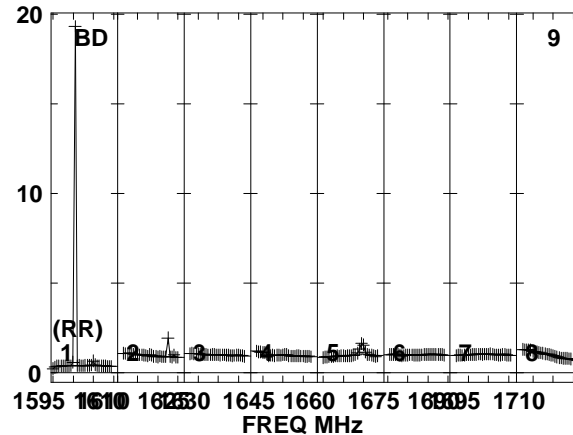
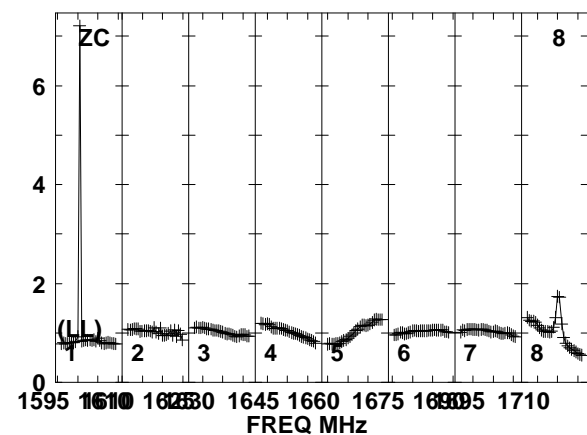
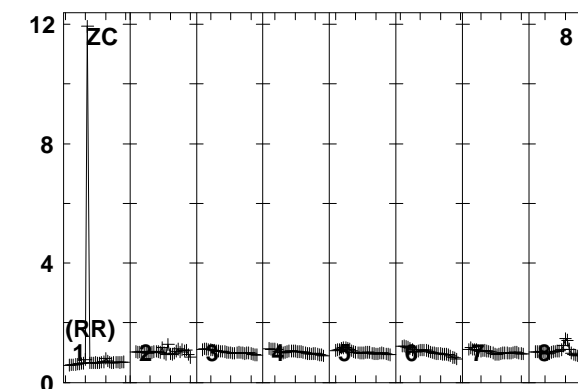
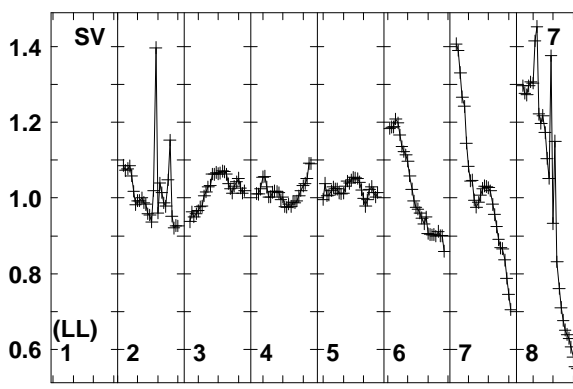
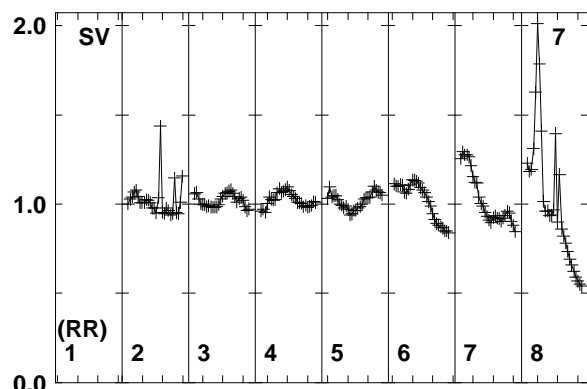
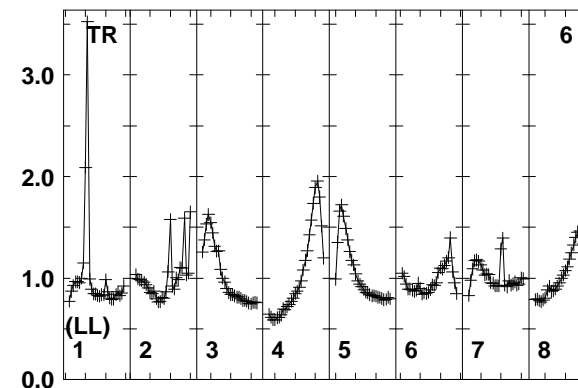
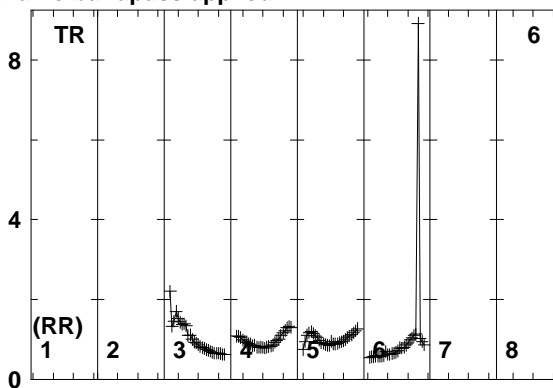
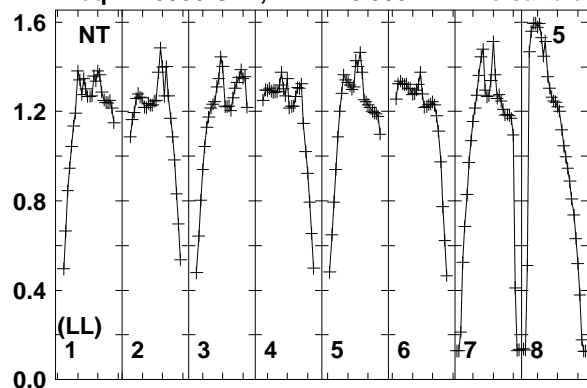

Lower frame: Real Jy
Total-power spectrum Antenna: NT (05)
Timerange: 00/11:14:25 to 00/11:18:09

Plot file version 438 created 11-AUG-2014 17:05:47

J2032+4127 EM110 2.UVDATA.1

Freq = 1.5950 GHz, Bw = 16.000 MH No calibration applied and no bandpass applied

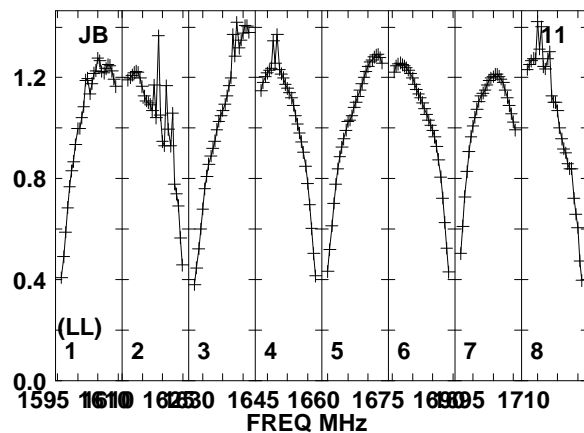
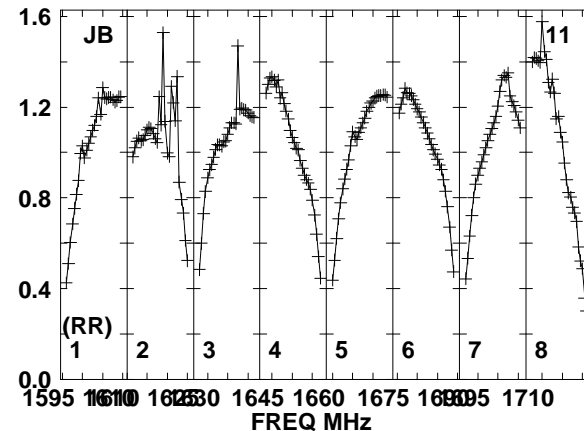
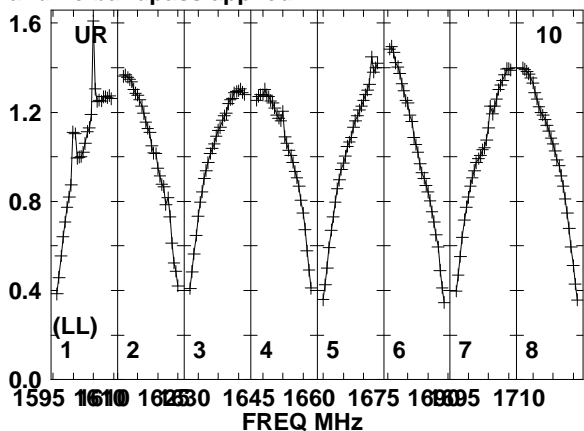
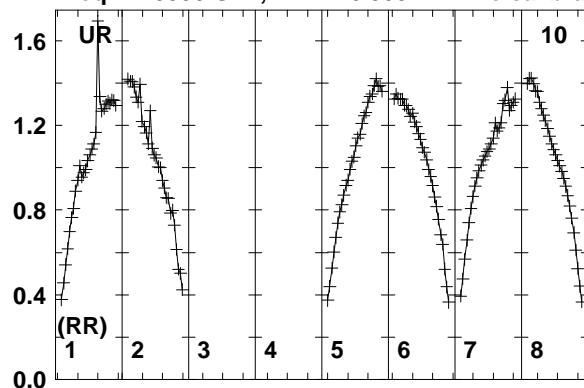

Lower frame: Real Jy
Total-power spectrum Antenna: UR (10)
Timerange: 00/11:14:25 to 00/11:18:09

Plot file version 439 created 11-AUG-2014 17:05:47

J2015+3710 EM110 2.UVDATA.1

Freq = 1.5950 GHz, Bw = 16.000 MH No calibration applied and no bandpass applied

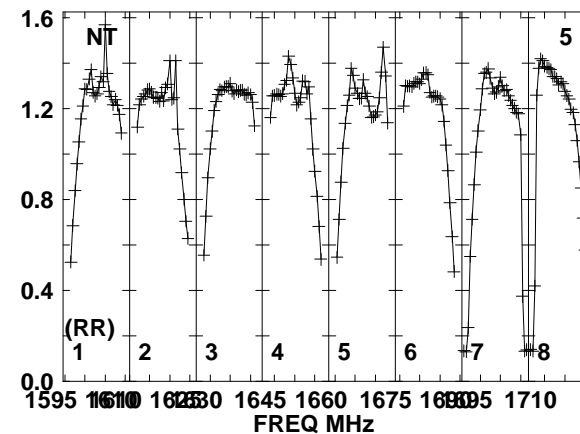
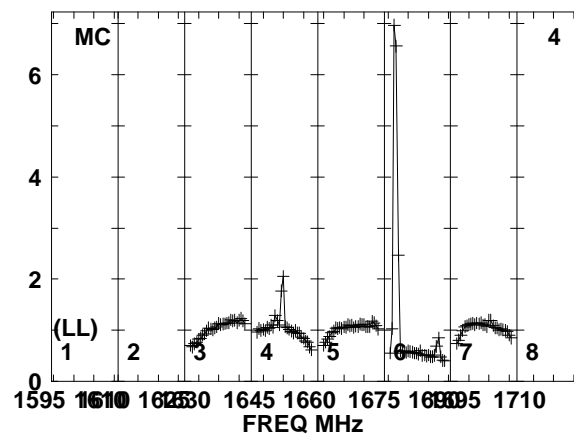
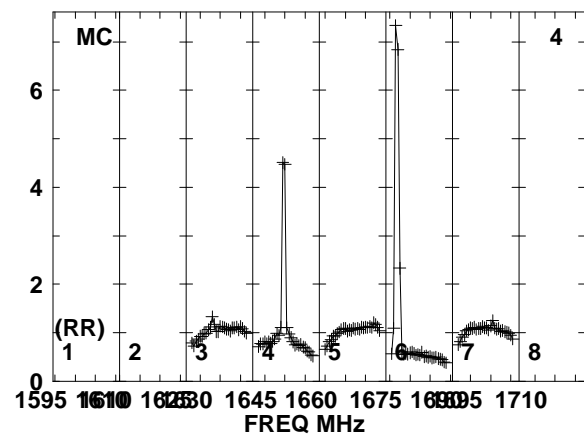
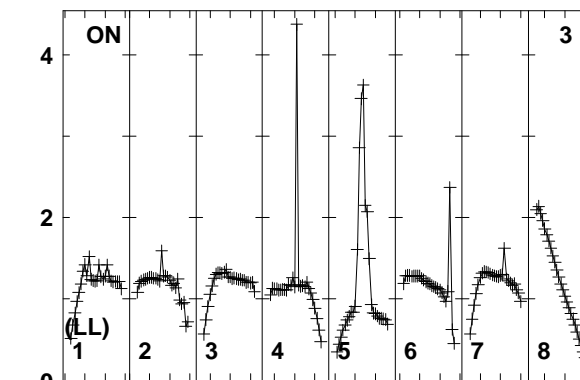
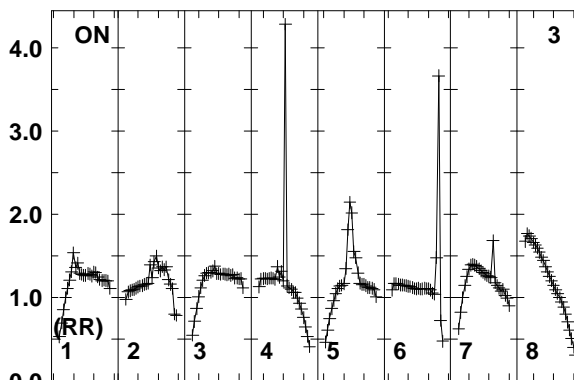
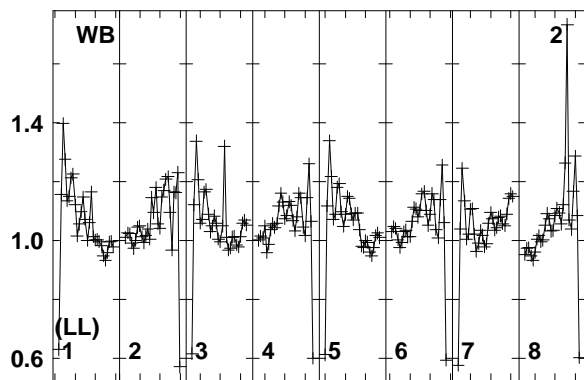
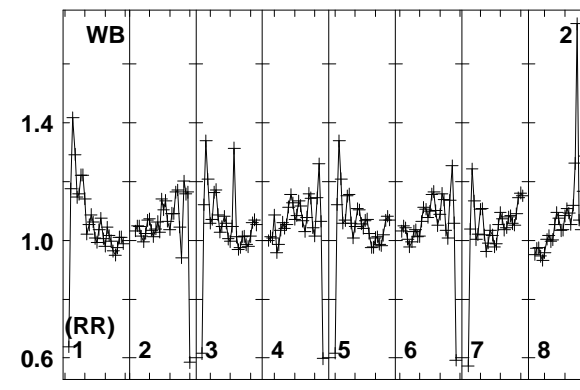
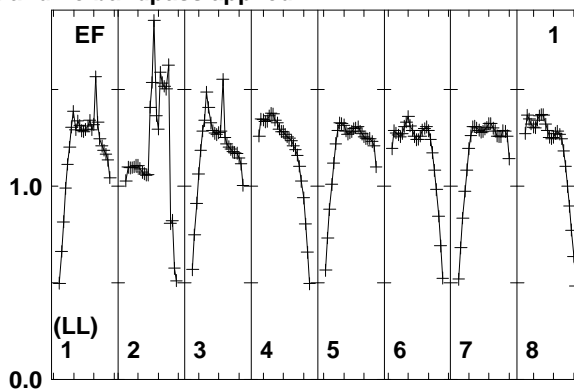
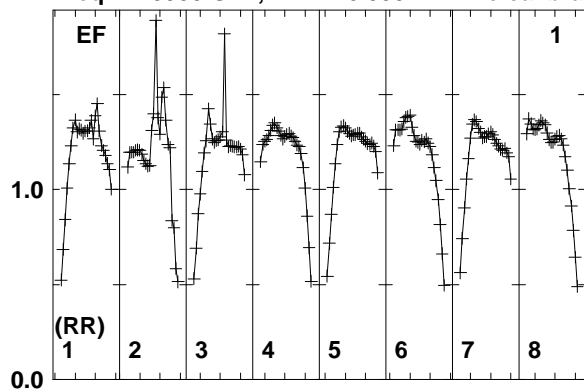

1595 1610 1625 1640 1655 1670 1685 1700 1710
FREQ MHz

1595 1610 1625 1640 1655 1670 1685 1700 1710
FREQ MHz

1595 1610 1625 1640 1655 1670 1685 1700 1710
FREQ MHz

Lower frame: Real Jy
Total-power spectrum Antenna: EF (01)
Timerange: 00/11:19:11 to 00/11:21:09

Plot file version 440 created 11-AUG-2014 17:05:47

J2015+3710 EM110 2.UVDATA.1

Freq = 1.5950 GHz, Bw = 16.000 MH No calibration applied and no bandpass applied

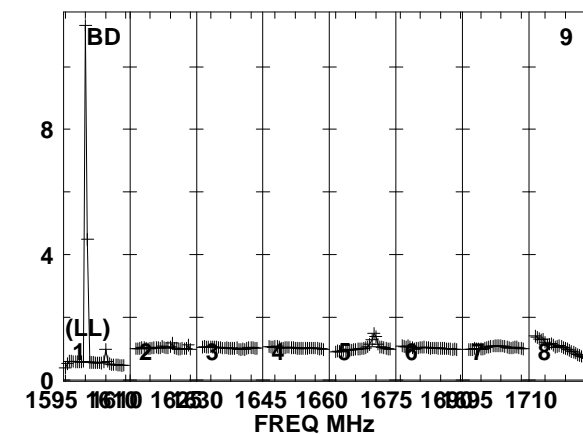
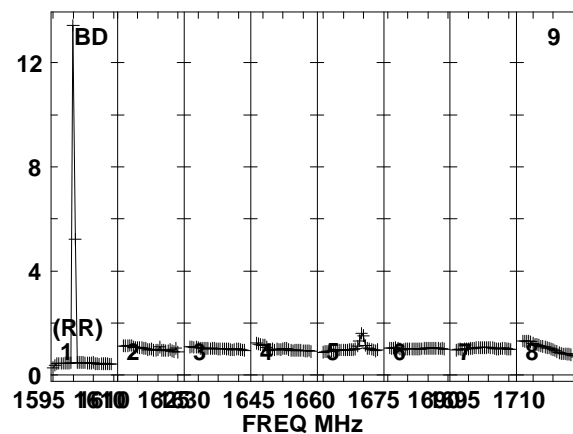
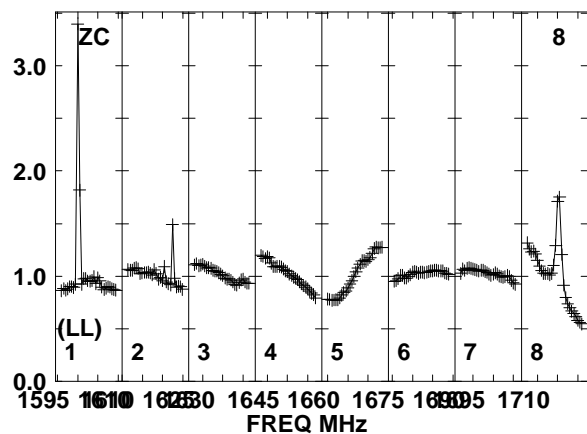
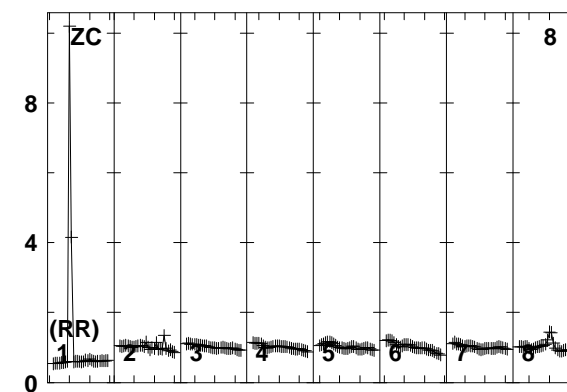
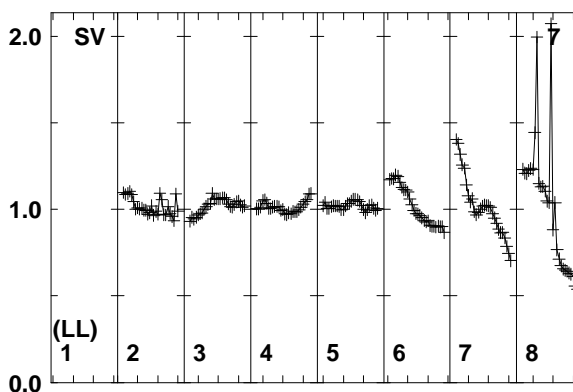
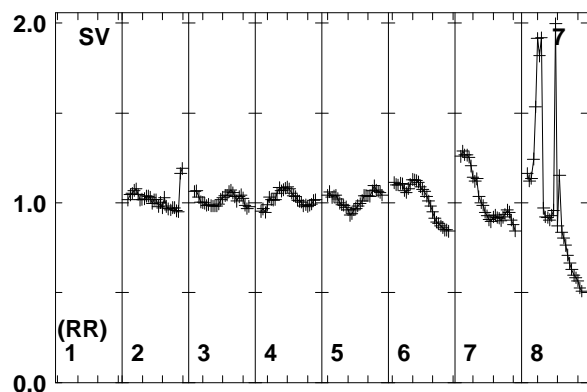
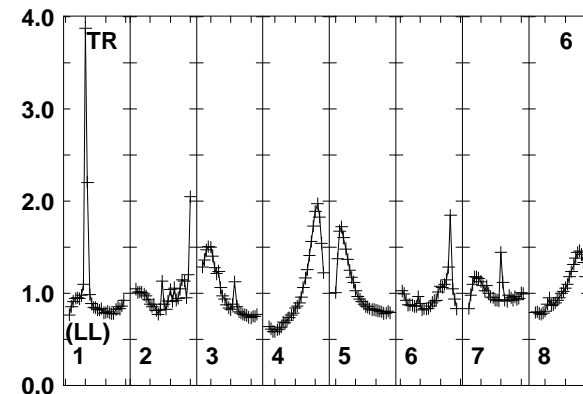
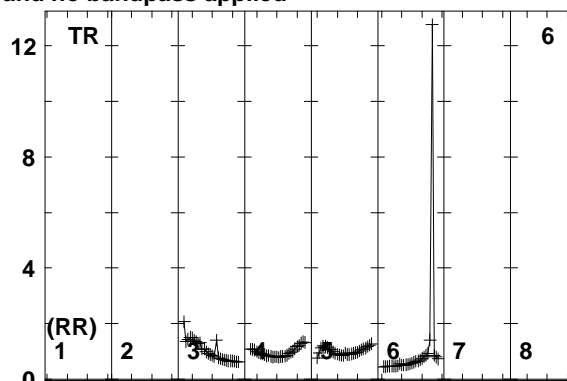
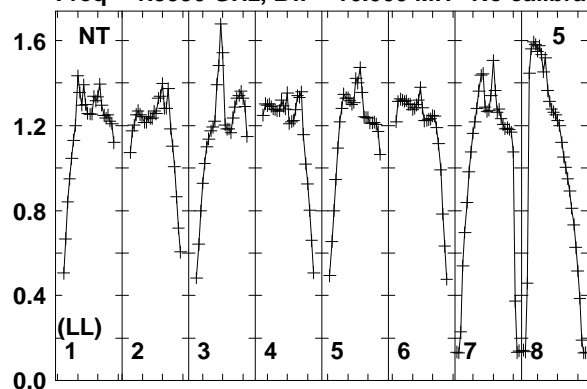

Lower frame: Real Jy
Total-power spectrum Antenna: NT (05)
Timerange: 00/11:19:11 to 00/11:21:09

Plot file version 441 created 11-AUG-2014 17:05:47

J2015+3710 EM110 2.UVDATA.1

Freq = 1.5950 GHz, Bw = 16.000 MH No calibration applied and no bandpass applied

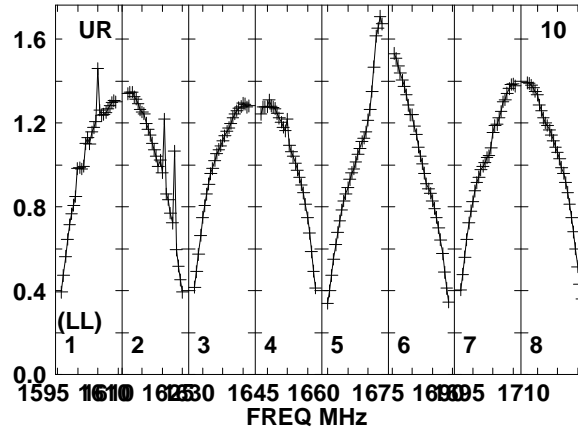
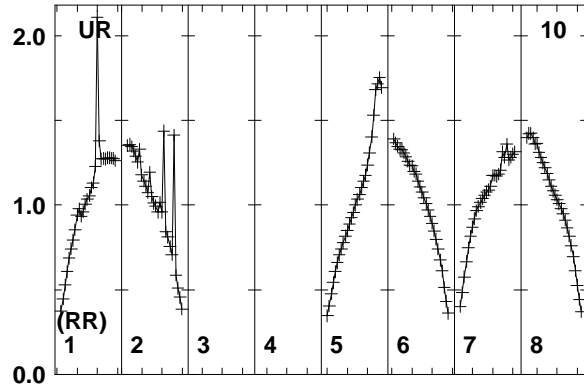

Lower frame: Real Jy
Total-power spectrum Antenna: UR (10)
Timerange: 00/11:19:11 to 00/11:21:09

Plot file version 442 created 11-AUG-2014 17:05:47

J2032+4127 EM110 2.UVDATA.1

Freq = 1.5950 GHz, Bw = 16.000 MH No calibration applied and no bandpass applied

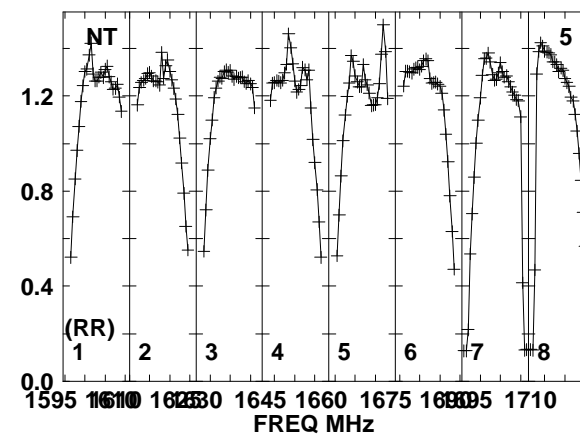
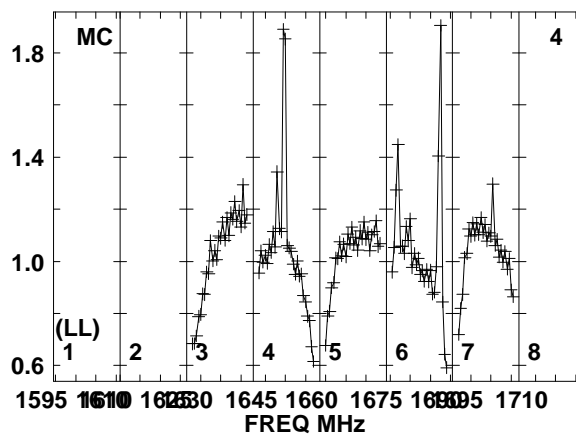
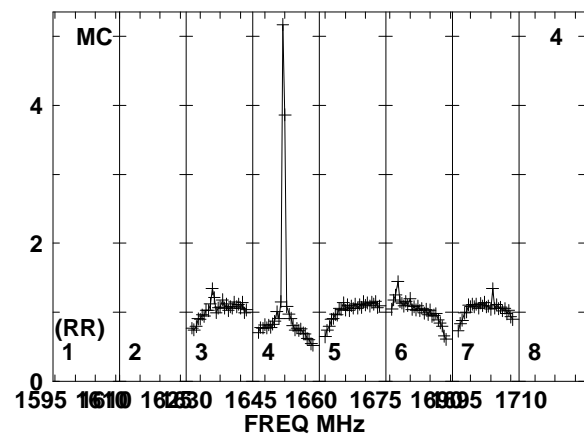
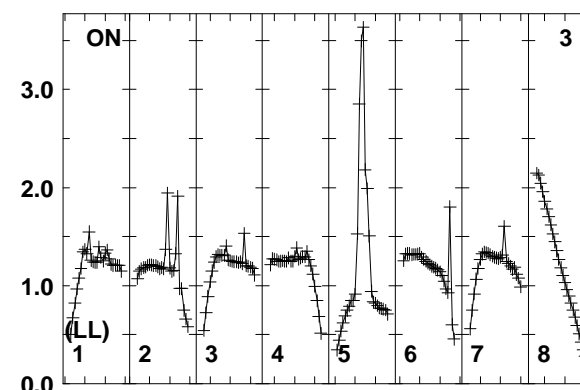
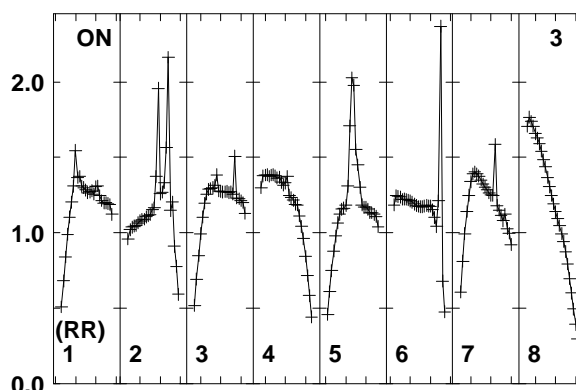
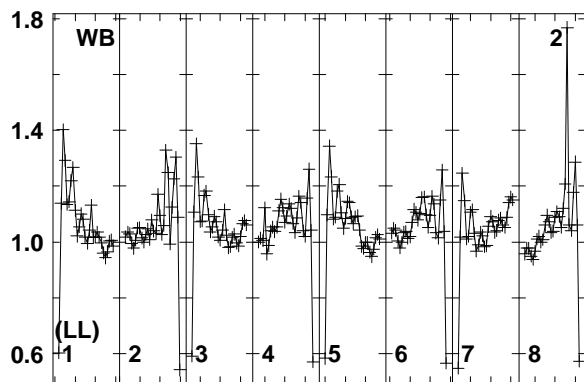
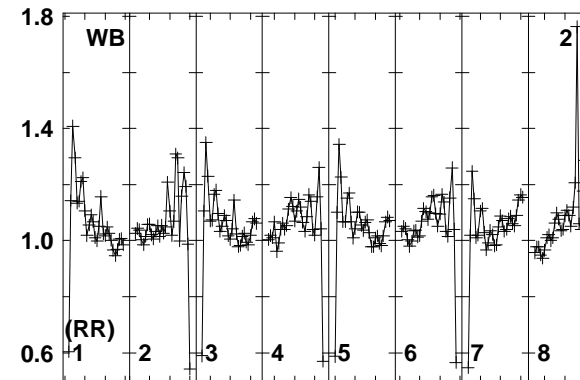
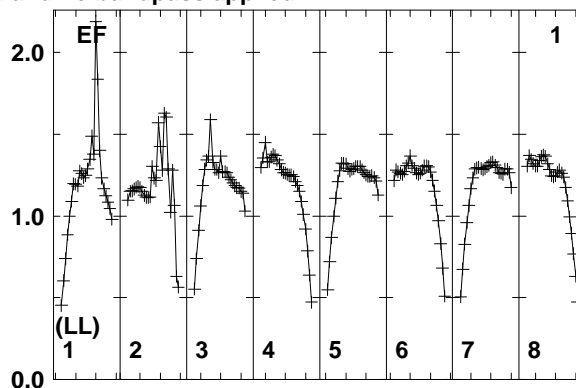
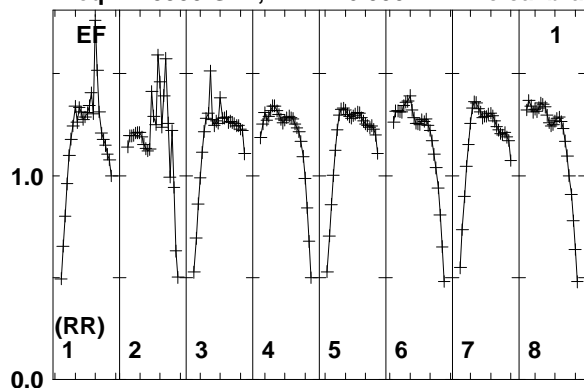

Lower frame: Real Jy
Total-power spectrum Antenna: EF (01)
Timerange: 00/11:21:11 to 00/11:25:09

Plot file version 443 created 11-AUG-2014 17:05:47

J2032+4127 EM110 2.UVDATA.1

Freq = 1.5950 GHz, Bw = 16.000 MH No calibration applied and no bandpass applied

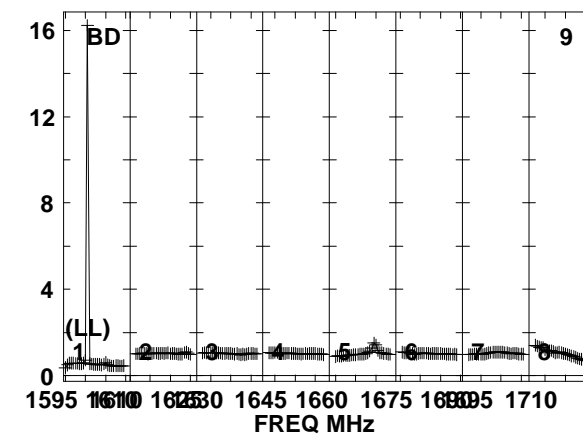
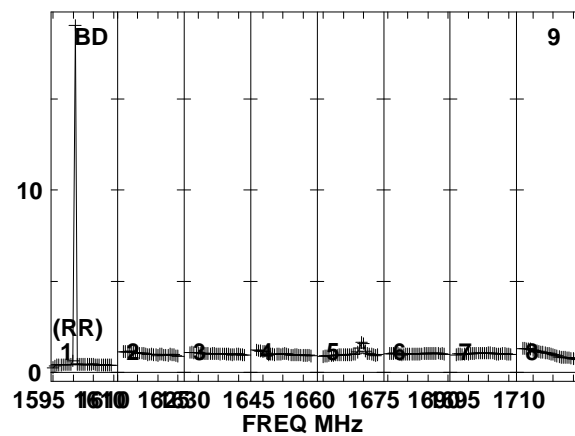
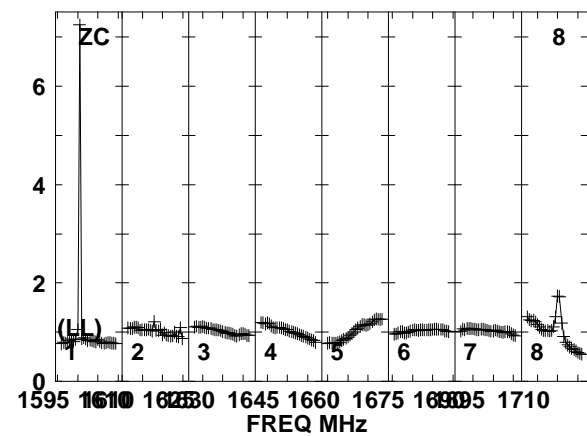
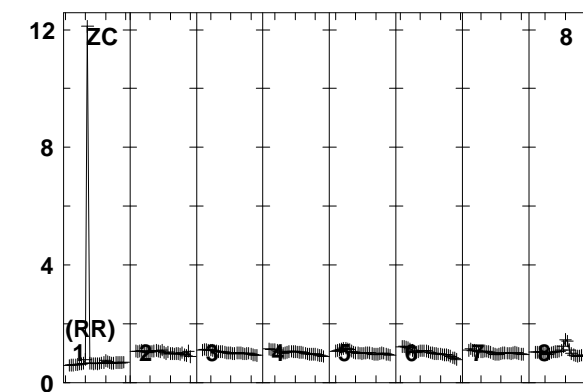
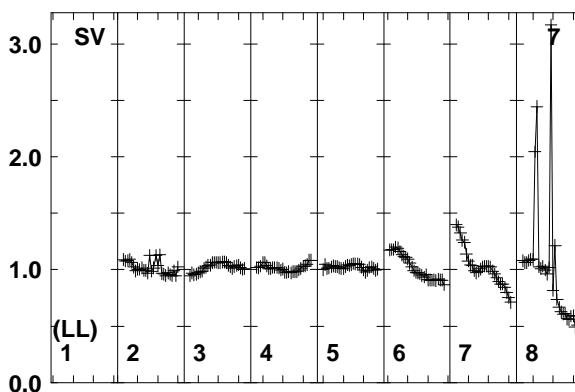
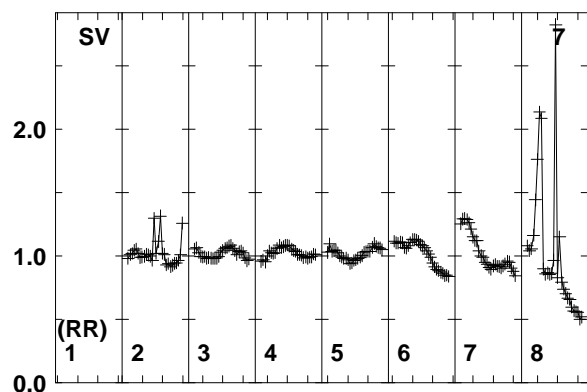
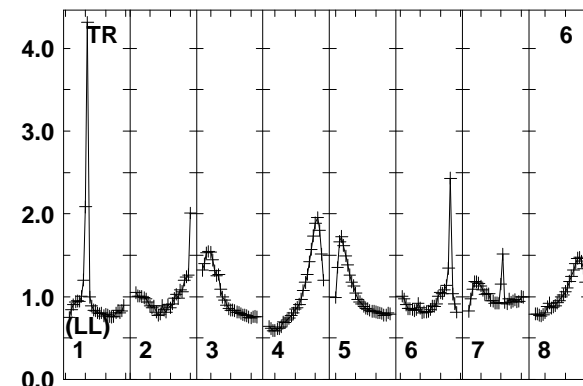
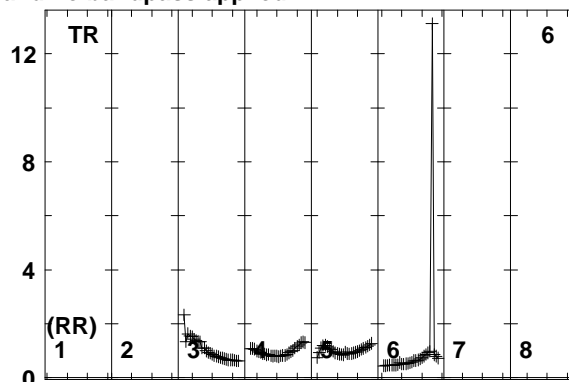
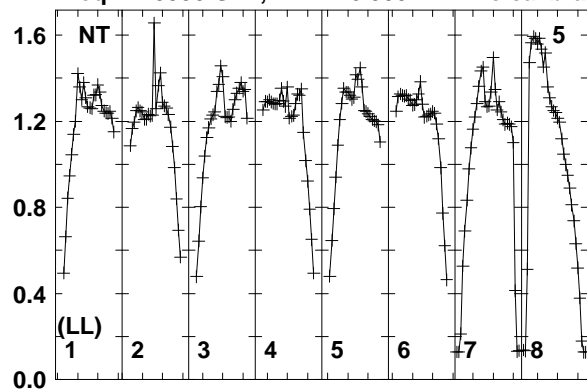

Lower frame: Real Jy
Total-power spectrum Antenna: NT (05)
Timerange: 00/11:21:11 to 00/11:25:09

Plot file version 444 created 11-AUG-2014 17:05:47

J2032+4127 EM110 2.UVDATA.1

Freq = 1.5950 GHz, Bw = 16.000 MH No calibration applied and no bandpass applied

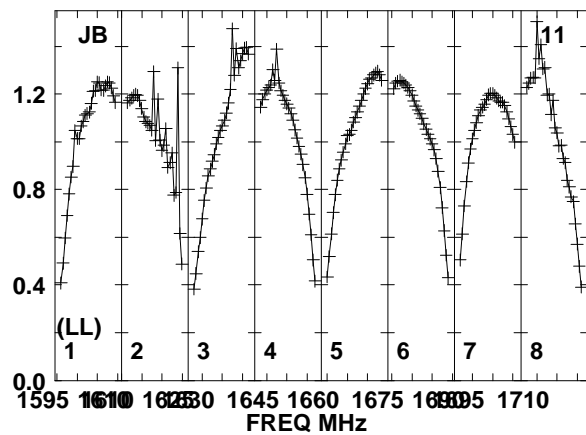
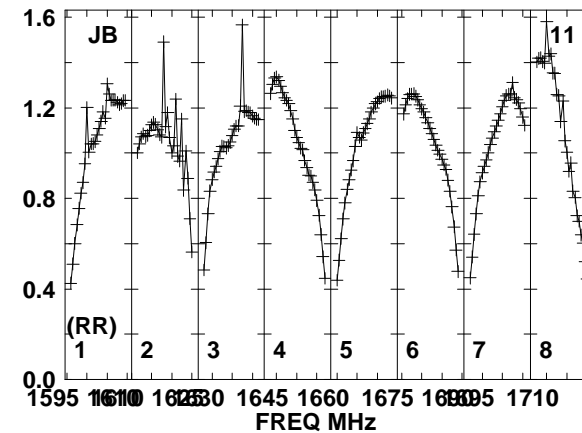
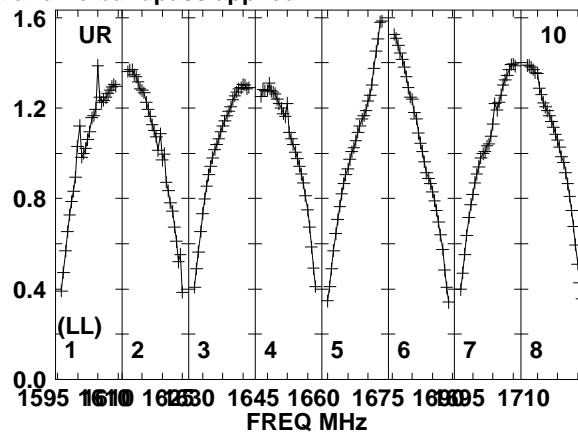
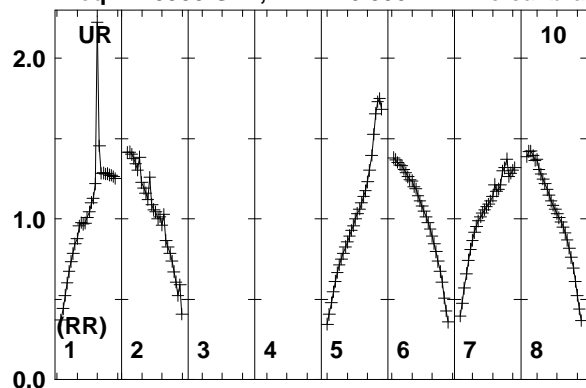

Lower frame: Real Jy
Total-power spectrum Antenna: UR (10)
Timerange: 00/11:21:11 to 00/11:25:09

Plot file version 445 created 11-AUG-2014 17:05:47

J2015+3710 EM110 2.UVDATA.1

Freq = 1.5950 GHz, Bw = 16.000 MH No calibration applied and no bandpass applied

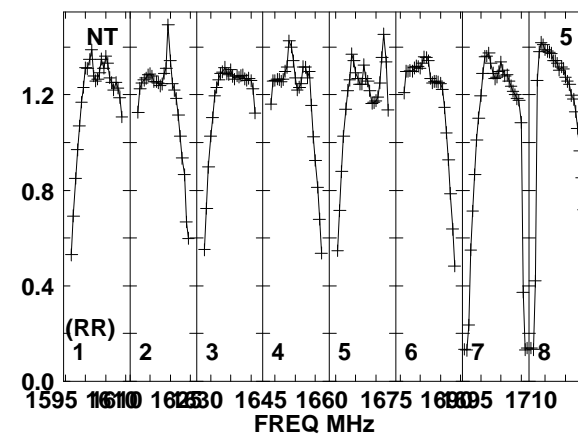
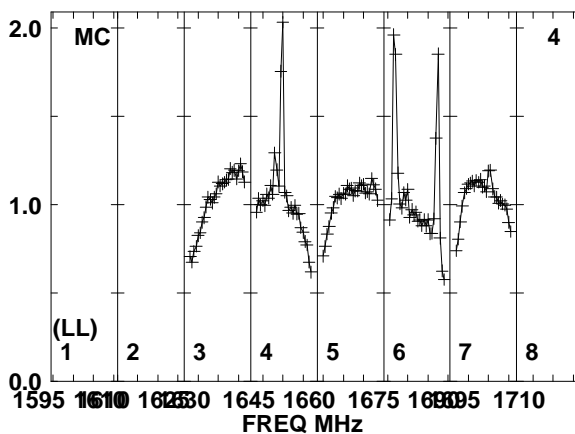
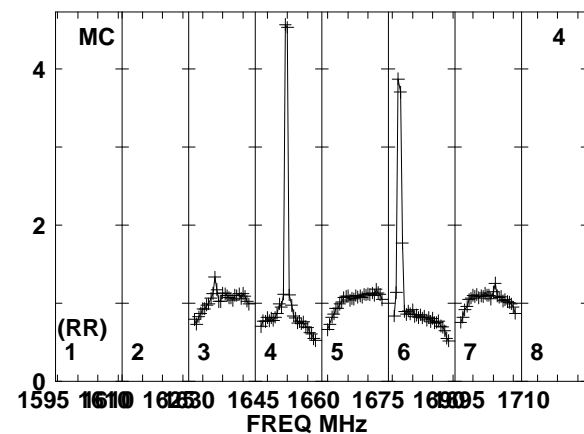
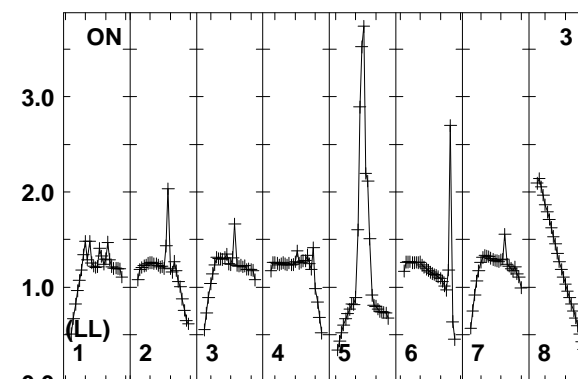
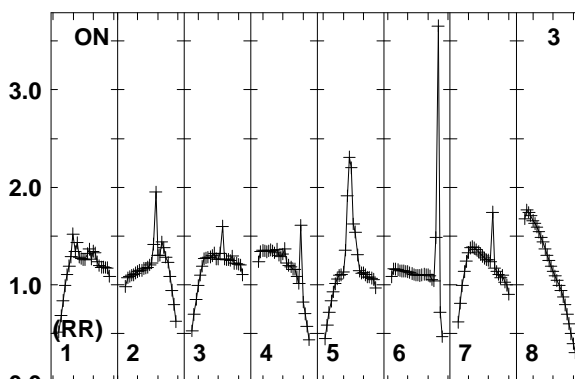
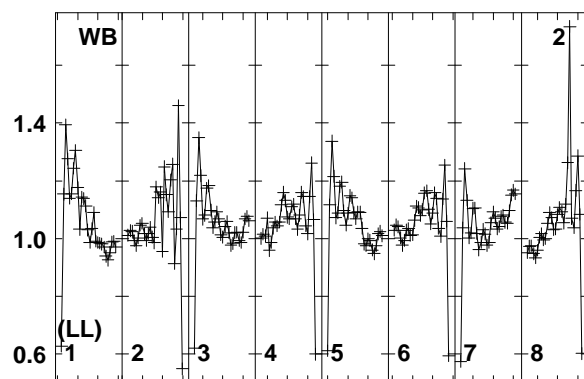
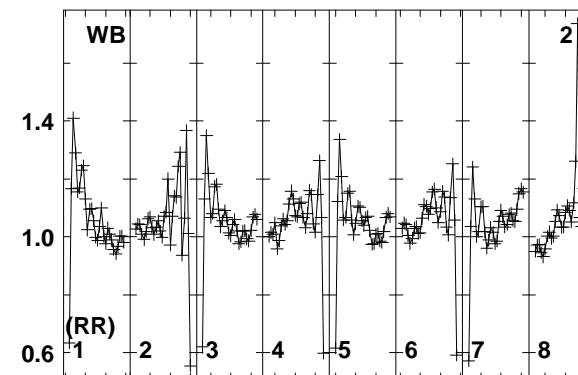
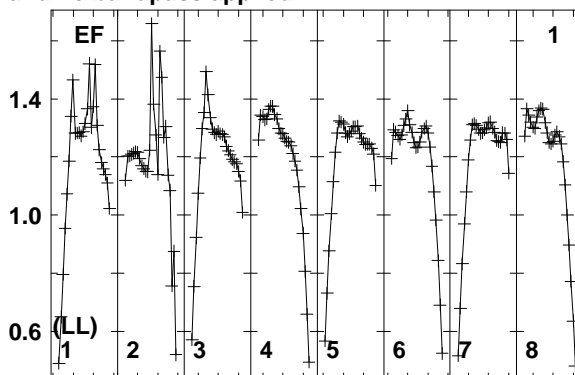
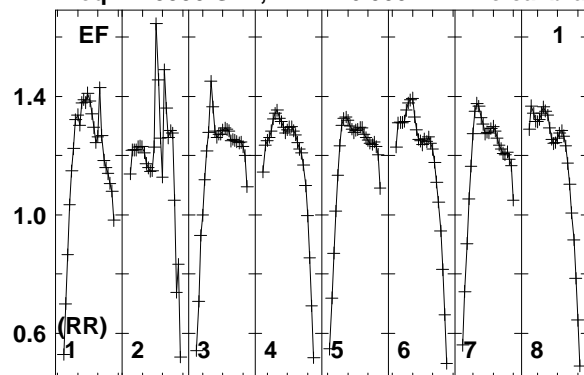

Lower frame: Real Jy
Total-power spectrum Antenna: EF (01)
Timerange: 00/11:26:11 to 00/11:28:09

Plot file version 446 created 11-AUG-2014 17:05:47

J2015+3710 EM110 2.UVDATA.1

Freq = 1.5950 GHz, Bw = 16.000 MH No calibration applied and no bandpass applied

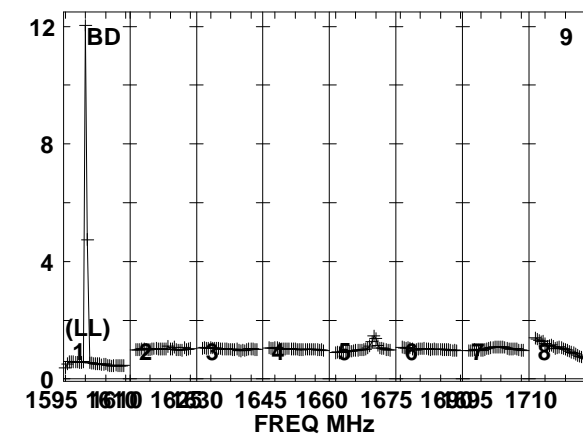
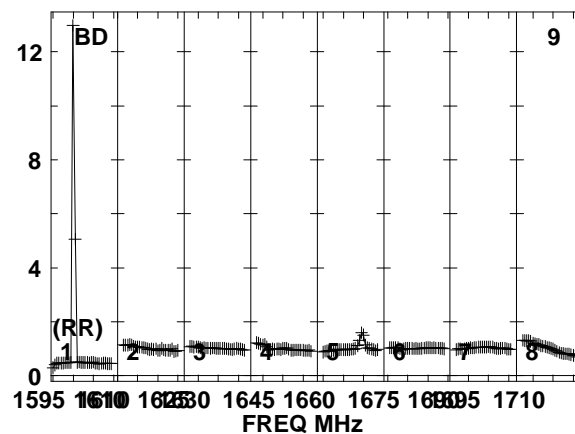
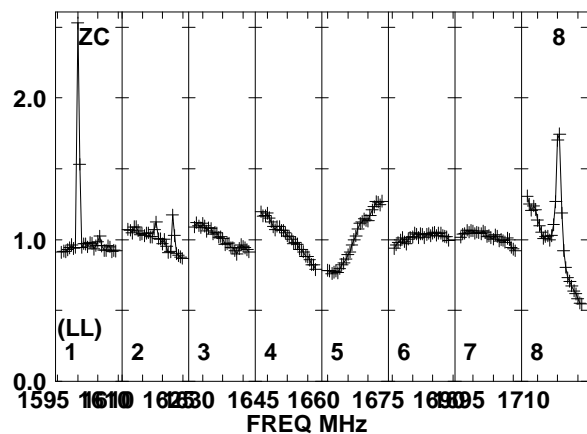
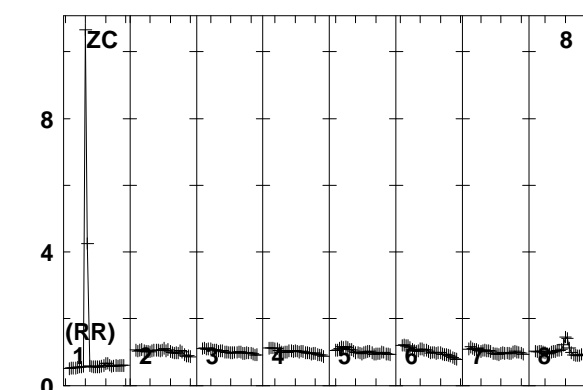
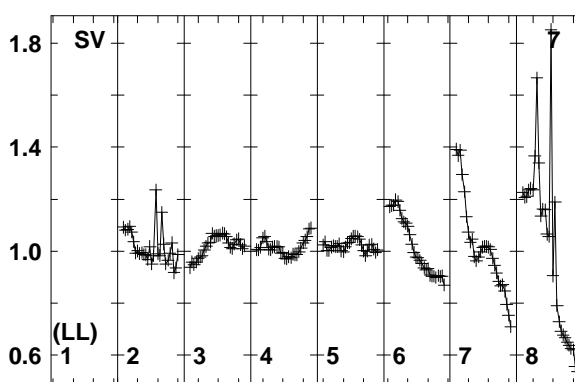
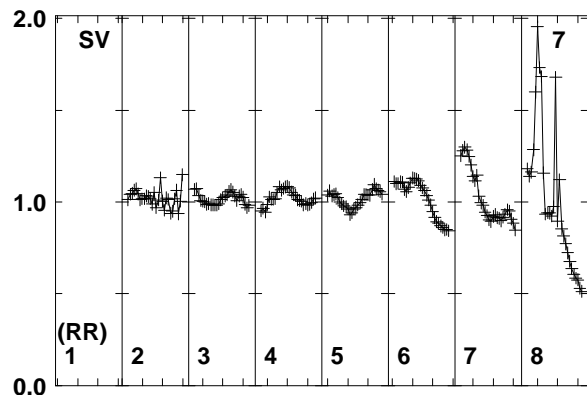
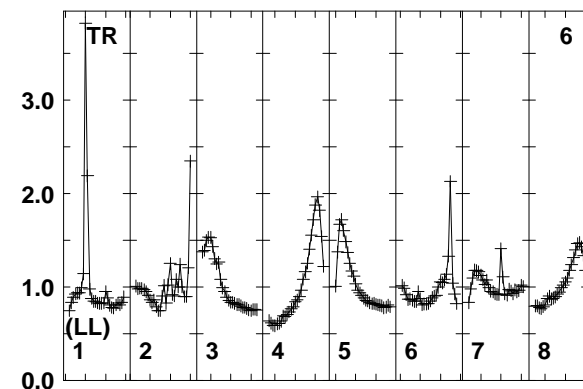
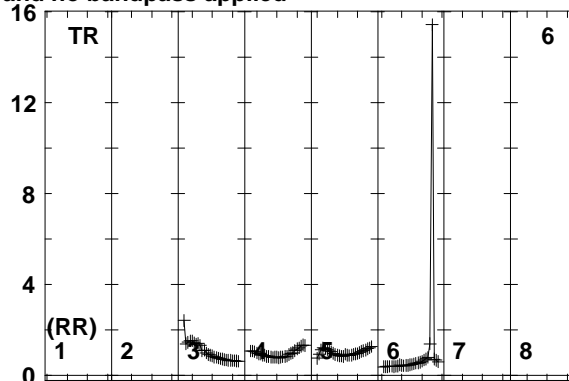
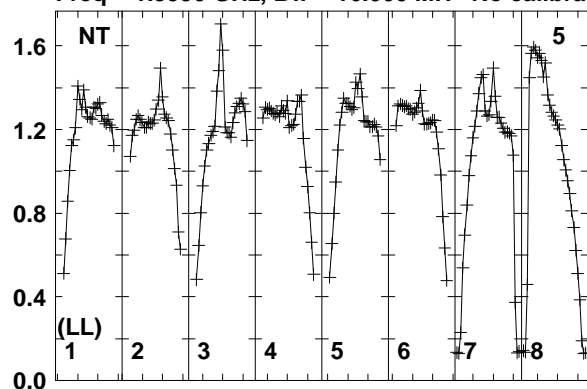

Lower frame: Real Jy
Total-power spectrum Antenna: NT (05)
Timerange: 00/11:26:11 to 00/11:28:09

Plot file version 447 created 11-AUG-2014 17:05:47

J2015+3710 EM110 2.UVDATA.1

Freq = 1.5950 GHz, Bw = 16.000 MH No calibration applied and no bandpass applied

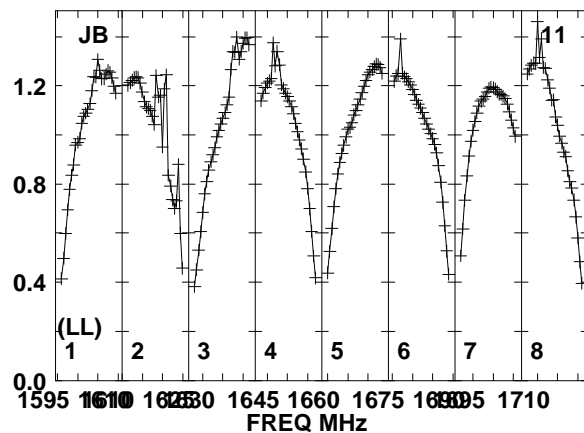
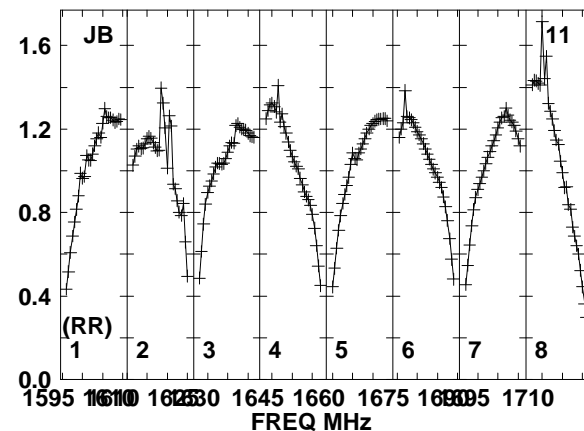
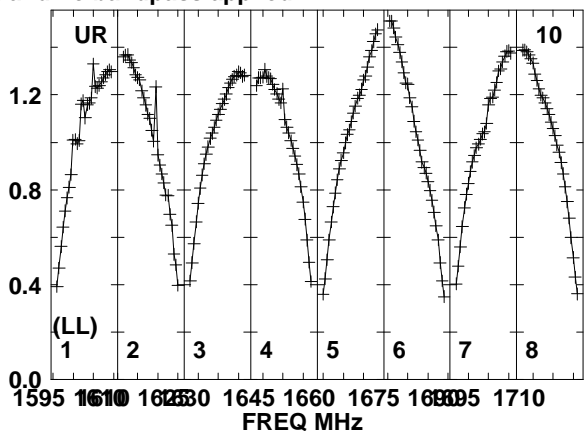
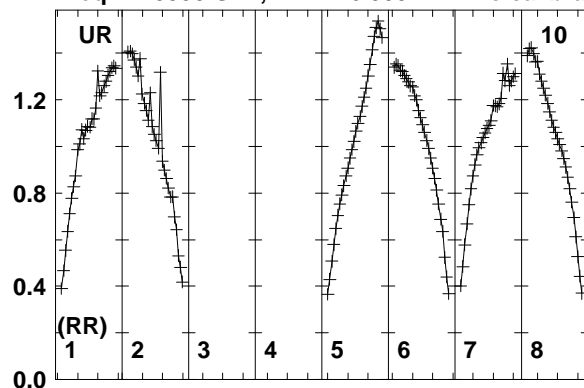

Lower frame: Real Jy
Total-power spectrum Antenna: UR (10)
Timerange: 00/11:26:11 to 00/11:28:09

Plot file version 448 created 11-AUG-2014 17:05:47

J2032+4127 EM110 2.UVDATA.1

Freq = 1.5950 GHz, Bw = 16.000 MH No calibration applied and no bandpass applied

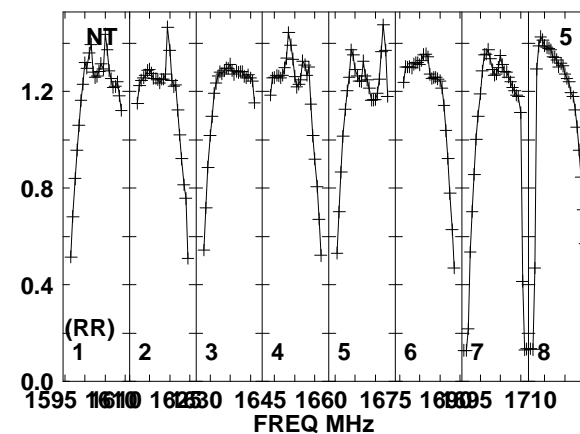
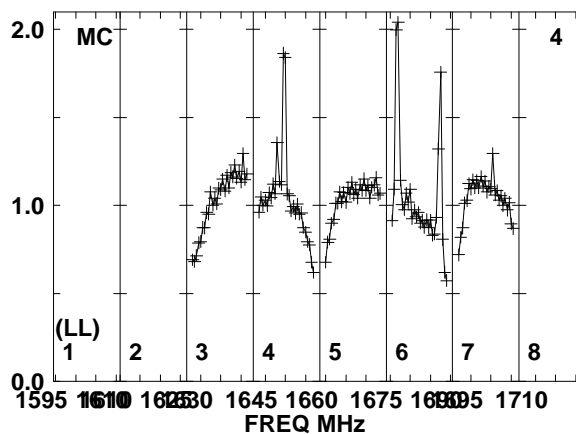
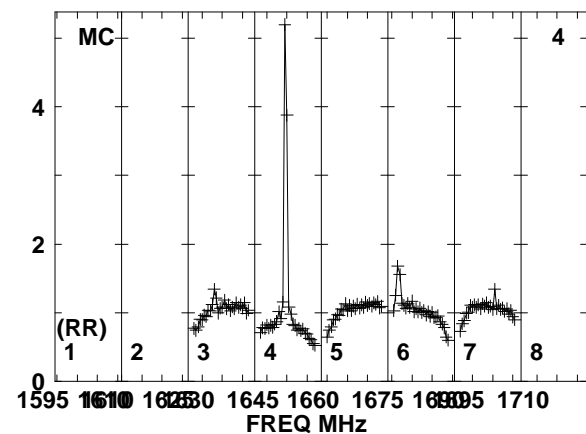
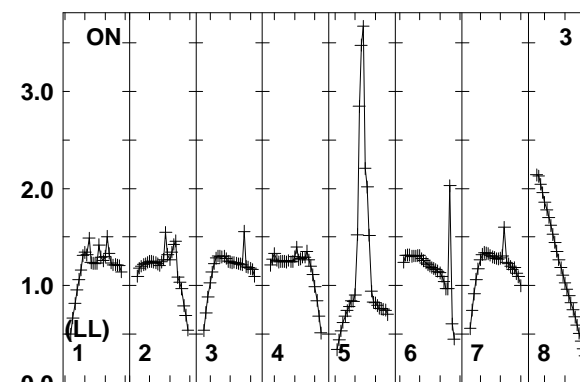
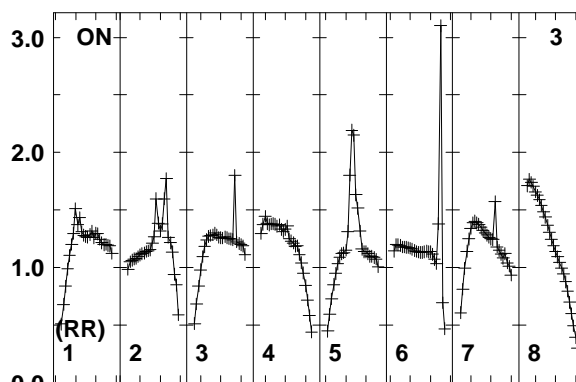
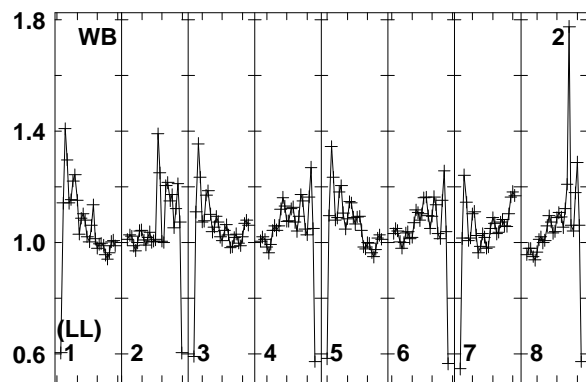
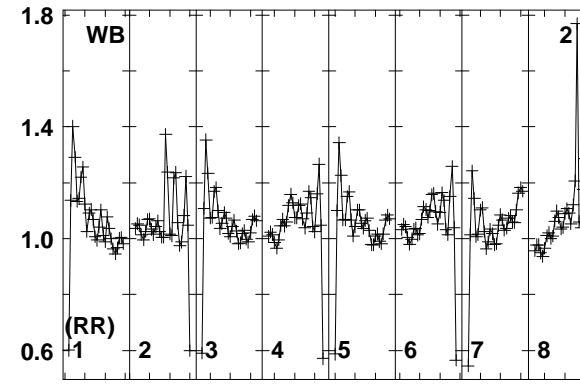
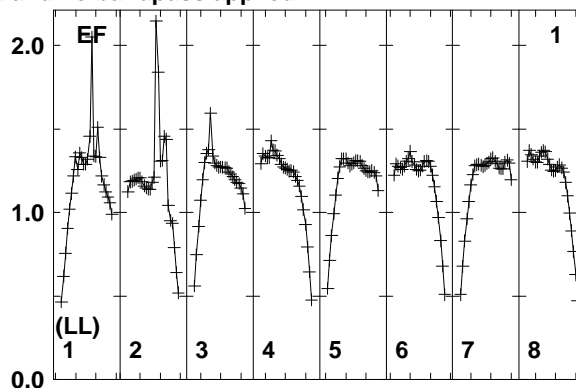
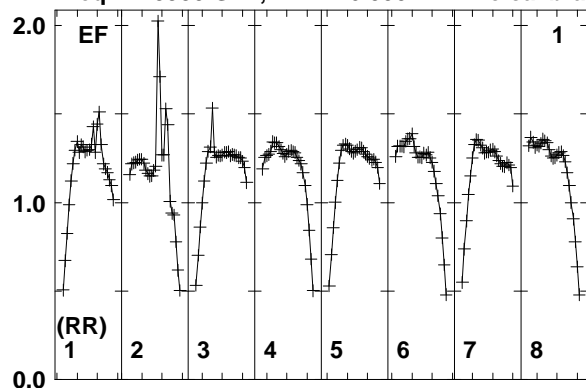

Lower frame: Real Jy
Total-power spectrum Antenna: EF (01)
Timerange: 00/11:28:24 to 00/11:32:08

Plot file version 449 created 11-AUG-2014 17:05:47

J2032+4127 EM110 2.UVDATA.1

Freq = 1.5950 GHz, Bw = 16.000 MH No calibration applied and no bandpass applied

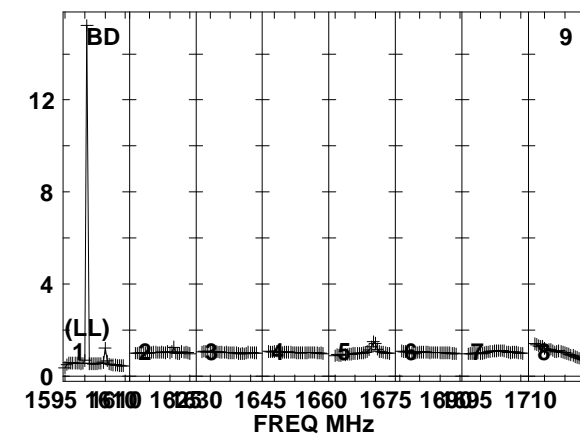
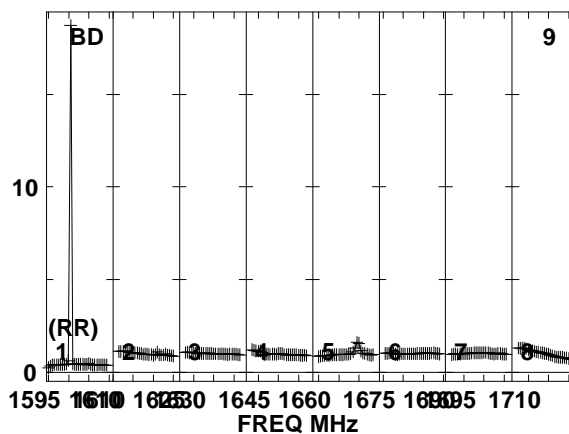
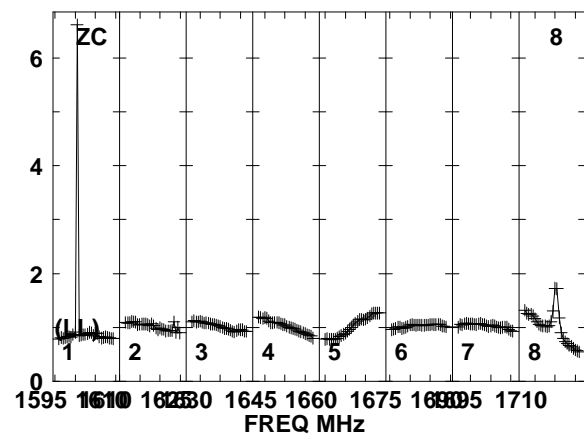
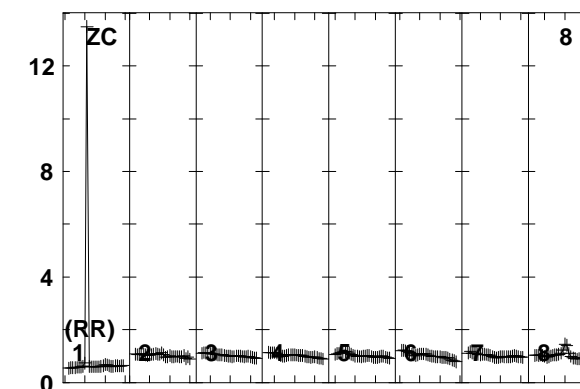
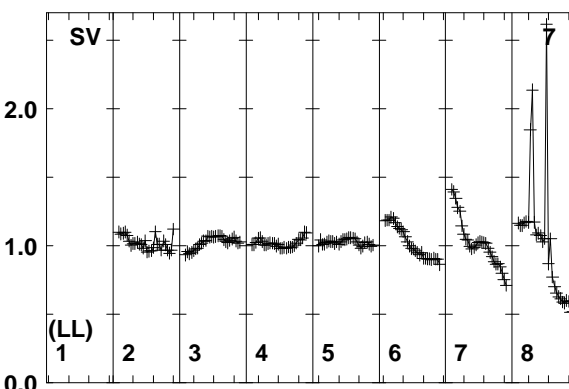
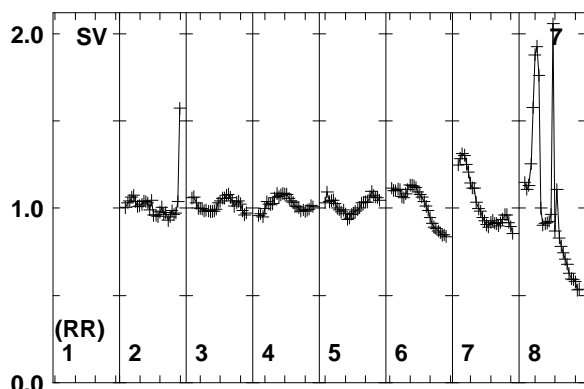
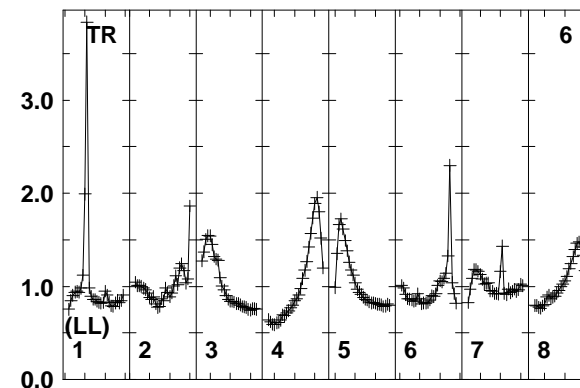
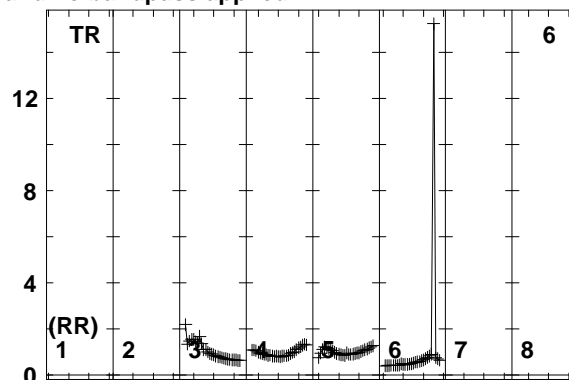
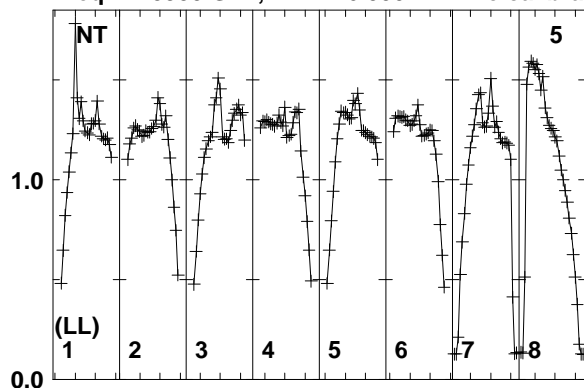

1595 1610 1625 1640 1655 1670 1685 1700 1710
FREQ MHz
Lower frame: Real Jy
Total-power spectrum Antenna: NT (05)
Timerange: 00/11:28:24 to 00/11:32:08

Plot file version 450 created 11-AUG-2014 17:05:47

J2032+4127 EM110 2.UVDATA.1

Freq = 1.5950 GHz, Bw = 16.000 MH No calibration applied and no bandpass applied

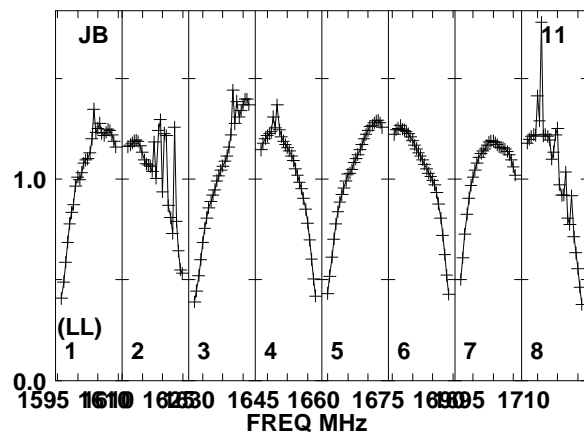
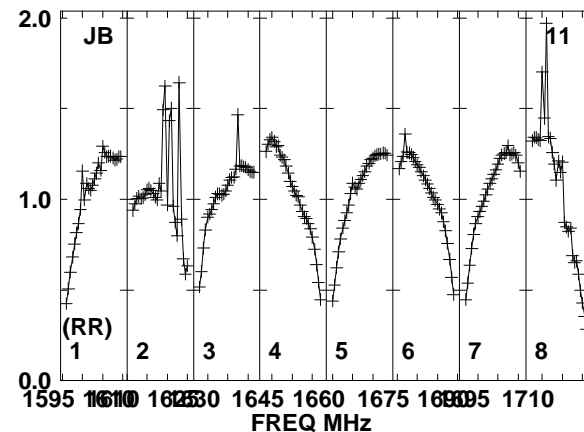
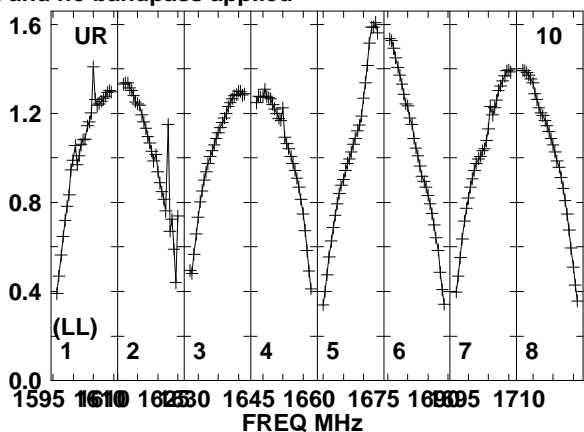
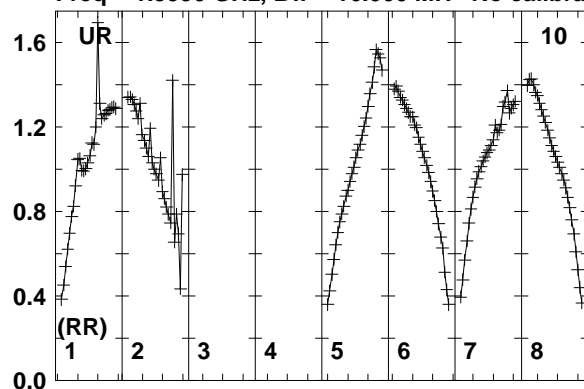

Lower frame: Real Jy
Total-power spectrum Antenna: UR (10)
Timerange: 00/11:28:24 to 00/11:32:08

Plot file version 451 created 11-AUG-2014 17:05:47

J2015+3710 EM110 2.UVDATA.1

Freq = 1.5950 GHz, Bw = 16.000 MH No calibration applied and no bandpass applied

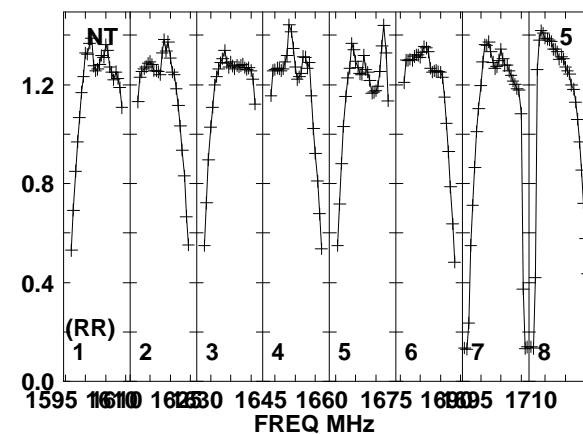
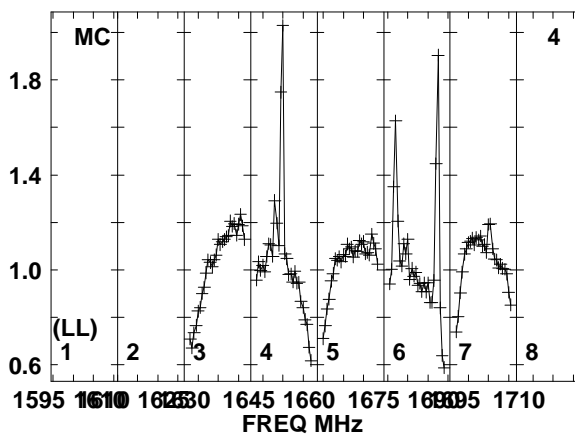
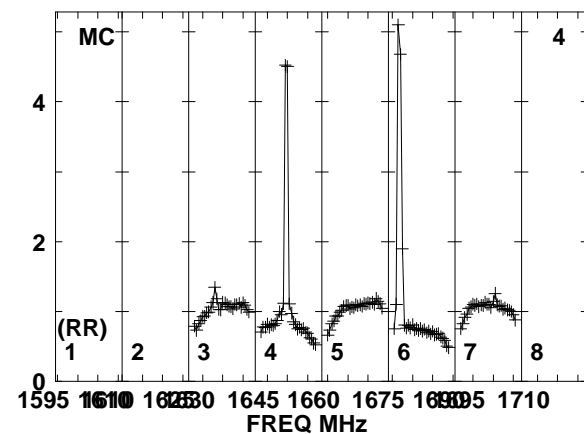
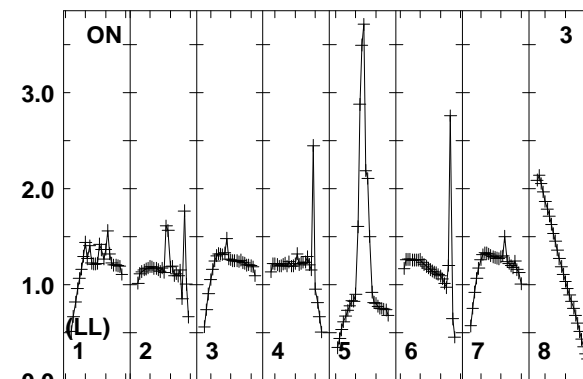
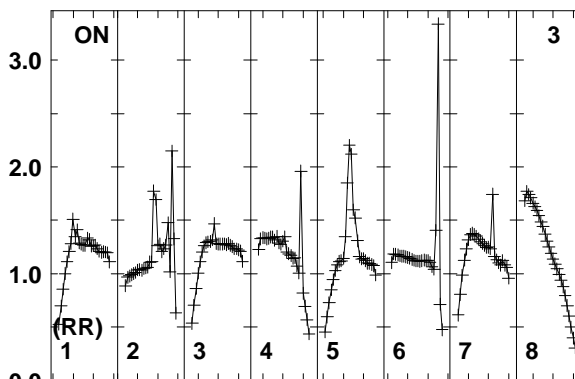
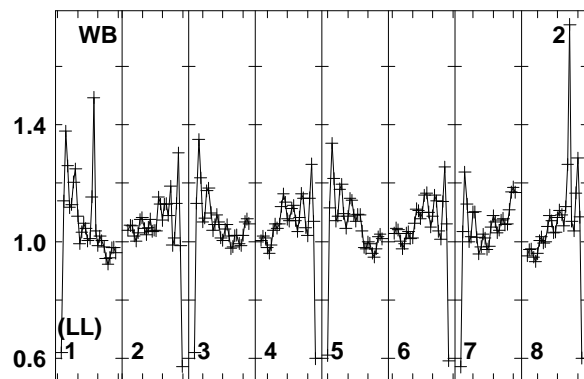
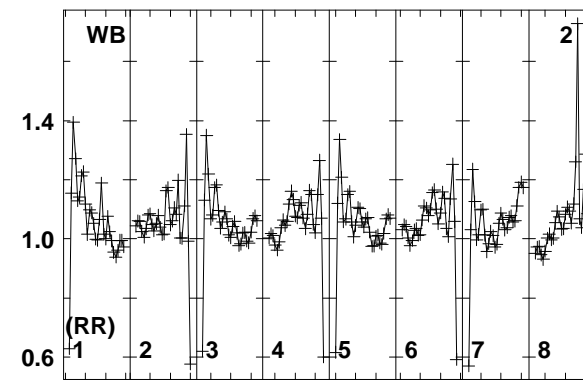
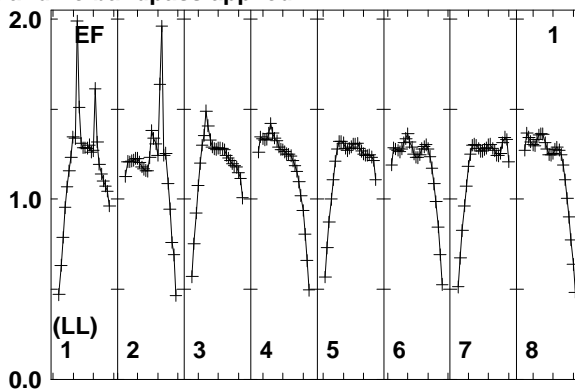
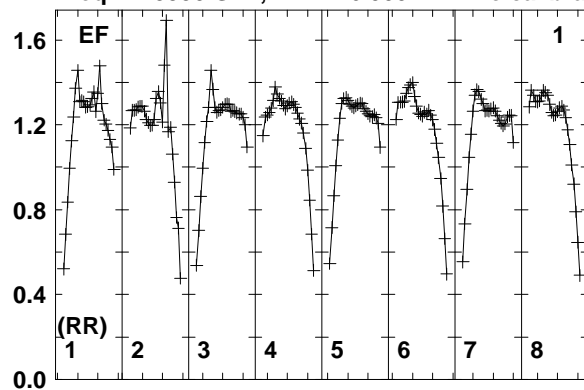

Lower frame: Real Jy
Total-power spectrum Antenna: EF (01)
Timerange: 00/11:32:24 to 00/11:34:08

Plot file version 452 created 11-AUG-2014 17:05:47

J2015+3710 EM110 2.UVDATA.1

Freq = 1.5950 GHz, Bw = 16.000 MH No calibration applied and no bandpass applied

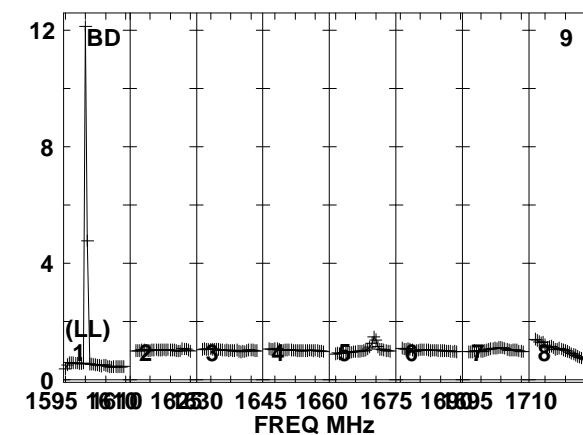
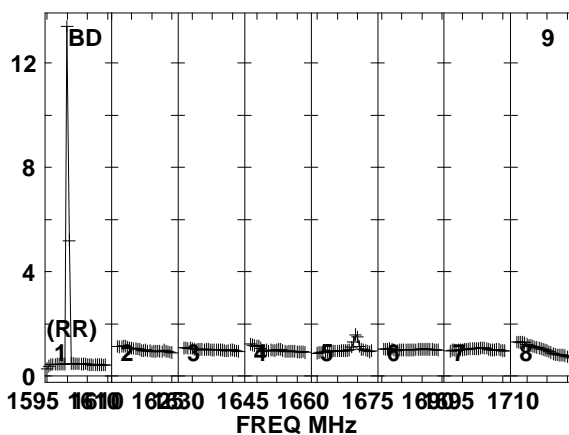
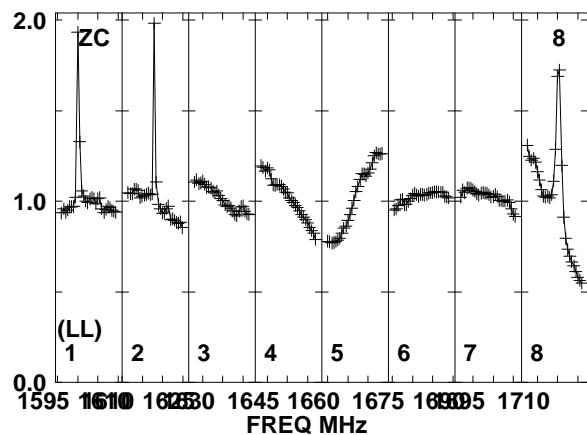
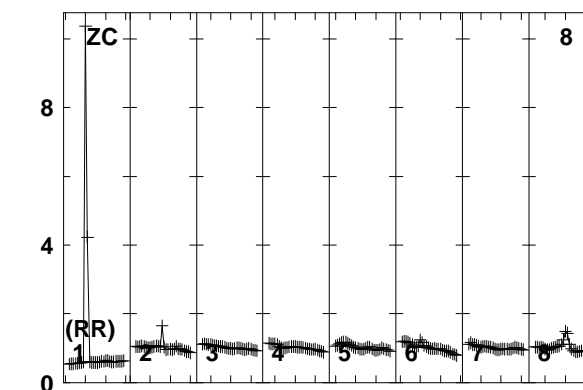
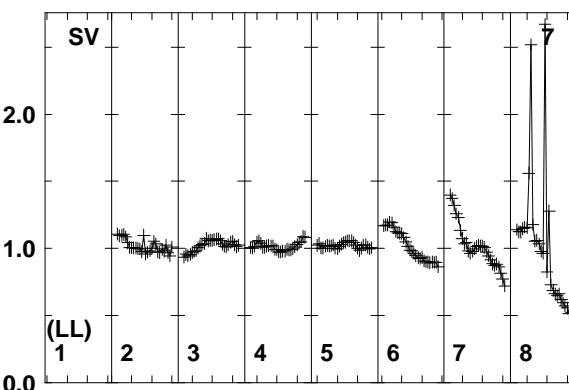
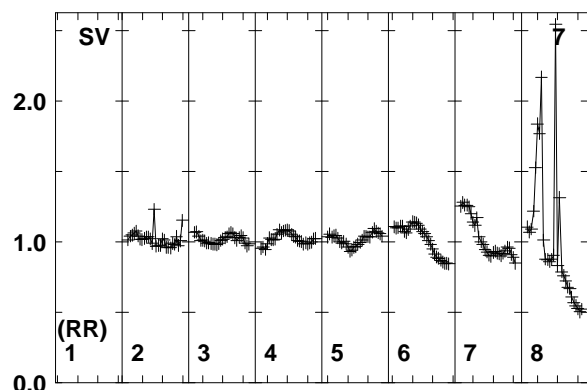
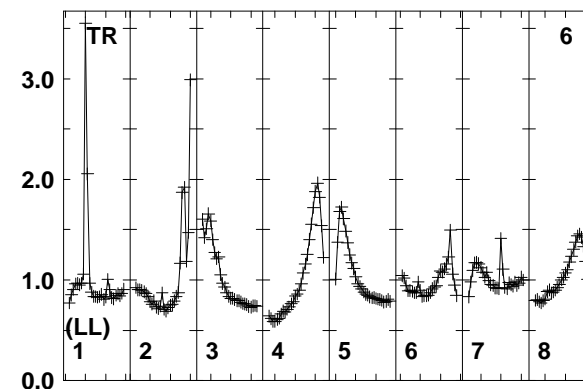
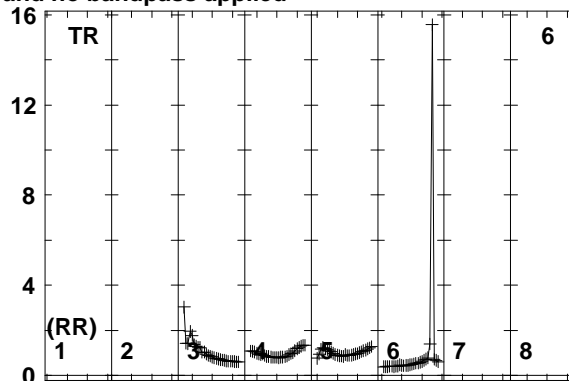
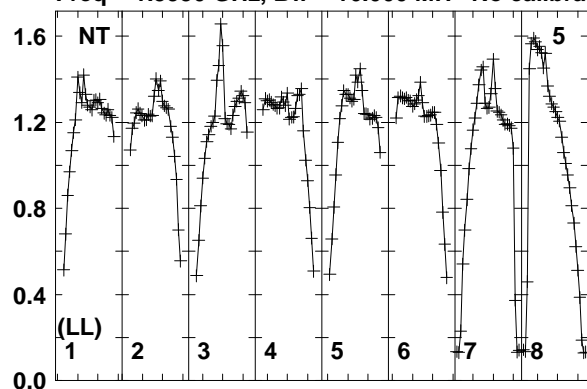

Lower frame: Real Jy
Total-power spectrum Antenna: NT (05)
Timerange: 00/11:32:24 to 00/11:34:08

Plot file version 453 created 11-AUG-2014 17:05:47

J2015+3710 EM110 2.UVDATA.1

Freq = 1.5950 GHz, Bw = 16.000 MH No calibration applied and no bandpass applied

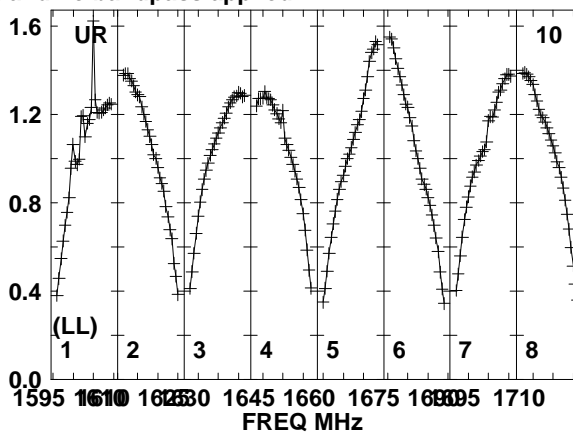
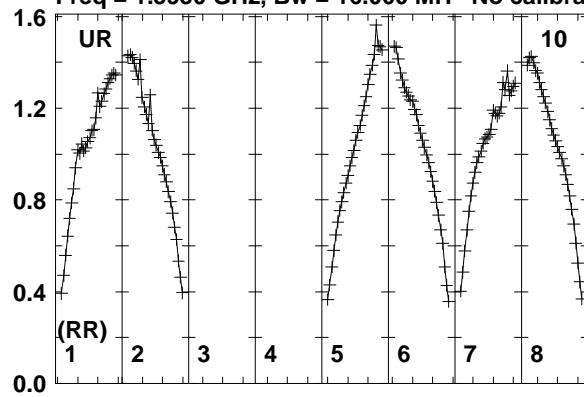

Lower frame: Real Jy
Total-power spectrum Antenna: UR (10)
Timerange: 00/11:32:24 to 00/11:34:08

Plot file version 454 created 11-AUG-2014 17:05:47

J2032+4127 EM110 2.UVDATA.1

Freq = 1.5950 GHz, Bw = 16.000 MH No calibration applied and no bandpass applied

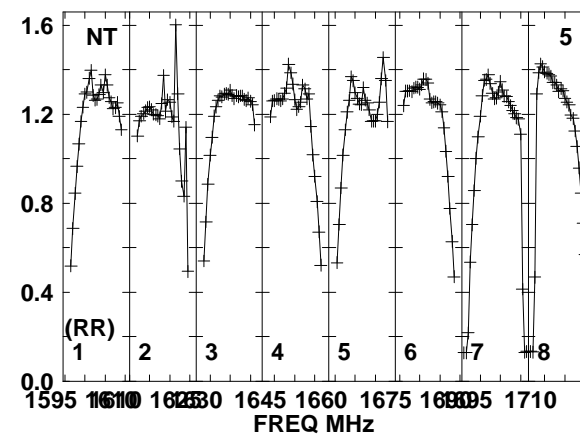
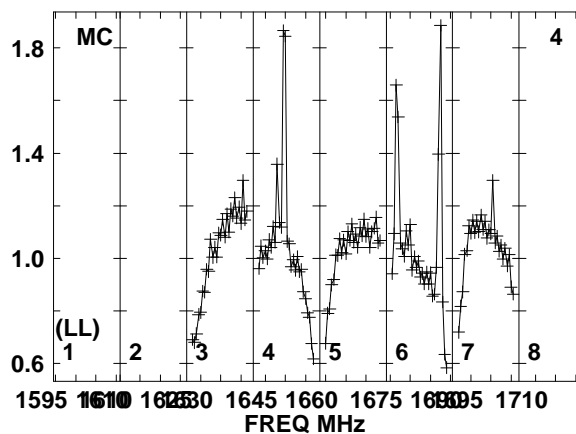
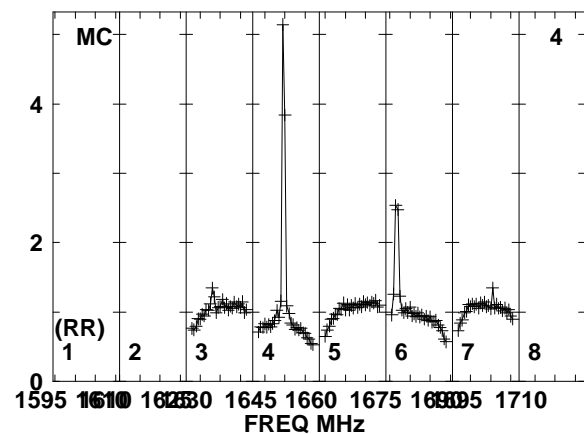
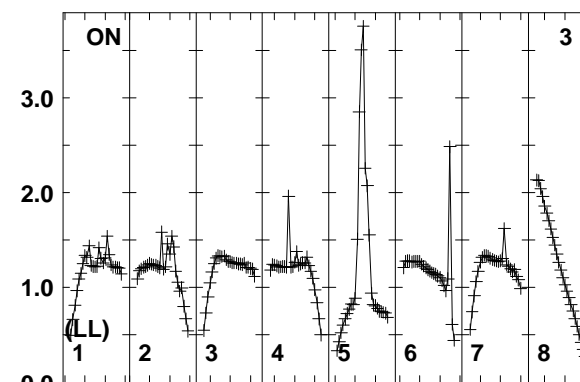
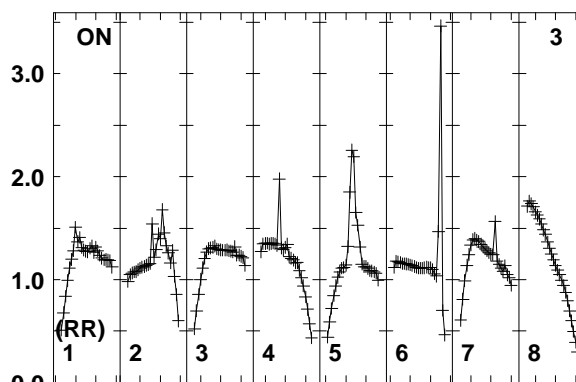
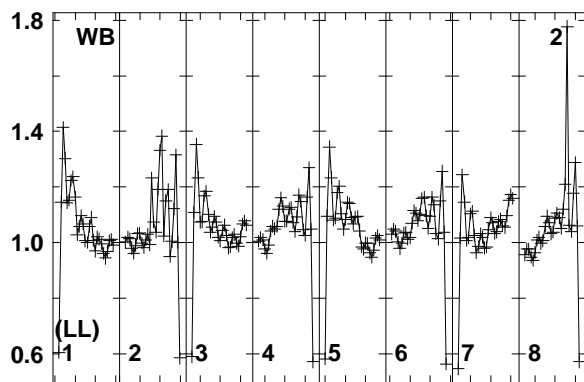
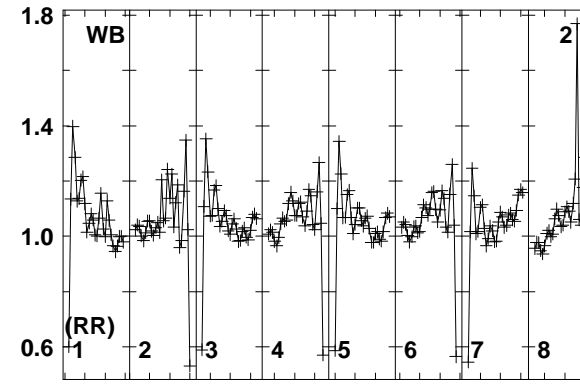
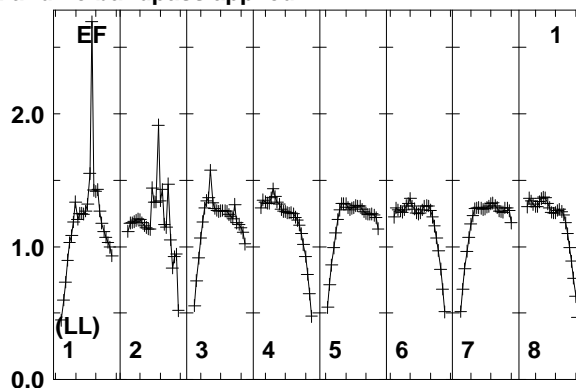
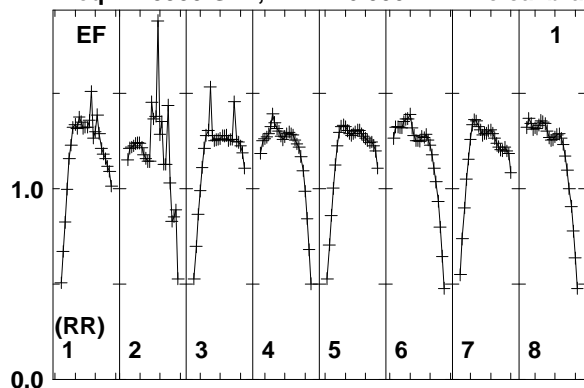

Lower frame: Real Jy
Total-power spectrum Antenna: EF (01)
Timerange: 00/11:34:11 to 00/11:38:09

Plot file version 455 created 11-AUG-2014 17:05:47

J2032+4127 EM110 2.UVDATA.1

Freq = 1.5950 GHz, Bw = 16.000 MH No calibration applied and no bandpass applied

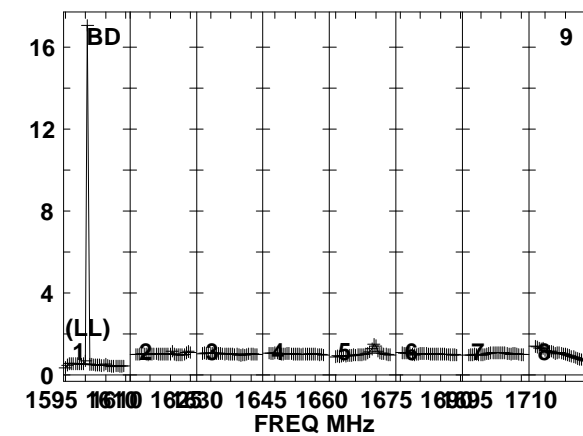
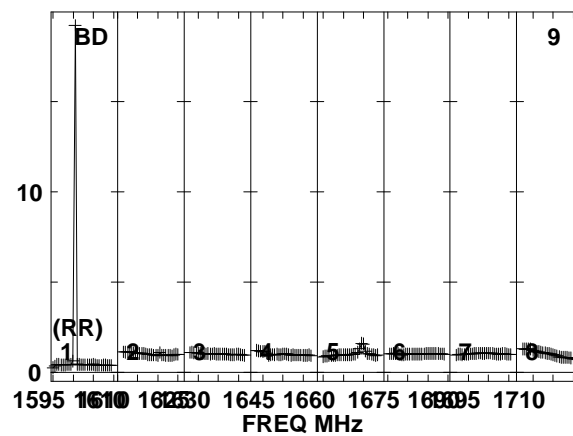
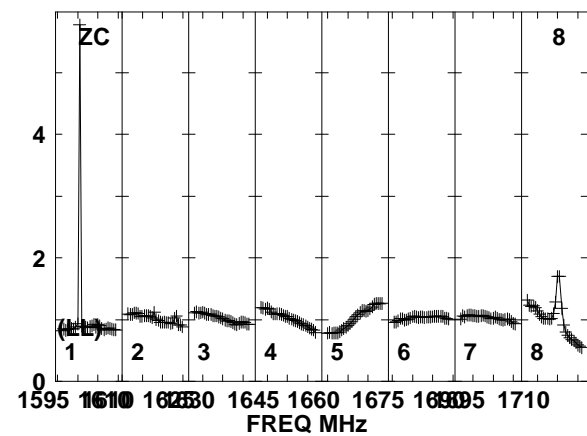
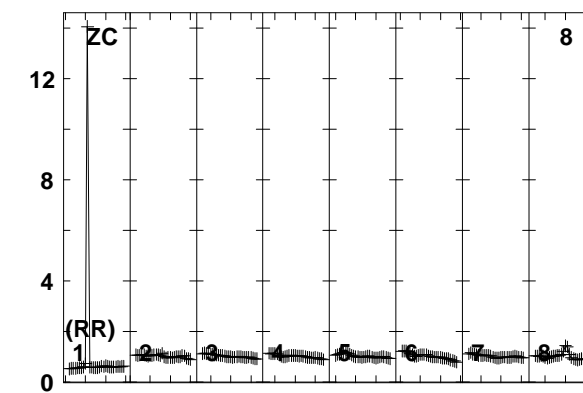
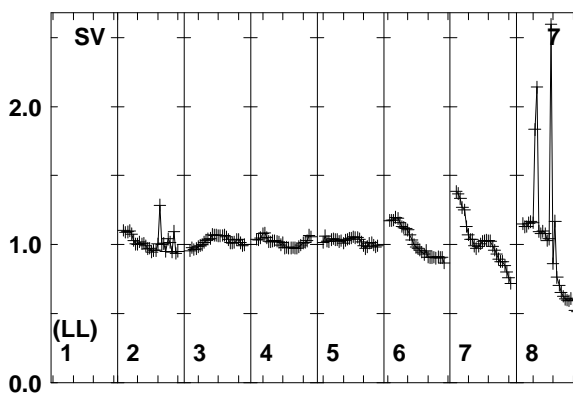
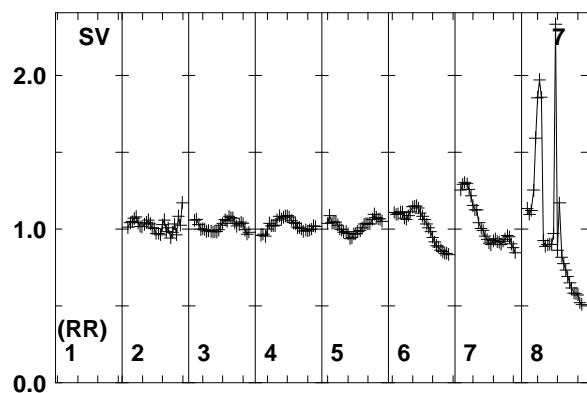
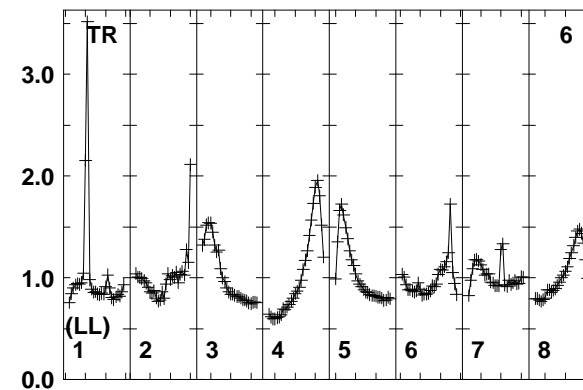
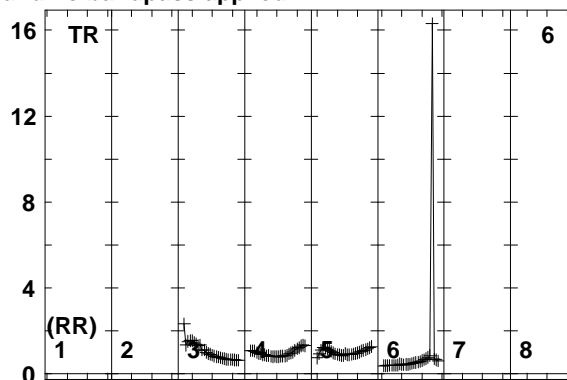
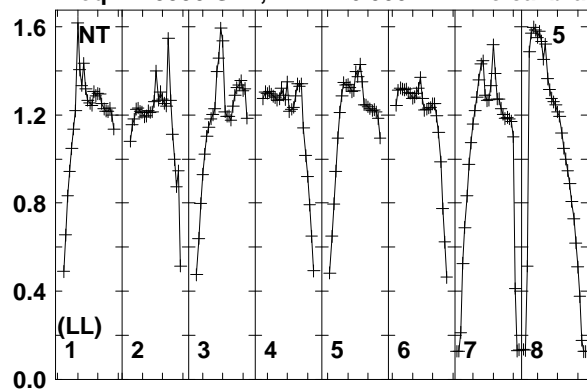

Lower frame: Real Jy
Total-power spectrum Antenna: NT (05)
Timerange: 00/11:34:11 to 00/11:38:09

Plot file version 456 created 11-AUG-2014 17:05:48

J2032+4127 EM110 2.UVDATA.1

Freq = 1.5950 GHz, Bw = 16.000 MH No calibration applied and no bandpass applied

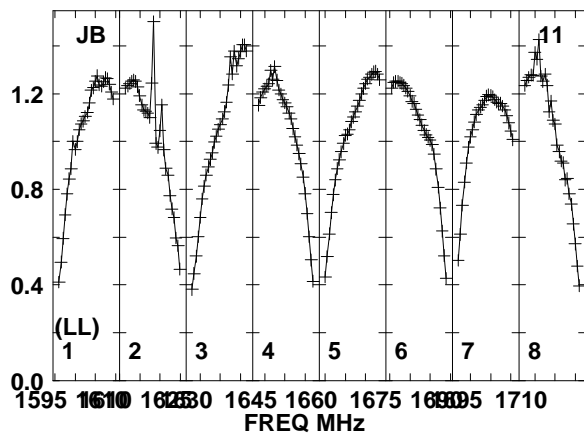
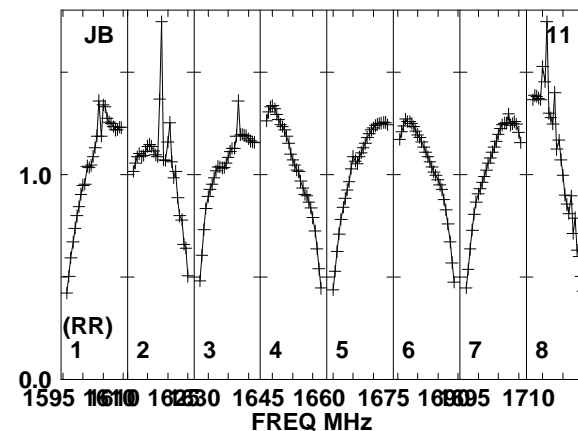
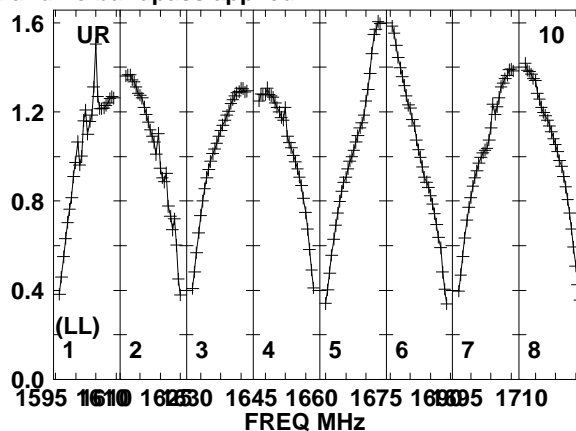
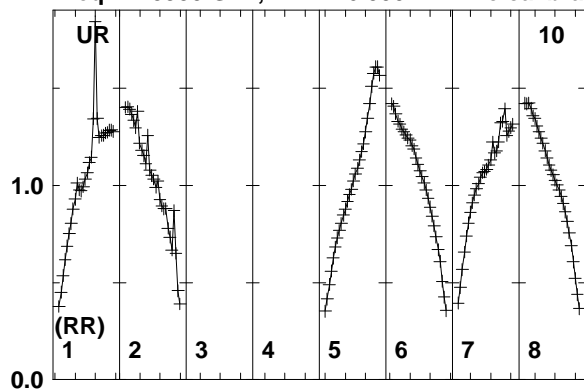

Lower frame: Real Jy
Total-power spectrum Antenna: UR (10)
Timerange: 00/11:34:11 to 00/11:38:09

Plot file version 457 created 11-AUG-2014 17:05:48

J2015+3710 EM110 2.UVDATA.1

Freq = 1.5950 GHz, Bw = 16.000 MH No calibration applied and no bandpass applied

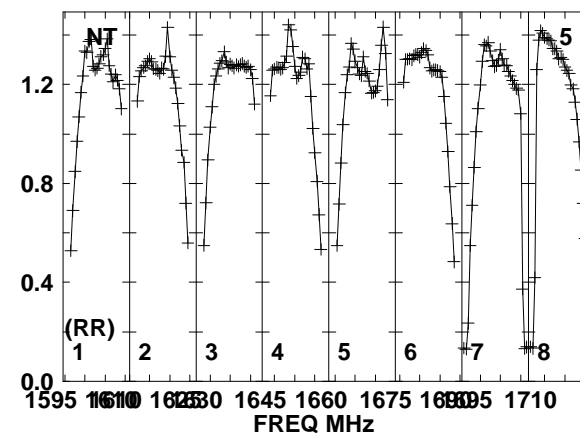
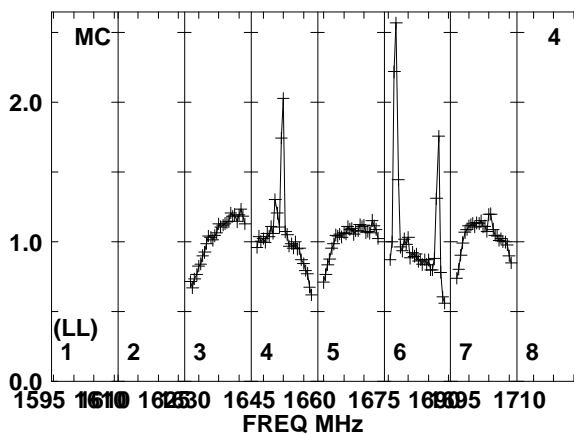
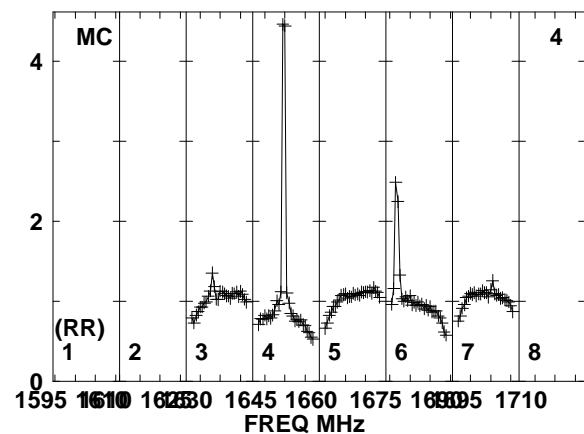
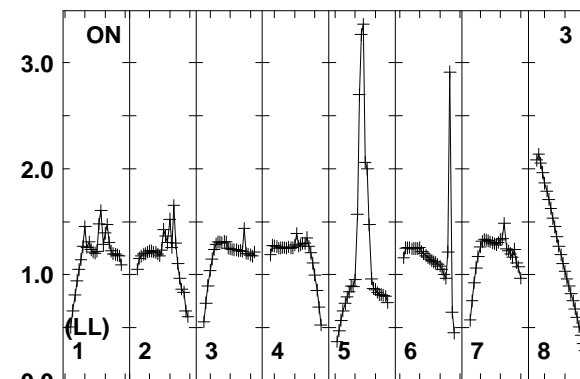
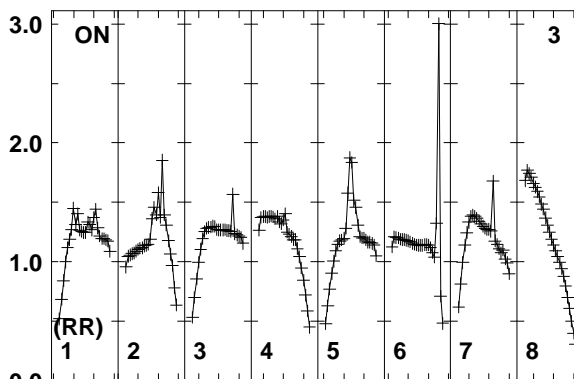
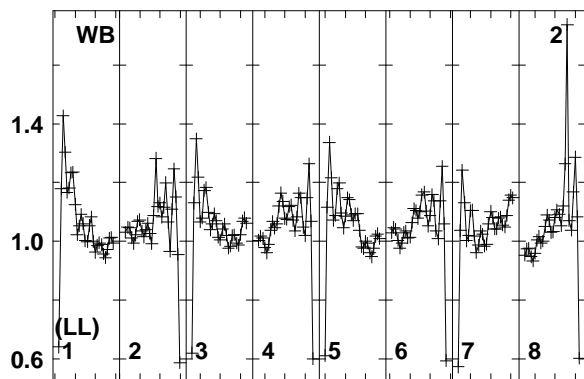
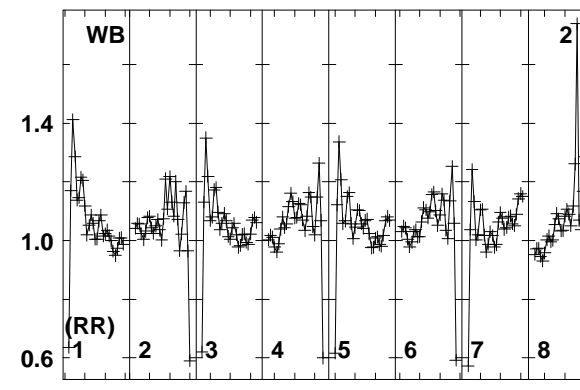
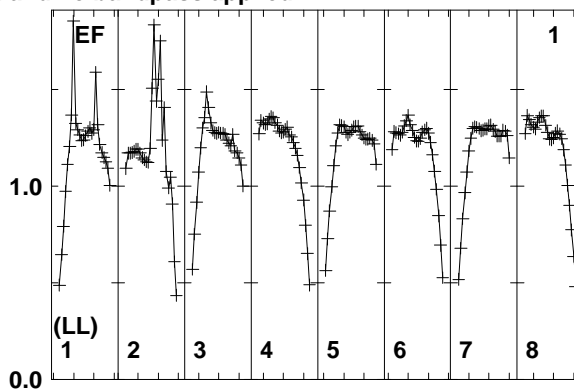
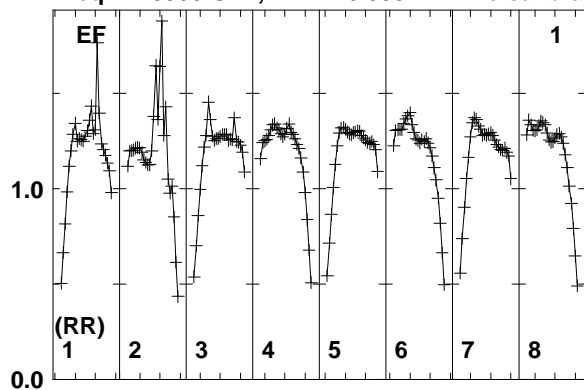

Lower frame: Real Jy
Total-power spectrum Antenna: EF (01)
Timerange: 00/11:39:11 to 00/11:41:09

Plot file version 458 created 11-AUG-2014 17:05:48

J2015+3710 EM110 2.UVDATA.1

Freq = 1.5950 GHz, Bw = 16.000 MH No calibration applied and no bandpass applied

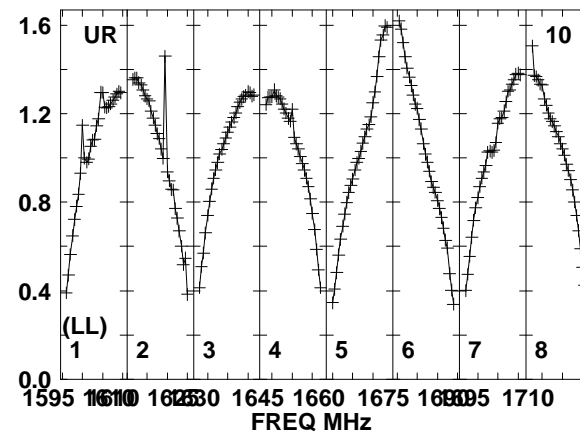
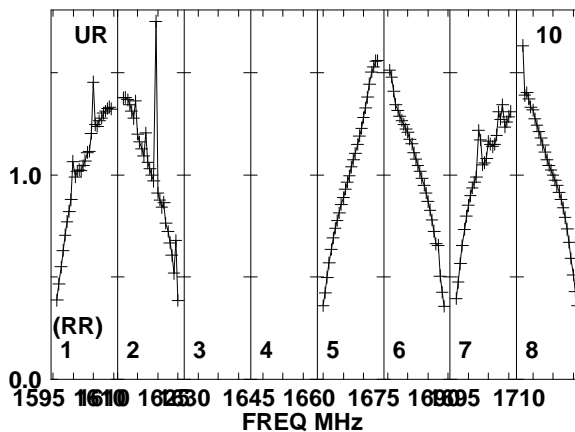
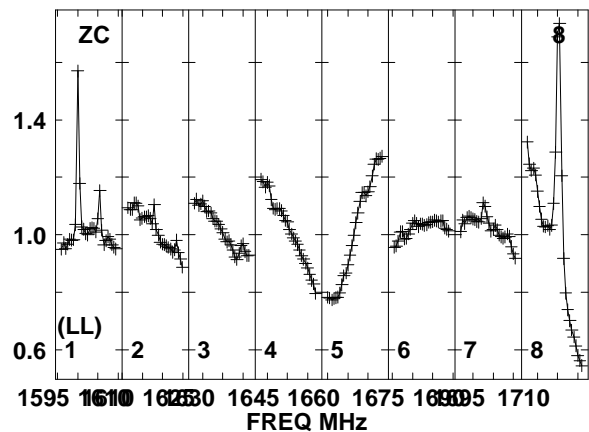
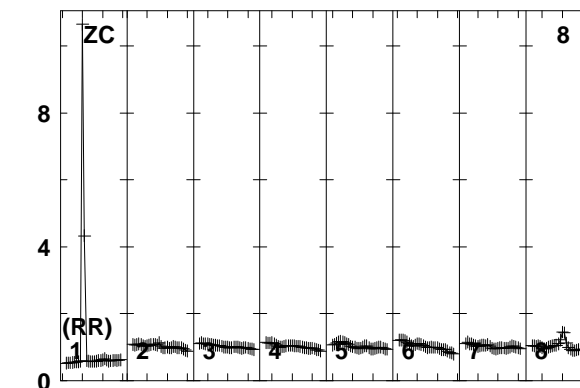
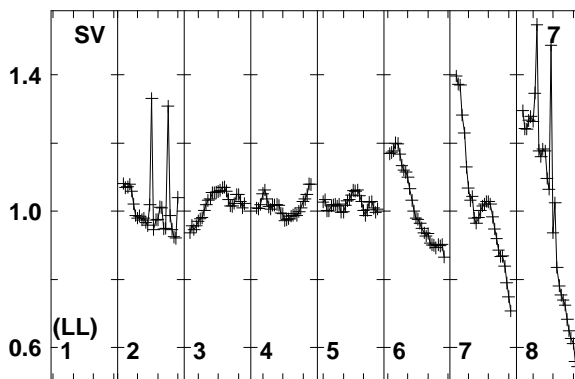
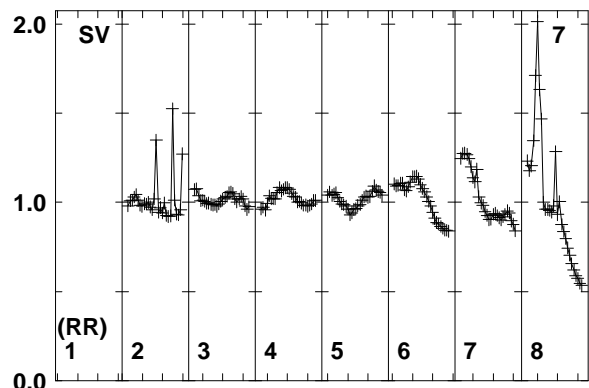
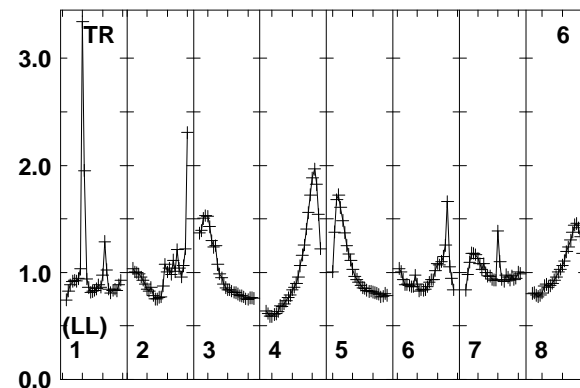
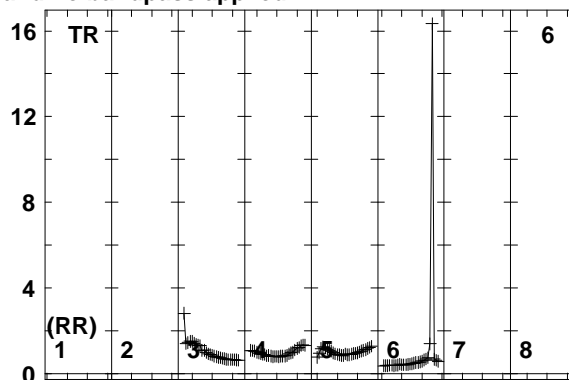
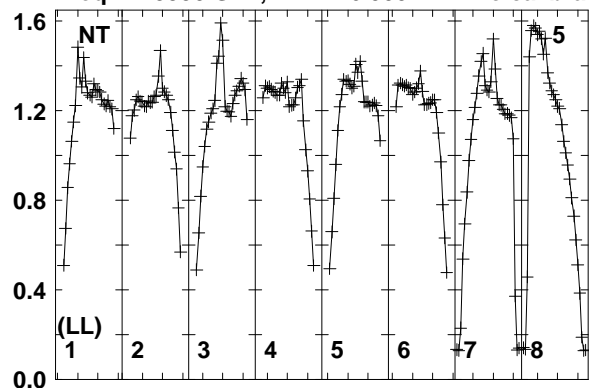

Lower frame: Real Jy
Total-power spectrum Antenna: NT (05)
Timerange: 00/11:39:11 to 00/11:41:09

Plot file version 459 created 11-AUG-2014 17:05:48

J2015+3710 EM110 2.UVDATA.1

Freq = 1.5950 GHz, Bw = 16.000 MH No calibration applied and no bandpass applied

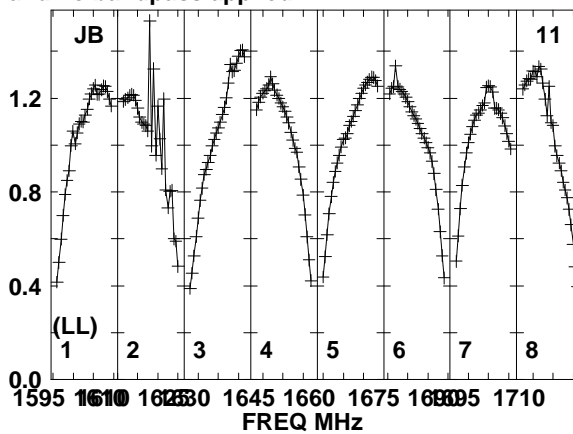
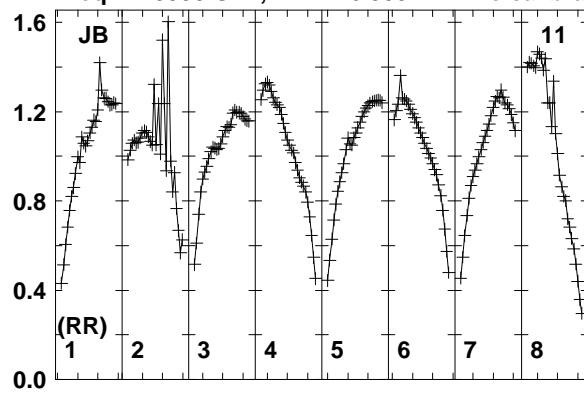

Lower frame: Real Jy
Total-power spectrum Antenna: JB (11)
Timerange: 00/11:39:11 to 00/11:41:09

Plot file version 460 created 11-AUG-2014 17:05:48

J2032+4127 EM110 2.UVDATA.1

Freq = 1.5950 GHz, Bw = 16.000 MH No calibration applied and no bandpass applied

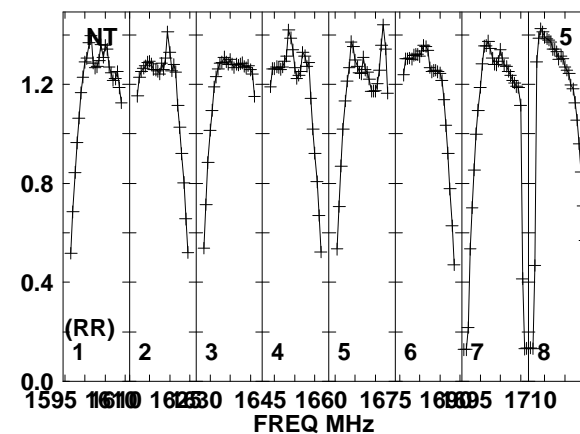
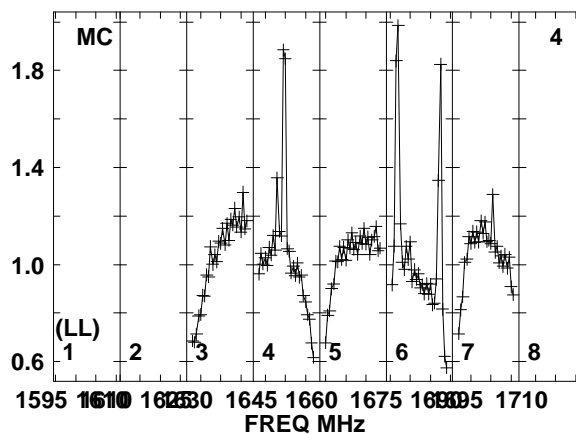
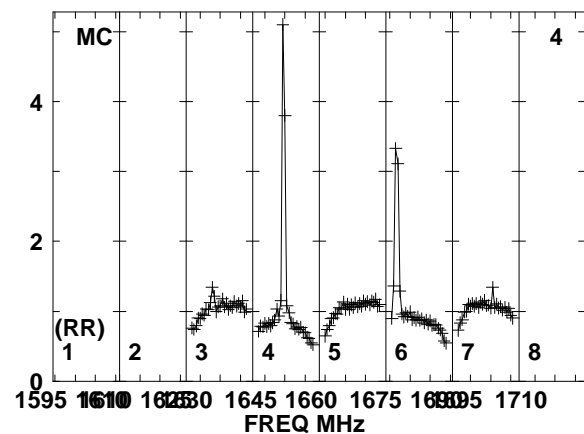
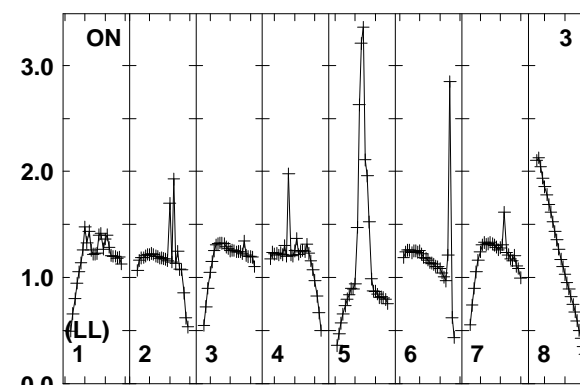
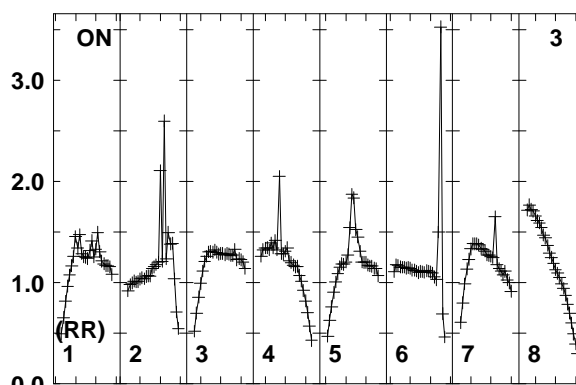
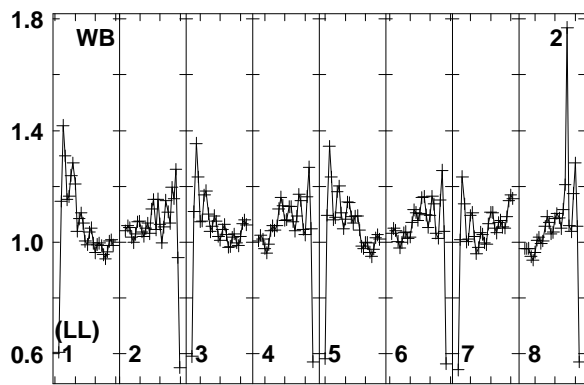
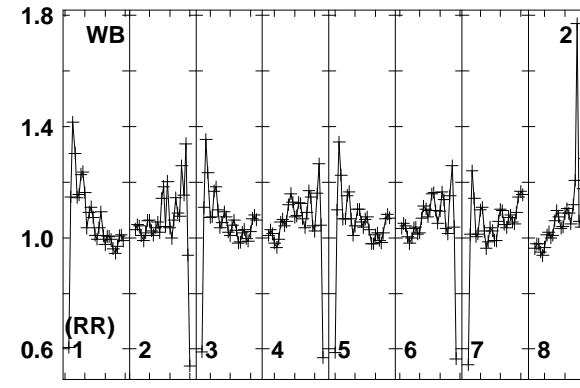
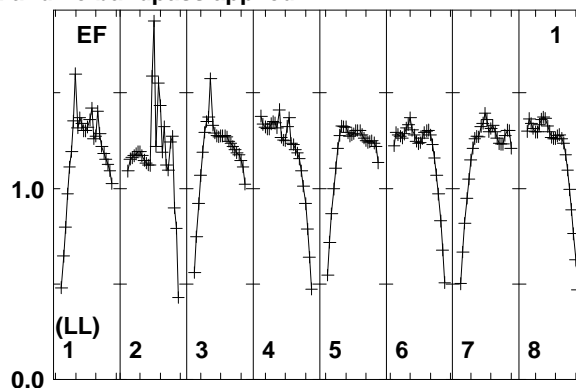
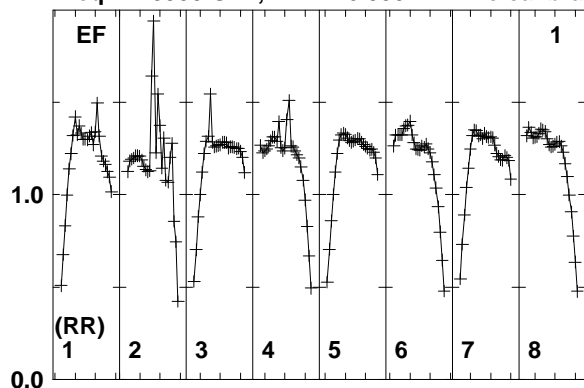

Lower frame: Real Jy
Total-power spectrum Antenna: EF (01)
Timerange: 00/11:41:13 to 00/11:45:09

Plot file version 461 created 11-AUG-2014 17:05:48

J2032+4127 EM110 2.UVDATA.1

Freq = 1.5950 GHz, Bw = 16.000 MH No calibration applied and no bandpass applied

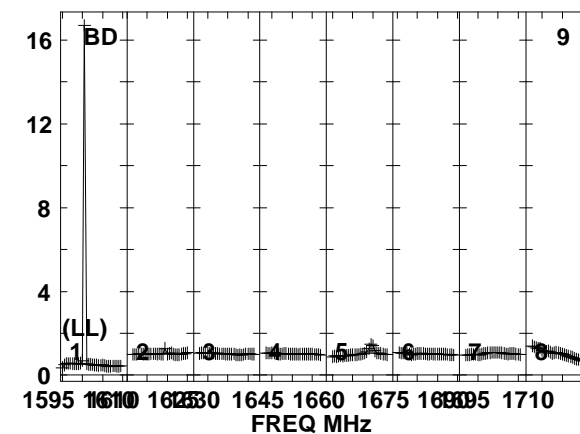
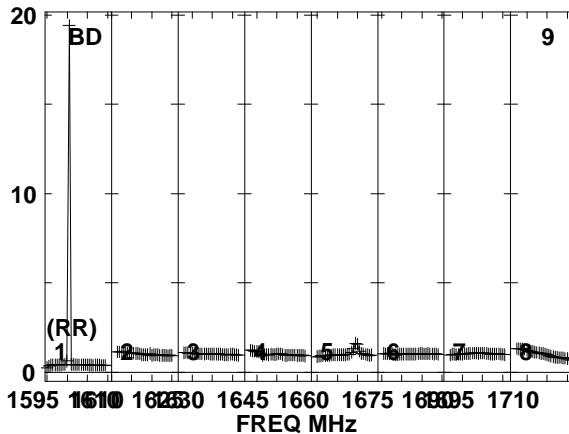
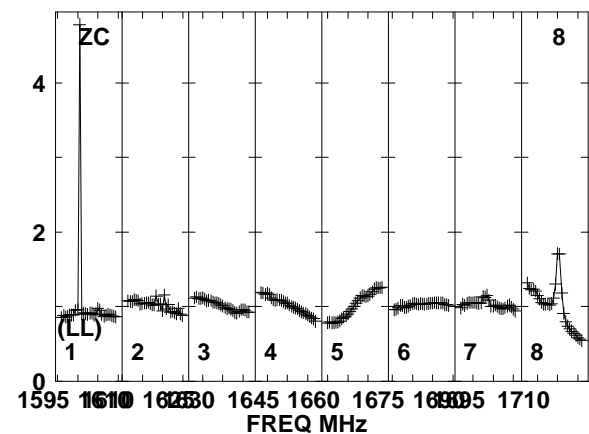
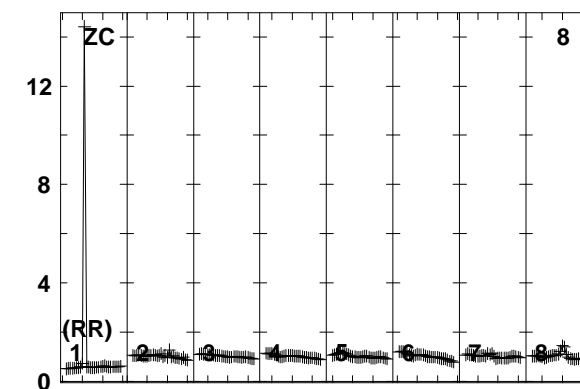
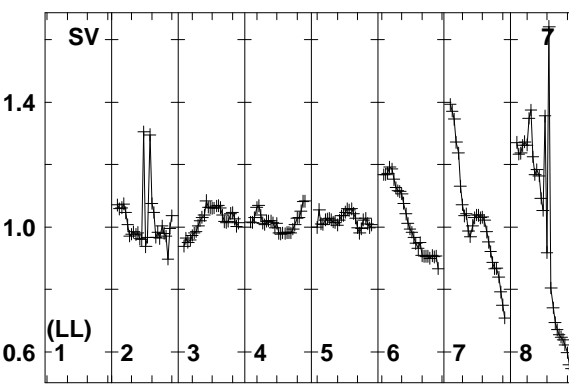
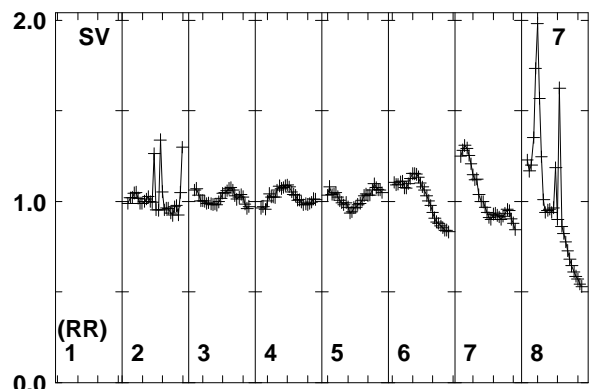
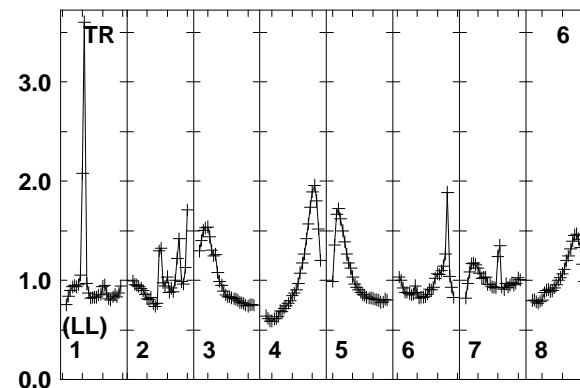
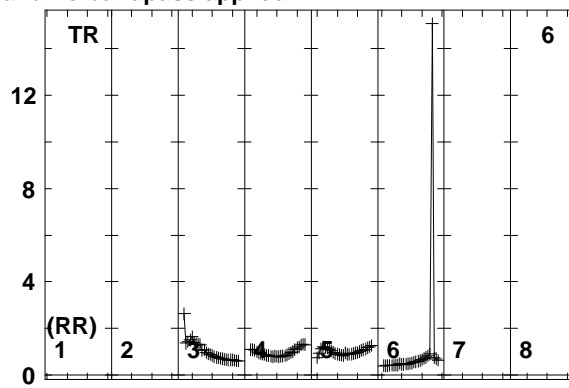
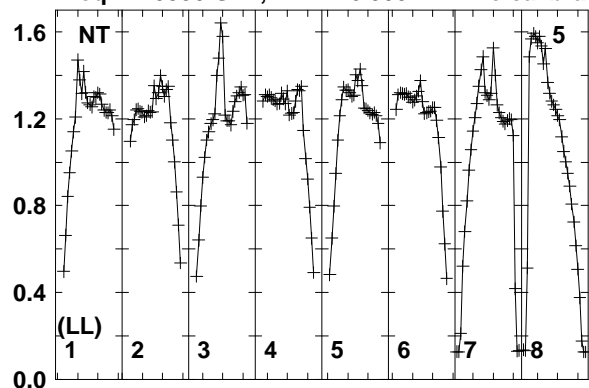

1595 1610 1625 1640 1655 1670 1685 1700 1715
FREQ MHz
Lower frame: Real Jy
Total-power spectrum Antenna: NT (05)
Timerange: 00/11:41:13 to 00/11:45:09

Plot file version 462 created 11-AUG-2014 17:05:48

J2032+4127 EM110 2.UVDATA.1

Freq = 1.5950 GHz, Bw = 16.000 MH No calibration applied and no bandpass applied

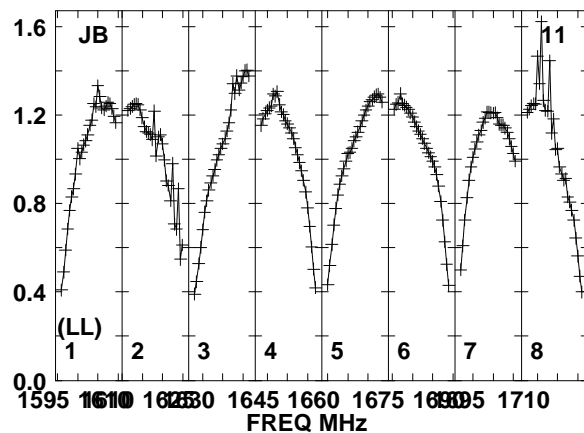
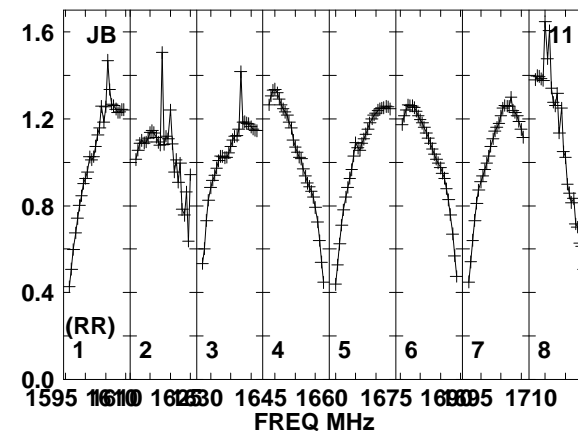
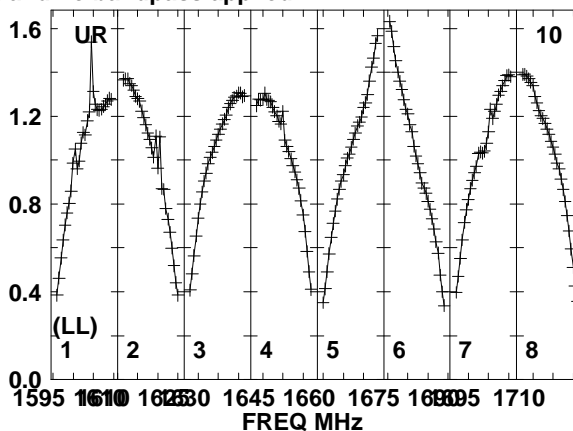
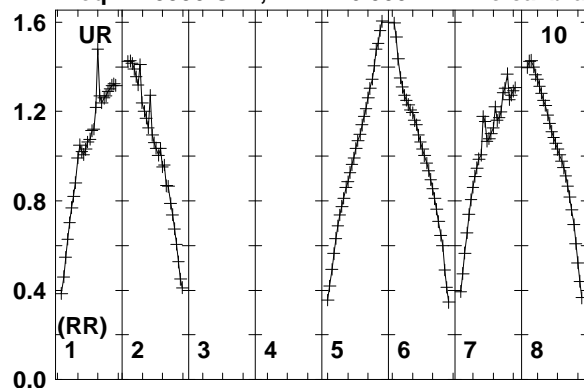

Lower frame: Real Jy
Total-power spectrum Antenna: UR (10)
Timerange: 00/11:41:13 to 00/11:45:09

Plot file version 463 created 11-AUG-2014 17:05:48

J2015+3710 EM110 2.UVDATA.1

Freq = 1.5950 GHz, Bw = 16.000 MH No calibration applied and no bandpass applied

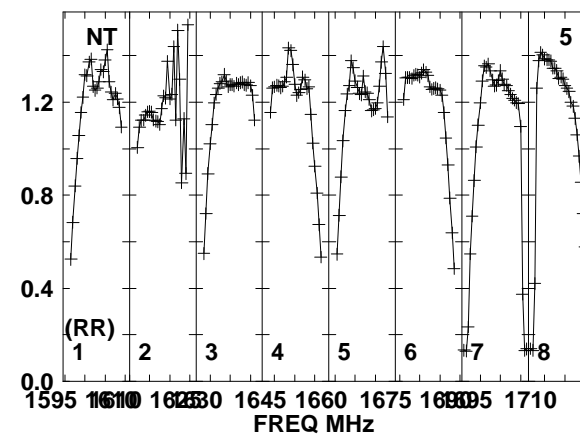
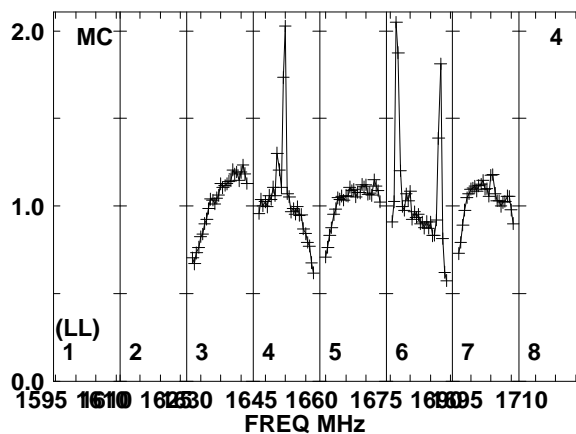
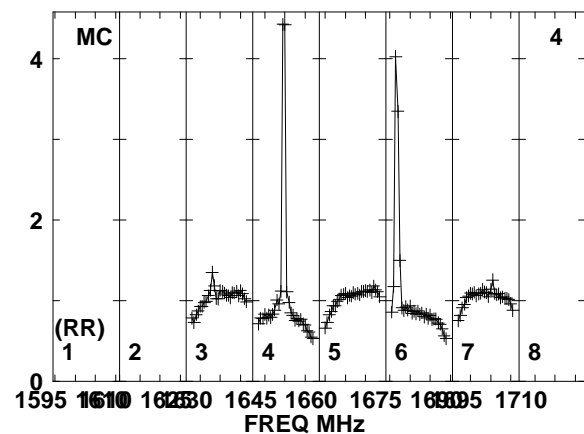
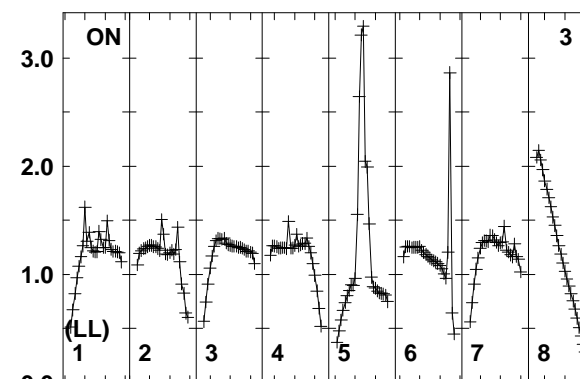
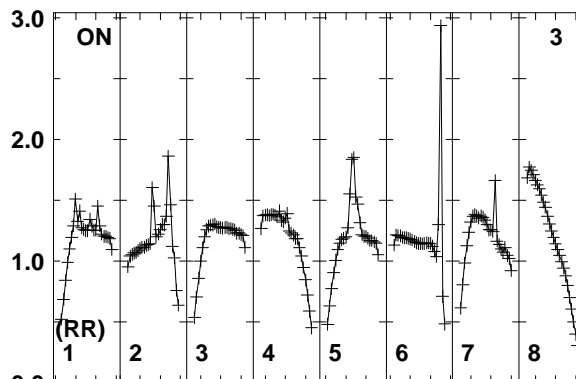
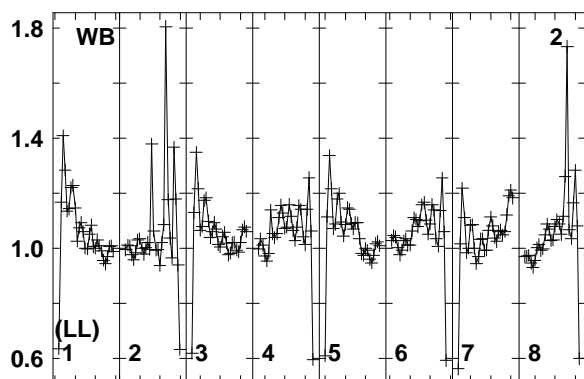
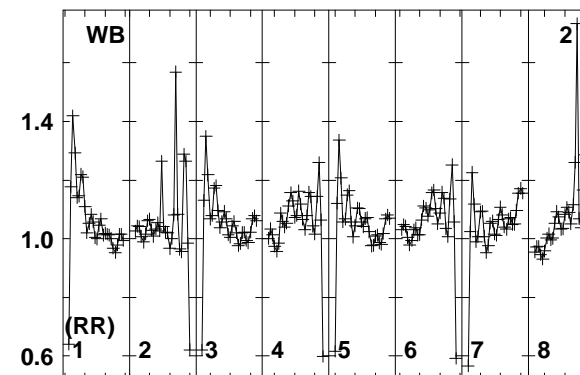
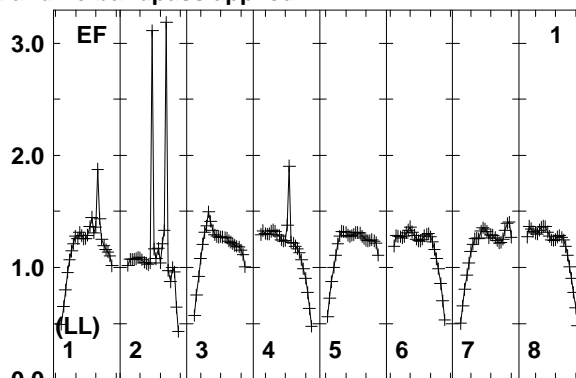
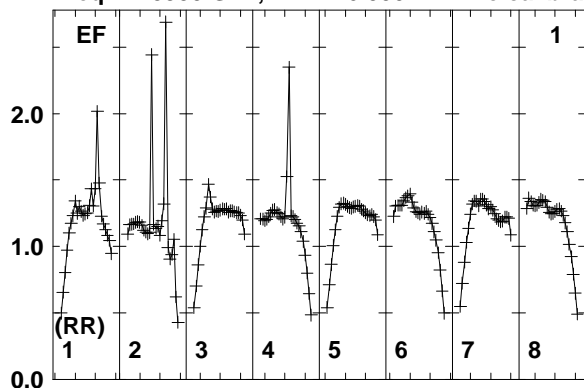

1595 1610 1625 1640 1655 1670 1685 1700 1710
FREQ MHz
Lower frame: Real Jy
Total-power spectrum Antenna: EF (01)
Timerange: 00/11:45:23 to 00/11:47:09

Plot file version 464 created 11-AUG-2014 17:05:48

J2015+3710 EM110 2.UVDATA.1

Freq = 1.5950 GHz, Bw = 16.000 MH No calibration applied and no bandpass applied

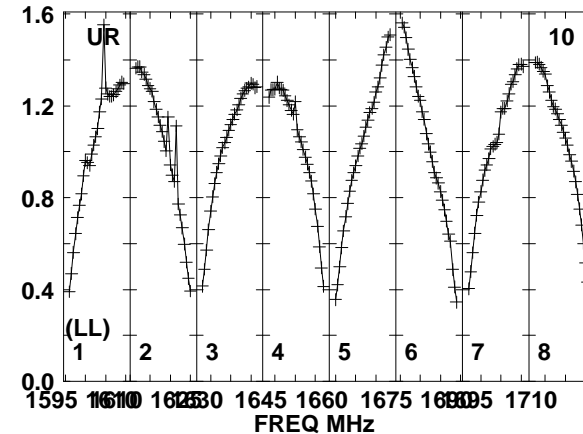
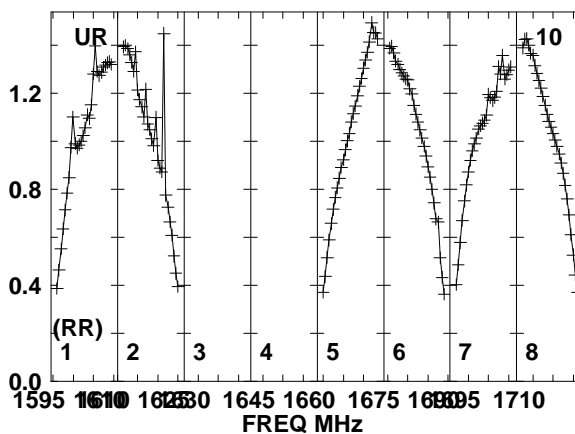
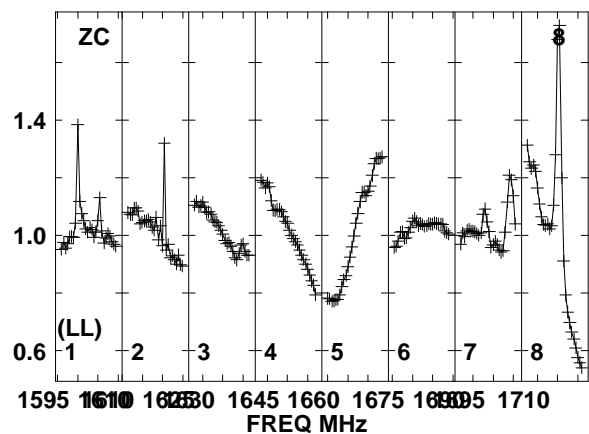
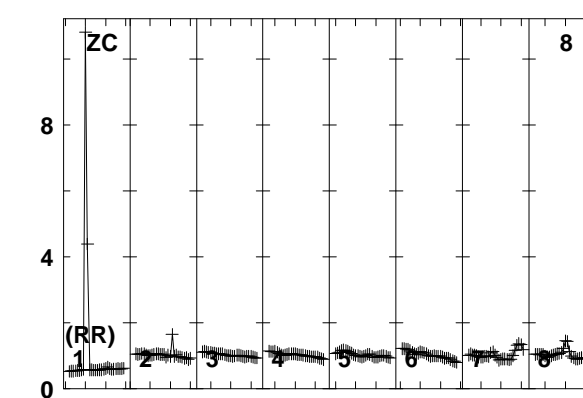
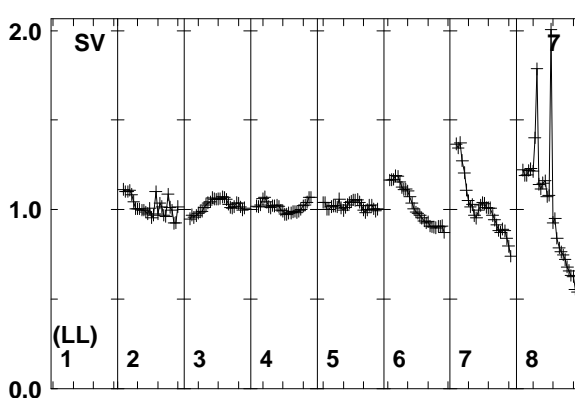
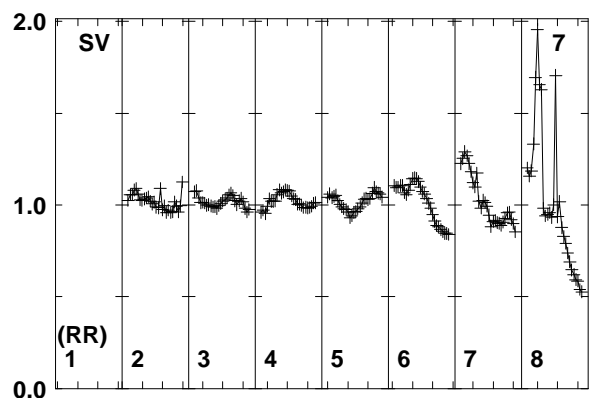
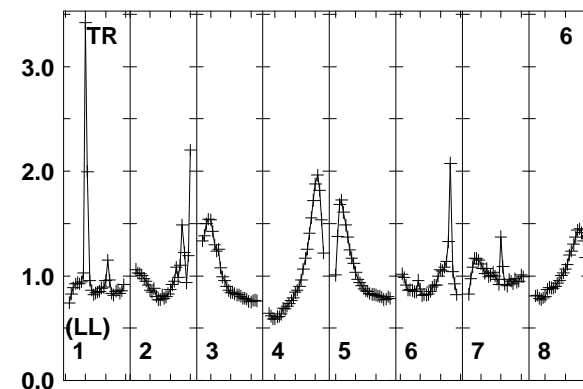
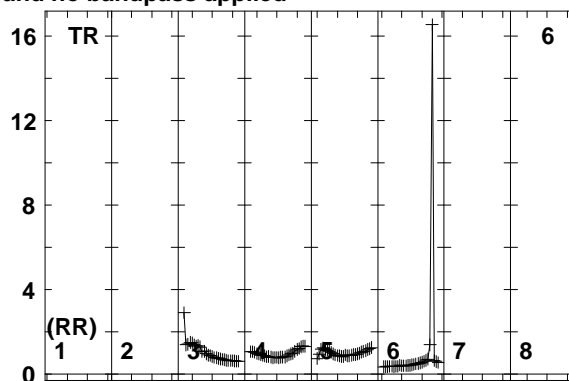
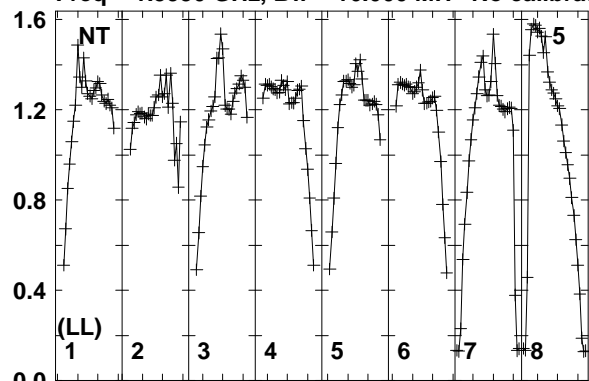

Lower frame: Real Jy
Total-power spectrum Antenna: NT (05)
Timerange: 00/11:45:23 to 00/11:47:09

Plot file version 465 created 11-AUG-2014 17:05:48
 J2032+4127 EM110 2.UVDATA.1
 Freq = 1.5950 GHz, Bw = 16.000 MH No calibration applied and no bandpass applied

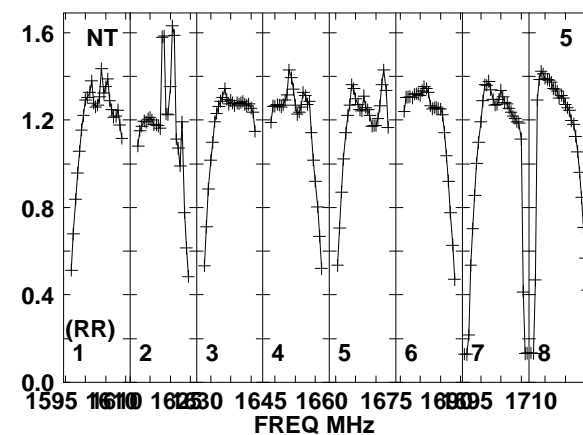
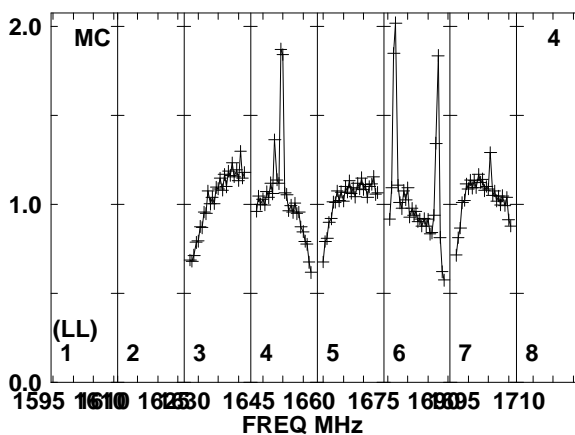
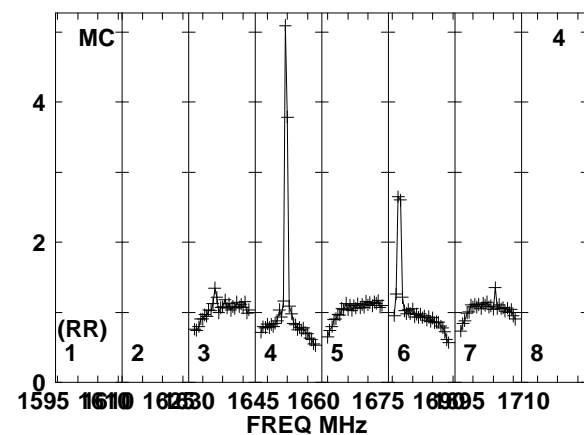
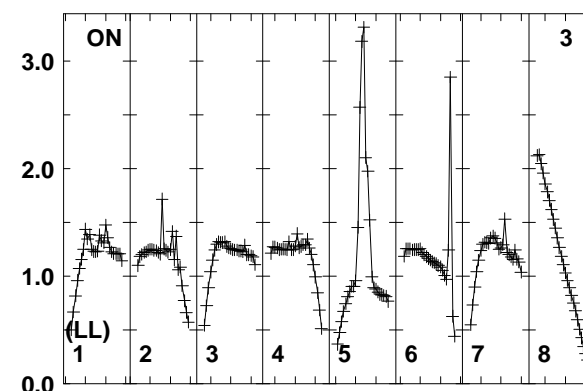
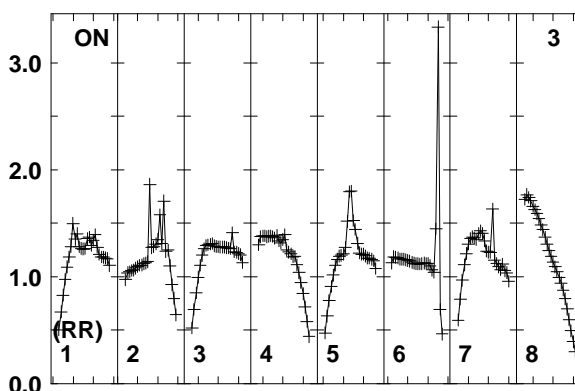
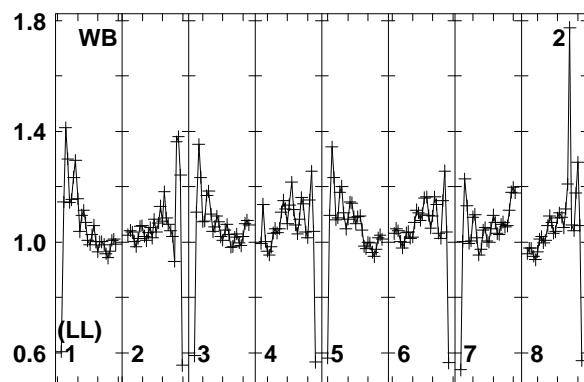
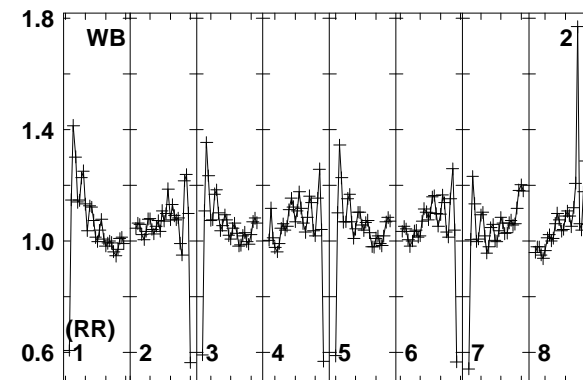
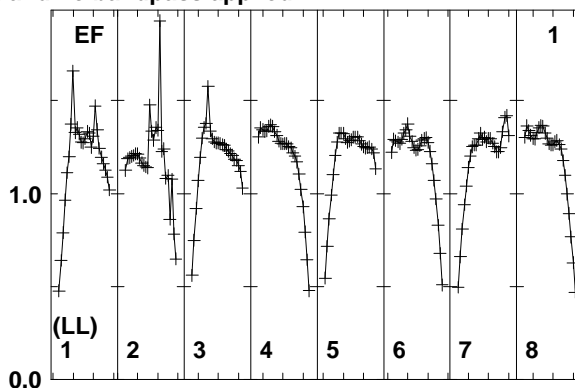
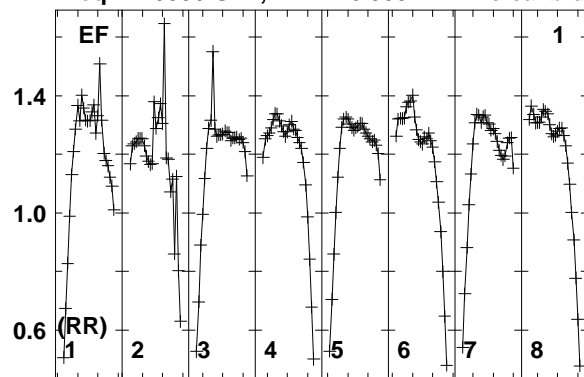

Lower frame: Real Jy
 Total-power spectrum Antenna: EF (01)
 Timerange: 00/11:47:11 to 00/11:51:09

Plot file version 466 created 11-AUG-2014 17:05:48

J2032+4127 EM110 2.UVDATA.1

Freq = 1.5950 GHz, Bw = 16.000 MH No calibration applied and no bandpass applied

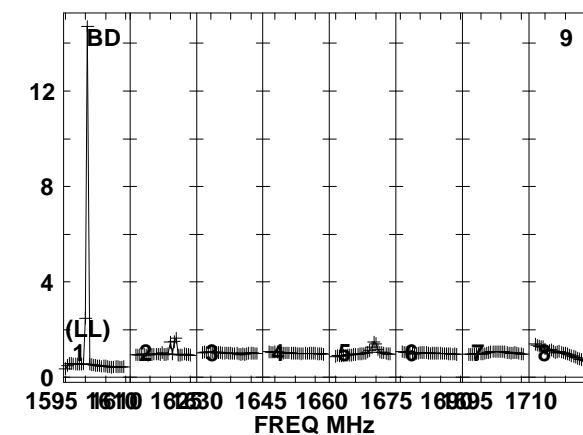
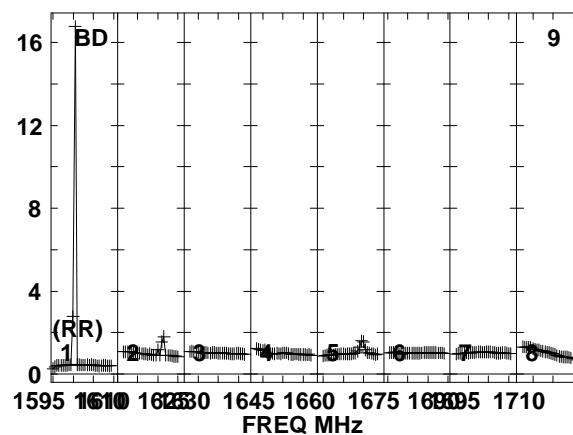
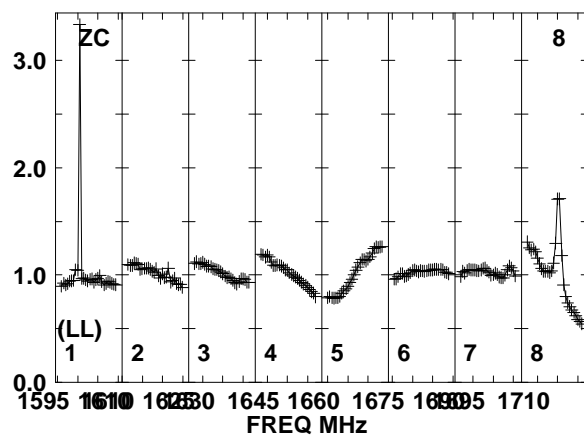
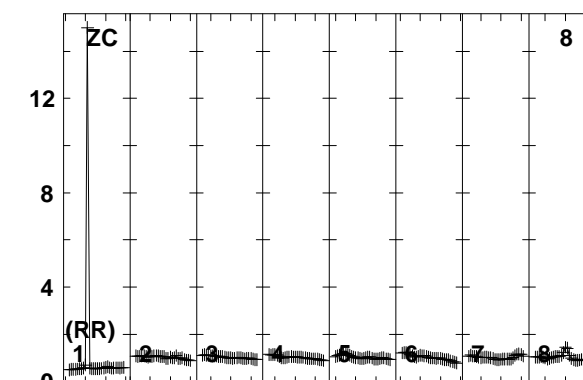
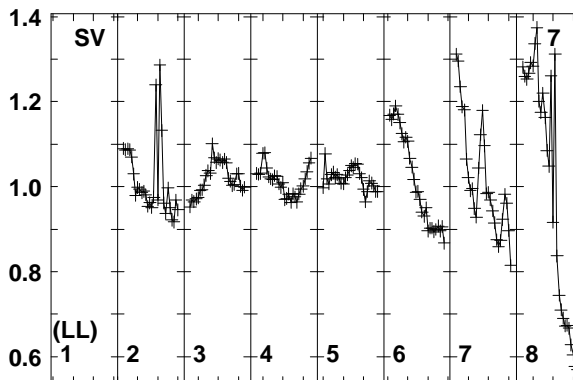
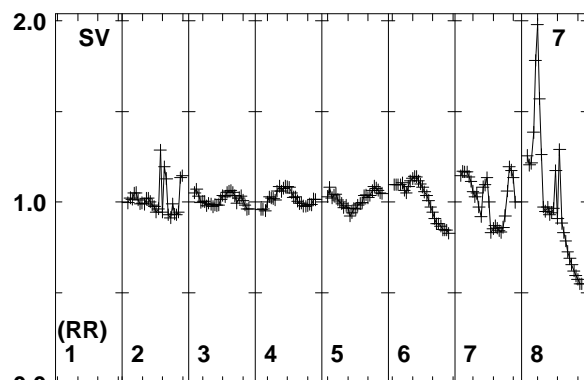
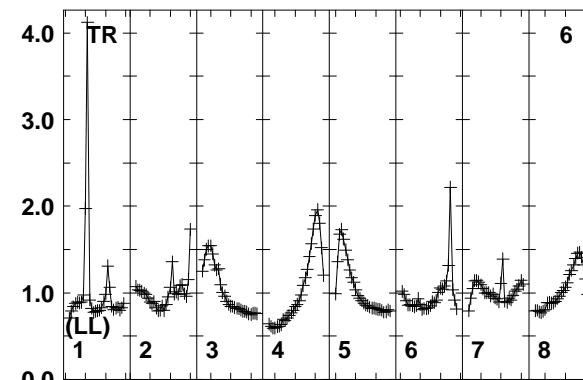
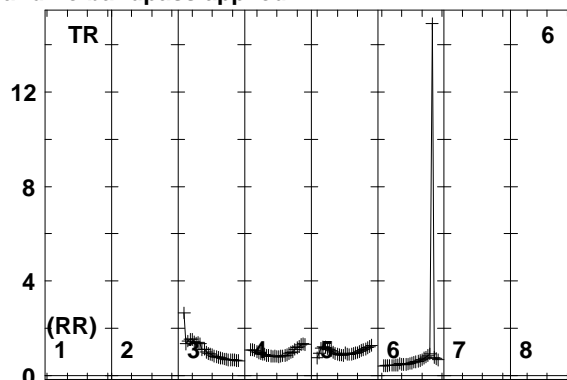
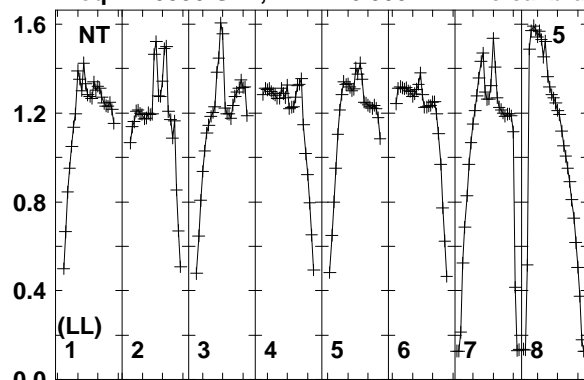

Lower frame: Real Jy
Total-power spectrum Antenna: NT (05)
Timerange: 00/11:47:11 to 00/11:51:09

Plot file version 467 created 11-AUG-2014 17:05:48

J2032+4127 EM110 2.UVDATA.1

Freq = 1.5950 GHz, Bw = 16.000 MH No calibration applied and no bandpass applied

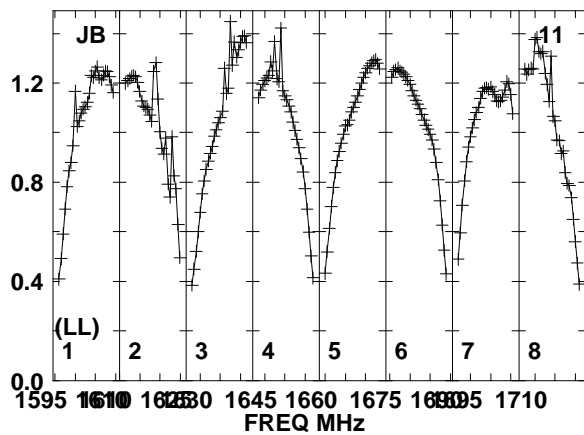
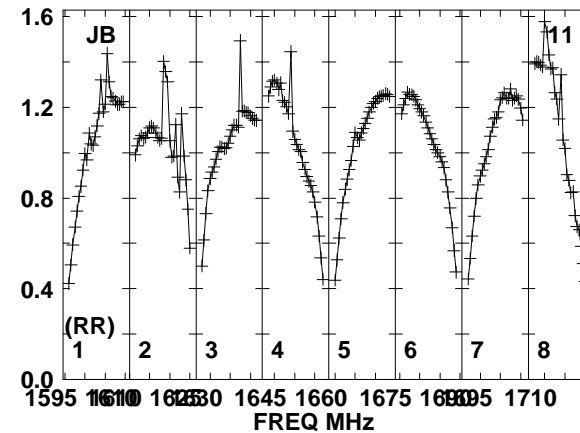
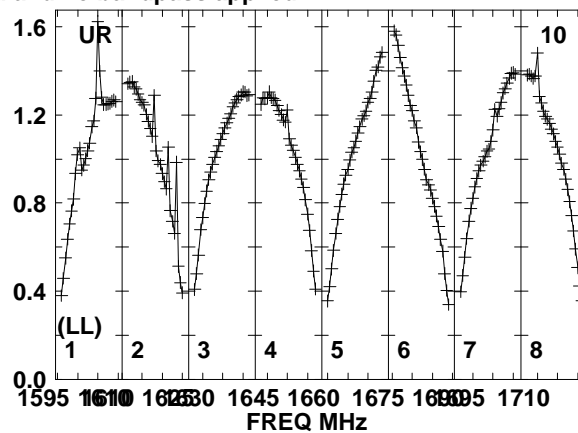
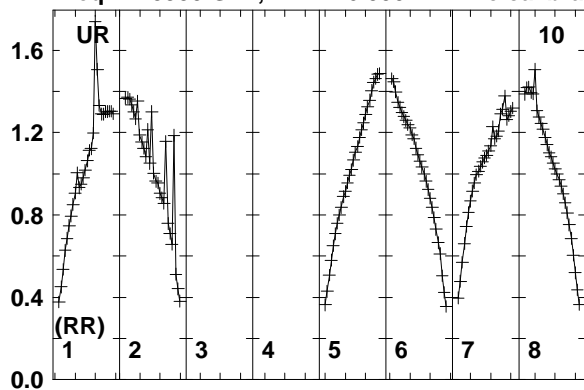

Lower frame: Real Jy
Total-power spectrum Antenna: UR (10)
Timerange: 00/11:47:11 to 00/11:51:09

Plot file version 468 created 11-AUG-2014 17:05:48
 J2015+3710 EM110 2.UVDATA.1
 Freq = 1.5950 GHz, Bw = 16.000 MH No calibration applied and no bandpass applied

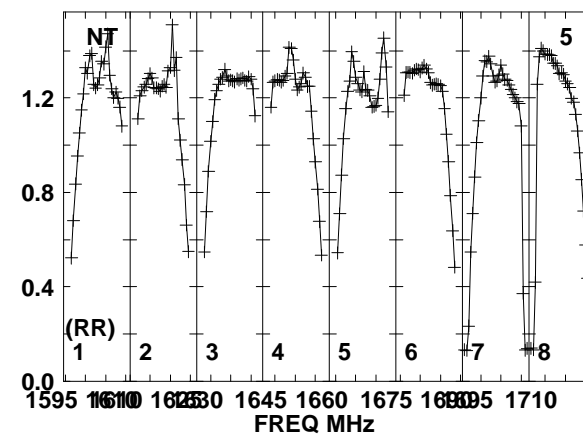
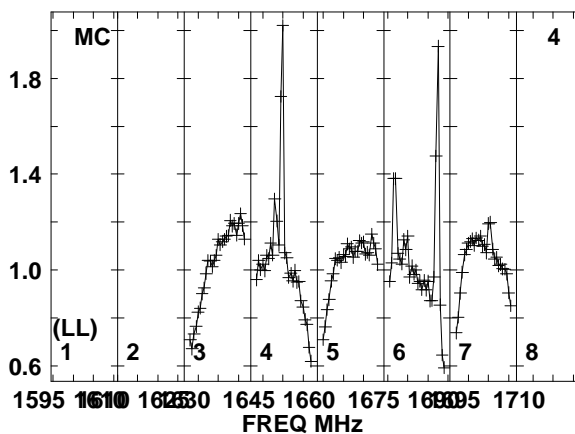
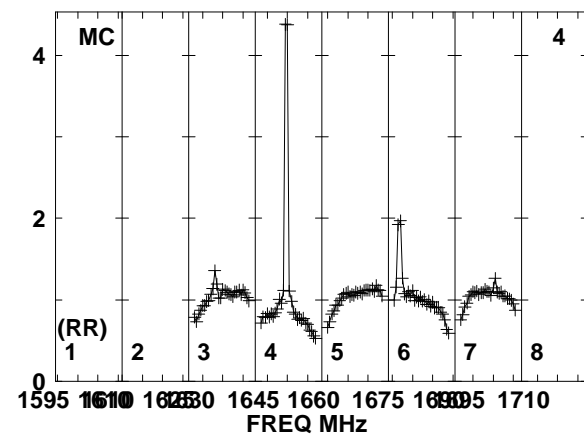
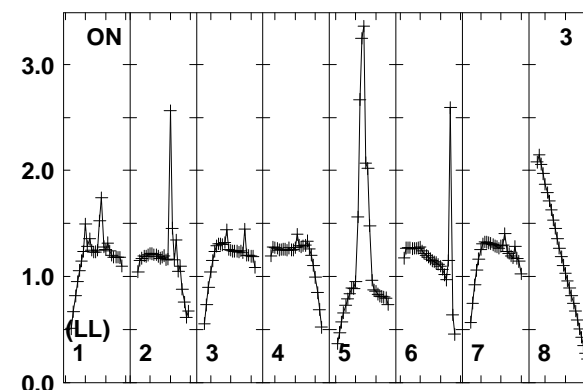
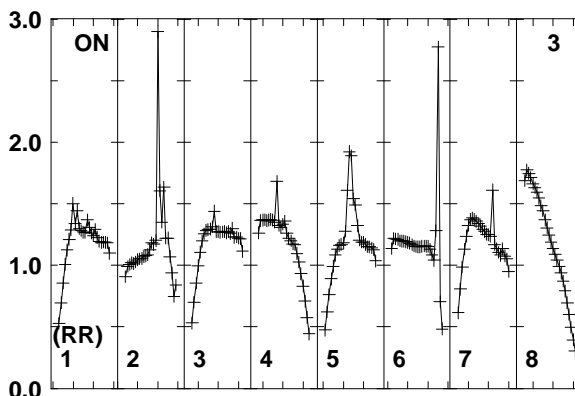
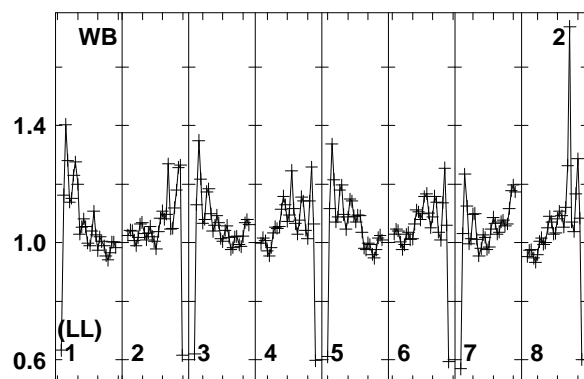
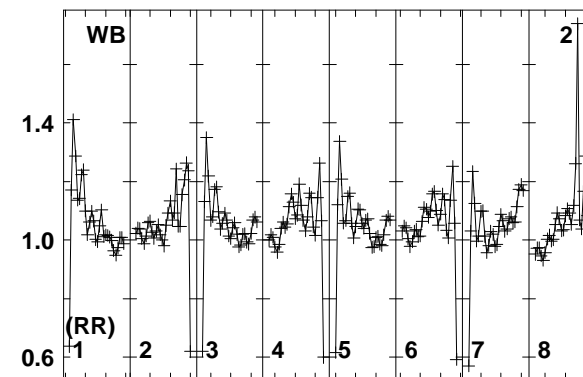
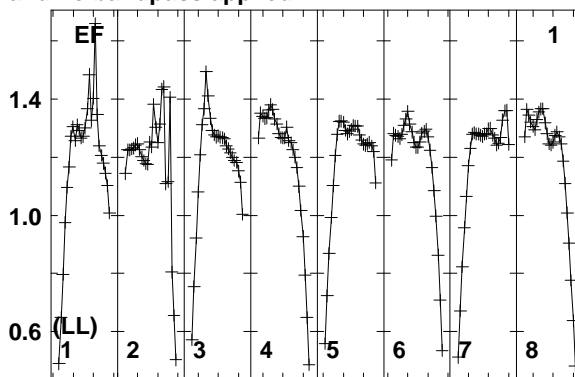
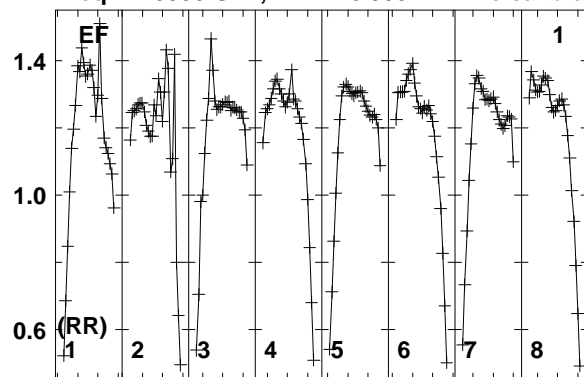

Lower frame: Real Jy
 Total-power spectrum Antenna: EF (01)
 Timerange: 00/11:52:11 to 00/11:54:09

Plot file version 469 created 11-AUG-2014 17:05:48

J2015+3710 EM110 2.UVDATA.1

Freq = 1.5950 GHz, Bw = 16.000 MH No calibration applied and no bandpass applied

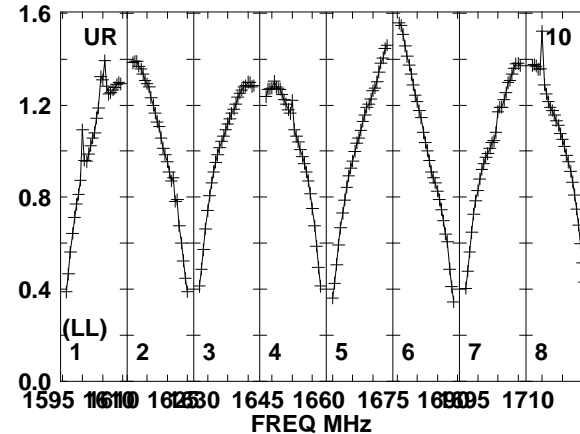
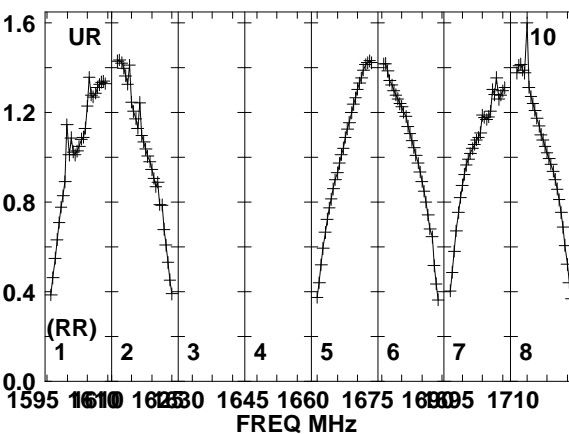
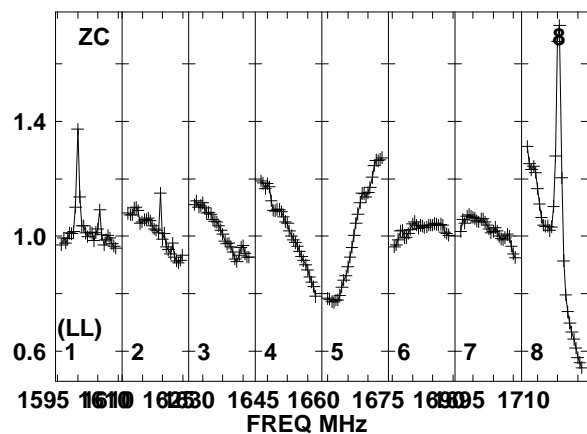
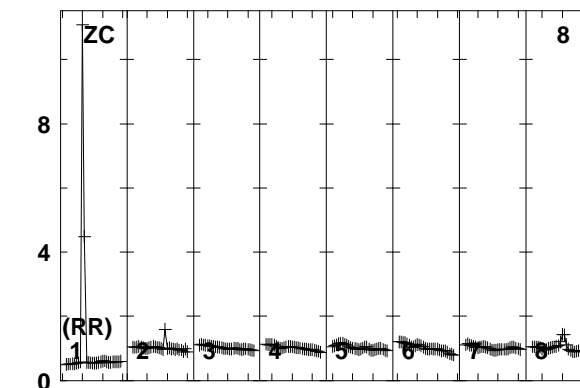
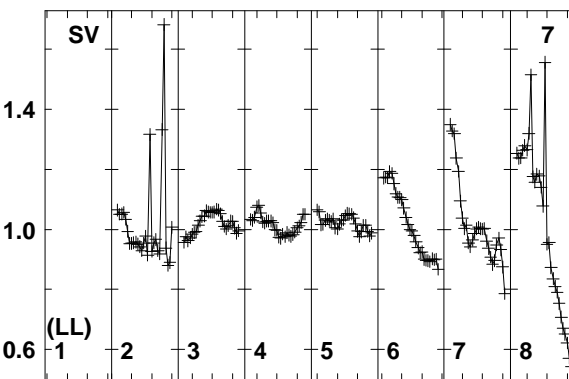
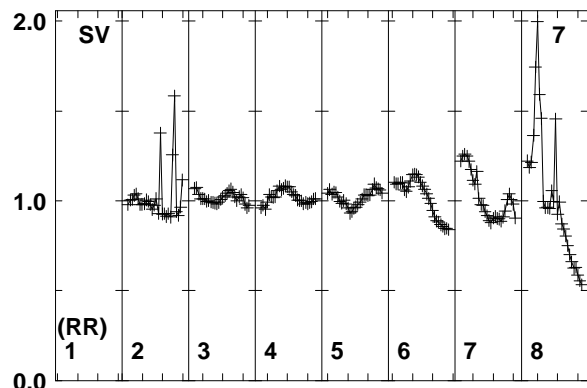
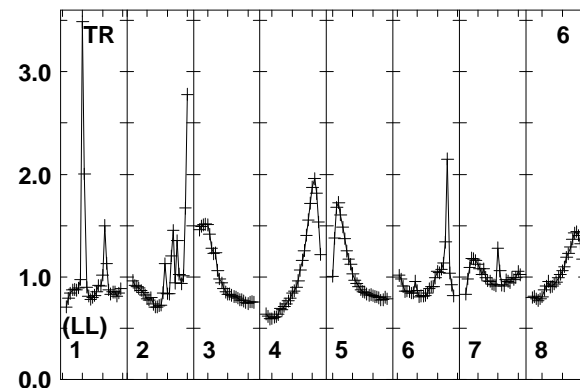
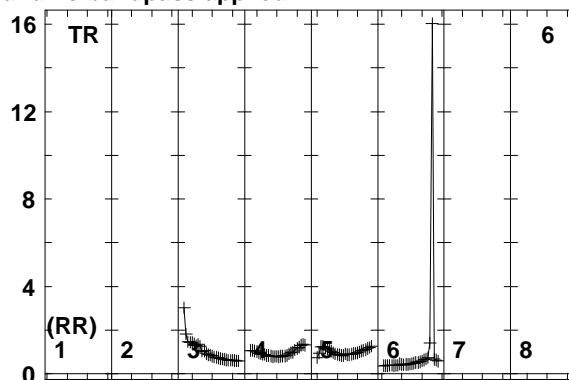
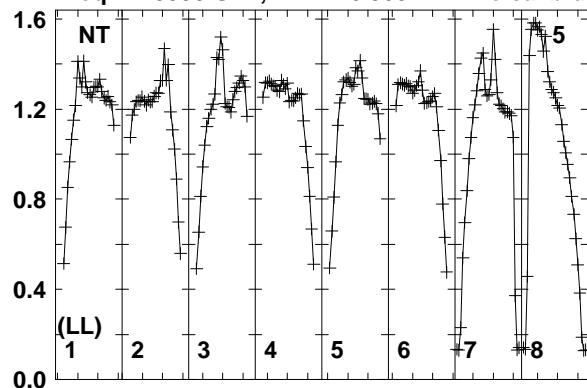

Lower frame: Real Jy
Total-power spectrum Antenna: NT (05)
Timerange: 00/11:52:11 to 00/11:54:09

Plot file version 470 created 11-AUG-2014 17:05:48

J2015+3710 EM110 2.UVDATA.1

Freq = 1.5950 GHz, Bw = 16.000 MH No calibration applied and no bandpass applied

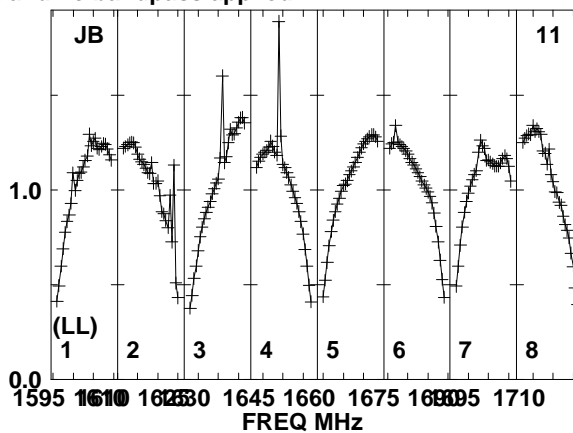
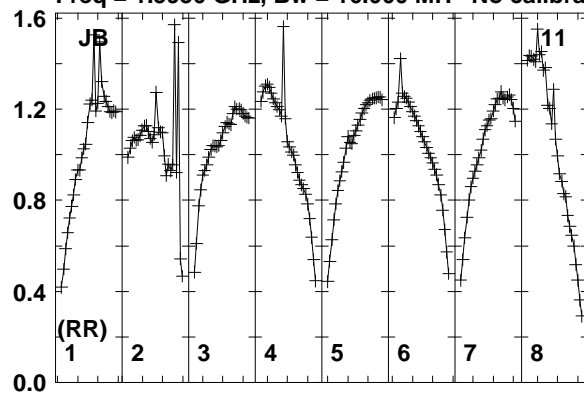

Lower frame: Real Jy
Total-power spectrum Antenna: JB (11)
Timerange: 00/11:52:11 to 00/11:54:09

Plot file version 471 created 11-AUG-2014 17:05:48

J2032+4127 EM110 2.UVDATA.1

Freq = 1.5950 GHz, Bw = 16.000 MH No calibration applied and no bandpass applied

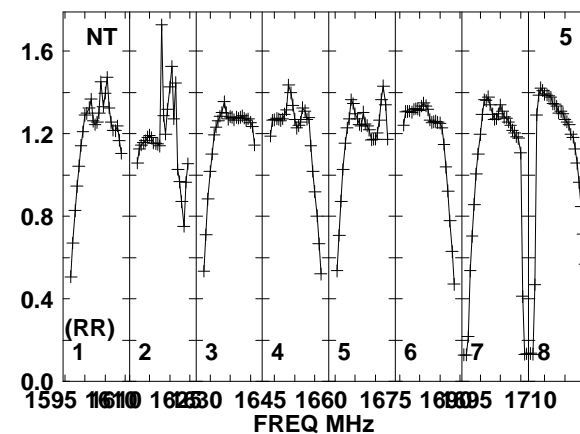
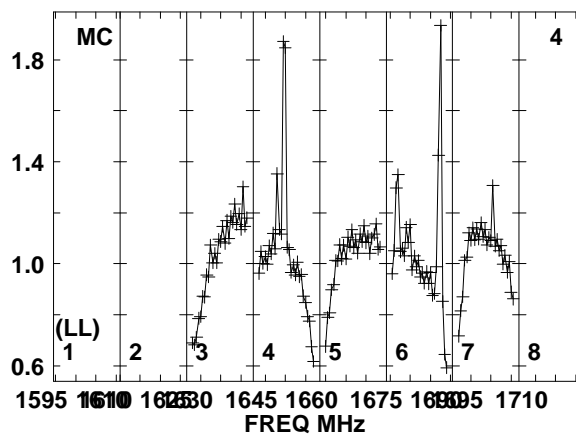
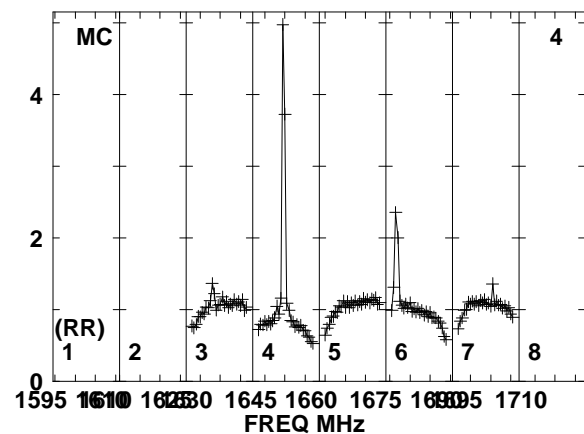
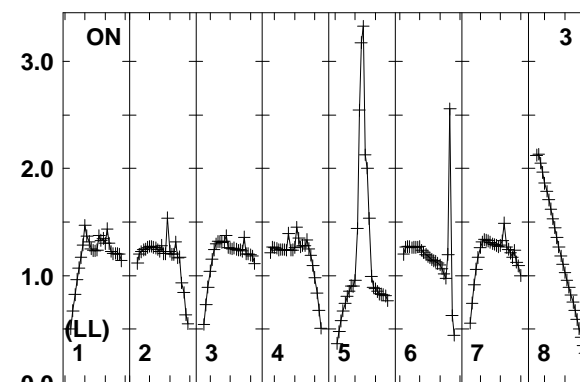
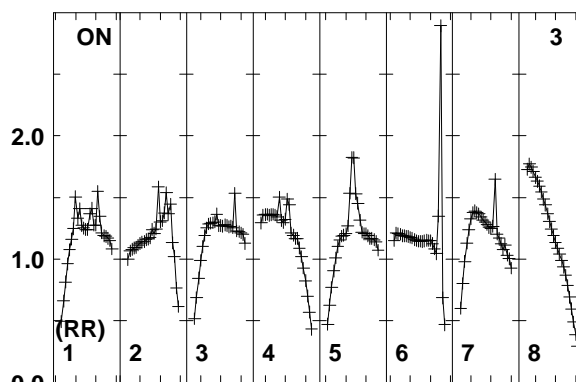
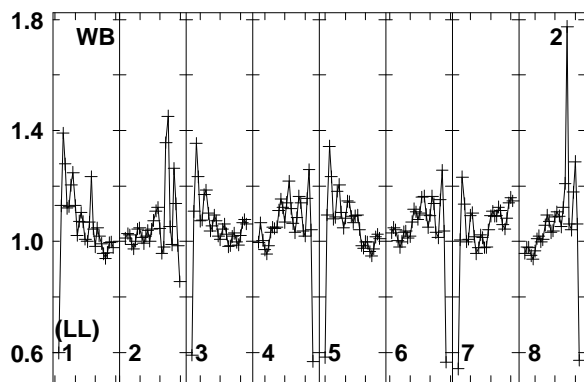
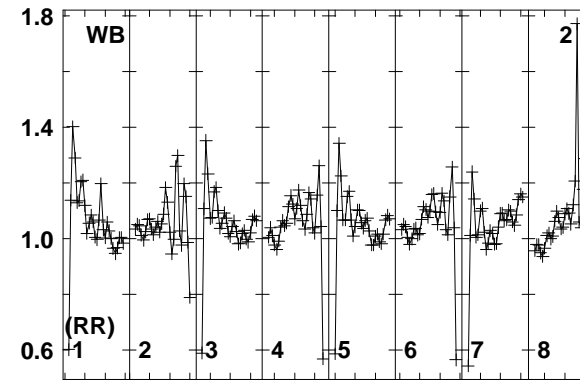
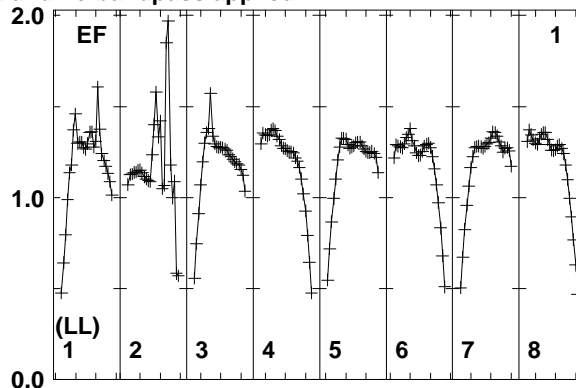
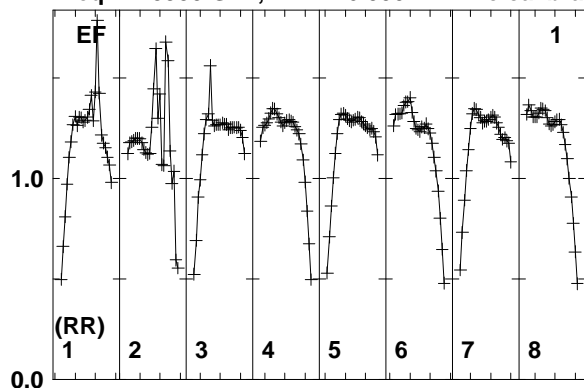

Lower frame: Real Jy
Total-power spectrum Antenna: EF (01)
Timerange: 00/11:54:13 to 00/11:58:09

Plot file version 472 created 11-AUG-2014 17:05:48

J2032+4127 EM110 2.UVDATA.1

Freq = 1.5950 GHz, Bw = 16.000 MH No calibration applied and no bandpass applied

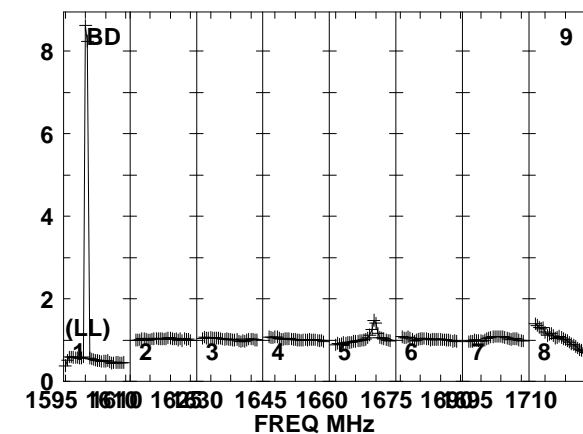
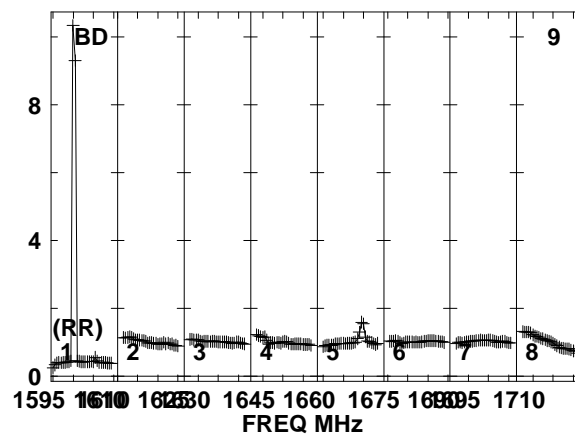
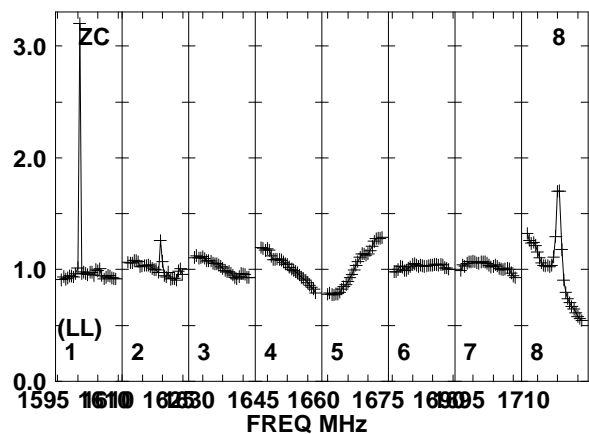
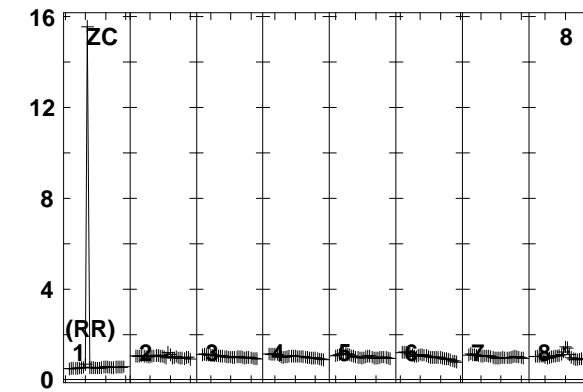
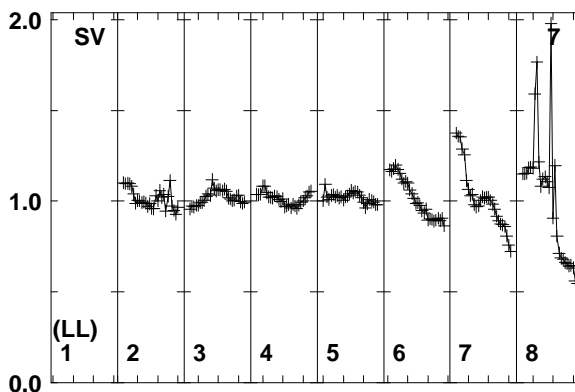
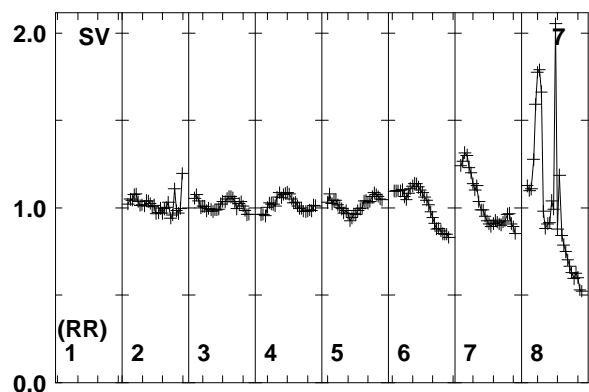
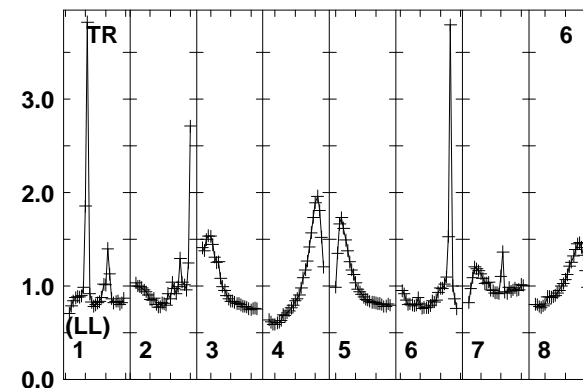
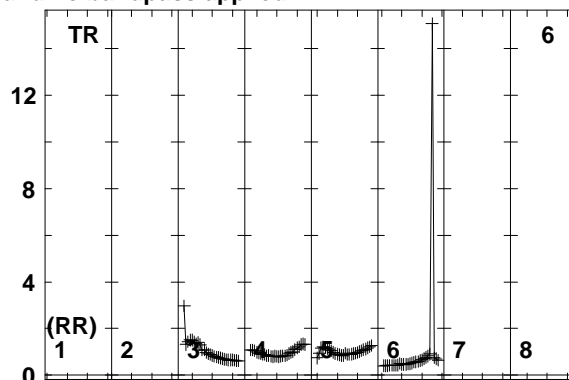
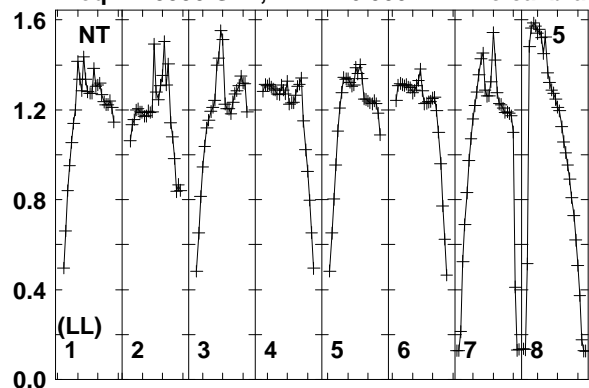

Lower frame: Real Jy
Total-power spectrum Antenna: NT (05)
Timerange: 00/11:54:13 to 00/11:58:09

Plot file version 473 created 11-AUG-2014 17:05:48

J2032+4127 EM110 2.UVDATA.1

Freq = 1.5950 GHz, Bw = 16.000 MH No calibration applied and no bandpass applied

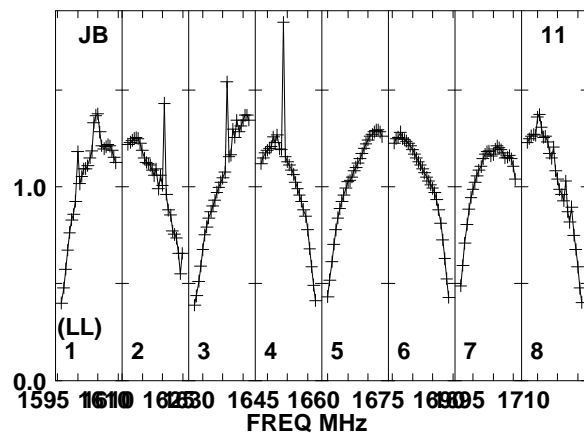
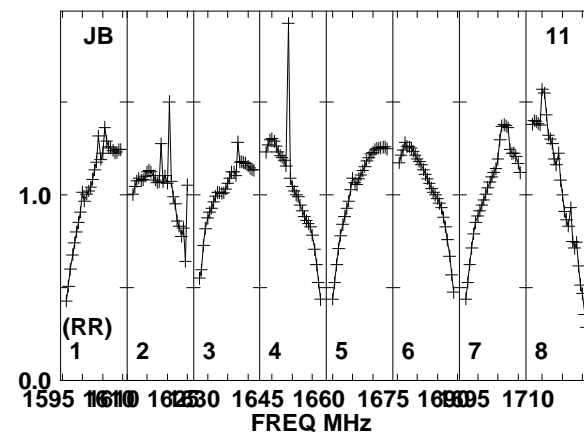
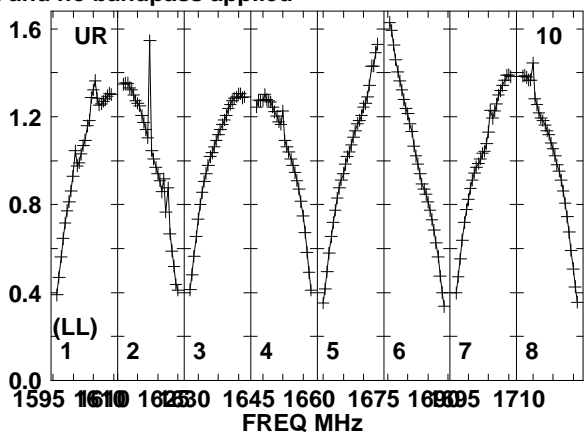
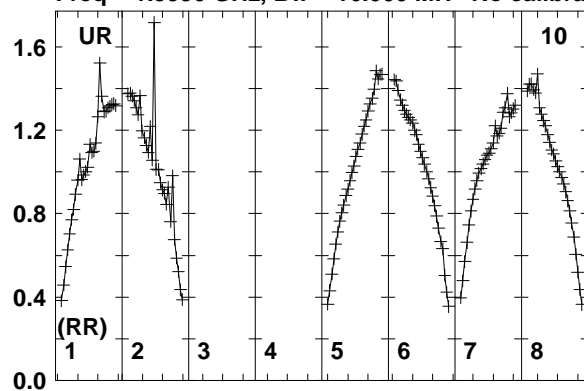

Lower frame: Real Jy
Total-power spectrum Antenna: UR (10)
Timerange: 00/11:54:13 to 00/11:58:09

Plot file version 474 created 11-AUG-2014 17:05:48

J2015+3710 EM110 2.UVDATA.1

Freq = 1.5950 GHz, Bw = 16.000 MH No calibration applied and no bandpass applied

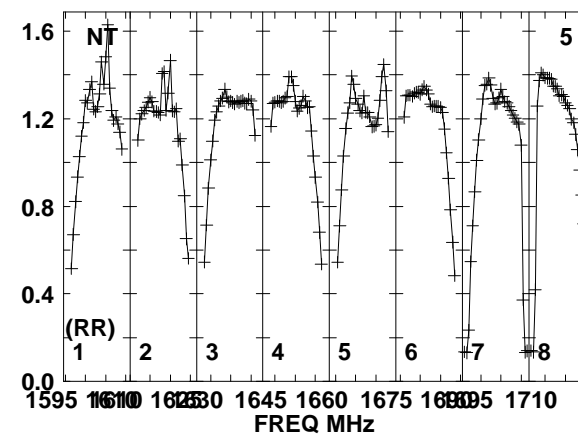
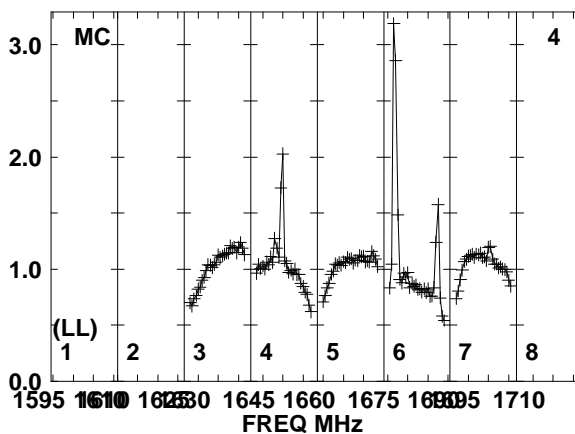
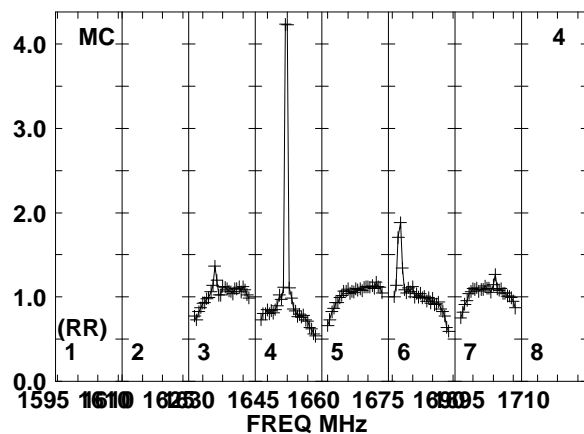
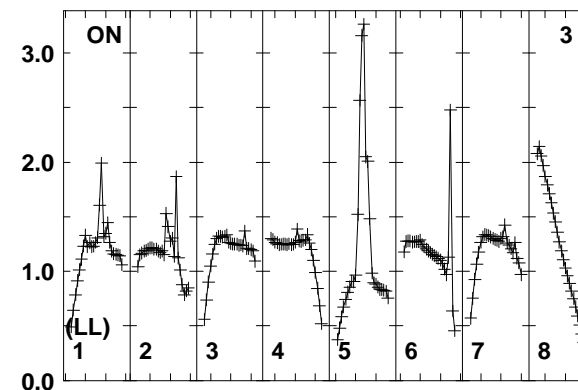
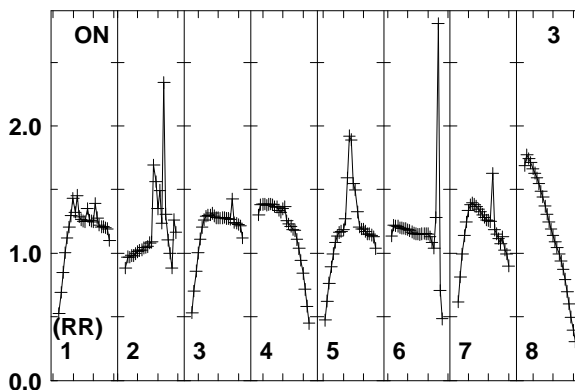
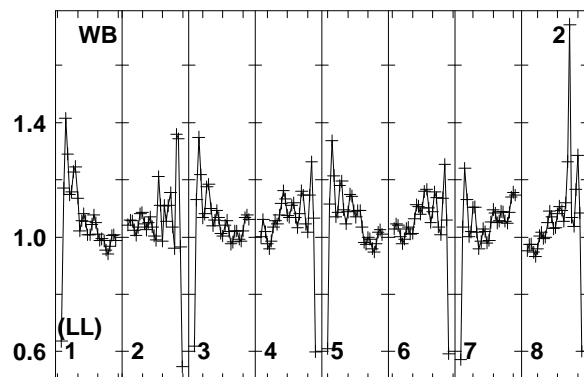
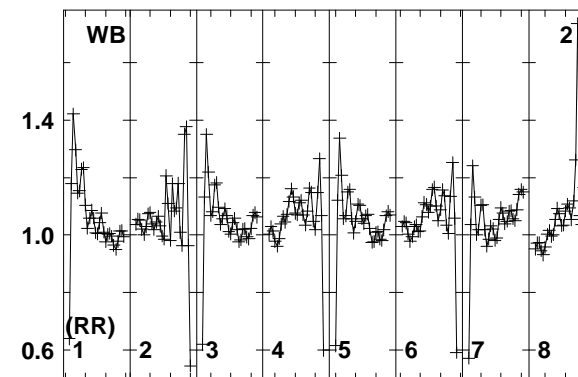
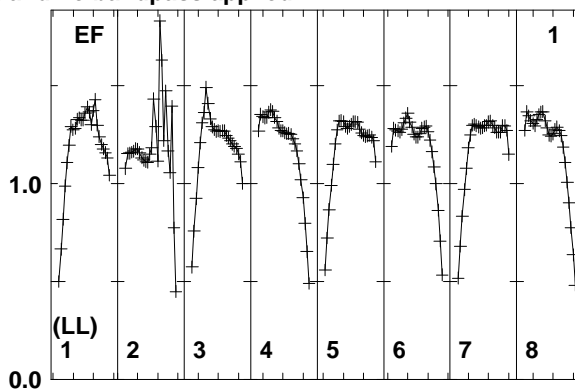
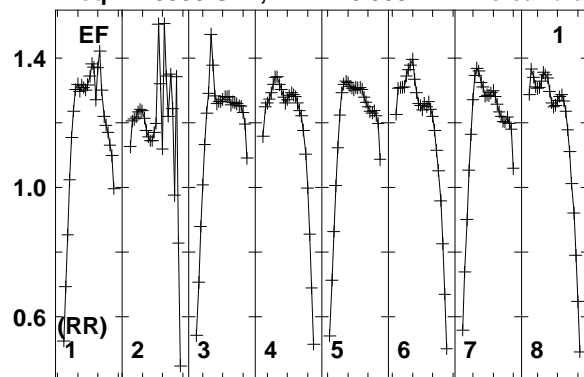

Lower frame: Real Jy
Total-power spectrum Antenna: EF (01)
Timerange: 00/11:58:22 to 00/12:00:08

Plot file version 475 created 11-AUG-2014 17:05:48

J2015+3710 EM110 2.UVDATA.1

Freq = 1.5950 GHz, Bw = 16.000 MH No calibration applied and no bandpass applied

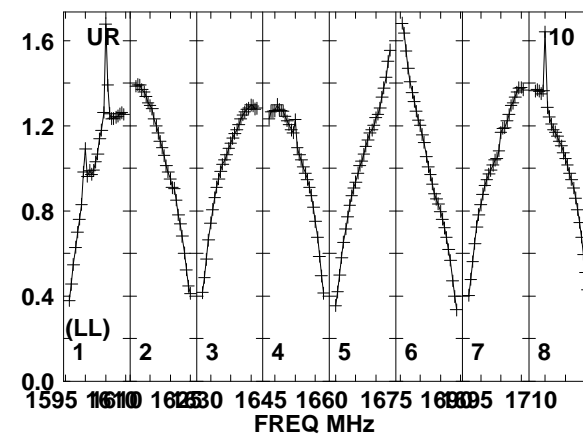
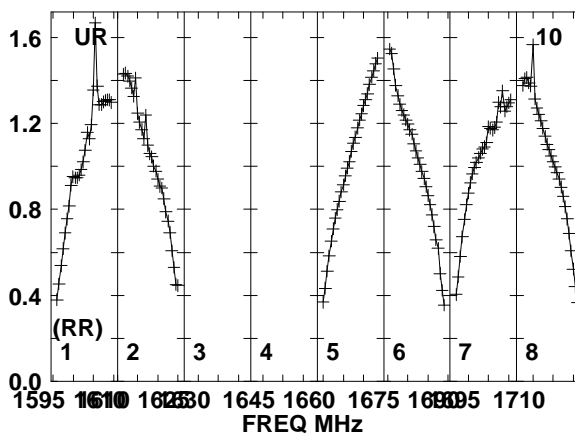
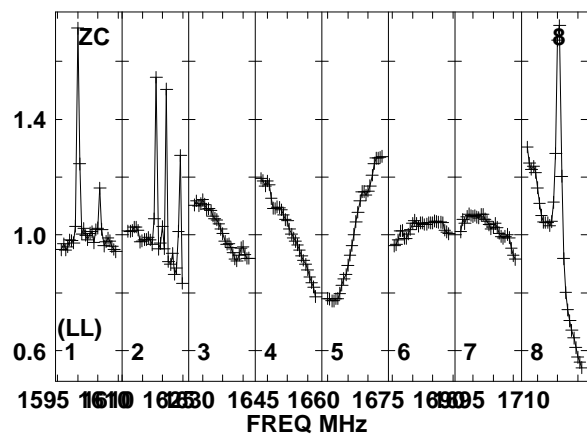
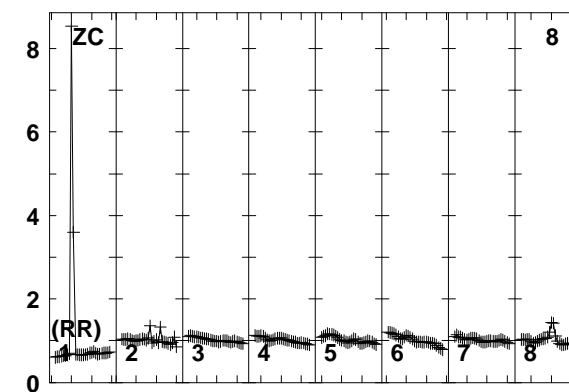
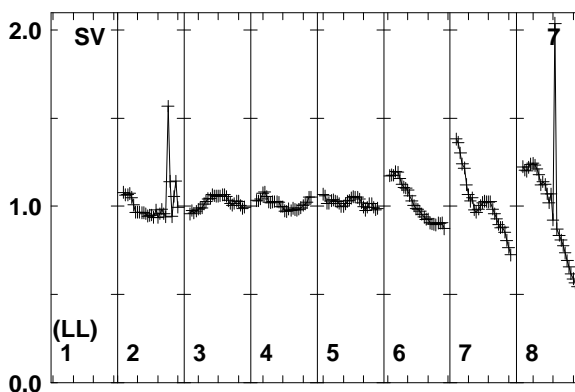
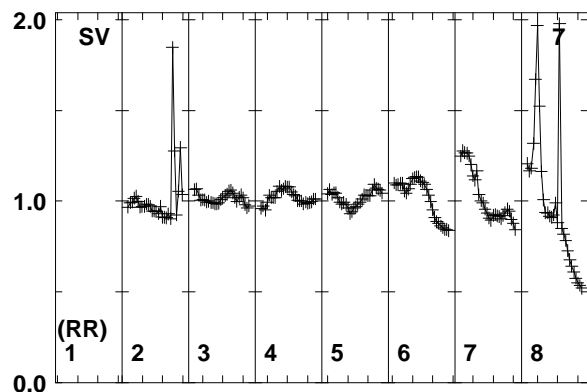
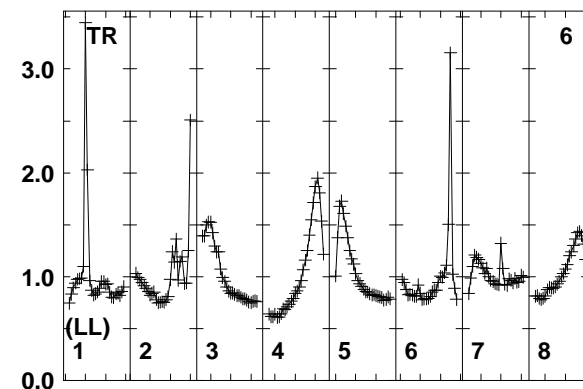
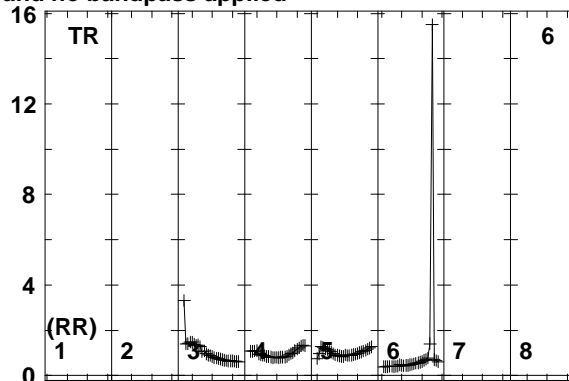
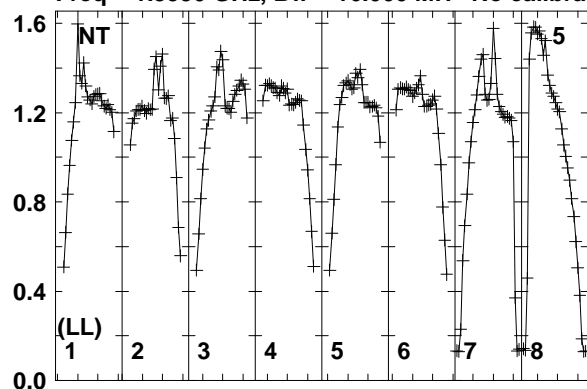

Lower frame: Real Jy
Total-power spectrum Antenna: NT (05)
Timerange: 00/11:58:22 to 00/12:00:08

Plot file version 476 created 11-AUG-2014 17:05:48

J2015+3710 EM110 2.UVDATA.1

Freq = 1.5950 GHz, Bw = 16.000 MH No calibration applied and no bandpass applied

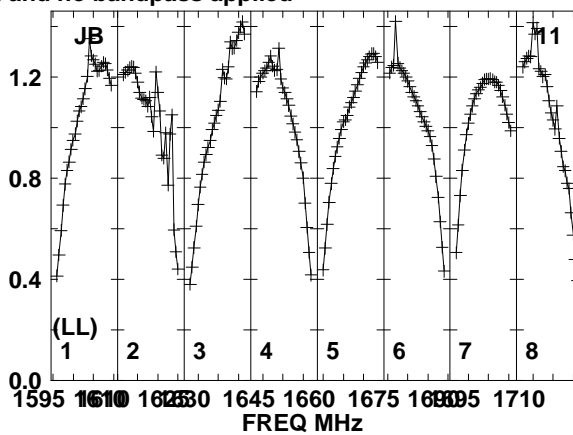
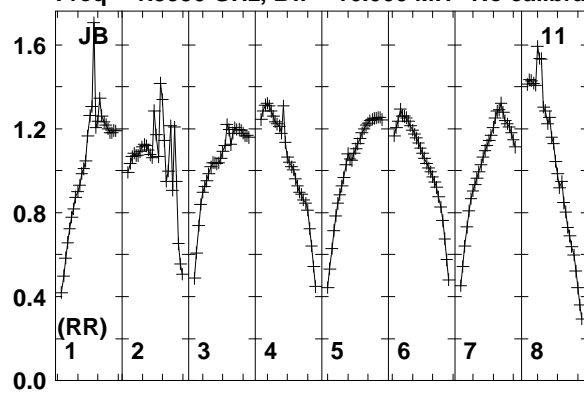

Lower frame: Real Jy
Total-power spectrum Antenna: JB (11)
Timerange: 00/11:58:22 to 00/12:00:08

Plot file version 477 created 11-AUG-2014 17:05:48

J2007+4029 EM110 2.UVDATA.1

Freq = 1.5950 GHz, Bw = 16.000 MH No calibration applied and no bandpass applied

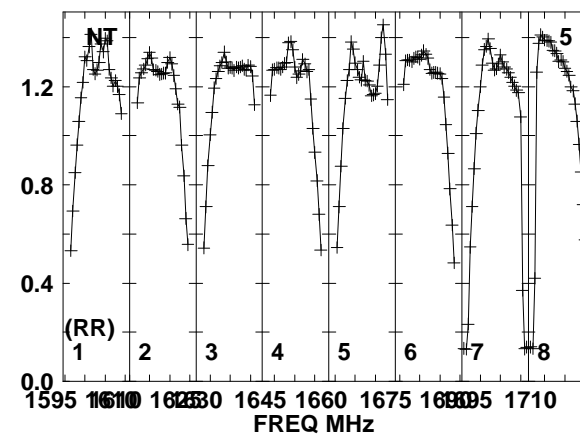
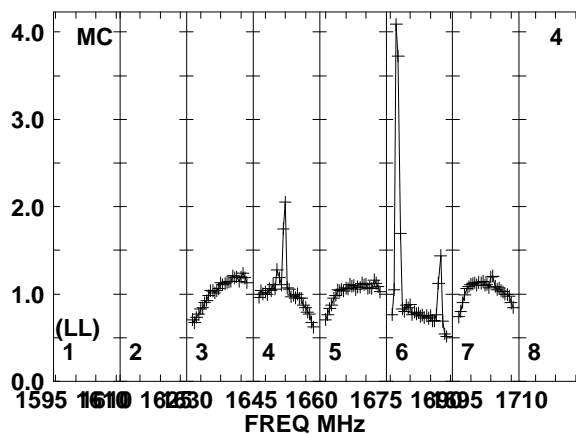
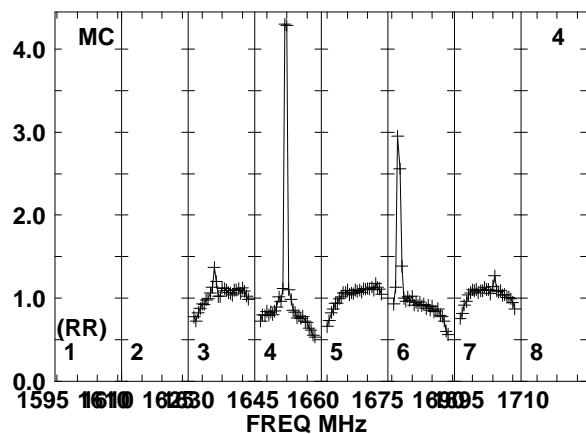
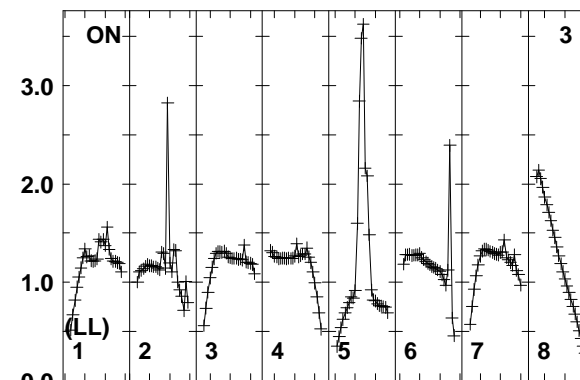
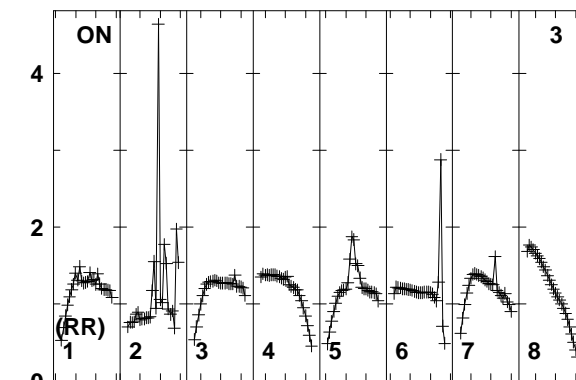
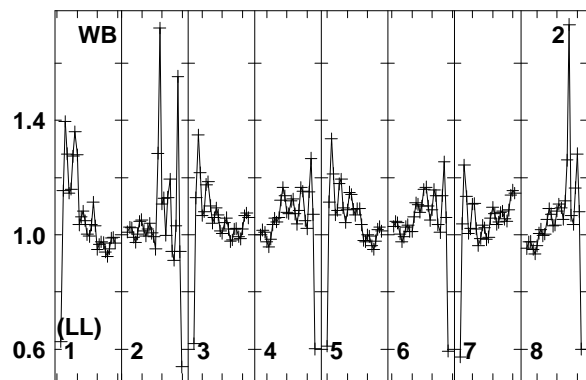
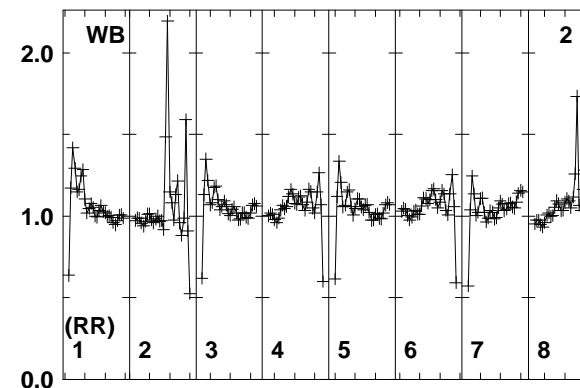
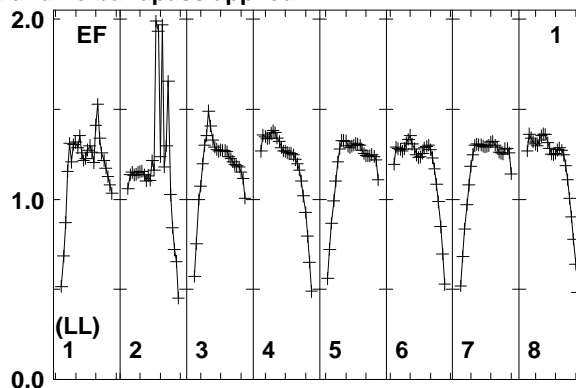
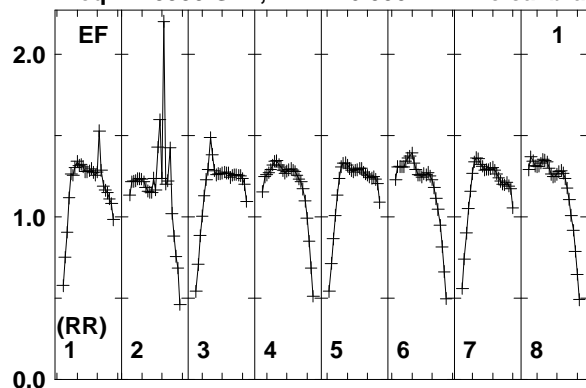

Lower frame: Real Jy
Total-power spectrum Antenna: EF (01)
Timerange: 00/12:00:18 to 00/12:01:08

Plot file version 478 created 11-AUG-2014 17:05:48

J2007+4029 EM110 2.UVDATA.1

Freq = 1.5950 GHz, Bw = 16.000 MH No calibration applied and no bandpass applied

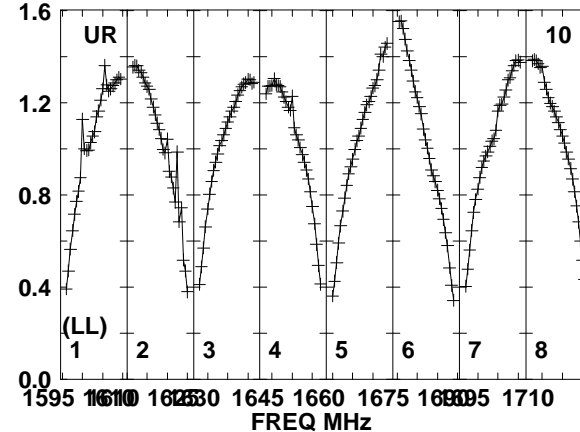
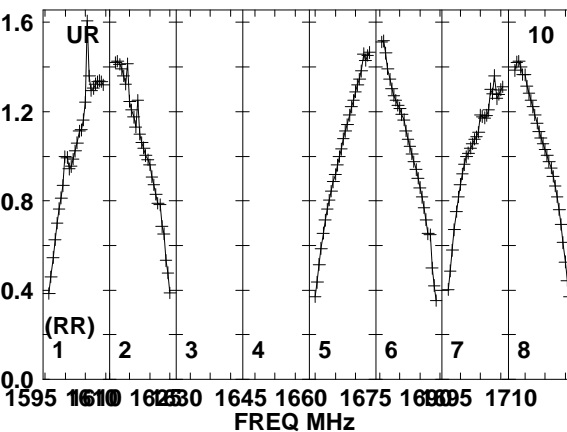
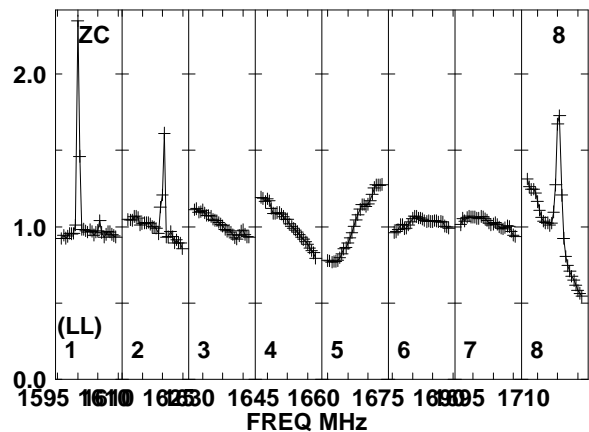
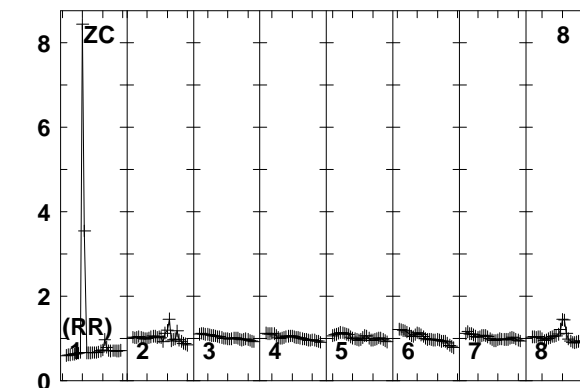
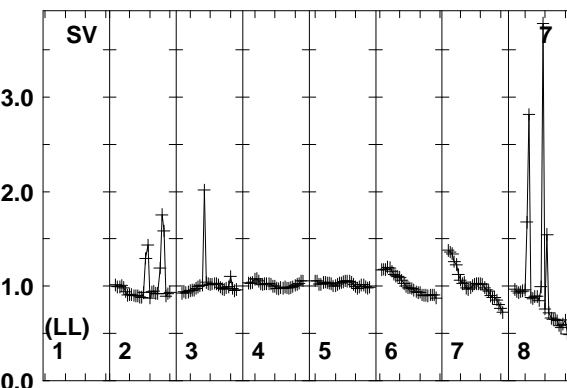
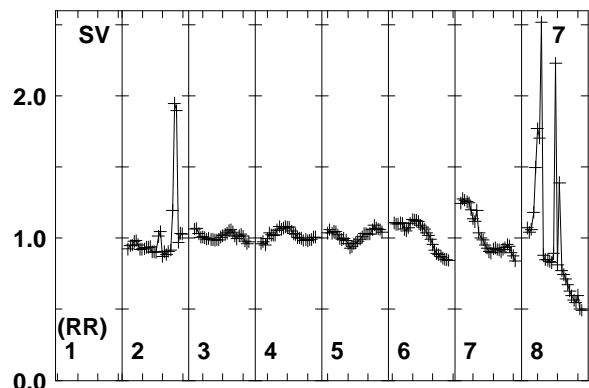
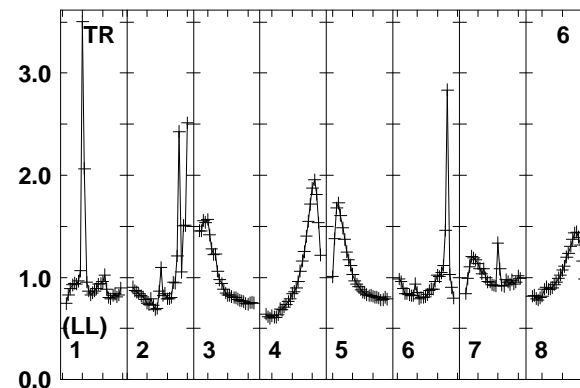
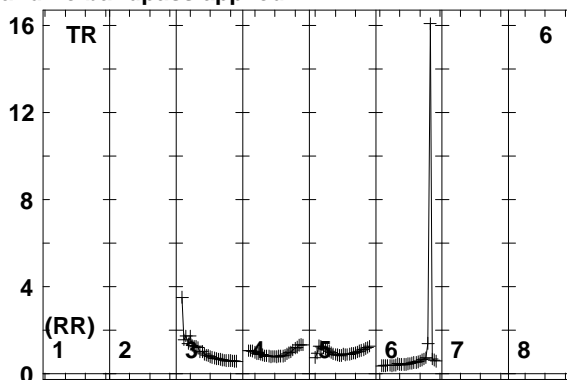
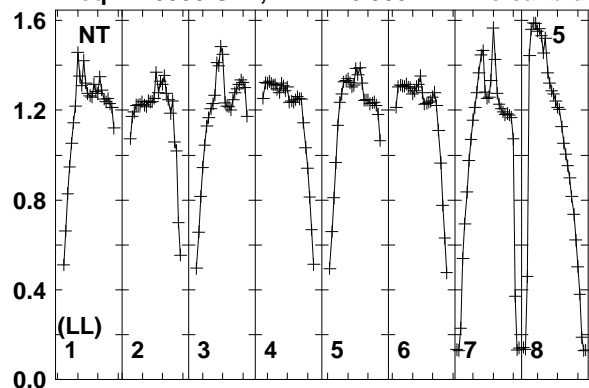

Lower frame: Real Jy
Total-power spectrum Antenna: NT (05)
Timerange: 00/12:00:18 to 00/12:01:08

Plot file version 479 created 11-AUG-2014 17:05:49

J2015+3710 EM110 2.UVDATA.1

Freq = 1.5950 GHz, Bw = 16.000 MH No calibration applied and no bandpass applied

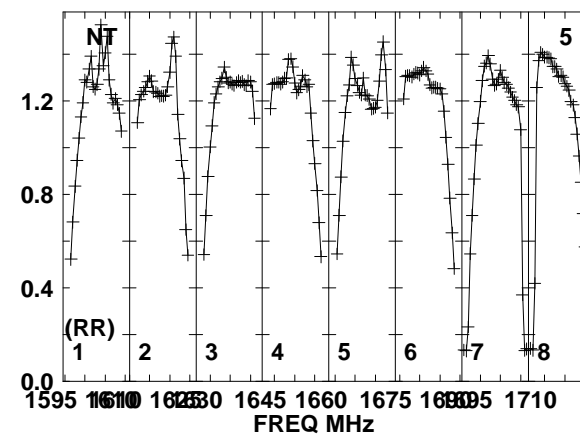
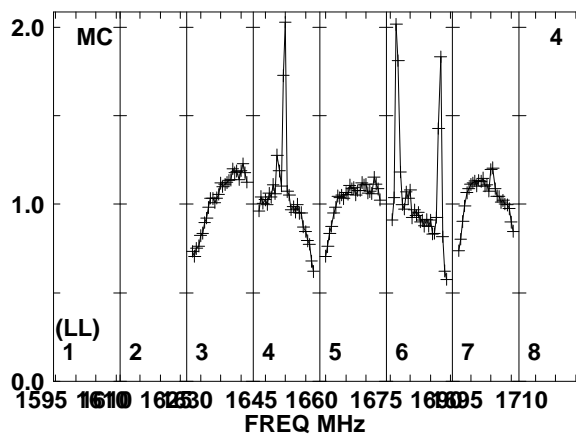
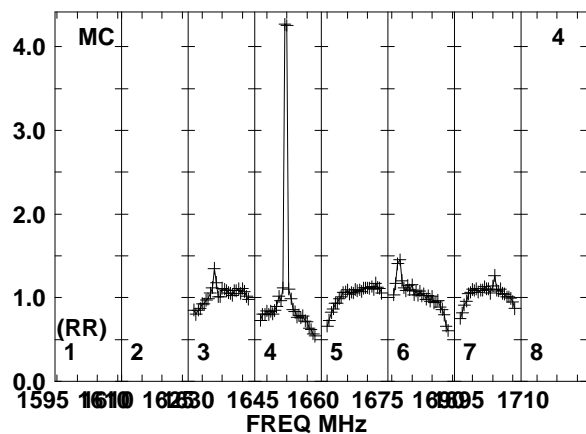
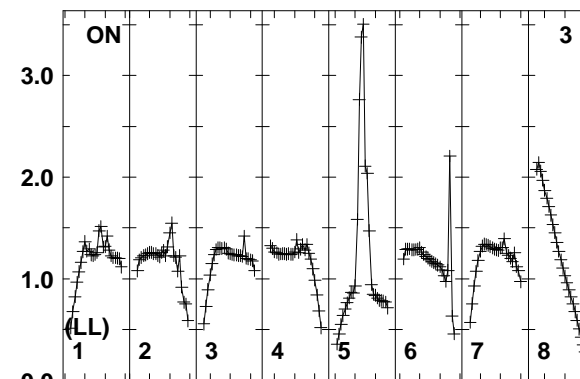
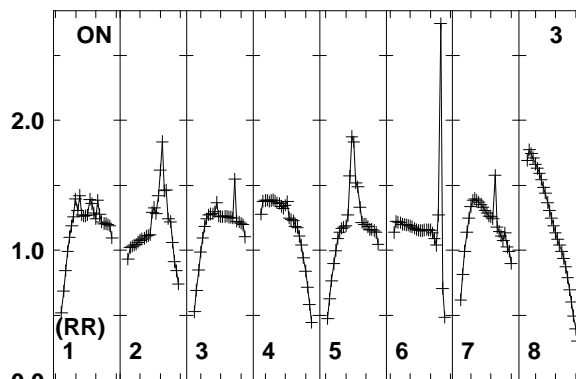
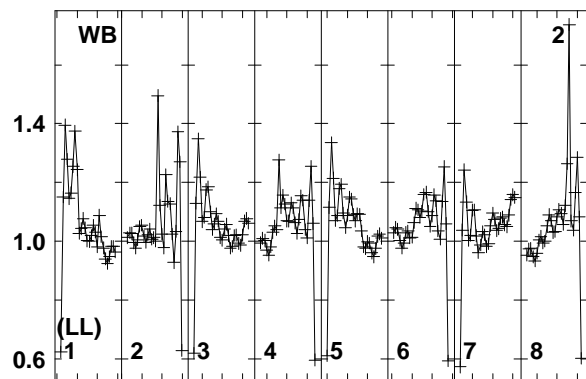
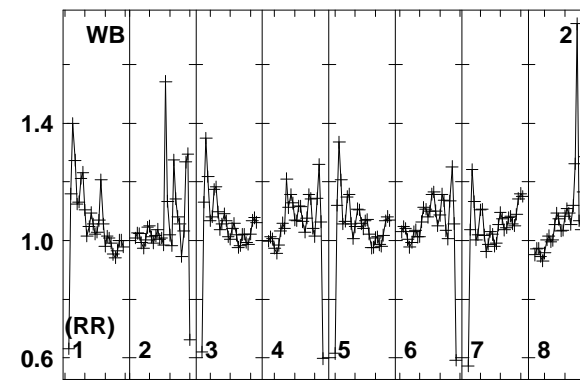
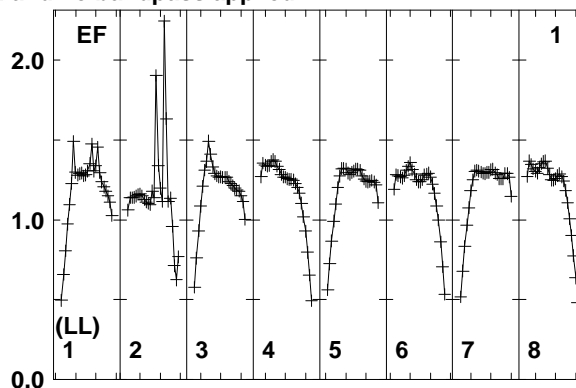
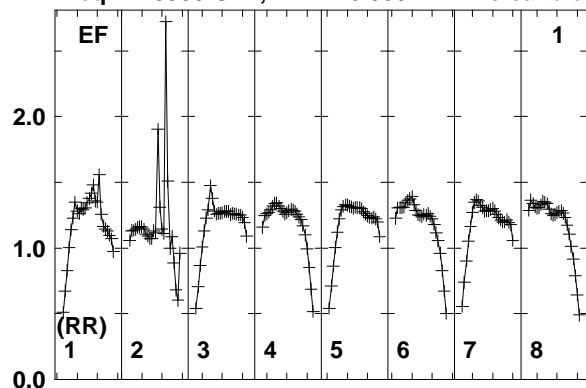

Lower frame: Real Jy
Total-power spectrum Antenna: EF (01)
Timerange: 00/12:02:11 to 00/12:04:09

Plot file version 480 created 11-AUG-2014 17:05:49

J2015+3710 EM110 2.UVDATA.1

Freq = 1.5950 GHz, Bw = 16.000 MH No calibration applied and no bandpass applied

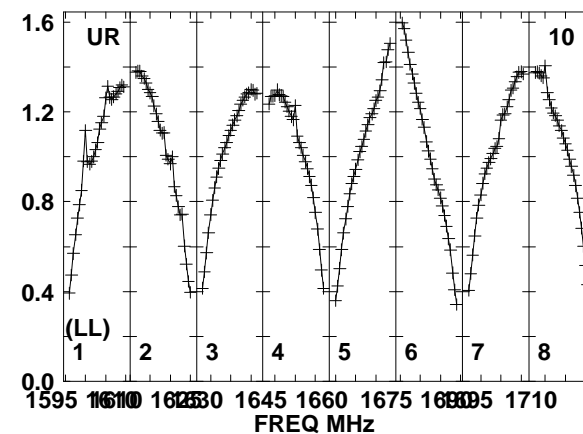
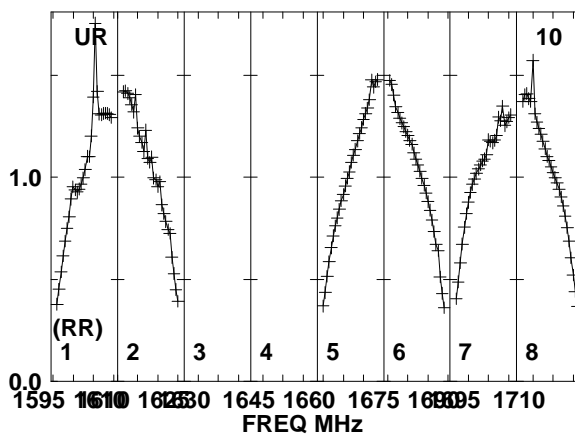
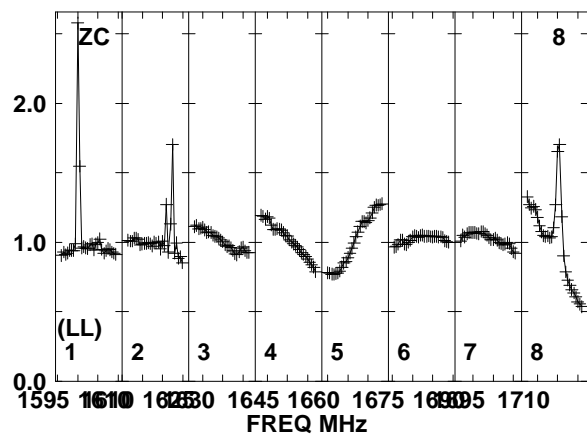
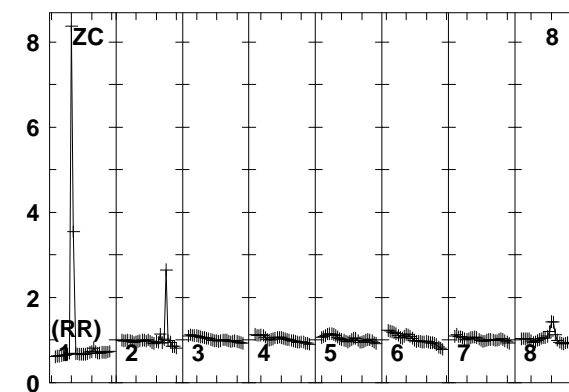
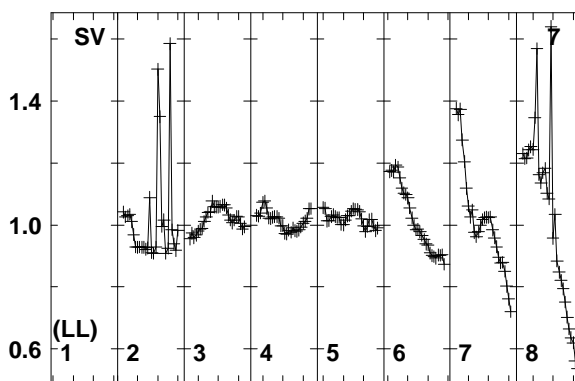
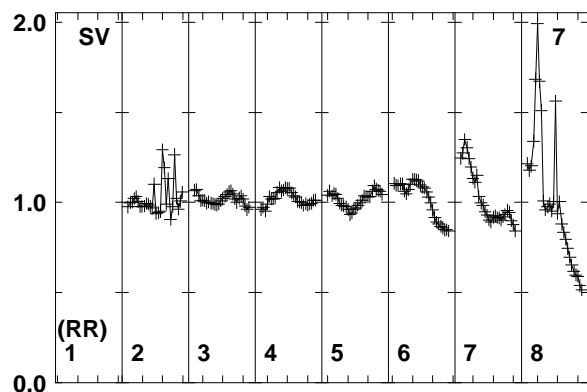
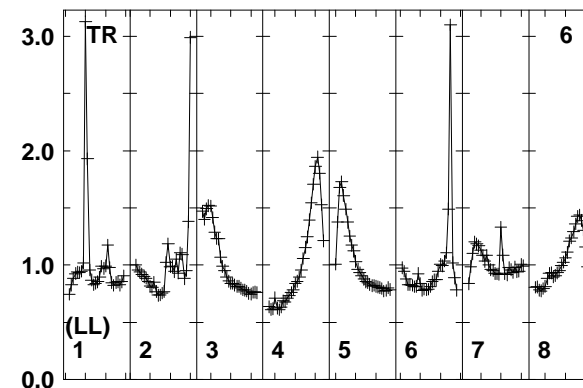
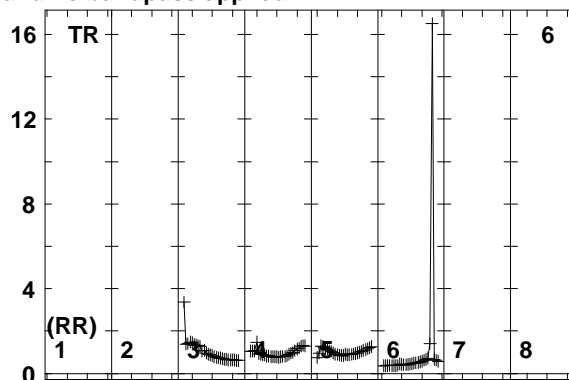
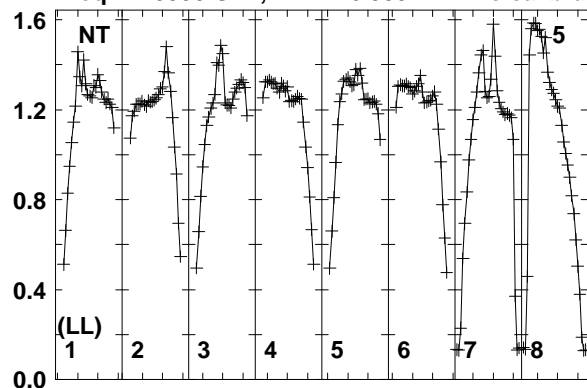

Lower frame: Real Jy
Total-power spectrum Antenna: NT (05)
Timerange: 00/12:02:11 to 00/12:04:09

Plot file version 481 created 11-AUG-2014 17:05:49

J2032+4127 EM110 2.UVDATA.1

Freq = 1.5950 GHz, Bw = 16.000 MH No calibration applied and no bandpass applied

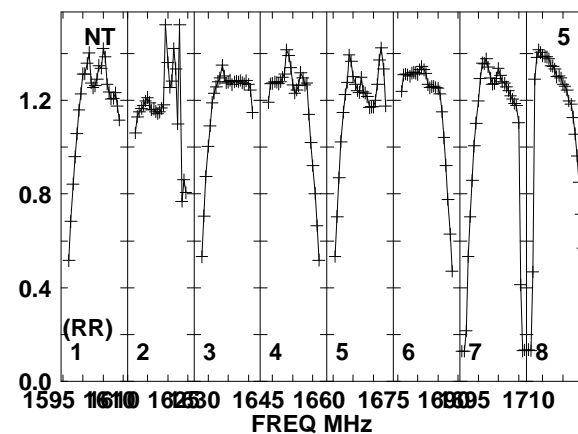
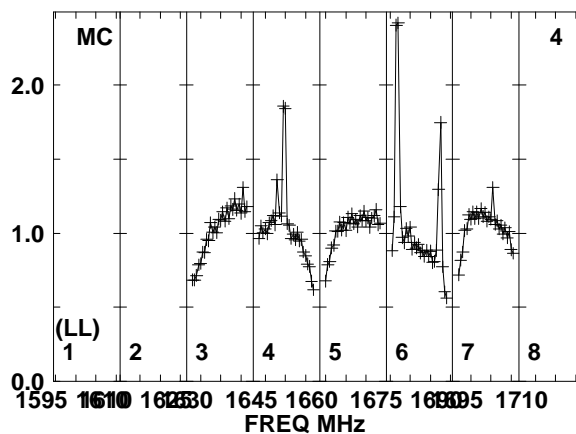
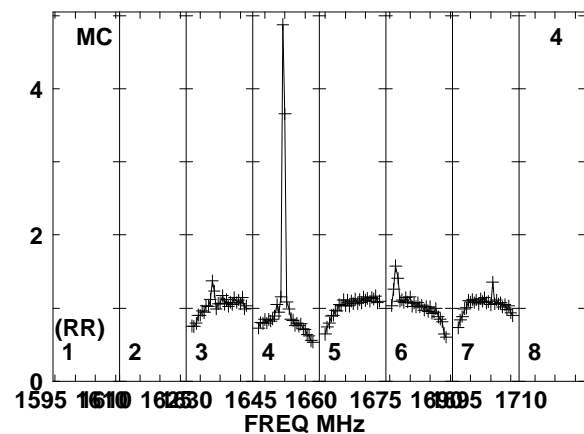
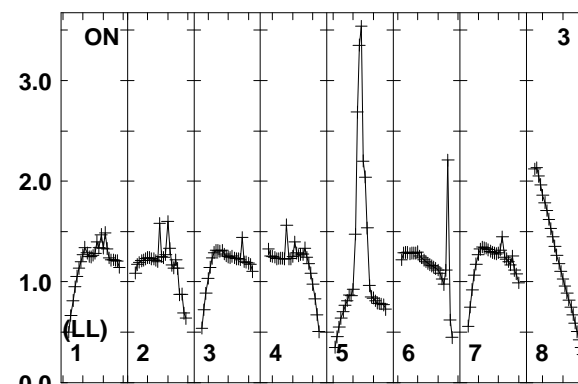
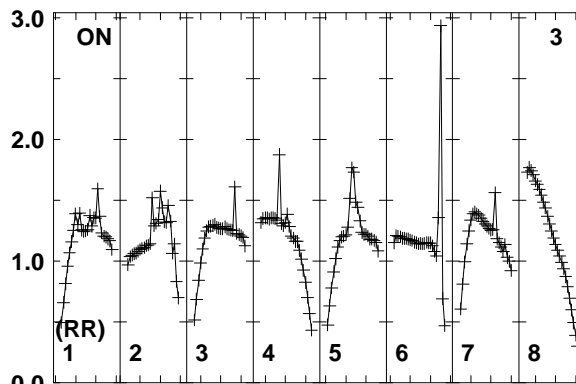
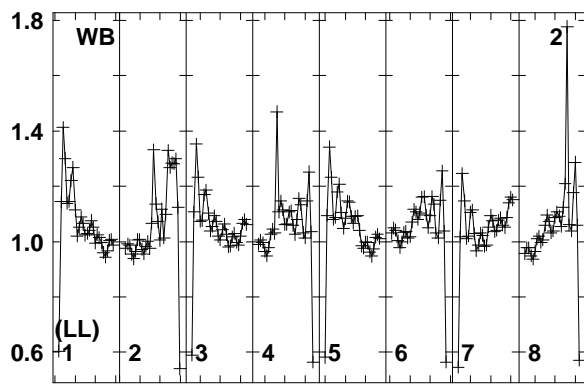
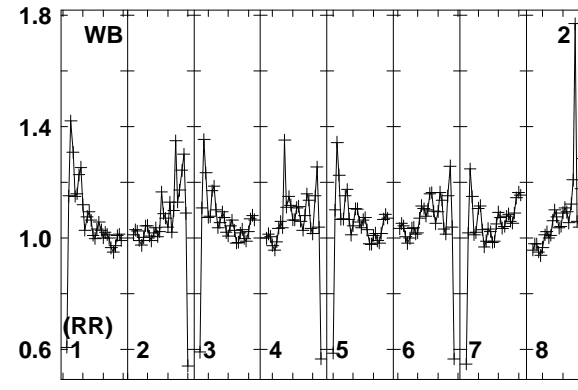
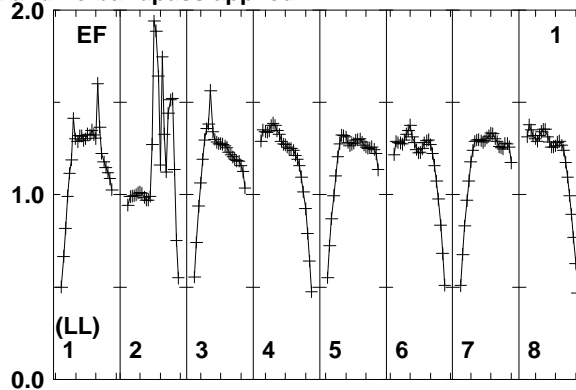
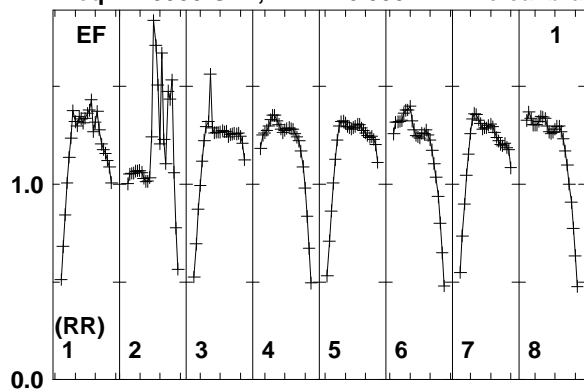

Lower frame: Real Jy
Total-power spectrum Antenna: EF (01)
Timerange: 00/12:04:11 to 00/12:08:09

Plot file version 482 created 11-AUG-2014 17:05:49

J2032+4127 EM110 2.UVDATA.1

Freq = 1.5950 GHz, Bw = 16.000 MH No calibration applied and no bandpass applied

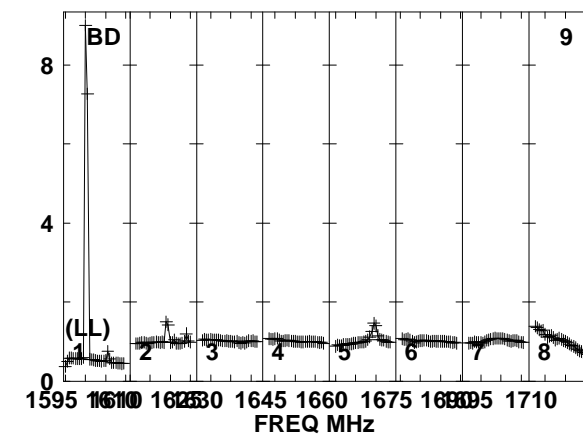
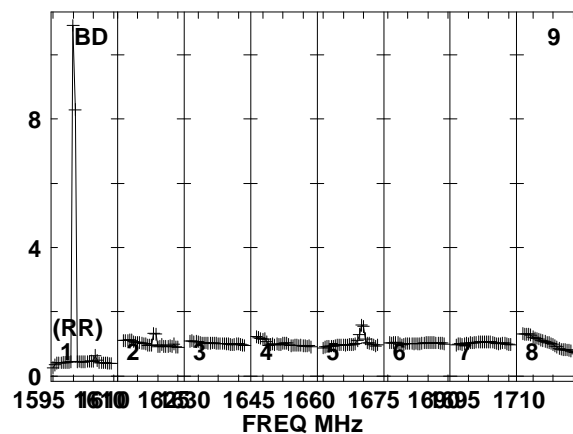
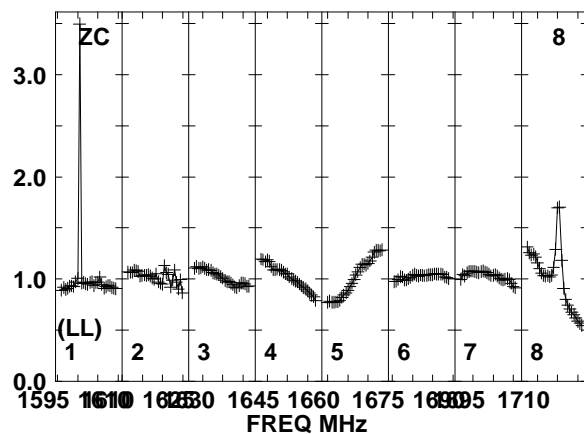
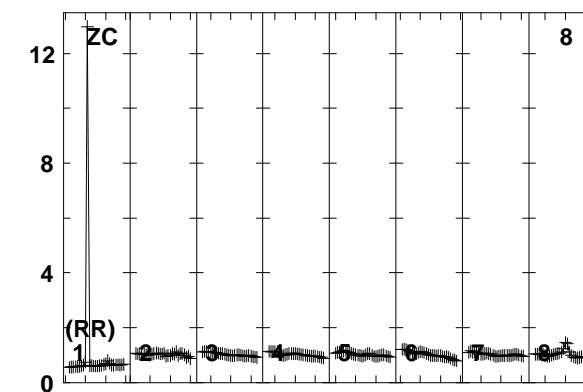
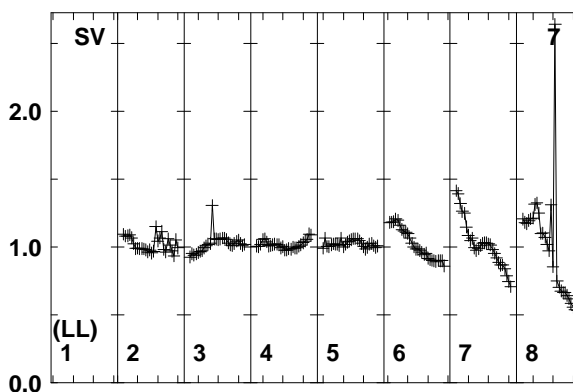
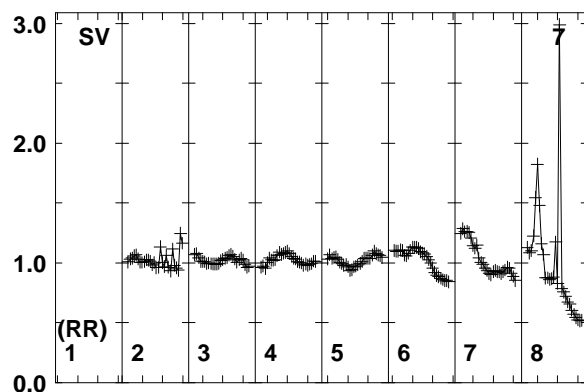
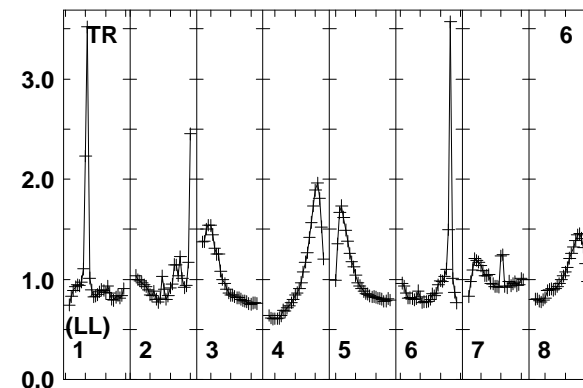
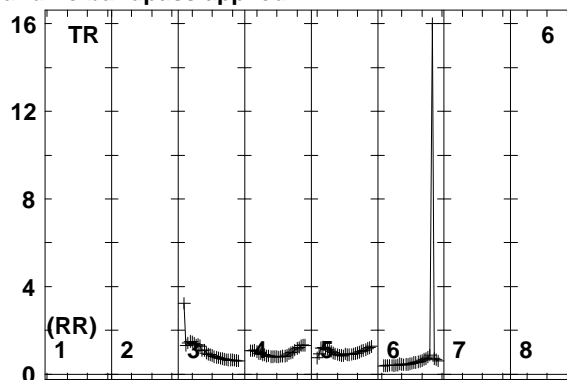
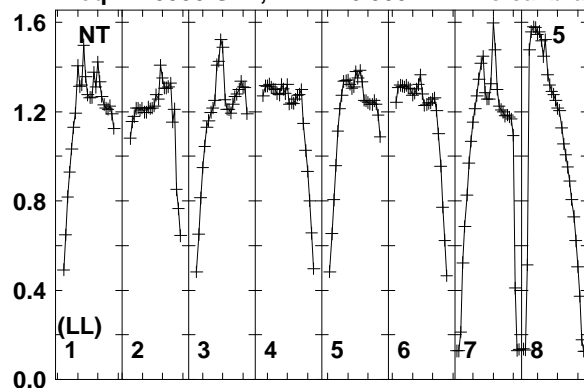

Lower frame: Real Jy
Total-power spectrum Antenna: NT (05)
Timerange: 00/12:04:11 to 00/12:08:09

Plot file version 483 created 11-AUG-2014 17:05:49

J2032+4127 EM110 2.UVDATA.1

Freq = 1.5950 GHz, Bw = 16.000 MH No calibration applied and no bandpass applied

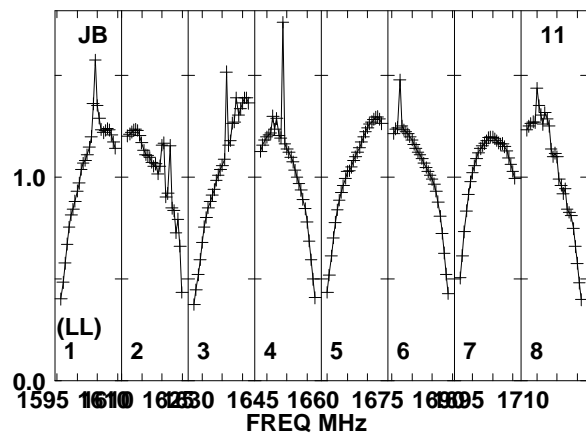
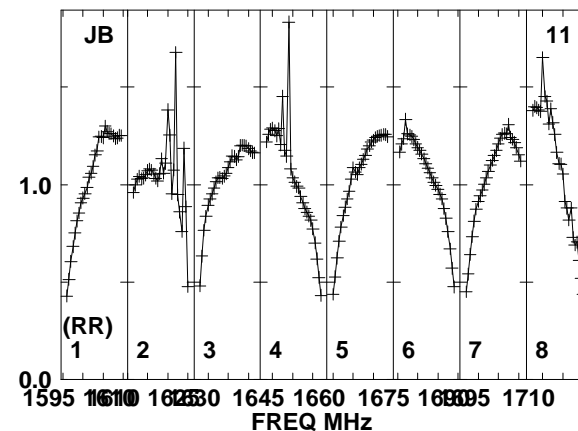
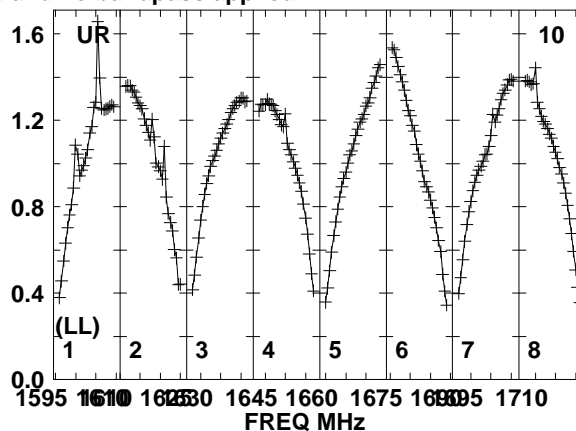
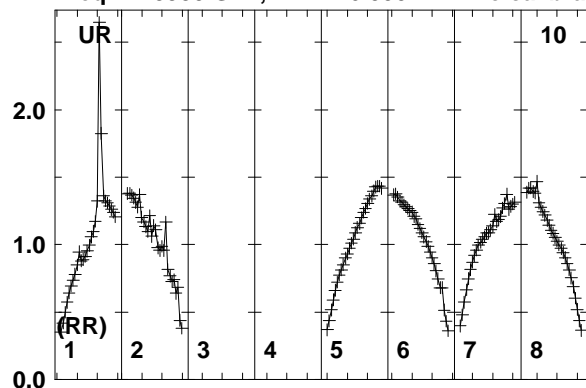

Lower frame: Real Jy
Total-power spectrum Antenna: UR (10)
Timerange: 00/12:04:11 to 00/12:08:09

Plot file version 484 created 11-AUG-2014 17:05:49

J2015+3710 EM110 2.UVDATA.1

Freq = 1.5950 GHz, Bw = 16.000 MH No calibration applied and no bandpass applied

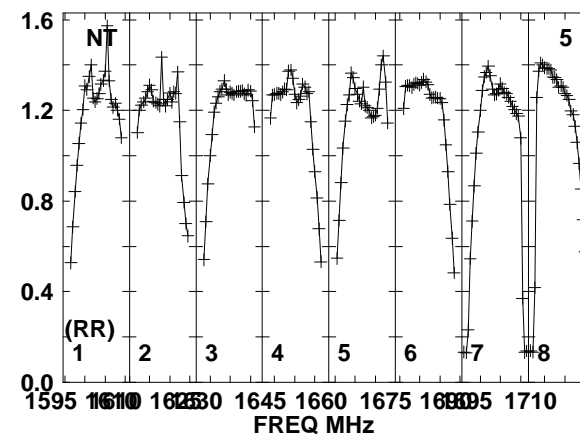
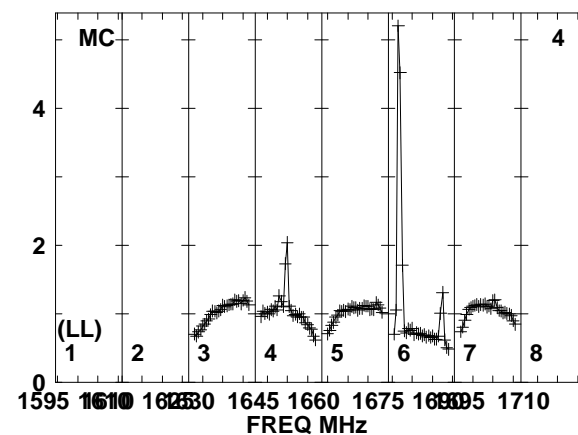
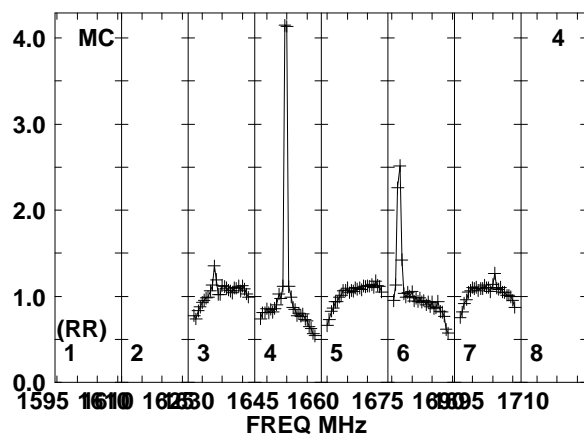
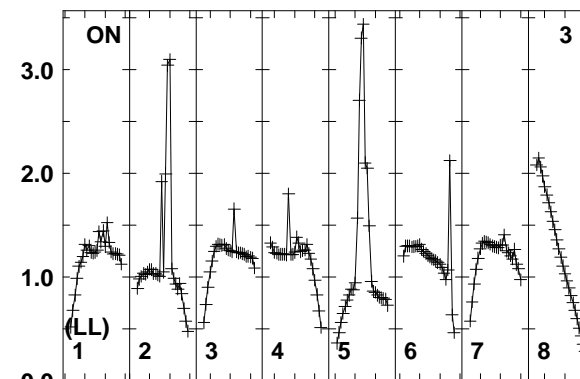
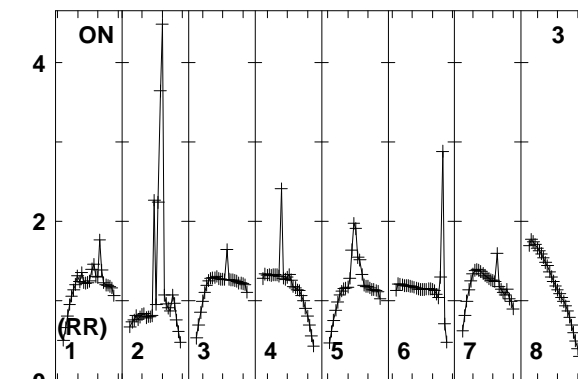
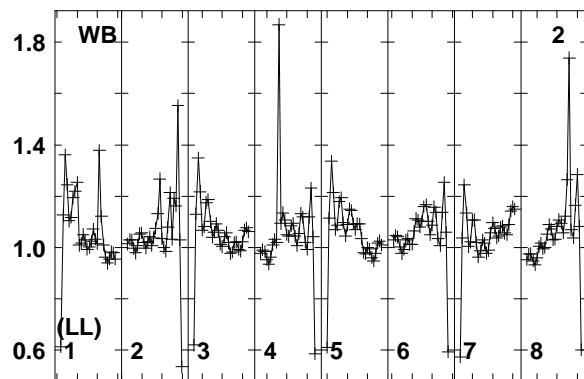
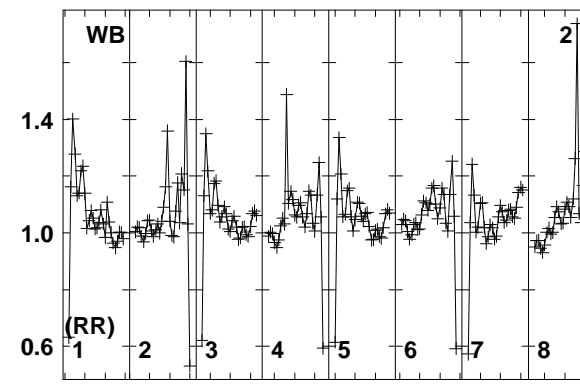
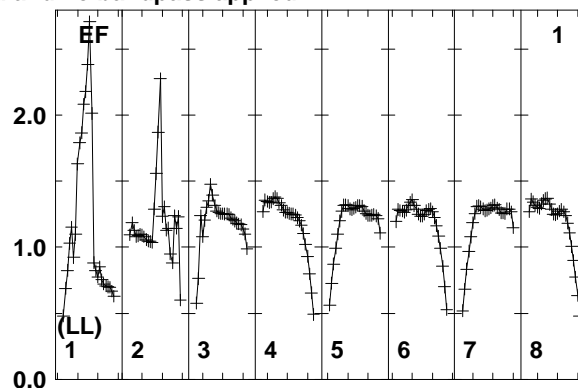
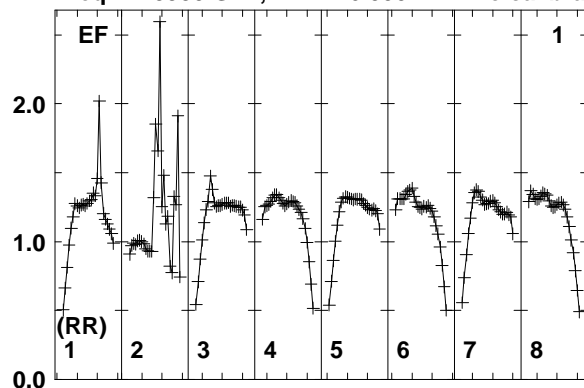

Lower frame: Real Jy
Total-power spectrum Antenna: EF (01)
Timerange: 00/12:08:21 to 00/12:10:09

Plot file version 485 created 11-AUG-2014 17:05:49

J2015+3710 EM110 2.UVDATA.1

Freq = 1.5950 GHz, Bw = 16.000 MH No calibration applied and no bandpass applied

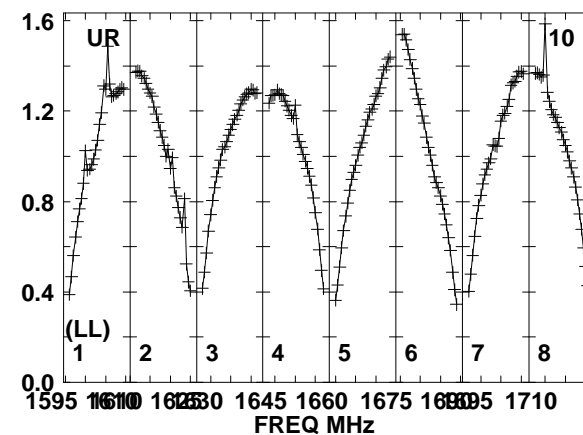
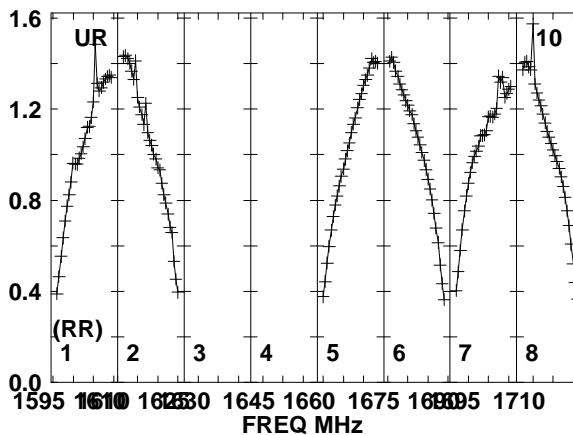
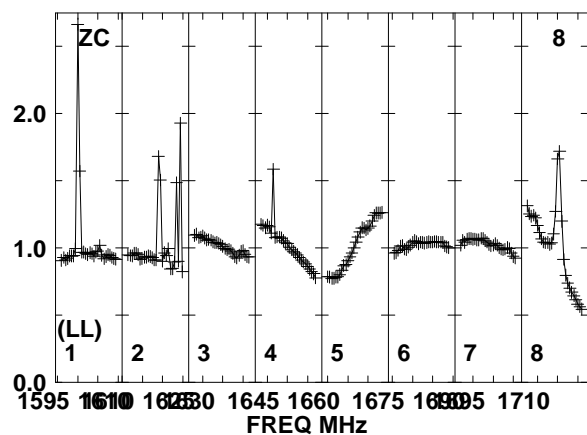
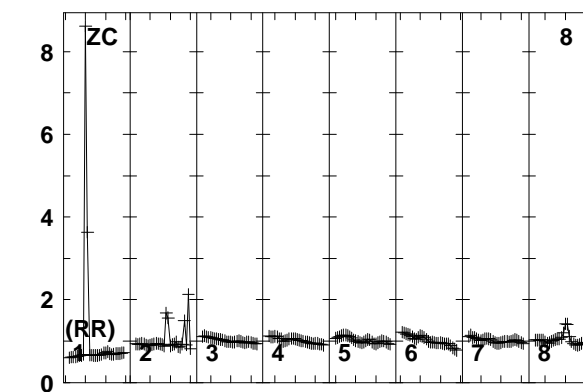
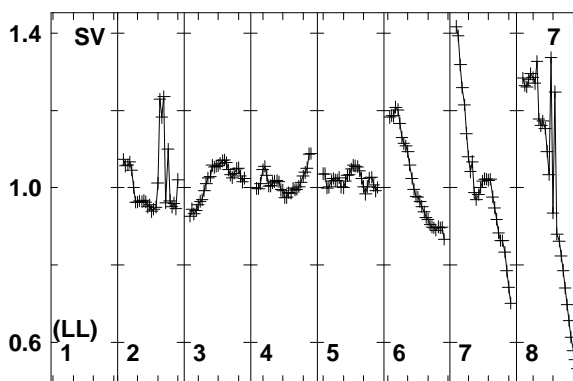
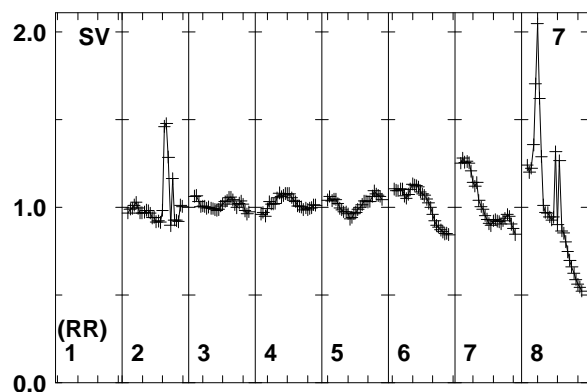
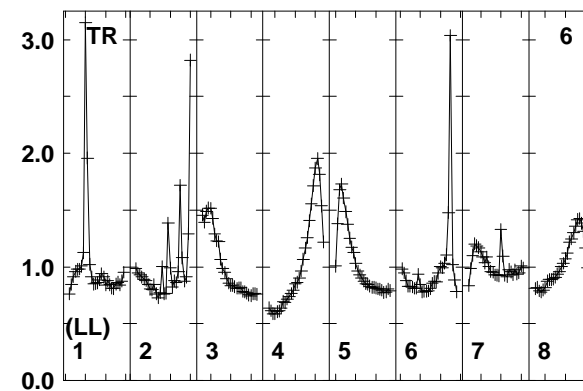
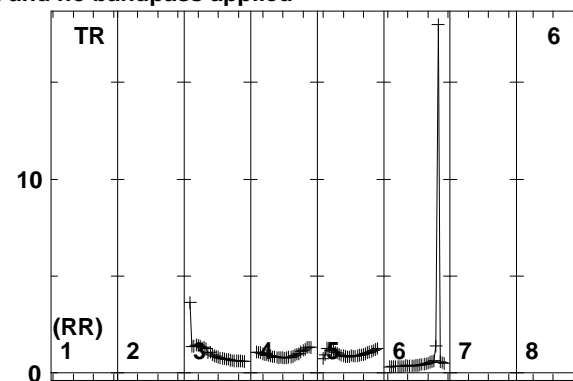
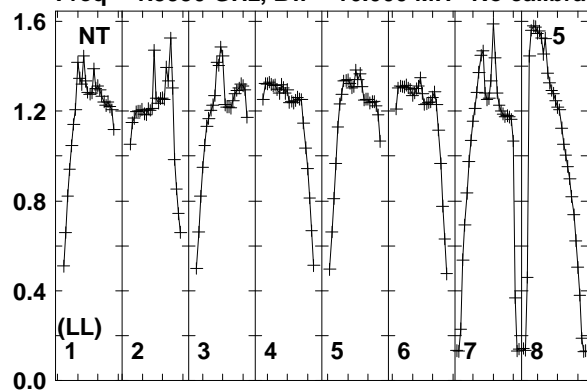

Lower frame: Real Jy
Total-power spectrum Antenna: NT (05)
Timerange: 00/12:08:21 to 00/12:10:09

Plot file version 486 created 11-AUG-2014 17:05:49

J2015+3710 EM110 2.UVDATA.1

Freq = 1.5950 GHz, Bw = 16.000 MH No calibration applied and no bandpass applied

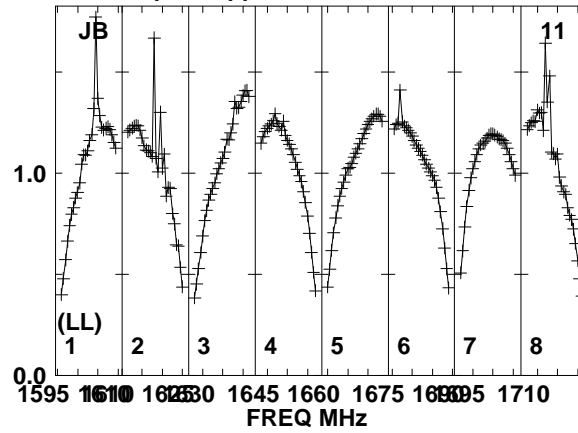
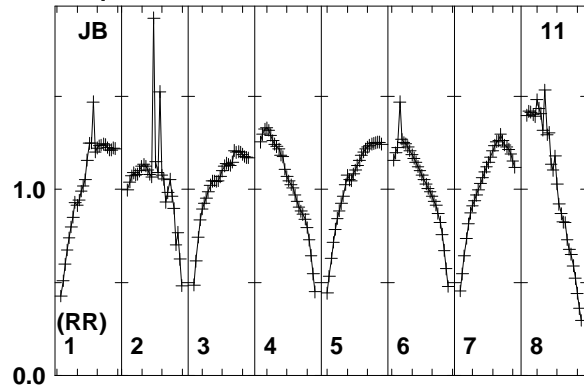

Lower frame: Real Jy
Total-power spectrum Antenna: JB (11)
Timerange: 00/12:08:21 to 00/12:10:09

Plot file version 487 created 11-AUG-2014 17:05:49

J2032+4127 EM110 2.UVDATA.1

Freq = 1.5950 GHz, Bw = 16.000 MH No calibration applied and no bandpass applied

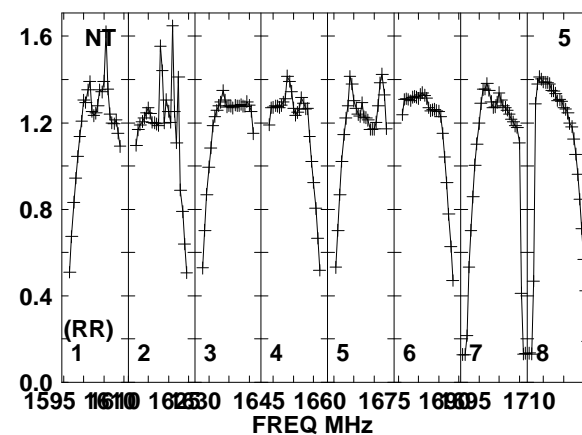
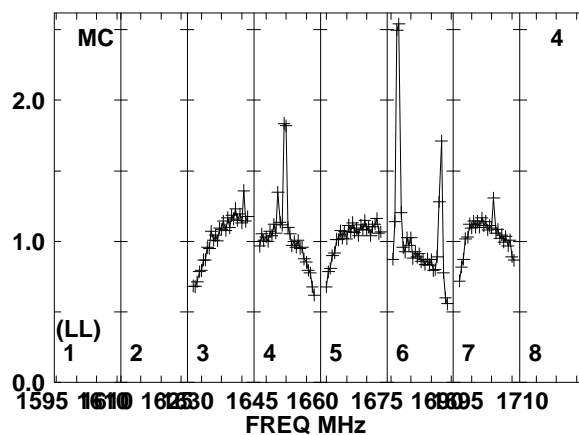
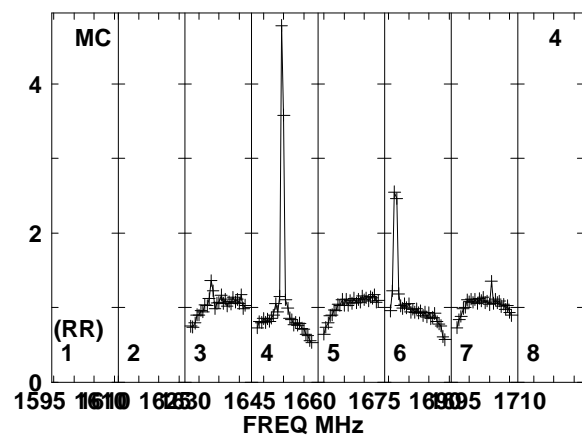
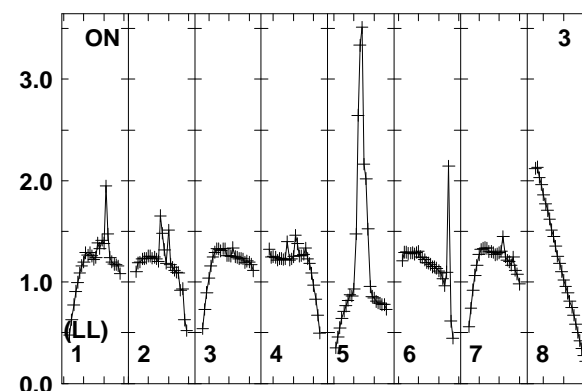
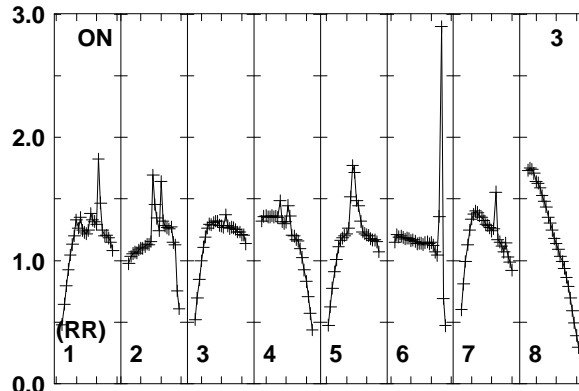
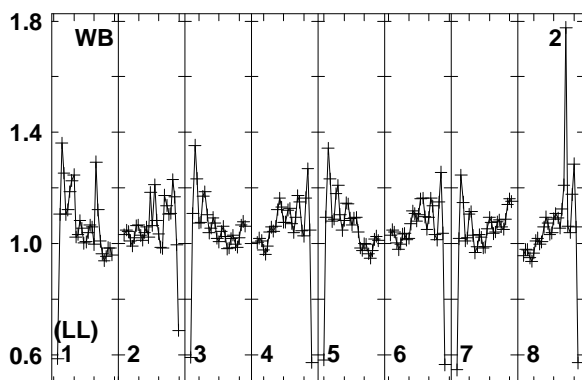
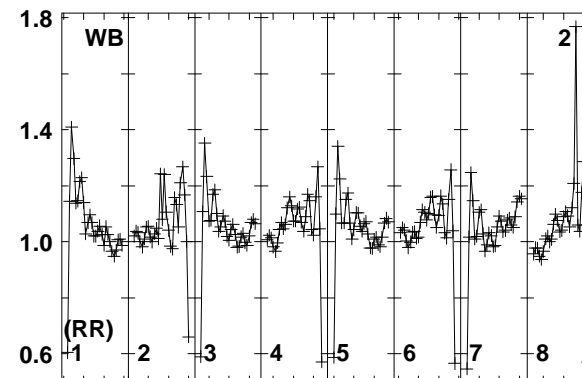
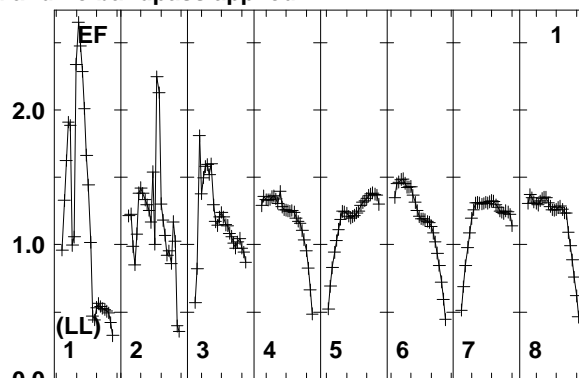
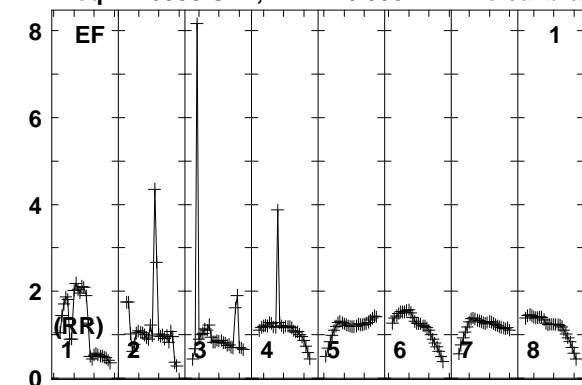

Lower frame: Real Jy
Total-power spectrum Antenna: EF (01)
Timerange: 00/12:10:13 to 00/12:14:09

Plot file version 488 created 11-AUG-2014 17:05:49

J2032+4127 EM110 2.UVDATA.1

Freq = 1.5950 GHz, Bw = 16.000 MH No calibration applied and no bandpass applied

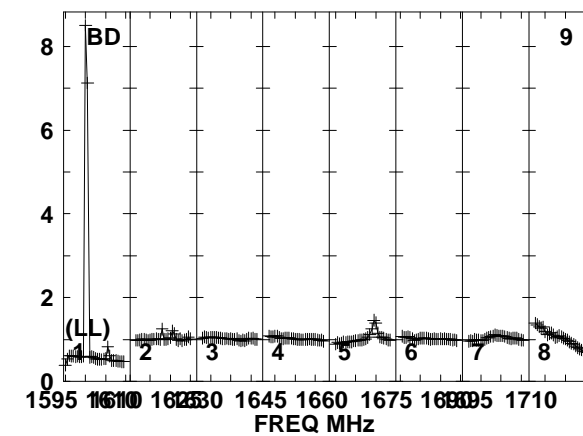
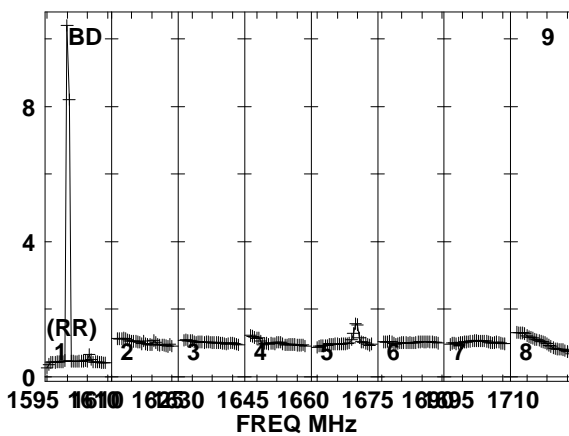
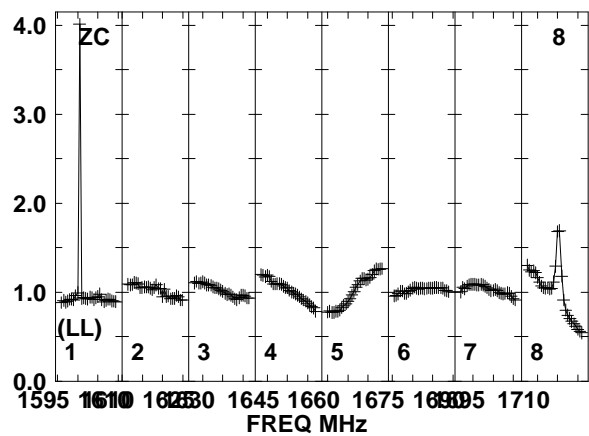
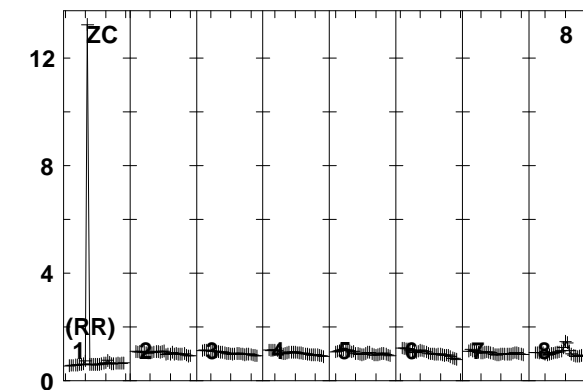
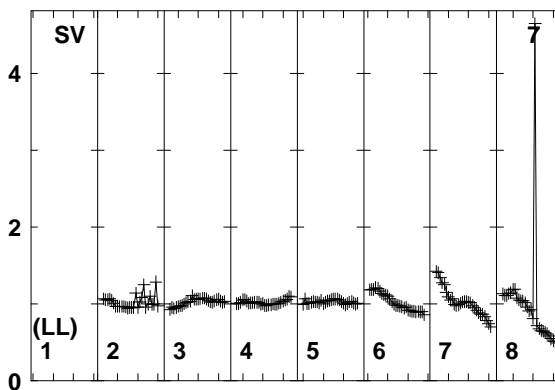
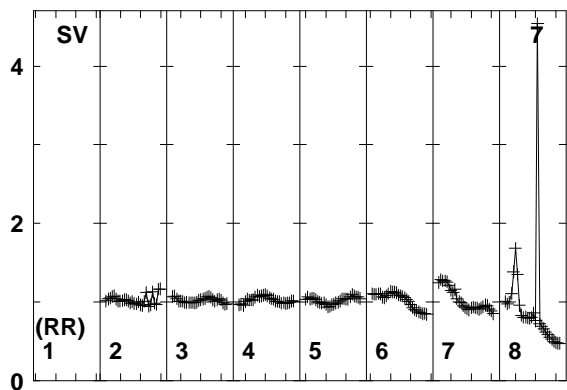
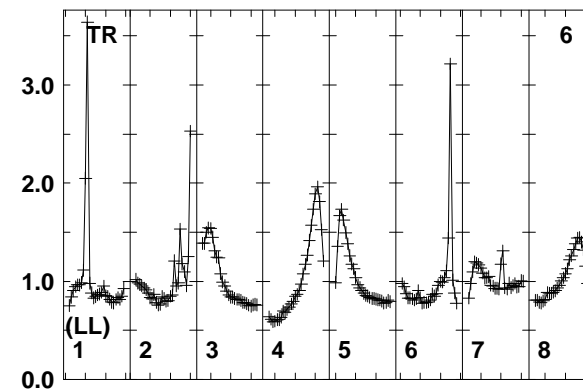
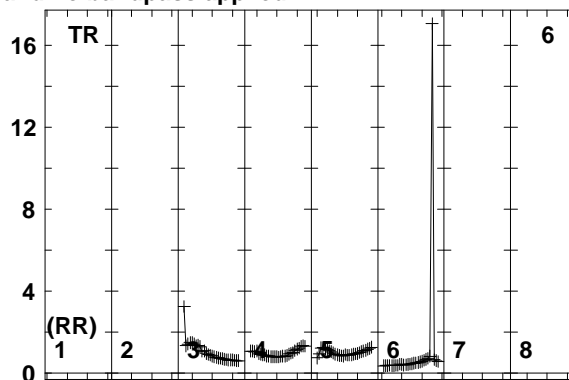
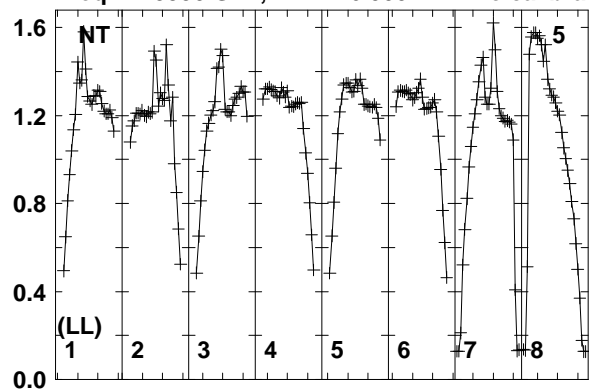

Lower frame: Real Jy
Total-power spectrum Antenna: NT (05)
Timerange: 00/12:10:13 to 00/12:14:09

Plot file version 489 created 11-AUG-2014 17:05:49

J2032+4127 EM110 2.UVDATA.1

Freq = 1.5950 GHz, Bw = 16.000 MH No calibration applied and no bandpass applied

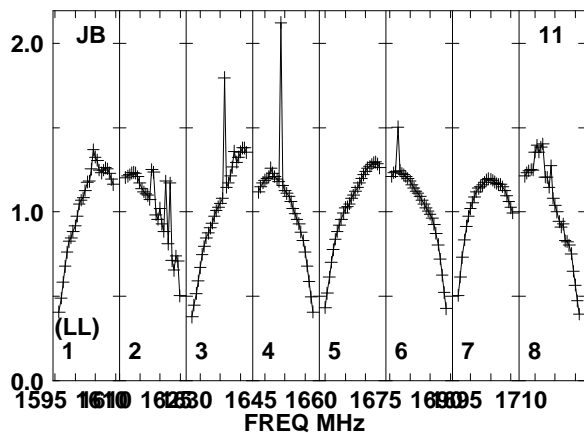
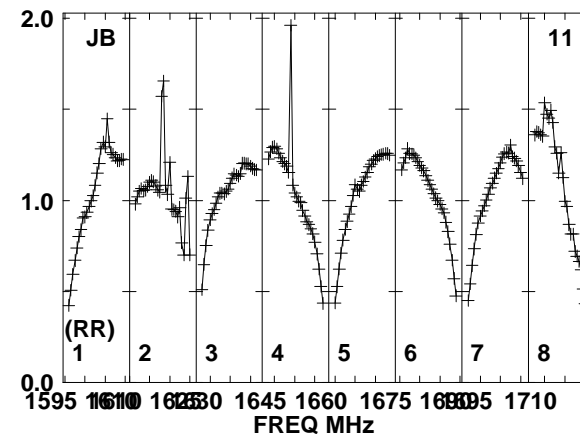
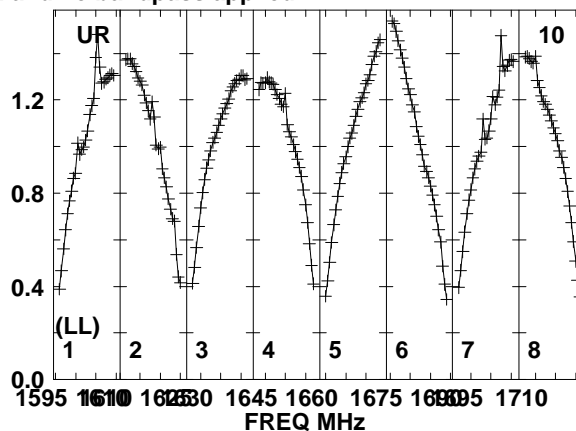
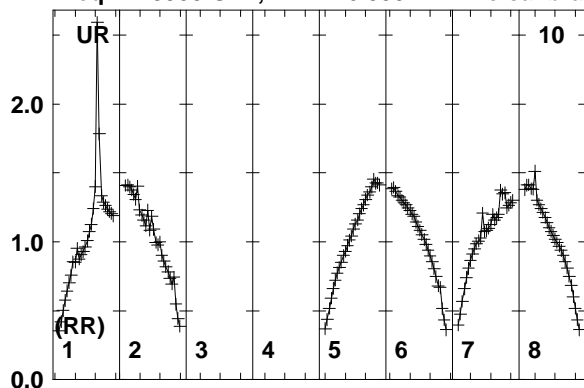

Lower frame: Real Jy
Total-power spectrum Antenna: UR (10)
Timerange: 00/12:10:13 to 00/12:14:09

Plot file version 490 created 11-AUG-2014 17:05:49

J2015+3710 EM110 2.UVDATA.1

Freq = 1.5950 GHz, Bw = 16.000 MH No calibration applied and no bandpass applied

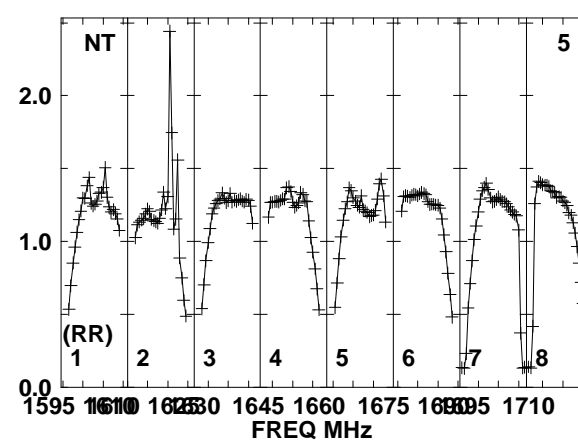
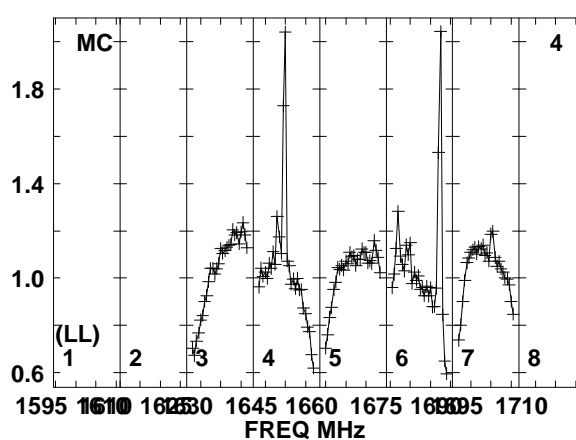
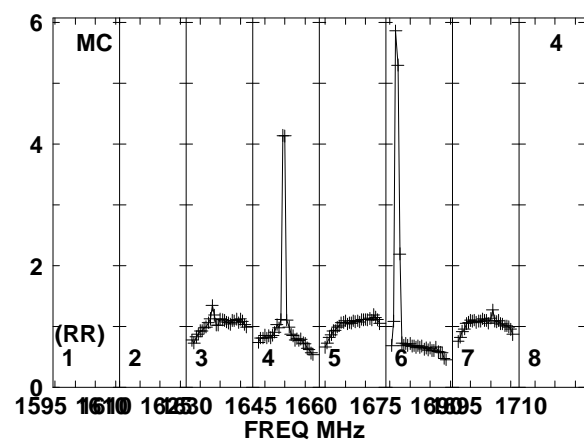
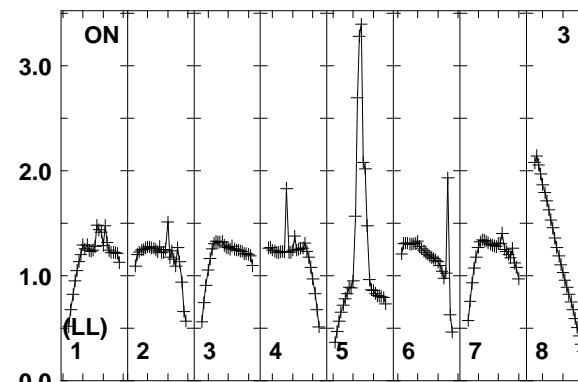
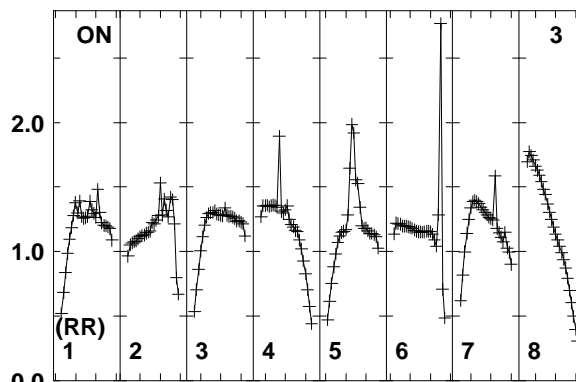
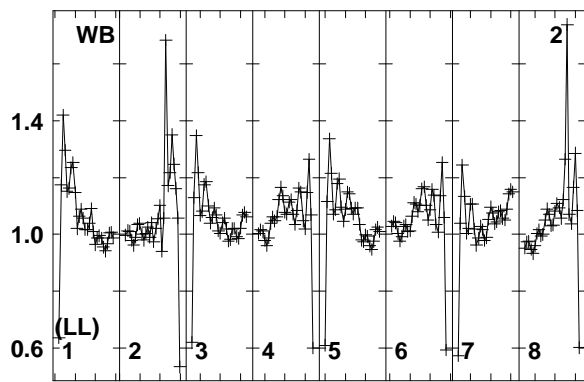
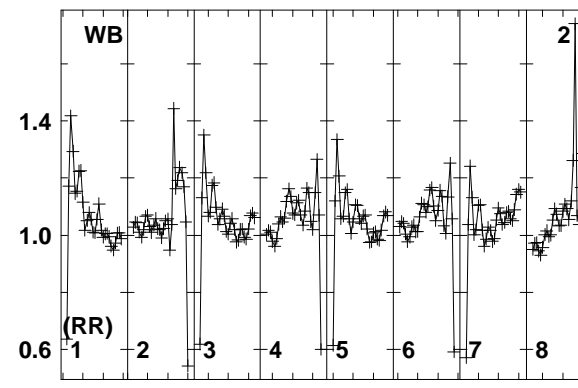
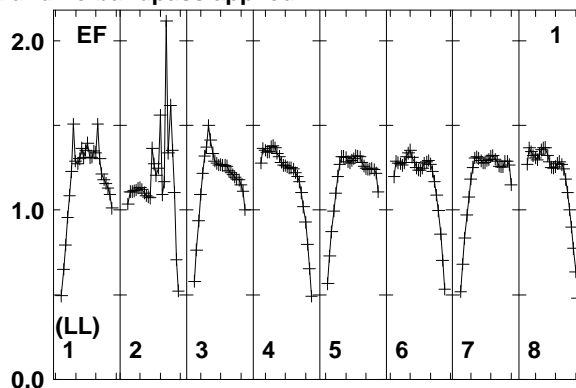
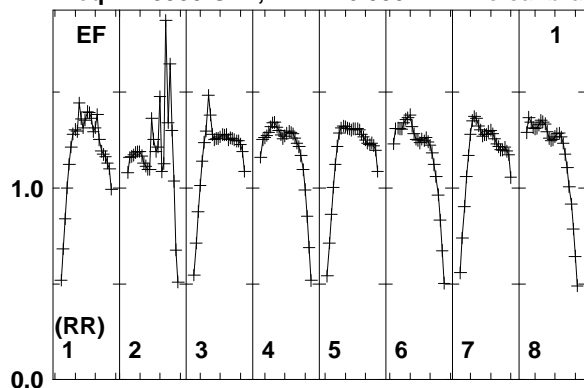

Lower frame: Real Jy
Total-power spectrum Antenna: EF (01)
Timerange: 00/12:15:11 to 00/12:17:09

Plot file version 491 created 11-AUG-2014 17:05:49

J2015+3710 EM110 2.UVDATA.1

Freq = 1.5950 GHz, Bw = 16.000 MH No calibration applied and no bandpass applied

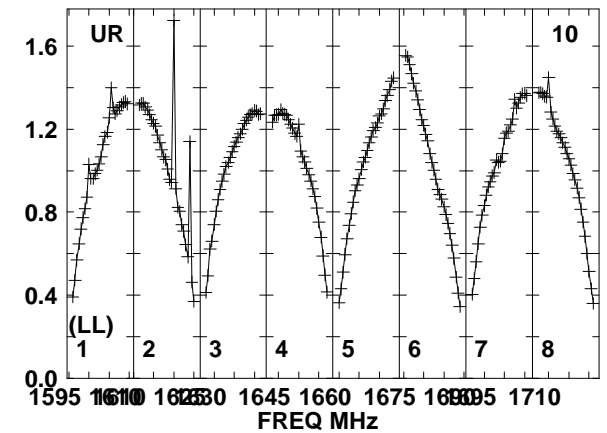
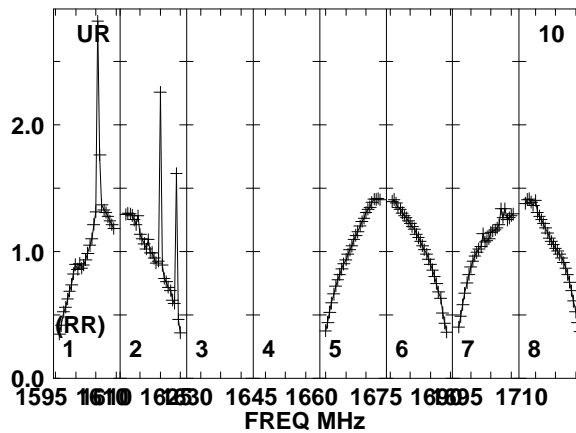
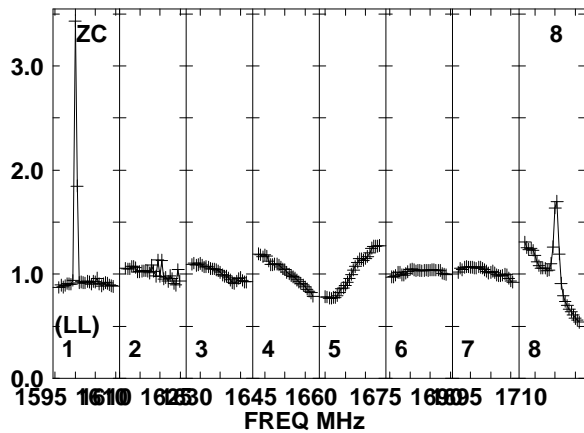
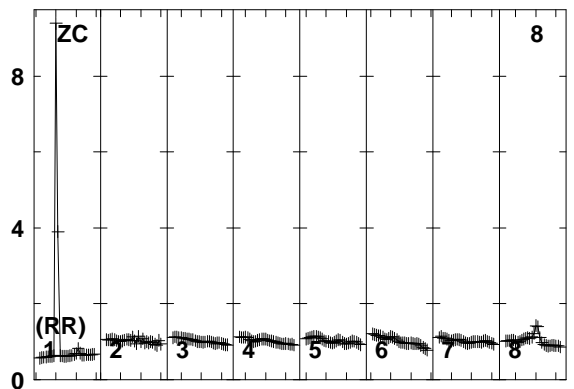
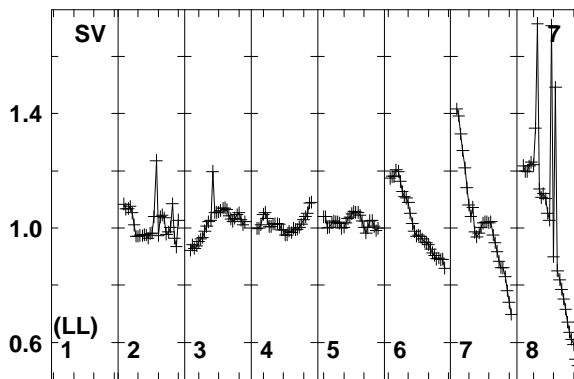
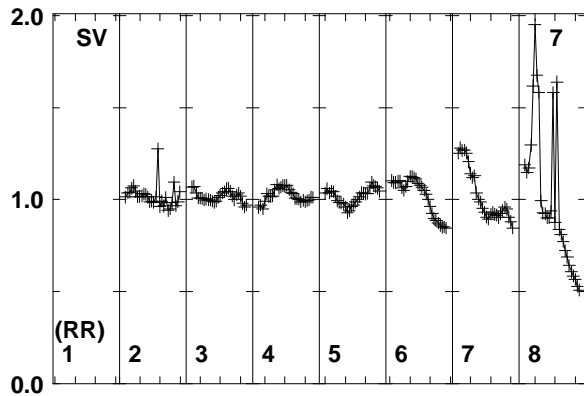
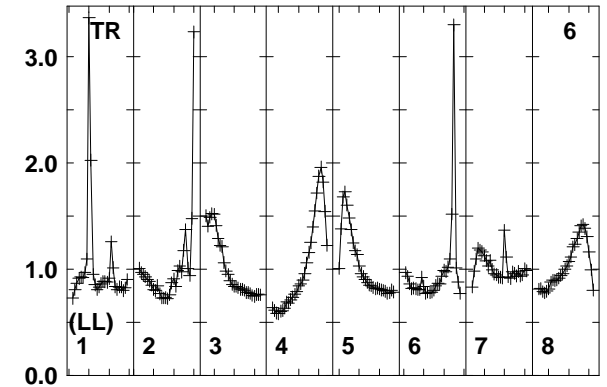
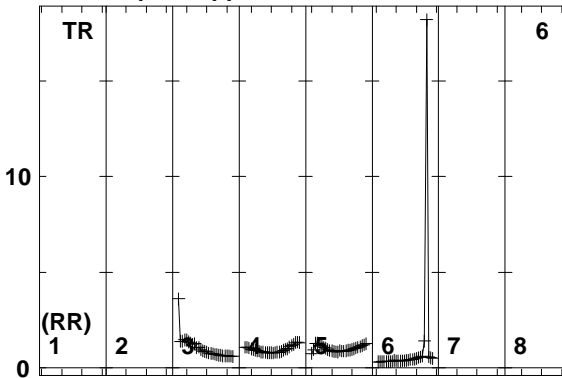
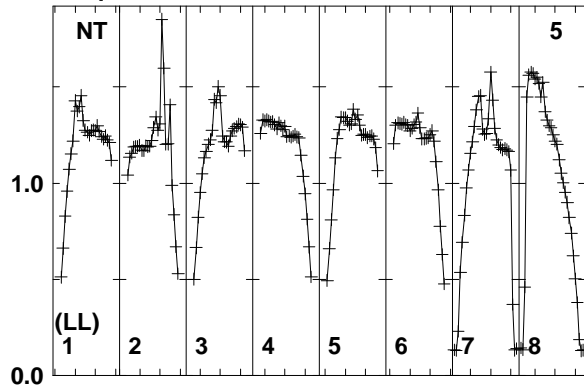

Lower frame: Real Jy
Total-power spectrum Antenna: NT (05)
Timerange: 00/12:15:11 to 00/12:17:09

Plot file version 492 created 11-AUG-2014 17:05:49

J2032+4127 EM110 2.UVDATA.1

Freq = 1.5950 GHz, Bw = 16.000 MH No calibration applied and no bandpass applied

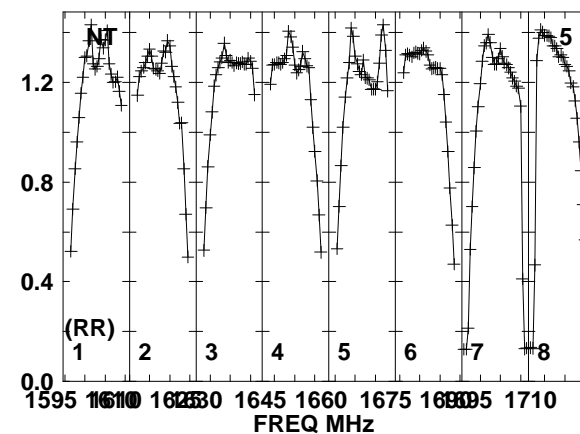
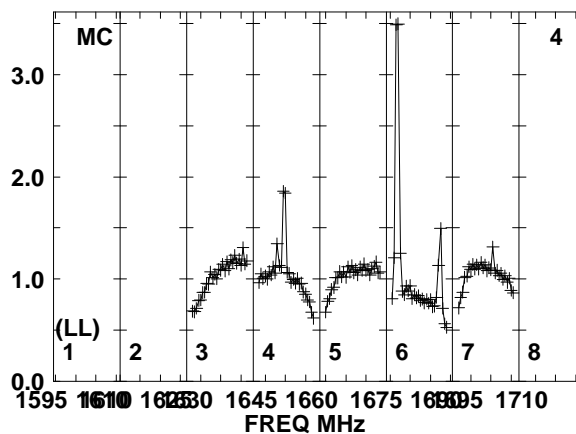
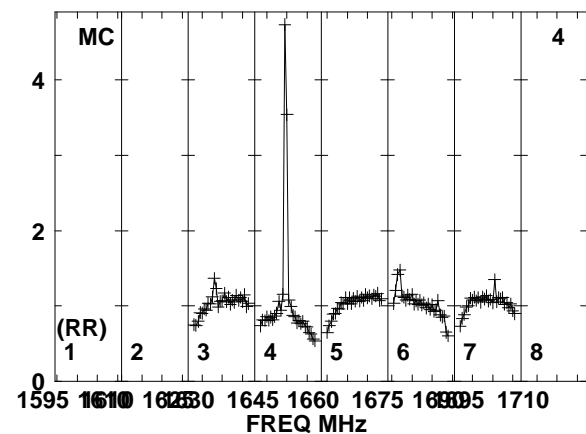
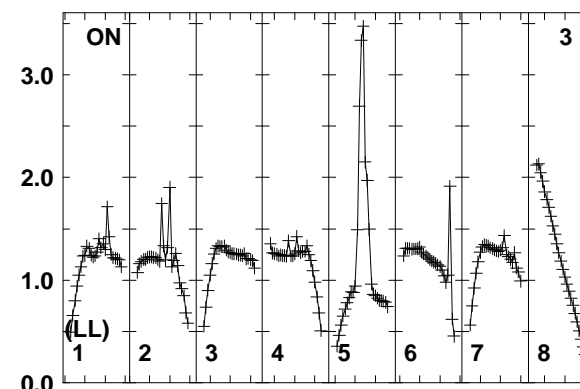
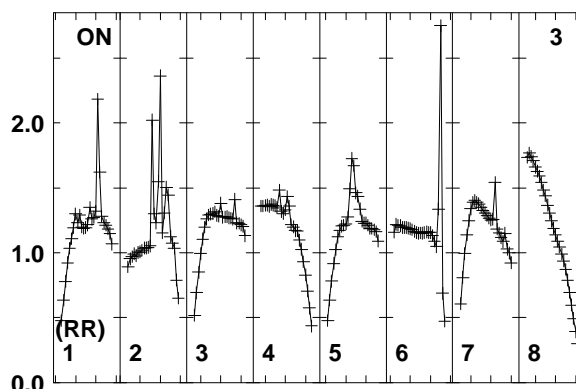
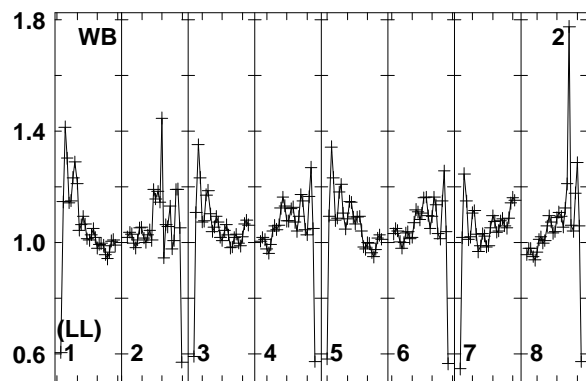
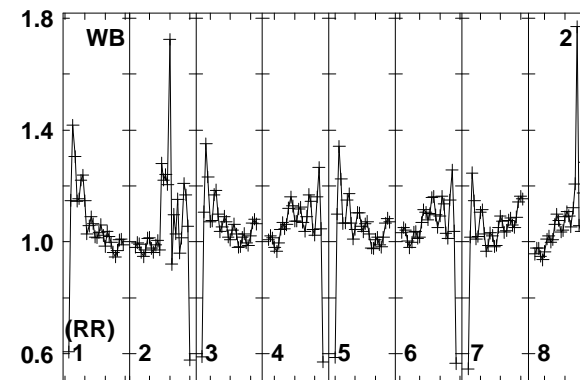
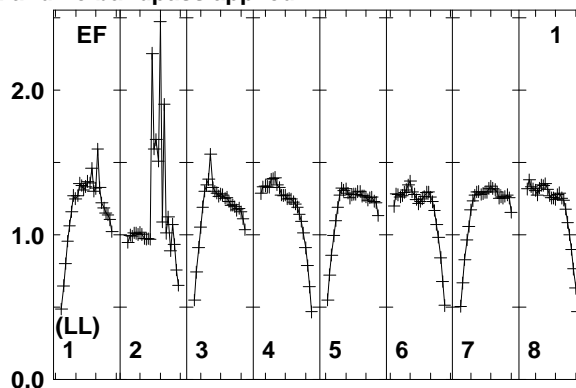
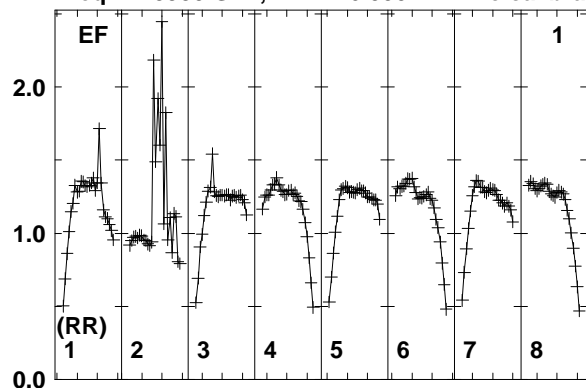

Lower frame: Real Jy
Total-power spectrum Antenna: EF (01)
Timerange: 00/12:17:11 to 00/12:21:09

Plot file version 493 created 11-AUG-2014 17:05:49

J2032+4127 EM110 2.UVDATA.1

Freq = 1.5950 GHz, Bw = 16.000 MH No calibration applied and no bandpass applied

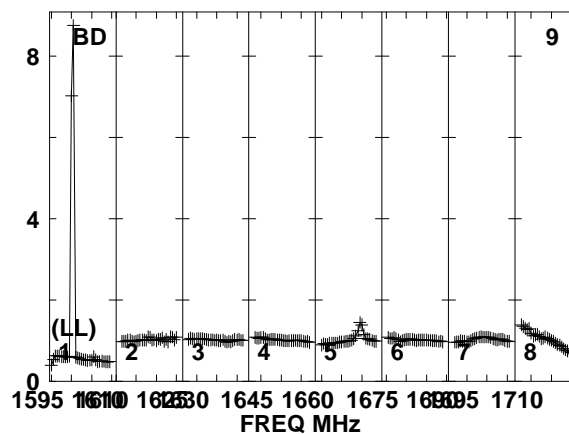
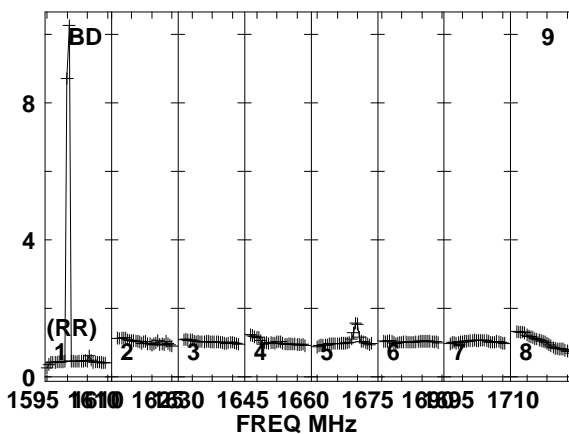
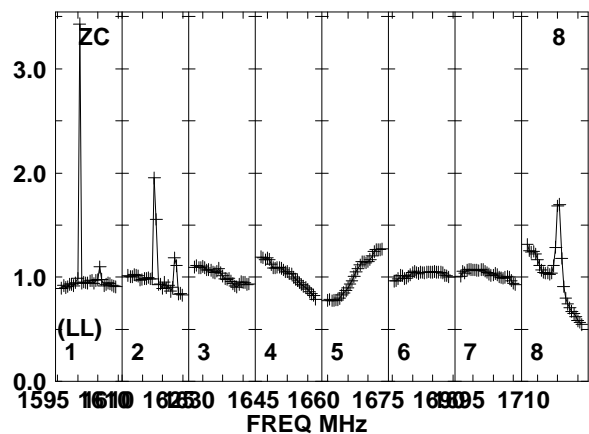
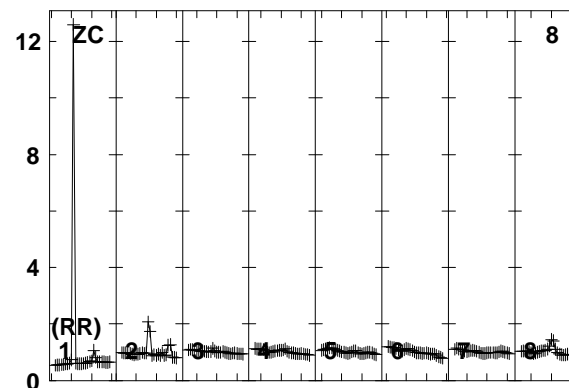
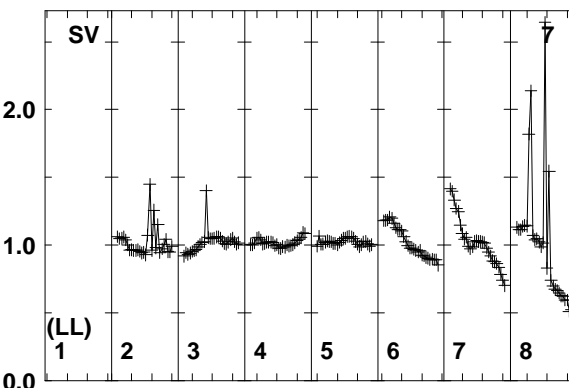
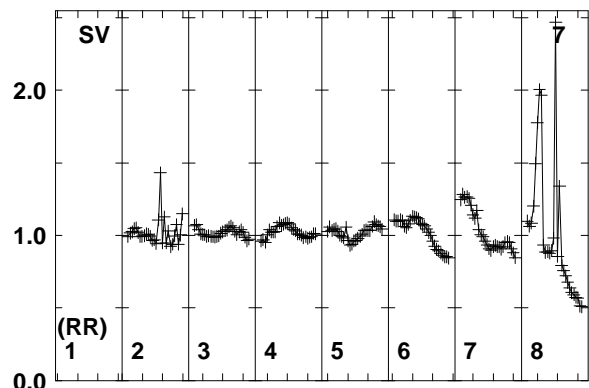
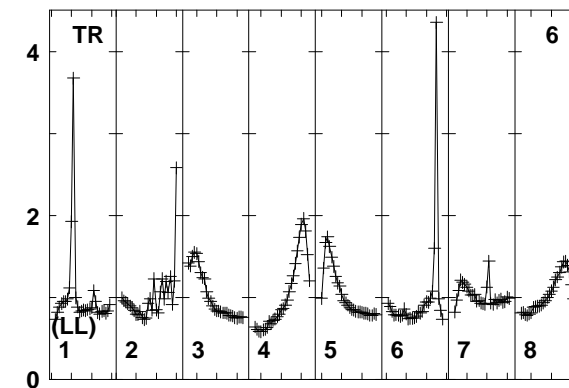
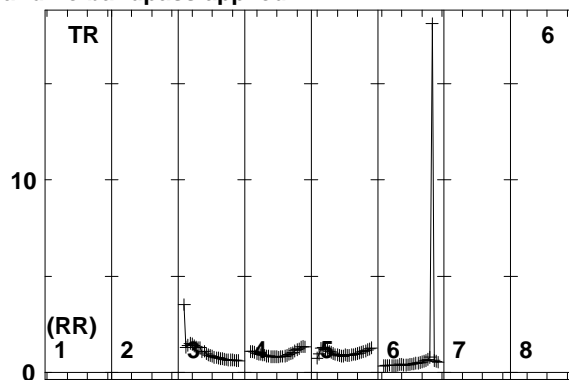
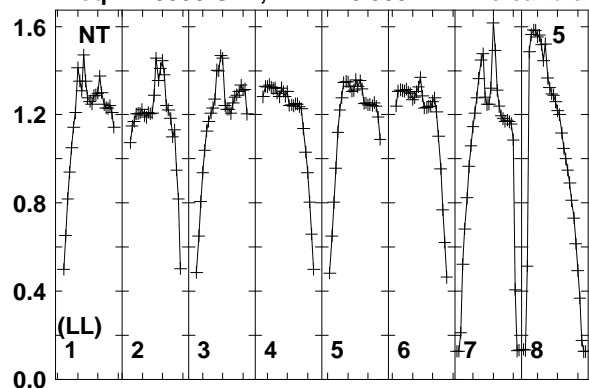

Lower frame: Real Jy
Total-power spectrum Antenna: NT (05)
Timerange: 00/12:17:11 to 00/12:21:09

Plot file version 494 created 11-AUG-2014 17:05:49

J2032+4127 EM110 2.UVDATA.1

Freq = 1.5950 GHz, Bw = 16.000 MH No calibration applied and no bandpass applied

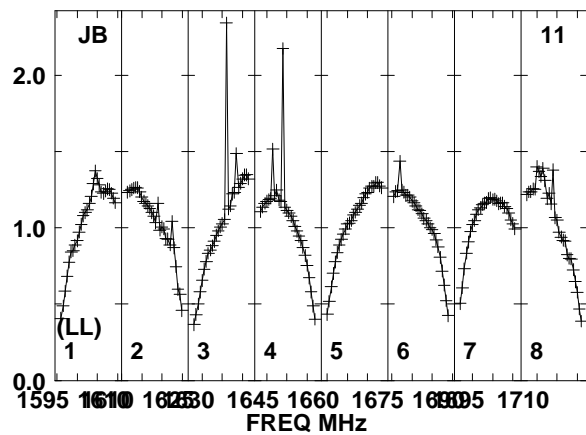
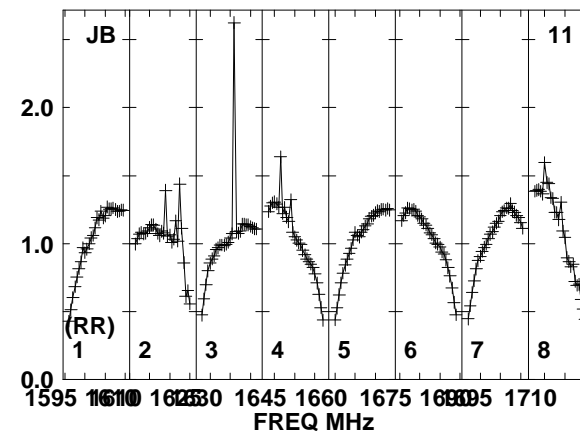
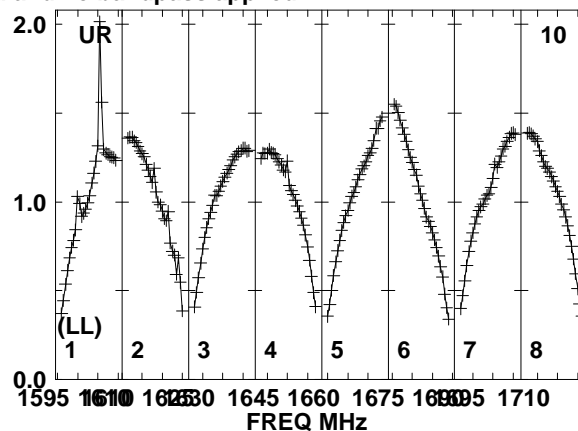
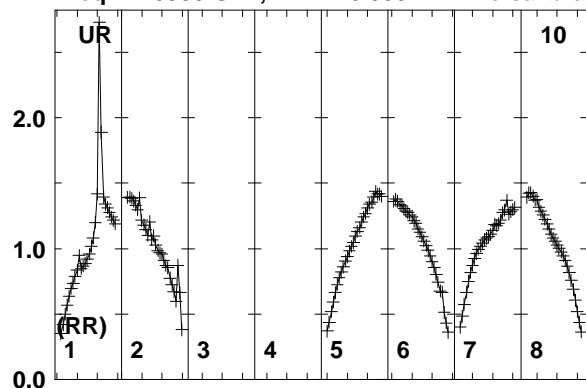

Lower frame: Real Jy
Total-power spectrum Antenna: UR (10)
Timerange: 00/12:17:11 to 00/12:21:09

Plot file version 495 created 11-AUG-2014 17:05:49

J2015+3710 EM110 2.UVDATA.1

Freq = 1.5950 GHz, Bw = 16.000 MH No calibration applied and no bandpass applied

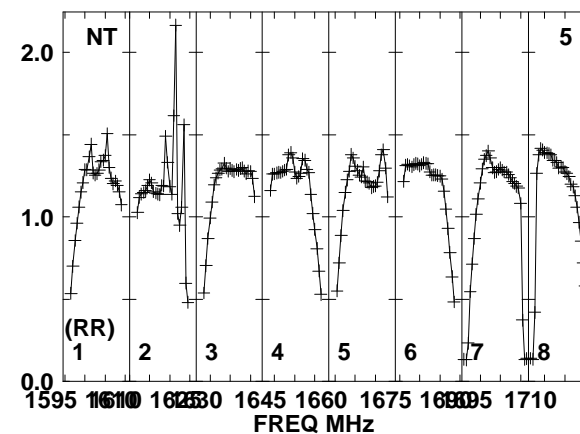
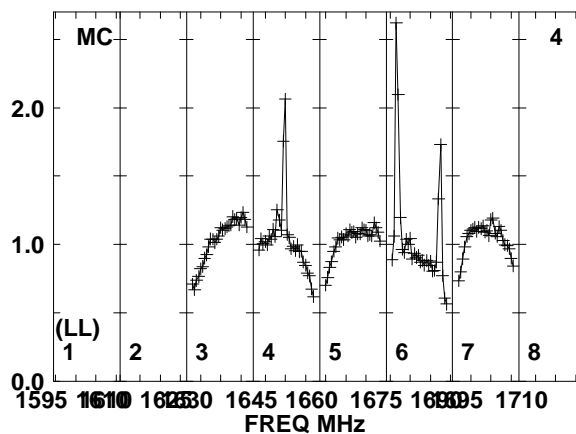
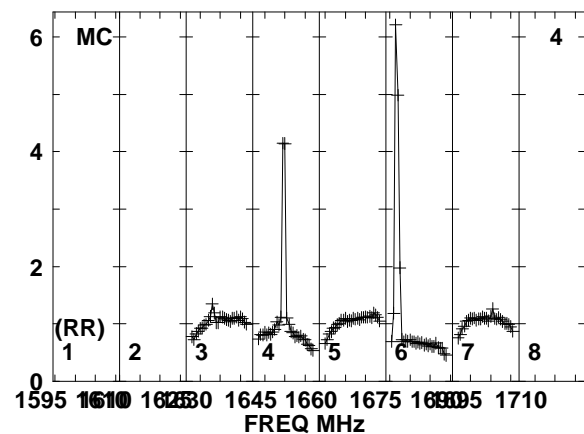
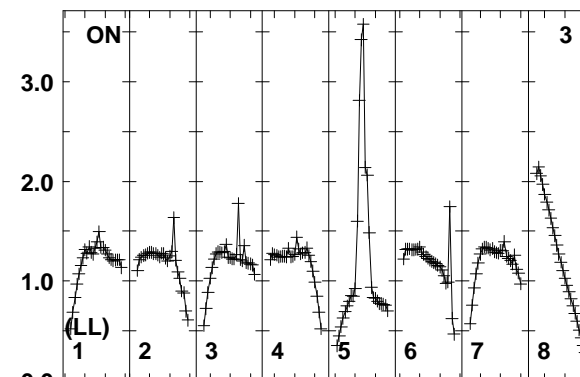
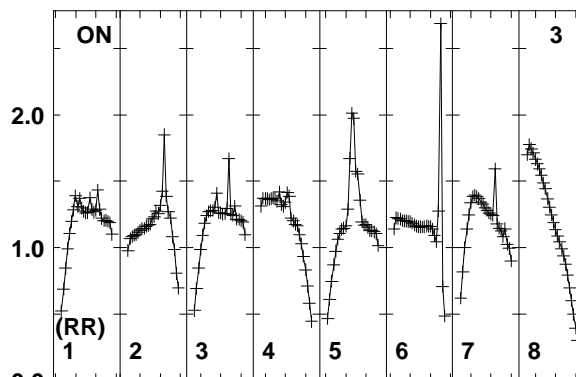
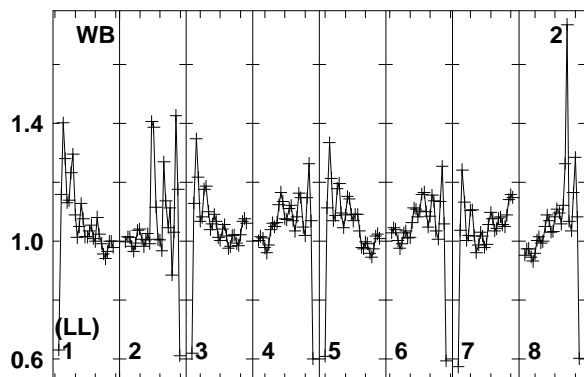
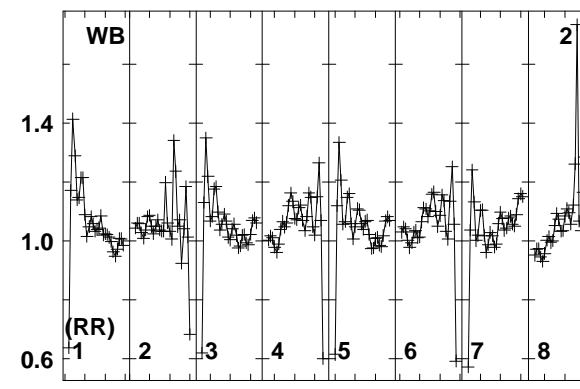
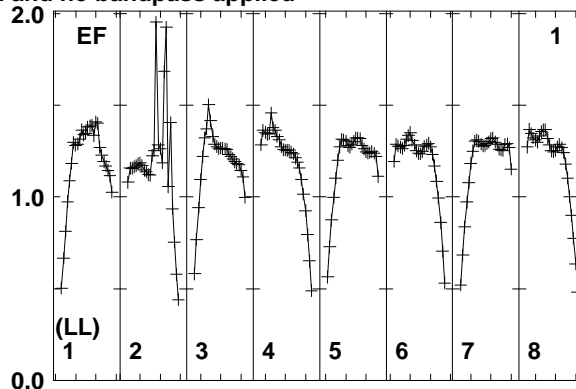
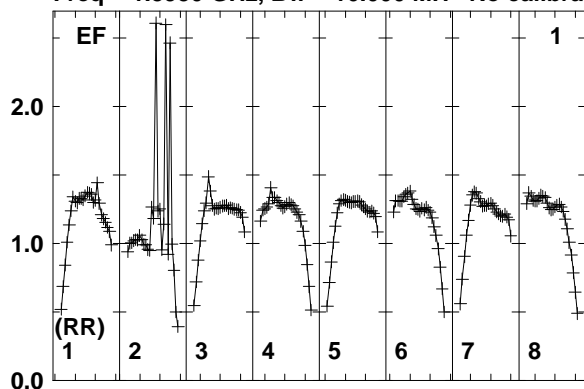

1595 1610 1625 1640 1655 1670 1685 1700 1710
FREQ MHz
Lower frame: Real Jy
Total-power spectrum Antenna: EF (01)
Timerange: 00/12:22:11 to 00/12:24:09

Plot file version 496 created 11-AUG-2014 17:05:49

J2015+3710 EM110 2.UVDATA.1

Freq = 1.5950 GHz, Bw = 16.000 MH No calibration applied and no bandpass applied

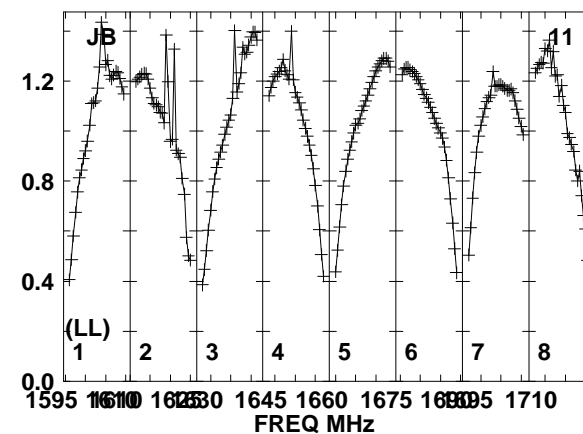
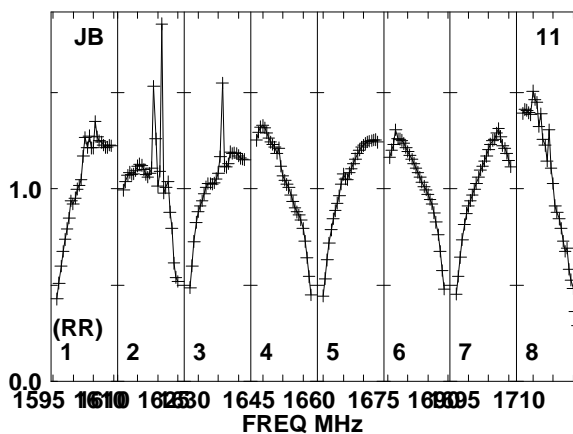
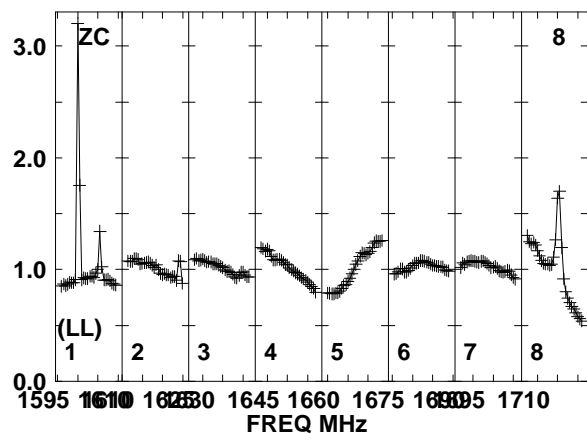
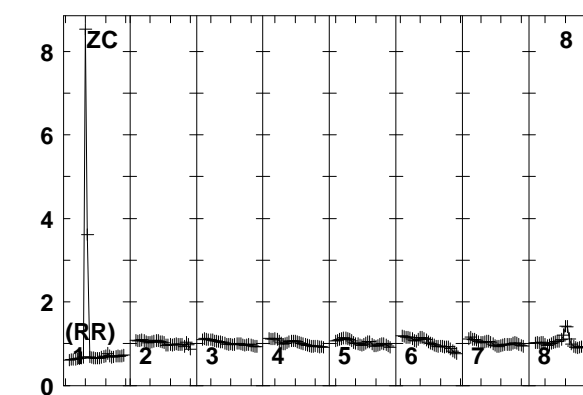
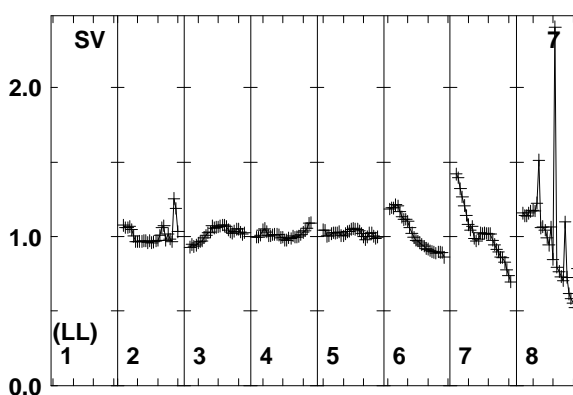
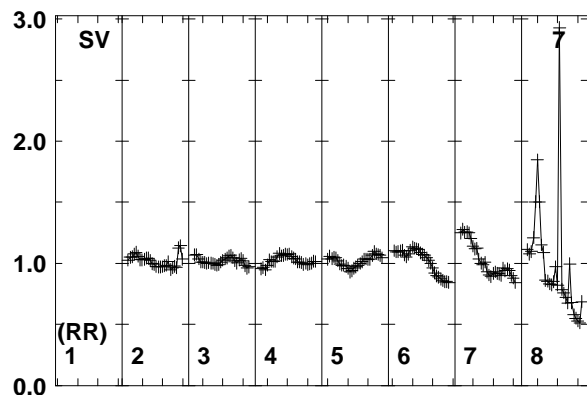
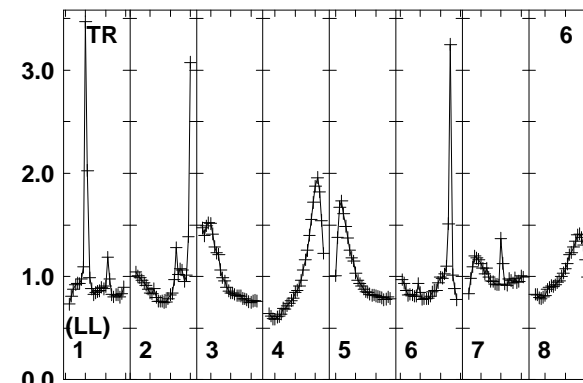
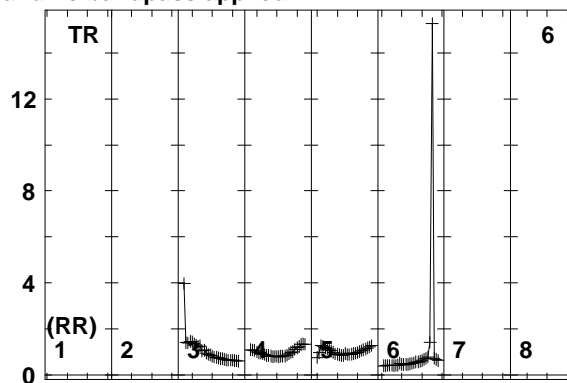
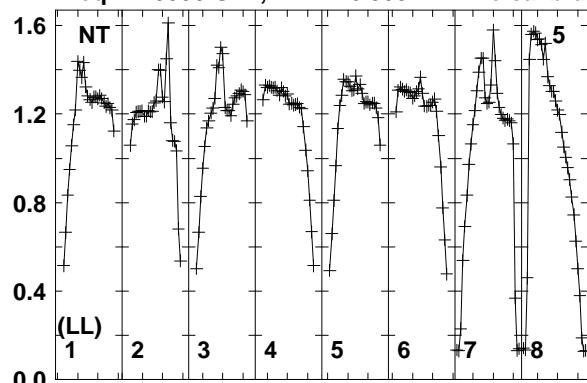

Lower frame: Real Jy
Total-power spectrum Antenna: NT (05)
Timerange: 00/12:22:11 to 00/12:24:09

Plot file version 497 created 11-AUG-2014 17:05:49

J2253+1608 EM110 2.UVDATA.1

Freq = 1.5950 GHz, Bw = 16.000 MH No calibration applied and no bandpass applied

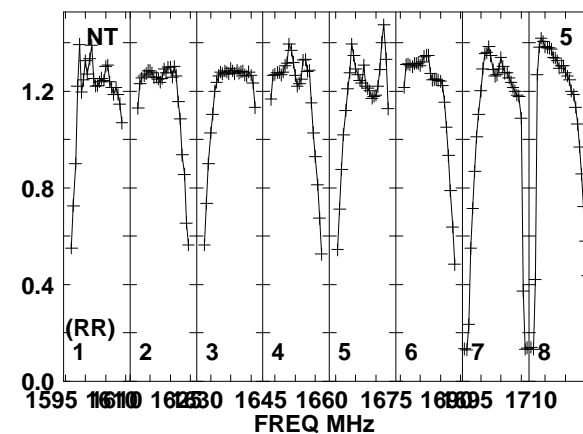
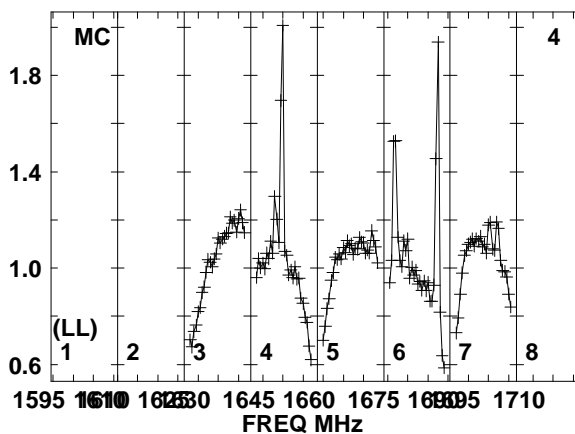
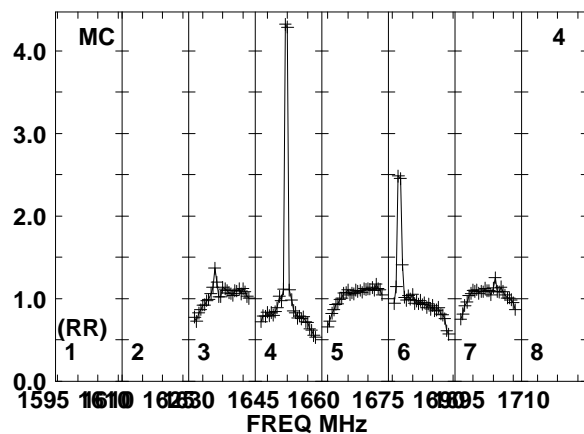
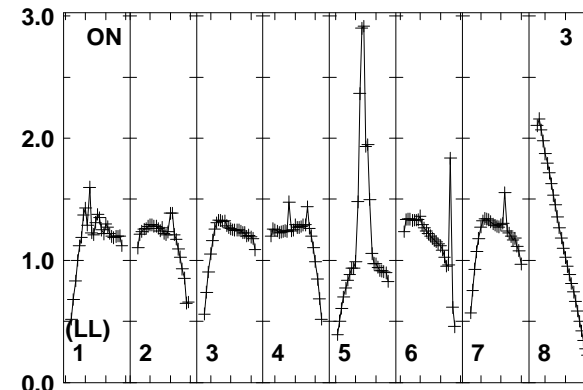
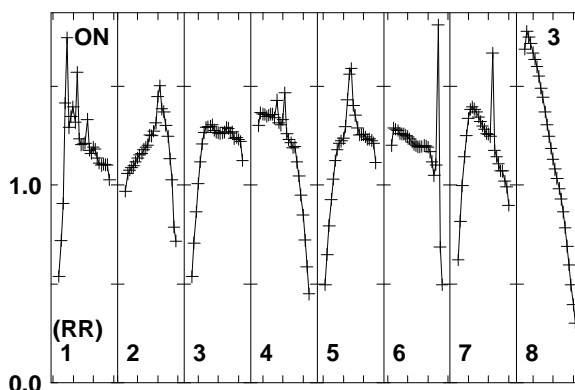
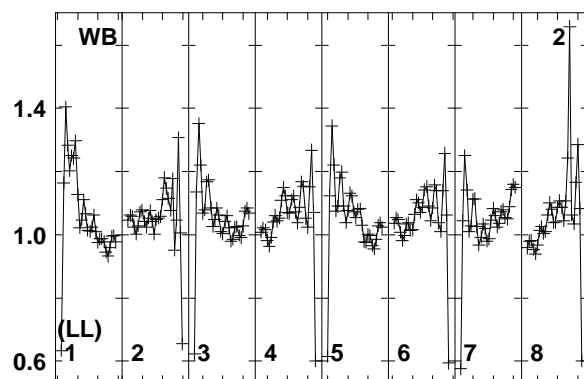
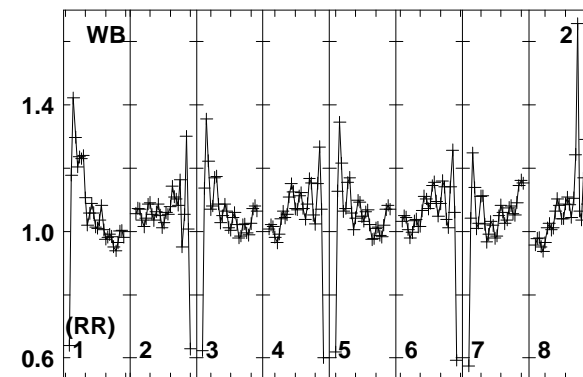
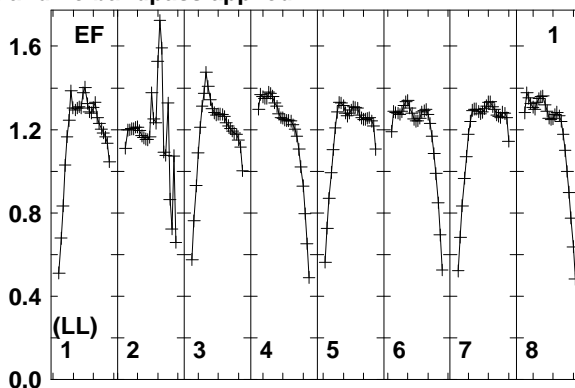
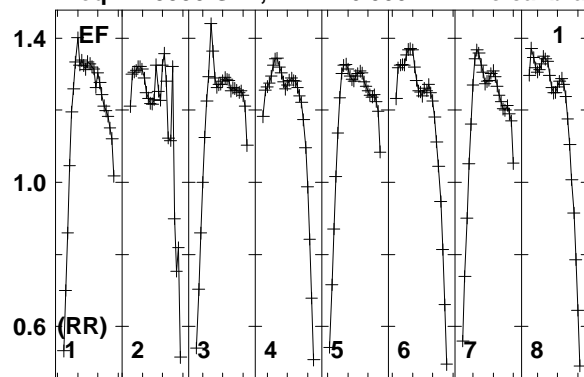

Lower frame: Real Jy
Total-power spectrum Antenna: EF (01)
Timerange: 00/12:26:01 to 00/12:29:59

Plot file version 498 created 11-AUG-2014 17:05:49

J2253+1608 EM110 2.UVDATA.1

Freq = 1.5950 GHz, Bw = 16.000 MH No calibration applied and no bandpass applied

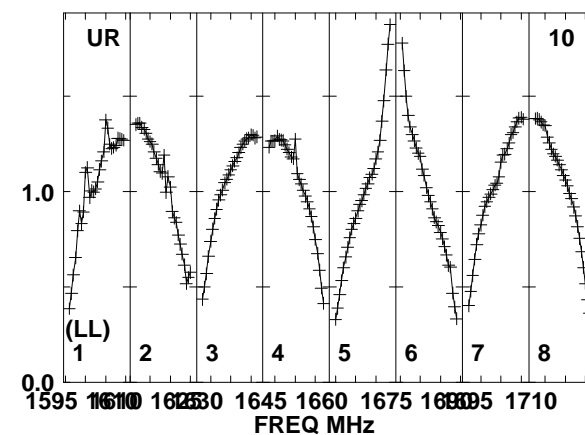
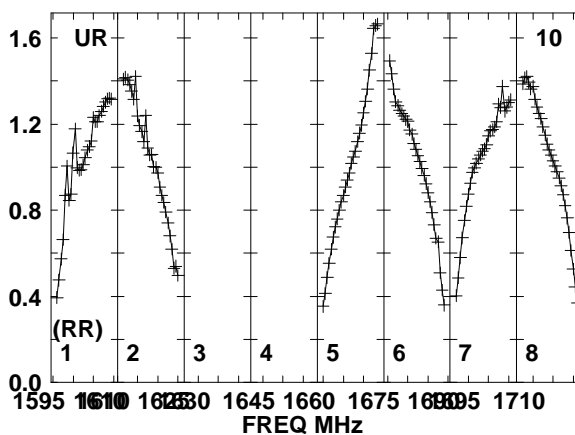
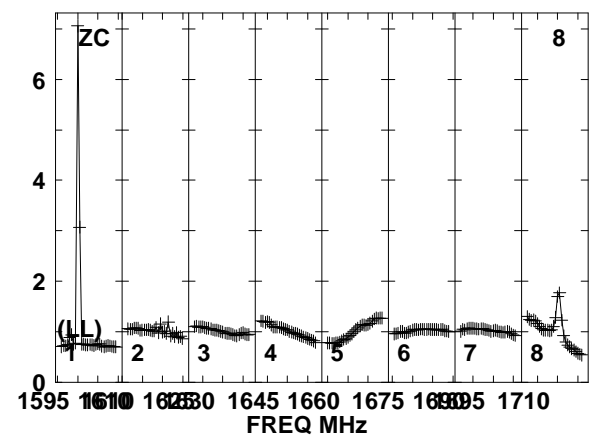
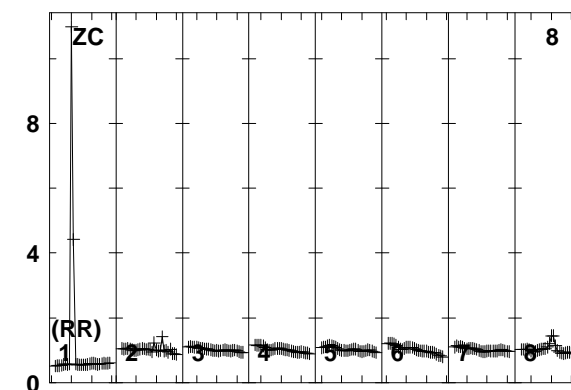
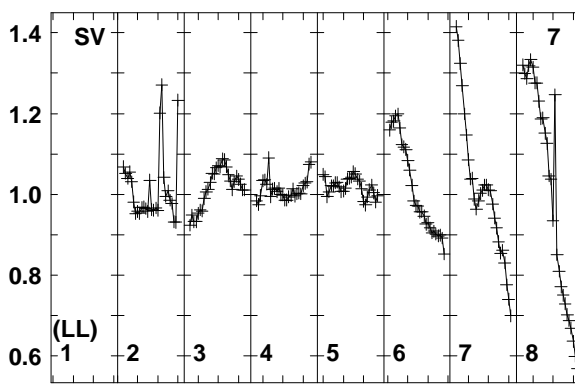
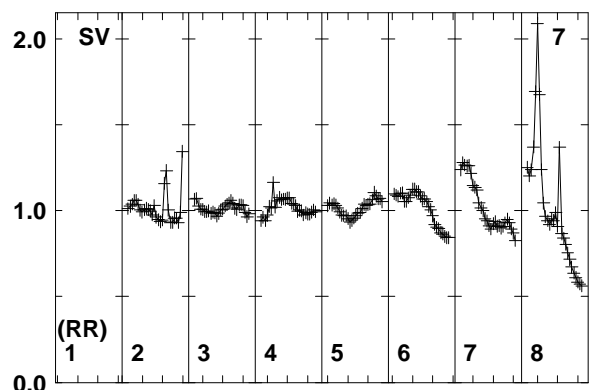
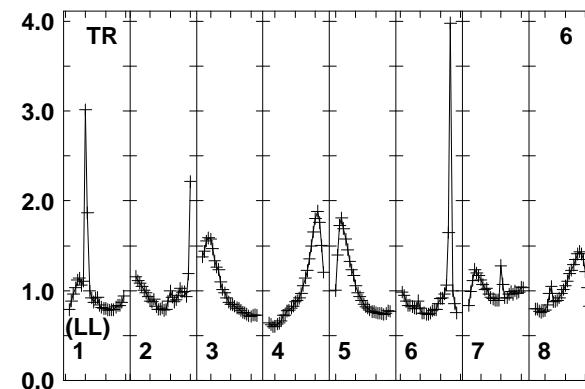
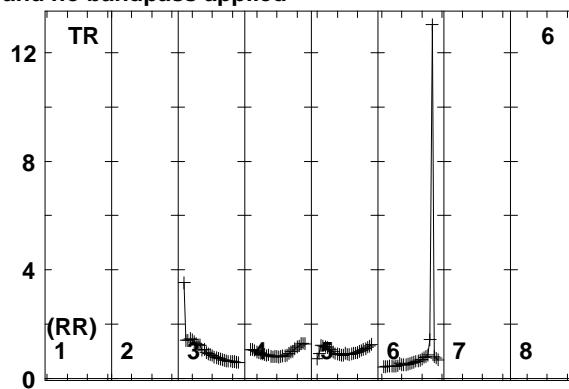
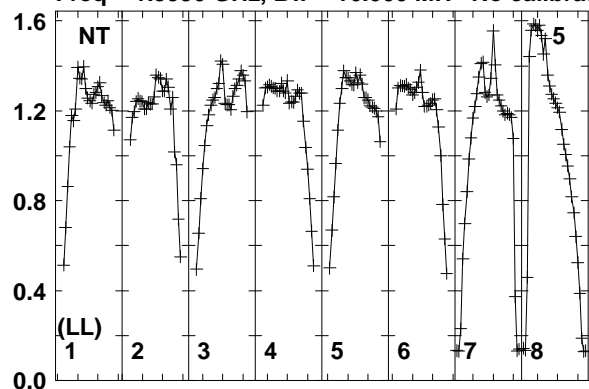

1595 1610 1625 1640 1655 1670 1685 1700 1715
FREQ MHz
Lower frame: Real Jy
Total-power spectrum Antenna: NT (05)
Timerange: 00/12:26:01 to 00/12:29:59

Plot file version 499 created 11-AUG-2014 17:05:50

J2253+1608 EM110 2.UVDATA.1

Freq = 1.5950 GHz, Bw = 16.000 MH No calibration applied and no bandpass applied

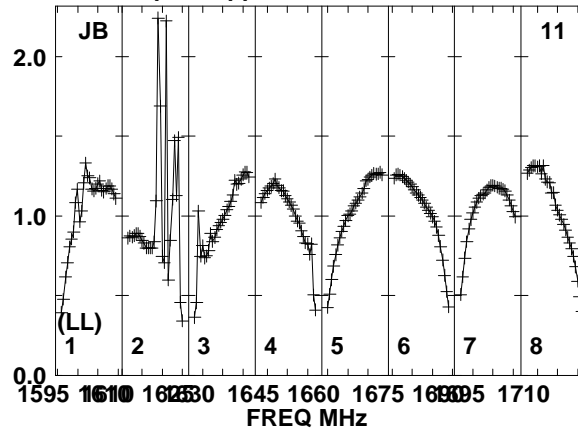
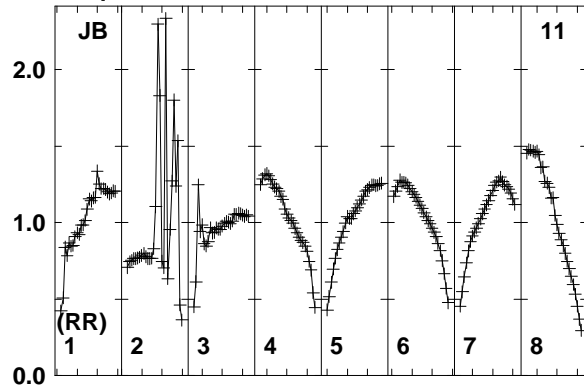

Lower frame: Real Jy
Total-power spectrum Antenna: JB (11)
Timerange: 00/12:26:01 to 00/12:29:59