

Plot file version 1 created 19-AUG-2016 17:19:11

OQ208 EM119D.UVDATA.1

Freq = 1.5950 GHz, Bw = 16.000 MH No calibration applied and no bandpass applied

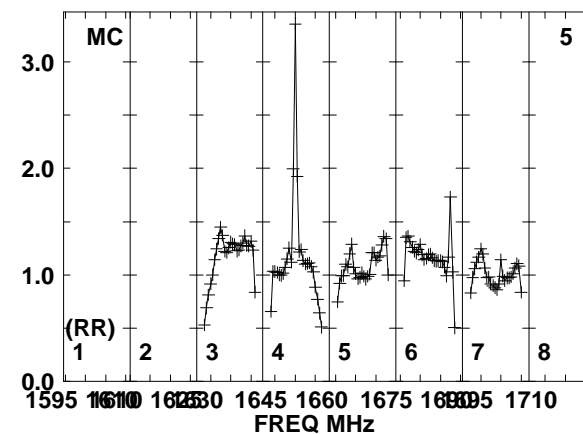
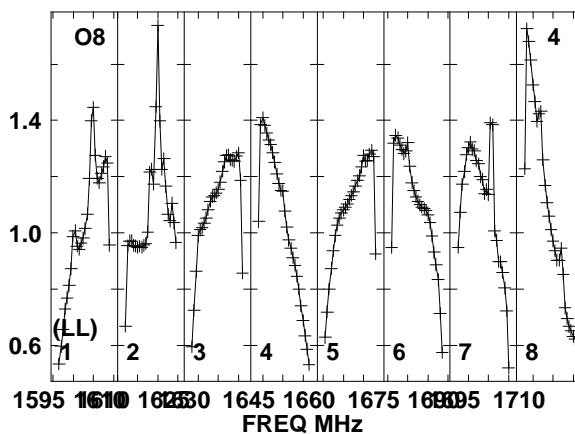
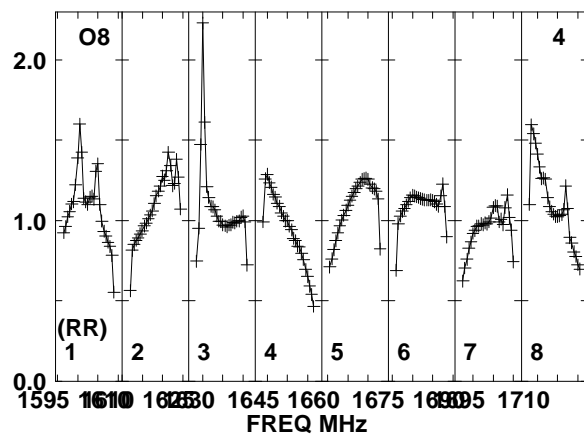
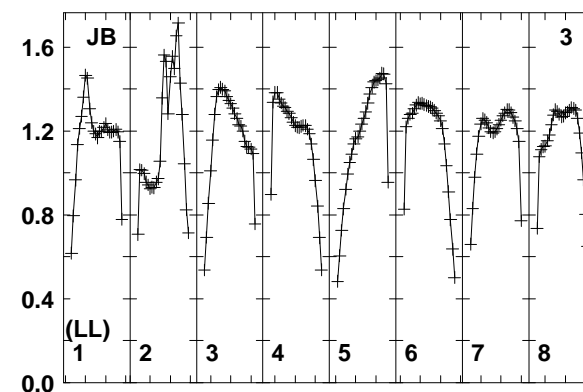
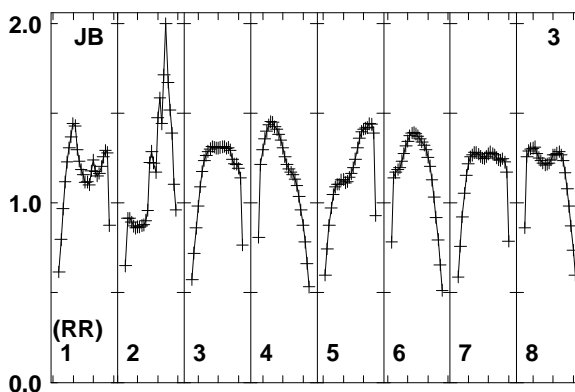
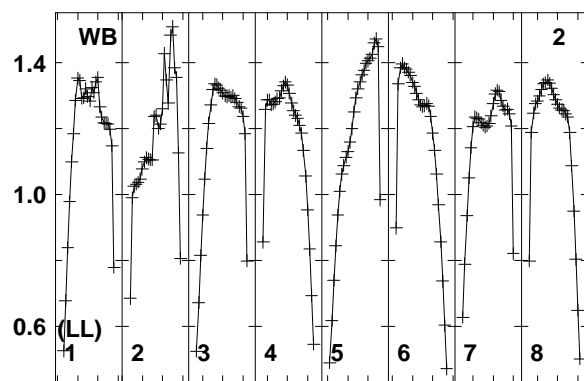
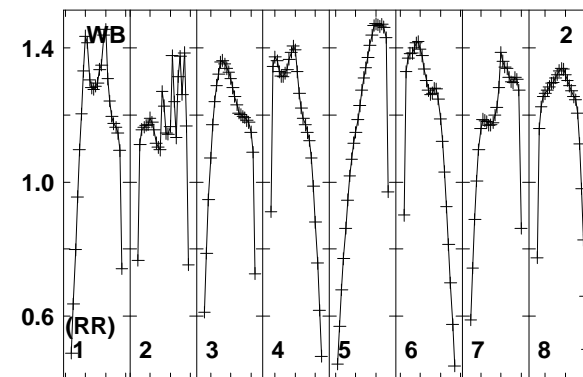
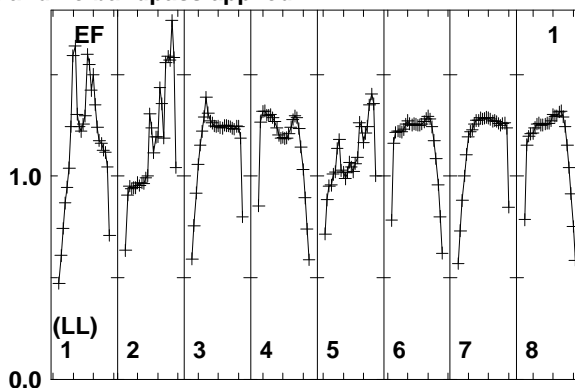
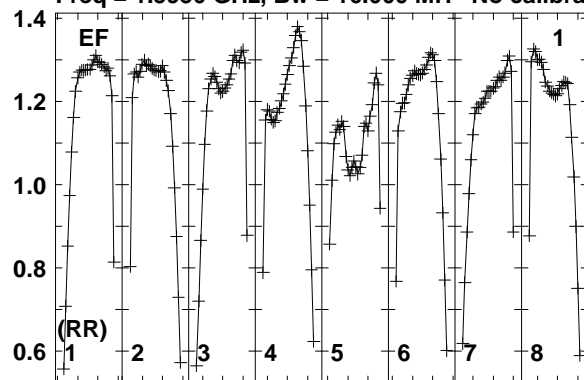

Lower frame: Real Jy
Total-power spectrum Antenna: EF (01)
Timerange: 00/00:01:01 to 00/00:06:00

Plot file version 2 created 19-AUG-2016 17:19:12

OQ208 EM119D.UVDATA.1

Freq = 1.5950 GHz, Bw = 16.000 MH No calibration applied and no bandpass applied

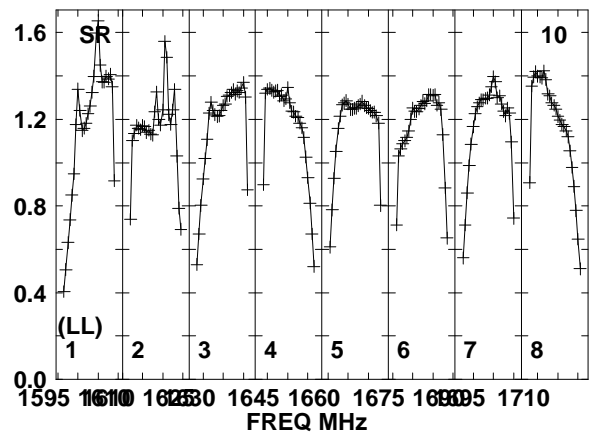
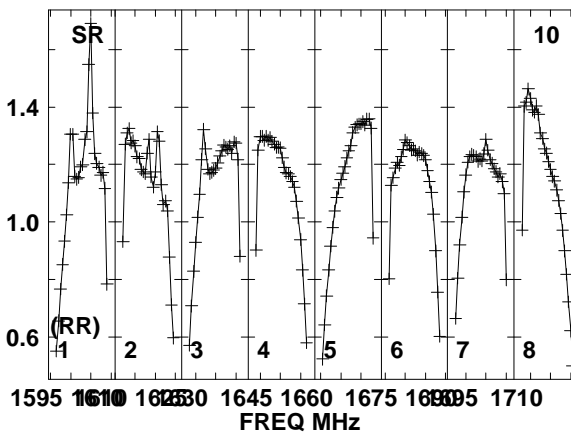
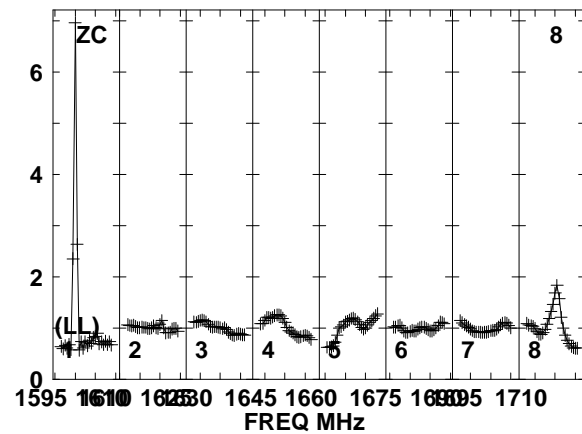
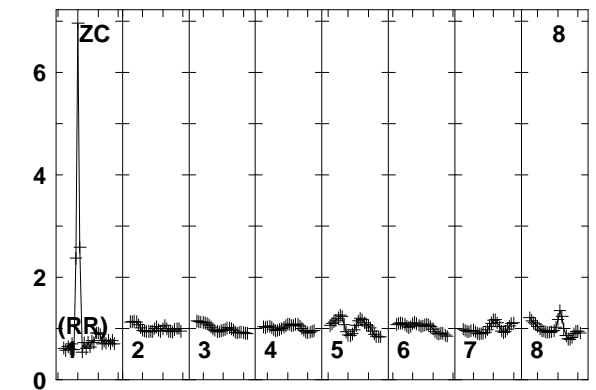
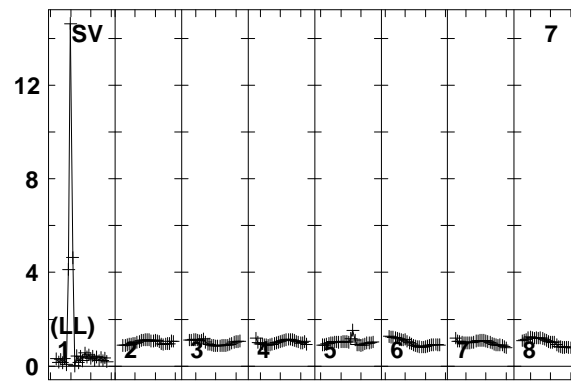
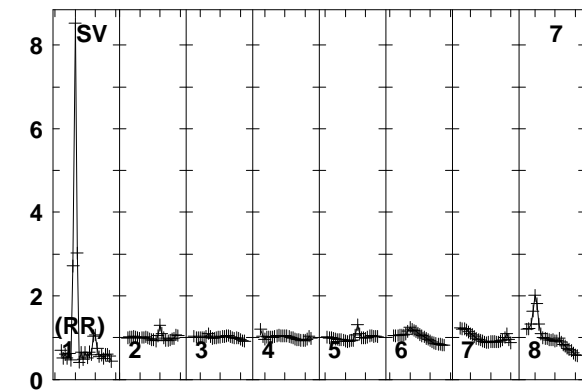
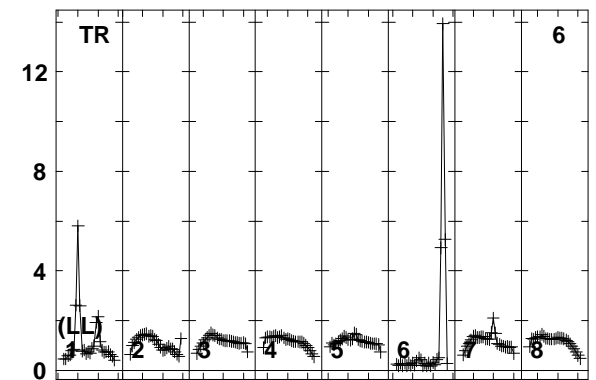
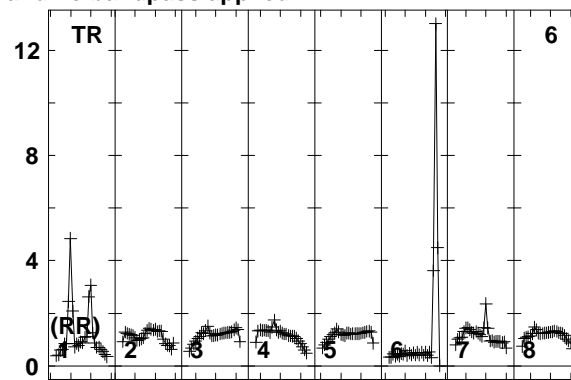
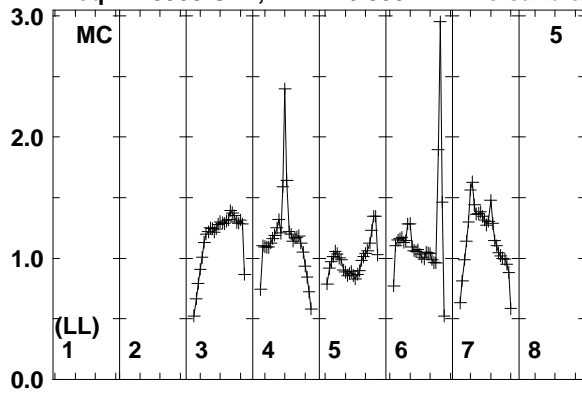

Lower frame: Real Jy
Total-power spectrum Antenna: MC (05)
Timerange: 00/00:01:01 to 00/00:06:00

Plot file version 3 created 19-AUG-2016 17:19:12

OQ208 EM119D.UVDATA.1

Freq = 1.5950 GHz, Bw = 16.000 MH No calibration applied and no bandpass applied

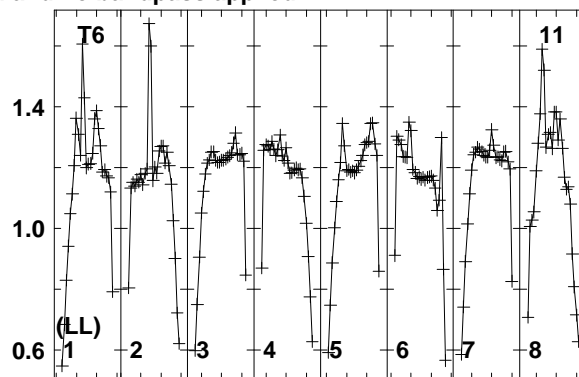
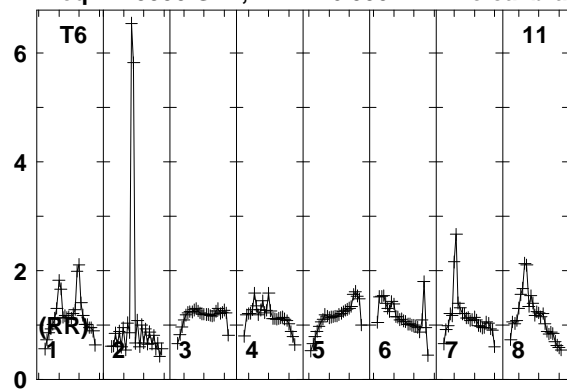

Lower frame: Real Jy
Total-power spectrum Antenna: T6 (11)
Timerange: 00/00:01:01 to 00/00:06:00

Plot file version 4 created 19-AUG-2016 17:19:12

J1642+2523 EM119D.UVDATA.1

Freq = 1.5950 GHz, Bw = 16.000 MH No calibration applied and no bandpass applied

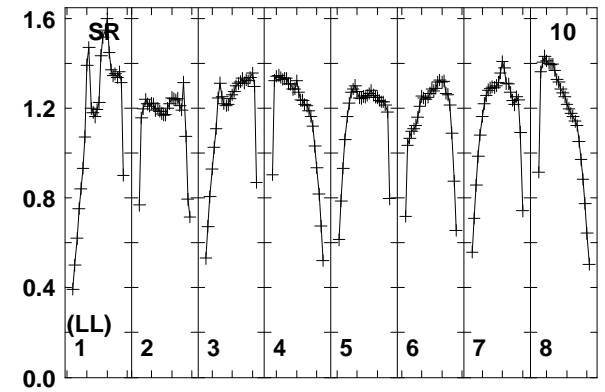
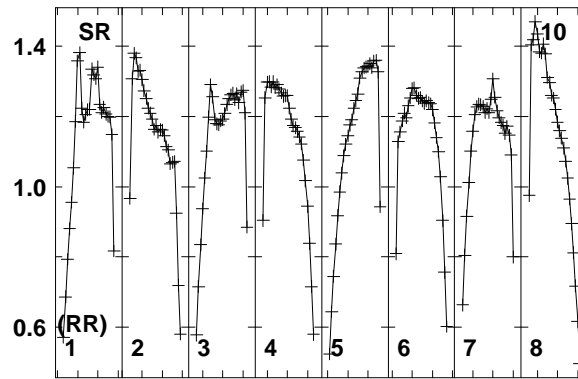
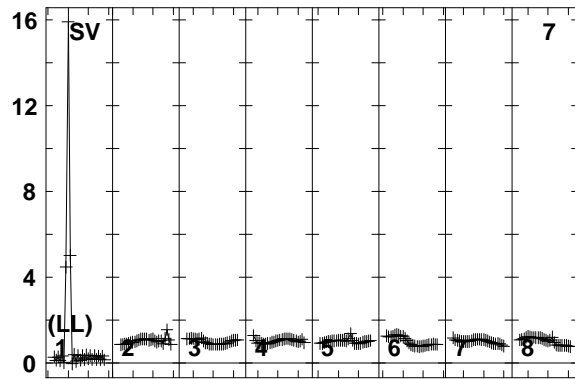
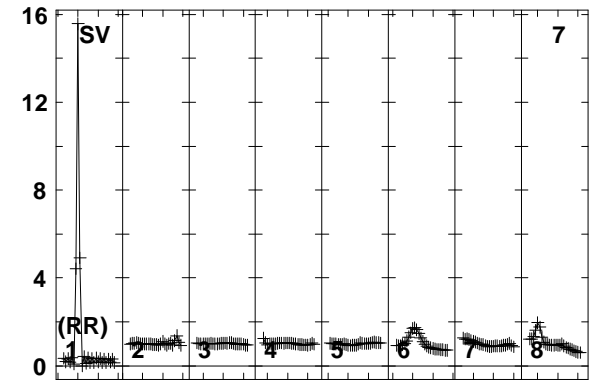
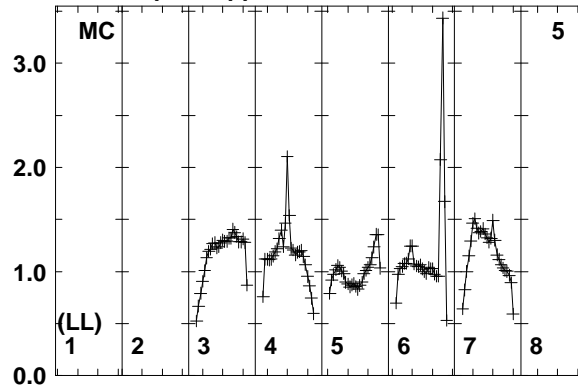
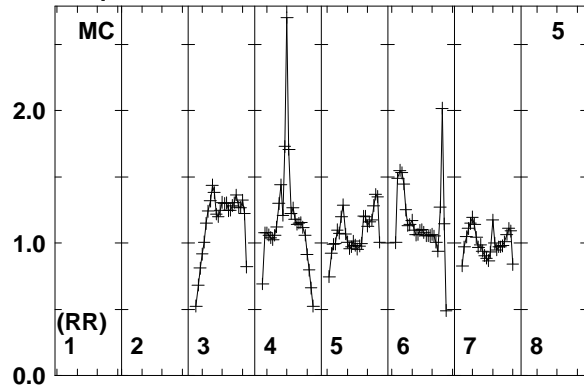

Lower frame: Real Jy
Total-power spectrum Antenna: MC (05)
Timerange: 00/00:07:02 to 00/00:07:29

Plot file version 5 created 19-AUG-2016 17:19:12

J1649+2635 EM119D.UVDATA.1

Freq = 1.5950 GHz, Bw = 16.000 MH No calibration applied and no bandpass applied

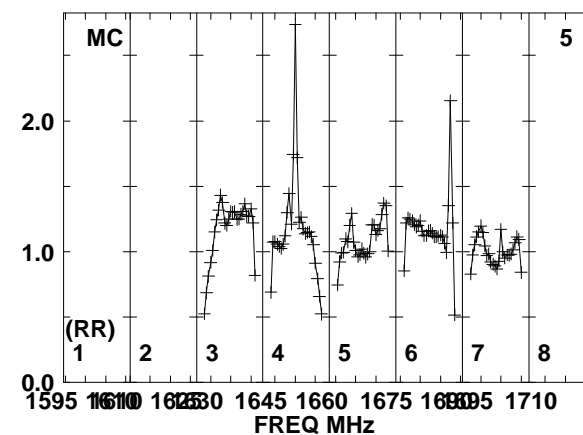
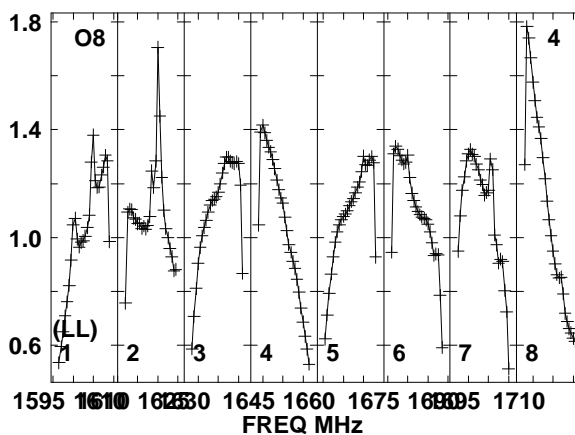
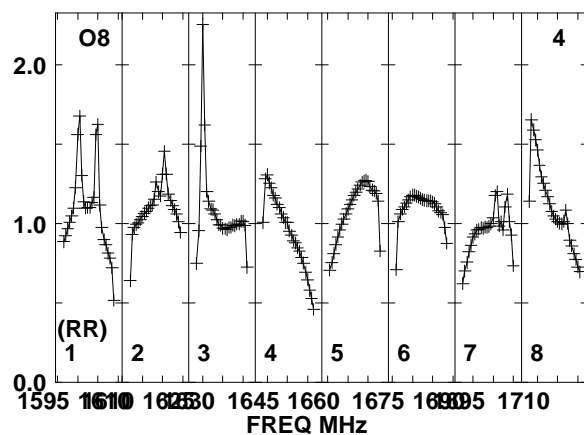
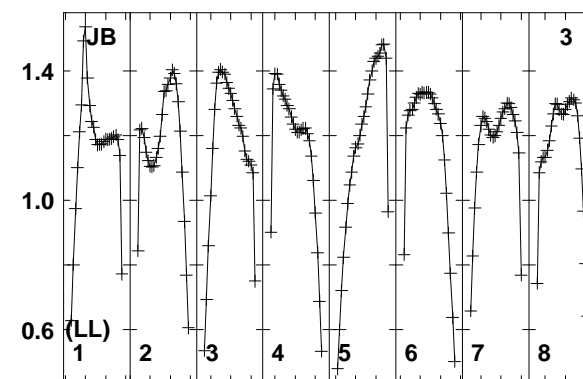
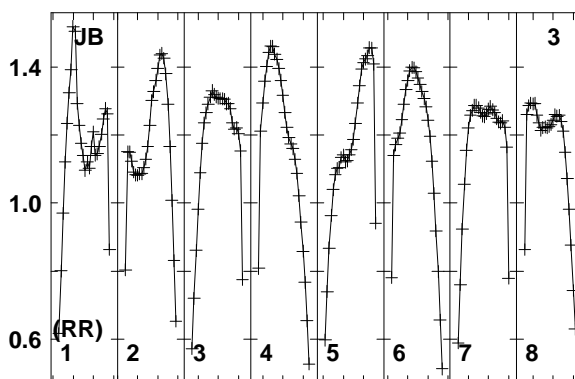
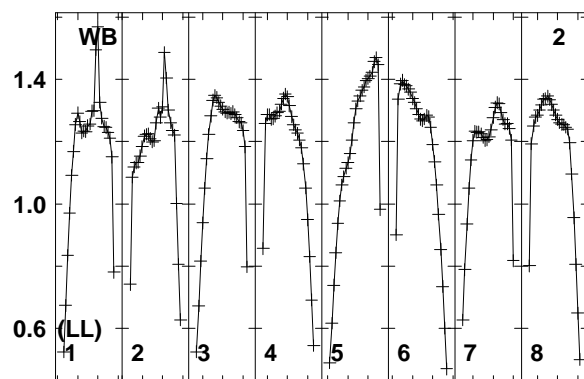
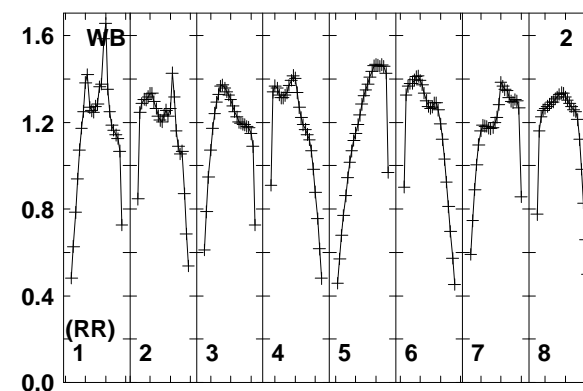
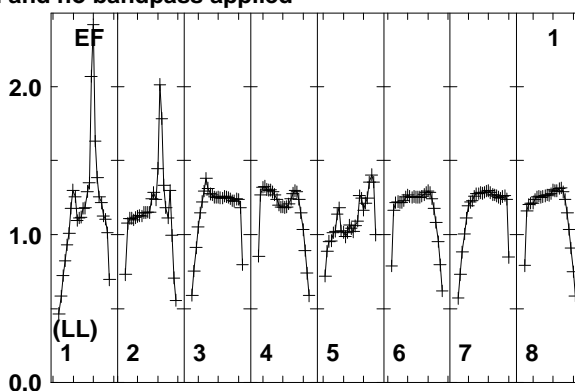
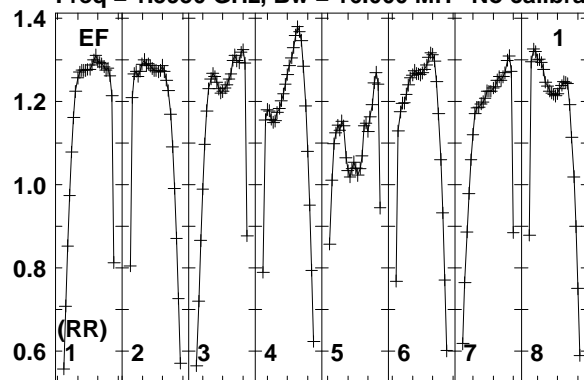

Lower frame: Real Jy
Total-power spectrum Antenna: EF (01)
Timerange: 00/00:07:38 to 00/00:11:00

Plot file version 6 created 19-AUG-2016 17:19:12

J1649+2635 EM119D.UVDATA.1

Freq = 1.5950 GHz, Bw = 16.000 MH No calibration applied and no bandpass applied

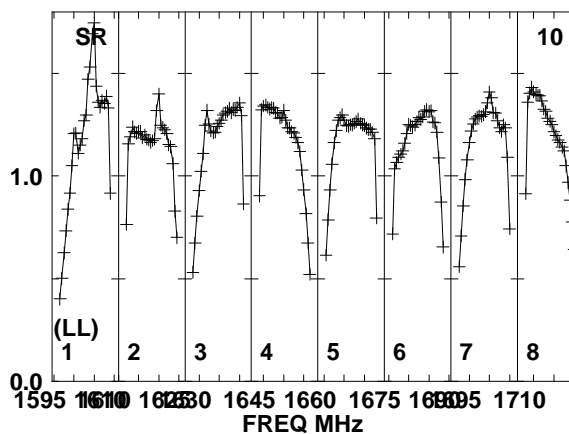
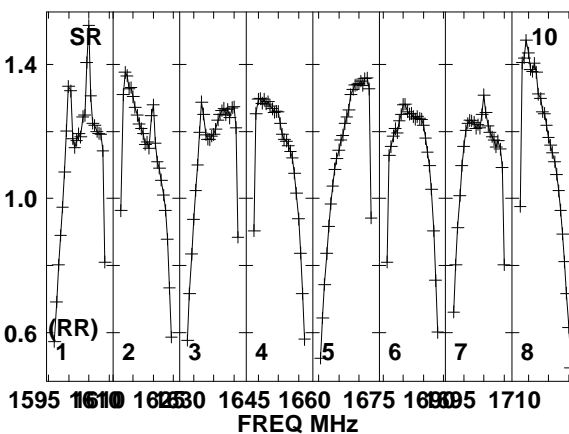
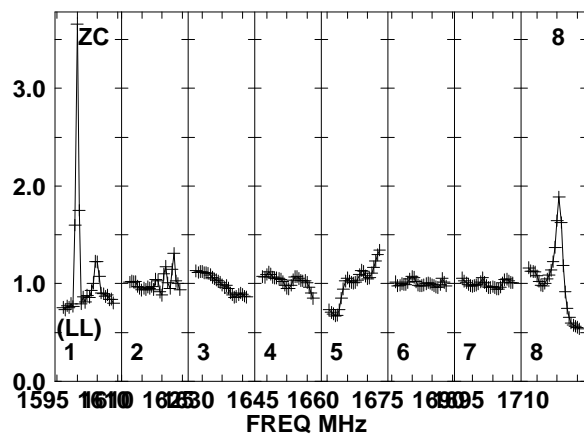
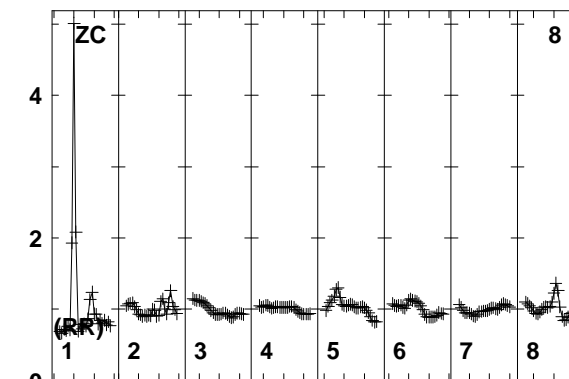
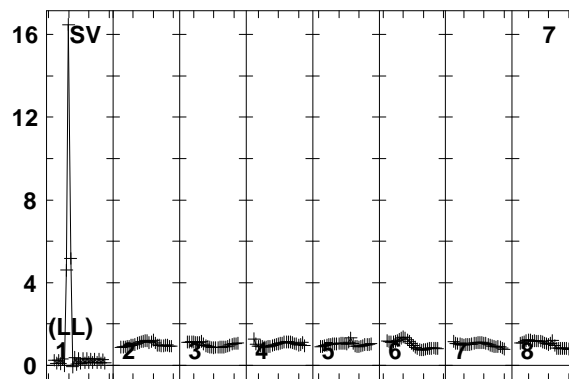
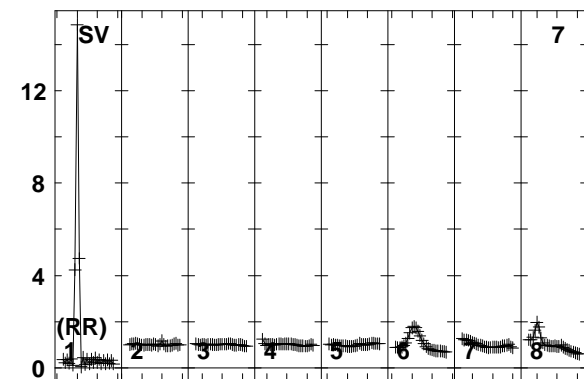
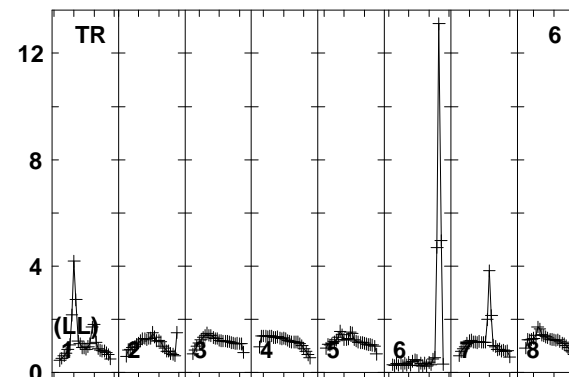
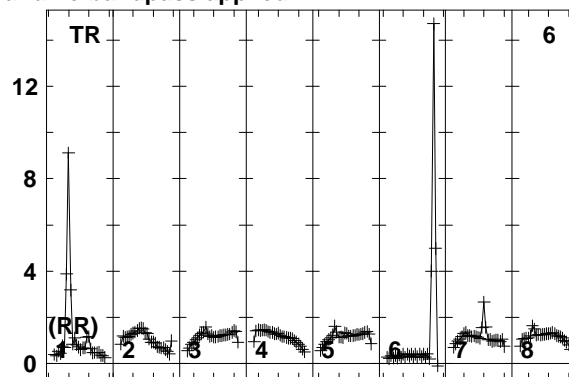
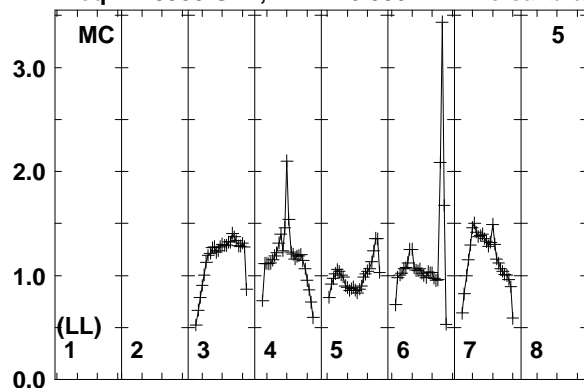

Lower frame: Real Jy
Total-power spectrum Antenna: MC (05)
Timerange: 00/00:07:38 to 00/00:11:00

Plot file version 7 created 19-AUG-2016 17:19:13

J1649+2635 EM119D.UVDATA.1

Freq = 1.5950 GHz, Bw = 16.000 MH No calibration applied and no bandpass applied

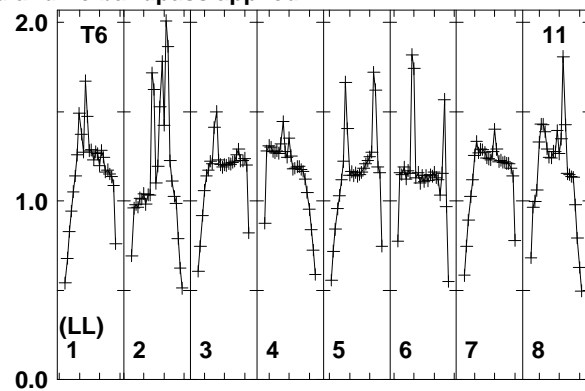
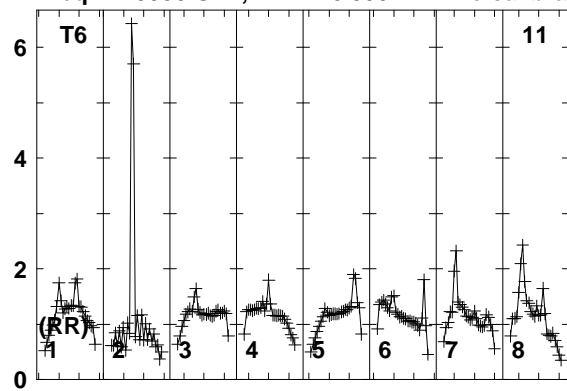

Lower frame: Real Jy
Total-power spectrum Antenna: T6 (11)
Timerange: 00/00:07:38 to 00/00:11:00

Plot file version 8 created 19-AUG-2016 17:19:13

J1642+2523 EM119D.UVDATA.1

Freq = 1.5950 GHz, Bw = 16.000 MH No calibration applied and no bandpass applied

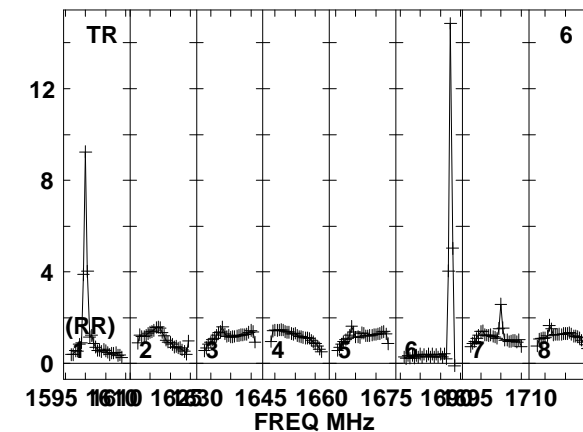
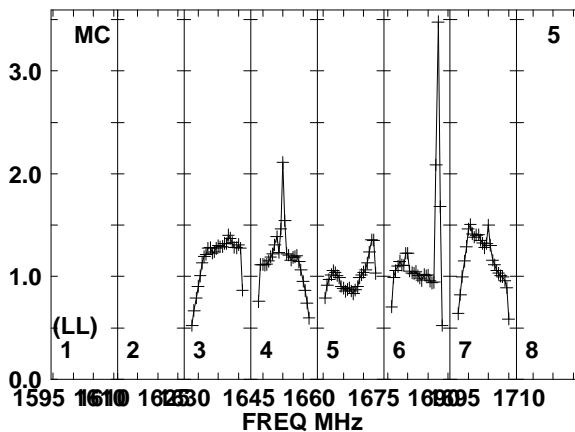
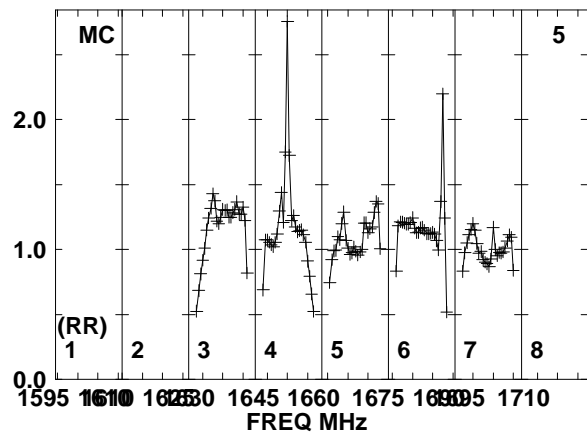
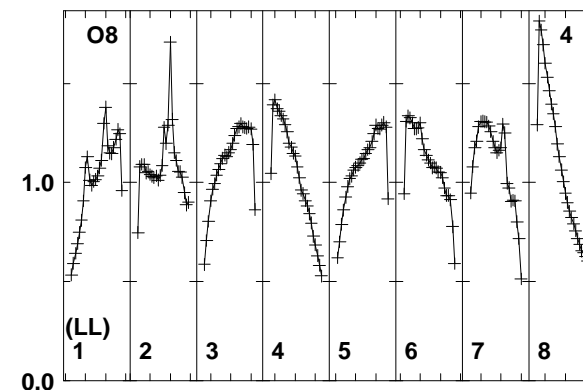
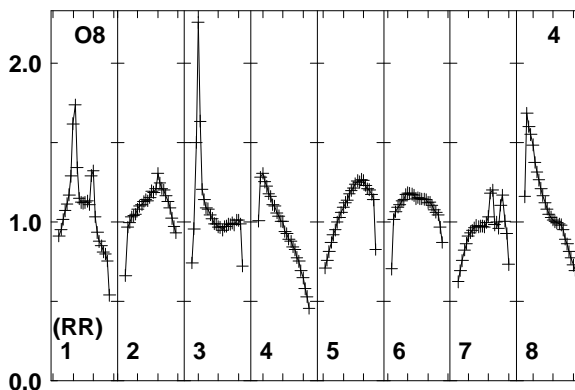
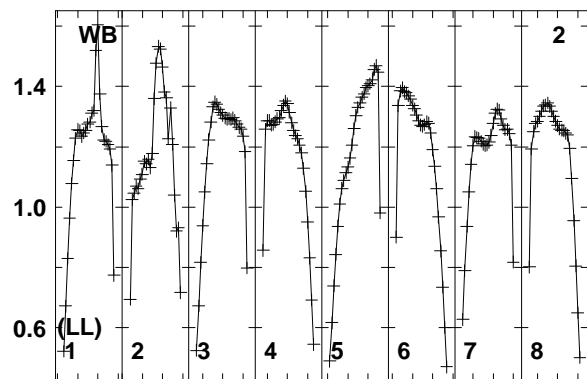
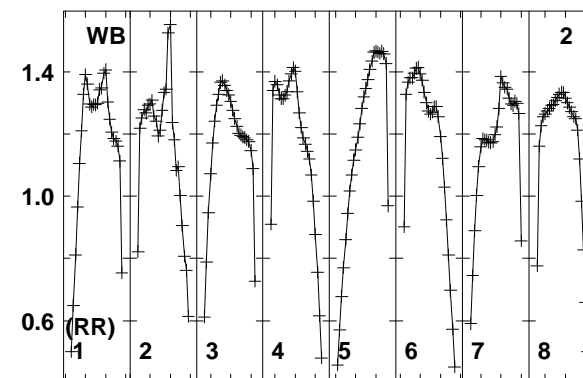
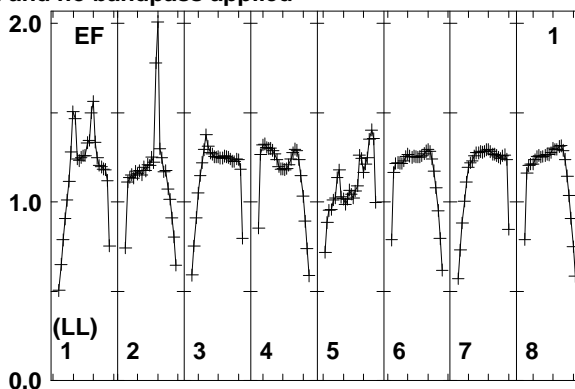
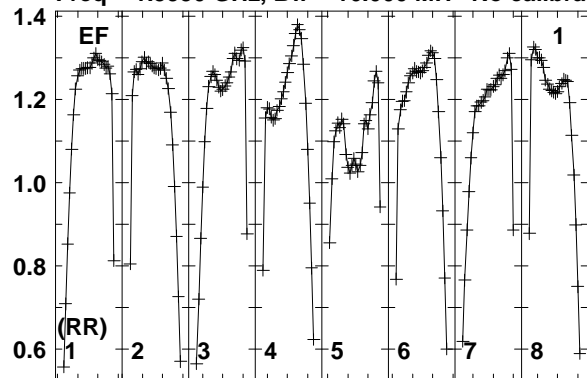

Lower frame: Real Jy
Total-power spectrum Antenna: EF (01)
Timerange: 00/00:12:00 to 00/00:13:30

Plot file version 9 created 19-AUG-2016 17:19:13

J1642+2523 EM119D.UVDATA.1

Freq = 1.5950 GHz, Bw = 16.000 MH No calibration applied and no bandpass applied

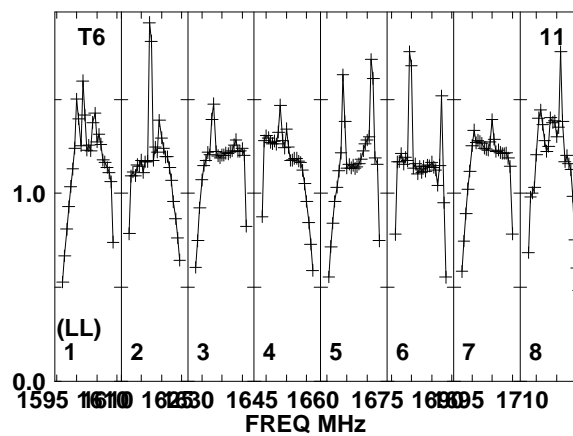
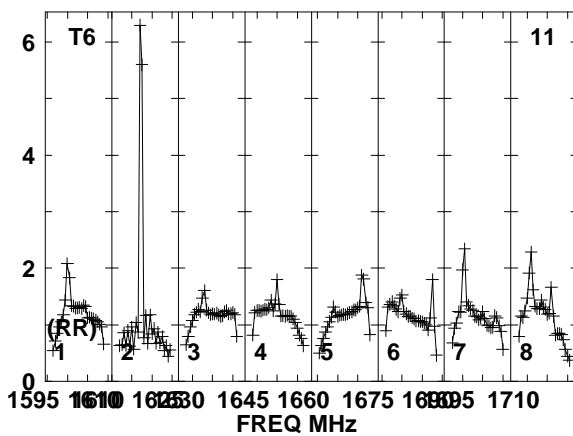
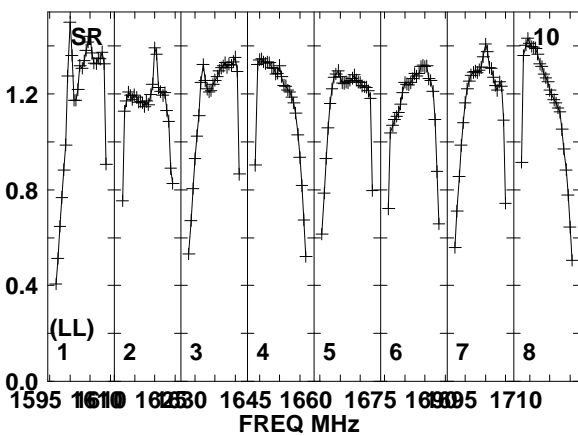
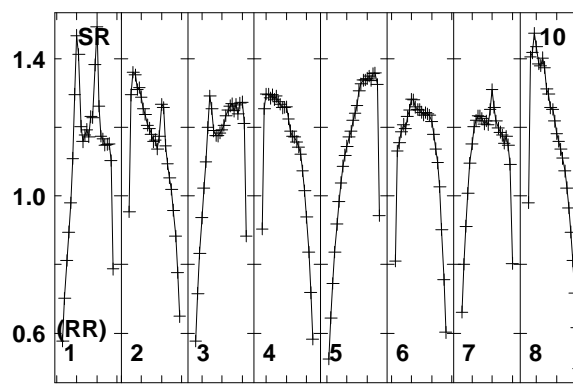
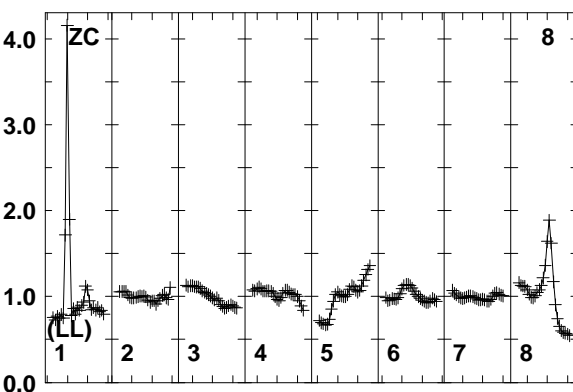
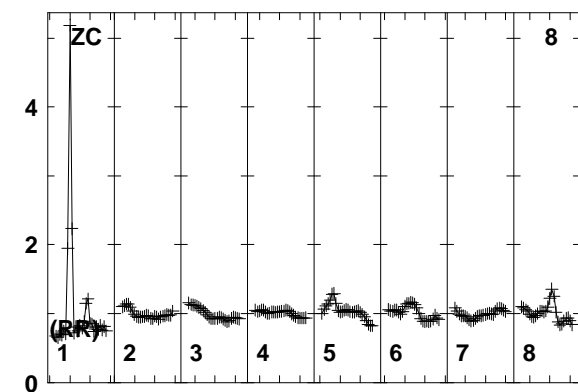
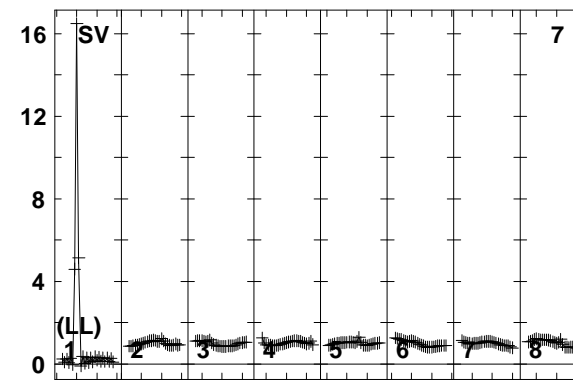
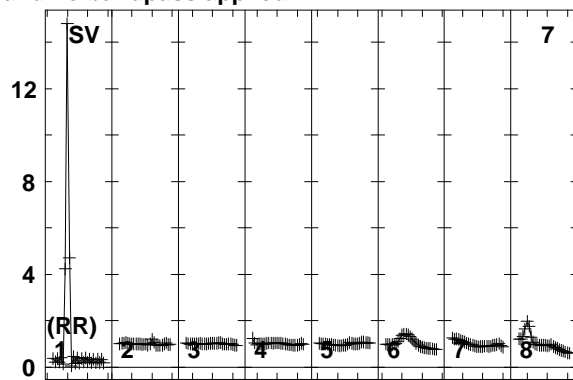
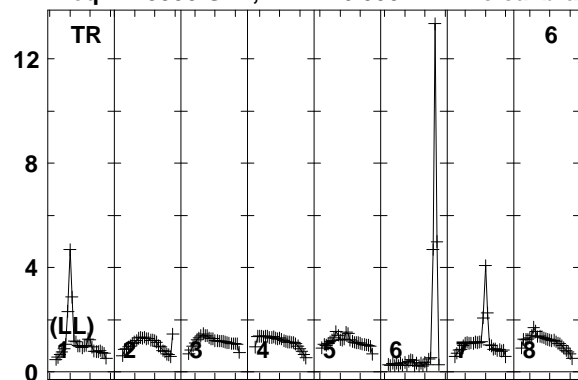

Lower frame: Real Jy
Total-power spectrum Antenna: TR (06)
Timerange: 00/00:12:00 to 00/00:13:30

Plot file version 10 created 19-AUG-2016 17:19:13

J1649+2635 EM119D.UVDATA.1

Freq = 1.5950 GHz, Bw = 16.000 MH No calibration applied and no bandpass applied

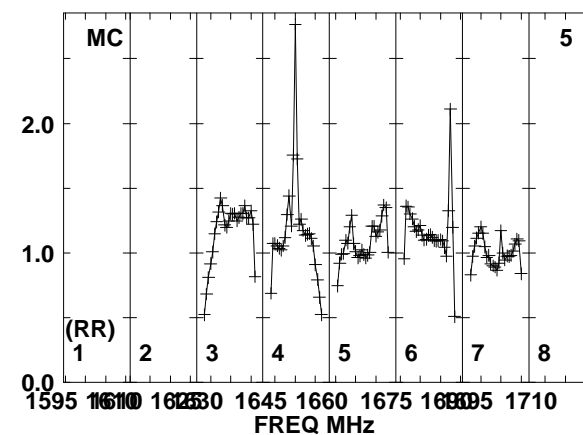
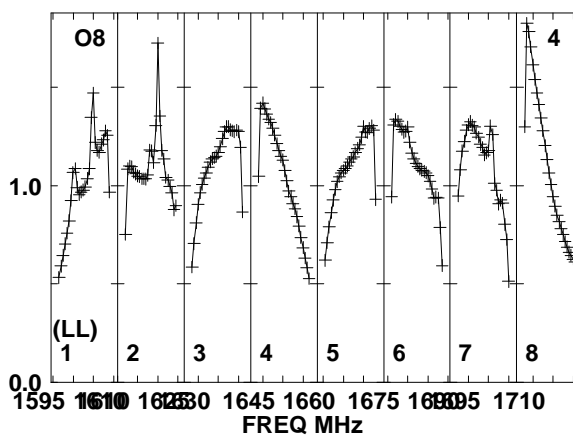
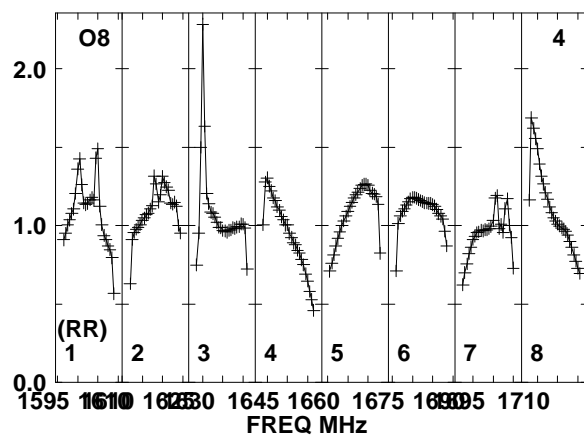
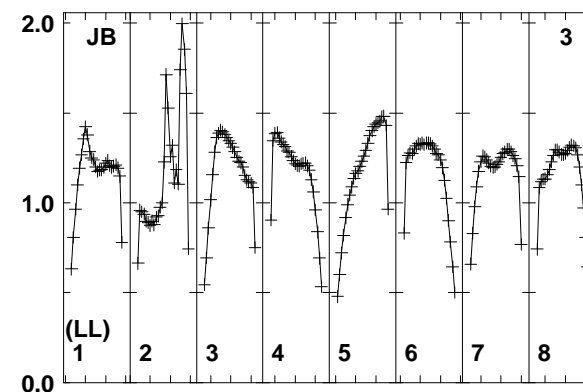
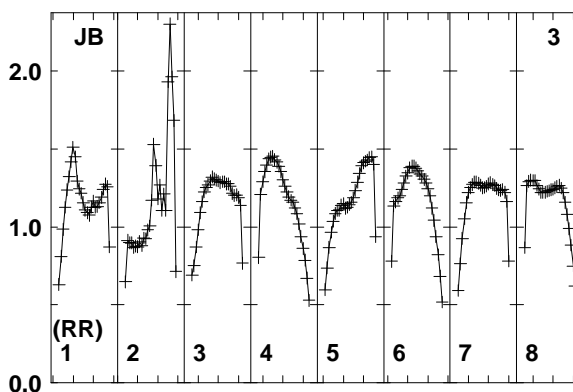
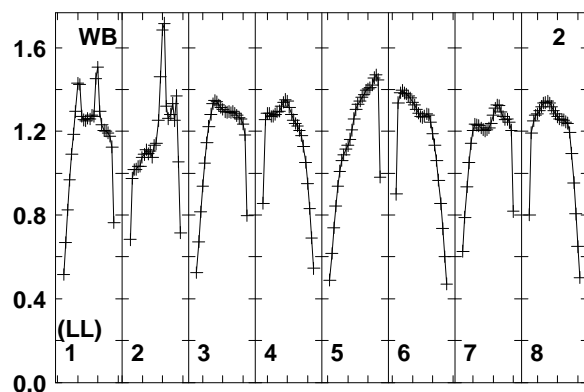
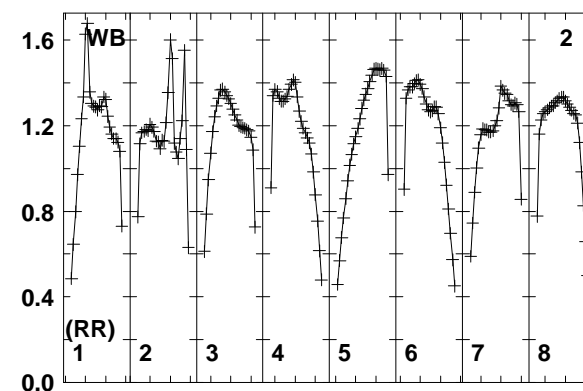
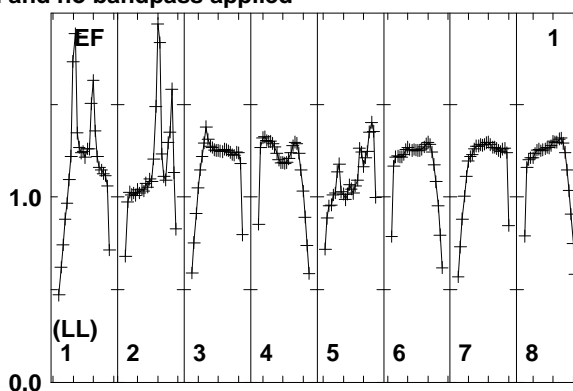
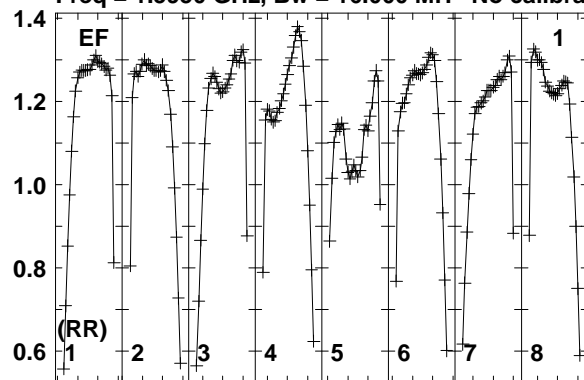

Lower frame: Real Jy
Total-power spectrum Antenna: EF (01)
Timerange: 00/00:13:32 to 00/00:17:00

Plot file version 11 created 19-AUG-2016 17:19:13

J1649+2635 EM119D.UVDATA.1

Freq = 1.5950 GHz, Bw = 16.000 MH No calibration applied and no bandpass applied

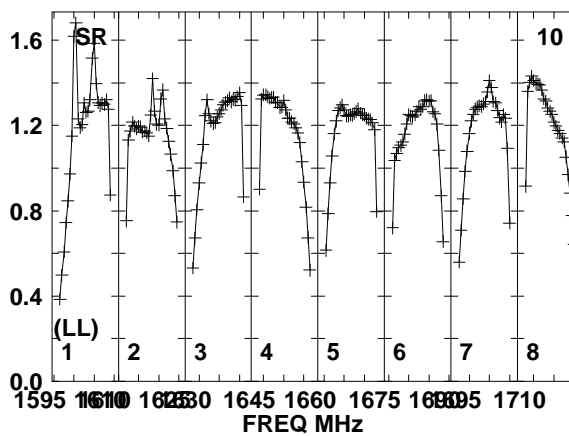
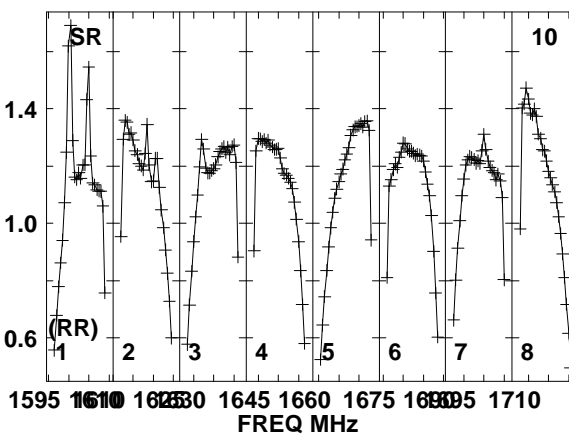
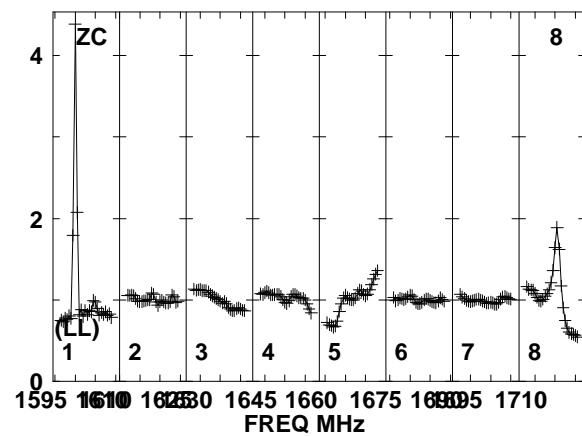
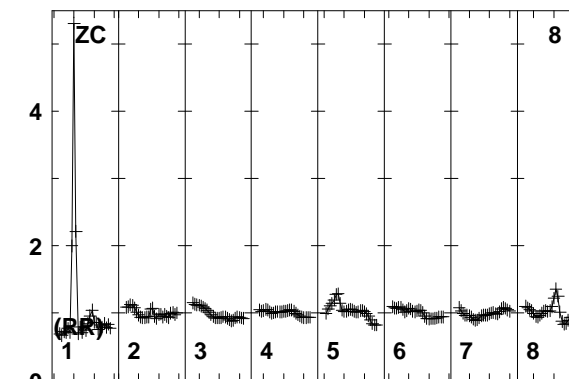
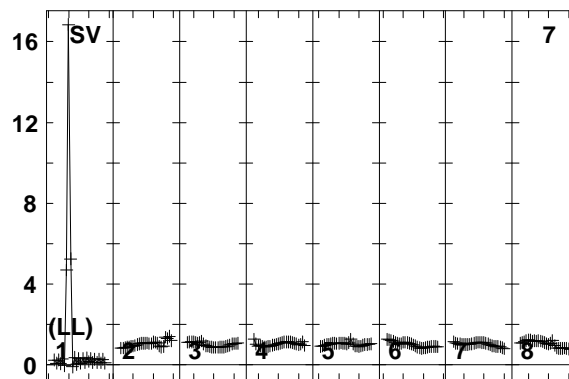
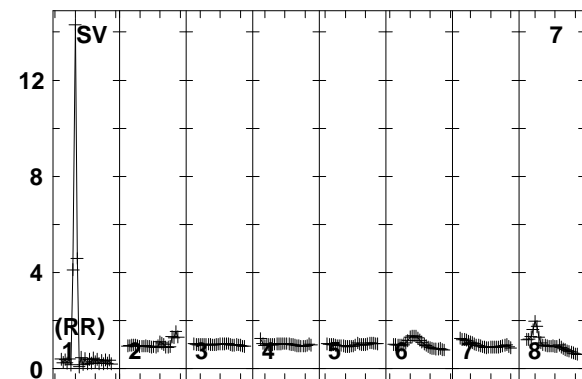
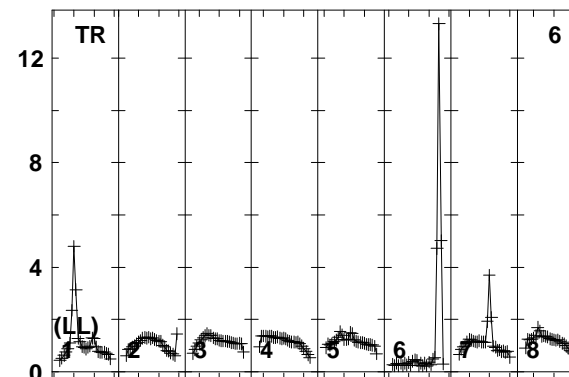
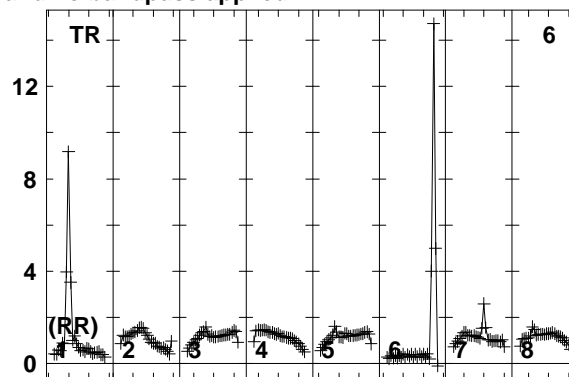
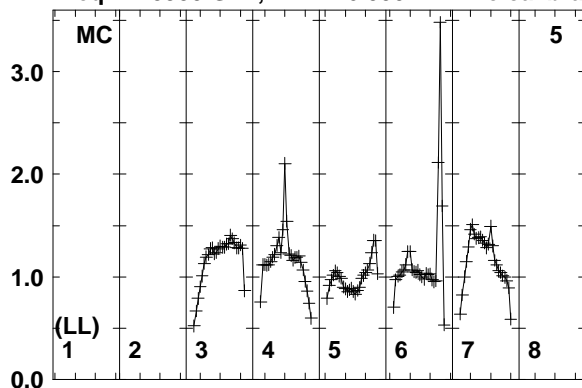

Lower frame: Real Jy
Total-power spectrum Antenna: MC (05)
Timerange: 00/00:13:32 to 00/00:17:00

Plot file version 12 created 19-AUG-2016 17:19:13

J1649+2635 EM119D.UVDATA.1

Freq = 1.5950 GHz, Bw = 16.000 MH No calibration applied and no bandpass applied

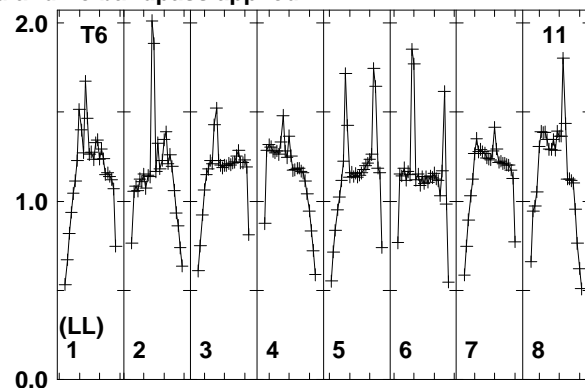
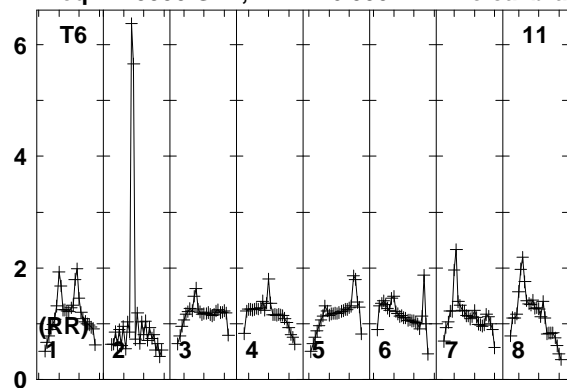

Lower frame: Real Jy
Total-power spectrum Antenna: T6 (11)
Timerange: 00/00:13:32 to 00/00:17:00

Plot file version 13 created 19-AUG-2016 17:19:13

J1642+2523 EM119D.UVDATA.1

Freq = 1.5950 GHz, Bw = 16.000 MH No calibration applied and no bandpass applied

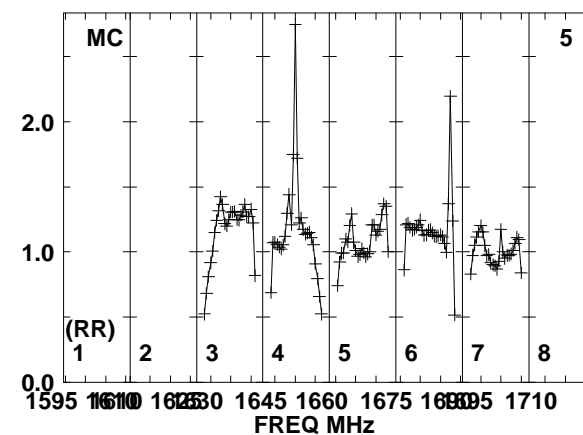
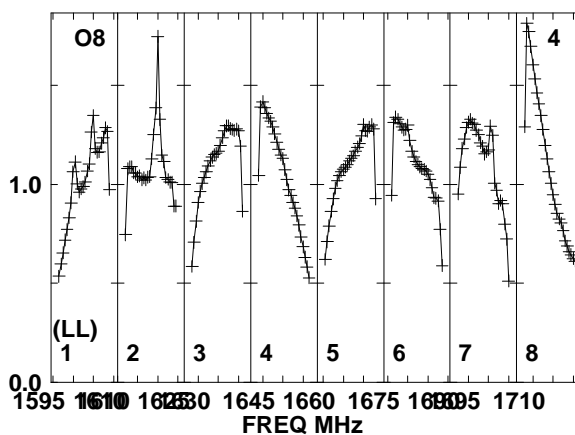
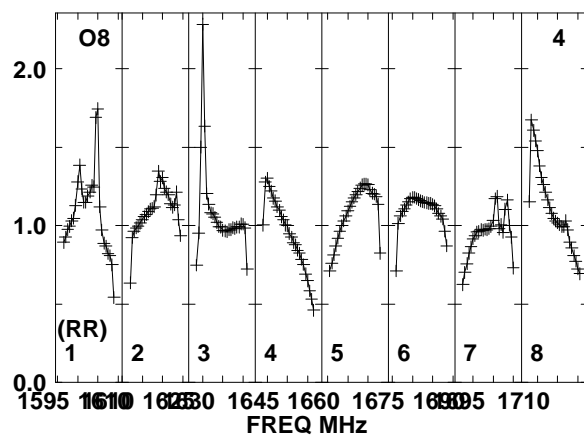
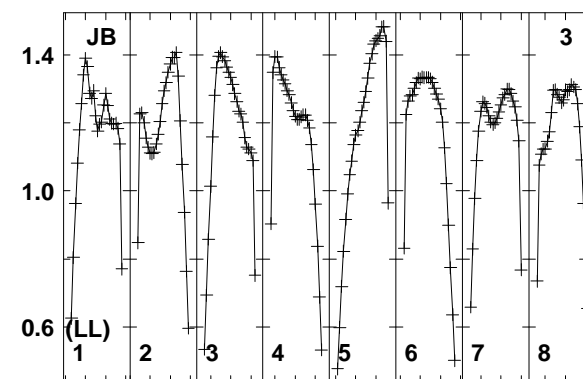
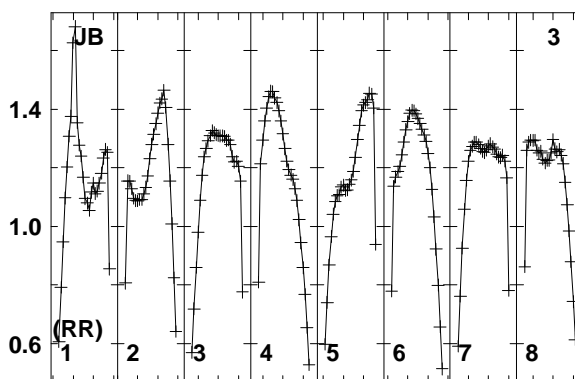
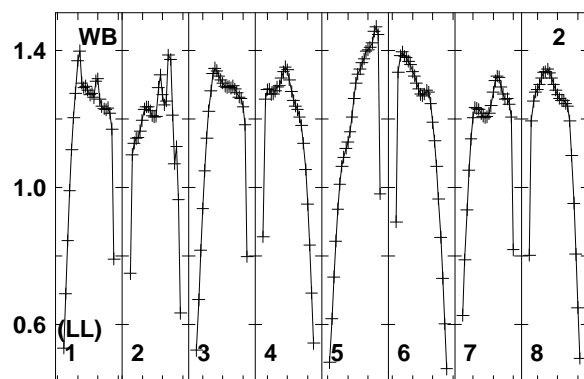
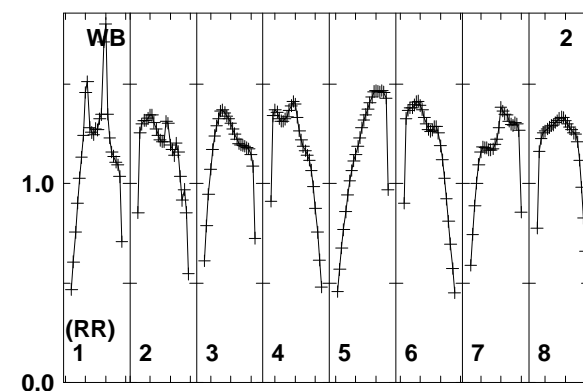
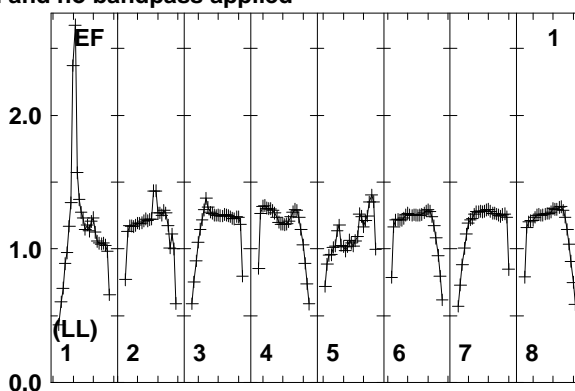
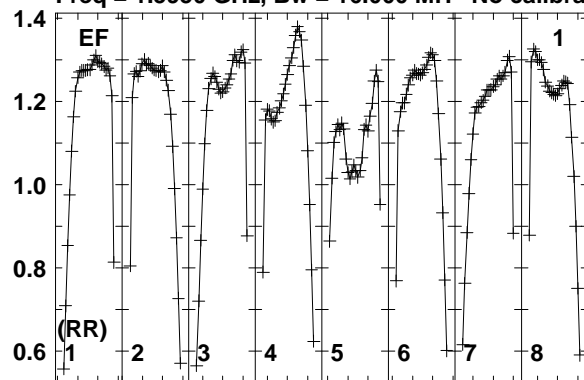

Lower frame: Real Jy
Total-power spectrum Antenna: EF (01)
Timerange: 00/00:17:08 to 00/00:18:30

Plot file version 14 created 19-AUG-2016 17:19:14

J1642+2523 EM119D.UVDATA.1

Freq = 1.5950 GHz, Bw = 16.000 MH No calibration applied and no bandpass applied

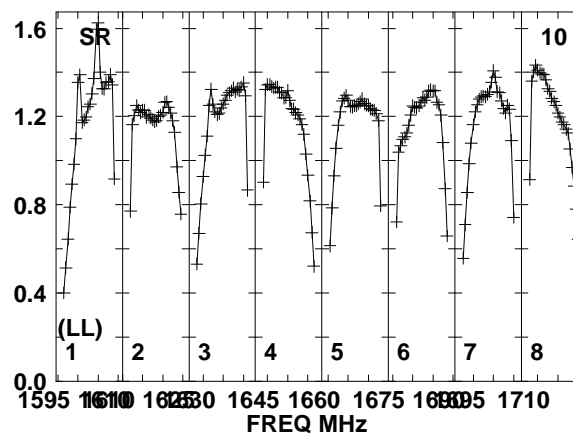
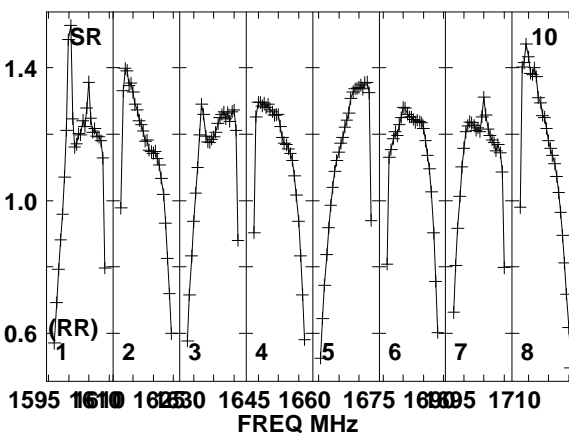
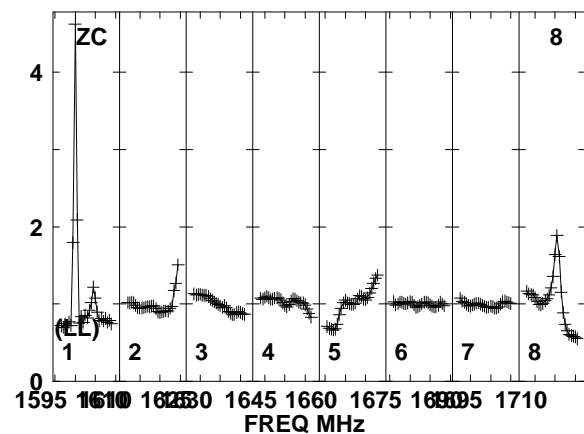
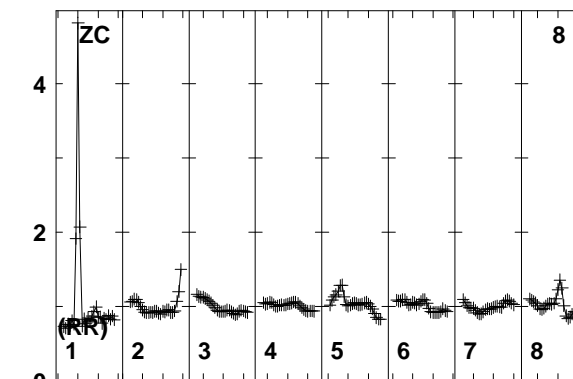
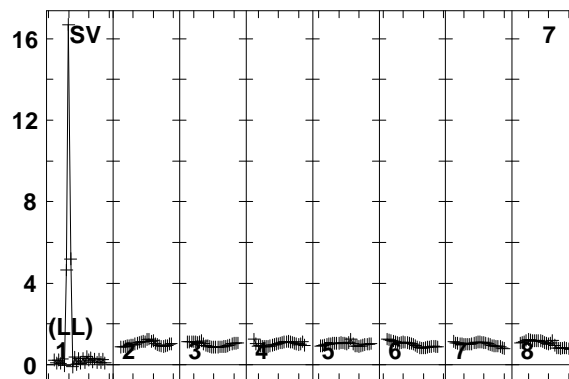
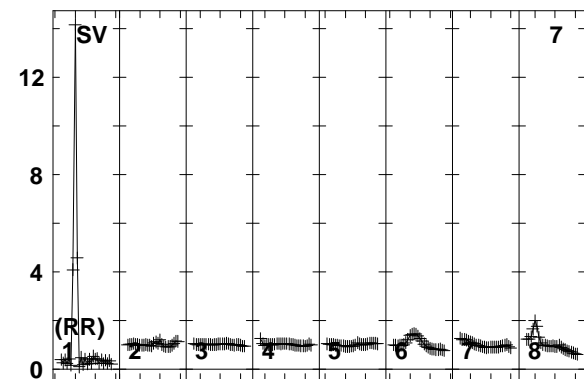
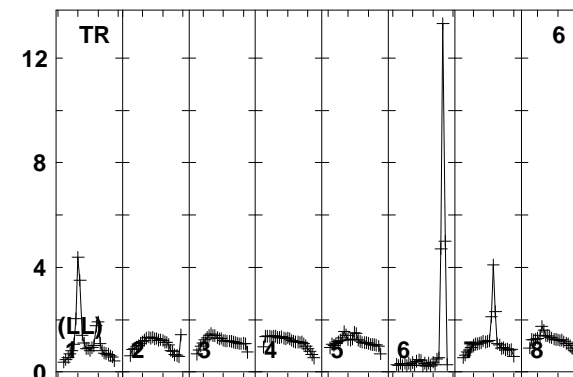
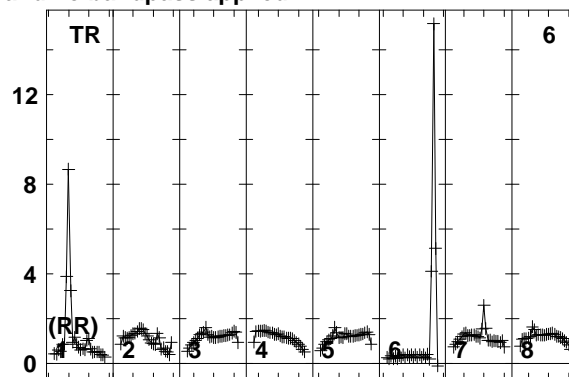
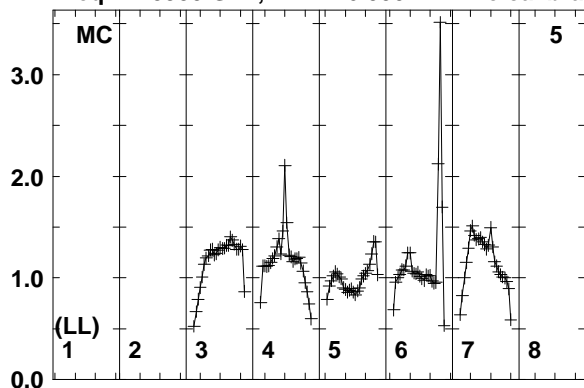

Lower frame: Real Jy
Total-power spectrum Antenna: MC (05)
Timerange: 00/00:17:08 to 00/00:18:30

Plot file version 15 created 19-AUG-2016 17:19:14

J1642+2523 EM119D.UVDATA.1

Freq = 1.5950 GHz, Bw = 16.000 MH No calibration applied and no bandpass applied

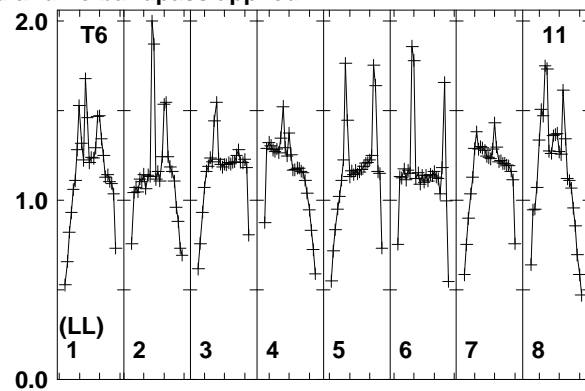
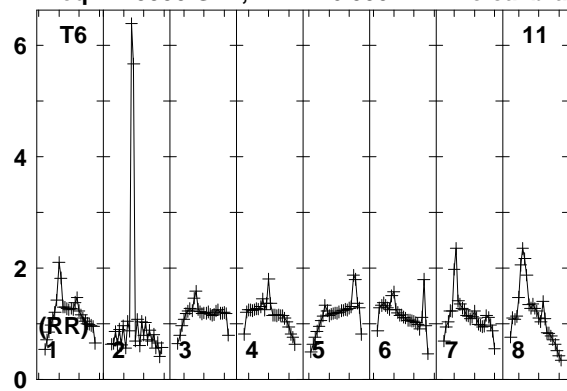

Lower frame: Real Jy
Total-power spectrum Antenna: T6 (11)
Timerange: 00/00:17:08 to 00/00:18:30

Plot file version 16 created 19-AUG-2016 17:19:14

J1649+2635 EM119D.UVDATA.1

Freq = 1.5950 GHz, Bw = 16.000 MH No calibration applied and no bandpass applied

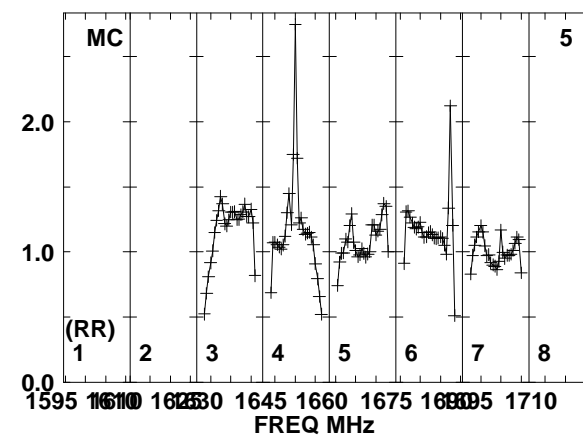
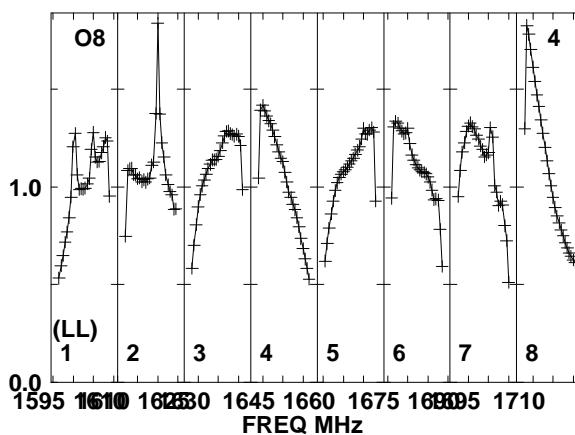
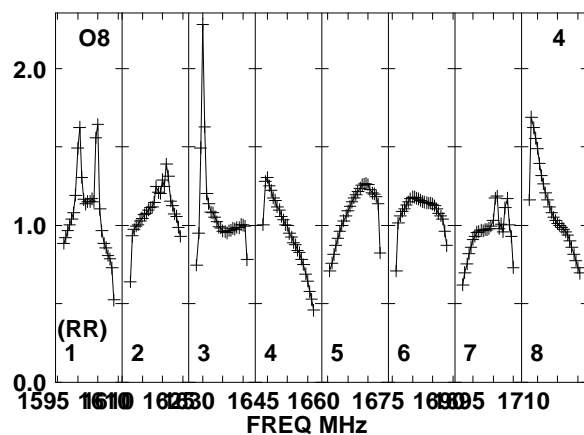
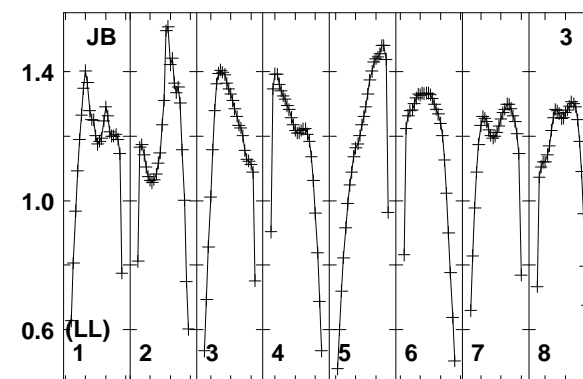
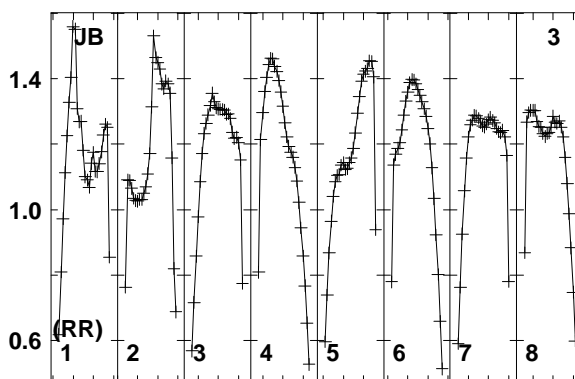
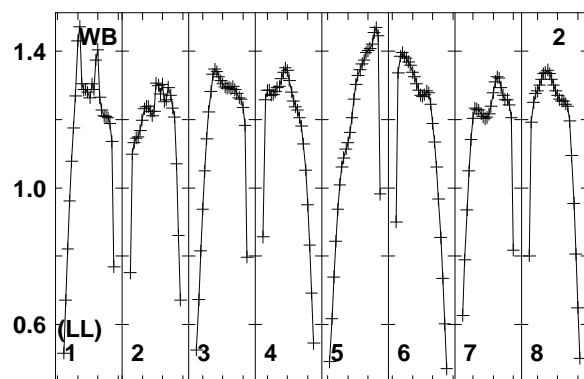
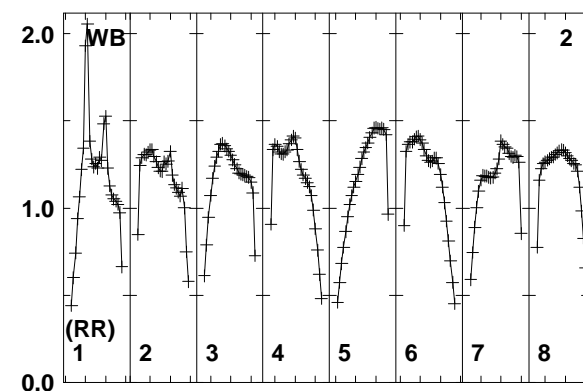
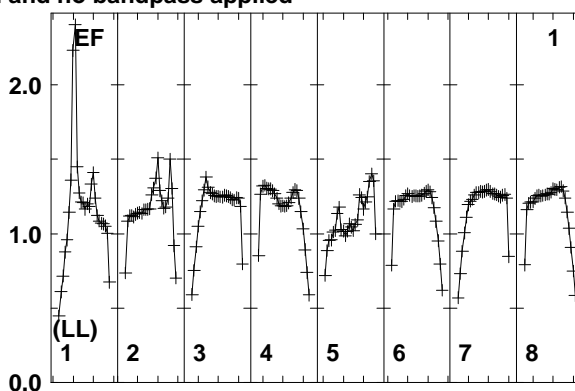
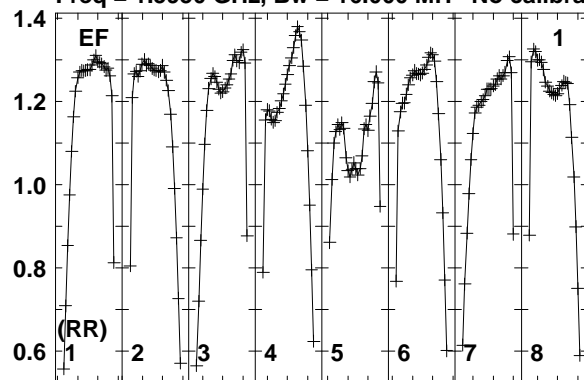

Lower frame: Real Jy
Total-power spectrum Antenna: EF (01)
Timerange: 00/00:18:38 to 00/00:22:00

Plot file version 17 created 19-AUG-2016 17:19:14

J1649+2635 EM119D.UVDATA.1

Freq = 1.5950 GHz, Bw = 16.000 MH No calibration applied and no bandpass applied

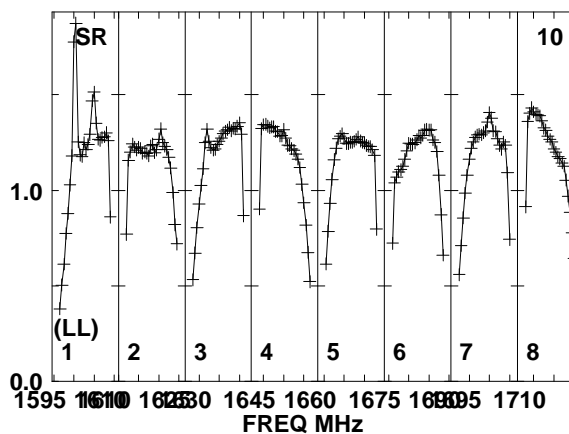
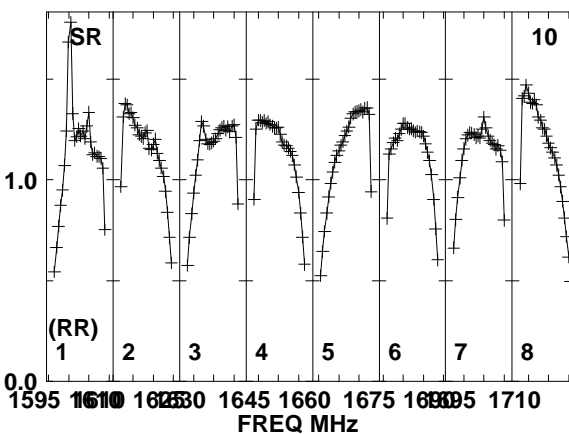
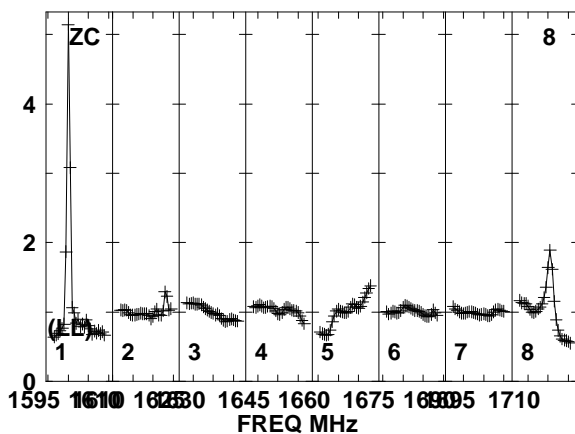
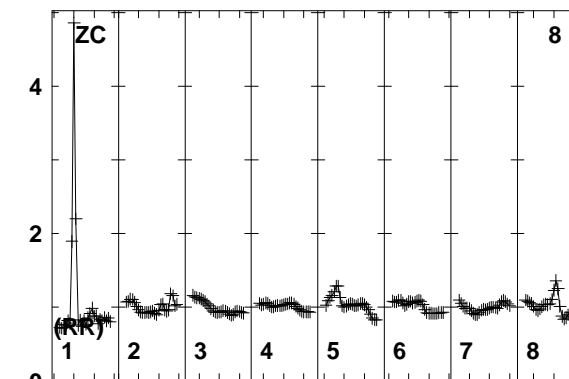
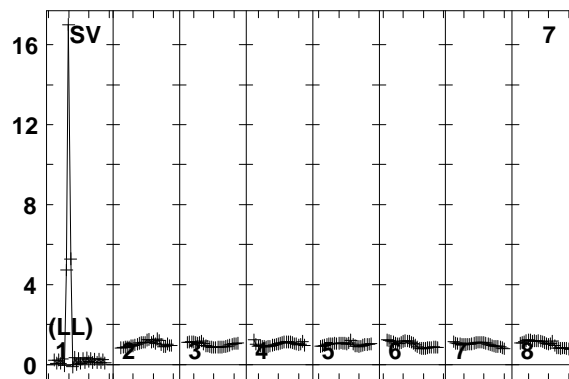
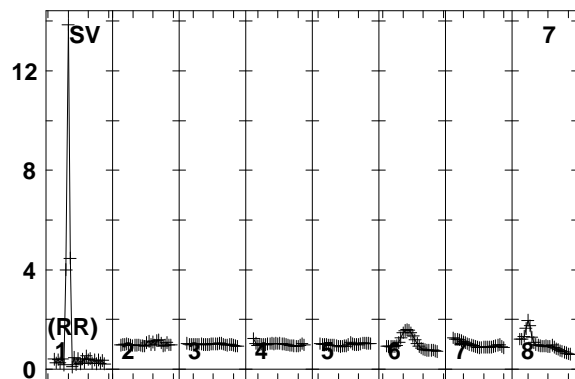
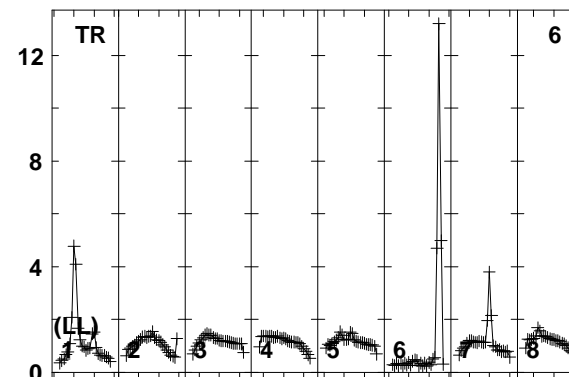
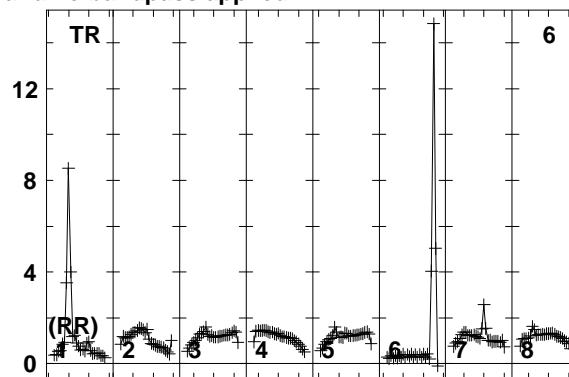
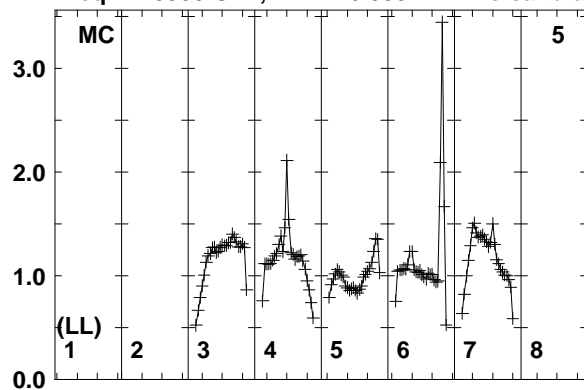

Lower frame: Real Jy
Total-power spectrum Antenna: MC (05)
Timerange: 00/00:18:38 to 00/00:22:00

Plot file version 18 created 19-AUG-2016 17:19:14

J1649+2635 EM119D.UVDATA.1

Freq = 1.5950 GHz, Bw = 16.000 MH No calibration applied and no bandpass applied

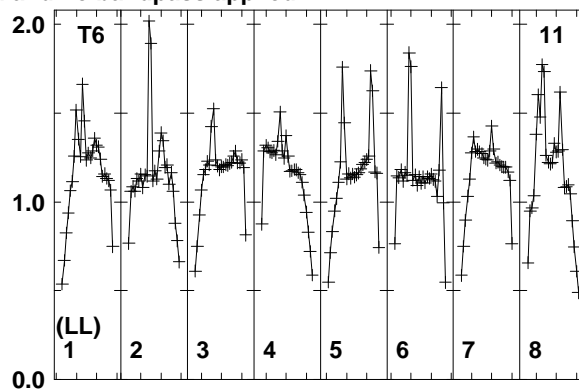
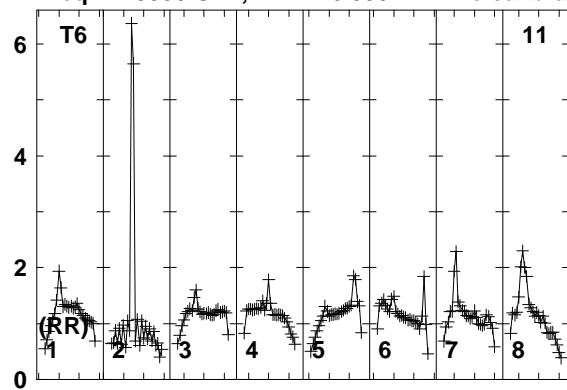

Lower frame: Real Jy
Total-power spectrum Antenna: T6 (11)
Timerange: 00/00:18:38 to 00/00:22:00

Plot file version 19 created 19-AUG-2016 17:19:14

J1642+2523 EM119D.UVDATA.1

Freq = 1.5950 GHz, Bw = 16.000 MH No calibration applied and no bandpass applied

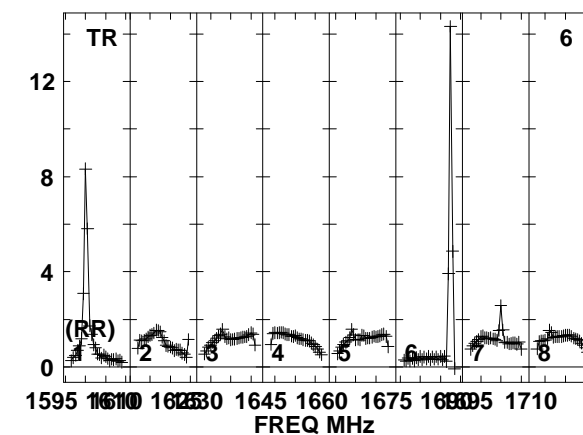
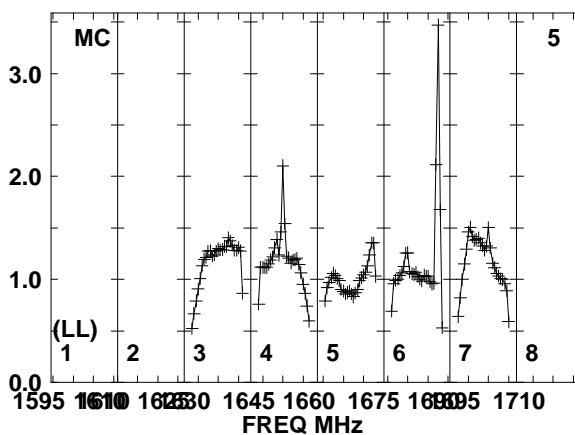
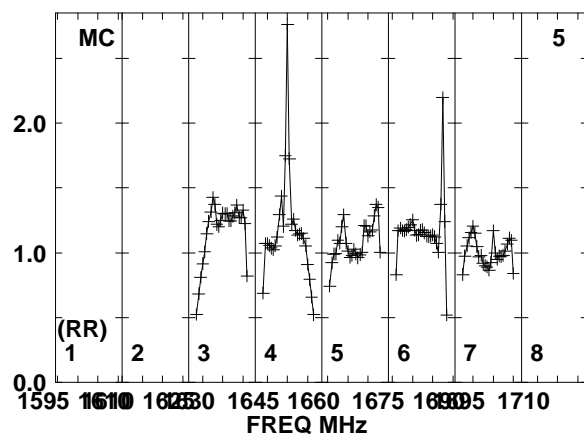
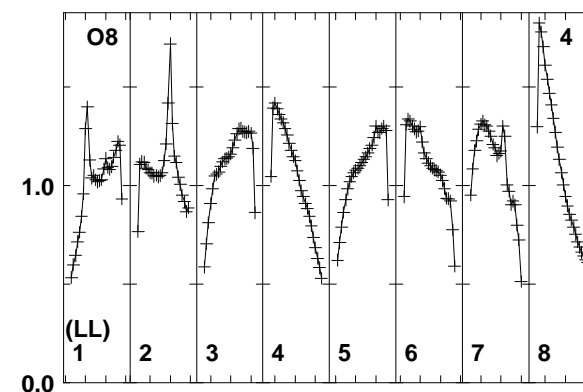
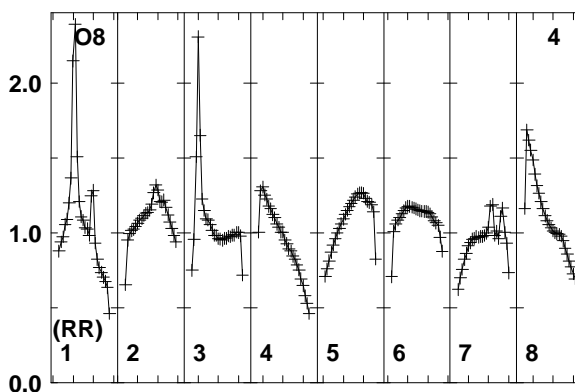
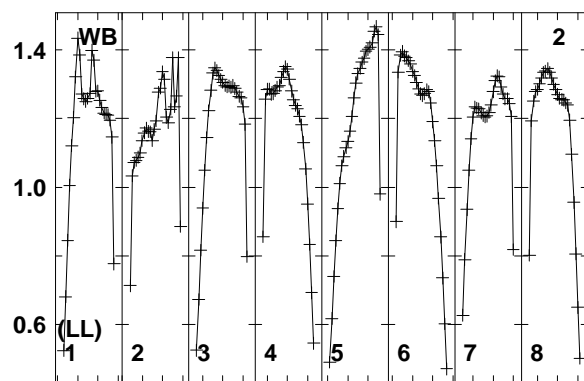
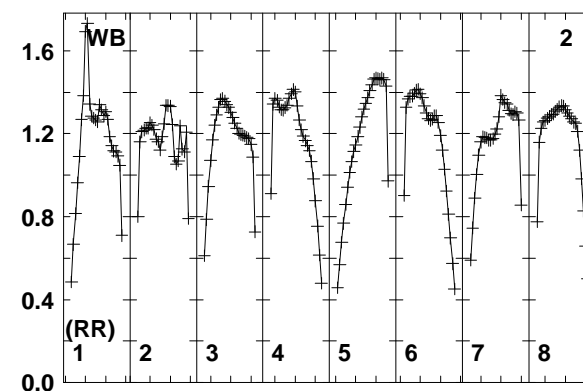
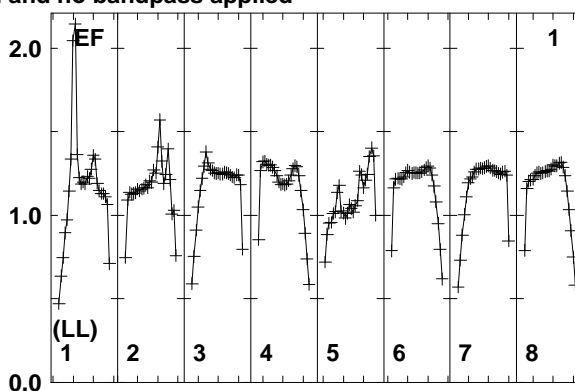
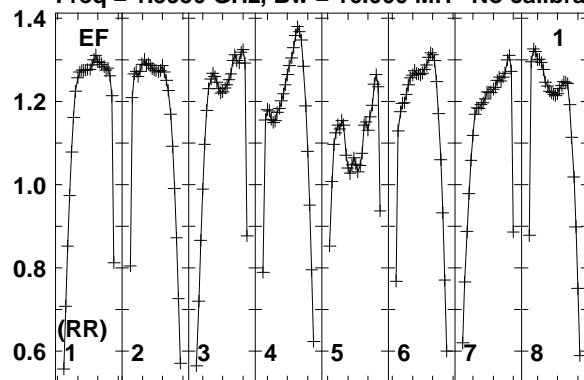

Lower frame: Real Jy
Total-power spectrum Antenna: EF (01)
Timerange: 00/00:23:00 to 00/00:24:30

Plot file version 20 created 19-AUG-2016 17:19:14

J1642+2523 EM119D.UVDATA.1

Freq = 1.5950 GHz, Bw = 16.000 MH No calibration applied and no bandpass applied

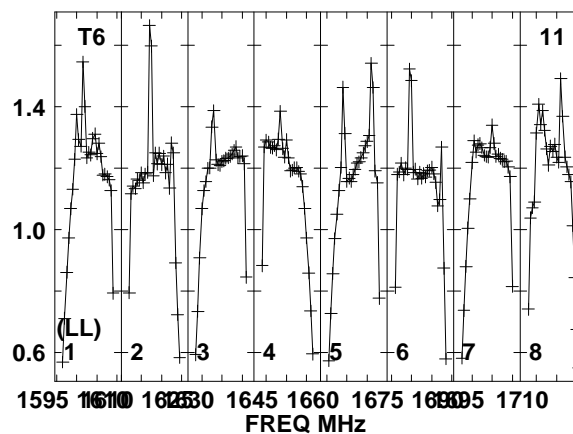
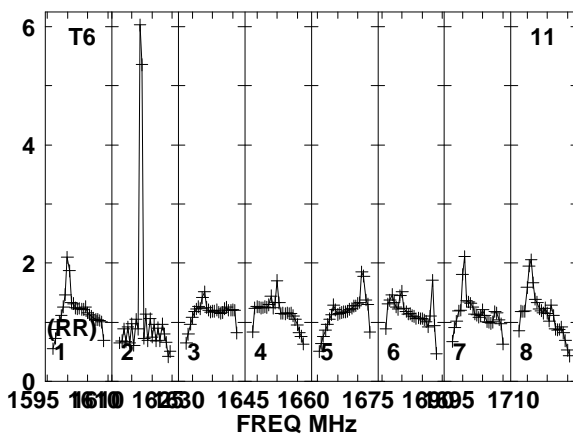
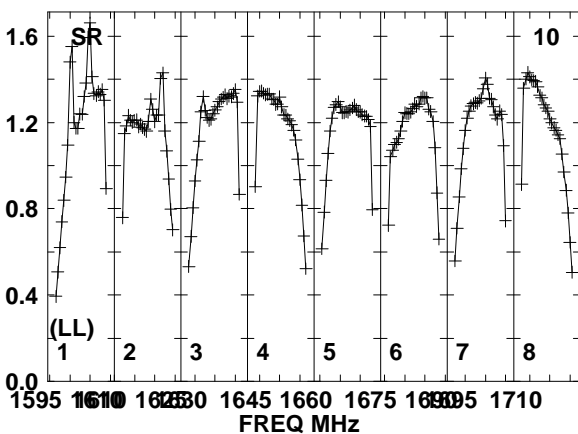
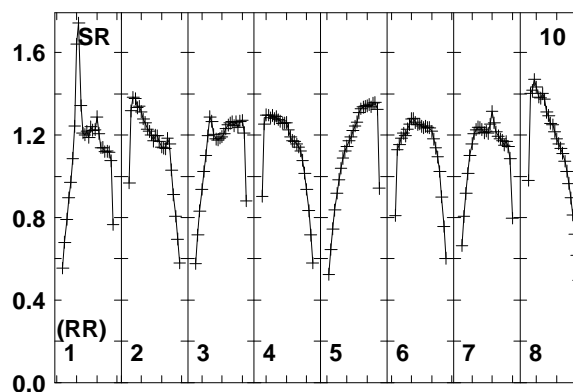
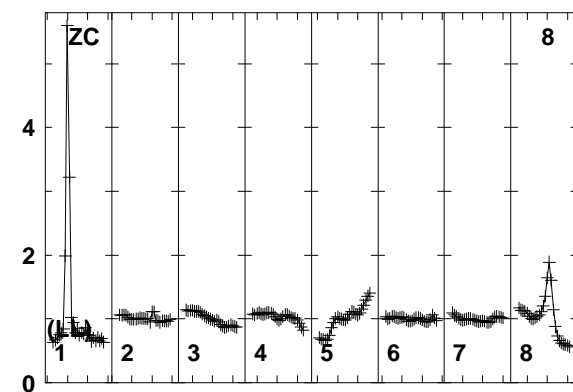
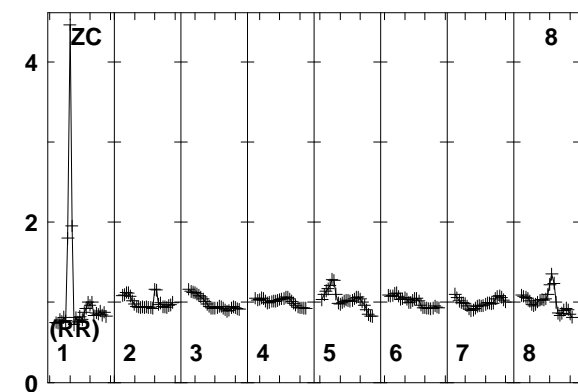
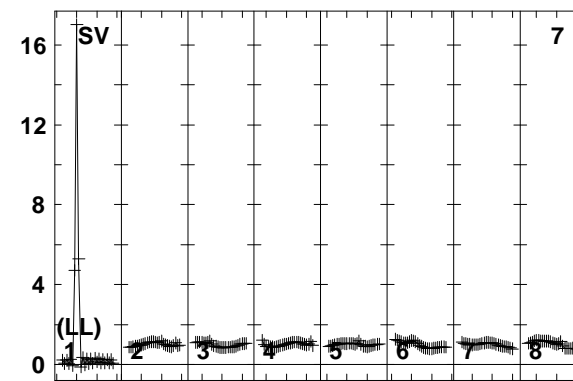
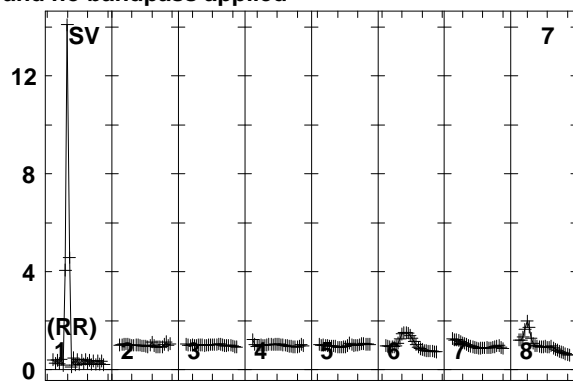
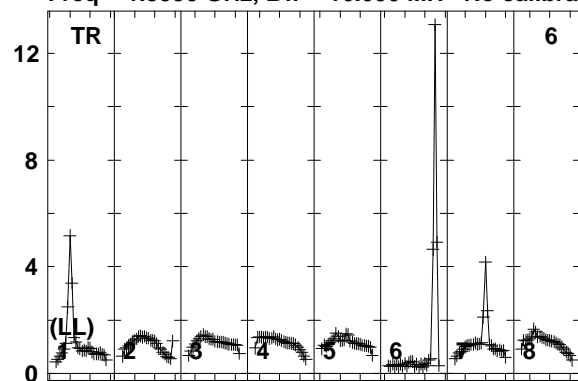

Lower frame: Real Jy
Total-power spectrum Antenna: TR (06)
Timerange: 00/00:23:00 to 00/00:24:30

Plot file version 21 created 19-AUG-2016 17:19:15

J1642+2523 EM119D.UVDATA.1

Freq = 1.5950 GHz, Bw = 16.000 MH No calibration applied and no bandpass applied

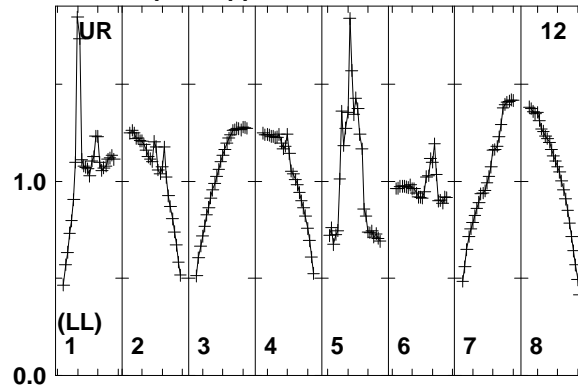
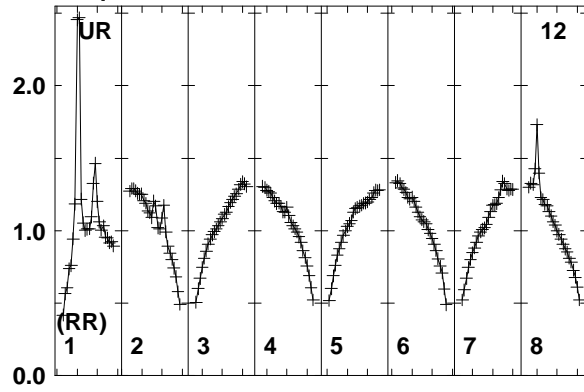

Lower frame: Real Jy
Total-power spectrum Antenna: UR (12)
Timerange: 00/00:23:00 to 00/00:24:30

Plot file version 22 created 19-AUG-2016 17:19:15

J1649+2635 EM119D.UVDATA.1

Freq = 1.5950 GHz, Bw = 16.000 MH No calibration applied and no bandpass applied

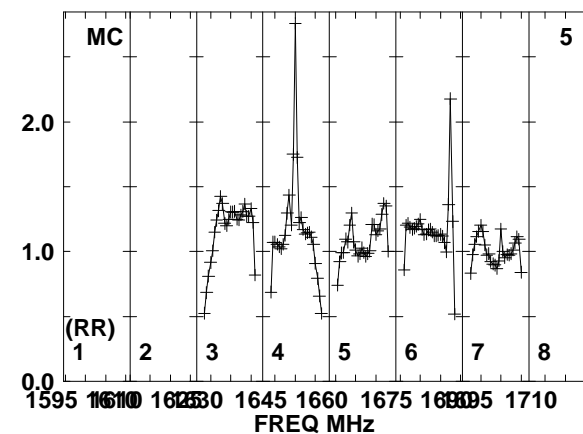
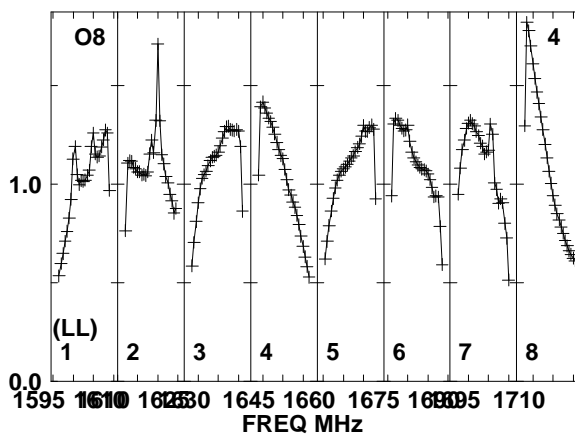
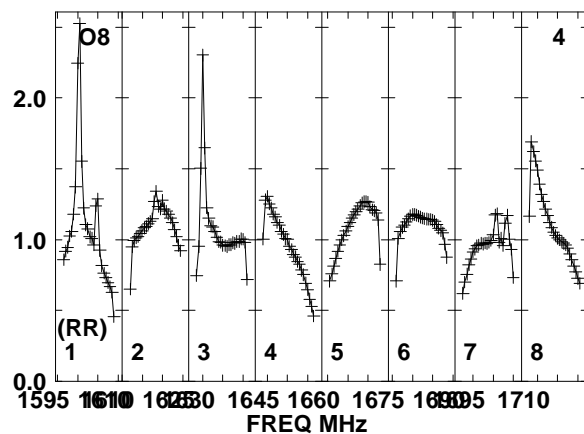
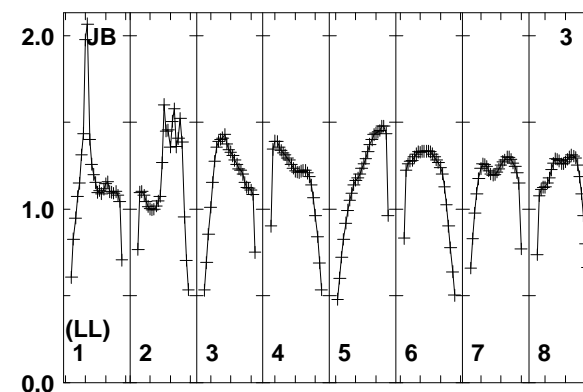
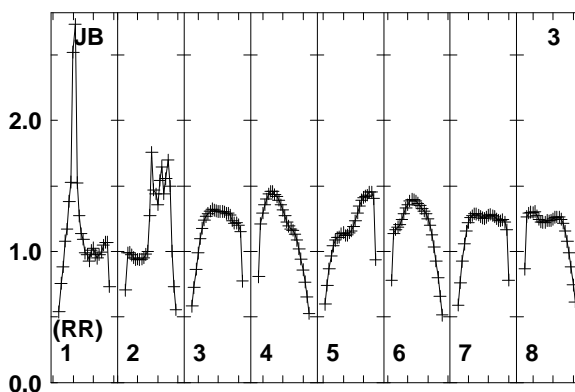
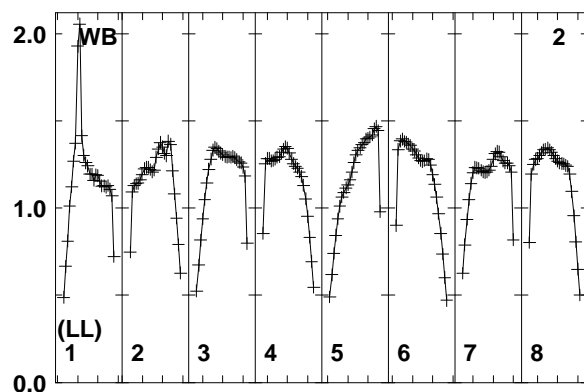
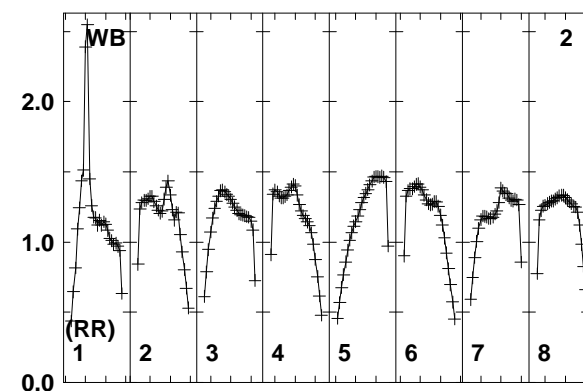
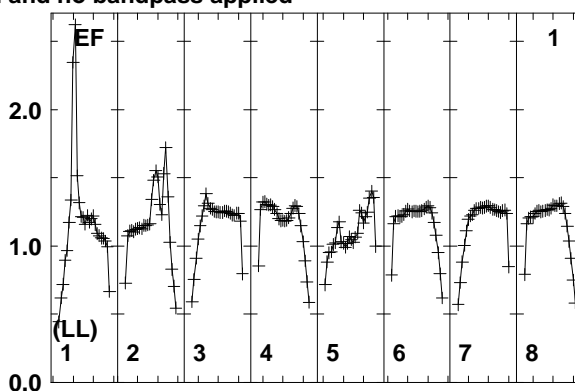
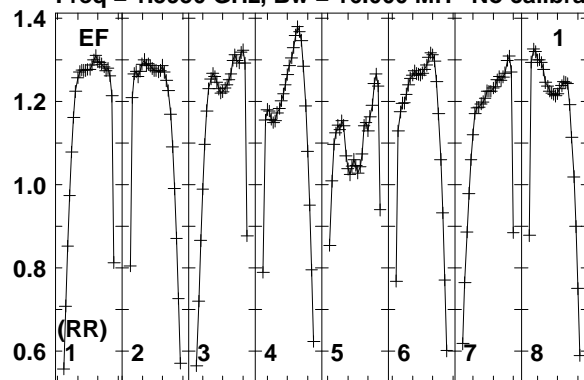

Lower frame: Real Jy
Total-power spectrum Antenna: EF (01)
Timerange: 00/00:24:31 to 00/00:28:00

Plot file version 23 created 19-AUG-2016 17:19:15

J1649+2635 EM119D.UVDATA.1

Freq = 1.5950 GHz, Bw = 16.000 MH No calibration applied and no bandpass applied

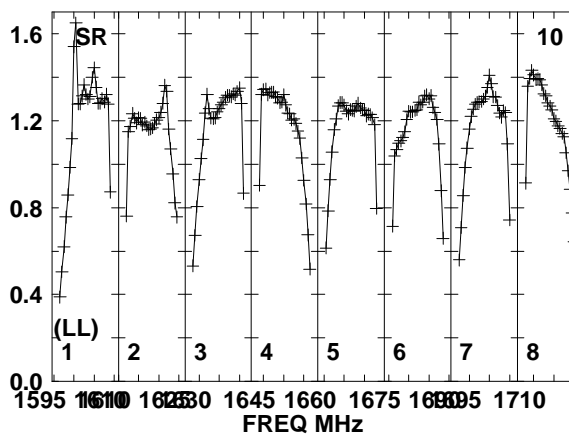
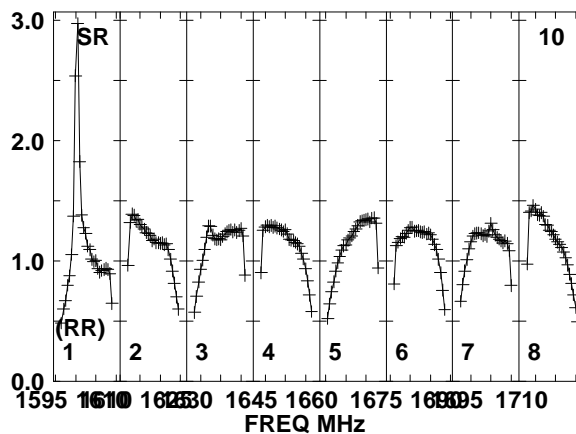
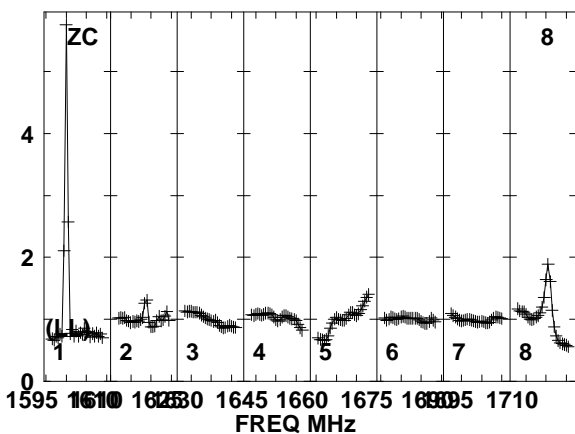
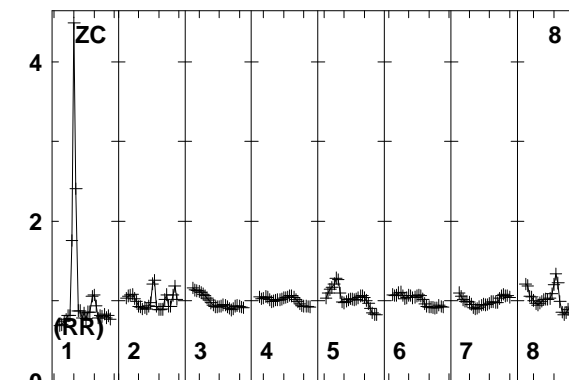
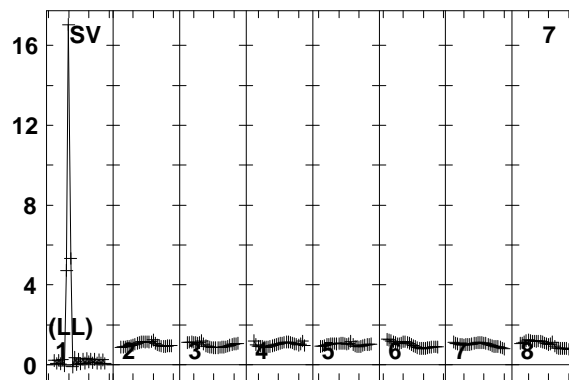
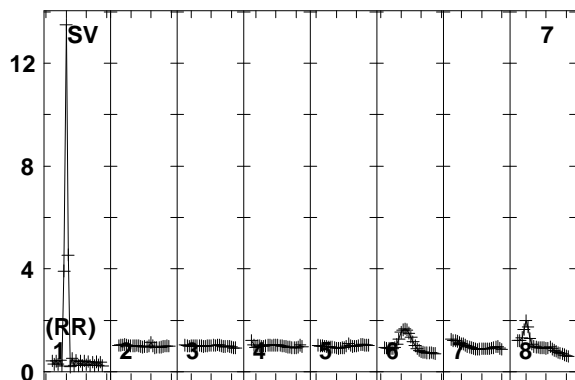
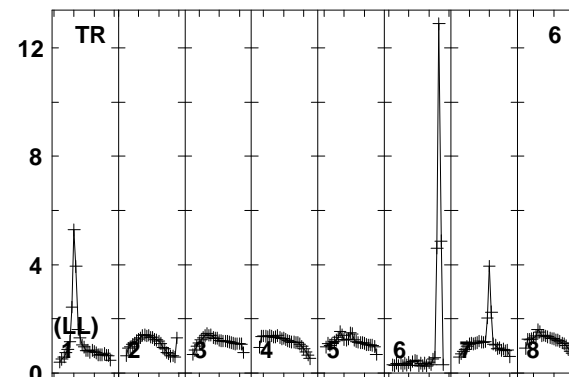
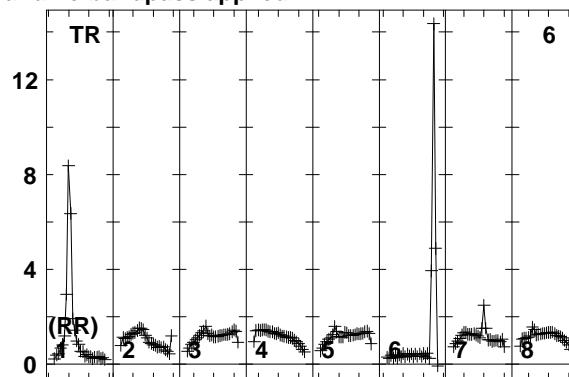
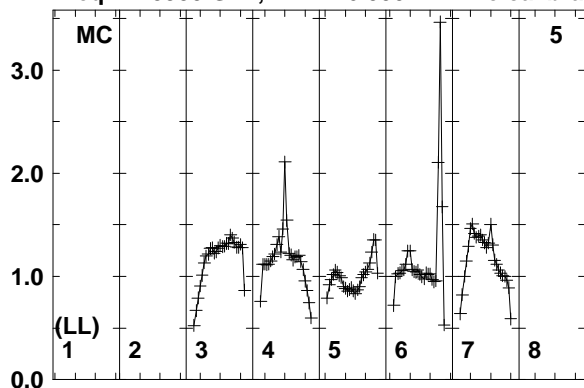

Lower frame: Real Jy
Total-power spectrum Antenna: MC (05)
Timerange: 00/00:24:31 to 00/00:28:00

Plot file version 24 created 19-AUG-2016 17:19:15

J1649+2635 EM119D.UVDATA.1

Freq = 1.5950 GHz, Bw = 16.000 MH No calibration applied and no bandpass applied

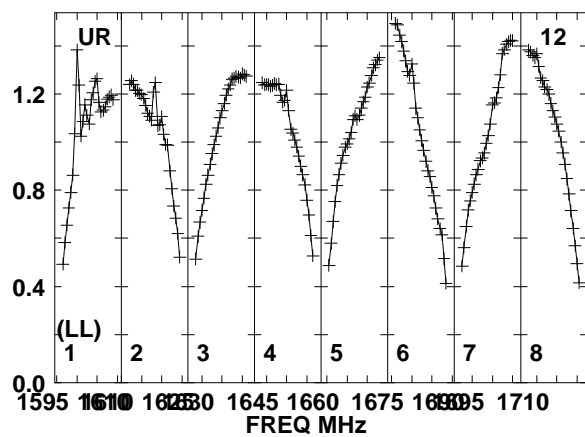
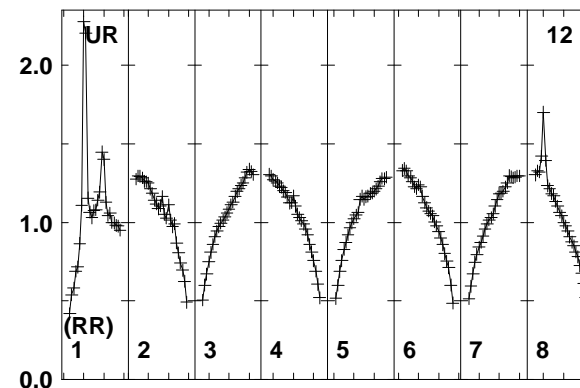
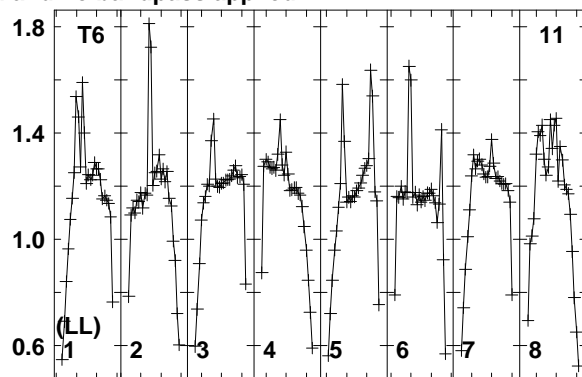
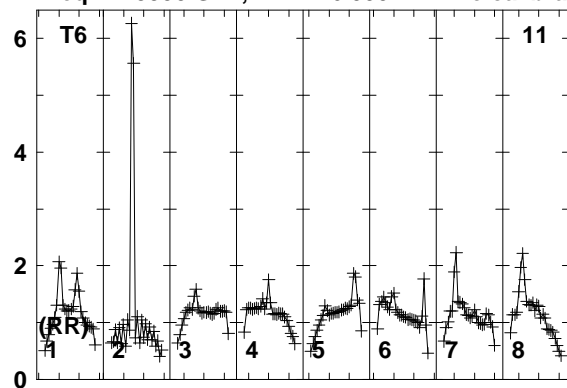

Lower frame: Real Jy
Total-power spectrum Antenna: T6 (11)
Timerange: 00/00:24:31 to 00/00:28:00

Plot file version 25 created 19-AUG-2016 17:19:15

J1642+2523 EM119D.UVDATA.1

Freq = 1.5950 GHz, Bw = 16.000 MH No calibration applied and no bandpass applied

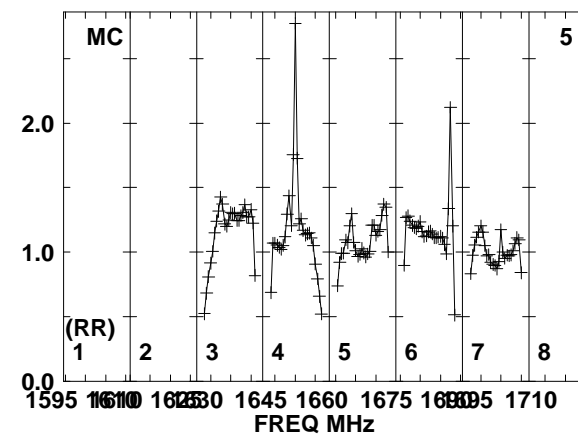
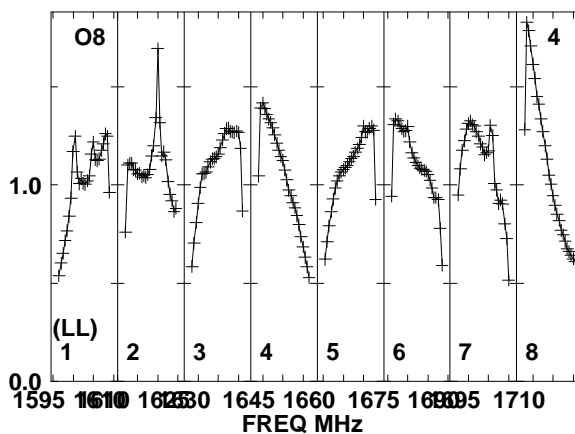
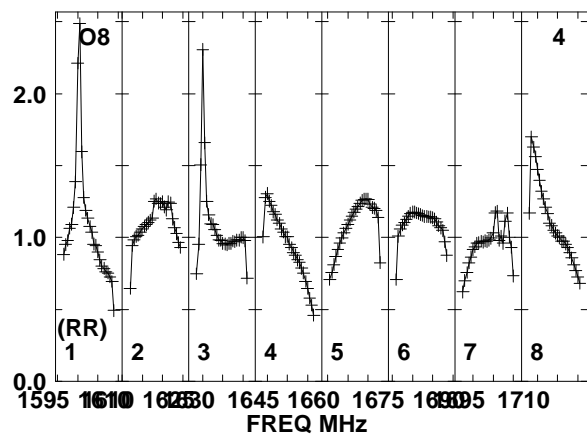
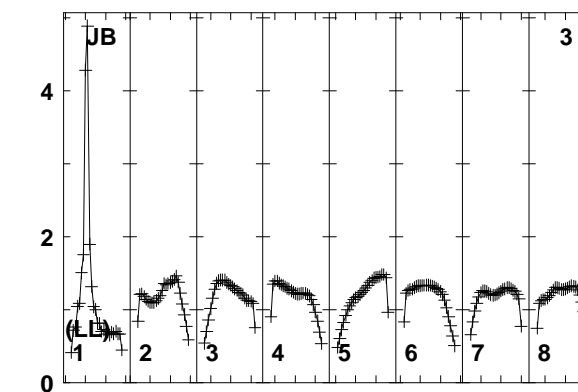
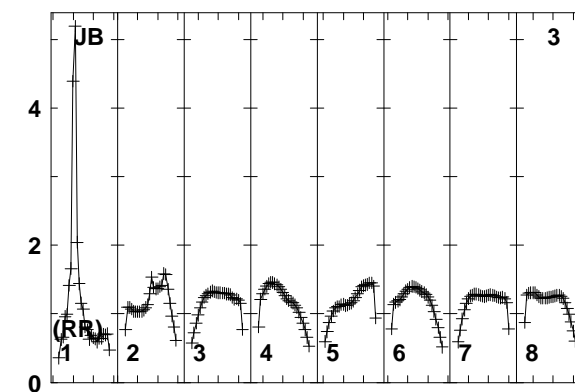
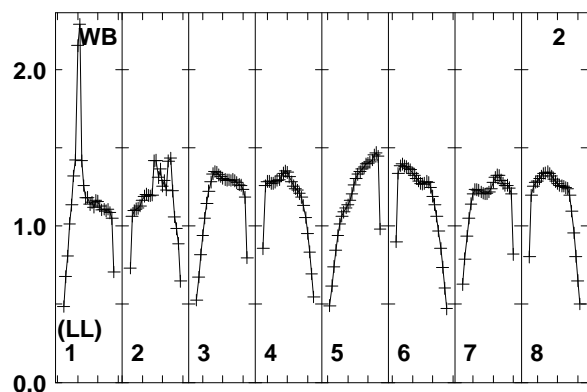
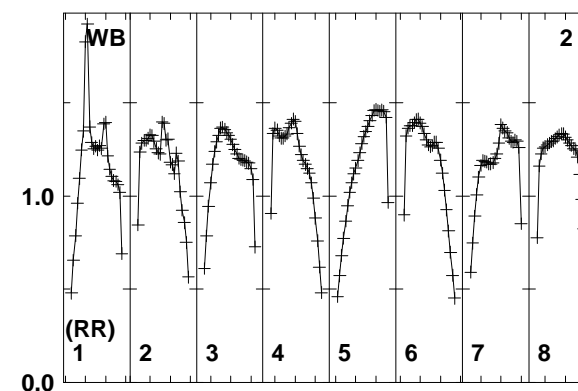
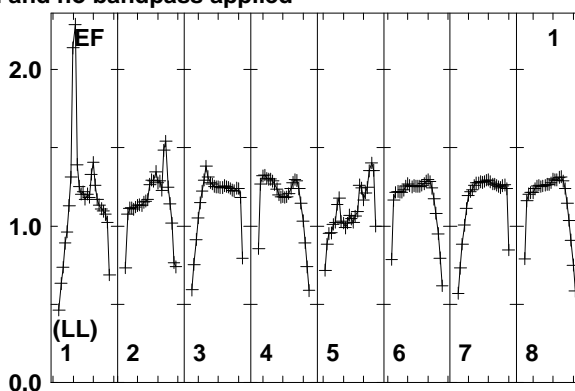
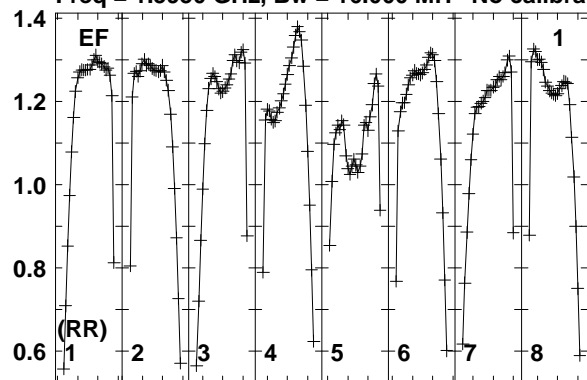

Lower frame: Real Jy
Total-power spectrum Antenna: EF (01)
Timerange: 00/00:28:08 to 00/00:29:30

Plot file version 26 created 19-AUG-2016 17:19:15
 J1642+2523 EM119D.UVDATA.1
 Freq = 1.5950 GHz, Bw = 16.000 MH No calibration applied and no bandpass applied

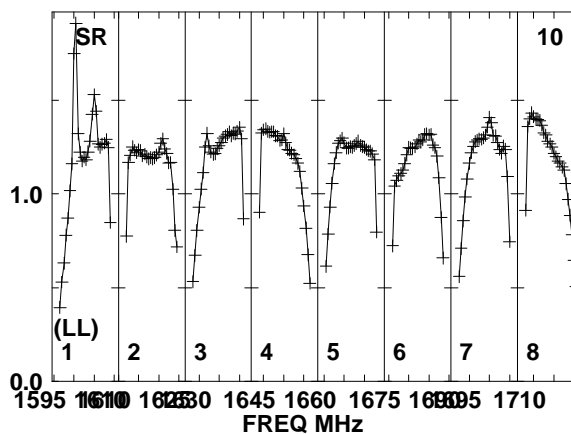
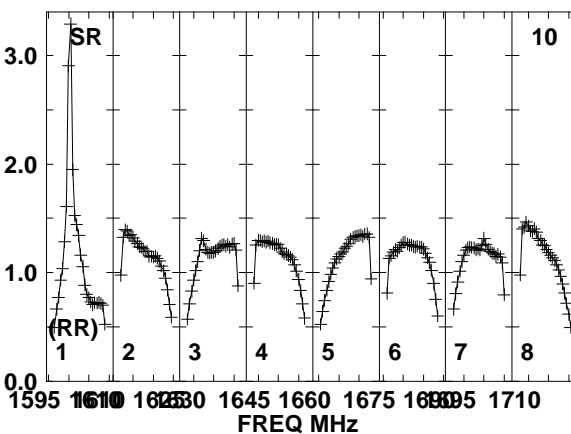
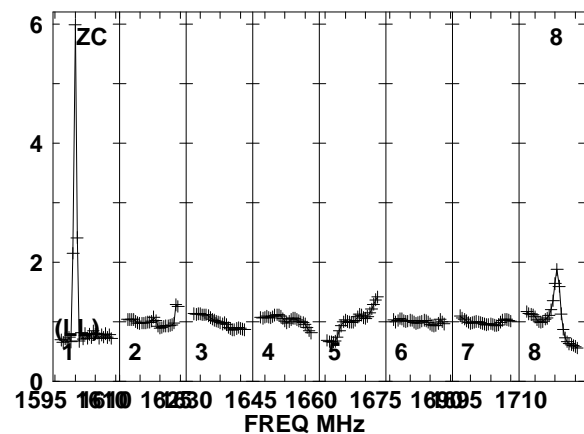
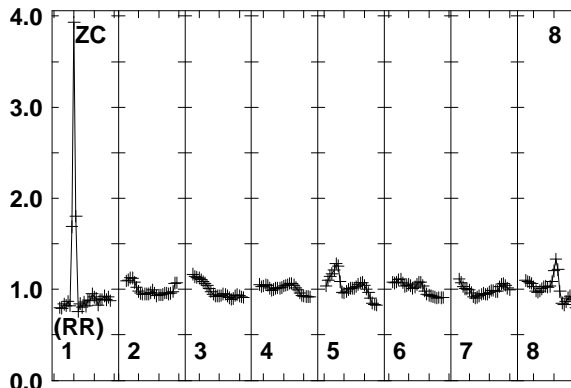
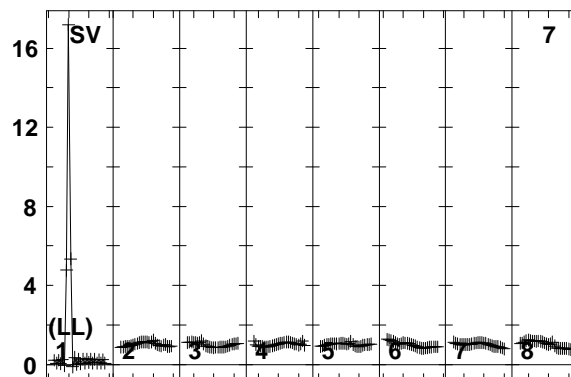
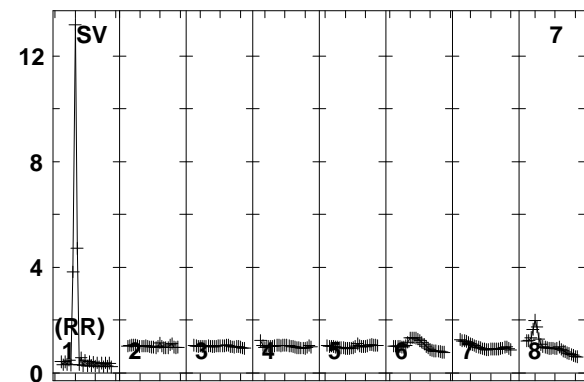
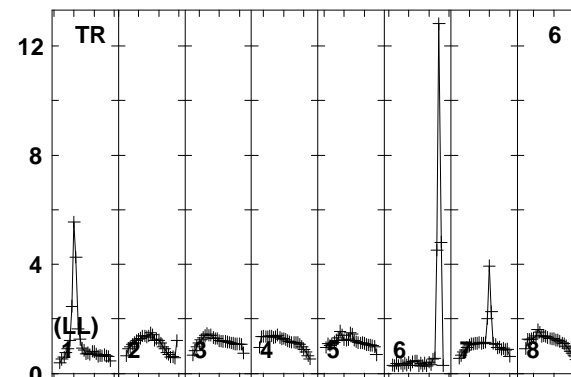
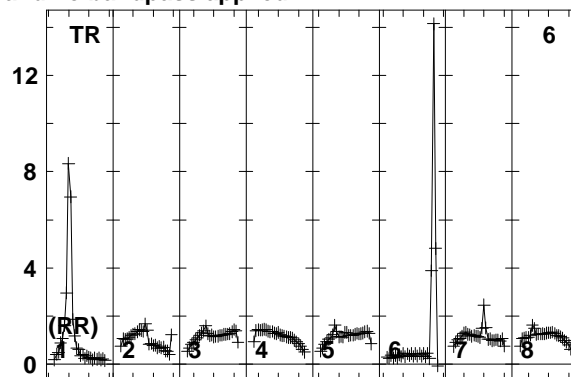
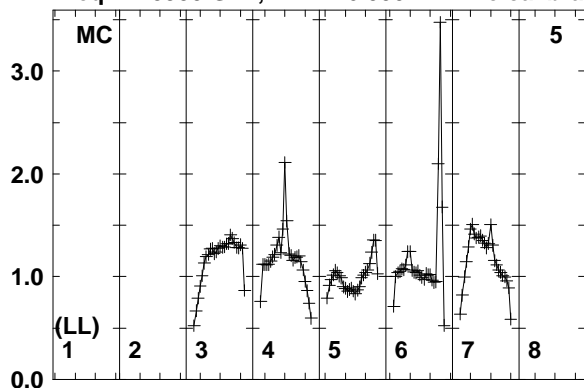

Lower frame: Real Jy
 Total-power spectrum Antenna: MC (05)
 Timerange: 00/00:28:08 to 00/00:29:30

Plot file version 27 created 19-AUG-2016 17:19:16

J1642+2523 EM119D.UVDATA.1

Freq = 1.5950 GHz, Bw = 16.000 MH No calibration applied and no bandpass applied

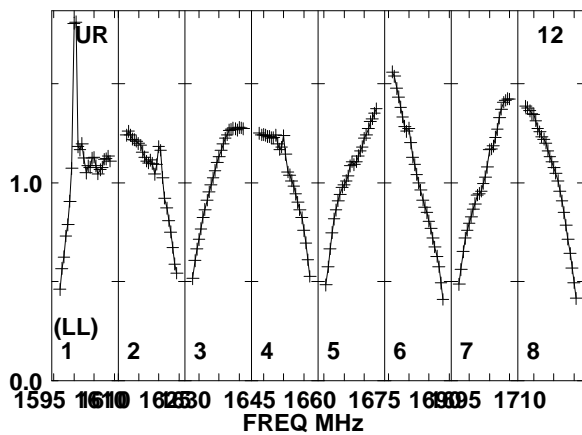
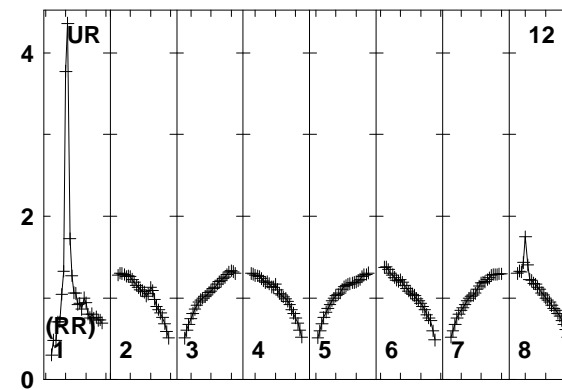
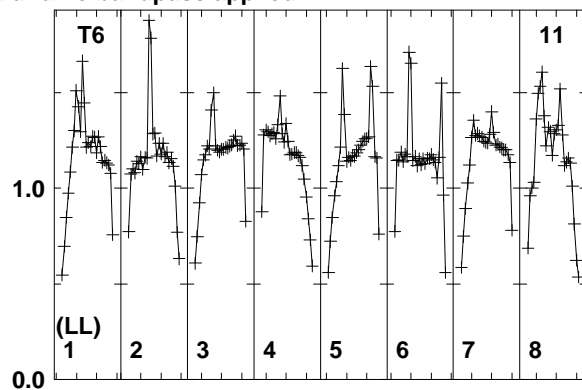
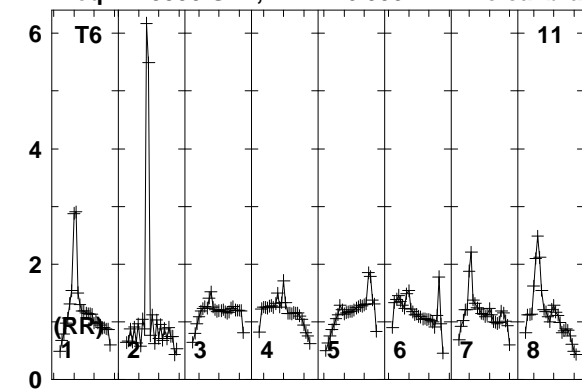

Lower frame: Real Jy
Total-power spectrum Antenna: T6 (11)
Timerange: 00/00:28:08 to 00/00:29:30

Plot file version 28 created 19-AUG-2016 17:19:16

J1649+2635 EM119D.UVDATA.1

Freq = 1.5950 GHz, Bw = 16.000 MH No calibration applied and no bandpass applied

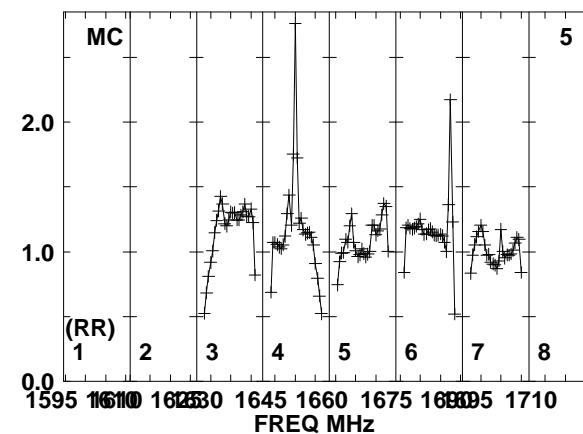
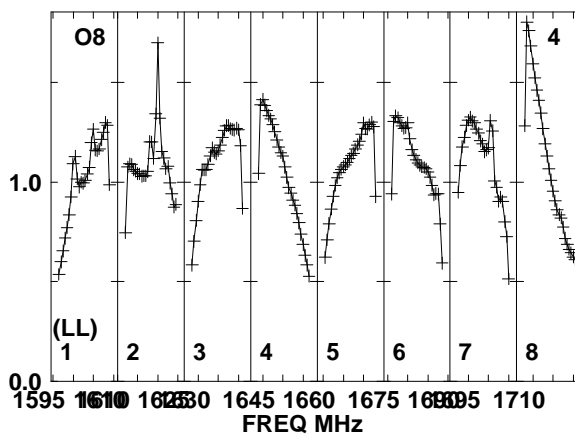
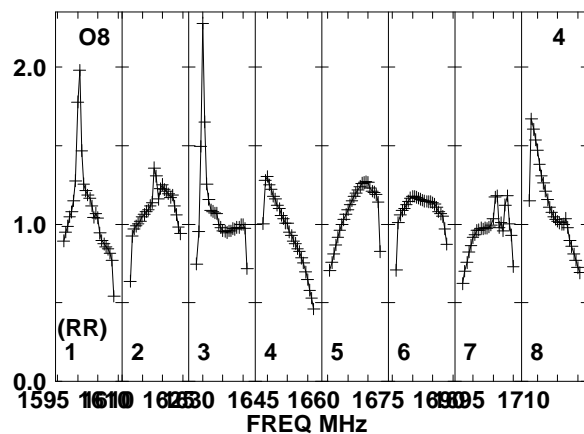
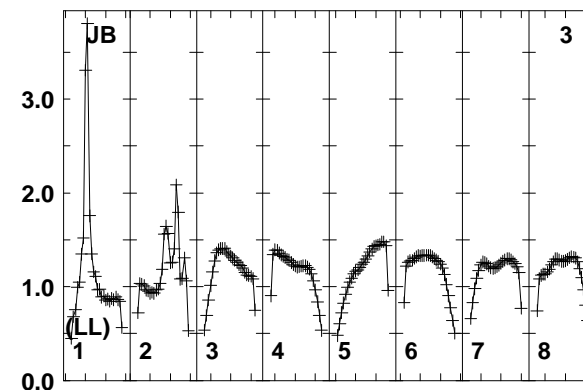
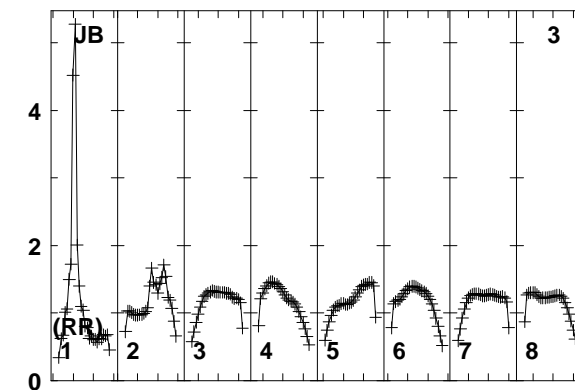
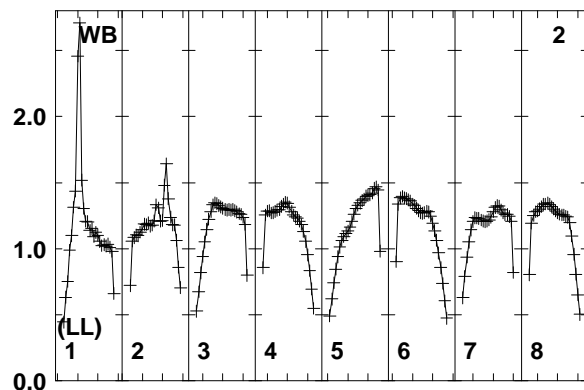
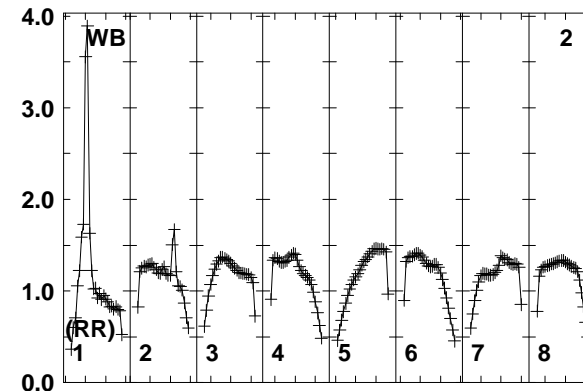
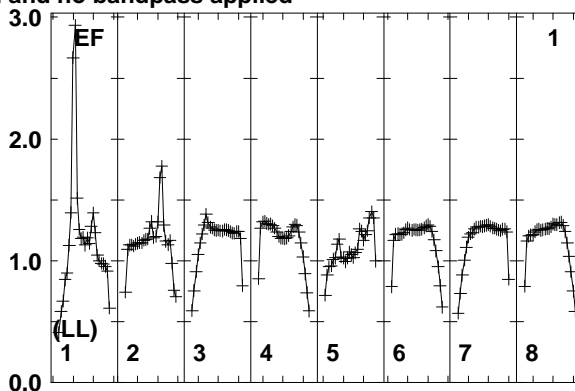
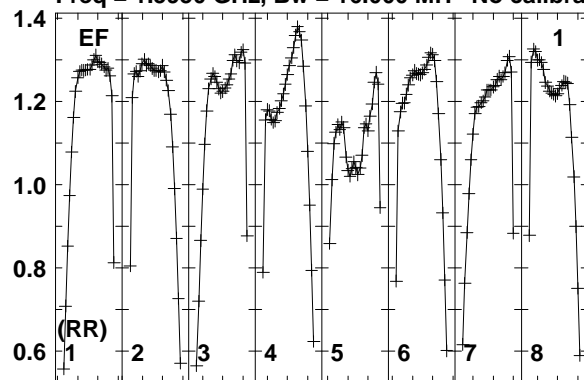

Lower frame: Real Jy
Total-power spectrum Antenna: EF (01)
Timerange: 00/00:29:38 to 00/00:33:00

Plot file version 29 created 19-AUG-2016 17:19:16

J1649+2635 EM119D.UVDATA.1

Freq = 1.5950 GHz, Bw = 16.000 MH No calibration applied and no bandpass applied

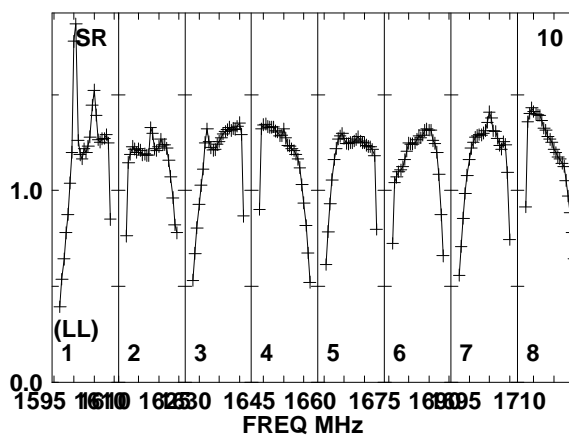
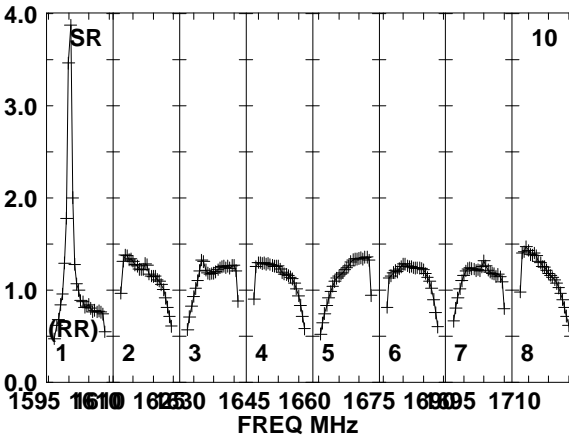
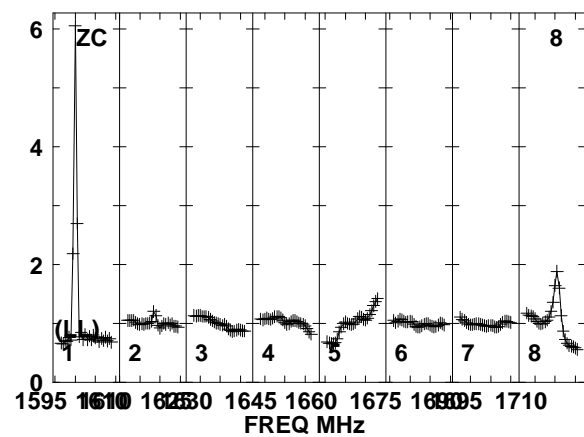
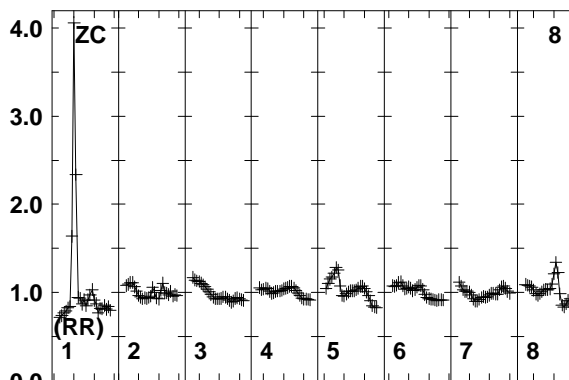
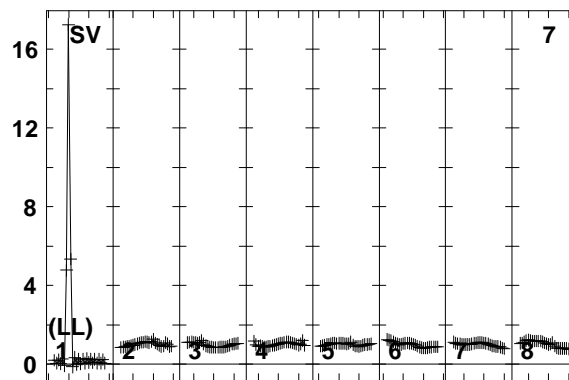
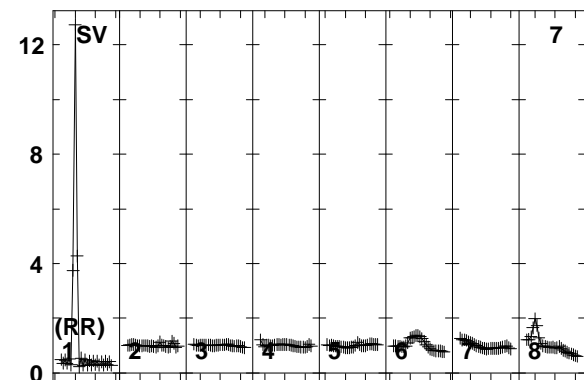
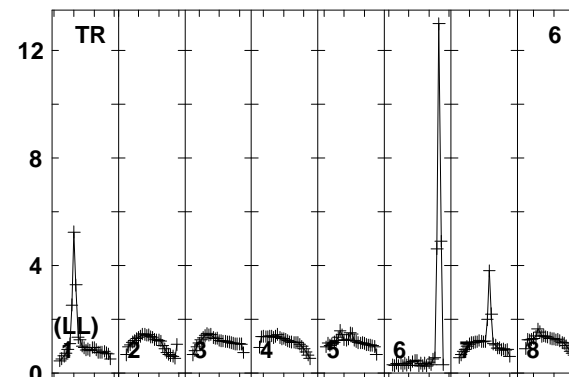
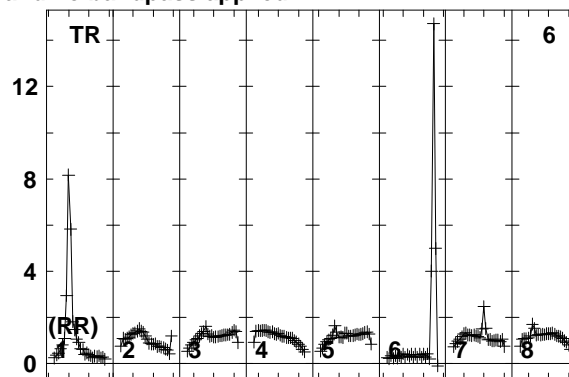
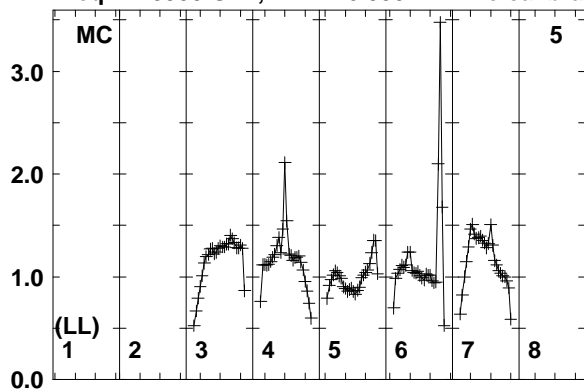

1595 1610 1625 1645 1660 1675 1690 1710
FREQ MHz

Lower frame: Real Jy
Total-power spectrum Antenna: MC (05)
Timerange: 00/00:29:38 to 00/00:33:00

Plot file version 30 created 19-AUG-2016 17:19:16

J1649+2635 EM119D.UVDATA.1

Freq = 1.5950 GHz, Bw = 16.000 MH No calibration applied and no bandpass applied

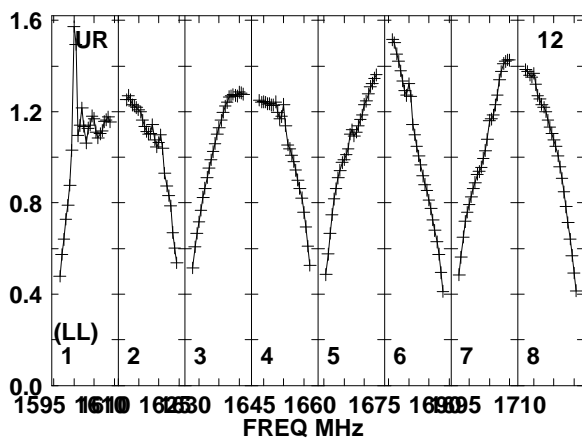
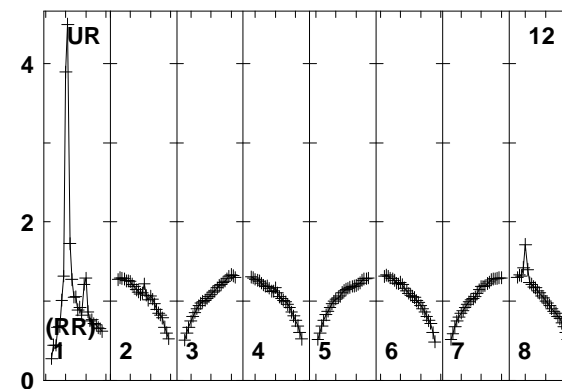
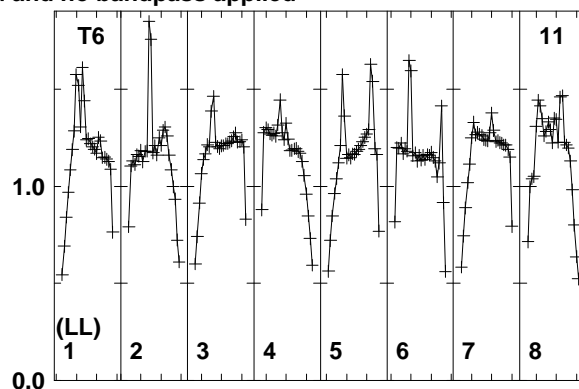
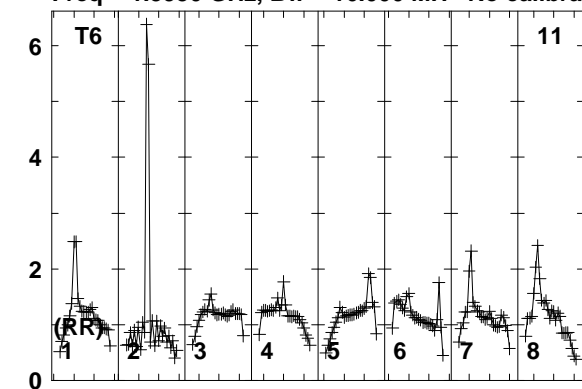

Lower frame: Real Jy
Total-power spectrum Antenna: T6 (11)
Timerange: 00/00:29:38 to 00/00:33:00

Plot file version 31 created 19-AUG-2016 17:19:16

J1642+2523 EM119D.UVDATA.1

Freq = 1.5950 GHz, Bw = 16.000 MH No calibration applied and no bandpass applied

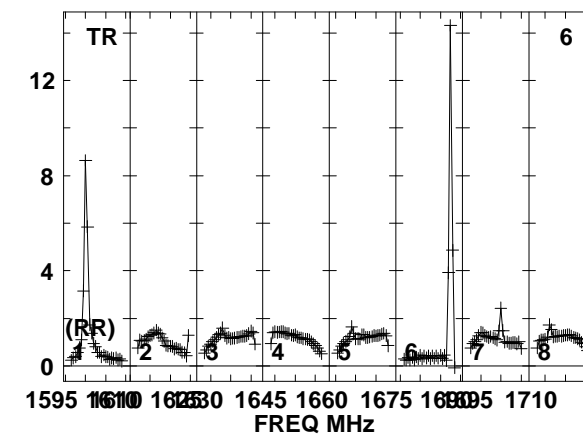
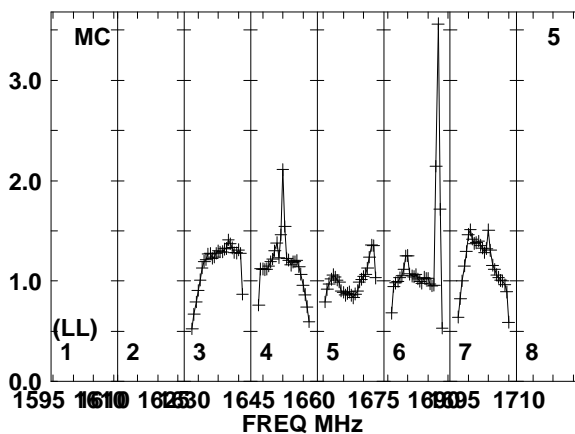
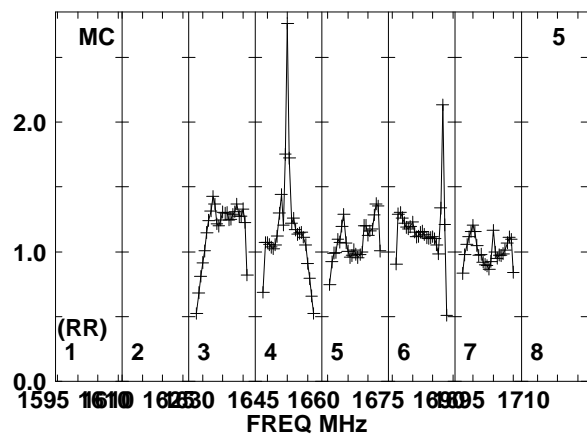
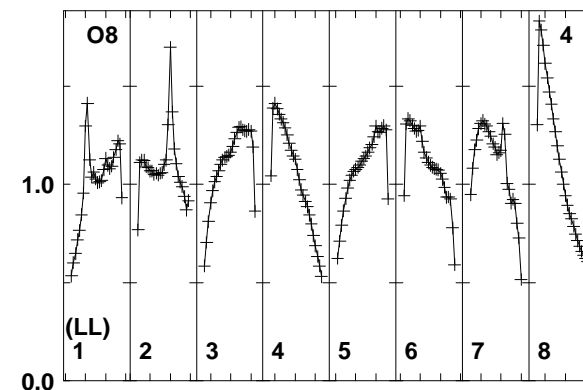
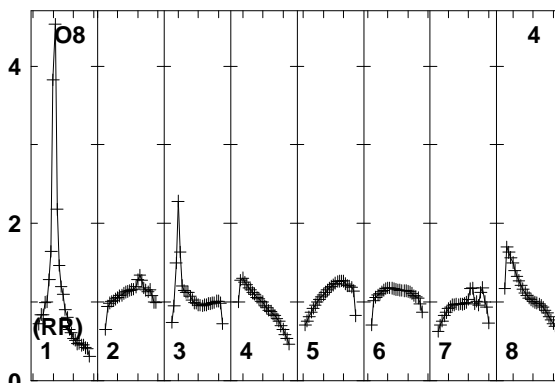
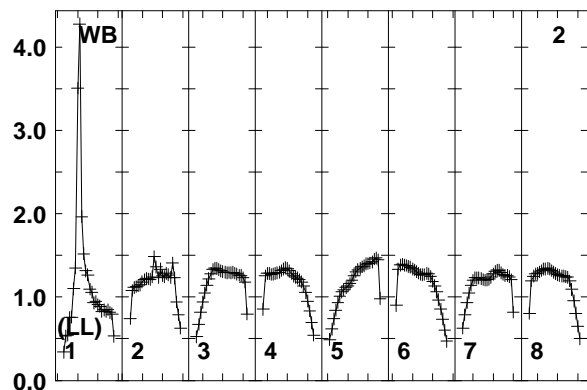
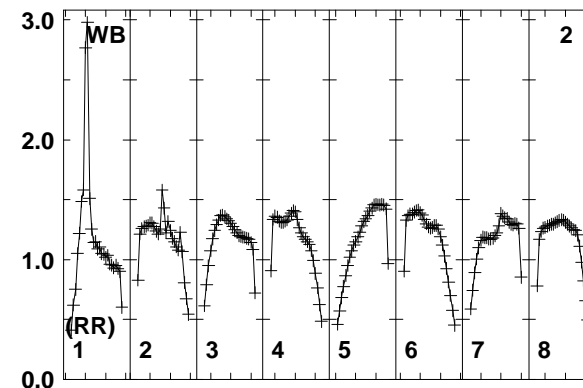
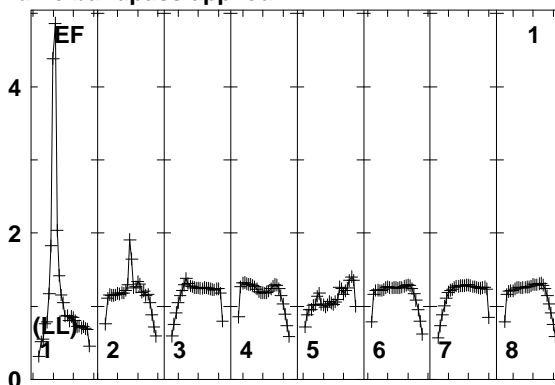
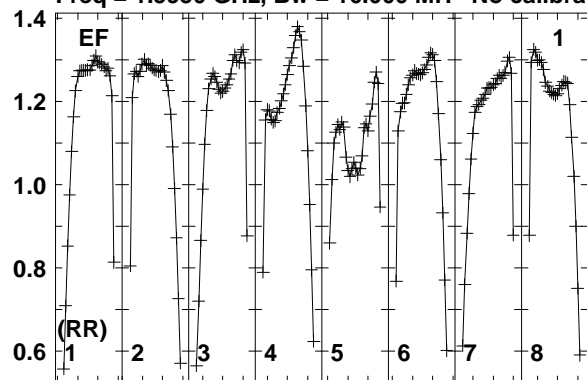

Lower frame: Real Jy
Total-power spectrum Antenna: EF (01)
Timerange: 00/00:34:01 to 00/00:35:29

Plot file version 32 created 19-AUG-2016 17:19:17

J1642+2523 EM119D.UVDATA.1

Freq = 1.5950 GHz, Bw = 16.000 MH No calibration applied and no bandpass applied

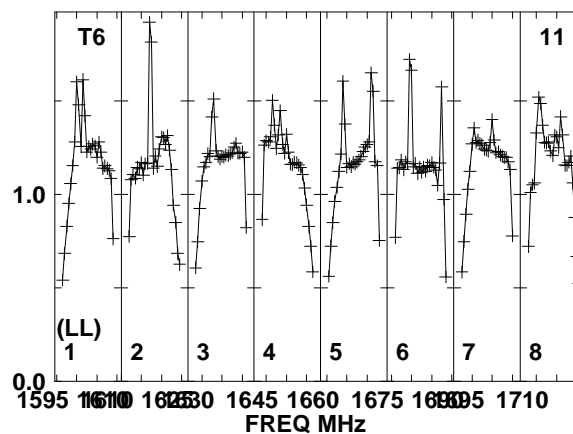
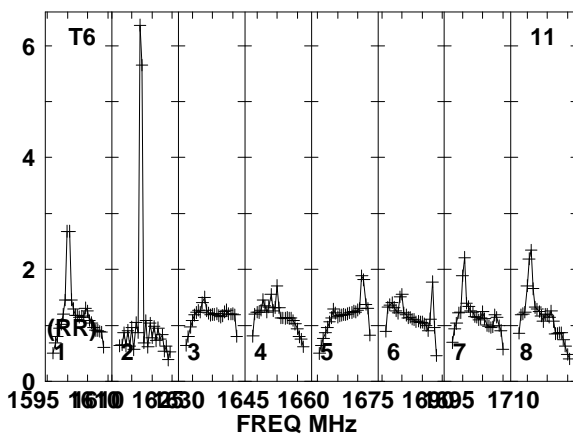
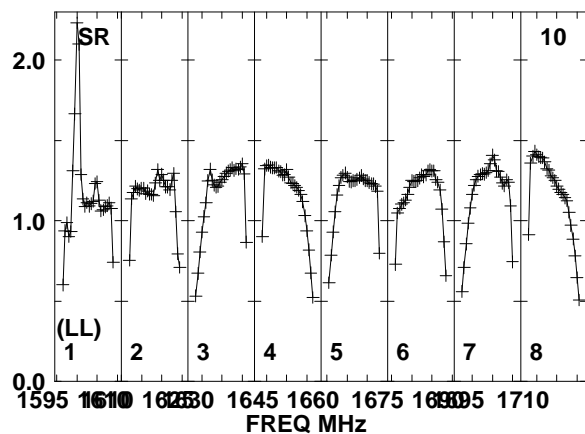
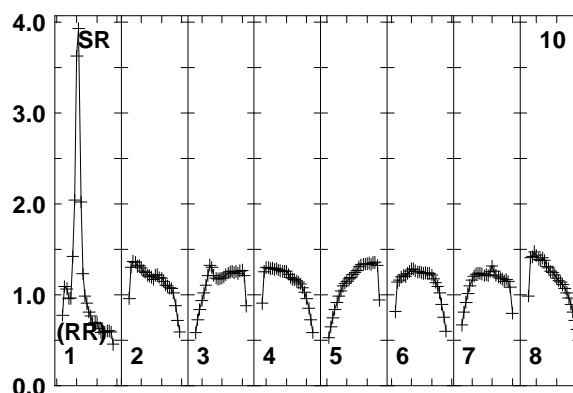
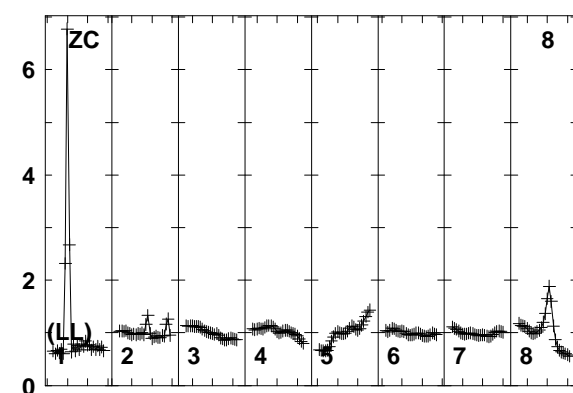
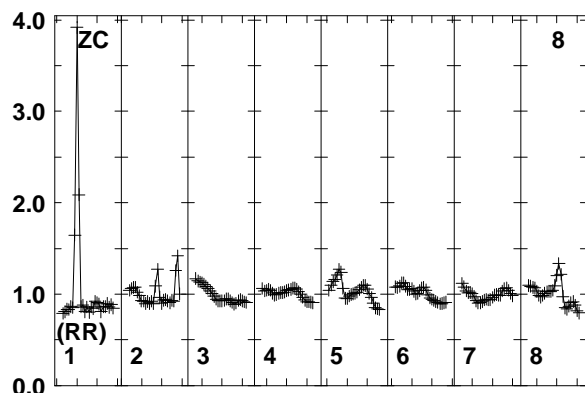
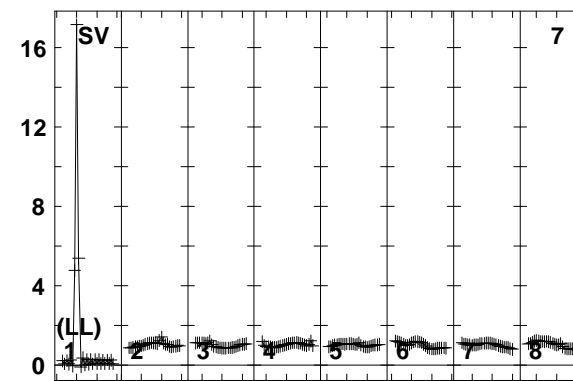
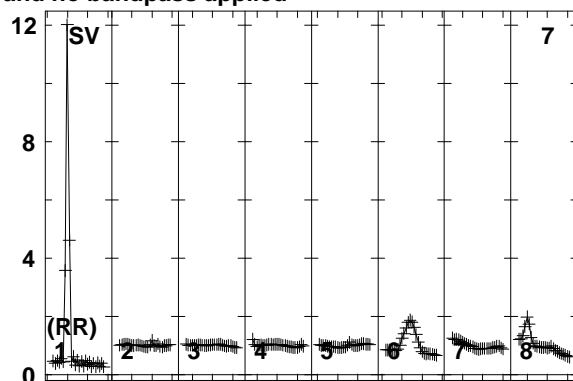
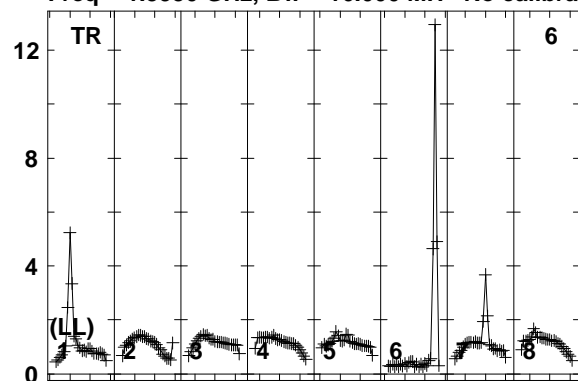

Lower frame: Real Jy
Total-power spectrum Antenna: TR (06)
Timerange: 00/00:34:01 to 00/00:35:29

Plot file version 33 created 19-AUG-2016 17:19:17

J1642+2523 EM119D.UVDATA.1

Freq = 1.5950 GHz, Bw = 16.000 MH No calibration applied and no bandpass applied

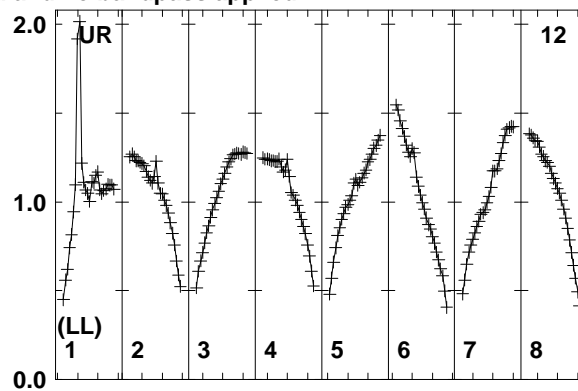
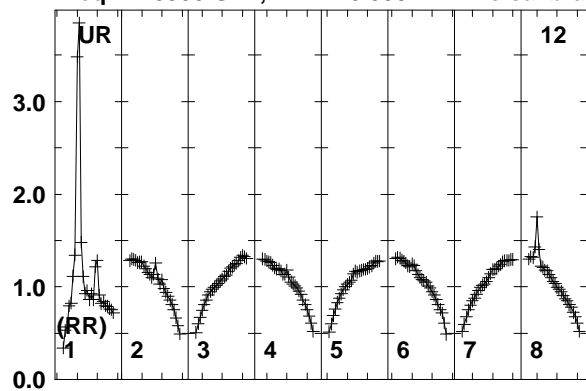

Lower frame: Real Jy
Total-power spectrum Antenna: UR (12)
Timerange: 00/00:34:01 to 00/00:35:29

Plot file version 34 created 19-AUG-2016 17:19:17

J1649+2635 EM119D.UVDATA.1

Freq = 1.5950 GHz, Bw = 16.000 MH No calibration applied and no bandpass applied

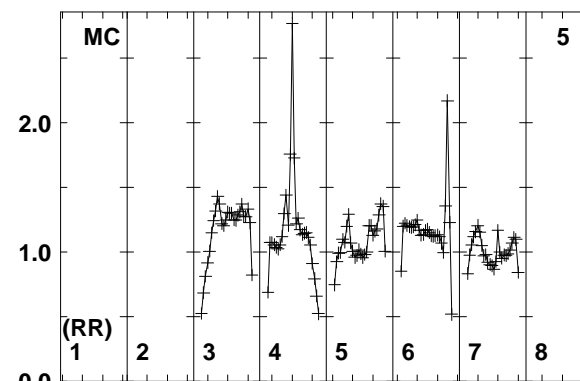
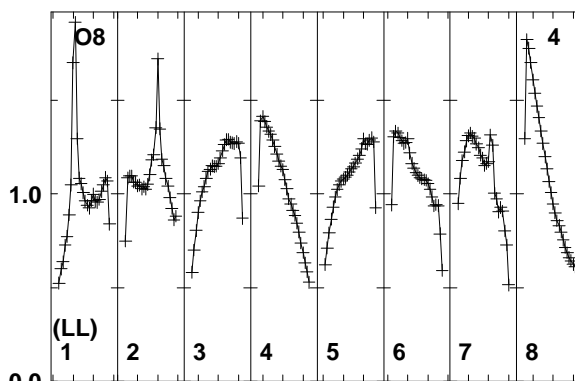
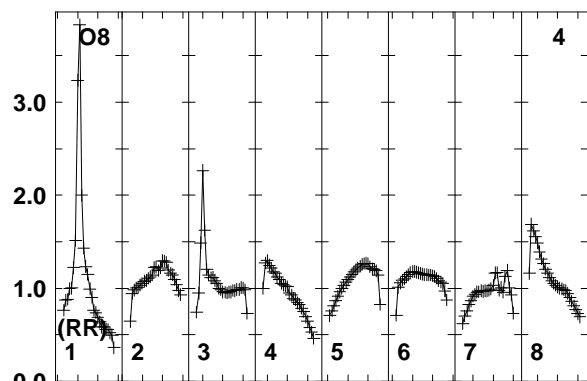
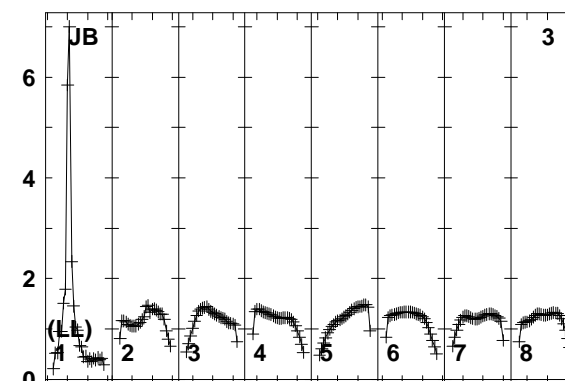
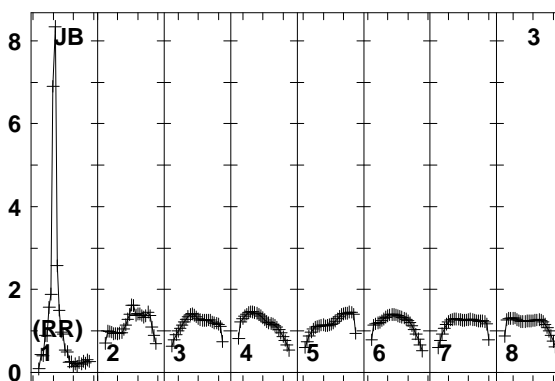
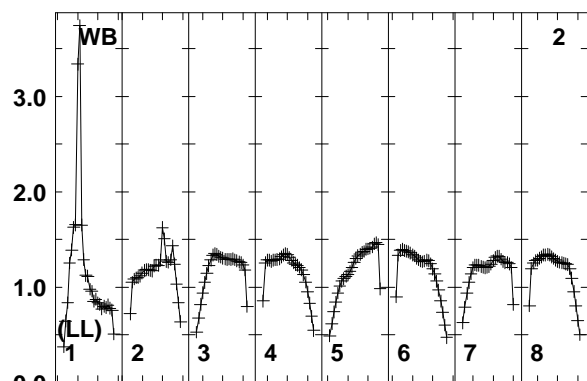
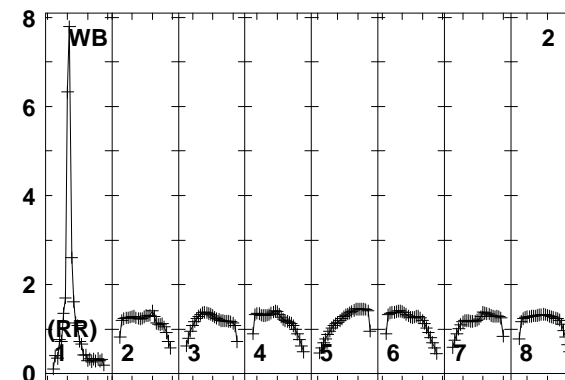
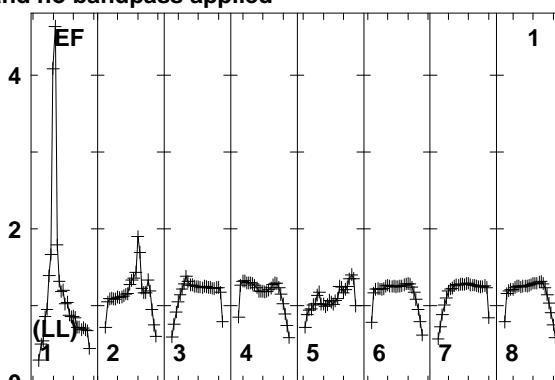
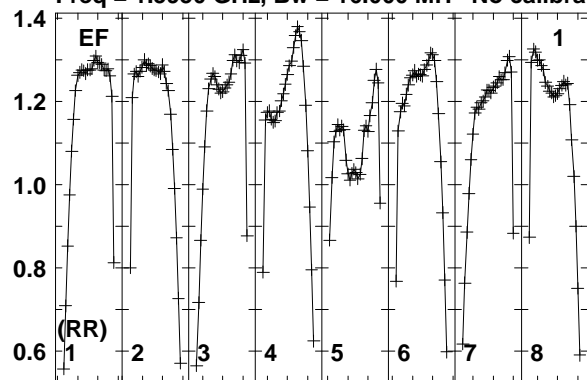

1595 1610 1625 1640 1655 1670 1685 1700 1715
FREQ MHz
Lower frame: Real Jy
Total-power spectrum Antenna: EF (01)
Timerange: 00/00:35:32 to 00/00:38:59

1595 1610 1625 1640 1655 1670 1685 1700 1715
FREQ MHz

1595 1610 1625 1640 1655 1670 1685 1700 1715
FREQ MHz

Plot file version 35 created 19-AUG-2016 17:19:17

J1649+2635 EM119D.UVDATA.1

Freq = 1.5950 GHz, Bw = 16.000 MH No calibration applied and no bandpass applied

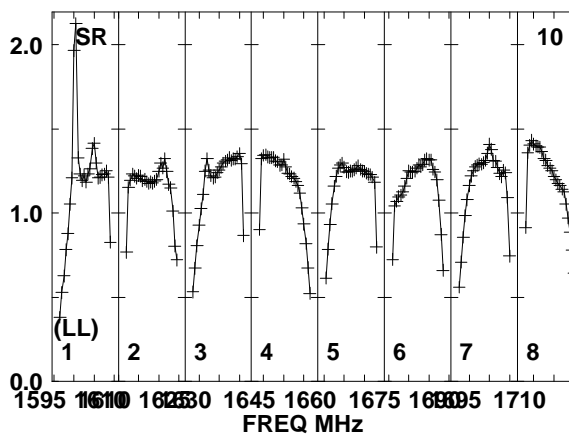
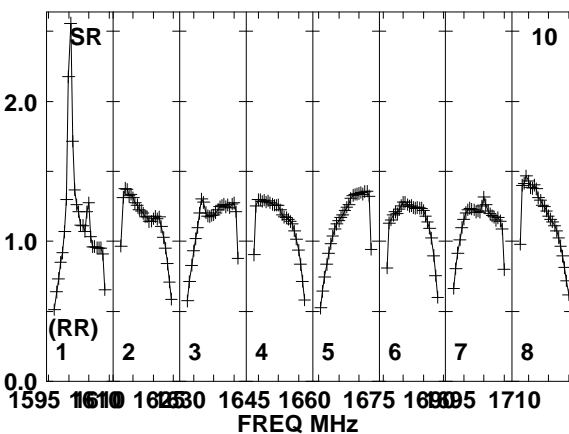
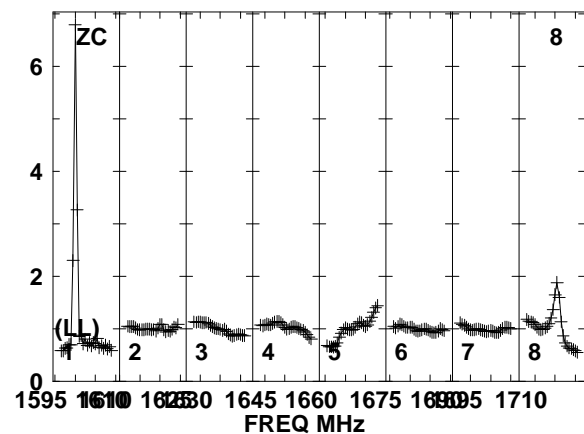
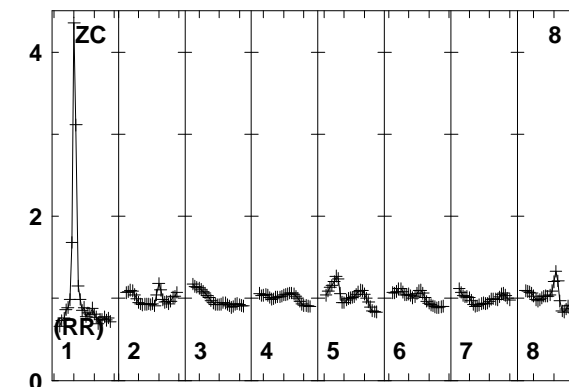
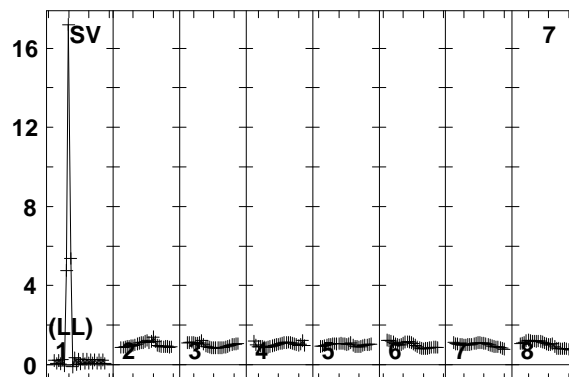
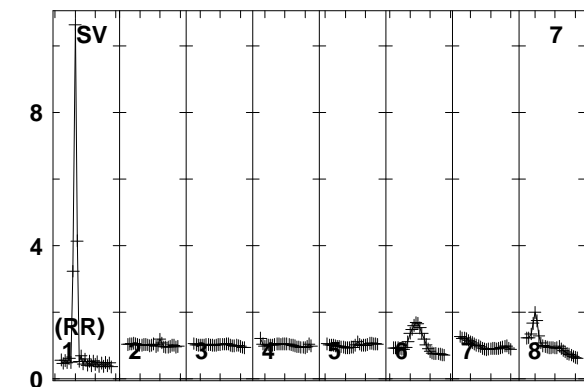
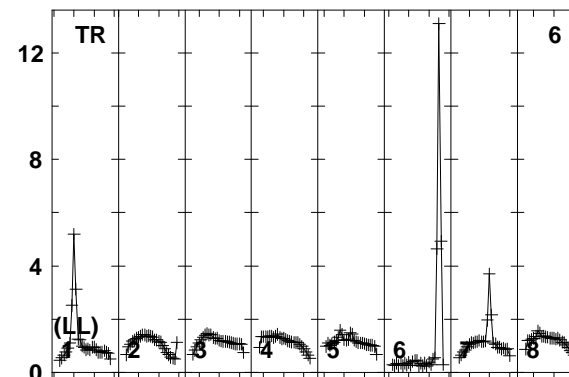
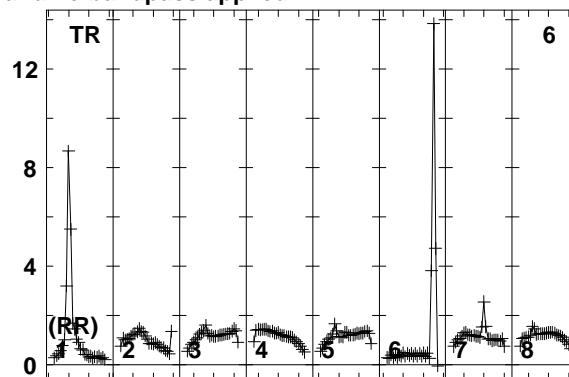
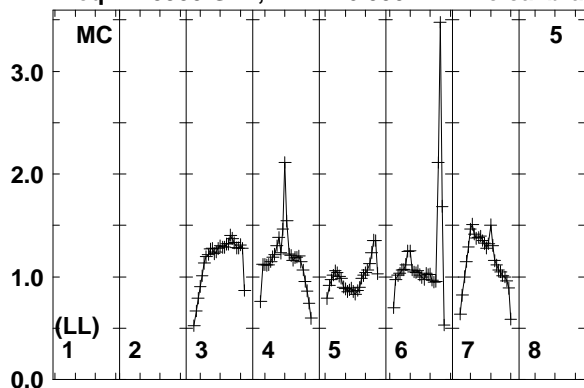

Lower frame: Real Jy
Total-power spectrum Antenna: MC (05)
Timerange: 00/00:35:32 to 00/00:38:59

Plot file version 36 created 19-AUG-2016 17:19:17

J1649+2635 EM119D.UVDATA.1

Freq = 1.5950 GHz, Bw = 16.000 MH No calibration applied and no bandpass applied

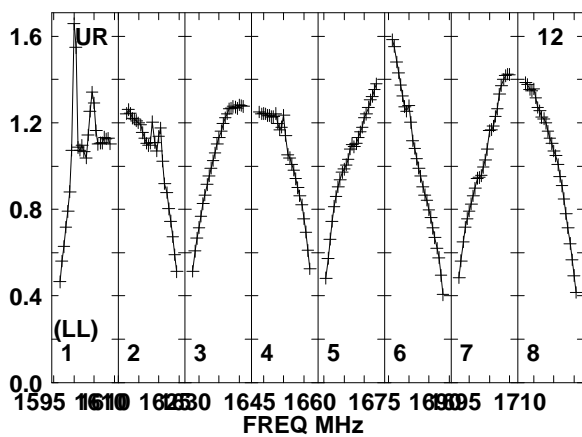
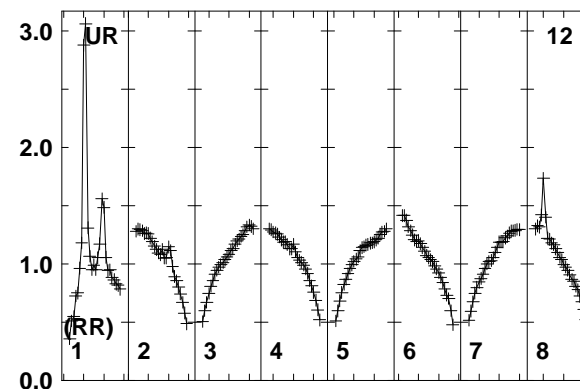
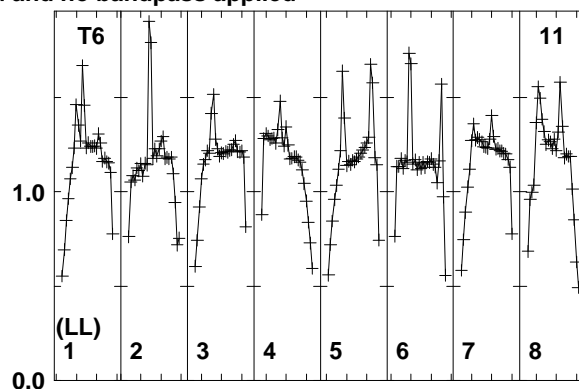
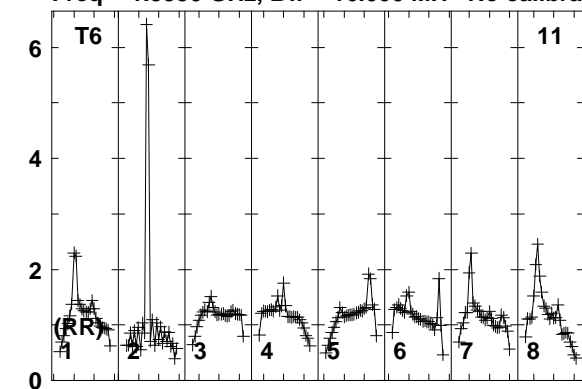

Lower frame: Real Jy
Total-power spectrum Antenna: T6 (11)
Timerange: 00/00:35:32 to 00/00:38:59

Plot file version 37 created 19-AUG-2016 17:19:17

J1642+2523 EM119D.UVDATA.1

Freq = 1.5950 GHz, Bw = 16.000 MH No calibration applied and no bandpass applied

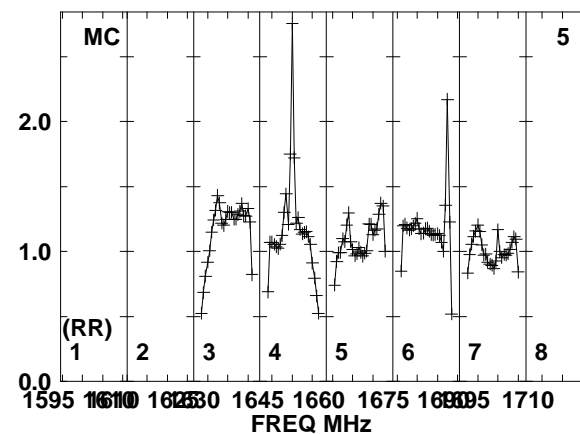
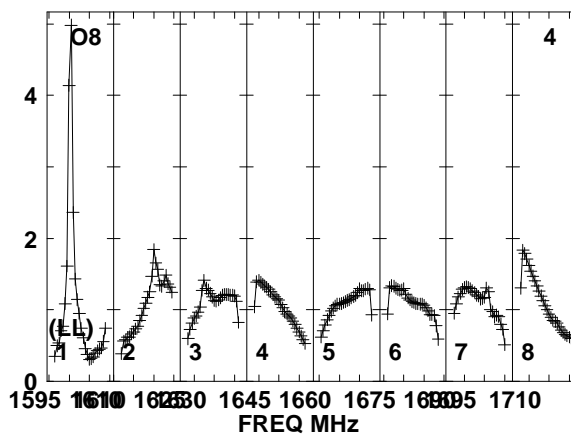
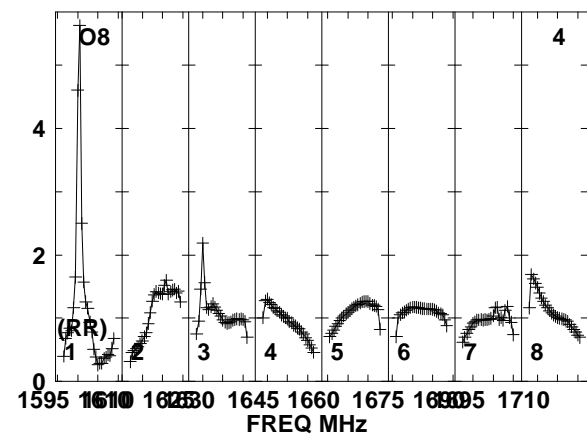
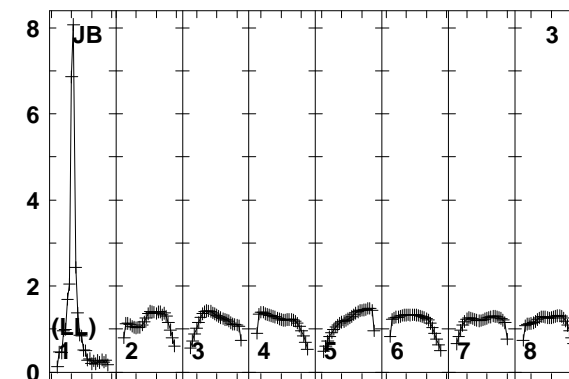
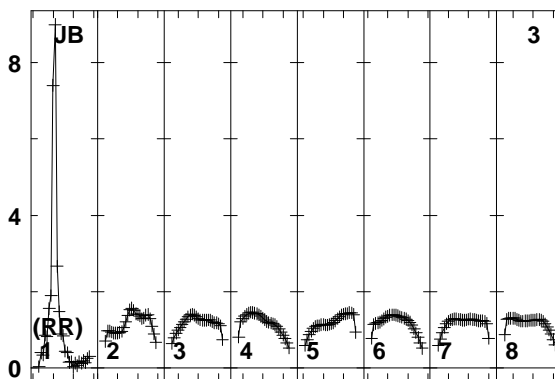
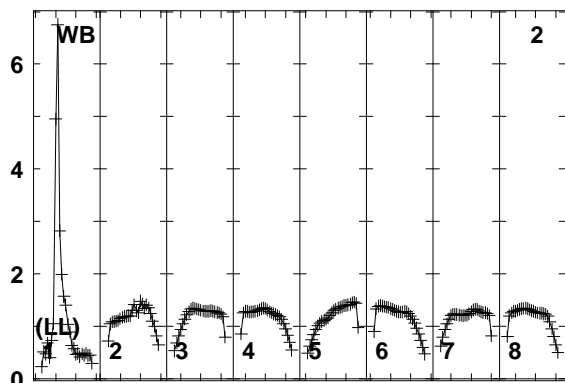
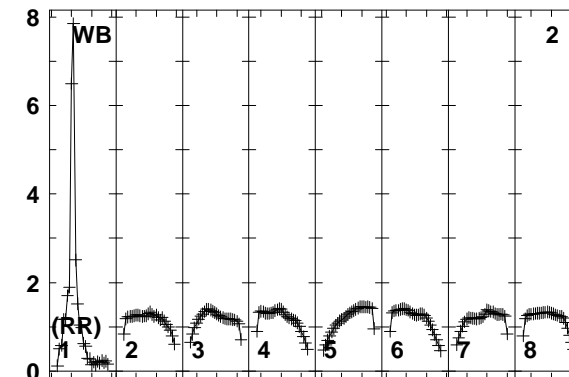
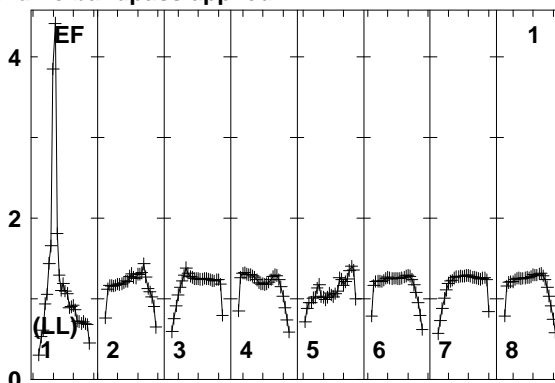
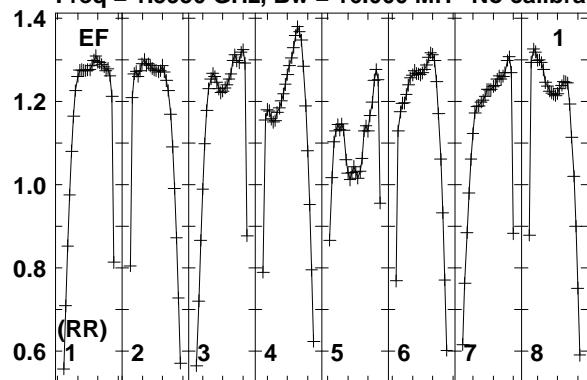

Lower frame: Real Jy
Total-power spectrum Antenna: EF (01)
Timerange: 00/00:39:07 to 00/00:40:30

Plot file version 38 created 19-AUG-2016 17:19:17

J1642+2523 EM119D.UVDATA.1

Freq = 1.5950 GHz, Bw = 16.000 MH No calibration applied and no bandpass applied

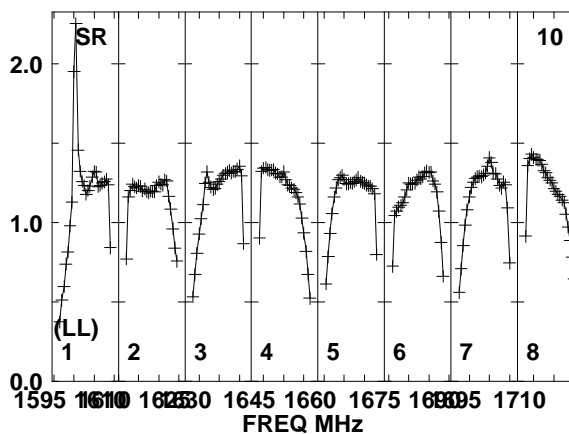
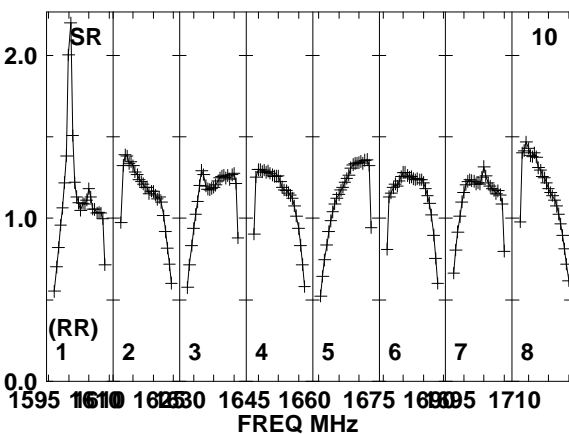
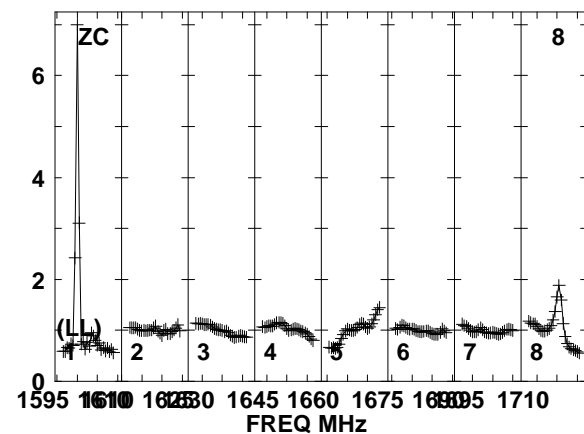
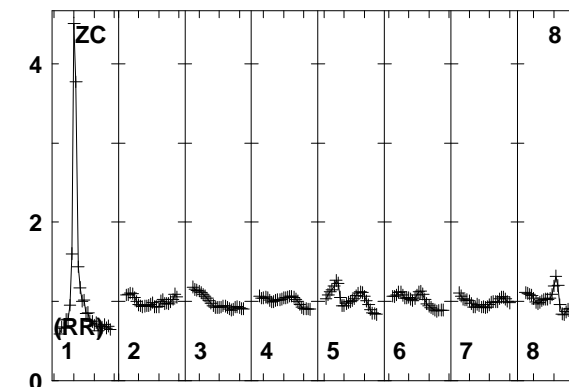
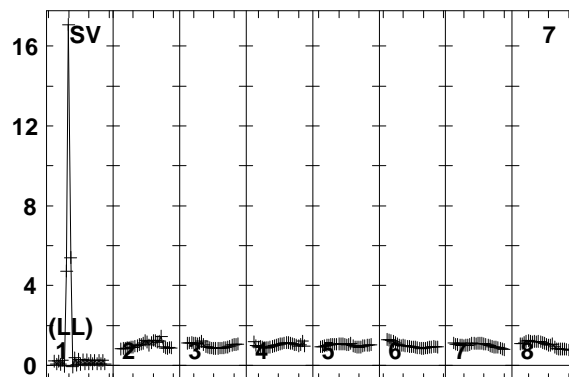
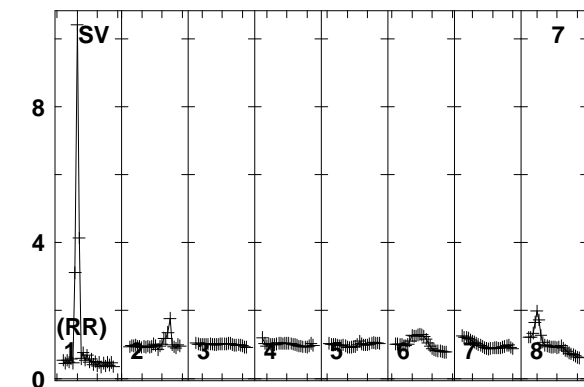
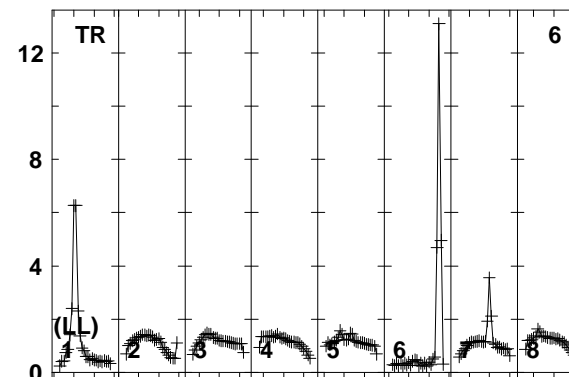
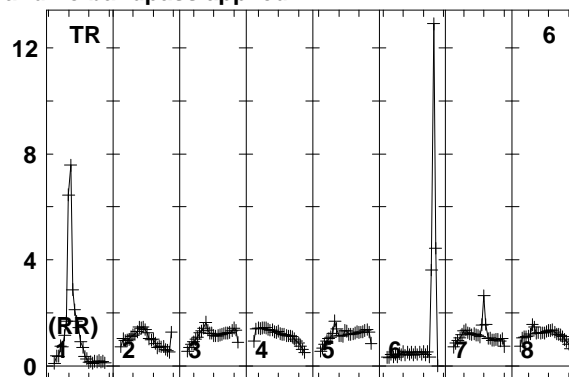
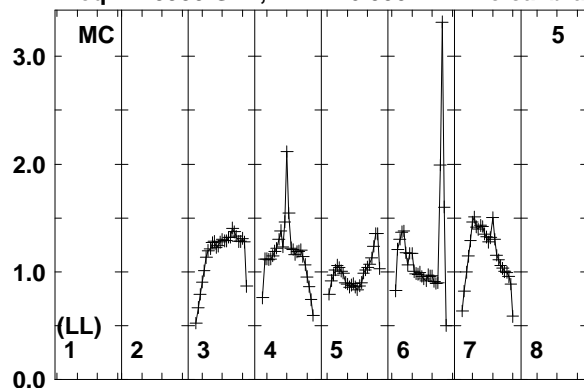

Lower frame: Real Jy
Total-power spectrum Antenna: MC (05)
Timerange: 00/00:39:07 to 00/00:40:30

Plot file version 39 created 19-AUG-2016 17:19:18

J1642+2523 EM119D.UVDATA.1

Freq = 1.5950 GHz, Bw = 16.000 MH No calibration applied and no bandpass applied

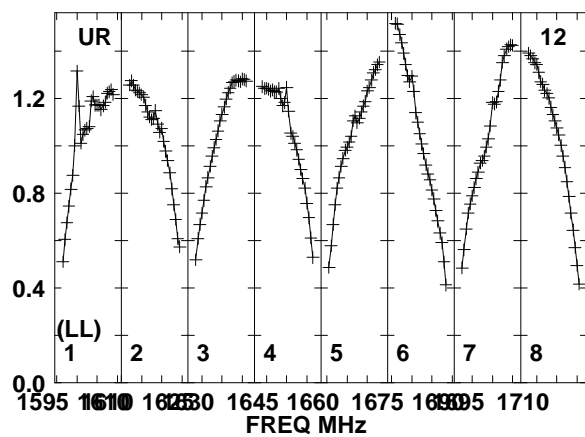
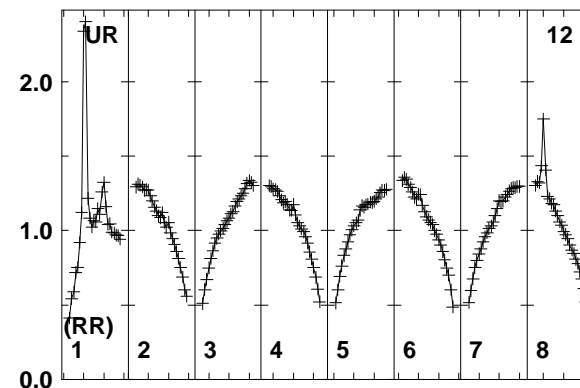
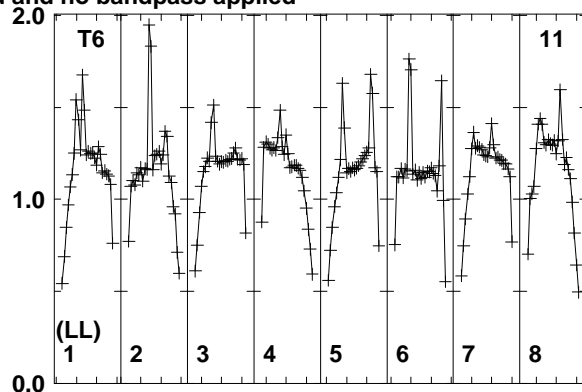
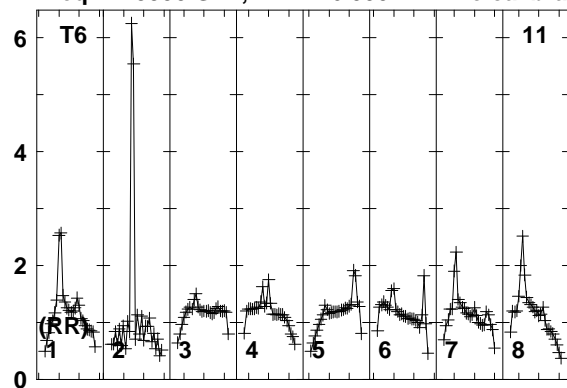

Lower frame: Real Jy
Total-power spectrum Antenna: T6 (11)
Timerange: 00/00:39:07 to 00/00:40:30

Plot file version 40 created 19-AUG-2016 17:19:18

J1649+2635 EM119D.UVDATA.1

Freq = 1.5950 GHz, Bw = 16.000 MH No calibration applied and no bandpass applied

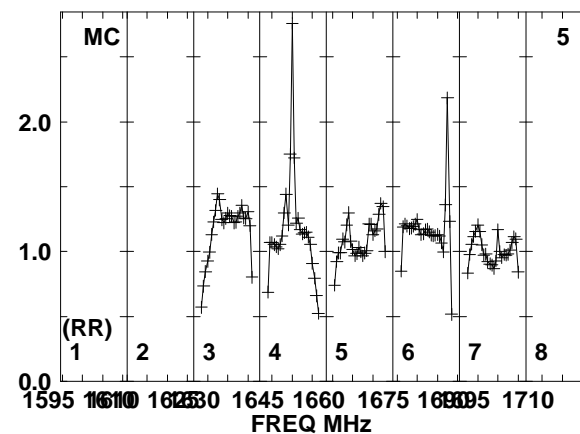
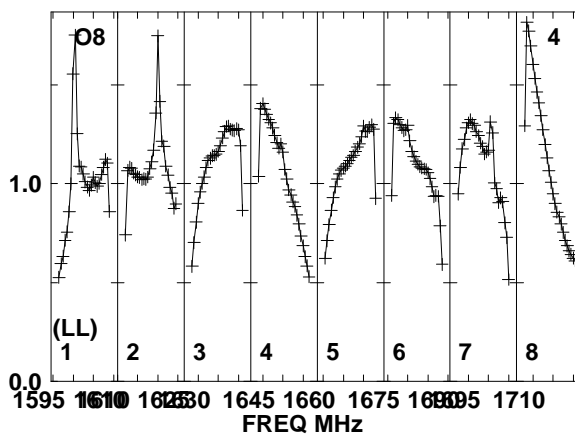
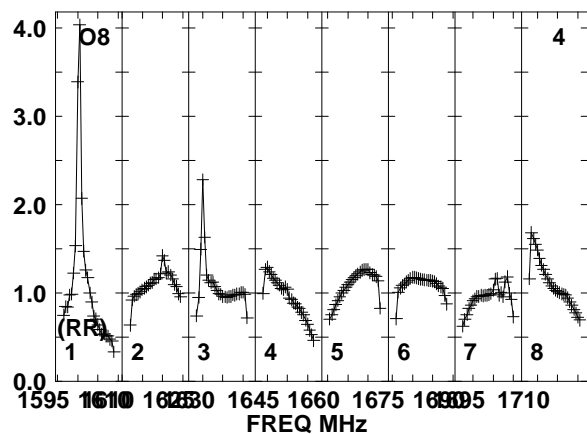
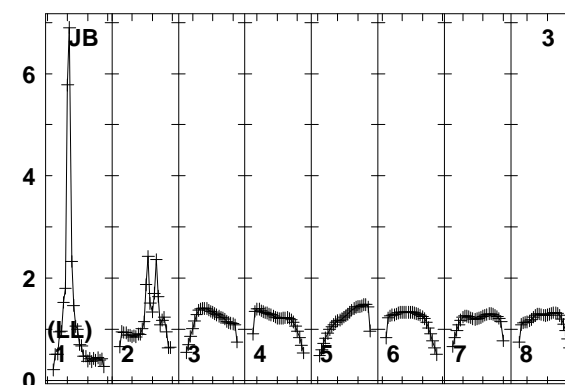
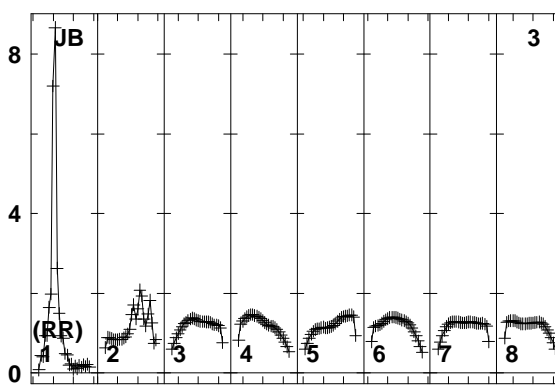
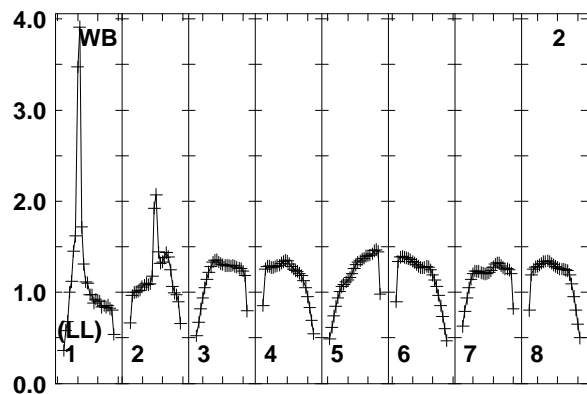
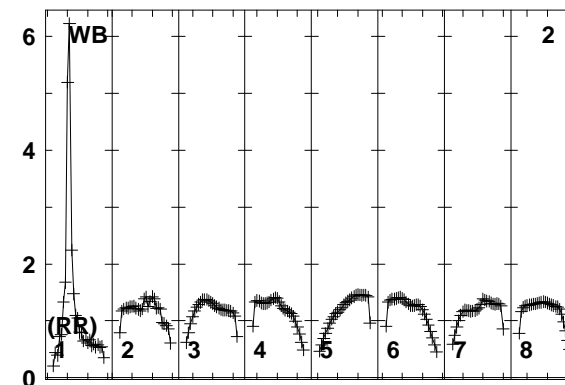
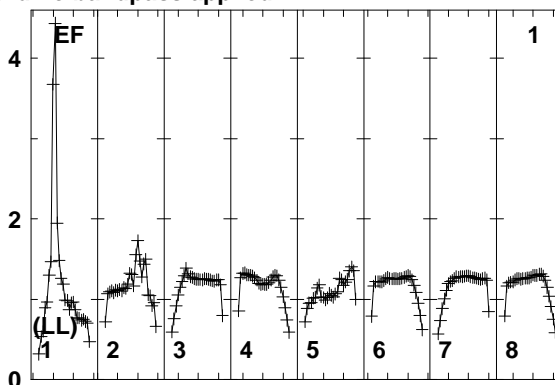
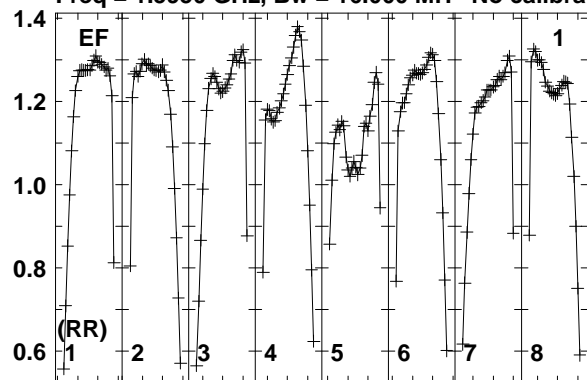

Lower frame: Real Jy
Total-power spectrum Antenna: EF (01)
Timerange: 00/00:40:38 to 00/00:44:00

Plot file version 41 created 19-AUG-2016 17:19:18

J1649+2635 EM119D.UVDATA.1

Freq = 1.5950 GHz, Bw = 16.000 MH No calibration applied and no bandpass applied

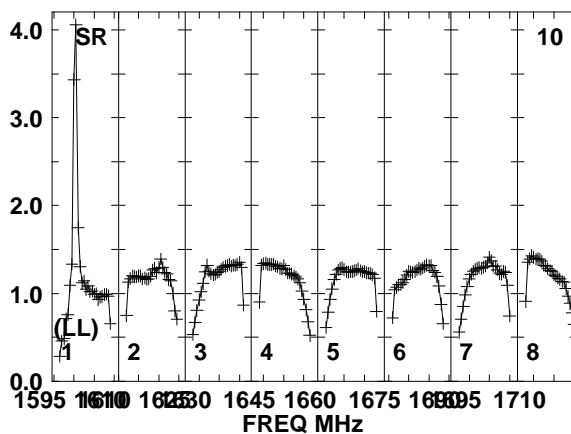
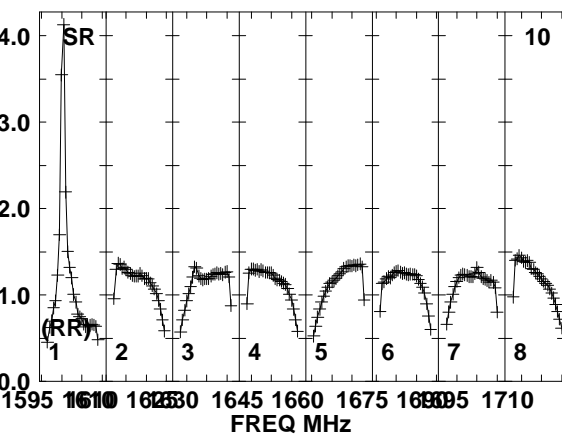
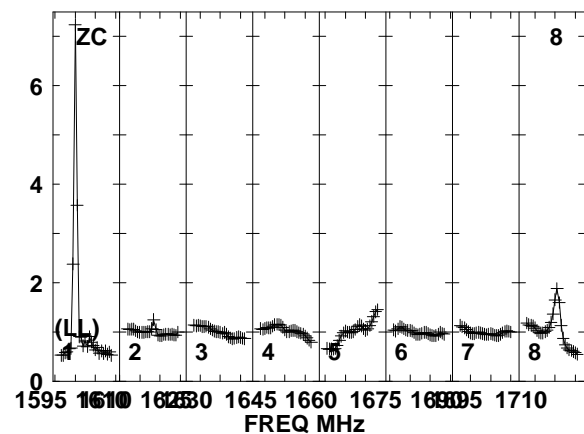
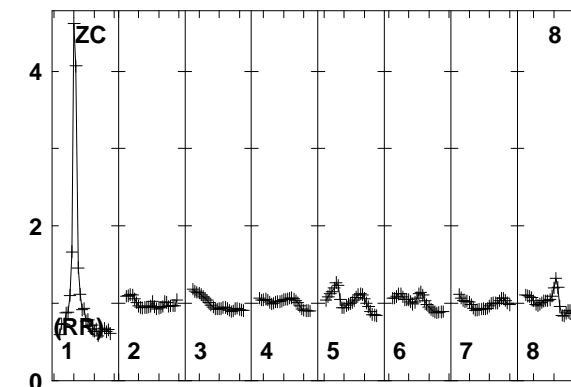
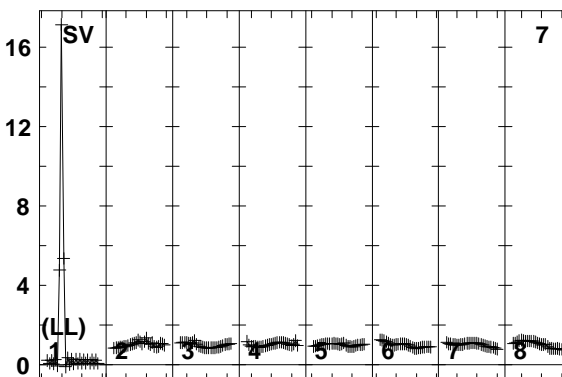
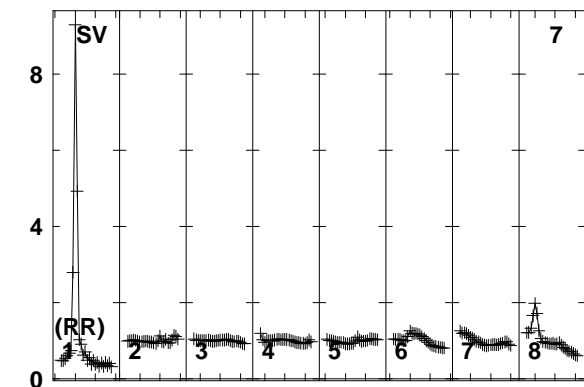
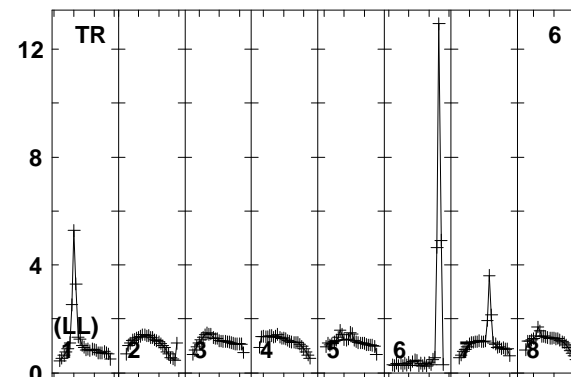
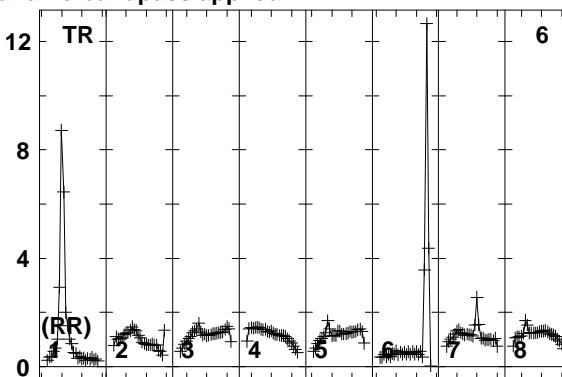
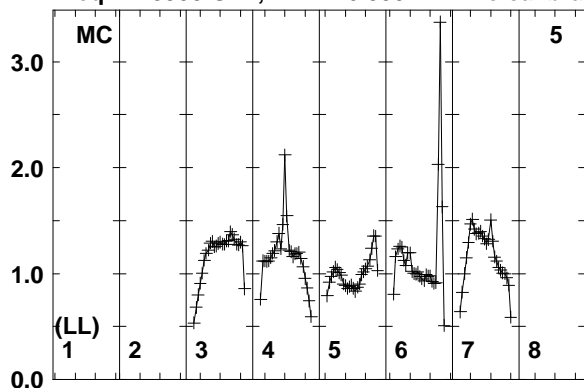

Lower frame: Real Jy
Total-power spectrum Antenna: MC (05)
Timerange: 00/00:40:38 to 00/00:44:00

Plot file version 42 created 19-AUG-2016 17:19:18

J1649+2635 EM119D.UVDATA.1

Freq = 1.5950 GHz, Bw = 16.000 MH No calibration applied and no bandpass applied

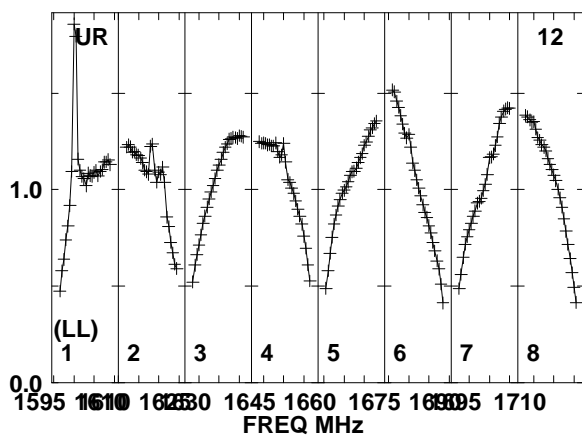
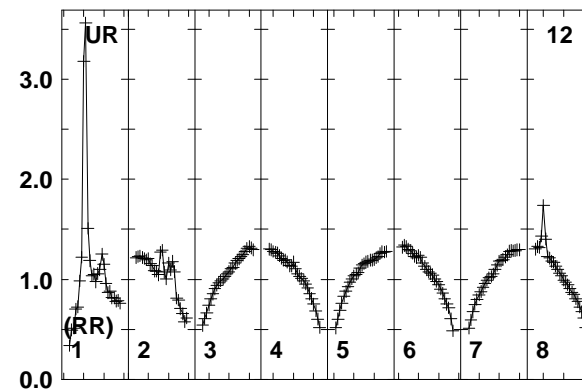
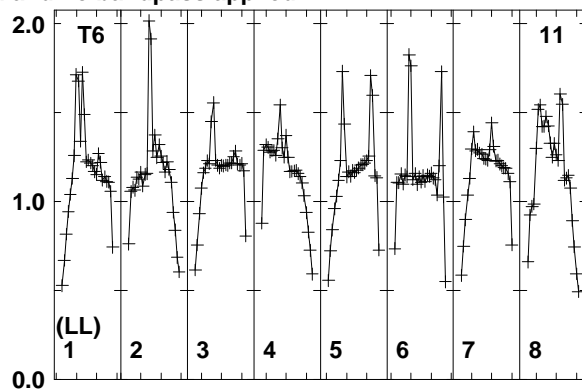
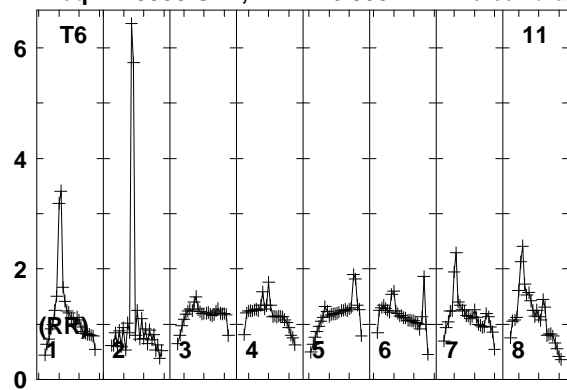

Lower frame: Real Jy
Total-power spectrum Antenna: T6 (11)
Timerange: 00/00:40:38 to 00/00:44:00

Plot file version 43 created 19-AUG-2016 17:19:18

J1642+2523 EM119D.UVDATA.1

Freq = 1.5950 GHz, Bw = 16.000 MH No calibration applied and no bandpass applied

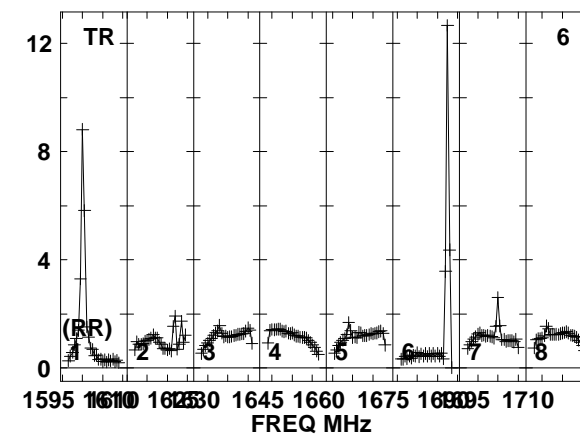
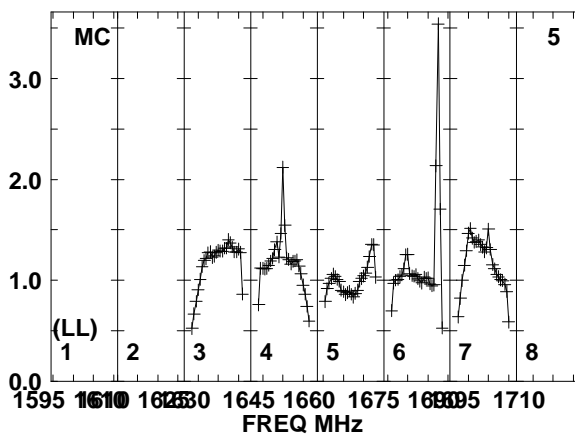
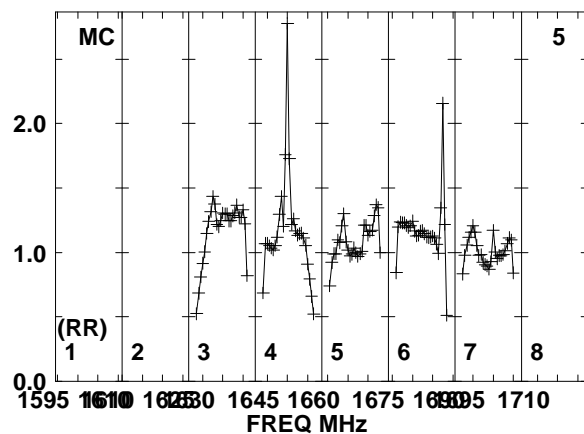
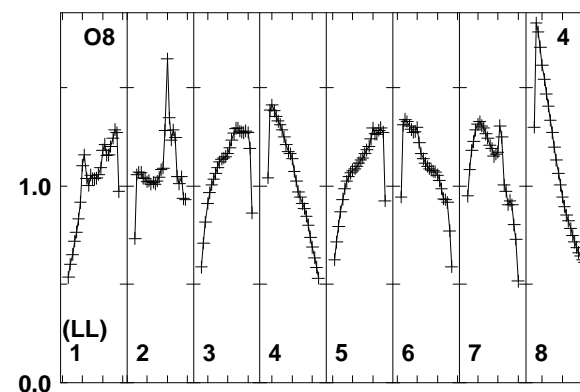
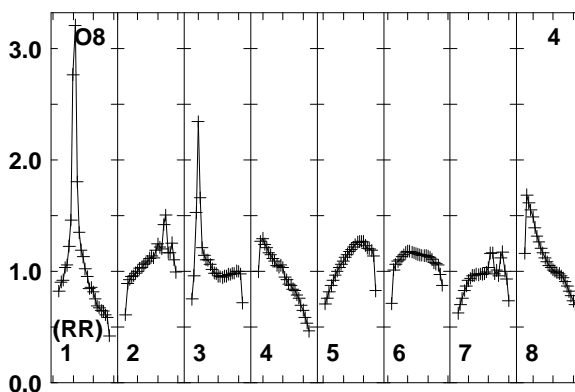
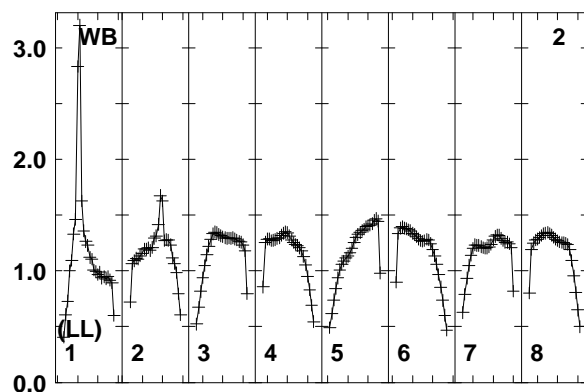
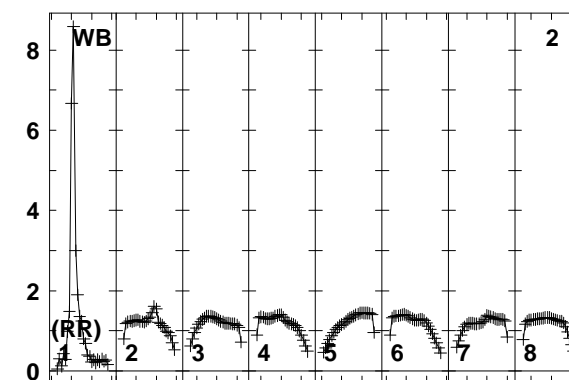
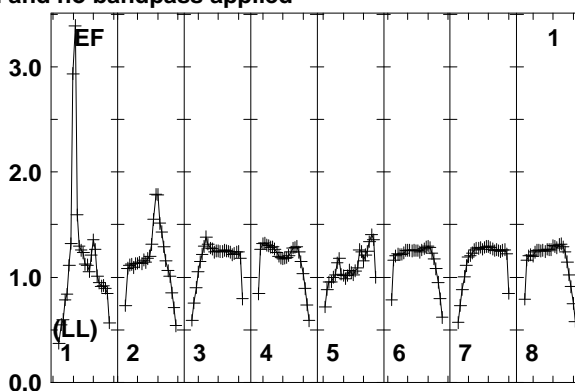
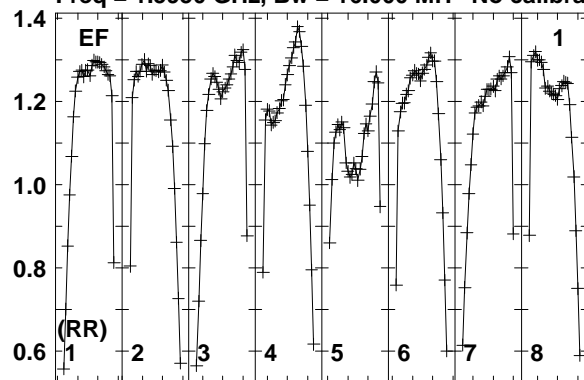

Lower frame: Real Jy
Total-power spectrum Antenna: EF (01)
Timerange: 00/00:45:00 to 00/00:46:29

Plot file version 44 created 19-AUG-2016 17:19:18

J1642+2523 EM119D.UVDATA.1

Freq = 1.5950 GHz, Bw = 16.000 MH No calibration applied and no bandpass applied

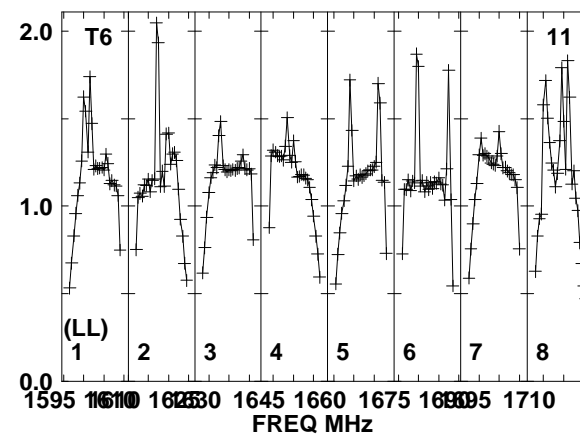
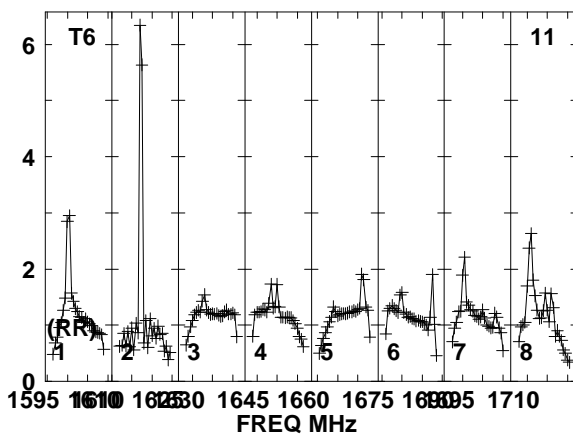
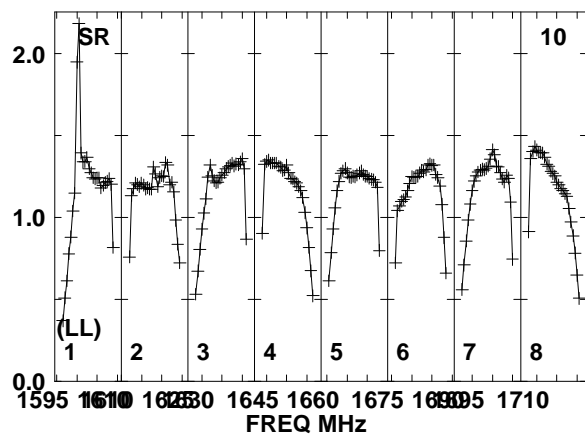
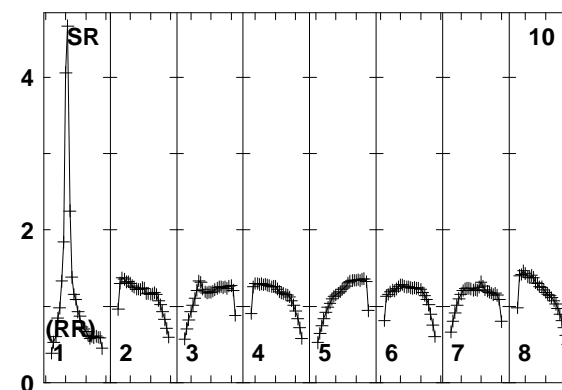
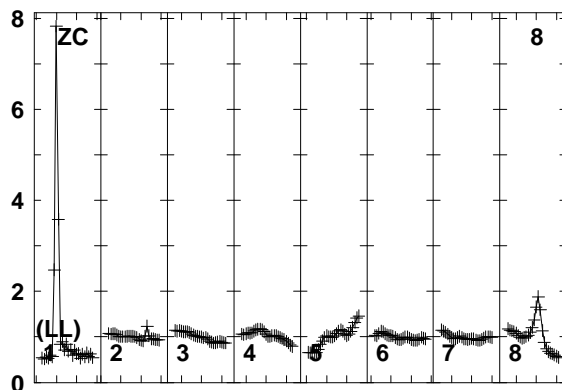
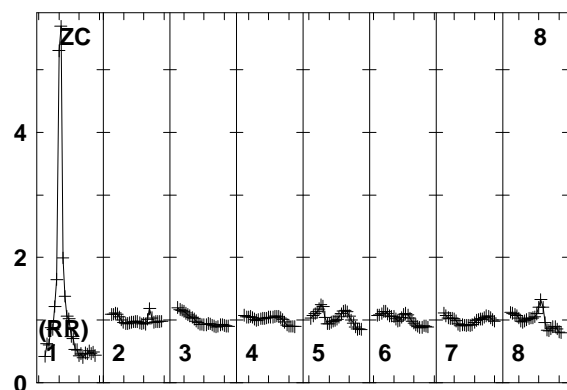
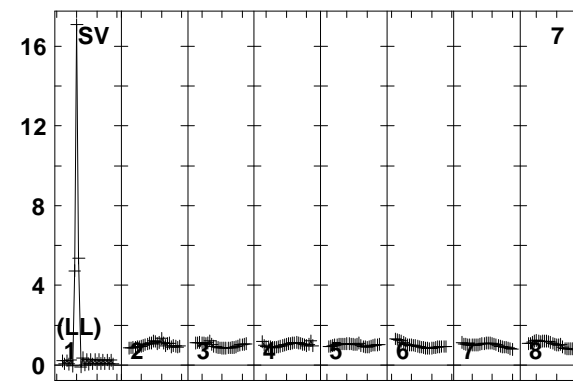
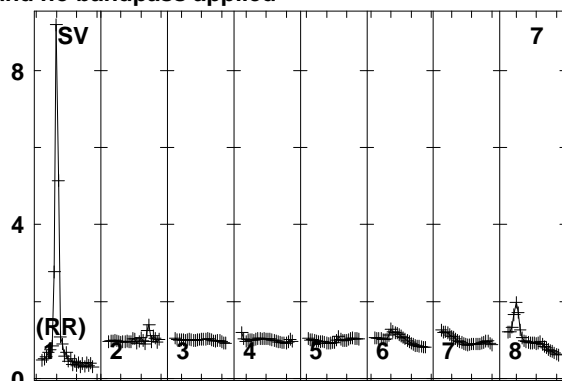
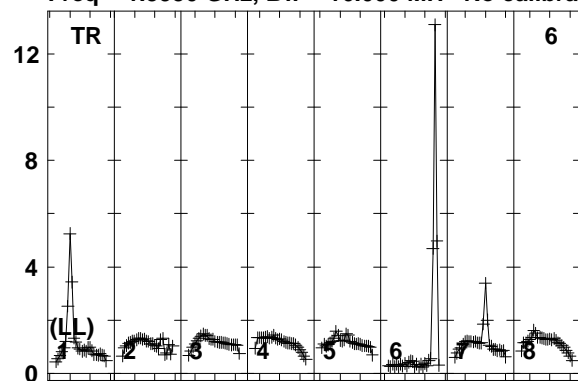

Lower frame: Real Jy
Total-power spectrum Antenna: TR (06)
Timerange: 00/00:45:00 to 00/00:46:29

Plot file version 45 created 19-AUG-2016 17:19:19

J1642+2523 EM119D.UVDATA.1

Freq = 1.5950 GHz, Bw = 16.000 MH No calibration applied and no bandpass applied

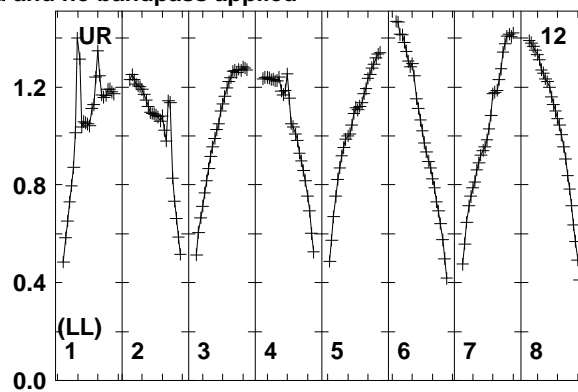
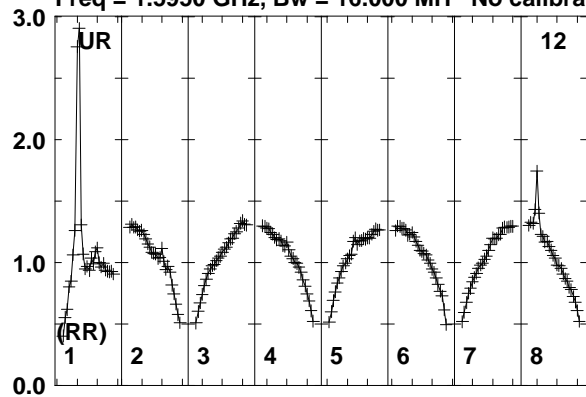

Lower frame: Real Jy
Total-power spectrum Antenna: UR (12)
Timerange: 00/00:45:00 to 00/00:46:29

Plot file version 46 created 19-AUG-2016 17:19:19

J1649+2635 EM119D.UVDATA.1

Freq = 1.5950 GHz, Bw = 16.000 MH No calibration applied and no bandpass applied

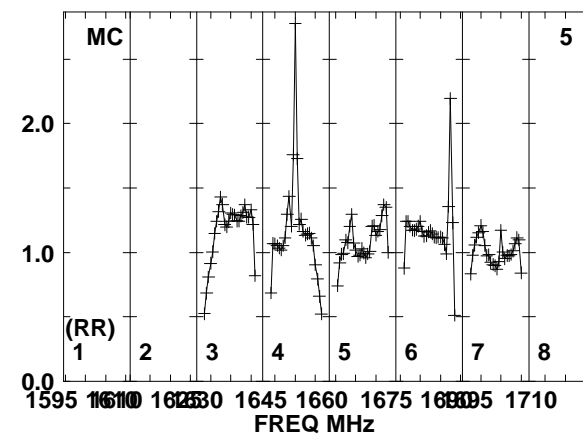
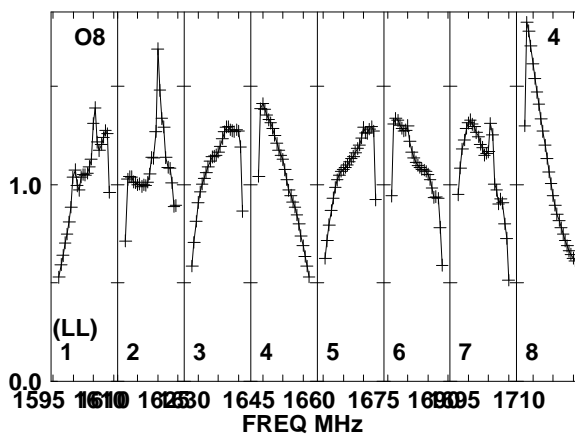
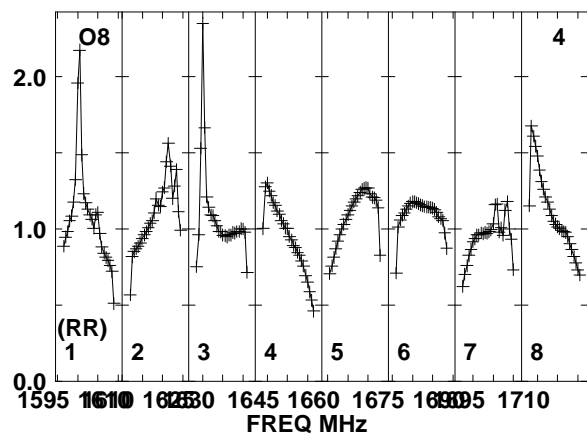
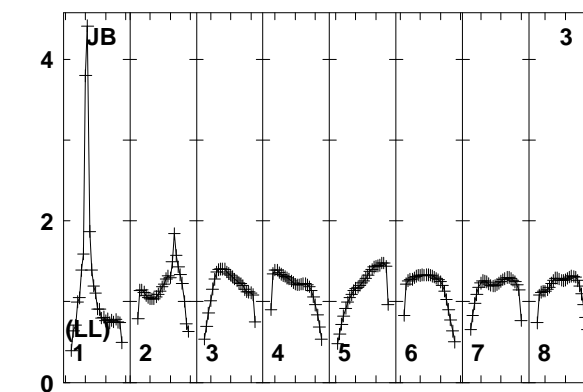
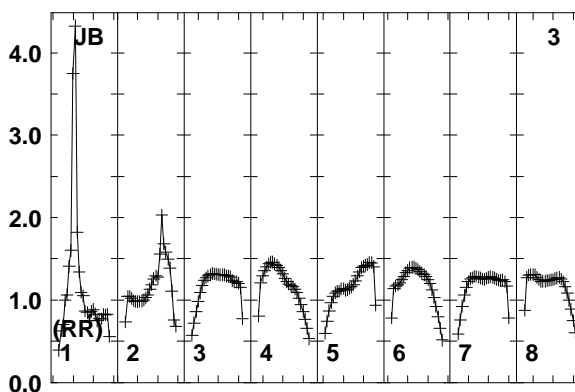
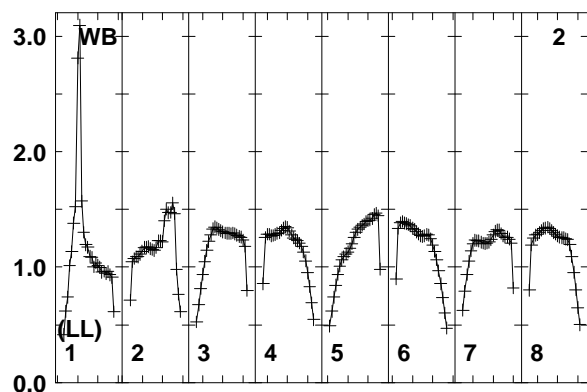
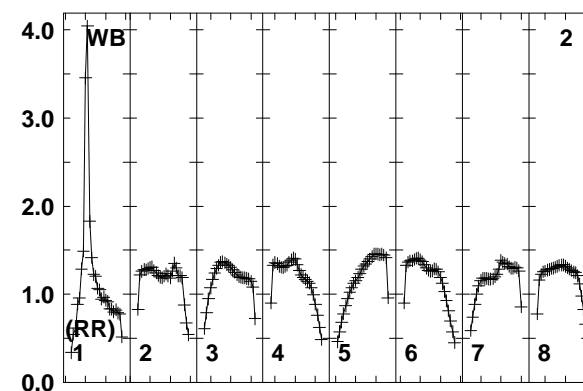
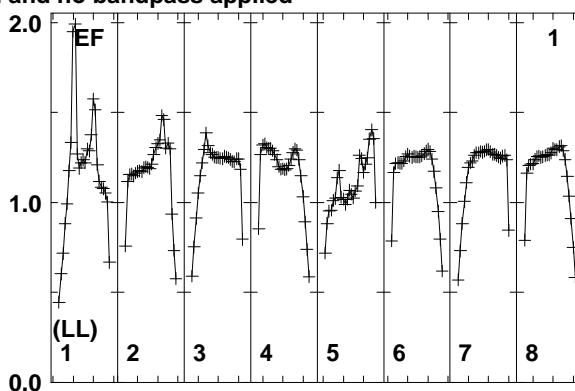
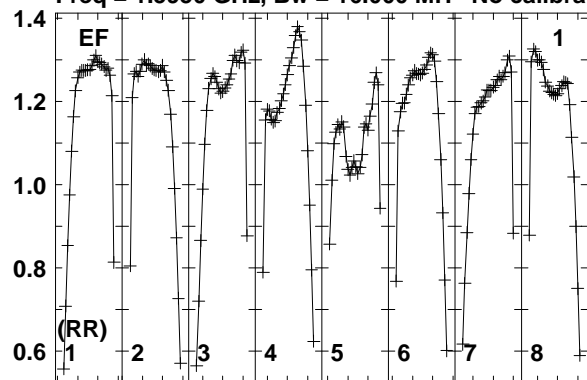

Lower frame: Real Jy
Total-power spectrum Antenna: EF (01)
Timerange: 00/00:46:32 to 00/00:49:59

Plot file version 47 created 19-AUG-2016 17:19:19

J1649+2635 EM119D.UVDATA.1

Freq = 1.5950 GHz, Bw = 16.000 MH No calibration applied and no bandpass applied

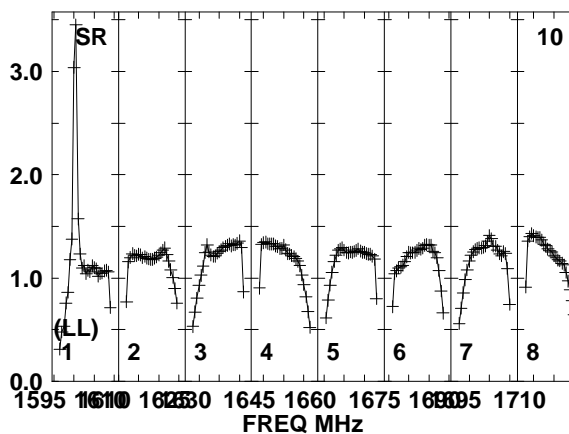
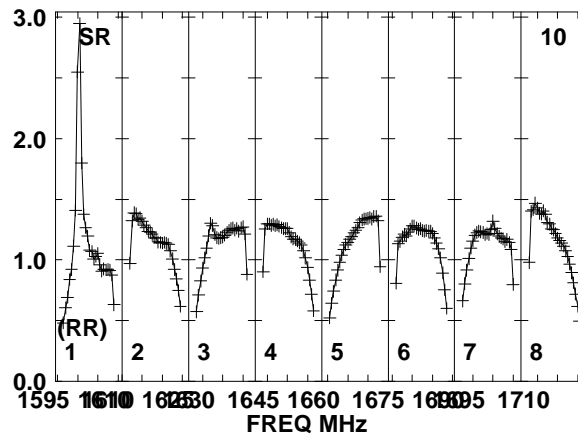
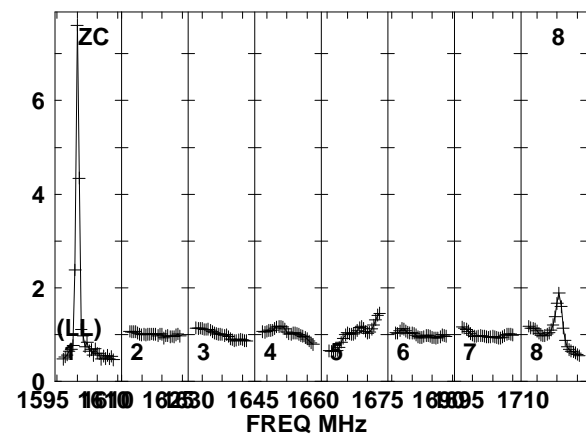
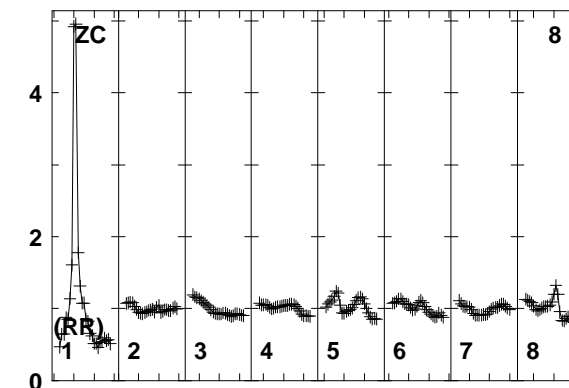
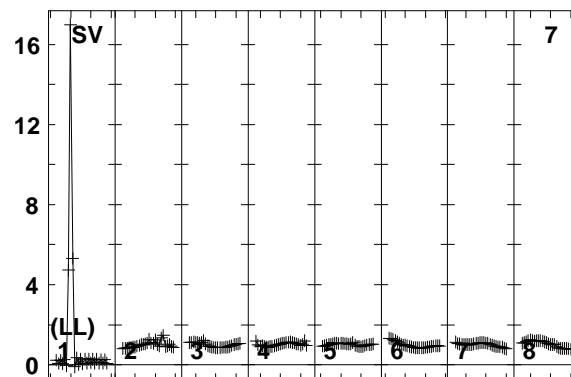
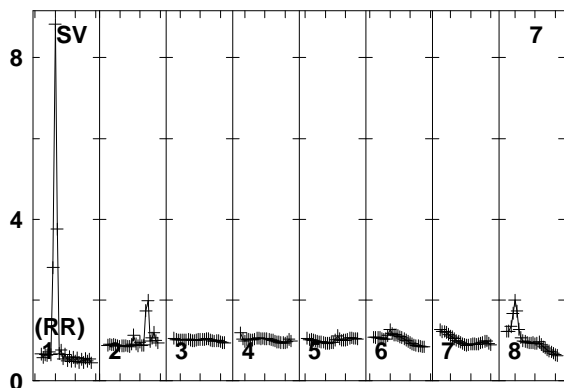
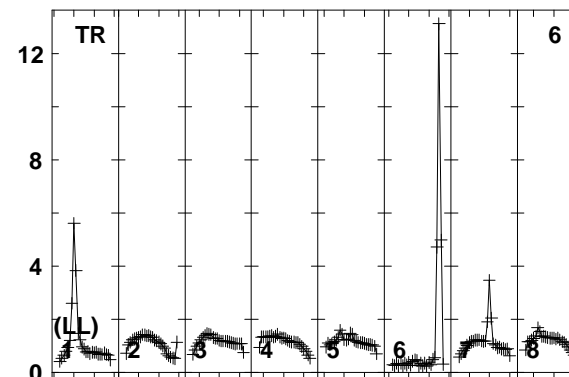
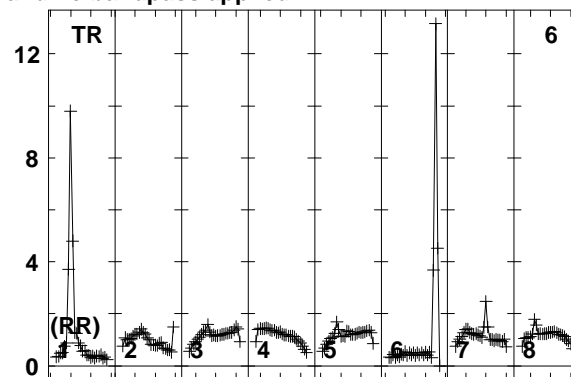
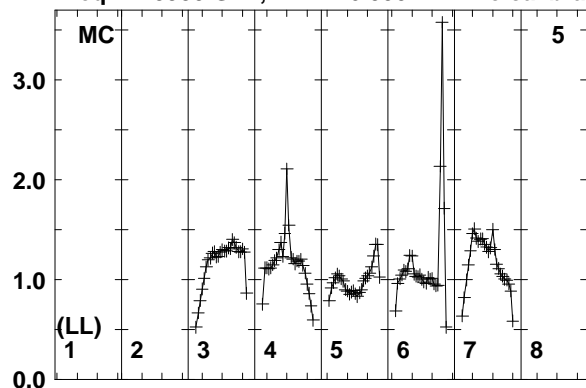

Lower frame: Real Jy
Total-power spectrum Antenna: MC (05)
Timerange: 00/00:46:32 to 00/00:49:59

Plot file version 48 created 19-AUG-2016 17:19:19

J1649+2635 EM119D.UVDATA.1

Freq = 1.5950 GHz, Bw = 16.000 MH No calibration applied and no bandpass applied

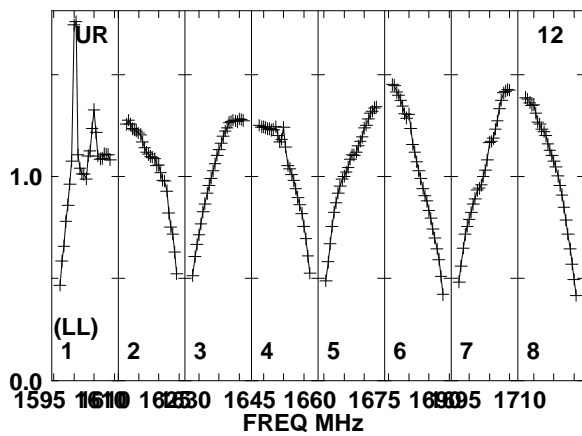
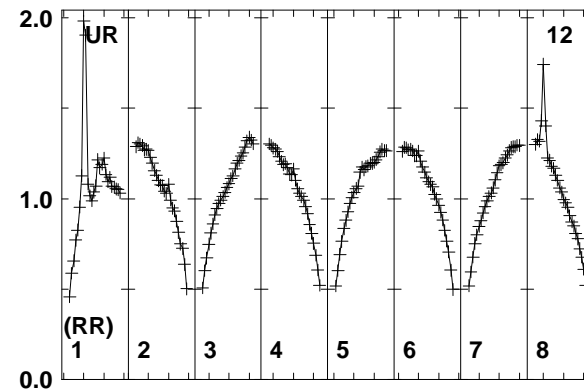
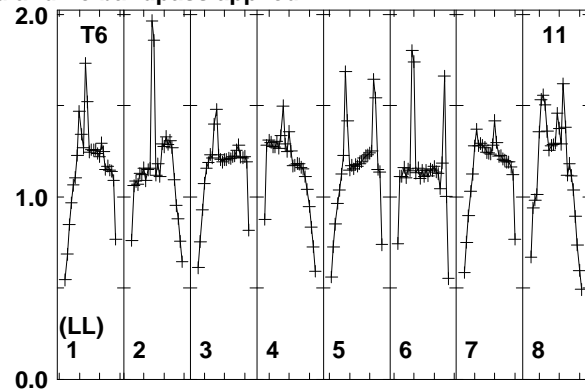
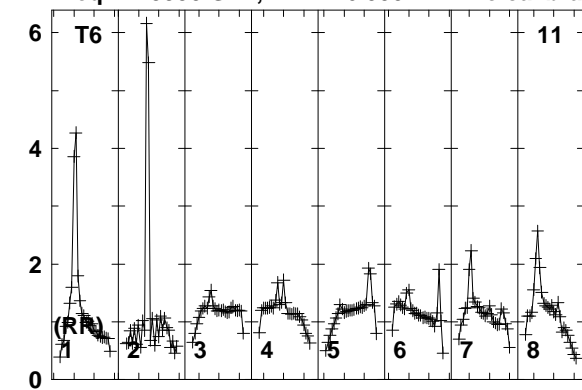

Lower frame: Real Jy
Total-power spectrum Antenna: T6 (11)
Timerange: 00/00:46:32 to 00/00:49:59

Plot file version 49 created 19-AUG-2016 17:19:19

J1642+2523 EM119D.UVDATA.1

Freq = 1.5950 GHz, Bw = 16.000 MH No calibration applied and no bandpass applied

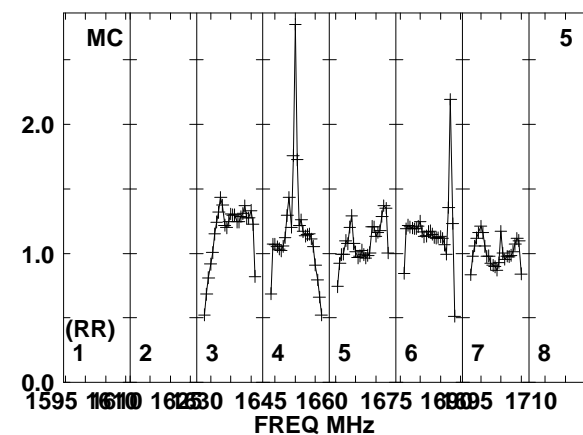
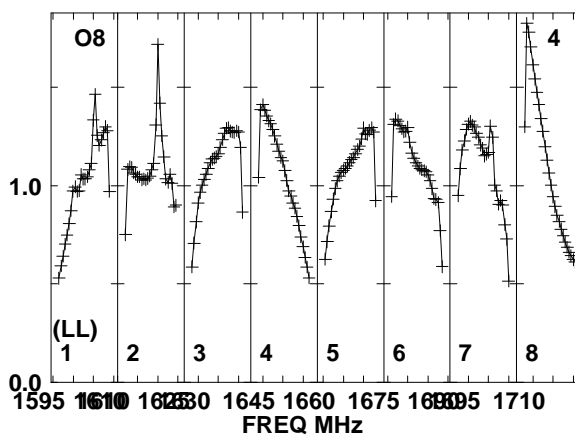
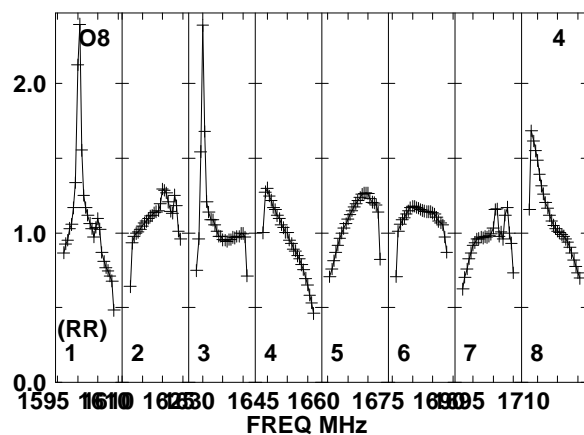
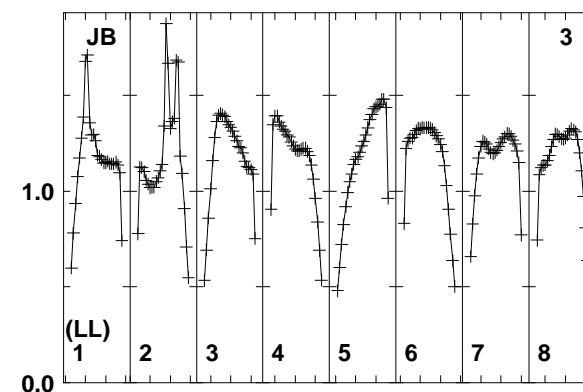
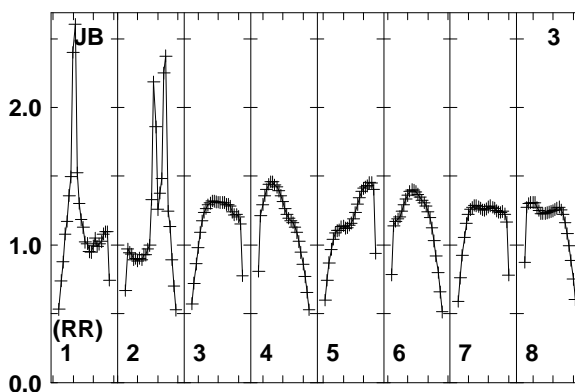
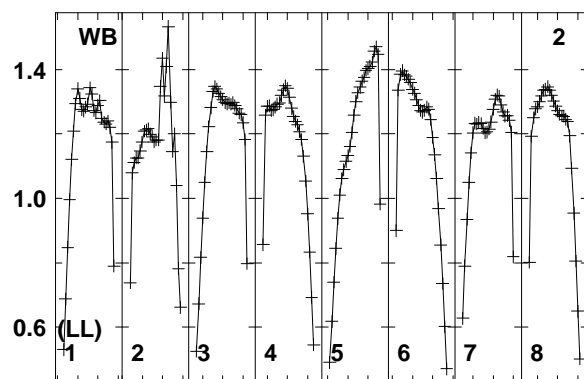
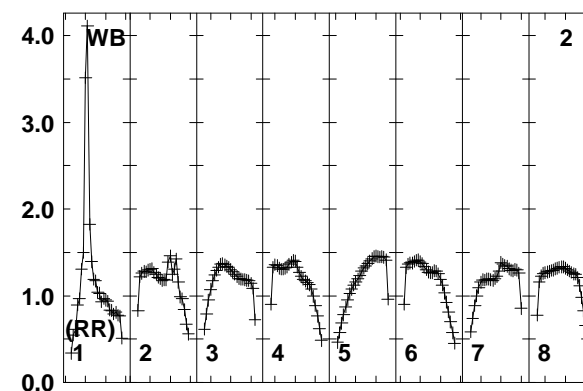
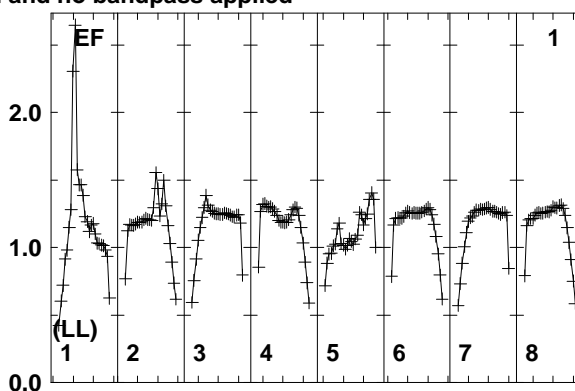
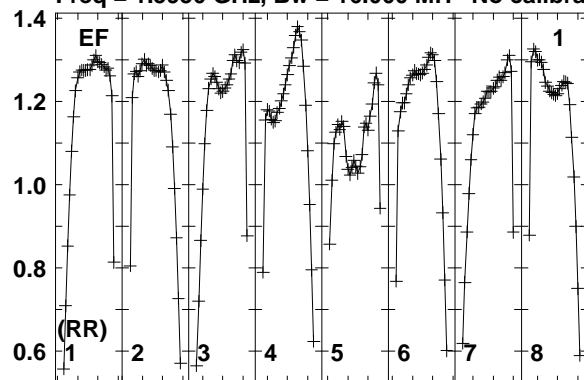

Lower frame: Real Jy
Total-power spectrum Antenna: EF (01)
Timerange: 00/00:50:08 to 00/00:51:29

Plot file version 50 created 19-AUG-2016 17:19:19

J1642+2523 EM119D.UVDATA.1

Freq = 1.5950 GHz, Bw = 16.000 MH No calibration applied and no bandpass applied

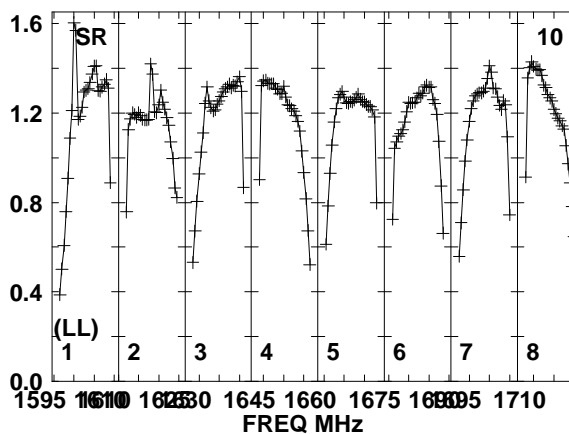
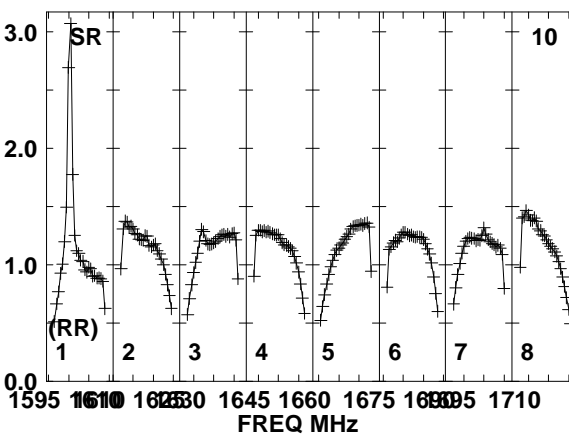
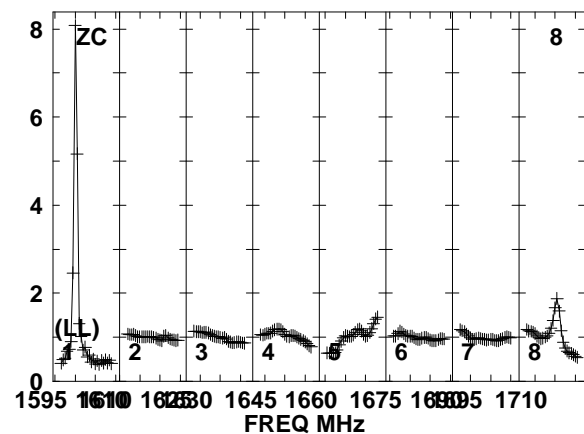
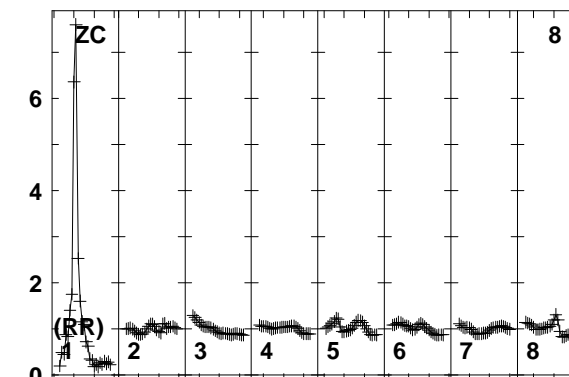
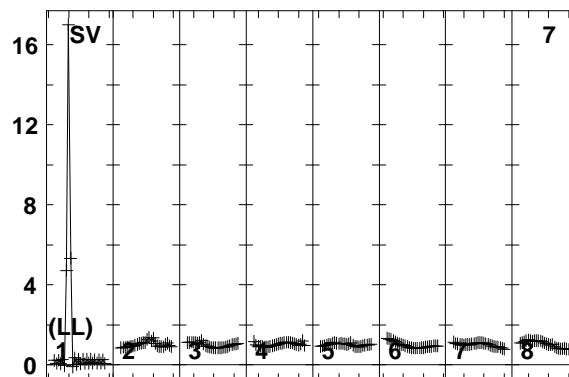
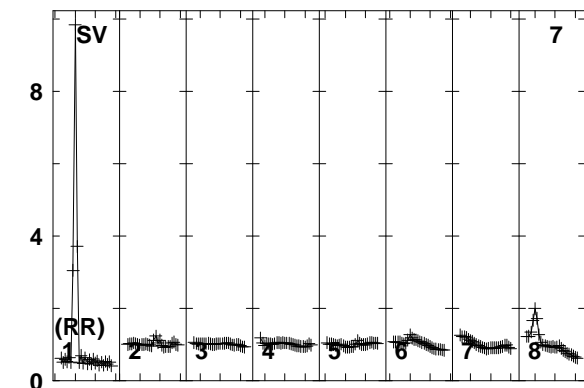
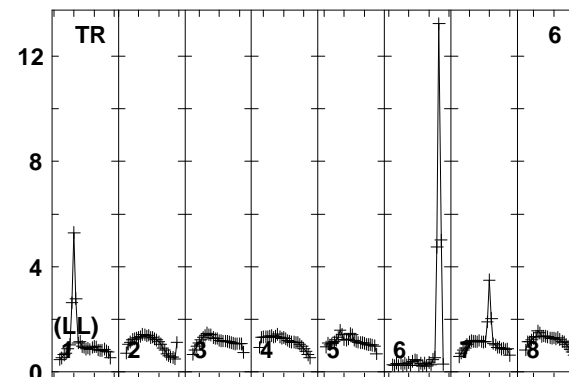
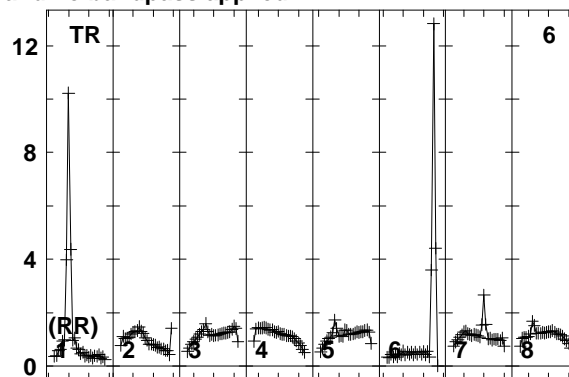
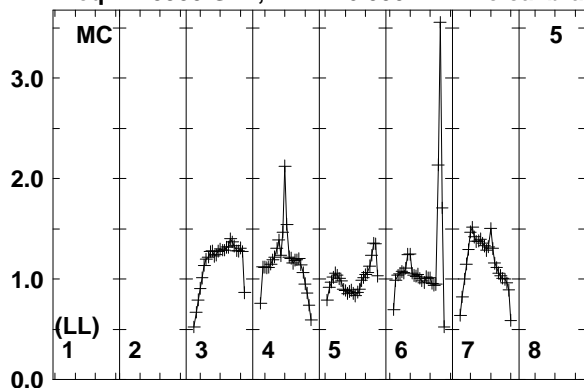

Lower frame: Real Jy
Total-power spectrum Antenna: MC (05)
Timerange: 00/00:50:08 to 00/00:51:29

Plot file version 51 created 19-AUG-2016 17:19:20

J1642+2523 EM119D.UVDATA.1

Freq = 1.5950 GHz, Bw = 16.000 MH No calibration applied and no bandpass applied

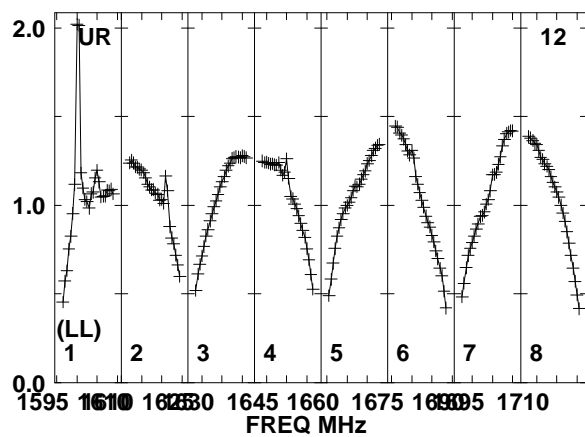
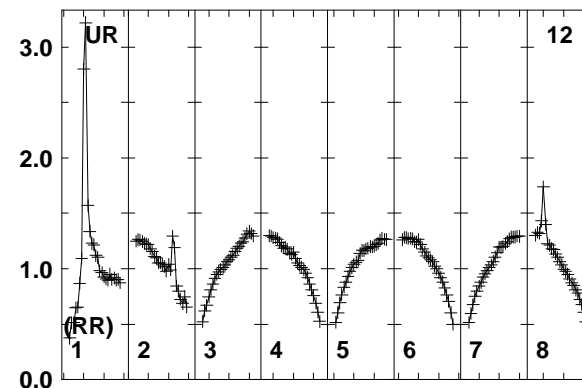
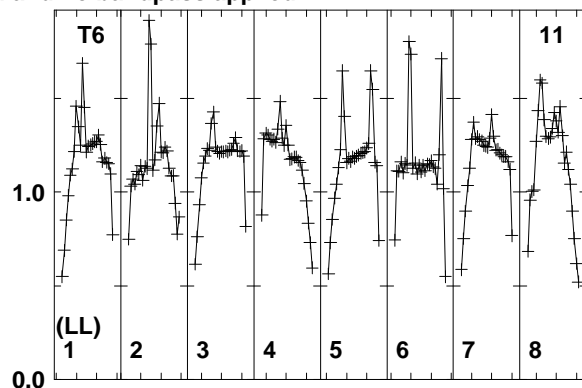
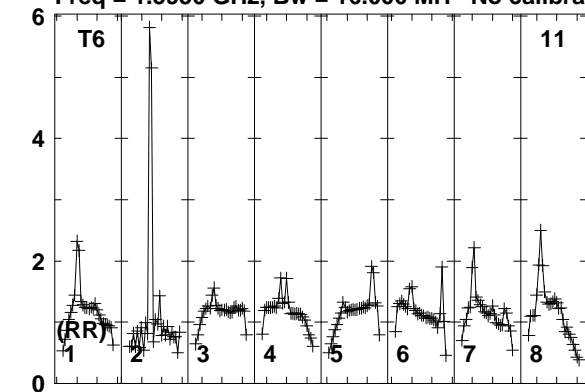

Lower frame: Real Jy
Total-power spectrum Antenna: T6 (11)
Timerange: 00/00:50:08 to 00/00:51:29

Plot file version 52 created 19-AUG-2016 17:19:20

J1649+2635 EM119D.UVDATA.1

Freq = 1.5950 GHz, Bw = 16.000 MH No calibration applied and no bandpass applied

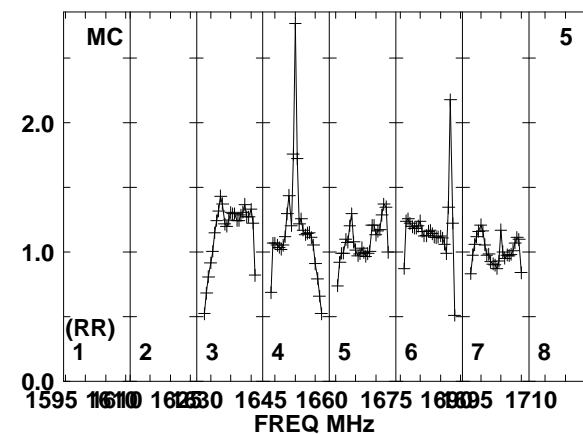
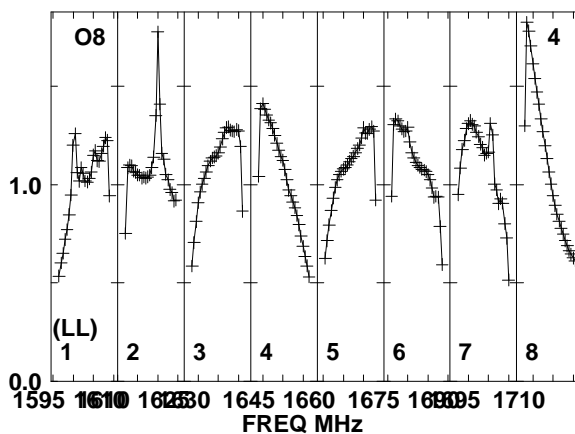
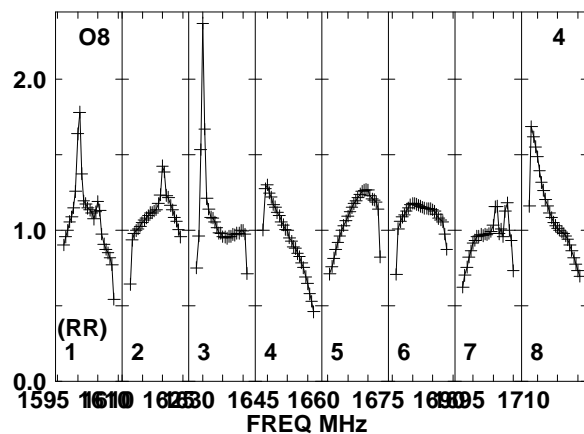
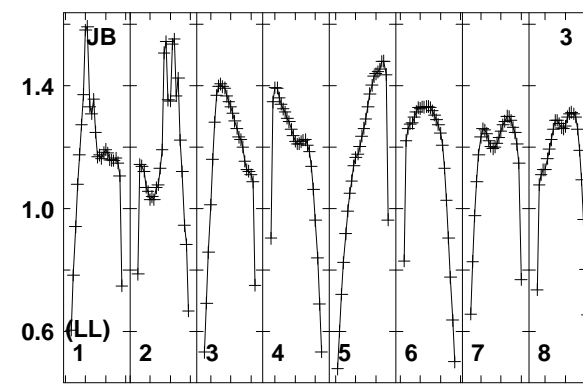
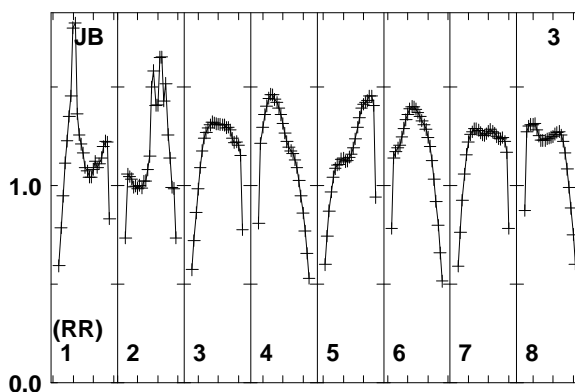
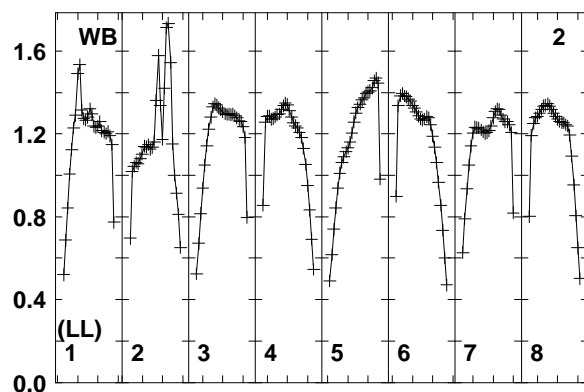
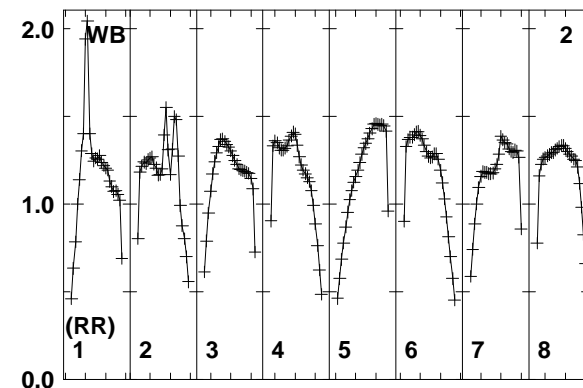
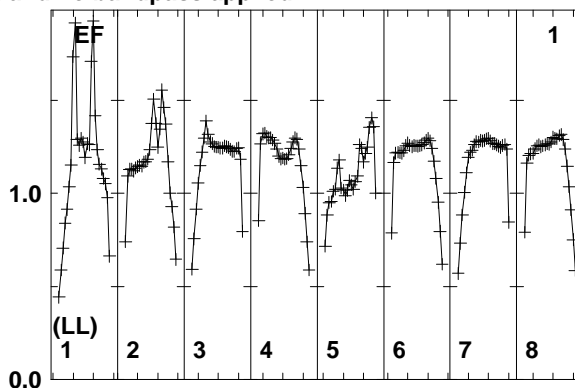
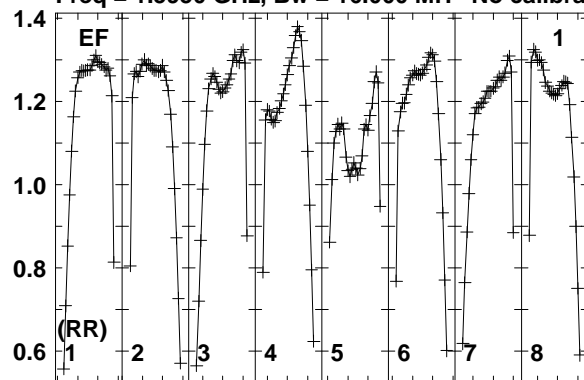

Lower frame: Real Jy
Total-power spectrum Antenna: EF (01)
Timerange: 00/00:51:38 to 00/00:55:00

Plot file version 53 created 19-AUG-2016 17:19:20

J1649+2635 EM119D.UVDATA.1

Freq = 1.5950 GHz, Bw = 16.000 MH No calibration applied and no bandpass applied

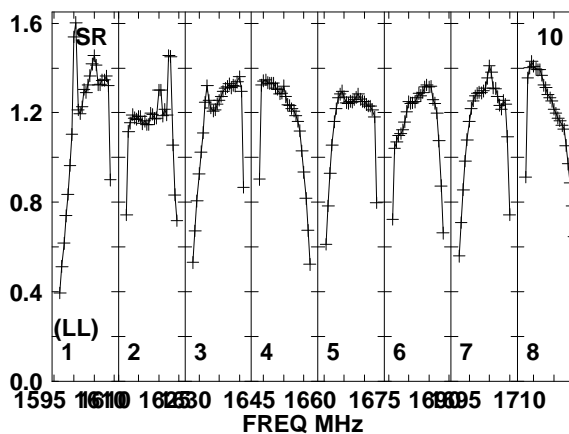
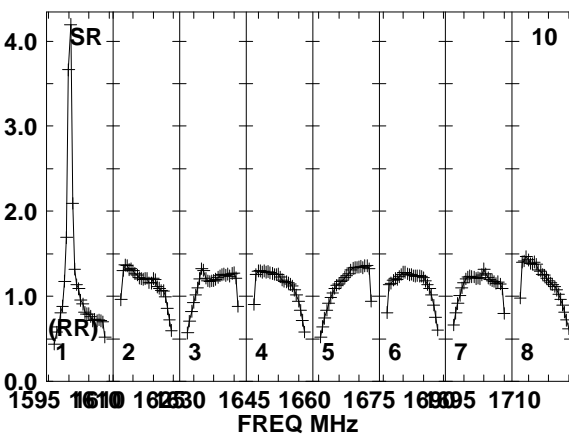
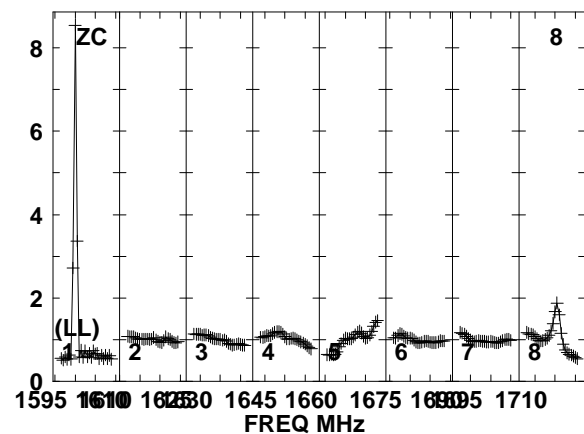
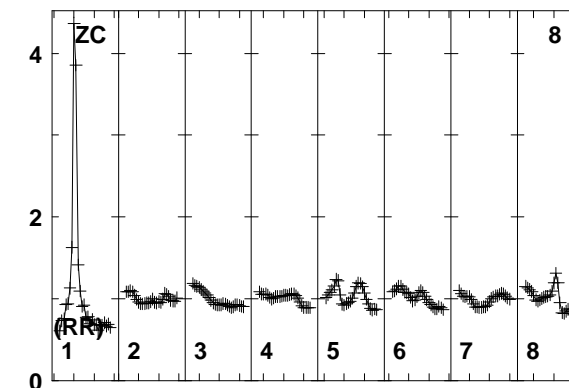
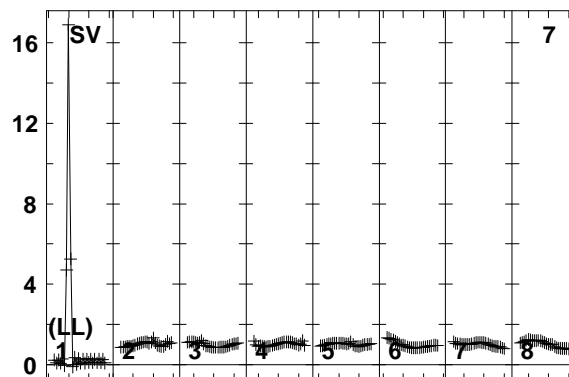
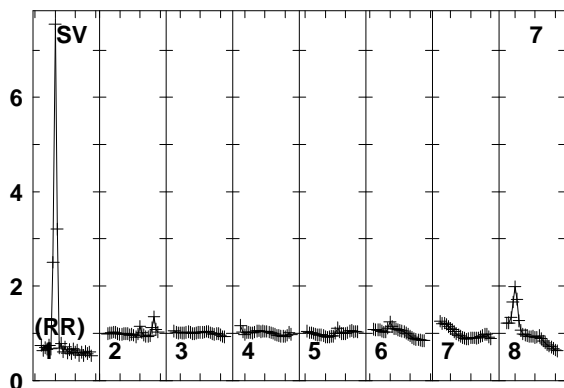
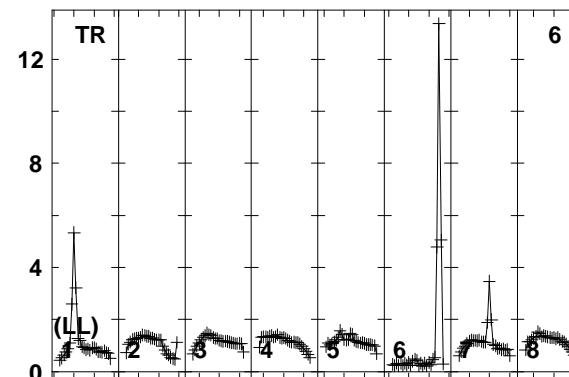
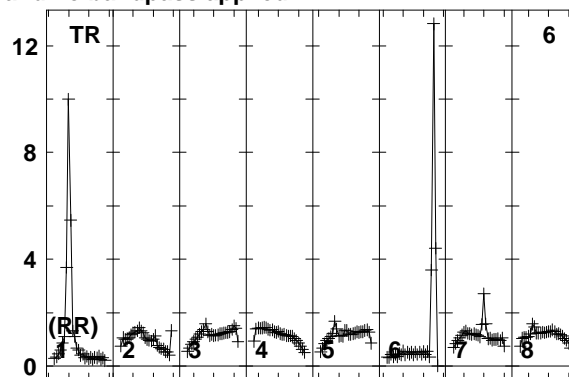
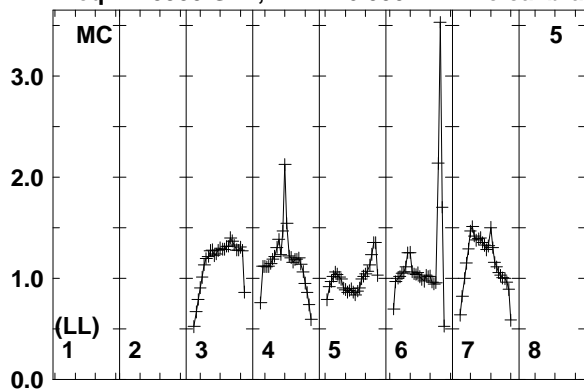

Lower frame: Real Jy
Total-power spectrum Antenna: MC (05)
Timerange: 00/00:51:38 to 00/00:55:00

Plot file version 54 created 19-AUG-2016 17:19:20

J1649+2635 EM119D.UVDATA.1

Freq = 1.5950 GHz, Bw = 16.000 MH No calibration applied and no bandpass applied

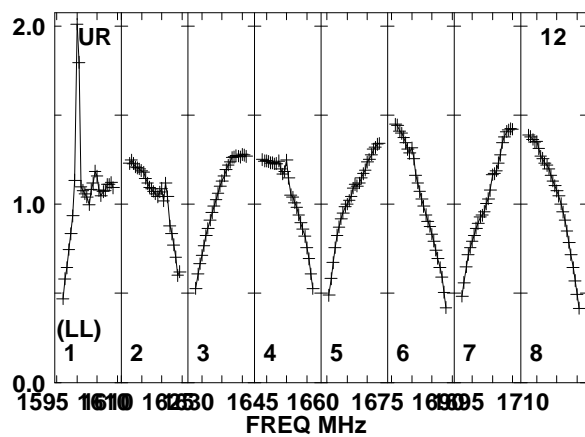
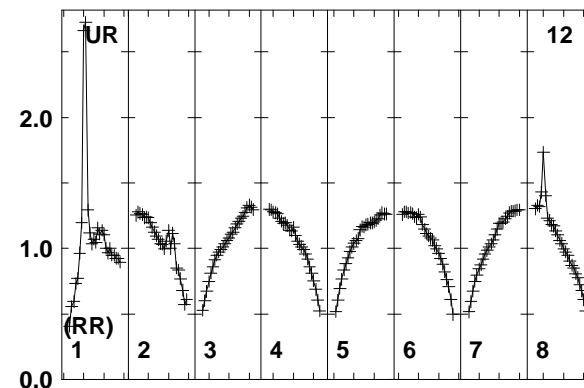
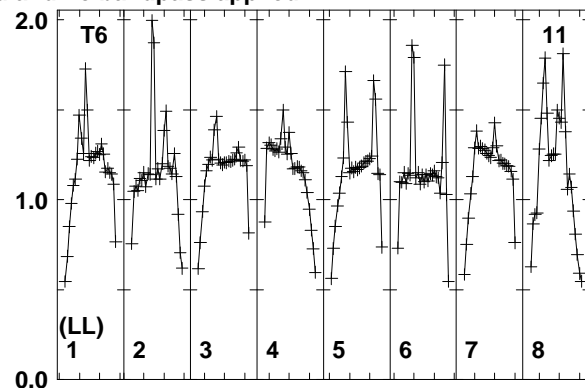
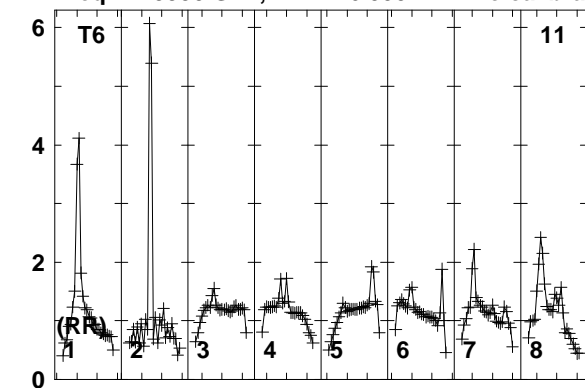

Lower frame: Real Jy
Total-power spectrum Antenna: T6 (11)
Timerange: 00/00:51:38 to 00/00:55:00

Plot file version 55 created 19-AUG-2016 17:19:20

J1642+2523 EM119D.UVDATA.1

Freq = 1.5950 GHz, Bw = 16.000 MH No calibration applied and no bandpass applied

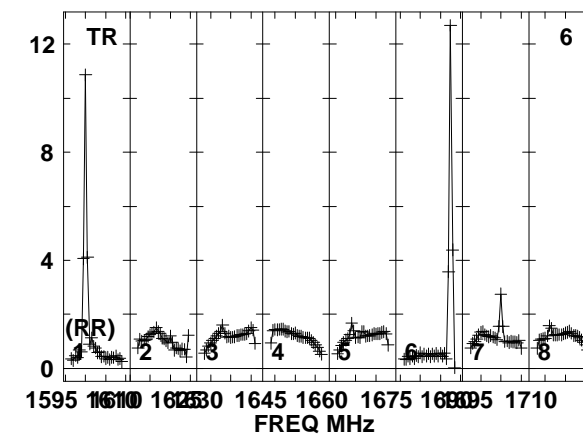
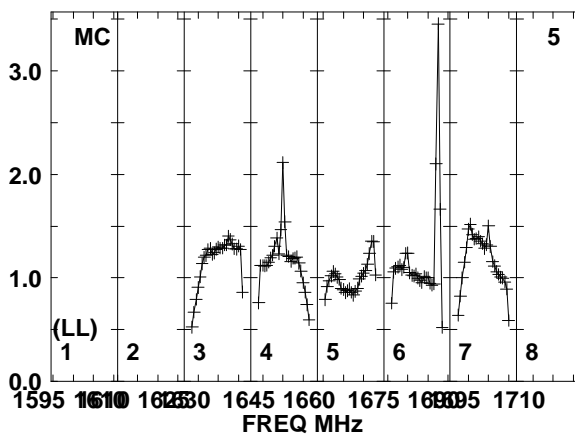
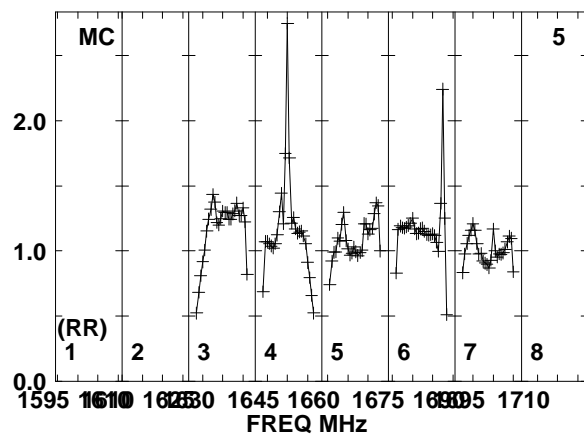
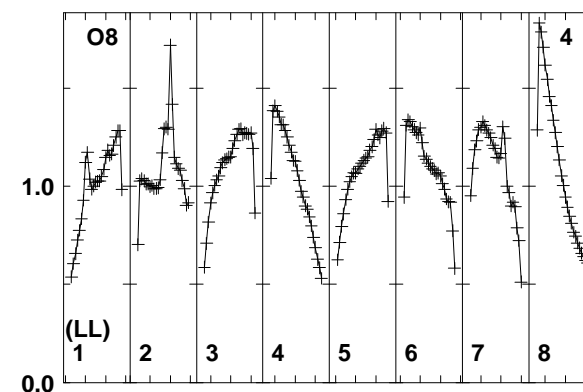
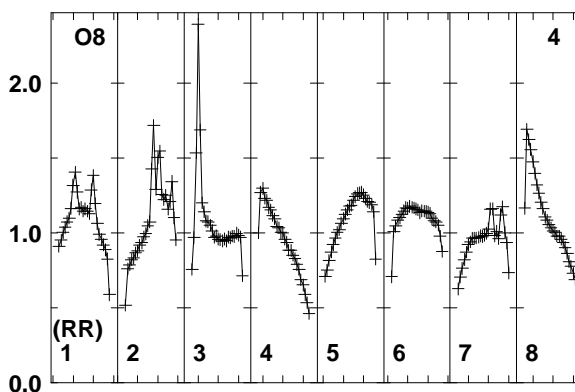
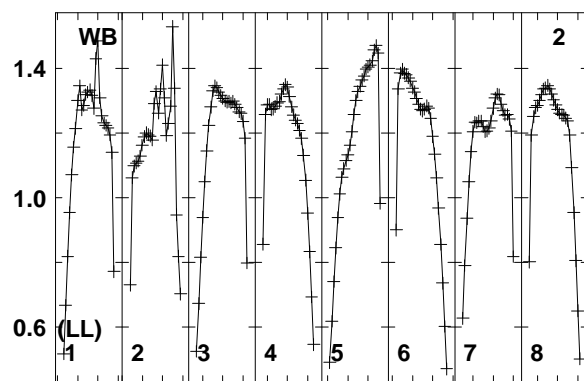
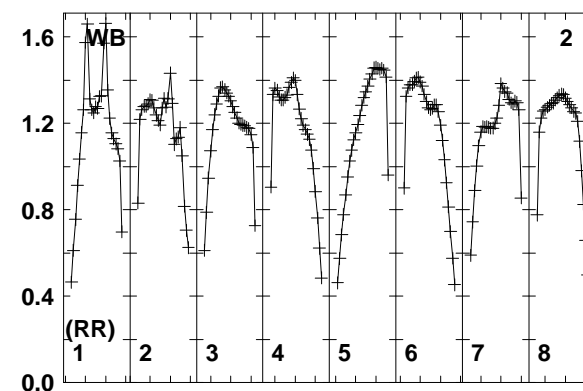
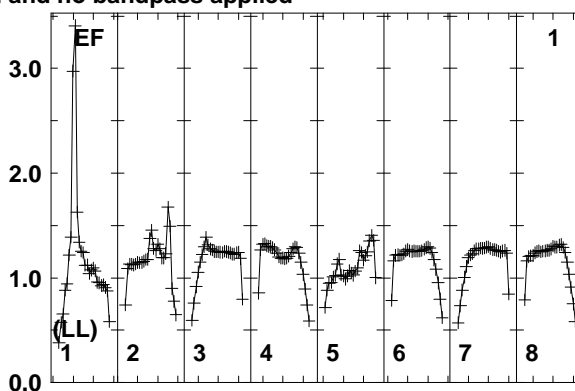
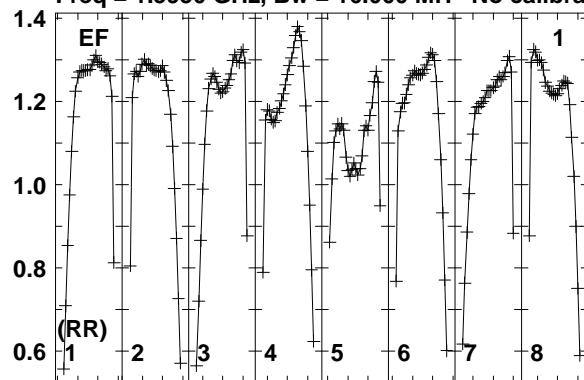

Lower frame: Real Jy
Total-power spectrum Antenna: EF (01)
Timerange: 00/00:56:00 to 00/00:57:29

Plot file version 56 created 19-AUG-2016 17:19:20

J1642+2523 EM119D.UVDATA.1

Freq = 1.5950 GHz, Bw = 16.000 MH No calibration applied and no bandpass applied

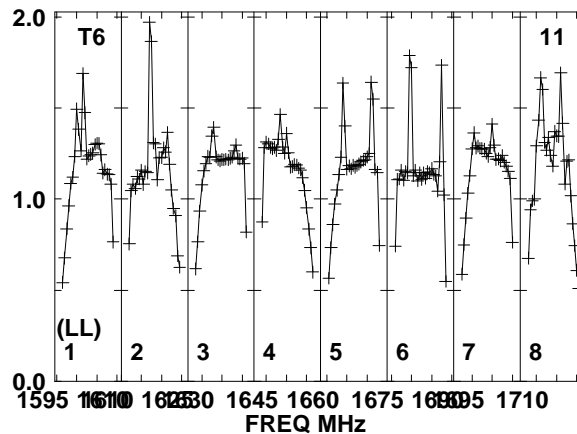
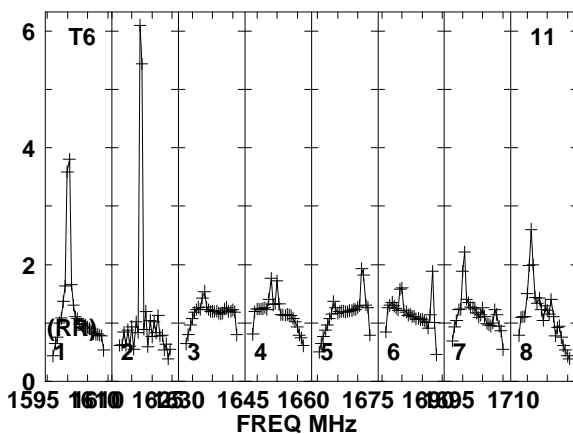
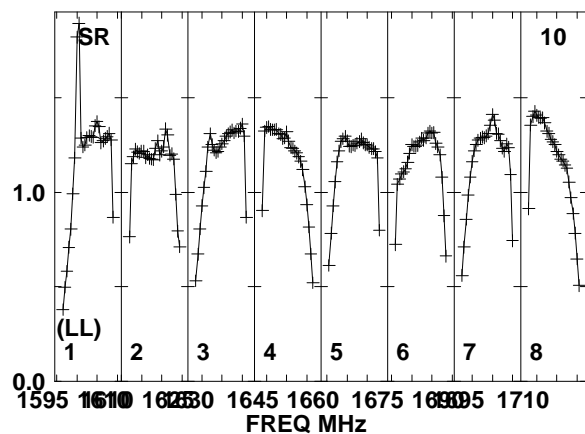
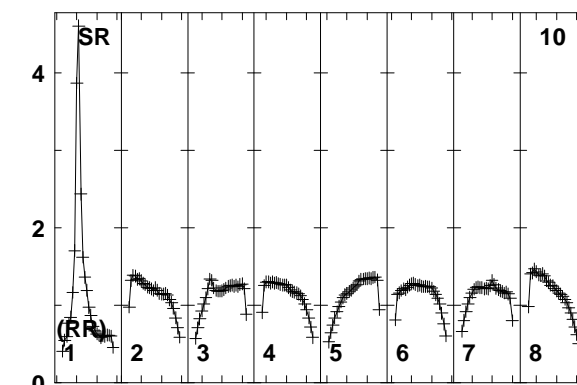
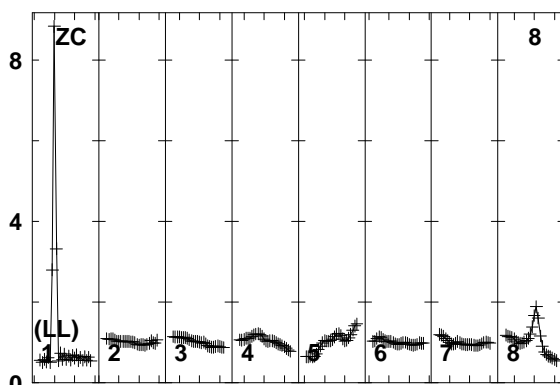
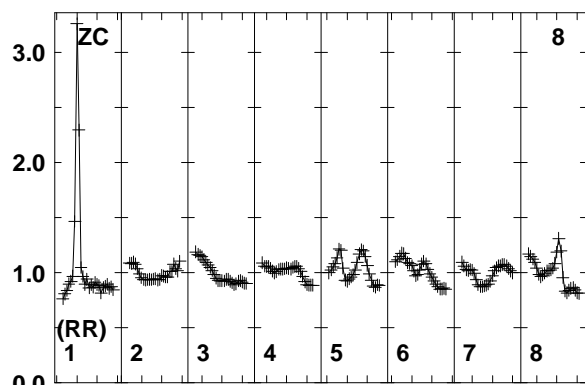
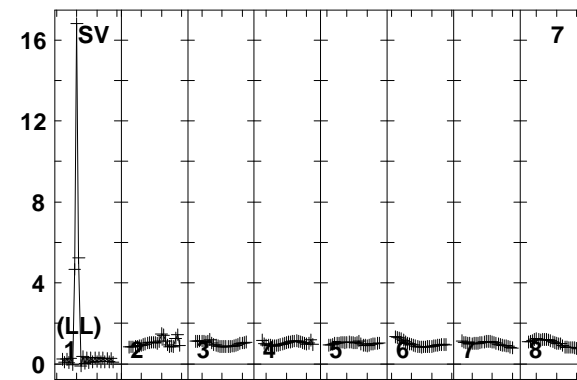
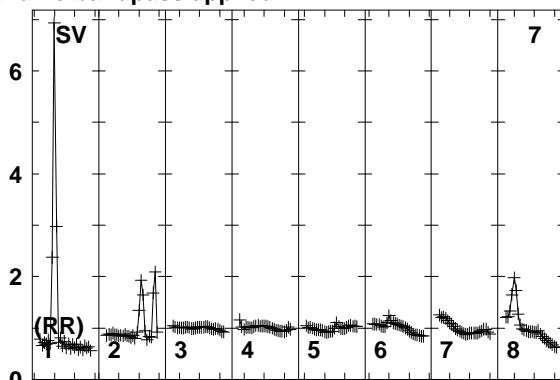
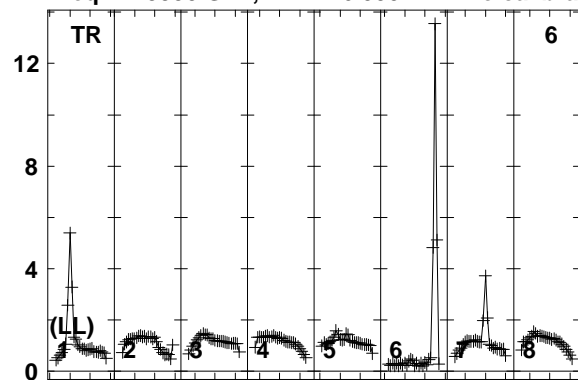

Lower frame: Real Jy
Total-power spectrum Antenna: TR (06)
Timerange: 00/00:56:00 to 00/00:57:29

Plot file version 57 created 19-AUG-2016 17:19:21

J1642+2523 EM119D.UVDATA.1

Freq = 1.5950 GHz, Bw = 16.000 MH No calibration applied and no bandpass applied

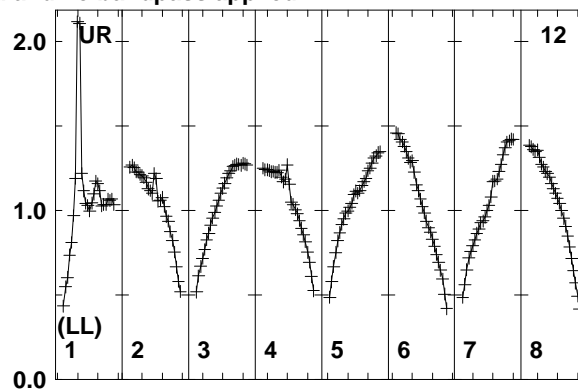
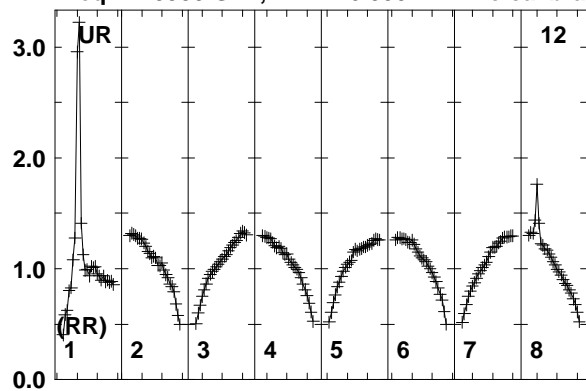

Lower frame: Real Jy
Total-power spectrum Antenna: UR (12)
Timerange: 00/00:56:00 to 00/00:57:29

Plot file version 58 created 19-AUG-2016 17:19:21

J1649+2635 EM119D.UVDATA.1

Freq = 1.5950 GHz, Bw = 16.000 MH No calibration applied and no bandpass applied

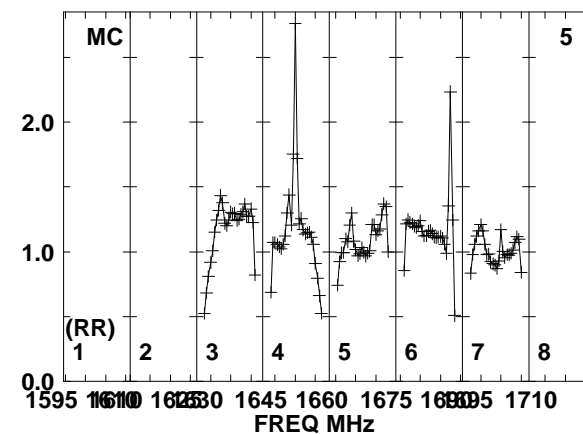
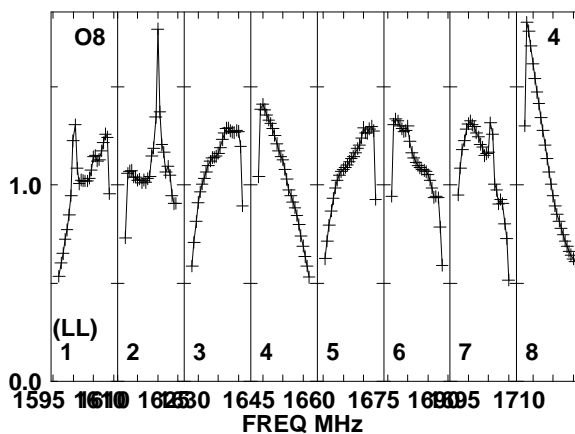
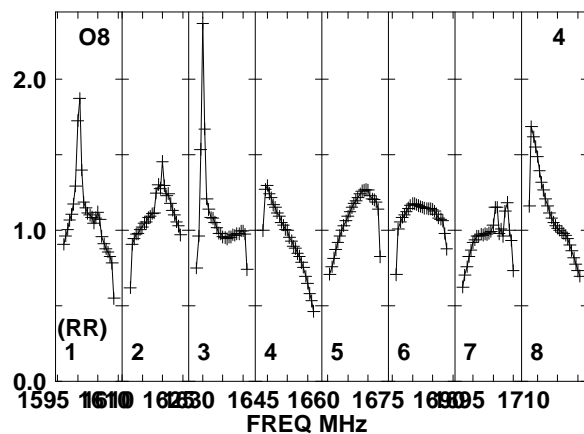
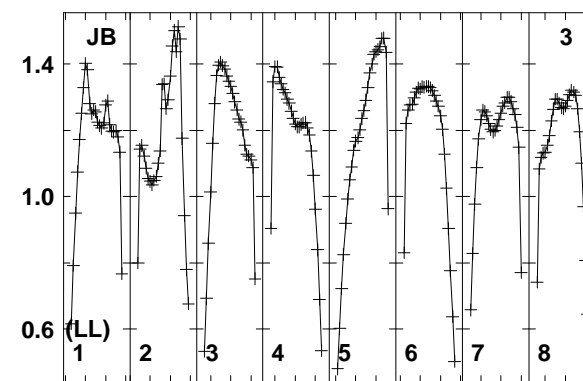
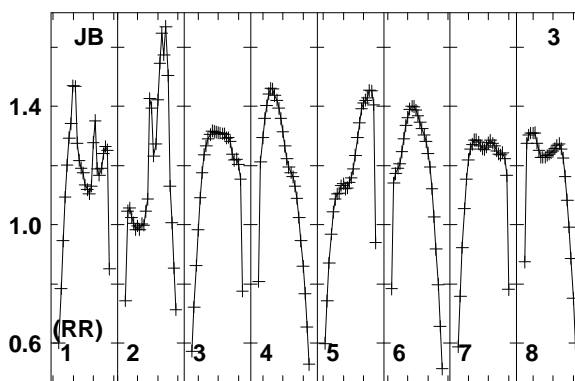
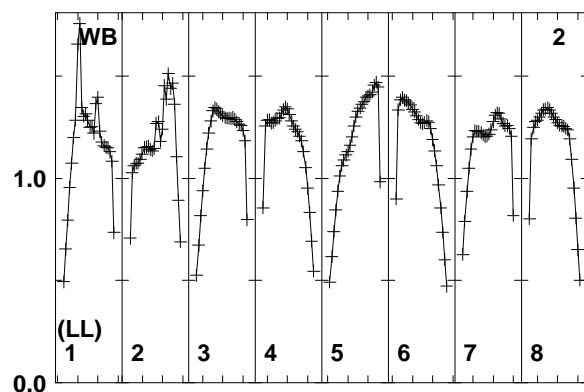
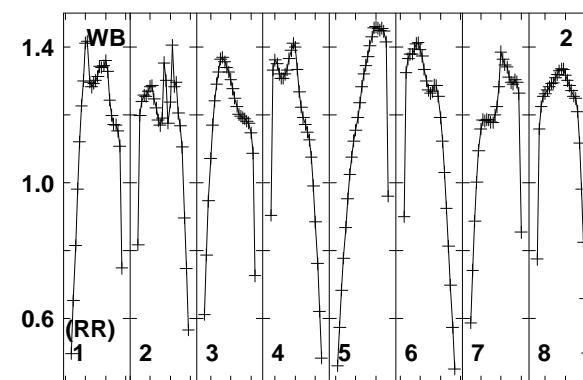
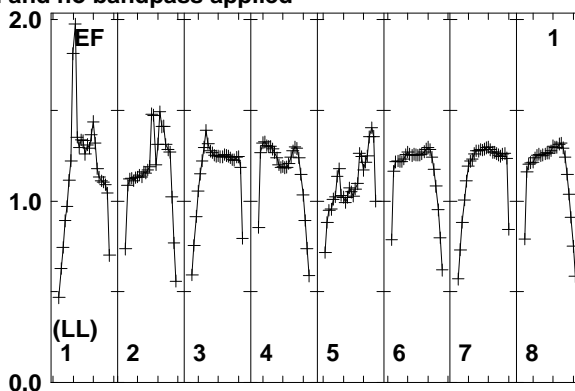
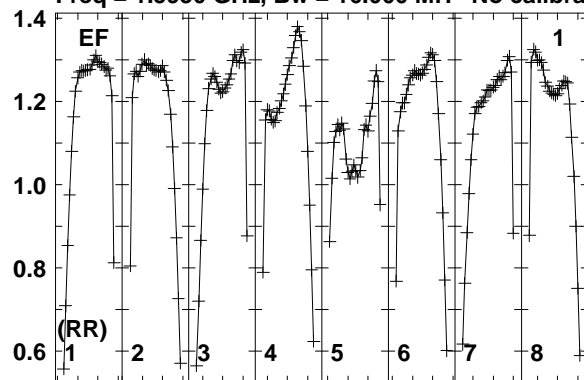

Lower frame: Real Jy
Total-power spectrum Antenna: EF (01)
Timerange: 00/00:57:32 to 00/01:01:00

Plot file version 59 created 19-AUG-2016 17:19:21

J1649+2635 EM119D.UVDATA.1

Freq = 1.5950 GHz, Bw = 16.000 MH No calibration applied and no bandpass applied

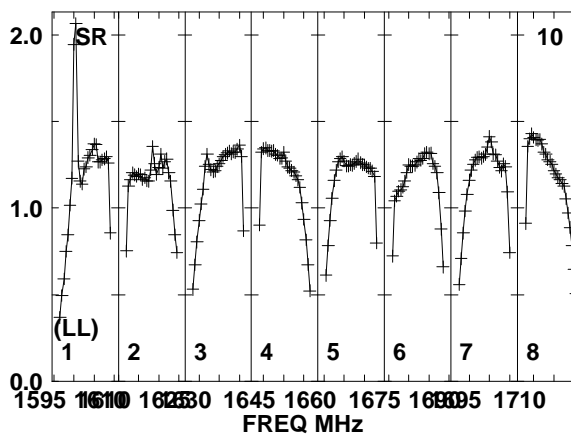
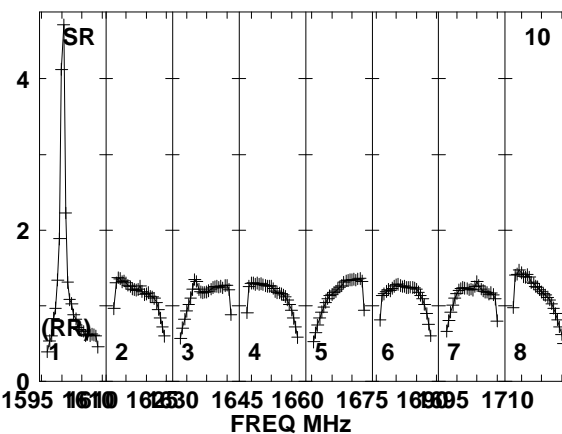
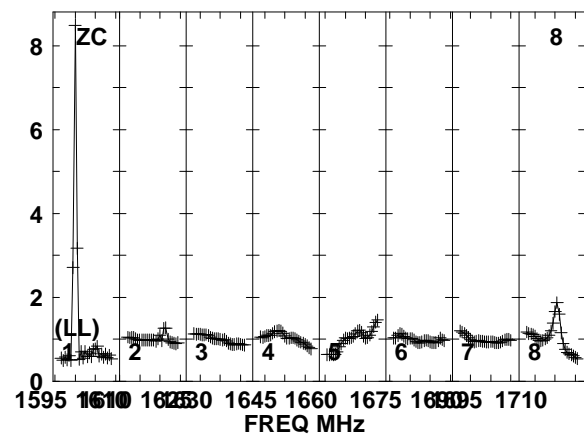
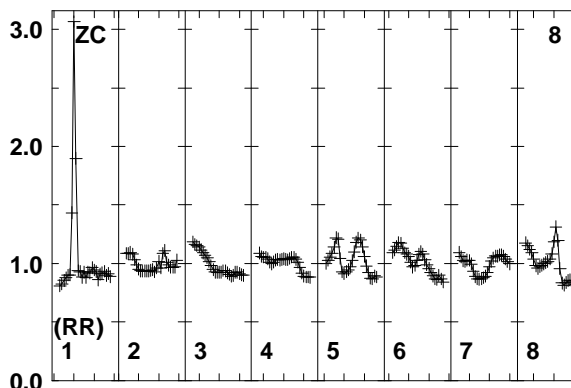
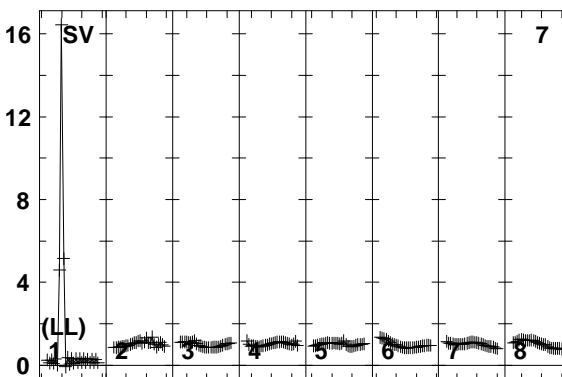
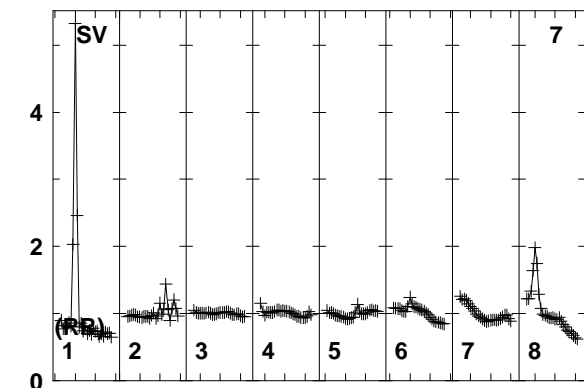
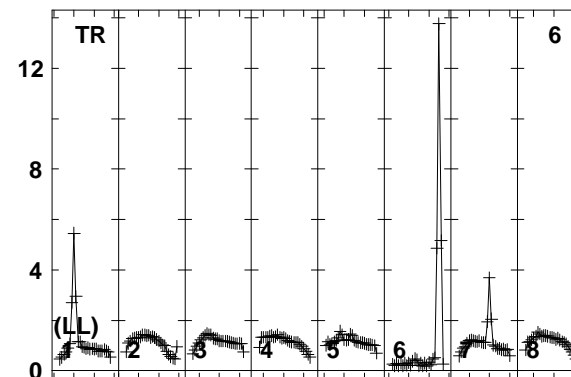
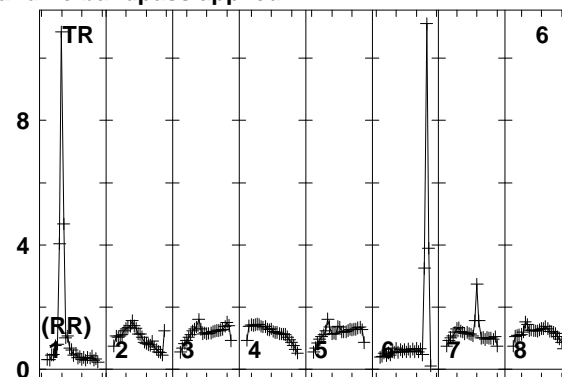
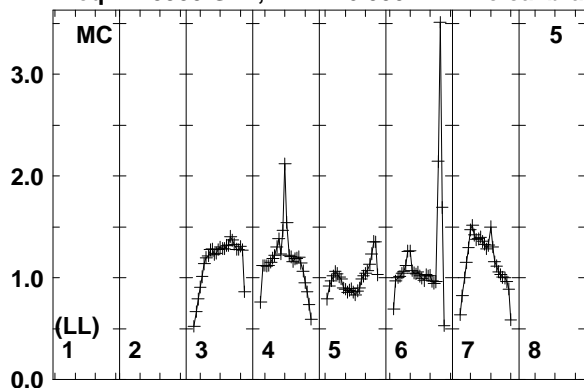

Lower frame: Real Jy
Total-power spectrum Antenna: MC (05)
Timerange: 00/00:57:32 to 00/01:01:00

Plot file version 60 created 19-AUG-2016 17:19:21

J1649+2635 EM119D.UVDATA.1

Freq = 1.5950 GHz, Bw = 16.000 MH No calibration applied and no bandpass applied

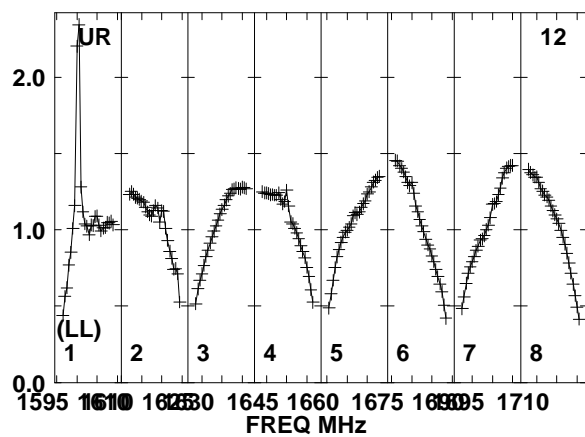
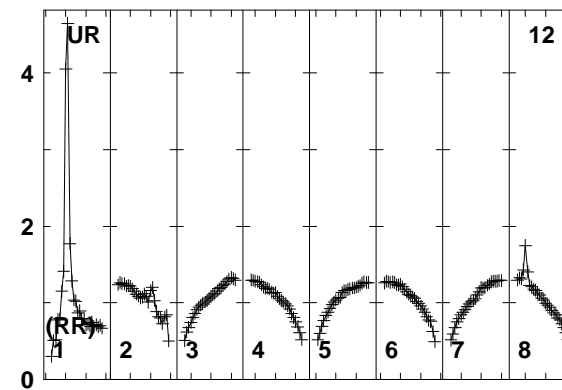
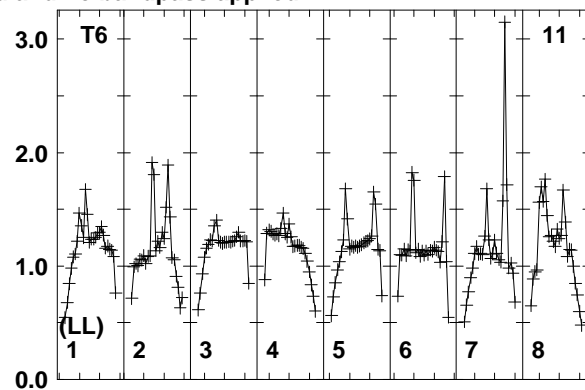
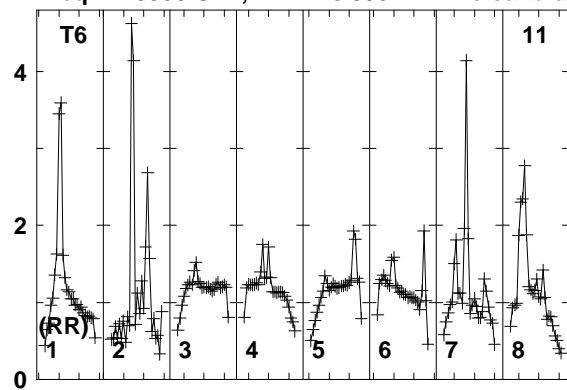

Lower frame: Real Jy
Total-power spectrum Antenna: T6 (11)
Timerange: 00/00:57:32 to 00/01:01:00

Plot file version 61 created 19-AUG-2016 17:19:21

J1642+2523 EM119D.UVDATA.1

Freq = 1.5950 GHz, Bw = 16.000 MH No calibration applied and no bandpass applied

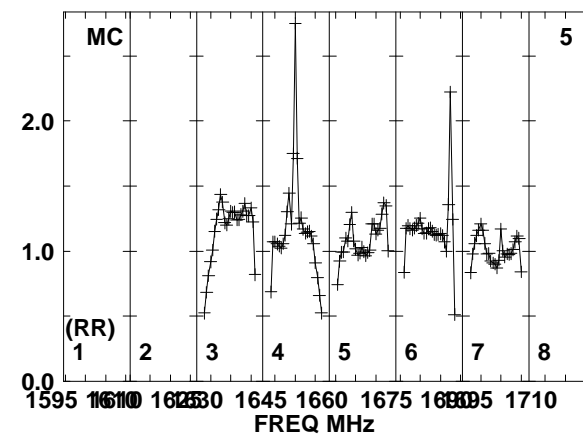
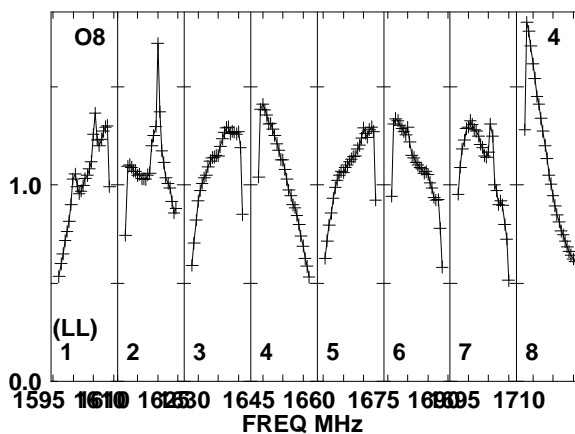
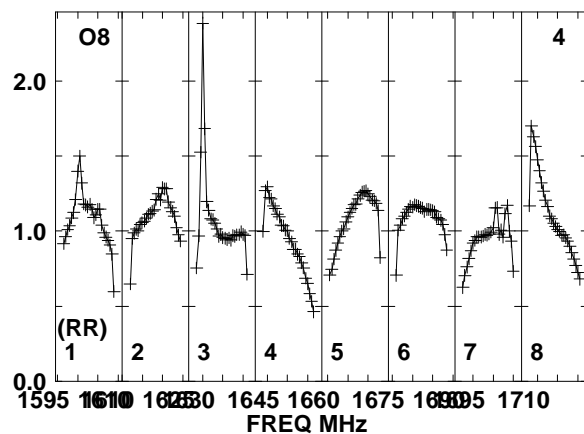
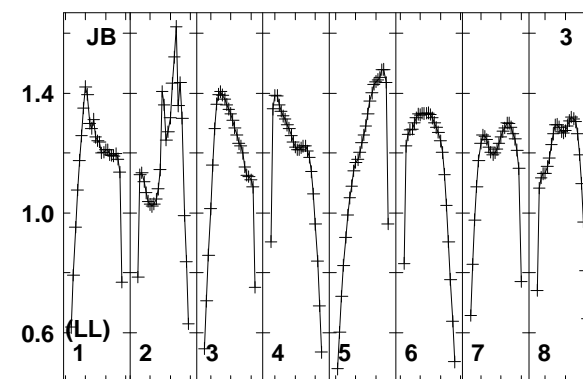
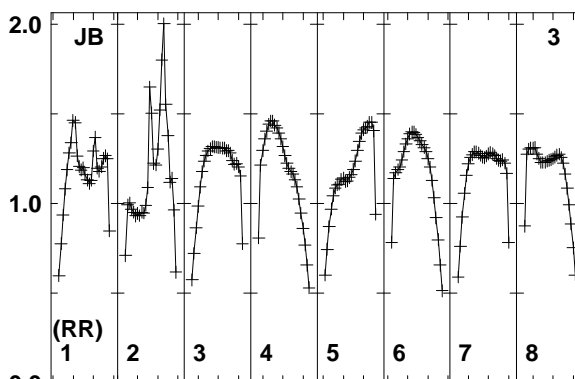
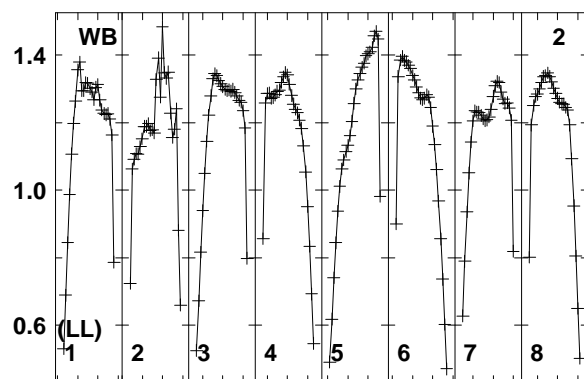
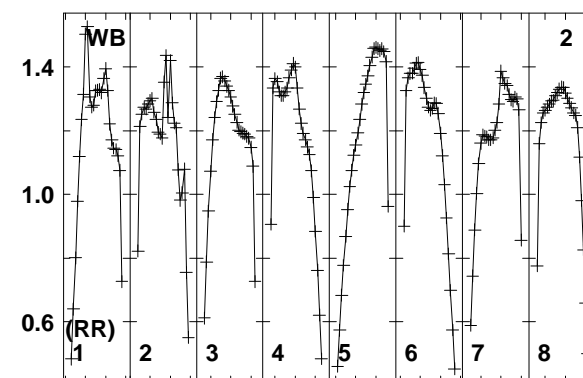
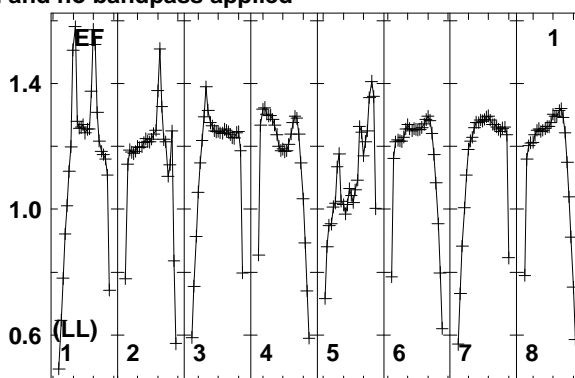
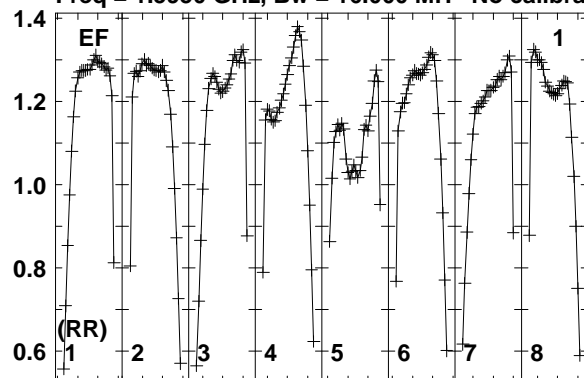

Lower frame: Real Jy
Total-power spectrum Antenna: EF (01)
Timerange: 00/01:01:07 to 00/01:02:29

Plot file version 62 created 19-AUG-2016 17:19:21
 J1642+2523 EM119D.UVDATA.1
 Freq = 1.5950 GHz, Bw = 16.000 MH No calibration applied and no bandpass applied

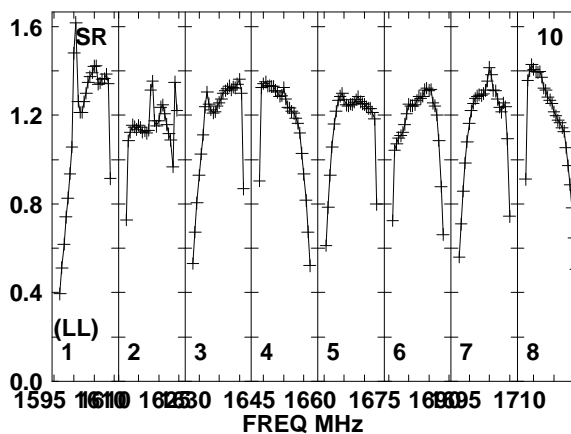
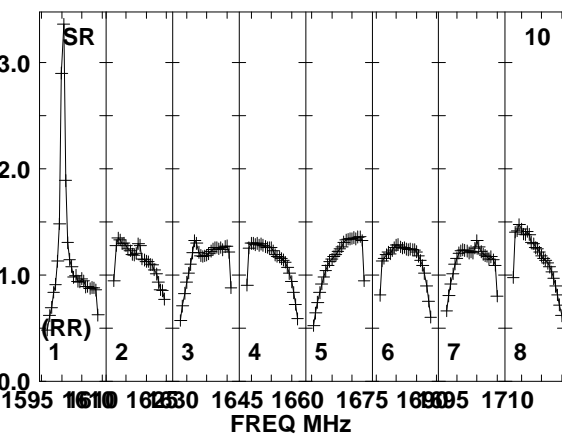
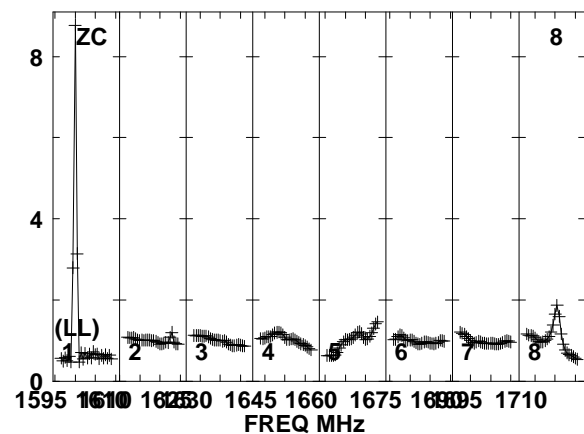
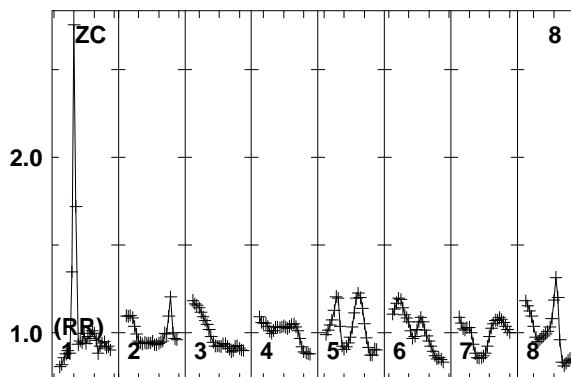
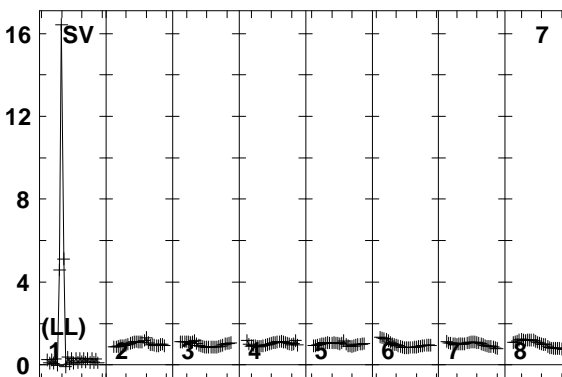
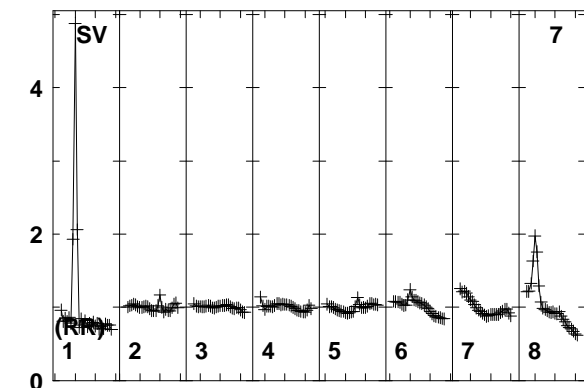
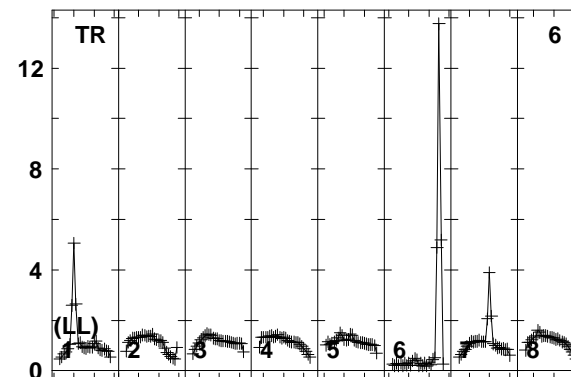
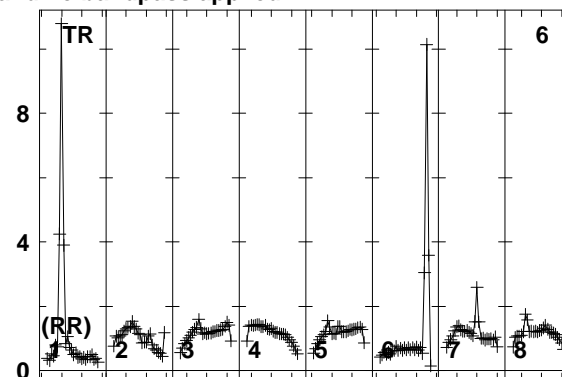
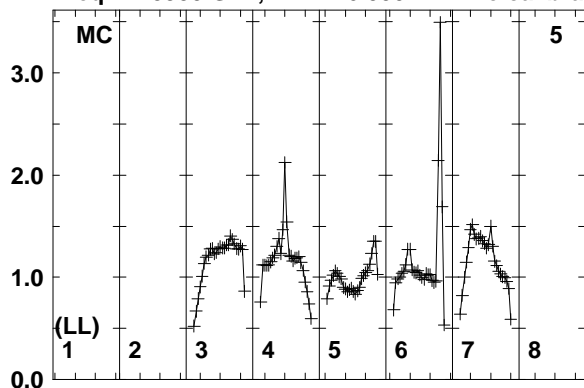

1595 1610 1625 1645 1660 1675 1695 1710
 FREQ MHz
 Lower frame: Real Jy
 Total-power spectrum Antenna: MC (05)
 Timerange: 00/01:01:07 to 00/01:02:29

Plot file version 63 created 19-AUG-2016 17:19:21

J1642+2523 EM119D.UVDATA.1

Freq = 1.5950 GHz, Bw = 16.000 MH No calibration applied and no bandpass applied

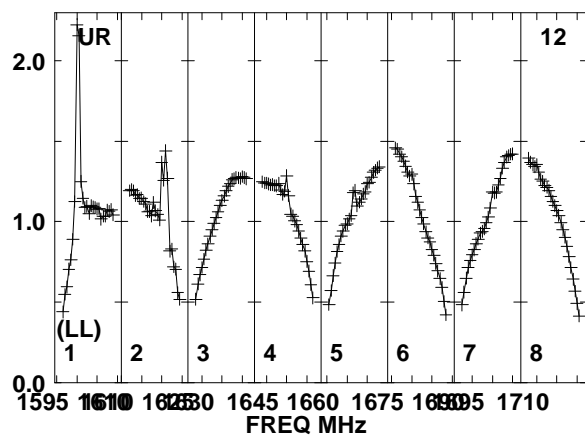
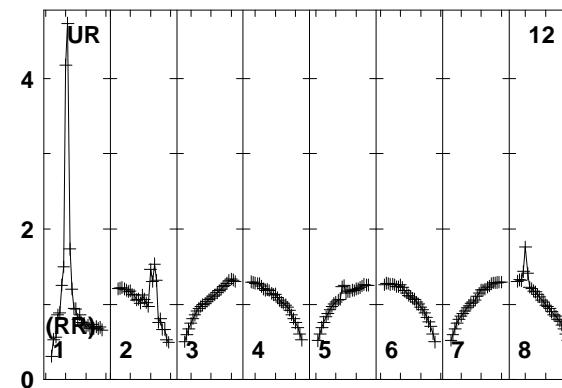
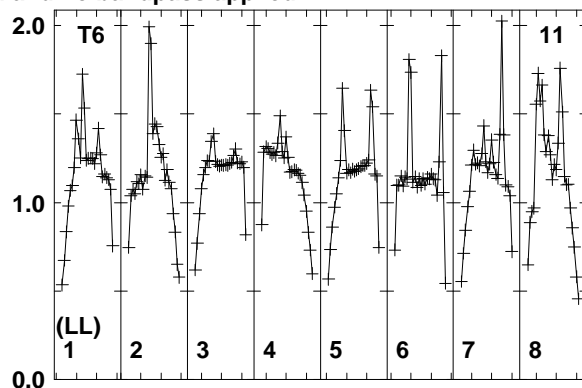
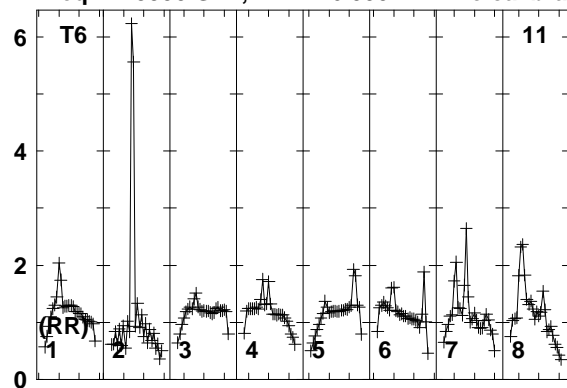

Lower frame: Real Jy
Total-power spectrum Antenna: T6 (11)
Timerange: 00/01:01:07 to 00/01:02:29

Plot file version 64 created 19-AUG-2016 17:19:22

J1649+2635 EM119D.UVDATA.1

Freq = 1.5950 GHz, Bw = 16.000 MH No calibration applied and no bandpass applied

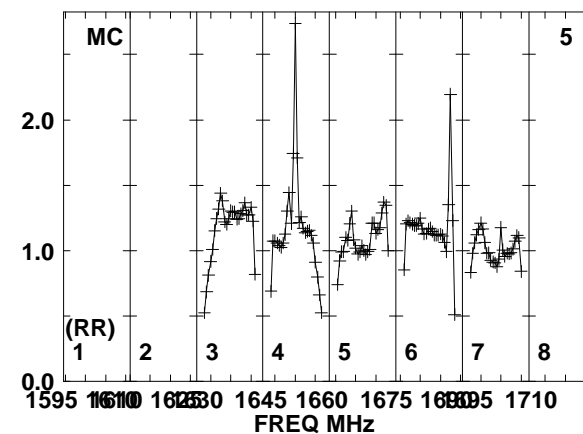
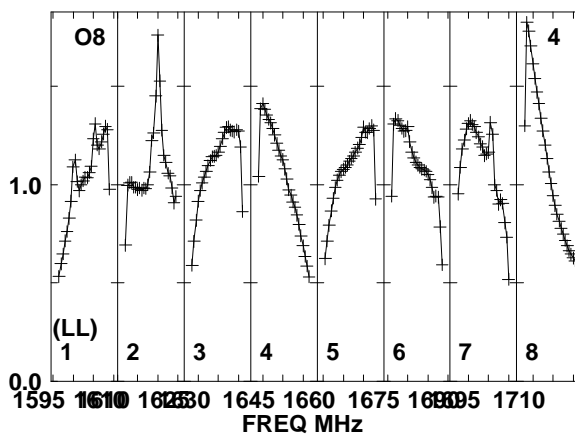
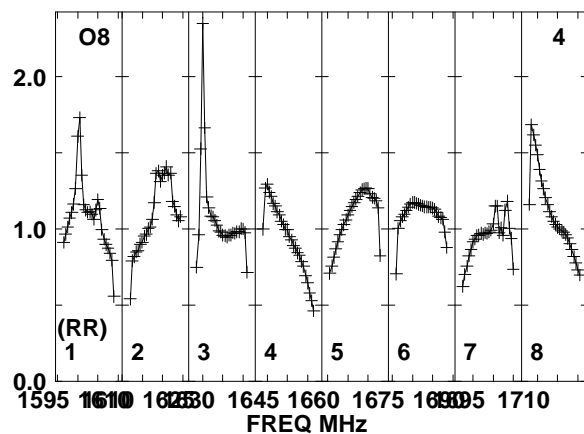
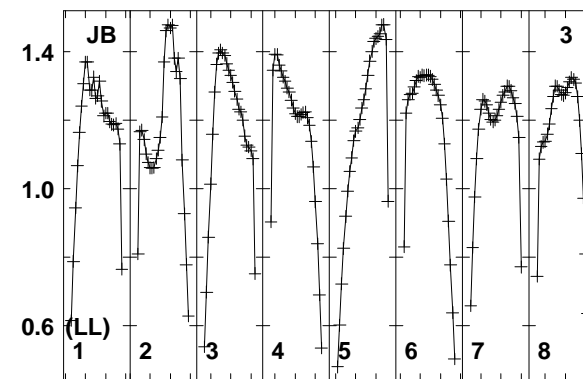
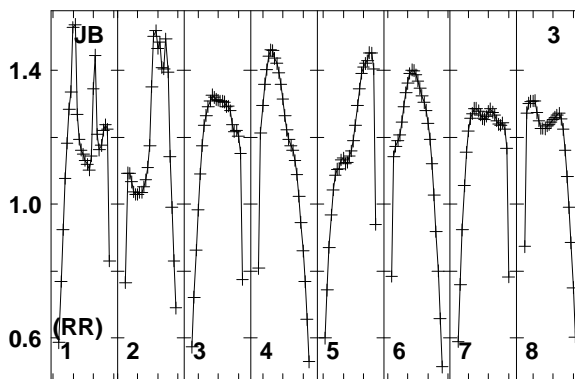
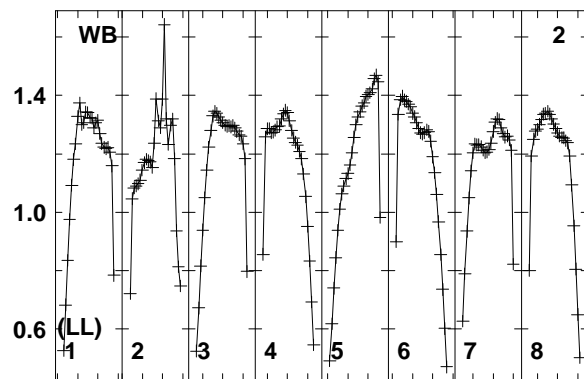
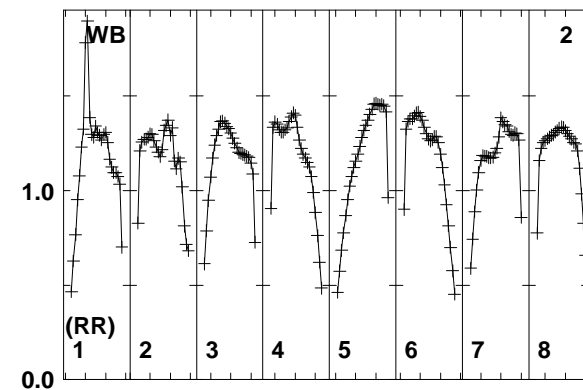
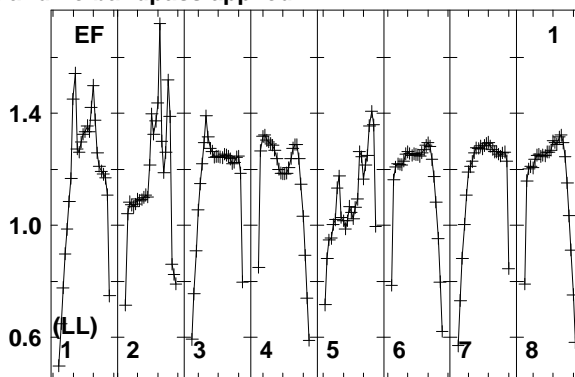
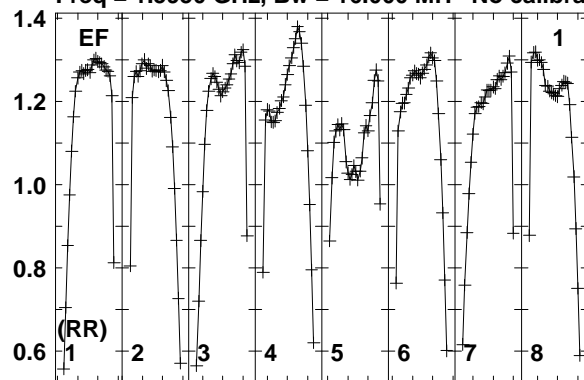

Lower frame: Real Jy
Total-power spectrum Antenna: EF (01)
Timerange: 00/01:02:38 to 00/01:06:00

Plot file version 65 created 19-AUG-2016 17:19:22

J1649+2635 EM119D.UVDATA.1

Freq = 1.5950 GHz, Bw = 16.000 MH No calibration applied and no bandpass applied

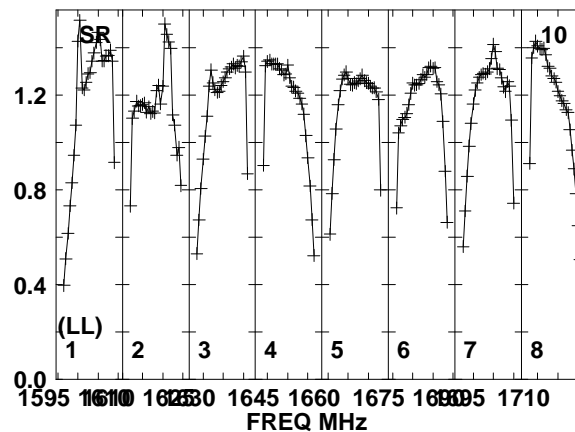
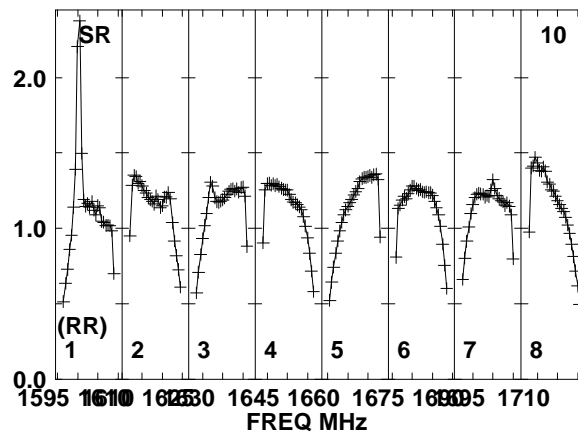
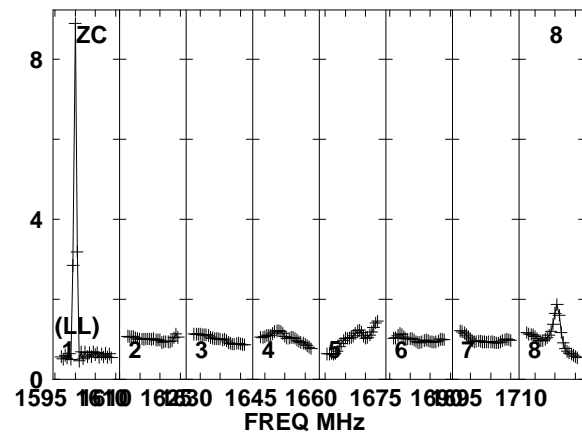
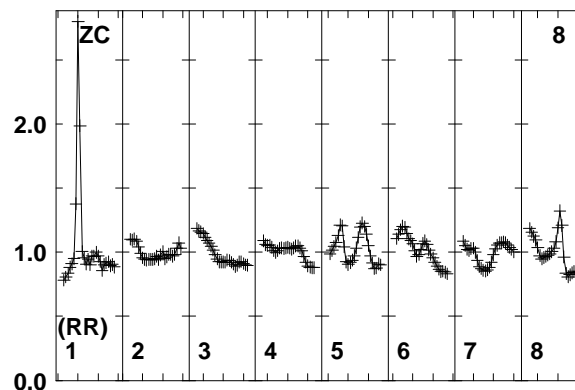
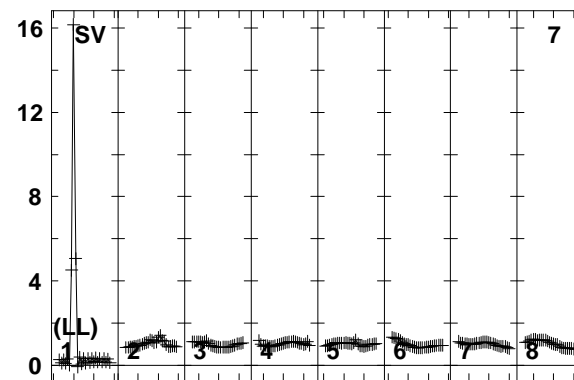
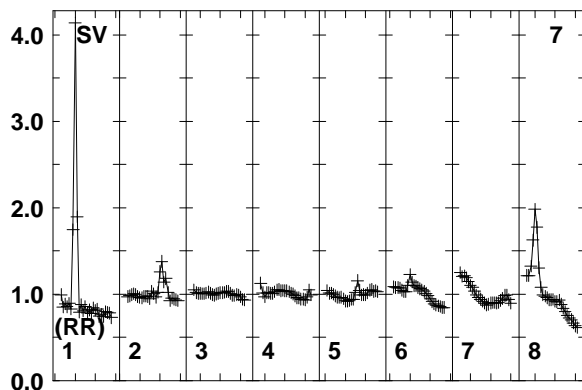
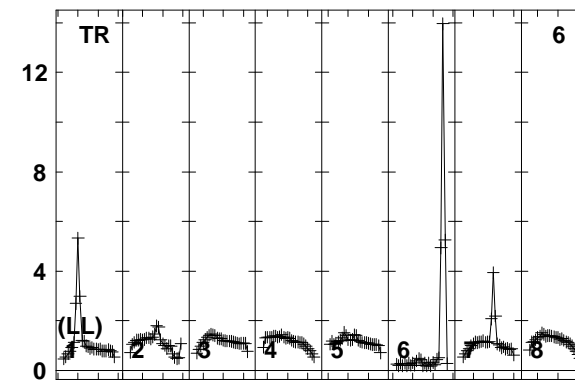
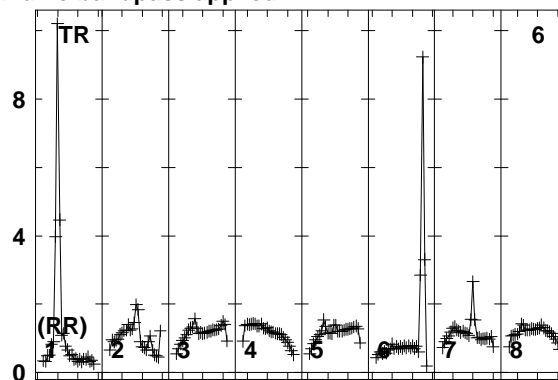
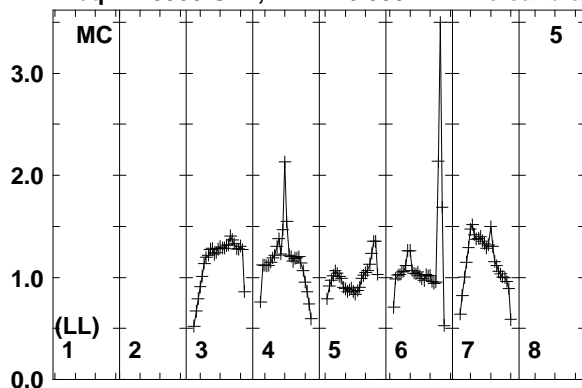

Lower frame: Real Jy
Total-power spectrum Antenna: MC (05)
Timerange: 00/01:02:38 to 00/01:06:00

Plot file version 66 created 19-AUG-2016 17:19:22

J1649+2635 EM119D.UVDATA.1

Freq = 1.5950 GHz, Bw = 16.000 MH No calibration applied and no bandpass applied

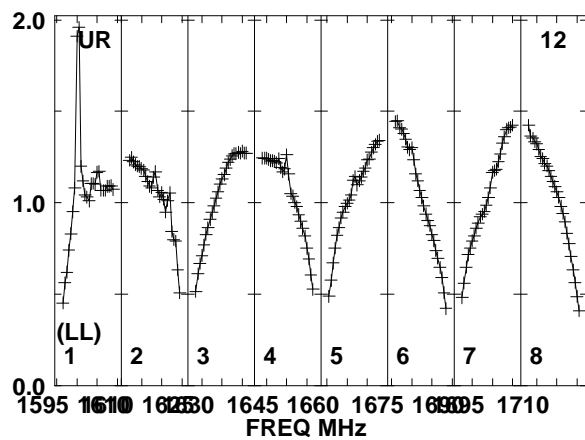
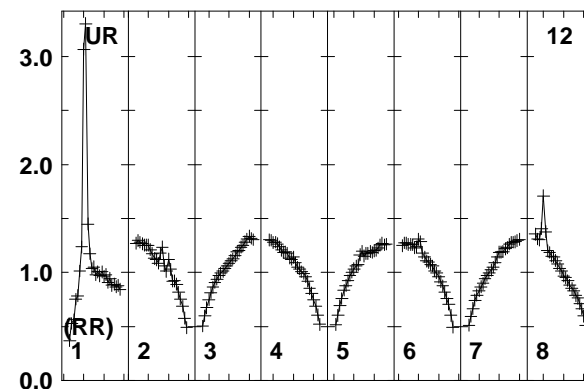
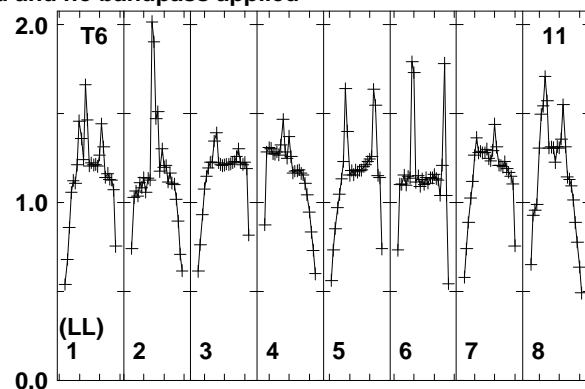
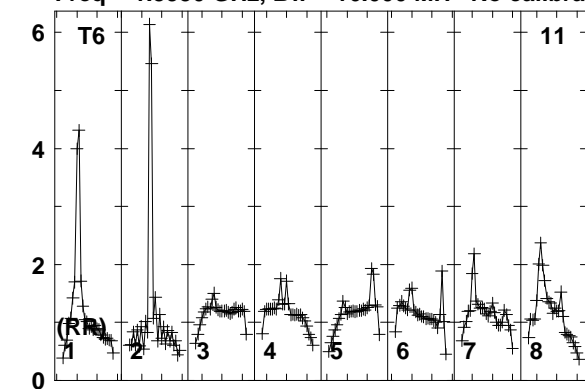

Lower frame: Real Jy
Total-power spectrum Antenna: T6 (11)
Timerange: 00/01:02:38 to 00/01:06:00

Plot file version 67 created 19-AUG-2016 17:19:22

J1642+2523 EM119D.UVDATA.1

Freq = 1.5950 GHz, Bw = 16.000 MH No calibration applied and no bandpass applied

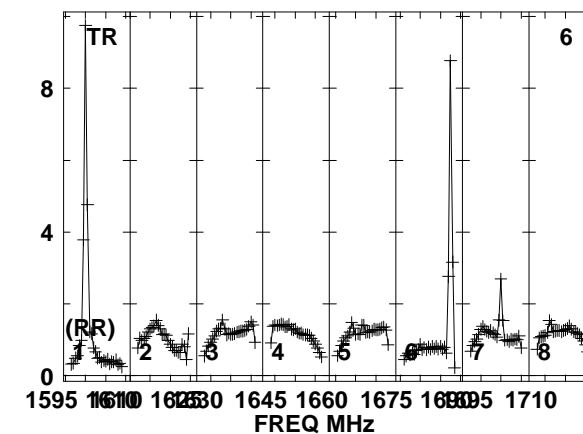
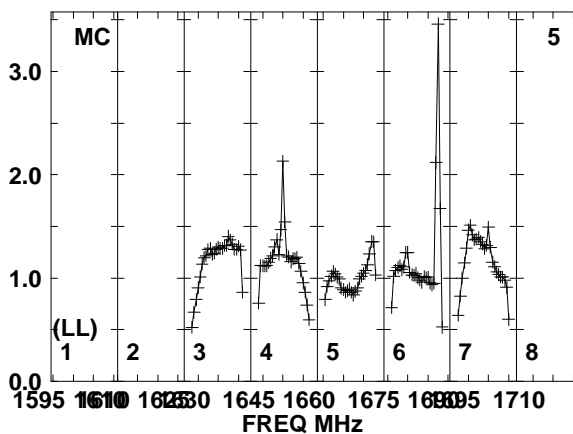
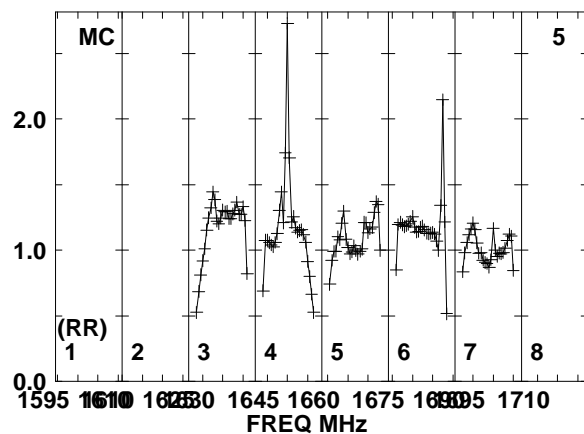
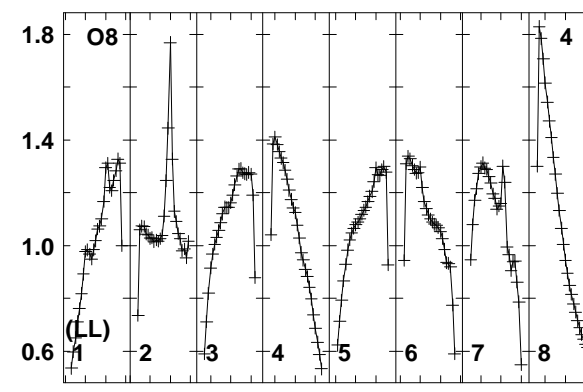
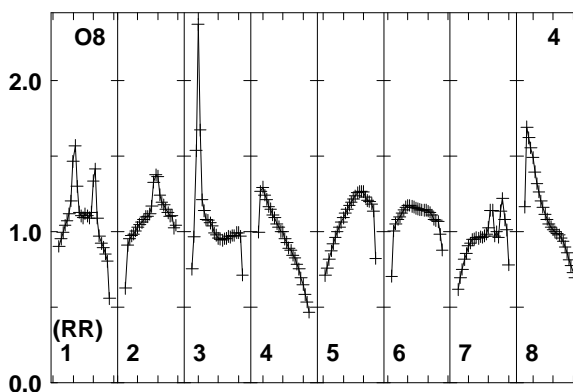
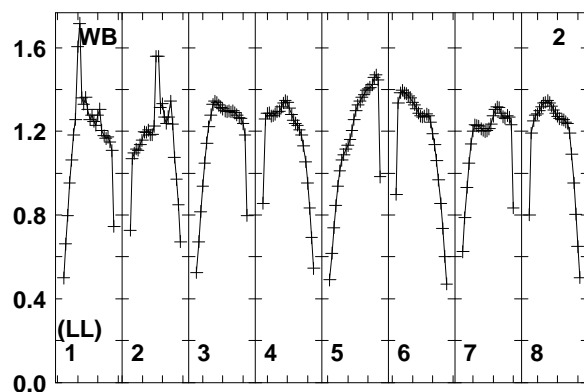
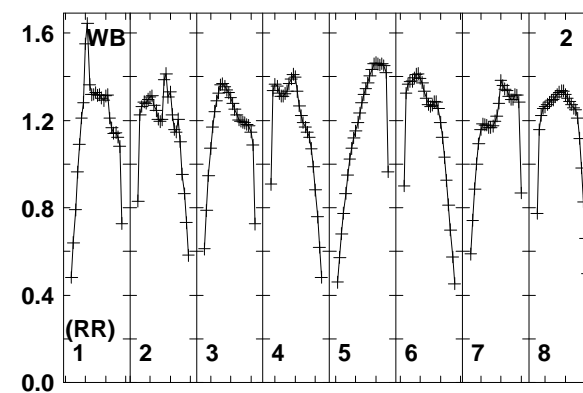
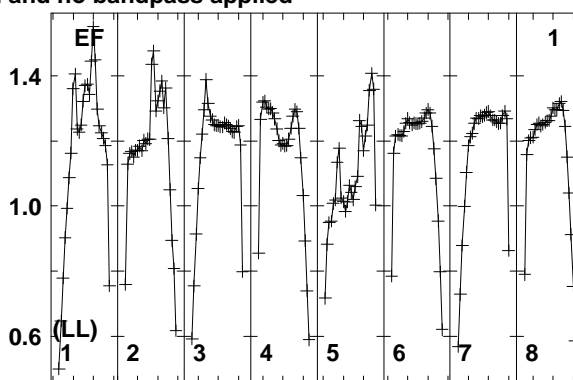
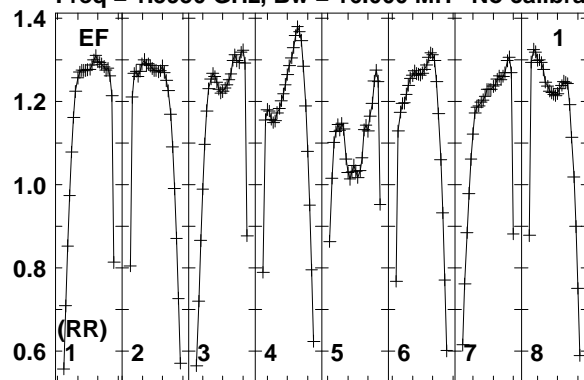

Lower frame: Real Jy
Total-power spectrum Antenna: EF (01)
Timerange: 00/01:07:01 to 00/01:08:30

Plot file version 68 created 19-AUG-2016 17:19:22

J1642+2523 EM119D.UVDATA.1

Freq = 1.5950 GHz, Bw = 16.000 MH No calibration applied and no bandpass applied

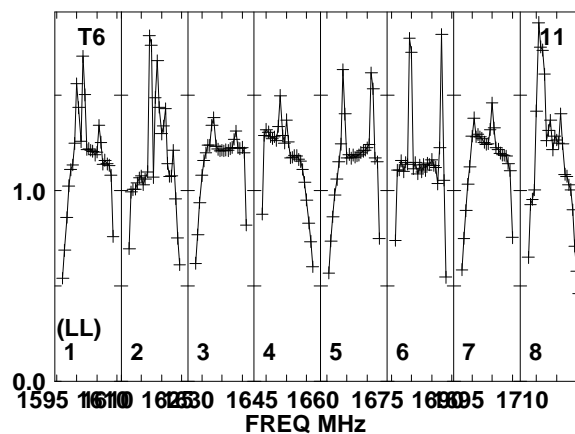
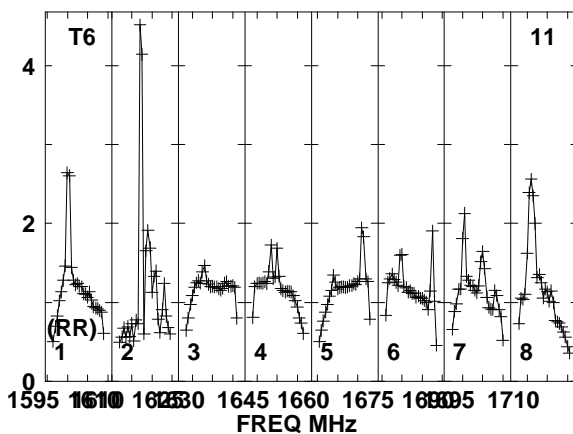
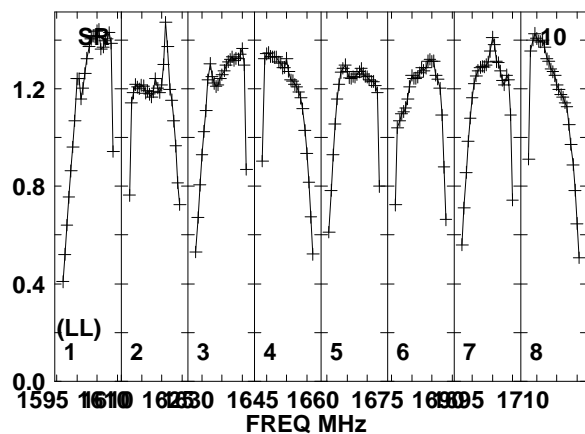
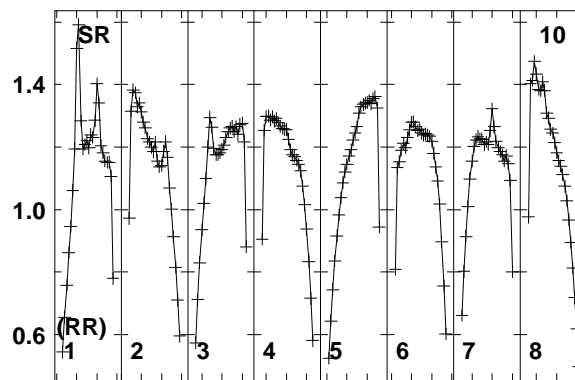
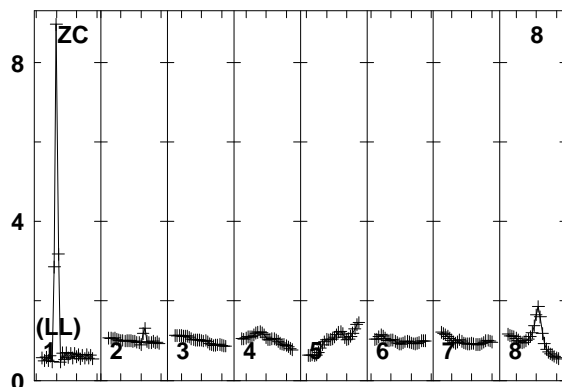
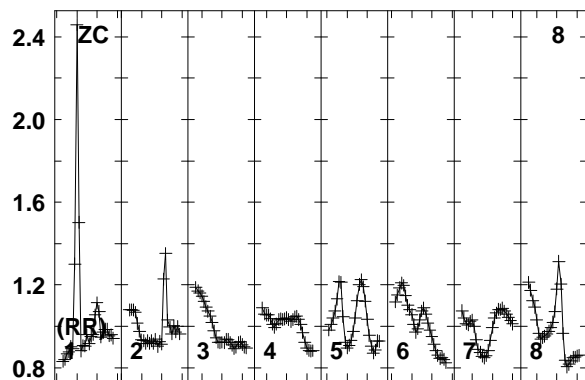
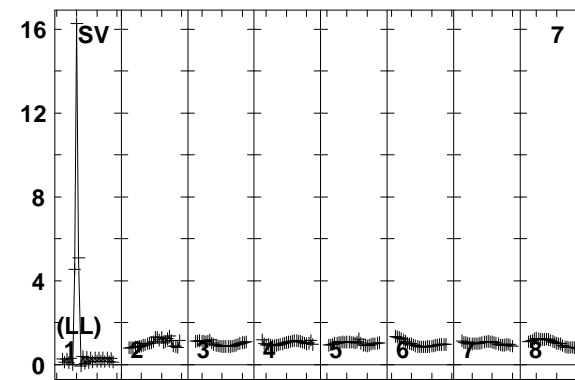
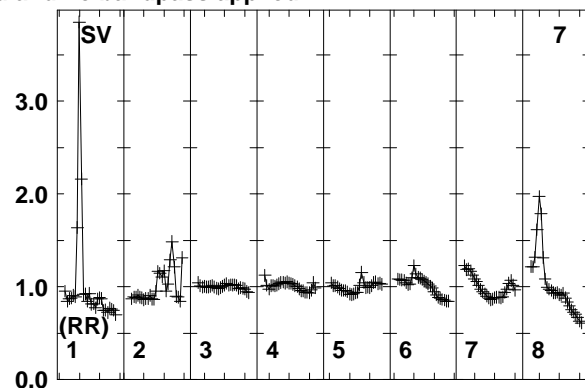
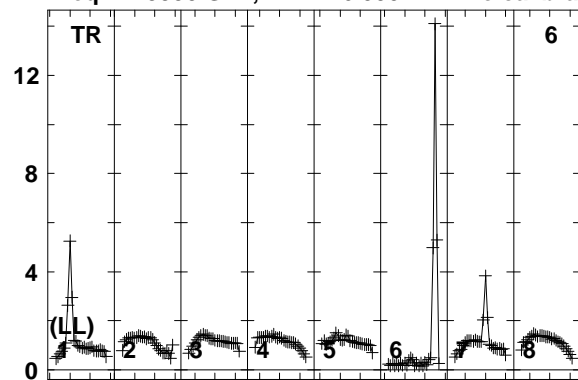

Lower frame: Real Jy
Total-power spectrum Antenna: TR (06)
Timerange: 00/01:07:01 to 00/01:08:30

Plot file version 69 created 19-AUG-2016 17:19:22

J1642+2523 EM119D.UVDATA.1

Freq = 1.5950 GHz, Bw = 16.000 MH No calibration applied and no bandpass applied

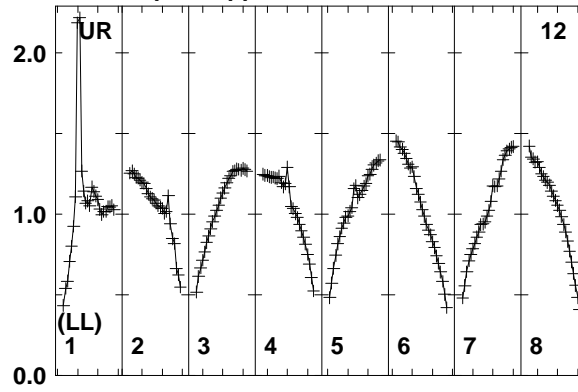
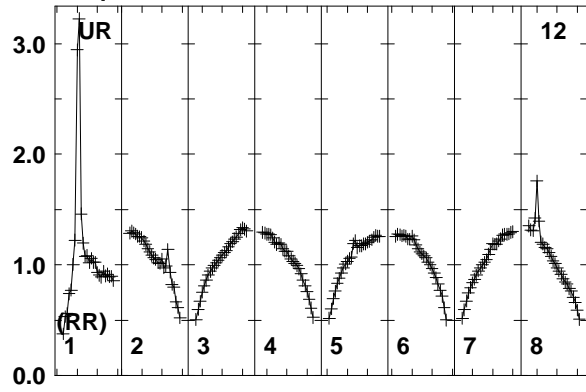

Lower frame: Real Jy
Total-power spectrum Antenna: UR (12)
Timerange: 00/01:07:01 to 00/01:08:30

Plot file version 70 created 19-AUG-2016 17:19:23

J1649+2635 EM119D.UVDATA.1

Freq = 1.5950 GHz, Bw = 16.000 MH No calibration applied and no bandpass applied

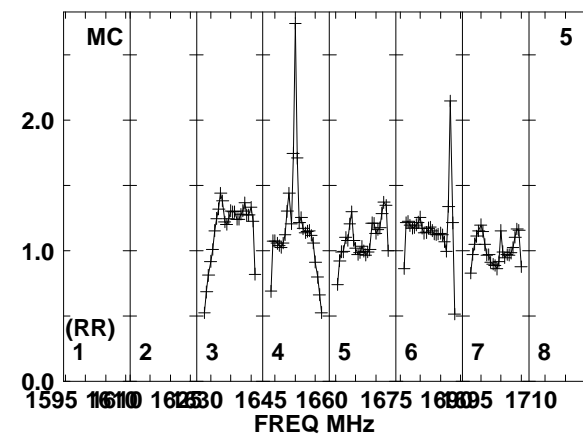
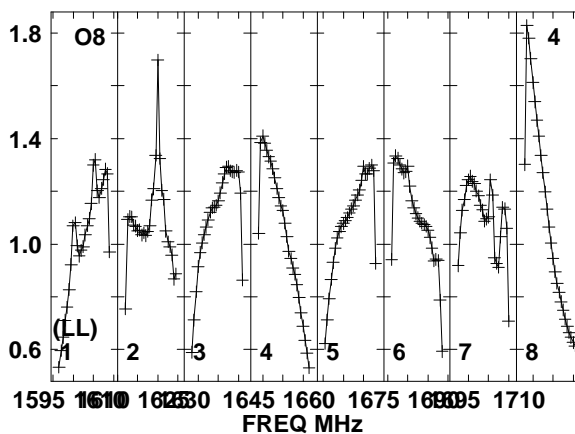
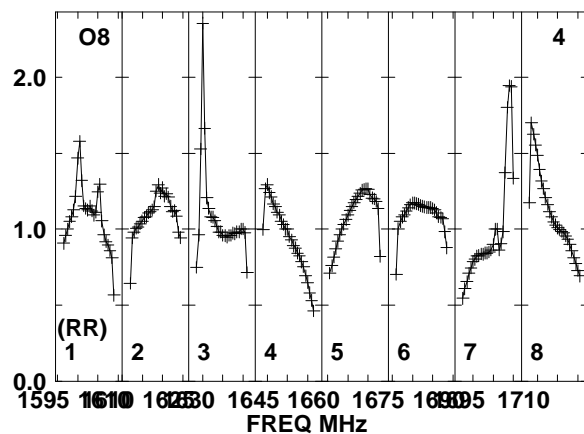
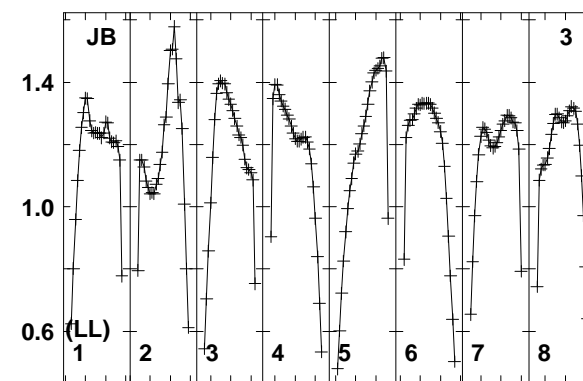
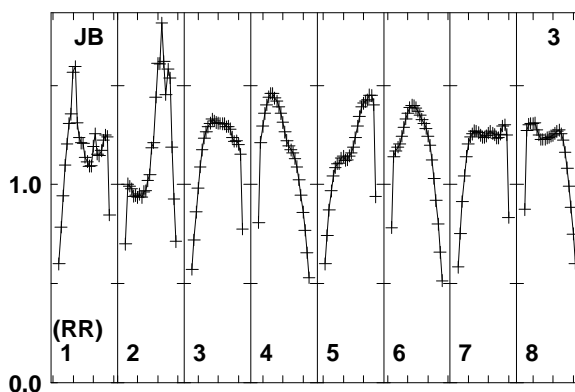
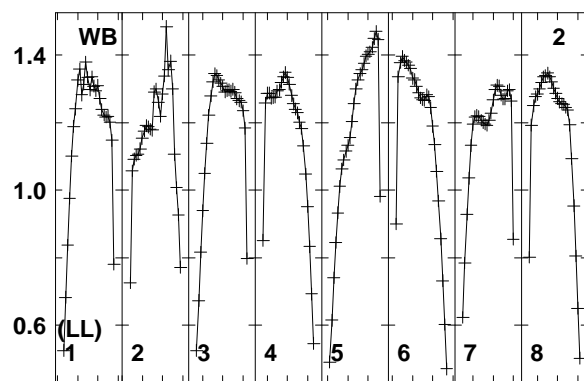
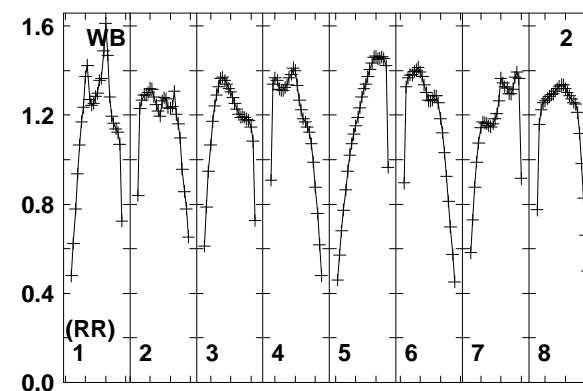
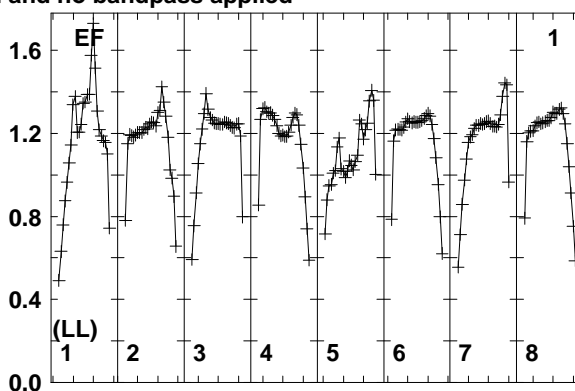
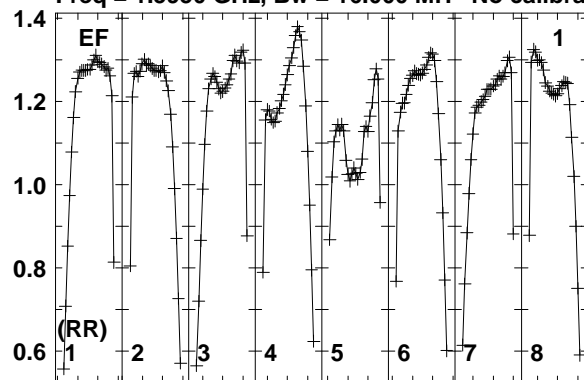

Lower frame: Real Jy
Total-power spectrum Antenna: EF (01)
Timerange: 00/01:08:33 to 00/01:11:59

Plot file version 71 created 19-AUG-2016 17:19:23

J1649+2635 EM119D.UVDATA.1

Freq = 1.5950 GHz, Bw = 16.000 MH No calibration applied and no bandpass applied

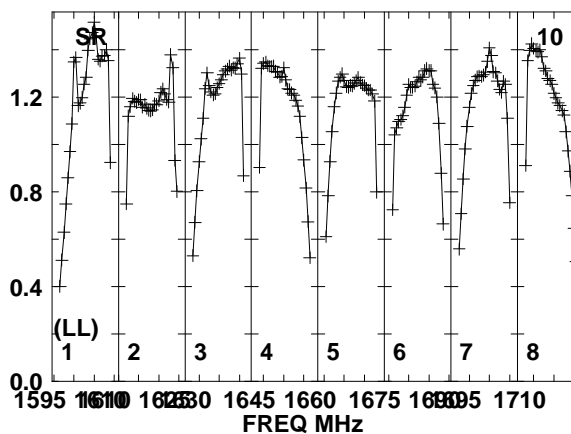
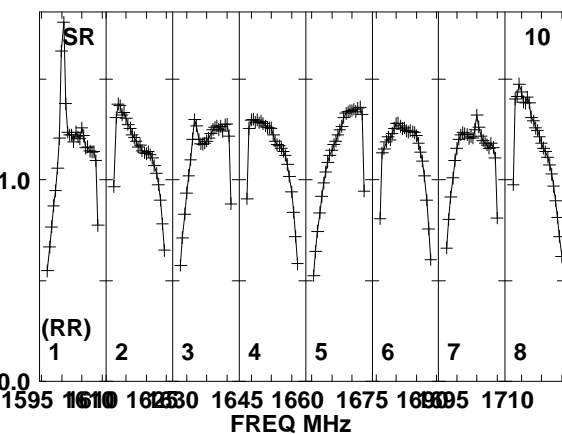
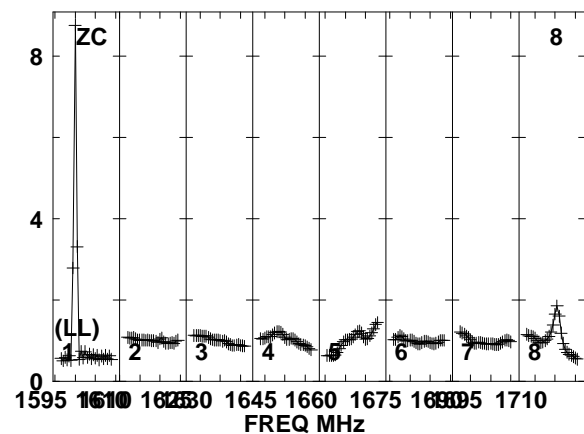
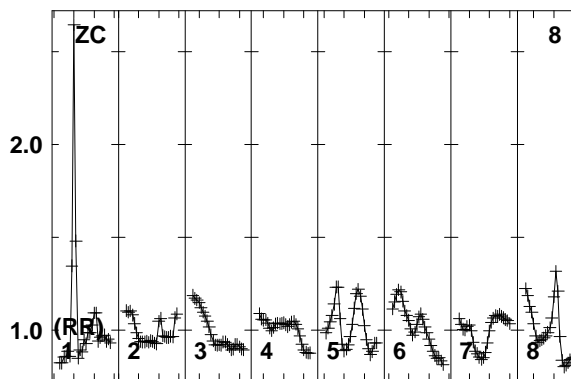
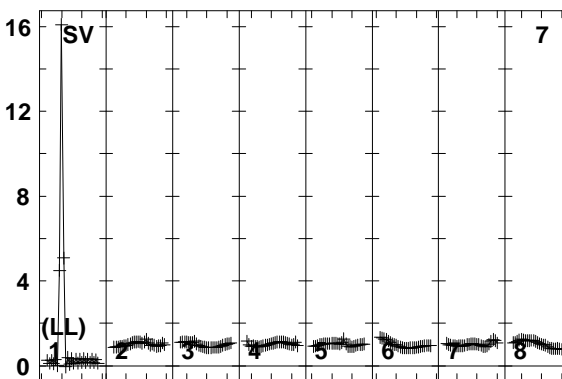
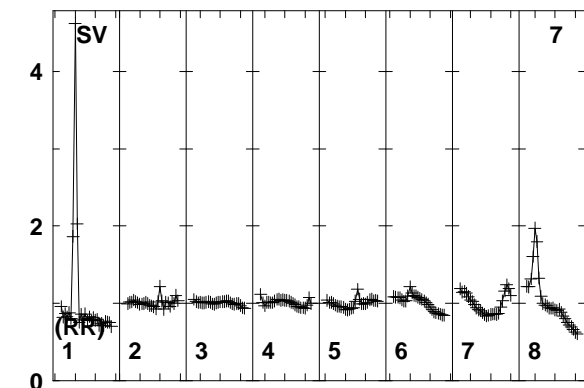
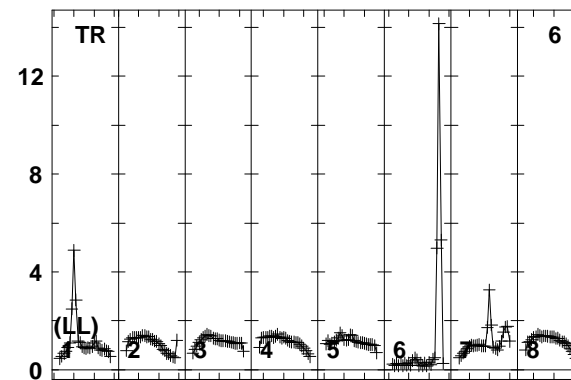
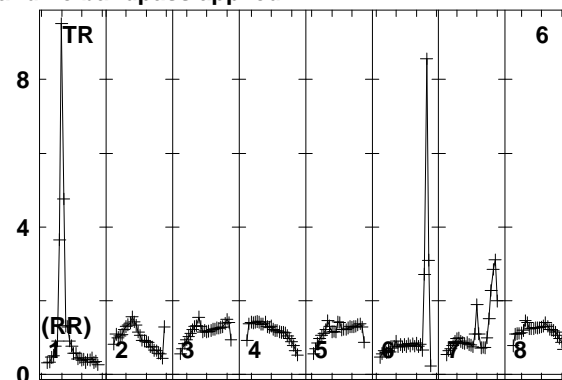
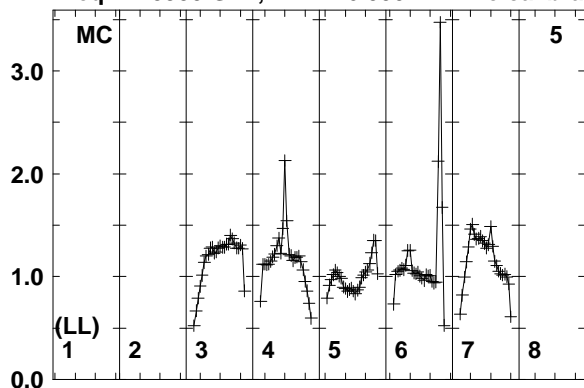

1595 1610 1625 1645 1660 1675 1695 1710
FREQ MHz
Lower frame: Real Jy
Total-power spectrum Antenna: MC (05)
Timerange: 00/01:08:33 to 00/01:11:59

Plot file version 72 created 19-AUG-2016 17:19:23

J1649+2635 EM119D.UVDATA.1

Freq = 1.5950 GHz, Bw = 16.000 MH No calibration applied and no bandpass applied

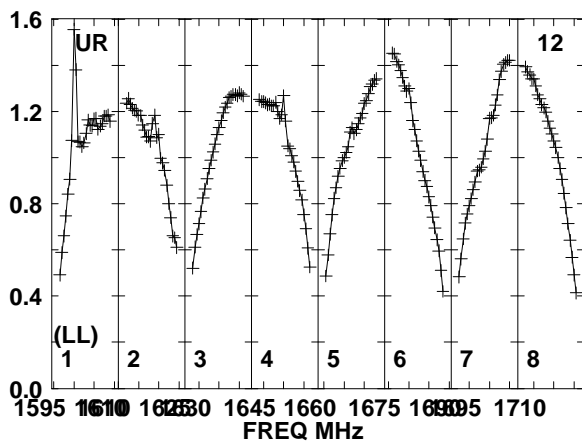
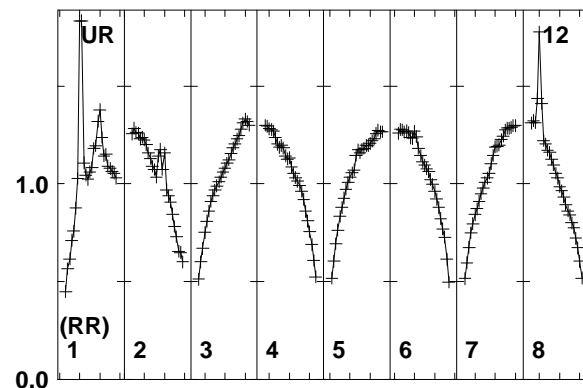
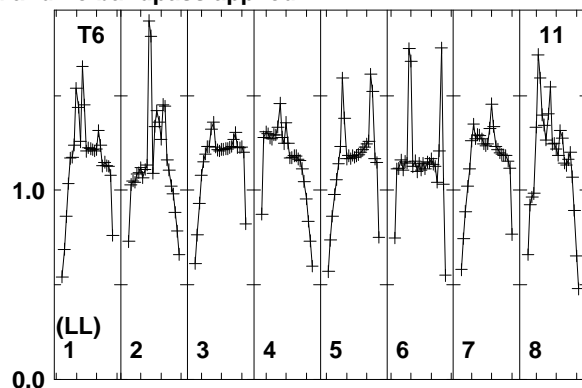
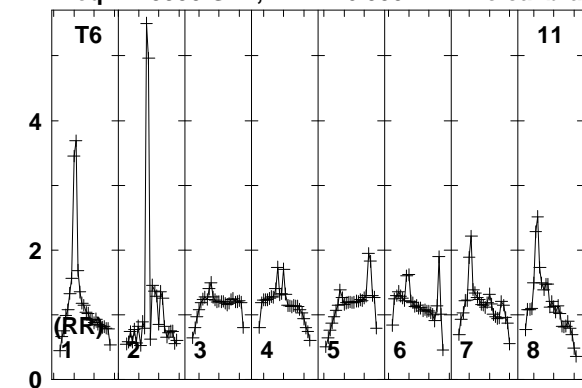

Lower frame: Real Jy
Total-power spectrum Antenna: T6 (11)
Timerange: 00/01:08:33 to 00/01:11:59

Plot file version 73 created 19-AUG-2016 17:19:23

J1642+2523 EM119D.UVDATA.1

Freq = 1.5950 GHz, Bw = 16.000 MH No calibration applied and no bandpass applied

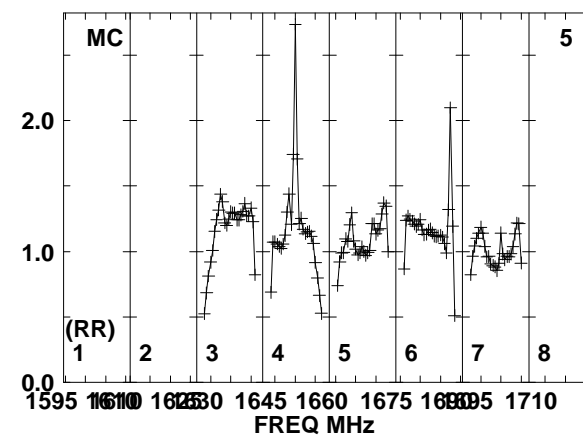
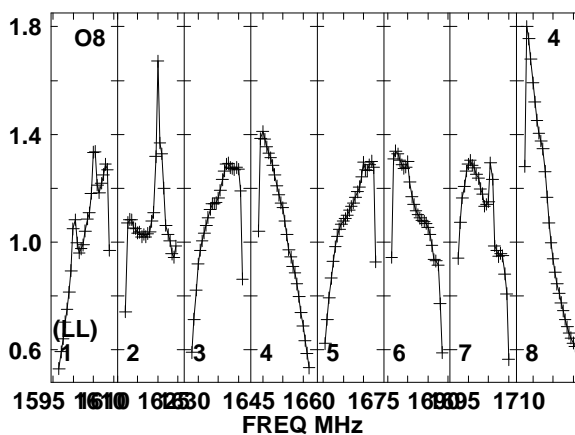
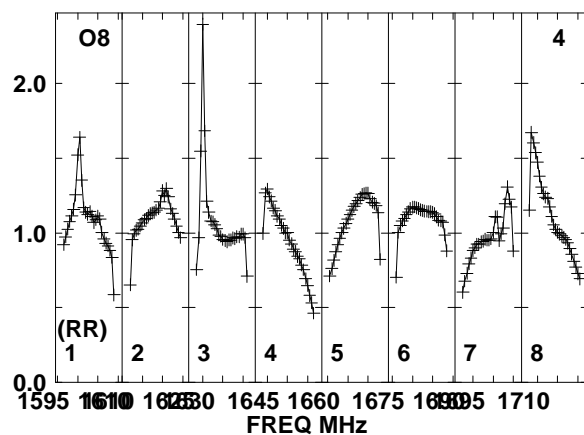
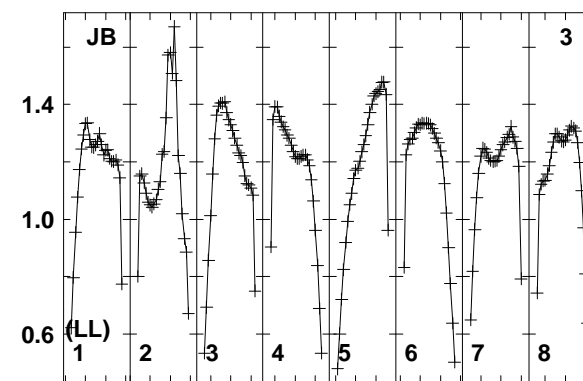
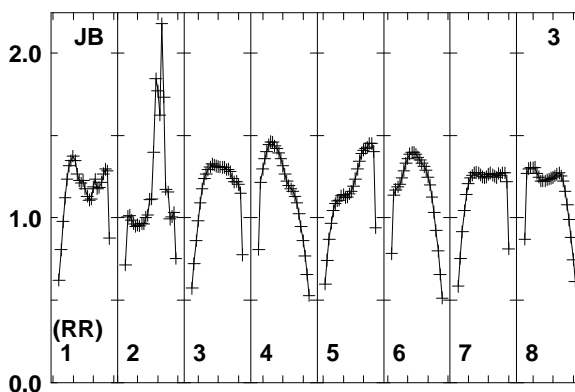
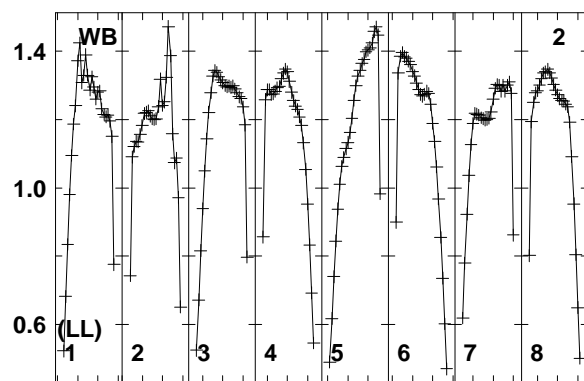
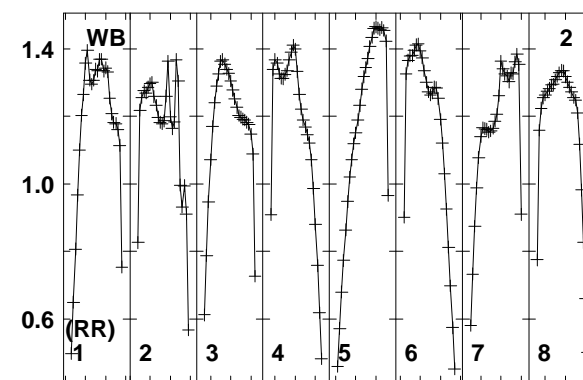
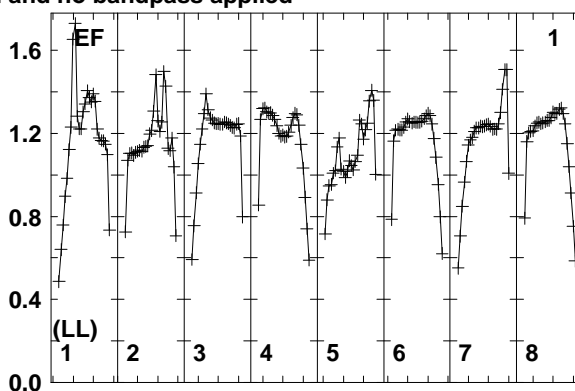
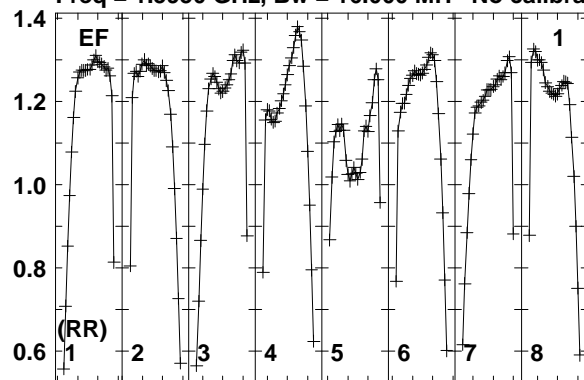

Lower frame: Real Jy
Total-power spectrum Antenna: EF (01)
Timerange: 00/01:12:08 to 00/01:13:30

Plot file version 74 created 19-AUG-2016 17:19:23

J1642+2523 EM119D.UVDATA.1

Freq = 1.5950 GHz, Bw = 16.000 MH No calibration applied and no bandpass applied

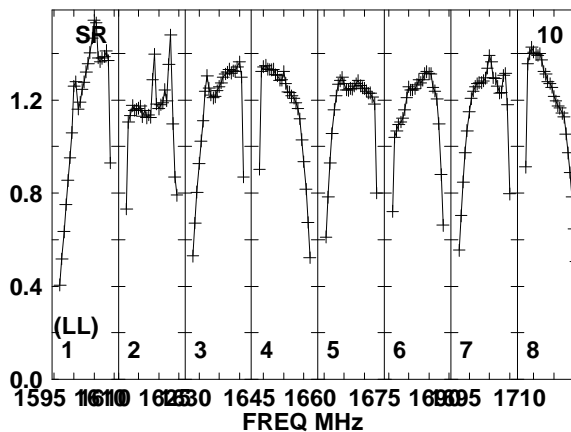
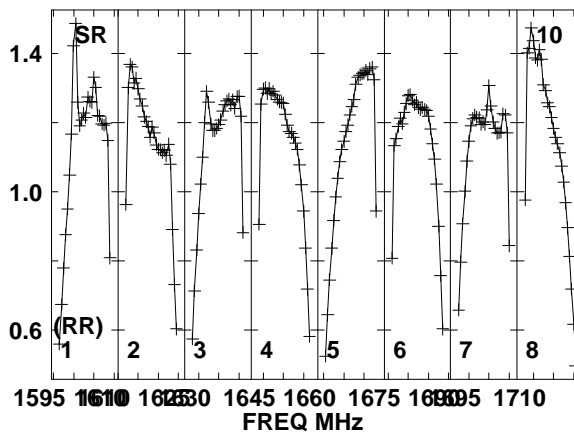
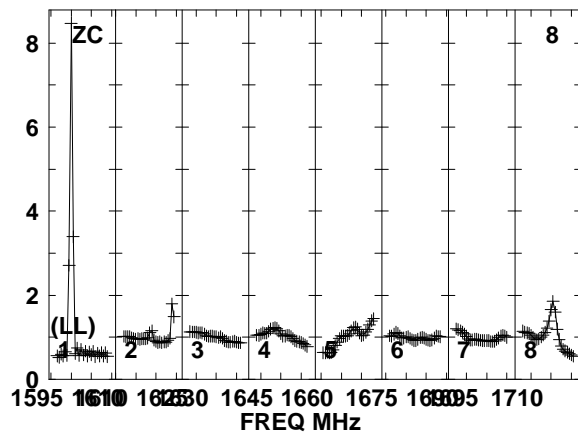
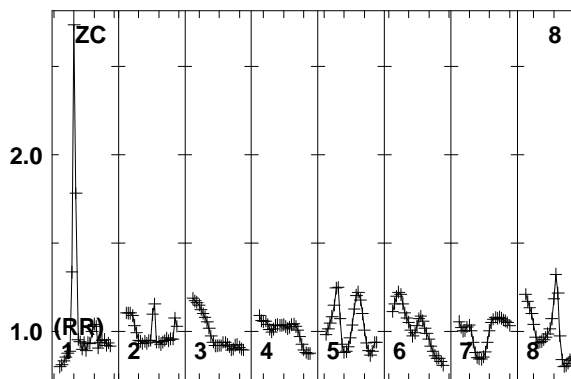
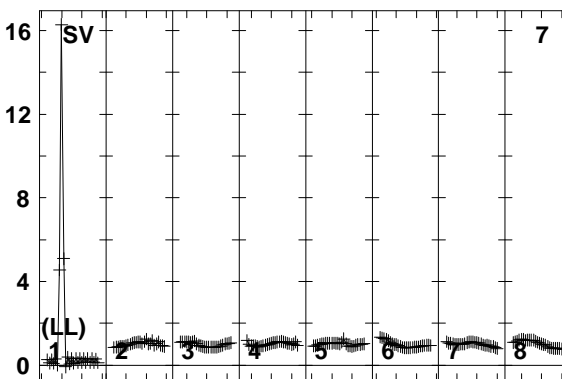
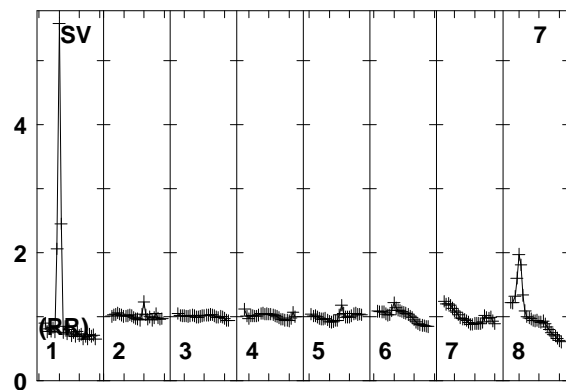
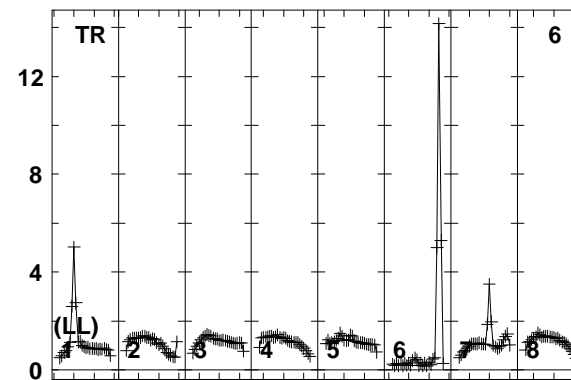
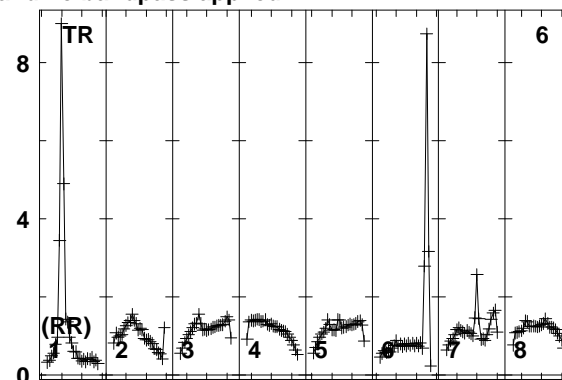
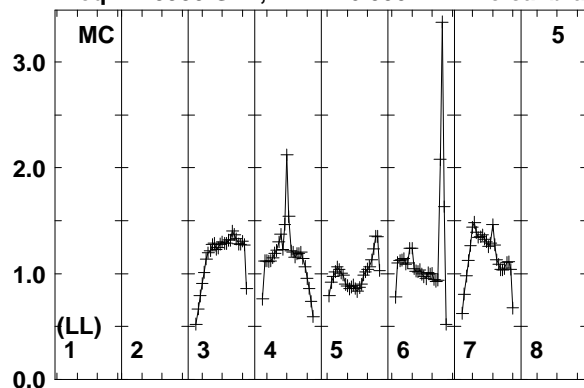

Lower frame: Real Jy
Total-power spectrum Antenna: MC (05)
Timerange: 00/01:12:08 to 00/01:13:30

Plot file version 75 created 19-AUG-2016 17:19:23

J1642+2523 EM119D.UVDATA.1

Freq = 1.5950 GHz, Bw = 16.000 MH No calibration applied and no bandpass applied

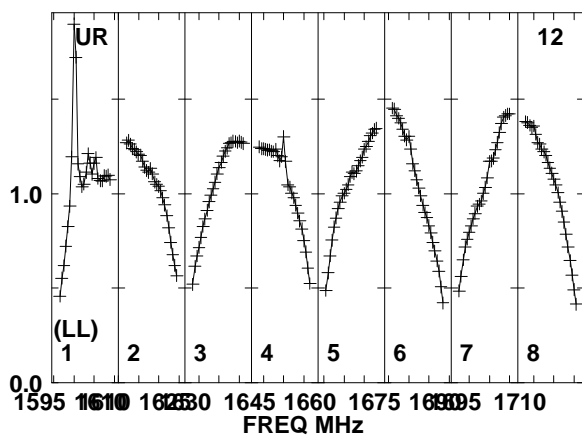
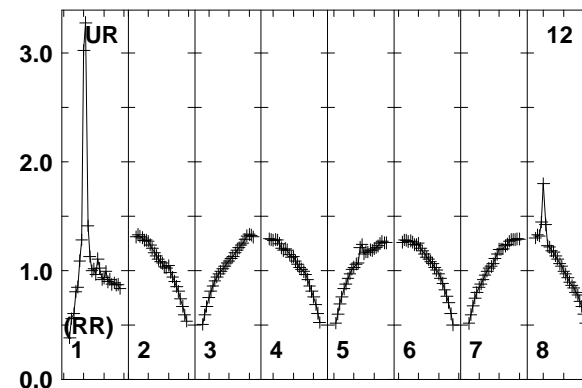
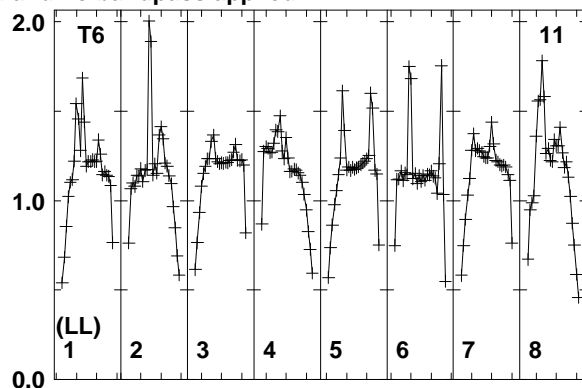
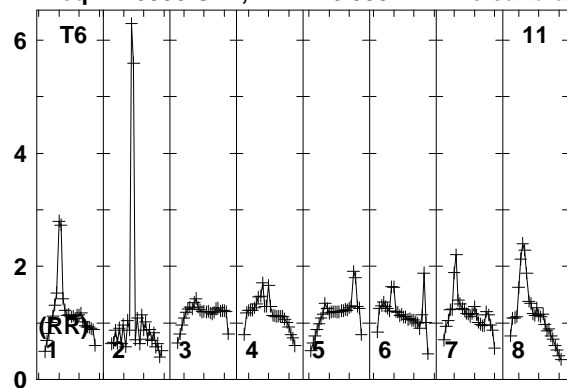

Lower frame: Real Jy
Total-power spectrum Antenna: T6 (11)
Timerange: 00/01:12:08 to 00/01:13:30

Plot file version 76 created 19-AUG-2016 17:19:23

J1649+2635 EM119D.UVDATA.1

Freq = 1.5950 GHz, Bw = 16.000 MH No calibration applied and no bandpass applied

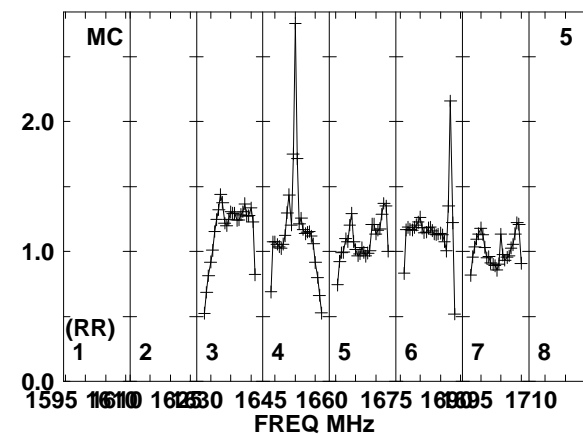
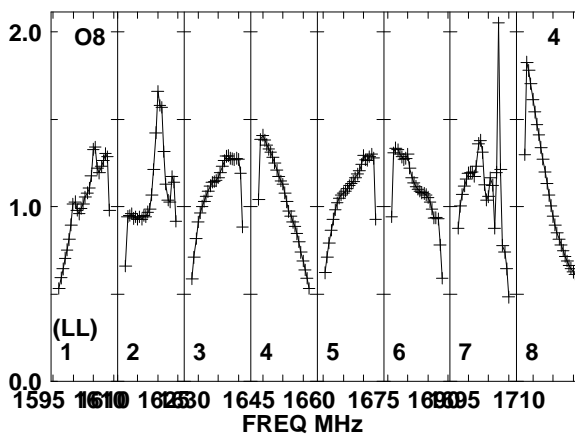
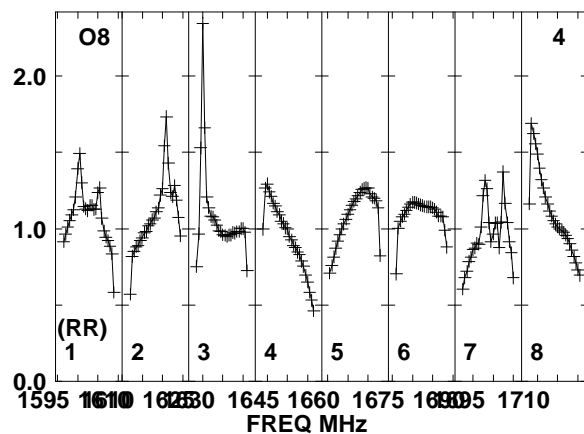
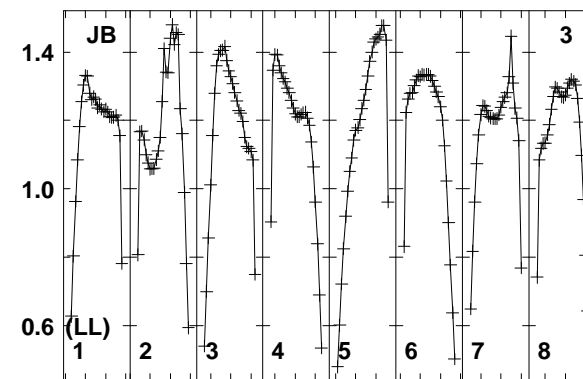
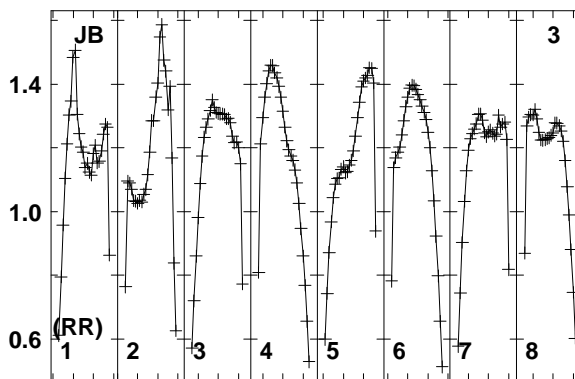
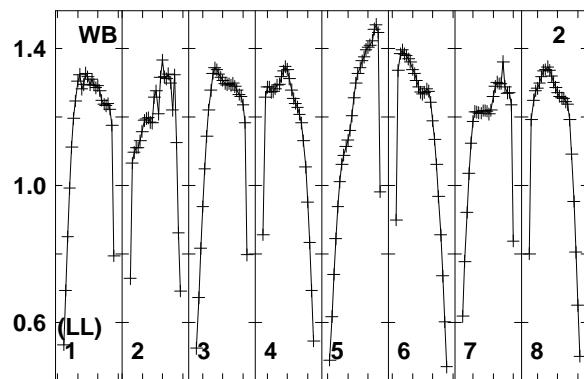
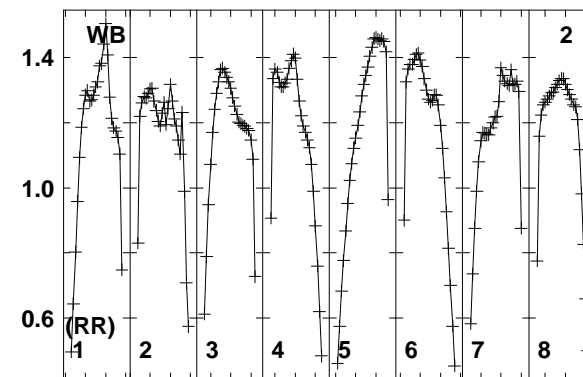
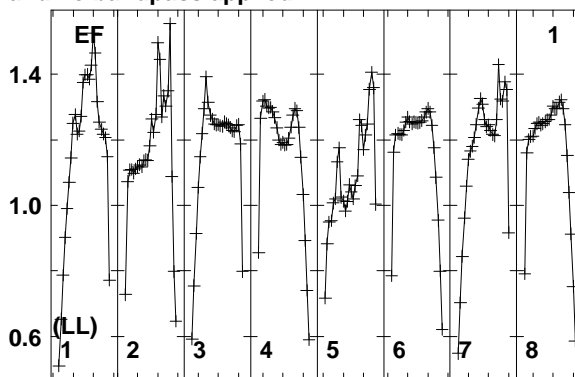
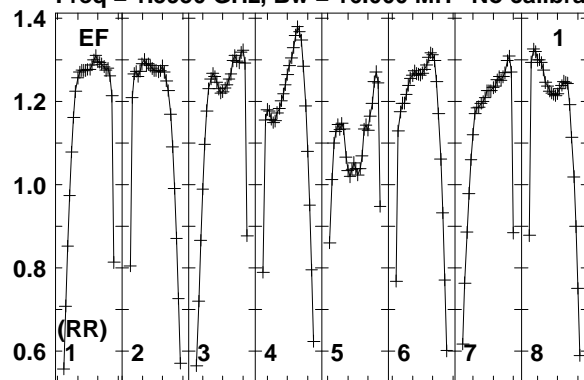

Lower frame: Real Jy
Total-power spectrum Antenna: EF (01)
Timerange: 00/01:13:38 to 00/01:16:59

Plot file version 77 created 19-AUG-2016 17:19:24

J1649+2635 EM119D.UVDATA.1

Freq = 1.5950 GHz, Bw = 16.000 MH No calibration applied and no bandpass applied

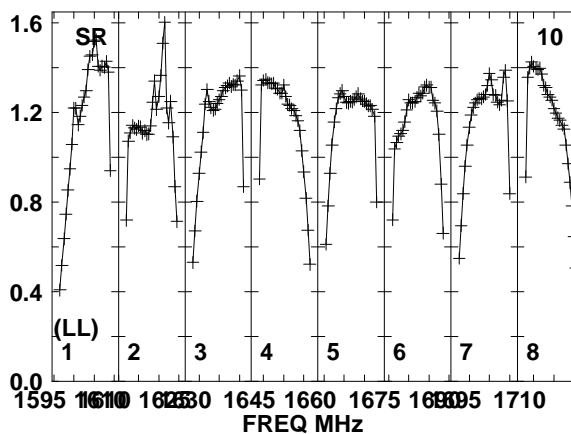
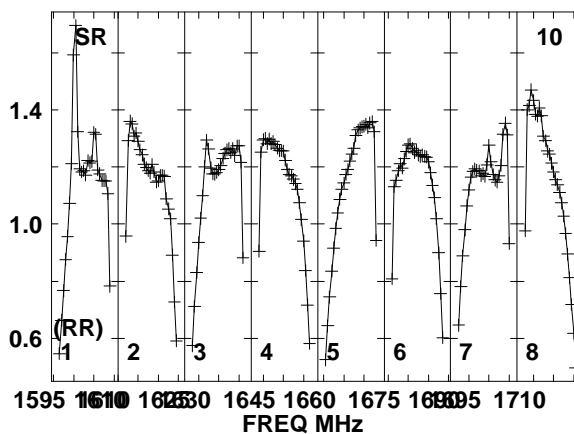
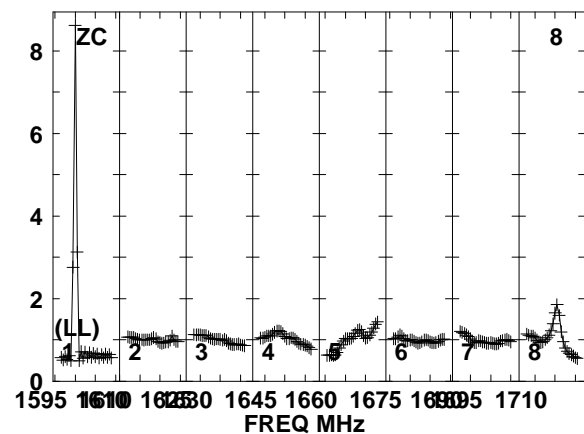
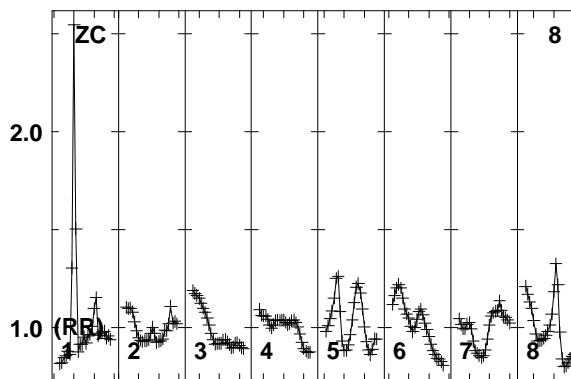
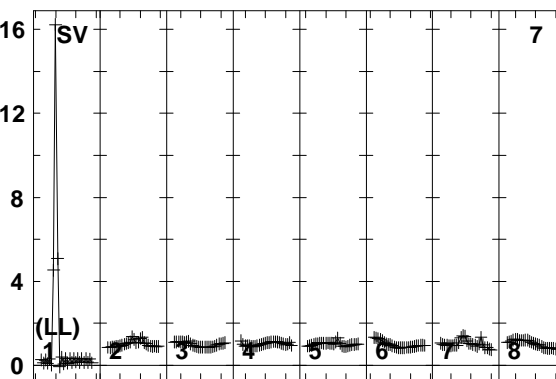
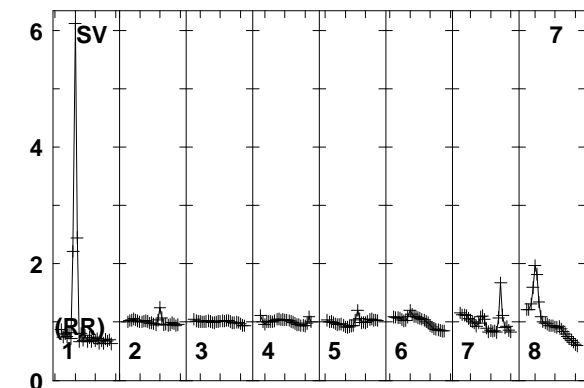
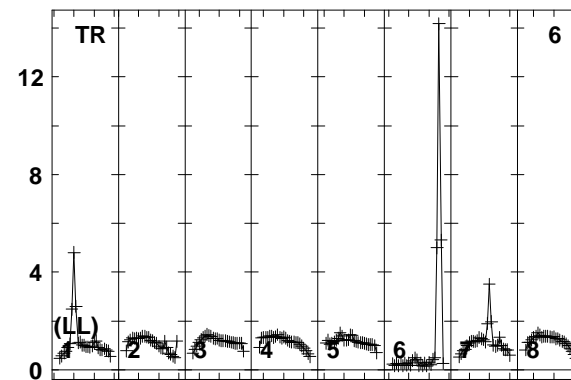
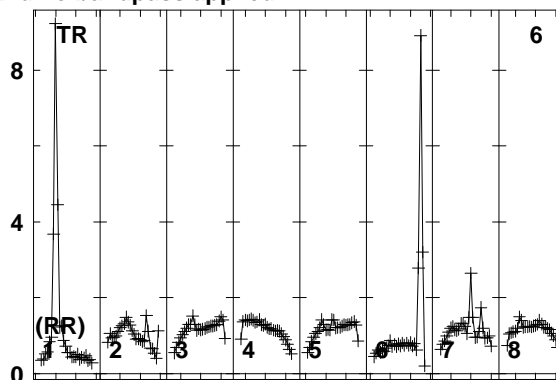
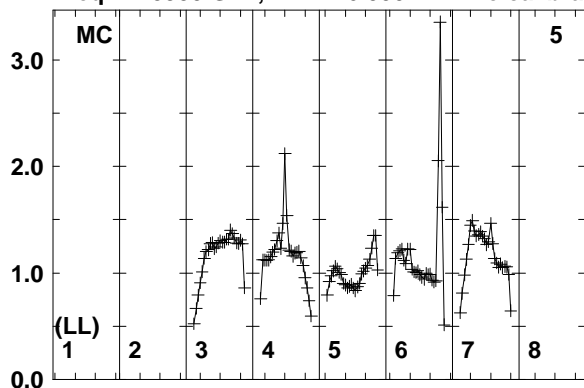

Lower frame: Real Jy
Total-power spectrum Antenna: MC (05)
Timerange: 00/01:13:38 to 00/01:16:59

Plot file version 78 created 19-AUG-2016 17:19:24

J1649+2635 EM119D.UVDATA.1

Freq = 1.5950 GHz, Bw = 16.000 MH No calibration applied and no bandpass applied

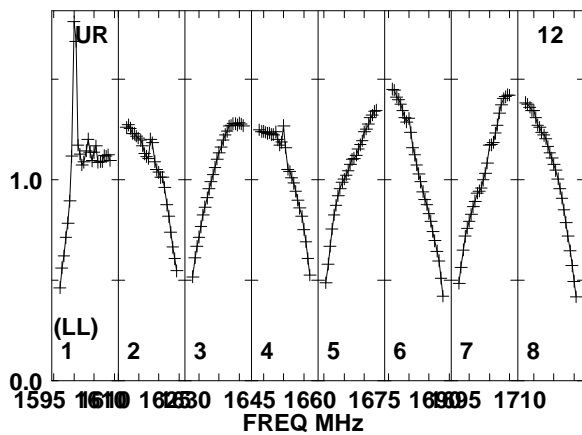
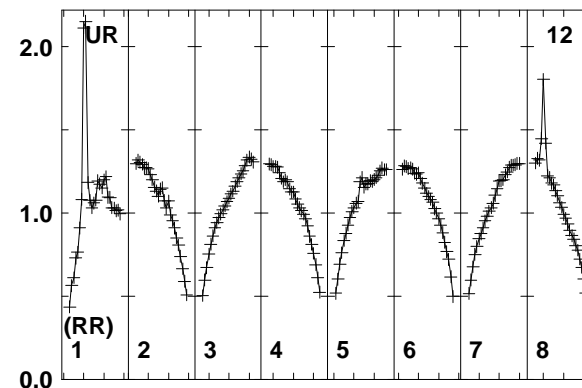
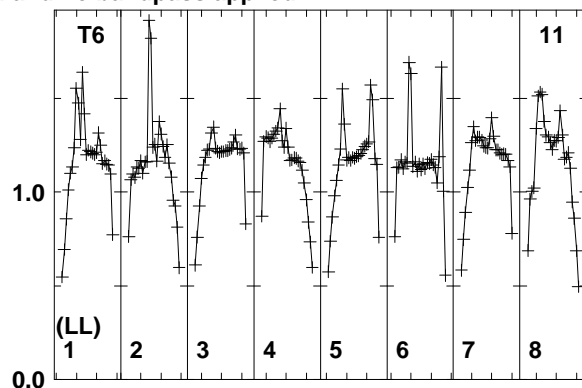
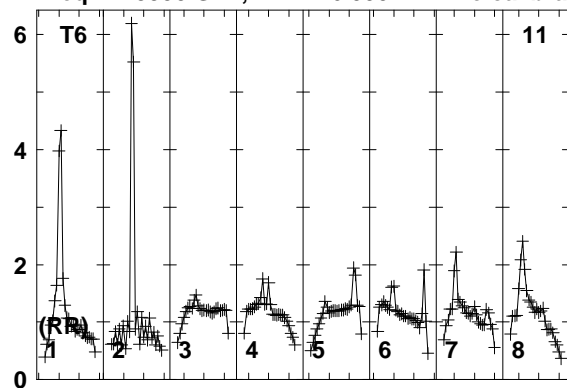

Lower frame: Real Jy
Total-power spectrum Antenna: T6 (11)
Timerange: 00/01:13:38 to 00/01:16:59

Plot file version 79 created 19-AUG-2016 17:19:24

J1642+2523 EM119D.UVDATA.1

Freq = 1.5950 GHz, Bw = 16.000 MH No calibration applied and no bandpass applied

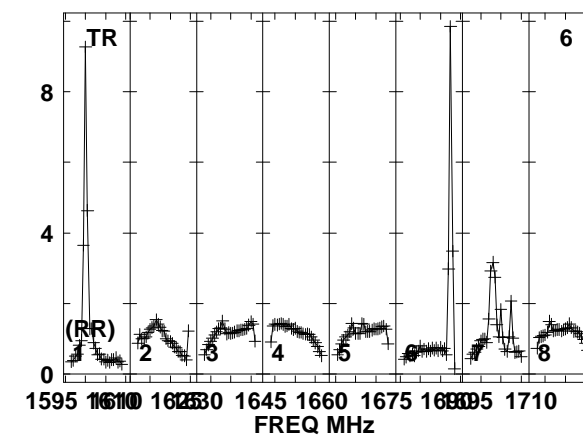
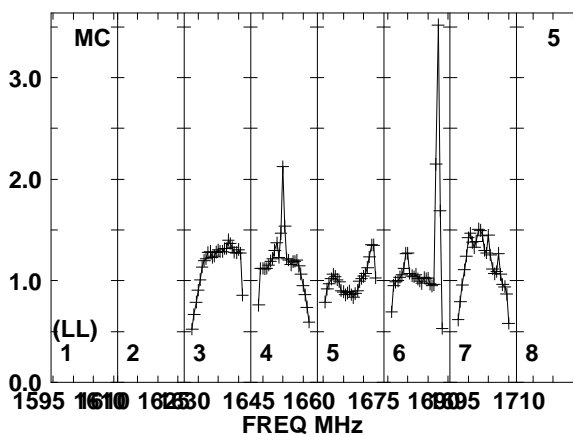
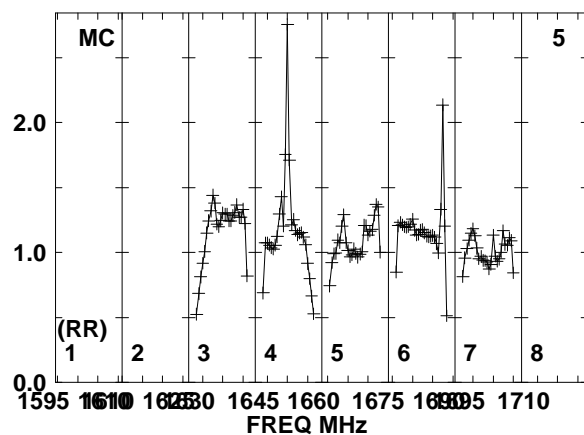
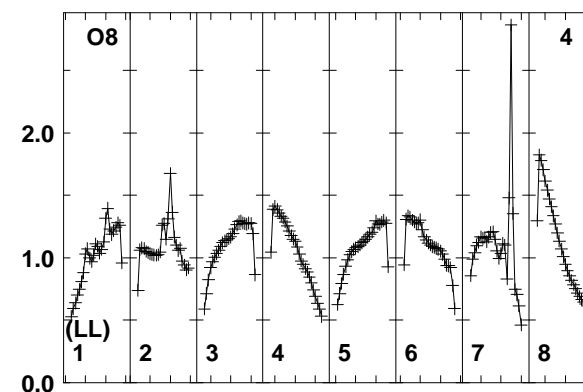
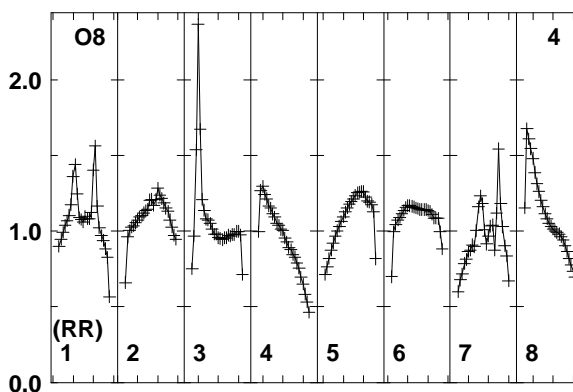
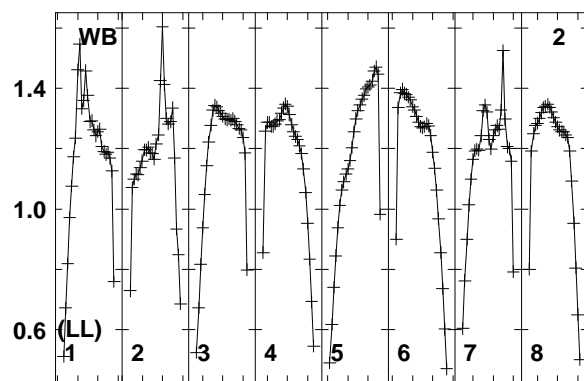
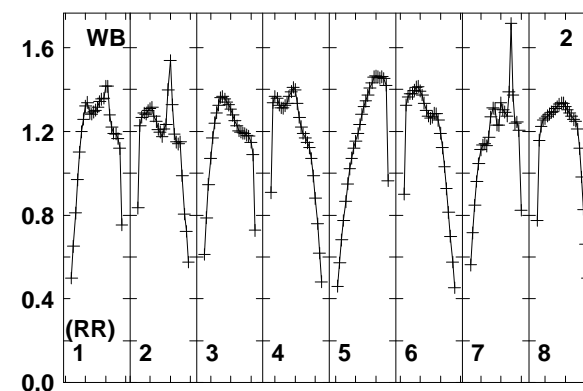
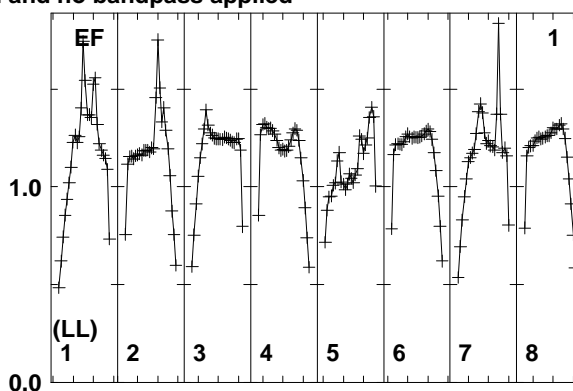
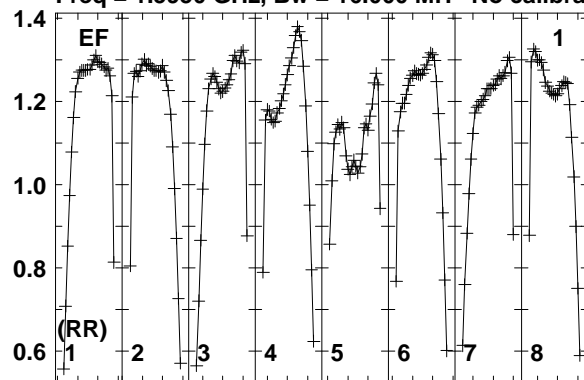

Lower frame: Real Jy
Total-power spectrum Antenna: EF (01)
Timerange: 00/01:18:00 to 00/01:19:30

Plot file version 80 created 19-AUG-2016 17:19:24

J1642+2523 EM119D.UVDATA.1

Freq = 1.5950 GHz, Bw = 16.000 MH No calibration applied and no bandpass applied

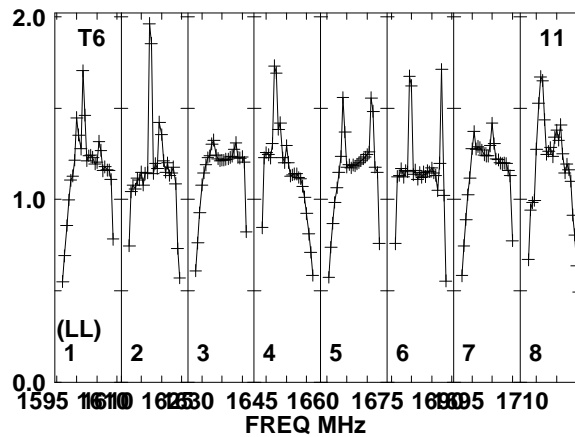
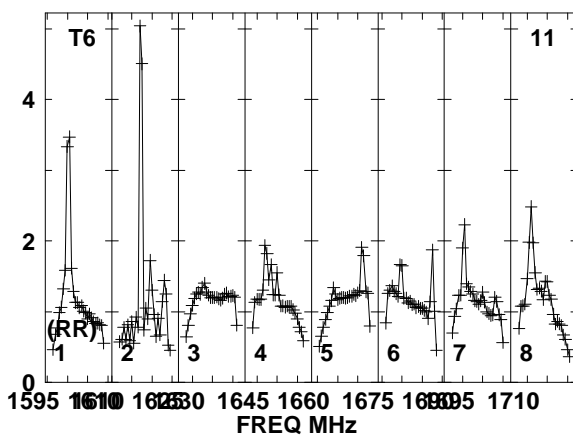
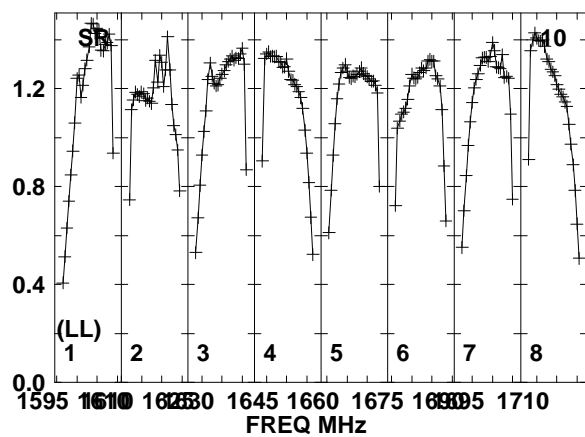
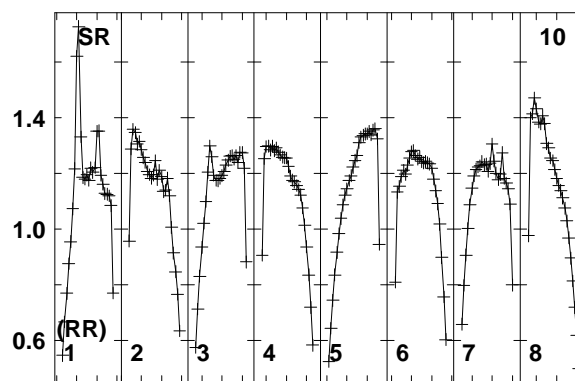
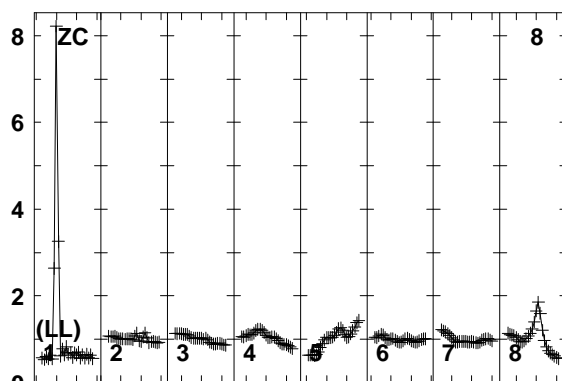
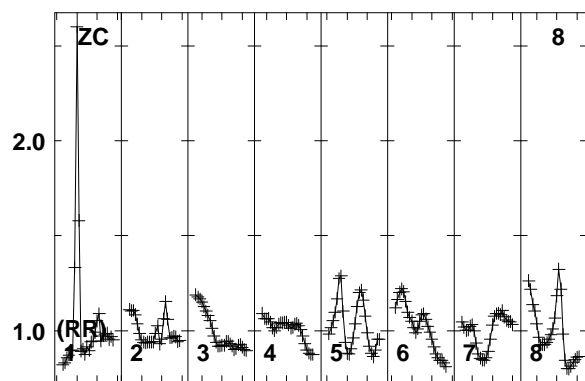
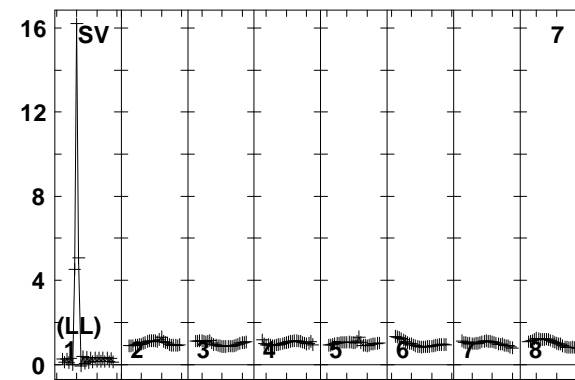
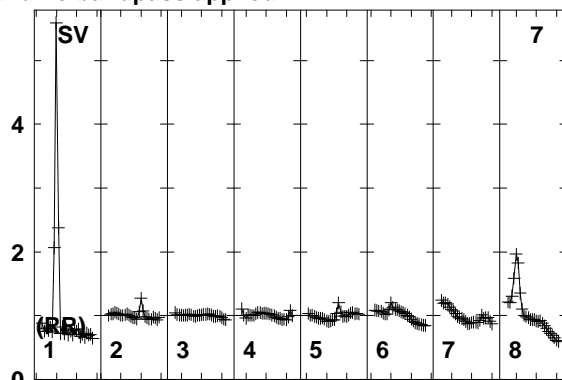
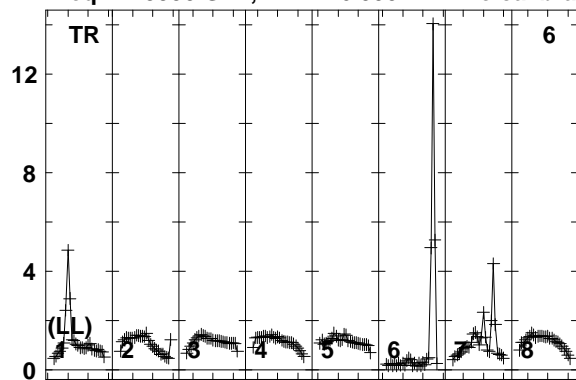

Lower frame: Real Jy
Total-power spectrum Antenna: TR (06)
Timerange: 00/01:18:00 to 00/01:19:30

Plot file version 81 created 19-AUG-2016 17:19:24

J1642+2523 EM119D.UVDATA.1

Freq = 1.5950 GHz, Bw = 16.000 MH No calibration applied and no bandpass applied

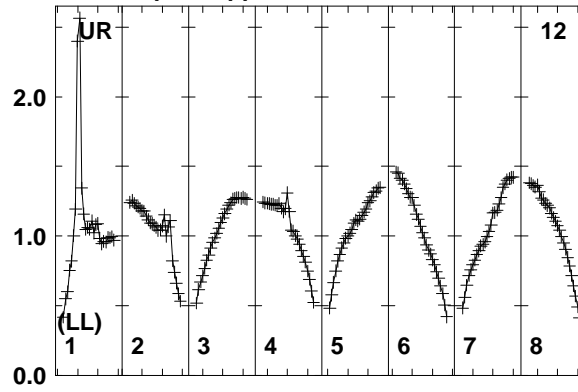
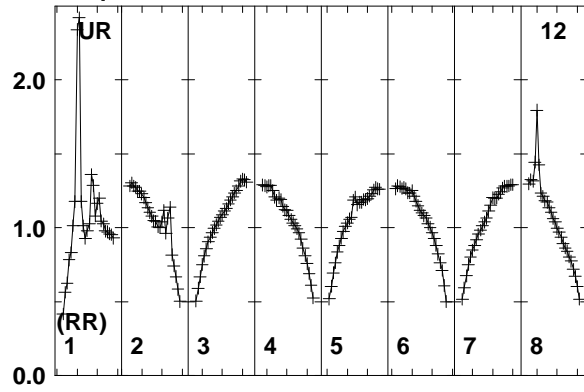

Lower frame: Real Jy
Total-power spectrum Antenna: UR (12)
Timerange: 00/01:18:00 to 00/01:19:30

Plot file version 82 created 19-AUG-2016 17:19:24

J1649+2635 EM119D.UVDATA.1

Freq = 1.5950 GHz, Bw = 16.000 MH No calibration applied and no bandpass applied

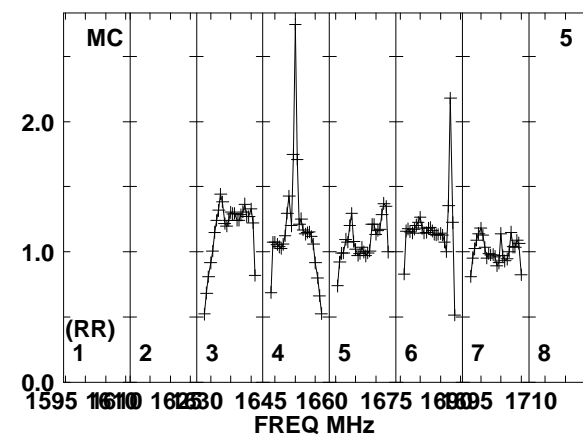
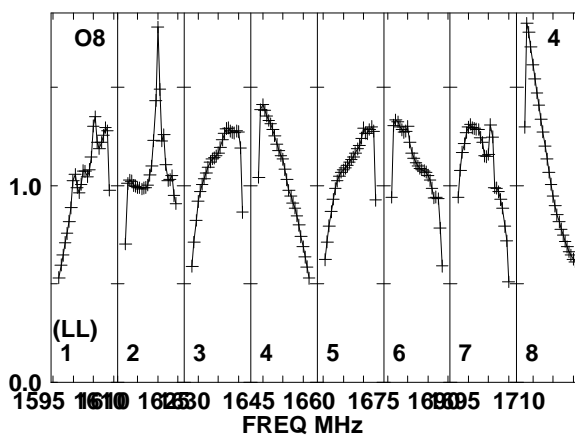
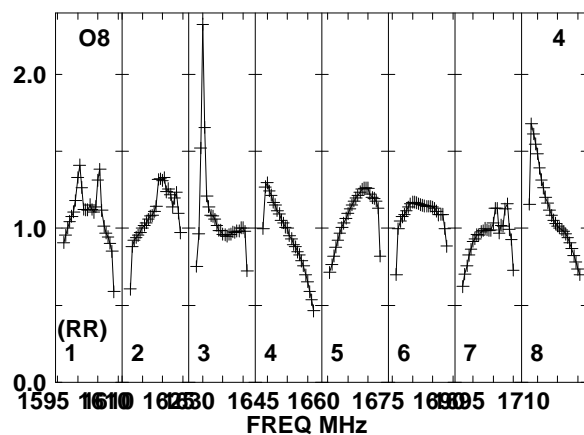
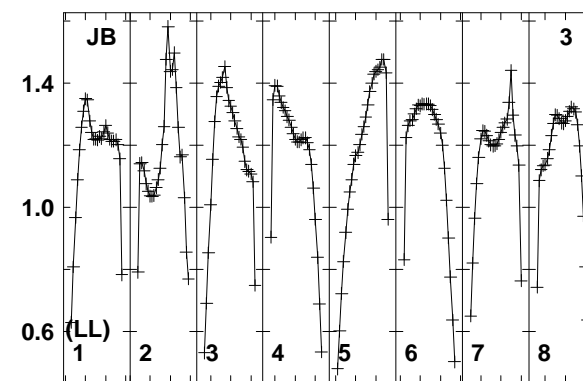
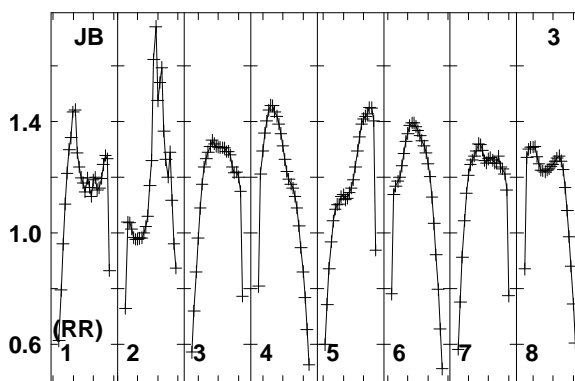
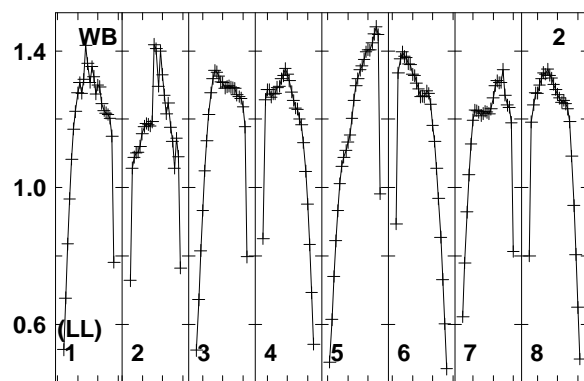
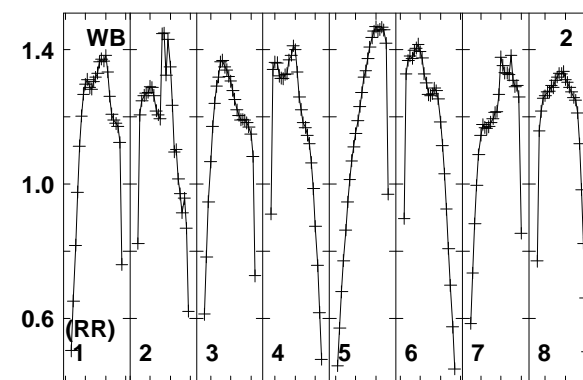
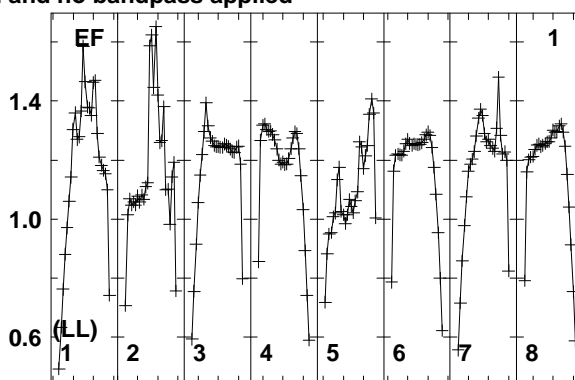
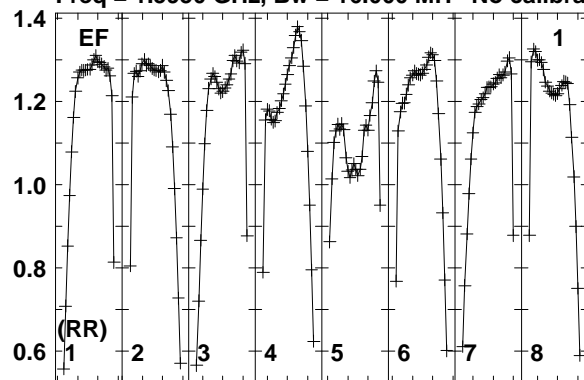

Lower frame: Real Jy
Total-power spectrum Antenna: EF (01)
Timerange: 00/01:19:32 to 00/01:23:00

Plot file version 83 created 19-AUG-2016 17:19:25

J1649+2635 EM119D.UVDATA.1

Freq = 1.5950 GHz, Bw = 16.000 MH No calibration applied and no bandpass applied

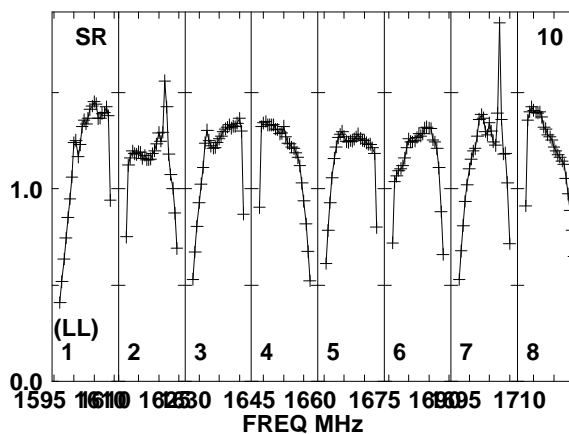
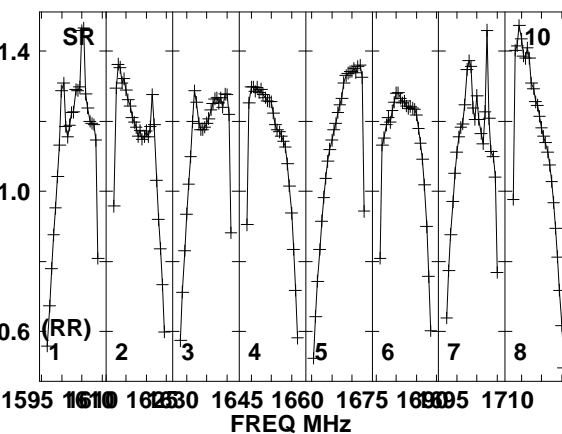
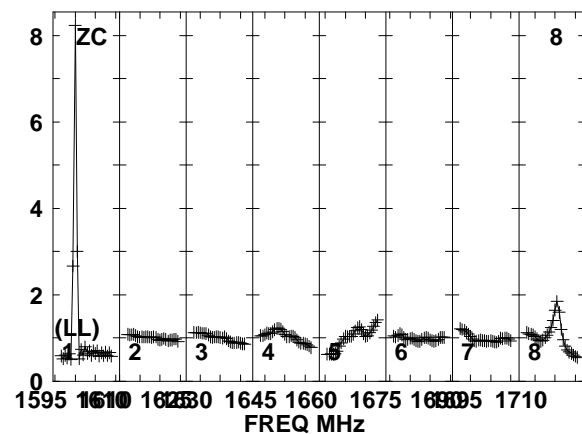
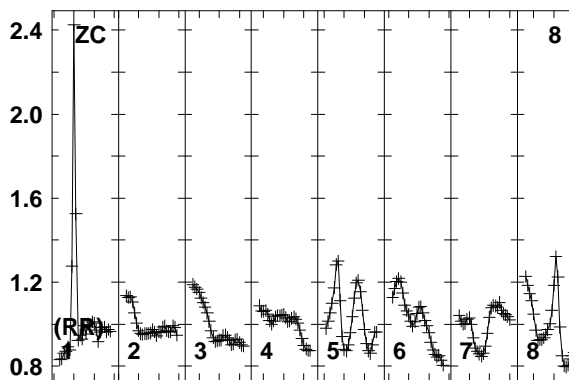
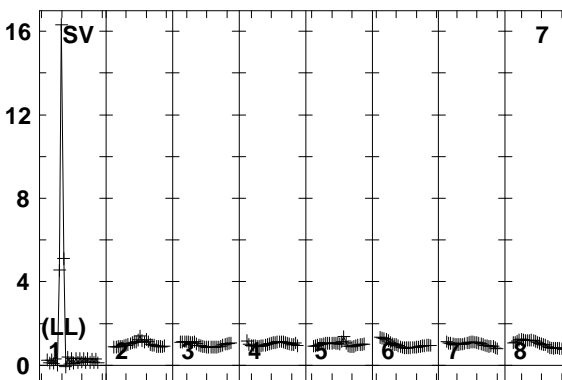
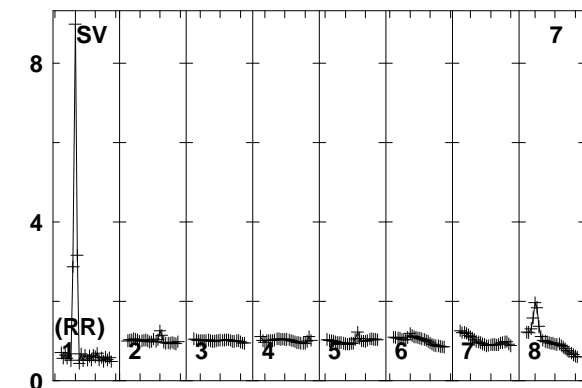
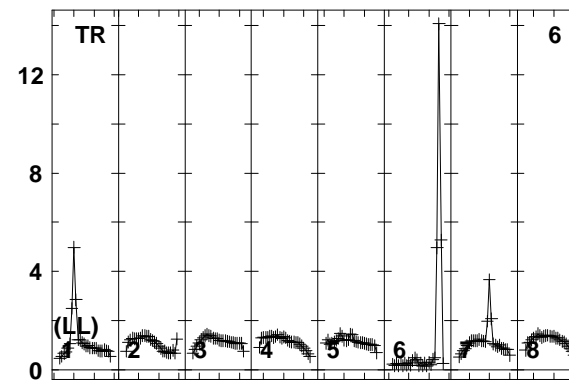
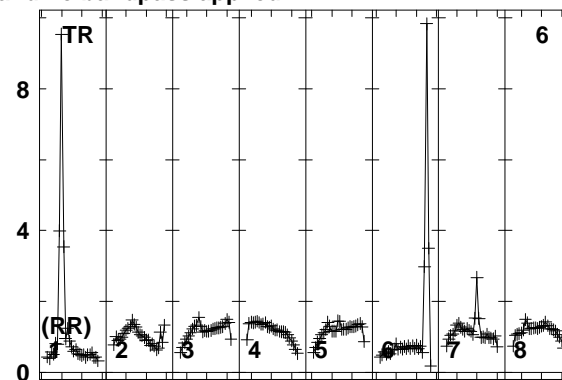
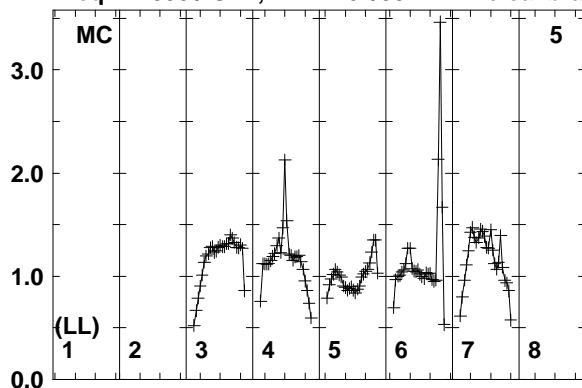

1595 1610 1625 1640 1655 1670 1685 1700 1715
FREQ MHz

Lower frame: Real Jy
Total-power spectrum Antenna: MC (05)
Timerange: 00/01:19:32 to 00/01:23:00

Plot file version 84 created 19-AUG-2016 17:19:25

J1649+2635 EM119D.UVDATA.1

Freq = 1.5950 GHz, Bw = 16.000 MH No calibration applied and no bandpass applied

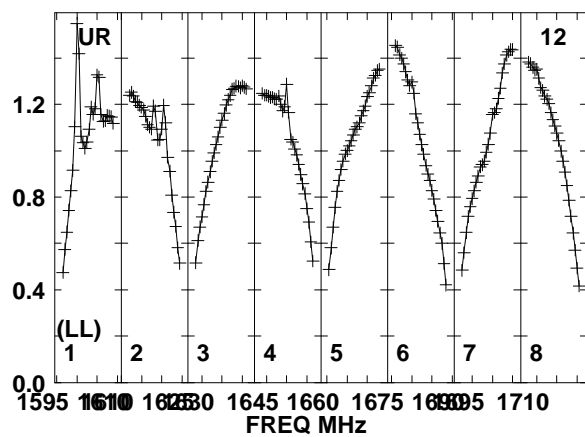
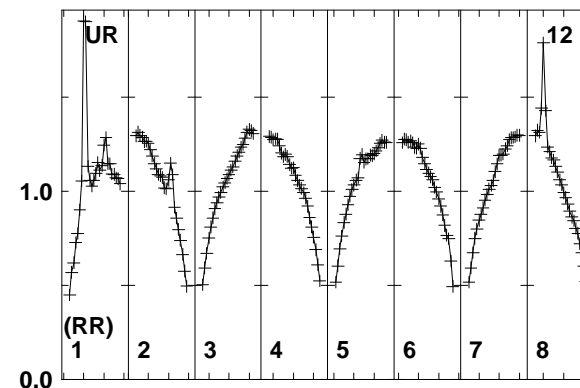
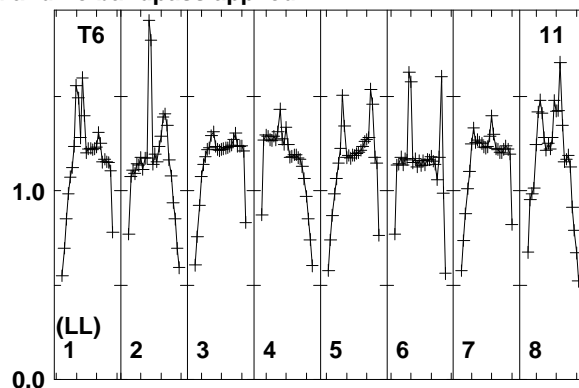
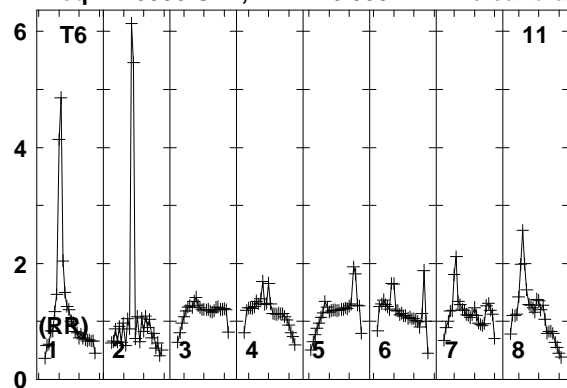

Lower frame: Real Jy
Total-power spectrum Antenna: T6 (11)
Timerange: 00/01:19:32 to 00/01:23:00

Plot file version 85 created 19-AUG-2016 17:19:25

J1642+2523 EM119D.UVDATA.1

Freq = 1.5950 GHz, Bw = 16.000 MH No calibration applied and no bandpass applied

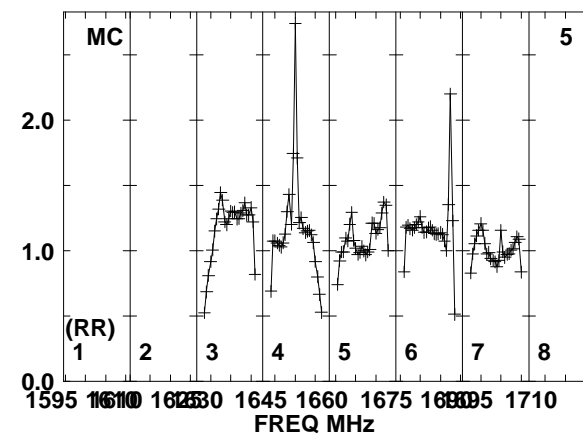
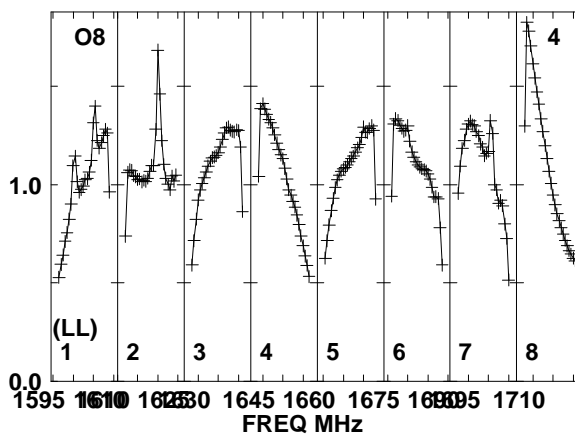
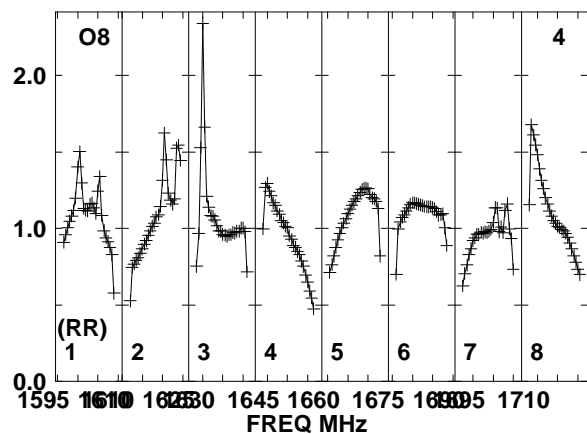
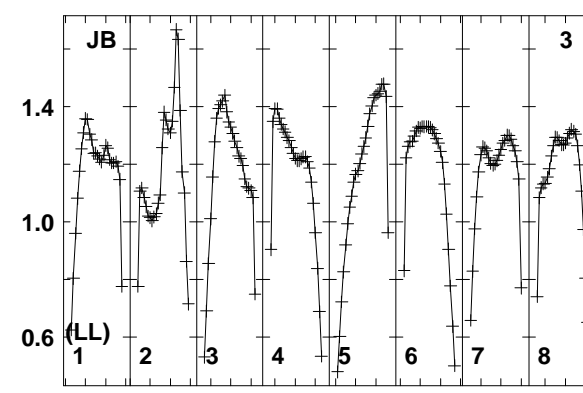
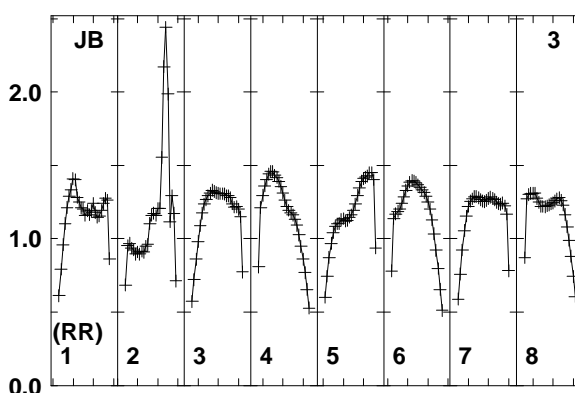
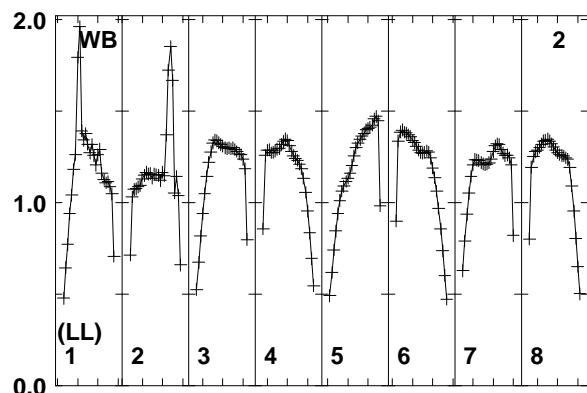
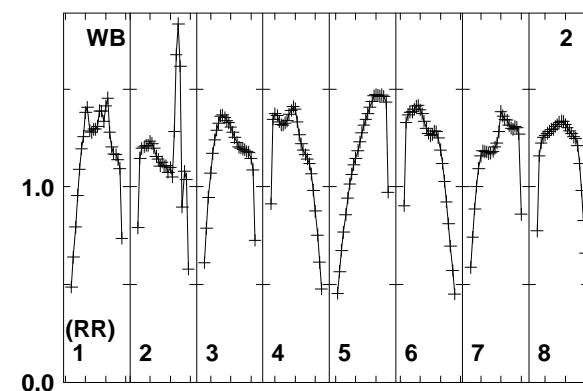
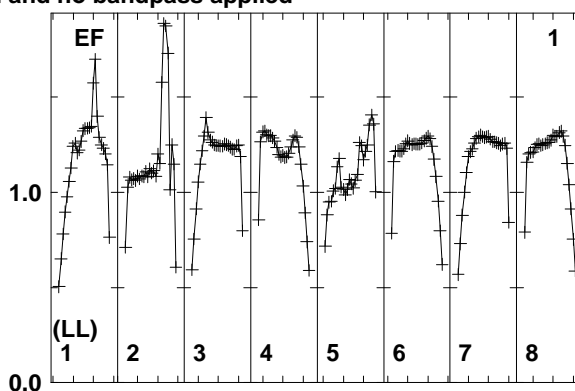
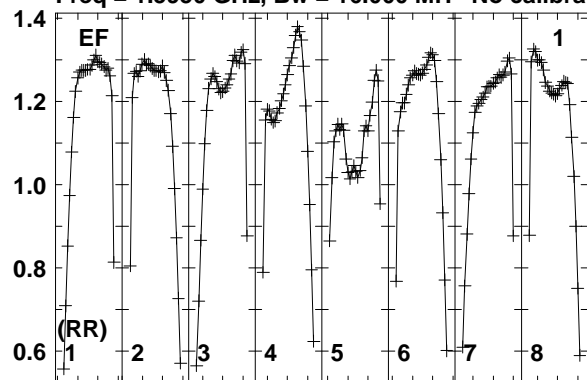

Lower frame: Real Jy
Total-power spectrum Antenna: EF (01)
Timerange: 00/01:23:08 to 00/01:24:29

Plot file version 86 created 19-AUG-2016 17:19:25

J1642+2523 EM119D.UVDATA.1

Freq = 1.5950 GHz, Bw = 16.000 MH No calibration applied and no bandpass applied

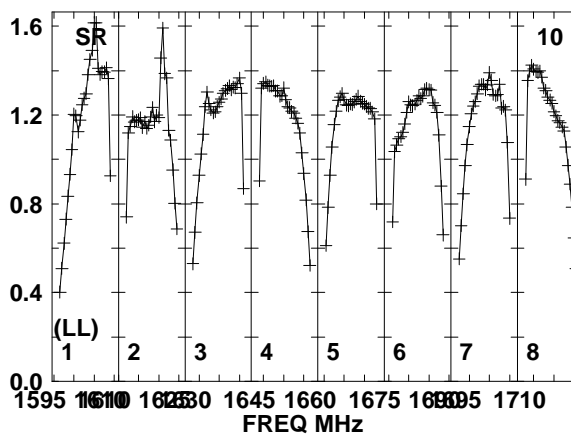
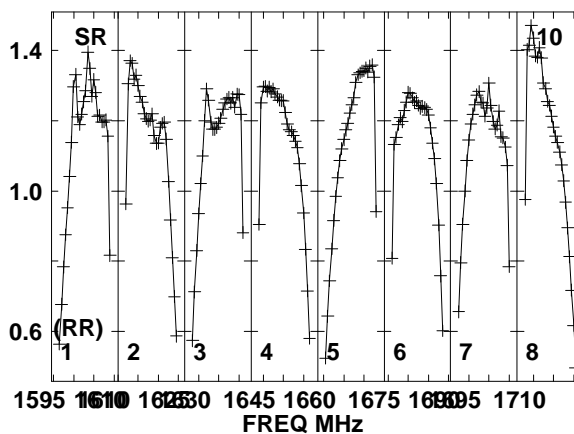
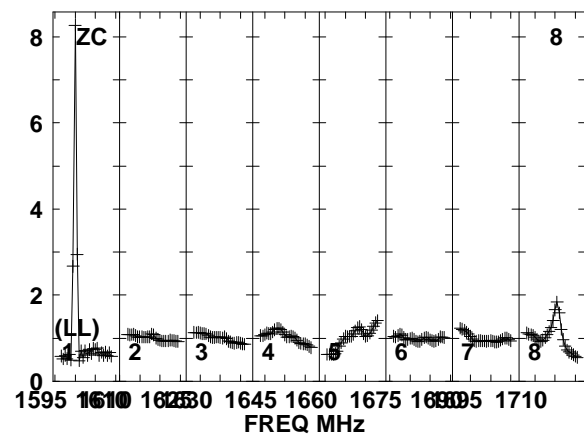
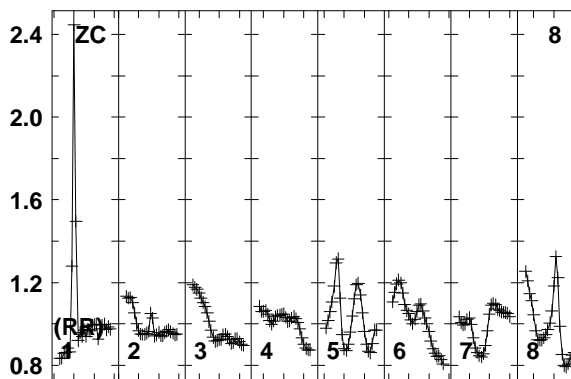
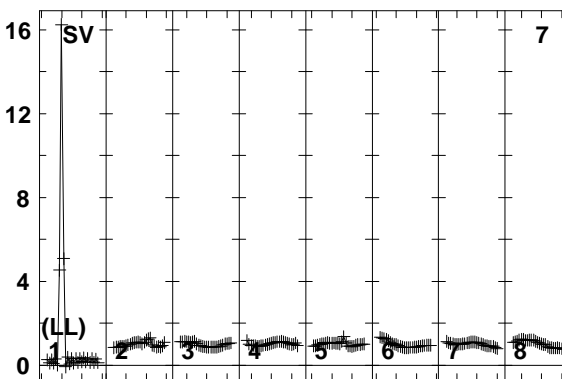
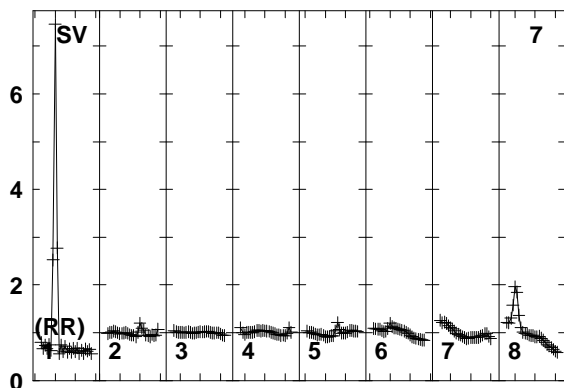
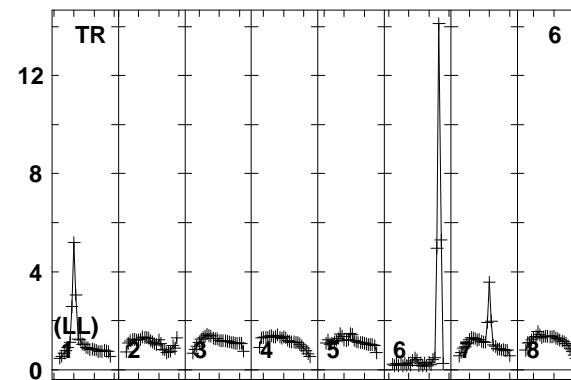
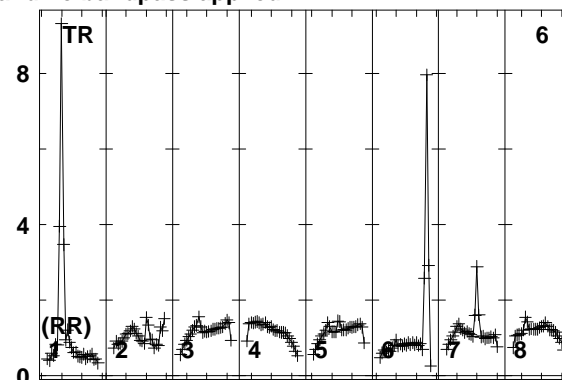
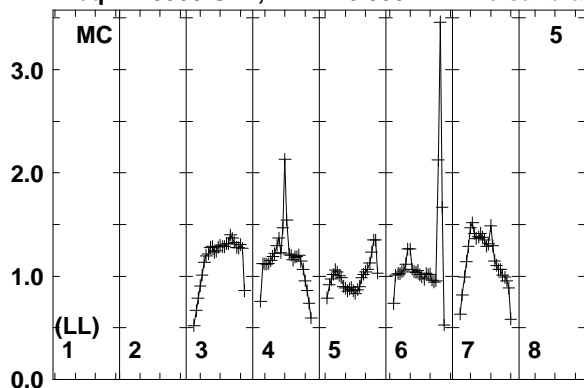

Lower frame: Real Jy
Total-power spectrum Antenna: MC (05)
Timerange: 00/01:23:08 to 00/01:24:29

Plot file version 87 created 19-AUG-2016 17:19:25

J1642+2523 EM119D.UVDATA.1

Freq = 1.5950 GHz, Bw = 16.000 MH No calibration applied and no bandpass applied

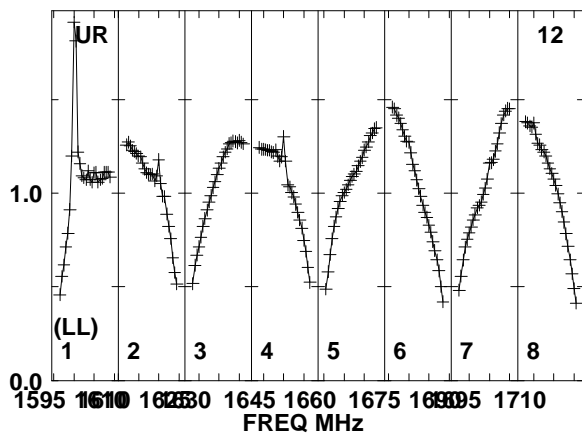
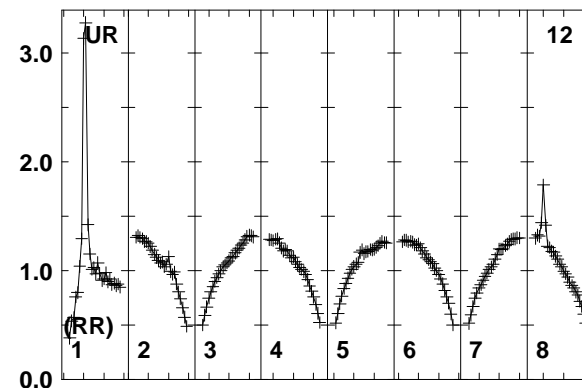
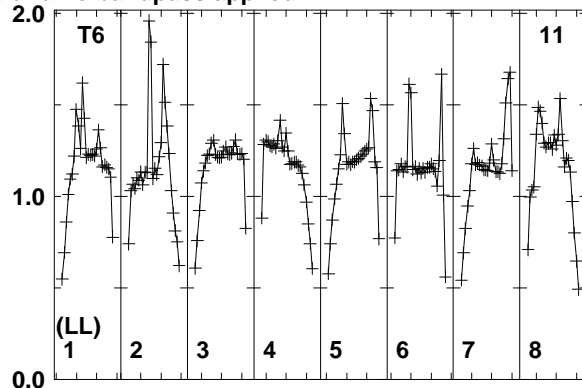
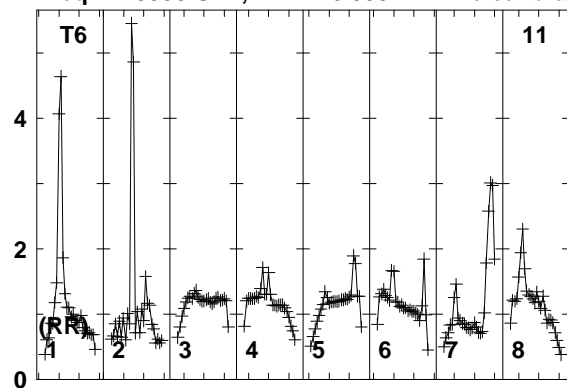

Lower frame: Real Jy
Total-power spectrum Antenna: T6 (11)
Timerange: 00/01:23:08 to 00/01:24:29

Plot file version 88 created 19-AUG-2016 17:19:25

J1649+2635 EM119D.UVDATA.1

Freq = 1.5950 GHz, Bw = 16.000 MH No calibration applied and no bandpass applied

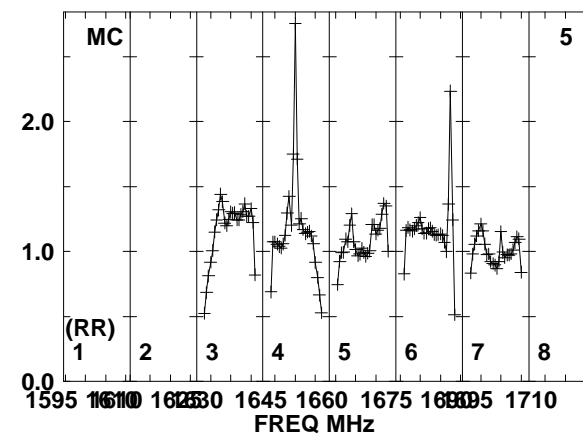
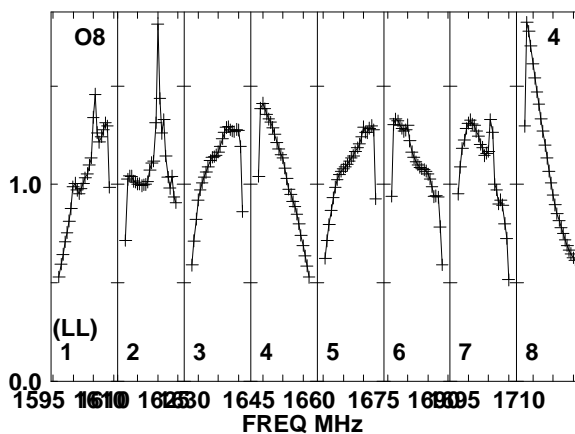
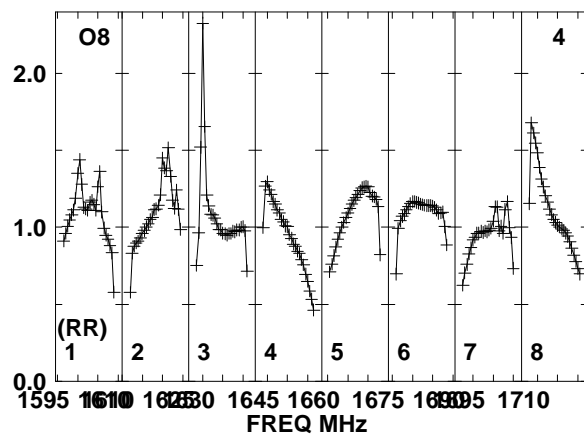
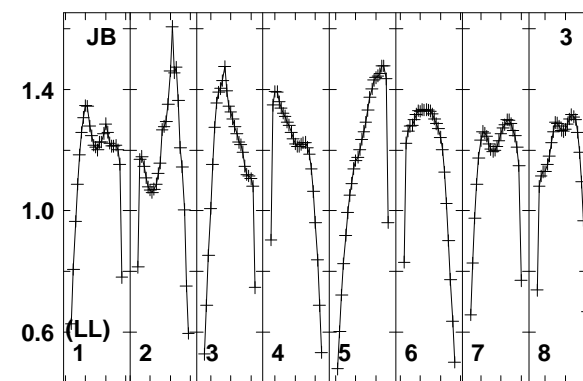
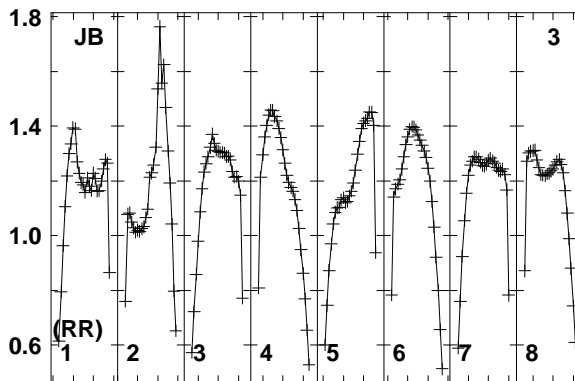
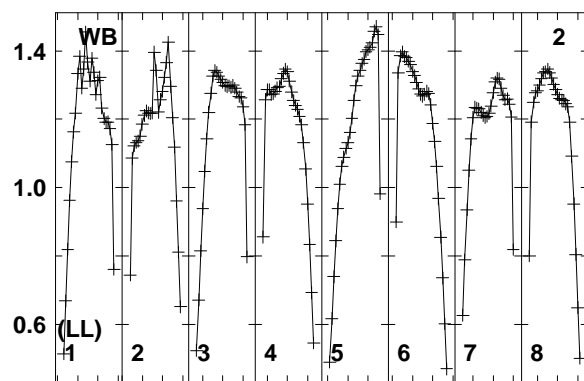
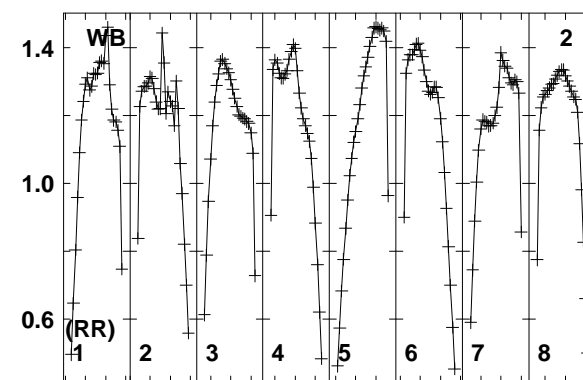
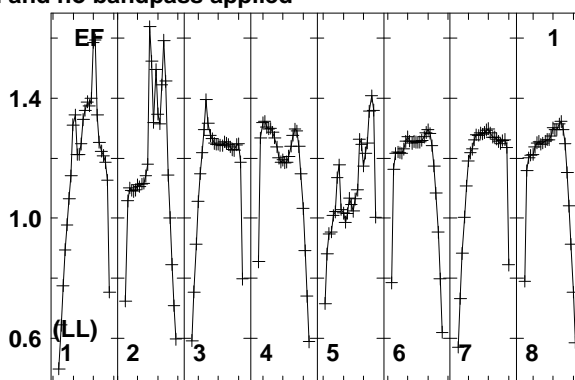
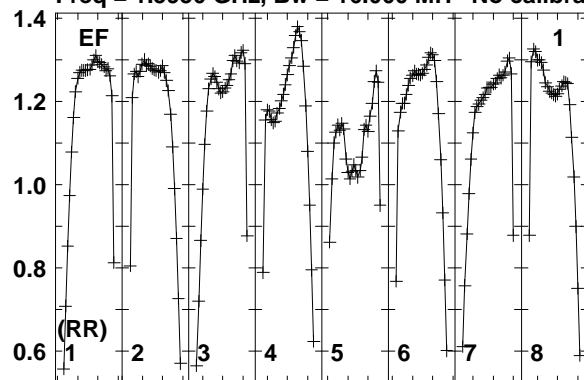

Lower frame: Real Jy
Total-power spectrum Antenna: EF (01)
Timerange: 00/01:24:38 to 00/01:28:00

Plot file version 89 created 19-AUG-2016 17:19:26

J1649+2635 EM119D.UVDATA.1

Freq = 1.5950 GHz, Bw = 16.000 MH No calibration applied and no bandpass applied

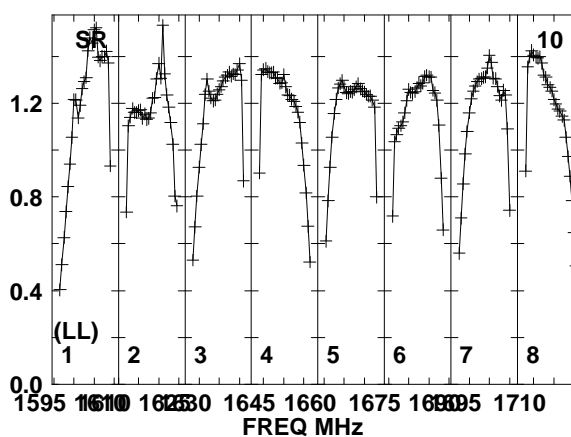
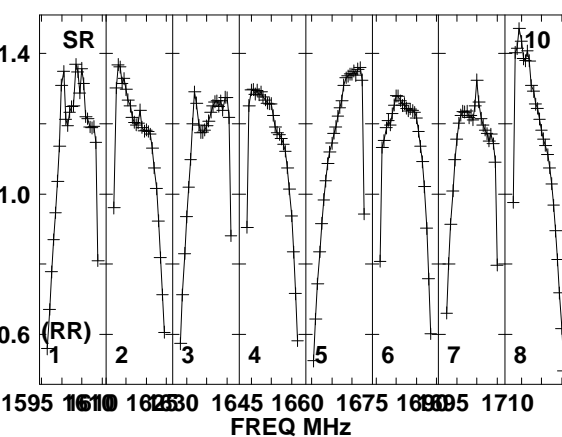
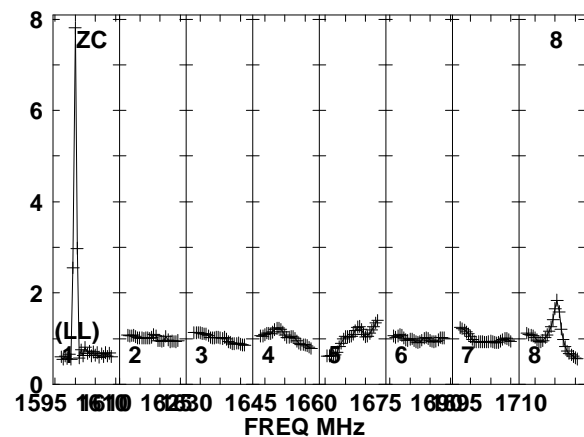
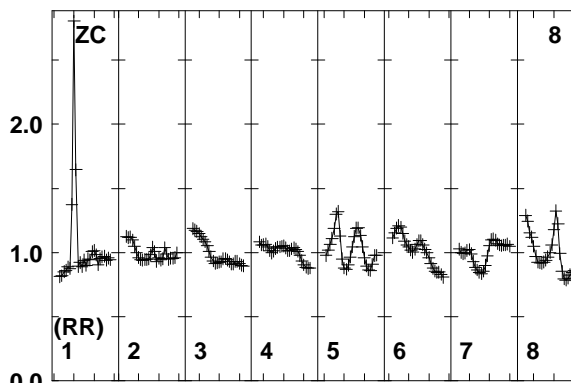
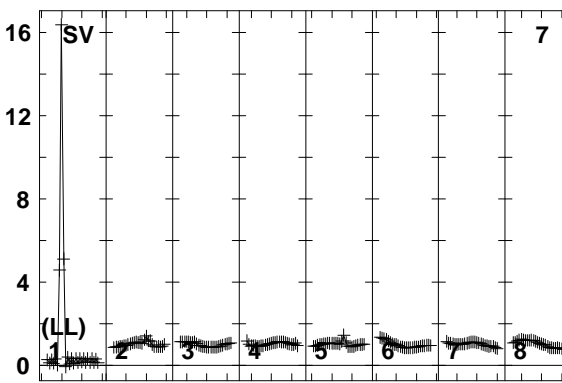
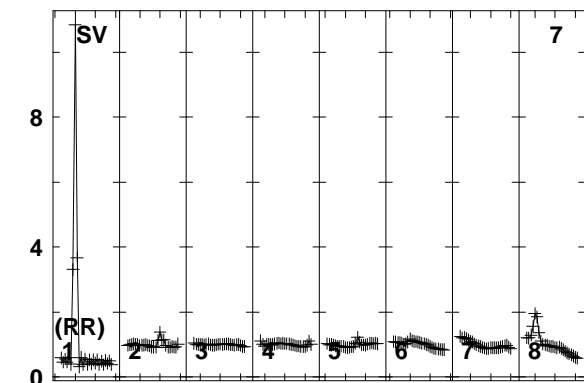
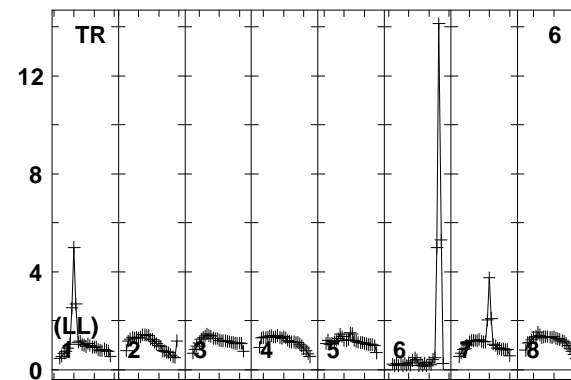
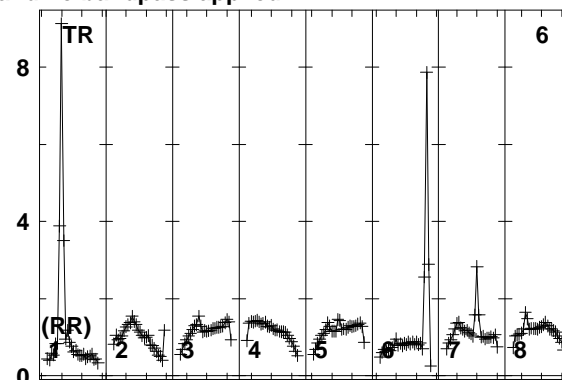
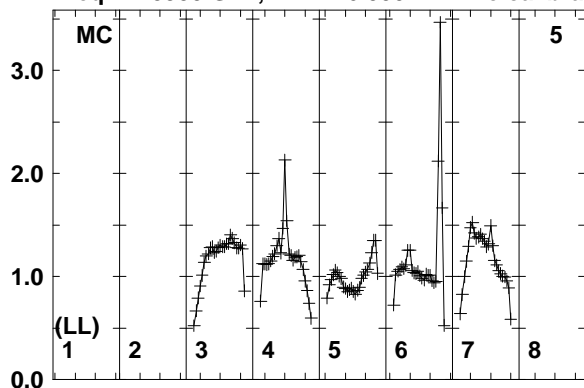

1595 1610 1625 1645 1660 1675 1690 1710
FREQ MHz
Lower frame: Real Jy
Total-power spectrum Antenna: MC (05)
Timerange: 00/01:24:38 to 00/01:28:00

Plot file version 90 created 19-AUG-2016 17:19:26

J1649+2635 EM119D.UVDATA.1

Freq = 1.5950 GHz, Bw = 16.000 MH No calibration applied and no bandpass applied

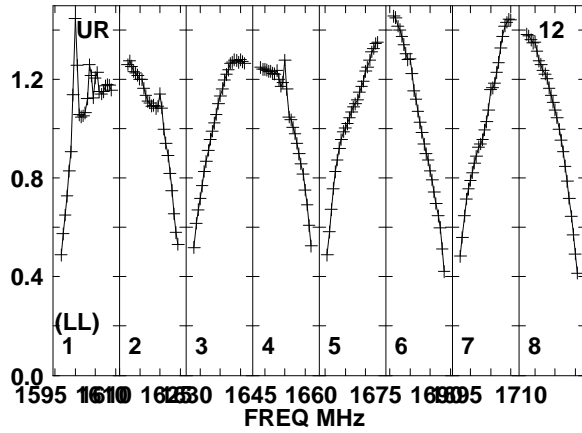
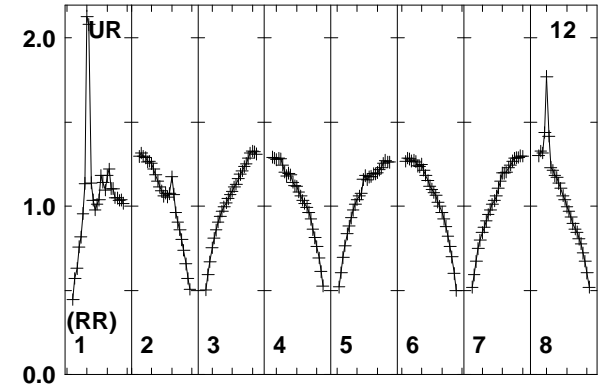
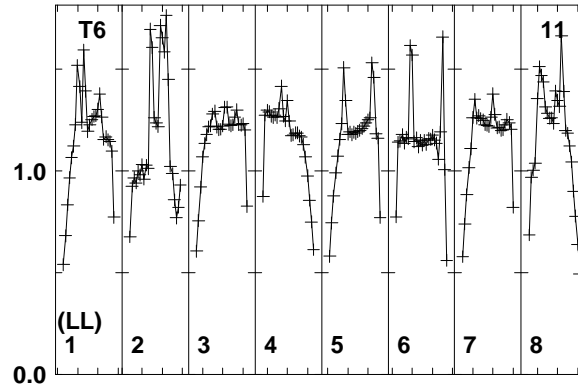
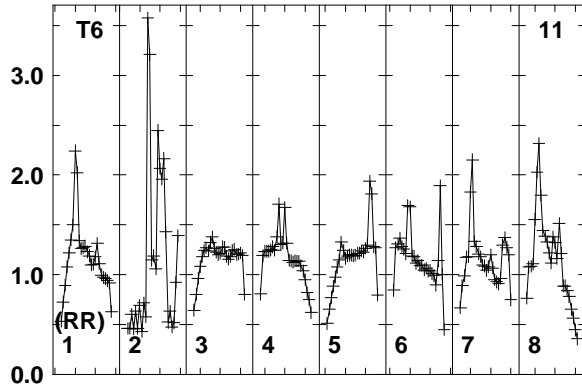

Lower frame: Real Jy
Total-power spectrum Antenna: T6 (11)
Timerange: 00/01:24:38 to 00/01:28:00

Plot file version 91 created 19-AUG-2016 17:19:26

J1642+2523 EM119D.UVDATA.1

Freq = 1.5950 GHz, Bw = 16.000 MH No calibration applied and no bandpass applied

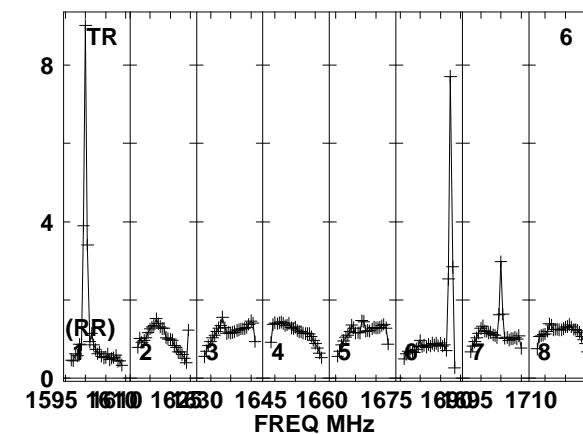
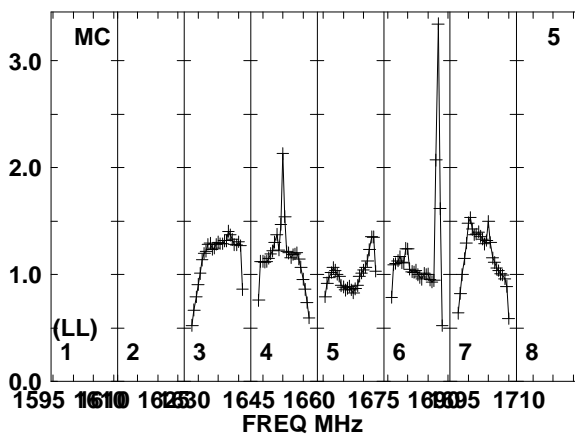
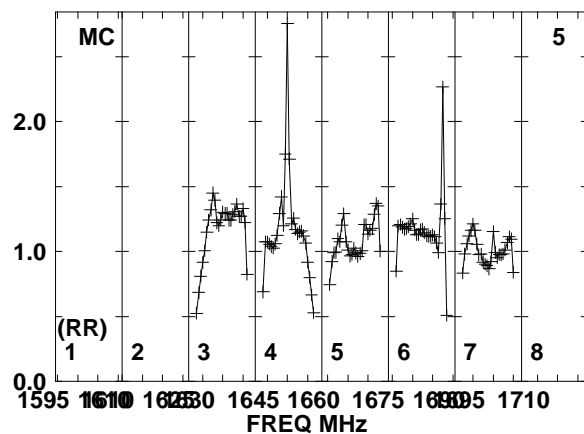
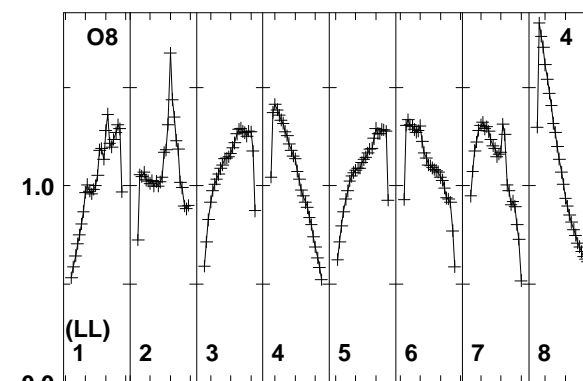
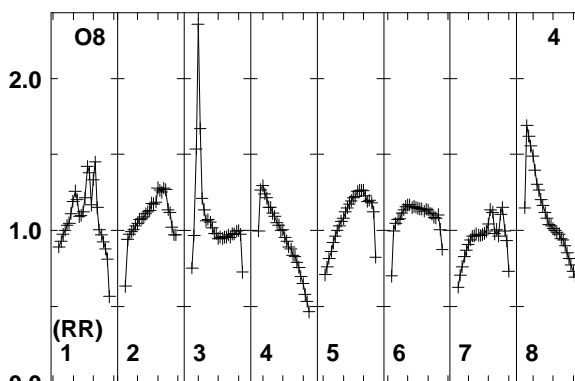
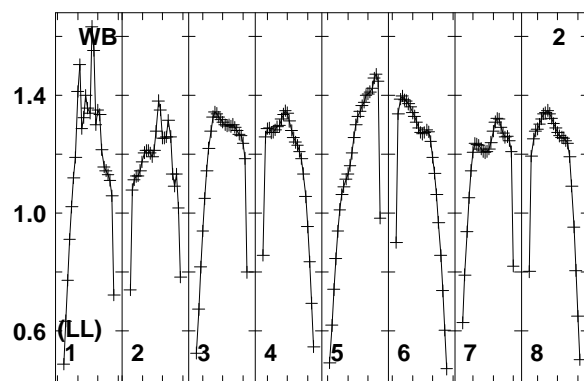
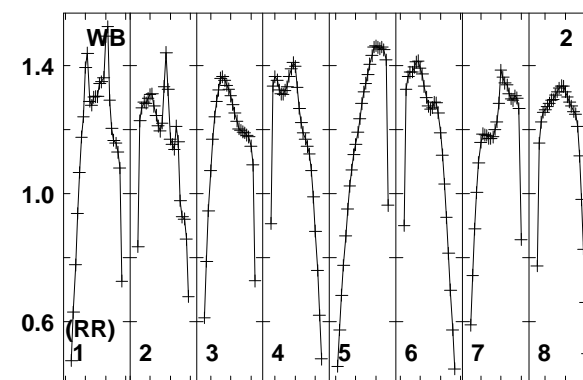
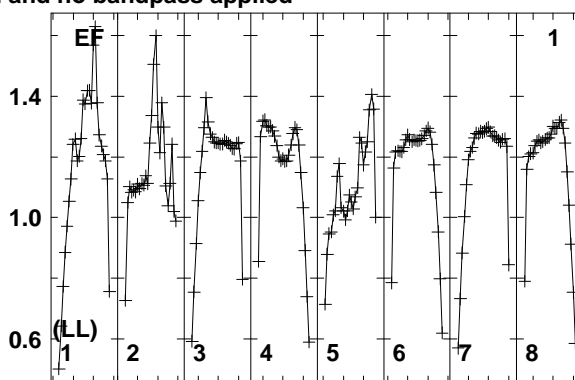
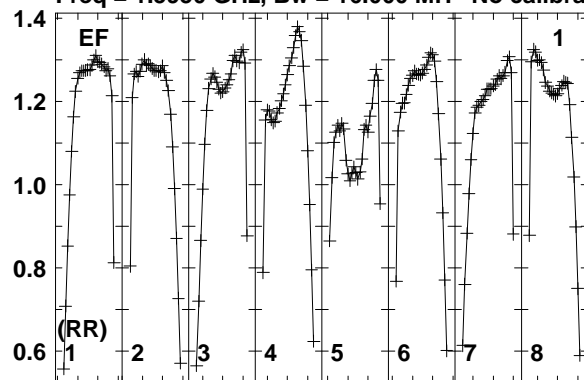

Lower frame: Real Jy
Total-power spectrum Antenna: EF (01)
Timerange: 00/01:29:00 to 00/01:30:30

Plot file version 92 created 19-AUG-2016 17:19:26

J1642+2523 EM119D.UVDATA.1

Freq = 1.5950 GHz, Bw = 16.000 MH No calibration applied and no bandpass applied

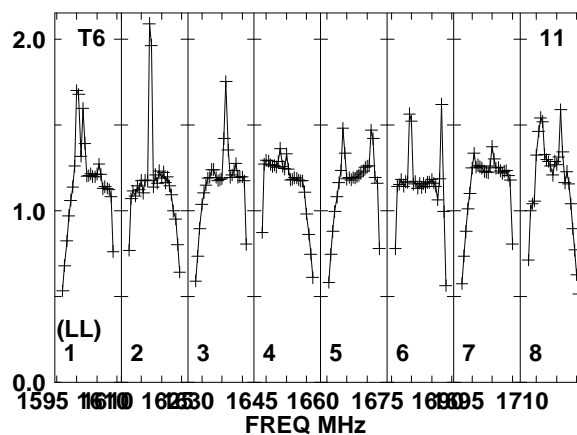
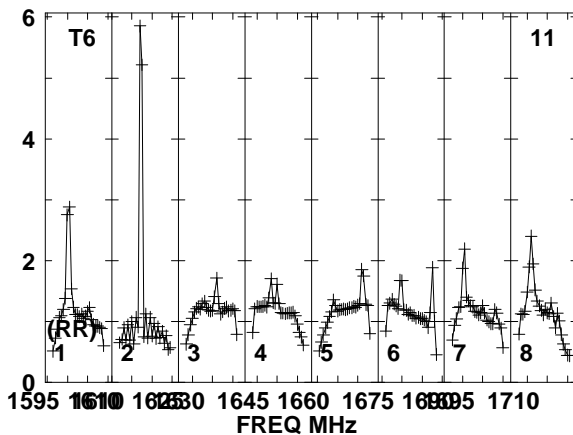
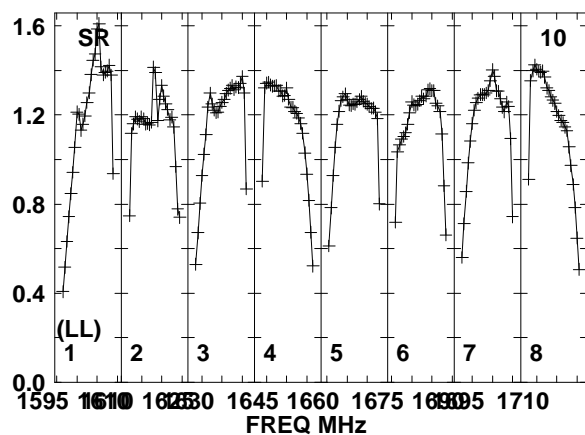
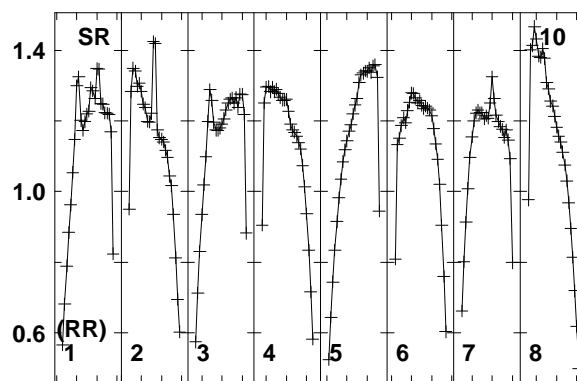
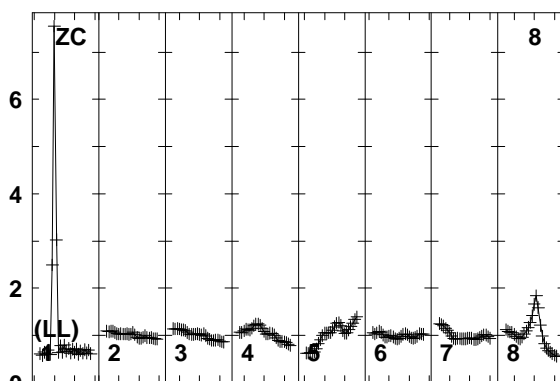
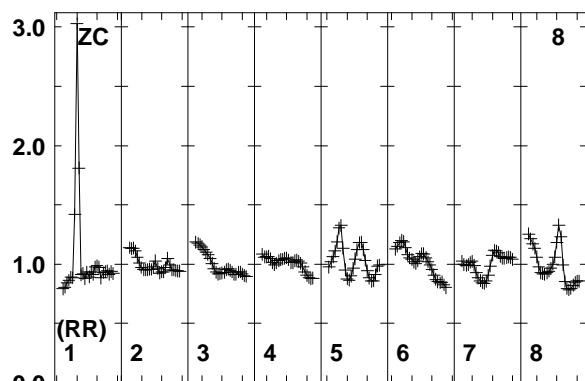
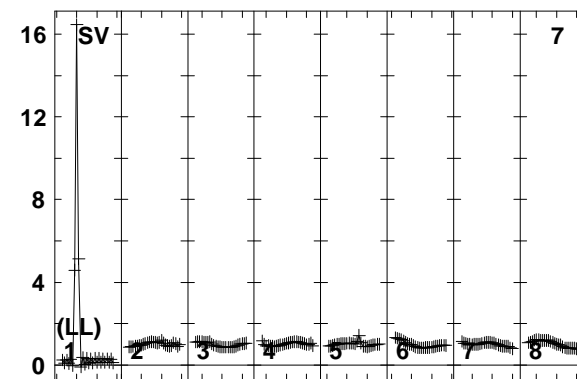
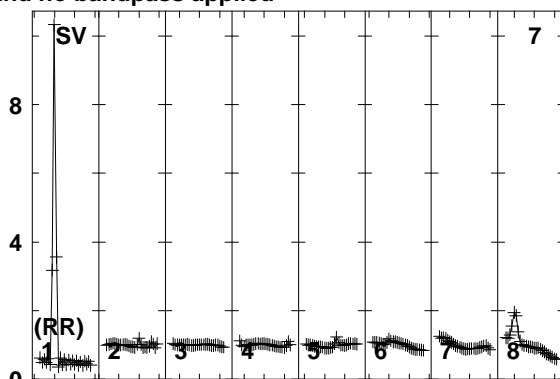
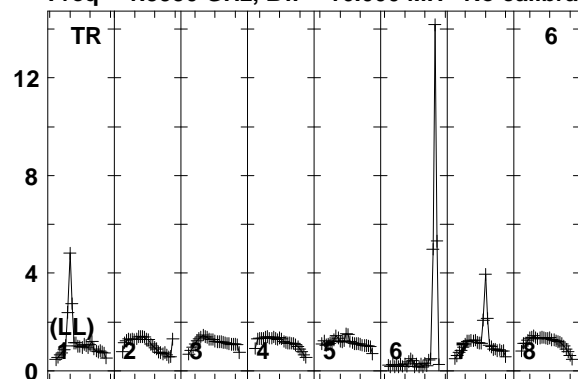

Lower frame: Real Jy
Total-power spectrum Antenna: TR (06)
Timerange: 00/01:29:00 to 00/01:30:30

Plot file version 93 created 19-AUG-2016 17:19:26

J1642+2523 EM119D.UVDATA.1

Freq = 1.5950 GHz, Bw = 16.000 MH No calibration applied and no bandpass applied

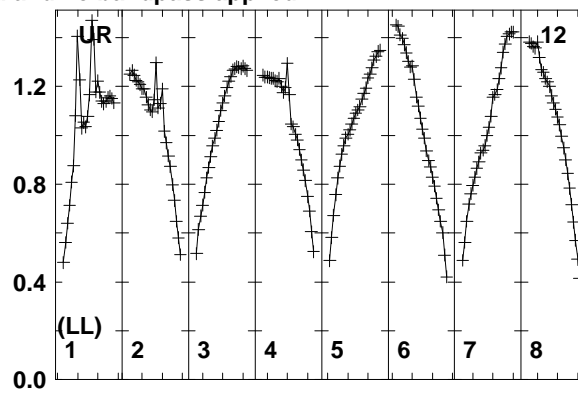
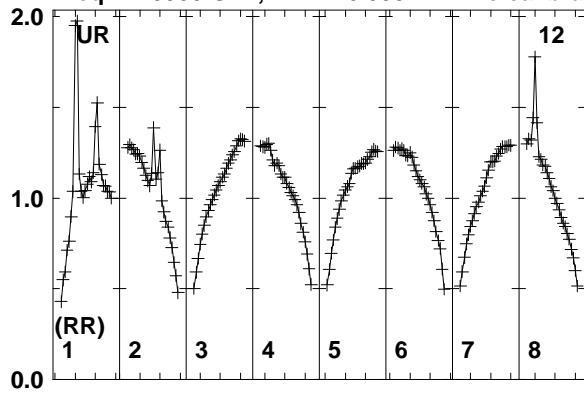

Lower frame: Real Jy
Total-power spectrum Antenna: UR (12)
Timerange: 00/01:29:00 to 00/01:30:30

Plot file version 94 created 19-AUG-2016 17:19:26

J1649+2635 EM119D.UVDATA.1

Freq = 1.5950 GHz, Bw = 16.000 MH No calibration applied and no bandpass applied

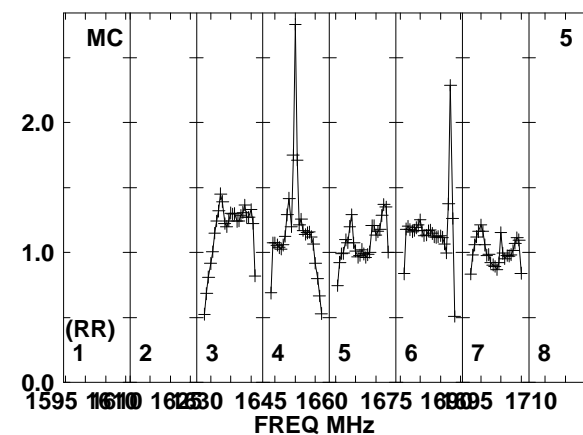
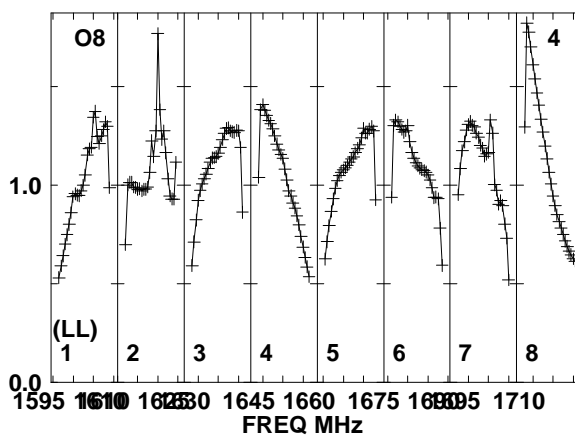
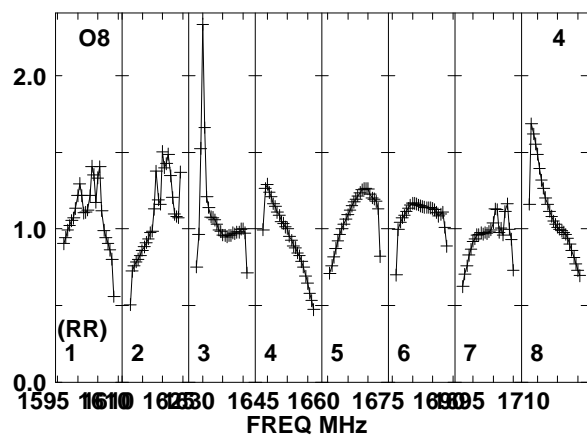
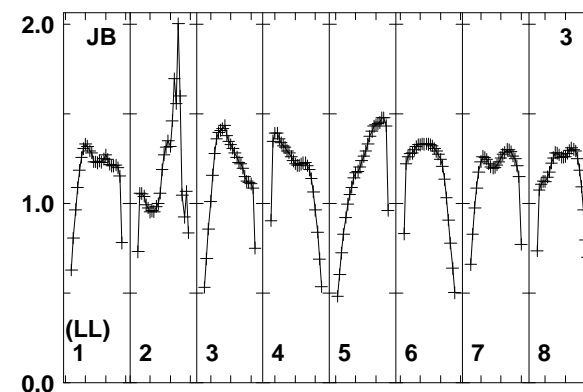
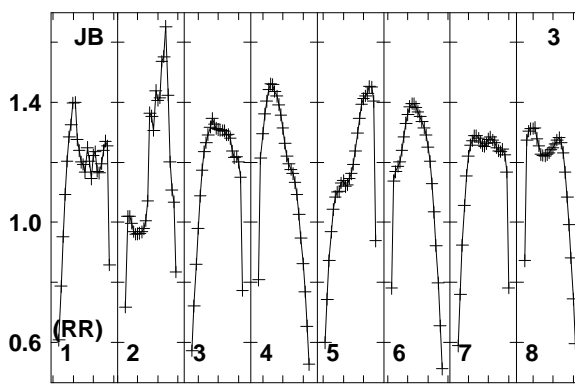
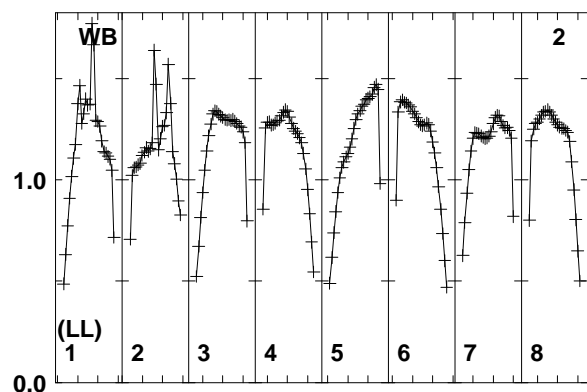
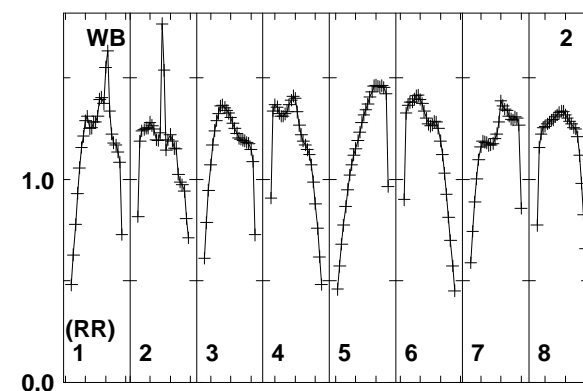
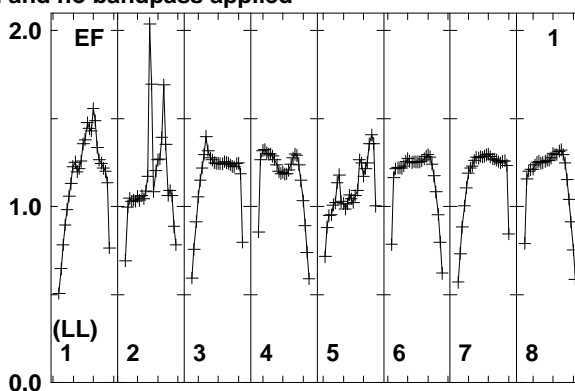
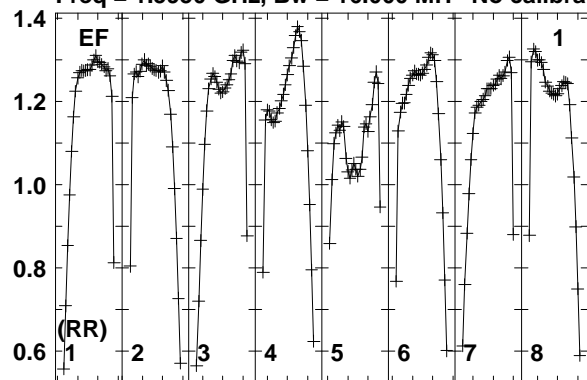

Lower frame: Real Jy
Total-power spectrum Antenna: EF (01)
Timerange: 00/01:30:32 to 00/01:33:59

Plot file version 95 created 19-AUG-2016 17:19:27

J1649+2635 EM119D.UVDATA.1

Freq = 1.5950 GHz, Bw = 16.000 MH No calibration applied and no bandpass applied

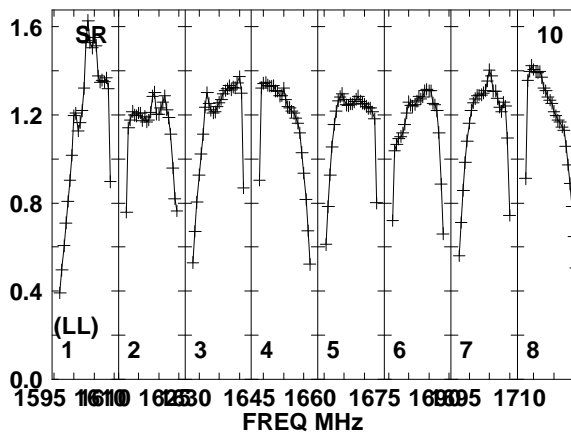
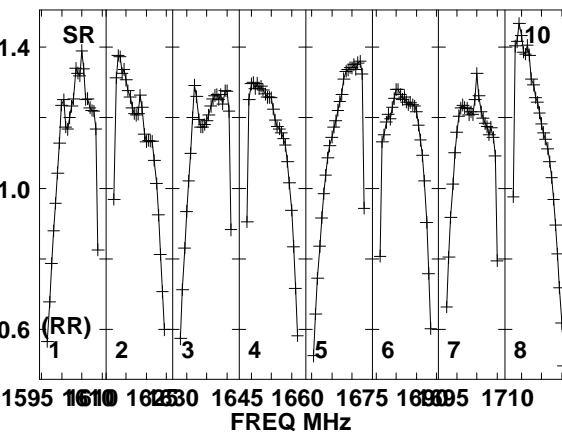
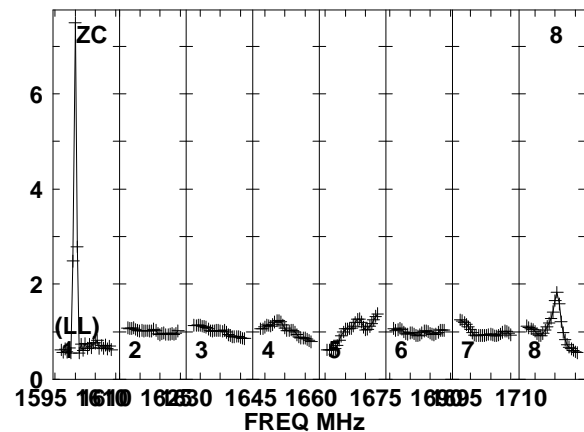
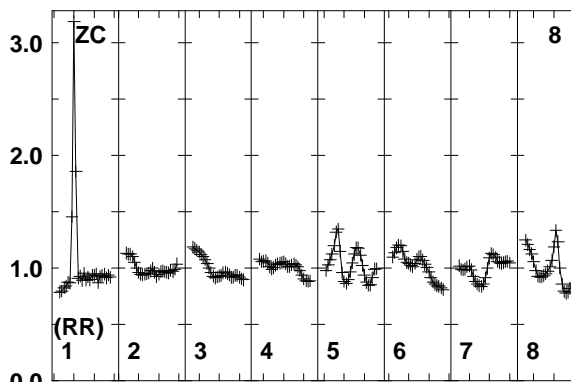
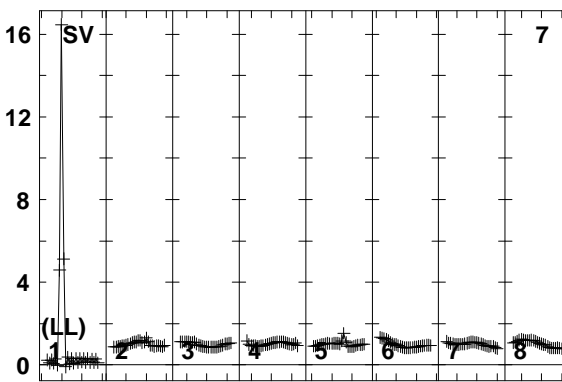
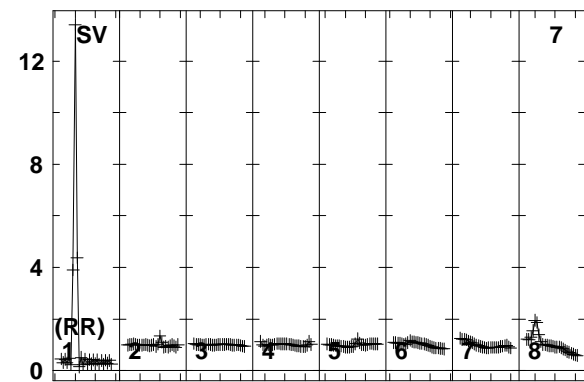
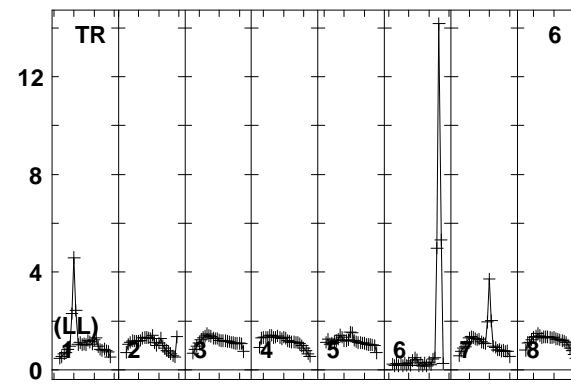
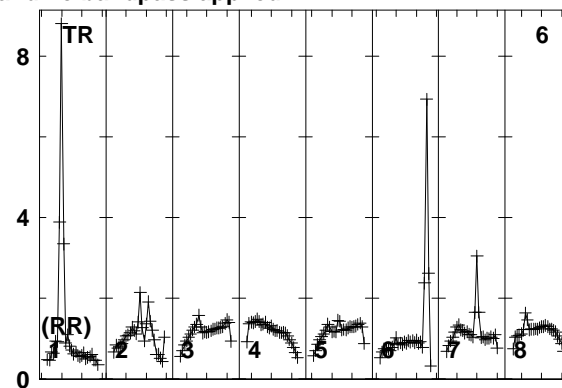
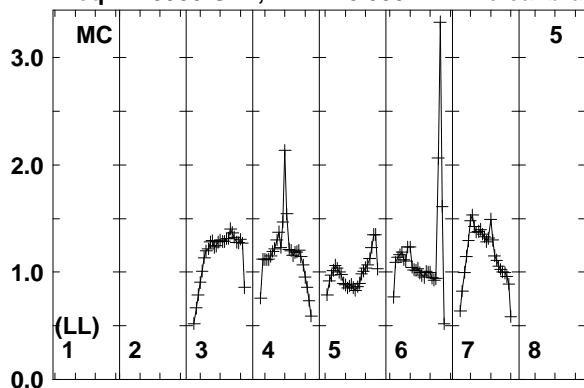

Lower frame: Real Jy
Total-power spectrum Antenna: MC (05)
Timerange: 00/01:30:32 to 00/01:33:59

Plot file version 96 created 19-AUG-2016 17:19:27

J1649+2635 EM119D.UVDATA.1

Freq = 1.5950 GHz, Bw = 16.000 MH No calibration applied and no bandpass applied

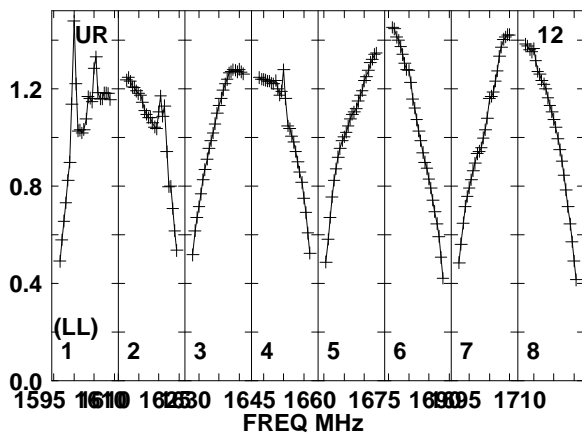
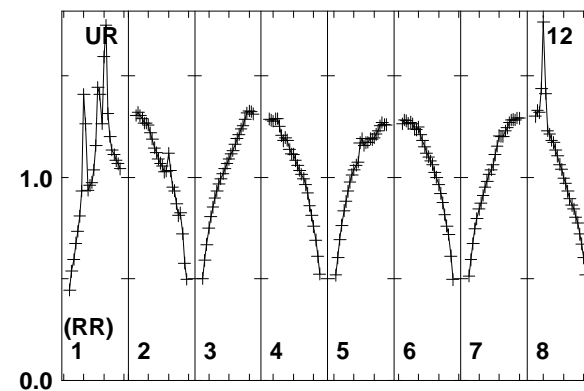
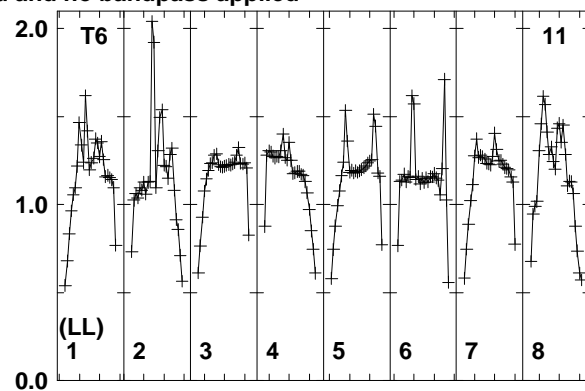
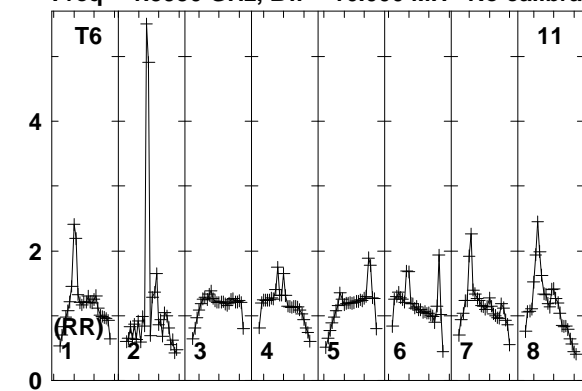

Lower frame: Real Jy
Total-power spectrum Antenna: T6 (11)
Timerange: 00/01:30:32 to 00/01:33:59

Plot file version 97 created 19-AUG-2016 17:19:27

J1642+2523 EM119D.UVDATA.1

Freq = 1.5950 GHz, Bw = 16.000 MH No calibration applied and no bandpass applied

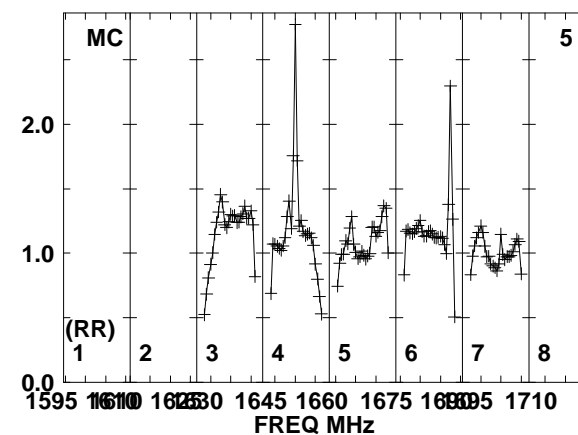
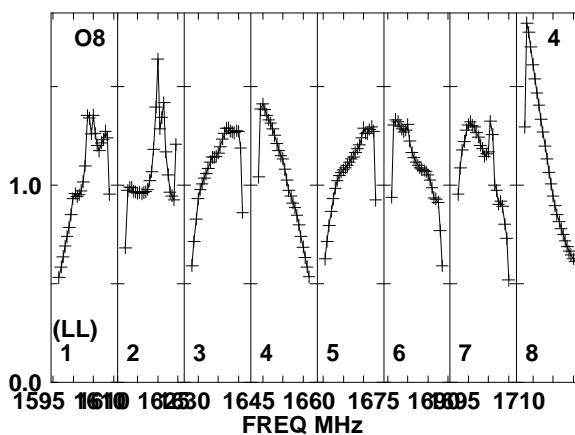
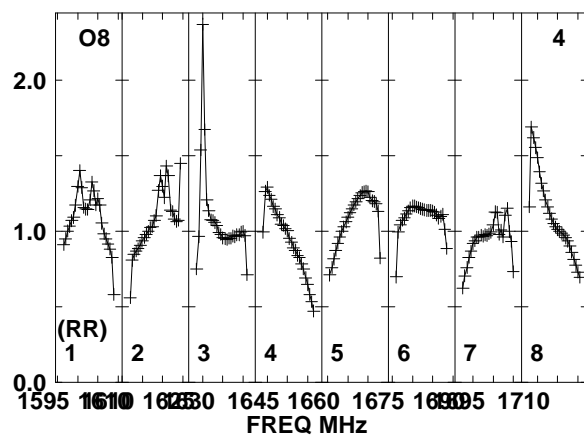
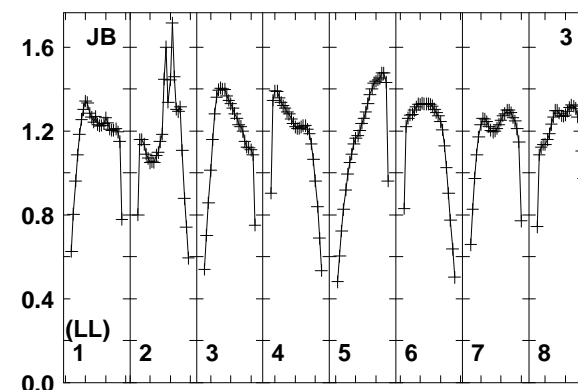
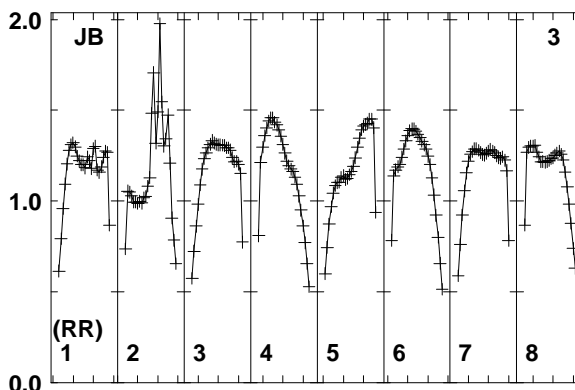
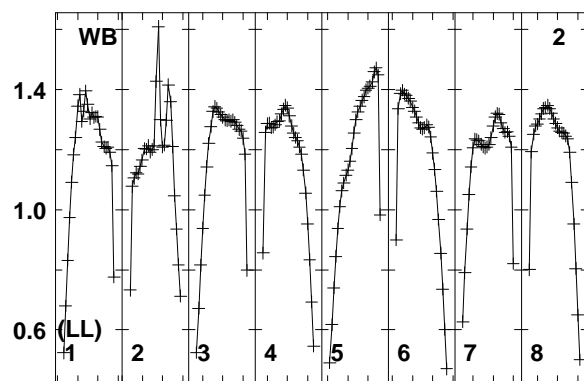
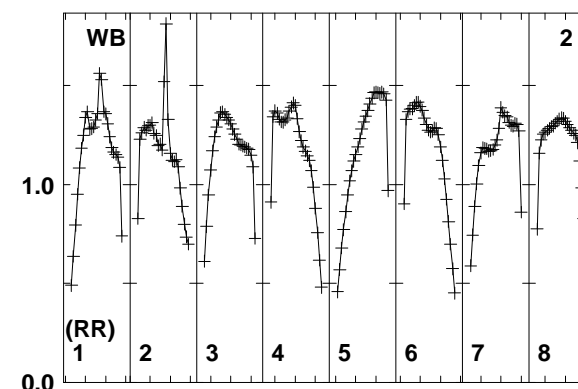
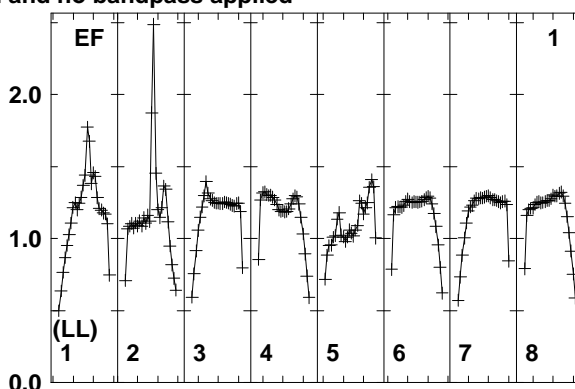
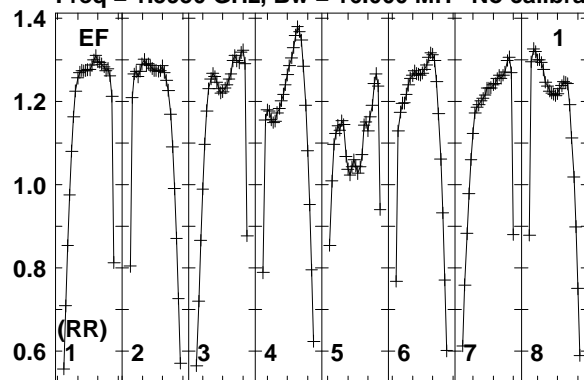

Lower frame: Real Jy
Total-power spectrum Antenna: EF (01)
Timerange: 00/01:34:08 to 00/01:35:29

Plot file version 98 created 19-AUG-2016 17:19:27

J1642+2523 EM119D.UVDATA.1

Freq = 1.5950 GHz, Bw = 16.000 MH No calibration applied and no bandpass applied

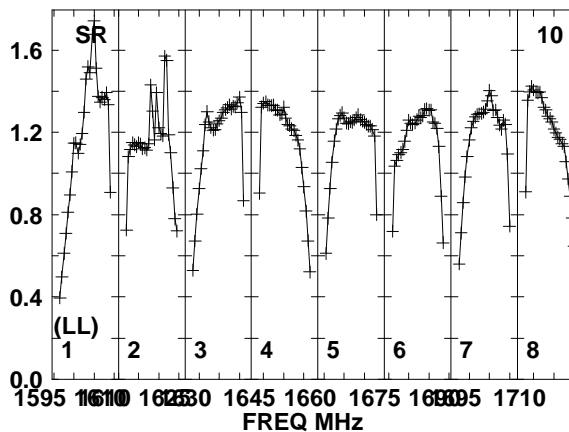
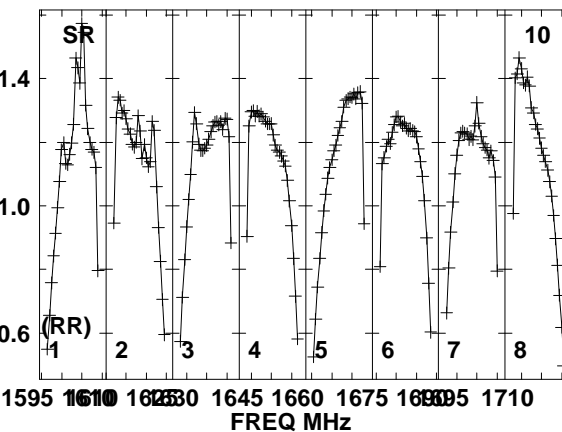
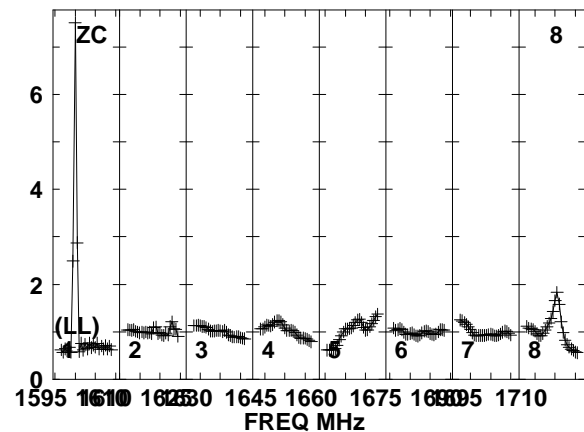
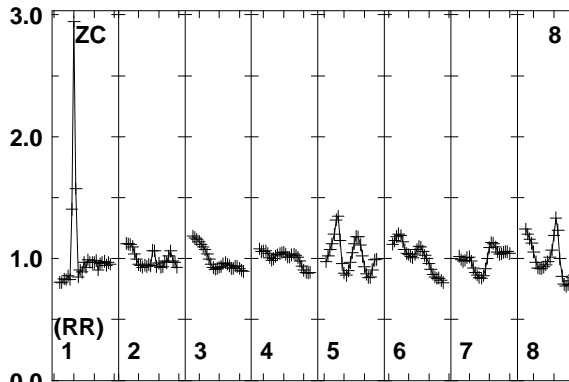
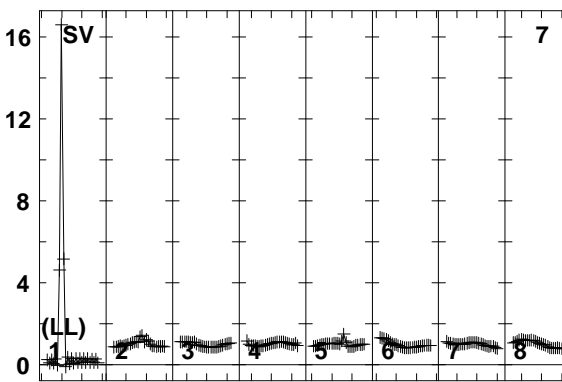
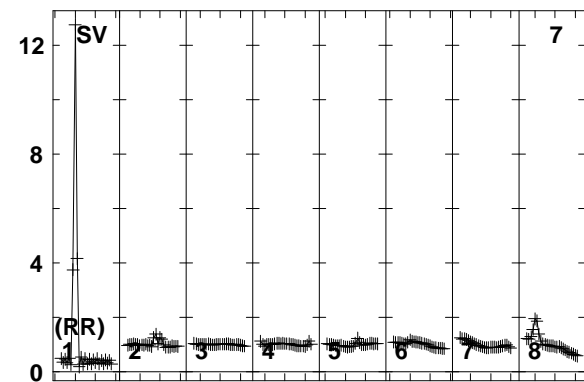
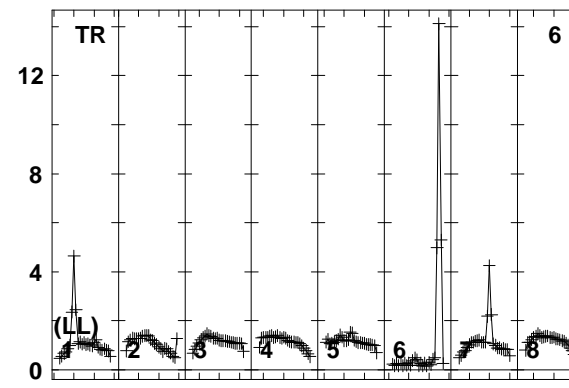
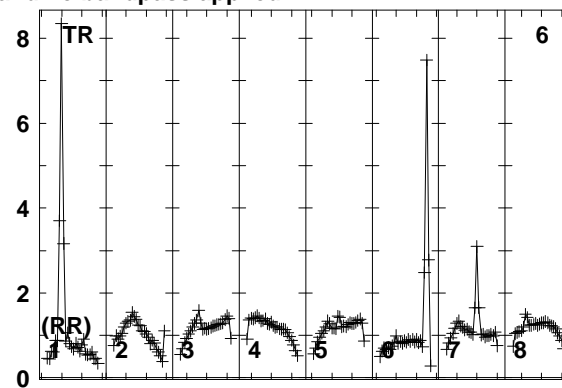
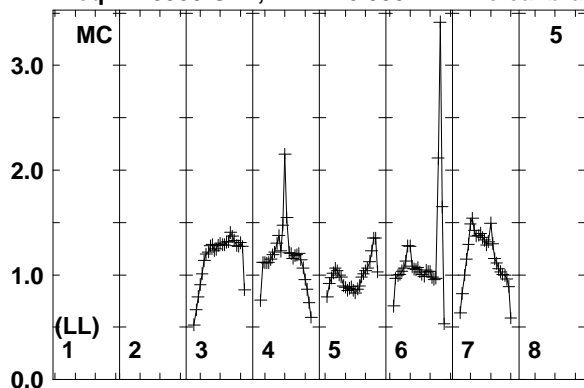

Lower frame: Real Jy
Total-power spectrum Antenna: MC (05)
Timerange: 00/01:34:08 to 00/01:35:29

Plot file version 99 created 19-AUG-2016 17:19:27

J1642+2523 EM119D.UVDATA.1

Freq = 1.5950 GHz, Bw = 16.000 MH No calibration applied and no bandpass applied

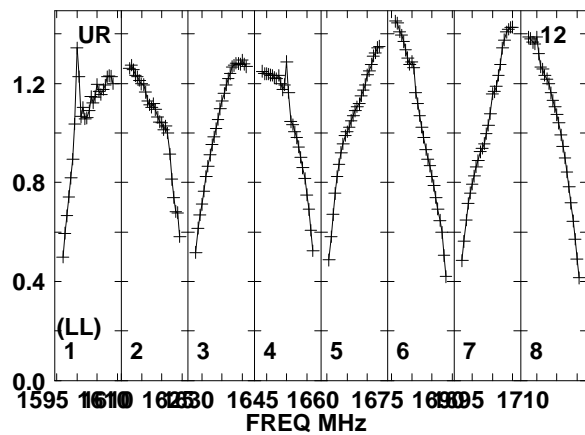
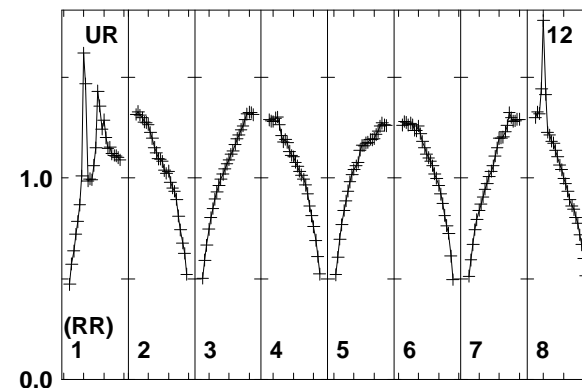
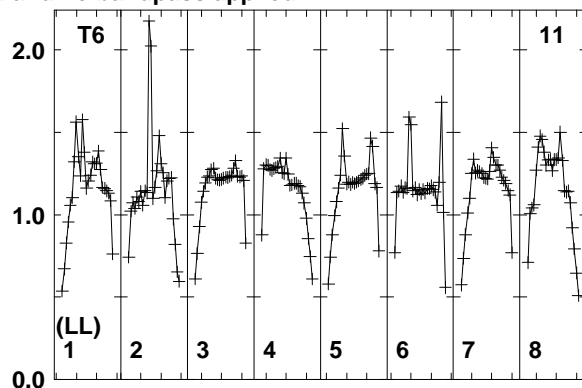
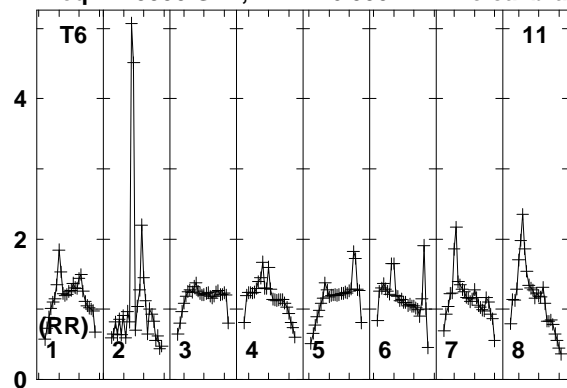

Lower frame: Real Jy
Total-power spectrum Antenna: T6 (11)
Timerange: 00/01:34:08 to 00/01:35:29

Plot file version 100 created 19-AUG-2016 17:19:27

J1649+2635 EM119D.UVDATA.1

Freq = 1.5950 GHz, Bw = 16.000 MH No calibration applied and no bandpass applied

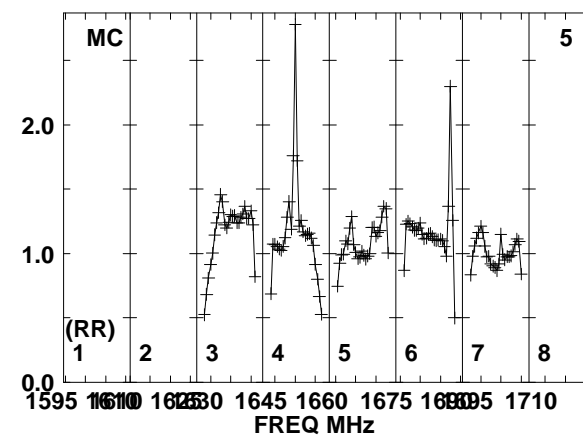
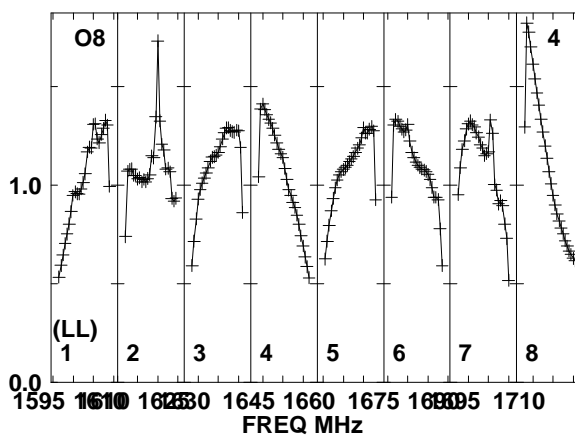
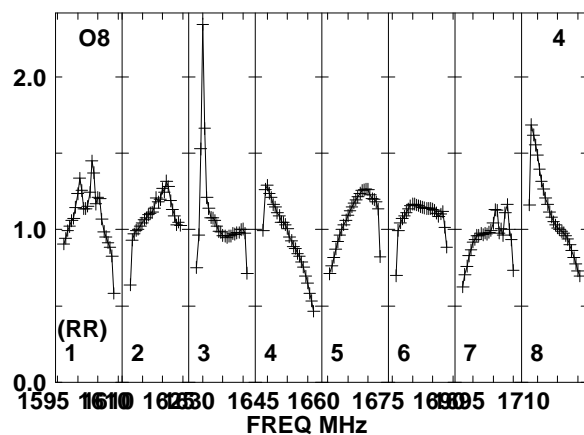
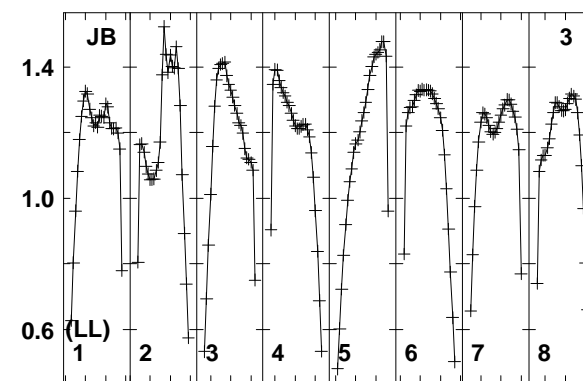
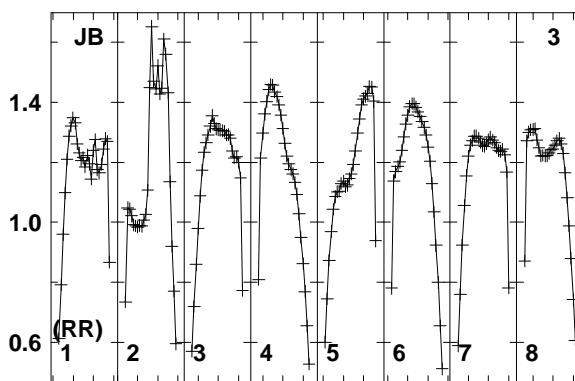
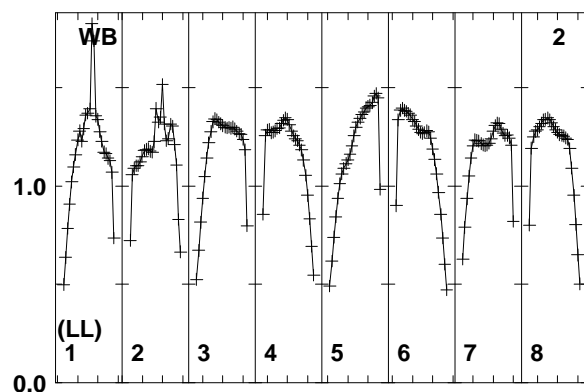
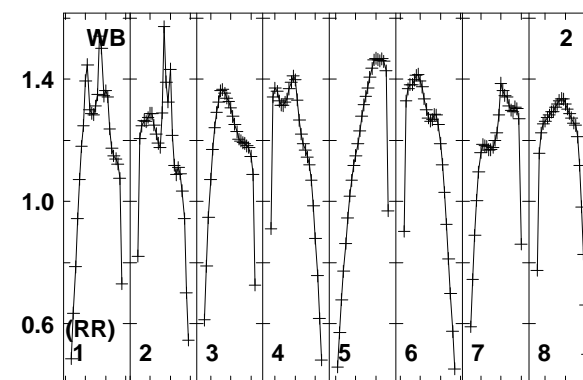
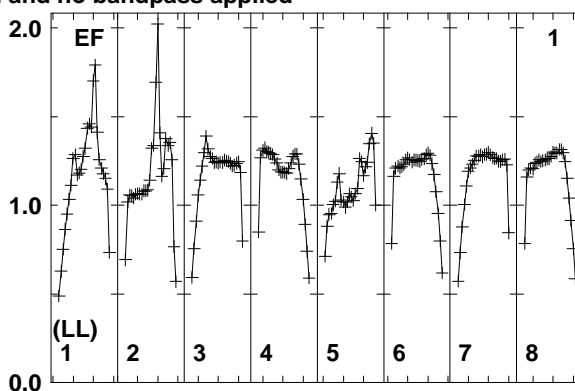
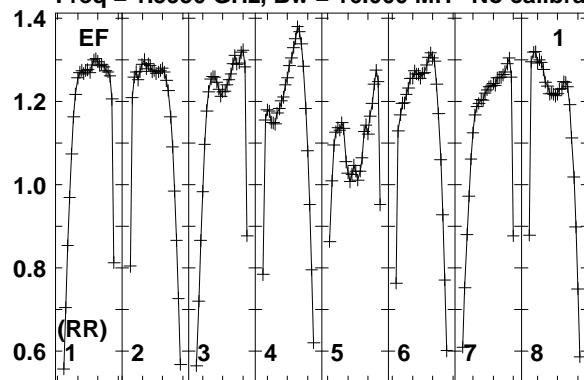

Lower frame: Real Jy
Total-power spectrum Antenna: EF (01)
Timerange: 00/01:35:38 to 00/01:38:59

Plot file version 101 created 19-AUG-2016 17:19:28

J1649+2635 EM119D.UVDATA.1

Freq = 1.5950 GHz, Bw = 16.000 MH No calibration applied and no bandpass applied

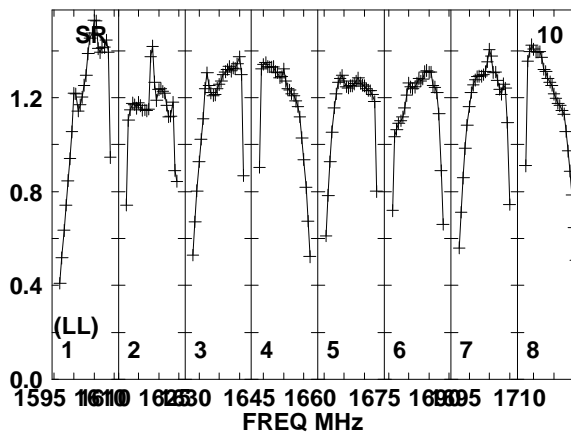
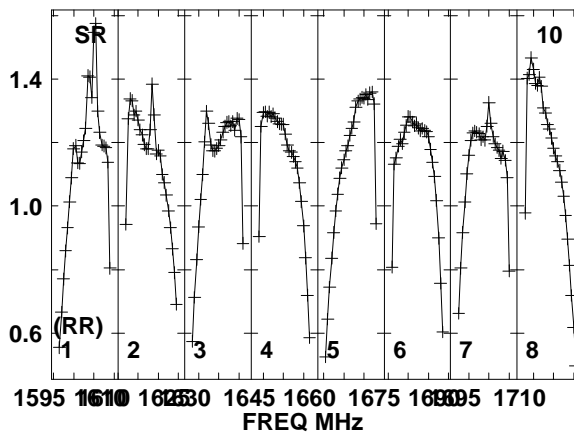
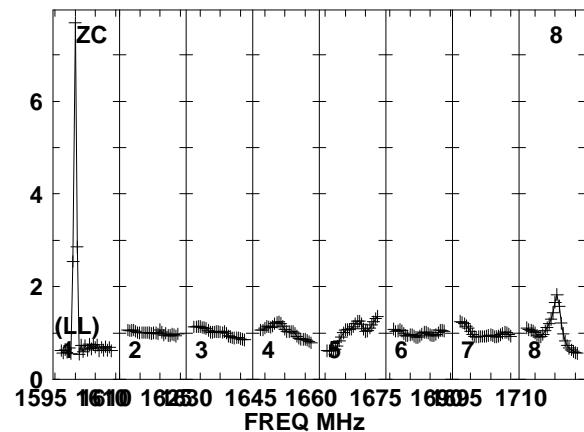
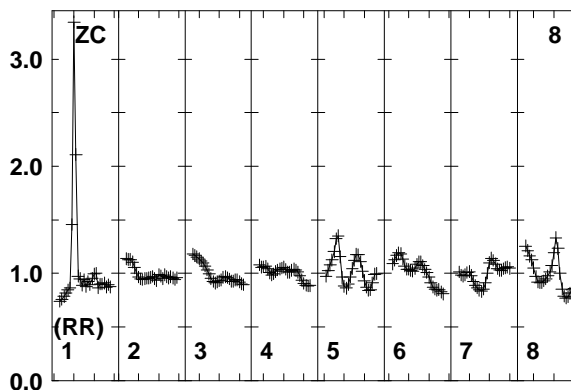
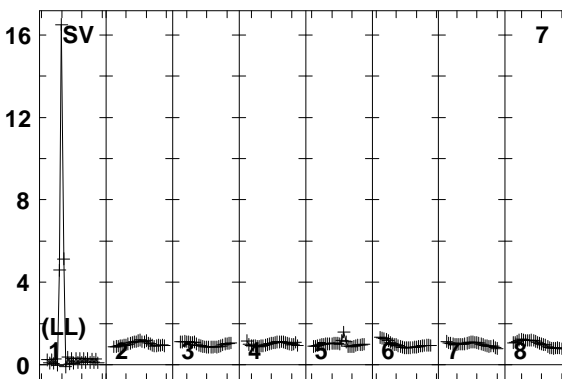
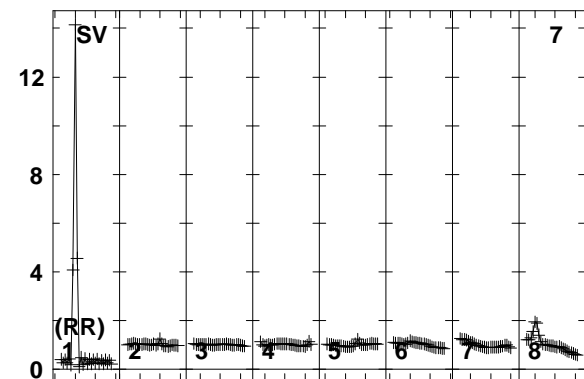
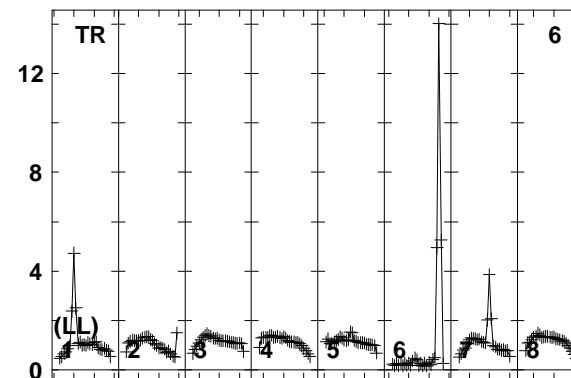
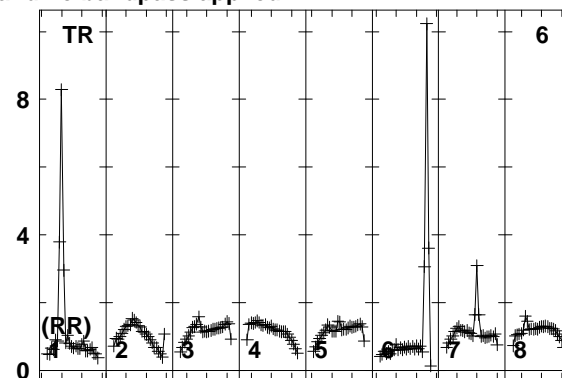
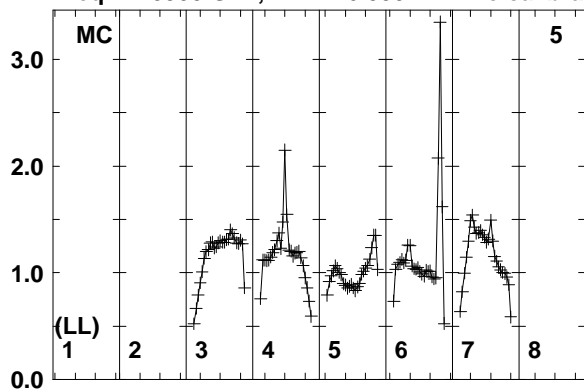

Lower frame: Real Jy
Total-power spectrum Antenna: MC (05)
Timerange: 00/01:35:38 to 00/01:38:59

Plot file version 102 created 19-AUG-2016 17:19:28

J1649+2635 EM119D.UVDATA.1

Freq = 1.5950 GHz, Bw = 16.000 MH No calibration applied and no bandpass applied

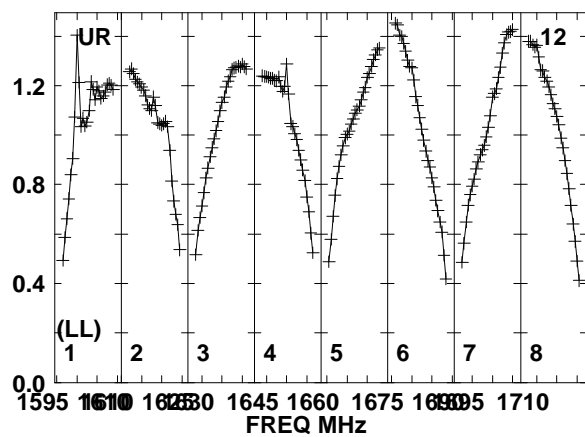
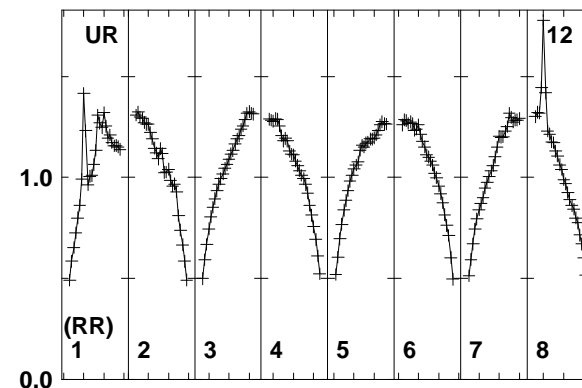
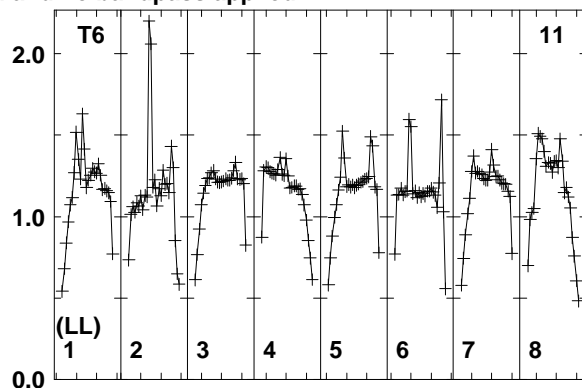
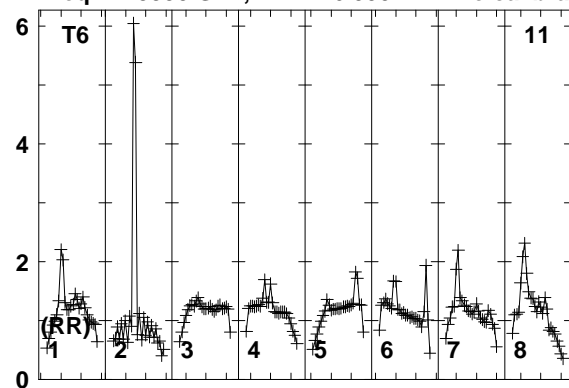

Lower frame: Real Jy
Total-power spectrum Antenna: T6 (11)
Timerange: 00/01:35:38 to 00/01:38:59

Plot file version 103 created 19-AUG-2016 17:19:28

J1642+2523 EM119D.UVDATA.1

Freq = 1.5950 GHz, Bw = 16.000 MH No calibration applied and no bandpass applied

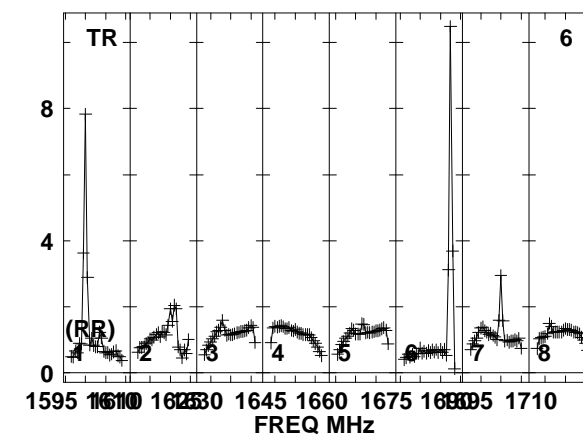
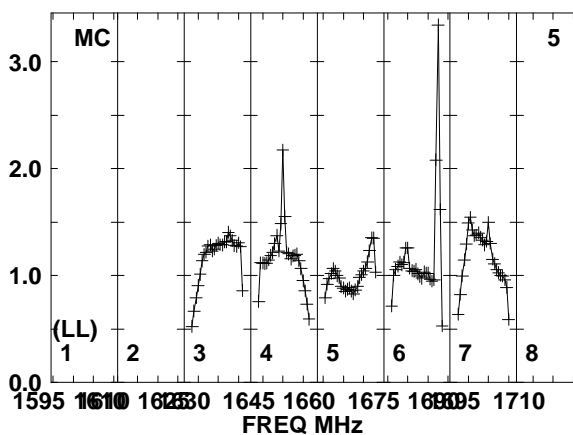
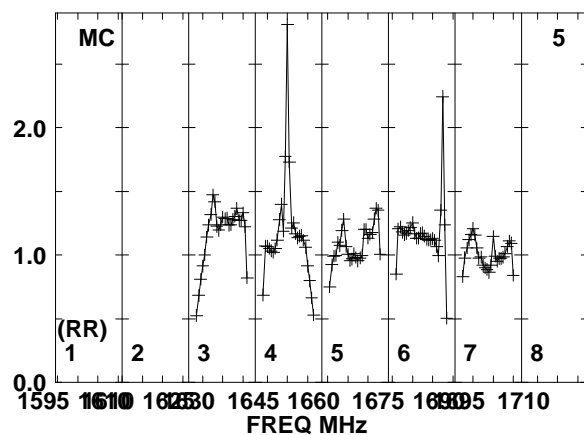
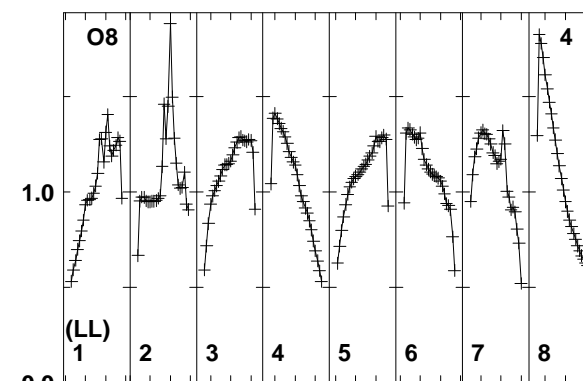
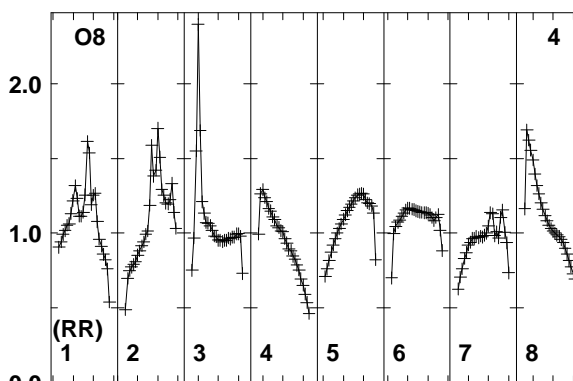
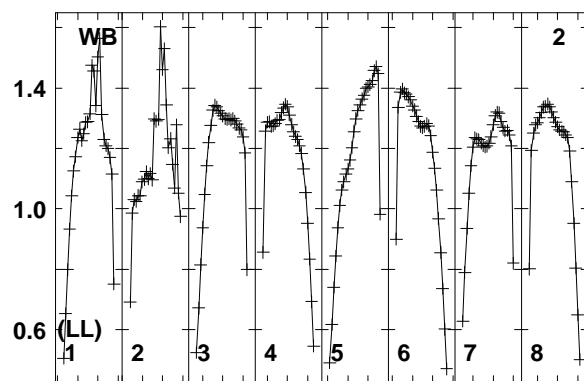
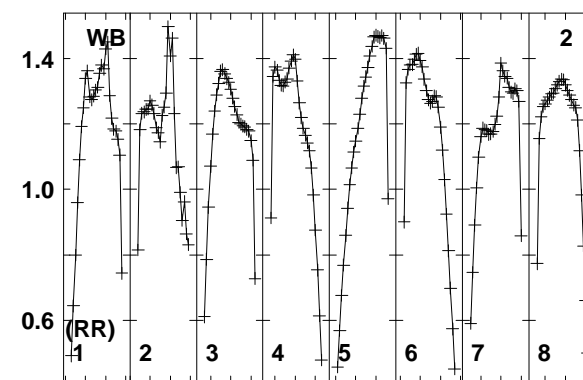
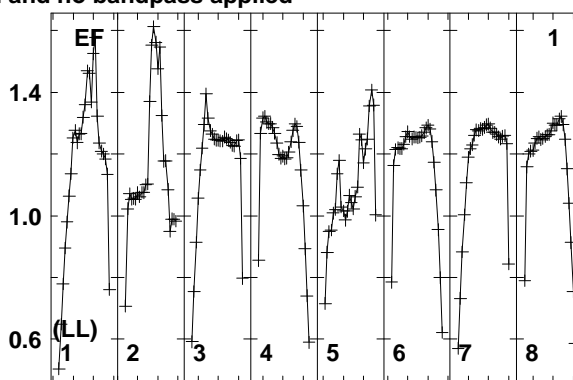
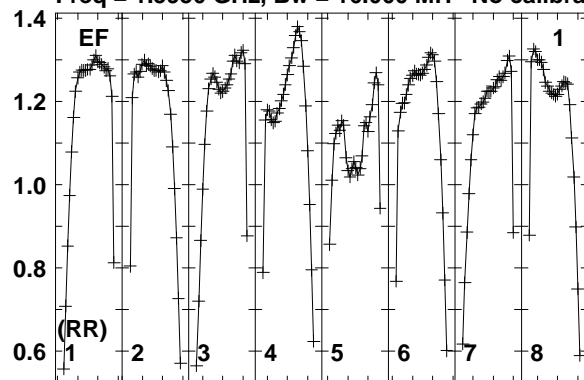

Lower frame: Real Jy
Total-power spectrum Antenna: EF (01)
Timerange: 00/01:40:00 to 00/01:41:29

Plot file version 104 created 19-AUG-2016 17:19:28

J1642+2523 EM119D.UVDATA.1

Freq = 1.5950 GHz, Bw = 16.000 MH No calibration applied and no bandpass applied

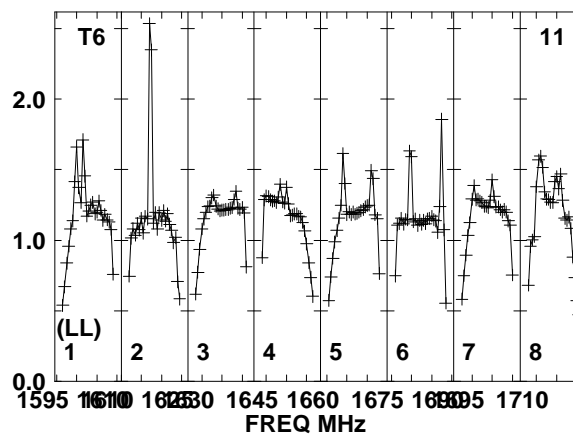
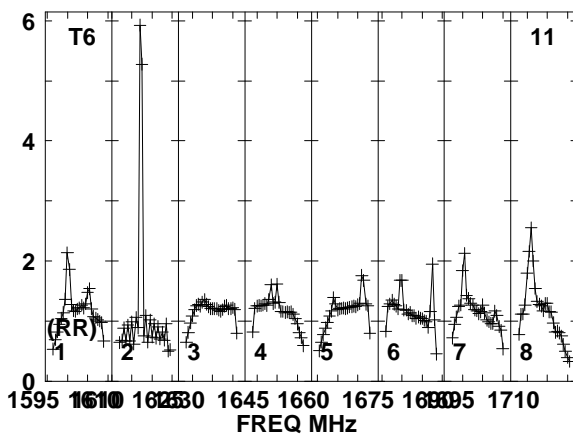
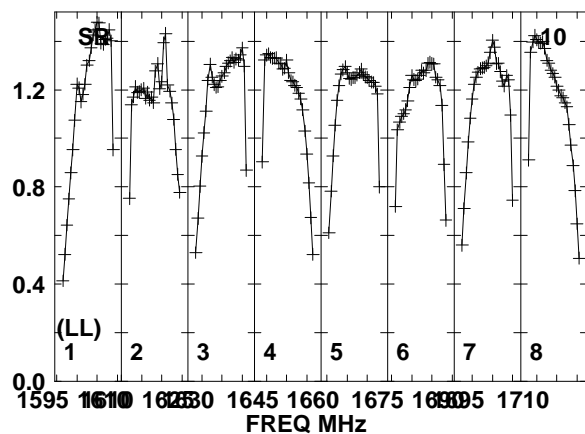
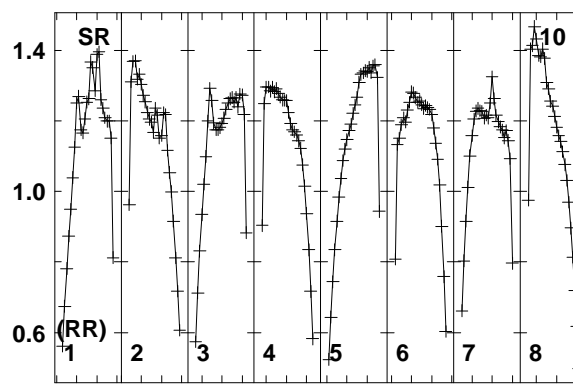
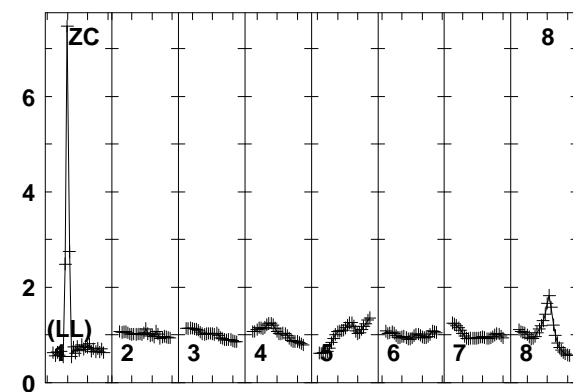
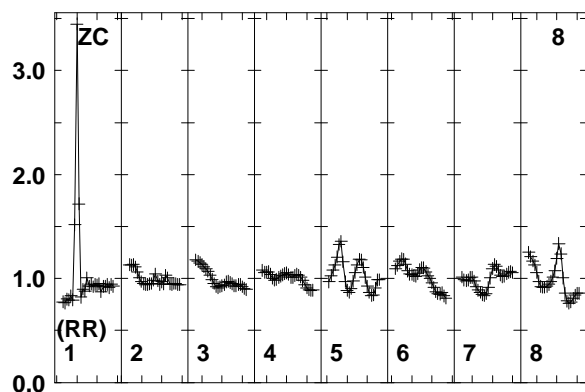
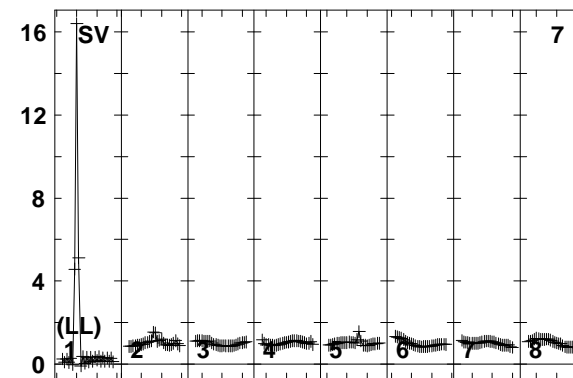
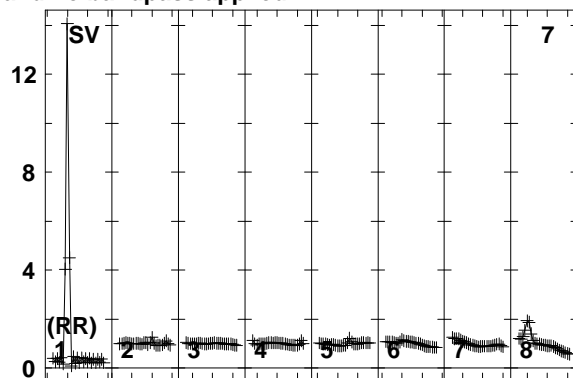
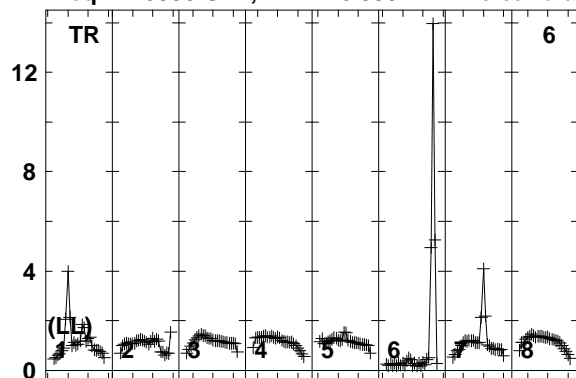

Lower frame: Real Jy
Total-power spectrum Antenna: TR (06)
Timerange: 00/01:40:00 to 00/01:41:29

Plot file version 105 created 19-AUG-2016 17:19:28

J1642+2523 EM119D.UVDATA.1

Freq = 1.5950 GHz, Bw = 16.000 MH No calibration applied and no bandpass applied

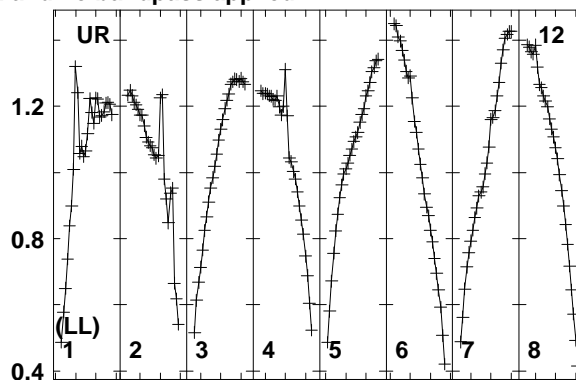
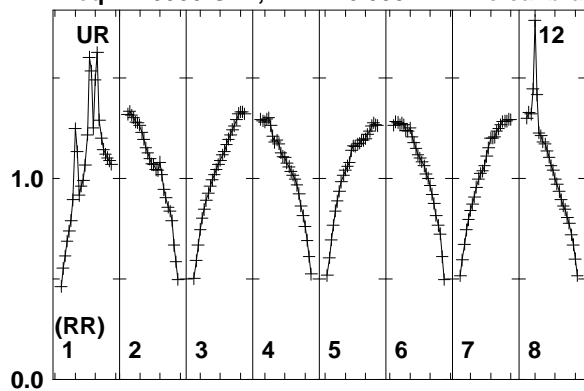

Lower frame: Real Jy
Total-power spectrum Antenna: UR (12)
Timerange: 00/01:40:00 to 00/01:41:29

Plot file version 106 created 19-AUG-2016 17:19:28

J1649+2635 EM119D.UVDATA.1

Freq = 1.5950 GHz, Bw = 16.000 MH No calibration applied and no bandpass applied

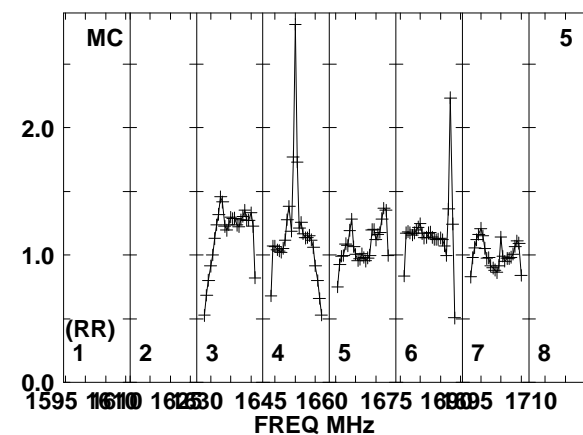
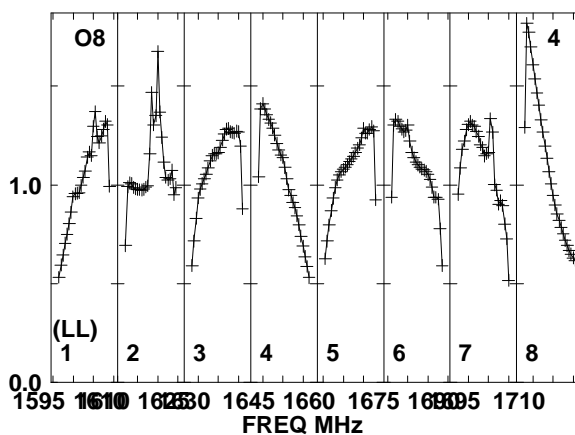
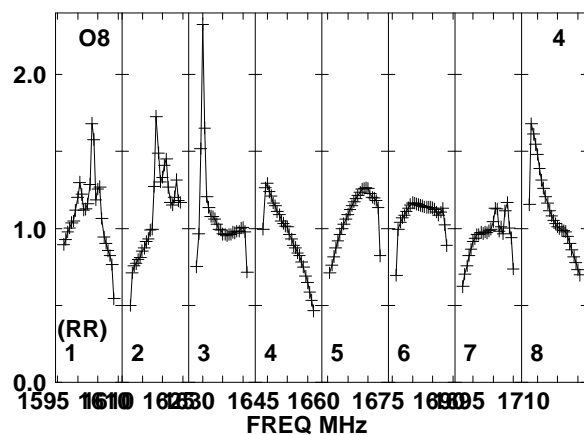
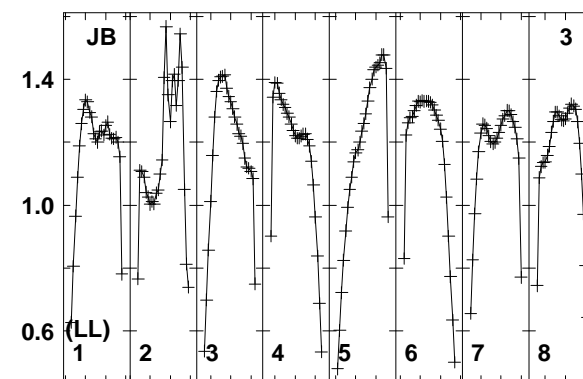
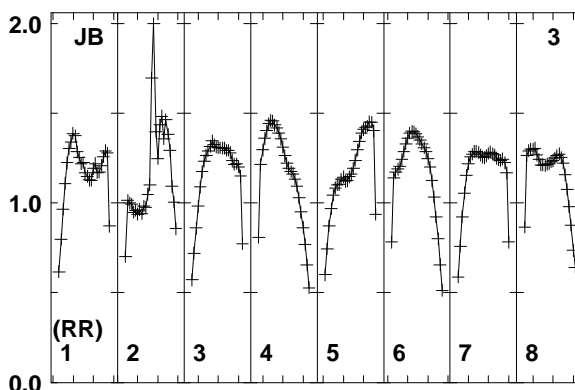
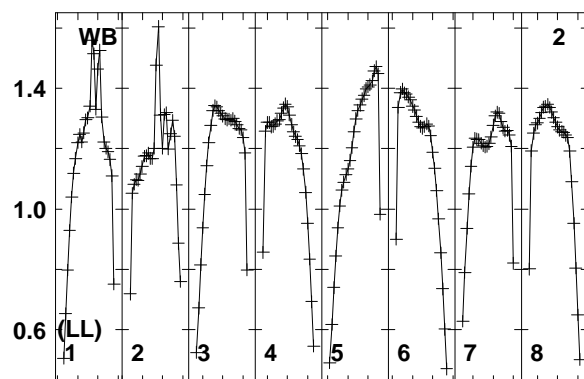
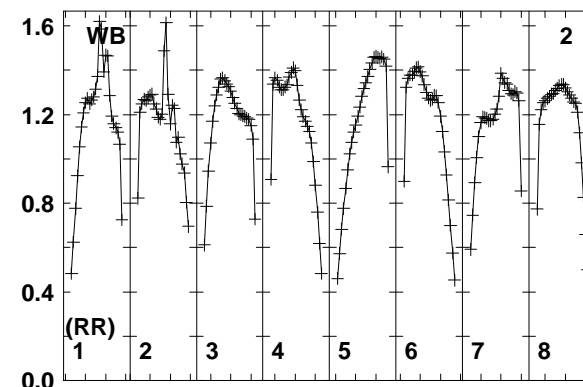
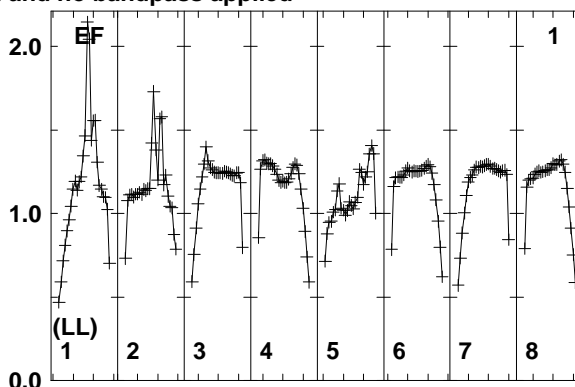
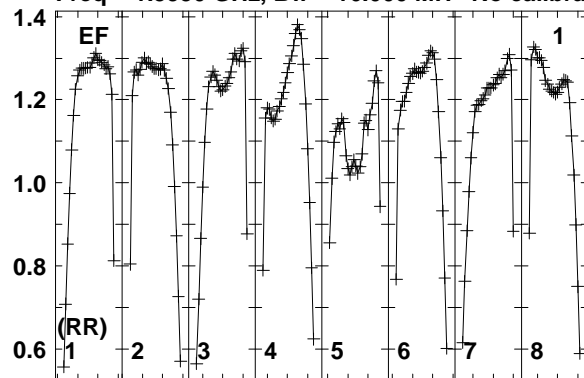

Lower frame: Real Jy
Total-power spectrum Antenna: EF (01)
Timerange: 00/01:41:32 to 00/01:44:59

Plot file version 107 created 19-AUG-2016 17:19:28

J1649+2635 EM119D.UVDATA.1

Freq = 1.5950 GHz, Bw = 16.000 MH No calibration applied and no bandpass applied

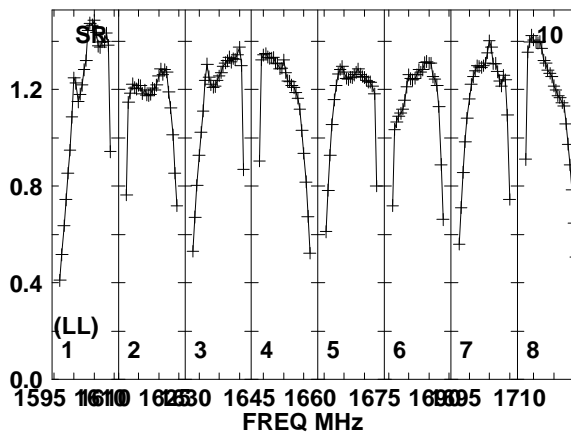
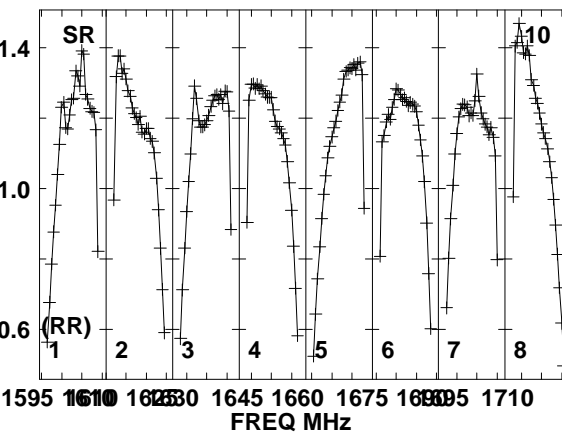
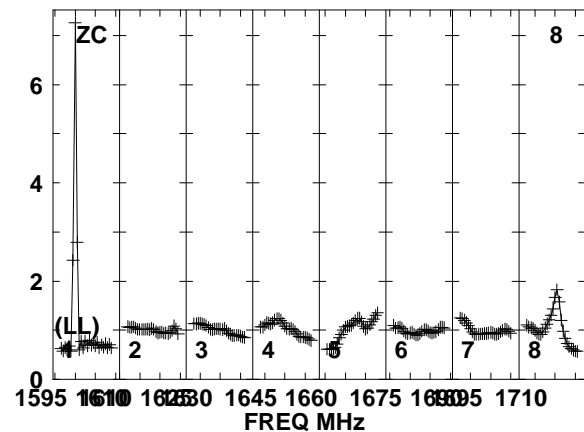
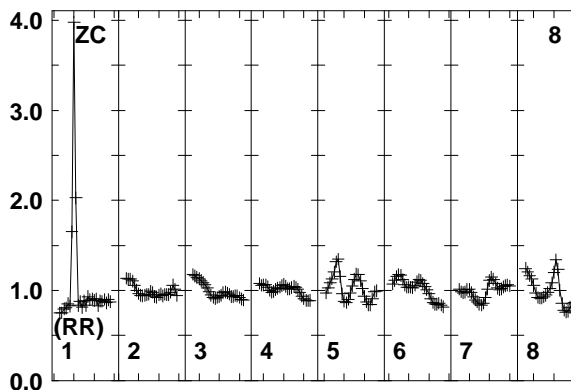
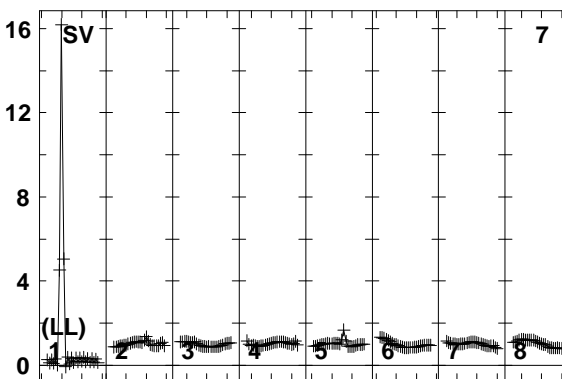
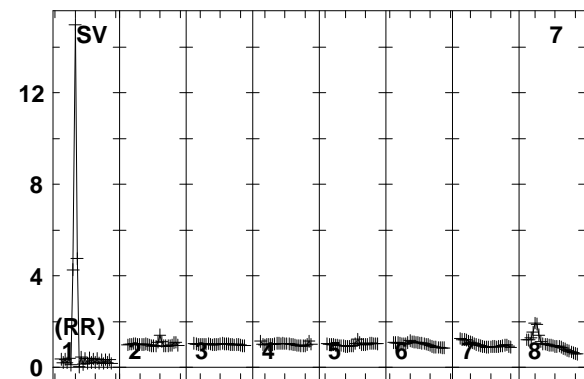
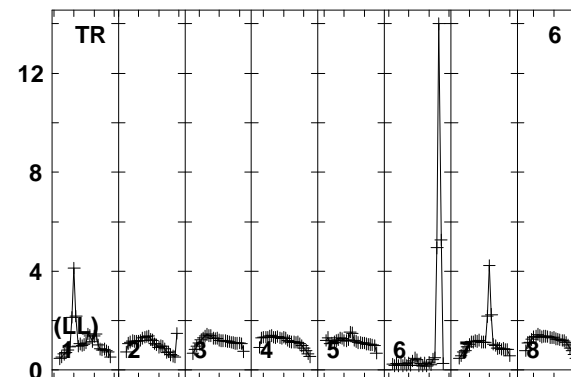
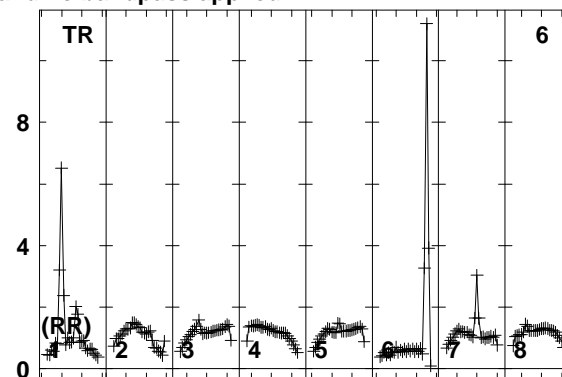
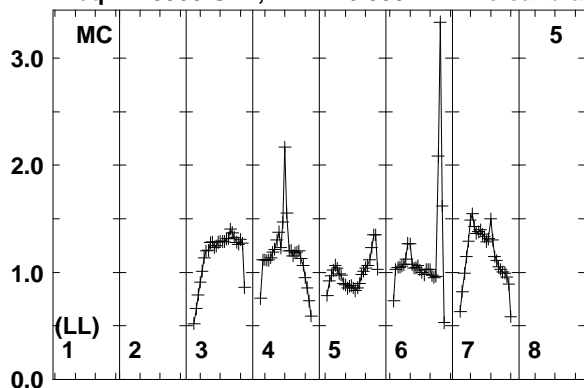

Lower frame: Real Jy
Total-power spectrum Antenna: MC (05)
Timerange: 00/01:41:32 to 00/01:44:59

Plot file version 108 created 19-AUG-2016 17:19:29

J1649+2635 EM119D.UVDATA.1

Freq = 1.5950 GHz, Bw = 16.000 MH No calibration applied and no bandpass applied

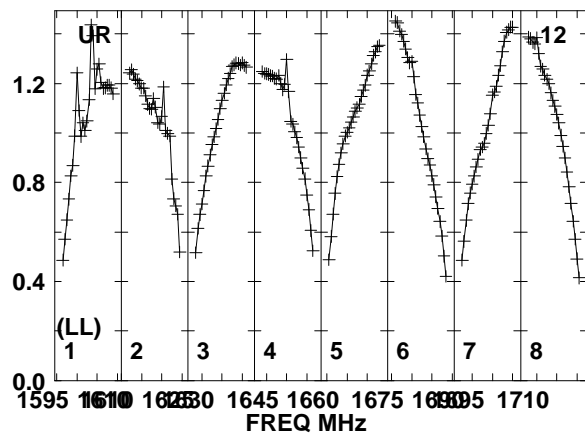
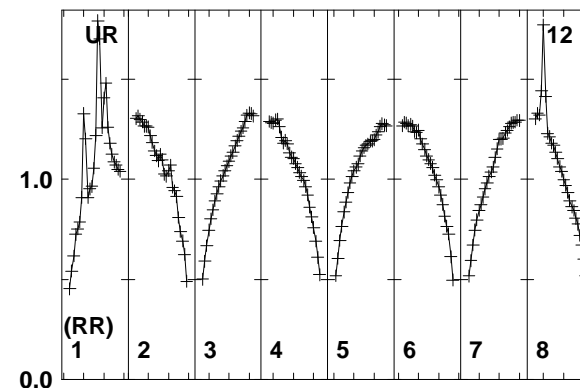
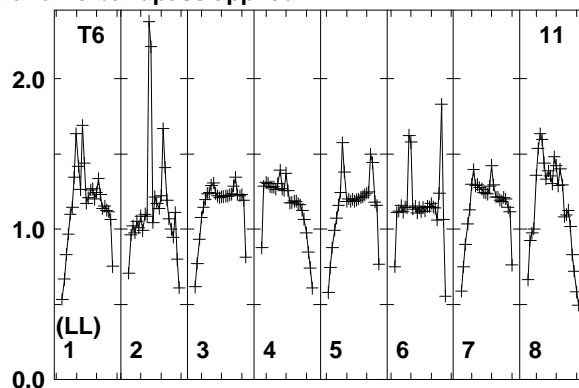
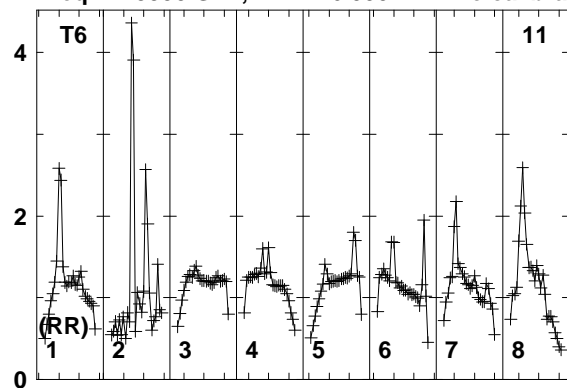

Lower frame: Real Jy
Total-power spectrum Antenna: T6 (11)
Timerange: 00/01:41:32 to 00/01:44:59

Plot file version 109 created 19-AUG-2016 17:19:29

J1642+2523 EM119D.UVDATA.1

Freq = 1.5950 GHz, Bw = 16.000 MH No calibration applied and no bandpass applied

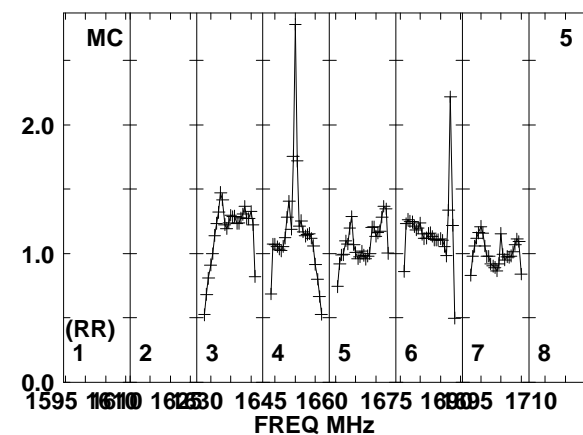
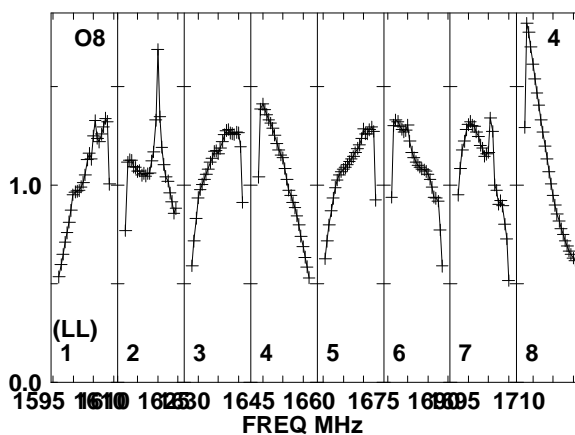
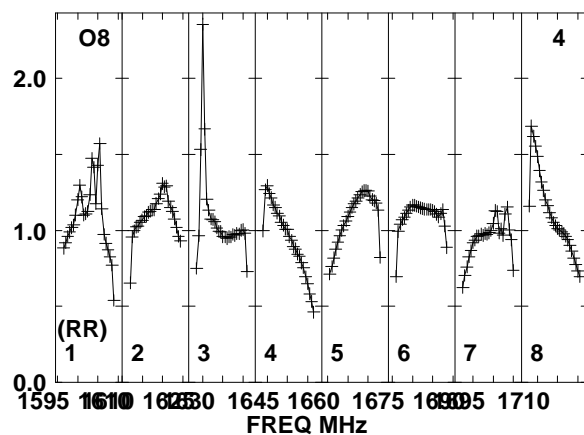
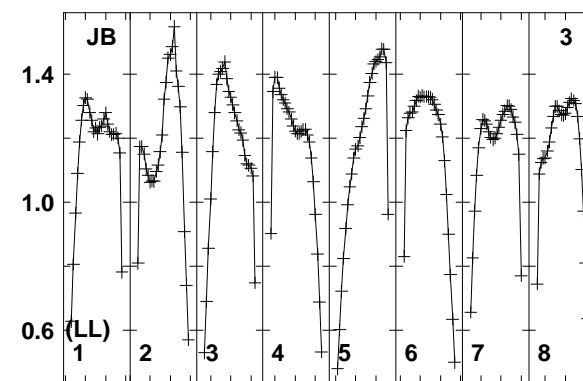
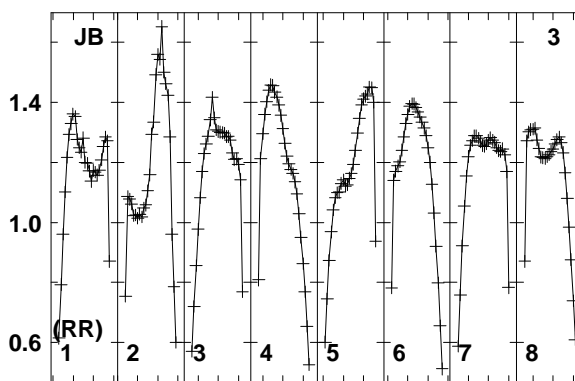
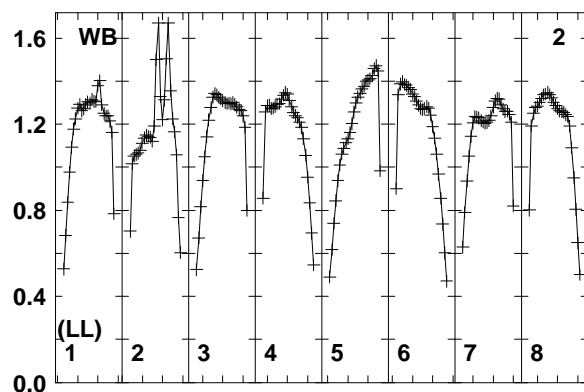
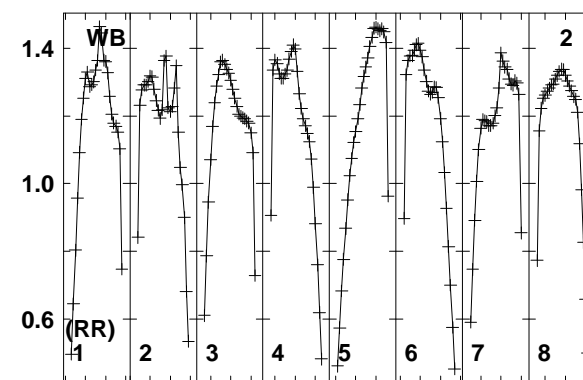
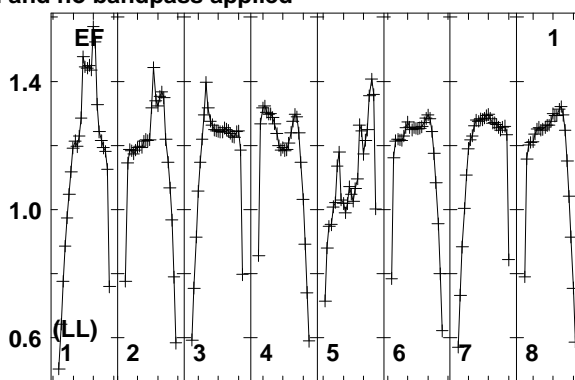
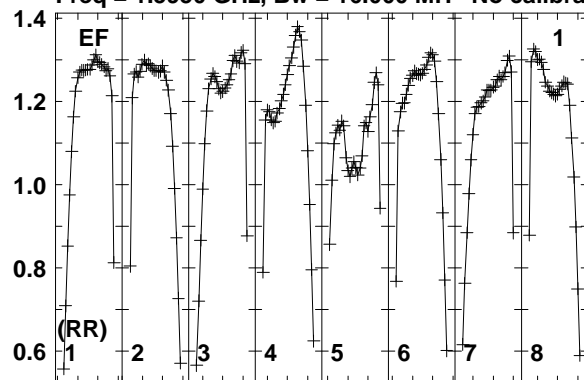

Lower frame: Real Jy
Total-power spectrum Antenna: EF (01)
Timerange: 00/01:45:08 to 00/01:46:30

Plot file version 110 created 19-AUG-2016 17:19:29

J1642+2523 EM119D.UVDATA.1

Freq = 1.5950 GHz, Bw = 16.000 MH No calibration applied and no bandpass applied

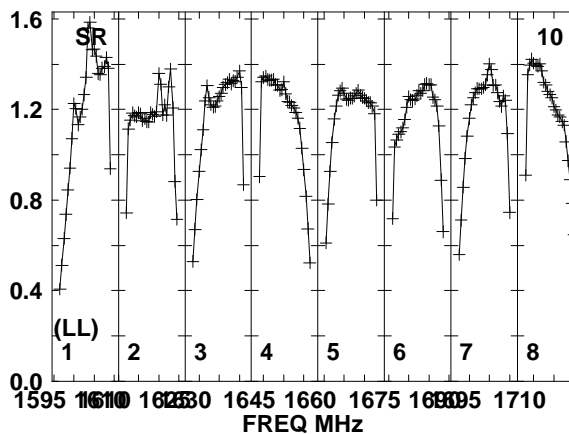
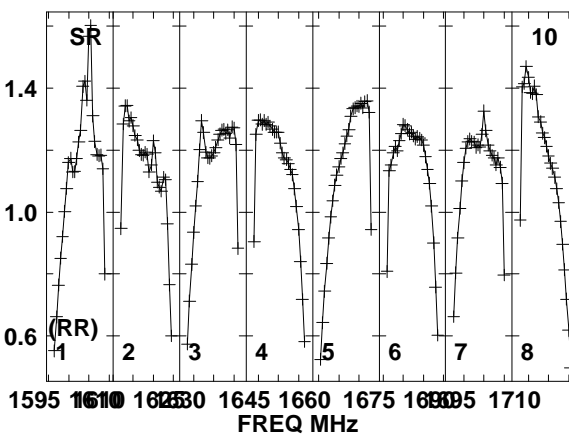
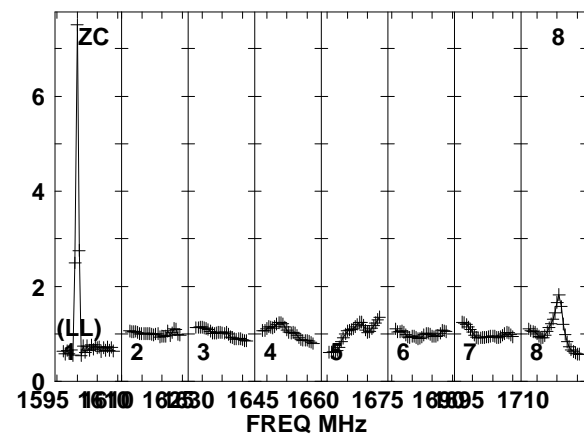
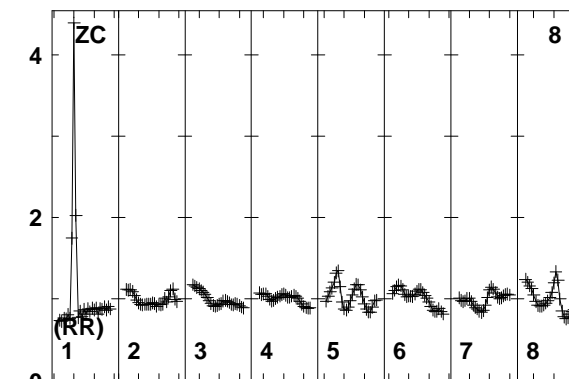
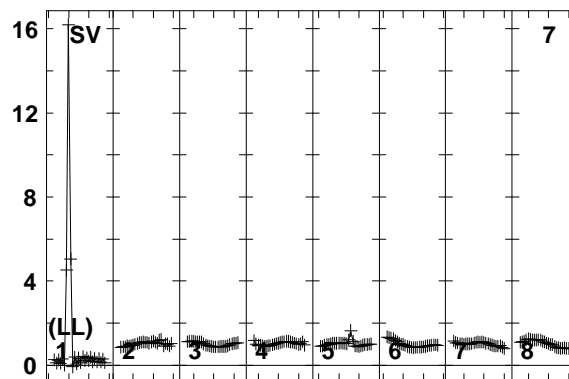
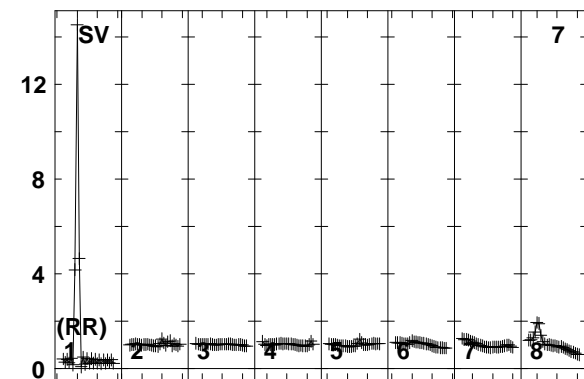
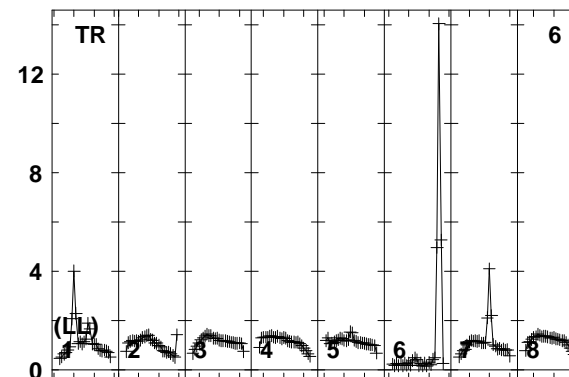
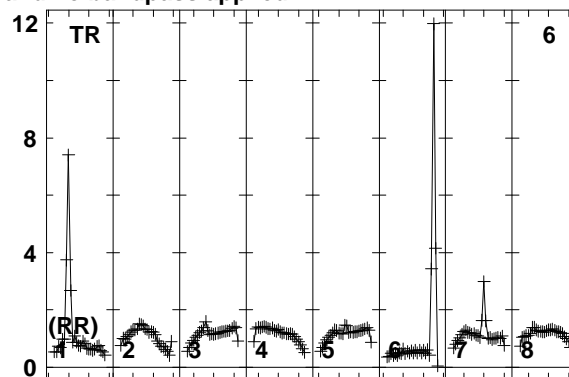
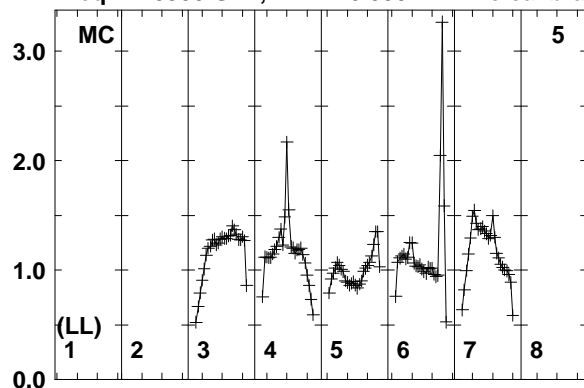

Lower frame: Real Jy
Total-power spectrum Antenna: MC (05)
Timerange: 00/01:45:08 to 00/01:46:30

Plot file version 111 created 19-AUG-2016 17:19:29

J1642+2523 EM119D.UVDATA.1

Freq = 1.5950 GHz, Bw = 16.000 MH No calibration applied and no bandpass applied

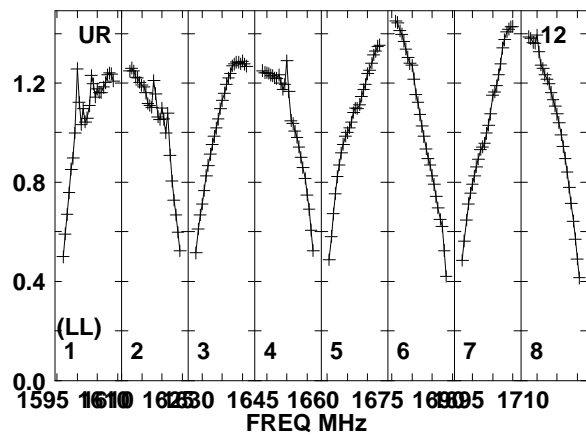
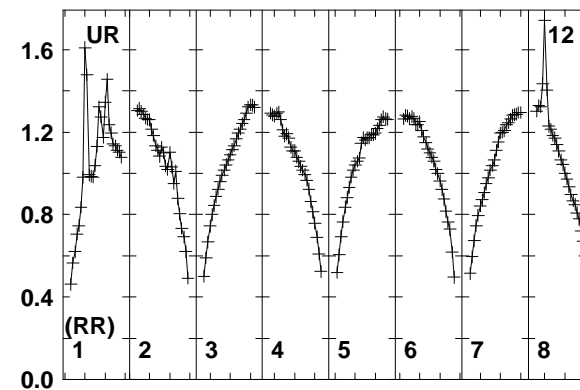
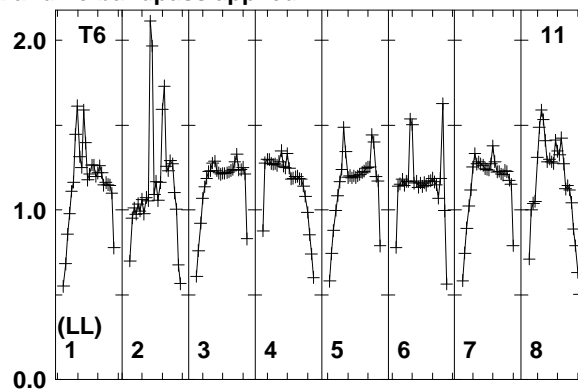
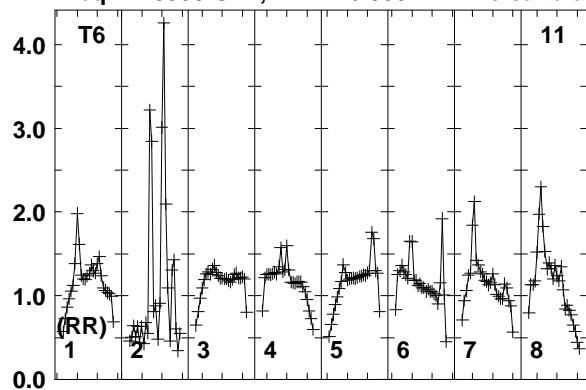

Lower frame: Real Jy
Total-power spectrum Antenna: T6 (11)
Timerange: 00/01:45:08 to 00/01:46:30

Plot file version 112 created 19-AUG-2016 17:19:29

NRAO512 EM119D.UVDATA.1

Freq = 1.5950 GHz, Bw = 16.000 MH No calibration applied and no bandpass applied

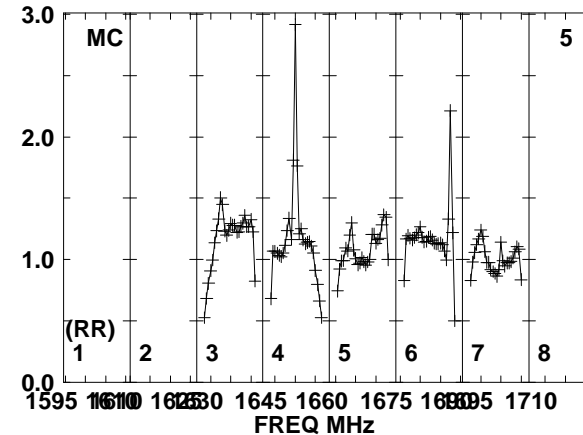
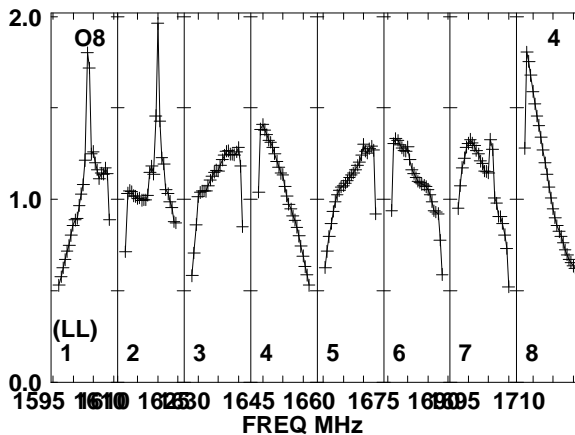
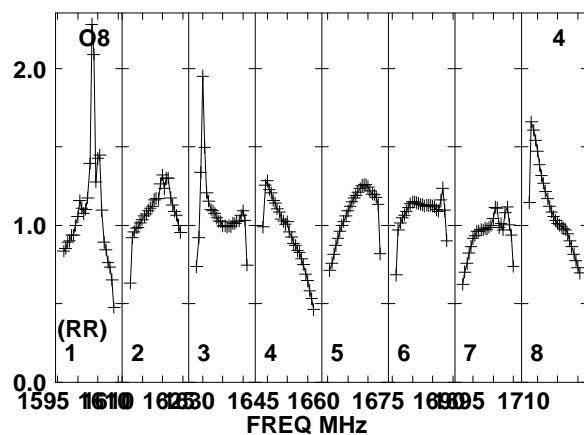
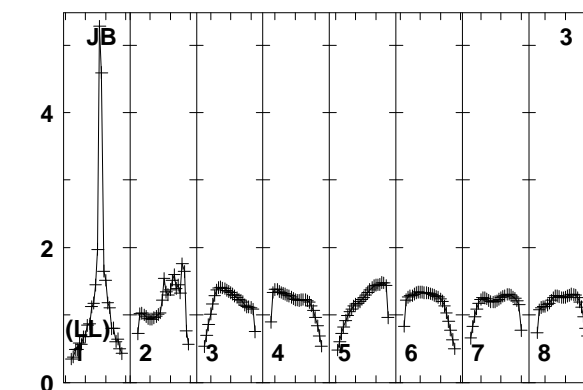
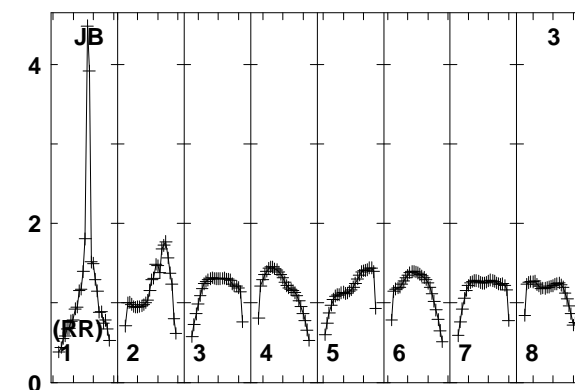
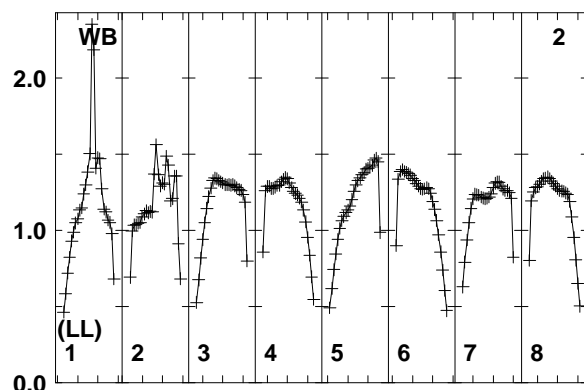
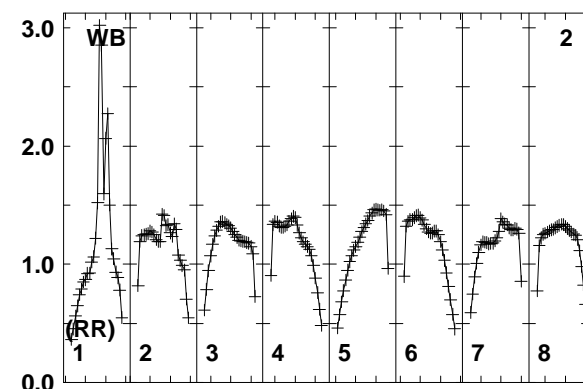
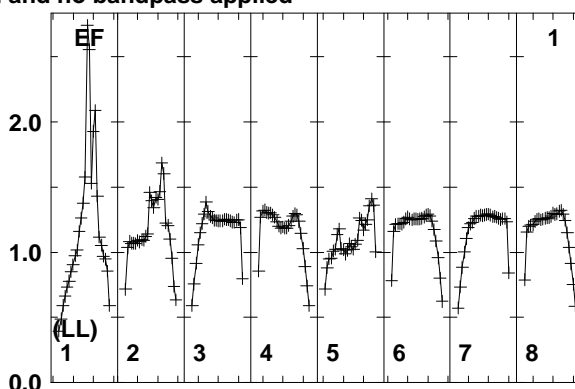
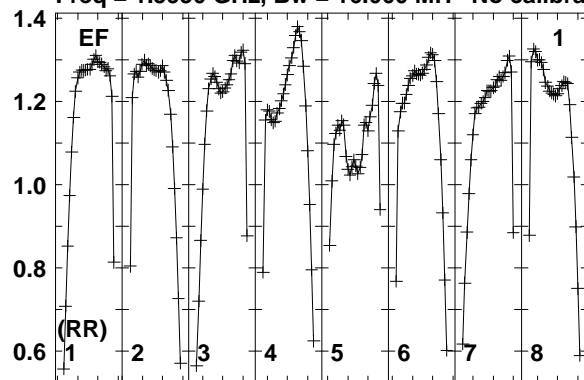

Lower frame: Real Jy
Total-power spectrum Antenna: EF (01)
Timerange: 00/01:47:01 to 00/01:52:00

Plot file version 113 created 19-AUG-2016 17:19:30

NRAO512 EM119D.UVDATA.1

Freq = 1.5950 GHz, Bw = 16.000 MH No calibration applied and no bandpass applied

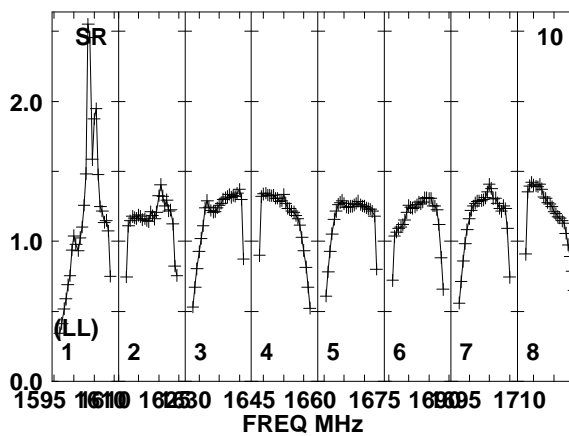
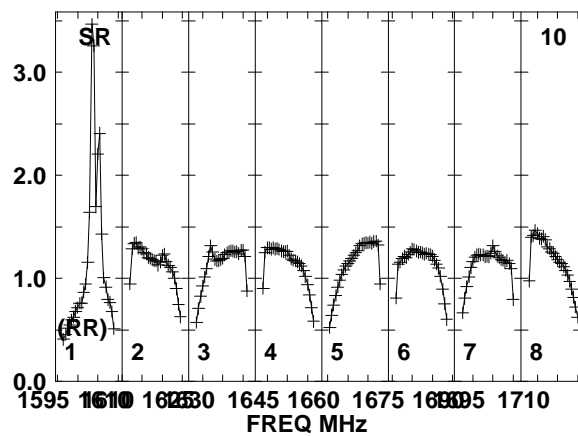
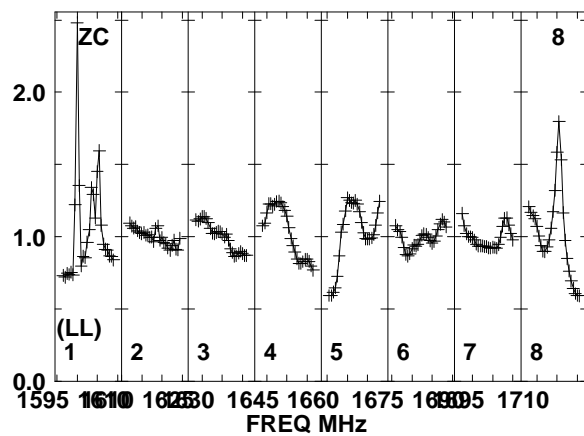
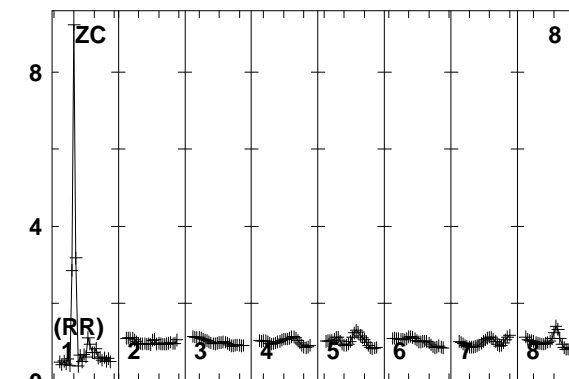
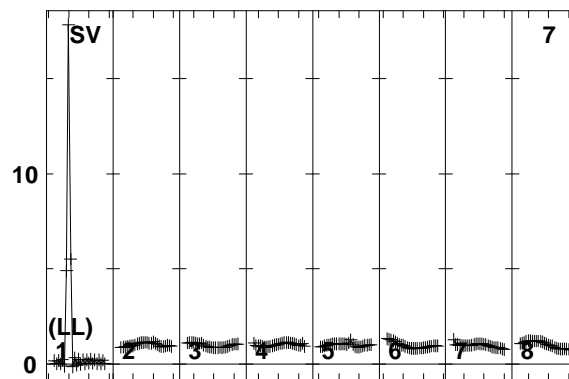
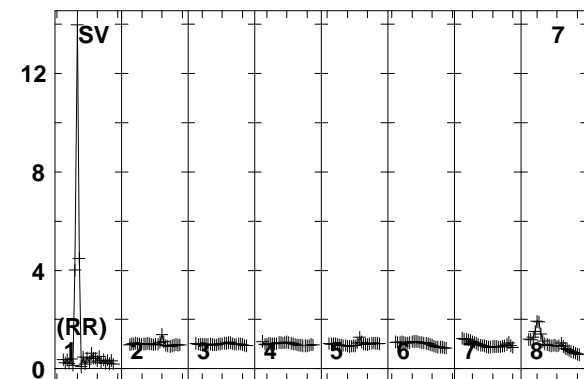
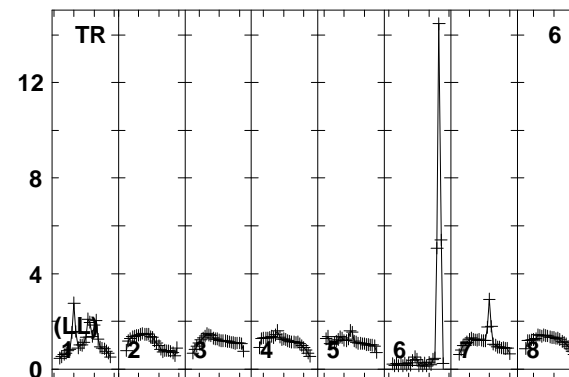
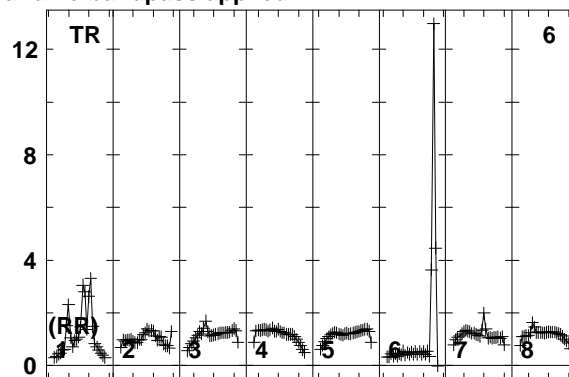
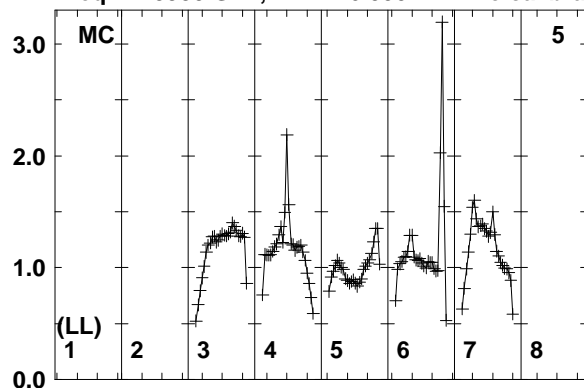

Lower frame: Real Jy
Total-power spectrum Antenna: MC (05)
Timerange: 00/01:47:01 to 00/01:52:00

Plot file version 114 created 19-AUG-2016 17:19:30

NRAO512 EM119D.UVDATA.1

Freq = 1.5950 GHz, Bw = 16.000 MH No calibration applied and no bandpass applied

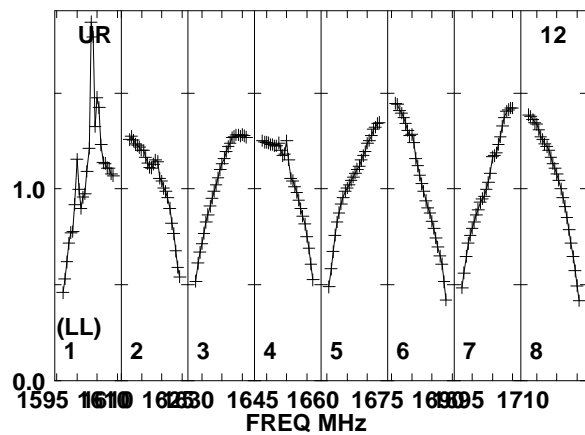
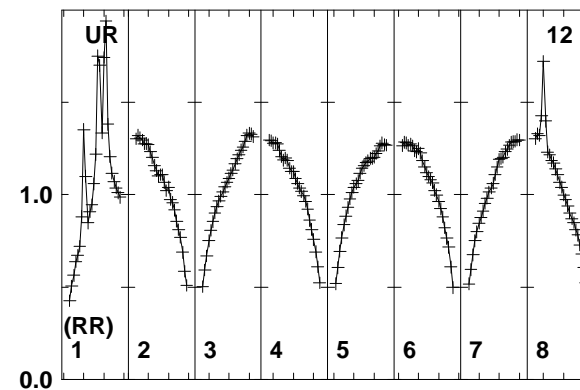
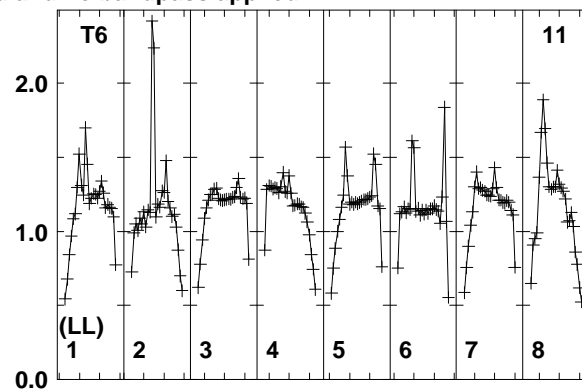
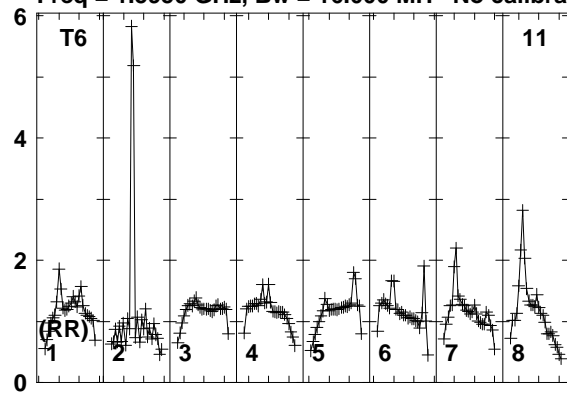

Lower frame: Real Jy
Total-power spectrum Antenna: T6 (11)
Timerange: 00/01:47:01 to 00/01:52:00

Plot file version 115 created 19-AUG-2016 17:19:30

J1642+2523 EM119D.UVDATA.1

Freq = 1.5950 GHz, Bw = 16.000 MH No calibration applied and no bandpass applied

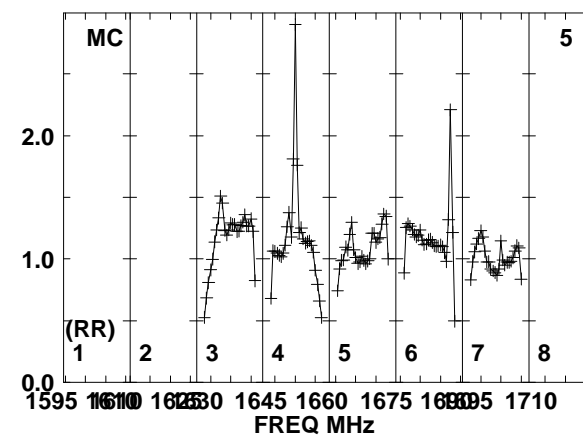
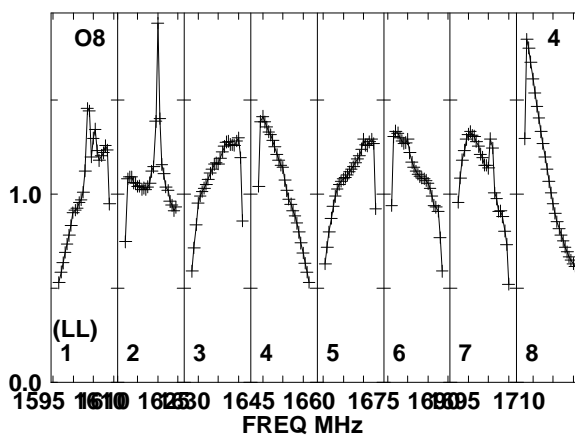
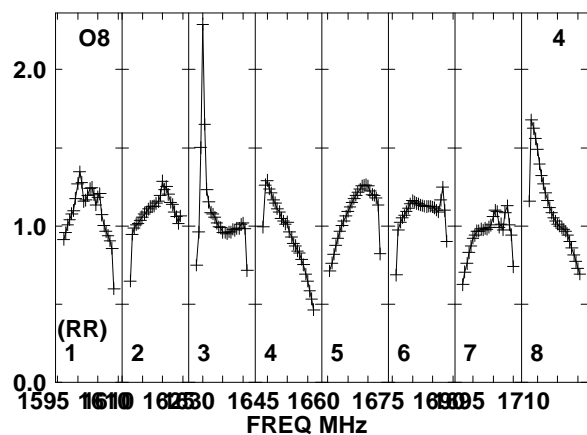
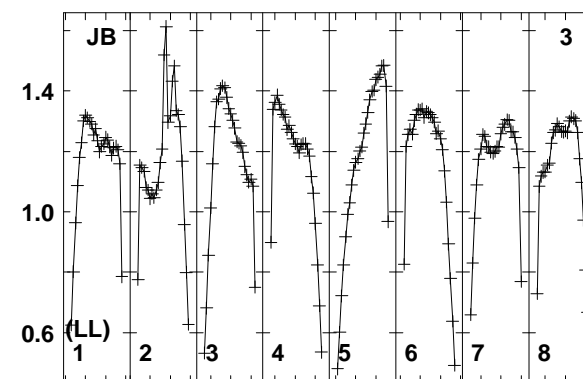
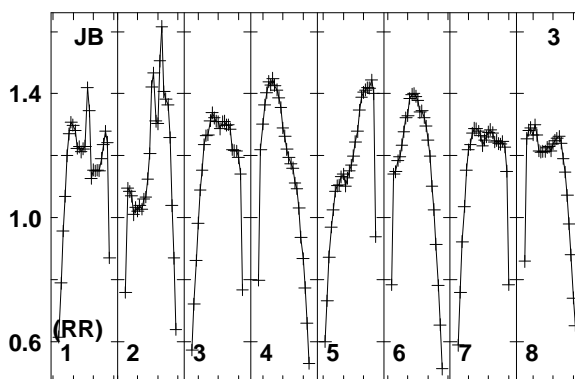
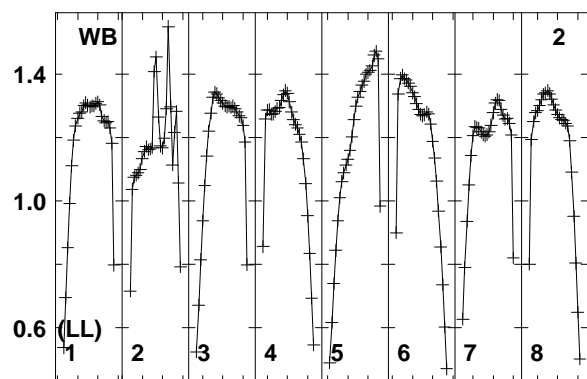
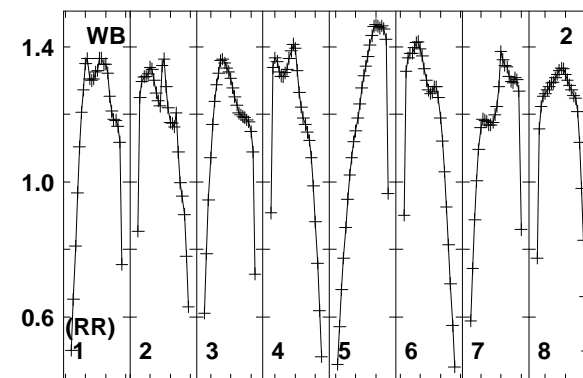
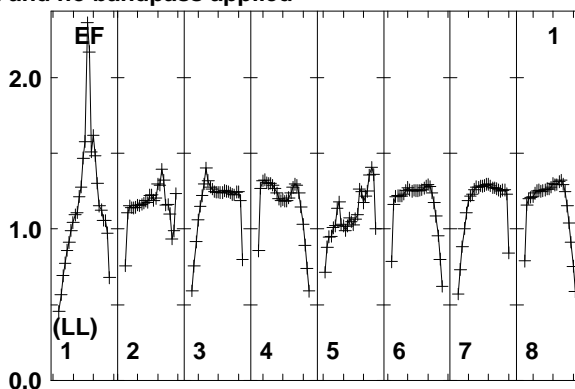
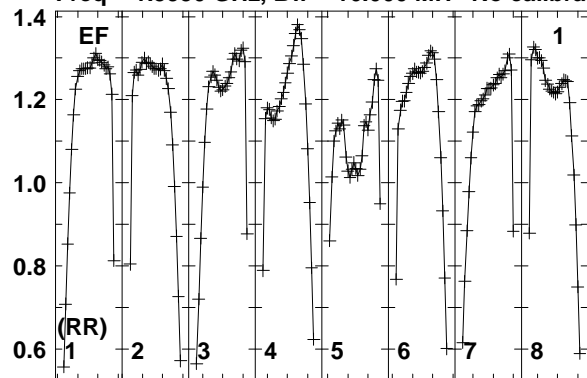

Lower frame: Real Jy
Total-power spectrum Antenna: EF (01)
Timerange: 00/01:53:00 to 00/01:54:29

Plot file version 116 created 19-AUG-2016 17:19:30

J1642+2523 EM119D.UVDATA.1

Freq = 1.5950 GHz, Bw = 16.000 MH No calibration applied and no bandpass applied

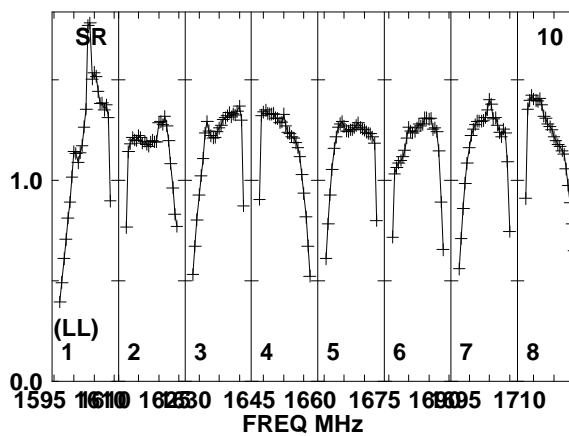
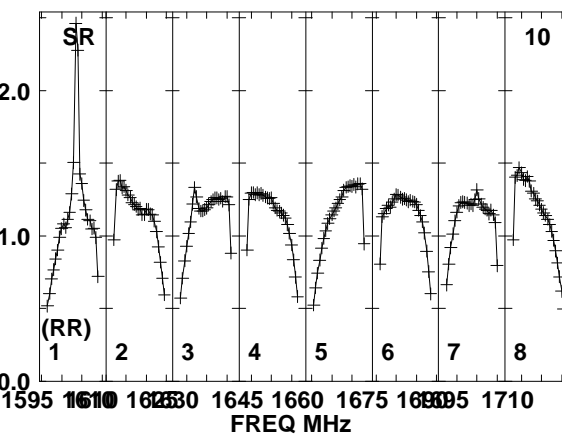
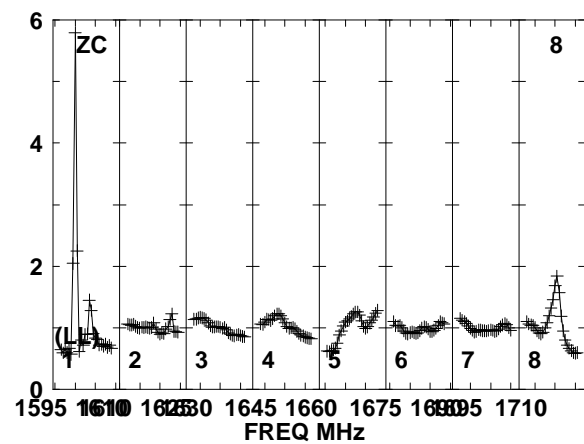
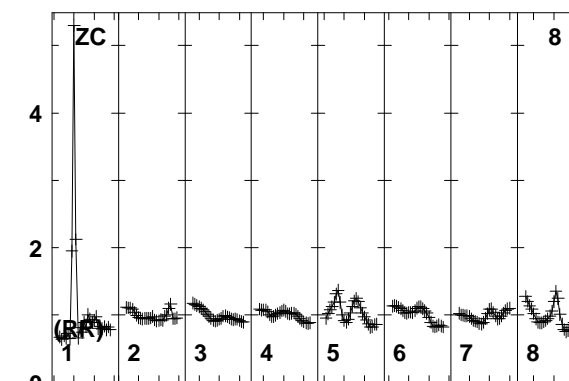
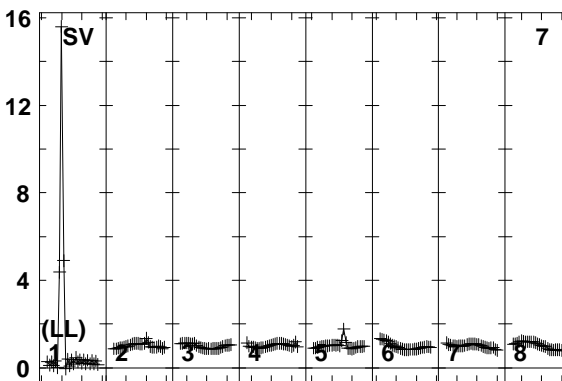
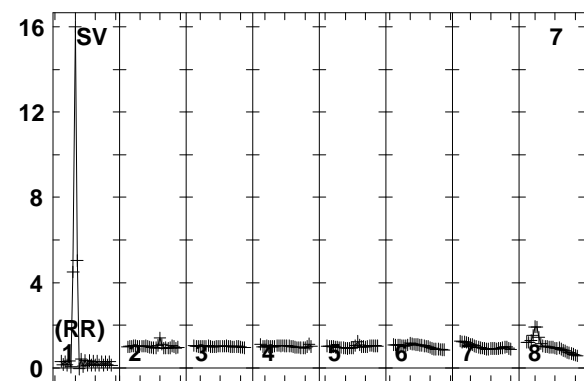
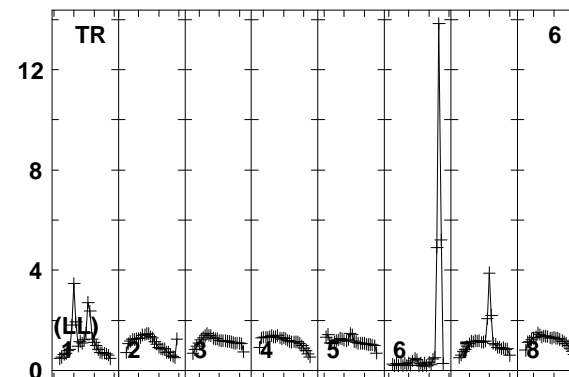
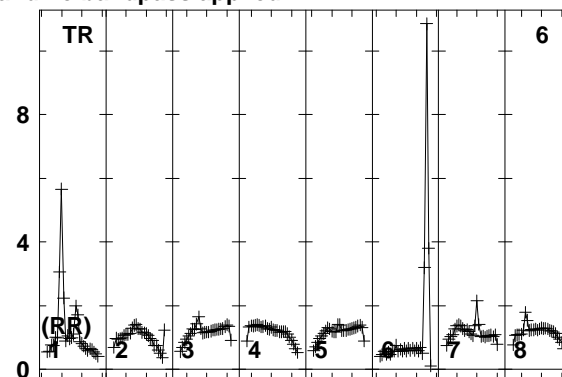
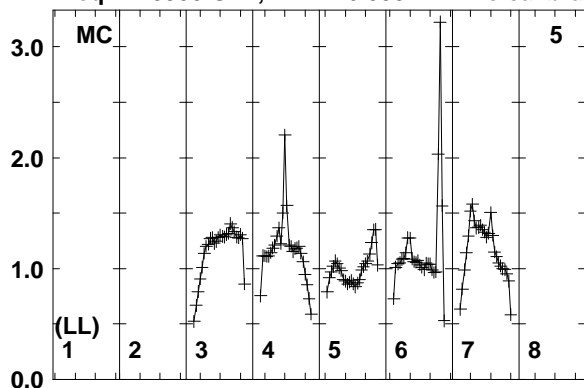

Lower frame: Real Jy
Total-power spectrum Antenna: MC (05)
Timerange: 00/01:53:00 to 00/01:54:29

Plot file version 117 created 19-AUG-2016 17:19:30

J1642+2523 EM119D.UVDATA.1

Freq = 1.5950 GHz, Bw = 16.000 MH No calibration applied and no bandpass applied

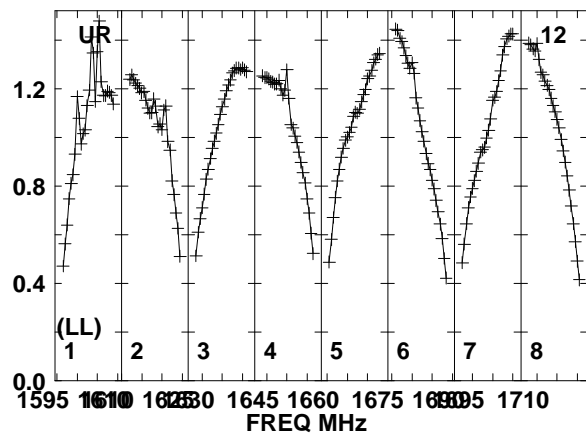
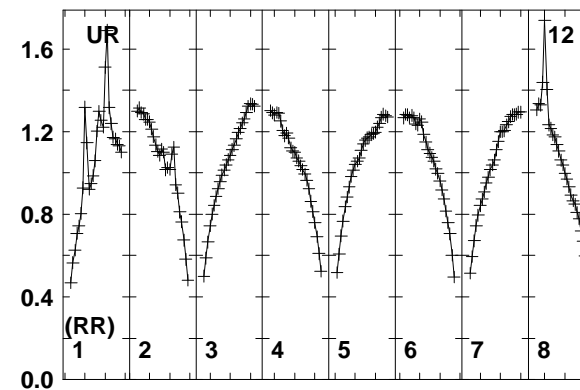
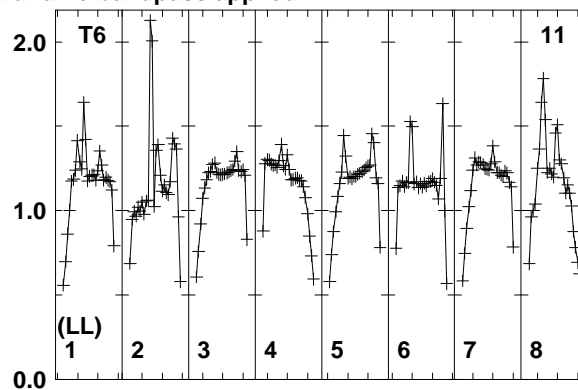
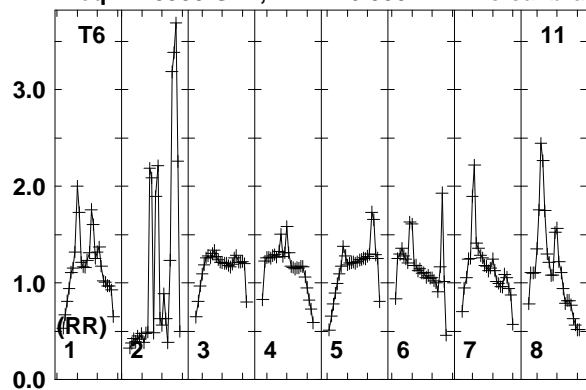

Lower frame: Real Jy
Total-power spectrum Antenna: T6 (11)
Timerange: 00/01:53:00 to 00/01:54:29

Plot file version 118 created 19-AUG-2016 17:19:31

J1649+2635 EM119D.UVDATA.1

Freq = 1.5950 GHz, Bw = 16.000 MH No calibration applied and no bandpass applied

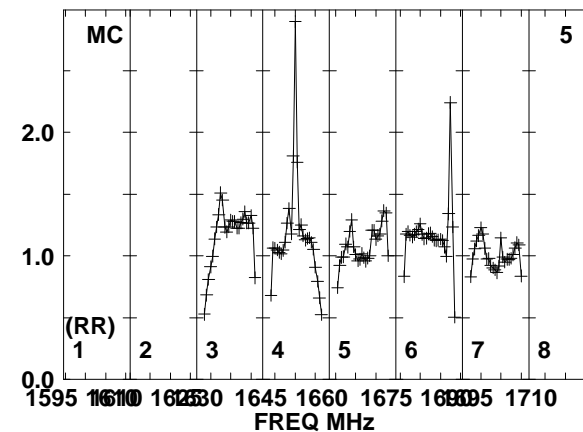
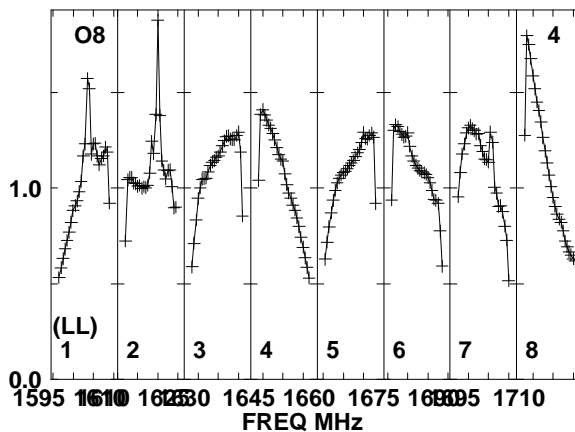
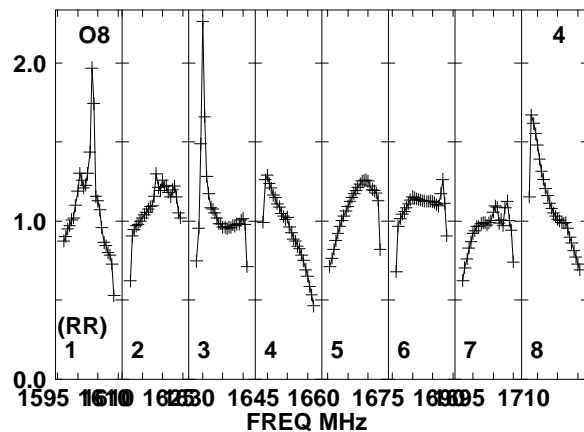
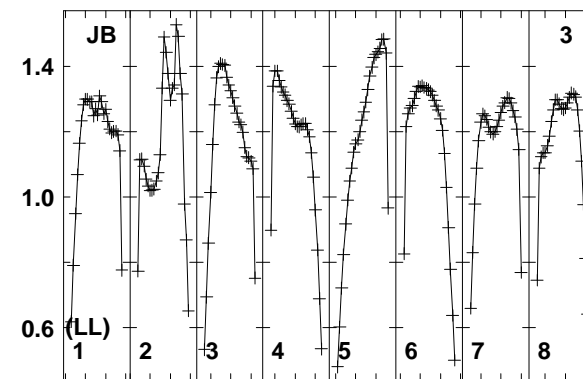
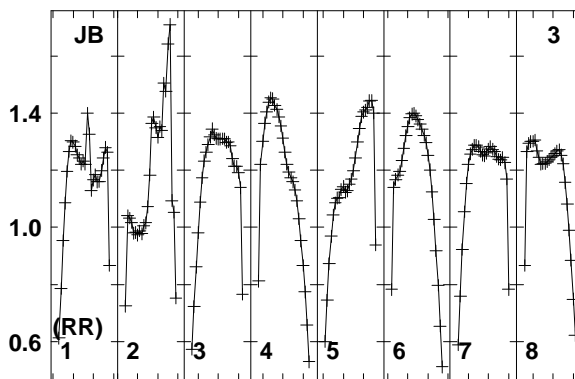
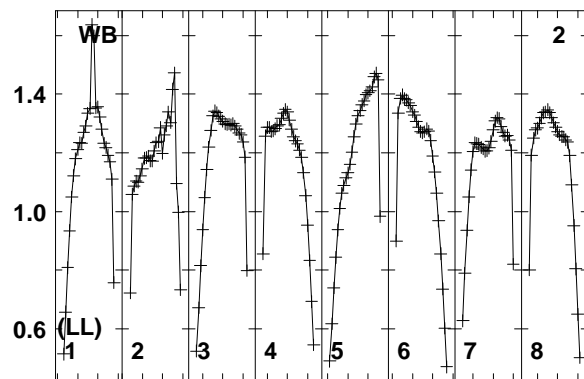
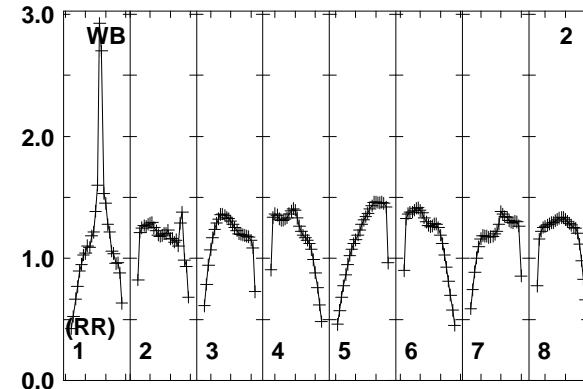
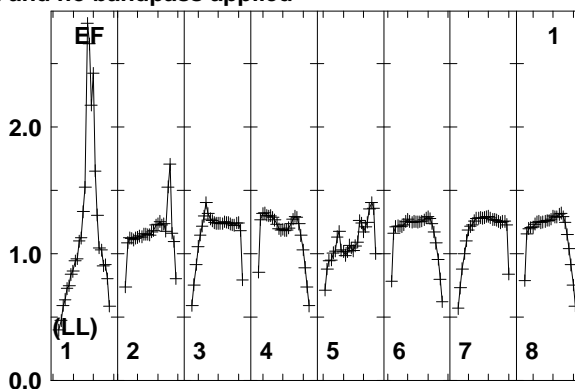
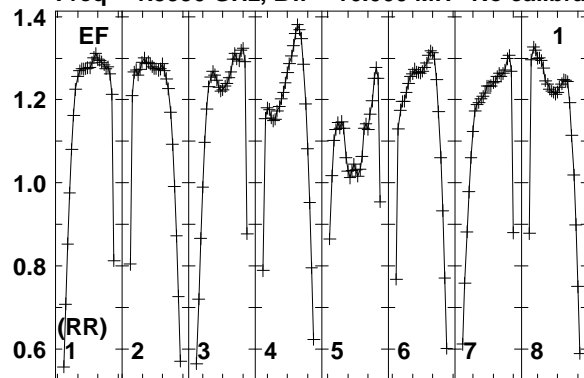

Lower frame: Real Jy
Total-power spectrum Antenna: EF (01)
Timerange: 00/01:54:37 to 00/01:57:59

Plot file version 119 created 19-AUG-2016 17:19:31

J1649+2635 EM119D.UVDATA.1

Freq = 1.5950 GHz, Bw = 16.000 MH No calibration applied and no bandpass applied

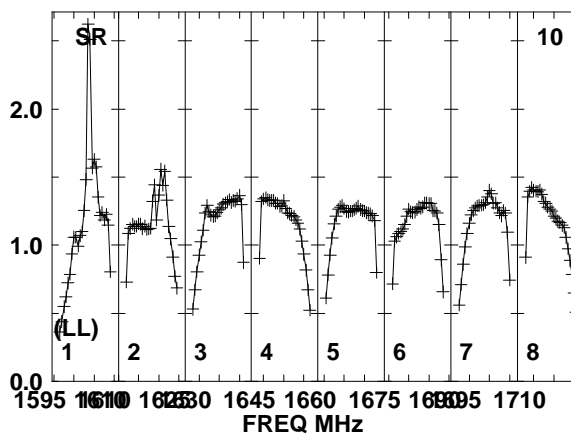
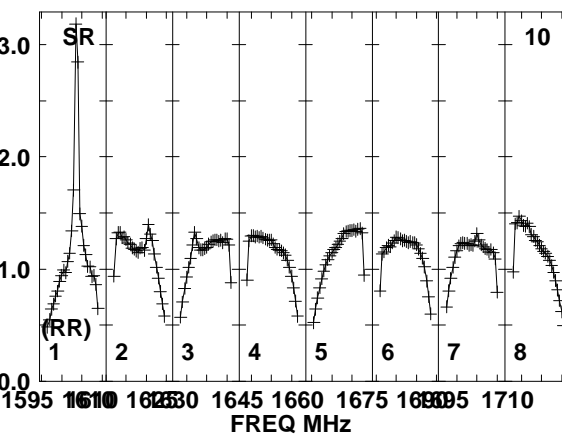
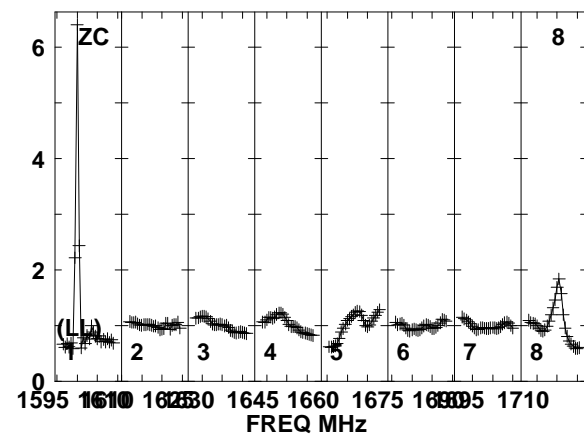
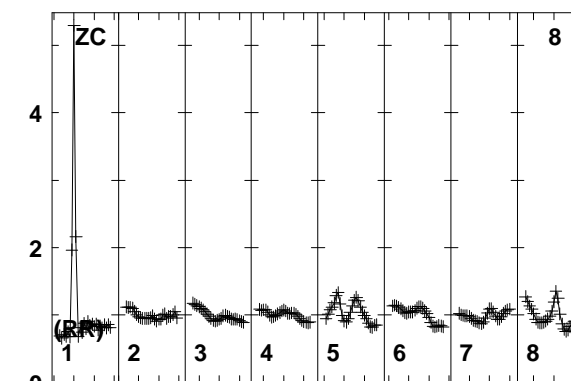
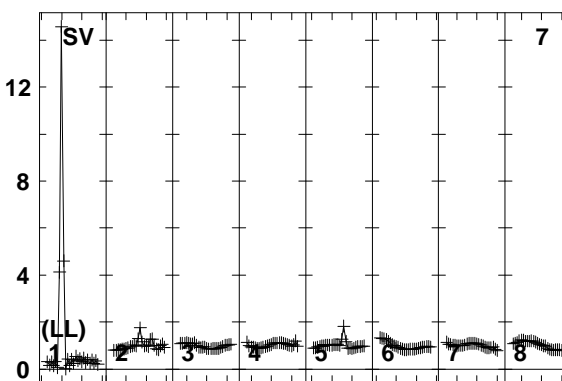
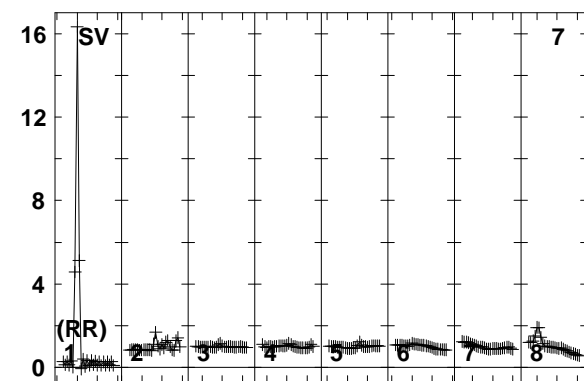
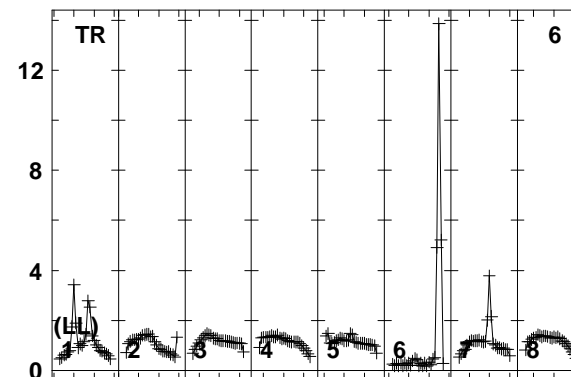
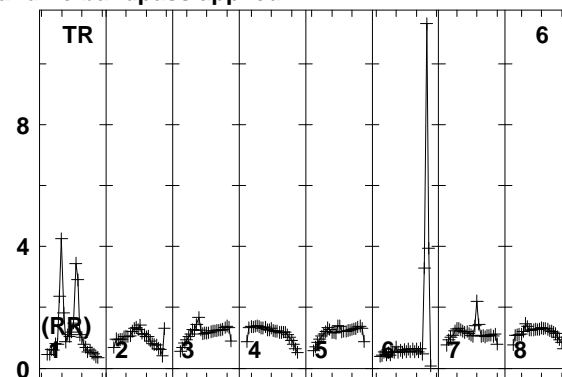
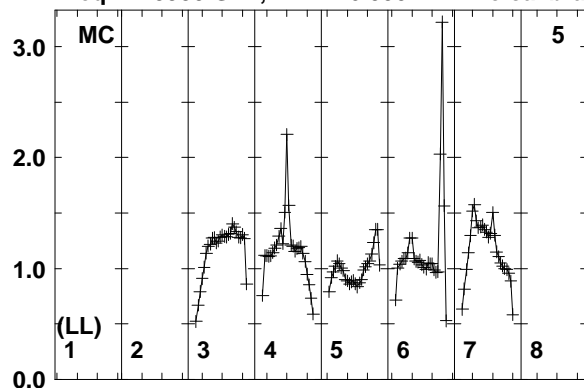

Lower frame: Real Jy
Total-power spectrum Antenna: MC (05)
Timerange: 00/01:54:37 to 00/01:57:59

Plot file version 120 created 19-AUG-2016 17:19:31

J1649+2635 EM119D.UVDATA.1

Freq = 1.5950 GHz, Bw = 16.000 MH No calibration applied and no bandpass applied

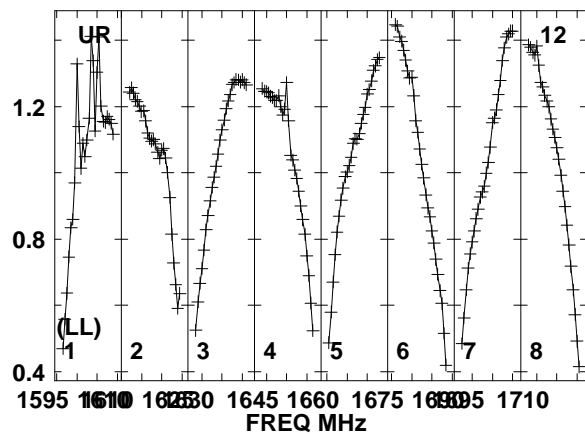
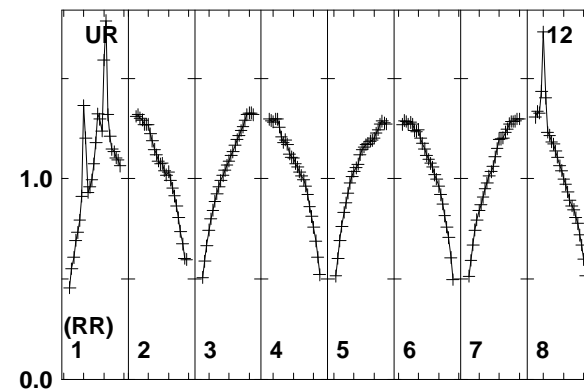
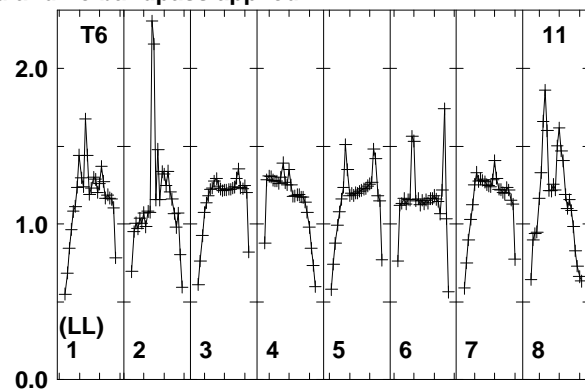
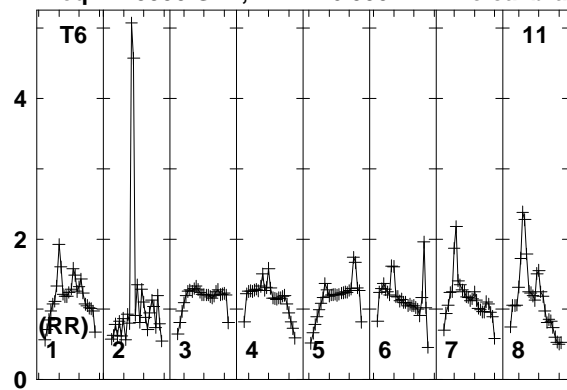

Lower frame: Real Jy
Total-power spectrum Antenna: T6 (11)
Timerange: 00/01:54:37 to 00/01:57:59

Plot file version 121 created 19-AUG-2016 17:19:31

J1642+2523 EM119D.UVDATA.1

Freq = 1.5950 GHz, Bw = 16.000 MH No calibration applied and no bandpass applied

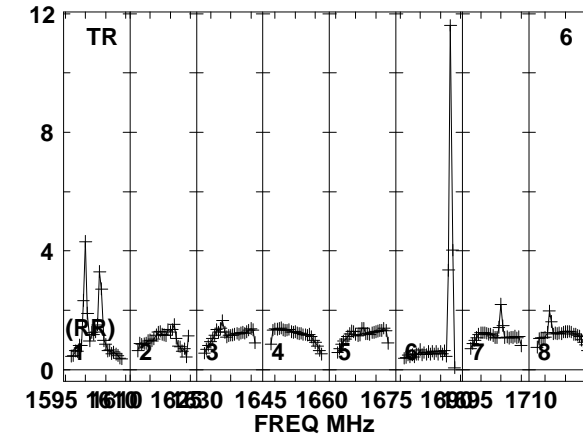
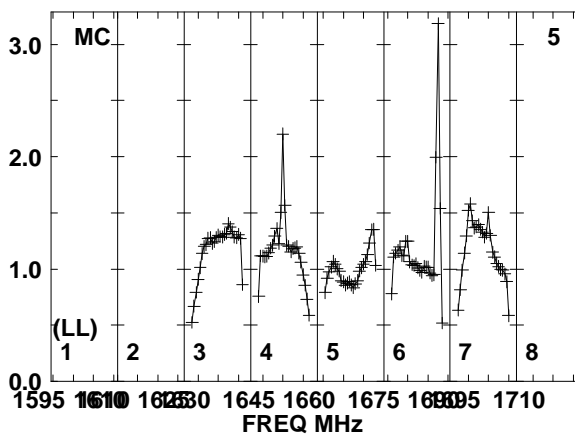
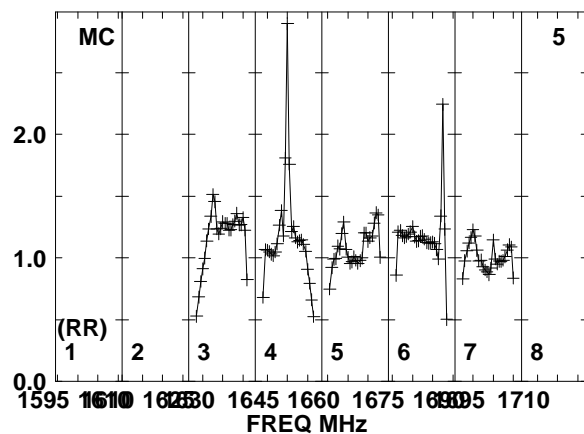
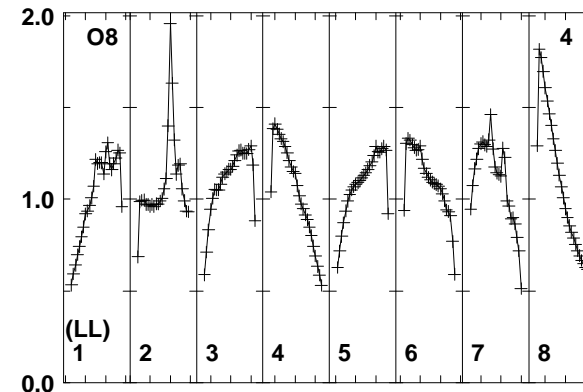
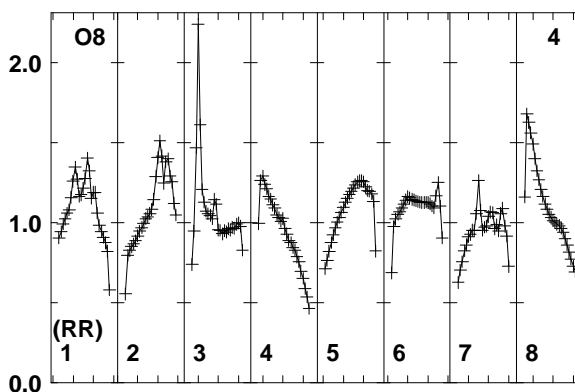
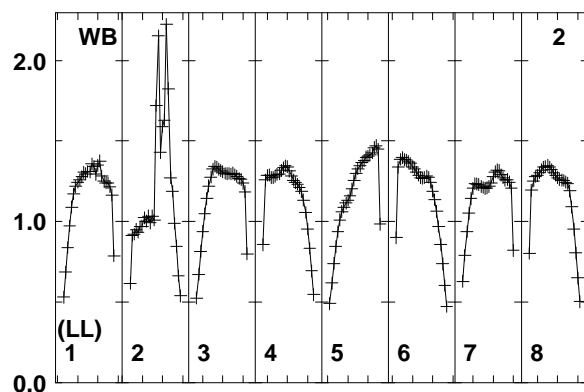
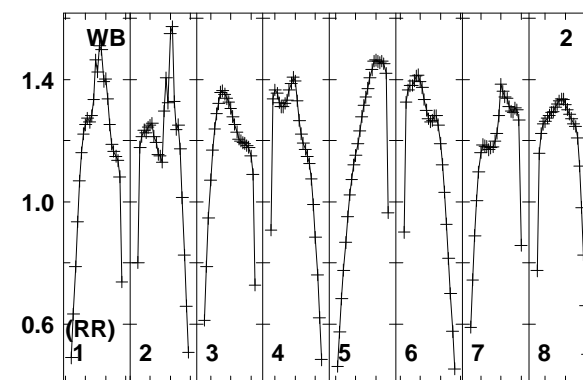
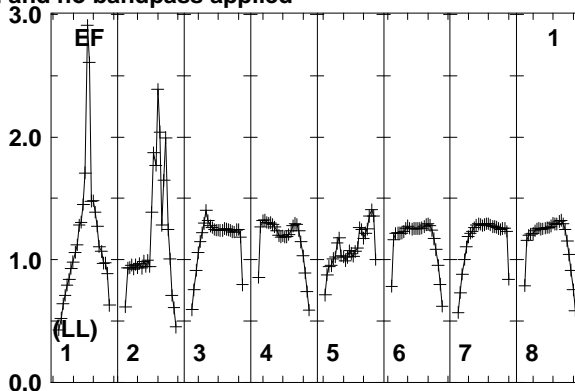
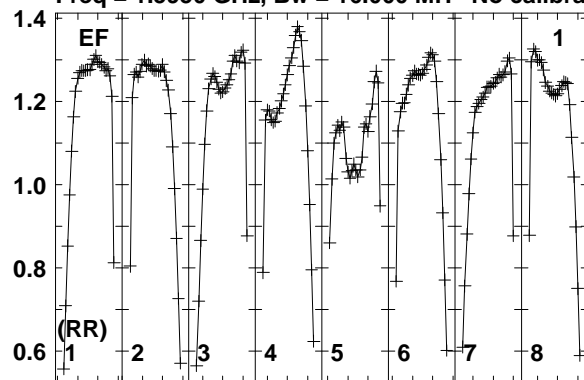

Lower frame: Real Jy
Total-power spectrum Antenna: EF (01)
Timerange: 00/01:58:08 to 00/01:59:30

Plot file version 122 created 19-AUG-2016 17:19:31

J1642+2523 EM119D.UVDATA.1

Freq = 1.5950 GHz, Bw = 16.000 MH No calibration applied and no bandpass applied

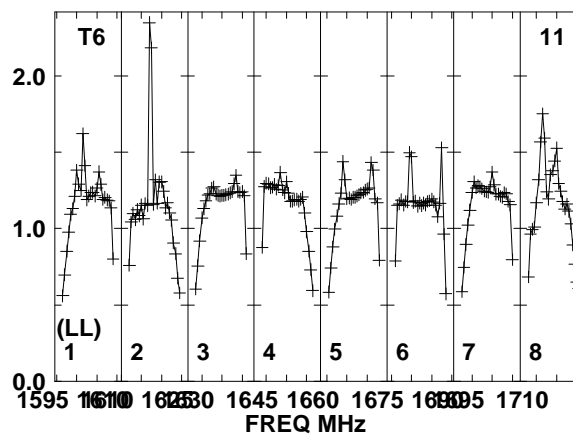
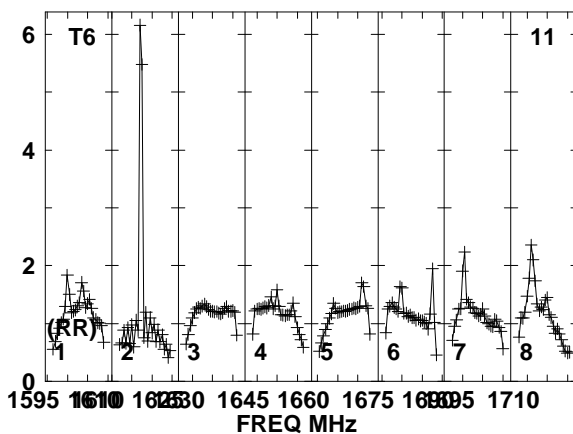
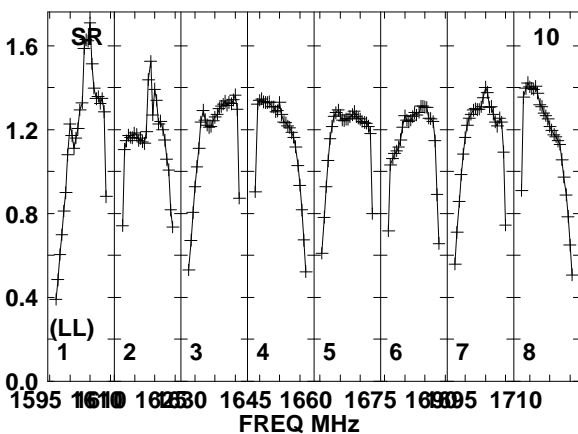
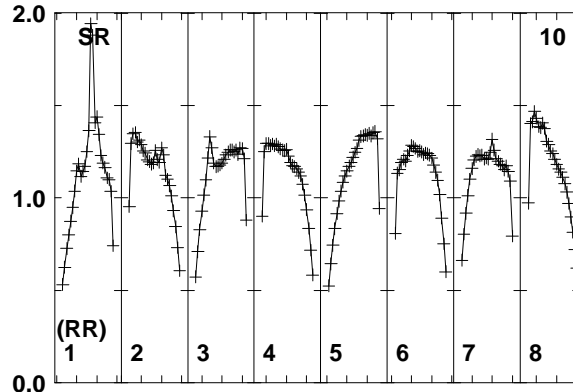
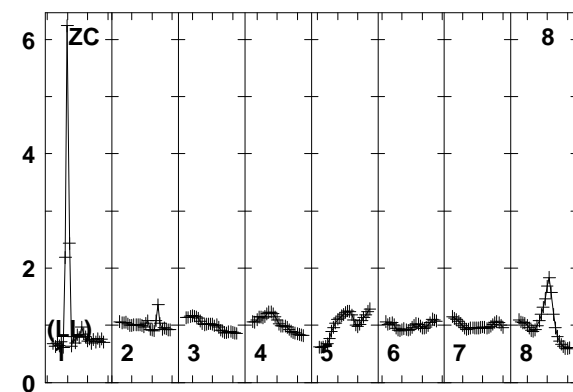
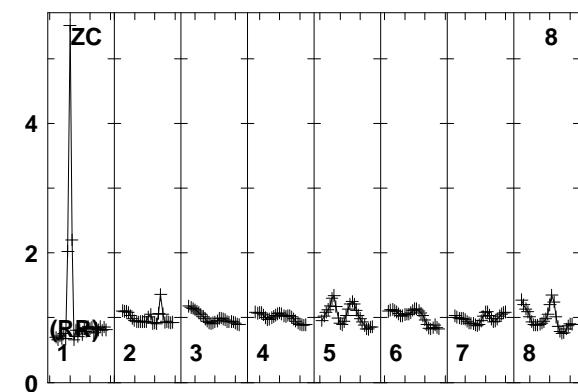
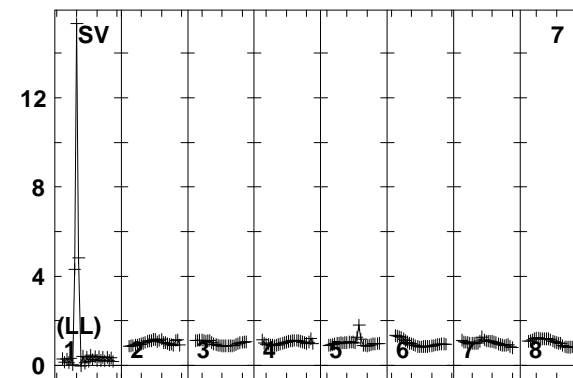
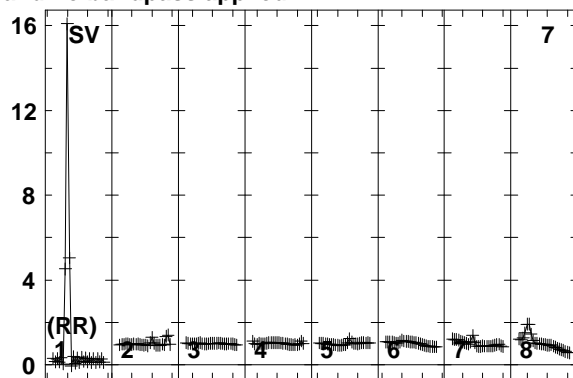
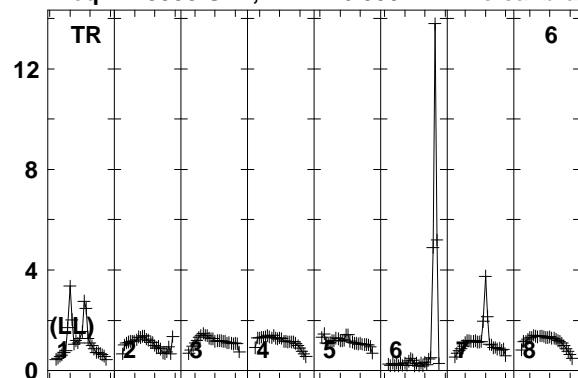

Lower frame: Real Jy
Total-power spectrum Antenna: TR (06)
Timerange: 00/01:58:08 to 00/01:59:30

Plot file version 123 created 19-AUG-2016 17:19:31

J1642+2523 EM119D.UVDATA.1

Freq = 1.5950 GHz, Bw = 16.000 MH No calibration applied and no bandpass applied

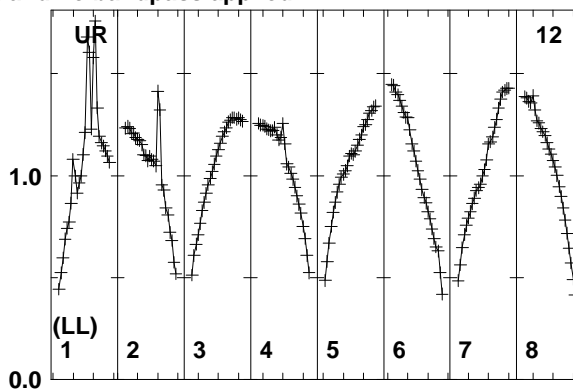
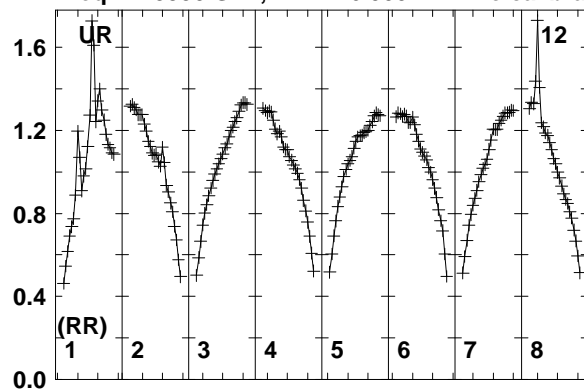

Lower frame: Real Jy
Total-power spectrum Antenna: UR (12)
Timerange: 00/01:58:08 to 00/01:59:30

Plot file version 124 created 19-AUG-2016 17:19:32

J1649+2635 EM119D.UVDATA.1

Freq = 1.5950 GHz, Bw = 16.000 MH No calibration applied and no bandpass applied

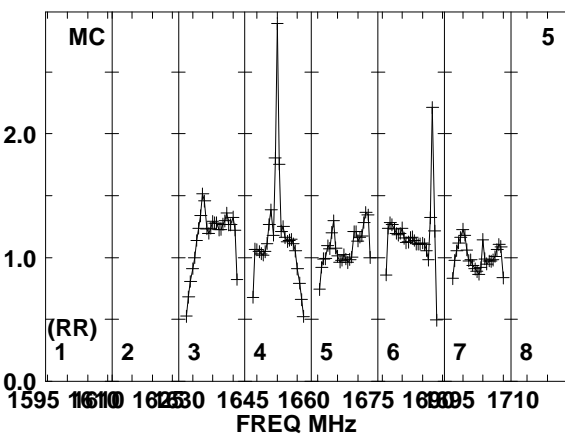
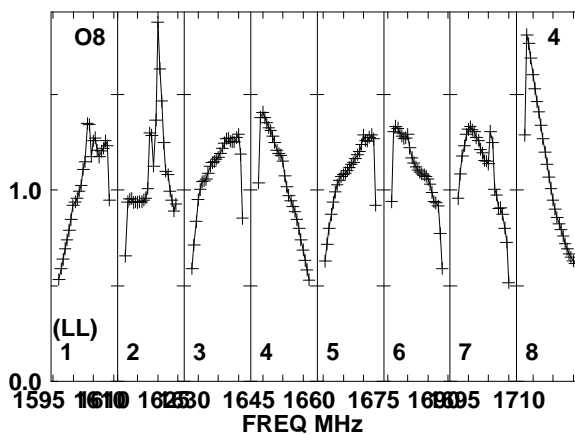
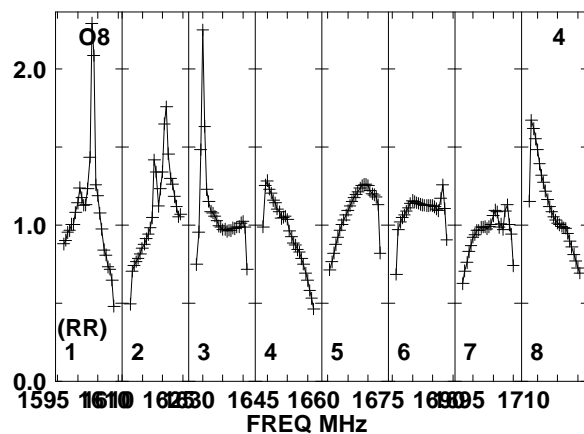
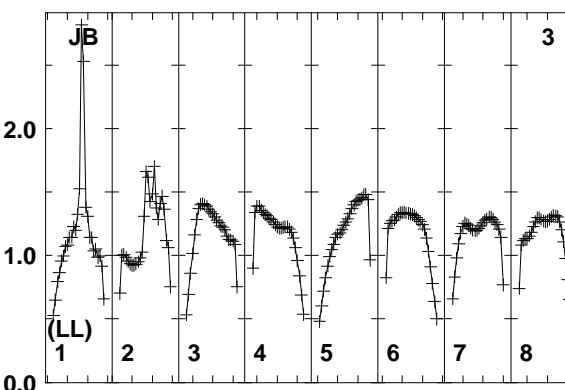
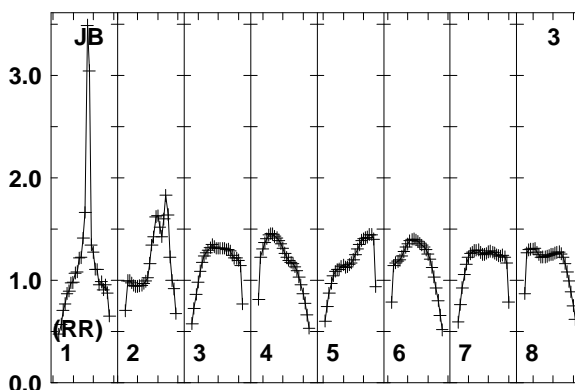
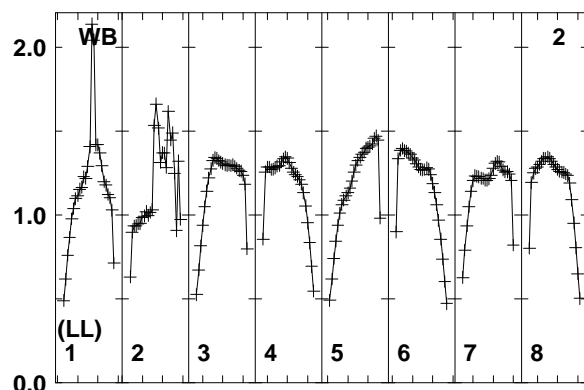
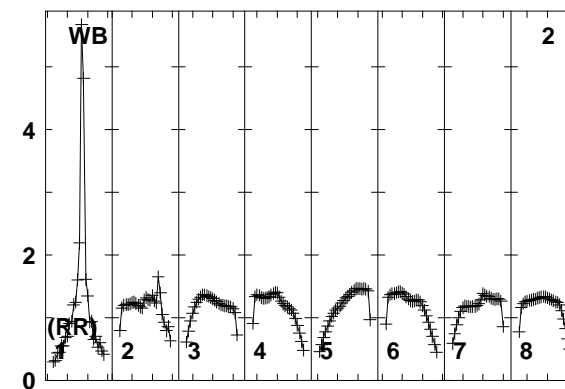
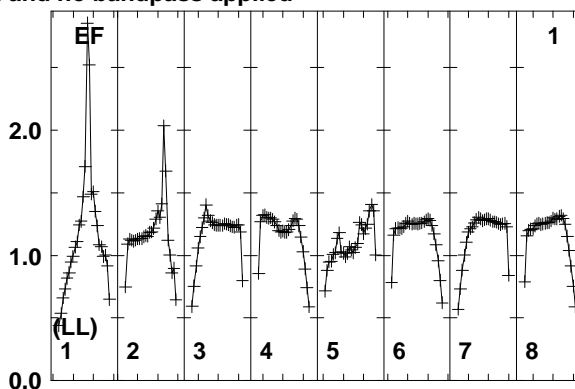
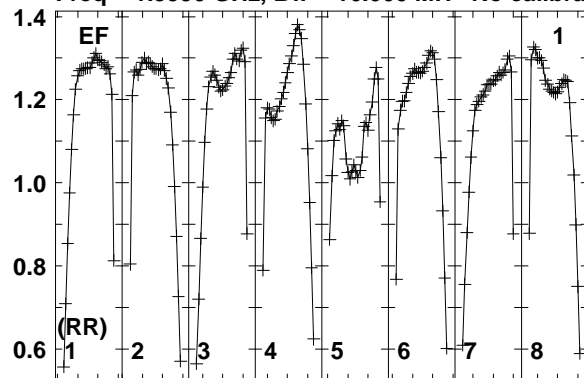

Lower frame: Real Jy
Total-power spectrum Antenna: EF (01)
Timerange: 00/01:59:32 to 00/02:02:59

Plot file version 125 created 19-AUG-2016 17:19:32

J1649+2635 EM119D.UVDATA.1

Freq = 1.5950 GHz, Bw = 16.000 MH No calibration applied and no bandpass applied

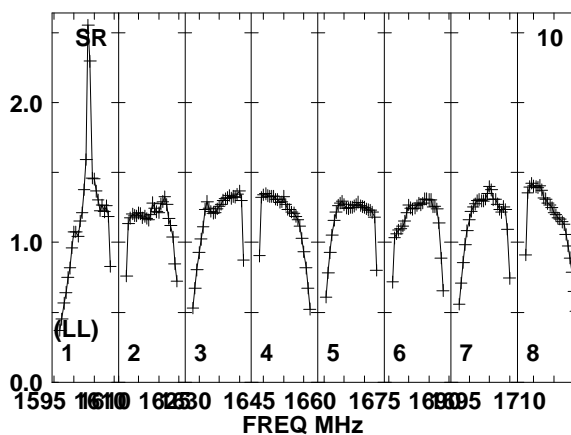
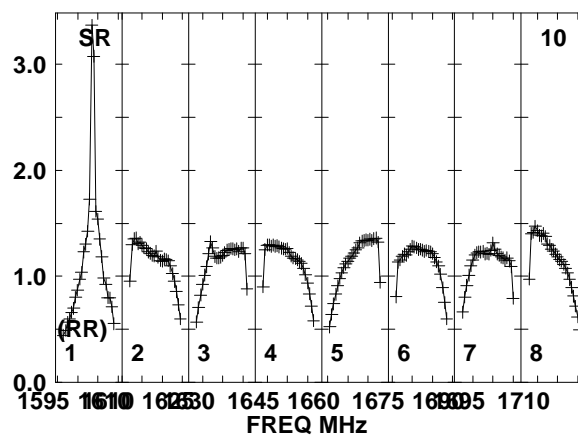
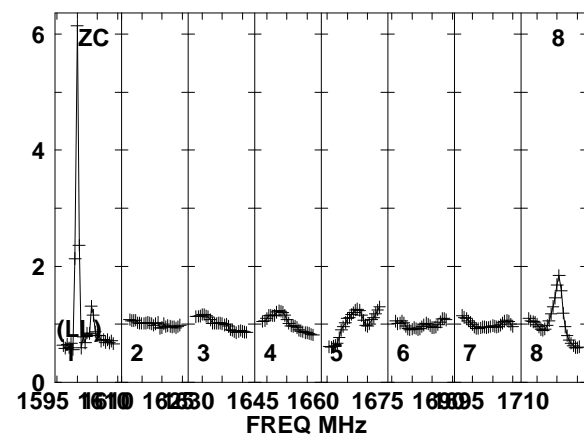
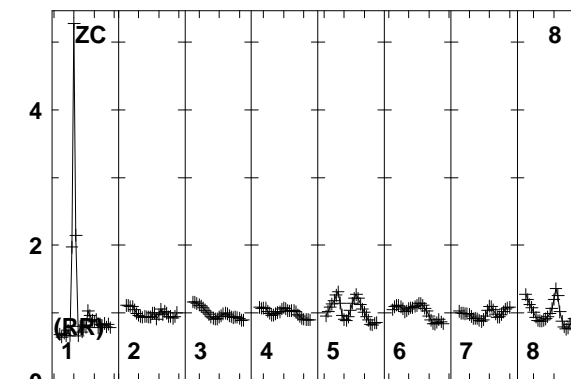
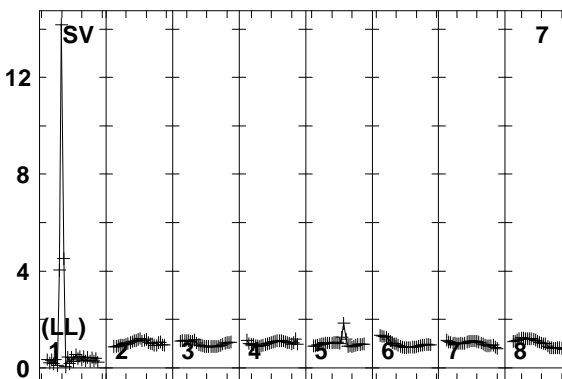
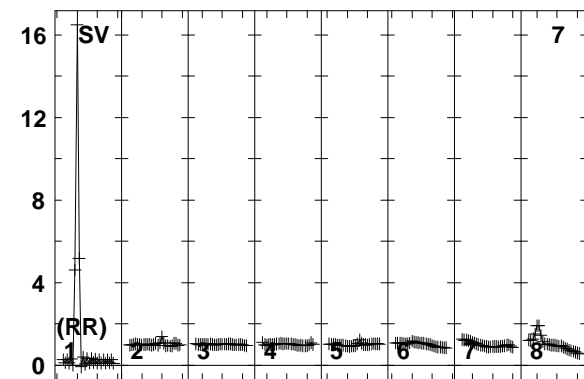
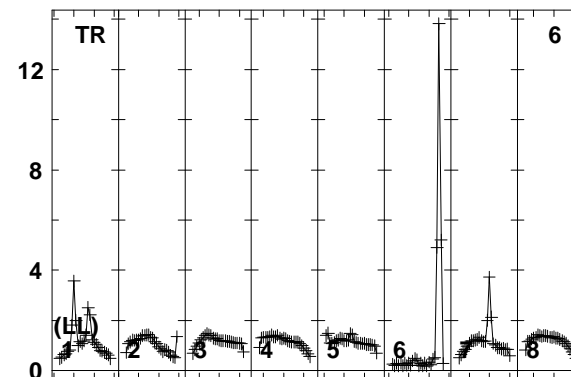
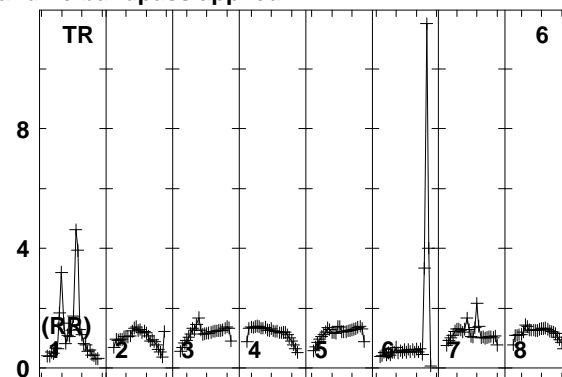
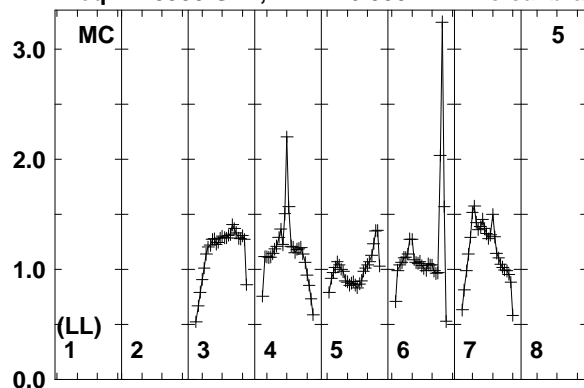

1595 1610 1625 1640 1655 1670 1685 1700 1715
FREQ MHz

1595 1610 1625 1640 1655 1670 1685 1700 1715
FREQ MHz

1595 1610 1625 1640 1655 1670 1685 1700 1715
FREQ MHz

Lower frame: Real Jy
Total-power spectrum Antenna: MC (05)
Timerange: 00/01:59:32 to 00/02:02:59

Plot file version 126 created 19-AUG-2016 17:19:32

J1649+2635 EM119D.UVDATA.1

Freq = 1.5950 GHz, Bw = 16.000 MH No calibration applied and no bandpass applied

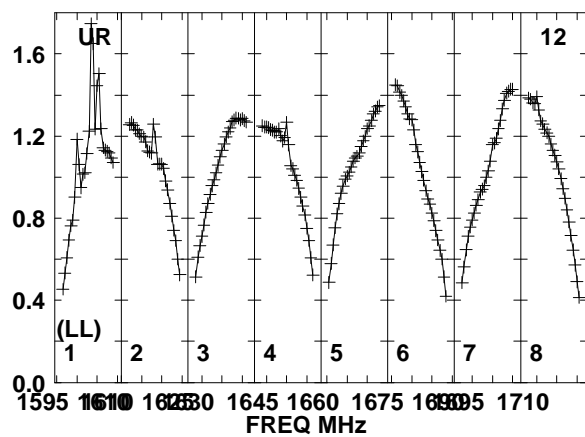
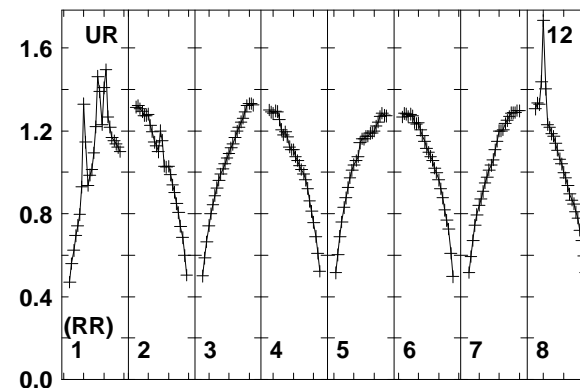
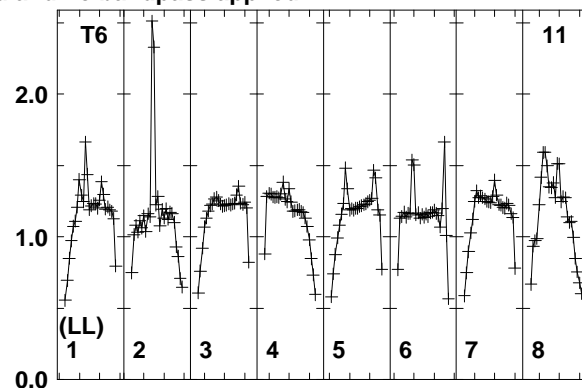
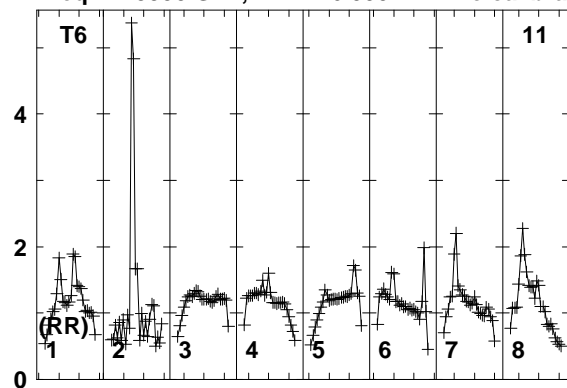

Lower frame: Real Jy
Total-power spectrum Antenna: T6 (11)
Timerange: 00/01:59:32 to 00/02:02:59

Plot file version 127 created 19-AUG-2016 17:19:32

J1642+2523 EM119D.UVDATA.1

Freq = 1.5950 GHz, Bw = 16.000 MH No calibration applied and no bandpass applied

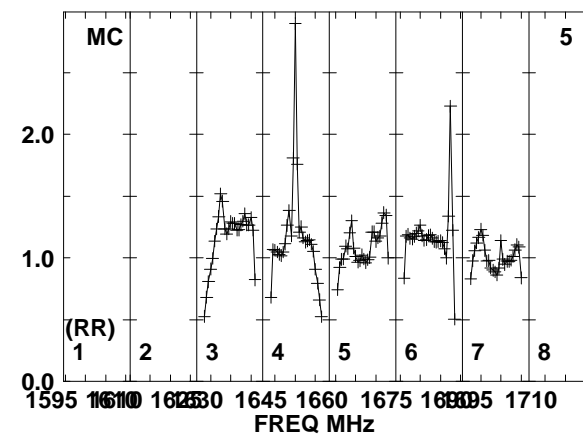
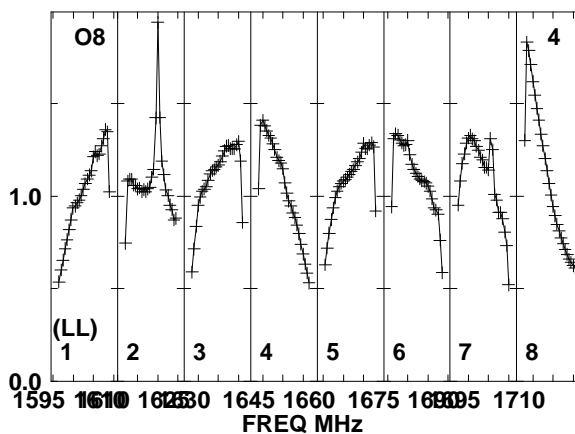
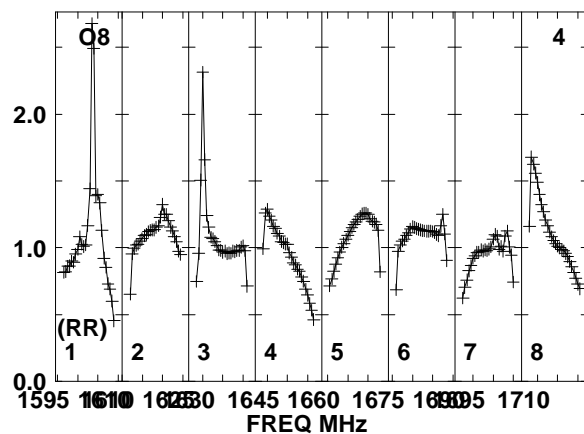
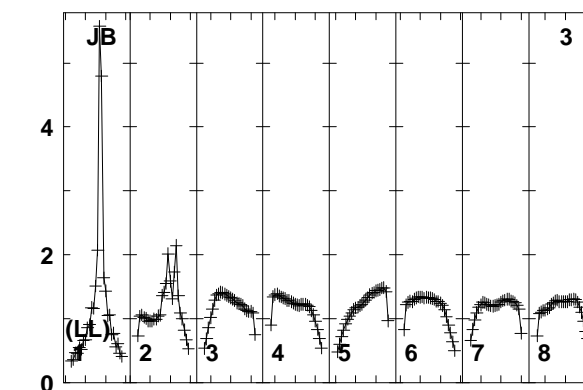
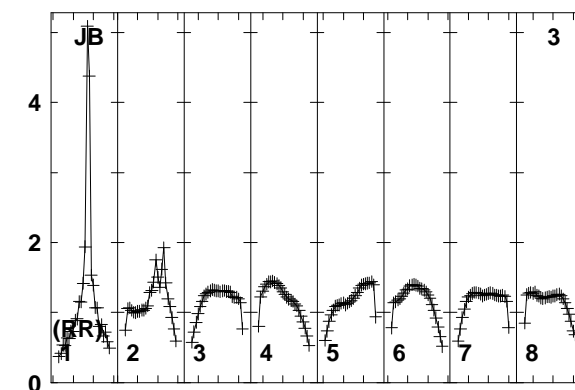
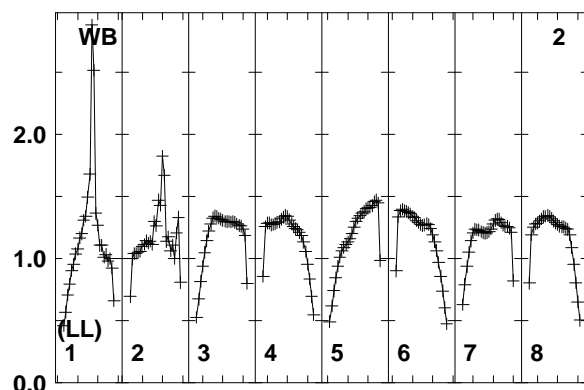
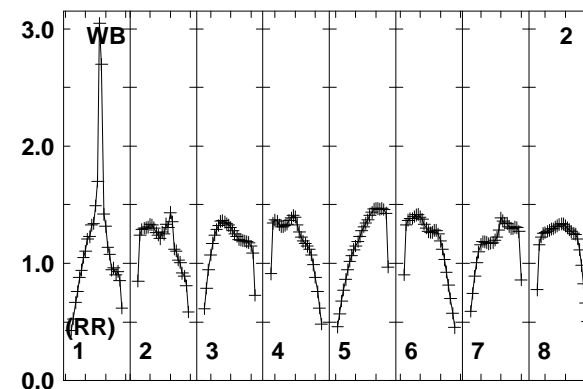
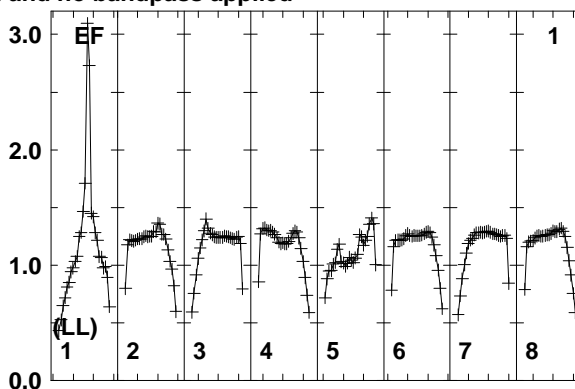
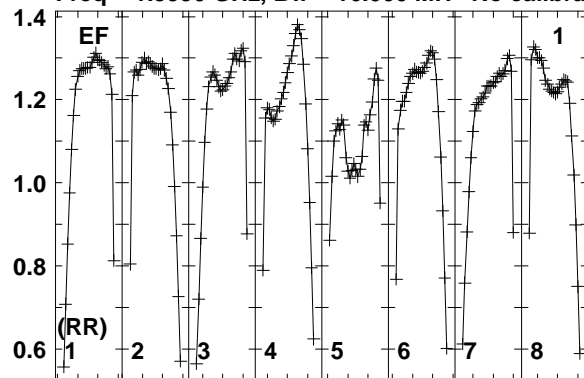

Lower frame: Real Jy
Total-power spectrum Antenna: EF (01)
Timerange: 00/02:04:00 to 00/02:05:29

Plot file version 128 created 19-AUG-2016 17:19:32

J1642+2523 EM119D.UVDATA.1

Freq = 1.5950 GHz, Bw = 16.000 MH No calibration applied and no bandpass applied

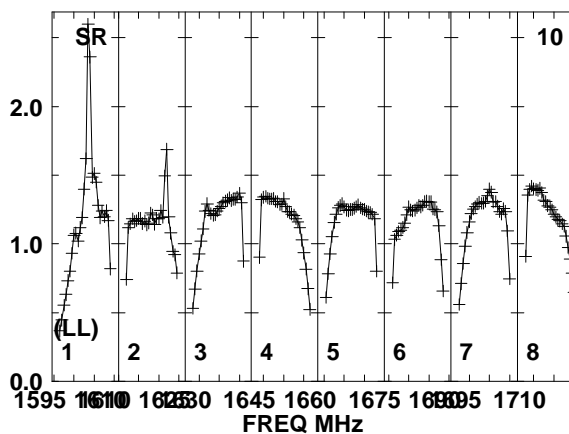
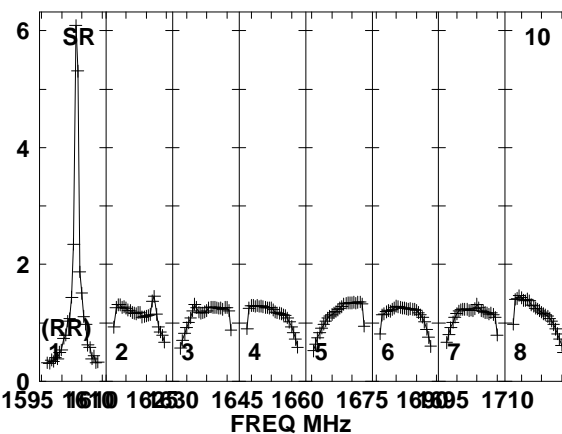
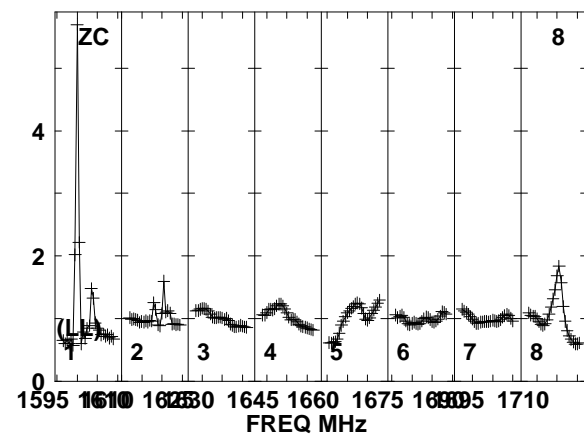
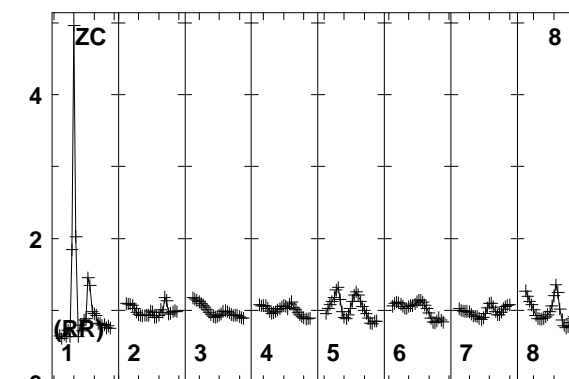
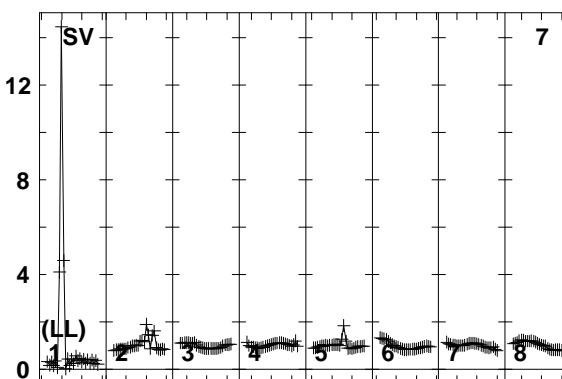
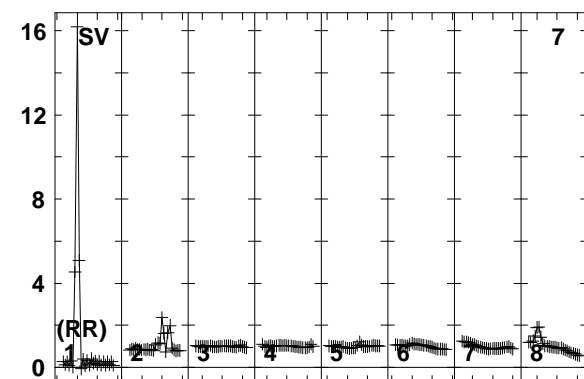
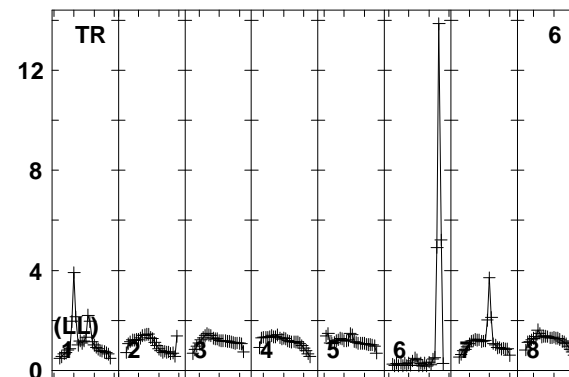
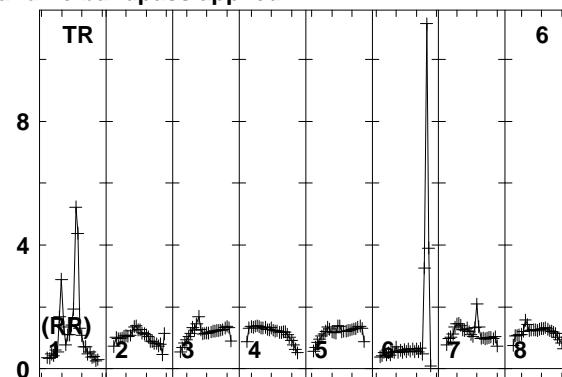
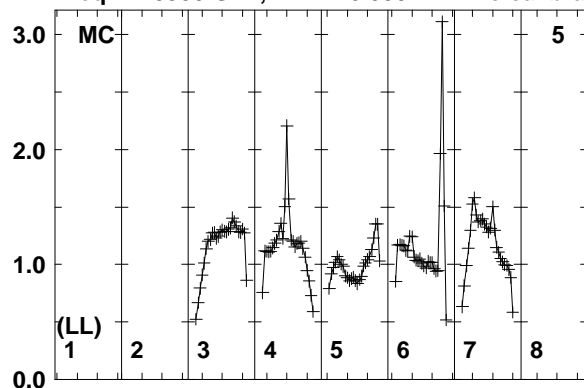

Lower frame: Real Jy
Total-power spectrum Antenna: MC (05)
Timerange: 00/02:04:00 to 00/02:05:29

Plot file version 129 created 19-AUG-2016 17:19:32

J1642+2523 EM119D.UVDATA.1

Freq = 1.5950 GHz, Bw = 16.000 MH No calibration applied and no bandpass applied

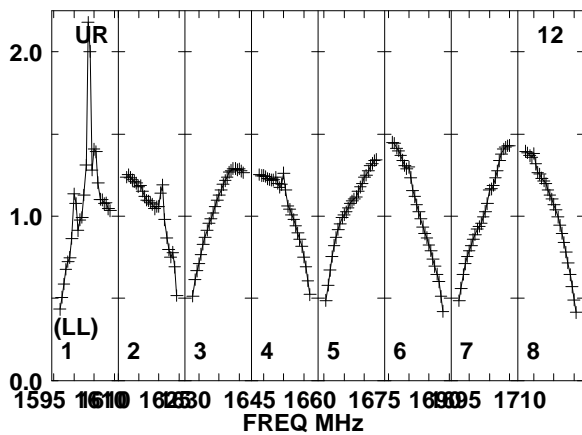
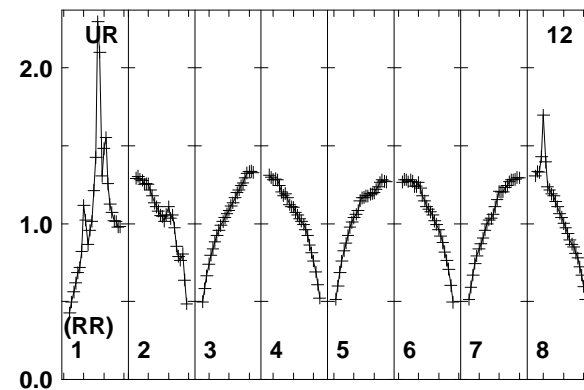
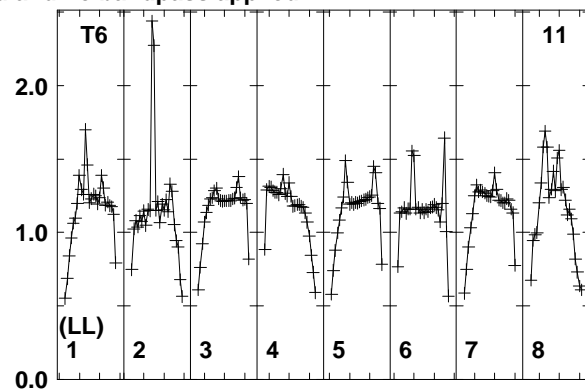
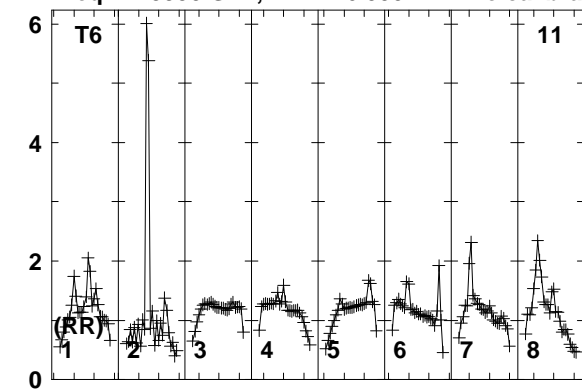

Lower frame: Real Jy
Total-power spectrum Antenna: T6 (11)
Timerange: 00/02:04:00 to 00/02:05:29

Plot file version 130 created 19-AUG-2016 17:19:33

J1649+2635 EM119D.UVDATA.1

Freq = 1.5950 GHz, Bw = 16.000 MH No calibration applied and no bandpass applied

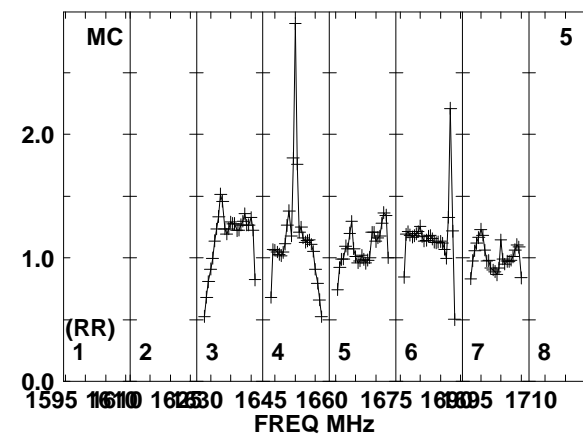
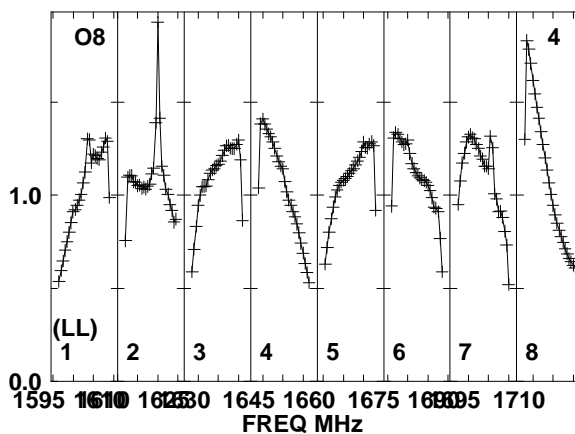
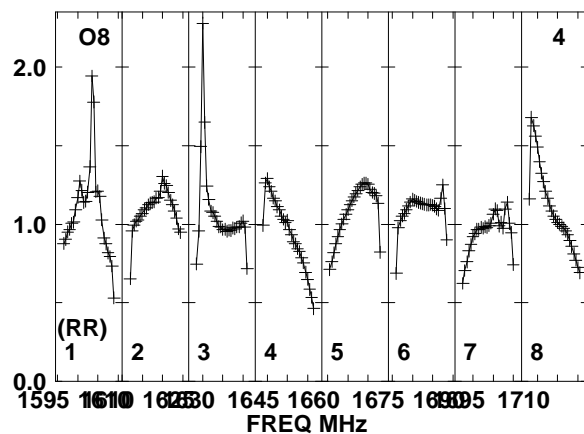
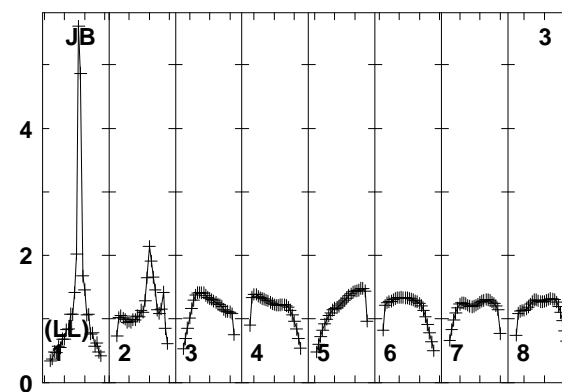
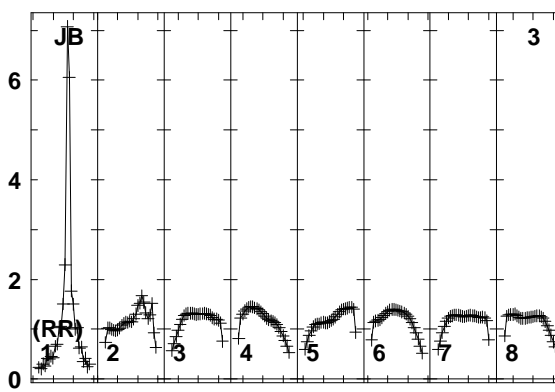
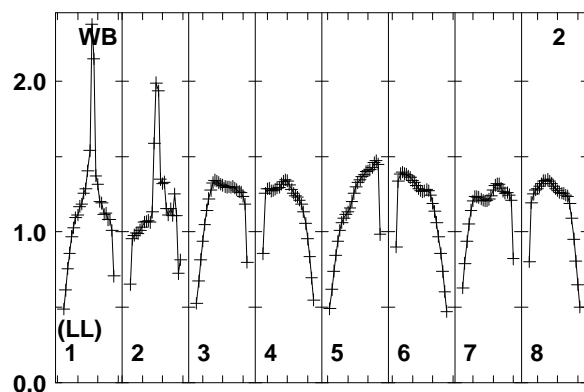
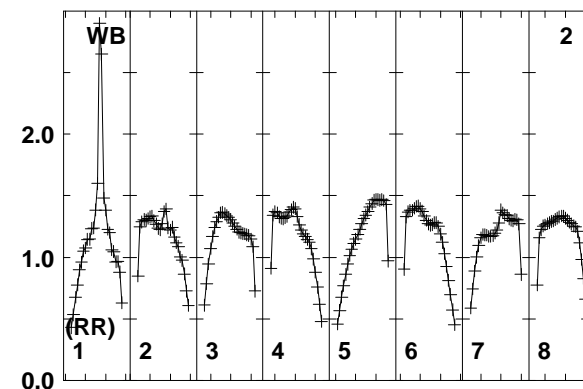
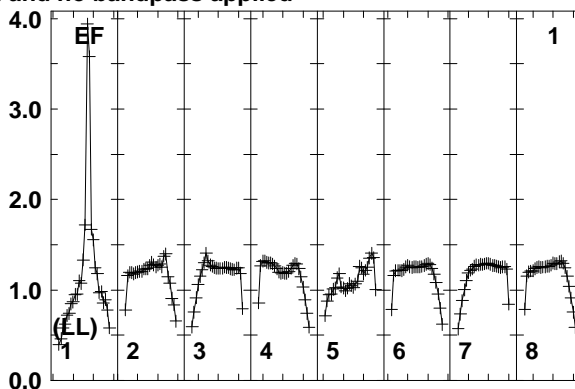
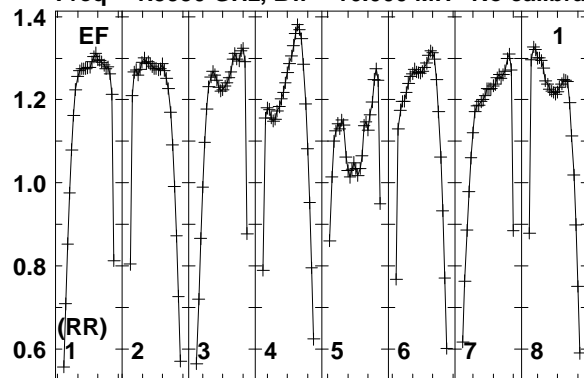

Lower frame: Real Jy
Total-power spectrum Antenna: EF (01)
Timerange: 00/02:05:38 to 00/02:08:59

Plot file version 131 created 19-AUG-2016 17:19:33

J1649+2635 EM119D.UVDATA.1

Freq = 1.5950 GHz, Bw = 16.000 MH No calibration applied and no bandpass applied

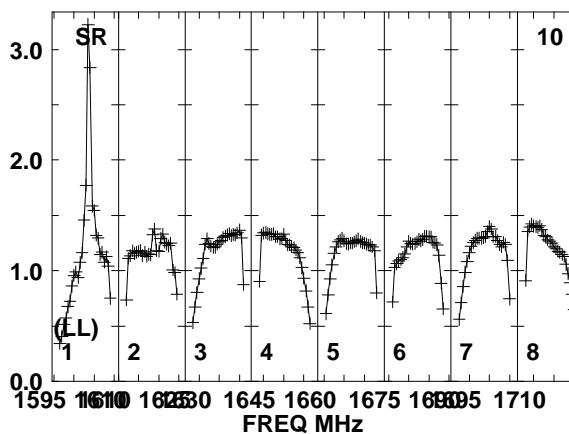
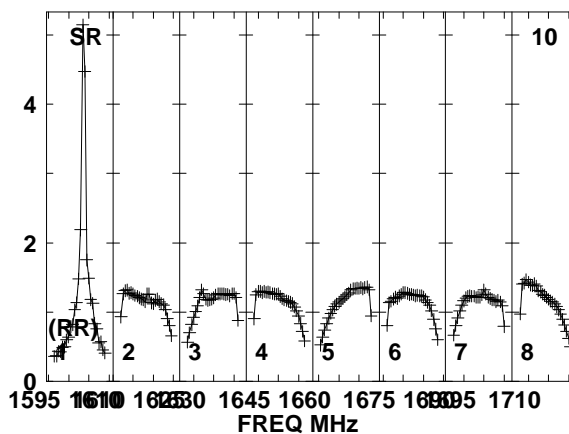
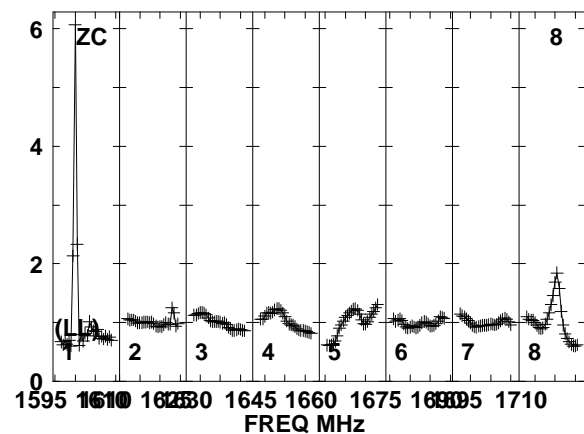
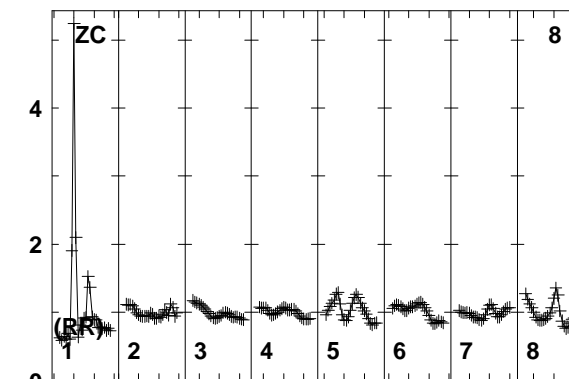
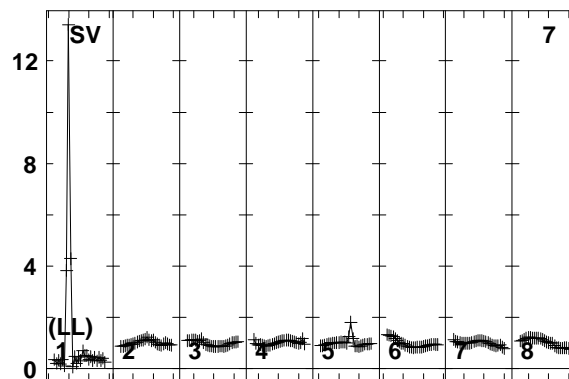
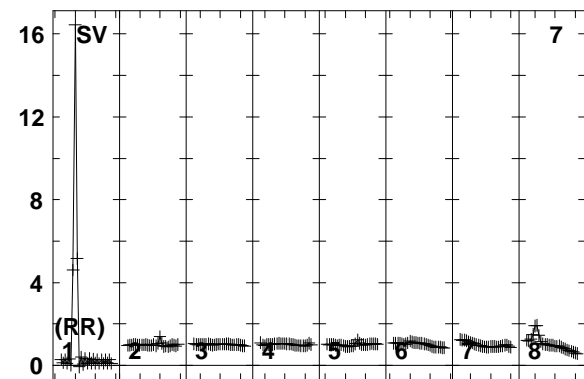
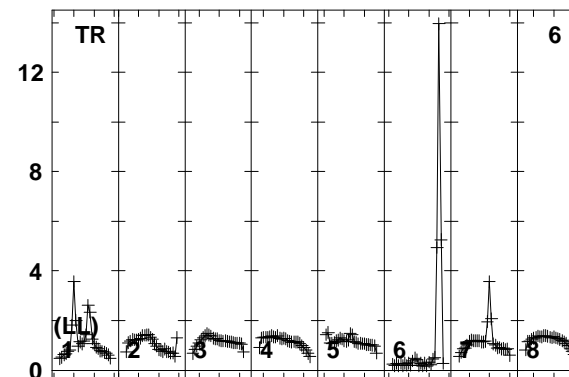
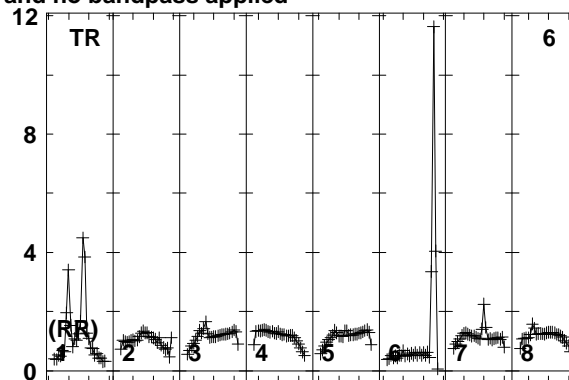
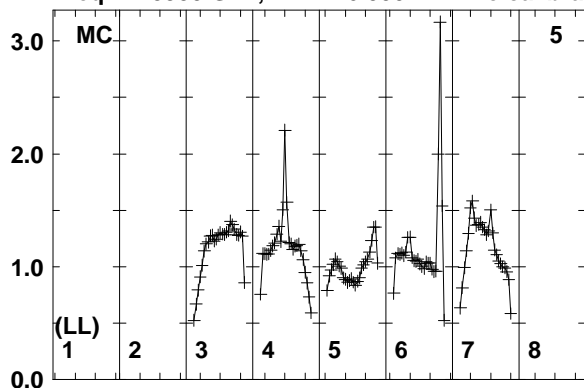

Lower frame: Real Jy
Total-power spectrum Antenna: MC (05)
Timerange: 00/02:05:38 to 00/02:08:59

Plot file version 132 created 19-AUG-2016 17:19:33

J1649+2635 EM119D.UVDATA.1

Freq = 1.5950 GHz, Bw = 16.000 MH No calibration applied and no bandpass applied

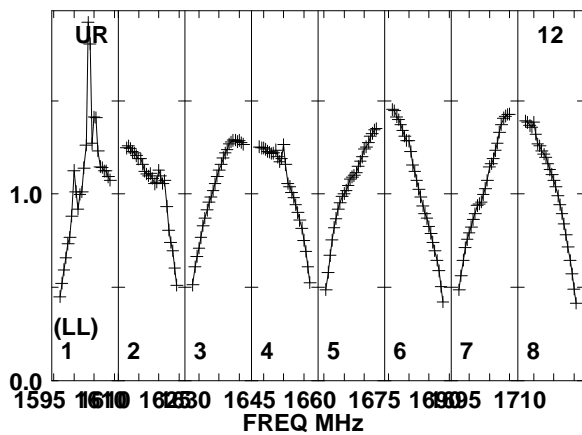
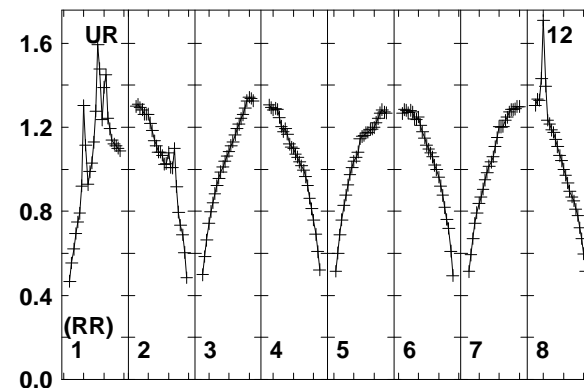
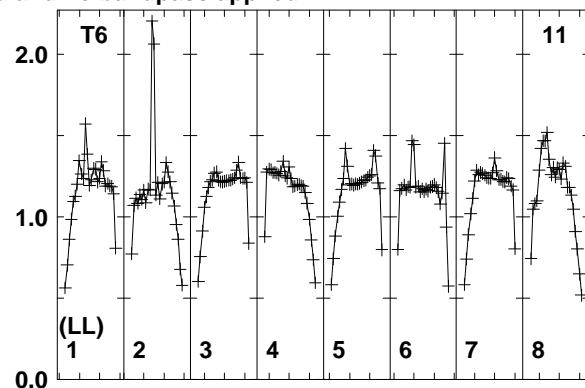
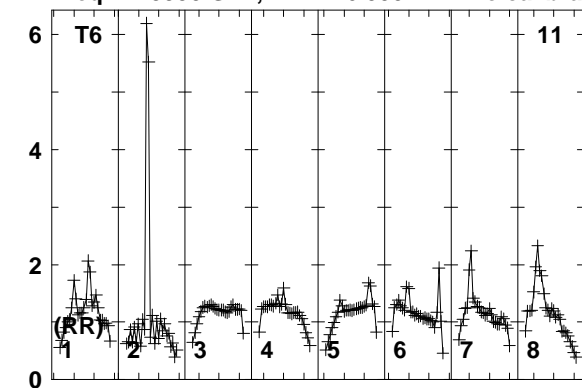

1595 1610 1625 1640 1655 1670 1685 1700
FREQ MHz

Lower frame: Real Jy
Total-power spectrum Antenna: T6 (11)
Timerange: 00/02:05:38 to 00/02:08:59

Plot file version 133 created 19-AUG-2016 17:19:33

J1642+2523 EM119D.UVDATA.1

Freq = 1.5950 GHz, Bw = 16.000 MH No calibration applied and no bandpass applied

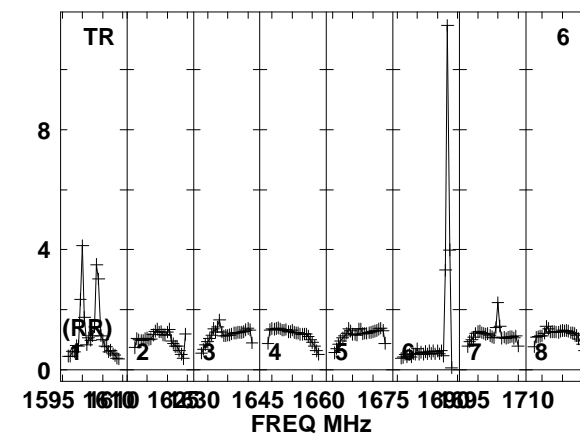
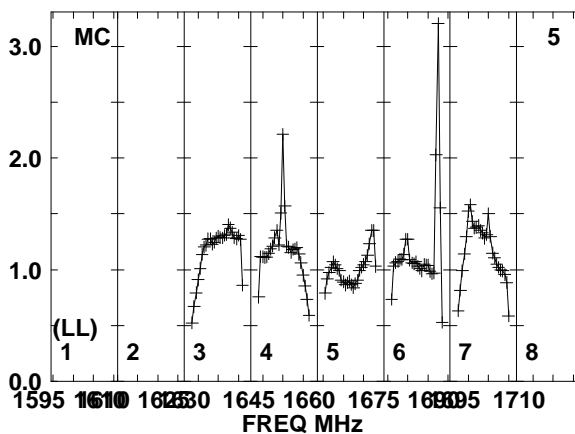
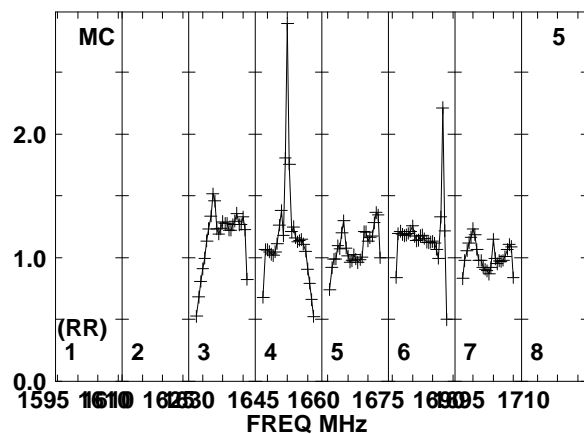
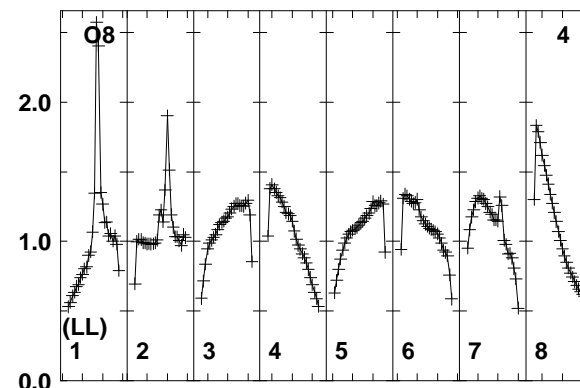
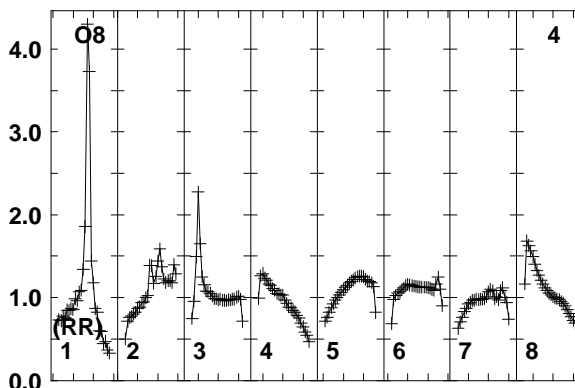
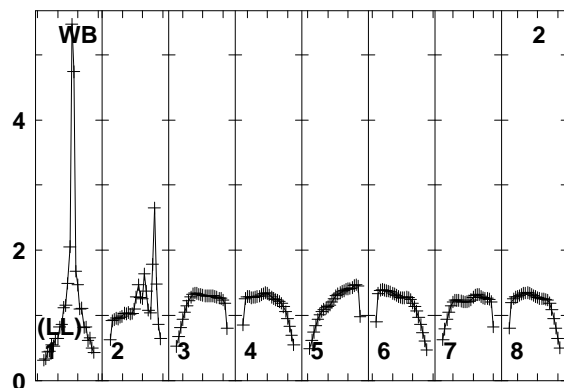
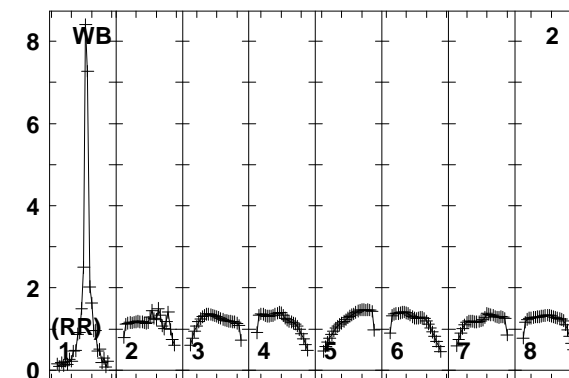
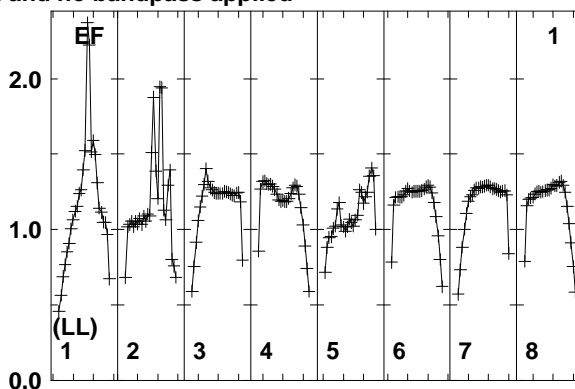
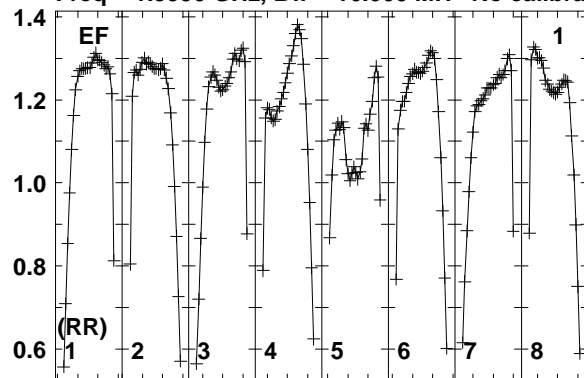

Lower frame: Real Jy
Total-power spectrum Antenna: EF (01)
Timerange: 00/02:09:08 to 00/02:10:30

Plot file version 134 created 19-AUG-2016 17:19:33

J1642+2523 EM119D.UVDATA.1

Freq = 1.5950 GHz, Bw = 16.000 MH No calibration applied and no bandpass applied

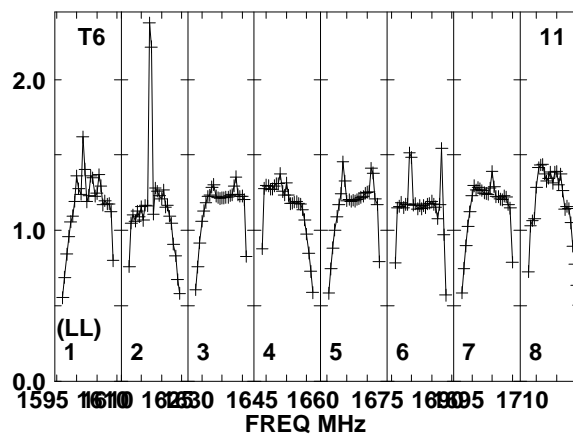
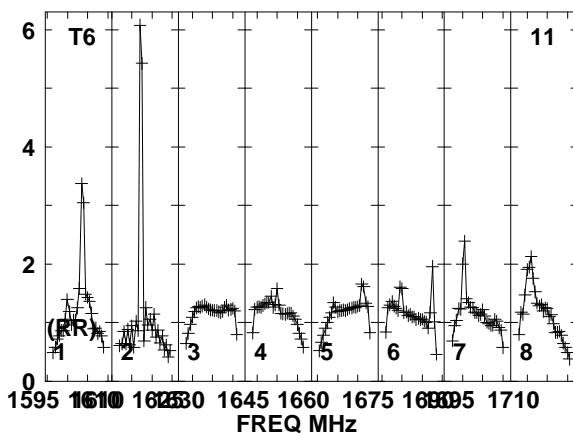
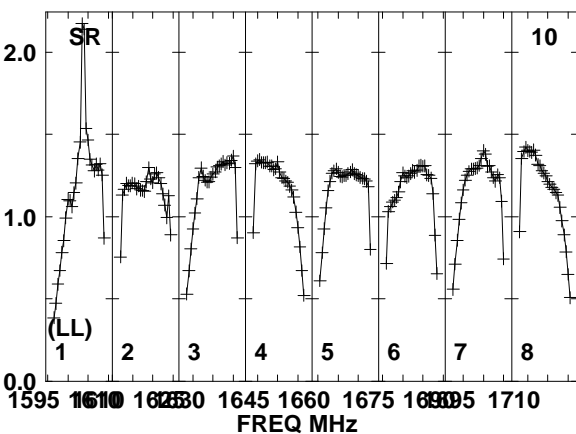
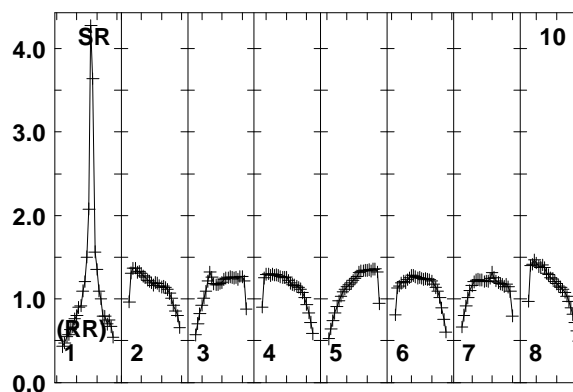
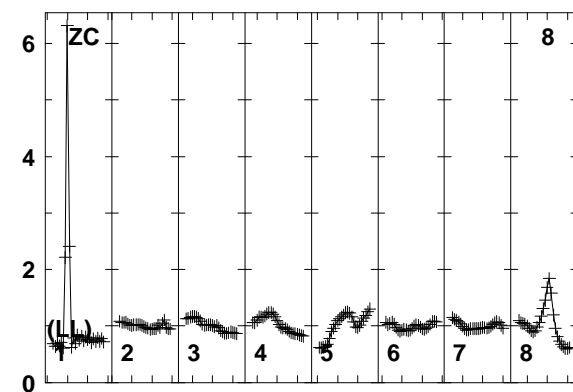
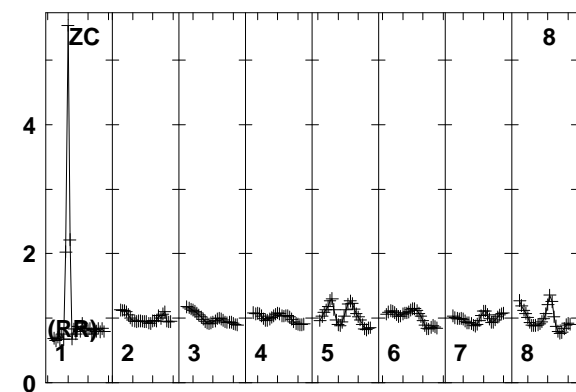
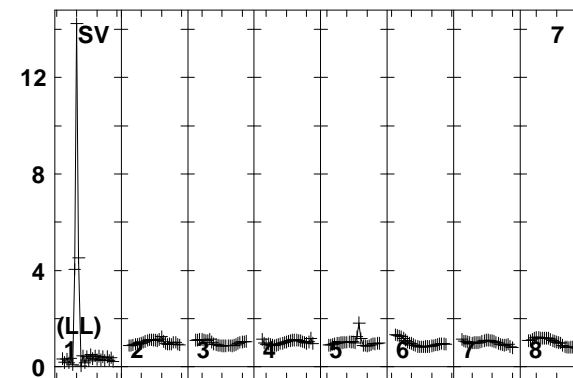
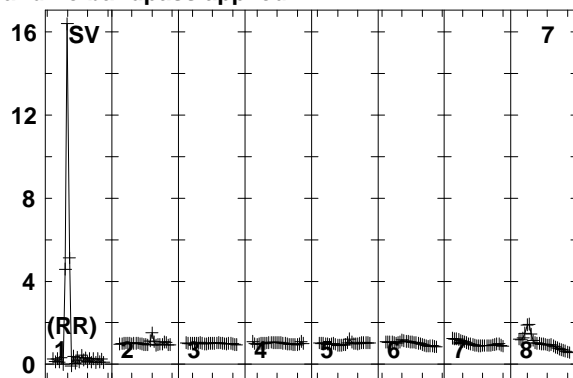
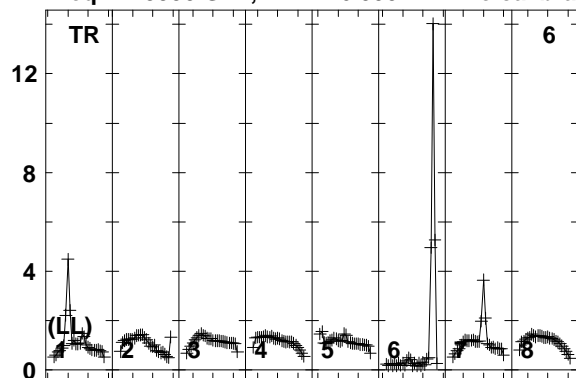

Lower frame: Real Jy
Total-power spectrum Antenna: TR (06)
Timerange: 00/02:09:08 to 00/02:10:30

Plot file version 135 created 19-AUG-2016 17:19:33

J1642+2523 EM119D.UVDATA.1

Freq = 1.5950 GHz, Bw = 16.000 MH No calibration applied and no bandpass applied

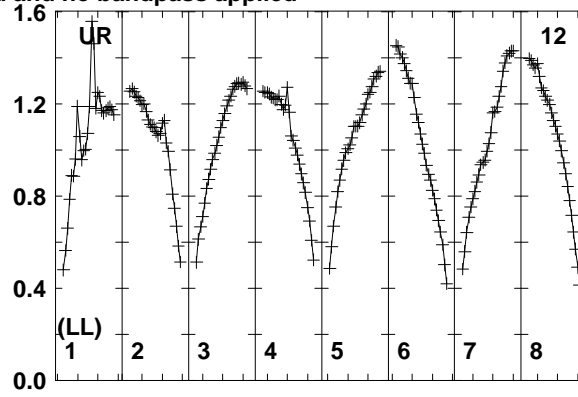
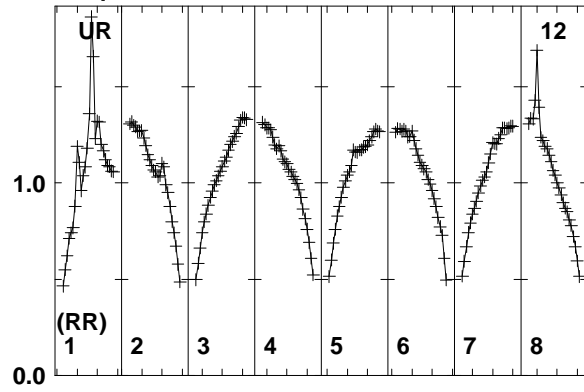

Lower frame: Real Jy
Total-power spectrum Antenna: UR (12)
Timerange: 00/02:09:08 to 00/02:10:30

Plot file version 136 created 19-AUG-2016 17:19:33

J1649+2635 EM119D.UVDATA.1

Freq = 1.5950 GHz, Bw = 16.000 MH No calibration applied and no bandpass applied

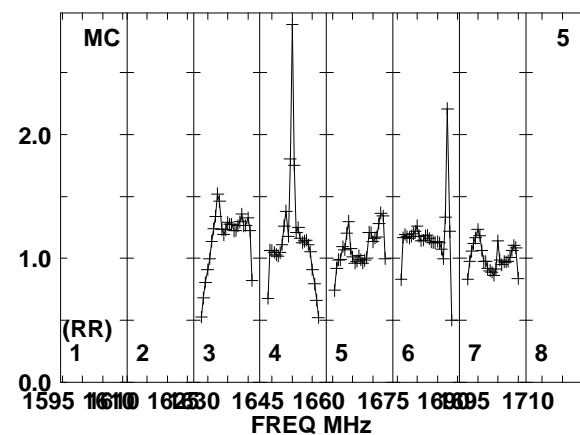
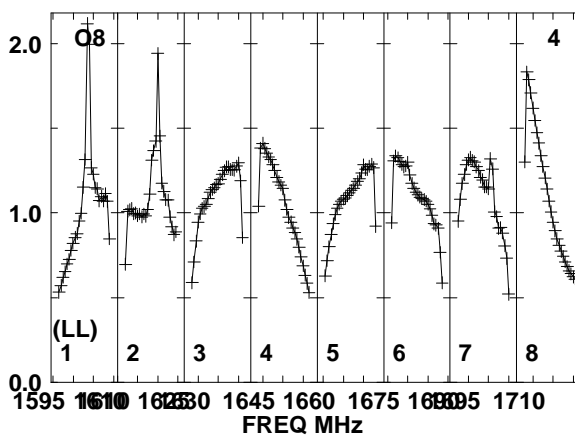
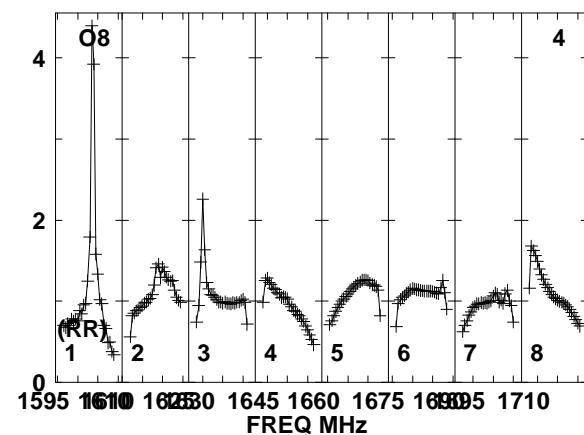
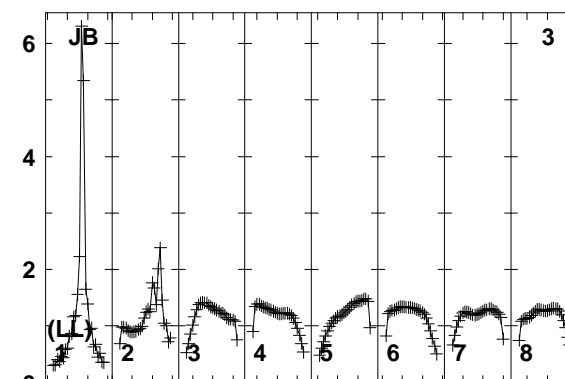
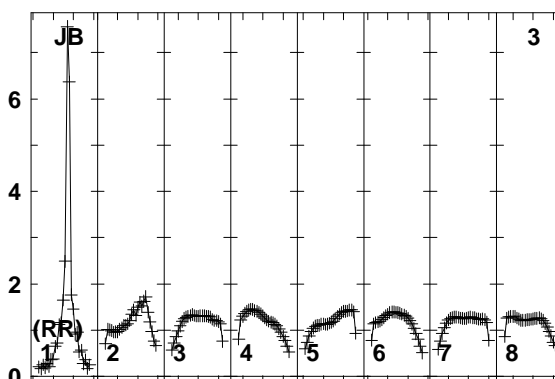
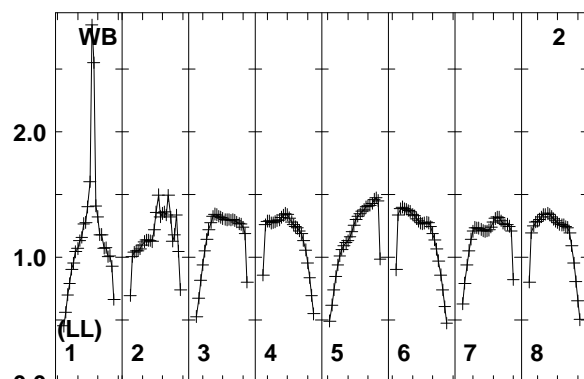
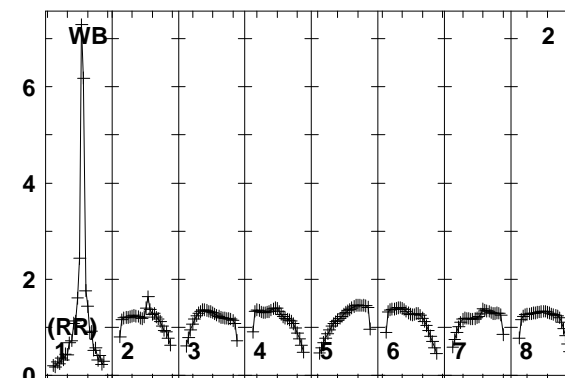
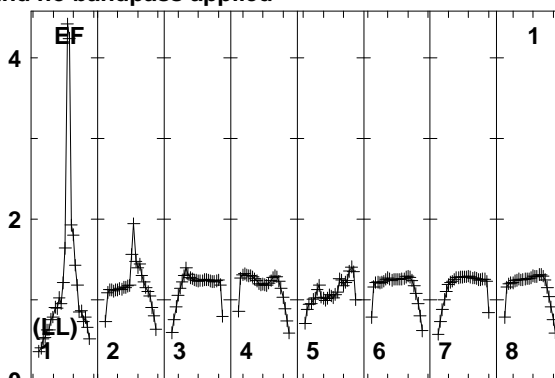
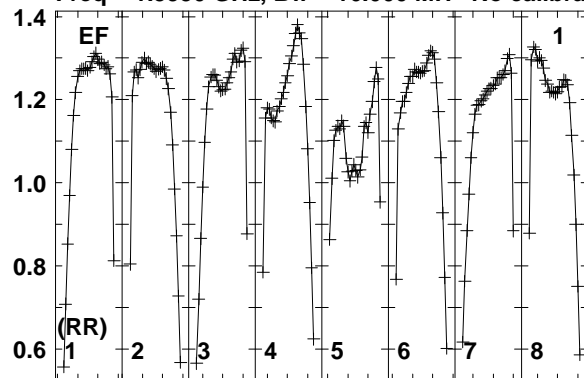

Lower frame: Real Jy
Total-power spectrum Antenna: EF (01)
Timerange: 00/02:10:33 to 00/02:14:00

Plot file version 137 created 19-AUG-2016 17:19:34

J1649+2635 EM119D.UVDATA.1

Freq = 1.5950 GHz, Bw = 16.000 MH No calibration applied and no bandpass applied

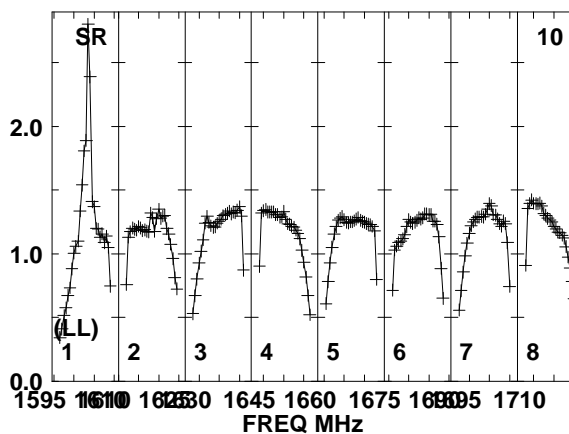
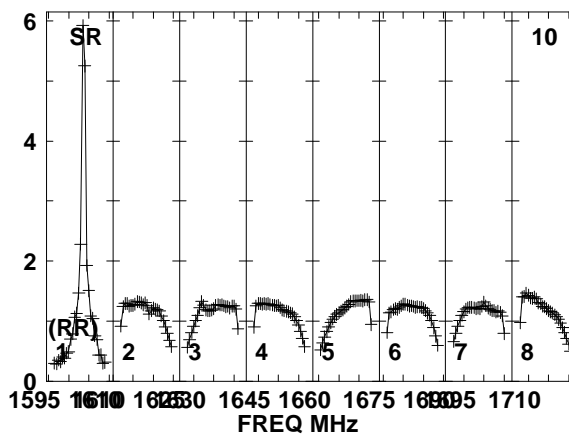
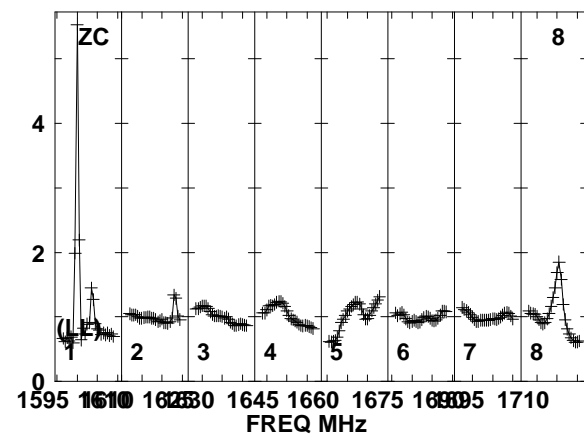
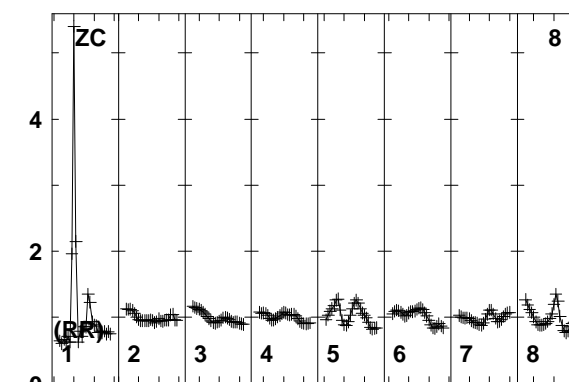
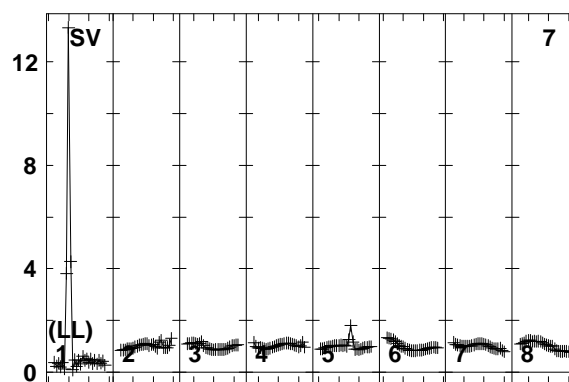
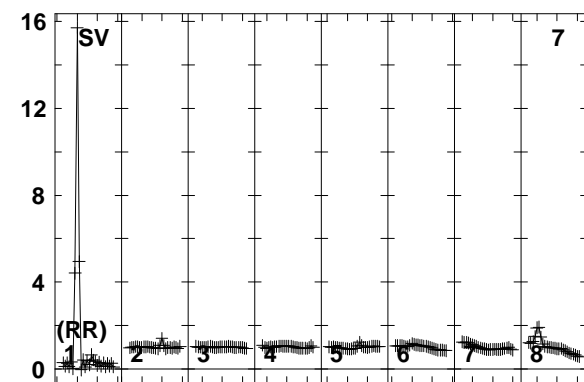
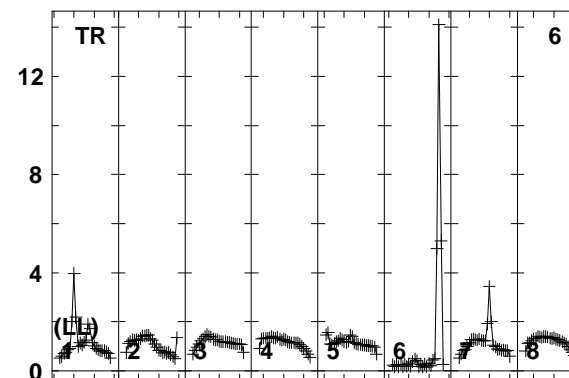
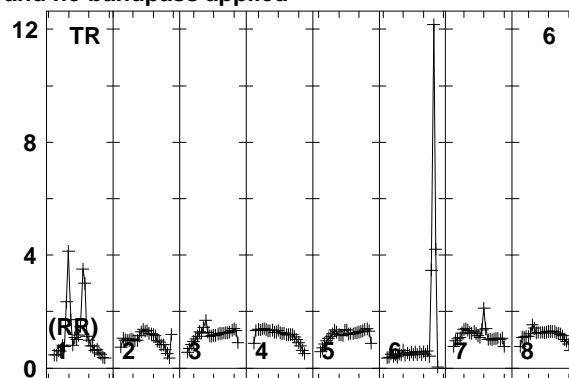
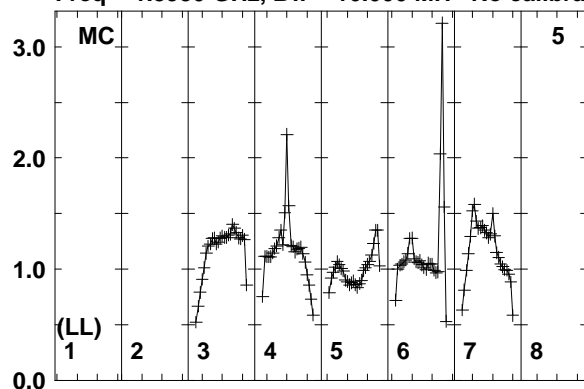

Lower frame: Real Jy
Total-power spectrum Antenna: MC (05)
Timerange: 00/02:10:33 to 00/02:14:00

Plot file version 138 created 19-AUG-2016 17:19:34

J1649+2635 EM119D.UVDATA.1

Freq = 1.5950 GHz, Bw = 16.000 MH No calibration applied and no bandpass applied

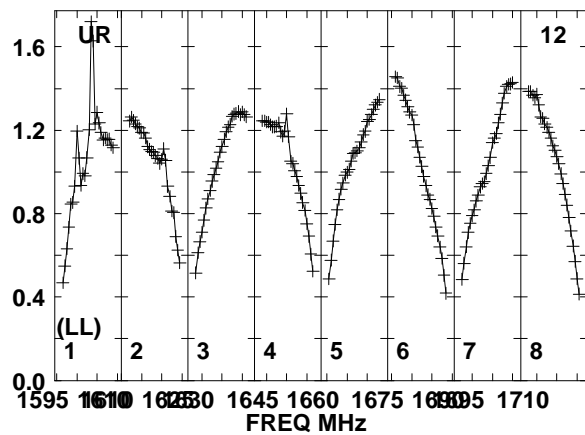
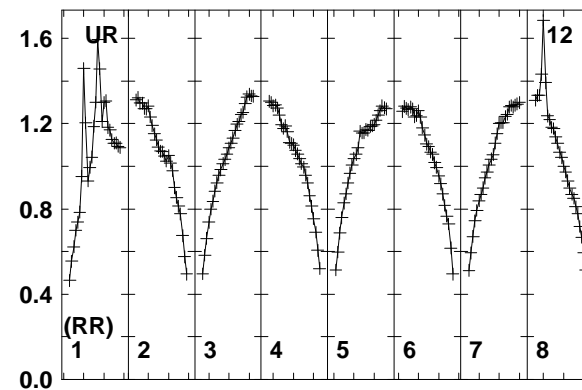
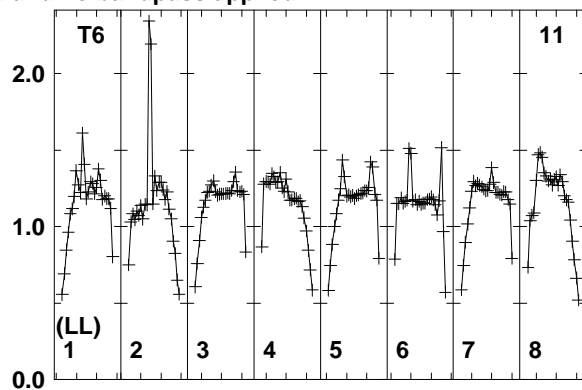
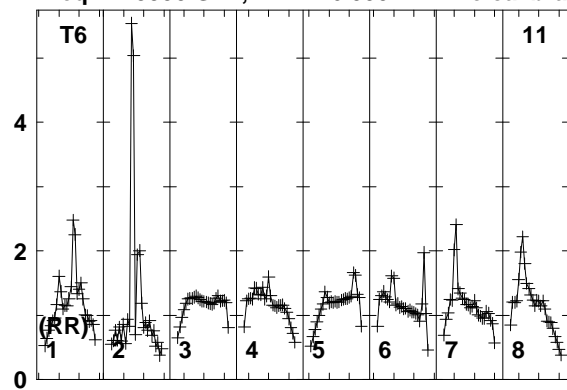

Lower frame: Real Jy
Total-power spectrum Antenna: T6 (11)
Timerange: 00/02:10:33 to 00/02:14:00

Plot file version 139 created 19-AUG-2016 17:19:34

J1642+2523 EM119D.UVDATA.1

Freq = 1.5950 GHz, Bw = 16.000 MH No calibration applied and no bandpass applied

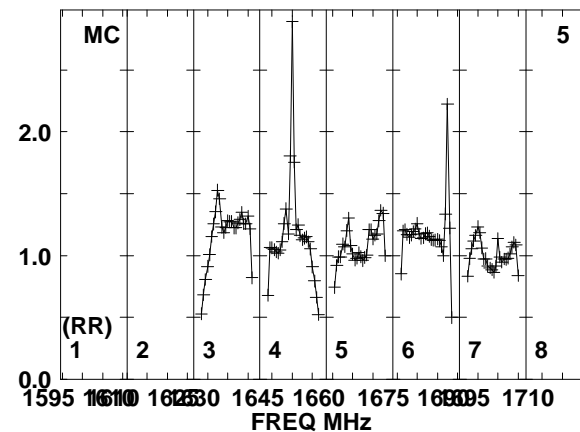
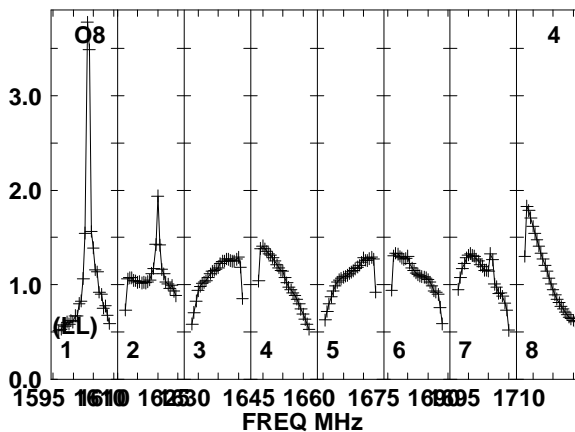
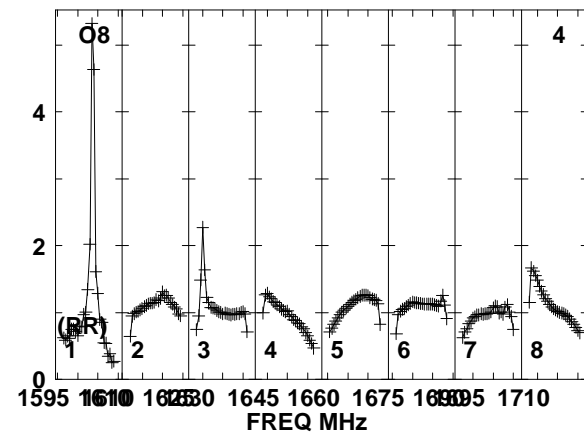
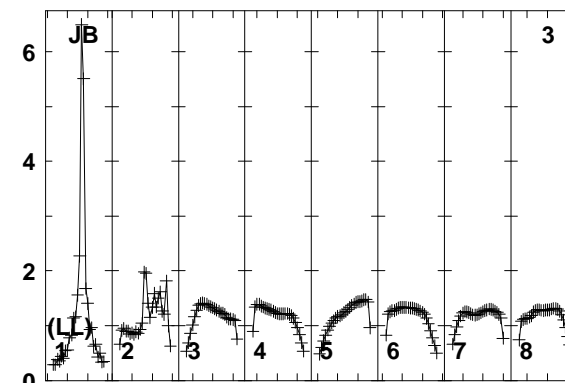
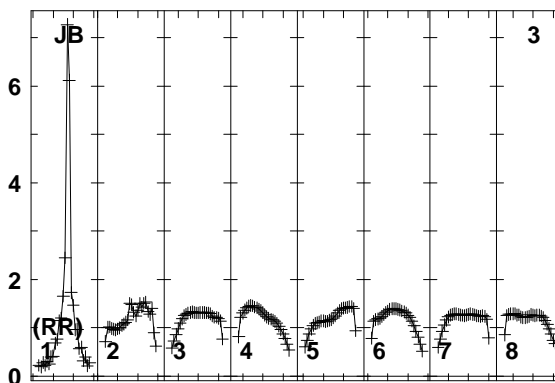
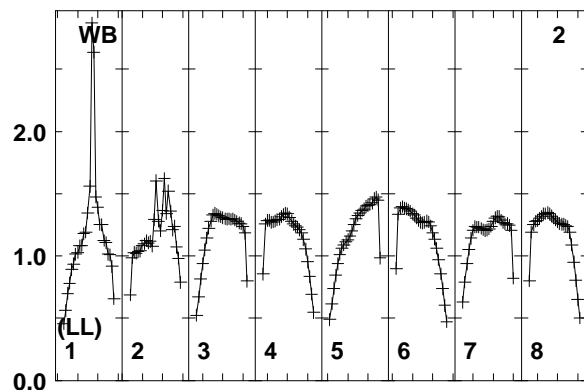
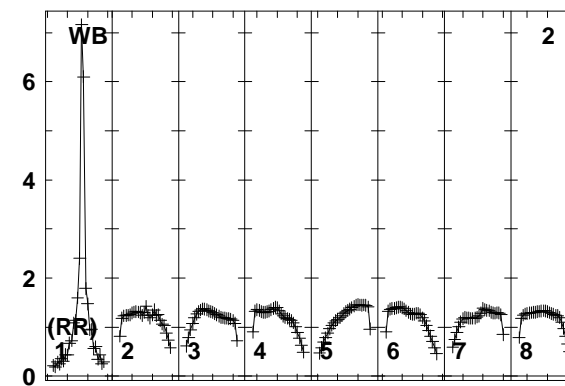
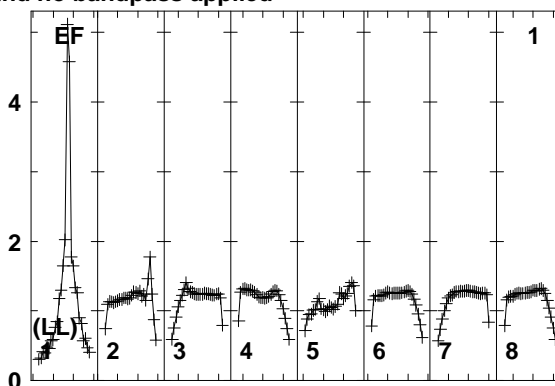
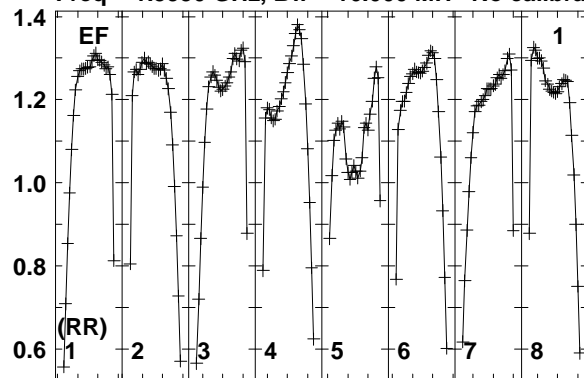

Lower frame: Real Jy
Total-power spectrum Antenna: EF (01)
Timerange: 00/02:15:01 to 00/02:16:29

Plot file version 140 created 19-AUG-2016 17:19:34

J1642+2523 EM119D.UVDATA.1

Freq = 1.5950 GHz, Bw = 16.000 MH No calibration applied and no bandpass applied

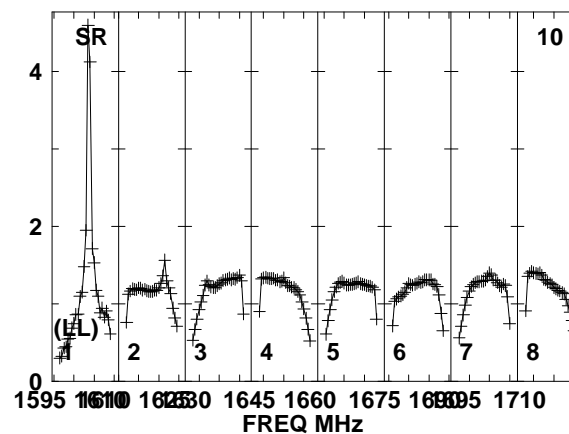
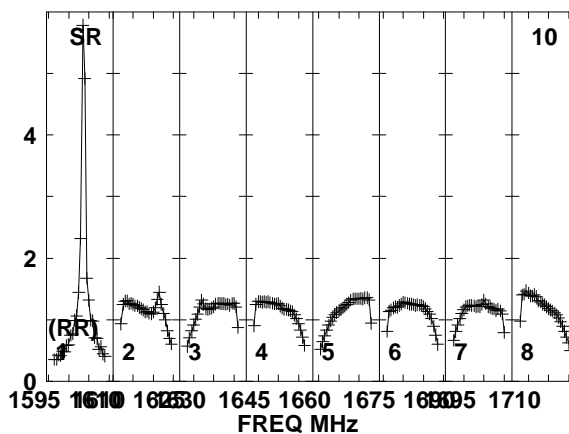
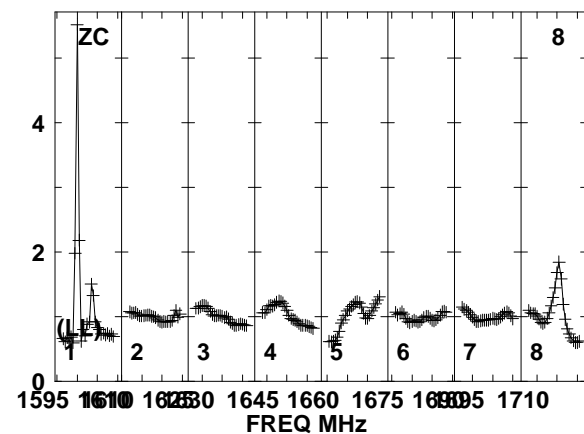
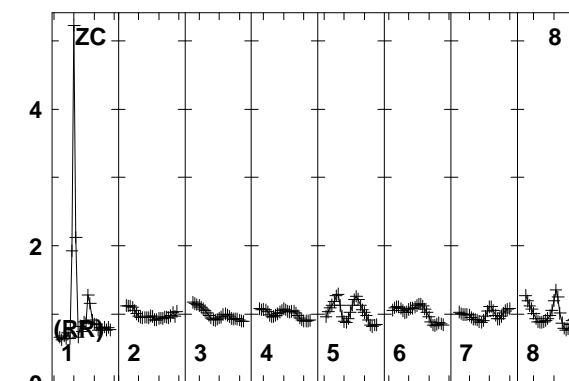
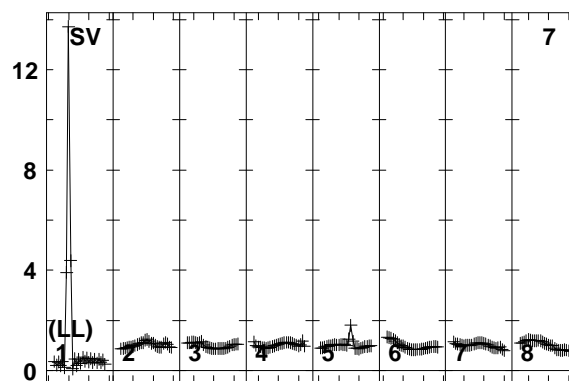
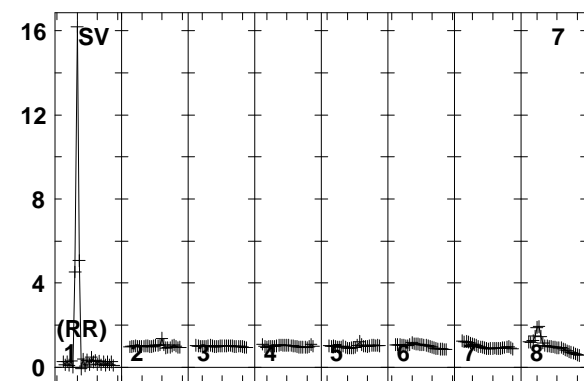
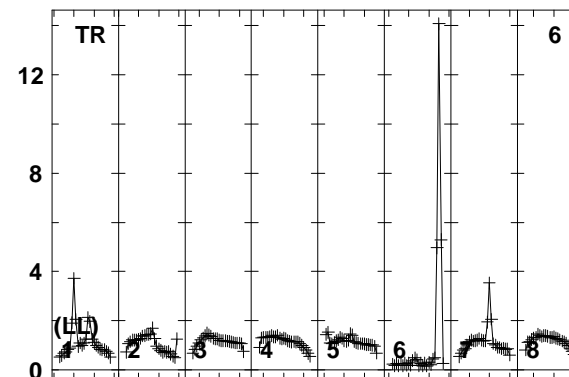
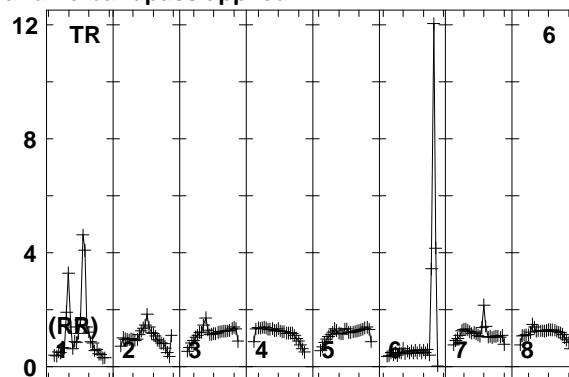
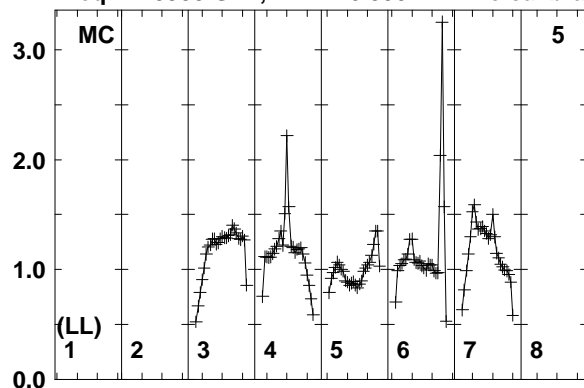

Lower frame: Real Jy
Total-power spectrum Antenna: MC (05)
Timerange: 00/02:15:01 to 00/02:16:29

Plot file version 141 created 19-AUG-2016 17:19:34

J1642+2523 EM119D.UVDATA.1

Freq = 1.5950 GHz, Bw = 16.000 MH No calibration applied and no bandpass applied

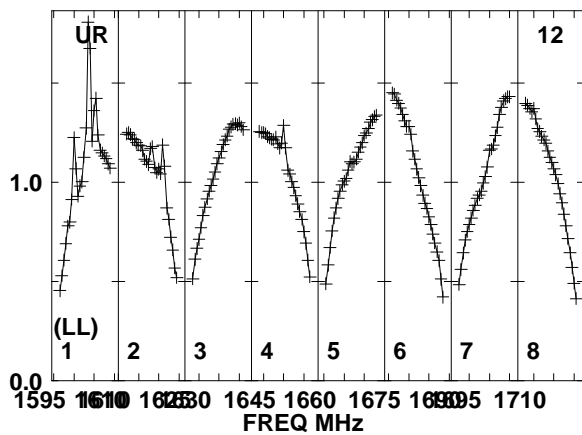
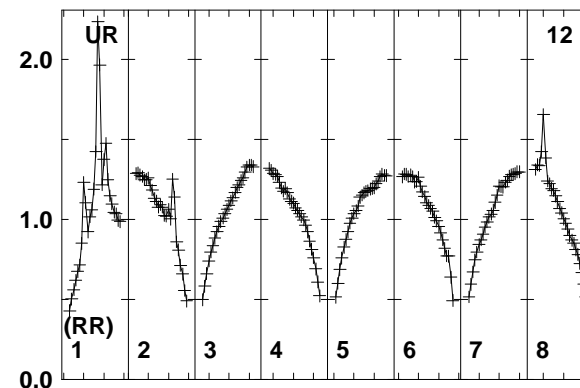
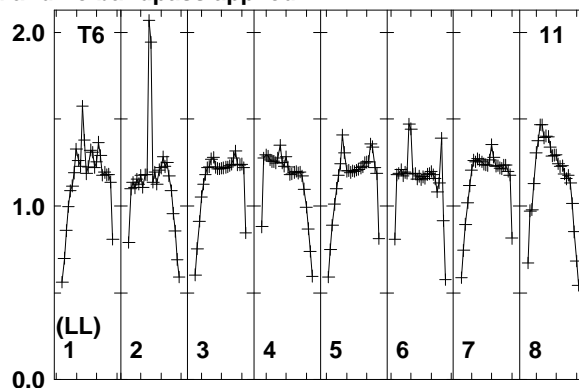
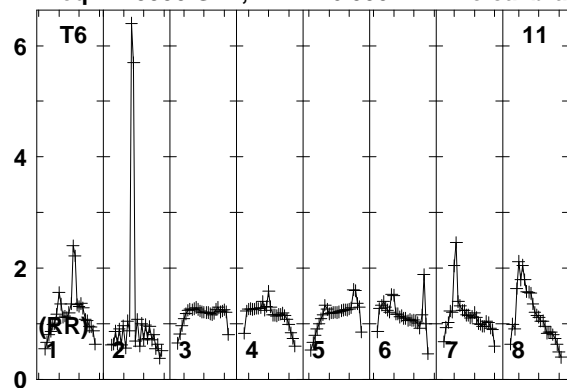

Lower frame: Real Jy
Total-power spectrum Antenna: T6 (11)
Timerange: 00/02:15:01 to 00/02:16:29

Plot file version 142 created 19-AUG-2016 17:19:34

J1649+2635 EM119D.UVDATA.1

Freq = 1.5950 GHz, Bw = 16.000 MH No calibration applied and no bandpass applied

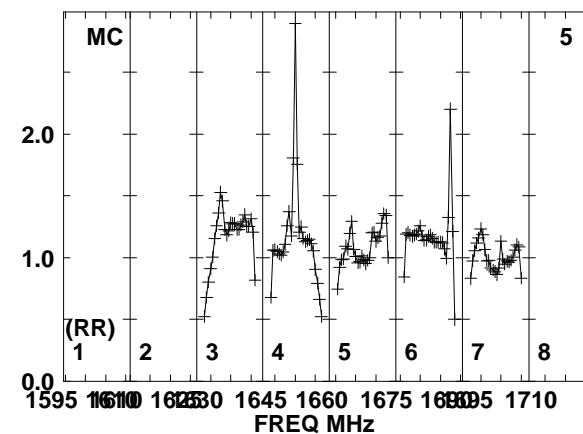
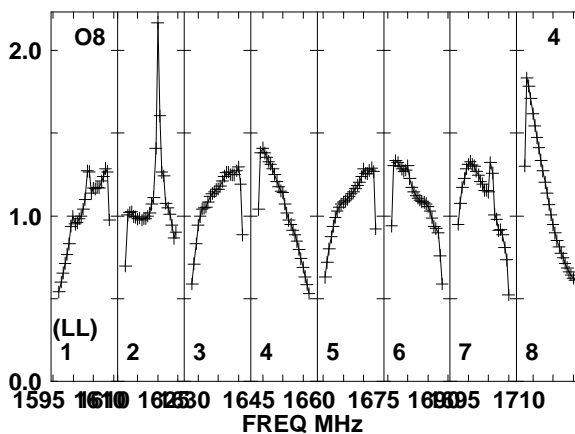
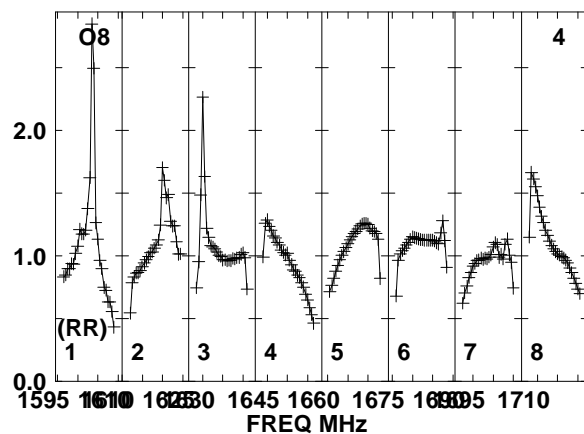
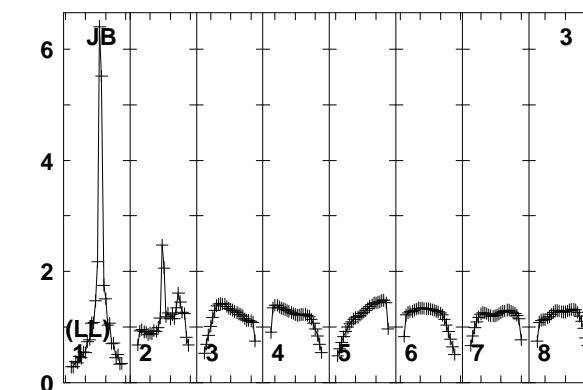
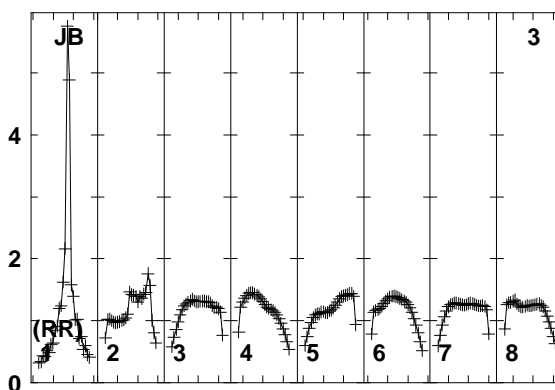
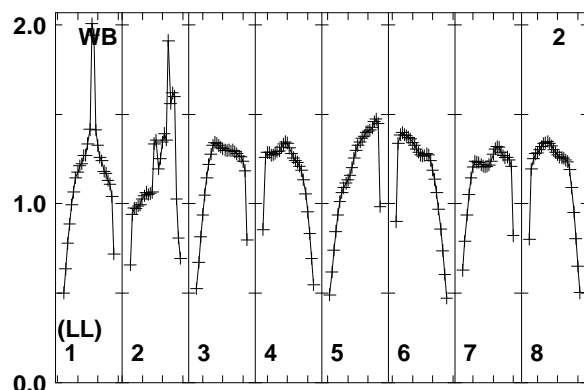
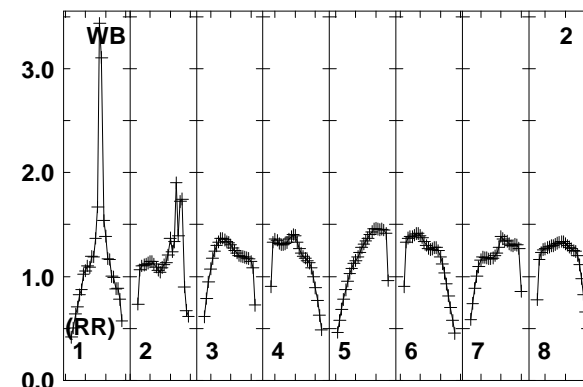
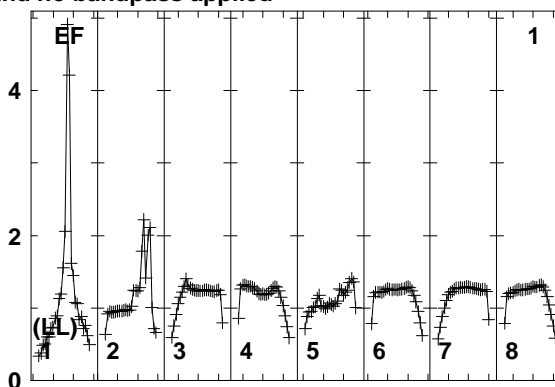
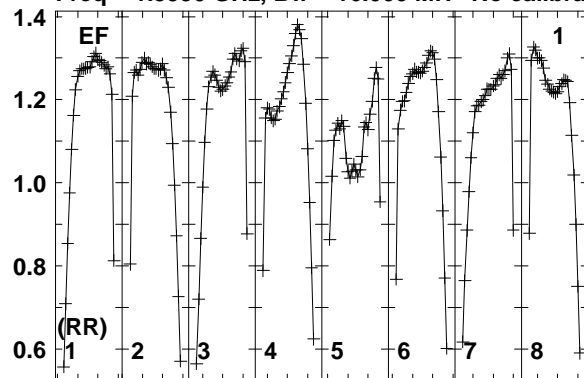

Lower frame: Real Jy
Total-power spectrum Antenna: EF (01)
Timerange: 00/02:16:38 to 00/02:20:00

Plot file version 143 created 19-AUG-2016 17:19:35

J1649+2635 EM119D.UVDATA.1

Freq = 1.5950 GHz, Bw = 16.000 MH No calibration applied and no bandpass applied

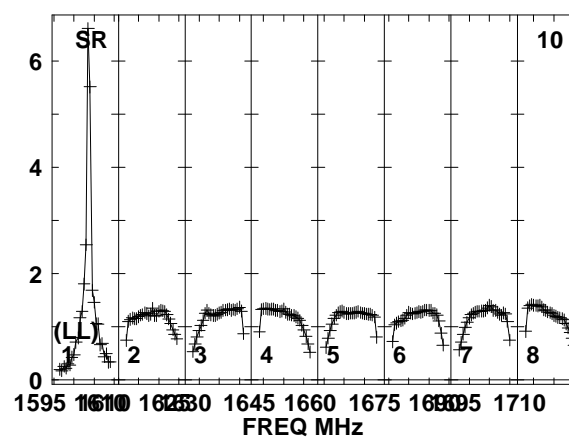
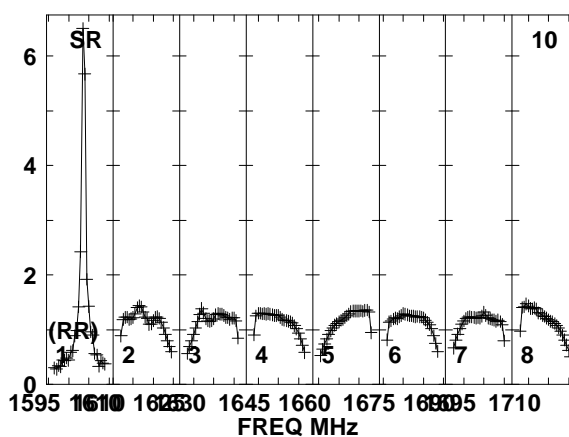
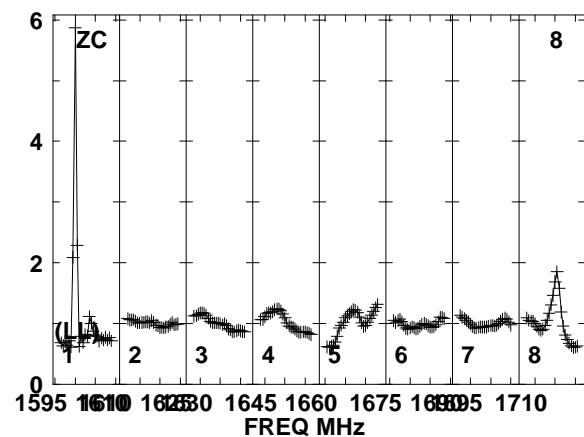
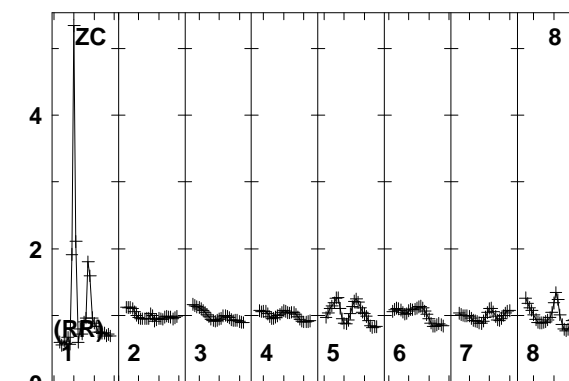
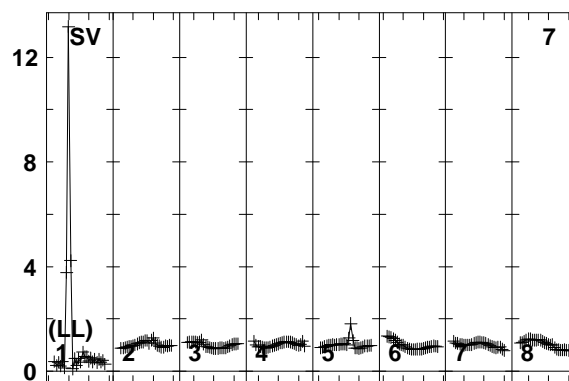
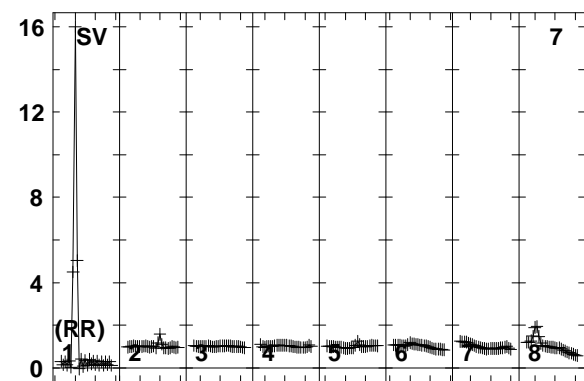
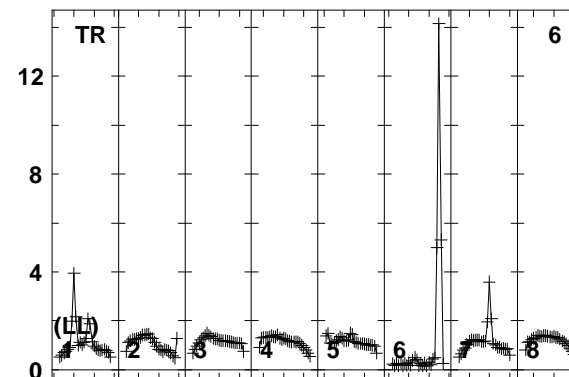
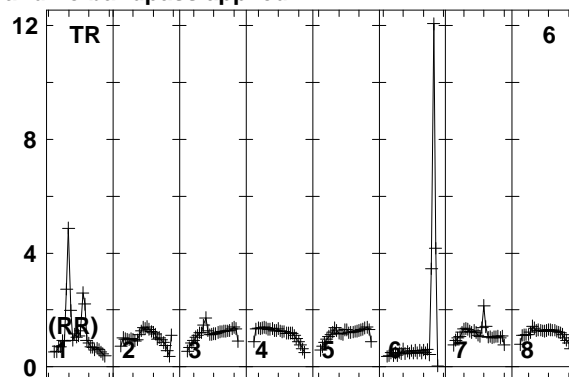
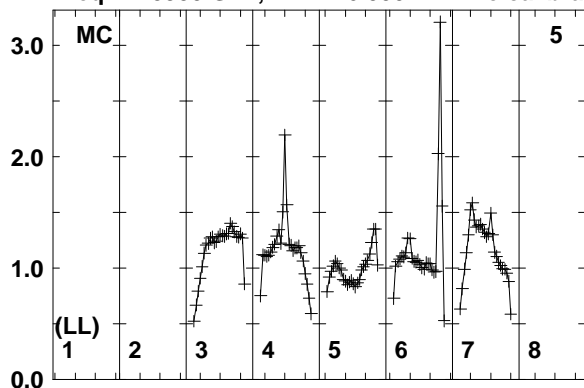

Lower frame: Real Jy
Total-power spectrum Antenna: MC (05)
Timerange: 00/02:16:38 to 00/02:20:00

Plot file version 144 created 19-AUG-2016 17:19:35

J1649+2635 EM119D.UVDATA.1

Freq = 1.5950 GHz, Bw = 16.000 MH No calibration applied and no bandpass applied

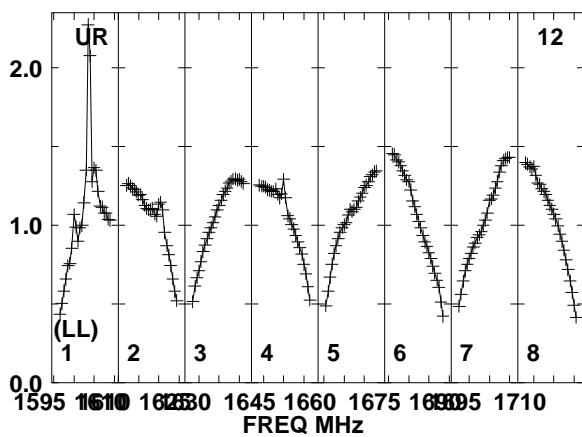
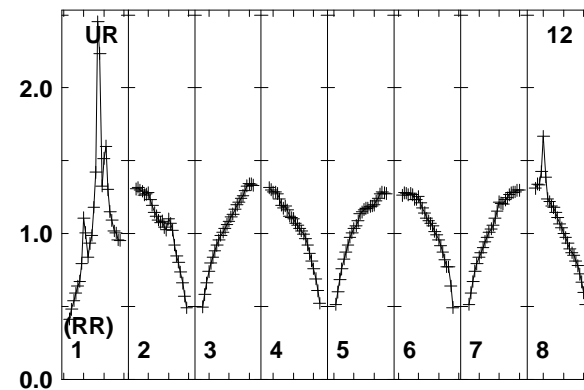
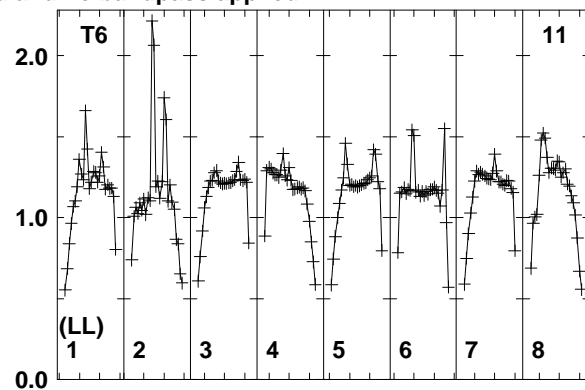
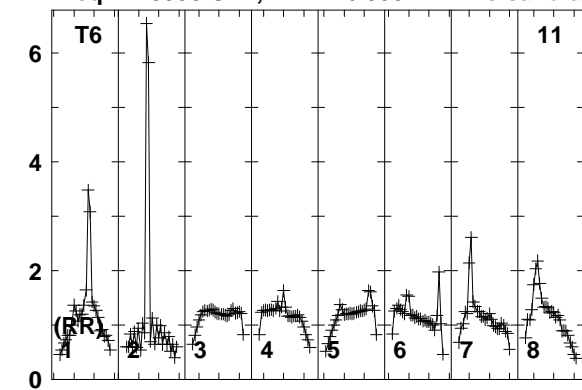

Lower frame: Real Jy
Total-power spectrum Antenna: T6 (11)
Timerange: 00/02:16:38 to 00/02:20:00

Plot file version 145 created 19-AUG-2016 17:19:35

J1642+2523 EM119D.UVDATA.1

Freq = 1.5950 GHz, Bw = 16.000 MH No calibration applied and no bandpass applied

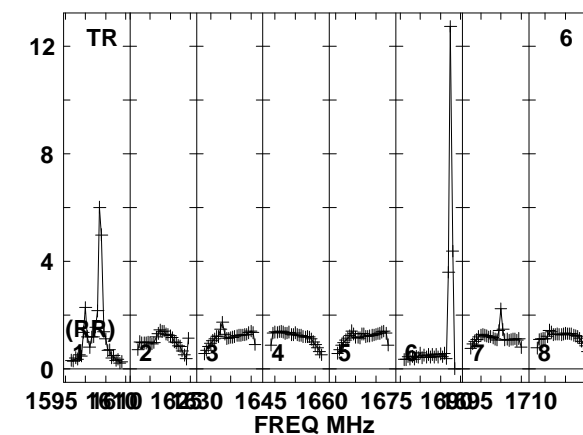
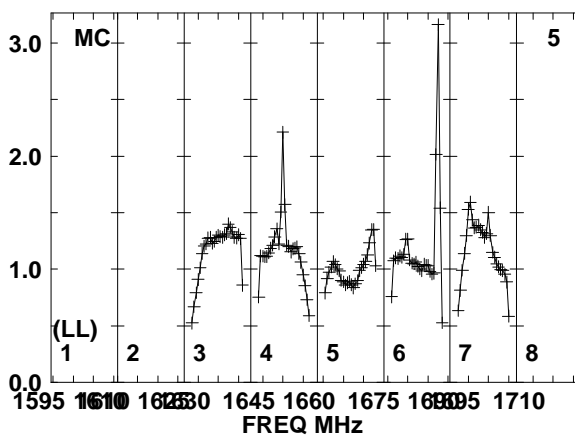
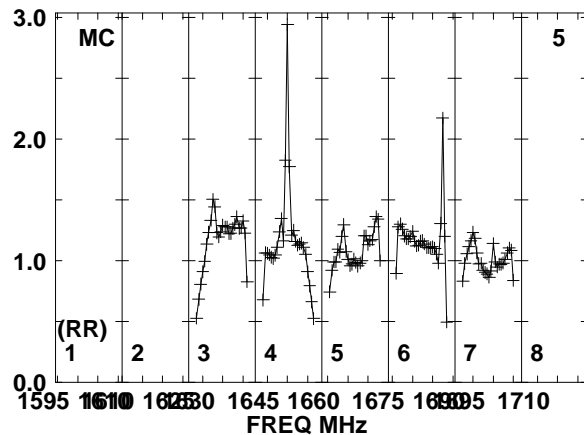
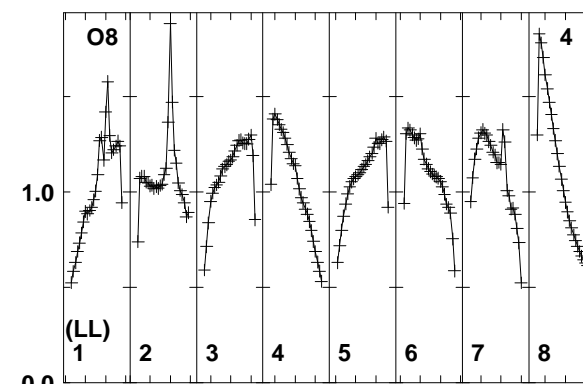
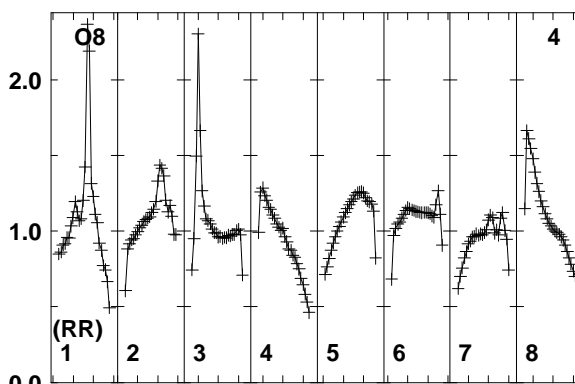
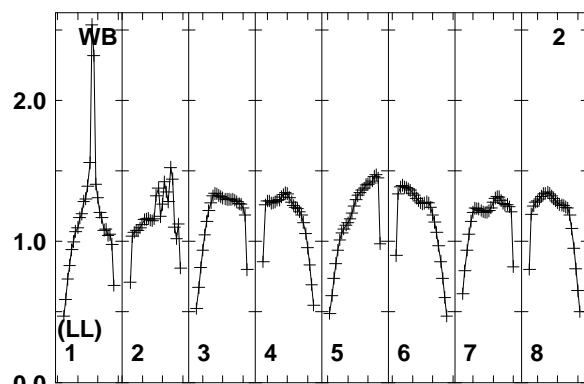
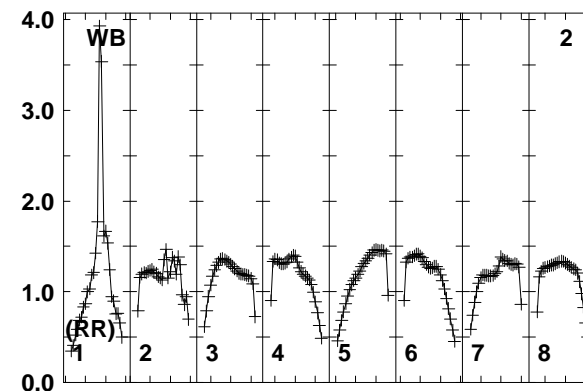
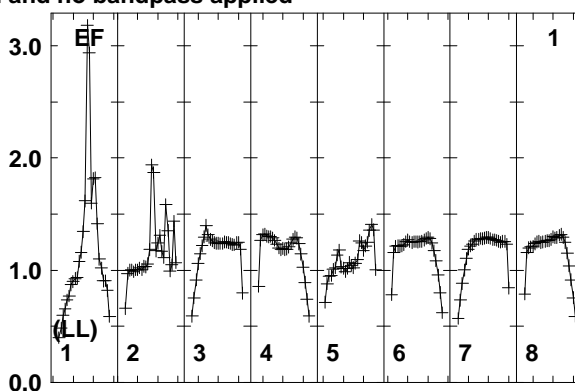
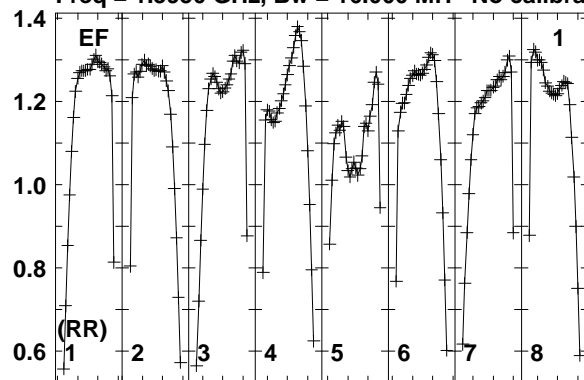

Lower frame: Real Jy
Total-power spectrum Antenna: EF (01)
Timerange: 00/02:20:08 to 00/02:21:29

Plot file version 146 created 19-AUG-2016 17:19:35

J1642+2523 EM119D.UVDATA.1

Freq = 1.5950 GHz, Bw = 16.000 MH No calibration applied and no bandpass applied

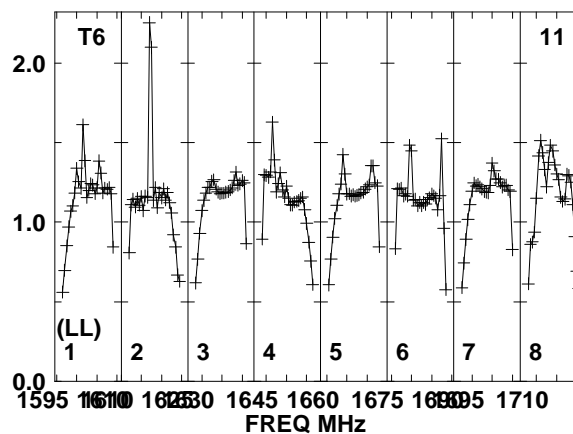
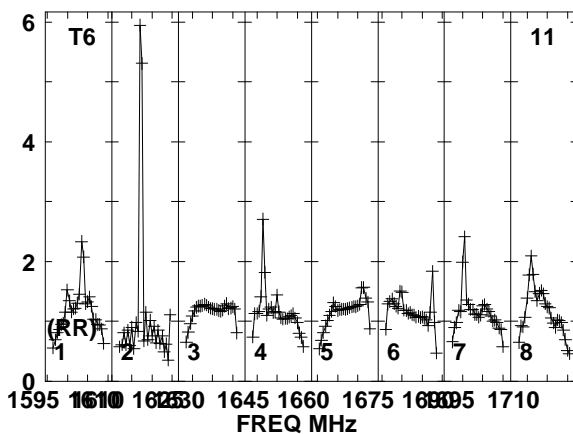
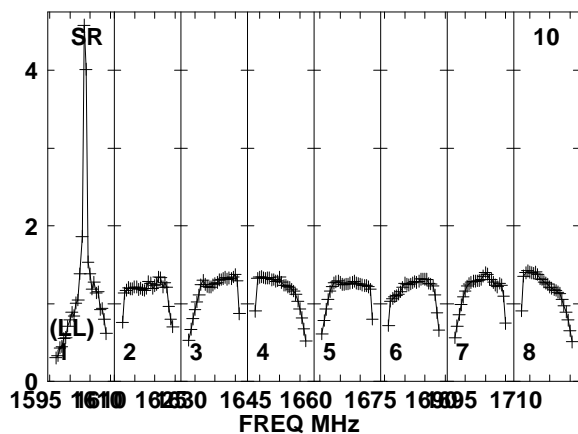
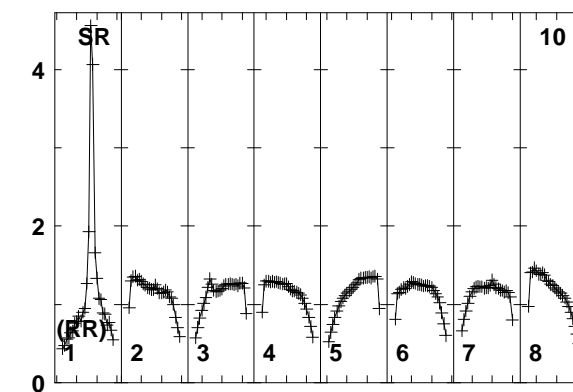
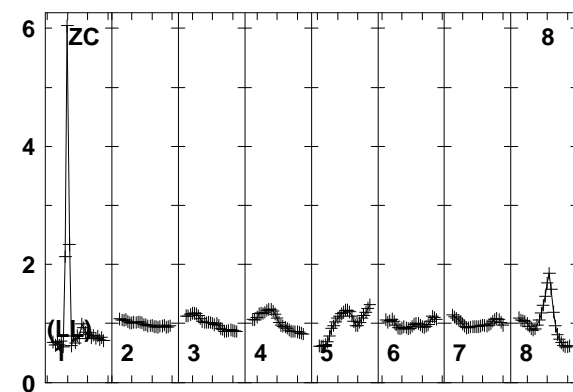
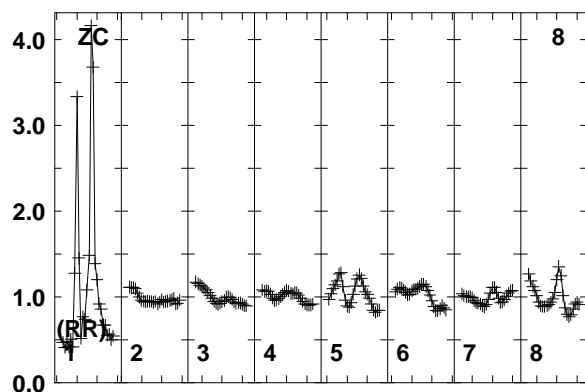
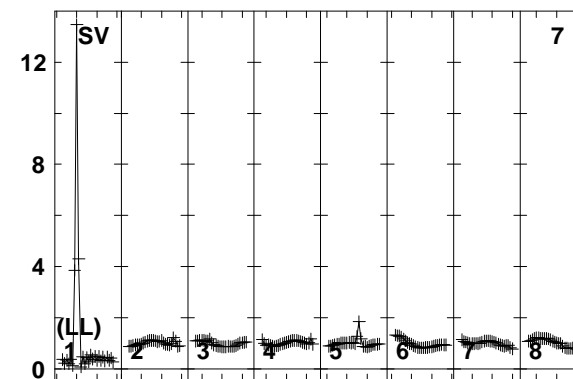
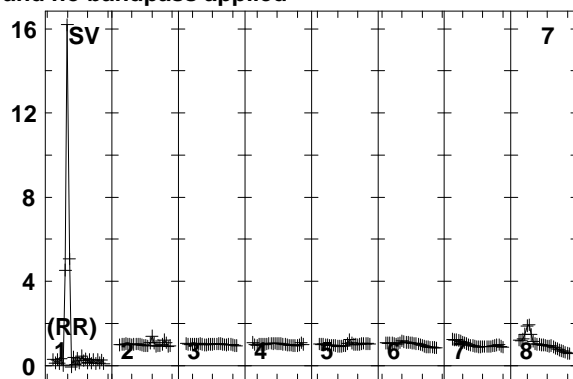
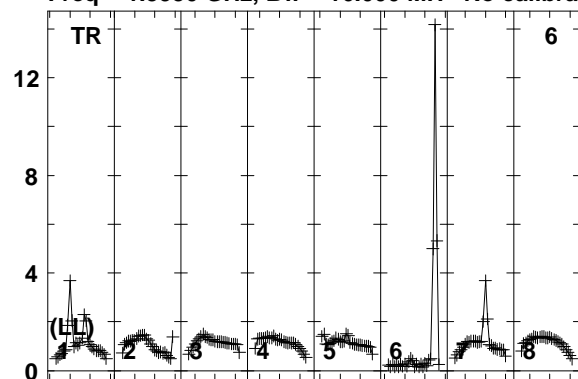

Lower frame: Real Jy
Total-power spectrum Antenna: TR (06)
Timerange: 00/02:20:08 to 00/02:21:29

Plot file version 147 created 19-AUG-2016 17:19:35

J1642+2523 EM119D.UVDATA.1

Freq = 1.5950 GHz, Bw = 16.000 MH No calibration applied and no bandpass applied

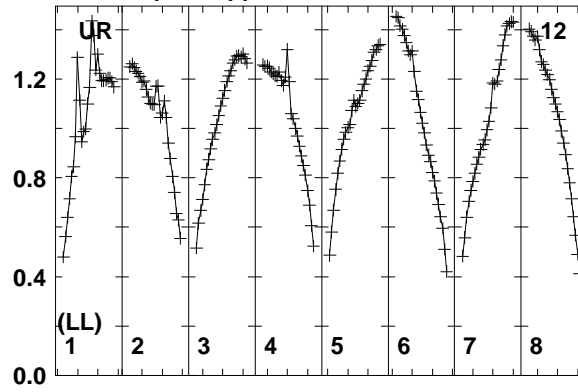
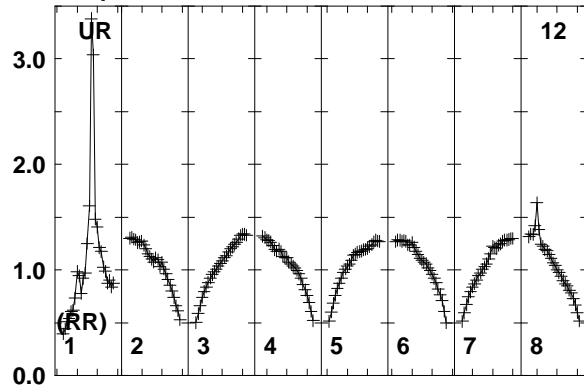

Lower frame: Real Jy
Total-power spectrum Antenna: UR (12)
Timerange: 00/02:20:08 to 00/02:21:29

Plot file version 148 created 19-AUG-2016 17:19:35

J1649+2635 EM119D.UVDATA.1

Freq = 1.5950 GHz, Bw = 16.000 MH No calibration applied and no bandpass applied

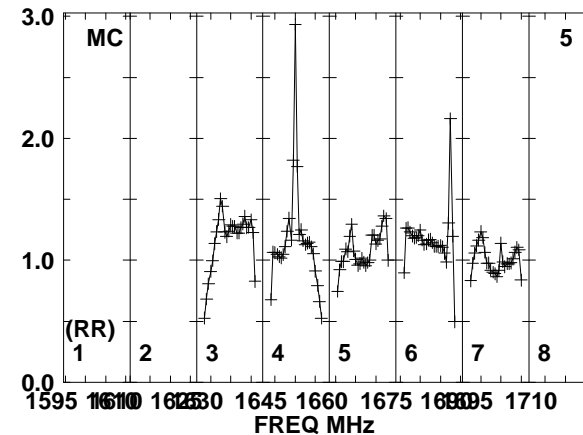
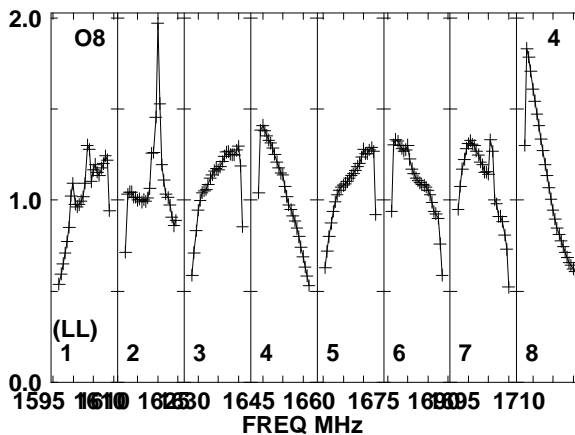
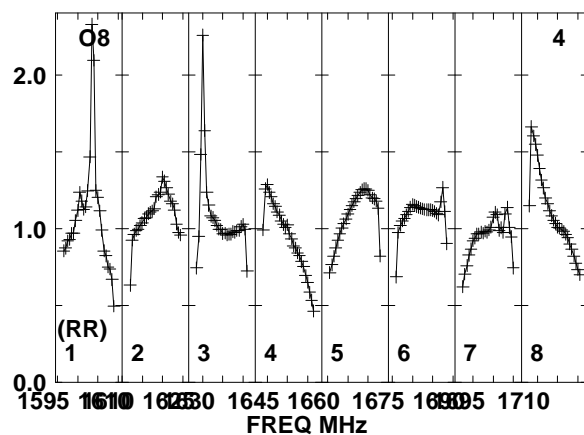
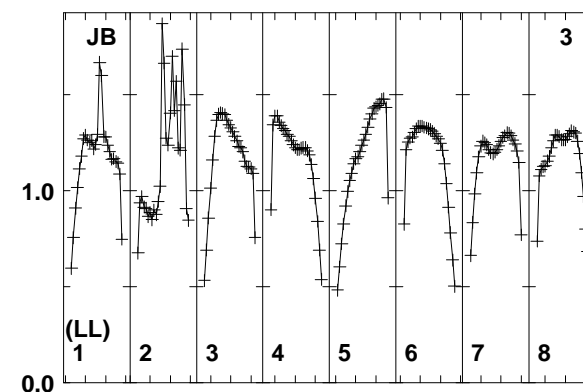
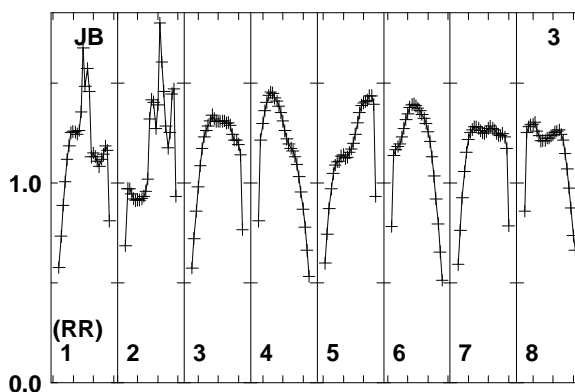
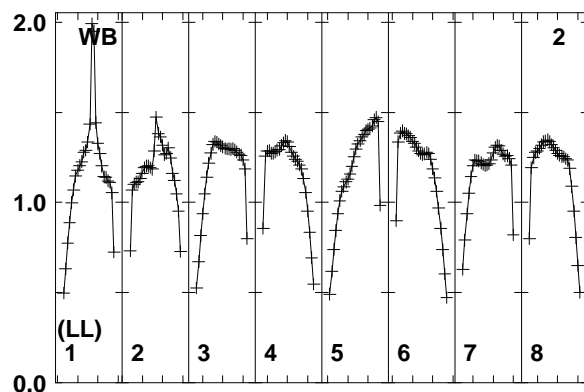
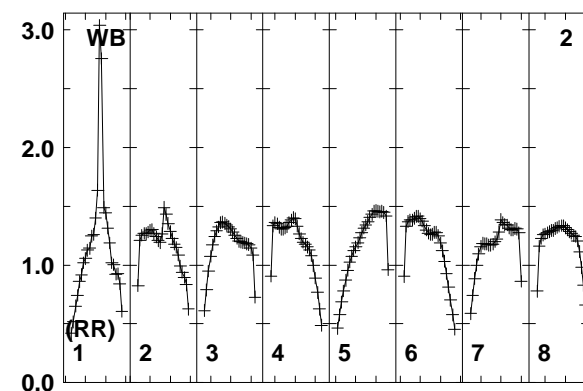
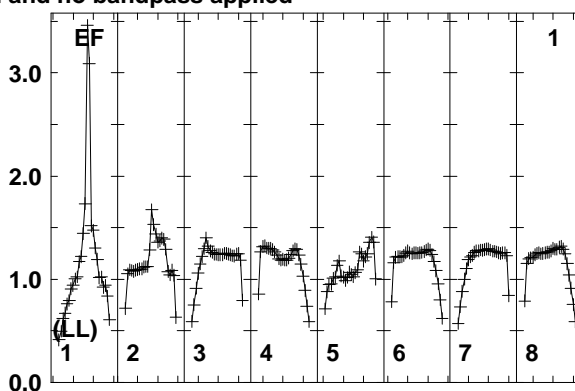
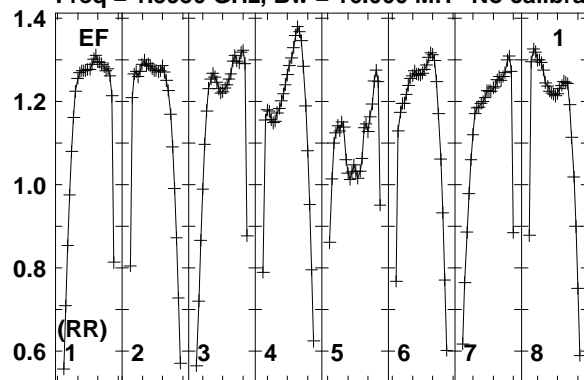

Lower frame: Real Jy
Total-power spectrum Antenna: EF (01)
Timerange: 00/02:21:33 to 00/02:25:00

Plot file version 149 created 19-AUG-2016 17:19:36

J1649+2635 EM119D.UVDATA.1

Freq = 1.5950 GHz, Bw = 16.000 MH No calibration applied and no bandpass applied

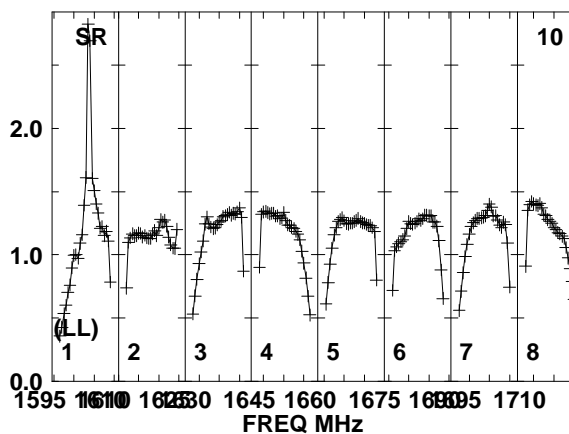
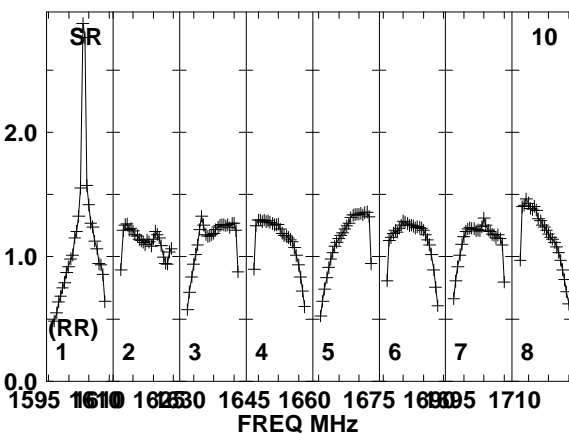
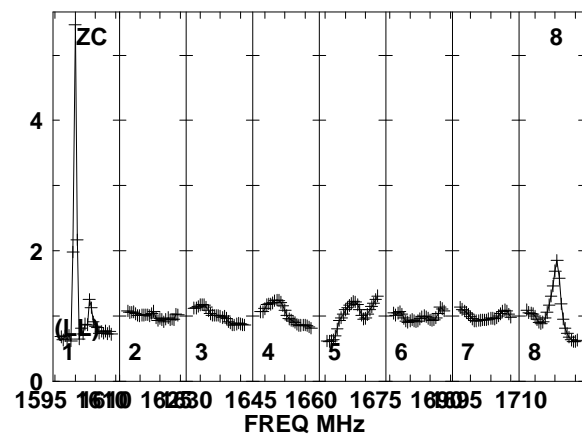
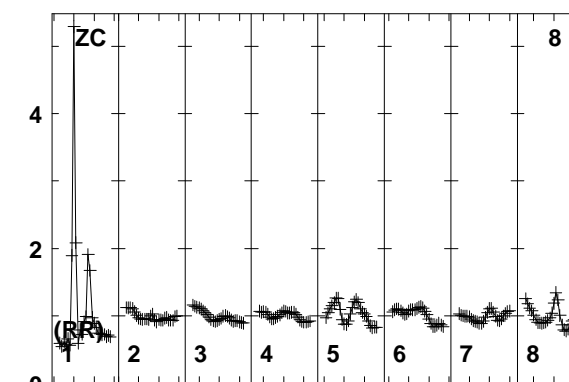
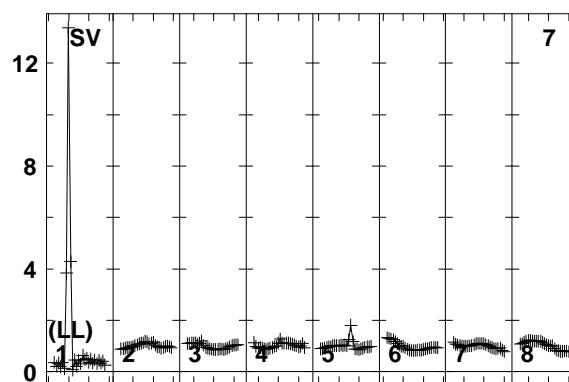
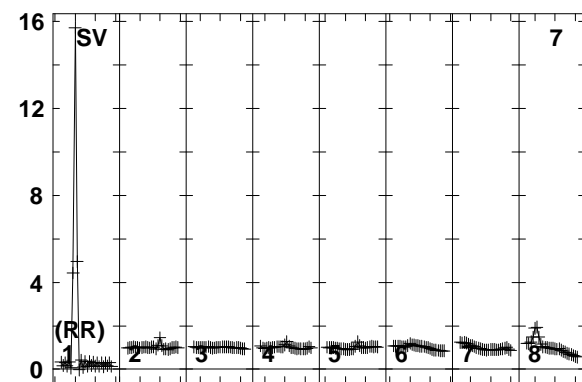
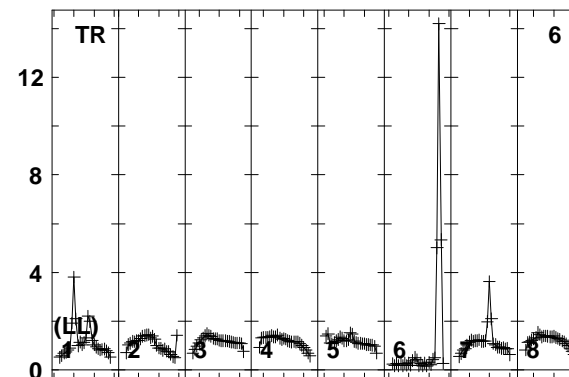
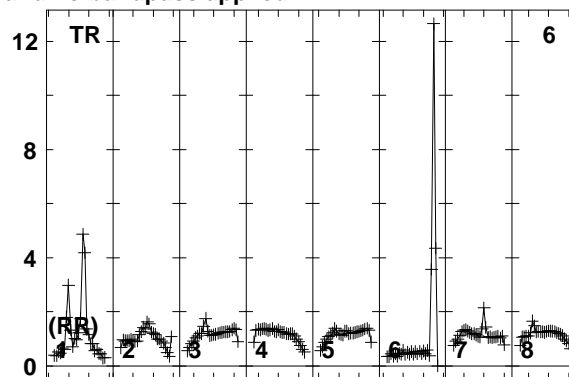
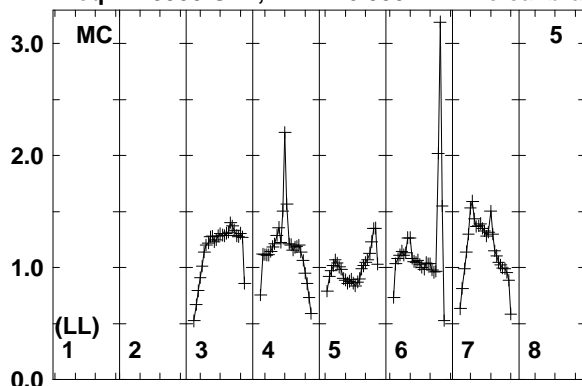

Lower frame: Real Jy
Total-power spectrum Antenna: MC (05)
Timerange: 00/02:21:33 to 00/02:25:00

Plot file version 150 created 19-AUG-2016 17:19:36

J1649+2635 EM119D.UVDATA.1

Freq = 1.5950 GHz, Bw = 16.000 MH No calibration applied and no bandpass applied

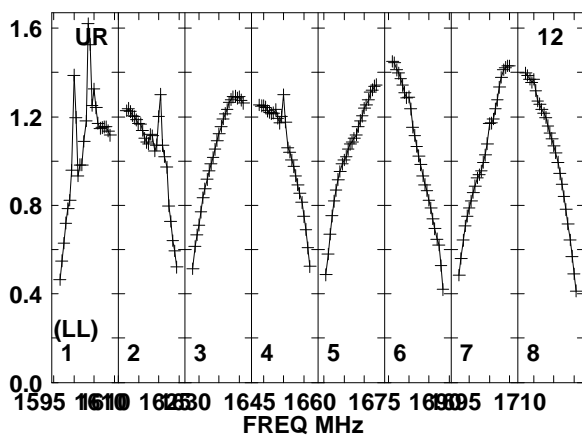
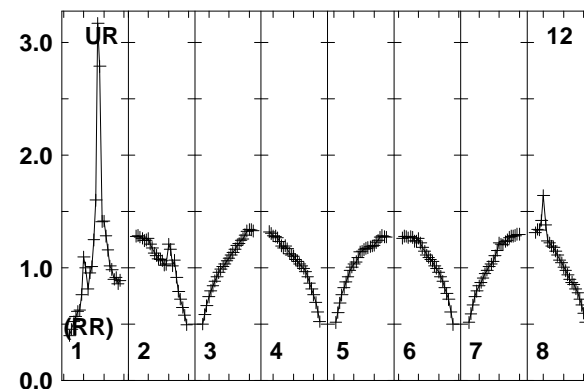
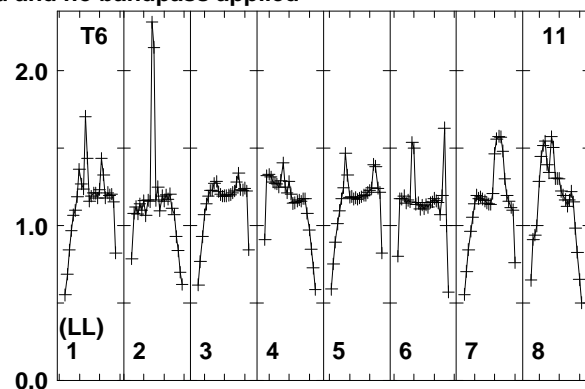
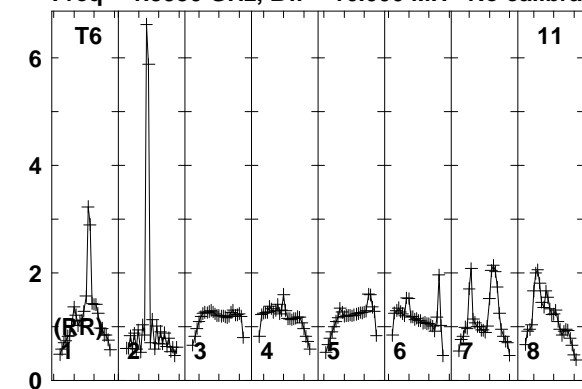

Lower frame: Real Jy
Total-power spectrum Antenna: T6 (11)
Timerange: 00/02:21:33 to 00/02:25:00

Plot file version 151 created 19-AUG-2016 17:19:36

J1642+2523 EM119D.UVDATA.1

Freq = 1.5950 GHz, Bw = 16.000 MH No calibration applied and no bandpass applied

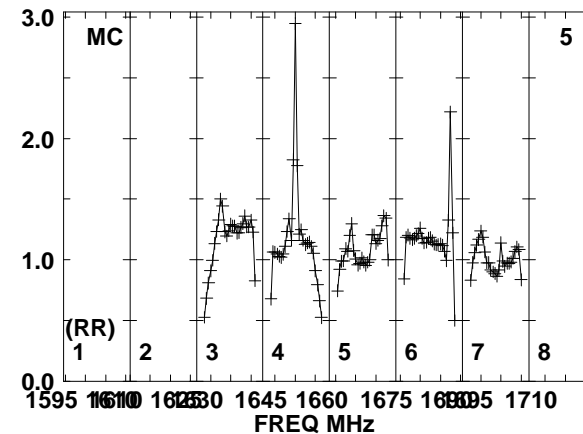
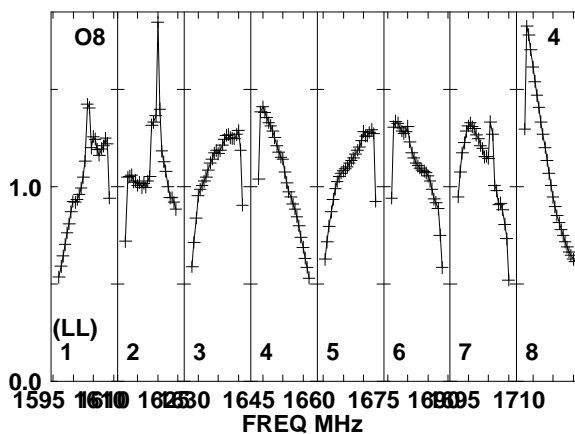
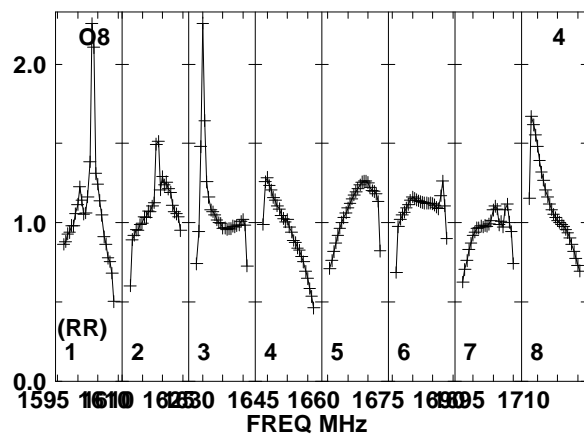
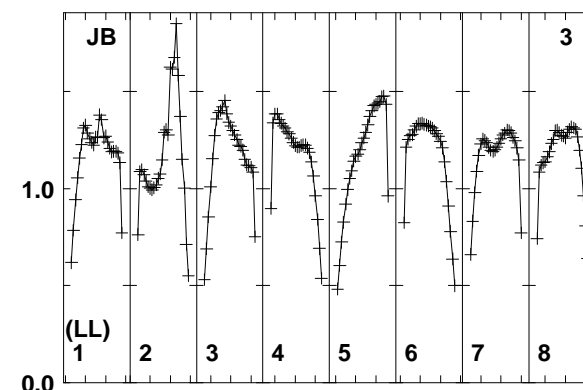
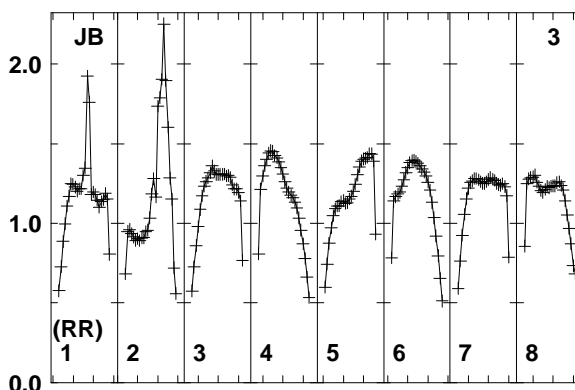
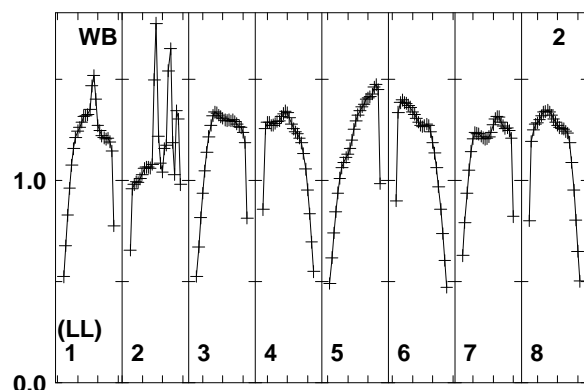
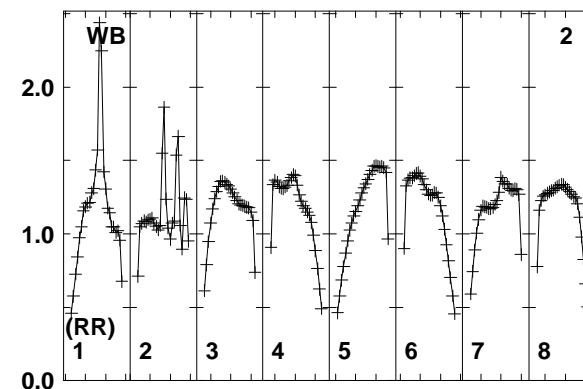
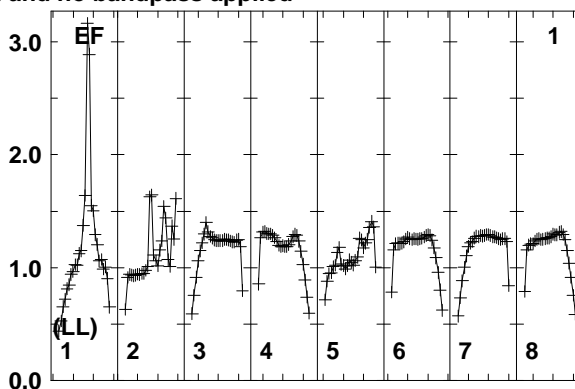
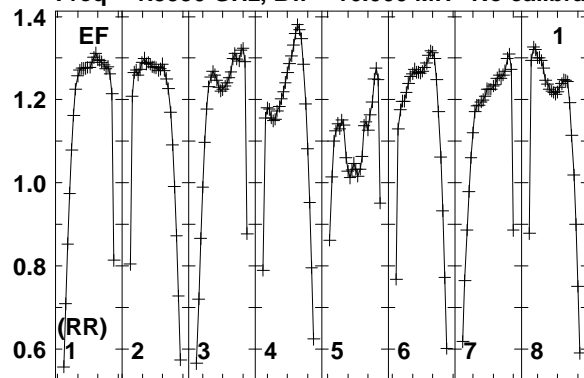

Lower frame: Real Jy
Total-power spectrum Antenna: EF (01)
Timerange: 00/02:26:01 to 00/02:27:30

Plot file version 152 created 19-AUG-2016 17:19:36

J1642+2523 EM119D.UVDATA.1

Freq = 1.5950 GHz, Bw = 16.000 MH No calibration applied and no bandpass applied

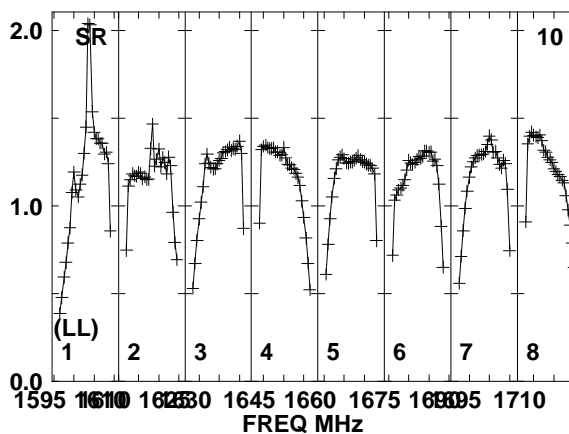
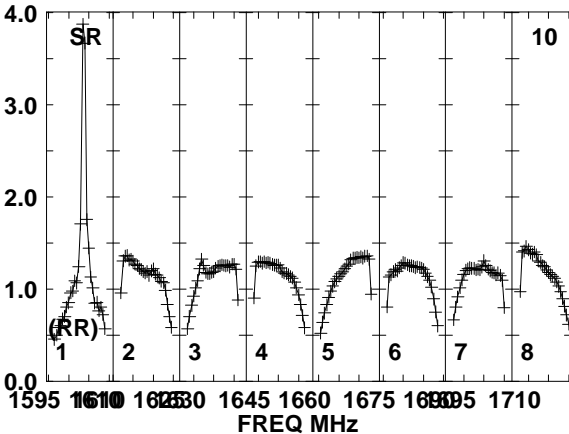
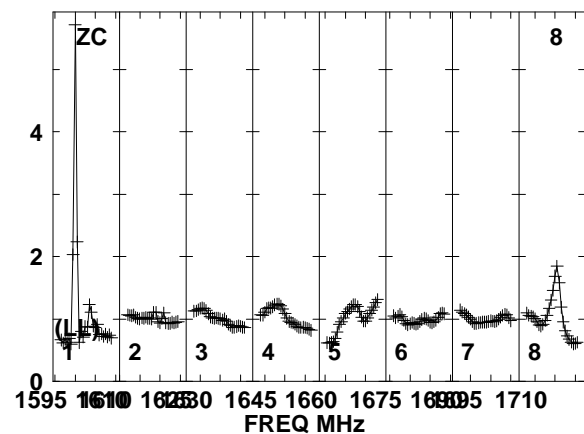
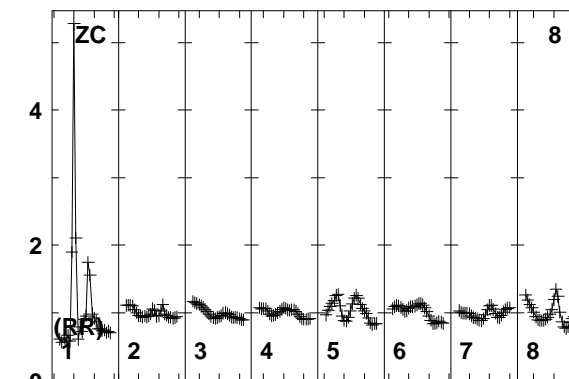
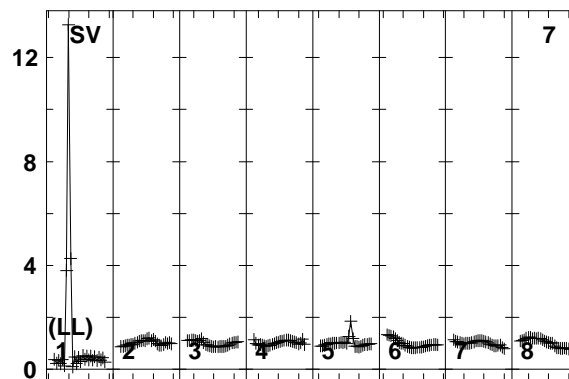
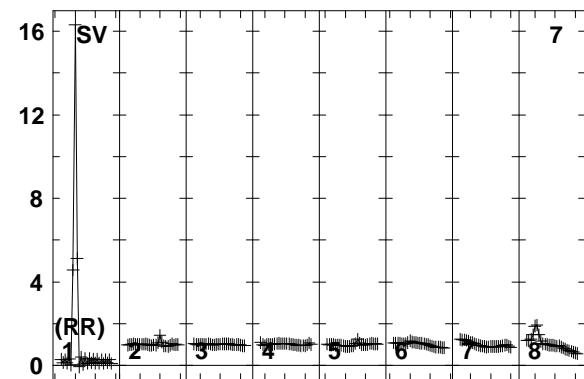
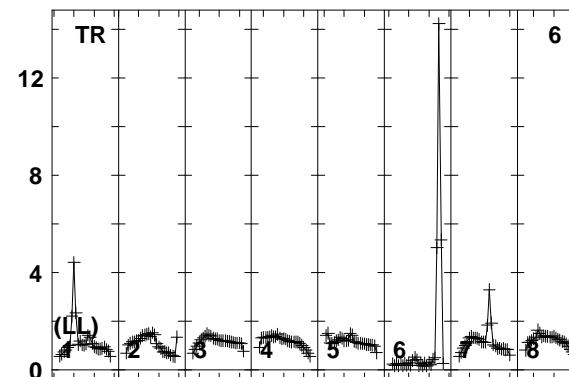
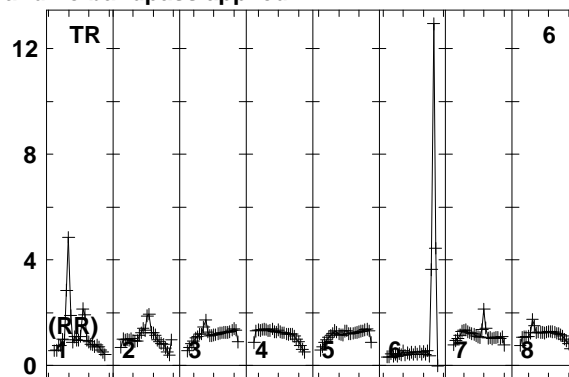
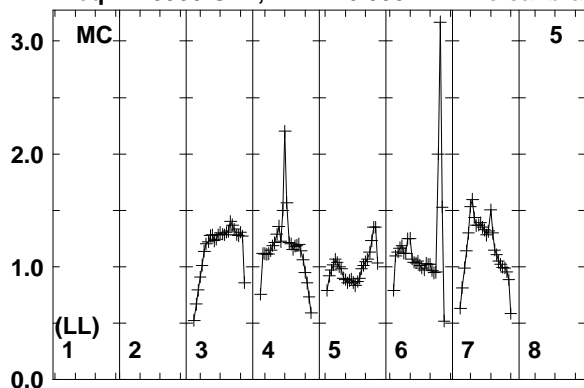

Lower frame: Real Jy
Total-power spectrum Antenna: MC (05)
Timerange: 00/02:26:01 to 00/02:27:30

Plot file version 153 created 19-AUG-2016 17:19:36

J1642+2523 EM119D.UVDATA.1

Freq = 1.5950 GHz, Bw = 16.000 MH No calibration applied and no bandpass applied

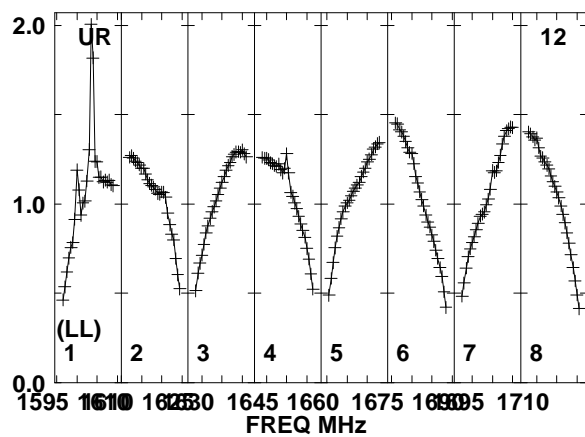
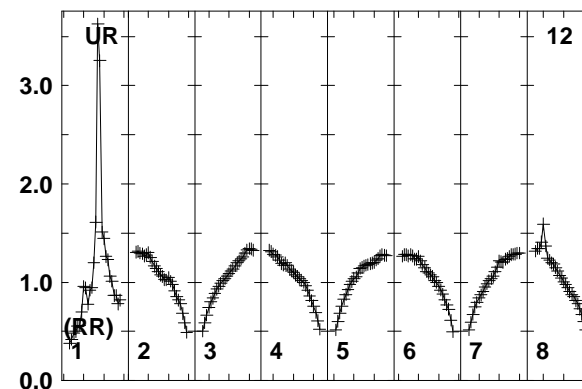
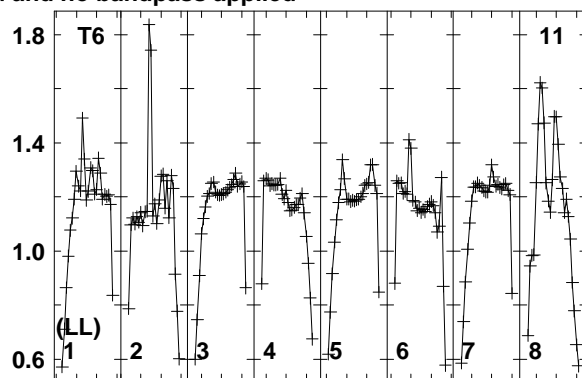
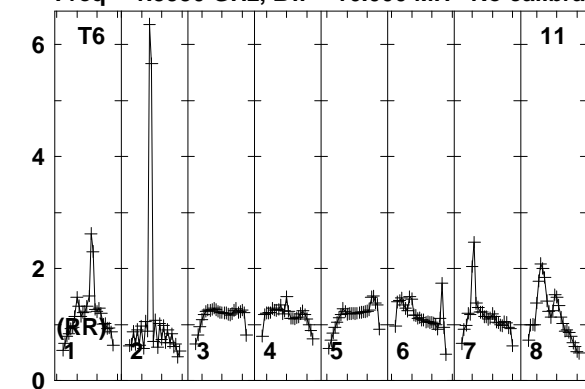

Lower frame: Real Jy
Total-power spectrum Antenna: T6 (11)
Timerange: 00/02:26:01 to 00/02:27:30

Plot file version 154 created 19-AUG-2016 17:19:36

J1649+2635 EM119D.UVDATA.1

Freq = 1.5950 GHz, Bw = 16.000 MH No calibration applied and no bandpass applied

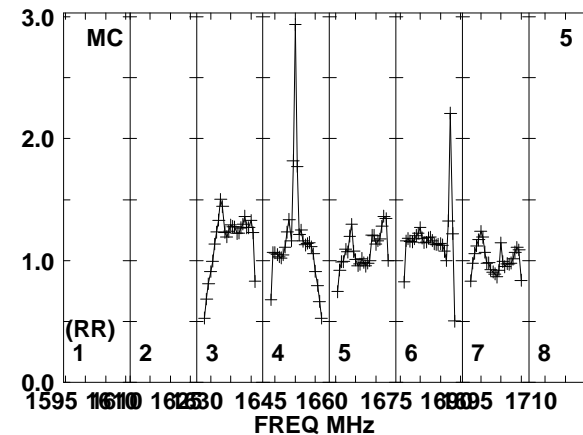
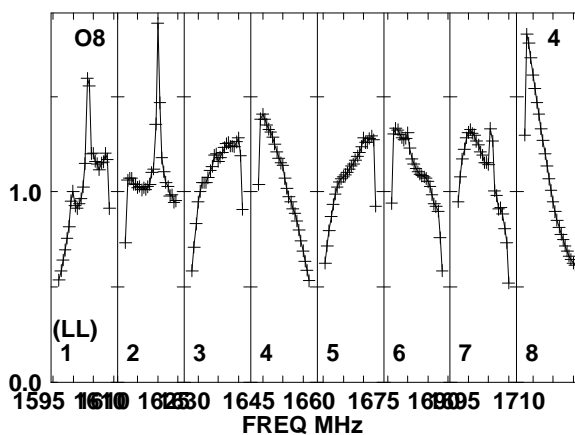
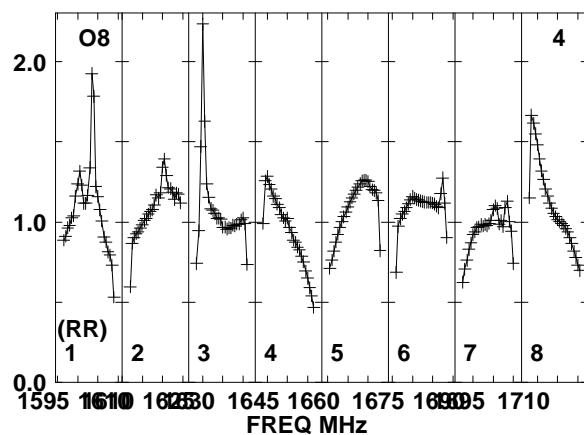
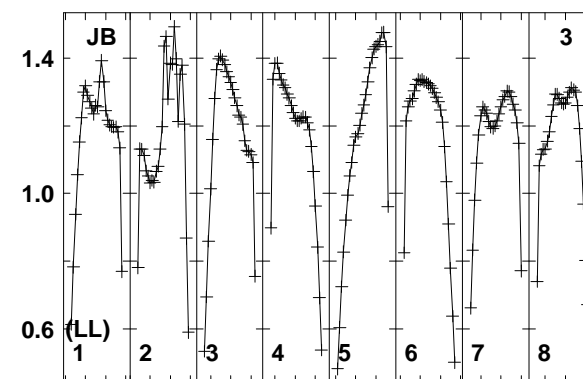
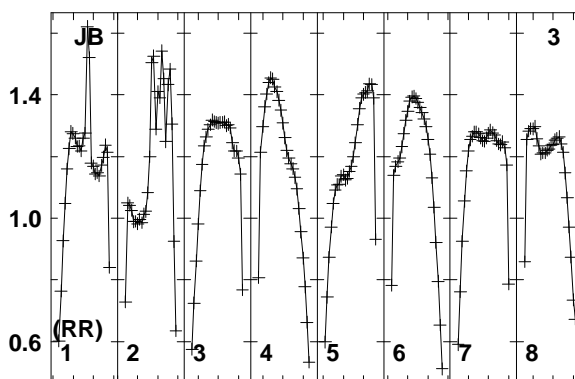
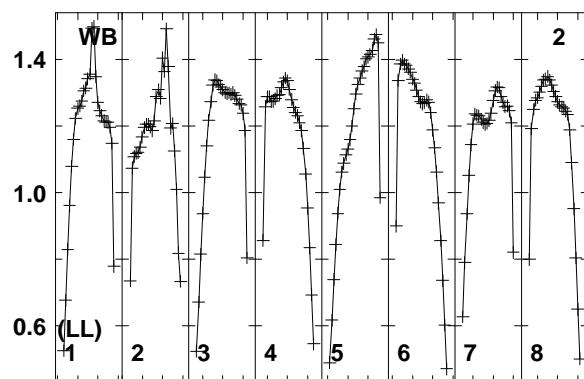
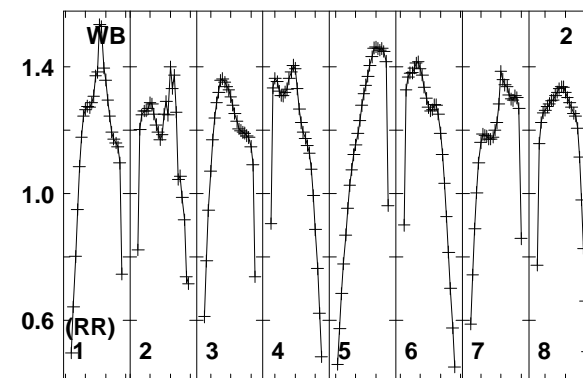
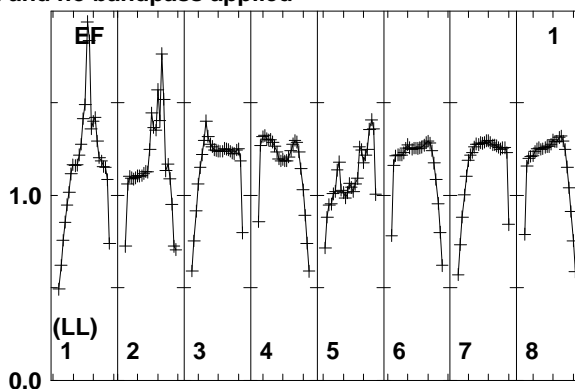
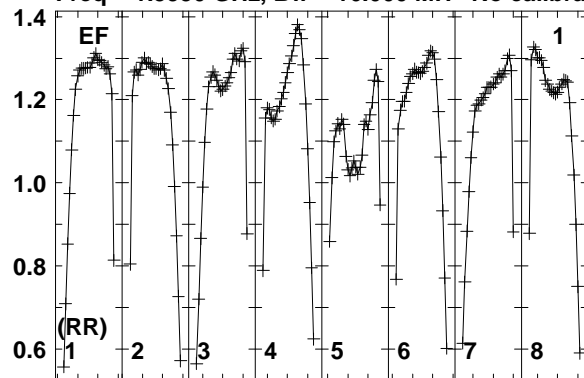

Lower frame: Real Jy
Total-power spectrum Antenna: EF (01)
Timerange: 00/02:27:37 to 00/02:30:59

Plot file version 155 created 19-AUG-2016 17:19:37

J1649+2635 EM119D.UVDATA.1

Freq = 1.5950 GHz, Bw = 16.000 MH No calibration applied and no bandpass applied

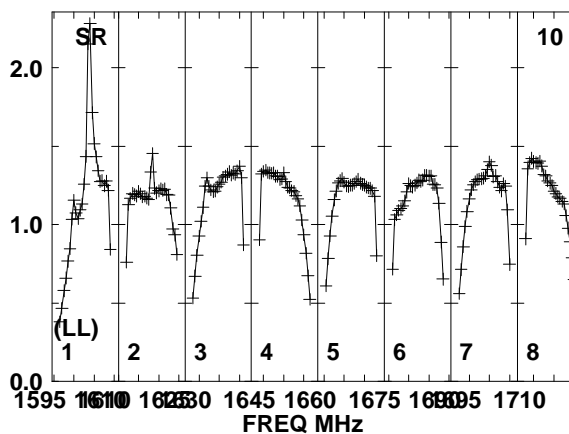
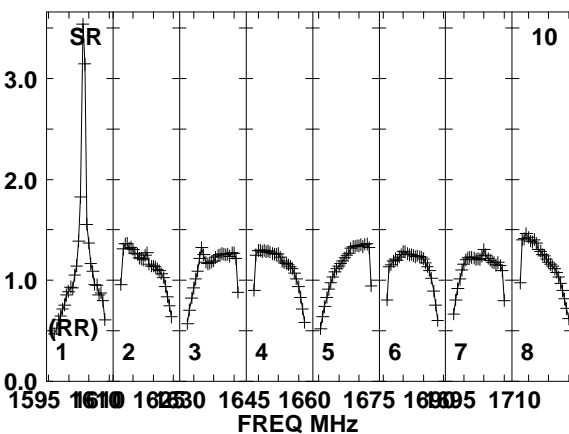
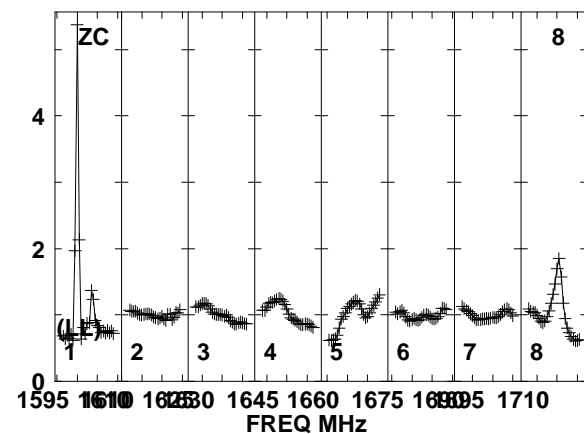
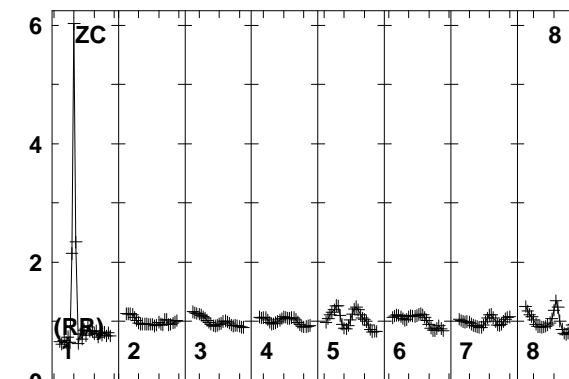
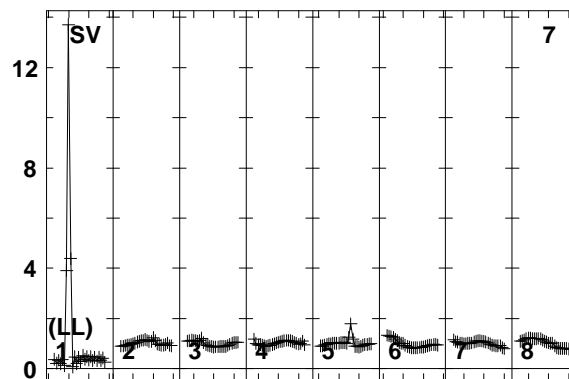
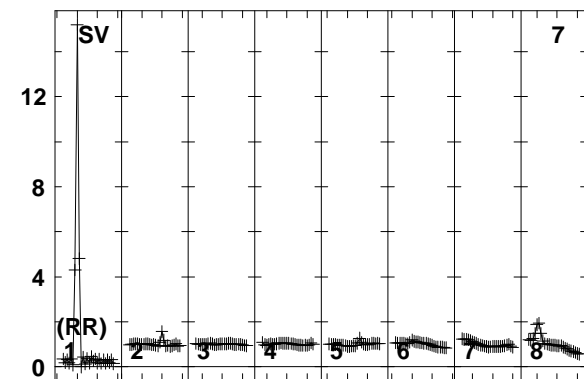
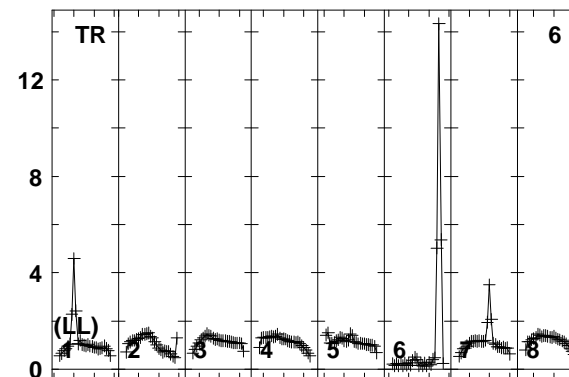
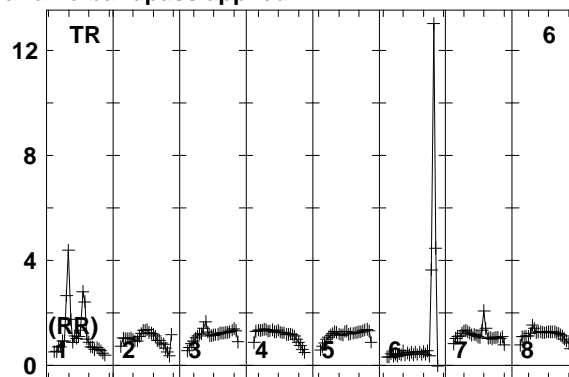
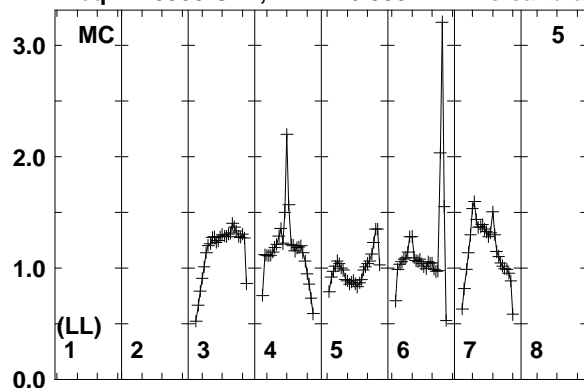

Lower frame: Real Jy
Total-power spectrum Antenna: MC (05)
Timerange: 00/02:27:37 to 00/02:30:59

Plot file version 156 created 19-AUG-2016 17:19:37

J1649+2635 EM119D.UVDATA.1

Freq = 1.5950 GHz, Bw = 16.000 MH No calibration applied and no bandpass applied

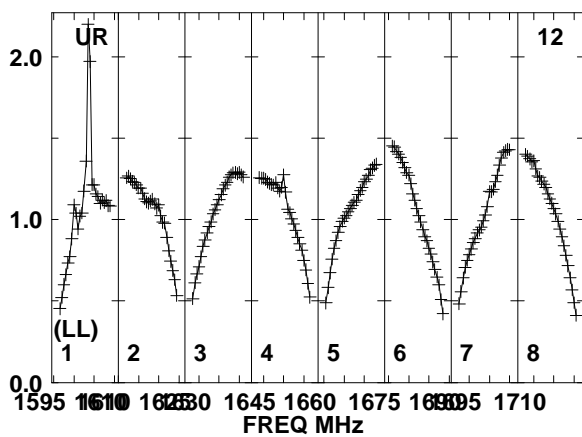
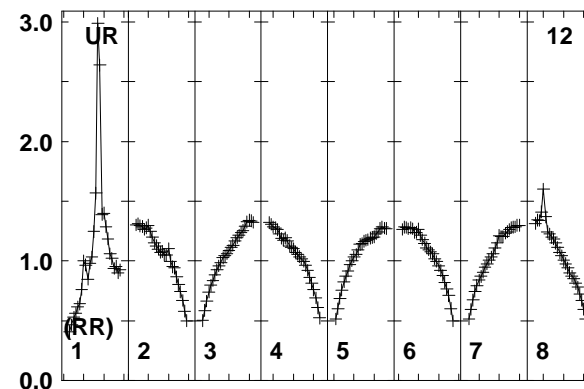
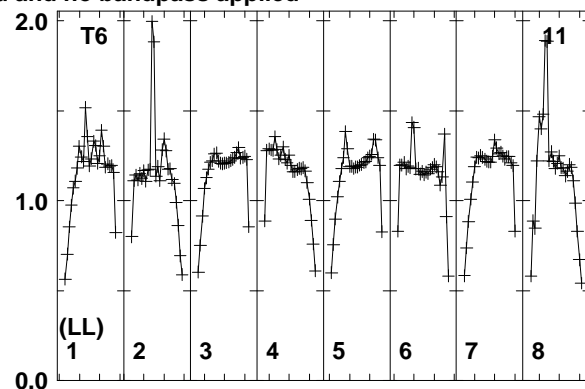
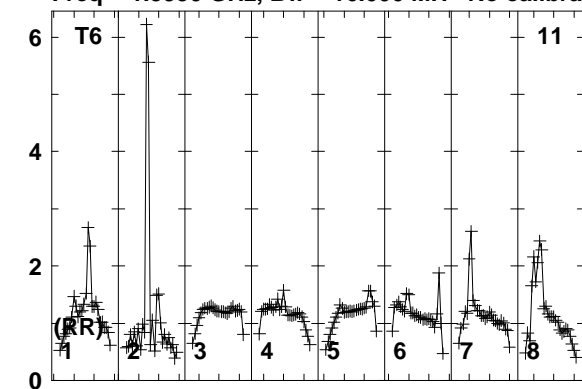

Lower frame: Real Jy
Total-power spectrum Antenna: T6 (11)
Timerange: 00/02:27:37 to 00/02:30:59

Plot file version 157 created 19-AUG-2016 17:19:37

J1642+2523 EM119D.UVDATA.1

Freq = 1.5950 GHz, Bw = 16.000 MH No calibration applied and no bandpass applied

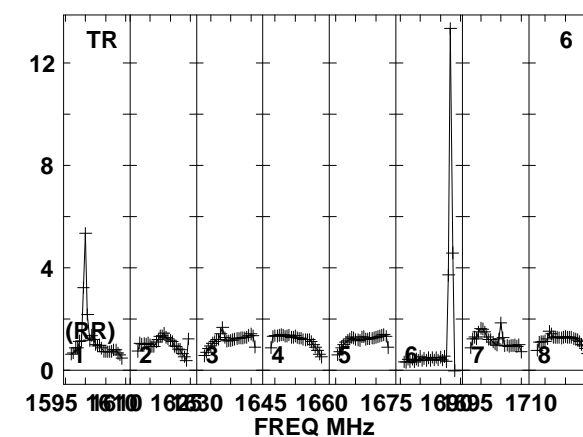
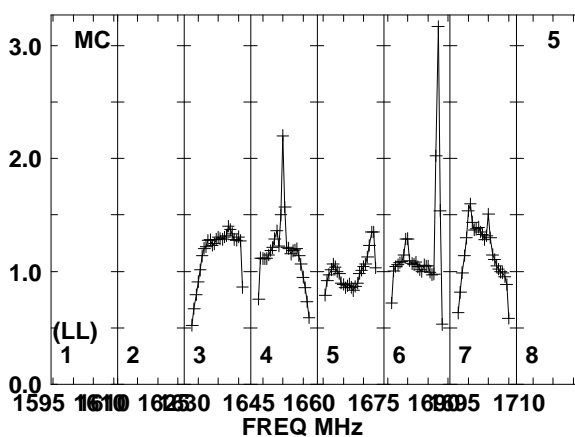
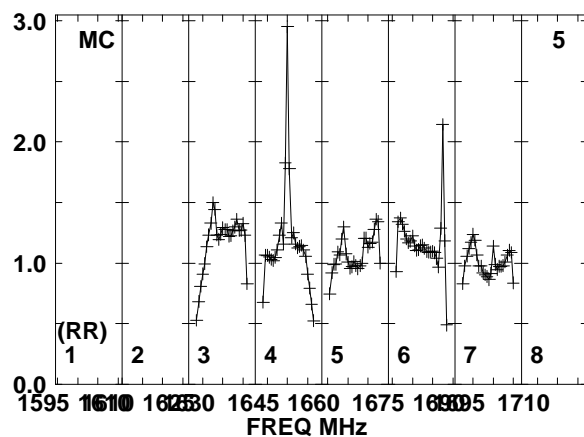
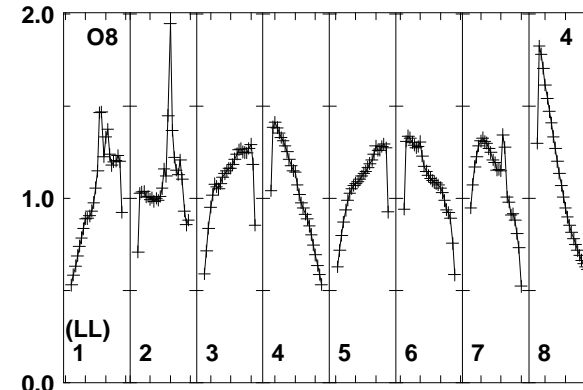
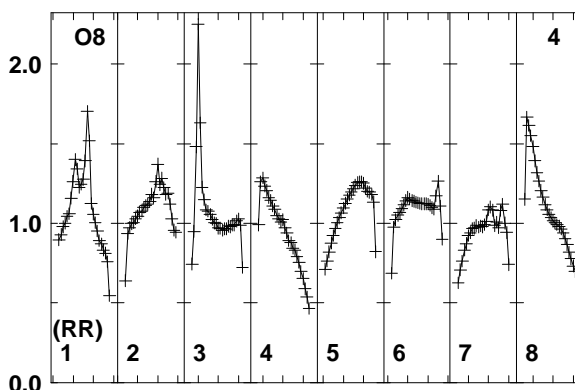
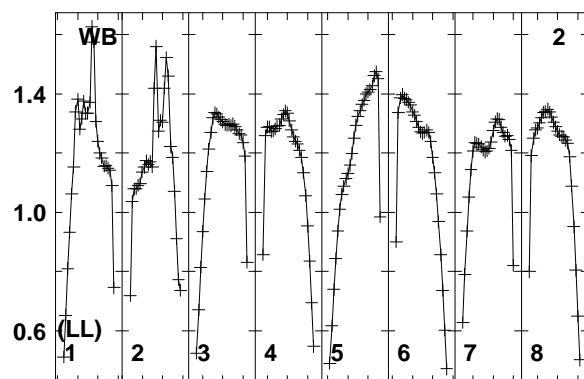
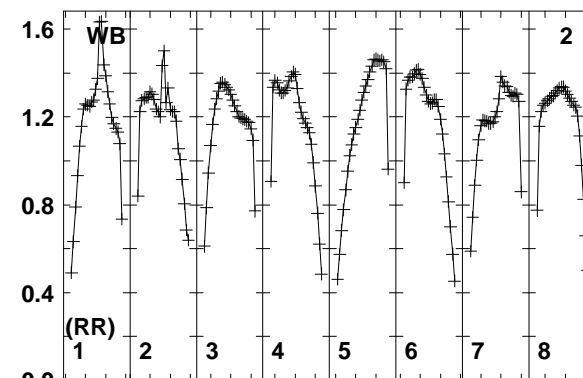
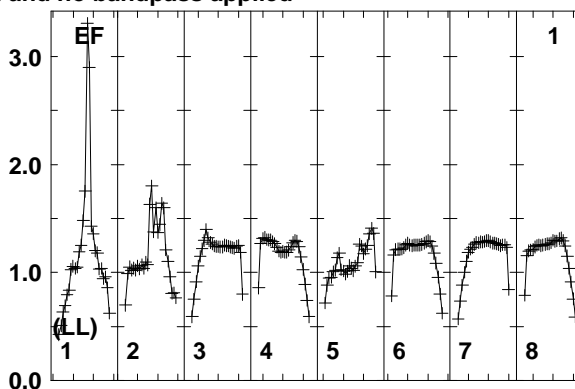
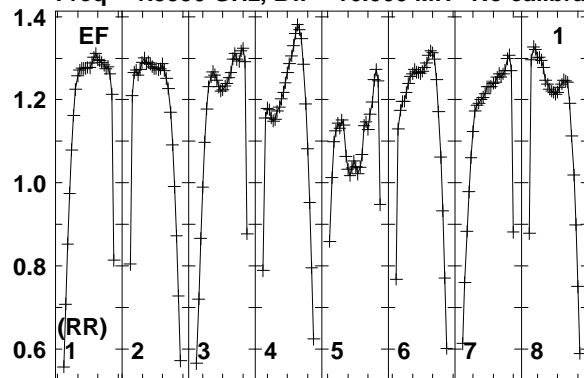

Lower frame: Real Jy
Total-power spectrum Antenna: EF (01)
Timerange: 00/02:31:07 to 00/02:32:29

Plot file version 158 created 19-AUG-2016 17:19:37

J1642+2523 EM119D.UVDATA.1

Freq = 1.5950 GHz, Bw = 16.000 MH No calibration applied and no bandpass applied

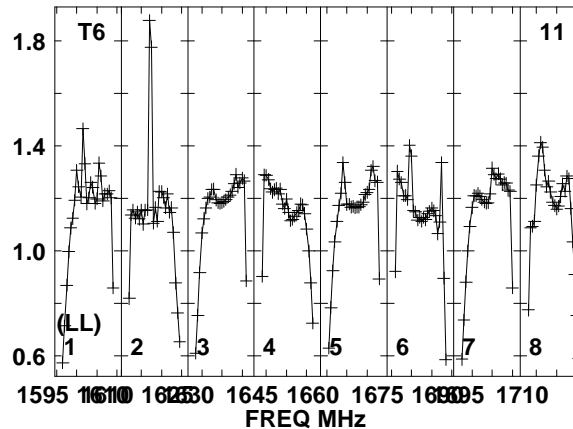
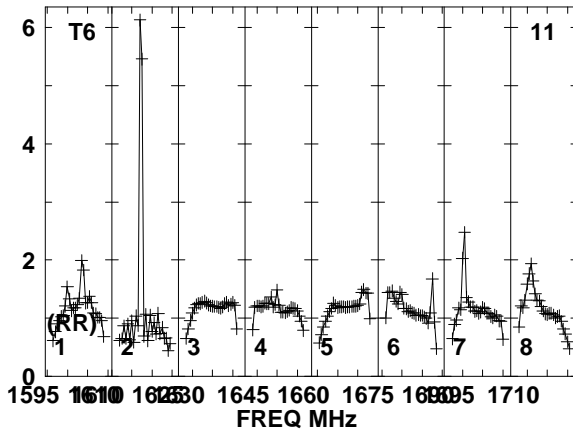
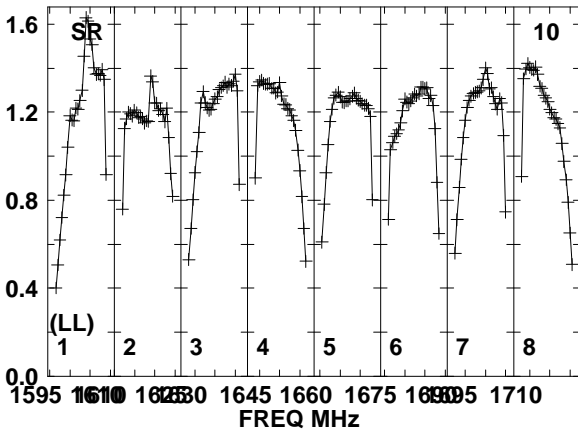
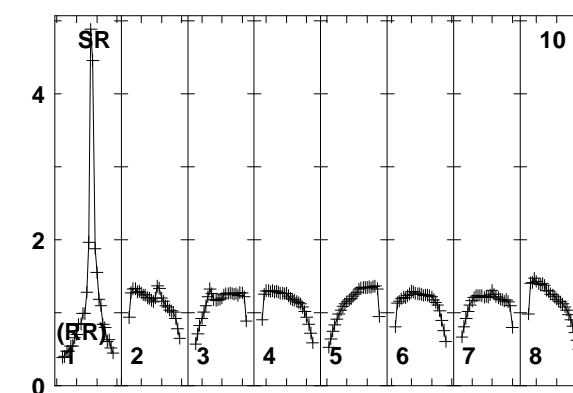
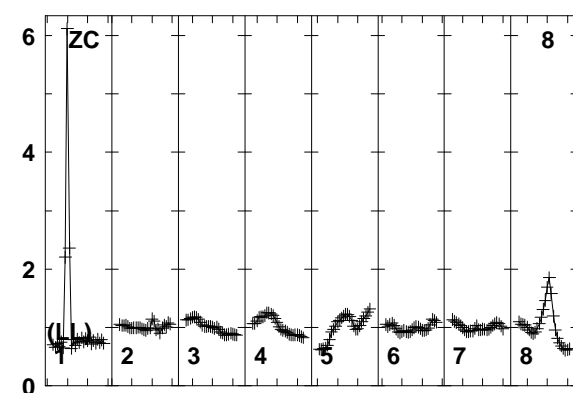
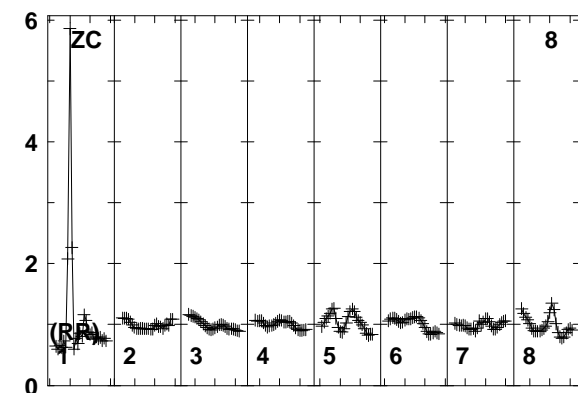
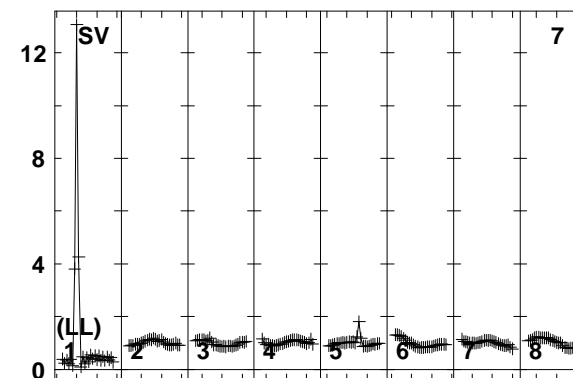
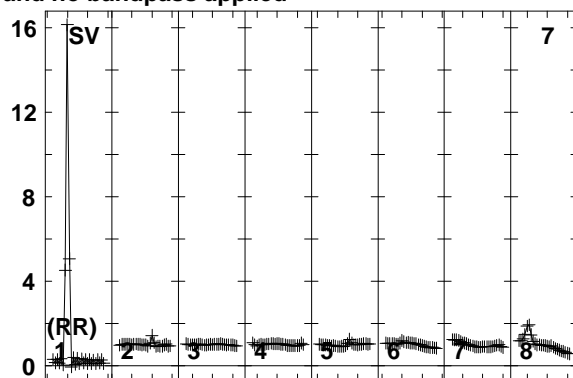
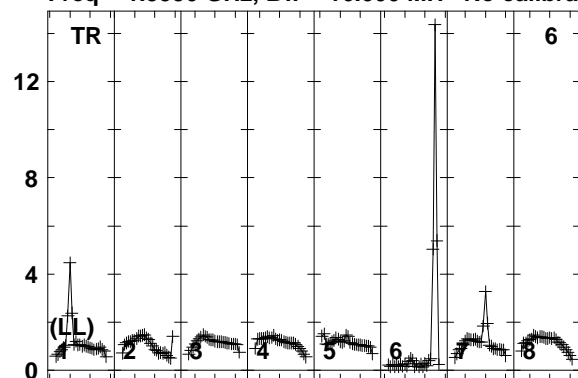

Lower frame: Real Jy
Total-power spectrum Antenna: TR (06)
Timerange: 00/02:31:07 to 00/02:32:29

Plot file version 159 created 19-AUG-2016 17:19:37

J1642+2523 EM119D.UVDATA.1

Freq = 1.5950 GHz, Bw = 16.000 MH No calibration applied and no bandpass applied

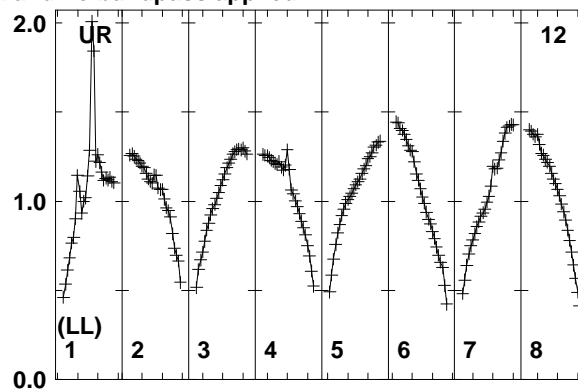
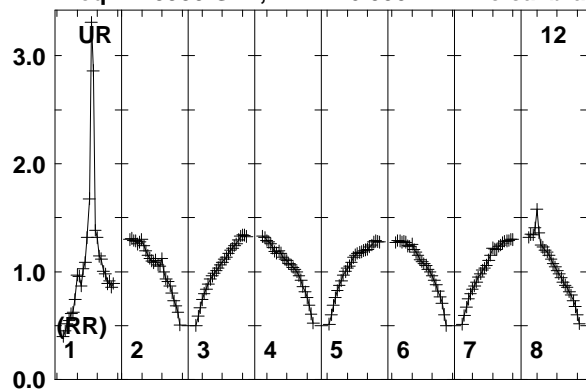

Lower frame: Real Jy
Total-power spectrum Antenna: UR (12)
Timerange: 00/02:31:07 to 00/02:32:29

Plot file version 160 created 19-AUG-2016 17:19:37

J1649+2635 EM119D.UVDATA.1

Freq = 1.5950 GHz, Bw = 16.000 MH No calibration applied and no bandpass applied

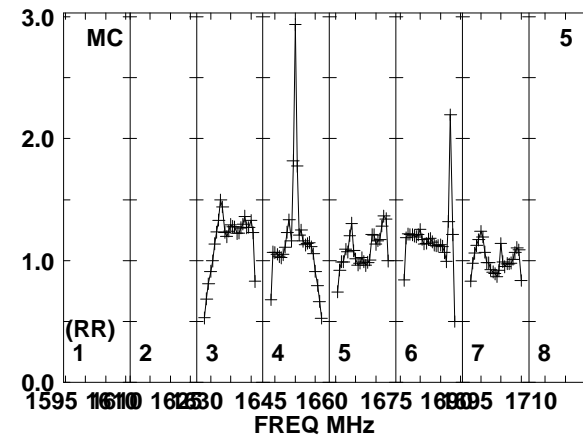
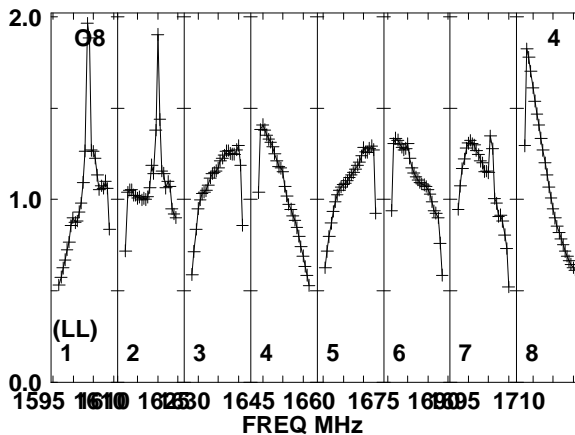
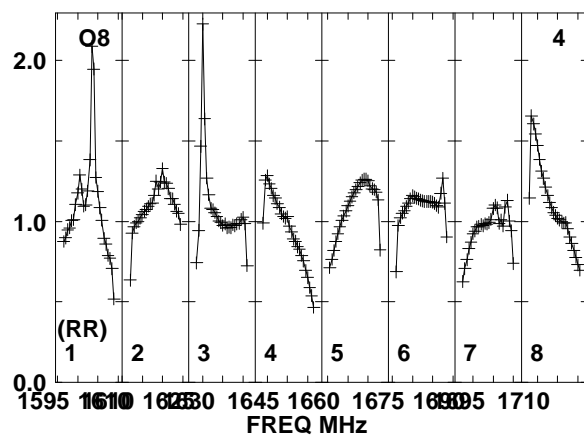
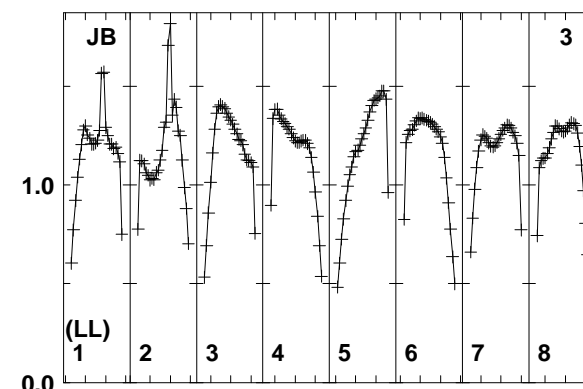
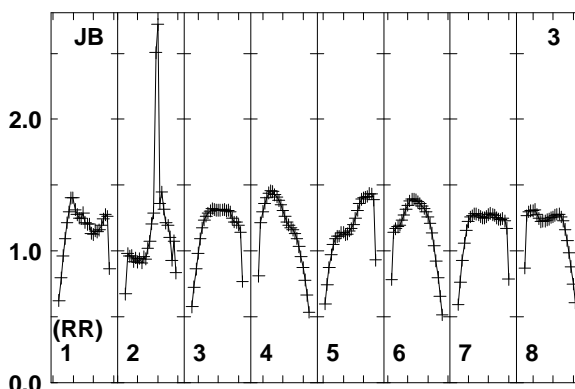
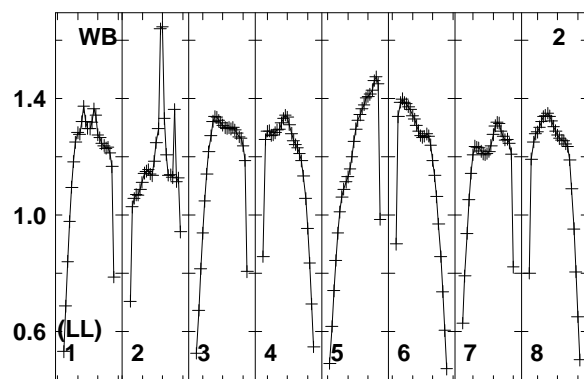
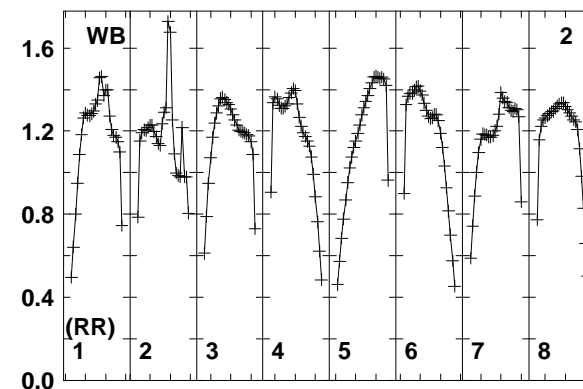
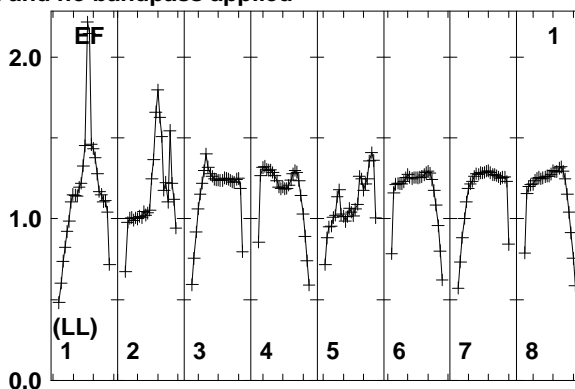
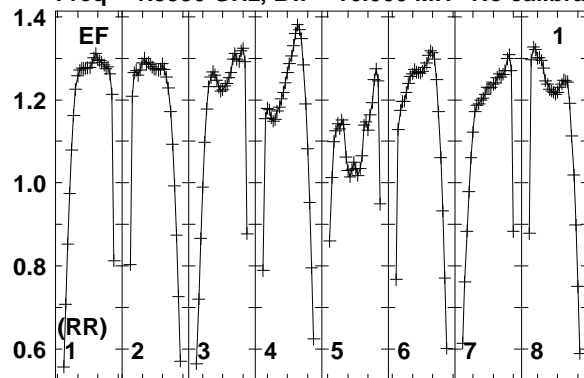

Lower frame: Real Jy
Total-power spectrum Antenna: EF (01)
Timerange: 00/02:32:33 to 00/02:36:00

Plot file version 161 created 19-AUG-2016 17:19:37

J1649+2635 EM119D.UVDATA.1

Freq = 1.5950 GHz, Bw = 16.000 MH No calibration applied and no bandpass applied

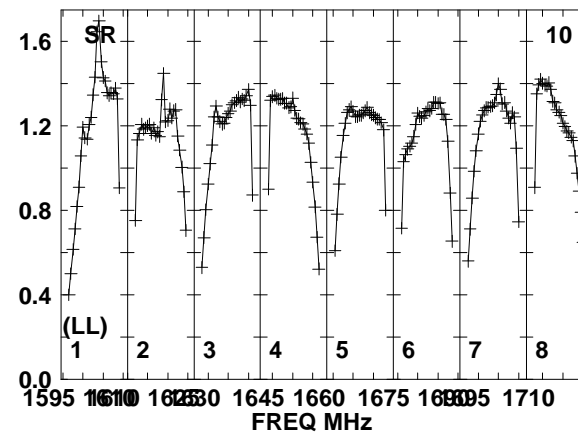
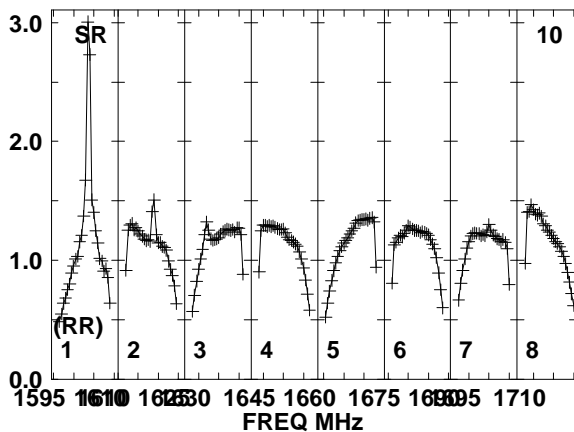
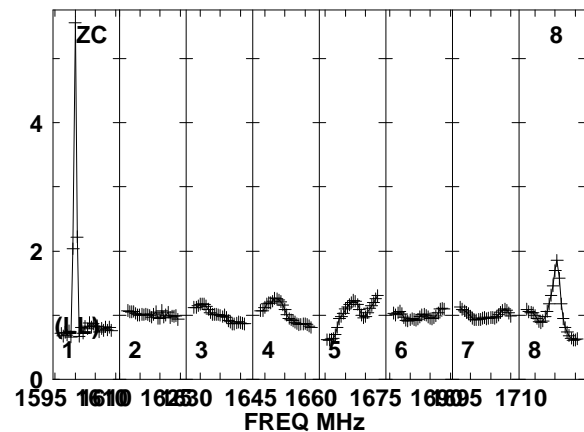
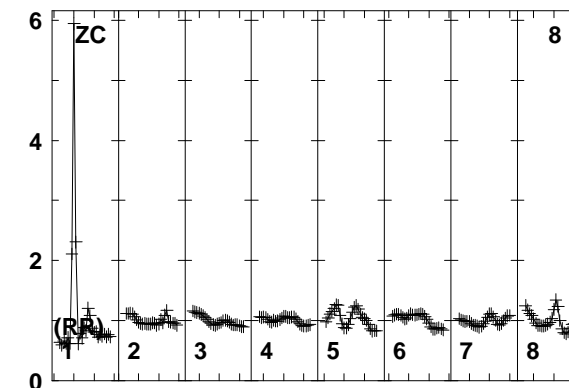
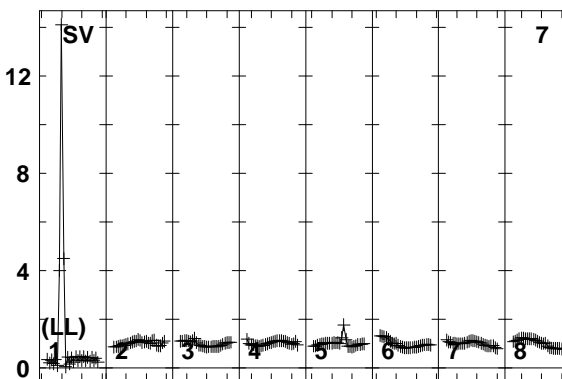
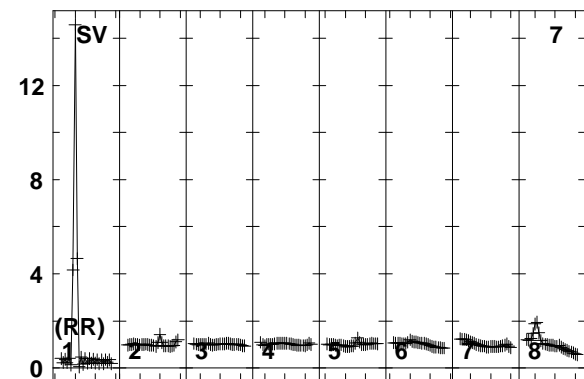
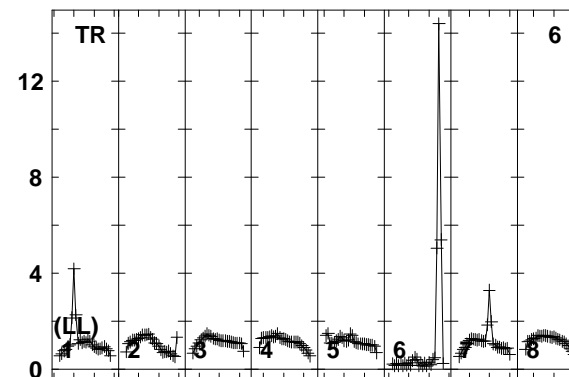
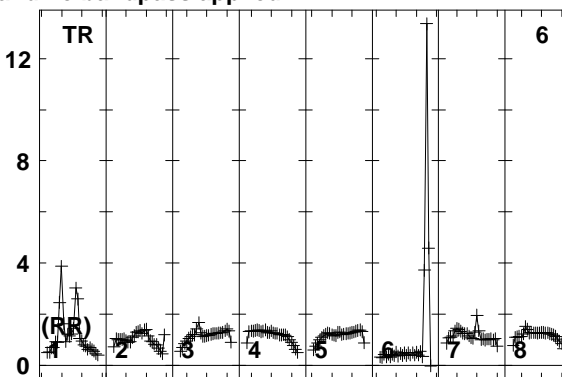
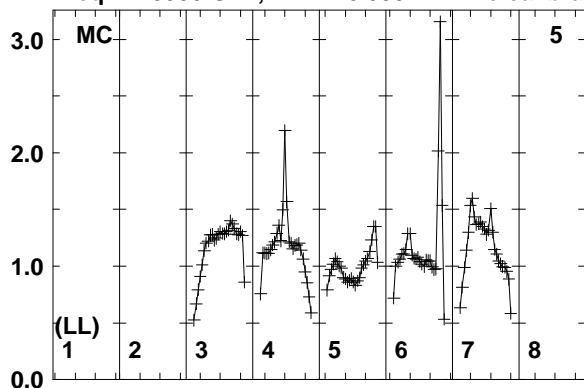

Lower frame: Real Jy
Total-power spectrum Antenna: MC (05)
Timerange: 00/02:32:33 to 00/02:36:00

Plot file version 162 created 19-AUG-2016 17:19:38

J1649+2635 EM119D.UVDATA.1

Freq = 1.5950 GHz, Bw = 16.000 MH No calibration applied and no bandpass applied

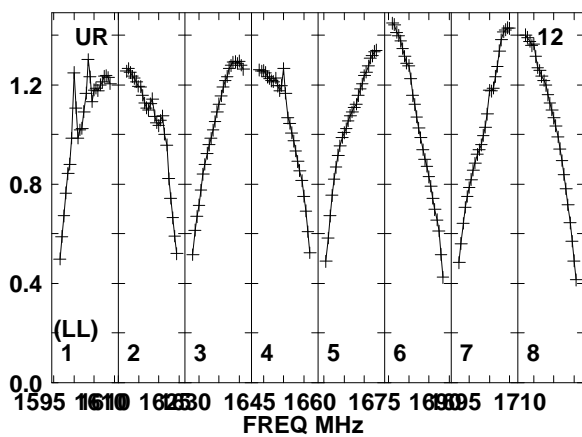
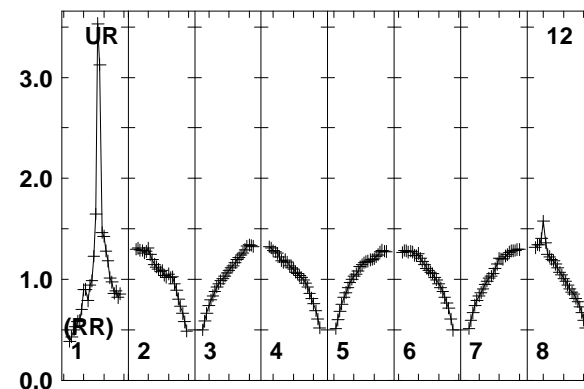
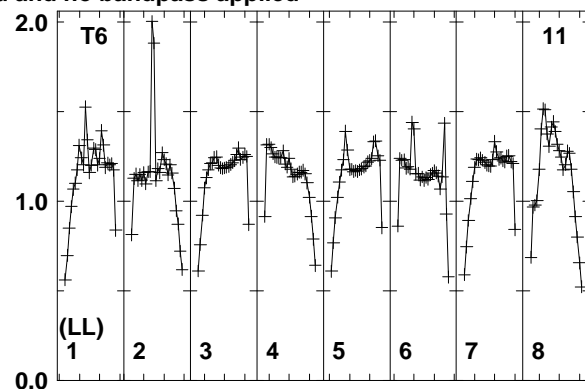
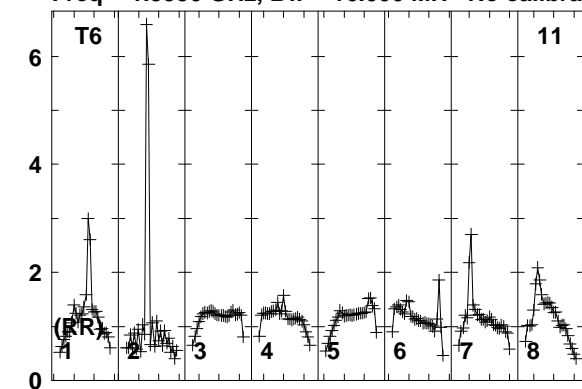

Lower frame: Real Jy
Total-power spectrum Antenna: T6 (11)
Timerange: 00/02:32:33 to 00/02:36:00

Plot file version 163 created 19-AUG-2016 17:19:38

J1642+2523 EM119D.UVDATA.1

Freq = 1.5950 GHz, Bw = 16.000 MH No calibration applied and no bandpass applied

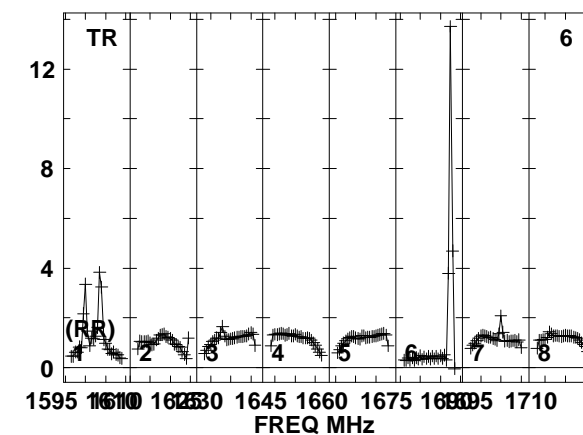
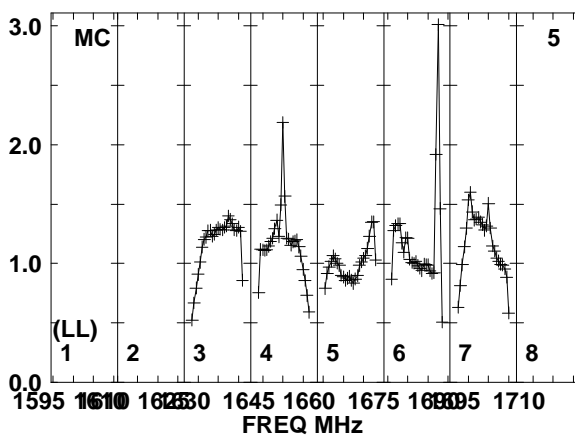
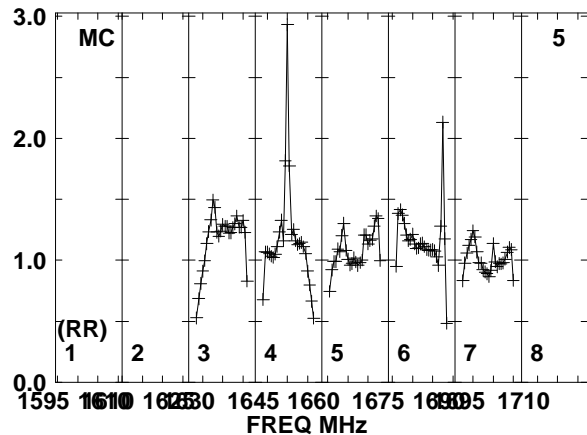
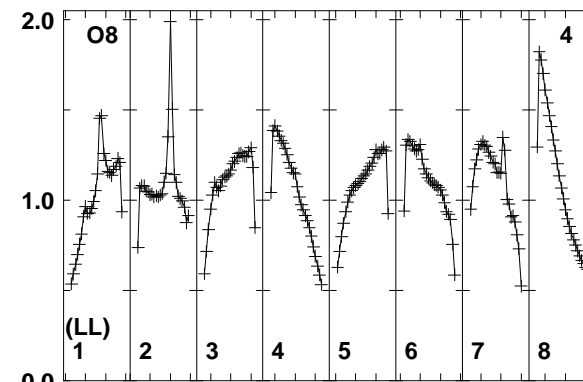
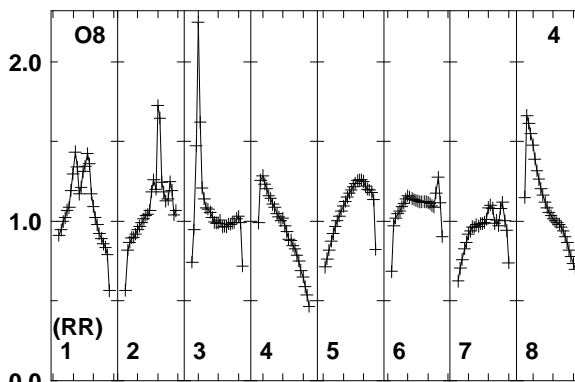
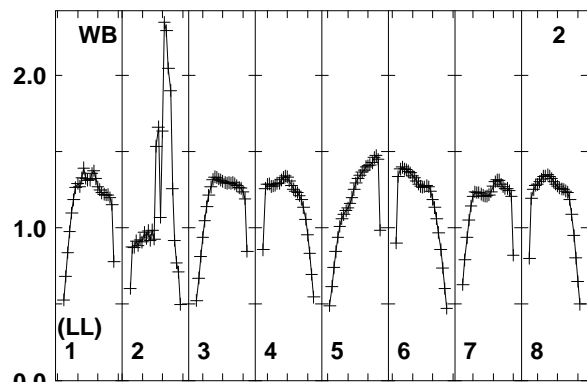
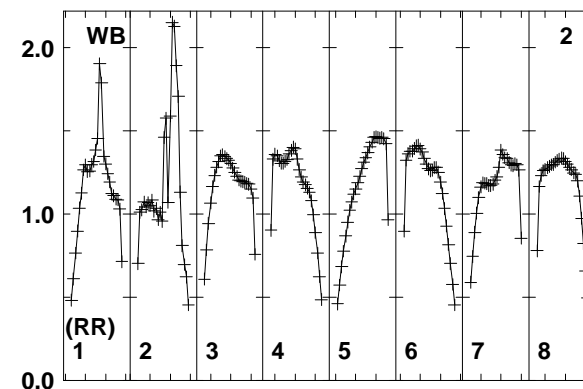
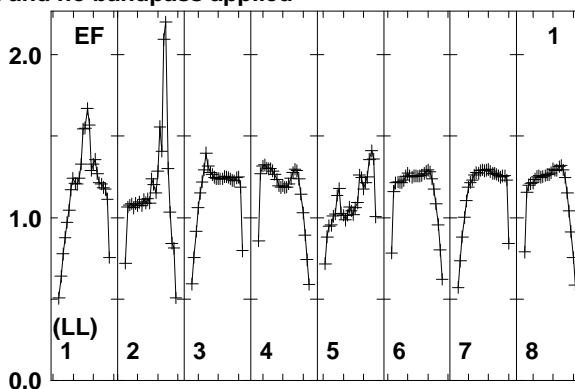
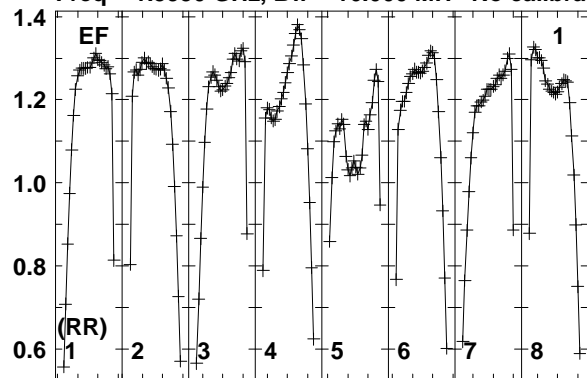

Lower frame: Real Jy
Total-power spectrum Antenna: EF (01)
Timerange: 00/02:36:08 to 00/02:37:29

Plot file version 164 created 19-AUG-2016 17:19:38

J1642+2523 EM119D.UVDATA.1

Freq = 1.5950 GHz, Bw = 16.000 MH No calibration applied and no bandpass applied

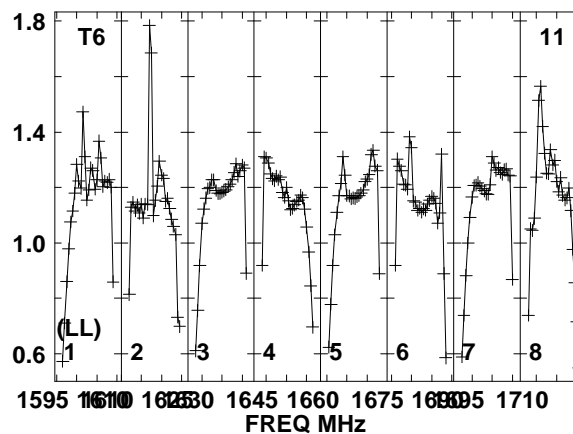
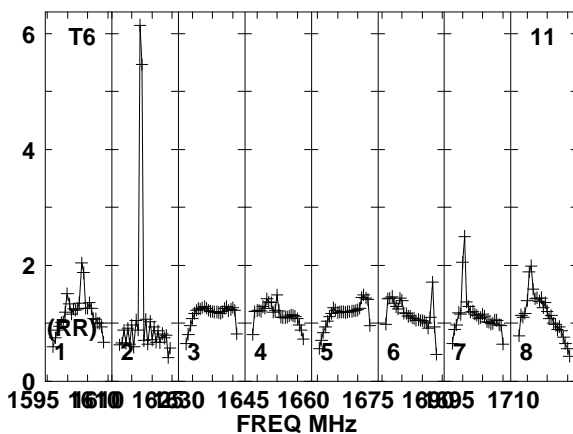
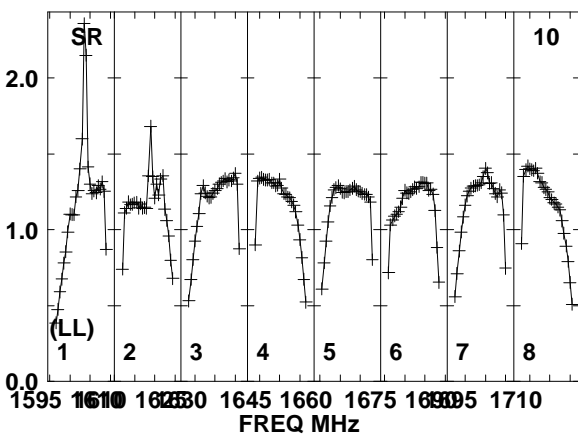
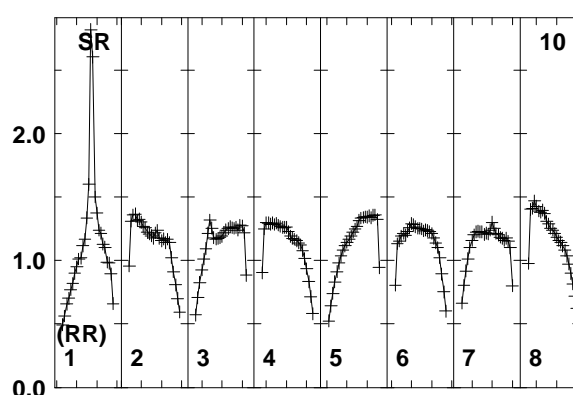
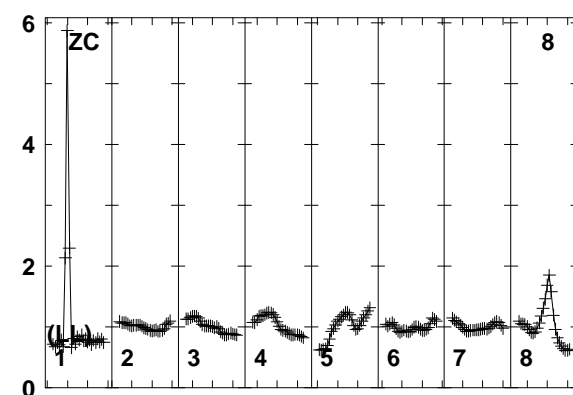
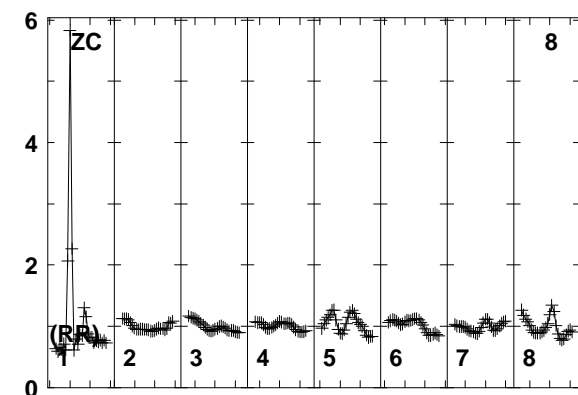
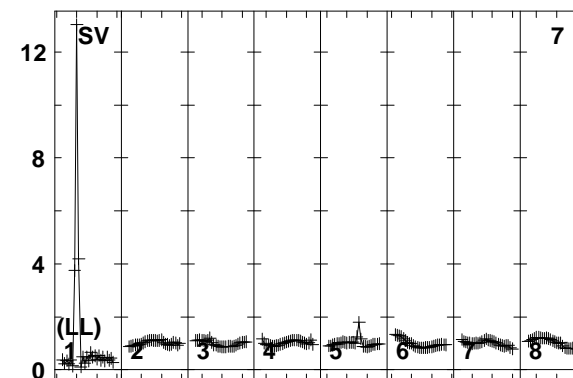
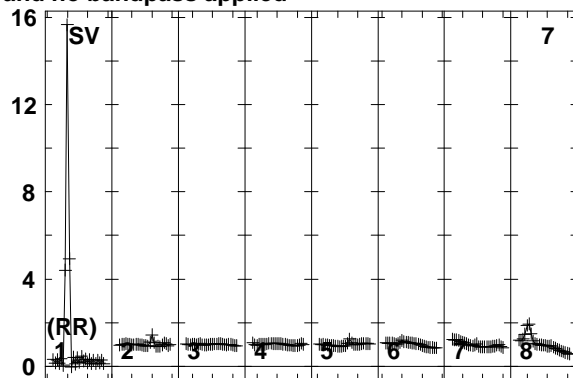
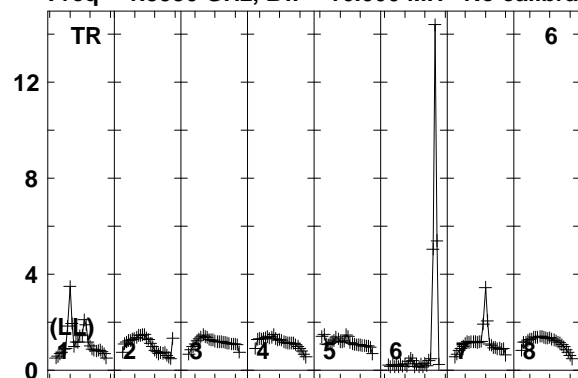

Lower frame: Real Jy
Total-power spectrum Antenna: TR (06)
Timerange: 00/02:36:08 to 00/02:37:29

Plot file version 165 created 19-AUG-2016 17:19:38

J1642+2523 EM119D.UVDATA.1

Freq = 1.5950 GHz, Bw = 16.000 MH No calibration applied and no bandpass applied

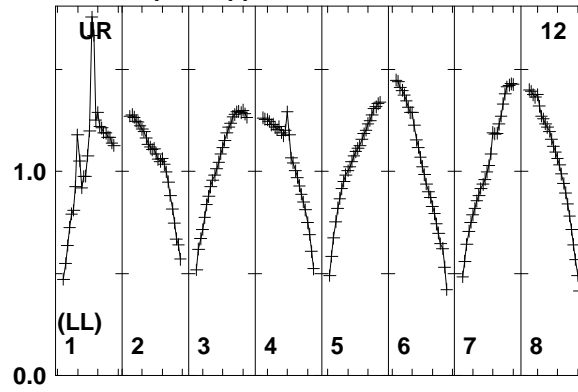
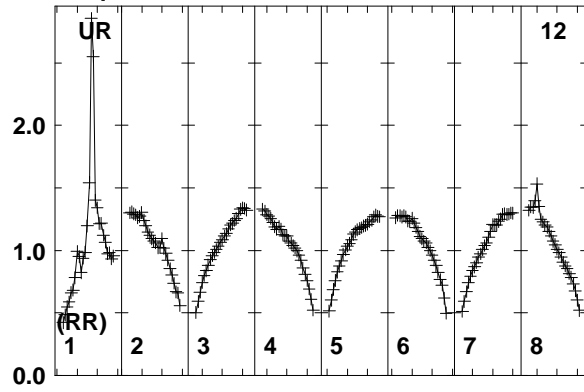

Lower frame: Real Jy
Total-power spectrum Antenna: UR (12)
Timerange: 00/02:36:08 to 00/02:37:29

Plot file version 166 created 19-AUG-2016 17:19:38

J1649+2635 EM119D.UVDATA.1

Freq = 1.5950 GHz, Bw = 16.000 MH No calibration applied and no bandpass applied

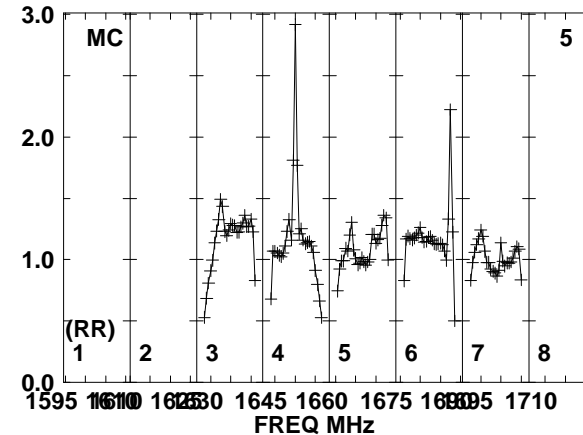
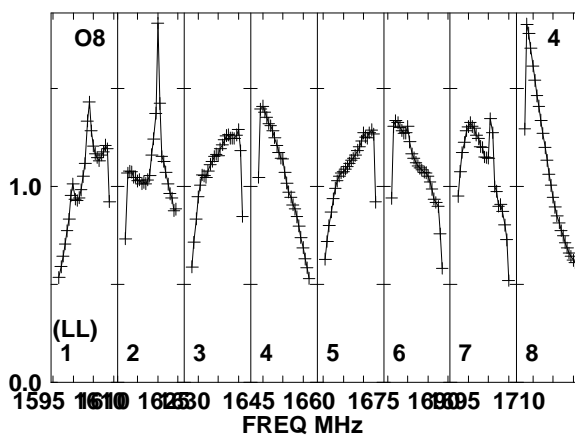
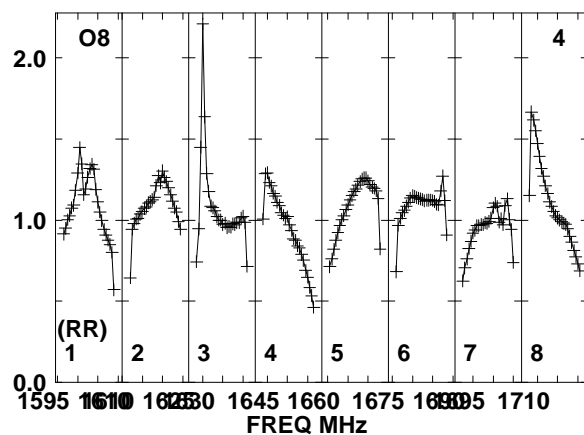
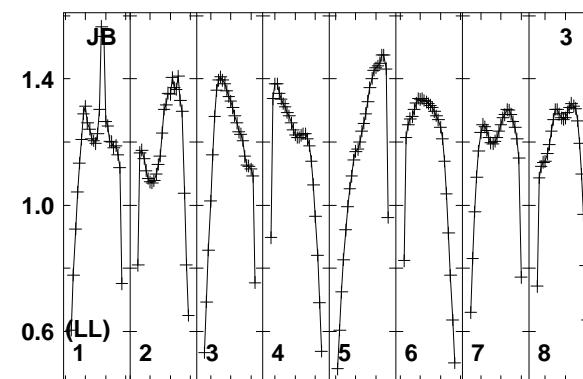
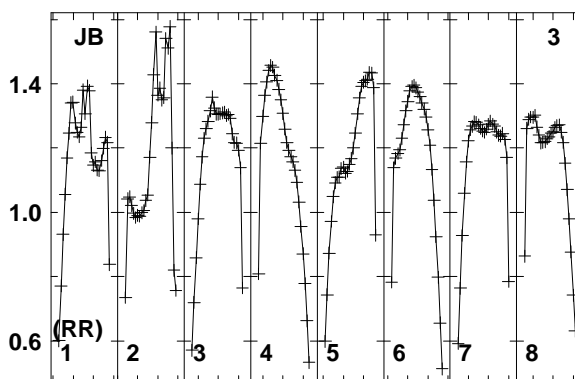
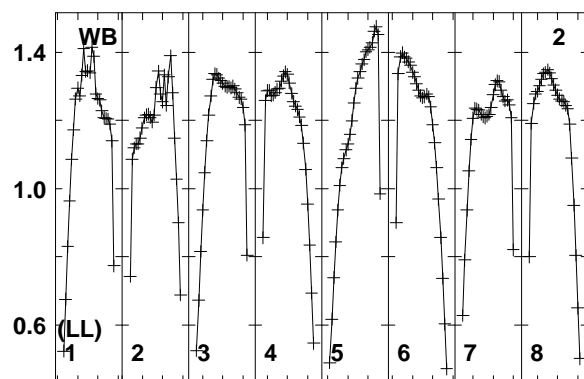
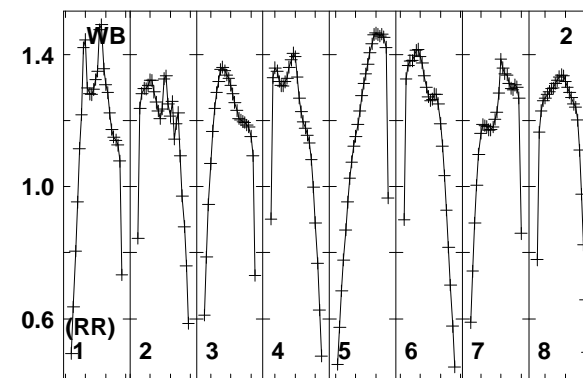
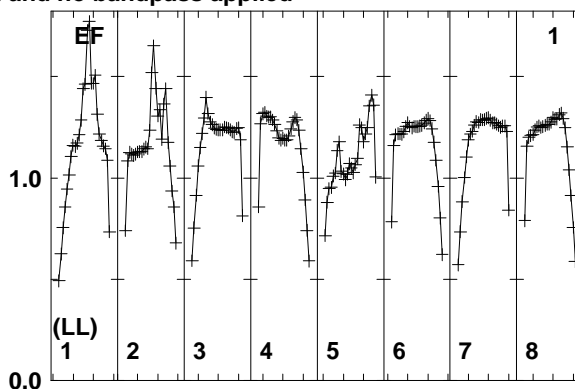
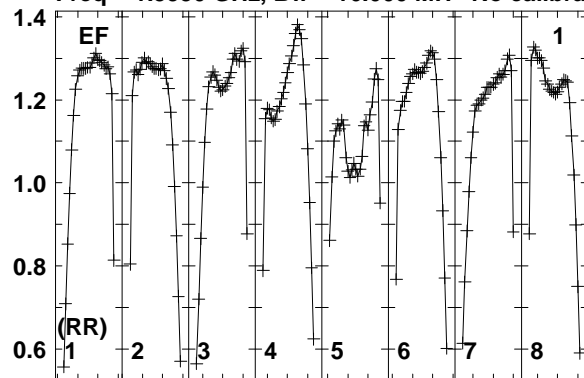

Lower frame: Real Jy
Total-power spectrum Antenna: EF (01)
Timerange: 00/02:38:30 to 00/02:41:59

Plot file version 167 created 19-AUG-2016 17:19:38

J1649+2635 EM119D.UVDATA.1

Freq = 1.5950 GHz, Bw = 16.000 MH No calibration applied and no bandpass applied

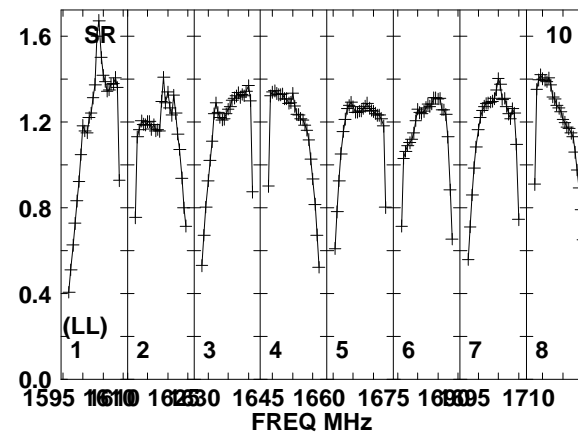
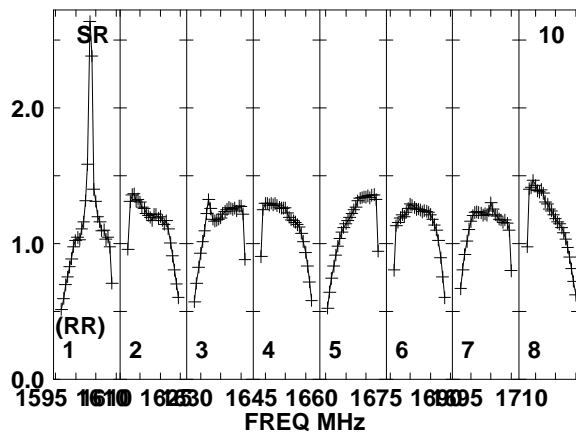
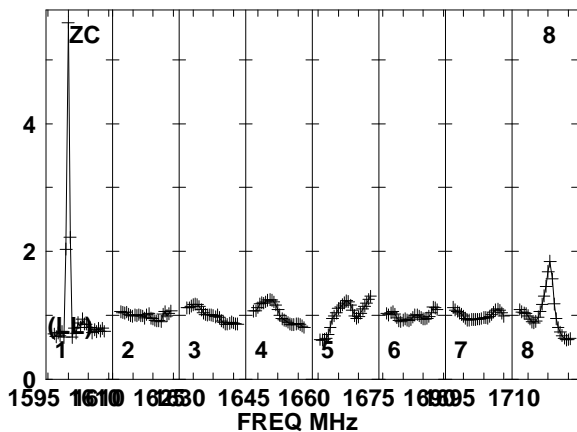
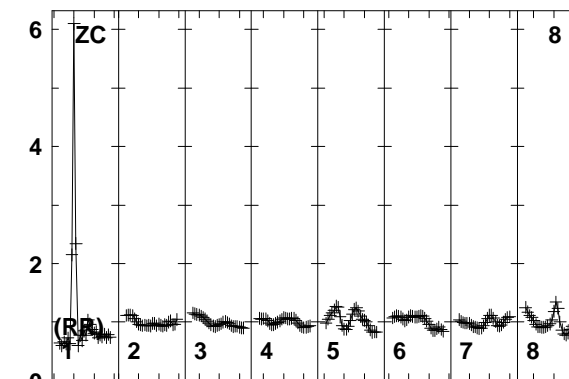
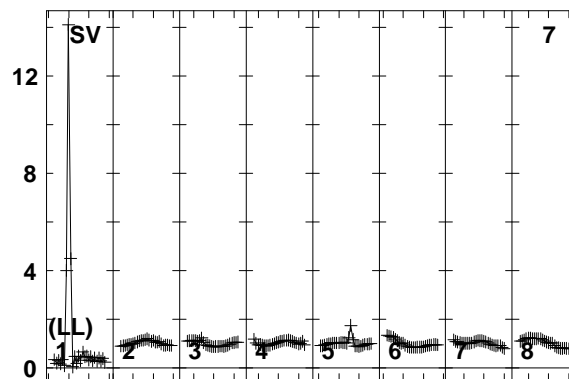
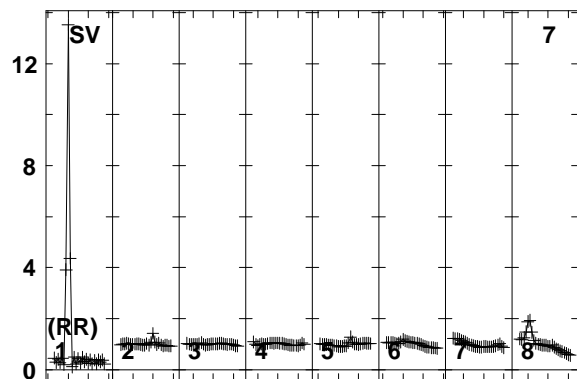
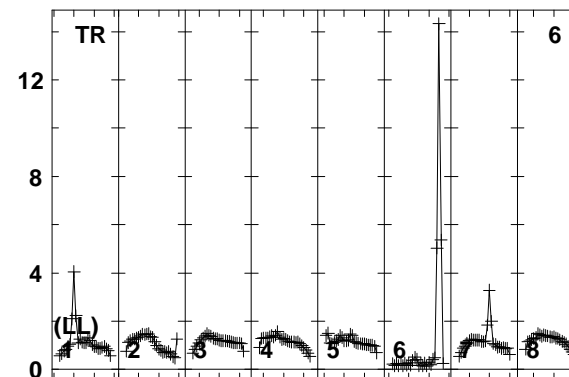
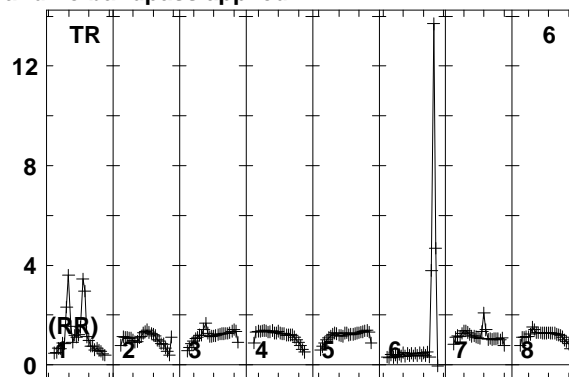
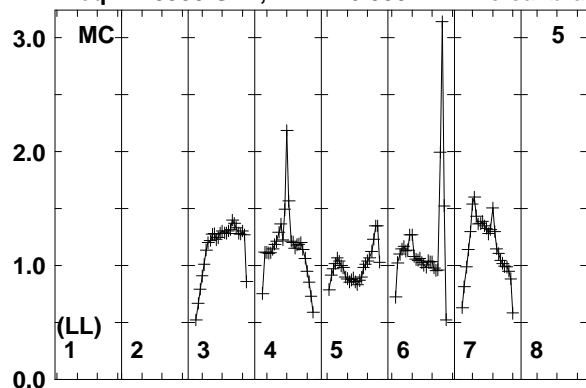

Lower frame: Real Jy
Total-power spectrum Antenna: MC (05)
Timerange: 00/02:38:30 to 00/02:41:59

Plot file version 168 created 19-AUG-2016 17:19:39

J1649+2635 EM119D.UVDATA.1

Freq = 1.5950 GHz, Bw = 16.000 MH No calibration applied and no bandpass applied

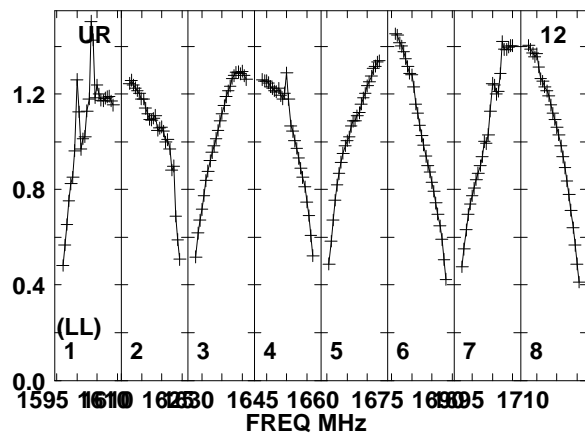
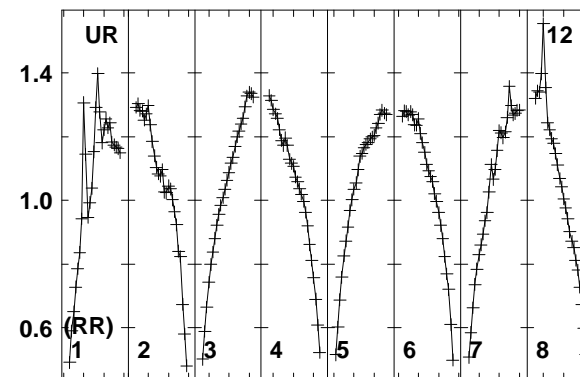
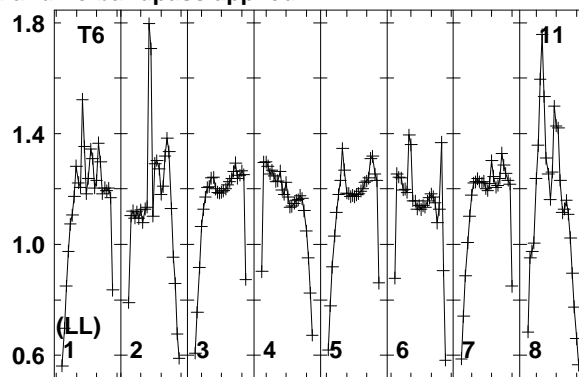
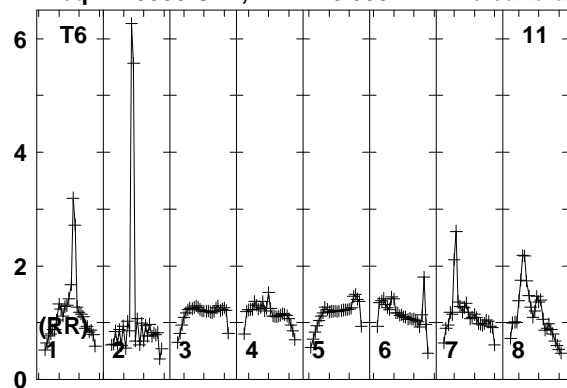

Lower frame: Real Jy
Total-power spectrum Antenna: T6 (11)
Timerange: 00/02:38:30 to 00/02:41:59

Plot file version 169 created 19-AUG-2016 17:19:39

J1642+2523 EM119D.UVDATA.1

Freq = 1.5950 GHz, Bw = 16.000 MH No calibration applied and no bandpass applied

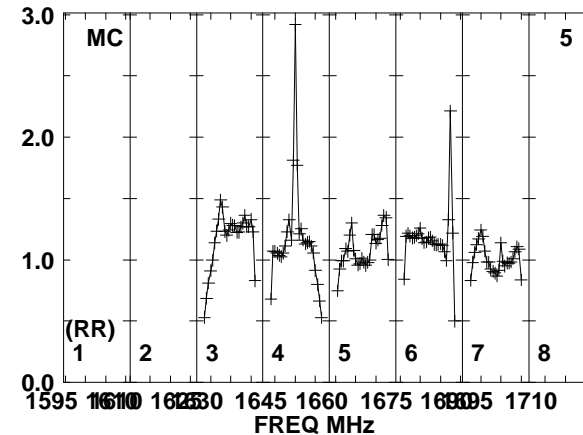
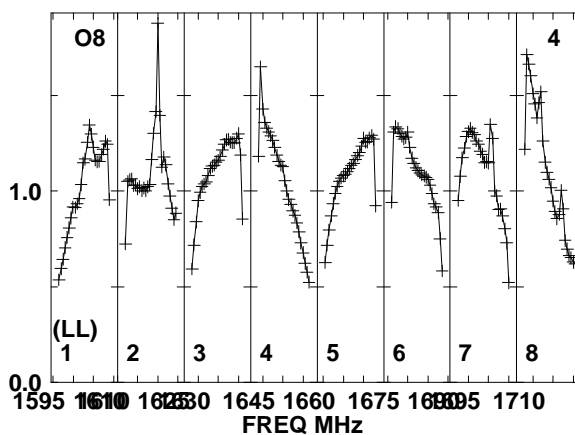
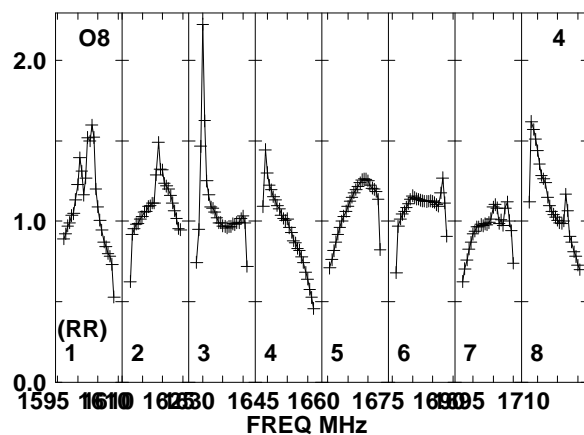
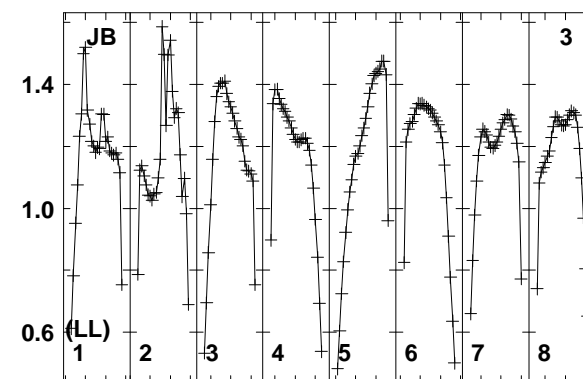
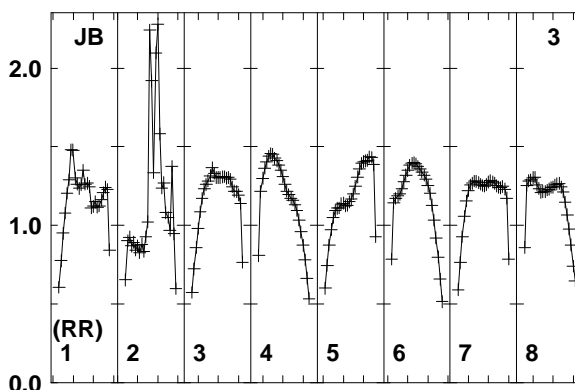
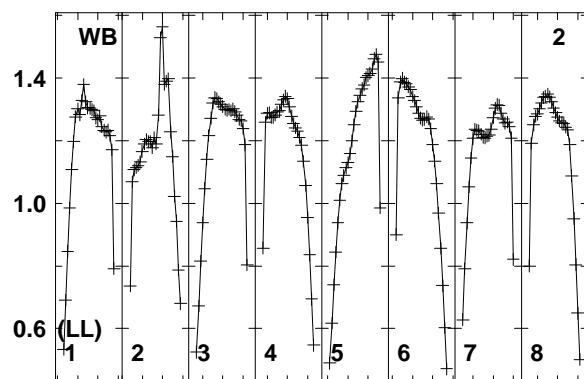
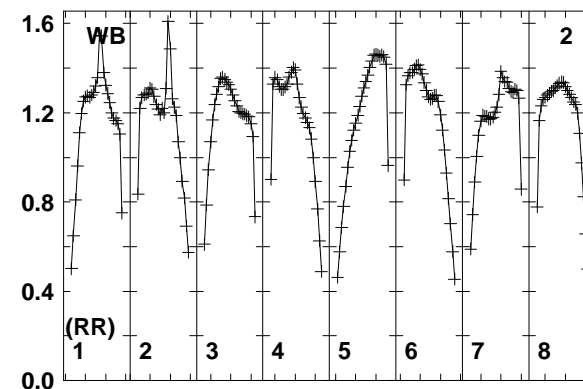
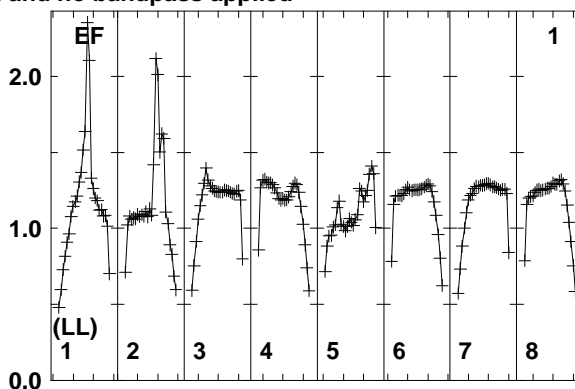
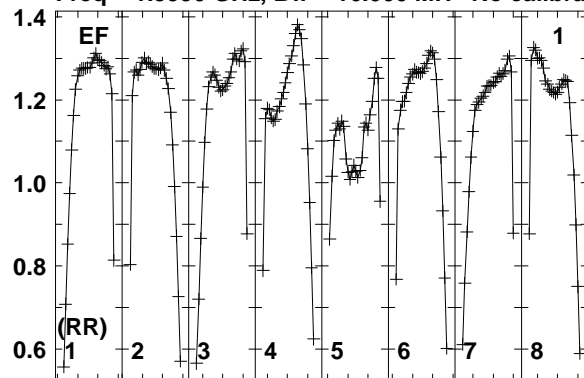

Lower frame: Real Jy
Total-power spectrum Antenna: EF (01)
Timerange: 00/02:42:07 to 00/02:43:30

Plot file version 170 created 19-AUG-2016 17:19:39

J1642+2523 EM119D.UVDATA.1

Freq = 1.5950 GHz, Bw = 16.000 MH No calibration applied and no bandpass applied

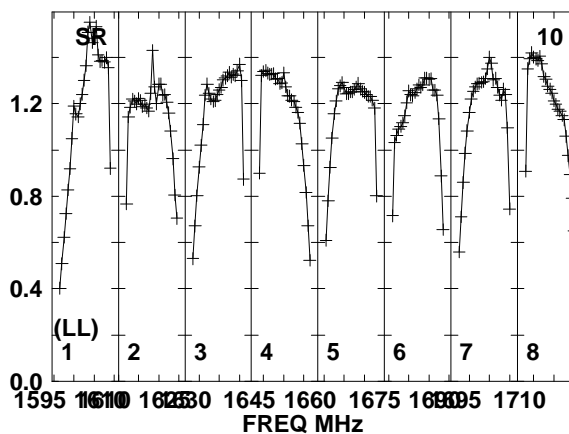
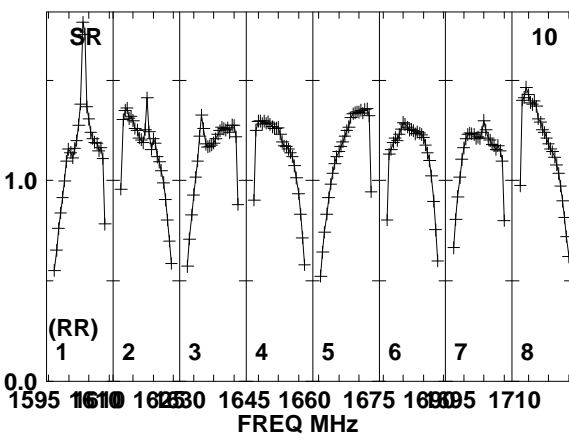
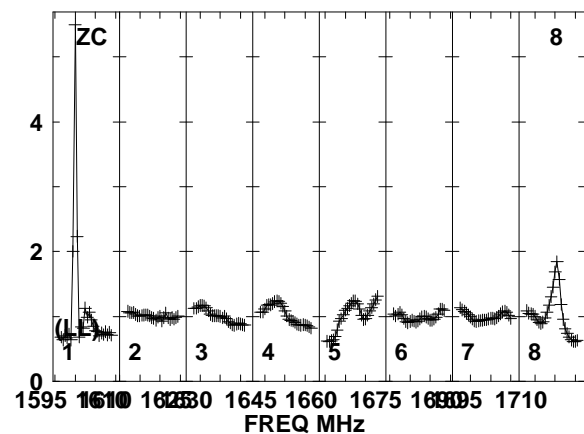
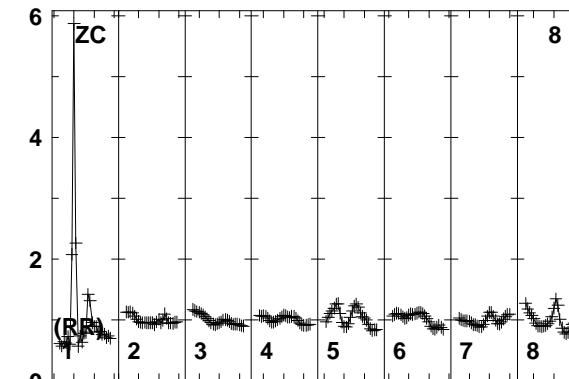
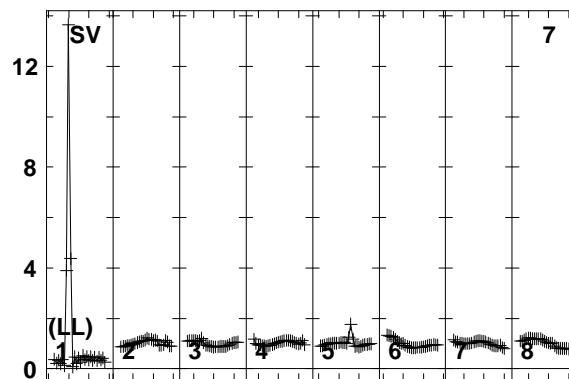
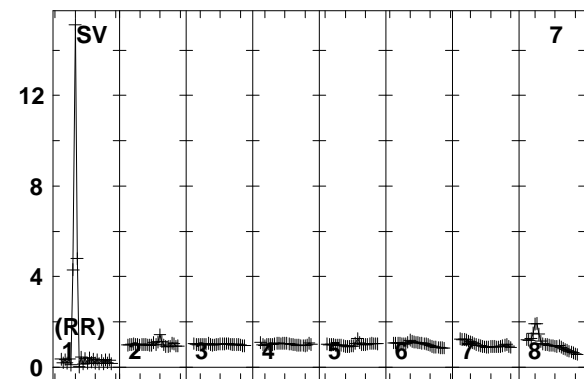
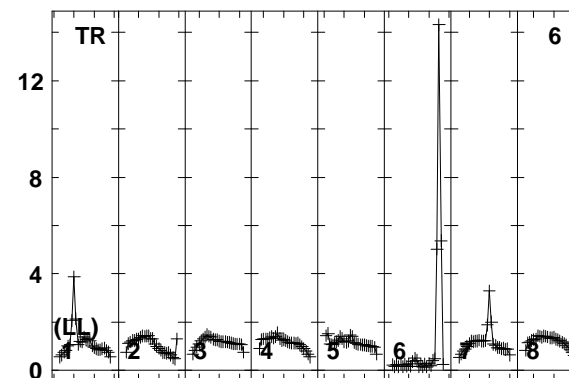
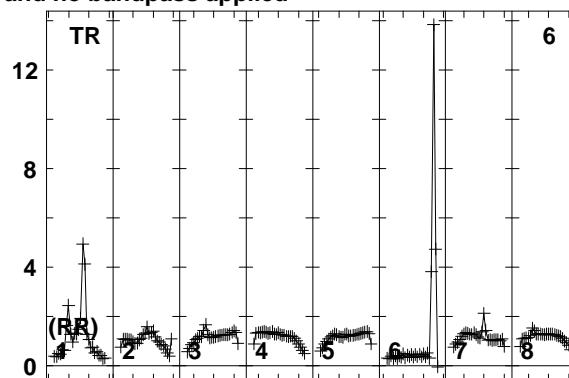
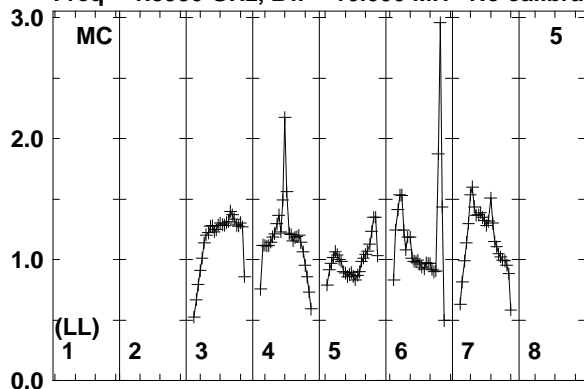

Lower frame: Real Jy
Total-power spectrum Antenna: MC (05)
Timerange: 00/02:42:07 to 00/02:43:30

Plot file version 171 created 19-AUG-2016 17:19:39

J1642+2523 EM119D.UVDATA.1

Freq = 1.5950 GHz, Bw = 16.000 MH No calibration applied and no bandpass applied

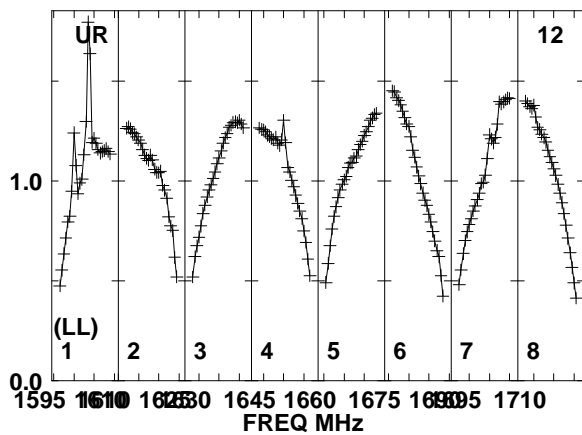
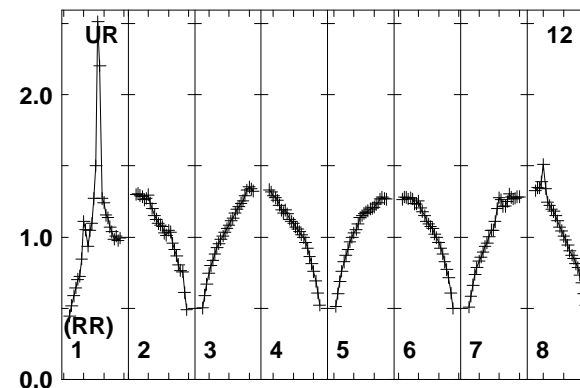
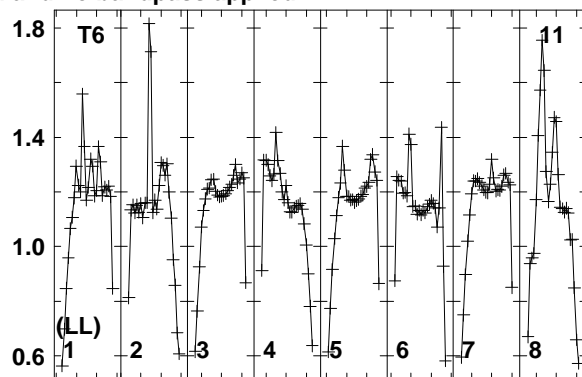
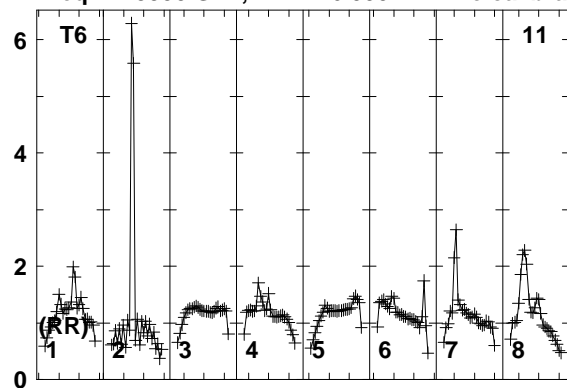

Lower frame: Real Jy
Total-power spectrum Antenna: T6 (11)
Timerange: 00/02:42:07 to 00/02:43:30

Plot file version 172 created 19-AUG-2016 17:19:39

J1649+2635 EM119D.UVDATA.1

Freq = 1.5950 GHz, Bw = 16.000 MH No calibration applied and no bandpass applied

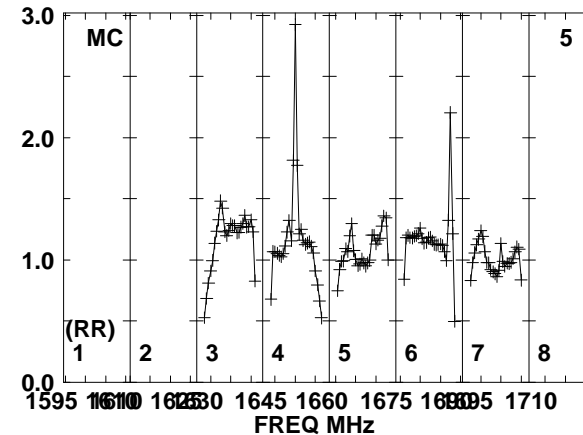
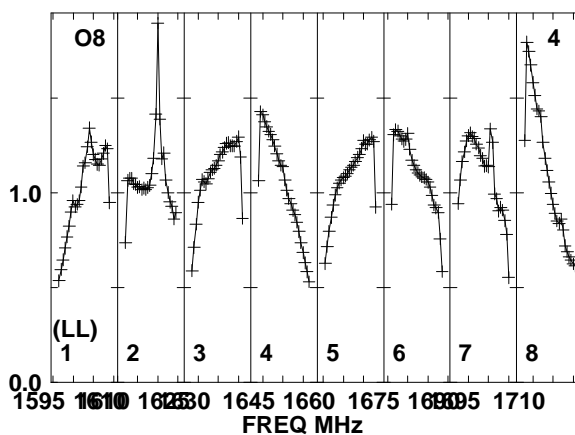
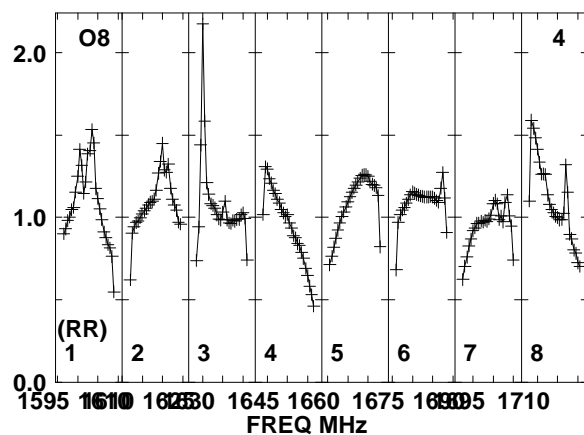
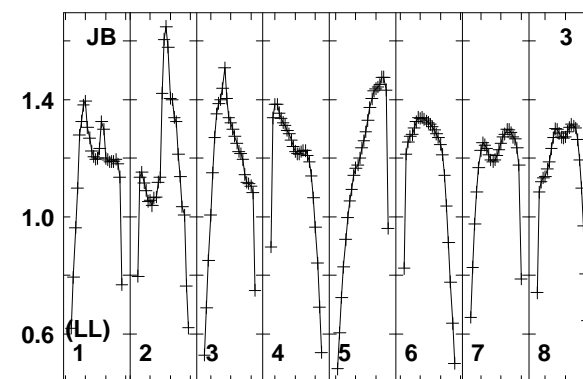
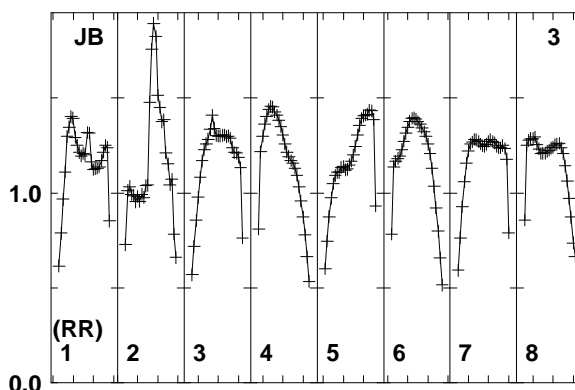
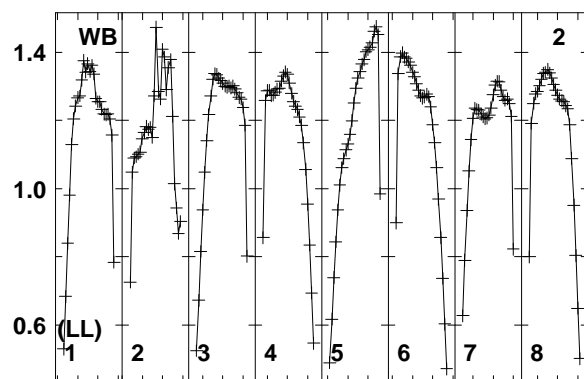
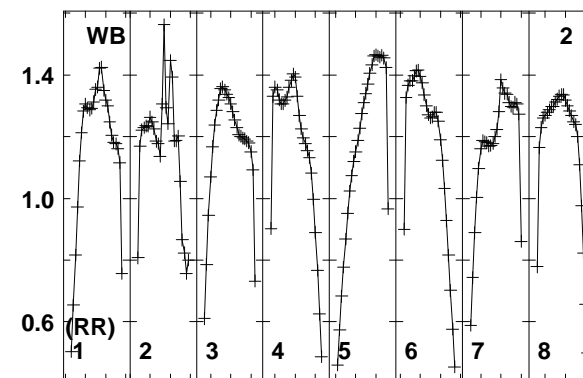
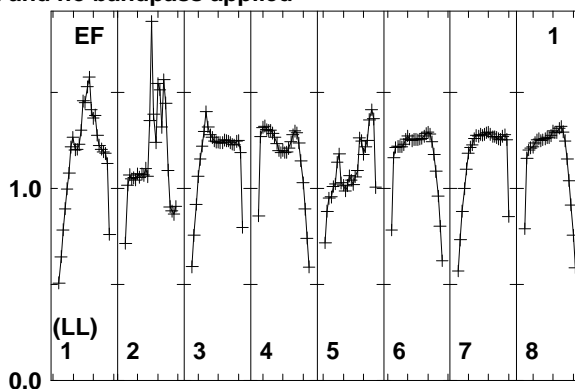
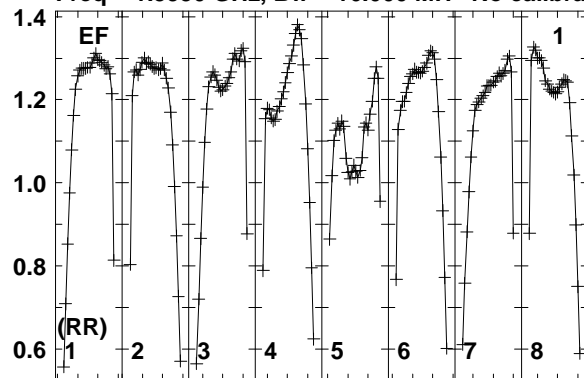

Lower frame: Real Jy
Total-power spectrum Antenna: EF (01)
Timerange: 00/02:43:37 to 00/02:46:59

Plot file version 173 created 19-AUG-2016 17:19:39

J1649+2635 EM119D.UVDATA.1

Freq = 1.5950 GHz, Bw = 16.000 MH No calibration applied and no bandpass applied

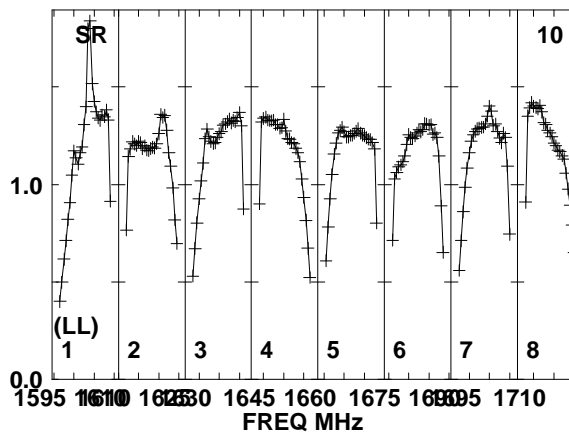
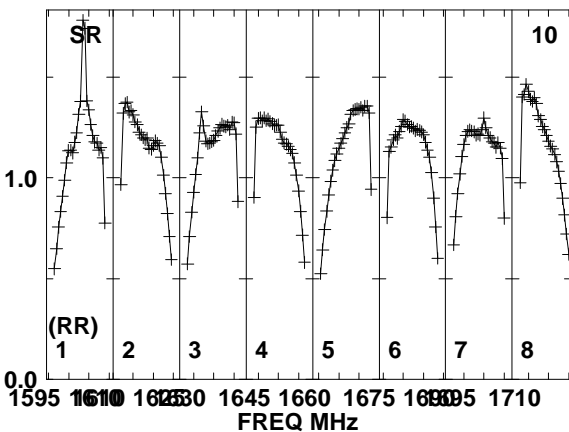
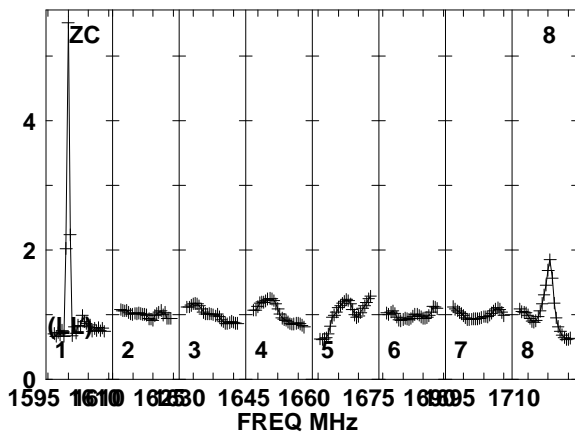
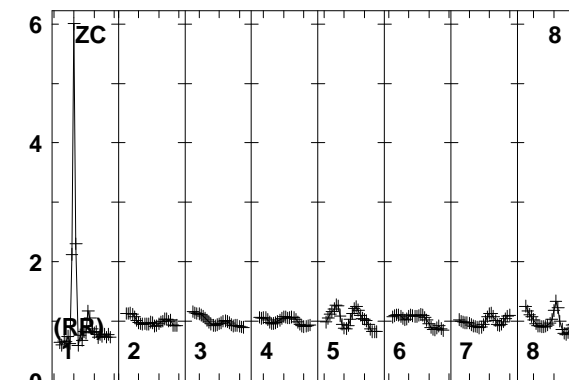
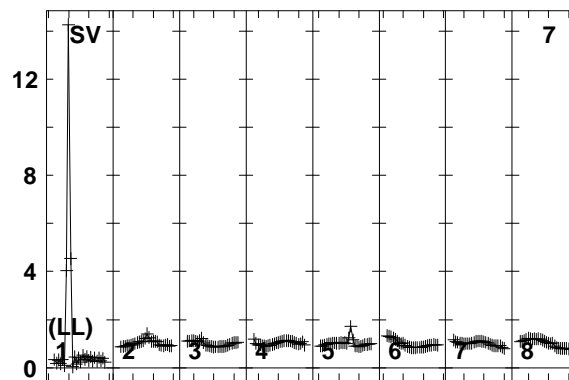
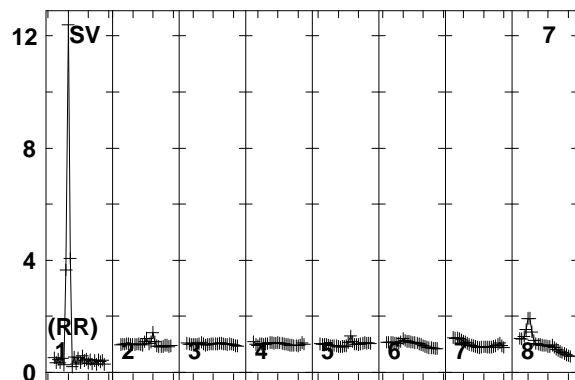
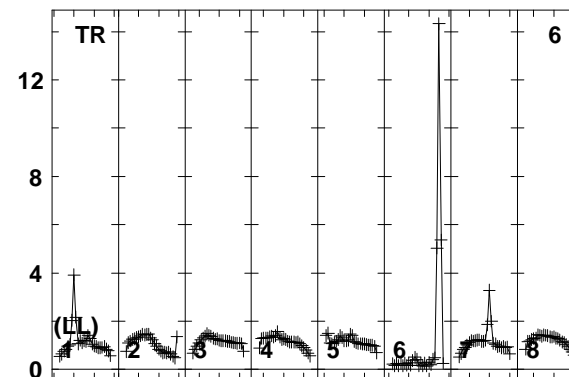
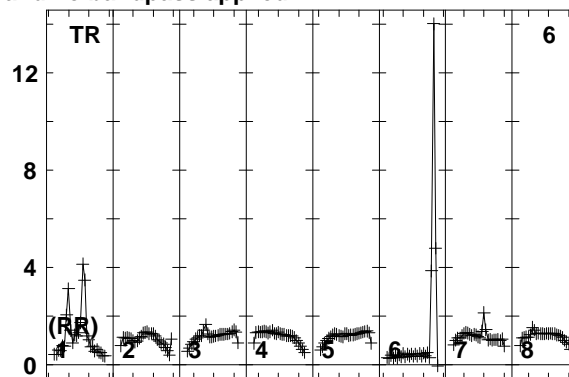
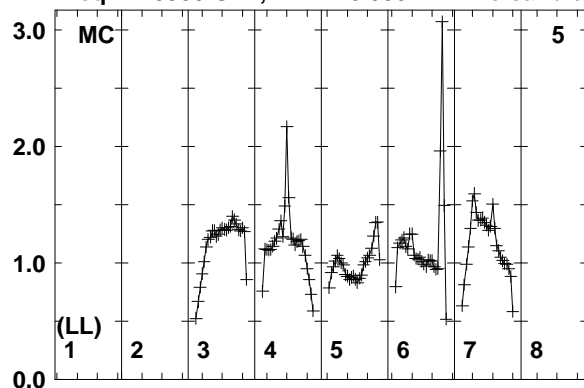

Lower frame: Real Jy
Total-power spectrum Antenna: MC (05)
Timerange: 00/02:43:37 to 00/02:46:59

Plot file version 174 created 19-AUG-2016 17:19:40

J1649+2635 EM119D.UVDATA.1

Freq = 1.5950 GHz, Bw = 16.000 MH No calibration applied and no bandpass applied

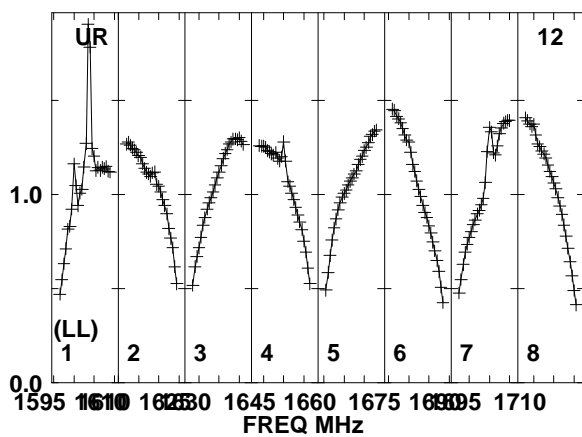
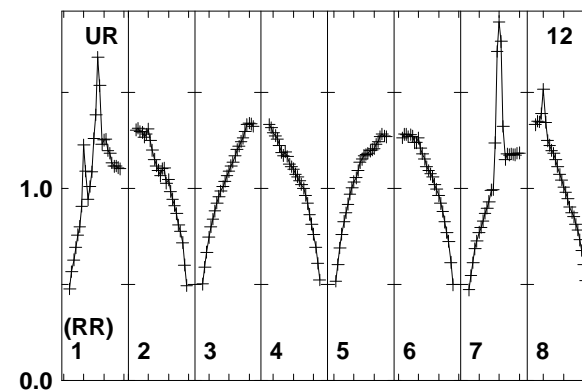
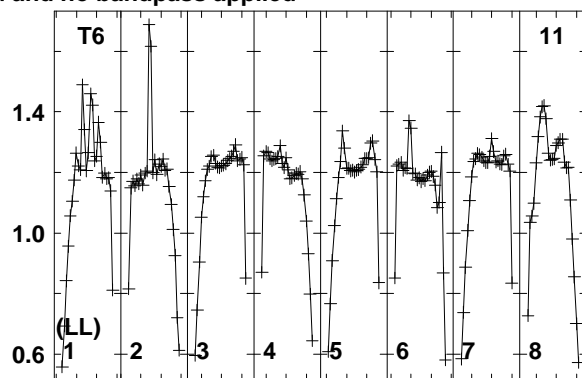
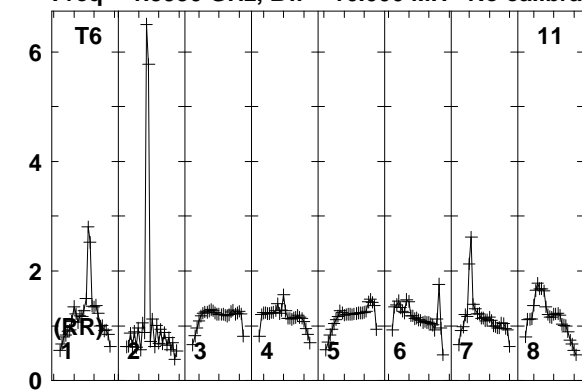

Lower frame: Real Jy
Total-power spectrum Antenna: T6 (11)
Timerange: 00/02:43:37 to 00/02:46:59

Plot file version 175 created 19-AUG-2016 17:19:40

J1642+2523 EM119D.UVDATA.1

Freq = 1.5950 GHz, Bw = 16.000 MH No calibration applied and no bandpass applied

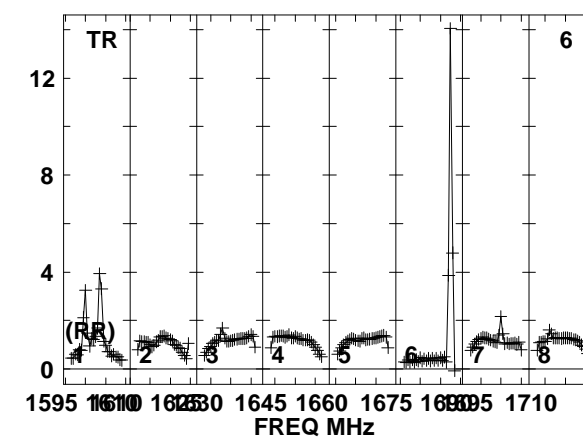
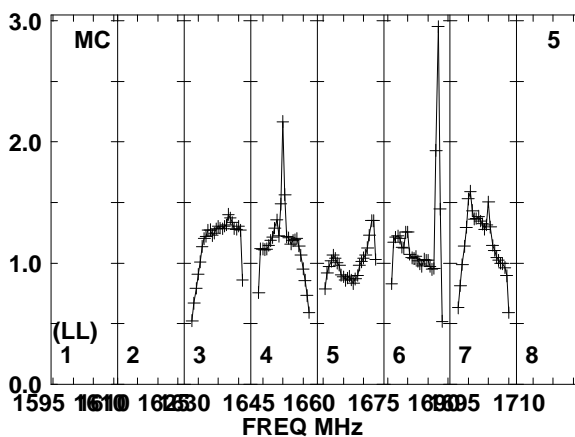
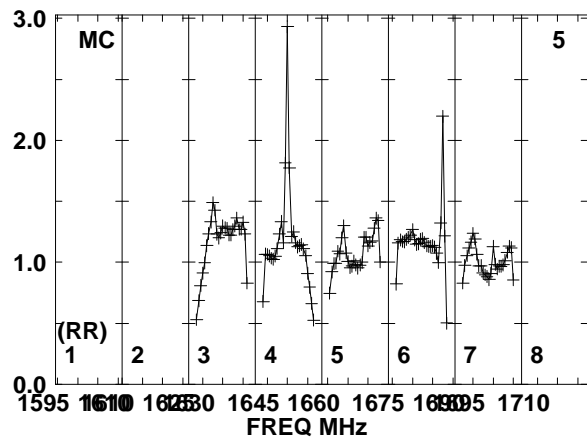
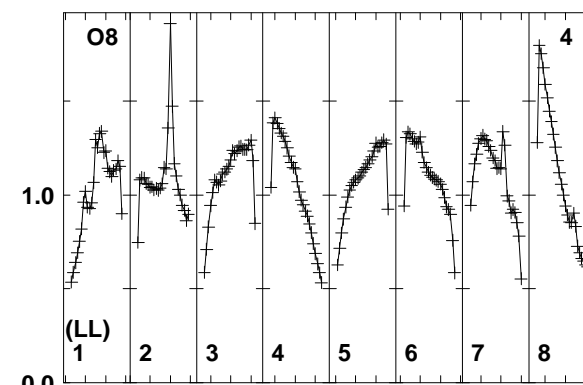
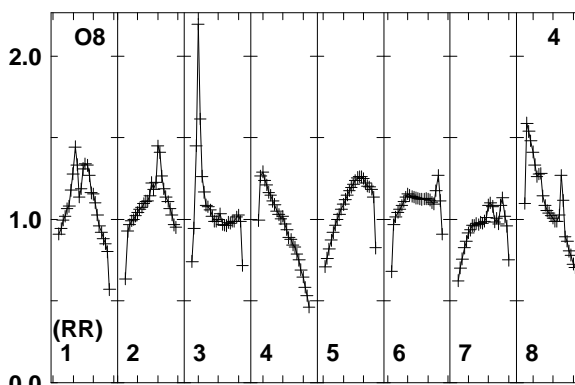
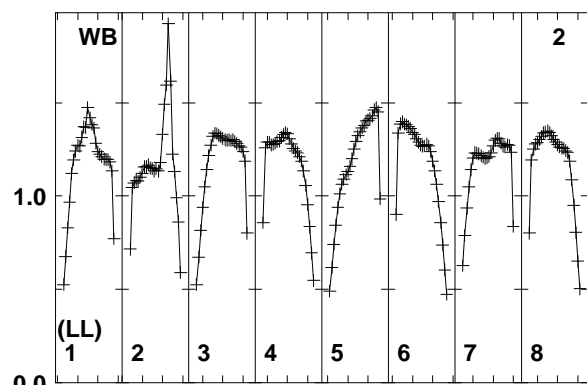
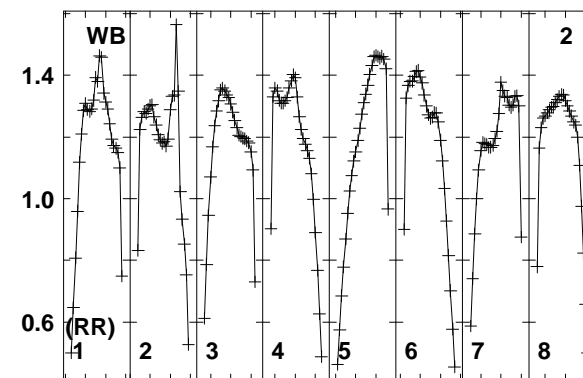
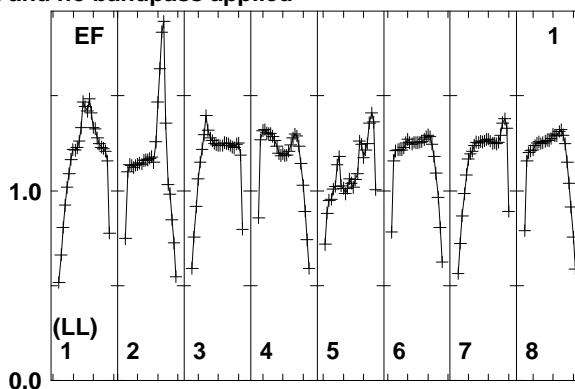
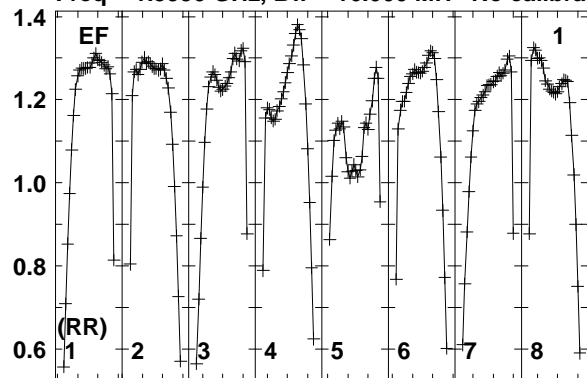

Lower frame: Real Jy
Total-power spectrum Antenna: EF (01)
Timerange: 00/02:47:07 to 00/02:48:30

Plot file version 176 created 19-AUG-2016 17:19:40

J1642+2523 EM119D.UVDATA.1

Freq = 1.5950 GHz, Bw = 16.000 MH No calibration applied and no bandpass applied

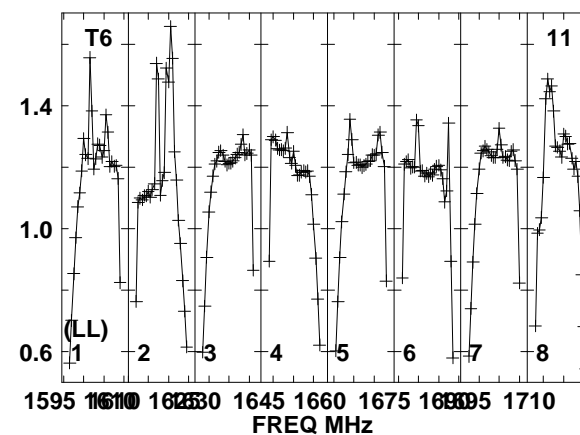
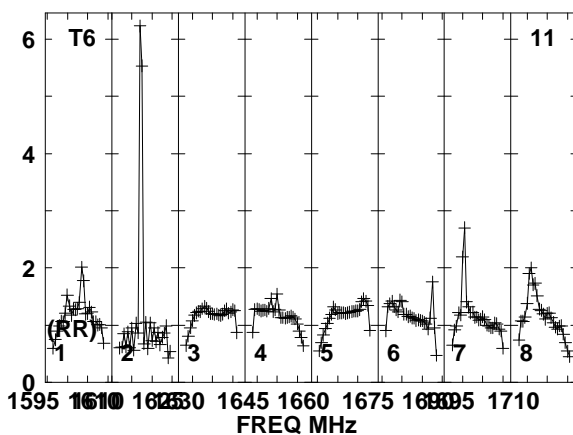
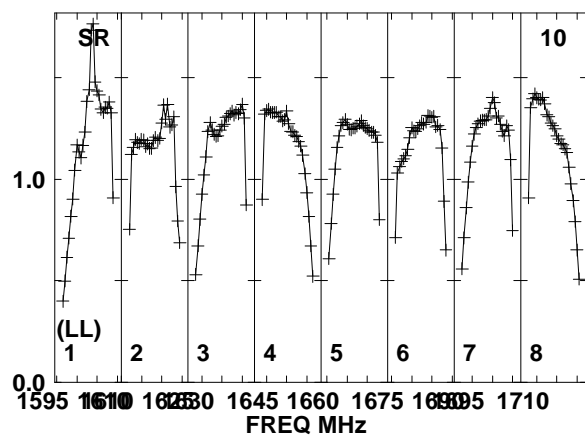
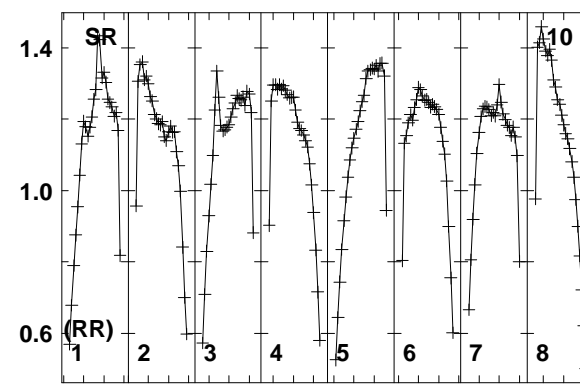
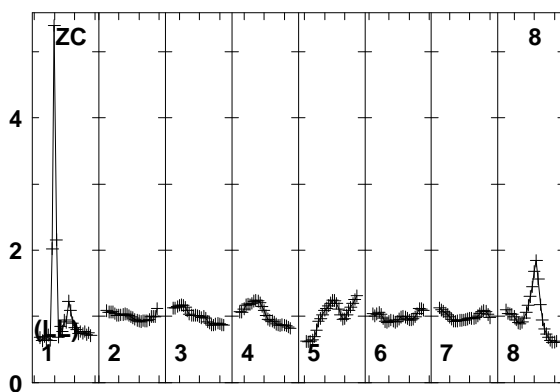
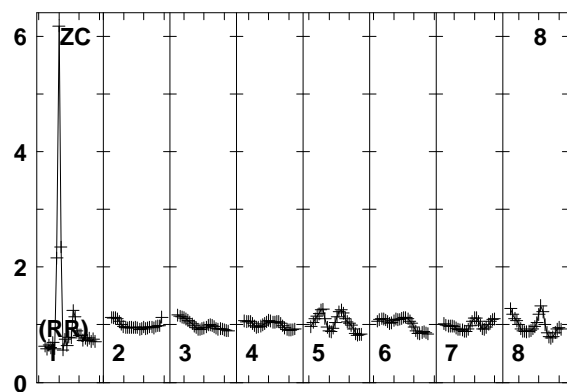
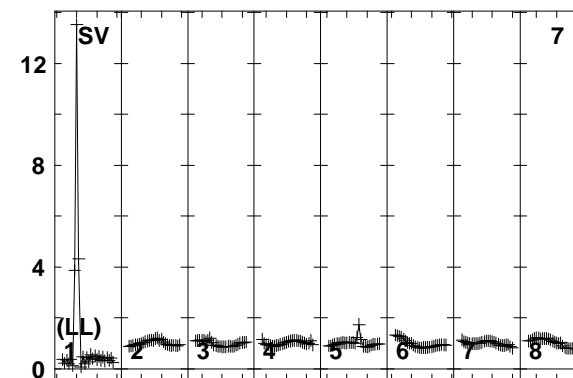
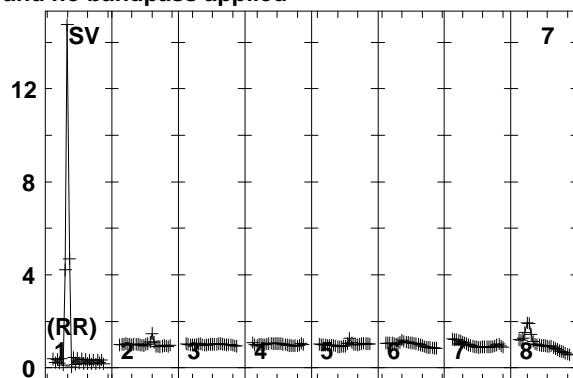
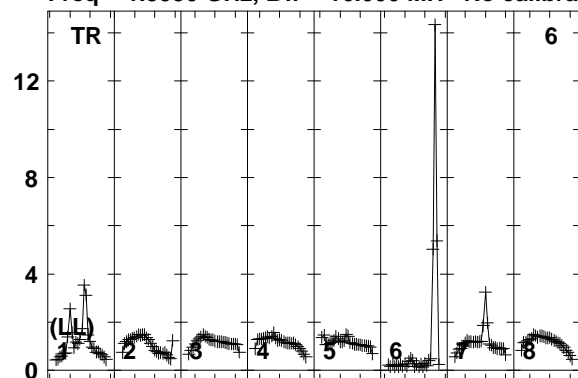

Lower frame: Real Jy
Total-power spectrum Antenna: TR (06)
Timerange: 00/02:47:07 to 00/02:48:30

Plot file version 177 created 19-AUG-2016 17:19:40

J1642+2523 EM119D.UVDATA.1

Freq = 1.5950 GHz, Bw = 16.000 MH No calibration applied and no bandpass applied

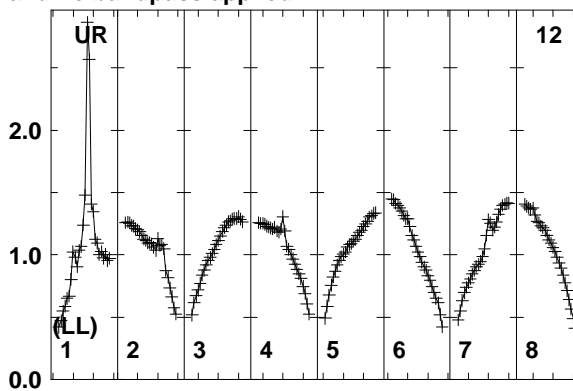
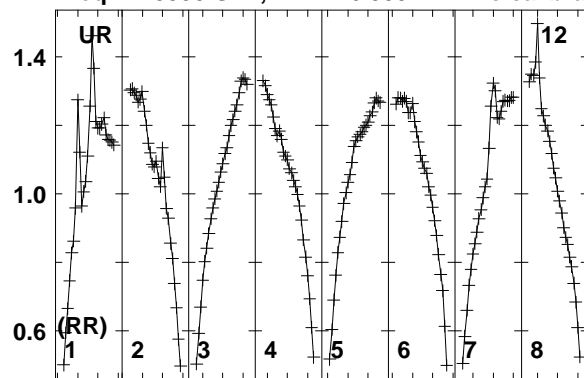

Lower frame: Real Jy
Total-power spectrum Antenna: UR (12)
Timerange: 00/02:47:07 to 00/02:48:30

Plot file version 178 created 19-AUG-2016 17:19:40

J1649+2635 EM119D.UVDATA.1

Freq = 1.5950 GHz, Bw = 16.000 MH No calibration applied and no bandpass applied

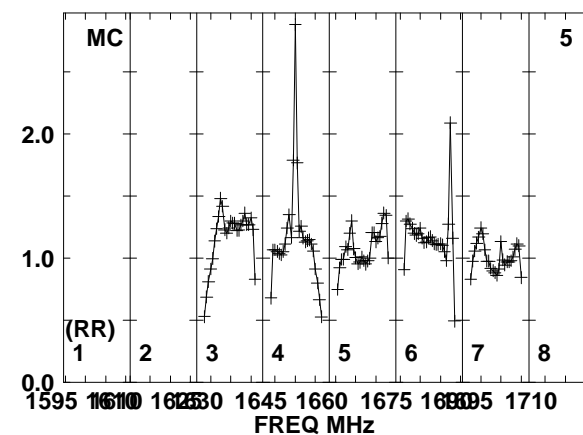
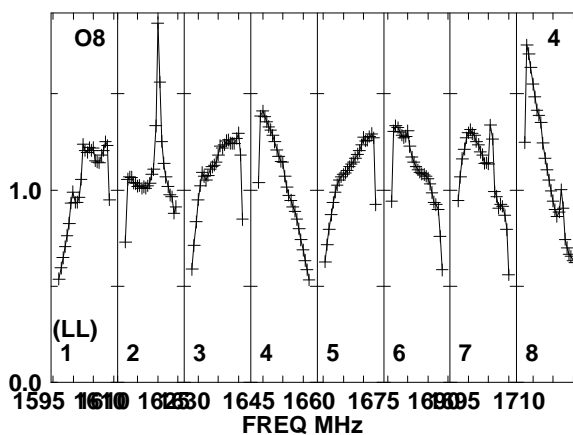
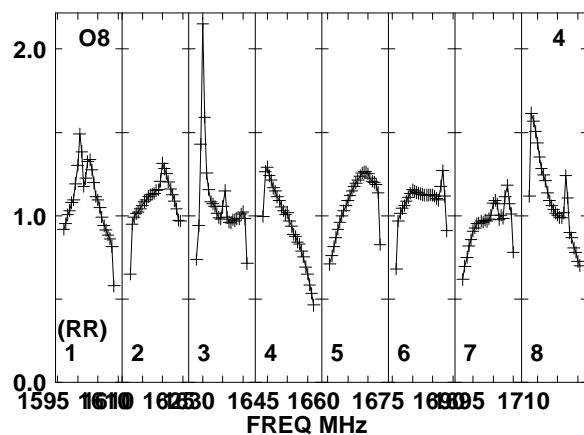
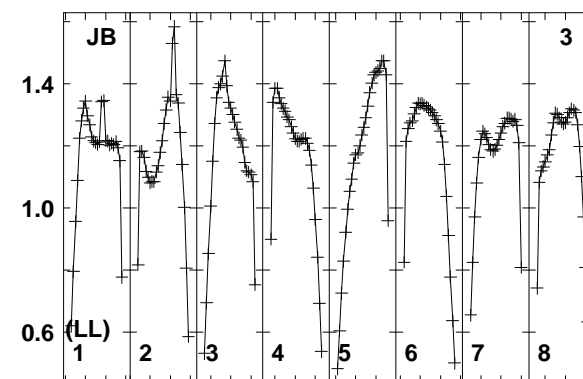
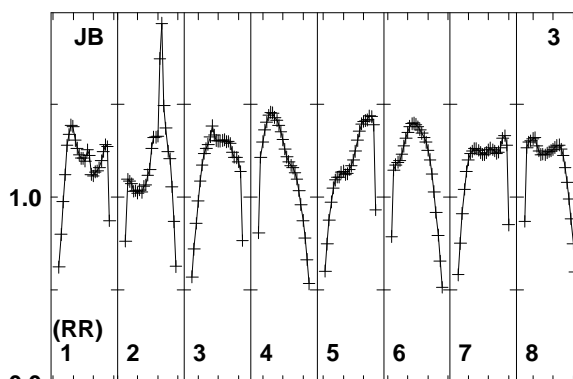
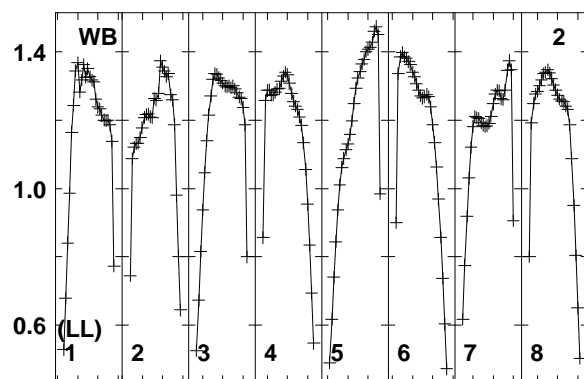
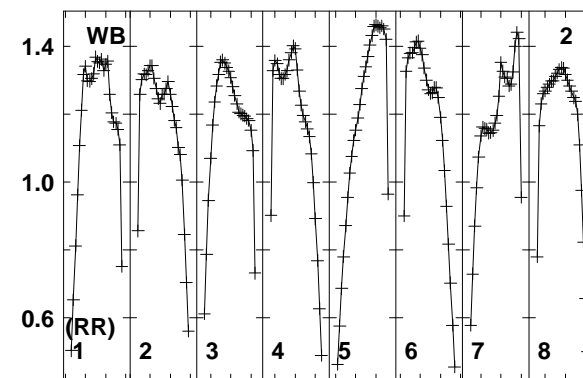
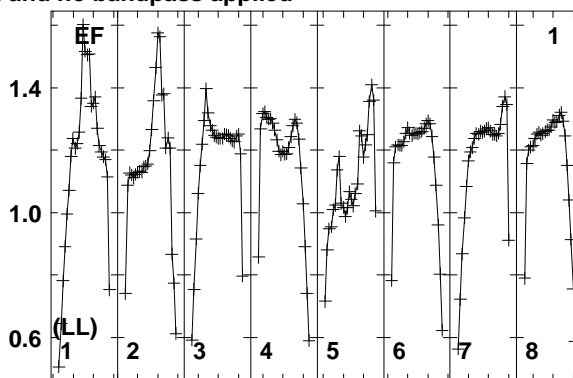
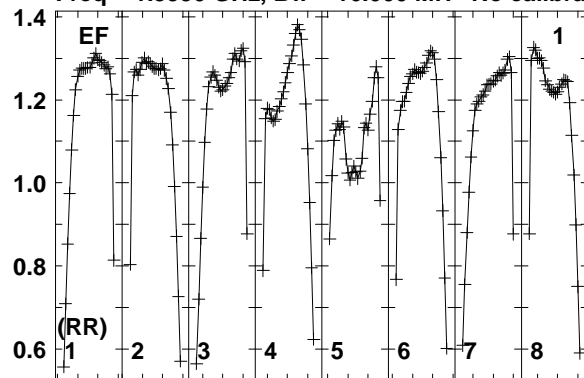

Lower frame: Real Jy
Total-power spectrum Antenna: EF (01)
Timerange: 00/02:48:32 to 00/02:52:00

Plot file version 179 created 19-AUG-2016 17:19:40

J1649+2635 EM119D.UVDATA.1

Freq = 1.5950 GHz, Bw = 16.000 MH No calibration applied and no bandpass applied

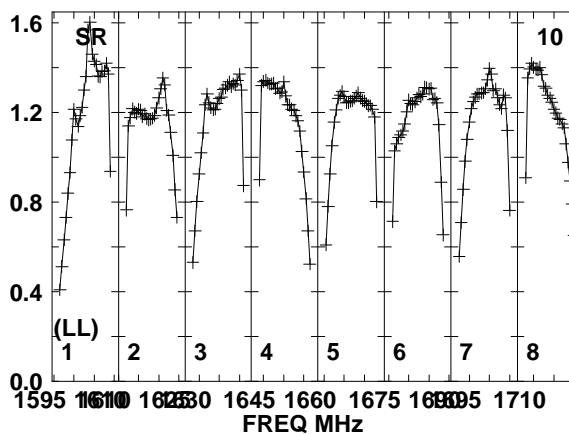
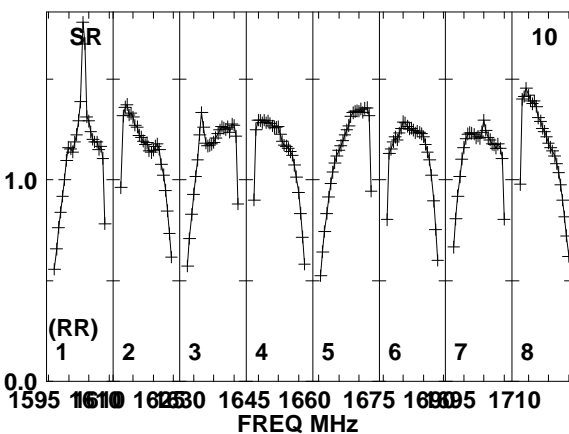
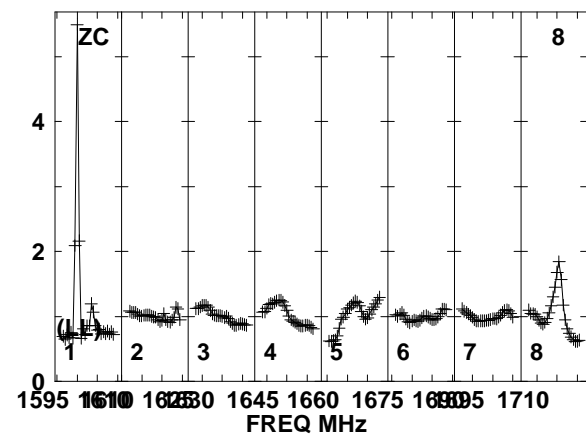
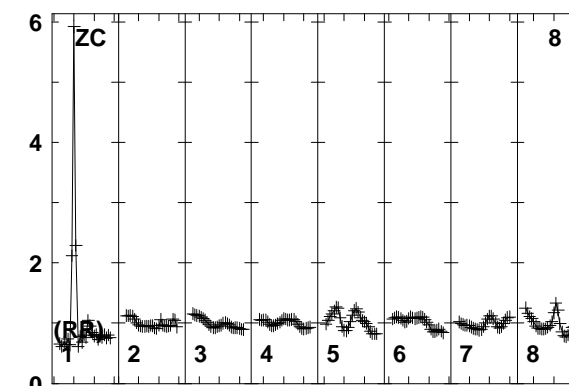
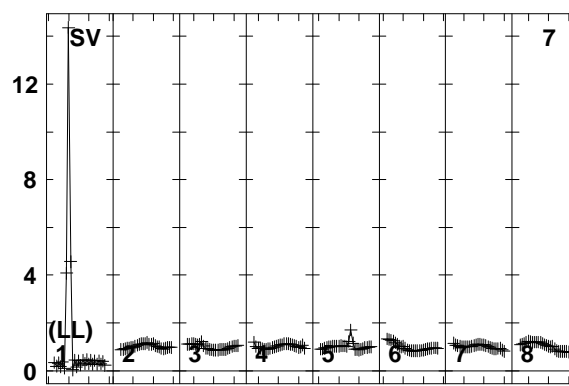
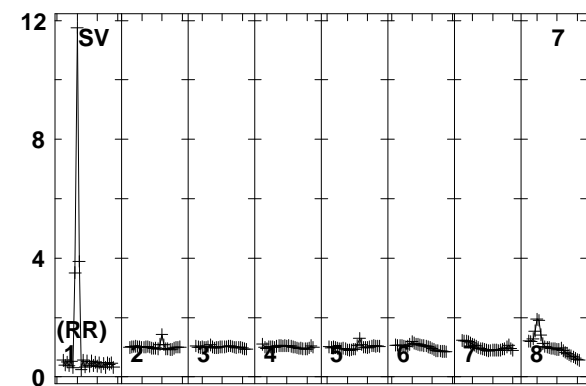
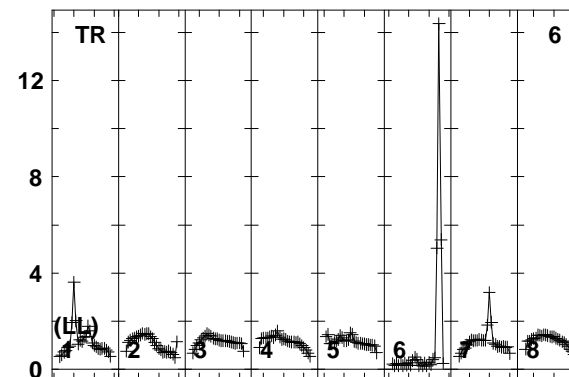
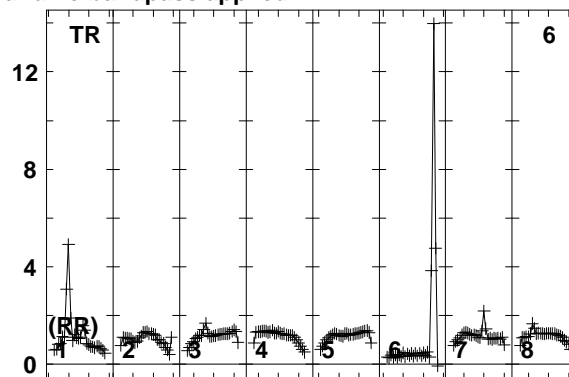
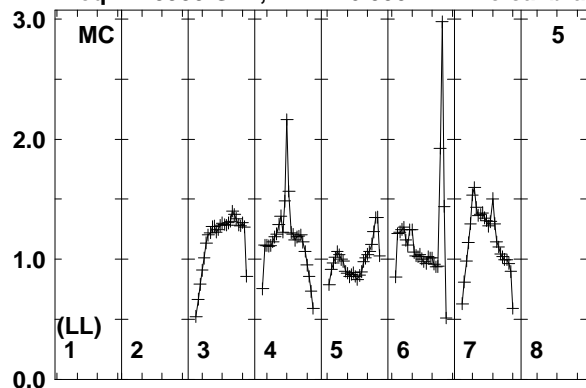

Lower frame: Real Jy
Total-power spectrum Antenna: MC (05)
Timerange: 00/02:48:32 to 00/02:52:00

Plot file version 180 created 19-AUG-2016 17:19:40

J1649+2635 EM119D.UVDATA.1

Freq = 1.5950 GHz, Bw = 16.000 MH No calibration applied and no bandpass applied

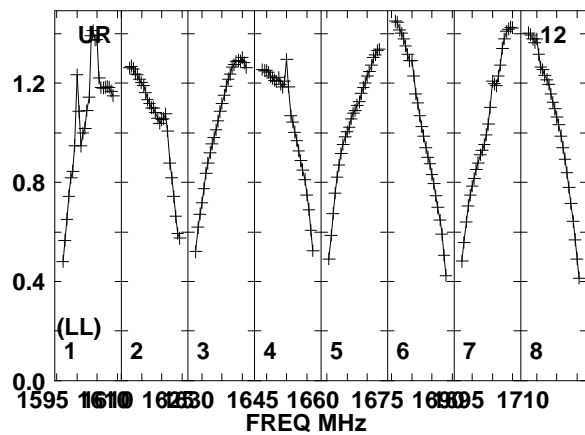
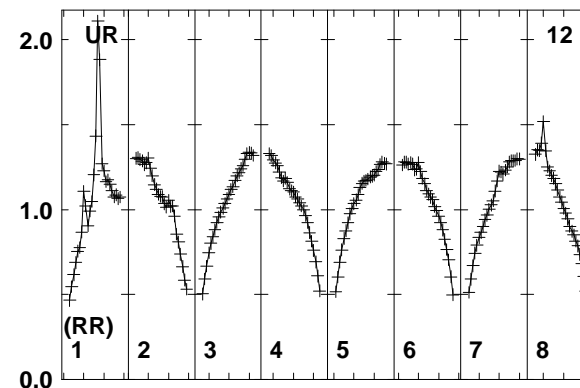
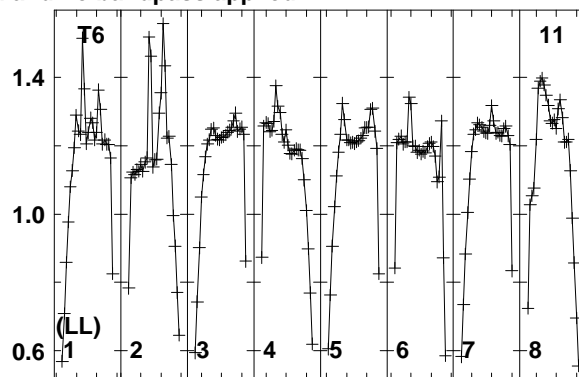
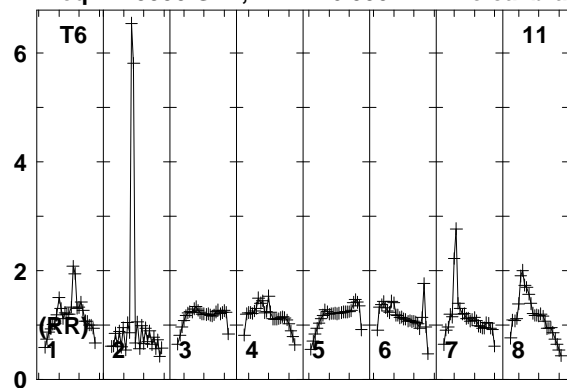

Lower frame: Real Jy
Total-power spectrum Antenna: T6 (11)
Timerange: 00/02:48:32 to 00/02:52:00

Plot file version 181 created 19-AUG-2016 17:19:41

J1642+2523 EM119D.UVDATA.1

Freq = 1.5950 GHz, Bw = 16.000 MH No calibration applied and no bandpass applied

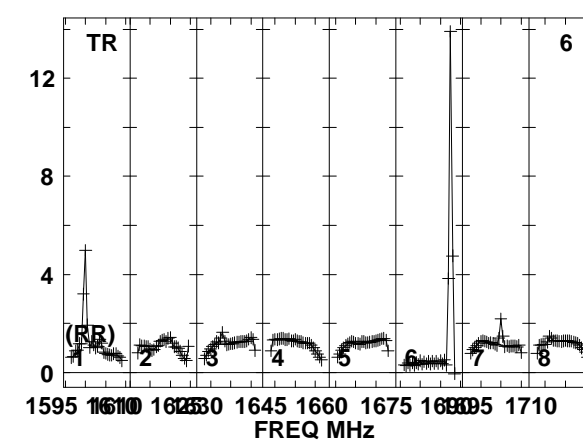
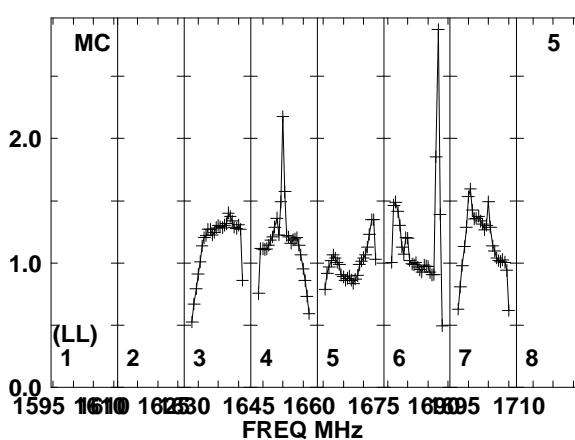
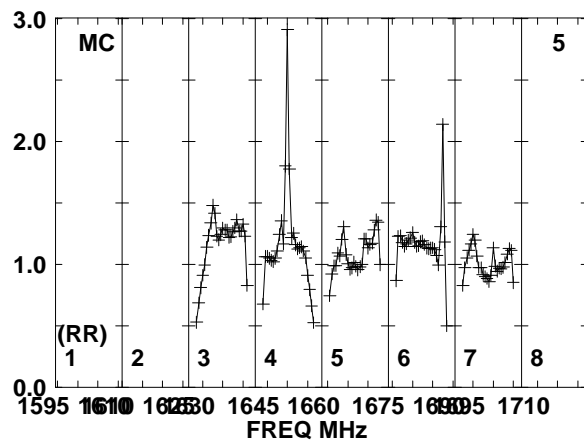
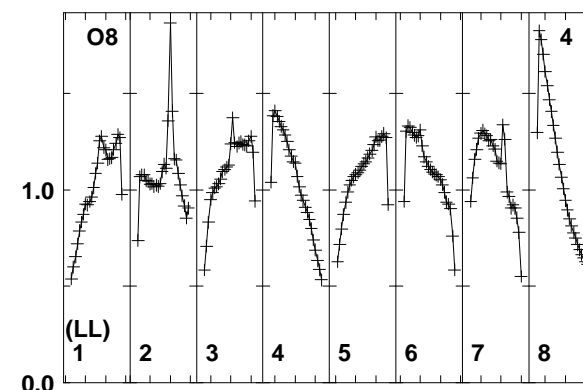
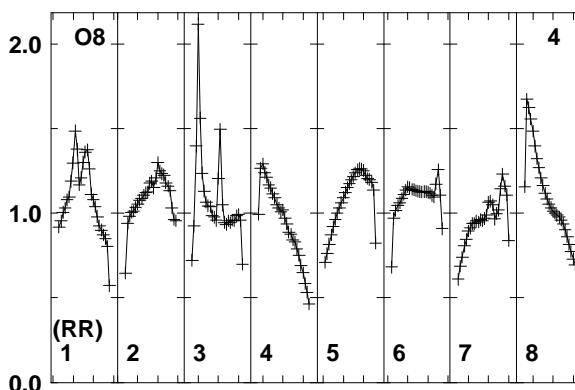
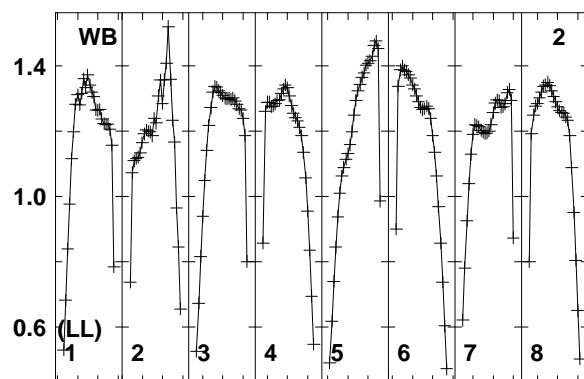
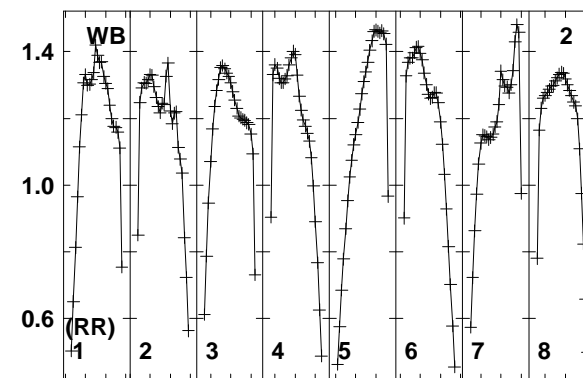
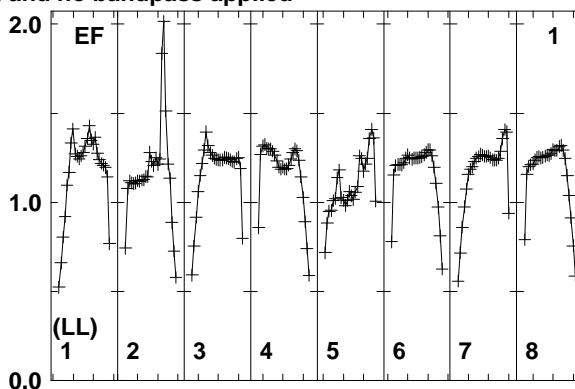
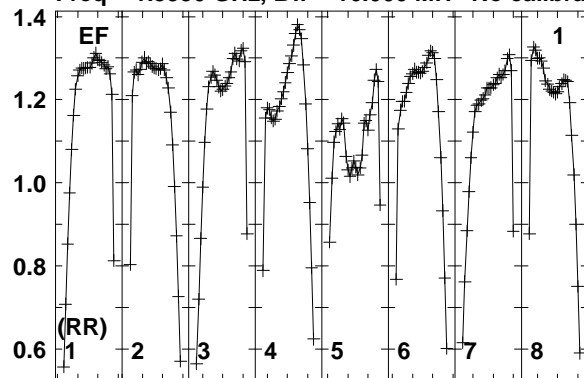

Lower frame: Real Jy
Total-power spectrum Antenna: EF (01)
Timerange: 00/02:52:08 to 00/02:53:29

Plot file version 182 created 19-AUG-2016 17:19:41

J1642+2523 EM119D.UVDATA.1

Freq = 1.5950 GHz, Bw = 16.000 MH No calibration applied and no bandpass applied

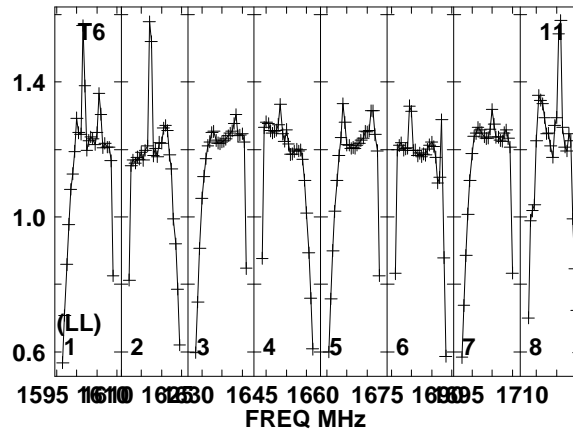
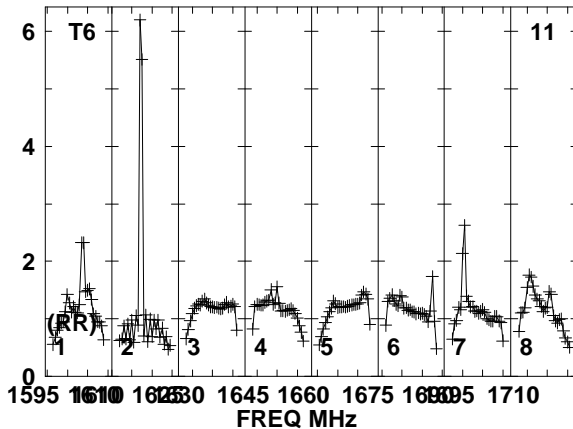
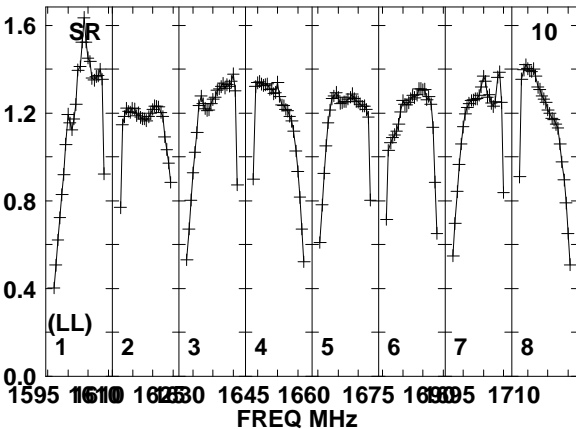
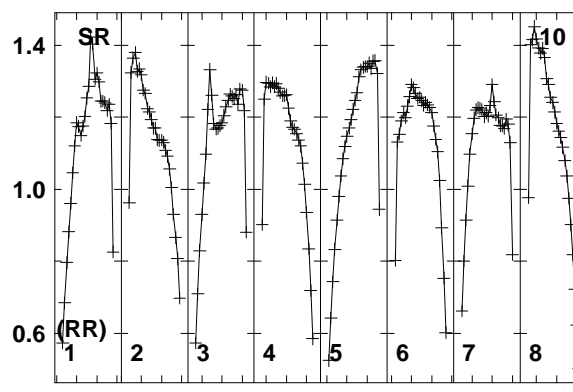
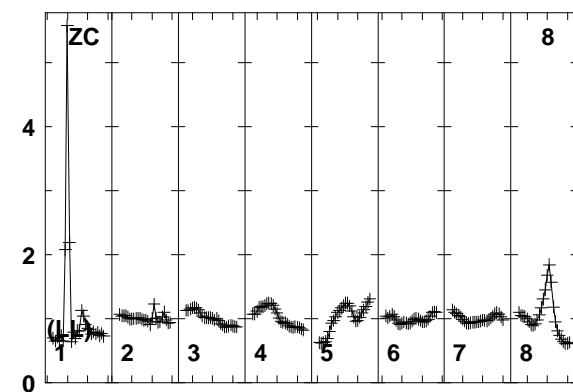
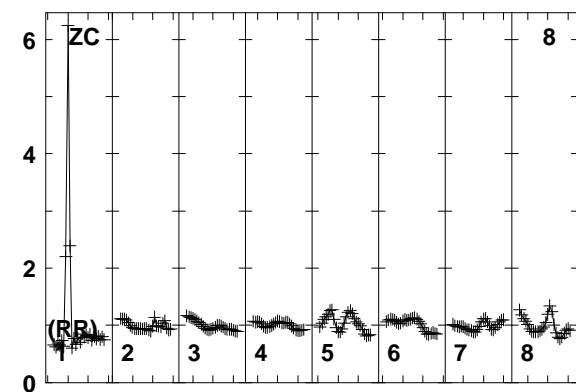
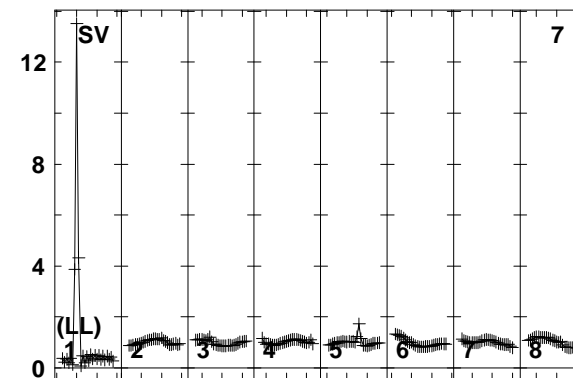
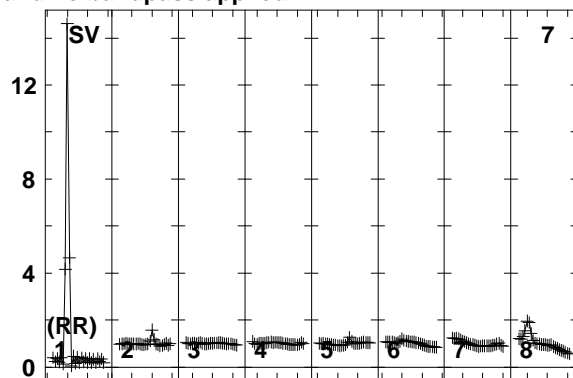
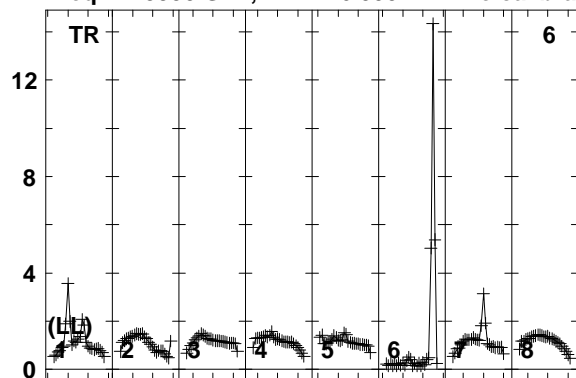

Lower frame: Real Jy
Total-power spectrum Antenna: TR (06)
Timerange: 00/02:52:08 to 00/02:53:29

Plot file version 183 created 19-AUG-2016 17:19:41

J1642+2523 EM119D.UVDATA.1

Freq = 1.5950 GHz, Bw = 16.000 MH No calibration applied and no bandpass applied

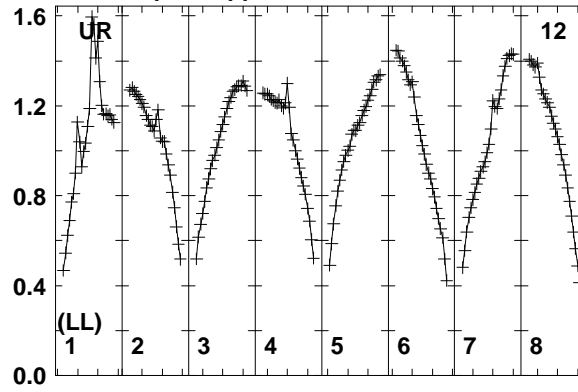
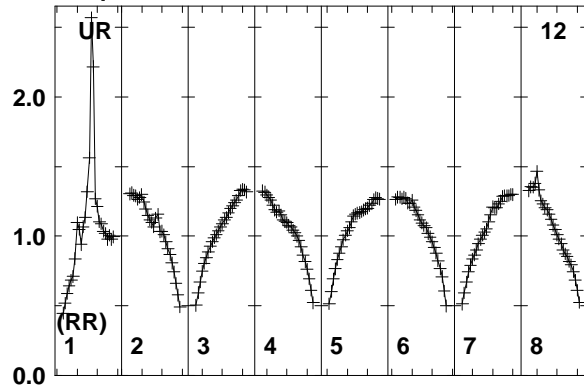

Lower frame: Real Jy
Total-power spectrum Antenna: UR (12)
Timerange: 00/02:52:08 to 00/02:53:29

Plot file version 184 created 19-AUG-2016 17:19:41

J1649+2635 EM119D.UVDATA.1

Freq = 1.5950 GHz, Bw = 16.000 MH No calibration applied and no bandpass applied

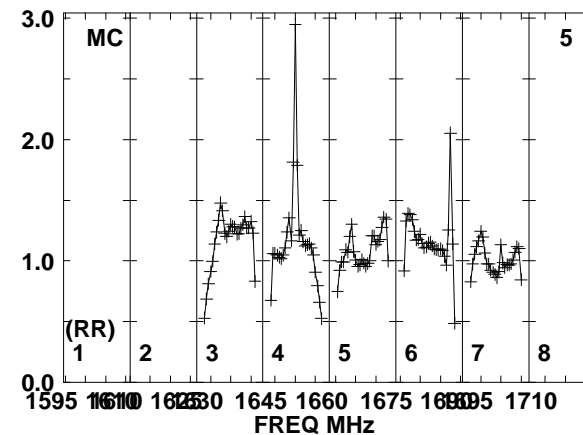
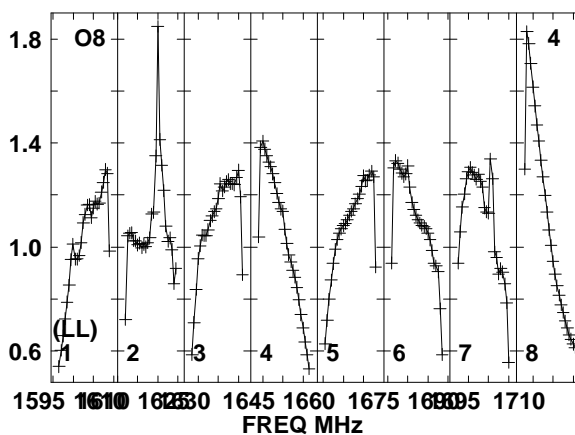
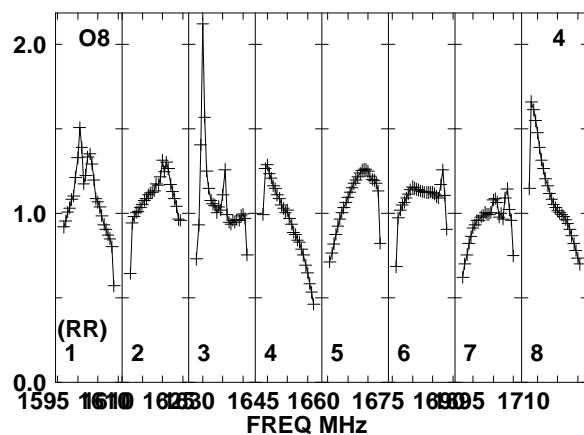
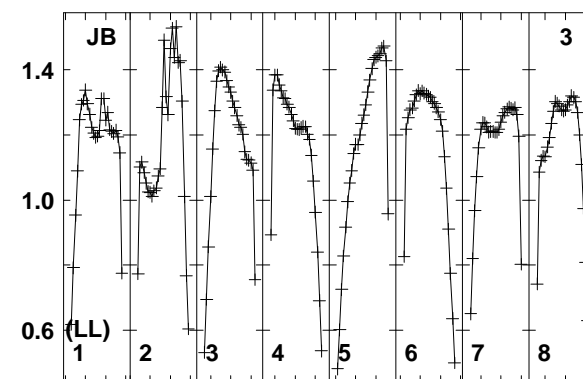
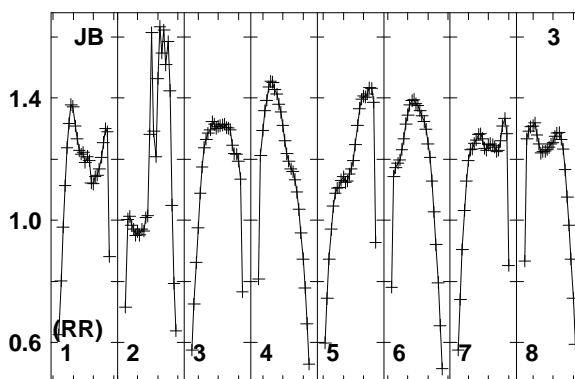
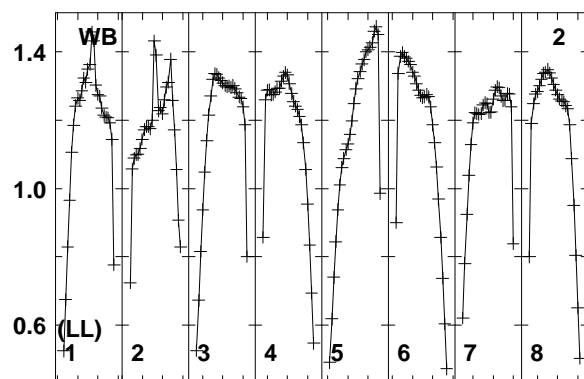
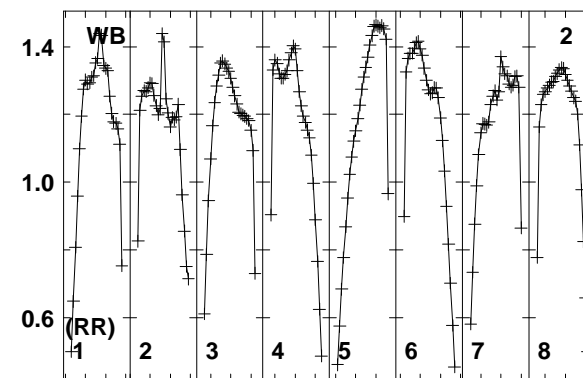
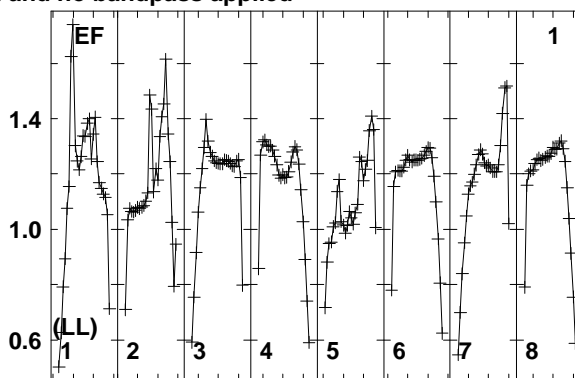
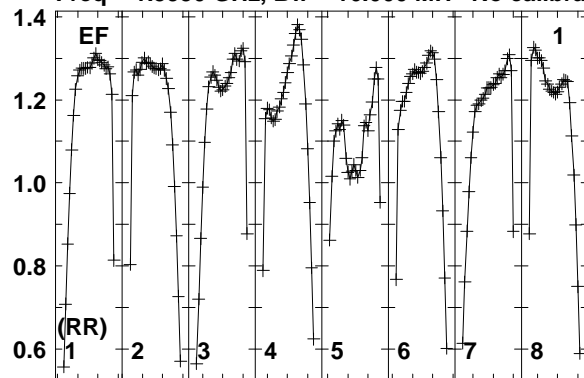

Lower frame: Real Jy
Total-power spectrum Antenna: EF (01)
Timerange: 00/02:54:31 to 00/02:58:00

Plot file version 185 created 19-AUG-2016 17:19:41

J1649+2635 EM119D.UVDATA.1

Freq = 1.5950 GHz, Bw = 16.000 MH No calibration applied and no bandpass applied

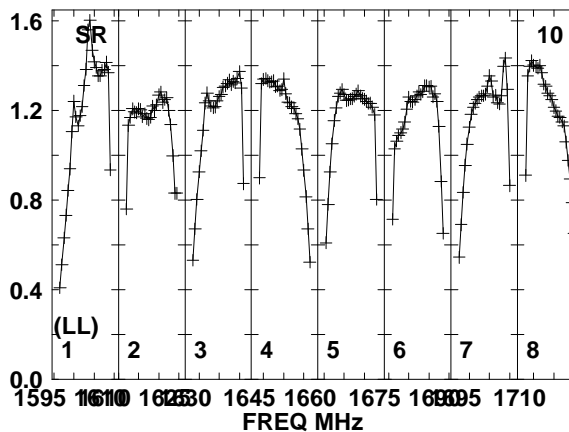
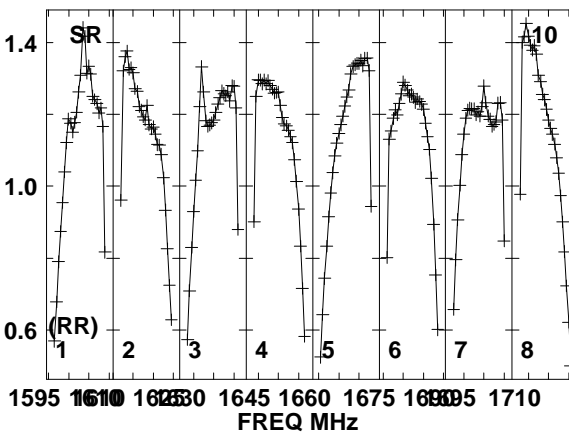
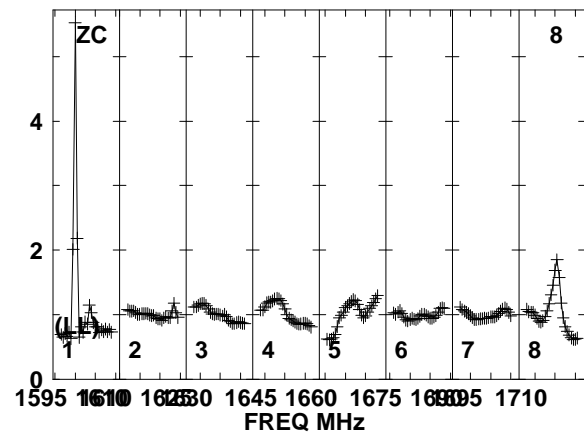
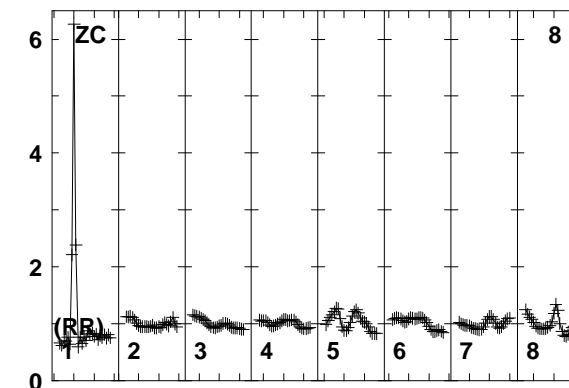
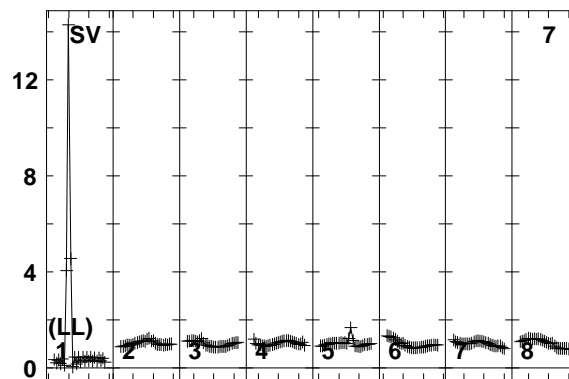
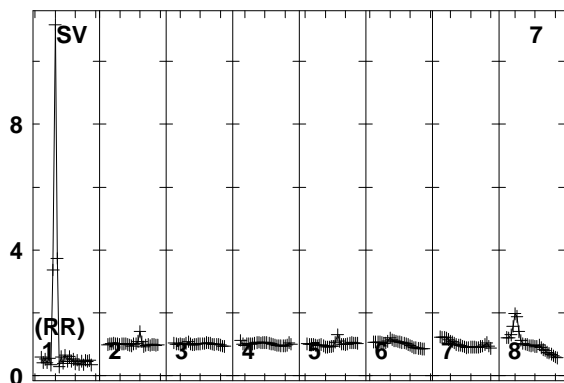
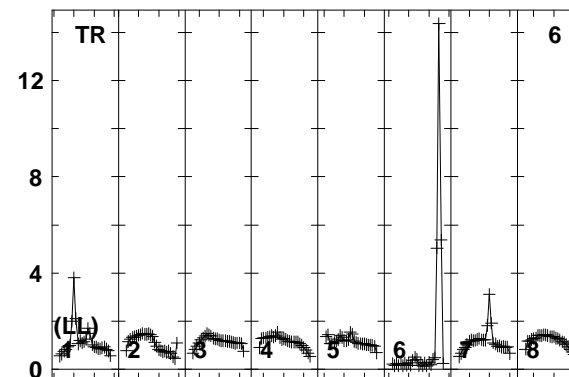
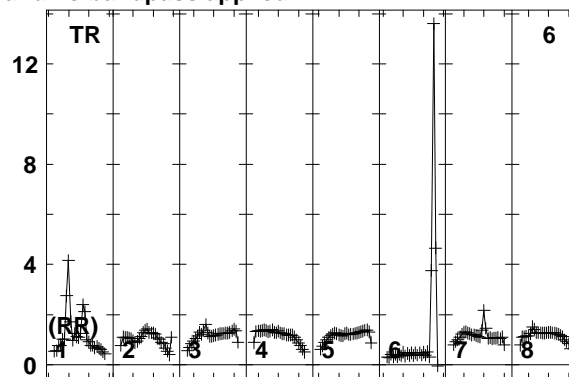
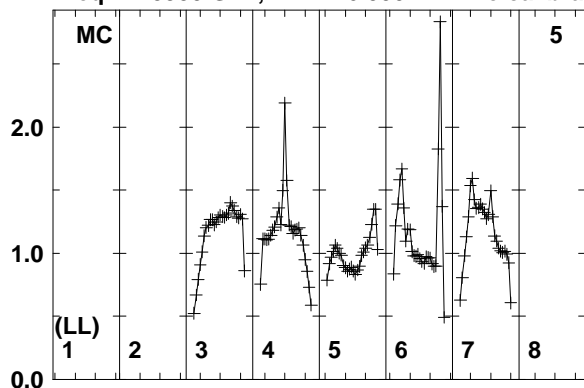

Lower frame: Real Jy
Total-power spectrum Antenna: MC (05)
Timerange: 00/02:54:31 to 00/02:58:00

Plot file version 186 created 19-AUG-2016 17:19:41

J1649+2635 EM119D.UVDATA.1

Freq = 1.5950 GHz, Bw = 16.000 MH No calibration applied and no bandpass applied

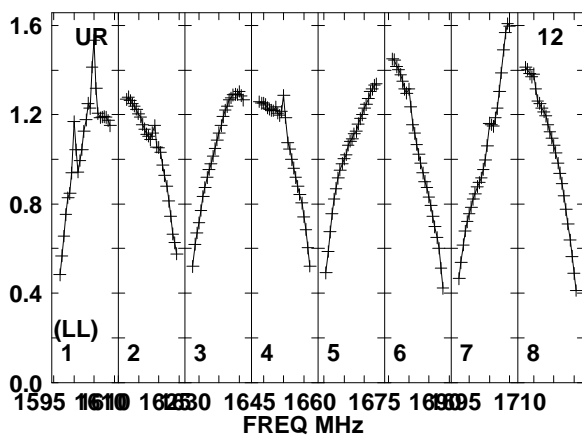
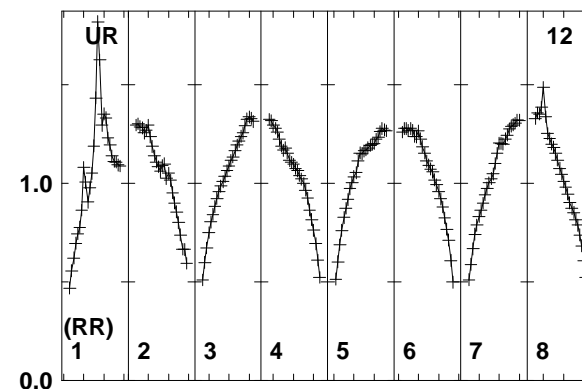
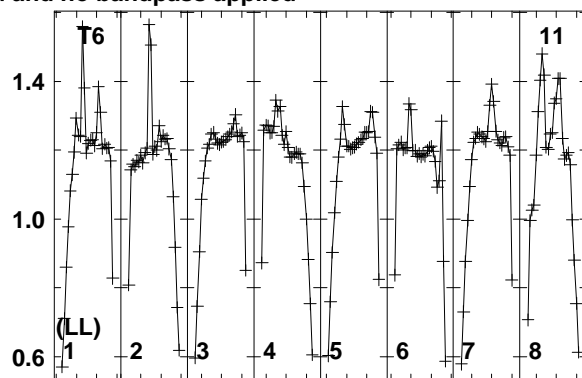
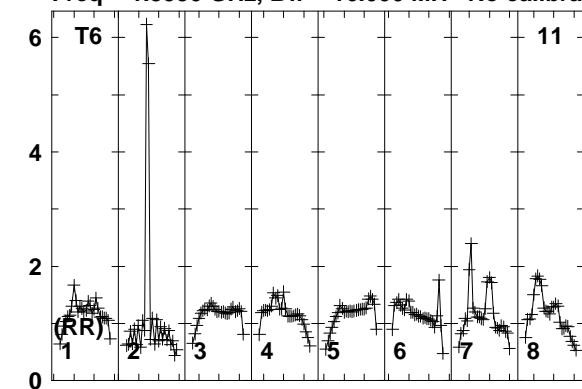

Lower frame: Real Jy
Total-power spectrum Antenna: T6 (11)
Timerange: 00/02:54:31 to 00/02:58:00

Plot file version 187 created 19-AUG-2016 17:19:42

J1642+2523 EM119D.UVDATA.1

Freq = 1.5950 GHz, Bw = 16.000 MH No calibration applied and no bandpass applied

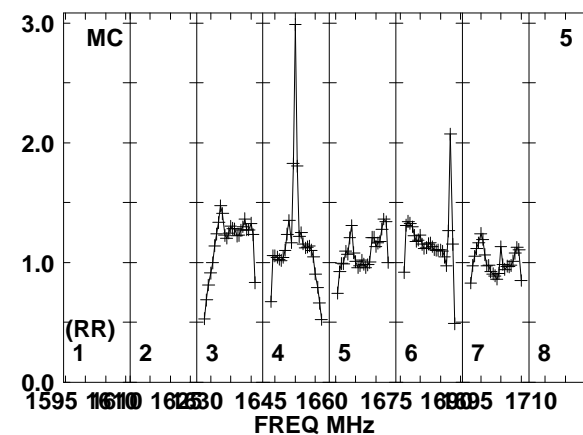
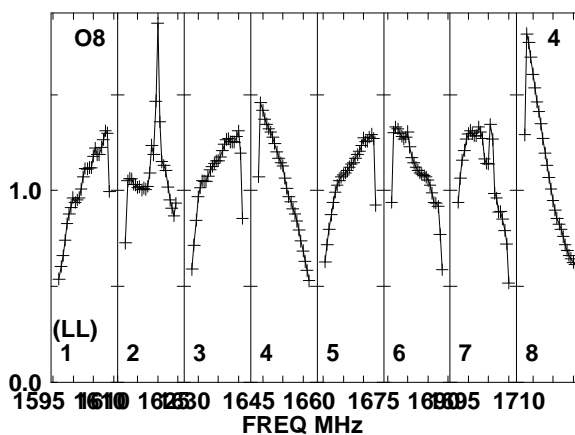
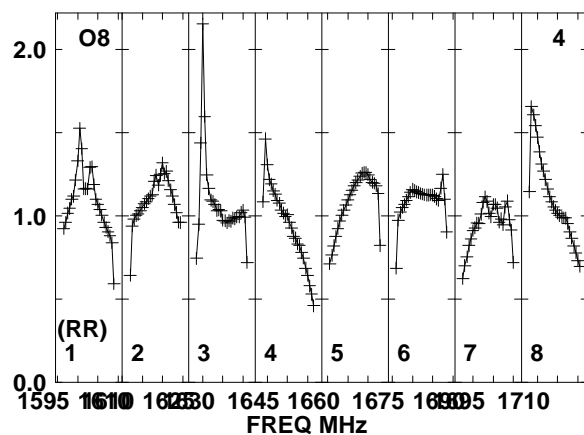
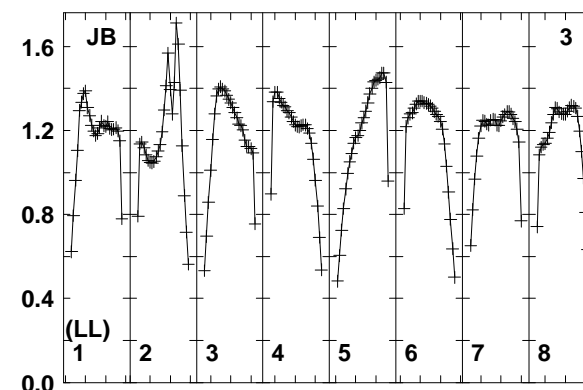
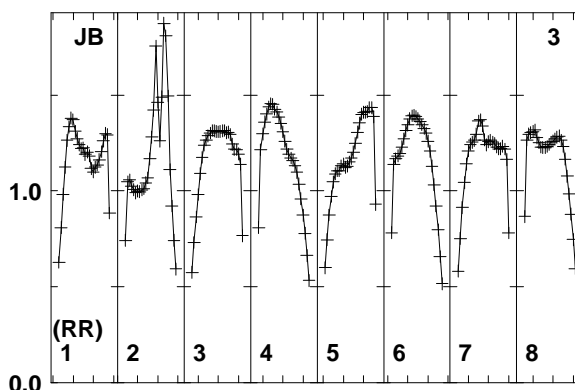
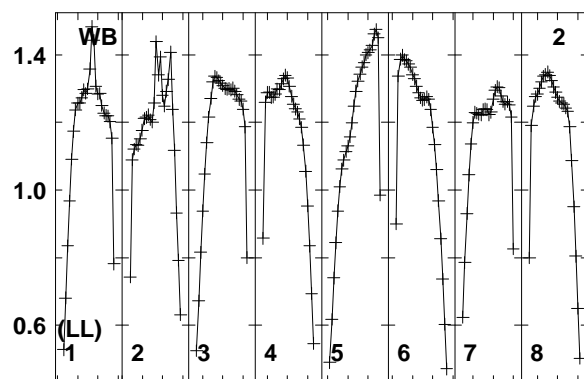
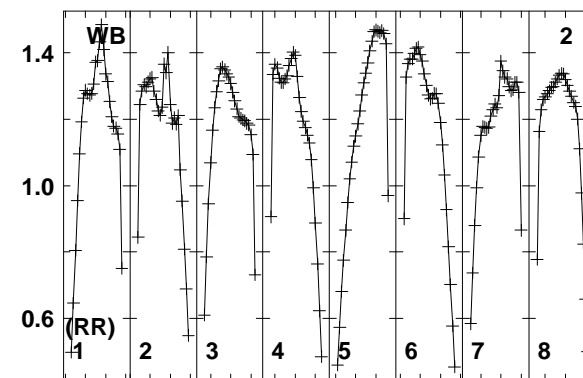
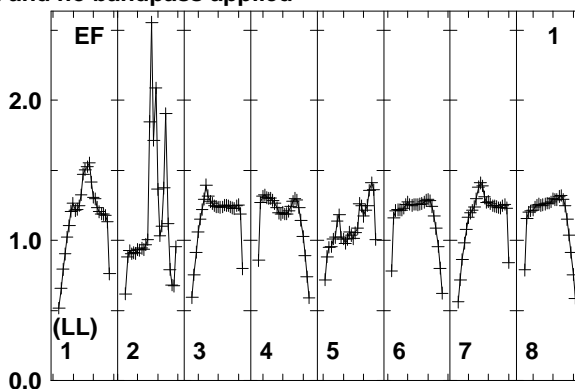
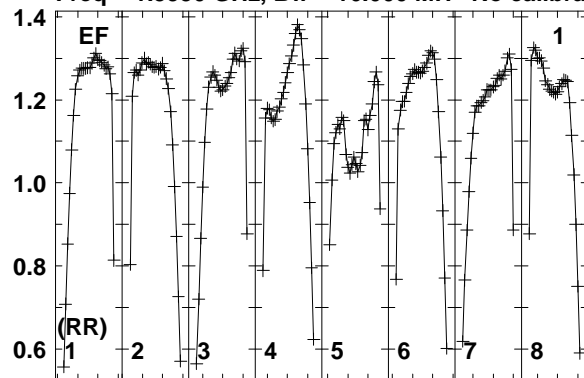

Lower frame: Real Jy
Total-power spectrum Antenna: EF (01)
Timerange: 00/02:58:07 to 00/02:59:30

Plot file version 188 created 19-AUG-2016 17:19:42

J1642+2523 EM119D.UVDATA.1

Freq = 1.5950 GHz, Bw = 16.000 MH No calibration applied and no bandpass applied

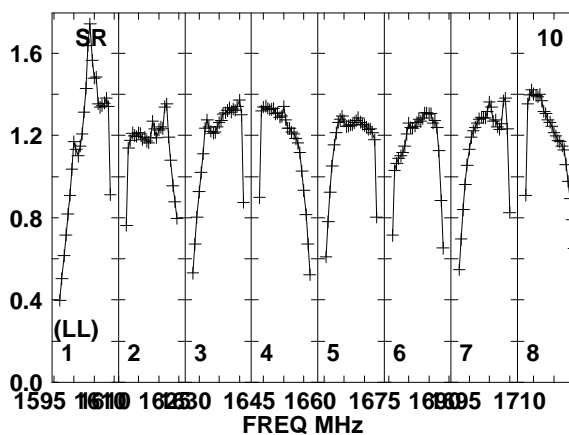
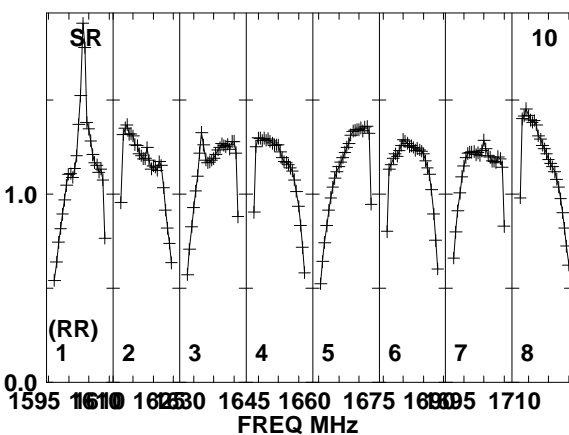
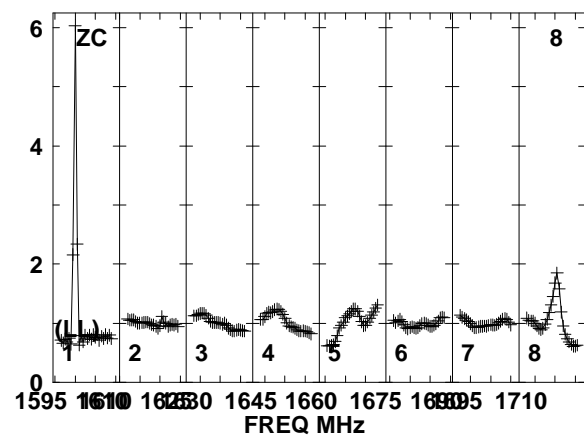
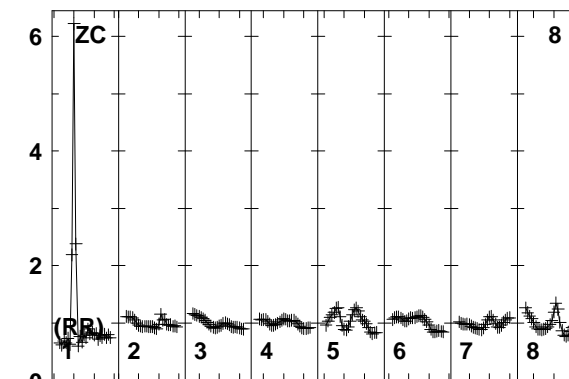
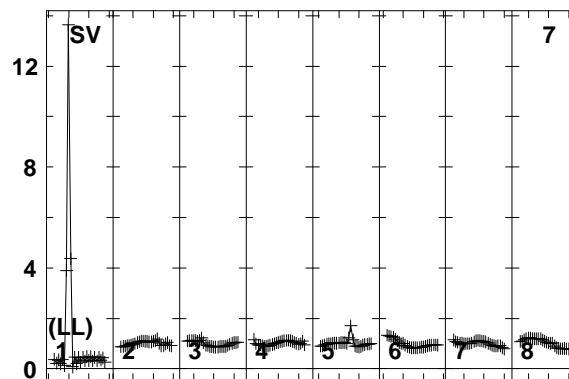
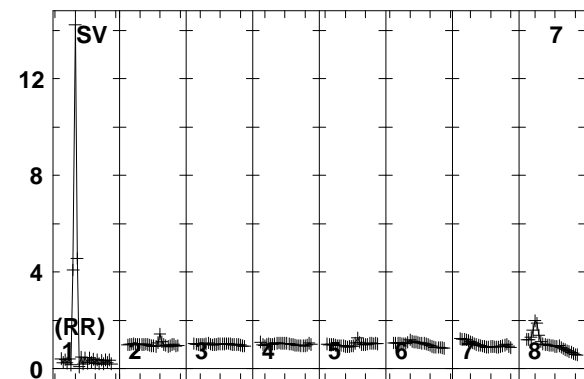
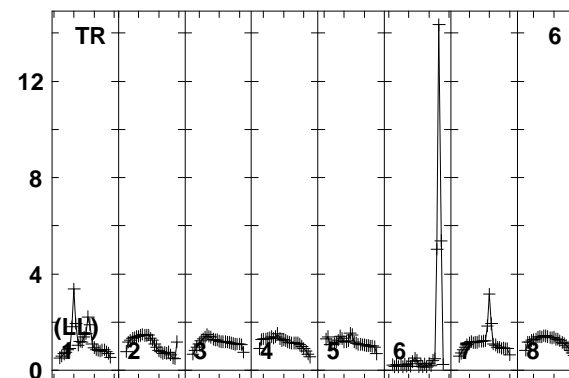
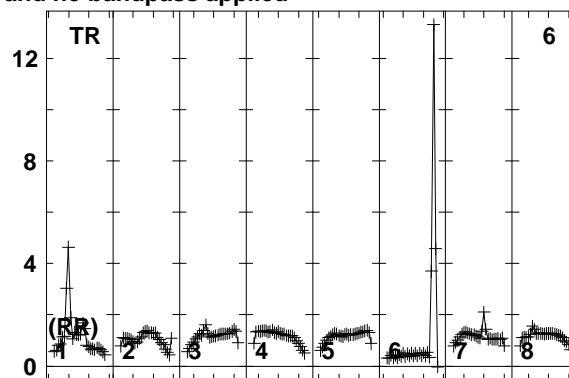
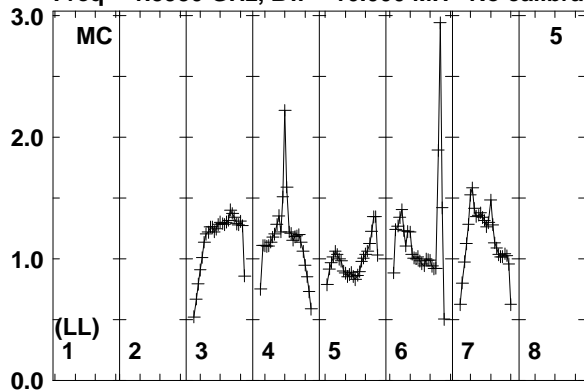

Lower frame: Real Jy
Total-power spectrum Antenna: MC (05)
Timerange: 00/02:58:07 to 00/02:59:30

Plot file version 189 created 19-AUG-2016 17:19:42

J1642+2523 EM119D.UVDATA.1

Freq = 1.5950 GHz, Bw = 16.000 MH No calibration applied and no bandpass applied

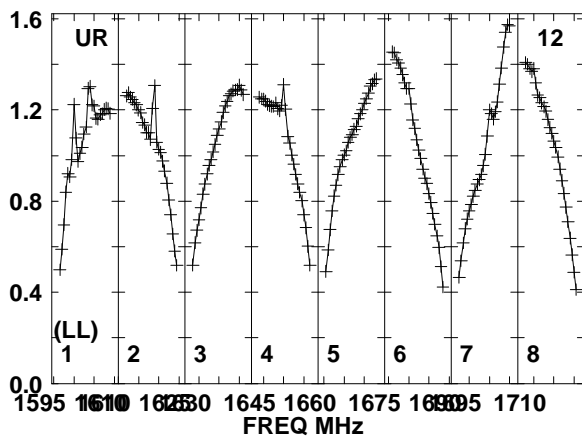
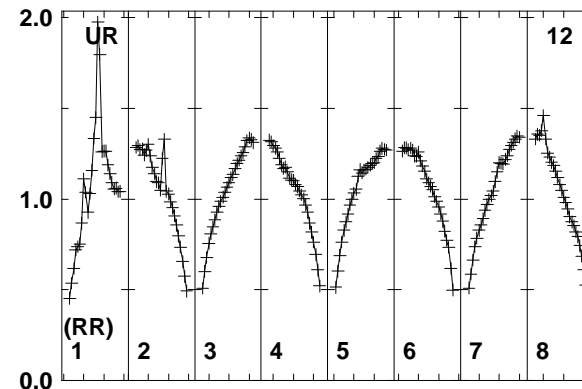
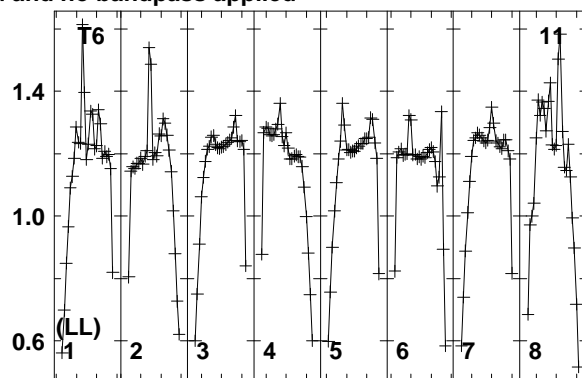
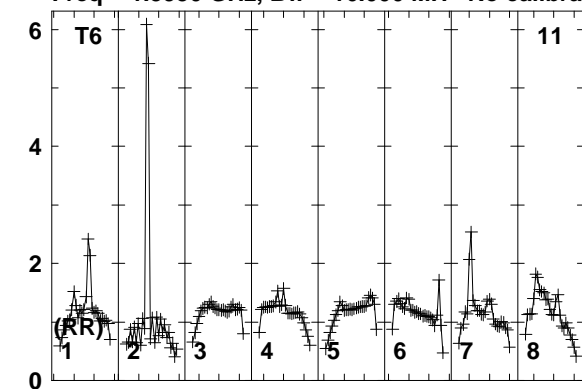

Lower frame: Real Jy
Total-power spectrum Antenna: T6 (11)
Timerange: 00/02:58:07 to 00/02:59:30

Plot file version 190 created 19-AUG-2016 17:19:42

J1649+2635 EM119D.UVDATA.1

Freq = 1.5950 GHz, Bw = 16.000 MH No calibration applied and no bandpass applied

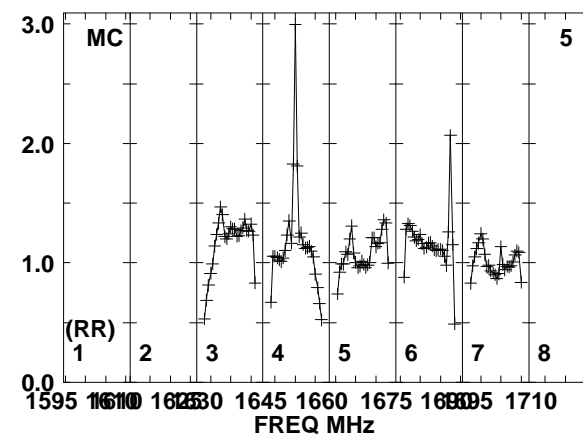
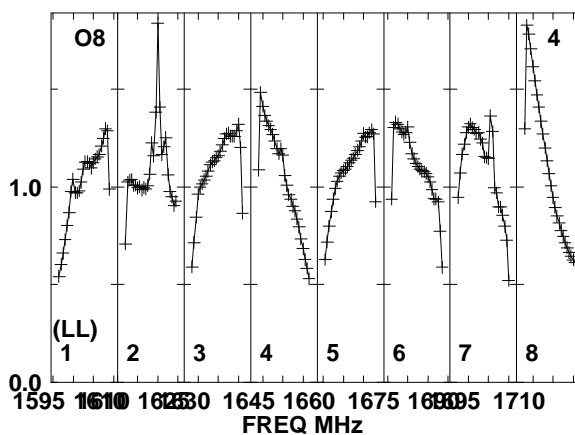
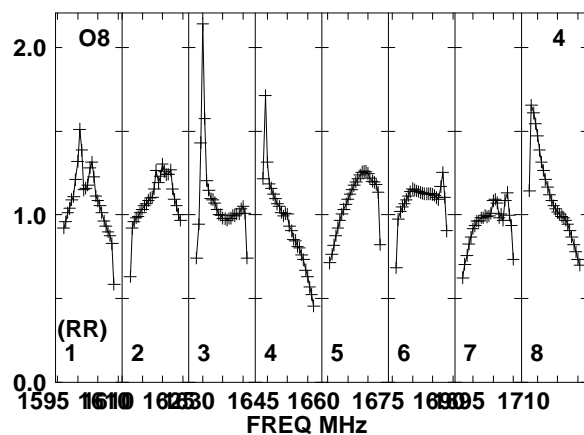
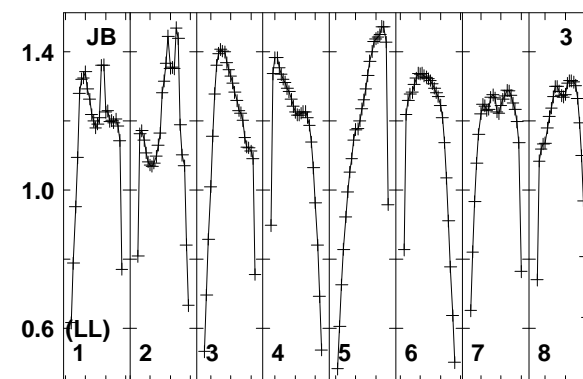
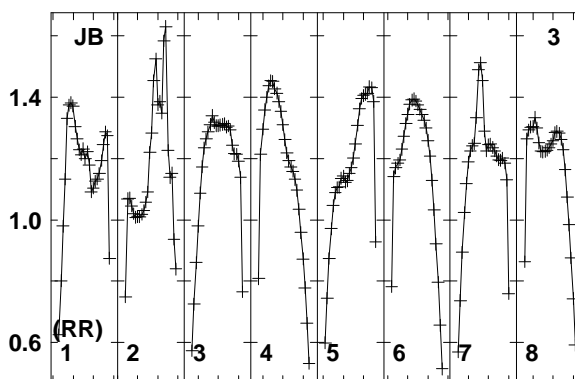
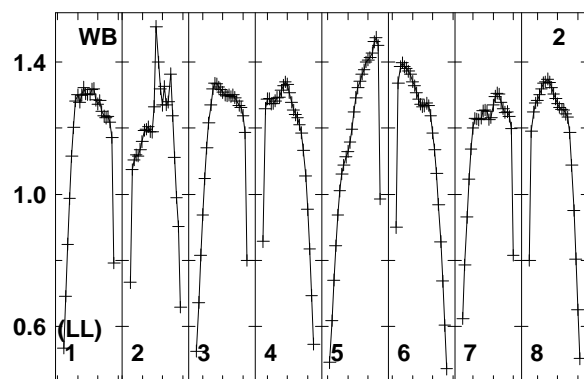
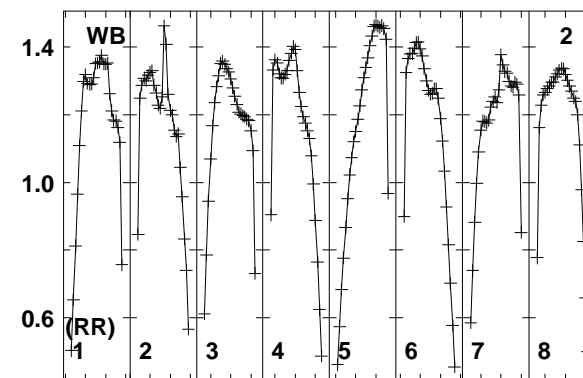
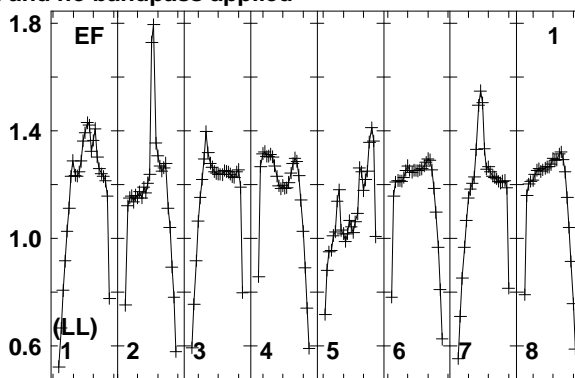
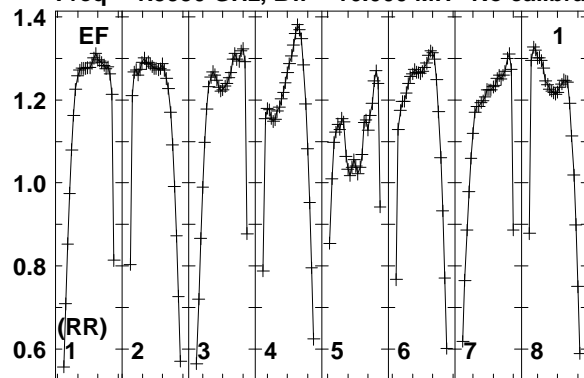

Lower frame: Real Jy
Total-power spectrum Antenna: EF (01)
Timerange: 00/02:59:38 to 00/03:03:00

Plot file version 191 created 19-AUG-2016 17:19:42

J1649+2635 EM119D.UVDATA.1

Freq = 1.5950 GHz, Bw = 16.000 MH No calibration applied and no bandpass applied

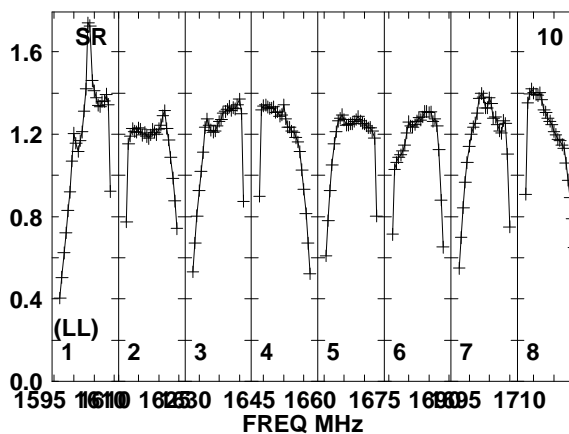
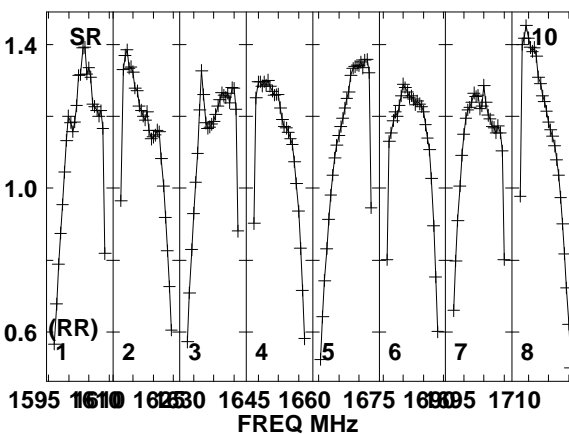
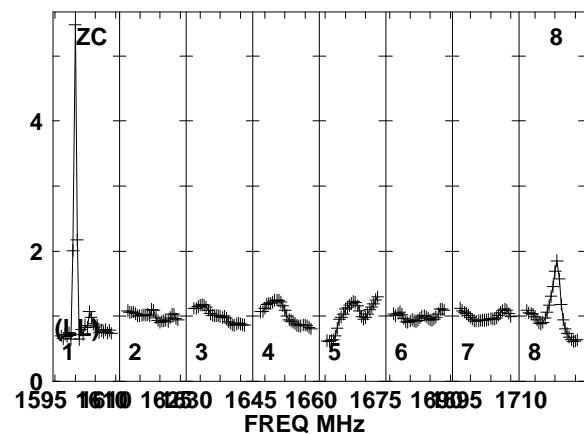
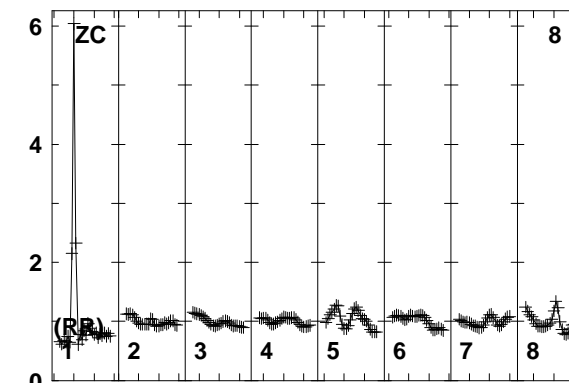
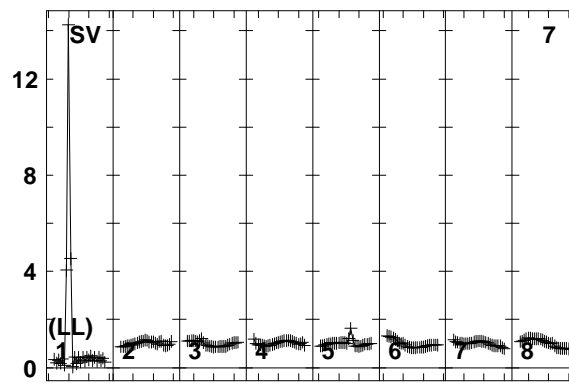
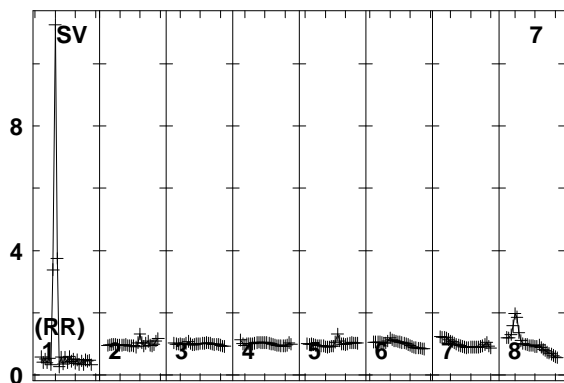
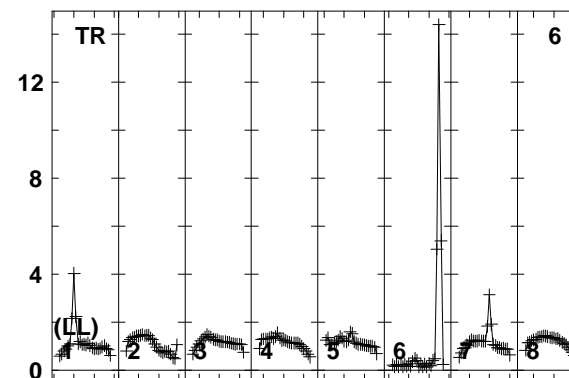
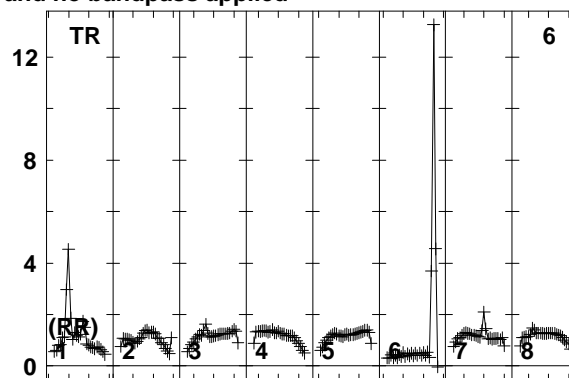
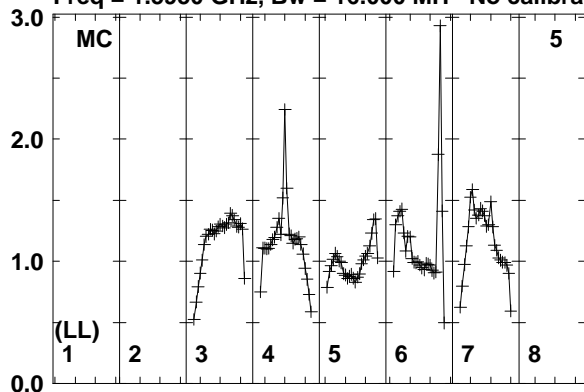

1595 1610 1625 1640 1655 1670 1685 1700 1715
FREQ MHz

1595 1610 1625 1640 1655 1670 1685 1700 1715
FREQ MHz

1595 1610 1625 1640 1655 1670 1685 1700 1715
FREQ MHz

Lower frame: Real Jy
Total-power spectrum Antenna: MC (05)
Timerange: 00/02:59:38 to 00/03:03:00

Plot file version 192 created 19-AUG-2016 17:19:42

J1649+2635 EM119D.UVDATA.1

Freq = 1.5950 GHz, Bw = 16.000 MH No calibration applied and no bandpass applied

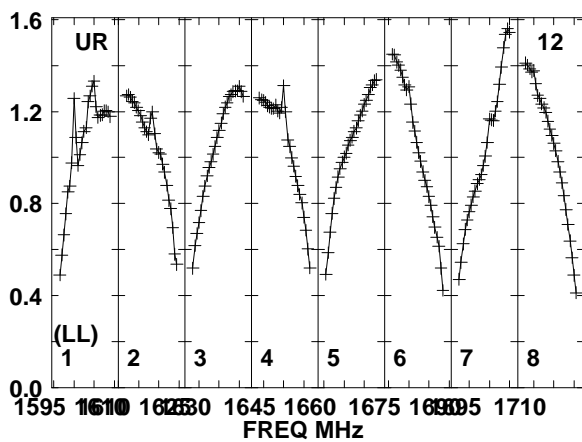
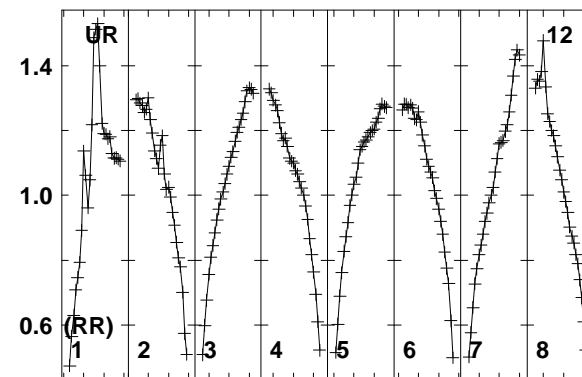
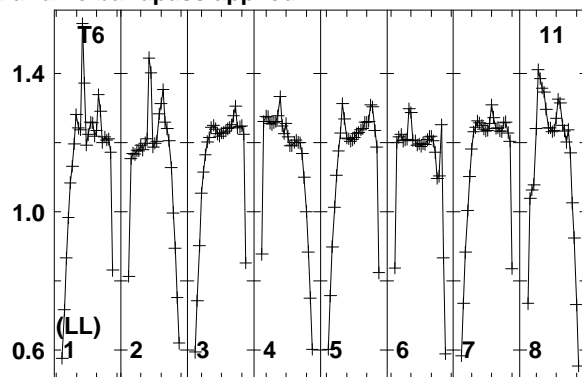
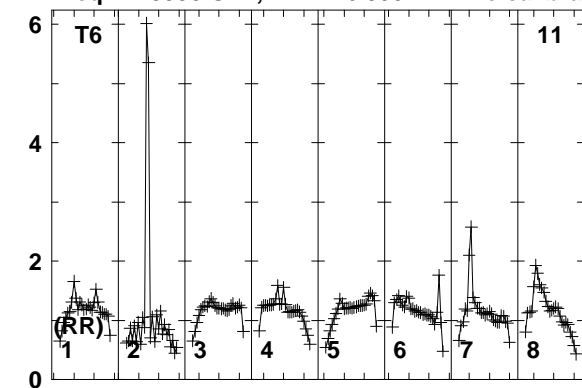

Lower frame: Real Jy
Total-power spectrum Antenna: T6 (11)
Timerange: 00/02:59:38 to 00/03:03:00

Plot file version 193 created 19-AUG-2016 17:19:43

J1642+2523 EM119D.UVDATA.1

Freq = 1.5950 GHz, Bw = 16.000 MH No calibration applied and no bandpass applied

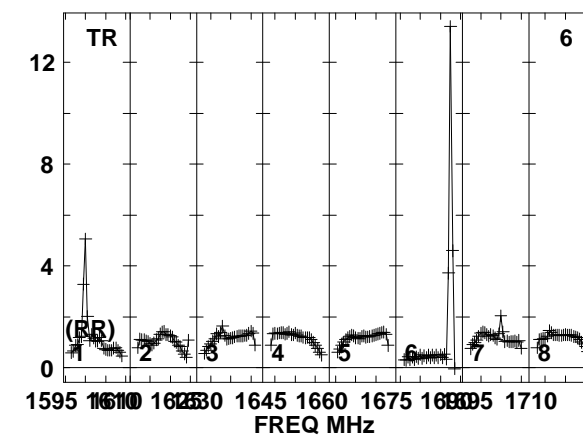
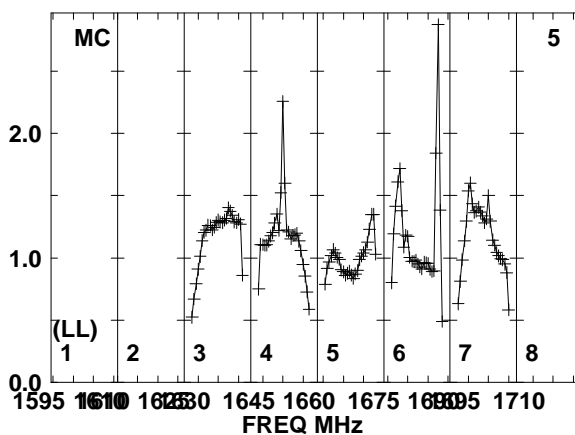
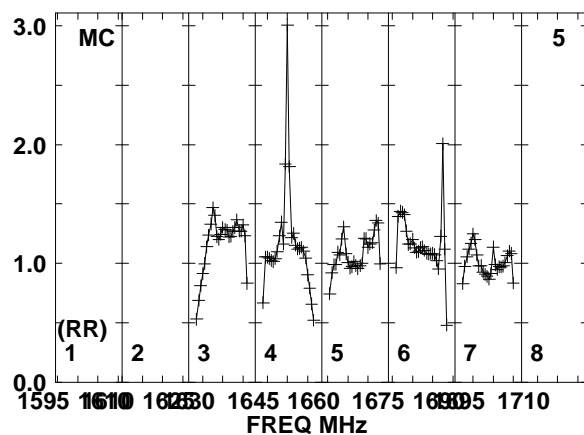
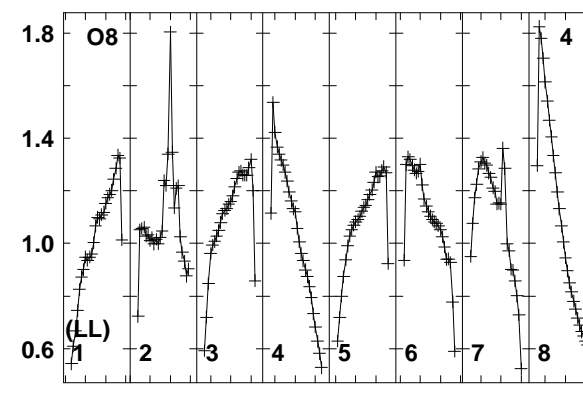
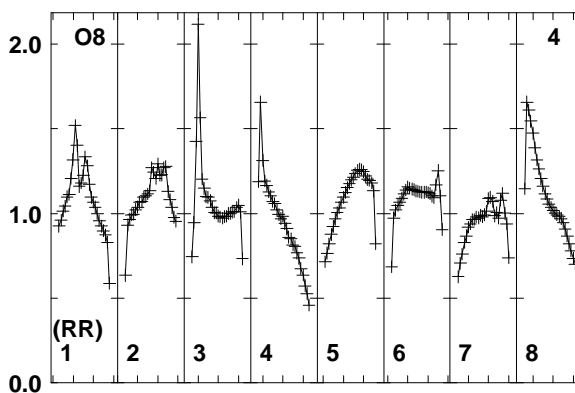
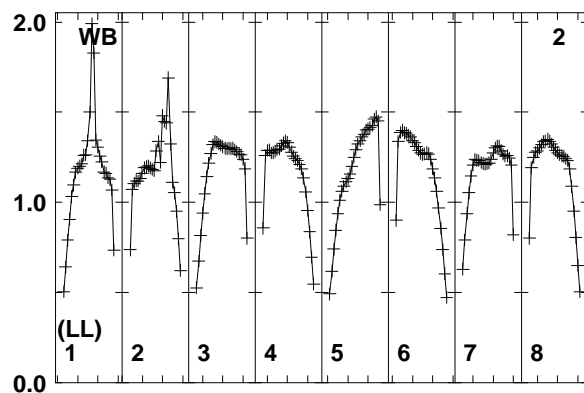
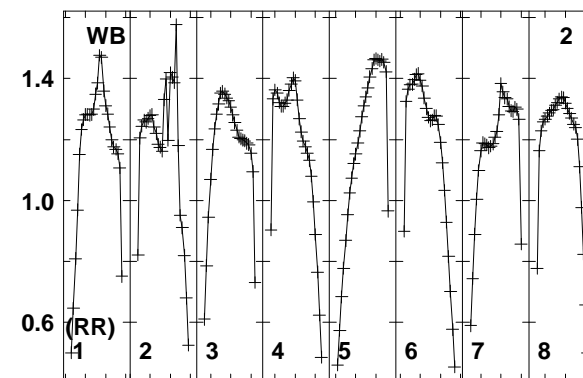
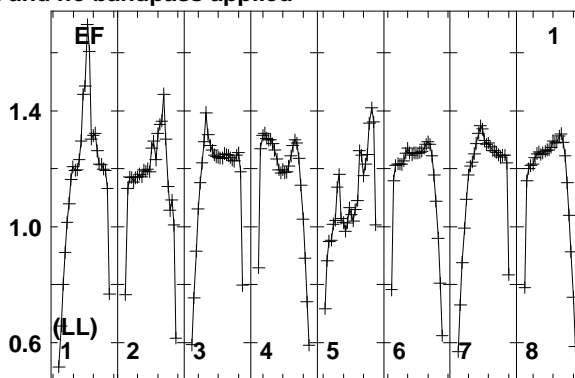
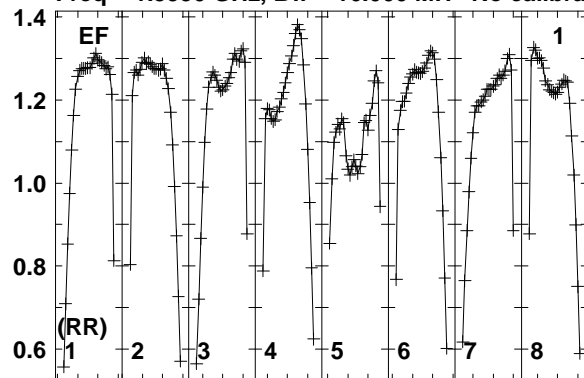

Lower frame: Real Jy
Total-power spectrum Antenna: EF (01)
Timerange: 00/03:03:08 to 00/03:04:30

Plot file version 194 created 19-AUG-2016 17:19:43

J1642+2523 EM119D.UVDATA.1

Freq = 1.5950 GHz, Bw = 16.000 MH No calibration applied and no bandpass applied

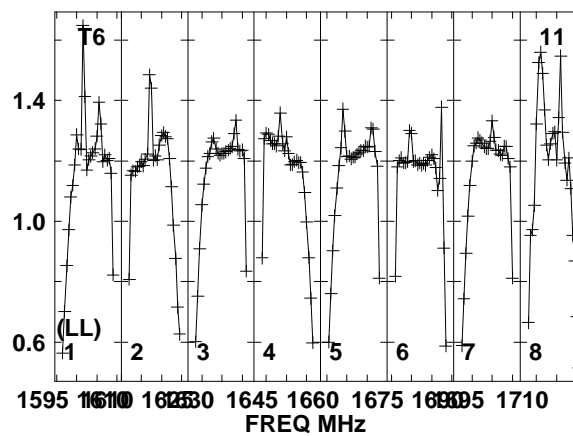
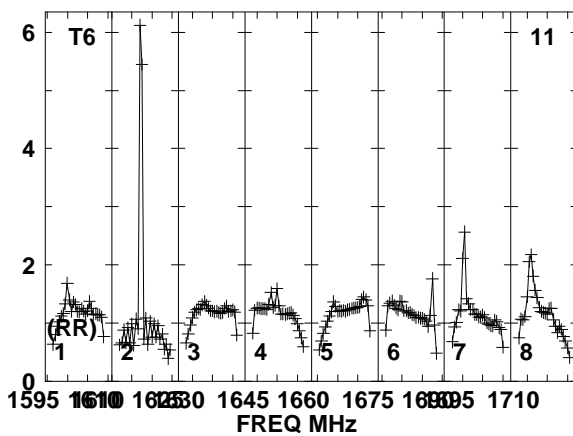
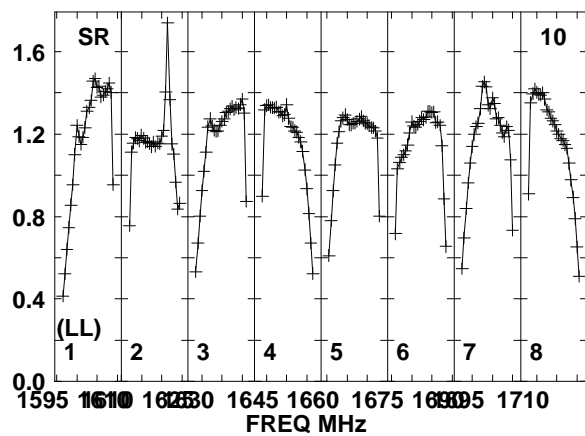
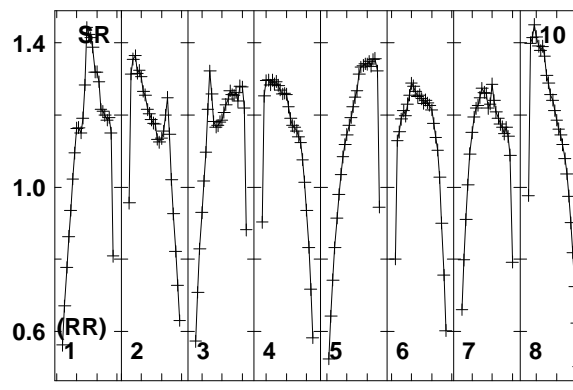
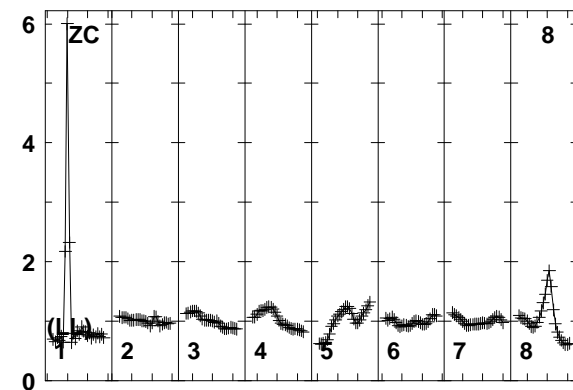
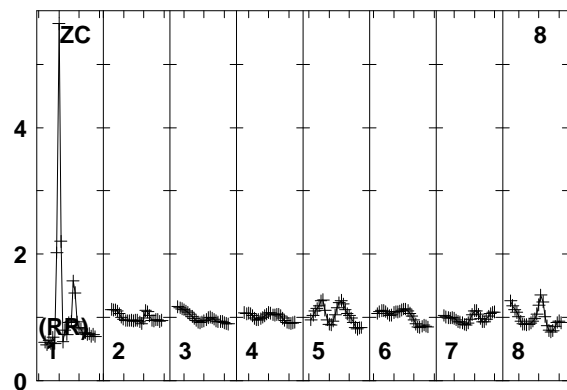
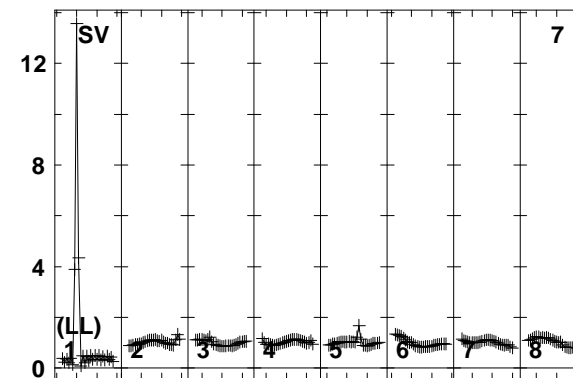
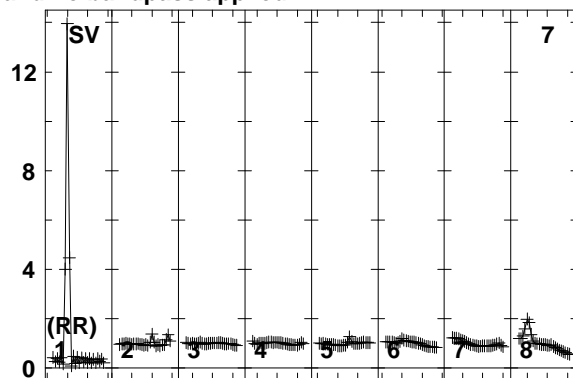
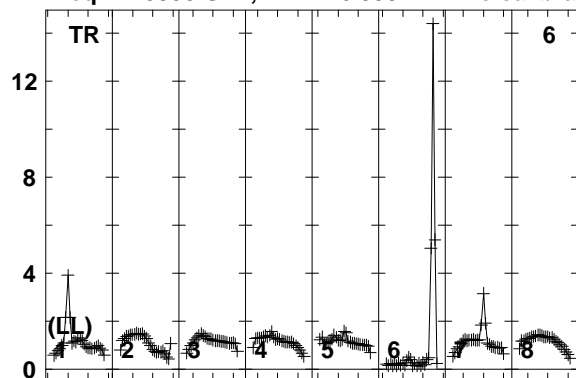

Lower frame: Real Jy
Total-power spectrum Antenna: TR (06)
Timerange: 00/03:03:08 to 00/03:04:30

Plot file version 195 created 19-AUG-2016 17:19:43

J1642+2523 EM119D.UVDATA.1

Freq = 1.5950 GHz, Bw = 16.000 MH No calibration applied and no bandpass applied

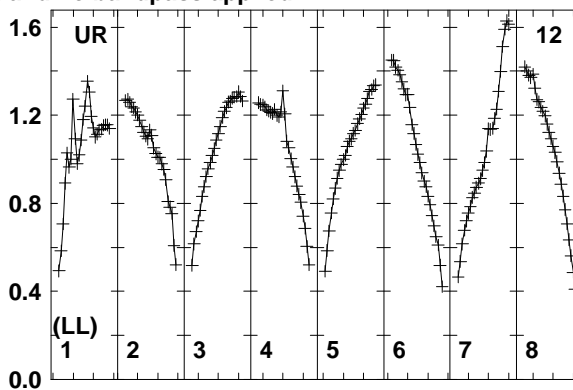
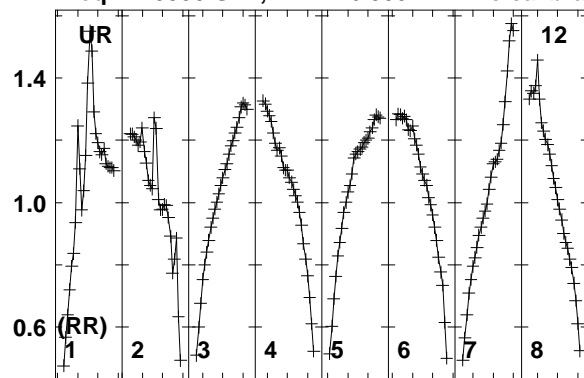

Lower frame: Real Jy
Total-power spectrum Antenna: UR (12)
Timerange: 00/03:03:08 to 00/03:04:30

Plot file version 196 created 19-AUG-2016 17:19:43

J1649+2635 EM119D.UVDATA.1

Freq = 1.5950 GHz, Bw = 16.000 MH No calibration applied and no bandpass applied

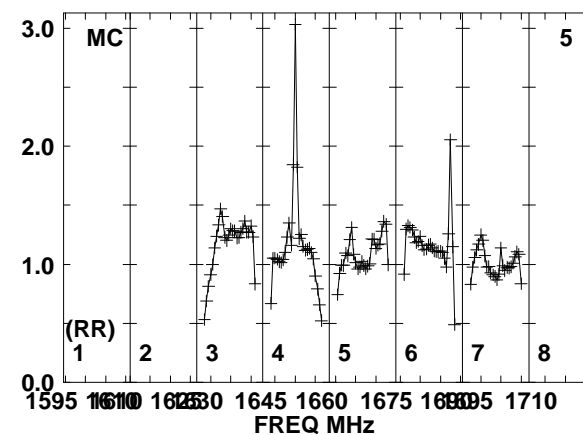
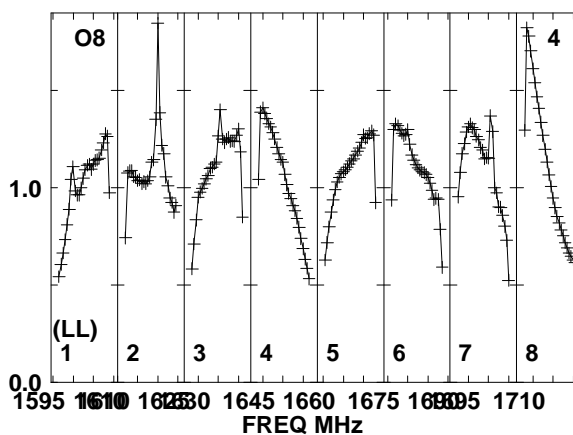
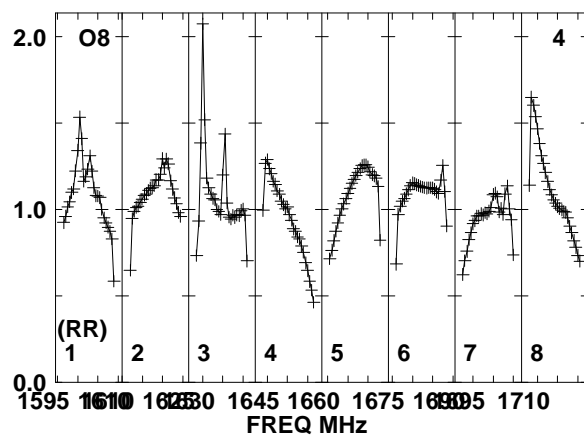
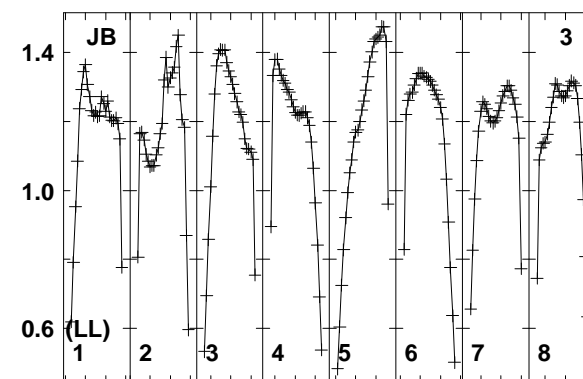
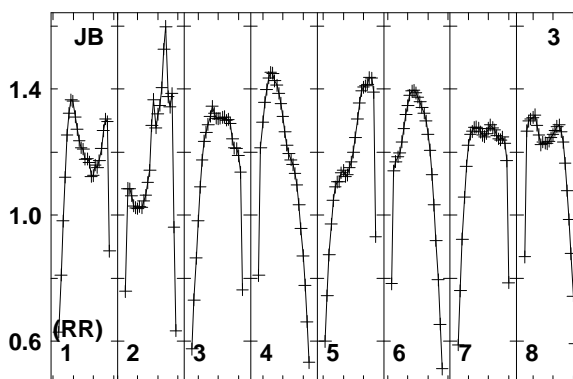
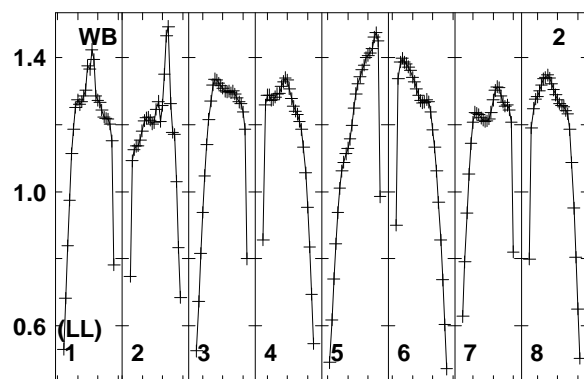
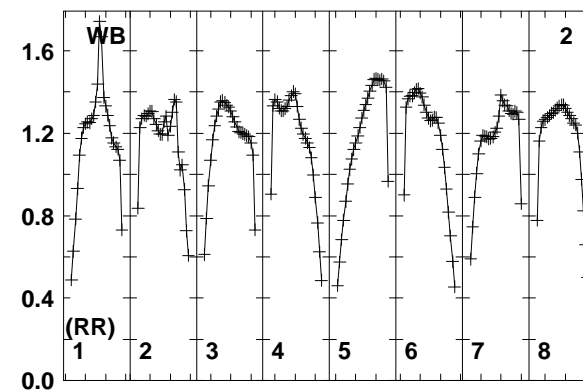
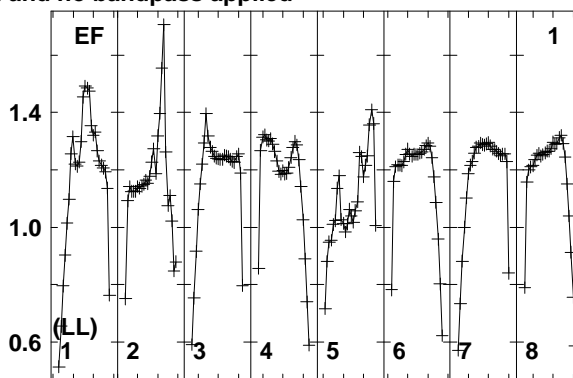
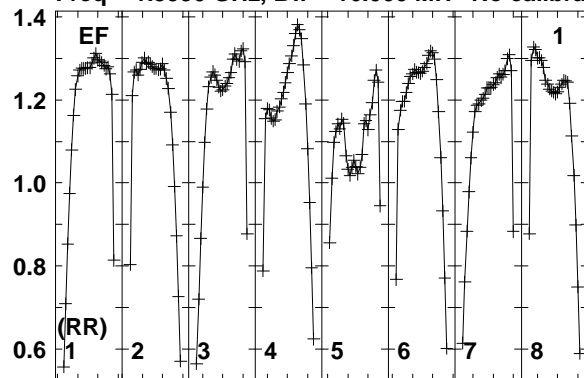

Lower frame: Real Jy
Total-power spectrum Antenna: EF (01)
Timerange: 00/03:04:33 to 00/03:08:00

Plot file version 197 created 19-AUG-2016 17:19:43

J1649+2635 EM119D.UVDATA.1

Freq = 1.5950 GHz, Bw = 16.000 MH No calibration applied and no bandpass applied

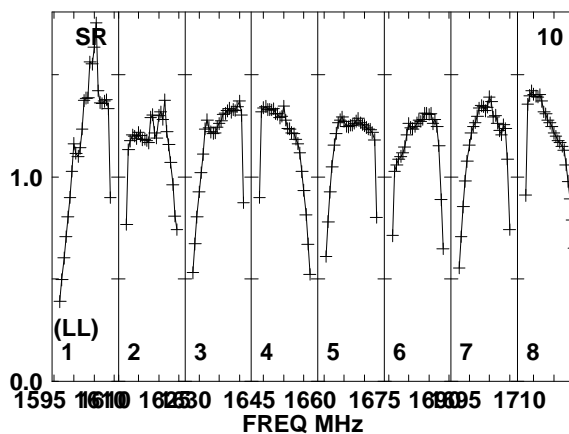
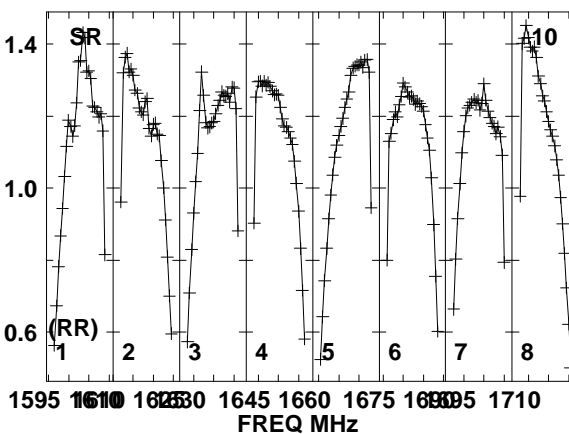
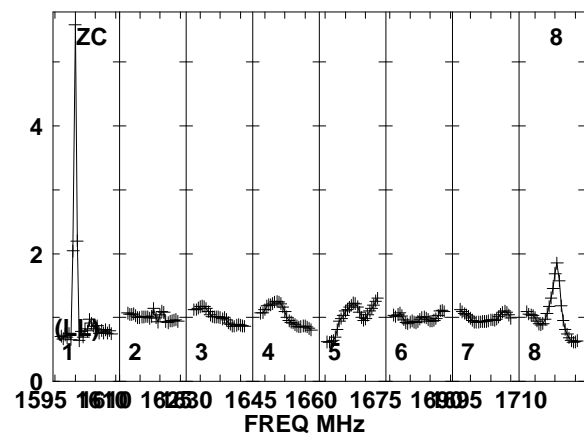
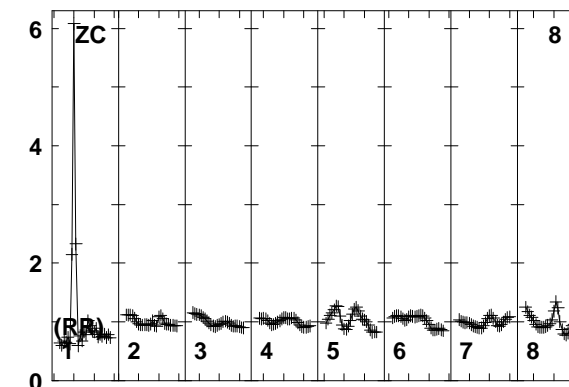
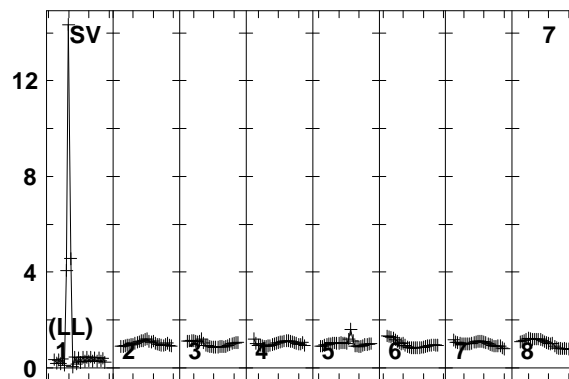
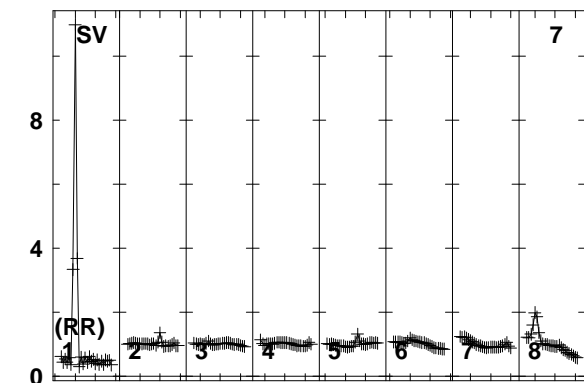
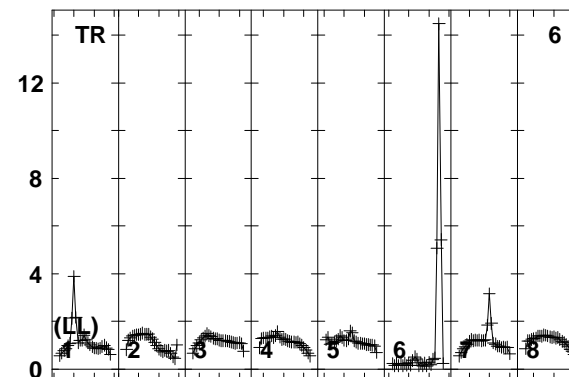
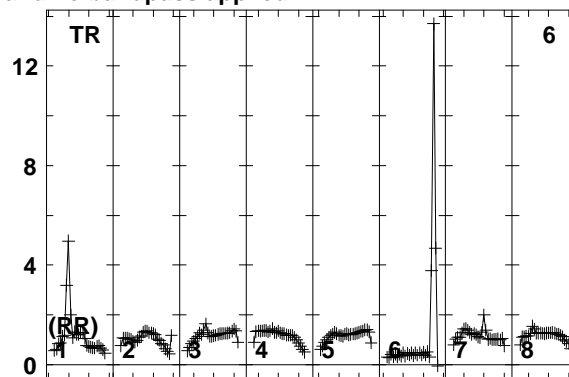
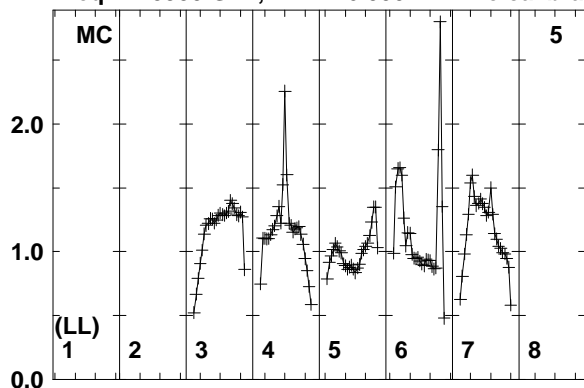

Lower frame: Real Jy
Total-power spectrum Antenna: MC (05)
Timerange: 00/03:04:33 to 00/03:08:00

Plot file version 198 created 19-AUG-2016 17:19:43

J1649+2635 EM119D.UVDATA.1

Freq = 1.5950 GHz, Bw = 16.000 MH No calibration applied and no bandpass applied

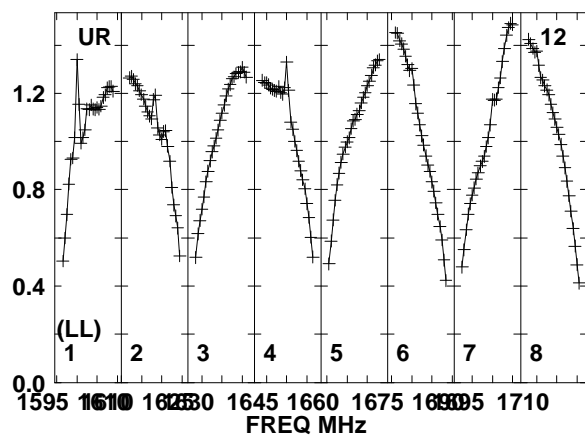
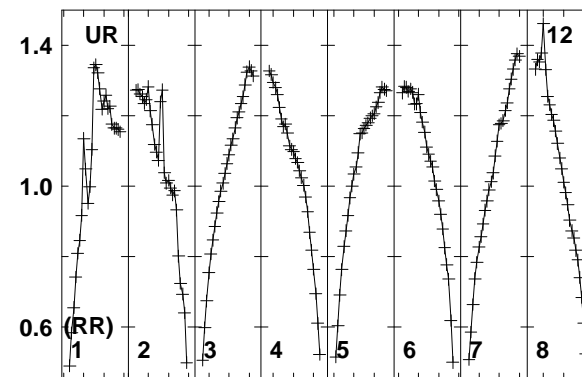
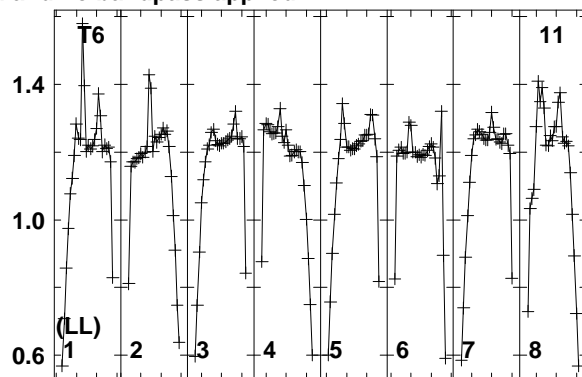
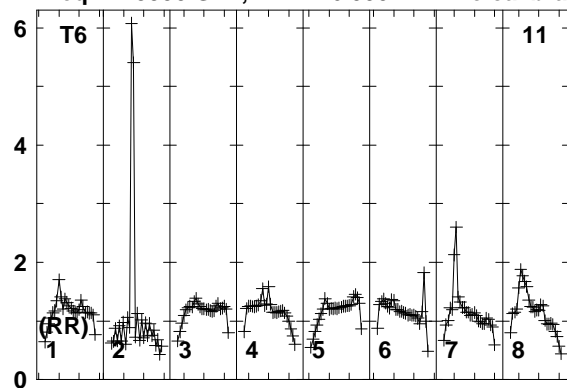

Lower frame: Real Jy
Total-power spectrum Antenna: T6 (11)
Timerange: 00/03:04:33 to 00/03:08:00

Plot file version 199 created 19-AUG-2016 17:19:43

J1642+2523 EM119D.UVDATA.1

Freq = 1.5950 GHz, Bw = 16.000 MH No calibration applied and no bandpass applied

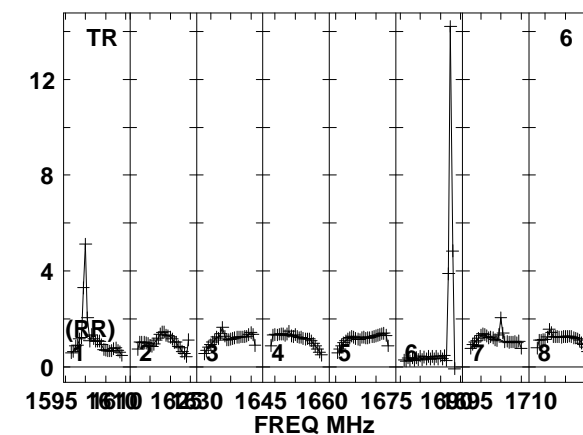
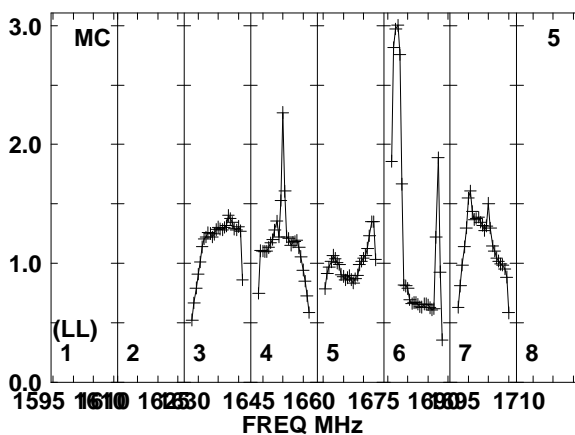
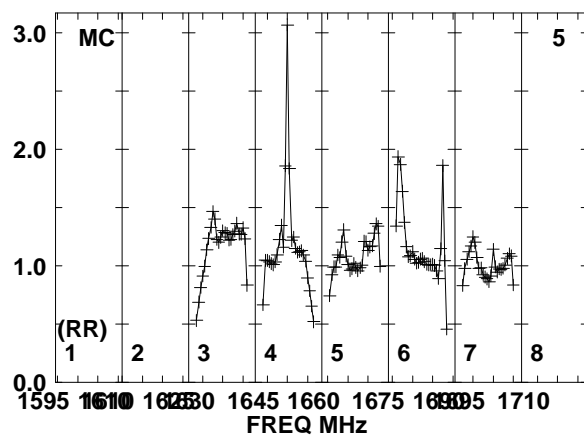
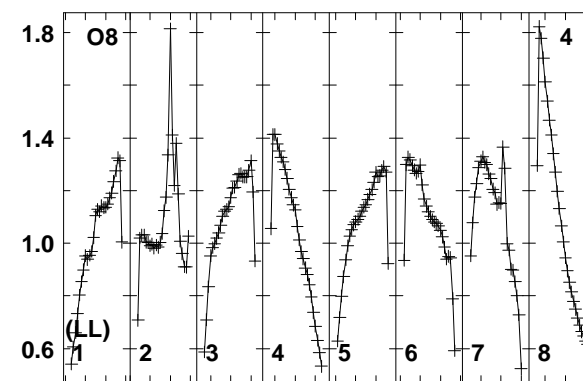
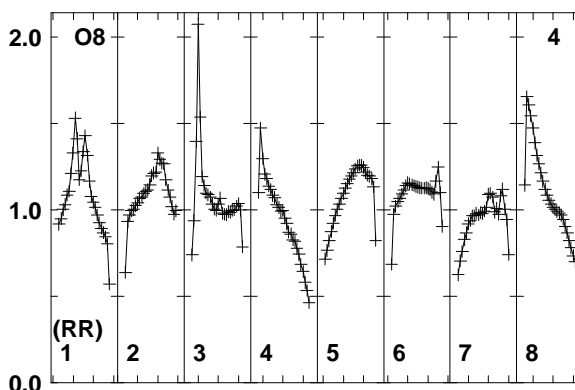
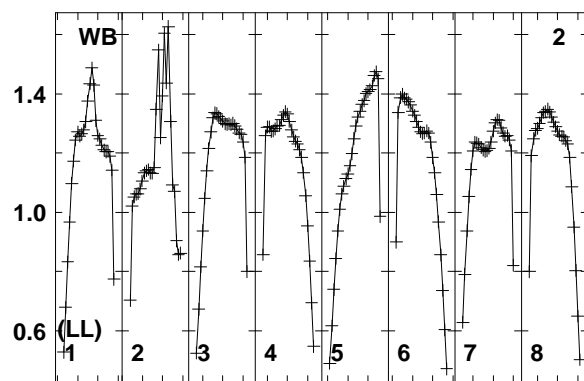
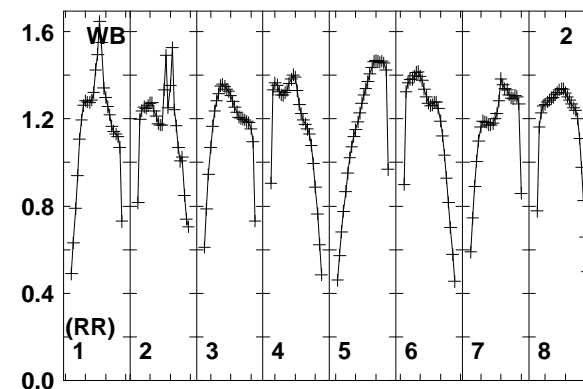
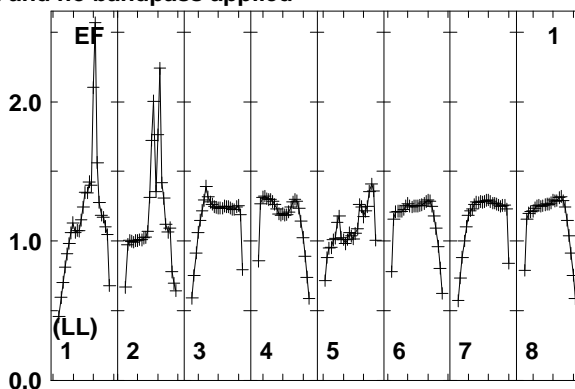
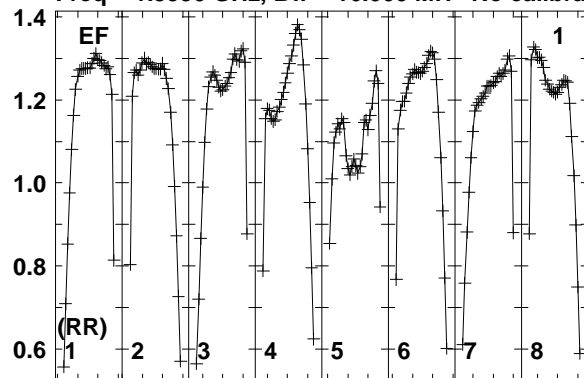

Lower frame: Real Jy
Total-power spectrum Antenna: EF (01)
Timerange: 00/03:08:07 to 00/03:09:30

Plot file version 200 created 19-AUG-2016 17:19:44

J1642+2523 EM119D.UVDATA.1

Freq = 1.5950 GHz, Bw = 16.000 MH No calibration applied and no bandpass applied

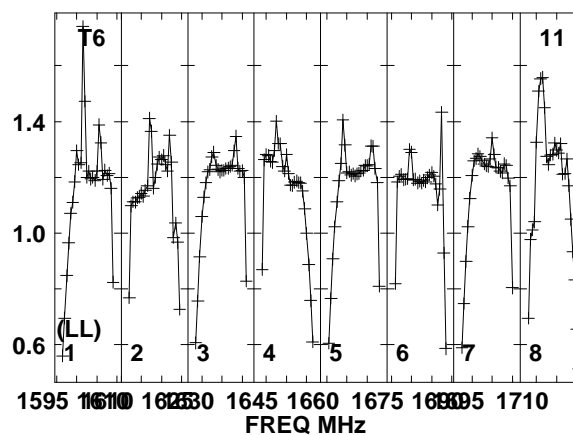
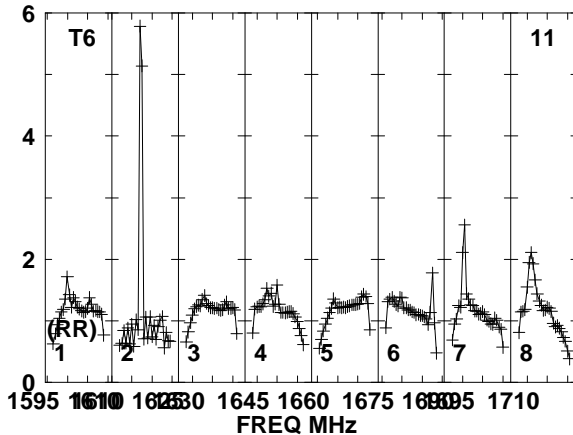
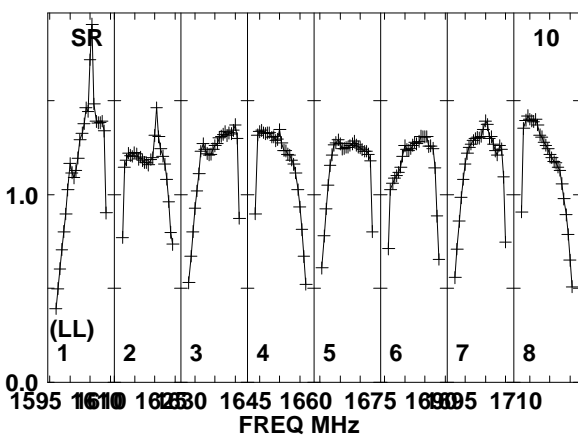
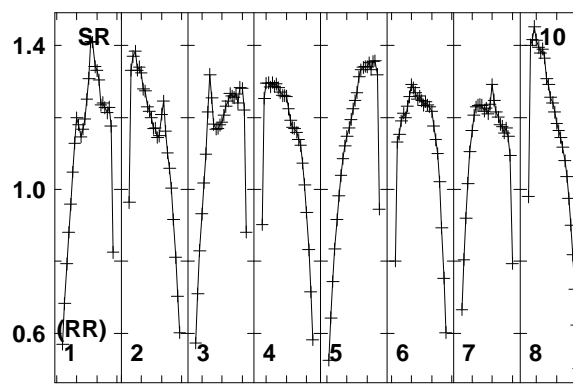
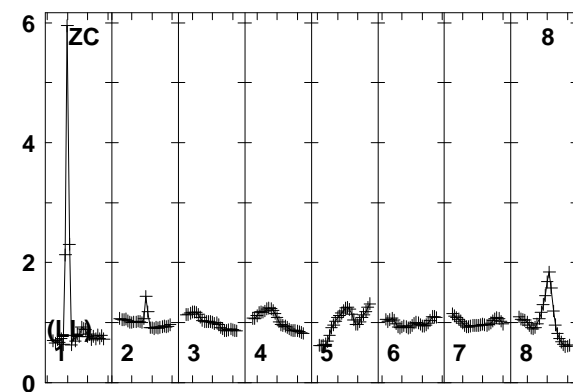
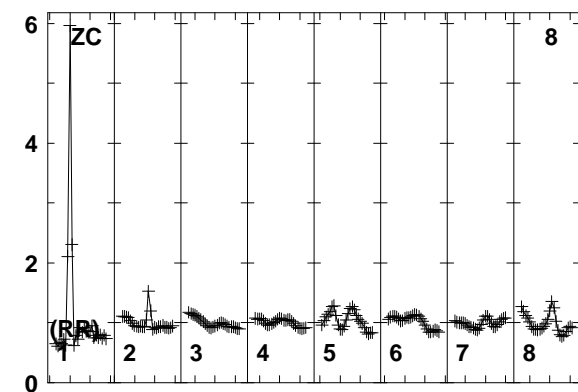
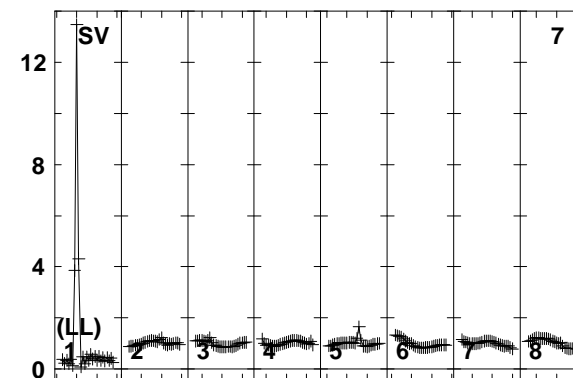
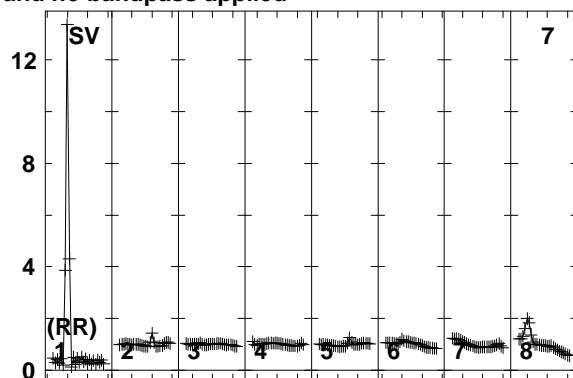
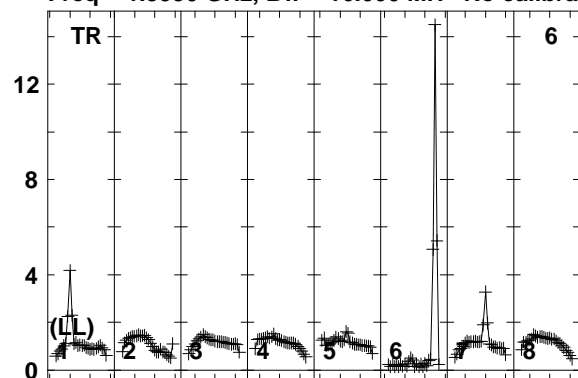

Lower frame: Real Jy
Total-power spectrum Antenna: TR (06)
Timerange: 00/03:08:07 to 00/03:09:30

Plot file version 201 created 19-AUG-2016 17:19:44

J1642+2523 EM119D.UVDATA.1

Freq = 1.5950 GHz, Bw = 16.000 MH No calibration applied and no bandpass applied

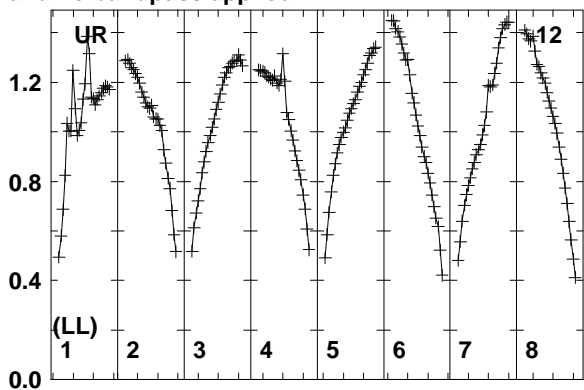
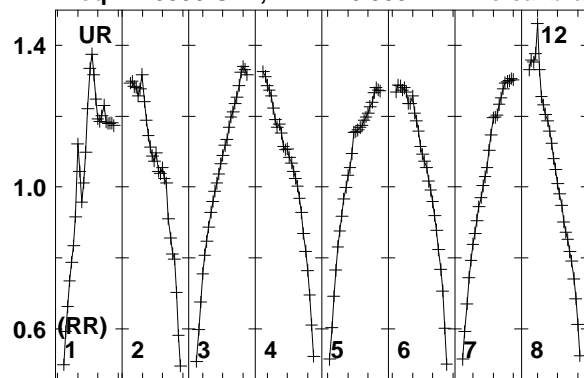

Lower frame: Real Jy
Total-power spectrum Antenna: UR (12)
Timerange: 00/03:08:07 to 00/03:09:30

Plot file version 202 created 19-AUG-2016 17:19:44

J1649+2635 EM119D.UVDATA.1

Freq = 1.5950 GHz, Bw = 16.000 MH No calibration applied and no bandpass applied

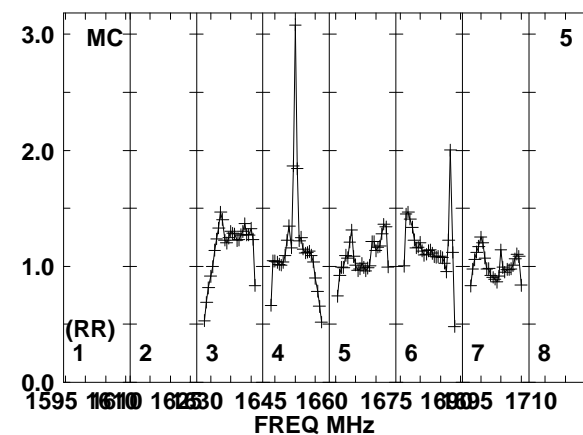
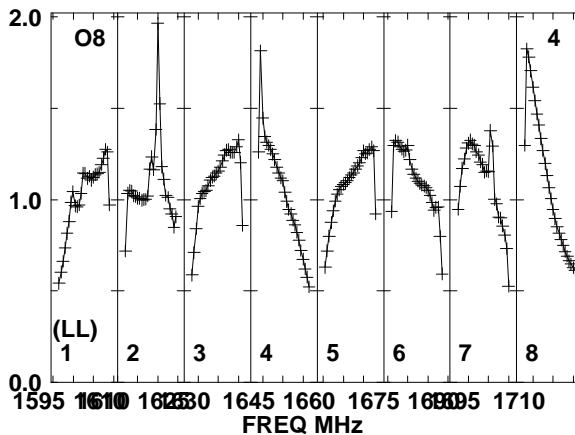
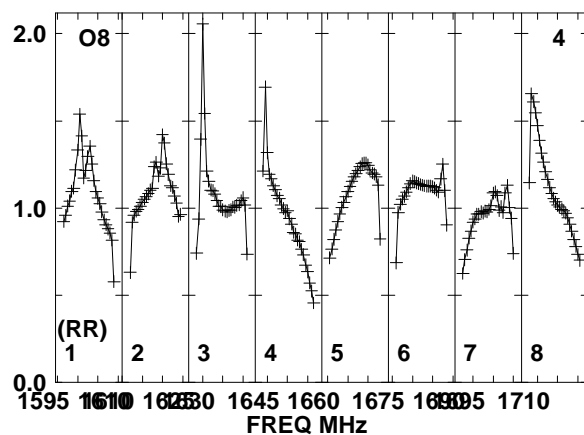
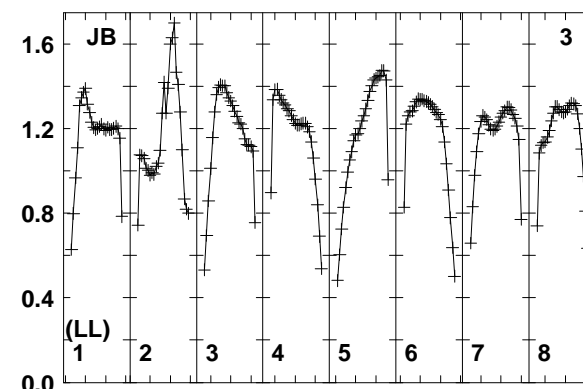
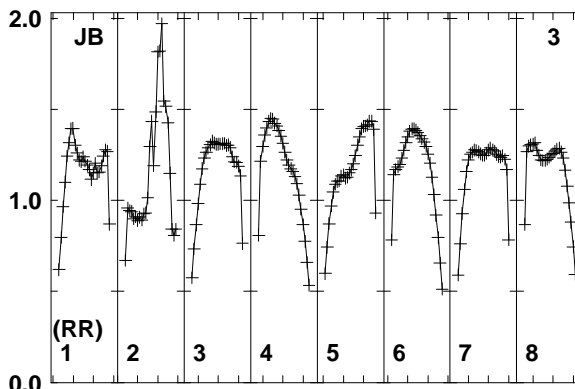
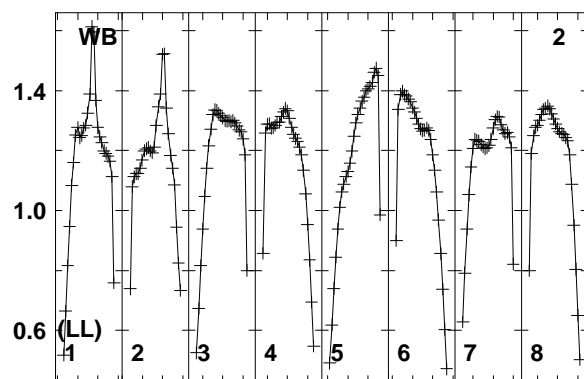
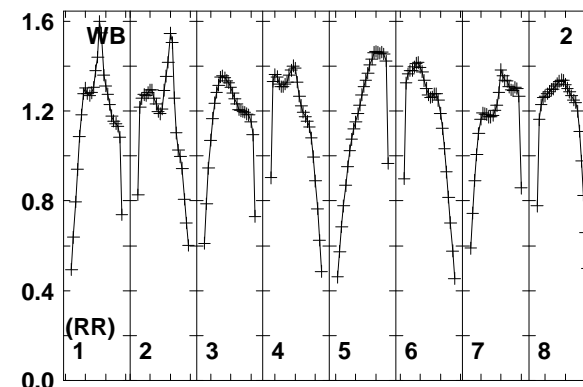
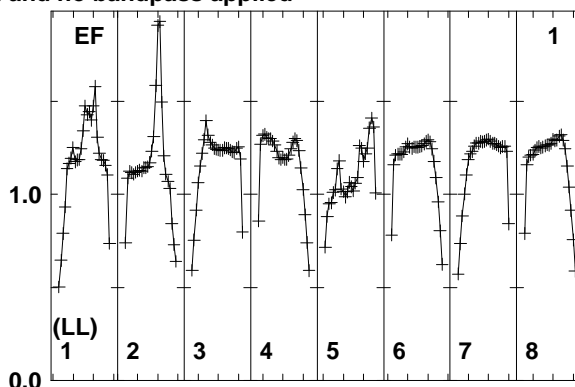
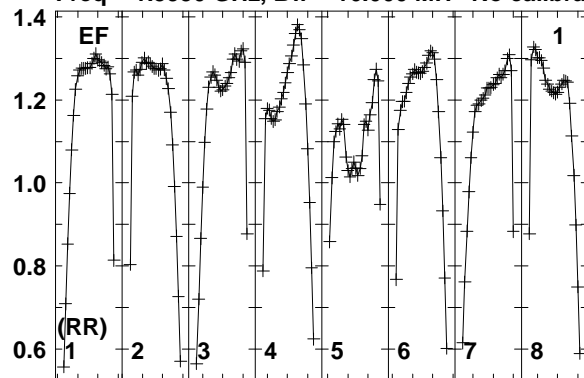

Lower frame: Real Jy
Total-power spectrum Antenna: EF (01)
Timerange: 00/03:10:31 to 00/03:14:00

Plot file version 203 created 19-AUG-2016 17:19:44

J1649+2635 EM119D.UVDATA.1

Freq = 1.5950 GHz, Bw = 16.000 MH No calibration applied and no bandpass applied

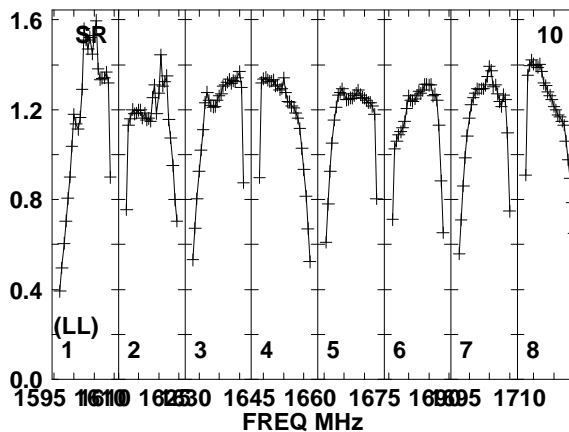
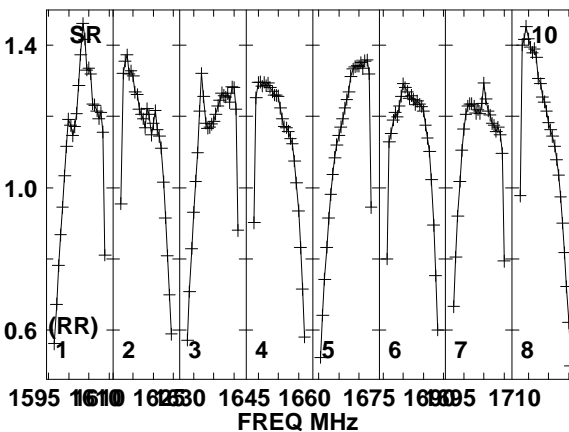
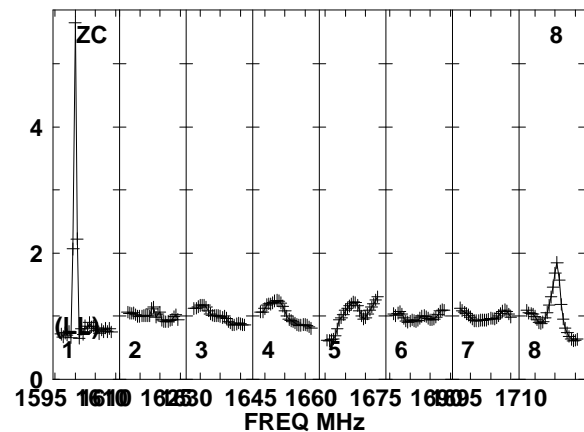
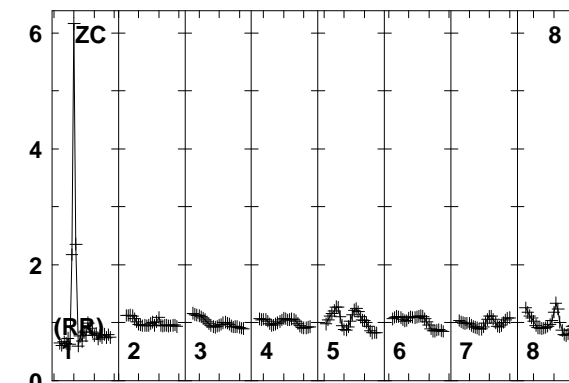
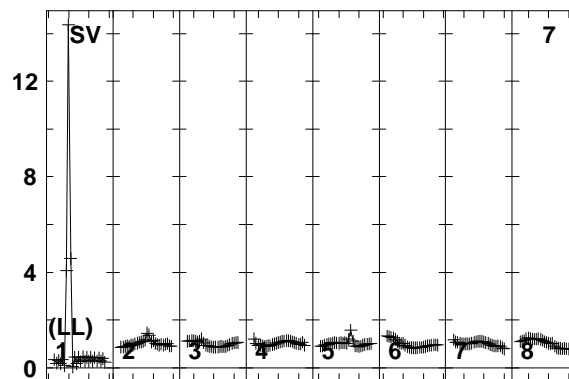
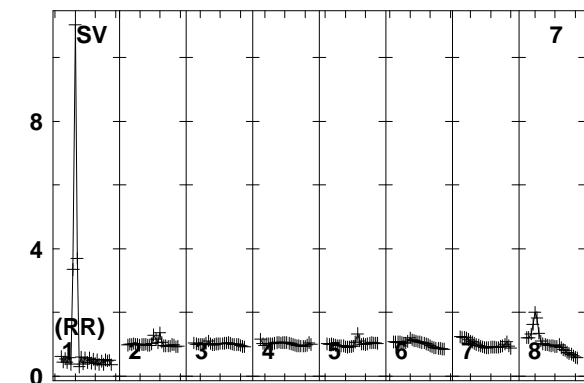
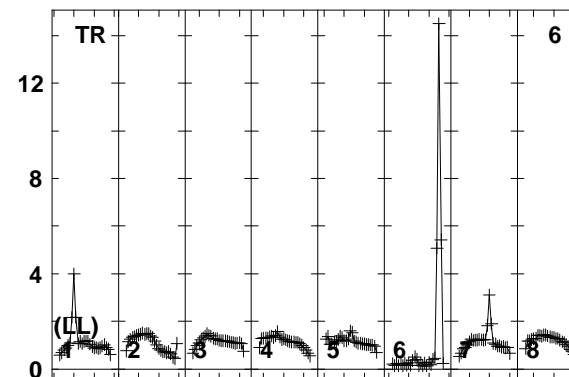
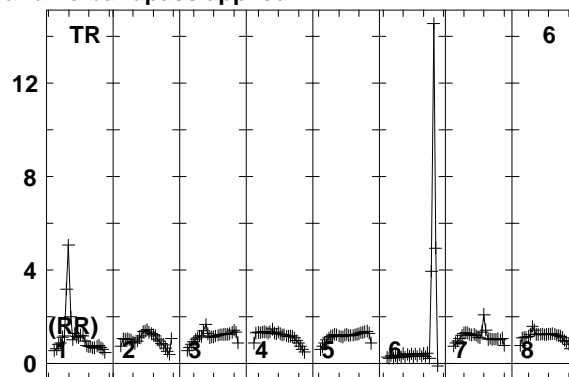
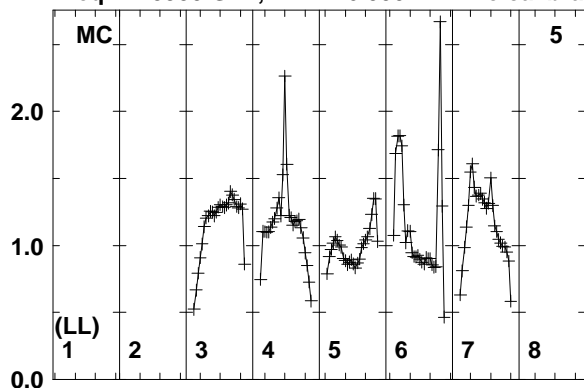

Lower frame: Real Jy
Total-power spectrum Antenna: MC (05)
Timerange: 00/03:10:31 to 00/03:14:00

Plot file version 204 created 19-AUG-2016 17:19:44

J1649+2635 EM119D.UVDATA.1

Freq = 1.5950 GHz, Bw = 16.000 MH No calibration applied and no bandpass applied

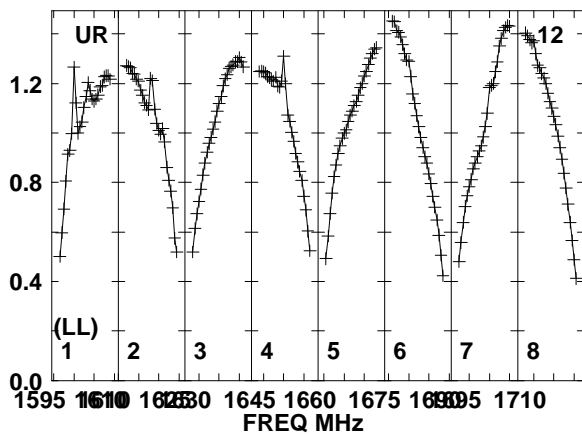
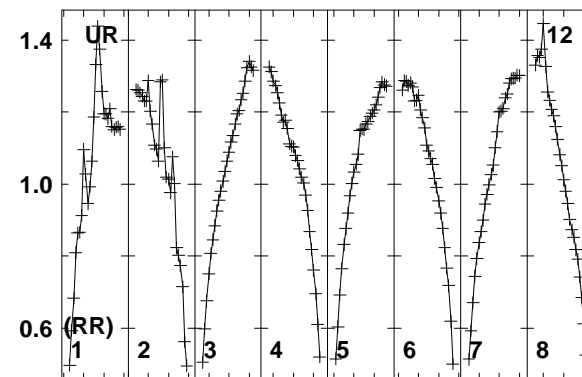
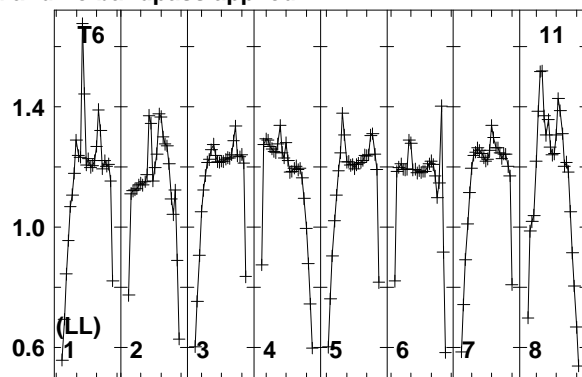
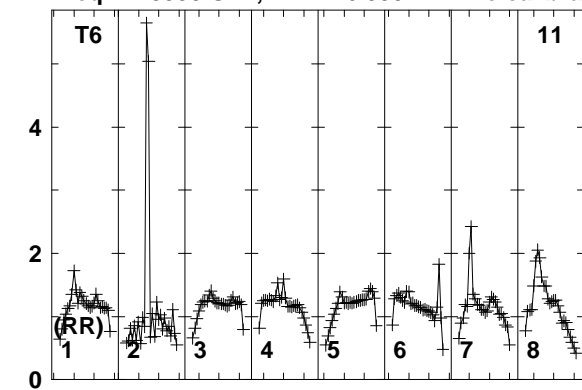

Lower frame: Real Jy
Total-power spectrum Antenna: T6 (11)
Timerange: 00/03:10:31 to 00/03:14:00

Plot file version 205 created 19-AUG-2016 17:19:44

J1642+2523 EM119D.UVDATA.1

Freq = 1.5950 GHz, Bw = 16.000 MH No calibration applied and no bandpass applied

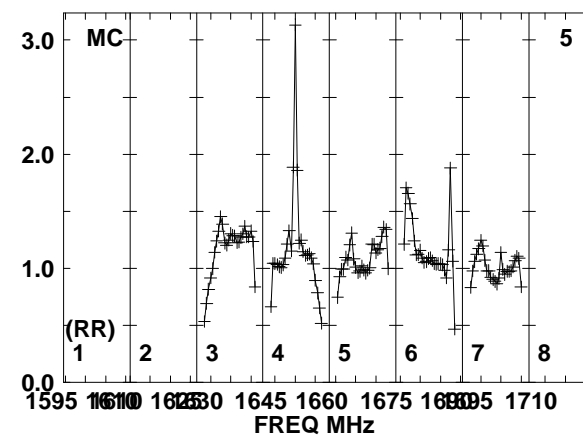
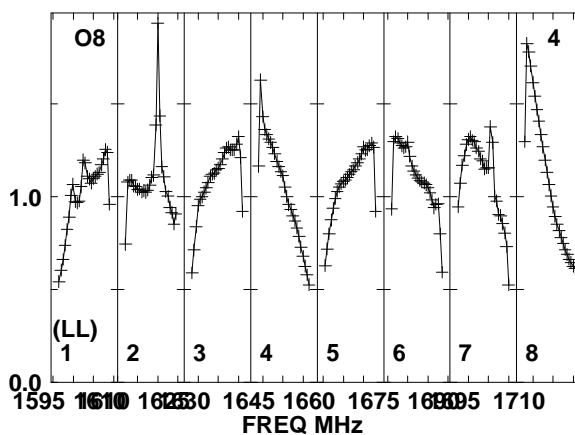
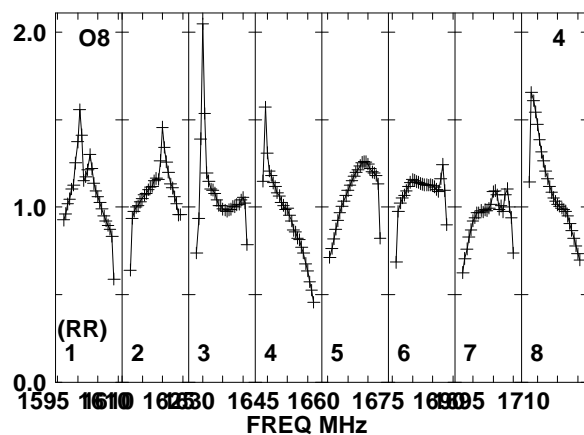
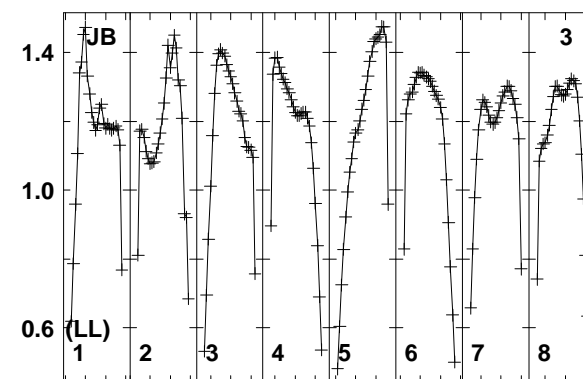
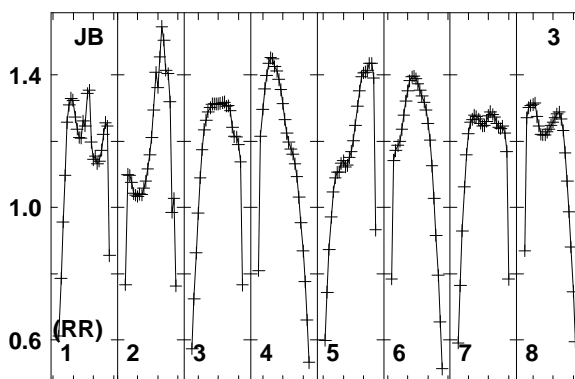
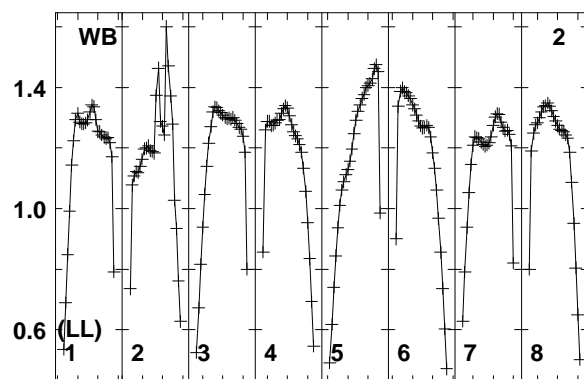
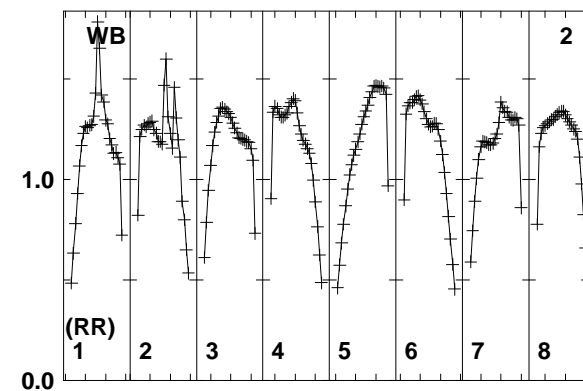
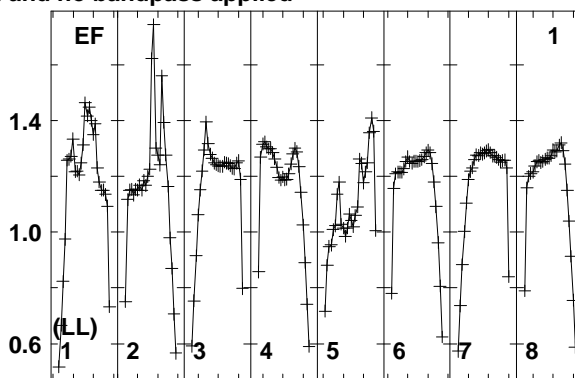
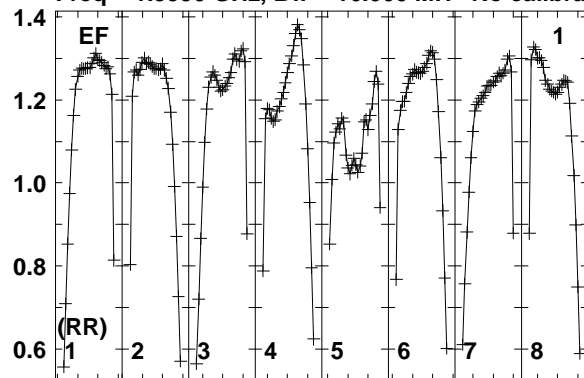

Lower frame: Real Jy
Total-power spectrum Antenna: EF (01)
Timerange: 00/03:14:07 to 00/03:15:30

Plot file version 206 created 19-AUG-2016 17:19:45

J1642+2523 EM119D.UVDATA.1

Freq = 1.5950 GHz, Bw = 16.000 MH No calibration applied and no bandpass applied

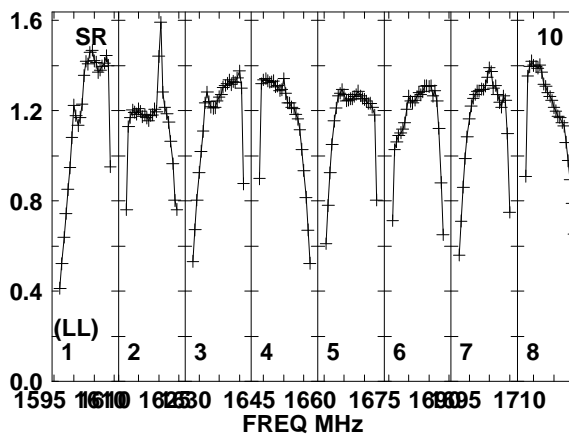
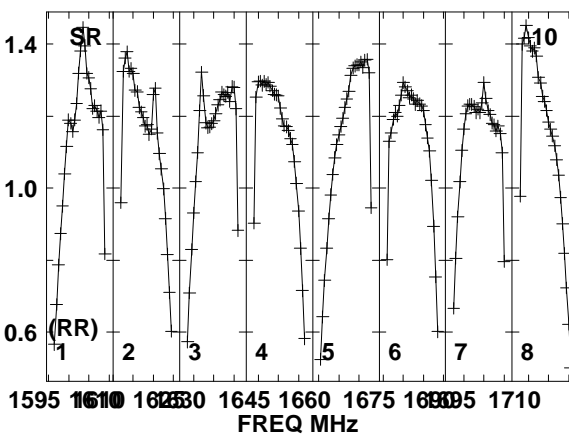
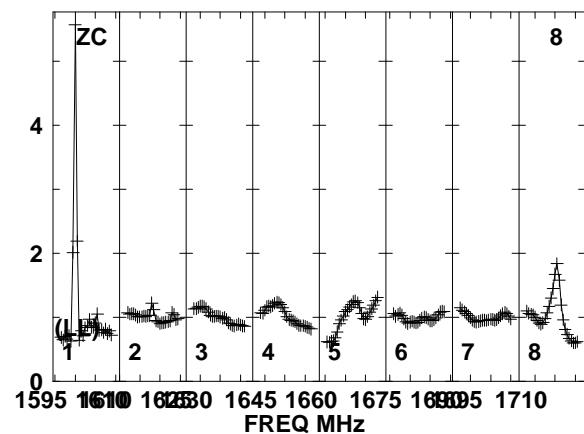
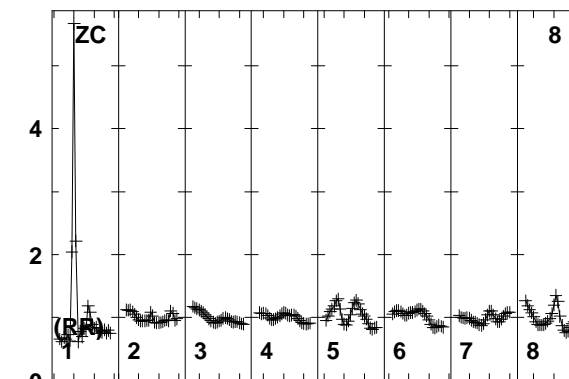
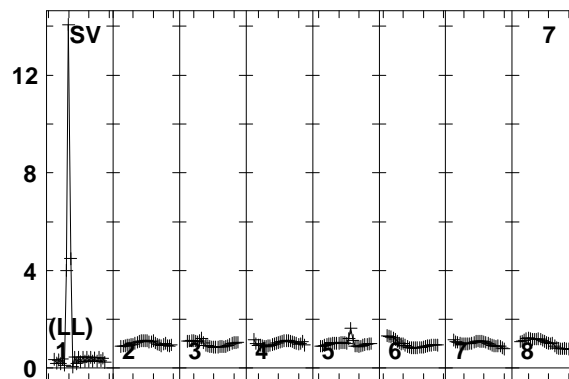
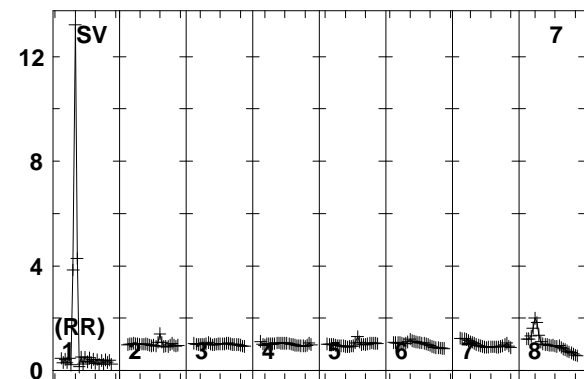
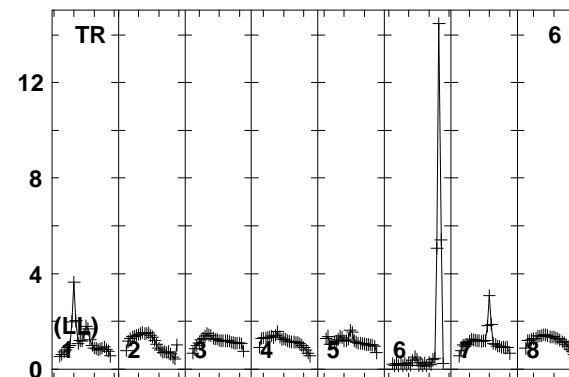
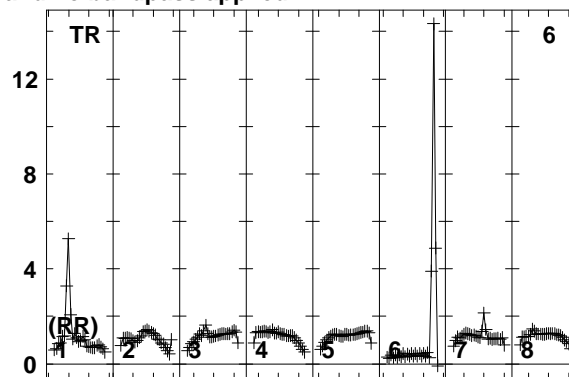
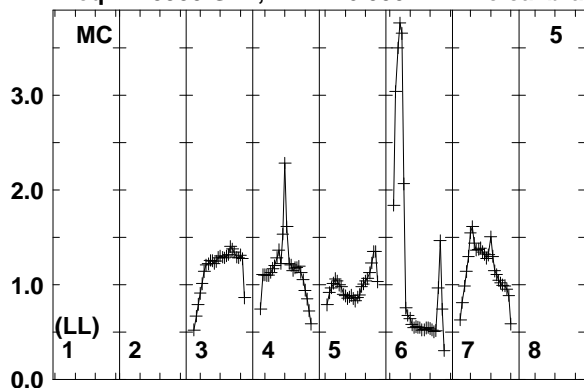

Lower frame: Real Jy
Total-power spectrum Antenna: MC (05)
Timerange: 00/03:14:07 to 00/03:15:30

Plot file version 207 created 19-AUG-2016 17:19:45

J1642+2523 EM119D.UVDATA.1

Freq = 1.5950 GHz, Bw = 16.000 MH No calibration applied and no bandpass applied

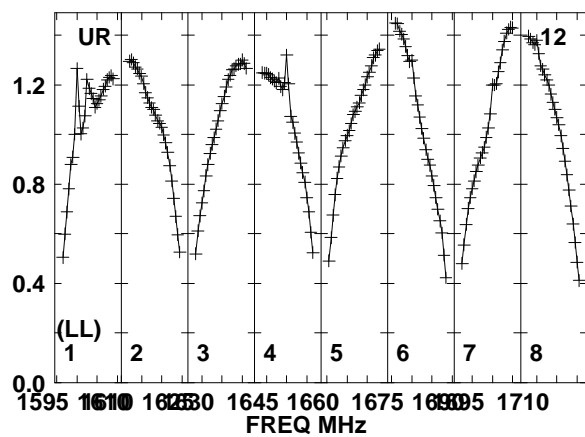
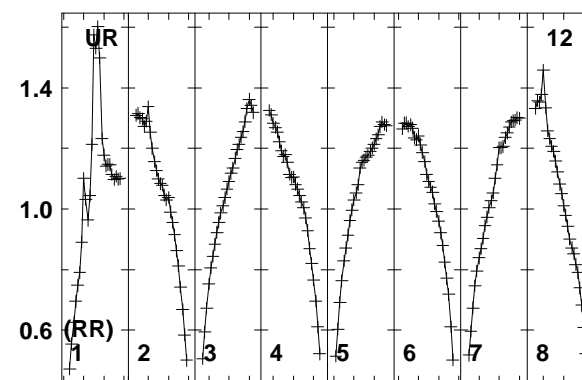
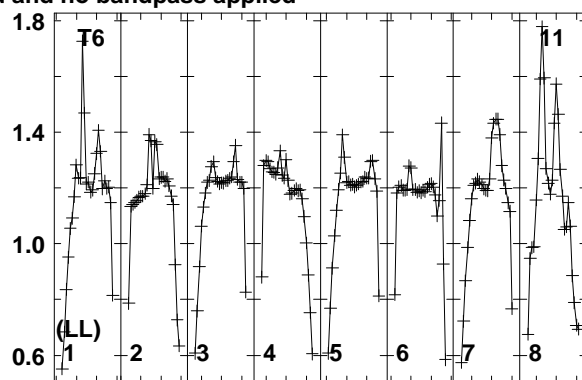
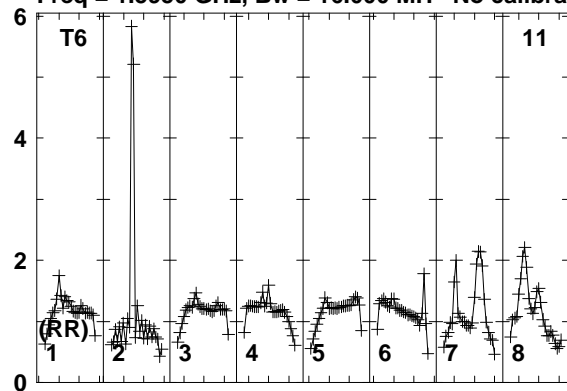

Lower frame: Real Jy
Total-power spectrum Antenna: T6 (11)
Timerange: 00/03:14:07 to 00/03:15:30

Plot file version 208 created 19-AUG-2016 17:19:45

J1649+2635 EM119D.UVDATA.1

Freq = 1.5950 GHz, Bw = 16.000 MH No calibration applied and no bandpass applied

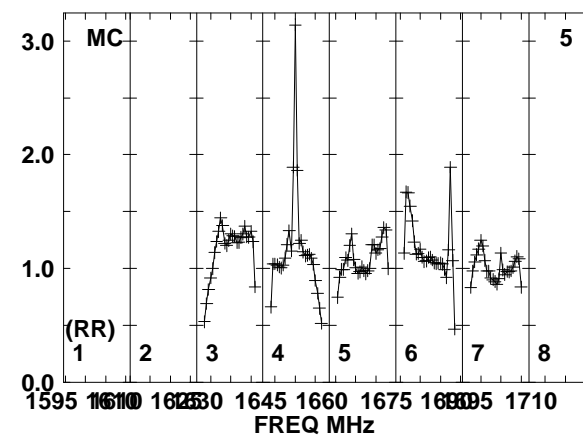
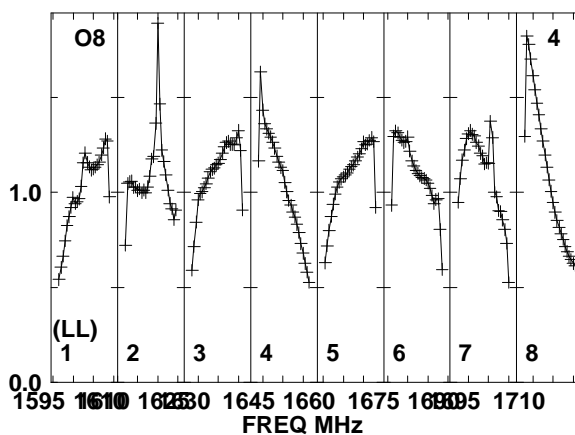
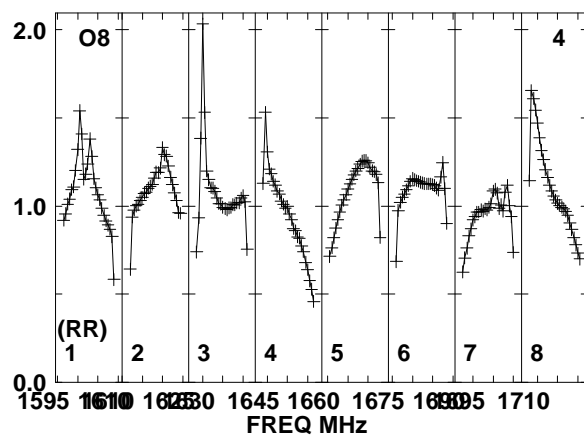
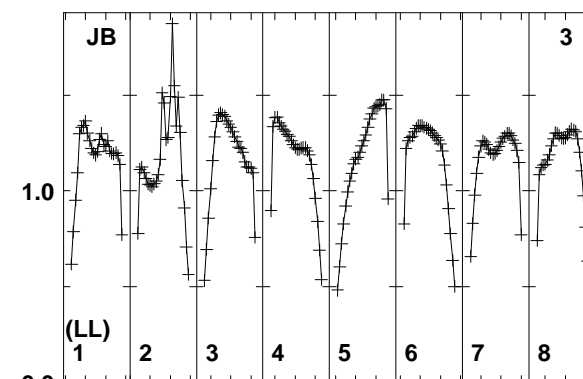
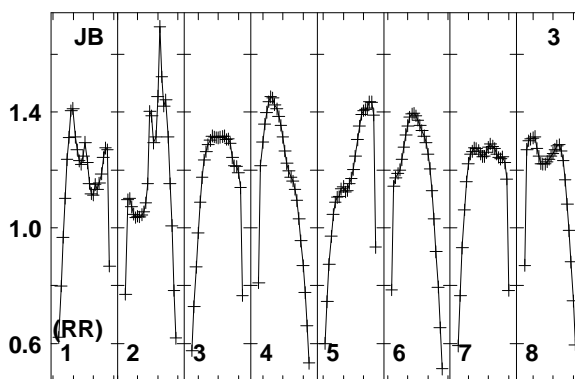
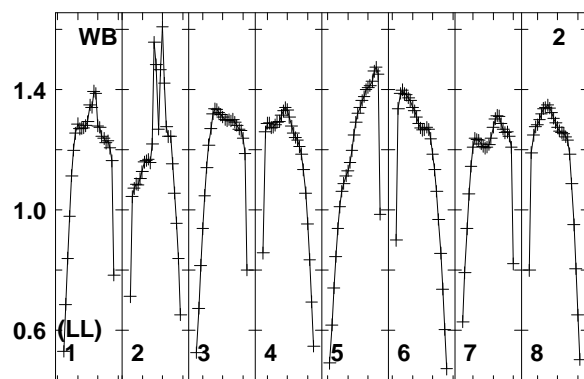
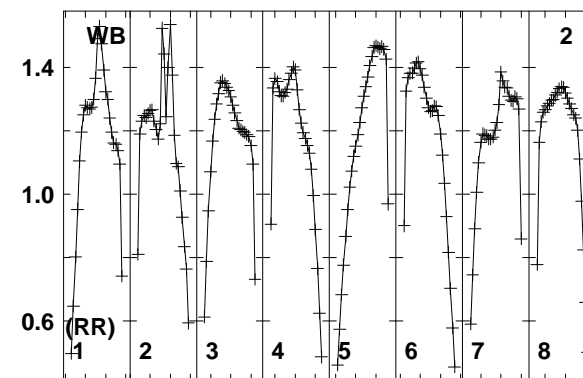
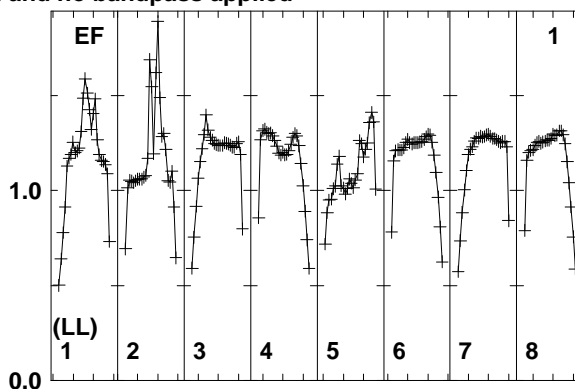
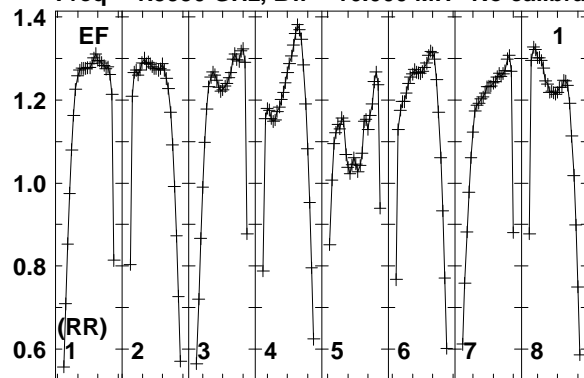

Lower frame: Real Jy
Total-power spectrum Antenna: EF (01)
Timerange: 00/03:15:38 to 00/03:19:00

Plot file version 209 created 19-AUG-2016 17:19:45

J1649+2635 EM119D.UVDATA.1

Freq = 1.5950 GHz, Bw = 16.000 MH No calibration applied and no bandpass applied

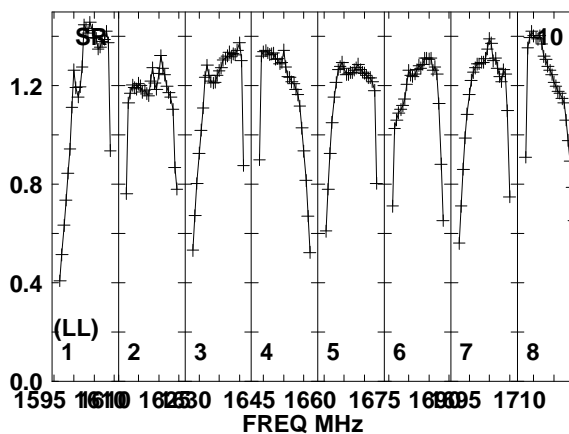
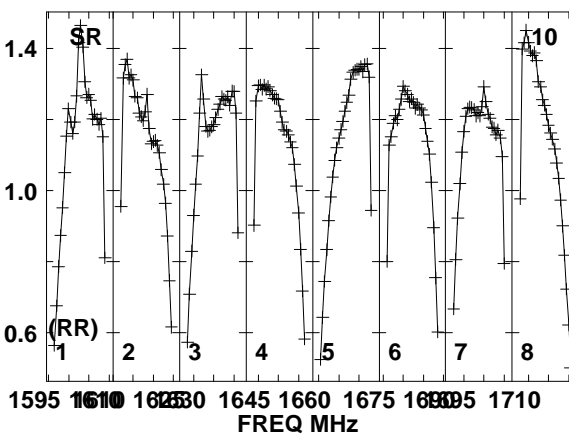
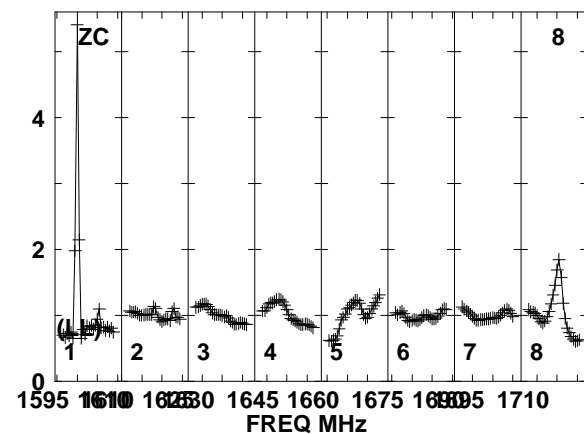
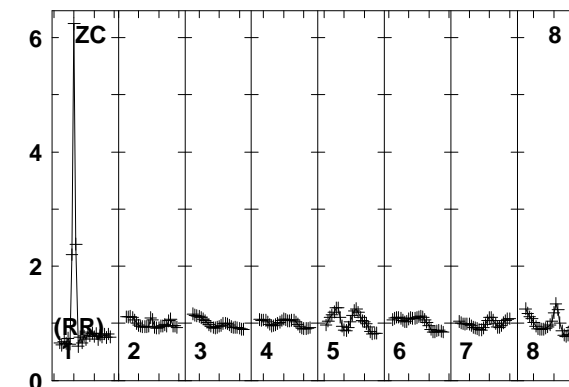
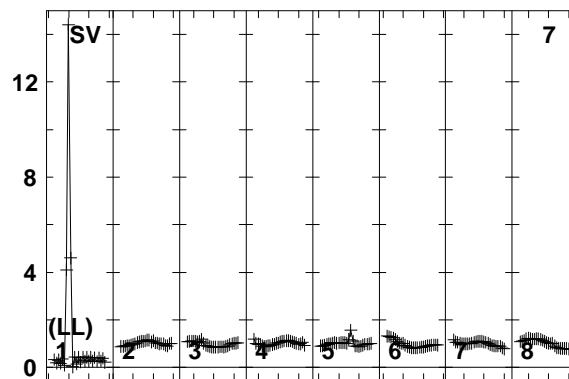
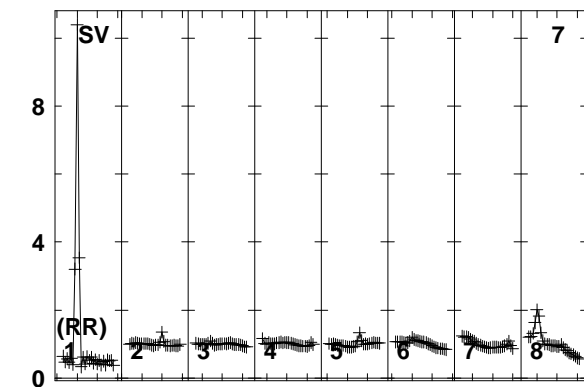
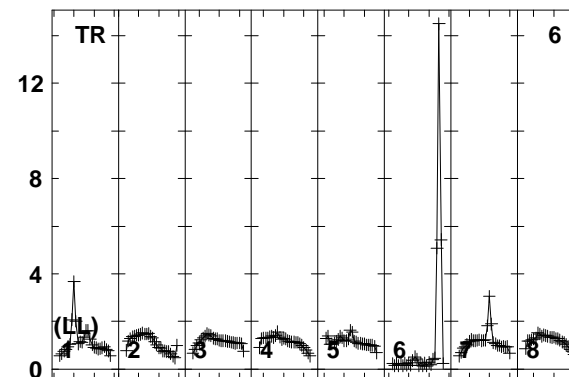
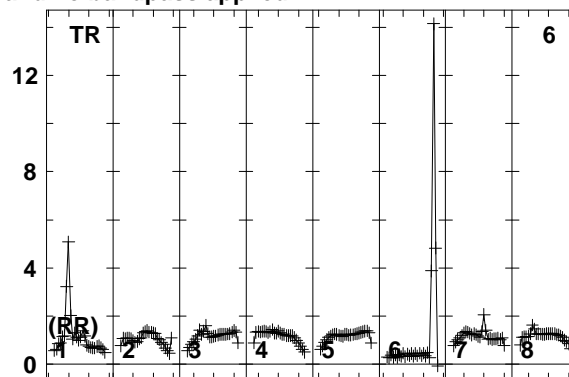
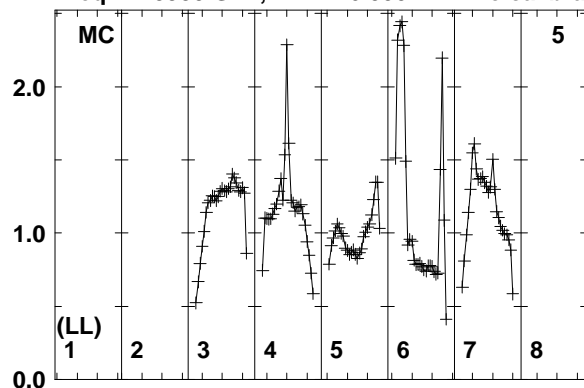

Lower frame: Real Jy
Total-power spectrum Antenna: MC (05)
Timerange: 00/03:15:38 to 00/03:19:00

Plot file version 210 created 19-AUG-2016 17:19:45

J1649+2635 EM119D.UVDATA.1

Freq = 1.5950 GHz, Bw = 16.000 MH No calibration applied and no bandpass applied

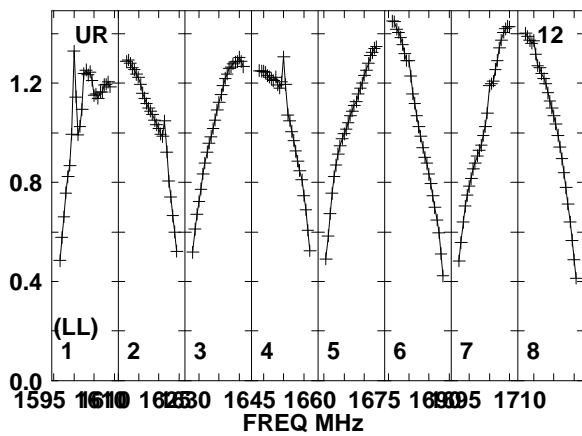
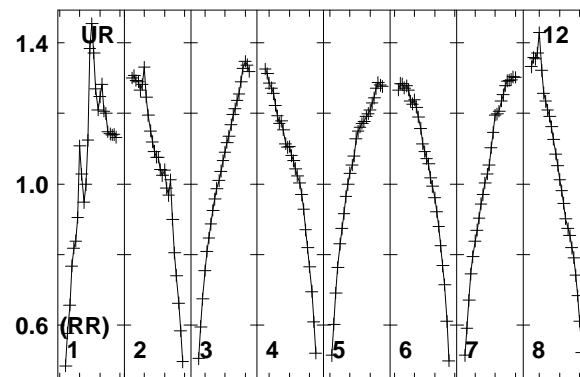
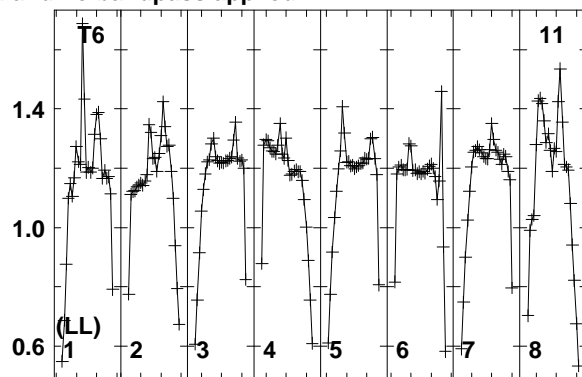
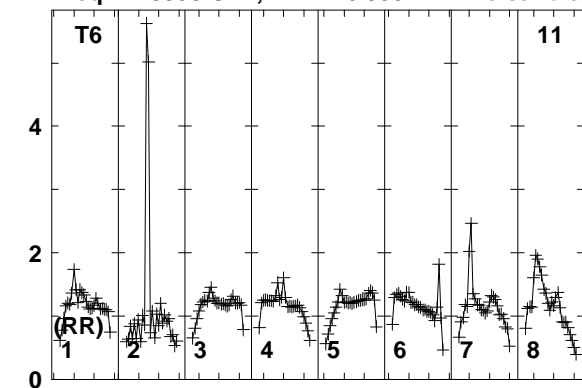

Lower frame: Real Jy
Total-power spectrum Antenna: T6 (11)
Timerange: 00/03:15:38 to 00/03:19:00

Plot file version 211 created 19-AUG-2016 17:19:45

J1642+2523 EM119D.UVDATA.1

Freq = 1.5950 GHz, Bw = 16.000 MH No calibration applied and no bandpass applied

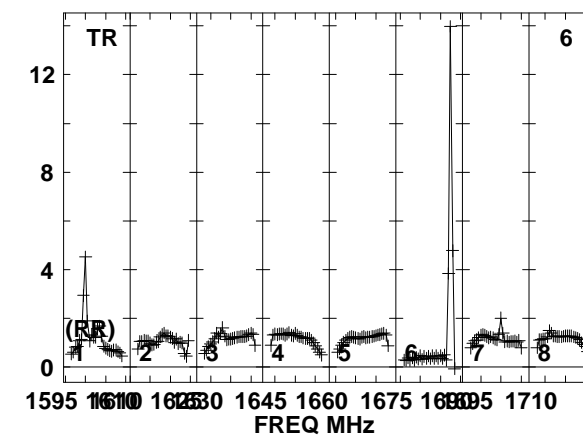
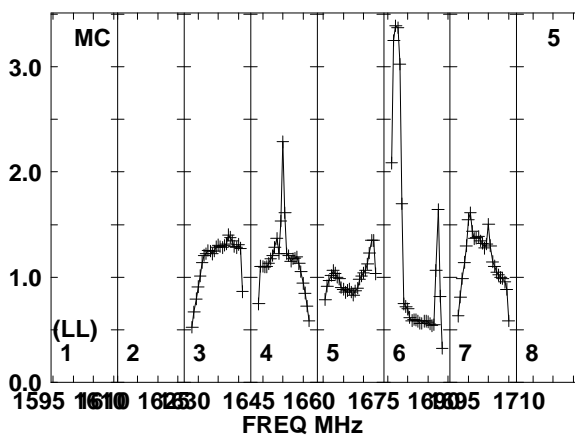
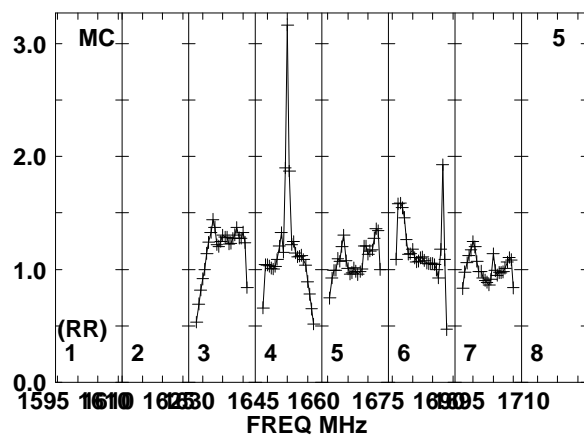
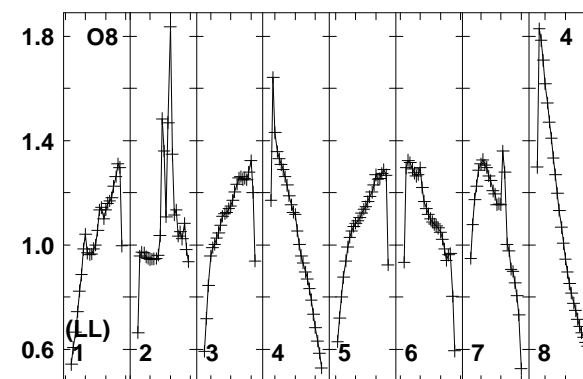
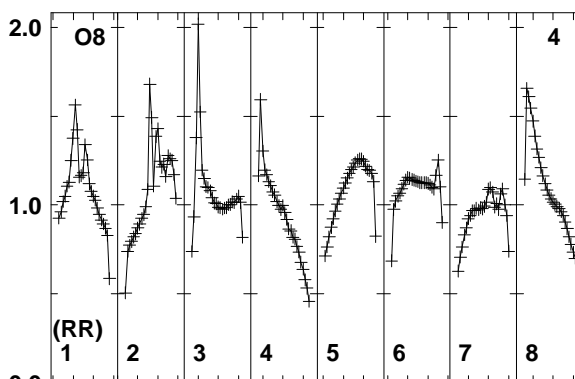
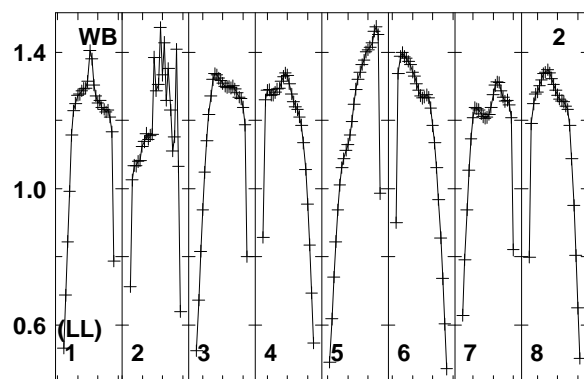
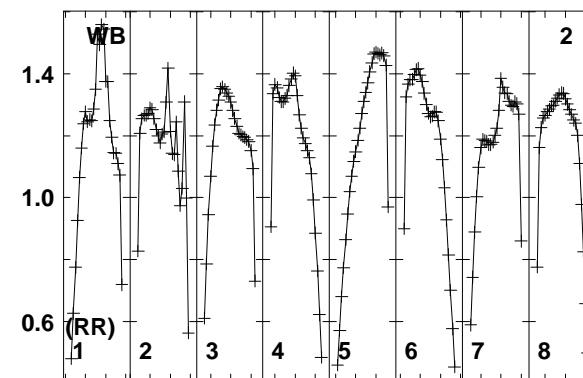
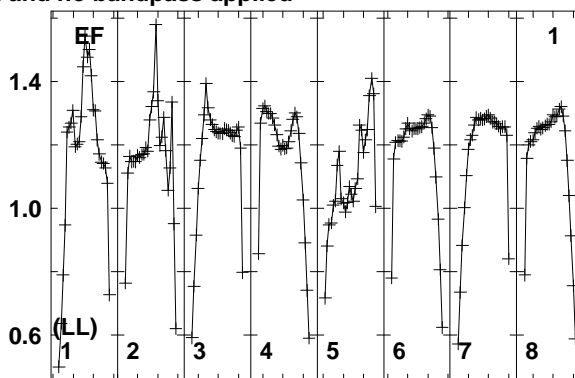
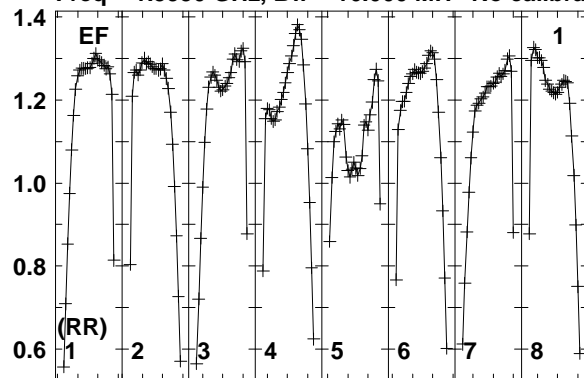

Lower frame: Real Jy
Total-power spectrum Antenna: EF (01)
Timerange: 00/03:19:08 to 00/03:20:30

Plot file version 212 created 19-AUG-2016 17:19:46

J1642+2523 EM119D.UVDATA.1

Freq = 1.5950 GHz, Bw = 16.000 MH No calibration applied and no bandpass applied

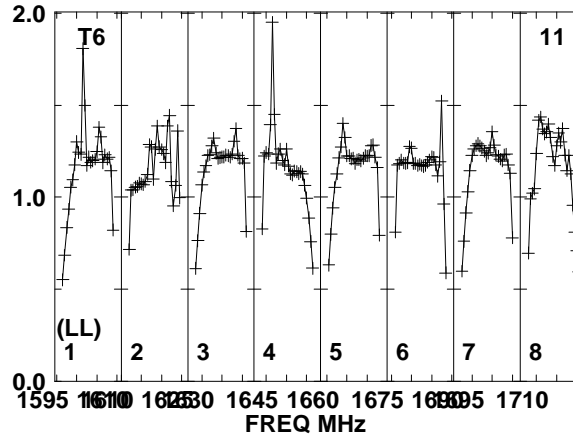
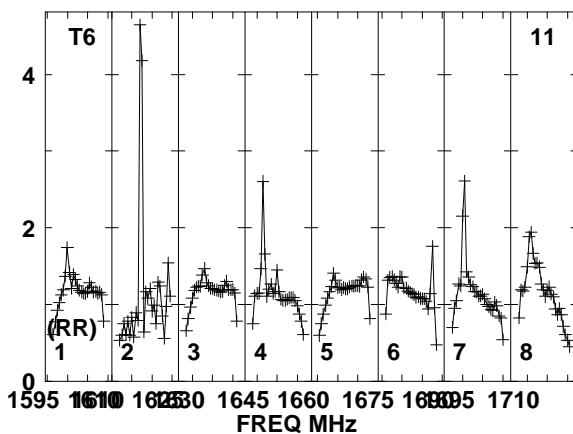
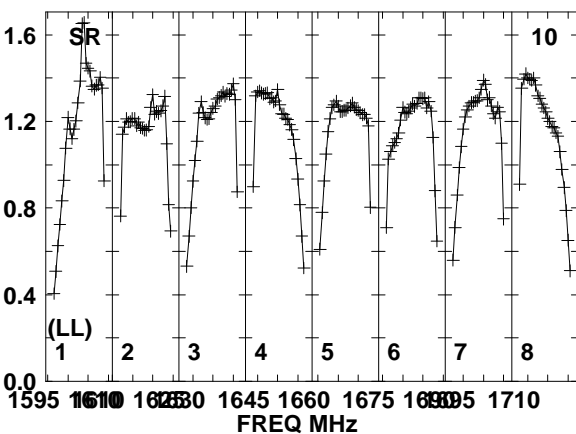
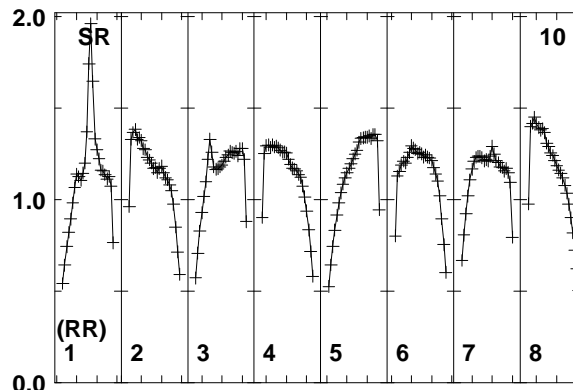
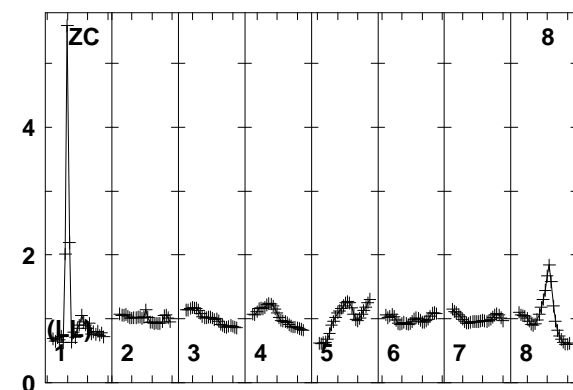
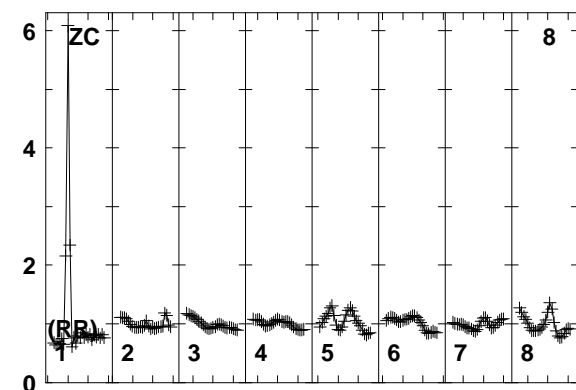
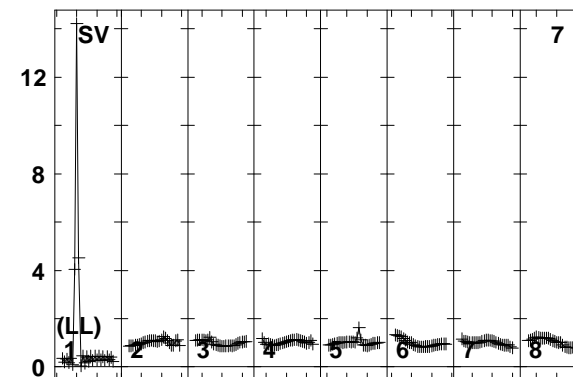
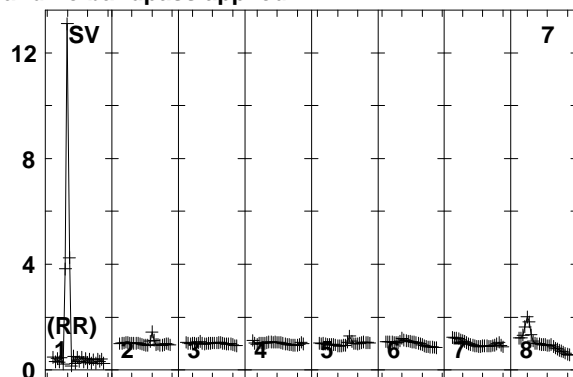
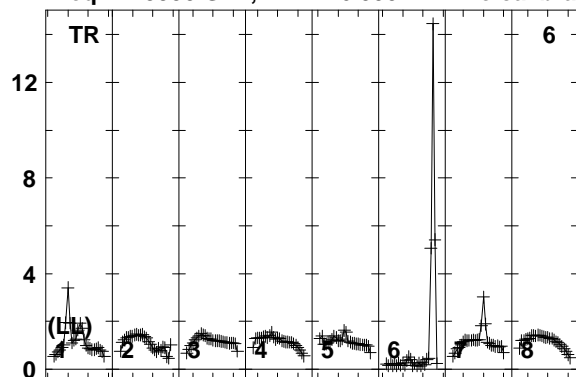

Lower frame: Real Jy
Total-power spectrum Antenna: TR (06)
Timerange: 00/03:19:08 to 00/03:20:30

Plot file version 213 created 19-AUG-2016 17:19:46

J1642+2523 EM119D.UVDATA.1

Freq = 1.5950 GHz, Bw = 16.000 MH No calibration applied and no bandpass applied

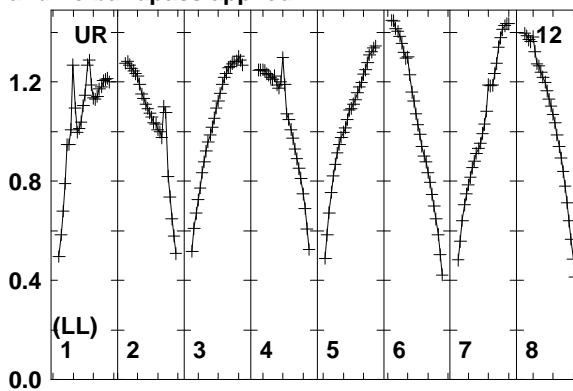
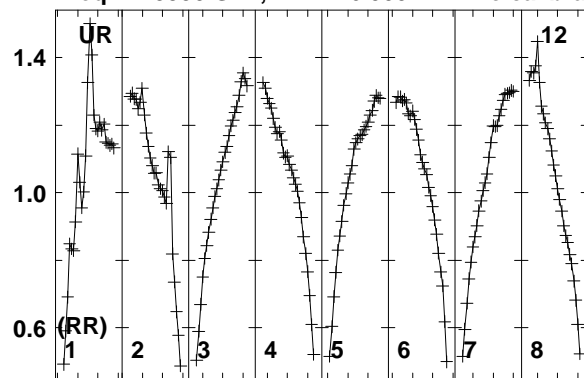

Lower frame: Real Jy
Total-power spectrum Antenna: UR (12)
Timerange: 00/03:19:08 to 00/03:20:30

Plot file version 214 created 19-AUG-2016 17:19:46

J1649+2635 EM119D.UVDATA.1

Freq = 1.5950 GHz, Bw = 16.000 MH No calibration applied and no bandpass applied

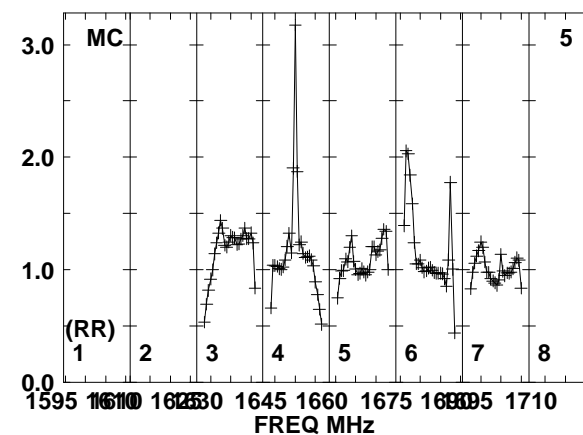
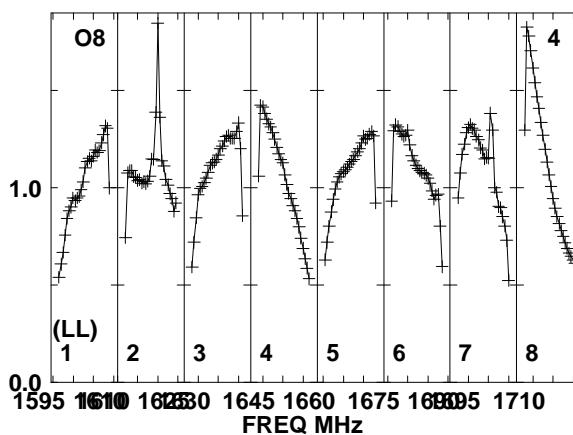
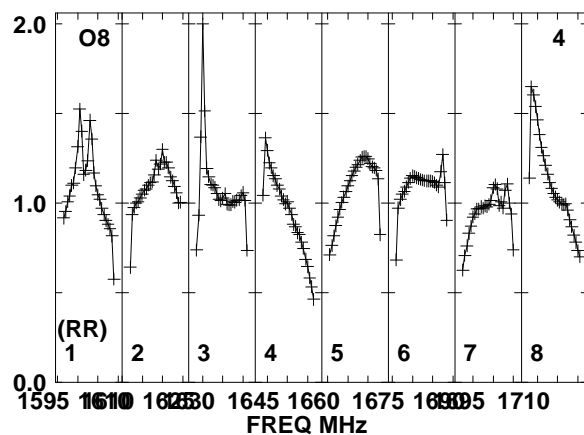
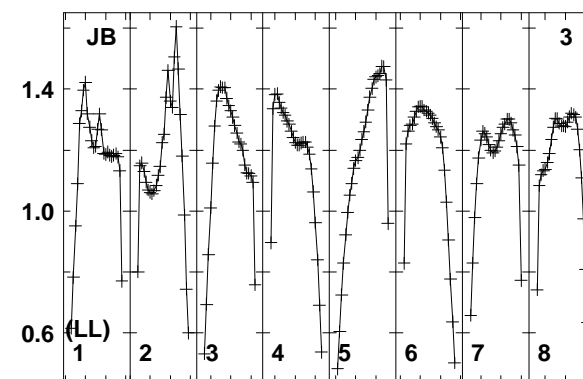
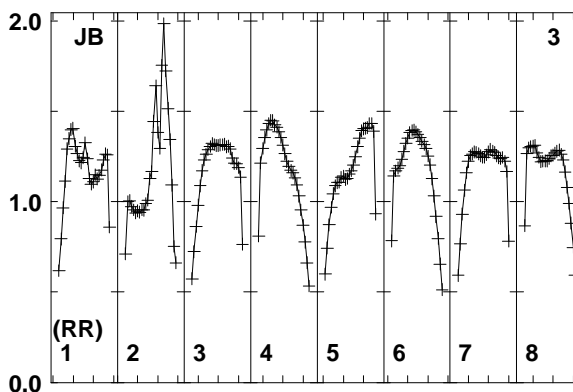
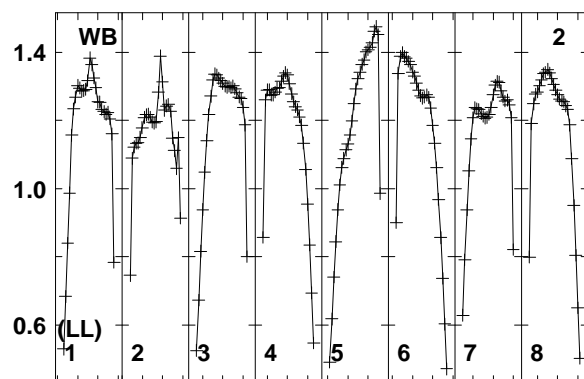
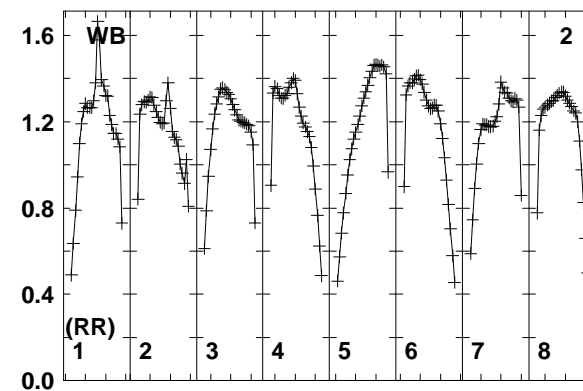
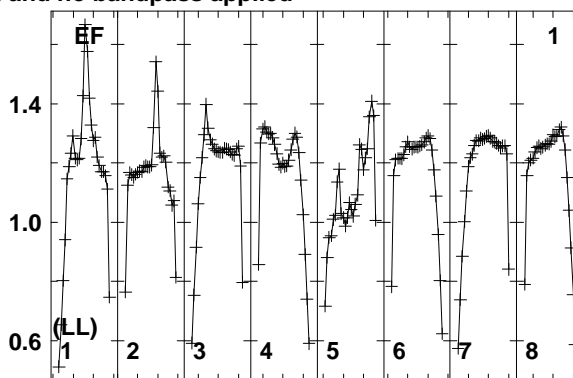
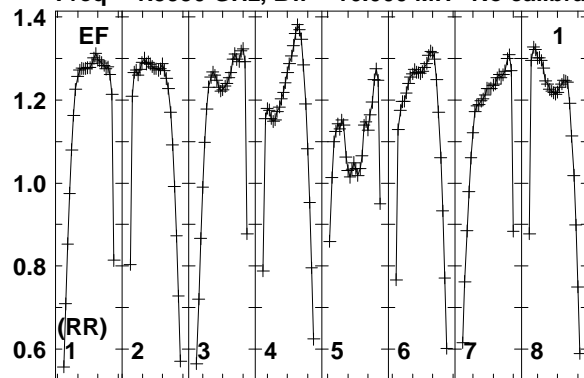

Lower frame: Real Jy
Total-power spectrum Antenna: EF (01)
Timerange: 00/03:20:32 to 00/03:24:00

Plot file version 215 created 19-AUG-2016 17:19:46

J1649+2635 EM119D.UVDATA.1

Freq = 1.5950 GHz, Bw = 16.000 MH No calibration applied and no bandpass applied

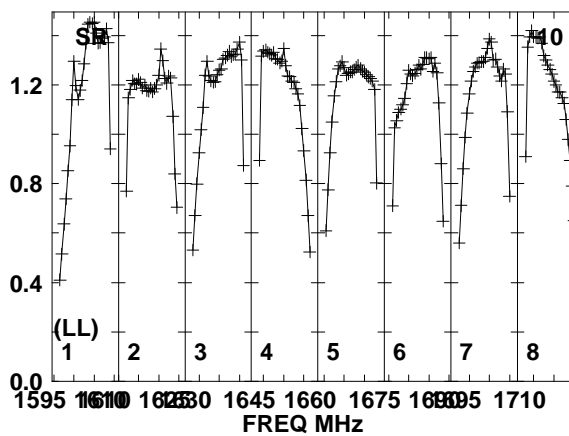
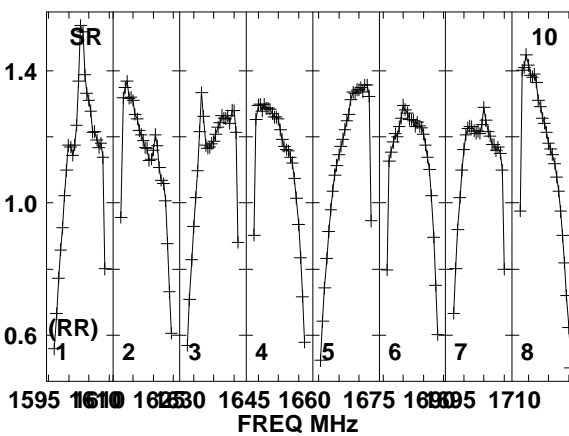
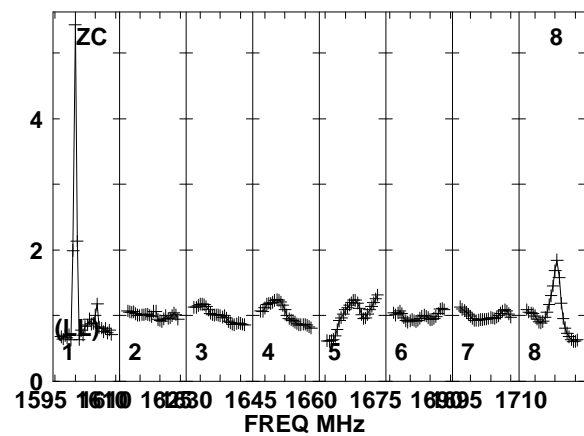
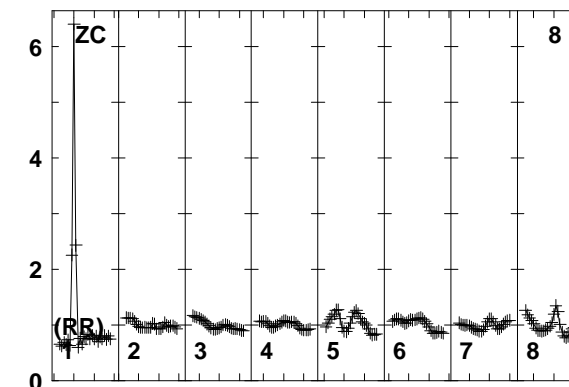
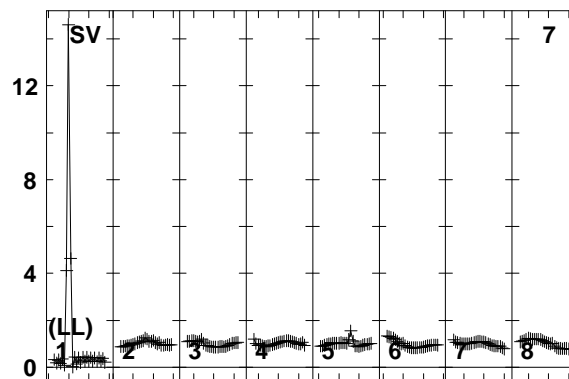
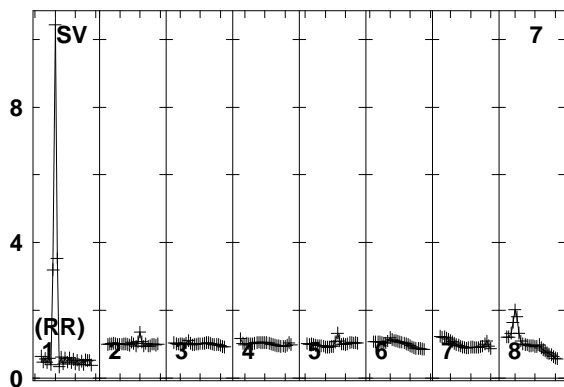
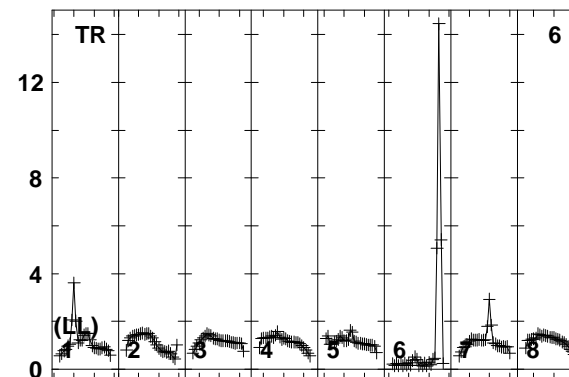
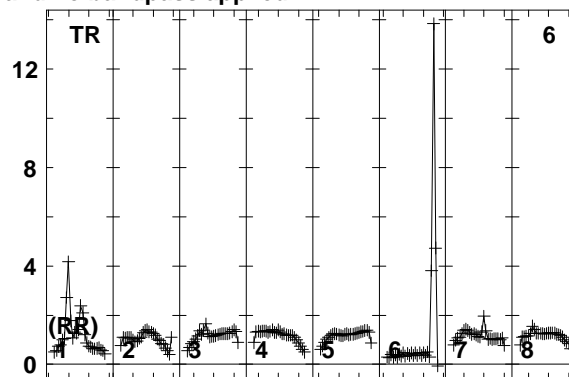
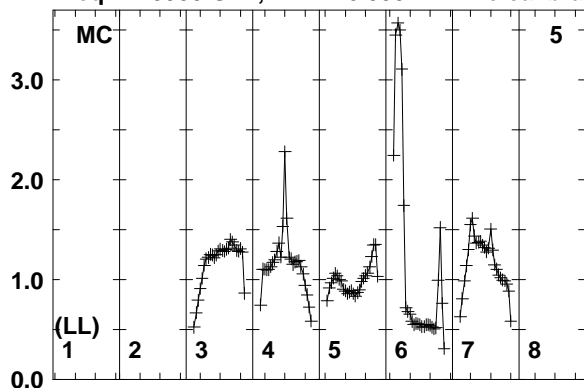

Lower frame: Real Jy
Total-power spectrum Antenna: MC (05)
Timerange: 00/03:20:32 to 00/03:24:00

Plot file version 216 created 19-AUG-2016 17:19:46

J1649+2635 EM119D.UVDATA.1

Freq = 1.5950 GHz, Bw = 16.000 MH No calibration applied and no bandpass applied

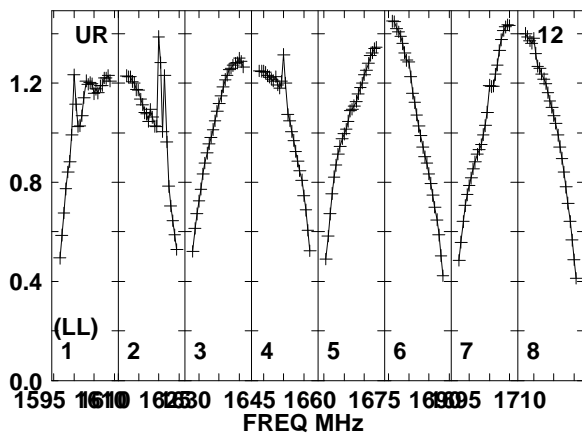
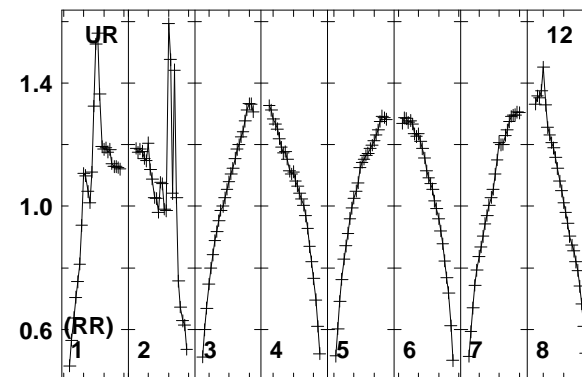
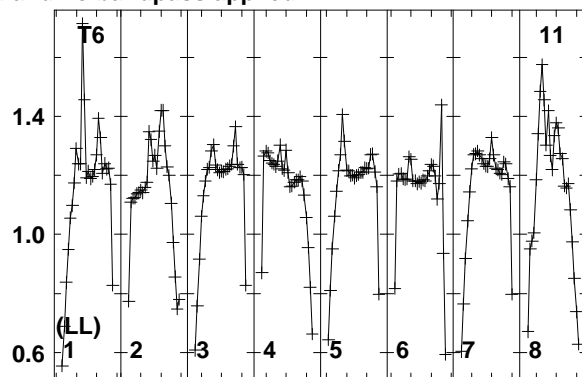
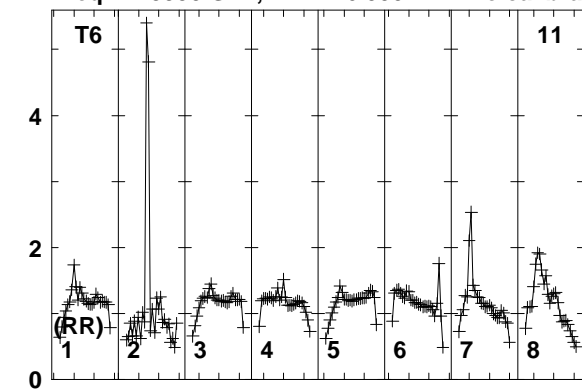

Lower frame: Real Jy
Total-power spectrum Antenna: T6 (11)
Timerange: 00/03:20:32 to 00/03:24:00

Plot file version 217 created 19-AUG-2016 17:19:46

J1642+2523 EM119D.UVDATA.1

Freq = 1.5950 GHz, Bw = 16.000 MH No calibration applied and no bandpass applied

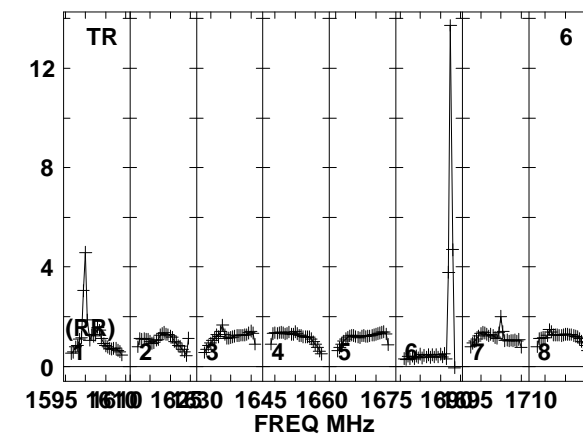
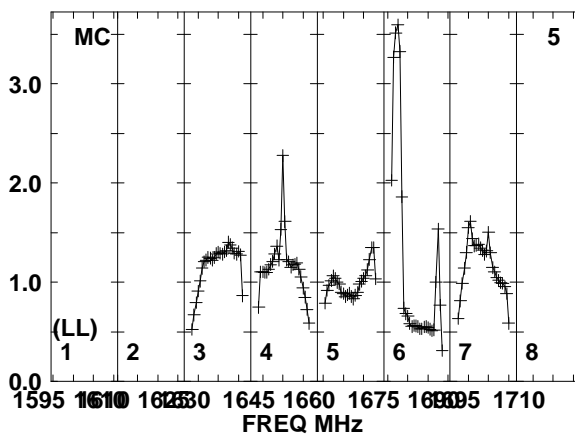
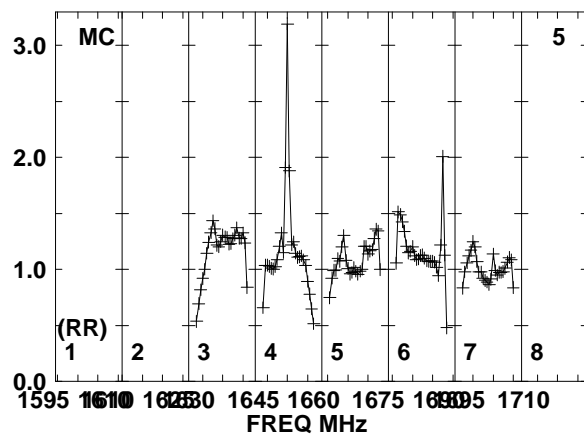
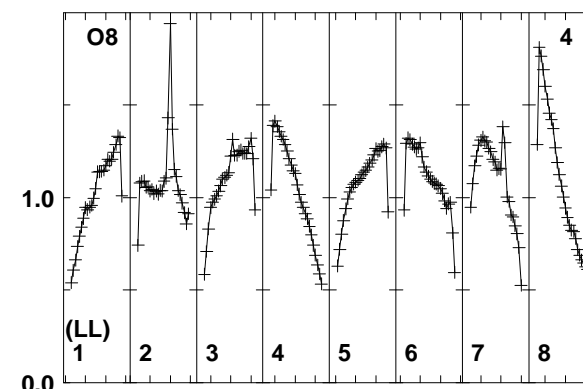
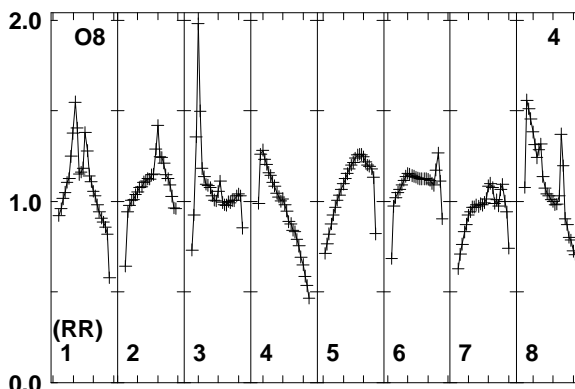
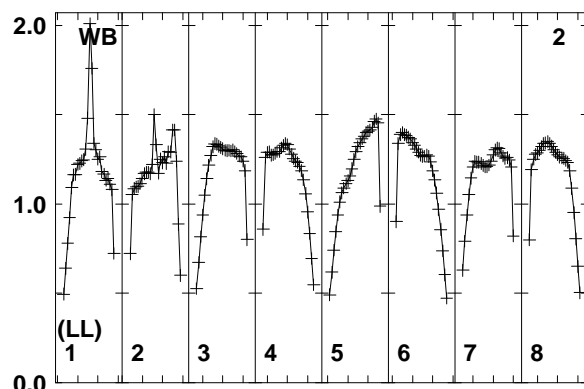
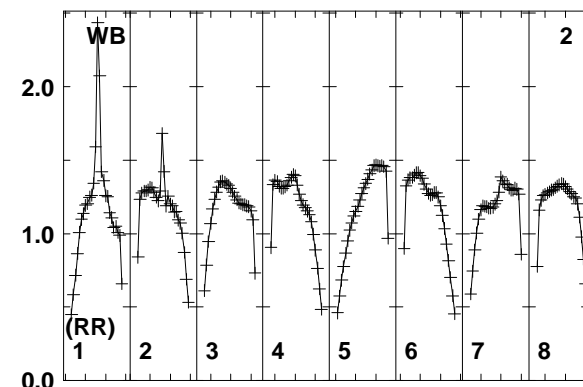
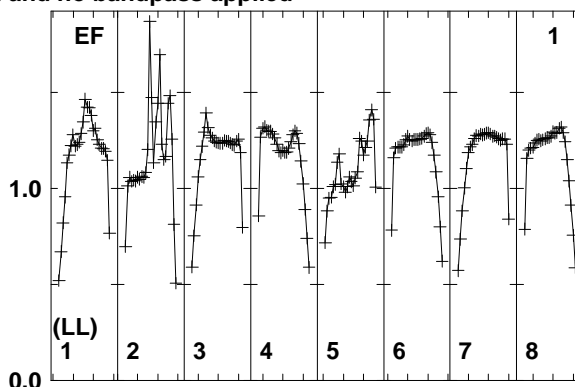
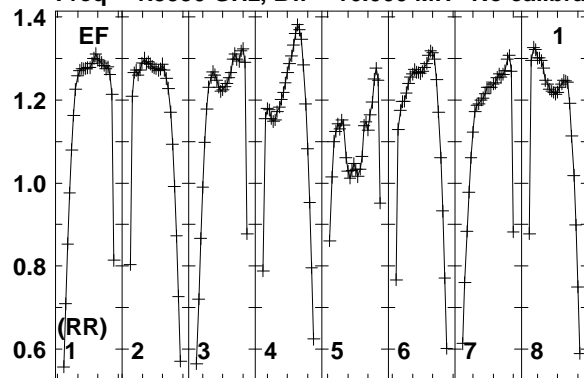

Lower frame: Real Jy
Total-power spectrum Antenna: EF (01)
Timerange: 00/03:24:07 to 00/03:25:30

Plot file version 218 created 19-AUG-2016 17:19:47

J1642+2523 EM119D.UVDATA.1

Freq = 1.5950 GHz, Bw = 16.000 MH No calibration applied and no bandpass applied

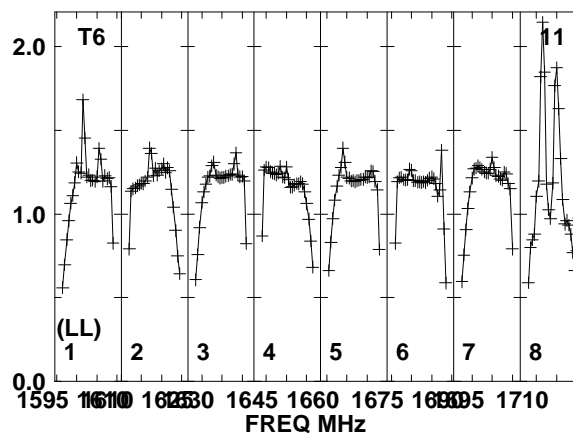
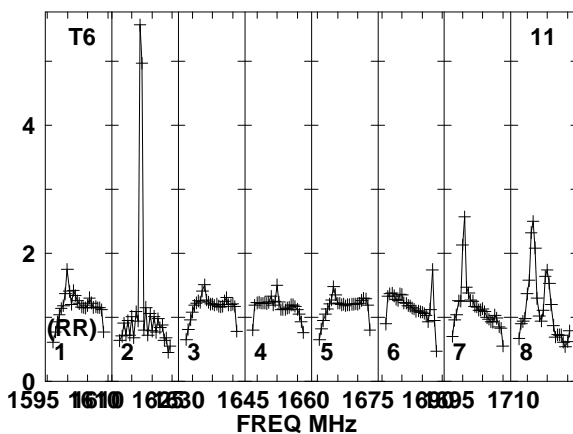
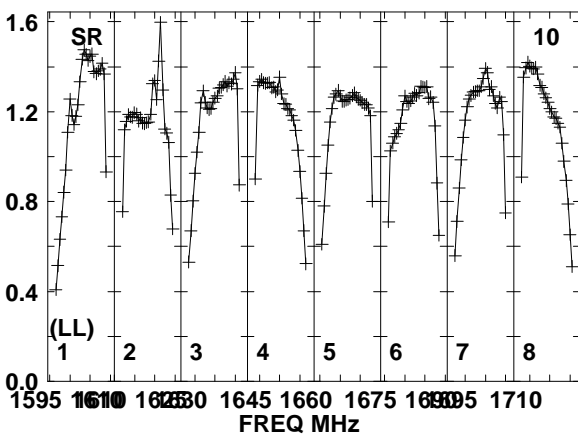
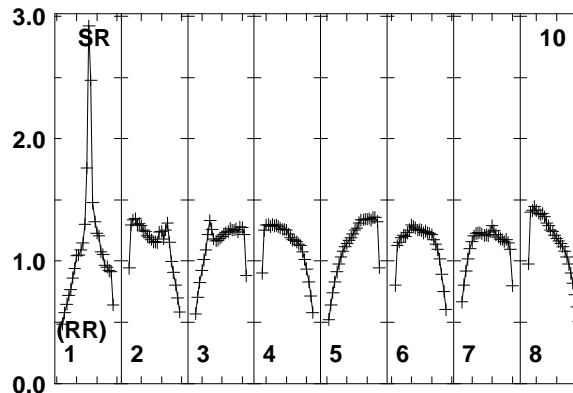
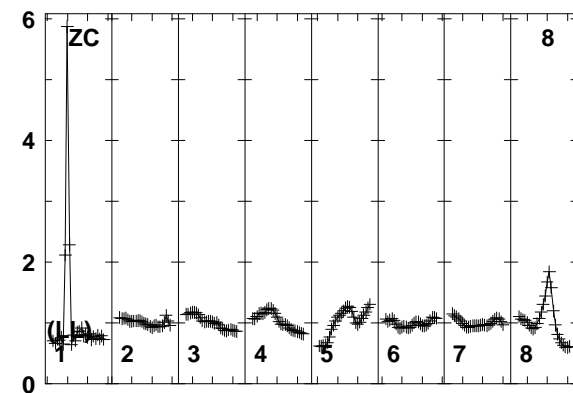
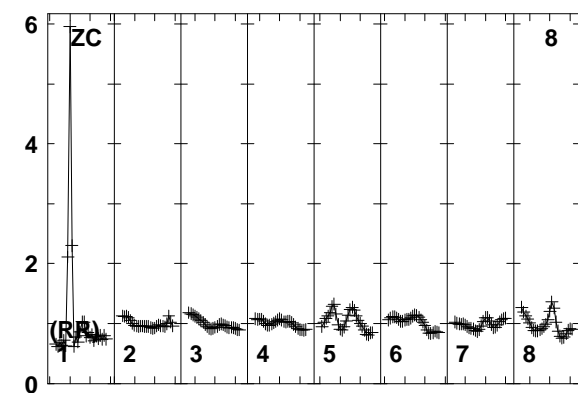
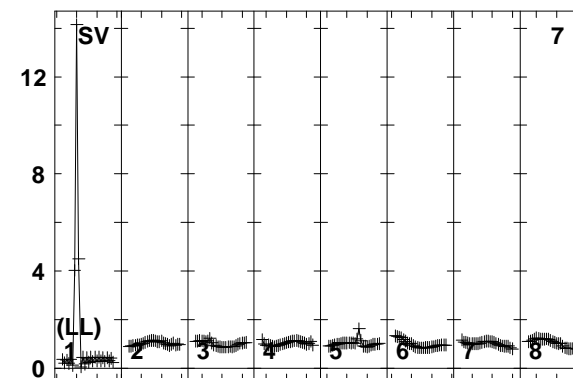
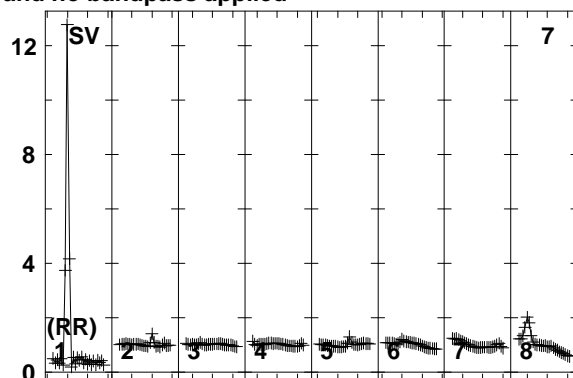
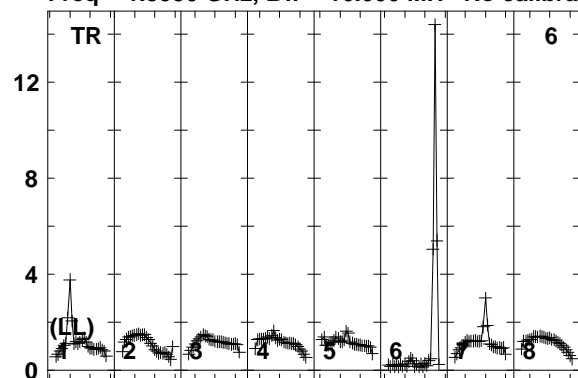

Lower frame: Real Jy
Total-power spectrum Antenna: TR (06)
Timerange: 00/03:24:07 to 00/03:25:30

Plot file version 219 created 19-AUG-2016 17:19:47

J1642+2523 EM119D.UVDATA.1

Freq = 1.5950 GHz, Bw = 16.000 MH No calibration applied and no bandpass applied

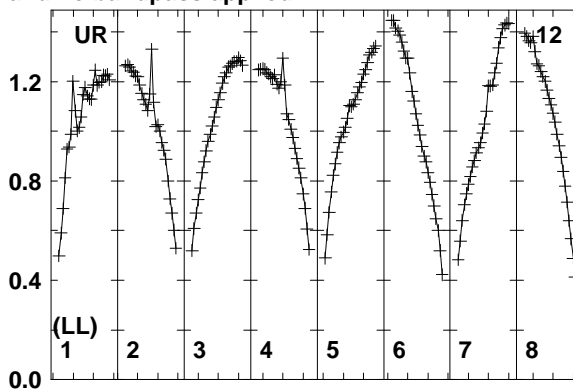
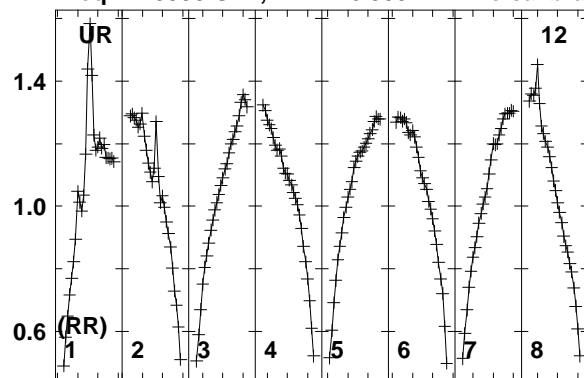

Lower frame: Real Jy
Total-power spectrum Antenna: UR (12)
Timerange: 00/03:24:07 to 00/03:25:30

Plot file version 220 created 19-AUG-2016 17:19:47

J1649+2635 EM119D.UVDATA.1

Freq = 1.5950 GHz, Bw = 16.000 MH No calibration applied and no bandpass applied

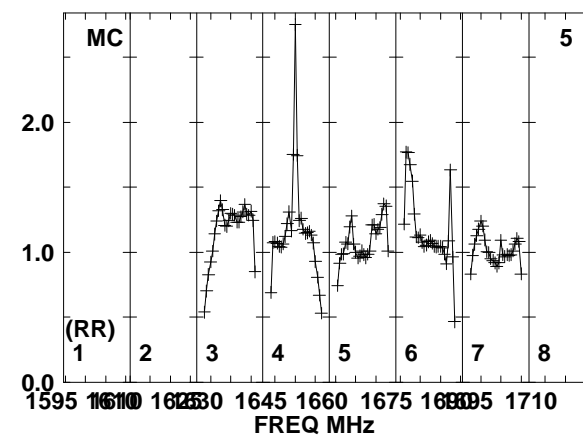
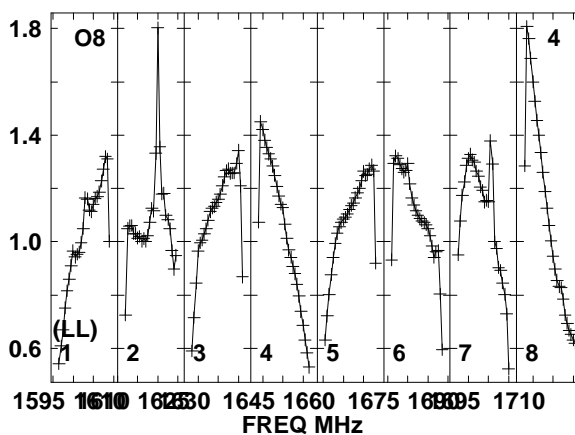
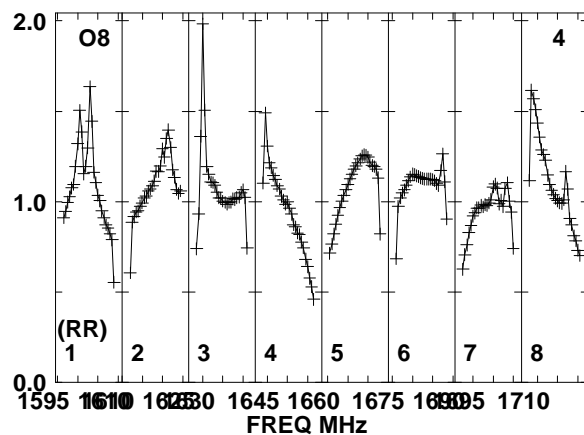
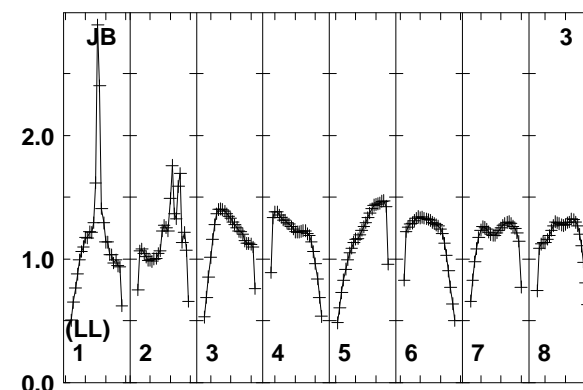
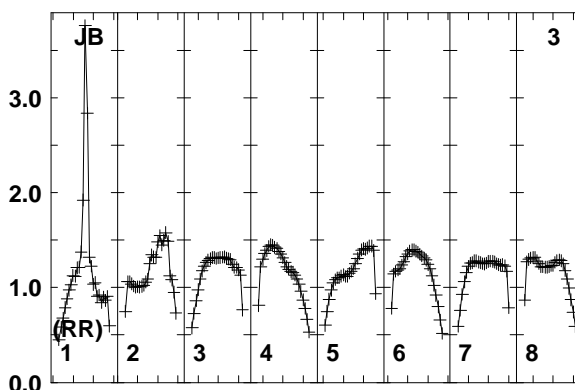
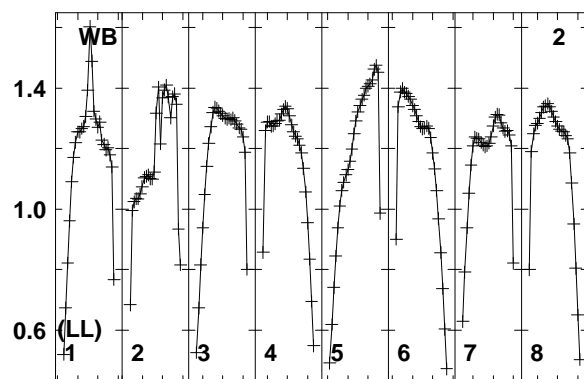
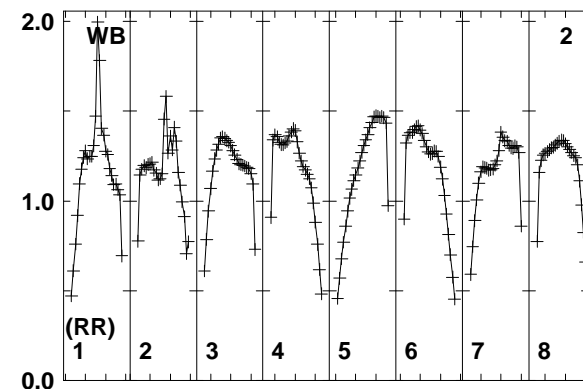
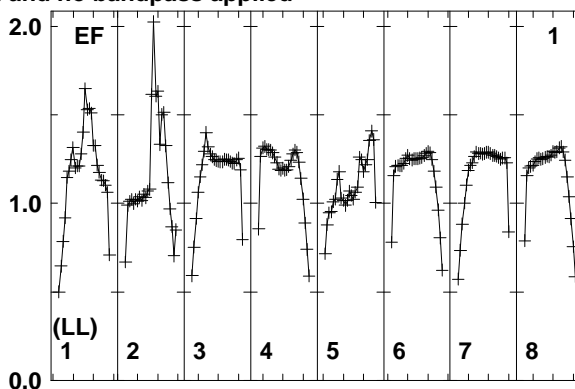
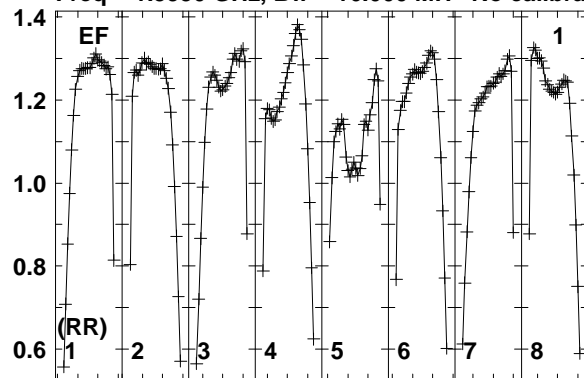

Lower frame: Real Jy
Total-power spectrum Antenna: EF (01)
Timerange: 00/03:26:31 to 00/03:30:00

Plot file version 221 created 19-AUG-2016 17:19:47

J1649+2635 EM119D.UVDATA.1

Freq = 1.5950 GHz, Bw = 16.000 MH No calibration applied and no bandpass applied

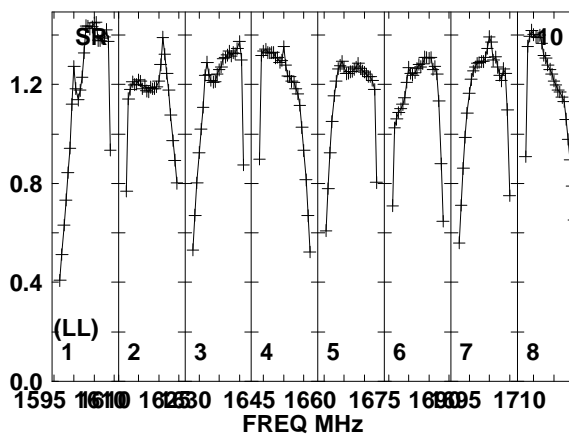
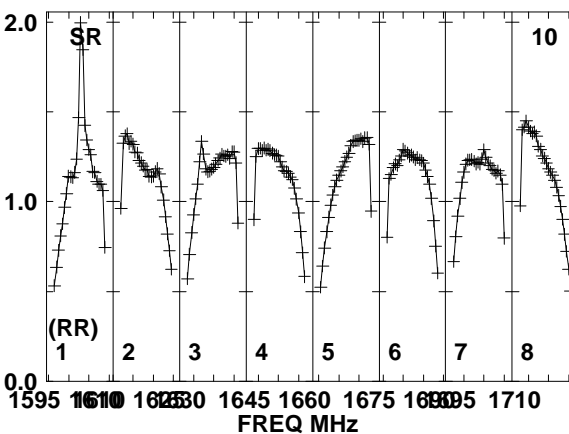
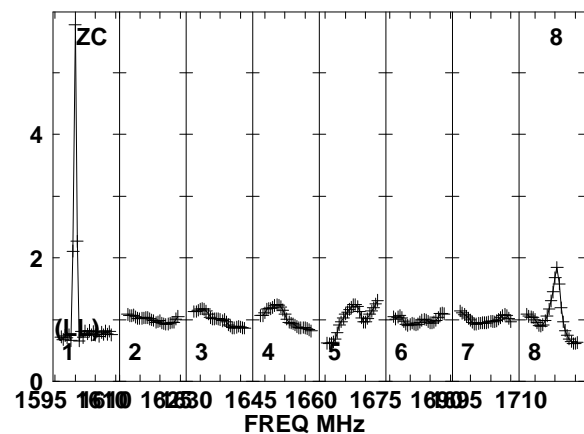
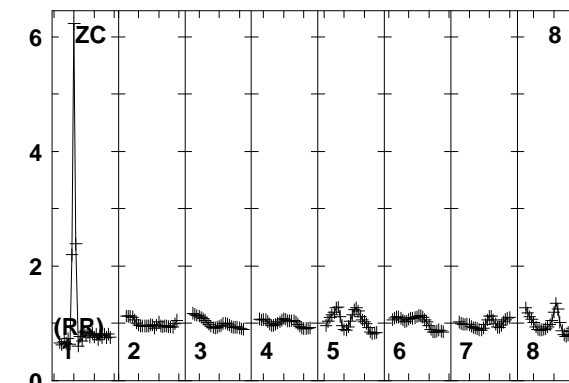
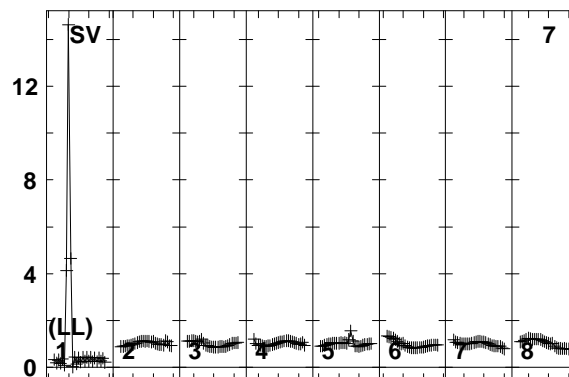
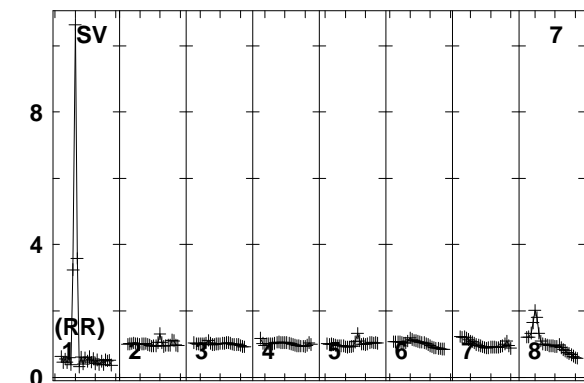
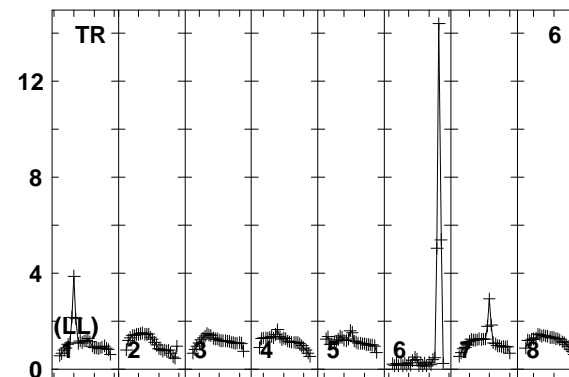
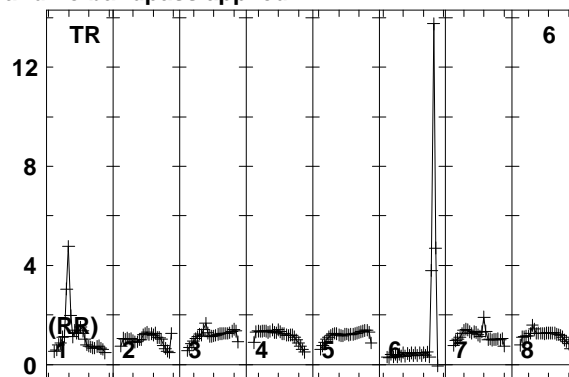
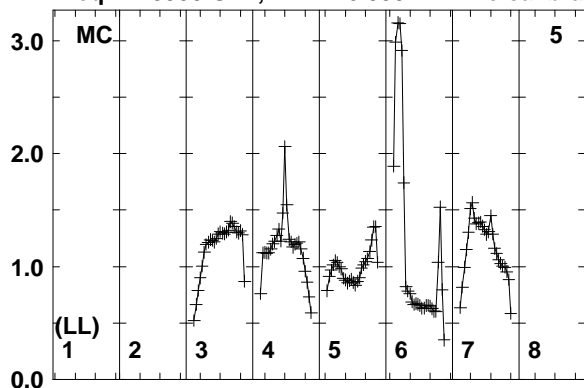

Lower frame: Real Jy
Total-power spectrum Antenna: MC (05)
Timerange: 00/03:26:31 to 00/03:30:00

Plot file version 222 created 19-AUG-2016 17:19:47

J1649+2635 EM119D.UVDATA.1

Freq = 1.5950 GHz, Bw = 16.000 MH No calibration applied and no bandpass applied

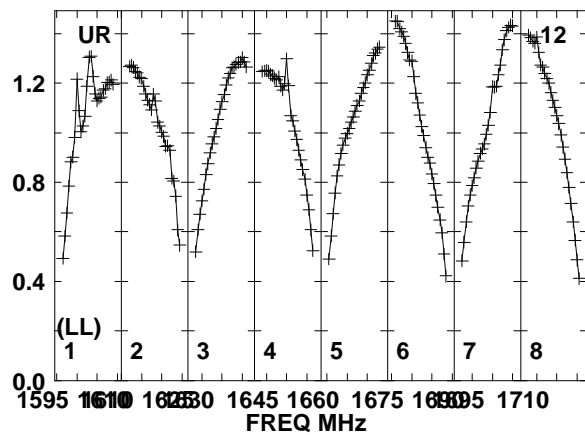
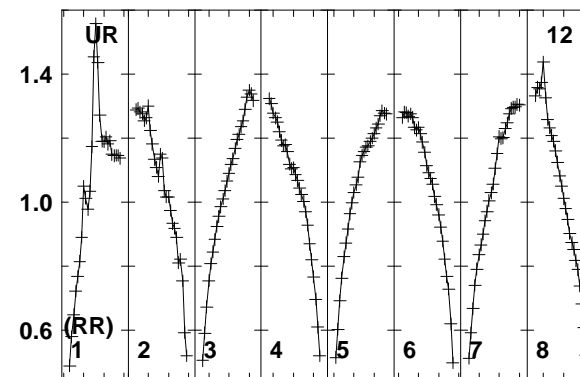
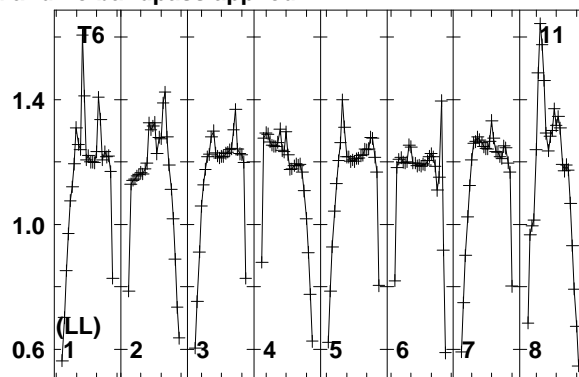
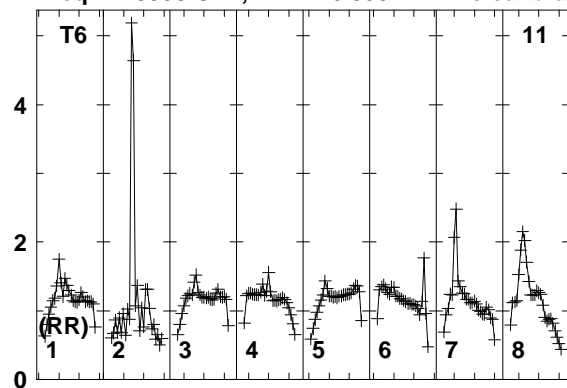

Lower frame: Real Jy
Total-power spectrum Antenna: T6 (11)
Timerange: 00/03:26:31 to 00/03:30:00

Plot file version 223 created 19-AUG-2016 17:19:47

J1642+2523 EM119D.UVDATA.1

Freq = 1.5950 GHz, Bw = 16.000 MH No calibration applied and no bandpass applied

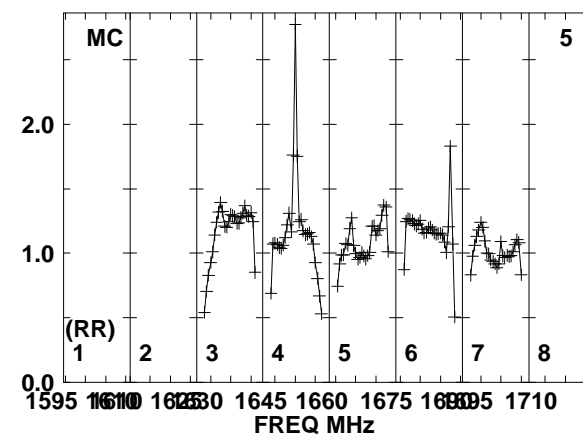
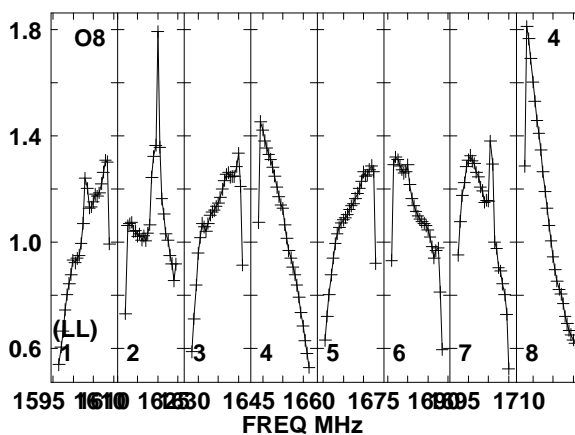
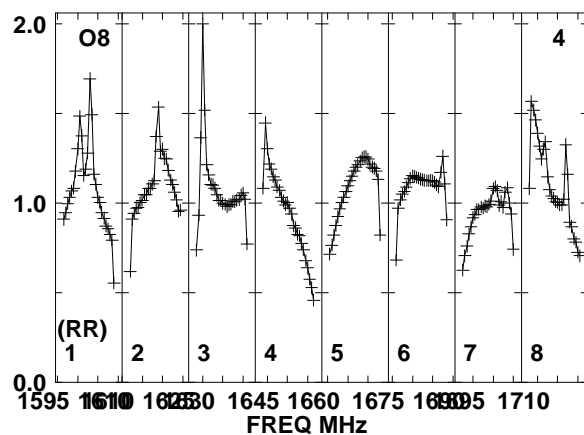
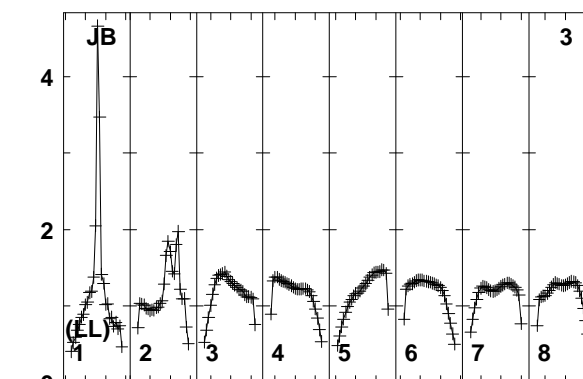
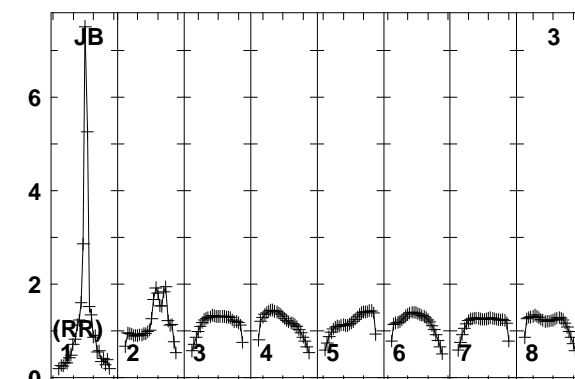
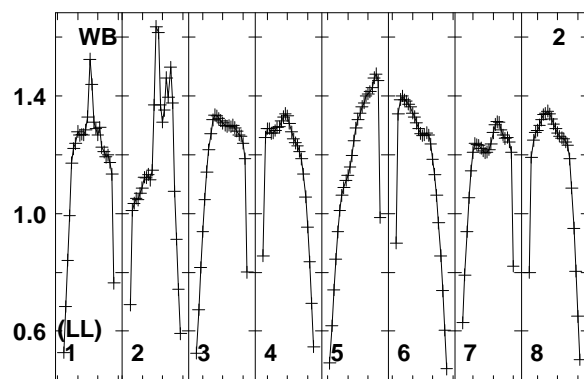
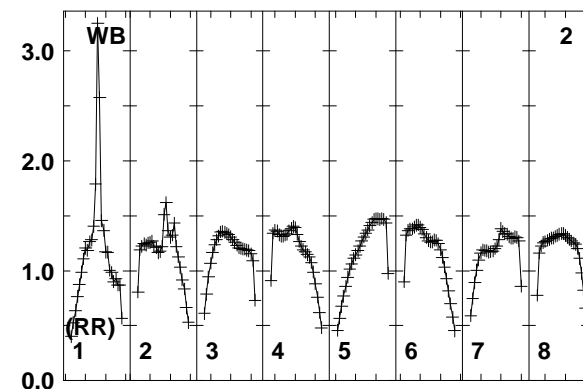
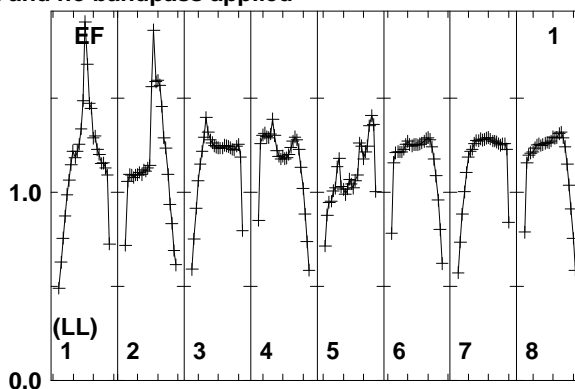
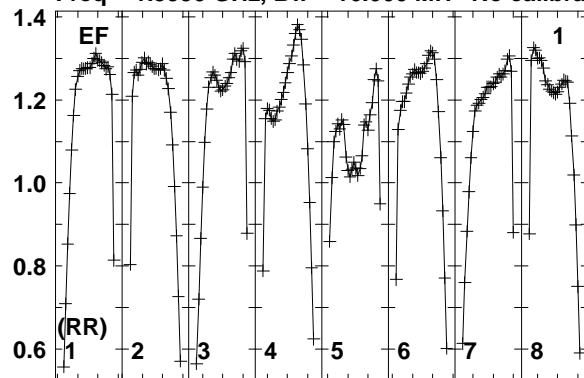

Lower frame: Real Jy
Total-power spectrum Antenna: EF (01)
Timerange: 00/03:30:07 to 00/03:31:29

Plot file version 224 created 19-AUG-2016 17:19:48

J1642+2523 EM119D.UVDATA.1

Freq = 1.5950 GHz, Bw = 16.000 MH No calibration applied and no bandpass applied

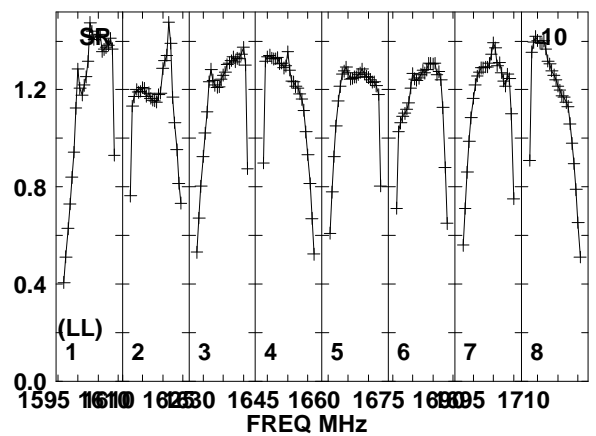
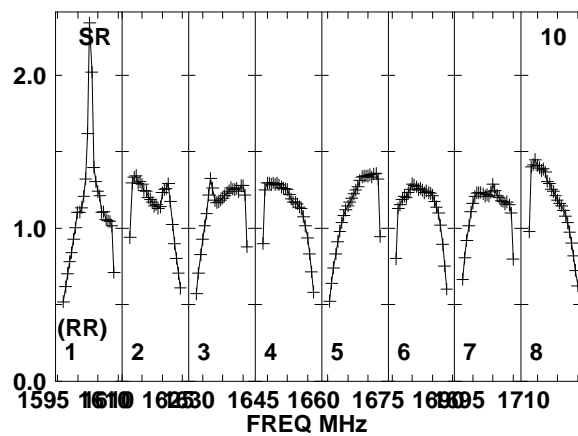
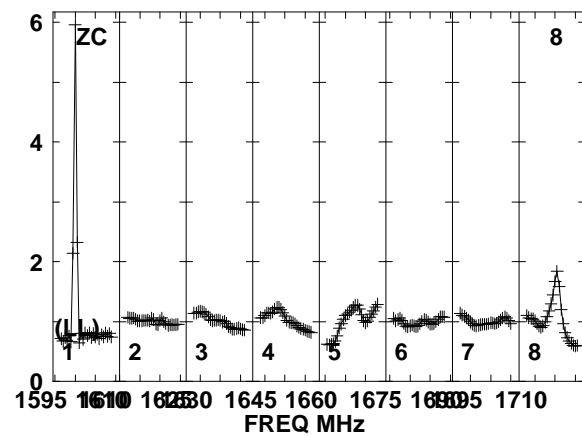
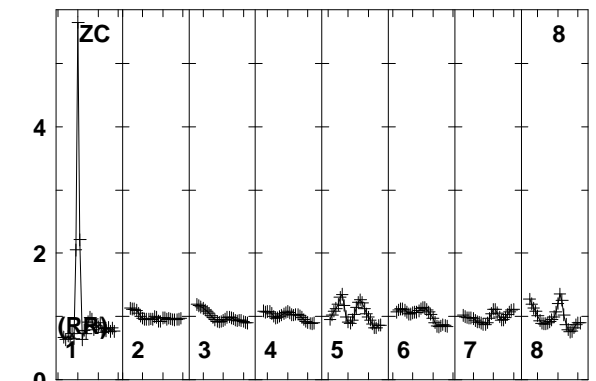
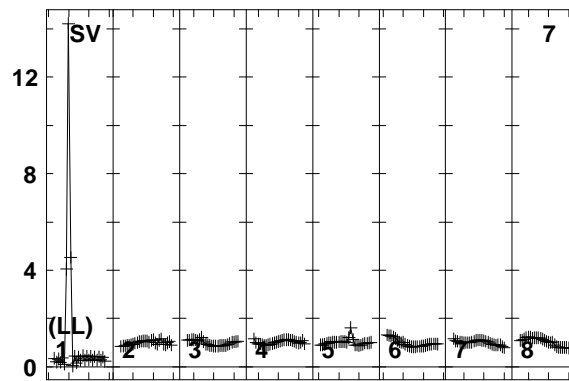
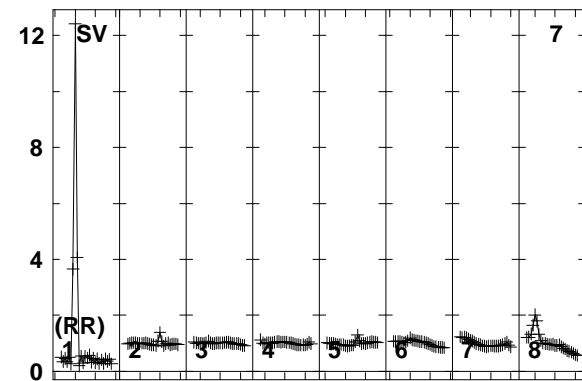
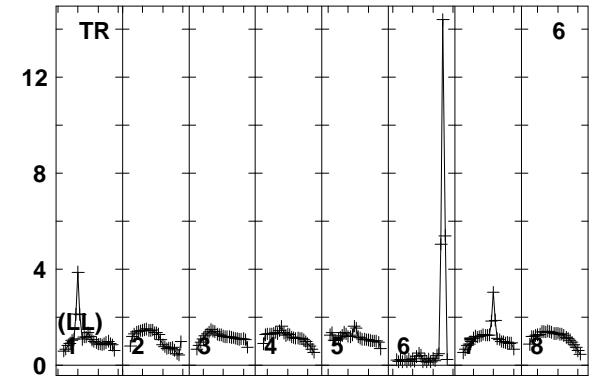
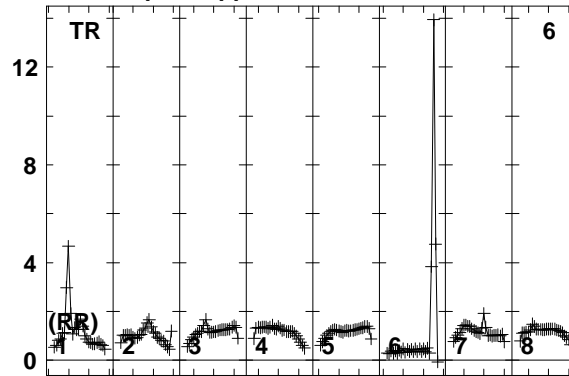
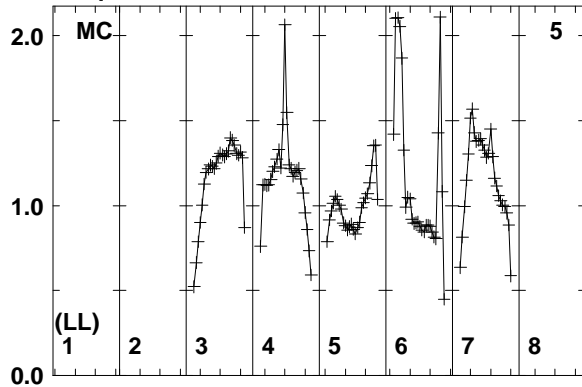

Lower frame: Real Jy
Total-power spectrum Antenna: MC (05)
Timerange: 00/03:30:07 to 00/03:31:29

Plot file version 225 created 19-AUG-2016 17:19:48

J1642+2523 EM119D.UVDATA.1

Freq = 1.5950 GHz, Bw = 16.000 MH No calibration applied and no bandpass applied

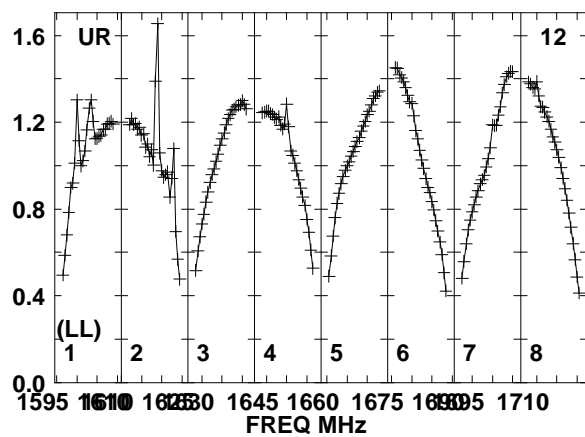
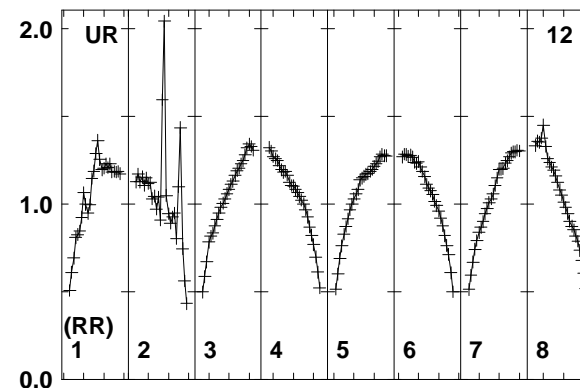
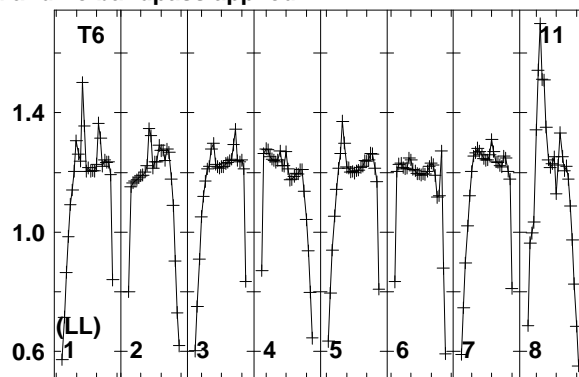
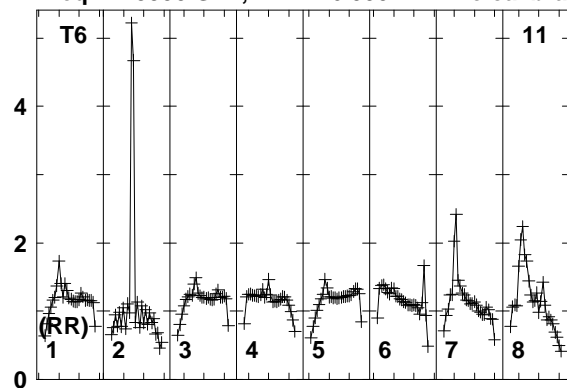

Lower frame: Real Jy
Total-power spectrum Antenna: T6 (11)
Timerange: 00/03:30:07 to 00/03:31:29

Plot file version 226 created 19-AUG-2016 17:19:48

J1649+2635 EM119D.UVDATA.1

Freq = 1.5950 GHz, Bw = 16.000 MH No calibration applied and no bandpass applied

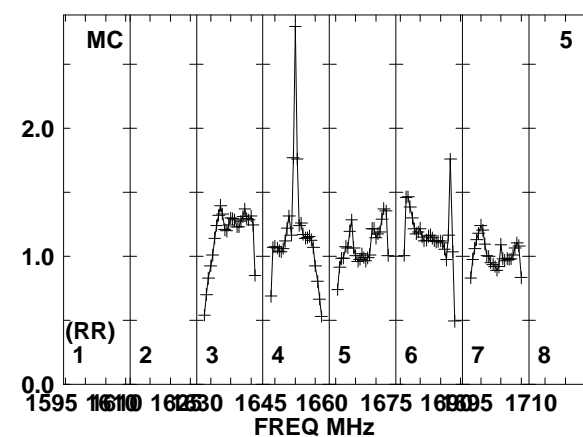
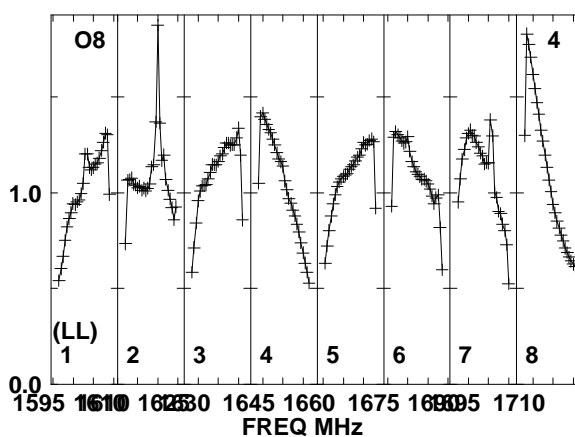
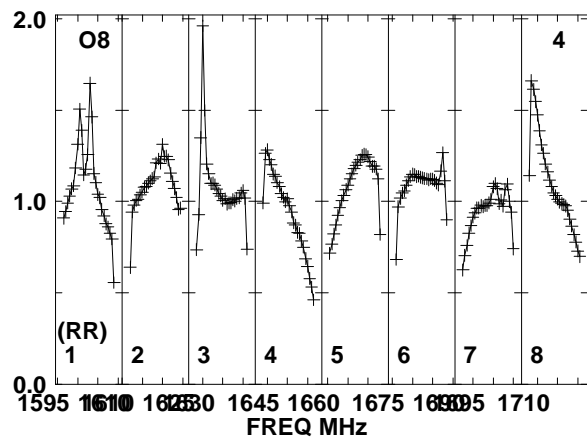
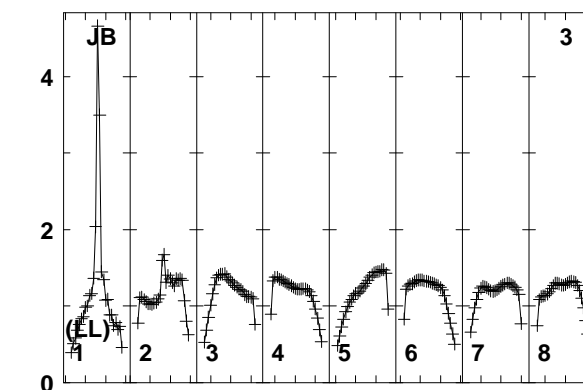
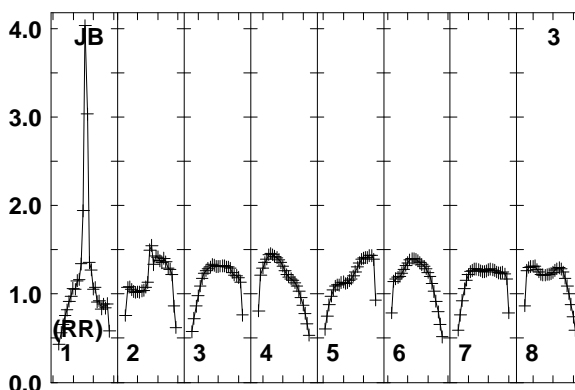
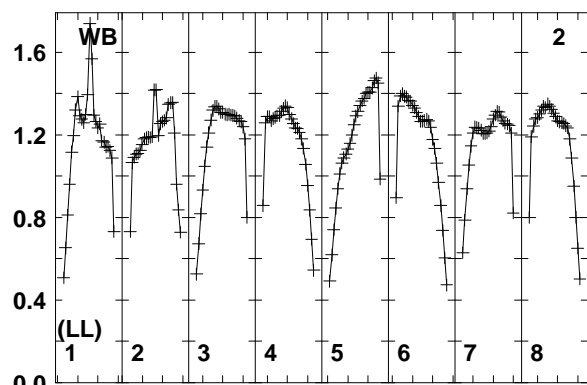
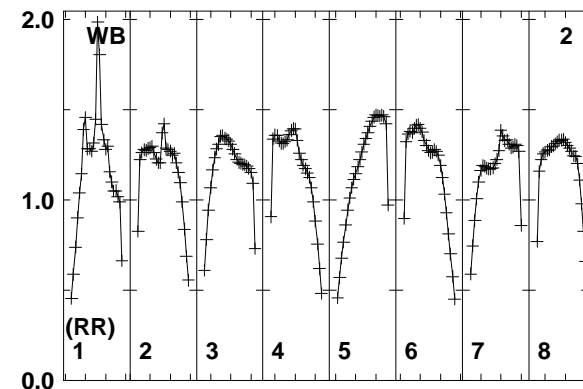
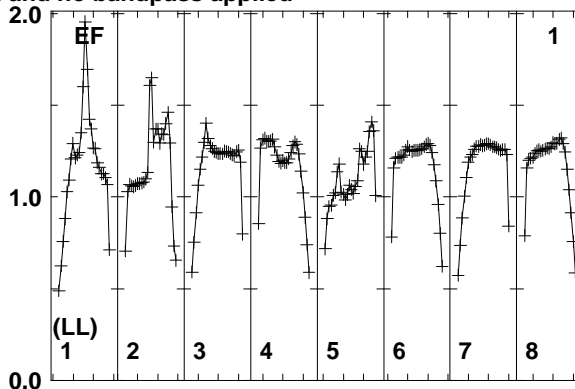
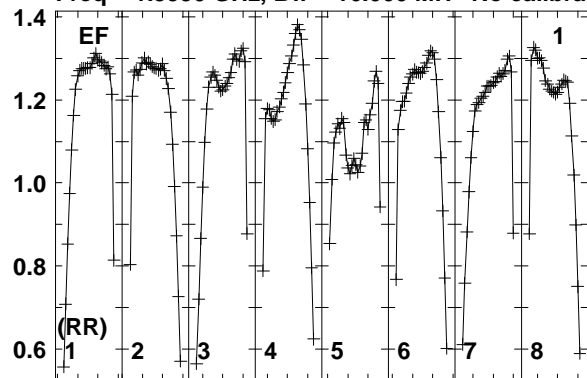

Lower frame: Real Jy
Total-power spectrum Antenna: EF (01)
Timerange: 00/03:31:38 to 00/03:35:00

Plot file version 227 created 19-AUG-2016 17:19:48

J1649+2635 EM119D.UVDATA.1

Freq = 1.5950 GHz, Bw = 16.000 MH No calibration applied and no bandpass applied

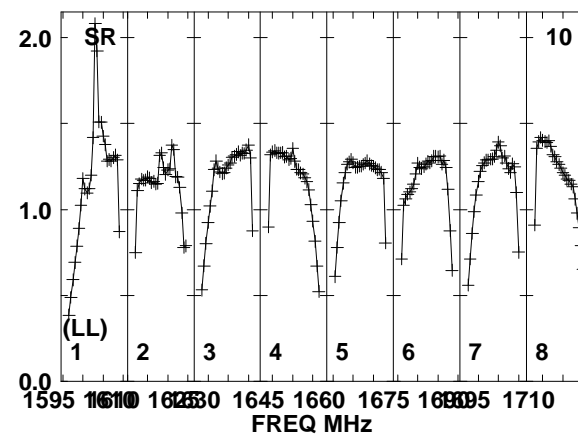
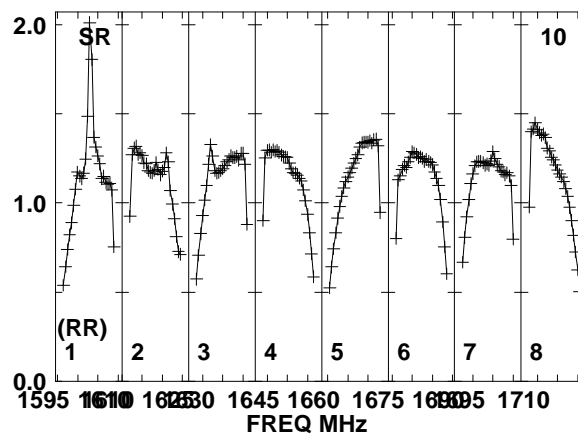
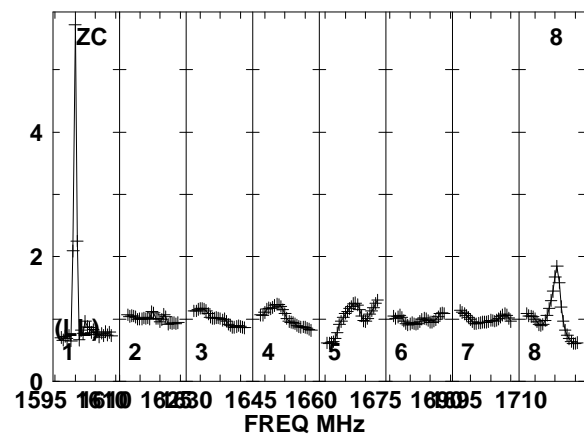
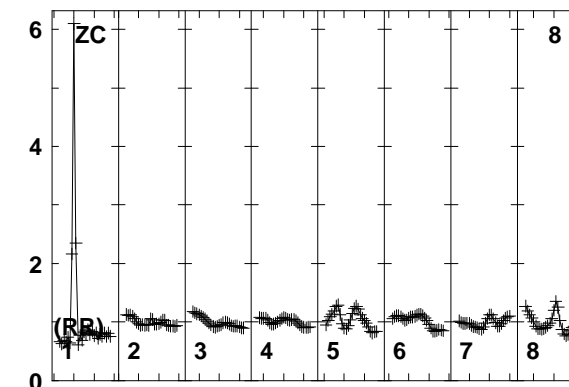
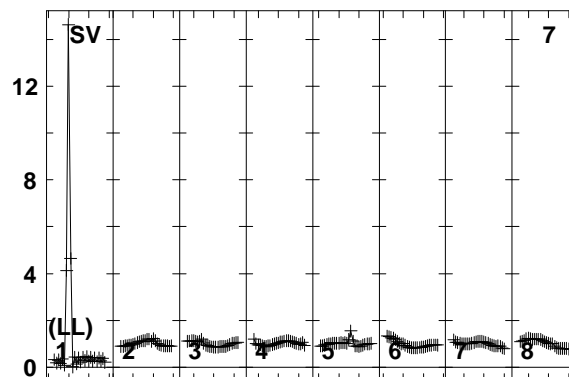
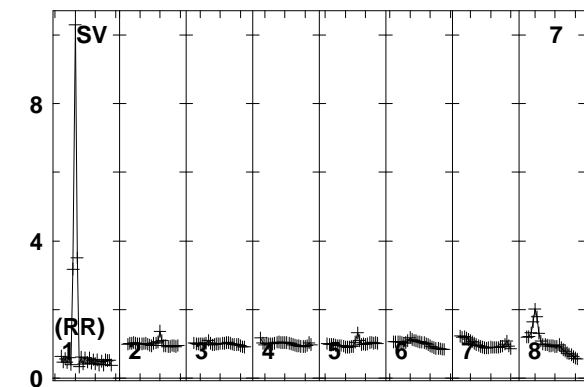
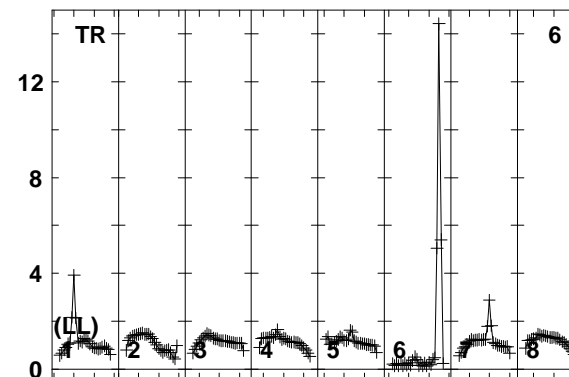
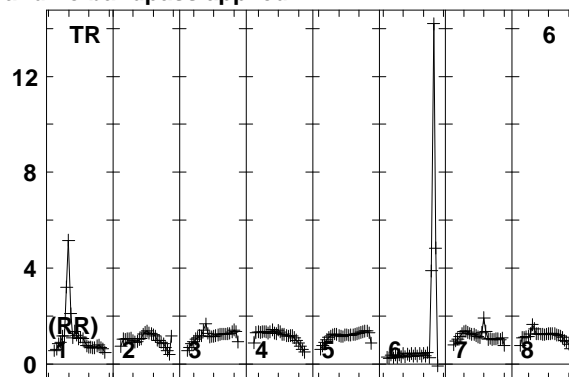
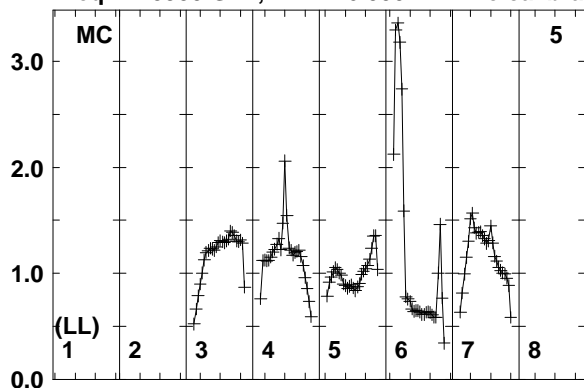

Lower frame: Real Jy
Total-power spectrum Antenna: MC (05)
Timerange: 00/03:31:38 to 00/03:35:00

Plot file version 228 created 19-AUG-2016 17:19:48

J1649+2635 EM119D.UVDATA.1

Freq = 1.5950 GHz, Bw = 16.000 MH No calibration applied and no bandpass applied

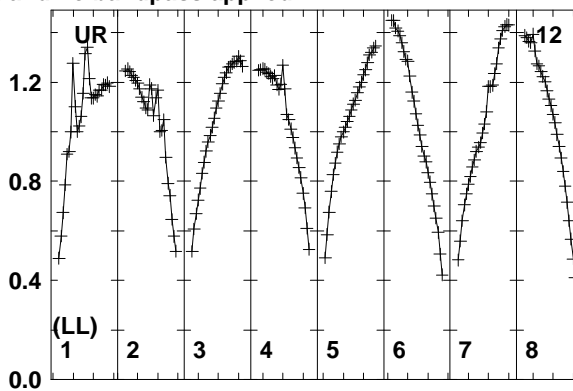
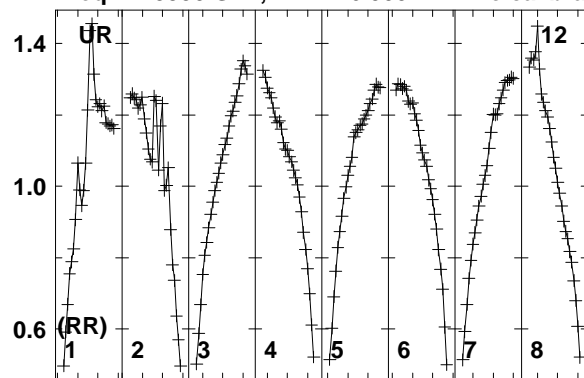

Lower frame: Real Jy
Total-power spectrum Antenna: UR (12)
Timerange: 00/03:31:38 to 00/03:35:00

Plot file version 229 created 19-AUG-2016 17:19:48

J1642+2523 EM119D.UVDATA.1

Freq = 1.5950 GHz, Bw = 16.000 MH No calibration applied and no bandpass applied

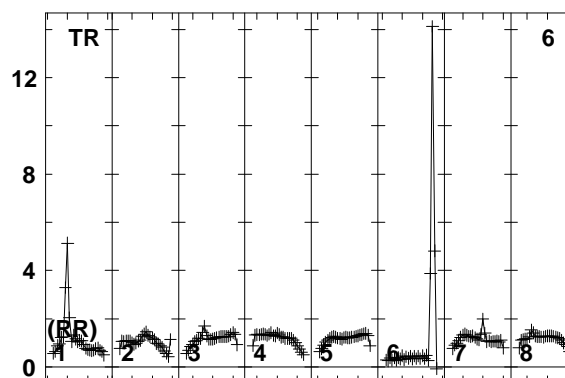
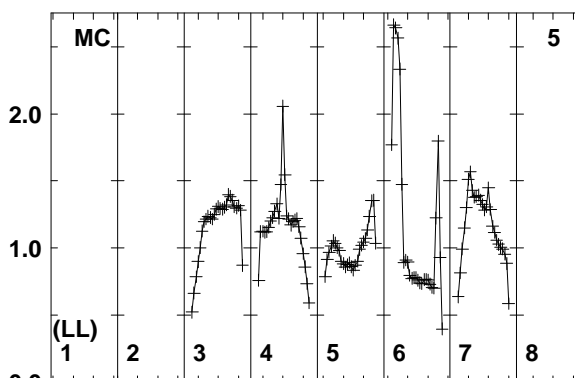
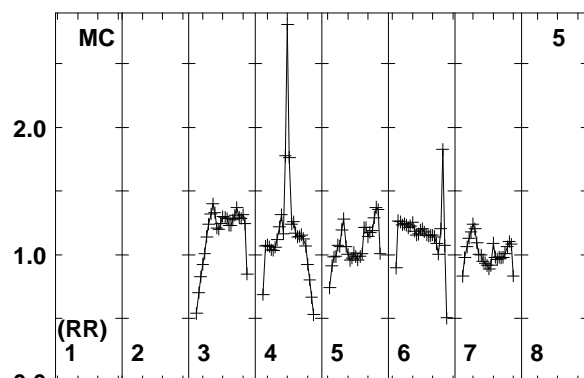
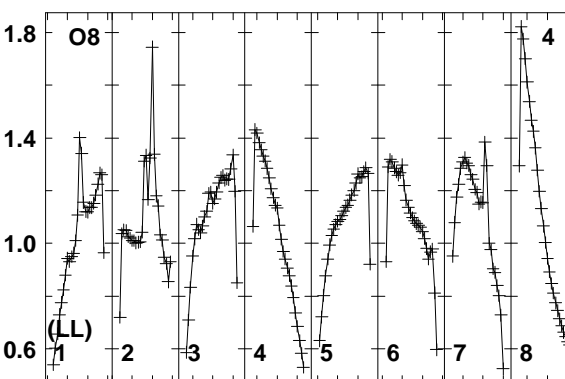
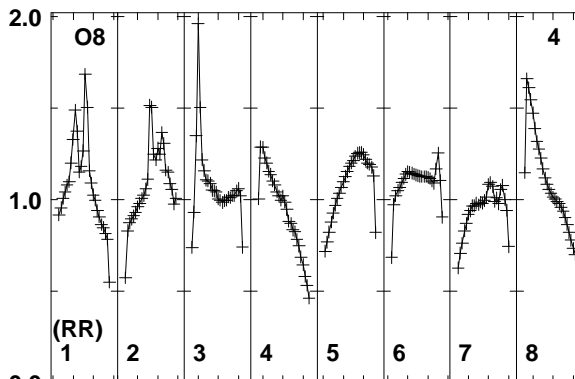
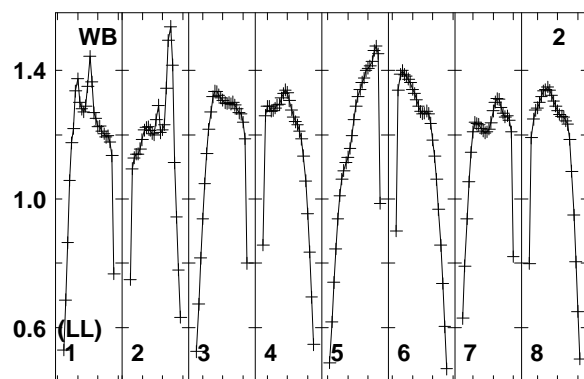
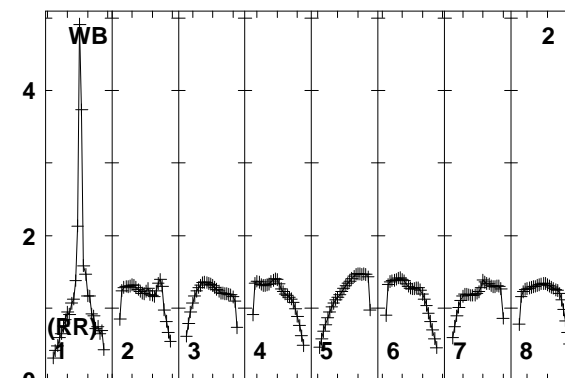
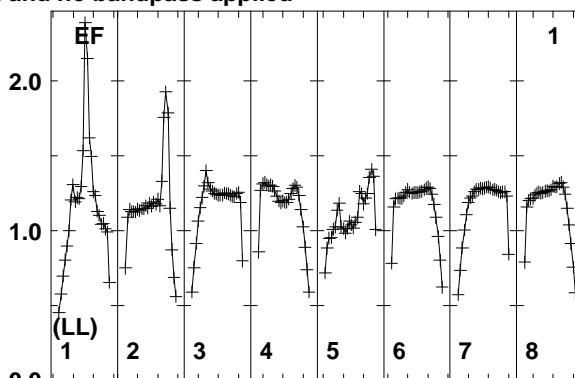
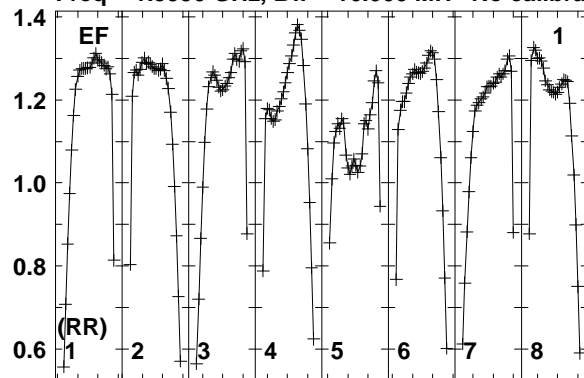

1595 1610 1625 1640 1655 1670 1685 1700 1710
FREQ MHz
Lower frame: Real Jy
Total-power spectrum Antenna: EF (01)
Timerange: 00/03:35:08 to 00/03:36:30

Plot file version 230 created 19-AUG-2016 17:19:48

J1642+2523 EM119D.UVDATA.1

Freq = 1.5950 GHz, Bw = 16.000 MH No calibration applied and no bandpass applied

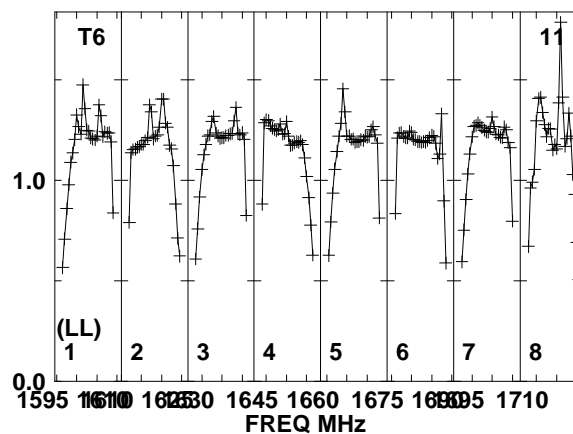
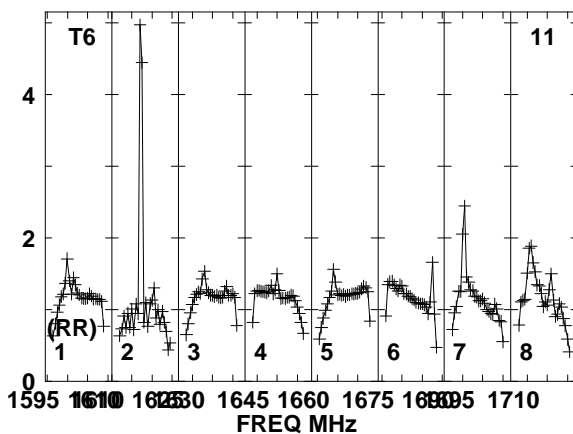
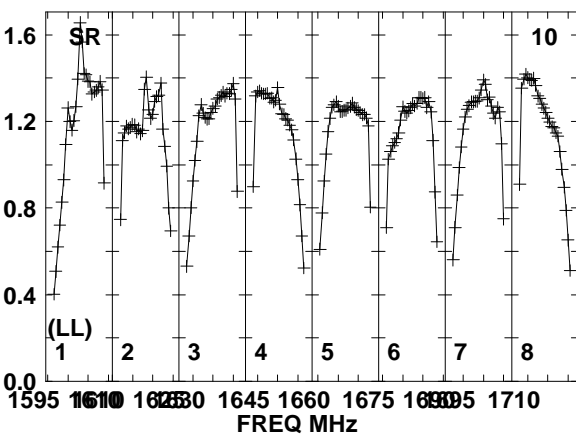
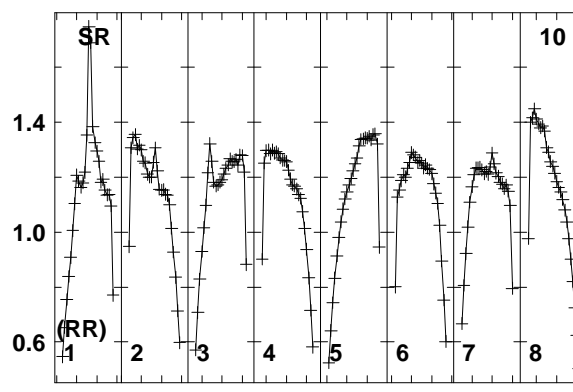
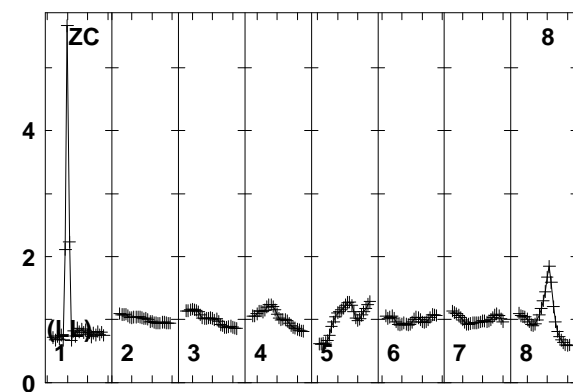
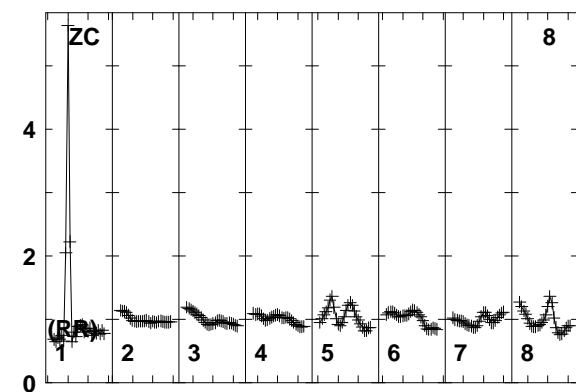
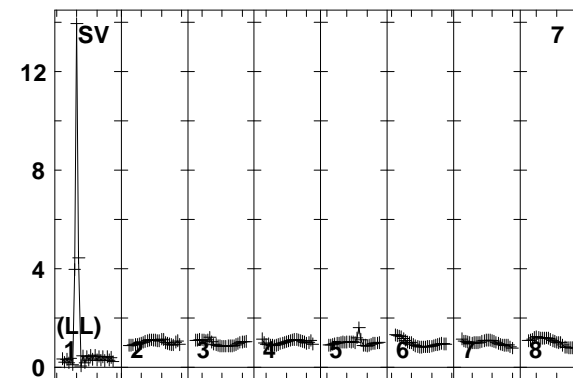
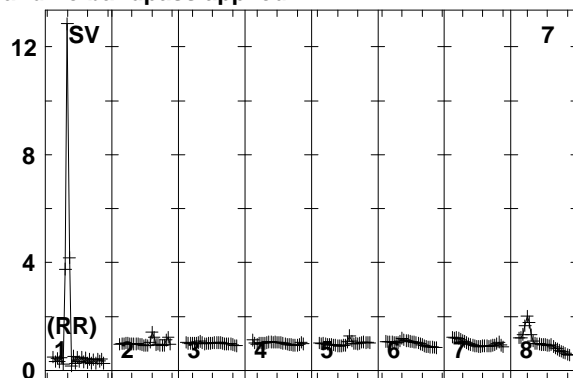
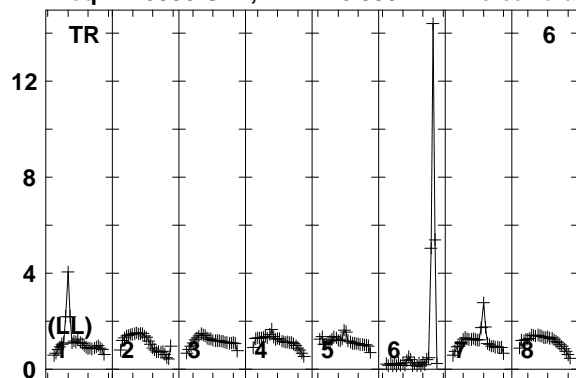

Lower frame: Real Jy
Total-power spectrum Antenna: TR (06)
Timerange: 00/03:35:08 to 00/03:36:30

Plot file version 231 created 19-AUG-2016 17:19:49

J1642+2523 EM119D.UVDATA.1

Freq = 1.5950 GHz, Bw = 16.000 MH No calibration applied and no bandpass applied

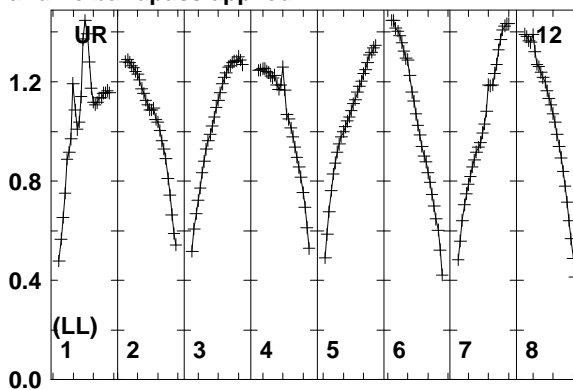
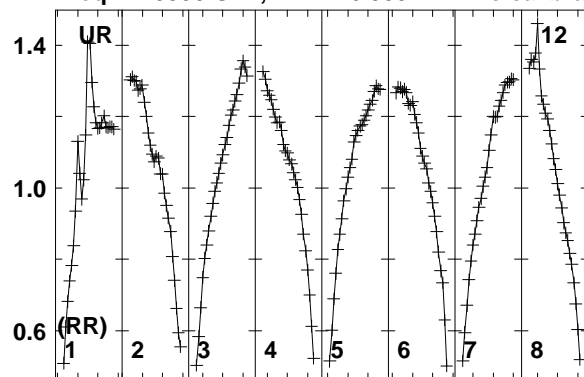

Lower frame: Real Jy
Total-power spectrum Antenna: UR (12)
Timerange: 00/03:35:08 to 00/03:36:30

Plot file version 232 created 19-AUG-2016 17:19:49

J1649+2635 EM119D.UVDATA.1

Freq = 1.5950 GHz, Bw = 16.000 MH No calibration applied and no bandpass applied

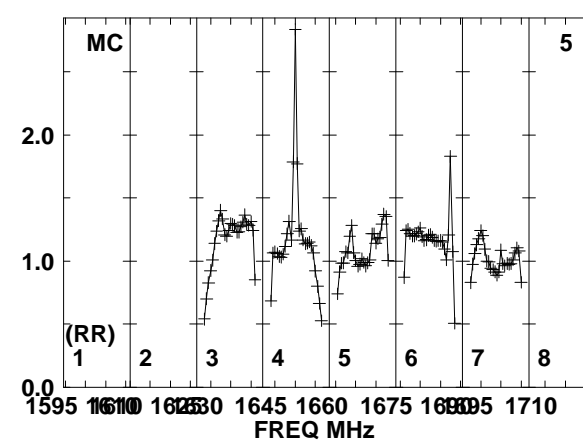
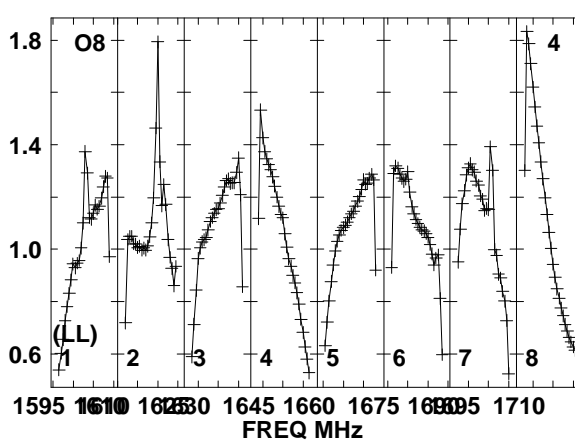
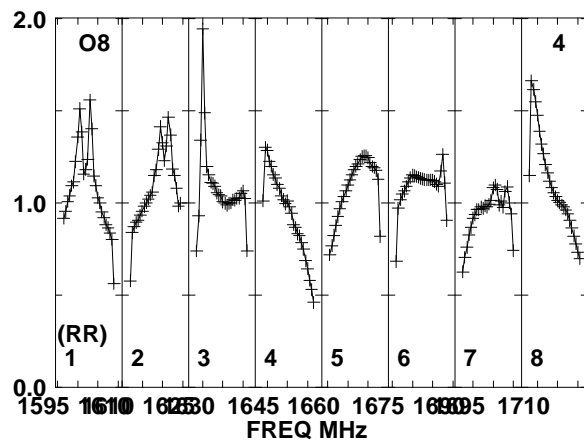
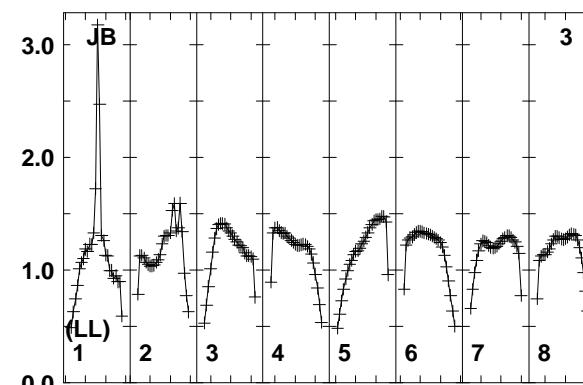
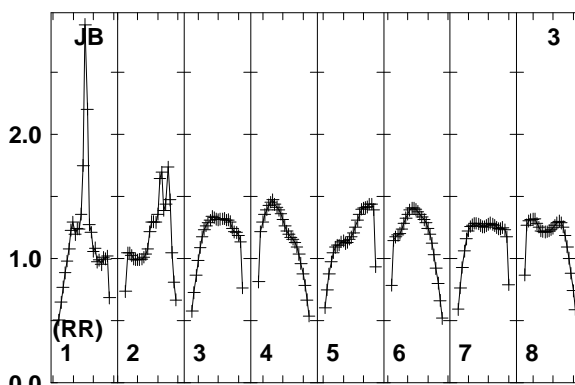
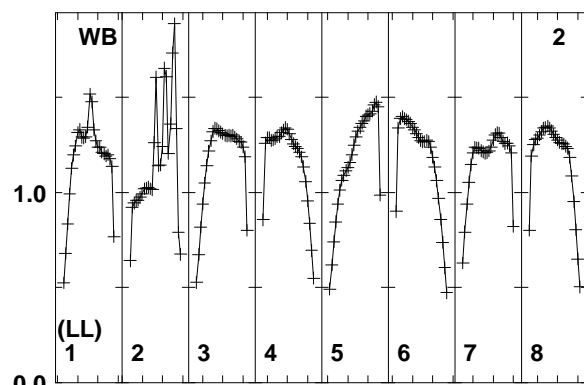
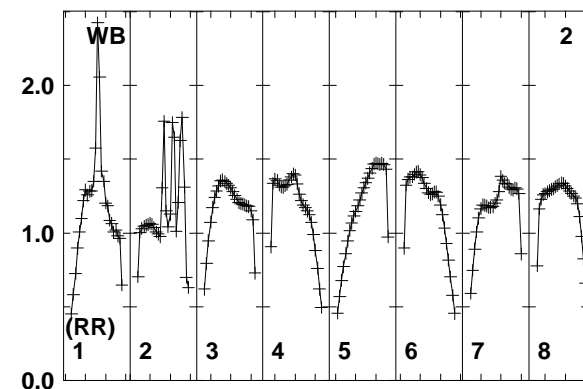
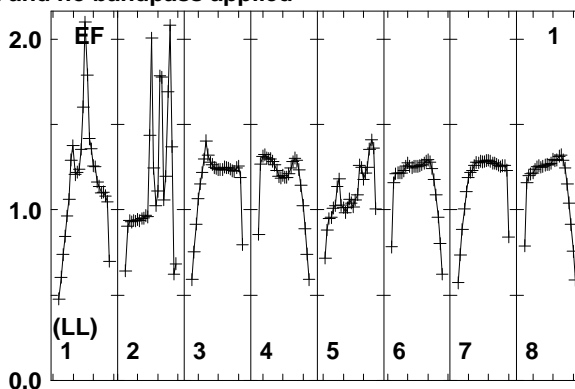
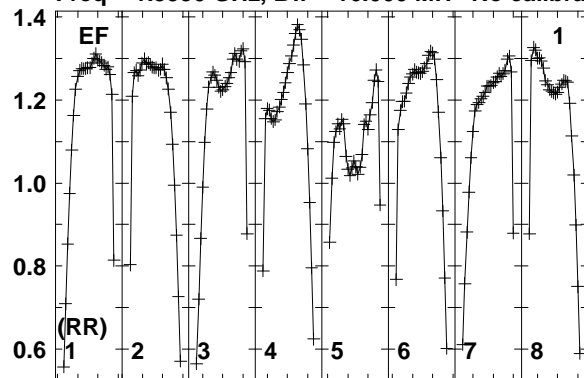

Lower frame: Real Jy
Total-power spectrum Antenna: EF (01)
Timerange: 00/03:36:33 to 00/03:39:59

Plot file version 233 created 19-AUG-2016 17:19:49

J1649+2635 EM119D.UVDATA.1

Freq = 1.5950 GHz, Bw = 16.000 MH No calibration applied and no bandpass applied

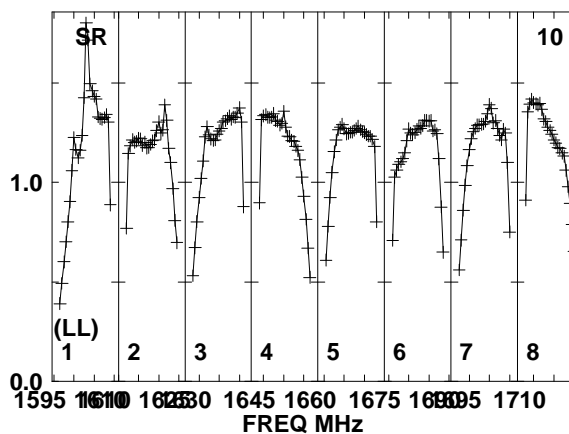
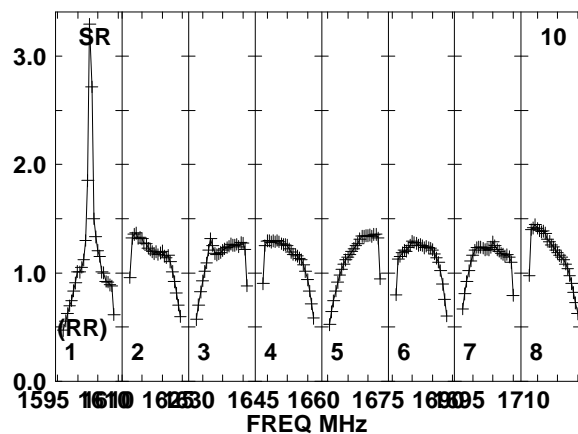
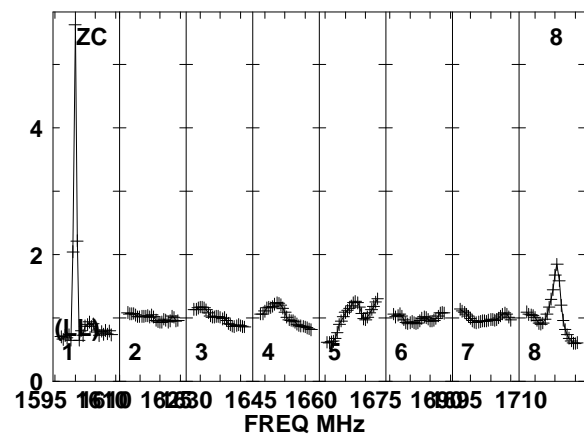
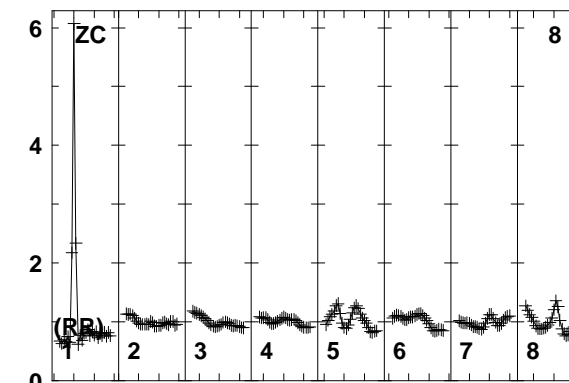
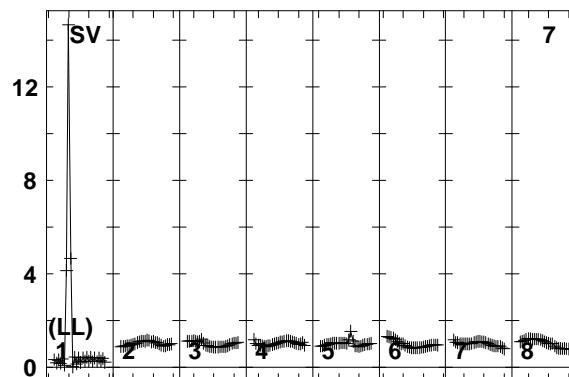
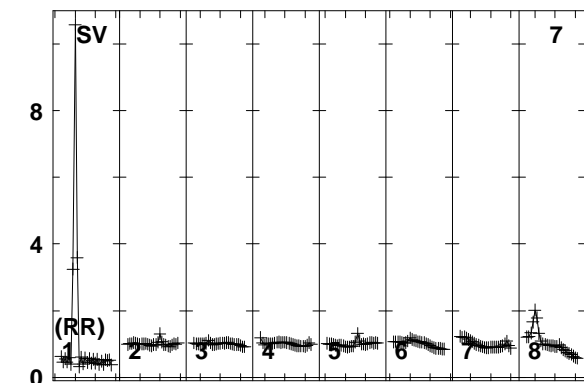
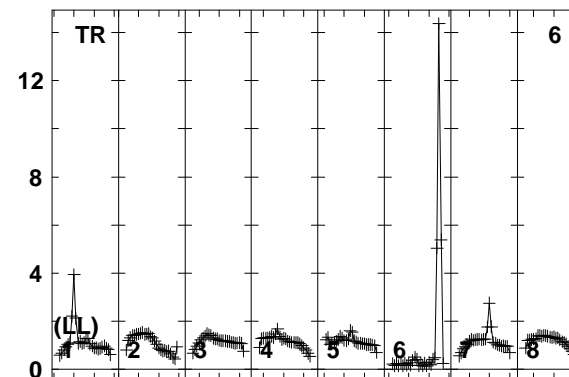
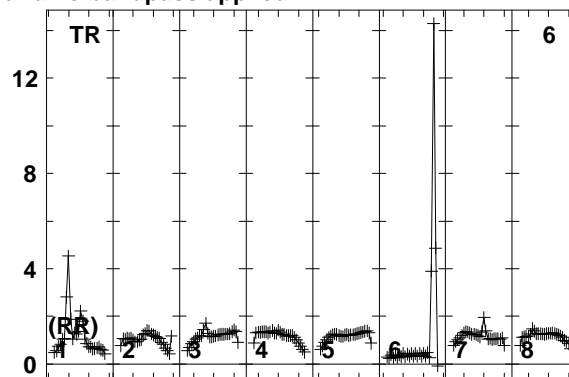
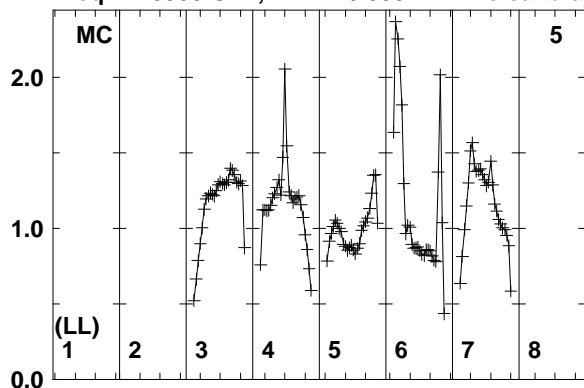

1595 1610 1625 1645 1660 1675 1690 1710
FREQ MHz

1595 1610 1625 1645 1660 1675 1690 1710
FREQ MHz

1595 1610 1625 1645 1660 1675 1690 1710
FREQ MHz

Lower frame: Real Jy
Total-power spectrum Antenna: MC (05)
Timerange: 00/03:36:33 to 00/03:39:59

Plot file version 234 created 19-AUG-2016 17:19:49

J1649+2635 EM119D.UVDATA.1

Freq = 1.5950 GHz, Bw = 16.000 MH No calibration applied and no bandpass applied

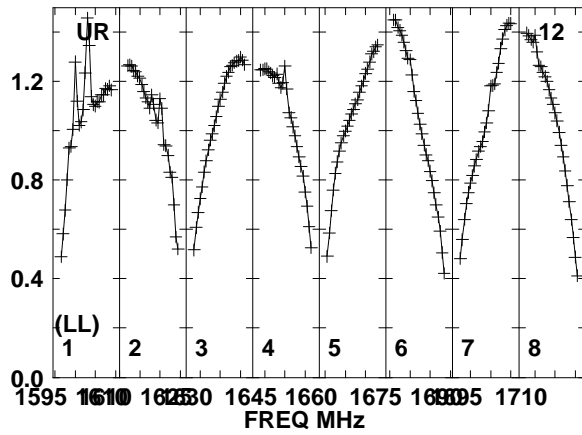
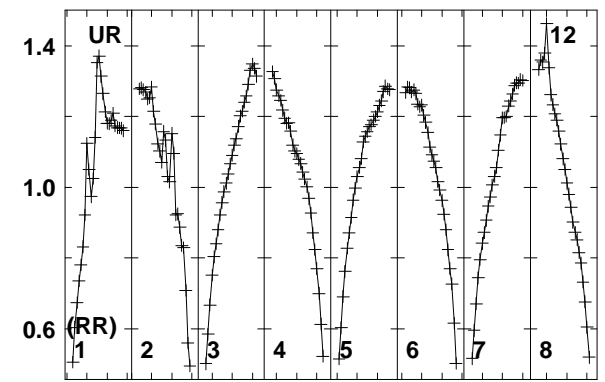
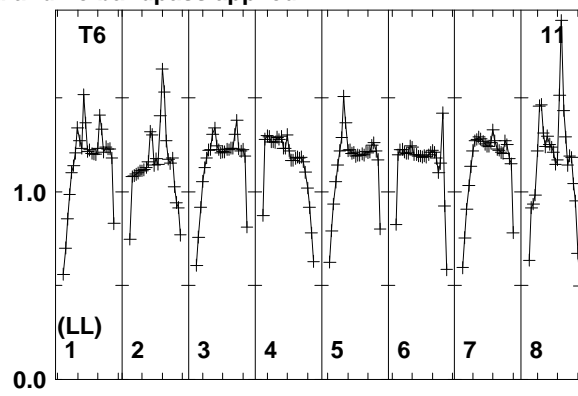
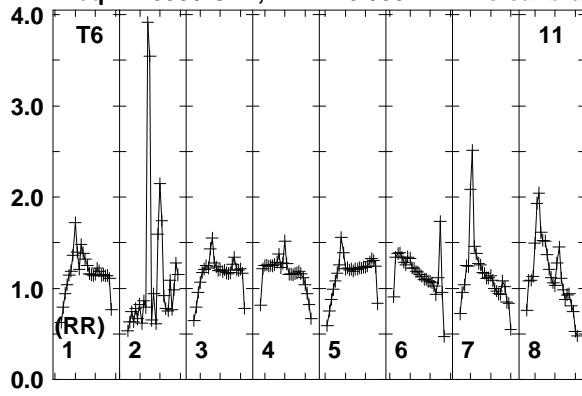

Lower frame: Real Jy
Total-power spectrum Antenna: T6 (11)
Timerange: 00/03:36:33 to 00/03:39:59

Plot file version 235 created 19-AUG-2016 17:19:49

J1642+2523 EM119D.UVDATA.1

Freq = 1.5950 GHz, Bw = 16.000 MH No calibration applied and no bandpass applied

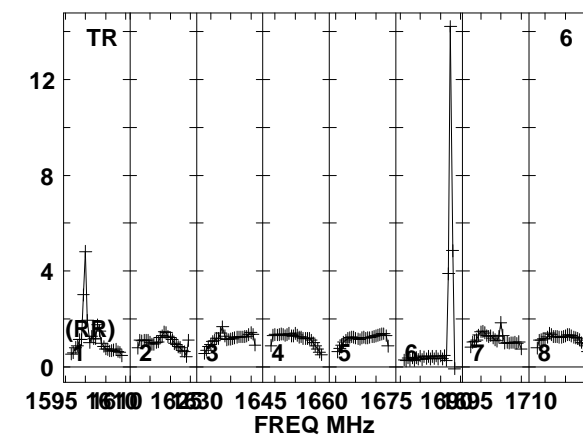
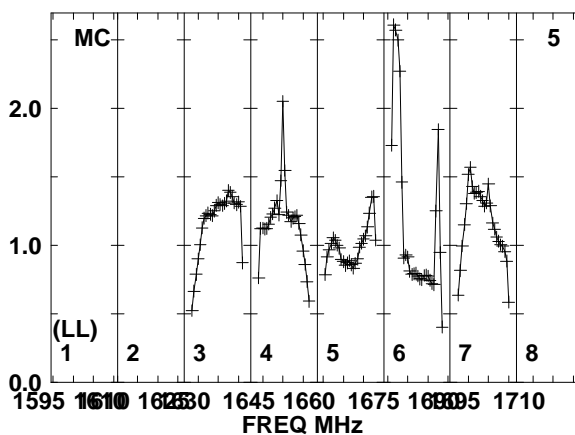
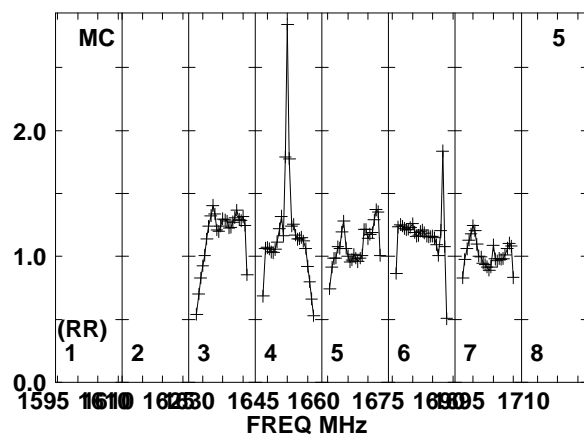
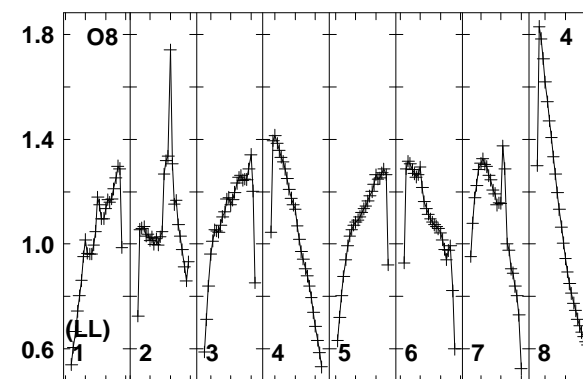
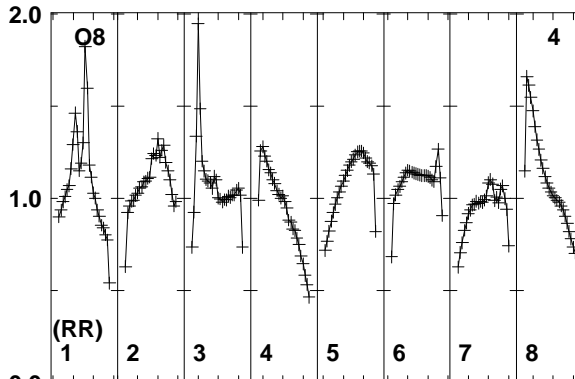
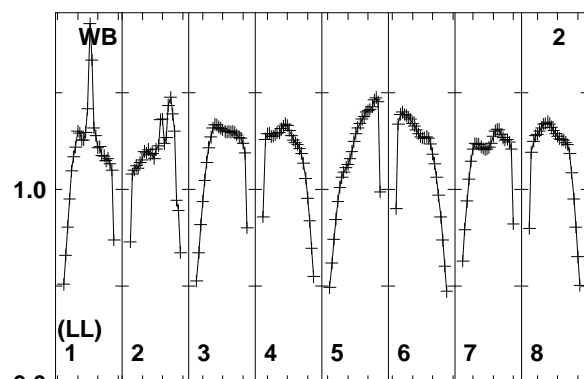
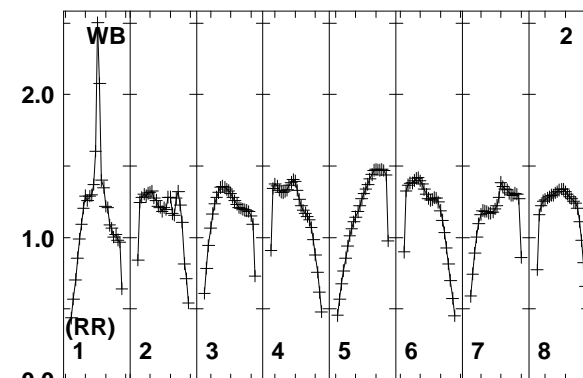
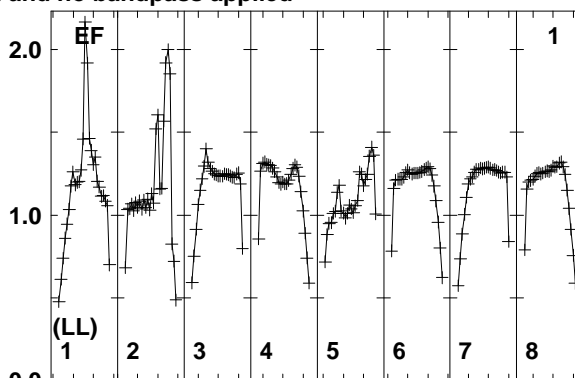
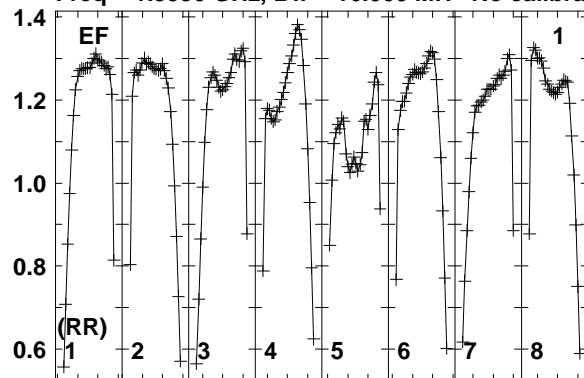

Lower frame: Real Jy
Total-power spectrum Antenna: EF (01)
Timerange: 00/03:40:07 to 00/03:41:30

Plot file version 236 created 19-AUG-2016 17:19:49

J1642+2523 EM119D.UVDATA.1

Freq = 1.5950 GHz, Bw = 16.000 MH No calibration applied and no bandpass applied

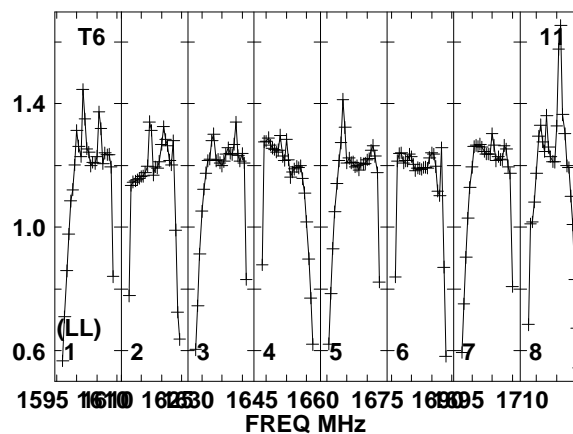
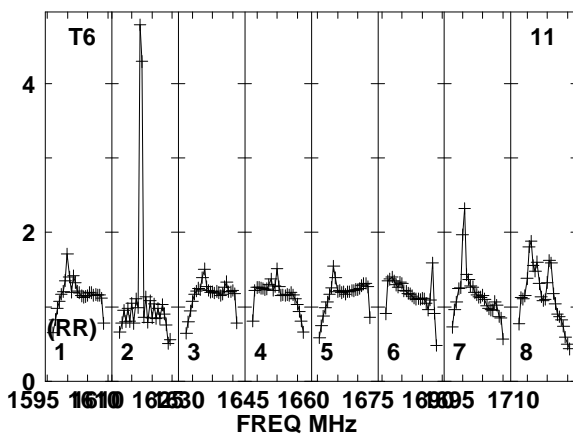
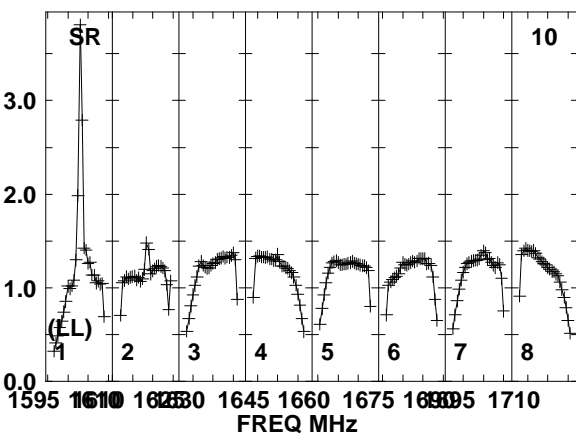
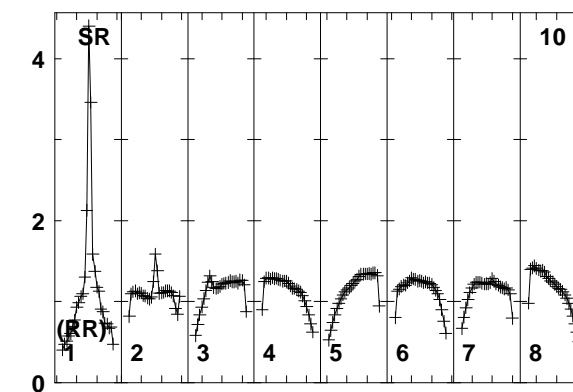
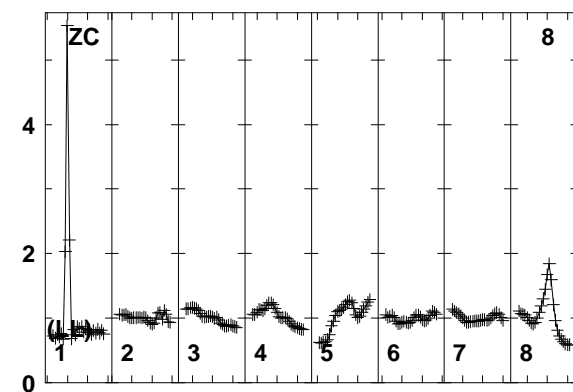
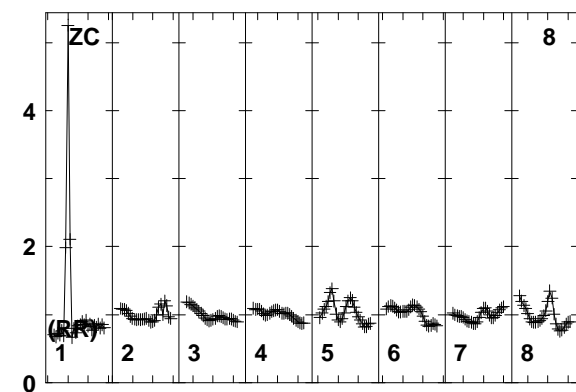
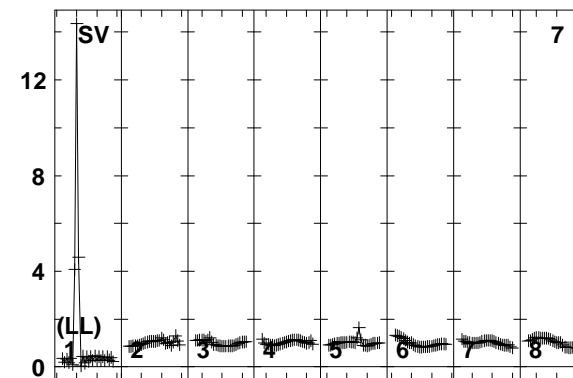
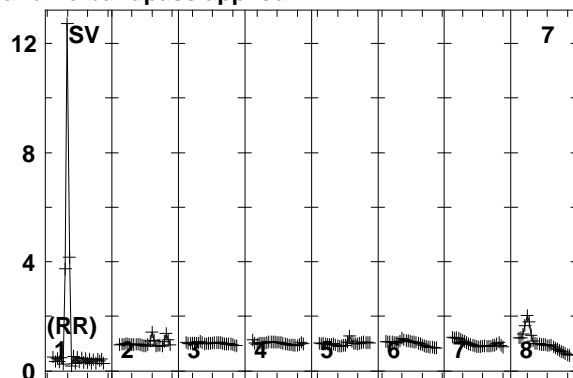
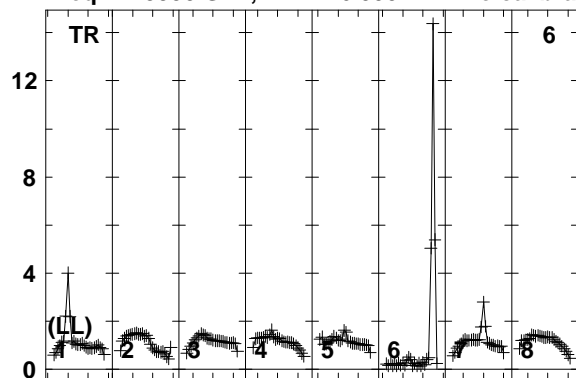

Lower frame: Real Jy
Total-power spectrum Antenna: TR (06)
Timerange: 00/03:40:07 to 00/03:41:30

Plot file version 237 created 19-AUG-2016 17:19:50

J1642+2523 EM119D.UVDATA.1

Freq = 1.5950 GHz, Bw = 16.000 MH No calibration applied and no bandpass applied

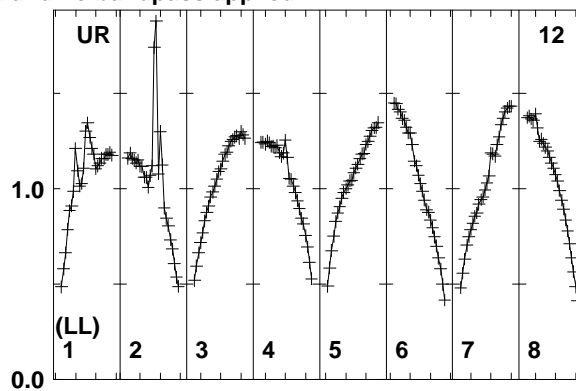
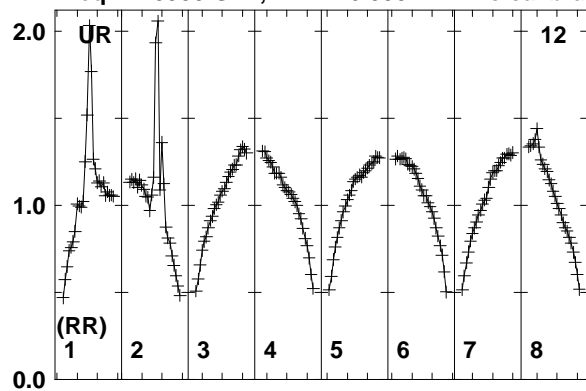

Lower frame: Real Jy
Total-power spectrum Antenna: UR (12)
Timerange: 00/03:40:07 to 00/03:41:30

Plot file version 238 created 19-AUG-2016 17:19:50

J1649+2635 EM119D.UVDATA.1

Freq = 1.5950 GHz, Bw = 16.000 MH No calibration applied and no bandpass applied

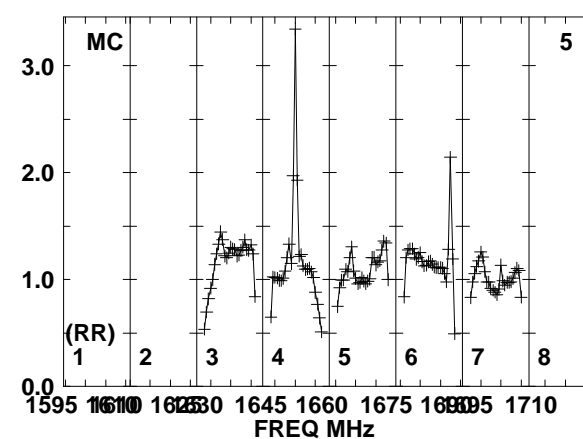
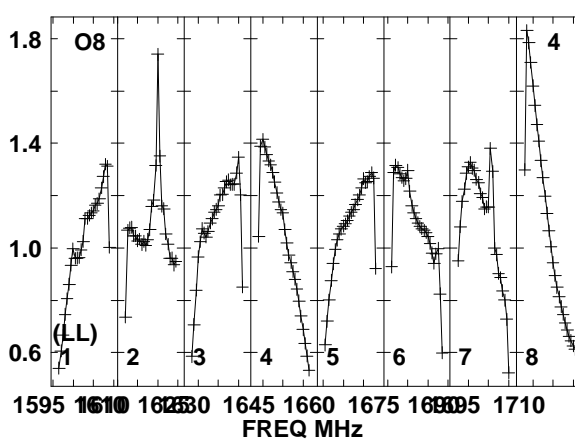
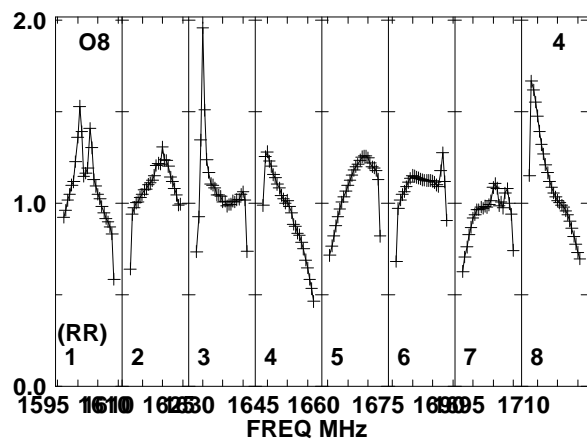
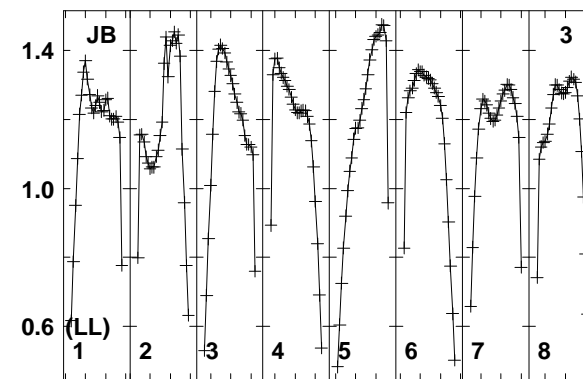
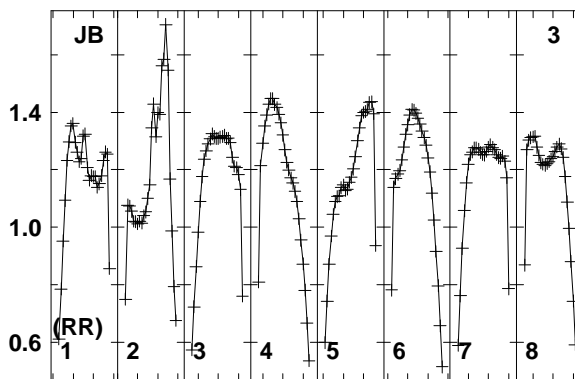
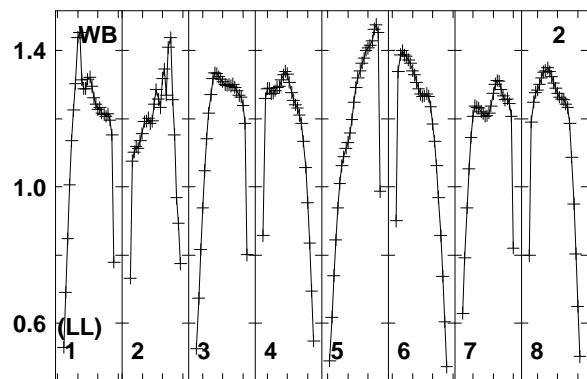
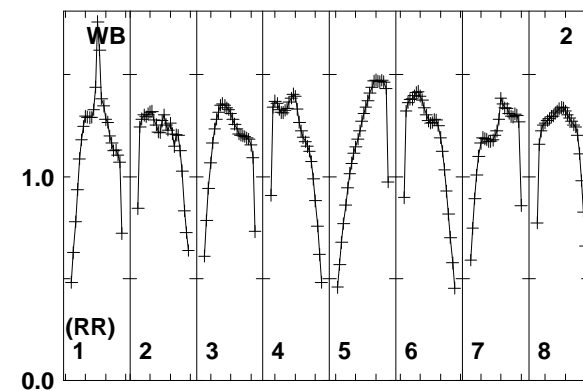
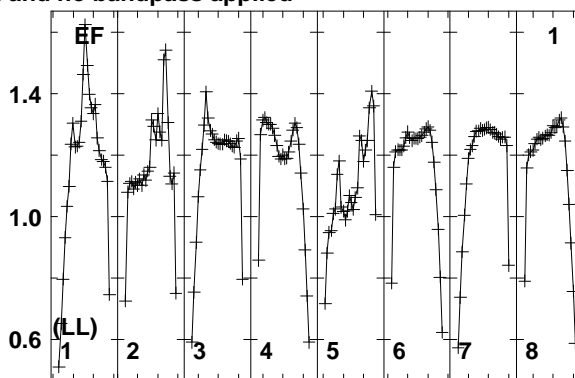
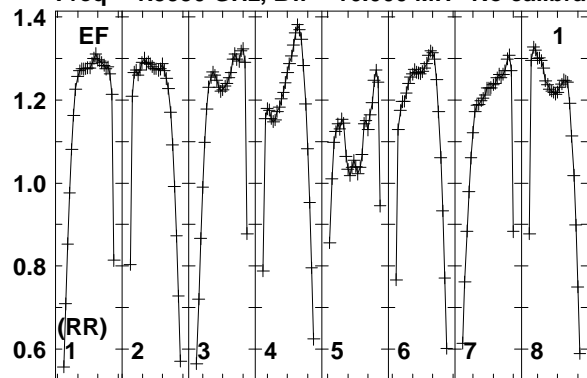

Lower frame: Real Jy
Total-power spectrum Antenna: EF (01)
Timerange: 00/03:42:31 to 00/03:46:00

Plot file version 239 created 19-AUG-2016 17:19:50

J1649+2635 EM119D.UVDATA.1

Freq = 1.5950 GHz, Bw = 16.000 MH No calibration applied and no bandpass applied

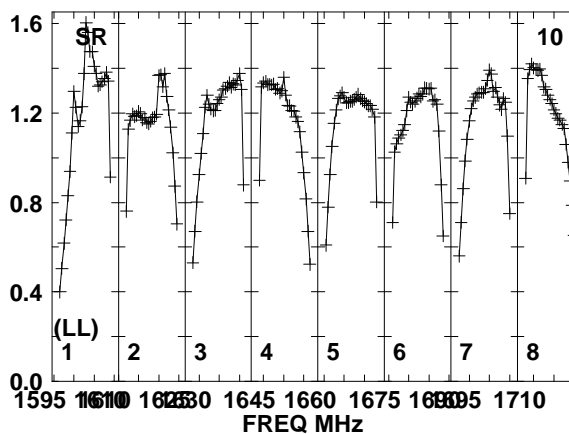
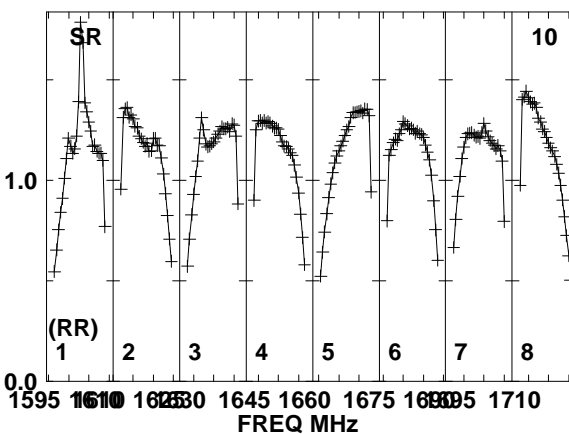
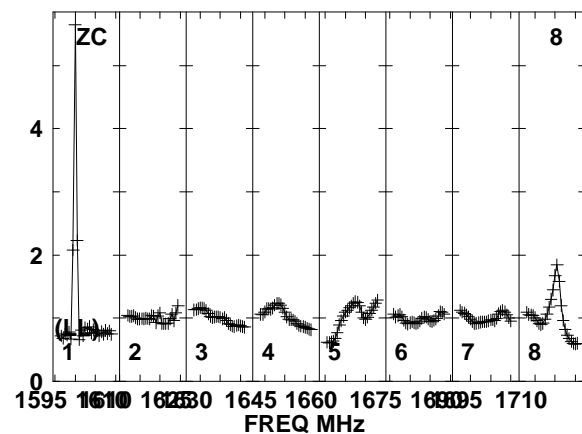
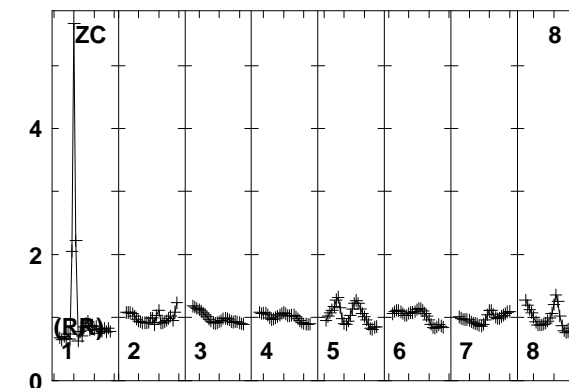
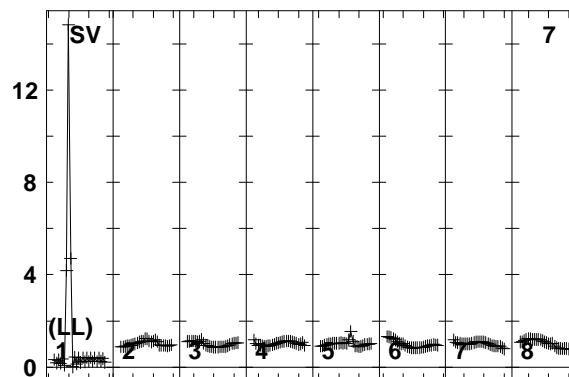
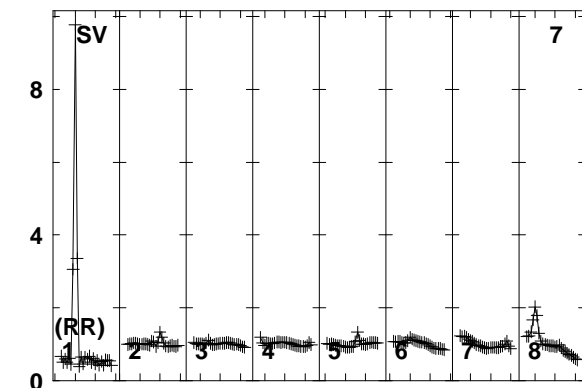
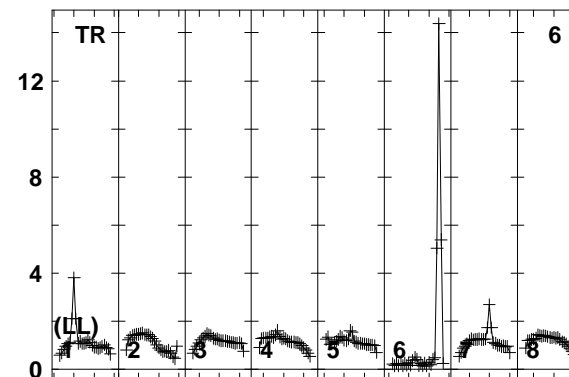
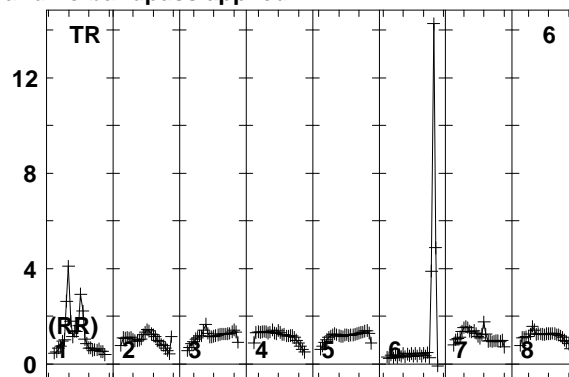
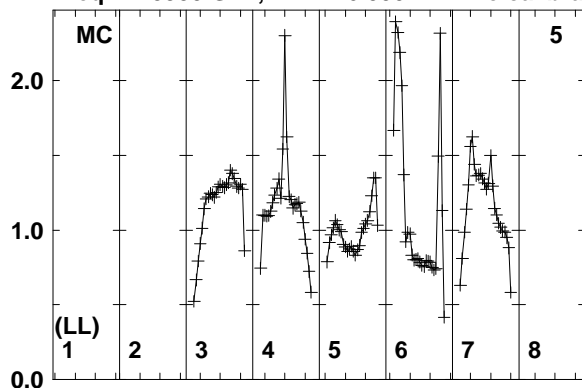

Lower frame: Real Jy
Total-power spectrum Antenna: MC (05)
Timerange: 00/03:42:31 to 00/03:46:00

Plot file version 240 created 19-AUG-2016 17:19:50

J1649+2635 EM119D.UVDATA.1

Freq = 1.5950 GHz, Bw = 16.000 MH No calibration applied and no bandpass applied

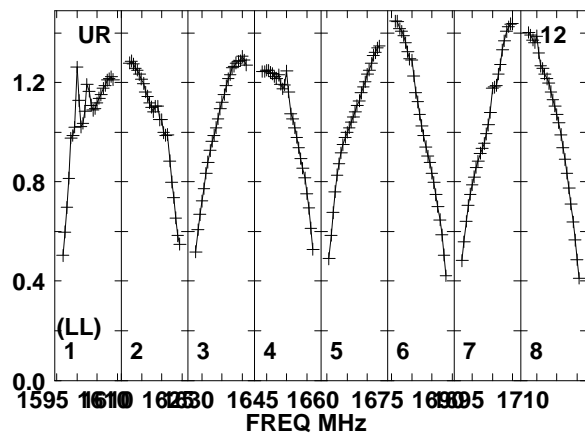
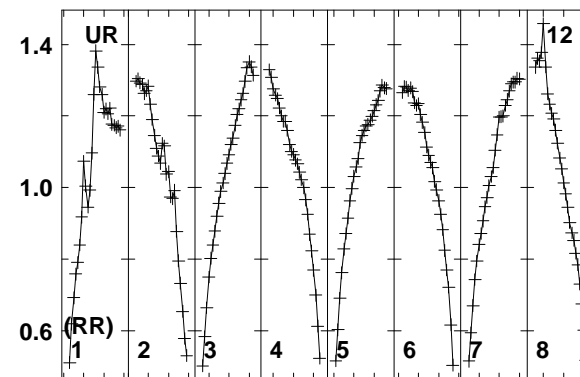
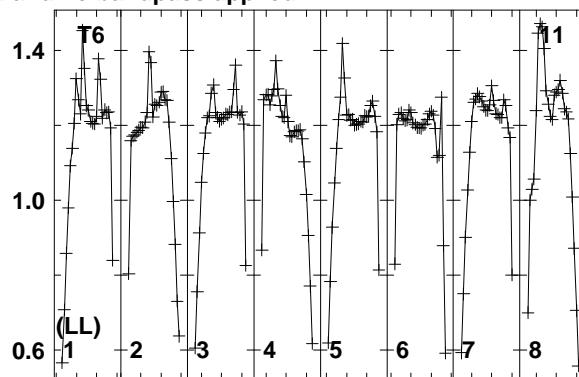
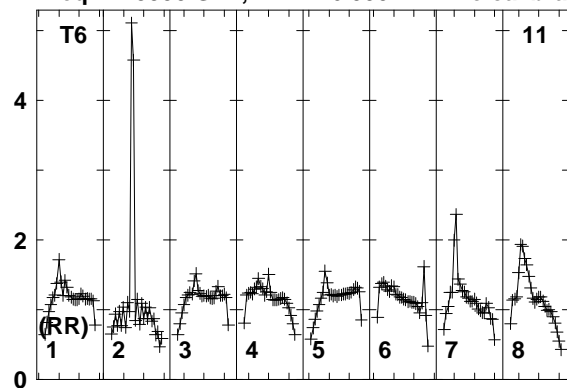

Lower frame: Real Jy
Total-power spectrum Antenna: T6 (11)
Timerange: 00/03:42:31 to 00/03:46:00

Plot file version 241 created 19-AUG-2016 17:19:50

J1642+2523 EM119D.UVDATA.1

Freq = 1.5950 GHz, Bw = 16.000 MH No calibration applied and no bandpass applied

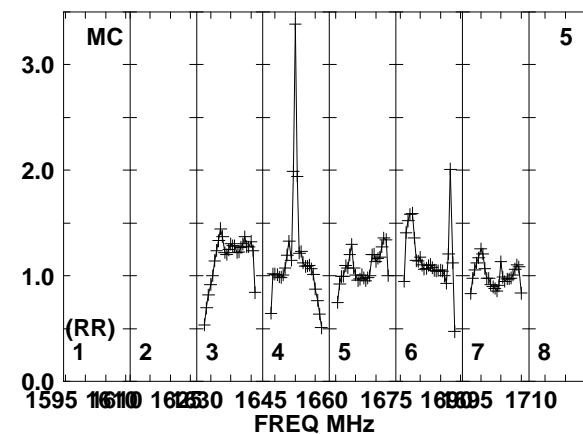
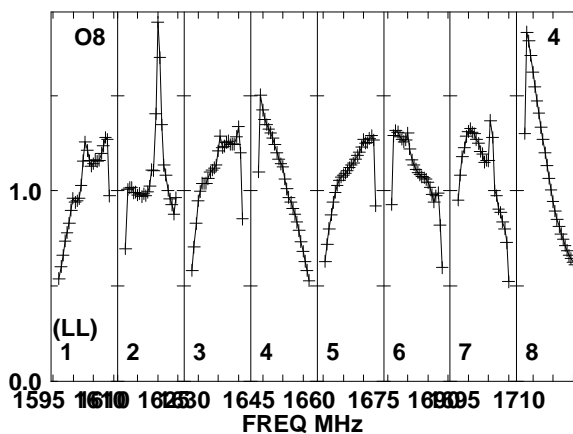
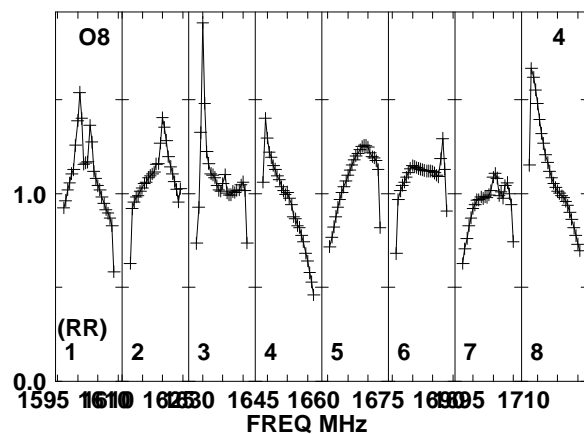
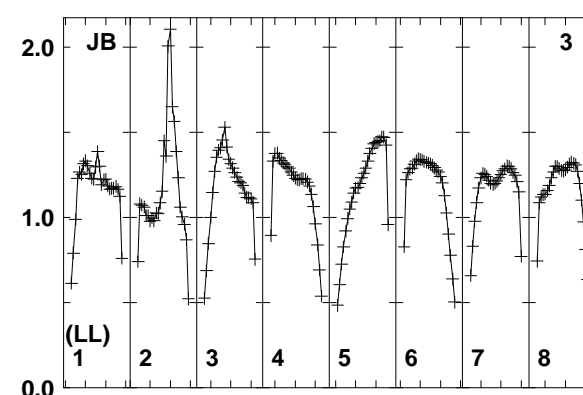
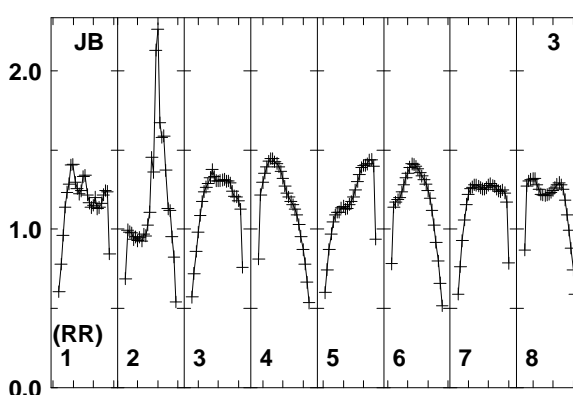
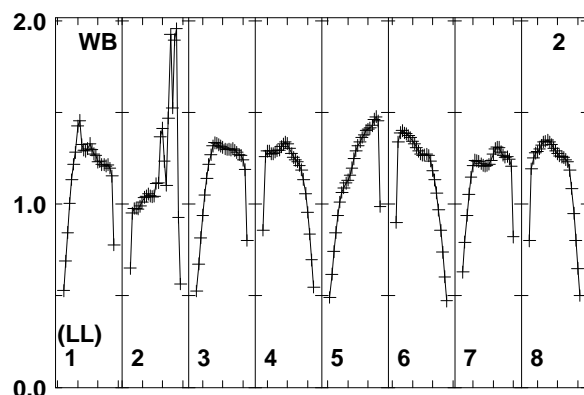
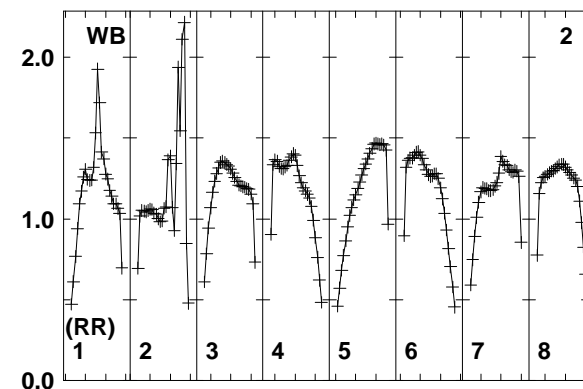
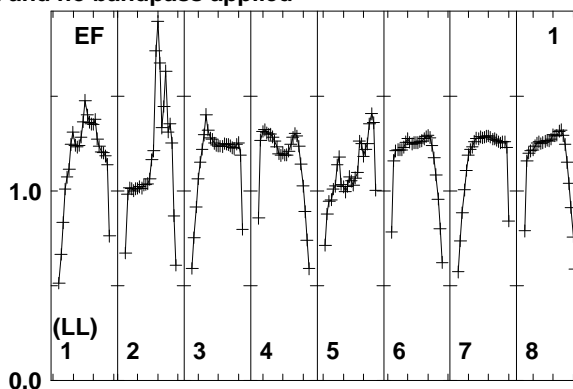
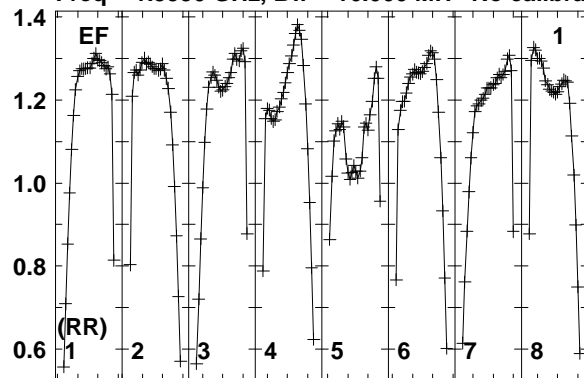

Lower frame: Real Jy
Total-power spectrum Antenna: EF (01)
Timerange: 00/03:46:07 to 00/03:47:29

Plot file version 242 created 19-AUG-2016 17:19:51

J1642+2523 EM119D.UVDATA.1

Freq = 1.5950 GHz, Bw = 16.000 MH No calibration applied and no bandpass applied

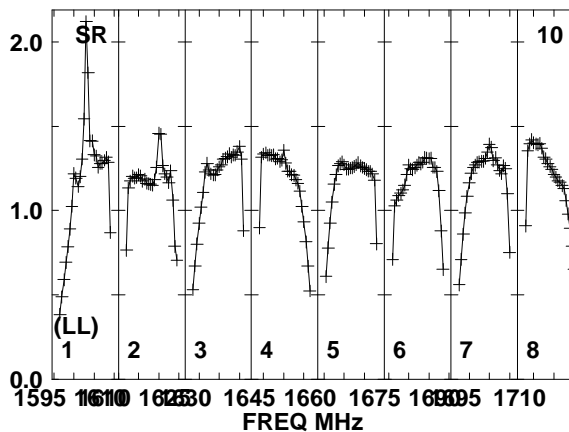
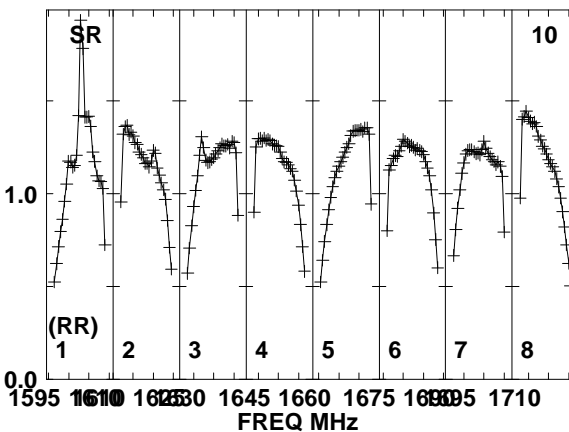
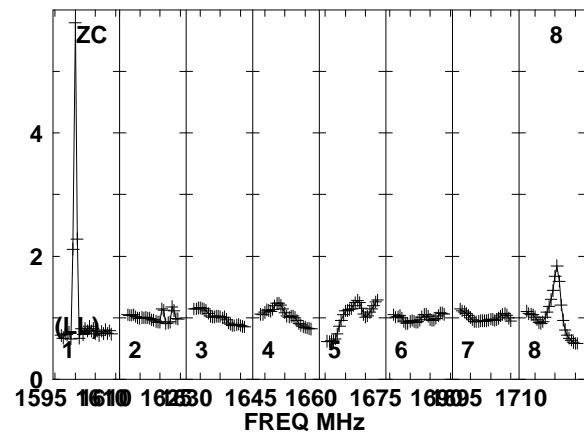
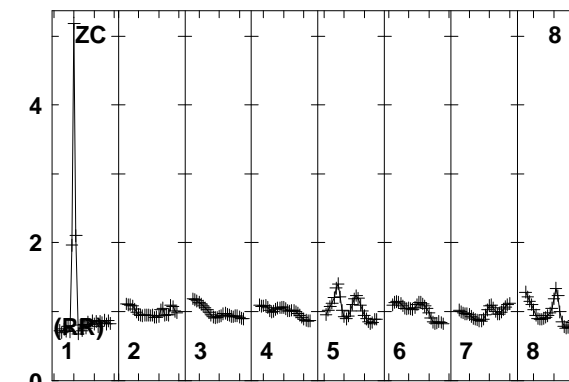
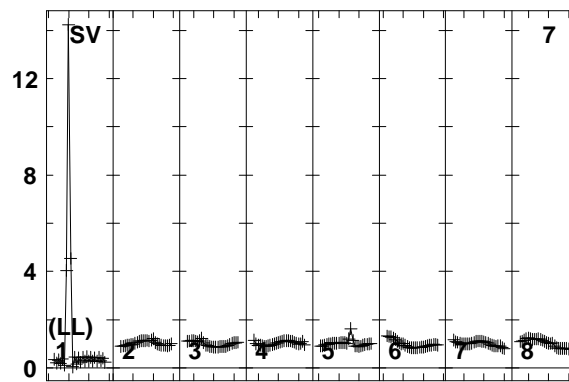
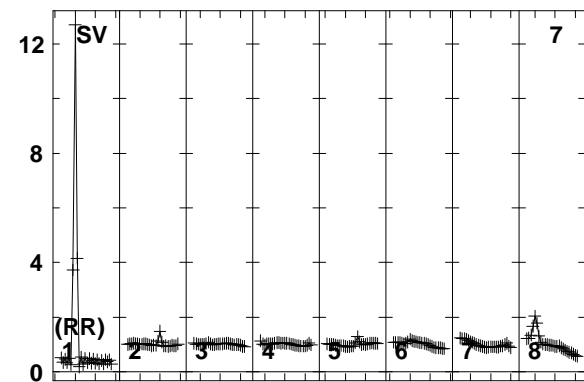
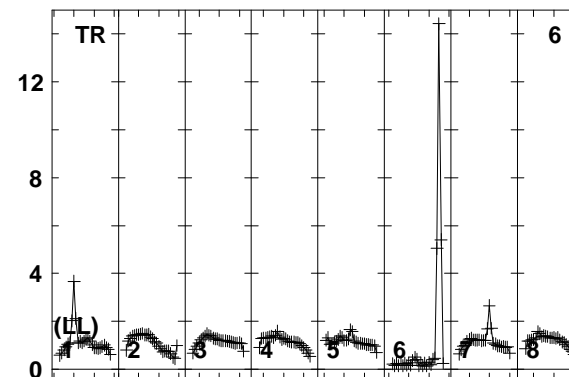
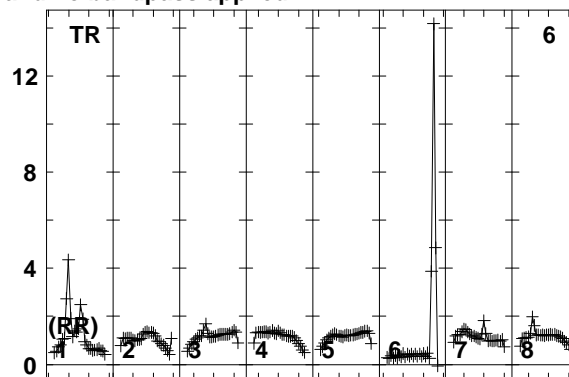
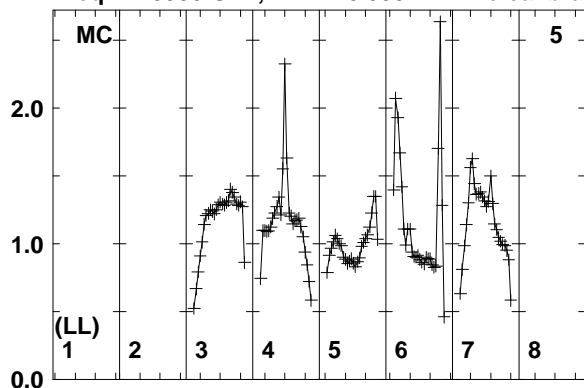

Lower frame: Real Jy
Total-power spectrum Antenna: MC (05)
Timerange: 00/03:46:07 to 00/03:47:29

Plot file version 243 created 19-AUG-2016 17:19:51

J1642+2523 EM119D.UVDATA.1

Freq = 1.5950 GHz, Bw = 16.000 MH No calibration applied and no bandpass applied

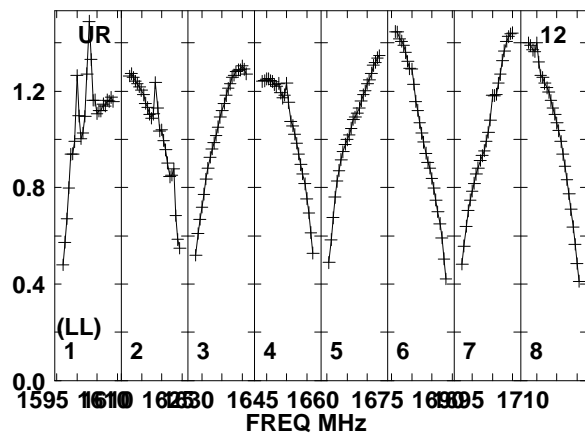
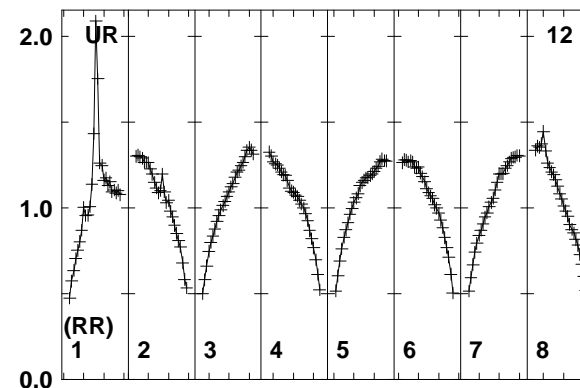
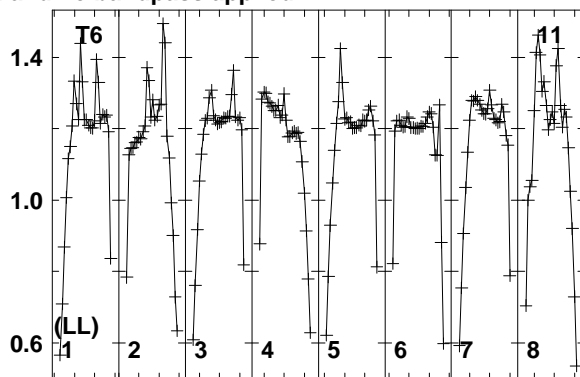
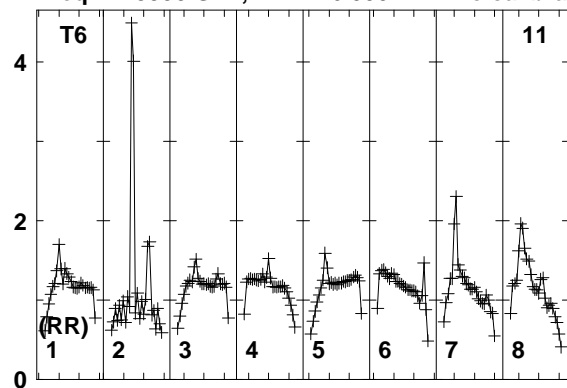

Lower frame: Real Jy
Total-power spectrum Antenna: T6 (11)
Timerange: 00/03:46:07 to 00/03:47:29

Plot file version 244 created 19-AUG-2016 17:19:51

J1649+2635 EM119D.UVDATA.1

Freq = 1.5950 GHz, Bw = 16.000 MH No calibration applied and no bandpass applied

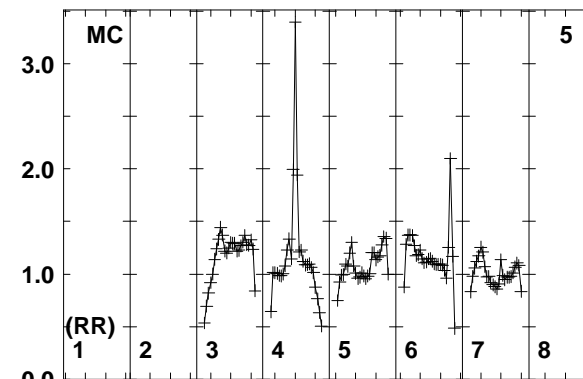
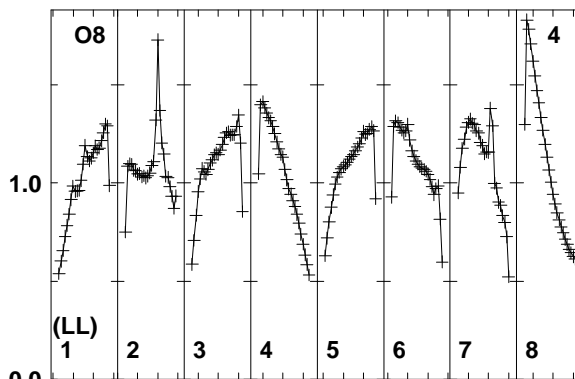
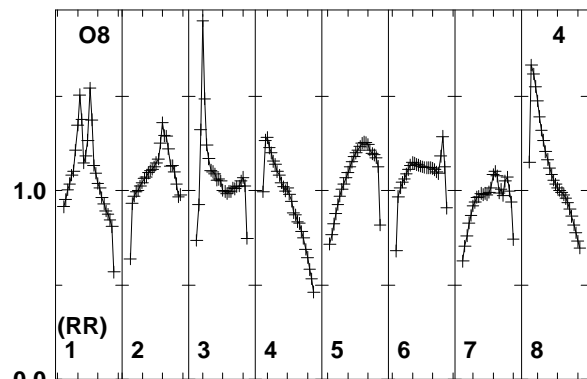
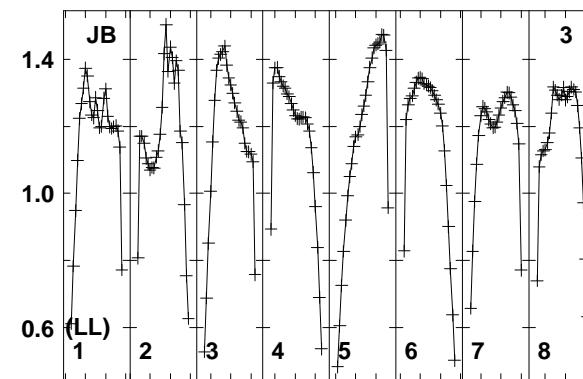
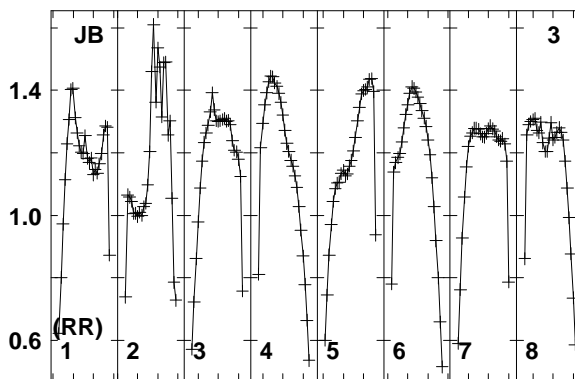
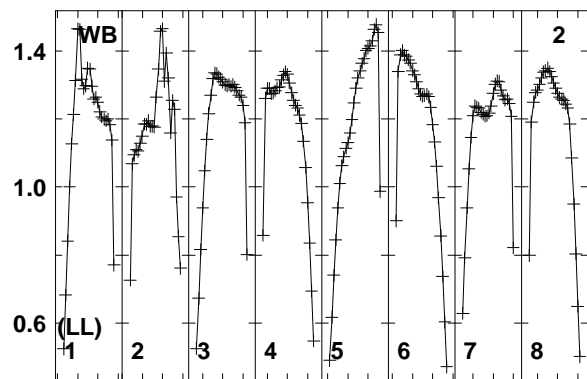
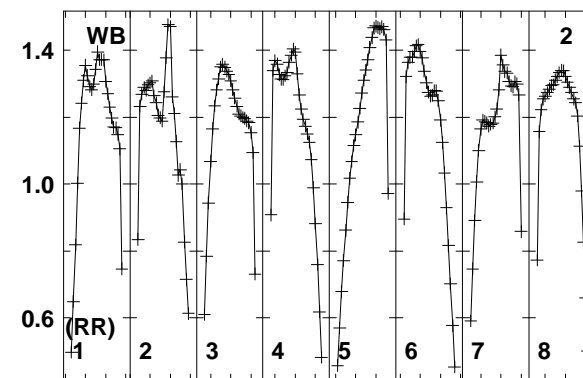
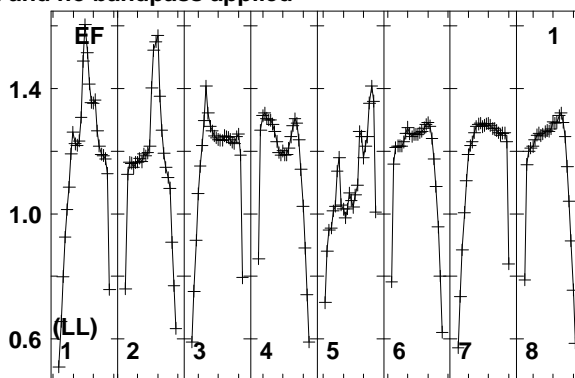
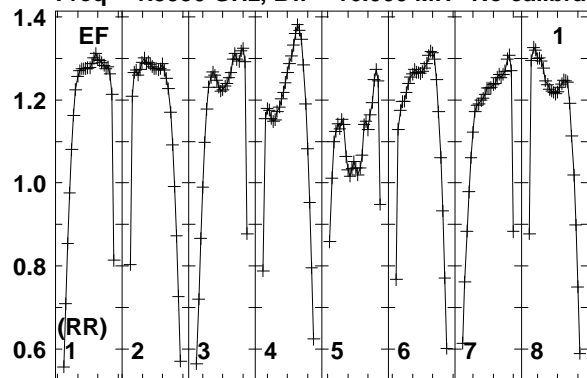

Lower frame: Real Jy
Total-power spectrum Antenna: EF (01)
Timerange: 00/03:47:38 to 00/03:51:00

Plot file version 245 created 19-AUG-2016 17:19:51

J1649+2635 EM119D.UVDATA.1

Freq = 1.5950 GHz, Bw = 16.000 MH No calibration applied and no bandpass applied

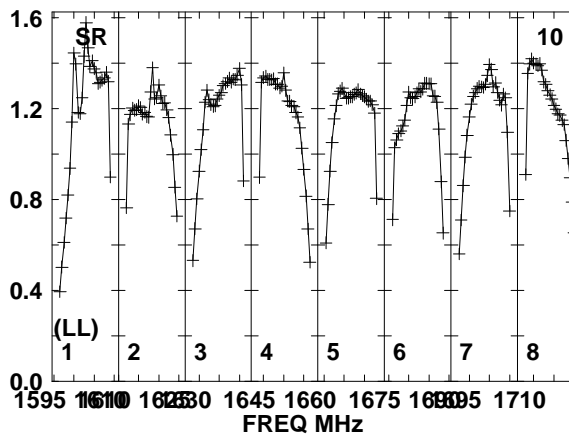
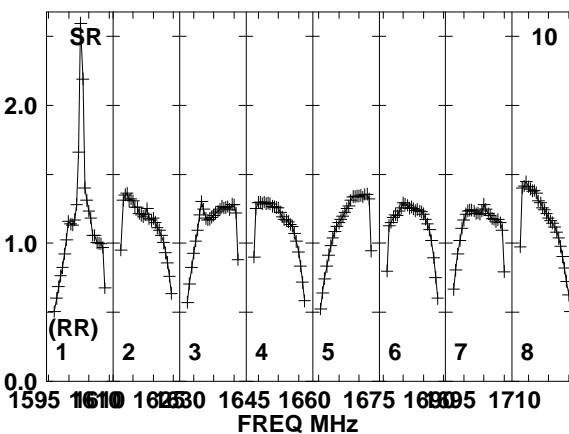
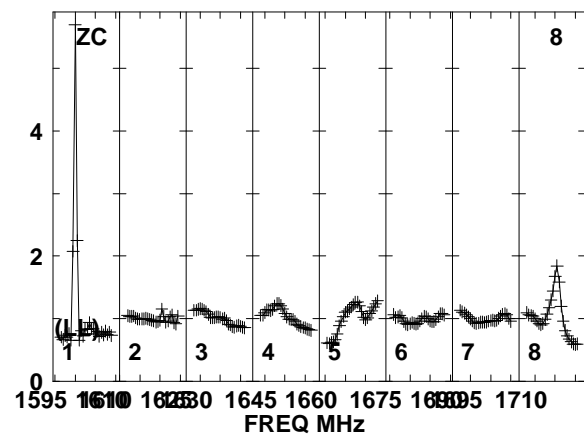
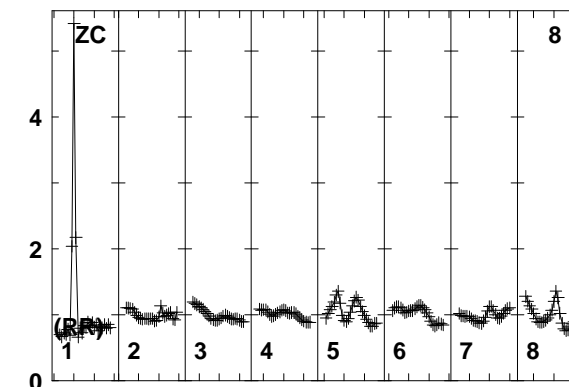
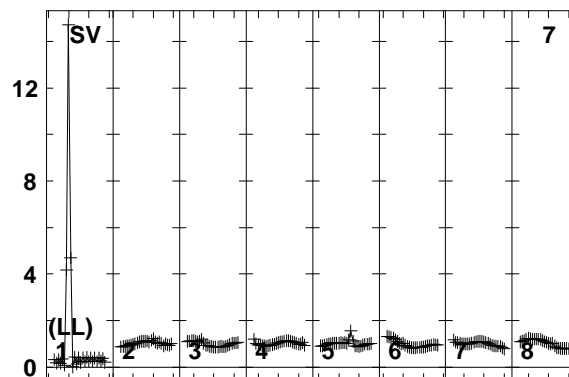
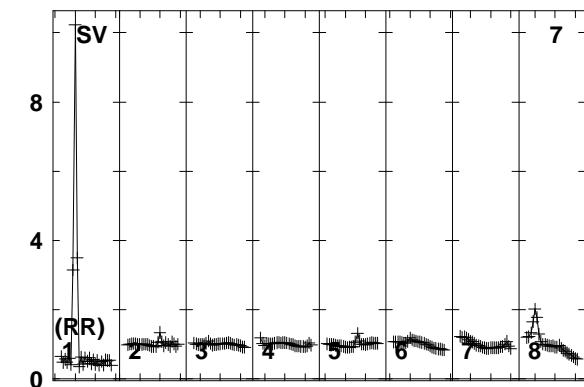
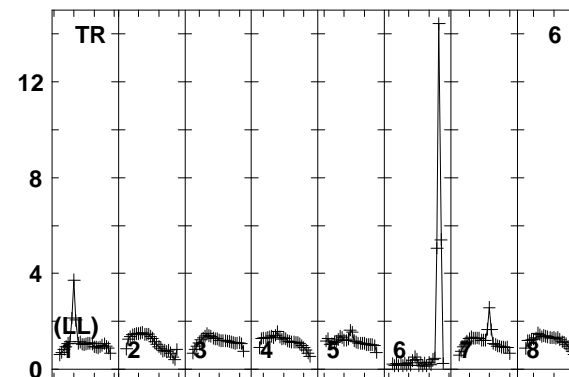
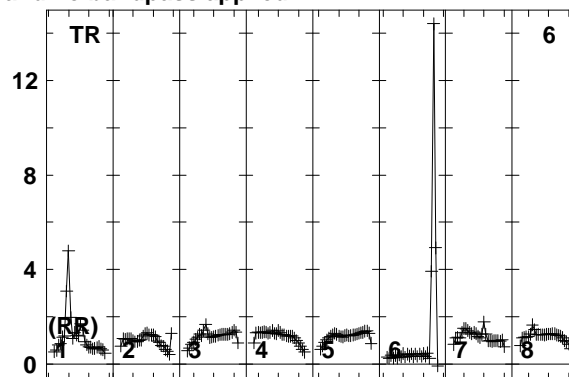
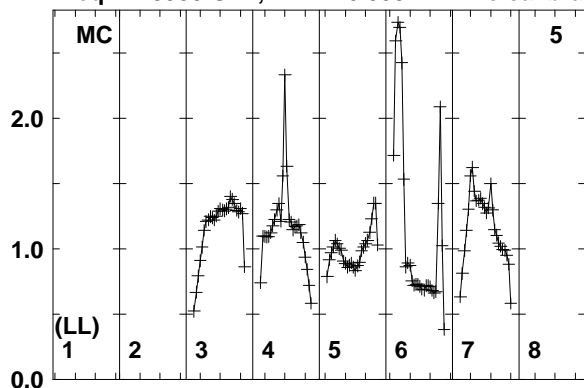

Lower frame: Real Jy
Total-power spectrum Antenna: MC (05)
Timerange: 00/03:47:38 to 00/03:51:00

Plot file version 246 created 19-AUG-2016 17:19:51

J1649+2635 EM119D.UVDATA.1

Freq = 1.5950 GHz, Bw = 16.000 MH No calibration applied and no bandpass applied

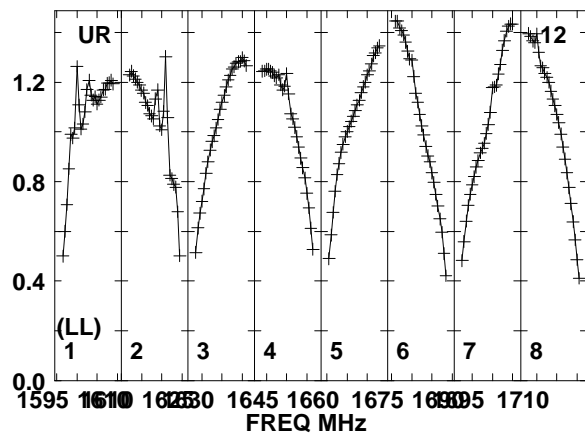
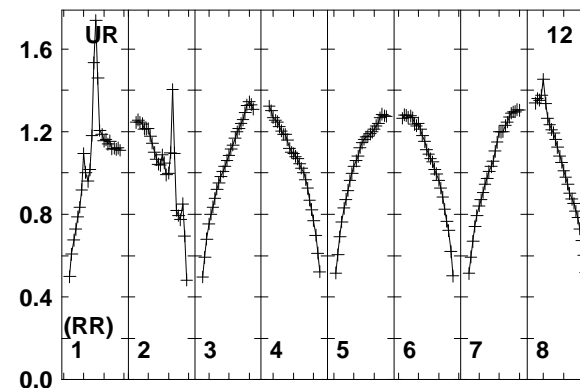
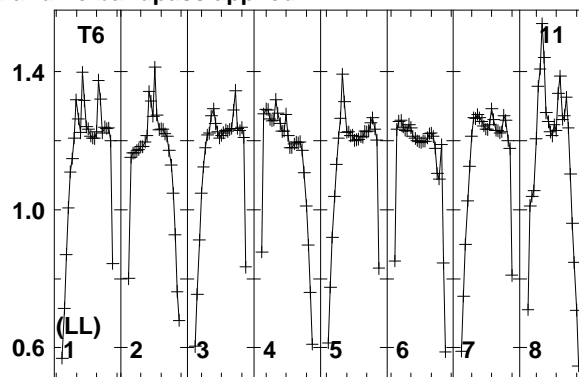
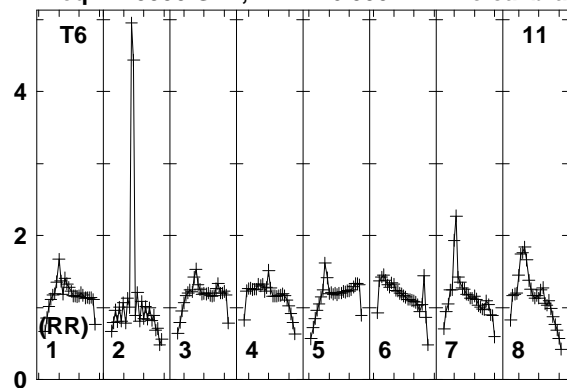

Lower frame: Real Jy
Total-power spectrum Antenna: T6 (11)
Timerange: 00/03:47:38 to 00/03:51:00

Plot file version 247 created 19-AUG-2016 17:19:51

J1642+2523 EM119D.UVDATA.1

Freq = 1.5950 GHz, Bw = 16.000 MH No calibration applied and no bandpass applied

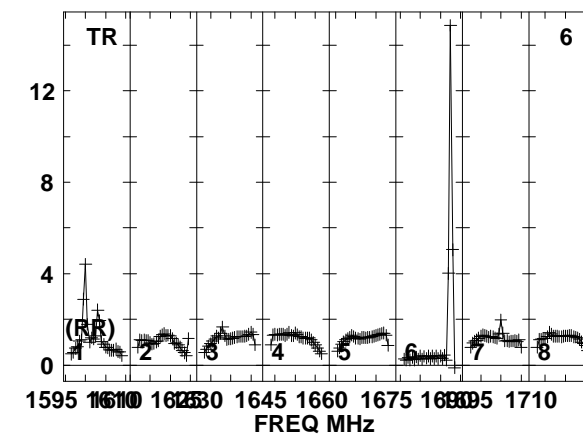
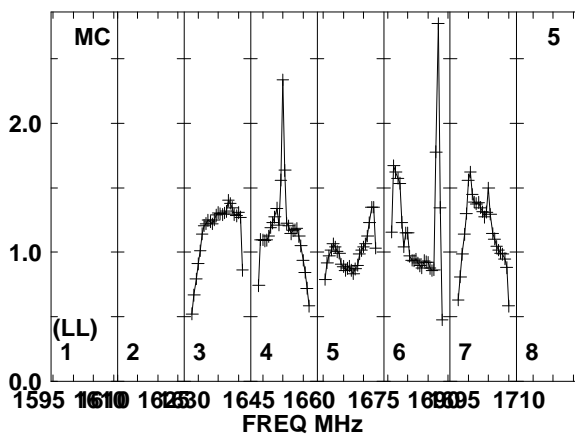
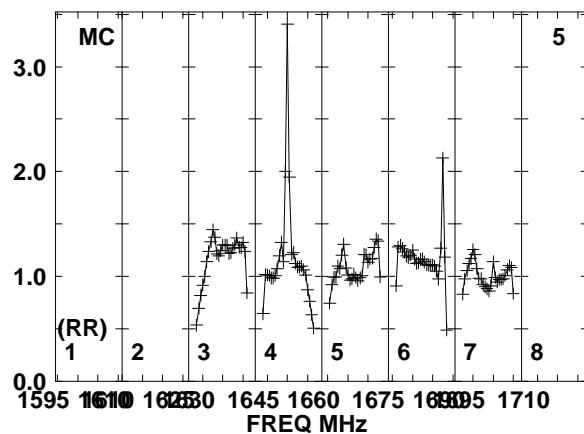
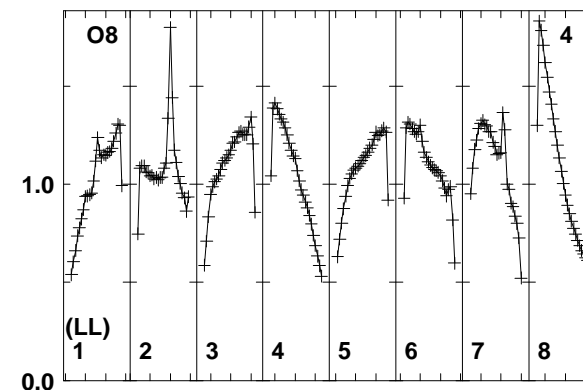
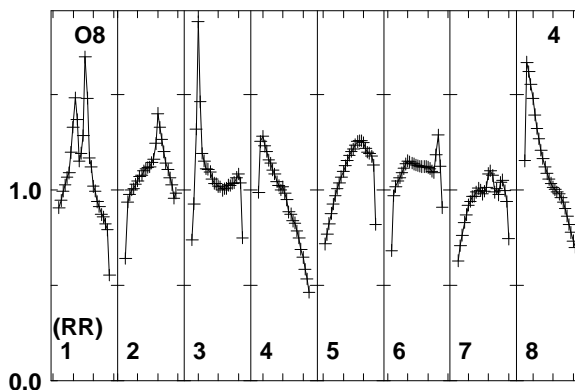
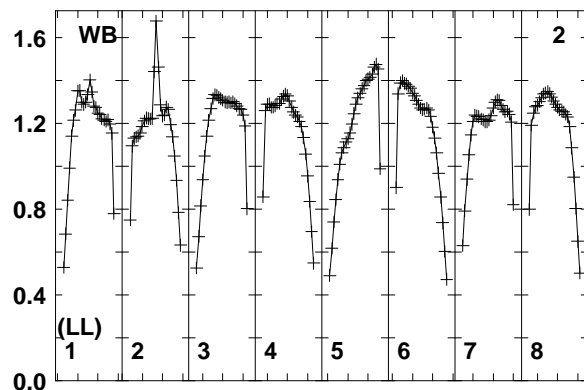
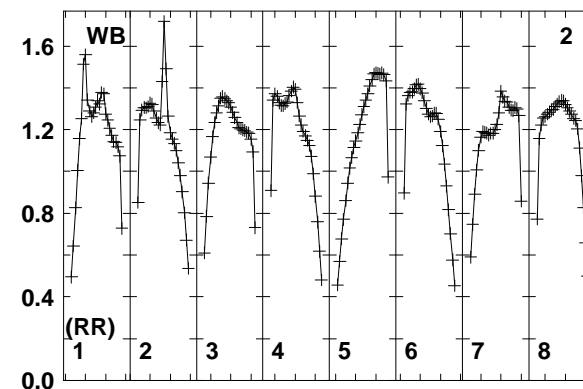
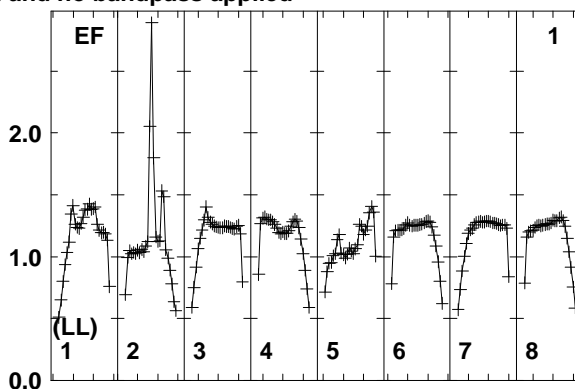
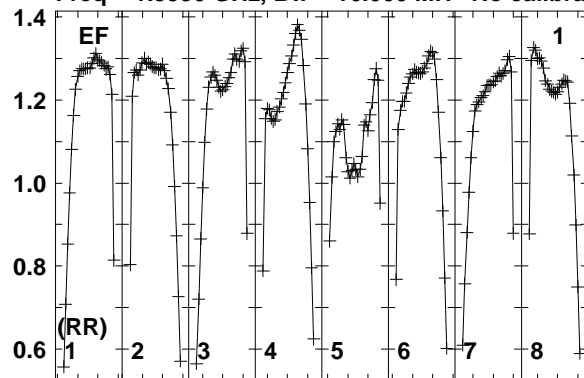

Lower frame: Real Jy
Total-power spectrum Antenna: EF (01)
Timerange: 00/03:51:08 to 00/03:52:30

Plot file version 248 created 19-AUG-2016 17:19:51

J1642+2523 EM119D.UVDATA.1

Freq = 1.5950 GHz, Bw = 16.000 MH No calibration applied and no bandpass applied

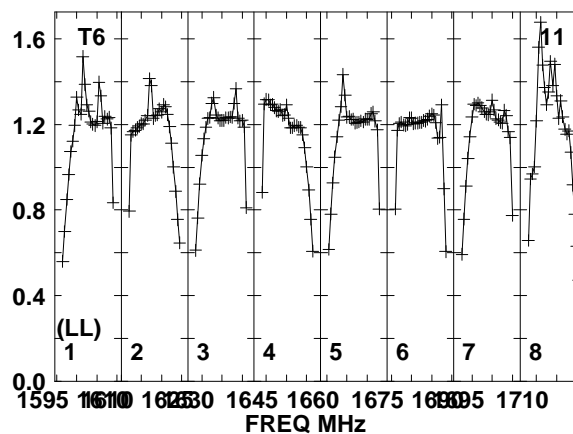
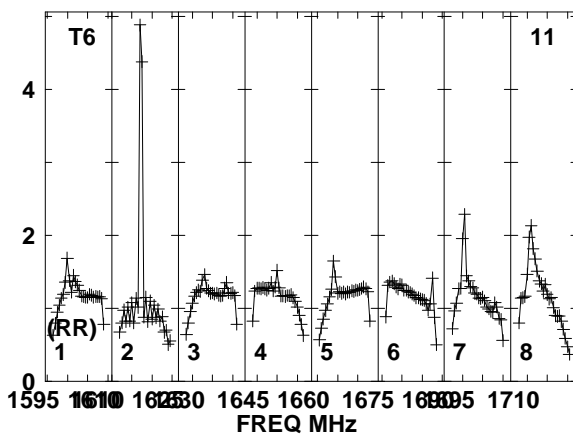
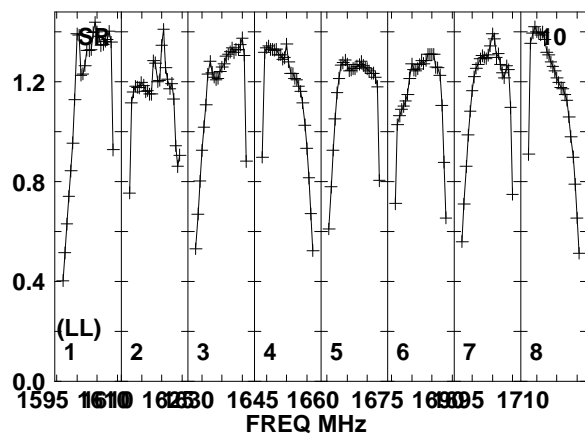
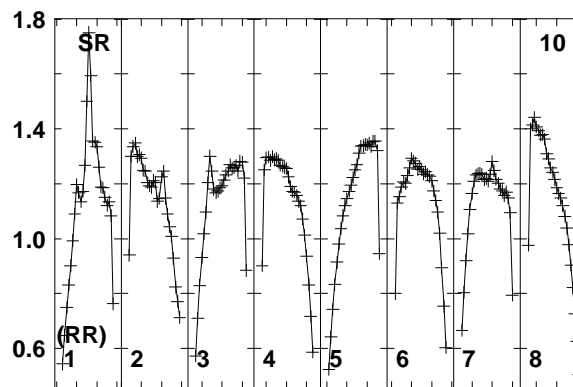
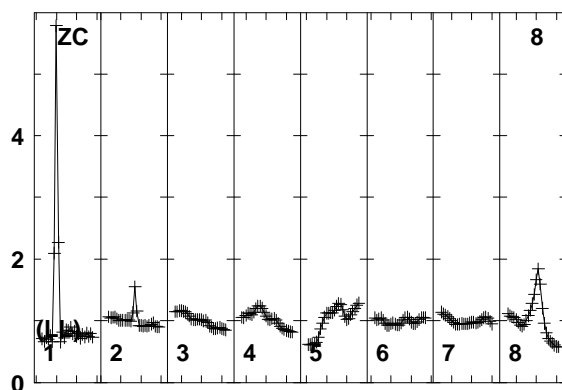
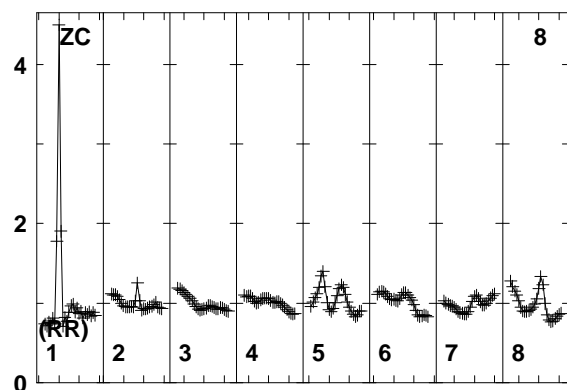
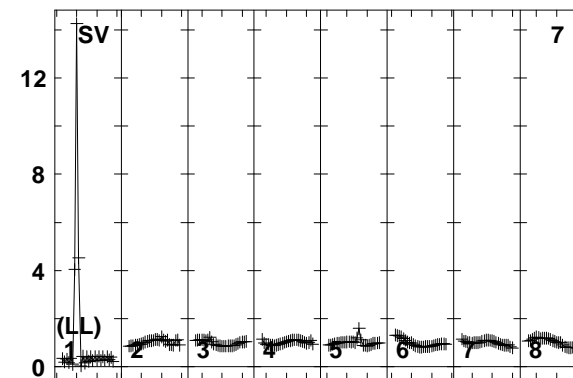
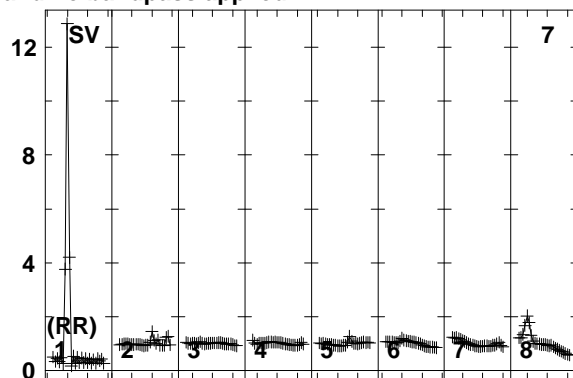
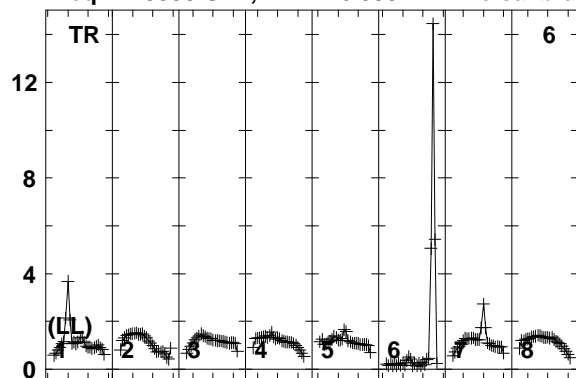

Lower frame: Real Jy
Total-power spectrum Antenna: TR (06)
Timerange: 00/03:51:08 to 00/03:52:30

Plot file version 249 created 19-AUG-2016 17:19:52

J1642+2523 EM119D.UVDATA.1

Freq = 1.5950 GHz, Bw = 16.000 MH No calibration applied and no bandpass applied

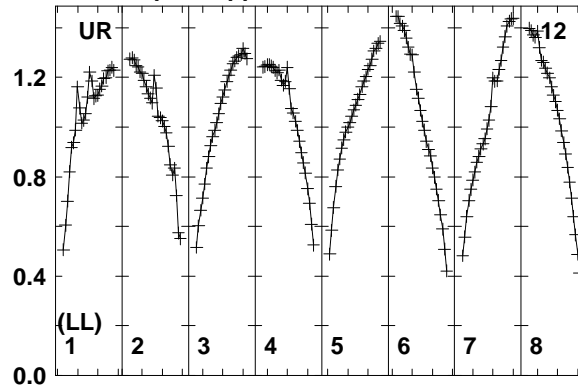
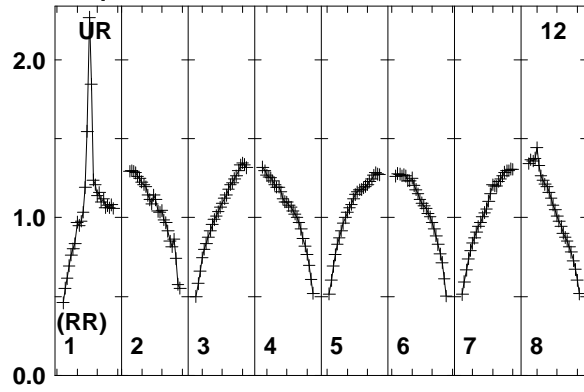

Lower frame: Real Jy
Total-power spectrum Antenna: UR (12)
Timerange: 00/03:51:08 to 00/03:52:30

Plot file version 250 created 19-AUG-2016 17:19:52

J1649+2635 EM119D.UVDATA.1

Freq = 1.5950 GHz, Bw = 16.000 MH No calibration applied and no bandpass applied

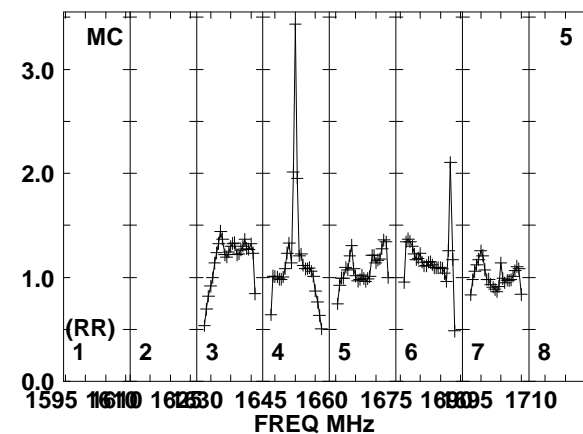
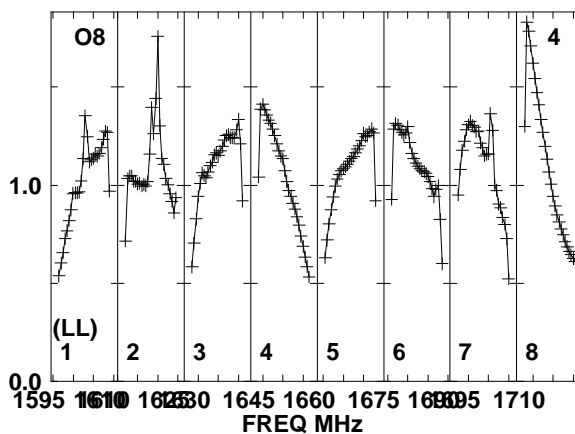
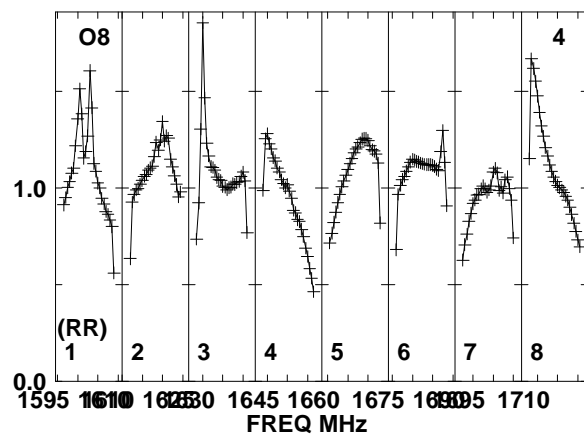
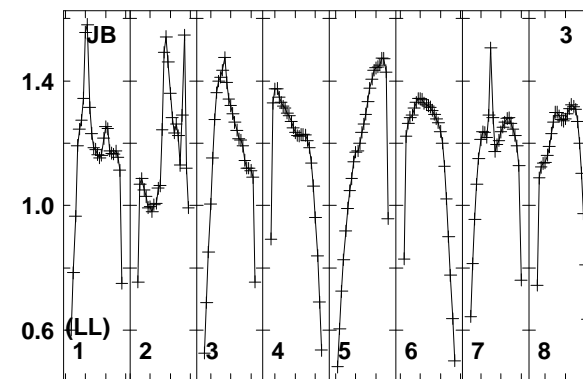
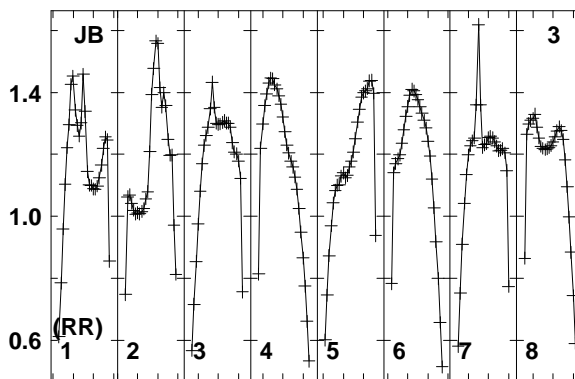
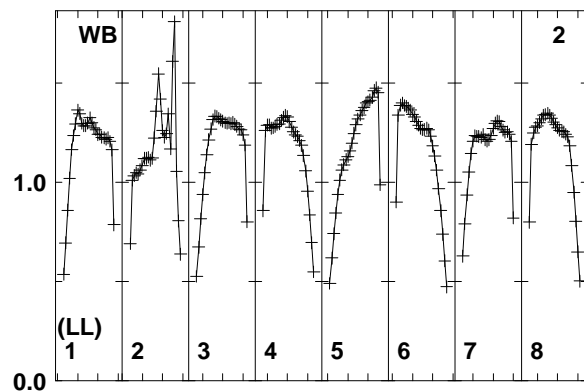
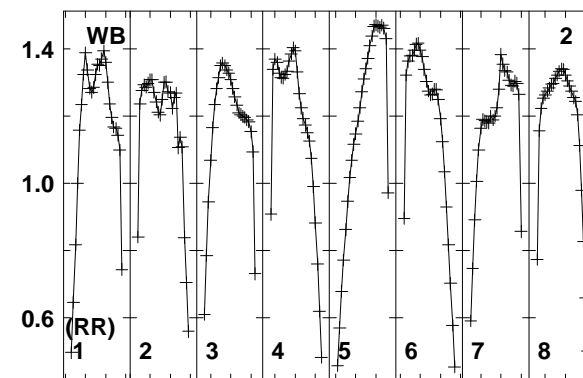
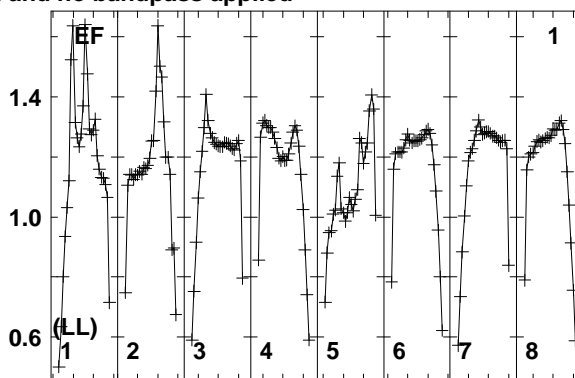
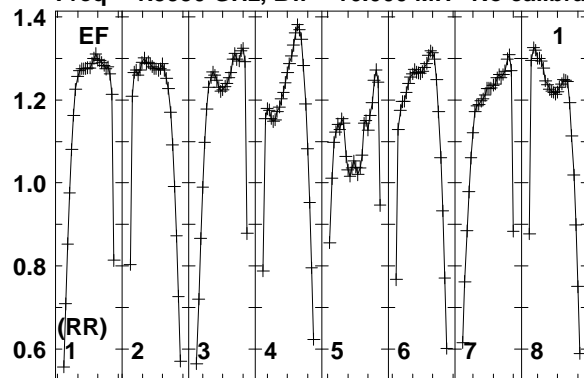

Lower frame: Real Jy
Total-power spectrum Antenna: EF (01)
Timerange: 00/03:52:32 to 00/03:56:00

Plot file version 251 created 19-AUG-2016 17:19:52

J1649+2635 EM119D.UVDATA.1

Freq = 1.5950 GHz, Bw = 16.000 MH No calibration applied and no bandpass applied

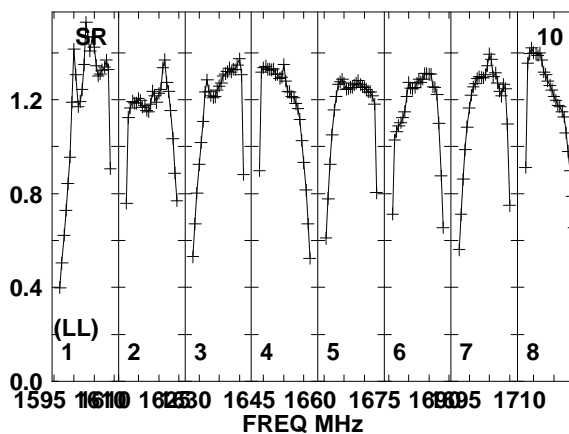
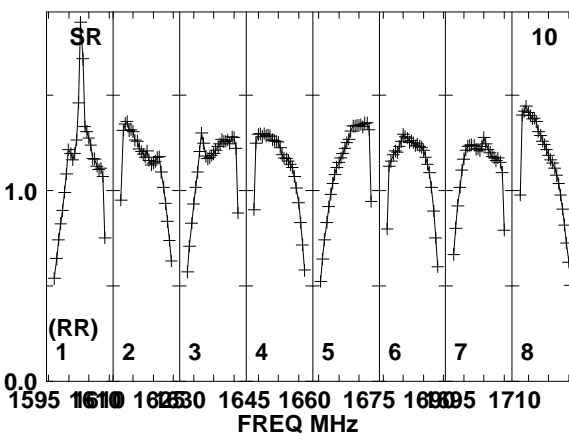
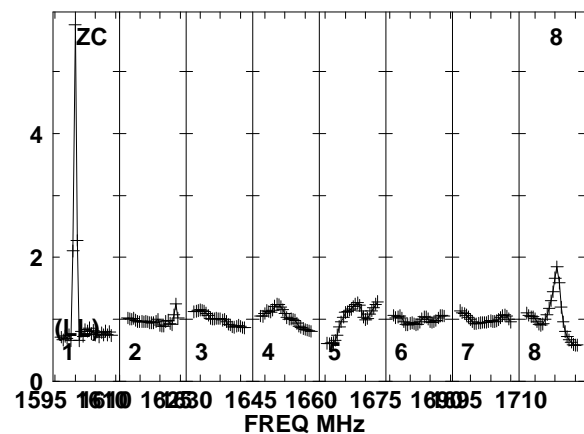
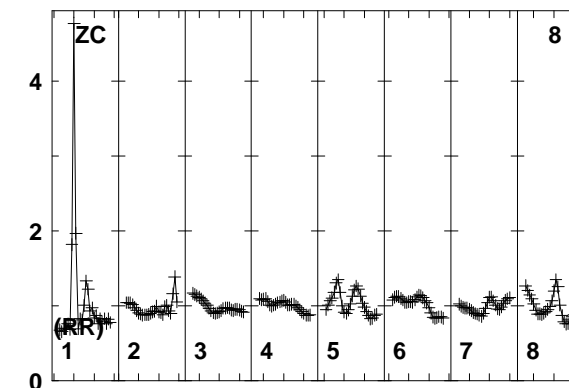
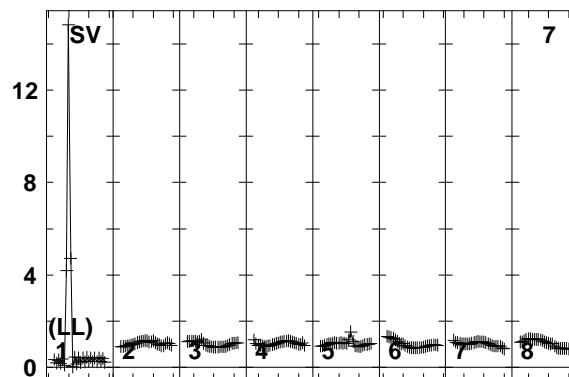
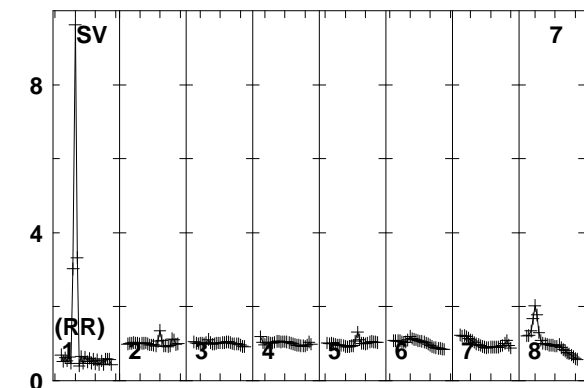
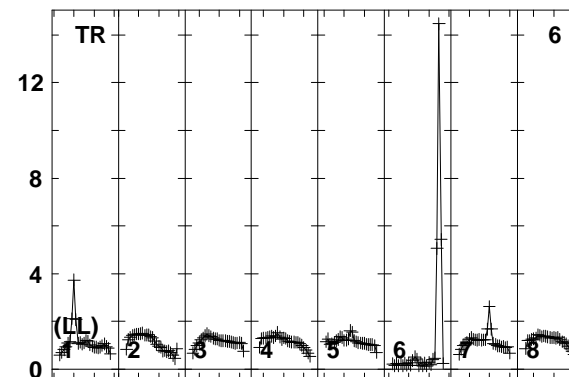
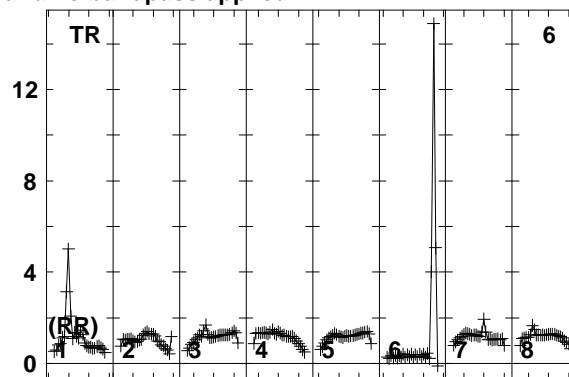
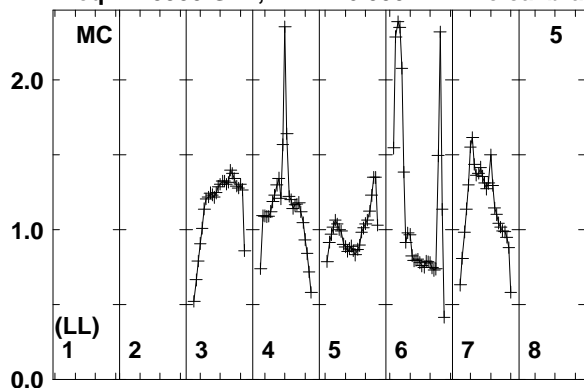

Lower frame: Real Jy
Total-power spectrum Antenna: MC (05)
Timerange: 00/03:52:32 to 00/03:56:00

Plot file version 252 created 19-AUG-2016 17:19:52

J1649+2635 EM119D.UVDATA.1

Freq = 1.5950 GHz, Bw = 16.000 MH No calibration applied and no bandpass applied

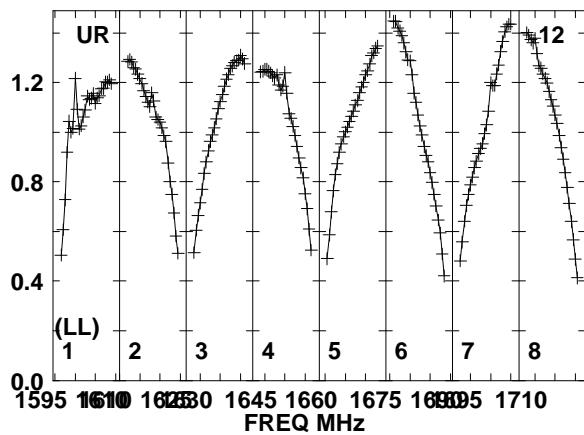
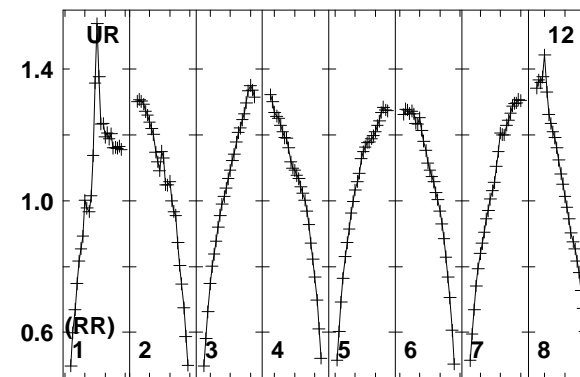
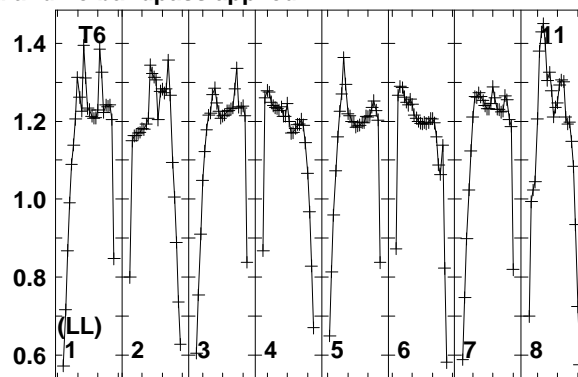
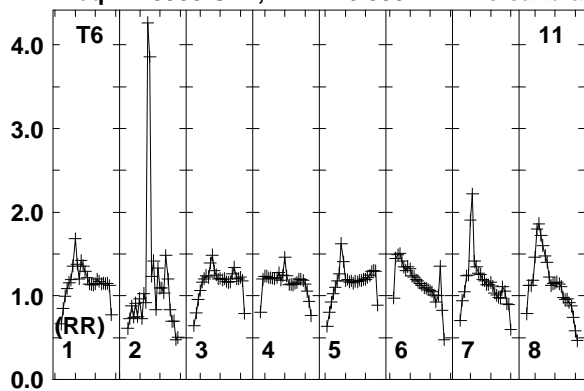

Lower frame: Real Jy
Total-power spectrum Antenna: T6 (11)
Timerange: 00/03:52:32 to 00/03:56:00

Plot file version 253 created 19-AUG-2016 17:19:52

J1642+2523 EM119D.UVDATA.1

Freq = 1.5950 GHz, Bw = 16.000 MH No calibration applied and no bandpass applied

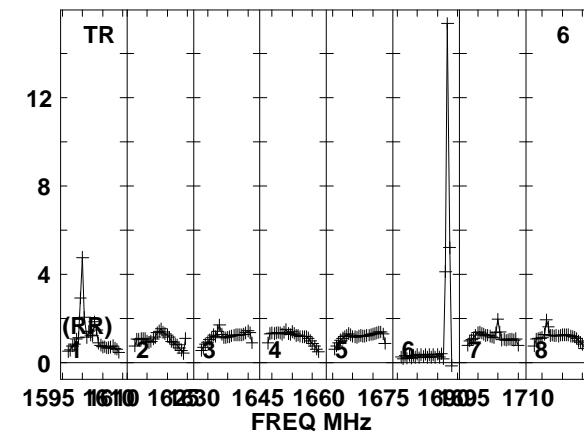
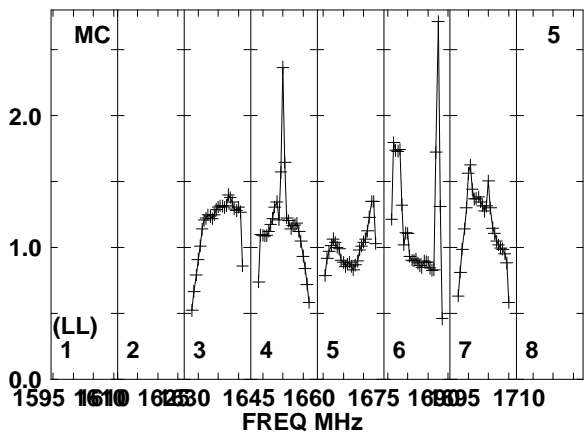
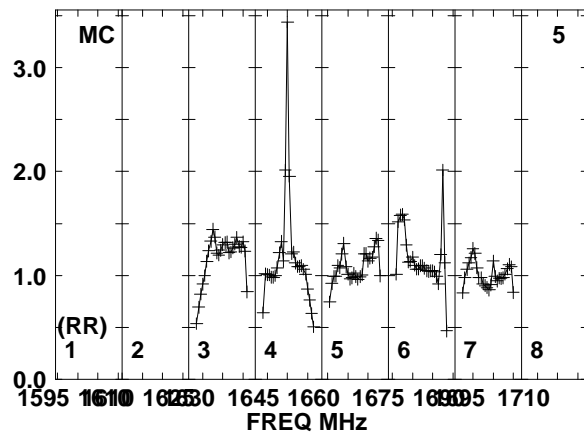
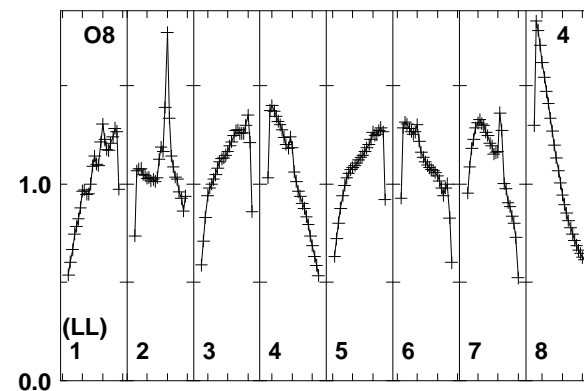
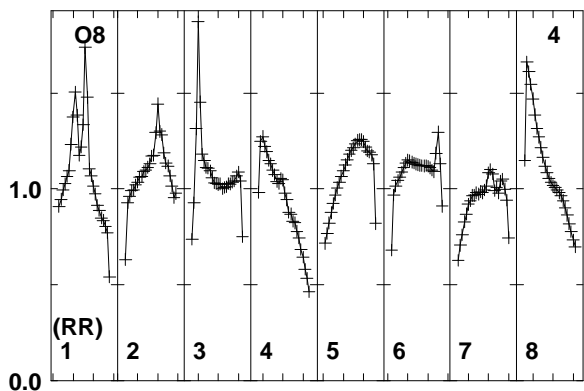
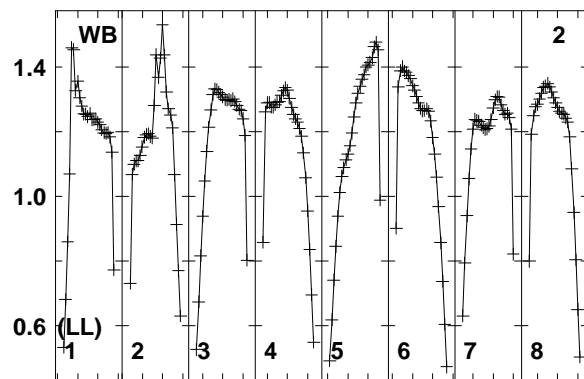
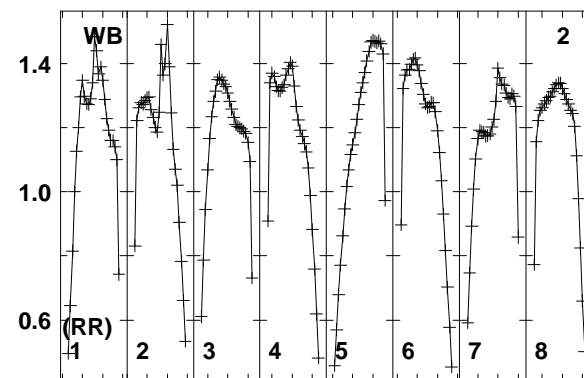
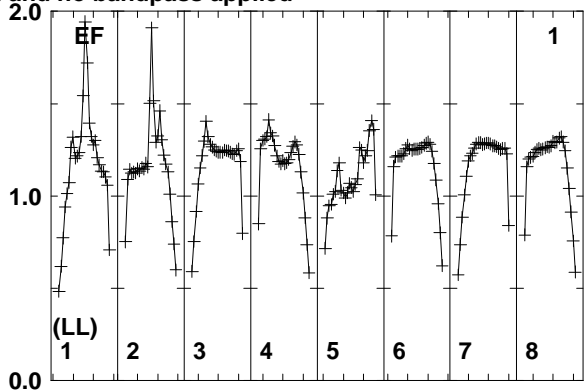
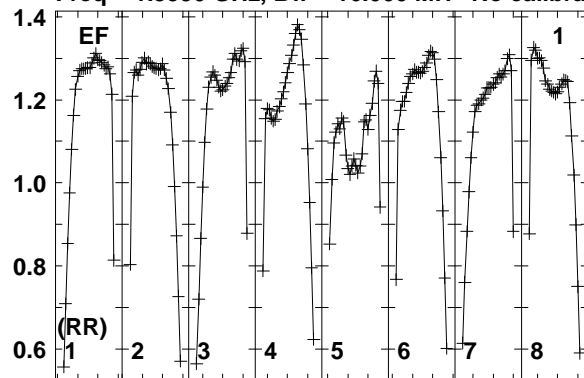

Lower frame: Real Jy
Total-power spectrum Antenna: EF (01)
Timerange: 00/03:56:07 to 00/03:57:30

Plot file version 254 created 19-AUG-2016 17:19:52

J1642+2523 EM119D.UVDATA.1

Freq = 1.5950 GHz, Bw = 16.000 MH No calibration applied and no bandpass applied

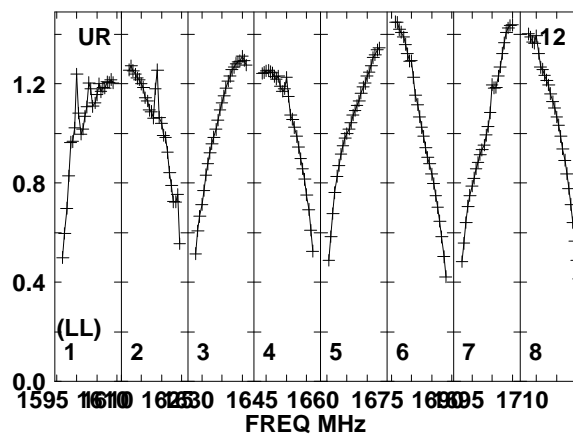
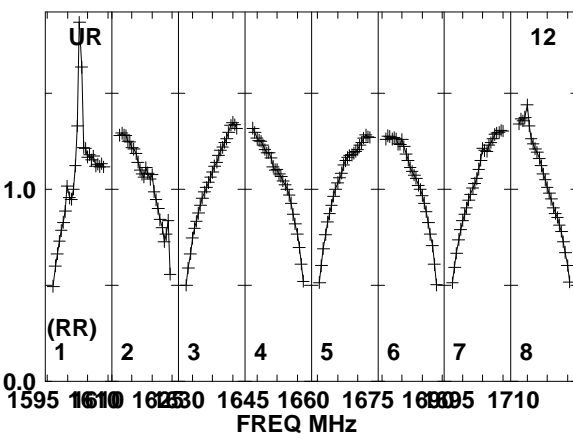
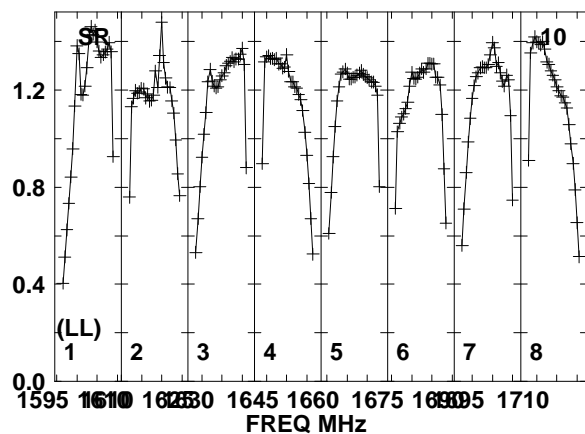
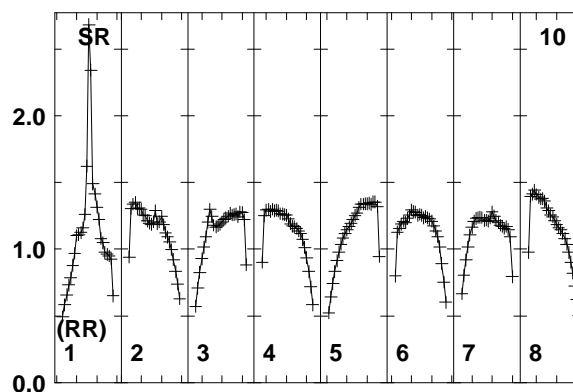
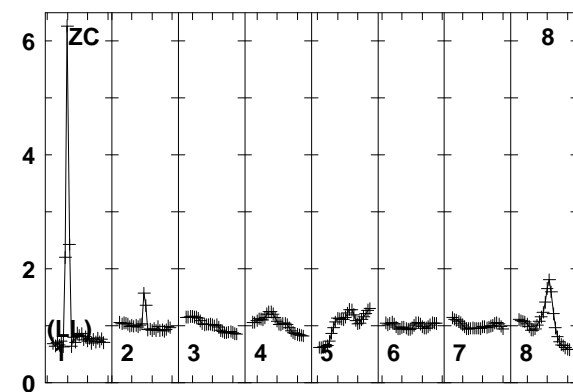
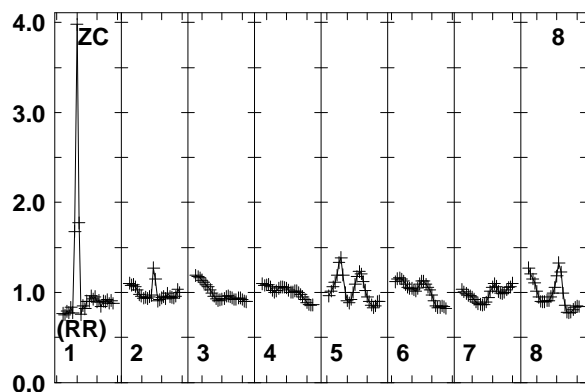
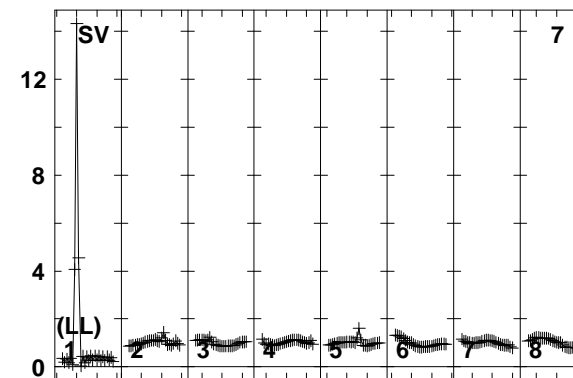
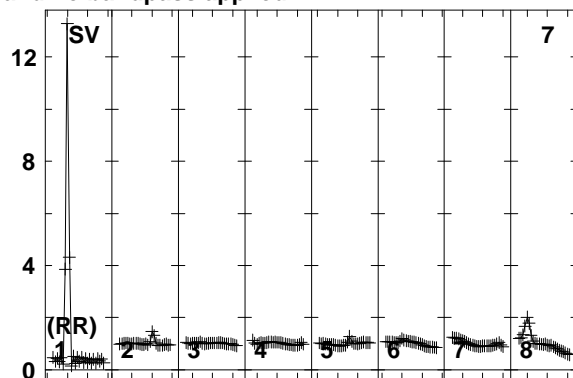
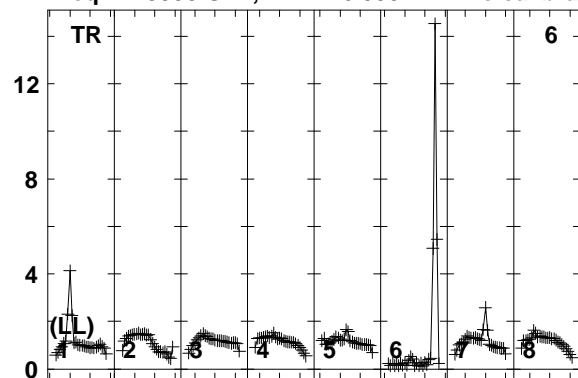

Lower frame: Real Jy
Total-power spectrum Antenna: TR (06)
Timerange: 00/03:56:07 to 00/03:57:30

Plot file version 255 created 19-AUG-2016 17:19:53

J1649+2635 EM119D.UVDATA.1

Freq = 1.5950 GHz, Bw = 16.000 MH No calibration applied and no bandpass applied

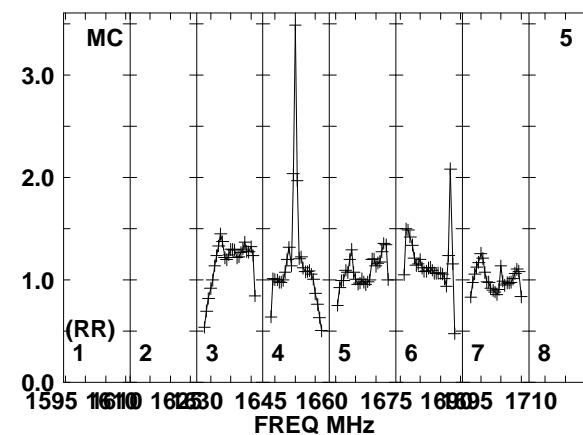
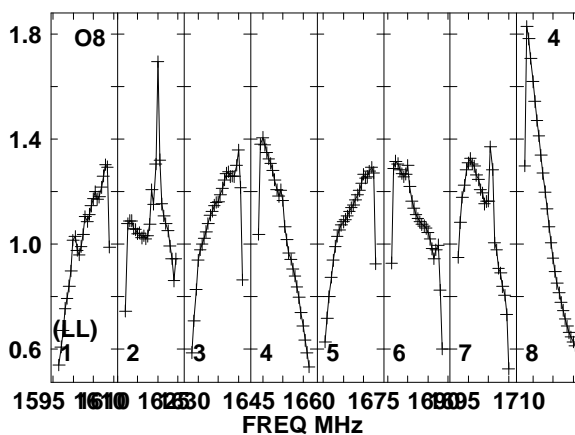
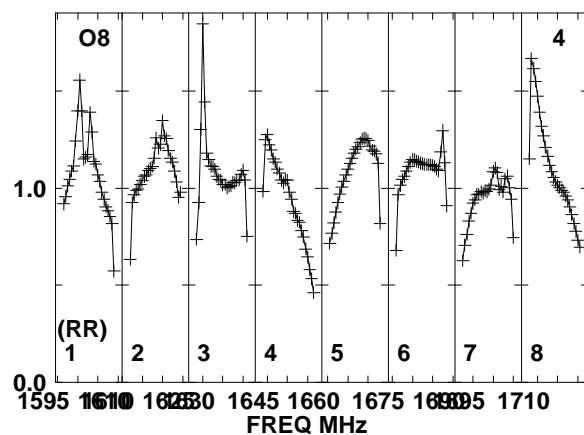
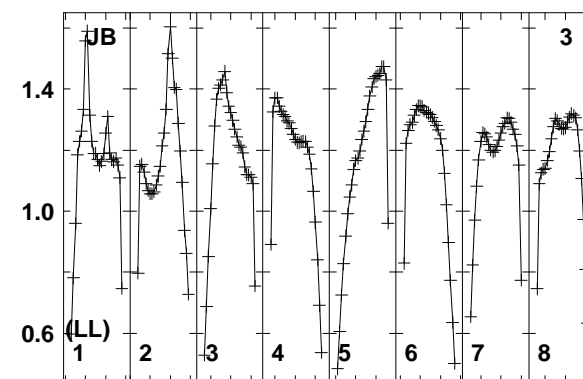
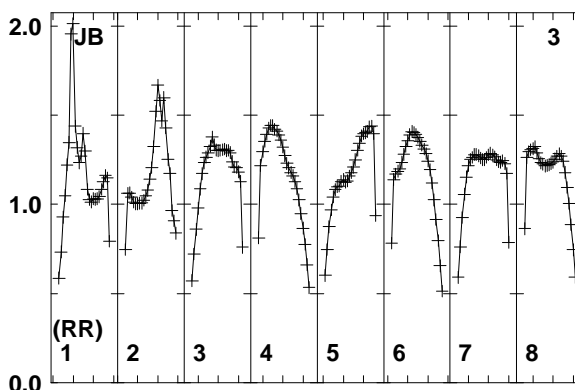
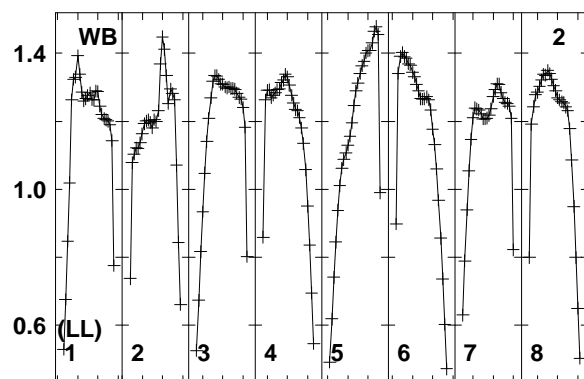
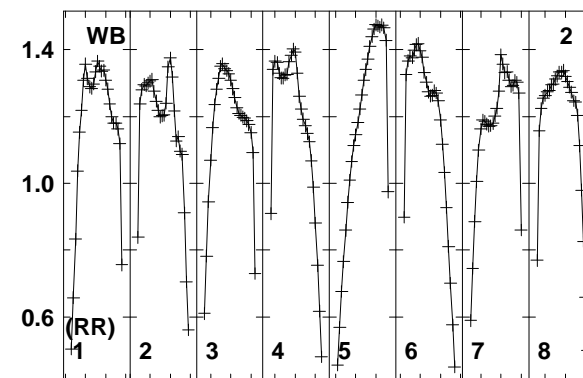
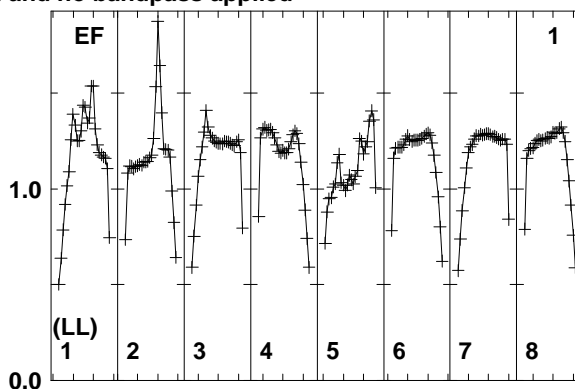
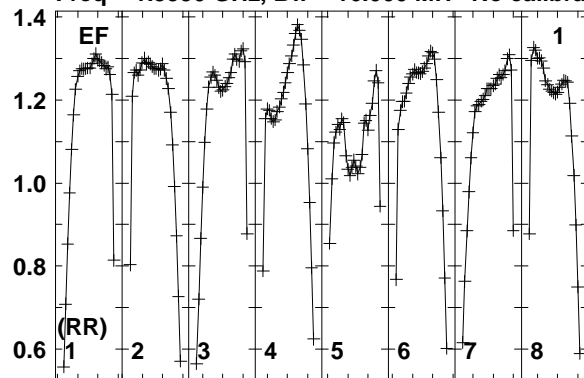

Lower frame: Real Jy
Total-power spectrum Antenna: EF (01)
Timerange: 00/03:58:31 to 00/04:02:00

Plot file version 256 created 19-AUG-2016 17:19:53

J1649+2635 EM119D.UVDATA.1

Freq = 1.5950 GHz, Bw = 16.000 MH No calibration applied and no bandpass applied

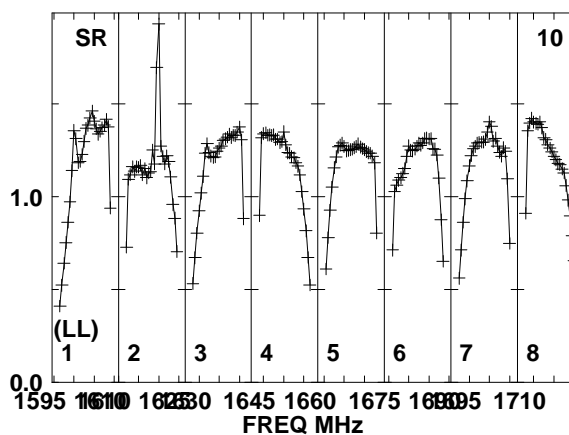
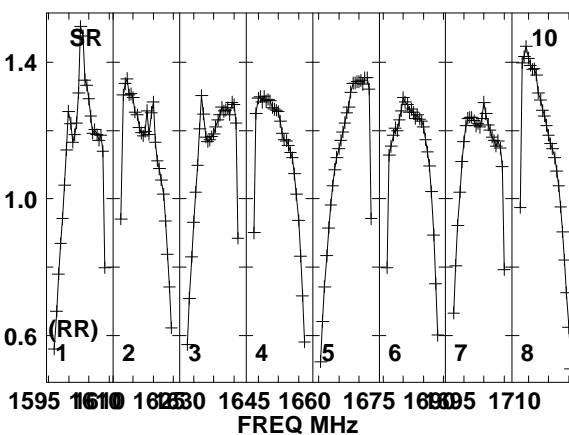
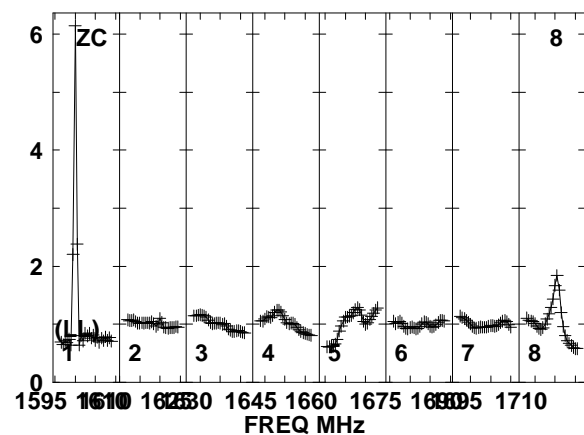
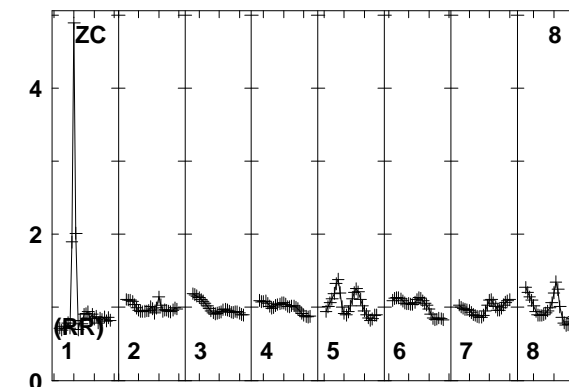
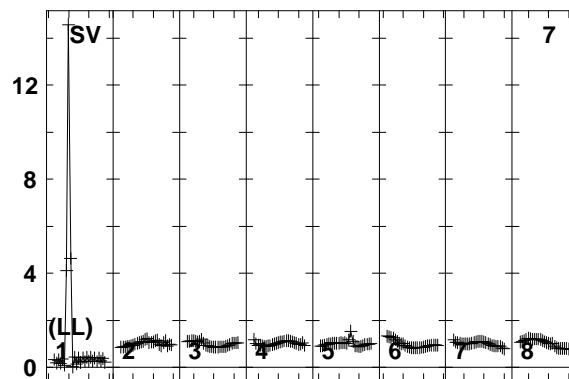
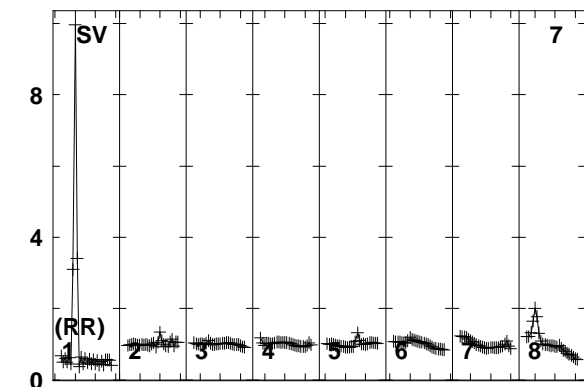
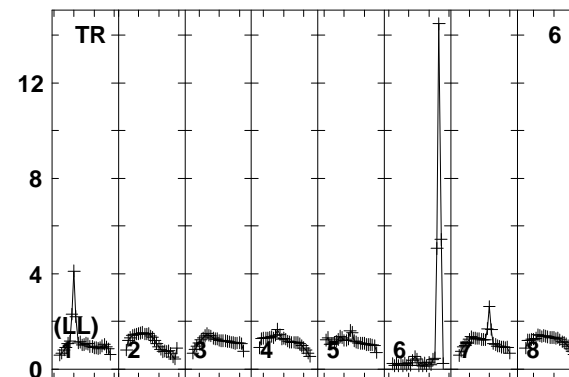
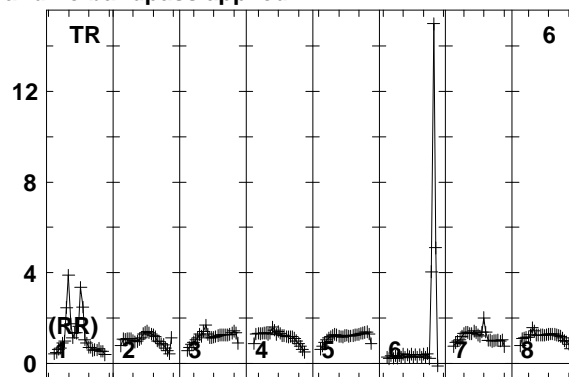
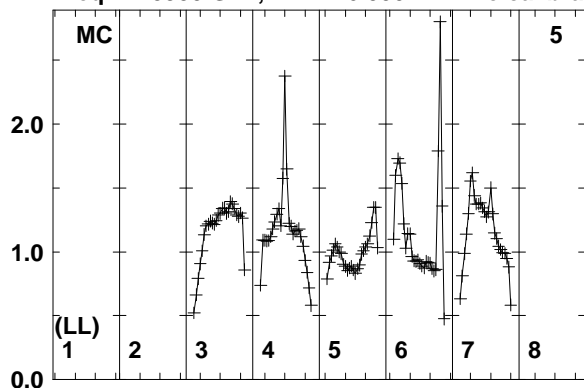

Lower frame: Real Jy
Total-power spectrum Antenna: MC (05)
Timerange: 00/03:58:31 to 00/04:02:00

Plot file version 257 created 19-AUG-2016 17:19:53

J1649+2635 EM119D.UVDATA.1

Freq = 1.5950 GHz, Bw = 16.000 MH No calibration applied and no bandpass applied

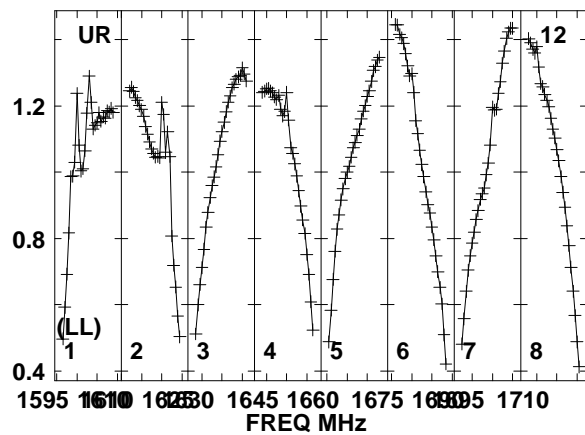
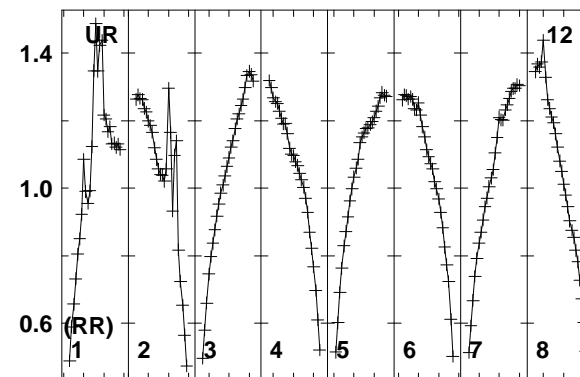
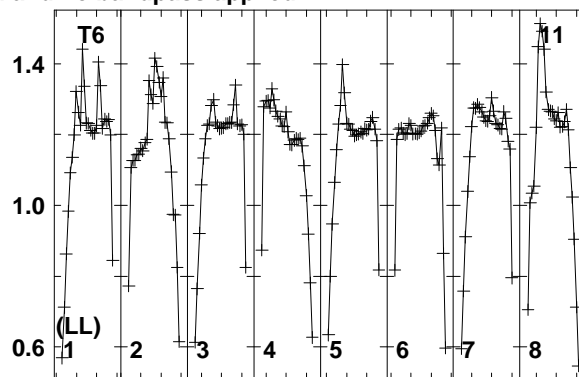
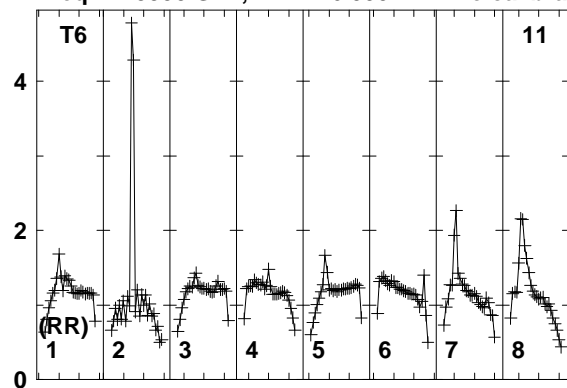

Lower frame: Real Jy
Total-power spectrum Antenna: T6 (11)
Timerange: 00/03:58:31 to 00/04:02:00

Plot file version 258 created 19-AUG-2016 17:19:53

J1642+2523 EM119D.UVDATA.1

Freq = 1.5950 GHz, Bw = 16.000 MH No calibration applied and no bandpass applied

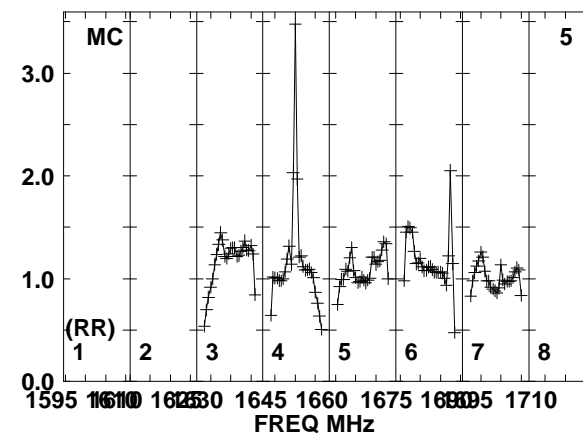
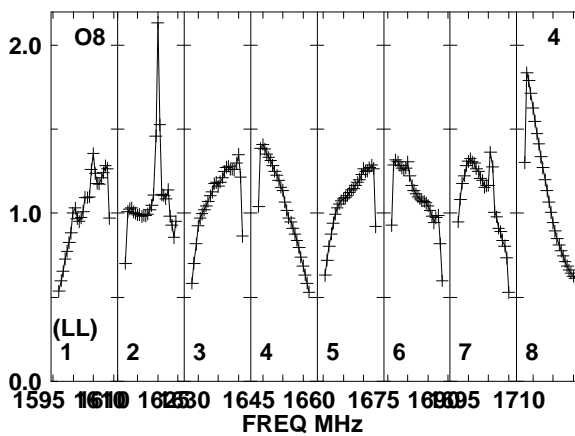
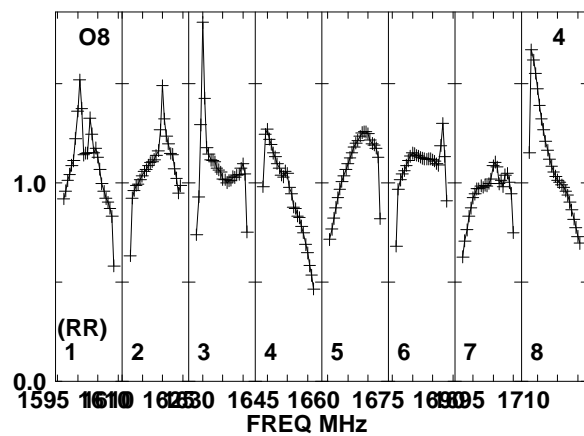
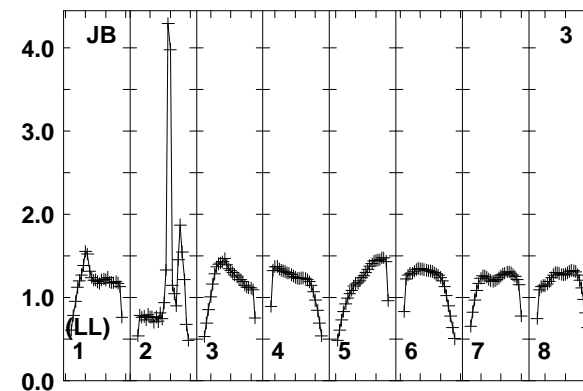
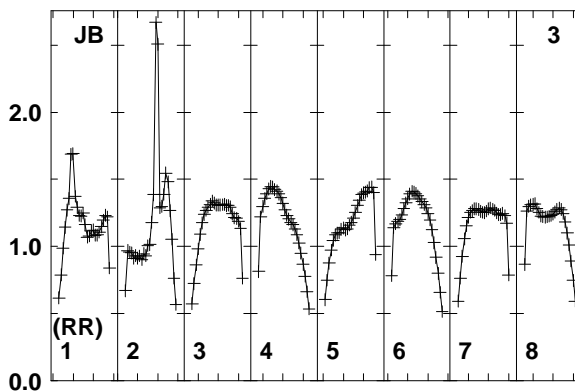
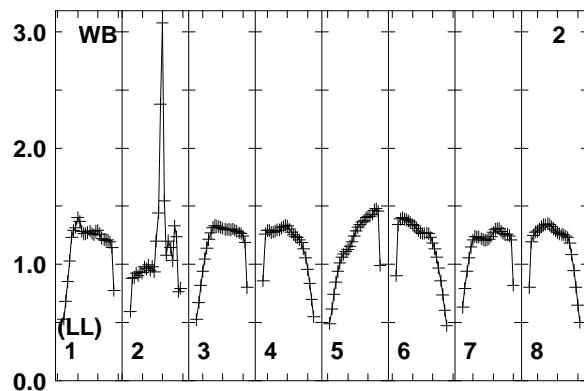
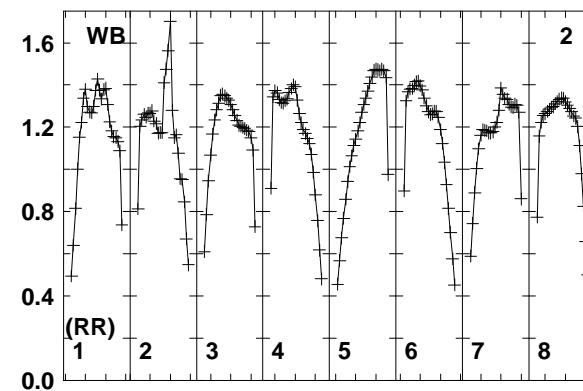
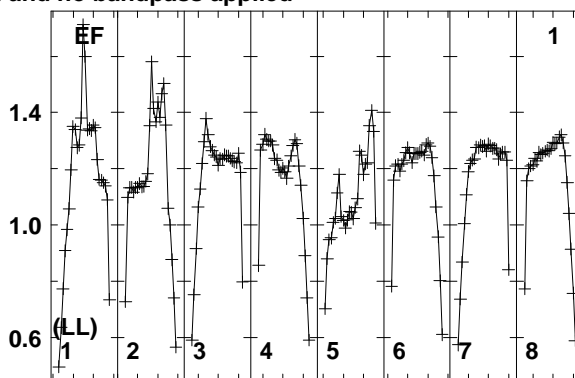
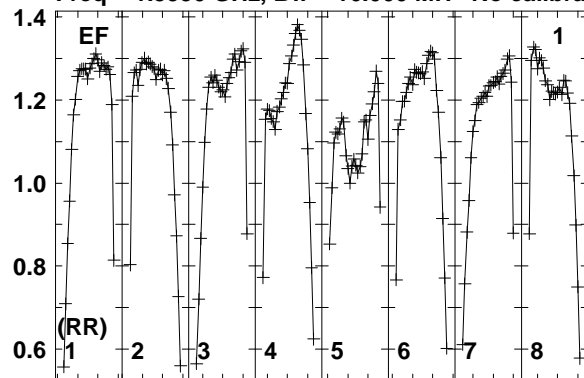

Lower frame: Real Jy
Total-power spectrum Antenna: EF (01)
Timerange: 00/04:02:07 to 00/04:03:29

Plot file version 259 created 19-AUG-2016 17:19:53

J1642+2523 EM119D.UVDATA.1

Freq = 1.5950 GHz, Bw = 16.000 MH No calibration applied and no bandpass applied

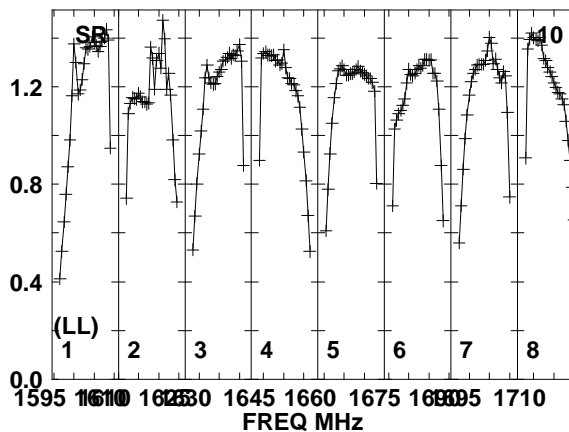
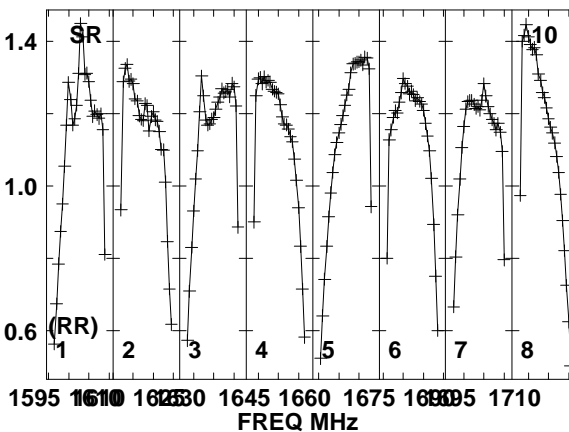
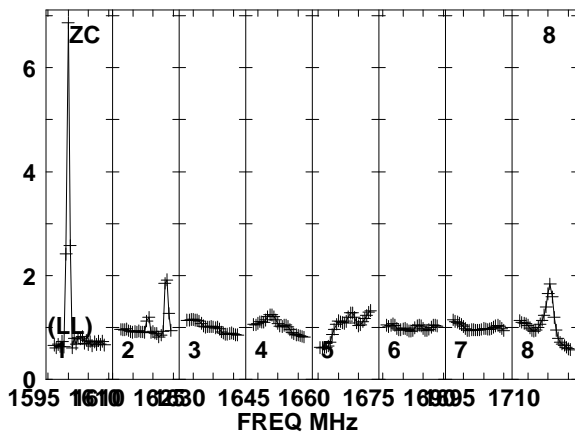
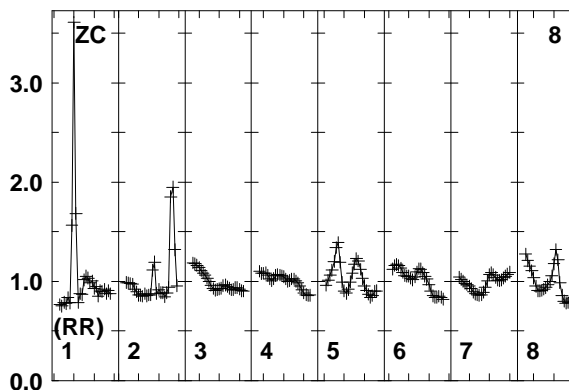
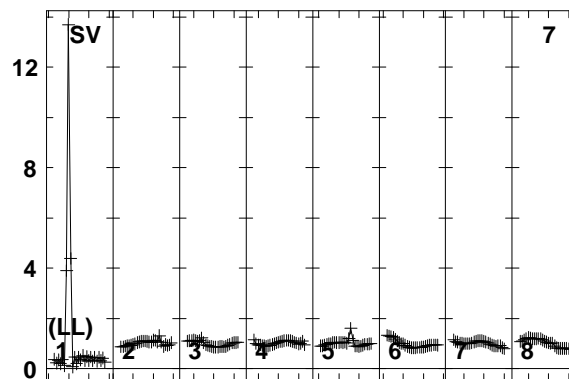
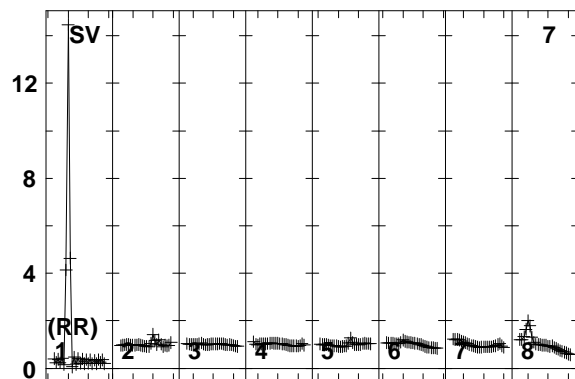
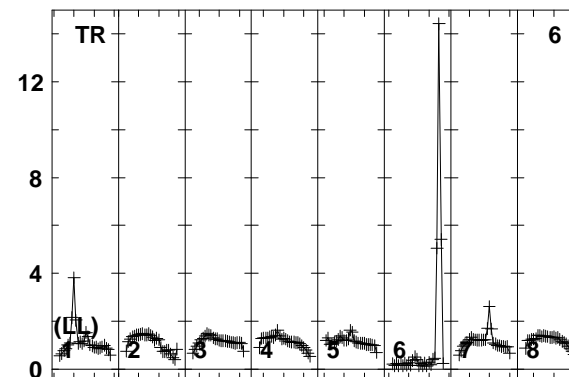
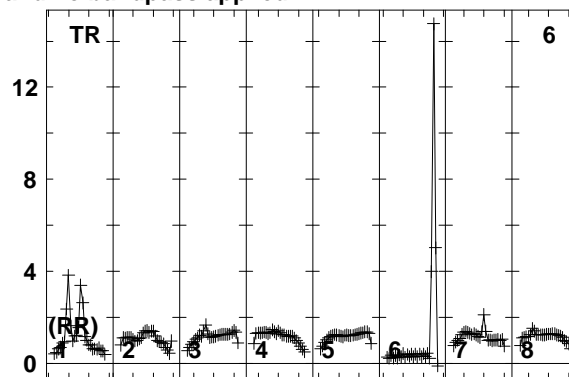
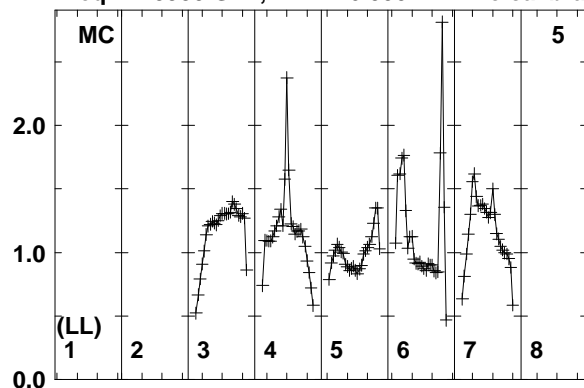

Lower frame: Real Jy
Total-power spectrum Antenna: MC (05)
Timerange: 00/04:02:07 to 00/04:03:29

Plot file version 260 created 19-AUG-2016 17:19:53

J1642+2523 EM119D.UVDATA.1

Freq = 1.5950 GHz, Bw = 16.000 MH No calibration applied and no bandpass applied

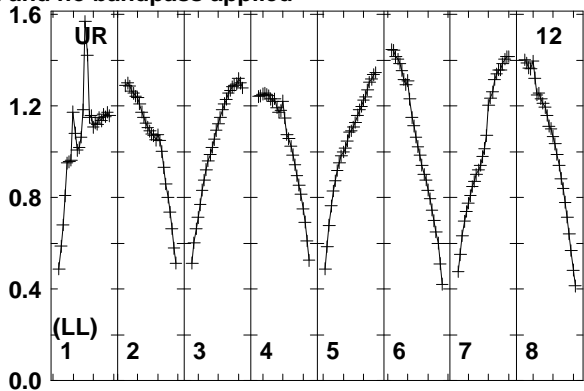
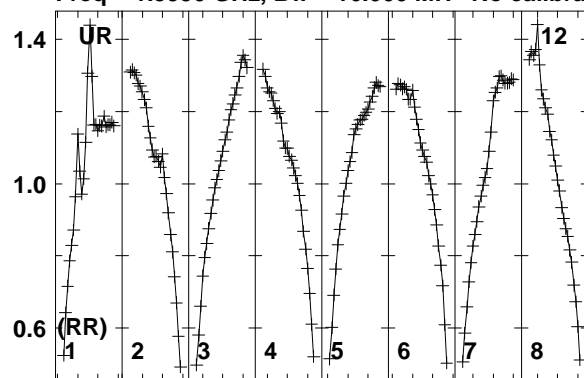

Lower frame: Real Jy
Total-power spectrum Antenna: UR (12)
Timerange: 00/04:02:07 to 00/04:03:29

Plot file version 261 created 19-AUG-2016 17:19:53

J1649+2635 EM119D.UVDATA.1

Freq = 1.5950 GHz, Bw = 16.000 MH No calibration applied and no bandpass applied

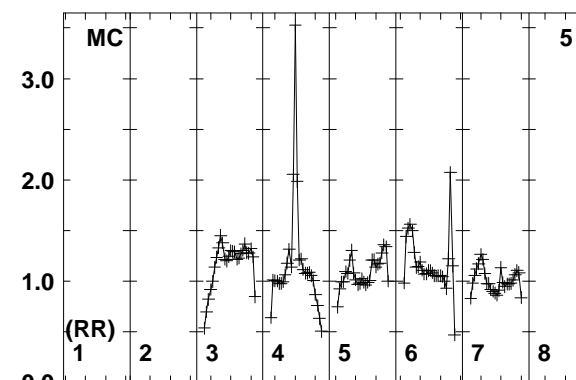
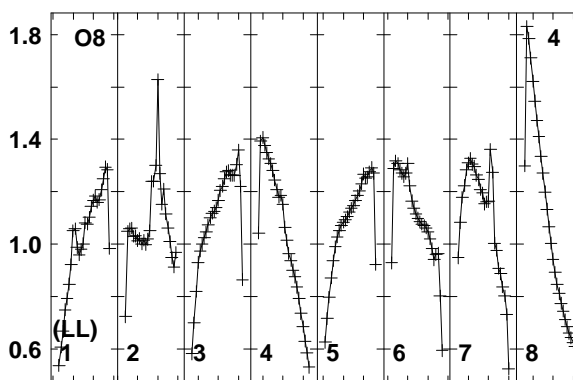
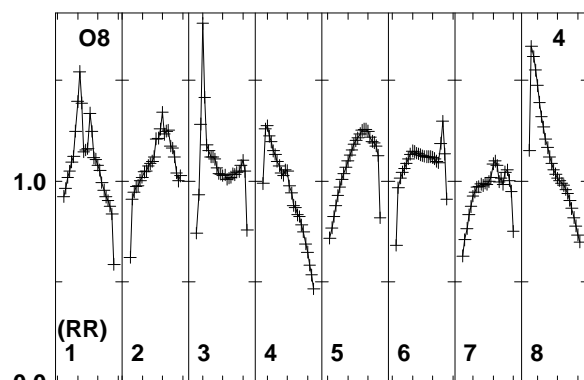
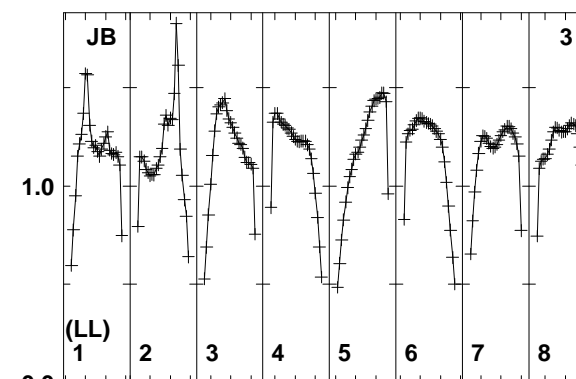
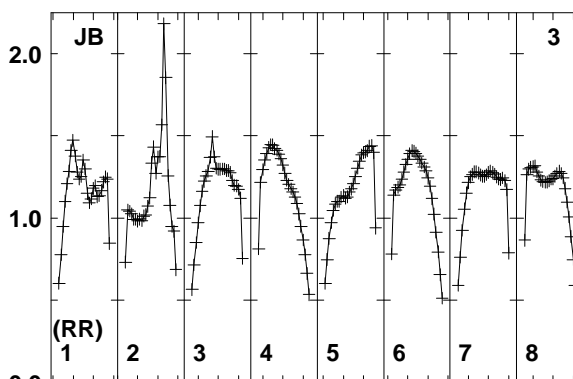
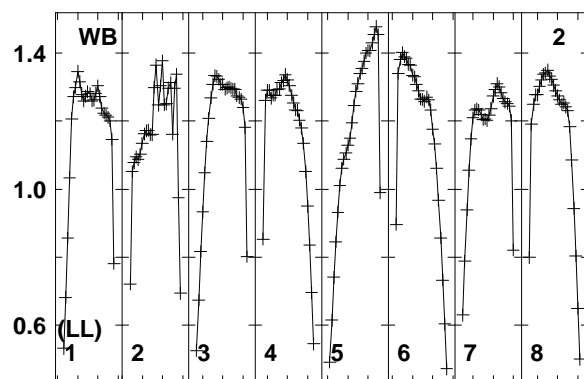
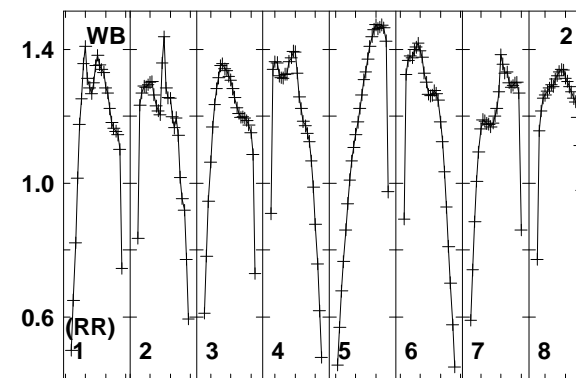
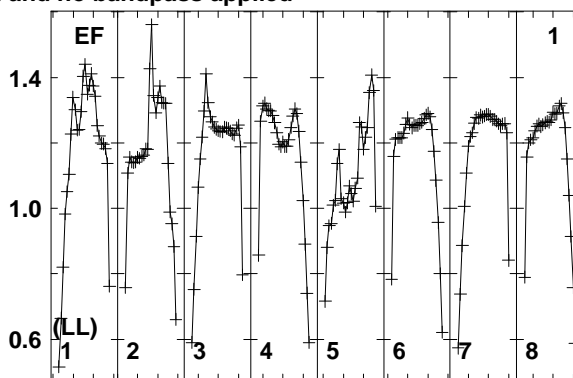
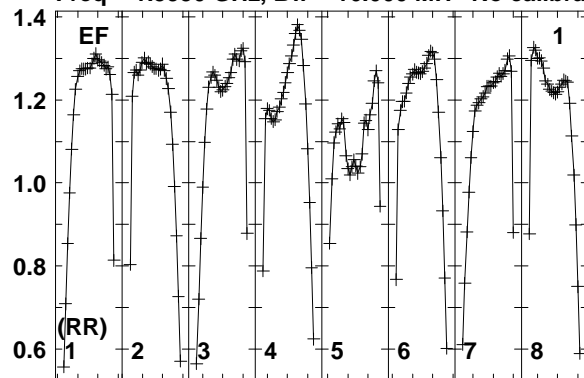

1595 1610 1625 1640 1655 1670 1685 1700 1710
FREQ MHz
Lower frame: Real Jy
Total-power spectrum Antenna: EF (01)
Timerange: 00/04:03:32 to 00/04:06:59

Plot file version 262 created 19-AUG-2016 17:19:54

J1649+2635 EM119D.UVDATA.1

Freq = 1.5950 GHz, Bw = 16.000 MH No calibration applied and no bandpass applied

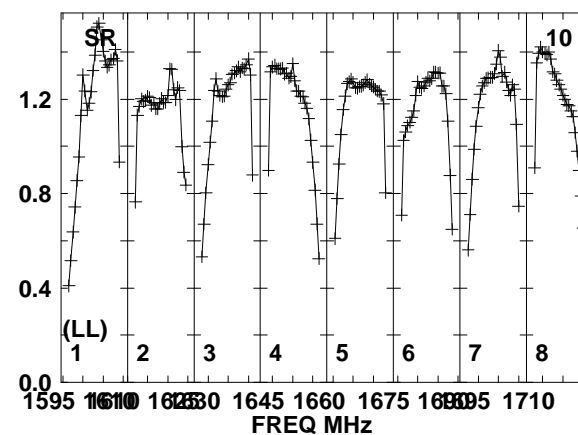
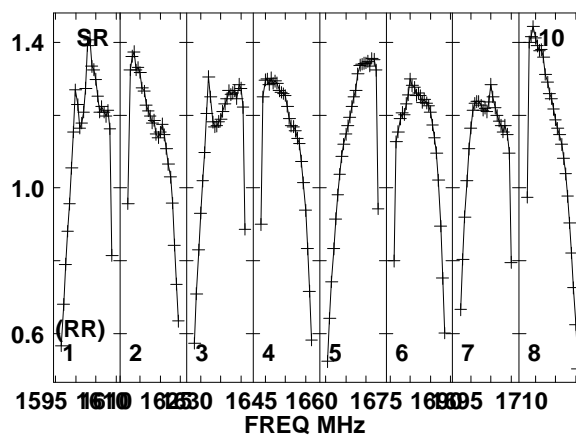
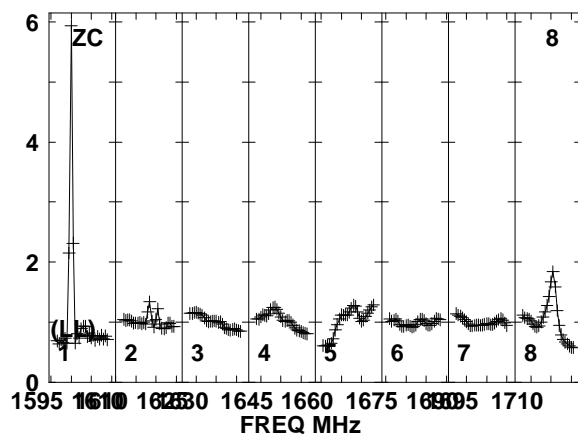
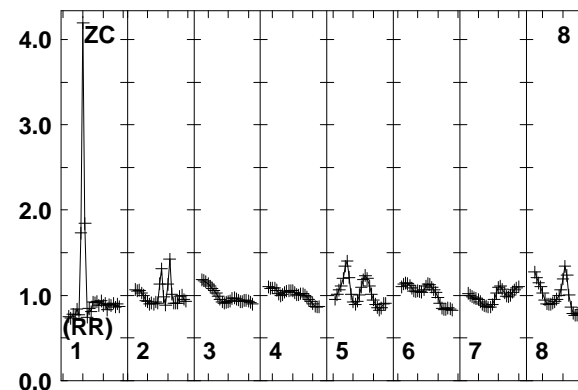
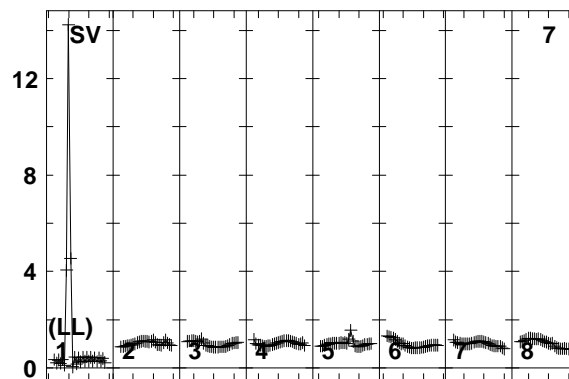
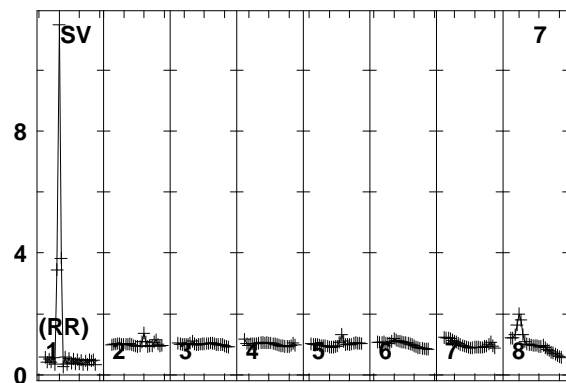
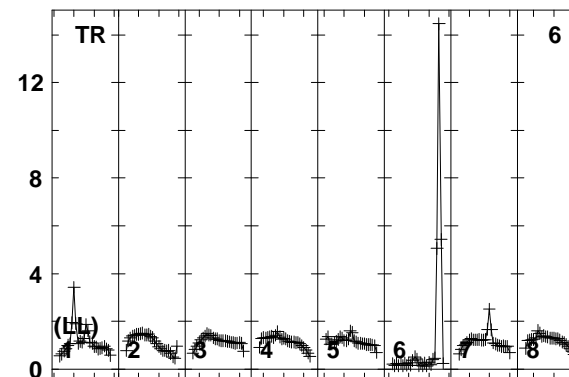
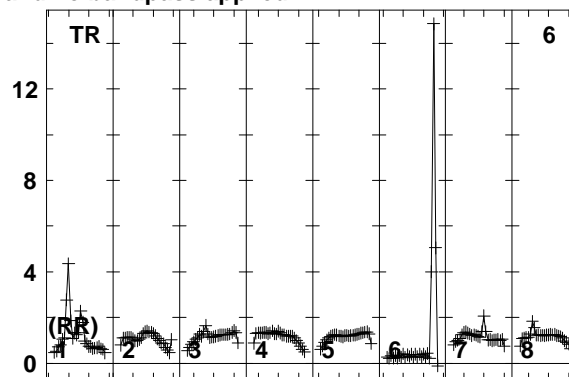
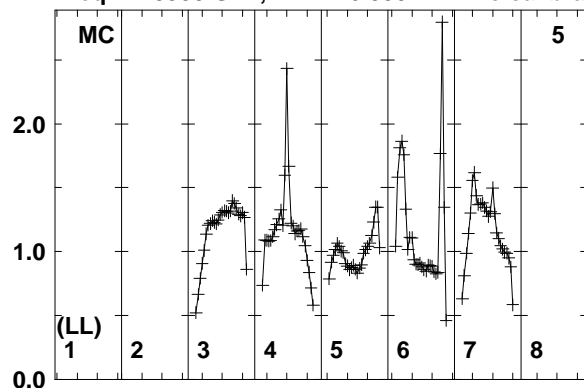

Lower frame: Real Jy
Total-power spectrum Antenna: MC (05)
Timerange: 00/04:03:32 to 00/04:06:59

Plot file version 263 created 19-AUG-2016 17:19:54

J1649+2635 EM119D.UVDATA.1

Freq = 1.5950 GHz, Bw = 16.000 MH No calibration applied and no bandpass applied

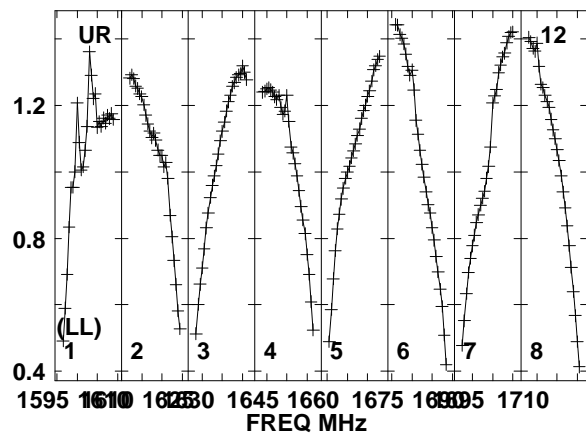
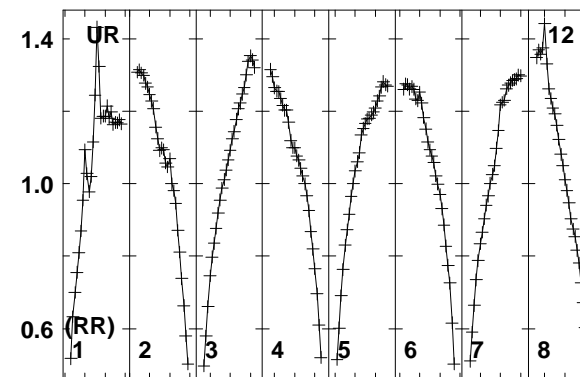
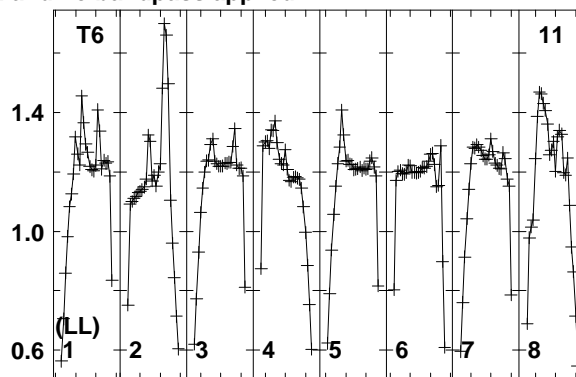
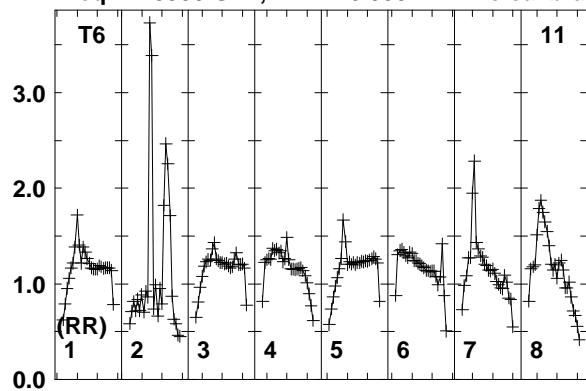

Lower frame: Real Jy
Total-power spectrum Antenna: T6 (11)
Timerange: 00/04:03:32 to 00/04:06:59

Plot file version 264 created 19-AUG-2016 17:19:54

J1642+2523 EM119D.UVDATA.1

Freq = 1.5950 GHz, Bw = 16.000 MH No calibration applied and no bandpass applied

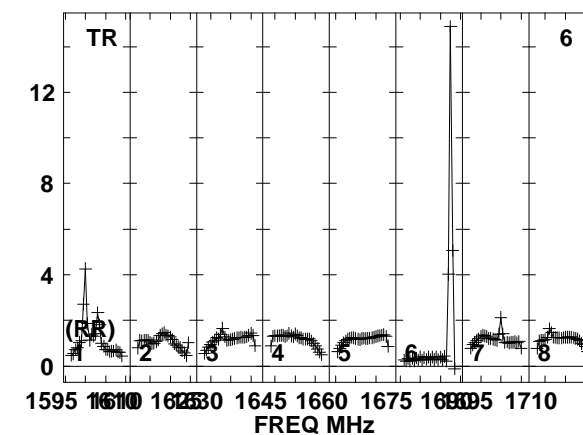
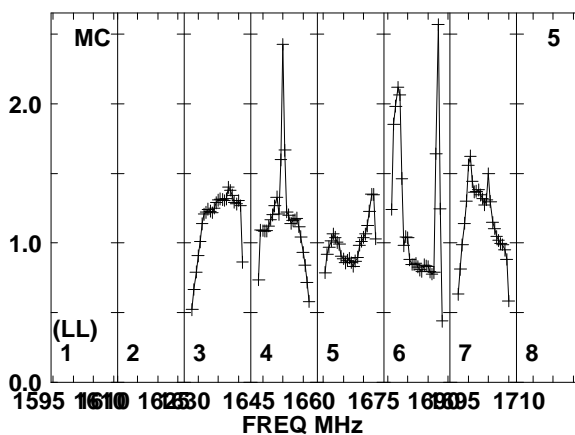
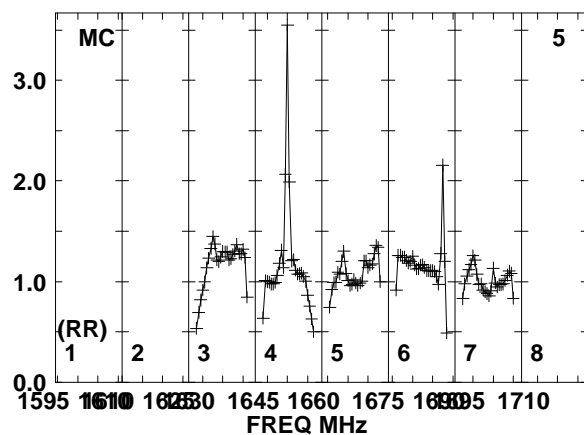
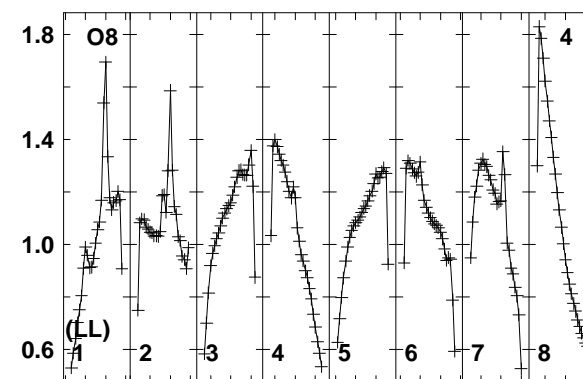
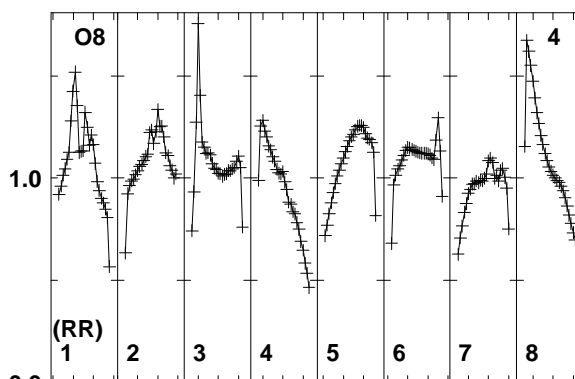
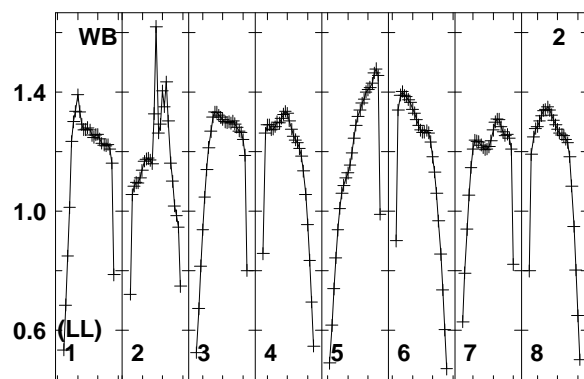
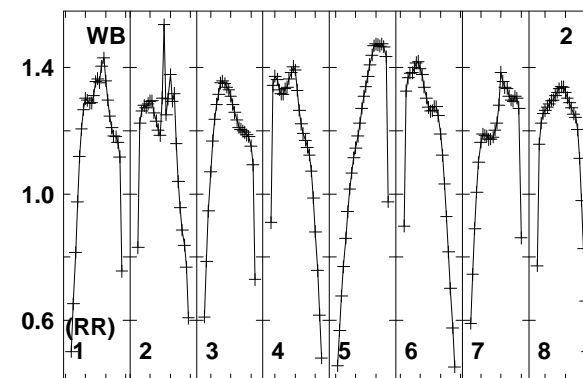
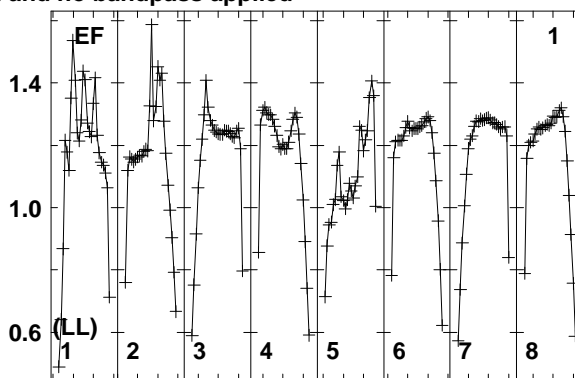
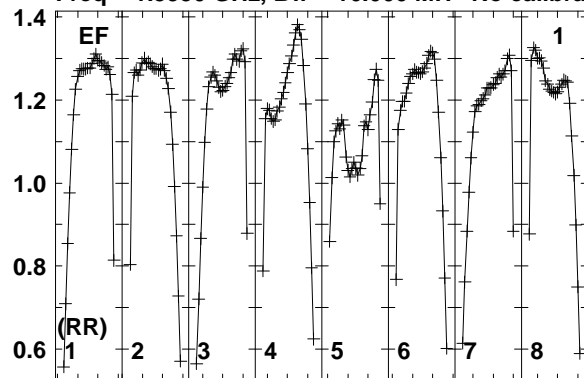

Lower frame: Real Jy
Total-power spectrum Antenna: EF (01)
Timerange: 00/04:07:08 to 00/04:08:30

Plot file version 265 created 19-AUG-2016 17:19:54

J1642+2523 EM119D.UVDATA.1

Freq = 1.5950 GHz, Bw = 16.000 MH No calibration applied and no bandpass applied

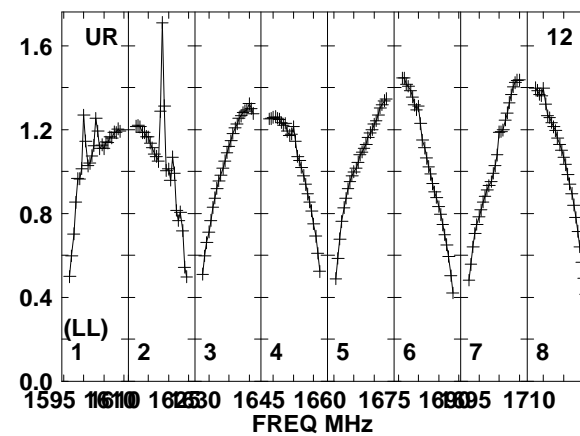
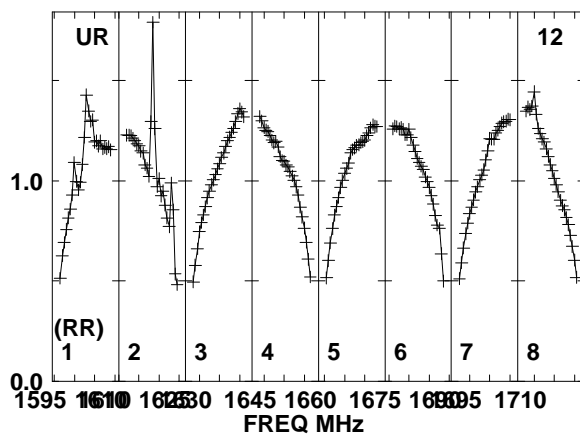
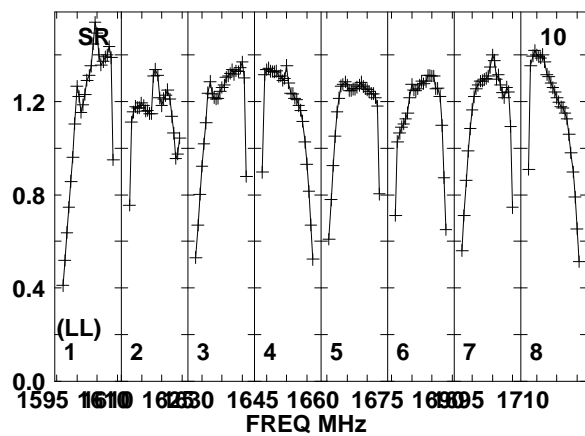
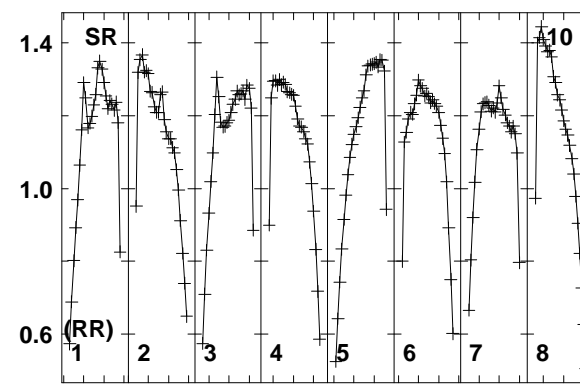
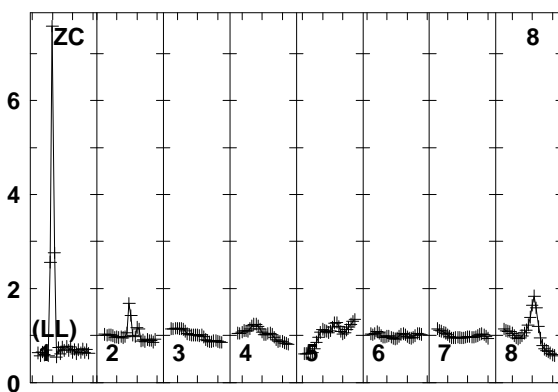
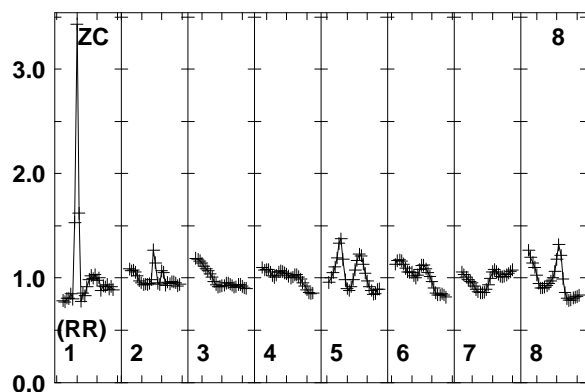
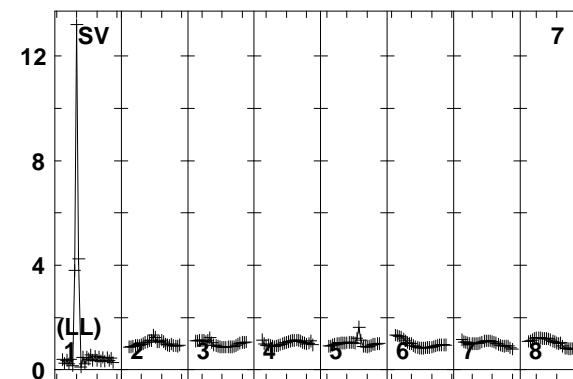
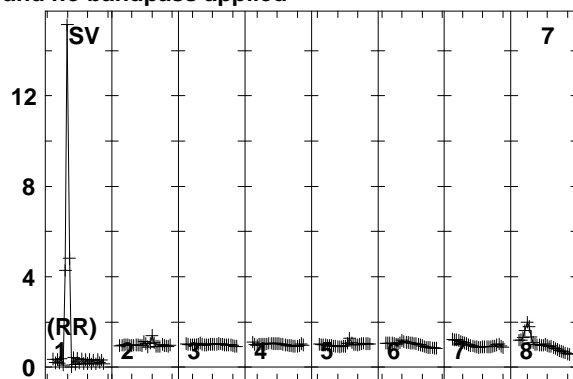
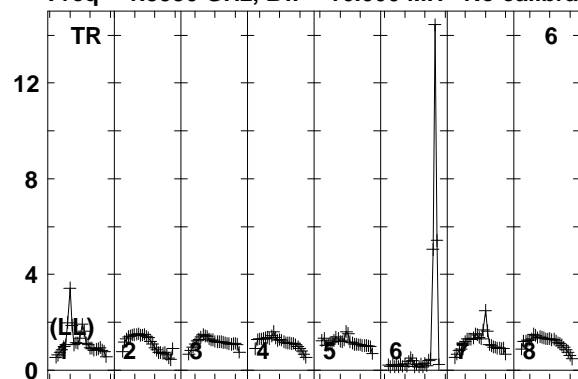

Lower frame: Real Jy
Total-power spectrum Antenna: TR (06)
Timerange: 00/04:07:08 to 00/04:08:30

Plot file version 266 created 19-AUG-2016 17:19:54

J1649+2635 EM119D.UVDATA.1

Freq = 1.5950 GHz, Bw = 16.000 MH No calibration applied and no bandpass applied

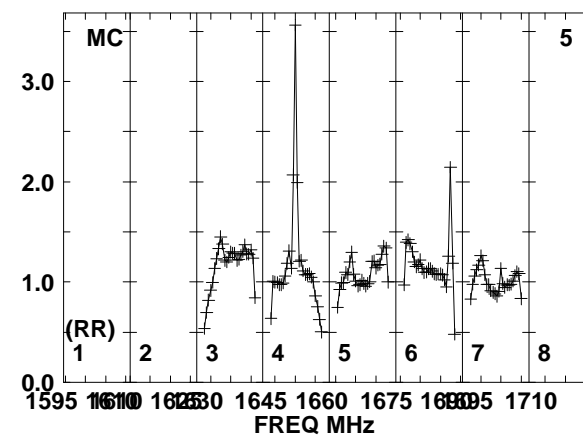
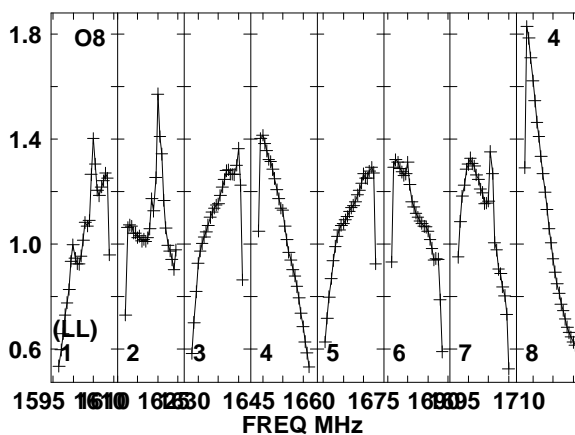
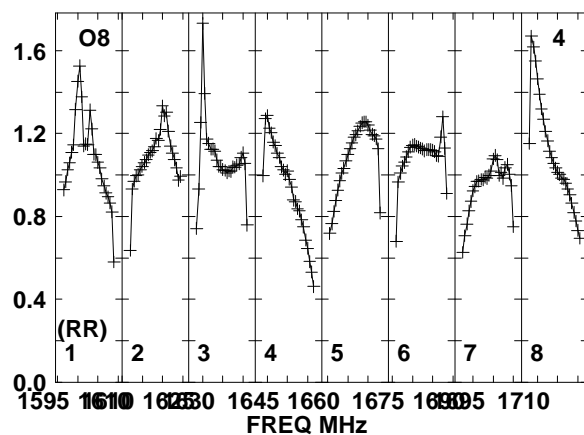
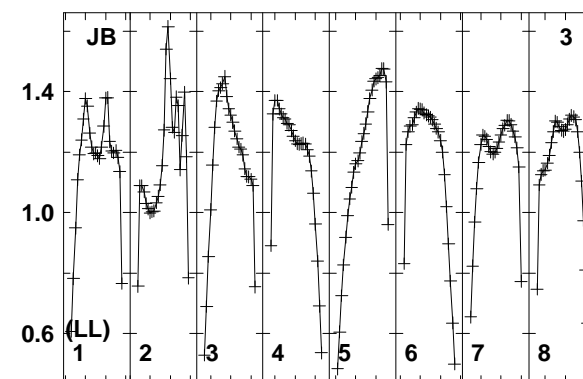
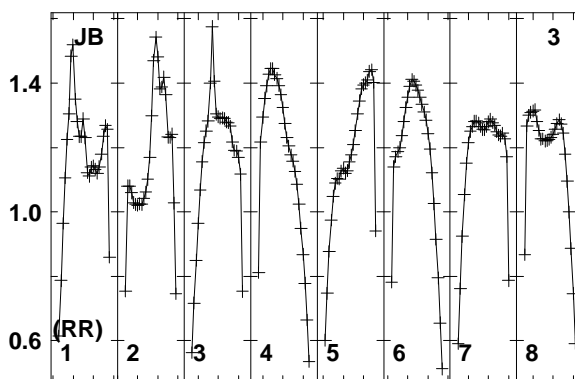
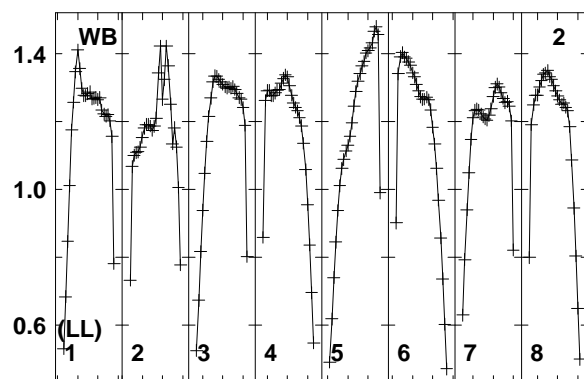
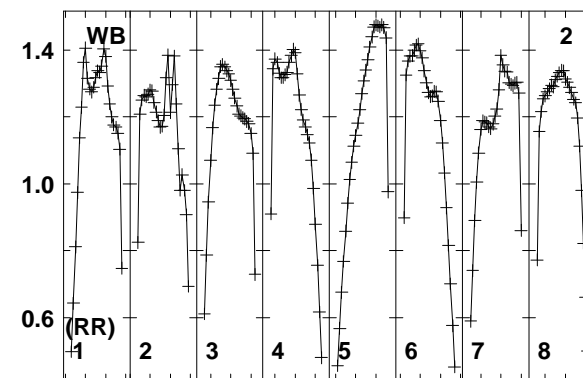
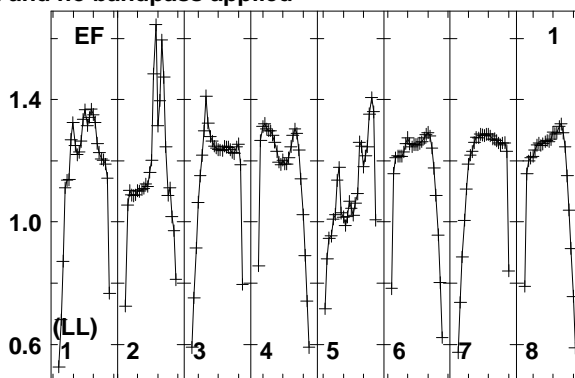
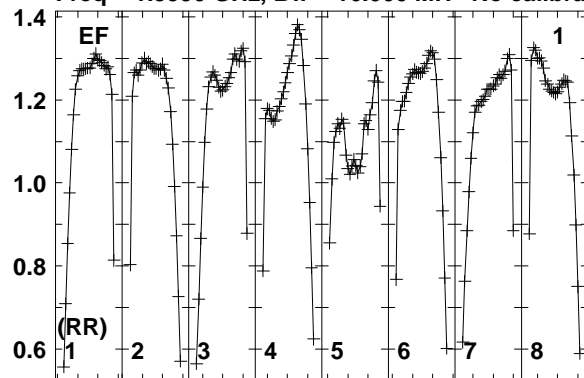

Lower frame: Real Jy
Total-power spectrum Antenna: EF (01)
Timerange: 00/04:08:33 to 00/04:11:59

Plot file version 267 created 19-AUG-2016 17:19:55

J1649+2635 EM119D.UVDATA.1

Freq = 1.5950 GHz, Bw = 16.000 MH No calibration applied and no bandpass applied

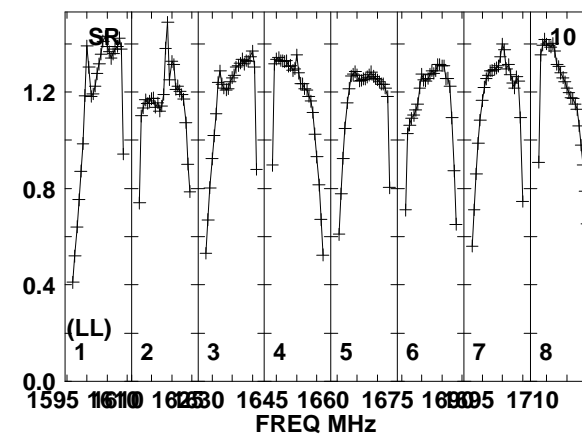
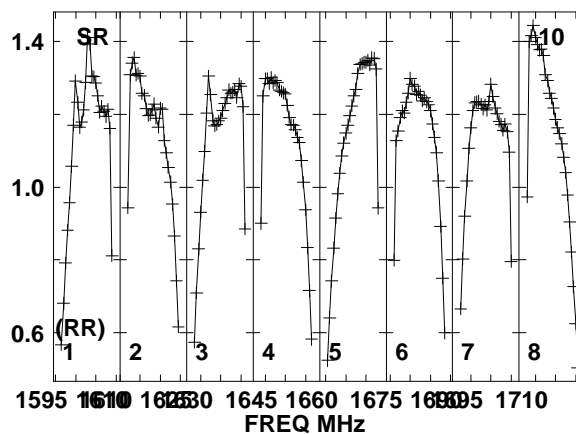
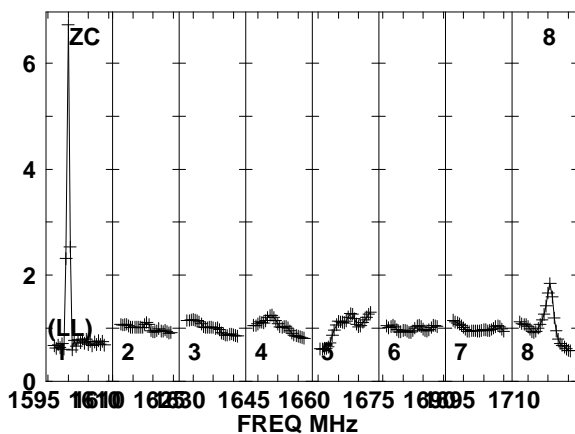
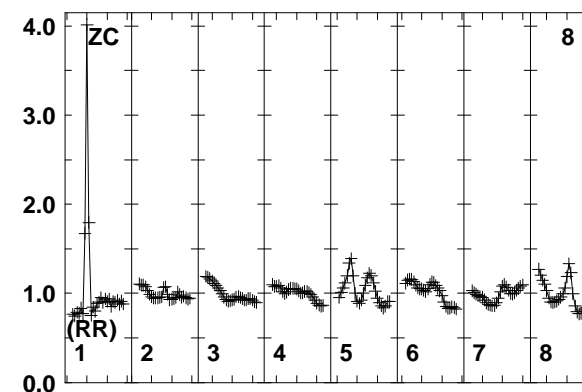
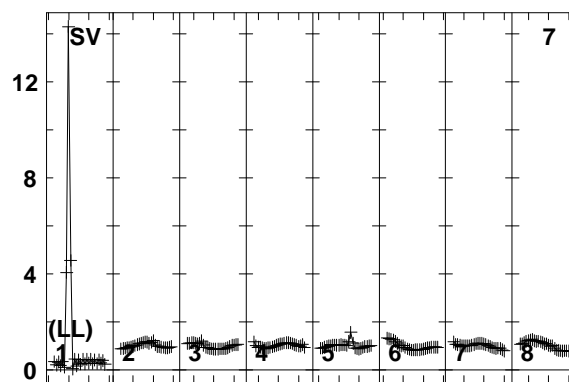
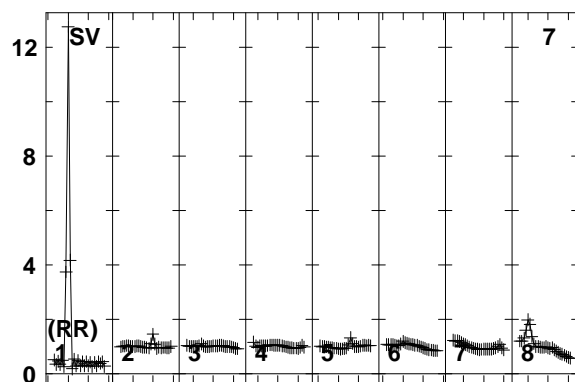
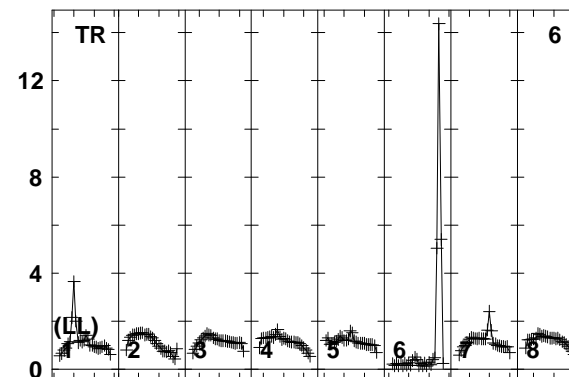
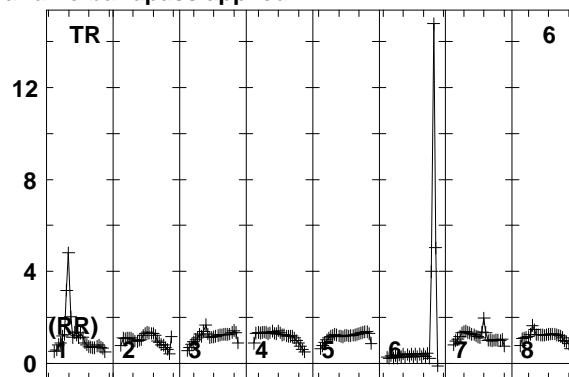
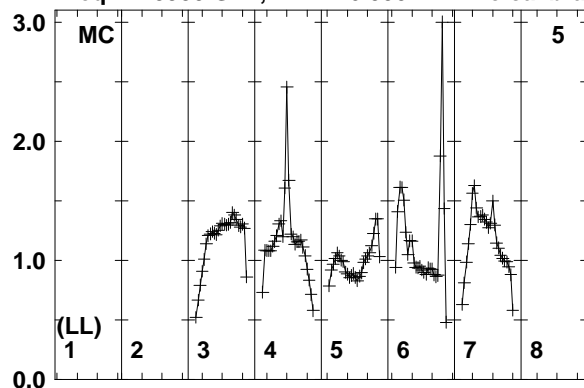

Lower frame: Real Jy
Total-power spectrum Antenna: MC (05)
Timerange: 00/04:08:33 to 00/04:11:59

Plot file version 268 created 19-AUG-2016 17:19:55

J1649+2635 EM119D.UVDATA.1

Freq = 1.5950 GHz, Bw = 16.000 MH No calibration applied and no bandpass applied

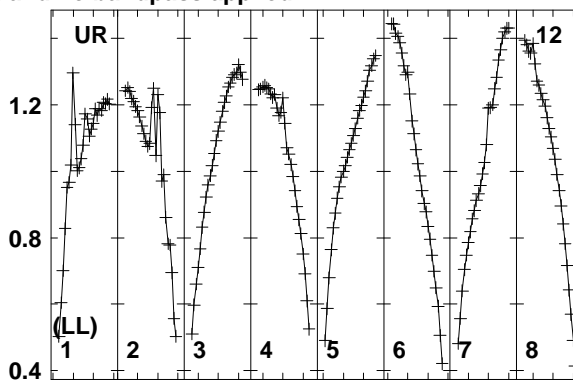
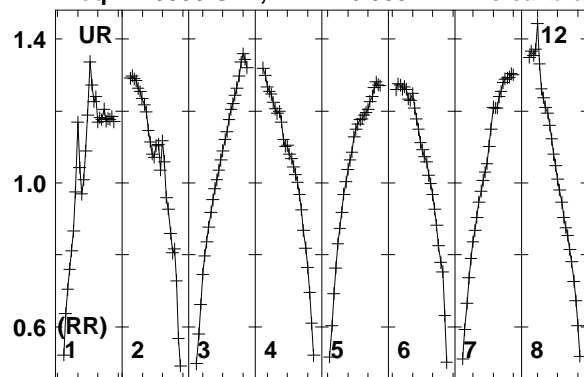

Lower frame: Real Jy
Total-power spectrum Antenna: UR (12)
Timerange: 00/04:08:33 to 00/04:11:59

Plot file version 269 created 19-AUG-2016 17:19:55

J1642+2523 EM119D.UVDATA.1

Freq = 1.5950 GHz, Bw = 16.000 MH No calibration applied and no bandpass applied

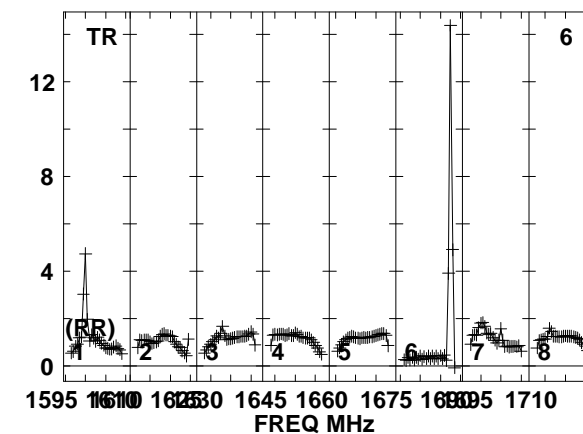
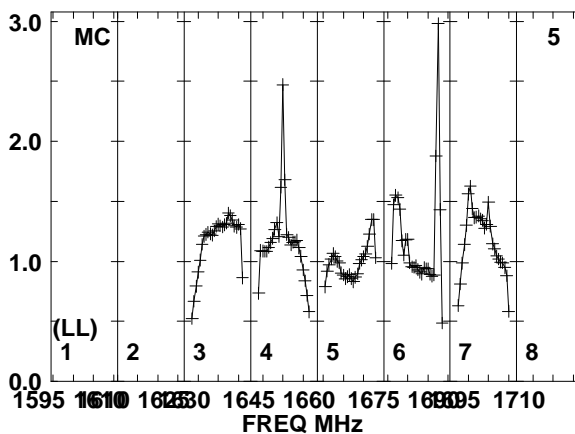
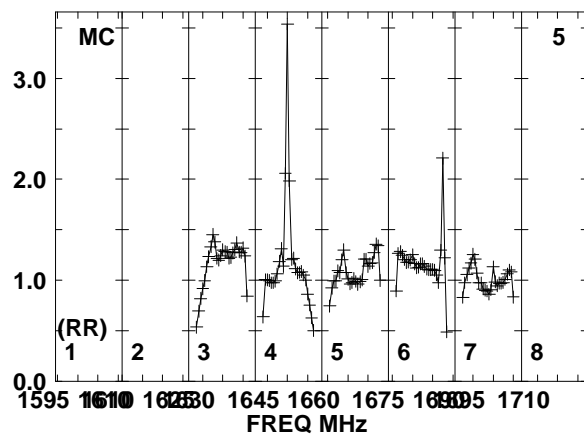
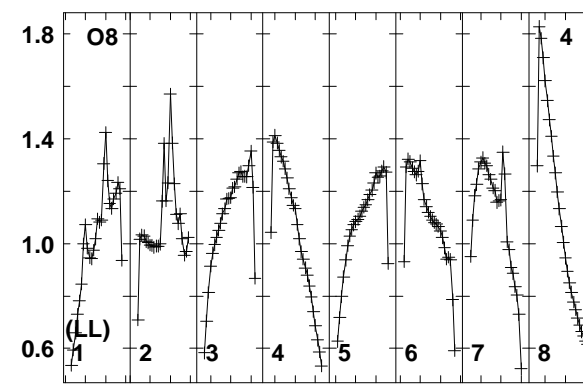
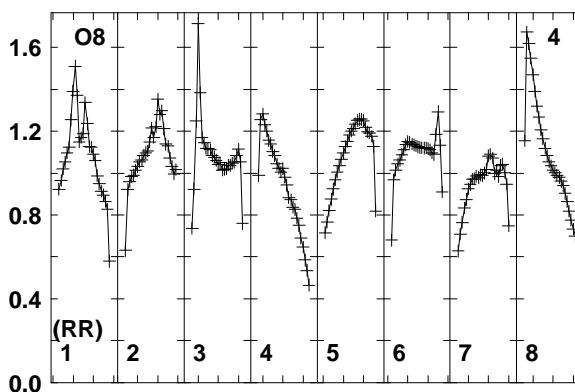
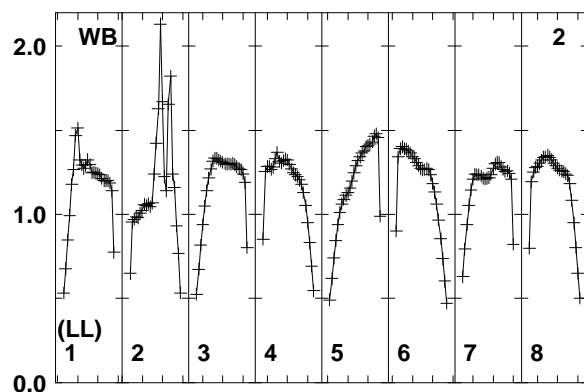
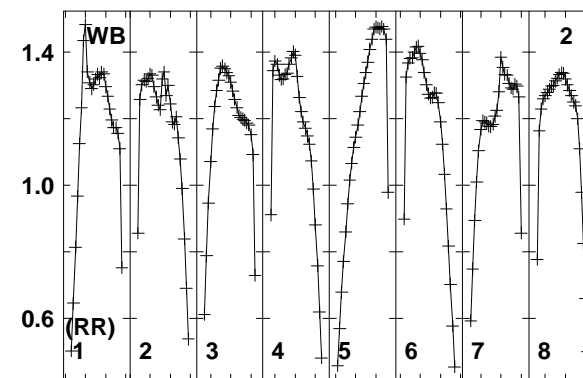
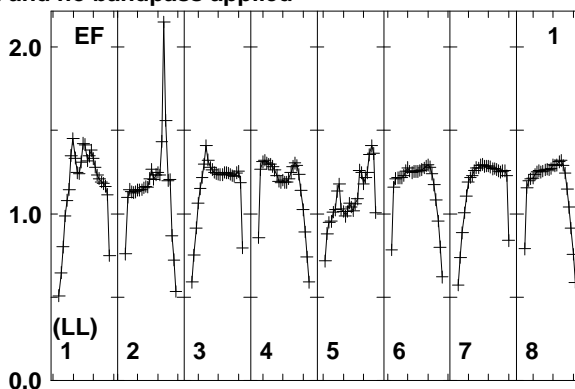
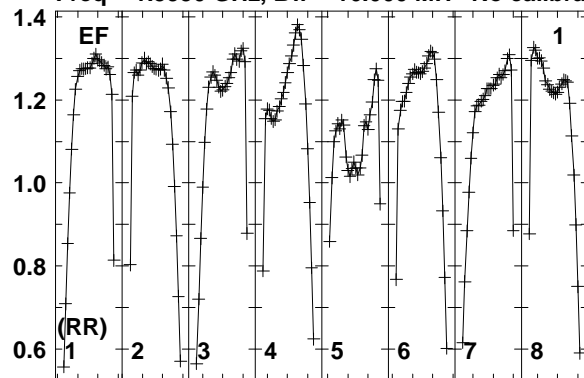

Lower frame: Real Jy
Total-power spectrum Antenna: EF (01)
Timerange: 00/04:12:07 to 00/04:13:30

Plot file version 270 created 19-AUG-2016 17:19:55

J1642+2523 EM119D.UVDATA.1

Freq = 1.5950 GHz, Bw = 16.000 MH No calibration applied and no bandpass applied

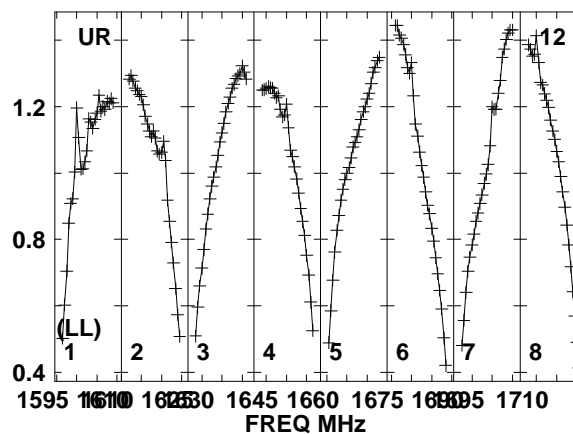
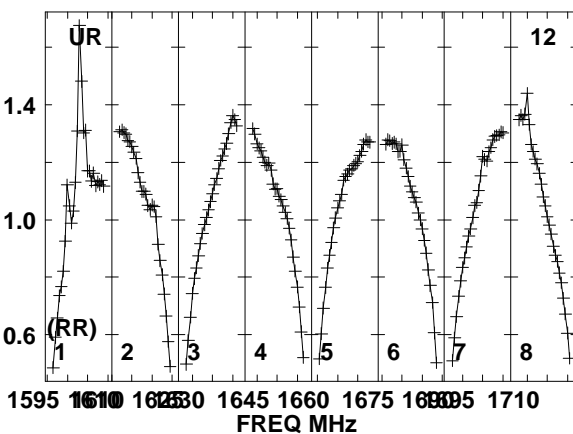
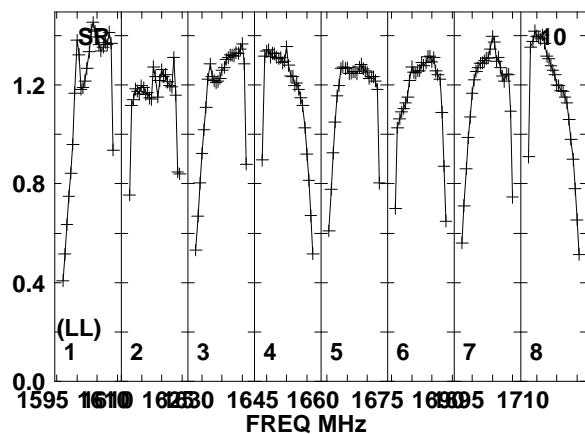
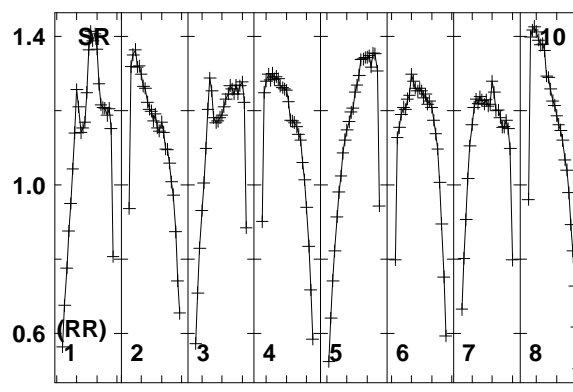
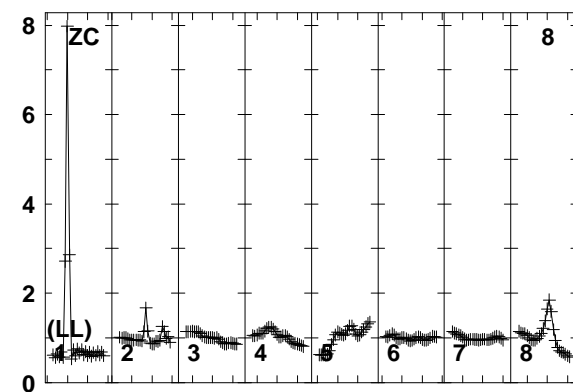
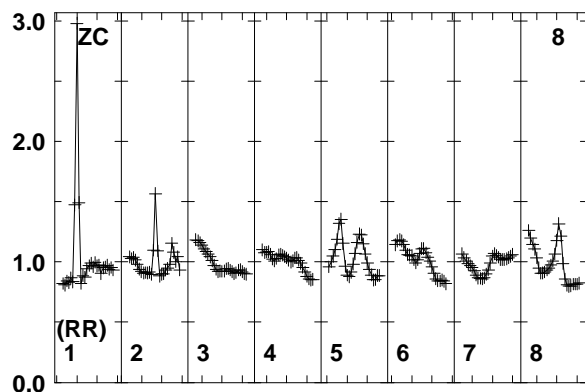
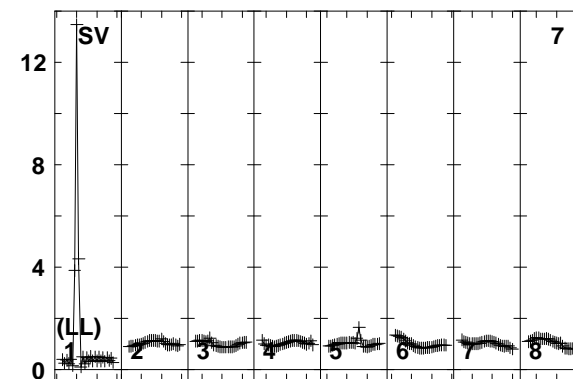
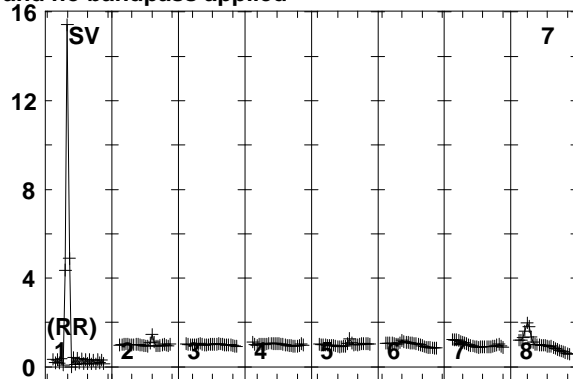
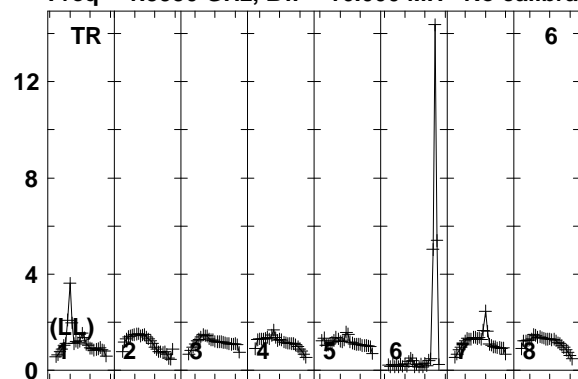

Lower frame: Real Jy
Total-power spectrum Antenna: TR (06)
Timerange: 00/04:12:07 to 00/04:13:30

Plot file version 271 created 19-AUG-2016 17:19:55

J1649+2635 EM119D.UVDATA.1

Freq = 1.5950 GHz, Bw = 16.000 MH No calibration applied and no bandpass applied

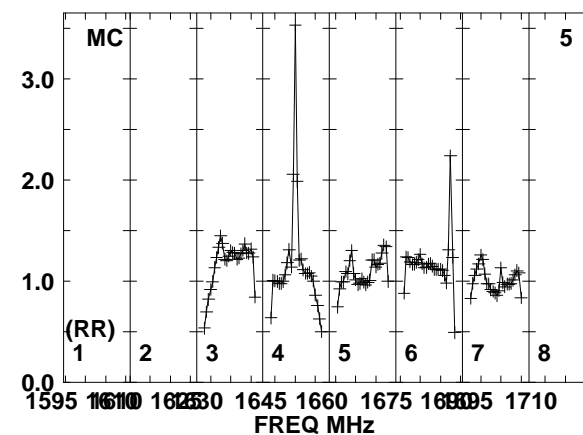
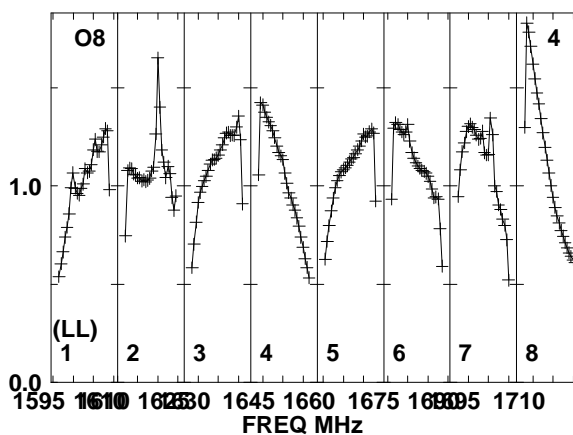
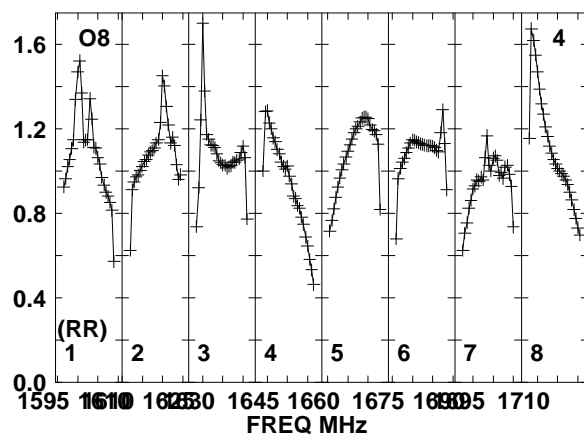
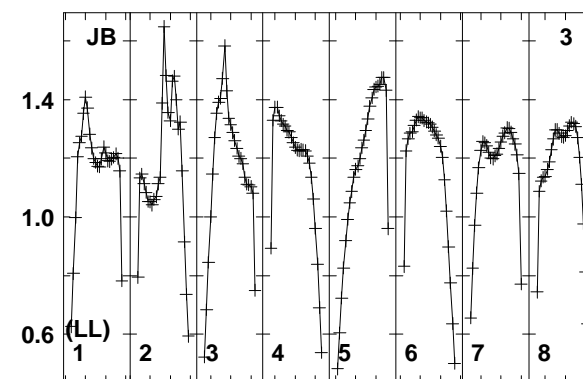
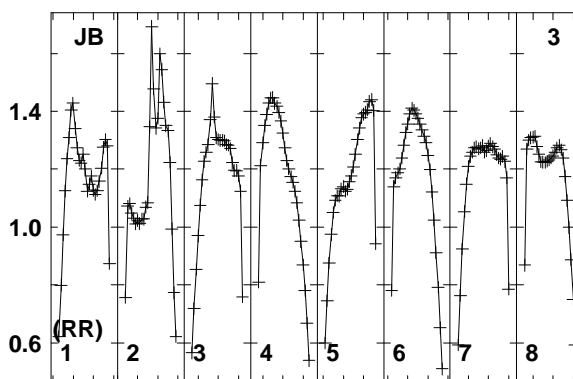
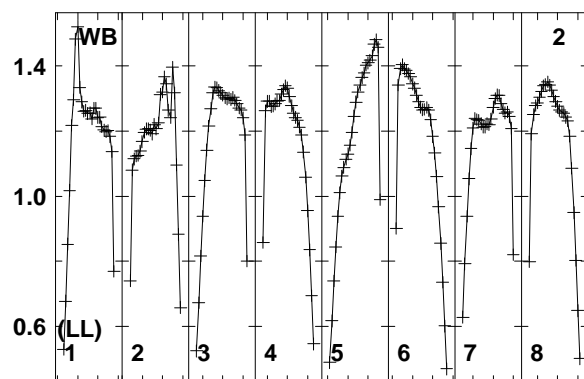
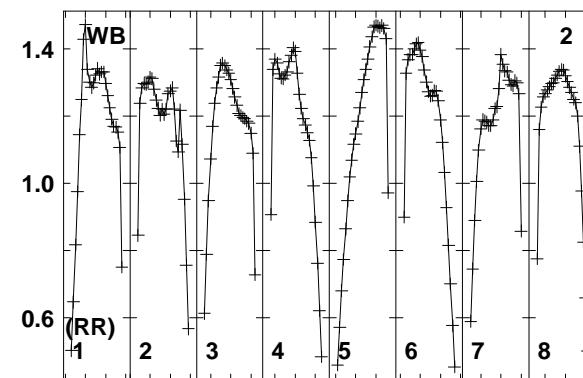
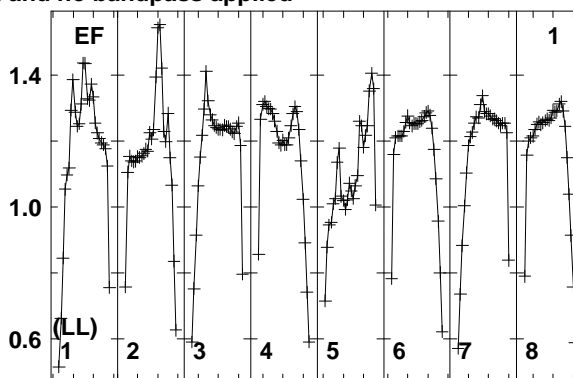
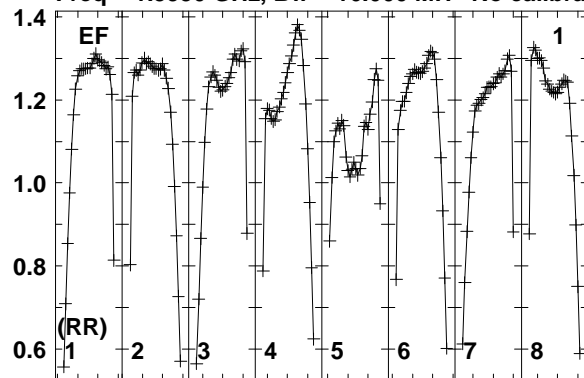

Lower frame: Real Jy
Total-power spectrum Antenna: EF (01)
Timerange: 00/04:14:30 to 00/04:18:00

Plot file version 272 created 19-AUG-2016 17:19:55

J1649+2635 EM119D.UVDATA.1

Freq = 1.5950 GHz, Bw = 16.000 MH No calibration applied and no bandpass applied

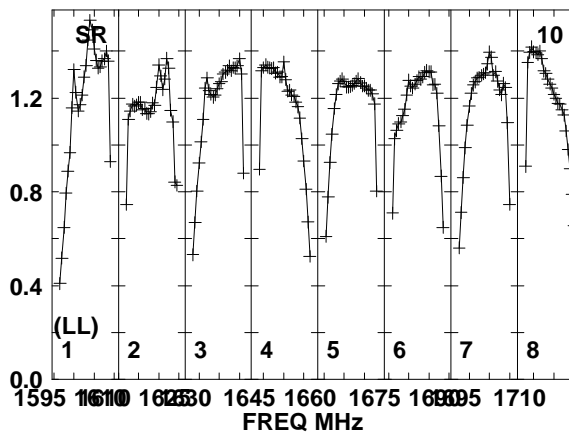
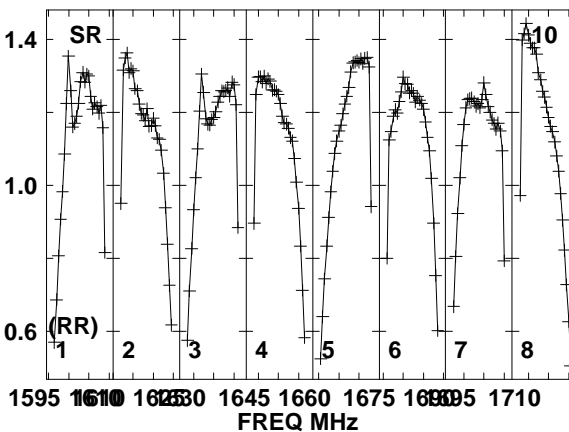
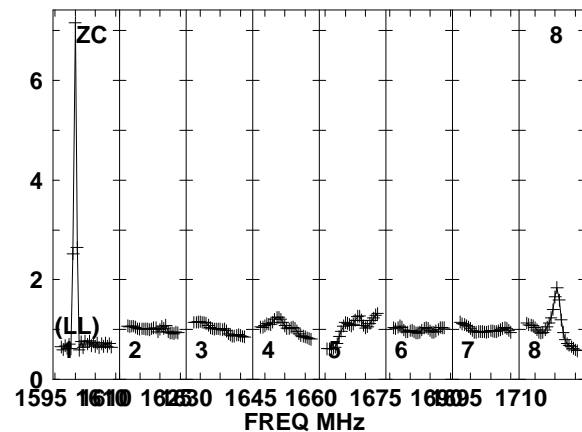
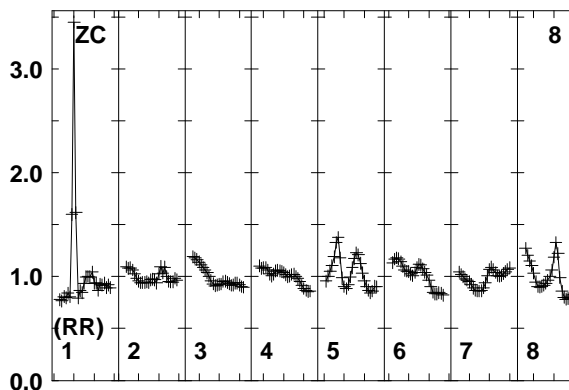
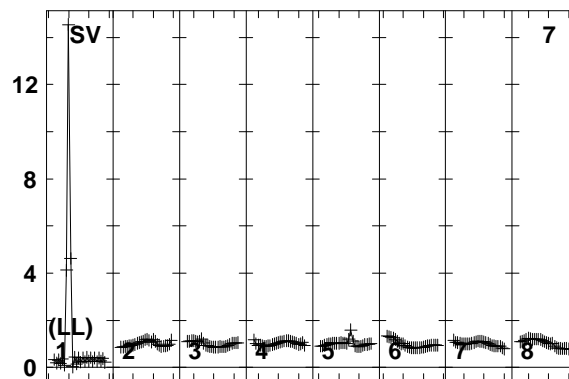
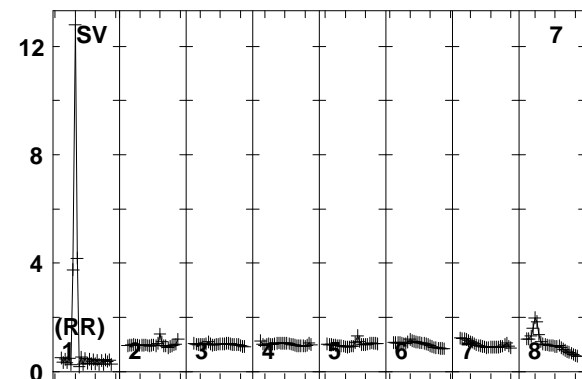
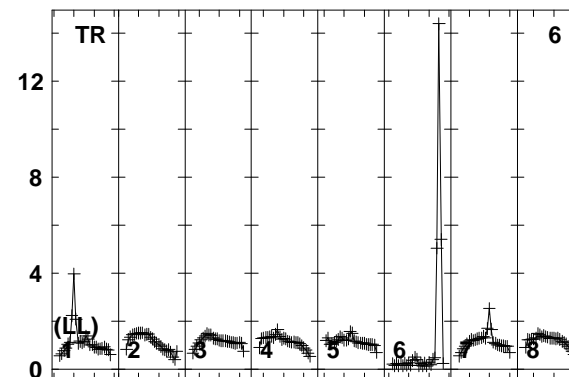
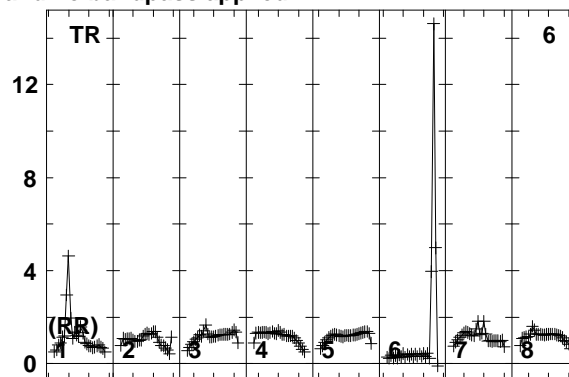
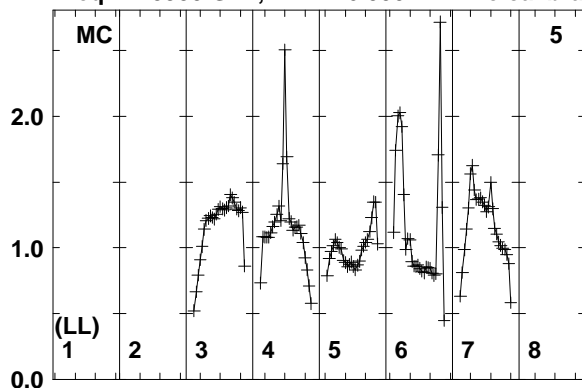

1595 1610 1625 1645 1660 1675 1690 1710
FREQ MHz
Lower frame: Real Jy
Total-power spectrum Antenna: MC (05)
Timerange: 00/04:14:30 to 00/04:18:00

Plot file version 273 created 19-AUG-2016 17:19:56

J1649+2635 EM119D.UVDATA.1

Freq = 1.5950 GHz, Bw = 16.000 MH No calibration applied and no bandpass applied

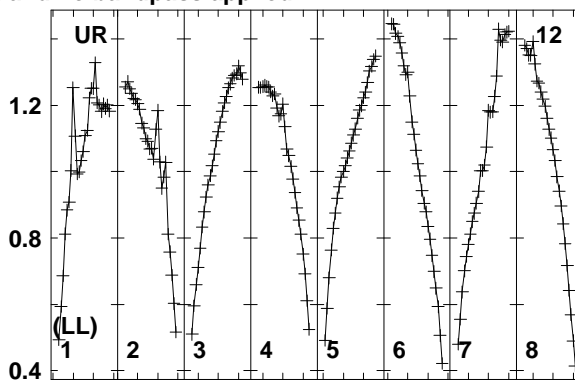
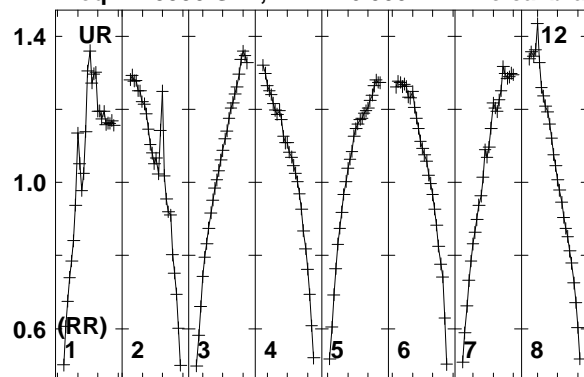

Lower frame: Real Jy
Total-power spectrum Antenna: UR (12)
Timerange: 00/04:14:30 to 00/04:18:00

Plot file version 274 created 19-AUG-2016 17:19:56

J1642+2523 EM119D.UVDATA.1

Freq = 1.5950 GHz, Bw = 16.000 MH No calibration applied and no bandpass applied

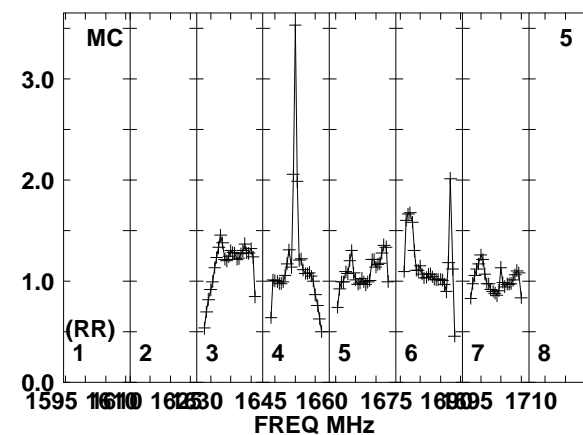
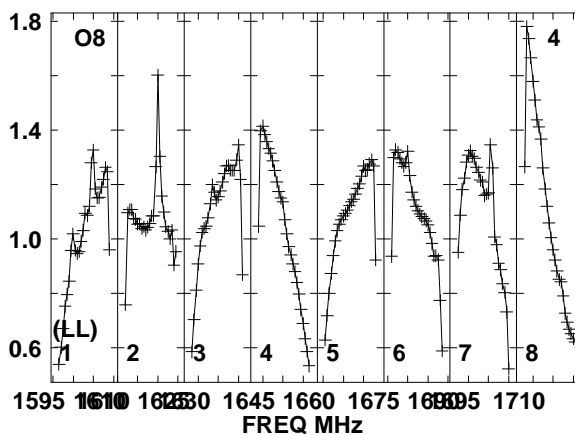
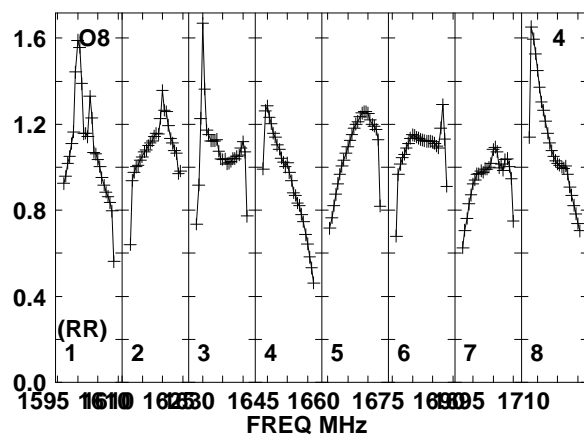
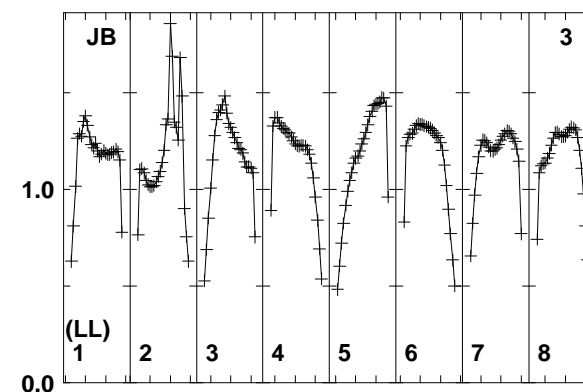
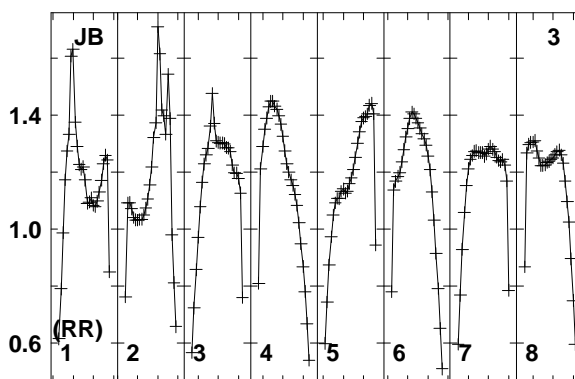
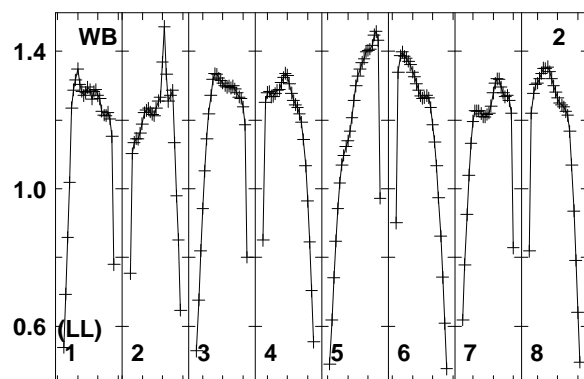
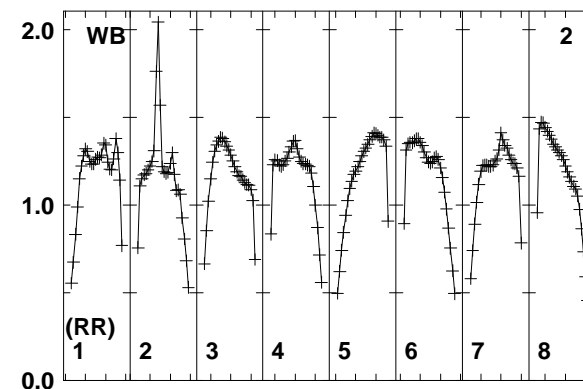
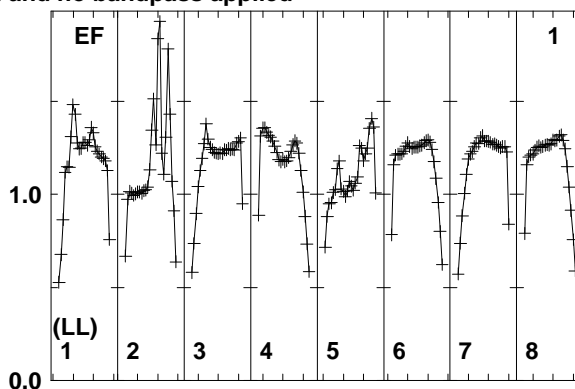
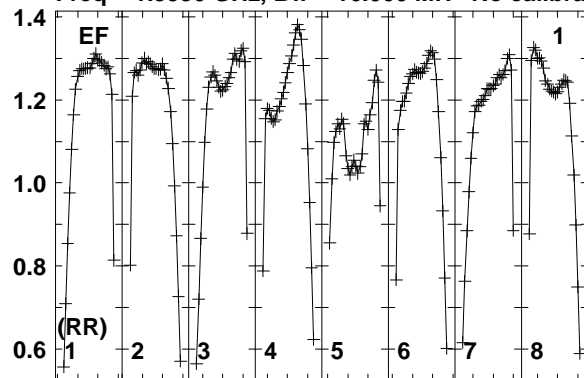

Lower frame: Real Jy
Total-power spectrum Antenna: EF (01)
Timerange: 00/04:18:07 to 00/04:19:29

Plot file version 275 created 19-AUG-2016 17:19:56

J1642+2523 EM119D.UVDATA.1

Freq = 1.5950 GHz, Bw = 16.000 MH No calibration applied and no bandpass applied

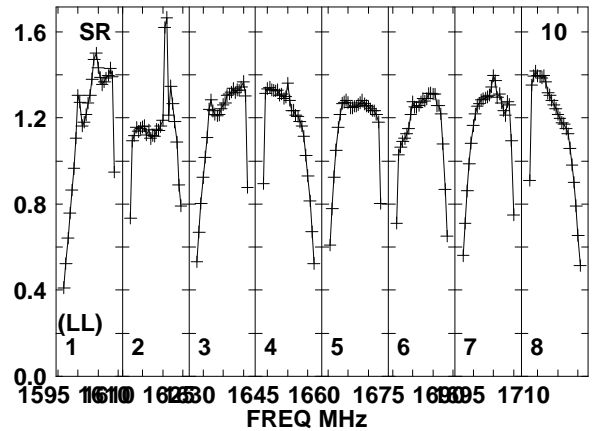
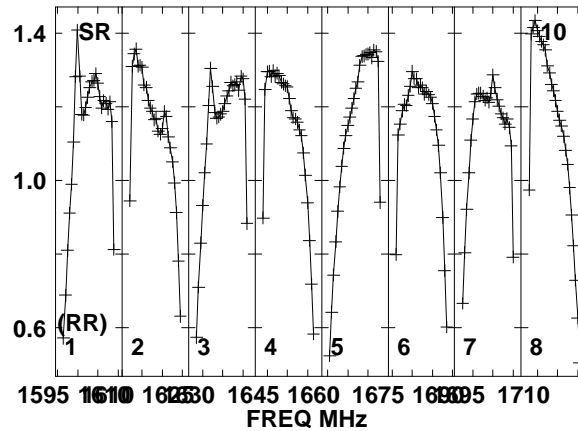
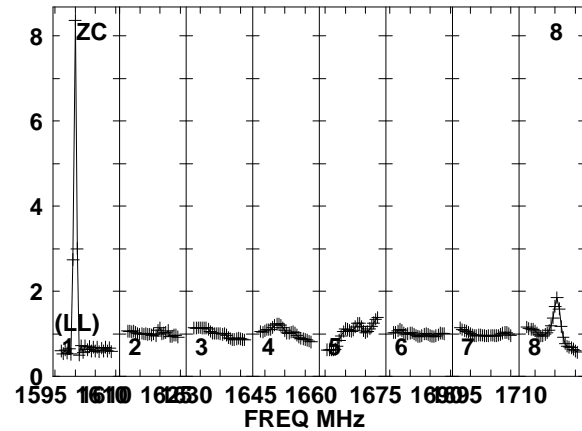
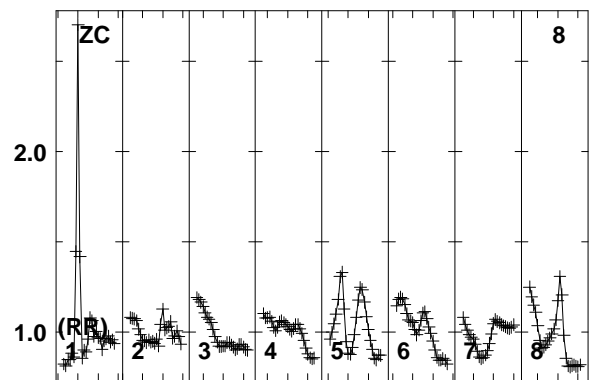
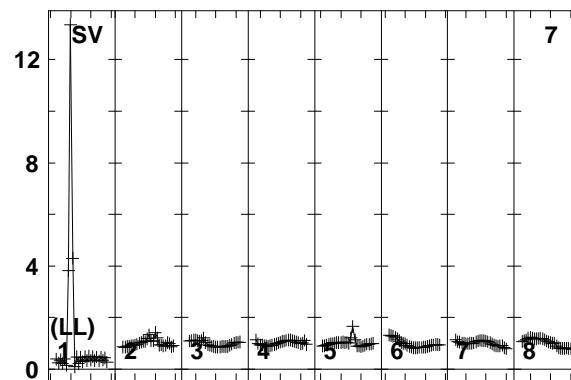
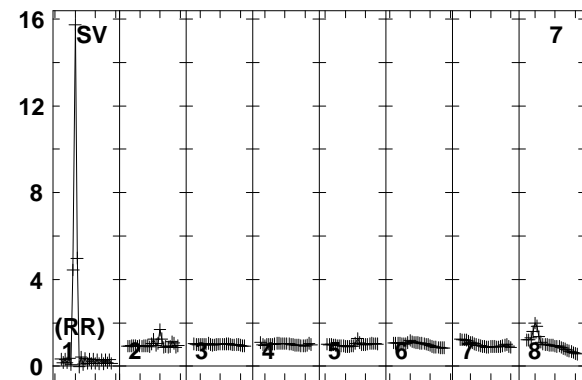
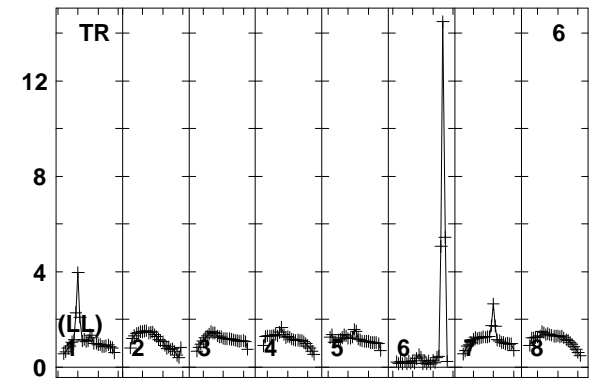
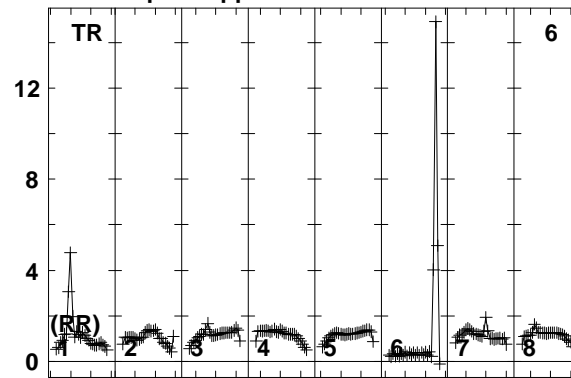
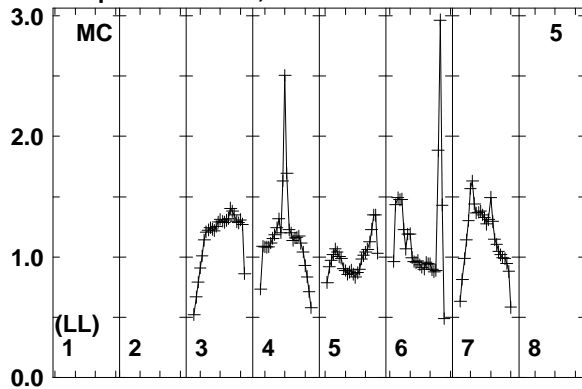

Lower frame: Real Jy
Total-power spectrum Antenna: MC (05)
Timerange: 00/04:18:07 to 00/04:19:29

Plot file version 276 created 19-AUG-2016 17:19:56

J1642+2523 EM119D.UVDATA.1

Freq = 1.5950 GHz, Bw = 16.000 MH No calibration applied and no bandpass applied

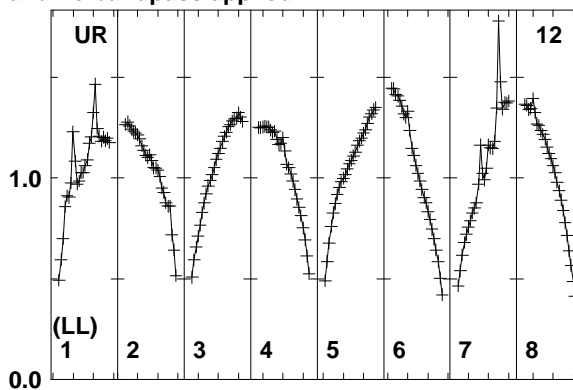
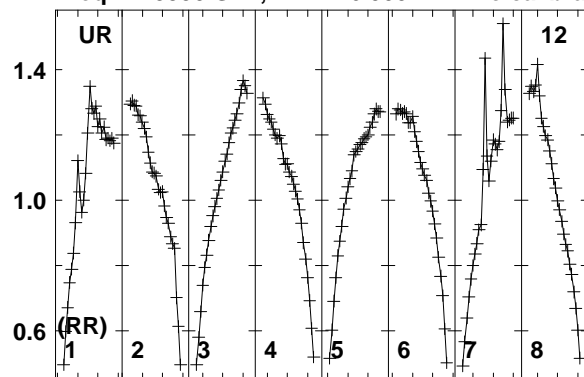

Lower frame: Real Jy
Total-power spectrum Antenna: UR (12)
Timerange: 00/04:18:07 to 00/04:19:29

Plot file version 277 created 19-AUG-2016 17:19:56

J1649+2635 EM119D.UVDATA.1

Freq = 1.5950 GHz, Bw = 16.000 MH No calibration applied and no bandpass applied

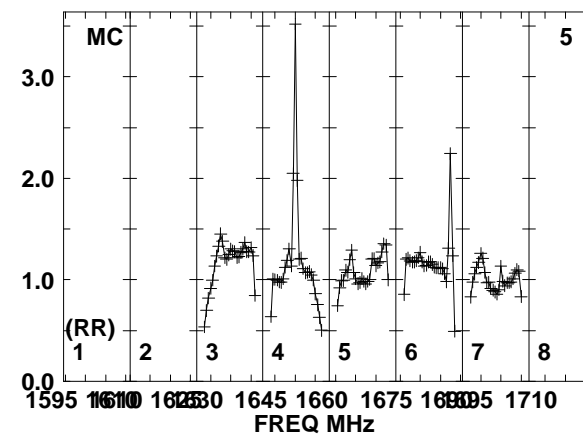
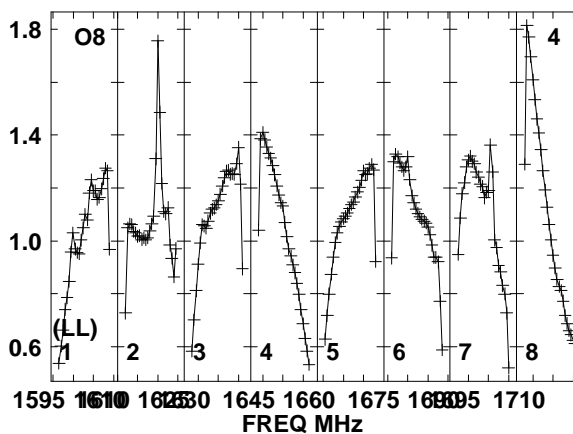
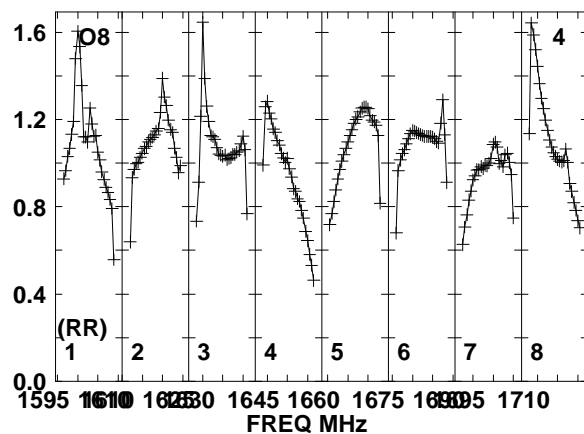
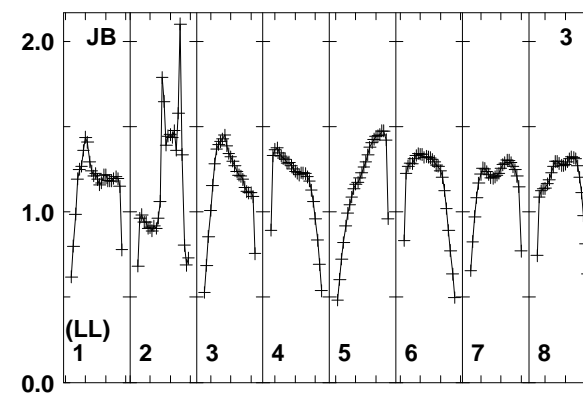
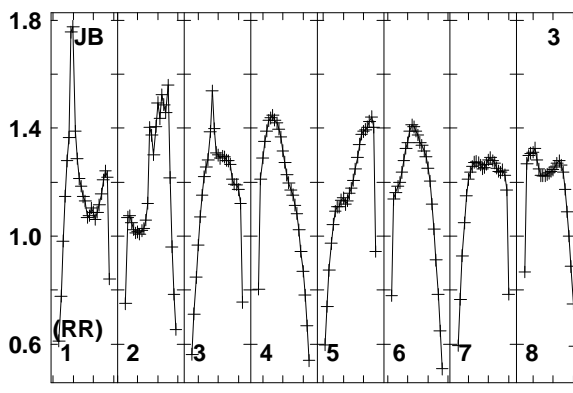
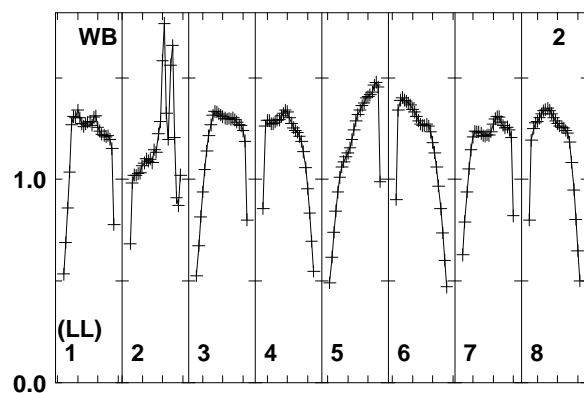
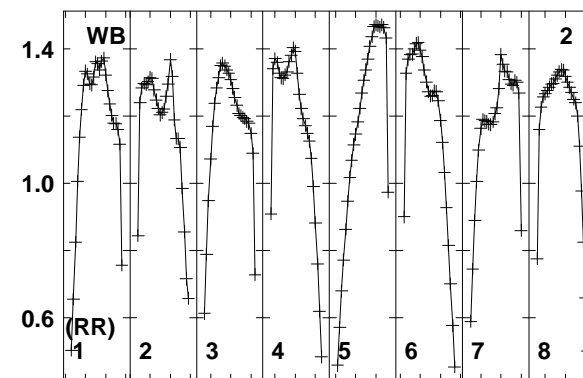
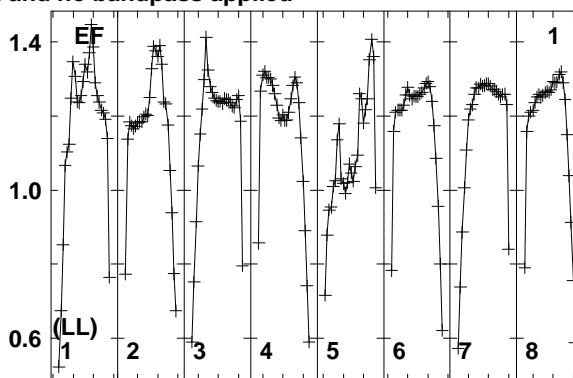
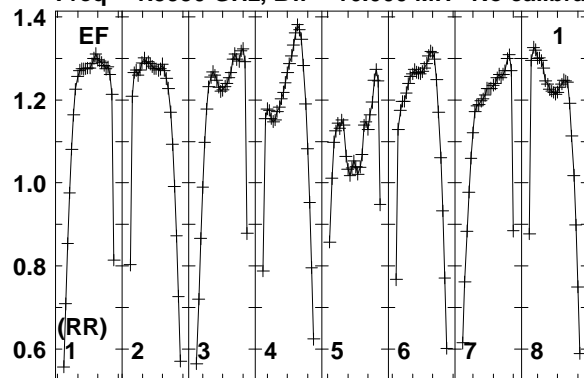

Lower frame: Real Jy
Total-power spectrum Antenna: EF (01)
Timerange: 00/04:19:38 to 00/04:23:00

Plot file version 278 created 19-AUG-2016 17:19:56

J1649+2635 EM119D.UVDATA.1

Freq = 1.5950 GHz, Bw = 16.000 MH No calibration applied and no bandpass applied

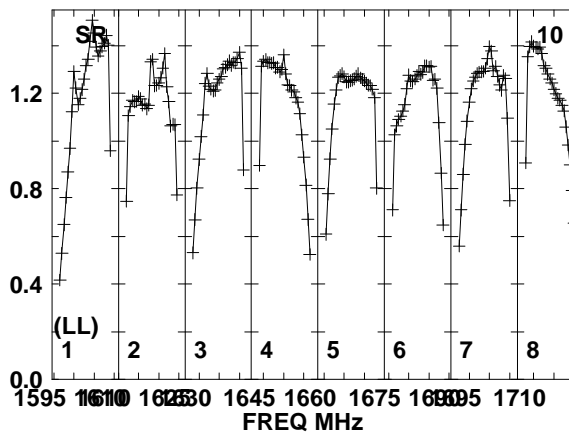
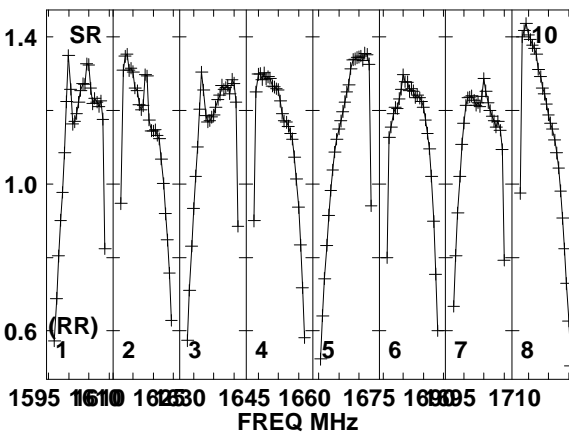
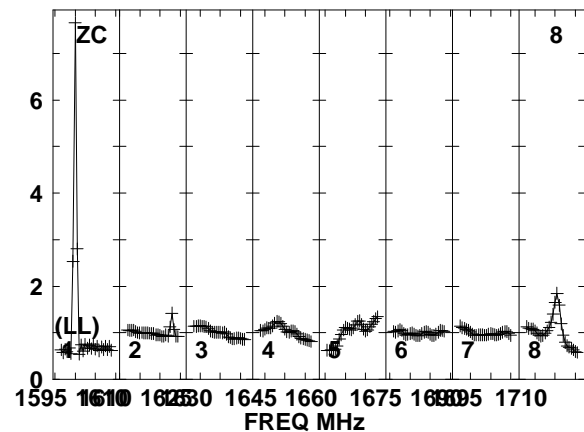
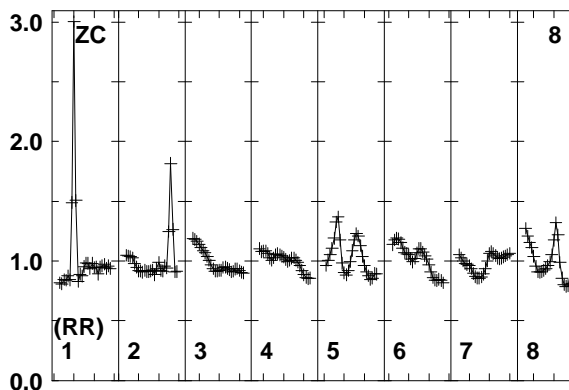
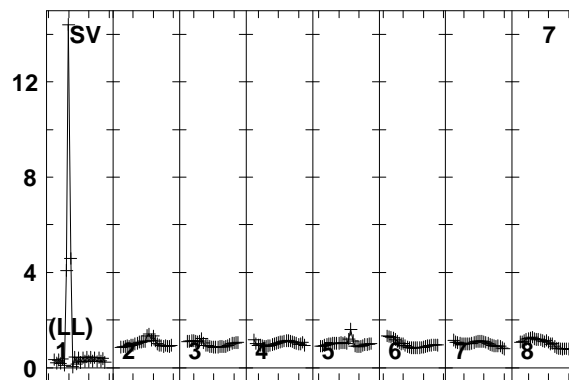
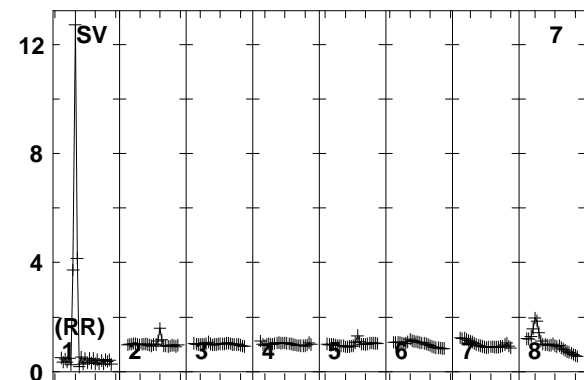
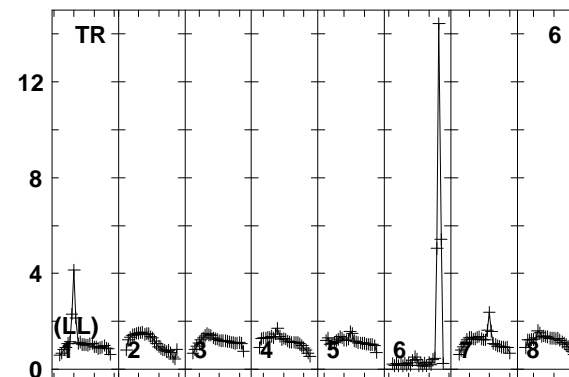
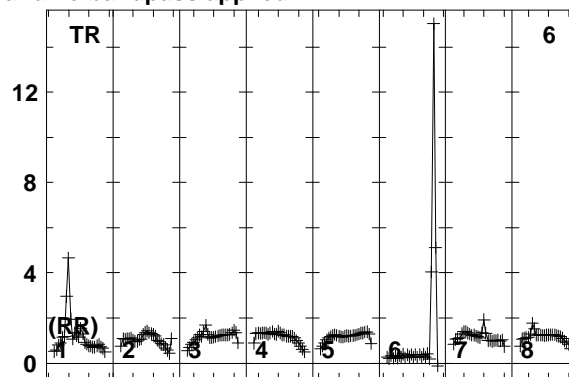
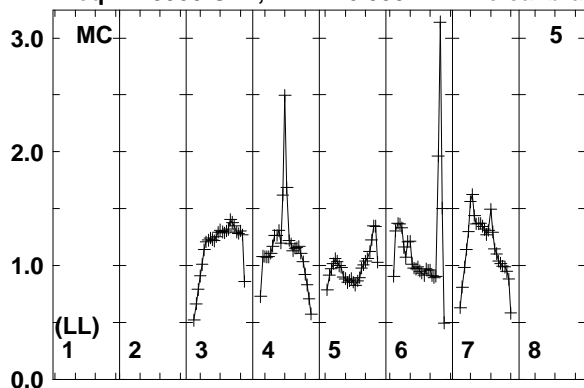

Lower frame: Real Jy
Total-power spectrum Antenna: MC (05)
Timerange: 00/04:19:38 to 00/04:23:00

Plot file version 279 created 19-AUG-2016 17:19:57

J1649+2635 EM119D.UVDATA.1

Freq = 1.5950 GHz, Bw = 16.000 MH No calibration applied and no bandpass applied

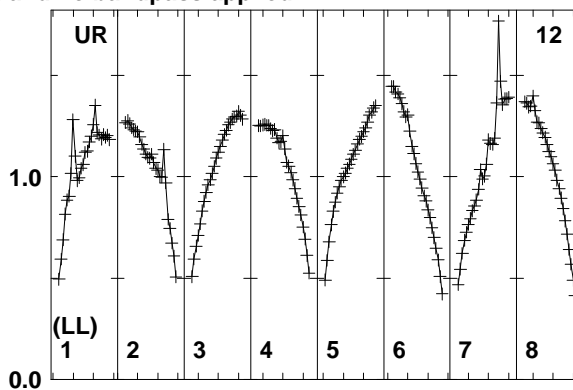
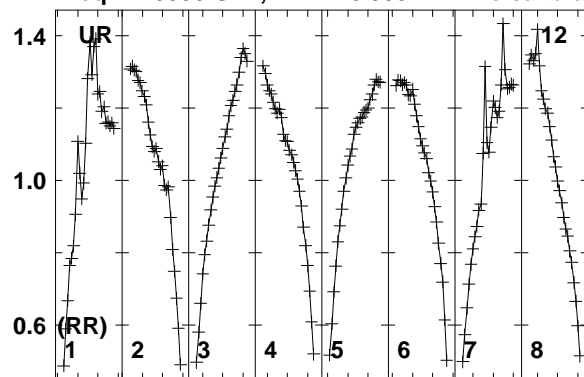

Lower frame: Real Jy
Total-power spectrum Antenna: UR (12)
Timerange: 00/04:19:38 to 00/04:23:00

Plot file version 280 created 19-AUG-2016 17:19:57

J1642+2523 EM119D.UVDATA.1

Freq = 1.5950 GHz, Bw = 16.000 MH No calibration applied and no bandpass applied

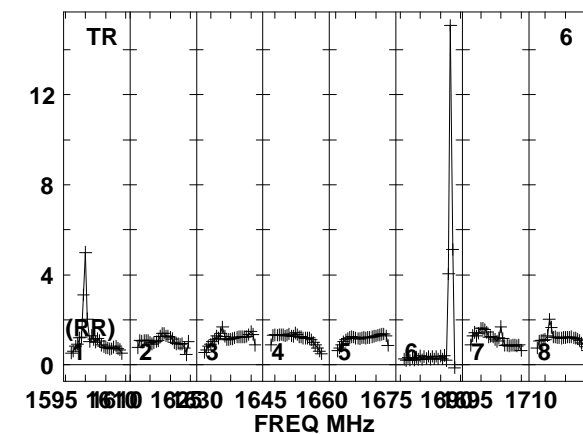
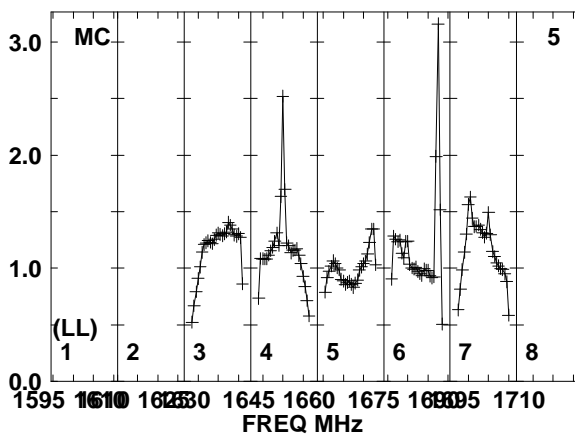
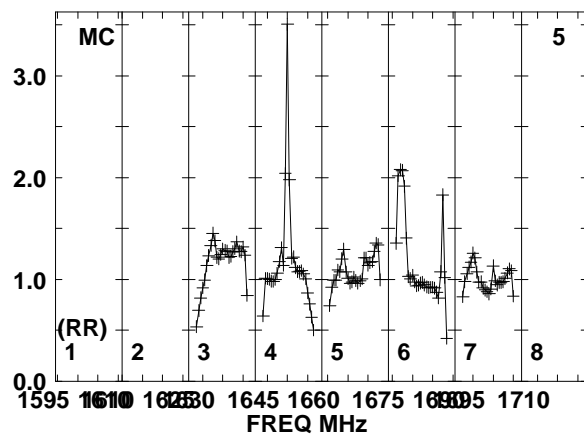
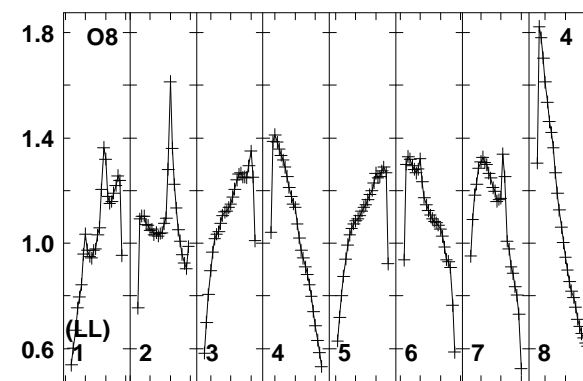
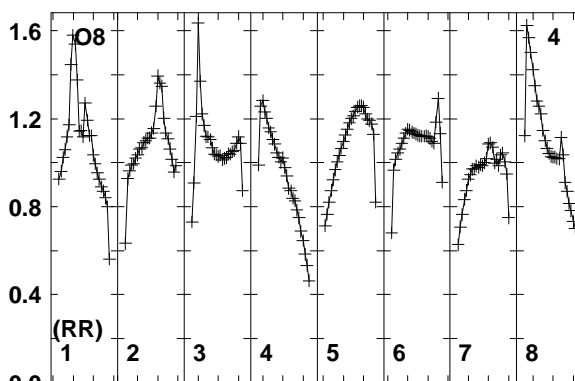
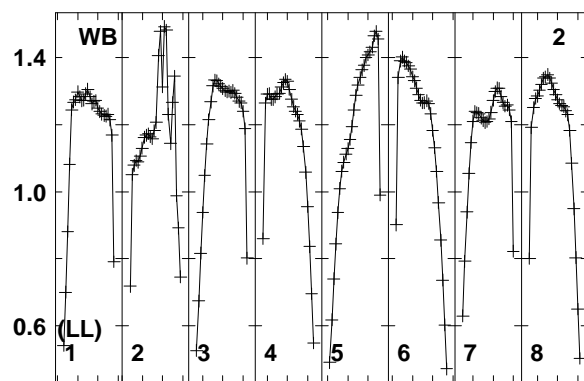
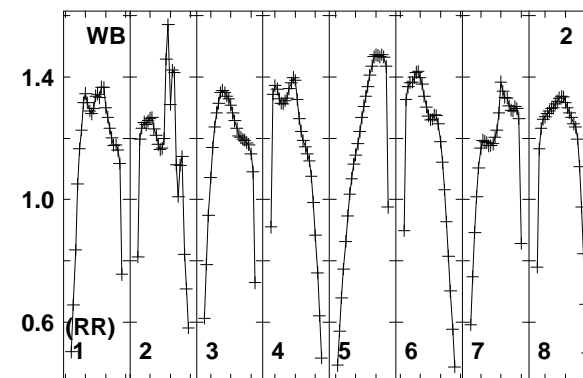
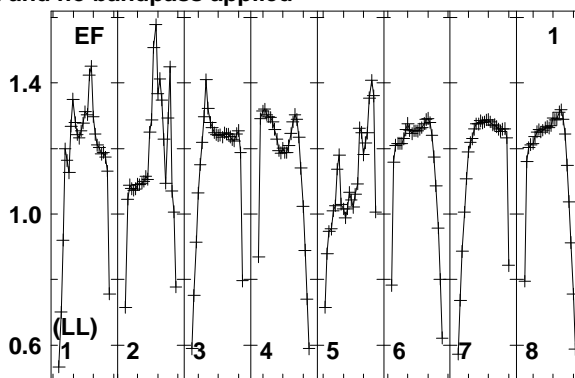
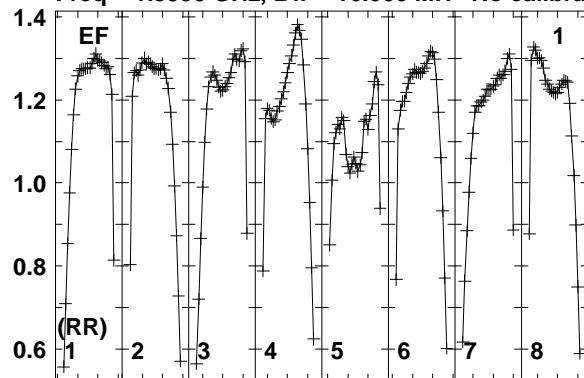

Lower frame: Real Jy
Total-power spectrum Antenna: EF (01)
Timerange: 00/04:23:08 to 00/04:24:30

Plot file version 281 created 19-AUG-2016 17:19:57

J1642+2523 EM119D.UVDATA.1

Freq = 1.5950 GHz, Bw = 16.000 MH No calibration applied and no bandpass applied

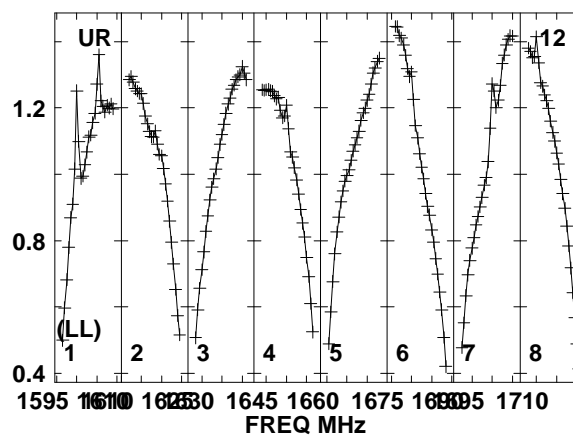
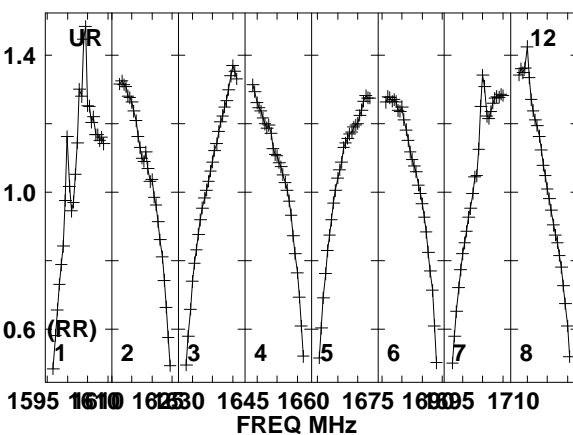
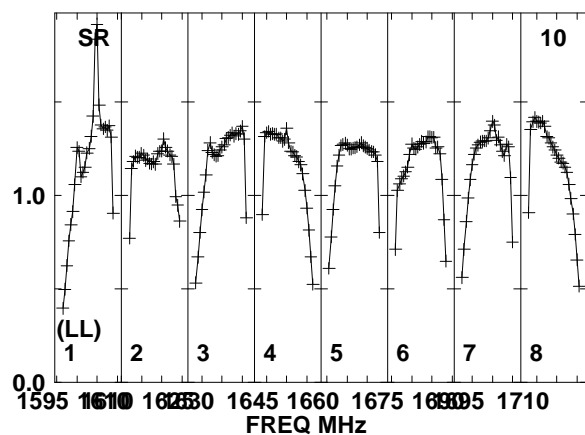
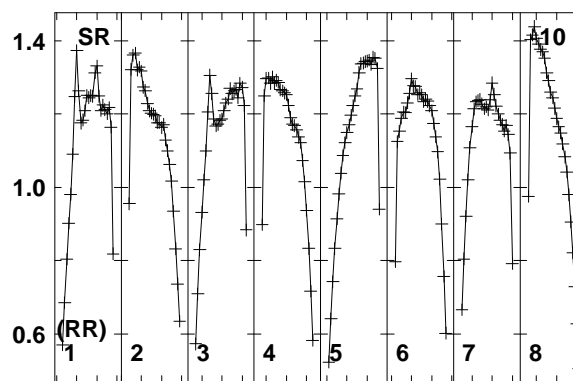
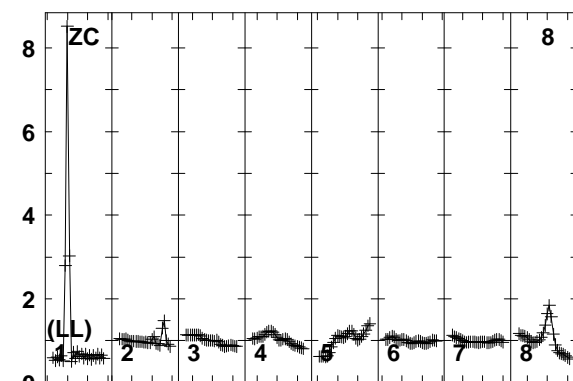
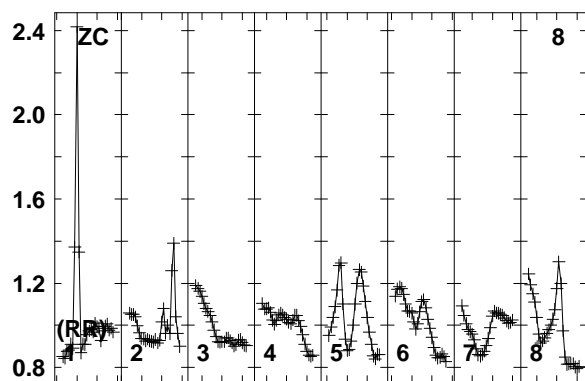
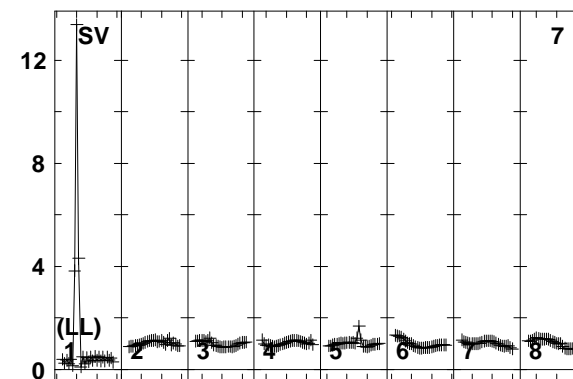
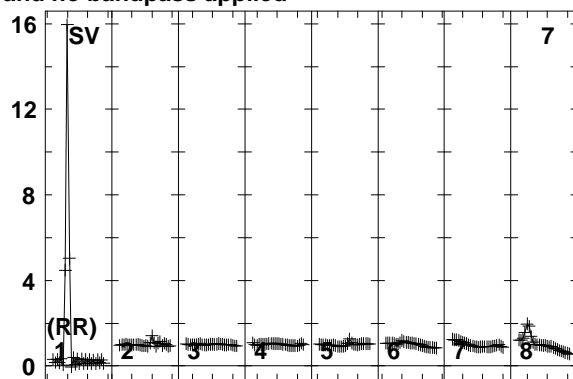
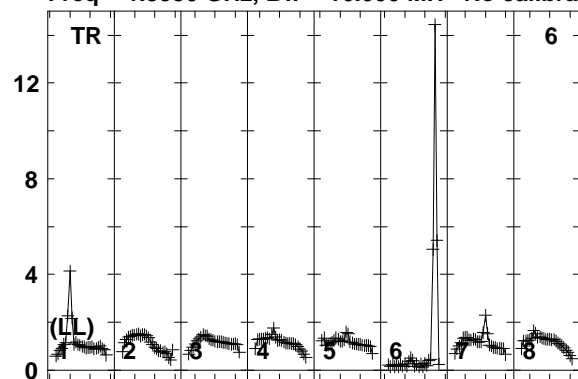

Lower frame: Real Jy
Total-power spectrum Antenna: TR (06)
Timerange: 00/04:23:08 to 00/04:24:30

Plot file version 282 created 19-AUG-2016 17:19:57

J1649+2635 EM119D.UVDATA.1

Freq = 1.5950 GHz, Bw = 16.000 MH No calibration applied and no bandpass applied

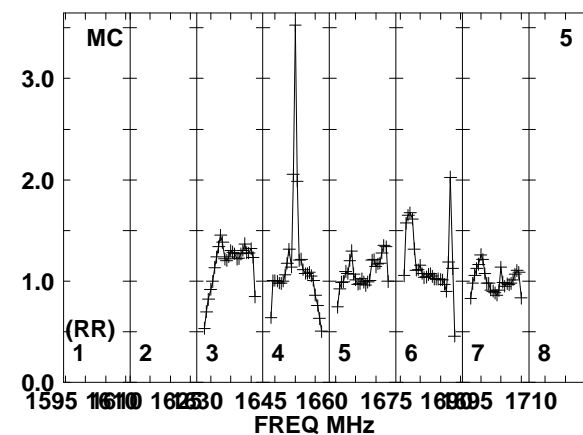
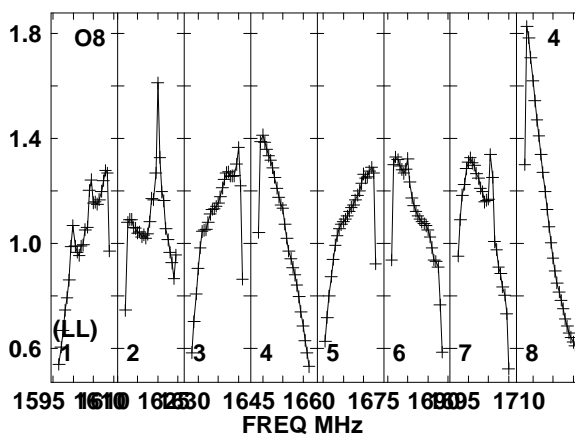
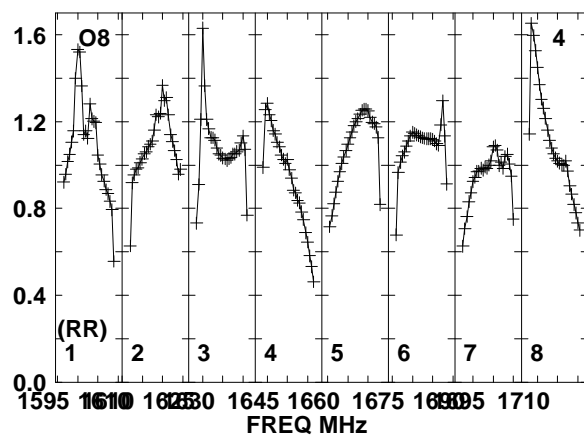
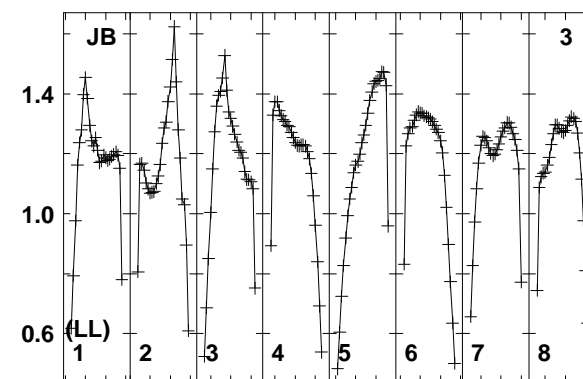
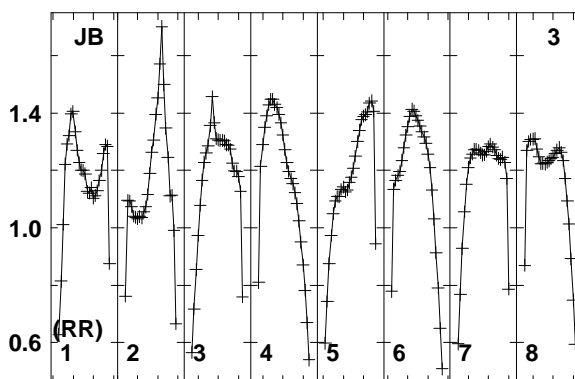
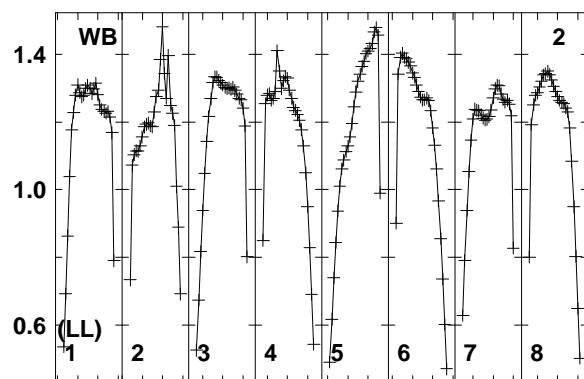
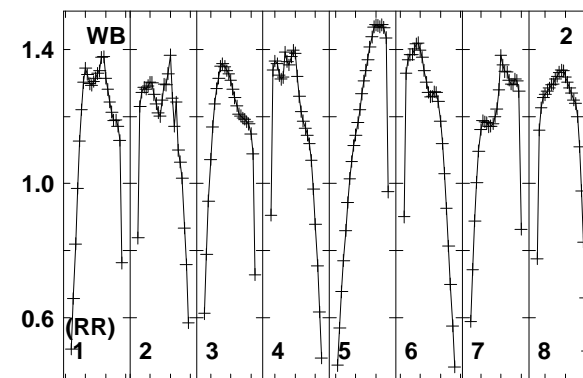
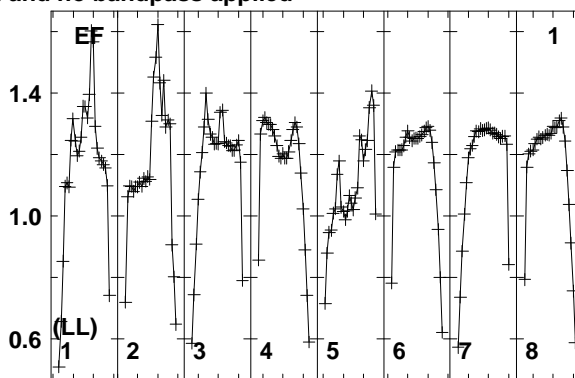
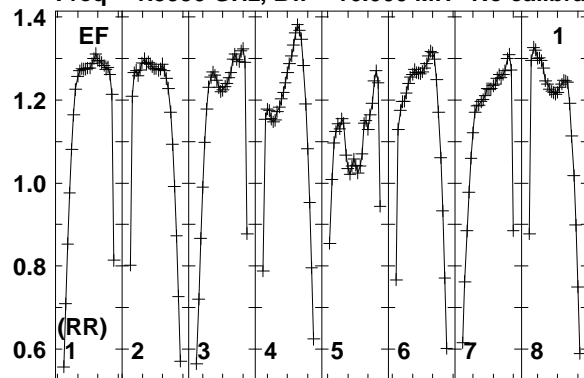

Lower frame: Real Jy
Total-power spectrum Antenna: EF (01)
Timerange: 00/04:24:32 to 00/04:28:00

Plot file version 283 created 19-AUG-2016 17:19:57

J1649+2635 EM119D.UVDATA.1

Freq = 1.5950 GHz, Bw = 16.000 MH No calibration applied and no bandpass applied

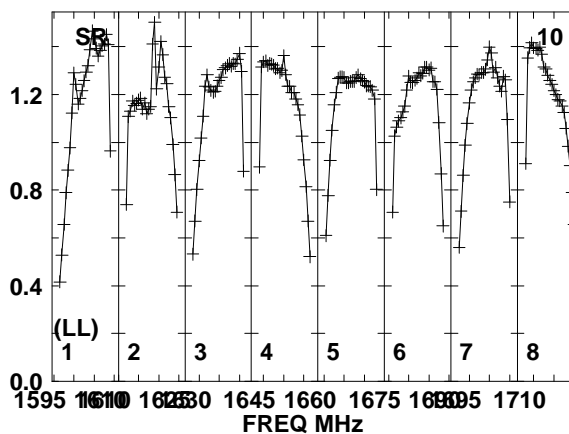
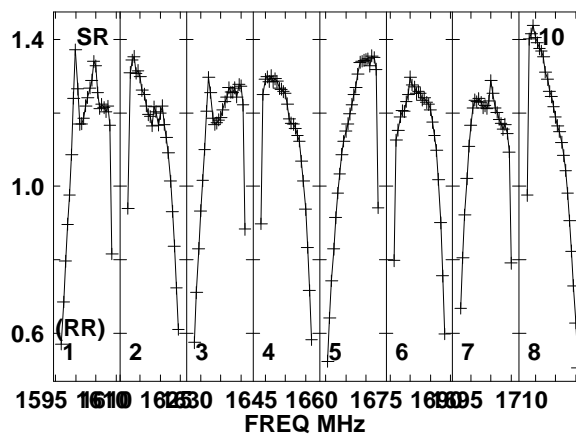
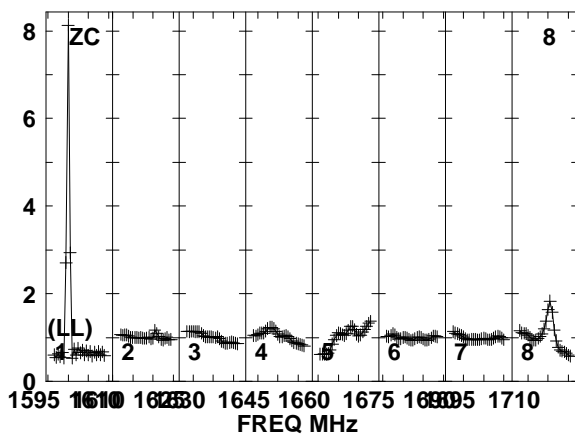
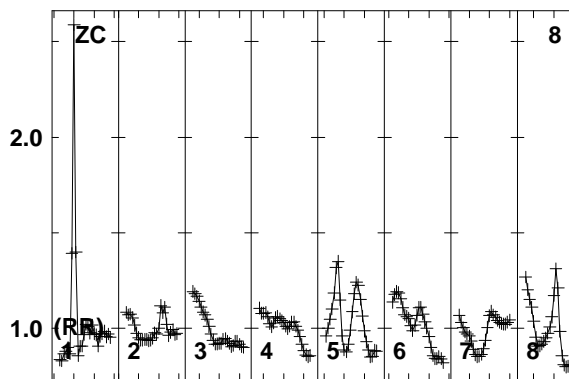
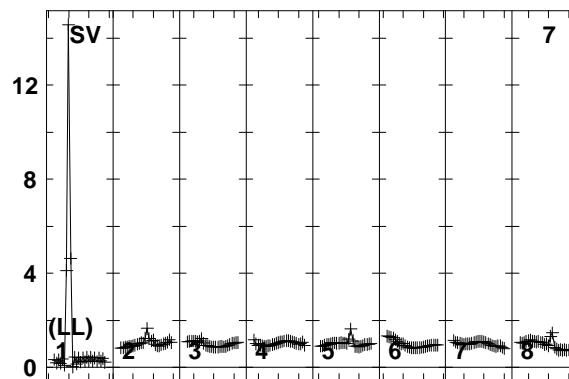
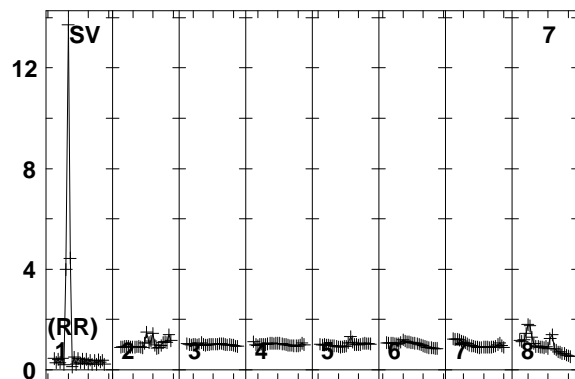
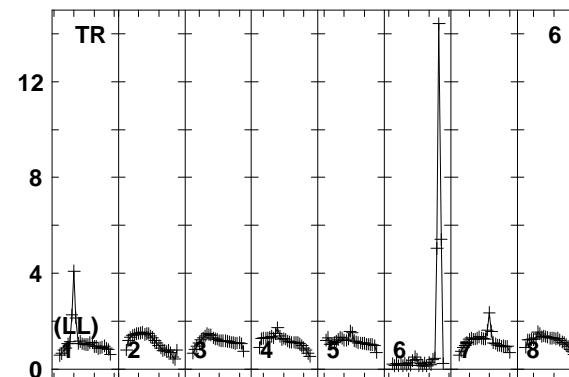
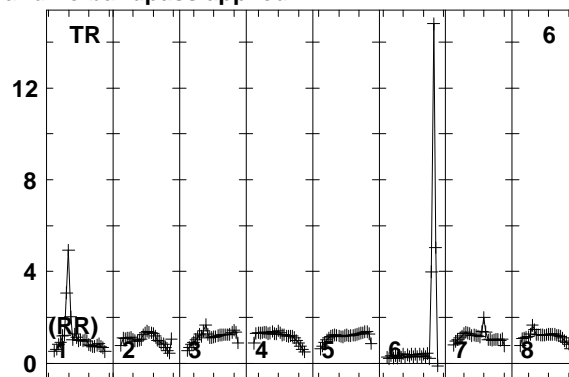
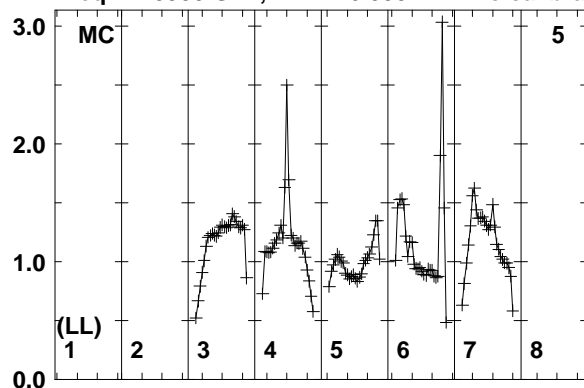

Lower frame: Real Jy
Total-power spectrum Antenna: MC (05)
Timerange: 00/04:24:32 to 00/04:28:00

Plot file version 284 created 19-AUG-2016 17:19:57

J1649+2635 EM119D.UVDATA.1

Freq = 1.5950 GHz, Bw = 16.000 MH No calibration applied and no bandpass applied

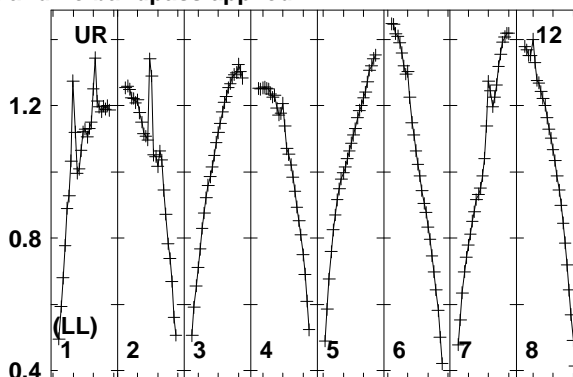
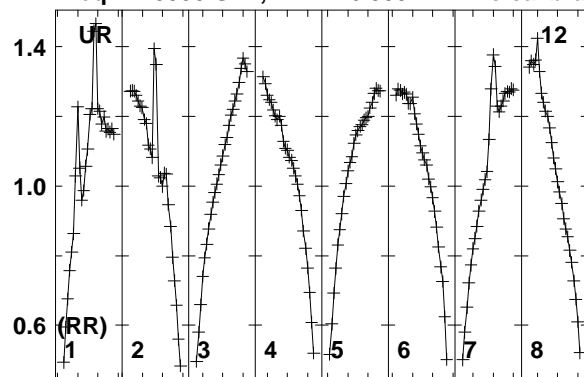

Lower frame: Real Jy
Total-power spectrum Antenna: UR (12)
Timerange: 00/04:24:32 to 00/04:28:00

Plot file version 285 created 19-AUG-2016 17:19:58

J1642+2523 EM119D.UVDATA.1

Freq = 1.5950 GHz, Bw = 16.000 MH No calibration applied and no bandpass applied

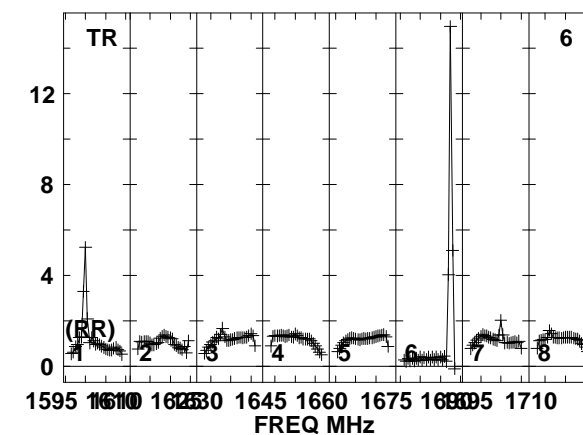
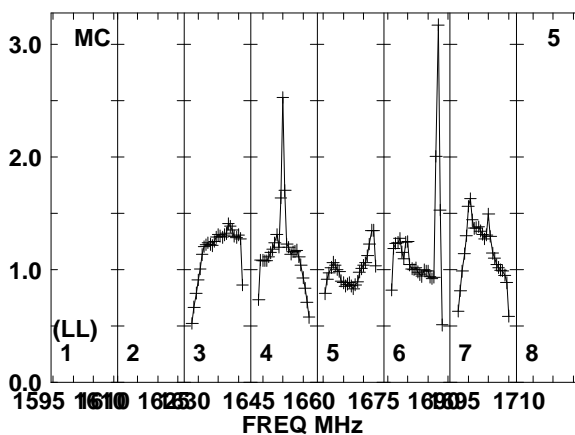
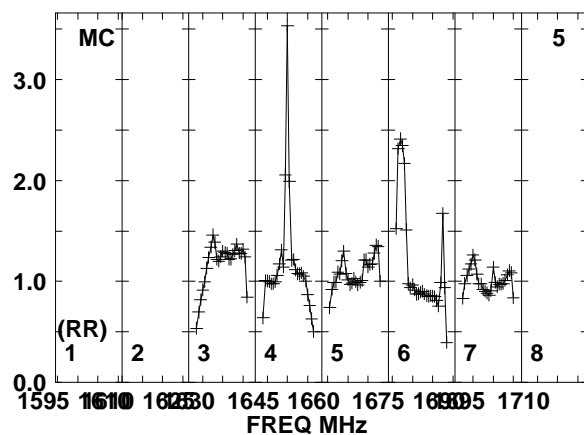
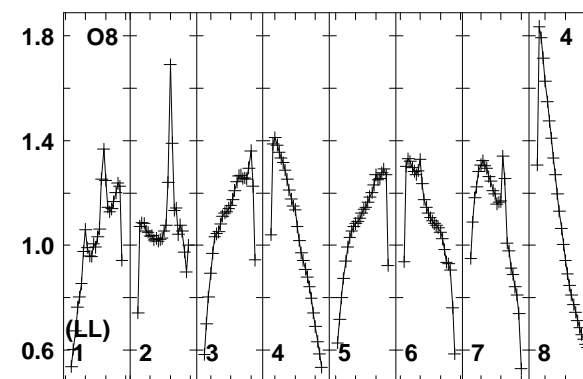
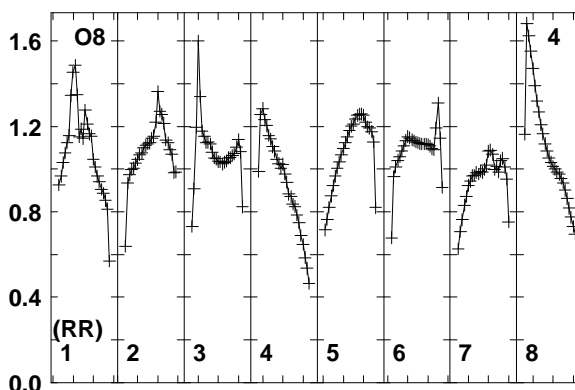
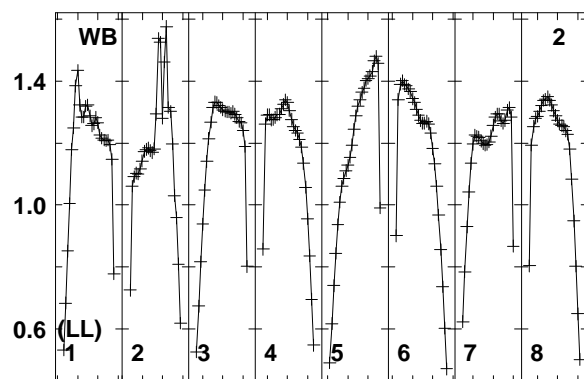
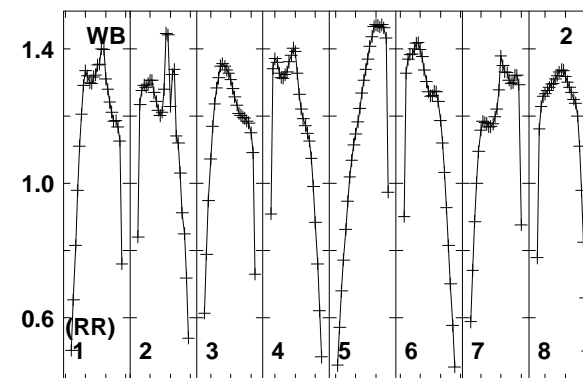
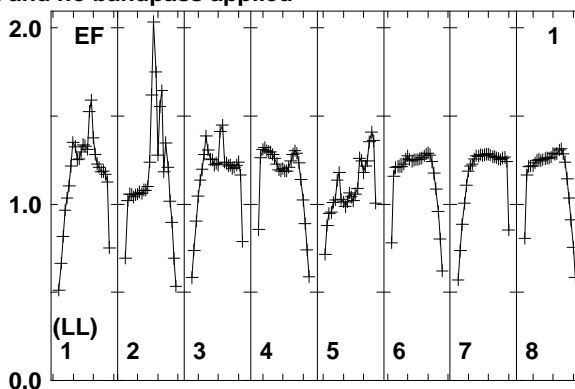
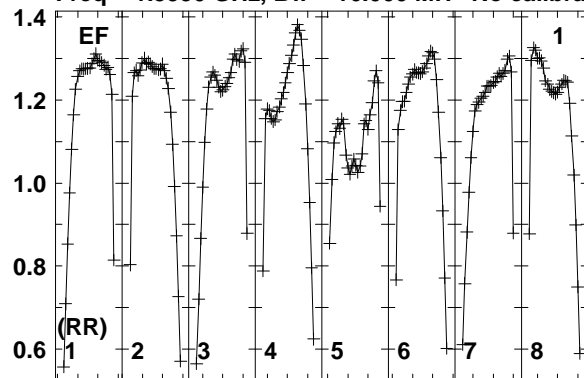

Lower frame: Real Jy
Total-power spectrum Antenna: EF (01)
Timerange: 00/04:28:08 to 00/04:29:29

Plot file version 286 created 19-AUG-2016 17:19:58

J1642+2523 EM119D.UVDATA.1

Freq = 1.5950 GHz, Bw = 16.000 MH No calibration applied and no bandpass applied

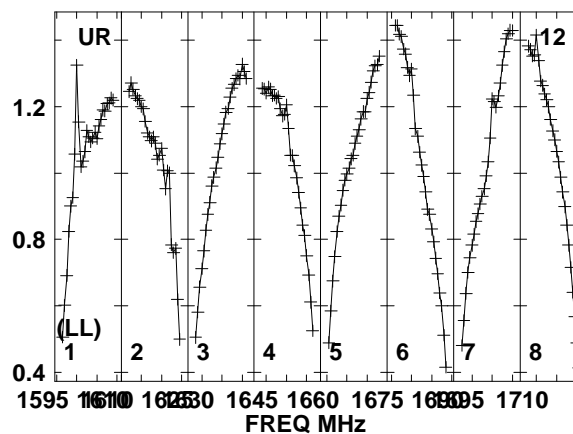
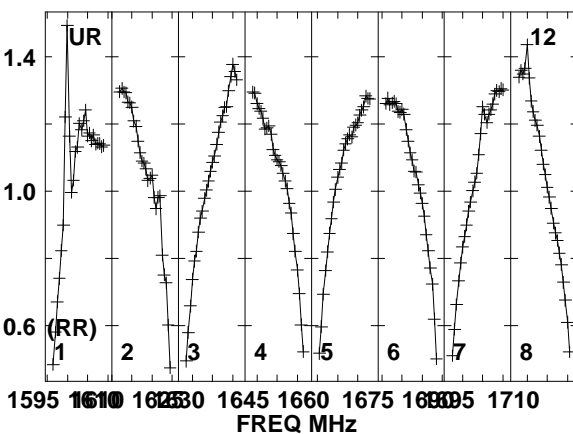
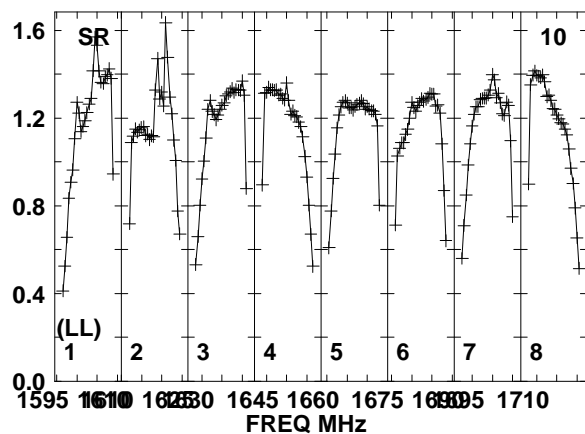
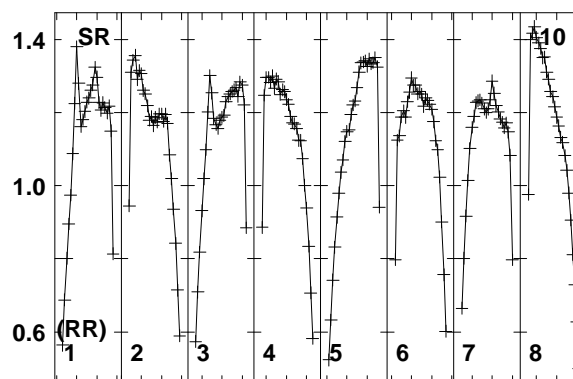
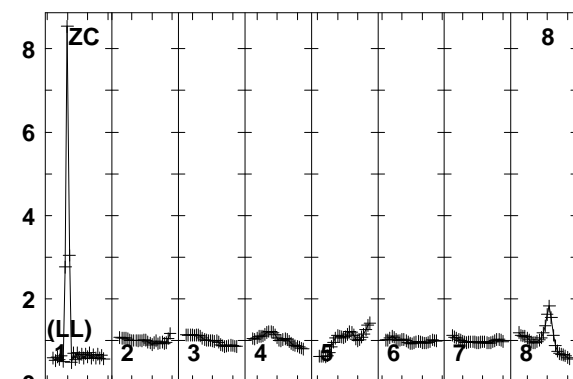
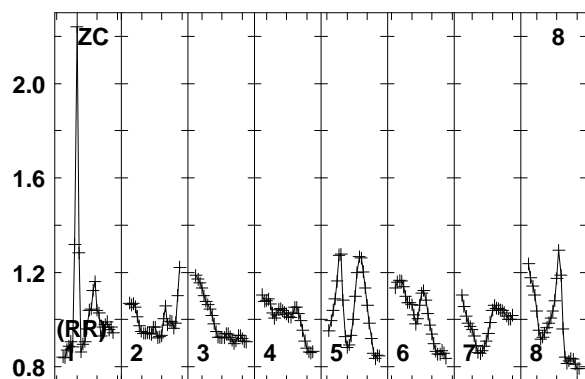
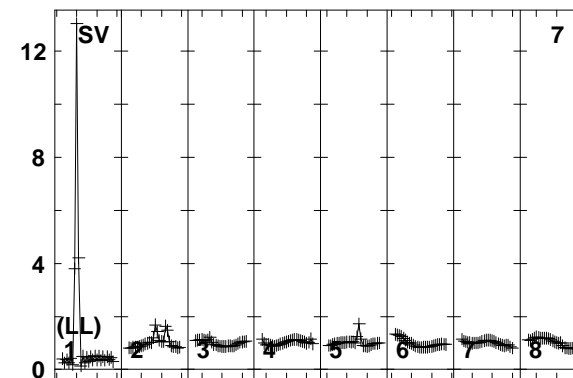
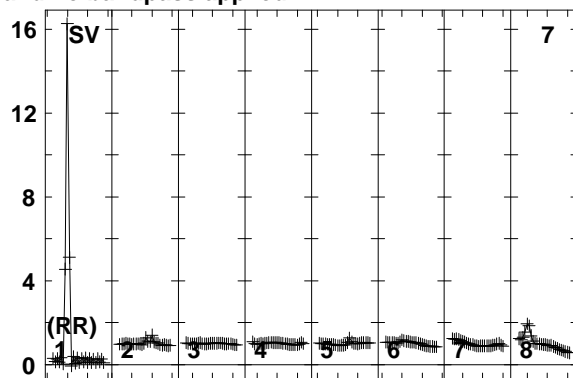
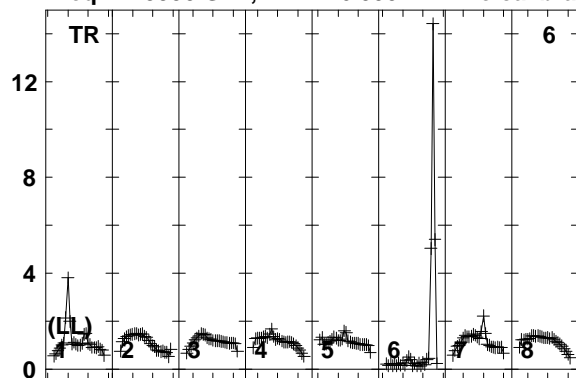

Lower frame: Real Jy
Total-power spectrum Antenna: TR (06)
Timerange: 00/04:28:08 to 00/04:29:29

Plot file version 287 created 19-AUG-2016 17:19:58

J1649+2635 EM119D.UVDATA.1

Freq = 1.5950 GHz, Bw = 16.000 MH No calibration applied and no bandpass applied

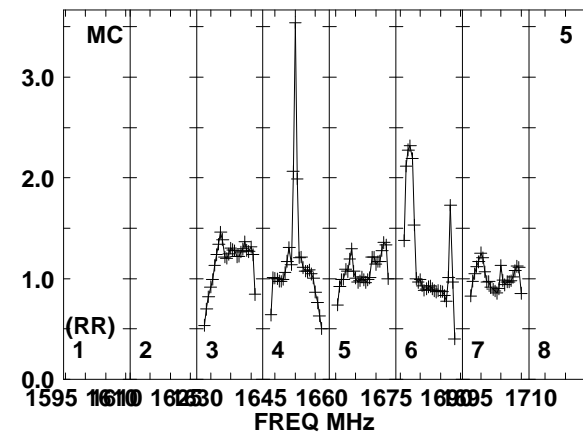
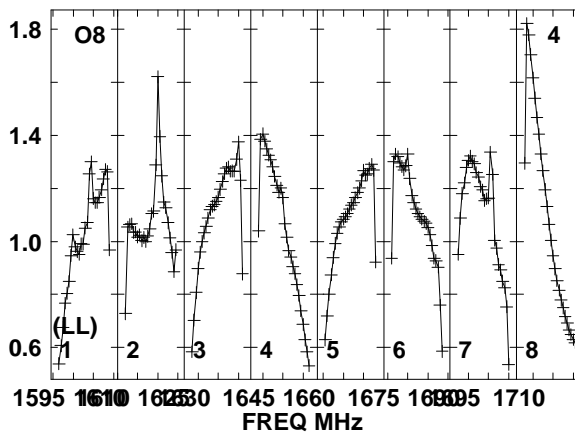
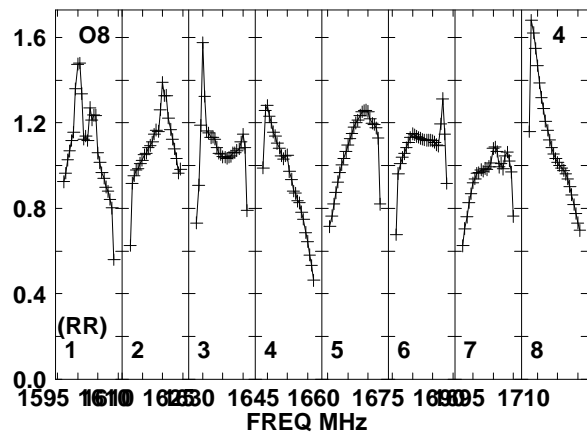
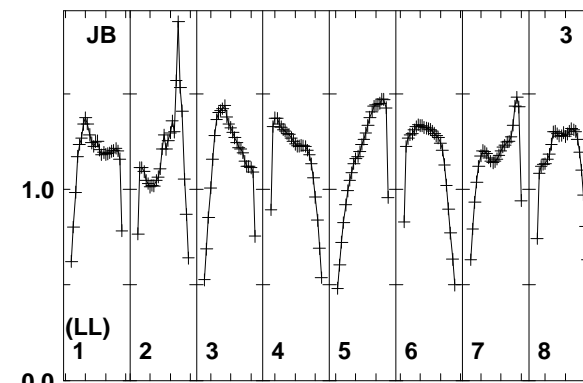
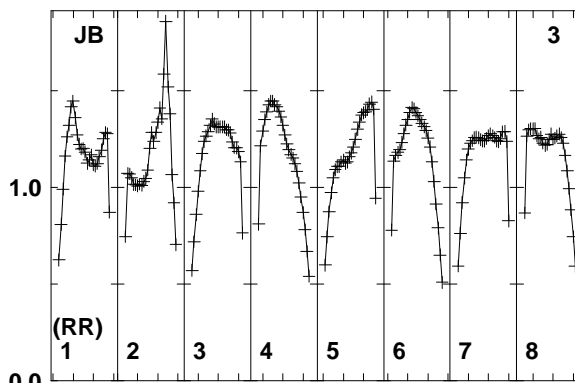
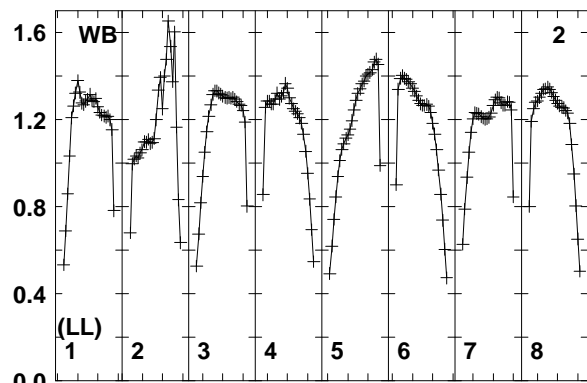
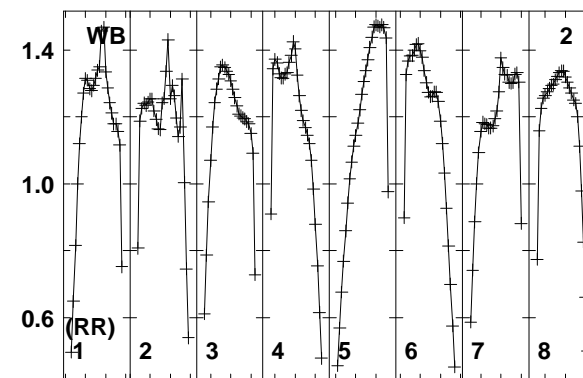
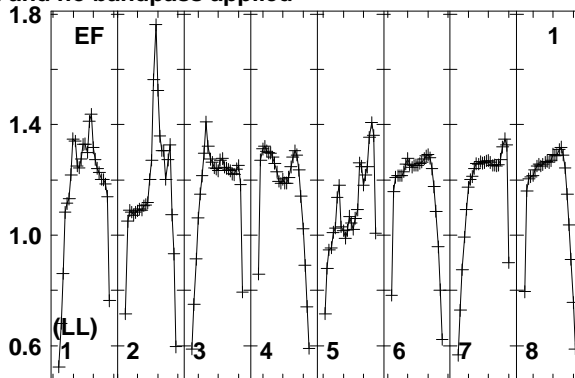
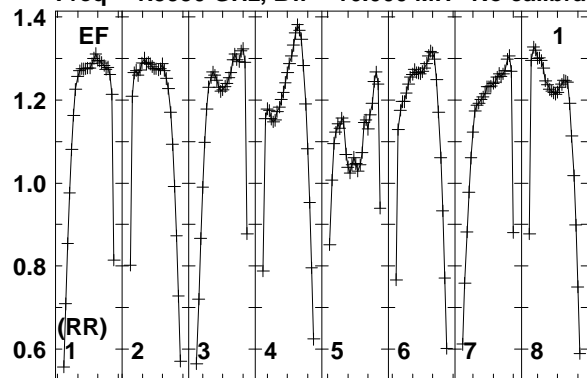

Lower frame: Real Jy
Total-power spectrum Antenna: EF (01)
Timerange: 00/04:30:31 to 00/04:34:00

Plot file version 288 created 19-AUG-2016 17:19:58

J1649+2635 EM119D.UVDATA.1

Freq = 1.5950 GHz, Bw = 16.000 MH No calibration applied and no bandpass applied

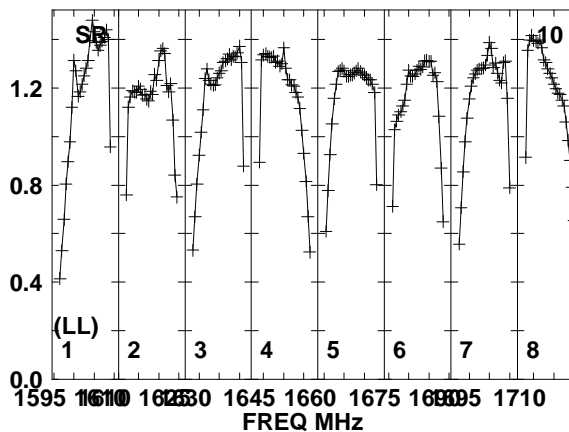
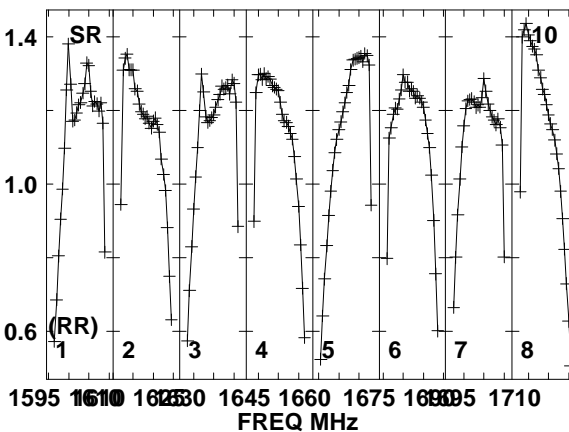
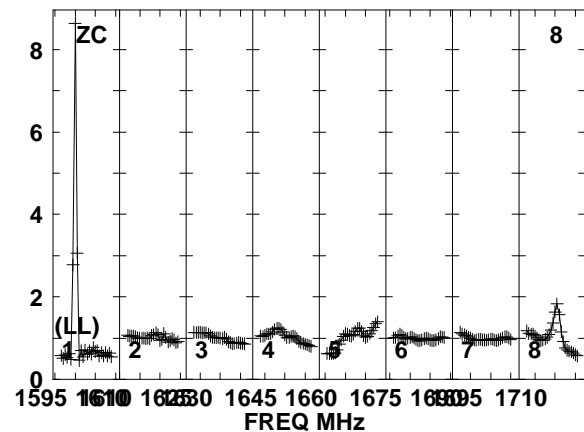
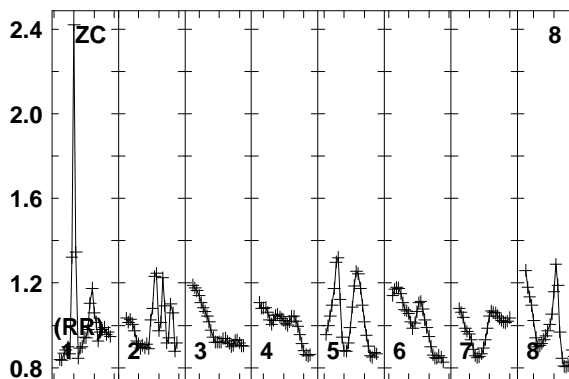
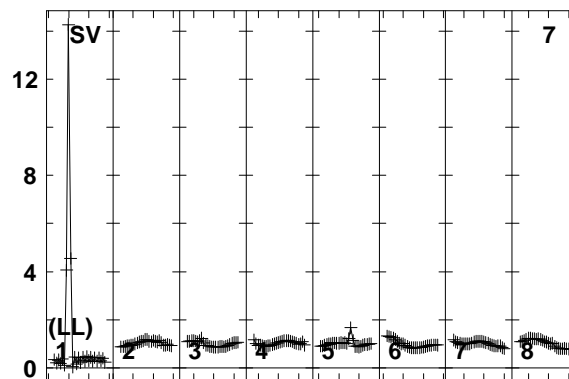
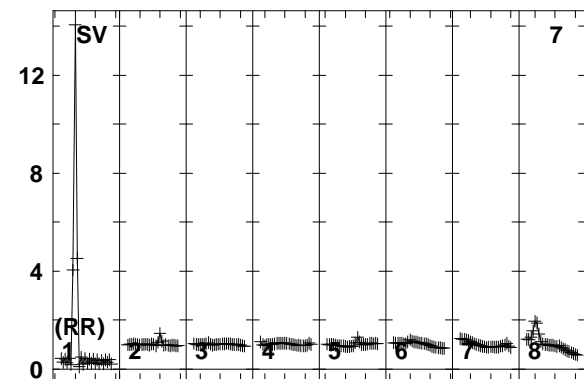
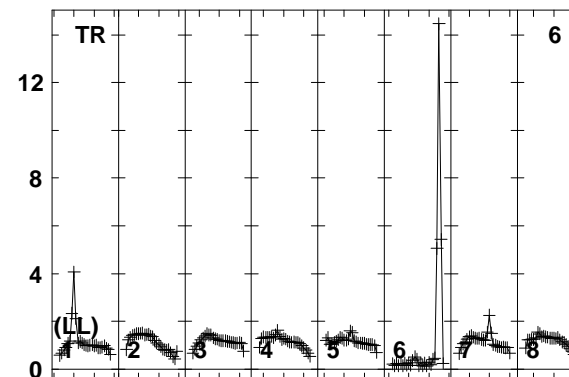
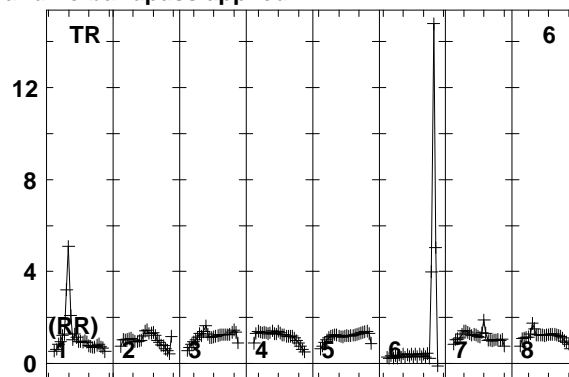
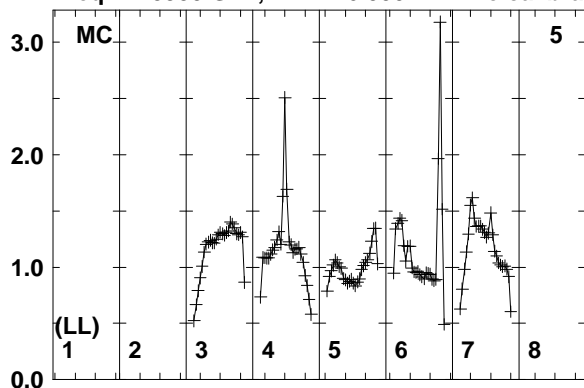

Lower frame: Real Jy
Total-power spectrum Antenna: MC (05)
Timerange: 00/04:30:31 to 00/04:34:00

Plot file version 289 created 19-AUG-2016 17:19:59

J1649+2635 EM119D.UVDATA.1

Freq = 1.5950 GHz, Bw = 16.000 MH No calibration applied and no bandpass applied

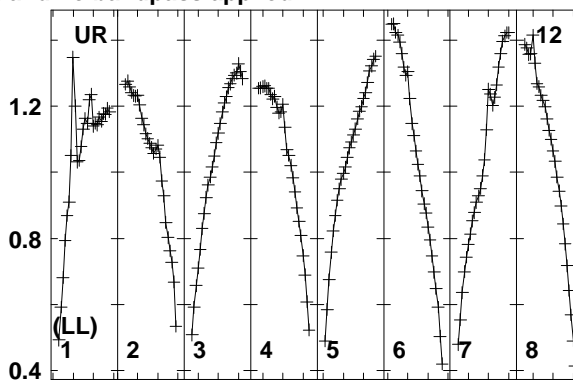
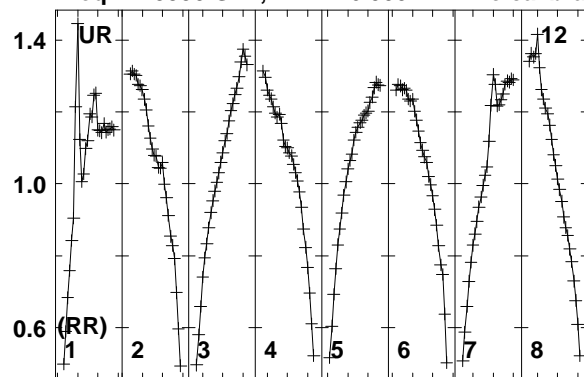

Lower frame: Real Jy
Total-power spectrum Antenna: UR (12)
Timerange: 00/04:30:31 to 00/04:34:00

Plot file version 290 created 19-AUG-2016 17:19:59

J1642+2523 EM119D.UVDATA.1

Freq = 1.5950 GHz, Bw = 16.000 MH No calibration applied and no bandpass applied

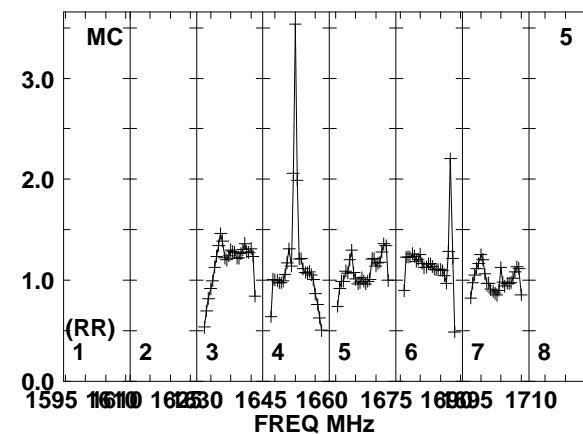
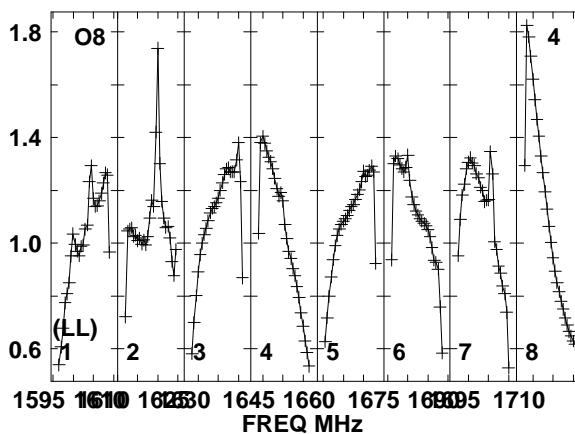
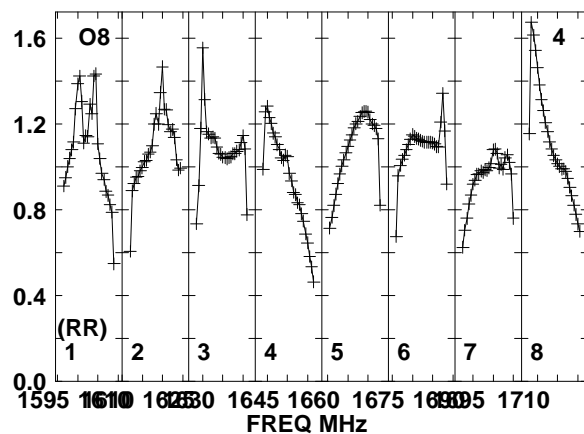
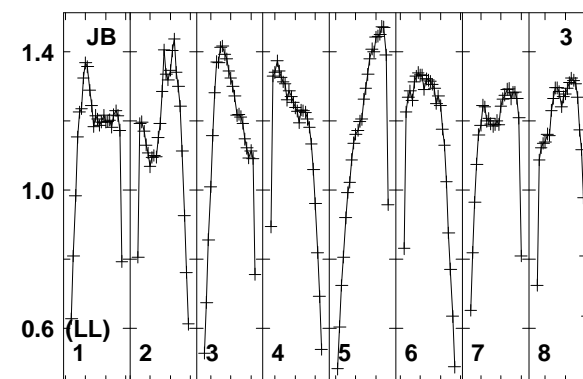
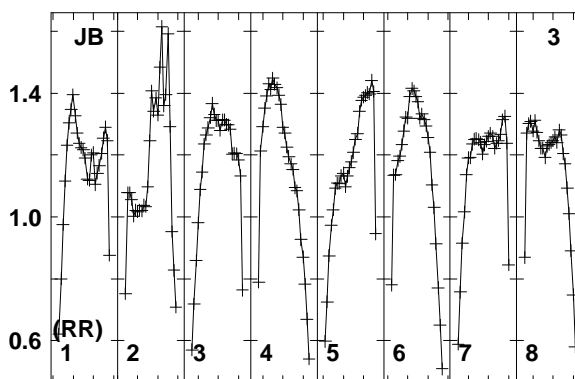
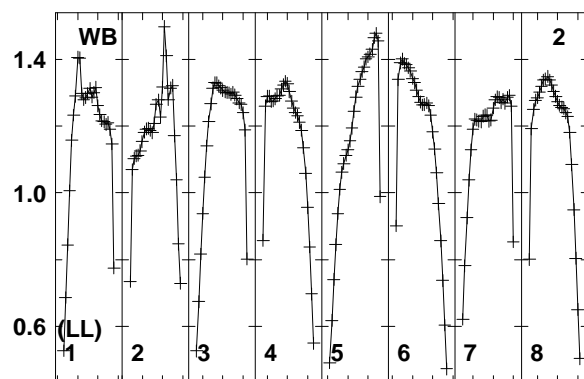
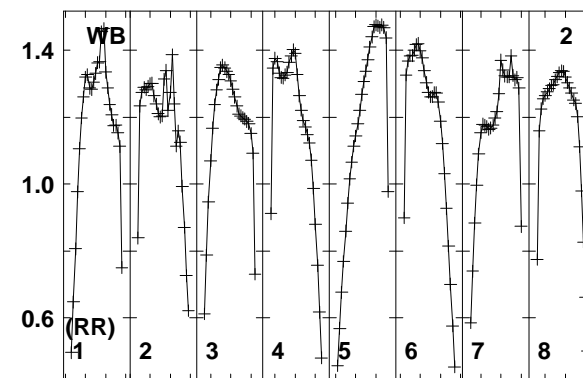
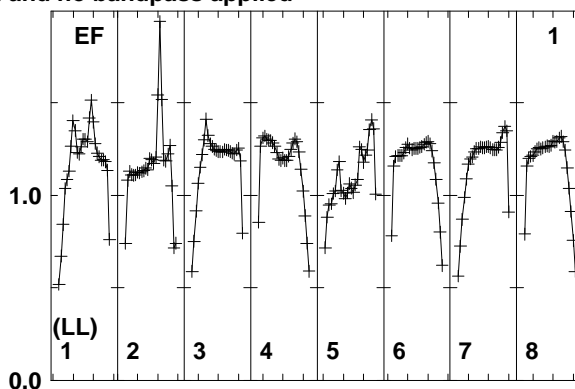
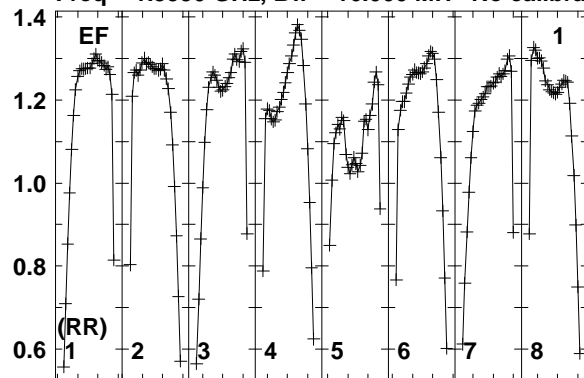

Lower frame: Real Jy
Total-power spectrum Antenna: EF (01)
Timerange: 00/04:34:07 to 00/04:35:30

Plot file version 291 created 19-AUG-2016 17:19:59

J1642+2523 EM119D.UVDATA.1

Freq = 1.5950 GHz, Bw = 16.000 MH No calibration applied and no bandpass applied

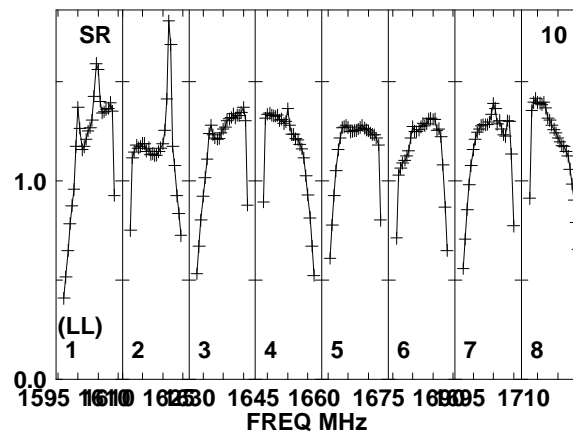
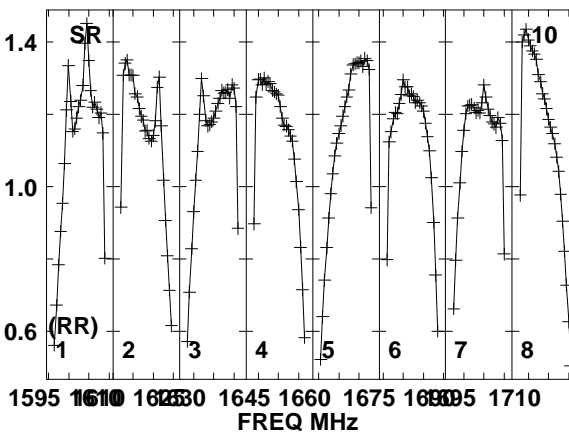
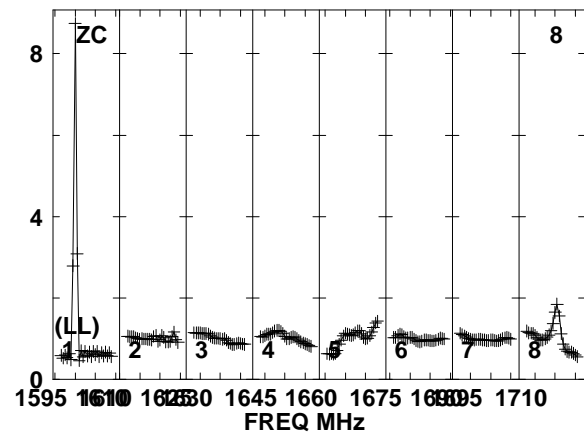
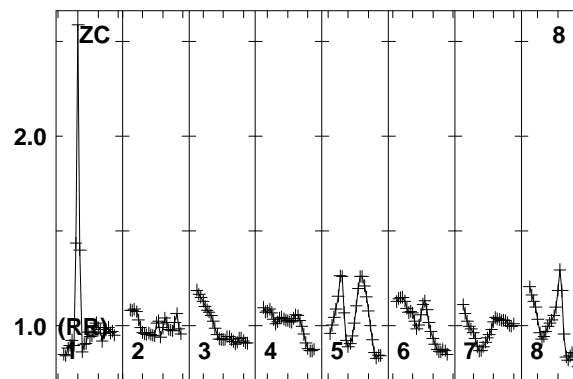
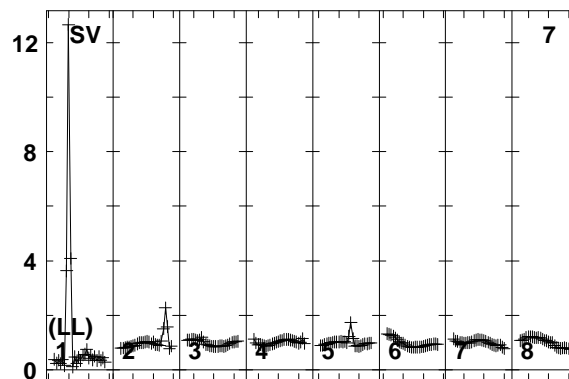
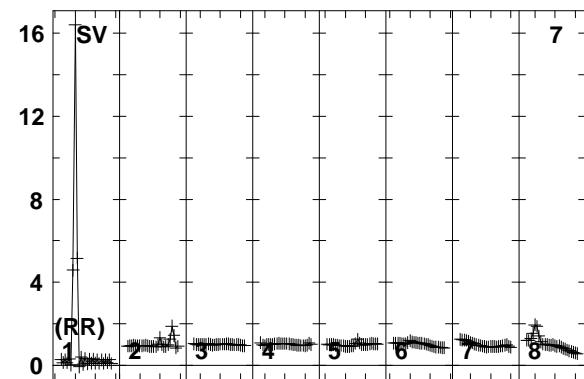
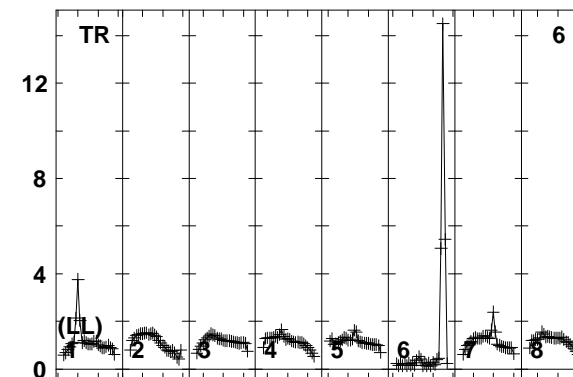
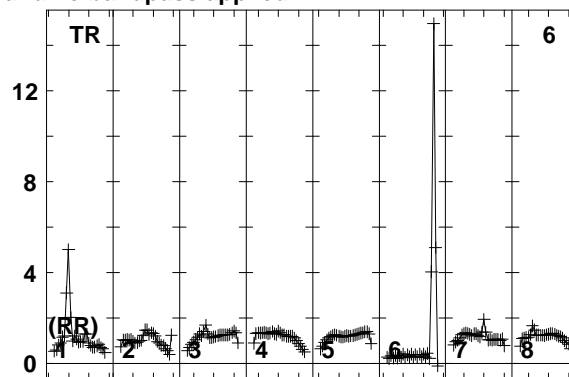
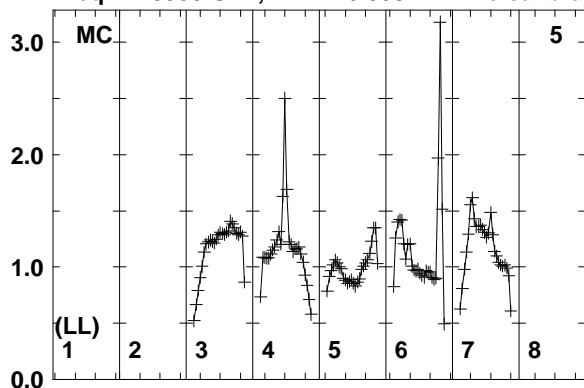

Lower frame: Real Jy
Total-power spectrum Antenna: MC (05)
Timerange: 00/04:34:07 to 00/04:35:30

Plot file version 292 created 19-AUG-2016 17:19:59

J1642+2523 EM119D.UVDATA.1

Freq = 1.5950 GHz, Bw = 16.000 MH No calibration applied and no bandpass applied

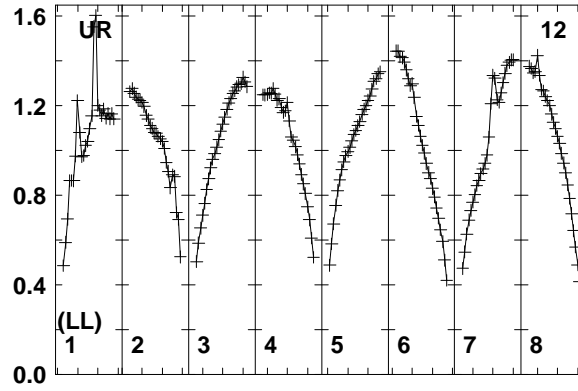
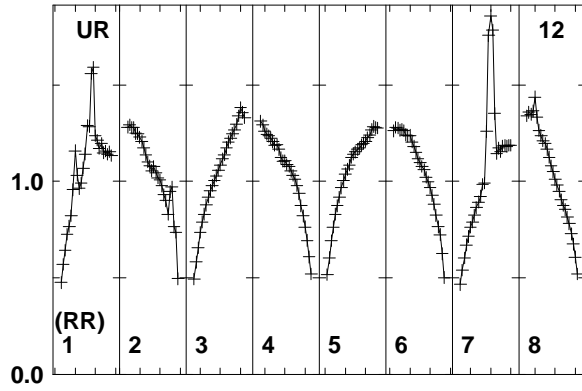

Lower frame: Real Jy
Total-power spectrum Antenna: UR (12)
Timerange: 00/04:34:07 to 00/04:35:30

Plot file version 293 created 19-AUG-2016 17:19:59

J1649+2635 EM119D.UVDATA.1

Freq = 1.5950 GHz, Bw = 16.000 MH No calibration applied and no bandpass applied

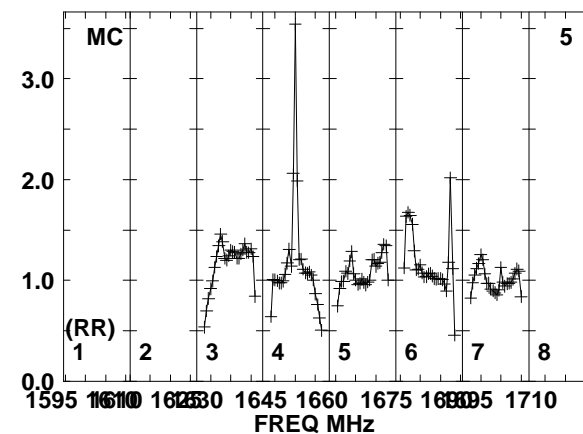
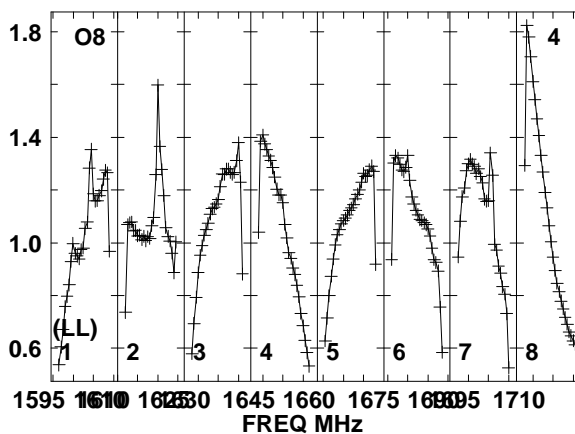
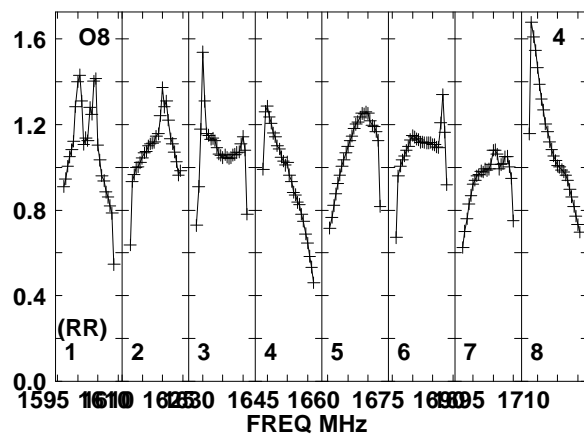
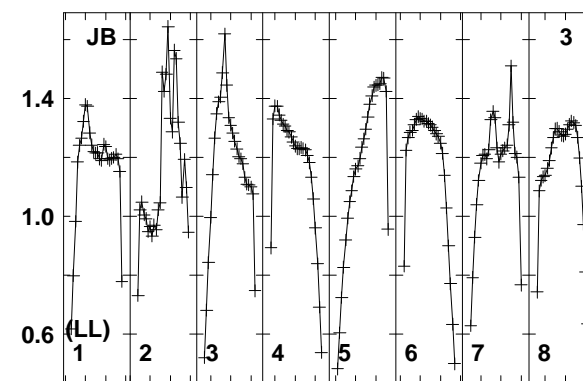
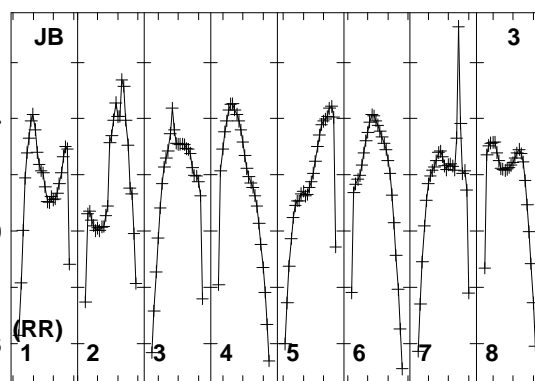
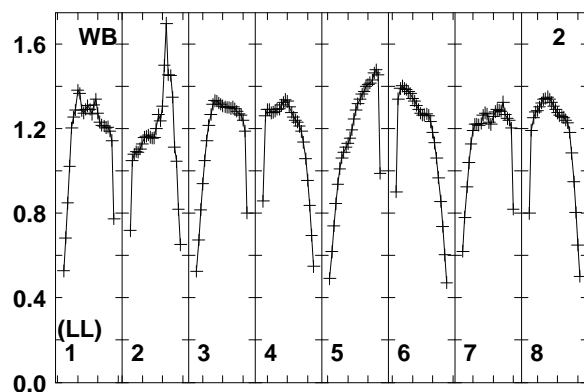
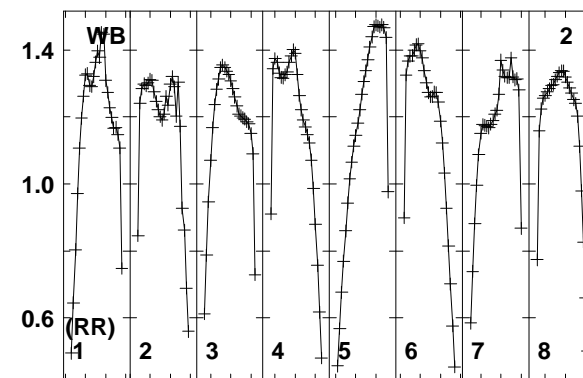
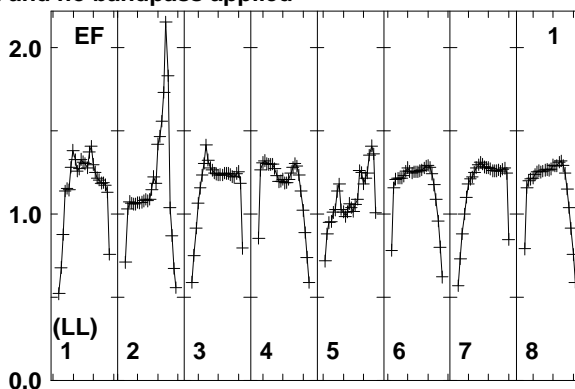
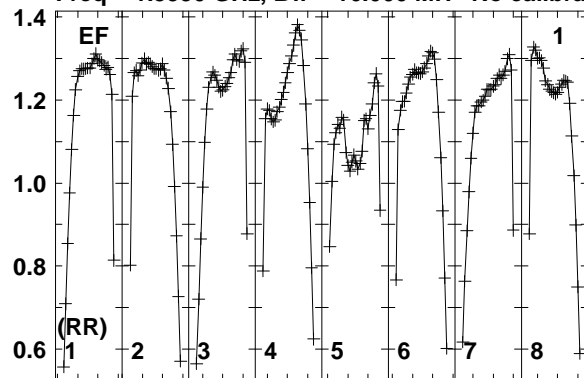

Lower frame: Real Jy
Total-power spectrum Antenna: EF (01)
Timerange: 00/04:35:38 to 00/04:39:00

Plot file version 294 created 19-AUG-2016 17:19:59

J1649+2635 EM119D.UVDATA.1

Freq = 1.5950 GHz, Bw = 16.000 MH No calibration applied and no bandpass applied

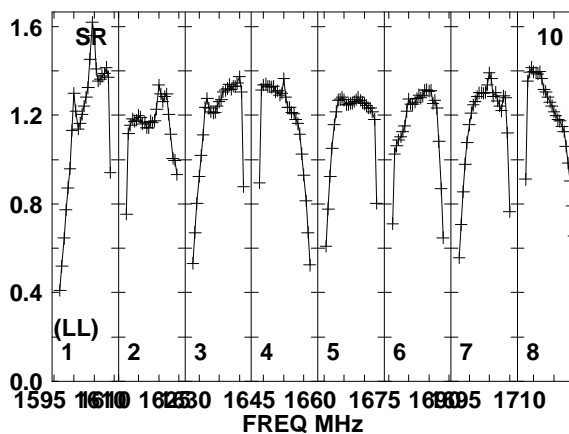
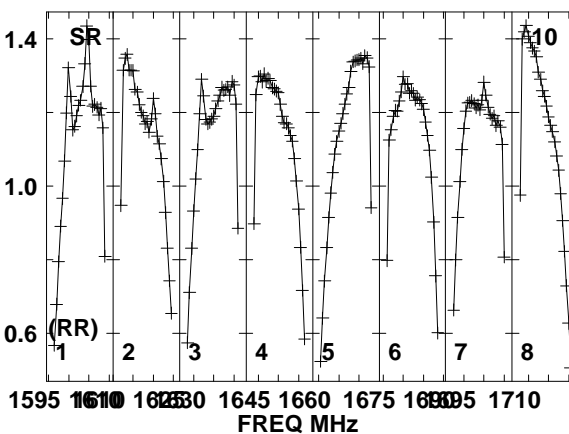
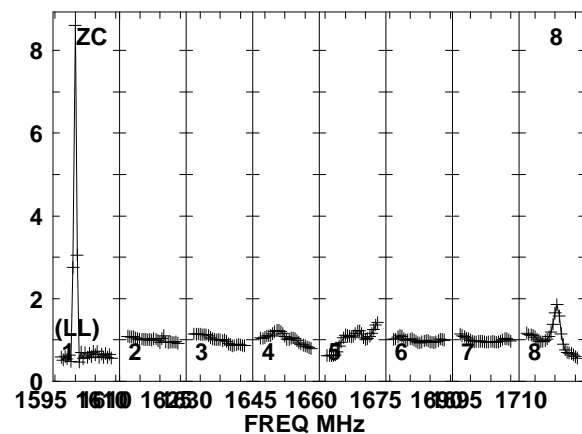
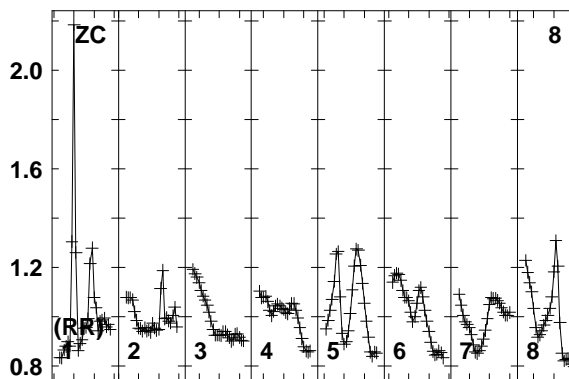
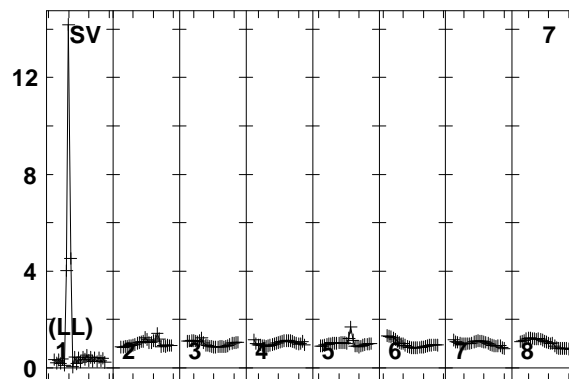
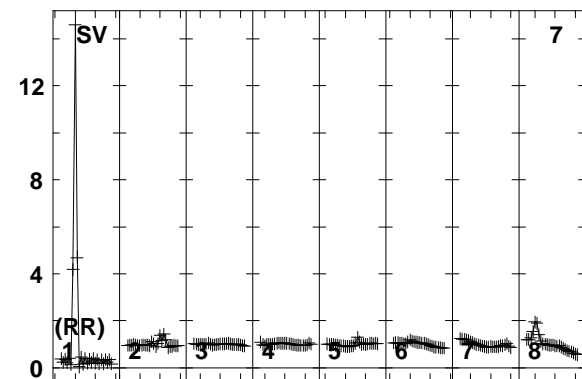
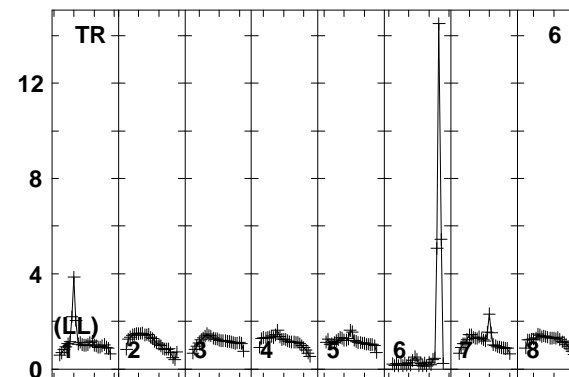
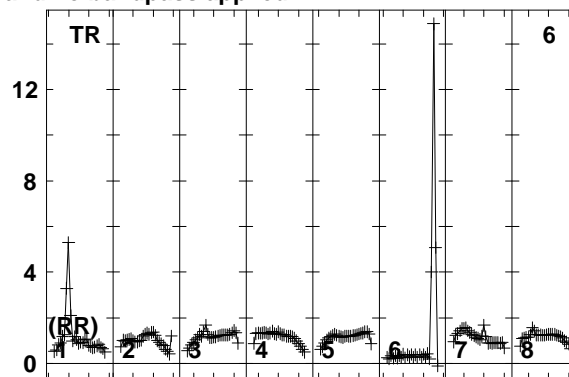
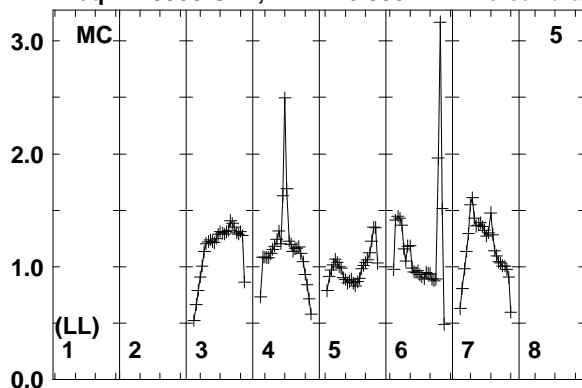

Lower frame: Real Jy
Total-power spectrum Antenna: MC (05)
Timerange: 00/04:35:38 to 00/04:39:00

Plot file version 295 created 19-AUG-2016 17:20:00

J1649+2635 EM119D.UVDATA.1

Freq = 1.5950 GHz, Bw = 16.000 MH No calibration applied and no bandpass applied

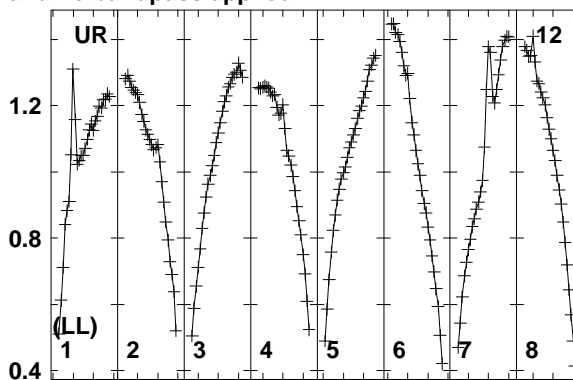
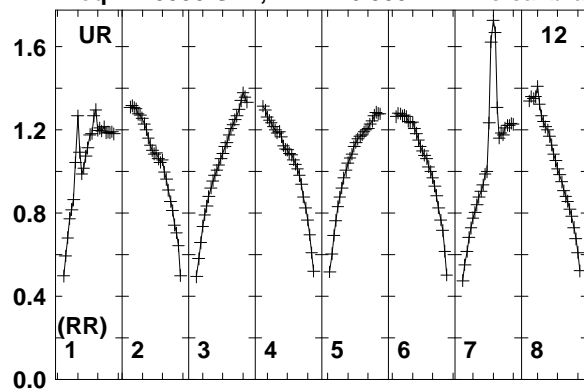

Lower frame: Real Jy
Total-power spectrum Antenna: UR (12)
Timerange: 00/04:35:38 to 00/04:39:00

Plot file version 296 created 19-AUG-2016 17:20:00

J1642+2523 EM119D.UVDATA.1

Freq = 1.5950 GHz, Bw = 16.000 MH No calibration applied and no bandpass applied

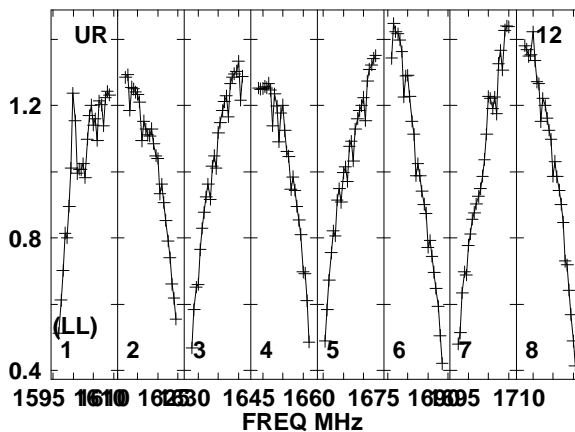
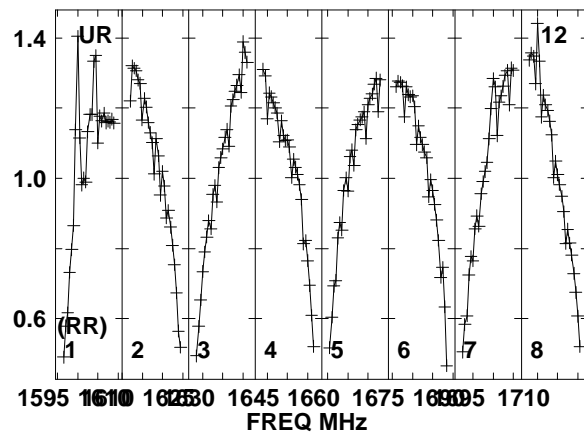
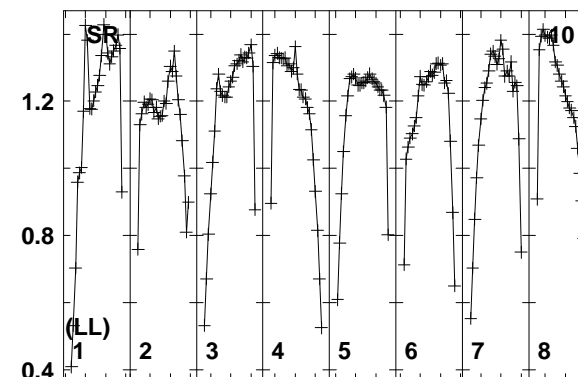
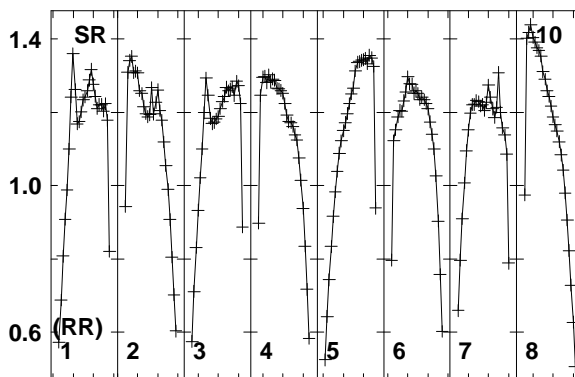
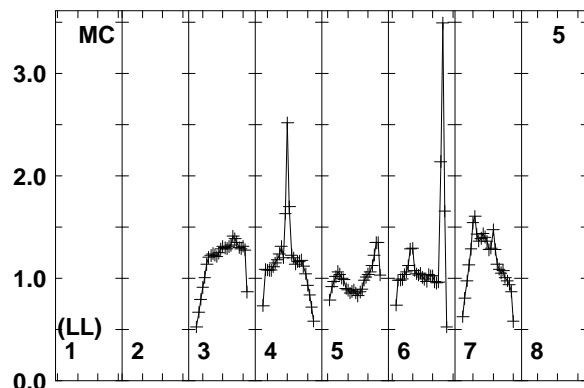
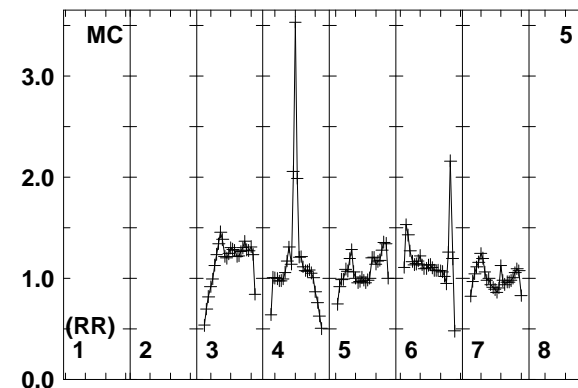
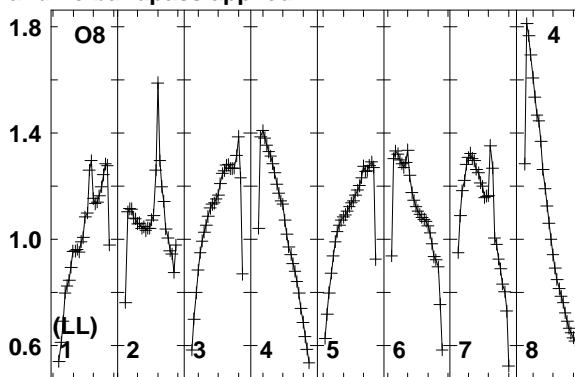
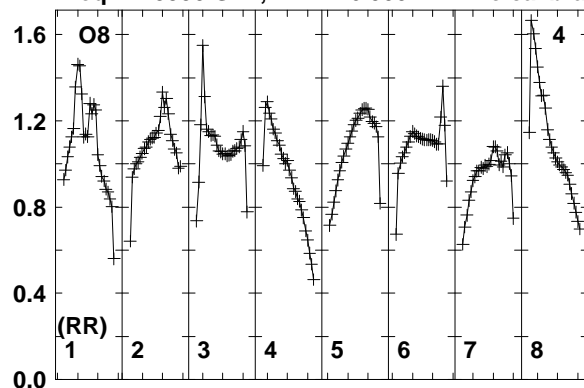

Lower frame: Real Jy
Total-power spectrum Antenna: O8 (04)
Timerange: 00/04:39:08 to 00/04:39:25